

UNITED STATES
PATENT AND TRADEMARK OFFICE



Patent Trial and Appeal Board Inventor Hour: Episode 18

Janet Gongola, Vice Chief Administrative Patent Judge

Jeffrey Fredman, Administrative Patent Judge

Ryan Flax, Lead Administrative Patent Judge

Special guests:

Phillip Kauffman, Lead Administrative Patent Judge

Mariessa Terrell, Attorney Advisory for Trademark Customer Outreach

May 25, 2023



UNITED STATES
PATENT AND TRADEMARK OFFICE ®

What is the Patent Trial and Appeal Board?

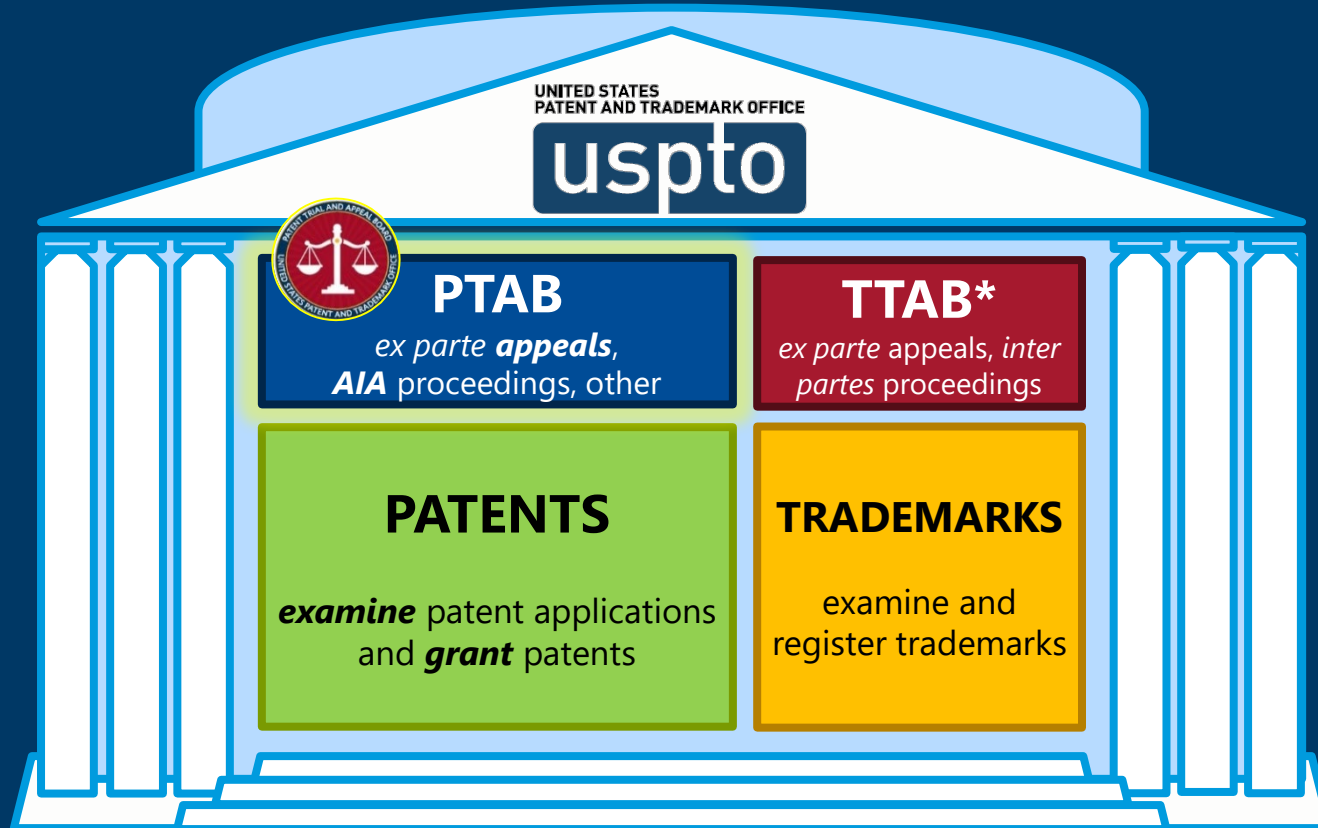

Today's agenda

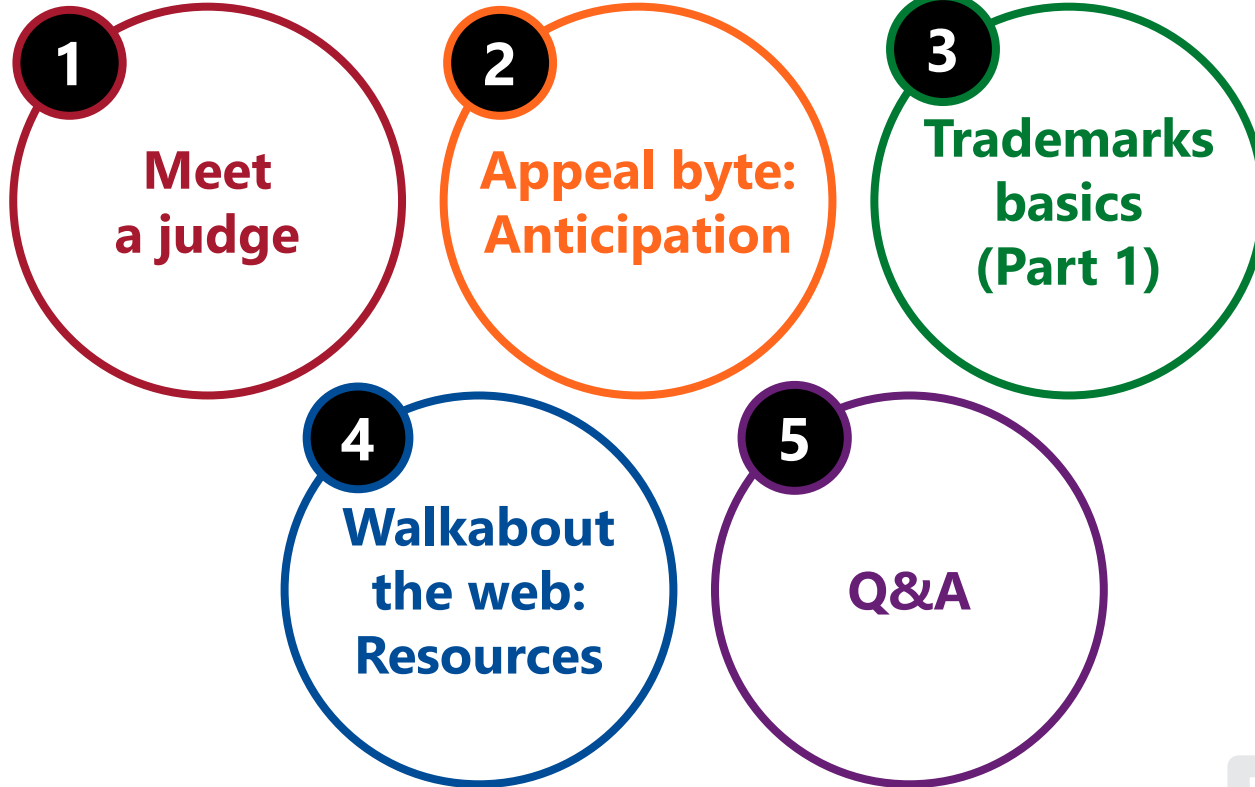

Question/comment submission

To send in questions or comments about the presentation, please email:

- PTABInventorHour@uspto.gov





Meet a judge

Phillip Kauffman, Lead Administrative Patent Judge

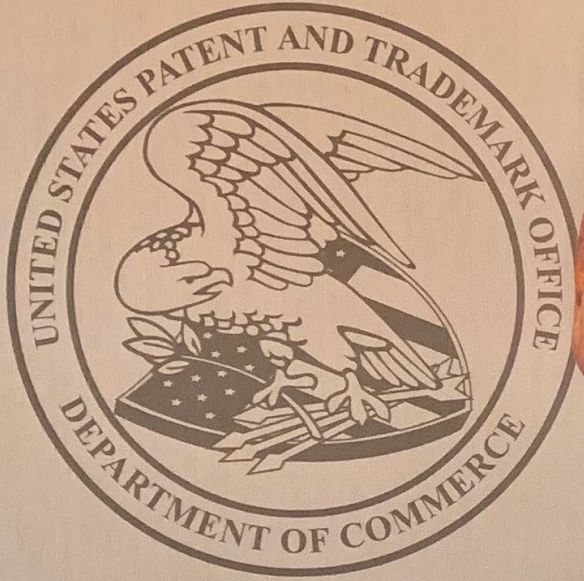

Phil Kauffman

Lead Administrative Patent Judge



Question/comment submission

To send in questions or comments about the presentation, please email:

- PTABInventorHour@uspto.gov

Jeffrey Fredman, Administrative Patent Judge



Appeal byte:

What is anticipation?

Patentability: statutory requirements

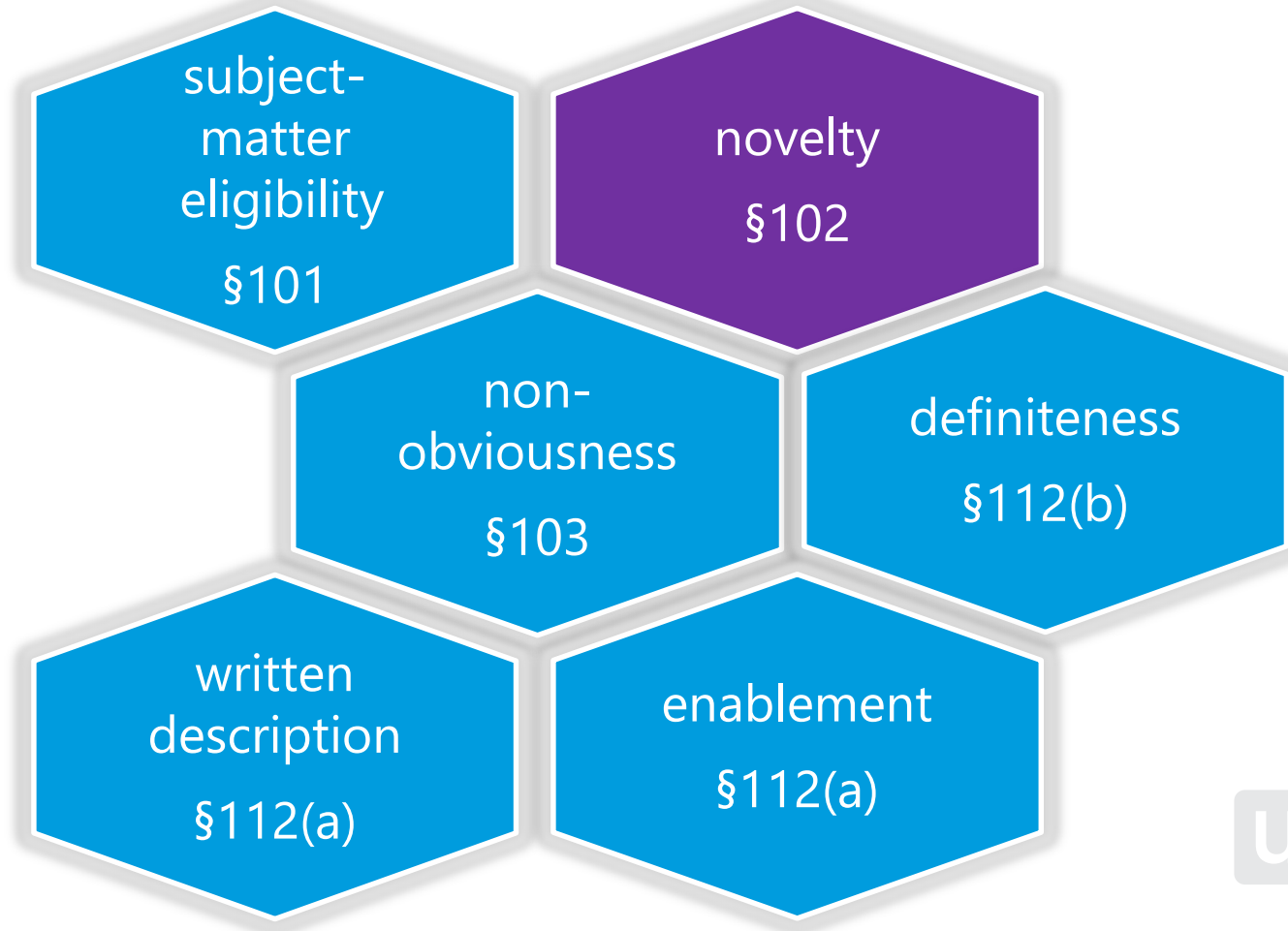

Novelty
(anticipation)

§102

(a) **NOVELTY; PRIOR ART.**—A person shall be entitled to a patent unless—

- (1) the claimed invention was **patented**, described in a **printed publication**, or in **public use, on sale, or otherwise available to the public** before the effective filing date of the claimed invention; or
- (2) the claimed invention was **described in a patent** issued under section 151, or in an **application** for patent **published** or deemed published under section 122(b), in which the patent or application, as the case may be, names **another inventor** and was **effectively filed before** the effective filing date of the claimed invention. . . .
-

35 U.S.C. § 102 (2013)

Compare with prior art

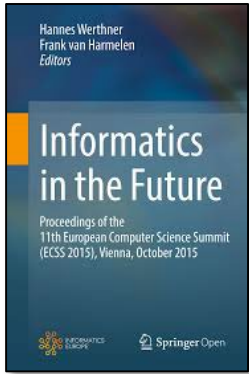

articles

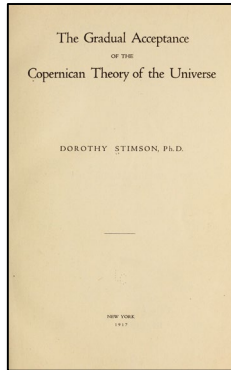
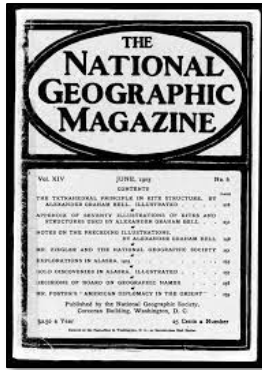

treatises

advertising/sales

patents



Differences from prior art

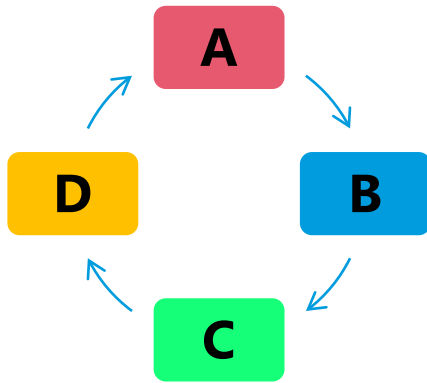

**Claimed
invention**

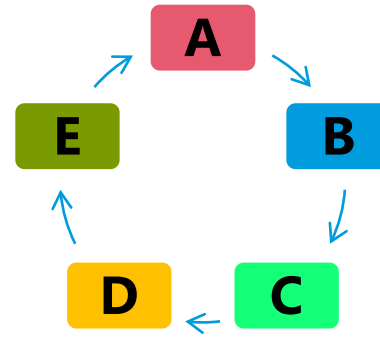

**Prior art
1**

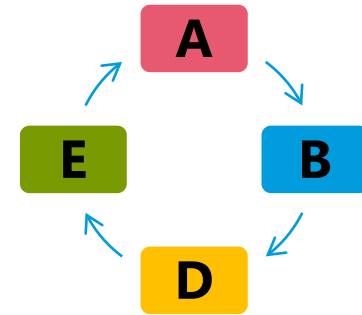

**Prior art
2**

Genus-species

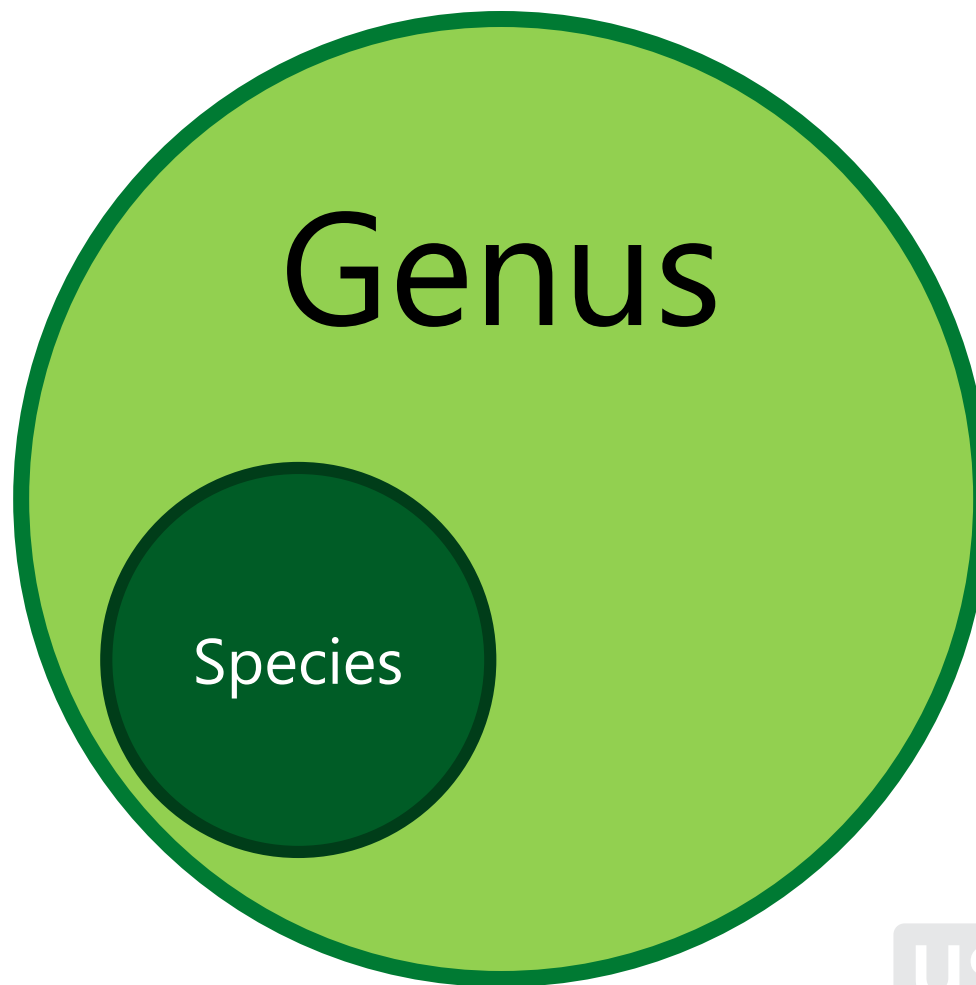

Genus-species

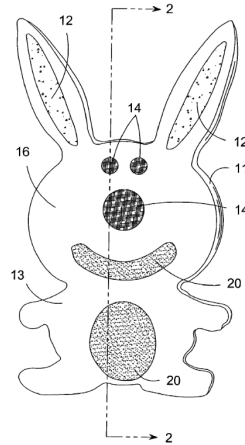
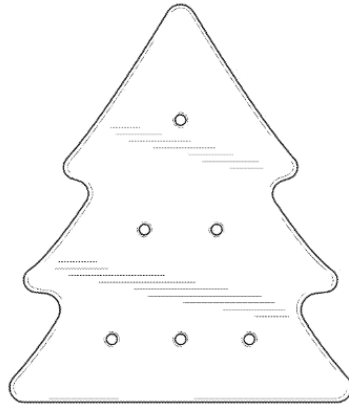
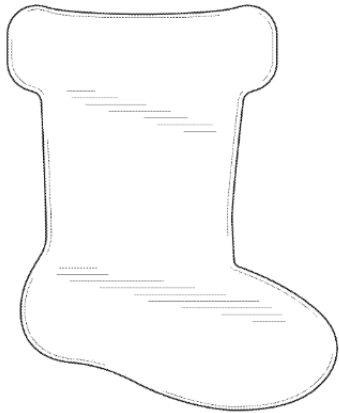

Invention:

Holiday themed cookies
filed January 4, 2022

Prior Art:

Halloween pumpkin cookie
patent published April 15, 2004

Inherency

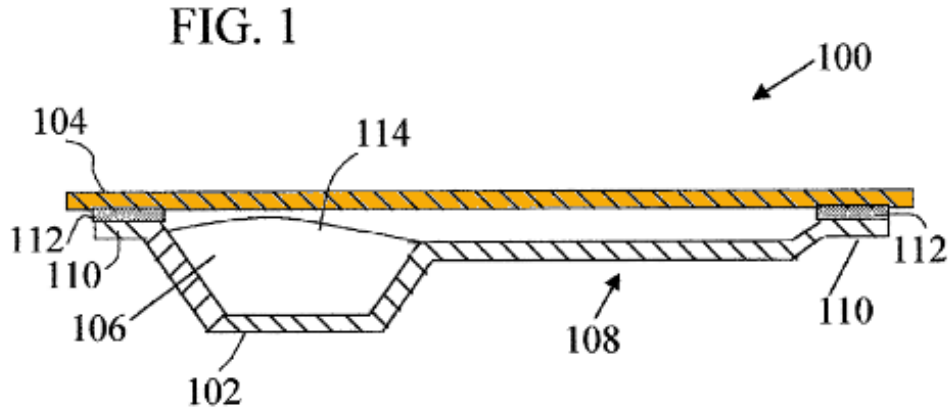
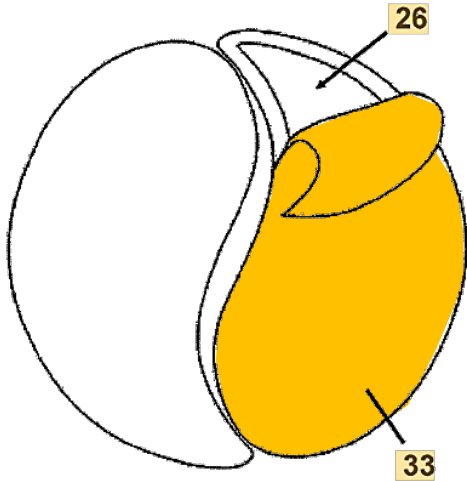

Invention:
Condiment (ketchup) container
with cover

Prior art:
Product container with a cover

Anticipation of ranges



Invention:
ice cream with **10-16% milkfat**

Prior art 1:
Ice cream with **14% milkfat**

Prior art 2:
Ice cream with **9.5-16.5% milkfat**

Prior art 3:
Ice cream with **3-20% milkfat**

Enabling prior art

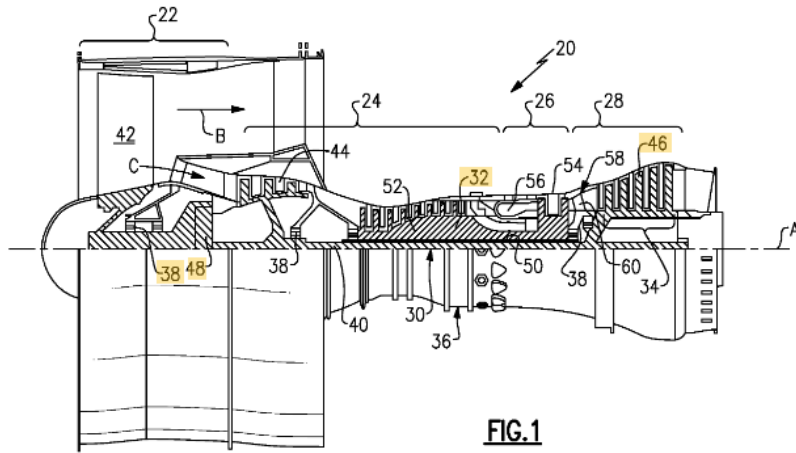

Invention:
Gas turbine engine for airplane

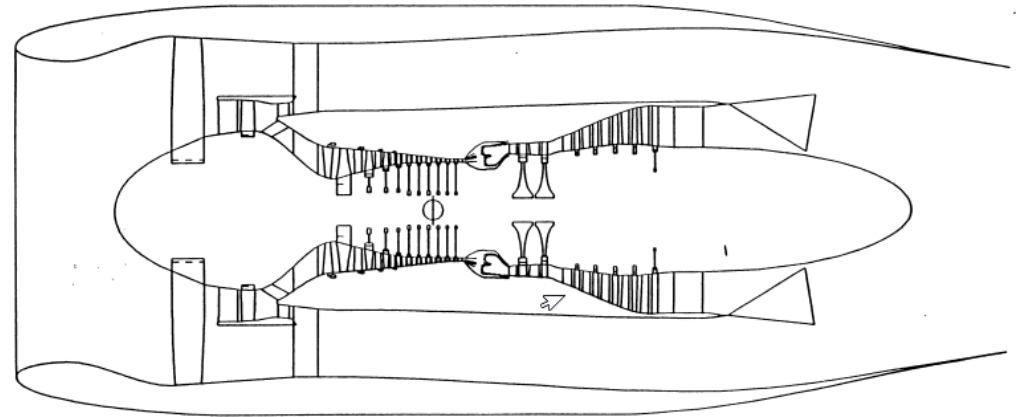

Practice tip

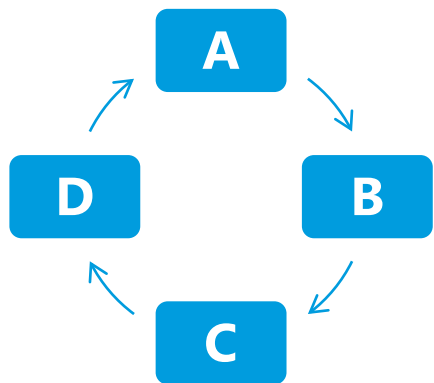

Anticipated original claim

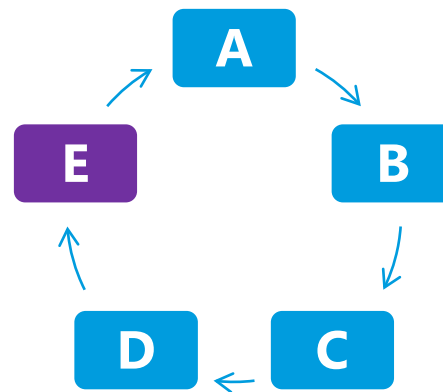
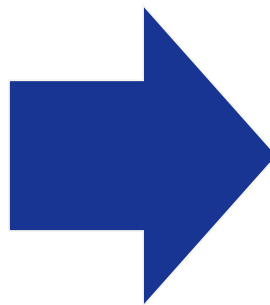

New amended claim

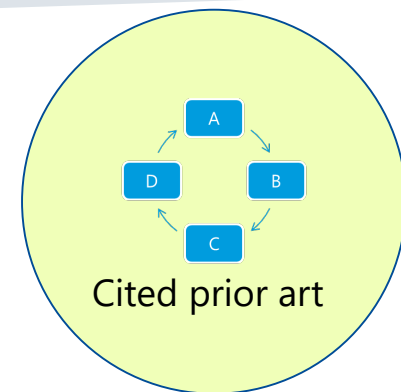

Intellectual property basics and helpful resources sessions



Unfamiliar with **patents**, **trademarks**, **copyrights**, and **trade secrets**? Don't miss this opportunity to learn from USPTO experts about intellectual property (IP) basics and potential ways to protect your innovation as you transition from idea to product. The discussion will cover:

- An overview of patents, trademarks, copyrights, and trade secrets
- Why innovators and entrepreneurs should consider protecting their IP
- Local resources and assistance available through the USPTO and other agencies

Multiple online sessions

- June 1, 2023 at 12 p.m. – 1:30 p.m. ET
- July 6, 2023 at 12 p.m. – 1:30 p.m. ET
- August 3, 2023 at 12 p.m. – 1:30 p.m. ET
- September 7, 2023 at 12 p.m. – 1:30 p.m. ET

For more information, go to:

www.uspto.gov/about-us/events/intellectual-property-basics-and-helpful-resources-18

Question/comment submission

To send in questions or comments about the presentation, please email:

- PTABInventorHour@uspto.gov



Mariessa Terrell, Attorney Advisory for Trademark Customer Outreach



Trademarks basics

Part 1

Discussion topics

- ® Trademarks and intellectual property
- ® Benefits of federal registration
- ® Selecting a trademark
- ® How to find help

Discussion topic

Trademarks fundamentals

What is a trademark?



What does a trademark do?

- **Identifies** the source of goods and services
- **Distinguishes** them from the goods and services of another party
- Provides legal **protection for a brand**

Traditional types of marks

Common **source identifiers**:

- Brand names
- Slogans
- Logos

COCA-COLA

**IT'S THE
REAL THING**

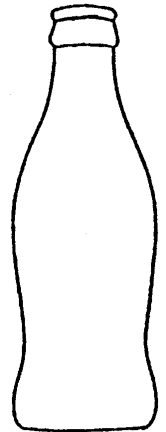

Discussion topic

Benefits of federal registration

Common law trademark rights

Rights

- Created **when you use** trademark in commerce
- Limited to **geographic** area where mark is used

Symbols

- Optional: TM SM
- Never: ®

Federal registration rights

Rights

- Created when you federally **register** a trademark
- Can bring **legal action** concerning trademark in federal court
- Enables recordation of registration with **United States Customs and Border Protection**
- Can be used as a basis for filing in **another country**
- May use the registration symbol, ®



Discussion topic

Selecting a trademark

Trademark selection challenges

Remember:

- Our mission is to register any trademark that is eligible for registration
- Not every trademark is registrable
- Not every trademark is enforceable
- Select a trademark that is both federally *registrable* and legally *protectable*



Registrable and protectable

Two main concepts:

- Likelihood of **confusion**
 - Likelihood of confusion refusal
- **Strength** of the trademark
 - Descriptiveness refusal

Discussion topic

Selecting a trademark: Likelihood of confusion

Likelihood of confusion

Concept:

- Avoid confusing consumers about the source of the goods and services.

Test:

- Are the trademarks **confusingly similar**?
- and
- Are the goods and/or services **related**?

Likelihood of confusion example

Your trademark

T.MARKEY

for

shirts

Registered trademark

T.MARKEY

for

pants



Likelihood of confusion example

Your trademark

T.MARKEY

for

shirts

Registered trademark

TEE MARQEE

for

pants



Likelihood of confusion example

Your trademark

T.MARKEY

for

shirts

Registered trademark

TEE MARQEE

for

golf flags



Suggestions for searching

- On your own:
 - USPTO database
 - **TESS** (Trademark Electronic Search System)
 - www.uspto.gov/SearchTrademarks
 - The internet
 - Option for searching for common law use



Discussion topic

How to find help

How to find help

- ① Trademark Assistance Center
 - www.uspto.gov/TrademarkAssistance
- ① Trademark basics registration toolkit
 - www.uspto.gov/TrademarkBasicsToolkit
- ① Trademark Basics Boot Camp webinars
 - www.uspto.gov/about-us/events/trademark-basics-boot-camp

Climate Change Mitigation Pilot Program



- Expedites examination for qualifying applications involving technologies that mitigate climate change by reducing greenhouse gas emissions
- Opened June 3, 2022
- Runs until June 5, 2023, or 1,000 grantable petitions (whichever is earlier)
- Free for qualifying applications
- Federal Register Notice: www.govinfo.gov/content/pkg/FR-2022-06-03/pdf/2022-11930.pdf



Ryan H. Flax, Lead Administrative Patent Judge



Walkabout the web:

Office resources

uspto UNITED STATES PATENT AND TRADEMARK OFFICE

About Us | Jobs | Contact Us | MyUSPTO

resources

Patents | Trademarks | IP Policy | Learning and Resources

Find It Fast

Public Events | Initiatives

New to IP?

- Patent basics
- Trademark basics
- Identify what kind of IP you have
- Inventor & entrepreneur resources
- Access our free services
- Training and education events
- USPTO in your region

From inspired to inspiring: Damian Earley
Young inventor hopes to inspire others to be environmentally friendly [FULL STORY](#)>

Latest news

Remarks

Record number of law firms boost participation in innovation economy among under-resourced inventors and small businesses

USPTO celebrates 2022 Patent Pro Bono Achievement Certificate recipients; calls for more participation among practitioners

USPTO announces Advance Notice of Proposed

“ [T]here is a crucial need for a new era of innovation, and for all of us to unite in helping every potential innovator in our country

Startup resources

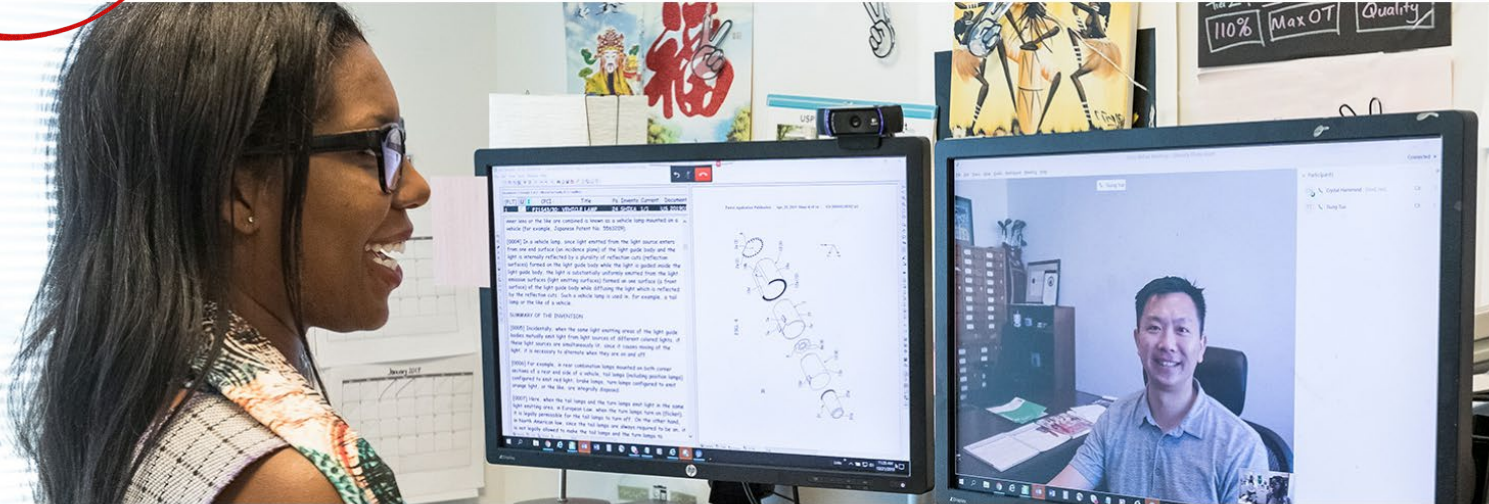

The USPTO's hub for startup resources can help you address the intellectual property (IP) challenges specific to startups, including securing funding and guarding against costly infringement litigation. For information on IP fundamentals, such as filing a patent or registering a trademark, check out [these resources for inventor and entrepreneurs](#).

Here you will find practical information and useful tools, available from a wide variety of government agencies, including the [Small Business Administration \(SBA\)](#), the [Minority Business Development Administration \(MBDA\)](#), and [Small Business Development Centers \(SBDCs\)](#). These agencies can assist you at every stage of growing your business, from your initial idea to entering the global marketplace.



Protect IP rights



Plan for success



Find funding



Engage experts





Protect IP rights

Guard your valuable work

You need to protect your IP if you want to succeed and attract investors.



- > [Identify the kind of IP you have](#)
- > [Protect your IP in the U.S.](#)
- > [Protect your IP abroad](#)
- > [Fight costly counterfeits](#) 
- > [Access IP training modules in five languages](#)
- > [Access resources for small and medium-sized enterprises](#)



Plan for success

Do your homework

Explore free government resources that can help you create a foundation for business success.





- > [Learn the steps to start your business](#) 
- > [Find a MBDA Center in your state](#) 
- > [Get free business counseling near you](#) 



Find funding

Access capital

There are many sources of startup funding, including grants, loans, and different kinds of investors.

- > [Choose the right funding](#) 
- > [Search federal grants](#) 
- > [Learn about America's Seed Fund](#) 
- > [Access SBA loans](#) 
- > [Review additional funding resources](#)



Engage experts

Get advice and assistance

Find mentors, partnerships, and technological assistance in your industry. Learn to navigate the domestic and international IP markets.

- > [Get free advice from business experts at SCORE](#) 
- > [Get help with manufacturing your technology](#) 
- > [Learn about IP protection in other countries](#)
- > [Utilize IP attachés to navigate the global market](#)



INVENTOR & ENTREPRENEUR RESOURCES



Get started

Learn about types of intellectual property (IP) and how to protect your idea or product.

- > Types of IP protection
- > Identify the kind of IP you have
- > Patents basics
- > Trademark basics
- > Copyright basics



Before you apply

Search existing patents and trademarks to find out if your idea is unique. If it is, create an account.

- > Search patents
- > Search trademarks
- > Create an account to apply
- > Attend a free training



Get help to apply

Set yourself up for success by learning via USPTO's free resources and find expert help.

- > Access our free services
- > Find resources near you
- > Find a patent attorney
- > Do I need a trademark attorney?



Apply for IP rights

Submit your application for a patent or trademark. See if you qualify for reduced patent fees.

- > Apply for a patent
- > Apply for a trademark
- > Costs to file
- > Reduced patent fees





After you apply

As your patent or trademark is examined you may need to take additional steps.

- > Check application status
- > Respond to a patent decision
- > Prepare for a patent interview
- > Respond to a trademark decision



Appeal or fix an issue

An applicant may petition a procedural rule or issue, or appeal a patent rejection or trademark refusal.

- > Learn about patent petitions
- > Learn about patent appeals
- > Learn about trademark petitions
- > Learn about trademark appeals



Entrepreneur resources

Learn about small business resources at the USPTO and other federal agencies.

- > Startup resources
- > License or sell your IP
- > Change patent owner
- > Change trademark owner
- > Other federal resources



Protect yourself

Don't be misled by false claims, scams, or companies offering services for unusually low prices.

- > Known patent scams
- > Known trademark scams
- > Prevent or report a scam



PATENT BASICS

Learn about the patent process



TRADEMARK BASICS

Learn about trademark registration



COPYRIGHT BASICS

Learn about protecting authorship

Patents FAQs

Inventor's Assistance by state

Helpful USPTO resources

[Inventor and entrepreneur resources](#)

[Patent and Trademark Resource Centers](#)

[USPTO locations](#)

Inventor and entrepreneur resources by state

There are lots of resources and assistance to make filing for a patent or registering a trademark easier, more affordable, and ultimately result in strong legal protection for your invention or brand. For example, if you can't afford an attorney, there are several programs that provide free legal representation. Use the map below to find out what is available in your state or at your regional office.

And remember, our [Inventor and entrepreneur resources page](#) is the USPTO hub for resources and information for inventors, entrepreneurs, and small businesses.

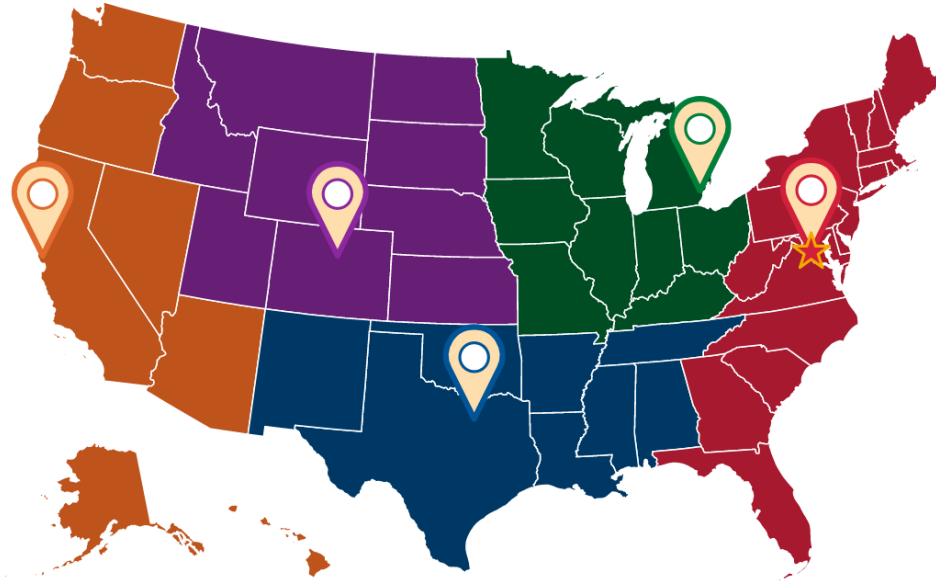

■ East Coast region
 ■ Midwest region
 ■ Texas region
 ■ Rocky Mountain region

■ Silicon Valley region
 📍 USPTO office location
 ★ USPTO headquarters

Select your state below to find resources

List of State Names				
Alabama	Hawaii	Michigan	North Carolina	Texas
Alaska	Idaho	Minnesota	North Dakota	Utah
Arizona	Illinois	Mississippi	Ohio	Vermont
Arkansas	Indiana	Missouri	Oklahoma	Virginia
California	Iowa	Montana	Oregon	Washington
Colorado	Kansas	Nebraska	Pennsylvania	West Virginia
Connecticut	Kentucky	Nevada	Puerto Rico	Wisconsin
Delaware	Louisiana	New Hampshire	Rhode Island	Wyoming
District of Columbia	Maine	New Jersey	South Carolina	
Florida	Maryland	New Mexico	South Dakota	
Georgia	Massachusetts	New York	Tennessee	

Main menu

Patents

Trademarks

IP Policy

Learning and Resources

About Us

Jobs

Contact Us

MyUSPTO

Office of the Chief Economist

Local: 571-272-6900
economics@uspto.gov

Intellectual property rights (IPR) infringement resource tool

The intellectual property rights (IPR) infringement resource tool provides access to a library of information produced by U.S. government agencies. Topics include bilateral and multilateral trade agreements with intellectual property (IP) provisions and annual (or other periodic) reports produced by executive branch and independent IP enforcement agencies. For more information, visit the [economic resources on IPR infringement](#) page.

[LINK TO RESOURCE TOOL](#)

Instructions for using the tool

- Use the **Title/Description search** boxes to filter the results to only include items with titles that contain the text that you searched for. To search for two separate strings, set the **drop-down** to either "AND" or "OR" and type in both string values. "AND" will only return results that contain both entered strings while "OR" will return results that contain **at least one** of the entered strings.
- Use the **Country drop-down** to filter the results to only include items concerning the selected country(ies).
- Use the **U.S. Agencies drop-down** to filter the results to only include items concerning the selected agency(ies).
- Use the **Year drop-down** to filter the results to only include items concerning the selected document year(s).
- Use the **Document Type drop-down** to filter the results to only include items matching the selected document type(s).
- **To clear all filters**, click the "Reset Filters" button on the top right hand side of the data inventory window.



List of U.S. agencies available on the tool

- Department of Homeland Security (DHS)
 - U.S. Customs and Border Protection (USCBP)
 - U.S. Immigration and Customs Enforcement (ICE)
- Executive Office of the President (EOP)
 - U.S. Intellectual Property Enforcement Coordinator (IPEC)
 - Office of the U.S. Representative (USTR)
- U.S. Department of Justice (DOJ)
 - Office of Justice Programs (OJP)
- Federal Bureau of Investigation (FBI)
- Federal Trade Commission (FTC)
- U.S. Food and Drug Administration (FDA)
- U.S. Government Accountability Office (GAO)
- U.S. Patent and Trademark Office (USPTO)
- U.S. International Trade Commission (USITC)

For questions, please contact: economics@uspto.gov 

Small and medium-sized ENTERPRISE RESOURCES



The United States Patent and Trademark Office (USPTO) published a [report](#) in 2022 that found intellectual property (IP)-intensive industries account for 41% of U.S. gross domestic product. Many of the businesses operating in those industries are small and medium-sized enterprises (SMEs). To support SMEs and other innovators, the USPTO created this page to share resources from federal agencies and international organizations for growing a business and for protecting intangible business assets like IP.

For information on IP fundamentals, such as filing a patent or registering a trademark, visit the USPTO's [inventor and entrepreneur resources page](#), and to find out about some of the ways the USPTO can assist you, [browse our free services](#).





IP valuation and business development

Find out how to evaluate your IP assets and develop your business.

- > [Valuing IP assets](#)
- > [IP diagnostic tool](#)
- > [Emerging Leaders Initiative](#)
- > [USA.gov's small business portal](#)



IP commercialization

Learn about IP technology transfer, licensing, and partnerships.

- > [Technology transfer basics](#)
- > [Patents for Humanity awards](#)
- > [National security partnerships](#)
- > [Marketplace for federal agriculture technology](#)
- > [Patents 4 Partnerships licensing](#)
- > [Marketplace for sustainable technology](#)



Protection for IP abroad

Learn about domestic IP policy initiatives, international IP treaties, and practical tools to protect your IP internationally.

- > [International IP protection](#)
- > [International IP toolkits](#)
- > [IP Attaché Program](#)
- > [Plant variety protection](#)
- > [Other IP policy information](#)
- > [World Intellectual Property Organization](#)



International trade and exporting

Access resources for growing and protecting your business through international cooperation.

- > [Information on exporting](#)
- > [Small businesses and trade](#)
- > [Reporting trade violations](#)
- > [Free trade agreements](#)
- > [Trainings and toolkits about IP rights](#)

Federal funding for innovation

- [CARES Act funding through the Minority Business Development Agency](#)
- [National Institutes of Health funding opportunities](#)
- [National Science Foundation programs for small businesses](#)
- [COVID-19 relief options through the Small Business Administration](#)
- [Additional funding resources can be found here](#)

Access our free services

The United States Patent and Trademark Office (USPTO) offers a wide range of intellectual property (IP) resources, including application assistance, education and training, and other services that support the full spectrum of customers—from independent patent and trademark filers, to attorneys and business advisors in both the private and public sectors. Learn more about what USPTO is doing to expand participation in the innovation ecosystem through [inclusive innovation](#), including our [Council for Inclusive Innovation \(CI²\)](#).

Using the icons below, select a category to filter the list by your area of interest.



All Resources



Patents













Trademarks

















Attorneys and
Business Advisors

Title	Description	Resource category
Application Assistance		
Application Assistance Unit (AAU)	Provides assistance with questions and issues pertaining to pre-examination processing of patent applications and the post-examination processing of patent applications.	
Finding a patent practitioner	Search the registry of active patent practitioners who are eligible to represent others before the USPTO in patent matters.	
Hiring a U.S.-licensed attorney for trademarks	Discover if you are required to hire an attorney and why you should hire an attorney for trademark matters, even if you are not required to.	
Inventors Assistance Center	Provides patent assistance and information to the public to help make filing a patent	







<p>Inventors Assistance Center</p>	<p>Provides patent assistance and information to the public to help make filing a patent application simple and efficient before, during, and after the patent application process (i.e., patent maintenance).</p>	
<p>Law School Clinic Certification Program</p>	<p>Under the supervision of an approved faculty clinic supervisor, law school students provide pro bono representation to individuals and small businesses throughout the country in the prosecution of patent and trademark applications before the USPTO.</p>	 
<p>Patent and Trademark Resource Centers</p>	<p>Nationwide network of 80+ libraries that offers the public trademark and patent assistance. These libraries provide access to examiner-based search systems, and staff demonstrate how to use search tools and offer classes on intellectual property.</p>	 
<p>Patent Electronic Business Center (EBC)</p>	<p>Assists customers with the various Patent Electronic Systems, including help with filing their electronic patent application submissions, reviewing patent applications, and using the patent search databases.</p>	
<p>Patent Pro Bono Program</p>	<p>Provides patent application preparation, filing, and prosecution services to qualifying under-resourced inventors and small businesses. A nationwide network of non-profit regional programs match volunteer patent practitioners with applicants.</p>	
<p>Patents Ombuds</p>	<p>Provides assistance to all applicants who get stalled or encounter challenges navigating the patent application process after submitting their application (post-filing), managing cases for each inquiry until they are resolved.</p>	
<p>Pro Se Assistance Program</p>	<p>Helps independent inventors successfully navigate the entire patent application process. Services include scheduled consultations, quick clinics, and reference materials to increase the applicant's likelihood of success.</p>	
<p>PTAB ex parte appeal brief preparation assistance</p>	<p>Provides an instructional tool on how to write an ex parte appeal brief and file it with the Patent Trial and Appeal Board (PTAB) after a patent examiner rejects claims in a</p>	 























<p>PTAB ex parte appeal brief preparation assistance</p>	<p>Provides an instructional tool on how to write an ex parte appeal brief and file it with the Patent Trial and Appeal Board (PTAB) after a patent examiner rejects claims in a patent application.</p>	 
<p>PTAB pro bono program</p>	<p>Matches financially under-resourced inventors with volunteer patent professionals to provide free legal assistance in preparing ex parte appeals to the PTAB.</p>	 
<p>Regional offices and assistance</p>	<p>Provide resources, education, and assistance in your state for filing patent or trademark applications, options for legal assistance, methods for searching for existing inventions and trademarks, and networking opportunities.</p>	 
<p>Small and micro entity patent discounts</p>	<p>Fees for filing, searching, examining, issuing, appealing, and maintaining patent applications and patents are reduced by 50% for qualifying small entities and 75% for qualifying micro entities that meet statutory definitions.</p>	
<p>Trademark Assistance Center</p>	<p>Provides general information about the trademark registration process.</p>	
<p>TTAB Assistance Center</p>	<p>Provides online assistance with filing documents in a Trademark Trial and Appeal Board (TTAB) proceeding, directs customers to specific TTAB Manual of Procedure sections for additional information, and provides status updates in pending proceedings.</p>	 
<p>TTAB pro bono clearinghouse program</p>	<p>Recognizes organizations that act as a referral clearinghouse to coordinate free legal services, by matching eligible members of the public with volunteer member attorneys, in proceedings before the Trademark Trial and Appeal Board.</p>	 
<p>Business Resources</p>		
<p>AccessUSPTO</p>	<p>Collaborates with national organizations whose members have intellectual property needs and connect them to USPTO's free services that can help them grow their business.</p>	  

















Business Resources		
AccessUSPTO	Collaborates with national organizations whose members have intellectual property needs and connect them to USPTO's free services that can help them grow their business.	  
International IP Attaché Program	Specialized IP attachés help U.S. businesses, legal representatives, and rights holders internationally. They also advocate to improve IP policies, laws, and regulations abroad, as well as provide IP training to foreign government officials.	  
International IP Toolkits	Provides detailed information about protecting and enforcing IP rights when doing business in specific international markets, along with contact information for local IP offices abroad and U.S. government officials who can assist.	  
Inventor and entrepreneur resources webpage	USPTO's hub for resources and information for inventors, entrepreneurs, and small businesses. This webpage provides centralized access to a variety of USPTO products and services.	 
Small and medium-sized enterprise resources	Resources provided by federal agencies and international organizations for small and medium-sized enterprises looking to grow or expand a business and protect intangible business assets, like intellectual property.	 
Startup resources webpage	Provides resources for new businesses, including securing funding, and guarding against infringement litigation. Also contains links to related startup and commercialization resources located at other government agencies.	 
TTAB Reading Room	Allows users to search for final decisions and precedential orders issued by the Trademark Trial and Appeal Board.	 
Education and Training		







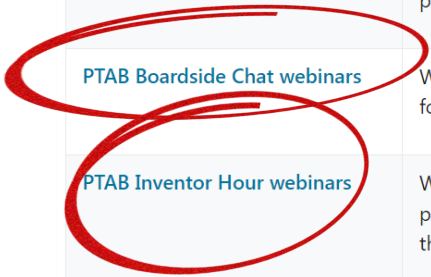

Education and Training		
China IP Road Shows and webinars	Programming initiative for U.S. businesses and rights holders on how to better protect IP in China. Related pilot programming for a similar audience covers how to better protect IP in the Southeast Asian region and other export markets.	  
Events offering CLE credits	Provides a list of upcoming USPTO events that may be eligible for continuing legal education (CLE) credits in your state.	  
Global Intellectual Property Academy IP eLearning modules	Self-study modules in English, Spanish, French, Arabic, and Russian, which cover all areas of IP protection, including trade secrets, patents, copyrights, trademarks, geographical indications, enforcement and trade.	  
Innovator events for everyone	Annual programs that provide relevant intellectual property, innovation, and invention resources to independent inventors, small businesses, entrepreneurs, and underrepresented or underserved populations (e.g., women and veterans).	  
Invention-Con	An annual three-day conference that provides an overview of IP protection and commercialization best practices. Participants learn about the importance of IP, what resources are available to them, and how to develop an IP strategy.	 
IP Identifier	Learn how to identify which of your creative ideas might be intellectual property assets and how to protect them.	 
IP workshops for K-12 educators	A monthly workshop for K-12 educators interested in integrating IP activities into their STEM/STEAM curriculum. Educators learn about IP and other topics related to innovation and entrepreneurship. Virtual "Office hours" are also available.	 
Legal Experience and Advancement Program (LEAP)	Provides training and oral advocacy opportunities for less experienced advocates to gain practical experience in proceedings before the Patent Trial and Appeal Board.	 



<p>National Summer Teacher Institute</p>	<p>A multiday professional development course offered to K-12 teachers to inspire and motivate student achievement in STEM disciplines, intellectual property, and entrepreneurship.</p>	<p> </p>
<p>One-day patent and trademark boot camps</p>	<p>Collaborates with local organizations to bring IP knowledge to internet deserts across America from rural areas to urban areas. Provides single-day, in-person, comprehensive overviews of how to file for a patent or register a trademark.</p>	<p> </p>
<p>Path to a Patent webinar series</p>	<p>A quarterly webinar series that provides education on intellectual property basics, patent searching, and guidance for drafting and submitting your patent application.</p>	<p></p>
<p>PTAB Boardside Chat webinars</p>	<p>Webinars that explain more complex aspects of Patent Trial and Appeal Board practices for ex parte appeals and AIA trial proceedings on a topic-by-topic basis.</p>	<p> </p>
<p>PTAB Inventor Hour webinars</p>	<p>Webinars that cover several introductory aspects of Patent Trial and Appeal Board practices, such as proceeding basics and other useful information for practicing before the PTAB.</p>	<p> </p>
<p>Public Search Facility</p>	<p>In-person assistance that provides public access to patent and trademark information, including online, microfilm, and books. Staff are available to assist public users with resources and training. Located in Alexandria, VA.</p>	<p> </p>
<p>Stakeholder Application Readiness Training (StART)</p>	<p>Three-day workshops that provide training and one-on-one assistance to independent inventors in preparing their patent application packet materials and filing those applications with the USPTO.</p>	<p></p>
<p>Stakeholder Offerings and Resources (SOaR)</p>	<p>Provides publicly-offered virtual training courses for both continuing legal credit and supporting inventors filing applications without legal representation.</p>	<p> </p>



<p>Stakeholder Training on Examination Practice and Procedure (STEPP)</p>	<p>Provides courses to help patent attorneys, agents, and inventors understand how, and why, a patent examiner makes decisions while reviewing patent applications.</p>	 
<p>Student programs</p>	<p>Provides a list of USPTO's paid and unpaid internship and externship opportunities for high school, college, graduate, and law school students.</p>	  
<p>Trademark Basics Boot Camp series</p>	<p>An eight-week series provides a comprehensive overview of federal trademark registration, including modules on searching, filing, examination, and keeping registered marks active. Attendees can register for some or all of the modules.</p>	
<p>Trademark Registration Toolkit (PDF)</p>	<p>Provides an overview of what a trademark is, the benefits of federal registration, how to apply for registration, and how to keep your registration alive.</p>	

PTAB contact info



By telephone:

- 571-272-9797 (general; appeals; and interferences)
- 571-272-7822 (trials; and PTACTS)

By email:

- PTAB_Appeals_Suggestions@USPTO.GOV
- Trials@uspto.gov
- PTABStatisticsQuestions@USPTO.GOV
- PTABOutreach@uspto.gov
- PTABP-TACTSAdmin@uspto.gov





uspto[®]

Future programs



Inventor Hour, Episode 19

Thursday, June 22, noon (ET)

Inventor Hour, Episode 20

Thursday, July 27, noon (ET)



