

EUROPEAN PATENT OFFICE  
U.S. PATENT AND TRADEMARK OFFICE

CPC NOTICE OF CHANGES 645

DATE: FEBRUARY 1, 2019

PROJECT RP0566

**The following classification changes will be effected by this Notice of Changes:**

<u>Action</u>	<u>Subclass</u>	<u>Group(s)</u>
<b>SCHEME:</b>		
Symbols Deleted:	A41D	2023/006, 2023/008
	A41D	31/0011, 31/0016, 31/0022, 31/0027, 31/0033, 31/0038, 31/0044, 31/005, 31/0055, 31/0061, 31/0066, 31/0072, 31/0077, 31/0083, 31/0088, 31/0094
	A41D	2400/20, 2400/22, 2400/34, 2400/60, 2400/62
Symbols New:	A41D	31/04, 31/06, 31/065, 31/08, 31/085, 31/10, 31/102, 31/12, 31/125, 31/14, 31/145, 31/18, 31/185, 31/24, 31/245, 31/26, 31/265, 31/28, 31/285, 31/30, 31/305, 31/32, 31/325
Titles Changed:	A41D	SUBCLASS
	A41D	7/00
	A41D	13/00, 13/0015, 13/02, 13/05
	A41D	20/00
	A41D	27/00, 27/08
	A41D	31/00, 31/0005, 31/02
	A42B	3/00
	G21F	3/02
Warnings New:	A41D	13/0015, 13/0017
	A41D	31/02, 31/04, 31/10, 31/102, 31/12, 31/125, 31/14, 31/145, 31/18, 31/185, 31/30, 31/305
	A62B	17/00
<b>DEFINITIONS:</b>		
Definitions Deleted: (no frozen (F) symbol definitions should be deleted)	A41D	31/0011,31/0016, 31/0022, 31/0033, 31/0038, 31/0044, 31/0055, 31/0066, 31/0077, 31/0083, 31/0088, 31/0094
	A41D	2400/20, 2400/60, 2400/62
Definitions New:	A41D	31/04, 31/06, 31/065, 31/08, 31/102, 31/12, 31/125, 31/14, 31/24, 31/26, 31/28, 31/30, 31/305, 31/32, 31/325
Definitions Modified:	A41C	3/122
	A41D	1/06
	A41D	7/00
	A41D	13/00, 13/0015, 13/002, 13/015, 13/02, 13/05
	A41D	20/00
	A41D	27/28
	A41D	31/0005, 31/02

CPC NOTICE OF CHANGES 645

DATE: FEBRUARY 1, 2019

PROJECT RP0566

**The following subclasses/groups are also impacted by this Notice of Changes (indicate subclasses/groups outside of the project scope, such as those listed in the CRL):**

A41B, A61H, A62B, D02G, D03D, F41H

**This Notice of Changes includes the following [Check the ones included]:**

1. CLASSIFICATION SCHEME CHANGES

- A. New, Modified or Deleted Group(s)
- B. New, Modified or Deleted Warning(s)
- C. New, Modified or Deleted Note(s)
- D. New, Modified or Deleted Guidance Heading(s)

2. DEFINITIONS

- A. New or Modified Definitions (Full definition template)
- B. Modified or Deleted Definitions (Definitions Quick Fix)

- 3.  REVISION CONCORDANCE LIST (RCL)
- 4.  CHANGES TO THE CPC-TO-IPC CONCORDANCE LIST (CICL)
- 5.  CHANGES TO THE CROSS-REFERENCE LIST (CRL)

## CPC NOTICE OF CHANGES 645

DATE: FEBRUARY 1, 2019

PROJECT RP0566

## 1. CLASSIFICATION SCHEME CHANGES

A. New, Modified or Deleted Group(s)**SUBCLASS A41D - OUTERWEAR; PROTECTIVE GARMENTS; ACCESSORIES**

<u>Type*</u>	<u>Symbol</u>	<u>Indent Level Number of dots (e.g. 0, 1, 2)</u>	<u>Title</u> <u>“CPC only” text should normally be enclosed in {curly brackets}**</u>	<u>Transferred to#</u>
M	A41D	Subclass	OUTERWEAR; PROTECTIVE GARMENTS; ACCESSORIES	
M	A41D 7/00	0	Bathing gowns; Swim-suits, drawers, or trunks; Beach suits	
M	A41D 13/00	0	Professional, industrial or sporting protective garments, e.g. surgeons' gowns or garments protecting against blows or punches (helmets A42B 3/00; clothing affording protection against chemical agents or for use at high altitudes A62B 17/00; life-saving garments for use at sea, diving suits B63C; bulletproof or armoured clothing F41H; clothing affording protection against radiation G21F 3/02)	
C	A41D 13/0015	1	{Sports garments other than provided for in groups A41D13/0007 - A41D13/088}	A41D13/0015, A41D31/18, A41D31/185
C	A41D 13/0017	2	{specially adapted for women}	A41D13/0017, A41D31/18, A41D31/185
M	A41D 13/02	1	Overalls (sweating suits A61H 36/00)	
M	A41D 13/05	1	protecting only a particular body part (ear protectors A61F 11/06)	
M	A41D 20/00	0	Wristbands or headbands, e.g. for absorbing sweat	
D	A41D 2023/006	1	{Protectors therefor}	<administrative transfer to A41D23/00>
D	A41D 2023/008	1	{using a slide fastener to adjust the neck loop}	<administrative transfer to A41D23/00>
M	A41D 27/00	0	Details of garments or of their making (buttons, pins, buckles, slide fasteners or the like A44B)	
M	A41D 27/08	1	Trimmings; Ornaments	
M	A41D 31/00	0	Materials specially adapted for outerwear	
M	A41D 31/0005	1	{made from a plurality of interconnected elements (A41D31/04 takes precedence)}	
D	A41D 31/0011	1	{Selection of special materials for protective garments (composition of materials for clothing affording protection against harmful chemical agents A62D5/00)}	<administrative transfer to A41D31/04>

## CPC NOTICE OF CHANGES 645

DATE: FEBRUARY 1, 2019

PROJECT RP0566

<b>Type*</b>	<b>Symbol</b>	<b>Indent Level Number of dots (e.g. 0, 1, 2)</b>	<b>Title</b> <b><u>“CPC only” text should normally be enclosed in {curly brackets}**</u></b>	<b>Transferred to#</b>
D	A41D 31/0016	2	{of layered products (A41D31/0022 - A41D31/0077 take precedence)}	<administrative transfer to A41D31/02>
D	A41D 31/0022	2	{against fire and heat}	<administrative transfer to A41D31/08>
D	A41D 31/0027	3	{using layered materials}	<administrative transfer to A41D31/085>
D	A41D 31/0033	2	{with thermal protective materials (heat and fire resistant materials A41D31/0022)}	<administrative transfer to A41D31/06>
D	A41D 31/0038	3	{using layered materials}	<administrative transfer to A41D31/065>
D	A41D 31/0044	2	{with shock absorbing materials}	<administrative transfer to A41D31/28>
D	A41D 31/005	3	{using layered materials}	<administrative transfer to A41D31/285>
D	A41D 31/0055	2	{resistant to mechanical aggressions, e.g. pierceproof materials (aprons resistant to mechanical aggressions A41D13/043)}	<administrative transfer to A41D31/24>
D	A41D 31/0061	3	{using layered materials}	<administrative transfer to A41D31/245>
D	A41D 31/0066	2	{against electric shocks or static electricity}	<administrative transfer to A41D31/26>
D	A41D 31/0072	3	{using layered materials}	<administrative transfer to A41D31/265>
D	A41D 31/0077	2	{with antibacterial or antimicrobial materials}	<administrative transfer to A41D31/30>
D	A41D 31/0083	3	{using layered materials}	<administrative transfer to A41D31/305>
D	A41D 31/0088	2	{with retroreflective materials}	<administrative transfer to A41D31/32>
D	A41D 31/0094	3	{using layered materials}	<administrative transfer to A41D31/325>
C	A41D 31/02	1	Layered materials (characterised by special function or use A41D 31/04)	A41D31/02, A41D 31/04, A41D 31/102, A41D 31/125, A41D 31/145, A41D 31/185
Q	A41D 31/04	1	characterised by special function or use {(protective clothing affording protection against heat or harmful chemical agents A62B17/00; composition of materials for clothing affording protection against harmful chemical agents A62D5/00)}	A41D 31/04, A41D 31/10, A41D 31/102, A41D 31/12, A41D 31/14, A41D 31/18, A62B 17/00, A62B17/001, A62B17/003, A62B17/005, A62B17/006, A62B17/008, A62B17/04, A62B17/08
N	A41D 31/06	2	Thermally protective, e.g. insulating	
N	A41D 31/065	3	{using layered materials}	
N	A41D 31/08	2	Heat resistant; Fire retardant	
N	A41D 31/085	3	{using layered materials}	

## CPC NOTICE OF CHANGES 645

DATE: FEBRUARY 1, 2019

PROJECT RP0566

<u>Type*</u>	<u>Symbol</u>	<u>Indent Level Number of dots (e.g. 0, 1, 2)</u>	<u>Title</u> <u>“CPC only” text should normally be enclosed in {curly brackets}**</u>	<u>Transferred to#</u>
N	A41D 31/10	2	Impermeable to liquids, e.g. waterproof; Liquid repellent	
N	A41D 31/102	3	Waterproof and breathable	
N	A41D 31/12	2	Hygroscopic; Water retaining	
N	A41D 31/125	3	{Moisture handling or wicking function through layered materials}	
Q	A41D 31/14	2	Air permeable, i.e. capable of being penetrated by gases (waterproof and breathable A41D 31/102)	A41D 31/14, A41D 31/145, A41D 31/102
N	A41D 31/145	3	{using layered materials}	
N	A41D 31/18	2	Elastic	
N	A41D 31/185	3	{using layered materials}	
N	A41D 31/24	2	Resistant to mechanical stress, e.g. pierce-proof {(aprons resistant to mechanical aggressions A41D13/043)}	
N	A41D 31/245	3	{using layered materials}	
N	A41D 31/26	2	Electrically protective, e.g. preventing static electricity or electric shock	
N	A41D 31/265	3	{using layered materials}	
N	A41D 31/28	2	Shock absorbing	
N	A41D 31/285	3	{using layered materials}	
Q	A41D 31/30	2	Antimicrobial, e.g. antibacterial	A41D 31/30, A41D 31/305
N	A41D 31/305	3	{using layered materials}	
N	A41D 31/32	2	Retroreflective	
N	A41D 31/325	3	{using layered materials}	
D	A41D 2400/20	1	Air permeability; Ventilation	<administrative transfer to A41D31/14 INV>
D	A41D 2400/22	1	Breathability, i.e. being vapour permeable and waterproof	<administrative transfer to A41D31/102 INV>
D	A41D 2400/34	1	Antimicrobial or antibacterial	<administrative transfer to A41D31/30 ADD>
D	A41D 2400/60	1	Moisture handling or wicking function	<administrative transfer to A41D31/12 INV>
D	A41D 2400/62	2	through several layers	<administrative transfer to A41D31/125 INV>

CPC NOTICE OF CHANGES 645

DATE: FEBRUARY 1, 2019

PROJECT RP0566

**SUBCLASS A42B - HATS; HEAD COVERINGS**

<u>Type*</u>	<u>Symbol</u>	<u>Indent Level Number of dots (e.g. 0, 1, 2)</u>	<u>Title</u> <b>“CPC only” text should normally be enclosed in {curly brackets}**</b>	<u>Transferred to#</u>
M	A42B 3/00	0	Helmets; Helmet covers {; Other protective head coverings} ({hoods for welders A61F9/06; } hoods as protection against chemical agents or for use at high altitudes A62B17/00; gas helmets A62B18/04; swimming helmets A63B33/00; defence protection helmets F41H1/04)	

**SUBCLASS G21F - PROTECTION AGAINST X-RADIATION, GAMMA RADIATION, CORPUSCULAR RADIATION OR PARTICLE BOMBARDMENT; TREATING RADIOACTIVELY CONTAMINATED MATERIAL; DECONTAMINATION ARRANGEMENTS THEREFOR**

<u>Type*</u>	<u>Symbol</u>	<u>Indent Level Number of dots (e.g. 0, 1, 2)</u>	<u>Title</u> <b>“CPC only” text should normally be enclosed in {curly brackets}**</b>	<u>Transferred to#</u>
M	G21F 3/02	1	Clothing	

\*N = new entries where reclassification into entries is involved; C = entries with modified file scope where reclassification of documents from the entries is involved; Q = new entries which are firstly populated with documents via administrative transfers from deleted (D) entries. Afterwards, the transferred documents into the Q entry will either stay or be moved to more appropriate entries, as determined by intellectual reclassification; E= existing entries with enlarged file scope, which receive documents from C or D entries, e.g. when a limiting reference is removed from the entry title; M = entries with no change to the file scope (no reclassification); D = deleted entries; F = frozen entries will be deleted once reclassification of documents from the entries is completed; U = entries that are unchanged.

NOTES:

- \*\*No {curly brackets} are used for titles in CPC only subclasses, e.g. C12Y, A23Y; 2000 series symbol titles of groups found at the end of schemes (orthogonal codes); or the Y section titles. The {curly brackets} are used for 2000 series symbol titles found interspersed throughout the main trunk schemes (breakdown codes).
- U groups: it is obligatory to display the required “anchor” symbol (U group), i.e. the entry immediately preceding a new group or an array of new groups to be created (in case new groups are not clearly subgroups of C-type groups). Always include the symbol, indent level and title of the U group in the table above.
- All entry types should be included in the scheme changes table above for better understanding of the overall scheme change picture. Symbol, indent level, and title are required for all types .
- “Transferred to” column must be completed for all C, D, F, and Q type entries. F groups will be deleted once reclassification is completed.
- When multiple symbols are included in the “Transferred to” column, avoid using ranges of symbols in order to be as precise as possible.
- For administrative transfer of documents, the following text should be used: “< administrative transfer to XX>”, “<administrative transfer to XX and YY simultaneously>”, or “<administrative transfer to XX, YY, ...and ZZ simultaneously>” when administrative transfer of the same documents is to more than one place.
- Administrative transfer to main trunk groups is assumed to be the source allocation type, unless otherwise indicated.
- Administrative transfer to 2000/Y series groups is assumed to be “additional information”.

## CPC NOTICE OF CHANGES 645

DATE: FEBRUARY 1, 2019

### PROJECT RP0566

- If needed, instructions for allocation type should be indicated within the angle brackets using the abbreviations “ADD” or “INV”: <administrative transfer to XX ADD> , <administrative transfer to XX INV>, or < administrative transfer to XX ADD, YY INV, ... and ZZ ADD simultaneously>.
- In certain situations, the “D” entries of 2000-series or Y-series groups may not require a destination (“Transferred to”) symbol, however it is required to specify “<no transfer>” in the “Transferred to” column for such cases.
- For finalisation projects, the deleted “F” symbols should have <no transfer> in the “Transferred to” column.
- For more details about the types of scheme change, see CPC Guide.

CPC NOTICE OF CHANGES 645

DATE: FEBRUARY 1, 2019

PROJECT RP0566

B. New, Modified or Deleted Warning(s)

**SUBCLASS A41D - OUTERWEAR; PROTECTIVE GARMENTS; ACCESSORIES**

<u>Type*</u>	<u>Location</u>	<u>Old Warning</u>	<u>New/Modified Warning</u>
N	A41D 13/0015		Group A41D 13/0015 is impacted by reclassification into groups A41D 31/18 and A41D 31/185. Groups A41D 13/0015, A41D 31/18, and A41D 31/185 should be considered in order to perform a complete search.
N	A41D 13/0017		Group A41D 13/0017 is impacted by reclassification into groups A41D 31/18 and A41D 31/185. Groups A41D 13/0017, A41D 31/18, and A41D 31/185 should be considered in order to perform a complete search.
N	A41D 31/02		Group A41D 31/02 is impacted by reclassification into groups A41D 31/04, A41D 31/102, A41D 31/125, A41D 31/145, and A41D 31/185. All groups listed in this Warning should be considered in order to perform a complete search.
N	A41D 31/04		Group A41D 31/04 is incomplete pending reclassification of documents from group A41D 31/02. Group A41D 31/04 is also impacted by reclassification into groups A41D 31/10, A41D 31/102, A41D 31/12, A41D 31/14, A41D 31/18, A62B 17/00, A62B 17/001, A62B 17/003, A62B 17/005, A62B 17/006, A62B 17/008, A62B 17/04, and A62B 17/08. All groups listed in this Warning should be considered in order to perform a complete search.
N	A41D 31/10		Group A41D 31/10 is incomplete pending reclassification of documents from group A41D 31/04. Groups A41D 31/04 and A41D 31/10 should be considered in order to perform a complete search.
N	A41D 31/102		Group A41D 31/102 is incomplete pending reclassification of documents from groups A41D 31/02, A41D 31/04, and A41D 31/14. All groups listed in this Warning should be considered in order to perform a complete search.



CPC NOTICE OF CHANGES 645

DATE: FEBRUARY 1, 2019

PROJECT RP0566

<u>Type*</u>	<u>Location</u>	<u>Old Warning</u>	<u>New/Modified Warning</u>
N	A41D 31/12		Group A41D 31/12 is incomplete pending reclassification of documents from group A41D 31/04. Groups A41D 31/04 and A41D 31/12 should be considered in order to perform a complete search.
N	A41D 31/125		Group A41D 31/125 is incomplete pending reclassification of documents from group A41D 31/02. Groups A41D 31/02 and A41D 31/125 should be considered in order to perform a complete search.
N	A41D 31/14		Group A41D 31/14 is incomplete pending reclassification of documents from group A41D 31/04. Group A41D 31/14 is also impacted by reclassification into groups A41D 31/145 and A41D 31/102. All groups listed in this Warning should be considered in order to perform a complete search.
N	A41D 31/145		Group A41D 31/145 is incomplete pending reclassification of documents from groups A41D 31/02 and A41D 31/14. Groups A41D 31/02, A41D 31/14, and A41D 31/145 should be considered in order to perform a complete search.
N	A41D 31/18		Group A41D 31/18 is incomplete pending reclassification of documents from groups A41D 13/0015, A41D 13/0017, and A41D 31/04. All groups listed in this Warning should be considered in order to perform a complete search.
N	A41D 31/185		Group A41D 31/185 is incomplete pending reclassification of documents from groups A41D 13/0015, A41D 13/0017, and A41D 31/02. All groups listed in this Warning should be considered in order to perform a complete search.
N	A41D 31/30		Group A41D 31/30 is impacted by reclassification into group A41D 31/305. Groups A41D 31/30 and A41D 31/305 should be considered in order to perform a complete search.

CPC NOTICE OF CHANGES 645

DATE: FEBRUARY 1, 2019

PROJECT RP0566

<u>Type*</u>	<u>Location</u>	<u>Old Warning</u>	<u>New/Modified Warning</u>
N	A41D 31/305		Group A41D 31/305 is incomplete pending reclassification of documents from group A41D 31/30. Groups A41D 31/30 and A41D 31/305 should be considered in order to perform a complete search.
N	A62B 17/00		Groups A62B 17/00 - A62B 17/08 are incomplete pending reclassification of documents from group A41D 31/04. All groups listed in this Warning should be considered in order to perform a complete search.

\*N = new warning, M = modified warning, D = deleted warning

NOTE: The "Location" column only requires the symbol PRIOR to the location of the warning. No further directions such as "before" or "after" are required.

## 2. A. DEFINITIONS (new)

**Insert:** The following new Definitions.

### A41D 31/04

#### Definition statement

*This place covers:*

Materials of protective clothing having camouflage pattern.

Illustrative example of subject matter classified in this group:

Figure 1.

Fabric suitable to provide a barrier effect against magnetic and electromagnetic fields and/or metalotherapy effects

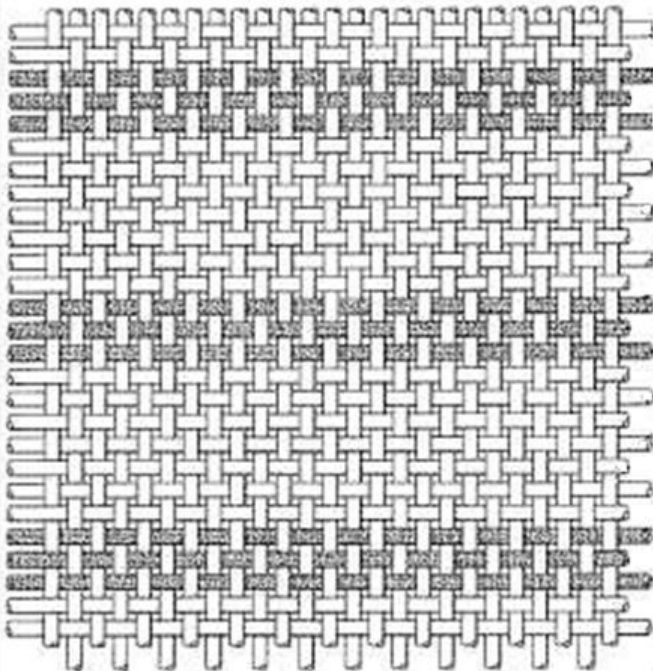

DATE: FEBRUARY 1, 2019

PROJECT RP0566

Figure 2.

Camouflage and other patterns, articles comprising them, and methods of making and using same



## References

### *Limiting references*

*This place does not cover:*

Protective clothing affording protection against heat or harmful chemical agents	<a href="#">A62B 17/00</a>
Materials for clothing protecting against harmful chemical agents	<a href="#">A62D 5/00</a>

CPC NOTICE OF CHANGES 645

DATE: FEBRUARY 1, 2019

PROJECT RP0566

**Informative references**

*Attention is drawn to the following places, which may be of interest for search:*

Camouflage flexible covers, screens, nets	<a href="#">F41H 3/02</a>
Clothing protecting against X radiations	<a href="#">G21F 3/025</a>

**Special rules of classification**

For protective clothing having camouflage pattern class in [A41D 13/00](#).

## A41D 31/06

### Definition statement

*This place covers:*

Only thermal protection against cold.

Illustrative example of subject matter classified in this group:

Figure 1.

Adjustable insulation apparatus

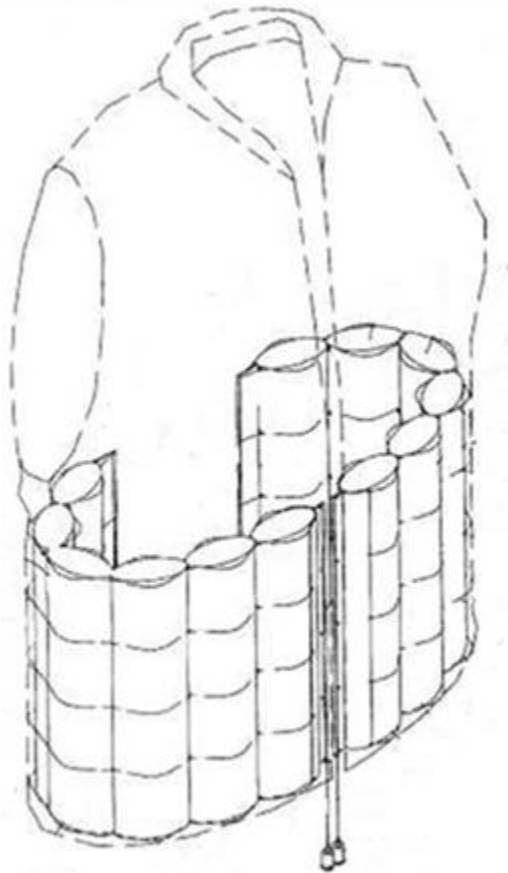

DATE: FEBRUARY 1, 2019

PROJECT RP0566

Figure 2.

Double-face velour fabric articles having improved dynamic insulation performance

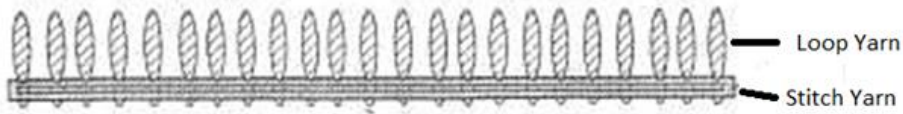

## References

### *Informative references*

*Attention is drawn to the following places, which may be of interest for search:*

Thermal insulation in general	<a href="#">F16L 59/07</a>
-------------------------------	----------------------------

## A41D 31/065

## References

### *Informative references*

*Attention is drawn to the following places, which may be of interest for search:*

Duvets	<a href="#">A47G 9/0207</a>
Pillows	<a href="#">A47G 9/10</a>
Loose filling materials for upholstery	<a href="#">B68G 1/00</a>
Filling of cushions, mattresses	<a href="#">B68G 7/06</a>
Non-woven fabrics formed by filamentary materials	<a href="#">D04H 3/02</a>
Quilting and filling with feathers	<a href="#">D05B 11/005</a>
Treatment of feathers	<a href="#">D06M 19/00</a>

## A41D 31/08

### Definition statement

*This place covers:*

Illustrative example of subject matter classified in this group:

Figure 1.

Fire resistant fleece fabric and garment

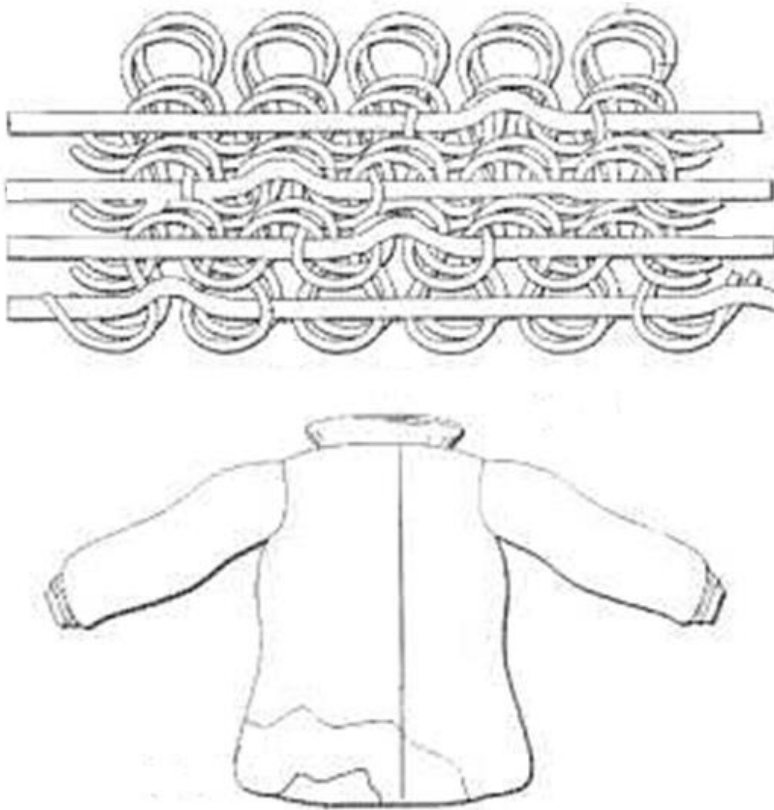

### References

#### *Informative references*

*Attention is drawn to the following places, which may be of interest for search:*

Fireproof yarns	<a href="#">D02G 3/443</a>
Woven fabrics using heat / flame proof threads	<a href="#">D03D 15/12</a>
Knitted with synthetic threads	<a href="#">D04B 1/16</a>



## A41D 31/102

### Definition statement

*This place covers:*

Waterproof/breathable material construction for non-protective garments, i.e. Gore-Tex.

Illustrative example of subject matter classified in this group:

Figure 1.

Vapor permeable buoyant insulation  
composition for garments

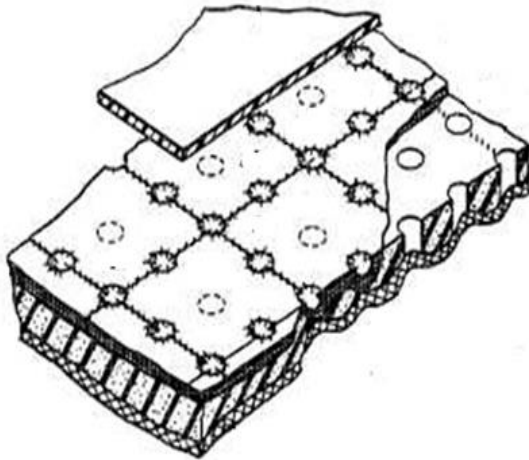
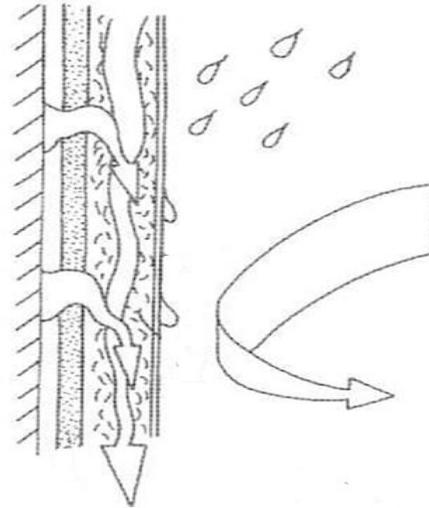

Figure 2.

Waterproof/breathable garment  
construction



## A41D 31/12

### Definition statement

*This place covers:*

Materials having a moisture handling or wicking function.

### Special rules of classification

In cases of ventilation without fans (or forced air circulation) of an outside garment:

- Every time there is any kind of ventilation: [A41D 27/28](#)
- When ventilation is done transversally (perpendicular) to the fabric: [A41D 27/28](#) alone
- When ventilation is done parallel to the fabric, i.e. with channels: [A41D 31/14](#) or [A41D 31/145](#) combined with [A41D 27/28](#)
- When ventilation is also used to regulate inside conditions (temperature, humidity etc.): add Indexing Code [A41D 13/002](#)
- When there are sweat handling or wicking properties, i.e. sweat transport in ventilation channels: add [A41D 31/12](#) or [A41D 31/125](#)

## A41D 31/125

### Special rules of classification

Special rules of classification

- In cases of ventilation without fans (or forced air circulation) of an outside garment
- Every time there is any kind of ventilation: [A41D 27/28](#)
- When ventilation is done transversally (perpendicular) to the fabric: [A41D 27/28](#) alone
- When ventilation is done parallel to the fabric, i.e. with channels: [A41D 31/14](#) or [A41D 31/145](#) combined with [A41D 27/28](#)
- When ventilation is also used to regulate inside conditions (temperature, humidity etc): add Indexing Code [A41D 13/002](#)
- When there are sweat handling or wicking properties, i.e. sweat transport in ventilation channels: add [A41D 31/12](#) or [A41D 31/125](#)

## A41D 31/14

### References

#### *Limiting references*

*This place does not cover:*

Waterproof and breathable materials for outerwear	<a href="#">A41D 31/102</a>
---	-----------------------------

### Special rules of classification

In cases of ventilation without fans (or forced air circulation) of an outside garment:

- Every time there is any kind of ventilation: [A41D 27/28](#)
- When ventilation is done transversally (perpendicular) to the fabric: [A41D 27/28](#) alone
- When ventilation is done parallel to the fabric, i.e. with channels: [A41D 31/14](#) or [A41D 31/145](#) combined with [A41D 27/28](#)
- When ventilation is also used to regulate inside conditions (temperature, humidity etc): add Indexing Code [A41D 13/002](#).
- When there are sweat handling or wicking properties, i.e. sweat transport in ventilation channels: add [A41D 31/12](#) or [A41D 31/125](#)

## A41D 31/24

### References

#### *Limiting references*

*This place does not cover:*

Aprons resistant to mechanical aggressions	<a href="#">A41D 13/043</a>
--	-----------------------------

#### *Informative references*

*Attention is drawn to the following places, which may be of interest for search:*

Cut resistant yarns	<a href="#">D02G 3/442</a>
Armoured clothing plate construction	<a href="#">F41H 5/0485</a>

### Special rules of classification

Also contains abrasion resistant materials

## A41D 31/26

### References

#### *Informative references*

*Attention is drawn to the following places, which may be of interest for search:*

Anti-static materials	<a href="#">C09K 3/16</a>
-----------------------	---------------------------

DATE: FEBRUARY 1, 2019

PROJECT RP0566

## A41D 31/28

### References

#### *Informative references*

*Attention is drawn to the following places, which may be of interest for search:*

Cushioning for helmets	<a href="#">A42B 3/12</a>
Cushions in bicycle seats	<a href="#">B62J 1/26</a>
Loose filling materials for upholstery	<a href="#">B68G 1/00</a>
Chemical aspects of damping compositions	<a href="#">C08K</a> , <a href="#">C08L</a> , <a href="#">C08J</a>
Springs, dampers	<a href="#">F16F 1/3605</a>
Shock absorbers	<a href="#">F16F 9/306</a>
Protective helmets (bulletproof)	<a href="#">F41H 1/04</a>

### Special rules of classification

Comprises materials of protective garments with shock absorbing means.

For protection of body parts not included in the subgroups of [A41D 13/05](#) and protection for several body parts in the same garment, class in [A41D 13/05](#).

For shock-absorbing means in general, i.e. pads, class in [A41D 13/015](#).

DATE: FEBRUARY 1, 2019

PROJECT RP0566

## A41D 31/30

### References

#### *Informative references*

*Attention is drawn to the following places, which may be of interest for search:*

Anthrax	<a href="#">A61L</a>
---------	----------------------

### Special rules of classification

For ABC suits (used to protect against chemical/biological/toxic environment) forward to [A62B 17/006](#) and do not class in [A41D 13/00](#).

## A41D 31/305

### References

#### *Informative references*

*Attention is drawn to the following places, which may be of interest for search:*

Laminates for surgical drapes	<a href="#">A61B 46/40</a>
-------------------------------	----------------------------

## A41D 31/32

### Definition statement

*This place covers:*

Reflective materials of electromagnetic waves, protecting against them.

### References

#### *Informative references*

*Attention is drawn to the following places, which may be of interest for search:*

Methods producing reflective surfaces
---------------------------------------

<a href="#">B29D 11/00605</a>
-------------------------------

## A41D 31/325

### Definition statement

*This place covers:*

Illustrative example of subject matter classified in this group.

Figure 1.

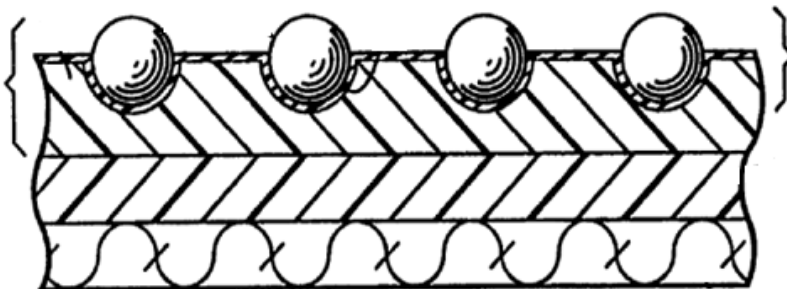

## **2.A. DEFINITIONS (modified)**

Insert: The following changes into the existing Definitions.

### **A41D 1/06**

#### **Special rules of classification**

Insert: The following new statement immediately after the last statement

“For leggings (leg outer coverings, over trousers) classify in [A41D 17/00](#)”.

For waist details or expansible/adjustable waist classify also in [A41F 9/00](#)  
and lower groups.



## A41D 7/00

### Definition statement

*This place covers:*

Replace: The existing figure with the following new figure and caption.



Figure 1.

CPC NOTICE OF CHANGES 645

DATE: FEBRUARY 1, 2019

PROJECT RP0566

Insert: The following new section: References/Informative references.

**References**

***Informative references***

*Attention is drawn to the following places, which may be of interest for search:*

Bathing caps	<a href="#">A42B 1/12</a>
--------------	---------------------------

## A41D 13/00

### Definition statement

*This place covers:*

Delete: The entire Definition statement section and figure.

Insert: The following new section: References/Limiting references.

### References

#### Limiting references

*This place does not cover:*

Helmets	<a href="#">A42B 3/00</a>
Clothing affording protection against chemical agents or for use at high altitudes	<a href="#">A62B 17/00</a>
Fire-fighters' clothes	<a href="#">A62B 17/003</a>
ABC suits (against chemical/ biological/ toxic environment)	<a href="#">A62B 17/006</a>
Life-saving garments for use at sea, diving suits	<a href="#">B63C</a>
Bulletproof or armoured clothing	<a href="#">F41H</a>
Bulletproof vest	<a href="#">F41H 1/02</a>
Camouflage flexible covers, screens, nets	<a href="#">F41H 3/02</a>
Clothing affording protection against radiation	<a href="#">G21F 3/02</a>
Clothing protecting against X radiations	<a href="#">G21F 3/025</a>

#### Informative references

*Attention is drawn to the following places, which may be of interest for search:*

Delete: The following rows from the Informative references table.

Fire-fighters' clothes	<a href="#">A62B 17/003</a>
------------------------	-----------------------------

DATE: FEBRUARY 1, 2019

PROJECT RP0566

ABC suits (against chemical/ biological/ toxic environment)	<a href="#">A62B 17/006</a>
Bulletproof vest	<a href="#">F41H 1/02</a>
Camouflage flexible covers, screens, nets	<a href="#">F41H 3/02</a>
Clothing protecting against X radiations	<a href="#">G21F 3/025</a>

## Special rules of classification

Replace: The reference symbol [A41D31/0011](#) in the following statement with [A41D 31/04](#)

For materials of protective clothing having camouflage pattern class in [A41D 31/0011](#).

Insert: The following paragraph immediately after the above statement.

Looping references between [A41D 13/00](#) and [A62B 17/00](#) have been identified. Until this inconsistency is resolved, the current classification practice in CPC is as follows: for clothing affording protection against chemical agents or for use at high altitudes classify in [A62B 17/00](#) and do not classify in [A41D 13/00](#).

Replace: The last paragraph "For ABC...not class in [A41D 13/00](#)" with the following new paragraph:

In particular for ABC suits (used to protect against chemical/biological/toxic environment) classify in [A62B 17/006](#) and do not classify in [A41D 13/00](#).

## A41D 13/0015

### Definition statement

*This place covers:*

Replace: The existing figure with the following new figure and caption.

Figure 1.

Wears for promoting sequential movements of inner muscles



### Informative references

*Attention is drawn to the following places, which may be of interest for search:*

Insert: The following rows into the Informative references table.

Elastic materials in outerwear	<a href="#">A41D 31/18</a>
Layered elastic materials in outerwear	<a href="#">A41D 31/185</a>

DATE: FEBRUARY 1, 2019

PROJECT RP0566

### **Special rules of classification**

Replace: The following statement (6<sup>th</sup> paragraph) “For sportive garments with embedded elastic bands but no compression class in [A41D 13/0015](#)” with

For sportive garments with embedded elastic bands but no compression class in [A41D 13/0015](#) or [A41D 31/18](#) or [A41D 31/185](#).

## A41D 13/002

### Definition statement

*This place covers:*

Replace: The existing figure with the following new figure and caption.

Figure 1.

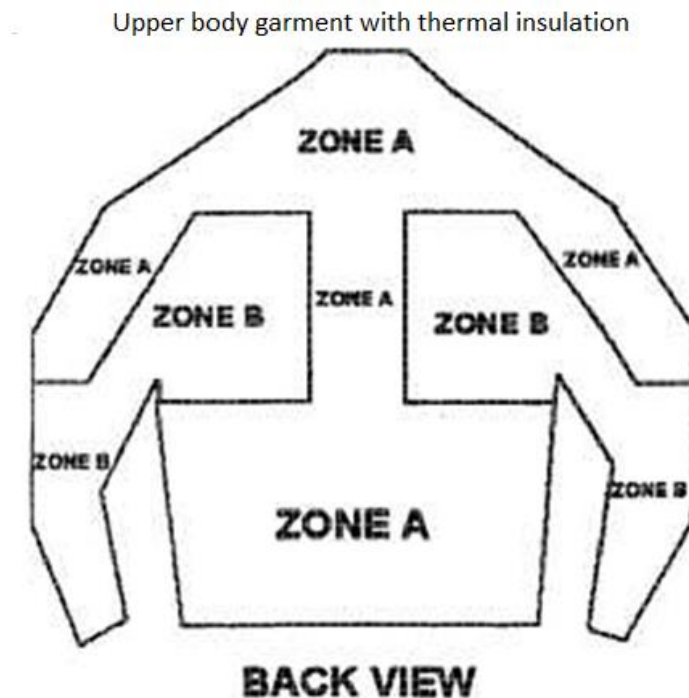

### Special rules of classification

Replace: The third bullet statement

“When ventilation is done parallel to the fabric (i.e. with channels): as additional information in [A41D 2400/20](#) combined with [A41D 27/28](#).

with the following new bullet statement:

- When ventilation is done parallel to the fabric (i.e. with channels): give [A41D 31/14](#) in addition to [A41D 27/28](#).

CPC NOTICE OF CHANGES 645

DATE: FEBRUARY 1, 2019

PROJECT RP0566

Replace: The fifth bullet statement

“When there are sweat handling or wicking properties, (i.e. sweat transport in ventilation channels): add as additional information in [A41D 2400/60](#) or **A41D400/620.**”

with the following new bullet statement:

- When there are sweat handling or wicking properties, (i.e. sweat transport in ventilation channels): give additionally [A41D31/12](#) or [A41D31/125](#).



## A41D 13/015

### Definition statement

*This place covers:*

Replace: The existing figure with the following new figure.

Fluid filled body padding for fall protection

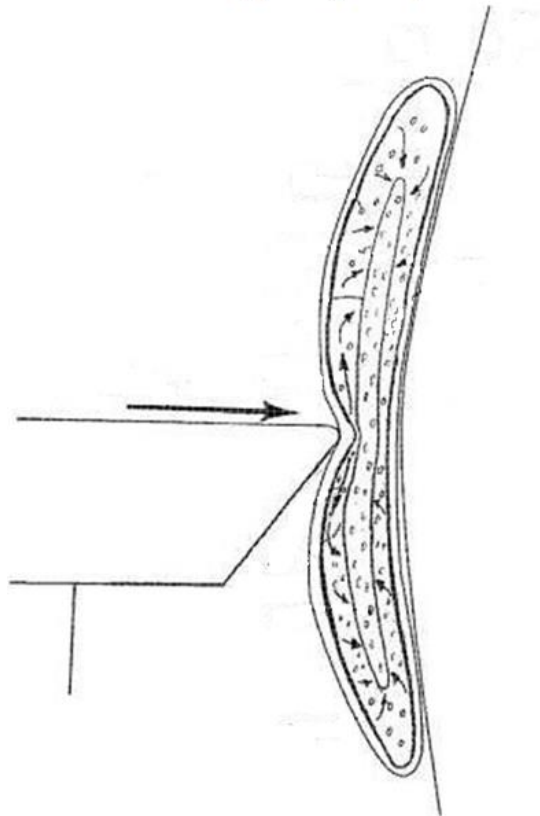

### Special rules of classification

Replace: The 3rd paragraph “For materials of ... in [A41D31/0044](#) and lower groups.”

with the following new statement:

For materials of protective garments with shock absorbing means classify in [A41D 31/28](#) and lower group.

## A41D 13/02

### Definition statement

*This place covers:*

Replace: The existing figure with the following new figure.

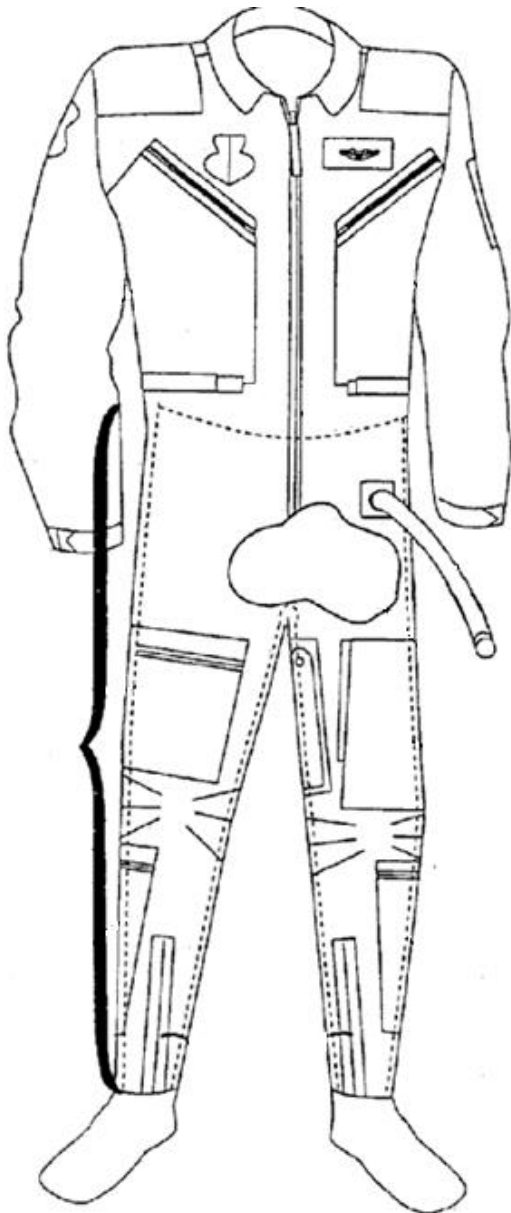

DATE: FEBRUARY 1, 2019

PROJECT RP0566

Insert: The following new section: References/Limiting references.

## References

### *Limiting references*

*This place does not cover:*

Sweating suits	<a href="#">A61H 36/00</a>
----------------	----------------------------

## Special rules of classification

Replace: The 4th paragraph “For sportive garments ...no compression class in [A41D13/0015](#)”

with the following new statement:

For sportive garments with embedded elastic bands but no compression class in [A41D 13/0015](#) or [A41D 31/18](#) or [A41D 31/185](#).

## A41D 13/05

### Definition statement

*This place covers:*

Replace: The existing three figures with the following new figures and captions  
"Figure 1., Figure 2., and Figure 3."

Figure 1.

Apparatus and Method for  
protecting earlobes of athletes

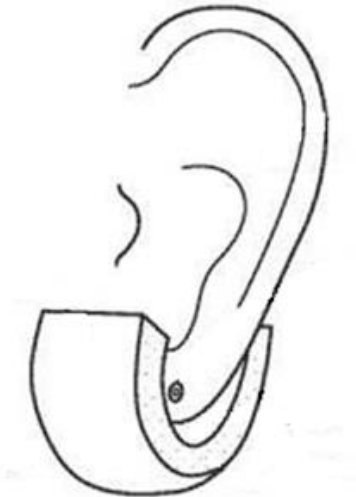

Figure 2.

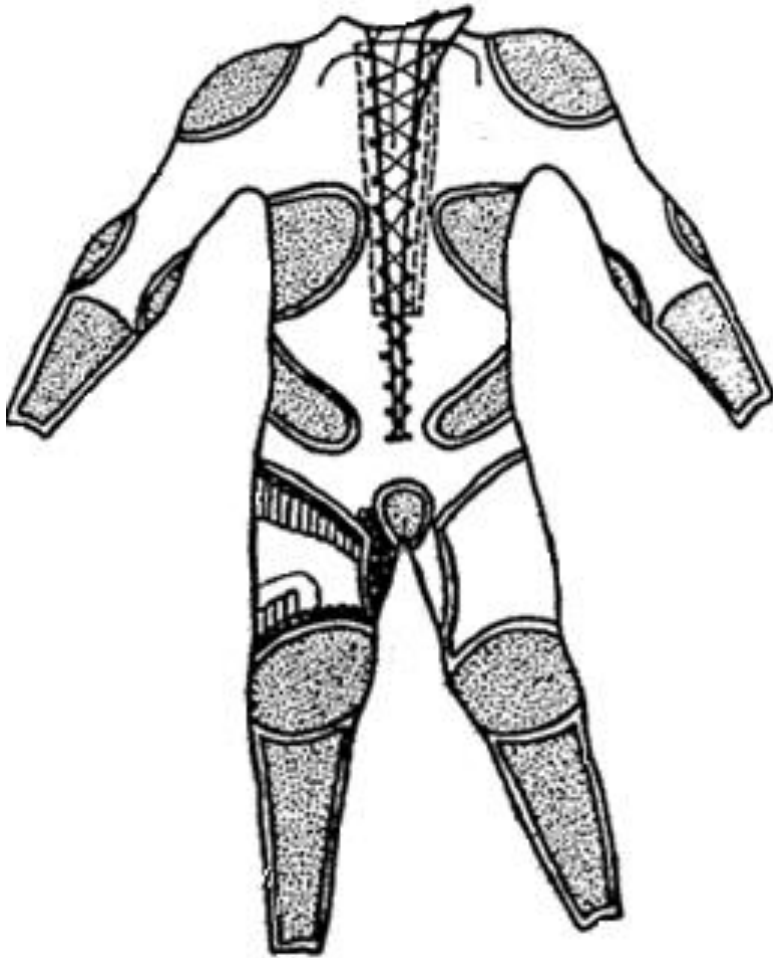
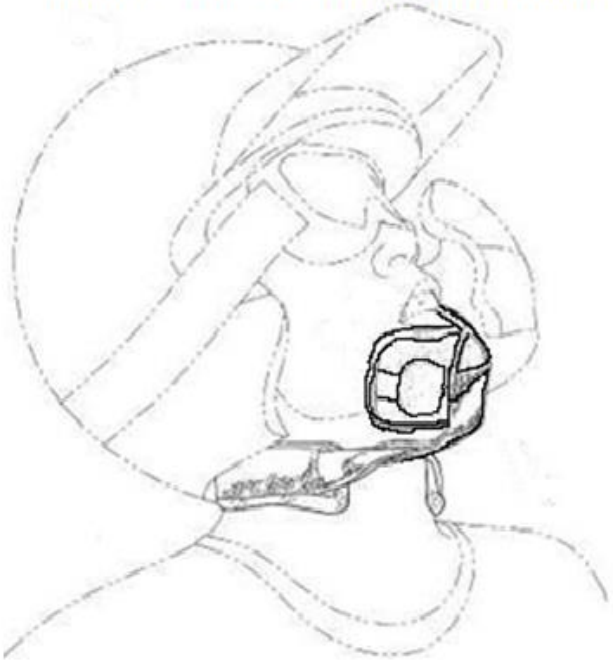

Figure 3.

Combination chin protector and mouth guard



Insert: The following new section: References/Limiting references.

### **References**

#### ***Limiting references***

*This place does not cover:*

Ear protectors	<a href="#">A61F 11/06</a>
----------------	----------------------------

#### ***Informative references***

*Attention is drawn to the following places, which may be of interest for search:*

Insert: The following rows into the Informative references table.

Sports brassières	<a href="#">A41C 3/00</a>
-------------------	---------------------------

DATE: FEBRUARY 1, 2019

PROJECT RP0566

### **Special rules of classification**

Replace: The 5th paragraph “For materials of protective garments with shock absorbing means class in [A41D 31/0044](#) and lower groups.”

with the following new statement:

For materials of protective garments with shock absorbing means class in [A41D 31/28](#) and lower group.

## A41D 20/00

### Definition statement

*This place covers:*

Replace: The existing figure with the following new figure.

Perspiration redirecting head  
band device

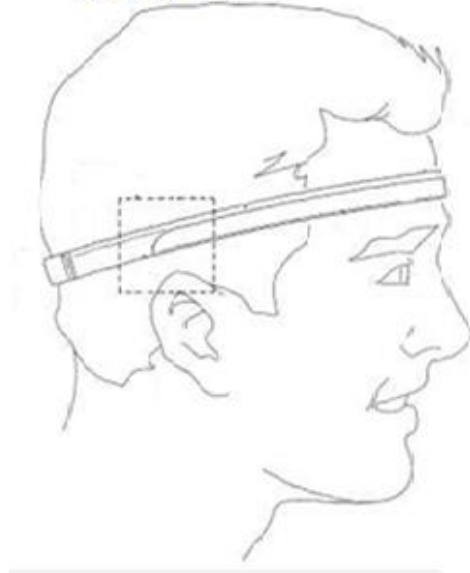

### References

#### Informative references

*Attention is drawn to the following places, which may be of interest for search:*

Insert: The following row into the Informative references table.

Hat fittings	<a href="#">A42C 5/02</a>
--------------	---------------------------



## A41D 27/28

### Definition statement

*This place covers:*

Replace: The existing figure with the following new figure and captions.

Figure 1.

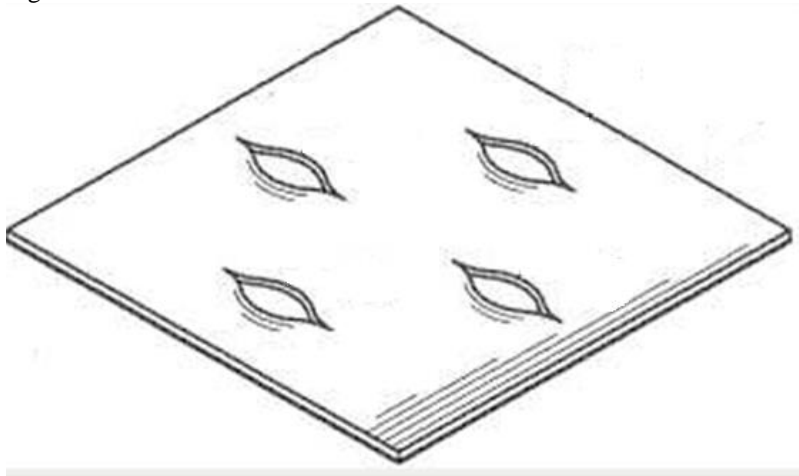
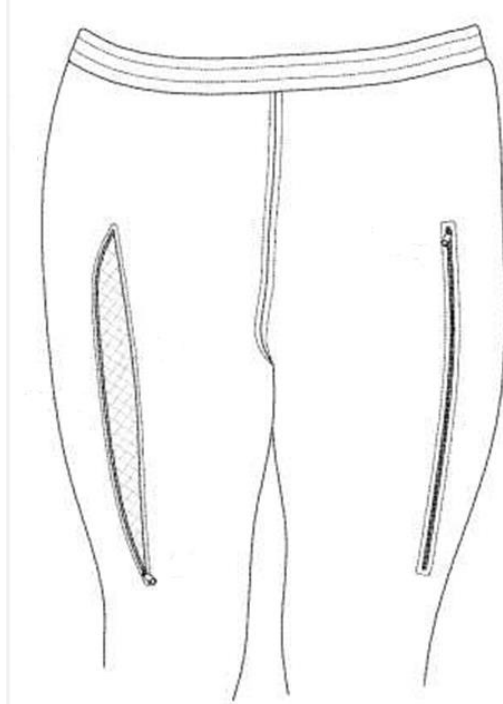

Figure 2.



## **Special rules of classification**

Replace: The 3<sup>rd</sup> and 5<sup>th</sup> bullet statement with the following new bullets:

- When ventilation is done parallel to the fabric, i.e. with channels: [A41D 31/14](#) or [A41D 31/145](#) combined with [A41D 27/28](#).
- When there are sweat handling or wicking properties, i.e. sweat transport in ventilation channels: add [A41D 31/12](#) or [A41D 31/125](#).

## A41D 31/0005

### Definition statement

*This place covers:*

Replace: The existing figure with the following new figure.

Clothing construction, hemless and seamless garment.

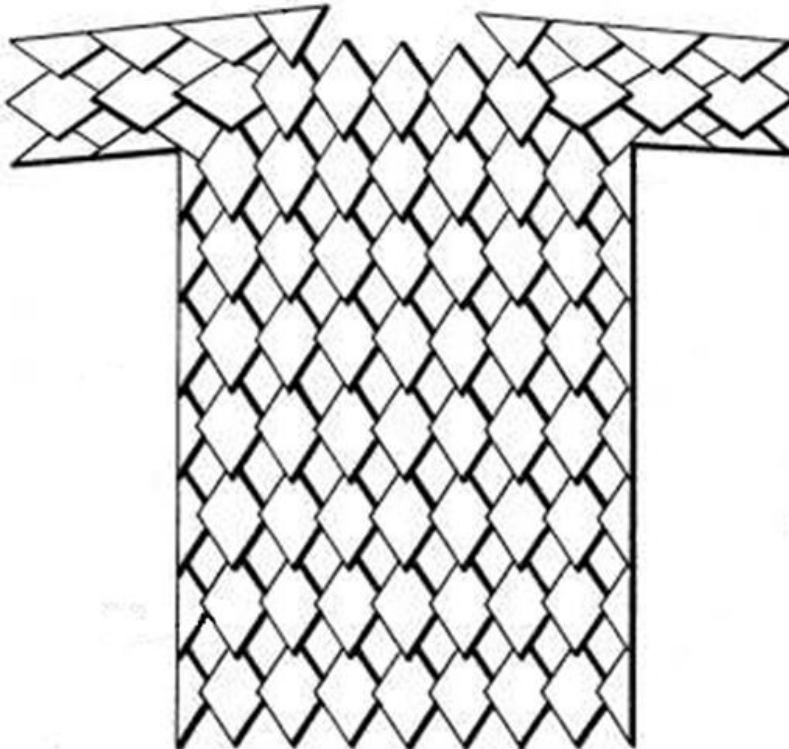

Insert: The following new section: References/Limiting references.

### References

#### *Limiting references*

*This place does not cover:*

Layered materials specially adapted for outerwear characterised by special function or use
--

A41D 31/04
------------

## A41D 31/02

### Definition statement

*This place covers:*

Delete: The existing figure:.

□ 728. [GB2329103](#) - Waterproof/breathable garment construction

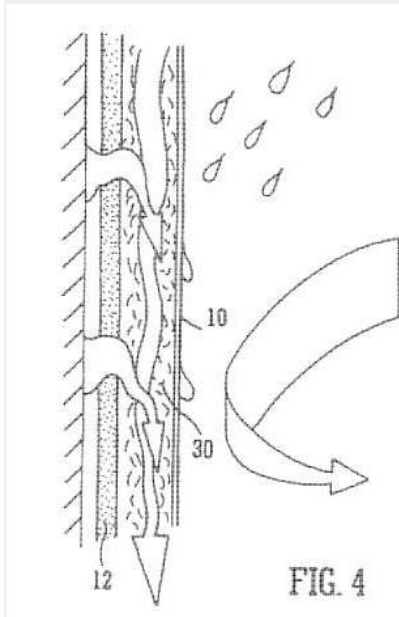

Insert: The following new figure.

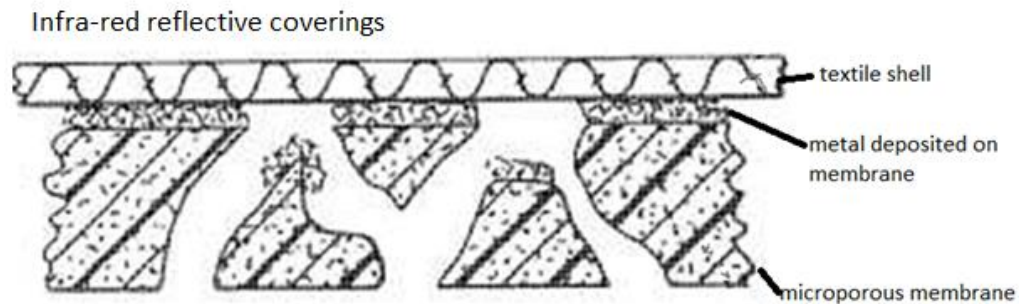

CPC NOTICE OF CHANGES 645

DATE: FEBRUARY 1, 2019

PROJECT RP0566

2. B. DEFINITIONS QUICK FIX

<b><u>Symbol</u></b>	<b><u>Location of change</u></b> (e.g., section title)	<b><u>Existing reference symbol</u></b> <b><u>or text</u></b>	<b><u>Action; New symbol; New text</u></b>
A41C 3/122	Informative references		Delete the Informative references section.
A41D 31/0011	Definitions		Delete the entire definition
A41D 31/0016	Definitions		Delete the entire definition
A41D 31/0022	Definitions		Delete the entire definition
A41D 31/0033	Definitions		Delete the entire definition
A41D 31/0038	Definitions		Delete the entire definition
A41D 31/0044	Definitions		Delete the entire definition
A41D 31/0055	Definitions		Delete the entire definition
A41D 31/0066	Definitions		Delete the entire definition
A41D 31/0077	Definitions		Delete the entire definition
A41D 31/0083	Definitions		Delete the entire definition
A41D 31/0088	Definitions		Delete the entire definition
A41D 31/0094	Definitions		Delete the entire definition
A41D 2400/20	Definitions		Delete the entire definition
A41D 2400/60	Definitions		Delete the entire definition
A41D 2400/62	Definitions		Delete the entire definition

NOTES:

- The table above is used for corrections or modifications to existing definitions, e.g. delete an entire definition or part thereof; propose new wording or modify wording of a section, change the symbol the definition is associated with, change or delete a reference symbol, etc.
- Do not delete (F) symbol definitions.

CPC NOTICE OF CHANGES 645

DATE: FEBRUARY 1, 2019

PROJECT RP0566

3. REVISION CONCORDANCE LIST (RCL)

<u>Type*</u>	<u>From CPC Symbol (existing)</u>	<u>To CPC Symbol(s)</u>
C	A41D 13/0015	A41D 13/0015, A41D 31/18, A41D 31/185
C	A41D 13/0017	A41D 13/0017, A41D 31/18, A41D 31/185
D	A41D 2023/006	<administrative transfer to A41D 23/00>
D	A41D 2023/008	<administrative transfer to A41D 23/00>
D	A41D 31/0011	<administrative transfer to A41D 31/04>
D	A41D 31/0016	<administrative transfer to A41D 31/02>
D	A41D 31/0022	<administrative transfer to A41D 31/08>
D	A41D 31/0027	<administrative transfer to A41D 31/085>
D	A41D 31/0033	<administrative transfer to A41D 31/06>
D	A41D 31/0038	<administrative transfer to A41D 31/065>
D	A41D 31/0044	<administrative transfer to A41D 31/28>
D	A41D 31/005	<administrative transfer to A41D 31/285>
D	A41D 31/0055	<administrative transfer to A41D 31/24>
D	A41D 31/0061	<administrative transfer to A41D 31/245>
D	A41D 31/0066	<administrative transfer to A41D 31/26>
D	A41D 31/0072	<administrative transfer to A41D 31/265>
D	A41D 31/0077	<administrative transfer to A41D 31/30>
D	A41D 31/0083	<administrative transfer to A41D 31/305>
D	A41D 31/0088	<administrative transfer to A41D 31/32>
D	A41D 31/0094	<administrative transfer to A41D 31/325>
C	A41D 31/02	A41D 31/02, A41D 31/04, A41D 31/102, A41D 31/125, A41D 31/145, A41D 31/185

CPC NOTICE OF CHANGES 645

DATE: FEBRUARY 1, 2019

PROJECT RP0566

<b>Type*</b>	<b>From CPC Symbol (existing)</b>	<b>To CPC Symbol(s)</b>
Q	A41D 31/04	A41D 31/04, A41D 31/10, A41D 31/102, A41D 31/12, A41D 31/14, A41D 31/18, A62B 17/00, A62B 17/001, A62B 17/003, A62B 17/005, A62B 17/006, A62B 17/008, A62B 17/04, A62B 17/08
Q	A41D 31/14	A41D 31/14, A41D 31/145, A41D 31/102
Q	A41D 31/30	A41D 31/30, A41D 31/305
D	A41D 2400/20	<administrative transfer to A41D 31/14 INV>
D	A41D 2400/22	<administrative transfer to A41D 31/102 INV>
D	A41D 2400/34	<administrative transfer to A41D 31/30 ADD>
D	A41D 2400/60	<administrative transfer to A41D 31/12 INV>
D	A41D 2400/62	<administrative transfer to A41D 31/125 INV>

\* C = entries with modified file scope where reclassification of documents from the entries is involved; Q = new entries which are firstly populated with documents via administrative transfers from deleted (D) entries. Afterwards, the transferred documents into the Q entry will either stay or be moved to more appropriate entries, as determined by intellectual reclassification; D = deleted entries; F = frozen entries will be deleted once reclassification of documents from the entries is completed.

NOTES:

- Only C, D, F, and Q type entries are included in the table above.
- When multiple symbols are included in the “To” column, do not use ranges of symbols.
- For administrative transfer of documents, the following text should be used: “< administrative transfer to XX>”, “<administrative transfer to XX and YY simultaneously>”, or “<administrative transfer to XX, YY, ...and ZZ simultaneously>” when administrative transfer of the same documents is to more than one place.
- Administrative transfer to main trunk groups is assumed to be the source allocation type, unless otherwise indicated.
- Administrative transfer to 2000/Y series groups is assumed to be “additional information”.
- If needed, instructions for allocation type should be indicated within the angle brackets using the abbreviations “ADD” or “INV”: <administrative transfer to XX ADD>, <administrative transfer to XX INV>, or < administrative transfer to XX ADD, YY INV, ... and ZZ ADD simultaneously>.
- In certain situations, the “D” entries of 2000-series or Y-series groups may not require a destination (“To”) symbol, however it is required to specify “<no transfer>” in the “To” column for such cases.
- RCL is not needed for finalisation projects.

CPC NOTICE OF CHANGES 645

DATE: FEBRUARY 1, 2019

PROJECT RP0566

4. CHANGES TO THE CPC-TO-IPC CONCORDANCE LIST (CICL)

<u>CPC</u>	<u>IPC</u>	<u>Action*</u>
A41D 2023/006		delete
A41D 2023/008		delete
A41D 31/0011		delete
A41D 31/0016		delete
A41D 31/0022		delete
A41D 31/0027		delete
A41D 31/0033		delete
A41D 31/0038		delete
A41D 31/0044		delete
A41D 31/005		delete
A41D 31/0055		delete
A41D 31/0061		delete
A41D 31/0066		delete
A41D 31/0072		delete
A41D 31/0077		delete
A41D 31/0083		delete
A41D 31/0088		delete
A41D 31/0094		delete
A41D 31/04	A41D 31/04	new
A41D 31/06	A41D 31/06	new
A41D 31/065	A41D 31/06	new
A41D 31/08	A41D 31/08	new
A41D 31/085	A41D 31/08	new
A41D 31/10	A41D 31/10	new
A41D 31/102	A41D 31/102	new
A41D 31/12	A41D 31/12	new
A41D 31/125	A41D 31/12	new
A41D 31/14	A41D 31/14	new
A41D 31/145	A41D 31/14	new
A41D 31/18	A41D 31/18	new
A41D 31/185	A41D 31/18	new
A41D 31/24	A41D 31/24	new
A41D 31/245	A41D 31/24	new
A41D 31/26	A41D 31/26	new
A41D 31/265	A41D 31/26	new
A41D 31/28	A41D 31/28	new
A41D 31/285	A41D 31/28	new
A41D 31/30	A41D 31/30	new
A41D 31/305	A41D 31/30	new
A41D 31/32	A41D 31/32	new
A41D 31/325	A41D 31/32	new
A41D 2400/20		delete
A41D 2400/22		delete
A41D 2400/34		delete
A41D 2400/60		delete
A41D 2400/62		delete



CPC NOTICE OF CHANGES 645

DATE: FEBRUARY 1, 2019

PROJECT RP0566

\*Action column:

- For an (N) or (Q) entry, provide an IPC symbol and complete the Action column with “NEW.”
- For an existing CPC main trunk entry or indexing entry where the existing IPC symbol needs to be changed, provide an updated IPC symbol and complete the Action column with “UPDATED.”
- For a (D) CPC entry or indexing entry complete the Action column with “DELETE.” IPC symbol does not need to be included in the IPC column.
- For an (N) 2000 series CPC entry which is positioned within the main trunk scheme (breakdown code) provide an IPC symbol and complete the action column with “NEW”.
- For an (N) 2000 series CPC entry positioned at the end of the CPC scheme (orthogonal code), with no IPC equivalent, complete the IPC column with “CPCONLY” and complete the action column with “NEW”.

NOTES:

- F symbols are not included in the CICL table above.
- E and M symbols are not included in the CICL table above unless a change to the existing IPC is desired.

## CPC NOTICE OF CHANGES 645

DATE: FEBRUARY 1, 2019

PROJECT RP0566

## 5. CROSS-REFERENCE LIST (CRL)

Scheme references impacted by this revision project

<u>Location of reference to be changed</u>	<u>Referenced subclass or group to be changed</u>	<u>Action; New reference symbol; New text</u>
A62B 17/00	A41D 31/0011	A41D 31/04
F41H 5/04	A41D 31/0055	A41D 31/24

Definitions references impacted by this revision project

<u>Location of reference to be changed</u>	<u>Referenced subclass or group to be changed</u>	<u>Section of definition</u>	<u>Action; New reference symbol; New text</u>
A41B 11/00	A41D 13/0015	Limiting references	A41D 31/18
A41B 11/14	A41D 13/0015	Special rules of classification	A41D 31/18
A41D 1/08	A41D 13/0015	Special rules of classification	A41D 31/18
A61H 2201/1697	A41D 2400/22	Informative references	Replace symbol by A41D 31/102
A62B 17/00	A41D 31/0011	Limiting references	Replace symbol by A41D 31/04
D02G 3/441	A41D 31/0066	Informative references	Replace symbol by A41D 31/26
D02G 3/442	A41D 31/0055	Informative references	Replace symbol by A41D 31/24
D02G 3/443	A41D 31/0022	Informative references	Replace symbol by A41D 31/08
D02G 3/449	A41D 31/0077	Informative references	Replace symbol by A41D 31/30
D03D 15/12	A41D 31/0022	Informative references	Replace symbol by A41D 31/08
F41H 5/04	A41D 31/0055	Limiting references	Replace symbol by A41D 31/24

## NOTES:

- The CRL tables above are used for changes to locations **outside** of the project scope. Changes to references in scheme titles or definitions **inside** the project scope will be reflected in the “scheme change” template or one of the “definition” templates.
- In addition to other changes proposed in the tables above, in the column titled “Referenced subclass or group to be changed,” **referenced** D symbols should indicate an action of “delete” or should indicate a replacement symbol and **referenced** F symbols should indicate a replacement symbol.
- When a reference is deleted, text related to that reference will also be deleted unless other references or a range of references associated with the same text remain.