

A41B

SHIRTS; UNDERWEAR; BABY LINEN; HANDKERCHIEFS

Definition statement

This place covers:

Underwear covers shirts, hosiery, baby linen and handkerchiefs.

In particular, the following subjects are classified as follows:

- Button-down shirts or formal dress shirts are classified in [A41B 1/00](#).
- Undershirts are classified in [A41B 9/06](#).
- Chemises, e.g. slips with shoulder straps worn beneath a dress, are classified in [A41B 9/06](#); slips that only cover the lower body are classified in [A41B 9/10](#).
- Bodices, e.g. baby onesies, are classified in [A41B 13/08](#).
- Overalls, e.g. coveralls or bodysuits for baby, are classified in [A41B 13/005](#).

Relationships with other classification places

Machines, appliances or methods are classified as inventive information in [A41H](#) and non-trivial technical and useful information with regard to the article of apparel may be discretionarily classified as additional information in [A41B](#) - [A41F](#).

References

Informative references

Attention is drawn to the following places, which may be of interest for search:

Outerwear, dressing-gowns, bathing costumes and pyjamas	A41D
Jackets, e.g. dress jackets or sport coats	A41D 1/02
Waistcoats, vests, jerseys, sweaters and t-shirts	A41D 1/04
Blouses, e.g. women's tops	A41D 1/18
Overalls, e.g. coveralls or Bodysuits (for adult)	A41D 13/02
Leggings, e.g. chaps	A41D 17/02

Glossary of terms

In this place, the following terms or expressions are used with the meaning indicated:

Dressing-gown	A loose gown worn while making one's toilet or when in dishabille.
Shirt	An upper body garment having a collar and an opening at the front which is fastened closed via fastening elements (e.g. buttons) disposed adjacent the opening, also referred to as a men's dress shirt, button-up shirt or button-down shirt
Chemise	Undergarment with shoulder strap worn beneath dress or the like, also referred to as slip
Bodices	Baby garment usually with sleeves but leaving the legs uncovered and fastening means at the crotch, also referred to as a onesie
Jacket	Lightweight long-sleeve garment typically having a collar and lapel extending below the front sides of the collar providing a central opening between the lapels, also referred to as a dress jacket or sport coat

Waistcoat	Upper body garment without sleeves also referred to as a vest in American English
Vest	T-shirt or casual top with or without sleeves
Jersey	Knitted garment with or without sleeves, also referred to as a sweater in American English
Sweater	Garment typically worn for playing team sports, also referred to as a jersey in American English
Blouse	Shirt having features specific to women, also referred to as a women's top
Overalls	A one-piece garment having an upper body portion (e.g. short or long sleeve top, bib secured by shoulder straps, etc.) and lower body portion (e.g. pants, shorts, etc.), also referred to as coveralls or bodysuits
Leggings	Lower body overgarment with or without seats for protecting a garment worn underneath, also referred to as chaps

A41B 1/00

Shirts

Definition statement

This place covers:

Shirt with buttons and a collar, i.e. men's dress shirt.

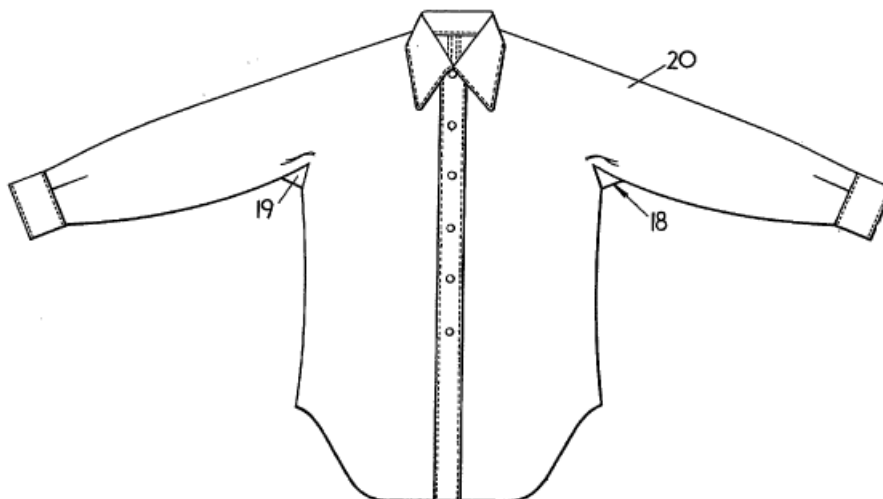

References

Informative references

Attention is drawn to the following places, which may be of interest for search:

T shirts	A41D 1/04
Blouses	A41D 1/18
Outerwear jackets	A41D 3/00

A41B 1/02**with front inserts****Definition statement***This place covers:*

Illustrative example of subject matter classified in this group.

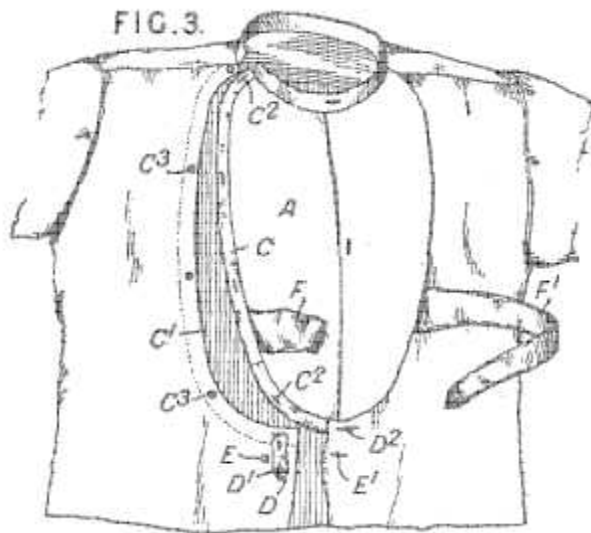
**References****Informative references***Attention is drawn to the following places, which may be of interest for search:*

Details of shirt fronts or front inserts	A41B 1/18
--	---------------------------

Special rules of classificationDetails of shirt-fronts, i.e. fastening of front inserts, are classified in [A41B 1/18](#).Shirts with front inserts, i.e. where the shirt is relevant, are classified in [A41B 1/02](#).**A41B 1/04****convertible into cami-knickers****Definition statement***This place covers:*

Shirts which are adapted at the lower end to pass between the legs.

Illustrative example of subject matter classified in this group.

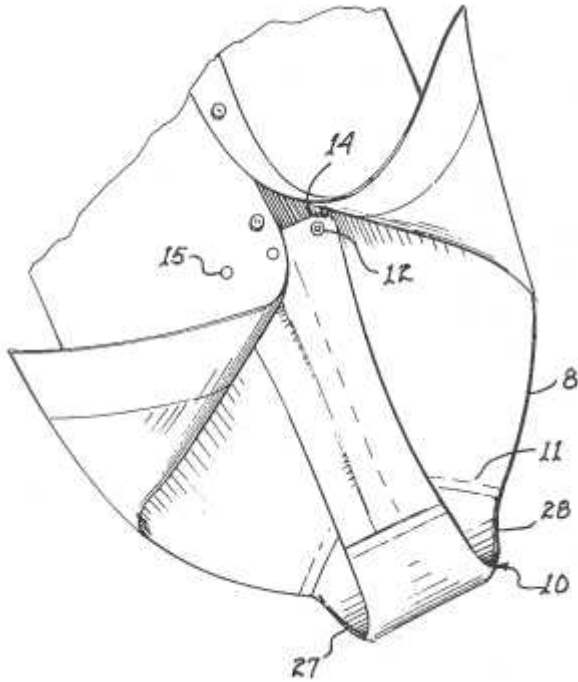

References

Informative references

Attention is drawn to the following places, which may be of interest for search:

Trouser supports attached to the shirt, waistcoat	A41F 5/00
---	---------------------------

A41B 1/06

exchangeably attached to underbodies, drawers, or the like

Definition statement

This place covers:

Illustrative example of subject matter classified in this group.

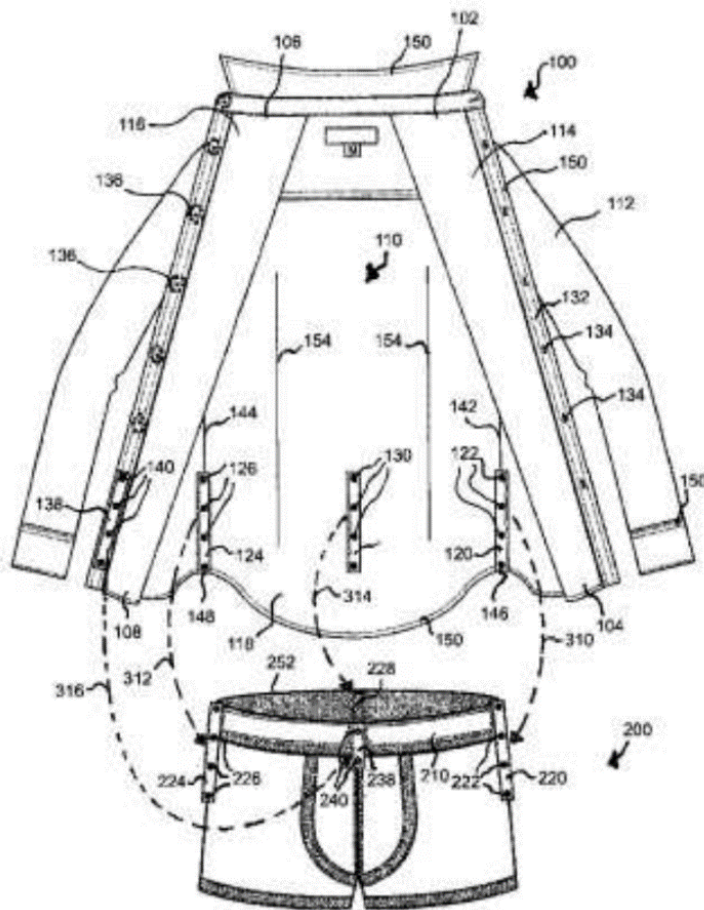
**A41B 1/08****Details****Definition statement**

This place covers:

Constructional details of shirts such as sleeves, pockets and seams that may also be used for accessories which can be attached to shirts.

Illustrative example of subject matter classified in this group.

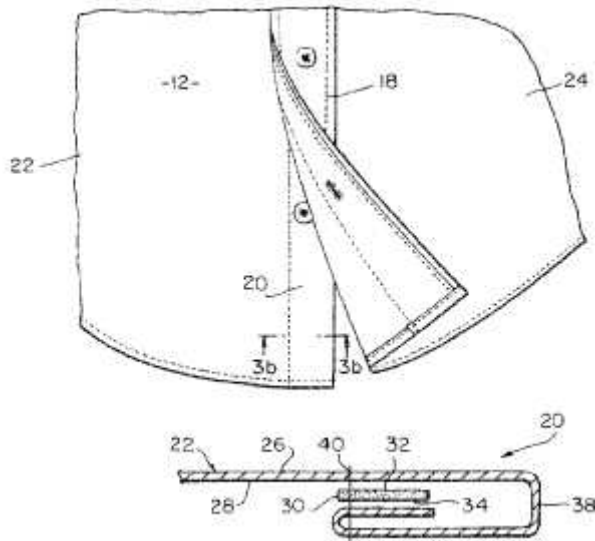

A41B 1/10

Closures (buttons [A44B 1/00](#); sleeve links [A44B 5/00](#))

Definition statement

This place covers:

Closures in shirts, not on collars or neckbands.

Illustrative example of subject matter classified in this group showing a dress shirt with switchable buttons.

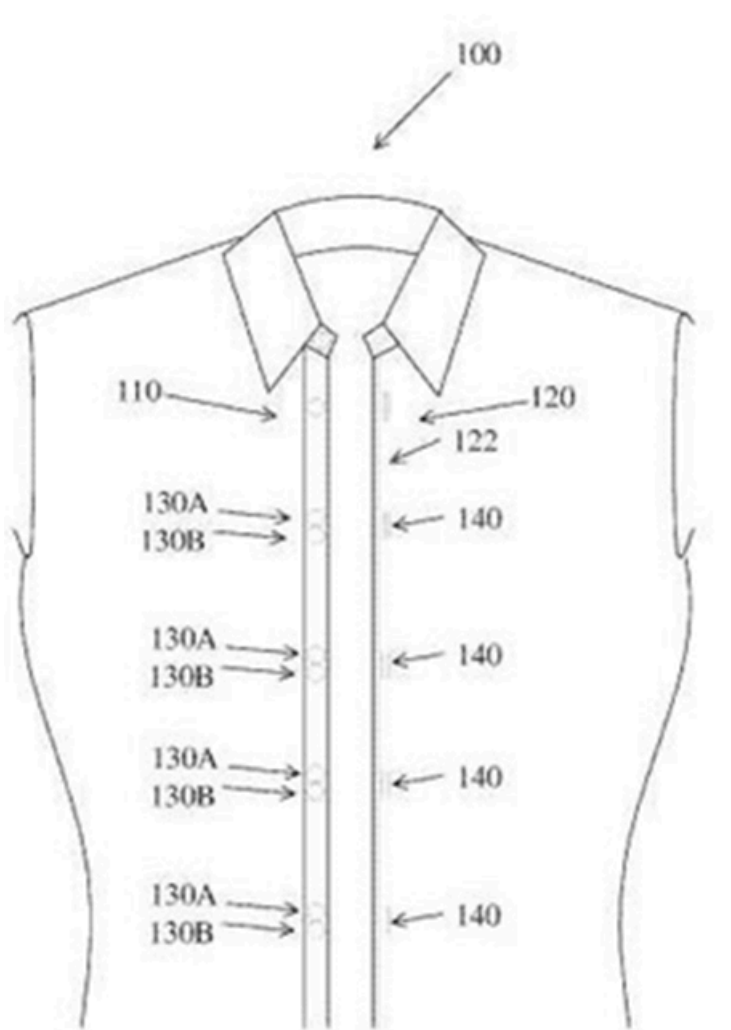

References

Limiting references

This place does not cover:

Buttons	A44B 1/00
Sleeve links	A44B 5/00

Informative references

Attention is drawn to the following places, which may be of interest for search:

Closures for collars or neckbands	A41B 3/02
-----------------------------------	---------------------------

A41B 1/12

Neckbands

Definition statement

This place covers:

Illustrative example of subject matter classified in this group.

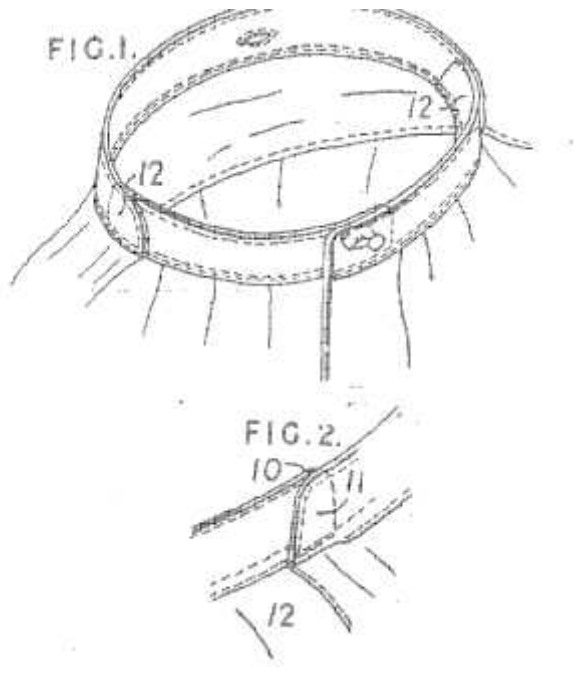

References

Informative references

Attention is drawn to the following places, which may be of interest for search:

Collars for shirts	A41B 3/00
Protectors for collars of outerwear	A41D 27/16
Cloth collars for outerwear	A41D 27/18

Special rules of classification

Neckbands deal with the vertical part touching the neck and are classified in [A41B 1/12](#).

Collars deal with the folded part over the neckband and are classified in [A41B 3/00](#).

Glossary of terms

In this place, the following terms or expressions are used with the meaning indicated:

Neckband	The part of the garment that encircles the neck.
Collar	The part of the garment which is folded over the neckband.

A41B 1/14

Stiffeners for neckbands

Definition statement

This place covers:

Illustrative example of subject matter classified in this group.

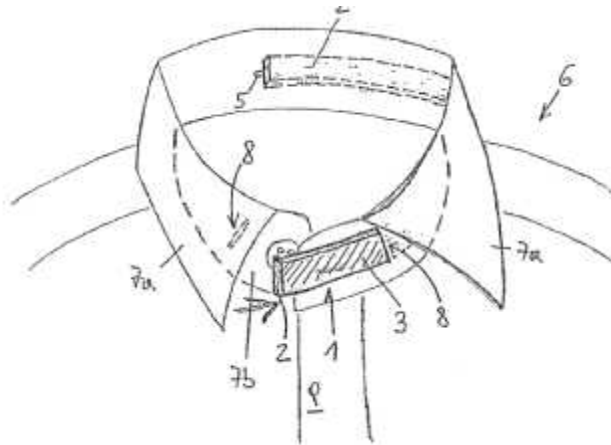

A41B 1/16

Adjustable neckbands

Definition statement

This place covers:

Illustrative example of subject matter classified in this group.

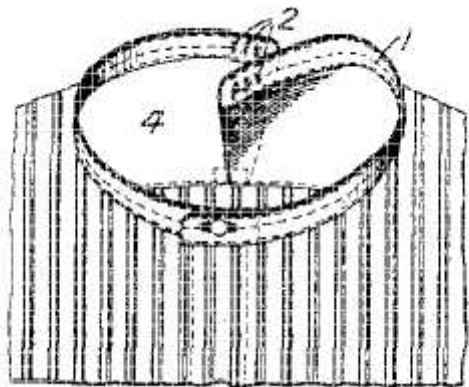

A41B 1/18

Shirt-fronts

Definition statement

This place covers:

Shirt-fronts and details of shirt-fronts, i.e. fastening of front inserts.

Illustrative example of subject matter classified in this group.

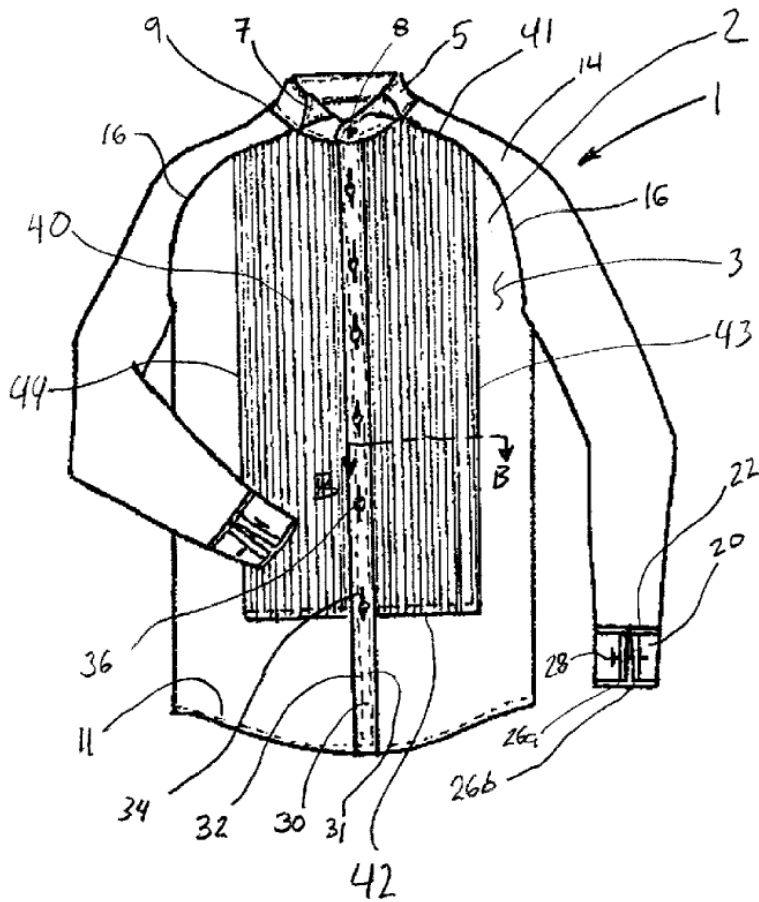

Relationships with other classification places

This group covers shirts with front inserts, whereas shirts per se are classified in [A41B 1/02](#).

A41B 1/20

Stiffeners for shirt-fronts

Definition statement

This place covers:

Illustrative example of subject matter classified in this group.

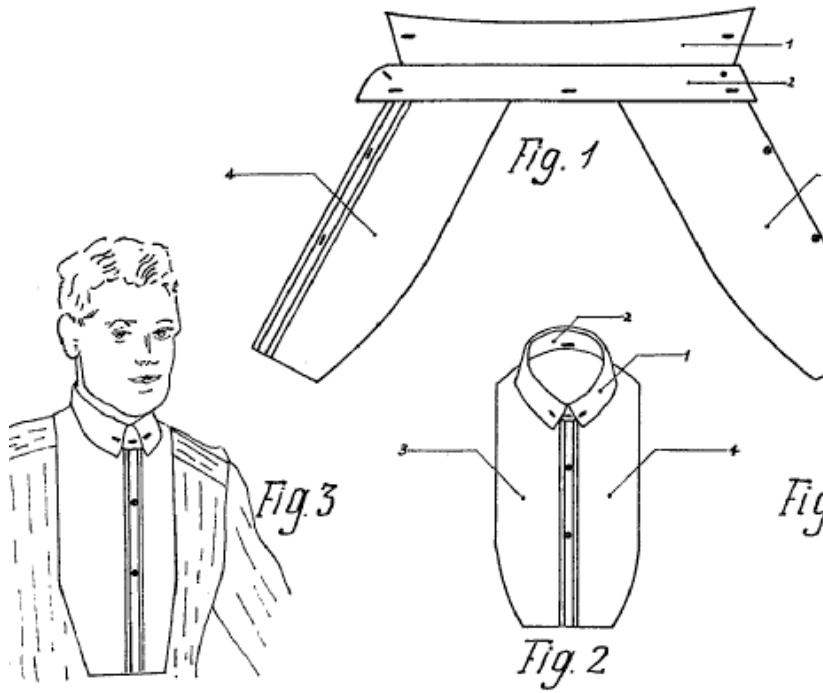

A41B 1/22

False shirt-fronts, e.g. dickeys, with or without attached collars; Means for attaching or stretching

Definition statement

This place covers:

Illustrative example of subject matter classified in this group.

□ 13. [GB677030](#) - Improvements in and relating to paper or like dickies or false shirt fronts

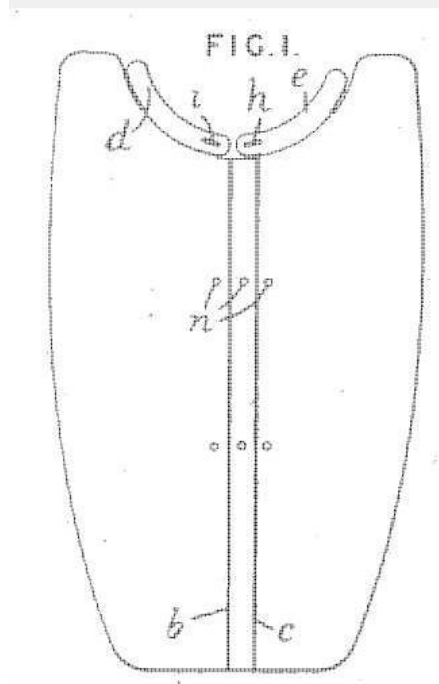

A41B 3/00**Collars ([A41B 1/00](#) takes precedence)****Definition statement***This place covers:*

Illustrative example of subject matter classified in this group showing an expandable shirt collar.

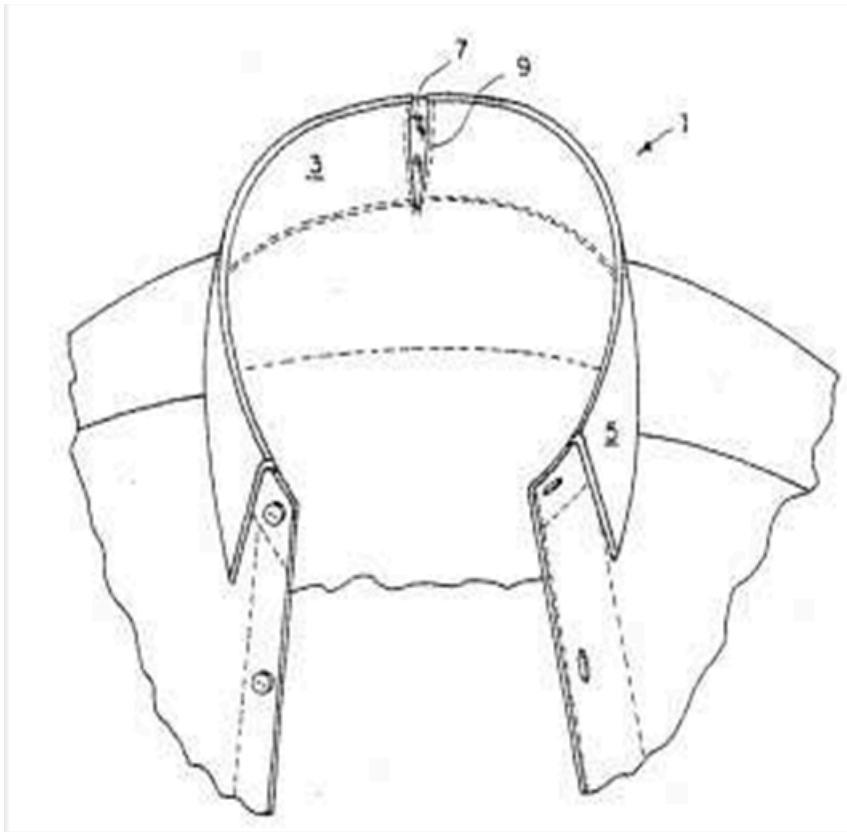
**References****Limiting references***This place does not cover:*

Shirts	A41B 1/00
Shirt neckbands	A41B 1/12

Informative references*Attention is drawn to the following places, which may be of interest for search:*

Cloth collars for outerwear	A41D 27/18
-----------------------------	----------------------------

Special rules of classificationVertical parts touching the neck are classified in [A41B 1/12](#).Folded parts over the neckband are classified in [A41B 3/00](#).

Glossary of terms

In this place, the following terms or expressions are used with the meaning indicated:

Neckband	The part of the garment that encircles the neck.
Collar	The part of the garment which is folded over the neckband.

A41B 3/02

Closures, e.g. tabs

Definition statement

This place covers:

Illustrative example of subject matter classified in this group.

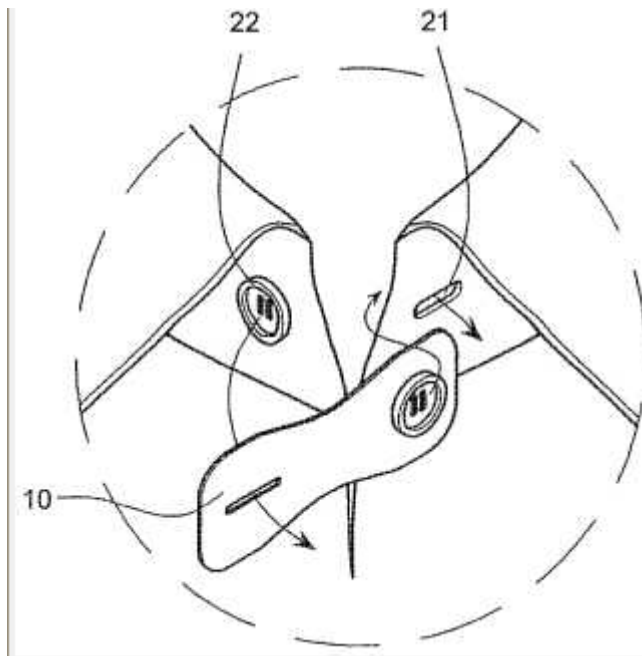

A41B 3/04**fastening to shirts (collar-studs [A44B 3/00](#))****Definition statement**

This place covers:

Illustrative example of subject matter classified in this group.

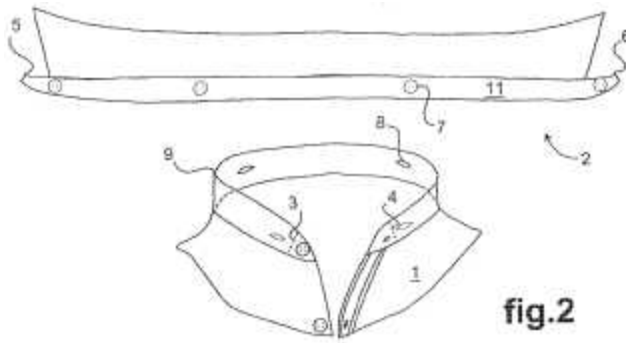
**References****Limiting references**

This place does not cover:

Collar-studs	A44B 3/00
--------------	---------------------------

A41B 3/06

Stiffeners for collars

Definition statement

This place covers:

Illustrative example of subject matter classified in this group.

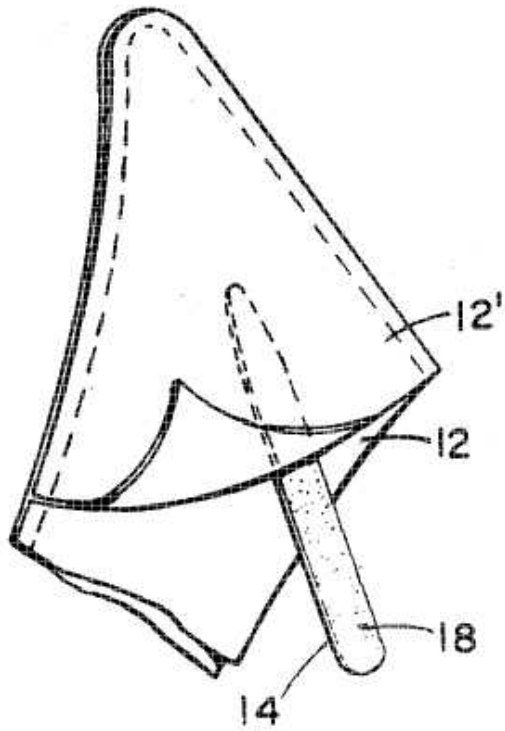

A41B 3/08**Combined stiffening and fastening devices****Definition statement**

This place covers:

Illustrative example of subject matter classified in this group.

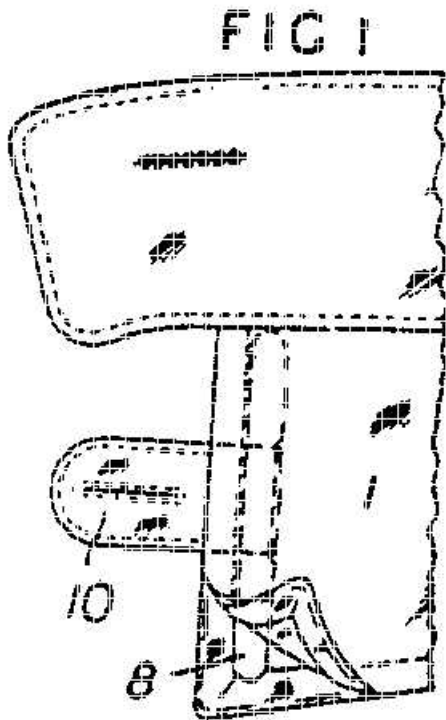
**A41B 3/10****chemically stiffened****References*****Informative references***

Attention is drawn to the following places, which may be of interest for search:

Processes for stiffening	D06
--------------------------	---------------------

A41B 3/12**with supports for neckties or cravats****Definition statement***This place covers:*

Illustrative example of subject matter classified in this group.

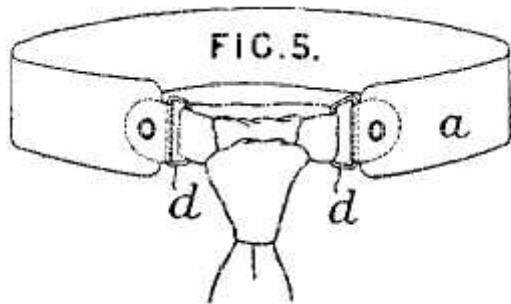
**References****Informative references***Attention is drawn to the following places, which may be of interest for search:*

Neckties provided with holding devices	A41D 25/003
Neckties with ready-made knot with holding devices	A41D 25/027
Neckties with knot tied by the user attachable to collar	A41D 25/12

A41B 3/14

Reversible collars

Definition statement

This place covers:

Illustrative example of subject matter classified in this group.

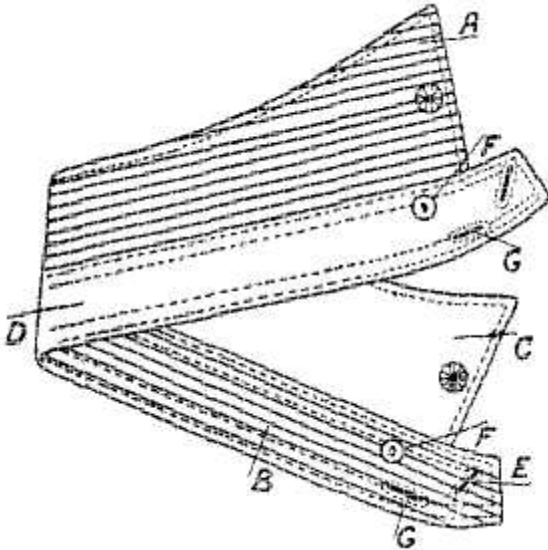

A41B 3/18

Protectors for collars

Definition statement

This place covers:

Protectors for collars of shirts.

Illustrative example of subject matter classified in this group.

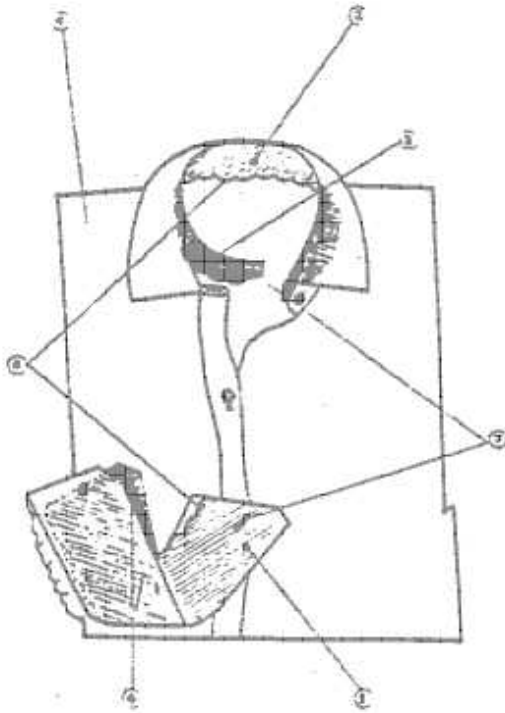

References

Informative references

Attention is drawn to the following places, which may be of interest for search:

Protectors for collars of outerwear	A41D 27/16
-------------------------------------	----------------------------

A41B 5/00

Fold-line formings for collars or cuffs

Definition statement

This place covers:

Illustrative example of subject matter classified in this group.

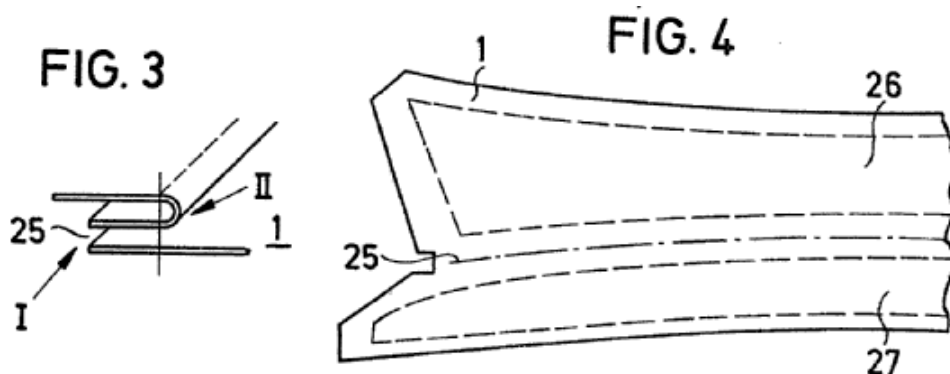

References

Informative references

Attention is drawn to the following places, which may be of interest for search:

Folding collar or cuff edges while manufacturing	A41H 33/00
--	----------------------------

A41B 7/00

Cuffs ([A41B 1/00](#), [A41B 3/00](#) take precedence; cuff links [A44B 5/00](#))

Definition statement

This place covers:

Illustrative example of subject matter classified in this group.

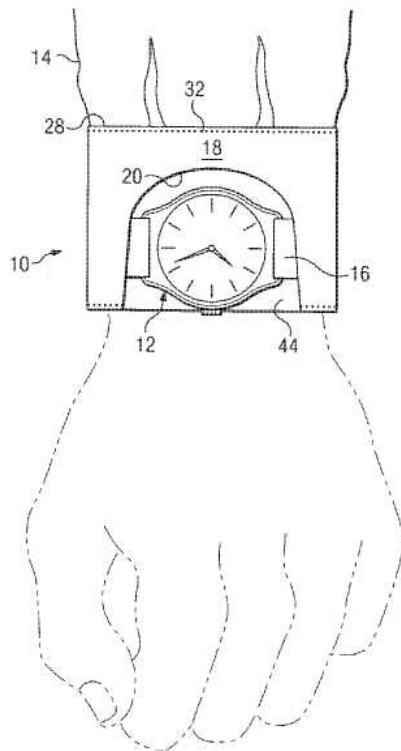

References

Limiting references

This place does not cover:

Shirts	A41B 1/00
Collars	A41B 3/00
Cuff links	A44B 5/00

Informative references

Attention is drawn to the following places, which may be of interest for search:

Fixation of watches on clothing	G04B 37/1433
---------------------------------	------------------------------

A41B 7/02

Closures for cuffs

Definition statement

This place covers:

Illustrative example of subject matter classified in this group.

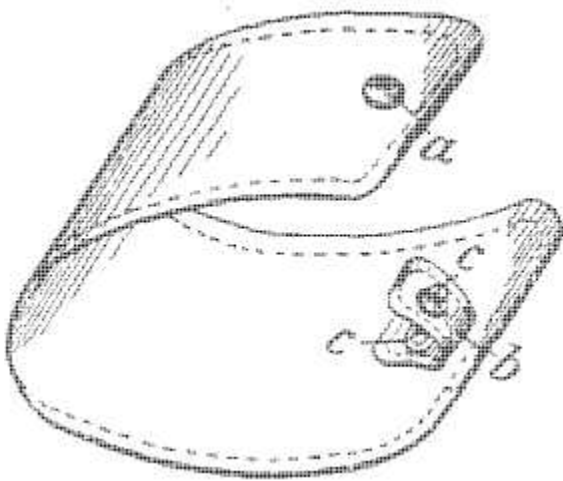

A41B 7/04

Fastening cuffs to shirts

Definition statement

This place covers:

Illustrative example of subject matter classified in this group.

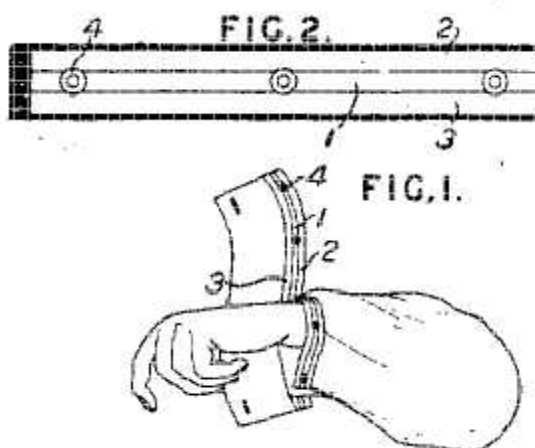

A41B 7/06

Fastening cuffs to the sleeves of jackets

Definition statement

This place covers:

Illustrative example of subject matter classified in this group.

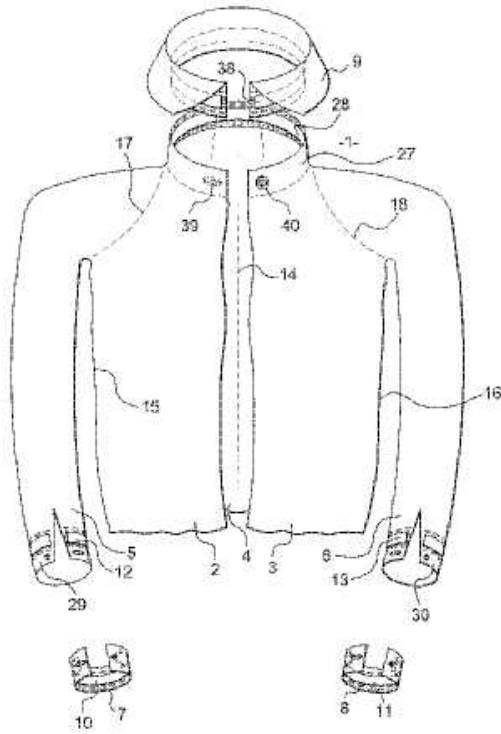

A41B 7/08

Stiffeners for cuffs

Definition statement

This place covers:

Illustrative example of subject matter classified in this group.

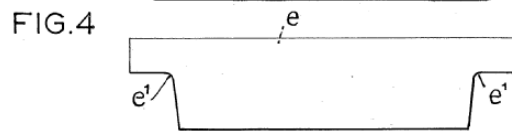
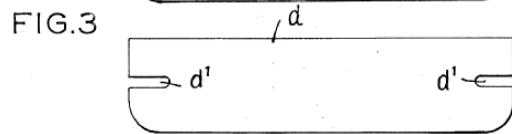
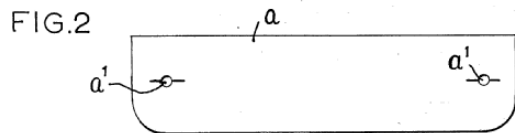
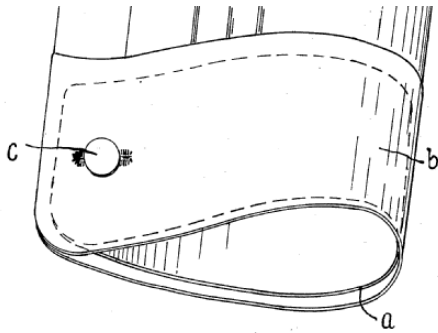

A41B 7/10**Reversible cuffs****Definition statement**

This place covers:

Illustrative example of subject matter classified in this group.

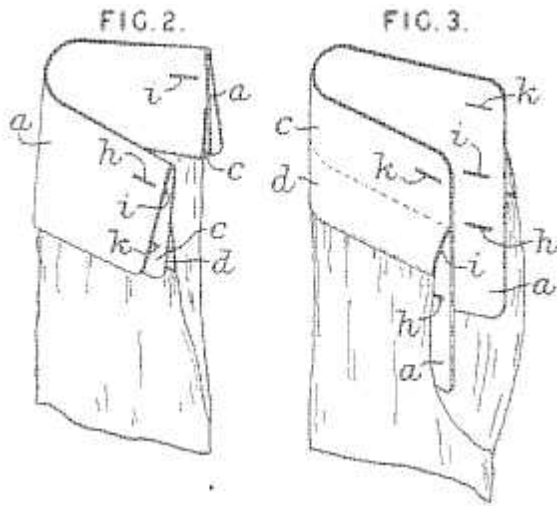
**A41B 7/12****Protectors for cuffs****Definition statement**

This place covers:

Illustrative example of subject matter classified in this group.

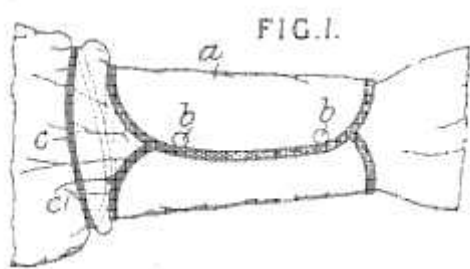
**A41B 9/00****Undergarments (corsets [A41C 1/00](#); brassières [A41C 3/00](#))****Definition statement**

This place covers:

Illustrative examples of subject matter classified in this group.

Illustrative example 1: Article of clothing providing increased air circulation

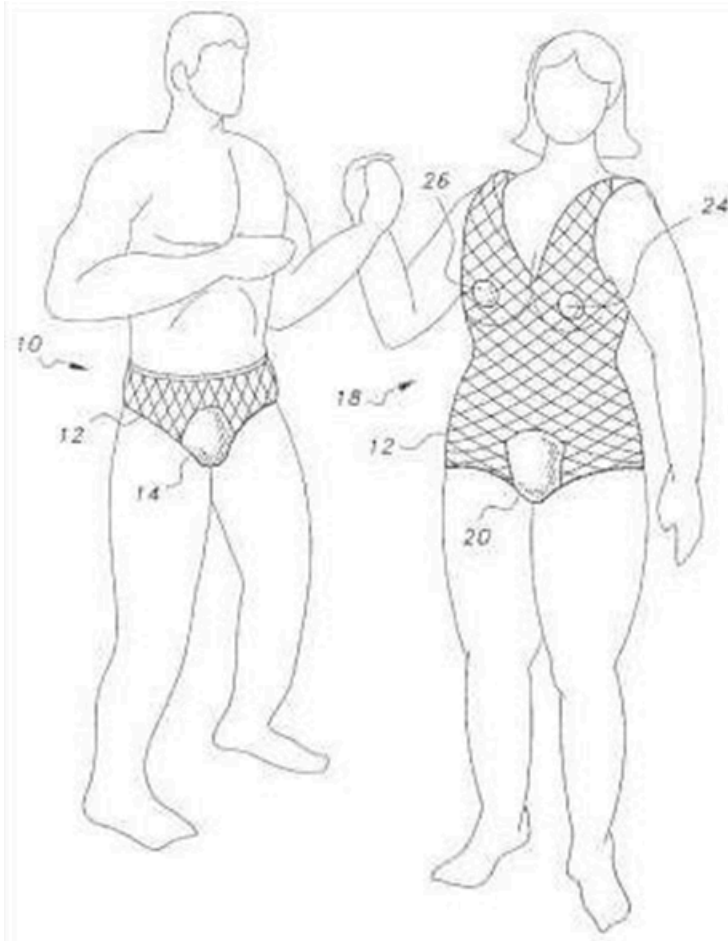

Illustrative example 2: Disposable thermal underwear

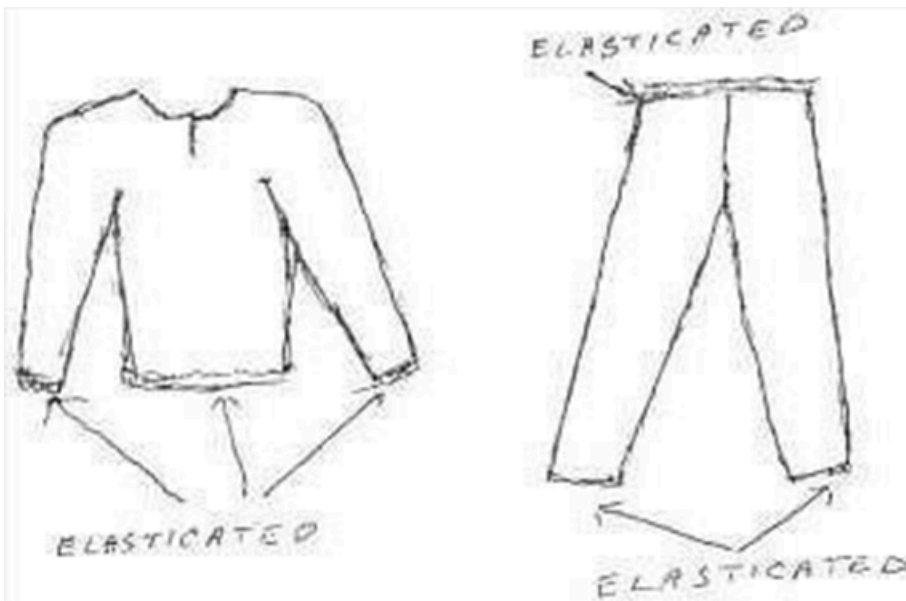

References

Limiting references

This place does not cover:

Corsets	A41C 1/00
Brassières	A41C 3/00

Informative references

Attention is drawn to the following places, which may be of interest for search:

Selection of special materials for underwear	A41B 17/00
Under-arm shields for outerwear and underwear, usually for absorbing sweat	A41D 27/13

A41B 9/001

{Underpants or briefs (specially adapted for men [A41B 9/02](#); specially adapted for ladies [A41B 9/04](#))}

Definition statement

This place covers:

Illustrative example of subject matter classified in this group.

□ 410. [JP2001020102](#) - (A) DISPOSABLE WEARING ARTICLE

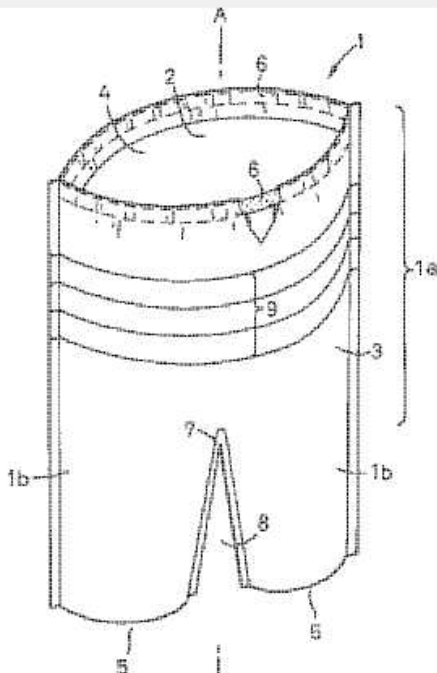

References**Limiting references**

This place does not cover:

Knitting panties	D04B 1/243
------------------	----------------------------

A41B 9/002

{with thong, tonga or string shape}

Definition statement

This place covers:

Illustrative example of subject matter classified in this group.

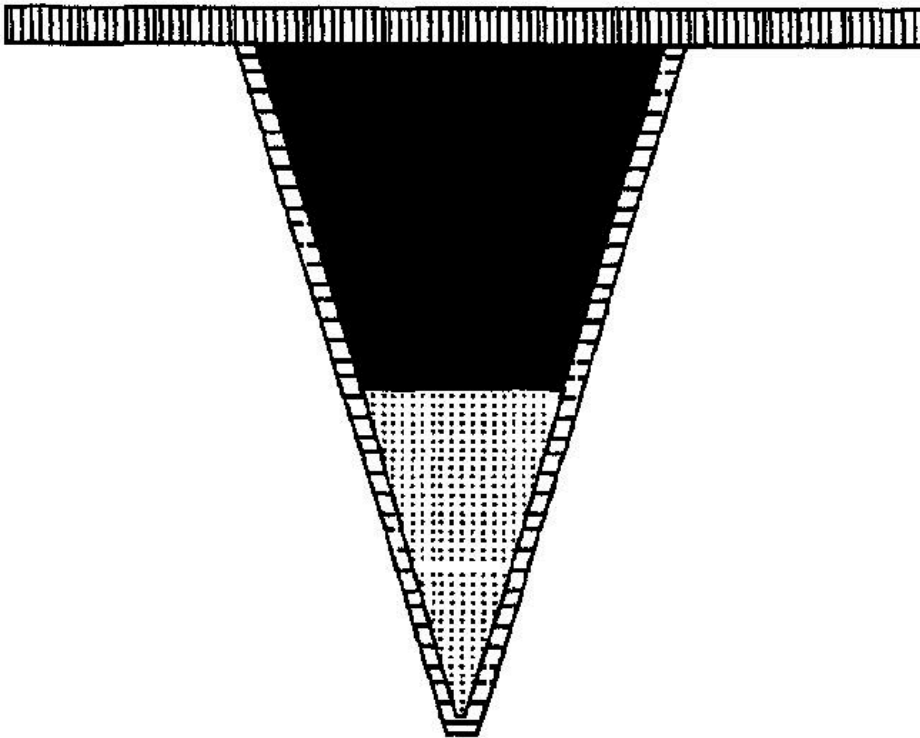

A41B 9/005

{with crotch line opening}

Definition statement

This place covers:

Illustrative example of subject matter classified in this group.

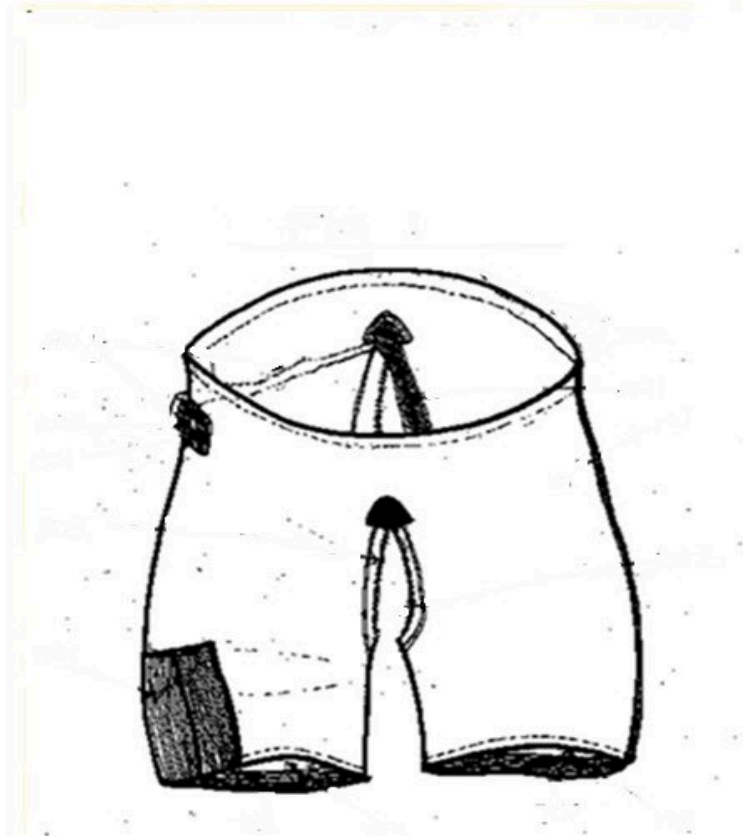

A41B 9/007

{with releasable connection between crotch and front part}

Definition statement

This place covers:

Illustrative example of subject matter classified in this group.

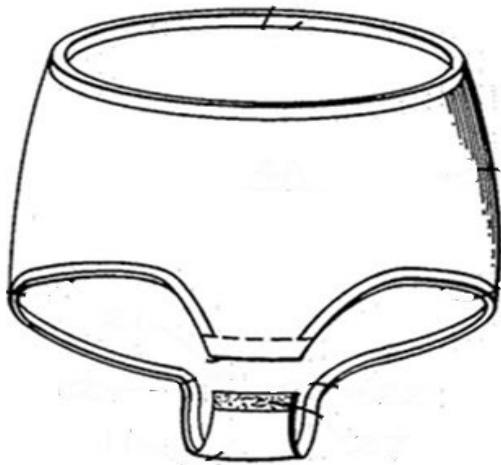

A41B 9/008**{with releasable waist connecting means}****Definition statement***This place covers:*

Illustrative example of subject matter classified in this group.

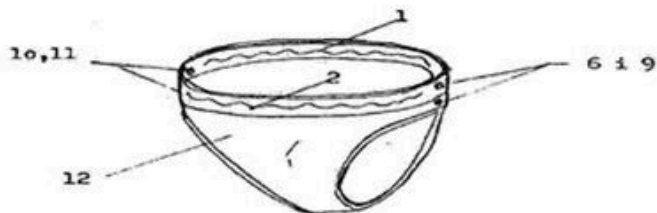
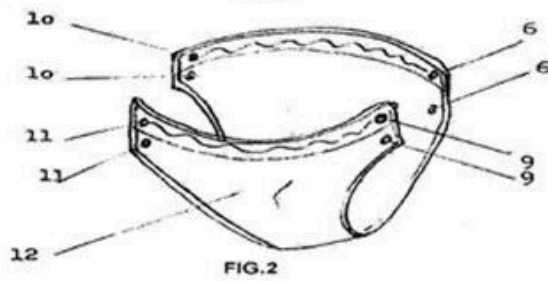
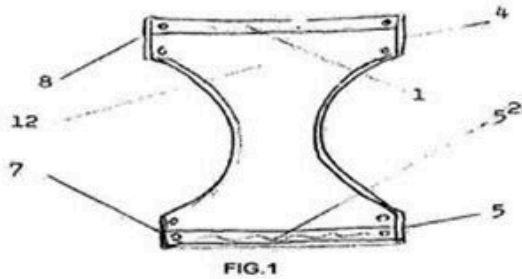

A41B 9/02**Drawers or underpants for men, with or without inserted crotch or seat parts****Definition statement**

This place covers:

Illustrative example of subject matter classified in this group.

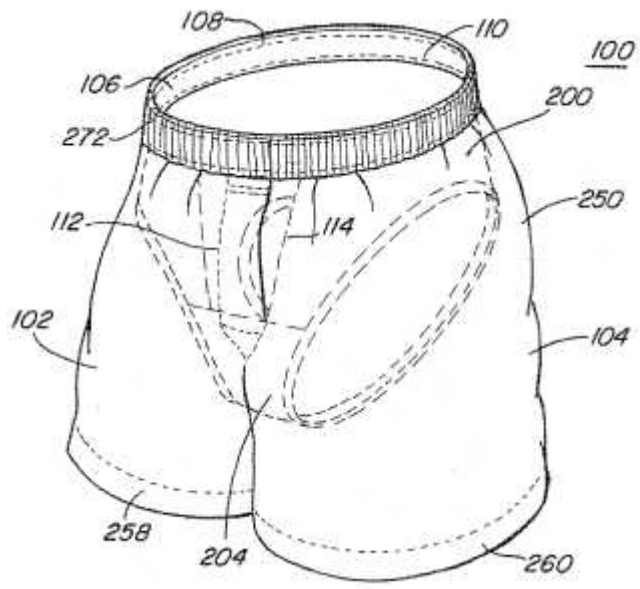
**References****Informative references**

Attention is drawn to the following places, which may be of interest for search:

Incontinence pants	A61F 5/44
Absorbent pants	A61F 13/496

A41B 9/023**{with separate spaces for genitals}****Definition statement***This place covers:*

Illustrative example of subject matter classified in this group.

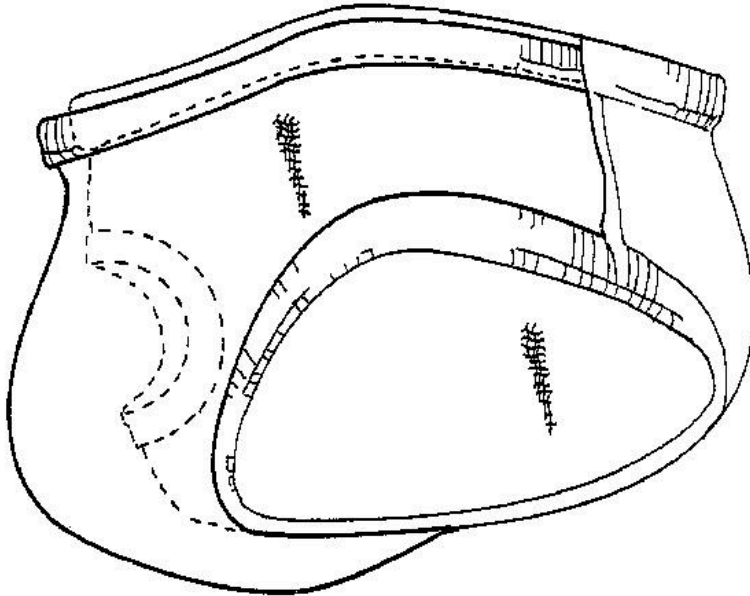
**References*****Limiting references****This place does not cover:*

Promoting male erection	A61F 5/41
Incontinence devices	A61F 5/44

A41B 9/04**Knickers for ladies, with or without inserted crotch or seat parts****Definition statement**

This place covers:

Illustrative example of subject matter classified in this group.

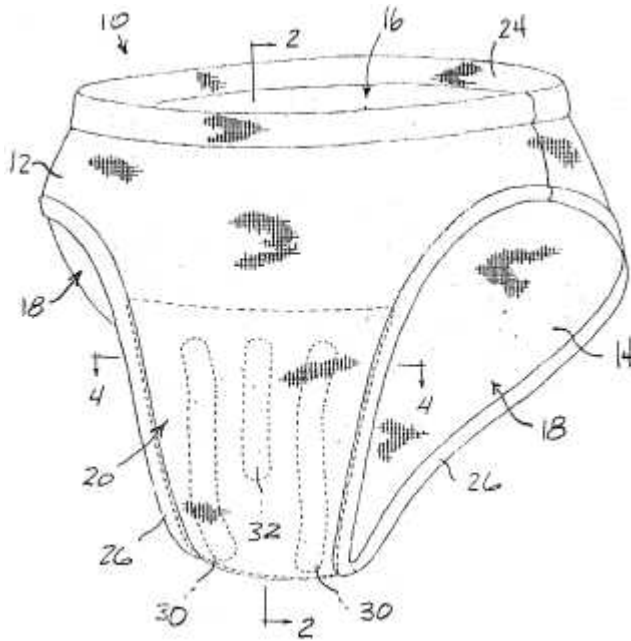
**References****Informative references**

Attention is drawn to the following places, which may be of interest for search:

Menstrual panties	A61F 13/496
Garments adhered to body to support absorbent pads	A61F 13/82

A41B 9/06**Undershirts; Chemises****Definition statement**

This place covers:

An undershirt is an upper body garment worn underneath a shirt. A chemise is an undergarment/slip with shoulder straps worn beneath a dress or the like.

Illustrative example of subject matter classified in this group.

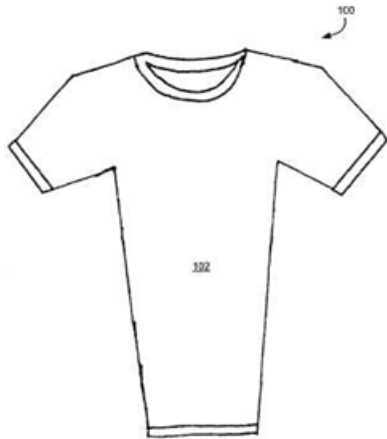

References

Informative references

Attention is drawn to the following places, which may be of interest for search:

Button down shirts	A41B 1/00
Petticoats, e.g. lower body slips	A41B 9/10
T shirts	A41D 1/04
Blouses	A41D 1/18
Pyjamas	A41D 10/00

A41B 9/08

Combined undergarments (panti-hose, body-stockings [A41B 11/14](#))

Definition statement

This place covers:

Illustrative example of subject matter classified in this group.

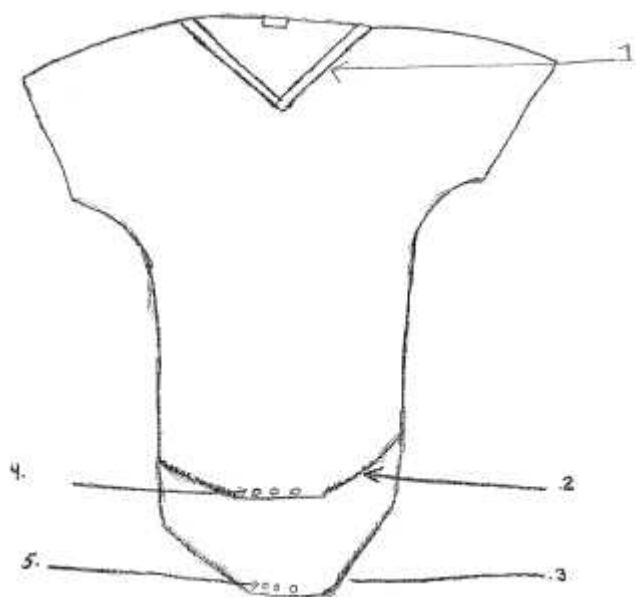

References

Limiting references

This place does not cover:

Panti-hose, body-stockings	A41B 11/14
----------------------------	----------------------------

A41B 9/10

Petticoats

Definition statement

This place covers:

Slips/underskirts that only cover the lower body.

A skirt or dress worn under a garment usually to shape the garment worn thereover (e.g. lift the skirt or dress to create a bell-shape) or provide warmth.

Illustrative example of subject matter classified in this group.

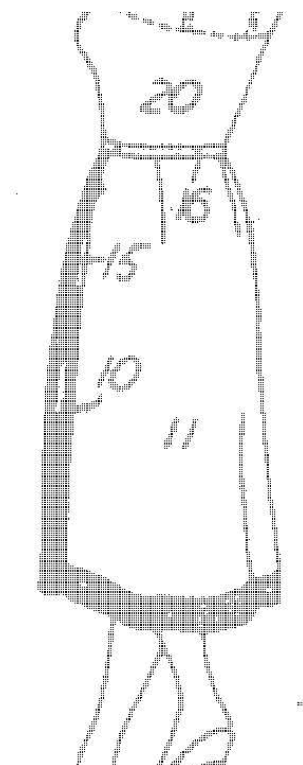

Relationships with other classification places

Slips that also cover the upper body or hang from the shoulders are covered by [A41B 9/06](#).

Glossary of terms

In this place, the following terms or expressions are used with the meaning indicated:

Petticoat	A light loose undergarment (originally of calico, flannel, silk, etc.; now frequently of synthetic material) hanging from the shoulders or waist, and worn by a woman or girl under a dress or skirt.
-----------	---

A41B 9/12

Protective undergarments (combined with swabs or absorbent pads or specially adapted for supporting them [A61F 13/15](#))

Definition statement

This place covers:

Textile protective undergarments.

Underwear having integral odor/sweat protection means.

Illustrative examples of subject matter classified in this group.

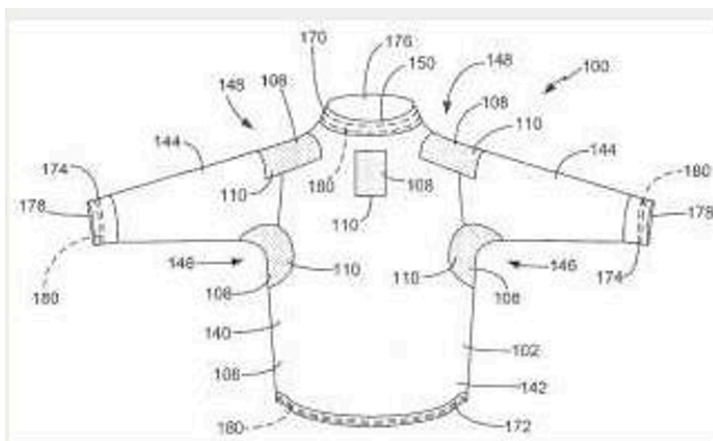
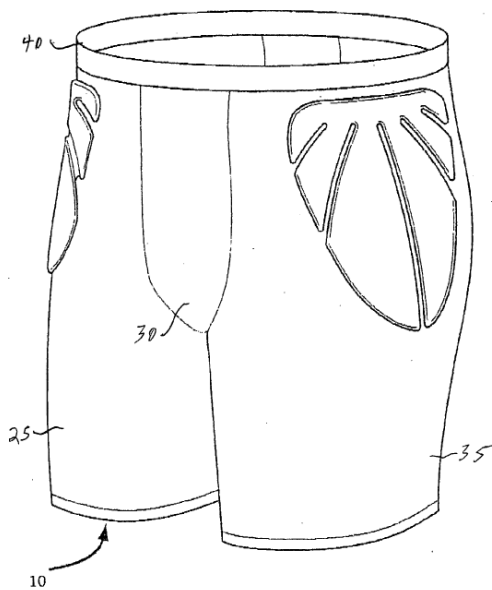

Relationships with other classification places

Absorbent pads for external or internal application to the body and supporting or fastening means therefor are classified in [A61F 13/15](#).

Absorbent pads attaching to the body are classified in [A61F 13/82](#).

Additives (for odour) of absorbent pads are classified in [A61F 2013/8408](#).

Relationships with other classification places

Separate under-arm shields for underwear or outerwear, usually for absorbing sweat, are to be classified in group [A41D 27/13](#).

Underwear having shock protecting means are to be classified in group [A41B 9/12](#) and also in group [A41D 13/05](#); i.e. [A41D 13/0506](#) if protection is for the hip.

References

Limiting references

This place does not cover:

Protective undergarments combined with swabs or absorbent pads or specially adapted for supporting them	A61F 13/15
---	----------------------------

Informative references

Attention is drawn to the following places, which may be of interest for search:

Absorbent pads for breast / torso	A61F 13/14
Body deodorants	A61Q 15/00
Textiles containing perfume or deodorants	D06M 13/005

A41B 9/14

Waistbands forming part of the undergarments; Closures therefor

Definition statement

This place covers:

Illustrative example of subject matter classified in this group.

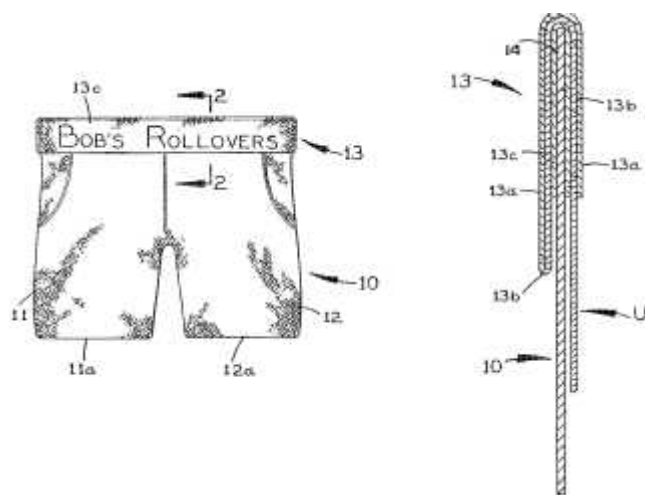

References

Informative references

Attention is drawn to the following places, which may be of interest for search:

Waistbands for trousers or skirts	A41F 9/00
-----------------------------------	---------------------------

A41B 9/16**Shoulder-straps forming part of the undergarments****Definition statement**

This place covers:

Illustrative example of subject matter classified in this group.

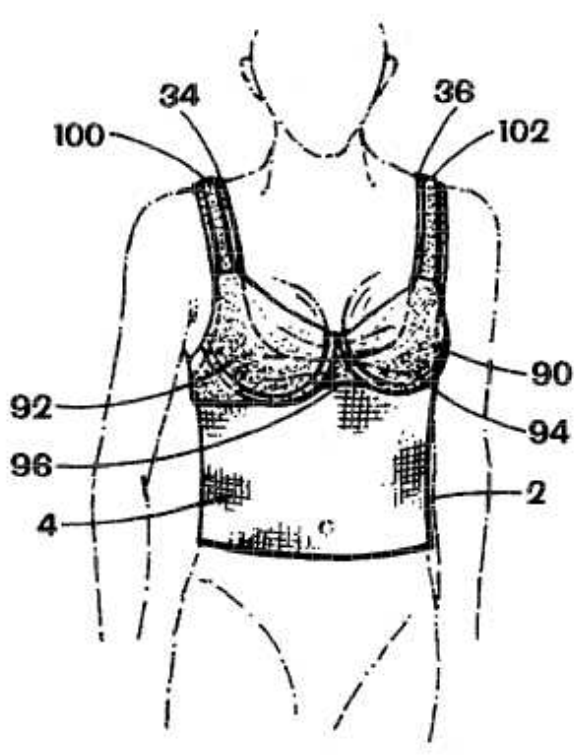
**References****Informative references**

Attention is drawn to the following places, which may be of interest for search:

Shoulder-straps in general	A41F 15/00
----------------------------	----------------------------

A41B 11/00

Hosiery; Panti-hose (elastic stockings for curative purposes [A61F 13/08](#))

Definition statement

This place covers:

Illustrative example of subject matter classified in this group.

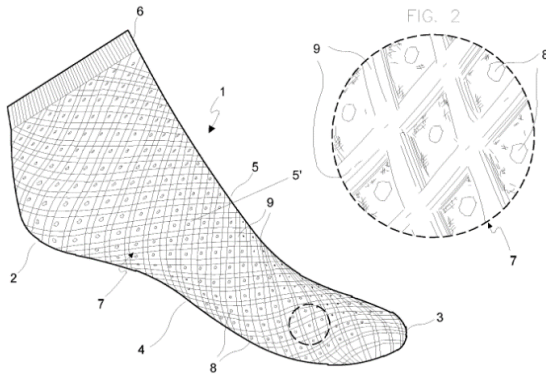

Relationships with other classification places

The term sock as used in this subclass (see Glossary) has a distinct meaning from the one used in group [A43B 17/00](#), where sock means an insole to be put in a shoe to make it fit better.

References

Limiting references

This place does not cover:

Compression elastic stockings for curative purposes	A61F 13/08
---	----------------------------

Informative references

Attention is drawn to the following places, which may be of interest for search:

Sporting garments with embedded elastic bands (but no compression therapeutic effect)	A41D 31/18
Insoles, inside shoes (also called socks)	A43B 17/00
Orthopaedic devices for feet	A61F 5/0111
Bandages for feet	A61F 13/064
Massage by own weight	A61H 7/003
Devices for stimulating reflex points acupuncture, shiatsu	A61H 39/04
Knitting stocking	D04B 1/26

Glossary of terms

In this place, the following terms or expressions are used with the meaning indicated:

Sock	A short stocking covering the foot and usually reaching to the calf of the leg; half-hose.
------	--

A41B 11/001

{Decoration; Marking}

Definition statement

This place covers:

Illustrative example of subject matter classified in this group.

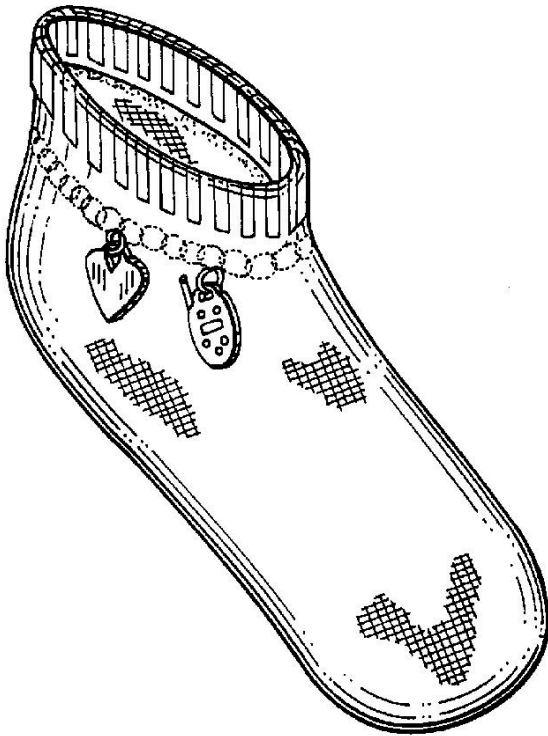

A41B 11/002

{Pairing socks (devices for keeping articles together during laundering
[D06F 95/008](#))}

Definition statement

This place covers:

Illustrative example of subject matter classified in this group.

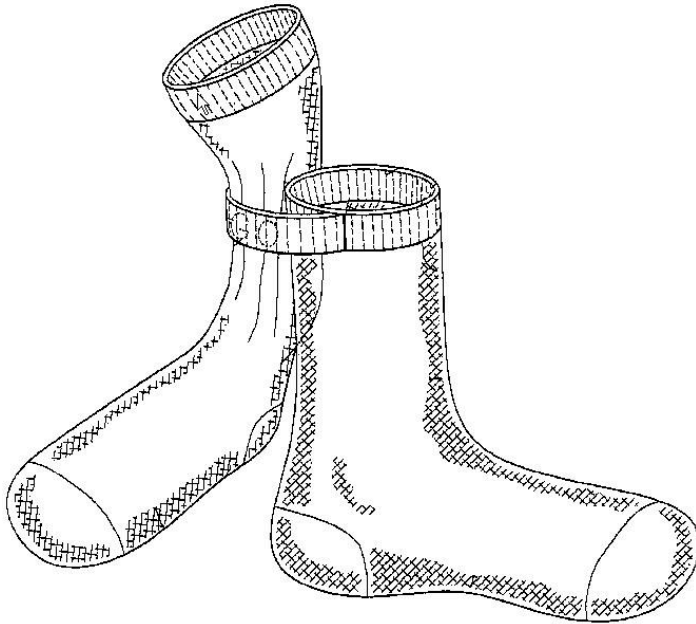

References

Limiting references

This place does not cover:

Marking laundry	D06F 93/005
-----------------	-----------------------------

A41B 11/003

{Hosiery with intermediate sections of different elasticity}

Definition statement

This place covers:

Illustrative example of subject matter classified in this group.

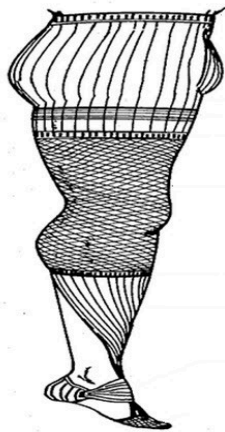

A41B 11/004

{Hosiery with separated toe sections}

Definition statement

This place covers:

Illustrative example of subject matter classified in this group.

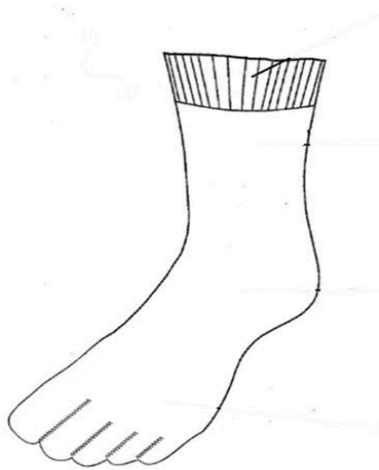

A41B 11/005

{Hosiery made essentially of a multi-ply construction}

Definition statement

This place covers:

Illustrative example of subject matter classified in this group.

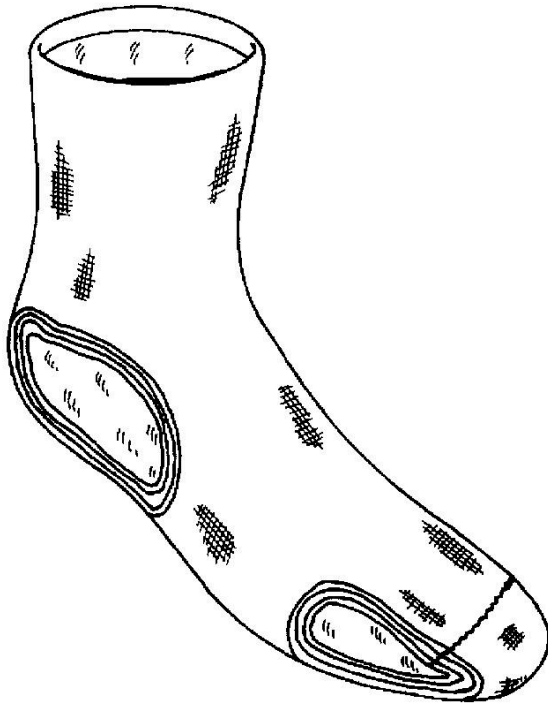

A41B 11/006**{Hosiery with pockets}****Definition statement***This place covers:*

Illustrative example of subject matter classified in this group.

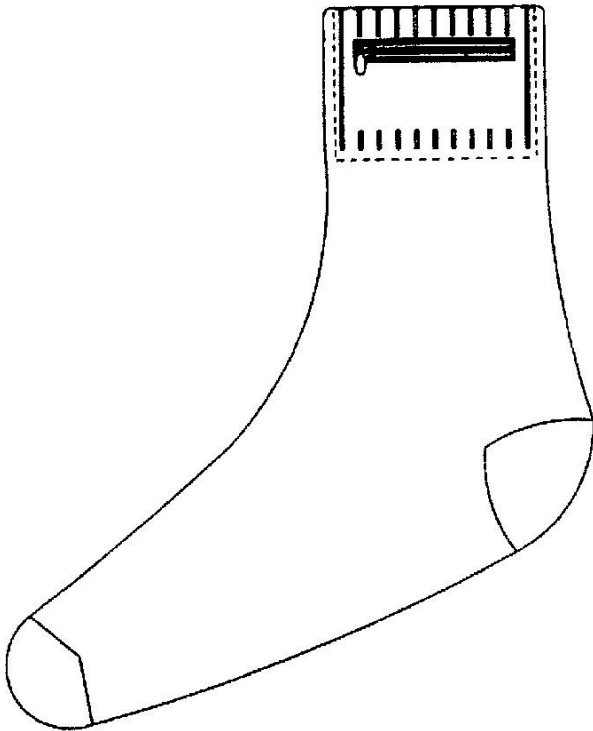
**References*****Limiting references****This place does not cover:*

Hosiery with shinguards	A63B 71/1225
-------------------------	------------------------------

A41B 11/007**{Hosiery with an added sole, e.g. sole made of rubber or leather}****Definition statement***This place covers:*

Illustrative example of subject matter classified in this group.

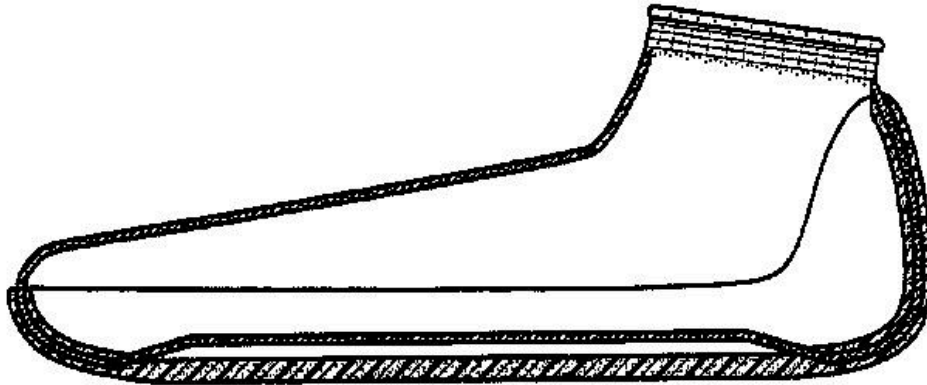
**References****Limiting references***This place does not cover:*

Hosiery with anti slip coating	A41B 11/008
Bathing shoes, socks for walking around swimmingpools, spas	A43B 5/08
Shoes with toes spreader	A43B 7/26
Profiled soles	A43B 13/223
Insoles, inside shoes (also called socks)	A43B 17/00
Swim aids for feet	A63B 31/11
Surfer feet devices	B63B 32/45
Water shoes	B63B 34/56

Special rules of classificationDifference between [A41B 11/007](#) & [A41B 11/008](#):For hosiery with anti-slip coating, i.e. very thin usually laminated layer or discrete coating portions, classify in [A41B 11/008](#)For hosiery with added sole, i.e. added sole separately made of rubber or leather, classify in [A41B 11/007](#).It is obvious that an added sole will have anti-slip properties but it cannot be considered a coating and should not be classed in [A41B 11/008](#), but in [A41B 11/007](#) alone.

Glossary of terms

In this place, the following terms or expressions are used with the meaning indicated:

Sock	Sense given in A41B : A short stocking covering the foot and usually reaching to the calf of the leg; half-hose. Sense given in A43B : A covering for the foot, of the nature of a light shoe, slipper, pump, sandal, patten, or clog.
------	--

A41B 11/008

{Hosiery with an anti-slip coating}

Definition statement

This place covers:

Illustrative example of subject matter classified in this group.



References

Limiting references

This place does not cover:

Hosiery with an added sole	A41B 11/007
Coating with silicone	B05C 1/00
Fabric treatment silicone	D06M 15/643

Special rules of classification

Difference between [A41B 11/007](#) & [A41B 11/008](#):

For hosiery with anti-slip coating, i.e. very thin usually laminated layer or discrete coating portions, classify in [A41B 11/008](#)

For hosiery with added sole, i.e. added sole separately made of rubber or leather, classify in [A41B 11/007](#).

It is obvious that an added sole will have anti-slip properties but it cannot be considered a coating and should not be classed in [A41B 11/008](#), but in [A41B 11/007](#) alone.

A41B 11/01

Seams

Definition statement

This place covers:

Illustrative example of subject matter classified in this group.

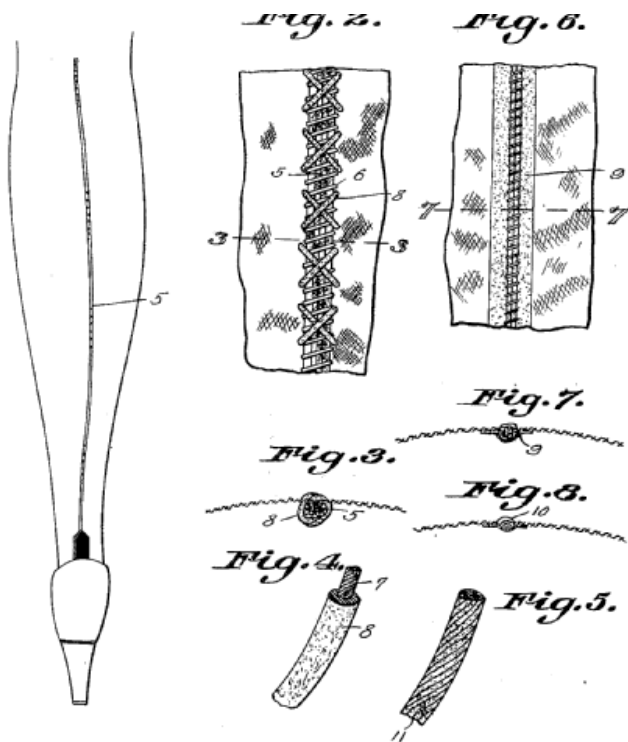

A41B 11/02

Reinforcements

Definition statement

This place covers:

Socks with protection for the feet should be classified here and in [A41D 13/06](#).

Comprises cushioning.

Illustrative example:

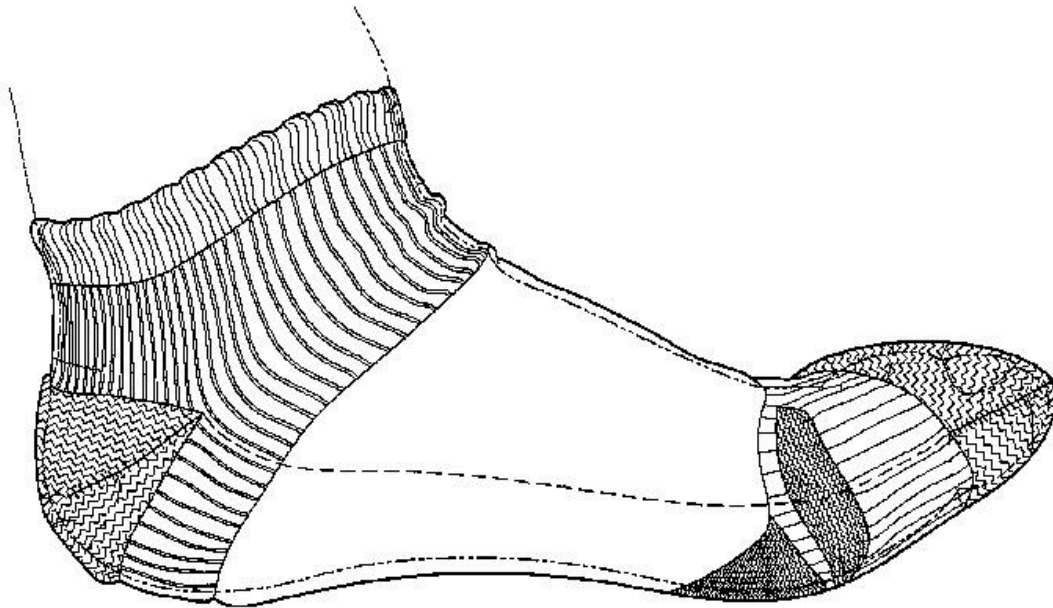

A41B 11/04
of the stocking top

Definition statement

This place covers:

Illustrative example of subject matter classified in this group.

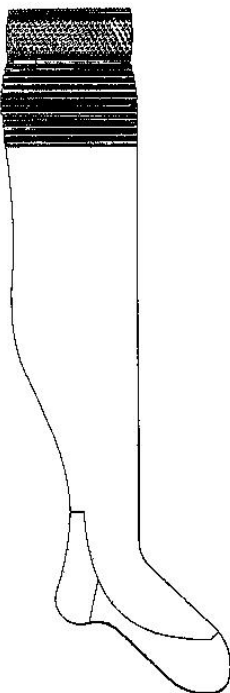

A41B 11/06

with interchangeable foot parts

Definition statement

This place covers:

Illustrative example of subject matter classified in this group.

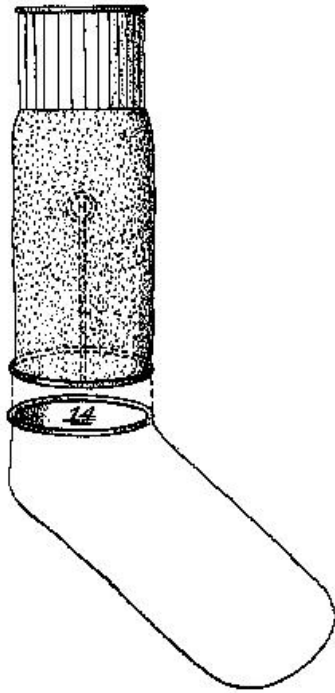

A41B 11/08

Stockings without foot parts

Definition statement

This place covers:

Illustrative examples of subject matter classified in this group.

Illustrative example 1: Multipurpose open-toed stocking

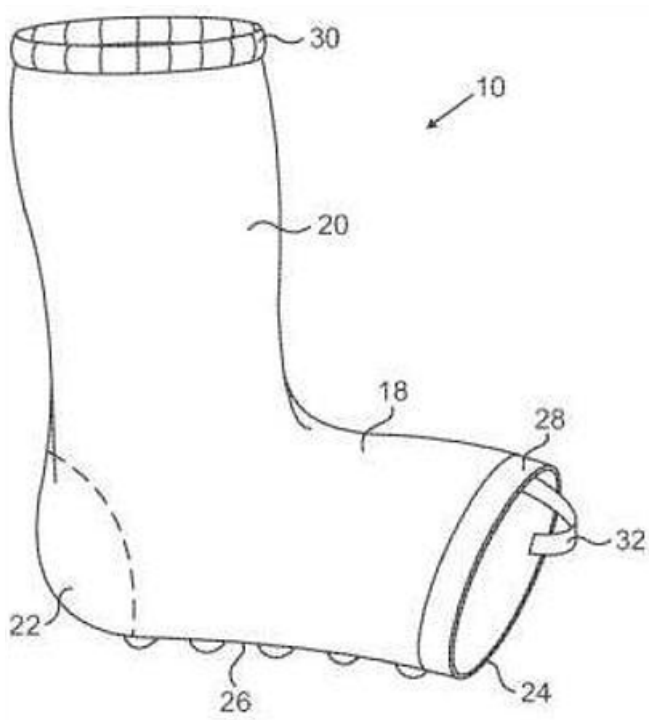

Illustrative example 2: Improvements in or relating to socks or stockings

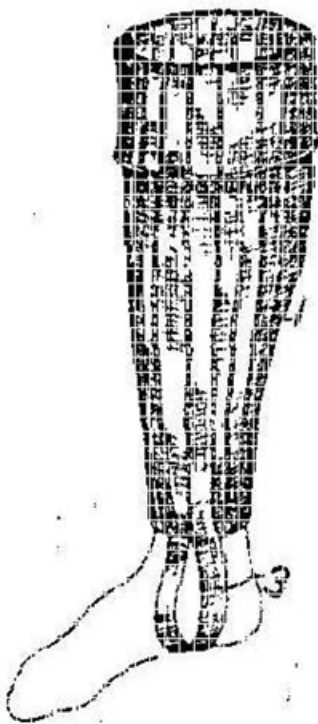

References

Informative references

Attention is drawn to the following places, which may be of interest for search:

Gaiters, spats	A41D 17/00
----------------	----------------------------

Overshoes	A43B 3/16 , A43B 5/18
Hosiery with shin guards	A63B 71/1225

Special rules of classification

Stockings without foot parts worn under garments or shoes are classified in [A41B 1/08](#).

Gaiters/Spats worn over garments and/or shoes are classified in [A41D 17/00](#).

Overshoes are classified in [A43B 3/16](#), [A43B 5/18](#).

Glossary of terms

In this place, the following terms or expressions are used with the meaning indicated:

Gaiter	A covering of cloth, leather, etc. for the ankle, or ankle and lower leg.
Spat	A short gaiter worn over the instep and reaching only a little way above the ankle, usually fastened under the foot by means of a strap.

A41B 11/10

Stocking protectors (to be put in footwear [A43B 23/28](#))

Definition statement

This place covers:

Socks covering only foot parts, e.g. footies/shoe liners.

Illustrative example of subject matter classified in this group.

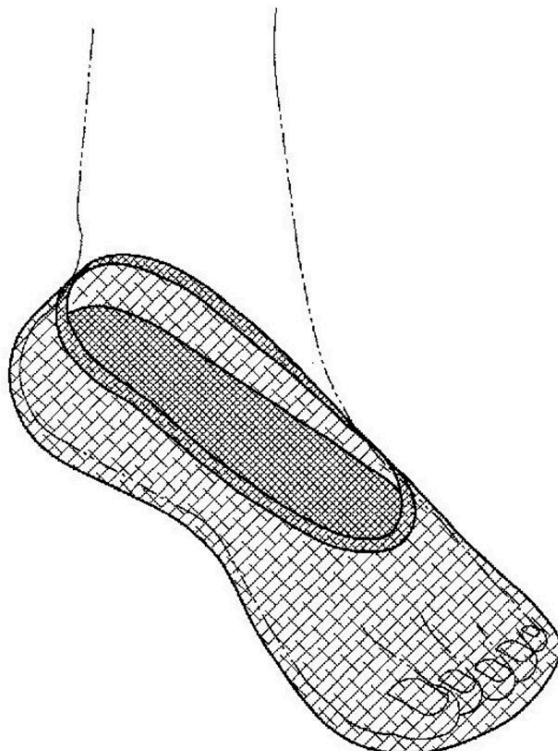

References

Limiting references

This place does not cover:

Protectors to be put in footwear	A43B 23/28
----------------------------------	----------------------------

Glossary of terms

In this place, the following terms or expressions are used with the meaning indicated:

Footie/ shoe liner	Socks covering only foot parts.
--------------------	---------------------------------

A41B 11/12

Means at the upper end to keep the stockings up ([A41B 11/04](#) takes precedence; stocking suspenders [A41F 11/00](#))

Definition statement

This place covers:

Illustrative example of subject matter classified in this group shown as a sport sock for supporting football shin guards, the sock having two cords, fixed by cord stops, arranged in horizontal sleeves, one below the knee and another at the ankle, the cords exiting at the rear through eyelets.

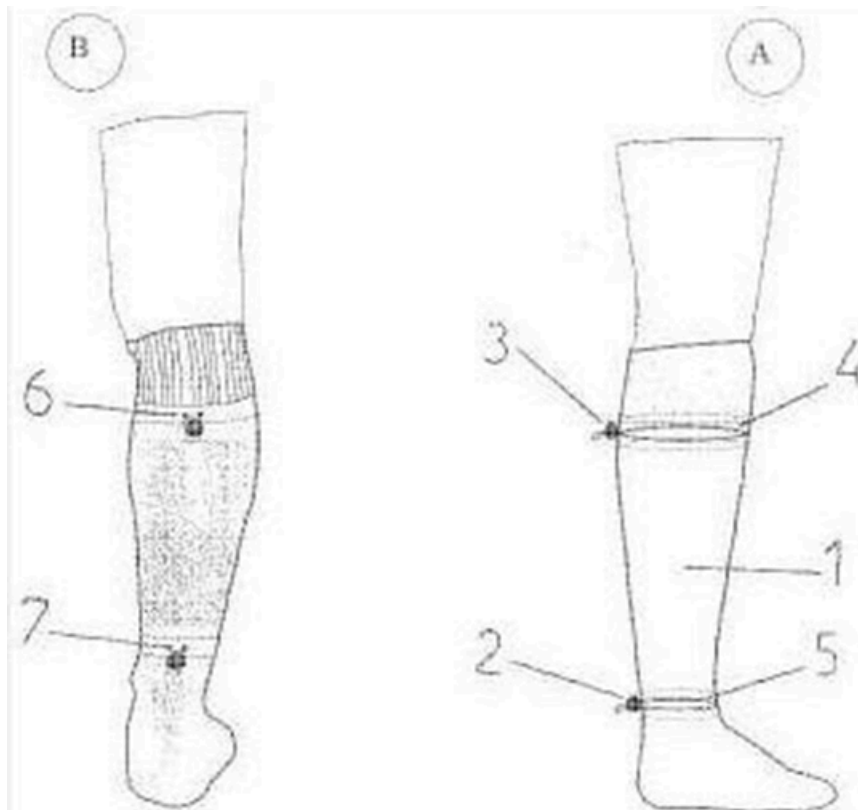

References

Limiting references

This place does not cover:

Reinforcements of the top of hosiery/stockings	A41B 11/04
Stocking suspenders	A41F 11/00

Special rules of classification

When suspension done by a different device from the stocking, classify in [A41F 11/00](#) and lower groups.

When suspension is integral with stocking classify in [A41B 11/12](#) and lower groups.

When stocking is adapted to allow separate garter to fasten, classify in [A41F 11/00](#) and lower groups and as additional information in [A41B 11/12](#).

Comprises cord inside sleeve at upper end.

A41B 11/121

{Elastic or flexible yarns knitted into the upper end}

Definition statement

This place covers:

Illustrative example of subject matter classified in this group.

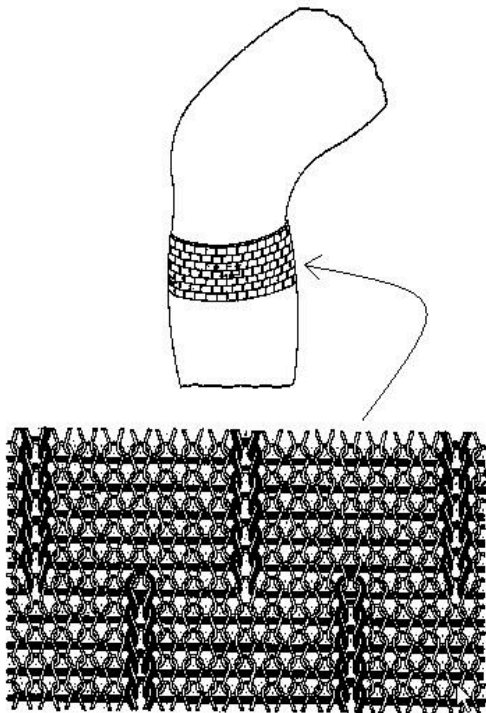

A41B 11/123

{Elastic or flexible bands attached at the upper end}

Definition statement

This place covers:

Illustrative example of subject matter classified in this group.

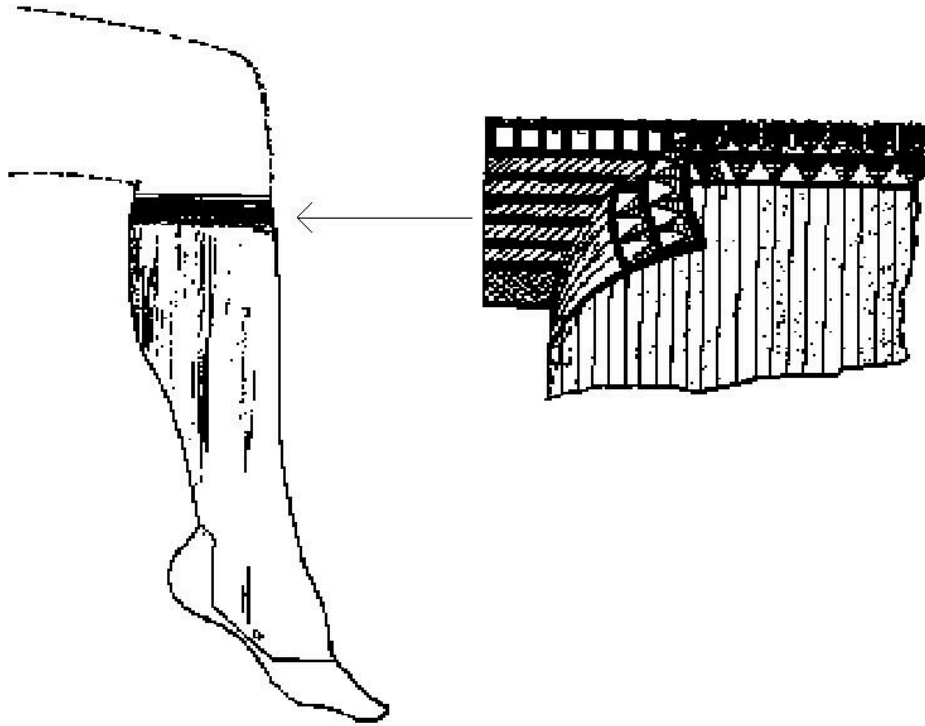

Special rules of classification

For cord inside sleeve at upper end classify in [A41B 11/12](#).

A41B 11/125

{Integrated adjustable garter}

Definition statement

This place covers:

Illustrative examples of subject matter classified in this group.



Fig.: 6

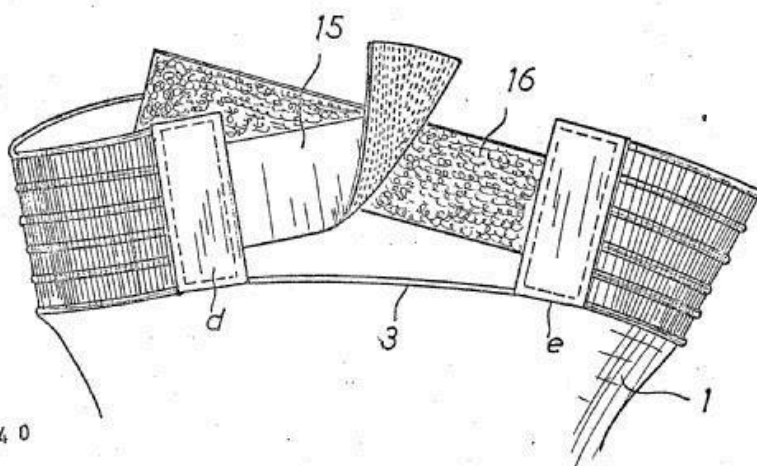

6717540

A41B 11/126

{having friction increasing means}

Definition statement

This place covers:

Illustrative example of subject matter classified in this group.

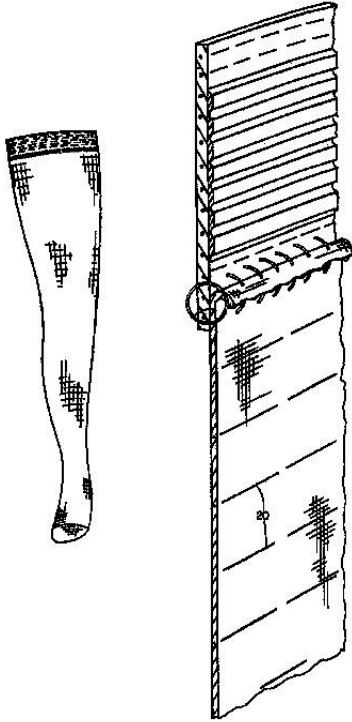

A41B 11/128**{in discontinuous form}****Definition statement***This place covers:*

Illustrative example of subject matter classified in this group.

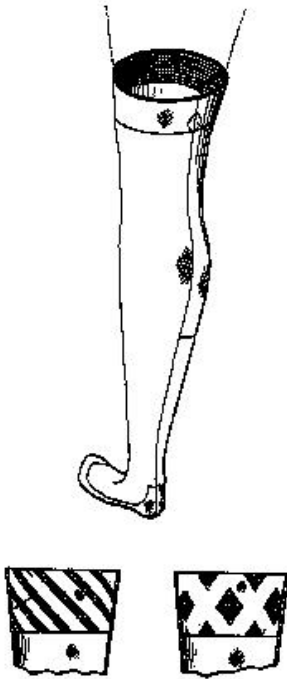
**References****Limiting references***This place does not cover:*

Coating silicone	B05C 1/00
Fabric treatment silicone	D06M 15/643

A41B 11/14**Panti-hose; Body-stockings****Definition statement***This place covers:*

Illustrative examples of subject matter classified in this group.

Illustrative example 1: Easy convenience pantsi-hose

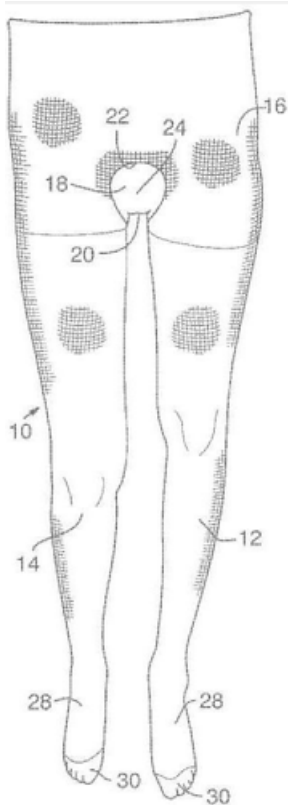

Illustrative example 2: Detachable multisectional body stocking hosiery

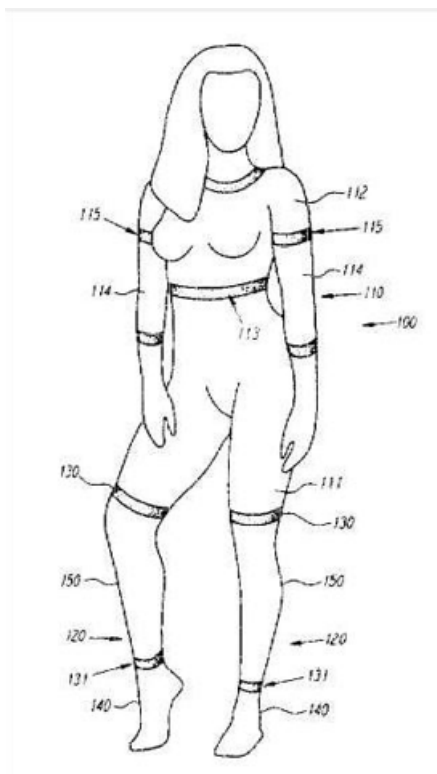

Relationships with other classification places

Underwear pantsi-hose and underwear body stockings belong to [A41B 11/14](#) and lower groups.

Relationships with other classification places

Sportive tights belong to [A41D 1/08](#) and lower groups.

Professional or sportive protective overalls belong to [A41D 13/02](#).

Sportive garments with embedded elastic bands but no compression belong to [A41D 31/18](#).

Compression stockings belong to [A61F 13/08](#).

References

Informative references

Attention is drawn to the following places, which may be of interest for search:

Sportive tights	A41D 1/08
Professional or sportive protective overalls	A41D 13/02

A41B 11/143

{Panti-hose made of two separated stockings}

Definition statement

This place covers:

Illustrative examples of subject matter classified in this group.

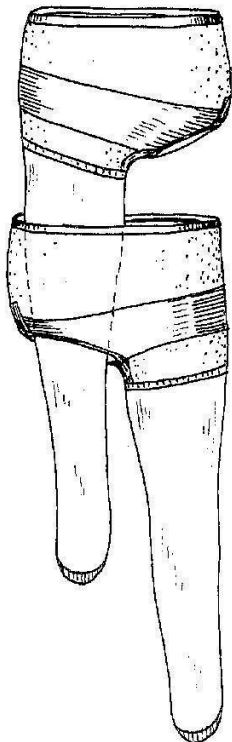

Fig.3

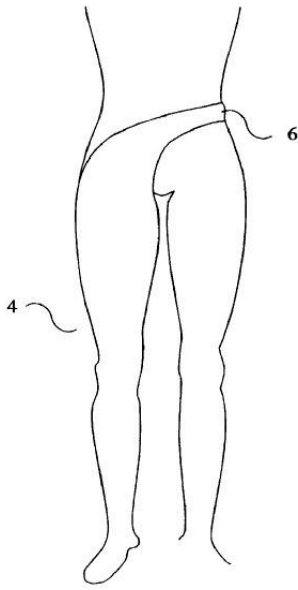

Fig.4

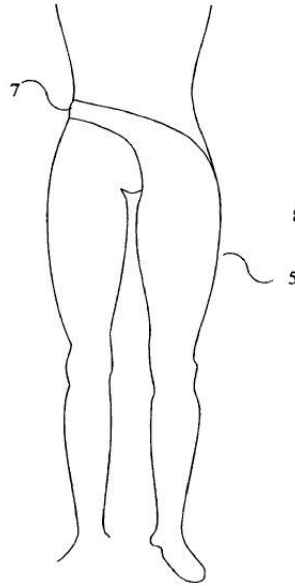
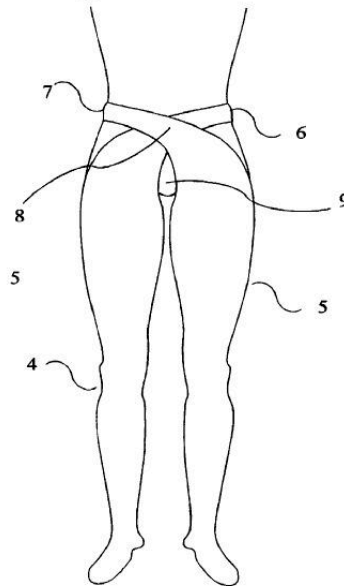

Fig.5



EP 0 936 881 B1

A41B 11/146

{connected at the waistband}

Definition statement

This place covers:

Illustrative examples of subject matter classified in this group.

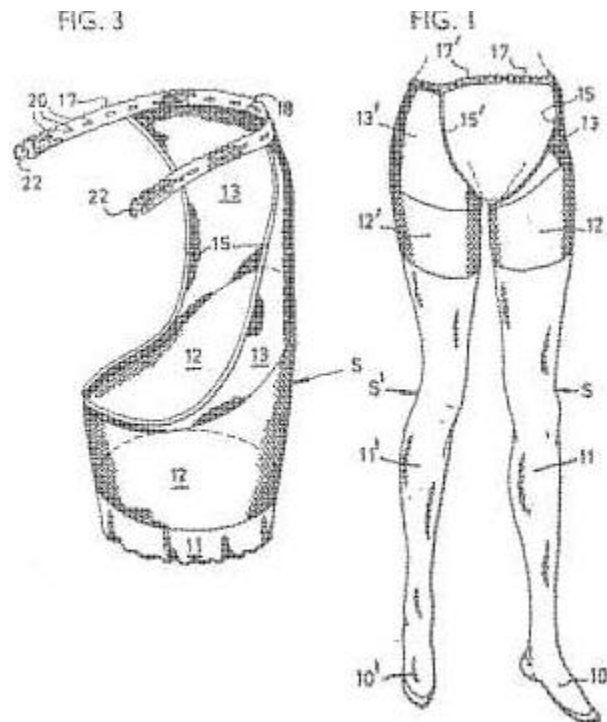

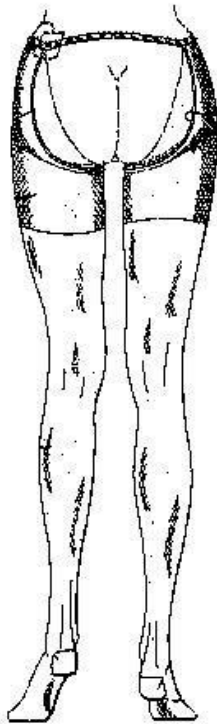

A41B 13/00

Baby linen (patients' garments specially adapted for babies [A41D 13/1272](#);
babies' napkins or holders therefor [A61F 13/15](#))

Definition statement

This place covers:

Clothing or other cloth articles for an infant such as infant underwear or bibs, etc.

Illustrative example of subject matter classified in this group.

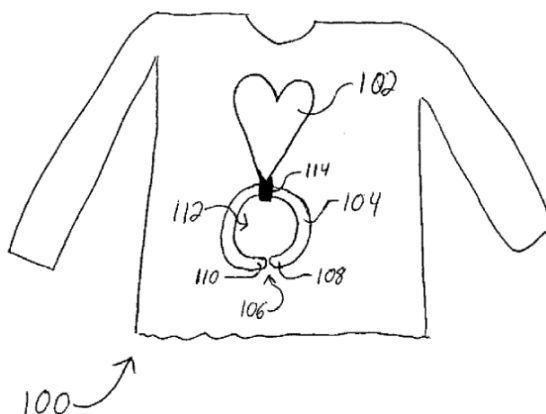

References

Limiting references

This place does not cover:

Patients' garments specially adapted for babies	A41D 13/1272
---	------------------------------

Absorbent pads, e.g. sanitary towels, swabs or tampons for external or internal application to the body	A61F 13/15
---	----------------------------

Informative references

Attention is drawn to the following places, which may be of interest for search:

Children's Clothing	A41D 11/00
Nursery furniture, devices for guiding / supporting children	A47D 13/08
Devices for preventing children from falling out of bed, restraining devices	A47D 15/005

A41B 13/005

{Babies overalls, e.g. bodysuits or bib overalls}

Definition statement

This place covers:

Illustrative example of subject matter classified in this group.

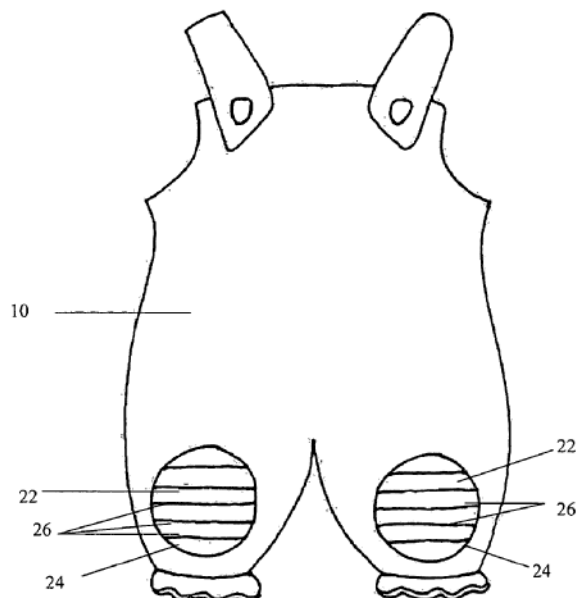
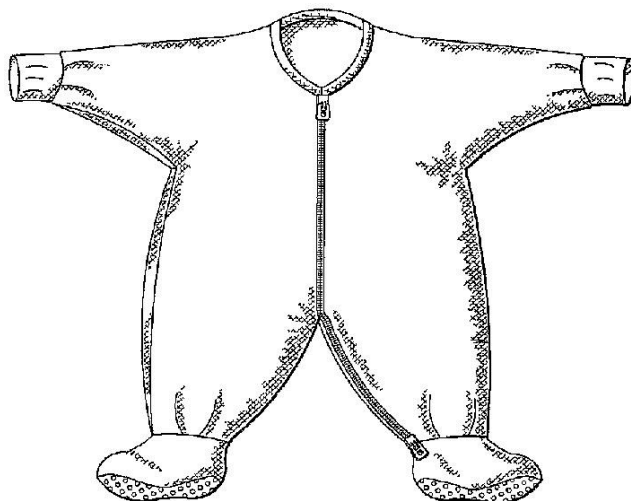

References

Informative references

Attention is drawn to the following places, which may be of interest for search:

Adult overalls	A41D 13/02
----------------	----------------------------

A41B 13/04

Babies' pants (combined with swabs or absorbent pads or specially adapted for supporting them [A61F 13/15](#))

Definition statement

This place covers:

Illustrative example of subject matter classified in this group.

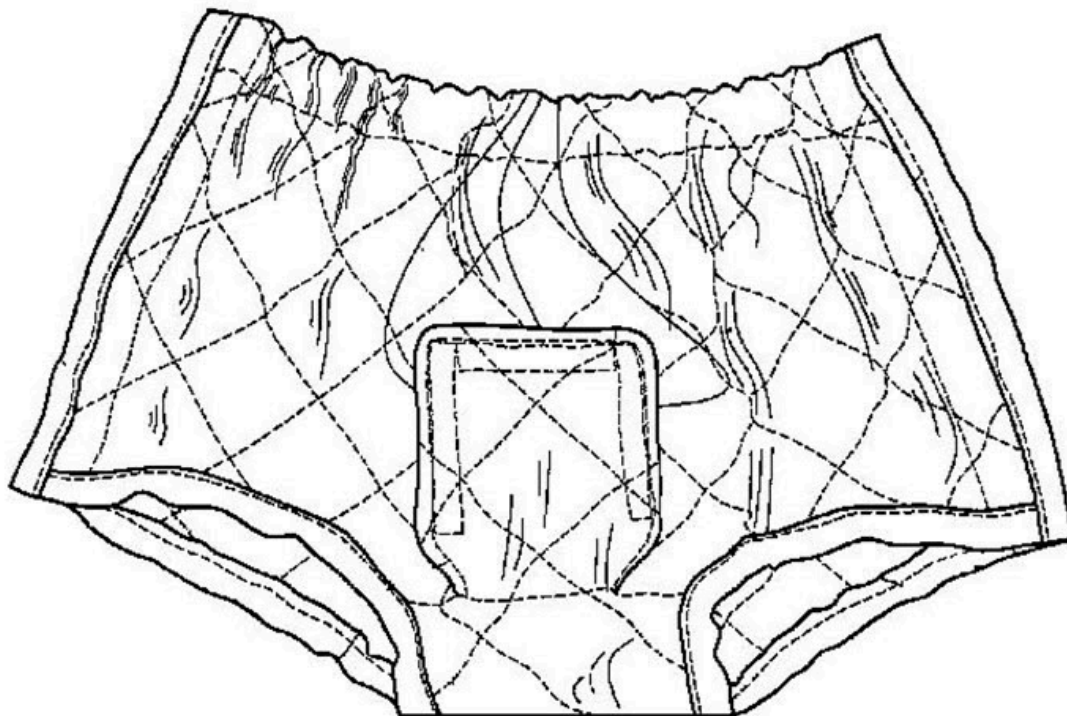

References

Limiting references

This place does not cover:

Baby's pants combined with swabs or absorbent pads or specially adapted for supporting them	A61F 13/15
---	----------------------------

A41B 13/06

Slip-in bags; Swaddling clothes

Definition statement

This place covers:

Sleeping-bags with the shape of a garment used as pyjamas for babies.

Illustrative example:

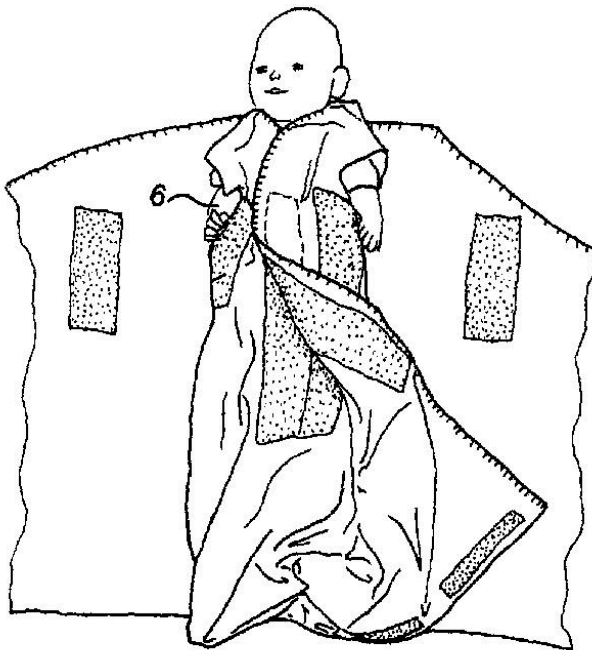

References

Informative references

Attention is drawn to the following places, which may be of interest for search:

Sleeping-bags with the shape of a garment used as pyjamas for adults	A41D 10/00
Blankets	A47G 9/0223
Travelling baby blanket	A47G 9/068
Sleeping bag	A47G 9/08

A41B 13/08

Bodices

Definition statement

This place covers:

Baby garment usually with sleeves but leaving the legs uncovered and fastening means at the crotch.

Illustrative example of subject matter classified in this group.

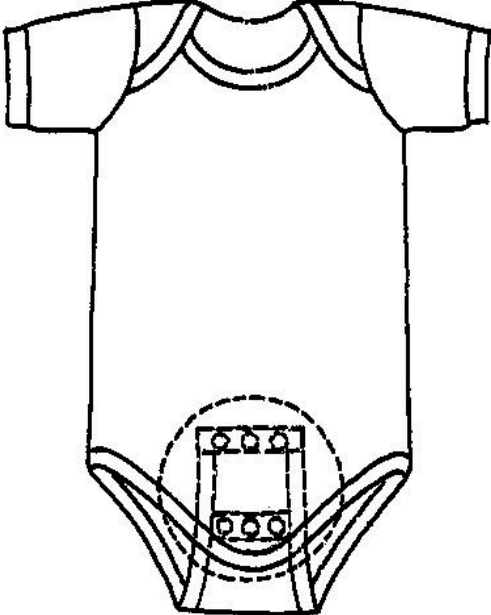

A41B 13/10

Bibs

Definition statement

This place covers:

Illustrative example of subject matter classified in this group.

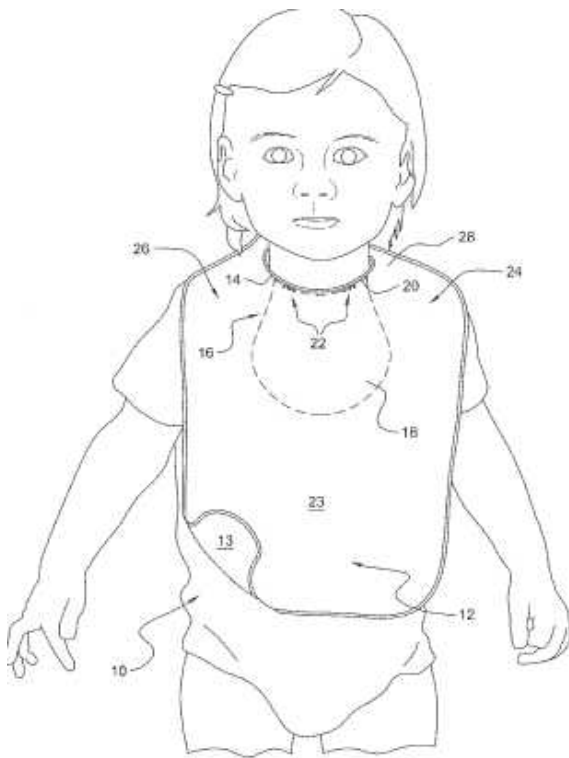

References

Informative references

Attention is drawn to the following places, which may be of interest for search:

Toilet/cosmetic protecting mantles, shoulder-shields, bibs (hairdresser)	A45D 44/08
Napkins attachable to clothing	A47G 11/002
Napkins with separate holding devices	A47G 21/165
Lap trays	A47G 23/0608
Surgical drapes	A61B 46/00

Special rules of classification

When protection is for children/babies, classify in bibs: [A41B 13/10](#). When protection is for adults, classify in aprons [A41D 13/04](#).

For protectors of neckties classify in [A41D 25/00](#).

A41B 13/103

{with a pocket}

Definition statement

This place covers:

Illustrative example of subject matter classified in this group.

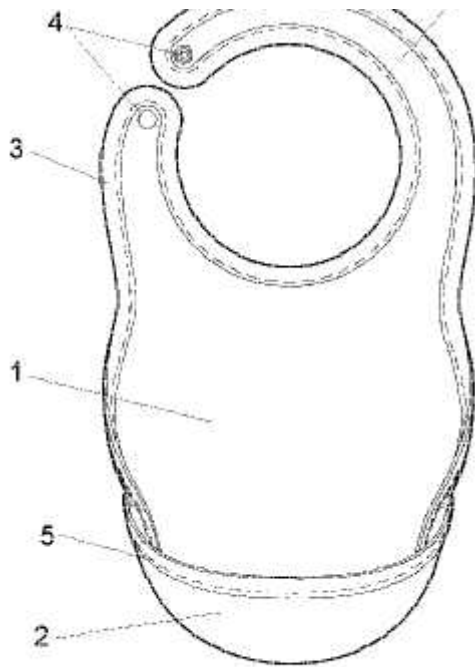

FIG. 3

A41B 13/106

{with fastening means for attachment to tray or table}

Definition statement

This place covers:

Illustrative example of subject matter classified in this group.

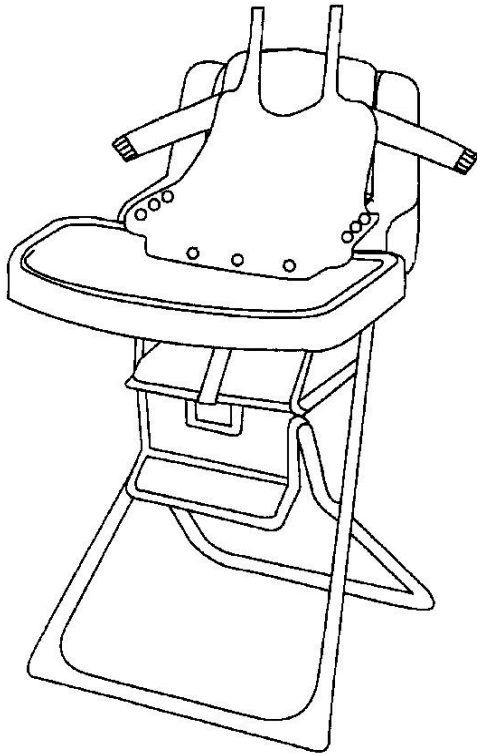

A41B 15/00

Handkerchiefs

Definition statement

This place covers:

Illustrative example of subject matter classified in this group.

Illustrative example 1: Handkerchief with improved hygiene, comprising two partially connected layers for filtering out virus-containing aerosols expelled during sneezing.

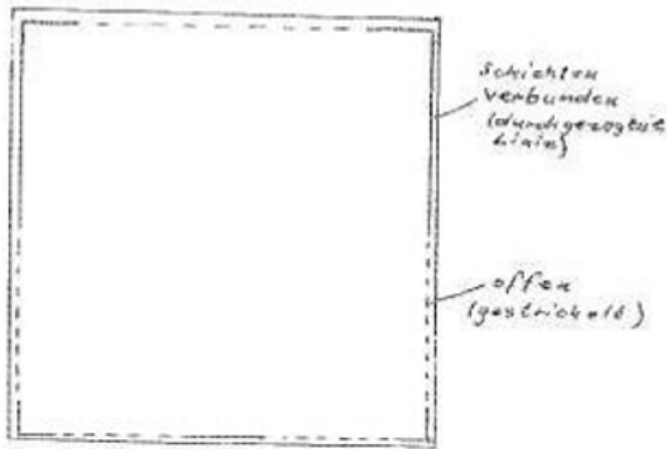

Illustrative example 2: Handkerchief with finger securing loop



References

Informative references

Attention is drawn to the following places, which may be of interest for search:

Paper tissues	A47K 10/16
Cleaning or scouring pads, wipes containing detergent	C11D 17/049

Special rules of classification

For exterior protection on arm of clothing to use as handkerchief, classify in [A41D 27/12](#) and [A41B 15/00](#).

If it has the shape of an armband, classify additionally in [A41D 20/00](#).

A41B 15/02

Simulations of breast pocket handkerchiefs; Their attachment

Definition statement

This place covers:

Illustrative example of subject matter classified in this group.

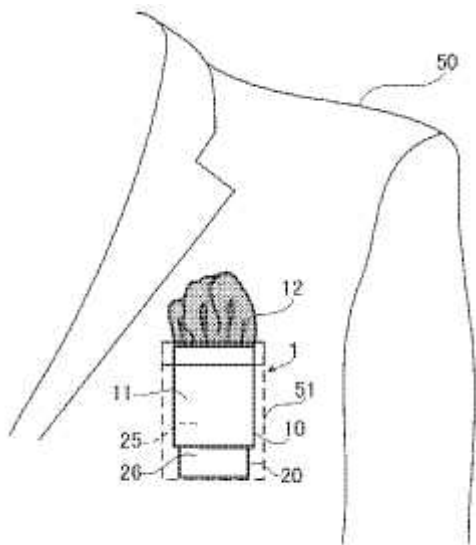

A41B 17/00

Selection of special materials for underwear

References

Limiting references

This place does not cover:

Textiles containing perfume or deodorants	D06M 13/005
---	-----------------------------

A41B 2400/36

Deodorising or perfuming

Relationships with other classification places

This place does not cover:

Containers for holding perfume which are to be classified in group [A45D 34/00](#).

Holders for air deodorants which are to be classified in group [A61L 9/12](#).

Relationships with other classification places

Body deodorants which are to be classified in group [A61Q 15/00](#).

Perfumes encapsulated in a carrier which are to be classified in group [C11D 3/505](#).

Perfumes released by thermal or chemical activation which are to be classified in group [C11D 3/507](#).

Textiles containing perfume or deodorants which are to be classified in group [D06M 13/005](#).