

A41D

OUTERWEAR; PROTECTIVE GARMENTS; ACCESSORIES

Definition statement

This place covers:

Outerwear covers athletic garments, jackets, trousers, shorts, skirts, maternity clothing, overgarments (overcoats, capes), dressing-gowns, bathing costumes, and pyjamas.

In particular, the following subjects are classified as follows:

- Jackets, e.g. dress jackets or sport coats, are classified in [A41D 1/02](#)
- Waistcoats, vests, jerseys, sweaters and T-shirts are classified in [A41D 1/04](#)
- For blouse, e.g. women's top, classify in [A41D 1/18](#)
- For overalls, e.g. coveralls or bodysuits for adult, classify in [A41D 13/02](#)
- For leggings, e.g. chaps, classify in [A41D 17/02](#)

Relationships with other classification places

This subclass covers outerwear and protective garments. It is known that some therapeutic devices can be worn by the patient and even be integrated into garments. Despite that, therapeutic devices per se are covered by the relevant subclasses of class [A61](#).

Outerwear does not cover shirts (i.e. button down shirts with a collar) [A41B 1/00](#), hosiery [A41B 11/00](#), baby linen [A41B 13/00](#) and handkerchiefs [A41B 15/00](#).

Garments fastenings and suspenders are classified in [A41F](#).

Machines, appliances or methods are classified as inventive information in [A41H](#) and non-trivial technical information with regard to the article of apparel may be discretionarily classified as additional information in [A41B](#) - [A41F](#).

References

Informative references

Attention is drawn to the following places, which may be of interest for search:

| | |
|---|-------------------------------|
| Button down shirt or formal dress shirt | A41B 1/00 |
| Chemise, e.g. slips with shoulder straps worn beneath a dress | A41B 9/06 |
| Chemise, e.g. slips that only cover the lower body | A41B 9/10 |
| Overalls, e.g. coveralls or bodysuits (for babies) | A41B 13/005 |
| Bodices, e.g. baby onesies | A41B 13/08 |
| Straps, bands | A45C 13/30 |
| Carrying straps around neck | A45F 2003/002 |
| Carrying straps around waist | A45F 3/005 |
| Carrying straps | A45F 3/14 |
| Carriers for hand articles | A45F 5/00 |
| Fastening articles to the garment | A45F 5/02 |
| Carriers for holding garments | A45F 5/06 |
| Garment bags | A47G 25/54 |
| Detecting heart/pulse rate for diagnostic purposes, worn by patient | A61B 5/02438 |

| | |
|---|------------------------------|
| Orthopaedic slings, straps for holding arms | A61F 5/3746 |
| Electromedical stimulation with electrodes | A61N 1/36014 |
| Magnetotherapy | A61N 2/00 |
| Radiation therapy | A61N 5/00 |
| Packaging for clothing | B65D 85/18 |
| Supports for musical instruments, straps | G10G 5/005 |

Glossary of terms

In this place, the following terms or expressions are used with the meaning indicated:

| | |
|---------------|---|
| Dressing-gown | a loose gown worn while making one's toilet or when in dishabille. |
| Jacket | lightweight long-sleeve garment typically having a collar and lapel extending below the front sides of the collar providing a central opening between the lapels, also referred to as a dress jacket or sport coat |
| Waistcoat | upper body garment without sleeves also referred to as a vest in American English |
| Vest | T-shirt or casual top with or without sleeves |
| Jersey | knitted garment with or without sleeves, also referred to as a sweater in American English |
| Sweater | garment typically worn for playing team sports, also referred to as a jersey in American English |
| Blouse | shirt having features specific to women, also referred to as a women's top |
| Overalls | a one-piece garment having an upper body portion (e.g. short or long sleeve top, bib secured by shoulder straps, etc.) and lower body portion (e.g. pants, shorts, etc.), also referred to as coveralls or bodysuits |
| Leggings | lower body overgarment with or without seats for protecting a garment worn underneath, also referred to as chaps |
| Shirt | an upper body garment having a collar and an opening at the front which is fastened closed via fastening elements (e.g. buttons) disposed adjacent the opening, also referred to as a men's dress shirt, button-up shirt or button-down shirt |
| Chemise | undergarment with shoulder strap worn beneath dress or the like, also referred to as a slip |
| Bodices | baby garment usually with sleeves but leaving the legs uncovered and fastening means at the crotch, also referred to as a onesie |

A41D 1/00

Garments (for children [A41D 11/00](#))

Definition statement

This place covers:

Also covers costumes and religious outfits.

Illustrative examples of subject matter classified in this group



References

Informative references

Attention is drawn to the following places, which may be of interest for search:

| | |
|--|----------------------------|
| Masks or dominoes for concealing identity, e.g. for theatrical use | A41G 7/00 |
| Sacks for dead corpses | A61G 17/06 |
| Disguises for artists for life-like imitation of creatures | A63J 7/005 |

A41D 1/002

{adapted to accommodate electronic equipment (patients' garments for medical monitoring [A41D 13/1281](#); luminous ornaments [A41D 27/085](#))}

Definition statement

This place covers:

Illustrative example of subject matter classified in this group.

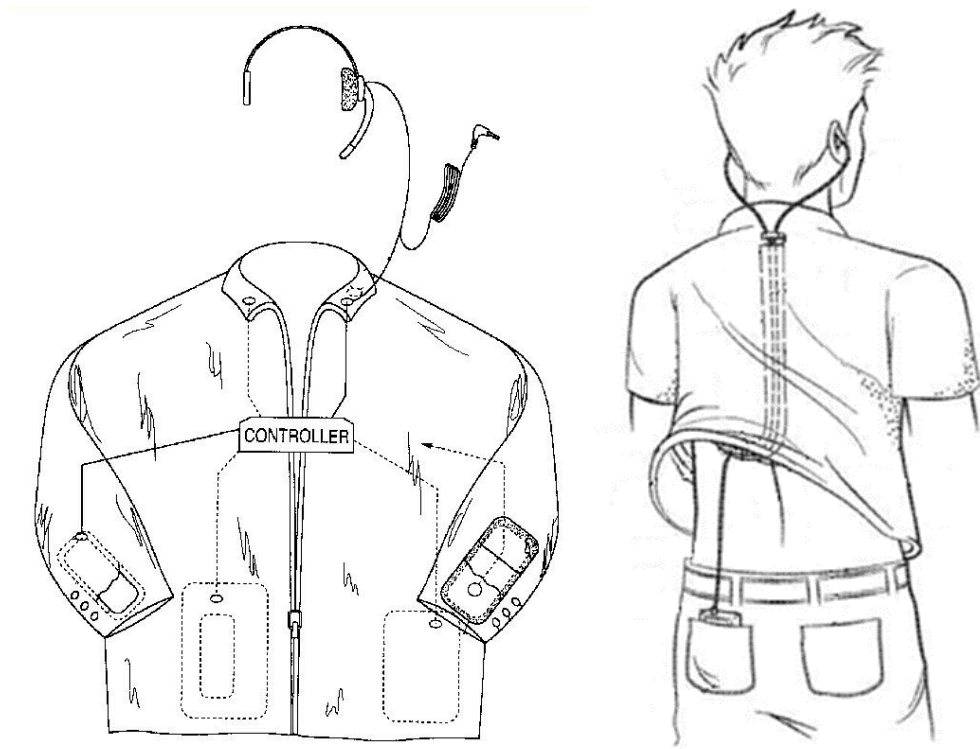

References

Informative references

Attention is drawn to the following places, which may be of interest for search:

| | |
|---|------------------------------|
| Detecting heart/pulse rate for diagnostic purposes, worn by patient | A61B 5/02438 |
| Electromedical stimulation with electrodes | A61N 1/36014 |
| Magnetotherapy | A61N 2/00 |
| Radiation therapy | A61N 5/00 |
| Wearable computers | G06F 1/163 |
| Remote control of information storage system (audio/video media) | G11B 19/025 |
| Conductors dispersed in non-conductive materials | H01B 1/20 |
| Switches | H01H 1/00 |
| Mechanisms of switches | H01H 3/16 |
| Semiconductors in flexible layers | H01L 23/5387 |
| Connections (switches) | H01R 4/58 |
| Portable transceivers carried on body | H04B 1/385 |

| | |
|------------------------------|--|
| Sound systems | H04R 1/10 , H04R 1/025 , H04R 5/023 |
| Multilayer printed circuits | H05K 1/036 |
| Printed circuits on textiles | H05K 1/038 |

Special rules of classification

When the subject is focused mainly on electronic equipment classify in this group as "additional information" only, and consider main classification in the relevant field.

For pockets adapted to receive electronic equipment consider classification in [A41D 27/205](#).

A41D 1/007

{made by a helically or spirally wound material}

Definition statement

This place covers:

Illustrative example of subject matter classified in this group.

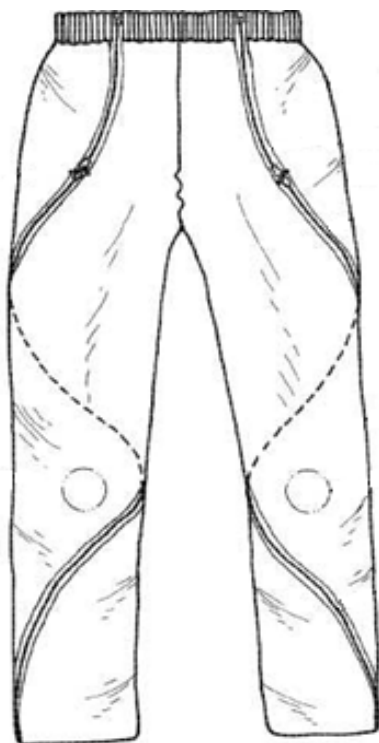

References

Informative references

Attention is drawn to the following places, which may be of interest for search:

| | |
|---|----------------------------|
| Seaming making a tubular fabric by helically winding it | D06H 5/007 |
|---|----------------------------|

A41D 1/02

Jackets

Definition statement

This place covers:

Lightweight long-sleeve garment typically having a collar and lapel extending below the front sides of the collar providing a central opening between the lapels.

Suit jackets.

Illustrative example of subject matter classified in this group.

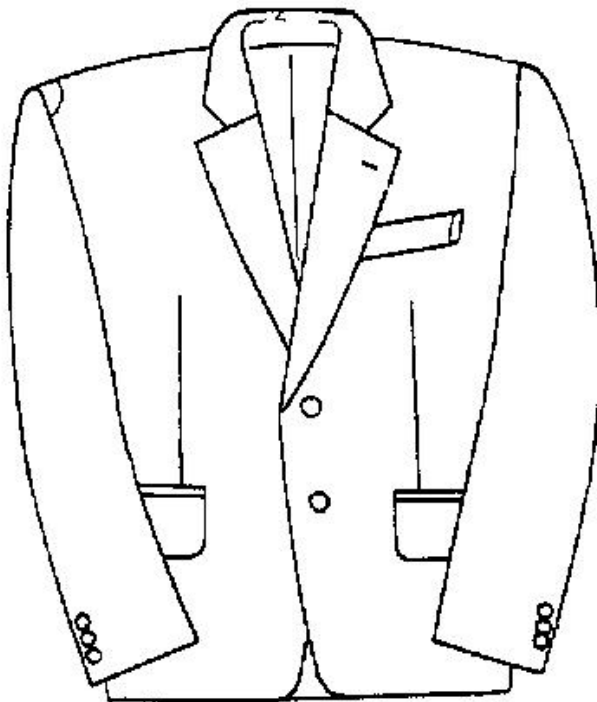

References

Informative references

Attention is drawn to the following places, which may be of interest for search:

| | |
|--|---------------------------|
| Overgarment jackets/coats, e.g. anoraks, parkas, short-length zip-up jackets, etc. | A41D 3/00 |
| Overcoats, e.g. trench coats, pea coats | A41D 3/02 |

Special rules of classification

For suit jackets classify in [A41D 1/02](#).

For outer jackets classify in [A41D 3/00](#).

A41D 1/04

Vests, jerseys, sweaters or the like

Definition statement

This place covers:

T-shirts, vests with or without sleeves, jerseys and sweaters.

Illustrative examples of subject matter classified in this group.

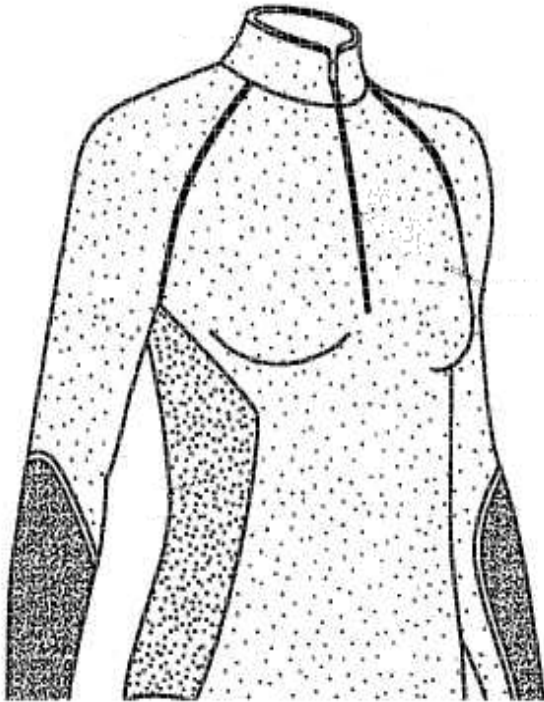

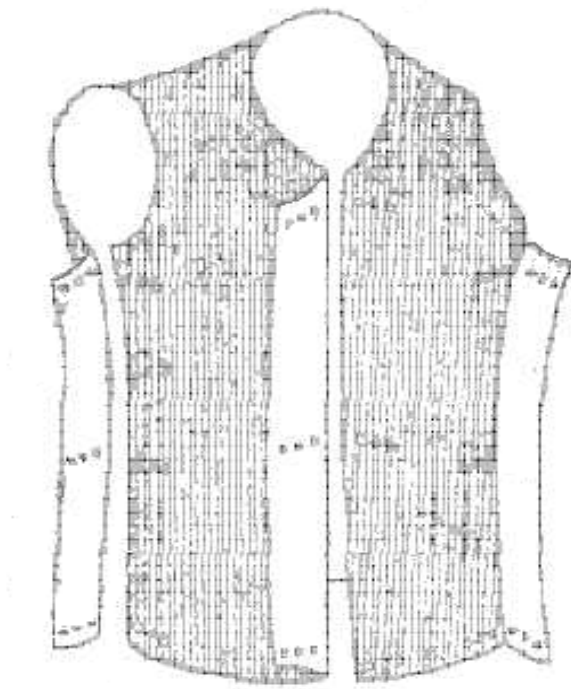

References

Informative references

Attention is drawn to the following places, which may be of interest for search:

| | |
|--------------------|---------------------------|
| Blouses | A41D 1/18 |
| Outerwear vests | A41D 3/00 |
| Button down shirts | A41B 1/00 |
| Undershirts | A41B 9/06 |
| Knitting | D04B 1/24 |

A41D 1/06

Trousers

Definition statement

This place covers:

Also covers details of trouser cuffs.

Illustrative examples of subject matter classified in this group.

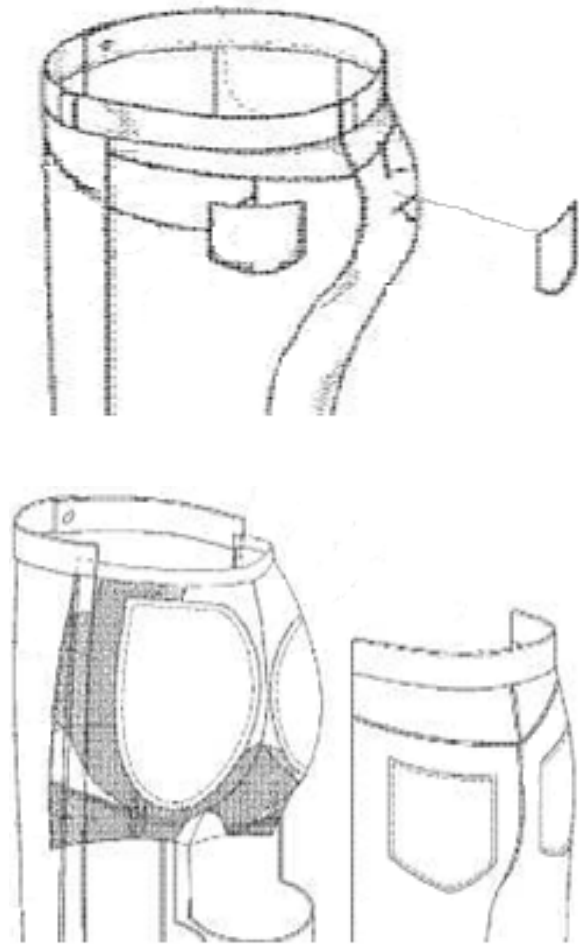

Special rules of classification

For all types of shorts classify in [A41D 1/089](#). For trousers adjusting its length classify in [A41D 15/002](#) and as additional information in [A41D 1/06](#).

For details of hems of trousers classify in [A41D 27/24](#) and as additional information in [A41D 1/06](#).

For protectors of the underedges of trousers classify only in [A41D 27/145](#).

For fastening the trouser cuff to the shoe classify in [A41F 17/00](#) and as additional information in [A41D 1/06](#).

For leggings (leg outer coverings, over trousers) classify in [A41D 17/00](#).

For waist details or expansible/adjustable waist classify also in [A41F 9/00](#) and lower groups.

A41D 1/08

especially adapted for sporting purposes

Definition statement

This place covers:

Illustrative example of subject matter classified in this group.

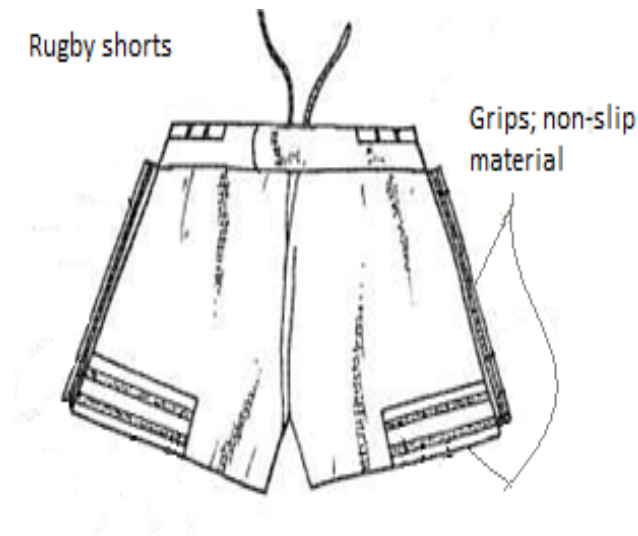

References

Informative references

Attention is drawn to the following places, which may be of interest for search:

| | |
|-------------------------|----------------------------|
| Bermuda swimming shorts | A41D 7/005 |
| Underwear panti-hose | A41B 11/14 |

Special rules of classification

For underwear panti-hose classify in [A41B 11/14](#) and subgroups.

For sportive tights classify in [A41D 1/08](#) and subgroups.

For sportive garments with embedded elastic bands but no compression, classify in [A41D 31/18](#).

For compression tights, elastic trousers with curative purposes consider classification in [A61F 13/08](#).

A41D 1/082

for skiing

Definition statement

This place covers:

Illustrative examples of subject matter classified in this group.

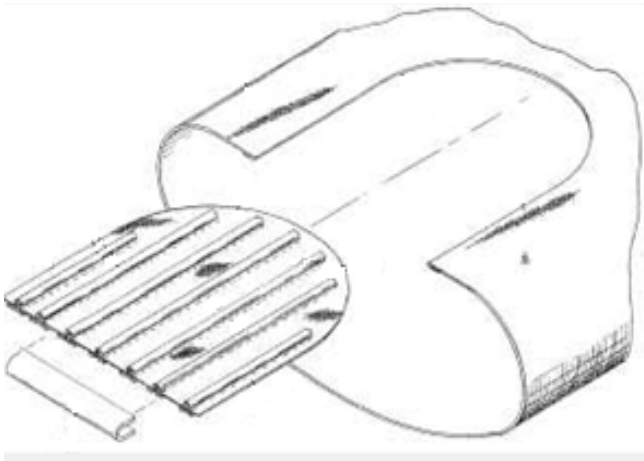
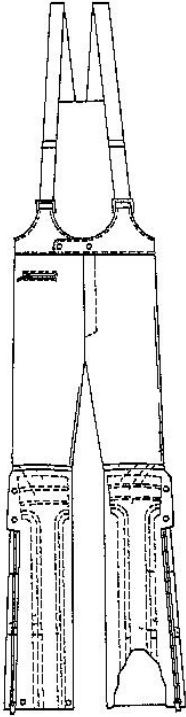

A41D 1/084**for cycling****Definition statement**

This place covers:

Illustrative example of subject matter classified in this group.

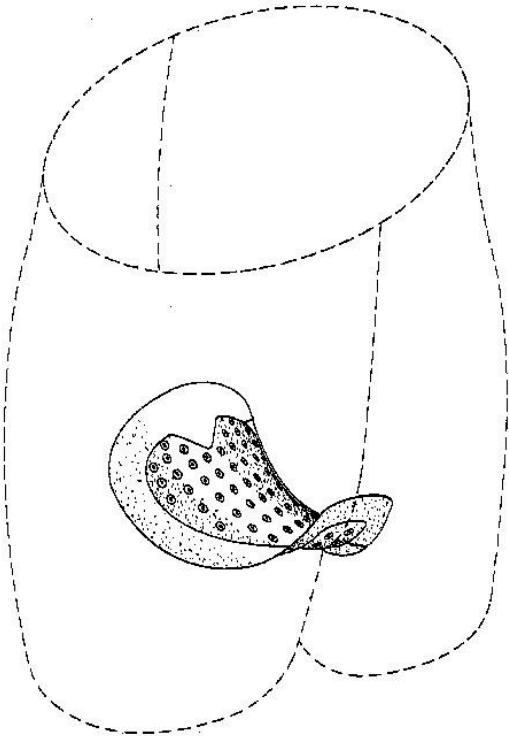
**References****Informative references**

Attention is drawn to the following places, which may be of interest for search:

| | |
|---|------------------------------|
| Sports pants with crotch reinforcement (not for cycling, i.e. garment protection) | A41D 1/088 |
| Buttocks protection in sports trousers not for cycling and not at crotch area | A41D 13/0537 |

Special rules of classification

Comprises padding for buttocks protection in cycling shorts.

When reinforcements are used as interface between body and cycling saddle, e.g. for impact or pressure reduction, or for saddle shaped reinforcements, even if the word "cycling" is not used, class only in [A41D 1/084](#), and not in [A41D 1/088](#). For all other crotch area reinforcements in sports trousers, e.g. garment protection, classify only in [A41D 1/088](#).

For buttocks protection in sports trousers not for cycling and not at crotch area, class in [A41D 13/0537](#).

A41D 1/086**for horse riding****Definition statement***This place covers:*

Illustrative example of subject matter classified in this group.

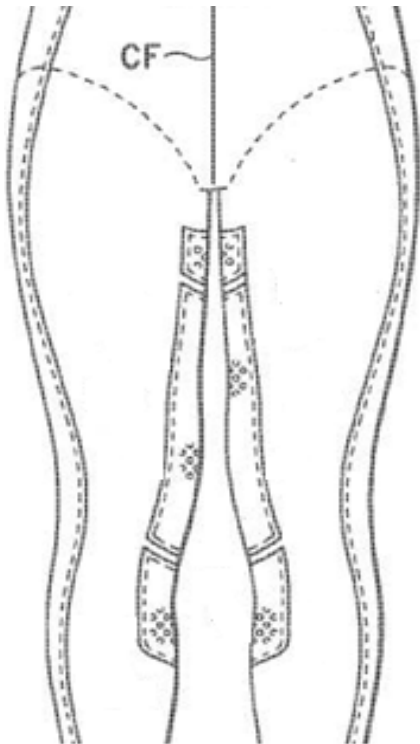
**References****Informative references***Attention is drawn to the following places, which may be of interest for search:*

| | |
|---------------------------------|----------------------------|
| Riding equipment or accessories | A63K 3/00 |
| Saddling equipment | B68C 1/126 |

A41D 1/088**{with crotch reinforcement}****Definition statement***This place covers:*

Comprises sports trousers with crotch area reinforcements, i.e. garment protection.

Illustrative example of subject matter classified in this group.

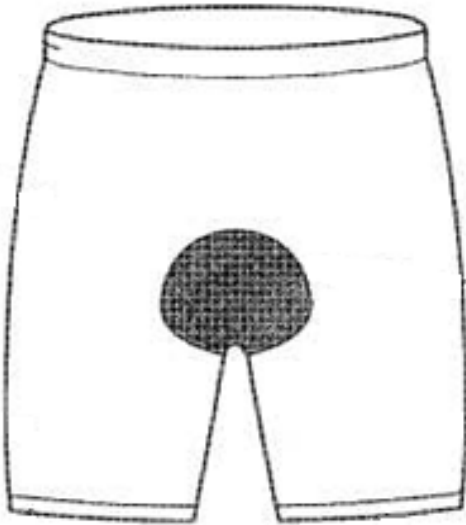

References

Informative references

Attention is drawn to the following places, which may be of interest for search:

| | |
|---|------------------------------|
| Cycling trousers (with saddle reinforcements and padding) | A41D 1/084 |
| Buttocks protection in sports trousers not for cycling and not at crotch area | A41D 13/0537 |
| Protectors for clothing, not in crotch area of sports trousers | A41D 27/12 |

Special rules of classification

When reinforcements are used as interface between body and cycling saddle, e.g. for impact or pressure reduction, or for saddle shaped reinforcements, even if the word "cycling" is not used, classify only in [A41D 1/084](#), and not in [A41D 1/088](#). For all other crotch area reinforcements in sports trousers e.g. garment protection, classify only in [A41D 1/088](#).

For buttocks protection in sports trousers not for cycling and not at crotch area, classify in [A41D 13/0537](#).

For clothing protection, i.e. patches avoiding wear and tear, not in crotch area of sports trousers, classify in [A41D 27/12](#).

A41D 1/089

Shorts

References

Informative references

Attention is drawn to the following places, which may be of interest for search:

| | |
|---------------------------|----------------------------|
| Bathing drawers or trunks | A41D 7/005 |
|---------------------------|----------------------------|

A41D 1/10

Means for maintaining the crease

Definition statement

This place covers:

Illustrative examples of subject matter classified in this group.



Fig. 1

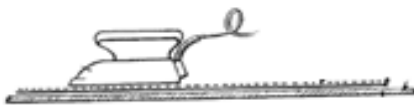

Fig. 2



Fig. 3



Fig. 4

Fig. 1

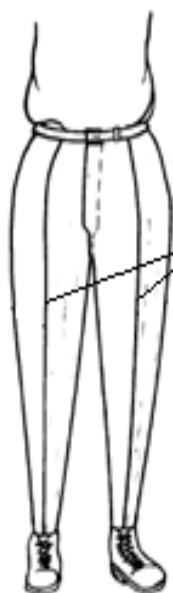
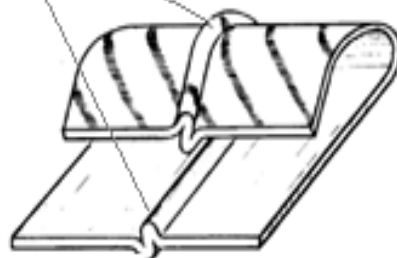

Fig. 2



Fig. 3



Crease

Glossary of terms

In this place, the following terms or expressions are used with the meaning indicated:

| | |
|--------|---|
| Crease | the line or mark produced on the surface of anything by folding; a furrow in a surface, such as is caused by folding; a fold, wrinkle, ridge, specifically in trousers. |
|--------|---|

A41D 1/12

Means for hiding bandy legs

Definition statement

This place covers:

Illustrative example of subject matter classified in this group.

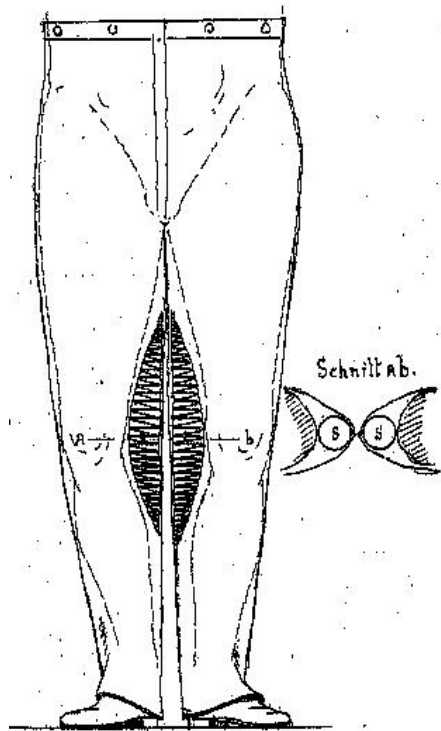

Glossary of terms

In this place, the following terms or expressions are used with the meaning indicated:

| | |
|------------|--|
| Bandy legs | curved laterally with the concavity inward |
|------------|--|

A41D 1/14

Skirts

Definition statement

This place covers:

Illustrative example of subject matter classified in this group.



A41D 1/16

Hooped skirts; Crinolines

Definition statement

This place covers:

Illustrative example of subject matter classified in this group.

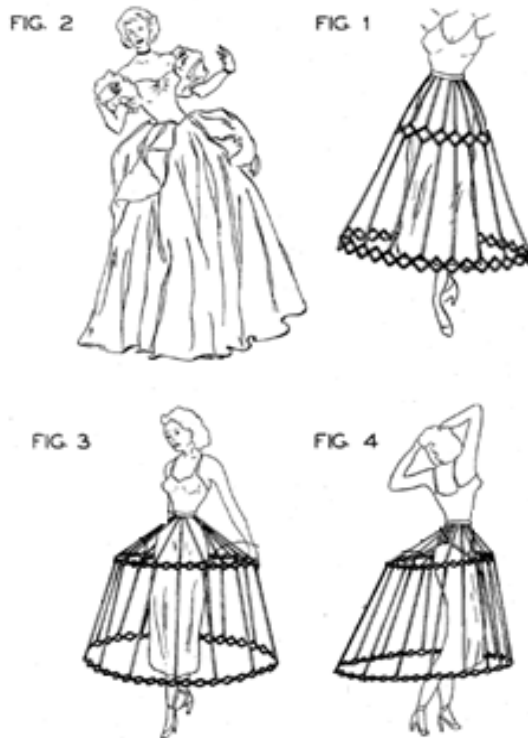

Glossary of terms

In this place, the following terms or expressions are used with the meaning indicated:

| | |
|--------------|--|
| Crinoline | a stiffened petticoat or underskirt made with a stiff fabric comprising a weft of horsehair and a warp of cotton or linen thread or an imitation fabric made of stiffened muslin or other material, designed to support the skirts of a woman's dress. |
| Hooped skirt | stiffened or expanded by hoops of whalebone, cane etc. |

A41D 1/18

Blouses

Definition statement

This place covers:

Upper body garments with features specifically meant for women.

Illustrative examples of subject matter classified in this group.

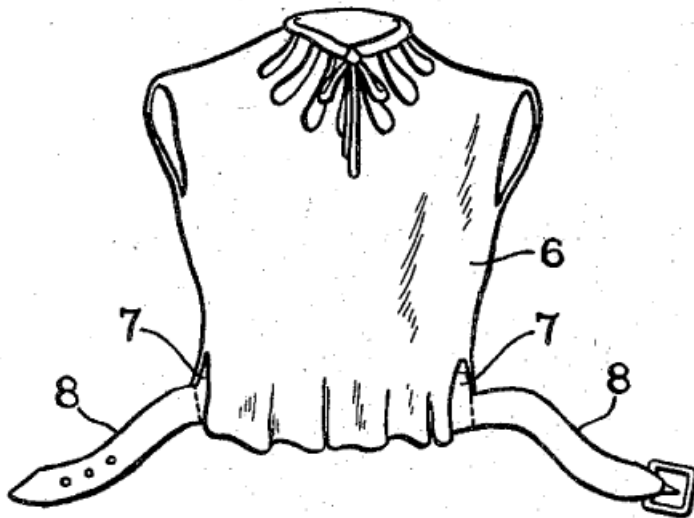
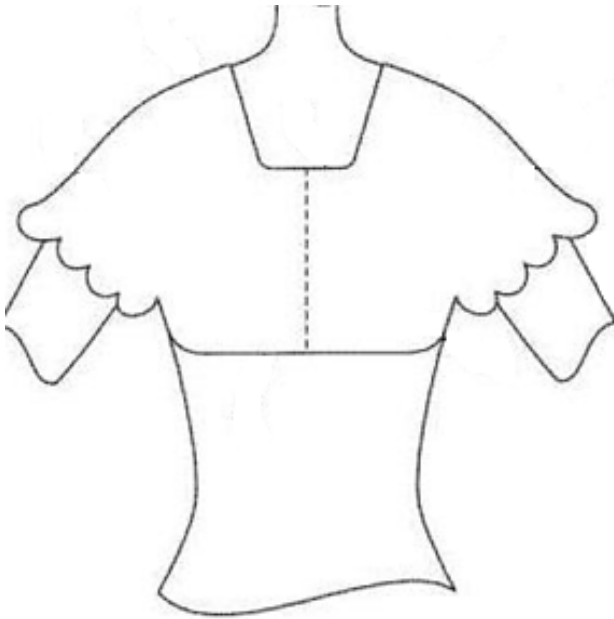

References

Informative references

Attention is drawn to the following places, which may be of interest for search:

| | |
|---|---------------------------|
| Vests (e.g. T-shirts, casual tops) in general | A41D 1/04 |
| Brassieres combined with corsets | A41C 1/06 |
| Brassieres combined with other garments | A41C 3/08 |

A41D 1/21

Maternity clothing; Clothing specially adapted for persons caring for infants

Definition statement

This place covers:

Illustrative examples of subject matter classified in this group.

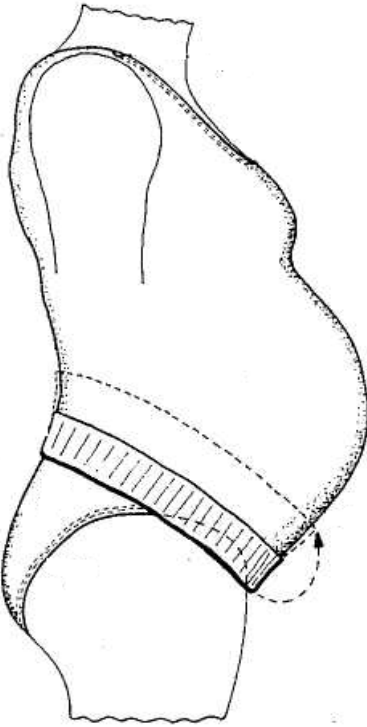

References

Informative references

Attention is drawn to the following places, which may be of interest for search:

| | |
|-------------------|---------------------------|
| Maternity corsets | A41C 1/10 |
|-------------------|---------------------------|

A41D 1/215

Nursing clothing, e.g. for breastfeeding

Definition statement

This place covers:

Illustrative example of subject matter classified in this group.

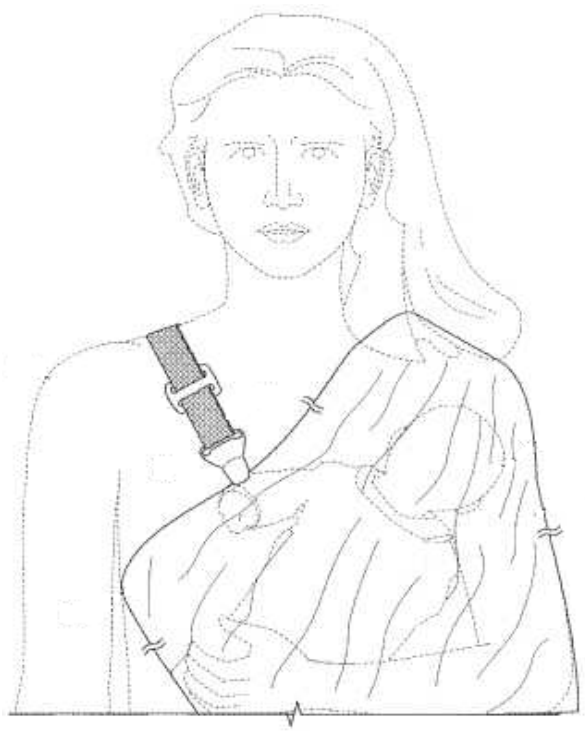

Comprises also other clothes worn by infant carer, i.e. stimulating baby

References

Informative references

Attention is drawn to the following places, which may be of interest for search:

| | |
|------------------------|-----------------------------|
| Baby-carriers | A47D 13/025 |
| Infant toys | A63H 33/006 |
| Educational appliances | G09B 1/00 |

A41D 1/22

Clothing specially adapted for women, not otherwise provided for

Definition statement

This place covers:

Comprises dresses and cleavage covers.

Illustrative example of subject matter classified in this group.

Cleavage cover

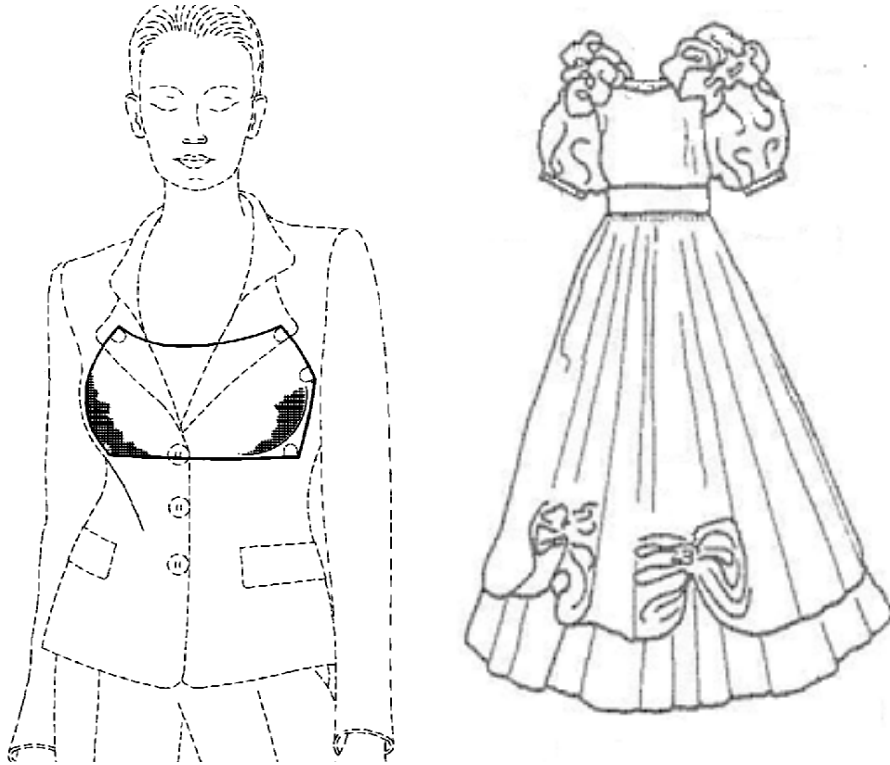

A41D 3/00

Overgarments (fur garments [A41D 5/00](#); for children [A41D 11/00](#); professional or sporting protective garments [A41D 13/00](#))

Definition statement

This place covers:

Outer jackets.

Illustrative examples of subject matter classified in this group.

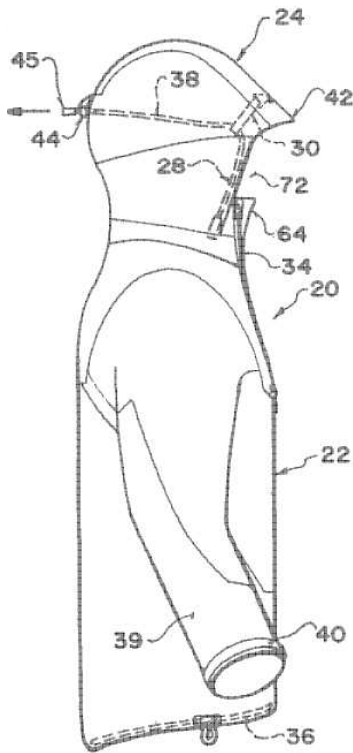

Relationships with other classification places

According to the Warning after the subclass title, the nature of the references in this subclass has not been determined as yet. Therefore, when classifying in [A41D 3/00](#), fur garments should also be classified in [A41D 5/00](#), until counter notice.

References

Informative references

Attention is drawn to the following places, which may be of interest for search:

| | |
|--|----------------------------|
| Suit jackets | A41D 1/02 |
| Non-outerwear vests | A41D 1/04 |
| Garments for children | A41D 11/00 |
| Professional, industrial or sporting protective garments | A41D 13/00 |
| Hoods attachable to clothing | A42B 1/048 |

Special rules of classification

References [A41D 5/00](#), [A41D 11/00](#) and [A41D 13/00](#) are non-limiting in the group [A41D 3/00](#). CPC will be updated/corrected once this inconsistency is resolved in IPC.

A41D 3/02

Overcoats

Definition statement

This place covers:

Illustrative example of subject matter classified in this group.

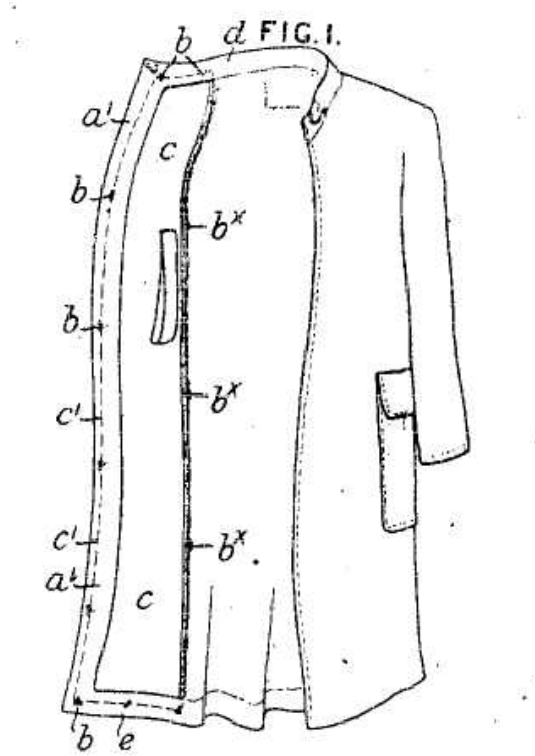

A41D 3/04

Raincoats

Definition statement

This place covers:

Illustrative example of subject matter classified in this group.

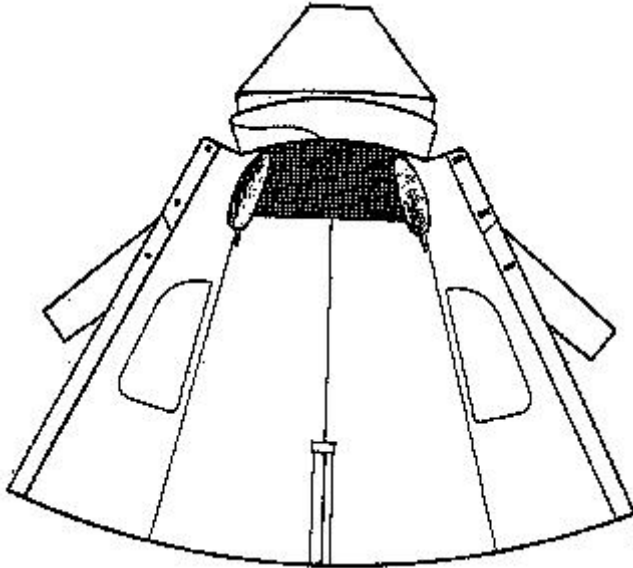

A41D 3/06

with leg-protecting means

Definition statement

This place covers:

Illustrative example of subject matter classified in this group.

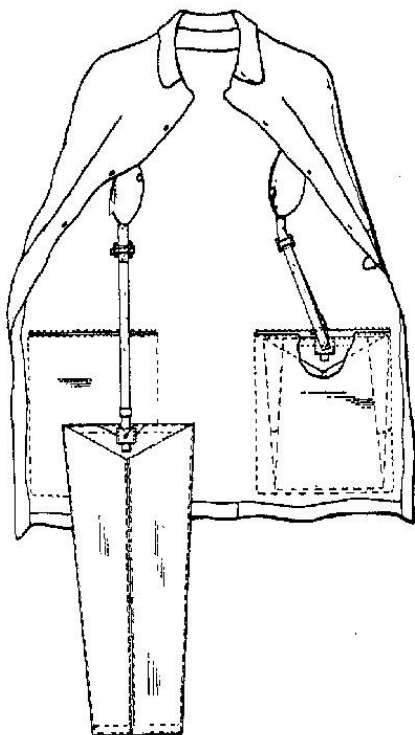

References

Informative references

Attention is drawn to the following places, which may be of interest for search:

| | |
|--|----------------------------|
| Leggings, rain protectors for legs alone | A41D 17/02 |
|--|----------------------------|

A41D 3/08

Capes

Definition statement

This place covers:

Illustrative example of subject matter classified in this group.

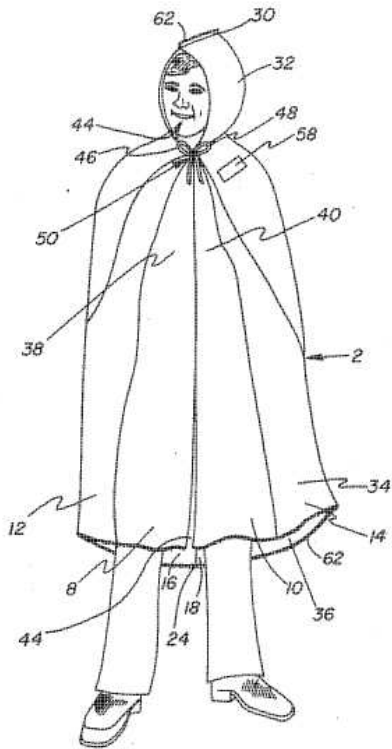

References

Informative references

Attention is drawn to the following places, which may be of interest for search:

| | |
|--------------------------|----------------------------|
| Cover for sitting person | A47G 9/066 |
|--------------------------|----------------------------|

A41D 5/00

Fur garments; Garments of fur substitutes

Definition statement

This place covers:

Illustrative examples of subject matter classified in this group.

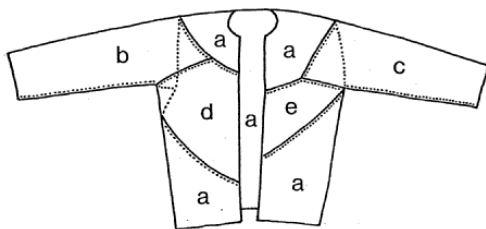
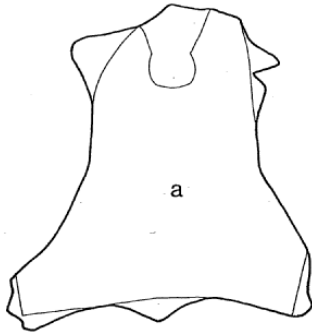

References

Informative references

Attention is drawn to the following places, which may be of interest for search:

| | |
|--|----------------------------|
| Making garments from natural or artificial fur | A41H 41/00 |
| Making articles from leather | B68F 1/00 |
| Manufacture and treatment of leather | C14B 1/00 |
| Artificial leather | D06N 3/00 |

A41D 5/003**{Garments of fur substitutes}****Definition statement***This place covers:*

Illustrative example of subject matter classified in this group.

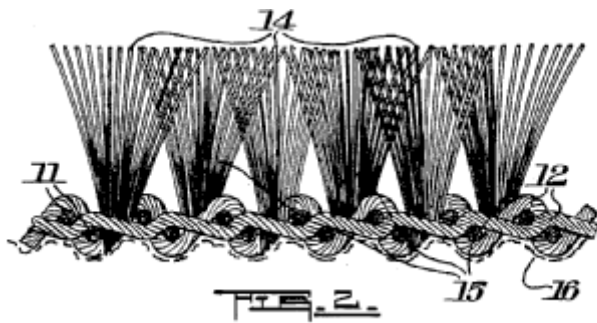
**A41D 5/006****{Accessories for fur garments, e.g. fur fasteners, artificial animal heads (fastening devices specially adapted for garments in general [A41F 1/00](#))}****Definition statement***This place covers:*

Illustrative example of subject matter classified in this group.

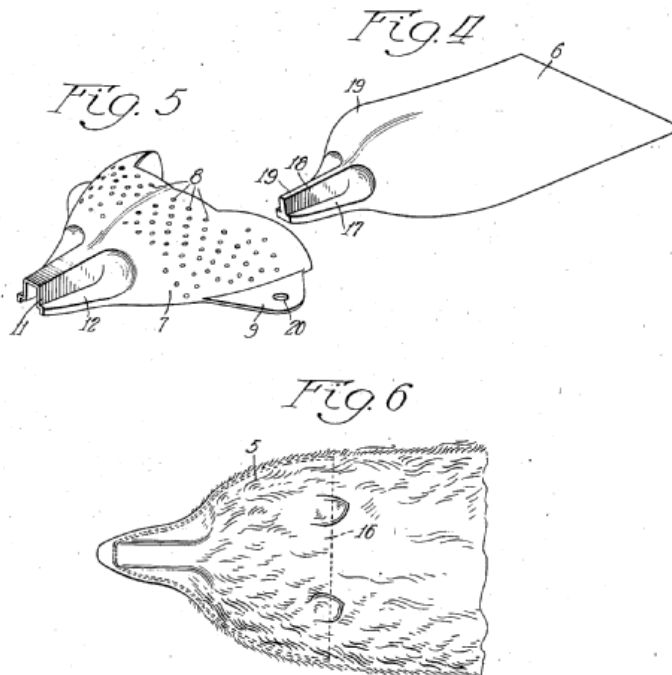

A41D 7/00

Bathing gowns; Swim-suits, drawers, or trunks; Beach suits

Definition statement

This place covers:

Illustrative examples of subject matter classified in this group.

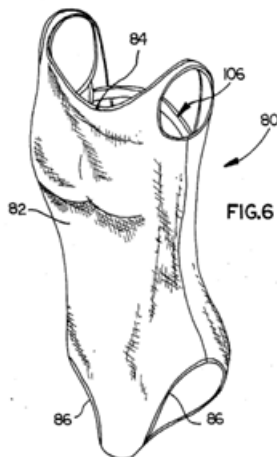

References

Informative references

Attention is drawn to the following places, which may be of interest for search:

| | |
|--------------|---------------------------|
| Bathing caps | A42B 1/12 |
|--------------|---------------------------|

A41D 7/001

{Non-sinkable swim-suits, drawers or trunks (life-saving equipment in water [B63C 9/08](#))}

Definition statement

This place covers:

Swimwear having an insert, attachment or feature which enables floating or prevents sinking, such as a buoyant foam element.

Illustrative example of subject matter classified in this group.

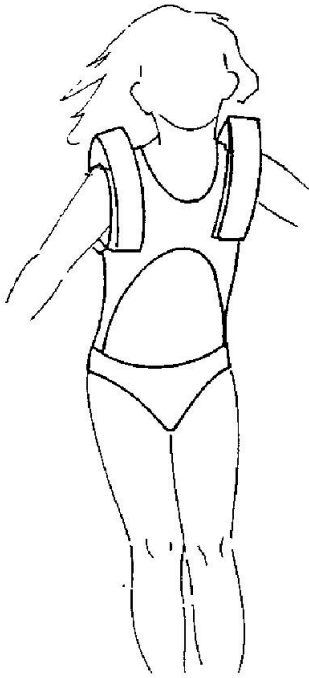

References

Limiting references

This place does not cover:

| | |
|--------------------------------|---------------------------|
| Life-saving equipment in water | B63C 9/08 |
|--------------------------------|---------------------------|

A41D 7/003

{provided with inflatable elements}

Definition statement

This place covers:

Illustrative example of subject matter classified in this group.

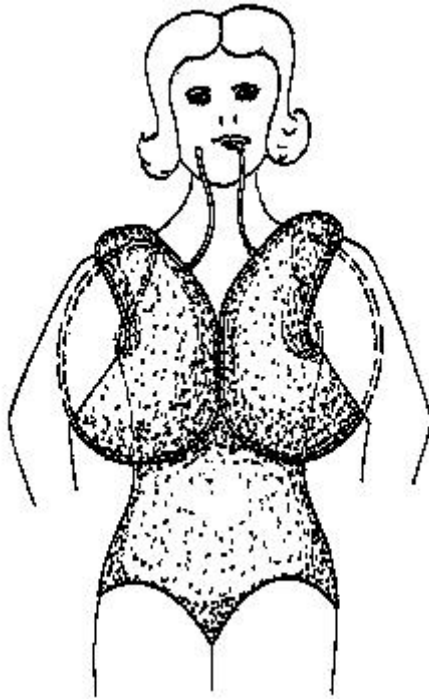

A41D 7/005

{Bathing drawers or trunks ([A41D 7/001](#) takes precedence)}

Definition statement

This place covers:

Comprises bermuda swimming shorts.

Illustrative example of subject matter classified in this group.

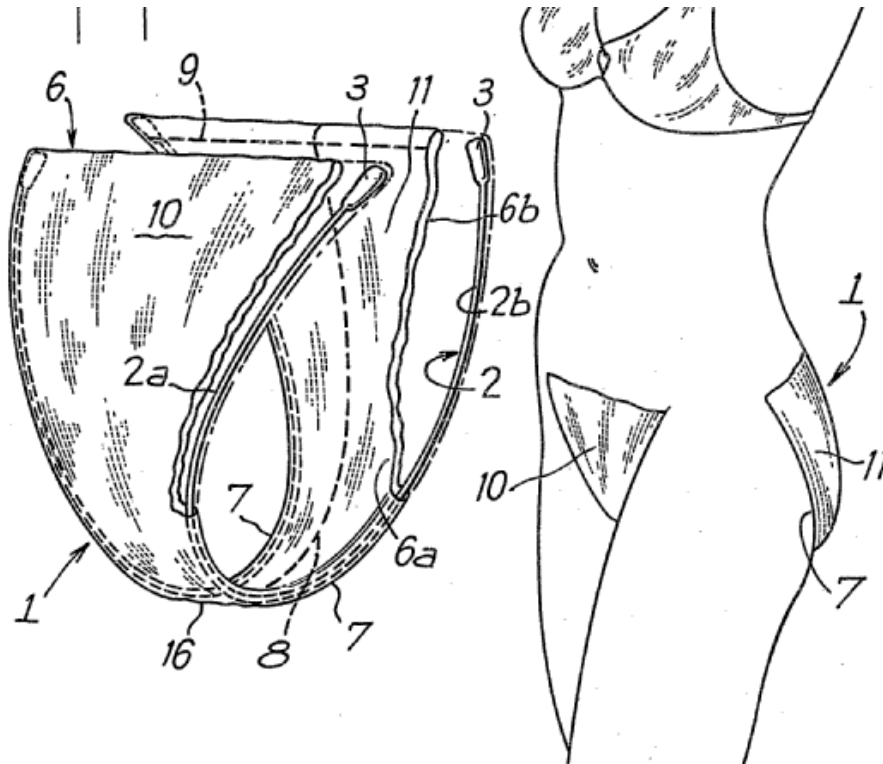

References

Limiting references

This place does not cover:

| | |
|--|----------------------------|
| Non-sinkable swim-suits, drawers or trunks | A41D 7/001 |
|--|----------------------------|

Informative references

Attention is drawn to the following places, which may be of interest for search:

| | |
|--------|----------------------------|
| Shorts | A41D 1/089 |
|--------|----------------------------|

A41D 7/006**{Beach clothing not designed for swimming}****Definition statement***This place covers:*

Illustrative example of subject matter classified in this group.

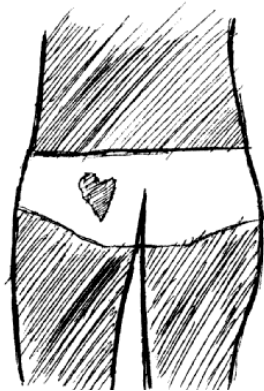
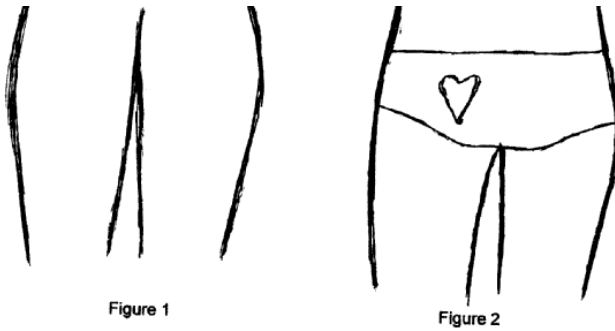
**References****Informative references***Attention is drawn to the following places, which may be of interest for search:*

| | |
|--|---|
| UV or other ranges of light protection | A41D 2400/26 |
| UV or other ranges of light permeability | A41D 2400/28 |
| Umbrellas | A45B 25/20 |
| Topical barriers, i.e. suncreams | A61K 8/0208 , A61Q 17/04 |
| Radiation therapy | A61N 5/0613 , A61N 2005/0645 |
| Fiber treatment | D06M 11/67 , D06M 23/00 |
| Dyeing textiles | D06P 1/00 |
| Outdoor fabrics for tents | D10B 2505/18 |
| Sun-shades | E04F 10/02 |
| Tents | E04H 15/54 |
| Filters with dyes | G02B 5/223 , G02B 5/208 |

A41D 7/008**{Beach capes or robes}****Definition statement***This place covers:*

Illustrative example of subject matter classified in this group.

**References****Informative references***Attention is drawn to the following places, which may be of interest for search:*

| | |
|--------------------------------|----------------------------|
| Towels, body-drying implements | A47K 10/02 |
|--------------------------------|----------------------------|

A41D 10/00**Pyjamas; Nightdresses****Definition statement***This place covers:*

Sleeping-bags with the shape of a garment used as pyjamas for adults.

Illustrative examples of subject matter classified in this group.

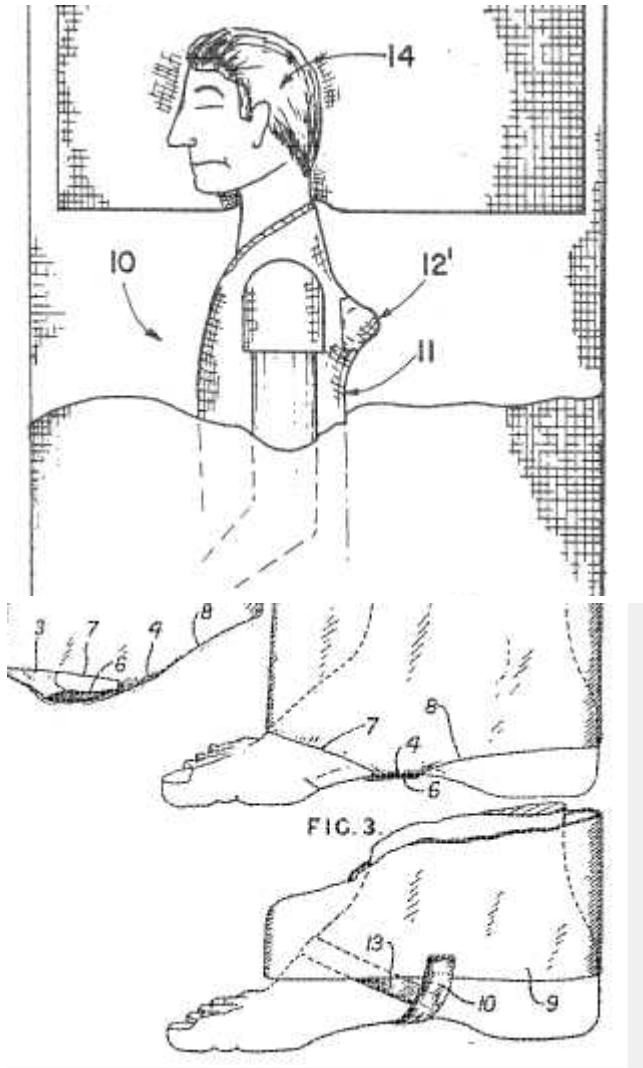

Relationships with other classification places

Always consider classification of sleeping-bags in group [A47G 9/08](#).

References

Informative references

Attention is drawn to the following places, which may be of interest for search:

| | |
|--|----------------------------|
| Sleeping-bags with the shape of a garment used as pyjamas for babies | A41B 13/06 |
|--|----------------------------|

A41D 11/00

Garments for children

Definition statement

This place covers:

Illustrative example of subject matter classified in this group.

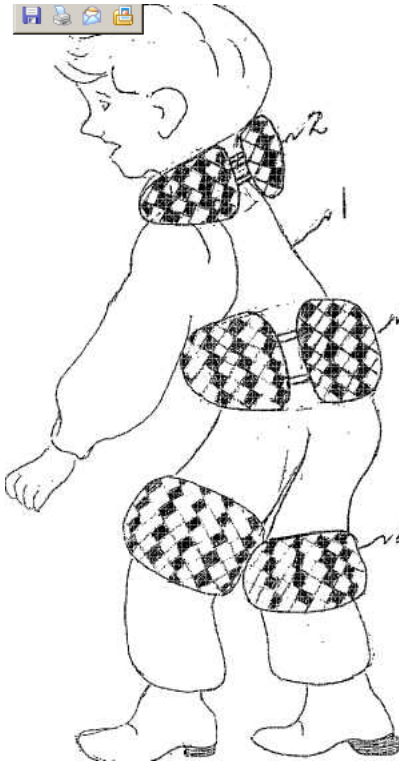

References

Informative references

Attention is drawn to the following places, which may be of interest for search:

| | |
|--------------------------------------|-----------------------------|
| Baby Linen | A41B 13/00 |
| Height measuring | A61B 5/1072 |
| Babies' nappies or holders therefore | A61F 13/15 |

A41D 13/00

Professional, industrial or sporting protective garments, e.g. surgeons' gowns or garments protecting against blows or punches (helmets [A42B 3/00](#); clothing affording protection against chemical agents or for use at high altitudes [A62B 17/00](#); life-saving garments for use at sea, diving suits [B63C](#); bulletproof or armoured clothing [F41H](#); clothing affording protection against radiation [G21F 3/02](#))

References

Limiting references

This place does not cover:

| | |
|--|-----------------------------|
| Helmets | A42B 3/00 |
| Clothing affording protection against chemical agents or for use at high altitudes | A62B 17/00 |
| Fire-fighters' clothes | A62B 17/003 |
| ABC suits (against chemical/ biological/ toxic environment) | A62B 17/006 |
| Life-saving garments for use at sea, diving suits | B63C |
| Bulletproof or armoured clothing | F41H |
| Bulletproof vest | F41H 1/02 |
| Camouflage flexible covers, screens, nets | F41H 3/02 |
| Clothing affording protection against radiation | G21F 3/02 |
| Clothing protecting against X radiations | G21F 3/025 |

Informative references

Attention is drawn to the following places, which may be of interest for search:

| | |
|---|---------------------------|
| Materials for clothing protecting against harmful chemical agents | A62D 5/00 |
|---|---------------------------|

Special rules of classification

Comprises protective clothing having camouflage pattern.

For materials of protective clothing having camouflage pattern class in [A41D 31/04](#).

Looping references between [A41D 13/00](#) and [A62B 17/00](#) have been identified. Until this inconsistency is resolved, the current classification practice in CPC is as follows: for clothing affording protection against chemical agents or for use at high altitudes classify in [A62B 17/00](#) and do not classify in [A41D 13/00](#).

In particular for ABC suits (used to protect against chemical/biological/toxic environment) classify in [A62B 17/006](#) and do not classify in [A41D 13/00](#).

A41D 13/0005

{Joints}

Definition statement

This place covers:

Illustrative examples of subject matter classified in this group.

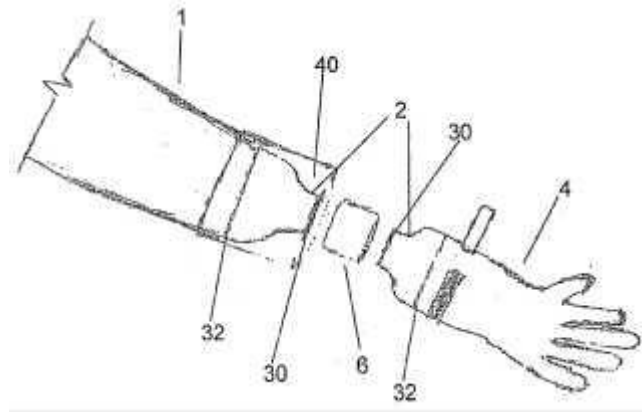

□ 12. [DE102008045572](#) - Protective clothing, particularly protective suit or protective trousers, has two collars that rest on each other for sealing connection between protective clothing and each protective section

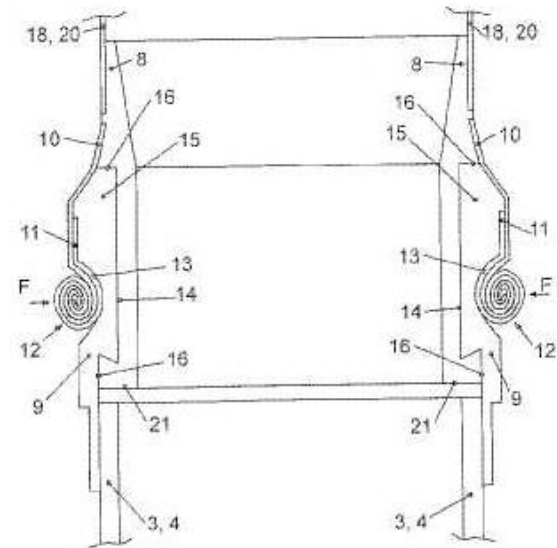

Special rules of classification

Comprises sealing attachments between protective garments, also glove and protective garment sealing attachments.

For glove and sleeve attachments without sealing class either in [A41D 19/0089](#) or [A41D 19/0041](#).

A41D 13/0007**{Garments with built-in harnesses (safety harnesses [A62B 35/00](#))}****Definition statement***This place covers:*

Illustrative example of subject matter classified in this group.

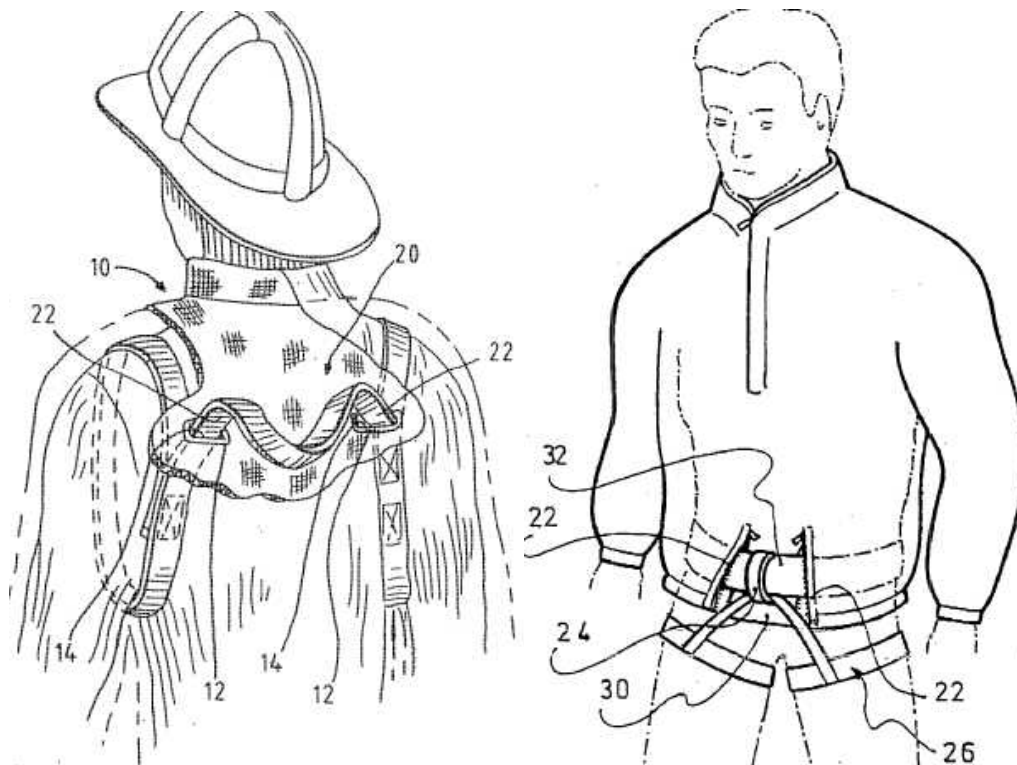
**References****Limiting references***This place does not cover:*

| | |
|------------------|----------------------------|
| Safety harnesses | A62B 35/00 |
|------------------|----------------------------|

Informative references*Attention is drawn to the following places, which may be of interest for search:*

| | |
|---|-----------------------------|
| Carrying straps | A45F 3/14 |
| Safety harnesses for already walking children | A47D 13/086 |
| Devices for lifting disabled patients | A61G 7/1023 |
| Life-saving, parachutes with clothing | A62B 35/00 |
| Parachutes with harnesses | B64D 17/30 |

A41D 13/001

{Garments protecting against insects}

Definition statement

This place covers:

Illustrative example of subject matter classified in this group.

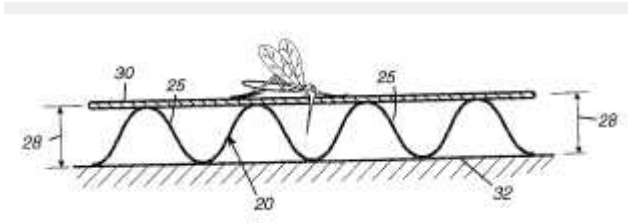

Special rules of classification

For layered textiles in garments protecting against insects class only in [A41D 13/001](#).

A41D 13/0012

{Professional or protective garments with pockets for particular uses, e.g. game pockets or with holding means for tools or the like}

Definition statement

This place covers:

Illustrative example of subject matter classified in this group.

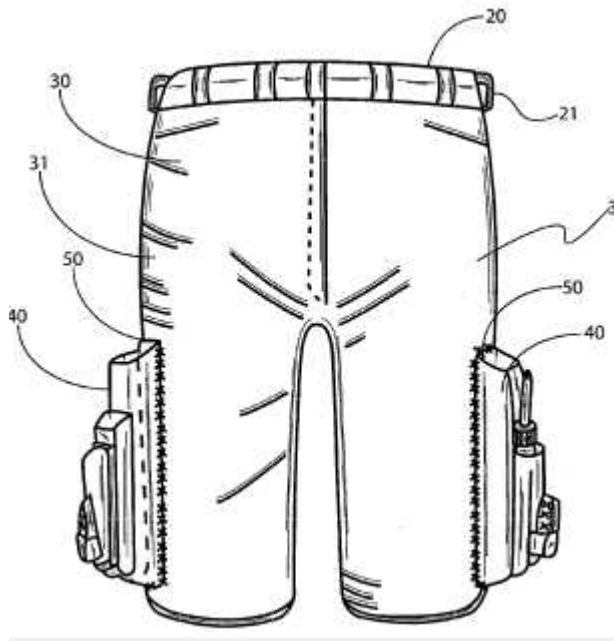

Special rules of classification

For professional or protective garments with pockets where the construction of the pocket is relevant per se class in [A41D 27/20](#) and lower groups and as additional information in [A41D 13/0012](#).

For medical staff garments with pockets for holding medical supplies class in [A41D 13/12](#) and in [A41D 13/0012](#).

A41D 13/0015

{Sports garments other than provided for in groups [A41D 13/0007](#) - [A41D 13/088](#)}

Definition statement

This place covers:

Illustrative example of subject matter classified in this group.

Figure 1.



References

Informative references

Attention is drawn to the following places, which may be of interest for search:

| | |
|--|------------------------------|
| Sportive tights | A41D 1/08 |
| Professional or sportive protective overalls | A41D 13/02 |
| Elastic materials in outerwear | A41D 31/18 |
| Layered elastic materials in outerwear | A41D 31/185 |
| Underwear panty-hose /body stocking | A41B 11/14 |
| Elastic trousers with curative purposes, compression stockings | A61F 13/08 |
| Elastic bands for exercising muscles | A63B 21/0552 |
| Weighted exercise suits | A63B 21/065 |
| Elastic bands for exercising muscles worn on body | A63B 21/4025 |

Special rules of classification

Comprises garments with embedded elastic bands but no compression garments which have a curative or medical effect.

For underwear panti-hose class in [A41B 11/14](#) and lower groups.

For sportive tights class in [A41D 1/08](#) and lower groups.

For underwear body stockings class in [A41B 11/14](#).

For professional or sportive protective overalls class in [A41D 13/02](#).

For sportive garments with embedded elastic bands but no compression class in [A41D 13/0015](#) or [A41D 31/18](#) or [A41D 31/185](#).

For compression stockings forward to [A61F 13/08](#).

A41D 13/0017

{specially adapted for women}

Definition statement

This place covers:

Illustrative example of subject matter classified in this group.

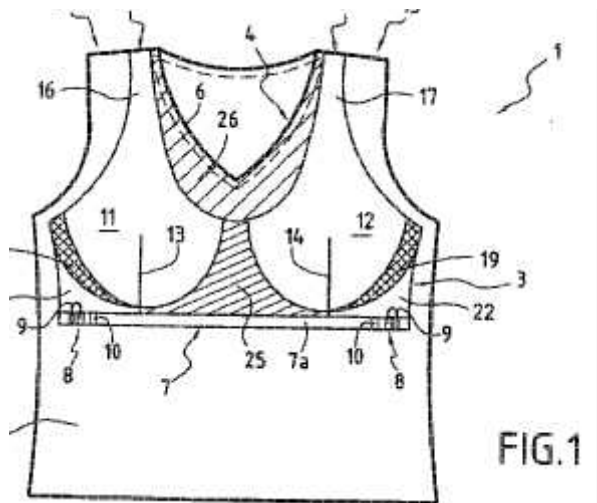

A41D 13/002

with controlled internal environment

Definition statement

This place covers:

Illustrative example of subject matter classified in this group.

- Figure 1.

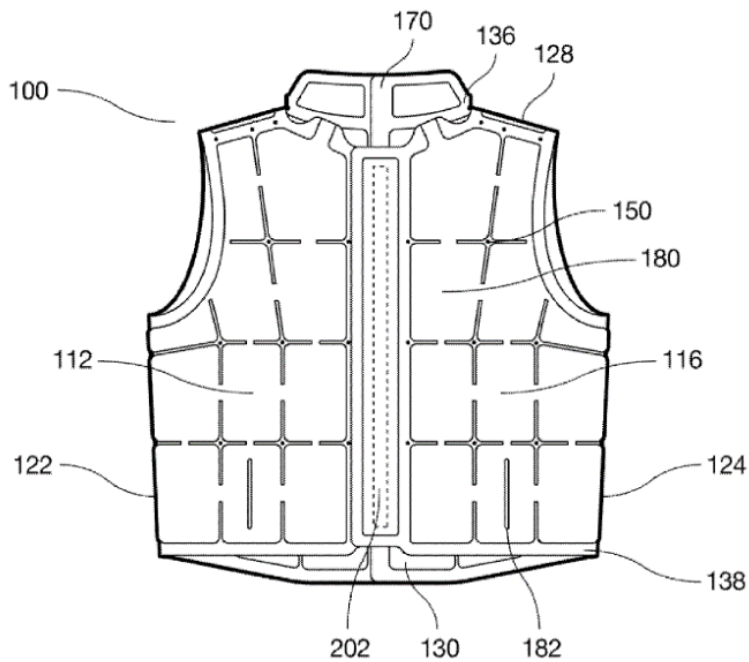

Relationships with other classification places

- Every time there's any kind of ventilation classify in [A41D 27/28](#).
- When ventilation is done transversally (perpendicular) to the fabric: classify only in [A41D 27/28](#).
- When ventilation is done parallel to the fabric (i.e. with channels): classify in [A41D 31/14](#) in addition to [A41D 27/28](#).
- When ventilation is also used to regulate inside conditions (temperature, humidity etc.): to be classified as additional information in [A41D 13/002](#).
- When there are sweat handling or wicking properties, (i.e. sweat transport in ventilation channels): to be classified as additional information in [A41D 31/12](#) or [A41D 31/125](#).

A41D 13/0025

{by means of forced air circulation}

Definition statement

This place covers:

Illustrative example of subject matter classified in this group.

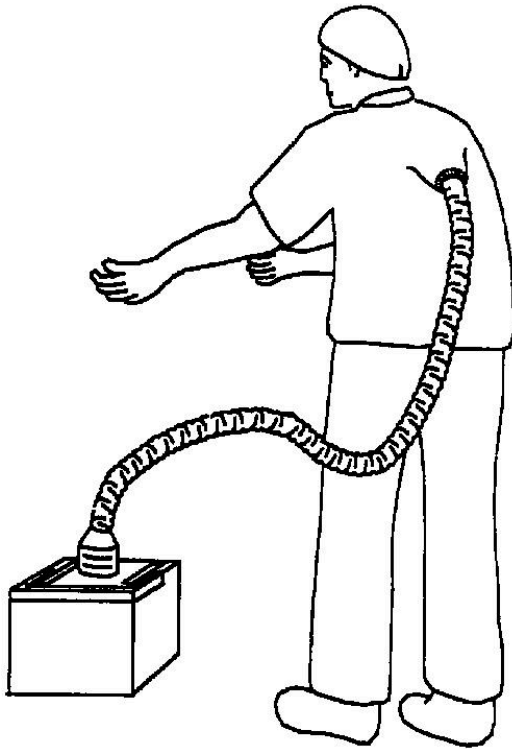

References

Informative references

Attention is drawn to the following places, which may be of interest for search:

| | |
|---------------------------------|-----------------------------|
| Furniture ventilated covers | A47C 7/742 |
| Vehicle's seat with ventilation | B60N 2/5621 |
| Portable air-conditioner units | F24F 1/04 |

A41D 13/005**with controlled temperature****Definition statement***This place covers:*

Illustrative example of subject matter classified in this group.

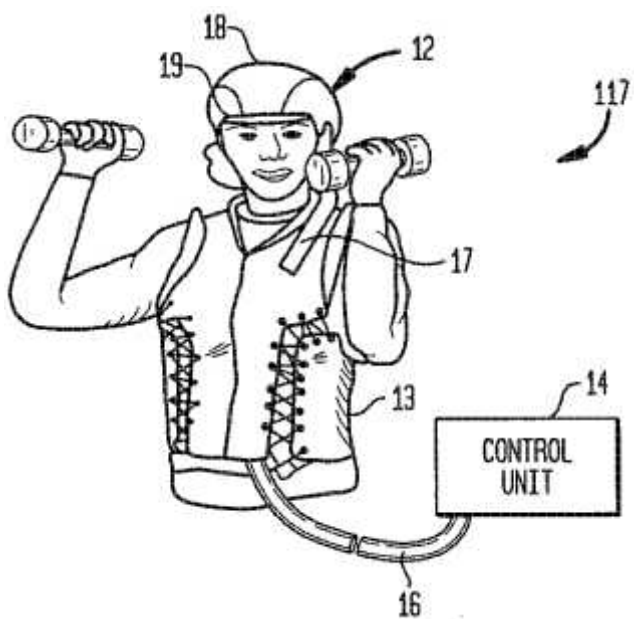
**References****Informative references***Attention is drawn to the following places, which may be of interest for search:*

| | |
|--|--------------------------------|
| Heating / Cooling therapy | A61F 7/02 |
| Heating / cooling incorporated in clothing | A61F 2007/0233 |
| Heat-exchange apparatus (also coolers) with conduits | F28D 15/00 |

A41D 13/0051**{Heated garments (heated divers' suits [B63C 11/28](#))}****Definition statement***This place covers:*

Illustrative example of subject matter classified in this group.

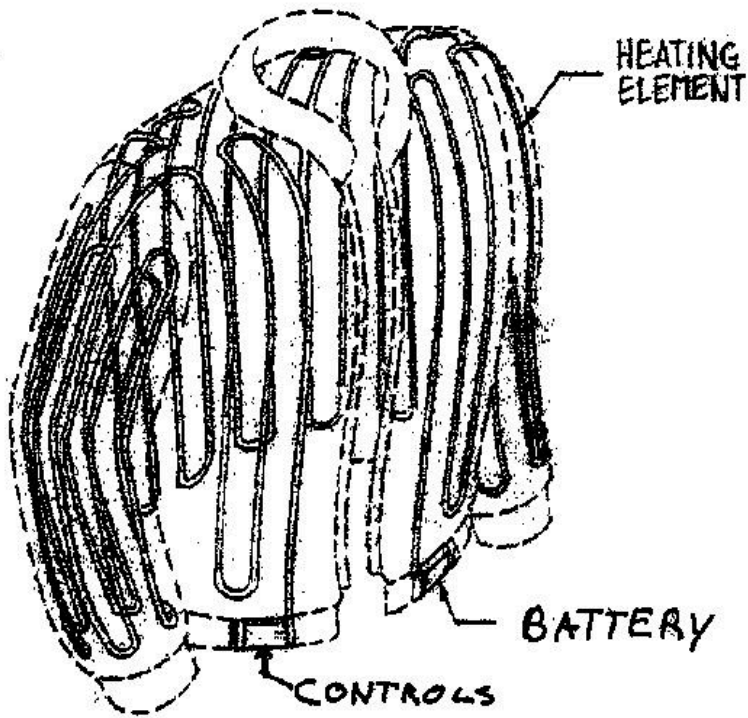
**References****Informative references***Attention is drawn to the following places, which may be of interest for search:*

| | |
|--|--------------------------------|
| Heating / Cooling therapy | A61F 7/02 |
| Heating / cooling incorporated in clothing | A61F 2007/0233 |
| Ohmic resist. heating in clothes | H05B 3/342 |

A41D 13/0053**{Cooled garments}****Definition statement***This place covers:*

Illustrative examples of subject matter classified in this group.

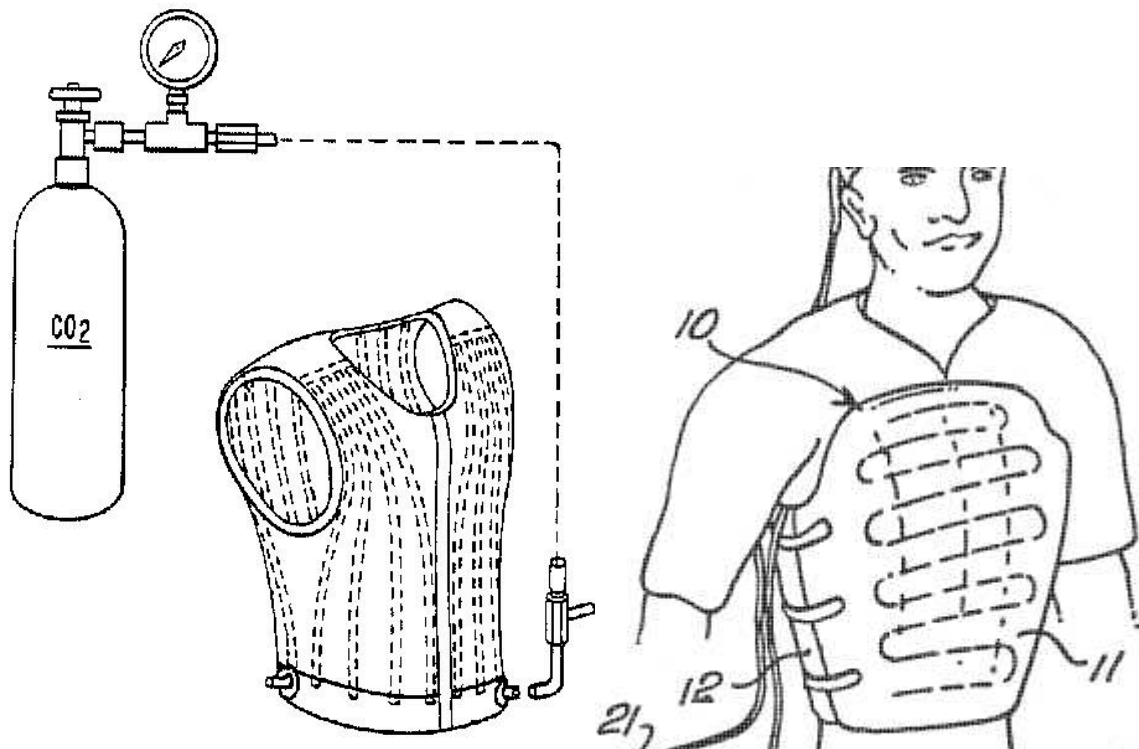
**References****Informative references***Attention is drawn to the following places, which may be of interest for search:*

| | |
|--|--------------------------------|
| Heating / Cooling therapy | A61F 7/02 |
| Heating / cooling incorporated in clothing | A61F 2007/0233 |
| Heat-exchange apparatus (also coolers) with conduits | F28D 15/00 |

A41D 13/0055**{by means of dry ice}****Definition statement***This place covers:*

Comprises dry ice, ice packs, gel packs.

Illustrative examples:

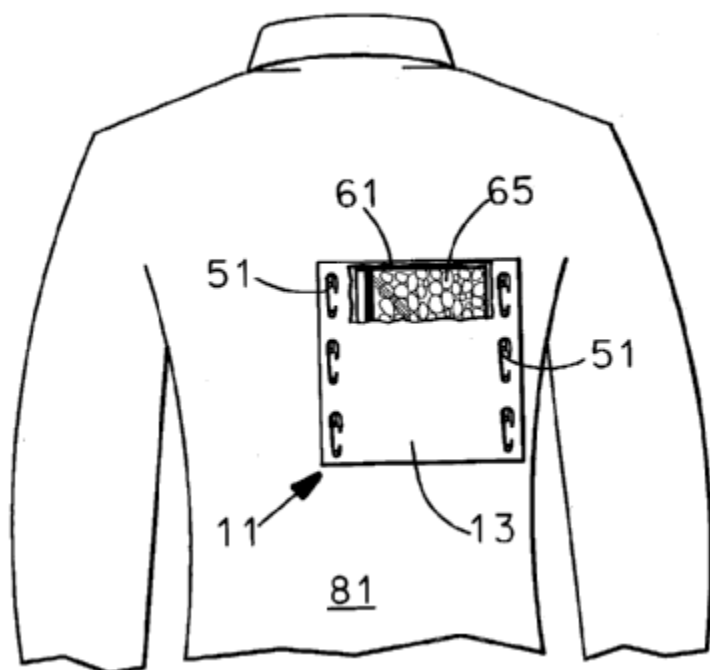
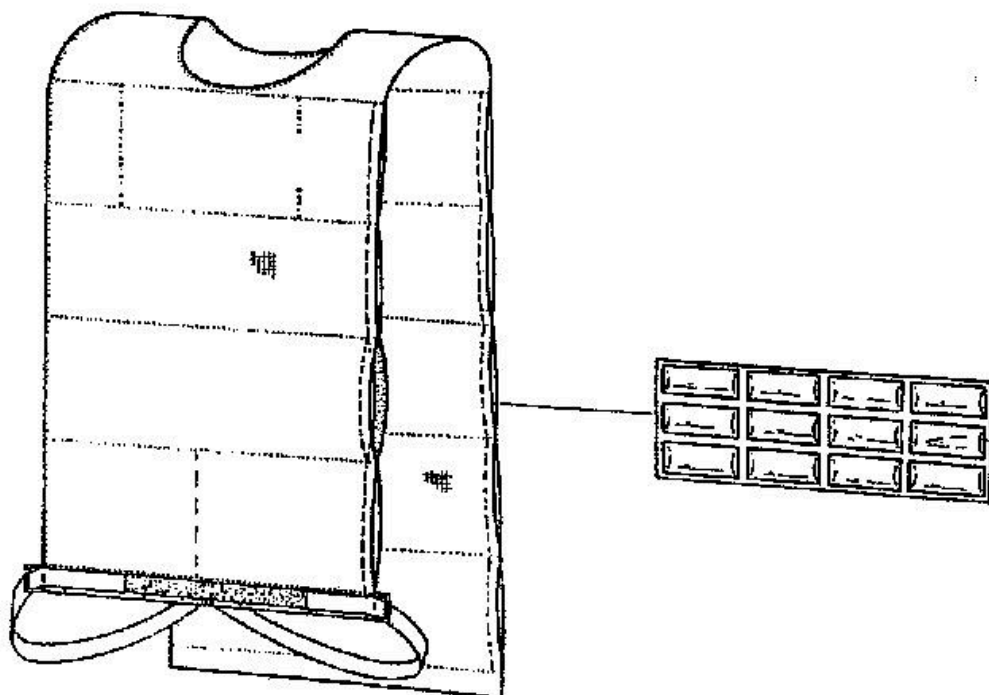

References

Informative references

Attention is drawn to the following places, which may be of interest for search:

| | |
|--|----------------------------|
| Ice-bags for therapeutic uses | A61F 7/10 |
| Cold exchangers, ice pockets | F25D 3/08 |
| Heat-storage apparatus in general, using latent heat | F28D 20/02 |

A41D 13/008

protecting against electric shocks or static electricity

Definition statement

This place covers:

Illustrative example of subject matter classified in this group.

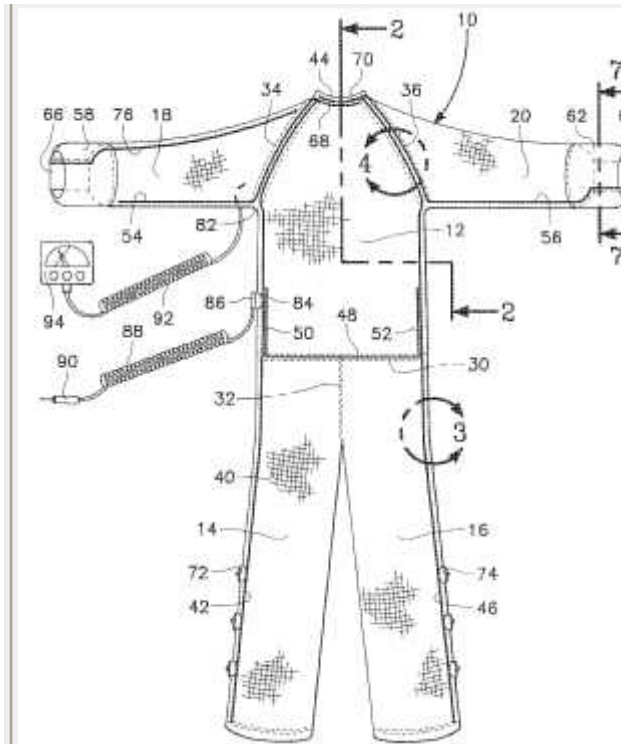
**References****Informative references**

Attention is drawn to the following places, which may be of interest for search:

| | |
|----------------------|----------------------------|
| Lightning conductors | H02G 13/00 |
|----------------------|----------------------------|

A41D 13/01

with reflective or luminous safety means {(visible signalling arrangements [G08B 5/00](#))}

References**Informative references**

Attention is drawn to the following places, which may be of interest for search:

| | |
|--|---|
| Lighting signalling worn by driver | B60Q 1/2673 , B60Q 7/00 |
| Lighting with clothing | F21V 33/0008 |
| Refracting surfaces | G02B 5/126 |
| Visible signalling arrangements attached on persons, reflective safety belts | G08B 5/004 |

| | |
|---|---|
| Indicating arrangements with diodes | G09F 9/33 |
| Illuminated signs | G09F 13/00 |
| Reflective surfaces radiated with aerials/antenna | H01Q 15/14 , H01Q 1/273 |

A41D 13/012

for aquatic activities, e.g. with buoyancy aids

Definition statement

This place covers:

Illustrative example of subject matter classified in this group.

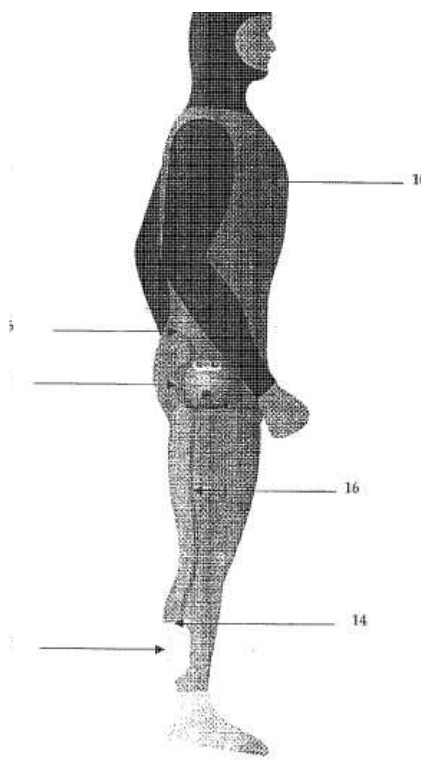

References

Informative references

Attention is drawn to the following places, which may be of interest for search:

| | |
|----------------------------|----------------------------|
| Boots with waterproof legs | A43B 23/06 |
| Life-jackets | B63C 9/11 |
| Diving suits | B63C 11/04 |

A41D 13/0125**{with buoyancy aids}****Definition statement***This place covers:*

Illustrative example of subject matter classified in this group.

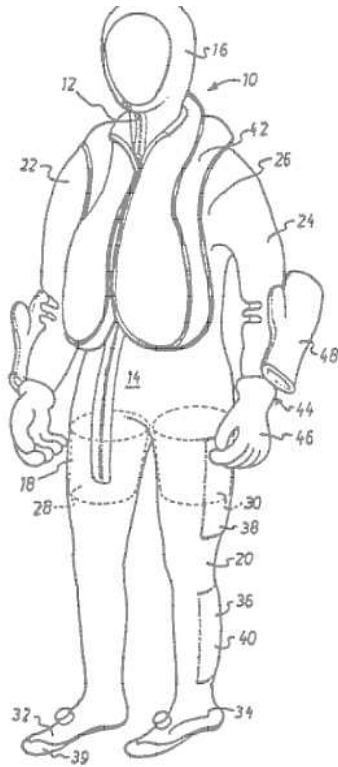
**References****Informative references***Attention is drawn to the following places, which may be of interest for search:*

| | |
|-----------------------|-----------------------------|
| Inflatable body suits | B63C 9/1055 |
|-----------------------|-----------------------------|

A41D 13/015**with shock-absorbing means ([A41D 13/05](#) takes precedence)****Definition statement***This place covers:*

Shock-absorbing means in general, i.e. pads.

Illustrative examples:

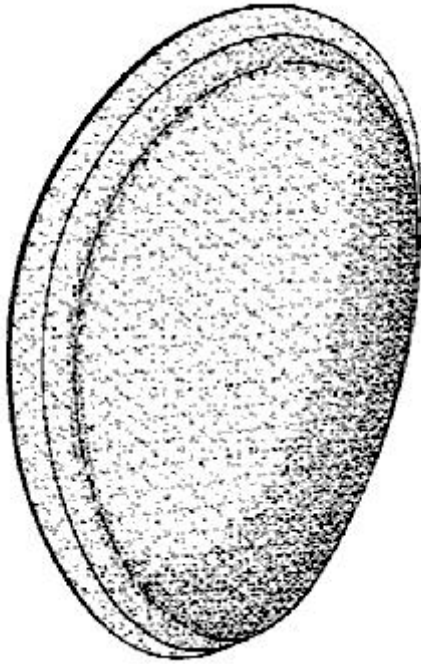

Fluid filled body padding for fall protection

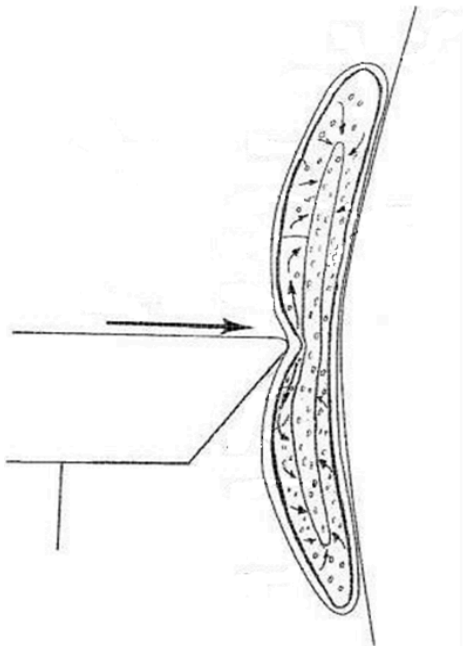

Relationships with other classification places

If the shock-absorbing is relevant per se, it should also be classified in [A41D 13/015](#).

Protection of body parts not included in the subgroups of [A41D 13/05](#) and protection for several body parts in the same garment, are classified in [A41D 13/05](#).

References

Informative references

Attention is drawn to the following places, which may be of interest for search:

| | |
|---|----------------------------|
| Cycling pants (with saddle reinforcements and padding) | A41D 1/084 |
| Protecting only a particular body part | A41D 13/05 |
| Materials of protective garments with shock absorbing means | A41D 31/28 |

Special rules of classification

Reference [A41D 13/05](#) is non-limiting in the subgroup [A41D 13/015](#). CPC will be updated/corrected once this inconsistency is resolved in IPC.

A41D 13/0151

{Shooting jackets with a recoil pad}

Definition statement

This place covers:

Comprises also archery protectors in the form of a garment.

Illustrative example:



References

Informative references

Attention is drawn to the following places, which may be of interest for search:

| | |
|-------------------------|------------------------------|
| Archery | A63B 2244/04 |
| Accessories for archery | F41B 5/14 |

Special rules of classification

When protector is only for the arm, classify in [A41D 13/08](#).

A41D 13/018

inflatable automatically

Definition statement

This place covers:

Illustrative example of subject matter classified in this group.

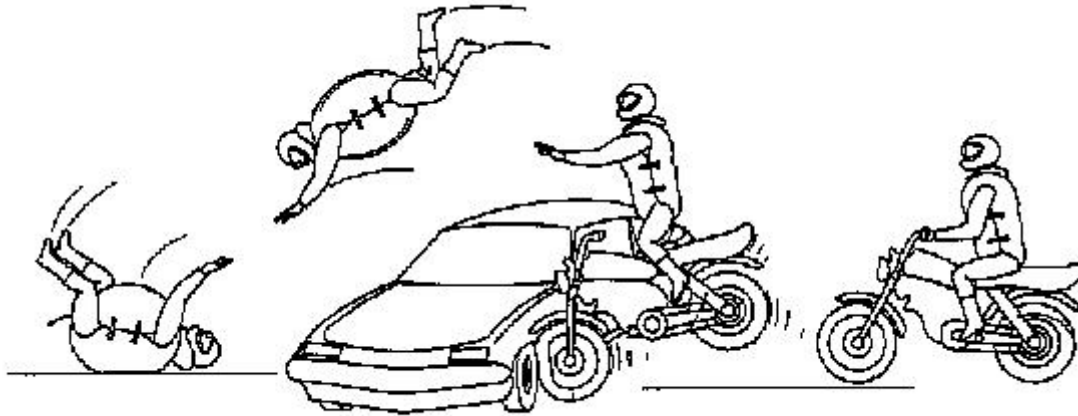

References

Informative references

Attention is drawn to the following places, which may be of interest for search:

| | |
|--------------------------------|------------------------------|
| Backpacks with shoulder straps | A45F 3/04 |
| Airbag triggering | B60R 21/0132 |
| Motorcycle safety equipment | B62J 27/00 |

A41D 13/02

Overalls {, e.g. bodysuits or bib overalls} (sweating suits [A61H 36/00](#))

Definition statement

This place covers:

One-piece garments having an upper body portion (e.g. short or long sleeve top, bib secured by shoulder straps, etc.) and a lower body portion (e.g. pants, shorts, etc.).

Illustrative example of subject matter classified in this group.

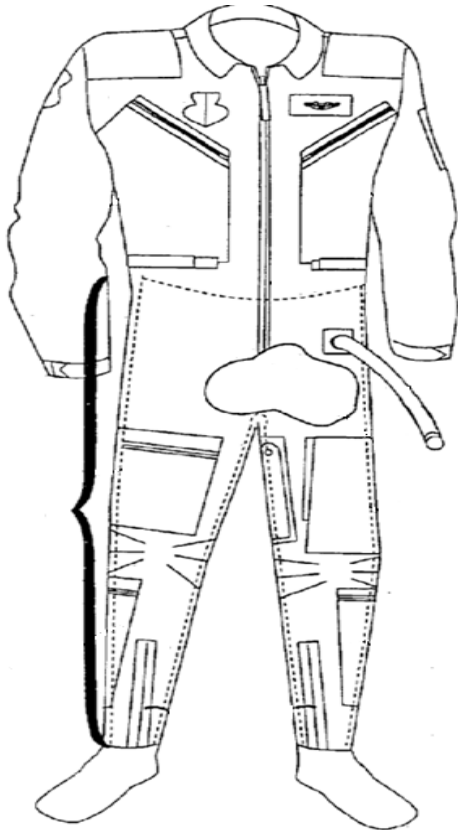

Relationships with other classification places

Sportive garments with embedded elastic bands but no compression are classified in groups [A41D 13/0015](#) or [A41D 31/18](#) or [A41D 31/185](#).

References

Limiting references

This place does not cover:

| | |
|----------------|----------------------------|
| Sweating suits | A61H 36/00 |
|----------------|----------------------------|

Informative references

Attention is drawn to the following places, which may be of interest for search:

| | |
|---|------------------------------|
| Patient suits | A41D 13/1263 |
| Drop-seat openings (donning facilities). | A41D 2400/44 |
| Underwear body stockings | A41B 11/14 |
| Baby overalls | A41B 13/005 |
| Compression tights, elastic garments with curative purposes | A61F 13/08 |
| Flight suits | B64D 10/00 |
| Packaging for clothing | B65D 85/18 |

A41D 13/04

Aprons; Fastening devices for aprons

Definition statement

This place covers:

Illustrative example of subject matter classified in this group.

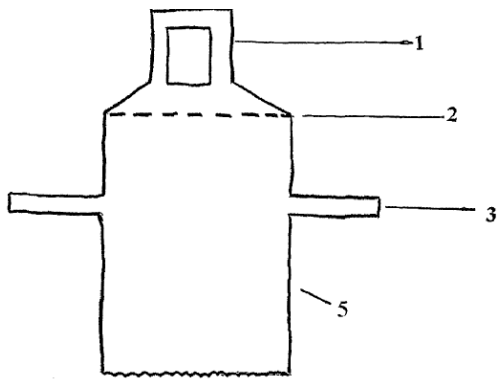
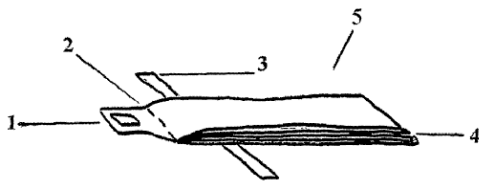

Figure 1 (Front view)



References

Informative references

Attention is drawn to the following places, which may be of interest for search:

| | |
|--|------------------------------|
| Toilet/cosmetic protecting mantles, shoulder-shields, bibs (hairdresser) | A45D 44/08 |
| Napkins attachable to clothing | A47G 11/002 |
| Napkin with separate holding devices | A47G 21/165 |
| Lap trays | A47G 23/0608 |
| Surgical drapes | A61B 46/00 |

Special rules of classification

When protection is for children/babies, class in bibs [A41B 13/10](#). When protection is for adults, class in aprons [A41D 13/04](#).

For protectors of neckties class in [A41D 25/00](#).

A41D 13/043

{Aprons resistant to mechanical aggressions, e.g. butcher's aprons}

Definition statement

This place covers:

Illustrative example of subject matter classified in this group.

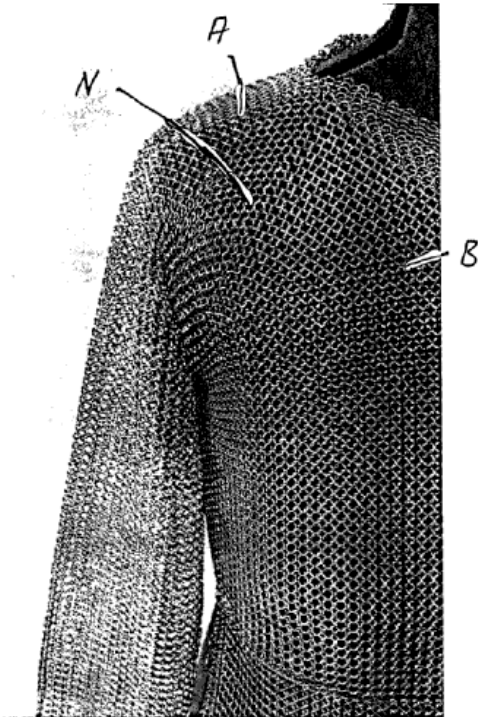

References

Informative references

Attention is drawn to the following places, which may be of interest for search:

| | |
|----------------------------|-----------------------------|
| Armour plate constructions | F41H 5/0492 |
|----------------------------|-----------------------------|

A41D 13/046

{Aprons secured to the user by means of one or more split hoops of resilient material}

Definition statement

This place covers:

Illustrative example of subject matter classified in this group.

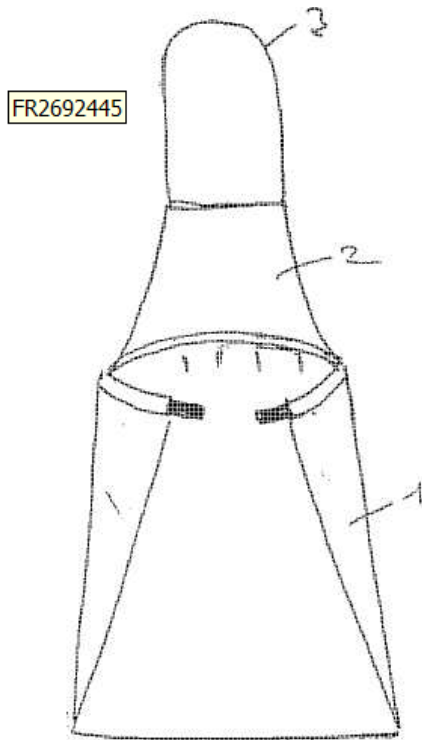

A41D 13/05

protecting only a particular body part (ear protectors [A61F 11/06](#))

Definition statement

This place covers:

Illustrative example of subject matter classified in this group.

Figure 1.

**Apparatus and Method for
protecting earlobes of athletes**



Figure 2.

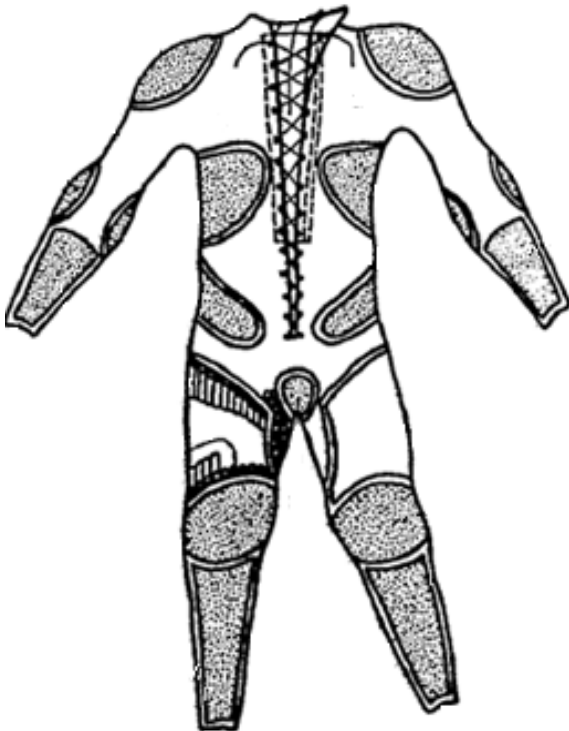
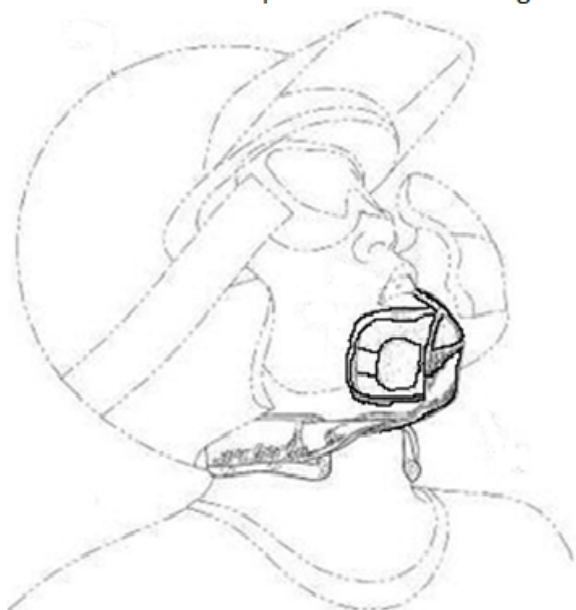

Figure 3.

Combination chin protector and mouth guard



References

Limiting references

This place does not cover:

| | |
|----------------|----------------------------|
| Ear protectors | A61F 11/06 |
|----------------|----------------------------|

Informative references

Attention is drawn to the following places, which may be of interest for search:

| | |
|---|----------------------------|
| Sports brassières | A41C 3/00 |
| Helmets with chin protectors integrated | A42B 3/205 |
| Hearing and cold protectors for the ear (internal & external) | A61F 11/06 |
| Body protectors for players / sports | A63B 71/08 |

Special rules of classification

Even if [A41D 13/05](#) takes precedence over [A41D 13/015](#), if the shock-absorbing is relevant per se it should also be classed in [A41D 13/015](#).

Comprises protection of body parts not included in the subgroups of [A41D 13/05](#) and protection for several body parts in the same garment.

Comprises external impact protection for the ears.

For shock-absorbing means in general, i.e. pads, class in [A41D 13/015](#).

For materials of protective garments with shock absorbing means class in [A41D 31/28](#) and lower group.

When protection is for clothing and not for body part, class in [A41D 13/04](#) or [A41D 27/12](#)

A41D 13/0506

{Hip}

Definition statement

This place covers:

Comprises groin, genitalia area.

Illustrative example:

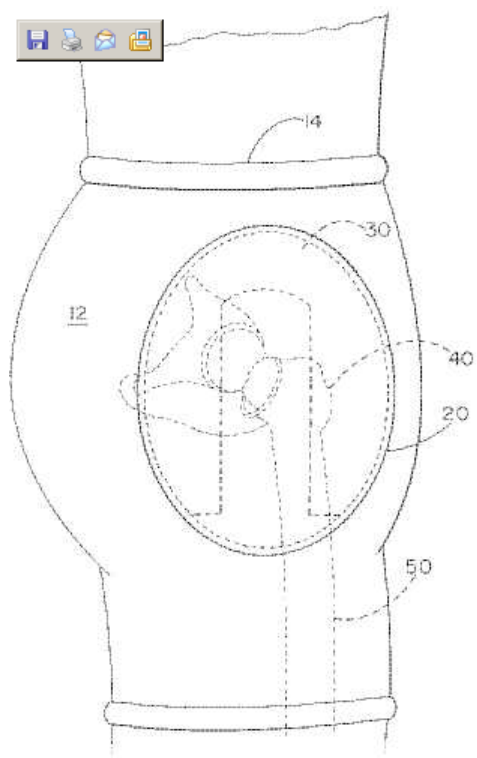

Special rules of classification

Includes hip shock-absorbing / protection pads, not shaping pads. For hip shaping pads classify in [A41D 27/26](#).

A41D 13/0512

{Neck or shoulders area}

Definition statement

This place covers:

Illustrative example of subject matter classified in this group.

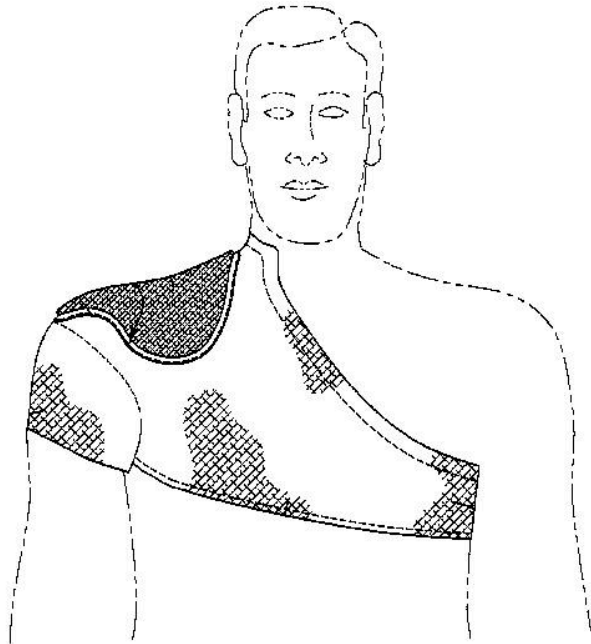

A41D 13/0518

{Chest}

Definition statement

This place covers:

Illustrative example of subject matter classified in this group.



A41D 13/0525

{Loin or waist area}

Definition statement

This place covers:

Illustrative example of subject matter classified in this group.

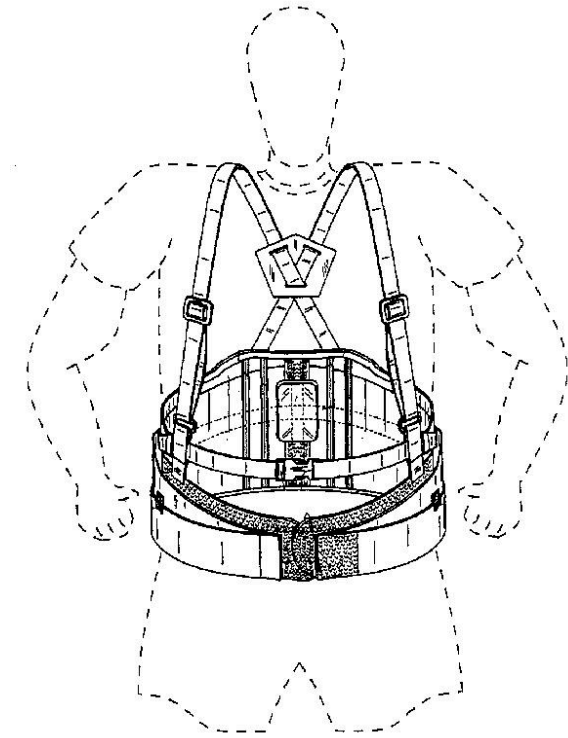

A41D 13/0531**{Spine}****Definition statement***This place covers:*

Illustrative example of subject matter classified in this group.

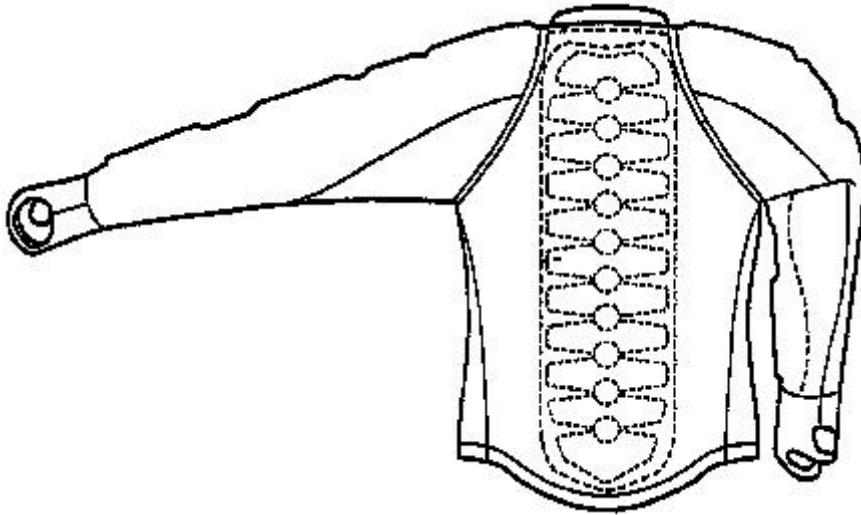
**References*****Informative references****Attention is drawn to the following places, which may be of interest for search:*

| | |
|--|----------------------------|
| Back strengthening devices (orthopaedic corsets) | A61F 5/026 |
|--|----------------------------|

A41D 13/0537**{Buttocks}****Definition statement***This place covers:*

Illustrative example of subject matter classified in this group.

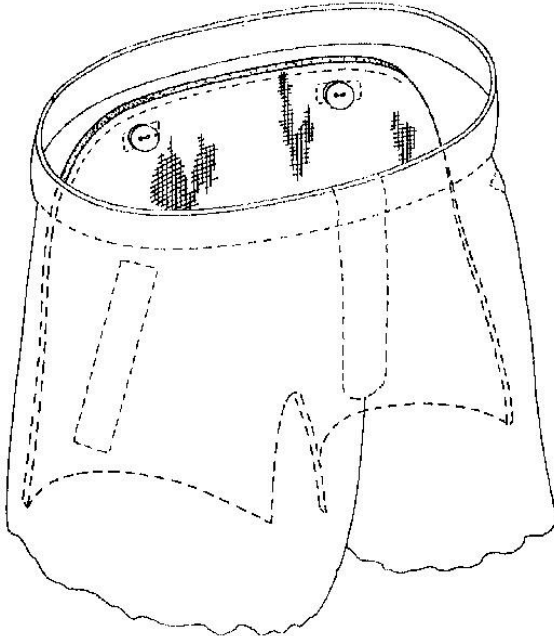
**References****Limiting references***This place does not cover:*

| | |
|---|----------------------------|
| Cycling pants (with saddle reinforcements & padding) | A41D 1/084 |
| Sports pants with crotch reinforcement (not for cycling, i.e. garment protection) | A41D 1/088 |

Special rules of classification

Comprises buttocks protection in sports trousers not for cycling and not at crotch area.

When reinforcements are used as interface between body and cycling saddle, e.g. for impact or pressure reduction, or for saddle shaped reinforcements, even if the word "cycling" is not used, class only in [A41D 1/084](#), and not in [A41D 1/088](#). For all other crotch area reinforcements in sports trousers, e.g. garment protection, classify only in [A41D 1/088](#).

A41D 13/0543

{Legs (knee or foot [A41D 13/06](#); protectors for the legs of players or sportmen [A63B 71/1225](#))}

Definition statement

This place covers:

Illustrative example of subject matter classified in this group.

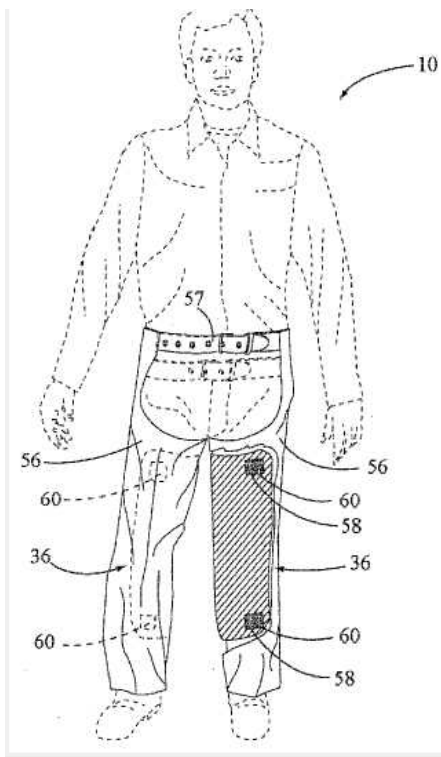
**References****Limiting references**

This place does not cover:

| | |
|---|----------------------------|
| Leggings | A41D 17/02 |
| Protectors for clothing | A41D 27/12 |
| Mending garments by adhesives or adhesive patches | A41H 27/00 |

Special rules of classification

For protection of trousers from rain, soiling with leggings class in [A41D 17/02](#).

For clothing protection, i.e. patches avoiding wear & tear, class in [A41D 27/12](#).

For mending garments by adhesive or adhesive patches, class in [A41H 27/00](#).

A41D 13/06

Knee or foot {(protectors for the legs of players or sportsmen [A63B 71/1225](#))}

Definition statement

This place covers:

Illustrative example of subject matter classified in this group.

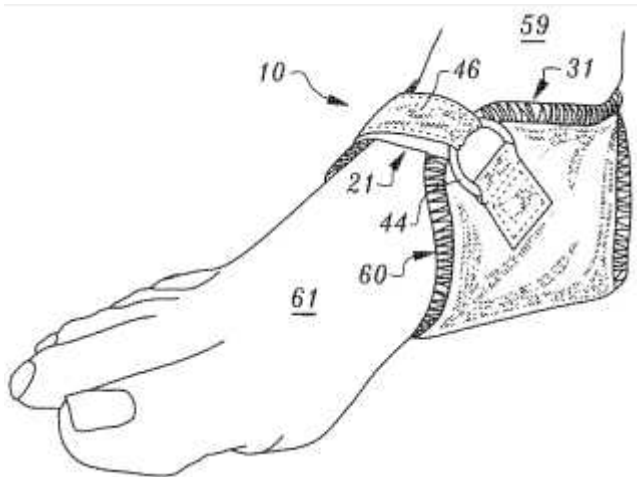
**Special rules of classification**

Socks with protection for the feet should be classified in [A41B 11/02](#) and as additional information in [A41D 13/06](#).

A41D 13/065

{Knee protectors}

Definition statement

This place covers:

Illustrative example of subject matter classified in this group.

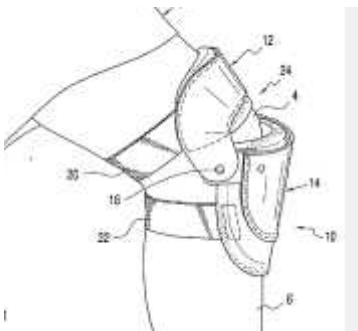
**References****Informative references**

Attention is drawn to the following places, which may be of interest for search:

| | |
|---------------------------|----------------------------|
| Kneelers, prayer supports | A47C 16/04 |
|---------------------------|----------------------------|

A41D 13/08

Arm or hand (protective gloves [A41D 19/015](#) {; protectors for the hands of players or sportsmen [A63B 71/14](#)})

Definition statement

This place covers:

Illustrative examples of subject matter classified in this group.

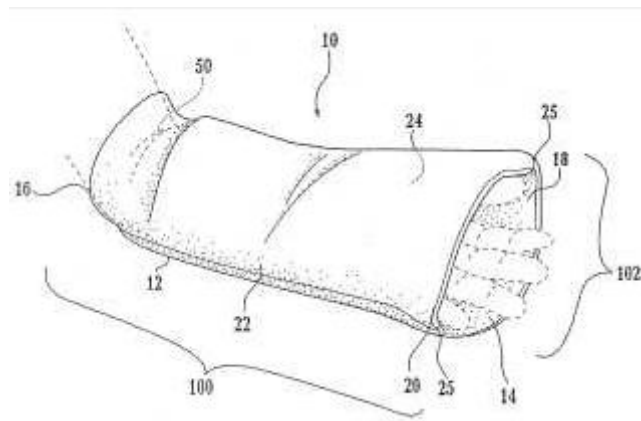
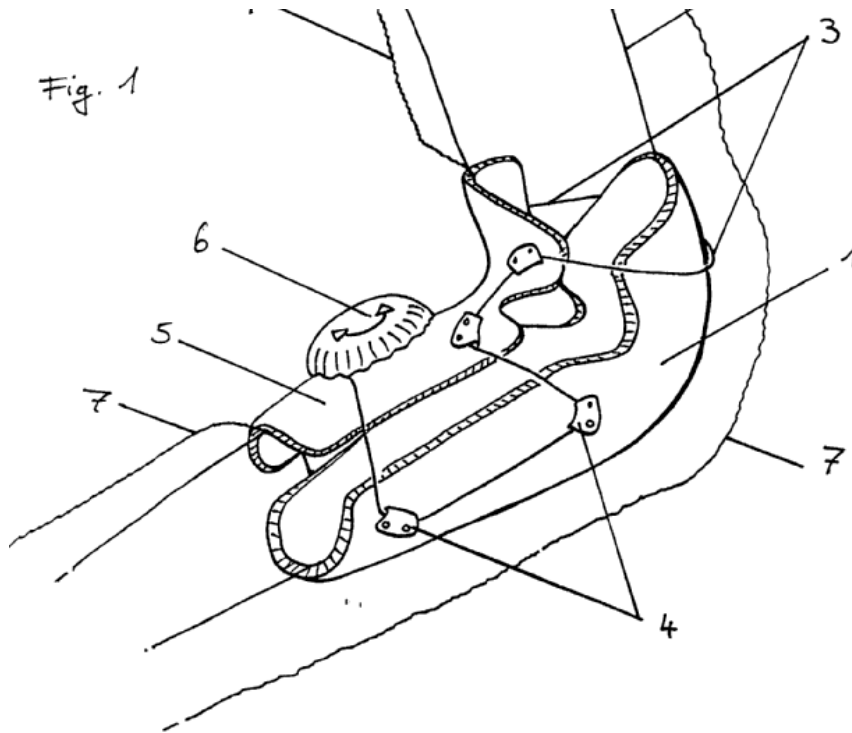

References

Informative references

Attention is drawn to the following places, which may be of interest for search:

| | |
|---|----------------------------|
| Orthopaedic devices for arm / hand / finger | A61F 5/013 |
| Elbow protectors for sportsmen | A63B 71/08 |

A41D 13/081**{Hand protectors}****Definition statement**

This place covers:

Comprises partial covering of hand.

Illustrative example:

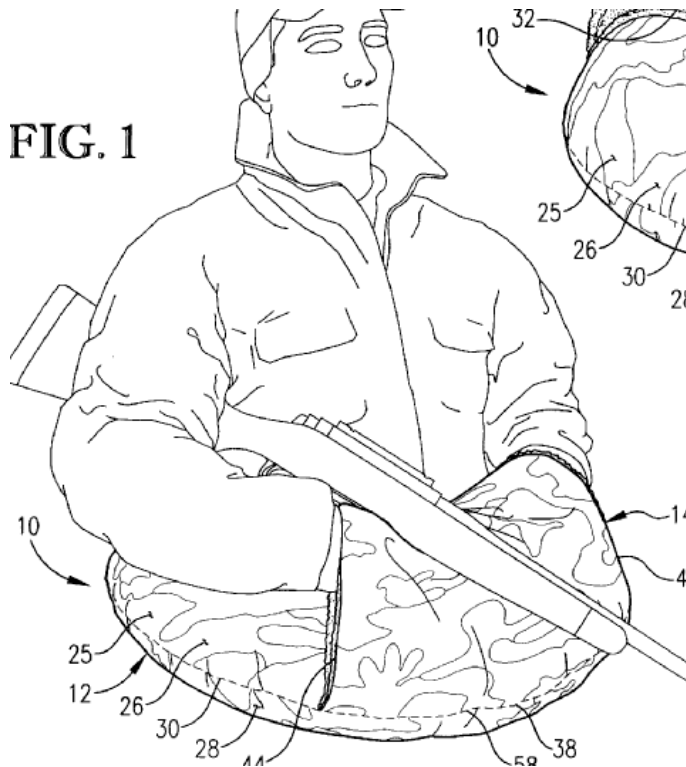
**References****Informative references**

Attention is drawn to the following places, which may be of interest for search:

| | |
|---|----------------------------|
| Orthopaedic devices for arm / hand / finger | A61F 5/013 |
| Guards for hand cutting tools | B26B 29/00 |
| Data gloves | G06F 3/014 |
| Capacitive touch screens | G06F 3/044 |

Special rules of classification

For complete covering of hand with fingers class in [A41D 19/00](#) and lower classes (gloves).

A41D 13/082

{especially for the inner part of the hand}

Definition statement

This place covers:

Illustrative example of subject matter classified in this group.

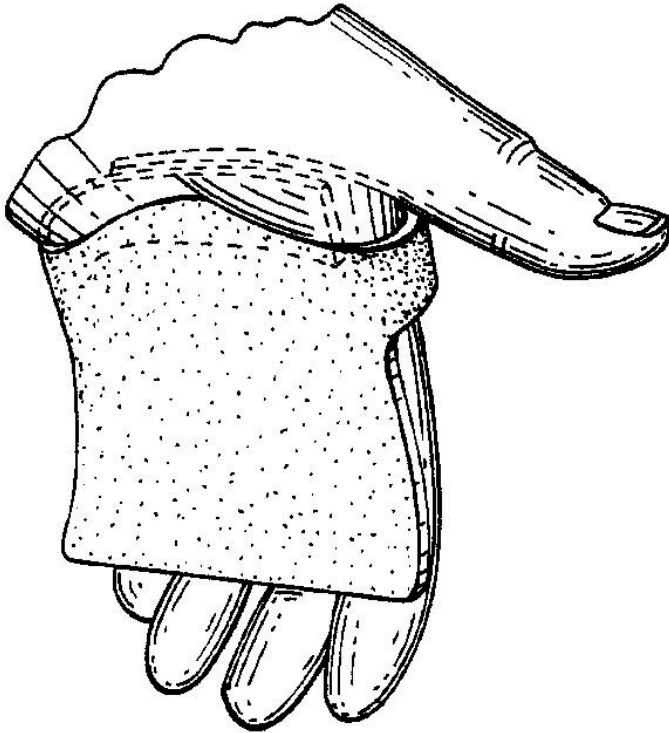
**References****Informative references**

Attention is drawn to the following places, which may be of interest for search:

| | |
|---------------------------------|----------------------------|
| Palm protectors for hand sewing | D05B 91/04 |
|---------------------------------|----------------------------|

A41D 13/084

{especially for the outer part of the hand}

Definition statement

This place covers:

Illustrative example of subject matter classified in this group.

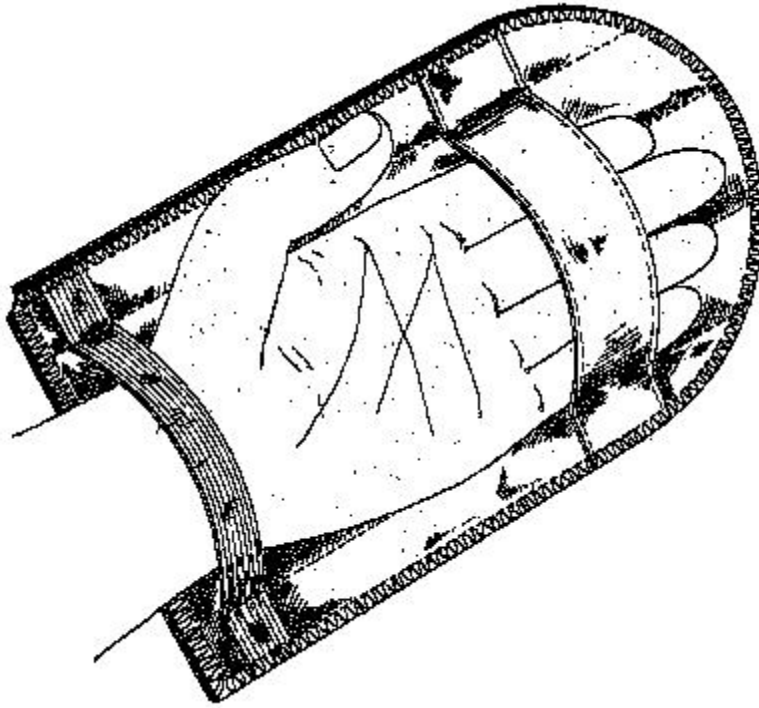

A41D 13/085

{with at least one hole for a handle or a stick}

Definition statement

This place covers:

Illustrative example of subject matter classified in this group.

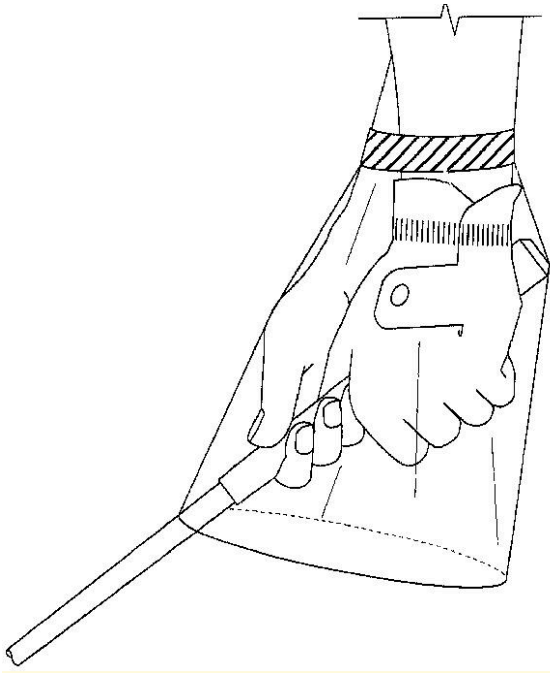

A41D 13/087**{especially for fingers}****Definition statement***This place covers:*

Illustrative example of subject matter classified in this group.

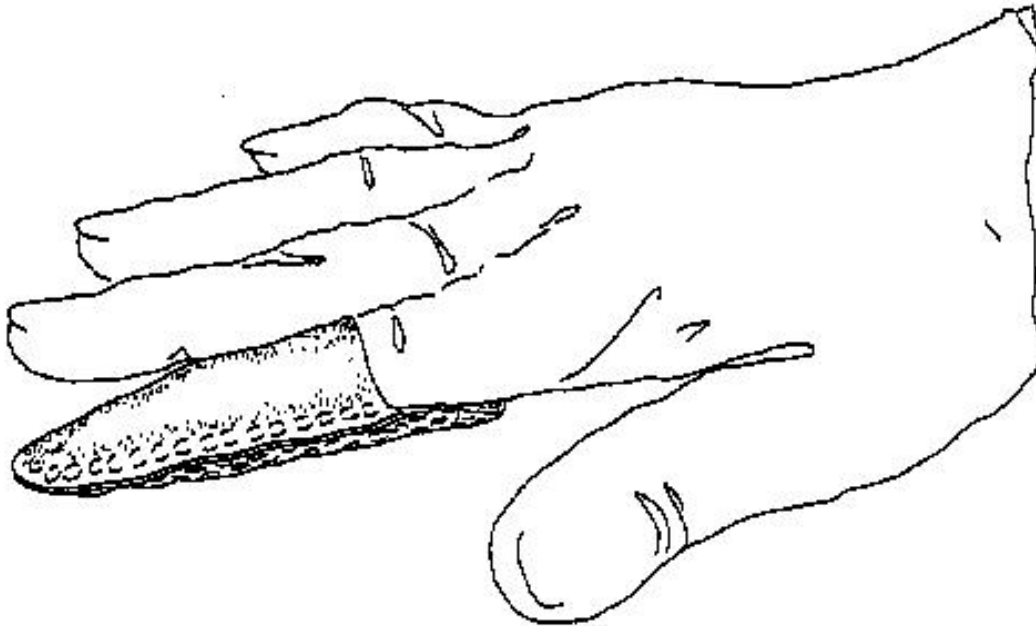
**References*****Informative references****Attention is drawn to the following places, which may be of interest for search:*

| | |
|--|--|
| Manicuring implements | A45D 29/00 |
| Orthopaedic devices for fingers | A61F 5/013 , A61F 5/10 |
| Devices for preventing finger-sucking | A61F 5/50 |
| Nail protectors, finger stalls | A61F 13/105 |
| Leaf turners | B42D 9/04 |
| Thimbles, finger shields, protectors for hand sewing | D05B 91/04 |
| Finger worn pointing device | G06F |
| Pointing devices | G06F 3/033 |
| Mobile pen-type handsets | H04M 1/0285 |
| Facilitating the use of keys in mobile devices | H04M 1/23 |

A41D 13/088**{especially for the wrist}****Definition statement***This place covers:*

Illustrative example of subject matter classified in this group.

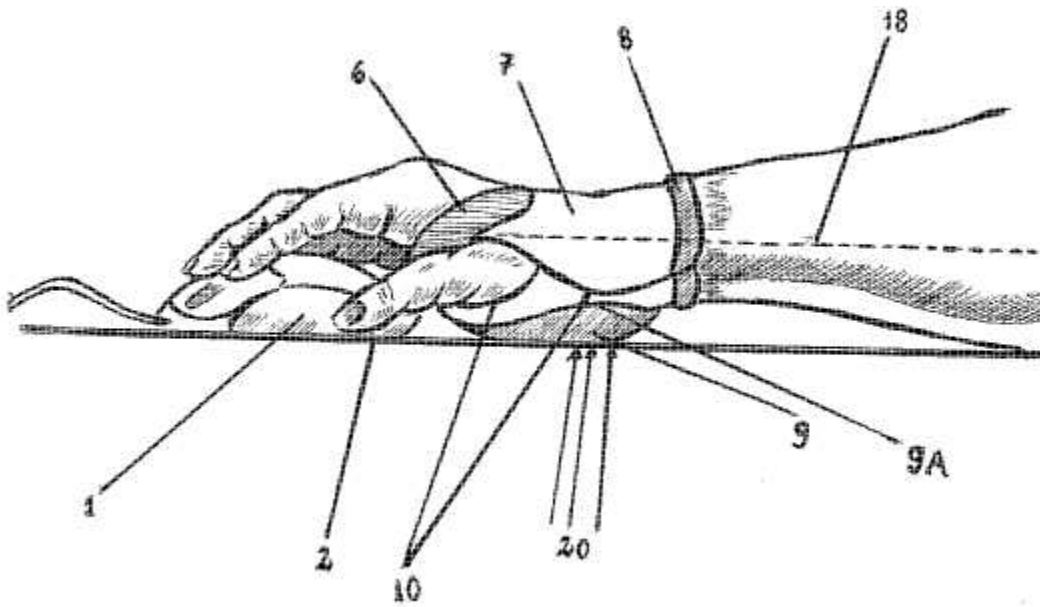
**References****Informative references***Attention is drawn to the following places, which may be of interest for search:*

| | |
|---|-----------------------------|
| Orthopaedic devices for arm / hand / finger | A61F 5/013 |
| Bandages for supporting wrist | A61F 13/107 |

A41D 13/11

Protective face masks, e.g. for surgical use, or for use in foul atmospheres (eye-masks [A61F 9/04](#) {; hoods affording protection against heat or harmful chemical agents [A62B 17/04](#)})

Definition statement

This place covers:

Illustrative examples of subject matter classified in this group.

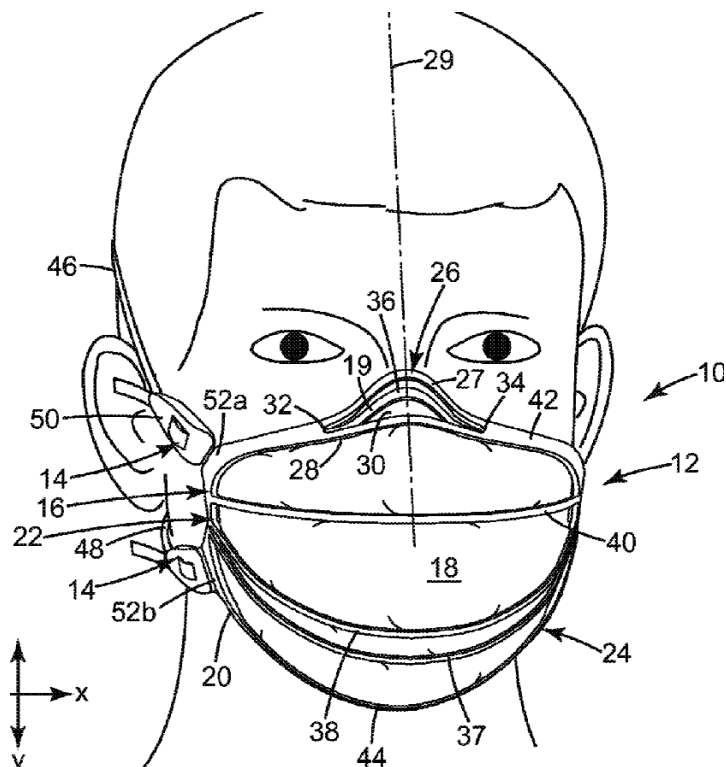

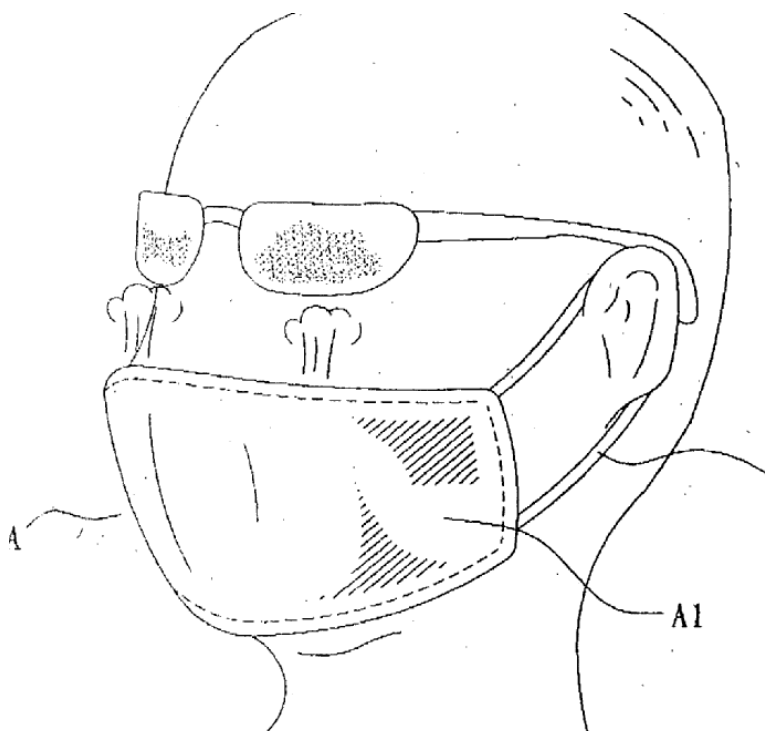

References

Informative references

Attention is drawn to the following places, which may be of interest for search:

| | |
|--|-----------------------------|
| Masks or dominoes for concealing identity, e.g. for theatrical use | A41G 7/00 |
| Masks for cosmetic treatment of the face | A45D 44/002 |
| Ear, face or lip protectors (cosmetics) | A45D 44/12 |
| Hearing and cold protectors for the ear | A61F 11/00 |
| Masks for respiratory patient treatment | A61M 16/06 |
| Respiratory apparatus (with filters) | A62B 7/00 |
| Masks protecting chemical agents or high altitude | A62B 18/00 |
| Filters for breathing protection purposes (with shape of mask) | A62B 23/025 |
| Nose filters | A62B 23/06 |
| Filter Cloth material | B01D 39/08 |

Special rules of classification

When mask protects against splashes/liquids, dust or exterior impact, classify in [A41D 13/11](#) and lower groups.

When filtering or respiratory protection of the mask is relevant, classify in [A62B 23/025](#).

When both kind of protection are specified, both classes should be given in [A41D 13/11](#) and [A62B 23/025](#).

A41D 13/1107

{characterised by their shape}

Definition statement

This place covers:

Illustrative example of subject matter classified in this group.

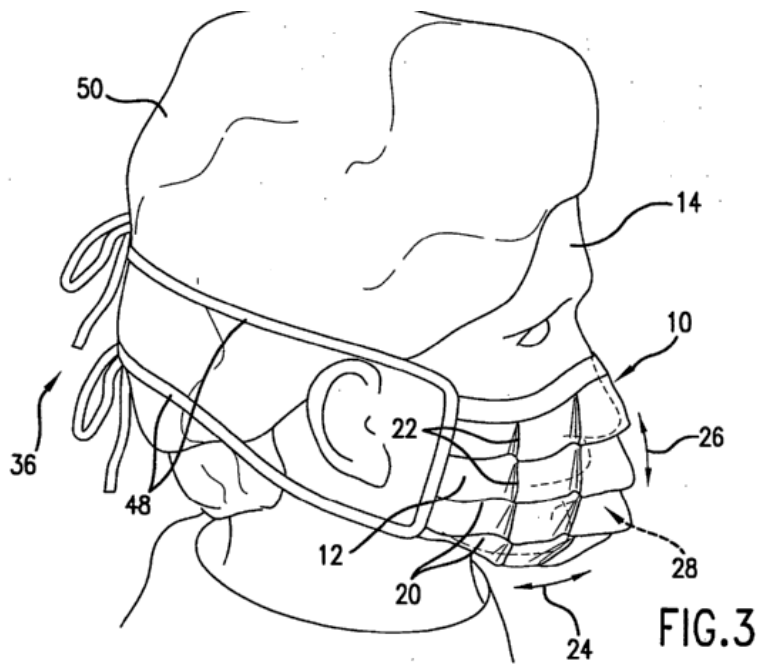

A41D 13/1115

{with a horizontal pleated pocket}

Definition statement

This place covers:

Illustrative example of subject matter classified in this group.

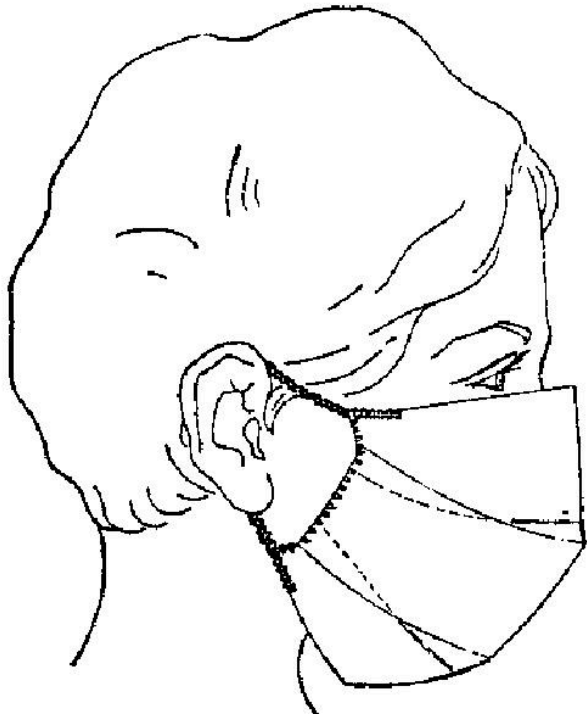

A41D 13/1123

{with a duckbill configuration}

Definition statement

This place covers:

Illustrative example of subject matter classified in this group.

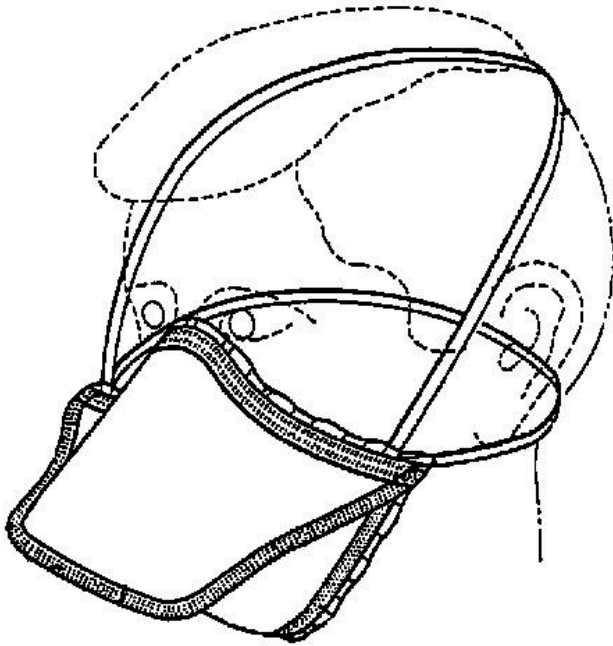

A41D 13/113

{with a vertical fold or weld}

Definition statement

This place covers:

Illustrative example of subject matter classified in this group.

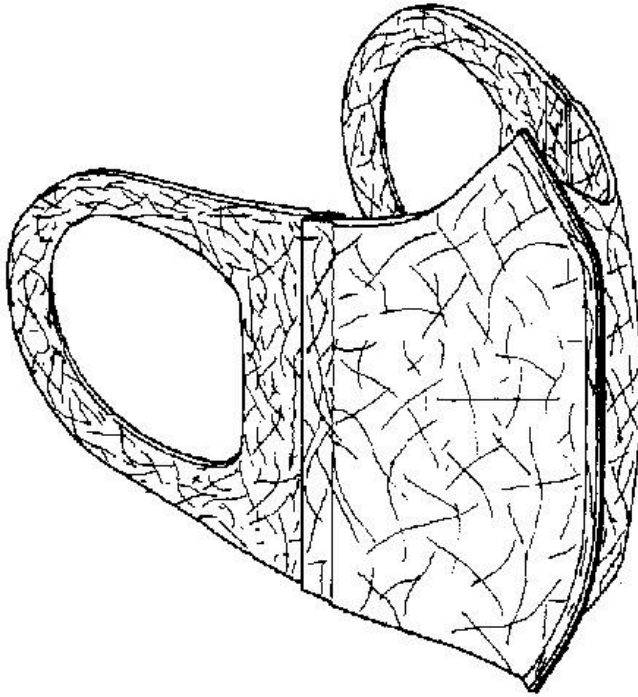

A41D 13/1138

{with a cup configuration}

Definition statement

This place covers:

Illustrative example of subject matter classified in this group.

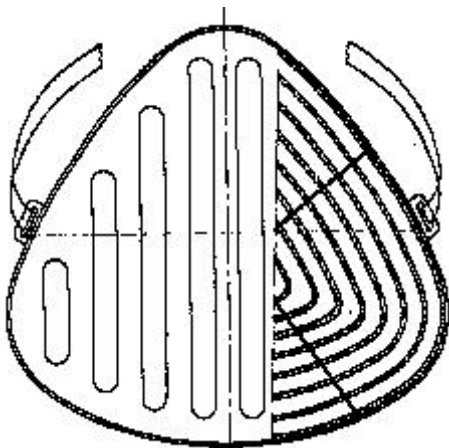

A41D 13/1146

{obtained by moulding}

Definition statement

This place covers:

Illustrative example of subject matter classified in this group.

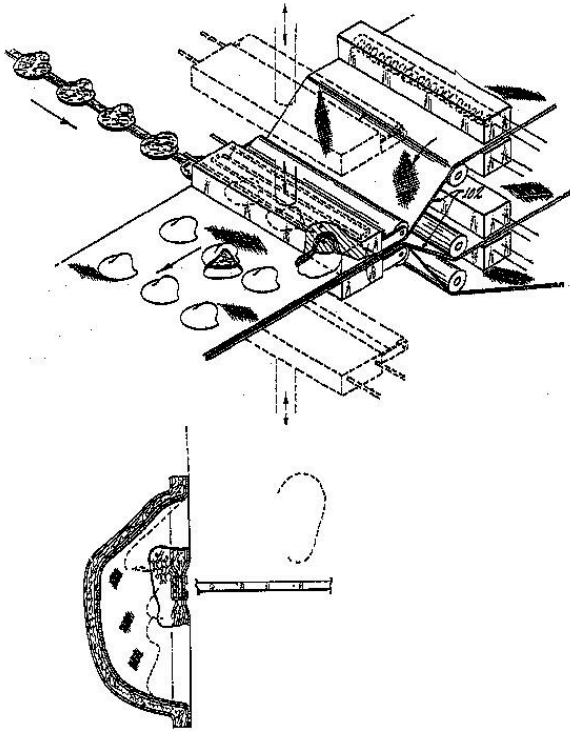

A41D 13/1153

{with a hood}

Definition statement

This place covers:

Illustrative example of subject matter classified in this group.

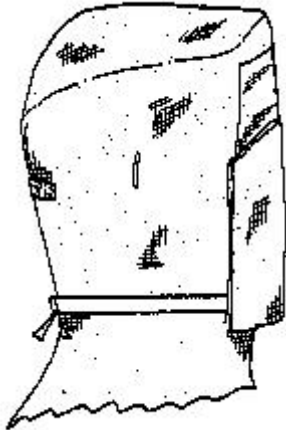

A41D 13/1161

{Means for fastening to the user's head}

Definition statement

This place covers:

Illustrative example of subject matter classified in this group.

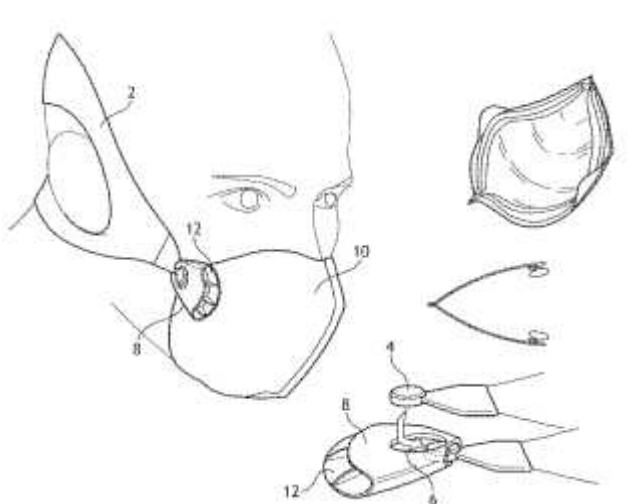

A41D 13/1176

{forming a complete seal at the edges of the mask}

Definition statement

This place covers:

Illustrative example of subject matter classified in this group.

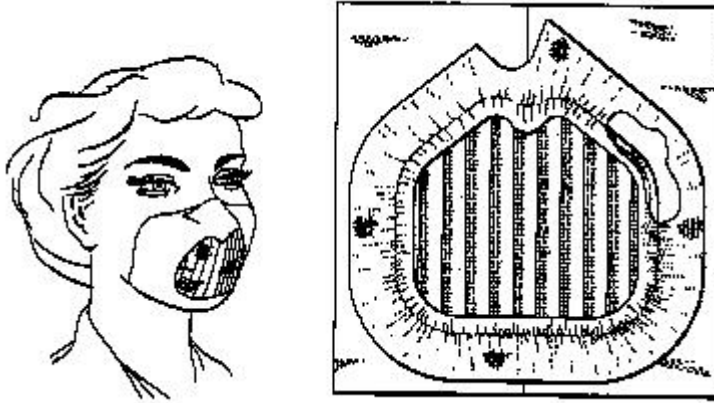

A41D 13/1184

{with protection for the eyes, e.g. using shield or visor}

Definition statement

This place covers:

Illustrative example of subject matter classified in this group.

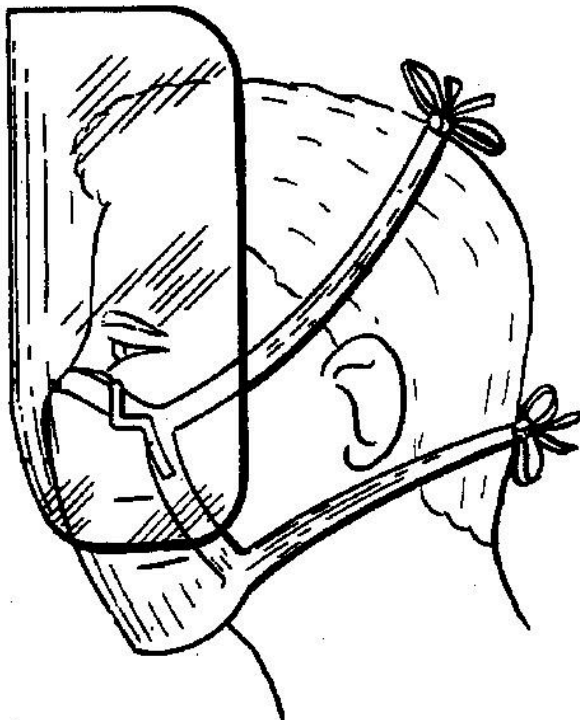

References

Informative references

Attention is drawn to the following places, which may be of interest for search:

| | |
|-----------|---------------------------|
| Eye-masks | A61F 9/04 |
|-----------|---------------------------|

A41D 13/12

Surgeons' or patients' gowns or dresses {(operating gloves [A61B 42/10](#))}

Definition statement

This place covers:

Comprises garments for medical staff other than surgeons, i. e. nursing personel. Illustrative examples:

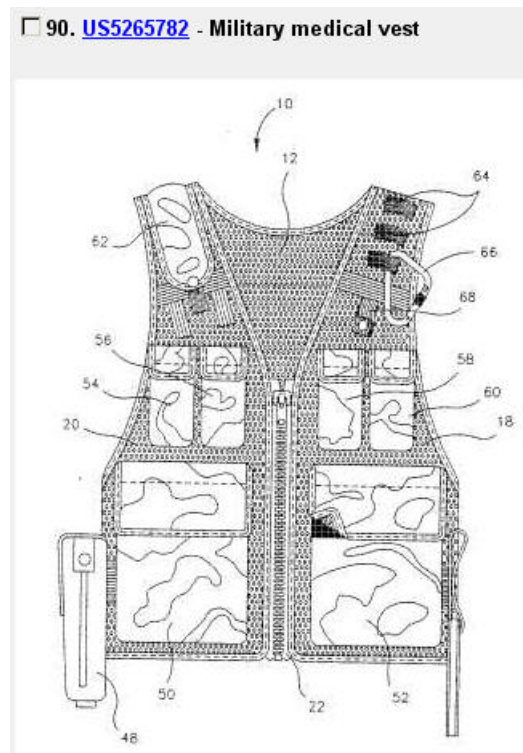

□ 16. [EP1862086](#) - PROTECTIVE MEDICAL DEVICE FOR RESIDUE-PRODUCING TECHNIQUES

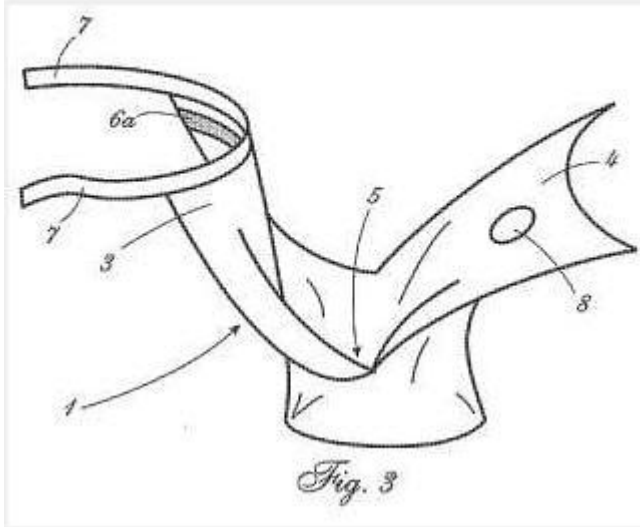

References

Limiting references

This place does not cover:

| | |
|----------------------------|--------------------------------|
| Surgeon's gowns or dresses | A41D 13/1209 . |
|----------------------------|--------------------------------|

Special rules of classification

For medical staff garments with pockets for holding medical supplies classify here and in [A41D 13/0012](#).

A41D 13/1209

{Surgeons' gowns or dresses}

Definition statement

This place covers:

Illustrative example of subject matter classified in this group.

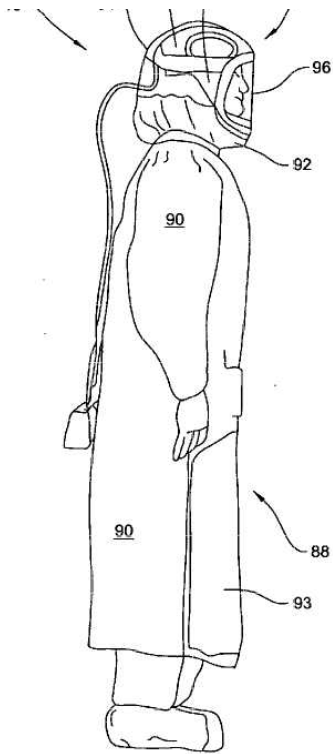

A41D 13/1236**{Patients' garments}****Definition statement***This place covers:*

Illustrative example of subject matter classified in this group.

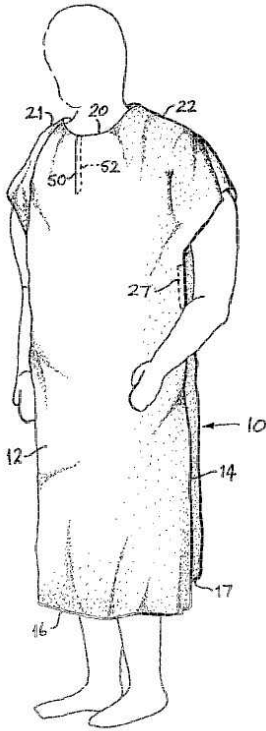
**References*****Informative references****Attention is drawn to the following places, which may be of interest for search:*

| | |
|------------------------------------|------------------------------|
| Insulin pumps portable on the body | A61M 5/14244 |
|------------------------------------|------------------------------|

Special rules of classification

Comprises gown shapes.

A41D 13/1245

{for the upper part of the body}

Definition statement

This place covers:

Illustrative example of subject matter classified in this group.

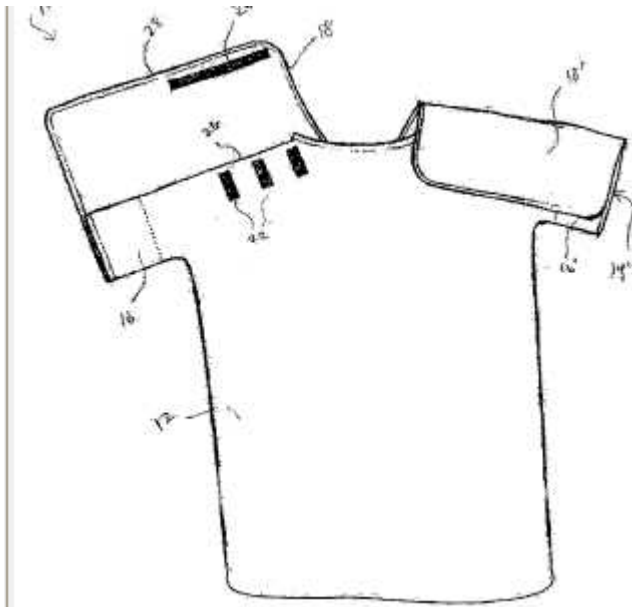

A41D 13/1254

{for the lower part of the body ([A41D 13/0506](#) takes precedence)}

Definition statement

This place covers:

Illustrative example of subject matter classified in this group.

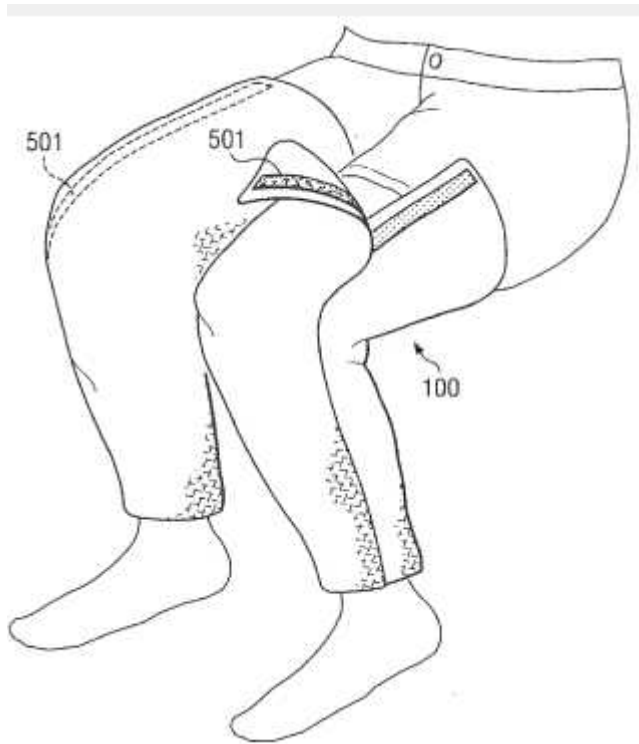
**References****Limiting references**

This place does not cover:

| | |
|--------------------------|------------------------------|
| Hip shock-absorbing pads | A41D 13/0506 |
|--------------------------|------------------------------|

Informative references

Attention is drawn to the following places, which may be of interest for search:

| | |
|--|---------------------------|
| Devices worn by the patient for reception of bodily fluids | A61F 5/44 |
|--|---------------------------|

A41D 13/1263**{Suits}****Definition statement***This place covers:*

Illustrative example of subject matter classified in this group.

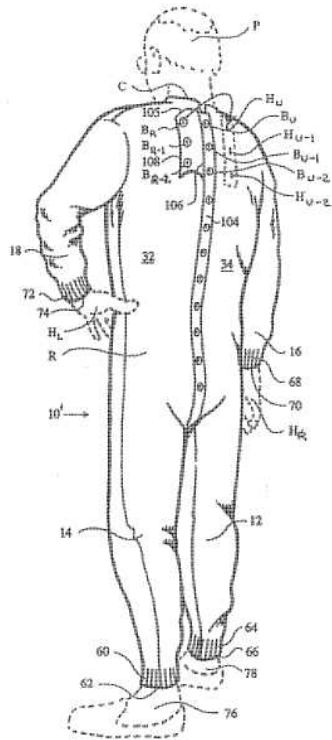
**References****Informative references***Attention is drawn to the following places, which may be of interest for search:*

| | |
|-----------------------------|----------------------------|
| Underwear body stockings | A41B 11/14 |
| Patient restraining devices | A61F 5/37 |

Special rules of classification

Comprises pants and shirt shape

A41D 13/1272**{specially adapted for babies}****Definition statement***This place covers:*

Illustrative example of subject matter classified in this group.

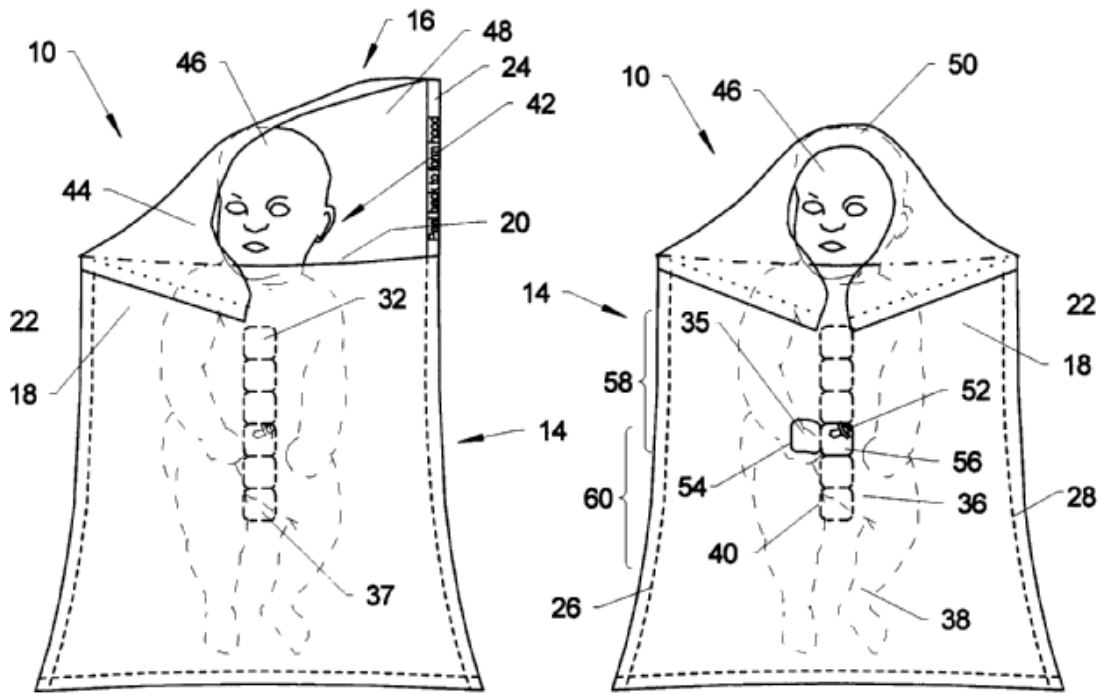

A41D 13/1281

{with incorporated means for medical monitoring}

Definition statement

This place covers:

The garment construction to hold means for medical monitoring. Illustrative example:

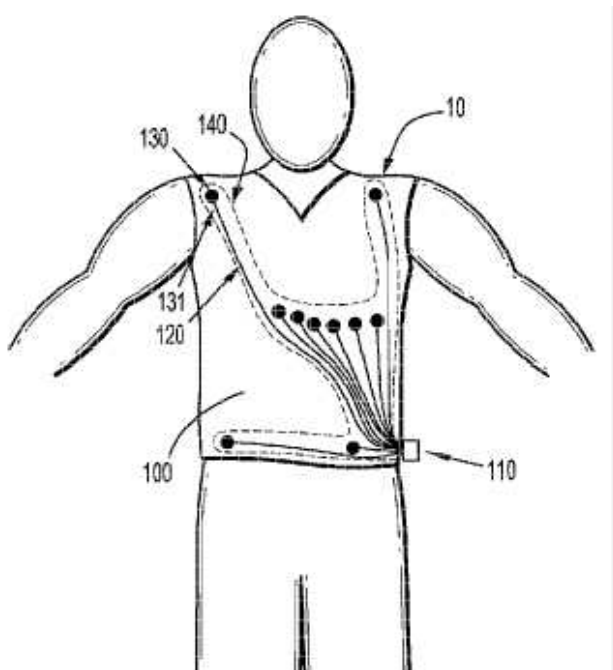

Relationships with other classification places

When the special means for medical monitoring are relevant per se, consider classification in [A61B 5/00](#).

References

Informative references

Attention is drawn to the following places, which may be of interest for search:

| | |
|--|------------------------------|
| Diagnosis by temperature mapping of body parts | A61B 5/015 |
| Detecting heart/pulse rate for diagnostic purposes, worn by patient | A61B 5/02438 |
| Marking methods by using thermochromic compounds, liquid crystals | B41M 5/287 |
| Tenebrescent material (darkening or bleaching due to change of wavelengths) i.e. crystals lenses | C09K 9/00 |
| Dyeing with phototropic dyes | D06P 1/004 |
| Photometry, using change in colour | G01J 1/50 |
| Supports for thermometers | G01K 1/14 |
| Measuring temperature upon physical/ chemical changes, change of colour | G01K 11/12 |

A41D 15/00

Convertible garments

Definition statement

This place covers:

Illustrative example of subject matter classified in this group.

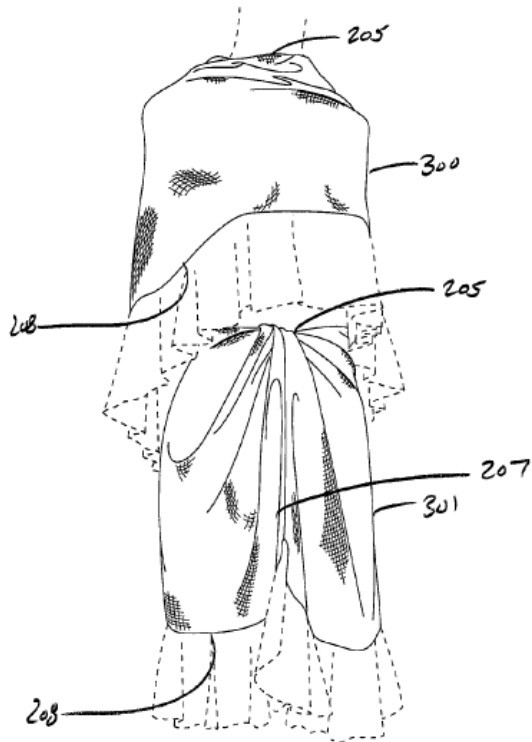

A41D 15/002**{in their length}****Definition statement***This place covers:*

Illustrative example of subject matter classified in this group.

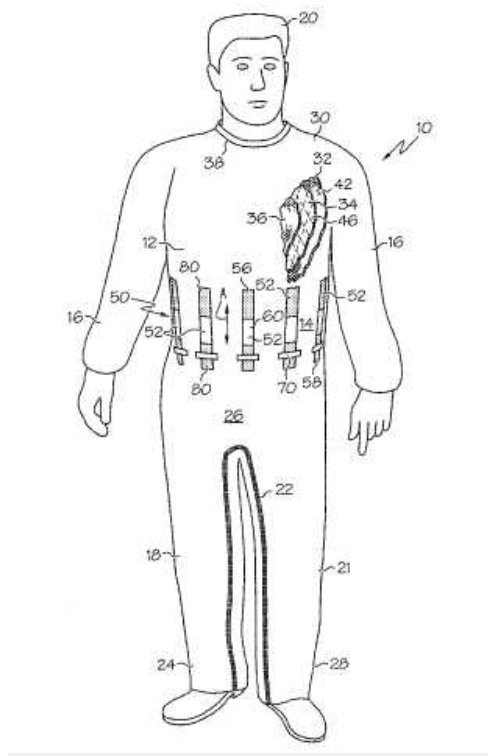
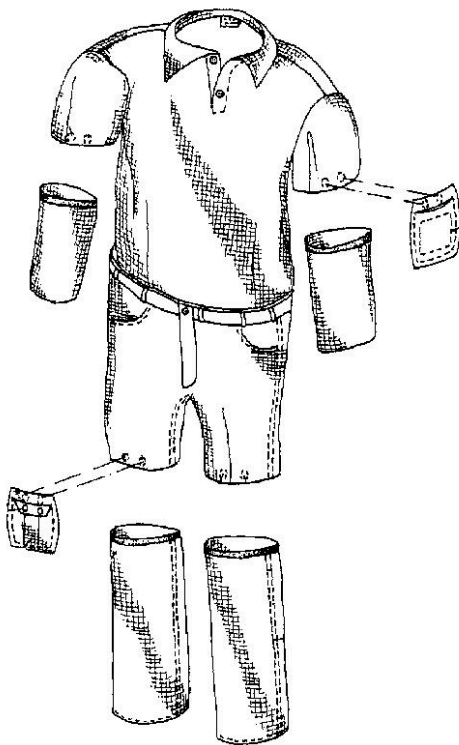
**References****Informative references***Attention is drawn to the following places, which may be of interest for search:*

| | |
|--------------------------|-----------------------------|
| Adjusting sleeve lengths | A41F 19/005 |
|--------------------------|-----------------------------|

Special rules of classificationFor pants adjusting its length class in [A41D 15/002](#) and [A41D 1/06](#).

A41D 15/005**{reversible garments}****Definition statement***This place covers:*

Illustrative example of subject matter classified in this group.

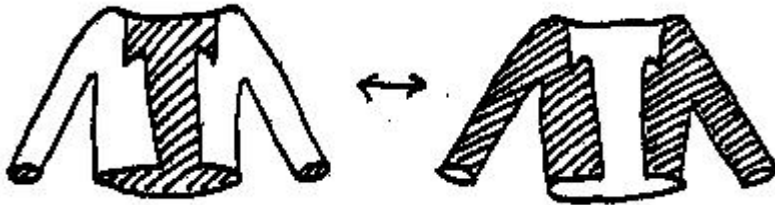
**A41D 15/007****{with bolero structure}****Definition statement***This place covers:*

Illustrative example of subject matter classified in this group.

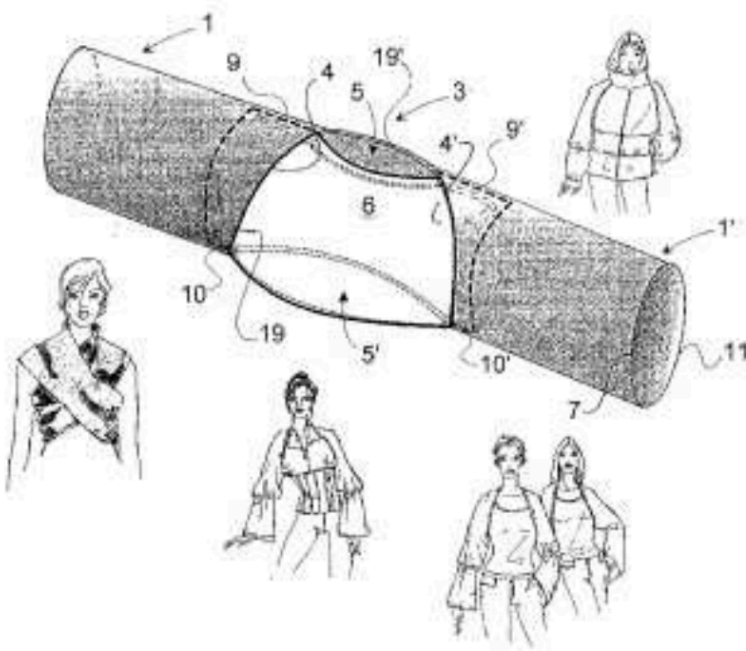

A41D 15/02

Skirts convertible into trousers

Definition statement

This place covers:

Illustrative example of subject matter classified in this group.

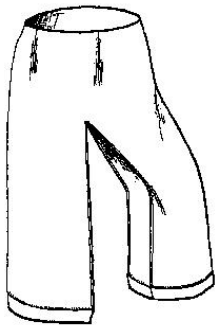
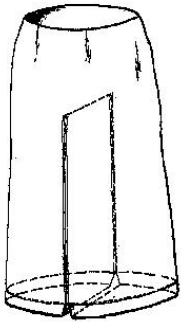

A41D 15/04

Garments convertible into other articles

Definition statement

This place covers:

Illustrative example of subject matter classified in this group.

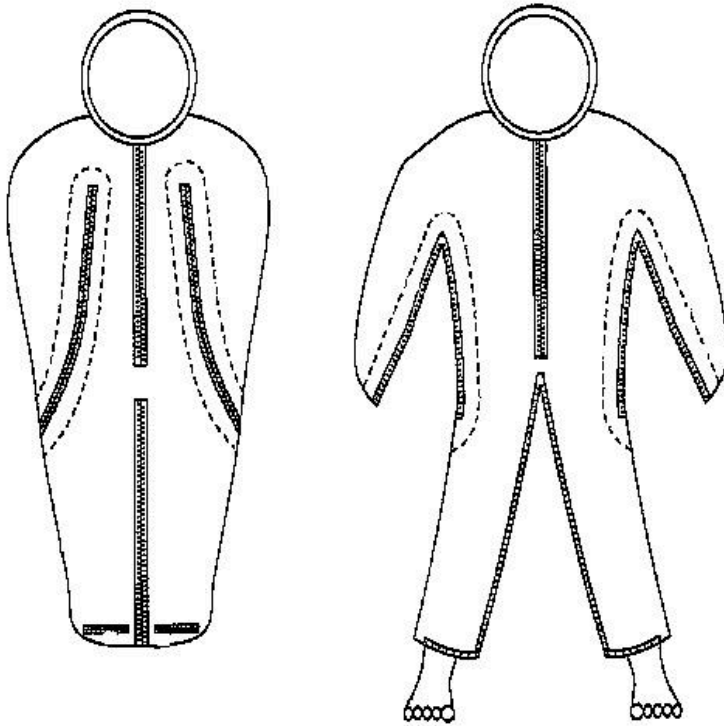

References

Informative references

Attention is drawn to the following places, which may be of interest for search:

| | |
|---|----------------------------|
| For travelling or camp articles | A45F 4/00 |
| Travelling/sleeping rugs convertible into robes | A47G 9/064 |

A41D 17/00

Gaiters; Spats

Definition statement

This place covers:

Illustrative example of subject matter classified in this group.

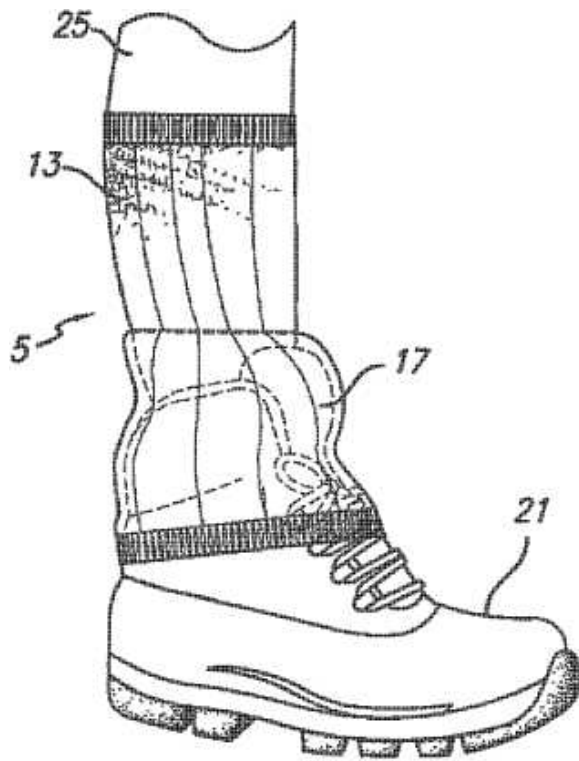

References

Informative references

Attention is drawn to the following places, which may be of interest for search:

| | |
|---------------------------------|----------------------------|
| Stockings without foot parts | A41B 11/08 |
| Overshoes | A43B 3/16 |
| Overshoes for sporting purposes | A43B 5/18 |

Special rules of classification

When worn under garments or shoes, class in stockings without foot parts [A41B 11/08](#).

When worn over garments and/or shoes, class in Gaiters/Spats [A41D 17/00](#) and lower groups.

When worn only over shoes, forward to Overshoes [A43B 3/16](#), [A43B 5/18](#).

Glossary of terms

In this place, the following terms or expressions are used with the meaning indicated:

| | |
|--------|---|
| Gaiter | a covering of cloth, leather, etc. for the ankle, or ankle and lower leg. |
|--------|---|

| | |
|------|--|
| Spat | a short gaiter worn over the instep and reaching only a little way above the ankle, usually fastened under the foot by means of a strap. |
|------|--|

A41D 17/005

{Fastening means for gaiters}

Definition statement

This place covers:

Illustrative example of subject matter classified in this group.

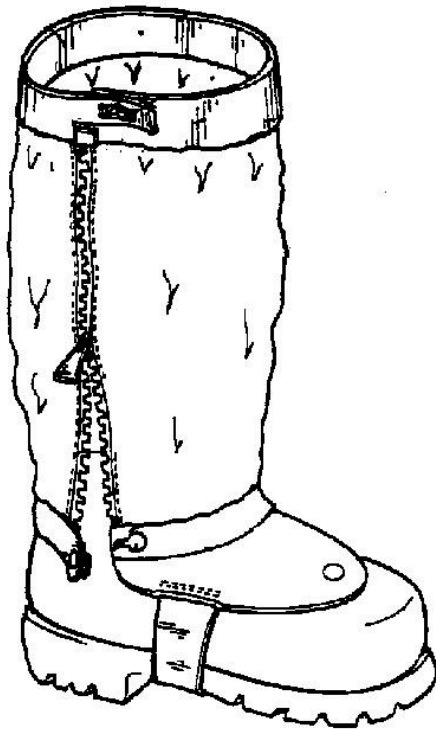

References

Informative references

Attention is drawn to the following places, which may be of interest for search:

| | |
|--|----------------------------|
| Straps on the lower end of legs of trousers for holding-down | A41F 17/04 |
| Overshoes | A43B 3/16 |
| Overshoes for sporting purposes | A43B 5/18 |

A41D 17/02

Leggings {, i.e. worn over lower body garments for protecting the garment underneath}

Definition statement

This place covers:

Lower body over garments with or without seats for protecting a garment worn underneath, also referred to as chaps.

Illustrative examples:

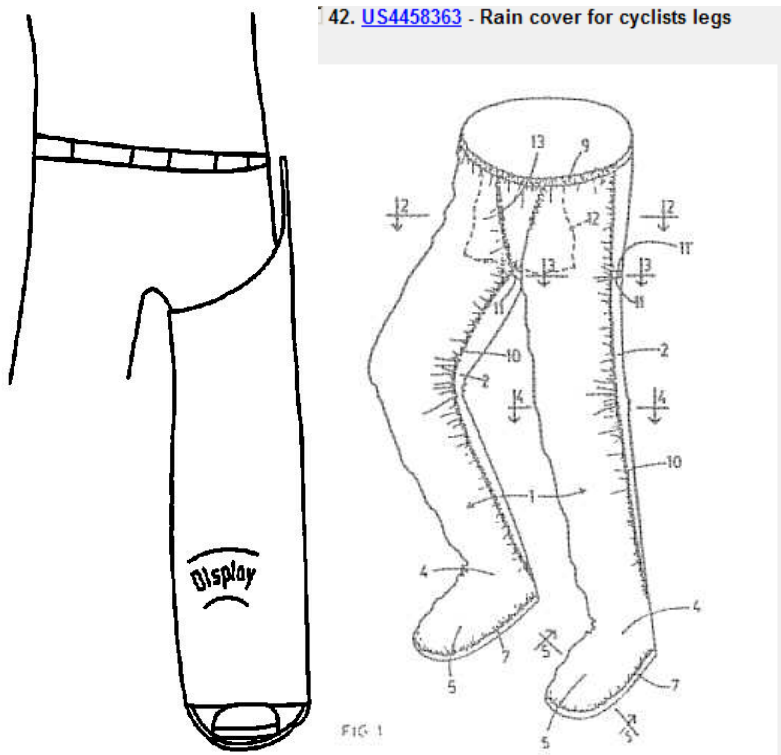

References

Informative references

Attention is drawn to the following places, which may be of interest for search:

| | |
|-------------------------------------|----------------------------|
| Outerwear tights | A41D 1/06 |
| Outerwear sportive tights | A41D 1/08 |
| Raincoats with leg protecting means | A41D 3/06 |
| Panti-hose (underwear tights) | A41B 11/14 |

Glossary of terms

In this place, the following terms or expressions are used with the meaning indicated:

| | |
|---------|--|
| Legging | Lower body overgarment with or without seats for protecting a garment worn underneath, also referred to as chaps |
|---------|--|

A41D 17/04

Puttees

Definition statement

This place covers:

Illustrative example of subject matter classified in this group.

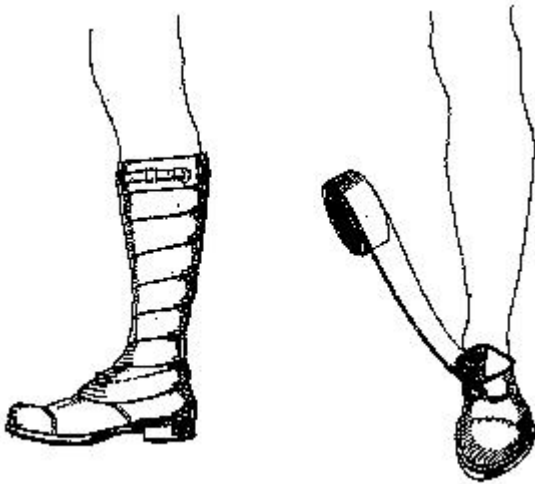

Glossary of terms

In this place, the following terms or expressions are used with the meaning indicated:

| | |
|--------|--|
| Puttee | a long strip of cloth or leather wound spirally round the leg from the ankle to the knee and worn by soldiers, walkers, etc., for protection and support in rough terrain. |
|--------|--|

A41D 19/00

Gloves (brush bodies shaped as gloves [A46B 5/04](#); gloves for washing the body [A47K 7/02](#); gloves for domestic washing or cleaning [A47L 13/18](#); surgical gloves [A61B 42/10](#); swimming gloves [A63B 31/02](#); as accessories for games or sports, e.g. baseball, boxing or golf gloves [A63B 71/14](#); gloves for glove-boxes [B25J 1/02](#))

Definition statement

This place covers:

Comprises complete covering of hand with fingers.

Illustrative examples:

□ 355. [US4831667](#) - Glove and method for producing the same

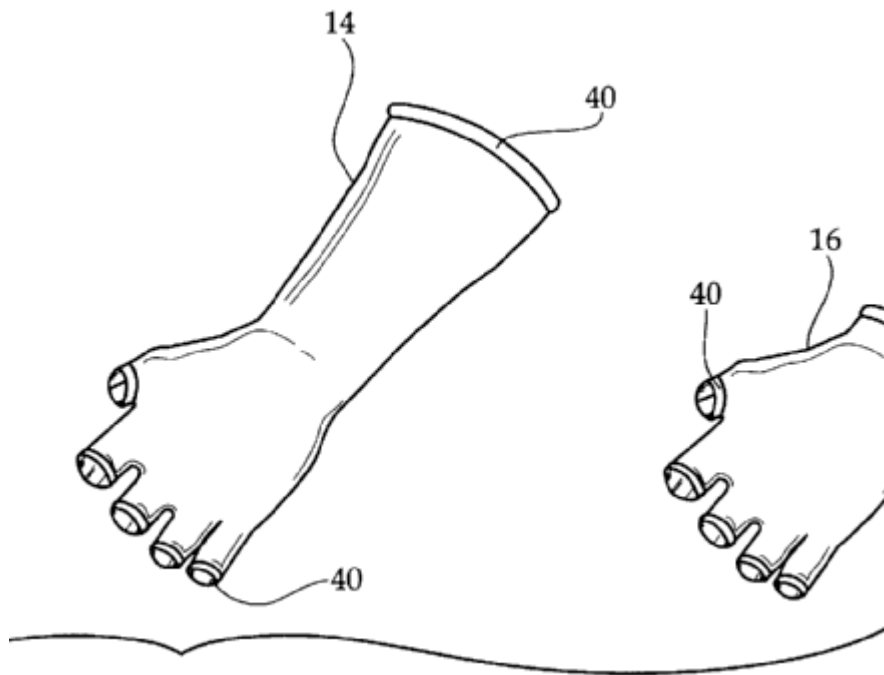
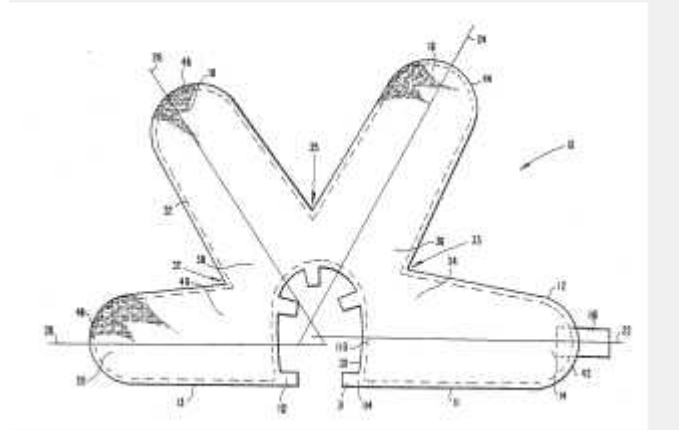

References

Informative references

Attention is drawn to the following places, which may be of interest for search:

| | |
|-----------------------------|--|
| Glove for curing / therapy | A61F 5/10 |
| Gloves delivering cosmetics | A61K 8/0208 , A45D 34/00 , A61M 35/003 |
| Yarns (for gloves) | D02G 3/442 |
| Knitting gloves | D04B 1/28 |

Special rules of classification

For partial covering or protection of hand class in [A41D 13/081](#) (hand protectors).

For seams of gloves, where the seam is not relevant, class additionally in [A41D 2300/50](#) or [A41D 2300/52](#).

For seams in general, class in [A41D 27/24](#) or [A41D 27/245](#)

A41D 19/0006

{made of several layers of material}

Definition statement

This place covers:

Illustrative example of subject matter classified in this group.



A41D 19/001

{Linings}

Definition statement

This place covers:

Illustrative example of subject matter classified in this group.

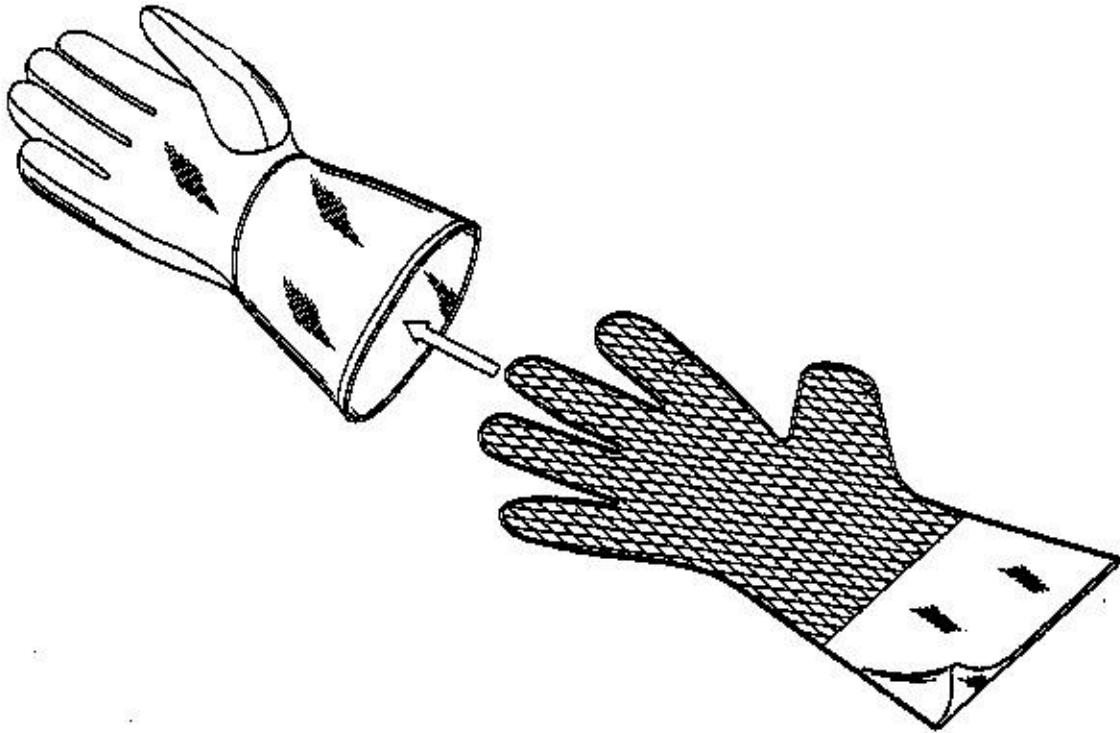

A41D 19/0013

{with openings, e.g. for the nails or for exposing jewellery}

Definition statement

This place covers:

Illustrative examples of subject matter classified in this group.

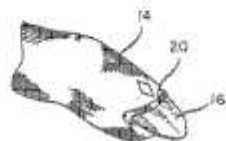
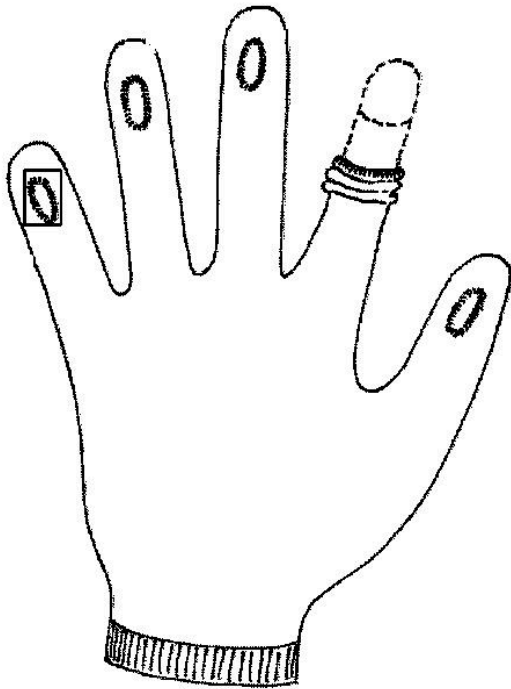

A41D 19/0017

{with slits for the fingers or part of the hand}

Definition statement

This place covers:

Illustrative example of subject matter classified in this group.

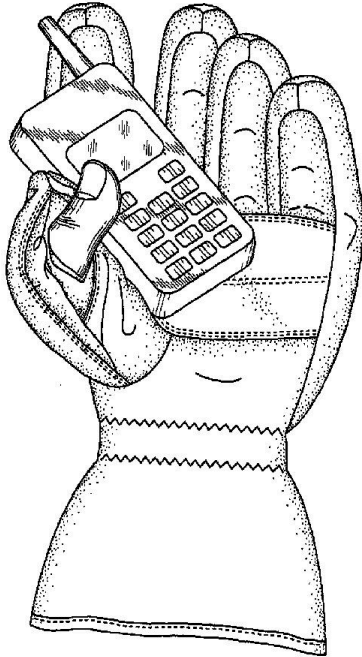

A41D 19/002

{with pockets}

Definition statement

This place covers:

Illustrative example of subject matter classified in this group.

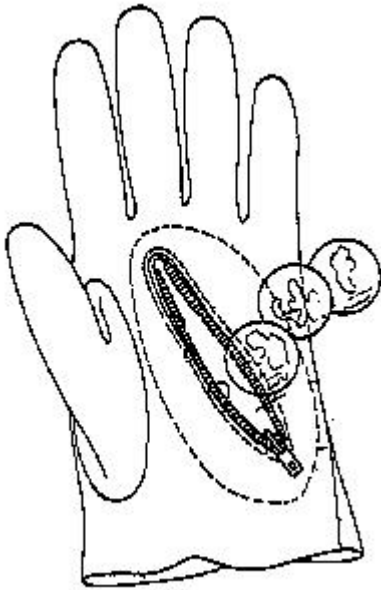

A41D 19/0024**{with accessories}****Definition statement***This place covers:*

Illustrative example of subject matter classified in this group.

□ 29. [US2009154142](#) - (A1 B2) **Glove supporting a pom pom at a finger tip**

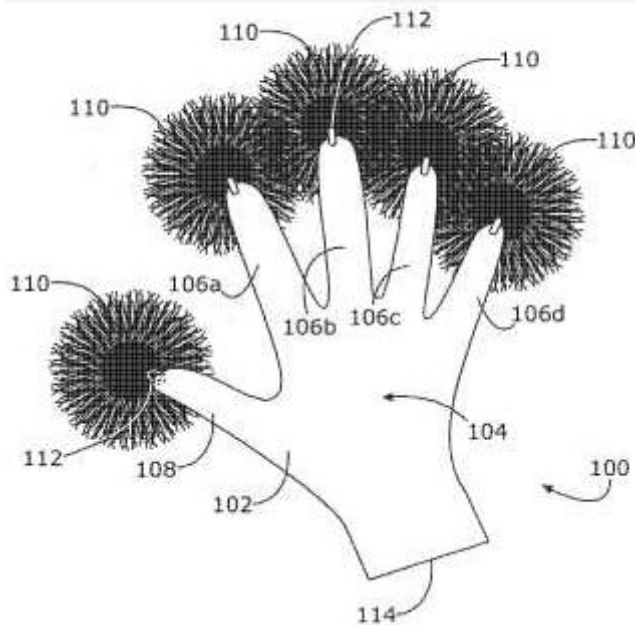
**References****Informative references***Attention is drawn to the following places, which may be of interest for search:*

| | |
|--|-----------------------------|
| Devices for massage | A61H 7/00 |
| Finger worn pointing device | G06F |
| Data gloves | G06F 3/014 |
| Pointing devices | G06F 3/033 |
| Capacitive touch screens | G06F 3/044 |
| Mobile pen-type handsets | H04M 1/0285 |
| Facilitating the use of keys in mobile devices | H04M 1/23 |

A41D 19/0027**{Measuring instruments, e.g. watch, thermometer}****Definition statement***This place covers:*

Illustrative example of subject matter classified in this group.

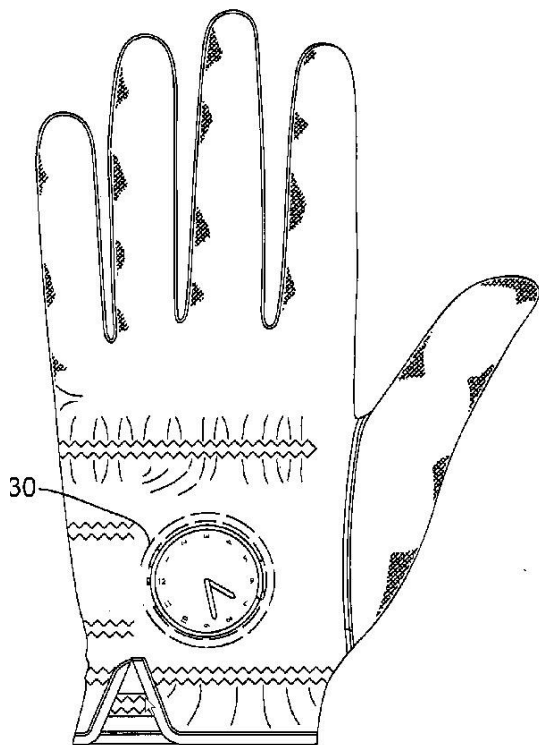
**References****Limiting references***This place does not cover:*

| | |
|--|------------------------------|
| Fixation of watch cases on items of clothing | G04B 37/1433 |
|--|------------------------------|

A41D 19/0031

{Whistles or other warning devices}

Definition statement

This place covers:

Illustrative example of subject matter classified in this group.

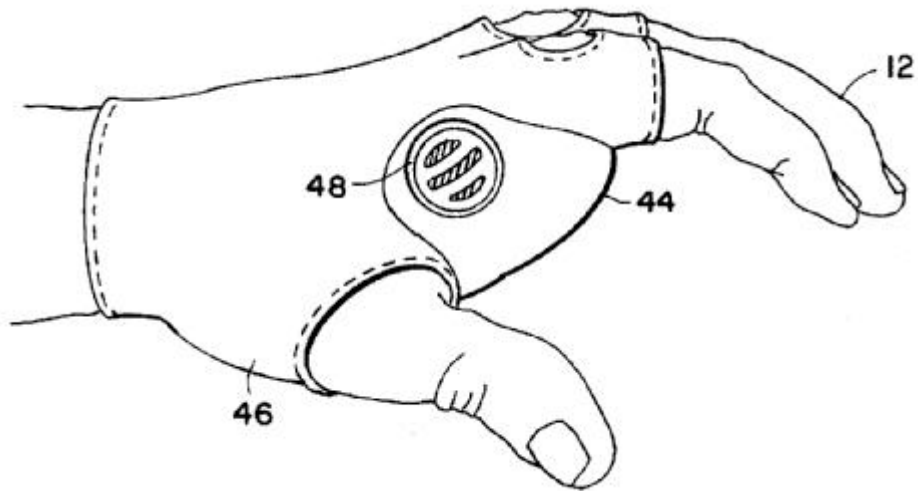

A41D 19/0034**{Retaining means}****Definition statement***This place covers:*

Illustrative example of subject matter classified in this group.

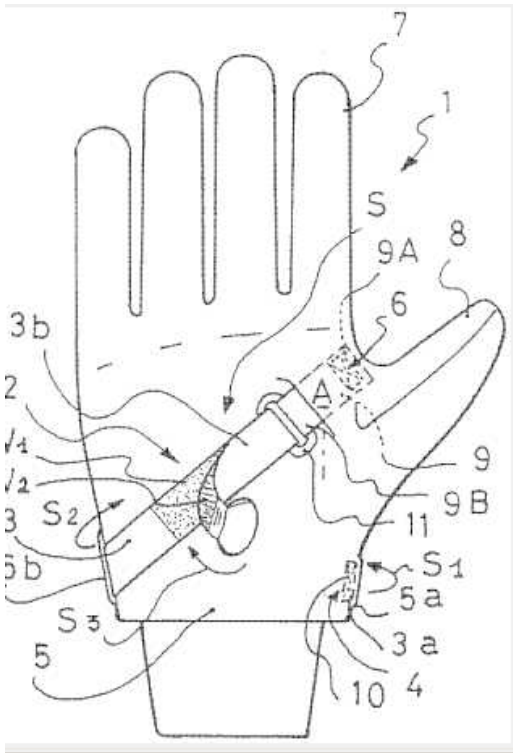
**Special rules of classification**

For fastening glove in cuff area (but not to another garment), class only in [A41F 1/06](#) .

For fastening glove in other area, class only in [A41F 1/06](#). For fastening glove to another garment class in [A41D 19/0041](#) or [A41D 19/0089](#).

For sealing attachments of glove and sleeve from protective garment class in [A41D 13/0005](#)

A41D 19/0037

{for fastening an article to the glove}

Definition statement

This place covers:

Illustrative example of subject matter classified in this group.

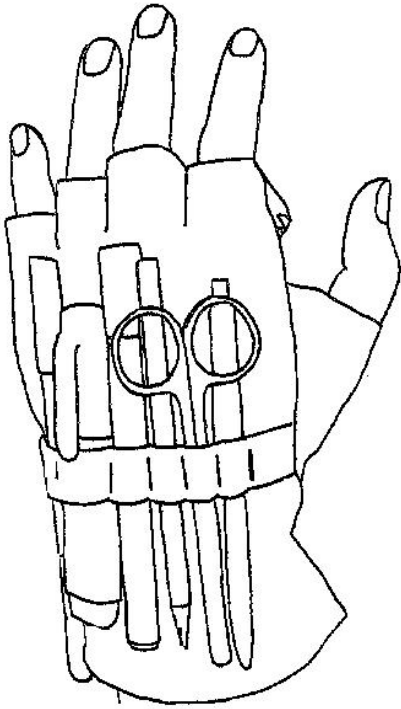

A41D 19/0041

{for connecting the glove to the garment or the arm of the user}

Definition statement

This place covers:

Illustrative example of subject matter classified in this group.

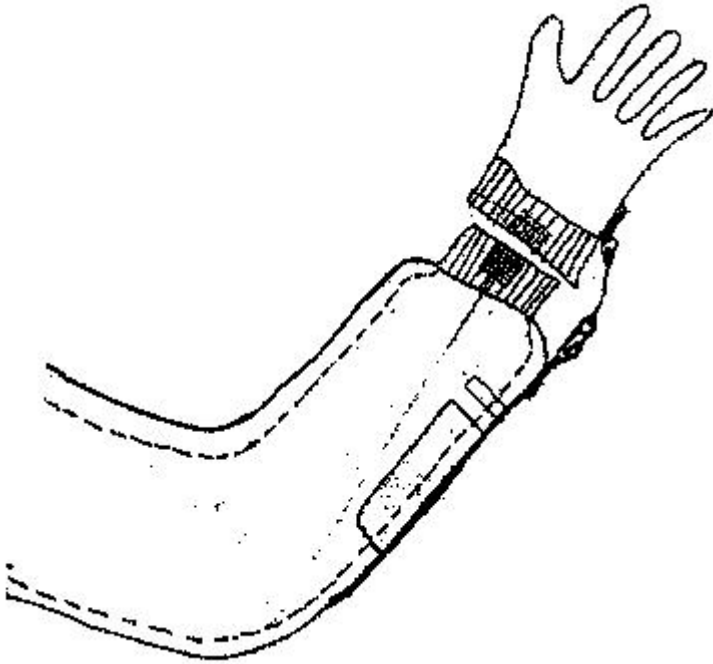

Special rules of classification

For fastening glove in cuff area (but not to another garment), classify only in [A41F 1/06](#).

For fastening glove in other area, classify only in [A41F 1/06](#).

For fastening glove to another garment classify in [A41D 19/0041](#) or [A41D 19/0089](#).

For sealing attachments of glove and sleeve from protective garment classify in [A41D 13/0005](#).

A41D 19/0044

{Cuff portions}

Definition statement

This place covers:

Illustrative example of subject matter classified in this group.

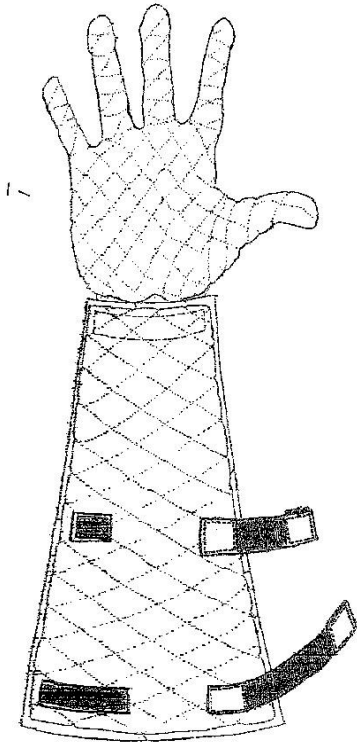

Special rules of classification

For fastening glove in cuff area (but not to another garment), class only in [A41F 1/06](#) .

For fastening glove in other area, class only in [A41F 1/06](#). For fastening glove to another garment class in [A41D 19/0041](#) or [A41D 19/0089](#).

For attachments of glove and sleeve from protective garment with sealing class in [A41D 13/0005](#).

A41D 19/0051**{Decorations}****Definition statement***This place covers:*

Illustrative example of subject matter classified in this group.

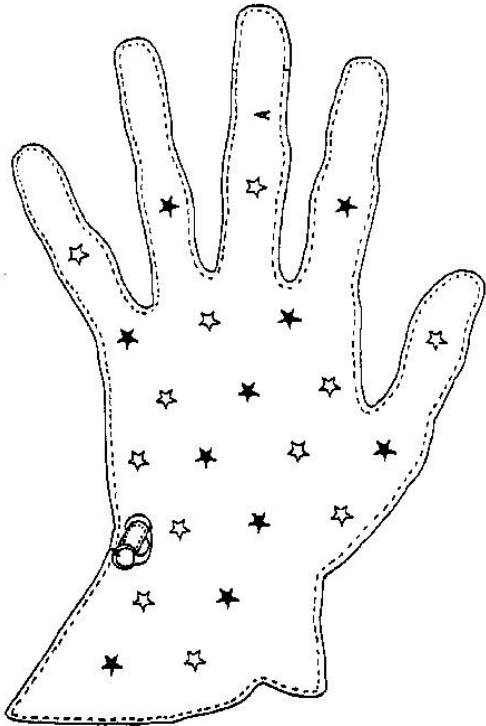
**A41D 19/0055****{Plastic or rubber gloves}****References****Informative references***Attention is drawn to the following places, which may be of interest for search:*

| | |
|---|--|
| Glove dispensers in surgery / diagnosis | A61B 42/40 |
| Surgery instruments detector | A61B 2090/0804 |
| Gloves delivering cosmetics | A61K 8/0208 , A45D 34/00 , A61M 35/003 |
| Dipping process | B05D 1/18 |
| Shaping by coating a mould | B29C 41/00 |
| Encapsulating inserts in plastic | B29C 70/70 |
| Producing gloves from plastics | B29D 99/0067 |
| Dispensing flat articles | B65D 83/0894 |
| Reinforced macromolecular compounds | C08J 5/005 |

| | |
|--|--|
| Coating shaped articles | C08J 7/04 |
| Magnet detectable rubber gloves | C08K 2201/01 , C08L 21/00 |
| Latex compounds | C08L 11/02 |
| Oilcloth obtained by covering fibrous webs with rubber, PU | D06N 3/14 |
| Safety control of machines | F16P 3/12 |
| Tags for object detection | G01V 15/00 |
| Alarms, ferromagnetic tags | G08B 13/2408 |

A41D 19/0058

{Three-dimensional gloves}

Definition statement

This place covers:

Illustrative example of subject matter classified in this group.

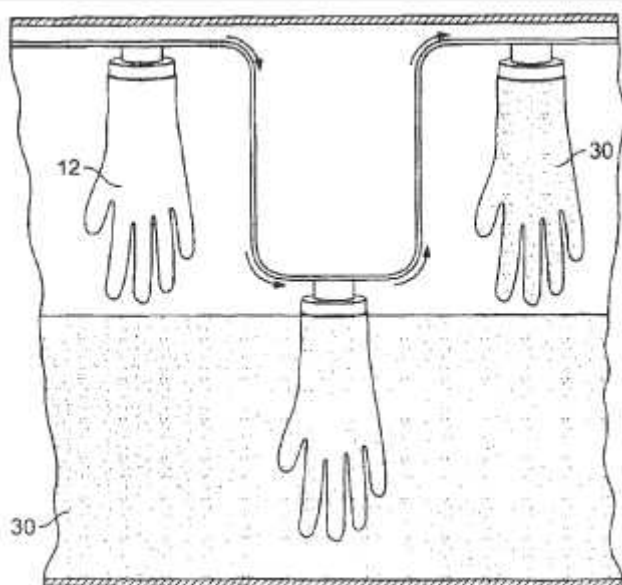

FIG. 3

A41D 19/0062

{made of one layer of material}

Definition statement

This place covers:

Illustrative example of subject matter classified in this group.

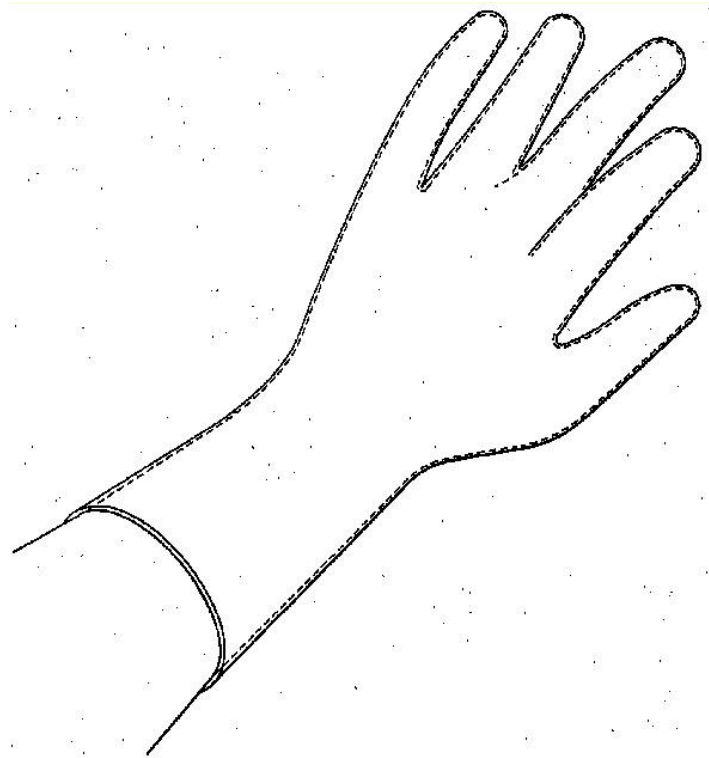

A41D 19/0065**{with a textile layer underneath}****Definition statement***This place covers:*

Illustrative example of subject matter classified in this group.

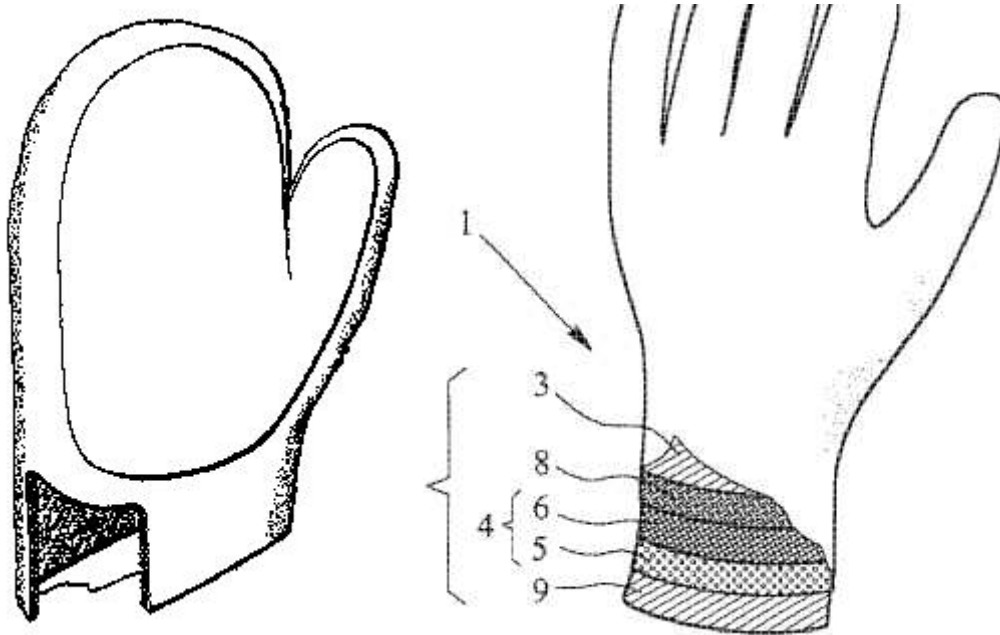
**References****Informative references***Attention is drawn to the following places, which may be of interest for search:*

| | |
|--------------------------|---------------------------|
| Dipping process | B05D 1/18 |
| Weft knitting for gloves | D04B 1/28 |

A41D 19/0068

{Two-dimensional gloves, i.e. obtained by superposition of two sheets of material}

Definition statement

This place covers:

Illustrative example of subject matter classified in this group.

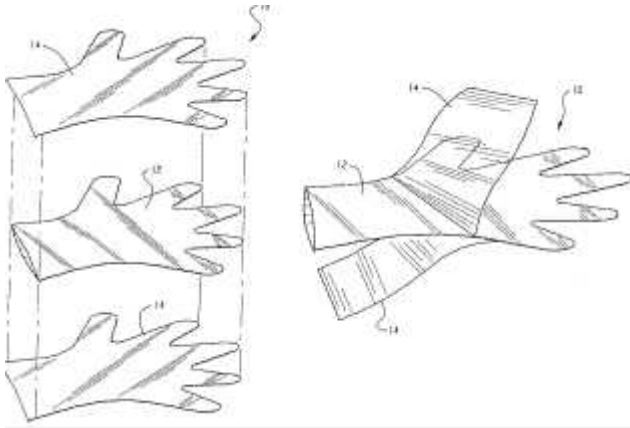

References

Informative references

Attention is drawn to the following places, which may be of interest for search:

| | |
|--|----------------------------|
| Sanitary / disposable caps (food / hospital) | A42B 1/012 |
|--|----------------------------|

A41D 19/0072

{made of one layer of material}

Definition statement

This place covers:

Illustrative example of subject matter classified in this group.

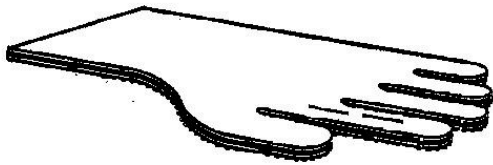
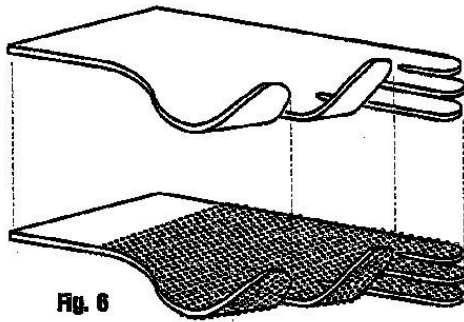

A41D 19/0075**{permitting handling and containing of waste materials}****Definition statement***This place covers:*

Illustrative example of subject matter classified in this group.

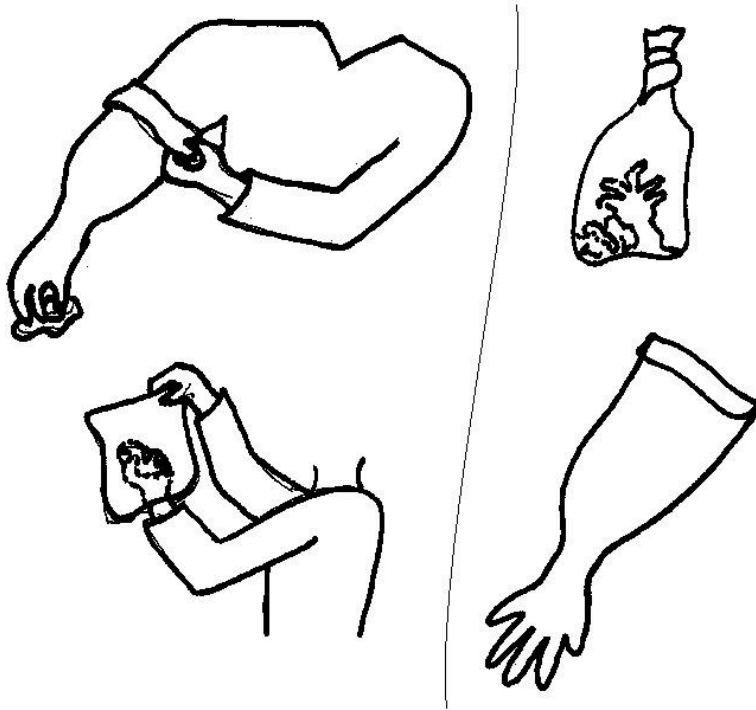
**References****Informative references***Attention is drawn to the following places, which may be of interest for search:*

| | |
|---|-----------------------------|
| Hand implements for removing excrements | E01H 1/1206 |
|---|-----------------------------|

A41D 19/0079

{with channels for conveying fluids}

Definition statement

This place covers:

Illustrative example of subject matter classified in this group.

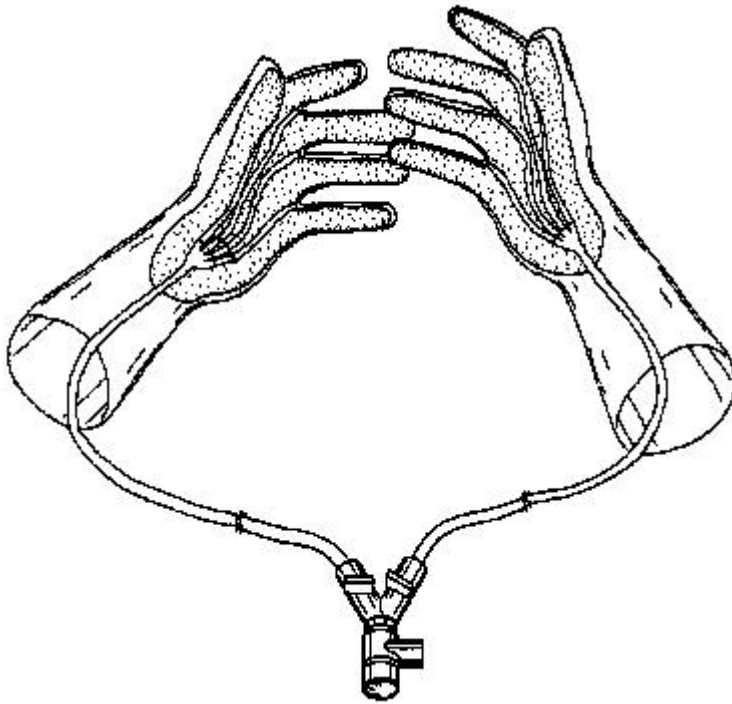

A41D 19/0082

{Details}

Definition statement

This place covers:

Illustrative example of subject matter classified in this group.

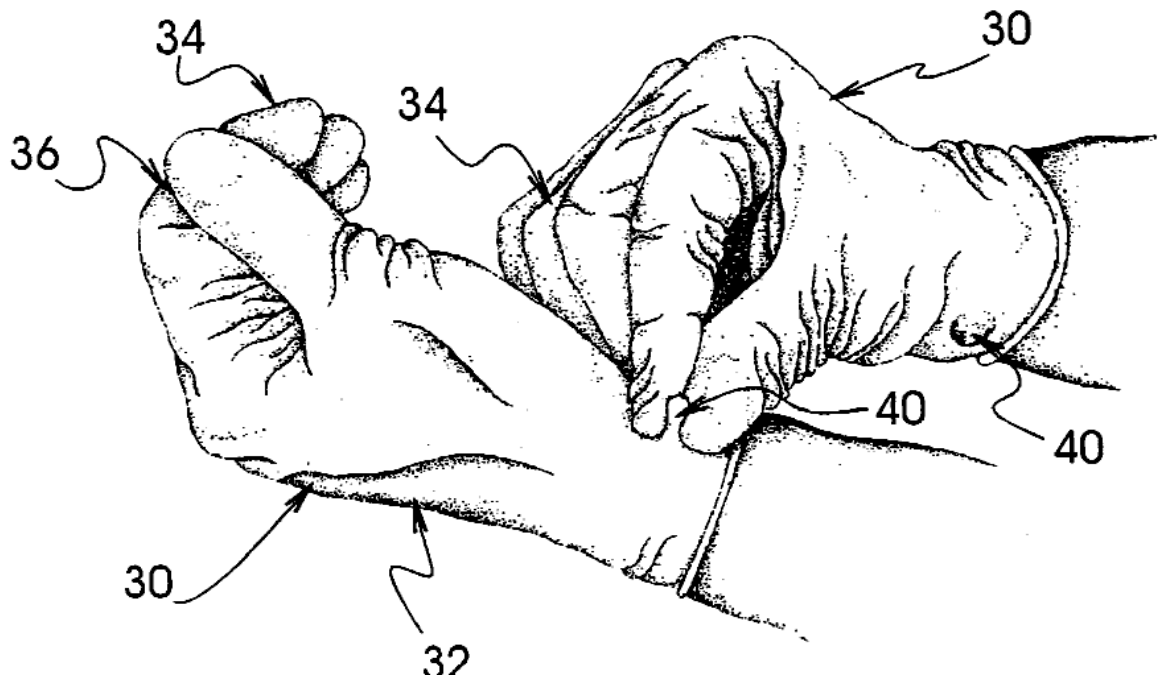

A41D 19/0086

{Nail-like attachments}

Definition statement

This place covers:

Illustrative example of subject matter classified in this group.

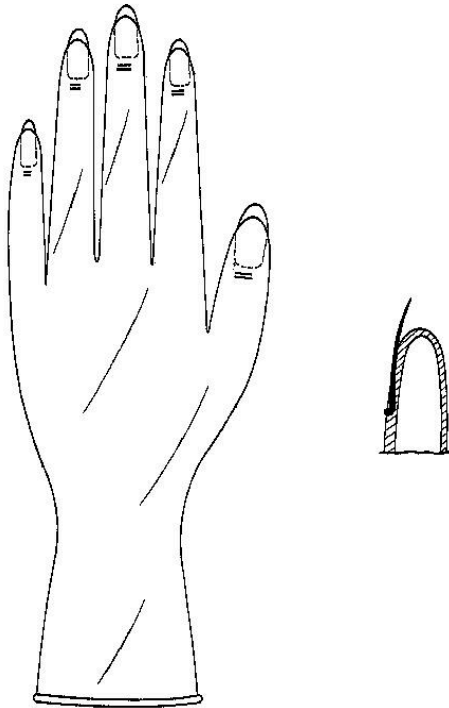

A41D 19/0089

{Joints between glove and cuff or garment}

Definition statement

This place covers:

Illustrative example of subject matter classified in this group.

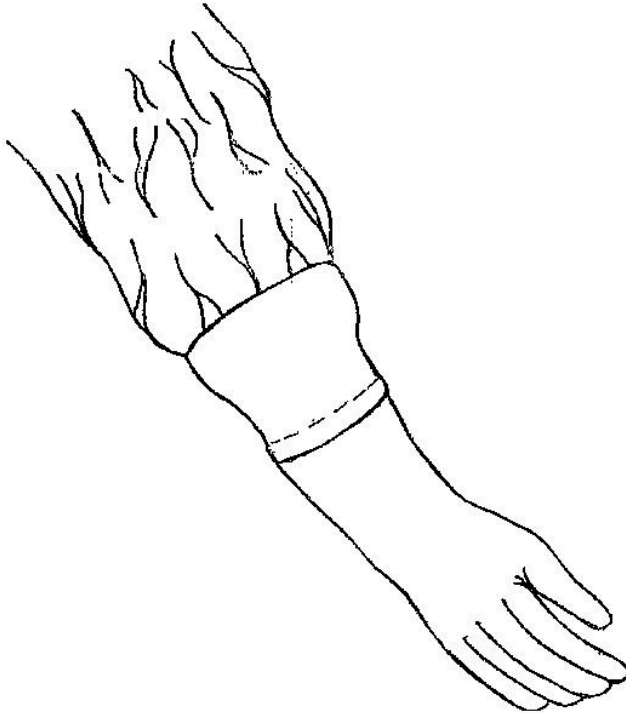

Special rules of classification

For fastening glove in cuff area (but not to another garment), classify only in [A41F 1/06](#).

For fastening glove in other area, classify only in [A41F 1/06](#).

For fastening glove to another garment class in [A41D 19/0041](#) or here ([A41D 19/0089](#)).

For sealing attachments of glove and sleeve from protective garment class in [A41D 13/0005](#).

A41D 19/0093

{Retaining means, e.g. loops for hanging the gloves}

Definition statement

This place covers:

Illustrative example of subject matter classified in this group.

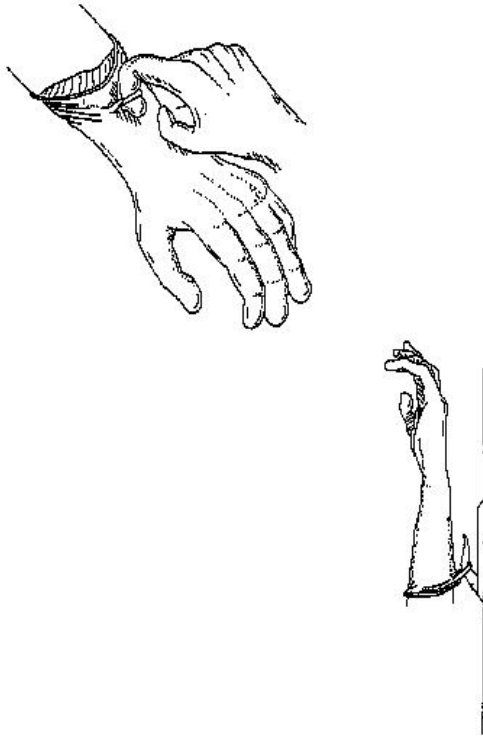

References

Informative references

Attention is drawn to the following places, which may be of interest for search:

| | |
|-------------------------------------|-----------------------------|
| Devices to assist donning of gloves | A47G 25/904 |
| Glove hooks on walls | A47G 25/92 |

A41D 19/0096

{Means for resisting mechanical agressions, e.g. cutting or piercing}

Definition statement

This place covers:

Illustrative example of subject matter classified in this group.

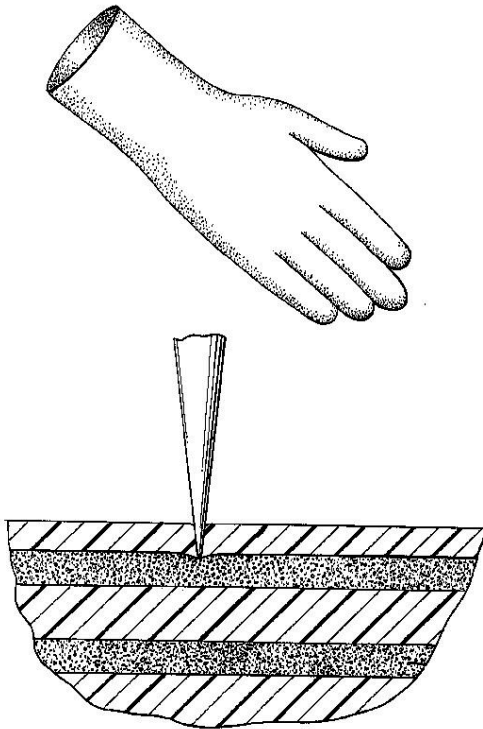

A41D 19/01

with undivided covering for all four fingers, i.e. mittens ({[A41D 19/0055](#)},
[A41D 19/015](#) take precedence)

Definition statement

This place covers:

Illustrative example of subject matter classified in this group.

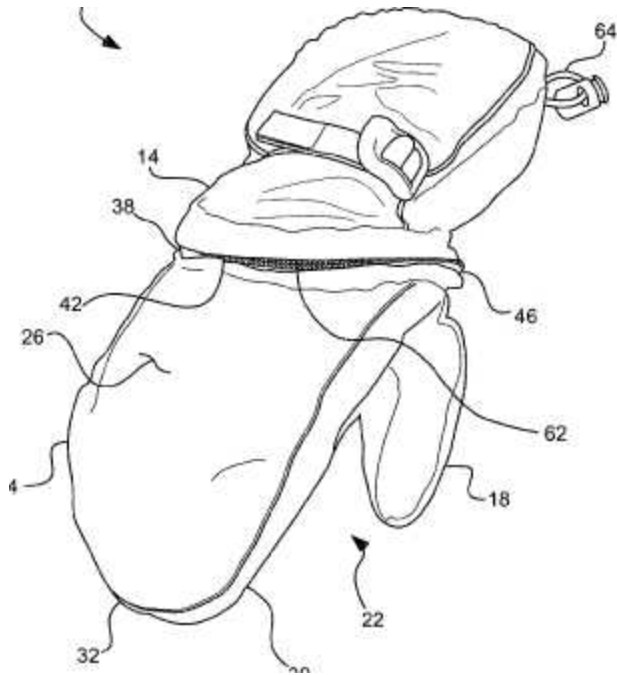
**References****Informative references**

Attention is drawn to the following places, which may be of interest for search:

| | |
|---------------------|----------------------------|
| Kitchen pot holders | A47J 45/10 |
|---------------------|----------------------------|

A41D 19/015

Protective gloves {(A41D 19/0055 takes precedence)}

Definition statement

This place covers:

Illustrative example of subject matter classified in this group.

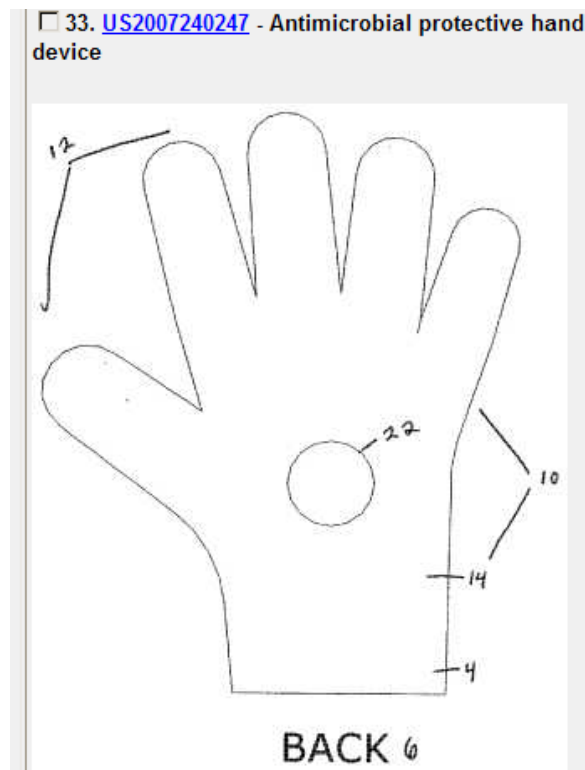

A41D 19/01505

{resistant to mechanical aggressions, e.g. cutting. piercing}

Definition statement

This place covers:

Illustrative examples of subject matter classified in this group.

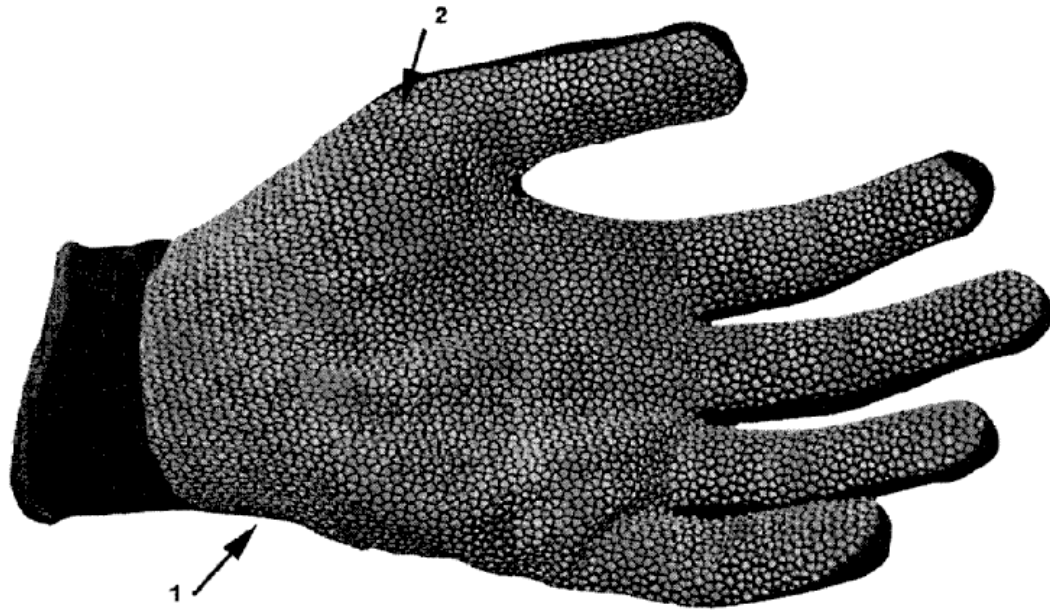

82. [US2007083968](#) - Puncture Resistant Glove

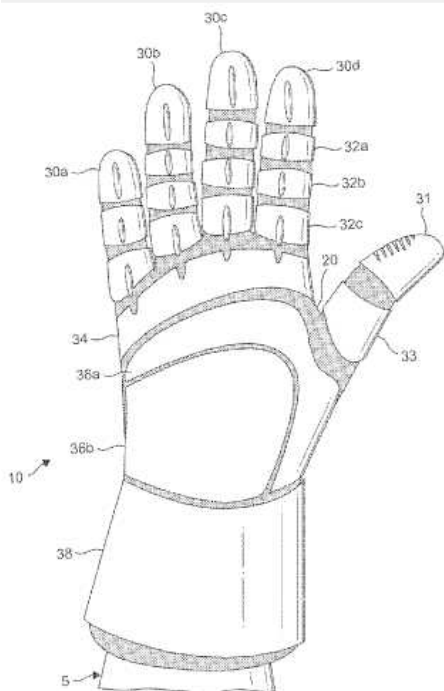

A41D 19/01511

{made of wire-mesh, e.g. butchers' gloves}

Definition statement

This place covers:

Illustrative example of subject matter classified in this group.

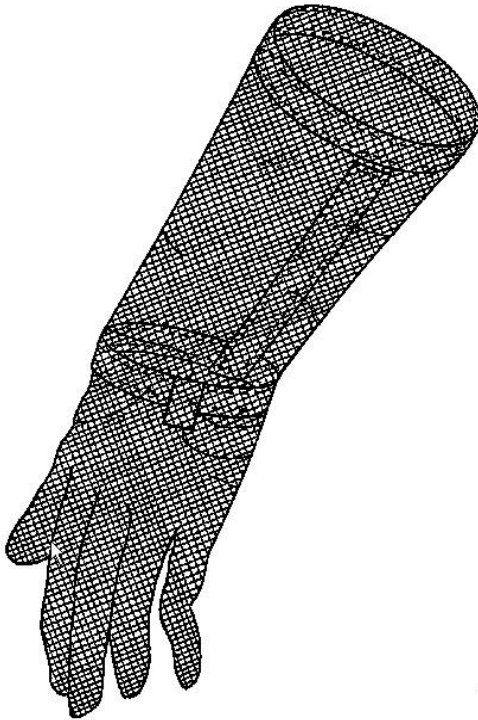

References

Informative references

Attention is drawn to the following places, which may be of interest for search:

| | |
|----------------------------|-----------------------------|
| Armour plate constructions | F41H 5/0492 |
|----------------------------|-----------------------------|

A41D 19/01517

{with protection against crushing, e.g. of the finger tips}

Definition statement

This place covers:

Illustrative examples of subject matter classified in this group.

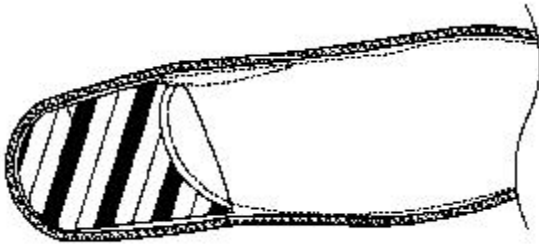
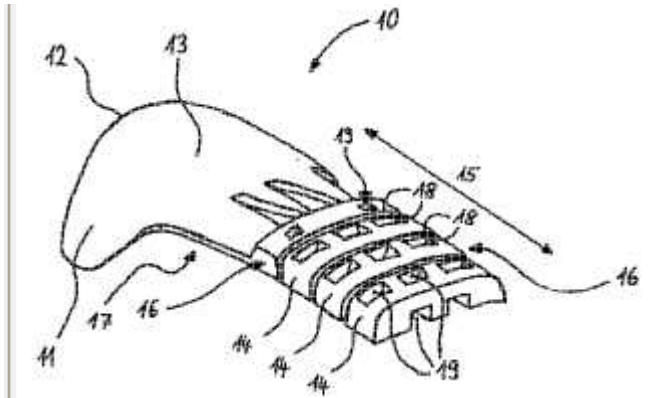

A41D 19/01523

{absorbing shocks or vibrations}

Definition statement

This place covers:

Illustrative example of subject matter classified in this group.

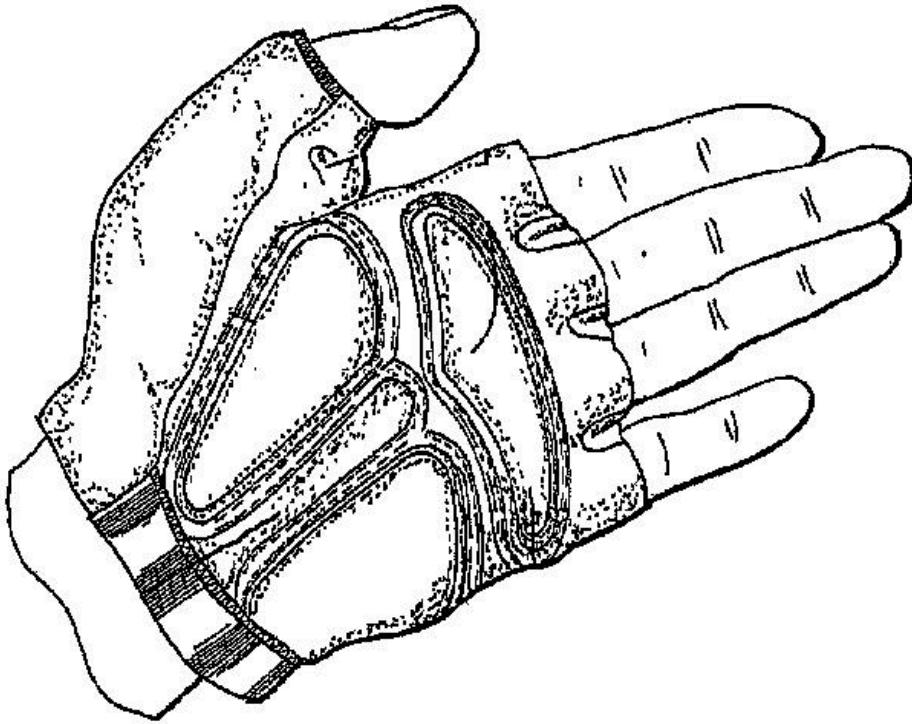

A41D 19/01529**{with thermal or fire protection}****Definition statement***This place covers:*

Illustrative examples of subject matter classified in this group.

□ 88. [US2005177923](#) - (A1 B2) Heat/cold resistant protective hand covering

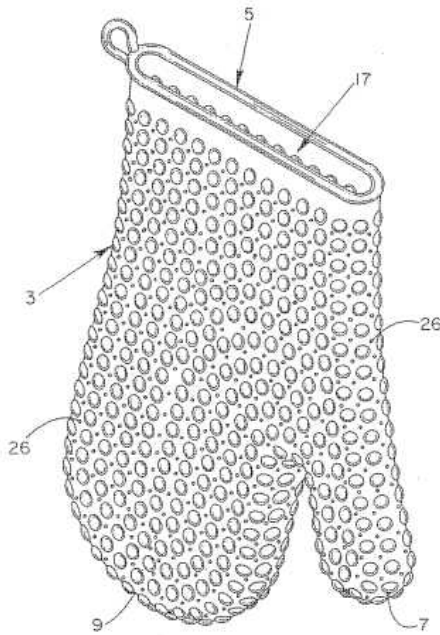

□ 305. [US4583248](#) - Insulated glove

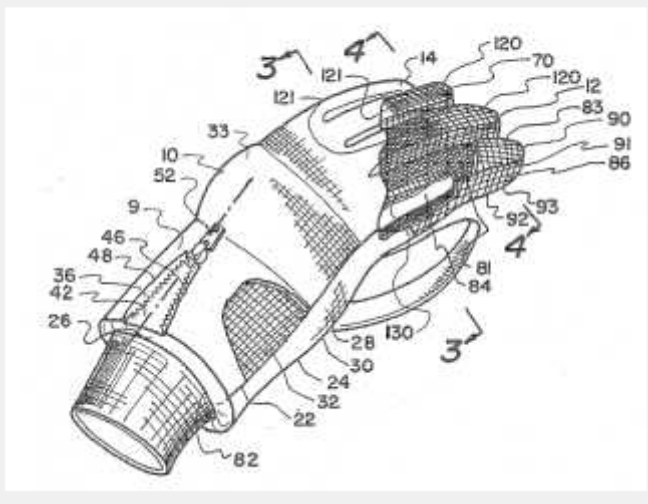

A41D 19/01535**{Heated gloves}****Definition statement***This place covers:*

Illustrative examples of subject matter classified in this group.

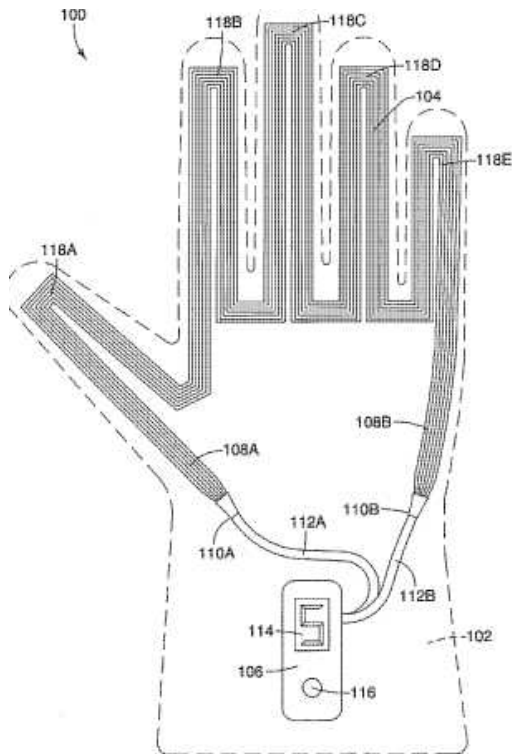
**References****Informative references***Attention is drawn to the following places, which may be of interest for search:*

| | |
|--|--------------------------------|
| Heating / cooling therapy of human body | A61F 7/00 |
| Hand heating / cooling | A61F 2007/0036 |
| Heating / cooling incorporated in clothing | A61F 2007/0233 |
| Ohmic-resist. heating in clothes | H05B 3/342 |

A41D 19/01541**{Cooled gloves}****Definition statement***This place covers:*

Illustrative example of subject matter classified in this group.

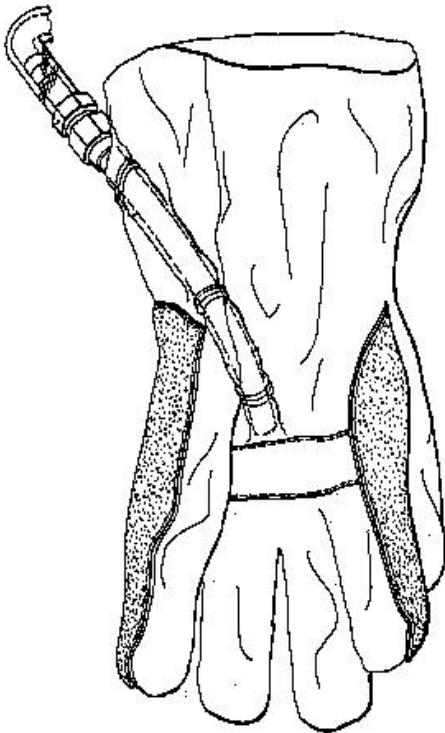
**References****Informative references***Attention is drawn to the following places, which may be of interest for search:*

| | |
|--|--------------------------------|
| Heating / cooling therapy of human body | A61F 7/00 |
| Hand heating / cooling | A61F 2007/0036 |
| Heating / cooling incorporated in clothing | A61F 2007/0233 |

A41D 19/01547**{with grip improving means}****Definition statement***This place covers:*

Illustrative examples of subject matter classified in this group.

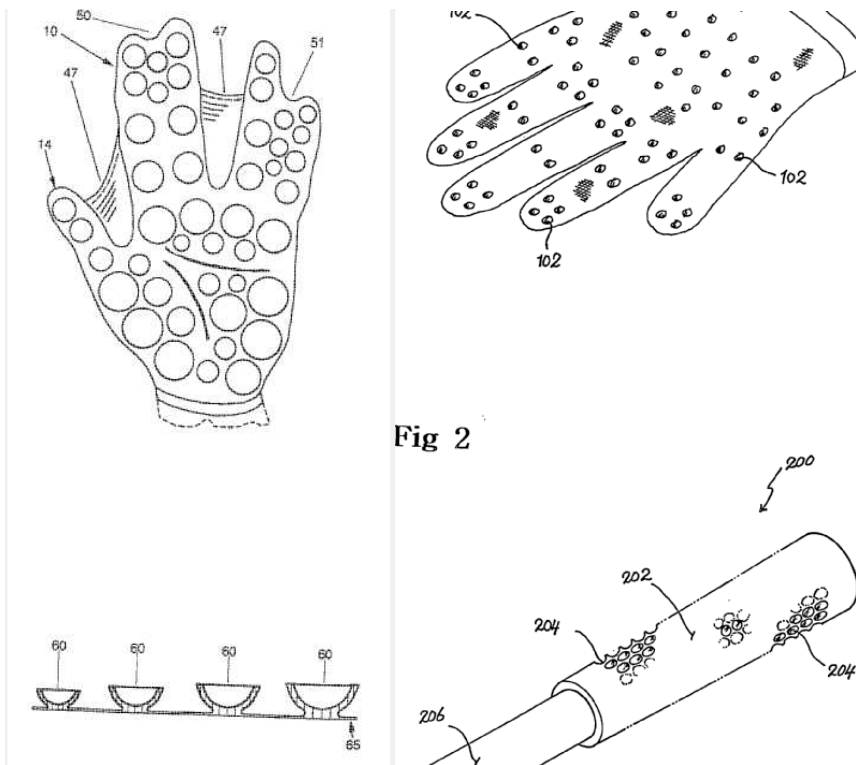

A41D 19/01552

{using hooks and loops fastening system}

Definition statement

This place covers:

Illustrative example of subject matter classified in this group.

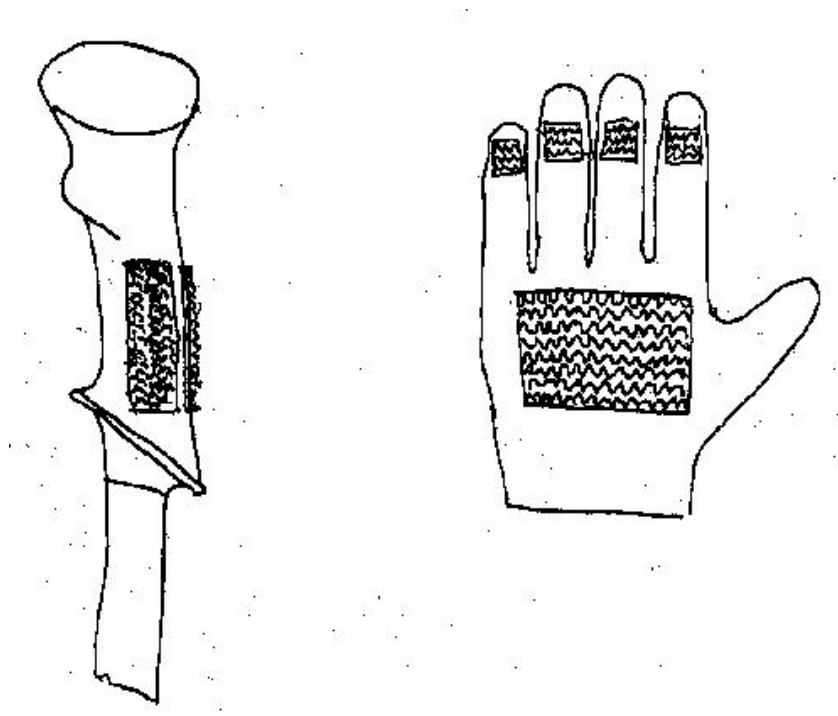

A41D 19/01558

{using a layer of grip improving material ([A41D 19/01552](#) takes precedence)}

Definition statement

This place covers:

Illustrative example of subject matter classified in this group.

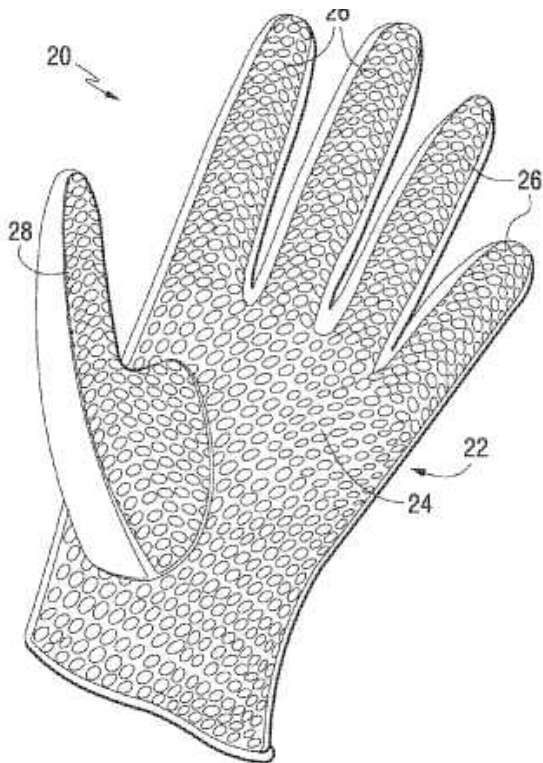
**A41D 19/01564**

{using strips of material}

Definition statement

This place covers:

Illustrative example of subject matter classified in this group.

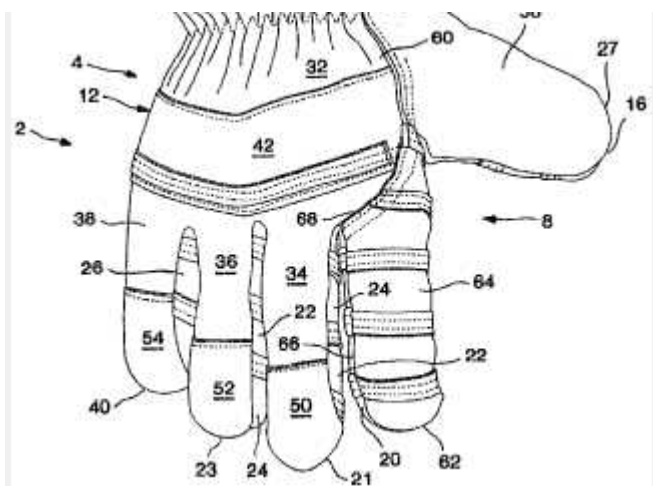

A41D 19/0157

{with luminous or reflective means (protective garments with reflective or luminous safety means [A41D 13/01](#))}

Definition statement

This place covers:

Illustrative example of subject matter classified in this group.

□ 112. [US5580154](#) - Glow-in-the-dark glove apparatus

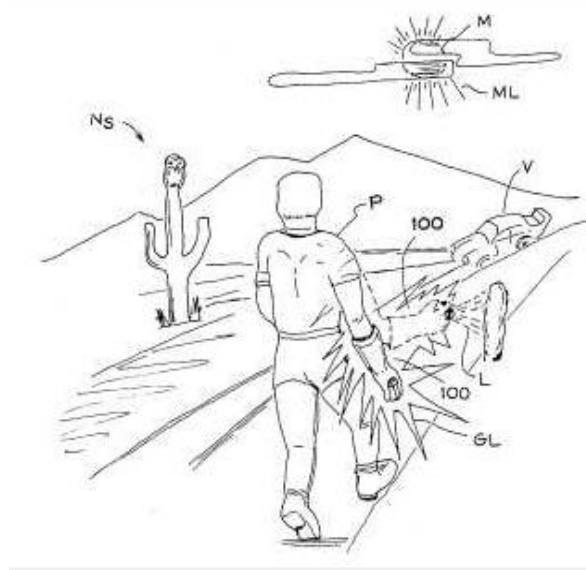

References

Informative references

Attention is drawn to the following places, which may be of interest for search:

| | |
|--|---|
| Lighting signalling worn by driver | B60Q 1/2673 , B60Q 7/00 |
| Structural combinations of lighting devices with clothing, gloves | F21V 33/0008 |
| Structural combination of light devices with fire-fighting equipment | F21V 33/0064 |
| Refracting surfaces | G02B 5/126 |
| Visible signalling arrangements attached on persons, reflective safety belts | G08B 5/004 |
| Indicating arrangements with diodes | G09F 9/33 |
| Illuminated signs | G09F 13/00 |

Special rules of classification

Reflective means include mirrors.

A41D 19/01582**{with means to restrain or support the hand}****Definition statement***This place covers:*

Illustrative examples of subject matter classified in this group.

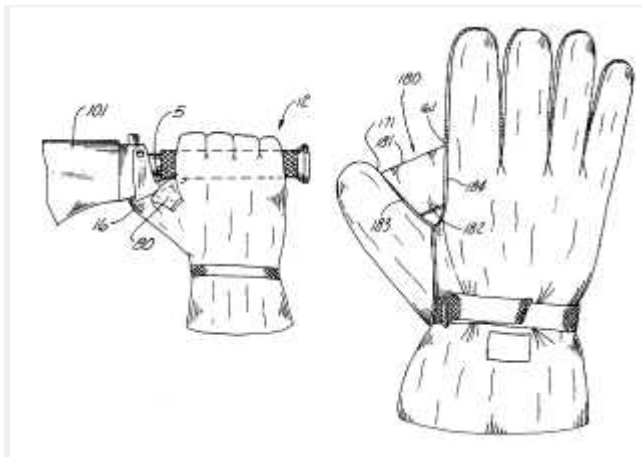
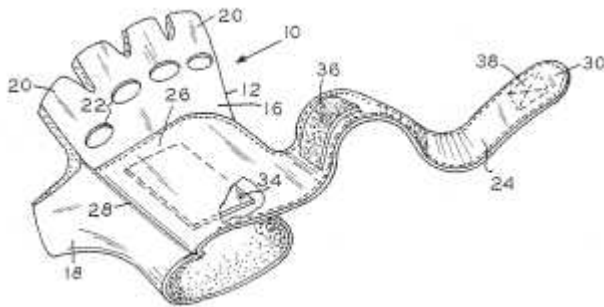
**References****Informative references***Attention is drawn to the following places, which may be of interest for search:*

| | |
|---------------------------------|---------------------------|
| Orthopaedic devices for fingers | A61F 5/10 |
|---------------------------------|---------------------------|

A41D 19/01588**{including rigid elements}****Definition statement***This place covers:*

Illustrative examples of subject matter classified in this group.

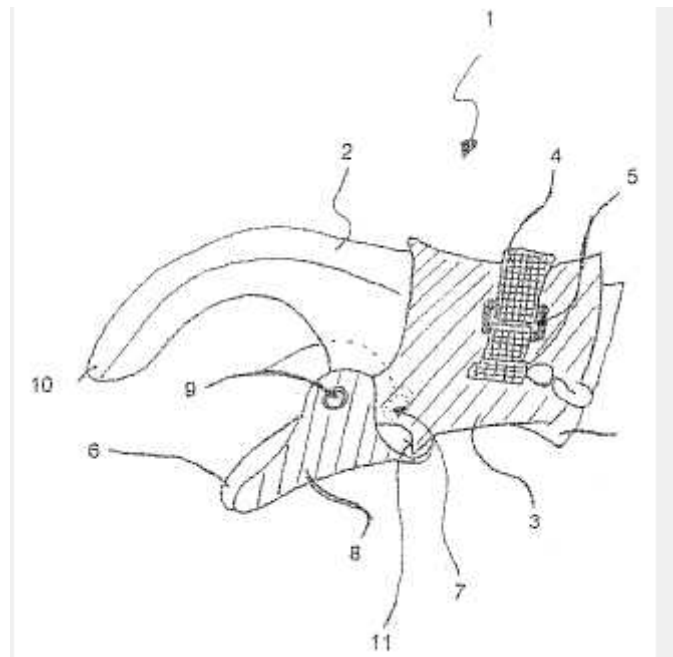
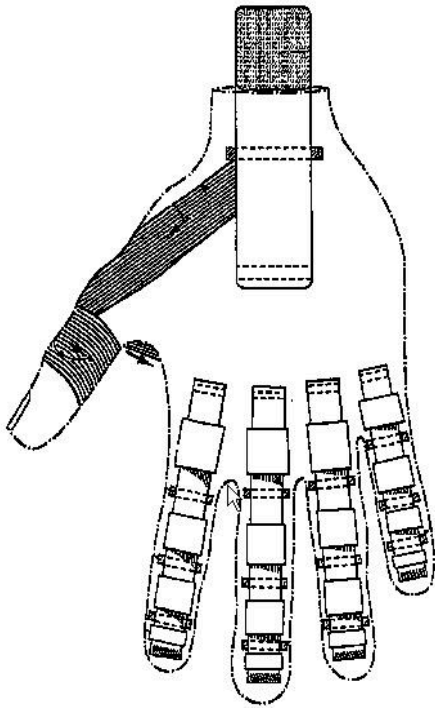

A41D 19/01594

{with accessories, e.g. tools, receptacles}

Definition statement

This place covers:

Illustrative example of subject matter classified in this group.

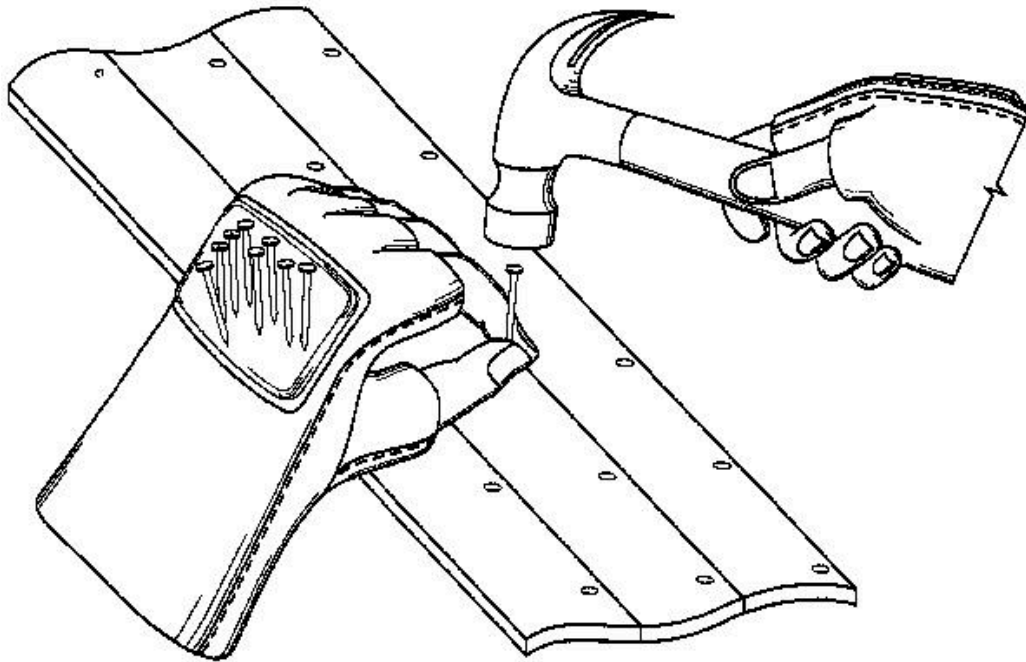

A41D 19/02

Arrangements for cutting-out, or shapes of, glove blanks

Definition statement

This place covers:

Illustrative example of subject matter classified in this group.

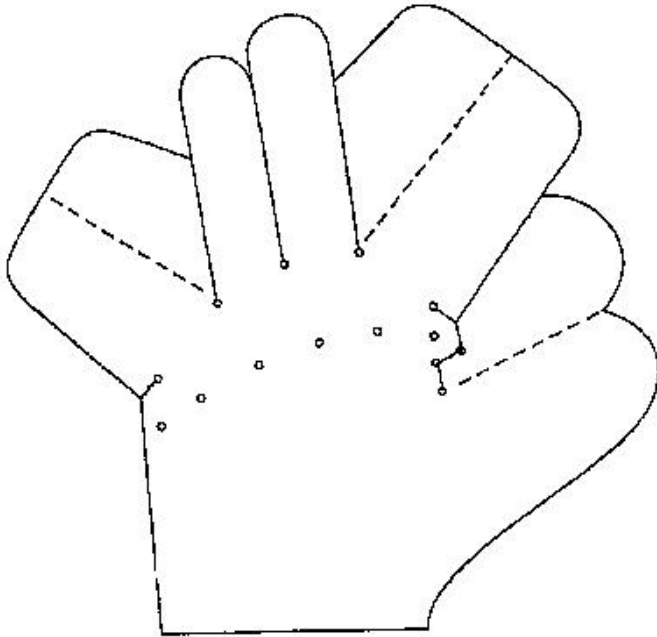

A41D 19/04

Appliances for making gloves; Measuring devices for glove-making

Definition statement

This place covers:

Illustrative example of subject matter classified in this group.

21. [US2005274750](#) - (A1 B2) Glove shaping device

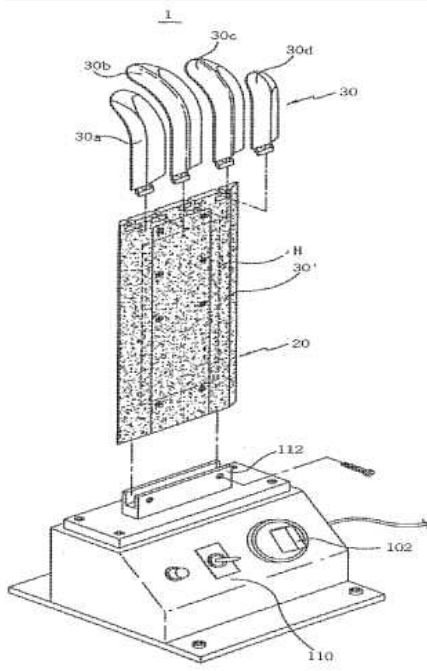

A41D 19/043

{Glove-turning machines (turning inside-out of tubular articles [D06G 3/00](#))}

Definition statement

This place covers:

Illustrative example of subject matter classified in this group.

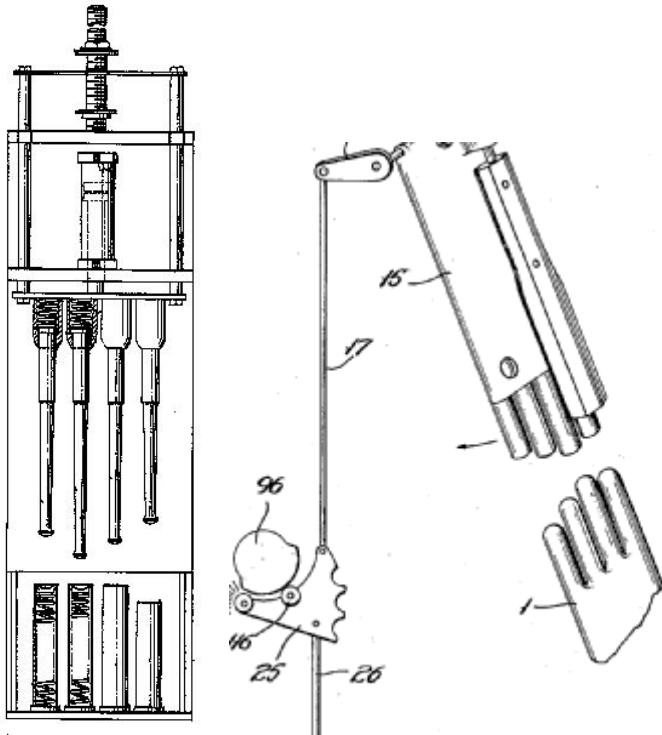

A41D 19/046**{Measuring devices for glove-making}****Definition statement**

This place covers:

Illustrative example of subject matter classified in this group.

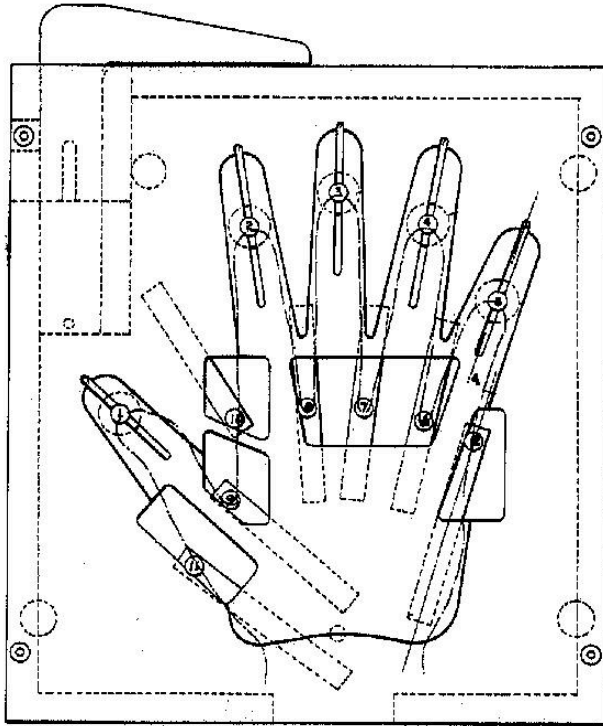
**References****Informative references**

Attention is drawn to the following places, which may be of interest for search:

| | |
|-----------------------|---------------------------|
| Measuring instruments | G01B 3/46 |
|-----------------------|---------------------------|

A41D 20/00

Wristbands or headbands, e.g. for absorbing sweat

Definition statement

This place covers:

Illustrative example of subject matter classified in this group.

Perspiration redirecting head
band device

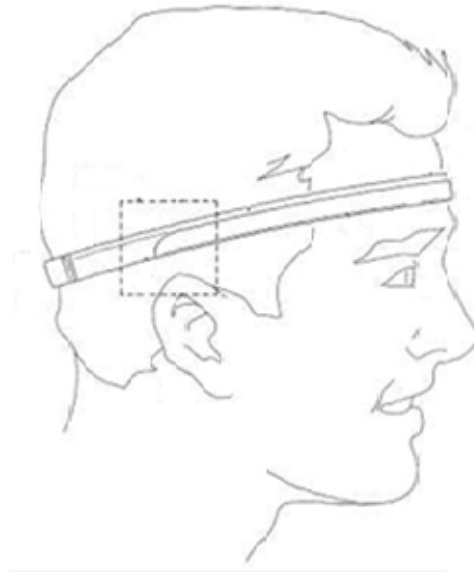

References

Informative references

Attention is drawn to the following places, which may be of interest for search:

| | |
|--------------------------------|----------------------------|
| Hat fittings | A42C 5/02 |
| Towels, body-drying implements | A47K 10/02 |

Special rules of classification

For exterior protection on arm to use as handkerchief, class in [A41D 27/12](#) and as additional information in [A41B 15/00](#).

If it has the shape of an armband, class additionally in [A41D 20/00](#).

A41D 23/00**Scarves; Head-scarves; Neckerchiefs****Definition statement**

This place covers:

Illustrative example of subject matter classified in this group.

**References****Informative references**

Attention is drawn to the following places, which may be of interest for search:

| | |
|--------------------|----------------------------|
| Soft caps, turbans | A42B 1/041 |
| Bonnets | A42B 1/045 |
| Veils | A42B 5/00 |

A41D 25/00

Neckties

Definition statement

This place covers:

Illustrative examples of subject matter classified in this group.

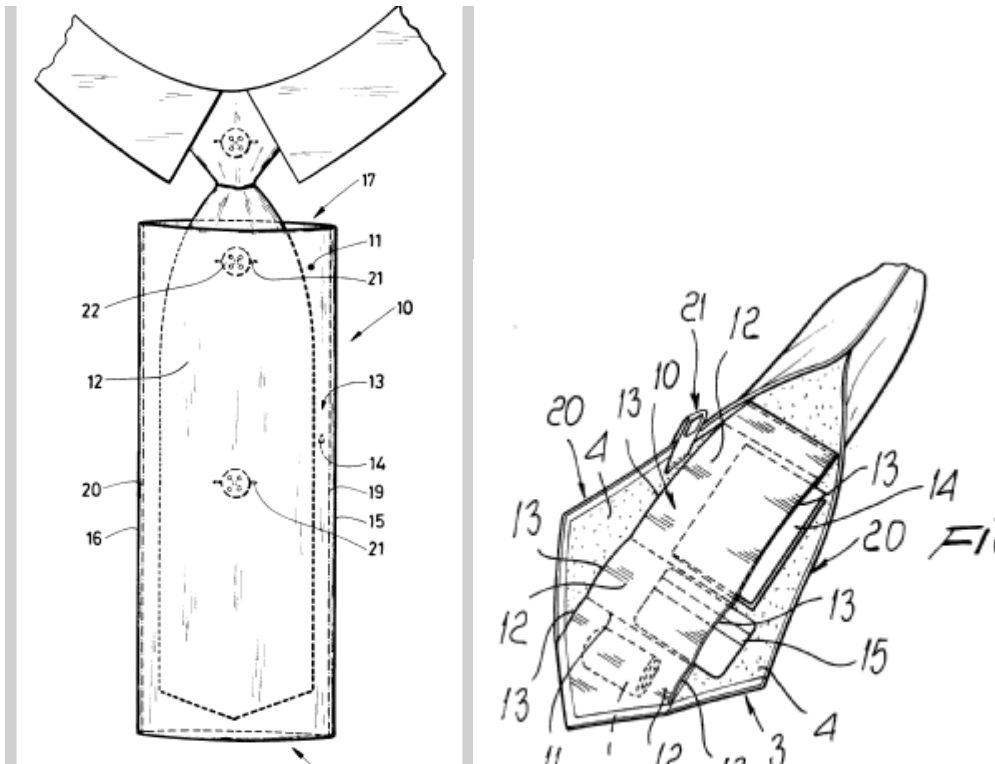

References

Informative references

Attention is drawn to the following places, which may be of interest for search:

| | |
|---------------------------|---------------------------|
| Decorative bow structures | D04D 7/10 |
|---------------------------|---------------------------|

Special rules of classification

Comprises ascot ties, bow ties and cravates.

Comprises protectors of neckties.

A41D 25/001**{Making neckties}****Definition statement***This place covers:*

Illustrative example of subject matter classified in this group.

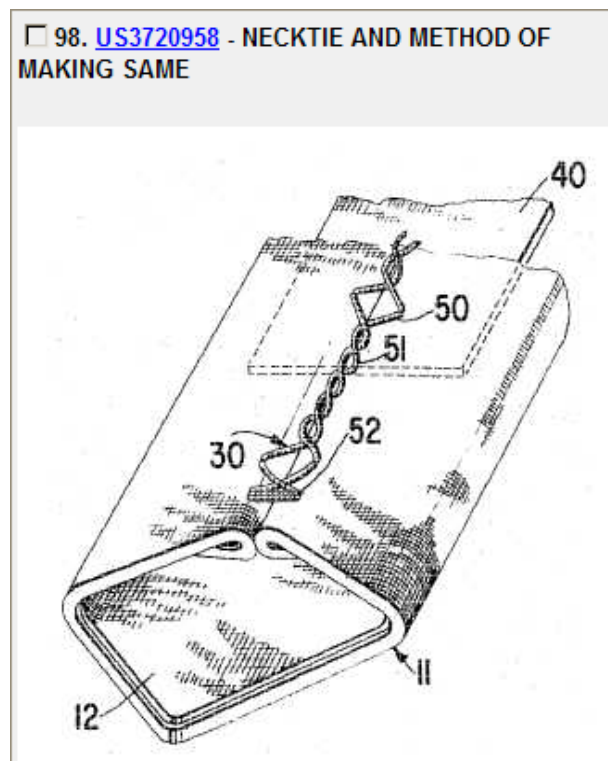

A41D 25/003

{Neckties provided with holding devices, e.g. button holes or loops for securing them to a shirt or for holding the two ends of the necktie}

Definition statement

This place covers:

Illustrative example of subject matter classified in this group.

I 117. [WO9300835](#) - IMPROVED APPARATUS FOR RESTRAINING A NECKTIE AND METHOD FOR USING THE SAME

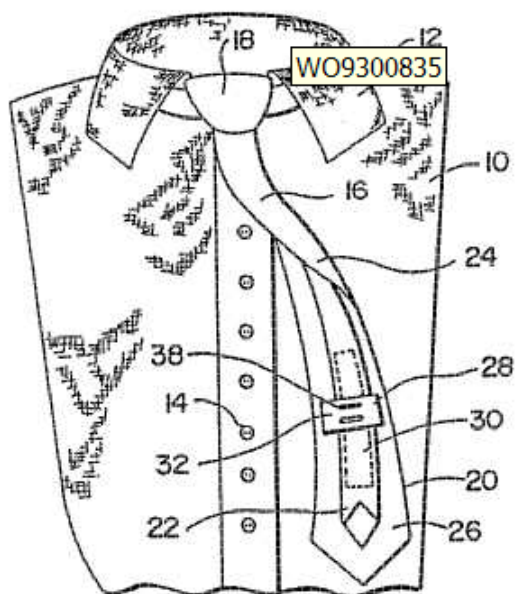

References

Informative references

Attention is drawn to the following places, which may be of interest for search:

| | |
|--|---------------------------|
| Shirt collars with supports for neckties | A41B 3/12 |
|--|---------------------------|

A41D 25/02

with ready-made knot or bow, with or without bands

Definition statement

This place covers:

Illustrative example of subject matter classified in this group.

93. [US5123118](#) - Clip-on necktie

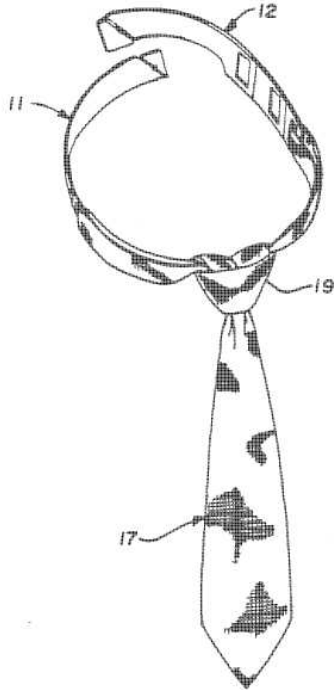

A41D 25/022

{with knot simulated by a ring or the like}

Definition statement

This place covers:

Illustrative example of subject matter classified in this group.

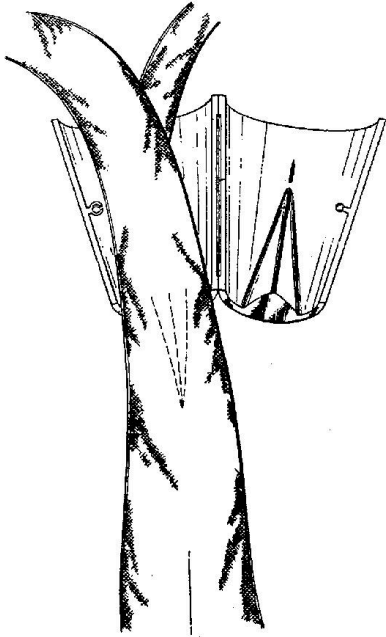

A41D 25/025

{Means for forming the knot or bow, e.g. combined with means for holding the tie}

Definition statement

This place covers:

Illustrative examples of subject matter classified in this group.

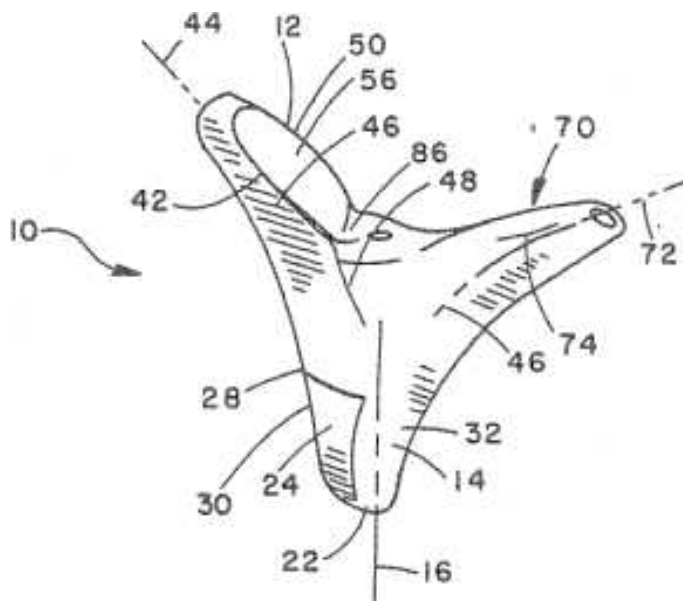
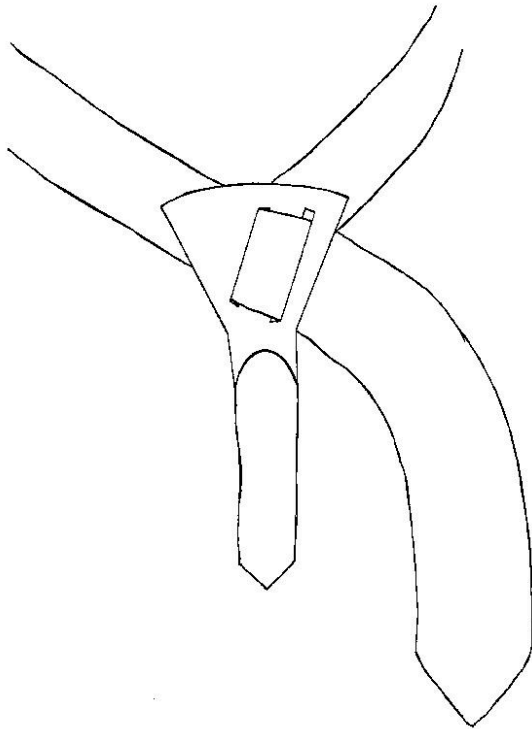

A41D 25/027

{Means for holding the necktie ([A41D 25/025](#) takes precedence)}

Definition statement

This place covers:

Illustrative example of subject matter classified in this group.

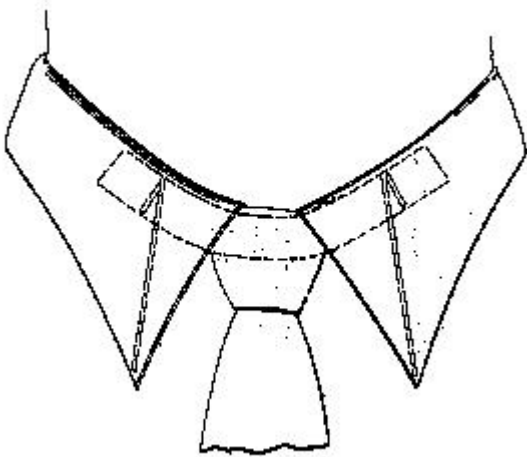

References

Informative references

Attention is drawn to the following places, which may be of interest for search:

| | |
|--|---------------------------|
| Shirt collars with supports for neckties | A41B 3/12 |
|--|---------------------------|

A41D 25/04

{Bands}; Fastening devices for the bands

Definition statement

This place covers:

Illustrative example of subject matter classified in this group.

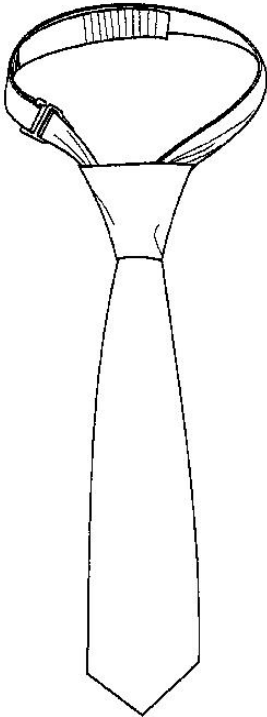

A41D 25/06

with knot, bow or like tied by the user

Definition statement

This place covers:

Illustrative examples of subject matter classified in this group.

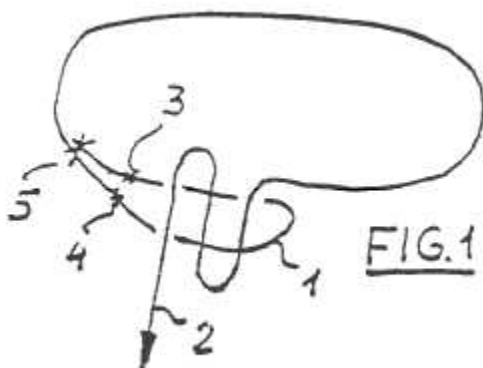

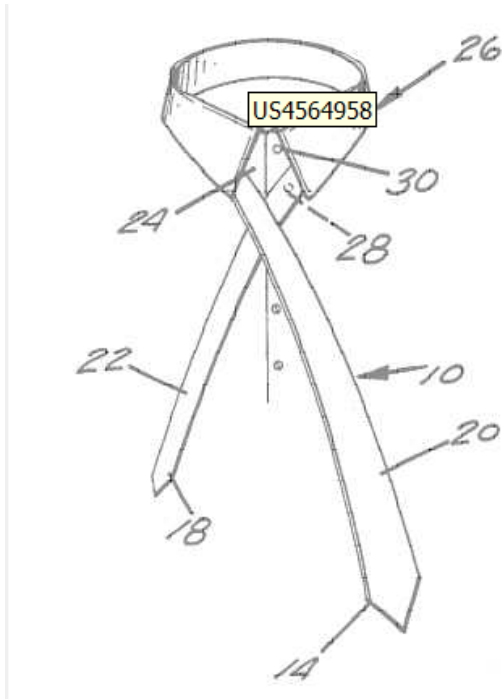

A41D 25/08

Means for forming or tying the knot, or the like

Definition statement

This place covers:

Illustrative example of subject matter classified in this group.

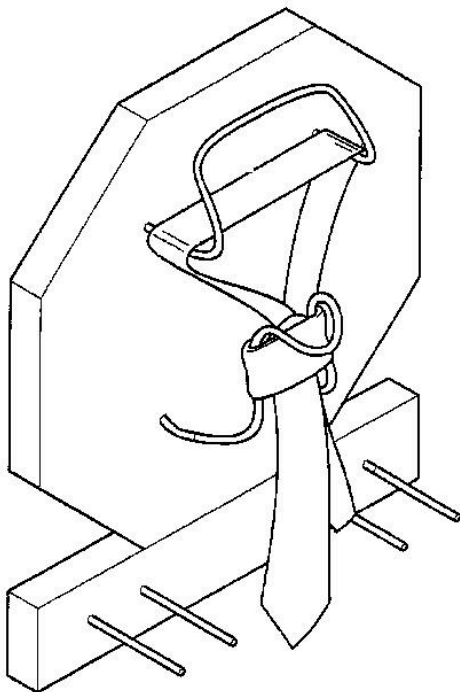

A41D 25/10

Means for holding the knot, or the like

Definition statement

This place covers:

Illustrative example of subject matter classified in this group.

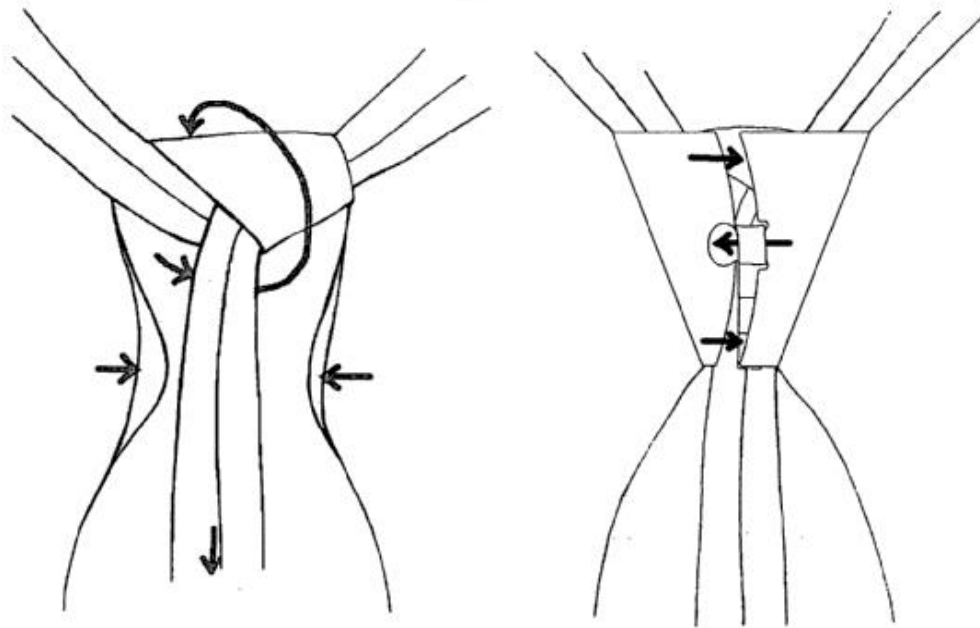

A41D 25/12

attachable to the collar or stud

Definition statement

This place covers:

Illustrative example of subject matter classified in this group.

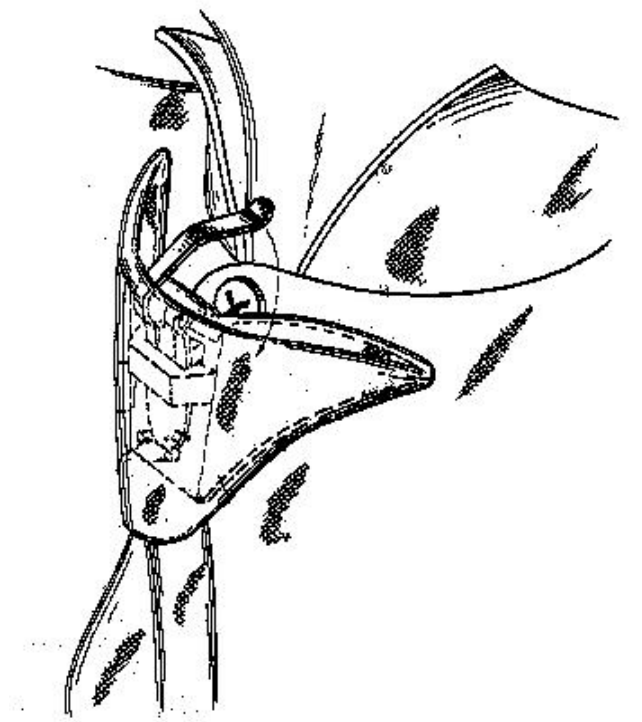

References

Informative references

Attention is drawn to the following places, which may be of interest for search:

| | |
|--|---------------------------|
| Shirt collars with supports for neckties | A41B 3/12 |
|--|---------------------------|

A41D 25/14

Means for forming and holding simultaneously

Definition statement

This place covers:

Illustrative example of subject matter classified in this group.

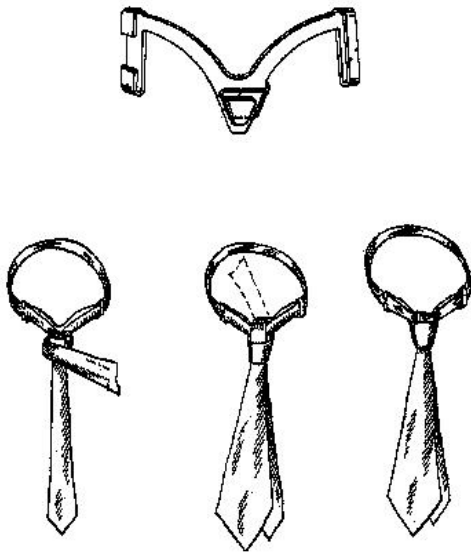

A41D 25/16

Linings; Stiffening-pieces

Definition statement

This place covers:

Illustrative example of subject matter classified in this group.

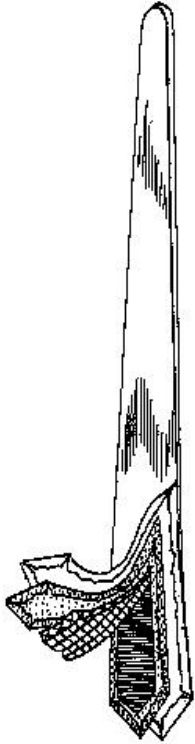

A41D 27/02

Linings

Definition statement

This place covers:

Illustrative example of subject matter classified in this group.

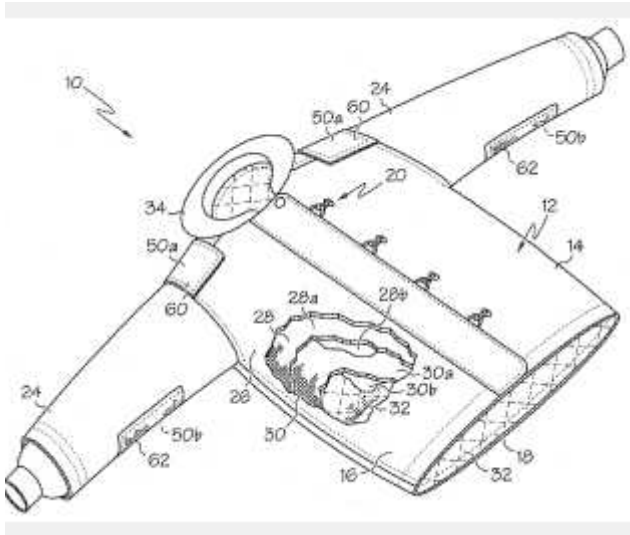

A41D 27/04

Removable linings

Definition statement

This place covers:

Illustrative example of subject matter classified in this group.

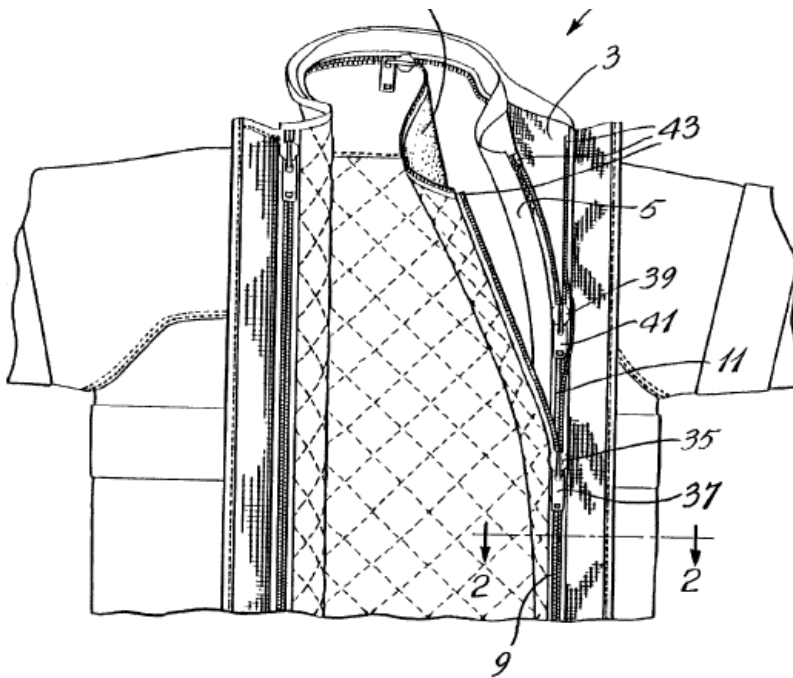

A41D 27/06

Stiffening-pieces

Definition statement

This place covers:

Illustrative example of subject matter classified in this group.

□ 252. [US6250116](#) - Textile support for reinforcing a shirt collar or similar piece

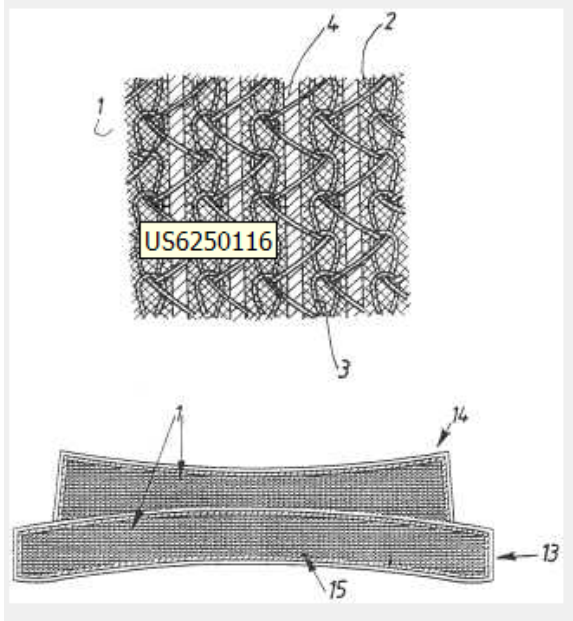

A41D 27/08

Trimmings; Ornaments

Definition statement

This place covers:

Illustrative example of subject matter classified in this group.

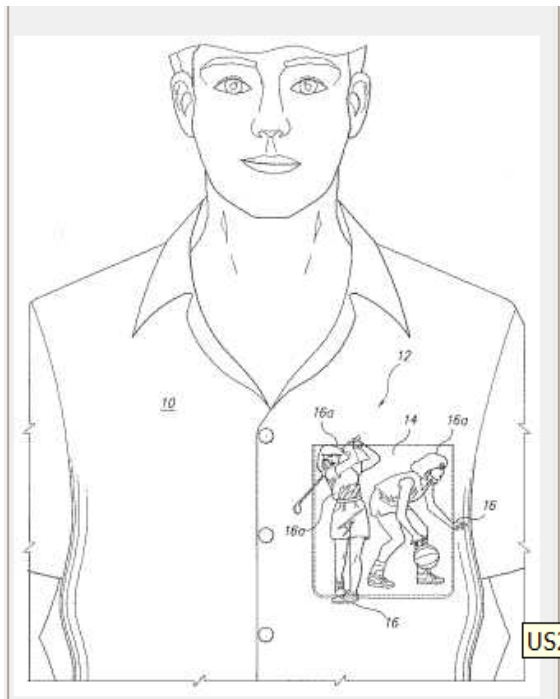

References

Informative references

Attention is drawn to the following places, which may be of interest for search:

| | |
|--|-----------------------------|
| Brooches (Decorative ornament or jewellery to be fastened on clothing) | A44C 1/00 |
| Printing imitating patterns | B41M 3/06 |
| Decoration of surfaces | B44C 1/10 |
| Decoration of surfaces by etching | B44C 1/22 |
| Processes for producing special ornamental bodies | B44C 5/00 |
| Decoration with light effects, holograms | B44F 1/10 |
| Imitation of artists work | B44F 11/00 |
| Labelling fabrics | B65C 5/00 |
| Mechanical ornamentation of leather | C14B 1/56 |
| Decorative bow structures | D04D 7/10 |
| Embroidery | D05C 7/02 |
| Decorating textiles | D06Q 1/00 |
| Decorating textiles with glass beads or other particulate material | D06Q 1/10 |
| Etching with laser for patterning surfaces | G03F 7/2053 |

| | |
|---|-----------------------------|
| Labels/ identification means | G09F 3/00 |
| Signs | G09F 7/00 |
| Mobile advertising by a carrier person / animal | G09F 21/02 |
| Fixed on clothing | G09F 21/023 |

A41D 27/085

{Luminous ornaments}

Definition statement

This place covers:

Illustrative example of subject matter classified in this group.



References

Informative references

Attention is drawn to the following places, which may be of interest for search:

| | |
|--|------------------------------|
| Decoration with light effects, holograms | B44F 1/10 |
| Lighting with clothing | F21V 33/0008 |
| Indicating arrangements with diodes | G09F 9/33 |
| Illuminated signs, luminous advertising being electroluminescent | G09F 13/22 |
| Circuits for light sources, controlling | H05B 47/105 |

Special rules of classification

Light emitting electronic textiles classed & treated in [G09F 13/22](#), [G09F 9/33](#)

A41D 27/10**Sleeves; Armholes****Definition statement**

This place covers:

Illustrative examples of subject matter classified in this group.

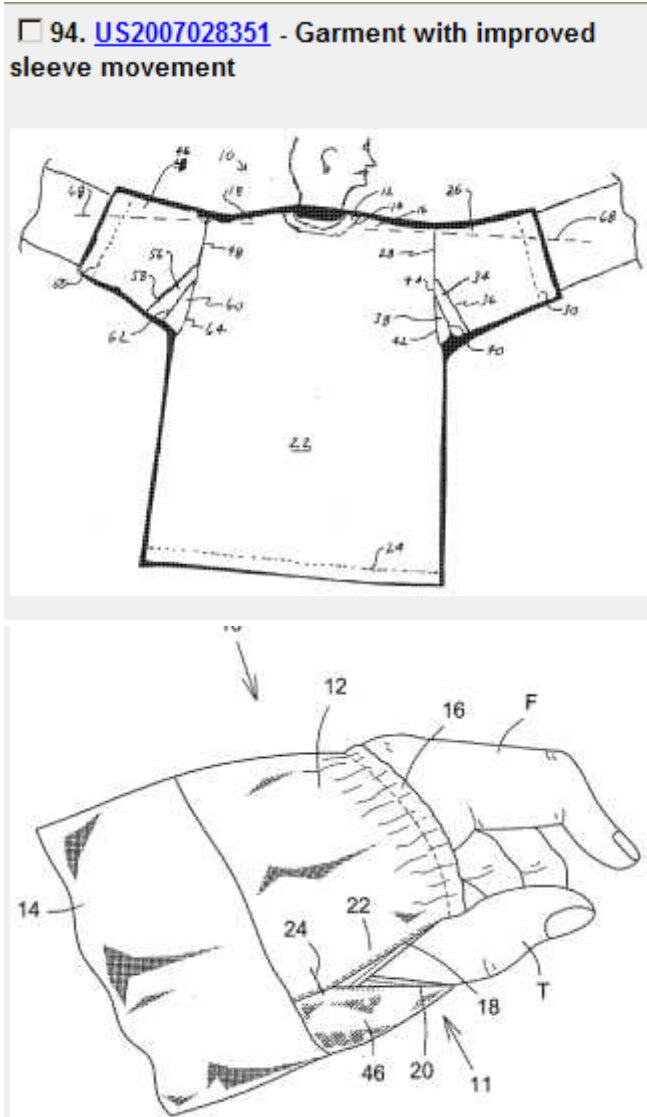
**A41D 27/12****Shields or protectors****Definition statement**

This place covers:

Protection of interior of clothing, usually for absorbing sweat.

Protection of exterior of clothing, i.e. patches avoiding wear and tear.

Illustrative example of subject matter classified in this group.

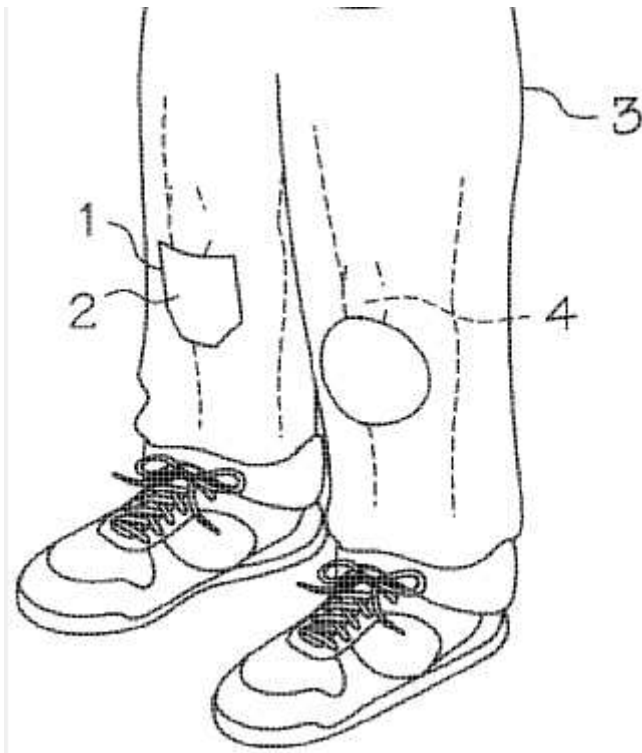

Relationships with other classification places

Mending of garments by adhesive or adhesive patches is classified as additional invention in group [A41H 27/00](#).

Exterior protections on arm to use as handkerchief are classified in groups [A41D 27/12](#) and [A41B 15/00](#).

Protection for e.g. from impacts for a particular body part, are classified in [A41D 13/05](#), knee protectors are classified in [A41D 13/065](#).

References

Informative references

Attention is drawn to the following places, which may be of interest for search:

| | |
|---|-----------------------------|
| Sports pants with crotch reinforcement (not for cycling, i.e. garment protection) | A41D 1/088 |
| Protecting exterior front part from getting dirty for adults | A41D 13/04 |
| Protection of trousers from rain, soiling with leggings | A41D 17/02 |
| Protectors of neckties | A41D 25/00 |
| Protectors for shirt collars | A41B 3/18 |
| Protectors for shirt cuffs | A41B 7/12 |
| Protective undergarments, when protection done by textile only | A41B 9/12 |
| Protecting exterior front part from getting dirty for children/babies | A41B 13/10 |
| Mending garments by adhesives or adhesive patches | A41H 27/00 |
| Toilet/cosmetic protecting mantles, shoulder-shields, bibs (hairstylist) | A45D 44/08 |
| Napkins attachable to clothing | A47G 11/002 |

| | |
|--------------------------------------|------------------------------|
| Napkin with separate holding devices | A47G 21/165 |
| Lap trays | A47G 23/0608 |
| Surgical drapes | A61B 46/00 |

A41D 27/13

Under-arm shields

Definition statement

This place covers:

Separate under-arm shields for underwear or outerwear, usually for absorbing sweat.

Illustrative example of subject matter classified in this group.

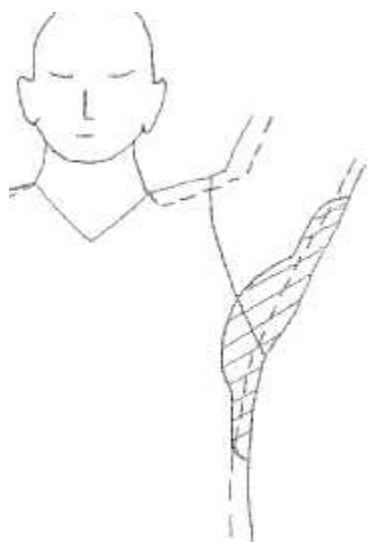

Relationships with other classification places

Textile protective undergarments and underwear having integral sweat/odor protection means are to be classified in [A41B 9/12](#).

References

Informative references

Attention is drawn to the following places, which may be of interest for search:

| | |
|---|-----------------------------|
| Absorbent pads for breast / torso | A61F 13/14 |
| Absorbent pads attaching to the body | A61F 13/82 |
| Body deodorants | A61Q 15/00 |
| Textiles containing perfume or deodorants | D06M 13/005 |

A41D 27/14**on the underedge of the garment****Definition statement***This place covers:*

Illustrative example of subject matter classified in this group.

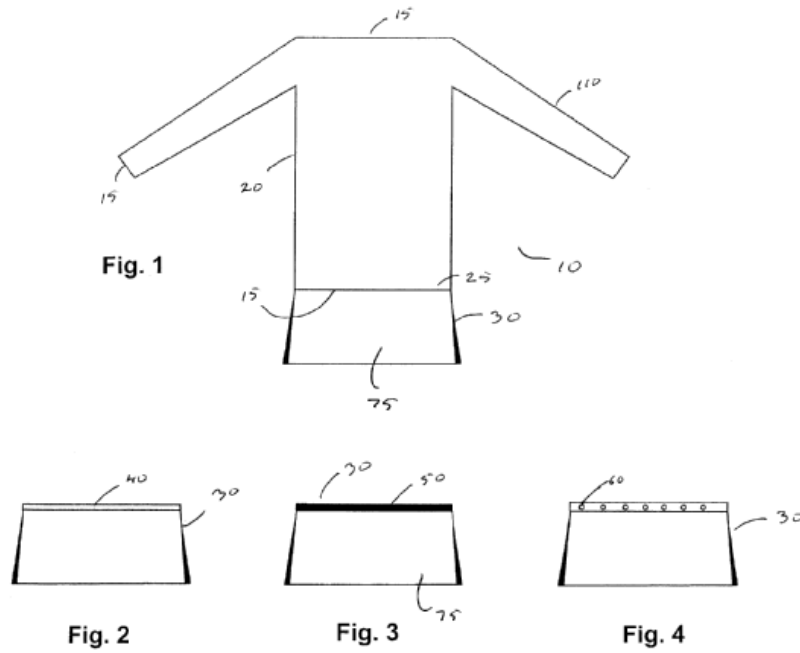
**A41D 27/145****{Piping edges; Protectors for the edges of trouser legs}****Definition statement***This place covers:*

Piping edges (clothing having trimming stitched in seams or along edges).

Illustrative example of subject matter classified in this group.

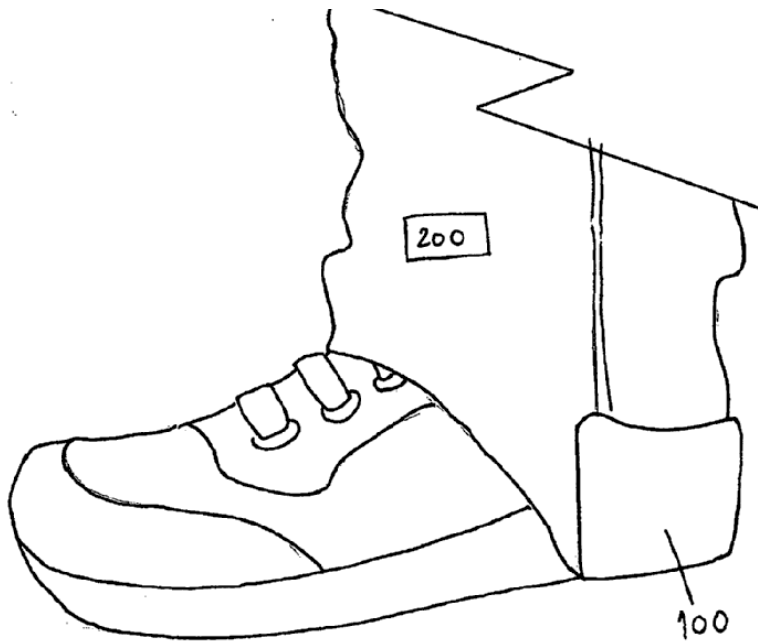

A41D 27/16

Collar-shields

Definition statement

This place covers:

Comprises protectors for collars of outerwear, not of shirts.

Illustrative example of subject matter classified in this group shown as an outdoor jacket having a detachable collar covering:

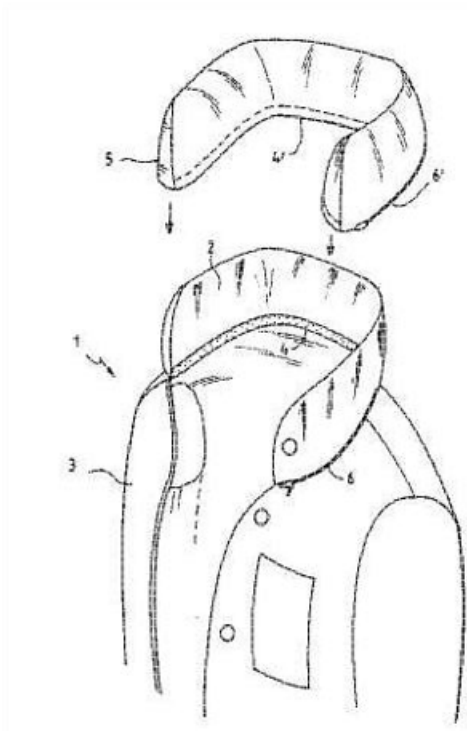

References

Informative references

Attention is drawn to the following places, which may be of interest for search:

| | |
|-----------------------------|---------------------------|
| Protection of shirt collars | A41B 3/18 |
| Protection of shirt cuffs | A41B 7/12 |

Special rules of classification

For protection of shirt collars, classify in [A41B 3/18](#).

For protection of shirt cuffs, classify in [A41B 7/12](#).

A41D 27/18

Cloth collars

Definition statement

This place covers:

Illustrative example of subject matter classified in this group.

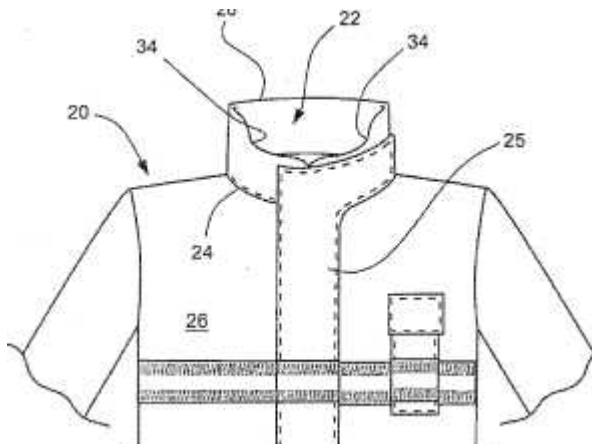

References

Informative references

Attention is drawn to the following places, which may be of interest for search:

| | |
|----------------------|---------------------------|
| Neckbands for shirts | A41B 1/12 |
| Collars for shirts | A41B 3/00 |

A41D 27/20

Pockets; Making or setting-in pockets

Definition statement

This place covers:

Illustrative example of subject matter classified in this group.

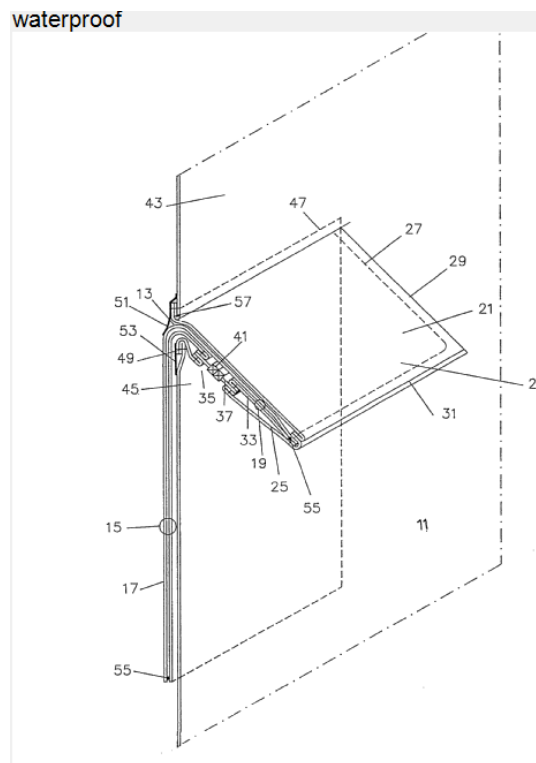

Special rules of classification

For professional or protective garments with pockets where the construction of the pocket is relevant per se classify in [A41D 27/20](#) and lower groups and in [A41D 13/0012](#).

For medical staff garments with pockets for holding medical supplies classify in [A41D 13/12](#) and in [A41D 13/0012](#).

A41D 27/201

{Pocket closures}

Definition statement

This place covers:

Illustrative example of subject matter classified in this group.

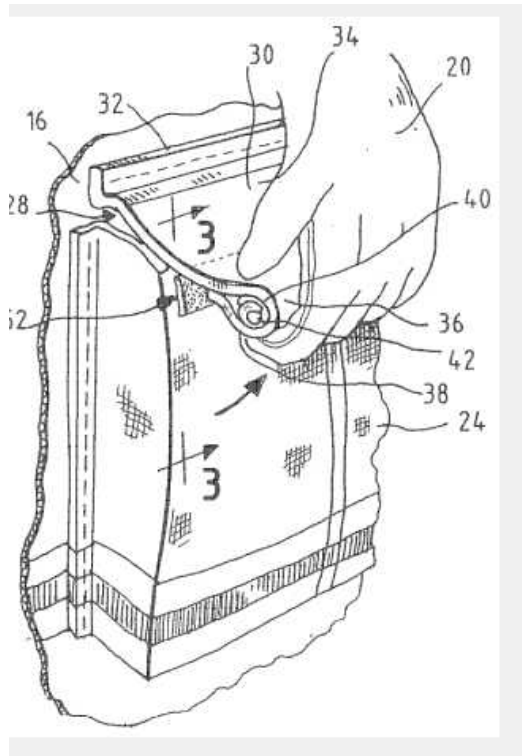

A41D 27/204

{Making or setting-in pockets (machines or appliances for folding the edges of pockets while manufacturing [A41H 33/00](#))}

Definition statement

This place covers:

Illustrative example of subject matter classified in this group.

✓ 79. [US4337881](#) - Apparatus for implanting pockets

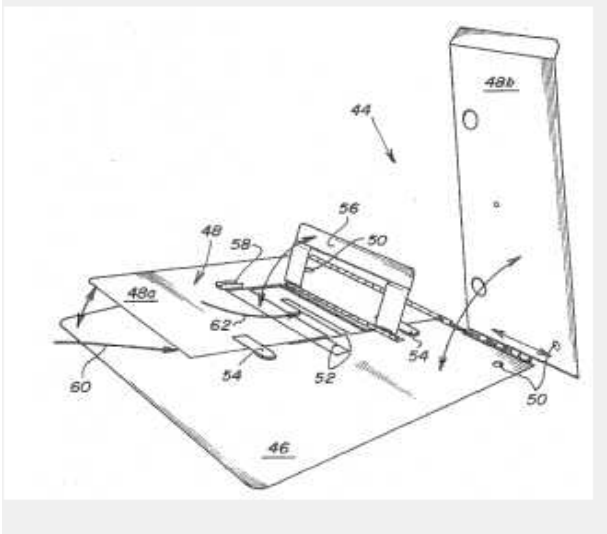

A41D 27/205

{Pockets adapted to receive a mobile phone or other electronic equipment}

Definition statement

This place covers:

Illustrative example of subject matter classified in this group.

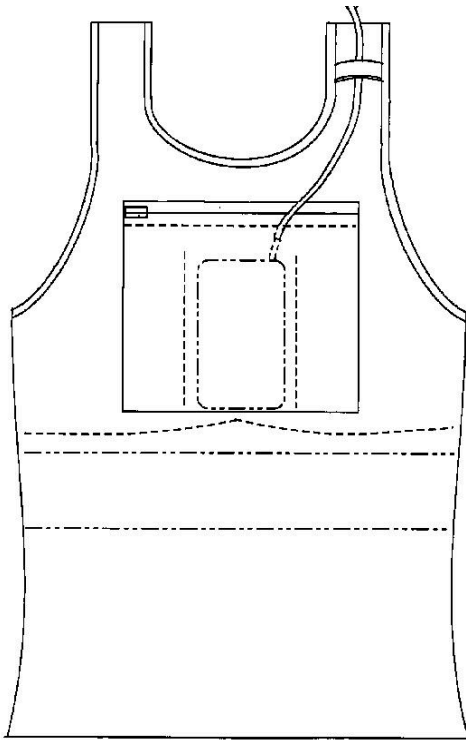

A41D 27/22**Loops or hooks for hanging-up (with locking devices [E05B 69/00](#))****Definition statement**

This place covers:

Illustrative example of subject matter classified in this group.

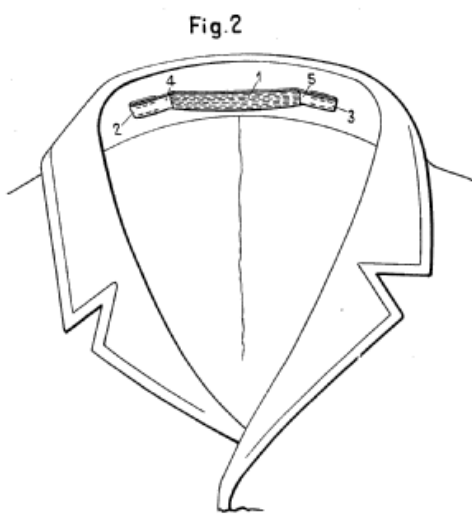
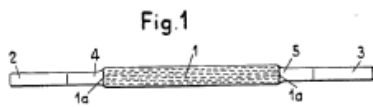
**References****Informative references**

Attention is drawn to the following places, which may be of interest for search:

| | |
|-----------------|----------------------------|
| Show hangers | A47F 7/00 |
| Clothes hangers | A47G 25/14 |

A41D 27/24

Hems; Seams

Definition statement

This place covers:

Illustrative example of subject matter classified in this group.

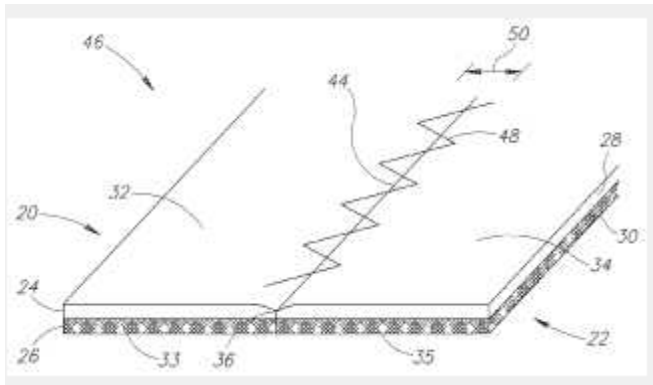

References

Informative references

Attention is drawn to the following places, which may be of interest for search:

| | |
|----------------------------------|----------------------------|
| Treating selvages or other edges | D06C 25/00 |
| Seaming textiles | D06H 5/00 |

Special rules of classification

Comprises stitch, when stitch and weld combined it should be classed in [A41D 27/24](#) and [A41D 27/245](#).

For methods of joining or sewing machines with adhesive without thread, always consult/forward to [B29C 65/00](#).

For seams of gloves, where the seam is not relevant, class in [A41D 2300/50](#) or [A41D 2300/52](#).

For details of hems of trousers class in [A41D 27/24](#) and [A41D 1/06](#).

A41D 27/245

{made by welding or gluing (joining of plastics by welding or gluing [B29C 65/00](#); sewing machines for concurrently making thread and welded seams [D05B 17/00](#); thermal or chemical fixing of seams and hems [D06M](#))}

Definition statement

This place covers:

Illustrative example of subject matter classified in this group.

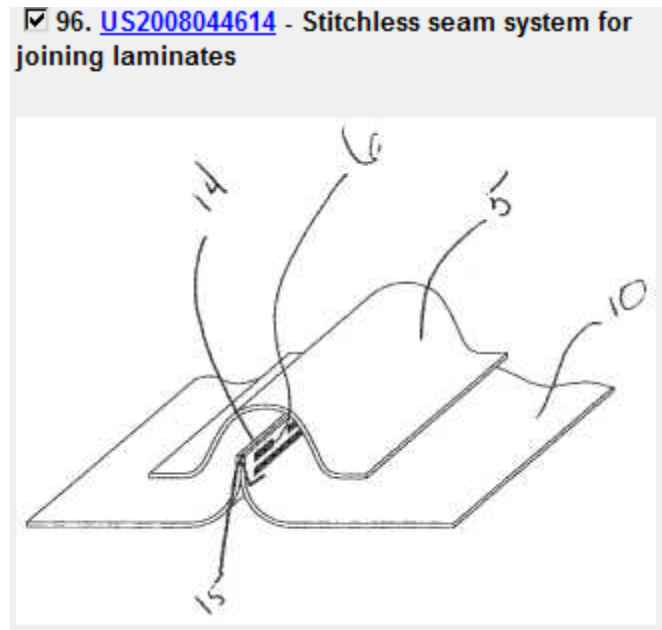

References

Informative references

Attention is drawn to the following places, which may be of interest for search:

| | |
|--|------------------------------|
| Mending garments by adhesives or adhesive patches | A41H 27/00 |
| Methods of joining or sewing machines with adhesive without thread | B29C 65/00 |
| Joining of performed parts | B29C 65/00 |
| Ultrasonic welding | B29C 65/08 |
| Welding & severing by ultrasonic vibrations | B29C 65/08 |
| Applying adhesive | B29C 65/52 |
| Layered products using adhesive | B32B 7/12 |
| Laminating using adhesive | B32B 37/1284 |
| Forming selvages by adhesion | D03D 47/50 |
| Thermal or chemical fixing of seams, hems and cuttings | D06M 23/18 |

Special rules of classification

When stitch and weld combined it should be classed in [A41D 27/24](#) and [A41D 27/245](#).

For methods of joining or sewing machines with adhesive without thread, always consult/forward to [B29C 65/00](#).

For seams of gloves, where the seam is not relevant, class in [A41D 2300/50](#) or [A41D 2300/52](#).

For methods of joining garment parts or blanks by gluing or welding, class also in [A41H 43/04](#).

A41D 27/26

Shoulder-pads; Hip-pads; Bustles

Definition statement

This place covers:

Illustrative examples of subject matter classified in this group.

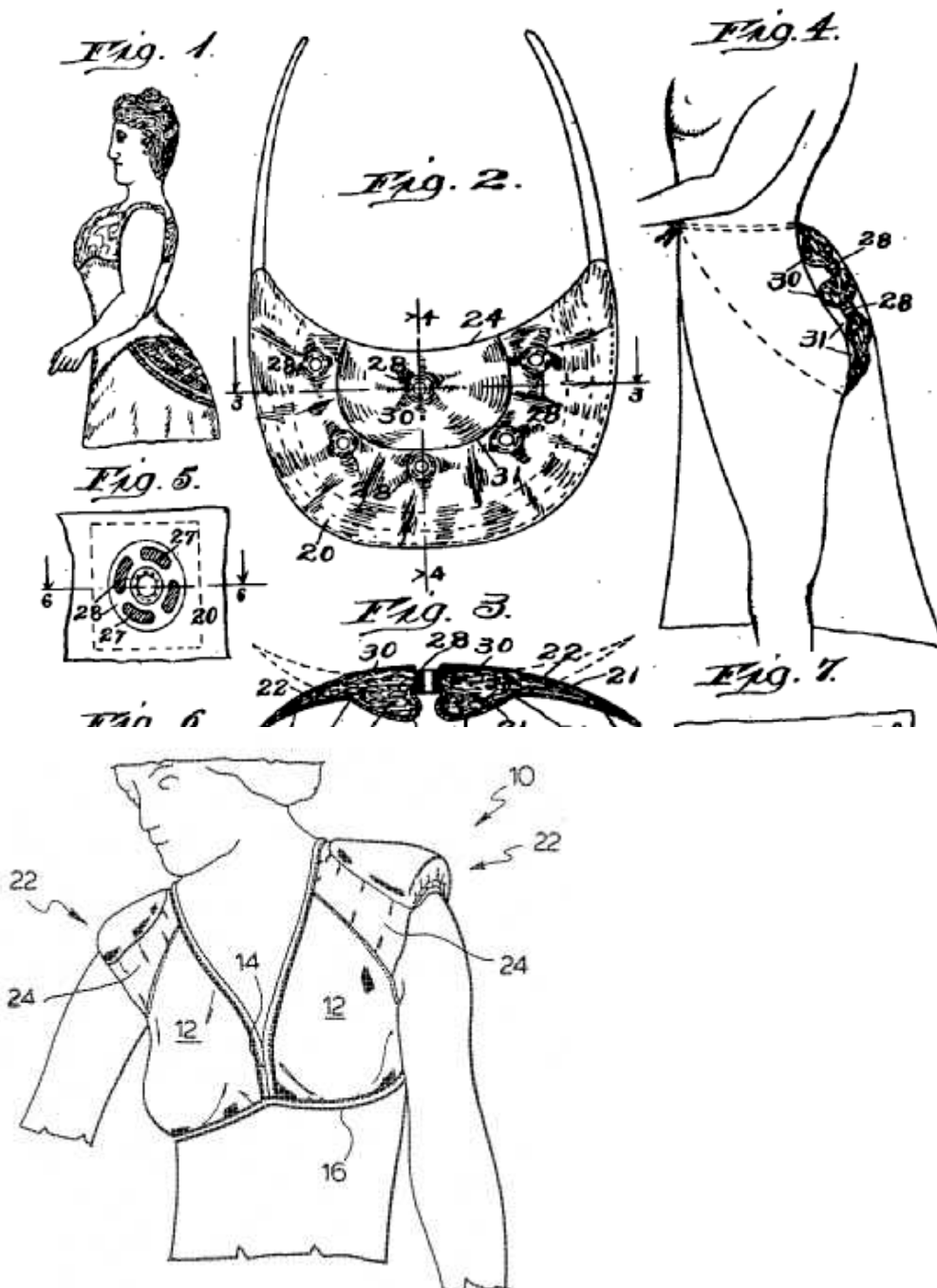

References

Informative references

Attention is drawn to the following places, which may be of interest for search:

| | |
|---|-----------------------------|
| Shoulder cushioning attachments for shoulder straps | A41F 15/007 |
|---|-----------------------------|

Special rules of classification

Includes only shaping pads, not protection pads.

For hip shock-absorbing / protection pads, refer to [A41D 13/0506](#) and [A41D 13/015](#).

A41D 27/28

Means for ventilation

Definition statement

This place covers:

Illustrative examples of subject matter classified in this group.

Figure 1.

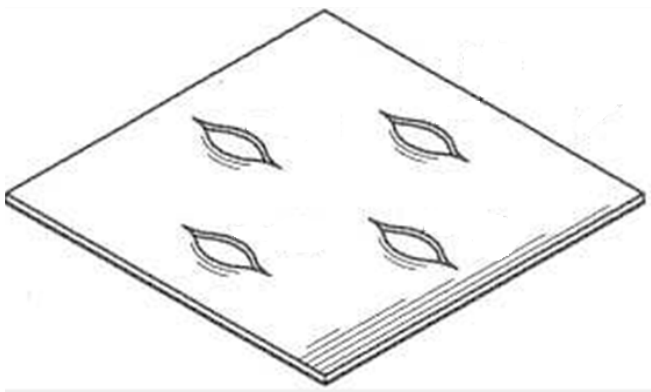
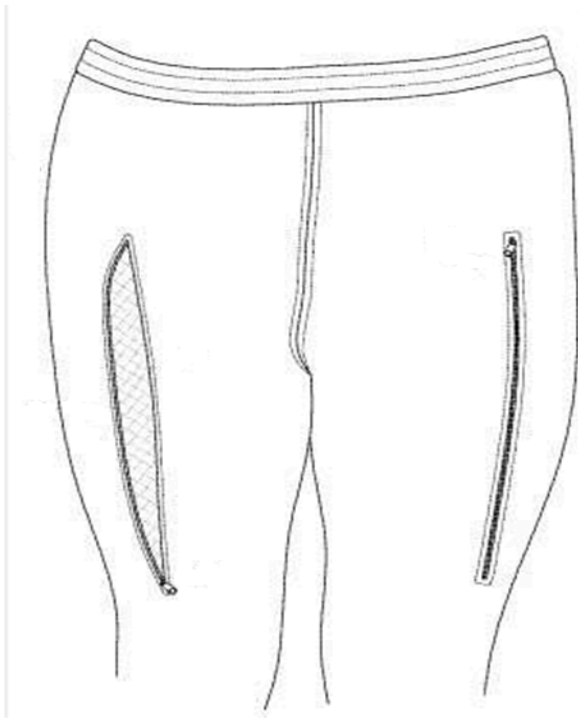

Figure 2.



References

Informative references

Attention is drawn to the following places, which may be of interest for search:

| | |
|----------------------|---------------------------|
| Ventilation in shoes | A43B 7/08 |
|----------------------|---------------------------|

Special rules of classification

In cases of ventilation without fans (or forced air circulation) of an outside garment:

- Everytime there's any kind of ventilation: [A41D 27/28](#).
- When ventilation is done transversally (perpendicular) to the fabric: [A41D 27/28](#) alone.
- When ventilation is done parallel to the fabric, i.e. with channels: [A41D 31/14](#) or [A41D 31/145](#) combined with [A41D 27/28](#).
- When ventilation is also used to regulate inside conditions (temperature, humidity etc) : add Indexing Code [A41D 13/002](#).
- When there are sweat handling or wicking properties, i.e. sweat transport in ventilation channels: add [A41D 31/12](#) or [A41D 31/125](#).

A41D 29/00

Uniforms; Parts or accessories of uniforms

Definition statement

This place covers:

Illustrative example of subject matter classified in this group.

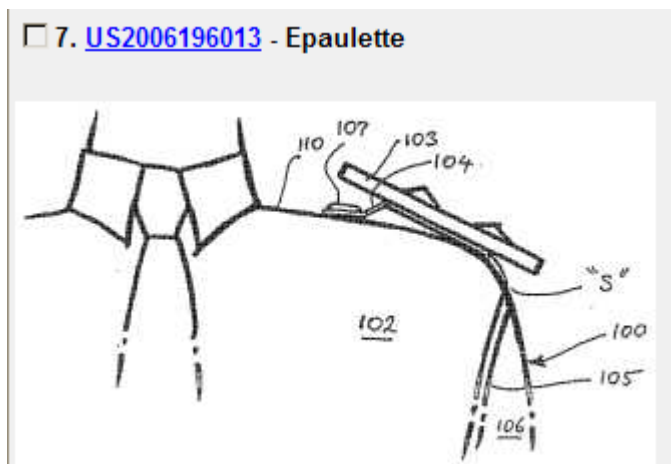

A41D 31/00

Materials specially adapted for outerwear

Relationships with other classification places

When the material aspects such as compositions used and/or construction (layered, woven, non-woven, knitted, etc.) are inventive and the structure of the garment per se is not inventive, classify in the respective material scheme(s) (e.g. [D03D](#), [D04H](#), [B32B](#), etc.) and use [D10B 2501/00](#), [B32B 2437/00](#), [D04B 1/24](#) and/or subgroups thereof to designate the use or application of the material in articles of apparel.

References

Informative references

Attention is drawn to the following places, which may be of interest for search:

| | |
|---|---|
| Composite separation membranes | B01D 69/02 , B01D 69/12 |
| Woven fabrics characterised by material | D03D 15/00 |
| Knitted with synthetic threads | D04B 1/16 |
| Making textile fabrics from fibers | D04H 1/00 |
| Other non-woven fabrics | D04H 13/00 |
| Mechanical treatment on fabrics | D06C |
| Coating fibres | D06M |
| Textiles containing perfume or deodorants | D06M 13/005 |
| Flexible sheet materials | D06N 7/00 |

Special rules of classification

For classification in [A41D 31/00](#), the garment's structural configuration (e.g. shape of the trouser, configuration of pocket(s), etc.) must be inventive and thus, be classified elsewhere in [A41D 1/00 - A41D 29/00](#) as well. The material serves to impart a particular function to the garment (e.g. permit a raincoat to be water-resistant or impermeable, prevent electric shock in industrial protective garments, etc.).

A41D 31/0005

{made from a plurality of interconnected elements ([A41D 31/04](#) takes precedence)}

Definition statement

This place covers:

Illustrative example of subject matter classified in this group.

Clothing construction, hemless and seamless garment.

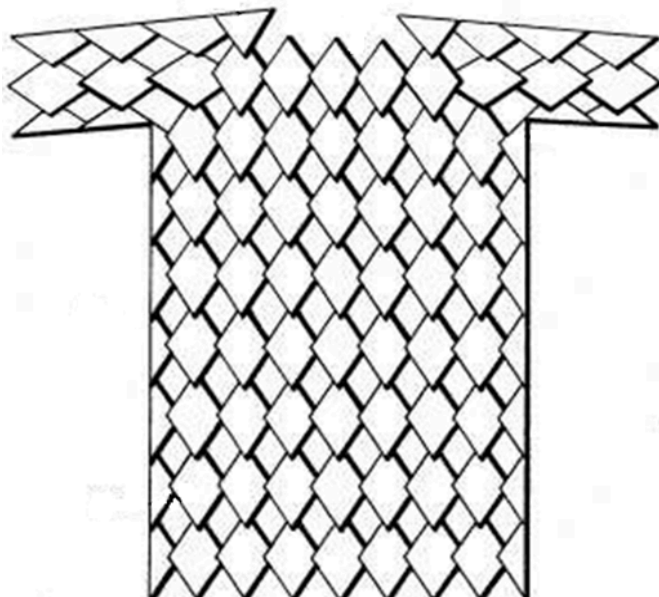

References

Limiting references

This place does not cover:

| | |
|--|----------------------------|
| Layered materials specially adapted for outerwear characterised by special function or use | A41D 31/04 |
|--|----------------------------|

Informative references

Attention is drawn to the following places, which may be of interest for search:

| | |
|--------------------------------------|-----------------------------|
| Armoured clothing plate construction | F41H 5/0485 |
|--------------------------------------|-----------------------------|

A41D 31/02

Layered materials (characterised by special function or use [A41D 31/04](#))

Definition statement

This place covers:

Illustrative example of subject matter classified in this group.

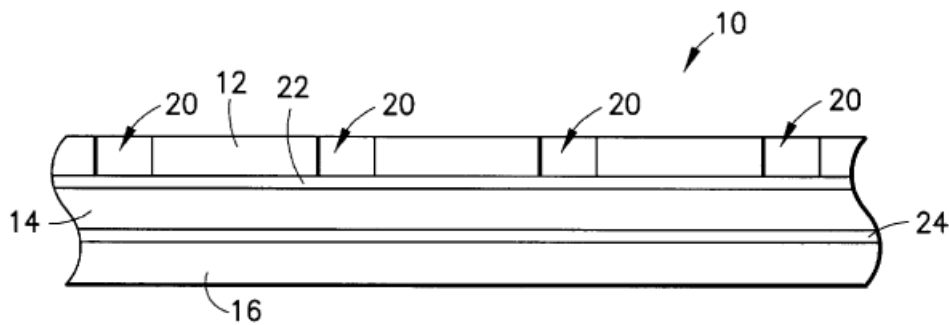

References

Limiting references

This place does not cover:

| | |
|--|----------------------------|
| Characterised by special function or use | A41D 31/04 |
|--|----------------------------|

Informative references

Attention is drawn to the following places, which may be of interest for search:

| | |
|---|-----------------------------|
| Laminated products with one fibrous layer | B32B 5/24 |
| Two or more fibrous layers | B32B 5/26 |
| Layered products, next to fibrous layer | B32B 27/12 |
| Laminating processes | B32B 38/12 |
| Double or multi-ply fabrics | D03D 11/00 |
| Treating fabrics with fluorine | D06M 15/277 |
| Producing multi-layer textile fabrics | D06M 17/00 |

A41D 31/04

characterised by special function or use (protective clothing affording protection against heat or harmful chemical agents or for use at high altitudes [A62B 17/00](#); composition of materials for coverings or clothing affording protection against harmful chemical agents [A62D 5/00](#))

Definition statement

This place covers:

Materials of protective clothing having camouflage pattern.

Illustrative example of subject matter classified in this group:

Figure 1.

Fabric suitable to provide a barrier effect against magnetic and electromagnetic fields and/or metallotherapy effects

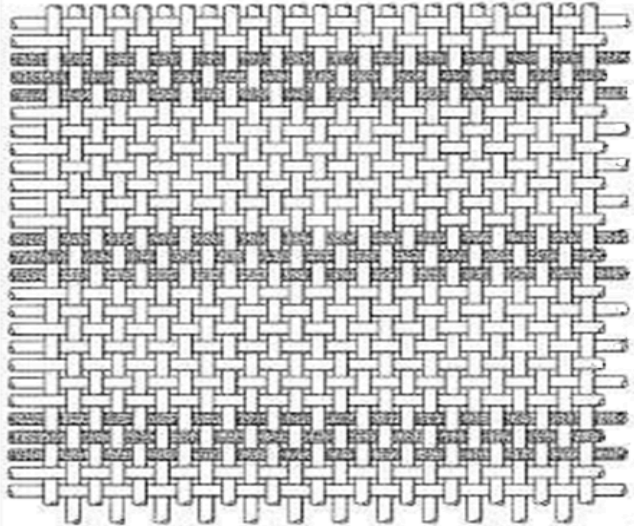

Figure 2.

Camouflage and other patterns, articles comprising them, and methods of making and using same



References

Limiting references

This place does not cover:

| | |
|--|----------------------------|
| Protective clothing affording protection against heat or harmful chemical agents | A62B 17/00 |
| Materials for clothing protecting against harmful chemical agents | A62D 5/00 |

Informative references

Attention is drawn to the following places, which may be of interest for search:

| | |
|---|----------------------------|
| Camouflage flexible covers, screens, nets | F41H 3/02 |
| Clothing protecting against X radiations | G21F 3/025 |

Special rules of classification

For protective clothing having camouflage pattern class in [A41D 13/00](#).

A41D 31/06**Thermally protective, e.g. insulating****Definition statement**

This place covers:

Only thermal protection against cold.

Illustrative example of subject matter classified in this group:

Figure 1.

Adjustable insulation apparatus

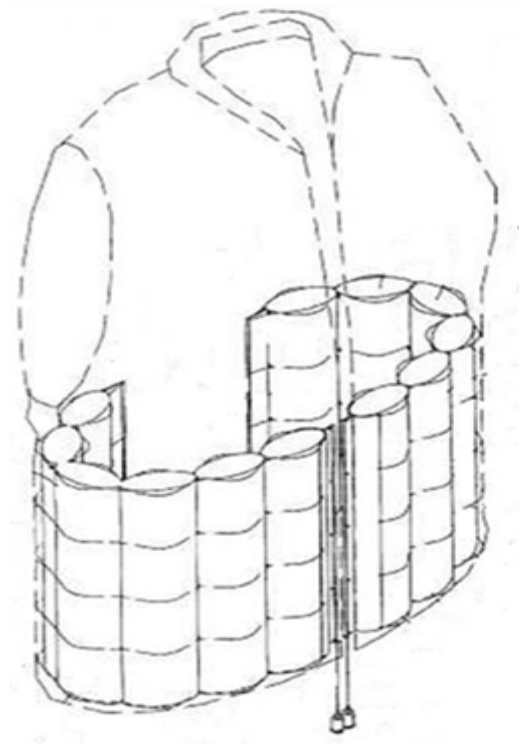
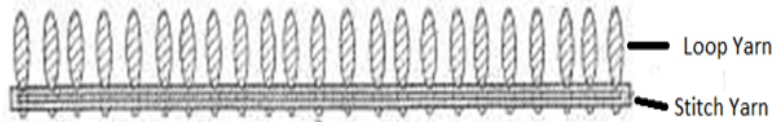

Figure 2.

Double-face velour fabric articles having improved dynamic insulation performance



References

Informative references

Attention is drawn to the following places, which may be of interest for search:

| | |
|-------------------------------|----------------------------|
| Thermal insulation in general | F16L 59/07 |
|-------------------------------|----------------------------|

A41D 31/065

{using layered materials}

References

Informative references

Attention is drawn to the following places, which may be of interest for search:

| | |
|---|-----------------------------|
| Duvets | A47G 9/0207 |
| Pillows | A47G 9/10 |
| Loose filling materials for upholstery | B68G 1/00 |
| Filling of cushions, mattresses | B68G 7/06 |
| Non-woven fabrics formed by filamentary materials | D04H 3/02 |
| Quilting and filling with feathers | D05B 11/005 |
| Treatment of feathers | D06M 19/00 |

A41D 31/08

Heat resistant; Fire retardant

Definition statement

This place covers:

Illustrative example of subject matter classified in this group:

Figure 1.

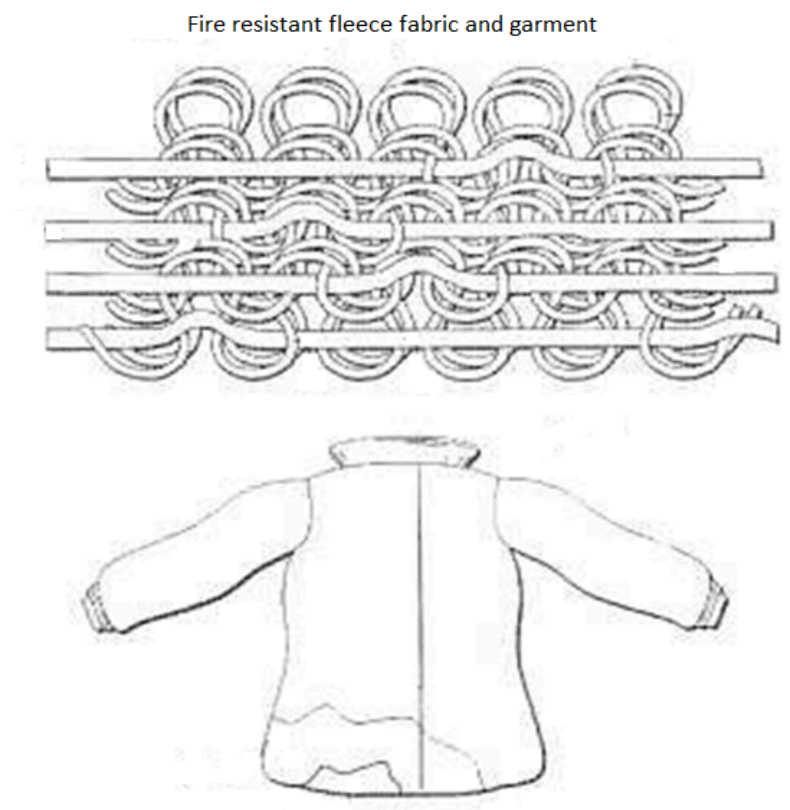

References

Informative references

Attention is drawn to the following places, which may be of interest for search:

| | |
|--|-----------------------------|
| Fireproof yarns | D02G 3/443 |
| Woven fabrics using heat / flame proof threads | D03D 15/513 |
| Knitted with synthetic threads | D04B 1/16 |

A41D 31/102

Waterproof and breathable

Definition statement

This place covers:

Waterproof/breathable material construction for non-protective garments, i.e. Gore-Tex.

Illustrative example of subject matter classified in this group:

Figure 1.

Vapor permeable buoyant insulation
composition for garments

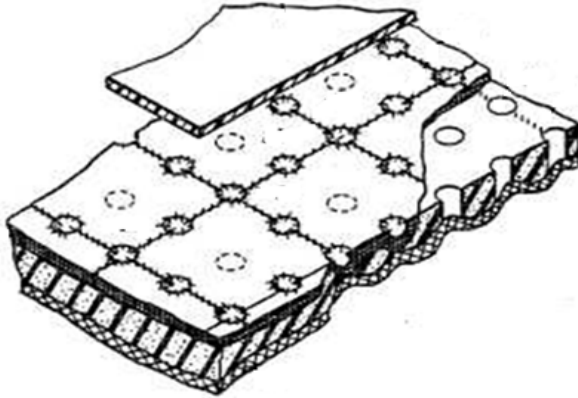
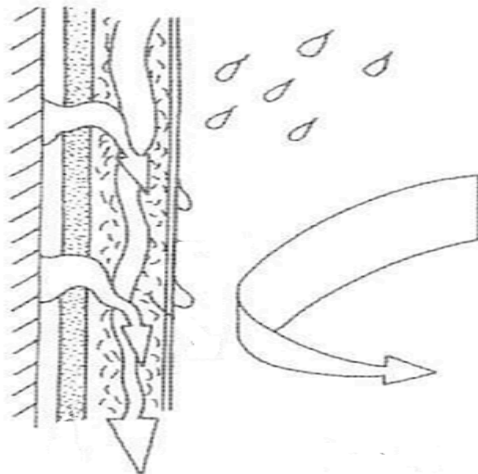

Figure 2.

Waterproof/breathable garment
construction



A41D 31/12

Hygroscopic; Water retaining

Definition statement

This place covers:

Materials having a moisture handling or wicking function.

Special rules of classification

In cases of ventilation without fans (or forced air circulation) of an outside garment:

- Every time there is any kind of ventilation: [A41D 27/28](#)
- When ventilation is done transversally (perpendicular) to the fabric: [A41D 27/28](#) alone
- When ventilation is done parallel to the fabric, i.e. with channels: [A41D 31/14](#) or [A41D 31/145](#) combined with [A41D 27/28](#)

- When ventilation is also used to regulate inside conditions (temperature, humidity etc.): add Indexing Code [A41D 13/002](#)
- When there are sweat handling or wicking properties, i.e. sweat transport in ventilation channels: add [A41D 31/12](#) or [A41D 31/125](#)

A41D 31/125

{Moisture handling or wicking function through layered materials}

Special rules of classification

Special rules of classification

- In cases of ventilation without fans (or forced air circulation) of an outside garment
- Every time there is any kind of ventilation: [A41D 27/28](#)
- When ventilation is done transversally (perpendicular) to the fabric: [A41D 27/28](#) alone
- When ventilation is done parallel to the fabric, i.e. with channels: [A41D 31/14](#) or [A41D 31/145](#) combined with [A41D 27/28](#)
- When ventilation is also used to regulate inside conditions (temperature, humidity etc): add Indexing Code [A41D 13/002](#)
- When there are sweat handling or wicking properties, i.e. sweat transport in ventilation channels: add [A41D 31/12](#) or [A41D 31/125](#)

A41D 31/14

Air permeable, i.e. capable of being penetrated by gases (waterproof and breathable [A41D 31/102](#))

References

Limiting references

This place does not cover:

| | |
|---|-----------------------------|
| Waterproof and breathable materials for outerwear | A41D 31/102 |
|---|-----------------------------|

Special rules of classification

In cases of ventilation without fans (or forced air circulation) of an outside garment:

- Every time there is any kind of ventilation: [A41D 27/28](#)
- When ventilation is done transversally (perpendicular) to the fabric: [A41D 27/28](#) alone
- When ventilation is done parallel to the fabric, i.e. with channels: [A41D 31/14](#) or [A41D 31/145](#) combined with [A41D 27/28](#)
- When ventilation is also used to regulate inside conditions (temperature, humidity etc): add Indexing Code [A41D 13/002](#).
- When there are sweat handling or wicking properties, i.e. sweat transport in ventilation channels: add [A41D 31/12](#) or [A41D 31/125](#)

A41D 31/24

Resistant to mechanical stress, e.g. pierce-proof {(aprons resistant to mechanical aggressions [A41D 13/043](#))}

References

Limiting references

This place does not cover:

| | |
|--|-----------------------------|
| Aprons resistant to mechanical aggressions | A41D 13/043 |
|--|-----------------------------|

Informative references

Attention is drawn to the following places, which may be of interest for search:

| | |
|--------------------------------------|-----------------------------|
| Cut resistant yarns | D02G 3/442 |
| Armoured clothing plate construction | F41H 5/0485 |

Special rules of classification

Also contains abrasion resistant materials

A41D 31/26

Electrically protective, e.g. preventing static electricity or electric shock

References

Informative references

Attention is drawn to the following places, which may be of interest for search:

| | |
|-----------------------|---------------------------|
| Anti-static materials | C09K 3/16 |
|-----------------------|---------------------------|

A41D 31/28

Shock absorbing

References

Informative references

Attention is drawn to the following places, which may be of interest for search:

| | |
|--|--|
| Cushioning for helmets | A42B 3/12 |
| Cushions in bicycle seats | B62J 1/26 |
| Loose filling materials for upholstery | B68G 1/00 |
| Chemical aspects of damping compositions | C08K , C08L , C08J |
| Springs, dampers | F16F 1/3605 |
| Shock absorbers | F16F 9/306 |
| Protective helmets (bulletproof) | F41H 1/04 |

Special rules of classification

Comprises materials of protective garments with shock absorbing means.

For protection of body parts not included in the subgroups of [A41D 13/05](#) and protection for several body parts in the same garment, class in [A41D 13/05](#).

For shock-absorbing means in general, i.e. pads, class in [A41D 13/015](#).

A41D 31/30

Antimicrobial, e.g. antibacterial

References**Informative references**

Attention is drawn to the following places, which may be of interest for search:

| | |
|---------|----------------------|
| Anthrax | A61L |
|---------|----------------------|

Special rules of classification

For ABC suits (used to protect against chemical/biological/toxic environment) forward to [A62B 17/006](#) and do not class in [A41D 13/00](#).

A41D 31/305

{using layered materials}

References**Informative references**

Attention is drawn to the following places, which may be of interest for search:

| | |
|-------------------------------|----------------------------|
| Laminates for surgical drapes | A61B 46/40 |
|-------------------------------|----------------------------|

A41D 31/32

Retroreflective

Definition statement

This place covers:

Reflective materials of electromagnetic waves, protecting against them.

References**Informative references**

Attention is drawn to the following places, which may be of interest for search:

| | |
|---------------------------------------|-------------------------------|
| Methods producing reflective surfaces | B29D 11/00605 |
|---------------------------------------|-------------------------------|

A41D 31/325**{using layered materials}****Definition statement***This place covers:*

Illustrative example of subject matter classified in this group.

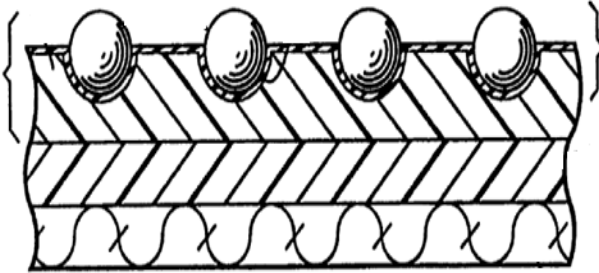

Infra-red reflective coverings

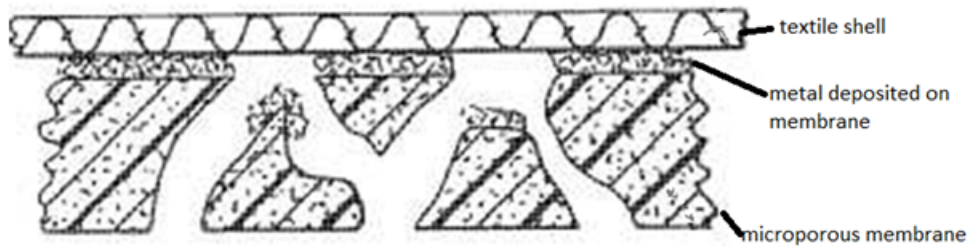
**A41D 2200/20****Hoods****References****Informative references***Attention is drawn to the following places, which may be of interest for search:*

| | |
|------------------------------|----------------------------|
| Soft hoods | A42B 1/04 |
| Hoods attachable to clothing | A42B 1/048 |

A41D 2300/33**using straps or ties****Relationships with other classification places**This place does not cover drawstrings inside pants which are to be classified in group [A41F 9/025](#).

A41D 2300/50

Seams

Special rules of classification

For seams of gloves, where the seam is not relevant, class additionally in [A41D 2300/50](#) or [A41D 2300/52](#).

For seams in general, class in [A41D 27/24](#) or [A41D 27/245](#).

A41D 2300/52

made by welding or gluing

Special rules of classification

When stitch and weld combined it should be classed in [A41D 27/24](#) and [A41D 27/245](#).

For methods of joining or sewing machines with adhesive without thread, always consult/forward to [B29C 65/00](#).

For seams of gloves, where the seam is not relevant, class in [A41D 2300/50](#) or [A41D 2300/52](#).

For seams in general, class in [A41D 27/24](#) or [A41D 27/245](#).

A41D 2400/14

inflatable

Special rules of classification

Comprises also already inflated sealed structures, i .e. air bubbles

A41D 2400/24

Reducing drag or turbulence in air or water

References

Informative references

Attention is drawn to the following places, which may be of interest for search:

| | |
|--------------|----------------------------|
| Flight suits | B64D 10/00 |
|--------------|----------------------------|

Special rules of classification

For increasing drag or turbulence in air or water, class in [A41D 2400/80](#)

A41D 2400/26

UV light protection

References

Informative references

Attention is drawn to the following places, which may be of interest for search:

| | |
|-----------|----------------------------|
| Umbrellas | A45B 25/20 |
|-----------|----------------------------|

Informative references

| | |
|----------------------------------|---|
| Topical barriers, i.e. suncreams | A61K 8/0208 , A61Q 17/04 |
| Radiation therapy | A61N 5/0613 , A61N 2005/0645 |
| Fiber treatment | D06M 11/67 , D06M 23/00 |
| Dyeing textiles | D06P 1/00 |
| Outdoor fabrics for tents | D10B 2505/18 |
| Sun-shades | E04F 10/02 |
| Tents | E04H 15/54 |
| Filters with dyes | G02B 5/223 , G02B 5/208 |

Special rules of classification

Comprises also protection for ranges other than UV, i.e. IR

A41D 2400/28**UV light permeability****References****Informative references**

Attention is drawn to the following places, which may be of interest for search:

| | |
|----------------------------------|---|
| Umbrellas | A45B 25/20 |
| Topical barriers, i.e. suncreams | A61K 8/0208 , A61Q 17/04 |
| Radiation therapy | A61N 5/0613 , A61N 2005/0645 |
| Fiber treatment | D06M 11/67 , D06M 23/00 |
| Dyeing textiles | D06P 1/00 |
| Outdoor fabrics for tents | D10B 2505/18 |
| Sun-shades | E04F 10/02 |
| Tents | E04H 15/54 |
| Filters with dyes | G02B 5/223 , G02B 5/208 |

Special rules of classification

Comprises also protection for ranges other than UV, i.e. IR

A41D 2400/36**Deoderising or perfuming****References****Informative references**

Attention is drawn to the following places, which may be of interest for search:

| | |
|---|-----------------------------|
| Containers for holding perfume | A45D 34/00 |
| Holders for air deodorants | A61L 9/12 |
| Body deodorants | A61Q 15/00 |
| Perfumes encapsulated in a carrier | C11D 3/505 |
| Perfumes released by thermal or chemical activation | C11D 3/507 |
| Textiles containing perfume or deodorants | D06M 13/005 |

A41D 2400/44**Donning facilities****Special rules of classification**

Comprises drop-seat opening for overalls

A41D 2400/70**Removability****Definition statement**

This place covers:

A part of the garment is removable from the garment itself.

Special rules of classification

If the garment has a feature which aids in removability from the wearer, classify in [A41D 2400/44](#).

A41D 2400/80**Friction or grip reinforcement****Special rules of classification**

Comprises function of increasing drag or turbulence in air or water

A41D 2600/202**Welding****References****Informative references**

Attention is drawn to the following places, which may be of interest for search:

| | |
|----------------------------------|---------------------------|
| Masks/eye protectors for welders | A61F 9/06 |
|----------------------------------|---------------------------|

| | |
|-----------------------------|----------------------------|
| Welding protection for head | B23K 9/322 |
|-----------------------------|----------------------------|