

B09B

DISPOSAL OF SOLID WASTE NOT OTHERWISE PROVIDED FOR

Definition statement

This place covers:

The disposal of solid waste involving single or combined operations, comprising features related to the disposal of solid waste. Such features must encompass the combination with:

- (a) additional steps specific for waste disposal; or
- (b) other aspects of the operation specific for waste disposal that are not fully classifiable in a single other subclass.

Relationships with other classification places

Features in relation to the disposal of solid waste but specific to an operation provided for in a single other subclass, which relate to a requirement or problem of a nature particular to the operation, are not covered by this subclass unless the method of operation is not provided for elsewhere.

References

References out of a residual place

Examples of places in relation to which this place is residual:

Obtaining proteins from waste water of starch manufacturing plants of like wastes	A23J 1/16
Animal feeding-stuffs from kitchen waste	A23K 10/20
Animal feeding-stuffs from waste material	A23K 10/26 , A23K 10/37
Animal feeding-stuffs from waste dairy products	A23K 10/28
Animal feeding-stuffs from distillers' or brewers' waste	A23K 10/38
Footwear made of rubber waste	A43B 1/12
Disinfection or sterilisation methods specially adapted for refuse	A61L 11/00
Processes for making harmful chemical substances harmless, or less harmful, by effecting a chemical change in the substances	A62D 3/00
Chemical or biological purification of waste gases	B01D 53/34
Crushing, pulverising or disintegrating in general; Milling grain	B02C
Disintegrating by knives or other cutting or tearing members, which chop material into fragments	B02C 18/00
Disintegrating by knives or other cutting or tearing members, which chop material into fragments, specially adapted for disintegrating garbage, waste or sewage	B02C 18/0084
Combinations of wet processes or apparatus with other processes or apparatus, e.g. for dressing ores or garbage	B03B 7/00
General arrangement of separating plant, e.g. flow sheets, specially adapted for refuse	B03B 9/06
Control of spray area of spraying plant, e.g. masking or side shields; Means for collection or re-use of excess material	B05B 12/16 , B05B 14/00
Prevent escape of dirt or fumes from the area where they are produced; Collecting or removing dirt or fumes from that area	B08B 15/00

References out of a residual place

Manufacture of articles from scrap or waste metal particles	B22F 8/00
Machines or arrangements for shearing stock while the latter is travelling otherwise than in the direction of the cut without regard to the exact dimensions of the resulting material, e.g. for cutting up scrap	B23D 25/14
Devices for recovering materials resulting from grinding or polishing	B24B 55/12
Edge trimming saw blades or tools combined with means to disintegrate waste	B27B 33/20
Recovery of plastics or other constituents of waste material containing plastics	B29B 17/00
Presses for consolidating scrap metal or for compacting used cars	B30B 9/32
Systematic disassembly of vehicles for recovery of salvageable components, e.g. for recycling	B62D 67/00
Refuse discharge from vessels, e.g. for ash	B63B 17/06
Arrangements of installation for treating waste water or sewage on vessels	B63J 4/006
Refuse receptacles	B65F 1/00
Vehicles particularly adapted for collecting refuse	B65F 3/00
Gathering or removal of refuse otherwise than by receptacles or vehicles	B65F 5/00
Cleaning or disinfecting devices combined with refuse receptacles or refuse vehicles	B65F 7/00
Ingredients generally applicable to manufacture of glasses, glazes or vitreous enamels	C03C 1/00
Hydraulic cements from oil shales, residues or waste other than slag	C04B 7/24
Calcium sulfate cements from phosphogypsum or from waste, e.g. purification products of smoke	C04B 11/26
Waste materials or refuse used as fillers for mortars, concrete, artificial stone or the like	C04B 18/04
Waste inorganic materials used as active ingredients for mortars, concrete, artificial stone or the like	C04B 22/0006
Waste organic materials used as active ingredients for mortars, concrete, artificial stone or the like	C04B 24/001
Waste materials or refuse used as compounding ingredients for clay-wares	C04B 33/132
Fertilisers from waste or refuse	C05F
Fertilisers made from household or town refuse	C05F 9/00
Regeneration of cellulose	C08B 16/00
Agglomerating foam fragments, e.g. waste foam	C08J 9/33
Recovery of waste materials of macromolecular substances	C08J 11/00
Compositions of reclaimed rubber	C08L 17/00
Recovery of luminescent materials	C09K 11/01
Destructive distillation, specially adapted for particular solid raw materials or solid raw materials in special form	C10B 53/00
Other processes not covered before; Features of destructive distillation processes in general	C10B 57/00

References out of a residual place

Production of liquid hydrocarbon mixtures from rubber or rubber waste	C10G 1/10
Recovery of petroleum waxes from hydrocarbon oils with the use of solvents	C10G 73/06
Solid fuels essentially based on sewage, house or town refuse	C10L 5/46
Solid fuels essentially based on industrial residues and waste materials	C10L 5/48
Working-up used lubricants based on mineral oils	C10M 175/02
Recovery of fats, fatty oils, or fatty acids from waste materials	C11B 13/00
Recovery of glycerol from a saponification liquor	C11D 19/00
Recovery of by-products of fermented solutions	C12F 3/00
Recovery of alcohol from press residues or other waste material	C12F 3/08
Biochemical production of ethanol from waste	C12P 7/08
Working-up raw materials other than ores, e.g. scrap, to produce non-ferrous metals or compounds thereof	C22B 7/00
Obtaining zinc or zinc oxide from muffle furnace residues	C22B 19/28
Obtaining zinc or zinc oxide from metallic residues or scrap	C22B 19/30
Obtaining tin from scrap	C22B 25/06
Regeneration of process liquids used in electrophoretic coating	C25D 13/24
Regeneration of process solutions used in electrolytic coating	C25D 21/16
Mechanical treatment of natural fibrous or filamentary material to obtain fibres or filaments, e.g. for spinning	D01B
Carbonising rags to recover animal fibres	D01C 5/00
Recovery of starting material, waste material or solvents during the manufacture of artificial filaments or the like	D01F 13/00
Disintegrating fibre-containing articles to obtain fibres for re-use	D01G 11/00
Arrangements for confining or removing dust, fly or the like	D01H 11/00
Regeneration of used chemical baths used for dry-cleaning or washing fibres, fabrics or the like	D06L 1/10
Dry treatment of waste paper or rags for making paper or for the production of cellulose	D21B 1/08
Defibrating waste paper	D21B 1/32
Processes for obtaining cellulose by working-up waste paper	D21C 5/02
Regeneration of pulp liquors by wet combustion	D21C 11/14
Re-use of pulp-water in wet end machines for making continuous webs of paper	D21F 1/66
Waste products added to the pulp or used in paper-impregnating material	D21H 17/01
Sewers, cesspools	E03F
Arrangements in buildings for the disposal of refuse	E04F 17/10
Combustion apparatus arrangements for burning uncombusted material from primary combustion	F23B 5/00
Consuming waste products by combustion	F23G
Removal or treatment of combustion products or combustion residues	F23J
Removing emulsion from waste photographic material	G03C 11/24

References out of a residual place

Collecting or recycling waste developer used in electrography, electrophotography or magnetography	G03G 21/10
Treating radioactively contaminated solids	G21F 9/28
Apparatus or processes for salvaging material from electric cables	H01B 15/00
Recovery of material from discharge tubes or lamps	H01J 9/52
Reclaiming serviceable parts of waste cells or batteries	H01M 6/52
Reclaiming serviceable parts of waste accumulators	H01M 10/54

Special rules of classification

In this subclass, it is desirable to classify the type(s) of solid waste with an appropriate Indexing symbol in [B09B 2101/00](#) – [B09B 2101/95](#).

Glossary of terms

In this place, the following terms or expressions are used with the meaning indicated:

Disposal	Discarding, e.g. dumping, or destroying of waste or its transformation into something useful or harmless.
Solid waste	Includes waste, which although it has liquid content, is for practical purposes handled as solid.

B09B 1/00

Dumping solid waste

Definition statement

This place covers:

Disposing of solid waste by means of dumping, either as bulk material or as discrete elements of stabilized and/or packaged waste. Dumping may be within underground cavities.

Example: US-A1-2003/053865

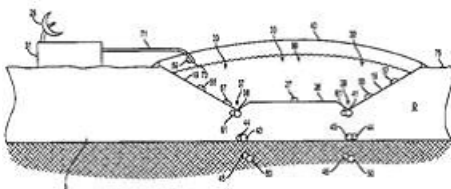

B09B 1/002

{Sea dumping}

Definition statement

This place covers:

Dumping solid waste on or into the seabed.

Illustrative example of subject matter classified in this group:

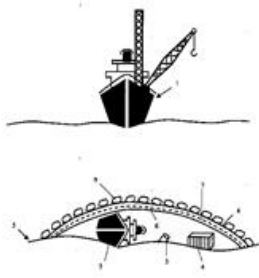

References

Informative references

Attention is drawn to the following places, which may be of interest for search:

Disposal of radioactively contaminated material by storage under water	G21F 9/24
--	---------------------------

B09B 1/004

{Covering of dumping sites}

Definition statement

This place covers:

Covering dumped waste, the cover means being applied to the top surface of the dumped waste.

Example: US-A1-2002/067953

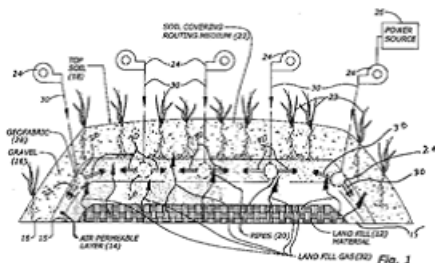

B09B 1/006

{Shafts or wells in waste dumps}

Definition statement

This place covers:

Shafts or wells and providing these in waste dumps, the shafts or wells being manufactured before, during or after dumping the solid waste.

Example: DE-A-4312267

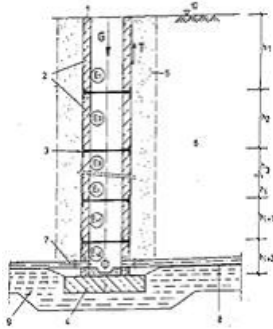

B09B 3/00

Destroying solid waste or transforming solid waste into something useful or harmless

Definition statement

This place covers:

Destroying solid waste or transforming solid waste or contaminated solids into something useful or harmless, as long as this is not fully classifiable in a single other subclass.

B09B 3/0066 (Frozen)

{Disposal of asbestos}

Definition statement

This place covers:

Disposal of asbestos or asbestos-containing waste other than by means of dumping.

Example: WO-A1-99/37590

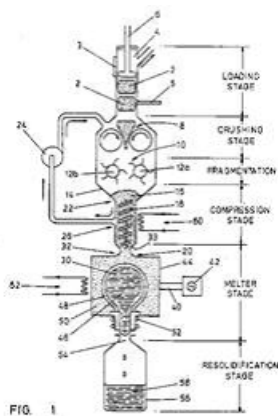

B09B 3/0075 (Frozen)

{Disposal of medical waste (casings for used articles, e.g. sharps [A61B 50/362](#); sterilisation of refuse [A61L 11/00](#); disposal of used needles or syringes [A61M 5/3205](#); disintegrating medical waste [B02C 19/0075](#))}

Definition statement

This place covers:

Disposal of medical waste other than by means of dumping.

Example: US-A-5656248

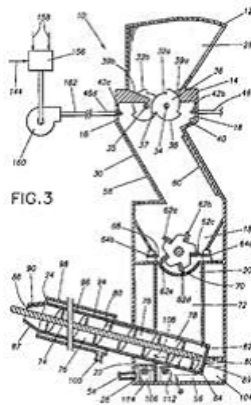

B09B 3/10

involving an adsorption step

References

Informative references

Attention is drawn to the following places, which may be of interest for search:

Separating processes involving the treatment of liquids with solid sorbents	B01D 15/00
Separation of gases or vapours by adsorption	B01D 53/02

B09B 3/20

Agglomeration, binding or encapsulation of solid waste

References

Informative references

Attention is drawn to the following places, which may be of interest for search:

Solidification of sludge	C02F 11/008
Waste materials as compounding ingredients in polymers	C08K 11/005

B09B 3/25

using mineral binders or matrix

References**Informative references**

Attention is drawn to the following places, which may be of interest for search:

Compositions of lime, magnesia, slag or cement	C04B
--	----------------------

B09B 3/40

involving thermal treatment, e.g. evaporation (processes using mineral binders involving a melting or softening step [B09B 3/29](#); involving radiation [B09B 3/50](#))

References**Limiting references**

This place does not cover:

Processes using mineral binders involving a melting or softening step	B09B 3/29
Involving radiation, e.g. electro-magnetic waves	B09B 3/50

References out of a residual place

Examples of places in relation to which this place is residual:

Methods or apparatus, e.g. incinerators, specially adapted for combustion of waste or low-grade fuels	F23G 5/00
---	---------------------------

B09B 3/60

Biochemical treatment, e.g. by using enzymes

Definition statement

This place covers:

Features related to processes that dispose solid waste via biochemical treatment, e.g. by using enzymes.

B09B 3/80

involving an extraction step

References**Informative references**

Attention is drawn to the following places, which may be of interest for search:

Separation by solvent extraction	B01D 11/00
----------------------------------	----------------------------

Glossary of terms

In this place, the following terms or expressions are used with the meaning indicated:

Extraction	Treatment of solid waste with solvents to separate the desired substance by using the difference in solubility.
------------	---

B09B 2101/02

Gases or liquids enclosed in discarded articles, e.g. aerosol cans or cooling systems of refrigerators

Definition statement

This place covers:

Disposal of waste, whereby the type of waste concerns discarded articles comprising gaseous or liquid materials. The disposal typically concerns actively removing the gaseous or liquid materials.

Illustrative example of subject matter classified in this group:

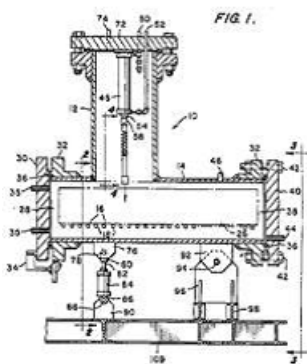

References

Informative references

Attention is drawn to the following places, which may be of interest for search:

Arrangements for charging or discharging refrigerant from refrigerators	F25B 45/00
---	----------------------------

B09B 2101/35

Asbestos

Definition statement

This place covers:

Disposal of waste whereby the type of waste concerns asbestos or asbestos-containing waste.

Illustrative example of subject matter classified in this group:

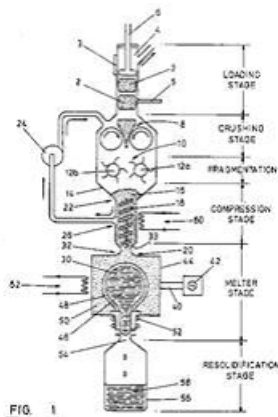

B09B 2101/65

Medical waste

Definition statement

This place covers:

Disposal of waste whereby the type of waste concerns medical waste.

Illustrative example of subject matter classified in this group:

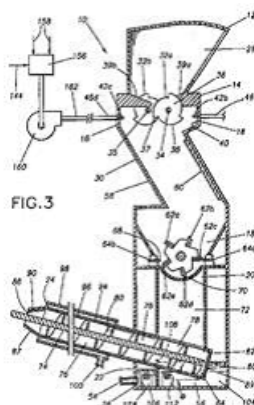

References

Informative references

Attention is drawn to the following places, which may be of interest for search:

Casings for used articles, e.g. sharps	A61B 50/362
Sterilisation of refuse	A61L 11/00
Disposal of used needles or syringes	A61M 5/3205
Disintegrating medical waste	B02C 19/0075