

G16H

HEALTHCARE INFORMATICS, i.e. INFORMATION AND COMMUNICATION TECHNOLOGY [ICT] SPECIALLY ADAPTED FOR THE HANDLING OR PROCESSING OF MEDICAL OR HEALTHCARE DATA

Definition statement

This place covers:

Cross-sectional aspects of computer, information or communication science with medical or healthcare science, where the focus is clearly placed on digital computing or data processing or handling system or methods, which are specially adapted for medical or healthcare science.

It deals with the ICT resources, devices, systems and methods for the handling and processing of information and data in healthcare, medicine and well-being.

Healthcare informatics tools include not only computers, systems and devices but also clinical guidelines, formal medical terminologies, and information and communication systems. It is applied to the areas of medical care, nursing, diagnosis, therapy, dentistry, surgery, pharmacy, public health, occupational health, wellbeing, medical research and medical cooperation.

Relationships with other classification places

In order to determine whether a technical subject relating to medical or healthcare science is classified in this subclass or in the relevant subclasses of [A61](#), the following should be observed:

- to classify a technical subject in this subclass it is required that the essential technical characteristics of the subject focus onto digital computing or data processing systems or methods;
- if the technical subject focuses onto aspects of medical science, e.g. physiological signals or medical conditions, or if the subject involves a significant interaction with the patient, e.g. details of a diagnostic measurement, then classification shall be directed to the appropriate subclasses of [A61](#);
- the mere presence of "a computer" or "a flowchart" in relation to "medical devices or procedures" is not a key element for classifying in this subclass; in this case classification shall rather be directed to the appropriate subclasses covering those medical devices or procedures;

If guidance indicated in the subparagraphs above cannot be used, classification is made in both this subclass and the appropriate subclasses of [A61](#).

References

Informative references

Attention is drawn to the following places, which may be of interest for search:

Signal processing or signal transmission associated to diagnostic measurements, e.g. signal waveform analysis	A61B 5/00
Digital computers in which all the computation is effected mechanically	G06C
Digital fluid-pressure computing devices	G06D
Optical computing devices	G06E
Electric digital data processing	G06F
Analogue computers	G06G
Hybrid computing arrangements	G06J
Computer systems based on specific computational models	G06N

Systems or methods specially adapted for administrative, commercial, financial, managerial or supervisory purposes	G06Q
Bioinformatics	G16B
Computational chemistry; Chemoinformatics; Computational materials science	G16C

Glossary of terms

In this place, the following terms or expressions are used with the meaning indicated:

Handling	of medical or healthcare data covers the acquisition, storage, retrieval, analysis, management, transmission or usage of such data
----------	--

Synonyms and Keywords

In patent documents, the word/expression in the first column is often used instead of the word/expression in the second column, which is used in the classification scheme of this place:

medical informatics, health informatics, clinical informatics, biomedical informatics	healthcare informatics
---	------------------------

G16H 10/00

ICT specially adapted for the handling or processing of patient-related medical or healthcare data (for medical reports [G16H 15/00](#); for therapies or health-improving plans [G16H 20/00](#); for the handling or processing of medical images [G16H 30/00](#))

Definition statement

This place covers:

ICT specially adapted for the handling or processing of patient-related medical or healthcare data, e.g. for electronic clinical trials or questionnaires, for data related to laboratory analysis or for patient-specific data.

References

Limiting references

This place does not cover:

ICT specially adapted for medical reports	G16H 15/00
ICT specially adapted for therapies or health-improving plans	G16H 20/00
ICT specially adapted for the handling or processing of medical images	G16H 30/00

Synonyms and Keywords

In patent documents, the following words/expressions are often used as synonyms:

- "electronic health record", "electronic medical record" and "electronic patient record"

G16H 10/20

for electronic clinical trials or questionnaires

Definition statement

This place covers:

ICT specially adapted for the handling and processing of patient-related medical or healthcare data for electronic clinical trials or questionnaires, surveys, polls, studies, forms, enquiries, statistics, with or without manually input data.

Example 1: Receiving first information about a patient via a first user interface that is communicatively coupled to a communication network, receiving second information about the patient via a second user interface that is communicatively coupled to the communication network, where the first information and the second information, together, comprise answered questions, evaluating the answered questions to yield follow-up questions and a suggested diagnosis, and transmitting the suggested diagnosis and the follow-up question to the second user interface via the communication network.

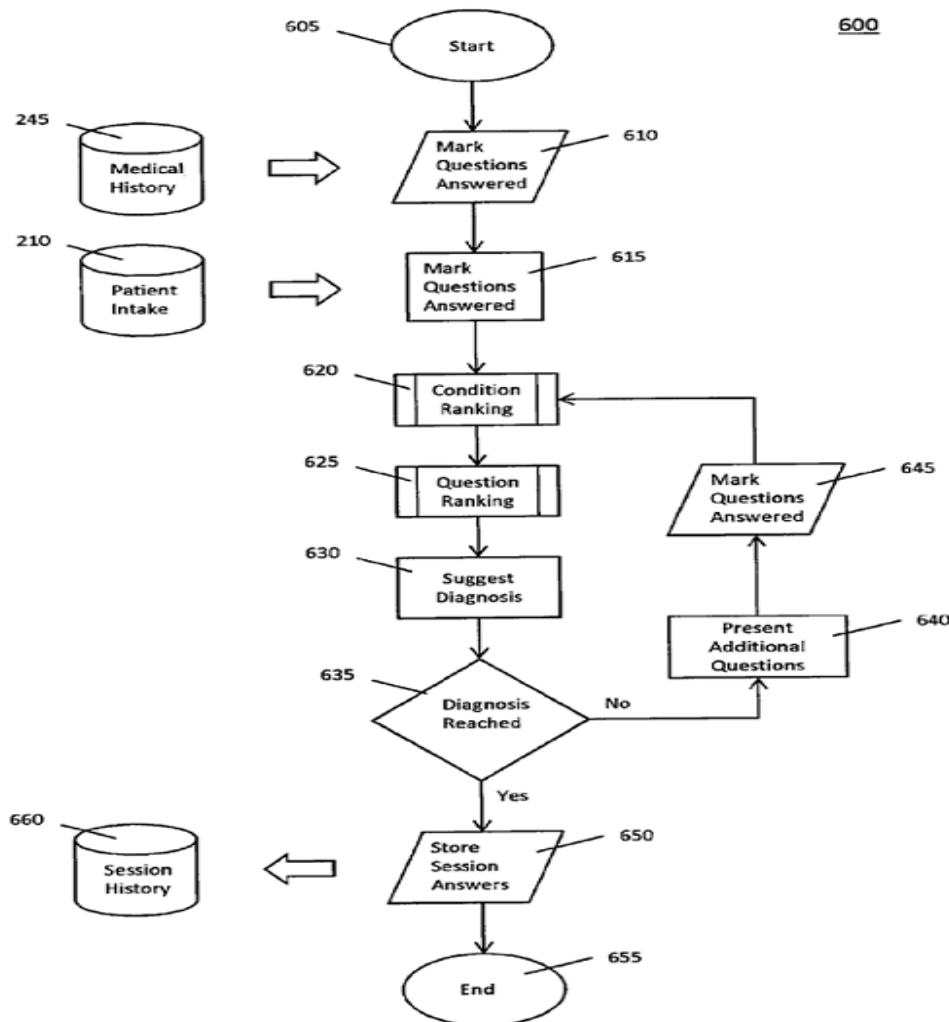

Example 2: A method for managing a clinical trial, comprising: enabling information exchanges over an Internet-based network with users participating in a clinical trial; deploying over the Internet-based network for use by the users clinical trial setup information including tools to automate creation of a data repository; providing to the users over the Internet-based network, collaborative clinical trial setup and administration functions which allow the users to use the clinical trial setup information

to collaborate with each other and administer the clinical trial; performing clinical trial management functions.

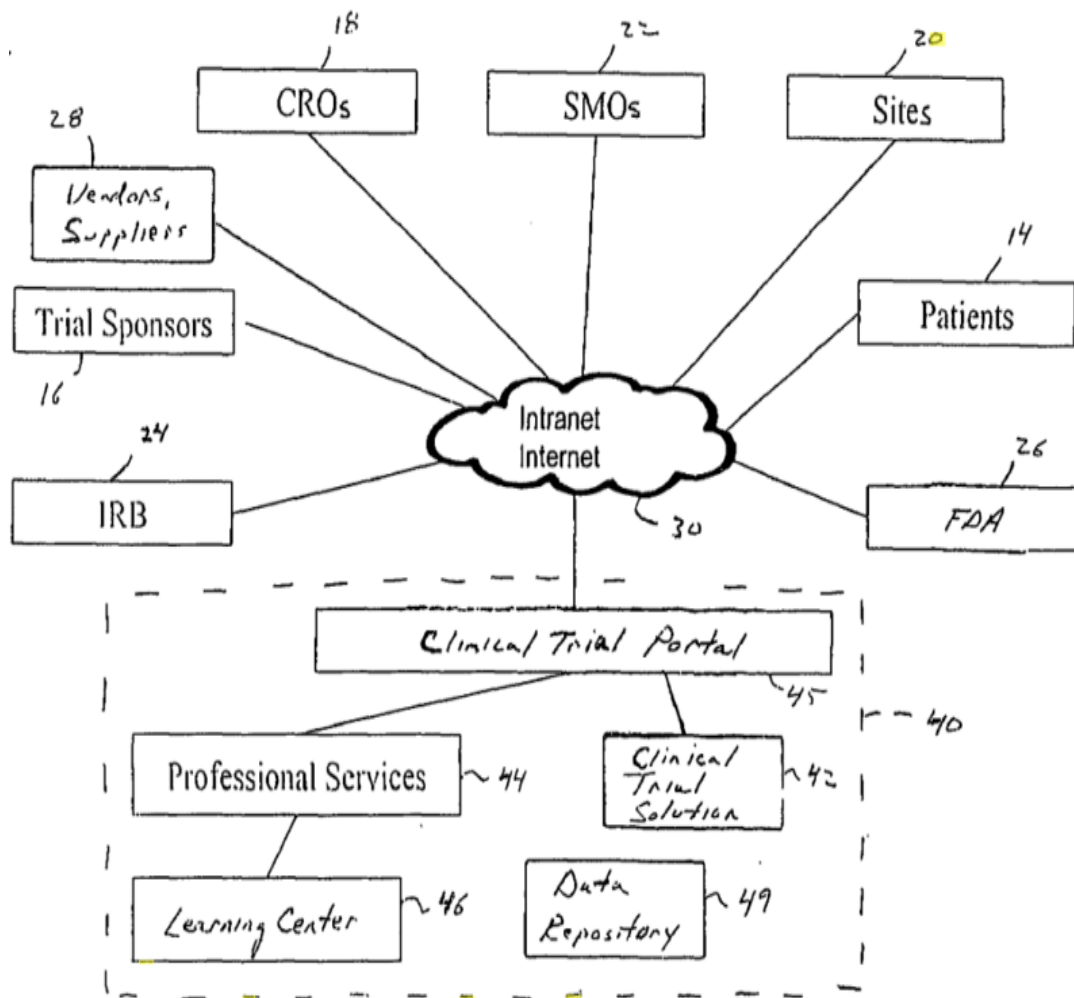

References

Informative references

Attention is drawn to the following places, which may be of interest for search:

Text processing	G06F 40/10
Electrically-operated educational appliances	G09B 5/00

G16H 10/40

for data related to laboratory analysis, e.g. patient specimen analysis

Definition statement

This place covers:

ICT specially adapted for the handling or processing of patient-related medical or healthcare data related to laboratory analysis.

For example:

- Administrative and organisational software for laboratories and for testing, e.g. identifiers and tags for examination containers

Definition statement

- Identifying, labelling, sending, tracking and logging of specimens, samples and of the analysis results
- Handling of point-of-care testing [POCT]
- Supervising processes related to laboratory work and testing
- Handling of RFID tags for laboratory containers

Example 1: Confidentially providing laboratory results to a consumer of a sample retrieval kit comprising: labelling the sample with a unique identification number; correlating the identification number with the consumer's identification number; testing the sample to obtain a clinical value; correlating the unique identification number with the clinical value; and electronically providing the clinical value to the consumer in a secure electronic manner.

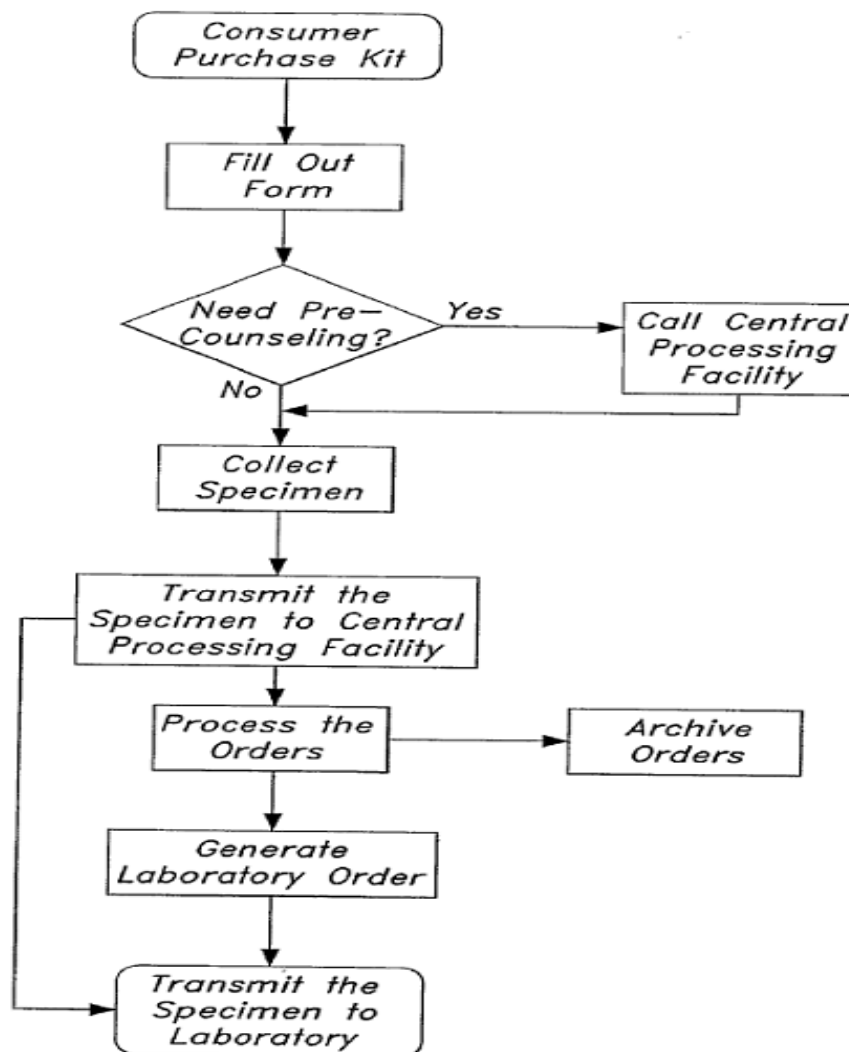

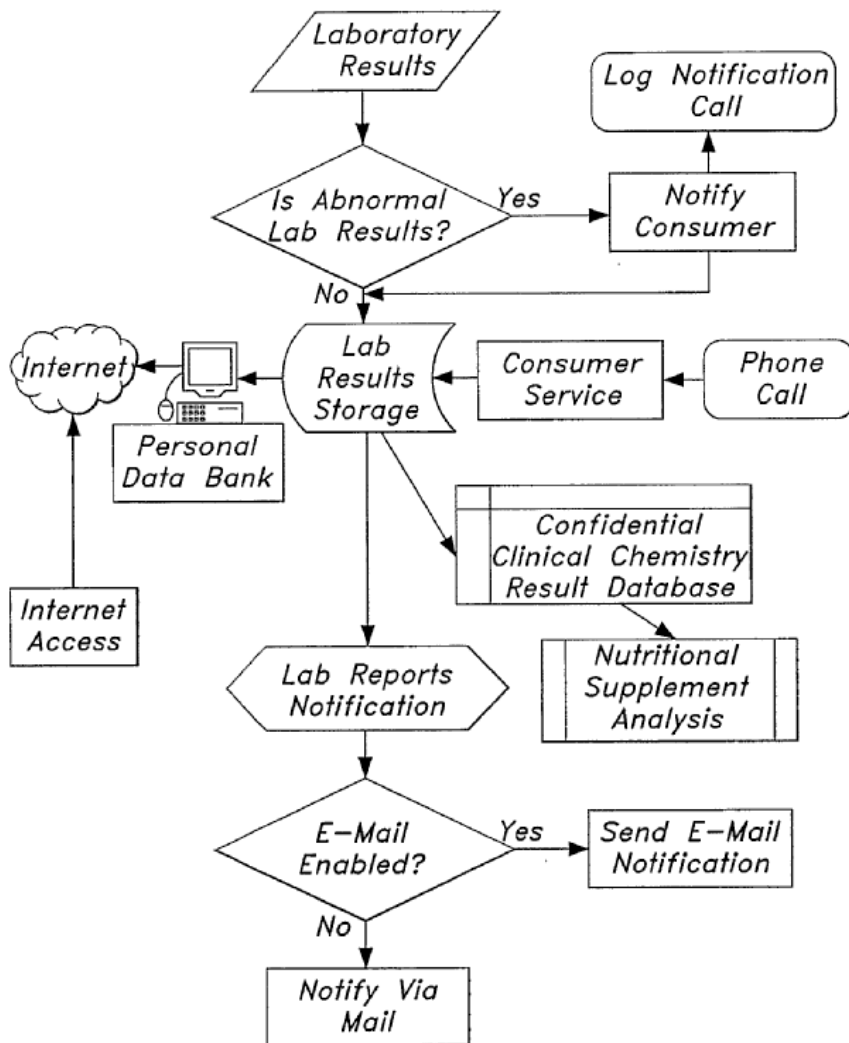

Example 2: Sample processing system with plurality of tracking devices coupled to a respective plurality of sample processing containers and storing sample identification information for a patient sample for use with sample processing devices configured to process the patient sample according to workflow steps of a processing protocol. A plurality of readers is configured to receive signals from the plurality of tracking devices. A controller may be coupled to the plurality of readers and configured

to determine if the patient sample is processed according to the processing protocol based at least in part on the signals from the plurality of tracking devices.

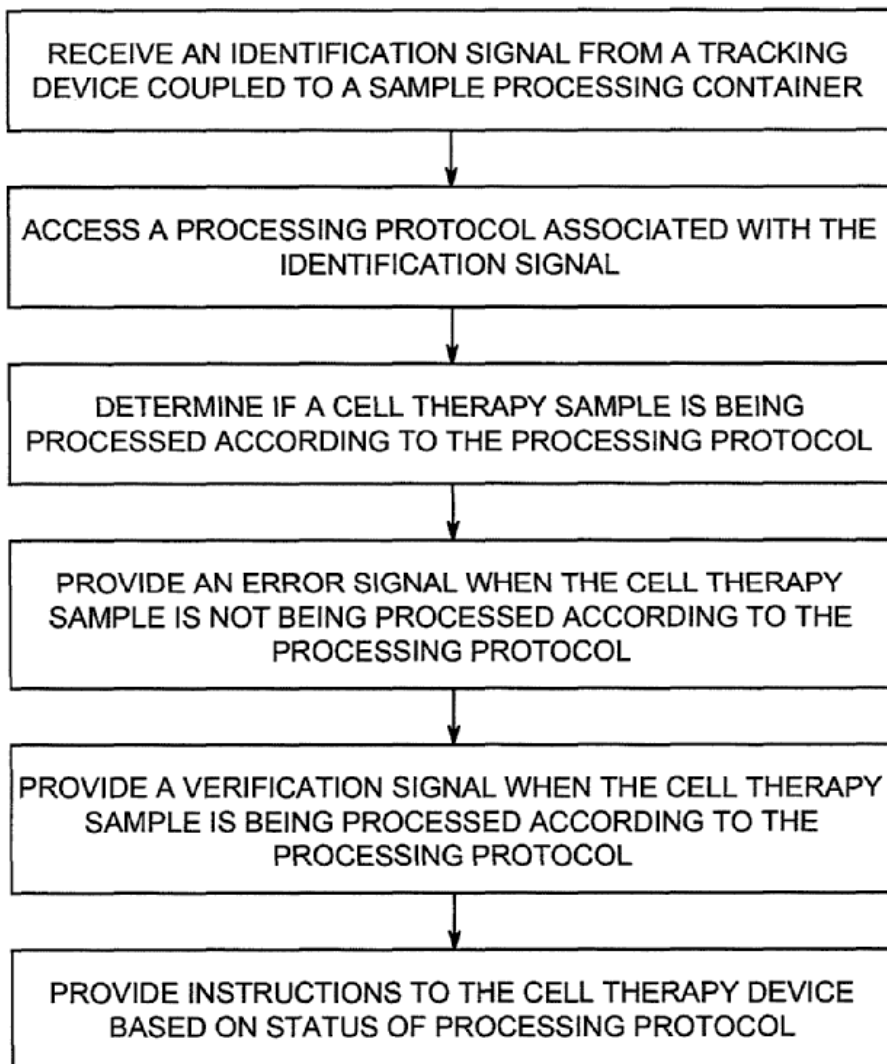

Relationships with other classification places

This group covers the case where a specimen is sent to testing or a laboratory, and/or if analysis results are sent from testing or a laboratory.

When data is sent to a server for analysis, and the result is sent back to the patient, then classification should be directed to telemedicine, which is covered by group [G16H 40/67](#).

References

Informative references

Attention is drawn to the following places, which may be of interest for search:

Medicinal preparations containing antigens or antibodies	A61K 39/00
Containers or dishes for laboratory use	B01L 3/00
Measuring or testing processes involving enzymes or microorganisms	C12Q 1/00
Investigating or analysing biological material	G01N 33/48

G16H 10/60

for patient-specific data, e.g. for electronic patient records

Definition statement

This place covers:

ICT specially adapted for the handling or processing of patient-specific data, e.g. for electronic patient records.

It covers patient records (in any form of: local, remote, confidential, public, centralized, distributed, condensed) or reference data thereto; their conversion and merging and handling, and corresponding privacy, security or confidentiality aspects.

It covers also databases, other data storage means and methods for handling patient-specific data, or reference data thereto.

Example: A central computer has access to consolidated medical and biographical records databases and provides controlled access for local or remotely situated patient computers and healthcare computers. Patients can control access to their own records and/or specific parts of their records. Patients, health care providers and/or interested individuals may also inquire about patient records. Patient records can also be created based on sorting and merging data from different sources.

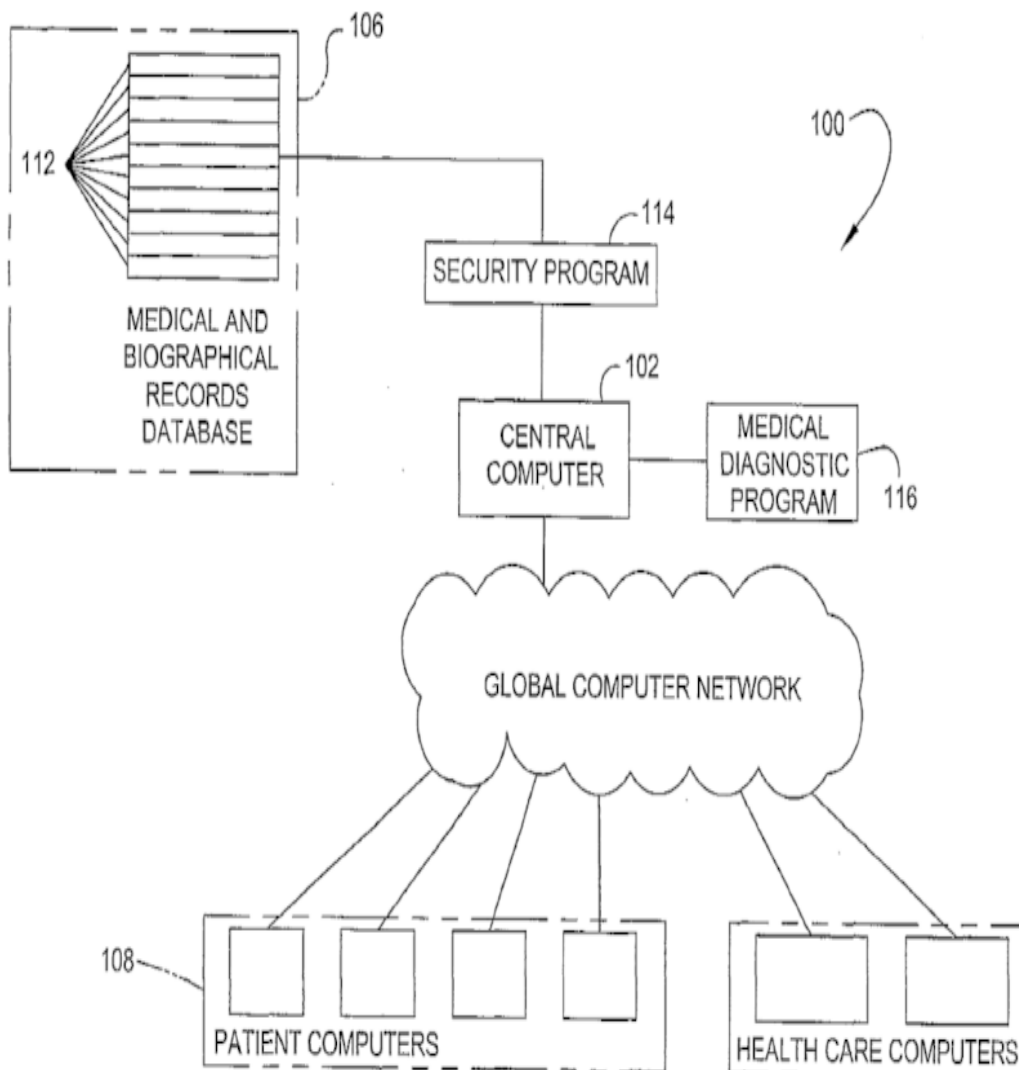

Relationships with other classification places

This group also covers databases or other storage means for patient-specific data.

Group [G16H 70/00](#) covers instead databases for medical references, i.e. medical data not linked to a specific patient.

References

Informative references

Attention is drawn to the following places, which may be of interest for search:

ICT specially adapted for the handling or processing of medical references	G16H 70/00
Information retrieval; Database structures therefor	G06F 16/00
Security arrangements for protecting computers, components thereof, programs or data against unauthorised activity	G06F 21/00

G16H 10/65

stored on portable record carriers, e.g. on smartcards, RFID tags or CD

Definition statement

This place covers:

ICT specially adapted for the handling or processing of patient-related medical or healthcare data for patient-specific data, e.g. for electronic patient records, which are stored on portable record carriers, e.g. on smartcards, RFID tags or CD.

At least part of the patient-specific data or reference data thereto, is stored in such a manner that it is wearable or portable for the patient. This is often used for assisting patient identification or fast access

to patient information, e.g. for accidents, emergencies, patient visits to doctor's offices or doctors' visits. It covers also patients' RFID tags.

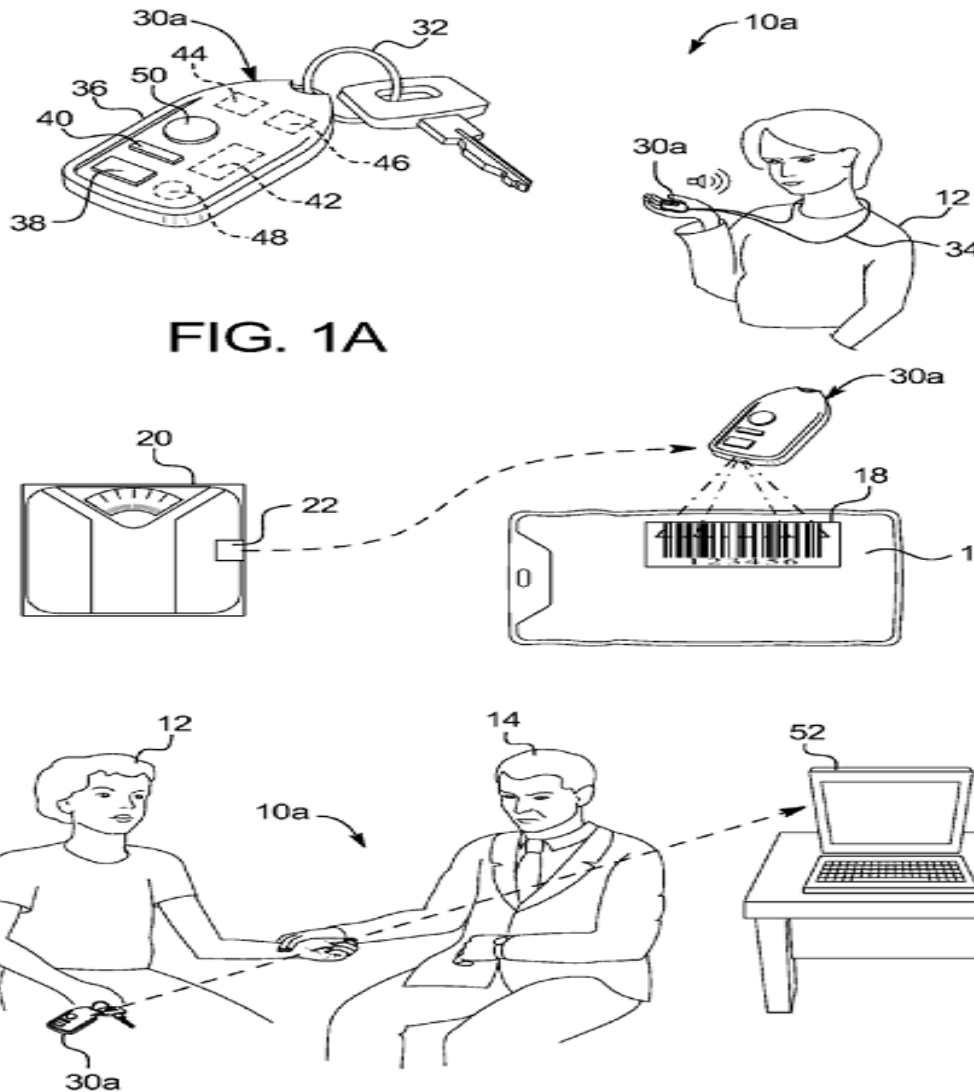

FIG. 1A

Glossary of terms

In this place, the following terms or expressions are used with the meaning indicated:

RFID	Radio-Frequency Identification
------	--------------------------------

G16H 15/00

ICT specially adapted for medical reports, e.g. generation or transmission thereof

Definition statement

This place covers:

ICT specially adapted for medical reports, e.g. generation or transmission or handling or processing thereof.

A medical report is an account of a person's health or wellbeing, or a person's medical, clinical or health history. It can be on paper, screen or merely stored.

Definition statement

It covers report generation and distribution, as well as codes, standards and software algorithms for generating reports, which are applicable to any kind of medical or healthcare data: patient-related data or non-patient-related data. Report analysis is however classified in the fitting diagnosis or treatment groups.

Example: Reporting healthcare data by creating displays or reports based on aggregating data from healthcare results data and history data. Optionally, patient progress indicators may be determined, narrative reports may be generated which integrate fixed textual matter with patient data, in various formats.

```

      Behavioral Health South, P.C.
Narrative: MC-SR - Managed Care - Session Review
-----Permanent Blank Line-----
Center Line-><UnderlineOn><BoldOn>MANAGED CARE SESSION
REVIEW<BoldOff><UnerlineOff>
-----Permanent Blank Line-----
-----Permanent Blank Line-----
Name.....<@Name (First I. Last)-Patient@>
SS Number.....<@Social Security Number-Patient@>
Date of Birth.....<@Date of Birth-Patient@>
Date of Evaluation.....<@Chart Note Date-Misc@>
Age.....<@Age-Patient@>
Sex.....<@Sex (male/female)-Patient@>
Marital Status.....<@Marital Status-Patient@>
Chart Number.....<@Chart #-Patient@>
Chart Entered By.....<@Chart Entered By-Misc@>
Diagnoses.....<@Diagnostic Code I (Header)-Patient@>
                   <@Diagnostic Code II (Header)-Patient@>
                   <@Diagnostic Code III (Header)-Patient@>
                   <@Diagnostic Code IV (Header)-Patient@>
                   <@Diagnostic Code V (Header)-Patient@>
-----Permanent Blank Line-----
-----Section 001-----
Assessment was based on <@Assessment@>.

The general treatment approaches utilized during this session
included <@Intervention@>.

Specific techniques included <@Techniques@>.

A consultation was completed on <@Mr. or Mrs.-Misc@> <@Name
(Last)-Patient@> regarding <@Consultation Focus@> by
<@his/her-Misc@> <@Consultee@>.
-----Section 002-----
<@Mr. or Mrs.-Misc@> <@Name (Last possessive)-Patient@> attitude
was <@Attitude - Client@>.

The content of the session was focused on <@Content - Session@>

Subjective distress was assessed as <@Subjective Distress@>.

<@Personality Organization@>.

<@Mr. or Mrs.-Misc@> <@Name (Last)-Patient@> is experiencing
<@Cognitive Impairment@> in cognitive functioning.

<@He/She-Misc@> demonstrated <@Interpersonal Impairment@> in
interpersonal relationships, <@Emotional Impairment@>, and
Managed Care - Session Review (MC-SR) Page 1

```

Relationships with other classification places

Group [G16H 10/60](#) covers the handling or processing of patient-specific data, i.e. any form of storing, logging, collecting, referencing, managing, making available, securing, translating, converting, displaying or the like of patient-specific data, e.g. of electronic patient records.

In contrast to that, this group covers the creation and management of reports, summaries, accounts, history documents or files, starting from patient-related and/or non-patient-related medical or healthcare data.

Relationships with other classification places

Examples are: reports of drug studies, reports of drug references, reports of medical practices, surgery reports, doctor's office reports or hospital reports.

References

Informative references

Attention is drawn to the following places, which may be of interest for search:

ICT specially adapted for the handling or processing for patient-specific data, e.g. for electronic patient records	G16H 10/60
---	----------------------------

G16H 20/00

ICT specially adapted for therapies or health-improving plans, e.g. for handling prescriptions, for steering therapy or for monitoring patient compliance

Definition statement

This place covers:

ICT specially adapted for therapies or health-improving plans, e.g. for handling prescriptions, monitoring patients' compliance, handling therapy or health-improving plans.

It relates to any kind of therapies, healthcare, regimen, strategies, trainings, plans, schedules, prescriptions or recommendations, relating to improving, restoring or maintaining health, well-being, or medical, clinical or bodily conditions. Well-being also includes lifestyle.

References

Informative references

Attention is drawn to the following places, which may be of interest for search:

Prescription lists	A61G 12/00
--------------------	----------------------------

Glossary of terms

In this place, the following terms or expressions are used with the meaning indicated:

Prescription	Healthcare plan for therapy
--------------	-----------------------------

G16H 20/10

relating to drugs or medications, e.g. for ensuring correct administration to patients

Definition statement

This place covers:

ICT specially adapted for therapy or health-improving plans which are based on drugs or medication, e.g. for ensuring correct administration to patients. It covers:

- prescription, delivery, controlling, administration and monitoring of medication;
- treatment by medication;
- prescription handling;
- compliance checking;
- medication cross-checking;

Definition statement

- checking drug interactions;
- adverse effects of medication.

With this, the aim is to make sure that the right patient receives the right medication at the right times and in the right dosages, form, procedure and route.

References

Informative references

Attention is drawn to the following places, which may be of interest for search:

ICT specially adapted for the handling or processing of medical references	G16H 70/00
--	----------------------------

G16H 20/13

delivered from dispensers

Definition statement

This place covers:

ICT specially adapted for therapy or health-improving plans which are based on drugs or medication delivered to patients from dispensers. Dispensers are meant as automatic machines or containers designed to release a specific amount of drugs or medications. It also covers tags and labels for drugs.

Example 1: Medication dispensing system comprising medicine cabinet with compartments containing medications for access by healthcare attendant for preparing medication dosages for patients; delivery device, e.g. mobile cart, with sections receiving dosages prescribed for patients. Medicine cabinet includes a processor and memory for storing the names of patients and their prescribed medication dosages, and a display screen for displaying the patient names and their respective prescribed medication dosages. The delivery device, e.g. tray, includes a display screen for displaying the patient names and their respective medication dosages, and a communication link with the medicine cabinet

through which the cabinet processor communicates to the delivery device the patient names and their respective medication dosages.

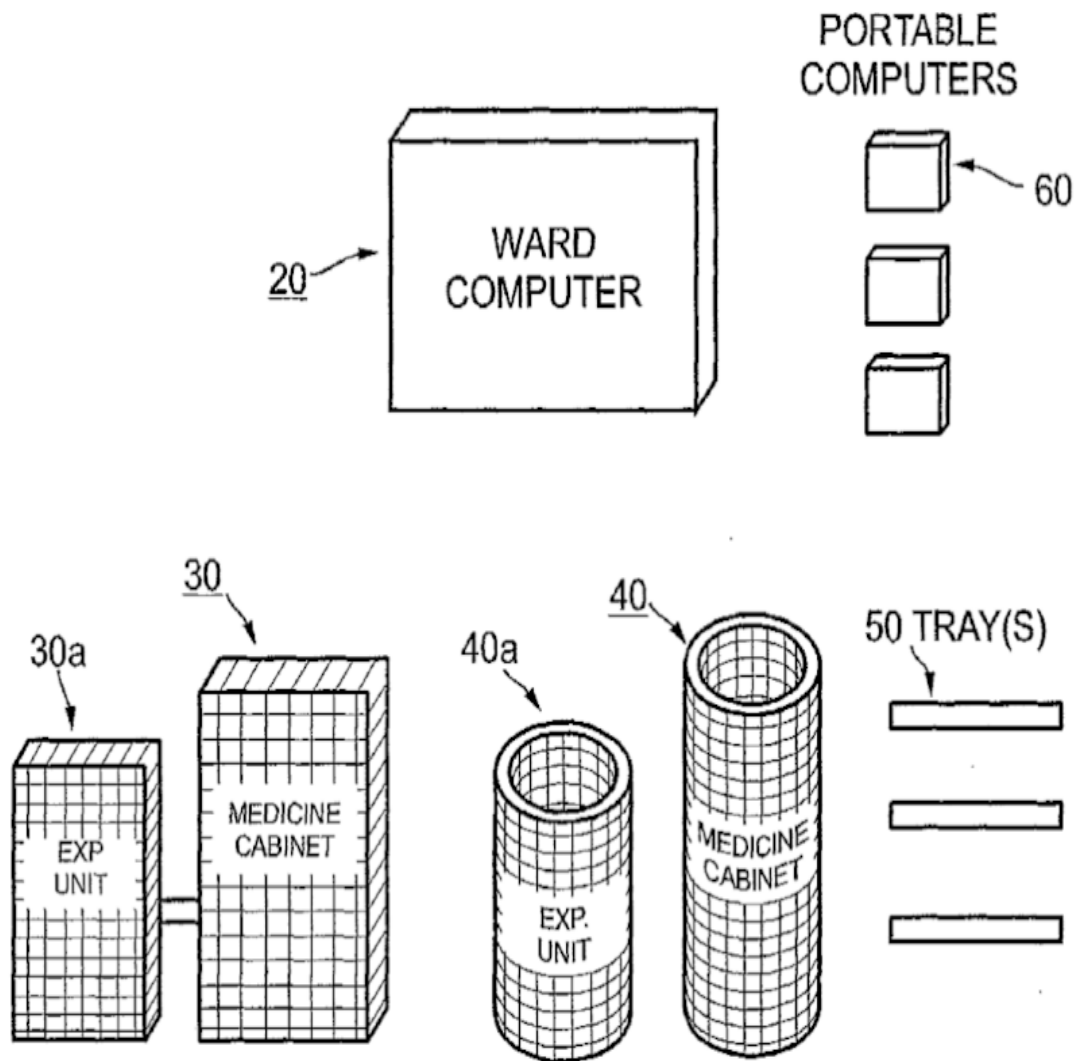

Example 2: Drug dispensing control system has a drug-dispensing unit with canister receiving a prescribed amount of medication from a prescription filling system. The canister includes a single dose

dispensing mechanism. A circuitry, provided in the drug-dispensing unit, allows access to a dose of the medication at a predetermined interval.

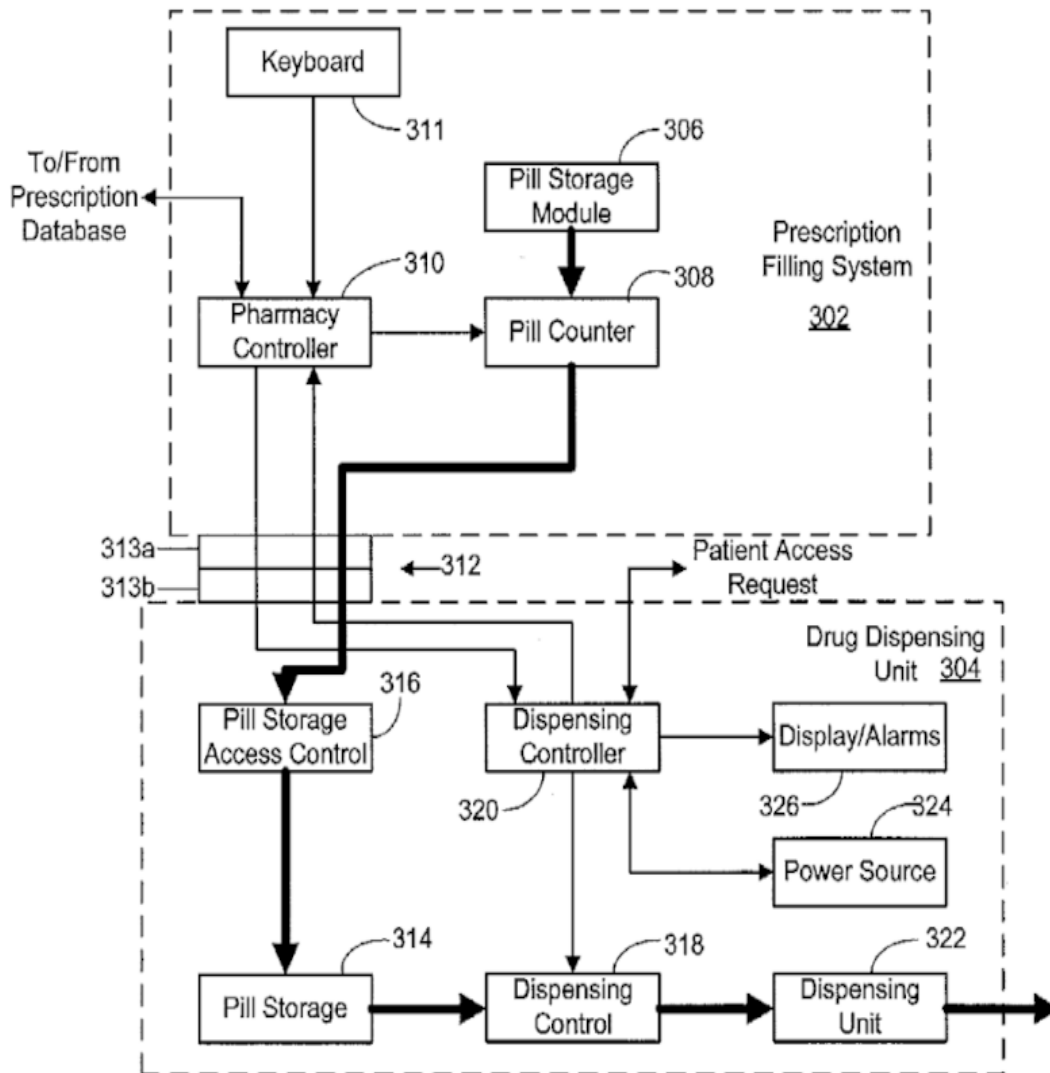

Example 3: Medication packets are automatically dispensed in the correct dosage amount and provided with identifiers and instructions, e.g. labels, tags, bar codes and/or human readable information.

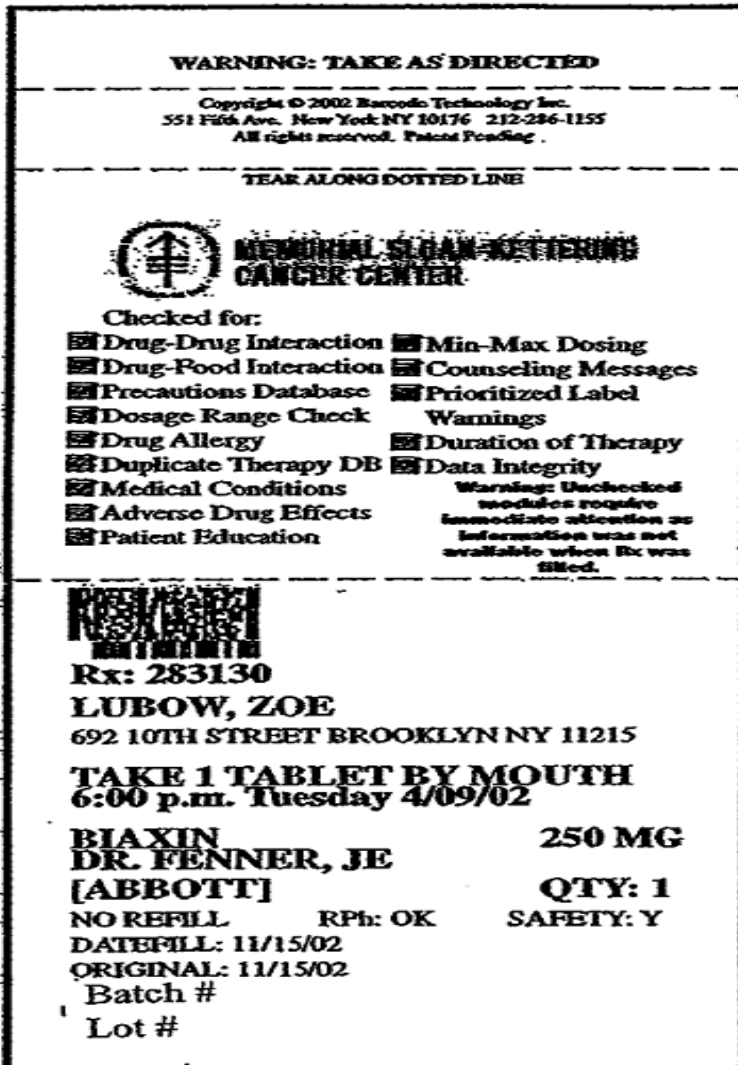

References

Informative references

Attention is drawn to the following places, which may be of interest for search:

Containers specially adapted for medical or pharmaceutical purposes	A61J 1/00
---	---------------------------

G16H 20/17

delivered via infusion or injection

Definition statement

This place covers:

ICT specially adapted for therapy or health-improving plans which are based on drugs or medication delivered to patients via infusion or injection.

Example: Communication system from medication infusion pump to hospital information management system, including a pump with pump operation circuitry for monitoring characteristics of pump operation indicative of administration of medication to a patient. A communication device is connected to the pump operation circuitry for communicating a pump signal representing the pump operation characteristics. The pump communication device communicates with a hospital information management system which receives the pump signal and which also includes a computer capable of storing, displaying and adjusting the pump operation characteristics.

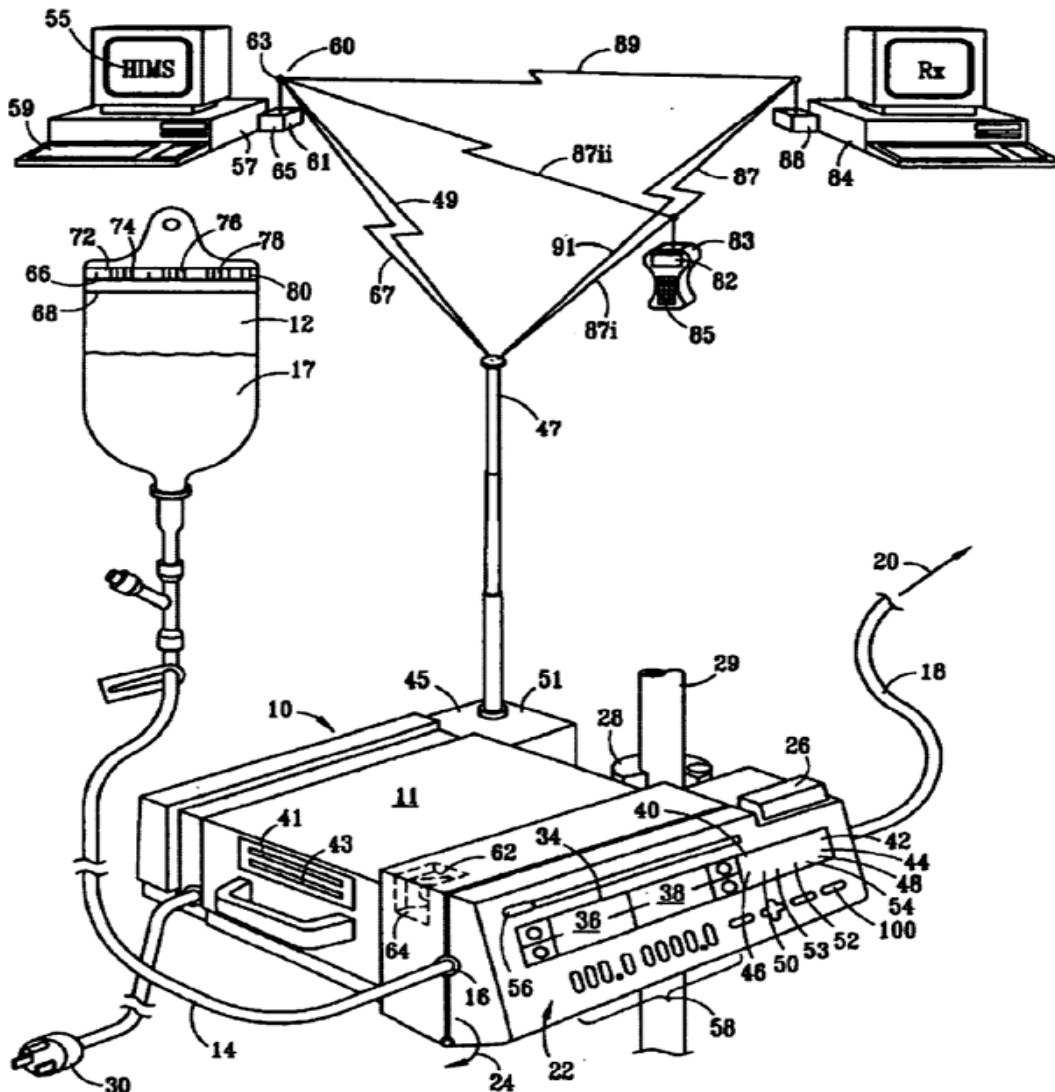

G16H 20/30

relating to physical therapies or activities, e.g. physiotherapy, acupuncture or exercising

Definition statement

This place covers:

ICT specially adapted for therapy or health-improving plans which are based on physical therapies or physical activities.

The following is a non-exhaustive list of therapies related to this group:

- physiotherapy;
- osteopathy;

Definition statement

- manual therapy;
- acupressure;
- exercising or similar physical activity;
- remedial gymnastics;
- thermal therapy;
- electric therapy;
- logopedics.

References

Informative references

Attention is drawn to the following places, which may be of interest for search:

Physical therapy apparatus, e.g. devices for locating or stimulating reflex points in the body; Artificial respiration; Massage; Bathing devices for special therapeutic or hygienic purposes or specific parts of the body	A61H
Handling of sleep disorders	A61M 21/02
Apparatus for physical training, gymnastics, swimming, climbing or fencing; Ball games; Training equipment	A63B

G16H 20/40

relating to mechanical, radiation or invasive therapies, e.g. surgery, laser therapy, dialysis or acupuncture

Definition statement

This place covers:

ICT specially adapted for therapy or health-improving plans which are based on mechanical, radiation or invasive therapies.

The following is a non-exhaustive list of therapies related to this group:

- surgery;
- laser therapy;
- dialysis;
- ventilation;
- acupuncture.

References

Informative references

Attention is drawn to the following places, which may be of interest for search:

Apparatus for radiation diagnosis or for radiation diagnosis combined with radiation therapy	A61B 6/00
Surgery	A61B 17/00 - A61B 90/00
Electrotherapy; Magnetotherapy; Radiation therapy; Ultrasound therapy	A61N
Devices using magnetic resonance effects	G01R 33/00

G16H 20/60

relating to nutrition control, e.g. diets

Definition statement

This place covers:

ICT specially adapted for therapy or health-improving plans which are based on nutrition control, e.g. diets.

It also covers the use of nutraceuticals, food supplements or food dispensers.

Example: Weight control programs, weight and diet goals, caloric intake and expenditure determination, planning and monitoring, determining nutritional or caloric contents.

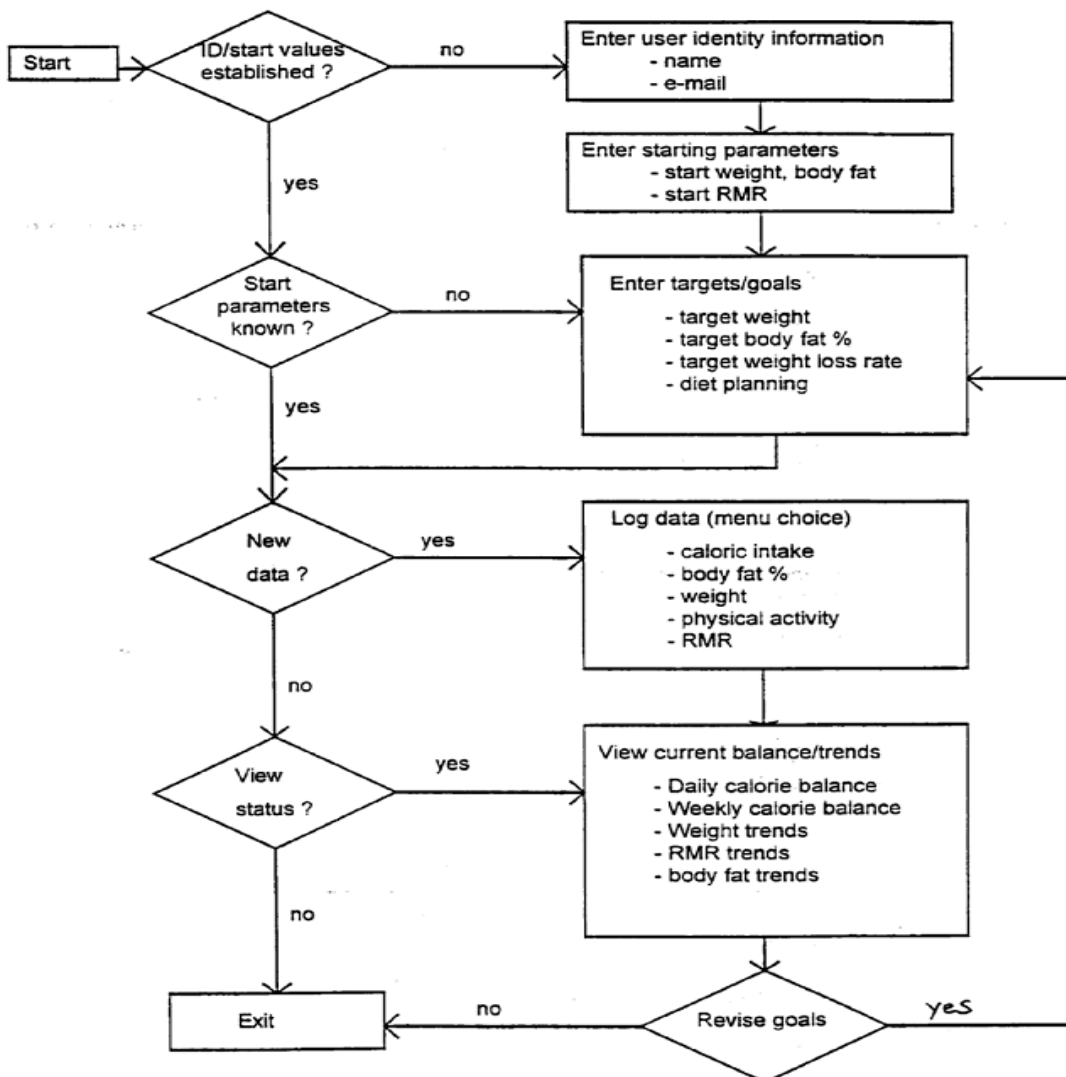

G16H 20/70

relating to mental therapies, e.g. psychological therapy or autogenous training

Definition statement

This place covers:

ICT specially adapted for therapy or health-improving plans which are based on mental therapies, e.g. psychotherapy, autogenous training, lifestyle management.

G16H 20/90

relating to alternative medicines, e.g. homeopathy or oriental medicines

Definition statement

This place covers:

ICT specially adapted for therapy or health-improving plans which are based on alternative medicines, e.g. homeopathy or oriental medicines, in particular Chinese medicine.

G16H 30/00

ICT specially adapted for the handling or processing of medical images (computed tomography [A61B 6/03](#))

Definition statement

This place covers:

ICT specially adapted for the handling or processing of medical, clinical or healthcare images, pictures, photographs, scans, or videos.

"Handling or processing" covers anything from generating, acquiring, transmitting, communicating, sharing, converting, formatting, viewing, using, editing, annotating, marking, tagging, storing, up to archiving and deleting.

References**Informative references**

Attention is drawn to the following places, which may be of interest for search:

Computed tomography	A61B 6/03
Image analysis	G06T 7/00
3D modelling for computer graphics	G06T 17/00
Manipulating 3D models or images for computer graphics	G06T 19/00

G16H 30/20

for handling medical images, e.g. DICOM, HL7 or PACS

Definition statement

This place covers:

ICT specially adapted for the handling of medical images.

For example:

- medical image acquisition, archiving, storing, managing or retrieving;
- systems, protocols and methods for medical image archiving and communication, e.g. DICOM, HL7 or PACS;
- ICT middleware for medical scenarios, i.e. making medical images available in the medical or healthcare field through the application of ICT.

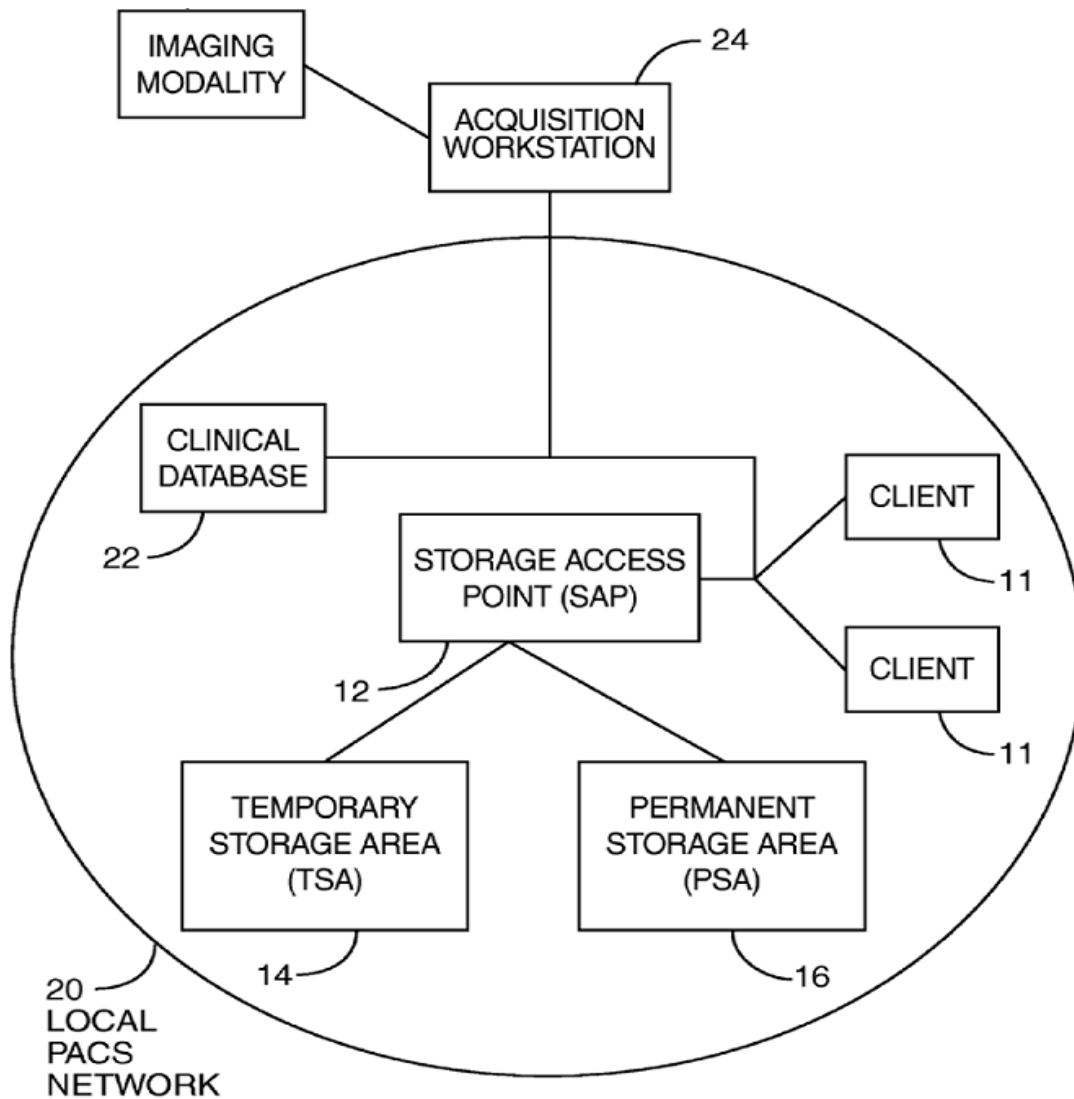

References

Informative references

Attention is drawn to the following places, which may be of interest for search:

Information retrieval; Database structures therefor	G06F 16/00
Transmission of digital information in general	H04L

Glossary of terms

In this place, the following terms or expressions are used with the meaning indicated:

DICOM	Digital Imaging and Communications in Medicine
HL7	Health Level Seven International
PACS	Picture Archiving and Communication Systems

G16H 30/40

for processing medical images, e.g. editing

Definition statement

This place covers:

ICT specially adapted for the processing of medical images.

For example:

- annotating, marking, tagging, editing or amending images, e.g. adding diagnosis or treatment information;
- adding or editing metadata of medical images.

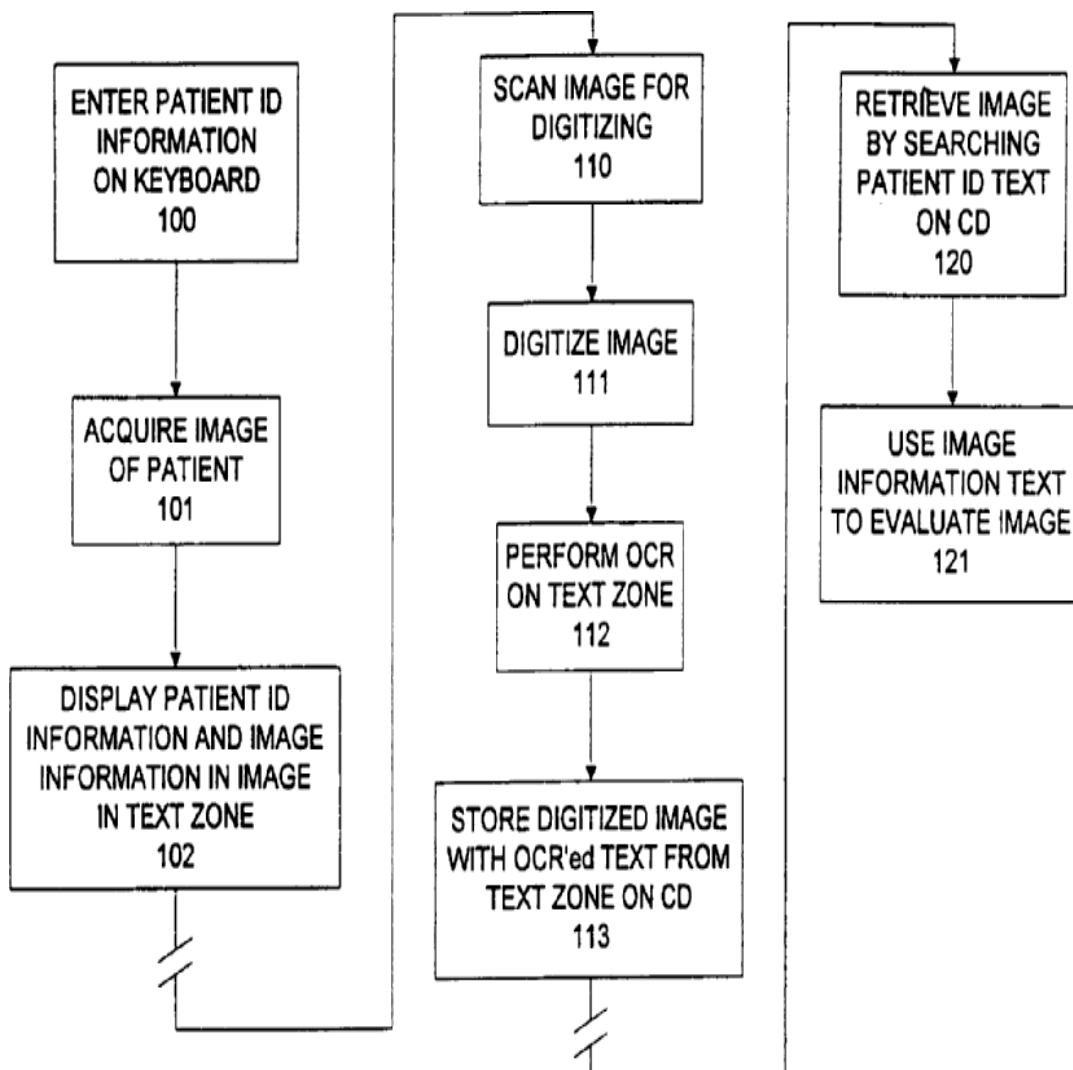

References

Informative references

Attention is drawn to the following places, which may be of interest for search:

Editing 2D figures and text; Combining 2D figures or text	G06T 11/60
Editing of 3D images	G06T 19/20

G16H 40/00

ICT specially adapted for the management or administration of healthcare resources or facilities; ICT specially adapted for the management or operation of medical equipment or devices

Definition statement

This place covers:

ICT specially adapted for the management, administration, handling, controlling, monitoring, treating, maintaining, configuring, servicing, networking, scheduling, using or operation of healthcare resources or facilities or of medical equipment or devices. It covers any kind of ICT which relates to these aspects.

Special rules of classification

If a document also discloses managerial, administrative or organisational, i.e. business method aspects, then the document should also be circulated to [G06Q](#).

G16H 40/20

for the management or administration of healthcare resources or facilities, e.g. managing hospital staff or surgery rooms

Definition statement

This place covers:

ICT specially adapted for the management or administration of healthcare resources or facilities, e.g. managing hospital or office staff, patients, surgery rooms, inventory management.

It covers also hospital networks, scheduling staff and equipment, measuring quality and efficiency, managing workflows, hygiene monitoring, also hygiene dispensers.

Hospital information systems.

Healthcare administrative and organisational software.

Example:

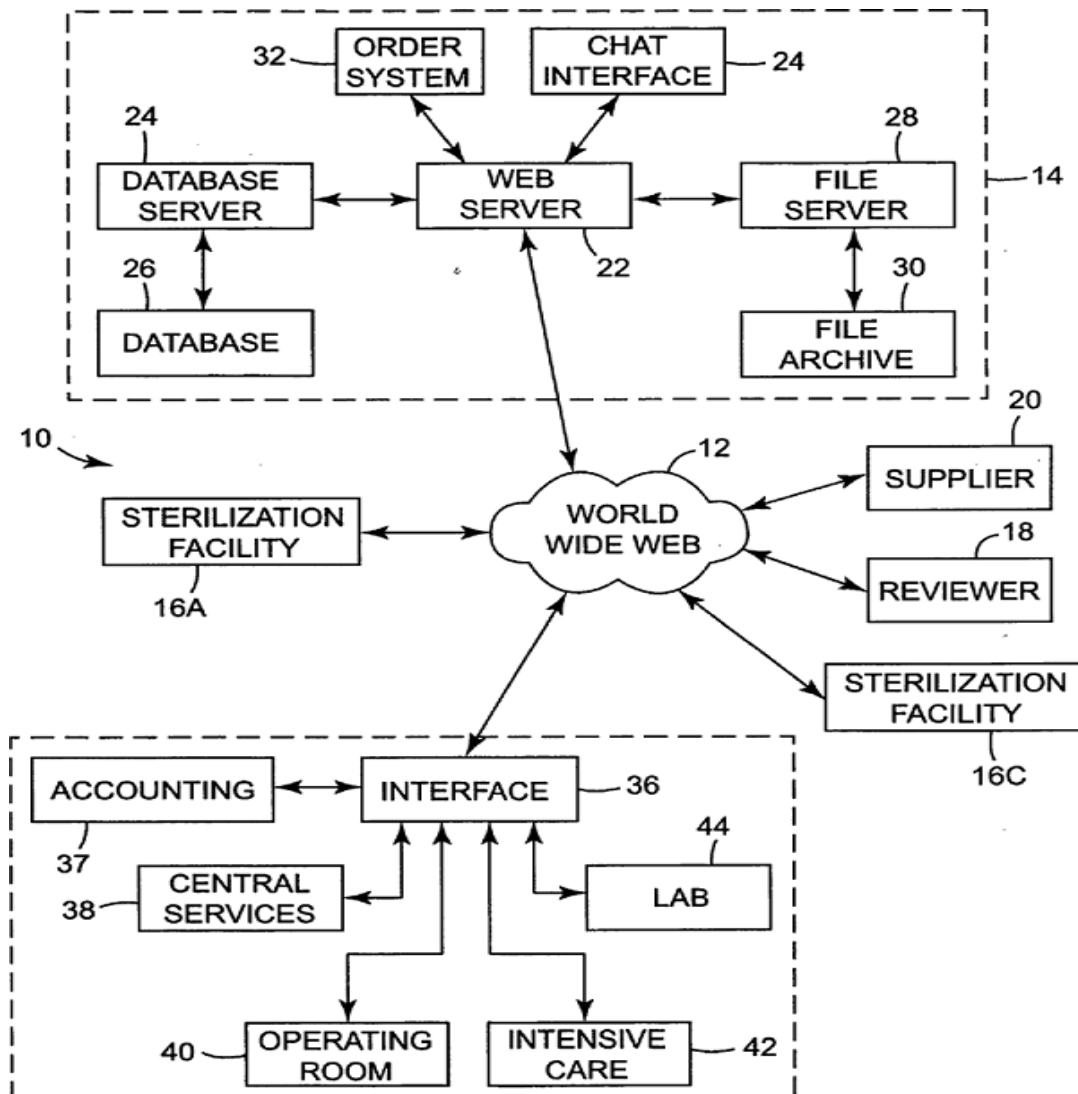

G16H 40/40

for the management of medical equipment or devices, e.g. scheduling maintenance or upgrades

Definition statement

This place covers:

ICT specially adapted for the management of medical equipment or devices, e.g. scheduling maintenance or upgrades, calibrating, servicing, updating, mending, or repairing. It is independent from whether it happens locally or remotely.

G16H 40/60

for the operation of medical equipment or devices

Definition statement

This place covers:

ICT specially adapted for the operation of medical equipment or devices, or of their interfaces.

Relationships with other classification places

This group covers aspects of the operation of medical equipment or devices where the focus is on the processing of medical or healthcare data, which results in transformation of said data.

The operation of medical equipment or devices, or of their interfaces, without transformation of medical or healthcare data, is covered by the relevant subclasses of class [A61](#).

References

Informative references

Attention is drawn to the following places, which may be of interest for search:

Computer-aided surgery	A61B 34/00
Computer interface arrangements	G06F 3/00 , G06F 13/00
Graphical user interfaces per se	G06F 3/048
Client/server computer systems	G06F 15/163
Transmission of digital information in general	H04L

Glossary of terms

In this place, the following terms or expressions are used with the meaning indicated:

Operation	covers also monitoring or control
Local	relates to operation by which (i) a patient, (ii) a medical equipment or device, and (iii) a medical practitioner or operator are in a single geographically enclosed area
Remote	relates to operation by which (i) a patient, (ii) a medical equipment or device, or (iii) a medical practitioner or operator are geographically separated
Transformation	of medical or healthcare data, means any contextual, content-related or structural transformation of said data

G16H 40/63

for local operation

Definition statement

This place covers:

ICT specially adapted for the local operation, monitoring or control of medical equipment or devices.

Example: A doctor controlling a surgery over Ethernet connection, but located in the same intensive care unit hosting the surgery room.

Relationships with other classification places

Graphical user interfaces of healthcare informatics for purposes other than local monitoring or control are classified in the corresponding use-specific subgroups of subclass [G16H](#).

G16H 40/67

for remote operation

Definition statement

This place covers:

ICT specially adapted for the remote operation of medical equipment or devices, or of their interfaces.

The following is a non-exhaustive list of subjects related to this group:

- remote monitoring of devices or patients;
- remote diagnosis;
- telemedicine;
- remote treatment;
- remote controlling of medical devices.

G16H 50/00

ICT specially adapted for medical diagnosis, medical simulation or medical data mining; ICT specially adapted for detecting, monitoring or modelling epidemics or pandemics

Definition statement

This place covers:

ICT specially adapted for medical diagnosis, medical simulation or medical data mining.

ICT specially adapted for monitoring, detecting or modelling of epidemics or pandemics. It also covers any subject-matter relating to medical, clinical, health-related or wellbeing-related diagnosis or diagnostic decisions, or merely diagnostic data processing, or data processing for supporting diagnosis; and also any algorithms or methods for medical, clinical, health-related or wellbeing-related decisions or for supporting such decisions. Also any kind of scoring, calculating indices, risks, or health-related values, bodily, physiologic or psychologic parameters.

It covers ICT adapted for medical simulation and modelling only insofar as it relates to medical disorders. Note that it is about ICT and data processing for medical simulation and modelling, not medical simulation and modelling as such.

Epidemics or pandemics can relate to any kind of diseases, illnesses, infections, bodily parameters, health issues, healthiness, bioterrorism, i.e. anything which causes medical, clinical, health-related or well-being symptoms to people.

G16H 50/20

for computer-aided diagnosis, e.g. based on medical expert systems

Definition statement

This place covers:

ICT specially adapted for medical diagnosis or computer-aided diagnosis, e.g. based on medical expert systems.

It covers any artificial intelligence or any heuristics used for supporting, assisting or automating diagnosis, or data analysis for diagnostic purposes.

It covers also rule-based systems, fuzzy logic, and also any trivial, i.e. non-complex computer-aided diagnosis and computer-aided medical decision making.

G16H 50/30

for calculating health indices; for individual health risk assessment

Definition statement

This place covers:

ICT specially adapted for calculating health indices, for individual health risk assessment.

The following is a non-exhaustive list of subjects related to this group:

- biorhythm analysis;
- body index;
- health index;
- health risks;
- heart age.

G16H 50/50

for simulation or modelling of medical disorders

Definition statement

This place covers:

ICT specially adapted for medical simulation or modelling of medical disorders.

It covers the simulation or modelling of the state, evolution or transformation of medical disorders.

References

Informative references

Attention is drawn to the following places, which may be of interest for search:

Computer-aided planning, simulation or modelling of surgical operations	A61B 34/10
Dental prostheses	A61C 13/00
Computer aided design	G06F 30/00
3D modelling for computer graphics	G06T 17/00
Models for scientific, medical, or mathematical purposes	G09B 23/00

G16H 50/70

for mining of medical data, e.g. analysing previous cases of other patients

Definition statement

This place covers:

ICT specially adapted for mining of medical data, e.g. analysing previous cases of other patients.

The following is a non-exhaustive list of subjects related to this group:

- data mining;
- data comparison;
- clustering;
- pattern recognition;
- case based reasoning;

Definition statement

- finding correlations between patients or diseases or treatments;
- retrospective studies;
- post analysis;
- regression.

Example: Data mining framework for mining structured clinical information includes a data miner that mines information from a clinical patient record (CPR) using domain-specific knowledge contained in a knowledge base. The data miner includes components for extracting information from the CPR, combining all available evidence over time, and drawing inferences from this combination process. The mined information may be stored in a structured CPR.

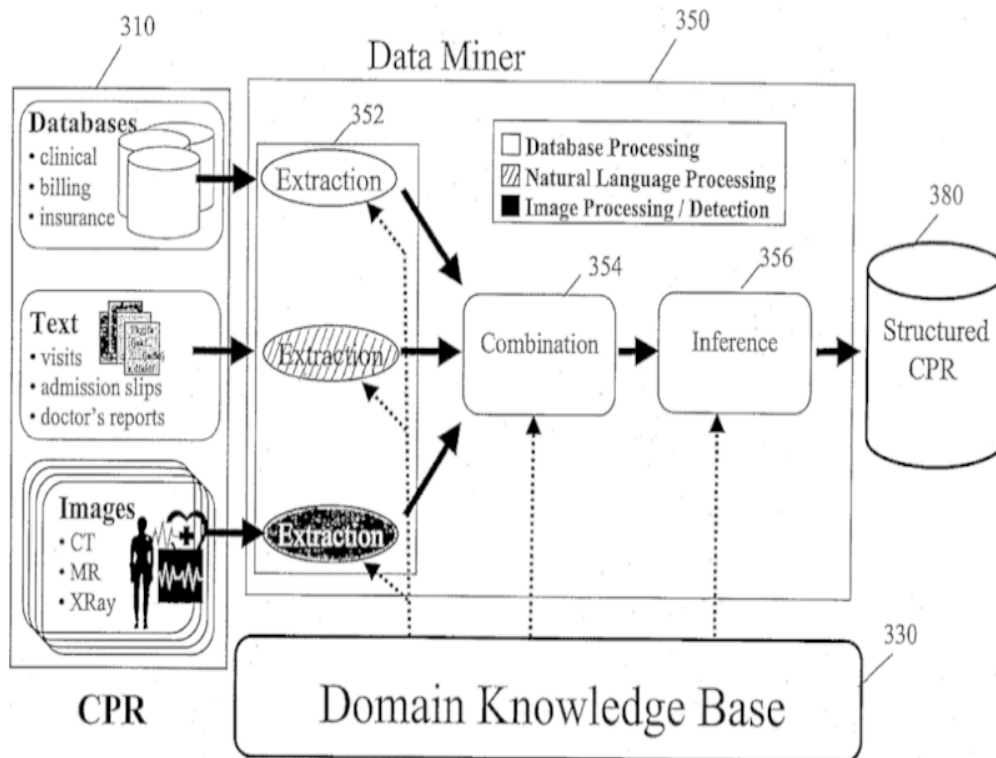

References

Informative references

Attention is drawn to the following places, which may be of interest for search:

Information retrieval; Database structures therefor	G06F 16/00
Pattern recognition	G06F 18/00
Arrangements for image or video recognition or understanding	G06V 10/00
Scenes; Scene-specific elements	G06V 20/00
Recognition of biometric, human-related or animal-related patterns in image or video data	G06V 40/00

G16H 50/80

for detecting, monitoring or modelling epidemics or pandemics, e.g. flu

Definition statement

This place covers:

ICT specially adapted for monitoring, detecting or modelling of epidemics or pandemics, e.g. for flu, Ebola, HIV or bioterrorism alerts.

It covers also medical data mining for detecting unusual medical patterns in geographic regions or population groups.

Relationships with other classification places

In this group, medical data mining is used for detecting and monitoring how an epidemic, pandemic or bioterrorism develops, evolves or spreads.

Group [G16H 50/70](#) covers instead medical data mining for diagnostic or treatment purposes for patients and diseases.

References

Informative references

Attention is drawn to the following places, which may be of interest for search:

ICT specially adapted for mining of medical data, e.g. analysing previous cases of other patients	G16H 50/70
ICT specially adapted for biostatistics; ICT specially adapted for bioinformatics-related machine learning or data mining, e.g. knowledge discovery or pattern finding	G16B 40/00

G16H 70/00

ICT specially adapted for the handling or processing of medical references

Definition statement

This place covers:

ICT specially adapted for the handling and processing of medical references, i.e. medical data not linked to a specific patient.

The following is a non-exhaustive list of subjects related to this group:

- drug references;
- drug side effects;
- pathologies; diseases; medical disorders.

Example: Retrieve, consolidate, verify, annotate, store, organize, update and share medical reference data.

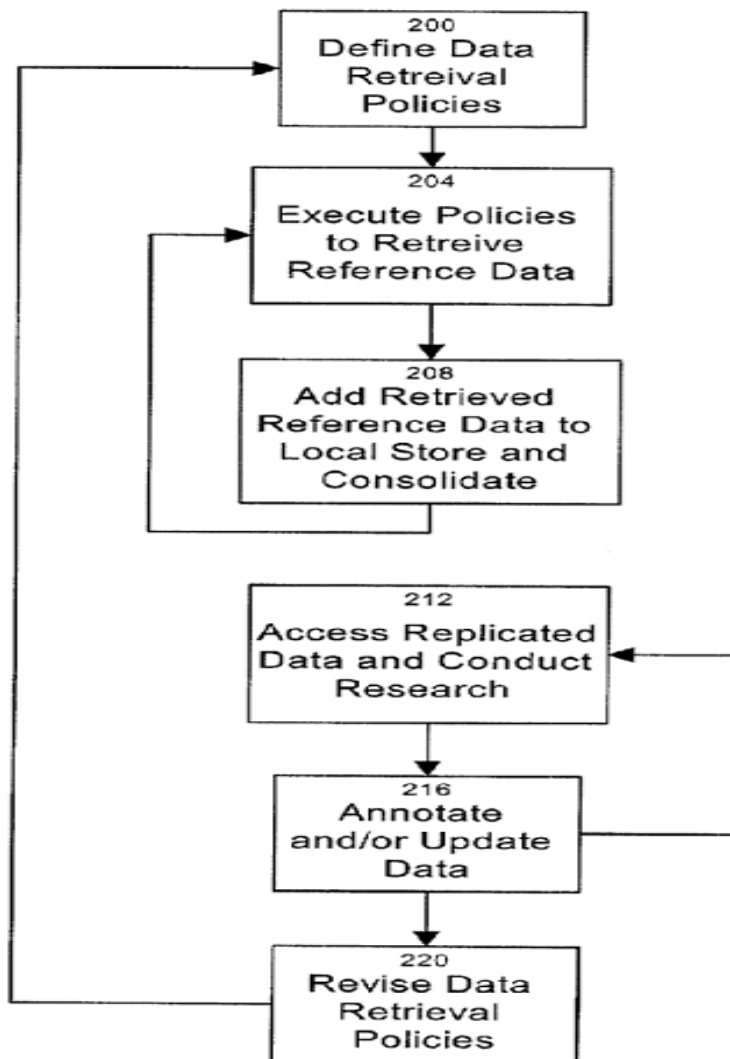

References

Informative references

Attention is drawn to the following places, which may be of interest for search:

Information retrieval; Database structures therefor	G06F 16/00
---	----------------------------

G16H 70/20

relating to practices or guidelines

Definition statement

This place covers:

ICT specially adapted for the handling and processing of medical references relating to:

- medical practises;
- clinical guidelines;
- general treatment protocols.

G16H 70/40**relating to drugs, e.g. their side effects or intended usage****Definition statement***This place covers:*

ICT specially adapted for the handling and processing of medical references relating to:

- drugs and medications, e.g. their side effects or intended usage;
- drugs pharmacology;
- drug details.

G16H 70/60**relating to pathologies****Definition statement***This place covers:*

ICT specially adapted for the handling and processing of medical references relating to pathologies. Also covers any kind of information related to pathophysiological processes, or to origins, nature, conditions and course of diseases, bodily malfunctions and other deviations from healthy conditions.

G16H 80/00**ICT specially adapted for facilitating communication between medical practitioners or patients, e.g. for collaborative diagnosis, therapy or health monitoring****Definition statement***This place covers:*

ICT specially adapted for facilitating communication between medical practitioners or patients, e.g. for collaborative diagnosis, therapy or health monitoring.

ICT specially adapted for consultations between medical practitioners or patients, their cooperation, teleconferencing, white-boarding, sharing findings or interworking.

The expression "between practitioners and/or patients" encompasses any of the following combinations:

- practitioner(s) – practitioner(s)
- practitioner(s) – patient(s)
- patient(s) – patient(s)