

# MARKS PUBLISHED FOR OPPOSITION

The following marks are published in compliance with section 12(a) of the Trademark Act of 1946. Applications for the registration of marks in more than one class have been filed as provided in section 30 of said act as amended by Public Law 772, 87th Congress, approved Oct. 9, 1962, 76 Stat. 769. Opposition under section 13 may be filed within thirty days of the date of this publication. See rules 2.101 to 2.105.

A separate fee of two hundred dollars for opposing each mark in each class must accompany the opposition.

## SECTION 1.— INTERNATIONAL CLASSIFICATION

The short titles associated below with the international class numbers are terms designed merely for quick identification and are not an official part of the international classification. The full names of international classes are given in section 6.1 of the trademark rules of practice.

The designation "U.S. Cl." appearing in this section refers to the U.S. class in effect prior to Sep. 1, 1973 rather than the international class which applies to applications filed on or after that date. For adoption of international classification see notice in the OFFICIAL GAZETTE of Jun. 26, 1973 (911 O.G. TM 210).

### Application in more than one class

SN 74-259,174. MARIE CLAIRE ALBUM, 75008 PARIS, FRANCE, FILED 3-26-1992.

**marie claire**  
BOUTIQUE · PARIS

NO CLAIM IS MADE TO THE EXCLUSIVE RIGHT TO USE "PARIS", APART FROM THE MARK AS SHOWN. "MARIE CLAIRE" IS NOT THE NAME OF A PARTICULAR LIVING INDIVIDUAL.

#### CLASS 3—COSMETICS AND CLEANING PREPARATIONS

FOR PERFUMES, COLOGNE, TOILET WATER; ESSENTIAL OILS FOR PERSONAL USE; PERSONAL DEODORANTS; POTPOURRI (U.S. CL. 51).

#### CLASS 4—LUBRICANTS AND FUELS

FOR CANDLES AND FUEL FOR HOUSEHOLD USE (U.S. CL. 15).

SN 75-032,019. BOARDROOM, INC., GREENWICH, CT. FILED 12-13-1995.

**BOTTOMLINE-BUSINESS.COM**

#### CLASS 35—ADVERTISING AND BUSINESS

FOR PROVIDING A WIDE RANGE OF BUSINESS INFORMATION VIA COMPUTER INFORMATION NETWORKS (U.S. CLS. 100, 101 AND 102).

#### CLASS 36—INSURANCE AND FINANCIAL

FOR PROVIDING A WIDE RANGE OF FINANCIAL INFORMATION VIA COMPUTER INFORMATION NETWORKS (U.S. CLS. 100, 101 AND 102).

SN 75-115,959. KABUSHIKI KAISHA F.D.C. PRODUCTS, TOKYO 150, JAPAN, FILED 6-5-1996.



OWNER OF JAPAN REG. NO. 4053152, DATED 9-5-1997, EXPIRES 9-5-2007.

OWNER OF JAPAN REG. NO. 4053151, DATED 9-5-1997, EXPIRES 9-5-2007.

OWNER OF JAPAN REG. NO. 4128084, DATED 3-27-1998, EXPIRES 3-27-2008.

OWNER OF JAPAN REG. NO. 4125307, DATED 3-20-1998, EXPIRES 3-20-2008.

THE MARK CONSISTS OF A CIRCULAR DESIGN COMPRISED OF ALTERNATING BLACK AND WHITE STRIPES, EACH OF WHICH SUGGESTS THE SHAPE OF THE LETTER "R".

**CLASS 8—HAND TOOLS**

FOR HAND TOOLS, NAMELY, PUNCHES, CHISELS, PLANES, NON-ELECTRIC DRILLS, SAWS AND FILES MADE OF METAL; HAND-OPERATED SHEARS; PRUNING SHEARS; HAND-OPERATED CHOPPERS; SCISSORS; PRUNING SCISSORS; SCISSOR BLADES; MANICURE IMPLEMENTS, NAMELY, NAIL CLIPPERS, NAIL SCISSORS AND NAIL SHEARS; JAPANESE GRIP SCISSORS; THREAD CLIPPERS; KITCHEN KNIVES, NAMELY, CARVING KNIVES, CHEF KNIVES, BUTCHER KNIVES, PARING KNIVES AND CLEAVERS; HUNTING KNIVES, FISHING KNIVES, SCALING KNIVES AND SPORT KNIVES; FOLDING KNIVES; PALETTE KNIVES; DRAWKNIVES; HAND-OPERATED CUTTERS; STRAW CUTTERS; GLASS CUTTERS; GLAZIERS' DIAMONDS; TABLEWARE, NAMELY, KNIVES, FORKS AND SPOONS, MADE OF PRECIOUS AND NON-PRECIOUS METAL; RAZORS; RAZOR BLADES; NON-ELECTRIC HAIR CLIPPERS; SUGAR TONGS; AXES; HATCHETS; SICKLES; SCYTHES; NON-ELECTRIC CAN OPENERS; DRIED BONITO PLANES; NUTCRACKERS, MADE OF NON-PRECIOUS METAL; GAFFS; SCOOPS; HOOKS (U.S. CLS. 23, 28 AND 44).

**CLASS 9—ELECTRICAL AND SCIENTIFIC APPARATUS**

FOR SPECTACLES; EYEGLASSES; PINCE-NEZ; SUNGLASSES; EYEGGLASS CASES; EYEGGLASS CHAINS AND CORDS; EYEGGLASS FRAMES AND PARTS AND FITTINGS THEREFOR; EYEGGLASS MOUNTINGS; EYEGGLASS LENSES; EYEGGLASS WIPES; EYEGGLASS TEMPLES; CONTACT LENSES; CONTACT LENSE CASES; SAFETY GOGGLES; SAFETY FACE MASKS; SWIMMING GOGGLES; SWIMMING FACE MASKS (U.S. CLS. 21, 23, 26, 36 AND 38).

**CLASS 14—JEWELRY**

FOR TEAPOTS OF PRECIOUS METAL; CUPS OF PRECIOUS METAL; WINE CUPS OF PRECIOUS METAL; DISHES OF PRECIOUS METAL; SALAD, SOUP AND RICE BOWLS OF PRECIOUS METAL; JUGS OF PRECIOUS METAL; BARRELS OF PRECIOUS METAL; POTS OF PRECIOUS METAL; BREAD CONTAINERS OF PRECIOUS METAL; NON-ELECTRIC COFFEE-POTS OF PRECIOUS METAL; NUTCRACKERS OF PRECIOUS METAL; PEPPER POTS OF PRECIOUS METAL; SUGAR BOWLS OF PRECIOUS METAL, SALT SHAKERS OF PRECIOUS METAL; EGG CUPS OF PRECIOUS METAL; NAPKIN RINGS OF PRECIOUS METAL; TRAYS OF PRECIOUS METAL; TOOTH PICK HOLDERS OF PRECIOUS METAL; SMOKERS' ARTICLES OF PRECIOUS METAL, NAMELY, LIGHTERS OF PRECIOUS METAL; KISERU (LONG ASIAN TOBACCO PIPES) OF PRECIOUS METAL; KISERU-SHEATHS OF PRECIOUS METAL; TOBACCO POUCHES OF PRECIOUS METAL; CIGARETTE CASES OF PRECIOUS METAL; CIGARETTE HOLDERS OF PRECIOUS METAL; ASHTRAYS OF PRECIOUS METAL; TOBACCO PIPES OF PRECIOUS METAL; EARRINGS; CLOTHING ORNAMENTS OF PRECIOUS METAL; BUCKLES OF PRECIOUS METAL; BADGES OF PRECIOUS METAL; HAT ORNAMENTS OF PRECIOUS METAL; HAT PINS OF PRECIOUS METAL; TIE CLIPS; TIE PINS; TIE TACKS; BRACELETS; BROOCHES; MEDALS; MEDALLIONS; CUFF-LINKS; PRECIOUS AND SEMI-PRECIOUS GEMSTONES AND THEIR IMITATIONS, NAMELY, EMERALDS, PEARLS, DIAMONDS, TOPAZ, OLIVINE, CHALCEDONY, SAPPHIRES, CORAL, ROCK CRYSTAL, OPAL, JADE, JASPER, AGATE, SARDONYX, RUBIES; THREADS OF PRECIOUS METAL; ARTIFICIAL GEMS; CLOCKS AND WATCHES, NAMELY, WRIST WATCHES, CLOCKS, POCKET WATCHES, AUTOMOBILE CLOCKS, STOP WATCHES, WALL CLOCKS, ALARM CLOCKS AND WATCHES, NECKLACE WATCHES, BROOCH WATCHES; PARTS AND ACCESSORIES FOR CLOCKS AND WATCHES, NAMELY, WATCH SPRINGS, CLOCK SPRINGS, WATCH CASES, CLOCK CASES, WATCH CHAINS, WATCH GLASSES, WATCH CRYSTALS, WATCH BANDS, CLOCK BANDS, PENDULUMS, DIALS (U.S. CLS. 2, 27, 28 AND 50).

**CLASS 26—FANCY GOODS**

FOR HAIR ORNAMENTS; HAIR PIECES; HAIRPADDING; BARRETTES; KAMOJI (JAPANESE FALSE HAIR); KANZASHI (JAPANESE ORNAMENTAL HAIR-PINS); KOGAI (JAPANESE ORNAMENTAL HAIRPINS); TABODOME (BACK HAIR PINS); TABOMINO (SPECIALLY SHAPED HAIR PIECES USED IN JAPANESE STYLE COIFFURING); TOUPEES; FALSE HAIR, TEGARA (JAPANESE HAIR TASSEL BANDS); NEGAKE (JAPANESE HAIR RIBBONS); HAIR NETS; HAIR BANDS; HAIR PINS; CHIGNONS; ROUND COMBS; HAIR RIBBONS; MOTOYUI (PAPER CORDS FOR TYING HAIR) (U.S. CLS. 37, 39, 40, 42 AND 50).

SN 75-345,521. WEBTONE TECHNOLOGIES, INC., ATLANTA, GA. BY ASSIGNMENT; BY ASSIGNMENT BROADWAY & SEYMOUR, INC., CHARLOTTE, NC. FILED 8-22-1997.

**CREATING CUSTOMER CONNECTIONS**

NO CLAIM IS MADE TO THE EXCLUSIVE RIGHT TO USE "CUSTOMER", APART FROM THE MARK AS SHOWN.

**CLASS 9—ELECTRICAL AND SCIENTIFIC APPARATUS**

FOR SOFTWARE FOR CUSTOMER RELATIONSHIP MANAGEMENT IN THE BANKING AND FINANCIAL INDUSTRY, NAMELY, COMPUTER SOFTWARE FOR PROVIDING CUSTOMER PROFILES WITH RESPECT TO TRANSACTIONS, INQUIRIES, COMPLAINTS AND OTHER INFORMATION SPECIFIC TO A PARTICULAR CUSTOMER FOR USE BY EMPLOYEES OF BANKING AND FINANCIAL INSTITUTIONS WHEN DEALING WITH THAT PARTICULAR CUSTOMER (U.S. CLS. 21, 23, 26, 36 AND 38).

**CLASS 37—CONSTRUCTION AND REPAIR**

FOR COMPUTER SERVICES, NAMELY, INSTALLATION OF CUSTOMER SALES AND SERVICES SOFTWARE FOR CUSTOMER RELATIONSHIP MANAGEMENT IN THE BANKING AND FINANCIAL INDUSTRY (U.S. CLS. 100, 103 AND 106).

**CLASS 41—EDUCATION AND ENTERTAINMENT**

FOR COMPUTER EDUCATION TRAINING SERVICES, NAMELY, TRAINING EMPLOYEES OF BANKING AND FINANCIAL INSTITUTIONS IN THE USE OF CUSTOMER SALES AND SERVICES SOFTWARE FOR CUSTOMER RELATIONSHIP MANAGEMENT IN THE BANKING AND FINANCIAL INDUSTRY (U.S. CLS. 100, 101 AND 107).

**CLASS 42—SCIENTIFIC, COMPUTER AND LEGAL SERVICES**

FOR COMPUTER SOFTWARE DESIGN FOR OTHERS FOR IMPLEMENTING AND CUSTOMIZING CUSTOMER RELATIONSHIP MANAGEMENT SOFTWARE, NAMELY, CUSTOMER PROFILE SOFTWARE FOR USE BY EMPLOYEES OF BANKING AND FINANCIAL INSTITUTIONS IN DEALING WITH THEIR CUSTOMERS AND MAINTENANCE SERVICES WITH RESPECT THERETO (U.S. CLS. 100 AND 101).

SN 75-390,845. A.P.S. AROSIO S.R.L, MONZA, ITALY, FILED 11-17-1997.



PRIORITY CLAIMED UNDER SEC. 44(D) ON ITALY APPLICATION NO. MI97C008452, FILED 9-22-1997, REG. NO. 811536, DATED 4-26-2000, EXPIRES 9-22-2007.

THE MARK CONSISTS OF THE LETTERS "AF" IN SPECIAL STYLIZED FORM.

#### CLASS 6—METAL GOODS

FOR METALLIC SHUTTERS FOR VENTILATION DUCTING, METALLIC PARTS AND FITTINGS THEREOF; METALLIC FRAMES FOR DOORS AND WINDOWS; METALLIC WINDOWS AND DOORS; METALLIC DRAW PIECES; METALLIC HANDLES; METALLIC PIPES AND SLEEVES; METALLIC JOINTS FOR DRAW PIECES AND PIPES; METALLIC HINGES, METALLIC PLATFORMS AND FOOTS FOR METALLIC FRAMES; METALLIC NUTS AND BOLTS, METALLIC BELT TIGHTENERS (U.S. CLS. 2, 12, 13, 14, 23, 25 AND 50).

#### CLASS 20—FURNITURE AND ARTICLES NOT OTHERWISE CLASSIFIED

FOR PLASTIC PARTS FOR USE WITH FRAMES FOR DOORS AND WINDOWS; AND PLASTIC PARTS FOR USE WITH NON-METALLIC PLATFORMS AND FRAMES, NAMELY, PLASTIC HANDLES, PLASTIC JOINTS, AND DRAW PIECES, AND PLASTIC HINGES (U.S. CLS. 2, 13, 22, 25, 32 AND 50).

#### CLASS 40—MATERIAL TREATMENT

FOR CUSTOM MANUFACTURE METAL TREATMENT SERVICES (U.S. CLS. 100, 103 AND 106).

SN 75-409,240. ST. JOHN KNITS, INC., IRVINE, CA. FILED 12-22-1997.

## ST. JOHN HOME

OWNER OF U.S. REG. NOS. 1,214,122, 2,075,884 AND OTHERS.

NO CLAIM IS MADE TO THE EXCLUSIVE RIGHT TO USE "HOME", APART FROM THE MARK AS SHOWN.

#### CLASS 8—HAND TOOLS

FOR TABLEWARE, NAMELY, KNIVES, FORKS AND SPOONS (U.S. CLS. 23, 28 AND 44).

#### CLASS 20—FURNITURE AND ARTICLES NOT OTHERWISE CLASSIFIED

FOR ARMCHAIRS, BED FRAMES, BEDROOM FURNITURE, BED, BENCHES, FURNITURE CABINETS, WOOD CARVINGS, CHAIRS, FURNITURE CHESTS, COUCHES, CUSHIONS, DIVANS, EMBROIDERY FRAMES, FIGURES, FIGURINES MADE OF BONE, IVORY, PLASTIC, PLASTER, WOOD AND WAX, LAWN FURNITURE, LIVING ROOM FURNITURE, JEWELRY BOXES NOT OF METAL, JEWELRY CASES NOT OF METAL, LOVE SEATS, MAGAZINE RACKS, NON-METAL BOXES, FURNITURE MIRRORS, NON-METAL MONEY BOXES, PICTURE FRAME MOLDINGS, MAGAZINE RACKS, SCULPTURES AS WALL DECORATIONS, SIDEBARDS, SOFAS, STATUETTES MADE OF BONE IVORY, PLASTIC, PLASTER, WOOD AND WAX; STOOLS, STORAGE RACKS, TABLES, VENETIAN BLINDS, WATERBEDS, WINDOW SHADES (U.S. CLS. 2, 13, 22, 25, 32 AND 50).

#### CLASS 21—HOUSEWARES AND GLASS

FOR DINNERWARE, NAMELY, DISHES, PLATES, BOWLS, CUPS AND MUGS, DRINKING GLASSES, FIGURES AND FIGURINES MADE OF CHINA, CRYSTAL, EARTHENWARE, GLASS, PORCELAIN, AND TERRA COTTA, COASTERS NOT OF PAPER AND NOT BEING TABLE LINEN, TRAYS, SHOT GLASSES; NAPKIN RINGS, BEVERAGES GLASSWARE, WINE BOTTLE CRADLES, BOTTLE STANDS, SOAP BOXES, GLASS BOXES, COSMETICS BRUSHES, EYEBROW BRUSHES, HAIR BRUSHES, NAIL BRUSHES, SHAVING BRUSHES, CHAMPAGNE BUCKETS, ICE BUCKETS, WINE COOLING BUCKETS, BUTTER COOLERS, BUTTER DISHES, CAKE SERVERS, CAKE STANDS, CANDELABRAS NOT OF PRECIOUS METAL, CANDLESTICKS NOT OF PRECIOUS METAL, CANISTER SETS, FITTED VANITY CASES, CAVIAR COOLERS, WIND CHIMES, CHINA ORNAMENTS, COCKTAIL PICKS, COCKTAIL SHAKERS, COFFEE CUPS, COMB CASES, HAIR COMBS, COMMEMORATIVE PLATES, COMPACTS SOLD EMPTY, PORTABLE BEVERAGE DISPENSERS, BASKETS, NAMELY, FLOWER, FITTED PICNIC, STEAMER, WASTEPAPER, WICKER, STRAW, WOOD AND CLOTH, FLOWER POT HOLDERS, DRINKING GLASSES, GLASS BOWLS, GOBLETS, NAPKIN HOLDERS, TISSUE HOLDERS, TOWEL HOLDERS, JUGS, GLASS PANS, PASTRY MOLDS, PIE SERVERS, PLATE GLASS, NAMELY, POLISHED AND SMOOTH, POWDER PUFFS, WINE RACKS, COCKTAIL SHAKERS, STATUES (MADE OF CHINA, CRYSTAL, EARTHENWARE, GLASS, PORCELAIN, TERRA COTTA), AND TEA SETS (U.S. CLS. 2, 13, 23, 29, 30, 33, 40 AND 50).

#### CLASS 24—FABRICS

FOR BATH LINENS, TABLE LINENS, BED BLANKETS, BED CANOPIES, BED SHEETS, BED SPREADS, PILLOW CASES, PILLOW SHAMS, CLOTH DOILIES, CLOTH LABELS, TABLE CLOTHS NOT OF PAPER, COMFORTERS, COTTON FABRIC, UNFITTED FABRIC FURNITURE COVERS, CURTAINS, DISH CLOTHS, DRAPERIES, FLANNEL, GLASS CLOTHS, HANDKERCHIEFS, KITCHEN TOWELS, QUILTS, FABRIC TABLE RUNNERS, SAIL CLOTHS, TAPESTRIES OF TEXTILE, FABRIC BATH MATS, TEXTILE PLACE MATS, TEXTILE WALL HANGINGS, TEA TOWELS, UPHOLSTERY FABRICS, WASHCLOTHS, WINDOW CURTAINS, WINDOW TREATMENTS, NAMELY, PUFFS, POUFS, SWAGS, AND VALANCES; AND WOOLEN FABRICS (U.S. CLS. 42 AND 50).

SN 75-433,990. ZI PANI VENTURES, LLC, WICHITA, KS. FILED 2-13-1998.

SN 75-495,403. INTELEX, INC., CARMEL, IN. BY ASSIGNMENT INTELEX, INC., LITTLE ROCK, AR. FILED 6-3-1998.



**CLASS 30—STAPLE FOODS**

FOR SANDWICHES, BAKERY GOODS, COFFEE, TEA, COCOA AND COFFEE, TEA, AND COCOA-BASED BEVERAGE DRINKS (U.S. CL. 46).

**CLASS 42—SCIENTIFIC, COMPUTER AND LEGAL SERVICES**

FOR RESTAURANT SERVICES (U.S. CLS. 100 AND 101).

---

SN 75-446,225. RAYTHEON TRAINING, INC., ARLINGTON, TX. FILED 3-6-1998.



NO CLAIM IS MADE TO THE EXCLUSIVE RIGHT TO USE "TRAINING", APART FROM THE MARK AS SHOWN.

**CLASS 35—ADVERTISING AND BUSINESS**

FOR PREPARATION AND DISSEMINATION OF ADVERTISING AND MARKETING MATTER AND MATERIALS FOR OTHERS; PROVIDING STATISTICAL INFORMATION; CONDUCTING BUSINESS AND MARKET RESEARCH AND SURVEYS; CONSULTATION IN THE FIELDS OF EMPLOYMENT, STAFF MANAGEMENT AND INDUSTRIAL ORGANIZATION AND MANAGEMENT (U.S. CLS. 100, 101 AND 102).

**CLASS 41—EDUCATION AND ENTERTAINMENT**

FOR EDUCATIONAL SERVICES, NAMELY, PROVIDING BUSINESS TRAINING, SEMINARS AND CONFERENCES IN A WIDE RANGE OF TOPICS RELATING TO TEAM BUILDING, BUSINESS PROCESSES AND KNOWLEDGE MANAGEMENT, AND DISTRIBUTING PRINTED MATTER AND TRAINING MATERIALS IN CONNECTION THEREWITH (U.S. CLS. 100, 101 AND 107).

**INTELEX**

OWNER OF U.S. REG. NO. 1,859,969.

**CLASS 35—ADVERTISING AND BUSINESS**

FOR RETAIL AND WHOLESALE DISTRIBUTORSHIPS IN THE FIELD OF NEW AND USED TELECOMMUNICATION AND DATA EQUIPMENT (U.S. CLS. 100, 101 AND 102).  
FIRST USE 9-1-1991; IN COMMERCE 9-1-1991.

**CLASS 36—INSURANCE AND FINANCIAL**

FOR BROKERAGE SERVICES IN THE FIELD OF NEW AND USED TELECOMMUNICATIONS EQUIPMENT (U.S. CLS. 100, 101 AND 102).  
FIRST USE 9-1-1991; IN COMMERCE 9-1-1991.

**CLASS 37—CONSTRUCTION AND REPAIR**

FOR MAINTENANCE AND REPAIR OF NEW AND USED TELECOMMUNICATIONS AND DATA EQUIPMENT (U.S. CLS. 100, 103 AND 106).  
FIRST USE 9-1-1991; IN COMMERCE 9-1-1991.

---

SN 75-503,023. ELANTEC SEMICONDUCTOR, INC., MILPITAS, CA. FILED 6-16-1998.

**ELANTEC**

**CLASS 9—ELECTRICAL AND SCIENTIFIC APPARATUS**

FOR ANALOG AMPLIFIER INTEGRATED CIRCUITS FOR USE IN COMMUNICATIONS DEVICES, COMPUTER SYSTEMS, VIDEO DEVICES, OPTICAL STORAGE DEVICES, AND DC-DC (DIRECT CURRENT-DIRECT CURRENT) CONVERTERS (U.S. CLS. 21, 23, 26, 36 AND 38).  
FIRST USE 2-1-1985; IN COMMERCE 2-1-1985.

**CLASS 16—PAPER GOODS AND PRINTED MATTER**

FOR DATA SHEETS AND DATA BOOKS CONTAINING THE SPECIFICATIONS FOR INTEGRATED CIRCUITS FOR USE IN COMMUNICATIONS DEVICES, COMPUTER SYSTEMS, VIDEO DEVICES, OPTICAL STORAGE DEVICES AND DC-DC (DIRECT CURRENT-DIRECT CURRENT) CONVERTERS (U.S. CLS. 2, 5, 22, 23, 29, 37, 38 AND 50).  
FIRST USE 2-1-1985; IN COMMERCE 2-1-1985.

SN 75-547,204. GINA SHOES LIMITED, LONDON E8 3DP,  
UNITED KINGDOM, FILED 9-2-1998.

GINA  
RL

OWNER OF U.S. REG. NO. 1,832,263.

#### CLASS 18—LEATHER GOODS

FOR HANDBAGS, EVENING BAGS, TRAVELING BAGS, PURSES, HOLDALLS, ATTACHE CASES, INCLUDING THE AFORESAID GOODS BEING MADE OF LEATHER, IMITATION LEATHER, SYNTHETIC MATERIALS, FABRIC, EMBROIDERED MATERIALS, BEADED MATERIALS, SILK, WOOLS, COTTON, LINEN; UMBRELLAS (U.S. CLS. 1, 2, 3, 22 AND 41).

#### CLASS 25—CLOTHING

FOR FOOTWEAR AND BELTS (U.S. CLS. 22 AND 39).

SN 75-552,779. POST OFFICE, THE, LONDON EC1V 9HQ,  
ENGLAND, FILED 9-14-1998.

PARCEL  FORCE  
WORLDWIDE

PRIORITY CLAIMED UNDER SEC. 44(D) ON UNITED KINGDOM APPLICATION NO. 2160766, FILED 3-12-1998, REG. NO. 2160766, DATED 10-16-1998, EXPIRES 3-12-2008.

OWNER OF U.S. REG. NOS. 1,879,334, 1,879,335 AND 1,883,124.

NO CLAIM IS MADE TO THE EXCLUSIVE RIGHT TO USE "WORLDWIDE", APART FROM THE MARK AS SHOWN.

#### CLASS 9—ELECTRICAL AND SCIENTIFIC APPARATUS

FOR ELECTRICAL, ELECTRONIC AND OPTICAL APPARATUS AND INSTRUMENTS, ALL FOR USE IN HANDLING, PROCESSING AND SORTING OF GOODS, MAIL AND PARCELS, NAMELY, APPARATUS AND INSTRUMENTS FOR TRACKING AND COORDINATING MAIL SORTING, CODING AND DELIVERY; VENDING MACHINES; MEASURING AND WEIGHING APPARATUS, NAMELY, LETTER SCALES; ADDING MACHINES; COUNTING MACHINES FOR COINS AND BILLS; COMPUTERS; COMPUTER SOFTWARE FOR USE IN TRACKING AND COORDINATING MAIL SORTING, CODING AND DELIVERY; PRINTERS, NAMELY, COMPUTER PRINTERS, INK PRINTERS, DAISY WHEEL PRINTERS, LASER PRINTERS; SMART CARDS, NAMELY, INTEGRATED CIRCUIT CARDS; OPTICAL SCANNERS; PARTS AND FITTINGS FOR ALL OF THE AFORESAID, SOLD TOGETHER THEREWITH (U.S. CLS. 21, 23, 26, 36 AND 38).

#### CLASS 16—PAPER GOODS AND PRINTED MATTER

FOR PAPER, NAMELY, STATIONERY PAPER AND COMPUTER PAPER, CARDBOARD AND CARDBOARD ARTICLES, NAMELY, BOXES, CARTONS, CONTAINERS AND MAILING TUBES, ALL MADE OF CARDBOARD; FILING TRAYS; PACKAGING AND WRAPPING MATERIALS, NAMELY, PAPER BAGS, PAPER ENVELOPES, PLASTIC BUBBLE WRAP, ALL FOR PACKAGING, PAPER WRAPPING AND PAPER GIFT WRAPPING; PRINTED MATTER, NAMELY LEAFLETS ABOUT HANDLING, PROCESSING, SORTING AND DELIVERY OF GOODS, MAIL AND PARCELS, PAMPHLETS ABOUT HANDLING, PROCESSING, SORTING AND DELIVERY OF GOODS, MAIL AND PARCELS, BROCHURES ABOUT HANDLING, PROCESSING, SORTING AND DELIVERY OF GOODS, MAIL AND PARCELS, AND INFORMATIONAL LITERATURE ABOUT HANDLING, PROCESSING, SORTING AND DELIVERY OF GOODS, MAIL AND PARCELS, PRINTED FORMS AND PRINTED POSTAL ORDER FORMS FOR MONEY TRANSFER; PRINTED CARDS, NAMELY, INDEX CARDS AND FILING CARDS; PRINTED TICKETS, LABELS, NAMELY, ADDRESS LABELS AND SHIPPING LABELS; POSTERS; GREETING CARDS; MAGAZINES AND JOURNALS RELATING TO DELIVERY OF GOODS, MAIL AND PARCELS; PHILATELIC PRODUCTS, NAMELY, POSTAL STAMPS AND STAMP ALBUMS; SEALING WAX AND SEALS APPLIED TO DOCUMENTS; CALENDARS AND DIARIES; WRITING MATERIALS, NAMELY, TABLETS, INK, INK STAMPS AND PADS, ALL FOR USE IN WRITING; OFFICE REQUISITES, NAMELY, STAPLERS, RUBBER BANDS, PUNCHES AND CORRECTING FLUID FOR TYPING; ENVELOPES AND PADDED PAPER BAGS; ADHESIVES AND ADHESIVE TAPES FOR STATIONERY OR HOUSEHOLD PURPOSES; PAPER CUTTERS; MAPS; PAPER, NAMELY, PRINTING PAPER AND CARBON PAPER; BLANK PAPER COMPUTER TAPES; BLANK PAPER COMPUTER CARDS FOR RECORDING PROGRAMS AND DATA; ADDRESSING MACHINES AND ADDRESS PLATES; FRANKING MACHINES; PRINTED INSTRUCTIONAL AND TEACHING MATERIALS RELATING TO DELIVERY OF GOODS, MAIL AND PARCELS; PARTS AND FITTINGS FOR THE AFORESAID GOODS SOLD TOGETHER THEREWITH (U.S. CLS. 2, 5, 22, 23, 29, 37, 38 AND 50).

#### CLASS 28—TOYS AND SPORTING GOODS

FOR TOYS, GAMES AND PLAYTHINGS, NAMELY, MECHANICAL ACTION TOYS, MODEL HOBBYCRAFT KITS, IMITATION VEHICLES AND MAIL BOXES (U.S. CLS. 22, 23, 38 AND 50).

#### CLASS 38—COMMUNICATION

FOR TELECOMMUNICATION SERVICES, NAMELY PERSONAL COMMUNICATION SERVICES AND TELEPHONE COMMUNICATION SERVICES (U.S. CLS. 100, 101 AND 104).

**CLASS 39—TRANSPORTATION AND STORAGE**

FOR POSTAL SERVICES, NAMELY, PARCEL PICK-UP AND DELIVERY; FREIGHT TRANSPORTATION BY TRUCK, TRAIN, AIR AND WATER; UNLOADING OF CARGO; GUARDED TRANSPORT OF VALUABLES BY TRUCK, TRAIN, AIR AND WATER; RENTAL OF VEHICLES; FREIGHT FORWARDING; WAREHOUSING SERVICES; RENTAL OF WAREHOUSES; TOURIST AGENCY SERVICES; TAXI TRANSPORT; TRANSPORTATION OF PASSENGERS AND/OR CARGO BY BUS; PROVIDING A COMPUTERIZED ONLINE DATABASE IN THE FIELD OF HANDLING, PROCESSING, SORTING AND DELIVERY OF GOODS, MAIL AND PARCELS (U.S. CLS. 100 AND 105).

**CLASS 42—SCIENTIFIC, COMPUTER AND LEGAL SERVICES**

FOR MAINTENANCE AND REPAIR OF COMPUTER SOFTWARE; COMPUTER CONSULTATION; COMPUTER SOFTWARE DESIGN FOR OTHERS; DESIGN OF COMPUTERS FOR OTHERS; DESIGN AND TESTING OF NEW PRODUCTS FOR OTHERS IN THE FIELDS OF COMPUTER NETWORKS, TELECOMMUNICATIONS SYSTEMS, OFFICE MACHINES, POSTAL SYSTEMS AND APPARATUS, AND DATA TRANSMISSION SYSTEMS; COMPUTER PROGRAMMING FOR OTHERS; COMPUTER SYSTEMS ANALYSIS; COMPUTER TIME SHARING SERVICES; RESEARCH AND DEVELOPMENT OF NEW PRODUCTS FOR OTHERS IN THE FIELD OF COMPUTER HARDWARE AND SOFTWARE; RENTAL AND LEASING OF COMPUTERS; UPDATING OF COMPUTER SOFTWARE; ENGINEERING DESIGN AND DRAWING SERVICES PROVIDED WITH THE AID OF COMPUTER SOFTWARE, NAMELY, COMPUTER ASSISTED DESIGN FOR OTHERS IN THE FIELD OF ENGINEERING (U.S. CLS. 100 AND 101).

---

SN 75-595,852. CORPORATE MEDIA PARTNERS, LOS ANGELES, CA. FILED 11-25-1998.

**ZIP ZAP ZOOM****CLASS 9—ELECTRICAL AND SCIENTIFIC APPARATUS**

FOR INTERACTIVE VIDEO GAME PROGRAMS (U.S. CLS. 21, 23, 26, 36 AND 38).

**CLASS 38—COMMUNICATION**

FOR VIDEO BROADCASTING SERVICES AND VIDEO ON DEMAND TRANSMISSION SERVICES; PROVIDING INFORMATION CONCERNING VIDEO BROADCASTING SERVICES AND VIDEO ON DEMAND TRANSMISSION SERVICES (U.S. CLS. 100, 101 AND 104).

**CLASS 41—EDUCATION AND ENTERTAINMENT**

FOR ENTERTAINMENT SERVICES, NAMELY, A SERIES OF PROGRAMS IN THE FIELDS OF NEWS, SPORTS, GAME INFORMATION, HOBBIES, FINANCE, FINE ARTS, AND ACADEMIC SUBJECT PROGRAMS DISTRIBUTED VIA TELEVISION, SATELLITE, AUDIO, AND VIDEO MEDIA; VIDEO ENTERTAINMENT INFORMATION SERVICES; PROVIDING AN ON-LINE COMPUTER DATABASE OF SCHEDULES FOR THE BROADCAST OF ENTERTAINMENT AND SPORTING EVENTS (U.S. CLS. 100, 101 AND 107).

SN 75-601,395. YAZAKI CORPORATION, TOKYO, JAPAN, FILED 12-8-1998.

**CLASS 9—ELECTRICAL AND SCIENTIFIC APPARATUS**

FOR RADIOS, NAMELY, SHORT-WAVE RADIOS, CITIZEN BAND RADIOS, TWO-WAY COMMUNICATION RADIOS AND MOBILE LAND RADIOS, COMPUTERS FOR CRUISE CONTROL FOR MOTOR VEHICLES, TRIP COMPUTERS, MONEY DISCRIMINATORS, NAMELY, MACHINES FOR SORTING, COUNTING STORING AND CALCULATING CURRENCY BILLS AND COINS, TACHOGRAPHS, TEMPERATURE RECORDERS FOR REFRIGERATOR TRUCKS, TAXI METERS, EVENT RECORDERS FOR TAXI CABS USED TO RECORD MOMENT-BY-MOMENT AND HOUR-BY-HOUR TAXI TRANSACTIONS SUCH AS TIME OF PASSENGER BOARDING AND DEPARTING, VACANCY, TIME REQUIRED FOR TRANSPORT BETWEEN ZONES, FARES FOR EACH TRANSACTION, RUNNING SPEED, RUNNING DISTANCE, FARE INDICATORS, SPEEDOMETER CABLES, TACHOGRAPH CABLES, TAXI METER CABLES, VEHICLE INFORMATION COLLECTION SYSTEMS, NAMELY, EVENT RECORDERS COMPRISED IN PART OF A CONTROL BOX, INTERNAL RAM A TEN CHANNEL SENSOR SIGNAL INPUT, A CLOCK, SOFTWARE AND DATACARD READERS ALL FOR COLLECTING DATA CONCERNING MAXIMUM SPEED, AVERAGE SPEED, RUNNING SPEED, RUNNING DISTANCE, PRODUCTION DATA RECORDERS CONSISTING OF CHART PAPER AND DIGITAL COUNTERS WHICH ATTACH DIRECTLY TO RECORD INDIVIDUAL MACHINE STOPPAGE DURING PRODUCTION, PRODUCTION INFORMATION GATHERING SYSTEMS, NAMELY, COMPUTER TERMINALS FOR RECORDING VEHICLE'S SPEED, RPMS, HOURS DRIVEN AND IDLING, AND BRAKING PATTERNS, REMOTE ENGINE STARTER SWITCHES FOR AUTOMOBILES, WIRING HARNESS ASSEMBLIES FOR AUTOMOBILES, ELECTRIC TERMINALS, CONNECTOR HOUSING TO INSULATE TERMINALS, ELECTRIC CONNECTORS, FUSE BOXES ASSOCIATED WITH WIRING HARNESS ASSEMBLIES, RELAYS, REGISTER IGNITION CABLES OR HIGH VOLTAGE RESISTANCE CABLES, ANTI-NOISE HIGH TENSION CABLES, BATTERY CABLES (U.S. CLS. 21, 23, 26, 36 AND 38).

**CLASS 12—VEHICLES**

FOR VEHICLE INSTRUMENT PANELS FOR AUTOMOBILES (U.S. CLS. 19, 21, 23, 31, 35 AND 44).

SN 75-614,392. COMMUNICATIONS 21, INC., ATLANTA, GA. FILED 12-31-1998.



#### **CLASS 35—ADVERTISING AND BUSINESS**

FOR BUSINESS MARKETING CONSULTING SERVICES AND PUBLIC RELATIONS SERVICES (U.S. CLS. 100, 101 AND 102).

FIRST USE 7-21-1992; IN COMMERCE 7-21-1992.

#### **CLASS 42—SCIENTIFIC, COMPUTER AND LEGAL SERVICES**

FOR GRAPHIC ART DESIGN AND WEB SITE DESIGN SERVICES FOR OTHERS (U.S. CLS. 100 AND 101).

FIRST USE 7-21-1992; IN COMMERCE 7-21-1992.

SN 75-620,499. UTILICORP HOLDINGS INC., KANSAS CITY, MO. FILED 1-13-1999.

## **AQUILA MERCHANT ENERGY PARTNERS**

NO CLAIM IS MADE TO THE EXCLUSIVE RIGHT TO USE "ENERGY PARTNERS", APART FROM THE MARK AS SHOWN.

THE ENGLISH TRANSLATION OF "AQUILA" IS "EAGLE".

#### **CLASS 4—LUBRICANTS AND FUELS**

FOR ENERGY COMMODITIES, NAMELY, NATURAL GAS, CRUDE OIL, FUEL OIL, COAL AND LIQUID FUELS, NAMELY, LIQUEFIED PROPANE AND NATURAL GAS LIQUIDS (U.S. CLS. 1, 6 AND 15).

#### **CLASS 35—ADVERTISING AND BUSINESS**

FOR BUSINESS MARKETING CONSULTING SERVICES FOR UTILITY COMPANIES, ENERGY SERVICE COMPANIES AND ENERGY MARKETERS; BUSINESS MANAGEMENT AND CONSULTING SERVICES FOR THE ENERGY INDUSTRY; BUSINESS MARKETING CONSULTING SERVICES IN THE FIELD OF BUYING, SELLING AND TRADING ELECTRIC POWER, NATURAL GAS, AND OTHER FUELS; BUSINESS MANAGEMENT SERVICES IN THE NATURE OF BILLING SERVICES; BUSINESS MANAGEMENT SERVICES IN THE NATURE OF ARRANGING FOR THE CREATION, MANAGEMENT, PROVISION, ACQUISITION, FINANCING, OPERATION AND OWNERSHIP OF POWER FACILITIES, FUEL SUPPLY AND DISTRIBUTION INFRASTRUCTURE, FUEL TRANSPORTATION, ELECTRIC TRANSMISSION, POWER SALES AND ENERGY USAGE BY OTHERS; INCENTIVE PROGRAMS TO PROMOTE ENERGY EFFICIENCY PROJECTS AND THE PURCHASE OF ENERGY-EFFICIENT EQUIPMENT TO INCREASE ENERGY EFFICIENCY AND SAVE NATURAL RESOURCES, THROUGH THIRD-PARTY FINANCING, OFFERED TO CUSTOMERS OF A PUBLIC UTILITY; PROCUREMENT SERVICES, NAMELY, PURCHASING FOR OTHERS ELECTRIC POWER, NATURAL GAS, NATURAL GAS LIQUIDS, OIL, LIQUEFIED PETROLEUM GAS, PETROCHEMICALS AND OTHER FUELS; BILLING SERVICES DISTRIBUTORSHIP SERVICES AND MAKING AVAILABLE FOR ACQUISITION POWER AND ITS BY-PRODUCTS FOR AND TO OTHERS, NAMELY, POWER AND ITS BY-PRODUCTS GENERATED FROM COGENERATION, DIESEL FUEL, NATURAL GAS, OIL, NATURAL GAS LIQUIDS, LIQUEFIED PETROLEUM GAS, COAL, AND RELATED ENERGY SOURCES; PROVIDING AND ARRANGING FOR LONG-TERM NATURAL GAS, OIL, NATURAL GAS LIQUIDS, LIQUEFIED PETROLEUM GAS, PETROCHEMICALS AND REFINED PETROLEUM PRODUCTS SUPPLY CONTRACTS; AND DISTRIBUTORSHIP SERVICES IN THE FIELD OF NATURAL GAS, OIL, NATURAL GAS LIQUIDS, LIQUEFIED PETROLEUM GAS, PETROCHEMICALS TO AND FROM OTHERS (U.S. CLS. 100, 101 AND 102).

#### **CLASS 36—INSURANCE AND FINANCIAL**

FOR RISK MANAGEMENT SERVICES AND COST CONTAINMENT IN THE FIELD OF ENERGY PRODUCTS, NAMELY, NATURAL GAS, LIQUEFIED NATURAL GAS, NATURAL GAS LIQUIDS, ELECTRICITY, AND POWER; COMMODITY BROKERAGE SERVICES AND FINANCING SERVICES IN THE FIELD OF ENERGY PRODUCTS, NAMELY, NATURAL GAS, LIQUEFIED NATURAL GAS, NATURAL GAS LIQUIDS, ELECTRICITY AND POWER (U.S. CLS. 100, 101 AND 102).

#### **CLASS 39—TRANSPORTATION AND STORAGE**

FOR REGULATED AND NONREGULATED UTILITY SERVICES, NAMELY, TRANSMISSION AND STORAGE OF ELECTRICITY AND NATURAL GAS (U.S. CLS. 100 AND 105).

#### **CLASS 40—MATERIAL TREATMENT**

FOR ELECTRIC POWER GENERATION FROM CONVENTIONAL AND ALTERNATIVE ENERGY SOURCES; ELECTRICAL UTILITY SERVICES, NAMELY, THE GENERATION OF ELECTRICITY; EQUIPMENT LEASING SERVICES FOR ENERGY-RELATED AND ENERGY USING EQUIPMENT, NAMELY, LEASING OF HEATING, COOLING, LIGHTING AND ELECTRIC POWER GENERATING SYSTEMS AND MACHINERY, INCLUDING TURBINES, BOILERS, GENERATORS, CHILLING PLANTS AND LIGHTING EQUIPMENT AND CONTROLS; REGULATED AND NONREGULATED UTILITY SERVICES NAMELY, THE PRODUCTION OF ELECTRICITY AND NATURAL GAS (U.S. CLS. 100, 103 AND 106).

**CLASS 42—SCIENTIFIC, COMPUTER AND LEGAL SERVICES**

FOR ENERGY USE MANAGEMENT; PROMOTING PUBLIC AWARENESS OF THE NEED FOR ENERGY CONSERVATION; MANAGEMENT OF ENERGY USE IN INDUSTRIAL, COMMERCIAL, GOVERNMENT AND RESIDENTIAL FACILITIES (U.S. CLS. 100 AND 101).

SN 75-641,378. NORTON PERFORMANCE PLASTICS CORPORATION, WAYNE, NJ. FILED 2-22-1999.

**VERSILIC****CLASS 9—ELECTRICAL AND SCIENTIFIC APPARATUS**

FOR FLEXIBLE SILICONE TUBING FOR LABORATORY USE (U.S. CLS. 21, 23, 26, 36 AND 38).

**CLASS 10—MEDICAL APPARATUS**

FOR FLEXIBLE SILICONE TUBING FOR MEDICAL USE (U.S. CLS. 26, 39 AND 44).

**CLASS 17—RUBBER GOODS**

FOR FLEXIBLE SILICON TUBING FOR GENERAL INDUSTRIAL USE (U.S. CLS. 1, 5, 12, 13, 35 AND 50).

SN 75-644,192. WORLD DO HAP SOOL ASSOCIATION, INC., FREDERICKSBURG, VA. FILED 2-17-1999.



NO CLAIM IS MADE TO THE EXCLUSIVE RIGHT TO USE "WORLD DO HAP SOOL ASSOCIATION", APART FROM THE MARK AS SHOWN.

THE MARK CONSISTS OF A DESIGN OF A CIRCLE WITH A VERTICAL FIST IN THE CENTER SURROUNDED BY TWO SWORDS WITH THE WORDS "DO HAP SOOL" IN CHINESE AT THE TOP AND "WORLD DO HAP SOOL ASSOCIATION" AT THE BOTTOM.

THE FOREIGN WORDING IN THE MARK TRANSLATES INTO ENGLISH AS ["DO HAP SOOL" MEANING "WEAPONS", "NATURE", "SKILL".]

SEC. 2(F).

**CLASS 25—CLOTHING**

FOR CLOTHING, NAMELY, ASCOTS, ATHLETIC FOOTWEAR, ATHLETIC SHOES, ATHLETIC UNIFORMS, BALLOON PANTS, BANDANAS, HEADBANDS, NECKBANDS, SWEATBANDS, WRISTBANDS, BASEBALL CAPS, BATHING TRUNKS, BEACHWEAR, MONEY BELTS, BELTS, BERETS, BERMUDA SHORTS, BLAZERS, BLOUSES, BODY SHAPERS, BODY SUITS, BOOTIES, BOOTS, BOTTOMS, BOXER SHORTS, UNDERWEAR BRIEFS, CAPS, OVERCOATS, RAINCOATS, SPORTS COATS, COATS, DICKIES, DUNGAREES, EAR MUFFS, FOOTWEAR, FOUL WEATHER GEAR, GOLF SHIRTS, GYM SHORTS, GYM SUITS, HALTER TOPS, HATS, HEAD WEAR, INFANTWEAR, LEATHER JACKETS, WIND RESISTANT JACKETS, JACKETS, JEANS, JERKINS, JERSEYS, JOGGING SUITS, JUMPERS, JUMPSUITS, KERCHIEFS, KIMONOS, KNEE HIGHS, KNIT SHIRTS, LEATHER JACKETS, LEG WARMERS, LEGGINGS, LEOTARDS, LIGHT-REFLECTING COATS, LIGHT-REFLECTING JACKETS, LOUNGEWEAR, EAR MUFFS, MUFFS, NECKERCHIEFS, NECKTIES, NECKWEAR, SWEAT PANTS, PANTS, PARKAS, POLO SHIRTS, PONCHOS, PULLOVERS, RAIN SUITS, RAINWEAR, ROBES, SARONGS, SASHES, SCARVES, SHAWLS, SHIRTS, KNIT SHIRTS, NIGHT SHIRTS, SPORT SHIRTS, SWEAT SHIRTS, UNDERSHIRTS, SHIRTS, SHOES, SHORT SETS, SWEAT SHORTS, SHORTS, SKIRTS, SKORTS, SLACKS, SLEEPWEAR, SMOCKS, SNEAKERS, THERMAL SOCKS, SOCKS, JOGGING SUITS, PLAYSUITS, SWEAT SUITS, WARM-UP SUITS, SUN VISORS, SUSPENDERS, TURTLENECK SWEATERS, V-NECK SWEATERS, SWEATERS, SWEAT SOCKS, SWIM TRUNKS, SWIM WEAR, SWIM SUITS, T-SHIRTS, TANK TOPS, TENNIS WEAR, TIES, TIGHTS, HALTER TOPS, TANK TOPS, TOPS, TRACKSUITS, TROUSERS, TUNICS, TURTLENECKS, UNDERCLOTHES, UNDERGARMENTS, UNDERPANTS, UNDERWEAR, UNIFORMS, UNITARDS, SUN VISORS, VISORS, WAISTCOATS, LEG WARMERS, WATER SOCKS, WINDSHIRTS, AND WRAPS (U.S. CLS. 22 AND 39).

FIRST USE 4-19-1970; IN COMMERCE 4-19-1970.

**CLASS 41—EDUCATION AND ENTERTAINMENT**

FOR MARTIAL ARTS INSTRUCTION (U.S. CLS. 100, 101 AND 107).

FIRST USE 4-19-1970; IN COMMERCE 4-19-1970.

SN 75-660,132. PROZYME, INC., SAN LEANDRO, CA. FILED 3-15-1999.

**STREPTAVIDIN PLUS**

NO CLAIM IS MADE TO THE EXCLUSIVE RIGHT TO USE "STREPTAVIDIN", APART FROM THE MARK AS SHOWN.

**CLASS 1—CHEMICALS**

FOR PURIFIED BIOCHEMICALS; NAMELY, A VARIANT OF THE PROTEIN CALLED STREPTAVIDIN AND FORMULATIONS INCLUDING THIS VARIANT OF STREPTAVIDIN, FOR USE AS REAGENTS IN BIOCHEMICAL RESEARCH (U.S. CLS. 1, 5, 6, 10, 26 AND 46).

FIRST USE 3-2-1995; IN COMMERCE 3-2-1995.

**CLASS 5—PHARMACEUTICALS**

FOR PURIFIED BIOCHEMICALS, NAMELY, A VARIANT OF THE PROTEIN CALLED STREPTAVIDIN AND FORMULATIONS INCLUDING THIS VARIANT OF STREPTAVIDIN, FOR USE AS REAGENTS IN CLINICAL DIAGNOSTIC APPLICATIONS (U.S. CLS. 6, 18, 44, 46, 51 AND 52).

FIRST USE 3-2-1995; IN COMMERCE 3-2-1995.



SN 75-663,397. VANDAVEER GROUP, INC., THE, HOUSTON, TX. FILED 3-22-1999.



NO CLAIM IS MADE TO THE EXCLUSIVE RIGHT TO USE "TEAM TREKS", APART FROM THE MARK AS SHOWN.

THE MARK PROVIDED IS IN BLACK AND WHITE, HOWEVER, THE WORD "TEAM" AND "VVV" SYMBOL WILL BE A DARK PURPLE AND THE "TREKS" WILL BE GREEN.

#### CLASS 41—EDUCATION AND ENTERTAINMENT

FOR INDIVIDUAL AND TEAM DEVELOPMENT WORKSHOPS CONDUCTED BY MANAGEMENT PSYCHOLOGISTS TO ENHANCE INDIVIDUAL, LEADER, AND TEAM EFFECTIVENESS THROUGH OUTDOOR-EXPERIENTIAL TREKKING (U.S. CLS. 100, 101 AND 107).

#### CLASS 42—SCIENTIFIC, COMPUTER AND LEGAL SERVICES

FOR CONSULTING SERVICES BY MANAGEMENT PSYCHOLOGISTS DESIGNED TO ENHANCE INDIVIDUAL, LEADER, AND TEAM EFFECTIVENESS THROUGH OUTDOOR-EXPERIENTIAL TREKKING (U.S. CLS. 100 AND 101).

SN 75-666,209. NEW WAVE GROUP AB, S-504 35 BORSA, SWEDEN, FILED 3-23-1999.

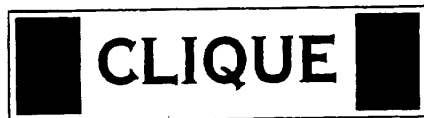

#### CLASS 18—LEATHER GOODS

FOR ANIMAL SKINS AND HIDES; TRUNKS; AND BAGS, NAMELY, BAGS FOR SPORT, ATHLETICS, BEACH, SHOPPING, TRAVEL AND SCHOOL (U.S. CLS. 1, 2, 3, 22 AND 41).

#### CLASS 25—CLOTHING

FOR SKI WEAR (U.S. CLS. 22 AND 39).

SN 75-696,930. OUTRAGEOUS INNOVATION, INC., NAPERVILLE, IL. FILED 5-3-1999.

## OUTRAGEOUS INNOVATION

#### CLASS 35—ADVERTISING AND BUSINESS

FOR BUSINESS CONSULTATION SERVICES, NAMELY DEVELOPING PROMOTIONAL CAMPAIGNS FOR BUSINESSES, PROMOTING THE SALE OF MEDIA PRODUCTS OF OTHERS, AND PROVIDING MEDIA MERCHANDISING VIA THE GLOBAL COMPUTER NETWORK (U.S. CLS. 100, 101 AND 102).

FIRST USE 1-21-1997; IN COMMERCE 3-1-1998.

#### CLASS 42—SCIENTIFIC, COMPUTER AND LEGAL SERVICES

FOR PROVIDING COMPUTER-BASED SERVICES, NAMELY, PROVIDING MEDIA MERCHANDISING VIA THE GLOBAL COMPUTER NETWORK (U.S. CLS. 100 AND 101).

FIRST USE 1-21-1997; IN COMMERCE 1-21-1997.

SN 75-701,092. JOH. WINKLHOFFER & SOHNE GMBH & CO. KG, D-81369 MUNICH, FED REP GERMANY, FILED 5-7-1999.

## DYNAKET

PRIORITY CLAIMED UNDER SEC. 44(D) ON ERPN CMNTY TM OFC APPLICATION NO. 001015155, FILED 12-14-1998, REG. NO. 1015155, DATED 3-27-2000, EXPIRES 3-27-2010.

#### CLASS 7—MACHINERY

FOR AUTOMOBILE AND MOTORCYCLE PARTS, NAMELY, ROLLER CHAINS, SLEEVE CHAINS, TOOTHED CHAINS, AND FLYER CHAINS FOR USE IN INTERNAL COMBUSTION ENGINES (U.S. CLS. 13, 19, 21, 23, 31, 34 AND 35).

#### CLASS 12—VEHICLES

FOR AUTOMOBILE AND MOTORCYCLE PARTS, NAMELY, ROLLER CHAINS, SLEEVE CHAINS, TOOTHED CHAINS AND FLYER CHAINS FOR USE IN TRANSMISSIONS AND FOR USE AS DRIVE CHAINS; BICYCLE PARTS, NAMELY ROLLER CHAINS, SLEEVE CHAINS AND TOOTHED CHAINS, FOR USE AS DRIVE CHAINS (U.S. CLS. 19, 21, 23, 31, 35 AND 44).

SN 75-707,909. SARKES TARZIAN, INC., BLOOMINGTON, IN. FILED 5-18-1999.

## TIME 2 ACT

#### CLASS 41—EDUCATION AND ENTERTAINMENT

FOR EDUCATIONAL SERVICES, NAMELY, CONDUCTING PROGRAMS IN THE FIELD OF ANTI-VIOLENCE AND ON-GOING TELEVISION PROGRAM FEATURING ANTI-VIOLENCE (U.S. CLS. 100, 101 AND 107).

FIRST USE 9-20-1998; IN COMMERCE 9-20-1998.

**CLASS 42—SCIENTIFIC, COMPUTER AND LEGAL SERVICES**

FOR TELEPHONE HOTLINE FOR REPORTING THREATS OF VIOLENCE (U.S. CLS. 100 AND 101).  
FIRST USE 9-20-1998; IN COMMERCE 9-20-1998.

SN 75-715,890. NETCENTIVES, INC., SAN FRANCISCO, CA.  
FILED 5-27-1999.

---

## REWARDING RELATIONSHIPS

**CLASS 9—ELECTRICAL AND SCIENTIFIC APPARATUS**

FOR COMPUTER SOFTWARE USED TO PRODUCE ELECTRONIC CASH AND TO CONDUCT, PROCESS, ANALYZE, AND TRANSMIT PURCHASE TRANSACTIONS, BUSINESS PROMOTIONAL PROGRAMS, AND CUSTOMER AND VENDOR LOYALTY AND INCENTIVE AWARD PROGRAMS VIA A GLOBAL COMPUTER INFORMATION NETWORK (U.S. CLS. 21, 23, 26, 36 AND 38).

**CLASS 35—ADVERTISING AND BUSINESS**

FOR CONDUCTING, PROCESSING, AND ANALYZING EMPLOYEE INCENTIVE AWARD PROGRAMS TO PROMOTE EMPLOYEE PERFORMANCE; CONDUCTING, PROCESSING, AND ANALYZING CONSUMER AND BUSINESS INCENTIVE AND LOYALTY AWARD PROGRAMS TO PROMOTE THE PURCHASING OF GOODS AND SERVICES OF OTHERS, AND TO PROMOTE TRAFFIC TO AND USAGE OF SITES ON THE GLOBAL COMPUTER NETWORK; PROVIDING INFORMATION AND ADVICE RELATING TO CONSUMER AND BUSINESS INCENTIVE, LOYALTY, AND MARKETING PROGRAMS (U.S. CLS. 100, 101 AND 102).

**CLASS 39—TRANSPORTATION AND STORAGE**

FOR PROVIDING INFORMATION AND ADVICE RELATING TO TRAVEL (U.S. CLS. 100 AND 105).

**CLASS 42—SCIENTIFIC, COMPUTER AND LEGAL SERVICES**

FOR CONSULTING SERVICES RELATING TO COMPUTERS AND COMPUTER SOFTWARE SYSTEMS FOR CONDUCTING AND MANAGING LOYALTY, INCENTIVE, AND MARKETING AWARD PROGRAMS (U.S. CLS. 100 AND 101).

SN 75-718,951. SOLD WORLDWIDE, LLC, WHITE PLAINS, NY. FILED 6-7-1999.

---

## FUTURE TRENDS GLOBAL LICENSING

NO CLAIM IS MADE TO THE EXCLUSIVE RIGHT TO USE "GLOBAL LICENSING", APART FROM THE MARK AS SHOWN.

**CLASS 35—ADVERTISING AND BUSINESS**

FOR BUSINESS MARKETING CONSULTATION AND BRAND DESIGNING SERVICES DIRECTED TO THE INTELLECTUAL PROPERTY AND MULTIMEDIA FIELDS; DISSEMINATION OF ADVERTISING FOR OTHERS VIA AN ON-LINE AND OFF-LINE COMMUNICATIONS NETWORK AND VIA DIGITAL/OPTICAL/ELECTRONIC DEVICES/MAGNETIC MEDIA (U.S. CLS. 100, 101 AND 102).

**CLASS 42—SCIENTIFIC, COMPUTER AND LEGAL SERVICES**

FOR LICENSING OF INTELLECTUAL PROPERTY (U.S. CLS. 100 AND 101).

SN 75-729,668. CANADIAN HOME PUBLISHERS, TORONTO, ONTARIO, CANADA, FILED 6-15-1999.

---

## GARDENING LIFE

PRIORITY CLAIMED UNDER SEC. 44(D) ON CANADA APPLICATION NO. 1013154, FILED 4-26-1999, REG. NO. TMA540315, DATED 1-25-2001, EXPIRES 1-25-2016.

NO CLAIM IS MADE TO THE EXCLUSIVE RIGHT TO USE "GARDENING", APART FROM THE MARK AS SHOWN.

**CLASS 16—PAPER GOODS AND PRINTED MATTER**

FOR MAGAZINES ON THE SUBJECT OF GARDENING, HOME DECORATING AND COOKING (U.S. CLS. 2, 5, 22, 23, 29, 37, 38 AND 50).

FIRST USE 3-14-1996; IN COMMERCE 3-14-1996.

**CLASS 41—EDUCATION AND ENTERTAINMENT**

FOR ENTERTAINMENT IN THE NATURE OF AN ONGOING TELEVISION PROGRAM ON THE TOPICS OF GARDENING, HOME DECORATING AND COOKING (U.S. CLS. 100, 101 AND 107).

SN 75-729,955. VIROX TECHNOLOGIES INC., MISSISSAUGA, ONTARIO, L5N 5R8, CANADA, FILED 6-16-1999.



PRIORITY CLAIMED UNDER SEC. 44(D) ON CANADA APPLICATION NO. 1004176, FILED 2-4-1999, REG. NO. 528792, DATED 6-5-2000, EXPIRES 6-5-2016.

**CLASS 3—COSMETICS AND CLEANING PREPARATIONS**

FOR SKIN CLEANSERS (U.S. CLS. 1, 4, 6, 50, 51 AND 52).

**CLASS 5—PHARMACEUTICALS**

FOR ALL PURPOSE DISINFECTANTS (U.S. CLS. 6, 18, 44, 46, 51 AND 52).

SN 75-734,710. DYNAMIC DENTAL SOLUTIONS, INC., NEW YORK, NY. FILED 6-23-1999.

---

## DYNAMIC DENTAL SOLUTIONS

NO CLAIM IS MADE TO THE EXCLUSIVE RIGHT TO USE "DENTAL", APART FROM THE MARK AS SHOWN.

**CLASS 3—COSMETICS AND CLEANING PREPARATIONS**

FOR CONSUMER DENTAL PRODUCTS, NAMELY, NON-MEDICATED DENTAL RINSE (U.S. CLS. 1, 4, 6, 50, 51 AND 52).

**CLASS 5—PHARMACEUTICALS**

FOR DENTAL BLEACHING GELS, DENTAL POLISH, DENTAL RINSES, DENTAL WAX, DENTAL ADHESIVES, AND DENTAL ABRASIVES (U.S. CLS. 6, 18, 44, 46, 51 AND 52).

**CLASS 10—MEDICAL APPARATUS**

FOR DENTAL PICKS AND DENTAL CAPS (U.S. CLS. 26, 39 AND 44).

**CLASS 21—HOUSEWARES AND GLASS**

FOR DENTAL FLOSS (U.S. CLS. 2, 13, 23, 29, 30, 33, 40 AND 50).

SN 75-735,640. PARROS BUSINESS CENTERS, L.L.C., SUMNER, WA. FILED 6-23-1999.

---

## MPC BUSINESS CENTER

NO CLAIM IS MADE TO THE EXCLUSIVE RIGHT TO USE "BUSINESS CENTER", APART FROM THE MARK AS SHOWN.

**CLASS 35—ADVERTISING AND BUSINESS**

FOR BUSINESS SERVICES, NAMELY PHOTOCOPYING SERVICES; WORD-PROCESSING AND TYPING SERVICES; RENTAL OF OFFICE MACHINERY AND EQUIPMENT; PHOTOCOPYING AND REPRODUCING DOCUMENTS FOR OTHERS; LEASE AND RENTAL OF COPY MACHINES, TYPEWRITERS, AND WORD PROCESSORS; AND PROVIDING FACILITIES FOR BUSINESS MEETINGS AND THE USE OF OFFICE EQUIPMENT AND MACHINERY (U.S. CLS. 100, 101 AND 102).

**CLASS 39—TRANSPORTATION AND STORAGE**

FOR POSTAL SERVICES, NAMELY PACKAGING ARTICLES FOR TRANSPORTATION, PARCEL DELIVERY AND RENTAL OF MAILBOXES (U.S. CLS. 100 AND 105).

SN 75-739,538. VICTORIA PRINCIPAL PRODUCTIONS, INC., BEVERLY HILLS, CA. FILED 6-29-1999.

## THE LIVING PRINCIPAL

**CLASS 9—ELECTRICAL AND SCIENTIFIC APPARATUS**

FOR ALL TYPES OF DATA CARRIERS AND RECORDING DISCS NAMELY, VIDEOCASSETTES, DVDS, CD-ROM DISCS, PROVIDING AN AUDIO-VISUAL PRESENTATION OF INFORMATION ON LIFESTYLE, BEAUTY AND HEALTH, NAMELY, COSMETICS, NUTRITION, HAIR AND SKIN CARE AND EXERCISE (U.S. CLS. 21, 23, 26, 36 AND 38).

**CLASS 16—PAPER GOODS AND PRINTED MATTER**

FOR NON-FICTION BOOKS AND MAGAZINES, FEATURING INFORMATION ON LIFESTYLE, BEAUTY AND HEALTH, NAMELY, COSMETICS, NUTRITION, HAIR AND SKIN CARE AND EXERCISE (U.S. CLS. 2, 5, 22, 23, 29, 37, 38 AND 50).

**CLASS 42—SCIENTIFIC, COMPUTER AND LEGAL SERVICES**

FOR PROVIDING A WEB SITE VIA THE INTERNET FEATURING INFORMATION ON LIFESTYLE, BEAUTY AND HEALTH, COSMETICS, NUTRITION, HAIR, SKIN CARE AND EXERCISE (U.S. CLS. 100 AND 101).

SN 75-740,214. SOLANTIS.COM, LLC, DULLES, VA. FILED 7-26-1999.



## Solantis.com

**CLASS 9—ELECTRICAL AND SCIENTIFIC APPARATUS**

FOR COMMUNICATION SERVERS; VOICE AND DATA INTEGRATION PRODUCTS, NAMELY, A CONVERTER BOX FOR TRANSMITTING VOICE AND DATA VIA A GLOBAL COMPUTER NETWORK, FEATURING COMPUTER HARDWARE AND DOWNLOADABLE SOFTWARE FOR USE IN ELECTRONICALLY TRANSMITTING VOICE AND DATA OVER GLOBAL COMPUTER INFORMATION NETWORKS AND INSTRUCTION MANUALS SOLD THEREWITH; AND COMPUTER SOFTWARE FOR ELECTRONICALLY TRANSMITTING VOICE AND DATA OVER GLOBAL COMPUTER INFORMATION NETWORKS (U.S. CLS. 21, 23, 26, 36 AND 38).

FIRST USE 7-1-1998; IN COMMERCE 7-1-1998.

**CLASS 37—CONSTRUCTION AND REPAIR**

FOR INSTALLATION OF COMPUTER NETWORKS AND COMPUTER SYSTEMS, MAINTENANCE OF COMPUTER HARDWARE AND COMPUTER SECURITY NETWORKS AND VIRTUAL PRIVATE NETWORKS, FOR OTHERS (U.S. CLS. 100, 103 AND 106).

FIRST USE 7-1-1998; IN COMMERCE 7-1-1998.

**CLASS 42—SCIENTIFIC, COMPUTER AND LEGAL SERVICES**

FOR COMPUTER SITE DESIGN; DESIGN AND INTEGRATION OF COMPUTERS; COMPUTER SERVICES, NAMELY, COMPUTER NETWORK SECURITY FOR OTHERS (U.S. CLS. 100 AND 101).

FIRST USE 7-1-1998; IN COMMERCE 7-1-1998.

**CLASS 41—EDUCATION AND ENTERTAINMENT**

FOR EDUCATIONAL SERVICES, NAMELY CONDUCTING CLASSES VIA A GLOBAL COMPUTER NETWORK IN THE FIELD OF REAL ESTATE AND TITLE INSURANCE, AND DISTRIBUTING COURSE MATERIALS IN CONNECTION THEREWITH (U.S. CLS. 100, 101 AND 107).

FIRST USE 7-27-1999; IN COMMERCE 7-27-1999.

SN 75-743,586. SYMBIOTICS, INC., SEDONA, AZ. BY ASSIGNMENT SYMBIOTICS, LLC, SEDONA, AZ. FILED 7-2-1999.

SN 75-755,155. MD TECHNOLOGIES, INC., BATON ROUGE, LA. FILED 8-12-1999.



NO CLAIM IS MADE TO THE EXCLUSIVE RIGHT TO USE "COLOSTRUM COMPANY", APART FROM THE MARK AS SHOWN.

**CLASS 3—COSMETICS AND CLEANING PREPARATIONS**

FOR SKIN CARE PREPARATIONS, NAMELY, SKIN CREAMS CONTAINING COLOSTRUM (U.S. CLS. 1, 4, 6, 50, 51 AND 52).

FIRST USE 7-0-1998; IN COMMERCE 7-0-1998.

**MEDTOPIA****CLASS 9—ELECTRICAL AND SCIENTIFIC APPARATUS**

FOR COMPUTER SOFTWARE FOR HANDLING HEALTHCARE CASE MANAGEMENT (U.S. CLS. 21, 23, 26, 36 AND 38).

FIRST USE 9-1-1996; IN COMMERCE 10-1-1998.

**CLASS 42—SCIENTIFIC, COMPUTER AND LEGAL SERVICES**

FOR APPLICATION SERVICES PROVIDER FEATURING SOFTWARE IN THE FIELD OF PERSONAL HEALTHCARE INFORMATION TO HEALTHCARE PROVIDERS AND THEIR PATIENTS VIA A GLOBAL COMPUTER NETWORK (U.S. CLS. 100 AND 101).

FIRST USE 9-1-1996; IN COMMERCE 10-1-1998.

**CLASS 30—STAPLE FOODS**

FOR FOOD PRODUCTS, NAMELY, READY TO EAT CEREAL-BASED SNACK FOOD BARS CONTAINING COLOSTRUM (U.S. CL. 46).

FIRST USE 7-0-1998; IN COMMERCE 7-0-1998.

SN 75-762,054. HISPANIC BROADCASTING CORPORATION, DALLAS, TX. FILED 7-27-1999.



SN 75-744,105. STEWART TITLE GUARANTY COMPANY, HOUSTON, TX. FILED 7-6-1999.

**STEWART UNIVERSITY**

OWNER OF U.S. REG. NOS. 1,854,852, 1,871,543 AND 1,897,723.

NO CLAIM IS MADE TO THE EXCLUSIVE RIGHT TO USE "UNIVERSITY", APART FROM THE MARK AS SHOWN.

NO CLAIM IS MADE TO THE EXCLUSIVE RIGHT TO USE "CORPORATION", APART FROM THE MARK AS SHOWN.

SEC. 2(F).

**CLASS 35—ADVERTISING AND BUSINESS**

FOR ADVERTISING SERVICES, NAMELY, PROMOTING THE GOODS AND SERVICES OF OTHERS THROUGH THE DISTRIBUTION OF PRINTED MATERIAL AND TELECOMMUNICATION CHANNELS (U.S. CLS. 100, 101 AND 102).

FIRST USE 6-7-1999; IN COMMERCE 6-7-1999.

**CLASS 9—ELECTRICAL AND SCIENTIFIC APPARATUS**

FOR EDUCATIONAL SOFTWARE FEATURING INSTRUCTION IN REAL ESTATE, NAMELY, TITLE INSURANCE (U.S. CLS. 21, 23, 26, 36 AND 38).

**CLASS 41—EDUCATION AND ENTERTAINMENT**

FOR ENTERTAINMENT SERVICES IN THE NATURE OF ON-GOING AUDIO PROGRAMS PROVIDED BY TELECOMMUNICATION CHANNELS, FEATURING MUSIC, NEWS, TALK SHOWS, LISTENER CALL-INS, TRAFFIC REPORTS, AND EVENTS, NAMELY, GRAND OPENINGS, REMOTE BROADCASTS, SPORTS, CHARITIES, FESTIVALS, AND LISTENER CONTESTS (U.S. CLS. 100, 101 AND 107).

FIRST USE 6-7-1999; IN COMMERCE 6-7-1999.

**CLASS 16—PAPER GOODS AND PRINTED MATTER**

FOR PRINTED INSTRUCTIONAL, EDUCATIONAL AND TEACHING MATERIALS IN THE FIELD OF REAL ESTATE AND TITLE INSURANCE (U.S. CLS. 2, 5, 22, 23, 29, 37, 38 AND 50).

FIRST USE 7-27-1999; IN COMMERCE 7-27-1999.

SN 75-768,921. POINTSUNIVERSE.COM, INC., STAMFORD, CT. FILED 8-5-1999.

SN 75-774,433. XACTWARE INFORMATION SERVICES, INC., OREM, UT. FILED 8-12-1999.

## POINTSUNIVERSE.COM

### CLASS 9—ELECTRICAL AND SCIENTIFIC APPARATUS

FOR COMPUTER E-COMMERCE SOFTWARE TO ALLOW USERS TO PERFORM ELECTRONIC BUSINESS TRANSACTIONS VIA A GLOBAL COMPUTER NETWORK AND TO RECORD AND PROCESS PURCHASE TRANSACTIONS IN ORDER TO TRACK THEM FOR PROMOTIONAL INCENTIVE AWARD PROGRAMS (U.S. CLS. 21, 23, 26, 36 AND 38).

### CLASS 16—PAPER GOODS AND PRINTED MATTER

FOR PUBLICATIONS, NAMELY, MANUALS, MAGAZINES, NEWSLETTERS, AND BROCHURES IN THE FIELDS OF MARKETING, MARKETING RESEARCH, PROMOTIONAL PROGRAMS, COMPUTER MANUALS AND COMPUTER SOFTWARE MANUALS IN THE FIELDS OF MARKETING, MARKET RESEARCH, PROMOTIONAL PROGRAMS (U.S. CLS. 2, 5, 22, 23, 29, 37, 38 AND 50).

### CLASS 35—ADVERTISING AND BUSINESS

FOR CONDUCTING EMPLOYEE INCENTIVE AWARD PROGRAMS TO PROMOTE EMPLOYEE PERFORMANCE; PROMOTING THE GOODS AND SERVICES OF OTHERS THROUGH THE ADMINISTRATION OF INCENTIVE AWARD PROGRAMS TO CONSUMERS AND PROMOTING THE USE OF SITES ON THE GLOBAL COMPUTER NETWORK OF OTHERS THROUGH THE ADMINISTRATION OF INCENTIVE AWARD PROGRAMS TO CONSUMERS; BUSINESS CONSULTING SERVICES, NAMELY THE DESIGN OF MEMBERSHIP AND DISCOUNT PROGRAMS OFFERED TO CONSUMERS PROVIDING DISCOUNTS FOR TRAVEL ENTERTAINMENT AND LEISURE ACTIVITIES, HEALTH, BEAUTY, FITNESS, DENTAL AND HEALTH PROGRAMS FINANCIAL AND INVESTMENT GOODS AND SERVICES, COMPUTER RELATED GOODS AND SERVICES, AND SECURITY AND EMERGENCY GOODS AND SERVICES; PROVIDING AN INFORMATION DIRECTORY OF SITES AVAILABLE ON COMPUTER NETWORKS (U.S. CLS. 100, 101 AND 102).

### CLASS 36—INSURANCE AND FINANCIAL

FOR ELECTRONIC CASH, ELECTRONIC CREDIT CARD, AND ELECTRONIC DEBIT CARD TRANSACTIONS (U.S. CLS. 100, 101 AND 102).

### CLASS 42—SCIENTIFIC, COMPUTER AND LEGAL SERVICES

FOR COMPUTER SERVICES, NAMELY PROVIDING COMPUTER SEARCH ENGINES FOR OBTAINING DATA ON COMPUTER NETWORKS; COMPUTER SERVICES, NAMELY, PROVIDING DATABASES FEATURING GENERAL AND LOCAL NEWS, AND INFORMATION OF INTEREST TO A SPECIFIC GEOGRAPHIC AREAS (U.S. CLS. 100 AND 101).

## XACTINFO.COM

### CLASS 35—ADVERTISING AND BUSINESS

FOR PROVIDING REFERRAL SERVICES TO HOMEOWNERS FOR HOME IMPROVEMENT, HOME REMODELING, AND HOME REPAIR SERVICE PROVIDERS (U.S. CLS. 100, 101 AND 102).

FIRST USE 8-3-1999; IN COMMERCE 8-3-1999.

### CLASS 37—CONSTRUCTION AND REPAIR

FOR PROVIDING A WEB SITE ON THE INTERNET FEATURING INFORMATION ABOUT HOME REPAIRS AND HOME MAINTENANCE, AND PROVIDING E-MAIL REMINDERS OF EVENTS RELEVANT TO THE MAINTENANCE OF THE HOME (U.S. CLS. 100, 103 AND 106).

FIRST USE 8-3-1999; IN COMMERCE 8-3-1999.

### CLASS 39—TRANSPORTATION AND STORAGE

FOR ELECTRONIC STORAGE FOR OTHERS OF DATA RELATING TO HOME WARRANTY INFORMATION AND BLUEPRINTS OF HOMES (U.S. CLS. 100 AND 105).

FIRST USE 8-3-1999; IN COMMERCE 8-3-1999.

---

SN 75-774,800. NEW WORLD NETWORK HOLDINGS, LTD., MIAMI, FL. FILED 8-13-1999.

## NEW WORLD NETWORK

NO CLAIM IS MADE TO THE EXCLUSIVE RIGHT TO USE "NETWORK", APART FROM THE MARK AS SHOWN.

### CLASS 37—CONSTRUCTION AND REPAIR

FOR INSTALLATION, MAINTENANCE, AND REPAIR OF CABLES FOR TRANSMISSION OF VOICE, VIDEO, DATA AND INFORMATION (U.S. CLS. 100, 103 AND 106).

### CLASS 38—COMMUNICATION

FOR TELECOMMUNICATIONS SERVICES, NAMELY, ELECTRONIC TRANSMISSION OF VOICE, VIDEO, DATA AND INFORMATION THROUGH CABLES (U.S. CLS. 100, 101 AND 104).

### CLASS 42—SCIENTIFIC, COMPUTER AND LEGAL SERVICES

FOR DESIGNING AND DEVELOPING CABLES USED FOR ELECTRONIC TRANSMISSION OF VOICE, VIDEO, DATA AND INFORMATION (U.S. CLS. 100 AND 101).

SN 75-775,770. SHOWSTAR ONLINE.COM, INC., KIRKLAND, WA. FILED 8-11-1999.

SN 75-778,161. OASC AT GREENVILLE, INC., GREENVILLE, SC. FILED 8-16-1999.



#### **CLASS 35—ADVERTISING AND BUSINESS**

FOR ELECTRONIC RETAILING SERVICES VIA A GLOBAL COMPUTER INFORMATION NETWORK FEATURING WORKS OF ART, BOOKS, MAGAZINES AND ART-RELATED MERCHANDISE; AUCTIONING SERVICES; COOPERATIVE ADVERTISING AND MARKETING OF WORKS OF ART, BOOKS, MAGAZINES AND ART-RELATED MERCHANDISE; PURCHASING AGENTS; AND PROVIDING AN ON-LINE INTERACTIVE COMPUTER DATABASE IN THE FIELD OF ART GALLERIES (U.S. CLS. 100, 101 AND 102).

#### **CLASS 36—INSURANCE AND FINANCIAL**

FOR APPRAISALS FOR INSURANCE CLAIMS OF PERSONAL PROPERTY (U.S. CLS. 100, 101 AND 102).

#### **CLASS 37—CONSTRUCTION AND REPAIR**

FOR RESTORATION IN THE FIELD OF WORKS OF ART (U.S. CLS. 100, 103 AND 106).

#### **CLASS 39—TRANSPORTATION AND STORAGE**

FOR ARRANGING TRAVEL TOURS; AND COMPUTER SERVICES, NAMELY, PROVIDING VIRTUAL REALITY ART TOURS AND VIRTUAL REALITY ART EXHIBITIONS VIA A GLOBAL COMPUTER INFORMATION NETWORK (U.S. CLS. 100 AND 105).

#### **CLASS 41—EDUCATION AND ENTERTAINMENT**

FOR PROVIDING AN ON-LINE INTERACTIVE COMPUTER DATABASE IN THE FIELD OF ARTIST BIOGRAPHIES, ART FESTIVAL, EDUCATIONAL INSTITUTES AND COURSES, ART EXHIBITIONS AND WORK TITLES (U.S. CLS. 100, 101 AND 107).

#### **CLASS 42—SCIENTIFIC, COMPUTER AND LEGAL SERVICES**

FOR COMPUTER SERVICES, NAMELY, PROVIDING SEARCH ENGINES FOR OBTAINING ARTIST BIOGRAPHIES, AND INFORMATION ON ARTIST BIOGRAPHIES, AND INFORMATION ON ART FESTIVALS, EDUCATION INSTITUTES AND COURSES, ART EXHIBITIONS, AND GALLERIES AND WORK TITLES; AUTHENTICATION IN THE FIELD OF WORKS OF ART; AND CONSULTATION IN THE FIELD OF ART (U.S. CLS. 100 AND 101).

## **OPERATIONS ASSOCIATES**

NO CLAIM IS MADE TO THE EXCLUSIVE RIGHT TO USE "ASSOCIATES", APART FROM THE MARK AS SHOWN.

SEC. 2(F).

#### **CLASS 35—ADVERTISING AND BUSINESS**

FOR BUSINESS MANAGEMENT CONSULTATION (U.S. CLS. 100, 101 AND 102).  
FIRST USE 0-0-1993; IN COMMERCE 0-0-1993.

#### **CLASS 42—SCIENTIFIC, COMPUTER AND LEGAL SERVICES**

FOR TECHNICAL CONSULTATION IN THE FIELDS OF ENGINEERING, ARCHITECTURAL DESIGN AND INFORMATION TECHNOLOGY; INDUSTRIAL ENGINEERING AND ARCHITECTURAL DESIGN SERVICES (U.S. CLS. 100 AND 101).  
FIRST USE 0-0-1993; IN COMMERCE 0-0-1993.

SN 75-784,583. ALL OUTDOORS, INC., TRAVERSE CITY, MI. FILED 8-25-1999.

## **ALL OUTDOORS**

OWNER OF U.S. REG. NO. 2,034,471.

NO CLAIM IS MADE TO THE EXCLUSIVE RIGHT TO USE "OUTDOORS", APART FROM THE MARK AS SHOWN.

#### **CLASS 16—PAPER GOODS AND PRINTED MATTER**

FOR MAGAZINES CONCERNING THE OUTDOORS (U.S. CLS. 2, 5, 22, 23, 29, 37, 38 AND 50).

#### **CLASS 35—ADVERTISING AND BUSINESS**

FOR ON-LINE RETAIL STORE SERVICES FEATURING HUNTING, FISHING, CAMPING AND GENERAL OUTDOOR RECREATIONAL EQUIPMENT AND PRODUCTS, EXCEPT FOR CLOTHING; ON-LINE WHOLESALE STORE SERVICES FEATURING HUNTING, FISHING, CAMPING AND GENERAL OUTDOOR RECREATIONAL EQUIPMENT AND PRODUCTS, EXCEPT FOR CLOTHING; ON-LINE WHOLESALE DISTRIBUTORSHIPS FEATURING HUNTING, FISHING, CAMPING AND GENERAL OUTDOOR RECREATIONAL EQUIPMENT AND PRODUCTS, EXCEPT FOR CLOTHING; DISSEMINATION OF ADVERTISING FOR OTHERS VIA AN ON-LINE ELECTRONIC COMMUNICATION NETWORK; AND ON-LINE ORDERING SERVICES FEATURING HUNTING, FISHING, CAMPING AND GENERAL OUTDOOR RECREATIONAL EQUIPMENT AND PRODUCTS, EXCEPT FOR CLOTHING; ELECTRONIC CATALOG SERVICES FEATURING HUNTING, FISHING, CAMPING AND GENERAL OUTDOOR RECREATIONAL PRODUCTS, EXCEPT FOR CLOTHING (U.S. CLS. 100, 101 AND 102).

**CLASS 38—COMMUNICATION**

FOR PROVIDING ON-LINE CHAT ROOMS FOR TRANSMISSION OF MESSAGES AMONG COMPUTER USERS CONCERNING EQUIPMENT, PRODUCTS, ACTIVITIES AND SERVICES RELATING TO HUNTING, FISHING, CAMPING AND GENERAL OUTDOOR RECREATION; AND PROVIDING ON-LINE ELECTRONIC BULLETIN BOARDS FOR TRANSMISSION OF MESSAGES AMONG COMPUTER USERS CONCERNING EQUIPMENT, PRODUCTS, ACTIVITIES AND SERVICES RELATING TO HUNTING, FISHING, CAMPING AND GENERAL OUTDOOR RECREATION (U.S. CLS. 100, 101 AND 104).

**CLASS 41—EDUCATION AND ENTERTAINMENT**

FOR ENTERTAINMENT SERVICES, NAMELY, PROVIDING A RADIO PROGRAM IN THE FIELD OF HUNTING, FISHING, CAMPING AND GENERAL OUTDOOR RECREATIONAL ACTIVITIES VIA A GLOBAL COMPUTER NETWORK; ENTERTAINMENT SERVICES, NAMELY, PROVIDING A TELEVISION PROGRAM IN THE FIELD OF HUNTING, FISHING, CAMPING AND GENERAL OUTDOOR RECREATIONAL ACTIVITIES VIA A GLOBAL COMPUTER NETWORK; AND PROVIDING A WEBSITE ON GLOBAL COMPUTER NETWORKS FEATURING INFORMATION IN THE FIELD OF EQUIPMENT, GOODS AND SERVICES RELATING TO HUNTING, FISHING, CAMPING AND GENERAL OUTDOOR RECREATIONAL ACTIVITIES (U.S. CLS. 100, 101 AND 107).

**CLASS 42—SCIENTIFIC, COMPUTER AND LEGAL SERVICES**

FOR COMPUTER SERVICES, NAMELY, PROVIDING ON-LINE MAGAZINES CONCERNING THE OUTDOORS (U.S. CLS. 100 AND 101).

**CLASS 36—INSURANCE AND FINANCIAL**

FOR BROKERAGE SERVICES IN THE FIELDS OF FINANCIAL SECURITIES, STOCKS, BONDS, MUTUAL FUNDS, MONEY MARKET FUNDS, COMMODITIES, FUTURES, OPTIONS, AND INDICES OF FINANCIAL SECURITIES; INVESTMENT SERVICES IN THE FIELDS OF FINANCIAL SECURITIES, STOCKS, BONDS, MUTUAL FUNDS, MONEY MARKET FUNDS, COMMODITIES, FUTURES, OPTIONS, AND INDICES OF FINANCIAL SECURITIES; SECURITIES BROKERAGE ACCOUNT SERVICES THAT FEATURE AN INTEREST BEARING FEATURE FOR CASH BETWEEN INVESTMENTS, ELECTRONIC CASH TRANSACTIONS, AND MARGIN LOAN SERVICES; BANKING SERVICES; CREDIT CARD AND DEBIT CARD SERVICES; CHECK PROCESSING AND BILL PAYMENT SERVICES; VARIABLE ANNUITY SERVICES, NAMELY, UNDERWRITING, ADMINISTRATION AND DISTRIBUTION OF VARIABLE ANNUITY INVESTMENTS; INVESTMENT ACCOUNT INFORMATION SERVICES, NAMELY, PROVIDING BROKERAGE ACCOUNT AND INVESTMENT ACCOUNT INFORMATION BY TELEPHONE, BY ELECTRONIC MEANS, AND VIA A GLOBAL COMMUNICATIONS NETWORK; ADMINISTRATION OF EMPLOYEE PENSION PLANS; FINANCIAL PLANNING; INSURANCE SERVICES, NAMELY, BROKERAGE IN THE FIELD OF LIFE INSURANCE; CASH MANAGEMENT ACCOUNT SERVICES; FIXED INCOME INVESTMENT SERVICES; ELECTRONIC FUND TRANSFER SERVICES; PROVIDING FINANCIAL PLANNING AND INVESTMENT STRATEGY INFORMATION AND ANALYSIS SERVICES; PROVIDING FINANCIAL PLANNING AND INVESTMENT STRATEGY INFORMATION AND ANALYSIS SERVICES VIA A GLOBAL COMMUNICATIONS NETWORK; PROVIDING FINANCIAL PORTFOLIO MANAGEMENT SERVICES; PROVIDING FINANCIAL PORTFOLIO MANAGEMENT SERVICES VIA A GLOBAL COMMUNICATIONS NETWORK; PROVIDING FINANCIAL AND INVESTMENT INFORMATION, FINANCIAL AND INVESTMENT NEWS, FINANCIAL AND INVESTMENT RESEARCH, FINANCIAL AND INVESTMENT DATABASES, ALL FOR USE BY INVESTORS IN THE ANALYSIS OF INVESTMENTS, FINANCES, AND FINANCIAL PLANNING VIA A GLOBAL COMPUTER NETWORK (U.S. CLS. 100, 101 AND 102).

**CLASS 41—EDUCATION AND ENTERTAINMENT**

FOR EDUCATIONAL SERVICES, NAMELY, CONDUCTING SEMINARS AND WORKSHOPS IN THE FIELDS OF INVESTMENT, FINANCE, FINANCIAL PLANNING, PORTFOLIO MANAGEMENT, RETIREMENT PLANNING, MONEY MANAGEMENT, INVESTMENT STRATEGY, AND ASSET ALLOCATION (U.S. CLS. 100, 101 AND 107).

---

SN 75-804,165. FLOORLINK, L.L.C, EARTH CITY, MO.  
FILED 9-15-1999.

**FLOORLINK****CLASS 35—ADVERTISING AND BUSINESS**

FOR WHOLESALE DISTRIBUTORSHIPS FEATURING FLOORING; INVENTORY TRACKING, CONTROL AND BILLING IN THE FIELD OF FLOORING VIA A GLOBAL COMPUTER NETWORK; AND BUSINESS SERVICES, NAMELY PROVIDING BUSINESS AND INVENTORY DATA TO MANUFACTURERS, WHOLESALERS AND RETAILERS VIA A GLOBAL COMPUTER NETWORK (U.S. CLS. 100, 101 AND 102).

FIRST USE 6-0-1999; IN COMMERCE 6-0-1999.

**CLASS 37—CONSTRUCTION AND REPAIR**

FOR PROVIDING INFORMATION IN THE FIELD OF FLOORING BY MEANS OF A WEB SITE ON A GLOBAL COMPUTER NETWORK (U.S. CLS. 100, 103 AND 106).

FIRST USE 6-0-1999; IN COMMERCE 6-0-1999.

SN 75-802,749. CHARLES SCHWAB & CO., INC., SAN FRANCISCO, CA. FILED 9-17-1999.

**SCHWAB SIGNATURE SERVICES ALLIANCE**

OWNER OF U.S. REG. NOS. 1,624,773, 2,092,676 AND OTHERS.

SN 75-807,953. BOWSER, WILLIAM M., LINCOLN, MA. AND SCHWARTZ, THOMAS S., LINCOLN, MA. FILED 9-27-1999.

## SMARTSTREET

### CLASS 35—ADVERTISING AND BUSINESS

FOR WHOLESALE DISTRIBUTORSHIPS FEATURING AUTO PARTS (U.S. CLS. 100, 101 AND 102).

### CLASS 36—INSURANCE AND FINANCIAL

FOR FINANCING SERVICES; FINANCIAL MANAGEMENT; FINANCIAL SERVICES IN THE NATURE OF AN INVESTMENT SECURITY; INSURANCE CONSULTATION, ADMINISTRATION AND BROKERAGE; INSURANCE UNDERWRITING IN THE FIELD OF AUTOMOBILE, LIFE, HEALTH, ACCIDENT, FIRE AND REAL ESTATE (U.S. CLS. 100, 101 AND 102).

### CLASS 40—MATERIAL TREATMENT

FOR CUSTOM MANUFACTURE OF AUTO PARTS (U.S. CLS. 100, 103 AND 106).

### CLASS 41—EDUCATION AND ENTERTAINMENT

FOR VEHICLE DRIVING INSTRUCTION (U.S. CLS. 100, 101 AND 107).

SN 75-808,088. LENTRADE, INC., DBA CHANTAL COOKWARE CORP., HOUSTON, TX. FILED 9-27-1999.

## CHANTAL

OWNER OF U.S. REG. NO. 1,328,576.

### CLASS 11—ENVIRONMENTAL CONTROL APPARATUS

FOR KITCHEN COOKWARE NAMELY, CHAFING DISHES AND WARMING PANS (U.S. CLS. 13, 21, 23, 31 AND 34).

FIRST USE 1-1-1988; IN COMMERCE 1-1-1988.

### CLASS 21—HOUSEWARES AND GLASS

FOR KITCHEN COOKWARE AND BAKEWARE, NAMELY, ELECTRIC KETTLES, METAL PANS, POTS, CASSEROLES, STEAMER INSERTS, CERAMIC PITCHERS AND BOWLS, PIE DISHES, LIDS FOR POTS AND PANS (U.S. CLS. 2, 13, 23, 29, 30, 33, 40 AND 50).

FIRST USE 1-1-1981; IN COMMERCE 1-1-1981.

SN 75-809,781. THERMOQUEST ITALIA S.P.A., MILAN, ITALY, FILED 9-28-1999.

## OXYTUNE

### CLASS 9—ELECTRICAL AND SCIENTIFIC APPARATUS

FOR GAS ANALYZERS (U.S. CLS. 21, 23, 26, 36 AND 38).

FIRST USE 10-0-1999; IN COMMERCE 10-0-1999.

### CLASS 10—MEDICAL APPARATUS

FOR GAS ANALYZERS FOR MEDICAL USE (U.S. CLS. 26, 39 AND 44).

FIRST USE 10-0-1999; IN COMMERCE 10-0-1999.

SN 75-813,776. AWARE, INC., BEDFORD, MA. FILED 10-4-1999.



## A W A R E

OWNER OF U.S. REG. NO. 2,119,256.

### CLASS 9—ELECTRICAL AND SCIENTIFIC APPARATUS

FOR COMPUTER HARDWARE, NAMELY MODEMS AND CHIPSETS; COMPUTER SOFTWARE, NAMELY TOOLS USED TO DESIGN PRODUCTS THAT WILL INCREASE THE USEABLE CAPACITY OF TELEPHONE AND COAXIAL CABLE, SOFTWARE USED FOR HIGH SPEED DIGITAL TRANSMISSION AND DATA COMPRESSION, SOFTWARE FOR VIDEO AND AUDIO IMAGE COMPRESSION, AND SOFTWARE USED TO COMPRESS DATA AND REDUCE DATA STORAGE AND TRANSMISSION REQUIREMENTS IN THE FIELD OF SEISMOLOGY (U.S. CLS. 21, 23, 26, 36 AND 38).

FIRST USE 6-1-1987; IN COMMERCE 6-1-1987.

### CLASS 42—SCIENTIFIC, COMPUTER AND LEGAL SERVICES

FOR UP-DATING OF COMPUTER SOFTWARE AND COMPUTER HARDWARE FOR OTHERS, MAINTENANCE OF COMPUTER SOFTWARE AND COMPUTER HARDWARE, AND TECHNICAL SUPPORT SERVICES, NAMELY, TROUBLESHOOTING OF COMPUTER HARDWARE AND SOFTWARE PROBLEMS VIA TELEPHONE, E-MAIL, AND IN PERSON (U.S. CLS. 100 AND 101).

FIRST USE 6-1-1987; IN COMMERCE 6-1-1987.

SN 75-815,477. MORRISON, TYLER, PORTLAND, OR. FILED 10-27-1999.

## HAIKU SOFTWARE

NO CLAIM IS MADE TO THE EXCLUSIVE RIGHT TO USE "SOFTWARE", APART FROM THE MARK AS SHOWN.



**CLASS 9—ELECTRICAL AND SCIENTIFIC APPARATUS**

FOR COMPUTER SOFTWARE FOR COMPUTER USERS AND WEB SERVER ADMINISTRATORS AND OR IMPLEMENTERS FOR GENERAL PERSONAL AND BUSINESS PRODUCTIVITY, DIGITAL DOCUMENT DELIVERY AND WORKFLOW MANAGEMENT, AND 'UTILITIES' THAT FACILITATE PERSONAL AND BUSINESS USE OF COMPUTERS AND THAT MAY BE DOWN-LOADED FROM A GLOBAL COMPUTER NETWORK (U.S. CLS. 21, 23, 26, 36 AND 38).

**CLASS 42—SCIENTIFIC, COMPUTER AND LEGAL SERVICES**

FOR COMPUTER SOFTWARE DESIGN AND PROGRAMMING FOR OTHERS; WEB SITE DESIGN AND PROGRAMMING/IMPLEMENTATION FOR OTHERS (U.S. CLS. 100 AND 101).

SN 75-818,480. EBENX, INC., MINNEAPOLIS, MN. FILED 10-8-1999.

**BENX****CLASS 36—INSURANCE AND FINANCIAL**

FOR CONSULTING IN THE FIELD OF COMPUTERIZED EMPLOYEE BENEFITS ADMINISTRATION, NAMELY, CONSULTING WITH EMPLOYERS, THEIR ADVISORS, HEALTH PLANS AND OTHER BENEFIT SERVICE AND PRODUCT SUPPLIERS REGARDING THE PROCUREMENT, ADMINISTRATION, AND PAYMENT OF EMPLOYEE BENEFITS (U.S. CLS. 100, 101 AND 102).

**CLASS 42—SCIENTIFIC, COMPUTER AND LEGAL SERVICES**

FOR COMPUTER CONSULTING, NAMELY, CONSULTING WITH EMPLOYERS, THEIR ADVISORS, HEALTH PLANS AND OTHER BENEFIT SERVICE AND PRODUCT SUPPLIERS REGARDING THE INFORMATION SYSTEMS NECESSARY TO SUPPORT COMPUTERIZED EMPLOYEE BENEFITS ADMINISTRATION (U.S. CLS. 100 AND 101).

SN 75-817,484. MALLINCKRODT INC., ST. LOUIS, MO. FILED 10-7-1999.

SN 75-818,953. SPINNRAD GMBH, D-45899 GELSENKIRCHEN, FED REP GERMANY, FILED 10-8-1999.

**SPINNRAD**

OWNER OF FED REP GERMANY REG. NO. 2057261, DATED 2-18-1994, EXPIRES 9-9-2003.

THE ENGLISH TRANSLATION OF THE WORD "SPINN-RAD" IS "SPINNING WHEEL".

**CLASS 16—PAPER GOODS AND PRINTED MATTER**

FOR NOTEBOOKS FOR ORGANIZING AND STORING PAPERWORK ASSOCIATED WITH THE DISPENSING OF CONTROLLED SUBSTANCES; AND PRINTED EDUCATIONAL BROCHURES TEACHING THE DISPENSING OF CONTROLLED SUBSTANCES (U.S. CLS. 2, 5, 22, 23, 29, 37, 38 AND 50).

FIRST USE 10-26-1998; IN COMMERCE 10-26-1998.

**CLASS 41—EDUCATION AND ENTERTAINMENT**

FOR PROVIDING EDUCATIONAL INFORMATION TO PHARMACIES INSTRUCTING A) HOW TO COMPLY WITH US DRUG ENFORCEMENT AGENCY REGULATIONS CONCERNING CONTROLLED SUBSTANCES, AND B) HOW TO DISPENSE CONTROLLED SUBSTANCES (U.S. CLS. 100, 101 AND 107).

FIRST USE 10-26-1998; IN COMMERCE 10-26-1998.

**CLASS 1—CHEMICALS**

FOR CHEMICAL PREPARATIONS FOR INDUSTRIAL, SCIENTIFIC, PHOTOGRAPHIC, AGRICULTURAL, HORTICULTURAL, AND FORESTRY PURPOSES, NAMELY, UNPROCESSED ARTIFICIAL RESINS AND PLASTICS FOR INDUSTRIAL USE, FERTILIZING PREPARATIONS FOR AGRICULTURAL AND HORTICULTURAL USE, CHEMICAL PREPARATIONS FOR PRESERVATION OF FOOD, ADHESIVES FOR INDUSTRIAL PURPOSES, AND TEXTILE IMPREGNATING CHEMICALS; FILTERING MATERIALS, NAMELY, FILTERING MATERIALS MADE OF CHEMICAL PREPARATIONS, MINERAL SUBSTANCES, VEGETABLE SUBSTANCES, UNPROCESSED PLASTICS, AND CERAMIC MATERIALS IN PARTICULATE FORM, ALL FOR USE AS INDUSTRIAL FILTERING MEDIA; ETHYL ALCOHOL, DENATURED ALCOHOL AND ISOPROPYL ALCOHOL FOR INDUSTRIAL USE; CHEMICAL PRODUCTS FOR INDUSTRIAL USE, NAMELY, STARCH SIZE, EMULSIFIERS FOR USE IN THE MANUFACTURE OF FOODS; CHEMICALS FOR ELECTROPHORESIS, NAMELY DECOLORANTS; POTASSIUM CHLORIDE WATER SOFTENING PREPARATIONS USED FOR SELF-PREPARATION OF HOUSEHOLD DETERGENTS; ACETIC ACID; ALUMINUM ACETATE; TEXTILE WATERPROOFING CHEMICALS; FIRE EXTINGUISHING COMPOSITIONS; FIREPROOFING PREPARATIONS; UNEXPOSED SENSITIZED FILMS; STAIN-PREVENTING CHEMICALS FOR USE ON FABRICS; CHEMICAL PREPARATIONS FOR PREVENTING THE TARNISHING OF GLASS; MONOMERIC AND POLYMERIC ESTERS USED AS PLASTICIZERS FOR SYNTHETIC RUBBER AND PLASTIC COMPOUNDS; SACCHARIN; AND CHEMICAL COMPOUNDS, NAMELY AMMONIUM CHLORIDE AND AMMONIUM CHLORIDE SPIRITS FOR INDUSTRIAL AND HOUSEHOLD USE (U.S. CLS. 1, 5, 6, 10, 26 AND 46).

**CLASS 3—COSMETICS AND CLEANING PREPARATIONS**

FOR LAUNDRY PREPARATIONS, NAMELY, BLEACH AND LAUNDRY DETERGENT; POLISHING PREPARATIONS FOR BOOTS, SHOES, AND LEATHER; COMMERCIAL CLEANING PREPARATIONS, NAMELY, DEGREASERS FOR USE ON WALLS, FLOORS, CEILINGS AND COUNTERTOPS; PREPARATIONS FOR CLEANING AND SCOURING, NAMELY, ABRASIVES FOR GENERAL HOUSEHOLD USE; DETERGENT SOAP; PERFUMERY, NAMELY, COLOGNES AND TOILET WATER; HAIR LOTIONS; COSMETICS, NAMELY, SOAP, LIPSTICKS, FACIAL CREAMS, BODY LOTIONS, EYE-SHADOW AND EYE-LINER; ETHEREAL OILS FOR USE IN SCENT LAMPS, AROMATIC THERAPY, COLOGNES, LOTIONS, CREAMS; DENTRIFICES; DEODORANTS; PERSONAL TOILETRY ITEMS, NAMELY, ROOM SCENT SPRAYS; STARCH FOR LAUNDRY PURPOSES; MEDICAL AND DEODORIZING SOAP; MEDICAL DENTRIFICES; EMERY PAPER AND SAND CLOTH; SCOURING LIQUIDS; ANTISTATIC CLEANING PREPARATIONS FOR USE ON GLASS, PLASTIC, AND WOODEN SURFACES; ETHEREAL ESSENCES FOR PERSONAL USE; POLISH FOR FURNITURE AND FLOORING; SACHETS FOR PERFUMING LINEN; DEPILATORY CREAMS; SHOE POLISH; WRINKLE SMOOTHING PREPARATIONS; FALSE NAILS; INCENSE; COTTON SWABS FOR COSMETIC PURPOSES; ARTIFICIAL EYELASHES; AND ADHESIVES FOR AFFIXING ARTIFICIAL EYELASHES (U.S. CLS. 1, 4, 6, 50, 51 AND 52).

**CLASS 4—LUBRICANTS AND FUELS**

FOR INDUSTRIAL OIL AND GREASE; SEAL LUBRICANTS; DIESEL FUEL; LIGHTING FUEL; CANDLES; WICKS FOR CANDLES; DUST ABSORBING AND MOISTENING PREPARATIONS FOR HOUSEHOLD USE; WOOD CHIPS FOR USE AS FUEL; BEESWAX FOR USE IN THE MANUFACTURE OF CANDLES; CHRISTMAS TREE CANDLES; OIL AND GREASED BASED LEATHER PRESERVATIVES; PARAFFIN; REFINED PETROLEUM PRODUCTS, NAMELY, NAPHTHENE BASED OILS FOR LAMPS; RAW PETROLEUM, NAMELY, CRUDE OIL; AND INDUSTRIAL OILS, NAMELY, STEARINE (U.S. CLS. 1, 6 AND 15).

**CLASS 5—PHARMACEUTICALS**

FOR PHARMACEUTICAL AND VETERINARY PREPARATIONS FOR USE IN THE TREATMENT OF CANCER, HEART DISEASE, VASCULAR DISEASES, NERVOUS SYSTEM AND HIGH BLOOD PRESSURE DISEASES; DIETETIC SUBSTANCES ADAPTED FOR MEDICAL USE, NAMELY, FOOD FOR MEDICALLY RESTRICTED DIETS, FOOD FOR DIABETICS, AND FOOD SUPPLEMENTS; FOOD FOR BABIES; ALL PURPOSE DISINFECTANTS; BIOPESTICIDES FOR HOUSEHOLD USE; FUNGICIDES AND HERBICIDES FOR AGRICULTURAL AND DOMESTIC USE; PLASTERS FOR MEDICAL PURPOSES; HOUSEHOLD DEODORIZING PRODUCTS, NAMELY, CARPET AND ROOM DEODORIZER; DISINFECTING DETERGENTS FOR MEDICAL PURPOSES; SANITARY TOWELS; SANITARY PANTY LINERS; SANITARY PANTIES; FEMININE HYGIENE PADS; ADULT DIAPERS; DENTAL MASTICS; MEDICATED CHEWING GUM TO PREVENT TOOTH DECAY; PHARMACEUTICAL PREPARATIONS, NAMELY, DRUGS FOR THE TREATMENT OF CANCER, HEART DISEASE, VASCULAR DISEASES, NERVOUS SYSTEM AND HIGH BLOOD PRESSURE DISEASES; HERBAL TEA FOR MEDICINAL PURPOSES; AND MEDICINAL ROOTS (U.S. CLS. 6, 18, 44, 46, 51 AND 52).

**CLASS 8—HAND TOOLS**

FOR CUTLERY, NAMELY, KNIVES, FORKS, AND SPOONS; HAND TOOLS, NAMELY, HAMMERS, SCREWDRIVERS, PLIERS, AND PINNERS; AND RAZORS (U.S. CLS. 23, 28 AND 44).

**CLASS 9—ELECTRICAL AND SCIENTIFIC APPARATUS**

FOR SCIENTIFIC MEASURING AND NAVIGATIONS INSTRUMENTS USED IN DETERMINATION OF PHYSICAL, CHEMICAL, MECHANICAL AND COMPOSITIONAL PROPERTIES OF MATERIALS, NAMELY, DILATOMETERS, CREEP TESTERS, STRENGTH AND RIGIDITY TESTERS, TEMPERATURE PROGRAMMERS AND CONTROLLERS; FIBER OPTICS AND FIBER OPTIC CABLES; REAGENT PAPER; MACHINES AND DEVICES FOR SOUND AND IMAGE RECORDING, TRANSMISSION AND REPRODUCTION, NAMELY, AUDIO CASSETTE RECORDERS, VIDEO CASSETTE RECORDERS, CD-ROM RECORDERS, AND DVD (DIGITAL VIDEO DISC) RECORDERS; BLANK MAGNETIC DATA MEDIA; PHONOGRAPH RECORDS FEATURING MUSIC; COMPUTERS; COMPUTER PROGRAMS FOR CREATING REFERENCE DATABASES AND BIBLIOGRAPHIES; PRE-RECORDED FILMS AND VIDEO TAPES FEATURING ANIMATED MOVIES; SPECTACLES; SPECTACLE CASES; FLAT IRONS; DENSITOMETERS; SCIENTIFIC APPARATUS AND INSTRUMENTS FOR TESTING PETROLEUM AND PETROCHEMICAL PRODUCTS, NAMELY, DISTILLATION ASSAY EQUIPMENT; METAL DETECTORS; SMOKE DETECTORS; PHOTOGRAPHIC SLIDE TRANSPARENCIES; DIFFRACTION APPARATUS FOR USE IN MICROSCOPY; BLANK FLOPPY DISKS FOR COMPUTERS; AUTOMATIC DOSAGE DISPENSERS FOR PHARMACEUTICAL PILLS AND CAPSULES; ELECTRIC DUST REMOVING APPARATUS, NAMELY, VACUUM CLEANERS AND PARTS THEREFOR; EXERCISING EQUIPMENT, NAMELY, UPPER BODY ERGOMETERS; BINOCULARS; TELESCOPES; FIRE EXTINGUISHERS; RESPIRATORY MASKS NOT FOR MEDICAL USE; FILTERS FOR RESPIRATORY MASKS; PROTECTIVE GLOVES FOR INDUSTRIAL USE; MAGNIFYING GLASSES; MICROSCOPES; ACID HYDROMETERS; PEDOMETERS; SOLAR BATTERIES; LABORATORY EQUIPMENT, NAMELY, HEAT REGULATING APPARATUS FOR LABORATORY USAGE IN PERFORMING EXPERIMENTATION; WATER LEVEL INDICATORS; EAR PLUGS NOT FOR MEDICAL PURPOSES; AND ELECTRICAL DEVICES, NAMELY, LIGHTNING ARRESTERS (U.S. CLS. 21, 23, 26, 36 AND 38).

**CLASS 10—MEDICAL APPARATUS**

FOR DENTURES; ELECTRICALLY ACTIVATED HEATING PADS FOR MEDICAL PURPOSES; ELECTRIC BLANKETS FOR MEDICAL PURPOSES; MEDICAL REHABILITATION EQUIPMENT, NAMELY, THERAPEUTIC WEIGHT AND EXERCISE EQUIPMENT USED IN PHYSICAL THERAPY; AEROSOL DISPENSERS FOR MEDICAL USE; BED VIBRATORS; SPHYGMOMANOMETERS; BLOOD PRESSURE MEASURING AND BLOOD ANALYZING APPARATUS; FINGER GUARDS FOR MEDICAL PURPOSES; FEEDING BOTTLES; NIPPLES FOR FEEDING BOTTLES; GALVANIC MUSCLE STIMULATING DEVICE FOR MEDICAL THERAPEUTIC USE; GLOVES FOR MASSAGE; HEARING AIDS FOR DEAF; APPLIANCES FOR WASHING BODY CAVITIES; INCONTINENCE SHEETS; MEDICAL EXAMINATION LAMPS; AIR CUSHIONS FOR MEDICAL PURPOSES; ELECTRIC MASSAGE APPARATUS; NURSING DEVICES FOR INFANTS, NAMELY, EAR PICKS; AND EAR PLUGS FOR MEDICAL PURPOSES (U.S. CLS. 26, 39 AND 44).

**CLASS 11—ENVIRONMENTAL CONTROL APPARATUS**

FOR HEATING AND COOLING MACHINES, NAMELY, STILLS WITH INTERNAL CONDENSERS AND SEPARATORS FOR DISTILLATION; AZEOTROPIC STILLS FOR USE IN THE DRY CLEANING AND LAUNDRY INDUSTRIES; FURNACES; SOLAR COLLECTORS; HEATING UNITS, STEAM GENERATING UNITS, REFRIGERATING UNITS, DRYING UNITS AND VENTILATING UNITS FOR HOUSEHOLD PURPOSES; INSTALLATIONS FOR COOKING, NAMELY, AUTOMATIC BREAD MAKERS FOR HOME USE, RICE COOKERS, SLOW COOKING POTS, ELECTRIC GRIDDLES, ELECTRIC ROASTERS, OVENS, TOASTERS, ELECTRIC THERMAL POTS, COFFEE MAKERS FOR DOMESTIC AND COMMERCIAL USE, INDUCTION

HEATERS, MICROWAVE OVENS, COOKING STOVES, GAS COOKING STOVES WITH OVENS, ELECTRIC FOOD PANS, AND ELECTRIC HOT PLATES; REFRIGERATORS, FREEZERS, WATER CHILLERS AND COMPRESSORS; SANITARY INSTALLATIONS, NAMELY, KITCHEN SINKS, BATHTUBS, SHOWER TROUGHS, WASHBASINS, TOILETS, AND BIDETS; WATER SUPPLY INSTALLATIONS, NAMELY, BATHTUBS, SINKS, SHOWERS, AND SHOWER DOORS; AIR CONDITIONING UNITS FOR VEHICLES; HEAT SINKS FOR USE IN HEATING, COOLING, AND VENTILATING APPARATUS; SEWAGE PURIFICATION UNITS; HEATING APPARATUS, NAMELY, HEAT ACCUMULATORS; HEAT PUMPS; DISINFECTANT DISPENSERS FOR TOILETS, WATER DISTRIBUTION UNITS, SHOWERS, ICEBOXES, ELECTRIC BREAD TOASTERS, ELECTRIC HOT AIR DRYERS, GERMICIDAL LAMPS FOR PURIFYING AIR, AND ELECTRIC HOT PLATES, NOT FOR MEDICAL PURPOSES; ELECTRIC ROOM DEODORIZING UNITS; WATER DISTILLATION UNITS; BATH LININGS; ICE MAKING MACHINES; ELECTRIC ICE BOXES; WATER SOFTENER UNITS; WATER FILTERING UNITS; REFRIGERATED BEVERAGE UNITS; ELECTRIC LIGHT BULBS; AND ELECTRIC PORTABLE POCKET LIGHTS (U.S. CLS. 13, 21, 23, 31 AND 34).

#### **CLASS 16—PAPER GOODS AND PRINTED MATTER**

FOR DISPOSABLE DIAPERS; PAPER GOODS, NAMELY, CARDBOARD, POSTERS, CARBON PAPER, BOND PAPER, CONSTRUCTION PAPER, CRAFT PAPER, CREPE PAPER, ONION SKIN PAPER, TRACING PAPER, TYPE WRITING PAPER, WRITING PAPER, NOTE CARDS, GIFT CARDS, AND GREETING CARDS; PRINTED MATTER, NAMELY, SPORTS TRADING CARDS, DANCE TEAM TRADING CARDS, MASCOT TRADING CARDS, ENTERTAINMENT TRADING CARDS, AND STICKERS; BOOKBINDING MATERIAL, NAMELY, BOOKBINDING TAPE, WIRE, AND CLOTH; MOUNTED PHOTOGRAPHS; WRITING AND DRAWING INSTRUMENTS; ADHESIVES FOR STATIONERY OR HOUSEHOLD PURPOSES; ARTISTS' PENS, PENCILS, AND BRUSHES; PAINT BRUSHES; ELECTRIC TYPEWRITERS; OFFICE PRODUCTS, NAMELY, UNGRADUATED RULERS FOR DRAFTING AND DRAWING, PENCIL HOLDERS AND PENCIL SHARPENERS, TRIANGLES AND COMPASSES FOR DRAFTING AND DRAWING, NOTE PAD HOLDERS, LETTER OPENERS, ERASERS, PAPER STAPLERS, STAPLE REMOVERS, PAPER HOLE PUNCHES, PAPER CLIP HOLDERS, ADHESIVE TAPE DISPENSERS, AND PAPER CUTTERS; TEACHING MATERIALS USED TO TEACH CHILDREN TO READ AND IMPROVE THEIR READING SKILLS; PLAYING CARDS; PRINTING BLOCKS; AND TEMPORARY REMOVABLE TATTOOS (U.S. CLS. 2, 5, 22, 23, 29, 37, 38 AND 50).

#### **CLASS 20—FURNITURE AND ARTICLES NOT OTHERWISE CLASSIFIED**

FOR OFFICE FURNITURE, GARDEN FURNITURE, FURNITURE FOR PRIVATE USE; FURNITURE MIRRORS AND FRAMES; DECORATIVE MATERIALS COMPOSED OF WOOD, CORK, REED, WILLOW TREE, RUSH, BONE, IVORY, TORTOISE-SHELL, AMBER, MOTHER-OF-PEARL, SEA FROTH AND PLASTIC; MATTRESSES; PILLOWS; STOPPERS MADE OF NATURAL CORKS; AND DRINKING STRAWS (U.S. CLS. 2, 13, 22, 25, 32 AND 50).

#### **CLASS 21—HOUSEWARES AND GLASS**

FOR GLASS STOPPERS; UTENSILS FOR HOUSEHOLD PURPOSES, NOT OF PRECIOUS METAL, NAMELY, FLOOR SQUEEGEES, BUCKETS, DUST PANS, SCOURING SPONGES, SPONGES FOR HOUSEHOLD PURPOSES, SCRUBBING BRUSHES, DUST BRUSHES, BROOMS, CLEANING RAGS, DUSTING CLOTHS, FLOOR MOPS, AND HAIR COMBS, BRUSHES AND BRUSH-MAKING MATERIAL, NAMELY, HAIR BRUSHES, SHAVING BRUSHES, CLEANING BRUSHES, AND DISH BRUSHES; CLEANING INSTRUMENTS, NAMELY, CLOTH RAGS FOR CLEANING, CLOTHS IMPREGNATED WITH A DETERGENT FOR CLEANING, AND HOUSEHOLD GLOVES FOR GENERAL USE; STEEL WOOL FOR CLEANING; PRODUCTS MADE OF GLASS, PORCELAIN, AND EARTH WARE, NAMELY, CERAMIC PLATES, CERAMIC FIGURINES, CERAMIC STEINS, PORCELAIN PLATES, PORCELAIN FIGURINES, PORCELAIN TRINKET BOXES, GLASS PLATES, GLASS DRINKING GLASSES, GLASS GOBLET, GLASS SERVING TRAYS AND GLASS DECANTERS; AND GLASS ART SCULPTURES (U.S. CLS. 2, 13, 23, 29, 30, 33, 40 AND 50).

#### **CLASS 25—CLOTHING**

FOR CLOTHING, NAMELY, HEADWEAR AND FOOTWEAR; AND INFANT CLOTH DIAPERS (U.S. CLS. 22 AND 39).

#### **CLASS 28—TOYS AND SPORTING GOODS**

FOR EAR PLUGS FOR SWIMMING PURPOSES; TOYS AND GAMES, NAMELY, BENDABLE TOY FIGURINES; GAMES, NAMELY, BOARD GAMES, CARD GAMES, AND HANDHELD UNITS FOR PLAYING VIDEO GAMES; TOYS, NAMELY, WATER SQUIRTING TOYS IN THE NATURE OF GUNS, BUBBLE MAKER WAND AND SOLUTION SETS, DOLLS, TOY FIGURES, JIGSAW AND MANIPULATIVE PUZZLES; GYMNASIAC AND SPORTING ARTICLES, NAMELY, WRIST GUARDS, ELBOW PROTECTORS, KNEE PROTECTORS, HELMETS FOR CYCLING, INLINE-SKATING, SCOOTING, SKATEBOARDING, SKATEBOARDS, INLINE-SKATES, SCOOTERS, BICYCLES, ABDOMINAL EXERCISING DEVICES, VERTEBRAL COLUMN EXERCISING DEVICES, ROWING EXERCISING APPARATUS, MULTI-PURPOSE EXERCISING APPARATUS TO IMPROVE THE FITNESS; AND CHRISTMAS TREE ORNAMENTS (U.S. CLS. 22, 23, 38 AND 50).

#### **CLASS 29—MEATS AND PROCESSED FOODS**

FOR MEAT, FISH, POULTRY, AND GAME; MEAT EXTRACTS; PRESERVED, DRIED, AND COOKED FRUITS AND VEGETABLES; JELLIES FOR FOOD; JAMS; FRUIT SAUCES; EGGS; MILK; EDIBLE OILS AND FATS; MILK PRODUCTS, NAMELY, YOGURT AND CHEESE; CANDIED NUTS; AND DAIRY-BASED FOOD BEVERAGES (U.S. CL. 46).

#### **CLASS 30—STAPLE FOODS**

FOR COFFEE, TEA, COCOA, SUGAR, RICE, TAPIOCA, SAGO, AND ARTIFICIAL COFFEE; CORN MEAL; CEREAL BASED SNACK FOOD; BREAD; PASTRIES; CONFECTIONERY CHIPS FOR BAKING; ICE CUBES; ICE MILK; ICE CREAM; HONEY; GOLDEN SYRUP; YEAST; BAKING POWDER; MUSTARD; VINEGAR; SAUCES; SPICES; FOOD FLAVORINGS; MALT EXTRACTS USED AS FLAVORING; CHOCOLATE COVERED NUTS; HERBAL FOOD BEVERAGES; AND SALT (U.S. CL. 46).

#### **CLASS 31—NATURAL AGRICULTURAL PRODUCTS**

FOR AGRICULTURAL SEEDS; LIVING ANIMALS; FRESH FRUITS AND VEGETABLES; PLANT SEEDS; LIVE PLANTS AND FLOWERS; ANIMAL FOODSTUFFS; MALT FOR BREWING AND DISTILLING; PET BEVERAGES; AND RAW AND UNPROCESSED NUTS (U.S. CLS. 1 AND 46).

**CLASS 32—LIGHT BEVERAGES**

FOR BEER; MINERAL WATER; AERATED WATER; NON-ALCOHOLIC BEVERAGES, NAMELY, FLAVORED AND UNFLAVORED BOTTLED DRINKING WATER; BEVERAGES CONTAINING FRUIT JUICES; FRUIT JUICES; AND SYRUPS FOR MAKING SOFT DRINKS (U.S. CLS. 45, 46 AND 48).

**CLASS 33—WINES AND SPIRITS**

FOR ALCOHOLIC BEVERAGES NAMELY, GIN, VODKA, WHISKEY, AND RUM; ALCOHOLIC COFFEE-BASED BEVERAGE; ALCOHOLIC MALT COOLERS; AND ALCOHOLIC TEA-BASED BEVERAGE (U.S. CLS. 47 AND 49).

**CLASS 35—ADVERTISING AND BUSINESS**

FOR FRANCHISING, NAMELY, OFFERING TECHNICAL ASSISTANCE IN THE ESTABLISHMENT AND OPERATION OF BUSINESSES OFFERING ENVIRONMENTALLY FRIENDLY PRODUCTS AND SERVICES; AND ORGANIZATION OF TRADE FAIRS IN THE ADVERTISING INDUSTRY (U.S. CLS. 100, 101 AND 102).

**CLASS 42—SCIENTIFIC, COMPUTER AND LEGAL SERVICES**

FOR ARCHITECTURAL DESIGN OF STORES AND SHOPS FOR OTHERS; COMPUTER PROGRAMMING FOR OTHERS; BEAUTY SALON AND HEALTH SPA FEATURING HAIR STYLING, HAIR CARE, SKIN CARE, NAIL CARE, AND MASSAGE SERVICES; CONSULTING SERVICES IN THE ENVIRONMENTAL AREA, NAMELY, PROVIDING KNOW-HOW IN THE AREAS OF ENVIRONMENT PROTECTION, ENERGY SUPPLY, ECOLOGICALLY BENEFICIAL USE OF DETERGENTS IN HOUSEHOLDS AND GARDENS, USE OF ECOLOGICALLY BENEFICIAL BODY AND BEAUTY PRODUCTS, AND USE OF ECOLOGICALLY BENEFICIAL CONSTRUCTION MATERIALS AND PRODUCTS; SCIENTIFIC AND INDUSTRIAL RESEARCH SERVICES; CONSULTING SERVICES IN THE FIELD OF BUILDING AND CONSTRUCTION PLANNING; MATERIAL TESTING; SERVICES IN THE AREA OF DESIGNING ONLINE SHOPS IN A GLOBAL COMPUTER NETWORK; WEB-PAGE DESIGN; AND WEB-HOSTING (U.S. CLS. 100 AND 101).

**CLASS 35—ADVERTISING AND BUSINESS**

FOR COMMERCIAL INFORMATION AND DIRECTORY SERVICES FEATURING DIRECTORIES FOR LOCATING PEOPLE, PLACES, ORGANIZATIONS, PHONE NUMBERS, WEB SITES, DATABASES, AND ELECTRONIC MAIL ADDRESSES ACCESSIBLE THROUGH THE USE OF A GLOBAL COMPUTER NETWORK; PROVIDING AN ON-LINE INTERACTIVE COMPUTER DATABASE IN THE FIELDS OF E-COMMERCE, BUYING, SELLING, TRADING, DISTRIBUTING AND PROCURING OF GOODS AND SERVICES; PROVIDING AN ON-LINE INTERACTIVE COMPUTER DATABASE IN THE FIELD OF BUYING, SELLING, TRADING, DISTRIBUTING, PROCURING AND DOWNLOADING OF DATA, INFORMATION, MEDIA AND COMPUTER SOFTWARE (U.S. CLS. 100, 101 AND 102).

**CLASS 42—SCIENTIFIC, COMPUTER AND LEGAL SERVICES**

FOR COMPUTER SERVICES, NAMELY, CREATING, MAINTAINING, DESIGNING AND IMPLEMENTING WEB SITES FOR OTHERS; REGISTRATION OF DOMAIN NAMES FOR IDENTIFICATION OF USERS ON A GLOBAL COMPUTER NETWORK; SEARCHING AND RETRIEVING INFORMATION, SITES, AND OTHER RESOURCES AVAILABLE ON COMPUTER NETWORKS FOR OTHERS; PROVIDING ON-LINE INDEXES OF AND LINKS TO THIRD PARTY WEB SITES IN THE FIELDS OF NEWS, WEATHER, SPORTS, ARTS, ENTERTAINMENT, FINANCE, BUSINESS, COMPUTERS, INTERNET, AND ELECTRONICS; PROVIDING TEMPORARY USE OF ON-LINE NON-DOWNLOADABLE SOFTWARE FOR PRODUCING GAMES, PUZZLES, QUIZZES, SCREEN SAVERS, GRAPHICAL IMAGES, TEXTUAL MESSAGES, GREETING CARDS, BUSINESS CARDS AND AUDIOVISUAL MEDIA; PROVIDING TEMPORARY USE OF ON-LINE NON-DOWNLOADABLE SOFTWARE FOR CREATING GAMES, PUZZLES, TOYS, TOOLS, DECORATIONS, ORNAMENTS AND MUSICAL INSTRUMENTS FROM PLANT MATERIALS, PAPER, WOOD, METAL, STONE, CLAY, FABRIC, PLASTIC AND VARIOUS PIGMENTS; PROVIDING TEMPORARY USE OF ON-LINE NON-DOWNLOADABLE SOFTWARE FOR PUBLISHING ELECTRONIC OR PRINTED LETTERS, DOCUMENTS, FORMS, PHOTOGRAPHS, BUSINESS CARDS, GREETING CARDS AND LABELS; ENHANCING WEB SITES FOR OTHERS WITH THE USE OF PRE-PROGRAMMED SOFTWARE FOR EDITING, TRANSLATING, INTERPRETING, CHANGING OR ADDING TO A WEB SITE'S TEXTUAL, GRAPHICAL OR AUDIOVISUAL ASPECTS BY MEANS OF A GLOBAL COMPUTER NETWORK; AND DIGITAL MEDIA CONTENT PRODUCTION SERVICES FOR OTHERS (U.S. CLS. 100 AND 101).

SN 75-820,203. KARAGOZ, ARMEN, BOULDER, CO. FILED 10-31-1999.

SN 75-829,811. STREPARAVA S.P.A., BRESCIA, ITALY, FILED 10-22-1999.

**EARTHFACE****CLASS 9—ELECTRICAL AND SCIENTIFIC APPARATUS**

FOR DOWNLOADABLE SOFTWARE FOR PRODUCING GAMES, PUZZLES, QUIZZES, SCREEN SAVERS, GRAPHICAL IMAGES, TEXTUAL MESSAGES, GREETING CARDS, BUSINESS CARDS AND AUDIOVISUAL MEDIA; DOWNLOADABLE SOFTWARE FOR CREATING GAMES, PUZZLES, TOYS, TOOLS, DECORATIONS, ORNAMENTS AND MUSICAL INSTRUMENTS FROM PLANT MATERIALS, PAPER, WOOD, METAL, STONE, CLAY, FABRIC, PLASTIC AND VARIOUS PIGMENTS; AND DOWNLOADABLE SOFTWARE FOR PUBLISHING ELECTRONIC OR PRINTED LETTERS, DOCUMENTS, FORMS, PHOTOGRAPHS, BUSINESS CARDS, GREETING CARDS AND LABELS (U.S. CLS. 21, 23, 26, 36 AND 38).

**streparava**

PRIORITY CLAIMED UNDER SEC. 44(D) ON ITALY APPLICATION NO. MI99C-008587, FILED 8-12-1999, REG. NO. MI99C-008587, DATED 8-12-1999, EXPIRES 8-12-2009.

**CLASS 7—MACHINERY**

FOR MACHINE TOOLS, NAMELY, DRILLING MACHINES, LATHES, MILLING AND DRILLING CENTERS, INDUSTRIAL PRODUCTION ROBOTS AND CAMSHAFTS (U.S. CLS. 13, 19, 21, 23, 31, 34 AND 35).

**CLASS 12—VEHICLES**

FOR MECHANICAL COMPONENTS FOR AUTOMOBILES, NAMELY, SUSPENSIONS, AXLES AND SOCK ABSORBERS (U.S. CLS. 19, 21, 23, 31, 35 AND 44).

---

SN 75-831,069. DYNAMIQUE PROVENCE, EGUILLES-EN-PROVENCE, FRANCE, FILED 10-26-1999.



NO CLAIM IS MADE TO THE EXCLUSIVE RIGHT TO USE "PROUVENCO", APART FROM THE MARK AS SHOWN.

THE ENGLISH TRANSLATION OF "PROUVENCO" IS "PROVENCE".

**CLASS 3—COSMETICS AND CLEANING PREPARATIONS**

FOR SOAPS, NAMELY SOAPS AND SHOWER GEL FOR BODY, FACE AND HANDS; PERFUMES; COSMETICS, NAMELY ESSENTIAL OILS FOR PERSONAL USE, BODY MILKS; MASSAGE OILS; POTPOURRI (U.S. CLS. 1, 4, 6, 50, 51 AND 52).

FIRST USE 2-0-1996; IN COMMERCE 2-0-1998.

**CLASS 24—FABRICS**

FOR TEXTILES, NAMELY TEXTILE PLACE MATS; TEXTILE TABLE NAPKINS; TEXTILE OVEN MITTS; TABLE COVERS, NAMELY, FABRIC TABLE COVERS; TEXTILE POT HOLDERS (U.S. CLS. 42 AND 50).

FIRST USE 2-0-1996; IN COMMERCE 2-0-1998.

---

SN 75-831,458. DR. BECKMANN GMBH, D-82229 SEEFELD, FED REP GERMANY, FILED 10-25-1999.

**BREATHE PLUS**

NO CLAIM IS MADE TO THE EXCLUSIVE RIGHT TO USE "BREATHE", APART FROM THE MARK AS SHOWN.

**CLASS 5—PHARMACEUTICALS**

FOR PHARMACEUTICAL PREPARATIONS FOR USE IN THE PREVENTION AND TREATMENT OF ALLERGIES AND RESPIRATORY DISEASES; BACTERICIDAL AND FUNGICIDAL HOUSEHOLD CLEANERS FOR GENERAL PURPOSES; ANTI-ALLERGY SPRAY THAT NEUTRALIZES ALLERGENS FOR ALLERGY AND RESPIRATORY THERAPY; BACTERIOSTATIC CLEANER FOR NEUTRALIZING ALLERGENS; MEDICATED HAIR CARE PREPARATIONS FOR ALLERGY PREVENTION, NAMELY, HYPO AND NON-ALLERGENIC HAIR SHAMPOO, HAIR CONDITIONER AND HAIR SPRAY FOR ALLERGY PREVENTION; PRE-MOISTENED PET WIPES FOR USE IN REDUCING DANDER IN THE TREATMENT OF RESPIRATORY AND ALLERGY CONDITIONS; MEDICATED PET SHAMPOO AND SPRAY FOR USE IN SUPPRESSING DANDER FOR ALLERGY PREVENTION AND RESPIRATORY THERAPY; PET HOUSEHOLD DEODORIZING PRODUCTS FOR ALLERGY PREVENTION AND ENVIRONMENTAL CONTROL, NAMELY, CARPET AND ROOM DEODORIZER, DEODORIZER FOR USE IN PET BEDS, AND DEODORIZER SPRAY FOR USE IN THE TREATMENT OF ALLERGIES AND RESPIRATORY CONDITIONS; GENERAL PURPOSE DEODORIZING PRODUCTS FOR ALLERGY PREVENTION AND ENVIRONMENTAL CONTROL, NAMELY, CARPET AND ROOM DEODORIZER, AND ODOR-NEUTRALIZING PREPARATION IN THE FORM OF A GEL FOR USE IN THE TREATMENT OF ALLERGIES AND RESPIRATORY CONDITIONS; AND TEST KITS TO DETERMINE THE PRESENCE AND PREVALENCE OF DUST MITES FOR USE IN THE TREATMENT OF ALLERGIES AND RESPIRATORY CONDITIONS (U.S. CLS. 6, 18, 44, 46, 51 AND 52).

**CLASS 10—MEDICAL APPARATUS**

FOR NEBULIZERS, AND COMPRESSORS, HOLDING CHAMBERS AND AEROSOL DELIVERY MASKS THEREFOR, ALL FOR USE IN RESPIRATORY THERAPY; THERAPEUTIC SAUNAS; APPARATUS FOR IRRIGATING SINUSES AND SINUS PASSAGES, SOLD EMPTY; RESPIRATORY APPARATUS, NAMELY, PEAK FLOW METERS FOR MEASURING EXPIRATORY FLOW (U.S. CLS. 26, 39 AND 44).

**CLASS 19—NON-METALLIC BUILDING MATERIALS**

FOR HYPO AND NON-ALLERGENIC BUILDING MATERIALS, NOT OF METAL; NAMELY, ASPHALT, BARRIERS OF CONCRETE, WOOD, OR PLASTIC; CONCRETE BLOCKS; BRICKS; WINDOW CASEMENTS; DOOR CASINGS; CEILING PANELS; CERAMIC TILES; CONCRETE; CONCRETE BEAMS; DOOR FRAMES; DOOR PANELS; DOORS; EROSION CONTROL FABRIC; FIBERBOARD; FLOOR TILES; FLOORING UNDERLAYMENTS; GLASS PANELS; GROUT; LUMBER; MORTARS; STONES; AND WINDOW FRAMES; ALL FOR USE IN ALLERGY PREVENTION AND ENVIRONMENTAL CONTROL (U.S. CLS. 1, 12, 33 AND 50).

**CLASS 24—FABRICS**

FOR ANTI-ALLERGY BEDDING, NAMELY, BED BLANKETS, COMFORTERS, MATTRESS COVERS, BOX-SPRING COVERS, PILLOW COVERS, AND DUVET LININGS AND COVERS; TEXTILE MATERIALS HAVING ANTI-ALLERGY PROPERTIES FOR USE IN THE MANUFACTURE OF BED BLANKETS, COMFORTERS, MATTRESS COVERS, BOX-SPRING COVERS, PILLOW COVERS, DUVET LININGS AND DUVET COVERS, AND BEDDING PRODUCTS; SHOWER CURTAINS (U.S. CLS. 42 AND 50).

**CLASS 37—CONSTRUCTION AND REPAIR**

FOR BUILDING CONSTRUCTION, REPAIR AND INSTALLATION FEATURING ALLERGY PROPHYLAXIS AND PREVENTION OF ENVIRONMENTAL CONTAMINANTS IN LIVING SPACE; INSTALLATION AND MAINTENANCE OF SYSTEMS IN BUILDINGS THAT FEATURE ALLERGY PROPHYLAXIS AND PREVENTION OF ENVIRONMENTAL CONTAMINANTS IN LIVING SPACE (U.S. CLS. 100, 103 AND 106).

**CLASS 42—SCIENTIFIC, COMPUTER AND LEGAL SERVICES**

FOR CONSULTATION IN THE FIELD OF BUILDING CONSTRUCTION, REPAIR AND INSTALLATION FEATURING ALLERGY PROPHYLAXIS AND PREVENTION OF ENVIRONMENTAL CONTAMINANTS IN LIVING SPACE; BIOLOGICAL ANALYSIS IN THE BUILDING CONSTRUCTION FIELD; SCIENTIFIC AND INDUSTRIAL RESEARCH (U.S. CLS. 100 AND 101).

SN 75-837,245. HIRSHBERG, LINDA, FAIRFIELD, IA. FILED 11-1-1999.

**EXPRESSIONS OF JOY****CLASS 16—PAPER GOODS AND PRINTED MATTER**

FOR POSTERS; CARDS, NAMELY, INDEX CARDS, FLASH CARDS, GREETING CARDS; ARTWORK, NAMELY, ART PRINTS, ART CALENDARS; PUBLICATIONS, NAMELY ARTICLES, ESSAYS, AND TEXTBOOKS, IN THE FIELD OF SPIRITUAL COMMENTARY, SELF HELP, RELIGION, PHILOSOPHY, AND GENERAL INTEREST (U.S. CLS. 2, 5, 22, 23, 29, 37, 38 AND 50).

FIRST USE 7-21-1982; IN COMMERCE 9-10-1982.

**CLASS 41—EDUCATION AND ENTERTAINMENT**

FOR EDUCATIONAL SERVICES, NAMELY, CONDUCTING SEMINARS AND SPEECHES IN THE FIELD OF SPIRITUAL COMMENTARY, SELF HELP, RELIGION, AND PHILOSOPHY (U.S. CLS. 100, 101 AND 107).

FIRST USE 10-12-1988; IN COMMERCE 10-12-1988.

SN 75-838,315. KEN'S FOODS, INC., MARLBOROUGH, MA. FILED 11-2-1999.



OWNER OF U.S. REG. NOS. 1,134,235 AND 1,135,834.

**CLASS 29—MEATS AND PROCESSED FOODS**

FOR FRUIT SAUCES (U.S. CL. 46).  
FIRST USE 1-1-1960; IN COMMERCE 1-1-1960.

**CLASS 30—STAPLE FOODS**

FOR SALAD DRESSING, COLE SLAW DRESSING, MAYONNAISE, TARTER SAUCE, MARINADE SAUCE, VINEGAR, COCKTAIL SAUCE, BARBEQUE SAUCE, DIPPING SAUCE, MUSTARD, FOOD DRESSING (U.S. CL. 46).

FIRST USE 1-1-1960; IN COMMERCE 1-1-1960.

SN 75-841,174. TIVO, INC., ALVISO, CA. FILED 11-4-1999.

**CLASS 9—ELECTRICAL AND SCIENTIFIC APPARATUS**

FOR COMPUTER HARDWARE, SOFTWARE AND PERIPHERALS FOR PERSONALIZED, INTERACTIVE TELEVISION PROGRAMMING; TELEVISIONS; TELEVISION REMOTE CONTROLS; COMMUNICATION DEVICES, NAMELY, TRANSMITTERS FOR TELEVISION, RADIO, AND WIRELESS TELEPHONE; RECEIVERS FOR TELEPHONE, AUDIO, AND VIDEO; AND SOFTWARE FOR USE THEREWITH; AND ACCOMPANYING MANUALS SOLD AS A UNIT (U.S. CLS. 21, 23, 26, 36 AND 38).

FIRST USE 1-7-1999; IN COMMERCE 1-7-1999.

**CLASS 35—ADVERTISING AND BUSINESS**

FOR PROMOTION OF GOODS AND SERVICES OF OTHERS THROUGH THE DISTRIBUTION OF ON-LINE PROMOTIONAL MATERIAL AND PROMOTIONAL CONTESTS; DATA PROCESSING SERVICES (U.S. CLS. 100, 101 AND 102).

FIRST USE 1-7-1999; IN COMMERCE 1-7-1999.

**CLASS 38—COMMUNICATION**

FOR SUBSCRIPTION TELEVISION BROADCASTING SERVICES; TRANSMISSION OF CABLE TELEVISION AND INTERACTIVE AUDIO AND VIDEO SERVICES; PERSONALIZED AND INTERACTIVE TELEVISION TRANSMISSION SERVICES (U.S. CLS. 100, 101 AND 104).

FIRST USE 1-7-1999; IN COMMERCE 1-7-1999.

**CLASS 41—EDUCATION AND ENTERTAINMENT**

FOR ENTERTAINMENT SERVICES, NAMELY INTERACTIVE ENTERTAINMENT SERVICES IN THE NATURE OF PROVIDING PERSONALIZED TELEVISION PROGRAMMING; AND ENTERTAINMENT INFORMATION, NAMELY AN ON-LINE GUIDE TO GUIDE TO PERSONALIZED AND INTERACTIVE TELEVISION PROGRAMMING (U.S. CLS. 100, 101 AND 107).

FIRST USE 1-7-1999; IN COMMERCE 1-7-1999.

SN 75-842,076. TIVO, INC., ALVISO, CA. FILED 11-5-1999.



#### **CLASS 9—ELECTRICAL AND SCIENTIFIC APPARATUS**

FOR COMPUTER HARDWARE, SOFTWARE AND PERIPHERALS FOR PERSONALIZED, INTERACTIVE TELEVISION PROGRAMMING; TELEVISIONS; TELEVISION REMOTE CONTROLS; COMMUNICATION DEVICES, NAMELY, TRANSMITTERS FOR TELEVISION, RADIO, AND WIRELESS TELEPHONE; RECEIVERS FOR TELEPHONE, AUDIO, AND VIDEO; AND SOFTWARE FOR USE THEREWITH; AND ACCOMPANYING MANUALS SOLD AS A UNIT (U.S. CLS. 21, 23, 26, 36 AND 38).

FIRST USE 1-7-1999; IN COMMERCE 1-7-1999.

#### **CLASS 35—ADVERTISING AND BUSINESS**

FOR PROMOTION OF GOODS AND SERVICES FOR OTHERS THROUGH THE DISTRIBUTION OF ON-LINE PROMOTIONAL MATERIAL AND PROMOTIONAL CONTESTS; DATA PROCESSING SERVICES (U.S. CLS. 100, 101 AND 102).

FIRST USE 1-7-1999; IN COMMERCE 1-7-1999.

#### **CLASS 38—COMMUNICATION**

FOR SUBSCRIPTION TELEVISION BROADCASTING SERVICES; TRANSMISSION OF CABLE TELEVISION AND INTERACTIVE AUDIO AND VIDEO SERVICES; PERSONALIZED AND INTERACTIVE TELEVISION TRANSMISSION SERVICES (U.S. CLS. 100, 101 AND 104).

FIRST USE 1-7-1999; IN COMMERCE 1-7-1999.

#### **CLASS 41—EDUCATION AND ENTERTAINMENT**

FOR ENTERTAINMENT SERVICES, NAMELY INTERACTIVE ENTERTAINMENT SERVICES IN THE NATURE OF PROVIDING PERSONALIZED TELEVISION PROGRAMMING; AND ENTERTAINMENT INFORMATION, NAMELY AN ON-LINE GUIDE TO GUIDE TO PERSONALIZED AND INTERACTIVE TELEVISION PROGRAMMING (U.S. CLS. 100, 101 AND 107).

FIRST USE 1-7-1999; IN COMMERCE 1-7-1999.

SN 75-842,507. NATIONAL DIAMOND PRODUCTS, INC., EDISON, NJ. FILED 11-8-1999.

**TRIRANGA**

THE ENGLISH TRANSLATION OF "TRIRANGA" IS "THREE COLORS".

#### **CLASS 29—MEATS AND PROCESSED FOODS**

FOR DRIED FRUITS, JELLIES, JAMS, MILK PRODUCTS EXCLUDING ICE CREAM, ICE MILK AND FROZEN YOGURT (U.S. CL. 46).

FIRST USE 1-1-1999; IN COMMERCE 8-1-1999.

#### **CLASS 30—STAPLE FOODS**

FOR SUGAR, RICE, FLOUR, SPICES, SAUCES (U.S. CL. 46).

FIRST USE 1-1-1999; IN COMMERCE 8-1-1999.

#### **CLASS 31—NATURAL AGRICULTURAL PRODUCTS**

FOR FRESH FRUITS AND VEGETABLES (U.S. CLS. 1 AND 46).

FIRST USE 1-1-1999; IN COMMERCE 8-1-1999.

SN 75-845,814. WORLD KITCHEN, INC., BIG FLATS, NY. BY ASSIGNMENT GENERAL HOUSEWARES CORP., HAUTE, IN. FILED 11-10-1999.

**OXO**

#### **CLASS 29—MEATS AND PROCESSED FOODS**

FOR PROCESSED FOODS, NAMELY, EDIBLE OILS (U.S. CL. 46).

#### **CLASS 30—STAPLE FOODS**

FOR STAPLE FOODS, NAMELY, SPICES (U.S. CL. 46).

SN 75-846,132. MAUI INNOVATIVE PERIPHERALS, INC., KIHAI, HI. BY ASSIGNMENT WHITCOMB & PELOSI PARTNERSHIP, KULA, HI. FILED 11-10-1999.

**CYCLOPX**

#### **CLASS 9—ELECTRICAL AND SCIENTIFIC APPARATUS**

FOR COMPUTER SOFTWARE DEVELOPMENT KITS FOR VIDEO GAME DEVELOPERS CONSISTING OF A 3D NAVIGATION HEADSET, EMBEDDED SOFTWARE DRIVERS, GAME DEVELOPMENT SOFTWARE, AND RELATED DOCUMENTATION (U.S. CLS. 21, 23, 26, 36 AND 38).

#### **CLASS 42—SCIENTIFIC, COMPUTER AND LEGAL SERVICES**

FOR TECHNICAL SUPPORT SERVICES FOR VIDEO GAME DEVELOPERS, NAMELY, PROVIDING TECHNICAL INFORMATION AND SUPPORT FOR USE OF PERIPHERAL COMPUTER HARDWARE AND SOFTWARE IN DEVELOPMENT OF VIDEO GAMES (U.S. CLS. 100 AND 101).

SN 75-846,807. ELECTROLUX ZANUSSI, S.P.A., 33170 PORTOFENONE, ITALY, FILED 11-12-1999.

## ZANUSSI

OWNER OF ITALY REG. NO. 274514, DATED 8-3-1973, EXPIRES 12-29-2002.

### CLASS 7—MACHINERY

FOR IRONING MACHINES, LAUNDRY WASHING MACHINES, DISHWASHING MACHINES, POT WASHING MACHINES, ELECTRIC EGG BEATERS AND ELECTRIC FOOD BLENDERS FOR DOMESTIC AND COMMERCIAL USE, ELECTRIC FOOD GRATERS, COFFEE GRINDERS FOR DOMESTIC USE, ELECTRIC VACUUM CLEANERS, ELECTRIC MACHINES FOR CLEANING POTTERY AND TABLEWARE, SMALL ELECTRIC MOTORS FOR USE IN KITCHEN APPLIANCES AND COMBINED ELECTRIC VACUUM CLEANERS AND FLOOR POLISHERS (U.S. CLS. 13, 19, 21, 23, 31, 34 AND 35).

### CLASS 9—ELECTRICAL AND SCIENTIFIC APPARATUS

FOR ELECTRIC FLAT IRONS, ELECTRIC SWITCHES, COIN-OPERATED VENDING MACHINES AND AUTOMATIC VENDING MACHINES (U.S. CLS. 21, 23, 26, 36 AND 38).

### CLASS 11—ENVIRONMENTAL CONTROL APPARATUS

FOR LAUNDRY DRYING MACHINES, ELECTRIC GAS LIGHTERS FOR GAS COOKERS, ELECTRIC HEATING KETTLES, ELECTRIC COFFEE POTS, ELECTRIC TEAPOTS, TOASTER, ELECTRIC FRYING MACHINES, NAMELY, DEEP FRYERS, ELECTRIC COFFEE PERCOLATORS, ELECTRIC DISH HEATERS, ROASTING JACKS, ELECTRIC PRESSURE-COOKERS, FREEZERS, ICE-MAKERS, ICED-WATER FOUNTAINS, COMPRESSION REFRIGERATORS, ABSORPTION REFRIGERATORS, ICE CREAM MAKERS, HEATERS, NAMELY, HOT-AIR FANS, VENTILATING BLOWERS, DRYING CABINETS, NAMELY, CLOTHES DRYING MACHINES, COMMERCIAL VENTILATING FANS, FURNACE BOILERS FOR CENTRAL HEATING, BOILERS FOR COMBINED WATER HEATING AND ROOM HEATING FOR DOMESTIC USE, RESIDENTIAL GAS FED HEATERS, COMMERCIAL GAS FED HEATERS, INDUSTRIAL GAS FED HEATERS, RESIDENTIAL FUEL OIL FED HEATERS, COMMERCIAL FUEL OIL FED HEATERS, INDUSTRIAL FUEL OIL FED HEATERS, RESIDENTIAL CRUDE OIL FED HEATERS, COMMERCIAL CRUDE OIL FED HEATERS, INDUSTRIAL CRUDE OIL FED HEATERS, AIR CONDITIONERS, DEHUMIDIFIERS, GAS COOKING STOVES, ELECTRIC COOKING STOVES, GAS KITCHEN RANGES, ELECTRIC KITCHEN RANGES, DOMESTIC ELECTRIC COOKING OVENS, COMMERCIAL ELECTRIC COOKING OVENS, DOMESTIC WATER HEATERS, COMMERCIAL WATER HEATERS, INDUSTRIAL WATER HEATERS, HEATING STOVES FED BY SOLID FUEL, GAS AND ELECTRICITY, RADIATING STOVES POWERED BY ELECTRICITY, GAS, OR WOOD FOR HEATING ROOMS, RADIATING STOVES POWERED BY ELECTRICITY, GAS, OR WOOD FOR HEATING BUILDINGS, EXTRACTION HOODS FOR COOKING TOPS, COMMERCIAL STEAM CONVECTION OVENS, ELECTRIC CUPBOARDS FOR HEATING CROCKERY AND FOOD, NAMELY, FOOD WARMERS AND DISH WARMERS, RADIATING HEATING PANELS, STEAM RADIATORS FOR HEATING BUILDINGS, ELECTRIC RADIATORS FOR HEATING BUILDINGS, ELECTRIC FANS AND CEILING FANS (U.S. CLS. 13, 21, 23, 31 AND 34).

### CLASS 20—FURNITURE AND ARTICLES NOT OTHERWISE CLASSIFIED

FOR KITCHEN CUPBOARDS AND SHELVES (U.S. CLS. 2, 13, 22, 25, 32 AND 50).

### CLASS 21—HOUSEWARES AND GLASS

FOR PORTABLE CONTAINERS FOR HOUSEWORK AND THE KITCHEN (U.S. CLS. 2, 13, 23, 29, 30, 33, 40 AND 50).

SN 75-853,431. CONSENSUS HEALTH, INC., EMERYVILLE, CA. FILED 11-19-1999.

## ONEBODY.COM

### CLASS 35—ADVERTISING AND BUSINESS

FOR PROVIDING ON-LINE BUSINESS MANAGEMENT SERVICES, NAMELY, SCHEDULING SERVICES, GROUP PURCHASING AND DIAGNOSTIC SERVICES IN THE FIELD OF HEALTHCARE BY MEANS OF A GLOBAL COMPUTER NETWORK; PHYSICIAN REFERRALS IN THE FIELD OF HEALTHCARE PROVIDED VIA A GLOBAL COMPUTER NETWORK; ON-LINE RETAIL SERVICES IN THE FIELD OF HEALTHCARE (U.S. CLS. 100, 101 AND 102).

### CLASS 38—COMMUNICATION

FOR PROVIDING ON-LINE CHAT ROOMS FOR TRANSMISSION OF MESSAGES AMONG COMPUTER USERS IN THE FIELD OF HEALTHCARE; TELECOMMUNICATIONS SERVICES, NAMELY, PROVIDED A GATEWAY LINK IN THE FIELD OF HEALTHCARE (U.S. CLS. 100, 101 AND 104).

### CLASS 41—EDUCATION AND ENTERTAINMENT

FOR PROVIDING CONTINUING EDUCATION IN THE FIELD OF HEALTHCARE BY MEANS OF A COMPUTER NETWORK (U.S. CLS. 100, 101 AND 107).

### CLASS 42—SCIENTIFIC, COMPUTER AND LEGAL SERVICES

FOR PROVIDING NEWS AND INFORMATION IN THE FIELD OF HEALTHCARE BY MEANS OF A GLOBAL COMPUTER NETWORK; COMPUTER SERVICES, NAMELY, PROVIDING SEARCH ENGINES FOR OBTAINING DATA ON A GLOBAL COMPUTER NETWORK; HEALTHCARE SERVICES; HEALTH CARE SERVICES IN THE NATURE OF PROVIDING RESEARCH IN THE FIELD OF HEALTHCARE FOR OTHERS; COMPUTER SERVICES, NAMELY PROVIDING ON-LINE PUBLICATIONS IN THE NATURE OF BOOKS, MAGAZINES AND NEWSLETTERS IN THE FIELD OF HEALTHCARE VIA A GLOBAL COMPUTER INFORMATION NETWORK (U.S. CLS. 100 AND 101).

SN 75-853,432. CONSENSUS HEALTH, INC., EMERYVILLE, CA. FILED 11-19-1999.

## ONEBODY

### CLASS 35—ADVERTISING AND BUSINESS

FOR PROVIDING ON-LINE BUSINESS MANAGEMENT SERVICES, NAMELY, SCHEDULING SERVICES, GROUP PURCHASING AND DIAGNOSTIC SERVICES IN THE FIELD OF HEALTHCARE BY MEANS OF A GLOBAL COMPUTER NETWORK; PHYSICIAN REFERRALS IN THE FIELD OF HEALTHCARE PROVIDED VIA A GLOBAL COMPUTER NETWORK; ON-LINE RETAIL SERVICES IN THE FIELD OF HEALTHCARE (U.S. CLS. 100, 101 AND 102).



**CLASS 38—COMMUNICATION**

FOR PROVIDING ON-CHAT ROOMS FOR TRANSMISSION OF MESSAGES AMONG COMPUTER USERS IN THE FIELD OF HEALTHCARE; TELECOMMUNICATIONS SERVICES, NAMELY PROVIDING A GATEWAY LINK IN THE FIELD OF HEALTHCARE BY MEANS OF A COMPUTER NETWORK (U.S. CLS. 100, 101 AND 104).

SN 75-859,115. KNORR-BREMSE AG, 80809 MUNCHEN, FED REP GERMANY, FILED 11-29-1999.

**KNORR-BREMSE****CLASS 41—EDUCATION AND ENTERTAINMENT**

FOR PROVIDING CONTINUING EDUCATION IN THE FIELD OF HEALTHCARE BY MEANS OF A COMPUTER NETWORK (U.S. CLS. 100, 101 AND 107).

PRIORITY CLAIMED UNDER SEC. 44(D) ON FED REP GERMANY APPLICATION NO. 39931202112, FILED 5-31-1999, REG. NO. 39931202, DATED 7-1-1999, EXPIRES 5-31-2009.

**CLASS 7—MACHINERY**

FOR VEHICLE PNEUMATIC AND HYDRAULIC COMPRESSORS; ELECTRIC SANDERS; VEHICLE AIR FILTERS (U.S. CLS. 13, 19, 21, 23, 31, 34 AND 35).

**CLASS 42—SCIENTIFIC, COMPUTER AND LEGAL SERVICES**

FOR PROVIDING NEWS AND INFORMATION IN THE FIELD OF HEALTHCARE BY MEANS OF A GLOBAL COMPUTER NETWORK; COMPUTER SERVICES, NAMELY PROVIDING SEARCH ENGINES FOR OBTAINING DATA ON A GLOBAL COMPUTER NETWORK; HEALTHCARE SERVICES; HEALTH CARE SERVICES IN THE NATURE OF PROVIDING RESEARCH IN THE FIELD OF HEALTHCARE FOR OTHERS; COMPUTER SERVICES, NAMELY PROVIDING ON-LINE PUBLICATIONS IN THE NATURE OF BOOKS, MAGAZINES AND NEWSLETTERS IN THE FIELD OF HEALTHCARE VIA A GLOBAL COMPUTER INFORMATION NETWORK (U.S. CLS. 100 AND 101).

**CLASS 9—ELECTRICAL AND SCIENTIFIC APPARATUS**

FOR PHYSICAL, MECHANICAL, PNEUMATIC, HYDRAULIC, ELECTROMECHANIC, ELECTROMAGNETIC, ELECTRICAL, AND ELECTRONIC SIGNALING UNITS; MECHANICAL, PNEUMATIC, HYDRAULIC, ELECTROMECHANIC, ELECTROMAGNETIC, ELECTRICAL, AND ELECTRONIC CONVEYORS; MECHANICAL, PNEUMATIC, HYDRAULIC, ELECTROMECHANIC, ELECTROMAGNETIC, ELECTRICAL, AND ELECTRONIC AMPLIFIERS FOR AMPLIFYING SIGNALS AND ACTUATORS; MECHANICAL, PNEUMATIC, HYDRAULIC, ELECTROMECHANIC, ELECTROMAGNETIC, ELECTRICAL, AND ELECTRONIC MEASURERS; THE FOREMENTIONED GOODS FOR VEHICLES, FOR STATIONS AND FOR RAILROAD LINES; MECHANICAL, PNEUMATIC, HYDRAULIC, ELECTROMECHANIC, ELECTROMAGNETIC, ELECTRICAL, AND ELECTRONIC CHECKING UNITS FOR CHECKING VEHICLES, STATIONS AND RAILROAD LINES; PHYSICAL, MECHANICAL, PNEUMATIC, HYDRAULIC, ELECTROMECHANIC, ELECTROMAGNETIC, ELECTRICAL AND ELECTRONIC CONTROLLERS FOR VEHICLES, STATIONS AND RAILROAD LINES; PHYSICAL, MECHANICAL, PNEUMATIC, HYDRAULIC, ELECTROMECHANIC, ELECTROMAGNETIC, ELECTRICAL, AND ELECTRONIC CLOSED-LOOP CONTROLLERS FOR VEHICLES, STATIONS AND RAILROAD LINES; PHYSICAL, MECHANICAL, PNEUMATIC, HYDRAULIC, ELECTROMECHANIC, ELECTROMAGNETIC, ELECTRICAL, AND ELECTRONIC SENSORS FOR VEHICLES, STATIONS AND RAILROAD LINES; VEHICLE DOOR CONTROLLERS; CLOSED-LOOP VEHICLE DOOR CONTROLLERS; VEHICLE DOOR SENSORS; VEHICLE AND TRAILER LEVEL CONTROLLERS; VEHICLE BRAKE CONTROLLERS; VEHICLE BRAKE CLOSED-LOOP CONTROLLERS; VEHICLE BRAKE SENSORS; TRAIN CONTROLLERS; BRAKE TEST CONTROLLERS FOR TRAINS AND FOR TESTING COMPLETENESS OF TRAINS; DRIVING AND BRAKING CONTROLLERS; TRACTION CONTROLLERS; RAILWAY VEHICLE WHEEL FLAT DETECTORS AND ELECTRONIC LOCATORS; OVAL RAILWAY VEHICLE WHEEL DETECTORS AND ELECTRONIC LOCATORS; RAILWAY VEHICLE DERAILMENT DETECTORS (U.S. CLS. 21, 23, 26, 36 AND 38).

SN 75-857,443. VERIDICOM, INC., SANTA CLARA, CA. FILED 11-24-1999.

**TRUSTED SENSOR**

NO CLAIM IS MADE TO THE EXCLUSIVE RIGHT TO USE "SENSOR", APART FROM THE MARK AS SHOWN.

**CLASS 9—ELECTRICAL AND SCIENTIFIC APPARATUS**

FOR ELECTRONIC DEVICES, NAMELY, ELECTRONIC IDENTIFICATION AUTHENTICATION PRODUCTS, IN THE NATURE OF ELECTRONIC AUTHENTICATION EQUIPMENT, NAMELY, COMPUTING ELEMENTS WITHIN INTEGRATED CIRCUITS AND PRINTED CIRCUIT BOARDS (U.S. CLS. 21, 23, 26, 36 AND 38).

**CLASS 38—COMMUNICATION**

FOR ELECTRONIC TRANSMISSION OF DATA VIA COMPUTER TERMINALS FOR PURPOSES OF ELECTRONIC COMMERCE, NAMELY, VERIFICATION OF IDENTITIES IN ELECTRONIC COMMERCE TRANSACTIONS (U.S. CLS. 100, 101 AND 104).

**CLASS 42—SCIENTIFIC, COMPUTER AND LEGAL SERVICES**

FOR COMPUTER SERVICES IN THE NATURE OF IDENTITY VERIFICATION SERVICES, NAMELY, SERVICES FOR ELECTRONICALLY VERIFYING IDENTITIES VIA A GLOBAL COMPUTER NETWORK (U.S. CLS. 100 AND 101).

**CLASS 12—VEHICLES**

FOR MECHANICAL, PNEUMATIC, HYDRAULIC, ELECTRIC, ELECTROMAGNETIC, ELECTROMECHANICAL, AND ELECTRONIC LAND VEHICLE BRAKES AND PARTS THEREFORE; PNEUMATIC SUSPENSIONS FOR LAND VEHICLES; WHEELS FOR VEHICLES; AXLE BEARINGS; VEHICLE AIR-CONDITIONING AND TOILET SYSTEMS; AUTOMATIC AND NON-AUTOMATIC COUPLINGS FOR RAIL AND ROAD VEHICLES, NAMELY, THRUST AND TRACTION COUPLINGS, TUBING COUPLERS, ELECTRO COUPLINGS, AIR-PRESSURE COUPLERS AND CABLE COUPLERS NOT FOR ENGINES; HOLDING STRUCTURES AND TIE RODS NOT FOR ENGINES; TRACTION AND COUPLING THRUST TRANSMITTERS; VEHICLE HYDRAULIC AND PNEUMATIC PUMPS; VEHICLE AIR DRYERS; VEHICLE PRESSURE HYDRAULIC AND PNEUMATIC

RESERVOIRS; VEHICLE DOORS; ELECTRIC POWER TRANSMISSIONS FOR VEHICLES; EQUIPMENT FOR BOGIES, A GROUPING OF WHEELS FOR TRAINS; VEHICLE AIR SUPPLIERS; WINDSHIELD WIPER BLADES; WINDSHIELD WIPER DRIVES; WINDSHIELD WIPER SPRAY NOZZLES; WINDSHIELD WIPER WATER CONTAINERS; WINDSHIELD WIPER WATER PUMPS; WINDSHIELD WIPER OPERATING VALVES FOR RAILWAY VEHICLES; WINDSHIELD WASHER AND WIPER DEVICES FOR RAILWAY VEHICLES; SHOCK ABSORBERS (U.S. CLS. 19, 21, 23, 31, 35 AND 44).

#### **CLASS 37—CONSTRUCTION AND REPAIR**

FOR REPAIR AND MAINTENANCE OF PRESSURE-MEDIUM OPERATED DEVICES AND APPARATUSES, NAMELY, COMPRESSORS, SUSPENSIONS, VEHICLE LEVELERS, COUPLERS, COUPLINGS, THRUST TRANSMITTERS, SHOCK ABSORBERS, WINDSHIELD WIPERS, PRESSURE MEDIUM RESERVOIRS, AIR FILTERS, PUMPS, DRYERS, SENSORS AND CONTROLLERS; REPAIR AND MAINTENANCE OF BRAKES; REPAIR AND MAINTENANCE OF ELECTRIC AND ELECTRONIC DEVICES AND APPARATUSES, NAMELY, SENSORS, CONTROLLERS, CLOSED-LOOP CONTROLLERS, AMPLIFIERS, SIGNALING UNITS, STORAGE INSTALLATIONS, MEASURERS, CONVEYORS, VEHICLE AND TRAILER CLOSED-LOOP LEVEL CONTROLLERS, AND VEHICLE AND TRAILER CLOSED-LOOP BRAKE CONTROLLERS (U.S. CLS. 100, 103 AND 106).

#### **CLASS 41—EDUCATION AND ENTERTAINMENT**

FOR PROVIDING COURSES, TRAINING AND FURTHER VOCATIONAL PROGRAMS RELATED TO VEHICLES, STATIONS AND RAILROAD LINES (U.S. CLS. 100, 101 AND 107).

---

SN 75-860,769. COVILLE, BRUCE F, SYRACUSE, NY. FILED 11-30-1999.

## **ODDLY ENOUGH**

#### **CLASS 9—ELECTRICAL AND SCIENTIFIC APPARATUS**

FOR [ITU] VIDEO RECORDINGS FEATURING LIVE ACTION PERFORMANCES OF CHILDREN'S STORIES, CD-ROMS FEATURING LIVE ACTION PERFORMANCES OF CHILDREN'S STORIES; SOUND RECORDINGS FEATURING SPOKEN WORD NARRATIONS OF CHILDREN'S STORIES [1A] SOUND RECORDINGS FEATURING MUSIC AND SOUNDTRACKS FROM MUSICAL PLAYS (U.S. CLS. 21, 23, 26, 36 AND 38).

FIRST USE 0-0-1996; IN COMMERCE 0-0-1996.

#### **CLASS 16—PAPER GOODS AND PRINTED MATTER**

FOR [ITU] SCHOOL SUPPLIES, NAMELY, NOTEBOOKS, NON-ELECTRICAL ERASER; PENS, PENCILS, STICKERS, TRADING CARDS, POSTERS, GREETING CARDS, NOTECARDS, CALENDARS, NEWSLETTERS FEATURING INFORMATION ABOUT CHILDREN'S STORIES AND CHILDREN'S WRITERS, MAGAZINES FEATURING INFORMATION ABOUT CHILDREN'S STORIES AND CHILDREN'S WRITERS, AND SERIES OF CHILDREN'S BOOKS (U.S. CLS. 2, 5, 22, 23, 29, 37, 38 AND 50).

#### **CLASS 25—CLOTHING**

FOR [ITU] SHIRTS, T-SHIRTS, CAPS, AND HEADWEAR (U.S. CLS. 22 AND 39).

#### **CLASS 28—TOYS AND SPORTING GOODS**

FOR [ITU] TOYS, NAMELY, ACTION FIGURES, DOLLS, PLUSH TOYS, AND BOARD GAMES BASED ON FICTIONAL CHARACTERS (U.S. CLS. 22, 23, 38 AND 50).

#### **CLASS 41—EDUCATION AND ENTERTAINMENT**

FOR ENTERTAINMENT AND EDUCATIONAL SERVICES, NAMELY PROVIDING LECTURES AND SEMINARS IN THE FIELD OF WRITING AND IN THE FIELD OF CHILDREN'S TOPICS, NAMELY, WRITING TECHNIQUES FOR CHILDREN AND STORY STRUCTURE TECHNIQUES FOR CHILDREN; ENTERTAINMENT SERVICES, NAMELY, LIVE PERFORMANCES IN THE NATURE OF CHILDREN'S STORYTELLING (U.S. CLS. 100, 101 AND 107).

FIRST USE 9-0-1993; IN COMMERCE 9-0-1993.

#### **CLASS 42—SCIENTIFIC, COMPUTER AND LEGAL SERVICES**

FOR [ITU] COMPUTER SERVICES, NAMELY, PROVIDING ONLINE BOOKS FEATURING INFORMATION ABOUT CHILDREN'S STORIES AND CHILDREN'S WRITERS, AND MAGAZINES FEATURING INFORMATION ABOUT CHILDREN'S STORIES AND CHILDREN'S WRITERS (U.S. CLS. 100 AND 101).

---

SN 75-862,703. MICHIGAN HUMANE SOCIETY, ROCHESTER HILLS, MI. FILED 12-3-1999.

## **PETS ACROSS AMERICA**

NO CLAIM IS MADE TO THE EXCLUSIVE RIGHT TO USE "PETS" AND "AMERICA", APART FROM THE MARK AS SHOWN.

#### **CLASS 35—ADVERTISING AND BUSINESS**

FOR COOPERATIVE PURCHASING OF ANIMAL SHELTER SUPPLIES AND VETERINARY SUPPLIES FOR MEMBERS (U.S. CLS. 100, 101 AND 102).

#### **CLASS 36—INSURANCE AND FINANCIAL**

FOR CHARITABLE FUNDRAISING SERVICES FOR ANIMAL SHELTER MEMBERS (U.S. CLS. 100, 101 AND 102).

#### **CLASS 42—SCIENTIFIC, COMPUTER AND LEGAL SERVICES**

FOR ASSOCIATION SERVICES PROMOTING THE INTERESTS OF ANIMAL SHELTERS (U.S. CLS. 100 AND 101).

---

SN 75-863,694. CULVER, JAMES W., SAUK VILLAGE, IL. FILED 12-3-1999.

## **DIVE CRITTERS**

NO CLAIM IS MADE TO THE EXCLUSIVE RIGHT TO USE "CRITTERS", APART FROM THE MARK AS SHOWN.

**CLASS 21—HOUSEWARES AND GLASS**

FOR CERAMIC AND GLASS FIGURES (U.S. CLS. 2, 13, 23, 29, 30, 33, 40 AND 50).

**CLASS 25—CLOTHING**

FOR CLOTHING, NAMELY, T-SHIRTS, SWEAT-SHIRTS, SHIRTS, HATS, JACKETS, BATHING SUITS AND SWIM WEAR (U.S. CLS. 22 AND 39).

**CLASS 28—TOYS AND SPORTING GOODS**

FOR TOYS, NAMELY, STUFFED AND PLUSH TOYS; SPORTING EQUIPMENT, NAMELY, EQUIPMENT FOR UNDERWATER ACTIVITIES (U.S. CLS. 22, 23, 38 AND 50).

SN 75-867,947. EAGLE FIRE INC., RICHMOND, VA. FILED 12-10-1999.



NO CLAIM IS MADE TO THE EXCLUSIVE RIGHT TO USE "YOUR FIRE PROTECTION COMPANY", APART FROM THE MARK AS SHOWN.

**CLASS 37—CONSTRUCTION AND REPAIR**

FOR INSTALLATION, MAINTENANCE AND REPAIR OF FIRE PROTECTION SYSTEMS (U.S. CLS. 100, 103 AND 106).

FIRST USE 12-15-1991; IN COMMERCE 12-15-1991.

**CLASS 42—SCIENTIFIC, COMPUTER AND LEGAL SERVICES**

FOR INSPECTION OF FIRE PROTECTION SYSTEMS (U.S. CLS. 100 AND 101).

FIRST USE 12-15-1991; IN COMMERCE 12-15-1991.

SN 75-872,520. WAKAI & CO., LTD., OSAKA, JAPAN, FILED 12-16-1999.

**WAKAI**

THE ENGLISH TRANSLATION OF THE WORD "WAKAI" IN THE MARK IS "YOUNG, IMMATURE" OR "RECONCILIATION".

**CLASS 6—METAL GOODS**

FOR METAL HARDWARE, NAMELY, NAILS, PEGS; WASHERS FOR SCREWS, BOLTS, RIVETS AND THREADED FASTENERS; NUTS, SCREWS, TACKS, PLUGS, BOLTS, RIVETS, THREADED FASTENERS; METAL TOOL BOXES; AND METAL SPRINGS (U.S. CLS. 2, 12, 13, 14, 23, 25 AND 50).

**CLASS 8—HAND TOOLS**

FOR STROPS; WHET STEELS; SHARPENING STONES; HAND TOOLS, NAMELY, PLANES, DRILLS, SAWS, AND CHISELS (U.S. CLS. 23, 28 AND 44).

**CLASS 20—FURNITURE AND ARTICLES NOT OTHERWISE CLASSIFIED**

FOR METAL CURTAIN FITTINGS, NAMELY, RODS, RINGS, SUPPORTS; PLASTIC THREADED FASTENERS; PLASTIC PLUGS; PLASTIC ANCHORS FOR SECURING PICTURES TO WALLS; NON-METAL HARDWARE, NAMELY, NAILS, PEGS, NUTS, SCREWS, TACKS, BOLTS, RIVETS AND CASTERS; AND NON-METAL, NON-ELECTRIC LOCKS (U.S. CLS. 2, 13, 22, 25, 32 AND 50).

SN 75-873,368. MODERN BUILDING SYSTEMS, INC., AUMSVILLE, OR. FILED 12-15-1999.

**THE SMART CHOICE****CLASS 35—ADVERTISING AND BUSINESS**

FOR RETAIL STORE SERVICES FEATURING MOBILE AND MODULAR BUILDINGS (U.S. CLS. 100, 101 AND 102).

FIRST USE 6-0-1989; IN COMMERCE 6-0-1989.

**CLASS 36—INSURANCE AND FINANCIAL**

FOR LEASING OF MOBILE BUILDINGS (U.S. CLS. 100, 101 AND 102).

FIRST USE 6-0-1989; IN COMMERCE 6-0-1989.

**CLASS 37—CONSTRUCTION AND REPAIR**

FOR CONSTRUCTION OF RESIDENTIAL AND COMMERCIAL BUILDINGS (U.S. CLS. 100, 103 AND 106).

FIRST USE 6-0-1989; IN COMMERCE 6-0-1989.

**CLASS 40—MATERIAL TREATMENT**

FOR CUSTOM MANUFACTURE OF MOBILE AND MODULAR BUILDINGS TO THE ORDER AND SPECIFICATION OF OTHERS (U.S. CLS. 100, 103 AND 106).

FIRST USE 6-0-1989; IN COMMERCE 6-0-1989.

SN 75-877,321. ELLIPSIS COMMUNICATIONS, LLC, MOORESTOWN, NJ. FILED 12-20-1999.

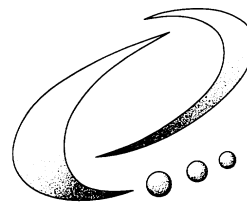

THE STIPLING IN THE DRAWING IS FOR SHADING PURPOSES ONLY AND DOES NOT INDICATE COLOR.

**CLASS 35—ADVERTISING AND BUSINESS**

FOR PREPARING AND PLACING MAGAZINE, TELEVISION AND RADIO ADVERTISEMENTS FOR OTHERS, DIRECT MAIL ADVERTISING, MARKET RESEARCH SERVICES, TELEMARKETING, ARRANGING AND CONDUCTING BUSINESS CONFERENCES AND BUSINESS MEETINGS, BUSINESS MARKETING CONSULTATION, AND PUBLIC RELATIONS SERVICES (U.S. CLS. 100, 101 AND 102).

FIRST USE 9-0-1999; IN COMMERCE 11-0-1999.

**CLASS 42—SCIENTIFIC, COMPUTER AND LEGAL SERVICES**

FOR CUSTOM WRITING SERVICES, NAMELY WRITING SPEECHES FOR OTHERS AND COMMERCIAL ART DESIGN (U.S. CLS. 100 AND 101).

FIRST USE 9-0-1999; IN COMMERCE 11-0-1999.

---

SN 75-877,322. ELLIPSIS COMMUNICATIONS, LLC, MOORESTOWN, NJ. FILED 12-20-1999.

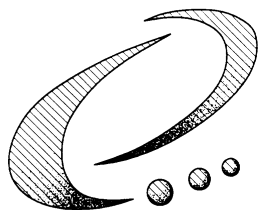

THE DRAWING IS LINED FOR THE COLOR GREEN. THE STIPPLING IS FOR SHADING PURPOSES ONLY AND DOES NOT INDICATE COLOR.

**CLASS 35—ADVERTISING AND BUSINESS**

FOR PREPARING AND PLACING MAGAZINE, TELEVISION AND RADIO ADVERTISEMENTS FOR OTHERS, DIRECT MAIL ADVERTISING, MARKET RESEARCH SERVICES, TELEMARKETING, ARRANGING AND CONDUCTING BUSINESS CONFERENCES AND BUSINESS MEETINGS, BUSINESS MARKETING CONSULTATION, AND PUBLIC RELATIONS SERVICES (U.S. CLS. 100, 101 AND 102).

FIRST USE 9-0-1999; IN COMMERCE 11-0-1999.

**CLASS 42—SCIENTIFIC, COMPUTER AND LEGAL SERVICES**

FOR CUSTOM WRITING SERVICES, NAMELY WRITING SPEECHES FOR OTHERS AND COMMERCIAL ART DESIGN (U.S. CLS. 100 AND 101).

FIRST USE 9-0-1999; IN COMMERCE 11-0-1999.

---

SN 75-877,984. RICHTREE MARKETS INC., TORONTO, ONTARIO, M5H 2G4, CANADA, FILED 12-22-1999.



PRIORITY CLAIMED UNDER SEC. 44(D) ON CANADA APPLICATION NO. 1,020,360, FILED 6-25-1999, REG. NO. 548405, DATED 7-19-2001, EXPIRES 7-19-2016.

NO CLAIM IS MADE TO THE EXCLUSIVE RIGHT TO USE "INC.", APART FROM THE MARK AS SHOWN.

**CLASS 35—ADVERTISING AND BUSINESS**

FOR BUSINESS MANAGEMENT CONSULTATION, RESTAURANT FRANCHISING, AND LICENSING OF RESTAURANTS (U.S. CLS. 100, 101 AND 102).

**CLASS 41—EDUCATION AND ENTERTAINMENT**

FOR EDUCATIONAL SERVICES, NAMELY, CONDUCTING SEMINARS AND CLASSES IN THE FIELD OF RESTAURANT SERVICES (U.S. CLS. 100, 101 AND 107).

**CLASS 42—SCIENTIFIC, COMPUTER AND LEGAL SERVICES**

FOR RESTAURANT AND CARRY-OUT RESTAURANT SERVICES (U.S. CLS. 100 AND 101).

---

SN 75-881,064. GREENSMART, INC., NEWBERRY, FL. FILED 12-27-1999.

**GREENSMART****CLASS 16—PAPER GOODS AND PRINTED MATTER**

FOR PRINTED INSTRUCTIONAL MATERIALS AND EDUCATIONAL MATERIALS NAMELY MAGAZINES, BOOKS AND NEWSLETTERS, ALL IN THE FIELDS OF SALES AND MARKETING, DESIGN AND DEVELOPMENT OF HIGH PERFORMANCE BUILDINGS, LENDING AND ENVIRO-LAND DEVELOPMENT (U.S. CLS. 2, 5, 22, 23, 29, 37, 38 AND 50).

FIRST USE 12-17-1999; IN COMMERCE 4-6-2000.

**CLASS 41—EDUCATION AND ENTERTAINMENT**

FOR EDUCATIONAL SERVICES NAMELY CONDUCTING SEMINARS, WORKSHOPS AND CONFERENCES IN THE FIELDS OF SALES MOTIVATION, ENVIRONMENTAL BUILDING, MARKETING, LENDING, ENVIRO-LAND DEVELOPMENT, HIGH PERFORMANCE HOUSING AND DISTRIBUTING PRINTED MATERIALS IN CONNECTION THEREWITH (U.S. CLS. 100, 101 AND 107).

FIRST USE 12-17-1999; IN COMMERCE 4-6-2000.

SN 75-882,236. SEIKO EPSON KABUSHIKI KAISHA, SHINJUKU-KU, TOKYO, JAPAN, FILED 12-28-1999.



OWNER OF JAPAN REG. NO. 4082379, DATED 11-14-1997, EXPIRES 11-14-2007.

OWNER OF JAPAN REG. NO. 4069545, DATED 10-17-1997, EXPIRES 10-17-2007.

OWNER OF JAPAN REG. NO. 4174066, DATED 8-7-1998, EXPIRES 8-7-2008.

OWNER OF JAPAN REG. NO. 4077529, DATED 10-31-1997, EXPIRES 10-31-2007.

NO CLAIM IS MADE TO THE EXCLUSIVE RIGHT TO USE "COLOR IMAGING", APART FROM THE MARK AS SHOWN.

#### CLASS 9—ELECTRICAL AND SCIENTIFIC APPARATUS

FOR COMPUTERS, WORD PROCESSORS AND COMPUTER EQUIPMENT, NAMELY PRINTERS, HELD-HELD COMPUTER TERMINALS, CALCULATORS, COMPUTER KEYBOARDS, MODEMS, COMPUTER DISPLAYS, FLOPPY DISC DRIVES, MONITORS, CATHODE RAY TUBES, BLANK MAGNETIC TAPES; BLANK MAGNETIC DISCS, BLANK MAGNETIC CARDS, BLANK OPTICAL MEMORY CARDS; CD-ROMS CONTAINING PICTURE BOOKS, CLIP ART, ART IMAGES, ART CREATION SOFTWARE, VIDEO GAME SOFTWARE, LANGUAGE TRANSLATION SOFTWARE, FINANCIAL ACCOUNTING SOFTWARE AND GENERAL PURPOSE DATABASE MANAGEMENT SOFTWARE; CD ROM PLAYERS; MAGNETIC DRUMS AND MAGNETO-OPTICAL DRIVES, MEMORY STORAGE PERIPHERAL DEVICES; COMPUTER PROGRAMS RECORDED FOR USE IN CONTROLLING THE OPERATION OF COMPUTER PRINTERS; LIQUID CRYSTAL PROJECTORS, LIQUID CRYSTAL TELEVISIONS, LIQUID CRYSTAL DISPLAYS, DIGITAL DISPLAY APPARATUS, OPTICAL SENSORS, IMAGE SENSORS AND IMAGE SCANNERS; INTEGRATED CIRCUIT, LARGE SCALE INTEGRATED CIRCUIT, SEMICONDUCTOR MEMORIES, DIODES, QUARTZ RESONATORS, QUARTZ OSCILLATORS, CRYSTAL-CONTROLLED TRANSMITTERS, OPTOELECTRONIC MEMORIES AND TRANSISTORS; INTEGRATED CIRCUIT MEMORY CARDS AND OPTICAL CARDS; RARE-EARTH MAGNETS, MAGNETS AND STEPPING MOTORS; AUDIO-VISUAL APPARATUS AND APPARATUS FOR RECORDING, TRANSMITTING OR REPRODUCING SOUND OR IMAGES, NAMELY, VIDEO CASSETTE RECORDERS, VIDEO CAMERAS, SOUND TAPES RECORDERS, VIDEO TAPE RECORDERS, VIDEO DISK PLAYERS AND VIDEO PROJECTORS; VOICE RECOGNITION SOFTWARE, CHARACTER RECOGNITION SOFTWARE; COMPUTER PRINTERS FOR WRITING LABELS; TELEVISION SETS, TELEVISION CAMERAS, VIDEO CAMERAS, DIGITAL CAMERAS, ANTENNAS AND VIDEO PRINTERS; AMMETERS, VOLTMETERS, FREQUENCY METERS, OSCILLOSCOPES, THERMOMETERS; AUTOMATED BILLING MACHINES AND AUTOMATED TELLER MACHINES; FACSIMILE MACHINES AND ELECTROSTATIC COPY MACHINES; SPECTACLES, SPECTACLE LENSES, EYEGLOSS FRAMES AND CONTACT LENSES AND PARTS OF ALL THE AFORESAID GOODS (U.S. CLS. 21, 23, 26, 36 AND 38).

#### CLASS 16—PAPER GOODS AND PRINTED MATTER

FOR INK RIBBONS AND INK RIBBON CASSETTES FOR COMPUTER PRINTERS, WORD PROCESSORS, FACSIMILE MACHINES AND COPY MACHINES; PRINTED MATTER, NAMELY, BOOKS, MAGAZINES, NEWSPAPER, MANUALS, CATALOGS AND PAMPHLETS, ALL IN THE FIELD OF COMPUTER RELATED MATTERS, NAMELY, COMPUTERS, COMPUTER PERIPHERALS AND SOFTWARE; PRINTING PAPER, COPY PAPER, TYPEWRITER PAPER, WRITING PAPER, COMPUTER PAPER, LABELS, NAMELY, ADDRESS LABELS, SHIPPING LABELS, BLANK AND PARTIALLY PRINTED LABELS NOT OF TEXTILES, PRINTED LABELS NOT OF TEXTILES; STATIONERY; ELECTRIC AND MANUAL TYPEWRITERS; OFFICE CHECK WRITING MACHINES AND PAPER SHREDDERS FOR OFFICE USE; PRINTED INSTRUCTIONAL AND TEACHING MATERIALS IN THE FIELD OF MATHEMATICS; AND PARTS FOR THE AFORESAID GOODS (U.S. CLS. 2, 5, 22, 23, 29, 37, 38 AND 50).

#### CLASS 37—CONSTRUCTION AND REPAIR

FOR MAINTENANCE AND REPAIR OF COMPUTERS, PRINTERS, WORD PROCESSORS, DISPLAYS, MODEMS, MONITORS, KEYBOARDS, SCANNERS, DIGITAL CAMERAS, FACSIMILE MACHINES, COPY MACHINES AND TV RECEIVERS (U.S. CLS. 100, 103 AND 106).

#### CLASS 42—SCIENTIFIC, COMPUTER AND LEGAL SERVICES

FOR RENTAL OF COMPUTERS AND COMPUTER PERIPHERALS, NAMELY PRINTERS, WORD PROCESSORS, DISPLAYS, MODEMS, MONITORS, KEYBOARDS, SCANNERS, DIGITAL CAMERAS, FACSIMILE MACHINES, COPY MACHINES AND TV RECEIVERS; COMPUTER PROGRAMING FOR OTHERS (U.S. CLS. 100 AND 101).

SN 75-882,446. TONNELLERIE TARANSAUD & CIE, 16100 MERPINS, FRANCE, FILED 12-29-1999.

The word "Taransaud" is written in a serif font and is enclosed within an oval border.

PRIORITY CLAIMED UNDER SEC. 44(D) ON FRANCE APPLICATION NO. 99803526, FILED 7-20-1999, REG. NO. 99/803526, DATED 7-20-1999, EXPIRES 7-20-2009.

"TARANSAUD" IS A FANCIFUL WORD.

#### CLASS 6—METAL GOODS

FOR METAL VATS, METAL SPIGOTS FOR BARRELS, VATS, LARGE CASKS AND DRUMS, METAL HOOPS FOR BARRELS, VATS LARGE CASKS AND DRUMS, METAL TAPS FOR BARRELS, VATS, LARGE CASKS AND DRUMS (U.S. CLS. 2, 12, 13, 14, 23, 25 AND 50).

#### CLASS 20—FURNITURE AND ARTICLES NOT OTHERWISE CLASSIFIED

FOR NON-METALLIC BARRELS, VATS, LARGE CASKS AND DRUMS, BOTTLE STOPPERS, CORKS, BOTTLE RACKS; SPIGOTS FOR BARRELS, VATS, LARGE CASKS AND DRUMS; HOOPS FOR BARRELS, VATS, LARGE CASKS AND DRUMS; TAPS FOR BARRELS, VATS, LARGE CASKS AND DRUMS; NON-METALLIC STANDS FOR BARRELS, VATS, LARGE CASKS AND DRUMS (U.S. CLS. 2, 13, 22, 25, 32 AND 50).

**CLASS 33—WINES AND SPIRITS**

FOR WINES AND DISTILLED SPIRITS (U.S. CLS. 47 AND 49).

---

SN 75-883,169. CFO PUBLISHING CORPORATION, BOSTON, MA. FILED 12-28-1999.

**ECFO**

OWNER OF U.S. REG. NOS. 1,387,874 AND 1,721,917.

**CLASS 16—PAPER GOODS AND PRINTED MATTER**

FOR PUBLICATIONS, NAMELY MAGAZINES OF FINANCIAL INFORMATION (U.S. CLS. 2, 5, 22, 23, 29, 37, 38 AND 50).

**CLASS 42—SCIENTIFIC, COMPUTER AND LEGAL SERVICES**

FOR COMPUTER SERVICES, NAMELY PROVIDING AN ON-LINE PUBLICATION IN THE FIELD OF FINANCIAL INFORMATION (U.S. CLS. 100 AND 101).

---

SN 75-887,805. STERNA SA, SWITZERLAND, FILED 1-5-2000.

**STERNA****CLASS 25—CLOTHING**

FOR CLOTHING, NAMELY PANTS, SHIRTS, TOPS, SHORTS, HATS, SHOES, FOOTWEAR AND SKI BOOTS (U.S. CLS. 22 AND 39).

**CLASS 28—TOYS AND SPORTING GOODS**

FOR SPORTING ARTICLES, NAMELY SOFTBALLS, BASEBALL, TENNIS BALLS, EXERCISE BICYCLES, SKIS, SNOW BOARD, SKI BINDINGS, SKI POLES, IN LINE SKATES, SKATEBOARDS, KNEE AND ELBOW GUARDS FOR ATHLETIC USE, EXERCISING EQUIPMENT, NAMELY WEIGHT LIFTING MACHINES, LEG, ANKLE AND WRIST WEIGHTS (U.S. CLS. 22, 23, 38 AND 50).

---

SN 75-889,361. BEVERAGE MARKETING USA, INC., LARCHMONT, NY. FILED 1-6-2000.

**RXMEMORY****CLASS 30—STAPLE FOODS**

FOR HERBAL FOOD BEVERAGES AND TEA BEVERAGES (U.S. CL. 46).

**CLASS 32—LIGHT BEVERAGES**

FOR FRUIT JUICE BEVERAGES, VEGETABLE JUICE BEVERAGES, CARBONATED SOFT DRINKS, NON-CARBONATED SOFT DRINKS, AND DRINKING WATER (U.S. CLS. 45, 46 AND 48).

SN 75-890,733. KNOWLEDGE BASED SYSTEMS, INC., COLLEGE STATION, TX. FILED 1-7-2000.

**INNOVATIVE IDEAS AND TECHNOLOGIES**

NO CLAIM IS MADE TO THE EXCLUSIVE RIGHT TO USE "TECHNOLOGIES", APART FROM THE MARK AS SHOWN.

**CLASS 41—EDUCATION AND ENTERTAINMENT**

FOR EDUCATIONAL SERVICES, NAMELY, PROVIDING TRAINING IN THE FIELD OF COMPUTER SOFTWARE USED FOR BUSINESS, BANKING, AVIATION, ENGINEERING AND MANUFACTURING APPLICATIONS (U.S. CLS. 100, 101 AND 107).

FIRST USE 12-15-1992; IN COMMERCE 12-15-1992.

**CLASS 42—SCIENTIFIC, COMPUTER AND LEGAL SERVICES**

FOR DESIGN AND MAINTENANCE OF COMPUTER SOFTWARE USED FOR BUSINESS, BANKING, AVIATION, ENGINEERING AND MANUFACTURING APPLICATIONS (U.S. CLS. 100 AND 101).

FIRST USE 12-15-1992; IN COMMERCE 12-15-1992.

---

SN 75-894,717. NETAVENUES.COM CORPORATION, WESTON, FL. FILED 1-11-2000.

**NETAVENUES.COM****CLASS 35—ADVERTISING AND BUSINESS**

FOR PROVIDING BUSINESS INFORMATION AS A TOOL IN THE NATURE OF COMPANY, PRODUCT, AND SERVICES INFORMATION BASED UPON PROFILES SUCH AS BIOCHEMISTRY, CONSUMER GOODS, ENTERTAINMENT, FOOD AND BEVERAGE, INTERNET, MEDICAL, PHARMACEUTICAL, TECHNOLOGY, COMPUTERS AND TELECOMMUNICATIONS, FINANCE, MANUFACTURING, NATURAL RESOURCES AND TRANSPORTATION (U.S. CLS. 100, 101 AND 102).

FIRST USE 10-12-1998; IN COMMERCE 10-12-1998.

**CLASS 36—INSURANCE AND FINANCIAL**

FOR FINANCIAL SERVICES PROVIDED AS AN INFORMATION TOOL, NAMELY, PROVIDING FINANCIAL NEWS, ACCOUNT AND PORTFOLIO INFORMATION, RETIREMENT FUND INFORMATION, INVESTMENT FUND PERFORMANCE INFORMATION, STOCK AND SECURITIES PERFORMANCE INFORMATION; INVESTMENT ADVISORY INFORMATION; STOCK BUYING AND STOCK SELLING INFORMATION; INDIVIDUAL BROKER AND BROKERAGE BUY/SELL INFORMATION; ON-TIME STOCK AND MARKET QUOTATIONS; MARKET COMMENTARY AND NEWS; AND FINANCIAL TOOLS, SUCH AS STOCK QUOTES, INTERACTIVE CHARTS, NEWS, MARKET DATA, SEC FILINGS, MOST ACTIVE STOCKS, PERSONALIZED PORTFOLIO, ECONOMIC CALENDAR, SECTOR RATINGS AND SPLITS CALENDAR; AND OTHER INFORMATION RELATING TO INVESTMENTS, FINANCIAL PLANNING SERVICES AND FINANCIAL PLANNING FOR RETIREMENT AND OTHER FINANCIAL ISSUES, ALL BY MEANS OF A WEB SITE ON THE INTERNET (U.S. CLS. 100, 101 AND 102).

FIRST USE 10-12-1998; IN COMMERCE 10-12-1998.

SN 75-897,490. YAMAHA CORPORATION OF AMERICA,  
BUENA PARK, CA. FILED 1-14-2000.

SN 75-898,342. PROGRAPH SYSTEMS, INC., PITTSBURGH,  
PA. FILED 1-18-2000.

## SAY YES TO MUSIC

NO CLAIM IS MADE TO THE EXCLUSIVE RIGHT TO USE "MUSIC", APART FROM THE MARK AS SHOWN.

### CLASS 6—METAL GOODS

FOR KEYCHAINS OF METAL (U.S. CLS. 2, 12, 13, 14, 23, 25 AND 50).

### CLASS 14—JEWELRY

FOR WATCHES AND RINGS BEING JEWELRY (U.S. CLS. 2, 27, 28 AND 50).

### CLASS 15—MUSICAL INSTRUMENTS

FOR MUSICAL NOVELTY ITEMS, NAMELY HARMONICAS, WHISTLES AND RECORDERS (U.S. CLS. 2, 21 AND 36).

### CLASS 16—PAPER GOODS AND PRINTED MATTER

FOR PRINTED MATERIALS, NAMELY BOOK COVERS, PENCILS, PENS, GENERAL PURPOSE BAGS OF PLASTIC, PAPER BANNERS, BROCHURES IN THE FIELD OF MUSIC, INSTRUCTIONAL AND INFORMATIONAL BOOKS IN THE FIELD OF MUSIC, POSTERS, FLYERS IN THE FIELD OF MUSIC, HANDOUTS, PICTURES, PRINTED AWARDS DRAWING RULERS, BUSINESS CARDS AND PAPER FILE MUSIC JACKETS (U.S. CLS. 2, 5, 22, 23, 29, 37, 38 AND 50).

### CLASS 18—LEATHER GOODS

FOR GENERAL PURPOSE BAGS, FANNY PACKS AND BACK PACKS (U.S. CLS. 1, 2, 3, 22 AND 41).

### CLASS 20—FURNITURE AND ARTICLES NOT OTHERWISE CLASSIFIED

FOR PLAQUES, KEYCHAINS OF NON-METAL (U.S. CLS. 2, 13, 22, 25, 32 AND 50).

### CLASS 21—HOUSEWARES AND GLASS

FOR CUPS (U.S. CLS. 2, 13, 23, 29, 30, 33, 40 AND 50).

### CLASS 24—FABRICS

FOR TOWELS (U.S. CLS. 42 AND 50).

### CLASS 25—CLOTHING

FOR CLOTHING, NAMELY SHIRTS, TEE SHIRTS, JACKETS, COATS, SWEATERS, HATS, SOCKS, GLOVES AND BLOUSES (U.S. CLS. 22 AND 39).

### CLASS 41—EDUCATION AND ENTERTAINMENT

FOR MUSIC EDUCATION SERVICES, NAMELY PROVIDING INFORMATIONAL, INSTRUCTIONAL AND ENTERTAINING MUSICAL PROGRAMS AT SCHOOLS, IN THE ELEMENTARY TO HIGH SCHOOL LEVEL, TO FOSTER INTEREST IN MUSIC (U.S. CLS. 100, 101 AND 107).

## PRINTELLECT

### CLASS 9—ELECTRICAL AND SCIENTIFIC APPARATUS

FOR COMPUTER SOFTWARE, NAMELY A PROJECT CREATION AND SPECIFICATION TOOL THAT LEADS A PRINT BUYER THROUGH THE STEPS OF CREATING AND PLANNING A PRINTED PIECE STEP-BY-STEP (U.S. CLS. 21, 23, 26, 36 AND 38).

### CLASS 42—SCIENTIFIC, COMPUTER AND LEGAL SERVICES

FOR ONLINE COMPUTER SERVICES, NAMELY PROVIDING A PROJECT CREATION AND SPECIFICATION TOOL THAT LEADS A PRINT BUYER THROUGH THE STEPS OF CREATING AND PLANNING A PRINTED PIECE STEP-BY-STEP (U.S. CLS. 100 AND 101).

SN 75-899,324. ATI PROPERTIES INC., LOS ANGELES, CA.  
FILED 1-19-2000.

## ALLDYNE

### CLASS 6—METAL GOODS

FOR ALLOY AND METAL AGGREGATE COMPOSITIONS IN BOTH SOLID AND POWDER FORM FOR FURTHER MANUFACTURE; AND METALS IN VARIOUS PRODUCT FORMS INTENDED FOR TOOL AND DIE MANUFACTURING (U.S. CLS. 2, 12, 13, 14, 23, 25 AND 50).

### CLASS 7—MACHINERY

FOR CUTTING TOOLS, TOOL BLANKS AND TOOL BITS FOR POWER-OPERATED MACHINES FOR MILLING, DRILLING, TURNING, AND THREADING (U.S. CLS. 13, 19, 21, 23, 31, 34 AND 35).

### CLASS 9—ELECTRICAL AND SCIENTIFIC APPARATUS

FOR WELDING ELECTRODES (U.S. CLS. 21, 23, 26, 36 AND 38).

SN 75-901,237. EVIL TWIN PRODUCTIONS, LLC, SHERMAN  
OAKS, CA. FILED 1-21-2000.

## EVIL TWIN

### CLASS 35—ADVERTISING AND BUSINESS

FOR PREPARING AND PRODUCING ADVERTISING AND PROMOTIONAL PROGRAMMING FOR OTHERS; PROVIDING ADVERTISING AGENCY SERVICES; PREPARING AUDIOVISUAL RECORDINGS FOR USE IN THE ADVERTISING AND MARKETING FIELDS (U.S. CLS. 100, 101 AND 102).

FIRST USE 12-0-1995; IN COMMERCE 12-0-1995.

**CLASS 41—EDUCATION AND ENTERTAINMENT**

FOR ENTERTAINMENT SERVICES, NAMELY, PRODUCTION OF MOTION PICTURE FILMS, TELEVISION, AND RADIO, AUDIO AND VIDEO RECORDING AND PRODUCTION FOR USE IN GLOBAL COMPUTER NETWORK PROGRAMMING AND CONTENT; PRODUCTION OF AUDIO-VISUAL RECORDINGS (U.S. CLS. 100, 101 AND 107).

FIRST USE 12-0-1995; IN COMMERCE 12-0-1995.

**CLASS 41—EDUCATION AND ENTERTAINMENT**

FOR PROVIDING A WEBSITE ON GLOBAL COMPUTER NETWORKS, FEATURING INTERACTIVE GAMES AND EDUCATIONAL MATERIALS FOR CHILDREN; ENTERTAINMENT SERVICES, NAMELY, PROVIDING AN ON-LINE COMPUTER GAME (U.S. CLS. 100, 101 AND 107).

SN 75-902,400. DIGITAL DOCUMENTS, INC., DBA DOCUMENT DEPOT, PRINCETON, NJ. FILED 1-24-2000.

 The logo for DocumentDepot features a stylized 'D' with three horizontal lines extending from its left side, followed by the word 'DocumentDepot' in a bold, italicized serif font.

NO CLAIM IS MADE TO THE EXCLUSIVE RIGHT TO USE "DOCUMENT", APART FROM THE MARK AS SHOWN.

**CLASS 35—ADVERTISING AND BUSINESS**

FOR COPYING AND COLOR COPYING DOCUMENTS FOR OTHERS, TYPING, MAILING SERVICES, NAMELY, PREPARATION OF MAILING LISTS AND LABELS; PREPARATION, HANDLING AND SORTING OF PRINTED MATERIALS FOR MAILING (U.S. CLS. 100, 101 AND 102).

FIRST USE 7-15-1998; IN COMMERCE 7-15-1998.

**CLASS 40—MATERIAL TREATMENT**

FOR DIGITAL COMPRESSION OF PICTURES, BUSINESS FILES, AND COMPUTER DATA, DIGITAL IMAGING SERVICES, DIGITAL RESTORATION AND/OR ENHANCEMENT OF PHOTOGRAPHS, MEDIA DUPLICATION OF DATA AND DIGITAL INFORMATION (U.S. CLS. 100, 103 AND 106).

FIRST USE 7-15-1998; IN COMMERCE 7-15-1998.

**CLASS 42—SCIENTIFIC, COMPUTER AND LEGAL SERVICES**

FOR GRAPHIC ARTS DESIGN, PRINTING, WEB PAGE DESIGN FOR OTHERS, COMPUTER CONSULTING NAMELY DATABASE DEVELOPMENT SERVICES (U.S. CLS. 100 AND 101).

FIRST USE 7-15-1998; IN COMMERCE 7-15-1998.

SN 75-911,625. ROMAN, JULIO, BRONX, NY. FILED 2-7-2000.

 The logo for Wishers features a crown above the word 'Wishers' written in a decorative, cursive script.
**CLASS 9—ELECTRICAL AND SCIENTIFIC APPARATUS**

FOR INTERACTIVE MULTIMEDIA COMPUTER GAME PROGRAM (U.S. CLS. 21, 23, 26, 36 AND 38).

**CLASS 25—CLOTHING**

FOR T-SHIRTS (U.S. CLS. 22 AND 39).

SN 75-912,182. STEWART, J. JOSEPH, AUSTIN, TX. FILED 2-8-2000.

**the company that thinks like a Man**

**CLASS 25—CLOTHING**

FOR T-SHIRTS, SHIRTS, HATS, CAPS, JACKETS, COATS, PANTS (U.S. CLS. 22 AND 39).

FIRST USE 12-4-1999; IN COMMERCE 1-10-2000.

**CLASS 42—SCIENTIFIC, COMPUTER AND LEGAL SERVICES**

FOR ONLINE INFORMATION SERVICES FOR MEN FEATURING INFORMATION ON A WIDE VARIETY OF TOPICS OF GENERAL INTEREST TO MEN (U.S. CLS. 100 AND 101).

FIRST USE 12-4-1999; IN COMMERCE 1-10-2000.

SN 75-912,805. OTTO BOCK ORTHOPADISCHE INDUSTRIE GMBH & CO., 37115 DUDERSTADT, FED REP GERMANY, FILED 2-8-2000.

**DMC PLUS**

PRIORITY CLAIMED UNDER SEC. 44(D) ON FED REP GERMANY APPLICATION NO. 39961156, FILED 10-2-1999, REG. NO. 39961156, DATED 11-12-1999, EXPIRES 10-31-2009.

**CLASS 9—ELECTRICAL AND SCIENTIFIC APPARATUS**

FOR ELECTRICAL CONTROLLERS FOR ARTIFICIAL LIMBS THAT SENSE PRESSURE AND BODY POTENTIAL AND MEASURE UNITS OF PRESSURE, BODY POTENTIAL AND POSITIONING FOR ARTIFICIAL LIMBS (U.S. CLS. 21, 23, 26, 36 AND 38).

**CLASS 10—MEDICAL APPARATUS**

FOR ARTIFICIAL LIMBS, PROSTHESES, NAMELY MYOELECTRICAL FOOT, LEG, ARM, FINGER AND KNEE PROSTHESES AND ARTIFICIAL HANDS (U.S. CLS. 26, 39 AND 44).



SN 75-914,157. WHEREAS.COM, INC., HOUSTON, TX.  
FILED 2-9-2000.

## WHEREAS.COM

### CLASS 41—EDUCATION AND ENTERTAINMENT

FOR EDUCATIONAL SERVICES, NAMELY, PROVIDING CONTINUING EDUCATION CLASSES, WORKSHOPS, SEMINARS, AND CONFERENCES FOR LAWYERS, ACCOUNTANTS, LEGAL, BUSINESS, ACCOUNTING, AND FINANCE PROFESSIONALS (U.S. CLS. 100, 101 AND 107).

### CLASS 42—SCIENTIFIC, COMPUTER AND LEGAL SERVICES

FOR CONSULTATION REGARDING CONTINUING EDUCATION AND TOPICS OF GENERAL INTEREST TO LEGAL, BUSINESS, ACCOUNTING, AND FINANCE PROFESSIONALS AVAILABLE VIA A GLOBAL COMMUNICATIONS NETWORK (U.S. CLS. 100 AND 101).

SN 75-918,200. INNOVATIVE INTERFACES, INC., EMERYVILLE, CA. FILED 2-14-2000.

**INNOVATIVE**  
i n t e r f a c e s

NO CLAIM IS MADE TO THE EXCLUSIVE RIGHT TO USE "INTERFACES", APART FROM THE MARK AS SHOWN.

### CLASS 9—ELECTRICAL AND SCIENTIFIC APPARATUS

FOR COMPUTER SOFTWARE, NAMELY FOR USE IN ORGANIZING LIBRARY RESOURCES ACCORDING TO THE DEWEY DECIMAL CLASSIFICATION OR OTHER PERSONAL DATA ORGANIZATION USED BY INSTITUTIONAL LIBRARIES (U.S. CLS. 21, 23, 26, 36 AND 38).  
FIRST USE 12-29-1978; IN COMMERCE 12-29-1978.

### CLASS 37—CONSTRUCTION AND REPAIR

FOR INSTALLATION, REPAIR, AND MAINTENANCE OF COMPUTER HARDWARE USED IN CONNECTION WITH AUTOMATION OF LIBRARY SYSTEMS, NAMELY FILING, CATEGORIZATION, CHECK-OUT, CHECK-IN, REFERENCE, ORDERING, PURCHASE, AND CATALOGING SYSTEMS, SAID SYSTEMS ACCESSIBLE VIA THE INTERNET (U.S. CLS. 100, 103 AND 106).  
FIRST USE 12-29-1978; IN COMMERCE 12-29-1978.

### CLASS 42—SCIENTIFIC, COMPUTER AND LEGAL SERVICES

FOR DESIGN FOR OTHERS, INSTALLATION, REPAIR, AND MAINTENANCE OF COMPUTER SOFTWARE USED IN CONNECTION WITH AUTOMATION OF LIBRARY SYSTEMS, NAMELY FILING, CATEGORIZATION, CHECK-OUT, CHECK-IN, REFERENCE, ORDERING, PURCHASE, AND CATALOGING SYSTEMS, SAID SYSTEMS ACCESSIBLE VIA THE INTERNET (U.S. CLS. 100 AND 101).  
FIRST USE 12-29-1978; IN COMMERCE 12-29-1978.

SN 75-918,819. FRANCE TELECOM INTERACTIVE, FRANCE, FILED 2-14-2000.

**Wanadoo**

PRIORITY CLAIMED UNDER SEC. 44(D) ON FRANCE APPLICATION NO. 99/807760, FILED 8-13-1999, REG. NO. 99807760, DATED 8-13-1999, EXPIRES 8-13-2009.  
OWNER OF U.S. REG. NO. 2,060,671.

### CLASS 9—ELECTRICAL AND SCIENTIFIC APPARATUS

FOR COMPUTERS, COMPUTER PERIPHERALS, COMPUTER MODEMS, DATA PROCESSORS, TELEPHONE AND TELECOPY TRANSMITTERS, COMPUTERS FOR USE IN TEACHING; COMPUTER PROGRAMS FOR THE PURPOSE OF PROVIDING ACCESS TO THE INTERNET; CASSETTE TAPE RECORDERS, VIDEO TAPE RECORDERS, CD-ROM RECORDERS; RADIO, TELEVISION AND WEB TRANSMITTERS; RADIOS, TELEVISION SETS, MONITORS, CD PLAYERS; BLANK MAGNETIC DATA MEDIA, BLANK OPTICAL DISCS (U.S. CLS. 21, 23, 26, 36 AND 38).

### CLASS 38—COMMUNICATION

FOR TELECOMMUNICATION SERVICES, NAMELY, PROVIDING TELECOMMUNICATION CONNECTIONS TO A GLOBAL COMPUTER AND DATABASE NETWORK; RADIO BROADCASTING, COMMUNICATION BY TELEGRAMS, BY ELECTRONIC TRANSMISSION OF MESSAGES AND DATA, OR BY TELEPHONE; ELECTRONIC TRANSMISSION OF DATA AND DOCUMENTS VIA COMPUTER TERMINALS; COMPUTER-AIDED TRANSMISSION OF MESSAGES AND IMAGES; PROVIDING INFORMATION ABOUT TELECOMMUNICATIONS; TELEPHONES AND PAGERS; ELECTRONIC MAIL SERVICES; PROVIDING MULTIPLE-USER ACCESS TIME, VIA LEASE, TO A GLOBAL COMPUTER INFORMATION NETWORK FOR THE TRANSFER AND DISSEMINATION OF A WIDE RANGE OF INFORMATION (U.S. CLS. 100, 101 AND 104).

### CLASS 42—SCIENTIFIC, COMPUTER AND LEGAL SERVICES

FOR PROVIDING INFORMATION IN THE FIELD OF COMPUTERS AND COMPUTER SOFTWARE; COMPUTER SOFTWARE DESIGN FOR OTHERS; COMPUTER HARDWARE AND SOFTWARE CONSULTING; COMPUTER, COMPUTER SOFTWARE AND SOFTWARE PACKAGE RENTAL; RENTAL OF PERSONAL COMPUTERS; DESIGN OF SOFTWARE PACKAGES FOR OTHERS; COMPUTER PROGRAMMING; PROFESSIONAL CONSULTING IN THE FIELD OF WEB SITE HOSTING AND WEB SITE DESIGN; VIDEOTAPING SERVICES; PROVIDING FACILITIES FOR EXHIBITIONS (U.S. CLS. 100 AND 101).

SN 75-919,141. LOUFRANI, FRANKLIN, LONDON, ENGLAND, FILED 2-15-2000.

**SMILEY**

OWNER OF U.S. REG. NOS. 957,363, 1,148,450 AND 1,154,955.

**CLASS 9—ELECTRICAL AND SCIENTIFIC APPARATUS**

FOR PROTECTIVE SPORTING HELMETS (U.S. CLS. 21, 23, 26, 36 AND 38).  
FIRST USE 5-16-1988; IN COMMERCE 5-16-1988.

**CLASS 28—TOYS AND SPORTING GOODS**

FOR TOYS, NAMELY PLUSH STUFFED TOYS AND PLASTIC BALLS, LATEX BALLS AND SQUEEZABLE BALLS; SPORTING GOODS, NAMELY KNEE PADS (U.S. CLS. 22, 23, 38 AND 50).  
FIRST USE 5-16-1988; IN COMMERCE 5-16-1988.

---

SN 75-926,308. COMMONVISION, L.L.C., HOUSTON, TX.  
FILED 2-23-2000.

## CommonPortal

THE MARK CONSISTS OF ONE WORD, WITH ALL LETTERS EXCEPT FOR THE LETTERS "C" AND "P" WRITTEN WITH SMALL LETTERS. "C" AND "P" ARE WRITTEN IN CAPITAL LETTERS.

**CLASS 35—ADVERTISING AND BUSINESS**

FOR BUSINESS MANAGEMENT AND CONSULTING SERVICES FOR AUGMENTING STAFF BY USING COMPUTER SOFTWARE (U.S. CLS. 100, 101 AND 102).

**CLASS 41—EDUCATION AND ENTERTAINMENT**

FOR CONDUCTING CLASSES AND SEMINARS IN THE FIELD OF COMPUTER PROGRAMMING INCLUDING SPECIFIC LANGUAGES AND MANIPULATION OF SOFTWARE (U.S. CLS. 100, 101 AND 107).

**CLASS 42—SCIENTIFIC, COMPUTER AND LEGAL SERVICES**

FOR DESIGN AND DEVELOPMENT OF COMPUTER PROGRAMS FOR OTHERS; CONSULTATION FOR DESIGN AND DEVELOPMENT OF COMPUTER SOFTWARE (U.S. CLS. 100 AND 101).

---

SN 75-927,683. BUCHER-BUCHNER EDITION MAX BUCHNER, D-30161 HANNOVER, FED REP GERMANY, FILED 2-25-2000.

## ARS MUNDI (stylized)

OWNER OF ERPN CMNTY TM OFC REG. NO. 000266759, DATED 9-17-1998, EXPIRES 5-20-2006.  
THE MARK MEANS "ART OF THE WORLD".

**CLASS 6—METAL GOODS**

FOR PREPRODUCTION OF ART WORK MADE OF OR ON NONPRECIOUS METAL NAMELY METAL STAMPS, STATUES AND FIGURINES (U.S. CLS. 2, 12, 13, 14, 23, 25 AND 50).

**CLASS 14—JEWELRY**

FOR REPRODUCTIONS OF JEWELS WITH HISTORIC AND ARTISTIC VALUE, NAMELY NECKLACES, RINGS AND BRACELETS (U.S. CLS. 2, 27, 28 AND 50).

**CLASS 16—PAPER GOODS AND PRINTED MATTER**

FOR REPRODUCTIONS OF ART WORK MADE OF OR ON PAPER, NAMELY ART PRINTS, DRAWINGS AND PAINTINGS (U.S. CLS. 2, 5, 22, 23, 29, 37, 38 AND 50).

**CLASS 19—NON-METALLIC BUILDING MATERIALS**

FOR REPRODUCTIONS OF ART WORK MADE OF OR ON STONE, NAMELY STATUES BUSTS AND FIGURINES (U.S. CLS. 1, 12, 33 AND 50).

**CLASS 20—FURNITURE AND ARTICLES NOT OTHERWISE CLASSIFIED**

FOR REPRODUCTIONS OF ART WORK MADE OF OR ON WOOD OR PLASTIC MATERIAL, NAMELY STATUES, BUSTS AND FIGURINES (U.S. CLS. 2, 13, 22, 25, 32 AND 50).

**CLASS 21—HOUSEWARES AND GLASS**

FOR REPRODUCTIONS OF ART WORK MADE OF OR ON CERAMIC, NAMELY STATUES BUSTS AND FIGURINES (U.S. CLS. 2, 13, 23, 29, 30, 33, 40 AND 50).

**CLASS 24—FABRICS**

FOR REPRODUCTIONS OF ART WORK MADE OF OR ON TEXTILES, NAMELY TEXTILE PRINTS, WALL HANGINGS AND WALL CARPETS (U.S. CLS. 42 AND 50).

---

SN 75-932,576. TPI RESTAURANT HOLDINGS, INC., NEW YORK, NY. FILED 3-1-2000.

## DESTINO

THE ENGLISH TRANSLATION OF THE WORD "DESTINO" IN THE MARK IS "DESTINY" OR "FATE".

**CLASS 39—TRANSPORTATION AND STORAGE**

FOR DELIVERY OF FOOD BY RESTAURANTS; FOOD DELIVERY (U.S. CLS. 100 AND 105).  
FIRST USE 8-27-1998; IN COMMERCE 8-27-1998.

**CLASS 42—SCIENTIFIC, COMPUTER AND LEGAL SERVICES**

FOR RESTAURANT SERVICES; CONTRACT FOOD SERVICES (U.S. CLS. 100 AND 101).  
FIRST USE 8-27-1998; IN COMMERCE 8-27-1998.

SN 75-932,926. PACIFIC SUNSET, AGOURA HILLS, CA.  
FILED 3-2-2000.

## JETCAMS

### CLASS 39—TRANSPORTATION AND STORAGE

FOR AIRCRAFT RENTAL SERVICES (U.S. CLS. 100 AND 105).

### CLASS 42—SCIENTIFIC, COMPUTER AND LEGAL SERVICES

FOR HIGH SPEED AERIAL PHOTOGRAPHY AND CINEMATOGRAPHY SERVICES (U.S. CLS. 100 AND 101).

---

SN 75-933,954. GOLD KIST INC., ATLANTA, GA. FILED 3-3-2000.

## DINNER IN A DASH

NO CLAIM IS MADE TO THE EXCLUSIVE RIGHT TO USE "DINNER", APART FROM THE MARK AS SHOWN.

### CLASS 29—MEATS AND PROCESSED FOODS

FOR PREPARED ENTREES CONSISTING PRIMARILY OF CHICKEN AND VEGETABLES (U.S. CL. 46).

### CLASS 30—STAPLE FOODS

FOR PREPARED ENTREES CONSISTING PRIMARILY OF PASTA OR RICE (U.S. CL. 46).

---

SN 75-936,537. ESTARA, INC., RESTON, VA. BY CHANGE OF NAME PUBLICWEBPHONE INC., RESTON, VA. FILED 3-6-2000.

## eStara

### CLASS 9—ELECTRICAL AND SCIENTIFIC APPARATUS

FOR VOICE ENABLING COMPUTER SOFTWARE FOCUSING SPECIFICALLY ON MAKING VOICE COMMUNICATIONS OVER GLOBAL COMPUTER INFORMATION NETWORKS MORE READILY AVAILABLE OR MORE PUBLICLY AVAILABLE (U.S. CLS. 21, 23, 26, 36 AND 38).

### CLASS 38—COMMUNICATION

FOR INTERNET-BASED TELEPHONE COMMUNICATIONS SERVICES, NAMELY, PROVIDING VOICE COMMUNICATIONS OVER GLOBAL COMPUTER INFORMATION NETWORKS (U.S. CLS. 100, 101 AND 104).

SN 75-936,683. CONAIR CORPORATION, STAMFORD, CT.  
FILED 3-4-2000.

## PLIMATIC

### CLASS 11—ENVIRONMENTAL CONTROL APPARATUS

FOR HAND HELD ELECTRIC HAIR DRYERS (U.S. CLS. 13, 21, 23, 31 AND 34).  
FIRST USE 11-1-1999; IN COMMERCE 11-1-1999.

### CLASS 20—FURNITURE AND ARTICLES NOT OTHERWISE CLASSIFIED

FOR NON-ELECTRIC HAND HELD MIRRORS (U.S. CLS. 2, 13, 22, 25, 32 AND 50).  
FIRST USE 12-1-1999; IN COMMERCE 12-1-1999.

### CLASS 21—HOUSEWARES AND GLASS

FOR NON-ELECTRIC HAIR BRUSHES (U.S. CLS. 2, 13, 23, 29, 30, 33, 40 AND 50).  
FIRST USE 12-1-1999; IN COMMERCE 12-1-1999.

---

SN 75-937,011. SAILER, JEFFREY W., STOCKTON, NJ.  
FILED 3-6-2000.



NO CLAIM IS MADE TO THE EXCLUSIVE RIGHT TO USE "NJ" AND "THE MAP OF THE STATE OF NEW JERSEY", APART FROM THE MARK AS SHOWN.

### CLASS 35—ADVERTISING AND BUSINESS

FOR PREPARING ADVERTISEMENTS FOR OTHERS (U.S. CLS. 100, 101 AND 102).  
FIRST USE 2-1-2000; IN COMMERCE 2-1-2000.

### CLASS 42—SCIENTIFIC, COMPUTER AND LEGAL SERVICES

FOR COMPUTER SERVICES, NAMELY DESIGNING AND IMPLEMENTING WEBSITES FOR OTHERS; GRAPHIC ART DESIGN FOR OTHERS; PROVIDING INFORMATION RELATED TO NEW JERSEY OVER A GLOBAL COMPUTER NETWORK (U.S. CLS. 100 AND 101).  
FIRST USE 2-1-2000; IN COMMERCE 2-1-2000.

SN 75-937,830. SHAKLEE CORPORATION, PLEASANTON, CA. BY CHANGE OF NAME; BY ASSIGNMENT SHAKLEE CORPORATION, PLEASANTON, CA. FILED 3-7-2000.

## WELLNESS NAVIGATOR

NO CLAIM IS MADE TO THE EXCLUSIVE RIGHT TO USE "WELLNESS", APART FROM THE MARK AS SHOWN.

### CLASS 9—ELECTRICAL AND SCIENTIFIC APPARATUS

FOR COMPUTER SOFTWARE FOR USE BY PHYSICIANS TO PROFILE THE HEALTH OF A PATIENT (U.S. CLS. 21, 23, 26, 36 AND 38).

### CLASS 35—ADVERTISING AND BUSINESS

FOR PROVIDING AN ONLINE INTERACTIVE WEBSITE FOR PRODUCT RECOMMENDATIONS BASED UPON THE USER'S INTEREST AND WELLNESS LEVEL (U.S. CLS. 100, 101 AND 102).

### CLASS 42—SCIENTIFIC, COMPUTER AND LEGAL SERVICES

FOR PROVIDING INFORMATION IN THE FIELDS OF HEALTH AND NUTRITION BY MEANS OF A GLOBAL COMPUTER INFORMATION NETWORK (U.S. CLS. 100 AND 101).

SN 75-939,365. GLOBAL PATENTS CORP., CARACAS, VENEZUELA, FILED 3-9-2000.

## X-TERIL

### CLASS 3—COSMETICS AND CLEANING PREPARATIONS

FOR DISINFECTANT SOAPS (U.S. CLS. 1, 4, 6, 50, 51 AND 52).

### CLASS 5—PHARMACEUTICALS

FOR ALL-PURPOSE DISINFECTANT, DISINFECTANT FOR CONTACT LENSES, DISINFECTANT FOR MEDICAL INSTRUMENT AND EQUIPMENT, DISINFECTANT FOR LIVING HUMAN AND ANIMAL PATIENTS, DISINFECTANT FOR FOODS, PLANTS AND CONTAMINATED FLUID BODIES (U.S. CLS. 6, 18, 44, 46, 51 AND 52).

SN 75-940,771. LEXINGTON FURNITURE INDUSTRIES, INC., LEXINGTON, NC. FILED 3-9-2000.

## LEXINGTON HOME BRANDS

OWNER OF U.S. REG. NOS. 831,030, 1,504,866 AND OTHERS.

NO CLAIM IS MADE TO THE EXCLUSIVE RIGHT TO USE "BRANDS", APART FROM THE MARK AS SHOWN.

### CLASS 20—FURNITURE AND ARTICLES NOT OTHERWISE CLASSIFIED

FOR FURNITURE (U.S. CLS. 2, 13, 22, 25, 32 AND 50).

### CLASS 35—ADVERTISING AND BUSINESS

FOR RETAIL FURNITURE STORE SERVICES; AND RETAIL STORE PRODUCT MERCHANDISING DISPLAY SERVICES FEATURING DEDICATED SPACE FOR A SINGLE BRAND (U.S. CLS. 100, 101 AND 102).

SN 75-941,353. EC SERVICES, INC., SANTA ANA, CA. FILED 3-10-2000.

## TRANSACTION POINT

### CLASS 35—ADVERTISING AND BUSINESS

FOR COMPUTERIZED ON-LINE TRACING OF DOCUMENTS AND PARCELS DELIVERED BY AIR AND COURIER (U.S. CLS. 100, 101 AND 102).

### CLASS 42—SCIENTIFIC, COMPUTER AND LEGAL SERVICES

FOR TITLE SEARCHING; PROVIDING TEMPORARY USE OF ON-LINE NON-DOWNLOADABLE SOFTWARE FOR INFORMATION ABOUT THE SHIPMENT OF PARCELS, PACKAGES AND LETTERS, INFORMATION REGARDING INSPECTIONS AND APPRAISALS OF SHIPPED GOODS, INFORMATION REGARDING ON-LINE TRANSACTION HISTORIES OF SHIPPED GOODS, INFORMATION REGARDING STATUS OF TITLE TRANSFERS OF SHIPPED GOODS, DATABASE MANAGEMENT REGARDING FINANCIAL DOCUMENTS, NAMELY BILLS OF LADING, PACKING LISTS, INSURANCE COMPLIANCE VERIFICATIONS, AND FREIGHT FORWARDER INTEGRATION (U.S. CLS. 100 AND 101).

SN 75-943,165. HEALTHY TO-GO, INC., DBA GLORIA'S KITCHEN, BURLINGAME, CA. FILED 3-14-2000.



NO CLAIM IS MADE TO THE EXCLUSIVE RIGHT TO USE "KITCHEN", APART FROM THE MARK AS SHOWN.

### CLASS 29—MEATS AND PROCESSED FOODS

FOR FROZEN ENTREES CONSISTING PRIMARILY OF MEAT, FISH, POULTRY OR VEGETABLES (U.S. CL. 46).

FIRST USE 1-0-1996; IN COMMERCE 1-0-1996.

### CLASS 30—STAPLE FOODS

FOR FROZEN ENTREES CONSISTING PRIMARILY OF PASTA OR RICE (U.S. CL. 46).

FIRST USE 1-0-1996; IN COMMERCE 1-0-1996.

SN 75-950,359. PILLSBURY COMPANY, THE, MINNEAPOLIS, MN. FILED 2-29-2000.



OWNER OF U.S. REG. NOS. 561,646, 942,910 AND OTHERS.

**CLASS 29—MEATS AND PROCESSED FOODS**

FOR FROZEN DINNER MIX CONSISTING PRIMARILY OF VEGETABLES; FROZEN DINNER MIX CONSISTING PRIMARILY OF VEGETABLES AND CONTAINING SMALLER PORTIONS RICE OR PASTA (U.S. CL. 46).  
FIRST USE 6-30-1999; IN COMMERCE 6-30-1999.

**CLASS 30—STAPLE FOODS**

FOR FROZEN DINNER MIX CONSISTING PRIMARILY OF PASTA; FROZEN DINNER MIX CONSISTING PRIMARILY OF PASTA OR RICE AND CONTAINING SMALLER PORTIONS OF VEGETABLES (U.S. CL. 46).  
FIRST USE 6-30-1999; IN COMMERCE 6-30-1999.

SN 75-980,246. ONTONE, INC., NEW YORK, NY. BY CHANGE OF NAME CASUALPLANET INC., NEW YORK, NY. FILED 1-29-2000.

**ONTONE**

**CLASS 9—ELECTRICAL AND SCIENTIFIC APPARATUS**

FOR SUNGLASSES (U.S. CLS. 21, 23, 26, 36 AND 38).  
FIRST USE 6-29-2000; IN COMMERCE 6-29-2000.

**CLASS 25—CLOTHING**

FOR CLOTHING FOR MEN AND WOMEN, NAMELY, SHIRTS, PANTS, T-SHIRTS, SWEATSHIRTS, SWEATPANTS, SWEATERS, SHORTS, JACKETS, COATS, SOCKS, FOOTWEAR, BELTS, HATS AND SCARVES (U.S. CLS. 22 AND 39).  
FIRST USE 6-29-2000; IN COMMERCE 6-29-2000.

SN 75-981,167. BAPTISTA'S BAKERY, INC., FRANKLIN, WI. FILED 4-7-2000.

**GOODNESS FROM THE HEART**

**CLASS 29—MEATS AND PROCESSED FOODS**

FOR EDIBLE OILS, NAMELY, OLIVE OIL; MEATS, NAMELY, HAM AND PROSCIUTTO HAM; TOPPINGS; SPREADS, NAMELY JELLIES JAMS AND PRESERVES (U.S. CL. 46).

**CLASS 30—STAPLE FOODS**

FOR SNACKS, BISCOTTI-TYPE BREAD SNACKS AND COOKIES (U.S. CL. 46).

SN 75-981,413. POLISHED INC., BOSTON, MA. FILED 4-19-2000.



**CLASS 35—ADVERTISING AND BUSINESS**

FOR RETAIL STORE SERVICES FEATURING BEAUTY CARE AND SPA SERVICES (U.S. CLS. 100, 101 AND 102).  
FIRST USE 12-21-2000; IN COMMERCE 12-21-2000.

**CLASS 42—SCIENTIFIC, COMPUTER AND LEGAL SERVICES**

FOR BEAUTY SALONS AND HEALTH SPA SERVICES (U.S. CLS. 100 AND 101).  
FIRST USE 12-21-2000; IN COMMERCE 12-21-2000.

SN 75-981,414. POLISHED INC., BOSTON, MA. FILED 4-19-2000.



**POLISHED**

**CLASS 35—ADVERTISING AND BUSINESS**

FOR RETAIL STORE SERVICES FEATURING BEAUTY CARE AND SPA SERVICES (U.S. CLS. 100, 101 AND 102).  
FIRST USE 12-21-2000; IN COMMERCE 12-21-2000.

**CLASS 42—SCIENTIFIC, COMPUTER AND LEGAL SERVICES**

FOR BEAUTY SALONS AND HEALTH SPA SERVICES (U.S. CLS. 100 AND 101).  
FIRST USE 12-21-2000; IN COMMERCE 12-21-2000.

SN 76-000,887. OKUMUS ENTERPRISES, LTD., DBA STAR LABEL PRODUCTS, PHILADELPHIA, PA. FILED 3-15-2000.



NO CLAIM IS MADE TO THE EXCLUSIVE RIGHT TO USE "LABEL PRODUCTS", APART FROM THE MARK AS SHOWN.

**CLASS 6—METAL GOODS**

FOR METAL NAMEPLATES (U.S. CLS. 2, 12, 13, 14, 23, 25 AND 50).  
FIRST USE 1-1-1980; IN COMMERCE 1-1-1980.

**CLASS 16—PAPER GOODS AND PRINTED MATTER**

FOR BLANK LABELS, PARTIALLY PRINTED LABELS, PRINTED LABELS, TAGS, DECALS AND ENVELOPES FOR PACKING LISTS, ALL NOT OF TEXTILE, AND LABEL DISPENSERS (U.S. CLS. 2, 5, 22, 23, 29, 37, 38 AND 50).  
FIRST USE 1-1-1980; IN COMMERCE 1-1-1980.

**CLASS 20—FURNITURE AND ARTICLES NOT OTHERWISE CLASSIFIED**

FOR NON-METAL NAMEPLATES (U.S. CLS. 2, 13, 22, 25, 32 AND 50).  
FIRST USE 1-1-1980; IN COMMERCE 1-1-1980.

**CLASS 42—SCIENTIFIC, COMPUTER AND LEGAL SERVICES**

FOR CUSTOM DESIGN AND PRINTING OF LABELS, TAGS, DECALS, NAMEPLATES AND FOLDING BOXES (U.S. CLS. 100 AND 101).  
FIRST USE 1-1-1980; IN COMMERCE 1-1-1980.

SN 76-001,901. SERAC SPORTS LTD., CALGARY, ALBERTA T2P 4K9, CANADA. FILED 3-16-2000.

**SERAC**

**CLASS 18—LEATHER GOODS**

FOR BACK PACKS (U.S. CLS. 1, 2, 3, 22 AND 41).  
FIRST USE 0-0-1992; IN COMMERCE 0-0-1992.

**CLASS 20—FURNITURE AND ARTICLES NOT OTHERWISE CLASSIFIED**

FOR SLEEPING BAGS (U.S. CLS. 2, 13, 22, 25, 32 AND 50).  
FIRST USE 0-0-1992; IN COMMERCE 0-0-1992.

SN 76-002,494. PALI S.P.A., I-33048 S. GIOVANNI AL NATISONE (UD), ITALY, FILED 3-17-2000.



NO CLAIM IS MADE TO THE EXCLUSIVE RIGHT TO USE "SINCE 1919" "MADE IN ITALY", APART FROM THE MARK AS SHOWN.

THE STIPPLING IS FOR SHADING PURPOSES ONLY AND DOES NOT INDICATE COLOR.

**CLASS 24—FABRICS**

FOR CHILDREN'S BED LINEN, NAMELY, SHEETS, BLANKETS, COVERS AND QUILTS (U.S. CLS. 42 AND 50).

**CLASS 28—TOYS AND SPORTING GOODS**

FOR TOYS MADE OF WOOD, NAMELY, ROCKING HORSES, PLAY HOUSES, PLAY CHAIRS, LITTLE CARTS, BLOCKS, PUZZLES, STROLLERS, CRADLES, WAGONS, CARS, TRUCKS, TRAINS, BOATS, AIRPLANES, DOLLS, DOLL HOUSES AND ANIMALS (U.S. CLS. 22, 23, 38 AND 50).

SN 76-003,018. WINTER PARK RECREATIONAL ASSOCIATION, WINTER PARK, CO. FILED 3-17-2000.



NO CLAIM IS MADE TO THE EXCLUSIVE RIGHT TO USE "WEST PORTAL", "RENTALS", AND "REPAIRS", APART FROM THE MARK AS SHOWN.

"THE MARK CONSISTS OF "WEST PORTAL RENTALS AND REPAIRS" WITH FANCIFUL DESIGN OF LETTERS "R".

**CLASS 35—ADVERTISING AND BUSINESS**

FOR RETAIL STORE SERVICES FEATURING SKIS, SNOWBOARDS, BOOTS, AND RELATED EQUIPMENT (U.S. CLS. 100, 101 AND 102).  
FIRST USE 11-17-1999; IN COMMERCE 11-17-1999.

**CLASS 37—CONSTRUCTION AND REPAIR**

FOR MAINTENANCE AND REPAIR OF SKIS, SNOWBOARDS, BOOTS, AND RELATED EQUIPMENT; MAINTENANCE SERVICE PROGRAM FOR SKIS, SNOWBOARDS, BOOTS AND RELATED EQUIPMENT (U.S. CLS. 100, 103 AND 106).

FIRST USE 11-17-1999; IN COMMERCE 11-17-1999.

**CLASS 41—EDUCATION AND ENTERTAINMENT**

FOR RENTAL OF SKIS, SNOWBOARDS, BOOTS, AND RELATED EQUIPMENT (U.S. CLS. 100, 101 AND 107).

FIRST USE 11-17-1999; IN COMMERCE 11-17-1999.

---

SN 76-005,573. TWENTIETH CENTURY FOX FILM CORPORATION, LOS ANGELES, CA. FILED 3-16-2000.

**FOXPLORATION**

OWNER OF U.S. REG. NO. 1,924,143.

**CLASS 39—TRANSPORTATION AND STORAGE**

FOR SIGHTSEEING TOURS OF MOTION PICTURE AND TELEVISION PRODUCTION FACILITIES (U.S. CLS. 100 AND 105).

**CLASS 41—EDUCATION AND ENTERTAINMENT**

FOR ENTERTAINMENT SERVICES IN THE NATURE OF PRODUCTION AND DISTRIBUTION OF MOTION PICTURE FILMS AND TELEVISION PROGRAMS; CONDUCTING ENTERTAINMENT EXHIBITIONS IN THE FIELD OF MOTION PICTURE AND TELEVISION PRODUCTION; EDUCATIONAL DEMONSTRATIONS; CINEMA THEATER SERVICES; PROVIDING ON-LINE INFORMATION IN THE FIELD OF ENTERTAINMENT AND EDUCATION VIA THE INTERNET (U.S. CLS. 100, 101 AND 107).

---

SN 76-013,821. HEALTHGROOVE, INC., PLANTATION, FL. FILED 3-30-2000.

**HEALTHGROOVE****CLASS 9—ELECTRICAL AND SCIENTIFIC APPARATUS**

FOR PRERECORDED VIDEO AND AUDIOTAPES IN THE FIELD OF HEALTH, FITNESS AND DIET (U.S. CLS. 21, 23, 26, 36 AND 38).

**CLASS 16—PAPER GOODS AND PRINTED MATTER**

FOR PRINTED BOOKS, NEWSLETTERS, MAGAZINES, BOOKLETS AND FORMS IN THE FIELD OF HEALTH, FITNESS AND DIET (U.S. CLS. 2, 5, 22, 23, 29, 37, 38 AND 50).

**CLASS 41—EDUCATION AND ENTERTAINMENT**

FOR EDUCATIONAL SERVICES, NAMELY CONDUCTING CLASSES, WORKSHOPS, COURSES OF INSTRUCTION AND SEMINARS IN THE FIELD OF HEALTH, FITNESS AND DIET AND DISTRIBUTING PRINTED COURSE MATERIALS IN THE FORM OF RELATED ARTICLES AND NEWSLETTERS ON HEALTH, FITNESS AND DIET IN CONNECTION THEREWITH (U.S. CLS. 100, 101 AND 107).

**CLASS 42—SCIENTIFIC, COMPUTER AND LEGAL SERVICES**

FOR MEDICAL, NUTRITION, BEHAVIORAL AND FITNESS COUNSELING SERVICES IN THE FIELD OF HEALTH, FITNESS AND DIET AND DISTRIBUTING PRINTED COURSE MATERIALS IN THE FORM OF RELATED ARTICLES AND NEWSLETTERS ON HEALTH, FITNESS, AND DIET IN CONNECTION THEREWITH AND PROVIDING INSTRUCTION IN THE FIELD OF HEALTH, FITNESS, AND DIET ONLINE VIA A GLOBALLY ACCESSIBLE NETWORK (U.S. CLS. 100 AND 101).

---

SN 76-014,377. COCHRAN-STYLES, PAULA, DBA WHITE ELEPHANT SERIES/WES, CINCINNATI, OH. FILED 3-31-2000.



NO CLAIM IS MADE TO THE EXCLUSIVE RIGHT TO USE "SERIES", APART FROM THE MARK AS SHOWN.

THE MARK CONSISTS OF AN ELEPHANT WEARING GLASSES. THE LENSES AND FRAMES OF THE GLASSES IN THE MARK ARE THE COLOR MAGENTA. THE INSIDE OF THE ELEPHANT'S EARS ARE THE COLOR HOT PINK. THE MARK CONSISTS IN PART OF THE LETTERS "WES" ON THE ELEPHANT'S CHEST. THE LETTERS ON THE ELEPHANT'S CHEST REPRESENT THE NAME "WHITE ELEPHANT SERIES". THE LINING ON THE ELEPHANT'S FACE IS A FEATURE OF THE MARK AND IS NOT INTENDED TO INDICATE COLOR. THE OUTLINE OF THE MARK IS BLACK. THE INSIDE COLOR OF THE ELEPHANT IS WHITE. THE WORDING "WHITE ELEPHANT SERIES" UNDER THE DRAWING IS THE COLOR OF MAGENTA, AND IS ITALICIZED.

**CLASS 16—PAPER GOODS AND PRINTED MATTER**

FOR EDUCATIONAL BOOKS IN THE FIELD OF MENTAL HEALTH (U.S. CLS. 2, 5, 22, 23, 29, 37, 38 AND 50).

**CLASS 42—SCIENTIFIC, COMPUTER AND LEGAL SERVICES**

FOR MENTAL HEALTH CONSULTING SERVICES (U.S. CLS. 100 AND 101).

SN 76-017,572. BOX WORLDWIDE, LLC, THE, MIAMI BEACH, FL. FILED 4-4-2000.

SN 76-018,609. SYMBIOTICS, INC., SEDONA, AZ. FILED 4-5-2000.



### CLASS 38—COMMUNICATION

FOR COMMUNICATION SERVICES, NAMELY, TELEVISION BROADCASTING VIA RADIO, CABLE, AND SATELLITE; BROADCASTING OF RADIO PROGRAMS, TELEVISION PROGRAMS, MULTIMEDIA PROGRAMMING VIA A GLOBAL COMPUTER NETWORK (U.S. CLS. 100, 101 AND 104).

FIRST USE 12-1-1999; IN COMMERCE 12-1-1999.

### CLASS 41—EDUCATION AND ENTERTAINMENT

FOR PROVIDING A WEBSITE FEATURING INFORMATION IN THE FIELD OF ENTERTAINMENT NAMELY, TELEVISION PROGRAMS, MUSIC, MUSIC VIDEOS, CONCERTS AND ARTISTS (U.S. CLS. 100, 101 AND 107).

FIRST USE 12-1-1999; IN COMMERCE 12-1-1999.

SN 76-017,847. KASSNET, INC., LOS ANGELES, CA. FILED 4-5-2000.



NO CLAIM IS MADE TO THE EXCLUSIVE RIGHT TO USE "VOICE, DATA AND VIDEO NETWORK SOLUTIONS" AND "INC.", APART FROM THE MARK AS SHOWN.

### CLASS 37—CONSTRUCTION AND REPAIR

FOR INSTALLATION OF TELECOMMUNICATIONS NETWORKS (U.S. CLS. 100, 103 AND 106).

FIRST USE 1-13-2000; IN COMMERCE 1-13-2000.

### CLASS 38—COMMUNICATION

FOR TELECOMMUNICATION SERVICES, NAMELY, PROVIDING MULTIPLE USER ACCESS TO A GLOBAL COMPUTER INFORMATION NETWORK; ISDN SERVICES; PROVIDING FRAME RELAY CONNECTIVITY SERVICES FOR DATA TRANSFER (U.S. CLS. 100, 101 AND 104).

FIRST USE 1-13-2000; IN COMMERCE 1-13-2000.

### CLASS 42—SCIENTIFIC, COMPUTER AND LEGAL SERVICES

FOR DESIGN OF TELECOMMUNICATION NETWORKS (U.S. CLS. 100 AND 101).

FIRST USE 1-13-2000; IN COMMERCE 1-13-2000.

## UDDERLY COLOSTRAL

### CLASS 3—COSMETICS AND CLEANING PREPARATIONS

FOR SKIN CARE PREPARATIONS, NAMELY, SKIN CREAMS BASED ON INTENT TO USE SKIN LOTIONS; TOPICAL SKIN SPRAYS; NON-MEDICATED LIP BALMS; HAIR CARE PREPARATIONS, NAMELY, SHAMPOOS AND CONDITIONERS (U.S. CLS. 1, 4, 6, 50, 51 AND 52).

FIRST USE 3-24-2000; IN COMMERCE 3-24-2000.

### CLASS 5—PHARMACEUTICALS

FOR DIETARY SUPPLEMENTS; NUTRITIONAL SUPPLEMENTS; DIETARY AND NUTRITIONAL SUPPLEMENTS CONTAINING COLOSTRUM; DIETARY AND NUTRITIONAL SUPPLEMENTS IN THE FORM OF POWDERS, CAPSULES, LIQUID CONCENTRATES AND BEVERAGE MIXES; NUTRACEUTICALS FOR USE AS A DIETARY SUPPLEMENT; NUTRACEUTICALS FOR THE TREATMENT OF AND/OR ENHANCEMENT OF JOINT HEALTH, GASTROINTESTINAL HEALTH, YEAST INFECTIONS, BACTERIAL INFECTIONS, AND IMMUNE SYSTEM HEALTH, NUTRITIONAL DRINK MIXES FOR USE AS A MEAL REPLACEMENT BASED ON INTENT TO USE DIETARY AND NUTRITIONAL SUPPLEMENTS; BEVERAGES CONTAINING COLOSTRUM (U.S. CLS. 6, 18, 44, 46, 51 AND 52).

FIRST USE 3-24-2000; IN COMMERCE 3-24-2000.

### CLASS 16—PAPER GOODS AND PRINTED MATTER

FOR [ITU] PAPER AND CARDBOARD PRODUCT DISPLAYS IN THE NATURE OF STAND-ALONE FLOOR DISPLAYS, STAND-ALONE COUNTERTOP DISPLAYS, AND SHELVING UNITS; PRINTED PUBLICATIONS IN THE NATURE OF BOOKS, MAGAZINES, BOOKLETS AND PAMPHLETS IN THE FIELD OF HEALTH (U.S. CLS. 2, 5, 22, 23, 29, 37, 38 AND 50).

### CLASS 20—FURNITURE AND ARTICLES NOT OTHERWISE CLASSIFIED

FOR [ITU] PRODUCT DISPLAYS (U.S. CLS. 2, 13, 22, 25, 32 AND 50).

### CLASS 25—CLOTHING

FOR T-SHIRTS (U.S. CLS. 22 AND 39).

FIRST USE 3-24-2000; IN COMMERCE 3-24-2000.

### CLASS 28—TOYS AND SPORTING GOODS

FOR [ITU] STUFFED ANIMALS (U.S. CLS. 22, 23, 38 AND 50).

### CLASS 29—MEATS AND PROCESSED FOODS

FOR [ITU] YOGURT CONTAINING COLOSTRUM; DAIRY-BASED BEVERAGES CONTAINING COLOSTRUM; ICE MILK, ICE CREAM AND FROZEN YOGURT CONTAINING COLOSTRUM; MIXES FOR MAKING ICE MILK; ICE CREAM AND FROZEN YOGURT (U.S. CL. 46).

### CLASS 30—STAPLE FOODS

FOR [ITU] READY-TO-EAT CEREAL BASED SNACK FOOD BARS; MIXES FOR MAKING ICE MILK; ICE CREAM AND FROZEN YOGURT (U.S. CL. 46).



SN 76-020,926. BAPTISTA'S BAKERY, INC., FRANKLIN, WI. FILED 4-7-2000.

SN 76-024,644. AGGREGATE INDUSTRIES, INC., SAUGUS, MA. FILED 4-12-2000.

## GOODNESS FROM THE HEART

### CLASS 16—PAPER GOODS AND PRINTED MATTER

FOR PRINTED FOOD RECIPES (U.S. CLS. 2, 5, 22, 23, 29, 37, 38 AND 50).

### CLASS 29—MEATS AND PROCESSED FOODS

FOR DIPS (U.S. CL. 46).

### CLASS 30—STAPLE FOODS

FOR BREADSTICKS, BREAD-SHAPED SNACKS AND SEASONINGS (U.S. CL. 46).

SN 76-021,789. CANADIAN CENTRE FOR HIGH PERFORMANCE INC., COLLINGWOOD, ONTARIO, CANADA, FILED 4-10-2000.

## ONE SMART WORLD

### CLASS 16—PAPER GOODS AND PRINTED MATTER

FOR ADULT EDUCATIONAL MATERIALS IN THE FIELDS OF HUMAN RESOURCE MANAGEMENT AND WORK EFFECTIVENESS, NAMELY, TRAINING MANUALS, WORKBOOKS, VIDEOTAPES AND AUDIOCASSETTES SOLD AS A UNIT; NEWSLETTERS AND BOOKS PERTAINING TO HUMAN RESOURCE MANAGEMENT AND WORK EFFECTIVENESS; NEWSLETTERS AND BOOKS PERTAINING TO ORGANIZATIONAL BEHAVIOUR AND EFFECTIVENESS; AND OFFICE PRODUCTS—NAMELY, MARKERS, PENS, CHALK, BINDERS, FILE FOLDERS, FILING BOXES, LABELS, FILING AND ORGANIZING TRAYS, PAPER CLIPS, PINS, STAPLERS, WHITEBOARDS, BULLETIN BOARDS, FLIPCHARTS, ADHESIVE NOTES, STOCK PAPER, NOTEBOOKS, DAYBOOKS, CALENDARS AND APPOINTMENT BOOKS (U.S. CLS. 2, 5, 22, 23, 29, 37, 38 AND 50).

### CLASS 41—EDUCATION AND ENTERTAINMENT

FOR PROVIDING PSYCHOLOGICAL TRAINING AND EDUCATION SEMINARS IN THE FIELD OF HUMAN RESOURCE MANAGEMENT AND WORK EFFECTIVENESS; AND PROVIDING ONLINE COMMUNITY AND INTERACTIVE WEBSITES ON A GLOBAL NETWORK OF COMPUTERS IN THE FIELDS OF ADULT AND CORPORATE EDUCATION (U.S. CLS. 100, 101 AND 107).



### CLASS 19—NON-METALLIC BUILDING MATERIALS

FOR NON-METALLIC TRANSPORTABLE BUILDING; STONE; ARTIFICIAL AND RECONSTITUTED STONE; ROCK, SAND AND GRAVEL; CONCRETE, CEMENT MIXES; COATED ROAD STONE (U.S. CLS. 1, 12, 33 AND 50).

FIRST USE 5-14-1997; IN COMMERCE 5-14-1997.

### CLASS 37—CONSTRUCTION AND REPAIR

FOR ROAD SURFACING AND REPAIRING; PROCESSING OF CRUSHED ROCK, STONE, SAND AND GRAVEL; QUARRYING (U.S. CLS. 100, 103 AND 106).

FIRST USE 5-14-1997; IN COMMERCE 5-14-1997.

### CLASS 42—SCIENTIFIC, COMPUTER AND LEGAL SERVICES

FOR TECHNICAL CONSULTING IN THE FIELD OF ROAD SURFACING AND REPAIRING, PROCESSING OF CRUSHED ROCK, STONE, SAND AND GRAVEL, AND QUARRYING (U.S. CLS. 100 AND 101).

FIRST USE 5-14-1997; IN COMMERCE 5-14-1997.

SN 76-026,063. QUALCOMM INCORPORATED, SAN DIEGO, CA. FILED 4-13-2000.

## QCHAT

### CLASS 38—COMMUNICATION

FOR TELECOMMUNICATION SERVICES, NAMELY, PROVIDING FOR TWO-WAY OR GROUP COMMUNICATIONS THROUGH THE USE OF TELEPHONES, WIRELESS TELEPHONES, PERSONAL DATA ASSISTANTS, AND COMPUTERS (U.S. CLS. 100, 101 AND 104).

### CLASS 42—SCIENTIFIC, COMPUTER AND LEGAL SERVICES

FOR PROVIDING INFORMATION VIA INTERACTIVE COMPUTERS, TELEPHONES, WIRELESS TELEPHONES, PERSONAL DATA ASSISTANTS FEATURING NEWS AND TOPICS OF GENERAL INTEREST (U.S. CLS. 100 AND 101).

SN 76-026,064. QUALCOMM INCORPORATED, SAN DIEGO, CA. FILED 4-13-2000.

SN 76-026,628. CREATIVE COMMUNICATIONS FOR THE PARISH, INC., FENTON, MN. FILED 4-14-2000.

## QLINK

### CLASS 38—COMMUNICATION

FOR TELECOMMUNICATION SERVICES, NAMELY, PROVIDING FOR TWO-WAY OR GROUP COMMUNICATIONS THROUGH THE USE OF TELEPHONES, WIRELESS TELEPHONES, PERSONAL DATA ASSISTANTS, AND COMPUTERS (U.S. CLS. 100, 101 AND 104).

### CLASS 42—SCIENTIFIC, COMPUTER AND LEGAL SERVICES

FOR PROVIDING INFORMATION VIA INTERACTIVE COMPUTERS, TELEPHONES, WIRELESS TELEPHONES, PERSONAL DATA ASSISTANTS FEATURING NEWS AND TOPICS OF GENERAL INTEREST (U.S. CLS. 100 AND 101).

SN 76-026,627. CREATIVE COMMUNICATIONS FOR THE PARISH, INC., FENTON, MO. FILED 4-14-2000.



OWNER OF U.S. REG. NOS. 2,380,577 AND 2,380,698.  
NO CLAIM IS MADE TO THE EXCLUSIVE RIGHT TO USE "BIBLE", APART FROM THE MARK AS SHOWN.

### CLASS 28—TOYS AND SPORTING GOODS

FOR TOYS, NAMELY PLUSH TOYS, BEANBAG TOYS, ACTION FIGURES, SOFT SCULPTURE TOYS, GLOW-IN-THE-DARK FIGURES, TOY TOTE BAGS, MOBILES, TOY ALARM CLOCKS WITH CHARACTER FIGURE DECORATIONS FOR CHILDREN, TOY BEDSIDE LAMPS WITH CHARACTER FIGURE DECORATIONS FOR CHILDREN, MANIPULATIVE PUZZLES, HAND PUPPETS, BATH TOYS, HAND HELD UNITS FOR PLAYING ELECTRONIC GAMES, PARTY FAVORS IN THE NATURE OF SMALL TOYS; AND GAMES, NAMELY BOARD GAMES, CARD GAMES, ACTION SKILLS GAMES, AND MANIPULATION GAMES (U.S. CLS. 22, 23, 38 AND 50).

### CLASS 41—EDUCATION AND ENTERTAINMENT

FOR EDUCATIONAL AND ENTERTAINMENT SERVICES FOR CHILDREN, NAMELY PRODUCTION OF A SERIES OF CHILDREN'S SHOWS FOR DISTRIBUTION VIA SATELLITE, TELEVISION AND VIDEO MEDIA (U.S. CLS. 100, 101 AND 107).

## THE BEDBUG BIBLE GANG

OWNER OF U.S. REG. NOS. 2,380,577 AND 2,380,698.  
NO CLAIM IS MADE TO THE EXCLUSIVE RIGHT TO USE "BIBLE", APART FROM THE MARK AS SHOWN.

### CLASS 28—TOYS AND SPORTING GOODS

FOR TOYS, NAMELY, PLUSH TOYS, BEANBAG TOYS, ACTION FIGURES, SOFT SCULPTURE TOYS, GLOW-IN-THE-DARK FIGURES, TOY TOTE BAGS, MOBILES, TOY ALARM CLOCKS WITH CHARACTER FIGURE DECORATIONS FOR CHILDREN, TOY BEDSIDE LAMPS WITH CHARACTER FIGURE DECORATIONS FOR CHILDREN, MANIPULATIVE PUZZLES, HAND PUPPETS, BATH TOYS, HAND HELD UNITS FOR PLAYING ELECTRONIC GAMES, PARTY FAVORS IN THE NATURE OF SMALL TOYS; AND GAMES, NAMELY BOARD GAMES, CARD GAMES, ACTION SKILLS GAMES, MANIPULATION GAMES (U.S. CLS. 22, 23, 38 AND 50).

### CLASS 41—EDUCATION AND ENTERTAINMENT

FOR EDUCATIONAL AND ENTERTAINMENT SERVICES FOR CHILDREN, NAMELY PRODUCTION OF A SERIES OF CHILDREN'S SHOWS FOR DISTRIBUTION VIA SATELLITE, TELEVISION AND VIDEO MEDIA (U.S. CLS. 100, 101 AND 107).

SN 76-026,790. FMC CORPORATION, PHILADELPHIA, PA. FILED 4-12-2000.

## MASTERING THE ART OF INNOVATIVE THINKING

### CLASS 40—MATERIAL TREATMENT

FOR CUSTOM MANUFACTURE OF HYDROCOLLOID FORMULATIONS AND FORMULATIONS CONTAINING HYDROCOLLOIDS TO THE ORDER AND SPECIFICATION OF OTHERS (U.S. CLS. 100, 103 AND 106).

### CLASS 42—SCIENTIFIC, COMPUTER AND LEGAL SERVICES

FOR TECHNICAL CONSULTATION AND RESEARCH IN THE USE, APPLICATION AND PROCESSING OF HYDROCOLLOID FORMULATIONS AND FORMULATIONS CONTAINING HYDROCOLLOIDS FOR USE IN INDUSTRY (U.S. CLS. 100 AND 101).

SN 76-026,800. ECOCLUB, S.A, ATHENS, GREECE, FILED 4-17-2000.



PRIORITY CLAIMED UNDER SEC. 44(D) ON GREECE APPLICATION NO. 146986, FILED 10-29-1999, REG. NO. 146986, DATED 10-29-1999, EXPIRES 10-29-2009.

#### **CLASS 16—PAPER GOODS AND PRINTED MATTER**

FOR PRINTED PUBLICATIONS AND PAPER GOODS, NAMELY, AGENDAS, PHOTOGRAPH ALBUMS, ATLASES, PRINTED AWARDS, PAPER BAGS AND MERCHANDISE PACKAGES, COOKBOOKS, BOOKS FEATURING TRAVEL, BUMPER STICKERS, CALENDARS, CHRISTMAS CARDS, GREETING CARDS, CLASSIFIED DIRECTORIES, HOTEL DIRECTORIES, ENCYCLOPEDIA FEATURING TOURISM, TRAVEL MAGAZINES, TOURISM NEWSLETTERS, NEWSPAPERS, MAGAZINE SUPPLEMENTS TO NEWSPAPERS, ALL FEATURING TOURISM, RECYCLED PAPER, PRINTED RECIPES SOLD AS A COMPONENT OF FOOD PACKAGING, PRINTED SEMINAR NOTES, WORKBOOKS FEATURING DIRECTED TO TOURISM (U.S. CLS. 2, 5, 22, 23, 29, 37, 38 AND 50).

#### **CLASS 25—CLOTHING**

FOR CLOTHING, NAMELY, T-SHIRTS, SWEATSHIRTS, HATS, AND JACKETS (U.S. CLS. 22 AND 39).

#### **CLASS 29—MEATS AND PROCESSED FOODS**

FOR PROCESSED ANCHOVIES, FRUIT PASTE, FRUIT PRESERVES, FRUIT PULPS, DRIED FRUITS, FRUITS PRESERVED IN ALCOHOL, PROCESSED GARLIC USED AS A VEGETABLE, MARMALADE, OLIVE OIL, PROCESSED OLIVES, PROCESSED PEPPERS, PICKLED VEGETABLES, PICKLES, TOMATO PUREE, RAISINS, SARDINES, FRUIT SAUCES (U.S. CL. 46).

#### **CLASS 30—STAPLE FOODS**

FOR BISCUITS, CAPERS, DRIED CHILI PEPPERS, CHILI POWDERS, CHILI SAUCE, CHILI SEASONING, CHOCOLATE, CINNAMON, CLOVES, COCOA, COFFEE, HERB TEA, PROCESSED HERBS, HONEY, LASAGNA, MACARONI, MARINADES, NOODLES, PASTA, PEPPER, PICANTE SAUCE, RAVIOLI, RICE, SALT, SAUCES, PASTA SHELLS, SPAGHETTI, SPICES, SUGAR, VINEGAR (U.S. CL. 46).

#### **CLASS 35—ADVERTISING AND BUSINESS**

FOR ADMINISTRATION OF CULTURAL AND EDUCATIONAL EXCHANGE PROGRAMS, ADVERTISING AGENCIES, NAMELY, PROMOTING THE SERVICES OF TOURISM THROUGH THE DISTRIBUTION OF PRINTED AND AUDIO PROMOTIONAL MATERIALS AND BY RENDERING SALES PROMOTION ADVICE, ADVERTISING AGENCIES, ADVERTISING AND COOPERATIVE MARKETING, DISSEMINATION OF ADVERTISING FOR OTHERS VIA AN ON-LINE ELECTRONIC COMMUNICATIONS NETWORK, ADVERTISING SERVICES, NAMELY PROVIDING ADVERTISING SPACE IN A PERIODICAL, RENTAL OF ADVERTISING SPACE; ARRANGING AND CONDUCTING BUSINESS CONFERENCES, MAIL ORDER BOOK CLUBS, TOURISM BUSINESS INFORMATION, BUSINESS MANAGEMENT OF HOTELS FOR OTHERS, BUSINESS MANAGEMENT, BUSINESS MARKETING CONSULTING SERVICES, BUSINESS NETWORKING, BUSINESS PLANNING,

BUSINESS RESEARCH, BUYING CLUBS, CAREER PLACEMENT, COMMERCIAL INFORMATION AND DIRECTORY AGENCY, COMPUTERIZED ON-LINE ORDERING SERVICES FOR PRODUCTS AND SERVICES MENTIONED ELSEWHERE IN THE APPLICATION, COMPUTERIZED ON-LINE RETAIL SERVICES IN THE FIELD OF PRODUCTS RETAILED TO FOOD AND TRAVEL, DIRECT MAIL ADVERTISING, TELEPHONE DIRECTORY INFORMATION, DISCOUNT CARDS FOR PROMOTING THE GOODS AND SERVICES OF OTHERS, HOTEL MANAGEMENT FOR OTHERS, JOB PLACEMENT; TRAVEL MANAGEMENT, MERCHANDISE PACKAGING, PRODUCT MERCHANDISING, BUSINESS NETWORKING, ON-LINE ORDERING SERVICES FEATURING TRAVEL AND COMMUNITY-ORGANIC PRODUCTS, ON-LINE RETAIL STORE SERVICES FEATURING TRAVEL AND COMMUNITY-ORGANIC PRODUCTS, PROMOTING THE GOODS AND SERVICES OF OTHERS BY PREPARING AND PLACING ADVERTISEMENT IN AN ELECTRONIC MAGAZINE ACCESSED THROUGH A GLOBAL COMPUTER NETWORK, PROMOTING THE GOODS AND SERVICES OF OTHERS THROUGH THE DISTRIBUTION OF DISCOUNT CARDS, PROMOTING THE SALE OF GOODS AND SERVICES OF OTHERS THROUGH THE DISTRIBUTION OF PRINTED MATERIAL AND PROMOTIONAL CONTESTS, PROMOTIONAL CAMPAIGNS FOR DEVELOPING BUSINESSES, TRAVEL MANAGEMENT (U.S. CLS. 100, 101 AND 102).

#### **CLASS 38—COMMUNICATION**

FOR BROADCASTING PROGRAMS VIA A GLOBAL COMPUTER NETWORK, ELECTRONIC TRANSMISSION OF DATA AND DOCUMENTS VIA COMPUTER TERMINALS, DELIVER OF MESSAGES BY ELECTRONIC TRANSMISSION, ELECTRONIC MAIL SERVICES, ELECTRONIC TRANSMISSION OF MESSAGES AND DATA, PROVIDING ON-LINE CHAT ROOMS FOR TRANSMISSION OF MESSAGES AMONG COMPUTER USERS CONCERNING ECOTOURISM, PROVIDING ON-LINE ELECTRONIC BULLETIN BOARDS FOR TRANSMISSION OF MESSAGES AMONG COMPUTER USERS CONCERNING ECOTOURISM, PROVIDING MULTIPLE-USER ACCESS TO A GLOBAL COMPUTER INFORMATION NETWORK (U.S. CLS. 100, 101 AND 104).

#### **CLASS 39—TRANSPORTATION AND STORAGE**

FOR ARRANGING TRAVEL TOURS AS A BONUS PROGRAM FOR CREDIT CARD CUSTOMERS, TRAVEL BOOKINGS AGENCIES, ARRANGING AND CONDUCTING CANOE EXPEDITIONS, TRAVEL CLUBS; ARRANGING OF CRUISES; ARRANGING EXCURSIONS FOR TOURISTS, ARRANGING AND CONDUCTING JUNGLE AND SAFARI EXPEDITIONS, TOUR GUIDE SERVICES, TRAVEL GUIDE SERVICES, TRAVEL INFORMATION SERVICES, TRANSPORTATION RESERVATION SERVICES; TOURIST AGENCY SERVICES, ARRANGING EXCURSIONS FOR TOURISTS; ARRANGING TRAVEL TOURS FOR OTHERS; CONDUCTING SIGHTSEEING TOURS FOR OTHERS, TRAVEL AGENCY SERVICES, NAMELY, MAKING RESERVATIONS AND BOOKINGS FOR TRANSPORTATION, TRAVEL GUIDE SERVICES (U.S. CLS. 100 AND 105).

#### **CLASS 42—SCIENTIFIC, COMPUTER AND LEGAL SERVICES**

FOR PROVIDING TEMPORARY HOUSING ACCOMMODATIONS, RATING OF ACCOMMODATIONS, ASSOCIATION SERVICES, NAMELY, PROMOTING THE INTERESTS OF TOURISM, CAFES, CAREER COUNSELING, SOCIAL CLUBS, COMPUTER SERVICES, NAMELY, CREATING AND MAINTAINING WEB SITES FOR OTHERS, COMPUTER SERVICES, NAMELY, DESIGNING AND IMPLEMENTING WEB SITES FOR OTHERS, COMPUTER SERVICES, NAMELY, PROVIDING DATABASES FEATURING GENERAL AND LOCAL NEWS, AND INFORMATION OF INTEREST TO SPECIFIC GEOGRAPHIC AREAS, COMPUTER SERVICES, NAMELY, PROVIDING ON-LINE TOURISM-ECOTOURISM NETWORK IN THE FIELD OF ECOTOURISM, CONSULTING SERVICES IN THE FIELD OF HOSPITALITY, DELICATESSENS, RESTAURANTS, SPONSOR-

ING, DEVELOPING, AND CARRYING FOR STUDENT EXCHANGE PROGRAMS, PREPARATION OF CUSTOMIZED GIFT BASKETS WITH SELECTED ITEMS REGARDING A PARTICULAR OCCASION OR THEME, HEALTH RESORTS, TOURIST HOTELS, MAKING HOTEL RESERVATIONS FOR OTHERS, HOTEL SERVICES FOR PREFERRED CUSTOMERS, RESORT HOTELS, NEWS AGENCIES, NAMELY, GATHERING AND DISSEMINATION OF NEWS, NEWS ANALYSIS AND FEATURES DISTRIBUTION, RENTAL OF ROOMS, TECHNICAL CONSULTING AND RESEARCH IN THE FIELD OF ECOTOURISM, RESTAURANTS, SOCIAL CLUBS (U.S. CLS. 100 AND 101).

SN 76-029,950. WENDLAR PRODUCTS, L.L.C., SALT LAKE CITY, UT. FILED 4-20-2000.

## FUN BUCKETS

NO CLAIM IS MADE TO THE EXCLUSIVE RIGHT TO USE "BUCKETS", APART FROM THE MARK AS SHOWN.

### CLASS 39—TRANSPORTATION AND STORAGE

FOR DELIVERY OF CUSTOMIZED METAL AND PLASTIC BUCKET-LIKE GIFT BASKETS WITH SELECTED ITEMS, NAMELY SOAPS, TOILETRIES, JAMS, JELLIES, COOKIES AND BISCUITS (U.S. CLS. 100 AND 105).

### CLASS 42—SCIENTIFIC, COMPUTER AND LEGAL SERVICES

FOR PREPARATION OF CUSTOMIZED METAL AND PLASTIC BUCKET-LIKE GIFT BASKETS WITH SELECTED ITEMS, NAMELY SOAPS, TOILETRIES, JAMS, JELLIES, COOKIES AND BISCUITS (U.S. CLS. 100 AND 101).

SN 76-027,142. WEINGART DESIGN INC., CLEVELAND, OH. FILED 4-17-2000.

## NOODLE SOUP

### CLASS 16—PAPER GOODS AND PRINTED MATTER

FOR PRINTED INSTRUCTIONAL EDUCATIONAL TEACHING MATERIALS, BOOKLETS, FLIERS, BROCHURES, STATIONERY, POSTERS, STICKERS, FOLDERS, NOTEPADS, POSTCARDS, AND NOTE-CARDS ALL IN THE FIELD OF PRENATAL, CHILD-BIRTH, AND PARENTING EDUCATION (U.S. CLS. 2, 5, 22, 23, 29, 37, 38 AND 50).

FIRST USE 1-5-2000; IN COMMERCE 1-5-2000.

### CLASS 35—ADVERTISING AND BUSINESS

FOR CATALOG, MAIL ORDER, AND ONLINE RETAIL SERVICES FEATURING PRINTED INSTRUCTIONAL MATERIALS, TOTE BAGS, BOOK BAGS, BUTTONS, SAFETY PLUG PROTECTORS, CUPS, VIDEOS, CLOTHING, MAGNETS, STICKERS, POSTERS, POSTCARDS, NOTECARDS, GREETING CARDS, POSTERS, COLORING BOOKS, PICTURE FRAMES, AND BREAST MILK STORAGE BAGS, IN THE FIELD OF PRENATAL, CHILDBIRTH, AND PARENTING EDUCATION (U.S. CLS. 100, 101 AND 102).

FIRST USE 1-5-2000; IN COMMERCE 1-5-2000.

SN 76-030,881. SALLIE MAE, INC., RESTON, VA. FILED 4-21-2000.

## WIRESCHOLARSHIP

### CLASS 36—INSURANCE AND FINANCIAL

FOR ON-LINE COMPUTER SERVICES, NAMELY, PROVIDING EDUCATIONAL SCHOLARSHIPS, AND ASSISTING STUDENTS IN APPLYING FOR FINANCIAL AID AND CONSULTATION IN THE FIELD OF DEVELOPING PROGRAMS TO PROVIDE HIGHER EDUCATION FINANCIAL AID ADVICE; ON-LINE SCHOLARSHIP SERVICES IN WHICH SCHOLARSHIP PROVIDERS CAN SEND AND RECEIVE SCHOLARSHIP APPLICATIONS VIA A GLOBAL COMPUTER NETWORK; PROVIDING SCHOLARSHIP AND FINANCIAL AID INFORMATION TO STUDENTS AND INSTITUTIONS VIA A GLOBAL COMPUTER NETWORK; PROVIDING EDUCATIONAL SCHOLARSHIPS IN THE NATURE OF ACADEMIC AND ATHLETIC SCHOLARSHIPS (U.S. CLS. 100, 101 AND 102).

FIRST USE 4-1-2000; IN COMMERCE 4-1-2000.

### CLASS 41—EDUCATION AND ENTERTAINMENT

FOR ADMINISTERING, MANAGING AND SUPERVISING EDUCATION SCHOLARSHIP PROGRAMS AND AWARDING EDUCATIONAL SCHOLARSHIPS FUNDED BY OTHERS TO SELECTED STUDENTS IN ORDER FOR YOUTHS TO OBTAIN POST-SECONDARY EDUCATION (U.S. CLS. 100, 101 AND 107).

FIRST USE 4-1-2000; IN COMMERCE 4-1-2000.

SN 76-029,897. LUTHERAN BROTHERHOOD, MINNEAPOLIS, MN. FILED 4-20-2000.

## CHARITABILITY

OWNER OF U.S. REG. NO. 2,135,083.

### CLASS 36—INSURANCE AND FINANCIAL

FOR ELECTRONIC FUNDS TRANSFER, FINANCIAL PLANNING, AND LOAN FINANCING SERVICES; CHARITABLE FINANCING SERVICES, NAMELY, PROVIDING MATCHING FUNDS OR GRANTS FOR CHURCH PROJECTS AND PROGRAMS (U.S. CLS. 100, 101 AND 102).

FIRST USE 8-0-1999; IN COMMERCE 8-0-1999.

### CLASS 41—EDUCATION AND ENTERTAINMENT

FOR EDUCATIONAL SERVICES, NAMELY, CONDUCTING CONFERENCES AND SEMINARS DIRECTED AT ENHANCING THE FINANCIAL AND CHARITABLE CONTRIBUTIONS OF CHURCH MEMBERS TO THEIR CONGREGATION (U.S. CLS. 100, 101 AND 107).

FIRST USE 8-0-1999; IN COMMERCE 8-0-1999.

SN 76-032,691. EMOTION, INC., VIENNA, VA. FILED 4-25-2000.

SN 76-034,248. IDAHO FRESH-PAK, INC., DBA IDAHOAN FOODS, LEWISVILLE, ID. FILED 4-25-2000.

eMotion

**CLASS 35—ADVERTISING AND BUSINESS**

FOR COMPUTERIZED DATA BASE MANAGEMENT (U.S. CLS. 100, 101 AND 102).  
FIRST USE 2-0-2000; IN COMMERCE 3-0-2000.

**CLASS 39—TRANSPORTATION AND STORAGE**

FOR ELECTRONIC STORAGE AND RETRIEVAL OF DATA IN THE FIELD OF DIGITAL MEDIA MANAGEMENT (U.S. CLS. 100 AND 105).  
FIRST USE 2-0-2000; IN COMMERCE 3-0-2000.

SN 76-033,032. AAA MINNESOTA/IOWA, BURNSVILLE, MN. FILED 4-24-2000.

**WORLDGUARD**

**CLASS 35—ADVERTISING AND BUSINESS**

FOR PROVIDING MEDICAL AND LEGAL REFERRALS FOR TRAVELERS (U.S. CLS. 100, 101 AND 102).  
FIRST USE 10-0-1999; IN COMMERCE 10-0-1999.

**CLASS 36—INSURANCE AND FINANCIAL**

FOR PROVIDING CURRENCY ADVICE, EMERGENCY CASH ADVANCES AND CASH TRANSFERS FOR TRAVELERS (U.S. CLS. 100, 101 AND 102).  
FIRST USE 10-0-1999; IN COMMERCE 10-0-1999.

**CLASS 39—TRANSPORTATION AND STORAGE**

FOR TRAVEL ADVICE, INFORMATION AND ASSISTANCE SERVICES, NAMELY, PROVIDING DIRECTIONS, PROVIDING ASSISTANCE WITH LOST OR STOLEN PASSPORTS, CREDIT CARDS AND TRAVELER'S CHECKS, PROVIDING COURIER SERVICES, AND PROVIDING GLOBAL AND EMERGENCY MESSAGE DELIVERY; TRAVEL AGENCY SERVICES, NAMELY, MAKING RESERVATIONS AND BOOKINGS FOR TRANSPORTATION; TRAVEL CLUBS; AND TRAVEL INFORMATION SERVICES (U.S. CLS. 100 AND 105).  
FIRST USE 10-0-1999; IN COMMERCE 10-0-1999.

**CLASS 42—SCIENTIFIC, COMPUTER AND LEGAL SERVICES**

FOR PROVIDING MEDICAL AND LEGAL ADVICE AND LANGUAGE INTERPRETING SERVICES FOR TRAVELERS (U.S. CLS. 100 AND 101).  
FIRST USE 10-0-1999; IN COMMERCE 10-0-1999.

**BORN TO BE FAMOUS**

**CLASS 29—MEATS AND PROCESSED FOODS**

FOR FROZEN, DEHYDRATED AND PROCESSED POTATOES; FROZEN, DEHYDRATED AND PROCESSED VEGETABLES; INSTANT PROCESSED POTATO MIXES (U.S. CL. 46).

**CLASS 30—STAPLE FOODS**

FOR SAUCES AND SEASONING MIXES FOR USE WITH POTATOES AND VEGETABLES (U.S. CL. 46).

**CLASS 31—NATURAL AGRICULTURAL PRODUCTS**

FOR FRESH POTATOES AND VEGETABLES (U.S. CLS. 1 AND 46).

SN 76-037,598. WHEELER, KEN, DALLAS, TX. FILED 5-1-2000.

**UNIVERSITY OF THE BLUES**

**CLASS 9—ELECTRICAL AND SCIENTIFIC APPARATUS**

FOR INSTRUCTIONAL AUDIO AND VIDEOTAPES ON THE SUBJECT OF GUITAR LESSONS (U.S. CLS. 21, 23, 26, 36 AND 38).  
FIRST USE 9-1-1993; IN COMMERCE 9-1-1993.

**CLASS 41—EDUCATION AND ENTERTAINMENT**

FOR EDUCATIONAL SERVICES, NAMELY, PROVIDING GUITAR LESSONS (U.S. CLS. 100, 101 AND 107).  
FIRST USE 9-1-1993; IN COMMERCE 9-1-1993.

SN 76-037,853. SEARS CANADA INC., TORONTO, ONTARIO, CANADA, FILED 5-1-2000.



NO CLAIM IS MADE TO THE EXCLUSIVE RIGHT TO USE "HOME", APART FROM THE MARK AS SHOWN.

**CLASS 4—LUBRICANTS AND FUELS**

FOR CANDLES (U.S. CLS. 1, 6 AND 15).

**CLASS 8—HAND TOOLS**

FOR FLATWARE, NAMELY KNIVES, FORKS AND SPOONS (U.S. CLS. 23, 28 AND 44).

**CLASS 20—FURNITURE AND ARTICLES NOT OTHERWISE CLASSIFIED**

FOR SNOW GLOBES, PICTURE FRAMES, FABRIC BATH MATS, PILLOWS, WINDOW TREATMENTS, NAMELY WINDOW SHADES (U.S. CLS. 2, 13, 22, 25, 32 AND 50).

**CLASS 21—HOUSEWARES AND GLASS**

FOR CANDLE HOLDERS NOT OF PRECIOUS METAL, BEVERAGE GLASSWARE, DINNERWARE, STAINLESS STEEL AND NONSTICK ALUMINUM COOKWARE, STAINLESS STEEL, NONSTICK AND ENAMEL BAKEWARE, TEA KETTLES, PANTRYWARE, NAMELY KITCHEN TOWEL RACKS, SALT AND PEPPER SHAKERS, MUGS AND SPOON RESTS FOR KITCHEN USE (U.S. CLS. 2, 13, 23, 29, 30, 33, 40 AND 50).

**CLASS 24—FABRICS**

FOR FABRIC BATH MATS (U.S. CLS. 42 AND 50).

**CLASS 27—FLOOR COVERINGS**

FOR ACCENT RUGS AND BROADLOOM CARPET (U.S. CLS. 19, 20, 37, 42 AND 50).

**CLASS 28—TOYS AND SPORTING GOODS**

FOR DECORATIVE ACCESSORIES, NAMELY, ARTIFICIAL WREATHS, TOPIARY TREES AND CHRISTMAS TREES (U.S. CLS. 22, 23, 38 AND 50).

SN 76-038,500. BROUSE COMPANY, LLC, THE, BROOKFIELD, WI. FILED 4-27-2000.

**KINDLE****CLASS 4—LUBRICANTS AND FUELS**

FOR WOOD SHAVINGS PACKAGED FOR USE AS FIRE STARTER IN FIREPLACES, CAMPFIRES AND GRILLS (U.S. CLS. 1, 6 AND 15).

**CLASS 31—NATURAL AGRICULTURAL PRODUCTS**

FOR WOOD SHAVINGS PACKAGED FOR USE AS ANIMAL BEDDING (U.S. CLS. 1 AND 46).

SN 76-038,576. TYR SPORT, INC., HUNTINGTON BEACH, CA. FILED 4-27-2000.

**AQUAPEL****CLASS 9—ELECTRICAL AND SCIENTIFIC APPARATUS**

FOR NOSE CLIPS FOR DIVERS AND SWIMMERS, SAFETY GOGGLES FOR SPORTS ACTIVITIES, NAMELY, SWIMMING, CYCLING, SURFING, SAILING AND WINDSURFING ACTIVITIES AND COMPONENT GOGGLE STRAPS THEREFOR (U.S. CLS. 21, 23, 26, 36 AND 38).

**CLASS 18—LEATHER GOODS**

FOR ALL PURPOSE SPORTS BAG, CARRY-ON BAGS, GYM BAGS, TOTE BAGS, BEACH DUFFEL BAGS (U.S. CLS. 1, 2, 3, 22 AND 41).

**CLASS 24—FABRICS**

FOR HIGH PERFORMANCE FABRIC FOR USE IN THE MANUFACTURE OF CLOTHING FOR MEN, WOMEN AND CHILDREN (U.S. CLS. 42 AND 50).

**CLASS 25—CLOTHING**

FOR HIGH PERFORMANCE CLOTHING FOR MEN, WOMEN AND CHILDREN, NAMELY, BRIEFS FOR TRIATHELETES, TRAINING SUITS, SHIRTS, T-SHIRTS, SWEATSHIRTS, TANK TOPS, VESTS, CROP TOPS, BRA TOPS, UNDERSHIRTS, OVERCOATS, BLOUSES, COATS, JACKETS, SWEATERS, PULLOVERS, SKIRTS, DRESSES, PANTS, SWEATPANTS, RUNNING SHORTS, BIKING SHORTS, ATHLETIC SHORTS, WATER SHORTS, WARM-UP JACKETS, WARM-UP PANTS, WARM-UP SUITS, WET SUITS, RACING SUITS, BIKE SHORTS, BIKE JERSEYS, BASEBALL CAPS, ANORAKS, CAT-SUITS, UNITARDS, LEOTARDS, WARM-UP TIGHTS, LEGGINGS, THONGS, BRIEFS, COVER-UPS, BEACH JACKETS, SHOES, SANDALS, BEACH FOOTWEAR, SOCKS, BELTS, HATS, CAPS, VISORS, SWIMWEAR, BATHING CAPS (U.S. CLS. 22 AND 39).

**CLASS 28—TOYS AND SPORTING GOODS**

FOR SWIM FINS, SWIM FLIPPERS, SWIM MASKS, SWIM FLOATS FOR RECREATIONAL USE, BATH TOYS, NAMELY, BATHING FLOATS, SWIM GOGGLES, SPORT GOGGLES FOR USE IN SWIMMING, CYCLING, SURFING, SAILING AND WINDSURFING AND COMPONENT GOGGLE STRAPS THEREFOR (U.S. CLS. 22, 23, 38 AND 50).

SN 76-039,219. NEWTRON PRODUCTS COMPANY, CINCINNATI, OH. FILED 5-2-2000.

**WATCHDOG****CLASS 9—ELECTRICAL AND SCIENTIFIC APPARATUS**

FOR ALARM DEVICE FOR DETECTING CARBON-MONOXIDE GAS (U.S. CLS. 21, 23, 26, 36 AND 38).  
FIRST USE 3-1-1999; IN COMMERCE 3-1-1999.

**CLASS 11—ENVIRONMENTAL CONTROL APPARATUS**

FOR AIR FILTER UNITS FOR USE IN INDUSTRIAL, COMMERCIAL, RESIDENTIAL AND INSTITUTIONAL AIR-CIRCULATION SYSTEMS (U.S. CLS. 13, 21, 23, 31 AND 34).  
FIRST USE 3-1-1999; IN COMMERCE 3-1-1999.

SN 76-042,887. QORUS.COM, INC., CHICAGO, IL. FILED 5-8-2000.

**AELIX****CLASS 35—ADVERTISING AND BUSINESS**

FOR BILLING SERVICES (U.S. CLS. 100, 101 AND 102).

**CLASS 38—COMMUNICATION**

FOR AUDIO TELECONFERENCING; ELECTRONIC TRANSMISSION OF MESSAGES AND DATA; ELECTRONIC VOICE MESSAGING, NAMELY, THE RECORDING, STORAGE, AND SUBSEQUENT TRANSMISSION OF VOICE MESSAGES BY TELEPHONE; FACSIMILE TRANSMISSION; TELECOMMUNICATIONS SERVICES, NAMELY, PROTOCOL CONVERSION SERVICES TRANSLATING MESSAGES AND INFORMATION BETWEEN VARIOUS TELECOMMUNICATIONS PROTOCOLS OR LANGUAGES; TELECOMMUNICATIONS SERVICES, NAMELY, PROVIDING A SUBSCRIPTION-BASED, ON-LINE INTERFACE FOR PROTOCOL-BASED COMMUNICATIONS, AND ELECTRONIC TRANSFER OF ENCRYPTED DATA BETWEEN SUBSCRIBERS AND ELECTRONIC MAIL AND MESSAGING SERVICES; TELECOMMUNICATIONS SERVICES, NAMELY, PROVIDING TELECOMMUNICATIONS CONNECTIONS TO A COMPUTER NETWORK THAT PROVIDES INTELLIGENCE AND/OR APPLICATION PROCESSING IN DATA NETWORK, SUCH AS PROTOCOL CONVERSION, REFORMATTING OR MESSAGE, AND NETWORK SECURITY; TELECOMMUNICATIONS SERVICES, NAMELY, PROVIDING A COMPUTER INTERFACE FOR CONNECTING INTERNETWORK PROTOCOL (IP) BASED SOLUTIONS TO IP DATA TRANSPORT NETWORKS; TELECOMMUNICATION SERVICES, NAMELY, CONVEYING TELEPHONE CALLS OVER A GLOBAL COMPUTER NETWORK AND GLOBAL COMPUTER NETWORK TELEPHONY SERVICES, NAMELY, ROUTING AND AUTHENTICATION FOR TELEPHONE CALLS SENT OVER A GLOBAL COMPUTER NETWORK USING THE INTERNET PROTOCOL (U.S. CLS. 100, 101 AND 104).

SN 76-044,309, MCKEEVER, JEFFREY D., PARADISE VALLEY, AZ. BY ASSIGNMENT MICROAGE COMPUTER CENTERS, INC., TEMPE, AZ. FILED 5-9-2000.

**CLASS 37—CONSTRUCTION AND REPAIR**

FOR COMPUTER SERVICES, NAMELY, PROVIDING OUTSOURCE SUPPORT IN THE NATURE OF MAINTENANCE AND REPAIR OF COMPUTER NETWORKS AND KIOSK SYSTEMS (U.S. CLS. 100, 103 AND 106).  
FIRST USE 12-0-1999; IN COMMERCE 12-0-1999.

**CLASS 42—SCIENTIFIC, COMPUTER AND LEGAL SERVICES**

FOR COMPUTER SERVICES, NAMELY, COMPUTER NETWORK CONFIGURATION AND INTEGRATION (U.S. CLS. 100 AND 101).  
FIRST USE 12-0-1999; IN COMMERCE 12-0-1999.

SN 76-043,444, WAGNER GMBH, 80634 MUNCHEN, FED REP GERMANY, FILED 5-8-2000.

SN 76-044,552, KROLL BACKGROUND AMERICA, NASHVILLE, TN. FILED 5-9-2000.

**FINALPACK**

PRIORITY CLAIMED UNDER SEC. 44(D) ON FED REP GERMANY APPLICATION NO. 39970234.2/1, FILED 11-10-1999, REG. NO. 39970234, DATED 11-10-1999, EXPIRES 11-30-2009.

**CLASS 10—MEDICAL APPARATUS**

FOR PLASTIC AND METAL STERILIZED CONTAINERS FOR HOSPITAL AND MEDICAL USE (U.S. CLS. 26, 39 AND 44).

**CLASS 16—PAPER GOODS AND PRINTED MATTER**

FOR PACKAGING MATERIAL, NAMELY, CARDBOARD, PAPER PACKAGING, AND PLASTIC BAGS AND BUBBLE PACKS FOR PACKAGING MEDICAL INSTRUMENTS AND APPARATUS (U.S. CLS. 2, 5, 22, 23, 29, 37, 38 AND 50).

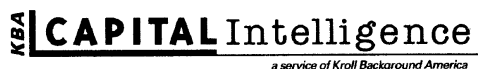

OWNER OF U.S. REG. NO. 2,346,104.  
NO CLAIM IS MADE TO THE EXCLUSIVE RIGHT TO USE "INTELLIGENCE" AND "A SERVICE OF", APART FROM THE MARK AS SHOWN.

**CLASS 35—ADVERTISING AND BUSINESS**

FOR COMPREHENSIVE BUSINESS INVESTIGATION SERVICES (U.S. CLS. 100, 101 AND 102).  
FIRST USE 7-31-1999; IN COMMERCE 7-31-1999.

**CLASS 42—SCIENTIFIC, COMPUTER AND LEGAL SERVICES**

FOR COMPREHENSIVE PRIVATE INVESTIGATION SERVICES (U.S. CLS. 100 AND 101).  
FIRST USE 7-31-1999; IN COMMERCE 7-31-1999.

SN 76-045,129. BYTES OF KNOWLEDGE, LLC, NASHVILLE, TN. FILED 5-10-2000.

## bytes of knowledge

### CLASS 41—EDUCATION AND ENTERTAINMENT

FOR CUSTOMIZED COMPUTER EDUCATION TRAINING (U.S. CLS. 100, 101 AND 107).  
FIRST USE 10-2-1995; IN COMMERCE 10-2-1995.

### CLASS 42—SCIENTIFIC, COMPUTER AND LEGAL SERVICES

FOR COMPUTER SERVICES, NAMELY, DESIGNING AND CREATING WEB SITES FOR OTHERS, COMPUTER CONSULTATION AND INFORMATION TECHNOLOGY STRATEGY AND IMPLEMENTATION IN THE NATURE OF COMPUTER SYSTEMS ANALYSIS, COMPUTER DIAGNOSTIC SERVICES, INSTALLATION AND UP-DATING OF COMPUTER SOFTWARE AND THE MONITORING OF COMPUTER SYSTEMS (U.S. CLS. 100 AND 101).  
FIRST USE 10-2-1995; IN COMMERCE 10-2-1995.

SN 76-047,722. OAKBROOK PROPERTIES, INC., ST. CHARLES, IL. FILED 5-15-2000.

## OAKBROOK PROPERTIES

NO CLAIM IS MADE TO THE EXCLUSIVE RIGHT TO USE "PROPERTIES", APART FROM THE MARK AS SHOWN.

### CLASS 36—INSURANCE AND FINANCIAL

FOR REAL ESTATE MANAGEMENT SERVICES (U.S. CLS. 100, 101 AND 102).  
FIRST USE 6-8-1998; IN COMMERCE 6-8-1998.

### CLASS 37—CONSTRUCTION AND REPAIR

FOR LAND DEVELOPMENT SERVICES, NAMELY, PLANNING AND LAYING OUT OF RESIDENTIAL AND/OR COMMERCIAL COMMUNITIES (U.S. CLS. 100, 103 AND 106).  
FIRST USE 6-8-1998; IN COMMERCE 6-8-1998.

SN 76-047,876. TECHNO DECO, INC., OKLAHOMA CITY, OK. FILED 5-12-2000.

## TECHNO DECO

NO CLAIM IS MADE TO THE EXCLUSIVE RIGHT TO USE "DECO", APART FROM THE MARK AS SHOWN.

### CLASS 14—JEWELRY

FOR JEWELRY (U.S. CLS. 2, 27, 28 AND 50).

### CLASS 35—ADVERTISING AND BUSINESS

FOR BUSINESS MARKETING CONSULTING SERVICES IN THE FIELD OF JEWELRY (U.S. CLS. 100, 101 AND 102).

### CLASS 40—MATERIAL TREATMENT

FOR CUSTOM MANUFACTURE OF JEWELRY (U.S. CLS. 100, 103 AND 106).

### CLASS 42—SCIENTIFIC, COMPUTER AND LEGAL SERVICES

FOR DESIGN FOR OTHERS IN THE FIELD OF JEWELRY, NAMELY HAND SKETCHING AND COMPUTER-AIDED DESIGN (U.S. CLS. 100 AND 101).

SN 76-048,256. HERAEUS KULZER GMBH & CO. KG, D-63450 HANAU, FED REP GERMANY, FILED 5-12-2000.

## PALABOND

PRIORITY CLAIMED UNDER SEC. 44(D) ON FED REP GERMANY APPLICATION NO. 39975545.4, FILED 12-1-1999, REG. NO. 39975545, DATED 2-8-2000, EXPIRES 12-31-2009.  
OWNER OF U.S. REG. NOS. 1,001,000, 1,644,213 AND OTHERS.

### CLASS 5—PHARMACEUTICALS

FOR CHEMICAL PRODUCTS, NAMELY, DENTAL ADHESIVES AND ADHESION PROMOTERS FOR THE MANUFACTURING, REPAIR AND FIXING OF DENTURES, CROWNS, BRIDGES, INLAYS AND ONLAYS; MEDICAL FILLING SUBSTANCES AND ACTIVE SUBSTANCES AS PART OF BONE CEMENT; BONE CEMENT FOR MEDICAL USE (U.S. CLS. 6, 18, 44, 46, 51 AND 52).

### CLASS 10—MEDICAL APPARATUS

FOR MEDICAL LABORATORY APPARATUS, NAMELY, MIXING PLATES, MIXING VESSELS, SYRINGES, MIXING APPARATUS AND APPLICATORS FOR MIXING AND PROCESSING BONE CEMENTS; DENTAL APPARATUS, NAMELY, SPATULAS, SPOONS, MIXING DISHES, MIXING PLATES, APPLICATORS (U.S. CLS. 26, 39 AND 44).

SN 76-048,280. PRIMAL ELEMENTS, INC., GARDEN GROVE, CA. FILED 5-15-2000.

## ISN'T IT AMAZING

### CLASS 3—COSMETICS AND CLEANING PREPARATIONS

FOR SOAPS FOR HANDS, FACE, AND BODY; PERSONAL CARE PRODUCTS, NAMELY, BATH GELS, SHOWER GELS AND LOTIONS FOR THE FACE AND BODY (U.S. CLS. 1, 4, 6, 50, 51 AND 52).

### CLASS 4—LUBRICANTS AND FUELS

FOR CANDLES (U.S. CLS. 1, 6 AND 15).



SN 76-048,669. NORTH TEXAS PUBLIC BROADCASTING, INC., DALLAS, TX. FILED 5-11-2000.

## KERA

### CLASS 9—ELECTRICAL AND SCIENTIFIC APPARATUS

FOR VIDEO RECORDINGS FEATURING A VARIETY OF SUBJECTS, NAMELY, HISTORY, MUSIC, ART, DOCUMENTARIES, AND SCIENCE, AND VIDEO RECORDINGS FEATURING EDUCATIONAL PROGRAMS FOR CHILDREN (U.S. CLS. 21, 23, 26, 36 AND 38).  
FIRST USE 9-11-1960; IN COMMERCE 9-11-1960.

### CLASS 16—PAPER GOODS AND PRINTED MATTER

FOR PRINTED INSTRUCTIONAL, EDUCATIONAL, AND TEACHING MATERIALS ON A VARIETY OF SUBJECTS, NAMELY, MATH, SCIENCE, HISTORY, ENGLISH, AND PHYSICAL FITNESS IN SUPPORT OF TEACHER TRAINING AND MATERIALS FOR STUDENTS (U.S. CLS. 2, 5, 22, 23, 29, 37, 38 AND 50).  
FIRST USE 9-11-1960; IN COMMERCE 9-11-1960.

### CLASS 38—COMMUNICATION

FOR TELEVISION, AUDIO, VIDEO AND RADIO BROADCASTING, INCLUDING HIGH DEFINITION AND DIGITAL TELEVISION, AND DIGITAL RADIO BY OVER-THE-AIR BROADCAST, CABLE, SATELLITE, MICROWAVE, ON-LINE AND GLOBAL COMPUTER NETWORK (U.S. CLS. 100, 101 AND 104).  
FIRST USE 9-11-1960; IN COMMERCE 9-11-1960.

### CLASS 41—EDUCATION AND ENTERTAINMENT

FOR PRODUCTION AND DISTRIBUTION OF EDUCATIONAL TELEVISION, RADIO AND VIDEO PROGRAMMING FOR OTHERS VIA OVER-THE-AIR BROADCAST, CABLE, SATELLITE, MICROWAVE, ON-LINE AND GLOBAL COMPUTER NETWORKS (U.S. CLS. 100, 101 AND 107).  
FIRST USE 9-11-1960; IN COMMERCE 9-11-1960.

SN 76-049,004. OPEX S.A. 95973 ROISSY - CHARLES DE GAULLE, FRANCE, FILED 5-16-2000.

## OPEX

OWNER OF U.S. REG. NO. 1,909,935.

### CLASS 9—ELECTRICAL AND SCIENTIFIC APPARATUS

FOR EYEWEAR, NAMELY, EYEGLASSES, SUNGLASSES AND EYEGLASS FRAMES; EYEWEAR ACCESSORIES, NAMELY, EYEGLASS CORDS AND EYEGLASS (U.S. CLS. 21, 23, 26, 36 AND 38).

### CLASS 16—PAPER GOODS AND PRINTED MATTER

FOR WRITING INSTRUMENTS (U.S. CLS. 2, 5, 22, 23, 29, 37, 38 AND 50).

### CLASS 18—LEATHER GOODS

FOR LUGGAGE, GARMENT BAGS FOR TRAVEL, BEAUTY CASES SOLD EMPTY, TOTE BAGS, ATTACHE CASES, BACK PACKS, WALLETS, FANNY PACKS AND HANDBAGS (U.S. CLS. 1, 2, 3, 22 AND 41).

### CLASS 20—FURNITURE AND ARTICLES NOT OTHERWISE CLASSIFIED

FOR FURNITURE, PICTURE FRAMES, KEY CHAINS NOT OF METAL AND JEWELRY BOXES NOT OF METAL (U.S. CLS. 2, 13, 22, 25, 32 AND 50).

### CLASS 25—CLOTHING

FOR SHIRTS, BLOUSES, T-SHIRTS, SWEATSHIRTS, SPORTS SHIRTS, KNIT SHIRTS, POLO SHIRTS, SWEATERS, SKIRTS, DRESSES, PANTS, SHORTS, JACKETS, VESTS, SOCKS, HOSIERY, UNDERGARMENTS, SLEEPWEAR, OUTERWEAR, SWIMWEAR, RAINWEAR, BELTS, GLOVES, MITTENS, FOOTWEAR, HEADWEAR, SCARVES, NECKWEAR AND SHAWLS (U.S. CLS. 22 AND 39).

SN 76-049,088. TRIPP ENTERPRISES, INC., SPARKS, NV. FILED 5-10-2000.



### CLASS 9—ELECTRICAL AND SCIENTIFIC APPARATUS

FOR ELECTRICAL LIGHT EMITTING DIODE (U.S. CLS. 21, 23, 26, 36 AND 38).  
FIRST USE 7-15-1951; IN COMMERCE 12-1-1953.

### CLASS 42—SCIENTIFIC, COMPUTER AND LEGAL SERVICES

FOR GRAPHIC ART DESIGN IN THE FIELD OF PLASTIC SIGN BOARDS AND PLASTIC DISPLAYS (U.S. CLS. 100 AND 101).  
FIRST USE 7-15-1951; IN COMMERCE 12-1-1953.

SN 76-049,259. SCHERRER, PETER, VENICE, CA. FILED 5-16-2000.

## STUDIO MOUSETRAP

OWNER OF U.S. REG. NO. 2,253,482.  
NO CLAIM IS MADE TO THE EXCLUSIVE RIGHT TO USE "STUDIO", APART FROM THE MARK AS SHOWN.

**CLASS 35—ADVERTISING AND BUSINESS**

FOR DEVELOPING PROMOTIONAL CAMPAIGNS FOR BUSINESS, PREPARING ADVERTISEMENTS FOR OTHERS FOR USE ON A GLOBAL COMPUTER NETWORK (U.S. CLS. 100, 101 AND 102).

FIRST USE 5-12-2000; IN COMMERCE 5-12-2000.

**CLASS 42—SCIENTIFIC, COMPUTER AND LEGAL SERVICES**

FOR GRAPHIC DESIGN SERVICES, WEB PAGE DESIGN SERVICES, PRELAUNCH MARKETING AND BRANDING CONSULTATION AND DESIGN SERVICES FOR OTHERS, CREATIVE CONSULTING AND DESIGN SERVICES RELATED TO THE IMPLEMENTATION OF A BUSINESS ENTITY THROUGH THE DESIGN OF STATIONERY, BUSINESS CARDS, AND GLOBAL NETWORK SITES (U.S. CLS. 100 AND 101).

FIRST USE 5-12-2000; IN COMMERCE 5-12-2000.

SN 76-049,674. EPICREALM OPERATING INC., RICHARDSON, TX. BY MERGER EPICREALM INC., RICHARDSON, TX. FILED 5-15-2000.

**CLASS 9—ELECTRICAL AND SCIENTIFIC APPARATUS**

FOR COMPUTER SOFTWARE FOR USE IN PROVIDING ACCESS TO AND ENHANCING AND PRIORITIZING CUSTOMER MOVEMENT WITHIN A GLOBAL COMPUTER COMMUNICATIONS NETWORK; COMPUTER SOFTWARE FOR DELIVERING AND DISTRIBUTING WEBSITE CONTENT FOR EASIER AND FASTER ACCESS BY END USERS (U.S. CLS. 21, 23, 26, 36 AND 38).

**CLASS 38—COMMUNICATION**

FOR PROVIDING MULTIPLE USER ACCESS TO A GLOBAL COMPUTER INFORMATION NETWORK (U.S. CLS. 100, 101 AND 104).

**CLASS 42—SCIENTIFIC, COMPUTER AND LEGAL SERVICES**

FOR COMPUTER CONSULTATION SERVICES; COMPUTER SERVICES, NAMELY, CREATING AND MAINTAINING WEB SITES FOR OTHERS; DESIGN OF COMPUTER NETWORKS FOR OTHERS, HOSTING THE WEB SITES OF OTHERS ON A COMPUTER SERVER FOR A GLOBAL COMPUTER NETWORK; COMPUTER SOFTWARE DESIGN FOR OTHERS (U.S. CLS. 100 AND 101).

SN 76-049,266. HAUSE MACHINES, INC., MONTPELIER, OH. FILED 5-16-2000.



OWNER OF U.S. REG. NO. 1,021,404.  
NO CLAIM IS MADE TO THE EXCLUSIVE RIGHT TO USE "MACHINES", APART FROM THE MARK AS SHOWN.  
THE MARK CONSISTS OF THE LETTER "H" IN THE MIDDLE OF A CIRCLE, WITH A WAVY HALF CIRCLE ABOVE AND BELOW IT. THE TERMS "HAUSE" ABOVE THE WORD "MACHINES" ARE ON THE RIGHT SIDE OF THE CIRCLE.

**CLASS 7—MACHINERY**

FOR MACHINES FOR PROCESSING METAL, NAMELY, AIR/HYDRAULIC POWER FEED UNITS, HYDRAULIC POWER FEED UNITS, SERVO HYDRAULIC POWER FEED UNITS, BALLSCREW POWER FEED UNITS, AND MULTIPLE SPINDLE HEADS (U.S. CLS. 13, 19, 21, 23, 31, 34 AND 35).

FIRST USE 2-2-2000; IN COMMERCE 2-2-2000.

**CLASS 40—MATERIAL TREATMENT**

FOR CUSTOM MANUFACTURE OF MACHINES FOR OTHERS IN THE METALWORKING INDUSTRY (U.S. CLS. 100, 103 AND 106).

FIRST USE 2-2-2000; IN COMMERCE 2-2-2000.

SN 76-050,341. PEP BOYS MANNY, MOE & JACK OF CALIFORNIA, THE, PHILADELPHIA, PA. FILED 5-15-2000.

**PROSTEER****CLASS 6—METAL GOODS**

FOR METAL UNFITTED HOSE FOR USE WITH LAND-VEHICLE POWER STEERING UNITS (U.S. CLS. 2, 12, 13, 14, 23, 25 AND 50).

**CLASS 7—MACHINERY**

FOR POWER STEERING PUMPS FOR LAND VEHICLES; GEARS FOR LAND-VEHICLE POWER STEERING UNITS (U.S. CLS. 13, 19, 21, 23, 31, 34 AND 35).

**CLASS 12—VEHICLES**

FOR FITTED PREFABRICATED HOSE FOR USE WITH LAND-VEHICLE POWER STEERING UNITS; COMPLETE RACK-AND-PINION STEERING UNITS FOR USE ON LAND VEHICLES (U.S. CLS. 19, 21, 23, 31, 35 AND 44).

**CLASS 17—RUBBER GOODS**

FOR NON-METAL UNFITTED HOSE FOR USE WITH LAND-VEHICLE POWER STEERING UNITS (U.S. CLS. 1, 5, 12, 13, 35 AND 50).

SN 76-052,626. E-TRAFFIC, INC., MOUNTAIN VIEW, CA. FILED 5-19-2000.

**TOPMOXIE**

SN 76-051,199. IMAGEON SOLUTIONS, INC., BIRMINGHAM, AL. FILED 5-18-2000.

**EMAGEON****CLASS 9—ELECTRICAL AND SCIENTIFIC APPARATUS**

FOR COMPUTER SOFTWARE FOR CAPTURING, STORING, ARCHIVING, AND PROVIDING ACCESS TO MEDICAL IMAGES (U.S. CLS. 21, 23, 26, 36 AND 38).

**CLASS 9—ELECTRICAL AND SCIENTIFIC APPARATUS**

FOR COMPUTER PROGRAMS, DOWNLOADED THROUGH A GLOBAL COMPUTER NETWORK, ENABLING ONLINE MERCHANTS TO PROVIDE PROMOTIONS AND OTHER PRODUCT INFORMATION, NAMELY, INFORMATION ABOUT THE PRICE AND CHARACTERISTICS OF PRODUCTS, TO CUSTOMERS (U.S. CLS. 21, 23, 26, 36 AND 38).

**CLASS 42—SCIENTIFIC, COMPUTER AND LEGAL SERVICES**

FOR SERVICES OF INSTALLING, CONFIGURING, AND MAINTAINING COMPUTER SOFTWARE FOR CAPTURING, STORING, ARCHIVING AND PROVIDING ACCESS TO MEDICAL IMAGES (U.S. CLS. 100 AND 101).

**CLASS 42—SCIENTIFIC, COMPUTER AND LEGAL SERVICES**

FOR PROVIDING TEMPORARY USE OF ON-LINE NON-DOWNLOADABLE SOFTWARE FOR ENABLING ON-LINE BUSINESSES TO PROVIDE PROMOTIONS AND MESSAGES RELATING TO ON-LINE PRODUCT AND SERVICE OFFERINGS (U.S. CLS. 100 AND 101).

SN 76-052,050. BEHINDTHEBEAT, INC., SAN FRANCISCO, CA. FILED 5-19-2000.

**VOICE OF THE ARTIST****CLASS 9—ELECTRICAL AND SCIENTIFIC APPARATUS**

FOR PRERECORDED DIGITAL AUDIO AND VIDEO DISCS AND PRERECORDED AUDIO TAPES AND VIDEO TAPES, ALL FEATURING MUSIC AND MUSIC-RELATED CONTENT; DOWNLOADABLE DIGITAL AUDIO AND VIDEO RECORDINGS FEATURING MUSIC AND MUSIC-RELATED CONTENT (U.S. CLS. 21, 23, 26, 36 AND 38).

SN 76-052,647. BLACK & VEATCH HOLDING COMPANY, KANSAS CITY, MO. FILED 5-19-2000.

**CONSTRUCTION BY DESIGN**

NO CLAIM IS MADE TO THE EXCLUSIVE RIGHT TO USE "CONSTRUCTION", APART FROM THE MARK AS SHOWN.

**CLASS 41—EDUCATION AND ENTERTAINMENT**

FOR AUDIO AND VIDEO PROGRAMMING SERVICES RELATING TO MUSIC AND MUSIC-RELATED CONTENT; ENTERTAINMENT SERVICES IN THE NATURE OF A LIVE STREAMING MEDIA FEATURING MUSIC AND MUSIC-RELATED CONTENT AND LECTURES IN THE FORM OF A LIVE STREAMING MEDIA FEATURING MUSIC AND MUSIC-RELATED CONTENT; PROVIDING A WEB SITE ON THE GLOBAL COMPUTER NETWORK FEATURING INFORMATION ON MUSIC AND MUSIC-RELATED CONTENT (U.S. CLS. 100, 101 AND 107).

**CLASS 9—ELECTRICAL AND SCIENTIFIC APPARATUS**

FOR COMPUTER SOFTWARE FOR PROJECT-RELATED CONSULTING APPLICATIONS, NAMELY DATA MANAGEMENT; ENGINEERING DESIGN APPLICATIONS; ARCHITECTURAL DESIGN APPLICATIONS, CONSTRUCTION PLANNING APPLICATIONS, CONSTRUCTION MANAGEMENT APPLICATIONS, PROCUREMENT OF MATERIALS AND EQUIPMENT, NAMELY LOGISTICS MANAGEMENT IN THE FIELDS OF ENGINEERING, ARCHITECTURE AND CONSTRUCTION; INFORMATION TECHNOLOGY, DATA MANAGEMENT, CONSTRUCTION, OPERATION, MAINTENANCE, ABATEMENT, TRAINING, DEMOLITION AND DECOMMISSIONING APPLICATIONS ALL IN THE FIELD OF CONSTRUCTION, ENGINEERING AND ARCHITECTURE (U.S. CLS. 21, 23, 26, 36 AND 38).

**CLASS 42—SCIENTIFIC, COMPUTER AND LEGAL SERVICES**

FOR PROVIDING AN INTERACTIVE COMPUTER DATABASE FOR THE SEARCH, RETRIEVAL, TRANSFER, AND DISTRIBUTION OF DIGITAL AUDIO AND VIDEO FILES CONTAINING MUSIC AND MUSIC-RELATED CONTENT; DISTRIBUTION OF DIGITAL AUDIO AND VIDEO FILES CONTAINING MUSIC AND MUSIC-RELATED CONTENT TO SUBSCRIBERS VIA THE GLOBAL COMPUTER NETWORK (U.S. CLS. 100 AND 101).

**CLASS 35—ADVERTISING AND BUSINESS**

FOR PROCUREMENT, NAMELY, PURCHASING EQUIPMENT, MACHINERY, MATERIALS AND SUPPLIES FOR OTHERS FOR USE IN CONNECTION WITH PROJECTS; DATA PROCESSING AND DATA MANAGEMENT FOR OTHERS (U.S. CLS. 100, 101 AND 102).

**CLASS 36—INSURANCE AND FINANCIAL**

FOR FINANCIAL ANALYSIS AND CONSULTATION SERVICES IN CONNECTION WITH ENGINEERING, ARCHITECTURAL AND CONSTRUCTION PROJECTS (U.S. CLS. 100, 101 AND 102).

**CLASS 37—CONSTRUCTION AND REPAIR**

FOR RESIDENTIAL AND COMMERCIAL BUILDING CONSTRUCTION, CONSTRUCTION PLANNING, CONSTRUCTION MANAGEMENT; BUILDING CONSTRUCTION CONSULTING; HOUSE AND BUILDING DEMOLITION; AND REPAIR AND RESTORATION OF RESIDENTIAL AND COMMERCIAL BUILDINGS FOR OTHERS (U.S. CLS. 100, 103 AND 106).

**CLASS 42—SCIENTIFIC, COMPUTER AND LEGAL SERVICES**

FOR ENGINEERING AND ARCHITECTURAL DESIGN (U.S. CLS. 100 AND 101).

---

SN 76-055,339. PBM LTD., CLEVELAND, OH. FILED 5-24-2000.

**GDI**

**CLASS 35—ADVERTISING AND BUSINESS**

FOR BUSINESS MANAGEMENT SERVICES; DOCUMENT MANAGEMENT SERVICES VIA A GLOBAL COMPUTER NETWORK, NAMELY SCANNING PAPER DOCUMENTS, INDEXING, REPRODUCING, AND ROUTING ELECTRONIC DOCUMENTS BOTH MANUALLY AND AUTOMATICALLY (U.S. CLS. 100, 101 AND 102).

FIRST USE 11-0-1999; IN COMMERCE 11-0-1999.

**CLASS 39—TRANSPORTATION AND STORAGE**

FOR DOCUMENT STORAGE SERVICES OVER A GLOBAL COMPUTER NETWORK (U.S. CLS. 100 AND 105).

FIRST USE 11-0-1999; IN COMMERCE 11-0-1999.

---

SN 76-055,625. BAXTER INTERNATIONAL INC., DEERFIELD, IL. FILED 5-24-2000.



THE MARK CONSISTS OF AN ANIMATED VERSION OF AN INTRAVENOUS SOLUTION CONTAINER.

**CLASS 9—ELECTRICAL AND SCIENTIFIC APPARATUS**

FOR DECORATIVE MAGNETS (U.S. CLS. 21, 23, 26, 36 AND 38).

**CLASS 16—PAPER GOODS AND PRINTED MATTER**

FOR NEWSLETTERS THAT ARE DIRECTED TO CORPORATE EMPLOYEES AND CUSTOMERS FEATURING INFORMATION ON THE DRUG DELIVERY FACILITY OPERATIONS, AND NOTE PADS (U.S. CLS. 2, 5, 22, 23, 29, 37, 38 AND 50).

**CLASS 20—FURNITURE AND ARTICLES NOT OTHERWISE CLASSIFIED**

FOR NON-METAL KEY CHAINS (U.S. CLS. 2, 13, 22, 25, 32 AND 50).

FIRST USE 6-0-1986; IN COMMERCE 6-0-1986.

**CLASS 25—CLOTHING**

FOR T-SHIRTS (U.S. CLS. 22 AND 39).

---

SN 76-056,572. KONAMI CO., LTD., TOKYO, JAPAN, FILED 5-25-2000.

## LEGEND OF BLUE EYES WHITE DRAGON

**CLASS 9—ELECTRICAL AND SCIENTIFIC APPARATUS**

FOR COMPUTER GAMES, NAMELY, COMPUTER GAME PROGRAMS; VIDEO GAMES FOR USE WITH TELEVISION SETS (U.S. CLS. 21, 23, 26, 36 AND 38).

**CLASS 28—TOYS AND SPORTING GOODS**

FOR BOARD GAMES, GAME PIECES AND INSTRUCTIONS SOLD AS A UNIT THEREWITH; CARD GAMES; STAND-ALONE VIDEO GAMES; DICE; TOYS; NAMELY, ACTION AND PLAY FIGURES (U.S. CLS. 22, 23, 38 AND 50).

---

SN 76-056,647. FORESTEXPRESS LLC, ENGLEWOOD, CO. BY ASSIGNMENT GEORGIA-PACIFIC CORPORATION, ATLANTA, GA. FILED 5-25-2000.

## FOREST DIRECT

NO CLAIM IS MADE TO THE EXCLUSIVE RIGHT TO USE "DIRECT", APART FROM THE MARK AS SHOWN.

**CLASS 16—PAPER GOODS AND PRINTED MATTER**

FOR PAPER PRODUCTS, NAMELY, NEWSPRINT, CORRUGATED BOXES, CORRUGATED CARDBOARD AND COMPONENTS THEREOF, NAMELY, CORRUGATING MEDIUM AND LINERBOARD, WRITING TABLETS, COATED PUBLICATION PAPERS, GLOSSY PUBLICATION PAPER, BLEACHED BOARD, SAFETY PAPER, RECYCLED PAPER, CARDBOARD, BOND PAPER, BLANK OR PARTIALLY PRINTED LABELS, PRINTED LABELS, PAPER TOWELS, NAPKINS AND TISSUES, PAPER PLATES, PAPER BAGS, PAPER, PRINTING, WRITING AND COPYING PAPER, CARBONLESS PAPER, THERMAL PAPER, STATIONERY, ENVELOPES, PAPER AND CARDBOARD CONTAINERS, BOXES AND PACKAGING, PAPER BIBS, PAPER PLACEMENTS AND TABLECLOTHS, AND PAPERBOARD (U.S. CLS. 2, 5, 22, 23, 29, 37, 38 AND 50).

**CLASS 19—NON-METALLIC BUILDING MATERIALS**

FOR PLYWOOD, LUMBER AND GYPSUM TILES (U.S. CLS. 1, 12, 33 AND 50).

**CLASS 35—ADVERTISING AND BUSINESS**

FOR ONLINE RETAIL AND WHOLESALE STORE SERVICES FEATURING PAPER PRODUCTS, PLYWOOD, LUMBER AND GYPSUM TILES VIA THE INTERNET (U.S. CLS. 100, 101 AND 102).

SN 76-057,220. VILLAHERMOSA, REINALDO, PERTH AMBOY, NJ. FILED 5-22-2000.

**CLASS 25—CLOTHING**

FOR SHIRTS, HATS, SHORTS, PANTS, SKIRTS, DRESSES, SKULL CAPS AND JACKETS (U.S. CLS. 22 AND 39).

**CLASS 28—TOYS AND SPORTING GOODS**

FOR TOYS, NAMELY; BEAN BAG DOLLS AND STUFFED ANIMALS (U.S. CLS. 22, 23, 38 AND 50).

SN 76-056,794. DETROIT WORLD OUTREACH ASSEMBLY OF GOD, REDFORD, MI. FILED 5-25-2000.

**WAY OF VICTORY****CLASS 9—ELECTRICAL AND SCIENTIFIC APPARATUS**

FOR RELIGIOUS AUDIO AND VIDEO TAPES (U.S. CLS. 21, 23, 26, 36 AND 38).  
FIRST USE 10-17-1994; IN COMMERCE 11-6-1994.

**CLASS 41—EDUCATION AND ENTERTAINMENT**

FOR ON-GOING RADIO AND TELEVISION PROGRAMS IN THE FIELD OF RELIGION (U.S. CLS. 100, 101 AND 107).  
FIRST USE 10-17-1994; IN COMMERCE 11-6-1994.

SN 76-057,270. MULTI LEVEL MEMORY TECHNOLOGY, CUPERTINO, CA. FILED 5-22-2000.

**IMAGE FLASH**

NO CLAIM IS MADE TO THE EXCLUSIVE RIGHT TO USE "FLASH", APART FROM THE MARK AS SHOWN.

**CLASS 9—ELECTRICAL AND SCIENTIFIC APPARATUS**

FOR INTEGRATED CIRCUITS (U.S. CLS. 21, 23, 26, 36 AND 38).

**CLASS 40—MATERIAL TREATMENT**

FOR CUSTOM MANUFACTURE OF INTEGRATED CIRCUITS FOR OTHERS (U.S. CLS. 100, 103 AND 106).

**CLASS 42—SCIENTIFIC, COMPUTER AND LEGAL SERVICES**

FOR DESIGN OF INTEGRATED CIRCUITS FOR OTHERS (U.S. CLS. 100 AND 101).

SN 76-056,937. WOODRUFF, RODERICK, FALLS CHURCH, VA. AND BRISCOE-WOODRUFF, CONSTANCE YVONNE, FALLS CHURCH, VA. FILED 5-26-2000.

**BLAX**

SN 76-057,733. SAPIENT CORPORATION, CAMBRIDGE, MA. FILED 5-25-2000.

**CLASS 35—ADVERTISING AND BUSINESS**

FOR PROVIDING AN ON-LINE COMPUTER DATABASE IN THE FIELD OF OFFERING RETAIL SALES OF CELLULAR PHONES (U.S. CLS. 100, 101 AND 102).

**OFFSPRING PARTNERS**

NO CLAIM IS MADE TO THE EXCLUSIVE RIGHT TO USE "PARTNERS", APART FROM THE MARK AS SHOWN.

**CLASS 42—SCIENTIFIC, COMPUTER AND LEGAL SERVICES**

FOR PROVIDING AN ON LINE COMPUTER DATABASE IN THE FIELDS OF - DESKTOP PUBLISHING FOR OTHERS, THE PUBLISHING AND THE PUBLISHING BUSINESS, TELEVISION DOCUMENTARIES AND AUTHORS (U.S. CLS. 100 AND 101).

**CLASS 35—ADVERTISING AND BUSINESS**

FOR BUSINESS MANAGEMENT AND CONSULTING SERVICES FOR START UP, EMERGING AND EXISTING COMPANIES; DEVELOPING AND PROVIDING MANAGEMENT INFRASTRUCTURE SERVICES FOR START UP, EMERGING AND EXISTING COMPANIES (U.S. CLS. 100, 101 AND 102).

**CLASS 42—SCIENTIFIC, COMPUTER AND LEGAL SERVICES**

FOR INFORMATION TECHNOLOGY CONSULTING AND ADVISORY SERVICES (U.S. CLS. 100 AND 101).

SN 76-059,710. INTERIM SERVICES PACIFIC, LLC, FORT LAUDERDALE, FL. FILED 5-31-2000.

 The logo for Spherion features the word "spherion" in a lowercase, sans-serif font. A vertical line is positioned above the letter 'i', extending slightly above and below the top and bottom of the letter.
**CLASS 9—ELECTRICAL AND SCIENTIFIC APPARATUS**

FOR COMPUTER SOFTWARE FOR ORGANIZING AND MAINTAINING BUSINESS TASKS IN THE FIELD OF ENGINEERING SOFTWARE APPLICATIONS (U.S. CLS. 21, 23, 26, 36 AND 38).

FIRST USE 5-11-2000; IN COMMERCE 5-11-2000.

SN 76-057,876. MSX INTERNATIONAL, INC., AUBURN HILLS, MI. FILED 5-26-2000.

**PEOPLE-XCHANGE****CLASS 35—ADVERTISING AND BUSINESS**

FOR HUMAN RESOURCES CONSULTING; HUMAN RESOURCES RESEARCH AND ANALYSIS; DATABASE COLLECTION AND MANAGEMENT; CONDUCTING STUDIES AND SURVEYS ON WORK FORCE PATTERNS AND CURRENT TRENDS IN THE WORK FORCE; PERSONNEL RECRUITMENT AND MANAGEMENT; CONTRACT STAFFING SERVICES; CAREER CONSULTING; CAREER MANAGEMENT; MANAGEMENT CONSULTING; EMPLOYMENT OUT PLACEMENT; EMPLOYMENT RELATED SERVICES, NAMELY, RECRUITING, INTERVIEWING AND HIRING VIA ANY GLOBAL INTERCONNECTED COMMUNICATION SYSTEM; BUSINESS CONSULTATION SERVICES IN THE FIELDS OF PERSONNEL MANAGEMENT, PLACEMENT, RECRUITMENT AND RELOCATION; MANAGEMENT ASSISTANCE SERVICES, NAMELY, CUSTOMIZING OF RECRUITMENT, TESTING AND TRAINING IN THE CLERICAL AND INDUSTRIAL STAFFING, LEGAL, ACCOUNTING, TECHNICAL, CONSULTING AND HEALTHCARE INDUSTRIES; HUMAN CAPITOL CONSULTING AND BENCH MARKING; ANALYSIS OF BENCH MARKING AND PERFORMANCE OF HUMAN RESOURCE FUNCTIONS; HUMAN CAPITOL BENCH MARKING SERVICES, NAMELY, AUTOMATING DATA CAPTURE, EXTRACTION AND LOAD PROCESS FOR HUMAN CAPITAL METRICS AND HUMAN RESOURCES BENCH MARKING; ESTABLISHING AND GENERATING METRICS IN THE NATURE OF BUSINESS STANDARDS FOR INTERNAL COMPANY COMPONENTS, AND PROVIDING BENCHMARK DATABASES VIA ANY GLOBAL INTERCONNECTED COMMUNICATIONS SYSTEM; HUMAN CAPITAL METRICS SERVICES, NAMELY, PROVIDING HUMAN CAPITAL METRICS, BENCH MARKING FORMULAS, AND DATA ELEMENTS IN DATA EXTRACTION, REPORTING AND DISPLAY SOFTWARE AND/OR SYSTEMS, TO ESTABLISH AND GENERATE METRICS FOR INTERNAL COMPANY COMPONENTS, ALLOWING TRANSFER OF DATA ELEMENTS ON AN AUTOMATED ELECTRONIC BASIS TO OBTAIN COMPETITIVE INDUSTRY BENCH MARKING INFORMATION, AND PROVIDING BENCH MARKING DATABASES VIA ANY GLOBAL INTERCONNECTED COMMUNICATION SYSTEM; EMPLOYEE TALENT ASSESSMENT AND DEVELOPMENT; EXECUTIVE COUNSELING IN THE NATURE OF CAREER COUNSELING FOR EXECUTIVES; OUT PLACEMENT AND EMPLOYMENT COUNSELING; CREATING, MAINTAINING AND PUBLISHING A SET OF INDEXES WHICH MEASURE THE ECONOMIC VALUE AND PERFORMANCE OF A WORK FORCE; PERMANENT AND TEMPORARY EMPLOYMENT SERVICES, NAMELY, PERMANENT AND TEMPORARY PLACEMENT OF PERSONNEL; EXECUTIVE RECRUITMENT SERVICES; EXECUTIVE SEARCH SERVICES; WORK FORCE MANAGEMENT SERVICES; STENOGRAPHIC AND ELECTRONIC MESSAGE TRANSCRIPTION SERVICES; PROVIDING SURVEYS OF THE ECONOMIC VALUE AND PERFORMANCE OF A WORK FORCE AND THE BENCH MARKING AND PERFORMANCE OF HUMAN RESOURCE FUNCTIONS; EMPLOYMENT SERVICES, NAMELY, COMPUTERIZED MATCHING OF PROSPECTIVE EMPLOYEES; COURT REPORTING AND TRANSCRIPTION SERVICES, NAMELY, THE RECORDING, TRANSCRIPTION AND

**CLASS 35—ADVERTISING AND BUSINESS**

FOR CONTRACT TO HIRE PERSONNEL EMPLOYMENT SERVICES; TEMPORARY PERSONNEL EMPLOYMENT SERVICES; EMPLOYEE ADMINISTRATION SERVICES, NAMELY, PROVISION OF HUMAN RESOURCES FOR OTHERS, PAYROLL PREPARATION SERVICES, PERSONNEL AND HUMAN RESOURCE MANAGEMENT CONSULTATION, AND CONSULTATION CONCERNING REGULATORY COMPLIANCE IN THE FIELD OF EMPLOYMENT LAW AND WORK-PLACE REGULATION; SINGLE SOURCE MANAGEMENT, NAMELY ACTING AS A SINGLE SOURCE FOR THE ADMINISTRATION, PROCUREMENT AND BILLING OF TEMPORARY PERSONNEL FOR OTHERS; PROCUREMENT SERVICES IN THE FIELD OF TEMPORARY LABOR, PERSONNEL TRAINING, AND EMPLOYMENT AND PERSONNEL CONSULTATION SERVICES (U.S. CLS. 100, 101 AND 102).

**CLASS 41—EDUCATION AND ENTERTAINMENT**

FOR PERSONNEL TRAINING, NAMELY, PROVIDING COURSES, SEMINARS AND WORKSHOPS TO EMPLOYEES IN THE EMPLOYEE BEHAVIOR, INFORMATION TECHNOLOGY, ENGINEERING AND TECHNICAL FIELDS (U.S. CLS. 100, 101 AND 107).

SN 76-058,349. WORLD THEATRE, INC., MORRISVILLE, NC. FILED 5-30-2000.

**WORLD THEATRE****CLASS 35—ADVERTISING AND BUSINESS**

FOR AUTOMATED ORDER PROCESSING SERVICES FOR OTHERS IN THE FIELD OF GENERAL CONSUMER MERCHANDISE (U.S. CLS. 100, 101 AND 102).

**CLASS 36—INSURANCE AND FINANCIAL**

FOR AUTOMATED PAYMENT PROCESSING SERVICES FOR OTHERS IN THE FIELD OF GENERAL CONSUMER MERCHANDISE (U.S. CLS. 100, 101 AND 102).

DELIVERY OF TESTIMONY AND OTHER VERBAL, NONVERBAL AND VISUAL COMMUNICATIONS; DOCUMENT SUMMARIZATION SERVICES; LITIGATION SUPPORT SERVICES RELATED TO DOCUMENTS, NAMELY, SECRETARIAL AND CLERICAL SERVICES; HUMAN RESOURCES SERVICES, NAMELY CONDUCTING FOR OTHERS PREEMPLOYMENT TESTS AND SCREENING OF POTENTIAL EMPLOYEES; AND EMPLOYMENT RELATED SERVICES, NAMELY, RECRUITING, INTERVIEWING AND HIRING VIA ANY GLOBAL INTERCONNECTED COMMUNICATION SYSTEM (U.S. CLS. 100, 101 AND 102).

FIRST USE 5-11-2000; IN COMMERCE 5-11-2000.

#### **CLASS 41—EDUCATION AND ENTERTAINMENT**

FOR HUMAN RESOURCES PUBLICATIONS OF BOOKS, PAMPHLETS, BROCHURES, REPORTS, AND NEWSLETTERS; EDUCATIONAL SERVICES, NAMELY, CONDUCTING CLASSES, SEMINARS, CONFERENCES AND WORKSHOPS FOR EMPLOYEES AND OTHERS ON THE PREVENTION OF WORK PLACE INJURIES AND CONSULTATION; PROVIDING WORKSHOPS AND SEMINARS RELATING TO ISSUES REGARDING HUMAN RESOURCES AND HUMAN CAPITAL; PROVIDING SEMINARS ON EMPLOYEE ATTRACTION, RETENTION AND ANALYSIS (U.S. CLS. 100, 101 AND 107).

FIRST USE 5-11-2000; IN COMMERCE 5-11-2000.

#### **CLASS 42—SCIENTIFIC, COMPUTER AND LEGAL SERVICES**

FOR DEVELOPMENT AND TESTING OF INFORMATION TECHNOLOGY SOFTWARE AND HARDWARE; EMPLOYMENT DATABASE MAINTENANCE; NON-DOWNLOADABLE COMPUTER SOFTWARE FOR ORGANIZING AND MAINTAINING BUSINESS TASKS IN THE FIELD OF ENGINEERING SOFTWARE APPLICATIONS; ENGINEERING, TECHNICAL WRITING AND CONSULTING SERVICES RELATED TO ENGINEERING AND TECHNICAL WRITING; PROVIDING MULTIMEDIA TESTING AND EVALUATION SYSTEMS FOR MEASURING SKILL LEVELS OF TEMPORARY AND PERMANENT EMPLOYEES (U.S. CLS. 100 AND 101).

FIRST USE 5-11-2000; IN COMMERCE 5-11-2000.

SN 76-059,947. STAN LEE MEDIA, INC., ENCINO, CA. FILED 5-30-2000.

## **THE STREAK**

#### **CLASS 16—PAPER GOODS AND PRINTED MATTER**

FOR CALENDARS, POSTERS; PUBLICATIONS, NAMELY BOOKS ON THE SUBJECT OF ANIMATED AND ADVENTURE STORIES, NOTEBOOKS, COMIC BOOKS, AND MAGAZINES FEATURING ARTICLES, REVIEWS, AND INFORMATION RELATED TO ANIMATED CARTOON CHARACTERS AND ADVENTURE STORIES, AND STORIES IN ILLUSTRATED FORM; TRADING CARDS; PENCIL CASES, PENCIL SHARPENERS, BOOKMARKS, PLAYING CARDS, GREETING CARDS, POSTCARDS, STATIONERY, DRAWING AND UNGRADUATED RULERS, STICKERS, DECALS, WRAPPING PAPER, STICKER BOOKS, PAPER NAPKINS, PAPER AND PLASTIC PLACEMATS, PAPER PARTY HATS, PAPER TABLE CLOTHS, ALL FEATURING ANIMATED CARTOON CHARACTERS (U.S. CLS. 2, 5, 22, 23, 29, 37, 38 AND 50).

#### **CLASS 35—ADVERTISING AND BUSINESS**

FOR RETAIL STORE SERVICES FEATURING CLOTHING, TOYS, GAMES, AND ELECTRONIC MEDIA, ALL OF WHICH FEATURE ANIMATED CARTOON CHARACTERS (U.S. CLS. 100, 101 AND 102).

SN 76-060,998. TURTLESNAP VENTURES, INC., BALTIMORE, MD. FILED 6-1-2000.

## **TURTLESNAP VENTURES**

NO CLAIM IS MADE TO THE EXCLUSIVE RIGHT TO USE "VENTURES", APART FROM THE MARK AS SHOWN.

#### **CLASS 35—ADVERTISING AND BUSINESS**

FOR BUSINESS CONSULTING SERVICES (U.S. CLS. 100, 101 AND 102).

#### **CLASS 36—INSURANCE AND FINANCIAL**

FOR VENTURE CAPITAL INVESTMENT (U.S. CLS. 100, 101 AND 102).

SN 76-063,155. ORYNOVA B.V., NETHERLANDS, FILED 6-5-2000.

## **ORYNOVA**

#### **CLASS 30—STAPLE FOODS**

FOR RICE, PROCESSED OATS AND BARLEY, FLOUR, TAPIOCA, SAGO AND PREPARATIONS MADE FROM CEREAL (U.S. CL. 46).

#### **CLASS 31—NATURAL AGRICULTURAL PRODUCTS**

FOR UNPROCESSED OATS AND BARLEY, FRESH FRUITS AND VEGETABLES, AGRICULTURAL SEEDS, NATURAL LIVING FLOWERS AND PLANTS (U.S. CLS. 1 AND 46).

#### **CLASS 42—SCIENTIFIC, COMPUTER AND LEGAL SERVICES**

FOR RESEARCH, NEW PRODUCT TESTING AND DIAGNOSIS, TECHNICAL INFORMATION AND CONSULTANCY SERVICES IN CONNECTION WITH PHARMACEUTICALS, COSMETICS, FOODS, AGRICULTURE, HORTICULTURE, FORESTRY, LIVESTOCK AND FISHERY (U.S. CLS. 100 AND 101).

SN 76-063,955. GLOBAL EMPLOYMENT SOLUTIONS, INC., GOLDEN, CO. FILED 6-5-2000.

## **GLOBAL EMPLOYMENT SOLUTIONS**

NO CLAIM IS MADE TO THE EXCLUSIVE RIGHT TO USE "EMPLOYMENT", APART FROM THE MARK AS SHOWN.

#### **CLASS 35—ADVERTISING AND BUSINESS**

FOR EMPLOYMENT AND HUMAN RESOURCE CONSULTING, TEMPORARY STAFFING AND EMPLOYEE LEASING (U.S. CLS. 100, 101 AND 102).

FIRST USE 9-0-1998; IN COMMERCE 9-0-1998.

**CLASS 42—SCIENTIFIC, COMPUTER AND LEGAL SERVICES**

FOR INFORMATION TECHNOLOGY CONSULTING; COMPUTER PROGRAMMING FOR OTHERS (U.S. CLS. 100 AND 101).

FIRST USE 4-0-1999; IN COMMERCE 4-0-1999.

**CLASS 42—SCIENTIFIC, COMPUTER AND LEGAL SERVICES**

FOR PRESS AND INFORMATION AGENCY; VETERINARY SERVICES; AGRICULTURAL SERVICES, NAMELY PLANTING SEEDS FOR OTHERS; LEGAL SERVICES; SCIENTIFIC AND INDUSTRIAL RESEARCH; COMPUTER PROGRAMMING FOR OTHERS; RENTAL OF AGRICULTURAL EQUIPMENT FOR AGRICULTURAL OPERATORS, ANIMAL BREEDING, VERMIN EXTERMINATION FOR AGRICULTURE; WEED KILLING SERVICES; COMPUTER CONSULTING; ENVIRONMENTAL PROTECTION CONSULTING; RENTAL OF COMPUTERS, RENTAL OF COMPUTER SOFTWARE; COMPUTER SOFTWARE PRODUCTION AND DESIGN; PROVIDING AGRICULTURAL INFORMATION TO OTHERS; PROVIDING METEOROLOGICAL INFORMATION TO OTHERS (U.S. CLS. 100 AND 101).

SN 76-064,709. EUROPAGRI, 75002 PARIS, FRANCE, FILED 6-7-2000.

SN 76-065,087. TONOS ENTERTAINMENT, INC., LOS ANGELES, CA. FILED 6-7-2000.

**AGRIFIRST**

PRIORITY CLAIMED UNDER SEC. 44(D) ON FRANCE APPLICATION NO. 99828118, FILED 12-7-1999, REG. NO. 99/828119, DATED 7-4-2000, EXPIRES 12-7-2009.

**GET INSIDE THE MUSIC**

NO CLAIM IS MADE TO THE EXCLUSIVE RIGHT TO USE "MUSIC", APART FROM THE MARK AS SHOWN.

**CLASS 5—PHARMACEUTICALS**

FOR PHARMACEUTICAL, VETERINARY AND HYGIENIC PRODUCTS, NAMELY VETERINARY VACCINES FOR FARM ANIMALS, DIETARY SUBSTANCES FOR MEDICAL USE NAMELY DIETARY SUPPLEMENTS, DIET PILLS AND CAPSULES, ALL-PURPOSE DISINFECTANTS AND DISINFECTANTS FOR MEDICAL PURPOSES, PREPARATIONS FOR DESTROYING VERMIN; FUNGICIDES, HERBICIDES, INSECTICIDES, PARASITICIDES, AND WEED KILLERS, ALL FOR DOMESTIC USE AND FOR AGRICULTURAL USE, POISONS FOR DESTROYING MICE, PREPARATIONS FOR DESTROYING VEGETATION, VERMIFUGES IN THE NATURE OF LIQUIDS, GELS OR SPRAYS (U.S. CLS. 6, 18, 44, 46, 51 AND 52).

**CLASS 41—EDUCATION AND ENTERTAINMENT**

FOR PROVIDING EDUCATIONAL MENTORING AND EDUCATIONAL COLLABORATION TO OTHERS IN THE MUSIC FIELD OVER THE INTERNET (U.S. CLS. 100, 101 AND 107).

FIRST USE 11-3-1999; IN COMMERCE 11-3-1999.

**CLASS 31—NATURAL AGRICULTURAL PRODUCTS**

FOR UNPREPARED AND UNTRANSFORMED AGRICULTURAL, HORTICULTURAL AND FORESTRY PRODUCTS, NAMELY SEEDS AND PLANTS, SEEDS IN THE NATURE OF PLANT SEEDS AND AGRICULTURAL SEEDS FOR SOWING; LIVE ANIMALS, FRESH FRUIT AND VEGETABLES; NATURAL PLANTS AND FLOWERS; ANIMAL FOODSTUFFS; MALT, LIVESTOCK FEED IN THE FORM OF CEREALS, FORAGE AND HAY; CEREALS IN SEED FORM, NAMELY UNPROCESSED CEREALS (U.S. CLS. 1 AND 46).

**CLASS 42—SCIENTIFIC, COMPUTER AND LEGAL SERVICES**

FOR PROVIDING INFORMATION RELATING TO MUSICIANS AND THE MUSIC INDUSTRY OVER THE INTERNET (U.S. CLS. 100 AND 101).

FIRST USE 11-3-1999; IN COMMERCE 11-3-1999.

**CLASS 38—COMMUNICATION**

FOR TELECOMMUNICATIONS SERVICES, NAMELY PROVIDING TELECOMMUNICATIONS CONNECTIONS TO A GLOBAL COMPUTER NETWORK, AND RENTAL OF TELECOMMUNICATIONS EQUIPMENT IN GENERAL; TELEPHONE AND OTHER TELECOMPUTERIZED COMMUNICATIONS SERVICES, ELECTRONIC AND DIGITAL TRANSMISSION OF FACSIMILE COMMUNICATIONS AND DATA FEATURING ENCRYPTION AND DECRYPTION; PROVIDING MULTI-USER ACCESS TO A GLOBAL COMPUTER INFORMATION NETWORK; BROADCASTING AUDIO/VISUAL AND MULTIMEDIA PROGRAMS OVER THE INTERNET (U.S. CLS. 100, 101 AND 104).

SN 76-065,841. PRECACHE, INC., NEW YORK, NY. FILED 6-9-2000.

**RAMBOX****CLASS 9—ELECTRICAL AND SCIENTIFIC APPARATUS**

FOR COMPUTER HARDWARE AND SOFTWARE FOR INTERCONNECTING, MANAGING, AND OPERATING LOCAL AND WIDE AREA NETWORKS (U.S. CLS. 21, 23, 26, 36 AND 38).

**CLASS 42—SCIENTIFIC, COMPUTER AND LEGAL SERVICES**

FOR DEVELOPMENT OF HARDWARE AND SOFTWARE FOR INTERCONNECTING, MANAGING AND OPERATING LOCAL AND WIDE AREA NETWORKS (U.S. CLS. 100 AND 101).



SN 76-065,842. PRECACHE, INC., NEW YORK, NY. FILED 6-9-2000.

SN 76-067,609. EMISSARY, LLC, AUSTIN, TX. FILED 6-2-2000.

## BORDERLESS COMPUTING

NO CLAIM IS MADE TO THE EXCLUSIVE RIGHT TO USE "COMPUTING", APART FROM THE MARK AS SHOWN.

### CLASS 9—ELECTRICAL AND SCIENTIFIC APPARATUS

FOR COMPUTER HARDWARE AND SOFTWARE FOR INTERCONNECTING, MANAGING, AND OPERATING LOCAL AND WIDE AREA NETWORKS (U.S. CLS. 21, 23, 26, 36 AND 38).

### CLASS 42—SCIENTIFIC, COMPUTER AND LEGAL SERVICES

FOR DEVELOPMENT OF HARDWARE AND SOFTWARE FOR INTERCONNECTING, MANAGING AND OPERATING LOCAL AND WIDE AREA NETWORKS (U.S. CLS. 100 AND 101).

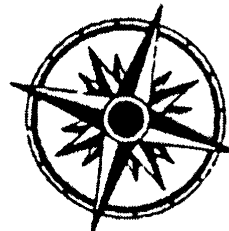

### CLASS 35—ADVERTISING AND BUSINESS

FOR STAFFING SERVICES IN THE FIELD OF CLINICAL RESEARCH, NAMELY PROVIDING PROFESSIONAL AND MEDICAL PERSONNEL ON A TEMPORARY BASIS TO PHARMACEUTICAL, MEDICAL DEVICE AND BIOTECHNOLOGY COMPANIES TO ASSIST WITH MEDICAL RESEARCH AND CLINICAL TESTING; COMPUTERIZED DATABASE MANAGEMENT AND DATA PROCESSING (U.S. CLS. 100, 101 AND 102).

FIRST USE 12-2-1996; IN COMMERCE 12-2-1996.

### CLASS 42—SCIENTIFIC, COMPUTER AND LEGAL SERVICES

FOR MEDICAL RESEARCH AND CLINICAL TESTING, NAMELY, CONDUCTING AND MANAGING CLINICAL TRIALS AND PRODUCT DEVELOPMENT STUDIES OF PHARMACEUTICAL, BIOTECHNOLOGY, AND HEALTHCARE PRODUCTS AND DEVICE; AND BIOSTATISTICAL ANALYSIS IN WRITING SERVICES; COMPILING MEDICAL RESEARCH INFORMATION FOR SUBMISSION TO REGULATORY AGENCIES IN THE FIELDS OF PHARMACEUTICAL, BIOTECHNOLOGY, AND HEALTHCARE PRODUCTS AND DEVICES (U.S. CLS. 100 AND 101).

FIRST USE 12-2-1996; IN COMMERCE 12-2-1996.

---

SN 76-065,873. DIGITALCONVERGENCE.COM INC., DALLAS, TX. FILED 6-8-2000.

**:Cue:Channel**

---

SN 76-069,162. DAYLE HADDON CONCEPTS, INC., NEW YORK, NY. FILED 6-13-2000.

## AGELESS PRINCIPLES

THE STYLIZED C'S IN THE MARK APPEAR IN THE COLOR RED.

### CLASS 9—ELECTRICAL AND SCIENTIFIC APPARATUS

FOR COMPUTER SOFTWARE THAT INSTALLS SEARCH ENGINES AND ADVERTISERS' BANNERS AND TABS ON A USER'S COMPUTER DESKTOP, WHICH LAUNCHES THE USER'S COMPUTER TO A WEBSITE ON THE INTERNET WHEN THE USER CLICKS ON THE BANNER OR TAB (U.S. CLS. 21, 23, 26, 36 AND 38).

### CLASS 35—ADVERTISING AND BUSINESS

FOR ADVERTISING FOR OTHERS VIA AN ON-LINE ELECTRONIC COMMUNICATION NETWORK (U.S. CLS. 100, 101 AND 102).

### CLASS 16—PAPER GOODS AND PRINTED MATTER

FOR NEWSLETTERS AND SYNDICATED MAGAZINE ARTICLES IN THE FIELD OF BEAUTY, HEALTH AND WELL-BEING (U.S. CLS. 2, 5, 22, 23, 29, 37, 38 AND 50).

### CLASS 41—EDUCATION AND ENTERTAINMENT

FOR EDUCATIONAL AND ENTERTAINMENT SERVICES IN THE NATURE OF ONGOING RADIO, ON-LINE, AND TELEVISION PROGRAMS IN THE FIELD OF BEAUTY, HEALTH AND WELL-BEING; AND PERSONAL APPEARANCES BY A BEAUTY, HEALTH AND WELL-BEING EXPERT PROVIDING COMMENTARY ON BEAUTY, HEALTH AND WELL-BEING ISSUES (U.S. CLS. 100, 101 AND 107).

SN 76-069,798. XEROX CORPORATION, STAMFORD, CT.  
FILED 6-12-2000.

SN 76-070,734. AMERITRADE, (INC.), OMAHA, NE. FILED  
6-13-2000.

## X5

### CLASS 37—CONSTRUCTION AND REPAIR

FOR INSTALLATION AND MAINTENANCE OF COMPUTER NETWORKS AND PRINTER NETWORKS (U.S. CLS. 100, 103 AND 106).

### CLASS 42—SCIENTIFIC, COMPUTER AND LEGAL SERVICES

FOR CONSULTING SERVICES FOR THE INSTALLATION AND MAINTENANCE OF CLIENT COMPUTER NETWORKS, NAMELY NETWORKS FOR PRINTERS AND MULTIFUNCTIONAL DEVICES COPIER, PRINTER, FACSIMILE MACHINE, AND SCANNER (U.S. CLS. 100 AND 101).

---

SN 76-070,674. HCB ENTERPRISES, INC., DALLAS, TX.  
FILED 6-15-2000.



NO CLAIM IS MADE TO THE EXCLUSIVE RIGHT TO USE "THE DRY CLEANER", APART FROM THE MARK AS SHOWN.

### CLASS 37—CONSTRUCTION AND REPAIR

FOR CLOTHING MAINTENANCE AND REPAIR SERVICES, NAMELY MENDING, LEATHER CLEANING FOR ANIMAL SKINS, HIDES AND IMITATIONS OF LEATHER, LAUNDRY AND DRY CLEANING SERVICES INCLUDING CLOTHING MAINTENANCE AND REPAIR SERVICES WHICH MAY BE ORDERED VIA GLOBAL COMPUTER NETWORKS (U.S. CLS. 100, 103 AND 106).

FIRST USE 9-30-1996; IN COMMERCE 9-30-1996.

### CLASS 39—TRANSPORTATION AND STORAGE

FOR PICK-UP AND DELIVERY SERVICES FOR CLOTH, CLOTHING, FABRIC AND LEATHER VIA GROUND TRANSPORTATION, INCLUDING PICK-UP AND DELIVERY SERVICES WHICH MAY BE ORDERED VIA GLOBAL COMPUTER NETWORKS (U.S. CLS. 100 AND 105).

FIRST USE 9-30-1996; IN COMMERCE 9-30-1996.

## AMERITRADE INVESTOR'S CUP

NO CLAIM IS MADE TO THE EXCLUSIVE RIGHT TO USE "INVESTOR'S", APART FROM THE MARK AS SHOWN.

### CLASS 25—CLOTHING

FOR CLOTHING, NAMELY, T-SHIRTS, SWEAT-SHIRTS, POLO SHIRTS, TWILL SHIRTS, AND JACKETS; AND HEADWEAR, NAMELY, CAPS (U.S. CLS. 22 AND 39).

### CLASS 36—INSURANCE AND FINANCIAL

FOR CONDUCTING CONTESTS AND SWEEPSTAKES RELATED TO THE STOCK MARK (U.S. CLS. 100, 101 AND 102).

---

SN 76-071,849. KONINKLIJKE KPN N.V., 2516 CK DEN HAG, NETHERLANDS, FILED 6-16-2000.

## SWITCHPOINT

PRIORITY CLAIMED UNDER SEC. 44(D) ON BENELUX APPLICATION NO. 0923844, FILED 9-28-1998, REG. NO. 0644489, DATED 8-2-1999, EXPIRES 9-28-2008.

### CLASS 9—ELECTRICAL AND SCIENTIFIC APPARATUS

FOR COMPUTER SOFTWARE FOR ENABLING A USER TO CONNECT FROM THE WORLDWIDE COMPUTER NETWORK TO ANOTHER COMPUTER NETWORK, AND FOR ENABLING A USER TO DIRECTLY CONNECT TO PAY FOR USE WEBSITES (U.S. CLS. 21, 23, 26, 36 AND 38).

### CLASS 38—COMMUNICATION

FOR TELECOMMUNICATION SERVICES, NAMELY ELECTRONIC DATA TRANSFER, INTERACTIVE TELECOMMUNICATION SERVICES, NAMELY, ENABLING A USER TO DISCONNECT A NORMAL PHONE CONNECTION AND ESTABLISH A NEW PHONE CONNECTION TO ANOTHER TELEPHONE NUMBER AT A DIFFERENT CHARGE RATE; TELECOMMUNICATION BY WAY OF ON-LINE COMPUTER NETWORKS; PROVIDING MULTIPLE-USER ACCESS TO A GLOBAL COMPUTER INFORMATION NETWORK (U.S. CLS. 100, 101 AND 104).

### CLASS 42—SCIENTIFIC, COMPUTER AND LEGAL SERVICES

FOR RENTAL OF COMPUTER HARDWARE AND SOFTWARE; COMPUTER PROGRAMMING FOR OTHERS; PROVIDING TEMPORARY USE OF ON-LINE NON-DOWNLOADABLE SOFTWARE THAT ENABLES CONNECTION FROM THE WORLDWIDE COMPUTER NETWORK TO A DIFFERENT COMPUTER NETWORK (U.S. CLS. 100 AND 101).

SN 76-072,466. HERMAN MILLER, INC., ZEELAND, MI.  
FILED 6-19-2000.

## EZCONNECT

### CLASS 9—ELECTRICAL AND SCIENTIFIC APPARATUS

FOR COMPUTER SOFTWARE FOR USE IN THE DESIGN AND LAYOUT OF OFFICE AND RESIDENTIAL FURNITURE, AND SPECIFYING, ORDERING, MONITORING THE PRODUCTION STATUS OF, AND DIAGNOSING CUSTOMER NEEDS PERTAINING TO OFFICE AND RESIDENTIAL FURNITURE (U.S. CLS. 21, 23, 26, 36 AND 38).

### CLASS 20—FURNITURE AND ARTICLES NOT OTHERWISE CLASSIFIED

FOR OFFICE AND RESIDENTIAL FURNITURE (U.S. CLS. 2, 13, 22, 25, 32 AND 50).

### CLASS 35—ADVERTISING AND BUSINESS

FOR ELECTRONIC RETAILING SERVICES VIA COMPUTER FEATURING FURNITURE (U.S. CLS. 100, 101 AND 102).

### CLASS 42—SCIENTIFIC, COMPUTER AND LEGAL SERVICES

FOR DESIGN FOR OTHERS IN THE FIELD OF OFFICE AND HOME OFFICE FURNITURE CONFIGURATION AND LAYOUT (U.S. CLS. 100 AND 101).

SN 76-074,855. TALEGA ASSOCIATES, LLC., SAN CLEMENTE, CA. FILED 6-21-2000.

## TALEGA GOLF COURSE

NO CLAIM IS MADE TO THE EXCLUSIVE RIGHT TO USE "GOLF COURSE", APART FROM THE MARK AS SHOWN.

THE ENGLISH TRANSLATION OF "TALEGA" IS "SACK OR BAG OR MONEY BAG".

### CLASS 18—LEATHER GOODS

FOR UMBRELLAS (U.S. CLS. 1, 2, 3, 22 AND 41).

### CLASS 24—FABRICS

FOR GOLF TOWELS (U.S. CLS. 42 AND 50).

### CLASS 25—CLOTHING

FOR SPORTING APPAREL, FOOTWEAR AND HEADWEAR FOR MEN, WOMEN AND CHILDREN, NAMELY, SHIRTS, T-SHIRTS, SWEATSHIRTS, BLOUSES, SWEATPANTS, SKIRTS, DRESSES, UNDERPANTS, SCARVES, NECKTIES, JEANS, TROUSERS, PANTS, SLACKS, SWEATERS, JACKETS, VESTS, SHORTS, SOCKS, GLOVES, VISORS, HATS, BELTS, SWIMWEAR AND SHOES (U.S. CLS. 22 AND 39).

### CLASS 28—TOYS AND SPORTING GOODS

FOR SPORTING GOODS NAMELY, GOLF BAGS, GOLF BAG COVERS, GOLF CLUBS, GOLF BALLS, GOLF TEES, GOLF BAG TAGS, STRAP COVERS FOR GOLF BAGS, HEAD COVERS FOR GOLF CLUBS, GOLF BALL MARKERS, GOLF GLOVES (U.S. CLS. 22, 23, 38 AND 50).

### CLASS 41—EDUCATION AND ENTERTAINMENT

FOR ENTERTAINMENT SERVICES, NAMELY, PROVIDING GOLF CLUB SERVICES AND FACILITIES AND GOLF TOURNAMENT SERVICES (U.S. CLS. 100, 101 AND 107).

### CLASS 42—SCIENTIFIC, COMPUTER AND LEGAL SERVICES

FOR RESTAURANT AND BAR SERVICES (U.S. CLS. 100 AND 101).

SN 76-074,856. TALEGA ASSOCIATES, LLC, SAN CLEMENTE, CA. FILED 6-21-2000.

## TALEGA

THE ENGLISH TRANSLATION OF "TALEGA" IS "SACK OR BAG OR MONEY BAG".

### CLASS 18—LEATHER GOODS

FOR UMBRELLAS (U.S. CLS. 1, 2, 3, 22 AND 41).

### CLASS 24—FABRICS

FOR GOLF TOWELS (U.S. CLS. 42 AND 50).

### CLASS 25—CLOTHING

FOR SPORTING APPAREL FOOTWEAR AND HEADWEAR FOR MEN, WOMEN AND CHILDREN, NAMELY SHIRTS, T-SHIRTS, SWEATSHIRTS, BLOUSES, SWEATPANTS, SKIRTS, DRESSES, UNDERPANTS, SCARVES, NECKTIES, JEANS, TROUSERS, PANTS, SLACKS, SWEATERS, JACKETS, VESTS, SHORTS, SOCKS, GLOVES, VISORS, HATS, BELTS, SWIMWEAR AND SHOES (U.S. CLS. 22 AND 39).

### CLASS 28—TOYS AND SPORTING GOODS

FOR SPORTING GOODS NAMELY, GOLF BAGS, GOLF BAG COVERS, GOLF CLUBS, GOLF BALLS, GOLF TEES, GOLF BAG TAGS, STRAP COVERS FOR GOLF BAGS, HEAD COVERS FOR GOLF CLUBS, GOLF BALL MARKERS, GOLF GLOVES (U.S. CLS. 22, 23, 38 AND 50).

### CLASS 41—EDUCATION AND ENTERTAINMENT

FOR ENTERTAINMENT SERVICES, NAMELY, PROVIDING GOLF CLUB SERVICES AND FACILITIES AND GOLF TOURNAMENT SERVICES (U.S. CLS. 100, 101 AND 107).

### CLASS 42—SCIENTIFIC, COMPUTER AND LEGAL SERVICES

FOR RESTAURANT AND BAR SERVICES (U.S. CLS. 100 AND 101).

SN 76-074,908. PENTAGON, INC., LOS ANGELES, CA.  
FILED 6-19-2000.

SN 76-075,682. UNITED AUTO GROUP, INC., DETROIT, MI.  
FILED 6-23-2000.

## PAZANGA

### CLASS 9—ELECTRICAL AND SCIENTIFIC APPARATUS

FOR SOFTWARE FOR INTEGRATING THE ONLINE AND OFFLINE OPERATIONS OF MANUFACTURERS AND RETAILERS, AND SOFTWARE FOR PROCESSING TRANSACTIONS AND CONDUCTING INVENTORY MANAGEMENT, ASSET MANAGEMENT AND CUSTOMER MANAGEMENT FOR AN ONLINE RETAIL SITE (U.S. CLS. 21, 23, 26, 36 AND 38).

### CLASS 35—ADVERTISING AND BUSINESS

FOR ELECTRONIC COMMERCE SERVICES, NAMELY BUSINESS CONSULTATION SERVICES (U.S. CLS. 100, 101 AND 102).

### CLASS 42—SCIENTIFIC, COMPUTER AND LEGAL SERVICES

FOR HOSTING THE WEB SITES OF OTHERS ON A COMPUTER SERVER; WEB SITE DESIGN FOR OTHERS, AND PROVIDING SEARCH ENGINES FOR OBTAINING DATA OVER THE GLOBAL COMPUTER NETWORK (U.S. CLS. 100 AND 101).



OWNER OF U.S. REG. NOS. 2,312,482, 2,317,190 AND 2,369,200.

NO CLAIM IS MADE TO THE EXCLUSIVE RIGHT TO USE "AUTO", APART FROM THE MARK AS SHOWN.

### CLASS 25—CLOTHING

FOR CLOTHING; NAMELY, SHIRTS AND CAPS (U.S. CLS. 22 AND 39).  
FIRST USE 10-0-1998; IN COMMERCE 10-0-1998.

### CLASS 35—ADVERTISING AND BUSINESS

FOR PROMOTING THE MARKETING AND SALE OF MOTOR VEHICLES THROUGH A NETWORK OF AUTOMOBILE DEALERSHIPS (U.S. CLS. 100, 101 AND 102).  
FIRST USE 10-0-1998; IN COMMERCE 10-0-1998.

SN 76-075,948. TRANSGENOMIC, INC, OMAHA, NE. FILED 6-23-2000.

## OLIGOSEP

### CLASS 1—CHEMICALS

FOR REAGENTS USED IN CHROMATOGRAPHY PROCESSES (U.S. CLS. 1, 5, 6, 10, 26 AND 46).

### CLASS 9—ELECTRICAL AND SCIENTIFIC APPARATUS

FOR CHROMATOGRAPHY EQUIPMENT, NAMELY, SEPARATION AND PURIFICATION COLUMNS USED IN SCIENTIFIC ANALYSIS (U.S. CLS. 21, 23, 26, 36 AND 38).

SN 76-078,436. SERVICESOURCE, INC., ALEXANDRIA, VA. BY CHANGE OF NAME FAIRFAX OPPORTUNITIES UNLIMITED, INC., ALEXANDRIA, VA. FILED 6-27-2000.

## SERVICESOURCE

### CLASS 35—ADVERTISING AND BUSINESS

FOR JOB PLACEMENT AND OUTSOURCING FOR PEOPLE WITH DISABILITIES (U.S. CLS. 100, 101 AND 102).  
FIRST USE 5-23-2000; IN COMMERCE 5-23-2000.

SN 76-075,402. J.R. SIMPLOT COMPANY, BOISE, ID. FILED 6-22-2000.

## ROASTWORKS GLOBAL GOURMET

OWNER OF U.S. REG. NO. 2,286,615.  
NO CLAIM IS MADE TO THE EXCLUSIVE RIGHT TO USE "GOURMET", APART FROM THE MARK AS SHOWN.

### CLASS 29—MEATS AND PROCESSED FOODS

FOR FROZEN VEGETABLES AND POTATOES (U.S. CL. 46).

### CLASS 30—STAPLE FOODS

FOR FROZEN AND REFRIGERATED ENTREES PRIMARILY CONTAINING PASTA OR RICE (U.S. CL. 46).

**CLASS 41—EDUCATION AND ENTERTAINMENT**

SN 76-079,783. STERNDRIVE LTD, EVERETT, WA. FILED 6-28-2000.

FOR JOB TRAINING FOR PEOPLE WITH DISABILITIES (U.S. CLS. 100, 101 AND 107).  
FIRST USE 5-23-2000; IN COMMERCE 5-23-2000.

**CLASS 42—SCIENTIFIC, COMPUTER AND LEGAL SERVICES**

FOR PHYSICAL REHABILITATION OF PEOPLE WITH DISABILITIES (U.S. CLS. 100 AND 101).  
FIRST USE 5-23-2000; IN COMMERCE 5-23-2000.

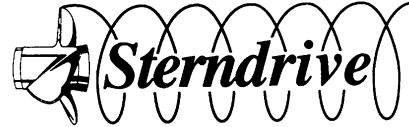

SN 76-078,827. INVESTMENT TECHNOLOGY GROUP, INC., NEW YORK, NY. FILED 6-28-2000.

NO CLAIM IS MADE TO THE EXCLUSIVE RIGHT TO USE "STERNDRIVE", APART FROM THE MARK AS SHOWN.

**SPI**

**CLASS 9—ELECTRICAL AND SCIENTIFIC APPARATUS**

FOR COMPUTER PROGRAMS FOR MANAGING AND PROVIDING AUTOMATED SECURITIES BROKERAGE, TRADING, AND TRADING STRATEGIES (U.S. CLS. 21, 23, 26, 36 AND 38).

**CLASS 35—ADVERTISING AND BUSINESS**

FOR RETAIL STORE FEATURING STERN DRIVE RELATED PARTS OR COMPONENTS (U.S. CLS. 100, 101 AND 102).  
FIRST USE 6-20-1994; IN COMMERCE 7-13-1994.

**CLASS 36—INSURANCE AND FINANCIAL**

FOR PROVIDING AND MANAGING AUTOMATED SECURITIES BROKERAGE, TRADING, AND TRADING STRATEGIES (U.S. CLS. 100, 101 AND 102).

**CLASS 37—CONSTRUCTION AND REPAIR**

FOR REPAIR AND REBUILDING SERVICES; NAMELY, REPAIR AND REBUILDING OF STERN DRIVE RELATED PARTS OR COMPONENTS (U.S. CLS. 100, 103 AND 106).  
FIRST USE 6-20-1994; IN COMMERCE 7-13-1994.

SN 76-079,407. LEVY'S LEATHERS LIMITED, WINNIPEG, MANITOBA R3B 2Z4, CANADA, FILED 6-27-2000.

SN 76-081,799. SWING SOLUTIONS, SUNNYVALE, CA. FILED 6-30-2000.

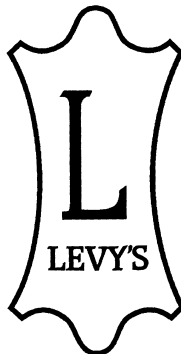

OWNER OF U.S. REG. NO. 2,342,104.

**CLASS 13—FIREARMS**

FOR RIFLE SLINGS, GUN HOLSTERS, GUN CASES, AND SHELL BELTS (U.S. CLS. 2 AND 9).  
FIRST USE 7-23-1999; IN COMMERCE 7-23-1999.

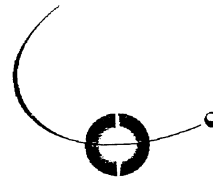

OWNER OF U.S. REG. NO. 2,393,088.  
THE STIPPLING IN THE DRAWING IS FOR SHADING PURPOSES ONLY.

**CLASS 25—CLOTHING**

FOR CLOTHING, NAMELY, POLO SHIRTS, TEE SHIRTS, SWEATSHIRTS, WIND RESISTANT JACKETS, AND CAPS (U.S. CLS. 22 AND 39).  
FIRST USE 7-0-1998; IN COMMERCE 7-0-1998.

**CLASS 15—MUSICAL INSTRUMENTS**

FOR CARRYING CASES FOR MUSICAL INSTRUMENTS AND STRAPS FOR GUITARS (U.S. CLS. 2, 21 AND 36).  
FIRST USE 7-23-1999; IN COMMERCE 7-23-1999.

**CLASS 41—EDUCATION AND ENTERTAINMENT**

FOR SERVICES, NAMELY INSTRUCTION IN THE FIELD OF GOLF, EMPHASIZING THE USE OF VIDEO SCREENS AND COMPUTERIZED EQUIPMENT TO ANALYZE GOLF SWINGS (U.S. CLS. 100, 101 AND 107).  
FIRST USE 7-0-1998; IN COMMERCE 7-0-1998.

SN 76-081,993. FOR CEOS ONLY. INC., MONTGOMERYVILLE, PA. BY MERGER; BY CHANGE OF NAME M&A GROUP, INC., MONTGOMERYVILLE, PA. FILED 6-30-2000.

## CEOONLY

### CLASS 36—INSURANCE AND FINANCIAL

FOR PROVIDING FINANCIAL INFORMATION AND FINANCIAL RESEARCH OF INTEREST TO EXECUTIVES (U.S. CLS. 100, 101 AND 102).

### CLASS 38—COMMUNICATION

FOR PROVIDING ON-LINE ELECTRONIC BULLETIN BOARDS AND ONLINE CHAT ROOMS FOR TRANSMISSION OF MESSAGES AMONG COMPUTER USERS ACCESSED VIA THE GLOBAL INFORMATION NETWORK WHICH ALLOWS EXECUTIVES TO EXCHANGE INFORMATION REGARDING HOW TO OBTAIN EQUITY OF FINANCE EMERGING COMPANIES AND HOW TO BUY AND SELL COMPANIES (U.S. CLS. 100, 101 AND 104).

SN 76-083,964. L'OREAL, 75008 PARIS, FRANCE, FILED 7-6-2000.

## DAILY TREAT

### CLASS 3—COSMETICS AND CLEANING PREPARATIONS

FOR NON-MEDICATED SKIN CARE PREPARATIONS, NAMELY, CREAMS, GELS, AND LOTIONS FOR THE SKIN AND FACE (U.S. CLS. 1, 4, 6, 50, 51 AND 52).

### CLASS 5—PHARMACEUTICALS

FOR ACNE TREATMENT PREPARATIONS (U.S. CLS. 6, 18, 44, 46, 51 AND 52).

SN 76-084,950. FREEDOM ELECTRONICS, INC., KENNESAW, GA. FILED 7-7-2000.

## FREEDOM ELECTRONICS

NO CLAIM IS MADE TO THE EXCLUSIVE RIGHT TO USE "ELECTRONICS", APART FROM THE MARK AS SHOWN.

### CLASS 7—MACHINERY

FOR ELECTRONIC VAPOR RECOVERY MOTORS FOR PETROLEUM DISPENSERS (U.S. CLS. 13, 19, 21, 23, 31, 34 AND 35).  
FIRST USE 1-0-1998; IN COMMERCE 1-0-1998.

### CLASS 9—ELECTRICAL AND SCIENTIFIC APPARATUS

FOR ELECTRONIC CIRCUIT BOARDS, COMPUTER AND RECEIPT PRINTERS, ELECTRONIC CONSOLES, NAMELY, ELECTRONIC CONTROL PANELS, ELECTRONIC PULSERS, NAMELY PULSE TIMERS FOR PETROLEUM DISPENSERS, ELECTRONIC POINT-OF-SALE TERMINALS, NAMELY COMPUTER TERMINALS AND CASH REGISTERS, ELECTRONIC POINT-OF-SALE PRINTERS, AND REPLACEMENT PARTS THEREFORE; REMANUFACTURED AND REBUILT ELECTRONIC EQUIPMENT, NAMELY COMPUTER PRINTERS AND RECEIPT PRINTERS, REMANUFACTURED AND REBUILT POINT-OF-SALE TERMINALS, NAMELY, COMPUTER TERMINALS, CASH REGISTERS, ELECTRONIC POINT-OF-SALE PRINTERS, AND REPLACEMENT PARTS THEREFOR (U.S. CLS. 21, 23, 26, 36 AND 38).  
FIRST USE 1-0-1998; IN COMMERCE 1-0-1998.

SN 76-086,036. PACIFIC INTERNATIONAL MARKETING, SALINAS, CA. FILED 7-5-2000.

## CORRAL DE TIERRA

THE ENGLISH TRANSLATION OF "CORRAL DE TIERRA" IS "BARNYARD OF THE EARTH".

### CLASS 31—NATURAL AGRICULTURAL PRODUCTS

FOR FRESH GRAPES (U.S. CLS. 1 AND 46).

### CLASS 33—WINES AND SPIRITS

FOR WINE (U.S. CLS. 47 AND 49).

SN 76-089,229. UNIVERSITY OF SOUTH DAKOTA, THE, VERMILLION, SD. FILED 7-14-2000.

## THE UNIVERSITY OF SOUTH DAKOTA SCHOOL OF MEDICINE

NO CLAIM IS MADE TO THE EXCLUSIVE RIGHT TO USE "UNIVERSITY" AND "SCHOOL OF MEDICINE", APART FROM THE MARK AS SHOWN.

### CLASS 41—EDUCATION AND ENTERTAINMENT

FOR MEDICAL EDUCATIONAL SERVICES, NAMELY, PROVIDING CLASSES, SEMINARS AND WORKSHOPS FOR THE GENERAL PUBLIC IN THE FIELD OF HEALTH AND DISSEMINATION OF RELATED EDUCATIONAL MATERIALS; PROVIDING CLASSES, SEMINARS, AND TRAINING FOR MEDICAL STUDENTS AND RESIDENTS; AND, PROVIDING CONTINUING MEDICAL EDUCATION FOR HEALTH CARE PROFESSIONALS (U.S. CLS. 100, 101 AND 107).  
FIRST USE 0-0-1975; IN COMMERCE 0-0-1975.

### CLASS 42—SCIENTIFIC, COMPUTER AND LEGAL SERVICES

FOR HEALTH CARE SERVICES AND MEDICAL RESEARCH (U.S. CLS. 100 AND 101).  
FIRST USE 0-0-1975; IN COMMERCE 0-0-1975.

SN 76-089,873. WORLD THEATRE, INC., MORRISVILLE, NC. FILED 7-17-2000.

**WTI**

**CLASS 35—ADVERTISING AND BUSINESS**

FOR ADVERTISING SERVICES, NAMELY, PROVIDING ADVERTISING SPACE ON A NETWORK OF ELECTRONIC BILLBOARDS, AUTOMATED ORDER PROCESSING SERVICES FOR OTHERS IN THE FIELD OF GENERAL CONSUMER MERCHANDISE (U.S. CLS. 100, 101 AND 102).

**CLASS 36—INSURANCE AND FINANCIAL**

FOR AUTOMATED PAYMENT PROCESSING SERVICES FOR OTHERS IN THE FIELD OF GENERAL CONSUMER MERCHANDISE (U.S. CLS. 100, 101 AND 102).

**CLASS 38—COMMUNICATION**

FOR VIDEO AND AUDIO BROADCASTING TO HOME-BASED RECORDING AND PLAYBACK SYSTEMS (U.S. CLS. 100, 101 AND 104).

**CLASS 41—EDUCATION AND ENTERTAINMENT**

FOR DISTRIBUTION OF MOTION PICTURES FOR OTHERS, NAMELY, DISTRIBUTION OF MOTION PICTURES IN DIGITAL FORM TO DIGITAL MOVIE THEATERS (U.S. CLS. 100, 101 AND 107).

SN 76-090,092. ETICK LIMITED, SYDNEY 2000, NEW SOUTH WALES, AUSTRALIA, FILED 7-14-2000.



**CLASS 35—ADVERTISING AND BUSINESS**

FOR PROVIDING AUDIT AND CERTIFICATION SERVICES TO BUSINESSES, BEING AUDIT AND CERTIFICATION SERVICES IN ACCORDANCE WITH STANDARDS, CODES OF PRACTICE AND/OR GOVERNMENT REGULATIONS ACROSS ALL INDUSTRIES; DEVELOPMENT, PUBLICATION AND REPRODUCTION OF PUBLICITY TEXTS RELATING TO STANDARDS, CODES OF PRACTICE AND GOVERNMENT REGULATIONS ACROSS ALL INDUSTRIES; BUSINESS MANAGEMENT AND CONSULTING SERVICES WITH RESPECT TO STANDARDS, CODES OF PRACTICE, OR GOVERNMENT REGULATIONS ACROSS ALL INDUSTRIES; OFFERING AND/OR RESELLING ANCILLARY AND RELATED PRODUCTS AND/OR SERVICES INCLUDING BUT NOT RESTRICTED TO MEMBERSHIPS OF INDUSTRY ASSOCIATIONS AND INDUSTRY AWARD PROGRAMS THAT ARE CONNECTED TO CERTIFICATION TO A RELEVANT STANDARD, CODE OF PRACTICE AND/OR GOVERNMENT REGULATION; PROVIDING ALL THE AFORESAID GOODS AND SERVICES BY TRADITIONAL "OFFLINE" MEANS AS WELL AS VIA ELECTRONIC AND/OR THE INTERNET (U.S. CLS. 100, 101 AND 102).

**CLASS 41—EDUCATION AND ENTERTAINMENT**

FOR TRAINING AND ACCREDITATION SERVICES WITH RESPECT TO THE SETTING UP, IMPLEMENTATION AND COMPLIANCE WITH STANDARDS, CODES OF PRACTICE AND/OR GOVERNMENT REGULATIONS, TESTING AND QUALITY ASSURANCE SERVICES PROVIDED IN CONNECTION WITH STANDARDS, CODES OF PRACTICE AND/OR GOVERNMENT REGULATIONS ACROSS ALL INDUSTRIES; PROVIDING ALL THE AFORESAID SERVICES VIA TRADITIONAL "OFFLINE" MEANS, NAMELY, SEMINARS, CLASSES, TRAINING COURSES, AS WELL AS VIA ELECTRONIC AND/OR THE INTERNET (U.S. CLS. 100, 101 AND 107).

**CLASS 42—SCIENTIFIC, COMPUTER AND LEGAL SERVICES**

FOR PROVIDING CONSULTING SERVICES TO VARIOUS INDUSTRIES TO ASSIST THEM TO OBTAIN ACCREDITATION IN COMPLIANCE WITH REGULATIONS AND/OR GUIDELINES LAID DOWN BY INDUSTRY OR BY GOVERNMENT; PROVIDING ALL THE AFORESAID SERVICES VIA TRADITIONAL "OFFLINE" MEANS, NAMELY, VISITING THE BUSINESSES AND MEETING WITH CLIENTS, AS WELL AS VIA THE INTERNET AND ONLINE (U.S. CLS. 100 AND 101).

SN 76-090,486. HEALTHCARE SOLUTIONS GROUP, INC., MUSKOGEE, OK. FILED 7-17-2000.

**CARE A\*T\*C**

NO CLAIM IS MADE TO THE EXCLUSIVE RIGHT TO USE "CARE", APART FROM THE MARK AS SHOWN.

**CLASS 36—INSURANCE AND FINANCIAL**

FOR THIRD PARTY ADMINISTRATION OF HEALTH CARE SERVICES, EMPLOYEE BENEFITS, WORKER'S COMPENSATION AND DISABILITY COVERAGE (U.S. CLS. 100, 101 AND 102).

FIRST USE 6-19-2000; IN COMMERCE 6-19-2000.

**CLASS 42—SCIENTIFIC, COMPUTER AND LEGAL SERVICES**

FOR MEDICAL HEALTH CARE SERVICES PROVIDED AS PART OF EMPLOYEE BENEFITS (U.S. CLS. 100 AND 101).

FIRST USE 6-19-2000; IN COMMERCE 6-19-2000.

SN 76-091,611. COVIA TECHNOLOGIES, INC., MOUNTAIN VIEW, CA. FILED 7-19-2000.

**CoVia**

**CLASS 9—ELECTRICAL AND SCIENTIFIC APPARATUS**

FOR COMPUTER SOFTWARE FACILITATING COLLABORATION AND COMMUNICATION OF BUSINESS THROUGH PERSONALIZED SECURE WEB SITES OVER A GLOBAL COMMUNICATION NETWORK (U.S. CLS. 21, 23, 26, 36 AND 38).

**CLASS 35—ADVERTISING AND BUSINESS**

FOR RETAIL ONLINE SERVICES FEATURING SOFTWARE; BUSINESS CONSULTATION SERVICES (U.S. CLS. 100, 101 AND 102).

**CLASS 41—EDUCATION AND ENTERTAINMENT**

FOR COMPUTER EDUCATION TRAINING SERVICES IN MAINTAINING, DESIGNING AND IMPLEMENTING SECURE PERSONALIZED WEB SITES FACILITATING COLLABORATION AND COMMUNICATION OVER A GLOBAL COMMUNICATIONS NETWORK (U.S. CLS. 100, 101 AND 107).

**CLASS 42—SCIENTIFIC, COMPUTER AND LEGAL SERVICES**

FOR CUSTOM COMPUTER SOFTWARE SERVICES, NAMELY, DESIGN AND IMPLEMENTATION OF PERSONALIZED SECURE WEB SITES FOR OTHERS, FACILITATING COMMUNICATIONS AND COLLABORATION OVER A GLOBAL COMPUTER NETWORK; HOSTING WEB SITES FOR OTHERS ON A COMPUTER SERVER FOR A GLOBAL COMPUTER NETWORK; MAINTAINING WEB SITES FOR OTHERS (U.S. CLS. 100 AND 101).

**CLASS 41—EDUCATION AND ENTERTAINMENT**

FOR EDUCATIONAL SERVICES, NAMELY, CONDUCTING SEMINARS AND WORKSHOPS IN THE FIELD OF SPELLING AND READING AND TEACHING METHODS EMPHASIZING IMAGERY, LISTENING, AND CORRECT DICTION (U.S. CLS. 100, 101 AND 107). FIRST USE 12-31-1981; IN COMMERCE 12-31-1981.

SN 76-091,875. CARDEN EDUCATIONAL FOUNDATION, INC., HILTON HEAD ISLAND, SC. FILED 7-20-2000.

SN 76-092,350. BROADWAY ENTERTAINMENT MARKETING, INC., DBA CELEBRITY EDGE, SANTA MONICA, CA. FILED 7-19-2000.



**THE CELEBRITY EDGE**

NO CLAIM IS MADE TO THE EXCLUSIVE RIGHT TO USE "EDUCATIONAL FOUNDATION", APART FROM THE MARK AS SHOWN. SEC. 2(F).

NO CLAIM IS MADE TO THE EXCLUSIVE RIGHT TO USE "THE CELEBRITY", APART FROM THE MARK AS SHOWN.

**CLASS 9—ELECTRICAL AND SCIENTIFIC APPARATUS**

FOR PRERECORDED AUDIO-VISUAL RECORDINGS ON COMPACT DISCS IN THE FIELD OF SPELLING AND READING AND TEACHING METHODS EMPHASIZING IMAGERY, LISTENING, AND CORRECT DICTION (U.S. CLS. 21, 23, 26, 36 AND 38). FIRST USE 12-31-1981; IN COMMERCE 12-31-1981.

**CLASS 35—ADVERTISING AND BUSINESS**

FOR BUSINESS MARKETING CONSULTING SERVICES FOR OTHERS IN THE ENTERTAINMENT INDUSTRY AND DEVELOPING PROMOTIONAL CAMPAIGNS FOR OTHERS IN THE ENTERTAINMENT INDUSTRY (U.S. CLS. 100, 101 AND 102). FIRST USE 12-15-1998; IN COMMERCE 12-15-1998.

**CLASS 16—PAPER GOODS AND PRINTED MATTER**

FOR PRINTED INSTRUCTIONAL, EDUCATIONAL, AND TEACHING MATERIALS IN THE FIELD SPELLING AND READING AND TEACHING METHODS EMPHASIZING IMAGERY, LISTENING, AND CORRECT DICTION (U.S. CLS. 2, 5, 22, 23, 29, 37, 38 AND 50). FIRST USE 12-31-1981; IN COMMERCE 12-31-1981.

**CLASS 38—COMMUNICATION**

FOR TELEVISION BROADCASTING IN THE NATURE OF AN ONGOING SERIES ABOUT A WIDE RANGE OF SUBJECTS FOCUSED UPON THE ENTERTAINMENT INDUSTRY (U.S. CLS. 100, 101 AND 104). FIRST USE 12-15-1998; IN COMMERCE 12-15-1998.

**CLASS 41—EDUCATION AND ENTERTAINMENT**

FOR PROVIDING INFORMATION ABOUT A WIDE RANGE OF SUBJECTS FOCUSED UPON THE ENTERTAINMENT INDUSTRY (U.S. CLS. 100, 101 AND 107). FIRST USE 12-15-1998; IN COMMERCE 12-15-1998.



SN 76-092,467. EVERYPATH, INC., SANTA CLARA, CA.  
FILED 7-20-2000.



#### CLASS 9—ELECTRICAL AND SCIENTIFIC APPARATUS

FOR COMPUTER SOFTWARE FOR USE IN DESIGNING, DEVELOPING, DEBUGGING, TESTING, DEPLOYING, RUNNING, MAINTAINING, MANAGING, MONITORING, AND REPORTING ON APPLICATIONS, WEBSITES, SOFTWARE, AND DATABASES FOR AN ENTERPRISE; COMPUTER SOFTWARE FOR PROVIDING ACCESS TO APPLICATIONS, WEBSITES, SOFTWARE, AND DATABASES THROUGH VOICE ACTIVATION, KEY-PAD, STYLUS, AND TOUCH-SCREEN INTERFACES ON MOBILE AND FIXED COMMUNICATIONS DEVICES, COMPUTERS, TELEPHONES, AND SMALL FORMAT DEVICES (U.S. CLS. 21, 23, 26, 36 AND 38).

#### CLASS 42—SCIENTIFIC, COMPUTER AND LEGAL SERVICES

FOR APPLICATION SERVICE PROVIDER SERVICES, NAMELY, PROVIDING, HOSTING, MANAGING, AND MAINTAINING APPLICATIONS, SOFTWARE, WEBSITES, AND DATABASES FOR OTHERS; COMPUTER SOFTWARE DESIGN AND DEVELOPMENT FOR OTHERS; COMPUTER PROGRAMMING SERVICES; CONSULTATION SERVICES IN THE FIELDS OF WEBSITE DESIGN, SOFTWARE, WIRELESS COMMUNICATIONS, AND DELIVERY OF CONTENT, DATA, AND INFORMATION TO MOBILE AND FIXED COMMUNICATIONS DEVICES, COMPUTERS, TELEPHONES, AND SMALL FORMAT DEVICES; DESIGNING AND IMPLEMENTING APPLICATIONS FOR OTHERS TO FACILITATE THE TRANSFER, TRANSLATION, AND ADAPTATION OF DATA THROUGH VOICE ACTIVATION, KEY-PAD, STYLUS, AND TOUCH-SCREEN INTERFACES ON MOBILE AND FIXED COMMUNICATIONS DEVICES, COMPUTERS, TELEPHONES, AND SMALL FORMAT DEVICES (U.S. CLS. 100 AND 101).

SN 76-092,675. MERCEDES-BENZ LENKUNGEN GMBH, D-45481 MULHEIM/RUHR, FED REP GERMANY, FILED 7-20-2000.

## STEERTRONIC

#### CLASS 9—ELECTRICAL AND SCIENTIFIC APPARATUS

FOR ELECTRONIC CONTROLS FOR STEERING SYSTEMS (U.S. CLS. 21, 23, 26, 36 AND 38).

#### CLASS 12—VEHICLES

FOR STEERING SYSTEMS FOR MOTOR VEHICLES COMPRISING STEERING COLUMNS AND JACKETS, STEERING GEARS, TIE RODS, DROP ARMS, TRACK LINKS, RACK AND PINION STEERINGS, STEERING COLUMNS AND JACKETS FOR STEERING SYSTEMS; MECHANICAL AND HYDRAULIC CONTROLS FOR STEERING SYSTEMS (U.S. CLS. 19, 21, 23, 31, 35 AND 44).

SN 76-093,161. NASSAU GROUP, INC., THE, WESTPORT, CT. FILED 7-20-2000.

## THE NASSAU GROUP

NO CLAIM IS MADE TO THE EXCLUSIVE RIGHT TO USE "GROUP", APART FROM THE MARK AS SHOWN.

#### CLASS 35—ADVERTISING AND BUSINESS

FOR PROVIDING CORPORATE DEVELOPMENT ADVISORY SERVICES IN THE FIELDS OF HEALTHCARE, ENVIRONMENTAL PRODUCTS AND SERVICES, INFORMATION TECHNOLOGY, ELECTRONIC COMMERCE AND CORPORATE FINANCE; AND PROVIDING INFORMATION IN THE FIELD OF CORPORATE DEVELOPMENT SERVICES VIA A GLOBAL COMPUTER NETWORK (U.S. CLS. 100, 101 AND 102).  
FIRST USE 6-0-1992; IN COMMERCE 6-0-1992.

#### CLASS 36—INSURANCE AND FINANCIAL

FOR PROVIDING INVESTMENT BANKING SERVICES; PROVIDING FINANCIAL ADVISORY SERVICES IN THE FIELDS OF HEALTHCARE, ENVIRONMENTAL PRODUCTS AND SERVICES, INFORMATION TECHNOLOGY, ELECTRONIC COMMERCE AND CORPORATE FINANCE; AND PROVIDING INFORMATION IN THE FIELDS OF FINANCE AND INVESTMENT BANKING SERVICES VIA A GLOBAL COMPUTER NETWORK (U.S. CLS. 100, 101 AND 102).  
FIRST USE 6-0-1992; IN COMMERCE 6-0-1992.

SN 76-094,466. SCIENCE AND ENGINEERING ASSOCIATES, INC., ALBUQUERQUE, NM. FILED 7-24-2000.

## SEATREAT

#### CLASS 10—MEDICAL APPARATUS

FOR CAMERA AND LASER DEVICE FOR MEDICAL USE, FOR THE TREATMENT OF CANCER, THAT INTEGRATES CONVENTIONAL IMAGING AND ADAPTIVE REAL-TIME PHOTODYNAMIC THERAPY DOSE OPTIMIZATION (U.S. CLS. 26, 39 AND 44).

#### CLASS 42—SCIENTIFIC, COMPUTER AND LEGAL SERVICES

FOR MEDICAL SERVICES FOR TREATING CANCER USING A DEVICE THAT INTEGRATES CONVENTIONAL IMAGING AND ADAPTIVE REAL-TIME PHOTODYNAMIC THERAPY DOSE OPTIMIZATION (U.S. CLS. 100 AND 101).

SN 76-094,573. OUTSOURCED ADMINISTRATIVE SYSTEMS, INC., INDIANAPOLIS, IN. FILED 7-19-2000.

online<sup>®</sup>Healthplan.com

NO CLAIM IS MADE TO THE EXCLUSIVE RIGHT TO USE "ONLINEHEALTHPLAN.COM", APART FROM THE MARK AS SHOWN.

#### CLASS 35—ADVERTISING AND BUSINESS

FOR PROVIDING ON-LINE HEALTH PLAN PROVIDER DIRECTORY INFORMATION (U.S. CLS. 100, 101 AND 102).

FIRST USE 4-8-2000; IN COMMERCE 4-8-2000.

#### CLASS 36—INSURANCE AND FINANCIAL

FOR ADMINISTRATION OF HEALTH PLANS FOR OTHERS, NAMELY, PROVIDING ON-LINE HEALTH PLAN INFORMATION, HEALTH PLAN PARTICIPANT INFORMATION, HEALTH PLAN BENEFIT INFORMATION, HEALTH PLAN BENEFIT ELIGIBILITY INFORMATION, HEALTH PLAN TREATMENT AUTHORIZATION INFORMATION, AND HEALTH PLAN CLAIMS STATUS INFORMATION (U.S. CLS. 100, 101 AND 102).

FIRST USE 4-8-2000; IN COMMERCE 4-8-2000.

SN 76-095,548. COMPRESSOR ENGINEERING CORPORATION, HOUSTON, TX. FILED 7-24-2000.

**ceco**

OWNER OF U.S. REG. NO. 2,223,814.

#### CLASS 7—MACHINERY

FOR STRUCTURAL PARTS OF COMPRESSORS, NAMELY CHANNEL VALVES, PLATE VALVES, CHECK VALVES, AUXILIARY VALVES AND STRIP-TYPE VALVES, CHANNEL AND SPRING SETS FOR VALVES, SEAT AND COVER GASKETS FOR VALVES, VALVE DISCS AND PLATES, VALVE SPRINGS AND COILS, VALVE STRIPS, PISTONS, PISTON RINGS, POWER PISTON RINGS, PISTON RODS, PISTON ROD GUIDES, PISTON ROD PACKING, PISTON ROD RINGS, PISTON ROD SPRINGS, PACKING CASES, MAIN BEARINGS, BUSHINGS FOR COMPRESSOR X-HEADS AND FOR COMPRESSOR CONNECTING RODS, CROSS HEADS AND CROSS HEAD SHOES, VALVE UNLOADERS FOR CHANNEL, PLATE AND STRIP VALVES, VALVE UNLOADER DIAPHRAGMS, SEAT PLATES, VALVE GUIDES AND VALVE GUIDE HOLDERS FOR COMPRESSOR CHANNEL VALVES, WEAR BUTTONS FOR COMPRESSOR HEADS, FRAMES, PORT HOLES, O-RINGS, VALVE COVERS, VALVE CAGES, VALVE CRABS, CRANKPINS, CRANKPIN BEARINGS, WEDGES, AND BOXES, PINS AND PIN BOXES, VALVE RING CHANNELS, VALVE RETAINERS, FLOW BALANCES, ORIFICES, CHECK VALVES, AUXILIARY VALVES, CONNECTING RODS, LUBRICATORS, CRANK SHAFTS, POWER HEADS, AND CYLINDER LINERS (U.S. CLS. 13, 19, 21, 23, 31, 34 AND 35).

FIRST USE 8-0-1969; IN COMMERCE 8-0-1969.

#### CLASS 37—CONSTRUCTION AND REPAIR

FOR REPAIR SERVICES, NAMELY, VALVE REPAIR AND TURBINE REPAIR (U.S. CLS. 100, 103 AND 106). FIRST USE 8-0-1969; IN COMMERCE 8-0-1969.

SN 76-095,735. SOPHEON N.V., 1082 LD AMSTERDAM, NETHERLANDS, FILED 7-24-2000.



OWNER OF BENELUX REG. NO. 0660844, DATED 2-2-2000, EXPIRES 2-2-2010.

#### CLASS 9—ELECTRICAL AND SCIENTIFIC APPARATUS

FOR RECORDED COMPUTER PROGRAMS AND COMPUTER SOFTWARE FOR USE IN DOCUMENT ANALYSIS, BUSINESS PROCESS ANALYSIS, LINGUISTIC ANALYSIS, DATA MODELING, STRUCTURED FORMATTING OF DATA FOR SELECTIVE OUTPUT AND TERMINOLOGY DATA BASES IN THE FIELD OF LIFE SCIENCES, HIGH TECH AND HEALTHCARE (U.S. CLS. 21, 23, 26, 36 AND 38).

#### CLASS 16—PAPER GOODS AND PRINTED MATTER

FOR INSTRUCTIONAL AND TEACHING MATERIAL, NAMELY, TEXTBOOKS, WORKBOOKS, AND PAMPHLETS FOR USE IN THE FIELD OF COMPUTERS, SOFTWARE, ELECTRIC DATA PROCESSING AND INFORMATION SCIENCE; PRINTED DOCUMENTATION, NAMELY, GUIDEBOOKS, HANDBOOKS AND MANUALS IN THE FIELD OF COMPUTERS, SOFTWARE, ELECTRONIC DATA PROCESSING AND INFORMATION SCIENCE (U.S. CLS. 2, 5, 22, 23, 29, 37, 38 AND 50).

#### CLASS 35—ADVERTISING AND BUSINESS

FOR ELECTRONIC DATA PROCESSING AND CONSULTING IN THE FIELD OF ELECTRONIC DATA PROCESSING (U.S. CLS. 100, 101 AND 102).

#### CLASS 41—EDUCATION AND ENTERTAINMENT

FOR EDUCATIONAL SERVICES, NAMELY, CONDUCTING CLASSES, SEMINARS, WORKSHOPS AND TRAINING COURSES IN THE FIELD OF COMPUTER HARDWARE, COMPUTER SOFTWARE AND DATA PROCESSING (U.S. CLS. 100, 101 AND 107).

**CLASS 42—SCIENTIFIC, COMPUTER AND LEGAL SERVICES**

FOR COMPUTER PROGRAMMING, NAMELY, PROGRAMMING FOR ELECTRONIC DATA PROCESSING; COMPUTER PROGRAMMING; DRAFTING TECHNICAL EXPERT REPORTS IN THE FIELD OF COMPUTERS; CONSULTING IN THE FIELD OF COMPUTERS, COMPUTER NETWORKS, COMPUTER PERIPHERALS; DESIGN AND PREPARATION OF COMPUTER PROGRAMS; UPDATING AND AMENDING COMPUTER PROGRAMS; COMPUTER CONSULTATION SERVICES, NAMELY, CONSULTING REGARDING CHOICE COMPUTER HARDWARE AND COMPUTER SOFTWARE; COMPUTER SYSTEMS ANALYSIS (U.S. CLS. 100 AND 101).

SN 76-098,506. ELRON SOFTWARE, INC., BURLINGTON, MA. FILED 7-31-2000.

# ELRON

**CLASS 9—ELECTRICAL AND SCIENTIFIC APPARATUS**

FOR COMPUTER PROGRAMS FOR MANAGING ACCESS TO AND/OR USAGE OF GLOBAL, WIDE AREA AND LOCAL NETWORKS, NAMELY, COMPUTER PROGRAMS FOR (1) ELECTRONIC MAIL ENCRYPTION AND NETWORK ACCESS PROTECTION, (2) TRACKING, REPORTING AND SCREENING OF WEB SITES, (3) FILTERING MONITORING AND BLOCKING COMMUNICATIONS VIA ELECTRONIC MAIL, NEWSGROUPS AND FTP SITES, (4) ANALYZING AND IMPROVING USAGE OF COMPUTER CHANNELS, (5) ENABLING HOME BANKING TRANSACTIONS, (5) DEVELOPMENT AND ENABLING OF NETWORK ACCESS CHANNELS AND MOBILE DEVICES, (6) DEVELOPMENT OF OPERATIONS SUPPORT SYSTEMS AND NETWORK OPERATION CENTERS, (7) MANAGEMENT OF TELECOMMUNICATIONS SYSTEMS, AND (8) MONITORING OF SOFTWARE USAGE AND REGISTRATION (U.S. CLS. 21, 23, 26, 36 AND 38).

FIRST USE 10-0-1997; IN COMMERCE 10-0-1997.

SN 76-096,409. KCI COMMUNICATIONS, INC., MCLEAN, VA. FILED 7-26-2000.

**MARKET MERIDIANS****CLASS 16—PAPER GOODS AND PRINTED MATTER**

FOR PRINTED PUBLICATIONS, NAMELY, NEWSLETTERS IN THE FIELD OF INVESTING (U.S. CLS. 2, 5, 22, 23, 29, 37, 38 AND 50).

**CLASS 42—SCIENTIFIC, COMPUTER AND LEGAL SERVICES**

FOR PROVIDING ON-LINE NEWSLETTERS IN THE FIELD OF INVESTING (U.S. CLS. 100 AND 101).

**CLASS 42—SCIENTIFIC, COMPUTER AND LEGAL SERVICES**

FOR COMPUTER CONSULTATION SERVICES; CUSTOM COMPUTER SOFTWARE DESIGN AND DEVELOPMENT SERVICES FOR OTHERS, NAMELY - INTEGRATION OF COMPUTER SYSTEMS AND NETWORKS; COMPUTER SUPPORT SERVICES; PROVIDING CONSULTATION ON THE USE, INTEGRATION AND OPERATION OF COMPUTER SOFTWARE PROGRAMS AND THE UPDATING OF COMPUTER SOFTWARE PROGRAMS (U.S. CLS. 100 AND 101).

FIRST USE 10-0-1997; IN COMMERCE 10-0-1997.

SN 76-097,547. HOUGHTON, NICHOLAS J., VANCOUVER, BRITISH COLUMBIA V6B 1P2, CANADA, FILED 7-26-2000.



SN 76-099,105. AWARE, INC., BEDFORD, MA. FILED 7-31-2000.

# VEDSL

**CLASS 14—JEWELRY**

FOR JEWELRY; DIAMONDS; SEMI-PRECIOUS GEMSTONES; PRECIOUS GEMSTONES (U.S. CLS. 2, 27, 28 AND 50).

**CLASS 35—ADVERTISING AND BUSINESS**

FOR WHOLESALE DISTRIBUTORSHIP FEATURING DIAMONDS AND GEMSTONES (U.S. CLS. 100, 101 AND 102).

**CLASS 40—MATERIAL TREATMENT**

FOR CUTTING OF DIAMONDS AND GEMSTONES (U.S. CLS. 100, 103 AND 106).

**CLASS 9—ELECTRICAL AND SCIENTIFIC APPARATUS**

FOR COMPUTER SOFTWARE, NAMELY SOFTWARE USED FOR USE IN HIGH-SPEED DIGITAL TRANSMISSION OVER TELEPHONE CABLE TO CARRY VOICE TRAFFIC (U.S. CLS. 21, 23, 26, 36 AND 38).

**CLASS 42—SCIENTIFIC, COMPUTER AND LEGAL SERVICES**

FOR COMPUTER SOFTWARE SUPPORT SERVICES OFFERED IN CONNECTION WITH THE SALE OF COMPUTER SOFTWARE, NAMELY TROUBLESHOOTING OF COMPUTER SOFTWARE PROBLEMS VIA TELEPHONE, E-MAIL, AND IN PERSON (U.S. CLS. 100 AND 101).

SN 76-099,873. ETERNAL PRESENCE, INC., PEORIA, AZ.  
FILED 7-31-2000.

SN 76-100,874. KING OF THE CAGE, INC., FONTANA, CA.  
FILED 7-31-2000.

## EP KIDS

NO CLAIM IS MADE TO THE EXCLUSIVE RIGHT TO USE "KIDS", APART FROM THE MARK AS SHOWN.

### CLASS 19—NON-METALLIC BUILDING MATERIALS

FOR STATUETTES, FIGURINES, HAND-HELD MONUMENTS AND BOXES FOR SMALL MISCELLANEOUS ITEMS MADE PRIMARILY OF STONE, MARBLE AND GRANITE WHICH PROMOTE THE PERPETUAL PRESENCE OF THOSE WHO ARE LIVING AND WHO HAVE PASSED ON (U.S. CLS. 1, 12, 33 AND 50).

FIRST USE 3-17-2000; IN COMMERCE 3-17-2000.

### CLASS 20—FURNITURE AND ARTICLES NOT OTHERWISE CLASSIFIED

FOR STATUETTES, FIGURINES, HAND-HELD MONUMENTS AND BOXES FOR SMALL MISCELLANEOUS ITEMS MADE PRIMARILY OF WOOD AND PLASTICS WHICH PROMOTE THE PERPETUAL PRESENCE OF THOSE WHO ARE LIVING AND WHO HAVE PASSED ON (U.S. CLS. 2, 13, 22, 25, 32 AND 50).

FIRST USE 3-17-2000; IN COMMERCE 3-17-2000.

SN 76-100,005. HERBY INDUSTRIE S.A., LA LOUPE, FRANCE, FILED 7-28-2000.

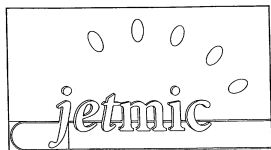

### CLASS 11—ENVIRONMENTAL CONTROL APPARATUS

FOR COOKWARE, NAMELY, COOKING GRILLS (U.S. CLS. 13, 21, 23, 31 AND 34).

### CLASS 20—FURNITURE AND ARTICLES NOT OTHERWISE CLASSIFIED

FOR RACKS FOR STORAGE OF FOOD PRODUCTS, HOUSEHOLD GOODS, KITCHEN UTENSILS AND FOOTWEAR (U.S. CLS. 2, 13, 22, 25, 32 AND 50).

### CLASS 21—HOUSEWARES AND GLASS

FOR BASKETS MADE OF WOOD, WICKER, OR STRAW; POTS; COOKWARE, NAMELY, COLANDERS AND MEAL COOKING SKEWERS AND SPITS; CLOTHES DRYING RACKS; BOTTLE OR WINE RACKS (U.S. CLS. 2, 13, 23, 29, 30, 33, 40 AND 50).



### CLASS 9—ELECTRICAL AND SCIENTIFIC APPARATUS

FOR VIDEOTAPES FEATURING MIXED MARTIAL ARTS FIGHTING (U.S. CLS. 21, 23, 26, 36 AND 38).

FIRST USE 5-10-1999; IN COMMERCE 5-10-1999.

### CLASS 41—EDUCATION AND ENTERTAINMENT

FOR LIVE MARTIAL ARTS CONTESTS (U.S. CLS. 100, 101 AND 107).

FIRST USE 5-10-1999; IN COMMERCE 5-10-1999.

SN 76-101,144. MAIRS GEOGRAPHISCHER VERLAG KURT MAIR GMBH & CO. KG, D-73760, OSTFILDERN (KEMNAT), FED REP GERMANY, FILED 8-2-2000.

NEW WORLD EDITION

OWNER OF FED REP GERMANY REG. NO. 39518.067, DATED 4-2-1996, EXPIRES 4-2-2011.

NO CLAIM IS MADE TO THE EXCLUSIVE RIGHT TO USE "EDITION", APART FROM THE MARK AS SHOWN.

### CLASS 9—ELECTRICAL AND SCIENTIFIC APPARATUS

FOR PRERECORDED DATA CARRIERS, NAMELY, CD-ROM, WITH CARTOGRAPHIC, GEOGRAPHIC AND/OR TOURISTIC CONTENTS, EG, CONTENT OF ATLASES, OF STREET MAPS, CITY MAPS AND COUNTRY MAPS, OF TRAVEL GUIDES, OF ILLUSTRATED BOOKS, OF PHOTOGRAPHS AND OF POSTERS (U.S. CLS. 21, 23, 26, 36 AND 38).

### CLASS 16—PAPER GOODS AND PRINTED MATTER

FOR PRINTED MATTER, NAMELY, BOOKS, MAGAZINES, ATLASES AND MAPS IN THE FIELD OF CARTOGRAPHY, GEOGRAPHY AND TOURISM, ESPECIALLY ATLASES, STREET MAPS, CITY MAPS, COUNTRY MAPS, TRAVEL GUIDES, ILLUSTRATED BOOKS, PHOTOGRAPHS AND POSTERS (U.S. CLS. 2, 5, 22, 23, 29, 37, 38 AND 50).

SN 76-101,183. GASNETWORKS, PITTSFIELD, MA. FILED 8-2-2000.



#### CLASS 36—INSURANCE AND FINANCIAL

FOR PROVIDING GAS REBATE PROGRAMS THAT PROMOTE ENERGY EFFICIENCY THROUGH CONSUMER AND CONTRACTOR EDUCATION (U.S. CLS. 100, 101 AND 102).

FIRST USE 2-10-2000; IN COMMERCE 2-10-2000.

#### CLASS 41—EDUCATION AND ENTERTAINMENT

FOR EDUCATIONAL SERVICES FOR OTHERS, NAMELY, DEVELOPING UNIFORM HIGH EFFICIENCY NATURAL GAS EDUCATIONAL PROGRAMS THAT PROMOTE ENERGY EFFICIENCY THROUGH CONSUMER AND CONTRACTOR EDUCATION (U.S. CLS. 100, 101 AND 107).

FIRST USE 2-10-2000; IN COMMERCE 2-10-2000.

---

SN 76-101,754. WINCOR NIXDORF GMBH & CO. KG, 33106 PADERBORN, FED REP GERMANY, FILED 8-2-2000.

**WINCOR  
NIXDORF**

PRIORITY CLAIMED UNDER SEC. 44(D) ON FED REP GERMANY APPLICATION NO. 39968002, FILED 10-29-1999, REG. NO. 39968002, DATED 4-26-2000, EXPIRES 10-31-2009.

#### CLASS 6—METAL GOODS

FOR METAL SAFES FOR CASH (U.S. CLS. 2, 12, 13, 14, 23, 25 AND 50).

#### CLASS 9—ELECTRICAL AND SCIENTIFIC APPARATUS

FOR AUTOMATIC TELLER MACHINES (ATM) AND AUTOMATIC ELECTRONIC CHANGE MAKING MACHINES; AUTOMATIC CASH REGISTERS; CASH REGISTERS; ELECTRONIC SAFES FOR CASH; CASH ACCEPTING MACHINE IN THE NATURE OF BANK-NOTE IDENTIFICATION AND VERIFICATION MODULES (BIM) AND CASH DEPOSIT MACHINES (CDM); CARD READING EQUIPMENT IN THE NATURE OF A CHIP CARD READER AND MAGNETIC CARD READER; AUDIO CASSETTE RECORDERS AND VIDEO CASSETTE RECORDERS; BAR CODE READERS; COMPUTERS FOR DATA PROCESSING; COMPUTER SOFTWARE PROGRAMS FOR USE IN ACCOUNT MANAGEMENT FOR BANKING; SOFTWARE PROGRAMS FOR PERSONAL IDENTIFICATION SYSTEMS FOR SERVICE AND SELF-SERVICE OPERATING MODES; SOFTWARE FOR SHELF LABEL CONTROL AND CLEARING PROCEDURES FOR CHECK-OUTS; SOFTWARE PROGRAMS FOR THE MANAGEMENT OF TRADE, AUTHORITIES AND INDUSTRY IN THE NATURE OF BOOKKEEPING, PERSONAL MANAGEMENT, PRODUCTION CONTROL, MATERIAL REQUIREMENTS; SOFTWARE PROGRAMS FOR ESTATE MANAGEMENT, NAMELY, BUILDING SECURITY, FIRE PREVENTION, ELECTRICAL, GAS AND WATER SUPPLY; SOFTWARE FOR TELECOMMUNICATIONS NETWORK CONTROL; PERIPHERAL COMPUTER EQUIPMENT; MAGNETIC AND OPTICAL DATA PROCESSORS; COMPUTER MONITORS; VIDEO MONITORS; COMPUTER PRINTER; COMPUTER HARDWARE ACCESSORY, NAMELY, NETWORKING HARDWARE TO CONNECT DATA PROCESSING WORKSTATIONS; IDENTIFICATION EQUIPMENT FOR INDIVIDUALS, NAMELY, IRIS SCANNER, RETINA SCANNER, HAND SCANNER, FINGERPRINT SCAN; FACE AND VOICE RECOGNITION EQUIPMENT FOR USE IN BANKS AND AUTHORITIES; SELF SERVICE TERMINALS COMPRISING COMPUTER HARDWARE AND MONITOR FOR USE FOR THE PRINTING AND ISSUING OF STATEMENTS WITHOUT PERSONAL SERVICE, SELF-BANKING SYSTEMS FOR THE CONCLUSION OF REMITTANCE AND RECEIPT OF MONEY WITHOUT PERSONAL SERVICE, SCHEDULING OF INFORMATION, SELF CHECK-IN AT AIRPORTS, BUS TERMINALS AND RAILWAY STATIONS, THE PURCHASE OF TICKETS FOR PUBLIC TRANSPORT OR PUBLIC EVENTS, THE PURCHASE OF ITEMS, NAMELY, STAMPS; BIOMETRIC SECURITY HARDWARE FOR IDENTIFYING INDIVIDUALS, NAMELY, IRIS SCANNERS AND HAND SCANNERS; BLANK ELECTRONIC CHIP CARDS; REMOTE CONTROLLED MODULES FOR DETERMINING PRICE AT MERCHANDISE SHELVES IN THE NATURE OF ELECTRONIC SHELF LABELS (ESL) (U.S. CLS. 21, 23, 26, 36 AND 38).

#### CLASS 35—ADVERTISING AND BUSINESS

FOR RENTING OF OFFICE MACHINES, CASH DISPENSING EQUIPMENT, COMPUTER PRINTERS, SELF SERVICE TERMINALS COMPRISING COMPUTER HARDWARE AND MONITOR FOR USE FOR THE PRINTING AND ISSUING OF STATEMENTS WITHOUT PERSONAL SERVICE, SELF-BANKING SYSTEMS FOR THE CONCLUSION OF REMITTANCE AND RECEIPT OF MONEY WITHOUT PERSONAL SERVICE, SCHEDULING OF INFORMATION, SELF CHECK-IN AT AIRPORTS, BUS TERMINALS AND RAILWAY STATIONS, THE PURCHASE OF TICKETS FOR PUBLIC TRANSPORT OR PUBLIC EVENTS, THE PURCHASE OF ITEMS, NAMELY, STAMPS AND DATA PROCESSING EQUIPMENT; CONSULTATION WITH ORGANIZATIONS AND THEIR MANAGEMENT, NAMELY, CONSULTATION FOR BUSINESS MANAGEMENT, BUSINESS, AND PERSONNEL MANAGEMENT; BUSINESS MARKETING CONSULTING SERVICES; DATA PROCESSING SERVICES; CONSULTATION IN THE FIELD OF DATA PROCESSING SERVICES; ANALYSIS IN THE AREA OF DATA PROCESSING; CONTRACTING WITH REPAIR AND MAINTENANCE SERVICE COMPANIES TO PROVIDE COMPUTER PROGRAMS, COMPUTER HARDWARE, COMPUTER PERIPHERY AND DATA PROCESSING EQUIPMENT REPAIR SERVICES TO EQUIPMENT END USERS (U.S. CLS. 100, 101 AND 102).

**CLASS 36—INSURANCE AND FINANCIAL**

FOR CONSULTATION IN THE AREA OF FINANCIAL ANALYSIS; BANKING (U.S. CLS. 100, 101 AND 102).

**CLASS 37—CONSTRUCTION AND REPAIR**

FOR MAINTENANCE AND REPAIR OF METAL SAFES FOR CASH, AUTOMATIC TELLER MACHINES, AUTOMATIC ELECTRONIC CHANGE MAKING MACHINES, AUTOMATIC CASH REGISTERS, CASH REGISTERS, CASH ACCEPTING MACHINES, CASH DEPOSIT MACHINES, SELF SERVICE TERMINALS COMPRISING COMPUTER HARDWARE AND MONITOR FOR USE FOR THE PRINTING AND ISSUING OF STATEMENTS WITHOUT PERSONAL SERVICE, SELF-BANKING SYSTEMS FOR THE CONCLUSION OF REMITTANCE AND RECEIPT OF MONEY WITHOUT PERSONAL SERVICE, SCHEDULING OF INFORMATION, SELF CHECK-IN AT AIRPORTS, BUS TERMINALS AND RAILWAY STATIONS, THE PURCHASE OF TICKETS FOR PUBLIC TRANSPORT OR PUBLIC EVENTS, THE PURCHASE OF ITEMS, NAMELY, STAMPS (U.S. CLS. 100, 103 AND 106).

**CLASS 39—TRANSPORTATION AND STORAGE**

FOR SERVICE PERFORMANCE REGARDING A LOGISTICAL ENTERPRISE, NAMELY, THE STORAGE, TRANSPORTATION, DELIVERY AND DISTRIBUTION OF GOODS BY TRUCKS, AIR AND RAILWAY (U.S. CLS. 100 AND 105).

**CLASS 41—EDUCATION AND ENTERTAINMENT**

FOR EDUCATIONAL SERVICES, NAMELY, CONDUCTING CLASSES, SEMINARS, CONFERENCES AND WORKSHOPS IN THE FIELD OF DATA PROCESSING TELECOMMUNICATION EQUIPMENT, HARDWARE AND COMPUTER SOFTWARE (U.S. CLS. 100, 101 AND 107).

**CLASS 42—SCIENTIFIC, COMPUTER AND LEGAL SERVICES**

FOR ARCHITECT SERVICES, NAMELY, THE PLANNING OF COMPUTER EQUIPPED ADMINISTRATIVE BUILDINGS, WAREHOUSES AND COMPUTER CASH POINT AND CHECK OUT WORKPLACES; DATA CONVERSION OF COMPUTER PROGRAM DATA OR INFORMATION; CONSULTATION IN THE FIELD OF INTERIOR DECORATING; COMPUTER CONSULTATION IN THE FIELD OF PRODUCT DEVELOPMENT (U.S. CLS. 100 AND 101).

---

SN 76-101,822. L'OREAL, 75008 PARIS, FRANCE, FILED 8-2-2000.

**DERCOS**

OWNER OF FRANCE REG. NO. 93/485,923, DATED 10-1-1993, EXPIRES 10-1-2003.

**CLASS 3—COSMETICS AND CLEANING PREPARATIONS**

FOR HAIR SHAMPOO AND HAIR MOUSSE (U.S. CLS. 1, 4, 6, 50, 51 AND 52).

**CLASS 5—PHARMACEUTICALS**

FOR MEDICATED LOTIONS FOR SEBORRHEA AND DANDRUFF (U.S. CLS. 6, 18, 44, 46, 51 AND 52).

SN 76-101,980. NATIONAL BLACK MBA ASSOCIATION, INC., CHICAGO, IL. FILED 7-31-2000.

**LEADERS OF TOMORROW  
GOLF & TENNIS CLASSIC**

OWNER OF U.S. REG. NO. 1,923,043.

**CLASS 25—CLOTHING**

FOR (ITU) CLOTHING, NAMELY, T-SHIRTS, SWEAT-SHIRTS, TANK TOPS, JACKETS, HATS, SCARVES, SHORTS, PANTS, SHOES, SOCKS, JOGGING SUITS, SWEAT SUITS, SHIRTS, SWEAT PANTS, UNDERWEAR, COATS, LEATHER COATS, BANDANNAS, SWEAT BANDS, GYM SHOES, TENNIS SHOES, AEROBIC SHOES, AND WALKING SHOES (U.S. CLS. 22 AND 39).

**CLASS 41—EDUCATION AND ENTERTAINMENT**

FOR (BASED ON USE IN COMMERCE) ENTERTAINMENT SERVICES, A MENTORING PROGRAM THAT PROVIDES GROUP AND ONE-ON-ONE MENTORING IN THE FIELDS OF LEADERSHIP AND CAREERS; PROVIDING WORKSHOPS IN THE AREA OF COMPUTER TRAINING, MONEY MANAGEMENT, GOAL SETTING AND INTERPERSONAL DEVELOPMENT; PLANNING, ARRANGING AND CONDUCTING EDUCATIONAL SEMINARS, CONFERENCES, AND WORKSHOPS IN THE FIELD OF DEVELOPING CRITICAL-THINKING SKILLS, PERSONAL AND PROFESSIONAL DEVELOPMENT SKILLS, LEADERSHIP SKILLS, AND PROGRAM IMPLEMENTATION SKILLS (U.S. CLS. 100, 101 AND 107).

FIRST USE 7-1-1997; IN COMMERCE 7-1-1997.

---

SN 76-102,104. H3ENVIRONMENTAL CORPORATION, VALLEY VILLAGE, CA. FILED 8-3-2000.

**H3ENVIRONMENTAL****CLASS 20—FURNITURE AND ARTICLES NOT OTHERWISE CLASSIFIED**

FOR MATTRESSES AND PILLOWS (U.S. CLS. 2, 13, 22, 25, 32 AND 50).

**CLASS 24—FABRICS**

FOR BED LINEN (U.S. CLS. 42 AND 50).

**CLASS 35—ADVERTISING AND BUSINESS**

FOR PROVIDING REFERRALS IN THE FIELDS OF HOME INSPECTIONS FOR REAL ESTATE AGENTS AND BUSINESS AND RESIDENTIAL INSPECTIONS, NAMELY, INSPECTIONS TO DIAGNOSE AND SOLVE ENVIRONMENTAL POLLUTION; PROVIDING MEDICAL REFERRALS IN THE FIELD OF ENVIRONMENTAL OR RELATED ILLNESSES; PROVIDING REFERRALS IN HEATING, VENTILATION AND AIR CONDITIONING EQUIPMENT TESTING, INSTALLATION AND REPAIR; PROVIDING REFERRALS IN PEST CONTROL; PROVIDING REFERRALS IN CARPET CLEANING; PROVIDING REFERRALS IN LEAD, ASBESTOS, MOLD AND ELECTROMAGNETISM ABATEMENT AND REMEDIATION SERVICES; PROVIDING REFERRALS IN LABORATORY TESTING OF REAL ESTATE FOR POLLUTANTS AND HAZARDOUS MATERIALS, INCLUDING BUT NOT LIMITED TO LEAD, ASBESTOS AND ELECTROMAGNETISM; PROVIDING REFERRALS IN FENG SHUI CONSULTATION; PROVIDING REFERRALS IN POST CONSTRUCTION AND ABATEMENT DEEP CLEANING; ONLINE RETAIL STORE SERVICES, FEATURING ENVIRONMENTALLY HEALTHY HOUSEHOLD AND BUSINESS PRODUCTS, NON-ELECTRIC HOUSEHOLD CLEANING PRODUCTS, HEPA, NAMELY HIGH EFFICIENCY PARTICULATE AIR, VACUUM CLEANERS, WATER SOFTENING UNITS, WATER FILTERING UNITS FOR PRODUCING POTABLE WATER FOR DOMESTIC USE, HOUSEHOLD AIR CLEANERS, AND DOMESTIC AIR FILTRATION SYSTEMS, COMPRISING FANS, FILTERS AND MODULES FOR STORING FILTRATION MEDIA (U.S. CLS. 100, 101 AND 102).

**CLASS 41—EDUCATION AND ENTERTAINMENT**

FOR EDUCATIONAL SERVICES, NAMELY, CONDUCTING IN-PERSON AND ONLINE CLASSES, WORKSHOPS AND SEMINARS IN THE FIELDS OF NON-TOXIC HOME AND BUSINESS CLEANING STRATEGIES, BIONOMICS, NAMELY THE STUDY OF THE RELATIONSHIP BETWEEN ENVIRONMENTS AND HEALTH AND IN MAINTAINING ECOLOGICALLY HEALTHY HOMES AND ENVIRONMENTALLY SAFE BUILDINGS AND INTERIORS (U.S. CLS. 100, 101 AND 107).

**CLASS 42—SCIENTIFIC, COMPUTER AND LEGAL SERVICES**

FOR CONSULTING SERVICES IN THE FIELD OF BIONOMICS, NAMELY ECOLOGICALLY HEALTHY BUILDINGS AND INTERIORS AND THE DESIGN AND FURNISHINGS THEREOF; PROVIDING INFORMATION ABOUT THE RELATIONSHIP BETWEEN ENVIRONMENTS AND HEALTHY LIFESTYLES, NAMELY, INFORMATION AND PUBLICATIONS ABOUT PERSONAL CARE PRODUCTS, NON-TOXIC CLEANING PRODUCTS AND METHODS, BUILDING AND INTERIOR ENVIRONMENTS, THE DESIGN AND FURNISHING THEREOF, AND HEALTHY LIFESTYLES (U.S. CLS. 100 AND 101).

SN 76-102,332. INFOCURE CORPORATION, ATLANTA, GA. FILED 8-3-2000.

**WHERE DOCTORS GET CONNECTED****CLASS 9—ELECTRICAL AND SCIENTIFIC APPARATUS**

FOR COMPUTER SOFTWARE FOR MEDICAL PRACTICE MANAGEMENT, NAMELY ENTERPRISE PRACTICE MANAGEMENT SOFTWARE FOR PHYSICIANS' OFFICES AND MEDICAL INSTITUTIONS, MEDICAL DATA REPORTING AND ANALYSIS SOFTWARE, COMPUTER SOFTWARE FOR RADIOLOGY PRACTICE MANAGEMENT, COMPUTER SOFTWARE FOR MEDICAL DATA ACQUISITION, ELECTRONIC CLAIM SUBMISSION AND REMITTANCE, COLLECTIONS, REPORTING, APPOINTMENT SCHEDULING, CONTRACT MANAGEMENT, ELECTRONIC STATEMENT PROCESSING, INSURANCE FOLLOW-UP, PATIENT FLOW MONITORING, REFERRAL MANAGEMENT, AND MARKETING, COMPUTER SOFTWARE FOR COMMUNICATING RADIOLOGICAL STUDIES OVER A COMPUTER NETWORK, PATIENT TRACKING, LETTER WRITING AND NARRATIVE REPORT WRITING SOFTWARE (U.S. CLS. 21, 23, 26, 36 AND 38).

**CLASS 42—SCIENTIFIC, COMPUTER AND LEGAL SERVICES**

FOR CONSULTING SERVICES IN THE FIELD OF COMPUTER ASSISTED MEDICAL PRACTICE MANAGEMENT; APPLICATION SERVICE PROVIDER SERVICES FOR DELIVERING SOFTWARE APPLICATIONS TO MEDICAL PRACTICES AND INSTITUTIONS OVER A GLOBAL COMPUTER NETWORK (U.S. CLS. 100 AND 101).

SN 76-103,057. SANDHILLS PUBLISHING COMPANY, LINCOLN, NE. FILED 8-7-2000.

**PCTODAY.COM****CLASS 16—PAPER GOODS AND PRINTED MATTER**

FOR MAGAZINE RELATED TO PERSONAL COMPUTERS (U.S. CLS. 2, 5, 22, 23, 29, 37, 38 AND 50). FIRST USE 9-19-1996; IN COMMERCE 9-19-1996.

**CLASS 42—SCIENTIFIC, COMPUTER AND LEGAL SERVICES**

FOR COMPUTER SERVICES, NAMELY, PROVIDING ONLINE MAGAZINES RELATED TO PERSONAL COMPUTERS (U.S. CLS. 100 AND 101). FIRST USE 9-19-1996; IN COMMERCE 9-19-1996.

SN 76-103,746. NOBILETTI, LINDA, MT. JULIET, TN. FILED 8-4-2000.

**CYBERLING****CLASS 28—TOYS AND SPORTING GOODS**

FOR DOLLS (U.S. CLS. 22, 23, 38 AND 50).

**CLASS 38—COMMUNICATION**

FOR PROVIDING ON-LINE CHAT ROOMS FOR TRANSMISSION OF MESSAGES AMONG COMPUTER USERS CONCERNING DOLLS (U.S. CLS. 100, 101 AND 104).

SN 76-104,559. CARACAL AGENCIES LIMITED, POOLE, DORSET BH12 4BQ, UNITED KINGDOM, FILED 8-7-2000.

**LIFER BRAND CRIMINAL****CLASS 9—ELECTRICAL AND SCIENTIFIC APPARATUS**

FOR PRERECORDED AUDIO COMPACT DISCS, AUDIO TAPES AND AUDIO CASSETTES FEATURING NEW-AGE MUSIC; COMPUTER GAME SOFTWARE (U.S. CLS. 21, 23, 26, 36 AND 38).

**CLASS 25—CLOTHING**

FOR TROUSERS, JEANS, PANTS, JACKETS, COATS, TRACK SUITS, T-SHIRTS, SHIRTS, JUMPERS, BLOUSES, TANK TOPS, VESTS, SHORTS, GLOVES, SHOES, ATHLETIC TRAINING SHOES, SLIPPERS, HATS AND CAPS (U.S. CLS. 22 AND 39).

SN 76-104,924. NATIONAL AUDUBON SOCIETY, INC., NEW YORK, NY. FILED 8-8-2000.

**AUDUBON CENTER**

OWNER OF U.S. REG. NOS. 1,213,258, 2,256,522 AND OTHERS.  
NO CLAIM IS MADE TO THE EXCLUSIVE RIGHT TO USE "CENTER", APART FROM THE MARK AS SHOWN.

**CLASS 41—EDUCATION AND ENTERTAINMENT**

FOR EDUCATIONAL SERVICES, NAMELY PROVIDING HABITAT-BASED SEMINARS AND PROGRAMS ON ENVIRONMENTAL AND CONSERVATION ISSUES (U.S. CLS. 100, 101 AND 107).

FIRST USE 1-1-1950; IN COMMERCE 1-1-1950.

**CLASS 42—SCIENTIFIC, COMPUTER AND LEGAL SERVICES**

FOR WILDLIFE AND ENVIRONMENTAL CONSERVATION AND PRESERVATION SERVICES, SCIENTIFIC RESEARCH AND ASSOCIATION SERVICES; NAMELY PROMOTING PUBLIC INTEREST IN WILDLIFE PRESERVATION AND ENVIRONMENTAL CONSERVATION (U.S. CLS. 100 AND 101).

FIRST USE 1-1-1950; IN COMMERCE 1-1-1950.

SN 76-105,381. R & L CARRIERS, INC., WILMINGTON, OH. FILED 8-4-2000.

**ROBERTS TRUCK SALES**

NO CLAIM IS MADE TO THE EXCLUSIVE RIGHT TO USE "TRUCK SALES", APART FROM THE MARK AS SHOWN.  
SEC. 2(F).

**CLASS 35—ADVERTISING AND BUSINESS**

FOR RETAIL STORE SERVICES FEATURING NEW AND USED COMMERCIAL TRUCKS AND TRAILERS, NAMELY, SINGLE AND TANDEM AXLE TRACTORS, STRAIGHT TRUCKS AND SLEEPERS TRACTORS (U.S. CLS. 100, 101 AND 102).

FIRST USE 1-0-1995; IN COMMERCE 1-0-1995.

**CLASS 37—CONSTRUCTION AND REPAIR**

FOR REPAIR AND MAINTENANCE SERVICES FOR NEW AND USED COMMERCIAL TRUCKS AND TRAILERS, NAMELY, SINGLE AND TANDEM AXLE TRACTORS, STRAIGHT TRUCKS AND SLEEPER TRACTORS (U.S. CLS. 100, 103 AND 106).

FIRST USE 1-0-1995; IN COMMERCE 1-0-1995.

SN 76-105,485. BANIEL ENTERPRISES, INC., NEW YORK, NY. FILED 8-7-2000.

**SCHRO'****CLASS 41—EDUCATION AND ENTERTAINMENT**

FOR PROVIDING AN INTERACTIVE TELEVISION PROGRAM IN THE FIELDS OF EDUCATION, COMPUTER TECHNOLOGY, COMPUTER CONSULTING, COMPUTER REPAIR, SCIENCE, MUSIC, COMEDY, AND MOVIES VIA THE INTERNET; AND PROVIDING RADIO BROADCASTS AND PROGRAMMING VIA THE INTERNET (U.S. CLS. 100, 101 AND 107).

**CLASS 42—SCIENTIFIC, COMPUTER AND LEGAL SERVICES**

FOR PROVIDING TEMPORARY USE OF ONLINE, NON-DOWNLOADABLE SOFTWARE FOR COMPUTER PROGRAMS FOR EDUCATIONAL AND ENTERTAINMENT PURPOSES, INCLUDING COMPUTER GAMES (U.S. CLS. 100 AND 101).

SN 76-106,155. HEARTTEA, INC., NEW YORK, NY. FILED 8-10-2000.

**CLASS 21—HOUSEWARES AND GLASS**

FOR EARTHENWARE MUGS (U.S. CLS. 2, 13, 23, 29, 30, 33, 40 AND 50).

**CLASS 30—STAPLE FOODS**

FOR TEA (U.S. CL. 46).



SN 76-106,739. DEVELOPMENTAL RESEARCH AND PRO-GRAMS, INC., SEATTLE, WA. FILED 8-8-2000.

SN 76-107,714. EASTERLY, KEITH, MOSES LAKE, WA. FILED 8-11-2000.

# SOAR

## CLASS 9—ELECTRICAL AND SCIENTIFIC APPARATUS

FOR PRERECORDED COMPACT DISCS, AND AUDIO AND VIDEO TAPES RELATING TO EDUCATIONAL CURRICULUM FOR GRADES 1-6 (U.S. CLS. 21, 23, 26, 36 AND 38).

## CLASS 16—PAPER GOODS AND PRINTED MATTER

FOR PRINTED INSTRUCTIONAL, EDUCATIONAL AND TEACHING MATERIALS RELATING TO EDUCATIONAL CURRICULUM FOR GRADES 1-6 (U.S. CLS. 2, 5, 22, 23, 29, 37, 38 AND 50).

## CLASS 41—EDUCATION AND ENTERTAINMENT

FOR EDUCATIONAL SERVICES, NAMELY PROVIDING TRAINING AND ON-GOING TECHNICAL ASSISTANCE TO EDUCATORS RELATING TO THE IMPLEMENTATION OF EDUCATIONAL CURRICULUM FOR GRADES 1-6 (U.S. CLS. 100, 101 AND 107).



NO CLAIM IS MADE TO THE EXCLUSIVE RIGHT TO USE "ONE NATION UNDER GOD" AND "WE MUTUALLY PLEDGE OUR LIVES, OUR FORTUNES AND OUR SACRED HONOR - FOR THE SUPPORT OF THIS DECLARATION WITH A FIRM RELIANCE ON THE PROTECTION OF DIVINE PROVIDENCE", APART FROM THE MARK AS SHOWN.

## CLASS 16—PAPER GOODS AND PRINTED MATTER

FOR PUBLICATIONS, NAMELY, BOOKS, MINI-BOOKS, BOOKLETS, PAMPHLETS, NEWSLETTERS, LEAFLETS, PRINTED INSTRUCTIONAL MATERIALS, AND BROCHURES DEALING WITH THE SUBJECTS OF BIBLICAL TRUTH AS IT RELATES TO AMERICAN HISTORY, POLITICS, LAW, GOVERNMENT, SCIENCE, AND RELIGION (U.S. CLS. 2, 5, 22, 23, 29, 37, 38 AND 50).

## CLASS 41—EDUCATION AND ENTERTAINMENT

FOR EDUCATIONAL SERVICES TO HELP RESTORE THE FOUNDATIONS OF OUR AMERICAN CHRISTIAN REPUBLIC, NAMELY, TEACHING OTHERS HOW TO PROPAGATE THE PRINCIPLES OF GOVERNMENT IN THE AMERICAN CHRISTIAN REPUBLIC BY CONDUCTING CONFERENCES, WORKSHOPS, SYMPOSIUMS, SEMINARS, LECTURES, DIALOGUES, AND CLASSES, AND DISTRIBUTING COURSE MATERIAL IN CONNECTION THEREWITH, AND DISSEMINATING EDUCATION MATERIALS, NAMELY PUBLICATIONS, AND PRERECORDED AUDIO AND VIDEO TAPES TO ADVANCE BIBLICAL PRINCIPLES OF SELF- AND CIVIL GOVERNMENT AS THE ONLY TRUE BASIS FOR A SOCIETY OF FREE PEOPLE, AND AS A BASIS OF PROMOTING COMMEMORATIVE EVENTS RELATED TO OUR NATION'S BIBLICAL HERITAGE (U.S. CLS. 100, 101 AND 107).

SN 76-106,916. DOMINGUEZ FOODS OF WASHINGTON, INC., ZILLAH, WA. FILED 8-10-2000.

# SU COCINA

THE ENGLISH TRANSLATION OF "SU COCINA" IS "YOUR KITCHEN".

## CLASS 29—MEATS AND PROCESSED FOODS

FOR CANNED VEGETABLES, BEANS, PEPPERS AND TOMATOES; DRIED VEGETABLES; TOMATO PASTE AND TOMATO PUREE (U.S. CL. 46).

## CLASS 30—STAPLE FOODS

FOR CORN FLOUR; SPICES; SEASONINGS; SALSA; AND TOMATO-BASED SAUCES (U.S. CL. 46).

SN 76-108,267. HARLEQUIN ENTERPRISES LIMITED, DON MILLS, ONTARIO M3B 3K9, CANADA, FILED 8-11-2000.

SN 76-110,310. UNISYS CORPORATION, BLUE BELL, PA. FILED 8-16-2000.

## APPROVED BY TEACHERS. LOVED BY KIDS!



### CLASS 16—PAPER GOODS AND PRINTED MATTER

FOR CHILDREN'S EDUCATIONAL PRODUCTS, NAMELY, A SERIES OF FICTION AND NON-FICTION BOOKS ON A VARIETY OF TOPICS; PRINTED INSTRUCTIONAL, EDUCATIONAL AND TEACHING MATERIALS COMPRISED OF TEXT AND/OR PICTORIAL REPRESENTATIONS FOR PRE-SCHOOL AND ELEMENTARY SCHOOL CHILDREN IN A WIDE VARIETY OF SUBJECTS; STICKERS; POSTERS; NOTE PADS; PAPER BANNERS; FLASH CARDS (U.S. CLS. 2, 5, 22, 23, 29, 37, 38 AND 50).

FIRST USE 3-0-1999; IN COMMERCE 3-0-1999.

### CLASS 28—TOYS AND SPORTING GOODS

FOR CHILDREN'S EDUCATIONAL PRODUCTS, NAMELY, BOARD GAMES, JIGSAW PUZZLES, MANIPULATIVE PUZZLES, CARD GAMES, DOMINOES, BINGO CARDS AND BINGO GAME PLAYING EQUIPMENT (U.S. CLS. 22, 23, 38 AND 50).

FIRST USE 9-0-1999; IN COMMERCE 9-0-1999.

THE LINING SHOWN IN THE DRAWING IS A FEATURE OF THE MARK.

### CLASS 9—ELECTRICAL AND SCIENTIFIC APPARATUS

FOR COMPUTER HARDWARE, NAMELY, SERVERS (U.S. CLS. 21, 23, 26, 36 AND 38).

### CLASS 41—EDUCATION AND ENTERTAINMENT

FOR EDUCATIONAL SERVICES, NAMELY, TRAINING OTHERS IN THE FIELD OF OPERATING, MAINTAINING AND REPAIRING COMPUTER SERVERS (U.S. CLS. 100, 101 AND 107).

### CLASS 42—SCIENTIFIC, COMPUTER AND LEGAL SERVICES

FOR CONSULTATION SERVICES IN THE FIELD OF OPERATING, MAINTAINING AND REPAIRING COMPUTER SERVERS; AND COMPUTER CONSULTATION SERVICES FOR DETERMINING, COMPATIBILITY OF COMPUTER HARDWARE AND COMPUTER SOFTWARE (U.S. CLS. 100 AND 101).

SN 76-110,251. ALLIANCE HEALTH NETWORK, INC., ERIE, PA. FILED 8-16-2000.

## NEWALLIANCE HEALTH PLAN

NO CLAIM IS MADE TO THE EXCLUSIVE RIGHT TO USE "HEALTH PLAN", APART FROM THE MARK AS SHOWN.

### CLASS 35—ADVERTISING AND BUSINESS

FOR COST MANAGEMENT FOR THE HEALTH CARE BENEFIT PLANS OF OTHERS (U.S. CLS. 100, 101 AND 102).

### CLASS 36—INSURANCE AND FINANCIAL

FOR UNDERWRITING INSURANCE FOR PRE-PAID HEALTH CARE; ADMINISTRATION OF PRE-PAID HEALTH CARE PLANS; ORGANIZING PRE-PAID HEALTH CARE PLANS (U.S. CLS. 100, 101 AND 102).

### CLASS 42—SCIENTIFIC, COMPUTER AND LEGAL SERVICES

FOR HEALTH CARE IN THE NATURE OF HEALTH MAINTENANCE ORGANIZATIONS (U.S. CLS. 100 AND 101).

SN 76-110,336. ELMARK, LTD., ASHBURN, VA. FILED 8-17-2000.

## THE OLD YANKEE FRAMER

NO CLAIM IS MADE TO THE EXCLUSIVE RIGHT TO USE "FRAMER", APART FROM THE MARK AS SHOWN.

### CLASS 35—ADVERTISING AND BUSINESS

FOR RETAIL STORE SERVICES FEATURING PICTURE FRAMES, FRAMED ART, EASELS, LAMPS, GIFTS AND FRAMING ACCESSORIES (U.S. CLS. 100, 101 AND 102).

FIRST USE 7-7-2000; IN COMMERCE 7-7-2000.

### CLASS 40—MATERIAL TREATMENT

FOR CUSTOM PICTURE FRAMING SERVICES (U.S. CLS. 100, 103 AND 106).

FIRST USE 7-7-2000; IN COMMERCE 7-7-2000.

SN 76-111,649. TERNOEY, STEVEN E., SANTA BARBARA, CA. FILED 8-15-2000.

SN 76-113,674. SOLUTIONARY, INC., OMAHA, NE. FILED 8-22-2000.

## LIGHT FORMS

NO CLAIM IS MADE TO THE EXCLUSIVE RIGHT TO USE "LIGHT", APART FROM THE MARK AS SHOWN.

### CLASS 41—EDUCATION AND ENTERTAINMENT

FOR EDUCATIONAL SERVICES, NAMELY TEACHING AND TRAINING IN THE FIELD OF ARCHITECTURAL DESIGN (U.S. CLS. 100, 101 AND 107).  
FIRST USE 7-1-1990; IN COMMERCE 7-1-1990.

### CLASS 42—SCIENTIFIC, COMPUTER AND LEGAL SERVICES

FOR ARCHITECTURAL DESIGN SERVICES AND CONSULTING SERVICES IN THE FIELD OF ARCHITECTURAL DESIGN (U.S. CLS. 100 AND 101).  
FIRST USE 2-1-1990; IN COMMERCE 2-1-1990.

---

SN 76-111,730. HOPE HEART INSTITUTE, THE, SEATTLE, WA. FILED 8-17-2000.

## TAKE HEART

### CLASS 9—ELECTRICAL AND SCIENTIFIC APPARATUS

FOR PRERECORDED VIDEO TAPES, AUDIO TAPES, COMPACT DISKS AND CASSETTES FEATURING EDUCATIONAL INFORMATION ON HEALTH ISSUES AND HEART DISEASE (U.S. CLS. 21, 23, 26, 36 AND 38).

### CLASS 16—PAPER GOODS AND PRINTED MATTER

FOR PRINTED MATERIALS, NAMELY, WORKBOOKS, PAMPHLETS, NEWSLETTERS AND INFORMATION BROCHURES FEATURING INFORMATION AND EDUCATION ON HEALTH ISSUES AND HEART DISEASE (U.S. CLS. 2, 5, 22, 23, 29, 37, 38 AND 50).

### CLASS 41—EDUCATION AND ENTERTAINMENT

FOR EDUCATIONAL SERVICES, NAMELY, WORKSHOPS, LECTURE SERIES AND SEMINARS FEATURING INFORMATION AND EDUCATION ON HEALTH ISSUES AND HEART DISEASE (U.S. CLS. 100, 101 AND 107).

### CLASS 42—SCIENTIFIC, COMPUTER AND LEGAL SERVICES

FOR HEALTH INFORMATION SERVICES; HEALTH INFORMATION SERVICES VIA A GLOBAL COMPUTER NETWORK (U.S. CLS. 100 AND 101).

## SOLUTIONARY

### CLASS 37—CONSTRUCTION AND REPAIR

FOR MAINTENANCE OF COMPUTER HARDWARE (U.S. CLS. 100, 103 AND 106).

### CLASS 41—EDUCATION AND ENTERTAINMENT

FOR CONSULTATION IN THE FIELD OF COMPUTER TRAINING (U.S. CLS. 100, 101 AND 107).

### CLASS 42—SCIENTIFIC, COMPUTER AND LEGAL SERVICES

FOR COMPUTER CONSULTATION IN THE FIELD OF COMPUTER NETWORKS, APPLICATIONS AND SECURITY, NAMELY, COMPUTER NETWORK, SYSTEMS AND APPLICATIONS SECURITY ASSESSMENTS AND ANALYSIS; MONITORING THE COMPUTER SYSTEMS OF OTHERS AND PROVIDING BACK-UP COMPUTER PROGRAMS AND FACILITIES, INCLUDING, MONITORING DATA COMMUNICATIONS AND COMPUTER NETWORKS AND SYSTEMS, SURVEILLANCE OF COMPUTER NETWORK AND SYSTEM USER TRAFFIC; AND COMPUTER NETWORK, SYSTEM AND APPLICATION INTRUSION DETECTION AND DISABLEMENT AND PROVIDING ALERTS REGARDING SUCH INTRUSIONS; COMPUTER SERVICES, NAMELY, ENCRYPTION AND AUTHENTICATION OF DATA; MAINTENANCE OF COMPUTER SOFTWARE; THE DESIGN, DEVELOPMENT AND PROGRAMMING DEPLOYMENT OF COMPUTER SOFTWARE, APPLICATIONS AND COMPUTER NETWORKS FOR OTHERS; COMPUTER CONSULTATION IN THE FIELD OF SYSTEM INTEGRATION, INSTALLATION AND IMPLEMENTATION SERVICES, SUPPORT AND MAINTENANCE OF COMPUTER SOFTWARE, HARDWARE, WEBSITES AND COMPUTER AND ELECTRONIC COMMUNICATIONS NETWORKS (U.S. CLS. 100 AND 101).

---

SN 76-113,860. KIDS FOR KIDS, INC., NEW YORK, NY. FILED 8-23-2000.

the  

 kids for kids  
 project

NO CLAIM IS MADE TO THE EXCLUSIVE RIGHT TO USE "PROJECT", APART FROM THE MARK AS SHOWN.

### CLASS 36—INSURANCE AND FINANCIAL

FOR FUND RAISING SERVICES FOR RESEARCH IN DUCHENNE MUSCULAR DYSTROPHY (U.S. CLS. 100, 101 AND 102).  
FIRST USE 6-21-2000; IN COMMERCE 6-21-2000.

### CLASS 41—EDUCATION AND ENTERTAINMENT

FOR ENTERTAINMENT SERVICES, NAMELY, LIVE MUSICAL AND DANCE PERFORMANCES BY A PERFORMING GROUP, AIMED AT INCREASING UNDERSTANDING OF DUCHENNE MUSCULAR DYSTROPHY (U.S. CLS. 100, 101 AND 107).  
FIRST USE 6-21-2000; IN COMMERCE 6-21-2000.

SN 76-114,081. R & M LEASING, INC., WILMINGTON, OH. FILED 8-22-2000.

SN 76-115,430. INTUIT INC., MOUNTAIN VIEW, CA. FILED 8-22-2000.

## ROBERTS TRUCK PARTS

NO CLAIM IS MADE TO THE EXCLUSIVE RIGHT TO USE "TRUCK PARTS", APART FROM THE MARK AS SHOWN.  
SEC. 2(F).

### CLASS 35—ADVERTISING AND BUSINESS

FOR RETAIL STORE SERVICES FEATURING HEAVY MOTOR VEHICLE PARTS, INCLUDING TRUCKS, TRACTORS AND TRAILERS, HEAVY CONSTRUCTION, HOISTING, EXCAVATING, ROAD BUILDING, AGRICULTURAL AND LAWN AND GARDEN EQUIPMENT (U.S. CLS. 100, 101 AND 102).

FIRST USE 8-0-1982; IN COMMERCE 8-0-1982.

### CLASS 37—CONSTRUCTION AND REPAIR

FOR REPAIR SERVICES FOR HEAVY MOTOR VEHICLES, INCLUDING TRUCKS, TRACTORS AND TRAILERS, HEAVY CONSTRUCTION, HOISTING, EXCAVATING, ROAD BUILDING, AGRICULTURAL AND LAWN AND GARDEN EQUIPMENT (U.S. CLS. 100, 103 AND 106).

FIRST USE 8-0-1982; IN COMMERCE 8-0-1982.

---

SN 76-114,753. UNITEDSCREENS GMBH, 85774 UNTERFOHRING, FED REP GERMANY, FILED 8-23-2000.

## POPSCREENS

PRIORITY CLAIMED UNDER SEC. 44(D) ON FED REP GERMANY APPLICATION NO. 30015700.2/4, FILED 2-28-2000, REG. NO. 30015700, DATED 11-27-2000, EXPIRES 2-28-2010.

### CLASS 35—ADVERTISING AND BUSINESS

FOR PLACING ADVERTISEMENTS FOR OTHERS, PREPARING ADVERTISEMENTS FOR OTHERS, ELECTRONIC BILLBOARD ADVERTISING, PREPARING AUDIO-VISUAL PRESENTATIONS FOR USE IN ADVERTISING, DISSEMINATION OF ADVERTISING FOR OTHERS VIA AN ON-LINE ELECTRONIC COMMUNICATIONS NETWORK, DISSEMINATION OF ADVERTISING MATTER, RENTAL OF ADVERTISING SPACE, BUSINESS MANAGEMENT AND CONSULTATION, MARKET ANALYSIS, CONDUCTING BUSINESS AND MARKET RESEARCH SURVEYS (U.S. CLS. 100, 101 AND 102).

### CLASS 38—COMMUNICATION

FOR BROADCASTING PROGRAMS VIA A GLOBAL COMPUTER NETWORK, ELECTRONIC TRANSMISSION OF MESSAGES AND DATA (U.S. CLS. 100, 101 AND 104).

### CLASS 42—SCIENTIFIC, COMPUTER AND LEGAL SERVICES

FOR COMPUTER PROGRAMMING FOR OTHERS (U.S. CLS. 100 AND 101).

## INTUITADVISOR

OWNER OF U.S. REG. NOS. 1,826,233, 1,944,876 AND OTHERS.

### CLASS 35—ADVERTISING AND BUSINESS

FOR PROVIDING BUSINESS MANAGEMENT CONSULTATION SERVICES FOR PROFESSIONALS IN THE FIELDS OF ACCOUNTING, FINANCIAL PLANNING, INSURANCE, INVESTMENT, TAX RETURN PREPARATION AND TAX PLANNING (U.S. CLS. 100, 101 AND 102).

### CLASS 36—INSURANCE AND FINANCIAL

FOR PROVIDING INFORMATION IN THE NATURE OF ADVICE, ANALYSIS, NEWS, AND OPINIONS FOR PROFESSIONALS IN THE FIELDS OF ACCOUNTING, FINANCE, FINANCIAL PLANNING, INSURANCE, INVESTMENT, TAX RETURN PREPARATION AND TAX PLANNING; TAX INFORMATION AND MANAGEMENT INFORMATION; ALL PROVIDED VIA COMPUTER AND COMMUNICATIONS NETWORKS (U.S. CLS. 100, 101 AND 102).

### CLASS 42—SCIENTIFIC, COMPUTER AND LEGAL SERVICES

FOR PROVIDING VIA COMPUTER AND COMMUNICATION NETWORKS THE USE OF NON-DOWNLOADABLE COMPUTER SOFTWARE FOR PERFORMING QUERIES AND TRANSACTIONS AND TRANSMITTING AND RECEIVING INFORMATION IN THE FIELDS OF ACCOUNTING, BANKING, FINANCE, FINANCIAL PLANNING, INSURANCE, INVESTMENT, TAX RETURN PREPARATION AND TAX PLANNING (U.S. CLS. 100 AND 101).

---

SN 76-116,105. MARRIOTT INTERNATIONAL, INC., BETHESDA, MD. FILED 8-24-2000.

## VACATION FOR LIFE

NO CLAIM IS MADE TO THE EXCLUSIVE RIGHT TO USE "VACATION", APART FROM THE MARK AS SHOWN.

### CLASS 36—INSURANCE AND FINANCIAL

FOR REAL ESTATE TIMESHARE SERVICES FEATURING A PERIODIC SWEEPSTAKES (U.S. CLS. 100, 101 AND 102).

FIRST USE 11-0-1999; IN COMMERCE 11-0-1999.

### CLASS 42—SCIENTIFIC, COMPUTER AND LEGAL SERVICES

FOR HOTEL SERVICES FEATURING A PERIODIC SWEEPSTAKES (U.S. CLS. 100 AND 101).

FIRST USE 11-0-1999; IN COMMERCE 11-0-1999.

SN 76-117,027. LAKE VIEW MOSS LIMITED, WESTLAND, NEW ZEALAND, FILED 8-25-2000.

SN 76-117,780. VIACORE, INC., ORANGE, CA. FILED 8-28-2000.

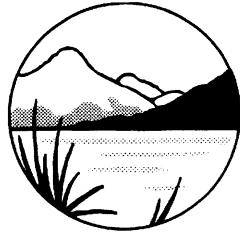

THE STIPPLING IS FOR SHADING PURPOSES.

**CLASS 1—CHEMICALS**

FOR PEAT (U.S. CLS. 1, 5, 6, 10, 26 AND 46).

**CLASS 31—NATURAL AGRICULTURAL PRODUCTS**

FOR AGRICULTURAL, HORTICULTURAL, AND FORESTRY PRODUCTS, NAMELY, PEAT MOSS, MOSS, SEEDS, LIVE NATURAL PLANTS AND FLOWERS, CUT FLOWERS, AND DRIED PLANTS (U.S. CLS. 1 AND 46).

SN 76-117,117. LA FAVORITA FOODS, INC., PATERSON, NJ. FILED 8-28-2000.

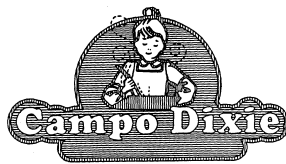

THE MARK IS LINED FOR THE COLORS BLUE AND RED.  
THE ENGLISH TRANSLATION OF "CAMPO" IS "COUNTRY".

**CLASS 29—MEATS AND PROCESSED FOODS**

FOR FRESH, FROZEN AND CANNED SEAFOOD, NAMELY SHRIMP, FISH AND LOBSTER TAILS; PROCESSED, CANNED, DRIED OR PRESERVED FRUITS; AND FRUIT PULP (U.S. CL. 46).

**CLASS 31—NATURAL AGRICULTURAL PRODUCTS**

FOR UNPROCESSED, RAW OR FRESH FRUITS (U.S. CLS. 1 AND 46).

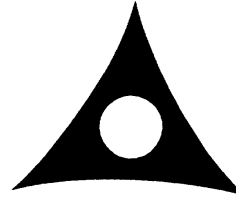

**CLASS 35—ADVERTISING AND BUSINESS**

FOR BUSINESS MANAGEMENT SERVICES, NAMELY, ASSISTING CLIENT IN MANAGING AND IMPLEMENTING BUSINESS PROCESSES, DEVELOPING BUSINESS STRATEGIES, AND PROVIDING STATISTICAL DATA IN CONNECTION THEREWITH; ON-LINE ORDERING SERVICES IN THE FIELDS OF INFORMATION TECHNOLOGY, ELECTRONIC COMPONENTS AND IN A WIDE VARIETY OF OTHER FIELDS; DATA PROCESSING SERVICES (U.S. CLS. 100, 101 AND 102).  
FIRST USE 12-14-1999; IN COMMERCE 12-14-1999.

**CLASS 38—COMMUNICATION**

FOR TELECOMMUNICATION SERVICES, NAMELY, ELECTRONIC TRANSMISSION AND ROUTING OF MESSAGES AND DATA USED BY BUSINESSES AND THEIR SUPPLIERS OR CUSTOMERS TO PROCESS ORDERS AND IMPLEMENT OTHER BUSINESS TRANSACTIONS AND PROCESSES (U.S. CLS. 100, 101 AND 104).  
FIRST USE 12-14-1999; IN COMMERCE 12-14-1999.

**CLASS 42—SCIENTIFIC, COMPUTER AND LEGAL SERVICES**

FOR COMPUTER SERVICES IN THE FIELD OF ELECTRONIC COMMERCE, NAMELY, CONVERTING DOCUMENTS USED BY BUSINESSES FOR PROCESSING OF ORDERS AND IMPLEMENTATION OF OTHER BUSINESSES TRANSACTIONS AND PROTOCOLS INTO ONE OR MORE PRE-DEFINED PROTOCOLS; COMPILING AND MANAGING DATA IN THE FORM OF AN ELECTRONIC CATALOG FOR OTHERS; PROVIDING ENCRYPTION OF MESSAGES AND DATA AND SECURED TRANSACTION SECURITY SERVICES FOR USERS OF TELECOMMUNICATIONS NETWORKS; ALL PROVIDED VIA A GLOBAL COMPUTER NETWORK (U.S. CLS. 100 AND 101).  
FIRST USE 12-14-1999; IN COMMERCE 12-14-1999.

SN 76-118,554. UGLY DUCKLING CAR SALES AND FINANCE CORPORATION, INC., PHOENIX, AZ. FILED 8-29-2000.

**LUCKY DUCK**

**CLASS 35—ADVERTISING AND BUSINESS**

FOR USED AUTOMOBILE DEALERSHIPS (U.S. CLS. 100, 101 AND 102).

**CLASS 36—INSURANCE AND FINANCIAL**

FOR FINANCIAL SERVICES RELATING TO AUTOMOBILES, NAMELY FINANCING FOR USED AUTOMOBILE SALES (U.S. CLS. 100, 101 AND 102).

SN 76-119,391. CHENEY, MICHAEL, CLACKAMAS, OR.  
FILED 8-22-2000.



NO CLAIM IS MADE TO THE EXCLUSIVE RIGHT TO USE "CORPORATION", APART FROM THE MARK AS SHOWN.

**CLASS 9—ELECTRICAL AND SCIENTIFIC APPARATUS**

FOR COMPUTER SOFTWARE, NAMELY, FOR CREATING PROFILES AND WORKSHEETS FOR USE IN BUILDING RELATIONSHIPS AND AVOIDING AND RESOLVING INTERPERSONAL CONFLICTS (U.S. CLS. 21, 23, 26, 36 AND 38).  
FIRST USE 7-0-1999; IN COMMERCE 7-0-1999.

**CLASS 16—PAPER GOODS AND PRINTED MATTER**

FOR BOOKS, NAMELY, A SERIES OF NON-FICTION BOOKS HAVING TO DO WITH BUILDING RELATIONSHIPS AND RESOLVING INTERPERSONAL CONFLICTS (U.S. CLS. 2, 5, 22, 23, 29, 37, 38 AND 50).  
FIRST USE 7-0-1999; IN COMMERCE 7-0-1999.

**CLASS 41—EDUCATION AND ENTERTAINMENT**

FOR CONDUCTING WORKSHOPS AND SEMINARS ON BUILDING RELATIONSHIPS AND RESOLVING INTERPERSONAL CONFLICTS AND PROVIDING EDUCATIONAL SERVICES THROUGH A WEBSITE, NAMELY, PROVIDING EDUCATIONAL INFORMATION ON BUILDING RELATIONSHIPS AND RESOLVING INTERPERSONAL CONFLICTS (U.S. CLS. 100, 101 AND 107).  
FIRST USE 7-0-1999; IN COMMERCE 7-0-1999.

SN 76-119,392. CHENEY, MICHAEL, CLACKAMAS, OR.  
FILED 8-22-2000.

**PERSONALITY PRIORITY**

**CLASS 9—ELECTRICAL AND SCIENTIFIC APPARATUS**

FOR COMPUTER SOFTWARE, NAMELY, FOR CREATING PROFILES AND WORKSHEETS FOR USE IN BUILDING RELATIONSHIPS AND AVOIDING AND RESOLVING INTERPERSONAL CONFLICTS (U.S. CLS. 21, 23, 26, 36 AND 38).  
FIRST USE 7-0-1999; IN COMMERCE 7-0-1999.

**CLASS 16—PAPER GOODS AND PRINTED MATTER**

FOR BOOKS, NAMELY, A SERIES OF NON-FICTION BOOKS HAVING TO DO WITH BUILDING RELATIONSHIPS AND RESOLVING INTERPERSONAL CONFLICTS (U.S. CLS. 2, 5, 22, 23, 29, 37, 38 AND 50).  
FIRST USE 7-0-1999; IN COMMERCE 7-0-1999.

**CLASS 41—EDUCATION AND ENTERTAINMENT**

FOR CONDUCTING WORKSHOPS AND SEMINARS ON BUILDING RELATIONSHIPS AND RESOLVING INTERPERSONAL CONFLICTS AND PROVIDING EDUCATIONAL SERVICES THROUGH A WEBSITE, NAMELY, PROVIDING EDUCATIONAL INFORMATION ON BUILDING RELATIONSHIPS AND RESOLVING INTERPERSONAL CONFLICTS (U.S. CLS. 100, 101 AND 107).  
FIRST USE 7-0-1999; IN COMMERCE 7-0-1999.

SN 76-120,683. FOCUS:IMPACT CORP., CHICAGO, IL.  
FILED 8-31-2000.



THE MARK CONSISTS OF THE DESIGN OF A STYLIZED EXCLAMATION POINT.

**CLASS 9—ELECTRICAL AND SCIENTIFIC APPARATUS**

FOR COMPUTER SOFTWARE USED FOR PROVIDING ON-LINE EMPLOYEE EDUCATION AND TRAINING IN THE FIELD OF COMPUTERS AND BUSINESS MANAGEMENT; USED FOR ELECTRONIC MAIL AND NETWORK CONFERENCING FOR CORPORATE COMMUNICATIONS PURPOSES AND USED TO CREATE JOB DESCRIPTIONS AND ORGANIZATIONAL FLOW-CHARTS FOR USE IN ORGANIZATIONAL MANAGEMENT (U.S. CLS. 21, 23, 26, 36 AND 38).  
FIRST USE 7-21-2000; IN COMMERCE 7-21-2000.

**CLASS 35—ADVERTISING AND BUSINESS**

FOR BUSINESS CONSULTING IN THE FIELDS OF EMPLOYEE EDUCATION AND TRAINING, CORPORATE COMMUNICATIONS, ORGANIZATIONAL MANAGEMENT AND ALIGNMENT, LEADERSHIP DEVELOPMENT, AND CHANGE MANAGEMENT (U.S. CLS. 100, 101 AND 102).  
FIRST USE 7-21-2000; IN COMMERCE 7-21-2000.

**CLASS 41—EDUCATION AND ENTERTAINMENT**

FOR EDUCATIONAL SERVICES, NAMELY, CONDUCTING TRAINING CLASSES IN USE AND OPERATION OF COMPUTERS; CONDUCTING CLASSES, SEMINARS AND WORKSHOPS IN THE FIELD OF BUSINESS ETIQUETTE AND BUSINESS MANAGEMENT; AND DISTRIBUTING COURSE MATERIALS IN CONNECTION THEREWITH (U.S. CLS. 100, 101 AND 107).  
FIRST USE 7-21-2000; IN COMMERCE 7-21-2000.

**CLASS 42—SCIENTIFIC, COMPUTER AND LEGAL SERVICES**

FOR WEB SITE DEVELOPMENT FOR OTHERS; HOSTING THE WEB SITES OF OTHERS ON A SERVER FOR A GLOBAL COMPUTER NETWORK; CONSULTATION SERVICES IN THE FIELD OF WEB SITE DEVELOPMENT AND HOSTING (U.S. CLS. 100 AND 101).  
FIRST USE 7-21-2000; IN COMMERCE 7-21-2000.

SN 76-120,684. FOCUS:IMPACT CORP., CHICAGO, IL.  
FILED 8-31-2000.

## FOCUS:IMPACT

### CLASS 9—ELECTRICAL AND SCIENTIFIC APPARATUS

FOR COMPUTER SOFTWARE USED FOR PROVIDING ON-LINE EMPLOYEE EDUCATION AND TRAINING IN THE FIELD OF COMPUTERS AND BUSINESS MANAGEMENT; USED FOR ELECTRONIC MAIL AND NETWORK CONFERENCING FOR CORPORATE COMMUNICATIONS PURPOSES AND USED TO CREATE JOB DESCRIPTIONS AND ORGANIZATIONAL FLOW-CHARTS FOR USE IN ORGANIZATIONAL MANAGEMENT (U.S. CLS. 21, 23, 26, 36 AND 38).

FIRST USE 7-21-2000; IN COMMERCE 7-21-2000.

### CLASS 35—ADVERTISING AND BUSINESS

FOR BUSINESS CONSULTING SERVICES IN THE FIELDS OF EMPLOYEE EDUCATION AND TRAINING, CORPORATE COMMUNICATIONS, ORGANIZATIONAL MANAGEMENT AND ALIGNMENT, LEADERSHIP DEVELOPMENT, AND CHANGE MANAGEMENT (U.S. CLS. 100, 101 AND 102).

FIRST USE 7-21-2000; IN COMMERCE 7-21-2000.

### CLASS 41—EDUCATION AND ENTERTAINMENT

FOR EDUCATIONAL SERVICES, NAMELY, CONDUCTING TRAINING CLASSES IN THE USE AND OPERATION OF COMPUTERS; CONDUCTING CLASSES, SEMINARS AND WORKSHOPS IN THE FIELD OF BUSINESS ETIQUETTE AND BUSINESS MANAGEMENT; AND DISTRIBUTING COURSE MATERIALS IN CONNECTION THEREWITH (U.S. CLS. 100, 101 AND 107).

FIRST USE 7-21-2000; IN COMMERCE 7-21-2000.

### CLASS 42—SCIENTIFIC, COMPUTER AND LEGAL SERVICES

FOR WEB SITE DEVELOPMENT FOR OTHERS; HOSTING THE WEB SITES OF OTHERS ON A SERVER FOR A GLOBAL COMPUTER NETWORK; CONSULTATION SERVICES IN THE FIELD OF WEB SITE DEVELOPMENT AND HOSTING (U.S. CLS. 100 AND 101).

FIRST USE 7-21-2000; IN COMMERCE 7-21-2000.

SN 76-121,322. LUCASFILM LTD., NICASIO, CA. FILED 9-1-2000.

## ZAM WESELL

### CLASS 16—PAPER GOODS AND PRINTED MATTER

FOR PAPER GOODS AND PRINTED MATTER, NAMELY, ADDRESS BOOKS; CHILDREN'S ACTIVITY BOOKS; COMIC BOOKS; COLORING BOOKS; NOTEBOOKS; COMPOSITION BOOKS; COPY BOOKS; EXERCISE BOOKS; GUEST BOOKS; PICTURE BOOKS; CHILDREN'S BOOKS; BOOKS ON SCIENCE FICTION; BOOKS ON TOPICS OF GENERAL INTEREST; BOOKS ON ENTERTAINMENT; BOOKS ON MOVIE-MAKING; BOOKS CONTAINING GAMES; GRAPHIC NOVELS; BOOKS CONTAINING SCREENPLAYS; SCRIPT BOOKS; BOOKS ON GEOGRAPHY; BOOKS ON SOCIOLOGY; BOOKS ON HISTORY; NOVELIZATIONS OF MOTION PICTURES; TECHNICAL MANUALS RELATING TO SCIENCE FICTION FILMS; INSTRUCTIONAL MANUALS AND STRATEGY GUIDES FOR GAMES; MAGAZINES IN THE FIELD OF ENTERTAINMENT AND

SCIENCE FICTION; PUBLICATIONS, NAMELY, JOURNALS, NEWSPAPERS, AND NEWSLETTERS IN THE FIELD OF ENTERTAINMENT AND SCIENCE FICTION; ANIMATION CELLS, BLOTTERS; BLUEPRINTS; BOOK COVERS; CARDBOARD CONTAINERS; CATALOGS IN THE FIELD OF ENTERTAINMENT AND SCIENCE FICTION; COIN ALBUMS; SCRAPBOOK ALBUMS; ARTS AND CRAFTS KITS FOR PAINTING, MODEL-MAKING, AND DRAWING; STAMP ALBUMS; PHOTOGRAPH ALBUMS; COLLECTOR ALBUMS; DECORATIVE RUBBER STAMPS; DIARIES; PAPER DOORKNOB HANGERS; HEIGHT CHARTS; IDENTIFICATION CARDS AND IDENTITY CARDS; INVITATIONS; LUNCH BAGS; MODELING MATERIALS AND COMPOUNDS FOR USE BY CHILDREN; PERSONAL ORGANIZERS; ORIGINAL ARTWORK PRINTS; PAPER NAME BADGES; PAPER MACHE; PAPER MACHE FIGURINES; PAPER TABLE CLOTHS; PHOTOGRAPHIC PRINTS; RIBBONS FOR GIFT WRAPPING; SOCIAL NOTE CARDS; BLANK NOTE CARDS; NON-MAGNETICALLY CODED TRANSPORTATION FARE CARDS; TISSUE PAPER; TRADING CARDS; WALLET CARDS; WRITING PADS; TRADING CARD MILK BOTTLE CAPS; POSTERS; BOOK PLATES; BOOK MARKS; CHECKBOOK HOLDERS AND COVERS; NON-ELECTRONIC PERSONAL PLANNERS AND ORGANIZERS; ARTIST MATERIALS, NAMELY, PENCILS, PENS, PAINTING SETS; BRUSHES; PAINTING SETS; PRINTED PAPER PATTERNS; RUB DOWN TRANSFERS; SKETCHBOOKS; BASKETS FOR DESK ACCESSORIES; GIFT WRAP; GIFT TAGS; GIFT BAGS; GIFT BOXES; CORRESPONDENCE NOTE PAPER; GREETING CARDS; PAPER PARTY DECORATIONS; PAPER NAPKINS; PAPER RIBBONS; PAPER PARTY BAGS; PAPER PARTY HATS; POSTCARDS; GIFT PACKAGE DECORATIONS MADE OF PAPER; STICKERS; STICKER BOOKS; STICKER KITS; CORK BOARDS; CHALK BOARDS; MEMORANDUM BOARDS; SCRAPBOOKS; NON-MAGNETICALLY CODED TELEPHONE CALLING CARDS; PLAYING CARDS; ART REPRODUCTIONS; LITHOGRAPHS; LITHOGRAPHIC PRINTS; HOLOGRAMS; IRON-ON PATCHES; CALENDARS; CARDBOARD FIGURES; TEMPORARY TATTOOS; SCHOOL AND OFFICE SUPPLIES, NAMELY, DRAFTING AND DRAWING RULERS, PENCILS, PENS, MARKERS, GLUE FOR STATIONERY OR HOUSEHOLD USE, DESK TOP ORGANIZERS, DESK STANDS AND HOLDERS FOR PENCILS, PENS, TAPE, PAPER CLIPS, AND NOTEPADS; BINDERS; DISPENSERS FOR ADHESIVE TAPES FOR STATIONERY OR HOUSEHOLD PURPOSES, CLIP BOARDS, STATIONERY, NOTEPADS, AND PENCIL SETS, NOTEPADS, ORGANIZERS FOR STATIONERY USE, PENCIL CASES; PENCIL SHARPENERS, STATIONERY PORTFOLIOS, DESK PADS AND STATIONERY SETS COMPRISED OF PAPER, ENVELOPE, SEALS, NOTEPADS; STENCILS; SHEET MUSIC; ADULT NOVELIZATIONS; READ-ALONG BOOKS AND CASSETTE TAPES SOLD AS A UNIT; CHILDREN'S CASSETTE RECORDED READ-ALONG BOOKS; ELECTRONIC BOOKS WITH SOUND BUTTONS; DICTIONARIES; NOVELS; WRAPPING AND CONTAINERS FOR FAST FOOD ITEMS; PAPER CAKE DECORATIONS; CREDIT CARDS; BANK CHECKS; LETTER OPENERS; PATTERNS FOR MAKING COSTUMES; LAP DESKS; EASELS; STENCILS; CRAFT KITS CONTAINING PAINT; PAINT BRUSHES; WOOD PIECES AND STENCILS; ARTS AND CRAFTS PAINT KITS CONTAINING SPONGES; BRUSHES; PAINT AND PAINT CUPS ACTIVITY KITS CONTAINING STAMPER MARKERS; RUBBER STAMPERS; INK PAD; COLORED PENCILS; STAMPER HOLDER; PAPER ACTIVITY KITS CONSISTING OF WRITING AND DRAWING IMPLEMENTS, DRAWING TEMPLATES, AND PAPER; PUTTY, DOUGH AND MODELING CLAY AND ACCESSORIES FOR USE WITH MODELING COMPOUNDS, CRAYON AND COLOR BY NUMBER KITS; ACTIVITY KITS CONSISTING OF MODELING COMPOUND AND RELATED ACCESSORIES FOR USE WITH MODELING COMPOUND SOLD AS A UNIT; SERIES OF FICTION BOOKS IN THE FIELD OF ENTERTAINMENT AND SCIENCE FICTION; BOOKS FEATURING PHOTOGRAPHIC PRINTS (U.S. CLS. 2, 5, 22, 23, 29, 37, 38 AND 50).

**CLASS 25—CLOTHING**

FOR MEN'S, WOMEN'S, AND CHILDREN'S CLOTHING AND ATHLETIC WEAR, NAMELY, UNDERWEAR, RAINWEAR, SLEEPWEAR, HOSE, HOSIERY, FOOTWEAR, BELTS, SUSPENDERS, CAPS, HEAD WEAR, KNIT CAPS, ATHLETIC SHOES, BATHROBES, BELTS, COATS, SHIRTS, GLOVES, HATS, JACKETS, JOGGING SUITS, LEATHER JACKETS, MITTENS, PAJAMAS, SCARVES, SHORTS, PANTS, SKIRTS, DRESSES, SLIPPERS, SOCKS, SWEATERS, SWIM WEAR, TANK TOPS, TIES, VESTS, MASQUERADE COSTUMES, ACCESSORIES, AND MASKS SOLD IN CONNECTION THEREWITH, CHILDREN'S FOOTWEAR, BOXER SHORTS, LONG UNDERWEAR, EXERCISE BRAS, HEADBANDS, WRISTBANDS, LEOTARDS, SINGLET, UNITARDS, VISORS, WARM-UP SUITS, OVERALLS, WIND-RESISTANT JACKETS, PARKAS, JUMPSUITS, CROP TOPS, FITNESS TOPS, TIGHTS, TENNISWEAR, ANORAKS, SWEATSHIRTS, SWEATPANTS, T-SHIRTS (U.S. CLS. 22 AND 39).

**CLASS 38—COMMUNICATION**

FOR COMPUTER SERVICES, NAMELY, PROVIDING AN ON-LINE ELECTRONIC BULLETIN BOARD AND CHAT ROOMS FOR THE TRANSMISSION OF MESSAGES AMONG COMPUTER USERS IN THE FIELD OF EDUCATION AND ENTERTAINMENT RELATING TO MOTION PICTURE FILMS, INTERACTIVE COMPUTER GAMES, TELEVISION SHOWS AND SCIENCE FICTION (U.S. CLS. 100, 101 AND 104).

**CLASS 41—EDUCATION AND ENTERTAINMENT**

FOR RADIO ENTERTAINMENT SERVICES, NAMELY, RADIO PROGRAMS FEATURING PERFORMANCES BY RADIO PERSONALITIES AND PEOPLE PORTRAYING FICTIONAL CHARACTERS AND BY RADIO PERSONALITIES AND PEOPLE DISCUSSING EDUCATIONAL AND ENTERTAINMENT TOPICS; ENTERTAINMENT, NAMELY, A CONTINUING VARIETY, NEWS, COMEDY, SCIENCE FICTION, AND EDUCATIONAL SHOW DISTRIBUTED OVER TELEVISION, SATELLITES, AUDIO, VIDEO, AND ELECTRONIC MEDIA; PRODUCTION AND DISTRIBUTION OF TELEVISION PROGRAMS FOR OTHERS; PRODUCTION AND DISTRIBUTION OF MOTION PICTURES; PRODUCTIONS AND DISTRIBUTION OF CABLE TELEVISION PROGRAM; PROVIDING NEWS AND INFORMATION IN THE FIELD OF EDUCATION AND ENTERTAINMENT RELATING TO SCIENCE FICTION TOPICS, COMPUTER GAMES, MOTION PICTURE FILMS VIA GLOBAL COMPUTER NETWORKS AND OTHER ELECTRONIC COMPUTER NETWORKS; ENTERTAINMENT SERVICES, NAMELY, PROVIDING INTERACTIVE COMPUTER GAMES BY MEANS OF A GLOBAL COMPUTER NETWORK AND OTHER ELECTRONIC COMPUTER NETWORKS; ENTERTAINMENT IN THE NATURE OF AN AMUSEMENT PARK RIDE; AMUSEMENT OR THEME PARK SERVICES; FAN CLUB SERVICES; AND ENTERTAINMENT IN THE NATURE OF COMPETITIONS IN THE FIELD OF ENTERTAINMENT TRIVIA; PROVIDING COMPUTER DATABASES, PROVIDING INFORMATION AND WEBSITES FEATURING AUDIO, VISUAL AND AUDIOVISUAL ENTERTAINMENT IN THE FIELD OF EDUCATION AND ENTERTAINMENT VIA GLOBAL COMPUTER NETWORKS (U.S. CLS. 100, 101 AND 107).

SN 76-121,333. LUCASFILM LTD., NICASIO, CA. FILED 9-1-2000.

**COUNT DOOKU****CLASS 16—PAPER GOODS AND PRINTED MATTER**

FOR PAPER GOODS AND PRINTED MATTER, NAMELY, ADDRESS BOOKS; CHILDREN'S ACTIVITY BOOKS; COMIC BOOKS; COLORING BOOKS; NOTEBOOKS; COMPOSITION BOOKS; COPY BOOKS; EXERCISE BOOKS; GUEST BOOKS; PICTURE BOOKS; CHILDREN'S BOOKS; BOOKS ON SCIENCE FICTION; BOOKS ON TOPICS OF GENERAL INTEREST; BOOKS ON ENTERTAINMENT; BOOKS ON MOVIE-MAKING; BOOKS CONTAINING PUZZLES AND GAMES; GRAPHIC NOVELS; BOOKS CONTAINING SCREENPLAYS; SCRIPT BOOKS; BOOKS ON GEOGRAPHY; BOOKS ON SOCIOLOGY; BOOKS ON HISTORY; NOVELIZATIONS OF MOTION PICTURES; TECHNICAL MANUALS RELATING TO SCIENCE FICTION FILMS; INSTRUCTIONAL MANUALS AND STRATEGY GUIDES FOR GAMES; MAGAZINES IN THE FIELD OF ENTERTAINMENT AND SCIENCE FICTION; PUBLICATIONS, NAMELY, JOURNALS, NEWSPAPERS, AND NEWSLETTERS IN THE FIELD OF ENTERTAINMENT AND SCIENCE FICTION; ANIMATION CELLS, BLOTTERS; BLUEPRINTS; BOOK COVERS; CARDBOARD CONTAINERS; CATALOGS IN THE FIELD OF ENTERTAINMENT AND SCIENCE FICTION; COIN ALBUMS; SCRAPBOOK ALBUMS; ARTS AND CRAFTS KITS FOR PAINTING, MODEL-MAKING, AND DRAWING; STAMP ALBUMS; PHOTOGRAPH ALBUMS; COLLECTOR ALBUMS; DECORATIVE RUBBER STAMPS; DIARIES; PAPER DOORKNOB HANGERS; HEIGHT CHARTS; IDENTIFICATION CARDS AND IDENTITY CARDS; INVITATIONS; LUNCH BAGS; MODELING MATERIALS AND COMPOUNDS FOR USE BY CHILDREN; PERSONAL ORGANIZERS; ORIGINAL ARTWORK PRINTS; PAPER NAME BADGES; PAPER MACHE; PAPER MACHE FIGURINES; PAPER TABLE CLOTHS; PHOTOGRAPHIC PRINTS; RIBBONS FOR GIFT WRAPPING; SOCIAL NOTE CARDS; BLANK NOTE CARDS; NON-MAGNETICALLY CODED TRANSPORTATION FARE CARDS; TISSUE PAPER; TRADING CARDS; WALLET CARDS; WRITING PADS; TRADING CARD MILK BOTTLE CAPS; POSTERS; BOOK PLATES; BOOK MARKS; CHECKBOOK HOLDERS AND COVERS; NON-ELECTRONIC PERSONAL PLANNERS AND ORGANIZERS; ARTIST MATERIALS, NAMELY, PENCILS, PENS, PAINTING SETS; BRUSHES; PAINTING SETS; PRINTED PAPER PATTERNS; RUB DOWN TRANSFERS; SKETCHBOOKS; BASKETS FOR DESK ACCESSORIES, GIFT WRAP; GIFT TAGS; GIFT BAGS; GIFT BOXES; CORRESPONDENCE NOTE PAPER; GREETING CARDS; PAPER PARTY DECORATIONS; PAPER NAPKINS; PAPER RIBBONS; PAPER PARTY BAGS; PAPER PARTY HATS; POSTCARDS; GIFT PACKAGE DECORATIONS MADE OF PAPER; STICKERS; STICKER BOOKS; STICKER KITS; CORK BOARDS; CHALK BOARDS; MEMORANDUM BOARDS; SCRAPBOOKS; NON-MAGNETICALLY CODED TELEPHONE CALLING CARDS; PLAYING CARDS; ART REPRODUCTIONS; LITHOGRAPHS; LITHOGRAPHIC PRINTS; HOLOGRAMS; IRON-ON PATCHES; CALENDARS; CARDBOARD FIGURES; TEMPORARY TATTOOS; SCHOOL AND OFFICE SUPPLIES, NAMELY, DRAFTING AND DRAWING RULERS, PENCILS, PENS, MARKERS, GLUE FOR STATIONERY OR HOUSEHOLD USE, DESK TOP ORGANIZERS, DESK STANDS AND HOLDERS FOR PENCILS, PENS, TAPE, PAPER CLIPS, AND NOTEPADS; BINDERS; DISPENSERS FOR ADHESIVE TAPES FOR STATIONERY OR HOUSEHOLD PURPOSES, CLIP BOARDS, STATIONERY, NOTEPADS, AND PENCIL SETS, NOTEPADS, ORGANIZERS FOR STATIONERY USE, PENCIL CASES; PENCIL SHARPENERS, STATIONERY PORTFOLIOS, DESK PADS AND STATIONERY SETS COMPRISED OF PAPER, ENVELOPE, SEALS, NOTEPADS; STENCILS; SHEET MUSIC; ADULT NOVELIZATIONS; READ-ALONG BOOKS AND CASSETTE TAPES SOLD AS A UNIT; CHILDREN'S CASSETTE RECORDED READ-ALONG BOOKS; ELECTRONIC BOOKS WITH SOUND BUTTONS; DICTIONARIES; NOVELS; WRAPPING AND CONTAINERS FOR FAST FOOD ITEMS; PAPER CAKE DECORATIONS; CREDIT



CARDS; BANK CHECKS; LETTER OPENERS; PATTERNS FOR MAKING COSTUMES; LAP DESKS; EASELS; STENCILS; CRAFT KITS CONTAINING PAINT; PAINT BRUSHES; WOOD PIECES AND STENCILS; ARTS AND CRAFTS PAINT KITS CONTAINING SPONGES; BRUSHES; PAINT AND PAINT CUPS ACTIVITY KITS CONTAINING STAMPER MARKERS; RUBBER STAMPERS; INK PAD; COLORED PENCILS; STAMPER HOLDER; PAPER ACTIVITY KITS CONSISTING OF WRITING AND DRAWING IMPLEMENTS, DRAWING TEMPLATES, AND PAPER; PUTTY, DOUGH AND MODELING CLAY AND ACCESSORIES FOR USE WITH MODELING COMPOUNDS; CRAYON AND COLOR BY NUMBER KITS; ACTIVITY KITS CONSISTING OF MODELING COMPOUND AND RELATED ACCESSORIES FOR USE WITH MODELING COMPOUND SOLD AS A UNIT; SERIES OF FICTION BOOKS IN THE FIELD OF ENTERTAINMENT AND SCIENCE FICTION; BOOKS FEATURING PHOTOGRAPHIC PRINTS (U.S. CLS. 2, 5, 22, 23, 29, 37, 38 AND 50).

PUR NETWORK AND OTHER ELECTRONIC COMPUTER NETWORKS; ENTERTAINMENT IN THE NATURE OF AN AMUSEMENT PARK RIDE; AMUSEMENT OR THEME PARK SERVICES; FAN CLUB SERVICES; AND ENTERTAINMENT IN THE NATURE OF COMPETITIONS IN THE FIELD OF ENTERTAINMENT TRIVIA; PROVIDING COMPUTER DATABASES, PROVIDING INFORMATION AND WEBSITES FEATURING AUDIO, VISUAL AND AUDIOVISUAL ENTERTAINMENT IN THE FIELD OF EDUCATION AND ENTERTAINMENT VIA GLOBAL COMPUTER NETWORKS (U.S. CLS. 100, 101 AND 107).

### **CLASS 25—CLOTHING**

FOR MEN'S, WOMEN'S, AND CHILDREN'S CLOTHING AND ATHLETIC WEAR, NAMELY, UNDERWEAR, RAINWEAR, SLEEPWEAR, HOSE, HOSIERY, FOOTWEAR, BELTS, SUSPENDERS, CAPS, HEAD WEAR, KNIT CAPS, ATHLETIC SHOES, BATHROBES, BELTS, COATS, SHIRTS, GLOVES, HATS, JACKETS, JOGGING SUITS, LEATHER JACKETS, MITTENS, PAJAMAS, SCARVES, SHORTS, PANTS, SKIRTS, DRESSES, SLIPPERS, SOCKS, SWEATERS, SWIM WEAR, TANK TOPS, TIES, VESTS, MASQUERADE COSTUMES, ACCESSORIES, AND MASKS SOLD IN CONNECTION THEREWITH, CHILDREN'S FOOTWEAR, BOXER SHORTS, LONG UNDERWEAR, EXERCISE BRAS, HEADBANDS, WRISTBANDS, LEOTARDS, SINGLET, UNITARDS, VISORS, WARM-UP SUITS, OVERALLS, WIND-RESISTANT JACKETS, PARKAS, JUMPSUITS, CROP TOPS, FITNESS TOPS, TIGHTS, TENNISWEAR, ANORAKS, SWEATSHIRTS, SWEATPANTS, T-SHIRTS (U.S. CLS. 22 AND 39).

### **CLASS 38—COMMUNICATION**

FOR COMPUTER SERVICES, NAMELY, PROVIDING AN ON-LINE ELECTRONIC BULLETIN BOARD AND CHAT ROOMS FOR THE TRANSMISSION OF MESSAGES AMONG COMPUTER USERS IN THE FIELD OF EDUCATION AND ENTERTAINMENT RELATING TO MOTION PICTURE FILMS, INTERACTIVE COMPUTER GAMES, TELEVISION SHOWS AND SCIENCE FICTION (U.S. CLS. 100, 101 AND 104).

### **CLASS 41—EDUCATION AND ENTERTAINMENT**

FOR RADIO ENTERTAINMENT SERVICES, NAMELY, RADIO PROGRAMS FEATURING PERFORMANCES BY RADIO PERSONALITIES AND PEOPLE PORTRAYING FICTIONAL CHARACTERS AND BY RADIO PERSONALITIES AND PEOPLE DISCUSSING EDUCATIONAL AND ENTERTAINMENT TOPICS; ENTERTAINMENT, NAMELY, A CONTINUING VARIETY, NEWS, COMEDY, SCIENCE FICTION, AND EDUCATIONAL SHOW DISTRIBUTED OVER TELEVISION, SATELLITES, AUDIO, VIDEO, AND ELECTRONIC MEDIA; PRODUCTION AND DISTRIBUTION OF TELEVISION PROGRAMS FOR OTHERS; PRODUCTION AND DISTRIBUTION OF MOTION PICTURES; PRODUCTIONS AND DISTRIBUTION OF CABLE TELEVISION PROGRAM; PROVIDING NEWS AND INFORMATION IN THE FIELD OF EDUCATION AND ENTERTAINMENT RELATING TO SCIENCE FICTION TOPICS, COMPUTER GAMES, MOTION PICTURE FILMS VIA GLOBAL COMPUTER NETWORKS AND OTHER ELECTRONIC COMPUTER NETWORKS; ENTERTAINMENT SERVICES, NAMELY, PROVIDING INTERACTIVE COMPUTER GAMES BY MEANS OF A GLOBAL COM-

SN 76-121,750. RENOWORKS SOFTWARE INC., CALGARY, ALBERTA, FILED 9-1-2000.

## **RENOWORKS**

### **CLASS 9—ELECTRICAL AND SCIENTIFIC APPARATUS**

FOR COMPUTER PROGRAM FOR PLANNING, DESIGNING AND ESTIMATING BUILDING RENOVATIONS (U.S. CLS. 21, 23, 26, 36 AND 38).

### **CLASS 37—CONSTRUCTION AND REPAIR**

FOR SERVICES OF PLANNING FOR CONSTRUCTION AND BUILDING RENOVATIONS (U.S. CLS. 100, 103 AND 106).

SN 76-122,151. LUND, GORDON FREDERICK, SAN JOSE, CA. AND LUND, LOIS KNUDSEN, SAN JOSE, CA. FILED 8-25-2000.

## **ECOIMAGES**

### **CLASS 9—ELECTRICAL AND SCIENTIFIC APPARATUS**

FOR PHOTOGRAPHIC SLIDES (U.S. CLS. 21, 23, 26, 36 AND 38).  
FIRST USE 8-9-1997; IN COMMERCE 3-2-1998.

### **CLASS 16—PAPER GOODS AND PRINTED MATTER**

FOR PHOTOGRAPHIC PRINTS (U.S. CLS. 2, 5, 22, 23, 29, 37, 38 AND 50).  
FIRST USE 8-9-1997; IN COMMERCE 3-2-1998.

SN 76-122,373. MILKEN FAMILY FOUNDATION, THE, SANTA MONICA, CA. FILED 9-5-2000.

SN 76-123,574. CASTELLO DI BORGEHESE, LLC, CUTCHOGUE, NY. FILED 9-7-2000.



NO CLAIM IS MADE TO THE EXCLUSIVE RIGHT TO USE "TEACHER ADVANCEMENT PROGRAM", APART FROM THE MARK AS SHOWN.

#### CLASS 9—ELECTRICAL AND SCIENTIFIC APPARATUS

FOR PUBLICATIONS, NAMELY, DOWNLOADABLE ELECTRONIC PUBLICATIONS IN THE NATURE OF BOOKS, REPORTS, BROCHURES, TRAINING AND INSTRUCTION MANUALS IN THE FIELDS OF TEACHING, TEACHERS, THE TEACHING PROFESSION AND EDUCATION ADMINISTRATION; PUBLICATIONS, NAMELY ELECTRONIC PUBLICATIONS, NAMELY BOOKS, REPORTS, BROCHURES, TRAINING AND INSTRUCTION MANUALS FEATURING CONTENT RELATED TO TEACHING, TEACHERS, THE TEACHING PROFESSION, AND EDUCATION ADMINISTRATION, WHICH ARE RECORDED ON OPTICAL, ELECTRONIC AND MAGNETIC MEDIA, INCLUDING COMPACT DISCS, LASER DISCS, CD ROMS, DVD'S, DVD ROMS, VIDEO TAPES, AND AUDIO OR VIDEO CASSETTES (U.S. CLS. 21, 23, 26, 36 AND 38).

#### CLASS 16—PAPER GOODS AND PRINTED MATTER

FOR BOOKS, REPORTS, BROCHURES, TRAINING AND INSTRUCTION MANUALS, AND MONOGRAPHS ON THE SUBJECTS OF TEACHING, TEACHERS, THE TEACHING PROFESSION, AND EDUCATION ADMINISTRATION (U.S. CLS. 2, 5, 22, 23, 29, 37, 38 AND 50).

#### CLASS 41—EDUCATION AND ENTERTAINMENT

FOR TRAINING SERVICES, NAMELY, WORKSHOPS, SEMINARS AND LECTURES FOR TEACHERS DIRECTED TO TEACHING AND TEACHING METHODS AND FOR SCHOOL ADMINISTRATORS DIRECTED TO THE MANAGEMENT, ADMINISTRATION, AND TRAINING OF TEACHERS (U.S. CLS. 100, 101 AND 107).



THE MARK CONSISTS OF THE FAMILY CREST OF THE DI BORGEHESE FAMILY AND INCLUDES AN EAGLE WITH SPREAD WINGS IN THE TOP PORTION OF THE CREST AND A STYLIZED DRAGON IN THE BOTTOM, SHADED PORTION OF THE CREST.

#### CLASS 29—MEATS AND PROCESSED FOODS

FOR SPECIALTY FOODS, NAMELY, EDIBLE OILS, PROCESSED OLIVES, JARS OF CONSERVED PEPPERS, PROCESSED MUSHROOMS, JAMS, CAVIAR, AND CHEESE (U.S. CL. 46).

#### CLASS 33—WINES AND SPIRITS

FOR WINE (U.S. CLS. 47 AND 49).

SN 76-123,885. PARKER RANCH, INC., KAMUELA, HI. FILED 9-6-2000.

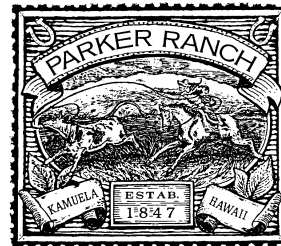

NO CLAIM IS MADE TO THE EXCLUSIVE RIGHT TO USE "KAMUELA HAWAII" AND "ESTAB. 1847", APART FROM THE MARK AS SHOWN.

THE STIPPLING CONTAINED IN THE MARK IS A FEATURE OF THE MARK AND IS NOT INTENDED TO INDICATE COLOR.

#### CLASS 18—LEATHER GOODS

FOR LEATHER GOODS, NAMELY LEATHER PATCHES (U.S. CLS. 1, 2, 3, 22 AND 41).  
FIRST USE 12-0-1988; IN COMMERCE 12-0-1988.

#### CLASS 26—FANCY GOODS

FOR ORNAMENTAL PATCHES MADE OF LEATHER (U.S. CLS. 37, 39, 40, 42 AND 50).  
FIRST USE 12-0-1988; IN COMMERCE 12-0-1988.

SN 76-124,974. LEGENDARY LOGOS, INC., PINEHURST, NC. FILED 9-12-2000.



**Old Farts  
Golf Club**

NO CLAIM IS MADE TO THE EXCLUSIVE RIGHT TO USE "GOLF CLUB", APART FROM THE MARK AS SHOWN.

**CLASS 25—CLOTHING**

FOR CLOTHING AND APPAREL, NAMELY, GOLF SHIRTS (U.S. CLS. 22 AND 39).  
FIRST USE 6-1-1999; IN COMMERCE 6-1-1999.

**CLASS 28—TOYS AND SPORTING GOODS**

FOR SPORTING ARTICLES, NAMELY, GOLF BALLS (U.S. CLS. 22, 23, 38 AND 50).  
FIRST USE 6-1-1999; IN COMMERCE 6-1-1999.

**CLASS 41—EDUCATION AND ENTERTAINMENT**

FOR GOLF CLUB SERVICES (U.S. CLS. 100, 101 AND 107).  
FIRST USE 6-1-1999; IN COMMERCE 6-1-1999.

SN 76-127,855. CRYSTAL SPRINGS ACQUISITION, LLC, HAMBURG, NJ. FILED 9-12-2000.



NO CLAIM IS MADE TO THE EXCLUSIVE RIGHT TO USE "GOLF & SPA RESORT", APART FROM THE MARK AS SHOWN.

**CLASS 41—EDUCATION AND ENTERTAINMENT**

FOR GOLF RESORTS; GOLF AND TENNIS INSTRUCTION; GOLF CLUB AND TENNIS RACKET FITTING; GOLF AND TENNIS EQUIPMENT AND ACCESSORY RENTAL; SWIM AND TENNIS RESORTS; GOLF DRIVING RANGES; HEALTH CLUBS; AND PHYSICAL FITNESS INSTRUCTION (U.S. CLS. 100, 101 AND 107).  
FIRST USE 3-13-2000; IN COMMERCE 3-13-2000.

**CLASS 42—SCIENTIFIC, COMPUTER AND LEGAL SERVICES**

FOR RESORT HOTELS; HOTELS; RESTAURANTS; COFFEE SHOPS; CATERING; COCKTAIL LOUNGES; PROVIDING FACILITIES FOR MEETINGS, CONFERENCES, SEMINARS, SYMPOSIUMS, EXHIBITIONS, AND BANQUETS; HEALTH SPAS; AND PHYSICAL FITNESS CONSULTATION (U.S. CLS. 100 AND 101).  
FIRST USE 3-13-2000; IN COMMERCE 3-13-2000.

SN 76-127,909. MOORE NORTH AMERICA, INC., GRAND ISLAND, NY. FILED 9-15-2000.



**CLASS 9—ELECTRICAL AND SCIENTIFIC APPARATUS**

FOR COMPUTER SOFTWARE FOR MANAGING WAREHOUSE AND RETAIL INVENTORIES AND COMPUTER HARDWARE FOR USE THEREWITH, NAMELY BAR CODE READERS, PRINTERS AND ACCESSORIES AND USER MANUAL SOLD THEREWITH; AND COMPUTER SOFTWARE SYSTEM FOR GENERATING PROJECT DEFINITIONS, AND INTERFACE TO PROVIDE A LINK TO HOST SYSTEM AND A CENTRAL LOCATION FOR PROCESSING (U.S. CLS. 21, 23, 26, 36 AND 38).

**CLASS 16—PAPER GOODS AND PRINTED MATTER**

FOR NON-TEXTILE BLANK OR PARTIALLY PRINTED LABELS, COMPUTER OR INKING RIBBONS, AND PAPER IDENTIFICATION TAGS (U.S. CLS. 2, 5, 22, 23, 29, 37, 38 AND 50).

**CLASS 37—CONSTRUCTION AND REPAIR**

FOR INSTALLATION OF COMPUTER HARDWARE, AND MAINTENANCE AND REPAIR SERVICES THEREFORE (U.S. CLS. 100, 103 AND 106).

**CLASS 41—EDUCATION AND ENTERTAINMENT**

FOR EDUCATIONAL SERVICES IN THE NATURE OF COMPUTER EDUCATION AND TRAINING (U.S. CLS. 100, 101 AND 107).

**CLASS 42—SCIENTIFIC, COMPUTER AND LEGAL SERVICES**

FOR INSTALLATION, REPAIR AND MAINTENANCE OF COMPUTER SOFTWARE SYSTEMS; COMPUTER CONSULTATION SERVICES; RADIO FREQUENCY SITE SURVEY; TECHNICAL SUPPORT SERVICES, NAMELY, TROUBLESHOOTING OF COMPUTER HARDWARE AND SOFTWARE PROBLEMS VIA ON-LINE, TELEPHONE, E-MAIL, AND IN PERSON; PRINTING SERVICES, AUTOMATIC DATA COLLECTION AND DATABASE MANIPULATION SERVICES IN THE FIELD OF WAREHOUSE AND RETAIL INVENTORY TRACKING (U.S. CLS. 100 AND 101).

SN 76-128,005. FREVO BRASIL INDUSTRIA DE BEBIDAS LTDA., BRAZIL, FILED 9-14-2000.

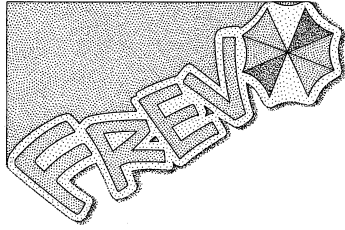

THE STIPLING IS FOR SHADING PURPOSES.

**CLASS 32—LIGHT BEVERAGES**

FOR NON ALCOHOLIC DRINKS, NAMELY BEERS, MINERAL WATER, CARBONATED SOFT DRINKS, FRUIT JUICES, CARBONATED FRUIT JUICES (U.S. CLS. 45, 46 AND 48).

**CLASS 33—WINES AND SPIRITS**

FOR ALCOHOLIC DRINKS, NAMELY, WINES, SUGAR CANE RUM, SPIRITS AND LIQUEURS (U.S. CLS. 47 AND 49).

**CLASS 29—MEATS AND PROCESSED FOODS**

FOR CHEESE AND CRACKER COMBINATIONS; FRIED PORK SNACKS, NAMELY PORK RINDS; PROCESSED EDIBLE SUNFLOWER SEEDS; PROCESSED NUTS, BEEF JERKY, BEEF STICKS; SNACK FOOD DIPS; PACKAGED MEAL COMBINATIONS CONSISTING PRIMARILY OF MEATS AND CHEESE, POTATO CHIPS AND POTATO CRISPS, CRACKERS AND SNACK DIPS, POTATO-BASED SNACK FOODS, NAMELY, POTATO CHIPS AND POTATO CRISPS (U.S. CL. 46).

**CLASS 30—STAPLE FOODS**

FOR PROCESSED UNPOPPED POPCORN; MICROWAVE POPCORN, CORN-BASED SNACK FOODS, NAMELY, CORN CHIPS AND TORTILLA CHIPS; CRACKERS; READY TO EAT GRAIN-BASED SNACK FOOD BARS; READY TO EAT GRANOLA-BASED SNACK FOOD BARS; MULTIGRAIN SNACK CHIPS; POPPED POPCORN, CANDY-COATED POPPED POPCORN; READY TO EAT POPPED POPCORN-BASED SNACK FOOD BARS; PRETZELS; PUFFED CORN-BASED SNACKS, NAMELY, CHEESE-FLAVORED PUFFED CORN SNACKS; READY TO EAT RICE-BASED SNACK FOOD BARS, SALSAS; SAUCES; READY-TO-EAT CEREAL DERIVED FOOD BARS, READY-TO-EAT ENERGY BARS; SNACK MIXES CONSISTING PRIMARILY OF CRACKERS, PRETZELS AND PROCESSED NUTS; PACKAGED MEAL COMBINATIONS CONSISTING PRIMARILY OF CRACKERS, NACHOS, TACOS, PIZZA, AND SALSA (U.S. CL. 46).

SN 76-129,104. SPEECHWORKS INTERNATIONAL, INC., BOSTON, MA. FILED 9-14-2000.

**SPEECHIFY**

**CLASS 9—ELECTRICAL AND SCIENTIFIC APPARATUS**

FOR COMPUTER SOFTWARE USED FOR CONVERTING TEXT TO SPEECH (U.S. CLS. 21, 23, 26, 36 AND 38).

**CLASS 42—SCIENTIFIC, COMPUTER AND LEGAL SERVICES**

FOR TECHNICAL CONSULTATION IN THE FIELD OF TEXT TO SPEECH SYSTEMS; CUSTOMIZED DESIGN AND TESTING OF TEXT TO SPEECH COMPUTER SYSTEMS FOR OTHERS; TECHNICAL SUPPORT SERVICES, NAMELY, TROUBLESHOOTING OF TEXT TO SPEECH COMPUTER SYSTEMS VIA TELEPHONE AND ON-LINE ELECTRONIC MEANS; AND INSTALLATION AND MAINTENANCE OF TEXT TO SPEECH SOFTWARE FOR OTHERS (U.S. CLS. 100 AND 101).

SN 76-130,169. CAREY, MARIAH, NEW YORK, NY. FILED 9-15-2000.

**MARIAH**

OWNER OF U.S. REG. NOS. 2,024,932 AND 2,207,439.

**CLASS 9—ELECTRICAL AND SCIENTIFIC APPARATUS**

FOR PRERECORDED PHONOGRAPH ALBUMS FEATURING SINGING AND MUSIC (U.S. CLS. 21, 23, 26, 36 AND 38).

FIRST USE 11-17-1998; IN COMMERCE 11-17-1998.

**CLASS 41—EDUCATION AND ENTERTAINMENT**

FOR ENTERTAINMENT SERVICES IN THE NATURE OF LIVE MUSICAL PERFORMANCES BY AN INDIVIDUAL (U.S. CLS. 100, 101 AND 107).

FIRST USE 3-16-2000; IN COMMERCE 3-16-2000.

SN 76-129,635. RECOT, INC., PLEASANTON, CA. FILED 9-15-2000.



OWNER OF U.S. REG. NO. 739,115.

SN 76-130,230. ENSITE INCORPORATED, OMAHA, NE. FILED 9-18-2000.

**ENSITE SAFARI SOLUTIONS**

NO CLAIM IS MADE TO THE EXCLUSIVE RIGHT TO USE "SOLUTIONS", APART FROM THE MARK AS SHOWN.

**CLASS 35—ADVERTISING AND BUSINESS**

FOR PROVIDING CONSUMERS AND COMPANIES IN OR RELATED TO THE NATURAL GAS, ELECTRIC POWER, FUEL OIL, TELECOMMUNICATIONS, CABLE, VIDEO, TELEPHONY, CELLULAR, DATA AND SATELLITE INDUSTRIES BUSINESS CONSULTING SERVICES, NAMELY, DEVELOPING STRATEGIC, MARKETING AND SALES PLANS, ANALYZING AND FORECASTING AND PLANNING NEW PRODUCTS, ASSISTING IN BRAND DEVELOPMENT, NAMING AND CONCEPT DEVELOPMENT, AND DEVELOPING AND ANALYZING STRATEGIC BUSINESS ALLIANCES AND COMBINATIONS (U.S. CLS. 100, 101 AND 102).

**CLASS 41—EDUCATION AND ENTERTAINMENT**

FOR EDUCATIONAL AND TRAINING SERVICES, NAMELY, COMPUTER EDUCATION TRAINING, CONDUCTING CLASSES, SEMINARS, CONFERENCES, WORKSHOPS AND DISTANCE LEARNING SESSIONS IN THE FIELDS OF COMPUTER SOFTWARE AND SERVICES, BUSINESS, SALES, MARKETING, GOVERNMENT AND CORPORATE STANDARDS AND PRACTICES (U.S. CLS. 100, 101 AND 107).

**CLASS 42—SCIENTIFIC, COMPUTER AND LEGAL SERVICES**

FOR COMPUTER SERVICES, NAMELY, THE DESIGN, DEVELOPMENT, PROGRAMMING AND DEPLOYMENT OF COMPUTER SOFTWARE AND APPLICATIONS FOR OTHERS; THE DESIGN, DEVELOPMENT, PROGRAMMING AND DEPLOYMENT OF WEBSITES FOR OTHERS, WEBSITE HOSTING SERVICES; COMPUTER CONSULTATION AND IMPLEMENTATION SERVICES, NAMELY, SYSTEM INTEGRATION, INSTALLATION OF COMPUTER SOFTWARE, SOFTWARE IMPLEMENTATION SERVICES, SUPPORT AND MAINTENANCE OF COMPUTER SOFTWARE AND WEB SITES (U.S. CLS. 100 AND 101).

---

SN 76-130,284. MYISLAND, INC., BELLEVUE, WA. BY CHANGE OF NAME XXXL CORPORATION, BELLEVUE, WA. FILED 9-18-2000.

**MYISLAND**

**CLASS 9—ELECTRICAL AND SCIENTIFIC APPARATUS**

FOR COMPUTER SOFTWARE, NAMELY FOR GAMES THAT MAY BE DOWNLOADED FROM A GLOBAL COMPUTER NETWORK (U.S. CLS. 21, 23, 26, 36 AND 38).

**CLASS 35—ADVERTISING AND BUSINESS**

FOR ARRANGING OF THE SUBSCRIPTIONS FOR THE MAGAZINES OF OTHERS VIA COMPUTER NETWORK AND GLOBAL COMPUTER NETWORK; ONLINE ORDERING SERVICES IN THE FIELD OF SUBSCRIPTIONS FOR PUBLICATIONS OF OTHERS; PROMOTING THE SUBSCRIPTIONS FOR PUBLICATIONS OF OTHERS BY PLACING ADVERTISEMENTS AND PROMOTIONAL DISPLAYS IN AN ELECTRONIC SITE ACCESSED THROUGH COMPUTER NETWORKS (U.S. CLS. 100, 101 AND 102).

**CLASS 41—EDUCATION AND ENTERTAINMENT**

FOR ENTERTAINMENT SERVICES, NAMELY, PROVIDING MULTI-USER ON-LINE COMPUTER GAMES; BROADCASTING AUDIO, VIDEO, PRERECORDED MUSIC, NEWS PROGRAMS, GRAPHICS, AND IMAGES VIA COMPUTER NETWORKS AND GLOBAL INFORMATION NETWORKS (U.S. CLS. 100, 101 AND 107).

---

SN 76-130,451. INTELLIGENT THERAPEUTIC SOLUTIONS, INC., DURHAM, NC. FILED 9-18-2000.

**NOVELCARE**

**CLASS 9—ELECTRICAL AND SCIENTIFIC APPARATUS**

FOR COMPUTER HARDWARE AND USER'S MANUAL SOLD THEREWITH FOR PROVIDING CLINICAL DECISION SUPPORT IN THE TREATMENT OF CHRONIC DISEASES; COMPUTER SOFTWARE AND USER'S MANUAL SOLD THEREWITH FOR PROVIDING CLINICAL DECISION SUPPORT IN THE TREATMENT OF CHRONIC DISEASES (U.S. CLS. 21, 23, 26, 36 AND 38).

**CLASS 42—SCIENTIFIC, COMPUTER AND LEGAL SERVICES**

FOR CLINICAL DECISION SUPPORT VIA THE INTERNET IN THE TREATMENT OF CHRONIC DISEASES (U.S. CLS. 100 AND 101).

---

SN 76-130,560. ITRON, INC., SPOKANE, WA. FILED 9-18-2000.

**Itron**

OWNER OF U.S. REG. NOS. 1,519,639 AND 2,304,681.

**CLASS 9—ELECTRICAL AND SCIENTIFIC APPARATUS**

FOR COMPUTER HARDWARE; COMPUTER HARDWARE, NAMELY, DISCS TAPES AND WIRES, ALL FOR CARRYING DATA; DRIVE APPARATUS FOR DISCS, TAPES OR WIRES, ALL FOR CARRYING DATA; COMPUTER HARDWARE FOR DATA COMMUNICATIONS BETWEEN COMPUTERS; COMPUTER SOFTWARE FOR USE BY THE UTILITIES INDUSTRY FOR AUTOMATING THE DISTRIBUTION OF UTILITY SERVICES TO CUSTOMERS; COMPUTER SOFTWARE FOR USE IN DATA COLLECTION AND CONTROL, COMMUNICATIONS AND DATA EXCHANGE, ELECTRONIC METER READING, OFF-SITE METER READING, KEYED METER READING, AND METER DATA RECORDERS, ALL FOR USE IN THE UTILITIES INDUSTRY; AND COMPUTER SOFTWARE FOR BILLING CUSTOMER ACCOUNTS, FOR SCHEDULING CUSTOMER ORDERS AND FOR MANAGING UTILITY METERS, ALL FOR USE IN THE UTILITIES INDUSTRY; COMPUTER SOFTWARE, NAMELY COMPUTER OPERATING PROGRAMS AND COMPUTER SOFTWARE FOR APPLICATION AND DATABASE INTEGRATION FOR USE IN THE UTILITIES INDUSTRY (U.S. CLS. 21, 23, 26, 36 AND 38).

**CLASS 42—SCIENTIFIC, COMPUTER AND LEGAL SERVICES**

FOR COMPUTER RELATED SERVICES AND CONSULTING FOR THE UTILITY INDUSTRIES, NAMELY COMPUTER-RELATED CONSULTING FOR ELECTRIC, GAS AND WATER FACILITIES MANAGEMENT (U.S. CLS. 100 AND 101).

SN 76-130,587. NIELSEN & BAINBRIDGE L.L.C., PARAMUS, NJ. FILED 9-19-2000.

 NielsenBainbridge

**CLASS 16—PAPER GOODS AND PRINTED MATTER**

FOR MATTING BOARD; MOUNTING BOARD; FOAM BOARDS FOR SIGNAGE OR DISPLAY PURPOSES; ILLUSTRATION AND GRAPHIC ART SKETCHING BOARDS; PAPER CORRUGATED BOARDS FOR USE IN PACKAGING AND CRAFTS; ADHESIVES FOR USE ON PHOTO ALBUMS, SCRAPBOOKS, PAPER CRAFTS, AND OTHER STATIONERY USES; PAPER CUTTERS, NAMELY, MATTING BOARD CUTTERS AND FRAMED ART PRINTS, PICTURES AND REPRODUCTIONS (U.S. CLS. 2, 5, 22, 23, 29, 37, 38 AND 50).

FIRST USE 3-10-2000; IN COMMERCE 3-10-2000.

**CLASS 20—FURNITURE AND ARTICLES NOT OTHERWISE CLASSIFIED**

FOR READY-MADE PICTURE FRAMES AND PICTURE FRAME MOLDINGS OF WOOD OR METAL (U.S. CLS. 2, 13, 22, 25, 32 AND 50).

FIRST USE 3-10-2000; IN COMMERCE 3-10-2000.

SN 76-130,708. AUGUST HAT COMPANY, INC., OXNARD, CA. FILED 9-18-2000.

**AUGUST ACCESSORIES**

OWNER OF U.S. REG. NO. 2,075,393.  
NO CLAIM IS MADE TO THE EXCLUSIVE RIGHT TO USE "ACCESSORIES", APART FROM THE MARK AS SHOWN.

**CLASS 18—LEATHER GOODS**

FOR HANDBAGS, TOTE BAGS, SATCHELS, PURSES AND WALLETS (U.S. CLS. 1, 2, 3, 22 AND 41).

FIRST USE 11-26-1995; IN COMMERCE 11-26-1995.

**CLASS 25—CLOTHING**

FOR MEN'S AND WOMEN'S HATS AND HEAD WEAR, SCARVES, MUFFLERS, GLOVES AND BELTS (U.S. CLS. 22 AND 39).

FIRST USE 11-26-1995; IN COMMERCE 11-26-1995.

SN 76-130,787. COLLINS, JOHN THOMAS, MOSS BEACH, CA. FILED 9-8-2000.

**TRUE TONES POETRY THESAURUS**

NO CLAIM IS MADE TO THE EXCLUSIVE RIGHT TO USE "POETRY THESAURUS", APART FROM THE MARK AS SHOWN.

**CLASS 9—ELECTRICAL AND SCIENTIFIC APPARATUS**

FOR MULTI-MEDIA SOFTWARE RECORDED ON CD-ROM CONSISTING OF DICTIONARIES AND THESAURUSES (U.S. CLS. 21, 23, 26, 36 AND 38).

**CLASS 16—PAPER GOODS AND PRINTED MATTER**

FOR REFERENCE BOOKS, NAMELY DICTIONARIES AND THESAURUSES (U.S. CLS. 2, 5, 22, 23, 29, 37, 38 AND 50).

SN 76-131,327. UNCLE BEN'S, INC., HOUSTON, TX. FILED 9-18-2000.

**KAN TONG****CLASS 29—MEATS AND PROCESSED FOODS**

FOR FROZEN AND PREPARED ENTREES CONSISTING PRIMARILY OF VEGETABLE AND/OR MEAT (U.S. CL. 46).

**CLASS 30—STAPLE FOODS**

FOR EGG ROLLS; FROZEN AND PREPARED ENTREES CONSISTING PRIMARILY OF RICE AND/OR NOODLES (U.S. CL. 46).

SN 76-131,765. FUGRO N.V., 2264 SG LEIDSCHENDAM, NETHERLANDS, FILED 9-20-2000.

## OCEANSTAR

### CLASS 9—ELECTRICAL AND SCIENTIFIC APPARATUS

FOR NAUTICAL APPARATUS, NAMELY, RECEIVERS FOR RECEIVING AND PROCESSING DATA FROM GLOBAL POSITIONING SATELLITES AND SHORE-BASED NAVIGATION STATIONS, TRANSMITTERS FOR SENDING AND RELAYING NAVIGATIONAL INFORMATION FROM GLOBAL POSITIONING SATELLITES AND SHORE-BASED NAVIGATION STATIONS (U.S. CLS. 21, 23, 26, 36 AND 38).

### CLASS 39—TRANSPORTATION AND STORAGE

FOR NAVIGATIONAL SERVICES, NAMELY, PROVIDING NAVIGATIONAL INFORMATION FOR USE IN SHIP PILOTING, PROVIDING GLOBAL POSITIONING AND NAVIGATION INFORMATION VIA RADIO, RADAR AND SATELLITE (U.S. CLS. 100 AND 105).

SN 76-132,862. SLINGO, INC., RIDGEWOOD, NJ. FILED 9-21-2000.

## X-PRESS SLINGO

OWNER OF U.S. REG. NO. 2,063,768.

### CLASS 9—ELECTRICAL AND SCIENTIFIC APPARATUS

FOR INTERACTIVE MULTIMEDIA COMPUTER GAME SOFTWARE THAT MAY BE DOWNLOADED FROM A GLOBAL COMPUTER NETWORK (U.S. CLS. 21, 23, 26, 36 AND 38).

FIRST USE 7-7-1998; IN COMMERCE 7-7-1998.

### CLASS 41—EDUCATION AND ENTERTAINMENT

FOR ENTERTAINMENT SERVICES, NAMELY PROVIDING ON-LINE INTERACTIVE MULTIMEDIA COMPUTER GAMES (U.S. CLS. 100, 101 AND 107).

FIRST USE 7-7-1998; IN COMMERCE 7-7-1998.

SN 76-133,311. PAUL HARRIS STORES, INC., INDIANAPOLIS, IN. FILED 9-20-2000.

## POWER PERKS

NO CLAIM IS MADE TO THE EXCLUSIVE RIGHT TO USE "PERKS", APART FROM THE MARK AS SHOWN.

### CLASS 16—PAPER GOODS AND PRINTED MATTER

FOR NON-MAGNETICALLY ENCODED DISCOUNT CARDS FOR PREFERRED CUSTOMERS USED TO PURCHASE MERCHANDISE AT DISCOUNTS SPECIFIED (U.S. CLS. 2, 5, 22, 23, 29, 37, 38 AND 50).

### CLASS 35—ADVERTISING AND BUSINESS

FOR RETAIL CLOTHING STORE SERVICES, NAMELY, PROVIDING MERCHANDISE DISCOUNTS AND INCENTIVES FOR PREFERRED CUSTOMERS (U.S. CLS. 100, 101 AND 102).

SN 76-134,498. HOTEL REPRESENTATIVE AG, LUCERNE, SWITZERLAND, FILED 9-25-2000.



NO CLAIM IS MADE TO THE EXCLUSIVE RIGHT TO USE "THE LEADING HOTELS OF THE WORLD", APART FROM THE MARK AS SHOWN.

"RELAIS & CHATEAUX" TRANSLATES INTO ENGLISH AS "CASTLE" AND "RELAYS"

### CLASS 35—ADVERTISING AND BUSINESS

FOR PROMOTING THE HOTEL SERVICES OF OTHERS BY PROVIDING INCENTIVE PROGRAMS IN THE NATURE OF SPECIAL RATES, PACKAGES AND GIFTS; ADVERTISING CONSULTATION IN THE PROMOTION, MARKETING AND ADVERTISING OF GOODS AND SERVICES OF OTHERS (U.S. CLS. 100, 101 AND 102).

### CLASS 42—SCIENTIFIC, COMPUTER AND LEGAL SERVICES

FOR MAKING HOTEL RESERVATIONS FOR OTHERS (U.S. CLS. 100 AND 101).

SN 76-134,554. HOTEL REPRESENTATIVE AG, CH-6005 LUCERNE, SWITZERLAND, FILED 9-25-2000.



THE MARK CONSISTS OF THE WORDS "THE LEADING LUXURY ALLIANCE, A PARTNER OF" AND AN ARBITRARY DESIGN.

### CLASS 35—ADVERTISING AND BUSINESS

FOR PROMOTING THE HOTEL SERVICES OF OTHERS BY PROVIDING INCENTIVE PROGRAMS IN THE NATURE OF SPECIAL RATES, PACKAGES AND GIFTS; ADVERTISING CONSULTATION IN THE PROMOTION, MARKETING AND ADVERTISING OF GOODS AND SERVICES OF OTHERS (U.S. CLS. 100, 101 AND 102).

**CLASS 42—SCIENTIFIC, COMPUTER AND LEGAL SERVICES**

FOR MAKING HOTEL RESERVATIONS FOR OTHERS (U.S. CLS. 100 AND 101).

SN 76-134,686. HEADSTEP AG, BERLIN, FED REP GERMANY, FILED 9-25-2000.

**HEADSTEP**

PRIORITY CLAIMED UNDER SEC. 44(D) ON FED REP GERMANY APPLICATION NO. 30031076.5/3, FILED 4-20-2000, REG. NO. 30031076, DATED 10-12-2000, EXPIRES 4-30-2010.

**CLASS 35—ADVERTISING AND BUSINESS**

FOR BUSINESS APPRAISALS; BUSINESS INFORMATION IN THE AREAS OF PERSONNEL RECRUITMENT AND PLACEMENT SERVICES; BUSINESS INVESTIGATIONS; BUSINESS MANAGEMENT AND BUSINESS ORGANIZATION CONSULTATION SERVICES; BUSINESS MANAGEMENT ASSISTANCE; BUSINESS RESEARCH; COMMERCIAL INFORMATION AGENCIES; COMPUTERIZED DATABASE MANAGEMENT SERVICES; PROFESSIONAL BUSINESS CONSULTATION SERVICES; EMPLOYMENT AGENCIES; BUSINESS MANAGEMENT ADVISORY SERVICES; PERSONNEL MANAGEMENT CONSULTANCY; PERSONNEL RECRUITMENT AND PLACEMENT SERVICES; PUBLIC RELATIONS; AND ALL OF THE FOREGOING SERVICES IN THE PERSONNEL RECRUITMENT AND PLACEMENT FIELD (U.S. CLS. 100, 101 AND 102).

**CLASS 36—INSURANCE AND FINANCIAL**

FOR FINANCIAL ANALYSIS AND CONSULTATION SERVICES; FINANCING SERVICES; MUTUAL FUND INVESTMENT; FINANCIAL SPONSORSHIP OF PROFESSIONAL EDUCATION (U.S. CLS. 100, 101 AND 102).

**CLASS 41—EDUCATION AND ENTERTAINMENT**

FOR ARRANGING AND CONDUCTING OF EDUCATIONAL CONFERENCES; EDUCATIONAL SERVICES, NAMELY, CONDUCTING SEMINARS AND WORKSHOPS AND TRAINING IN THE FIELD OF PERSONNEL RECRUITMENT AND PLACEMENT SERVICES (U.S. CLS. 100, 101 AND 107).

**CLASS 42—SCIENTIFIC, COMPUTER AND LEGAL SERVICES**

FOR CONSULTANCY SERVICES IN THE FIELD OF PSYCHOLOGICAL TESTING AND VOCATIONAL GUIDANCE (U.S. CLS. 100 AND 101).

SN 76-135,297. INTELESIS, INC., JACKSONVILLE, FL. FILED 9-26-2000.

**INTELESIS****CLASS 9—ELECTRICAL AND SCIENTIFIC APPARATUS**

FOR SOFTWARE FOR CREATION, MAINTENANCE AND MANAGEMENT OF WEB SITES; SOFTWARE FOR CONDUCTING MEETINGS ON A GLOBAL COMPUTER NETWORK (U.S. CLS. 21, 23, 26, 36 AND 38).

FIRST USE 1-0-1998; IN COMMERCE 1-0-1998.

**CLASS 35—ADVERTISING AND BUSINESS**

FOR CONSULTATION SERVICES IN THE FIELD OF BUSINESS, BUSINESS MANAGEMENT AND EVENT MANAGEMENT; PRODUCTION OF MULTIMEDIA BUSINESS PRESENTATIONS OF OTHERS FOR MEETINGS, CONFERENCES AND TRADESHOWS (U.S. CLS. 100, 101 AND 102).

FIRST USE 1-0-1998; IN COMMERCE 1-0-1998.

**CLASS 42—SCIENTIFIC, COMPUTER AND LEGAL SERVICES**

FOR COMPUTER PROGRAMMING SERVICES; CONSULTING SERVICES IN THE FIELD OF COMPUTERS AND GLOBAL COMPUTER NETWORKS (U.S. CLS. 100 AND 101).

FIRST USE 1-0-1998; IN COMMERCE 1-0-1998.

SN 76-135,878. CENTRAL VIRGINIA EDUCATIONAL TELECOMMUNICATIONS CORPORATION, FALLS CHURCH, VA. FILED 9-22-2000.

**MHZ TV**

NO CLAIM IS MADE TO THE EXCLUSIVE RIGHT TO USE "TV", APART FROM THE MARK AS SHOWN.

**CLASS 38—COMMUNICATION**

FOR TELEVISION BROADCASTING (U.S. CLS. 100, 101 AND 104).

**CLASS 41—EDUCATION AND ENTERTAINMENT**

FOR PRODUCTION AND DISTRIBUTION OF TELEVISION PROGRAMS (U.S. CLS. 100, 101 AND 107).

SN 76-136,072. SOLVAY (SOCIETE ANONYME), BRUSSELS, BELGIUM, FILED 9-22-2000.

**VINYLOOP****CLASS 1—CHEMICALS**

FOR UNPROCESSED PLASTIC; UNPROCESSED SYNTHETIC RESINS; COMPOUNDS MADE OF SUCH MATERIALS FOR INDUSTRIAL USE AND FOR USE IN FURTHER MANUFACTURING (U.S. CLS. 1, 5, 6, 10, 26 AND 46).

**CLASS 40—MATERIAL TREATMENT**

FOR TREATMENT OF MATERIALS, IN PARTICULAR THE RECYCLING OF PVC BASED MATERIALS; SCIENTIFIC, INDUSTRIAL AND TECHNICAL INFORMATION IN RESPECT OF THE RECYCLING OF PVC BASED MATERIALS (U.S. CLS. 100, 103 AND 106).

**CLASS 42—SCIENTIFIC, COMPUTER AND LEGAL SERVICES**

FOR RESEARCH SERVICES AND SCIENTIFIC, INDUSTRIAL AND TECHNICAL CONSULTANCY SERVICES IN THE FIELD OF THE RECYCLING OF PVC BASED MATERIALS (U.S. CLS. 100 AND 101).



SN 76-136,370. AMERICAN NURSES ASSOCIATION, INC., WASHINGTON, DC. FILED 9-25-2000.

SN 76-137,987. ENTENIAL, PARIS, FRANCE, FILED 9-29-2000.

# NURSESKEEPINGTHECARE INHEALTHCARE

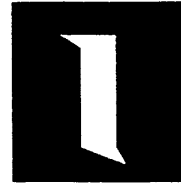

## CLASS 41—EDUCATION AND ENTERTAINMENT

FOR EDUCATIONAL SERVICES, NAMELY, CONDUCTING CLASSES, SEMINARS, CONFERENCES AND WORKSHOPS IN THE FIELDS OF NURSING AND HEALTHCARE; NURSE TRAINING (U.S. CLS. 100, 101 AND 107).

PRIORITY CLAIMED UNDER SEC. 44(D) ON FRANCE APPLICATION NO. 00/3028802, FILED 5-18-2000, REG. NO. 00/3028802, DATED 5-18-2000, EXPIRES 5-18-2010.

## CLASS 42—SCIENTIFIC, COMPUTER AND LEGAL SERVICES

FOR NURSING CARE; HEALTHCARE; CONSULTATION IN THE FIELD OF NURSING AND HEALTHCARE (U.S. CLS. 100 AND 101).

## CLASS 35—ADVERTISING AND BUSINESS

FOR ADVERTISING AGENCY SERVICES; BUSINESS MANAGEMENT AND MANAGEMENT ASSISTANCE SERVICES; BUSINESS MANAGEMENT AND ORGANIZATION CONSULTING SERVICES (U.S. CLS. 100, 101 AND 102).

## CLASS 36—INSURANCE AND FINANCIAL

FOR INSURANCE CONSULTING AND INFORMATION SERVICES; FINANCING SERVICES; FINANCIAL CONSULTING, INFORMATION AND EVALUATION FOR OTHERS; MUTUAL FUND AND CAPITAL FUND INVESTMENT SERVICES; SAFE DEPOSIT BOX SERVICES; SAVINGS BANK SERVICES; CREDIT BUREAUS; LOAN FINANCING AND MORTGAGE LENDING SERVICES; CREDIT AND DEBIT CARD SERVICES; ISSUANCE OF CREDIT CARDS AND TRAVELERS' CHECKS; EXCHANGING MONEY FOR OTHERS; BANKING SERVICES; REAL ESTATE APPRAISAL AND MANAGEMENT; AND REAL ESTATE LOANS (U.S. CLS. 100, 101 AND 102).

SN 76-136,371. AMERICAN NURSES ASSOCIATION, INC., WASHINGTON, DC. FILED 9-25-2000.



## CLASS 37—CONSTRUCTION AND REPAIR

FOR BUILDING CONSTRUCTION AND REPAIR (U.S. CLS. 100, 103 AND 106).

## CLASS 42—SCIENTIFIC, COMPUTER AND LEGAL SERVICES

FOR COMPUTER SOFTWARE DESIGN, EXPERT EVALUATIONS OF COMPUTER SOFTWARE, COMPUTER ENGINEERING AND TECHNICAL PROJECT STUDIES IN THE FIELD OF COMPUTER SOFTWARE (U.S. CLS. 100 AND 101).

SN 76-139,414. ADAMS, YVETTE, STEVENSON RANCH, CA. FILED 10-3-2000.

## CLASS 41—EDUCATION AND ENTERTAINMENT

FOR EDUCATIONAL SERVICES, NAMELY, CONDUCTING CLASSES, SEMINARS, CONFERENCES AND WORKSHOPS IN THE FIELDS OF NURSING AND HEALTHCARE; NURSE TRAINING (U.S. CLS. 100, 101 AND 107).



## CLASS 42—SCIENTIFIC, COMPUTER AND LEGAL SERVICES

FOR NURSING CARE; HEALTHCARE; CONSULTATION IN THE FIELD OF NURSING AND HEALTHCARE (U.S. CLS. 100 AND 101).

THE STIPLING IS A FEATURE OF THE MARK AND NOT INTENDED TO INDICATE COLOR.

**CLASS 9—ELECTRICAL AND SCIENTIFIC APPARATUS**

FOR PRE-RECORDED VIDEO CASSETTE TAPES, PRE-RECORDED AUDIO CASSETTE TAPES, CD-ROMS, DIGITAL VIDEO DISKS AND DIGITAL DISKS FEATURING ADULT ENTERTAINMENT; INTERACTIVE MULTIMEDIA COMPUTER SOFTWARE RECORDED ON CARTRIDGES AND TAPES FEATURING ADULT ENTERTAINMENT AND ADULT-THEMED PICTURES; VIDEO GAME PROGRAMS FOR USE WITH A COMPUTER OR TELEVISION FEATURING ADULT ENTERTAINMENT; VIDEO AND COMPUTER GAME PROGRAMS FEATURING ADULT ENTERTAINMENT (U.S. CLS. 21, 23, 26, 36 AND 38).

**CLASS 16—PAPER GOODS AND PRINTED MATTER**

FOR CARTOONS, NAMELY, CARTOON PRINTS, NEWSPAPER CARTOONS, NEWSPAPER COMIC STRIPS, MAGAZINE CARTOONS, AND MAGAZINE COMIC STRIPS; SERIES OF COMIC BOOKS; CALENDARS; PLAYING CARD CASES; PLASTIC SHOPPING BAGS (U.S. CLS. 2, 5, 22, 23, 29, 37, 38 AND 50).

**CLASS 18—LEATHER GOODS**

FOR ATHLETIC BAGS; TOTE BAGS; BEACH BAGS; BACKPACKS; FANNY PACKS; WAIST PACKS; KNAPSACKS; CREDIT CARD, BUSINESS CARD AND CALLING CARD CASES; KEY CASES; WALLETS; PURSES; TEXTILE SHOPPING BAGS, LEATHER SHOPPING BAGS, MESH SHOPPING BAGS (U.S. CLS. 1, 2, 3, 22 AND 41).

**CLASS 25—CLOTHING**

FOR CLOTHING, NAMELY, TEE SHIRTS, KNIT SHIRTS, POLO SHIRTS, CAPS, HATS, HEAD WEAR, VISORS, HEAD BANDS, SWEAT BANDS, WRIST BANDS, SLEEPWEAR, LOUNGEWEAR, UNDERWEAR, BRIEFS, UNDERPANTS, BOXER SHORTS, UNDERSHIRTS AND SOCKS; MASQUERADE AND HALLOWEEN COSTUMES (U.S. CLS. 22 AND 39).

**CLASS 41—EDUCATION AND ENTERTAINMENT**

FOR ENTERTAINMENT SERVICES, NAMELY, PROVIDING ADULT ENTERTAINMENT FEATURING PHOTOGRAPHIC IMAGES, PICTURES, COMIC STRIPS, JOKES, PRE-RECORDED VIDEOS AND ARTICLES VIA GLOBAL COMPUTER NETWORKS (U.S. CLS. 100, 101 AND 107).

SN 76-139,924. KAPLAN, FELLISSA M., CALABASAS, CA. AND KAPLAN, RICHARD J., CALABASAS, CA. FILED 9-29-2000.



THE NAME "LISSI KAPLAN" IDENTIFIES A LIVING INDIVIDUAL WHOSE CONSENT IS OF RECORD.

**CLASS 16—PAPER GOODS AND PRINTED MATTER**

FOR STATIONERY (U.S. CLS. 2, 5, 22, 23, 29, 37, 38 AND 50).

**CLASS 20—FURNITURE AND ARTICLES NOT OTHERWISE CLASSIFIED**

FOR PICTURE FRAMES (U.S. CLS. 2, 13, 22, 25, 32 AND 50).

**CLASS 21—HOUSEWARES AND GLASS**

FOR VASES, CANDLESTICK HOLDERS, PLATES, DISHES, CUPS, MUGS, SAUCERS, PLATTERS, BEVERAGE GLASSWARE, SERVING TRAYS, SUGAR BOWLS, CREAMERS, ALL OF THE AFOREMENTIONED GOODS BEING MADE OF PORCELAIN AND CERAMIC (U.S. CLS. 2, 13, 23, 29, 30, 33, 40 AND 50).

**CLASS 24—FABRICS**

FOR LINENS (U.S. CLS. 42 AND 50).

**CLASS 27—FLOOR COVERINGS**

FOR WALLPAPER (U.S. CLS. 19, 20, 37, 42 AND 50).

SN 76-141,121. ENCHANTMENT INTERNATIONAL, INC., NEW YORK, NY. FILED 10-5-2000.

**CARAPAN**

THE ENGLISH TRANSLATION OF "CARAPAN" WHICH IS A NATIVE AMERICAN WORD MEANING "A BEAUTIFUL PLACE OF TRANQUILITY WHERE ONE COMES TO RESTORE ONE'S SPIRIT".

**CLASS 35—ADVERTISING AND BUSINESS**

FOR RETAIL STORE SERVICES AND RETAIL STORE SERVICES VIA A GLOBAL COMPUTER NETWORK ALL IN THE AREAS OF BATH, BODY AND HAIR CARE PRODUCTS, NAMELY, BODY LOTION, BODY CLEANSING GEL, BODY SOAP, SHAMPOO, CONDITIONER, BODY HYDRATING MIST, MINERAL BATH SALTS, BODY AND MASSAGE OIL, BODY FRAGRANCE; AROMA THERAPY PRODUCTS, NAMELY, MASSAGE OIL, CANDLES, ESSENCE, INCENSE; CANDLES, GREETING CARDS, POSTERS, CRAFTS, NAMELY BASKETS, BOOKS, MUSICAL SOUND RECORDINGS, GIFT BASKETS COMPOSED OF BODY LOTION, BODY CLEANSING GEL, BODY SOAP, SHAMPOO, CONDITIONER, BODY HYDRATING MIST, MINERAL BATH SALTS, BODY AND MASSAGE OIL, BODY FRAGRANCE, ESSENCE, INCENSE AND AROMA THERAPY CANDLES (U.S. CLS. 100, 101 AND 102).

FIRST USE 4-0-1988; IN COMMERCE 4-0-1988.

**CLASS 42—SCIENTIFIC, COMPUTER AND LEGAL SERVICES**

FOR HEALTH SPA SERVICES (U.S. CLS. 100 AND 101). FIRST USE 4-0-1988; IN COMMERCE 4-0-1988.

SN 76-145,508. BACCO, LLC, IRON RIDGE, WI. FILED 10-12-2000.

## BACCO

### CLASS 20—FURNITURE AND ARTICLES NOT OTHERWISE CLASSIFIED

FOR PATIO FURNITURE, NAMELY, TABLE, BENCHES, FOOTSTOOLS, AND CHAIRS; AND CHAIR PADS (U.S. CLS. 2, 13, 22, 25, 32 AND 50).

### CLASS 21—HOUSEWARES AND GLASS

FOR CUPS, MUGS, SPORTS BOTTLE SOLD EMPTY, PLATES, AND INSULATED SLEEVE HOLDERS FOR BEVERAGE CANS AND BOTTLES (U.S. CLS. 2, 13, 23, 29, 30, 33, 40 AND 50).

SN 76-146,618. TRINESYS LLC, CHARLOTTE, NC. BY ASSIGNMENT WINSLOW III, ROBERT R., GREENSBORO, NC. FILED 10-16-2000.

## TRINESYS

### CLASS 35—ADVERTISING AND BUSINESS

FOR BUSINESS CONSULTATION (U.S. CLS. 100, 101 AND 102).

### CLASS 36—INSURANCE AND FINANCIAL

FOR ADMINISTRATION OF EMPLOYEE BENEFIT PLANS; INSURANCE BROKERAGE (U.S. CLS. 100, 101 AND 102).

### CLASS 42—SCIENTIFIC, COMPUTER AND LEGAL SERVICES

FOR CONSULTATION IN THE FIELD OF HUMAN RESOURCES AND EMPLOYEE BENEFIT PLANS; COMPUTER SOFTWARE DESIGN AND DEVELOPMENT SERVICES FOR OTHERS (U.S. CLS. 100 AND 101).

SN 76-146,877. TAYLOR & FRANCIS, INC., PHILADELPHIA, PA. FILED 10-13-2000.

## WORLD OF LEARNING

### CLASS 16—PAPER GOODS AND PRINTED MATTER

FOR SERIES OF BOOKS FEATURING LISTINGS OF UNIVERSITIES, COLLEGES, SCHOOLS OF ART AND MUSIC, LIBRARIES, LEARNED SOCIETIES, RESEARCH INSTITUTES, MUSEUMS AND ART GALLERIES (U.S. CLS. 2, 5, 22, 23, 29, 37, 38 AND 50).

FIRST USE 0-0-1950; IN COMMERCE 0-0-1950.

### CLASS 41—EDUCATION AND ENTERTAINMENT

FOR ELECTRONIC PUBLISHING SERVICES FOR A SERIES OF BOOKS FEATURING LISTINGS OF UNIVERSITIES, COLLEGES, SCHOOLS OF ART, MUSIC, LIBRARIES, LEARNED SOCIETIES, RESEARCH INSTITUTES, MUSEUMS AND ART GALLERIES (U.S. CLS. 100, 101 AND 107).

FIRST USE 5-28-1997; IN COMMERCE 5-28-1997.

SN 76-147,418. GIEVES & HAWKES INTERNATIONAL LIMITED, LONDON W1X 2JR, ENGLAND, FILED 10-16-2000.

## GIEVES

### CLASS 3—COSMETICS AND CLEANING PREPARATIONS

FOR COSMETICS, PERFUME, COLOGNE, AFTER-SHAVE LOTION, SOAPS, DENTIFRICES, ANTIPERSPIRANTS AND DEODORANTS FOR PERSONAL USE, TALCUM POWDER, ESSENTIAL OILS FOR PERSONAL USE, ESSENTIAL OILS FOR USE IN THE MANUFACTURE OF SCENTED PRODUCTS; NON-MEDICATED TOILET PREPARATIONS, NAMELY SHAVING CREAM, HAIR LOTIONS, SHAMPOOS AND CONDITIONERS; NON-MEDICATED PREPARATION FOR CARE OF THE SKIN, NAMELY SKIN CREAMS, BODY OILS, LOTIONS, FACIAL CREAMS, MOISTURIZERS, CLEANSERS AND TONERS, SUNTAN CREAMS, LOTIONS AND OILS, AFTER-SUN LOTIONS, BATH AND SHOWER CREAMS, OILS, GELS AND FOAMS (U.S. CLS. 1, 4, 6, 50, 51 AND 52).

### CLASS 25—CLOTHING

FOR FORMAL, CASUAL AND SPORTS CLOTHING FOR MEN AND WOMEN NAMELY COATS, RAINCOATS, OVERCOATS, JACKETS, BLAZERS, BLOUSONS, WAISTCOATS, SUITS, DRESS SUITS, MORNING SUITS, TROUSERS, CASUAL TROUSERS, JEANS, SWEAT PANTS, WARM-UP SUITS, SHORTS, SHIRTS, DRESS SHIRTS, CASUAL SHIRTS, T-SHIRTS, SWEATSHIRTS, POLO SHIRTS, TIES, BOW TIES, JUMPERS, PULL-OVERS, SWEATERS, SLIPOVERS, CARDIGANS, SKIRTS, DRESSES, HOSE, SOCKS, STOCKINGS, SWIMWEAR, UNDERWEAR, NIGHTWEAR, DRESSING GOWNS, SCARVES, GLOVES, HATS, CAPS, VISORS, HEADBANDS, WRISTBANDS, SUSPENDERS, BELTS, SHOES, SANDALS, GENERAL PURPOSE SPORTS SHOES (U.S. CLS. 22 AND 39).

SN 76-148,852. CAPITAL PERFORMANCE INTERNATIONAL, INC., FREEPORT, GRAND BAHAMA, BAHAMAS, FILED 10-18-2000.

## WEBSHERIFFONLINE

### CLASS 9—ELECTRICAL AND SCIENTIFIC APPARATUS

FOR COMPUTER SOFTWARE PROGRAMS FOR USE IN GLOBAL COMPUTER NETWORKING AND RESTRICTING ACCESS TO AND BY COMPUTER NETWORKS TO AND OF UNDESIRE WEB SITES, MEDIA AND INDIVIDUALS AND FACILITIES; COMPUTER SOFTWARE PROGRAMS FOR FINANCIAL, SALES, PAYMENT AND DEBT TRANSACTIONS WITHOUT INTEREST CHARGING AND INTEREST PAYMENT (U.S. CLS. 21, 23, 26, 36 AND 38).

### CLASS 36—INSURANCE AND FINANCIAL

FOR PROVIDING SERVICES AND INFORMATION FOR FINANCIAL, SALES, PAYMENT AND DEBT TRANSACTIONS WITHOUT INTEREST CHARGING AND INTEREST PAYMENT OVER GLOBAL COMPUTER NETWORKS (U.S. CLS. 100, 101 AND 102).

### CLASS 38—COMMUNICATION

FOR PROVIDING MULTIPLE-USER ACCESS TO GLOBAL COMPUTER NETWORKS (U.S. CLS. 100, 101 AND 104).

**CLASS 42—SCIENTIFIC, COMPUTER AND LEGAL SERVICES**

FOR COMPUTER SECURITY SERVICES, NAMELY, RESTRICTING ACCESS TO AND BY COMPUTER NETWORKS TO AND OF UNDESIRE WEB SITES, MEDIA AND INDIVIDUALS AND FACILITIES (U.S. CLS. 100 AND 101).

SN 76-148,853. CAPITAL PERFORMANCE INTERNATIONAL, INC., FREEPORT, GRAND BAHAMA, BAHAMAS, FILED 10-18-2000.

**WEBSHARIFONLINE****CLASS 9—ELECTRICAL AND SCIENTIFIC APPARATUS**

FOR COMPUTER SOFTWARE PROGRAMS FOR USE IN GLOBAL COMPUTER NETWORKING AND RESTRICTING ACCESS TO AND BY COMPUTER NETWORKS TO AND OF UNDESIRE WEB SITES, MEDIA AND INDIVIDUALS AND FACILITIES; COMPUTER SOFTWARE PROGRAMS FOR FINANCIAL, SALES, PAYMENT AND DEBT TRANSACTIONS WITHOUT INTEREST CHARGING AND INTEREST PAYMENT (U.S. CLS. 21, 23, 26, 36 AND 38).

**CLASS 36—INSURANCE AND FINANCIAL**

FOR PROVIDING SERVICES AND INFORMATION FOR FINANCIAL, SALES, PAYMENT AND DEBT TRANSACTION WITHOUT INTEREST CHARGING AND INTEREST PAYMENT OVER GLOBAL COMPUTER NETWORKS (U.S. CLS. 100, 101 AND 102).

**CLASS 38—COMMUNICATION**

FOR PROVIDING MULTIPLE-USER ACCESS TO GLOBAL COMPUTER NETWORKS (U.S. CLS. 100, 101 AND 104).

**CLASS 42—SCIENTIFIC, COMPUTER AND LEGAL SERVICES**

FOR COMPUTER SECURITY SERVICES, NAMELY, RESTRICTING ACCESS TO AND BY COMPUTER NETWORKS TO AND OF UNDESIRE WEB SITES, MEDIA AND INDIVIDUALS AND FACILITIES (U.S. CLS. 100 AND 101).

SN 76-149,235. UNIGLOBE.COM INC., RENTON, WA. FILED 10-18-2000.

**WIRED FOR TRAVEL****CLASS 39—TRANSPORTATION AND STORAGE**

FOR TRAVEL AGENCY SERVICES, NAMELY, ARRANGING TRAVEL TOURS; MAKING RESERVATIONS AND BOOKINGS FOR AIR, CAR, AND CRUISES; TRAVEL GUIDE SERVICES; ARRANGING TRAVEL VISAS, PASSPORTS AND TRAVEL DOCUMENTS FOR PERSONS TRAVELING ABROAD VIA THE INTERNET (U.S. CLS. 100 AND 105).

FIRST USE 8-0-1999; IN COMMERCE 8-0-1999.

**CLASS 42—SCIENTIFIC, COMPUTER AND LEGAL SERVICES**

FOR TRAVEL AGENCY SERVICES, NAMELY, MAKING RESERVATIONS AND BOOKINGS FOR HOTELS VIA THE INTERNET (U.S. CLS. 100 AND 101).

FIRST USE 8-0-1999; IN COMMERCE 8-0-1999.

SN 76-149,651. LION BIOSCIENCE AG, 69120 HEIDELBERG, FED REP GERMANY, FILED 10-18-2000.

**πSCOUT**

PRIORITY CLAIMED UNDER SEC. 44(D) ON FED REP GERMANY APPLICATION NO. 30030036.7/0, FILED 4-18-2000, REG. NO. 300330367, DATED 7-18-2000, EXPIRES 4-30-2010.

OWNER OF U.S. REG. NO. 2,270,316.

**CLASS 9—ELECTRICAL AND SCIENTIFIC APPARATUS**

FOR COMPUTER SOFTWARE FOR SCIENTIFIC AND COMMERCIAL PURPOSES, NAMELY, FOR THE ANALYSIS OF BIOLOGICAL, CHEMICAL AND MEDICAL DATA, FOR THE ANALYSIS OF PHARMACEUTICAL AND CHEMICAL COMPONENTS AND STRUCTURES AND FOR THE ANALYSIS OF THE INTERACTION BETWEEN BIOLOGICAL AND CHEMICAL COMPONENTS (U.S. CLS. 21, 23, 26, 36 AND 38).

**CLASS 42—SCIENTIFIC, COMPUTER AND LEGAL SERVICES**

FOR COMPUTER PROGRAMMING FOR OTHERS IN THE NATURE OF DEVELOPING SOFTWARE FOR THE ANALYSIS OF BIOLOGICAL, CHEMICAL, AND MEDICAL DATA, FOR THE ANALYSIS OF PHARMACEUTICAL AND CHEMICAL COMPONENTS AND STRUCTURES AND FOR THE INTERACTION BETWEEN BIOLOGICAL AND CHEMICAL COMPONENTS (U.S. CLS. 100 AND 101).

SN 76-150,261. IBBOTSON ASSOCIATES, INC., CHICAGO, IL. FILED 10-19-2000.

**IBBOTSON****CLASS 16—PAPER GOODS AND PRINTED MATTER**

FOR PUBLICATIONS NAMELY, NEWSLETTERS, NEWSPAPERS, MAGAZINES, BROCHURES, PAMPHLETS, AND BOOKS IN THE FIELD OF FINANCE (U.S. CLS. 2, 5, 22, 23, 29, 37, 38 AND 50).

FIRST USE 12-0-1977; IN COMMERCE 12-0-1977.

**CLASS 35—ADVERTISING AND BUSINESS**

FOR BUSINESS RESEARCH (U.S. CLS. 100, 101 AND 102).

FIRST USE 12-0-1977; IN COMMERCE 12-0-1977.

**CLASS 42—SCIENTIFIC, COMPUTER AND LEGAL SERVICES**

FOR PROVIDING CUSTOM SOFTWARE DESIGN, SOFTWARE RESEARCH, AND SOFTWARE CONSULTATION SERVICES TO INSTITUTIONAL MONEY MANAGERS, PLAN SPONSORS, CONSULTANTS, FINANCIAL PLANNERS, BROKERS, PRIVATE BANKERS, AND SMALL MONEY MANAGERS (U.S. CLS. 100 AND 101).  
FIRST USE 12-0-1977; IN COMMERCE 12-0-1977.

---

SN 76-151,976. SUCCESSFUL MONEY MANAGEMENT SEMINARS, INC., TUALATIN, OR. FILED 10-23-2000.

## FINANCIAL STRATEGIES FOR SUCCESSFUL RETIREMENT

OWNER OF U.S. REG. NO. 1,788,990.  
SEC. 2(F).

**CLASS 16—PAPER GOODS AND PRINTED MATTER**

FOR WORKBOOKS DEALING WITH FINANCIAL PLANNING FOR RETIREMENT (U.S. CLS. 2, 5, 22, 23, 29, 37, 38 AND 50).  
FIRST USE 8-0-1988; IN COMMERCE 8-0-1988.

**CLASS 41—EDUCATION AND ENTERTAINMENT**

FOR FINANCIAL PLANNING SEMINARS FOR RETIREMENT (U.S. CLS. 100, 101 AND 107).  
FIRST USE 8-0-1988; IN COMMERCE 8-0-1988.

---

SN 76-152,679. INTERCOMPONENTWARE, AG, 69190 WALLDORF, FED REP GERMANY, FILED 10-23-2000.

## LIFESENSOR

**CLASS 38—COMMUNICATION**

FOR TELECOMMUNICATIONS, VIDEO TELECONFERENCING, AND ELECTRONIC TRANSMISSION OF DATA AND DOCUMENTS VIA COMPUTER TERMINALS AND WIRELESS DEVICES (U.S. CLS. 100, 101 AND 104).

**CLASS 40—MATERIAL TREATMENT**

FOR DOCUMENT DATA TRANSFER AND PHYSICAL CONVERSION SERVICES, NAMELY PROVIDING DATA TRANSFER SERVICES BY WIRELESS DEVICES AND VIA A GLOBAL COMPUTER NETWORK (U.S. CLS. 100, 103 AND 106).

SN 76-152,792. BOOK OF HOPE, INC., POMPANO BEACH, FL. FILED 10-24-2000.

## THERE'S HOPE FOR TODAY

**CLASS 9—ELECTRICAL AND SCIENTIFIC APPARATUS**

FOR ELECTRONIC PUBLICATIONS, NAMELY, BOOKS FEATURING RELIGIOUS MATERIAL RECORDED ON CD ROM'S (U.S. CLS. 21, 23, 26, 36 AND 38).

**CLASS 16—PAPER GOODS AND PRINTED MATTER**

FOR BOOKS, MAGAZINES, AND PERIODICALS, ALL FEATURING RELIGIOUS MATERIAL (U.S. CLS. 2, 5, 22, 23, 29, 37, 38 AND 50).

**CLASS 41—EDUCATION AND ENTERTAINMENT**

FOR PRODUCTION OF RELIGIOUS TELEVISION PROGRAMS, AND ENTERTAINMENT IN THE NATURE OF ON-GOING TELEVISION PROGRAMS IN THE FIELD OF RELIGION; PROVIDING AN ON-LINE WEBSITE FEATURING EDUCATIONAL INFORMATION IN THE FIELD OF RELIGION (U.S. CLS. 100, 101 AND 107).

---

SN 76-153,901. GURROLA, LEONEL, GLENDORA, CA. AND GURROLA, ALMIKAR, GLENDORA, CA. FILED 10-26-2000.

## LEONEL Y ALMIKAR LOS ASES DE SINALOA

THE ENGLISH TRANSLATION OF "LEONEL Y ALMIKAR LOS ASES DE SINALOA" IS "LEONEL Y ALMIKAR, THE ACES FROM SINALOA".

**CLASS 9—ELECTRICAL AND SCIENTIFIC APPARATUS**

FOR PHONOGRAPH RECORDS, PRE-RECORDED AUDIO CASSETTE TAPES, PRE-RECORDED COMPACT DISCS PRE-RECORDED VIDEO CASSETTE TAPES, ALL FEATURING MUSICAL ACTIVITIES (U.S. CLS. 21, 23, 26, 36 AND 38).  
FIRST USE 7-1-1997; IN COMMERCE 7-1-1997.

**CLASS 41—EDUCATION AND ENTERTAINMENT**

FOR ENTERTAINMENT IN THE NATURE OF LIVE PERFORMANCES IN SPANISH PROVIDED BY A MUSICAL GROUP IN PERSONAL APPEARANCES AND CONCERTS, AND AUDIO RECORDING AND PRODUCTION (U.S. CLS. 100, 101 AND 107).  
FIRST USE 7-1-1997; IN COMMERCE 7-1-1997.

---

SN 76-154,149. ADVANCE MAGAZINE PUBLISHERS INC., NEW YORK, NY. FILED 10-27-2000.

## PARADE PARTNERS

OWNER OF U.S. REG. NO. 508,181 AND OTHERS.

**CLASS 16—PAPER GOODS AND PRINTED MATTER**

FOR GENERAL INTEREST AND LIFESTYLE NEWSLETTERS, BROCHURES, PAMPHLETS AND POSTERS (U.S. CLS. 2, 5, 22, 23, 29, 37, 38 AND 50).

**CLASS 35—ADVERTISING AND BUSINESS**

FOR OPERATING AN INTERNET SITE FOR THE DISSEMINATION OF INFORMATION ABOUT THE BUSINESS OF PUBLISHING MAGAZINES AND NEWSPAPER (U.S. CLS. 100, 101 AND 102).

**CLASS 41—EDUCATION AND ENTERTAINMENT**

FOR OPERATING AN INTERNET SITE FOR THE DISSEMINATION OF INFORMATION ABOUT MAGAZINES AND NEWSPAPERS (U.S. CLS. 100, 101 AND 107).

SN 76-154,732. SHINJUKU TRADING INC., OAKLAND, CA. FILED 10-30-2000.

**THAI**  
FRESH

NO CLAIM IS MADE TO THE EXCLUSIVE RIGHT TO USE "THAI", APART FROM THE MARK AS SHOWN.

**CLASS 29—MEATS AND PROCESSED FOODS**

FOR PROCESSED MEAT, FISH AND SEAFOOD, PROCESSED VEGETABLES, FRUIT AND VEGETABLE PRESERVES AND DRIED FRUITS; BAMBOO SHOOTS, BEAN CURD, COCONUT MILK, PROCESSED GINKO NUTS, DRIED MUSHROOMS, EDIBLE OILS AND FATS; PROCESSED, FLAKED AND PREPARED COCONUT; SEASONED COOKING OILS; SEASONED VEGETABLES; COOKED MUSHROOMS; PROCESSED EDIBLE SEEDS; PROCESSED NUTS; COOKED, PICKLED AND DRIED FRUITS AND VEGETABLES; SOY-BASED BEVERAGES USED AS MILK SUBSTITUTES; TOFU; PROCESSED BEAN SPROUTS; PROCESSED WATER CHESTNUTS; SOUPS; SOUP PRE-PACKAGED IN SERVING-SIZE CUPS; SOUP MIXES; SOUP MIXES CONTAINING NOODLES; PACKAGED ENTREES CONSISTING PRIMARILY OF MEAT, FISH, POULTRY OR VEGETABLES; DRIED SHRIMP; SHRIMP PASTE (U.S. CL. 46).

**CLASS 30—STAPLE FOODS**

FOR STAPLE FOODS, NAMELY, COOKED, PICKLED AND DRIED CHILI PEPPERS; MUSTARDS, SPICES, SAUCES EXCLUDING APPLE AND CRANBERRY SAUCES, VINEGAR, LOOSE TEAS, TEA BAGS, BISCUITS, CRACKERS, COOKIES; FLAVORED NOODLES AND TEMPURA BATTER MIX; ORIENTAL NOODLES; NOODLES WITH ORIENTAL SAUCE; PACKAGED NOODLES; DRIED HERBS AND SPICES; SPICE POWDERS; SEASONING BLENDS; SOY SAUCES; DRIED GINGER; CRYSTALLIZED GINGER; SEASONING PASTES; COOKING SAUCES, NAMELY, BARBECUE, OYSTER, HOISIN, KUNG PAO, STIR FRY, LEMON, FISH, SOY-BEAN, BLACK BEAN, PEANUT, AND CHILI SAUCES; CONDIMENTS, NAMELY, PLUM SAUCE, MUSTARDS, SWEET AND SOUR SAUCE, DUCK SAUCE, AND SALAD DRESSINGS; RICE AND RICE BLENDS; TEA; PACKAGED ENTREES CONSISTING PRIMARILY OF PASTA OR RICE; SALADS CONSISTING PRIMARILY OF PASTA OR RICE (U.S. CL. 46).

SN 76-157,195. HAMILTON BEACH/PROCTOR-SILEX, INC., GLEN ALLEN, VA. FILED 10-31-2000.

**SILEX**

OWNER OF U.S. REG. NO. 307,541.

**CLASS 7—MACHINERY**

FOR FOOD AND BEVERAGE COOKING AND PROCESSING APPLIANCES, NAMELY ELECTRIC COFFEE GRINDERS, ELECTRIC MEAT GRINDERS, ELECTRIC JUICERS, ELECTRIC JUICE EXTRACTORS, ELECTRIC BLENDERS, ELECTRIC DRINK MIXERS, ELECTRIC FOOD MIXERS, ELECTRIC FOOD PROCESSORS, ELECTRIC HAND BLENDERS, ELECTRIC HAND MIXERS, ELECTRIC STAND MIXERS, ELECTRIC FLATBREAD MAKERS, ELECTRIC FOOD CHOPPERS, KNIFE SHARPENING MACHINES, ELECTRIC KNIVES, ELECTRIC CAN OPENERS AND ELECTRIC SCISSORS (U.S. CLS. 13, 19, 21, 23, 31, 34 AND 35).

**CLASS 9—ELECTRICAL AND SCIENTIFIC APPARATUS**

FOR CLOTHES IRONS, NAMELY ELECTRIC CLOTHES IRONS AND THEIR COMPONENT PARTS, STEAM IRONS AND TRAVEL IRON PRODUCTS, NAMELY TRAVEL CLOTHES IRONS, FOREIGN VOLTAGE CONVERTER AND ADAPTOR SETS AND CLOTHES STEAMERS (U.S. CLS. 21, 23, 26, 36 AND 38).

**CLASS 11—ENVIRONMENTAL CONTROL APPARATUS**

FOR ELECTRIC TOASTERS, TOASTER OVENS, ELECTRIC ROASTER OVENS, ELECTRIC SANDWICH MAKERS, ELECTRIC COFFEEMAKERS, ELECTRIC COFFEEMAKERS AND CARAFES SOLD TOGETHER AS A UNIT, ELECTRIC COFFEEMARKER/GRINDERS, ELECTRIC COOKERS, ELECTRIC POTS AND PANS, ELECTRIC KETTLES, ELECTRIC HOT POTS, ELECTRIC GRILLS, ELECTRIC GRIDDLES, ELECTRIC SKILLET/GRIDDLES, ELECTRIC SLOW FOOD COOKERS, ELECTRIC OVEN BROILERS, ELECTRIC WAFFLE BAKERS AND ELECTRIC WAFFLE BAKERS/SANDWICH GRILLS (U.S. CLS. 13, 21, 23, 31 AND 34).

SN 76-157,908. HALLIDAY, JUDY, LOS ALTOS, CA. FILED 11-2-2000.

**THIN WITHIN**

NO CLAIM IS MADE TO THE EXCLUSIVE RIGHT TO USE "THIN", APART FROM THE MARK AS SHOWN.

**CLASS 41—EDUCATION AND ENTERTAINMENT**

FOR PROVIDING WEIGHT LOSS SEMINARS (U.S. CLS. 100, 101 AND 107).  
FIRST USE 5-28-1975; IN COMMERCE 5-28-1975.

**CLASS 42—SCIENTIFIC, COMPUTER AND LEGAL SERVICES**

FOR CONSULTING SERVICES IN THE FIELD OF WEIGHT LOSS (U.S. CLS. 100 AND 101).  
FIRST USE 5-28-1975; IN COMMERCE 5-28-1975.

SN 76-158,066. BABBAGE'S ETC. LLC, GRAPEVINE, TX.  
FILED 11-2-2000.

## GAMESTOP.COM

OWNER OF U.S. REG. NO. 1,707,460.

### CLASS 9—ELECTRICAL AND SCIENTIFIC APPARATUS

FOR COMPUTER SOFTWARE USED TO PROVIDE ACCESS TO THE INTERNET (U.S. CLS. 21, 23, 26, 36 AND 38).

### CLASS 38—COMMUNICATION

FOR PROVIDING MULTI-USER ACCESS TO A GLOBAL COMPUTER INFORMATION NETWORK (U.S. CLS. 100, 101 AND 104).

### CLASS 41—EDUCATION AND ENTERTAINMENT

FOR PROVIDING A WEB SITE CONTAINING INFORMATION ON VIDEO GAMES, COMPUTER GAMES AND ELECTRONIC GAMES (U.S. CLS. 100, 101 AND 107).

### CLASS 39—TRANSPORTATION AND STORAGE

FOR ELECTRONIC STORAGE AND RETRIEVAL SERVICES OF DIGITIZED INTERNATIONAL TRADE DOCUMENTS (U.S. CLS. 100 AND 105).

FIRST USE 10-30-2000; IN COMMERCE 10-30-2000.

SN 76-159,387. HOLMSTROM, ERIC J., SAN MATEO, CA.  
FILED 11-6-2000.

## 5SCORE

### CLASS 9—ELECTRICAL AND SCIENTIFIC APPARATUS

FOR COMPUTER GAME SOFTWARE (U.S. CLS. 21, 23, 26, 36 AND 38).

### CLASS 28—TOYS AND SPORTING GOODS

FOR GAMES, NAMELY, BOARD GAMES, CARD GAMES, HAND HELD UNIT FOR PLAYING VIDEO GAMES, ACTION SKILL GAMES, AND PROMOTIONAL GAME MATERIALS (U.S. CLS. 22, 23, 38 AND 50).

SN 76-158,496. VASS, JEROME R., DBA THE VASS COMPANY, TELLURIDE, CO. FILED 11-3-2000.

## COMPETITIVE SELLING VOICE

### CLASS 9—ELECTRICAL AND SCIENTIFIC APPARATUS

FOR TRAINING AND INSTRUCTIONAL SOFTWARE FOR USE IN THE FIELDS OF SALES AND MARKETING, SALES PROMOTION, AND SALES STRATEGY (U.S. CLS. 21, 23, 26, 36 AND 38).

FIRST USE 7-0-2000; IN COMMERCE 7-0-2000.

### CLASS 16—PAPER GOODS AND PRINTED MATTER

FOR PUBLICATIONS; NAMELY TEACHING AND INSTRUCTIONAL MANUALS AND PRINTED MATERIALS RELATING TO SALES AND MARKETING PROMOTION AND SALES STRATEGY (U.S. CLS. 2, 5, 22, 23, 29, 37, 38 AND 50).

FIRST USE 7-0-2000; IN COMMERCE 7-0-2000.

SN 76-160,719. HORSESHOE GAMING HOLDING CORP.,  
TINLEY PARK, IL. FILED 11-7-2000.

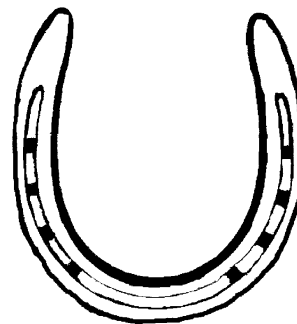

### CLASS 16—PAPER GOODS AND PRINTED MATTER

FOR PRINTED MATERIALS AND GUIDES IN THE FIELD OF GAMING, GAMBLING, AND CASINO SERVICES (U.S. CLS. 2, 5, 22, 23, 29, 37, 38 AND 50).

FIRST USE 4-5-1998; IN COMMERCE 4-5-1998.

SN 76-158,730. AVIARC CORPORATION, SEATTLE, WA.  
FILED 11-2-2000.

## AVIARC

### CLASS 41—EDUCATION AND ENTERTAINMENT

FOR ENTERTAINMENT SERVICES IN THE NATURE OF CASINO AND GAMING SERVICES (U.S. CLS. 100, 101 AND 107).

FIRST USE 4-5-1998; IN COMMERCE 4-5-1998.

### CLASS 38—COMMUNICATION

FOR ELECTRONIC TRANSMISSION OF DIGITIZED INTERNATIONAL TRADE DOCUMENTS BY MEANS OF A GLOBAL COMPUTER NETWORK (U.S. CLS. 100, 101 AND 104).

FIRST USE 10-30-2000; IN COMMERCE 10-30-2000.

### CLASS 42—SCIENTIFIC, COMPUTER AND LEGAL SERVICES

FOR HOTEL, RESTAURANT, NIGHTCLUB AND BAR SERVICES (U.S. CLS. 100 AND 101).

FIRST USE 4-5-1998; IN COMMERCE 4-5-1998.

SN 76-161,106. INTERVISION, INC., TOKYO, JAPAN, FILED 11-6-2000.

## ROBO.DEX

### CLASS 35—ADVERTISING AND BUSINESS

FOR ARRANGING AND CONDUCTING TRADE-SHOWS AND EXHIBITIONS IN THE FIELD OF ROBOTIC AND ROBOTS; ADVERTISING FOR OTHERS (U.S. CLS. 100, 101 AND 102).

### CLASS 42—SCIENTIFIC, COMPUTER AND LEGAL SERVICES

FOR PROVIDING INFORMATION RELATING TO ROBOTICS AND ROBOTS (U.S. CLS. 100 AND 101).

---

SN 76-161,845. SCOTT PAPER LIMITED, MISSISSAUGA, ONTARIO, CANADA, FILED 11-8-2000.

## EASY-FLOW

### CLASS 16—PAPER GOODS AND PRINTED MATTER

FOR PAPER TOWELS (U.S. CLS. 2, 5, 22, 23, 29, 37, 38 AND 50).

### CLASS 21—HOUSEWARES AND GLASS

FOR PAPER TOWEL DISPENSERS (U.S. CLS. 2, 13, 23, 29, 30, 33, 40 AND 50).

---

SN 76-162,504. PLANETII USA, INC., BROOKLYN, NY, FILED 11-9-2000.

## PLANETII

### CLASS 38—COMMUNICATION

FOR PROVIDING ON-LINE CHAT ROOMS FOR TRANSMISSION OF MESSAGES AMONG COMPUTER USERS, NAMELY, STUDENTS, PARENTS OF STUDENTS, TEACHERS AND TUTORS IN THE FIELDS OF EDUCATION AND THE SCIENCES (U.S. CLS. 100, 101 AND 104).

### CLASS 41—EDUCATION AND ENTERTAINMENT

FOR ON-LINE EDUCATIONAL SERVICES PROVIDED VIA A GLOBAL COMPUTER NETWORK, NAMELY PROVIDING LESSON PLANS, HOMEWORK ASSIGNMENTS, EXERCISES AND QUESTIONS IN THE FIELDS OF MATHEMATICS AND THE SCIENCES FOR CHILDREN IN KINDERGARTEN THROUGH COLLEGE; PROVIDING ON-LINE EDUCATIONAL RESEARCH SERVICES VIA GLOBAL COMPUTER NETWORK, NAMELY SERVICES WHICH ALLOW STUDENTS, PARENTS OF STUDENTS AND TEACHERS TO RESEARCH AND TRACK STUDENT ACADEMIC PROGRESS; PROVIDING EDUCATIONAL INFORMATION VIA A GLOBAL COMPUTER NETWORK, NAMELY, INFORMATION CONCERNING TUTORS IN THE FIELDS OF MATHEMATICS AND THE SCIENCES (U.S. CLS. 100, 101 AND 107).

SN 76-163,381. HIREABILITY.COM LLC, MANCHESTER, NH, FILED 11-10-2000.

## SARAH

### CLASS 9—ELECTRICAL AND SCIENTIFIC APPARATUS

FOR COMPUTER SOFTWARE, NAMELY, SOFTWARE FOR USE IN SEARCHING, MATCHING, AND TRACKING RESUMES AND CONTACT MANAGEMENT THROUGH STORAGE OF EMPLOYEE PERSONNEL INFORMATION, IN THE FIELDS OF EMPLOYMENT RECRUITING, STAFFING AND HIRING (U.S. CLS. 21, 23, 26, 36 AND 38).

### CLASS 35—ADVERTISING AND BUSINESS

FOR PROVIDING AN ON-LINE COMPUTER DATABASE FOR SEARCHING, MATCHING, AND TRACKING RESUMES AND CONTACT MANAGEMENT THROUGH STORAGE OF EMPLOYEE PERSONNEL INFORMATION, IN THE FIELDS OF EMPLOYMENT RECRUITING, HIRING, AND STAFFING VIA A GLOBAL COMPUTER NETWORK (U.S. CLS. 100, 101 AND 102).

---

SN 76-163,550. NELVANA LIMITED, TORONTO, ONTARIO, CANADA, FILED 11-13-2000.

## MAKING GREAT FRIENDS

### CLASS 35—ADVERTISING AND BUSINESS

FOR LICENSING OF MERCHANDISE RELATING TO ANIMATED AND LIVE-ACTION SHORT AND LONG FILMS; AND WHOLESALE DISTRIBUTORSHIPS FEATURING PRE-RECORDED VIDEOTAPES, VIDEO DISCS, AND CD-ROM'S (U.S. CLS. 100, 101 AND 102).  
FIRST USE 6-0-2000; IN COMMERCE 6-0-2000.

### CLASS 41—EDUCATION AND ENTERTAINMENT

FOR PRODUCTION AND DISTRIBUTION OF ANIMATED AND LIVE-ACTION SHORT AND LONG FILMS; AND VIDEOTAPE PRODUCTION SERVICES (U.S. CLS. 100, 101 AND 107).  
FIRST USE 6-0-2000; IN COMMERCE 6-0-2000.

---

SN 76-163,597. CRIM DE LA CRIM, LLC, MARTINSBURG, WV, FILED 11-10-2000.

## CRIM DE LA CRIM

### CLASS 16—PAPER GOODS AND PRINTED MATTER

FOR COLLECTIBLE BOOKS, PAPERS, DOCUMENTS, PICTURES, POST CARDS, DIARIES, TRADING CARDS, NEWSPAPERS, PHOTO ALBUMS, CALENDARS, MAGAZINES, AND GREETING CARDS, ALL COLLECTIBLE IN NATURE (U.S. CLS. 2, 5, 22, 23, 29, 37, 38 AND 50).



**CLASS 20—FURNITURE AND ARTICLES NOT OTHERWISE CLASSIFIED**

FOR ANTIQUE FURNITURE, NAMELY, TABLES, CHAIRS, SOFAS, BUREAUS, MIRRORS, HUTCHES, DRESSERS, BEDS, BENCHES, BOOK CASES, DESKS, COFFEE TABLES, AND ARMOIRES, (U.S. CLS. 2, 13, 22, 25, 32 AND 50).

SN 76-163,797. MATSUSHITA KOTOBUKI ELECTRONICS INDUSTRIES OF AMERICA, INC., VANCOUVER, WA. FILED 11-13-2000.

**PICTURESTAGE****CLASS 38—COMMUNICATION**

FOR PROVIDING AN ON-LINE ELECTRONIC BULLETIN BOARD FOR POSTING PHOTOGRAPHS FOR SHARING WITH OTHERS (U.S. CLS. 100, 101 AND 104).

**CLASS 39—TRANSPORTATION AND STORAGE**

FOR ELECTRONIC STORAGE OF PHOTOGRAPHS (U.S. CLS. 100 AND 105).

**CLASS 40—MATERIAL TREATMENT**

FOR ELECTRONIC IMAGING, SCANNING, DIGITIZING, ALTERATION AND/OR RETOUCHING OF PHOTOGRAPHIC IMAGES (U.S. CLS. 100, 103 AND 106).

**CLASS 42—SCIENTIFIC, COMPUTER AND LEGAL SERVICES**

FOR COMPUTER SERVICES, NAMELY, PROVIDING A WEBSITE FOR OTHERS FOR UPLOADING AND SHARING PHOTOGRAPHS OVER A GLOBAL COMPUTER NETWORK (U.S. CLS. 100 AND 101).

SN 76-163,932. SONDICO INTERNATIONAL LIMITED, CHESHIRE WA 16 9PD, ENGLAND, FILED 11-6-2000.

**SONDICO****CLASS 25—CLOTHING**

FOR SOCCER SHIRTS, T-SHIRTS, SWEATSHIRTS, SHORTS (U.S. CLS. 22 AND 39).  
FIRST USE 8-0-1992; IN COMMERCE 8-0-1992.

**CLASS 28—TOYS AND SPORTING GOODS**

FOR SOCCER BALLS, SHINGUARDS, GLOVES FOR USE IN SOCCER (U.S. CLS. 22, 23, 38 AND 50).  
FIRST USE 8-0-1992; IN COMMERCE 8-0-1992.

SN 76-164,147. ABLOY OY, JOENSUU, FINLAND, FILED 11-13-2000.

**ABLOY PROTEC**

OWNER OF U.S. REG. NOS. 927,239 AND 1,782,388.

**CLASS 6—METAL GOODS**

FOR METAL LOCKS AND KEYS THEREFOR, METAL KEY BLANKS, METAL KEY DEPOSITS, METAL KEY CABINETS AND METAL KEY RACKS FOR STORAGE OF KEYS, METAL STRIKER PLATES, HANDLES AND FITTINGS FOR DOORS AND WINDOWS, METAL DOOR CLOSURES AND DOOR OPENERS, AND COMPONENT AND REPLACEMENT PARTS AND ACCESSORIES THEREFOR, NAMELY LOCK CYLINDERS, LOCKING DISCS, LOCK CASES, LOCK BOLTS, ESCUTCHEONS, ROSES, AND COVER PLATES (U.S. CLS. 2, 12, 13, 14, 23, 25 AND 50).

**CLASS 9—ELECTRICAL AND SCIENTIFIC APPARATUS**

FOR ELECTRIC AND ELECTRONIC LOCKS, LOCK CONTROLS AND DECODERS, ELECTRICALLY OPERATED DOOR OPENERS AND CONTROLS THEREFOR (U.S. CLS. 21, 23, 26, 36 AND 38).

**CLASS 37—CONSTRUCTION AND REPAIR**

FOR INSTALLATION, REPAIR AND MAINTENANCE SERVICES FOR LOCKS, FITTINGS AND VARIOUS SECURITY, SURVEILLANCE AND CONTROL APPARATUS AND SYSTEMS (U.S. CLS. 100, 103 AND 106).

**CLASS 42—SCIENTIFIC, COMPUTER AND LEGAL SERVICES**

FOR SECURITY SERVICES NAMELY, DESIGN OF SECURITY SYSTEMS TO CUSTOMER SPECIFICATIONS FOR ESTABLISHING LOCKING AND RECORDING SYSTEMS FOR HOTELS, HOME AND COMMERCIAL ESTABLISHMENTS, DESIGN OF SECURITY FITTINGS FOR DOORS AND LOCKS, DESIGN OF MASTERKEYING SYSTEMS; LOCKSMITHING SERVICES (U.S. CLS. 100 AND 101).

SN 76-165,076. FABRICA DE BOTAS FOX, S.A. DE C.V., 37460 LEON, GUANAJUATO, MEXICO, FILED 11-14-2000.

Morgan &  
**Miller**  
by **FOX**

**CLASS 18—LEATHER GOODS**

FOR LEATHER SOLD IN BULK; IMITATION LEATHER SOLD IN BULK; SKINS; HIDES; TRUNKS AND TRAVELING BAGS; UMBRELLAS; PARASOLS AND WALKING STICKS; WHIPS, HARNESS STRAPS AND SADDLERY (U.S. CLS. 1, 2, 3, 22 AND 41).

**CLASS 25—CLOTHING**

FOR CLOTHING, NAMELY, BOOTS, SHOES AND SLIPPERS (U.S. CLS. 22 AND 39).

SN 76-166,093. DPT LABORATORIES, LTD., SAN ANTONIO, TX. FILED 11-15-2000.

## READY TO MARKET

### CLASS 40—MATERIAL TREATMENT

FOR CUSTOM MANUFACTURE OF CONSUMER HEALTHCARE PRODUCTS FOR OTHERS (U.S. CLS. 100, 103 AND 106).

### CLASS 42—SCIENTIFIC, COMPUTER AND LEGAL SERVICES

FOR RESEARCH AND DEVELOPMENT OF NEW CONSUMER HEALTHCARE PRODUCTS (U.S. CLS. 100 AND 101).

SN 76-166,942. MYREPAIRSHOP, INC., HOUSTON, TX. FILED 11-17-2000.

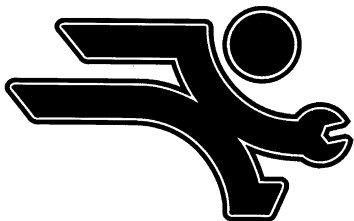

### CLASS 37—CONSTRUCTION AND REPAIR

FOR PROVIDING INDEPENDENT AUTOMOTIVE SERVICE PROFESSIONALS AND CAR OWNERS WITH INFORMATION AND DATABASES FEATURING TUNE-UP AND LUBRICATION SPECIFICATIONS, PREVENTIVE MAINTENANCE SCHEDULES AND TECHNICAL AUTOMOTIVE INFORMATION BY MEANS OF A GLOBAL COMPUTER NETWORK (U.S. CLS. 100, 103 AND 106).

### CLASS 42—SCIENTIFIC, COMPUTER AND LEGAL SERVICES

FOR PROVIDING HAZARDOUS MATERIALS INFORMATION AND MATERIAL SAFETY DATA SHEET INFORMATION BY MEANS OF A GLOBAL COMPUTER NETWORK (U.S. CLS. 100 AND 101).

SN 76-166,946. MYREPAIRSHOP, INC., HOUSTON, TX. FILED 11-17-2000.

## MYREPAIRSHOP

### CLASS 37—CONSTRUCTION AND REPAIR

FOR PROVIDING INDEPENDENT AUTOMOTIVE SERVICE PROFESSIONALS AND CAR OWNERS WITH INFORMATION AND DATABASES FEATURING TUNE-UP AND LUBRICATION SPECIFICATIONS, PREVENTIVE MAINTENANCE SCHEDULES AND TECHNICAL AUTOMOTIVE INFORMATION BY MEANS OF A GLOBAL COMPUTER NETWORK (U.S. CLS. 100, 103 AND 106).

### CLASS 42—SCIENTIFIC, COMPUTER AND LEGAL SERVICES

FOR PROVIDING HAZARDOUS MATERIALS INFORMATION AND MATERIAL SAFETY DATA SHEET INFORMATION BY MEANS OF A GLOBAL COMPUTER NETWORK (U.S. CLS. 100 AND 101).

SN 76-167,452. MINI GOLD, INC., KWANAK-KU, SEOUL, REPUBLIC OF KOREA, FILED 11-20-2000.

## mini GOLD

NO CLAIM IS MADE TO THE EXCLUSIVE RIGHT TO USE "GOLD", APART FROM THE MARK AS SHOWN.

### CLASS 14—JEWELRY

FOR GOLD PLATING, GOLD FOIL, GOLD BULLION, PLATINUM, ALUMINUM GOLD, SILVER BULLION, DIAMONDS; EARRING; BUCKLES MADE OF PRECIOUS METALS; TIE PIN; PENDANTS; MEDALS; NECKLACES; RINGS; BROOCH SET WITH JEWELS; CHARMS AND BRACELETS (U.S. CLS. 2, 27, 28 AND 50).

### CLASS 40—MATERIAL TREATMENT

FOR GOLD PLATING (U.S. CLS. 100, 103 AND 106).

SN 76-168,494. KEVIN L. WINSLOW, M.D., P.A., JACKSONVILLE, FL. FILED 11-20-2000.

## SAVEMYEGGS.COM

### CLASS 35—ADVERTISING AND BUSINESS

FOR FRANCHISING OF MEDICAL SERVICES (U.S. CLS. 100, 101 AND 102).

### CLASS 41—EDUCATION AND ENTERTAINMENT

FOR TRAINING AND EDUCATIONAL SERVICES, NAMELY, CONDUCTING ONE-ON-ONE LABORATORY INSTRUCTION IN THE FIELD OF MEDICAL SERVICES (U.S. CLS. 100, 101 AND 107).

### CLASS 42—SCIENTIFIC, COMPUTER AND LEGAL SERVICES

FOR COUNSELING, TESTING, LABORATORY RESEARCH AND PREPARATIONS IN THE FIELD OF FERTILITY AND MEDICAL TREATMENT SERVICES; MEDICAL SERVICES, NAMELY, ASSISTED REPRODUCTIVE SERVICES; PROVISION OF INFORMATION REGARDING FERTILITY AND REPRODUCTIVE SERVICES (U.S. CLS. 100 AND 101).

SN 76-168,788. TRENDMASTERS, INC., ST. LOUIS, MO.  
FILED 11-22-2000.

## DJ JOHNNY BOT

NO CLAIM IS MADE TO THE EXCLUSIVE RIGHT TO USE "DJ" AND "BOT", APART FROM THE MARK AS SHOWN.

### CLASS 9—ELECTRICAL AND SCIENTIFIC APPARATUS

FOR AUDIO CASSETTE RECORDER WITH MICROPHONE ENCASED IN A LIGHTED PROGRAMMABLE ROBOT TOY (U.S. CLS. 21, 23, 26, 36 AND 38).

### CLASS 28—TOYS AND SPORTING GOODS

FOR TOYS, NAMELY PROGRAMMABLE TALKING ROBOTIC TOYS WITH AUDIO CASSETTE RECORDERS, MICROPHONES AND LIGHTS (U.S. CLS. 22, 23, 38 AND 50).

SN 76-169,675. THREE DOG BAKERY, INC., KANSAS CITY, MO. FILED 11-22-2000.

## WE PITY THE KITTIES

NO CLAIM IS MADE TO THE EXCLUSIVE RIGHT TO USE "KITTIES", APART FROM THE MARK AS SHOWN.

### CLASS 25—CLOTHING

FOR HATS, SHIRTS AND SWEATSHIRTS (U.S. CLS. 22 AND 39).  
FIRST USE 7-0-1999; IN COMMERCE 7-0-1999.

### CLASS 31—NATURAL AGRICULTURAL PRODUCTS

FOR CAT FOOD, CAT TREATS, DOG FOOD AND DOG TREATS (U.S. CLS. 1 AND 46).  
FIRST USE 5-31-2000; IN COMMERCE 5-31-2000.

SN 76-170,438. SEECOMMERCE, PALO ALTO, CA. FILED 11-22-2000.

## SEEFINANCE

OWNER OF U.S. REG. NOS. 2,453,923 AND 2,484,616.

### CLASS 9—ELECTRICAL AND SCIENTIFIC APPARATUS

FOR COMPUTER SOFTWARE FOR ALLOWING MANUFACTURING AND OTHER COMPANIES TO ANALYZE, VIEW AND DISTRIBUTE FINANCIAL PERFORMANCE AND OTHER CORPORATE DATA VIA THE INTERNAL OR EXTERNAL COMPUTER NETWORKS; COMPUTER SOFTWARE THAT ALLOWS USERS TO COLLABORATE USING ON-LINE DISPLAY AND TRANSMISSION OF INFORMATION IN ORDER TO IMPROVE MANUFACTURING AND BUSINESS PERFORMANCE (U.S. CLS. 21, 23, 26, 36 AND 38).

### CLASS 42—SCIENTIFIC, COMPUTER AND LEGAL SERVICES

FOR COMPUTER SOFTWARE DESIGN FOR OTHERS; AND HOSTING THE WEB SITES OF OTHERS ON A COMPUTER SERVER FOR A GLOBAL COMPUTER NETWORK (U.S. CLS. 100 AND 101).

SN 76-172,074. VISION-EASE LENS, INC., BROOKLYN PARK, MN. FILED 11-28-2000.

## VISION-EASE LENS

OWNER OF U.S. REG. NO. 1,020,990.  
NO CLAIM IS MADE TO THE EXCLUSIVE RIGHT TO USE "LENS", APART FROM THE MARK AS SHOWN.

### CLASS 9—ELECTRICAL AND SCIENTIFIC APPARATUS

FOR OPHTHALMIC LENSES FOR EYEGLASSES (U.S. CLS. 21, 23, 26, 36 AND 38).  
FIRST USE 3-1-1952; IN COMMERCE 3-1-1952.

### CLASS 35—ADVERTISING AND BUSINESS

FOR WHOLESALE DISTRIBUTORSHIP IN THE FIELD OF OPHTHALMIC LENSES FOR EYEGLASSES (U.S. CLS. 100, 101 AND 102).  
FIRST USE 3-1-1952; IN COMMERCE 3-1-1952.

### CLASS 40—MATERIAL TREATMENT

FOR CUSTOM MANUFACTURE OF OPHTHALMIC LENSES FOR EYEGLASSES (U.S. CLS. 100, 103 AND 106).  
FIRST USE 3-1-1952; IN COMMERCE 3-1-1952.

SN 76-172,781. TRICOM USA, INC., JERSEY CITY, NJ. FILED 11-27-2000.



NO CLAIM IS MADE TO THE EXCLUSIVE RIGHT TO USE "LATINA", APART FROM THE MARK AS SHOWN.

THE STIPPLING AND LINING ARE USED TO INDICATE SHADING AND COLOR VARIATIONS, BUT THAT COLOR IS NOT CLAIMED IN THE MARK.

THE ENGLISH TRANSLATION OF "LATINA" IS "LATIN".

### CLASS 9—ELECTRICAL AND SCIENTIFIC APPARATUS

FOR PREPAID MAGNETICALLY ENCODED TELEPHONE CALLING CARDS (U.S. CLS. 21, 23, 26, 36 AND 38).

FIRST USE 11-5-1999; IN COMMERCE 11-5-1999.

**CLASS 16—PAPER GOODS AND PRINTED MATTER**

FOR TELEPHONE CALLING CARDS, NOT MAGNETICALLY ENCODED (U.S. CLS. 2, 5, 22, 23, 29, 37, 38 AND 50).

FIRST USE 11-5-1999; IN COMMERCE 11-5-1999.

**CLASS 38—COMMUNICATION**

FOR LONG DISTANCE TELEPHONE SERVICES (U.S. CLS. 100, 101 AND 104).

FIRST USE 11-5-1999; IN COMMERCE 11-5-1999.

SN 76-172,799. TRICOM USA, INC., JERSEY CITY, NJ. FILED 11-27-2000.

**TRICOM INTERNATIONAL**

NO CLAIM IS MADE TO THE EXCLUSIVE RIGHT TO USE "INTERNATIONAL", APART FROM THE MARK AS SHOWN.

**CLASS 9—ELECTRICAL AND SCIENTIFIC APPARATUS**

FOR PREPAID MAGNETICALLY ENCODED TELEPHONE CALLING CARDS (U.S. CLS. 21, 23, 26, 36 AND 38).

**CLASS 16—PAPER GOODS AND PRINTED MATTER**

FOR TELEPHONE CALLING CARDS, NOT MAGNETICALLY ENCODED (U.S. CLS. 2, 5, 22, 23, 29, 37, 38 AND 50).

**CLASS 38—COMMUNICATION**

FOR LONG DISTANCE TELEPHONE SERVICES (U.S. CLS. 100, 101 AND 104).

SN 76-173,643. AMERICAN PAYROLL ADVANCE LTD., WOOSTER, OH. FILED 11-30-2000.

**AMERICAN PAYROLL  
ADVANCE LTD. STREET  
STOCK WORLD  
CHAMPIONSHIP**

NO CLAIM IS MADE TO THE EXCLUSIVE RIGHT TO USE "AMERICAN" AND "LTD. STREET STOCK WORLD CHAMPIONSHIP", APART FROM THE MARK AS SHOWN.

**CLASS 25—CLOTHING**

FOR CLOTHING, NAMELY, T-SHIRTS, HATS, BALL CAPS, SWEATERS, JACKETS AND SWEATSHIRTS (U.S. CLS. 22 AND 39).

FIRST USE 9-3-2000; IN COMMERCE 9-3-2000.

**CLASS 41—EDUCATION AND ENTERTAINMENT**

FOR ENTERTAINMENT, NAMELY, AUTOMOBILE RACES (U.S. CLS. 100, 101 AND 107).

FIRST USE 9-3-2000; IN COMMERCE 9-3-2000.

SN 76-175,116. OKENA, INC., WALTHAM, MA. FILED 12-4-2000.

**STORMWATCH****CLASS 9—ELECTRICAL AND SCIENTIFIC APPARATUS**

FOR COMPUTER SOFTWARE FOR USE IN IDENTIFYING, DETECTING, PREVENTING AND REMOVING COMPUTER VIRUSES, INTRUSIONS AND OTHER SECURITY RISKS AND FOR ALERTING THE USER OF SUCH VIRUSES AS WELL AS OTHER ANOMALOUS CONDITIONS (U.S. CLS. 21, 23, 26, 36 AND 38).

FIRST USE 11-30-2000; IN COMMERCE 11-30-2000.

**CLASS 42—SCIENTIFIC, COMPUTER AND LEGAL SERVICES**

FOR PROVIDING MAINTENANCE AND UPGRADE SERVICES IN THE AREA OF COMPUTER SOFTWARE USED TO PROTECT COMPUTERS FROM VIRUSES, INTRUSIONS AND OTHER SECURITY RISKS (U.S. CLS. 100 AND 101).

FIRST USE 11-30-2000; IN COMMERCE 11-30-2000.

SN 76-177,284. SEDONA CONSULTING GROUP, LLC, BLOOMINGTON, MN. FILED 12-7-2000.

**SHARP SKY****CLASS 35—ADVERTISING AND BUSINESS**

FOR BUSINESS MANAGEMENT CONSULTING SERVICES IN THE FIELD OF INFORMATION TECHNOLOGY (U.S. CLS. 100, 101 AND 102).

**CLASS 42—SCIENTIFIC, COMPUTER AND LEGAL SERVICES**

FOR COMPUTER CONSULTING SERVICES IN THE FIELD OF INFORMATION TECHNOLOGY (U.S. CLS. 100 AND 101).

SN 76-178,642. AIMNET SOLUTIONS, INC., HOLLISTON, MA. FILED 12-11-2000.



NO CLAIM IS MADE TO THE EXCLUSIVE RIGHT TO USE "SOLUTIONS", APART FROM THE MARK AS SHOWN.

**CLASS 35—ADVERTISING AND BUSINESS**

FOR OUTSOURCING SERVICES FOR OTHERS IN THE FIELDS OF COMPUTER AND TELECOMMUNICATIONS NETWORKS, NAMELY WIDE AREA NETWORKS, LOCAL AREA NETWORKS AND NETWORK MANAGEMENT (U.S. CLS. 100, 101 AND 102).

**CLASS 42—SCIENTIFIC, COMPUTER AND LEGAL SERVICES**

FOR CONSULTING IN THE FIELDS OF COMPUTER AND TELECOMMUNICATIONS NETWORKS, NAMELY WIDE AREA NETWORKS, LOCAL AREA NETWORKS AND NETWORK MANAGEMENT (U.S. CLS. 100 AND 101).

SN 76-186,835. SAVILLE, TOM, FRESNO, CA. FILED 12-26-2000.

**BIG3D****CLASS 16—PAPER GOODS AND PRINTED MATTER**

FOR LARGE FORMAT LENTICULAR 3D GRAPHIC DESIGNS; LARGE FORMAT PRINTED GRAPHICS WHICH APPEAR THREE DIMENSIONAL TO THE VIEWER (U.S. CLS. 2, 5, 22, 23, 29, 37, 38 AND 50).

FIRST USE 9-1-1998; IN COMMERCE 9-1-1998.

SN 76-179,503. HARRIS TRUST AND SAVINGS BANK, CHICAGO, IL. FILED 12-12-2000.

**SILVER LIONS CLUB**

NO CLAIM IS MADE TO THE EXCLUSIVE RIGHT TO USE "CLUB", APART FROM THE MARK AS SHOWN.

**CLASS 39—TRANSPORTATION AND STORAGE**

FOR ARRANGING AND CONDUCTING LOCAL AND TRAVEL TOURS FOR THE PURPOSE OF PROMOTING BANKING AND FINANCIAL SERVICES (U.S. CLS. 100 AND 105).

**CLASS 42—SCIENTIFIC, COMPUTER AND LEGAL SERVICES**

FOR GRAPHIC ART DESIGN, NAMELY, CREATION OF LARGE LENTICULAR 3D GRAPHIC DESIGNS FOR OTHERS (U.S. CLS. 100 AND 101).

FIRST USE 9-1-1998; IN COMMERCE 9-1-1998.

SN 76-186,887. TASTY, INC., CARLSBAD, CA. FILED 12-27-2000.



NO CLAIM IS MADE TO THE EXCLUSIVE RIGHT TO USE "TASTY", APART FROM THE MARK AS SHOWN. THE MARK IS LINED TO INDICATE THE COLORS GREEN AND BLUE.

**CLASS 41—EDUCATION AND ENTERTAINMENT**

FOR ARRANGING AND CONDUCTING SEMINARS IN THE FIELDS OF BANKING AND FINANCE FOR THE PURPOSE OF PROMOTING BANKING AND FINANCIAL SERVICES; AND ENTERTAINMENT SERVICES, NAMELY ARRANGING AND CONDUCTING PARTIES AND SOCIAL EVENTS AT FORMAL AND INFORMAL VENUES FOR THE PURPOSE OF PROMOTING BANKING AND FINANCIAL SERVICES (U.S. CLS. 100, 101 AND 107).

**CLASS 29—MEATS AND PROCESSED FOODS**

FOR TOMATO PASTE, PEANUT BUTTER AND CANNED VEGETABLES (U.S. CL. 46).

FIRST USE 7-5-1999; IN COMMERCE 7-5-1999.

SN 76-181,765. BADGER AIR BRUSH CO., FRANKLIN PARK, IL. FILED 12-15-2000.

**TOTALLY TATTOO**

NO CLAIM IS MADE TO THE EXCLUSIVE RIGHT TO USE "TATTOO", APART FROM THE MARK AS SHOWN.

**CLASS 3—COSMETICS AND CLEANING PREPARATIONS**

FOR BODY PAINT AND CLEANSING PADS (U.S. CLS. 1, 4, 6, 50, 51 AND 52).

FIRST USE 2-23-2000; IN COMMERCE 2-23-2000.

**CLASS 30—STAPLE FOODS**

FOR TOMATO SAUCE, KETCHUP, MAYONNAISE, VINEGAR, PROCESSED CEREALS, HONEY, MUSTARD, HOT SAUCE (U.S. CL. 46).

FIRST USE 7-5-1999; IN COMMERCE 7-5-1999.

SN 76-187,463. AGILE PRINTING COMPANY, INC., WASHINGTON, D.C., DC. FILED 12-28-2000.

**AGILE****CLASS 21—HOUSEWARES AND GLASS**

FOR STENCILS AND APPLICATORS FOR MAKEUP IN THE NATURE OF BODY PAINT (U.S. CLS. 2, 13, 23, 29, 30, 33, 40 AND 50).

FIRST USE 2-23-2000; IN COMMERCE 2-23-2000.

**CLASS 35—ADVERTISING AND BUSINESS**

FOR PHOTOCOPYING SERVICES (U.S. CLS. 100, 101 AND 102).

FIRST USE 7-0-1969; IN COMMERCE 7-0-1969.

**CLASS 42—SCIENTIFIC, COMPUTER AND LEGAL SERVICES**

FOR PRINTING SERVICES FEATURING OFFSET, LABEL, LITHOGRAPHIC, AND ARTWORK (U.S. CLS. 100 AND 101).

FIRST USE 7-0-1969; IN COMMERCE 7-0-1969.

SN 76-187,706. VERIDIAN INFORMATION SOLUTIONS, INC., ARLINGTON, VA. FILED 1-2-2001.

## VERIFIDES

### CLASS 35—ADVERTISING AND BUSINESS

FOR LICENSING CUSTOMIZED HARDWARE, SOFTWARE, AND FIRMWARE FOR CONTROLLING ACCESS TO AND PREVENTING UNAUTHORIZED COPYING AND DISTRIBUTION OF DIGITAL CONTENT (U.S. CLS. 100, 101 AND 102).

### CLASS 42—SCIENTIFIC, COMPUTER AND LEGAL SERVICES

FOR COMPUTER SERVICES, NAMELY, DESIGNING, IMPLEMENTING AND INTEGRATING CUSTOMIZED HARDWARE, SOFTWARE, AND FIRMWARE FOR CONTROLLING ACCESS TO AND PREVENTING UNAUTHORIZED COPYING AND DISTRIBUTION OF DIGITAL CONTENT (U.S. CLS. 100 AND 101).

SN 76-187,707. DARDEN CORPORATION, ORLANDO, FL. FILED 1-2-2001.

## BAHAMARITA

### CLASS 32—LIGHT BEVERAGES

FOR PREPARED NON-ALCOHOLIC BEVERAGES, NAMELY, FRUIT FRUIT-FLAVORED NON-ALCOHOLIC DRINKS (U.S. CLS. 45, 46 AND 48).  
FIRST USE 2-19-1996; IN COMMERCE 2-19-1996.

### CLASS 33—WINES AND SPIRITS

FOR PREPARED ALCOHOLIC BEVERAGES, NAMELY, PREPARED ALCOHOLIC COCKTAILS (U.S. CLS. 47 AND 49).  
FIRST USE 2-19-1996; IN COMMERCE 2-19-1996.

SN 76-188,591. KAPLAN MCLAUGHLIN DIAZ, SAN FRANCISCO, CA. FILED 1-2-2001.

## KMD ARCHITECTS AND PLANNERS

NO CLAIM IS MADE TO THE EXCLUSIVE RIGHT TO USE "ARCHITECTS AND PLANNERS", APART FROM THE MARK AS SHOWN.

### CLASS 35—ADVERTISING AND BUSINESS

FOR BUSINESS SERVICES, NAMELY, STRATEGIC PLANNING AND CONSULTATION FOR BUSINESS ADMINISTRATION AND MANAGEMENT IN THE FIELDS OF ARCHITECTURE, URBAN DESIGN AND PLANNING, AND LAND USE (U.S. CLS. 100, 101 AND 102).

FIRST USE 12-31-1990; IN COMMERCE 11-30-1993.

### CLASS 37—CONSTRUCTION AND REPAIR

FOR REAL ESTATE AND LAND DEVELOPMENT SERVICES, NAMELY PLANNING AND LAYING OUT OF RESIDENTIAL AND/OR COMMERCIAL COMMUNITIES; CONSTRUCTION MANAGEMENT (U.S. CLS. 100, 103 AND 106).

FIRST USE 12-31-1990; IN COMMERCE 11-30-1993.

### CLASS 42—SCIENTIFIC, COMPUTER AND LEGAL SERVICES

FOR ARCHITECTURE DESIGN FOR OTHERS; LANDSCAPE ARCHITECTURE FOR OTHERS; INTERIOR DESIGN FOR OTHERS; CONSULTATION SERVICES, NAMELY, PROGRAMMING, PLANNING AND STRATEGIC PLANNING IN THE FIELDS OF LAND AND SPACE USE AND FUNCTIONALITY (U.S. CLS. 100 AND 101).

FIRST USE 12-31-1990; IN COMMERCE 11-30-1993.

SN 76-188,605. UNIEK, INC., WAUNAKEE, WI. FILED 1-2-2001.



OWNER OF U.S. REG. NO. 2,361,600.

### CLASS 16—PAPER GOODS AND PRINTED MATTER

FOR FRAMED ART PRINTS OR PICTURES OR REPRODUCTION (U.S. CLS. 2, 5, 22, 23, 29, 37, 38 AND 50).

### CLASS 20—FURNITURE AND ARTICLES NOT OTHERWISE CLASSIFIED

FOR WALL MIRRORS (U.S. CLS. 2, 13, 22, 25, 32 AND 50).

SN 76-188,855. FLYNN, RANDY MICHAEL, POPLARVILLE, MS. FILED 12-29-2000.

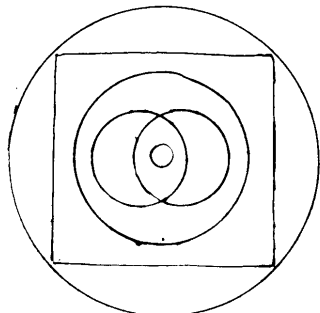

**CLASS 16—PAPER GOODS AND PRINTED MATTER**

FOR BOOKS, NAMELY, A COLLECTION OF POETRY (U.S. CLS. 2, 5, 22, 23, 29, 37, 38 AND 50).

**CLASS 25—CLOTHING**

FOR CLOTHING, NAMELY, HATS, JACKETS, AND SHIRTS (U.S. CLS. 22 AND 39).

---

SN 76-189,200. FREEDMAN, RICHARD, MENTOR, OH. FILED 1-2-2001.



NO CLAIM IS MADE TO THE EXCLUSIVE RIGHT TO USE "AWARD", APART FROM THE MARK AS SHOWN. THE MARK CONSISTS OF THE WORDING "POP" AND "AWARD" INSIDE A BOX THAT IS DIVIDED INTO TWO PARTS. INSIDE THE BOX IS THE DEPICTION OF A BASEBALL.

**CLASS 25—CLOTHING**

FOR WEARING APPAREL, NAMELY SHIRTS (U.S. CLS. 22 AND 39).  
FIRST USE 1-0-1996; IN COMMERCE 9-0-1997.

**CLASS 41—EDUCATION AND ENTERTAINMENT**

FOR SPORTS EDUCATION SERVICES, NAMELY PRODUCING INCENTIVES TO PEOPLE TO DEMONSTRATE EXCELLENCE IN THE FIELD OF ATHLETICS THROUGH THE ISSUANCE OF AWARDS (U.S. CLS. 100, 101 AND 107).  
FIRST USE 1-0-1996; IN COMMERCE 9-0-1997.

SN 76-191,692. SCHLUMBERGER SYSTEMES, MONTROUGE PARIS, FRANCE, FILED 1-2-2001.

**ETIS**

**CLASS 9—ELECTRICAL AND SCIENTIFIC APPARATUS**

FOR ELECTRONIC MEMORY CARDS; DEVICES FOR ELECTRONIC TRANSACTIONS USING ELECTRONIC MEMORY CARDS, NAMELY ELECTRONIC MEMORY CARD TERMINALS AND SERVERS; SOFTWARE TOOLS AND SOFTWARE APPLICATIONS FOR OPERATING ELECTRONIC MEMORY CARDS AND PROCESSING TRANSACTIONS USING ELECTRONIC MEMORY CARDS (U.S. CLS. 21, 23, 26, 36 AND 38).

**CLASS 35—ADVERTISING AND BUSINESS**

FOR BUSINESS MANAGEMENT SERVICES FOR OTHERS IN THE FIELD OF DESIGNING, MANUFACTURING, INSTALLING AND OPERATING SYSTEMS UTILIZING ELECTRONIC PAYMENT CARDS (U.S. CLS. 100, 101 AND 102).

**CLASS 42—SCIENTIFIC, COMPUTER AND LEGAL SERVICES**

FOR TECHNICAL CONSULTING SERVICES FOR ASSISTING BANKING COMPANIES WITH INTEGRATION FROM MAGNETIC STRIPE CARDS TO OTHER PAYMENT SCHEMES, CARD ISSUANCE, ELECTRONIC PURSE, AND MULTI-APPLICATION IMPLEMENTATIONS; TECHNICAL CONSULTING SERVICES FOR ASSISTING MOBILE TELECOMMUNICATION COMPANIES WITH VALUE-ADDED PAYMENT SERVICES IN THE GSM (GLOBAL SYSTEM FOR MOBILE COMMUNICATIONS) ENVIRONMENT, PERSONALIZATION AND OVER-THE-AIR CUSTOMIZATION, PREPAYMENT SOLUTIONS, AND SECURITY SCHEMES THEREFOR; TECHNICAL CONSULTING SERVICES FOR ASSISTING WIRELINE TELECOMMUNICATION COMPANIES WITH ELECTRONIC PURSE, PREPAYMENT SOLUTIONS, AND SECURITY SCHEMES THEREFOR (U.S. CLS. 100 AND 101).

---

SN 76-191,791. WEISS, MICHELLE, NEW YORK, NY. FILED 1-8-2001.

**NUTRITION EVOLVED**

NO CLAIM IS MADE TO THE EXCLUSIVE RIGHT TO USE "NUTRITION", APART FROM THE MARK AS SHOWN.

**CLASS 5—PHARMACEUTICALS**

FOR NUTRITIONAL SUPPLEMENTS (U.S. CLS. 6, 18, 44, 46, 51 AND 52).

**CLASS 9—ELECTRICAL AND SCIENTIFIC APPARATUS**

FOR PRE-RECORDED VIDEOTAPES ON NUTRITION (U.S. CLS. 21, 23, 26, 36 AND 38).

**CLASS 16—PAPER GOODS AND PRINTED MATTER**

FOR PAPER PUBLICATIONS ON NUTRITION (U.S. CLS. 2, 5, 22, 23, 29, 37, 38 AND 50).

**CLASS 25—CLOTHING**

FOR CLOTHING, NAMELY, T-SHIRTS, SHIRTS, TANK TOPS, HATS, LEOTARDS, AND SWEAT PANTS (U.S. CLS. 22 AND 39).

SN 76-192,894. LIFT-U, DIVISION OF HOGAN MFG., INC., ESCALON, CA. FILED 1-11-2001.

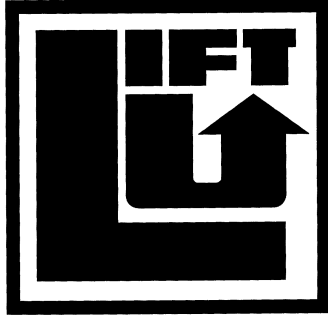

OWNER OF U.S. REG. NOS. 1,355,215 AND 2,111,623.

**CLASS 1—CHEMICALS**

FOR ADHESIVE COMPOUNDS FOR USE IN TRANSIT VEHICLE WHEELCHAIR RAMPS (U.S. CLS. 1, 5, 6, 10, 26 AND 46).

**CLASS 2—PAINTS**

FOR PAINT FOR TRANSIT VEHICLE WHEELCHAIR RAMPS (U.S. CLS. 6, 11 AND 16).

**CLASS 4—LUBRICANTS AND FUELS**

FOR LUBRICANTS FOR TRANSIT VEHICLE WHEELCHAIR RAMPS (U.S. CLS. 1, 6 AND 15).

**CLASS 6—METAL GOODS**

FOR TRANSIT VEHICLE WHEELCHAIR RAMP PARTS, NAMELY, METAL ACCESS PANELS, METAL ANCHORS FOR SECURING WHEELCHAIR RAMP PARTS, METAL BARRIERS, METAL BARS, METAL BEAMS, METAL BOLTS, METAL CABLE CLIPS, METAL CABLE WIRE, METAL CLAMPS, METAL COTTER PINS, METAL FASTENING HOOKS, METAL NUTS, METAL HINGES, METAL KNOBS, METAL LATCHES, METAL LIDS, METAL RAILS, METAL RIVETS, METAL SCREWS, METAL SHIMS, METAL WASHERS, METAL LOCKS AND KEYS THEREFOR, METAL SUPPORTS, METAL TUBING, METAL BRACES, METAL CHAINS, METAL CHANNELS TO CREATE INTERNAL PASSAGES, METAL PLATES FOR MOUNTING AND PROTECTING PARTS, METAL PLATES FOR REINFORCEMENT, METAL SPRINGS, METAL RINGS, METAL CAM PLATES, METAL GEARS, METAL HANDLES, METAL LEVERS, METAL PINS, METAL PULLEYS, METAL ROLLERS, METAL SHAFT COUPLINGS, METAL SHAFTS, METAL SPROCKETS (U.S. CLS. 2, 12, 13, 14, 23, 25 AND 50).

**CLASS 7—MACHINERY**

FOR TRANSIT VEHICLE WHEELCHAIR RAMP PARTS, NAMELY, GEAR REDUCER FOR ELECTRICAL MOTORS, NON-METAL BEARINGS, NON-METAL BELTS, NON-METAL FRICTION DISCS, AND NON-METAL MOUNTS (U.S. CLS. 13, 19, 21, 23, 31, 34 AND 35).

**CLASS 9—ELECTRICAL AND SCIENTIFIC APPARATUS**

FOR ELECTRICAL MOTORS, ELECTRICAL CABLES, ELECTRICAL SOLENOIDS, ELECTRICAL SWITCHES, ELECTRICAL ENCLOSURES (U.S. CLS. 21, 23, 26, 36 AND 38).

**CLASS 12—VEHICLES**

FOR TRANSIT VEHICLE WHEELCHAIR RAMPS; AND TRANSIT VEHICLE WHEELCHAIR RAMP STRUCTURAL PARTS (U.S. CLS. 19, 21, 23, 31, 35 AND 44).

**CLASS 16—PAPER GOODS AND PRINTED MATTER**

FOR DETAIL DRAWINGS AND DIAGRAMS FOR USE, ASSEMBLY AND MAINTENANCE OF TRANSIT VEHICLE WHEELCHAIR RAMPS (U.S. CLS. 2, 5, 22, 23, 29, 37, 38 AND 50).

**CLASS 17—RUBBER GOODS**

FOR GENERAL PURPOSE SILICONE RUBBER SEALANT, AND TRANSIT VEHICLE WHEELCHAIR RAMP PARTS, NAMELY, NEOPRENE SPONGES, NEOPRENE GASKETS, PLASTIC TUBING, PLASTIC WASHERS, AND PLASTIC WEAR STRIPS (U.S. CLS. 1, 5, 12, 13, 38 AND 50).

**CLASS 20—FURNITURE AND ARTICLES NOT OTHERWISE CLASSIFIED**

FOR PLASTIC PULLEYS (U.S. CLS. 2, 13, 22, 25, 32 AND 50).

**CLASS 27—FLOOR COVERINGS**

FOR RUBBER MATS FOR TRANSIT VEHICLE WHEELCHAIR RAMPS; AND ANTI-SKID FLOOR COVERINGS FOR TRANSIT VEHICLE WHEELCHAIR RAMPS (U.S. CLS. 19, 20, 37, 42 AND 50).

SN 76-193,952. CENTRE TECHNIQUE DES INDUSTRIES MECANIKES, 60300 SENLIS, FRANCE, FILED 1-12-2001.

**CETIM-SERTI**

PRIORITY CLAIMED UNDER SEC. 44(D) ON FRANCE APPLICATION NO. TM003040724, FILED 7-13-2000, REG. NO. 003040724, DATED 7-13-2000, EXPIRES 7-13-2010.

**CLASS 7—MACHINERY**

FOR MACHINE TOOLS, NAMELY, FEEDERS; INDUSTRIAL ROBOTIZED MACHINE TOOLS, NAMELY, CRIMPING CAMS FOR METAL PART CRIMPING MACHINES, CRIMPING CAMS FOR METAL BOX CRIMPING MACHINES; METAL CRIMPING MACHINES, METAL BOX CRIMPING MACHINES, METAL PART CRIMPING MACHINES; INDUSTRIAL ROBOTIZED METAL BOX CRIMPING MACHINES (U.S. CLS. 13, 19, 21, 23, 31, 34 AND 35).

**CLASS 9—ELECTRICAL AND SCIENTIFIC APPARATUS**

FOR SIGNAL ACQUISITION AND ANALYSIS SOFTWARE FOR CRIMPING LINE MONITORING (U.S. CLS. 21, 23, 26, 36 AND 38).



**CLASS 37—CONSTRUCTION AND REPAIR**

FOR MACHINE TOOL INSTALLATION AND MAINTENANCE SERVICES; INSTALLATION AND MAINTENANCE SERVICES FOR METAL PART CRIMPING MACHINES (U.S. CLS. 100, 103 AND 106).

**CLASS 42—SCIENTIFIC, COMPUTER AND LEGAL SERVICES**

FOR CONSULTING SERVICES, NAMELY, SERVICES PROVIDED BY AN ENGINEER IN RELATION TO INDUSTRIAL CRIMPING MACHINES; IN PARTICULAR NEEDS AND CONSTRAINTS ASSESSMENTS, RESEARCH AND TECHNIQUE DESIGN, SITE ANALYSIS, TECHNICAL ASSISTANCE, REMOTE MONITORING AND CONTROL, EXPERT EVALUATIONS, ACQUISITION AND CERTIFICATION OF INDUSTRIAL PROPERTY RIGHTS (U.S. CLS. 100 AND 101).

---

SN 76-194,282. E.K. SUCCESS, LTD., CLIFTON, NJ. FILED 1-12-2001.

**HIPGRL68**

OWNER OF U.S. REG. NO. 2,451,956.

**CLASS 3—COSMETICS AND CLEANING PREPARATIONS**

FOR COSMETICS, NAMELY, CLEANSING PREPARATIONS, NAMELY, SKIN CLEANSERS; PERSONAL DEODORANTS; NAIL POLISH; LIPSTICK; LIP LINER; EYE SHADOW; EYE PENCIL; EYE LINER; EYEBROW PENCILS; FACE POWDER; BLUSH; PERFUME; BUBBLE BATH; SKIN AND HAIR CONDITIONERS; SKIN MOISTURIZER; SHOWER GEL; LIQUID SOAP; BODY SPRITZER; AND TALCUM POWDER (U.S. CLS. 1, 4, 6, 50, 51 AND 52).

**CLASS 8—HAND TOOLS**

FOR CUTLERY, NAMELY, FLATWARE (U.S. CLS. 23, 28 AND 44).

**CLASS 9—ELECTRICAL AND SCIENTIFIC APPARATUS**

FOR SUNGLASSES; VIDEOTAPES, CD-ROMS, AUDIO-TAPES, PRERECORDED TAPES, AND COMPACT DISCS FEATURING ANIMATED GIRL CHARACTERS; PHOTOGRAPHIC CAMERAS AND EXPOSED CAMERA FILM; BLANK MAGNETIC DATA CARRIERS; PHOTOGRAPHIC PROJECTORS; BLANK ELECTRONIC CHIP CARDS; VIDEO GAME CARTRIDGES AND VIDEO GAMES DISCS, COMPUTER GAME PROGRAMS AND COMPUTER GAME SOFTWARE AND COMPUTER GAME TAPES; DECORATIVE REFRIGERATOR MAGNETS, AND COVERS FOR WIRELESS PHONES (U.S. CLS. 21, 23, 26, 36 AND 38).

**CLASS 11—ENVIRONMENTAL CONTROL APPARATUS**

FOR LAMPS AND LAMP SHADES (U.S. CLS. 13, 21, 23, 31 AND 34).

**CLASS 14—JEWELRY**

FOR JEWELRY, CLOCKS, WATCHES, WRIST WATCHES, CUFF LINKS, TIE PINS (U.S. CLS. 2, 27, 28 AND 50).

**CLASS 16—PAPER GOODS AND PRINTED MATTER**

FOR WRITING INSTRUMENTS, NAMELY, PENS, PENCILS, MARKERS, CRAYONS, STICKERS; STICKER BINDERS; STICKER BOOKS; NOTEBOOKS; NOTEBOOKS AND NECKLACE COMBINATIONS SOLD TOGETHER AS A UNIT; DRAWING AND DRAFTING RULERS; WIRE BOUND THEME BOOKS; PENCIL SHARPENERS; PAPER POUCHES FOR PACKAGING; STATIONERY SETS; ERASERS; ADDRESS BOOKS, JOURNALS; TEMPORARY TATTOOS; DAILY JOURNAL PLANNERS; CHILDREN'S BOOKS; PAMPHLETS, BROCHURES, AND NEWSLETTERS ABOUT GIRL CARTOON CHARACTERS; PAPER PARTY BAGS, PAPER PARTY DECORATIONS, AND PAPER PARTY HATS (U.S. CLS. 2, 5, 22, 23, 29, 37, 38 AND 50).

**CLASS 18—LEATHER GOODS**

FOR TRUNK AND TRAVELING BAGS, UMBRELLAS, PARASOLS, LEATHER BACKPACKS AND SHOPPING BAGS, ALL PURPOSE SPORTS BAGS, RUCKSACKS, WALKING STICKS, HOLDALLS, COSMETIC BAGS AND CASES SOLD EMPTY (U.S. CLS. 1, 2, 3, 22 AND 41).

**CLASS 20—FURNITURE AND ARTICLES NOT OTHERWISE CLASSIFIED**

FOR NON-METAL KEY CHAINS (U.S. CLS. 2, 13, 22, 25, 32 AND 50).

**CLASS 21—HOUSEWARES AND GLASS**

FOR CONTAINERS FOR HOUSEHOLD OR KITCHEN USE, PLATES, DRINKING GLASSES, CUPS, MUGS, ORNAMENTS MADE OF CERAMIC, HAIR BRUSHES AND COMBS, NAIL BRUSHES, AND HOUSEHOLD UTENSILS, NAMELY, POT AND PAN SCRAPERS, ROLLING PINS, SPATULAS, TURNERS, AND WHISKS (U.S. CLS. 2, 13, 23, 29, 30, 33, 40 AND 50).

**CLASS 24—FABRICS**

FOR TABLECLOTHS, BED SHEETS, TEXTILES NAPKINS AND PLACE MATS (U.S. CLS. 42 AND 50).

**CLASS 25—CLOTHING**

FOR CLOTHING, NAMELY, T-SHIRTS, DRESSES, HATS, SWIMWEAR, FOOTWEAR, SOCKS, TIES AND SLIPPERS (U.S. CLS. 22 AND 39).

**CLASS 26—FANCY GOODS**

FOR HAIR BANDS, CLOTHING BUCKLES, HAIR BUCKLES, AND SHOE BUCKLES, BELT AND CLOTHING CLASPS (U.S. CLS. 37, 39, 40, 42 AND 50).

**CLASS 28—TOYS AND SPORTING GOODS**

FOR TOYS, NAMELY, DOLLS, BOARD GAMES, PLUSH TOYS, MOBILES, GYMNAS TIC APPARATUS, SPORTING ARTICLES, NAMELY, BASEBALLS, SOFTBALLS, BASKETBALLS, CHRISTMAS TREE DECORATIONS, JIGSAW PUZZLES, TEDDY BEARS, BALLOONS, BODYBUILDING APPARATUS, NAMELY, EXERCISE BARS, AND EXERCISE BENCHES, GLOVES FOR GAMES, NAMELY, BASEBALL, SOFTBALL, AND GOLF GLOVES, HANDHELD UNIT FOR PLAYING ELECTRONIC GAMES, CARD GAMES, BAGS ADAPTED FOR HOLDING SPORTS EQUIPMENT, NAMELY, BASEBALL, SOFTBALL, AND GOLF (U.S. CLS. 22, 23, 38 AND 50).

**CLASS 30—STAPLE FOODS**

FOR FROZEN CONFECTIONS AND FLAVORED ICES, CHOCOLATE, COFFEE, TEA, COCOA, CEREAL BASED SNACK FOOD, READY TO EAT CEREAL DERIVED FOOD BARS, BREAD, CHOCOLATE EGGS, CONFECTIONERY SUGAR (U.S. CL. 46).

**CLASS 41—EDUCATION AND ENTERTAINMENT**

FOR PRODUCTION OF RADIO AND TELEVISION PROGRAMS, PRODUCTION OF VIDEOTAPE, PUBLICATION OF BOOKS, TEXT AND PRINTED MATTER, NAMELY, ANIMATED CHARACTERS; THEATER PRODUCTIONS; MOTION PICTURE FILM PRODUCTION, ORGANIZATION OF EXHIBITIONS FOR ENTERTAINMENT PURPOSES, ARRANGING AND CONDUCTING OF SPORTS COMPETITIONS, LIVE PERFORMANCES BY A MUSICAL BAND; ENTERTAINMENT, NAMELY, A CONTINUING CARTOON SHOW DISTRIBUTED OVER TELEVISION (U.S. CLS. 100, 101 AND 107).

---

SN 76-196,944. LEO BURNETT WORLDWIDE, INC., CHICAGO, IL. FILED 1-19-2001.



OWNER OF U.S. REG. NOS. 222,360 AND 2,222,195.  
NO CLAIM IS MADE TO THE EXCLUSIVE RIGHT TO USE "IP", APART FROM THE MARK AS SHOWN.

**CLASS 35—ADVERTISING AND BUSINESS**

FOR ADVERTISING AGENCY SERVICES, NAMELY STRATEGIC CONSULTING IN THE AREA OF THE ONLINE MARKETING CONNECTED WITH THE GLOBAL COMPUTER INFORMATION NETWORK; DEVELOPING ADVERTISING AND MEDIA PLANS; NEGOTIATING THE PLACEMENT OF MEDIA ONLINE; TRACKING THE PERFORMANCE OF ONLINE ADVERTISING; AND CREATING PROGRAMS, INCENTIVES AND PROMOTIONS TO OPTIMIZE ONLINE ADVERTISING PERFORMANCE (U.S. CLS. 100, 101 AND 102).

FIRST USE 1-0-1999; IN COMMERCE 1-0-1999.

**CLASS 42—SCIENTIFIC, COMPUTER AND LEGAL SERVICES**

FOR COMPUTER SERVICES, NAMELY, MONITORING AND MANAGING THE USE OF THIRD PARTY ADVERTISING SERVERS (U.S. CLS. 100 AND 101).

FIRST USE 1-0-1999; IN COMMERCE 1-0-1999.

---

SN 76-197,923. ALL-STATES INC., CHICAGO, IL. FILED 1-22-2001.

**RAP-TIGHT**

OWNER OF U.S. REG. NO. 1,088,762.

**CLASS 6—METAL GOODS**

FOR STAINLESS STEEL CABLE TIES (U.S. CLS. 2, 13, 14, 23, 25 AND 50).

**CLASS 8—HAND TOOLS**

FOR MANUALLY-OPERATED, HAND-HELD TENSIONING TOOLS FOR APPLYING CABLE TIES AROUND BUNDLES OF WIRES AND THE LIKE AND TENSIONING THE TIES BY A RATCHETING ACTION (U.S. CLS. 23, 28 AND 44).

**CLASS 9—ELECTRICAL AND SCIENTIFIC APPARATUS**

FOR WIRE MARKERS AND CABLE MARKERS (U.S. CLS. 21, 23, 26, 36 AND 38).

**CLASS 17—RUBBER GOODS**

FOR NETWORKING TUBING KITS COMPRISING SLIT CORRUGATED TUBING, HOOK-AND-LOOP TIES AND CABLE TIES; PLASTIC HEAT SHRINK TUBING FOR WIRES; INSULATED BRAIDED SLEEVING FOR POWER LINES (U.S. CLS. 1, 5, 12, 13, 35 AND 50).

**CLASS 20—FURNITURE AND ARTICLES NOT OTHERWISE CLASSIFIED**

FOR PLASTIC HOOK-AND-LOOP STYLE CABLE TIES; PLASTIC CABLE TIE MOUNTING BASES; PLASTIC CABLE SPACERS; PLASTIC CABLE TIE KITS COMPRISING VARIOUS SIZES, COLORS AND STRENGTHS OF TIES; AND PLASTIC CABLE CLAMPS (U.S. CLS. 2, 13, 22, 25, 32 AND 50).

---

SN 76-199,133. CAMP DRESSER & MCKEE INC., CAMBRIDGE, MA. FILED 1-24-2001.

## INTEGRATED COMPETITIVE UTILITY SERVICES ICUS

OWNER OF U.S. REG. NO. 2,119,705.  
NO CLAIM IS MADE TO THE EXCLUSIVE RIGHT TO USE "UTILITY SERVICES", APART FROM THE MARK AS SHOWN.

**CLASS 35—ADVERTISING AND BUSINESS**

FOR BUSINESS MANAGEMENT CONSULTING, BUSINESS PROJECT MANAGEMENT, AND BUSINESS PLANNING SERVICES (U.S. CLS. 100, 101 AND 102).

**CLASS 37—CONSTRUCTION AND REPAIR**

FOR CONSTRUCTION PLANNING, CONSTRUCTION MANAGEMENT SUPERVISION, COMMERCIAL AND GOVERNMENTAL CONSTRUCTION IN A WIDE VARIETY OF APPLICATIONS AND FIELDS, GENERAL CONTRACTING SERVICES, AND ENVIRONMENTAL REMEDIATION SERVICES, NAMELY, WASTE DISPOSAL (U.S. CLS. 100, 103 AND 106).

**CLASS 40—MATERIAL TREATMENT**

FOR ENVIRONMENTAL REMEDIATION SERVICES, NAMELY, SOIL, WASTE AND/OR WATER TREATMENT SERVICES (U.S. CLS. 100, 103 AND 106).

**CLASS 42—SCIENTIFIC, COMPUTER AND LEGAL SERVICES**

FOR REVIEWING AND EVALUATING STANDARDS AND PRACTICES TO ASSURE COMPLIANCE WITH ENVIRONMENTAL, SAFETY, ZONING, AND PROCUREMENT LAWS AND REGULATIONS; EVALUATION AND TESTING OF LAND, WATER, AND AIR FOR THE PRESENCE OF HAZARDOUS MATERIALS; ENGINEERING; ENVIRONMENTAL DESIGN FOR OTHERS; AND CONSULTING AND DESIGN SERVICES IN THE FIELDS OF INFORMATION MANAGEMENT SYSTEMS, COMPUTER SYSTEM MAINTENANCE AND MANAGEMENT, AND INSTRUMENTATION AND CONTROL TECHNOLOGIES USED BY UTILITIES (U.S. CLS. 100 AND 101).

SN 76-200,161. AYOUB RUG CLEANING CO., SILVER SPRING, MD. FILED 1-26-2001.

**HANNA AYOUB**

THE NAME "HANNA AYOUB" DOES NOT IDENTIFY A LIVING INDIVIDUAL.

**CLASS 35—ADVERTISING AND BUSINESS**

FOR RETAIL STORE FEATURING RUGS (U.S. CLS. 100, 101 AND 102).  
FIRST USE 0-0-1951; IN COMMERCE 0-0-1951.

**CLASS 37—CONSTRUCTION AND REPAIR**

FOR RUG CLEANING (U.S. CLS. 100, 103 AND 106).  
FIRST USE 0-0-1951; IN COMMERCE 0-0-1951.

SN 76-201,048. PERMA-FIX ENVIRONMENTAL SERVICES, INC., GAINESVILLE, FL. FILED 1-26-2001.



OWNER OF U.S. REG. NO. 1,627,652.  
NO CLAIM IS MADE TO THE EXCLUSIVE RIGHT TO USE "ENVIRONMENTAL SERVICES", APART FROM THE MARK AS SHOWN.

**CLASS 37—CONSTRUCTION AND REPAIR**

FOR DISPOSAL OF ALL HAZARDOUS AND NON-HAZARDOUS WASTES; WASTE DISPOSAL SERVICES, NAMELY, DEEP WELL INJECTION (U.S. CLS. 100, 103 AND 106).  
FIRST USE 12-8-2000; IN COMMERCE 12-8-2000.

**CLASS 39—TRANSPORTATION AND STORAGE**

FOR STORAGE OF ALL HAZARDOUS AND NON-HAZARDOUS WASTES; MIXED WASTE STORAGE (U.S. CLS. 100 AND 105).  
FIRST USE 12-8-2000; IN COMMERCE 12-8-2000.

**CLASS 40—MATERIAL TREATMENT**

FOR TREATMENT OF ALL HAZARDOUS AND NON-HAZARDOUS WASTES; MIXED WASTE TREATMENT; HAZARDOUS AND NON-HAZARDOUS WASTEWATER TREATMENT; MIXED WASTE INCINERATION; ON-SITE STABILIZATION OF HAZARDOUS AND NON-HAZARDOUS WASTES; FUEL BLENDING (U.S. CLS. 100, 103 AND 106).

FIRST USE 12-8-2000; IN COMMERCE 12-8-2000.

SN 76-201,429. CAPPO, INC. OF AMERICA, LIVINGSTON, TX. FILED 1-30-2001.

**CLASS 35—ADVERTISING AND BUSINESS**

FOR BUSINESS MANAGEMENT AND PROFESSIONAL BUSINESS CONSULTATION FOR OTHERS; ENGINEERING PERSONNEL AND RECRUITMENT; PERSONNEL MANAGEMENT CONSULTATION (U.S. CLS. 100, 101 AND 102).

FIRST USE 4-14-1988; IN COMMERCE 4-14-1988.

**CLASS 37—CONSTRUCTION AND REPAIR**

FOR CONSTRUCTION SERVICES, NAMELY PLANNING AND LAYING OUT CHEMICAL AND POWER PLANTS, INSTALLATION, MAINTENANCE AND REPAIR OF CHEMICAL AND POWER PLANTS (U.S. CLS. 100, 103 AND 106).

FIRST USE 4-14-1988; IN COMMERCE 4-14-1988.

**CLASS 42—SCIENTIFIC, COMPUTER AND LEGAL SERVICES**

FOR ENGINEERING AND CONSULTING SERVICES OF CONSTRUCTION OF CHEMICAL AND POWER PLANTS, TECHNICAL ENGINEERING SERVICES FOR THE CONSTRUCTION, OPERATION, MAINTENANCE, REPAIRS AND INSTALLATION OF CHEMICAL AND POWER PLANTS, PIPELINES AND OTHER RELATED PROJECTS (U.S. CLS. 100 AND 101).

FIRST USE 4-14-1988; IN COMMERCE 4-14-1988.

SN 76-201,611. BURNS PHILP FOOD INC., OAKLAND, CA. FILED 1-30-2001.

**HELPING BAKERS BAKE****CLASS 30—STAPLE FOODS**

FOR YEAST; BREAD AND BAKERY PRODUCT MIXES MADE WITH YEAST; FLAVORING ADDITIVES FOR USE IN MAKING BREAD (U.S. CL. 46).  
FIRST USE 9-30-2000; IN COMMERCE 9-30-2000.

**CLASS 42—SCIENTIFIC, COMPUTER AND LEGAL SERVICES**

FOR PROVIDING INFORMATION IN THE FIELD OF BREAD BAKING AND BREAD RELATED ACTIVITIES, PROVIDED IN PRINT AND ONLINE (U.S. CLS. 100 AND 101).

FIRST USE 9-30-2000; IN COMMERCE 9-30-2000.

SN 76-201,631. PESCAFREEZE SEAFOOD CORPORATION, COHASSET, MA. FILED 1-30-2001.

SN 76-206,831. NEW MILLENNIUM ROOFING, INC., INDIANAPOLIS, IN. FILED 2-8-2001.

## APPLYING THE SCIENCE OF QUALITY

### CLASS 29—MEATS AND PROCESSED FOODS

FOR SEAFOOD AND FROZEN SEAFOOD (U.S. CL. 46).

### CLASS 35—ADVERTISING AND BUSINESS

FOR WHOLESALE DISTRIBUTORSHIPS AND RETAIL STORE SERVICES FEATURING SEAFOOD AND FROZEN SEAFOOD PRODUCTS (U.S. CLS. 100, 101 AND 102).

---

SN 76-201,684. MITSUBISHI GAS CHEMICAL COMPANY, INC., CHIYODA-KU, TOKYO, JAPAN, FILED 1-30-2001.

## AGELESSOMAC

OWNER OF U.S. REG. NO. 1,109,001.

### CLASS 17—RUBBER GOODS

FOR PLASTIC FILM FOR INDUSTRIAL AND COMMERCIAL PACKING USE HAVING THE ABILITY OF ABSORBING OXYGEN (U.S. CLS. 1, 5, 12, 13, 35 AND 50).

### CLASS 20—FURNITURE AND ARTICLES NOT OTHERWISE CLASSIFIED

FOR PACKAGING CONTAINERS OF PLASTIC HAVING THE ABILITY OF ABSORBING OXYGEN (U.S. CLS. 2, 13, 22, 25, 32 AND 50).

---

SN 76-205,249. P.R. PERFORMANCE, INC., DELAND, FL. FILED 2-6-2001.



### CLASS 30—STAPLE FOODS

FOR TEA BASED BOTTLED BEVERAGES (U.S. CL. 46).  
FIRST USE 11-1-2000; IN COMMERCE 11-2-2000.

### CLASS 32—LIGHT BEVERAGES

FOR FRUIT JUICE BEVERAGES IN BOTTLES (U.S. CLS. 45, 46 AND 48).  
FIRST USE 11-1-2000; IN COMMERCE 11-2-2000.



### CLASS 37—CONSTRUCTION AND REPAIR

FOR ROOFING INSTALLATION AND REPAIR (U.S. CLS. 100, 103 AND 106).  
FIRST USE 12-15-1999; IN COMMERCE 12-15-1999.

### CLASS 40—MATERIAL TREATMENT

FOR RESIDENTIAL AND COMMERCIAL WATER-PROOFING OF WALLS AND BUILDINGS (U.S. CLS. 100, 103 AND 106).  
FIRST USE 12-15-1999; IN COMMERCE 12-15-1999.

---

SN 76-209,155. SEARS, WILLIAM, CAPISTRANO BEACH, CA. FILED 2-12-2001.

## THE L.E.A.N PROGRAM

NO CLAIM IS MADE TO THE EXCLUSIVE RIGHT TO USE "PROGRAM", APART FROM THE MARK AS SHOWN.

### CLASS 5—PHARMACEUTICALS

FOR NUTRITIONAL SUPPLEMENTS (U.S. CLS. 6, 18, 44, 46, 51 AND 52).

### CLASS 16—PAPER GOODS AND PRINTED MATTER

FOR INSTRUCTIONAL MATERIALS DIRECTED TOWARD NUTRITION AND HEALTH (U.S. CLS. 2, 5, 22, 23, 29, 37, 38 AND 50).

### CLASS 41—EDUCATION AND ENTERTAINMENT

FOR FAMILY FITNESS INSTRUCTION (U.S. CLS. 100, 101 AND 107).

### CLASS 42—SCIENTIFIC, COMPUTER AND LEGAL SERVICES

FOR FAMILY HEALTH AND FITNESS CONSULTATION (U.S. CLS. 100 AND 101).

---

SN 76-211,627. HAYDEN FERRY LAKESIDE, LLC, PHOENIX, AZ. FILED 2-16-2001.

## HAYDEN FERRY LAKESIDE

THE NAME "HAYDEN FERRY" DOES NOT IDENTIFY A LIVING INDIVIDUAL.

**CLASS 36—INSURANCE AND FINANCIAL**

FOR REAL ESTATE SERVICES IN THE FIELDS OF INVESTMENT BROKERAGE AND LAND ACQUISITION, LISTING, LEASING AND MANAGEMENT EQUITY SHARING, NAMELY, MANAGING AND ARRANGING CO-OWNERSHIP OF REAL ESTATE (U.S. CLS. 100, 101 AND 102).  
FIRST USE 6-9-2000; IN COMMERCE 6-9-2000.

**CLASS 37—CONSTRUCTION AND REPAIR**

FOR REAL ESTATE SITE SELECTION AND DEVELOPMENT (U.S. CLS. 100, 103 AND 106).  
FIRST USE 6-9-2000; IN COMMERCE 6-9-2000.

SN 76-212,358. MACE TRADEMARK CORP, BENNINGTON, VT. FILED 2-20-2001.



OWNER OF U.S. REG. NO. 1,778,643.

**CLASS 6—METAL GOODS**

FOR DOOR AND WINDOW AUXILIARY LOCK DEVICES IN THE NATURE OF A BAR MADE OF METAL (U.S. CLS. 2, 12, 13, 14, 23, 25 AND 50).  
FIRST USE 7-1-1991; IN COMMERCE 7-1-1991.

**CLASS 9—ELECTRICAL AND SCIENTIFIC APPARATUS**

FOR PERSONAL SECURITY ALARMS IN THE NATURE OF A PORTABLE SONIC SIREN (U.S. CLS. 21, 23, 26, 36 AND 38).  
FIRST USE 7-1-1991; IN COMMERCE 7-1-1991.

SN 76-213,317. CYBERSTATEU.COM, LAFAYETTE, CA. FILED 2-16-2001.

**LOGILENT**

**CLASS 41—EDUCATION AND ENTERTAINMENT**

FOR EDUCATIONAL SERVICES, NAMELY, CONDUCTING CLASSES, SEMINARS, AND WORKSHOPS IN THE FIELDS OF COMPUTER HARDWARE, COMPUTER SOFTWARE, COMPUTER SYSTEMS NETWORKING, TELECOMMUNICATIONS, AND INFORMATION PROCESSING (U.S. CLS. 100, 101 AND 107).

**CLASS 42—SCIENTIFIC, COMPUTER AND LEGAL SERVICES**

FOR PREPARING, ADMINISTERING, AND SCORING STANDARDIZED TESTS FOR INDIVIDUALS AND COMPANIES IN THE FIELDS OF COMPUTER HARDWARE, COMPUTER SOFTWARE, COMPUTER SYSTEMS NETWORKING, TELECOMMUNICATIONS, AND INFORMATION PROCESSING (U.S. CLS. 100 AND 101).

SN 76-215,520. USBANCORP, INC., JOHNSTOWN, PA. FILED 2-23-2001.



NO CLAIM IS MADE TO THE EXCLUSIVE RIGHT TO USE "FINANCIAL", APART FROM THE MARK AS SHOWN.

**CLASS 35—ADVERTISING AND BUSINESS**

FOR BUSINESS CONSULTATION SERVICES; ACCOUNTING SERVICES; INCOME TAX PREPARATION SERVICES; ASSET AND LIABILITY MANAGEMENT SERVICES (U.S. CLS. 100, 101 AND 102).

**CLASS 36—INSURANCE AND FINANCIAL**

FOR BANKING SERVICES; CORPORATE, INSTITUTIONAL AND PERSONAL TRUST SERVICES; FINANCIAL PLANNING AND PORTFOLIO MANAGEMENT; FINANCIAL GUARANTEE AND SURETY SERVICES; BROKERAGE IN THE FIELDS OF STOCKS, BONDS, COMMODITIES, INSURANCE, ANNUITIES AND MUTUAL FUNDS; MORTGAGE BANKING, LENDING AND BROKERAGE SERVICES; TRAVEL AGENCY SERVICES, NAMELY ISSUING TRAVELERS CHECKS; BUSINESS BROKERS; ESTATE ADMINISTRATION SERVICES; TITLE INSURANCE SERVICES; MAINTAINING MORTGAGE ESCROW ACCOUNTS; LOAN PROCESSING SERVICES; INSURANCE UNDERWRITING IN THE FIELD OF LIFE, HEALTH, ACCIDENT, MEDICAL AND PROPERTY; CREDIT LIFE REINSURANCE SERVICES; AND DEBT RECOVERY AND COLLECTION AGENCY SERVICES (U.S. CLS. 100, 101 AND 102).

**CLASS 39—TRANSPORTATION AND STORAGE**

FOR TRAVEL AGENCY SERVICES, NAMELY MAKING RESERVATIONS AND BOOKING FOR TRANSPORTATION (U.S. CLS. 100 AND 105).

**CLASS 42—SCIENTIFIC, COMPUTER AND LEGAL SERVICES**

FOR HOSTING THE WEBSITES OF OTHERS ON A COMPUTER SERVER FOR A GLOBAL COMPUTER NETWORK; PRINTING SERVICES; CONCIERGE SERVICES FOR OTHERS COMPRISING MAKING REQUESTED PERSONAL ARRANGEMENTS AND RESERVATIONS AND PROVIDING CUSTOMER-SPECIFIC INFORMATION TO MEET INDIVIDUAL NEEDS RENDERED TOGETHER IN A BANK; TRAVEL AGENCY SERVICES, NAMELY MAKING RESERVATIONS AND BOOKING FOR TEMPORARY LODGING (U.S. CLS. 100 AND 101).

SN 76-218,794. ROLAND CORPORATION, OSAKA, JAPAN, FILED 3-1-2001.

**SOUNDCanvas**

OWNER OF U.S. REG. NO. 2,226,755.

**CLASS 9—ELECTRICAL AND SCIENTIFIC APPARATUS**

FOR MUSIC SOUND GENERATORS AND MUSIC SOUND GENERATOR MODULES (U.S. CLS. 21, 23, 26, 36 AND 38).

FIRST USE 6-0-1991; IN COMMERCE 6-0-1991.

**CLASS 15—MUSICAL INSTRUMENTS**

FOR ELECTRONIC MUSICAL EQUIPMENT, NAMELY, KEYBOARDS AND SYNTHESIZERS (U.S. CLS. 2, 21 AND 36).

FIRST USE 6-0-1991; IN COMMERCE 6-0-1991.

SN 76-222,784. NORTH AMERICAN RETAIL DEALERS ASSOCIATION, LOMBARD, IL. FILED 3-12-2001.

**NARDA**

**CLASS 41—EDUCATION AND ENTERTAINMENT**

FOR EDUCATIONAL SERVICES, NAMELY, CONDUCTING BUSINESS CLASSES FOR RETAILERS AND DISTRIBUTORS OF HOME ELECTRONICS AND APPLIANCES (U.S. CLS. 100, 101 AND 107).

FIRST USE 7-12-1948; IN COMMERCE 7-12-1948.

**CLASS 42—SCIENTIFIC, COMPUTER AND LEGAL SERVICES**

FOR ASSOCIATION SERVICES, NAMELY PROMOTING THE INTERESTS OF MANUFACTURERS, RETAILERS, AND DISTRIBUTORS OF HOME ELECTRONICS AND APPLIANCES (U.S. CLS. 100 AND 101).

FIRST USE 7-12-1948; IN COMMERCE 7-12-1948.

SN 76-223,699. PARADIGM PACKAGING, INC., CARLSTADT, NJ. FILED 3-13-2001.

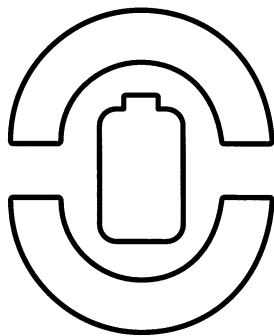
**CLASS 20—FURNITURE AND ARTICLES NOT OTHERWISE CLASSIFIED**

FOR PLASTIC CONTAINERS FOR MEDICATION, VITAMINS, AND NUTRITIONAL SUPPLEMENTS AND NON-METAL CLOSURES FOR CONTAINERS (U.S. CLS. 2, 13, 22, 25, 32 AND 50).

**CLASS 21—HOUSEWARES AND GLASS**

FOR MOLDED CONTAINERS FOR FOODS (U.S. CLS. 2, 13, 23, 29, 30, 33, 40 AND 50).

**CLASS 40—MATERIAL TREATMENT**

FOR CUSTOM MANUFACTURE OF PLASTIC CONTAINERS THROUGH EXTRUSION AND BLOW MOLDING (U.S. CLS. 100, 103 AND 106).

SN 76-224,156. CLARITY, LLC, TROY, MI. FILED 3-14-2001.

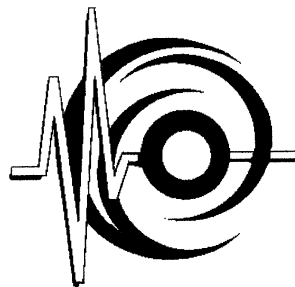
**CLASS 9—ELECTRICAL AND SCIENTIFIC APPARATUS**

FOR COMPUTER SOFTWARE FOR IMPROVING VOICE SIGNAL QUALITY AND THE INTELLIGIBILITY OF SPEECH CONTENT USED IN VOICE INTERFACE SYSTEMS, COMMAND AND CONTROL SYSTEMS, RADIO INTERCOM SYSTEMS, MICROPHONE SYSTEMS, WIRELESS COMMUNICATIONS SYSTEMS AND TELECOMMUNICATIONS SYSTEMS; TELECOMMUNICATIONS EQUIPMENT, NAMELY MICROPHONES AND DIGITAL SIGNAL PROCESSORS; MICROPHONE SYSTEMS COMPRISING A MICROPHONE UNIT AND DIGITAL SIGNAL PROCESSORS (U.S. CLS. 21, 23, 26, 36 AND 38).

**CLASS 35—ADVERTISING AND BUSINESS**

FOR LICENSING OF COMPUTER SOFTWARE FOR IMPROVING VOICE SIGNAL QUALITY AND THE INTELLIGIBILITY OF SPEECH CONTENT, FOR TELECOMMUNICATIONS, FOR VOICE INTERFACE SYSTEMS, FOR COMMAND AND CONTROL SYSTEMS, FOR RADIO INTERCOM SYSTEMS, FOR MICROPHONE SYSTEMS, AND FOR COMMUNICATIONS SYSTEMS (U.S. CLS. 100, 101 AND 102).

SN 76-226,302. ARAMARK EDUCATIONAL RESOURCES, INC., GOLDEN, CO. FILED 3-16-2001.

**SET YOUR MIND FREE**

**CLASS 16—PAPER GOODS AND PRINTED MATTER**

FOR BOOKMARKS AND POSTERS (U.S. CLS. 2, 5, 22, 23, 29, 37, 38 AND 50).

FIRST USE 12-1-2000; IN COMMERCE 12-1-2000.

**CLASS 41—EDUCATION AND ENTERTAINMENT**

FOR EDUCATIONAL SERVICES, NAMELY, CONDUCTING PROGRAMS IN THE FIELD OF READING AND LITERACY (U.S. CLS. 100, 101 AND 107).

FIRST USE 12-1-2000; IN COMMERCE 12-1-2000.

SN 76-226,458. ENVELOPE MANUFACTURERS ASSOCIATION FOUNDATION FOR PAPER-BASED COMMUNICATIONS, ALEXANDRIA, VA. FILED 3-20-2001.



NO CLAIM IS MADE TO THE EXCLUSIVE RIGHT TO USE "FOUNDATION FOR PAPER-BASED COMMUNICATIONS", APART FROM THE MARK AS SHOWN.

#### **CLASS 41—EDUCATION AND ENTERTAINMENT**

FOR EDUCATION SERVICES, NAMELY PROVIDING TRAINING COURSES AND COURSES OF INSTRUCTION IN THE FIELDS OF ENVELOPE DESIGN AND PRODUCTION AND PAPER-BASED MAIL COMMUNICATIONS SYSTEMS (U.S. CLS. 100, 101 AND 107).  
FIRST USE 1-1-2000; IN COMMERCE 1-1-2000.

#### **CLASS 42—SCIENTIFIC, COMPUTER AND LEGAL SERVICES**

FOR RESEARCH SERVICES, NAMELY, PROVIDING RESEARCH IN THE FIELDS OF ENVELOPE DESIGN AND PRODUCTION AND PAPER-BASED MAIL AND COMMUNICATIONS SYSTEMS (U.S. CLS. 100 AND 101).  
FIRST USE 1-1-2000; IN COMMERCE 1-1-2000.

SN 76-228,148. TOURTELLOTTE, JOHN E, SCOTTSDALE, AZ. FILED 3-22-2001.

## **DIPLOMATS WITHOUT BORDERS/DIPOMATES SANS FRONTIERES**

THE TRANSLATION OF "DIPOMATES SANS FRONTIERES" IS "DIPLOMATS WITHOUT BOARDERS".

#### **CLASS 41—EDUCATION AND ENTERTAINMENT**

FOR INDIVIDUAL AND GROUP COACHING IN THE FIELD OF GLOBAL LEADERSHIP AND GLOBAL LEADERSHIP CHANGES AND PRIVATE DIPLOMACY (U.S. CLS. 100, 101 AND 107).

#### **CLASS 42—SCIENTIFIC, COMPUTER AND LEGAL SERVICES**

FOR PRIVATE DIPLOMACY CONSULTING, NAMELY, ADVISING CONCERNING GLOBAL LEADERSHIP AND GLOBAL LEADERSHIP CHANGES AND PRIVATE DIPLOMACY (U.S. CLS. 100 AND 101).

SN 76-230,727. TREASURED MEMORIES, INC., VALRICO, FL. FILED 3-27-2001.



THE MARK CONSISTS OF THE WORDS "TREASURED MEMORIES" AND THE DESIGN OF A FLOWER.

#### **CLASS 41—EDUCATION AND ENTERTAINMENT**

FOR WEDDING PLANNING SERVICES (U.S. CLS. 100, 101 AND 107).  
FIRST USE 3-1-2000; IN COMMERCE 3-1-2000.

#### **CLASS 42—SCIENTIFIC, COMPUTER AND LEGAL SERVICES**

FOR WEDDING PHOTOGRAPHY SERVICES (U.S. CLS. 100 AND 101).  
FIRST USE 3-1-2000; IN COMMERCE 3-1-2000.

SN 76-232,492. BETTER COMFORT SYSTEMS, INC., MALDEN, MA. FILED 3-29-2001.

## **YOU CALL, WE'RE THERE**

#### **CLASS 35—ADVERTISING AND BUSINESS**

FOR RETAIL SERVICES, FEATURING, HEATING, VENTILATION, AIR-CONDITIONING AND HVAC PRODUCTS (U.S. CLS. 100, 101 AND 102).  
FIRST USE 12-12-1995; IN COMMERCE 2-15-2001.

#### **CLASS 37—CONSTRUCTION AND REPAIR**

FOR REPAIR, INSTALLATION AND MAINTENANCE OF HEATING, VENTILATION, AIR-CONDITIONING AND HVAC PRODUCTS (U.S. CLS. 100, 103 AND 106).  
FIRST USE 12-12-1995; IN COMMERCE 2-15-2001.

SN 76-233,263. ZYMEQUEST, INC., BEVERLY, MA. FILED 3-30-2001.

## **TRANSFORMING TRANSFUSION MEDICINE**

NO CLAIM IS MADE TO THE EXCLUSIVE RIGHT TO USE "TRANSFUSION MEDICINE", APART FROM THE MARK AS SHOWN.

#### **CLASS 5—PHARMACEUTICALS**

FOR CLINICAL MEDICAL RE-AGENTS FOR PROCESSING HUMAN AND ANIMAL BLOOD AND BLOOD COMPONENTS FOR USE IN BLOOD TRANSFUSIONS AND ANY EXTRACORPOREAL BLOOD PROCESSING STORED IN BAGS, BOTTLES, SYRINGES, AND OTHER SUCH CONTAINERS USED TO STORE SUCH SUBSTANCES IN THE MEDICAL FIELD (U.S. CLS. 6, 18, 44, 46, 51 AND 52).

**CLASS 10—MEDICAL APPARATUS**

FOR MEDICAL DEVICES, NAMELY, TUBING AND VALVE ASSEMBLY SETS AND ELECTROMECHANICAL FLUID INSTRUMENTS, AND OTHER SIMILAR OR RELATED DEVICES, THAT PROCESS HUMAN AND ANIMAL RED BLOOD CELLS AND BLOOD COMPONENTS WITH CLINICAL MEDICAL RE-AGENTS FOR THE PURPOSE OF CONVERTING AND CHEMICALLY MODIFYING BLOOD GROUPS AND OTHER BLOOD ANTIGENS AND ACTIVELY PROCESSING BLOOD AND BLOOD COMPONENTS FOR USE IN BLOOD TRANSFUSIONS AND OTHER USES IN THE MEDICAL, VETERINARY AND RESEARCH FIELDS (U.S. CLS. 26, 39 AND 44).

SN 76-234,599. E.K. SUCCESS, LTD., CLIFTON, NJ. FILED 4-3-2001.

**MOOVUE**

**CLASS 1—CHEMICALS**

FOR UNEXPOSED BLACK AND WHITE PHOTOGRAPHIC FILM (U.S. CLS. 1, 5, 6, 10, 26 AND 46). FIRST USE 1-9-2001; IN COMMERCE 1-9-2001.

**CLASS 40—MATERIAL TREATMENT**

FOR FILM PROCESSING AND PHOTO-FINISHING (U.S. CLS. 100, 103 AND 106). FIRST USE 1-9-2001; IN COMMERCE 1-9-2001.

SN 76-236,114. SHERRY, MARK, GRANADA HILLS, CA. FILED 4-6-2001.

**JAM BROTHERS**

NO CLAIM IS MADE TO THE EXCLUSIVE RIGHT TO USE "JAM", APART FROM THE MARK AS SHOWN.

**CLASS 9—ELECTRICAL AND SCIENTIFIC APPARATUS**

FOR SERIES OF PRERECORDED COMPACT DISCS, AUDIOCASSETTES AND PHONOGRAPH RECORDS FEATURING MUSICAL SOUND RECORDINGS (U.S. CLS. 21, 23, 26, 36 AND 38).

**CLASS 41—EDUCATION AND ENTERTAINMENT**

FOR ENTERTAINMENT, NAMELY LIVE PERFORMANCES BY A MUSICAL BAND (U.S. CLS. 100, 101 AND 107).

SN 76-236,999. COMPOSITE OPTICS, INCORPORATED, SAN DIEGO, CA. FILED 4-9-2001.

**COMPOSITE OPTICS, INCORPORATED**

NO CLAIM IS MADE TO THE EXCLUSIVE RIGHT TO USE "COMPOSITE" AND "INCORPORATED", APART FROM THE MARK AS SHOWN.

**CLASS 40—MATERIAL TREATMENT**

FOR CUSTOM MANUFACTURING OF ADVANCED COMPOSITE PRODUCTS FOR THE SPACE AND AEROSPACE INDUSTRIES (U.S. CLS. 100, 103 AND 106). FIRST USE 1-6-1976; IN COMMERCE 1-6-1976.

**CLASS 42—SCIENTIFIC, COMPUTER AND LEGAL SERVICES**

FOR DESIGN, ENGINEERING, AND TESTING OF ADVANCED COMPOSITE PRODUCTS FOR THE SPACE AND AEROSPACE INDUSTRIES (U.S. CLS. 100 AND 101). FIRST USE 1-6-1976; IN COMMERCE 1-6-1976.

SN 76-238,034. FAIRLEIGH DICKINSON UNIVERSITY, TEANECK, NJ. FILED 4-11-2001.

THE LEADER IN GLOBAL EDUCATION



NO CLAIM IS MADE TO THE EXCLUSIVE RIGHT TO USE "UNIVERSITY", APART FROM THE MARK AS SHOWN.

THE ENGLISH TRANSLATION OF "FORTITER ET SUAVITER" IS "BRAVELY AND PLEASURABLY".

**CLASS 41—EDUCATION AND ENTERTAINMENT**

FOR EDUCATION SERVICES IN THE NATURE OF COURSES AND OTHER INSTRUCTION AT THE POST-SECONDARY LEVEL (U.S. CLS. 100, 101 AND 107). FIRST USE 10-1-2000; IN COMMERCE 9-27-2000.

**CLASS 42—SCIENTIFIC, COMPUTER AND LEGAL SERVICES**

FOR ASSOCIATION SERVICES, NAMELY PROMOTING THE INTERESTS OF ALUMNI AND OTHER UNIVERSITY CONSTITUENTS (U.S. CLS. 100 AND 101). FIRST USE 10-1-2000; IN COMMERCE 9-27-2000.

SN 76-240,067. CHRISTIAN VIDEO LICENSING INTERNATIONAL, LLC, LOS ANGELES, CA. FILED 4-13-2001.

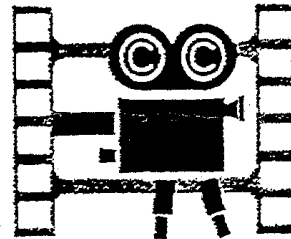

THE MARK CONSISTS OF THE DESIGN OF A FILM PROJECTOR RESTING UPON A TRIPOD OVER WHICH THERE ARE TWO REELS OF FILM, EACH BEARING THE LETTER "C". TO THE LEFT AND RIGHT OF THE FILM PROJECTOR ARE TWO STRIPS OF SEGMENTED FILM.



**CLASS 35—ADVERTISING AND BUSINESS**

FOR COPYRIGHT MANAGEMENT AND ADMINISTRATION SERVICES (U.S. CLS. 100, 101 AND 102).

SN 76-243,625. IMS PRODUCTS, INC., RIVERSIDE, CA. FILED 4-18-2001.

**IMS PRO SERIES**

OWNER OF U.S. REG. NOS. 2,308,727, 2,405,162 AND OTHERS.

NO CLAIM IS MADE TO THE EXCLUSIVE RIGHT TO USE "PRO SERIES", APART FROM THE MARK AS SHOWN.

**CLASS 42—SCIENTIFIC, COMPUTER AND LEGAL SERVICES**

FOR COPYRIGHT LICENSING SERVICES (U.S. CLS. 100 AND 101).

**CLASS 7—MACHINERY**

FOR MOTORCYCLE PARTS, NAMELY, ENGINE VALVES, CRANKSHAFT DISASSEMBLY PLATES BEING PART OF THE CRANKSHAFT, AND PISTON KITS COMPRISED OF PISTON RINGS, SIR CLIPS, WRIST PINS AND WRIST PIN BEARINGS (U.S. CLS. 13, 19, 21, 23, 31, 34 AND 35).

FIRST USE 9-25-1996; IN COMMERCE 9-25-1996.

SN 76-240,788. WAGERLOGIC LIMITED, STRFOVOLOS, NICOSIA, CYPRUS, FILED 4-13-2001.

**RAGS TO RICHES****CLASS 9—ELECTRICAL AND SCIENTIFIC APPARATUS**

FOR COMPUTER GAME SOFTWARE THAT MAY BE DOWNLOADED FROM A GLOBAL COMPUTER NETWORK (U.S. CLS. 21, 23, 26, 36 AND 38).

**CLASS 12—VEHICLES**

FOR MOTORCYCLE PARTS, NAMELY, AXLE BEARINGS, WHEEL BEARINGS, CLUTCHES, FOOTPEGS, BRAKE ROTOR PROTECTION GUARDS, CLUTCHES, HYDRAULIC CLUTCHES, OIL-LINE PROTECTION GUARDS, SHIFT LEVERS, UNIVERSAL BRAKE CABLE GUIDES AND MIRROR PIVOTS (U.S. CLS. 19, 21, 23, 31, 35 AND 44).

FIRST USE 9-25-1996; IN COMMERCE 9-25-1996.

**CLASS 42—SCIENTIFIC, COMPUTER AND LEGAL SERVICES**

FOR PROVIDING TEMPORARY USE OF ON-LINE DOWNLOADABLE GAME SOFTWARE (U.S. CLS. 100 AND 101).

SN 76-243,954. HORTEX, INCORPORATED, DENVER, CO. FILED 4-20-2001.

SN 76-241,739. UCB, S.A., B-1070 BRUSSELS, BELGIUM, FILED 4-16-2001.

**ALLERGY ONE**

NO CLAIM IS MADE TO THE EXCLUSIVE RIGHT TO USE "ALLERGY", APART FROM THE MARK AS SHOWN.

**CLASS 16—PAPER GOODS AND PRINTED MATTER**

FOR PRINTED PUBLICATIONS, NAMELY BOOKLETS, BROCHURES, BINDER KITS AND PRINTED SLIDE KITS, ALL ON THE TOPIC OF ALLERGIES AND ALLERGY TREATMENT (U.S. CLS. 2, 5, 22, 23, 29, 37, 38 AND 50).

FIRST USE 1-12-2001; IN COMMERCE 1-12-2001.

**CLASS 16—PAPER GOODS AND PRINTED MATTER**

FOR STICKER BOOKS, STICKERS (U.S. CLS. 2, 5, 22, 23, 29, 37, 38 AND 50).

**CLASS 41—EDUCATION AND ENTERTAINMENT**

FOR EDUCATIONAL SERVICES, NAMELY WORKSHOPS AND LECTURES FOR PHYSICIANS ON THE TOPIC OF ALLERGIES AND ALLERGY TREATMENT (U.S. CLS. 100, 101 AND 107).

FIRST USE 1-12-2001; IN COMMERCE 1-12-2001.

**CLASS 25—CLOTHING**

FOR CLOTHING, NAMELY, HEADWEAR, SHIRTS, PANTS, SHORTS, AND UNDERGARMENTS (U.S. CLS. 22 AND 39).

**CLASS 28—TOYS AND SPORTING GOODS**

FOR FULL LINE OF TOYS, GAMES AND PLAYTHINGS (U.S. CLS. 22, 23, 38 AND 50).

**CLASS 41—EDUCATION AND ENTERTAINMENT**

FOR ENTERTAINMENT SERVICES, NAMELY, PROVIDING A WEB SITE OF ON LINE ENTERTAINMENT FOR CHILDREN FEATURING MEMORY GAMES, MANIPULATIVE PUZZLES, JIG SAW PUZZLES, COLORING BOOKS, GREETING CARDS, POSTERS, SCREEN SAVERS, AND INTERACTIVE STORY BOOKS (U.S. CLS. 100, 101 AND 107).

SN 76-244,097. OSBORNE Y CIA S.A., 11500, PUERTO DE SANTA MARIA (CADIZ), SPAIN, FILED 4-23-2001.

**THE PASSION OF SPAIN**

NO CLAIM IS MADE TO THE EXCLUSIVE RIGHT TO USE "SPAIN", APART FROM THE MARK AS SHOWN.

**CLASS 33—WINES AND SPIRITS**

FOR WINES, BRANDY, DISTILLED SPIRITS MADE FROM FRUIT, DISTILLED SPIRITS, PORT WINES, SHERRY AND LIQUEURS (U.S. CLS. 47 AND 49).

**CLASS 35—ADVERTISING AND BUSINESS**

FOR FRANCHISING, NAMELY, OFFERING TECHNICAL ASSISTANCE IN THE ESTABLISHMENT AND/OR OPERATION OF BARS AND RESTAURANTS (U.S. CLS. 100, 101 AND 102).

SN 76-244,592. GODSPEAKS, INC., ATLANTA, GA. FILED 4-23-2001.

**GODSPEAKS****CLASS 16—PAPER GOODS AND PRINTED MATTER**

FOR PAPER GOODS AND PRINTED MATTER, NAMELY, A SERIES OF NON-FICTION AND FICTION BOOKS AND JOURNALS IN THE FIELD OF RELIGION AND SPIRITUAL MATTERS; POSTERS; AND PRINTED SIGNS (U.S. CLS. 2, 5, 22, 23, 29, 37, 38 AND 50).

FIRST USE 7-1-1999; IN COMMERCE 9-1-1999.

**CLASS 25—CLOTHING**

FOR CLOTHING AND APPAREL, NAMELY, T-SHIRTS (U.S. CLS. 22 AND 39).

FIRST USE 3-1-2000; IN COMMERCE 3-1-2000.

SN 76-245,107. BLG ENTERPRISES, INC., PASCOAG, RI. FILED 4-24-2001.

**THE DISMANTLER****CLASS 7—MACHINERY**

FOR POWER OPERATED WRENCHES FOR TIGHTENING AND LOOSENING FASTENERS (U.S. CLS. 13, 19, 21, 23, 31, 34 AND 35).

**CLASS 8—HAND TOOLS**

FOR MANUALLY OPERATED WRENCHES FOR TIGHTENING AND LOOSENING FASTENERS (U.S. CLS. 23, 28 AND 44).

SN 76-245,609. TMB PRODUCTIONS, PALISADES, NY. FILED 4-24-2001.

**THEY MIGHT BE GIANTS**

OWNER OF U.S. REG. NO. 1,643,976.

**CLASS 9—ELECTRICAL AND SCIENTIFIC APPARATUS**

FOR MUSICAL SOUND RECORDINGS, MUSICAL VIDEO RECORDINGS AND MOUSE PADS (U.S. CLS. 21, 23, 26, 36 AND 38).

FIRST USE 3-0-1986; IN COMMERCE 3-0-1986.

**CLASS 25—CLOTHING**

FOR T-SHIRTS AND HATS (U.S. CLS. 22 AND 39).

FIRST USE 1-0-1987; IN COMMERCE 1-0-1987.

SN 76-247,708. HUTCHINS-LOGUE, INC., LOS GATOS, CA. FILED 4-27-2001.

**GREEN ZEBRA****CLASS 29—MEATS AND PROCESSED FOODS**

FOR SNACK MIX CONSISTING PRIMARILY OF PROCESSED FRUITS, PROCESSED NUTS AND/OR RAISINS; CHEESE SPREADS, NUT-BASED SPREADS, AND FRUIT-BASED SPREADS; PROTEIN BASED, NUTRIENT-DENSE SNACK BARS (U.S. CL. 46).

**CLASS 30—STAPLE FOODS**

FOR SNACK MIX CONSISTING PRIMARILY OF CRACKERS, PRETZELS AND /OR CANDIED NUTS; COOKIES AND CRACKERS (U.S. CL. 46).

SN 76-248,628. INGHAM, JEFF, ENCINITAS, CA. FILED 4-30-2001.

**NATURE'S HEALING PRODUCTS**

OWNER OF U.S. REG. NO. 2,329,526.

NO CLAIM IS MADE TO THE EXCLUSIVE RIGHT TO USE "HEALING PRODUCTS", APART FROM THE MARK AS SHOWN.

**CLASS 3—COSMETICS AND CLEANING PREPARATIONS**

FOR SKIN CARE PRODUCTS, NAMELY, SOAP FOR PERSONAL USE, FACE MASQUES, BODY POWDER, CLEANSERS FOR THE FACE, HANDS AND BODY, BODY SCRUBS, ESSENTIAL BODY OILS, SUN SCREEN AND SUN BLOCK PREPARATIONS, SPA TREATMENTS, BEAUTY MASKS, SHOWER GELS, BATH OIL, PERFUMED SOAP, ROOM FRAGRANCES, HERBAL SKIN CARE PRODUCTS, HERBAL CREAM, HERBAL MASSAGE OIL, HERBAL FACE CLEANSER, AND HERBAL BATH OIL (U.S. CLS. 1, 4, 6, 50, 51 AND 52).

FIRST USE 2-8-1999; IN COMMERCE 4-24-1999.

**CLASS 25—CLOTHING**

FOR CLOTHING, NAMELY, T-SHIRTS, SPORTS SHIRTS, SWEATSHIRTS, SHORTS, PANTS, CAPS AND HEADWEAR (U.S. CLS. 22 AND 39).

FIRST USE 2-8-1999; IN COMMERCE 4-24-1999.

SN 76-249,911. BOEHRINGER INGELHEIM INTERNATIONAL GMBH, 55216 INGELHEIM AM RHEIN, FED REP GERMANY, FILED 5-2-2001.

**MENOPRET**

OWNER OF FED REP GERMANY REG. NO. 30049922, DATED 7-5-2000, EXPIRES 7-31-2010.

**CLASS 5—PHARMACEUTICALS**

FOR PHARMACEUTICAL PREPARATIONS FOR THE TREATMENT OF PREMENSTRUAL AND CLIMACTERIAL SYMPTOMS, DIETARY SUPPLEMENTS FOR MEDICINAL PURPOSES; PLANT DERIVED FOOD SUPPLEMENTS FOR NON-MEDICAL PURPOSES (U.S. CLS. 6, 18, 44, 46, 51 AND 52).

**CLASS 29—MEATS AND PROCESSED FOODS**

FOR PLANT DERIVED FOOD ADDITIVES FOR NON-NUTRITIONAL PURPOSES FOR USE AS A FLAVORING, INGREDIENT OR FILLER (U.S. CL. 46).

SN 76-250,197. BEAUCRE MERCHANDISING CO., LTD., SEOUL, REPUBLIC OF KOREA, FILED 5-3-2001.

**ON & ON****CLASS 18—LEATHER GOODS**

FOR HANDBAGS, SUITCASES, WALLETS (NOT MADE OF PRECIOUS METALS), KEY CASES (MADE OF LEATHER), TRAVELING BAGS, BRIEFCASES, OPERA BAGS, RUCKSACKS, UMBRELLAS AND PARASOLS (U.S. CLS. 1, 2, 3, 22 AND 41).

**CLASS 25—CLOTHING**

FOR SUITS, SKIRTS, JACKETS, TROUSERS, SLACKS, DRESS SHIRTS, OVERCOATS, RAINCOATS, CARDIGANS, SWEATERS, VESTS, T-SHIRTS, BLOUSES, NEG-LIGES, UNDERSHIRTS, SWIMSUITS, SOCKS, STOCKINGS, SHAWLS, SCARVES, GLOVES, HATS AND CAPS, SUSPENDERS FOR CLOTHING, BELTS FOR CLOTHING, SHOES, SANDALS AND BOOTS (U.S. CLS. 22 AND 39).

SN 76-250,977. WOOD CONNECTION, INC., MODESTO, CA. FILED 4-30-2001.

**WOOD CONNECTION, INC.**

NO CLAIM IS MADE TO THE EXCLUSIVE RIGHT TO USE "WOOD" OR "INC.", APART FROM THE MARK AS SHOWN.

**CLASS 19—NON-METALLIC BUILDING MATERIALS**

FOR ARTICLES OF WOOD, NAMELY, TRIM, DOOR FRAMES, AND WINDOW FRAMES (U.S. CLS. 1, 12, 33 AND 50).

FIRST USE 1-2-1990; IN COMMERCE 1-27-1995.

**CLASS 20—FURNITURE AND ARTICLES NOT OTHERWISE CLASSIFIED**

FOR ARTICLES OF WOOD IN THE NATURE OF FURNITURE, NAMELY CABINETS, COUNTERS, COUNTER TOPS, COMPUTER PODIUMS, PICTURE FRAMES, AND STORE FIXTURES IN THE NATURE OF DISPLAY CABINETS AND CASH REGISTER STANDS (U.S. CLS. 2, 13, 22, 25, 32 AND 50).

FIRST USE 1-2-1990; IN COMMERCE 1-27-1995.

SN 76-251,574. 4LANE DIGITAL, INC., BURLINGTON, VT. FILED 5-4-2001.

**4LANE DIGITAL**

NO CLAIM IS MADE TO THE EXCLUSIVE RIGHT TO USE "DIGITAL", APART FROM THE MARK AS SHOWN.

**CLASS 38—COMMUNICATION**

FOR OPERATION OF TELECOMMUNICATIONS NETWORKS FOR PUBLISHERS (U.S. CLS. 100, 101 AND 104).

FIRST USE 11-28-2000; IN COMMERCE 11-28-2000.

**CLASS 42—SCIENTIFIC, COMPUTER AND LEGAL SERVICES**

FOR DESIGNING ELECTRONIC MEDIA SYSTEMS, NAMELY, WEBSITES, ELECTRONIC PUBLISHING AND DATABASES, FOR PUBLISHERS; HOSTING THE WEBSITES OF PUBLISHERS; MAINTENANCE AND MONITORING OF WEBSITES FOR PUBLISHERS (U.S. CLS. 100 AND 101).

FIRST USE 11-28-2000; IN COMMERCE 11-28-2000.

SN 76-255,011. A A CARBIDES, INC., SALT LAKE CITY, UT. FILED 5-10-2001.

SN 76-256,408. COALITION FOR RESPONSIBLE TOBACCO RETAILING, ALEXANDRIA, VA. FILED 5-11-2001.

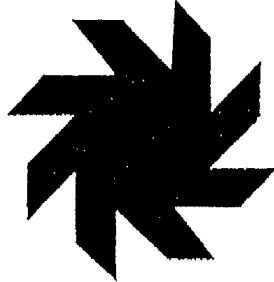

**CLASS 35—ADVERTISING AND BUSINESS**

FOR RETAIL STORE SERVICES FEATURING POWER TOOLS AND POWER TOOL PARTS (U.S. CLS. 100, 101 AND 102).

FIRST USE 5-1-1974; IN COMMERCE 5-1-1974.

**CLASS 37—CONSTRUCTION AND REPAIR**

FOR REPAIR SERVICES, NAMELY, POWER TOOL AND POWER TOOL PART REPAIR SERVICES (U.S. CLS. 100, 103 AND 106).

FIRST USE 5-1-1974; IN COMMERCE 5-1-1974.



SN 76-256,343. STAPLES, THELMA, HILLSIDE, NJ. FILED 5-14-2001.

**Y NOT B SAVED**

**CLASS 25—CLOTHING**

FOR APPAREL, NAMELY, SHIRTS, T-SHIRTS, BLOUSES, SWEATPANTS, PANTS, JACKETS, COATS, LEGGINGS, SHORTS, CAPS AND HATS (U.S. CLS. 22 AND 39).

**CLASS 42—SCIENTIFIC, COMPUTER AND LEGAL SERVICES**

FOR ONE-ON-ONE RELIGIOUS COUNSELING (U.S. CLS. 100 AND 101).

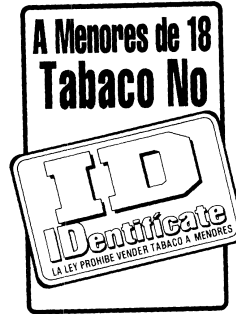

OWNER OF U.S. REG. NOS. 2,303,225 AND 2,351,107.  
NO CLAIM IS MADE TO THE EXCLUSIVE RIGHT TO USE "ID IDENTIFICATE", "A MENORES DE 18 TABACO NO" OR "LA LEY PROHIBE VENDER TABACO A MENORES", APART FROM THE MARK AS SHOWN.

THE ENGLISH TRANSLATION OF "A MENORES DE 18 TABACO NO ID IDENTIFICATE LA LEY PROHIBE VENDER TABACO A MENORES" IS "UNDER 18 NO TOBACCO. WE CARD, THE LAW PROHIBITS THE SALE OF TOBACCO TO MINORS".

**CLASS 41—EDUCATION AND ENTERTAINMENT**

FOR EDUCATIONAL SERVICES, NAMELY, SEMINARS AND TRAINING WORKSHOPS FOR TOBACCO RETAILERS AND THEIR EMPLOYEES ON THE LAWS PROHIBITING SALES OF TOBACCO TO MINORS AND TECHNIQUES FOR COMPLYING WITH SUCH LAWS, AND DISTRIBUTION OF COURSE MATERIAL IN CONNECTION THEREWITH (U.S. CLS. 100, 101 AND 107).

FIRST USE 9-1-2000; IN COMMERCE 9-1-2000.

**CLASS 42—SCIENTIFIC, COMPUTER AND LEGAL SERVICES**

FOR PROMOTION OF RESPONSIBLE RETAILING AND RETAILER'S AWARENESS OF AND COMPLIANCE WITH THE LAWS PROHIBITING SALES OF TOBACCO TO MINORS (U.S. CLS. 100 AND 101).

FIRST USE 9-1-2000; IN COMMERCE 9-1-2000.



SN 76-256,863. WRIGHT EXPRESS LLC, SOUTH PORTLAND, ME. FILED 5-14-2001.

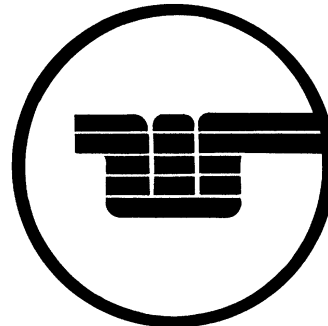

OWNER OF U.S. REG. NOS. 1,743,484 AND 2,353,883.

**CLASS 35—ADVERTISING AND BUSINESS**

FOR MANAGEMENT INFORMATION SERVICES, INVOLVING THE COLLECTION AND REPORTING OF FUELING AND OTHER PURCHASE DATA ASSOCIATED WITH FLEET VEHICLE USAGE (U.S. CLS. 100, 101 AND 102).

FIRST USE 2-22-1999; IN COMMERCE 2-22-1999.

**CLASS 36—INSURANCE AND FINANCIAL**

FOR COMMERCIAL FLEET CREDIT CARD SERVICES (U.S. CLS. 100, 101 AND 102).

FIRST USE 2-22-1999; IN COMMERCE 2-22-1999.

SN 76-257,552. NAUTILUS INTERNATIONAL (CAYMAN) LIMITED, SEVEN MILE BEACH, CAYMAN ISLANDS, FILED 9-5-2000.



NO CLAIM IS MADE TO THE EXCLUSIVE RIGHT TO USE "STURDY", APART FROM THE MARK AS SHOWN.

**CLASS 9—ELECTRICAL AND SCIENTIFIC APPARATUS**

FOR SAFETY EQUIPMENT, NAMELY, SAFETY SHOES AND BOOTS, PROTECTIVE GLOVES, HARD HATS (U.S. CLS. 21, 23, 26, 36 AND 38).

**CLASS 25—CLOTHING**

FOR WORK CLOTHING, NAMELY, COVERALLS (U.S. CLS. 22 AND 39).

SN 76-258,031. FONDAREX SA, 1806 ST. LEGIER, SWITZERLAND, FILED 5-16-2001.

**VACUREX**

PRIORITY CLAIMED UNDER SEC. 44(D) ON SWITZERLAND APPLICATION NO. 01435/2001, FILED 2-9-2001, REG. NO. 482408, DATED 3-7-2001, EXPIRES 2-9-2011.

**CLASS 7—MACHINERY**

FOR VACUUM MACHINES FOR HIGH PRESSURE DIE CAST MOLDINGS, LOW PRESSURE DIE CAST MOLDINGS, SAND MOLDING, METAL CASTING, AND COMPONENT PARTS THEREFOR; VACUUM MACHINES FOR PLASTIC INJECTION MOLDING AND COMPONENT PARTS THEREFOR; CONVEYORS FOR MOLTEN METAL, NAMELY, FOR THE AUTOMATIC FEEDING OF FOUNDRY MACHINES AND COMPONENT PARTS THEREFOR; AND PRESSURIZED MOLDING AND CASTING MACHINES AND COMPONENT PARTS THEREFOR (U.S. CLS. 13, 19, 21, 23, 31, 34 AND 35).

**CLASS 9—ELECTRICAL AND SCIENTIFIC APPARATUS**

FOR ELECTRICAL CONTROLLERS FOR VACUUM MACHINES FOR HIGH PRESSURE DIE CAST MOLDING, LOW PRESSURE DIE CAST MOLDINGS, SAND MOLDING, AND METAL CASTING, VACUUM MACHINES FOR PLASTIC INJECTION MOLDING, CONVEYORS FOR MOLTEN METAL AND PRESSURIZED MOLDING AND CASTING MACHINES (U.S. CLS. 21, 23, 26, 36 AND 38).

SN 76-259,690. YIHUA INTERNATIONAL GROUP (U.S.A.) INC., CITY OF INDUSTRY, CA. FILED 5-21-2001.



THE WORDING "YI HUA" IN CHINESE MEANS "COMFORT AND ELEGANT".

**CLASS 19—NON-METALLIC BUILDING MATERIALS**

FOR FLOORING MATERIALS MADE OF WOOD OR BAMBOO (U.S. CLS. 1, 12, 33 AND 50).

FIRST USE 12-1-2000; IN COMMERCE 12-1-2000.

**CLASS 20—FURNITURE AND ARTICLES NOT OTHERWISE CLASSIFIED**

FOR FURNITURE, PICTURE FRAMES AND WOOD SCREENS (U.S. CLS. 2, 13, 22, 25, 32 AND 50).

FIRST USE 12-1-2000; IN COMMERCE 12-1-2000.

SN 76-260,237. BE HERE CORPORATION, CUPERTINO, CA. FILED 5-17-2001.

**TOTALVIEW****CLASS 9—ELECTRICAL AND SCIENTIFIC APPARATUS**

FOR CAMERA LENSES; COMPUTER HARDWARE; COMPUTER SOFTWARE FOR RECEIVING, PROCESSING, MANIPULATING, COMPRESSING, DECOMPRESSING AND EDITING IMAGES; COMPUTER SOFTWARE FOR MANIPULATING, COMPRESSING AND DECOMPRESSING IMAGES FOR TRANSMISSION (U.S. CLS. 21, 23, 26, 36 AND 38).

**CLASS 41—EDUCATION AND ENTERTAINMENT**

FOR VIDEO CINEMATOGRAPHIC, PHOTOGRAPHIC AND COMPUTER IMAGE PRODUCTION AND POST-PRODUCTIONS SERVICES, NAMELY, VIDEO RECORDING, EDITING, AND IMAGE ENHANCEMENT AND MANIPULATION (U.S. CLS. 100, 101 AND 107).

SN 76-260,795. NATIONAL BRAIN TUMOR FOUNDATION, OAKLAND, CA. FILED 5-21-2001.

### ANGEL ADVENTURE

#### CLASS 36—INSURANCE AND FINANCIAL

FOR CHARITABLE FUNDRAISING SERVICES FOR BRAIN TUMOR PATIENTS, FAMILIES, AND RESEARCH (U.S. CLS. 100, 101 AND 102). FIRST USE 3-31-2000; IN COMMERCE 3-31-2000.

#### CLASS 41—EDUCATION AND ENTERTAINMENT

FOR ORGANIZING AND CONDUCTING COMMUNITY WALKING AND RUNNING EVENTS FOR BRAIN TUMOR PATIENTS, FAMILIES, AND RESEARCH (U.S. CLS. 100, 101 AND 107). FIRST USE 3-31-2000; IN COMMERCE 3-31-2000.

SN 76-262,955. SUBSTANCE ABUSE MANAGEMENT, INC., MILWAUKEE, WI. FILED 5-23-2001.

### ESAMI

#### CLASS 35—ADVERTISING AND BUSINESS

FOR MANAGEMENT OF DRUG TESTING PROGRAMS FOR OTHERS; ON-LINE RETAIL STORE SERVICES FEATURING EDUCATIONAL MATERIALS IN THE FIELD OF DRUG AND ALCOHOL TESTING SERVICES FOR SUBSTANCE ABUSE (U.S. CLS. 100, 101 AND 102).

#### CLASS 41—EDUCATION AND ENTERTAINMENT

FOR EDUCATIONAL SERVICES, NAMELY, CONDUCTING COURSES, SEMINARS AND CONFERENCES IN THE FIELD OF DRUG AND ALCOHOL TESTING SERVICES FOR SUBSTANCE ABUSE (U.S. CLS. 100, 101 AND 107).

#### CLASS 42—SCIENTIFIC, COMPUTER AND LEGAL SERVICES

FOR COMPUTER SERVICES, NAMELY, PROVIDING DATA BASES IN THE FIELD OF DRUG AND ALCOHOL TESTING SERVICES FOR SUBSTANCE ABUSE (U.S. CLS. 100 AND 101).

SN 76-262,956. SUBSTANCE ABUSE MANAGEMENT, INC., MILWAUKEE, WI. FILED 5-23-2001.



#### CLASS 35—ADVERTISING AND BUSINESS

FOR MANAGEMENT OF DRUG TESTING PROGRAMS FOR OTHERS; ON-LINE RETAIL STORE SERVICES FEATURING EDUCATIONAL MATERIALS IN THE FIELD OF DRUG AND ALCOHOL TESTING SERVICES FOR SUBSTANCE ABUSE (U.S. CLS. 100, 101 AND 102).

#### CLASS 41—EDUCATION AND ENTERTAINMENT

FOR EDUCATIONAL SERVICES, NAMELY, CONDUCTING COURSES, SEMINARS AND CONFERENCES IN THE FIELD OF DRUG AND ALCOHOL TESTING SERVICES FOR SUBSTANCE ABUSE (U.S. CLS. 100, 101 AND 107).

#### CLASS 42—SCIENTIFIC, COMPUTER AND LEGAL SERVICES

FOR COMPUTER SERVICES, NAMELY, PROVIDING DATA BASES IN THE FIELD OF DRUG AND ALCOHOL TESTING SERVICES FOR SUBSTANCE ABUSE (U.S. CLS. 100 AND 101).

SN 76-263,383. WOOD CONNECTION, INC., MODESTO, CA. FILED 5-29-2001.

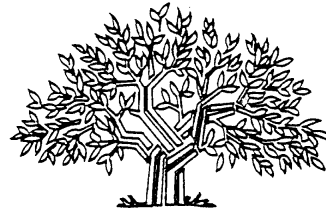

#### CLASS 19—NON-METALLIC BUILDING MATERIALS

FOR ARTICLES OF WOOD, NAMELY, TRIM, DOOR FRAMES, WINDOW FRAMES (U.S. CLS. 1, 12, 33 AND 50). FIRST USE 4-23-2001; IN COMMERCE 4-23-2001.

#### CLASS 20—FURNITURE AND ARTICLES NOT OTHERWISE CLASSIFIED

FOR ARTICLES OF WOOD IN THE NATURE OF FURNITURE, NAMELY CABINETS, COUNTERS, COUNTER TOPS, COMPUTER PODIUMS, PICTURE FRAMES, AND STORE FIXTURES IN THE NATURE OF DISPLAY CABINETS AND CASH REGISTER STANDS (U.S. CLS. 2, 13, 22, 25, 32 AND 50). FIRST USE 4-23-2001; IN COMMERCE 4-23-2001.

SN 76-264,512. BROADCAST MANAGER, INC., NEW YORK, NY. FILED 5-31-2001.



NO CLAIM IS MADE TO THE EXCLUSIVE RIGHT TO USE "VIEWEREMAIL.COM", APART FROM THE MARK AS SHOWN. THE LINING AND STIPLING ARE FEATURES OF THE MARK AND DO NOT INDICATE COLOR.

**CLASS 35—ADVERTISING AND BUSINESS**

FOR COMPUTERIZED DATABASE MANAGEMENT IN THE NATURE OF ON-LINE DATABASE COLLECTION SERVICES FOR THE TELEVISION INDUSTRY (U.S. CLS. 100, 101 AND 102).

FIRST USE 10-1-2000; IN COMMERCE 10-1-2000.

**CLASS 38—COMMUNICATION**

FOR ELECTRONIC MAIL SERVICES (U.S. CLS. 100, 101 AND 104).

FIRST USE 10-1-2000; IN COMMERCE 10-1-2000.

SN 76-268,080. BLITZ DISTRIBUTION, INC., HUNTINGTON BEACH, CA. FILED 6-6-2001.

**THE FIRM UNITED****CLASS 16—PAPER GOODS AND PRINTED MATTER**

FOR DECALS, STICKERS AND PAPER BANNERS (U.S. CLS. 2, 5, 22, 23, 29, 37, 38 AND 50).

FIRST USE 5-1-2000; IN COMMERCE 6-1-2000.

**CLASS 25—CLOTHING**

FOR CLOTHING, NAMELY, T-SHIRTS, WOVEN SHIRTS, PANTS, SHORTS, HEADWEAR, FOOTWEAR AND BELTS (U.S. CLS. 22 AND 39).

FIRST USE 5-1-2000; IN COMMERCE 6-1-2000.

**CLASS 28—TOYS AND SPORTING GOODS**

FOR SKATEBOARDS, SKATEBOARD ACCESSORIES SOLD SEPARATELY, NAMELY, WHEELS, TRUCKS, BEARINGS AND MOUNTS (U.S. CLS. 22, 23, 38 AND 50).

FIRST USE 5-1-2000; IN COMMERCE 6-1-2000.

SN 76-268,309. TI GROUP AUTOMOTIVE SYSTEMS CORPORATION, WARREN, MI. FILED 6-7-2001.

**TI Automotive**

NO CLAIM IS MADE TO THE EXCLUSIVE RIGHT TO USE "AUTOMOTIVE", APART FROM THE MARK AS SHOWN.

**CLASS 6—METAL GOODS**

FOR COLD ROLLED STEEL, MAGNETIC SHIELDING STEEL, COPPER COATED STEEL AND NICKEL COATED STEEL IN STRIP AND SHEET FORM FOR USE IN FURTHER MANUFACTURE OR CONSTRUCTION; METAL STRUCTURAL FORMS, NAMELY, SPACE FRAMES, METAL TUBES, INSTRUMENT PANEL BEAMS, RADIATOR CLOSURES AND ENGINE CRADLES; METAL FLUID LINES AND TUBES; COUPLINGS, QUICK CONNECTORS AND FITTINGS FOR FLUID LINES AND HOSES; METAL FUEL, OIL, BRAKE FLUID AND COOLANT HOSES (U.S. CLS. 2, 12, 13, 14, 23, 25 AND 50).

**CLASS 7—MACHINERY**

FOR PARTS AND ACCESSORIES FOR ENGINES, NAMELY, DIAPHRAGM CARBURETORS, ROTARY CARBURETORS AND FLOAT BOWL CARBURETORS, IGNITION UNITS, FUEL INJECTION UNITS, FUEL RAILS, PUSH RODS, CHAIN OILERS, MIXING OIL PUMPS, AIR FILTER UNITS, FUEL FILTER UNITS, AIR PURGE UNITS, FUEL TANKS, AND FUEL PUMPS; CHAIN OILERS FOR POWER CHAIN SAWS, AND PARTS AND ACCESSORIES FOR VEHICLES, NAMELY, AIR FILTER UNITS, FUEL FILTER UNITS, AIR PURGE UNITS, FUEL TANK UNITS, BELLOWS PUMPS, REFRIGERATION PUMPS, FUEL PUMPS, FUEL MODULES, FUEL LINES, OIL COOLERS; AND PARTS AND COMPONENTS FOR ALL OF THE ABOVE (U.S. CLS. 13, 19, 21, 23, 31, 34 AND 35).

**CLASS 11—ENVIRONMENTAL CONTROL APPARATUS**

FOR COMMERCIAL DOMESTIC, INDUSTRIAL, RESIDENTIAL AND VEHICLE AIR CONDITIONING, HEATING, FREEZING AND REFRIGERATION UNITS, NAMELY, COLD WALL EVAPORATORS, NO-FROST EVAPORATORS, ROLL-BOND EVAPORATORS, CHEST FREEZER EVAPORATORS, AIR CONDITIONING EVAPORATORS, EVAPORATORS, FREEZER SHELF UNITS, FREEZER CONDENSERS, WAVELINE CONDENSERS, STATIC CONDENSERS, DYNAMIC CONDENSERS, HOT WALL CONDENSERS, CONDENSERS, ACCUMULATORS, HEAT EXCHANGERS, DOOR WARMERS, SHOCK LOOPS, SUCTION AND DISCHARGE PIPES, COMPRESSORS, INTERNAL OIL COOLERS, OIL SUPPLY TUBES, TRUCK REFRIGERATION PUMPS, HEATER UNITS, OIL COOLING UNITS; AND PARTS AND COMPONENTS FOR ALL OF THE ABOVE (U.S. CLS. 13, 21, 23, 31 AND 34).

**CLASS 12—VEHICLES**

FOR HYDRO-FORMED AUTOMOTIVE STRUCTURAL PARTS; VEHICLE STRUCTURAL PARTS, NAMELY, INSTRUMENT PANEL BEAMS, RADIATOR CLOSURES, ENGINE CRADLES, SPACE FRAMES, TUBES; VEHICLE ENGINE PARTS, NAMELY, DIAPHRAGM CARBURETORS, ROTARY CARBURETORS, FLOAT BOWL CARBURETORS, CARBURETORS, FUEL IGNITION UNITS, INJECTION UNITS, MIXING OIL PUMPS, AIR FILTER ASSEMBLIES, FUEL FILTER ASSEMBLIES, AIR PURGE UNITS, FUEL RAILS, DIESEL FUEL TUBING, PUSH RODS; VEHICLES PARTS AND ACCESSORIES, NAMELY, FUEL TANK UNITS, PLASTIC FUEL TANKS, FILLER NECKS, FUEL PUMP MODULES, FUEL PUMPS, TRANSMISSION OIL COOLERS, ENGINE OIL COOLERS, BELLOWS PUMPS, TRUCK REFRIGERATION PUMPS, FLEXIBLE EXHAUST COUPLINGS, RECEIVERS, DRYERS, ACCUMULATORS, HEATER UNITS, POWER STEERING UNITS, BRAKES, ABS/ESP UNITS, RADIATOR HOSES, HEATER HOSES, AIR CONDITIONING HOSES, FUEL LINES, VAPOR LINES, OIL LINES, COOLANT LINES, AND BRAKE LINES INCLUDING RIGID AND FLEXIBLE TUBES AND HOSES AND COUPLINGS, CONNECTORS, FITTINGS AND BUNDLES THEREFOR; AND PARTS AND COMPONENTS FOR ALL OF THE ABOVE (U.S. CLS. 19, 21, 23, 31, 35 AND 44).

**CLASS 17—RUBBER GOODS**

FOR NON-METAL RIGID AND FLEXIBLE LINES AND HOSES FOR AIR, COOLANT, FUEL VAPOR, IDOL, BRAKE, TRANSMISSION, POWER STEERING, REFRIGERANT AND OTHER FLUIDS IN VEHICLES; AND COUPLINGS, CONNECTORS AND FITTING FOR ALL OF THE ABOVE (U.S. CLS. 1, 5, 12, 13, 35 AND 50).

SN 76-268,317. N.A. TAYLOR CO., INC., GLOVERSVILLE, NY. FILED 6-7-2001.

SN 76-272,450. GOLF HORIZONS, INC., ALEXANDRIA, VA. FILED 6-18-2001.

## BOATENT

### CLASS 12—VEHICLES

FOR BOAT STRUCTURAL PARTS, NAMELY BOAT TOPS (U.S. CLS. 19, 21, 23, 31, 35 AND 44).

### CLASS 22—CORDAGE AND FIBERS

FOR PROTECTIVE CANOPIES FOR BOATS (U.S. CLS. 1, 2, 7, 19, 22, 42 AND 50).

---

SN 76-268,734. SACKIT, INC., HOUSTON, TX. FILED 6-8-2001.

## A/CDS

### CLASS 17—RUBBER GOODS

FOR AIR CONDITIONING CONDENSATE DRAINAGE SYSTEM FOR ROOFS OF BUILDINGS, NAMELY, PVC STRIPS WITH TWO RIBS FOR CHANNELING CONDENSATE FROM AIR CONDITIONERS TO THE ROOF DRAINS (U.S. CLS. 1, 5, 12, 13, 35 AND 50).

### CLASS 19—NON-METALLIC BUILDING MATERIALS

FOR AIR CONDITIONING CONDENSATE DRAINAGE SYSTEM FOR ROOFS OF BUILDINGS, NAMELY, ASPHALT-BASED STRIPS WITH TWO RIBS FOR CHANNELING CONDENSATE FROM AIR CONDITIONERS TO THE ROOF DRAINS (U.S. CLS. 1, 12, 33 AND 50).

---

SN 76-270,972. KNR INTERNATIONAL, LLC, DBA COMMANDO TRADING SYSTEMS, SCOTTSDALE, AZ. FILED 6-13-2001.

## COMMANDO

### CLASS 9—ELECTRICAL AND SCIENTIFIC APPARATUS

FOR COMPUTER SOFTWARE THAT ASSISTS THE USER IN ANALYZING FINANCIAL DATA AND MAKING INVESTMENT DECISIONS, AND INSTALLATION AND OPERATION MANUALS SOLD AS A UNIT THEREWITH (U.S. CLS. 21, 23, 26, 36 AND 38).  
FIRST USE 3-1-1998; IN COMMERCE 3-1-1998.

### CLASS 16—PAPER GOODS AND PRINTED MATTER

FOR PRINTED MATERIALS, NAMELY, BOOKS THAT PROVIDE INFORMATION AND METHODOLOGIES TO ASSIST IN MAKING FINANCIAL INVESTMENT DECISIONS (U.S. CLS. 2, 5, 22, 23, 29, 37, 38 AND 50).  
FIRST USE 8-15-1997; IN COMMERCE 8-15-1997.

## SCORE4KIDS CARD

NO CLAIM IS MADE TO THE EXCLUSIVE RIGHT TO USE "CARD", APART FROM THE MARK AS SHOWN.

### CLASS 9—ELECTRICAL AND SCIENTIFIC APPARATUS

FOR MAGNETICALLY ENCODED CARDS FOR USE IN A MEMBERSHIP DISCOUNT PROGRAM (U.S. CLS. 21, 23, 26, 36 AND 38).

### CLASS 16—PAPER GOODS AND PRINTED MATTER

FOR DISCOUNT COUPONS AND VOUCHERS (U.S. CLS. 2, 5, 22, 23, 29, 37, 38 AND 50).

### CLASS 35—ADVERTISING AND BUSINESS

FOR ADMINISTRATION AND MANAGEMENT OF A CONSUMER DISCOUNT PROGRAM FOR ENABLING PARTICIPANTS TO OBTAIN DISCOUNTS ON GOODS AND SERVICES PROVIDED BY PARTICIPATING BUSINESSES THROUGH USE OF A DISCOUNT CARD OR COUPON (U.S. CLS. 100, 101 AND 102).

---

SN 76-273,787. NEOGEO, INC., LOS ANGELES, CA. FILED 6-18-2001.

## DESIGN BY VOSLENZA

NO CLAIM IS MADE TO THE EXCLUSIVE RIGHT TO USE "DESIGN BY", APART FROM THE MARK AS SHOWN.

### CLASS 25—CLOTHING

FOR MEN'S, WOMEN'S AND CHILDREN'S CLOTHING, NAMELY, SUITS, PANTS, SHIRTS, SHORTS, SKIRTS, JACKETS, T-SHIRTS, JERSEYS, TOPS, SOCKS, ANKLETS, GOWNS, SWIMWEAR, BATHING CAPS, BATHING TRUNKS, BATHROBES, BLOUSES, BODY SUITS, TANK TOPS, TIES, COATS, COVERALLS, DRESSES, VESTS, INFANTWEAR, JEANS, JUMPERS, KILTS, SWEATERS, LEGGINGS, LEOTARDS, LINGERIE, MINISKIRTS, PAJAMAS, PANTYHOSE, PONCHOS, PULLOVERS, RAINWEAR, ROBES, AND ROMPERS (U.S. CLS. 22 AND 39).

### CLASS 35—ADVERTISING AND BUSINESS

FOR WHOLESALE AND RETAIL STORES FEATURING APPAREL (U.S. CLS. 100, 101 AND 102).

---

SN 76-274,360. ADVANCED H2O, INC., BELLEVUE, WA. FILED 6-19-2001.

## MICROSTRUCTURED

### CLASS 11—ENVIRONMENTAL CONTROL APPARATUS

FOR WATER PURIFICATION UNITS (U.S. CLS. 13, 21, 23, 31 AND 34).



**CLASS 30—STAPLE FOODS**

FOR TEA, NON-ALCOHOLIC TEA-BASED BEVERAGES, COFFEE, AND NON-ALCOHOLIC COFFEE-BASED BEVERAGES (U.S. CL. 46).

**CLASS 32—LIGHT BEVERAGES**

FOR SOFT DRINKS; FRUIT JUICES; SOFT DRINKS MADE WITH FRUIT JUICES; FRUIT-FLAVORED SOFT DRINKS (U.S. CLS. 45, 46 AND 48).

SN 76-274,731. GRADY-WHITE BOATS, INC., GREENVILLE, NC. FILED 6-20-2001.

**GRADY-WHITE**

OWNER OF U.S. REG. NO. 1,143,292.

**CLASS 8—HAND TOOLS**

FOR HAND TOOLS, NAMELY MULTIPLE FUNCTION FOLDING POCKET TOOLS (U.S. CLS. 23, 28 AND 44).  
FIRST USE 11-16-2000; IN COMMERCE 11-16-2000.

**CLASS 12—VEHICLES**

FOR BOATS (U.S. CLS. 19, 21, 23, 31, 35 AND 44).  
FIRST USE 9-0-1960; IN COMMERCE 9-0-1960.

**CLASS 18—LEATHER GOODS**

FOR SPORT BAGS (U.S. CLS. 1, 2, 3, 22 AND 41).  
FIRST USE 11-13-2000; IN COMMERCE 11-13-2000.

**CLASS 21—HOUSEWARES AND GLASS**

FOR DRINKING CUPS AND BEVERAGE CAN HOLDERS (U.S. CLS. 2, 13, 23, 29, 30, 33, 40 AND 50).  
FIRST USE 8-1-1982; IN COMMERCE 8-1-1982.

**CLASS 24—FABRICS**

FOR AFGHANS (U.S. CLS. 42 AND 50).  
FIRST USE 10-25-2000; IN COMMERCE 10-25-2000.

**CLASS 25—CLOTHING**

FOR CLOTHING, NAMELY HATS AND SHIRTS (U.S. CLS. 22 AND 39).  
FIRST USE 8-1-1982; IN COMMERCE 8-1-1982.

SN 76-277,348. PGI, INC., ARLINGTON, VA. FILED 6-27-2001.

**EMOTION ENGINEERING****CLASS 35—ADVERTISING AND BUSINESS**

FOR ARRANGING AND CONDUCTING BUSINESS MEETINGS FOR OTHERS (U.S. CLS. 100, 101 AND 102).

**CLASS 41—EDUCATION AND ENTERTAINMENT**

FOR SPECIAL EVENT PLANNING SERVICES FOR OTHERS (U.S. CLS. 100, 101 AND 107).

SN 76-279,394. CELEXAS GAMES, INC., FORMERLY CELESTIAL GAMES, INC., MONUMENT, CO. FILED 7-2-2001.

**CELEXAS GAMES**

NO CLAIM IS MADE TO THE EXCLUSIVE RIGHT TO USE "GAMES", APART FROM THE MARK AS SHOWN.

**CLASS 16—PAPER GOODS AND PRINTED MATTER**

FOR PLAYING CARDS OF UNIQUE DESIGN (U.S. CLS. 2, 5, 22, 23, 29, 37, 38 AND 50).

**CLASS 28—TOYS AND SPORTING GOODS**

FOR EQUIPMENT COMPRISED OF PLAYING CARDS OF UNIQUE DESIGN, DICE, CARD TRAYS, AND GAME BOARDS OR CLOTH GAME LAYOUTS FOR PLAYING THE CARD AND DICE GAMES (U.S. CLS. 22, 23, 38 AND 50).

SN 76-280,238. ORBIMED ADVISORS LLC, NEW YORK, NY. FILED 7-3-2001.

**ORBIMED ADVISORS**

NO CLAIM IS MADE TO THE EXCLUSIVE RIGHT TO USE "ADVISORS", APART FROM THE MARK AS SHOWN.

**CLASS 16—PAPER GOODS AND PRINTED MATTER**

FOR BASED ON INTENT TO USE PUBLICATIONS, NAMELY, REPORTS, NEWSLETTERS, BULLETINS, LETTERS AND PORTFOLIO RECOMMENDATIONS ADVISING ON AND MANAGING HEDGE FUNDS, MUTUAL FUNDS, PRIVATE INVESTMENT FUNDS AND VENTURE CAPITAL FUNDS AND ANALYZING AND MANAGING INVESTMENTS IN BIOTECHNOLOGY AND PHARMACEUTICAL COMPANIES (U.S. CLS. 2, 5, 22, 23, 29, 37, 38 AND 50).

**CLASS 36—INSURANCE AND FINANCIAL**

FOR PROVIDING INVESTMENT AND FINANCIAL SERVICES, NAMELY, ADVISING AND MANAGING HEDGE FUNDS, MUTUAL FUNDS, PRIVATE INVESTMENT FUNDS AND VENTURE CAPITAL FUNDS; PROVIDING ONLINE FINANCIAL SERVICES, NAMELY PROVIDING ACCESS TO INFORMATION ON PERFORMANCE OF INVESTMENT FUNDS VIA A GLOBAL COMPUTER NETWORK (U.S. CLS. 100, 101 AND 102).  
FIRST USE 10-0-1998; IN COMMERCE 10-0-1998.

SN 76-280,290. MAXIMUM FUSS, INC., CHICAGO, IL.  
FILED 7-5-2001.

THE STIPPLING IS FOR SHADING PURPOSES ONLY.  
THE MARK CONSISTS OF A CUSTOM FONT IN THE  
FOLLOWING COLORS: A BLACK "F", A CURSIVE PURPLE  
"U", A BLACK "S" AND A SECOND BLACK "S".

**CLASS 3—COSMETICS AND CLEANING PREPARATIONS**

FOR COSMETICS (U.S. CLS. 1, 4, 6, 50, 51 AND 52).

**CLASS 16—PAPER GOODS AND PRINTED MATTER**

FOR COMIC BOOKS (U.S. CLS. 2, 5, 22, 23, 29, 37, 38 AND 50).

SN 76-283,404. GORDON GROUP CRUISES, INC., DAVIE,  
FL. FILED 7-11-2001.



OWNER OF U.S. REG. NOS. 2,059,054 AND 2,400,211.  
NO CLAIM IS MADE TO THE EXCLUSIVE RIGHT TO  
USE "GROUP" AND "PROFESSIONAL CRUISE PLAN-  
NERS", APART FROM THE MARK AS SHOWN.  
THE MARK CONSISTS IN PART OF A STYLIZED  
REPRESENTATION OF A SHIP AND THE GLOBE.

**CLASS 39—TRANSPORTATION AND STORAGE**

FOR TRAVEL AGENCY SERVICES, NAMELY, MAK-  
ING RESERVATIONS AND BOOKINGS FOR AIRLINE  
AND AUTOMOBILE TRANSPORTATION, AND ARRAN-  
GING OF CRUISES AND TRAVEL TOURS (U.S. CLS. 100  
AND 105).

**CLASS 42—SCIENTIFIC, COMPUTER AND LEGAL SERVICES**

FOR TRAVEL AGENCY SERVICES, NAMELY, HOTEL  
RESERVATIONS SERVICES (U.S. CLS. 100 AND 101).

SN 76-284,550. GREEN COUNTY FOODS, INC., MONROE,  
WI. FILED 7-13-2001.

**RICHLY DESERVED**

**CLASS 30—STAPLE FOODS**

FOR CANDY, BONBONS, CAKES, CAKE FILLINGS,  
CHOCOLATES, CHOCOLATE PETITS FOURS (U.S. CL.  
46).

FIRST USE 1-0-1988; IN COMMERCE 1-0-1988.

**CLASS 35—ADVERTISING AND BUSINESS**

FOR MAIL ORDER CATALOG SERVICES FEATUR-  
ING CANDY, BONBONS, CAKES, CAKE FILLINGS,  
CHOCOLATES, CHOCOLATE PETITS FOURS (U.S.  
CLS. 100, 101 AND 102).

FIRST USE 1-0-1988; IN COMMERCE 1-0-1988.

SN 76-289,256. HUGA TUGA CREATIONS, LLC, STRAT-  
FORD, CT. FILED 7-23-2001.

**HUGA TUGA CREATIONS**

NO CLAIM IS MADE TO THE EXCLUSIVE RIGHT TO  
USE "CREATIONS", APART FROM THE MARK AS  
SHOWN.

**CLASS 16—PAPER GOODS AND PRINTED MATTER**

FOR PRINTED PUBLICATIONS, NAMELY, CHIL-  
DREN'S BOOKS (U.S. CLS. 2, 5, 22, 23, 29, 37, 38 AND 50).

**CLASS 28—TOYS AND SPORTING GOODS**

FOR PLUSH TOYS (U.S. CLS. 22, 23, 38 AND 50).

SN 76-291,094. SYNOPSISYS, INC., MOUNTAIN VIEW, CA.  
FILED 7-20-2001.

**THIN-SITE**

**CLASS 9—ELECTRICAL AND SCIENTIFIC APPARATUS**

FOR COMPUTER SOFTWARE FOR ACCESSING  
ELECTRONIC DESIGN AUTOMATION SOFTWARE  
OVER COMPUTER NETWORKS (U.S. CLS. 21, 23, 26, 36  
AND 38).

**CLASS 42—SCIENTIFIC, COMPUTER AND LEGAL SERVICES**

FOR APPLICATION SERVICE PROVIDER (ASP) FEAT-  
URING SOFTWARE USED FOR ELECTRONICS DE-  
SIGN AUTOMATION (U.S. CLS. 100 AND 101).

SN 76-292,897. BARNES & NOBLE COLLEGE BOOKSTORES, INC., NEW YORK, NY. FILED 7-31-2001.

SN 76-298,363. 7-ELEVEN, INC., DALLAS, TX. FILED 8-10-2001.

## CARESNACKAGES

### CLASS 30—STAPLE FOODS

FOR CARE PACKAGES CONSISTING PRIMARILY OF SNACK MIX THAT CONSIST PRIMARILY OF CRACKERS, PRETZELS, CANDIED NUTS AND/OR POPPED POPCORN PACKAGED WITH POTATO CHIPS, CANDY, BOOKS, BEVERAGES, TOILETRIES AND GIFT ITEMS (U.S. CL. 46).

### CLASS 35—ADVERTISING AND BUSINESS

FOR RETAIL STORE, MAIL ORDER AND ONLINE RETAIL STORE SERVICES FEATURING CARE PACKAGES CONTAINING SNACK FOODS, BEVERAGES, CANDY, BOOKS, BEVERAGES, TOILETRIES AND GIFT ITEMS (U.S. CLS. 100, 101 AND 102).

SN 76-295,262. CASSANDRA BRYAN, GILDA DIXON, CHARLES SCHLENZ, TRUSTEES OF DAY MEMORIAL TRUST, PORT ROYAL, PA. FILED 8-7-2001.

## ADOPT-A-COW

### CLASS 41—EDUCATION AND ENTERTAINMENT

FOR EDUCATIONAL SERVICES, NAMELY, CONDUCTING SEMINARS, CLASSES AND LECTURES CONCERNING COW PROTECTION, OX POWER AND VEGETARIANISM (U.S. CLS. 100, 101 AND 107).  
FIRST USE 11-1-1985; IN COMMERCE 11-1-1985.

### CLASS 42—SCIENTIFIC, COMPUTER AND LEGAL SERVICES

FOR PROMOTING PUBLIC AWARENESS OF THE NEED TO PROTECT THE COW AND OX SO THEY CAN LIVE OUT THEIR LIFE SPAN AND AVOID THE SLAUGHTERHOUSE (U.S. CLS. 100 AND 101).  
FIRST USE 11-1-1985; IN COMMERCE 11-1-1985.

SN 76-295,773. PRIME TABLE GAMES LLC, LAS VEGAS, NV. FILED 8-7-2001.

## 21 + 3

OWNER OF U.S. REG. NOS. 2,458,139 AND 2,458,140.

### CLASS 28—TOYS AND SPORTING GOODS

FOR EQUIPMENT FOR PLAYING CASINO GAMES, NAMELY, LAYOUT CLOTHS, PROCEDURE MANUALS AND PLAYER ADVICE CARDS (U.S. CLS. 22, 23, 38 AND 50).  
FIRST USE 6-0-2000; IN COMMERCE 6-0-2000.

### CLASS 41—EDUCATION AND ENTERTAINMENT

FOR ENTERTAINMENT SERVICES IN THE NATURE OF CASINO GAMES (U.S. CLS. 100, 101 AND 107).  
FIRST USE 6-0-2000; IN COMMERCE 6-0-2000.

## SLURP AND GULP

OWNER OF U.S. REG. NOS. 1,507,444 AND 1,586,016.

### CLASS 21—HOUSEWARES AND GLASS

FOR PLASTIC BEVERAGE CONTAINERS (U.S. CLS. 2, 13, 23, 29, 30, 33, 40 AND 50).

### CLASS 32—LIGHT BEVERAGES

FOR SOFT DRINKS (U.S. CLS. 45, 46 AND 48).

SN 76-298,917. AMERICA HARVEST, INC., RYE BROOK, NY. FILED 8-14-2001.

## ANGEL HARVEST

### CLASS 36—INSURANCE AND FINANCIAL

FOR CHARITABLE FUNDRAISING SERVICES (U.S. CLS. 100, 101 AND 102).  
FIRST USE 8-5-1995; IN COMMERCE 8-5-1995.

### CLASS 42—SCIENTIFIC, COMPUTER AND LEGAL SERVICES

FOR CHARITABLE SERVICES; NAMELY, COLLECTING SURPLUS AND SALVAGEABLE FOOD AND REDISTRIBUTING SUCH FOOD TO THE NEEDY (U.S. CLS. 100 AND 101).  
FIRST USE 11-30-1995; IN COMMERCE 11-30-1995.

SN 76-299,226. HARRISON, REX H., PLANO, TX. FILED 8-15-2001.

## VIGILANZ

### CLASS 9—ELECTRICAL AND SCIENTIFIC APPARATUS

FOR SECURITY CAMERAS AND MICROPHONES (U.S. CLS. 21, 23, 26, 36 AND 38).

### CLASS 42—SCIENTIFIC, COMPUTER AND LEGAL SERVICES

FOR PROVIDING SECURITY SERVICES BY MEANS OF ALLOWING FOR THE VIEWING AND ACCESSING OF INFORMATION RECORDED FROM SECURITY CAMERAS AND OTHER MONITORING DEVICES ALL PROVIDED OVER THE INTERNET (U.S. CLS. 100 AND 101).

SN 76-303,010. WARNER-LAMBERT COMPANY, MORRIS PLAINS, NJ. FILED 8-23-2001.

SN 76-308,604. NEVILLE LAND COMPANY, DBA ISLAND SPORTS CENTER, PITTSBURGH, PA. FILED 9-5-2001.

## QUINT

### CLASS 3—COSMETICS AND CLEANING PREPARATIONS

FOR COSMETICS, PERFUMERY, SOAPS AND SHAVING PREPARATIONS (U.S. CLS. 1, 4, 6, 50, 51 AND 52).

### CLASS 8—HAND TOOLS

FOR RAZORS AND RAZOR BLADES (U.S. CLS. 23, 28 AND 44).

---

SN 76-305,359. ENERGY VALUE CHAIN, L.P., HOUSTN, TX. FILED 8-27-2001.

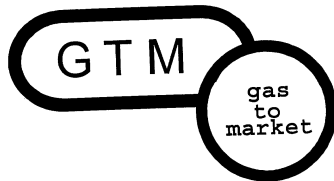

NO CLAIM IS MADE TO THE EXCLUSIVE RIGHT TO USE "GAS", APART FROM THE MARK AS SHOWN.

### CLASS 9—ELECTRICAL AND SCIENTIFIC APPARATUS

FOR COMPUTER SOFTWARE USED FOR REVENUE ANALYSIS AND ACCOUNTING (U.S. CLS. 21, 23, 26, 36 AND 38).

### CLASS 42—SCIENTIFIC, COMPUTER AND LEGAL SERVICES

FOR PROVIDING TEMPORARY USE OF ONLINE NON-DOWNLOADABLE COMPUTER SOFTWARE USED FOR REVENUE ACCOUNTING AND ANALYSIS (U.S. CLS. 100 AND 101).

---

SN 76-308,063. GREENWICH WORKSHOP, INC., SHELTON, CT. FILED 9-4-2001.

## FLITTENS

### CLASS 16—PAPER GOODS AND PRINTED MATTER

FOR ART BOOKS AND ART PRINTS (U.S. CLS. 2, 5, 22, 23, 29, 37, 38 AND 50).

### CLASS 21—HOUSEWARES AND GLASS

FOR PORCELAIN FIGURINES (U.S. CLS. 2, 13, 23, 29, 30, 33, 40 AND 50).



ISLAND SPORTS CENTER

NO CLAIM IS MADE TO THE EXCLUSIVE RIGHT TO USE "SPORTS CENTER", APART FROM THE MARK AS SHOWN.

### CLASS 35—ADVERTISING AND BUSINESS

FOR PROVIDING FACILITIES FOR BUSINESS MEETINGS (U.S. CLS. 100, 101 AND 102).

### CLASS 41—EDUCATION AND ENTERTAINMENT

FOR PROVIDING FACILITIES FOR RECREATION ACTIVITIES; PHYSICAL FITNESS INSTRUCTION (U.S. CLS. 100, 101 AND 107).

---

SN 76-309,282. BROWNLIE,, ALAN, PAGOSA SPRINGS, CO. FILED 9-6-2001.

## THER-E-QUEST

### CLASS 10—MEDICAL APPARATUS

FOR EQUINE THERAPEUTIC EQUIPMENT (U.S. CLS. 26, 39 AND 44).

### CLASS 18—LEATHER GOODS

FOR SADDLES, SADDLE PADS, SADDLE CUSHIONS, HANDICAPPED SADDLES, RIDER CUSHIONS, BAREBACK PADS, AND OTHER EQUINE TACK AND EQUIPMENT (U.S. CLS. 1, 2, 3, 22 AND 41).

---

SN 76-309,829. NEEDLES, BELVERD E., JR., WINNETKA, IL. FILED 9-6-2001.

## PRINTSAMERICA

### CLASS 16—PAPER GOODS AND PRINTED MATTER

FOR BOOKS ON THE SUBJECT OF FINE ART (U.S. CLS. 2, 5, 22, 23, 29, 37, 38 AND 50).

### CLASS 36—INSURANCE AND FINANCIAL

FOR ART BROKERAGE (U.S. CLS. 100, 101 AND 102).

SN 76-312,676. UNIVERSITY OF WASHINGTON, SEATTLE, WA. FILED 9-13-2001.

SN 76-315,201. MAC MAN ENTERPRISES, INC., CHICAGO, IL. FILED 9-19-2001.

## BIONEXT

### CLASS 16—PAPER GOODS AND PRINTED MATTER

FOR PRINTED MATERIALS NAMELY BOOKS, BROCHURES, NEWSLETTERS, PROGRAMS AND REPORTS RELATING TO BIOMEDICAL RESEARCH AND EDUCATION (U.S. CLS. 2, 5, 22, 23, 29, 37, 38 AND 50).

### CLASS 42—SCIENTIFIC, COMPUTER AND LEGAL SERVICES

FOR BIOMEDICAL RESEARCH SERVICES (U.S. CLS. 100 AND 101).

SN 76-314,940. WISE WOMEN SPEAK, LLC, COLUMBIA, MD. FILED 9-19-2001.

## WISE WOMEN SPEAK

### CLASS 16—PAPER GOODS AND PRINTED MATTER

FOR PRINTED MATERIAL, NAMELY, NEWSLETTER, CALENDARS, STATIONERY, GREETING CARDS AND A SERIES OF ILLUSTRATED GIFT BOOKS, ALL FEATURING ADVICE QUOTATIONS FROM EVERYDAY WOMEN (U.S. CLS. 2, 5, 22, 23, 29, 37, 38 AND 50).

### CLASS 41—EDUCATION AND ENTERTAINMENT

FOR EDUCATIONAL SERVICES, NAMELY CONDUCTING WORKSHOPS AND DISCUSSION GROUPS DESIGNED TO ENHANCE WOMEN'S DISCOVERY OF THEIR OWN WISDOM AND INCLUDING THE DEVELOPMENT OF PERSONAL JOURNALS (U.S. CLS. 100, 101 AND 107).

SN 76-315,087. MAC MAN ENTERPRISES, INC., CHICAGO, IL. FILED 9-19-2001.

## LET ME DO THIS!

### CLASS 25—CLOTHING

FOR CLOTHING, NAMELY JACKETS, HATS AND T-SHIRTS (U.S. CLS. 22 AND 39).

### CLASS 35—ADVERTISING AND BUSINESS

FOR ON-LINE ORDERING SERVICES FEATURING CLOTHING AND CONCERT MERCHANDISE (U.S. CLS. 100, 101 AND 102).

## THE WORLD IS HURTIN'

### CLASS 25—CLOTHING

FOR CLOTHING, NAMELY JACKETS, HATS AND T-SHIRTS (U.S. CLS. 22 AND 39).

### CLASS 35—ADVERTISING AND BUSINESS

FOR ON-LINE ORDERING SERVICES FEATURING CLOTHING AND CONCERT MERCHANDISE (U.S. CLS. 100, 101 AND 102).

SN 76-317,043. HEAR IN AMERICA INC., LOUISVILLE, KY. FILED 9-25-2001.

## HEAR IN AMERICA

### CLASS 10—MEDICAL APPARATUS

FOR HEARING AIDS (U.S. CLS. 26, 39 AND 44).

### CLASS 42—SCIENTIFIC, COMPUTER AND LEGAL SERVICES

FOR AUDIOLOGY AND HEARING AID SERVICES (U.S. CLS. 100 AND 101).

SN 76-317,945. PAH LEASING LLC, DALLAS, TX. FILED 9-20-2001.

## THE BOULDERS

### CLASS 36—INSURANCE AND FINANCIAL

FOR RESIDENTIAL PROPERTY MANAGEMENT SERVICES (U.S. CLS. 100, 101 AND 102).  
FIRST USE 12-31-1983; IN COMMERCE 12-31-1983.

### CLASS 37—CONSTRUCTION AND REPAIR

FOR REAL ESTATE DEVELOPMENT (U.S. CLS. 100, 103 AND 106).  
FIRST USE 12-31-1983; IN COMMERCE 12-31-1983.

SN 76-318,763. WBEZ ALLIANCE, INC., CHICAGO, IL. FILED 9-28-2001.

## BRING YOUR MIND BACK TO LIFE

### CLASS 38—COMMUNICATION

FOR RADIO BROADCASTING SERVICES (U.S. CLS. 100, 101 AND 104).

**CLASS 41—EDUCATION AND ENTERTAINMENT**

FOR ENTERTAINMENT AND EDUCATIONAL SERVICES, NAMELY, THE PRODUCTION AND DISTRIBUTION OF NEWS AND CULTURAL PROGRAMMING VIA RADIO BROADCASTS AND THE GLOBAL COMPUTER NETWORK (U.S. CLS. 100, 101 AND 107).

SN 76-321,072. PACIFIC CONTINENTAL APPAREL, INC., RANCHO DOMINGUEZ, CA. FILED 10-3-2001.

**ZENMECHANICS****CLASS 18—LEATHER GOODS**

FOR PURSES, HANDBAGS, AND TOTE BAGS (U.S. CLS. 1, 2, 3, 22 AND 41).  
FIRST USE 8-27-2001; IN COMMERCE 8-27-2001.

**CLASS 25—CLOTHING**

FOR MEN'S AND WOMEN'S CLOTHING, NAMELY, KNIT AND WOVEN TOPS, TROUSERS, JEANS, SLACKS, SHORTS, SHIRTS, T-SHIRTS, SWEATSHIRTS, JACKETS, AND HEADWEAR, NAMELY, HATS (U.S. CLS. 22 AND 39).  
FIRST USE 8-27-2001; IN COMMERCE 8-27-2001.

SN 76-321,239. LA POINTIQUE INTERNATIONAL, LTD., TUKWILA, WA. FILED 10-4-2001.

**COOLPRENE****CLASS 10—MEDICAL APPARATUS**

FOR MEDICAL EQUIPMENT, NAMELY, NEOPRENE AND ELASTIC SUPPORTS FOR THE KNEE, ELBOW, WRIST, ANKLE, THIGH, SHIN OR WAIST; PROTECTORS FOR THE KNEE AND ELBOW; GUARDS FOR THE ARMS, SHIN AND HAND (U.S. CLS. 26, 39 AND 44).

**CLASS 28—TOYS AND SPORTING GOODS**

FOR SPORTING EQUIPMENT, NAMELY, NEOPRENE AND ELASTIC SUPPORTS FOR THE KNEE, ELBOW, WRIST, ANKLE, THIGH, SHIN OR WAIST; PROTECTORS FOR THE KNEE AND ELBOW; GUARDS FOR THE ARMS, SHIN AND HAND (U.S. CLS. 22, 23, 38 AND 50).

SN 78-007,712. GARIETY, TERRY, PORTLAND, OR. FILED 5-11-2000.

**ONECLICKMEDIA ONE  
CLICK MEDIA  
ONECLICKMEDIA  
1CLICKMEDIA 1 CLICK  
MEDIA**

NO CLAIM IS MADE TO THE EXCLUSIVE RIGHT TO USE "MEDIA", APART FROM THE MARK AS SHOWN.

**CLASS 9—ELECTRICAL AND SCIENTIFIC APPARATUS**

FOR CD-ROMS, DVDS, COMPACT DISCS, VIDEO TAPES, AND MOTION PICTURE FILMS, ALL FEATURING MUSIC, NARRATIVES, PHOTOGRAPHS, ARTWORK, AND FILMED INTERVIEWS (U.S. CLS. 21, 23, 26, 36 AND 38).

**CLASS 41—EDUCATION AND ENTERTAINMENT**

FOR PRODUCTION OF INFORMATIONAL, EDUCATIONAL, EDUCATIONAL AND ENTERTAINMENT PROGRAMS FEATURING AUDIO, VIDEO, MUSIC, NARRATIVES, PHOTOGRAPHS, IMAGES, ARTWORK, INTERVIEWS, TEXT AND LINKS TO WEB SITES AND DELIVERED BY WAY OF CUSTOMER'S CHOOSING, NAMELY, DVD, CD-ROM, COMPACT DISC, VIDEO CASSETTE, AUDIO CASSETTE, MOTION PICTURE FILM, RADIO, TELEPHONE, DIGITAL SERVERS, THE INTERNET, SATELLITE, CABLE AND BROADCAST TELEVISION (U.S. CLS. 100, 101 AND 107).

SN 78-015,403. CANSHOW INDUSTRIAL CO., LTD., TAI-CHUNG HSIEN, TAIWAN, FILED 7-5-2000.

**AKINNER****CLASS 8—HAND TOOLS**

FOR KITCHEN KNIVES, FORKS AND SPOONS (U.S. CLS. 23, 28 AND 44).  
FIRST USE 12-10-1984; IN COMMERCE 9-1-1991.

**CLASS 21—HOUSEWARES AND GLASS**

FOR HOUSEHOLD UTENSILS, NAMELY, CHEESE AND VEGETABLE GRATERS (U.S. CLS. 2, 13, 23, 29, 30, 33, 40 AND 50).  
FIRST USE 12-10-1984; IN COMMERCE 9-1-1991.

SN 78-016,004. PONTIKOS, STEVE, HUDSON, OH. FILED 7-10-2000.

**XTREME ONLINE**

NO CLAIM IS MADE TO THE EXCLUSIVE RIGHT TO USE "ONLINE", APART FROM THE MARK AS SHOWN.

**CLASS 41—EDUCATION AND ENTERTAINMENT**

FOR ENTERTAINMENT SERVICES, NAMELY PROVIDING AN ONLINE COMPUTER GAME INVOLVING MULTIPLE ONLINE USERS (U.S. CLS. 100, 101 AND 107).  
FIRST USE 12-1-1995; IN COMMERCE 3-1-1998.

**CLASS 42—SCIENTIFIC, COMPUTER AND LEGAL SERVICES**

FOR HOSTING THE WEBSITES OF OTHERS ON A COMPUTER SERVER FOR A GLOBAL COMPUTER NETWORK, COMPUTER SERVICES, NAMELY DESIGNING AND IMPLEMENTING NETWORK WEB PAGES FOR OTHERS, CUSTOM COMPUTER PROGRAMMING AND E-MAIL SERVICES (U.S. CLS. 100 AND 101).  
FIRST USE 12-1-1995; IN COMMERCE 3-1-1998.

SN 78-016,751. REACH PUBLISHING SYSTEMS, INC., CINCINNATI, OH. FILED 7-14-2000.

## HACKS SPORTS

NO CLAIM IS MADE TO THE EXCLUSIVE RIGHT TO USE "SPORTS", APART FROM THE MARK AS SHOWN.

### CLASS 16—PAPER GOODS AND PRINTED MATTER

FOR MAGAZINES FEATURING HIGH SCHOOL SPORTS (U.S. CLS. 2, 5, 22, 23, 29, 37, 38 AND 50).  
FIRST USE 8-22-1999; IN COMMERCE 8-22-1999.

### CLASS 35—ADVERTISING AND BUSINESS

FOR COOPERATIVE ADVERTISING AND MARKETING (U.S. CLS. 100, 101 AND 102).  
FIRST USE 8-22-1999; IN COMMERCE 8-22-1999.

### CLASS 42—SCIENTIFIC, COMPUTER AND LEGAL SERVICES

FOR COMPUTER SERVICES, NAMELY PROVIDING ON-LINE MAGAZINES FEATURING HIGH SCHOOL SPORTS (U.S. CLS. 100 AND 101).  
FIRST USE 8-22-1999; IN COMMERCE 8-22-1999.

SN 78-019,783. ACTIVE CLAIMS MANAGEMENT INC., WATERLOO, ONTARIO, FILED 8-4-2000.

## TRAVEL GENIE

NO CLAIM IS MADE TO THE EXCLUSIVE RIGHT TO USE "TRAVEL", APART FROM THE MARK AS SHOWN.

### CLASS 39—TRANSPORTATION AND STORAGE

FOR TRAVEL INFORMATION SERVICES, NAMELY, PROVIDING TRAVEL INFORMATION BY TELEPHONE; TRAVEL AGENCY SERVICES, NAMELY, MAKING RESERVATIONS AND BOOKING FOR TRANSPORTATION (U.S. CLS. 100 AND 105).  
FIRST USE 7-31-2000; IN COMMERCE 7-31-2000.

### CLASS 42—SCIENTIFIC, COMPUTER AND LEGAL SERVICES

FOR HEALTH INFORMATION SERVICES, NAMELY, PROVIDING HEALTH CARE INFORMATION BY TELEPHONE; TRAVEL AGENCY SERVICES, NAMELY, MAKING RESERVATIONS AND BOOKING FOR TEMPORARY ACCOMMODATIONS (U.S. CLS. 100 AND 101).  
FIRST USE 7-31-2000; IN COMMERCE 7-31-2000.

SN 78-021,088. ENCOMPASS SERVICES CORPORATION, HOUSTON, TX. FILED 8-14-2000.

## ENCOMPASS CLEANING SYSTEMS

NO CLAIM IS MADE TO THE EXCLUSIVE RIGHT TO USE "CLEANING SYSTEMS", APART FROM THE MARK AS SHOWN.

### CLASS 37—CONSTRUCTION AND REPAIR

FOR REPAIR, REPLACEMENT AND MAINTENANCE OF HEATING, VENTILATION, AND AIR CONDITIONING EQUIPMENT AND SYSTEMS; BUILDING CONSTRUCTION AND RENOVATION (U.S. CLS. 100, 103 AND 106).

### CLASS 42—SCIENTIFIC, COMPUTER AND LEGAL SERVICES

FOR ARCHITECTURAL BUILDING DESIGN SERVICES (U.S. CLS. 100 AND 101).

SN 78-022,302. BIOREASON, INC., SANTA FE, IL. FILED 8-22-2000.

## KNOWLEDGEPHARM

### CLASS 9—ELECTRICAL AND SCIENTIFIC APPARATUS

FOR COMPUTER SOFTWARE FOR DATA ANALYSIS AND INTERPRETATION IN THE FIELD OF AUTOMATED DRUG DISCOVERY (U.S. CLS. 21, 23, 26, 36 AND 38).

### CLASS 42—SCIENTIFIC, COMPUTER AND LEGAL SERVICES

FOR RESEARCH AND DEVELOPMENT FOR OTHERS AND PROVIDING INFORMATION TO OTHERS IN THE FIELD OF AUTOMATED DRUG DISCOVERY (U.S. CLS. 100 AND 101).

SN 78-022,312. BIOREASON, INC., SANTA FE, NM. FILED 8-22-2000.

## TOXPHARMER

### CLASS 9—ELECTRICAL AND SCIENTIFIC APPARATUS

FOR COMPUTER SOFTWARE FOR DATA ANALYSIS AND INTERPRETATION IN THE FIELD OF AUTOMATED DRUG DISCOVERY (U.S. CLS. 21, 23, 26, 36 AND 38).

### CLASS 42—SCIENTIFIC, COMPUTER AND LEGAL SERVICES

FOR RESEARCH AND DEVELOPMENT FOR OTHERS AND PROVIDING INFORMATION TO OTHERS IN THE FIELD OF AUTOMATED DRUG DISCOVERY (U.S. CLS. 100 AND 101).

SN 78-022,480. MILLIPORE CORPORATION, BEDFORD, MA. FILED 8-23-2000.

## ENCOMPASS

### CLASS 7—MACHINERY

FOR HIGH VISCOSITY FLUID DISPENSING SYSTEMS FOR USE IN THE MICROELECTRONICS INDUSTRY (U.S. CLS. 13, 19, 21, 23, 31, 34 AND 35).

**CLASS 9—ELECTRICAL AND SCIENTIFIC APPARATUS**

FOR CONTROLLERS FOR HIGH VISCOSITY FLUID DISPENSING SYSTEMS FOR USE IN THE MICROELECTRONICS INDUSTRY (U.S. CLS. 21, 23, 26, 36 AND 38).

---

SN 78-022,629. INTRADO INC., BOULDER, CO. BY MERGER SCC COMMUNICATIONS CORP., BOULDER, CO. FILED 8-23-2000.

**SCC**

OWNER OF U.S. REG. NO. 2,370,781.

**CLASS 9—ELECTRICAL AND SCIENTIFIC APPARATUS**

FOR COMPUTER SOFTWARE FOR USE IN MANAGEMENT OF EMERGENCY SUPPORT INFORMATION SYSTEMS, NAMELY, MAINTAINING AND UPDATING DATA BASES; COMPUTER SOFTWARE FOR USE IN PROVIDING EMERGENCY SUPPORT INFORMATION VIA TELEPHONE, GLOBAL COMPUTER NETWORKS, FACSIMILE, PAGERS, WIRELESS AND CELLULAR TELEPHONES, AND WIRELESS COMMUNICATION DEVICES, AND COMMUNICATIONS DEVICES FROM CALLERS TO EMERGENCY MANAGEMENT SYSTEM PERSONNEL (U.S. CLS. 21, 23, 26, 36 AND 38).  
FIRST USE 1-31-1986; IN COMMERCE 1-31-1986.

**CLASS 38—COMMUNICATION**

FOR DELIVERY OF MESSAGES BY ELECTRONIC TRANSMISSION; ELECTRONIC TRANSMISSION OF MESSAGES AND DATA; ELECTRONIC VOICE MESSAGING, NAMELY, THE RECORDING, STORAGE AND SUBSEQUENT TRANSMISSION OF VOICE MESSAGES BY TELEPHONE, WIRELESS, SATELLITE AND GLOBAL COMPUTER NETWORKS; PROVIDING TELECOMMUNICATIONS CONNECTIONS TO A GLOBAL COMPUTER NETWORK FOR USE BY EMERGENCY ADMINISTRATION PERSONNEL, PUBLIC SERVICE ACCESS PROVIDERS, PUBLIC SAFETY AGENCIES AND COMMERCIAL FIRMS PROVIDING EMERGENCY SERVICES; BROADCASTING EMERGENCY SITUATIONS VIA TELEPHONE, RADIO, TELEVISION, CABLE TELEVISION, WIRELESS, SATELLITE AND GLOBAL COMPUTER NETWORKS (U.S. CLS. 100, 101 AND 104).  
FIRST USE 1-31-1986; IN COMMERCE 1-31-1986.

---

SN 78-022,795. TRADESCAPE TECHNOLOGIES, LLC, NEW YORK, NY. FILED 8-24-2000.

**TRADESCAPE**

**CLASS 9—ELECTRICAL AND SCIENTIFIC APPARATUS**

FOR COMPUTER E-COMMERCE SOFTWARE FOR USE IN EXECUTING, ALSO KNOWN AS BUYING, SELLING, AND TRADING, SECURITIES TRANSACTIONS; COMPUTER E-COMMERCE SOFTWARE TO ALLOW USERS TO PERFORM ELECTRONIC BUSINESS TRANSACTIONS VIA A GLOBAL COMPUTER NETWORK (U.S. CLS. 21, 23, 26, 36 AND 38).

**CLASS 35—ADVERTISING AND BUSINESS**

FOR PROVIDING BUSINESS INFORMATION ON THE FINANCIAL MARKETS VIA A GLOBAL COMMUNICATION NETWORK; PROVIDING BUSINESS INFORMATION ON BUYING, SELLING, AND TRADING SECURITIES VIA A GLOBAL COMMUNICATION NETWORK (U.S. CLS. 100, 101 AND 102).

**CLASS 36—INSURANCE AND FINANCIAL**

FOR FINANCIAL INFORMATION PROVIDED BY ELECTRONIC MEANS; FINANCIAL INVESTMENT IN THE FIELD OF SECURITIES; AUTOMATED SECURITIES BROKERAGE (U.S. CLS. 100, 101 AND 102).

---

SN 78-022,839. MEMETRICS INC., WILMINGTON, DE. FILED 8-24-2000.

**XOS**

**CLASS 9—ELECTRICAL AND SCIENTIFIC APPARATUS**

FOR COMPUTER SOFTWARE FOR TRACKING ONLINE BEHAVIOR AND ACTIVITIES OF USERS OF ELECTRONIC COMMUNICATIONS NETWORKS; COMPUTER SOFTWARE FOR DIRECTING INFORMATIONAL CONTENT TO ONLINE USERS BASED ON USER PROFILES, ACTIVITIES AND BEHAVIOR; COMPUTER SOFTWARE FOR PRODUCT FULFILLMENT; COMPUTER SOFTWARE FOR INTERACTIVE MANAGEMENT OF ONLINE CONTENT; COMPUTER SOFTWARE FOR PROVIDING OTHERS WITH INFORMATION ABOUT USER BEHAVIOR, ACTIVITIES AND PROFILES; COMPUTER SOFTWARE FOR ONLINE TARGET MARKETING; COMPUTER SOFTWARE FOR CUSTOMIZING PRODUCT OFFERINGS FOR PRESENTATION TO CUSTOMERS OVER AN ELECTRONIC COMMUNICATIONS NETWORK; COMPUTER SOFTWARE FOR DESIGNING CUSTOMER SERVICE BY IDENTIFYING PREFERENCES OF CUSTOMERS FROM VARIABLE CUSTOMER SERVICE FEATURES OR OPTIONS PRESENTED TO CUSTOMERS; COMPUTER SOFTWARE FOR DEVELOPMENT AND DESIGN OF PRODUCTS BY IDENTIFYING CUSTOMER PRODUCT PREFERENCES FROM VARIABLE FEATURES OR OPTIONS PRESENTED TO CUSTOMERS; COMPUTER SOFTWARE FOR OPTIMIZING PRODUCT MARKETING BY IDENTIFYING PREFERENCES OF CUSTOMERS FROM VARIABLE MARKETING FEATURES OR OPTIONS PRESENTED TO CUSTOMERS AND COMPUTER SOFTWARE FOR FACILITATION OF COMMUNICATIONS BETWEEN ONLINE BUYERS AND SELLERS (U.S. CLS. 21, 23, 26, 36 AND 38).



**CLASS 35—ADVERTISING AND BUSINESS**

FOR COMPUTER AND INFORMATION SERVICES FOR OTHERS, NAMELY TRACKING AND PROFILING ONLINE BEHAVIOR AND ACTIVITIES OF USERS OF ELECTRONIC COMMUNICATIONS NETWORKS; DISSEMINATION OF ADVERTISING, NAMELY DIRECTING INFORMATIONAL ADVERTISEMENT AND PROMOTION CONTENT TO ONLINE USERS BASED ON USER PROFILES, ACTIVITIES AND BEHAVIORS; CUSTOMIZING PRODUCT OFFERINGS FOR ONLINE PRESENTATION; DESIGNING CUSTOMER SERVICE BY IDENTIFYING PREFERENCES OF CUSTOMERS FROM VARIABLE CUSTOMER SERVICE FEATURES OR OPTIONS PRESENTED TO CUSTOMERS; OPTIMIZING PRODUCT MARKETING BY IDENTIFYING PREFERENCES OF CUSTOMERS FROM VARIABLE MARKETING FEATURES OR OPTIONS PRESENTED TO CUSTOMERS; DATABASE MANAGEMENT AND CONDUCTING BUSINESS AND CUSTOMER RESEARCH SURVEYS; ONLINE TARGET MARKETING SERVICES; USER PROFILING; MARKET RESEARCH AND ANALYSIS AND STRATEGIC MARKETING; RESEARCH AND ANALYSIS OF ONLINE CONSUMER BEHAVIOR; LICENSING OF COMPUTER SOFTWARE (U.S. CLS. 100, 101 AND 102).

**CLASS 42—SCIENTIFIC, COMPUTER AND LEGAL SERVICES**

FOR DESIGNING COMPUTER SOFTWARE FOR OTHERS; AND COMPUTER SERVICES, NAMELY DESIGNING AND IMPLEMENTING NETWORK WEBSITE FEATURES FOR OTHERS; WEBSITE TRAFFIC MONITORING; CREATING AND MAINTAINING WEBSITES FOR OTHERS; CREATING WEBSITES FOR OTHERS, NAMELY CUSTOMIZATION OF ONLINE CONTENT ACCORDING TO USER PROFILING; PRODUCT DEVELOPMENT; CONSULTING ON WEBSITE DESIGN; PROVIDING SERVICES TO OPTIMIZE ONLINE MARKETING DEVELOPMENT AND DESIGN OF PRODUCTS BY IDENTIFYING CUSTOMER PRODUCT PREFERENCES FROM VARIABLE FEATURES OR OPTIONS PRESENTED TO CUSTOMERS (U.S. CLS. 100 AND 101).

SN 78-026,135. HUXHOLD, JAMES B., INDIANAPOLIS, IN. FILED 9-15-2000.

**STAY FOCUSED****CLASS 16—PAPER GOODS AND PRINTED MATTER**

FOR PAPER GOODS AND PRINTED MATTER; NAMELY, BUMPER STICKERS, NOTE PADS, POSTERS, AND PAPER BANNERS (U.S. CLS. 2, 5, 22, 23, 29, 37, 38 AND 50).

**CLASS 28—TOYS AND SPORTING GOODS**

FOR GOLF BALLS; GOLF CLUB HEADS; GOLF CLUB SHAFTS; GOLF BAGS; GOLF CLUB HEAD COVERS; AND OTHER RELATED GOLF PRODUCTS, NAMELY, TEES; DIVOT REPAIR TOOLS; GOLF BALL MARKERS; GOLF BALL RETRIEVERS; GOLF BALL SLEEVES; GOLF BAG COVERS; GOLF BAGS TAGS; GOLF CLUB GRIPS; GOLF CARTS; GOLF GLOVES; GOLF TOWELS; AND GOLF UMBELLAS (U.S. CLS. 22, 23, 38 AND 50).

SN 78-026,155. RICHARDS, CLINTON H., LAS VEGAS, NV. AND RICHARDS, JENIECE M., LAS VEGAS, NV. FILED 9-15-2000.

**SUNDAYS UNLIMITED****CLASS 20—FURNITURE AND ARTICLES NOT OTHERWISE CLASSIFIED**

FOR LOUNGE CHAIR CUSHIONS, SEAT CUSHIONS FOR LOUNGE CHAIRS, FITTED FABRIC FURNITURE COVERS FOR LOUNGE CHAIRS (U.S. CLS. 2, 13, 22, 25, 32 AND 50).

**CLASS 24—FABRICS**

FOR BEACH TOWELS, UNFITTED FABRIC FURNITURE COVERS FOR LOUNGE CHAIRS (U.S. CLS. 42 AND 50).

SN 78-026,395. EMHART INC., NEWARK, DE. FILED 9-18-2000.

**OWNING THE CUSTOMER'S TOTAL EXPERIENCE****CLASS 6—METAL GOODS**

FOR METAL FASTENERS, NAMELY, ANCHORS, BOLTS, BRACKETS, BUSHINGS, CLIPS, INSERTS, NAILS, NUTS, PINS, RIVETS, SCREWS, SLEEVES, STAPLES, STUDS, TACKS, AND WASHERS (U.S. CLS. 2, 12, 13, 14, 23, 25 AND 50).

**CLASS 42—SCIENTIFIC, COMPUTER AND LEGAL SERVICES**

FOR SCIENTIFIC RESEARCH IN THE FIELD OF DEVELOPING FASTENER PRODUCTS FOR OTHERS (U.S. CLS. 100 AND 101).

SN 78-027,944. CONVERGIA, INC., POINTE CLAIRE, QUEBEC, FILED 9-27-2000.

**CONVERGIA****CLASS 38—COMMUNICATION**

FOR TELECOMMUNICATIONS SERVICES, NAMELY, PROVIDING LOCAL AND LONG DISTANCE TELEPHONE SERVICES; PROVIDING TELECOMMUNICATIONS CONNECTIONS TO A GLOBAL COMPUTER NETWORK; PROVIDING MULTIPLE-USER HIGH SPEED ACCESS TO A GLOBAL COMPUTER INFORMATION NETWORK; PROVIDING FIBER OPTIC NETWORK SERVICE; PROVIDING LOCAL AND LONG DISTANCE ELECTRONIC, ELECTRIC, AND DIGITAL TRANSMISSION OF VOICE, DATA, IMAGES, GRAPHICS, SIGNALS, AND MESSAGES BY MEANS OF TELEPHONE, TELEGRAPHIC, CABLE, GLOBAL COMPUTER NETWORK AND SATELLITE TRANSMISSIONS; PROVIDING TELEPHONE VOICE MESSAGING SERVICES (U.S. CLS. 100, 101 AND 104).

**CLASS 42—SCIENTIFIC, COMPUTER AND LEGAL SERVICES**

FOR HOSTING THE WEB SITES OF OTHERS ON A COMPUTER SERVER FOR A GLOBAL COMPUTER NETWORK (U.S. CLS. 100 AND 101).

SN 78-028,510. SCOTT M. SMITH AND ASSOCIATES, INC., PROVO, UT. FILED 10-1-2000.

**SURVEYPRO****CLASS 35—ADVERTISING AND BUSINESS**

FOR COMPUTER SERVICES, NAMELY COMPUTERIZED DATABASE MANAGEMENT (U.S. CLS. 100, 101 AND 102).

FIRST USE 7-6-2000; IN COMMERCE 7-6-2000.

**CLASS 42—SCIENTIFIC, COMPUTER AND LEGAL SERVICES**

FOR HOSTING THE WEB SITES OF OTHERS ON A COMPUTER SERVER FOR GLOBAL COMPUTER NETWORK (U.S. CLS. 100 AND 101).

FIRST USE 7-6-2000; IN COMMERCE 7-6-2000.

SN 78-028,849. NNOTE.COM, INC., LAKE BLUFF, IL. FILED 10-3-2000.

**BOLDWING****CLASS 36—INSURANCE AND FINANCIAL**

FOR FINANCIAL SERVICES, NAMELY, PROVIDING MORTGAGE LOAN INFORMATION TO REALTORS, LENDERS AND PURCHASERS; MORTGAGE BROKERAGE; MORTGAGE BANKING; MORTGAGE LENDING; MORTGAGE INSURANCE; PROVIDING CENTRALIZED LOAN ORIGINATION, PROCESSING AND TRACKING SERVICES FOR LENDERS AND BORROWERS VIA A GLOBAL COMPUTER NETWORK; PREPARATION OF FINANCIAL REPORTS AND ANALYSES; MONEY EXCHANGE SERVICES; FISCAL ASSESSMENTS; FINANCIAL VALUATIONS; FIDUCIARY REPRESENTATION SERVICES; INSURANCE SERVICES, NAMELY, UNDERWRITING EXTENDED WARRANTY CONTRACTS IN THE FIELD OF REAL ESTATE TRANSACTIONS; FINANCIAL MANAGEMENT; PROVIDING A WEB SITE CONTAINING INFORMATION CONCERNING SERVICE PROVIDERS IN THE FIELDS OF MORTGAGE BANKING, LENDING, AND REAL ESTATE (U.S. CLS. 100, 101 AND 102).

**CLASS 38—COMMUNICATION**

FOR COMMUNICATION SERVICES, NAMELY PROVIDING MULTIPLE USER ACCESS TO THE GLOBAL COMPUTER NETWORK; ELECTRONIC TRANSMISSION OF MESSAGES AND DATA BETWEEN BUSINESS PARTNERS; ELECTRONIC TRANSMISSION OF MESSAGES AND DATA BETWEEN SERVICE PROVIDERS IN THE FIELDS OF MORTGAGE BANKING, LENDING AND REAL ESTATE (U.S. CLS. 100, 101 AND 104).

**CLASS 42—SCIENTIFIC, COMPUTER AND LEGAL SERVICES**

FOR COMPUTER SERVICES NAMELY, PROVIDING INFORMATION AT THE SPECIFIC REQUEST OF END-USERS BY MEANS OF GLOBAL COMPUTER NETWORKS IN THE FIELD OF MORTGAGE BANKING LENDING AND REAL ESTATE (U.S. CLS. 100 AND 101).

SN 78-029,728. CELLULAR WAREHOUSE, DUBLIN, CA. FILED 10-9-2000.

**PLANETARY COMMUNICATIONS**

NO CLAIM IS MADE TO THE EXCLUSIVE RIGHT TO USE "COMMUNICATIONS", APART FROM THE MARK AS SHOWN.

**CLASS 9—ELECTRICAL AND SCIENTIFIC APPARATUS**

FOR TELECOMMUNICATIONS APPARATUS AND INSTRUMENTS, NAMELY CELLULAR/DIGITAL PHONES, AND PAGERS (U.S. CLS. 21, 23, 26, 36 AND 38).

**CLASS 35—ADVERTISING AND BUSINESS**

FOR RETAIL STORE SERVICES FEATURING TELECOMMUNICATIONS PRODUCTS (U.S. CLS. 100, 101 AND 102).

SN 78-029,731. CELLULAR WAREHOUSE, DUBLIN, CA. FILED 10-9-2000.

**GET INTO GIZMOTION****CLASS 9—ELECTRICAL AND SCIENTIFIC APPARATUS**

FOR TELECOMMUNICATIONS APPARATUS AND INSTRUMENTS, NAMELY CELLULAR/DIGITAL PHONES, AND PAGERS (U.S. CLS. 21, 23, 26, 36 AND 38).

**CLASS 35—ADVERTISING AND BUSINESS**

FOR RETAIL STORE SERVICES FEATURING TELECOMMUNICATIONS PRODUCTS (U.S. CLS. 100, 101 AND 102).

SN 78-029,732. CELLULAR WAREHOUSE, DUBLIN, CA. FILED 10-9-2000.

**GIZMOBILITY****CLASS 9—ELECTRICAL AND SCIENTIFIC APPARATUS**

FOR TELECOMMUNICATIONS APPARATUS AND INSTRUMENTS, NAMELY CELLULAR/DIGITAL PHONES, AND PAGERS (U.S. CLS. 21, 23, 26, 36 AND 38).

**CLASS 35—ADVERTISING AND BUSINESS**

FOR RETAIL STORE SERVICES FEATURING TELECOMMUNICATIONS PRODUCTS (U.S. CLS. 100, 101 AND 102).

SN 78-030,513. OTTAWAY NEWSPAPERS, INC., DBA CAPE COD TIMES, HYANNIS, MA. FILED 10-13-2000.



NO CLAIM IS MADE TO THE EXCLUSIVE RIGHT TO USE "ONLINE", APART FROM THE MARK AS SHOWN. THE MARK CONSISTS OF THE STYLIZED WORDS "CAPE COD ONLINE" WITH THE OUTLINE OF A MAP OF CAPE COD AND THE ISLANDS, MASSACHUSETTS. SEC. 2(F).

#### **CLASS 35—ADVERTISING AND BUSINESS**

FOR ADVERTISING SERVICES, NAMELY PROVIDING SPACE IN AN ONLINE NEWSPAPER AND DISSEMINATION OF ADVERTISEMENTS AND CLASSIFIED ADVERTISING FOR OTHERS ONLINE (U.S. CLS. 100, 101 AND 102).

FIRST USE 5-1-1996; IN COMMERCE 5-1-1996.

#### **CLASS 42—SCIENTIFIC, COMPUTER AND LEGAL SERVICES**

FOR COMPUTER SERVICES, NAMELY PROVIDING INTERNET NEWSPAPER FEATURING GENERAL AND LOCAL NEWS, INTERNET INFORMATION OF INTEREST TO VISITORS, SENIOR CITIZENS AND THE ENTIRE COMMUNITY OF CAPE COD, AND HOSTING DIGITAL CONTENT ON THE INTERNET (U.S. CLS. 100 AND 101).

FIRST USE 5-1-1996; IN COMMERCE 5-1-1996.

SN 78-030,880. HEWLETT-PACKARD COMPANY, PALO ALTO, CA. FILED 10-16-2000.

## **WORLD E-INCLUSION**

#### **CLASS 36—INSURANCE AND FINANCIAL**

FOR CHARITABLE FUND-RAISING (U.S. CLS. 100, 101 AND 102).

#### **CLASS 41—EDUCATION AND ENTERTAINMENT**

FOR EDUCATIONAL SERVICES, NAMELY, CONDUCTING CLASSES, WORKSHOPS, SEMINARS AND CONFERENCES IN THE FIELD OF COMPUTER AND INFORMATION TECHNOLOGY (U.S. CLS. 100, 101 AND 107).

#### **CLASS 42—SCIENTIFIC, COMPUTER AND LEGAL SERVICES**

FOR PROVIDING CONSULTING SERVICES IN THE FIELD OF COMPUTER AND INFORMATION TECHNOLOGY (U.S. CLS. 100 AND 101).

SN 78-031,060. REALITY BASED LEARNING COMPANY, REDMOND, WA. FILED 10-17-2000.

## **LITERACY LAUNCHER @HOME**

NO CLAIM IS MADE TO THE EXCLUSIVE RIGHT TO USE "LITERACY LAUNCHER", APART FROM THE MARK AS SHOWN.

#### **CLASS 9—ELECTRICAL AND SCIENTIFIC APPARATUS**

FOR DOWNLOADABLE EDUCATIONAL SOFTWARE TO DETERMINE KINDERGARTEN READINESS DELIVERED VIA THE INTERNET (U.S. CLS. 21, 23, 26, 36 AND 38).

#### **CLASS 42—SCIENTIFIC, COMPUTER AND LEGAL SERVICES**

FOR COMPUTER SERVICES, NAMELY, PROVIDING TEMPORARY USE VIA THE INTERNET OF NON-DOWNLOADABLE EDUCATIONAL SOFTWARE TO DETERMINE KINDERGARTEN READINESS (U.S. CLS. 100 AND 101).

SN 78-031,512. STOVER, GERRIT T., NORTHAMPTON, MA. FILED 10-19-2000.

## **LANDBASE**

#### **CLASS 36—INSURANCE AND FINANCIAL**

FOR REAL ESTATE LISTING SERVICES PROVIDED VIA A GLOBAL COMPUTER NETWORK (U.S. CLS. 100, 101 AND 102).

#### **CLASS 41—EDUCATION AND ENTERTAINMENT**

FOR EDUCATIONAL SERVICES, NAMELY, COURSES AND SEMINARS IN THE FIELD OF REAL ESTATE (U.S. CLS. 100, 101 AND 107).

SN 78-031,900. HEWLETT-PACKARD COMPANY, PALO ALTO, CA. FILED 10-23-2000.

## **JETSERIES**

OWNER OF U.S. REG. NO. 1,844,420.

#### **CLASS 2—PAINTS**

FOR TONER CARTRIDGES AND INK JET CARTRIDGES FOR PRINTERS (U.S. CLS. 6, 11 AND 16).

#### **CLASS 9—ELECTRICAL AND SCIENTIFIC APPARATUS**

FOR COMPUTERS, COMPUTER PRINTERS AND PARTS THEREFOR, INTEGRATED CIRCUITS, COMPUTER CHIPS AND COMPUTER PERIPHERALS (U.S. CLS. 21, 23, 26, 36 AND 38).

**CLASS 16—PAPER GOODS AND PRINTED MATTER**

FOR COMPUTER PRINTING PAPER; STATIONERY; ENVELOPES; PLASTIC TRANSPARENCY FILMS; PRINTED PUBLICATIONS, NAMELY BROCHURES, PAMPHLETS, NEWSLETTERS, CATALOGS, MANUALS, TECHNICAL BULLETINS, AND DATA SHEETS FEATURING COMPUTERS AND COMPUTER PRINTERS (U.S. CLS. 2, 5, 22, 23, 29, 37, 38 AND 50).

SN 78-033,852. PAPPAKOSTAS, MARK JAMES, PALO ALTO, CA. FILED 11-3-2000.

**MERLONA****CLASS 32—LIGHT BEVERAGES**

FOR BEER (U.S. CLS. 45, 46 AND 48).

**CLASS 33—WINES AND SPIRITS**

FOR WINE (U.S. CLS. 47 AND 49).

SN 78-033,541. OXFORD BIOMEDICA PLC, OXFORD, UNITED KINGDOM, FILED 11-2-2000.

SN 78-034,576. CHEMPULSE, HOUSTON, TX. FILED 11-9-2000.

**CHEMPULSE****SMARTOMICS**

PRIORITY CLAIMED UNDER SEC. 44(D) ON UNITED KINGDOM APPLICATION NO. 2247588, FILED 10-5-2000, REG. NO. 2247588, DATED 10-5-2000, EXPIRES 10-5-2010.

**CLASS 35—ADVERTISING AND BUSINESS**

FOR ELECTRONIC RETAILING SERVICES VIA COMPUTER FEATURING BULK AND COMMODITY CHEMICALS (U.S. CLS. 100, 101 AND 102).

**CLASS 36—INSURANCE AND FINANCIAL**

FOR ON-LINE EXCHANGE OF BULK AND COMMODITY CHEMICALS (U.S. CLS. 100, 101 AND 102).

**CLASS 1—CHEMICALS**

FOR CHEMICAL AND BIOCHEMICAL PRODUCTS FOR USE IN THE GENE DELIVERY TECHNOLOGY, ENZYMES AND CHEMICALS FOR IN VITRO USE IN LABORATORIES AND FOR ANALYSIS FOR USE IN THE GENE DELIVERY TECHNOLOGY, MICRO-ORGANISMS, DEOXYRIBONUCLEIC ACID SEQUENCES, CLONING VEHICLES AND RECOMBINANT DEOXYRIBONUCLEIC ACID AND VARIATIONS THEREOF, ALL FOR IN VIVO USE IN GENE DELIVERY TECHNOLOGY AND CATALYSTS FOR GENE DELIVERY TECHNOLOGY (U.S. CLS. 1, 5, 6, 10, 26 AND 46).

SN 78-034,578. SHELL OIL COMPANY, HOUSTON, TX. FILED 11-9-2000.

**CHEMODITY EXCHANGE**

NO CLAIM IS MADE TO THE EXCLUSIVE RIGHT TO USE "EXCHANGE", APART FROM THE MARK AS SHOWN.

**CLASS 5—PHARMACEUTICALS**

FOR GENE THERAPY AND PROPHYLAXIS PRODUCTS, NAMELY, GENE DELIVERY PRODUCTS; ENZYMES AND ENZYME PREPARATIONS FOR USE IN THE MEDICAL INDUSTRY, VECTORS, RETROVIRAL VECTORS, VECTOR AND RETROVIRAL VECTOR MANUFACTURING PREPARATIONS, ALL FOR USE IN GENE DELIVERY TECHNOLOGY, PRODUCTS FOR USE IN VECTOR PRODUCTION TECHNOLOGIES, NEUROGENOMICS PRODUCTS; PHARMACEUTICAL PREPARATIONS CONTAINING NUCLEIC ACIDS FOR ASSISTANCE IN DELIVERING GENE THERAPY AND PROPHYLAXIS, NAMELY, GENE DELIVERY SYSTEMS; VACCINES FOR USE IN THE TREATMENT OF DISEASES OF THE BRAIN AND NERVOUS SYSTEM AND MOTOR NEURONE DISEASES, GENE THERAPY AND PROPHYLAXIS AND CHEMICALS AND BIOCHEMICALS FOR USE IN THE MEDICAL INDUSTRY (U.S. CLS. 6, 18, 44, 46, 51 AND 52).

**CLASS 35—ADVERTISING AND BUSINESS**

FOR ELECTRONIC RETAILING SERVICES VIA COMPUTER FEATURING BULK AND COMMODITY CHEMICALS (U.S. CLS. 100, 101 AND 102).

**CLASS 36—INSURANCE AND FINANCIAL**

FOR ON-LINE EXCHANGE OF BULK AND COMMODITY CHEMICALS (U.S. CLS. 100, 101 AND 102).

**CLASS 42—SCIENTIFIC, COMPUTER AND LEGAL SERVICES**

FOR SCIENTIFIC AND MEDICAL RESEARCH AND DEVELOPMENT, GENETIC ENGINEERING SERVICES, BIOTECHNOLOGY SERVICES, NAMELY, BIOTECHNOLOGY RESEARCH IN THE DEVELOPMENT OF THERAPEUTIC PRODUCTS AND VACCINES; MEDICAL RESEARCH AND DEVELOPMENT IN THE FIELD OF VECTOR PRODUCTION TECHNOLOGIES (U.S. CLS. 100 AND 101).

SN 78-036,599. STROUBE, WILLIAM P., DALLAS, TX. FILED 11-27-2000.

**DIVERSITY FOR PEACE****CLASS 35—ADVERTISING AND BUSINESS**

FOR PROMOTING SOCCER COMPETITIONS AND EVENTS FOR OTHERS (U.S. CLS. 100, 101 AND 102).

**CLASS 36—INSURANCE AND FINANCIAL**

FOR FUNDRAISING SERVICES, NAMELY, PROCURING SPONSORSHIP MONEY FOR SOCCER TEAMS TO ATTEND SOCCER TOURNAMENTS (U.S. CLS. 100, 101 AND 102).

SN 78-036,652. NASH, LANI L., NASHVILLE, TN. FILED 11-27-2000.

**LANI NASH**

THE NAME "LANI NASH" IDENTIFIES A LIVING INDIVIDUAL WHOSE CONSENT IS OF RECORD.

**CLASS 9—ELECTRICAL AND SCIENTIFIC APPARATUS**

FOR COMPACT DISCS FEATURING "PRERECORDED" "MUSIC", AUDIO TAPES FEATURING "PRERECORDED" "MUSIC", VIDEO TAPES FEATURING "PRERECORDED" "MUSICAL", PERFORMANCE; DVDS FEATURING "PRERECORDED" "MUSICAL PERFORMANCE" (U.S. CLS. 21, 23, 26, 36 AND 38).

**CLASS 16—PAPER GOODS AND PRINTED MATTER**

FOR POSTERS; SOUVENIR PROGRAMS/POSTERS CONCERNING MUSICAL PERFORMANCE (U.S. CLS. 2, 5, 22, 23, 29, 37, 38 AND 50).

**CLASS 21—HOUSEWARES AND GLASS**

FOR PLASTIC CUPS (U.S. CLS. 2, 13, 23, 29, 30, 33, 40 AND 50).

**CLASS 25—CLOTHING**

FOR T-SHIRTS; SWEATSHIRTS; BASEBALL CAPS; HATS (U.S. CLS. 22 AND 39).

SN 78-036,975. BICOMCORPORATION, TOYONAKA-SHI, OSAKA PREFECTURE, JAPAN, FILED 11-29-2000.

**BICOM**  
ARK FOR BIO

THE MARK IS LINED FOR THE COLORS RED, GREEN AND BLUE.

THE MARK CONSISTS OF (1) THE WORD "BICOM" IN STYLIZED FORM WITH THE LETTER "O" BEING A RED CIRCLE INSIDE OF A GREEN RING INSIDE OF A BLUE RING; AND (2) THE PHRASE "ARK FOR BIO".

**CLASS 40—MATERIAL TREATMENT**

FOR ENVIRONMENTAL REMEDIATION SERVICES, NAMELY, SOIL, WASTE AND/OR WATER TREATMENT SERVICES (U.S. CLS. 100, 103 AND 106).

**CLASS 42—SCIENTIFIC, COMPUTER AND LEGAL SERVICES**

FOR CONSULTATION IN THE FIELD OF ENVIRONMENTAL REMEDIATION SERVICES, NAMELY, SOIL, WASTE AND/OR WATER TREATMENT SERVICES; TECHNICAL CONSULTATION SERVICES IN THE FIELD OF ENVIRONMENTAL BIOTECHNOLOGY (U.S. CLS. 100 AND 101).

SN 78-040,660. SENSEI PARTNERS LLC, MENLO PARK, CA. FILED 12-27-2000.

**SENSEI CATALYTIC CONVERTER**

THE ENGLISH TRANSLATION OF THE WORD "SENSEI" IN THE MARK IS "MASTER" OR "TEACHER".

**CLASS 35—ADVERTISING AND BUSINESS**

FOR BUSINESS MANAGEMENT AND CONSULTATION SERVICES FOR START-UP TECHNOLOGY COMPANIES (U.S. CLS. 100, 101 AND 102).

**CLASS 36—INSURANCE AND FINANCIAL**

FOR FINANCIAL ANALYSIS AND CONSULTATION SERVICES, NAMELY, FINANCING FOR START UP TECHNOLOGY COMPANIES (U.S. CLS. 100, 101 AND 102).

SN 78-041,749. WILKEN, ARDEN, SANTA ROSA, CA. AND WILKEN, JACK ROGER, SANTA ROSA, CA. FILED 1-4-2001.

**School for  
INNER  
SOUND**

NO CLAIM IS MADE TO THE EXCLUSIVE RIGHT TO USE "SCHOOL FOR INNER SOUND", APART FROM THE MARK AS SHOWN.

**CLASS 16—PAPER GOODS AND PRINTED MATTER**

FOR PRINTING INSTRUCTIONAL MATERIALS, NAMELY, MANUALS AND BOOKS FOR SOUND THERAPY, SOUND HEALING, MUSIC THERAPY AND MUSIC EDUCATION (U.S. CLS. 2, 5, 22, 23, 29, 37, 38 AND 50).

**CLASS 41—EDUCATION AND ENTERTAINMENT**

FOR EDUCATIONAL SERVICES, NAMELY, PROVIDING COURSES AND PROFESSIONAL TRAINING IN THE FORM OF CLASSES, WORKSHOPS, SEMINARS AND CORRESPONDANCE COURSES IN SOUND THERAPY, SOUND HEALING, MUSIC THERAPY AND MUSIC EDUCATION (U.S. CLS. 100, 101 AND 107).

SN 78-041,946. NETCHEMISTRY, INC., IRVINE, CA. FILED 1-5-2001.

SN 78-049,695. JAMES, STEWART, M., WHITE BEAR LAKE, MN. FILED 2-22-2001.



#### **CLASS 9—ELECTRICAL AND SCIENTIFIC APPARATUS**

FOR BROWSER-BASED WEBSITE AND INTRANET BUSINESS APPLICATIONS DEVELOPMENT AND HOSTING SOFTWARE APPLICATIONS (U.S. CLS. 21, 23, 26, 36 AND 38).

FIRST USE 8-1-2000; IN COMMERCE 8-2-2000.

#### **CLASS 42—SCIENTIFIC, COMPUTER AND LEGAL SERVICES**

FOR COMPUTER SERVICES, NAMELY, DESIGNING AND IMPLEMENTING NETWORK WEB AND INTRANET WEB PAGES FOR OTHERS; DESIGNING AND IMPLEMENTING WEBSITES FOR OTHERS; HOSTING THE WEBSITES AND INTRANET SITES OF OTHERS ON A COMPUTER SERVER FOR A GLOBAL COMPUTER NETWORK (U.S. CLS. 100 AND 101).

FIRST USE 8-1-2000; IN COMMERCE 8-2-2000.

SN 78-047,105. DIAMONDCLUSTER INTERNATIONAL, INC., CHICAGO, IL. FILED 2-7-2001.

## **DIAMONDCLUSTER**

PRIORITY CLAIMED UNDER SEC. 44(D) ON SPAIN APPLICATION NO. 2345788M, FILED 9-25-2000.

#### **CLASS 35—ADVERTISING AND BUSINESS**

FOR BUSINESS MANAGEMENT AND CONSULTATION SERVICES (U.S. CLS. 100, 101 AND 102).

FIRST USE 9-11-2000; IN COMMERCE 9-11-2000.

#### **CLASS 42—SCIENTIFIC, COMPUTER AND LEGAL SERVICES**

FOR COMPUTER CONSULTING SERVICES IN THE FIELD OF INFORMATION TECHNOLOGY, NAMELY, STRATEGIC PLANNING AND PROJECT MANAGEMENT OF INFORMATION TECHNOLOGY DEVELOPMENT (U.S. CLS. 100 AND 101).

FIRST USE 9-11-2000; IN COMMERCE 9-11-2000.

## **MIGUEL DE UNAMUNO FOUNDATION**

THE NAME "MIGUEL DE UNAMUNO" DOES NOT IDENTIFY A LIVING INDIVIDUAL.

#### **CLASS 16—PAPER GOODS AND PRINTED MATTER**

FOR BOOKS IN FICTION, POETRY, NON-FICTION, ANTHOLOGIES (U.S. CLS. 2, 5, 22, 23, 29, 37, 38 AND 50).

#### **CLASS 41—EDUCATION AND ENTERTAINMENT**

FOR EDUCATIONAL SERVICES, NAMELY, CLASSES, SEMINARS, CONFERENCES, SYMPOSIA, WORKSHOPS IN THE HUMANITIES AND FOREIGN LANGUAGES AT THE A.P. AND COLLEGE LEVEL; PRODUCTION AND DISTRIBUTION OF EDUCATIONAL MATERIALS IN THE NATURE OF FILMS/VIDEOS AND AUDIO TAPES; PUBLICATION AND DISTRIBUTION OF EDUCATIONAL AND LITERARY MATERIALS, NAMELY, TEXT BOOKS, PAMPHLETS, NOVELS, SHORT STORIES AND POETRY (U.S. CLS. 100, 101 AND 107).

SN 78-050,602. HUESTON, MIKE, SARASOTA, FL. AND HUESTON, JEAN, SARASOTA, FL. FILED 2-28-2001.

## **ADJ PLUS**

NO CLAIM IS MADE TO THE EXCLUSIVE RIGHT TO USE "A DJ", APART FROM THE MARK AS SHOWN.

#### **CLASS 35—ADVERTISING AND BUSINESS**

FOR ON-LINE RETAIL STORE SERVICES AND MAIL ORDER SERVICES FEATURING MUSIC MEMORABILIA (U.S. CLS. 100, 101 AND 102).

FIRST USE 5-1-1984; IN COMMERCE 5-1-1984.

#### **CLASS 41—EDUCATION AND ENTERTAINMENT**

FOR DISC JOCKEYS FOR PARTIES AND SPECIAL EVENTS (U.S. CLS. 100, 101 AND 107).

FIRST USE 5-1-1984; IN COMMERCE 5-1-1984.

SN 78-052,231. ARBO, INC., LAFAYETTE, CA. FILED 3-9-2001.

## **SNACKTACULAR**

#### **CLASS 29—MEATS AND PROCESSED FOODS**

FOR SNACK BARS CONSISTING PRIMARILY OF FRUIT WITH CEREAL (U.S. CL. 46).

#### **CLASS 30—STAPLE FOODS**

FOR SNACK BARS CONSISTING PRIMARILY OF CEREAL WITH FRUIT (U.S. CL. 46).

SN 78-055,010. PROCTER & GAMBLE COMPANY, THE, CINCINNATI, OH. FILED 3-26-2001.

SN 78-059,832. BATH & BODY WORKS, INC., REYNOLDSBURG, OH. FILED 4-23-2001.

## ABSOLUTE TULIP

### CLASS 3—COSMETICS AND CLEANING PREPARATIONS

FOR PERSONAL CARE PRODUCTS, NAMELY, AFTERSHAVE, ANTIPERSPIRANT, ASTRINGENT FOR THE FACE, ASTRINGENT FOR THE SKIN, BATH OIL, BATH BEADS, BATH SALTS, BLUSH, BODY GLITTER, BODY OIL, BODY SCRUB, BUBBLE BATH, COLOGNE, CREAM FOR THE BODY, CREAM FOR THE CUTICLES, CREAM FOR THE EYES, CREAM FOR THE FACE, CREAM FOR THE HANDS, DEODORANT, ESSENTIAL OILS, EXFOLIATORS FOR THE SKIN, EYE GELS, EYE MAKEUP PENCILS, EYE SHADOW, FACE HIGHLIGHTER, FACIAL MASKS, FACE MIST, FACE SCRUB, FOOT SOAK, FOUNDATION, FOUNDATION, FRAGRANT BODY SPLASH, FRAGRANT BODY MIST, HAIR CONDITIONER, HAIR GLITTER, HAIR HIGHLIGHTER, HAIR MASCARA, HAIR POMADE, HAIR RINSES, HAIR REMOVING CREAMS, HAIR SHAMPOO, HAIR SPRAY, HAIR STRAIGHTENER, HAIR STYLIZING GEL, HAIR STYLIZING MOUSSE, LOTION FOR THE BODY, LOTION FOR THE FACE, LOTION FOR THE HANDS, LIP BALM, LIP GLOSS, LIP LINER, LIP MAKEUP PENCILS, LIPSTICK, MAKEUP FOR THE BODY, MAKEUP FOR THE FACE, MAKEUP REMOVER, MASCARA, NAIL CORRECTOR PENS, NAIL POLISH, NAIL STENCILS, NON-MEDICATED BLEMISH STICK, NON-MEDICATED CLEANSER FOR THE FACE, NON-MEDICATED FOOT SPRAY, NON-MEDICATED MOOD ENHANCING MASSAGE OINTMENT, NON-MEDICATED MOOD ENHANCING SKIN CREAM, OIL BLOTTING SHEETS FOR THE SKIN, PERFUME, POWDER FOR THE BODY, POWDER FOR THE FACE, POWDER FOR THE FEET, PUMICE STONES FOR PERSONAL USE, SALT SCRUBS FOR THE SKIN, SHAVING CREAM, SHOWER GEL, SKIN BRONZING CREAM, SOAP FOR THE BODY, SOAP FOR THE FACE, SOAP FOR THE HANDS, SUN BLOCK FOR THE BODY, SUN BLOCK FOR THE FACE, SUNTAN LOTION FOR THE BODY, SUNTAN LOTION FOR THE FACE, SUNLESS TANNING LOTION FOR THE BODY, SUNLESS TANNING LOTION FOR THE FACE, PRE-SUNTANNING LOTION FOR THE BODY, PRE-SUNTANNING LOTION FOR THE FACE, POST-SUNTANNING LOTION FOR THE BODY, POST-SUNTANNING LOTION FOR THE FACE, TALCUM POWDER; POTPOURRI, ROOM FRAGRANCING GELS, ROOM SPRAYS AND SACHETS (U.S. CLS. 1, 4, 6, 50, 51 AND 52).



THE STIPPLING SHOWN IN THE DRAWING IS A FEATURE OF THE MARK FOR SHADING PURPOSES ONLY, AND IS NOT INTENDED TO INDICATE COLOR.

THE MARK CONSISTS OF WORDS "CONSUMERAISLES" APPEARING ON AN ABSTRACT OVAL SHAPE WHICH CONTAINS A SHOPPING CART CONTAINING GROCERY ITEMS AND .COM APPEARING BELOW THE WORDS "CONSUMERAISLES" AND ON THE LOWER RIGHT BELOW AND OUTSIDE THE ABSTRACT OVAL SHAPE.

### CLASS 9—ELECTRICAL AND SCIENTIFIC APPARATUS

FOR COMPUTER COMMUNICATIONS SOFTWARE CONSISTING OF A SIMULATED RETAIL ENVIRONMENT WHICH ALLOWS CUSTOMERS TO TEST AND REACT TO RETAIL PRODUCTS, ADVERTISING AND SHOPPING SCENARIOS IN REAL TIME (U.S. CLS. 21, 23, 26, 36 AND 38).

### CLASS 35—ADVERTISING AND BUSINESS

FOR PROVIDING ON-LINE SURVEYS FOR TRACKING CONSUMERS' PURCHASES OF PRODUCTS AND REACTIONS TO RETAIL PRODUCTS, ADVERTISING AND SHOPPING SCENARIOS IN REAL TIME; AND PROVIDING REAL TIME CONSUMER PRODUCT MARKET RESEARCH VIA A GLOBAL COMPUTER NETWORK (U.S. CLS. 100, 101 AND 102).

### CLASS 42—SCIENTIFIC, COMPUTER AND LEGAL SERVICES

FOR PROVIDING COMPUTER RESEARCH SERVICES FOR OTHERS, NAMELY PROVIDING REAL TIME CONSUMER PRODUCT MARKET RESEARCH VIA A GLOBAL COMPUTER NETWORK (U.S. CLS. 100 AND 101).

### CLASS 4—LUBRICANTS AND FUELS

FOR CANDLES (U.S. CLS. 1, 6 AND 15).

### CLASS 5—PHARMACEUTICALS

FOR SCENTED ROOM SPRAYS AND ROOM DEODORIZING SPRAYS (U.S. CLS. 6, 18, 44, 46, 51 AND 52).

### CLASS 11—ENVIRONMENTAL CONTROL APPARATUS

FOR ELECTRIC FRAGRANCE DISPENSERS AND REFILLS THEREFOR (U.S. CLS. 13, 21, 23, 31 AND 34).

SN 78-061,087. HIKARI SALES USA, INC., HAYWARD, CA. FILED 4-30-2001.

## POND SOLUTIONS

NO CLAIM IS MADE TO THE EXCLUSIVE RIGHT TO USE "POND", APART FROM THE MARK AS SHOWN.

**CLASS 1—CHEMICALS**

FOR WATER CONDITIONERS FOR OUTDOOR PONDS (U.S. CLS. 1, 5, 6, 10, 26 AND 46).

**CLASS 11—ENVIRONMENTAL CONTROL APPARATUS**

FOR FILTRATION APPARATUS AND MEDIA THEREFOR FOR OUTDOOR PONDS (U.S. CLS. 13, 21, 23, 31 AND 34).

**CLASS 31—NATURAL AGRICULTURAL PRODUCTS**

FOR FISH FOOD (U.S. CLS. 1 AND 46).

---

SN 78-061,883. ESPERANTO SOFTWARE, INC., ATLANTA, GA. FILED 5-3-2001.

**COVAST****CLASS 9—ELECTRICAL AND SCIENTIFIC APPARATUS**

FOR COMPUTER SOFTWARE FOR INTEGRATING BUSINESS APPLICATIONS, DATABASES, AND BUSINESS INFORMATION IN THE FIELD OF E-COMMERCE; COMPUTER-READABLE DATA STORAGE MEDIA, NAMELY, CD-ROMS, DVDS, DISKETTES, AND FLOPPY DISKS FEATURING APPLICATION INTEGRATION SOFTWARE (U.S. CLS. 21, 23, 26, 36 AND 38).

**CLASS 16—PAPER GOODS AND PRINTED MATTER**

FOR PRINTED MATERIALS, NAMELY, USER MANUALS, INFORMATIONAL FLYERS, AND BROCHURES FOR COMPUTER SOFTWARE (U.S. CLS. 2, 5, 22, 23, 29, 37, 38 AND 50).

**CLASS 42—SCIENTIFIC, COMPUTER AND LEGAL SERVICES**

FOR COMPUTER SOFTWARE AND HARDWARE CONSULTATION SERVICES, AND COMPUTER SOFTWARE CONFIGURATION SERVICES (U.S. CLS. 100 AND 101).

---

SN 78-064,782. STATERA, INC., GREENWOOD VILLAGE, CO. FILED 5-21-2001.

**STATERA****CLASS 35—ADVERTISING AND BUSINESS**

FOR ELECTRONIC COMMERCE CONSULTING ON THE GLOBAL INFORMATION NETWORK (U.S. CLS. 100, 101 AND 102).

**CLASS 42—SCIENTIFIC, COMPUTER AND LEGAL SERVICES**

FOR PREPARATION OF CUSTOM SOFTWARE APPLICATIONS FOR OTHERS FOR ELECTRONIC COMMERCE ON THE GLOBAL INFORMATION NETWORK (U.S. CLS. 100 AND 101).

SN 78-065,899. CAREGAIN, INC., LAWRENCEVILLE, NJ. FILED 5-25-2001.

**TOTAL-E-CARE****CLASS 35—ADVERTISING AND BUSINESS**

FOR HEALTH CARE AND FINANCIAL COST ANALYSIS, HEALTH CARE EXPENSE AND UTILIZATION REVIEW, COST CONTAINMENT BY USE OF MEDICAL RISK PROFILING TECHNOLOGIES, CONSULTATION OF COST ANALYSIS SERVICES TO EMPLOYERS AND EMPLOYEES, RETIREMENT PLANNING FOR HEALTHCARE SECURITY FOR EMPLOYEES AND PATIENTS (U.S. CLS. 100, 101 AND 102).

**CLASS 36—INSURANCE AND FINANCIAL**

FOR FINANCIAL SERVICES, NAMELY, CONSULTATION, INFORMATION AND TECHNOLOGY INFRASTRUCTURE FOR THE IMPLEMENTATION, ADMINISTRATION, MARKETING, BRAND MANAGEMENT, AND CLAIMS MANAGEMENT, INCLUDING CREDIT CARD BASED TRANSACTION PROCESSING AND SERVICES FOR HEALTHCARE CLAIMS, OF DEFINED CONTRIBUTION HEALTH CARE AND FINANCIAL SERVICES PLANS BY AND FOR EMPLOYERS, HEALTH CARE PROVIDERS, HEALTH CARE PRACTITIONERS, LABORATORIES, FINANCIAL SERVICES PROVIDERS, HEALTH CARE PLANS AND INSURERS, BENEFIT MANAGERS, THIRD PARTY ADMINISTRATORS, PHARMACEUTICAL COMPANIES, AND EMPLOYEES, ALL BY MEANS OF GLOBAL COMMUNICATIONS NETWORKS (U.S. CLS. 100, 101 AND 102).

**CLASS 42—SCIENTIFIC, COMPUTER AND LEGAL SERVICES**

FOR PROVIDING HEALTHCARE INFORMATION DIRECTED TO A PATIENT BASED ON THEIR HEALTHCARE STATUS AND PROFILE, HEALTH MAINTENANCE ORGANIZATION PLANS MAINTENANCE AND ENROLLMENT SERVICES, INDIVIDUAL HEALTH RISK ASSESSMENT AND PROVIDING CONSULTATION SERVICES TO EMPLOYEES AND EMPLOYERS (U.S. CLS. 100 AND 101).

---

SN 78-069,988. ADAMS TECHNOLOGIES, INC., LITTLETON, CO. FILED 6-19-2001.

**EASYCOIL****CLASS 7—MACHINERY**

FOR MACHINES FOR DISPENSING COILED METAL (U.S. CLS. 13, 19, 21, 23, 31, 34 AND 35).

**CLASS 16—PAPER GOODS AND PRINTED MATTER**

FOR CARDBOARD BOXES FOR DISPENSING COILED METAL (U.S. CLS. 2, 5, 22, 23, 29, 37, 38 AND 50).



SN 78-070,696. O'HALLORAN, GERARD, MINNEAPOLIS, MN. FILED 6-23-2001.

SN 78-076,509. MOTORVAC TECHNOLOGIES, SANTA ANA, CA. FILED 7-30-2001.

## SMART ATTACK

### CLASS 16—PAPER GOODS AND PRINTED MATTER

FOR BOOKS FEATURING INSTRUCTIONAL AND TEACHING INFORMATION REGARDING SELF-HELP, FINANCE, ENTERTAINMENT, READING, VOCABULARY, SCIENCE, MATHEMATICS, SOCIOLOGY, PSYCHOLOGY, HISTORY, MEDICINE, HEALTH, AND ALTERNATIVE MEDICINE (U.S. CLS. 2, 5, 22, 23, 29, 37, 38 AND 50).

### CLASS 28—TOYS AND SPORTING GOODS

FOR GAMES AND PLAYTHINGS IN THE FORM OF CARD GAMES AND BOARD GAMES (U.S. CLS. 22, 23, 38 AND 50).

### CLASS 41—EDUCATION AND ENTERTAINMENT

FOR ENTERTAINMENT NAMELY A CONTINUING GAME SHOW DISTRIBUTED OVER TELEVISION, SATELLITE, AUDIO AND VIDEO AND OVER THE INTERNET (U.S. CLS. 100, 101 AND 107).



NO CLAIM IS MADE TO THE EXCLUSIVE RIGHT TO USE "SMOKE", APART FROM THE MARK AS SHOWN.

### CLASS 1—CHEMICALS

FOR CHEMICAL THAT PRODUCES A NON-CARCINOGENIC, NON-HAZARDOUS VAPOR USED TO DETECT LEAKS IN ANY CLOSED SYSTEM (U.S. CLS. 1, 5, 6, 10, 26 AND 46).  
FIRST USE 7-18-2001; IN COMMERCE 7-18-2001.

### CLASS 7—MACHINERY

FOR MACHINE USED TO PRODUCE VAPORS FOR LEAK DETECTION IN ANY CLOSED SYSTEM (U.S. CLS. 13, 19, 21, 23, 31, 34 AND 35).  
FIRST USE 7-18-2001; IN COMMERCE 7-18-2001.

SN 78-073,126. UNITED DAIRY FARMERS, INC., CINCINNATI, OH. FILED 7-10-2001.

## BEECHWOOD FARMS

### CLASS 29—MEATS AND PROCESSED FOODS

FOR MILK (U.S. CL. 46).

### CLASS 30—STAPLE FOODS

FOR PREPARED FOOD PRODUCTS, NAMELY, DELI SANDWICHES (U.S. CL. 46).

### CLASS 32—LIGHT BEVERAGES

FOR BOTTLED DRINKING WATER; ORANGE JUICE (U.S. CLS. 45, 46 AND 48).

SN 78-077,962. VERT TECH LLC, WILMINGTON, DE. FILED 8-7-2001.

## VERTICALNET

### CLASS 9—ELECTRICAL AND SCIENTIFIC APPARATUS

FOR COMPUTER SOFTWARE FOR USE IN THE ACQUISITION, TRACKING AND PAYMENT FOR GOODS AND SERVICES (U.S. CLS. 21, 23, 26, 36 AND 38).  
FIRST USE 7-1-2000; IN COMMERCE 7-1-2000.

SN 78-074,540. MOTT'S INC., STAMFORD, CT. FILED 7-18-2001.

## THE GOODNESS OF APPLES THE MOTT'S WAY

### CLASS 29—MEATS AND PROCESSED FOODS

FOR FOOD PRODUCTS MADE FROM PROCESSED APPLES, NAMELY APPLESAUCE (U.S. CL. 46).

### CLASS 32—LIGHT BEVERAGES

FOR DRINK PRODUCTS MADE FROM APPLES, NAMELY, APPLE JUICE (U.S. CLS. 45, 46 AND 48).

### CLASS 16—PAPER GOODS AND PRINTED MATTER

FOR INSTRUCTION MANUALS FOR THE INSTALLATION AND USE OF COMPUTER SOFTWARE (U.S. CLS. 2, 5, 22, 23, 29, 37, 38 AND 50).  
FIRST USE 7-1-2000; IN COMMERCE 7-1-2000.

### CLASS 42—SCIENTIFIC, COMPUTER AND LEGAL SERVICES

FOR COMPUTER PROGRAMMING FOR OTHERS AND COMPUTER CONSULTING SERVICES REGARDING THE USE AND MODIFICATION OF COMPUTER SOFTWARE (U.S. CLS. 100 AND 101).  
FIRST USE 7-1-2000; IN COMMERCE 7-1-2000.

SN 78-078,817. COCONUT-ISLAND NETWORK, L.L.C., AMERICAN FORK, UT. FILED 8-13-2001.

SN 78-081,424. CUSTOM REST BEDDING, INC., SOUTH EL MONTE, CA. FILED 8-28-2001.

## TEAM DUPLICATION COURSE

NO CLAIM IS MADE TO THE EXCLUSIVE RIGHT TO USE "DUPLICATION COURSE", APART FROM THE MARK AS SHOWN.

### CLASS 9—ELECTRICAL AND SCIENTIFIC APPARATUS

FOR PRE-RECORDED VIDEOTAPES FEATURING INFORMATION ON BUILDING A NETWORK MARKETING BUSINESS (U.S. CLS. 21, 23, 26, 36 AND 38).

### CLASS 16—PAPER GOODS AND PRINTED MATTER

FOR PRINTED INSTRUCTIONAL AND EDUCATIONAL MATERIALS FEATURING INFORMATION ON BUILDING A NETWORK MARKETING BUSINESS (U.S. CLS. 2, 5, 22, 23, 29, 37, 38 AND 50).

### CLASS 35—ADVERTISING AND BUSINESS

FOR PROVIDING ADVISORY INFORMATION IN THE FIELD OF BUILDING A NETWORK MARKETING BUSINESS (U.S. CLS. 100, 101 AND 102).

SN 78-080,153. AMERICAN EURO FOODS, LLC, BROOKFIELD, CT. FILED 8-20-2001.

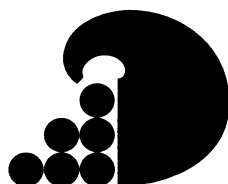

*American  
Euro Foods*

NO CLAIM IS MADE TO THE EXCLUSIVE RIGHT TO USE "AMERICAN", APART FROM THE MARK AS SHOWN.

### CLASS 35—ADVERTISING AND BUSINESS

FOR IMPORT SERVICES IN THE FIELD OF FOOD AND BEVERAGES; WHOLESALE DISTRIBUTORSHIP FEATURING FOOD PRODUCTS BY PRIVATE LABEL AND BRANDED FOOD PRODUCTS (U.S. CLS. 100, 101 AND 102).

FIRST USE 8-1-2000; IN COMMERCE 8-1-2000.

### CLASS 36—INSURANCE AND FINANCIAL

FOR FOOD BROKERAGE SERVICES IN THE FIELD OF FOOD PRODUCTS AND INGREDIENTS BY PRIVATE LABEL AND BRANDED (U.S. CLS. 100, 101 AND 102).

FIRST USE 8-1-2000; IN COMMERCE 8-1-2000.

## Vivètique

### CLASS 20—FURNITURE AND ARTICLES NOT OTHERWISE CLASSIFIED

FOR MATTRESSES, BOX SPRINGS, FUTON BEDS, PILLOWS AND MATTRESS TOPPERS (U.S. CLS. 2, 13, 22, 25, 32 AND 50).

### CLASS 24—FABRICS

FOR BEDDING PRODUCTS, NAMELY, BLANKETS, COMFORTERS, SHAMS, SHEETS, PILLOW CASES, BED SPREADS, DUST RUFFLES, MATTRESS PADS, AND DUVETS (U.S. CLS. 42 AND 50).

SN 78-083,465. USA LABS, INC., MEDLEY, FL. FILED 9-11-2001.

## YOUTH CODE

### CLASS 3—COSMETICS AND CLEANING PREPARATIONS

FOR BATH CARE PREPARATIONS, NAMELY, BATH FOAM, EXFOLIATING LOOFAH SCRUB GEL, BODY LOTION, FRAGRANT BODY MIST, AND BATH GEL (U.S. CLS. 1, 4, 6, 50, 51 AND 52).

### CLASS 4—LUBRICANTS AND FUELS

FOR CANDLES (U.S. CLS. 1, 6 AND 15).

SN 78-083,512. NAUGHTON, TERRY D, SANTA CLARITA, CA. FILED 9-11-2001.

## JUNGLE JOCKS

OWNER OF U.S. REG. NO. 1,941,837.

NO CLAIM IS MADE TO THE EXCLUSIVE RIGHT TO USE "JOCKS", APART FROM THE MARK AS SHOWN.

### CLASS 9—ELECTRICAL AND SCIENTIFIC APPARATUS

FOR INTERACTIVE VIDEO GAME PROGRAM; VIDEO GAME DISCS, VIDEO GAME SOFTWARE (U.S. CLS. 21, 23, 26, 36 AND 38).

### CLASS 25—CLOTHING

FOR CLOTHING, NAMELY, CAPS, SHIRTS, SLACKS, DRESSES, SOCKS, SHOES AND FOOTBALL JERSEYS (U.S. CLS. 22 AND 39).

**CLASS 28—TOYS AND SPORTING GOODS**

FOR PROMOTIONAL GAME CARDS, PROMOTIONAL GAME MATERIALS; TOY, NAMELY, BATTERY-POWERED COMPUTER GAME WITH LCD SCREEN WHICH FEATURES ANIMATION AND SOUND EFFECTS; COLLECTIBLE TOY FIGURES; TOY ACTION FIGURES AND ACCESSORIES THEREFOR; TRANSFORMING ROBOTIC TOY VEHICLES; ATHLETIC EQUIPMENT, NAMELY, MOUTH GUARDS, FOOTBALL PADS, STRIKING BAGS, AND HAND WRAPS; VOLLEY BALL GAME PLAYING EQUIPMENT; FOOTBALLS; BASKETBALLS; BASEBALLS; SOCCER BALLS; AND RACKETBALLS; AND EXERCISE EQUIPMENT, NAMELY, MANUALLY OPERATED JOGGING MACHINES, ROWING MACHINES, STAIR-STEPPING MACHINES, STATIONARY CICLELS, ABDOMINAL BOARDS, CHEST EXPANDERS, CHEST PULLS, WEIGHT LIFTING MACHINES; AND WEIGHT LIFTING BARS AND WEIGHTS (U.S. CLS. 22, 23, 38 AND 50).

SN 78-084,255. APACHE MINNESOTA THOM MCAN, INC., WEST NYACK, NY. FILED 9-17-2001.

**PUSH OR GET PULLED**

**CLASS 25—CLOTHING**

FOR FOOTWEAR AND CLOTHING, NAMELY, SHIRTS, T-SHIRTS, SWEATSHIRTS, VESTS, JACKETS, JERSEYS, ANORAKS, JUMPSUITS, WARM-UP SUITS, PANTS, SWEATPANTS, SHORTS, HATS, VISORS, HEADBANDS, WRISTBANDS, GLOVES, SOCKS, HOSIERY, AND BELTS (U.S. CLS. 22 AND 39).

**CLASS 35—ADVERTISING AND BUSINESS**

FOR RETAIL STORE SERVICES IN THE FIELD OF FOOTWEAR, CLOTHING, BAGS AND RELATED ACCESSORIES (U.S. CLS. 100, 101 AND 102).

SN 78-084,238. INNOVASE LLC, SAN DIEGO, CA. FILED 9-17-2001.

**INNOVASE**

**CLASS 5—PHARMACEUTICALS**

FOR DIGESTIVE MEDICATION AND TOPICAL OINTMENTS FOR DERMATOLOGY USE (U.S. CLS. 6, 18, 44, 46, 51 AND 52).

**CLASS 42—SCIENTIFIC, COMPUTER AND LEGAL SERVICES**

FOR DEVELOPMENT AND RESEARCH SERVICES REGARDING NEW PROCEDURES AND PROCESSES FOR THIRD PARTIES (U.S. CLS. 100 AND 101).

SN 78-085,660. LATTICE INTELLECTUAL PROPERTY LIMITED, LONDON, UNITED KINGDOM, FILED 9-26-2001.

**PRESEQ**

**CLASS 9—ELECTRICAL AND SCIENTIFIC APPARATUS**

FOR COMPUTER SOFTWARE FOR THE DESIGN, DEVELOPMENT AND OPERATION OF DIAGNOSTICS MODELS FOR THE DIAGNOSIS OF FAULTS IN EQUIPMENT AND SYSTEMS (U.S. CLS. 21, 23, 26, 36 AND 38).

**CLASS 42—SCIENTIFIC, COMPUTER AND LEGAL SERVICES**

FOR DESIGNING, DEVELOPING AND OPERATING DIAGNOSTIC MODELS FOR THE DIAGNOSIS OF FAULTS IN EQUIPMENT AND SYSTEMS (U.S. CLS. 100 AND 101).

\* \* \* \* \*

## SECTION 2.— INTERNATIONAL CLASSIFICATION

The short titles associated below with the international class numbers are terms designed merely for quick identification and are not an official part of the international classification. The full names of international classes are given in section 6.1 of the trademark rules of practice.

The designation "U.S. Cl." appearing in this section refers to the U.S. class in effect prior to Sep. 1, 1973 rather than the international class which applies to applications filed on or after that date. For adoption of international classification see notice in the OFFICIAL GAZETTE of Jun. 26, 1973 (911 O.G. TM 210).

### Application in one class

#### CLASS 1—CHEMICALS

SN 75-609,763. PLANT HEALTH CARE, INC., PITTSBURGH, PA. FILED 12-21-1998.

### FLOWER SAVER

NO CLAIM IS MADE TO THE EXCLUSIVE RIGHT TO USE "FLOWER", APART FROM THE MARK AS SHOWN, FOR BIOLOGICAL FERTILIZERS AND SOIL CONDITIONERS FOR DOMESTIC, HORTICULTURAL AND COMMERCIAL USE (U.S. CLS. 1, 5, 6, 10, 26 AND 46).  
FIRST USE 7-1-1997; IN COMMERCE 9-1-1997.

SN 75-669,670. DYNAMITE MARKETING, INC., MERIDIAN, ID. FILED S.R. 10-30-1999; AM. P.R. 2-22-2000.

### CHANGING THE WAY THE WORLD FERTILIZES

FOR LIQUID FERTILIZER PRODUCTS FOR DOMESTIC USE (U.S. CLS. 1, 5, 6, 10, 26 AND 46).  
FIRST USE 8-12-1997; IN COMMERCE 8-12-1997.

SN 75-671,584. COGNIS DEUTSCHLAND GMBH, DUESSELDORF, FED REP GERMANY, BY ASSIGNMENT HENKEL KOMMANDITGESELLSCHAFT AUF AKTIEN, D-40191 DUESSELDORF, FED REP GERMANY, FILED 3-31-1999.

The logo for carechemicals features a stylized, curved line above the word "carechemicals" in a lowercase, sans-serif font.

PRIORITY CLAIMED UNDER SEC. 44(D) ON FED REP GERMANY APPLICATION NO. 39856272, FILED 10-1-1998, REG. NO. 39856272, DATED 6-8-2000, EXPIRES 10-31-2008.

FOR BASIC AND INTERMEDIATE CHEMICALS FOR USE IN THE MANUFACTURE OF COSMETICS, PERSONAL CARE PRODUCTS, PHARMACEUTICALS, DETERGENTS AND CLEANERS (U.S. CLS. 1, 5, 6, 10, 26 AND 46).

FIRST USE 1-1-2000; IN COMMERCE 1-1-2000.

#### CLASS 1—(Continued).

SN 75-753,975. LES PECHERIES MARINARD LTEE, PROVINCE OF QUEBEC, CANADA, FILED 7-15-1999.

The logo for Kitomer features the word "Kitomer" in a stylized, outlined, serif font with a registered trademark symbol.

PRIORITY CLAIMED UNDER SEC. 44(D) ON CANADA APPLICATION NO. 1019928, FILED 6-18-1999, REG. NO. TMA539382, DATED 1-9-2001, EXPIRES 1-9-2016.

THE DRAWING IS LINED FOR THE COLORS BLUE AND RED.

FOR CHEMICAL, NAMELY CHITOSAN SOLD IN BULK USED IN WASTE WATER TREATMENT, IN AGRICULTURE AND IN MANUFACTURE OF COSMETICS (U.S. CLS. 1, 5, 6, 10, 26 AND 46).

SN 75-800,829. CHISSO CORPORATION, KITA-KU, OSAKA-SHI, OSAKA, JAPAN, FILED 9-15-1999.

The logo for Silaplane features the word "Silaplane" in a bold, italicized, sans-serif font.

OWNER OF JAPAN REG. NO. 1891974, DATED 9-29-1986, EXPIRES 9-29-2006.

FOR SILICONE RESINS FOR USE IN THE MANUFACTURE AND TREATMENT OF MATERIALS IN A WIDE VARIETY OF INDUSTRIES AND FOR GENERAL INDUSTRIAL USE (U.S. CLS. 1, 5, 6, 10, 26 AND 46).

FIRST USE 11-11-1994; IN COMMERCE 11-11-1994.

**CLASS 1—(Continued).**

SN 76-039,928. TIMAC, 35400 SAINT-MALO, FRANCE, FILED 5-3-2000.

**NUTRIBALANCE**

FOR FERTILIZERS FOR AGRICULTURAL, HORTICULTURAL, AND DOMESTIC USE, FERTILIZERS FOR USE IN GARDENING, GREENHOUSES, TREE NURSERIES, AND GOLF COURSES (U.S. CLS. 1, 5, 6, 10, 26 AND 46).

SN 76-040,499. ORION 21 A.D. PTY LIMITED, SUMNER PARK, QUEENSLAND, AUSTRALIA, FILED 5-3-2000.

**ALLUMAGEL**

PRIORITY CLAIMED UNDER SEC. 44(D) ON AUSTRALIA APPLICATION NO. 831254, FILED 4-10-2000, REG. NO. 831254, DATED 4-10-2000, EXPIRES 4-10-2010.

FOR CHEMICAL PRODUCTS, NAMELY LUMINESCENT GELS FOR COATING OF SURFACES OF ARTICLES AND PROCESSED LUMINESCENT MOLDABLE RESINS FOR APPLICATION ON SURFACES OF ARTICLES (U.S. CLS. 1, 5, 6, 10, 26 AND 46).

SN 76-045,602. DALE CHRISTENSON, ATLANTIC BEACH, FL. FILED 5-11-2000.

**DING ALL**

NO CLAIM IS MADE TO THE EXCLUSIVE RIGHT TO USE "DING", APART FROM THE MARK AS SHOWN.

FOR SURFBOARD REPAIR KITS COMPRISING OF UNPROCESSED ARTIFICIAL RESIN, HARDENER, FIBERGLASS CLOTH, SANDPAPER/APPLICATORS, INSTRUCTIONS THEREFORE (U.S. CLS. 1, 5, 6, 10, 26 AND 46).

FIRST USE 10-1-1986; IN COMMERCE 10-1-1986.

SN 76-109,177. STRATAGENE, LA JOLLA, CA. FILED 8-15-2000.

**ABSOLUTELY RNA**

NO CLAIM IS MADE TO THE EXCLUSIVE RIGHT TO USE "RNA", APART FROM THE MARK AS SHOWN.

FOR KITS FOR NUCLEIC ACID PURIFICATION AND ISOLATION COMPRISED PRIMARILY OF LABORATORY REAGENTS FOR LIFE SCIENCES RESEARCH USE; SCIENTIFIC LABORATORY REAGENTS (U.S. CLS. 1, 5, 6, 10, 26 AND 46).

FIRST USE 8-0-2000; IN COMMERCE 8-0-2000.

**CLASS 1—(Continued).**

SN 76-119,983. MIDWEST INDUSTRIAL SUPPLY, INC., CANTON, OH. FILED 9-1-2000.



FOR DUST SUPPRESSION COMPOSITIONS MADE UP OF SYNTHETIC ORGANIC MATERIAL IN LIQUID FORM FOR COAL, MINERALS, ORES AND SYNFUEL (U.S. CLS. 1, 5, 6, 10, 26 AND 46).

FIRST USE 8-0-1999; IN COMMERCE 8-0-1999.

SN 76-127,270. BK GIULINI CHEMIE GMBH & CO. OHG, D-67065 LUDWIGSHAFEN/RHEIN, FED REP GERMANY, FILED 9-12-2000.

**DILURIT**

OWNER OF FED REP GERMANY REG. NO. 651534, DATED 8-8-1952, EXPIRES 8-8-2002.

FOR CHEMICAL PRODUCTS FOR INDUSTRIAL PURPOSES, ESPECIALLY FOR THE PAPER INDUSTRY, CONTAINING PROCESS CHEMICALS FOR PULP, PAPER AND BOARD PRODUCTION AND FOR WATER TREATMENT, NAMELY BIOCIDES, SLIMICIDES AND ANTIMICROBIAL AGENTS (U.S. CLS. 1, 5, 6, 10, 26 AND 46).

SN 76-127,273. BK GIULINI CHEMIE GMBH & CO. OHG, D-67065 LUDWIGSHAFEN/RHEIN, FED REP GERMANY, FILED 9-12-2000.

**LABUFLOC**

OWNER OF FED REP GERMANY REG. NO. 925069, DATED 1-5-1974, EXPIRES 1-5-2004.

FOR CHEMICAL PRODUCTS FOR INDUSTRIAL PURPOSES, ESPECIALLY FOR THE PAPER INDUSTRY, CONTAINING PROCESS CHEMICALS FOR PULP, PAPER AND BOARD PRODUCTION, NAMELY FLOCCULENT, CHEMICALS USED IN THE RETENTION OF PROCESS AND WASTE WATER, FIXING AND DISPERSING AGENTS, AND CHEMICALS USED FOR WATER TREATMENT, NAMELY FLOCCULENTS (U.S. CLS. 1, 5, 6, 10, 26 AND 46).

**CLASS 1—(Continued).**

SN 76-132,296. KALO, INC., OVERLAND PARK, KS. FILED 9-21-2000.

**KALO**

SEC. 2(F).  
FOR LIQUID AND DRY WATER SOLUBLE TANK MIX SPRAY ADJUVANTS, SOIL SURFACTANTS, AND SPECIALTY PRODUCT ADDITIVES TO ENHANCE THE PERFORMANCE OF PESTICIDES, IMPROVE SPRAY DEPOSITION AND PROMOTE THE INFILTRATION AND LATERAL MOVEMENT OF WATER INTO SOILS AND OTHER PLANT MEDIA (U.S. CLS. 1, 5, 6, 10, 26 AND 46).

FIRST USE 0-0-1932; IN COMMERCE 0-0-1932.

SN 76-133,980. OSCA, INC., LAFAYETTE, LA. FILED 9-22-2000.

**INSULGEL**

FOR COMPLETIONS CHEMICALS FOR USE IN THE OIL AND GAS INDUSTRY, NAMELY, INSULATING PACKER FLUID, BRINE-BASED INSULATING VISCOFIED FLUIDS FOR REDUCING HEAT TRANSFER IN A VARIETY OF APPLICATIONS IN THE OIL AND GAS INDUSTRY, NAMELY, FOR USE AS A PACKER FLUID TO MINIMIZE COOL DOWN OF OIL AND GAS AS IT IS BEING PRODUCED AND IN PIPELINES AS OIL AND GAS IS BEING TRANSPORTED (U.S. CLS. 1, 5, 6, 10, 26 AND 46).

FIRST USE 3-0-1999; IN COMMERCE 3-0-1999.

SN 76-153,213. AUXEIN CORPORATION, LANSING, MI. FILED 10-25-2000.

**NUTRX**

FOR FERTILIZER THAT ENHANCES NUTRIENT UPTAKE IN PLANTS RESULTING IN IMPROVED OVERALL PLANT HEALTH AND GROWTH PROMOTION FOR AGRICULTURAL AND DOMESTIC USE (U.S. CLS. 1, 5, 6, 10, 26 AND 46).

SN 76-177,757. PROMEGA CORPORATION, MADISON, WI. FILED 12-8-2000.

**ALUQUANT**

FOR REAGENTS USED IN SCIENTIFIC OR MEDICAL RESEARCH FOR THE DETECTION OF NUCLEIC ACIDS (U.S. CLS. 1, 5, 6, 10, 26 AND 46).

**CLASS 1—(Continued).**

SN 76-183,232. OMS INVESTMENTS, INC., WILMINGTON, DE. FILED 12-18-2000.

**FALL FEEDINGS BRING  
SPRING GREENINGS**

FOR FERTILIZERS FOR DOMESTIC USE (U.S. CLS. 1, 5, 6, 10, 26 AND 46).

SN 76-192,566. CIBA SPECIALTY CHEMICALS WATER TREATMENTS LIMITED, WEST YORKSHIRE BD12 OJZ, ENGLAND, FILED 1-11-2001.

**MAGNASOL**

FOR CHEMICAL COAGULANT FOR THE TREATMENT OF EFFLUENT DISCHARGES (U.S. CLS. 1, 5, 6, 10, 26 AND 46).

SN 76-205,496. GRAHAM, CHARLES H., GULF SHORES, AL. FILED 2-5-2001.

**EARTH SOURCE TURF  
PRODUCTS**

NO CLAIM IS MADE TO THE EXCLUSIVE RIGHT TO USE "TURF PRODUCTS", APART FROM THE MARK AS SHOWN.

FOR ORGANIC FERTILIZERS - LIQUID AND GRANULAR FOR USE IN TURF GRASS INDUSTRY (U.S. CLS. 1, 5, 6, 10, 26 AND 46).

SN 76-242,949. COVERT COMPANY, INC., BALTIMORE, MD. FILED 4-19-2001.

***Quiet Times***

FOR HOT MELT ADHESIVE SPECIFICALLY FORMULATED TO BOND FURNITURE SOFT COMPONENTS ONE TO EACH OTHER RESULTING IN COMPLETE BOND AND REDUCED NOISE ASSOCIATED WITH OTHER HOT MELTS (U.S. CLS. 1, 5, 6, 10, 26 AND 46).

FIRST USE 12-0-1999; IN COMMERCE 2-0-2000.

**CLASS 1—(Continued).**

SN 76-256,521. OLD WORLD INDUSTRIES, INC., NORTH-BROOK, IL. FILED 5-14-2001.

**LIFETIME**

FOR ANTIFREEZE AND COOLANT FOR VEHICLE ENGINES (U.S. CLS. 1, 5, 6, 10, 26 AND 46).

SN 76-260,013. VENTAS DE ESPECIALIDADES QUIMICAS, S.A., BARCELONA, SPAIN, FILED 5-21-2001.

**AMINAT**

FOR CHEMICALS FOR USE IN THE MANUFACTURE OF COSMETICS, PRESERVATIVES AND EMULSIFIERS (U.S. CLS. 1, 5, 6, 10, 26 AND 46).

SN 76-270,063. TROPICAL SEAS, INC., DAYTONA BEACH, FL. FILED 6-12-2001.

**SYN-O-Meter**

FOR CHEMICALLY TREATED LABELS FOR INDICATING UV RAY LEVELS (U.S. CLS. 1, 5, 6, 10, 26 AND 46).  
FIRST USE 11-0-1999; IN COMMERCE 11-0-1999.

SN 76-275,965. MCCALIP, WINSTON A., MALIBU, CA. FILED 6-25-2001.

**PLANT SODA**

NO CLAIM IS MADE TO THE EXCLUSIVE RIGHT TO USE "PLANT", APART FROM THE MARK AS SHOWN.  
FOR COMBINATION FERTILIZER SUPPLEMENT AND CARBONATED WATER FOR USE ON CROPS AND HOUSEHOLD PLANTS (U.S. CLS. 1, 5, 6, 10, 26 AND 46).

SN 76-284,666. MERQUINSA MERCADOS QUIMICOS, S.L., 08160 MONTMELO, BARCELONA, SPAIN, FILED 7-13-2001.

**PEARLBOND**

OWNER OF U.S. REG. NOS. 1,816,539, 1,836,482 AND 2,238,070.  
FOR POLYURETHANE POLYMERS FOR USE IN THE MANUFACTURE OF PLASTICS AND ADHESIVES (U.S. CLS. 1, 5, 6, 10, 26 AND 46).

**CLASS 1—(Continued).**

SN 76-296,302. ALZO INC., SAYREVILLE, NJ. FILED 8-7-2001.

**POLYLIPID**

FOR POLYMERIC POLYURETHANE CHEMICAL ADDITIVES FOR USE AS EMOLLIENTS, CONDITIONERS, SOFTENERS, SURFACTANTS, STATIC REDUCING AGENTS AND SKIN ADHERING AGENTS FOR USE IN THE MANUFACTURE OF COSMETIC, PHARMACEUTICAL AND PERSONAL CARE PRODUCTS (U.S. CLS. 1, 5, 6, 10, 26 AND 46).

SN 76-298,851. AMERICAN CASEIN COMPANY, BURLINGTON, NJ. FILED 8-13-2001.

**CASECRETE**

FOR PROTEIN POLYMERS FOR THE CONSTRUCTION INDUSTRY (U.S. CLS. 1, 5, 6, 10, 26 AND 46).  
FIRST USE 3-19-1993; IN COMMERCE 3-19-1993.

SN 76-305,282. SCENTCO, LLC, THOMASVILLE, GA. FILED 8-27-2001.

**PAINT-POURRI**

FOR FRAGRANCE ADDITIVE FOR HOUSE PAINTS, VARNISHES AND INDUSTRIAL COATINGS (U.S. CLS. 1, 5, 6, 10, 26 AND 46).

SN 76-310,767. HOC INDUSTRIES, INC., WICHITA, KS. FILED 9-10-2001.

**NO MORE MR. ICE GUY**

FOR AIRCRAFT DEICING FLUID (U.S. CLS. 1, 5, 6, 10, 26 AND 46).

SN 76-314,925. CAPITOL USA, LLC, DALTON, GA. FILED 9-18-2001.

**THE SMART WAY TO INSTALL**

FOR ADHESIVES FOR USE IN THE FLOOR COVERING INDUSTRY (U.S. CLS. 1, 5, 6, 10, 26 AND 46).

**CLASS 1—(Continued).**

SN 76-314,926. CAPITOL USA, LLC, DALTON, GA. FILED 9-18-2001.

**IQ**

FOR ADHESIVES FOR USE IN THE FLOOR COVERING INDUSTRY (U.S. CLS. 1, 5, 6, 10, 26 AND 46).

SN 76-319,138. INNOVATION LABORATORIES, INC., MIAMI, FL. FILED 9-28-2001.

**PolicosanolPlus**

FOR CHEMICALS FOR USE IN THE MANUFACTURE OF COSMETICS, PHARMACEUTICALS, BEVERAGES AND NUTRITIONAL SUPPLEMENTS (U.S. CLS. 1, 5, 6, 10, 26 AND 46).

SN 76-321,951. ARCHAESOLUTIONS, INC., TYRONE, GA. FILED 10-5-2001.

**SEPTIC.SOLUTIONS**

FOR WATER BASED SOLUTION OF BIOLOGIC COMPOUNDS USED FOR THE TREATMENT OF SEPTIC TANK SYSTEMS BY AIDING IN THE BREAKDOWN OF SOLID WASTE MATTER AND THE ABATEMENT OF ASSOCIATED ODORS (U.S. CLS. 1, 5, 6, 10, 26 AND 46).  
FIRST USE 8-30-2001; IN COMMERCE 8-30-2001.

SN 78-015,831. GENENCOR INTERNATIONAL, INC., PALO ALTO, CA. FILED 7-7-2000.

**LOWGEN**

FOR CHEMICALS, NAMELY, LOW-ALLERGENCITY ENZYMES, PEPTIDES, ANTIBODIES AND PROTEINS ALL FOR USE IN THE MANUFACTURE OF PERSONAL CARE PRODUCTS, NAMELY, HAIR CARE, ORAL CARE, SKIN CARE AND COLOR COSMETIC PRODUCTS; CHEMICAL BIOMATERIALS, NAMELY, LOW IMMUNOGENIC ENZYMES, PEPTIDES, ANTIBODIES AND PROTEINS ALL FOR USE IN THE MANUFACTURE OF PERSONAL CARE PRODUCTS, NAMELY, HAIR CARE, ORAL CARE, SKIN CARE AND COLOR COSMETIC PRODUCTS (U.S. CLS. 1, 5, 6, 10, 26 AND 46).

**CLASS 1—(Continued).**

SN 78-034,959. ROHM AND HAAS COMPANY, PHILADELPHIA, PA. FILED 11-13-2000.



THE MARK CONSISTS OF A TRIANGLE, CONTAINING THE WORD "PURACRYL" ACROSS THE TOP AND A STYLIZED DIAMOND DESIGN BENEATH THE WORD.

FOR ACRYLIC EMULSION POLYMER FOR USE IN THE MANUFACTURE OF DECORATIVE PAINTS AND COATING MATERIALS FOR BUILDINGS AND OTHER STRUCTURES FOR USE BY PROFESSIONAL AND NON-PROFESSIONAL PAINTERS (U.S. CLS. 1, 5, 6, 10, 26 AND 46).

SN 78-049,123. AMERSHAM PHARMACIA BIOTECH UK LIMITED, LITTLE CHALFONT, UNITED KINGDOM, FILED 2-19-2001.

**TEMPLIPI**

FOR CHEMICAL KITS COMPRISED OF LYSIS BUFFER AND ENZYME FOR GENERATION OF DNA FOR SEQUENCING OR CLONING, AND OBTAINING REACTIONS FOR RESTRICTION ANALYSIS FROM PLAKES, BACTERIAL COLONIES OR BACTERIAL CULTURES (U.S. CLS. 1, 5, 6, 10, 26 AND 46).

SN 78-051,424. BAY CHEMICAL COMPANY, TAMPA, FL. FILED 3-5-2001.

**MICROPEL**

FOR FERTILIZER FOR AGRICULTURAL USE (U.S. CLS. 1, 5, 6, 10, 26 AND 46).

SN 78-053,882. HUNTSMAN PETROCHEMICAL CORPORATION, AUSTIN, TX. FILED 3-19-2001.

**JEFFLINK**

FOR CHEMICALS FOR USE IN THE PREPARATION OF POLYUREA AND POLYURETHANE (U.S. CLS. 1, 5, 6, 10, 26 AND 46).



**CLASS 1—(Continued).**

SN 78-076,338. FOMO PRODUCTS, INC., NORTON, OH.  
FILED 7-30-2001.



OWNER OF U.S. REG. NOS. 1,247,077, 2,469,144 AND OTHERS.

NO CLAIM IS MADE TO THE EXCLUSIVE RIGHT TO USE "SEAL", APART FROM THE MARK AS SHOWN.

FOR ADHESIVES AND SEALANTS FOR GENERAL USE (U.S. CLS. 1, 5, 6, 10, 26 AND 46).

SN 78-077,729. RUTGERS ORGANICS CORPORATION,  
STATE COLLEGE, PA. FILED 8-6-2001.

**NAXCAT**

FOR LIQUID AND GRANULAR ARYL SULFONIC ACIDS HAVING PRIMARY APPLICATIONS AS ORGANIC CATALYSTS AND STRONG ORGANIC ACIDS (U.S. CLS. 1, 5, 6, 10, 26 AND 46).

FIRST USE 10-31-1999; IN COMMERCE 10-31-1999.

SN 78-079,276. ARCH CHEMICALS, INC., NORWALK, CT.  
FILED 8-15-2001.

**QUICK CHLOR**

NO CLAIM IS MADE TO THE EXCLUSIVE RIGHT TO USE "CHLOR", APART FROM THE MARK AS SHOWN.

FOR CHEMICALS USED TO SANITIZE AND TO TREAT WATER, SWIMMING POOLS, SPAS AND HOT TUBS (U.S. CLS. 1, 5, 6, 10, 26 AND 46).

SN 78-079,278. ARCH CHEMICALS, INC., NORWALK, CT.  
FILED 8-15-2001.

**ALGAE BAN**

NO CLAIM IS MADE TO THE EXCLUSIVE RIGHT TO USE "ALGAE", APART FROM THE MARK AS SHOWN.

FOR CHEMICALS USED TO SANITIZE AND TO TREAT WATER, SWIMMING POOLS, SPAS AND HOT TUBS (U.S. CLS. 1, 5, 6, 10, 26 AND 46).

**CLASS 1—(Continued).**

SN 78-079,283. ARCH CHEMICALS, INC., NORWALK, CT.  
FILED 8-15-2001.

**PACE PLUS**

OWNER OF U.S. REG. NO. 963,329.

FOR CHEMICALS USED TO SANITIZE AND TO TREAT WATER, SWIMMING POOLS, SPAS AND HOT TUBS (U.S. CLS. 1, 5, 6, 10, 26 AND 46).

SN 78-084,476. GUSTAVO, REBORA, CELAYA, MEXICO,  
FILED 9-19-2001.

**MEZFER CROWN**

FOR FERTILIZERS FOR AGRICULTURAL AND DOMESTIC USE (U.S. CLS. 1, 5, 6, 10, 26 AND 46).

SN 78-084,904. PACKARD BIOSCIENCE COMPANY, MERIDEN, CT. FILED 9-21-2001.

**HYDROGEL**

FOR 3-DIMENSIONAL MICROARRAY SUBSTRATE FOR USE FOR IMMOBILIZATION OF BIOMOLECULES SUCH AS PROTEINS, ANTIBODIES, OLIGONUCLEOTIDES, DNA, AND OTHER COMPLEX MOLECULES IN A MICROARRAY FORMAT FOR THE LIFE SCIENCE RESEARCH MARKET (U.S. CLS. 1, 5, 6, 10, 26 AND 46).  
FIRST USE 11-0-2000; IN COMMERCE 11-0-2000.

**CLASS 2—PAINTS**

SN 75-836,221. GS METALS CORP., PINCKNEYVILLE, IL.  
FILED 10-29-1999.

**FLEX-E-COAT**

FOR CORROSION INHIBITING PAINT-TYPE FINISHES APPLIED TO BASE METALS THAT FORM WIRE MESH SUPPORT STRUCTURES; RUST PRESERVATIVE COATINGS IN THE NATURE OF ELECTRO-DEPOSITED FINISHES APPLIED TO BASE METALS THAT FORM WIRE MESH SUPPORT STRUCTURES; AND SEALER COATINGS IN THE NATURE OF ELECTRO-DEPOSITED FINISHES APPLIED TO BASE METALS THAT FORM WIRE MESH SUPPORT STRUCTURES (U.S. CLS. 6, 11 AND 16).

FIRST USE 10-18-1998; IN COMMERCE 10-18-1998.

**CLASS 2—(Continued).**

SN 75-932,295. CROWN COMPUTER SUPPLIES, INC., RICHARDSON, TX. FILED 3-1-2000.

**INFINIMAX**

FOR LASER AND INK JET CARTRIDGES; PHOTO-COPIER TONER CARTRIDGES (U.S. CLS. 6, 11 AND 16). FIRST USE 9-0-1997; IN COMMERCE 9-0-1997.

SN 76-003,802. ILLINOIS TOOL WORKS INC., GLENVIEW, IL. FILED 3-20-2000.

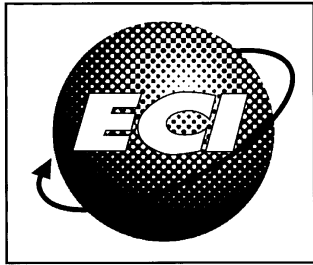

THE STIPPLING SHOWN IS TO INDICATE SHADING. FOR COATINGS IN THE NATURE OF AUTOMOBILE FINISHING, PAINT PRIMERS, AND SOLVENTS IN THE NATURE OF A PAINT PRIMER FOR USE IN PREPARING PAINTED SURFACES FOR REFINISHING (U.S. CLS. 6, 11 AND 16). FIRST USE 1-0-1998; IN COMMERCE 1-0-1998.

SN 76-145,253. BENJAMIN MOORE & CO., MONTVALE, NJ. FILED 10-11-2000.

**COLOR PREVIEW**

NO CLAIM IS MADE TO THE EXCLUSIVE RIGHT TO USE "COLOR", APART FROM THE MARK AS SHOWN. FOR COLORANTS FOR USE IN THE MANUFACTURE OF PAINTS (U.S. CLS. 6, 11 AND 16). FIRST USE 1-31-2000; IN COMMERCE 1-31-2000.

SN 76-169,222. DECOART INC., STANFORD, KY. FILED 11-21-2000.

**MAGIC MEDIUM**

NO CLAIM IS MADE TO THE EXCLUSIVE RIGHT TO USE "MEDIUM", APART FROM THE MARK AS SHOWN. FOR ADDITIVE TO PAINTS USED FOR ARTS AND CRAFTS PROJECTS (U.S. CLS. 6, 11 AND 16).

**CLASS 2—(Continued).**

SN 76-315,706. ACE HARDWARE CORPORATIO, OAK BROOK, IL. FILED 9-17-2001.

**COLOR YOUR LIFE**

FOR INDOOR AND OUTDOOR PAINT, COATINGS AND VARNISHES (U.S. CLS. 6, 11 AND 16).

SN 76-315,739. SPECTRA SYSTEMS CORP., PROVIDENCE, RI. FILED 9-21-2001.

**VERICOAT**

FOR COATINGS USED ON CD'S AND DVD'S FOR AUTHENTICATION AND ANTI-COUNTERFEITING (U.S. CLS. 6, 11 AND 16).

SN 76-315,740. SPECTRA SYSTEMS CORP., PROVIDENCE, RI. FILED 9-21-2001.

**SPECTRASHIFT**

FOR COATINGS, NAMELY TRANSPARENT WATER BASED, LACQUER AND CLEAR ADHESIVE COATINGS WITH LIGHT STIMULATED MATERIAL WHICH RESULT IN THE COATING BECOMING OPAQUE WHEN ILLUMINATED WITH UV LIGHT; AND COLORED WATER BASED LACQUER, AND ADHESIVE COATINGS WITH LIGHT STIMULATED MATERIALS WHICH RESULT IN THE COATING CHANGING COLOR WHEN ILLUMINATED WITH UV LIGHT (U.S. CLS. 6, 11 AND 16).

SN 78-071,680. J.M. HUBER CORPORATION, EDISON, NJ. FILED 6-29-2001.

**HUBERCOM**

FOR COMPOSITE PIGMENT FOR USE IN PAPER AND PAPERBOARD APPLICATIONS TO IMPROVE OPTICAL AND PRINTING PERFORMANCE (U.S. CLS. 6, 11 AND 16).

**CLASS 3—COSMETICS AND CLEANING PREPARATIONS**

**CLASS 3—(Continued).**

SN 75-530,346. BEIERSDORF AKTIENGESELLSCHAFT, 20245 HAMBURG, FED REP GERMANY, FILED 8-4-1998.

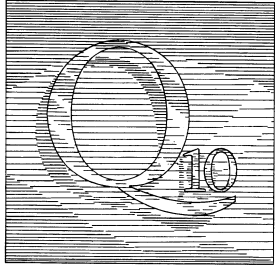

PRIORITY CLAIMED UNDER SEC. 44(D) ON ERPN CMNTY TM OFC APPLICATION NO. 000799494, FILED 4-15-1998, REG. NO. 000799494, DATED 3-19-1999, EXPIRES 3-19-2009.

NO CLAIM IS MADE TO THE EXCLUSIVE RIGHT TO USE "Q10", APART FROM THE MARK AS SHOWN.

THE MARK CONSISTS OF THE DESIGNATION "Q10" WHICH HAS BLUE AND WHITE BANDS AND CASTS A SHADOW OF DARK BLUE OVER A BACKGROUND OF BLUE AND DARK BLUE.

FOR PREPARATIONS FOR BODY AND BEAUTY CARE, NAMELY, PREPARATIONS FOR SKIN AND FACE CARE IN THE FORM OF CREAMS, GELS AND LOTIONS, SKIN AND FACE CLEANSERS, SUNSCREEN AND SUN BLOCKS PREPARATIONS (U.S. CLS. 1, 4, 6, 50, 51 AND 52).

SN 75-698,204. WET DREAMS, INC., LAND O'LAKES, FL. FILED 5-5-1999.

**BODY ACTION**

NO CLAIM IS MADE TO THE EXCLUSIVE RIGHT TO USE "BODY", APART FROM THE MARK AS SHOWN.

FOR SKIN CARE PREPARATIONS, NAMELY BODY LOTION (U.S. CLS. 1, 4, 6, 50, 51 AND 52).

SN 75-861,749. SUN RESEARCH LLC, SANTA CRUZ, CA. FILED 12-2-1999.

**BURNOUT**

FOR SUNSCREEN TOPICAL PREPARATIONS, NAMELY LOTIONS, SUNSCREENS, SUNBLOCKS, CREAMS, GELS, SPRAYS, LIP BALMS, MOISTURIZERS, AFTER-SUN LOTIONS AND GELS, SHAMPOOS, CONDITIONERS, FACE WASHES AND BODY WASHES (U.S. CLS. 1, 4, 6, 50, 51 AND 52).

FIRST USE 7-1-1998; IN COMMERCE 11-13-1998.

**CLASS 3—(Continued).**

SN 75-912,646. CALIFORNIA TAN, INC., LOS ANGELES, CA. BY ASSIGNMENT CALIFORNIA SUNCARE, INC., LOS ANGELES, CA. FILED 2-8-2000.

**AMBROSIA**

FOR TANNING PRODUCTS, NAMELY, TANNING LOTIONS, TANNING GELS, TANNING OILS, TANNING MOUSSES, TANNING SPRAYS AND TANNING CREAMS SOLD EXCLUSIVELY IN SALONS (U.S. CLS. 1, 4, 6, 50, 51 AND 52).

SN 76-008,974. SARKLI-REPECHAGE, LTD., NEW YORK, NY. FILED 3-24-2000.



THE MARK CONSISTS OF A STYLIZED WAVE DESIGN WHICH WRAPS AROUND PACKAGING FOR THE GOODS. SEC. 2(F).

FOR NON-MEDICATED SKIN CARE PREPARATIONS, NAMELY, SKIN LOTIONS, SKIN CREAMS, SKIN TONERS, SKIN AMPOULES AND SERUMS, SKIN CLEANSERS, SKIN SOAPS, SKIN MASKS, AND SKIN POWDERS; BODY CREAMS, BODY OILS, BODY MASKS, BODY POWDERS, BODY CLEANERS, AND BODY SOAPS, AND COSMETICS, NAMELY LIPSTICK, PRESSED POWDER, BLUSH, FOUNDATION, MASCARA, EYE SHADOW AND EYE, LIP AND BROW PENCILS, SOLD THROUGH SPAS AND SKIN CARE SALONS (U.S. CLS. 1, 4, 6, 50, 51 AND 52).

FIRST USE 0-0-1994; IN COMMERCE 0-0-1994.

**CLASS 3—(Continued).**

SN 76-023,347. CUTEX COMPANY, THE, JACKSON, WY.  
FILED 1-27-2000.

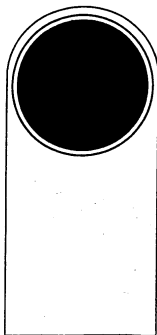

THE MARK CONSISTS OF AN OUTER RECTANGLE SHAPE, WITH A ROUNDED TOP, A BLACK SINGLE-BORDERED CIRCLE INSIDE THE TOP PORTION OF THE RECTANGLE, WITH THE BACKGROUND COLOR IN THE UPPER PORTION, FADING TO LIGHTER GRADATION OF THE BACKGROUND COLOR, THEN TO WHITE AT THE BOTTOM OF THE RECTANGLE, ALL USED AS A BACKGROUND DESIGN ON PACKAGING.

FOR NAIL POLISH REMOVERS (U.S. CLS. 1, 4, 6, 50, 51 AND 52).

FIRST USE 3-31-1999; IN COMMERCE 3-31-1999.

SN 76-031,565. AUTOGRAPH, INC., CLEVELAND, OH.  
FILED 4-21-2000.

**SILK SHAMPOO**

NO CLAIM IS MADE TO THE EXCLUSIVE RIGHT TO USE "SILK", APART FROM THE MARK AS SHOWN.

FOR ARTIFICIAL PLANT CLEANERS (U.S. CLS. 1, 4, 6, 50, 51 AND 52).

SN 76-046,291. HOUBIGANT, INC., NEW YORK, NY. FILED  
5-10-2000.

**PARFUMS HOUBIGANT  
PARIS**

NO CLAIM IS MADE TO THE EXCLUSIVE RIGHT TO USE "PARFUMES" AND "PARIS", APART FROM THE MARK AS SHOWN.

THE ENGLISH TRANSLATION OF THE TERM "PARFUMS" IN THE MARK IS "PERFUMES".

FOR PERFUMERY, COSMETICS AND TOILET PREPARATIONS, NAMELY, PERFUME, ANTI-WRINKLE CREAM, LIPSTICK, MAKEUP, COLOGNE, CONCEALERS, TONERS, FOUNDATION, BATH OIL AND NON-MEDICATED BATH SALTS, NON-MEDICATED POWDERS, SKIN LOTIONS; ESSENTIAL OILS FOR PERSONAL USE (U.S. CLS. 1, 4, 6, 50, 51 AND 52).

**CLASS 3—(Continued).**

SN 76-048,092. LADY BURD EXCLUSIVE COSMETICS, INC.,  
FARMINGDALE, NY. FILED 5-15-2000.

**EYE BLUSH**

NO CLAIM IS MADE TO THE EXCLUSIVE RIGHT TO USE "EYE", APART FROM THE MARK AS SHOWN.

FOR EYE SHADOW (U.S. CLS. 1, 4, 6, 50, 51 AND 52).

SN 76-052,489. ESTIM LUX SARL, L-1930 LUXEMBOURG,  
LUXEMBOURG, BY CHANGE OF NAME ESTIM LUX  
SARL, L-1930 LUXEMBOURG, LUXEMBOURG, FILED 5-  
19-2000.

**JUST SALON**

PRIORITY CLAIMED UNDER SEC. 44(D) ON BENELUX  
APPLICATION NO. 0950895, FILED 11-22-1999, REG. NO.  
0658935, DATED 11-22-1999, EXPIRES 11-22-2009.

NO CLAIM IS MADE TO THE EXCLUSIVE RIGHT TO USE "SALON", APART FROM THE MARK AS SHOWN.

FOR NON-MEDICATED HAIR CARE PREPARATIONS, NAMELY, PEROXIDE FOR BLEACHING HAIR, HAIR LOTIONS, SHAMPOO, HAIR DYES AND HAIR COLORING; NON-MEDICATED SKIN CARE PREPARATIONS, NAMELY, FACIALS, PEELINGS, AND FACIAL AND BODY SCRUBS; NON-MEDICATED SOAPS, NAMELY, FACIAL SOAPS, HAND SOAPS, SHOWER GELS, BATH GELS, AND BUBBLE BATH; PERFUMES; TOOTHPASTE; AND NON-MEDICATED COSMETICS, NAMELY, MAKE-UP (U.S. CLS. 1, 4, 6, 50, 51 AND 52).

SN 76-057,369. AVON PRODUCTS, INC., NEW YORK, NY.  
FILED 5-26-2000.

**BECOMING**

OWNER OF U.S. REG. NO. 1,585,259.

FOR FRAGRANCES, NAMELY PERFUMES, COLOGNES, EAU DE PARFUM, EAU DE TOILETTE, FRAGRANCED BODY SPRAY AND ROOM FRAGRANCES IN SPRAY FORM; MAKEUP REMOVER, SKIN CLEANSING SCRUB, FACIAL CLEANSER, EYE CREAM, FACIAL CREAM, FACIAL LOTION, FACIAL MASK, FACIAL SKIN TONER, HAND AND BODY LOTION, TALCUM POWDER, LIQUID TALC, BATH AND SHOWER GEL, BATH FOAM, BATH OIL, NON-MEDICATED BATH SALTS, LIP MOISTURIZER, NON-MEDICATED LIP BALM, LIPSTICK, LIP LINER, LIP GLOSS, FACIAL FOUNDATION, FACIAL POWDER, FACIAL CONCEALER, BLUSH, MASCARA, EYEBROW PENCIL, EYESHADOW, EYE LINER; HAIR CARE PREPARATIONS; NAIL CARE PREPARATIONS; DEODORANTS AND ANTIPERSPIRANTS; AND SOAPS, ALONE, IN COMBINATION AND/OR IN GIFT SETS COMPRISED OF SOME OR ALL OF THESE ITEMS (U.S. CLS. 1, 4, 6, 50, 51 AND 52).

**CLASS 3—(Continued).**

SN 76-061,453. ECT, INCORPORATED, BRIDGEPORT, PA.  
FILED 6-1-2000.

**POWER GUARD**

FOR CLEANING COMPOSITIONS FOR AIRPLANE  
AND INDUSTRIAL TURBINE ENGINES (U.S. CLS. 1, 4,  
6, 50, 51 AND 52).

FIRST USE 1-1-2001; IN COMMERCE 1-1-2001.

SN 76-068,675. TRAN, DON, WESTMINISTER, CA. FILED 6-  
14-2000.

**PRECISION**

FOR COSMETIC NAIL CARE PRODUCTS NAMELY  
ARTIFICIAL FINGERNAILS (U.S. CLS. 1, 4, 6, 50, 51  
AND 52).

FIRST USE 1-3-1990; IN COMMERCE 6-29-1990.

SN 76-073,160. REDMOND PRODUCTS, INC., STAMFORD,  
CT. FILED 6-19-2000.

**REAL VOLUME SWELL GEL**

OWNER OF U.S. REG. NO. 1,989,692.  
NO CLAIM IS MADE TO THE EXCLUSIVE RIGHT TO  
USE "VOLUME" OR "GEL", APART FROM THE MARK AS  
SHOWN.

FOR HAIR GEL, NAMELY, GEL TO FOAM STYLER  
(U.S. CLS. 1, 4, 6, 50, 51 AND 52).

SN 76-074,466. LABORATORIOS RECAMIER LTDA., CALI,  
COLOMBIA, FILED 6-21-2000.

**TANGA**

FOR SUN TANNING PREPARATIONS; SUN PROTEC-  
TION CREAMS; SUN PROTECTION LOTIONS; SUN  
CARE PRODUCTS, NAMELY, LOTIONS, OILS, GELS,  
SPRAYS AND CREAMS; SUN BLOCK PREPARATIONS  
(U.S. CLS. 1, 4, 6, 50, 51 AND 52).

**CLASS 3—(Continued).**

SN 76-085,020. IDEATIONS OF NEVADA, INC., HAYDEN,  
ID. FILED 7-6-2000.

**TOCOLŪR**

THE MARK CONSISTS OF THE WORD "TOCOLUR"  
WITH A DIACRITICAL MACRON OVER THE LETTER  
"U". THE MARK IS PRESENTED IN TYPED FORM AND  
WITHOUT ANY CLAIM AS TO SPECIAL FORM

FOR ANTIOXIDANT INGREDIENT SOLD AS AN  
INTEGRAL COMPONENT OF SKIN LOTION AND SKIN  
PRODUCTIONS, NAMELY, HAND, SKIN AND BODY  
LOTIONS, AND NIGHT, SKIN, BODY AND EYE  
CREAMS (U.S. CLS. 1, 4, 6, 50, 51 AND 52).

SN 76-108,269. BLISS WORLD LLC, BROOKLYN, NY. FILED  
8-11-2000.

**freshweight**

FOR SKIN CLARIFIERS, CLEANSERS, CREAM,  
EMOLLIENTS, LIGHTENERS, LOTION, MASKS, MOIST-  
URIZER, SCRUBS, SOAPS AND TONERS; SHOWER  
GEL; BODY FIRING GELS AND LOTIONS; BODY  
CREAM, OIL, EMULSIONS, MASKS AND SCRUBS;  
MAKEUP; LIPSTICK; LIP GLOSS; NAIL POLISH; EYE  
MAKEUP; BLUSH; MASCARA; HAND CREAM; FOOT  
CREAM; EXFOLIATING BODY SCRUBS; SUN BLOCK;  
AFTER-SUN LOTIONS; SELF-TANNING SKIN PRE-  
PARATIONS; CUTICLE CONDITIONERS; FACIAL  
CLEANSERS, CREAMS, EMULSIONS, MASKS AND  
SCRUBS (U.S. CLS. 1, 4, 6, 50, 51 AND 52).

SN 76-117,902. MANA PRODUCTS, INC., LONG ISLAND  
CITY, NY. FILED 8-28-2000.

**SOAKED IN CUDDLES**

FOR BATH PRODUCTS, NAMELY BATH GELS, BATH  
OILS, BATH POWDERS, BATH SALTS, BODY SPRAYS,  
BODY SPLASHES, BUBBLE BATH, HAIR CONDI-  
TIONERS AND HAIR SHAMPOOS, AND SKIN CARE  
PREPARATIONS, NAMELY SKIN CLEANSERS, SKIN  
CLEANSING BARS, SKIN TONERS, SKIN MOISTURI-  
ZERS, EYE GEL, MAKEUP REMOVER, NON-MEDI-  
CATED BLEMISH TREATMENT CREAMS, FADE  
CREAMS, FADE GELS, FACIAL MASKS AND FACIAL  
SCRUBS (U.S. CLS. 1, 4, 6, 50, 51 AND 52).

**CLASS 3—(Continued).**

SN 76-117,904. MANA PRODUCTS, INC., LONG ISLAND CITY, NY. FILED 8-28-2000.

**SOAKED IN TICKLES**

FOR BATH PRODUCTS, NAMELY BATH GELS, BATH OILS, BATH POWDERS, BATH SALTS, BODY SPRAYS, BODY SPLASHES, BUBBLE BATH, HAIR CONDITIONERS AND HAIR SHAMPOOS, AND SKIN CARE PREPARATIONS, NAMELY SKIN CLEANSERS, SKIN CLEANSING BARS, SKIN TONERS, SKIN MOISTURIZERS, EYE GEL, MAKEUP REMOVER, NON-MEDICATED BLEMISH TREATMENT CREAMS, FADE CREAMS, FADE GELS, FACIAL MASKS AND FACIAL SCRUBS (U.S. CLS. 1, 4, 6, 50, 51 AND 52).

SN 76-118,534. MASCOLO, BRUNO, PIANO, TX. AND MASCOLO, GAETANO, DALLAS, TX. FILED 8-29-2000.



FOR HAIR CARE PRODUCTS, NAMELY, HAIR SHAMPOO, HAIR CONDITIONER, HAIR TONIC, HAIR GEL, HAIR SPRAY, HAIR MOUSSE, HAIR POMADE, HAIR DYE, HAIR COLOR GEL, HAIR SCULPTING GEL AND HAIR LOTION; SKIN CARE PRODUCTS, NAMELY SKIN CLEANSER, SKIN MOISTURIZER, SKIN CREAM, SKIN TONER AND SKIN LOTION; AND COSMETIC PRODUCTS, NAMELY EYE SHADOWS, MASCARA, BLUSH, MAKEUP FOUNDATION, CONCEALER, FACE POWDER, LIPSTICK, NAIL POLISH AND EYELINER (U.S. CLS. 1, 4, 6, 50, 51 AND 52).

SN 76-118,641. COOPERATIVE BEAUTY VENTURES, L.L.C., NEW YORK, NY. FILED 8-29-2000.

**CONTROL[D] SUBSTANCE**

FOR HAIR CARE PRODUCTS, NAMELY, STYLING POMADE (U.S. CLS. 1, 4, 6, 50, 51 AND 52).

SN 76-119,793. CLINIQUE LABORATORIES, INC., NEW YORK, NY. FILED 8-30-2000.

**TAILORING FOR MEN**

OWNER OF U.S. REG. NO. 1,852,832.  
NO CLAIM IS MADE TO THE EXCLUSIVE RIGHT TO USE "FOR MEN", APART FROM THE MARK AS SHOWN.  
FOR COSMETICS, TOILETRIES AND FRAGRANCES, NAMELY, LOTIONS, GELS, CREAMS, SERUMS, FOR THE FACE AND BODY; COLOGNES, AFTER SHAVE LOTIONS, SHAVE GEL, SHAVE CREAM, AND SHAMPOO (U.S. CLS. 1, 4, 6, 50, 51 AND 52).

**CLASS 3—(Continued).**

SN 76-122,497. PERETTI, ELSA, MONTE CARLO, MONACO, FILED 9-1-2000.

**ELSA PERETTI**

OWNER OF U.S. REG. NOS. 1,807,381, 1,853,131 AND OTHERS.

THE NAME "ELSA PERETTI" IDENTIFIES A LIVING INDIVIDUAL WHOSE CONSENT IS OF RECORD.

FOR PERFUMES AND COLOGNES (U.S. CLS. 1, 4, 6, 50, 51 AND 52).

SN 76-124,131. PHILOSOPHY, INC., PHOENIX, AZ. FILED 9-8-2000.

**IN THE HAIR AFTER**

FOR MAKE-UP KITS COMPRISED OF LIPSTICK, LIP GLOSS, LIP LINER, LIP BALM, BLUSH, FOUNDATION, EYE SHADOW, EYE LINER, MASCARA, CONCEALER, COSMETIC PENCILS, AND FACIAL POWDER; COSMETICS, NAMELY, LIPSTICK, LIP GLOSS, LIP LINER, LIP BALM, BLUSH, FOUNDATION, EYE SHADOW, EYE LINER, MASCARA, CONCEALER, COSMETIC PENCILS, AND FACIAL POWDER; FRAGRANCES, NAMELY, PERFUME, COLOGNE, AND AFTER-SHAVE; NON-MEDICATED SKIN CARE PRODUCTS, NAMELY, SOAP, SCRUBS, TONER, CONDITIONER, EXFOLIATORS, SKIN CLARIFIER, WRINKLE REMOVING SKIN CARE PREPARATIONS, AND MOISTURIZER; FACE AND BODY LOTION, CREAM, OIL, GEL AND SPRAY; SUN SCREEN PREPARATIONS, NAMELY, LOTION, CREAM, GEL, AND SPRAY; NON-MEDICATED FACE AND BODY SKIN LIGHTENER; HAIR CARE PRODUCTS, NAMELY, SHAMPOO, CONDITIONER, RINSE, GEL, MOUSSE, SPRAY AND TONIC; BATH CARE PRODUCTS, NAMELY, SOAP, SALTS, CRYSTALS, BEADS, GEL, OIL, POWDER, AND BUBBLE BATH; NAIL CARE PREPARATIONS, NAMELY, CUTICLE CREAM, CUTICLE REMOVING PREPARATIONS, NAIL ENAMEL, NAIL POLISH, NAIL POLISH REMOVER, NAIL POLISH BASE COAT, NAIL POLISH TOP COAT, AND NAIL STRENGTHENERS; PERSONAL DEODORANT (U.S. CLS. 1, 4, 6, 50, 51 AND 52).

SN 76-124,707. GUTHY-RENKER CORPORATION, PALM DESERT, CA. FILED 9-8-2000.

**BRIGHT ESSENTIALS**

FOR SKIN AND BODY CARE PREPARATIONS NAMELY, SKIN CLEANSERS, SKIN MOISTURIZERS, SKIN LOTIONS, SUN SCREEN PREPARATIONS AND SKIN SOAPS (U.S. CLS. 1, 4, 6, 50, 51 AND 52).

**CLASS 3—(Continued).**

SN 76-126,020. HELENA RUBINSTEIN, PARIS, FRANCE, FILED 9-11-2000.

**CLOSE PERFECTION**

PRIORITY CLAIMED UNDER SEC. 44(D) ON FRANCE APPLICATION NO. 00/3.013.417, FILED 3-10-2000, REG. NO. 003013417, DATED 3-10-2000, EXPIRES 3-10-2010.

FOR PERFUMES, TOILET WATER, NON-MEDICATED GELS AND SALTS FOR THE BATH AND THE SHOWER, TOILET SOAPS, BODY DEODORANTS; COSMETICS, NAMELY, CREAMS, MILKS, LOTIONS, GELS AND POWDERS FOR THE FACE, BODY AND HANDS; SUN SCREEN AND SUN TANNING PREPARATIONS; MAKEUP; HAIR SHAMPOOS; GELS, SPRAYS, MOUSSES AND NON-MEDICATED BALMS FOR HAIR STYLING AND HAIR CARE; HAIR SPRAY; HAIR COLORING AND HAIR DECOLORANT PREPARATIONS; PERMANENT WAVING AND CURLING PREPARATIONS; ESSENTIAL OILS FOR PERSONAL USE; DENTFRIFICES (U.S. CLS. 1, 4, 6, 50, 51 AND 52).

SN 76-126,718. GAPARDIS HEALTH & BEAUTY, INC., MIAMI, FL. FILED 9-11-2000.

**MAXI WHITE**

NO CLAIM IS MADE TO THE EXCLUSIVE RIGHT TO USE "WHITE", APART FROM THE MARK AS SHOWN.

FOR BEAUTY AND SKIN CARE PRODUCTS, NAMELY SOAPS, LOTIONS, MILKS, CREAMS, GELS, AND SERUMS FOR THE FACE AND BODY; AND DEPIGMENTARY PRODUCTS, NAMELY LOTIONS, MILKS, CREAMS, GELS, AND SERUMS FOR THE FACE AND BODY (U.S. CLS. 1, 4, 6, 50, 51 AND 52).

FIRST USE 0-0-1997; IN COMMERCE 4-0-2000.

SN 76-127,915. TAE, KIM WON, ROCKVILLE, MD. FILED 9-15-2000.

**BRAID-SO-NEW**

FOR HAIR CARE PREPARATIONS (U.S. CLS. 1, 4, 6, 50, 51 AND 52).

SN 76-144,123. OZKLEEN EURASIA LIMITED, 87007 F.T. LABAN, MALAYSIA, FILED 10-10-2000.

**KITCHEN POWER**

NO CLAIM IS MADE TO THE EXCLUSIVE RIGHT TO USE "KITCHEN", APART FROM THE MARK AS SHOWN.

FOR BATHROOM AND KITCHEN CLEANING PREPARATIONS (U.S. CLS. 1, 4, 6, 50, 51 AND 52).

**CLASS 3—(Continued).**

SN 76-146,193. CAUDALIES, 75017 PARIS, FRANCE, FILED 10-13-2000.

**VINOLIFT**

OWNER OF FRANCE REG. NO. 98764845, DATED 12-17-1998, EXPIRES 12-17-2008.

FOR SKIN SOAP, BODY SOAP, PERFUME, ESSENTIAL OILS FOR PERSONAL USE, HAIR LOTIONS, DENTFRIFICES AND COSMETICS, NAMELY, BATH AND SHOWER GELS, TOILET WATER, COLOGNE, WATER PERFUME, COSMETIC CREAMS, GELS, BALMS, LOTIONS, EMULSIONS FOR THE SKIN TO RETARD AGING, EMULSIONS TO HYDRATE, EMULSIONS TO REGENERATE, EMULSIONS FOR THE SKIN TO PREVENT WRINKLES, BEAUTY MASKS, MAKEUP FOUNDATION, MAKEUP CREAM, MAKEUP POWDER, MASCARA, EYE-LINER, FALSE EYE-LASHES, SUN-TANNING AND AFTER SUN PREPARATIONS, CLEANSING MILK, GELS, BALMS, EMULSIONS, LOTIONS FOR TOILET PURPOSES, LIP BALMS AND CREAMS, LIPSTICKS, SHAVE AND AFTER SHAVE CREAMS, GELS, BALMS AND LOTIONS (U.S. CLS. 1, 4, 6, 50, 51 AND 52).

SN 76-166,838. TOO, INC., COLUMBUS, OH. FILED 11-16-2000.

**UP ALL NIGHT**

FOR PERSONAL CARE PRODUCTS, NAMELY, FRAGRANT BODY SPLASH AND FRAGRANT BODY WASH (U.S. CLS. 1, 4, 6, 50, 51 AND 52).

FIRST USE 4-14-2001; IN COMMERCE 4-14-2001.

SN 76-171,105. HANS SCHWARZKOPF GMBH & CO. KG, HAMBURG, FED REP GERMANY, FILED 11-27-2000.

**SCHWARZKOPF CARVE**

OWNER OF FED REP GERMANY REG. NO. 30004415.1, DATED 4-14-2000, EXPIRES 1-31-2010.

OWNER OF U.S. REG. NOS. 613,665, 2,299,418 AND OTHERS.

THE ENGLISH TRANSLATION OF THE WORD "SCHWARZKOPF" IN THE MARK IS "BLACK HEAD".

FOR HAIR CARE PREPARATIONS, NAMELY, HAIR CONDITIONERS, HAIR SHAMPOOS, HAIR TONING PREPARATIONS, HAIR COLORING PREPARATIONS, HAIR LIGHTENING PREPARATIONS, HAIR SETTING PREPARATIONS AND HAIR STYLING PREPARATIONS, PERMANENT WAVE PREPARATIONS FOR THE HAIR (U.S. CLS. 1, 4, 6, 50, 51 AND 52).

**CLASS 3—(Continued).**

SN 76-171,107. HANS SCHWARZKOPF GMBH & CO. KG, HAMBURG, FED REP GERMANY, FILED 11-27-2000.

**SCHWARZKOPF CARVER**

OWNER OF FED REP GERMANY REG. NO. 30004421.6, DATED 4-14-2000, EXPIRES 1-31-2010.

OWNER OF U.S. REG. NOS. 613,665, 2,299,418 AND OTHERS.

THE ENGLISH TRANSLATION OF THE WORD "SCHWARZKOPF" IN THE MARK IS "BLACK HEAD".

FOR HAIR CARE PREPARATIONS, NAMELY, HAIR CONDITIONERS, HAIR SHAMPOOS, HAIR TONING PREPARATIONS, HAIR COLORING PREPARATIONS, HAIR LIGHTENING PREPARATIONS, HAIR SETTING PREPARATIONS AND HAIR STYLING PREPARATIONS, PERMANENT WAVE PREPARATIONS FOR THE HAIR (U.S. CLS. 1, 4, 6, 50, 51 AND 52).

SN 76-177,490. HANS SCHWARZKOPF GMBH & CO. KG, HAMBURG, FED REP GERMANY, FILED 12-7-2000.



**Schwarzkopf & feminine**

PRIORITY CLAIMED UNDER SEC. 44(D) ON FED REP GERMANY APPLICATION NO. 30029376.3/0, FILED 6-9-2000, REG. NO. 30043996.2, DATED 9-18-2000, EXPIRES 6-30-2010.

OWNER OF U.S. REG. NOS. 613,665, 2,299,418 AND OTHERS.

THE ENGLISH TRANSLATION OF "SCHWARZKOPF" IS "BLACK HEAD".

FOR HAIR CARE AND COLORING PREPARATION, NAMELY, HAIR CONDITIONERS, HAIR SHAMPOOS, HAIR TONING PREPARATIONS, HAIR COLORING PREPARATIONS, HAIR LIGHTENING PREPARATIONS, HAIR SETTING AND HAIR STYLING PREPARATIONS, AND PERMANENT WAVE PREPARATIONS FOR THE HAIR (U.S. CLS. 1, 4, 6, 50, 51 AND 52).

SN 76-180,800. FIELDS, GLADENE ELAINE, CARSON, CA. FILED 12-13-2000.

**SACHETS BY ELAINE**

NO CLAIM IS MADE TO THE EXCLUSIVE RIGHT TO USE "SACHETS", APART FROM THE MARK AS SHOWN.

FOR POUCHES CONTAINING SCENTED POTPOURRI (U.S. CLS. 1, 4, 6, 50, 51 AND 52).

**CLASS 3—(Continued).**

SN 76-185,955. LIDL STIFTUNG & CO. KG, 74172 NECK-ARSULM, FED REP GERMANY, FILED 12-22-2000.

**CORPAL**

OWNER OF FED REP GERMANY REG. NO. 1135523, DATED 3-1-1989, EXPIRES 11-7-2007.

FOR HAND CLEANING PREPARATIONS, PERFUMES, ESSENTIAL OILS FOR PERSONAL USE, COSMETICS, DEODORANTS FOR PERSONAL USE, HAIR LOTIONS, PREPARATIONS FOR THE CLEANING, CARE AND GROOMING OF THE HAIR, SUN SCREEN, DENTIFRICES, PERFUMED ROOM FRAGRANCES (U.S. CLS. 1, 4, 6, 50, 51 AND 52).

SN 76-194,186. PERSONATALIE, BROOKLINE, MA. FILED 1-16-2001.

*PERSONATALIE*

FOR MAKE UP AND COSMETICS PREPARATIONS, NAMELY, LIP LINERS, LIP CREAM, LIQUID LIP LINERS, LIP GLOSS AND LIPSTICK (U.S. CLS. 1, 4, 6, 50, 51 AND 52).

SN 76-224,838. KENZO, 75001 PARIS, FRANCE, FILED 3-15-2001.

**ETOLE**

PRIORITY CLAIMED UNDER SEC. 44(D) ON FRANCE APPLICATION NO. 003051921, FILED 9-15-2000, REG. NO. 003051921, DATED 9-15-2000, EXPIRES 9-15-2010.

THE ENGLISH TRANSLATION OF "ETOLE" IS "STOLE". FOR TOILET SOAPS, PERFUMES, COLOGNES, EAU DE TOILETTE, ESSENTIAL OILS FOR PERSONAL USE, COSMETICS, AND HAIR LOTIONS (U.S. CLS. 1, 4, 6, 50, 51 AND 52).

SN 76-229,917. BROCARD PARFUMS GMBH, BERLIN, FED REP GERMANY, FILED 3-22-2001.

**B R O C A R D**

PRIORITY CLAIMED UNDER SEC. 44(D) ON FED REP GERMANY APPLICATION NO. 30074074.303, FILED 9-29-2000, REG. NO. 30074074, DATED 3-12-2001, EXPIRES 9-30-2010.

NO CLAIM IS MADE TO THE EXCLUSIVE RIGHT TO USE "PARFUMS", APART FROM THE MARK AS SHOWN. THE ENGLISH TRANSLATION OF "PARFUMS" IS "PERFUME".

FOR COSMETICS, PERFUME, SOAPS (U.S. CLS. 1, 4, 6, 50, 51 AND 52).



**CLASS 3—(Continued).**

SN 76-229,918. BROCARD PARFUMS GMBH, BERLIN, FED REP GERMANY, FILED 3-22-2001.



PRIORITY CLAIMED UNDER SEC. 44(D) ON FED REP GERMANY APPLICATION NO. 30074073503, FILED 9-29-2000, REG. NO. 30074073, DATED 3-12-2001, EXPIRES 3-9-2010.

NO CLAIM IS MADE TO THE EXCLUSIVE RIGHT TO USE "PARFUMS", APART FROM THE MARK AS SHOWN. THE ENGLISH TRANSLATION OF "PARFUMS" IS "PERFUME".

FOR COSMETICS, PERFUME, SOAPS (U.S. CLS. 1, 4, 6, 50, 51 AND 52).

SN 76-230,799. OPI PRODUCTS, INC., NORTH HOLLYWOOD, CA. FILED 3-27-2001.

**DRIPDRY**

FOR NAIL POLISH DRYING LIQUIDS (U.S. CLS. 1, 4, 6, 50, 51 AND 52).

SN 76-231,164. ANGELETTA, JOSEPH G., MAMARONECK, NY. FILED 3-27-2001.



OWNER OF U.S. REG. NOS. 1,546,470, 1,897,554 AND 1,902,828.

FOR LOTIONS, NAMELY, SUNSCREEN; SUN BLOCK; SUNTAN OIL; SUN BLOCK PREPARATIONS; SUNSCREEN PREPARATIONS; SUNTAN PREPARATIONS (U.S. CLS. 1, 4, 6, 50, 51 AND 52).

**CLASS 3—(Continued).**

SN 76-234,970. ENTITY, INC., VAN NUYS, CA. FILED 4-2-2001.

**SPA\*LUNA**

THE ENGLISH TRANSLATION OF "LUNA" IS "MOON".

FOR EYE SHADOW, EYEBROW PENCIL, EYELASH LINER PENCIL, MASCARA, SKIN FRESHENING CREAM AND LOTION, FACIAL CLEANSERS IN THE FORM OF LOTIONS AND CREAMS, SKIN MOISTURIZER, EYE AND THROAT EMOLLIENT, SKIN DISCOLORATION COVER-UP, LIQUID MAKE-UP BASE, ROUGE, TRANSLUCENT FACE POWDER, DUSTING POWDER, COLOGNE, AFTER SHAVE LOTION, COSMETIC BODY LOTION, TALC FOR PERSONAL CARE, DEODORANT STICK FOR PERSONAL CARE, PERFUME, HAND AND BODY LOTION, BODY SHAMPOO, AFTER-BATH BODY LOTION WITH FRAGRANCE, FACIAL MOISTURIZING LOTION, LIQUID MAKE-UP BASE, BLEMISH STICK, BRUSH-ON POWDERED COLORING, EYEBROW PENCIL, EYE SHADOW, LIPSTICK, LIP LINER PENCIL, FACIAL MOISTURIZER, FACIAL CREAM, FACIAL SKIN ASTRINGENT FOR COSMETIC PURPOSES, EYE AND THROAT OIL, EXTERNAL BODY CLEANSER CONSISTING OF LOTIONS AND CREAMS, MILK BATH, HAND AND BODY LOTION, HAIR SHAMPOO, HAIR CONDITIONER, HAIR THICKENING COLOGNE, SCENTED BODY LOTION, NAIL STRENGTHENING POLISH, NAIL POLISH, NAIL POLISH REMOVER, NAIL BASE COAT, CUTICLE CREAM, SUN TAN LOTION, SUN TAN OIL, PERSONAL DEODORANT SPRAY, PERSONAL DEODORANT ROLL-ON, BODY TALC, LIQUID HAND SOAP, HAIR THICKENING LOTION, HAIR SPRAY, MEN'S COLOGNE, MEN'S AFTER SHAVE BALM, CREAM CONDITIONER CONTAINING SKIN NUTRIENTS INCLUDING VITAMINS, PROTEINS, AND MINERALS; SKIN TONERS, NON-MEDICATED SKIN MOISTURIZERS, SEMI-MATTE FOUNDATION MAKE-UP, SKIN LUBRICANT USED TO AID SEXUAL RELATIONS, MEN'S BODY SOAP, BODY MOISTURIZING LOTION, SKIN FIRMLING LOTION, AND SKIN TONING LOTION (U.S. CLS. 1, 4, 6, 50, 51 AND 52).

SN 76-236,831. HARD CANDY L.L.C., LOS ANGELES, CA. FILED 4-3-2001.

**HARD CANDY**



OWNER OF U.S. REG. NOS. 1,987,262, 2,362,340 AND OTHERS.

FOR HAIR CARE PRODUCTS, NAMELY GLITTER FOR HAIR (U.S. CLS. 1, 4, 6, 50, 51 AND 52). FIRST USE 4-1-2000; IN COMMERCE 4-1-2000.

**CLASS 3—(Continued).**

SN 76-237,869. ASSOCIATED INTERNATIONAL MARKET-  
ING, INC., CANYON LAKE, TX. FILED 4-9-2001.

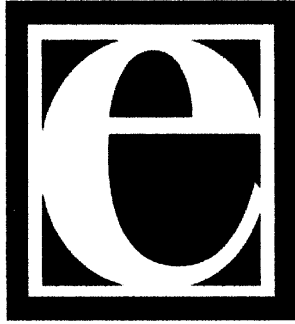

THE MARK IS COMPRISED OF A SMALL "E" IN GOLD, ENCASED IN A RECTANGULAR GOLD BOX OUTLINE, INSIDE A LARGER BOX WITH BLACK BACKGROUND BEHIND THE GOLD "E" AND THE GOLD RECTANGULAR OUTLINE BORDERING THE "E" TOUCHING THE "E" ON ALL FOUR SIDES CREATING A VERY SIGNIFICANT TRADEMARK.

FOR NON-MEDICATED SKIN CARE PREPARATIONS (U.S. CLS. 1, 4, 6, 50, 51 AND 52).

FIRST USE 5-18-2000; IN COMMERCE 6-10-2000.

SN 76-271,311. CHESEBROUGH-POND'S INC., WILMINGTON, DE. FILED 6-14-2001.

## **DOVE FOR THE WAY IT MAKES YOU FEEL**

OWNER OF U.S. REG. NOS. 1,698,261, 2,413,151 AND OTHERS.

FOR BEAUTY SOAP BARS, PRE-MOISTENED COSMETIC TOWELETTES, NON-MEDICATED TOWELETTES IMPREGNATED WITH SKIN CLEANSERS, PRE-MOISTENED NON-MEDICATED COSMETIC TOWELETTES FOR ALL OVER BODY FRESHENING, DEODORANT AND ANTI-PERSPIRANT, BODY WASH, FACIAL CLEANSERS, FACIAL SKIN TONER, FACIAL SKIN MOISTURIZERS (U.S. CLS. 1, 4, 6, 50, 51 AND 52).

**CLASS 3—(Continued).**

SN 76-272,038. FLOOD COMPANY, THE, HUDSON, OH. FILED 6-18-2001.

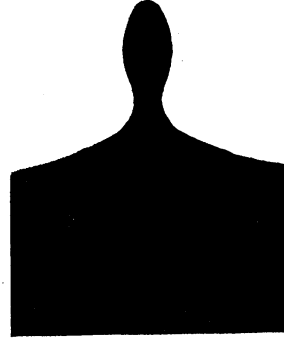

OWNER OF U.S. REG. NOS. 1,263,897, 2,482,086 AND OTHERS.

FOR SURFACE PREPARATIONS FOR WOOD SURFACES TO BE PAINTED OR STAINED IN THE NATURE OF SURFACE CLEANERS (U.S. CLS. 1, 4, 6, 50, 51 AND 52).

FIRST USE 2-9-1970; IN COMMERCE 2-9-1970.

SN 76-274,305. GRAHAM WEBB INTERNATIONAL LIMITED PARTNERSHIP, CARLSBAD, CA. FILED 6-20-2001.

## **QUICK DRAW**

FOR COSMETICS, NAMELY, FOUNDATION, POWDER, BLUSH, EYE SHADOW, EYE PENCILS, EYE LINER, MASCARA, LIP PENCILS, LIPSTICKS, LIP GLOSS, BODY PAINT, CONCEALER AND NAIL POLISH (U.S. CLS. 1, 4, 6, 50, 51 AND 52).

SN 76-275,136. HOPE DIAMOND COLLECTION, INC., NASHVILLE, TN. FILED 6-22-2001.

## **FABLE CLARITY**

OWNER OF U.S. REG. NO. 2,469,969.

FOR EAU DE PARFUM, EAU DE TOILETTE, PERFUME, COLOGNE, SKIN SOAP, BATH/SHOWER GEL, BODY MOISTURIZERS, AFTER SHAVE LOTIONS AND CREAMS (U.S. CLS. 1, 4, 6, 50, 51 AND 52).

SN 76-278,236. GLOBAL TELECAST & COMMUNICATION, LLC, MIAMI, FL. FILED 6-28-2001.

## **L'ETERNELLE JEUNESSE**

THE TERMS "L' ETERNELLE JEUNESSE" MEAN "ETERNAL YOUTH" IN ENGLISH.

FOR ANTI-WRINKLE CREAM; SKIN CLEANSING LOTIONS; SKIN CLEANSING CREAMS; SKIN CLEANSERS; SKIN MOISTURIZERS; FACIAL MASKS; SKINS MASKS; SKIN TONERS; COSMETIC PREPARATIONS FOR SKIN RENEWAL; FACIAL PEELS; AND SKIN CLEANSING GEL (U.S. CLS. 1, 4, 6, 50, 51 AND 52).

**CLASS 3—(Continued).**

SN 76-281,692. DAOU, SASSINE SASSOON, RIDGEFIELD PARK, NJ. FILED 7-9-2001.

**GOLDEN JEANS LEGEND**

FOR PERFUMES, COLOGNES, ESSENTIAL OILS FOR PERSONAL USE, HAIR PRODUCTS, NAMELY, SHAMPOO, CONDITIONER, HAIR SPRAY, HAIR GEL, HAIR MOUSSE, HAIR CARE PREPARATIONS AND COSMETICS, FOUNDATION MAKEUP, LIPSTICK, BLUSHER, EYE SHADOW, EYE LINER, MASCARA, EYEBROW PENCIL, MAKEUP REMOVER, LIP LINER AND CONCEALER (U.S. CLS. 1, 4, 6, 50, 51 AND 52).

SN 76-282,418. UNILEVER N.V., 3013 AL ROTTERDAM, NETHERLANDS, FILED 7-9-2001.

**SUMA**

OWNER OF U.S. REG. NOS. 1,072,071, 2,108,166 AND OTHERS.  
FOR DISHWASHING DETERGENTS AND DETERGENT RINSE AIDS FOR INSTITUTIONAL USE (U.S. CLS. 1, 4, 6, 50, 51 AND 52).

SN 76-285,687. HERBALIFE INTERNATIONAL, INC., LOS ANGELES, CA. FILED 7-16-2001.

**SKIN ACTIVATOR**

NO CLAIM IS MADE TO THE EXCLUSIVE RIGHT TO USE "SKIN", APART FROM THE MARK AS SHOWN.  
FOR FACIAL CREAMS, EYE CREAMS, BODY LOTION (U.S. CLS. 1, 4, 6, 50, 51 AND 52).

SN 76-289,110. AMERICAN DENTAL SUPPLY, LLC, IRVINE, CA. FILED 7-23-2001.

**PeriodentRx**

FOR NON-MEDICATED ORAL CLEANSER, MOUTHWASH, NON-MEDICATED ORAL RINSE, TOOTHPASTE, ORAL CARE PRODUCTS, NAMELY, BREATH SPRAY, BREATH MINTS; TEETH WHITENING AND BLEACHING SYSTEM CONSISTING OF MOUTH TRAYS, GEL SOLUTION AND APPLICATORS, SOLD AS A UNIT (U.S. CLS. 1, 4, 6, 50, 51 AND 52).

**CLASS 3—(Continued).**

SN 76-289,471. DAOU, SASSINE SASSOON, RIDGEFIELD PARK, NJ. FILED 7-25-2001.

**LOVE & BEACH**

FOR PERFUMES, COLOGNES, ESSENTIAL OILS FOR PERSONAL USE, HAIR PRODUCTS, NAMELY, SHAMPOO, CONDITIONER, HAIR SPRAY, HAIR GEL, HAIR MOUSSE, HAIR CARE PREPARATIONS AND COSMETICS, FOUNDATION MAKEUP, LIPSTICK, BLUSHER, EYE SHADOW, EYE LINER, MASCARA, EYEBROW PENCIL, MAKEUP REMOVER, LIP LINER AND CONCEALER (U.S. CLS. 1, 4, 6, 50, 51 AND 52).

SN 76-292,697. AVEDA CORPORATION, MINNEAPOLIS, MN. FILED 7-30-2001.

**COLOR CONSERVATION**

NO CLAIM IS MADE TO THE EXCLUSIVE RIGHT TO USE "COLOR", APART FROM THE MARK AS SHOWN.  
FOR HAIR CARE PREPARATIONS; NON-MEDICATED SKIN CARE PREPARATIONS; COSMETICS (U.S. CLS. 1, 4, 6, 50, 51 AND 52).

SN 76-293,779. J.M. PRODUCTS, INC., LITTLE ROCK, AR. FILED 8-3-2001.



FOR HAIR SPRAYS, CONDITIONERS, SHAMPOOS, NON-MEDICATED SCALP TREATMENTS, HAIR MOISTURIZERS, AND HAIR CARE PREPARATIONS (U.S. CLS. 1, 4, 6, 50, 51 AND 52).  
FIRST USE 10-1-1976; IN COMMERCE 10-1-1976.

SN 76-294,488. CHANEL, INC., NEW YORK, NY. FILED 8-2-2001.

**WITH ABSOLUTE  
PRECISION**

OWNER OF U.S. REG. NOS. 2,091,534, 2,390,459 AND OTHERS.  
FOR NON-MEDICATED SKIN CARE PREPARATIONS (U.S. CLS. 1, 4, 6, 50, 51 AND 52).

**CLASS 3—(Continued).**

SN 76-295,687. URTXINTXA, 64100 BAYONNE, FRANCE, FILED 8-7-2001.

**EDELLE**

FOR COSMETICS, SKIN CARE CREAMS, PERFUMES, EAU DE COLOGNE, EAU DE TOILETTE, NAIL ENAMELS, LIPSTICKS, SKIN CLEANSING CREAMS AND LOTION, PERSONAL SOAPS, ESSENTIAL OILS FOR PERSONAL USE, HAIR LOTIONS, TOOTHPASTE (U.S. CLS. 1, 4, 6, 50, 51 AND 52).

FIRST USE 1-27-1999; IN COMMERCE 1-3-2000.

SN 76-297,236. DAOU, SASSINE SASSOON, RIDGEFIELD PARK, NJ. FILED 8-10-2001.

**NEW JEANS**

FOR PERFUMES, COLOGNES, ESSENTIAL OILS FOR PERSONAL USE, HAIR PRODUCTS, NAMELY, SHAMPOO, CONDITIONER, HAIR SPRAY, HAIR GEL, HAIR MOUSSE, HAIR CARE PREPARATIONS AND COSMETICS, FOUNDATION MAKEUP, LIPSTICK, BLUSHER, EYE SHADOW, EYE LINER, MASCARA, EYEBROW PENCIL, MAKEUP REMOVER, LIP LINER AND CONCEALER (U.S. CLS. 1, 4, 6, 50, 51 AND 52).

SN 76-298,733. RAMSEY, ERIC, DBA VANITY BRANDS INTERNATIONAL, NEWBURY PARK, CA. FILED 8-13-2001.

**SOFTKOTE**

FOR SKIN LOTION, SKIN SOFTENER (U.S. CLS. 1, 4, 6, 50, 51 AND 52).

SN 76-301,498. TWO MARIES, INC., CHINO, CA. FILED 8-17-2001.

**CLEEN 4 TEEN**

FOR SKIN CARE PREPARATIONS AND SUN BLOCK PREPARATIONS (U.S. CLS. 1, 4, 6, 50, 51 AND 52).

SN 76-302,588. NORTHERN GROUP, INC., HICKSVILLE, NY. FILED 8-20-2001.

**SCENTOLOGY**

FOR FRAGRANCES, NAMELY, PERFUMES, COLOGNES, SHOWER GEL, BODY LOTION, FRAGRANT ROOM SPRAYS, AND MASSAGE OILS (U.S. CLS. 1, 4, 6, 50, 51 AND 52).

**CLASS 3—(Continued).**

SN 76-302,910. CALTECH INDUSTRIES, INC., MIDLAND, MI. FILED 8-22-2001.

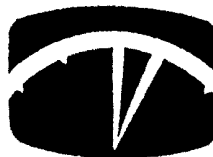

FOR GENERAL PURPOSE CLEANERS, GENERAL PURPOSE CITRUS-SCENTED CLEANERS, AND GENERAL PURPOSE CLEANERS; CLEANERS FOR HARD SURFACES (U.S. CLS. 1, 4, 6, 50, 51 AND 52).

FIRST USE 1-0-1998; IN COMMERCE 1-0-1998.

SN 76-302,913. CALTECH INDUSTRIES, INC., MIDLAND, MI. FILED 8-22-2001.

**CITREX**

OWNER OF U.S. REG. NO. 1,724,961.  
FOR GENERAL PURPOSE CLEANERS, GENERAL PURPOSE CITRUS-SCENTED CLEANERS, AND GENERAL PURPOSE CLEANERS; CLEANERS FOR HARD SURFACES (U.S. CLS. 1, 4, 6, 50, 51 AND 52).

FIRST USE 10-3-1967; IN COMMERCE 10-3-1967.

SN 76-303,278. CHESEBROUGH-POND'S INC., WILMINGTON, DE. FILED 8-22-2001.

OWNER OF U.S. REG. NOS. 1,178,774, 2,341,483 AND OTHERS.

FOR FABRIC SOFTENER (U.S. CLS. 1, 4, 6, 50, 51 AND 52).

**CLASS 3—(Continued).**

SN 76-303,279. CHESEBROUGH-POND'S INC., WILMINGTON, DE. FILED 8-22-2001.



OWNER OF U.S. REG. NOS. 1,178,774, 2,341,483 AND OTHERS.

THE STIPPLING IN THE DRAWING IS FOR TONE AND CONTRAST ONLY AND NOT TO INDICATE ANY SPECIFIC COLOR.

FOR FABRIC SOFTENER (U.S. CLS. 1, 4, 6, 50, 51 AND 52).

SN 76-304,708. MELALEUCA, INC., IDAHO FALLS, ID. FILED 8-27-2001.

**TOUGH & TENDER**

OWNER OF U.S. REG. NO. 1,779,961.  
FOR ALL PURPOSE CLEANING PREPARATION (U.S. CLS. 1, 4, 6, 50, 51 AND 52).  
FIRST USE 1-4-2001; IN COMMERCE 1-4-2001.

SN 76-306,295. SASSABY, INC., NEW YORK, NY. FILED 8-29-2001.

**WEATHER WEAR**

FOR LIPSTICK (U.S. CLS. 1, 4, 6, 50, 51 AND 52).  
FIRST USE 3-0-2001; IN COMMERCE 3-0-2001.

SN 76-307,469. REFINED TECHNOLOGIES, INC., WICHITA, KS. FILED 9-4-2001.

**PETRO BLAST**

NO CLAIM IS MADE TO THE EXCLUSIVE RIGHT TO USE "PETRO", APART FROM THE MARK AS SHOWN.  
FOR INDUSTRIAL DEGREASERS AND CLEANERS (U.S. CLS. 1, 4, 6, 50, 51 AND 52).

**CLASS 3—(Continued).**

SN 76-315,522. LADOVE, INC., HIALEAH, FL. FILED 9-21-2001.

**WICKED LIQUID**

FOR HAIR STYLING PRODUCTS, NAMELY, HAIR SPRAY (U.S. CLS. 1, 4, 6, 50, 51 AND 52).  
FIRST USE 9-7-2001; IN COMMERCE 9-9-2001.

SN 76-315,635. KENRA, LLC, INDIANAPOLIS, IN. FILED 9-12-2001.

**UNREEL**

FOR HAIR CARE PREPARATIONS (U.S. CLS. 1, 4, 6, 50, 51 AND 52).

SN 78-028,293. PROCTER & GAMBLE COMPANY, THE, CINCINNATI, OH. BY ASSIGNMENT OLAY COMPANY, INC., CINCINNATI, OH. FILED 9-29-2000.

**VITANIACIN**

FOR INGREDIENTS CONTAINING THE VITAMINS B AND E, SOLD AS A COMPONENT PART OF COSMETICS, NAMELY, CUTICLE CONDITIONER (U.S. CLS. 1, 4, 6, 50, 51 AND 52).

SN 78-040,512. AKSENTIJEVICH,RADOVAN,I, WATERLOO, BELGIUM, FILED 12-22-2000.

**DERIKMAXI**

THE NAME "DERIKMAXI" DOES NOT IDENTIFY A LIVING INDIVIDUAL.

THE MARK CONSISTS OF ONE WORD.  
FOR COSMETICS, NAMELY - HAIR COLOR, COLOR SHAMPOO, HAIR LACQUERS, HAIR GEL, HAIR FOAM, NAIL LACQUERS, LIPSTICKS, AND EYE LINER (U.S. CLS. 1, 4, 6, 50, 51 AND 52).

**CLASS 3—(Continued).**

SN 78-042,056. COLE, DEBRA, JEAN, FAIR OAKS, CA.  
FILED 1-7-2001.



FOR NAIL GEL, NAMELY GEL TO COVER AND ENHANCE NATURAL NAILS (U.S. CLS. 1, 4, 6, 50, 51 AND 52).

FIRST USE 12-17-2000; IN COMMERCE 12-17-2000.

SN 78-049,707. KANE, AMANDA WYNNE-EGAN, KENNETT SQUARE, PA. FILED 2-22-2001.



NO CLAIM IS MADE TO THE EXCLUSIVE RIGHT TO USE "A SOAP AND TOILETRIES COMPANY", APART FROM THE MARK AS SHOWN.

FOR HANDMADE SOAP AND TOILETRIES, NAMELY, NON-MEDICATED HANDMADE SOAPS, SHAMPOO BARS, SKIN LOTIONS, HERBAL BATH MIXTURES, PERSONAL TRAVEL SOAPS, LIP BALMS, AND SKIN SALVES (U.S. CLS. 1, 4, 6, 50, 51 AND 52).

FIRST USE 2-14-2001; IN COMMERCE 2-14-2001.

SN 78-053,741. FIRESTEIN, CHELSEA, DELRAY BEACH, FL.  
FILED 3-18-2001.

**CHELSEA GIRL**

FOR NON-MEDICATED SKIN CARE PREPARATIONS; FACIAL CLEANSER, SKIN MOISTURIZERS, ANTI-AGING CREAMS, SKIN TONERS, BODY WASH, LIP TREATMENTS, NAMELY NON-MEDICATED LIP GLOSS, LIPSTICK AND LIP BALM, EXFOLIATORS; HAIR CARE PRODUCTS, NAMELY SHAMPOOS, CONDITIONERS, HAIR SPRAYS, HAIR MOUSSE, HAIR STYLING GEL, HAIR STYLING CREAM, HAIR SHINE SPRAYS AND GELS; COSMETICS: LIPSTICK, ROUGE, MASCARA, FOUNDATION, EYE SHADOW, LIP GLOSS, LIP LINER, FACE POWDER (U.S. CLS. 1, 4, 6, 50, 51 AND 52).

**CLASS 3—(Continued).**

SN 78-057,731. SAGE PRODUCTS, INC., CRYSTAL LAKE, IL.  
FILED 4-10-2001.



NO CLAIM IS MADE TO THE EXCLUSIVE RIGHT TO USE "WASH", APART FROM THE MARK AS SHOWN.

THE STIPLING IS A FEATURE OF THE MARK AND NOT INTENDED TO INDICATE COLOR.

FOR PERSONAL BATHING SYSTEM IN THE NATURE OF A SERIES OF MICROWAVABLE, DISPOSABLE, ULTRA-SOFT, SINGLE USE, CLEANSING WASH-CLOTHS IMPREGNATED WITH RINSE-FREE SOAP AND LOTION FOR USE IN PERSONAL HYGIENE AND CAPS CONTAINING RINSE FREE NON-MEDICATED SHAMPOO AND CONDITIONER FOR WASHING HAIR (U.S. CLS. 1, 4, 6, 50, 51 AND 52).

SN 78-061,072. NATRON, INC., IRVINE, CA. FILED 4-30-2001.



FOR DISPOSABLE WIPES IMPREGNATED WITH CHEMICALS OR COMPOUNDS FOR HOUSEHOLD USE (U.S. CLS. 1, 4, 6, 50, 51 AND 52).

SN 78-065,769. GILLETTE COMPANY, THE, BOSTON, MA.  
FILED 5-25-2001.

**SOOTHERS**

FOR ANTI-PERSPIRANTS AND DEODORANTS (U.S. CLS. 1, 4, 6, 50, 51 AND 52).

SN 78-066,322. POWER AISLE BODY PRODUCTS, LLC,  
FREEHOLD, NJ. FILED 5-30-2001.

**PARADISE ISLES**

FOR COSMETIC AND TOILETRY PREPARATIONS, NAMELY, HAND AND BODY SOAP IN BAR AND LIQUID FORM, BATH AND SHOWER GEL, FACIAL CLEANSERS AND SCRUBS, BODY LOTIONS AND BODY CREAMS, BODY WASH AND BODY MISTS WITH AND WITHOUT FRAGRANCE, SUN BLOCK PREPARATIONS AND SUN CARE LOTIONS AND SUNSCREEN PREPARATIONS, HAND LOTION, AND FACIAL LOTION; HAIR CARE PREPARATIONS, NAMELY, HAIR SHAMPOO, HAIR CONDITIONER, AND HAIR STYLING GEL (U.S. CLS. 1, 4, 6, 50, 51 AND 52).

**CLASS 3—(Continued).**

SN 78-070,572. INTERNATIONAL SPECIALTY TREATMENTS, LLC, OAKVILLE, CT. FILED 6-22-2001.

**NATURAL 10**

NO CLAIM IS MADE TO THE EXCLUSIVE RIGHT TO USE "NATURAL", APART FROM THE MARK AS SHOWN. FOR NAIL CARE PRODUCTS, NAMELY, NAIL POLISH, NAIL POLISH WITH FLUORIDE, NAIL MOISTURIZERS, FLUORIDE AND CALCIUM NAIL TREATMENTS, NAIL BUILDERS TO INCREASE THICKNESS, NAIL STRENGTHENERS, NAIL POLISH TOP COATS AND SEALERS, NAIL POLISH BASE COATS, NAIL CUTICLE CONDITIONERS AND TREATMENTS, WAX TREATMENTS, ANTI-BACTERIAL HAND SCRUBS, NAIL BUFFERS, NAIL CLEANSERS, BAR SOAPS, LIQUID SOAPS, ABRASIVE PREPARATIONS FOR NAILS, NAIL FILES AND IMPLEMENTS, NAIL POLISHING STONES, NAIL BUFFING CREAMS, NAIL POLISH REMOVER, NAIL POLISH BOTTLE OPENERS, NAIL POLISH REMOVER PADS, NAIL POLISH REMOVER IN JARS WITH INTERNAL MECHANICAL PADS, SPONGES OR MOLDED INSERTS TO FACILITATE AND ACCELERATE POLISH REMOVAL; HAND CARE PRODUCTS, NAMELY HAND LOTION, HAND CREAMS, SUNSCREEN LOTIONS, SKIN TONERS, BLEMISH LIGHTENERS; FOOT AND TOENAIL CARE PRODUCTS, NAMELY FOOT CREAMS AND MOISTURIZING LOTIONS, SKIN SLOUGHING LOTIONS, BUFFING CREAMS, TOENAIL POLISH WITH FLUORIDE, TOENAIL STRENGTHENER TREATMENTS WITH FLUORIDE, ANTI-FUNGAL NAIL TREATMENTS, ANTI-BACTERIAL FOOT SCRUBS, EFFERVESCENT CRYSTALS FOR BATHS AND FOOT BATHS, BAR SOAPS, FOOT SOAKS, BATH SALTS, FILES, BUFFERS, SANDING BLOCKS, TOE SPREADERS TO AID IN POLISH APPLICATION AND DRYING, COOLING GELS, FRAGRANCED FOOT POWDERS AND SPRAYS (U.S. CLS. 1, 4, 6, 50, 51 AND 52).

SN 78-072,499. JASCAL INTERNATIONAL, INC., PLANO, TX. FILED 7-5-2001.

**JASCAL**

FOR COSMETICS (U.S. CLS. 1, 4, 6, 50, 51 AND 52).

SN 78-077,728. GILLETTE COMPANY, THE, BOSTON, MA. FILED 8-6-2001.

**POWER STRIPE**

FOR ANTIPERSPIRANTS AND DEODORANTS (U.S. CLS. 1, 4, 6, 50, 51 AND 52).

SN 78-077,745. STONER INCORPORATED, QUARRYVILLE, PA. FILED 8-6-2001.

**CUT**

FOR ALL PURPOSE NON-CHLORINATED CLEANING AND DEGREASING PREPARATIONS (U.S. CLS. 1, 4, 6, 50, 51 AND 52).  
FIRST USE 1-31-2001; IN COMMERCE 1-31-2001.

**CLASS 3—(Continued).**

SN 78-079,823. AVON PRODUCTS, INC., NEW YORK, NY. FILED 8-17-2001.

**CATCH A WINK MOM**

FOR SCENTED PILLOW SPRAY (U.S. CLS. 1, 4, 6, 50, 51 AND 52).

SN 78-082,378. LEWIS, VICKI A, COTTONWOOD, CA. AND LEWIS, ROBERT G, COTTONWOOD, CA. AND MITOMA, KOJI, ATASCADERO, CA. FILED 9-3-2001.

**LIQUA CLEAN**

NO CLAIM IS MADE TO THE EXCLUSIVE RIGHT TO USE "CLEAN", APART FROM THE MARK AS SHOWN. FOR AUTOMOTIVE CLEANING PREPARATIONS (U.S. CLS. 1, 4, 6, 50, 51 AND 52).  
FIRST USE 9-3-2001; IN COMMERCE 9-3-2001.

SN 78-082,500. COLLECTION 2000 COSMETICS, INC., MIAMI, FL. FILED 9-4-2001.

**TEEN 2000**

OWNER OF U.S. REG. NO. 1,244,076.  
NO CLAIM IS MADE TO THE EXCLUSIVE RIGHT TO USE "TEEN", APART FROM THE MARK AS SHOWN. FOR COSMETICS; LIPSTICKS; NAIL POLISH; ANTI-PERSPIRANT; DEODORANT; BODY LOTIONS; SHAMPOOS; BODY POWDERS (U.S. CLS. 1, 4, 6, 50, 51 AND 52).

SN 78-084,985. X M INTERNATIONAL, L.L.C., PROVO, UT. FILED 9-21-2001.

**MAMRALIN-ARA**

FOR COSMETICS, FOR APPLICATION TO THE BREASTS (U.S. CLS. 1, 4, 6, 50, 51 AND 52).

SN 78-086,542. AVON PRODUCTS, INC., NEW YORK, NY. FILED 10-2-2001.

**MIRROR SHINE**

FOR COSMETICS, NAMELY - NAIL ENAMEL (U.S. CLS. 1, 4, 6, 50, 51 AND 52).

**CLASS 4—LUBRICANTS AND FUELS**

**CLASS 4—(Continued).**

SN 75-924,659. GULF HYDROCARBON PARTNERS, LTD., HOUSTON, TX. FILED 2-22-2000.

**SYNDIESEL**

FOR SYNTHETIC DIESEL FUEL (U.S. CLS. 1, 6 AND 15).  
FIRST USE 5-1-1995; IN COMMERCE 9-1-1996.

SN 76-045,755. EXXON MOBIL CORPORATION, IRVING, TX. FILED 5-11-2000.



OWNER OF U.S. REG. NOS. 902,251, 919,445 AND OTHERS.

NO CLAIM IS MADE TO THE EXCLUSIVE RIGHT TO USE "NO KEROSENE ODOR", "CEAR" AND "SYNTHETIC PORTABLE HEATER FUEL", APART FROM THE MARK AS SHOWN.

FOR FUEL FOR USE IN PORTABLE HEATERS (U.S. CLS. 1, 6 AND 15).

FIRST USE 10-27-1998; IN COMMERCE 10-27-1998.

SN 76-101,025. INDUSTRIA DE DISENO TEXTIL, S.A., AKA INDITEX, S.A., 15080 CORUNA, SPAIN, FILED 8-1-2000.

**ZARA**

PRIORITY CLAIMED UNDER SEC. 44(D) ON SPAIN APPLICATION NO. 2312772, FILED 5-3-2000, REG. NO. 2312772, DATED 10-5-2000, EXPIRES 10-5-2010.

OWNER OF U.S. REG. NOS. 1,922,163, 2,038,110 AND OTHERS.

THE ENGLISH TRANSLATION OF "ZARA" IS "MAIZE OR INDIAN CORN".

FOR CANDLES (U.S. CLS. 1, 6 AND 15).

SN 76-130,269. R. B. HOWES & CO., NORTH KINGSTOWN, RI. FILED 9-18-2000.

**ROUST-A-BOUT**

FOR OIL SUPPLEMENTS FOR USE IN VEHICLES AND OTHER OIL-LUBRICATED MACHINERY (U.S. CLS. 1, 6 AND 15).

**CLASS 4—(Continued).**

SN 76-140,671. BLUE OX, INC., SELMA, AL. FILED 10-2-2000.

**FOREST FRESH**

FOR WOOD CHIPS FOR SMOKING AND FLAVORING FOOD (U.S. CLS. 1, 6 AND 15).  
FIRST USE 7-15-2000; IN COMMERCE 9-22-2000.

SN 76-153,772. CARGILL, INCORPORATED, WAYZATA, MN. FILED 10-25-2000.

**NATUREWAX**

FOR VEGETABLE-BASED WAX FOR USE IN THE MANUFACTURE OF CANDLES, WAXED PAPER, AND WAXED CARDBOARD (U.S. CLS. 1, 6 AND 15).

SN 76-258,819. SPX CORPORATION, MUSKEGON, MI. FILED 5-16-2001.

**TRANSJEL**

FOR LAND VEHICLE TRANSMISSION SEAL AND ASSEMBLY LUBRICANTS (U.S. CLS. 1, 6 AND 15).  
FIRST USE 0-0-1980; IN COMMERCE 0-0-1980.

SN 76-301,630. ROYAL LUBRICANTS, INC., DBA ANDEROL COMPANY, HANOVER, NJ. FILED 8-9-2001.

**ANDEROL**

FOR INDUSTRIAL OILS, GREASES, LUBRICANTS AND SYNTHETIC LUBRICANTS (U.S. CLS. 1, 6 AND 15).

SN 76-319,140. EL PASO CORPORATION, HOUSTON, TX. FILED 9-28-2001.

**SHORELINK**

FOR NATURAL GAS (U.S. CLS. 1, 6 AND 15).

SN 76-321,942. BEHNKE LUBRICANTS, INC., MENOMONEE FALLS, WI. FILED 10-9-2001.

**COMPRESYN**

FOR SYNTHETIC CARBON-BASED LUBRICANT (U.S. CLS. 1, 6 AND 15).



**CLASS 4—(Continued).**

SN 76-322,116. ROYAL PURPLE, INC., PORTER, TX. FILED 10-9-2001.

**THE PERFORMANCE OIL THAT OUTPERFORMS!**

FOR SYNTHETIC, PARA-SYNTHETIC AND HYDRO-CARBON LUBRICANTS FOR - AUTOMOBILES - NAMELY CRANKCASE LUBRICANTS, GEAR OILS; AND INDUSTRIAL USES - NAMELY, LUBRICANTS FOR COMPRESSORS, PUMPS, GAS AND STEAM TURBINES, GEAR BOXES, MOTOR BEARINGS, GAS AND DIESEL ENGINES, TRANSMISSIONS, BEARINGS, GEARS, CHAINS, AND AIR TOOLS (U.S. CLS. 1, 6 AND 15).

FIRST USE 7-0-2001; IN COMMERCE 7-0-2001.

SN 76-322,194. BLAZE PRODUCTS CORPORATION, SHELVILLE, KY. FILED 10-5-2001.

**CLEARWICK**

FOR CONTAINERS OF LIQUID FUEL FOR USE AS A HEAT SOURCE (U.S. CLS. 1, 6 AND 15).  
FIRST USE 5-19-2001; IN COMMERCE 5-19-2001.

SN 76-322,196. BLAZE PRODUCTS CORPORATION, SHELVILLE, KY. FILED 10-5-2001.

**THE CLEAR ADVANTAGE**

FOR CONTAINERS OF LIQUID FUEL FOR USE AS A HEAT SOURCE (U.S. CLS. 1, 6 AND 15).  
FIRST USE 5-19-2001; IN COMMERCE 5-19-2001.

SN 78-021,821. MOTHER EVE'S, INC., HAM LAKE, MN. FILED 8-18-2000.

**CARING CANDLES**

NO CLAIM IS MADE TO THE EXCLUSIVE RIGHT TO USE "CANDLES", APART FROM THE MARK AS SHOWN. FOR CANDLES (U.S. CLS. 1, 6 AND 15).  
FIRST USE 3-1-2000; IN COMMERCE 8-13-2000.

SN 78-057,159. USA LABS, INC., MEDLEY, FL. FILED 4-6-2001.

**MAGICAL LIGHTS**

NO CLAIM IS MADE TO THE EXCLUSIVE RIGHT TO USE "LIGHTS", APART FROM THE MARK AS SHOWN. FOR CANDLES (U.S. CLS. 1, 6 AND 15).

**CLASS 5—PHARMACEUTICALS**

SN 74-571,379. WEED-MASTER WESTERN, INC., REGINA, SASKATCHEWAN, S4P 3J8, CANADA, BY ASSIGNMENT YELLOWBIRD PRODUCTS LIMITED, CALGARY, ALBERTA, T2R 1L5, CANADA, FILED 9-9-1994.

**WEEDEX**

PRIORITY CLAIMED UNDER SEC. 44(D) ON CANADA APPLICATION NO. 751,959, FILED 4-8-1994, REG. NO. TMA446,237, DATED 8-18-1995, EXPIRES 8-18-2010.

FOR PESTICIDES FOR DOMESTIC AND AGRICULTURAL PURPOSES (U.S. CLS. 6, 18, 44, 46, 51 AND 52).

SN 75-614,613. ENERGIQUE, INC., WOODBINE, IA. FILED 1-4-1999.

**ENERGIQUE**

FOR HERBAL AND NUTRITIONAL SUPPLEMENTS; HOMEOPATHIC SUPPLEMENTS COMPRISED OF HERBALS AND PLANTS USED TO STIMULATE THE BODY TO HEAL USING ENERGETIC PATTERNS (U.S. CLS. 6, 18, 44, 46, 51 AND 52).

FIRST USE 4-1-1992; IN COMMERCE 4-1-1992.

SN 75-876,553. BAYER CORPORATION, ELKHART, IN. FILED 12-21-1999.

**YOU KNOW IT WORKS**

FOR ANTI-INFECTIVE PHARMACEUTICAL PREPARATION FOR HUMAN USE (U.S. CLS. 6, 18, 44, 46, 51 AND 52).

FIRST USE 1-26-2000; IN COMMERCE 3-22-2000.

SN 76-038,452. NOVOGEN RESEARCH PTY LIMITED, NEW SOUTH WALES, AUSTRALIA, FILED 4-28-2000.



OWNER OF AUSTRALIA REG. NO. 785135, DATED 2-10-1999, EXPIRES 2-10-2009.

FOR PREPARATIONS DERIVED FROM PLANT EXTRACTS AND HERBAL EXTRACTS FOR USE AS DIETARY SUPPLEMENTS; ISOFLAVONE CONTAINING PREPARATIONS FOR USE AS DIETARY SUPPLEMENTS; PHYTO-OESTROGEN DIETARY SUPPLEMENTS (U.S. CLS. 6, 18, 44, 46, 51 AND 52).

**CLASS 5—(Continued).**

SN 76-064,110. UNITED INDUSTRIES CORPORATION, ST. LOUIS, MO. FILED 6-6-2000.

**SPECTRACIDE TERMINATE**

OWNER OF U.S. REG. NOS. 716,317, 2,298,941 AND OTHERS.

FOR TERMITICIDES FOR DOMESTIC OR COMMERCIAL USE (U.S. CLS. 6, 18, 44, 46, 51 AND 52).  
FIRST USE 2-1-1998; IN COMMERCE 2-1-1998.

SN 76-064,120. VANMOOR, ARTHUR, BOCA RATON, FL. FILED 6-6-2000.

**VEGETARIAN VARIETY**

NO CLAIM IS MADE TO THE EXCLUSIVE RIGHT TO USE "VEGETARIAN", APART FROM THE MARK AS SHOWN.

FOR VITAMINS AND NUTRITIONAL SUPPLEMENTS (U.S. CLS. 6, 18, 44, 46, 51 AND 52).

SN 76-099,219. OKASAWARA, MAURICIO SUSSUMU, SAO PAULO, BRAZIL, FILED 7-28-2000.



NO CLAIM IS MADE TO THE EXCLUSIVE RIGHT TO USE "BRAZIL", APART FROM THE MARK AS SHOWN.  
FOR NATURAL FOOD SUPPLEMENTS (U.S. CLS. 6, 18, 44, 46, 51 AND 52).

SN 76-105,433. BYK GULDEN LOMBERG CHEMISCHE FABRIK GMBH, 78467 KONSTANZ, FED REP GERMANY, FILED 8-7-2000.

**AMAVIO**

FOR PHARMACEUTICAL PREPARATIONS FOR THE TREATMENT OF GASTROINTESTINAL AND RESPIRATORY DISEASES (U.S. CLS. 6, 18, 44, 46, 51 AND 52).

**CLASS 5—(Continued).**

SN 76-127,265. VARGAS, MARIA C., AURORA, IL. FILED 9-12-2000.



THE STIPPLING IS A FEATURE OF THE MARK AND DOES NOT INDICATE COLOR.

THERE IS NO TRANSLATION OF THE WORD "AYRUECA".

FOR DIETARY SUPPLEMENTS, VITAMINS AND MINERALS, AND HERBAL SUPPLEMENTS (U.S. CLS. 6, 18, 44, 46, 51 AND 52).

SN 76-138,597. SAFESCIENCE, INC., BOSTON, MA. FILED 9-29-2000.

**CLEANSWEEP**

FOR INSECTICIDES, FUNGICIDES, AND HERBICIDES FOR DOMESTIC AND AGRICULTURAL USE (U.S. CLS. 6, 18, 44, 46, 51 AND 52).

SN 76-180,205. MISSION PHARMACAL COMPANY, SAN ANTONIO, TX. FILED 12-13-2000.

**IT'S ABOUT THE BABY**

FOR PRENATAL MULTI-VITAMINS AND MULTI-MINERALS (U.S. CLS. 6, 18, 44, 46, 51 AND 52).

SN 76-182,434. PHARMACIA CORPORATION, PEAPACK, NJ. FILED 12-18-2000.

**ZAPTIX**

FOR PHARMACEUTICAL PREPARATIONS FOR THE TREATMENT OF ARTHRITIS, PAIN, DYSMENORRHEA, DISORDERS OF THE CENTRAL NERVOUS SYSTEM, CARDIOVASCULAR CONDITIONS, OPHTHALMOLOGICAL DISORDERS, UROLOGICAL DISORDERS, AND DISORDERS AND CONDITIONS ASSOCIATED WITH THE FIELDS OF ONCOLOGY AND ENDOCRINOLOGY; PHARMACEUTICALS IN THE NATURE OF ANTIBIOTICS (U.S. CLS. 6, 18, 44, 46, 51 AND 52).

**CLASS 5—(Continued).**

SN 76-191,436. ASTRAZENECA AB, S 151 85 SODERTALJE, SWEDEN, FILED 1-8-2001.

**SYMBICORT**

OWNER OF SWEDEN REG. NO. 239,026, DATED 8-14-1992, EXPIRES 8-14-2002.

OWNER OF U.S. REG. NO. 1,885,787.  
FOR PHARMACEUTICAL PREPARATIONS AND SUBSTANCES FOR THE TREATMENT OF DISEASES AND DISORDERS OF THE RESPIRATORY SYSTEM (U.S. CLS. 6, 18, 44, 46, 51 AND 52).

**CLASS 5—(Continued).**

SN 76-200,464. AMGEN INC., THOUSAND OAKS, CA. FILED 1-26-2001.

**PRECRIL**

FOR PHARMACEUTICAL PREPARATIONS FOR USE IN THE TREATMENT OF ONCOLOGICAL, NEUROLOGICAL, ENDOCRINOLOGICAL, INFLAMMATORY AND UROLOGICAL DISEASES AND DISORDERS AND RENAL DISEASES, AND COMPLICATIONS ASSOCIATED THEREWITH (U.S. CLS. 6, 18, 44, 46, 51 AND 52).

SN 76-200,454. AMGEN INC., THOUSAND OAKS, CA. FILED 1-26-2001.

**VANIREN**

FOR PHARMACEUTICAL PREPARATIONS FOR USE IN THE TREATMENT OF RENAL DISEASE AND COMPLICATIONS ASSOCIATED THEREWITH (U.S. CLS. 6, 18, 44, 46, 51 AND 52).

SN 76-200,465. AMGEN INC., THOUSAND OAKS, CA. FILED 1-26-2001.

**CESTRATA**

FOR PHARMACEUTICAL PREPARATIONS FOR USE IN THE TREATMENT OF ONCOLOGICAL, NEUROLOGICAL, ENDOCRINOLOGICAL, INFLAMMATORY AND UROLOGICAL DISEASES AND DISORDERS AND RENAL DISEASES, AND COMPLICATIONS ASSOCIATED THEREWITH (U.S. CLS. 6, 18, 44, 46, 51 AND 52).

SN 76-200,455. AMGEN INC., THOUSAND OAKS, CA. FILED 1-26-2001.

**MAPRISA**

FOR PHARMACEUTICAL PREPARATIONS FOR USE IN THE TREATMENT OF ONCOLOGICAL, NEUROLOGICAL, ENDOCRINOLOGICAL, INFLAMMATORY AND UROLOGICAL DISEASES AND DISORDERS AND RENAL DISEASES, AND COMPLICATIONS ASSOCIATED THEREWITH (U.S. CLS. 6, 18, 44, 46, 51 AND 52).

SN 76-200,466. AMGEN INC., THOUSAND OAKS, CA. FILED 1-26-2001.

**OMNIZOR**

FOR PHARMACEUTICAL PREPARATIONS FOR USE IN THE TREATMENT OF ONCOLOGICAL, NEUROLOGICAL, ENDOCRINOLOGICAL, INFLAMMATORY AND UROLOGICAL DISEASES AND DISORDERS AND RENAL DISEASES, AND COMPLICATIONS ASSOCIATED THEREWITH (U.S. CLS. 6, 18, 44, 46, 51 AND 52).

SN 76-200,456. AMGEN INC., THOUSAND OAKS, CA. FILED 1-26-2001.

**TALADUR**

FOR PHARMACEUTICAL PREPARATIONS FOR USE IN THE TREATMENT OF ONCOLOGICAL, NEUROLOGICAL, ENDOCRINOLOGICAL, INFLAMMATORY AND UROLOGICAL DISEASES AND DISORDERS AND RENAL DISEASES, AND COMPLICATIONS ASSOCIATED THEREWITH (U.S. CLS. 6, 18, 44, 46, 51 AND 52).

SN 76-200,467. AMGEN INC., THOUSAND OAKS, CA. FILED 1-26-2001.

**RIVALAX**

FOR PHARMACEUTICAL PREPARATIONS FOR USE IN THE TREATMENT OF ONCOLOGICAL, NEUROLOGICAL, ENDOCRINOLOGICAL, INFLAMMATORY AND UROLOGICAL DISEASES AND DISORDERS AND RENAL DISEASES, AND COMPLICATIONS ASSOCIATED THEREWITH (U.S. CLS. 6, 18, 44, 46, 51 AND 52).

**CLASS 5—(Continued).**

SN 76-200,468. AMGEN INC., THOUSAND OAKS, CA. FILED 1-26-2001.

**DRESINAL**

FOR PHARMACEUTICAL PREPARATIONS FOR USE IN THE TREATMENT OF ONCOLOGICAL, NEUROLOGICAL, ENDOCRINOLOGICAL, INFLAMMATORY AND UROLOGICAL DISEASES AND DISORDERS AND RENAL DISEASES, AND COMPLICATIONS ASSOCIATED THEREWITH (U.S. CLS. 6, 18, 44, 46, 51 AND 52).

SN 76-216,916. AQUARIUM PHARMACEUTICALS, INC., CHALFONT, PA. FILED 2-27-2001.

**BETTAFIX**

FOR ANTI-BACTERIAL PHARMACEUTICALS FOR TROPICAL FISH (U.S. CLS. 6, 18, 44, 46, 51 AND 52).

SN 76-236,542. WATER-JEL TECHNOLOGIES, LLC, CARLSTADT, NJ. FILED 4-6-2001.

**BURN JEL**

OWNER OF U.S. REG. NO. 1,762,382.  
SEC. 2(F).  
FOR PHARMACEUTICAL PREPARATIONS FOR THE TREATMENT OF SKIN BURNS (U.S. CLS. 6, 18, 44, 46, 51 AND 52).  
FIRST USE 5-11-1992; IN COMMERCE 5-11-1992.

SN 76-242,421. E.I. DU PONT DE NEMOURS AND COMPANY, WILMINGTON, DE. FILED 4-10-2001.

**CIMARRON**

FOR HERBICIDES FOR AGRICULTURAL USE (U.S. CLS. 6, 18, 44, 46, 51 AND 52).

SN 76-253,368. AMUROL CONFECTIONS COMPANY, YORKVILLE, IL. FILED 5-4-2001.

**DIET RESCUE MINTS**

NO CLAIM IS MADE TO THE EXCLUSIVE RIGHT TO USE "MINTS", APART FROM THE MARK AS SHOWN.  
FOR DIETARY SUPPLEMENTS (U.S. CLS. 6, 18, 44, 46, 51 AND 52).

**CLASS 5—(Continued).**

SN 76-262,081. MISSION PHARMACAL COMPANY, SAN ANTONIO, TX. FILED 5-24-2001.

**RELYTE**

FOR PHARMACEUTICAL PREPARATIONS, NAMELY, POTASSIUM MAGNESIUM CITRATE WAX MATRIX TABLETS, USED TO REPLENISH POTASSIUM AND MAGNESIUM ELECTROLYTES FOR PATIENTS TAKING DIURETICS (U.S. CLS. 6, 18, 44, 46, 51 AND 52).

SN 76-265,712. ARDENT PHARMACEUTICALS, INC., DURHAM, NC. FILED 6-1-2001.



NO CLAIM IS MADE TO THE EXCLUSIVE RIGHT TO USE "PHARMACEUTICALS", APART FROM THE MARK AS SHOWN.

FOR PHARMACEUTICAL PREPARATIONS, NAMELY ANALGESICS, URINARY INCONTINENCE AGENTS, CARDIO-PROTECTORS, TREATMENTS FOR NARCOTIC OVERDOSE AND ADDICTION, IMMUNO-MODULATORS, NEURO-PROTECTORS, TREATMENTS FOR DEPRESSION, AND TREATMENTS FOR GLAUCOMA (U.S. CLS. 6, 18, 44, 46, 51 AND 52).

SN 76-267,531. ROYAL SOURCE, INC., DBA ONE SOURCE, LAKE BLUFF, IL. FILED 6-6-2001.

**RESEARCH YOU CAN COUNT ON. PRODUCTS YOU CAN TRUST.**

FOR DIETARY AND NUTRITIONAL SUPPLEMENTS (U.S. CLS. 6, 18, 44, 46, 51 AND 52).  
FIRST USE 10-29-1998; IN COMMERCE 10-29-1998.

**CLASS 5—(Continued).**

SN 76-277,453. J.R. CARLSON LABORATORIES, INC., AR-LINGTON HEIGHTS, IL. FILED 6-28-2001.

## HOMOCYSTEINE GUARD ELITE

NO CLAIM IS MADE TO THE EXCLUSIVE RIGHT TO USE "HOMOCYSTEINE", APART FROM THE MARK AS SHOWN.

FOR NUTRITIONAL SUPPLEMENT (U.S. CLS. 6, 18, 44, 46, 51 AND 52).

---

SN 76-282,983. INTERVET INC., MILLSBORO, DE. FILED 7-10-2001.

## RACEGARD

FOR PREPARATION FOR THE TREATMENT OF GASTROENTEROLOGICAL DISORDERS IN HORSES (U.S. CLS. 6, 18, 44, 46, 51 AND 52).

---

SN 76-292,028. RTP PHARMA INC., QUEBEC, CANADA, FILED 7-30-2001.

## TREXOR

FOR PHARMACEUTICAL PREPARATION, NAMELY, A LIPID LOWERING AGENT (U.S. CLS. 6, 18, 44, 46, 51 AND 52).

---

SN 76-294,044. NORTHWEST BIOTHERAPEUTICS, INC., BOTHELL, WA. FILED 8-2-2001.

## HURX

FOR PHARMACEUTICAL PREPARATIONS, NAMELY HUMAN MONOCLONAL ANTIBODIES FOR USE IN THE TREATMENT OF CANCER (U.S. CLS. 6, 18, 44, 46, 51 AND 52).

---

SN 76-295,230. NUTRITIONAL PRODUCTS CORPORATION, STAFFORD, VA. FILED 8-6-2001.

## NUTRITIONAL PIT STOP

NO CLAIM IS MADE TO THE EXCLUSIVE RIGHT TO USE "NUTRITIONAL", APART FROM THE MARK AS SHOWN.

FOR VITAMINS (U.S. CLS. 6, 18, 44, 46, 51 AND 52).

**CLASS 5—(Continued).**

SN 76-297,376. COTTRELL INTERNATIONAL, LLC, DBA COTTRELL, LTD., DENVER, CO. FILED 8-8-2001.

## V-CIDE

FOR STERILIZATION AND/OR DISINFECTANT SOLUTION FOR USE IN MEDICAL PROCEDURES (U.S. CLS. 6, 18, 44, 46, 51 AND 52).

---

SN 76-298,709. GORMAN, STEVEN, WEST HILLS, CA. FILED 8-14-2001.

## LOOK FOR THE UNION LABEL VITAMINS & SUPPLEMENTS

NO CLAIM IS MADE TO THE EXCLUSIVE RIGHT TO USE "VITAMINS & SUPPLEMENTS", APART FROM THE MARK AS SHOWN.

FOR VITAMINS AND VITAMIN SUPPLEMENTS; HERBAL SUPPLEMENTS; AND HOMEOPATHIC SUPPLEMENTS (U.S. CLS. 6, 18, 44, 46, 51 AND 52).

---

SN 76-302,400. NELSON, MICHAEL T., SACRAMENTO, CA. FILED 8-20-2001.

## MINT-O-NIC

FOR LOZENGES CONTAINING NICOTINE FOR USE IN SMOKING CESSATION (U.S. CLS. 6, 18, 44, 46, 51 AND 52).

---

SN 76-302,401. NELSON, MICHAEL T., SACRAMENTO, CA. FILED 8-20-2001.

## NIC-O-MINT

FOR LOZENGES CONTAINING NICOTINE FOR USE IN SMOKING CESSATION (U.S. CLS. 6, 18, 44, 46, 51 AND 52).

---

SN 76-305,971. NANJI CORPORATION INTERNATIONAL, THE, TULSA, OK. FILED 8-28-2001.

## GAIN-IT

FOR DIETARY FOOD SUPPLEMENT (U.S. CLS. 6, 18, 44, 46, 51 AND 52).

FIRST USE 10-2-1986; IN COMMERCE 10-2-1986.

**CLASS 5—(Continued).**

SN 76-306,902. OCUSOFT, INC., RICHMOND, TX. FILED 8-29-2001.

**CURA-TEARS**

FOR MEDICATED EYE PRODUCTS, NAMELY, LUBRICANTS, DROPS, OINTMENTS, GELS, IRRIGATING SOLUTIONS, CREAMS, AND PRE-MOISTENED MEDICAL WIPES (U.S. CLS. 6, 18, 44, 46, 51 AND 52).

SN 76-307,394. MOBLEY, DARRYL L. SR., DANVILLE, CA. FILED 8-30-2001.

**WORSHIP YOUR BODY**

FOR DIETARY SUPPLEMENTS (U.S. CLS. 6, 18, 44, 46, 51 AND 52).  
FIRST USE 1-20-1998; IN COMMERCE 1-20-1998.

SN 76-307,395. MOBLEY, DARRYL L. SR., DANVILLE, CA. FILED 8-30-2001.

**FEMFERTILITY**

FOR DIETARY SUPPLEMENTS (U.S. CLS. 6, 18, 44, 46, 51 AND 52).  
FIRST USE 1-20-1998; IN COMMERCE 1-20-1998.

SN 76-307,504. AW BOON HAW (USA), INC., VERO BEACH, FL. FILED 9-4-2001.

**CORDYNINE**

FOR DIETARY AND NUTRITIONAL SUPPLEMENTS (U.S. CLS. 6, 18, 44, 46, 51 AND 52).

SN 76-307,505. AW BOON HAW (USA), INC., VERO BEACH, FL. FILED 9-4-2001.

**PROCORDY**

FOR DIETARY AND NUTRITIONAL SUPPLEMENTS (U.S. CLS. 6, 18, 44, 46, 51 AND 52).

SN 76-307,833. BIO CENTER, INC., LOS ANGELES, CA. FILED 9-4-2001.

**BIO CENTER**

FOR HERBAL AND NON-HERBAL DIETARY SUPPLEMENTS (U.S. CLS. 6, 18, 44, 46, 51 AND 52).

**CLASS 5—(Continued).**

SN 76-309,508. ASTRAZENECA AB, S-151 85 SODERTALJE, SWEDEN, FILED 9-5-2001.

**TEPICOL**

FOR PHARMACEUTICAL PREPARATIONS AND SUBSTANCES FOR THE PREVENTATION AND TREATMENT OF DISEASES AND DISORDERS OF THE RESPIRATORY SYSTEM, CENTRAL NERVOUS SYSTEM, PERIPHERAL NERVOUS SYSTEM, CARDIOVASCULAR SYSTEM, GASTRO-INTESTINAL SYSTEM; PHARMACEUTICAL PREPARATIONS AND SUBSTANCES FOR USE IN PAIN CONTROL, ANAESTHESIA, ONCOLOGY, INFECTION, INFLAMMATION, UROLOGY, GYNAECOLOGY; PHARMACEUTICAL PREPARATIONS AND SUBSTANCES FOR THE TREATMENT AND PREVENTION OF DIABETES (U.S. CLS. 6, 18, 44, 46, 51 AND 52).

SN 76-309,990. RVI TECHNOLOGY CORPORATION, PARLIPPANY, NJ. FILED 9-7-2001.



The logo for Rovimix features the word "Rovimix" in a bold, italicized, sans-serif font. A curved line arches over the letters "o" and "v", extending from the top of the "o" to the top of the "x".

OWNER OF U.S. REG. NO. 607,836.  
FOR VITAMIN SUPPLEMENT (U.S. CLS. 6, 18, 44, 46, 51 AND 52).

SN 76-310,284. NICHE PRODUCTS, INC., ROLLING HILLS ESTATES, CA. FILED 9-7-2001.

**RAZZLEBERRY**

FOR NUTRITIONAL AND DIETARY SUPPLEMENTS (U.S. CLS. 6, 18, 44, 46, 51 AND 52).

SN 76-311,459. PARKER HUGHES INSTITUTE, ROSEVILLE, MN. FILED 9-10-2001.

**SAMPIDINE**

FOR PHARMACEUTICALS, NAMELY ANTI-VIRALS (U.S. CLS. 6, 18, 44, 46, 51 AND 52).

**CLASS 5—(Continued).**

SN 76-311,640. SCHERING CORPORATION, KENILWORTH, NJ. FILED 9-12-2001.

**ASMADIL**

FOR ANTI-ASTHMA PREPARATION (U.S. CLS. 6, 18, 44, 46, 51 AND 52).

SN 76-311,641. SCHERING CORPORATION, KENILWORTH, NY. FILED 9-12-2001.

**ASMAVAIR**

FOR ANTI-ASTHMA PREPARATION (U.S. CLS. 6, 18, 44, 46, 51 AND 52).

SN 76-311,644. SCHERING CORPORATION, KENILWORTH, NJ. FILED 9-12-2001.

**FORENEX**

FOR ANTI-ASTHMA PREPARATION (U.S. CLS. 6, 18, 44, 46, 51 AND 52).

SN 76-312,659. METAGENICS, INC., SAN CLEMENTE, CA. FILED 9-12-2001.

**ENDURABOLIC**

FOR DIETARY SUPPLEMENTS (U.S. CLS. 6, 18, 44, 46, 51 AND 52).  
FIRST USE 1-10-2000; IN COMMERCE 1-10-2000.

SN 76-314,938. SERIO, JOSEPH P., WESTMINSTER, MA. FILED 9-14-2001.

**STOP POP**

FOR MEDICATED CANDY (U.S. CLS. 6, 18, 44, 46, 51 AND 52).

SN 76-316,186. PBI/GORDON CORPORATION, KANSAS CITY, MO. FILED 9-25-2001.

**AZATROL**

FOR INSECTICIDES (U.S. CLS. 6, 18, 44, 46, 51 AND 52).

**CLASS 5—(Continued).**

SN 76-320,930. GENERAL NUTRITION INVESTMENT COMPANY, PHOENIX, AZ. FILED 10-3-2001.

**LOVERS LANE**

FOR DIETARY SUPPLEMENT SMOOTHIE (U.S. CLS. 6, 18, 44, 46, 51 AND 52).

SN 76-321,231. 40 J'S LLC, FORT THOMAS, KY. FILED 9-29-2001.

**MYCREME**

FOR OINTMENT FOR TREATMENT OF FEMALE SEXUAL AROUSAL DISORDER (U.S. CLS. 6, 18, 44, 46, 51 AND 52).  
FIRST USE 8-15-2001; IN COMMERCE 8-15-2001.

SN 76-321,890. HEALTHWORKS INTERNATIONAL, LLC., WINNSBORO, LA. FILED 10-4-2001.

**GO GO GOLD**

FOR DIETARY SUPPLEMENTS (U.S. CLS. 6, 18, 44, 46, 51 AND 52).

SN 78-014,802. ROCKY MOUNTAIN MEDICAL INSTITUTE, GREENWOOD VILLAGE, CO. FILED 6-28-2000.

**PREMIER MICRONUTRIENT CORPORATION**  
**"PROTECTING THE HUMAN GENOME THROUGH MICRONUTRIENTS"**

NO CLAIM IS MADE TO THE EXCLUSIVE RIGHT TO USE "PREMIER MICRONUTRIENT CORPORATION", APART FROM THE MARK AS SHOWN.  
FOR DIETARY SUPPLEMENTS CONTAINING MICRONUTRIENTS (U.S. CLS. 6, 18, 44, 46, 51 AND 52).

SN 78-025,578. INTRAMEDICA CORP., MIAMI, FL. FILED 9-12-2000.

**PROTEC**

OWNER OF U.S. REG. NOS. 1,813,584 AND 2,059,437.  
FOR STERILIZING AND DISINFECTING PREPARATIONS FOR USE IN LABORATORIES, HOSPITALS, DENTAL AND MEDICAL SETTINGS (U.S. CLS. 6, 18, 44, 46, 51 AND 52).

**CLASS 5—(Continued).**

SN 78-028,352. IMMUNO-DYNAMICS, INC., BOUTON, IA. FILED 9-29-2000.

**NUTRIMMUNE**

FOR BIOLOGICS, NAMELY, VETERINARY PREPARATION FOR THE AMELIORATION OF SYSTEMIC, ENTERIC AND UDDER INFECTIONS IN BOVINE ANIMALS (U.S. CLS. 6, 18, 44, 46, 51 AND 52).

SN 78-033,327. LIFESCIENCE CORPORATION OF AMERICA, EDISON, NJ. FILED 11-1-2000.

**DEPOGEL**

FOR PHARMACEUTICAL PREPARATION, NAMELY DRUG DELIVERY POLYMER (U.S. CLS. 6, 18, 44, 46, 51 AND 52).

SN 78-034,013. VAST RESOURCES, INC., DBA TOPCO SALES, SAN FERNANDO, CA. FILED 11-6-2000.

**EROTIQUE TOUCH**

THE WORD "EROTIQUE" TRANSLATES AS "EROTIC". FOR PERSONAL LUBRICANTS, MALE GENITAL DESENSITIZERS, AND DOUCHES (U.S. CLS. 6, 18, 44, 46, 51 AND 52).

SN 78-042,912. LIPTIS LABORATORIES, INC., KEW GARDENS, NY. FILED 1-12-2001.

**HEPACHOLINE**

FOR PHARMACEUTICAL PREPARATIONS, NAMELY MEDICATIONS FOR THE TREATMENT OF LIVER DISEASE (U.S. CLS. 6, 18, 44, 46, 51 AND 52).

SN 78-043,704. BOEHRINGER INGELHEIM PHARMACEUTICALS, INC., RIDGEFIELD, CT. FILED 1-18-2001.

**YOU CAN MAKE IT HAPPEN**

FOR NUTRITIONAL SUPPLEMENT (U.S. CLS. 6, 18, 44, 46, 51 AND 52).

**CLASS 5—(Continued).**

SN 78-049,308. ANDRX CORPORATION, DAVIE, FL. FILED 2-20-2001.

**RELIZON**

FOR GENERIC PHARMACEUTICAL PRODUCT, NAMELY, PHARMACEUTICAL PREPARATIONS USED AS AN ANTIDEPRESSANT, AS A PSYCHOTROPIC PREPARATION FOR THE TREATMENT AND PREVENTION OF DISEASES OF THE CENTRAL NERVOUS SYSTEM, AND TO ASSIST IN THE CESSATION OF USE OF TOBACCO PRODUCTS (U.S. CLS. 6, 18, 44, 46, 51 AND 52).

SN 78-053,318. BAYER CORPORATION, PITTSBURGH, PA. FILED 3-15-2001.



OWNER OF U.S. REG. NOS. 523,578, 2,312,429 AND OTHERS.

NO CLAIM IS MADE TO THE EXCLUSIVE RIGHT TO USE "KIDS", APART FROM THE MARK AS SHOWN.

THE STIPPLING IS FOR SHADING PURPOSES. SEC. 2(F) AS TO "ONE-A-DAY". FOR NUTRITIONAL SUPPLEMENTS (U.S. CLS. 6, 18, 44, 46, 51 AND 52).

SN 78-054,261. PHARMACIA CORPORATION, PEAPACK, NJ. FILED 3-21-2001.

**CROSMAR**

FOR PHARMACEUTICAL PREPARATIONS, NAMELY PREPARATIONS FOR THE TREATMENT OF INFECTIOUS DISEASES, ONCOLOGICAL PREPARATIONS, ANALGESICS, PREPARATIONS FOR THE TREATMENT AND SYMPTOMS OF DIABETES, PREPARATIONS FOR THE TREATMENT OF OPHTHALMOLOGICAL CONDITIONS AND DISEASES, PREPARATIONS FOR THE TREATMENT OF CENTRAL NERVOUS SYSTEMS DISEASES AND DISORDERS, PREPARATIONS FOR THE TREATMENT OF PARKINSON'S DISEASE, GYNECOLOGICAL PREPARATIONS, ANTI-INFLAMMATORY PHARMACEUTICAL PREPARATIONS, PREPARATIONS FOR THE TREATMENT OF CARDIOVASCULAR DISEASES AND CONDITIONS, HORMONAL PREPARATIONS AND PREPARATIONS FOR THE TREATMENT OF MIGRAINE (U.S. CLS. 6, 18, 44, 46, 51 AND 52).



**CLASS 5—(Continued).**

SN 78-054,269. PHARMACIA CORPORATION, PEAPACK, NJ. FILED 3-21-2001.

**FULDOS**

FOR PHARMACEUTICAL PREPARATIONS, NAMELY PREPARATIONS FOR THE TREATMENT OF INFECTIOUS DISEASES, ONCOLOGICAL PREPARATIONS, ANALGESICS, PREPARATIONS FOR THE TREATMENT AND SYMPTOMS OF DIABETES, PREPARATIONS FOR THE TREATMENT OF OPHTHALMOLOGICAL CONDITIONS AND DISEASES, PREPARATIONS FOR THE TREATMENT OF CENTRAL NERVOUS SYSTEMS DISEASES AND DISORDERS, PREPARATIONS FOR THE TREATMENT OF PARKINSON'S DISEASE, GYNECOLOGICAL PREPARATIONS, ANTI-INFLAMMATORY PHARMACEUTICAL PREPARATIONS, PREPARATIONS FOR THE TREATMENT OF CARDIOVASCULAR DISEASES AND CONDITIONS, HORMONAL PREPARATIONS AND PREPARATIONS FOR THE TREATMENT OF MIGRAINES (U.S. CLS. 6, 18, 44, 46, 51 AND 52).

SN 78-054,403. PHARMACIA CORPORATION, PEAPACK, NJ. FILED 3-22-2001.

**TUPRESS**

FOR PHARMACEUTICAL PREPARATIONS, NAMELY PREPARATIONS FOR THE TREATMENT OF INFECTIOUS DISEASES, ONCOLOGICAL PREPARATIONS, ANALGESICS, PREPARATIONS FOR THE TREATMENT AND SYMPTOMS OF DIABETES, PREPARATIONS FOR THE TREATMENT OF OPHTHALMOLOGICAL CONDITIONS AND DISEASES, PREPARATIONS FOR THE TREATMENT OF CENTRAL NERVOUS SYSTEMS DISEASES AND DISORDERS, PREPARATIONS FOR THE TREATMENT OF PARKINSON'S DISEASE, GYNECOLOGICAL PREPARATIONS, ANTI-INFLAMMATORY PHARMACEUTICAL PREPARATIONS, PREPARATIONS FOR THE TREATMENT OF CARDIOVASCULAR DISEASES AND CONDITIONS, HORMONAL PREPARATIONS AND PREPARATIONS FOR THE TREATMENT OF MIGRAINES (U.S. CLS. 6, 18, 44, 46, 51 AND 52).

SN 78-055,019. NATIONAL ENZYME COMPANY, INC., FORSYTH, MO. FILED 3-26-2001.

**ENZYMEUNIVERSITY.COM**

FOR NUTRICEUTICALS FOR USE AS A DIETARY SUPPLEMENT (U.S. CLS. 6, 18, 44, 46, 51 AND 52).

**CLASS 5—(Continued).**

SN 78-056,657. PHARMACIA CORPORATION, PEAPACK, NJ. FILED 4-4-2001.

**ETESIA**

FOR PHARMACEUTICAL PREPARATIONS, NAMELY, PREPARATIONS FOR THE TREATMENT OF INFECTIOUS DISEASES, DYSMENORRHEA, DISORDERS OF THE CENTRAL NERVOUS SYSTEM, CARDIOVASCULAR CONDITIONS, UROLOGICAL DISORDERS, OPHTHALMOLOGICAL CONDITIONS, AND DISORDERS AND CONDITIONS ASSOCIATED WITH THE FIELDS OF ONCOLOGY AND ENDOCRINOLOGY, PREPARATIONS FOR THE TREATMENT OF PARKINSON'S DISEASE, GYNECOLOGICAL PREPARATIONS, ANTI-INFLAMMATORY PREPARATIONS, HORMONAL PREPARATIONS, PREPARATIONS FOR THE TREATMENT OF MIGRAINES; PHARMACEUTICALS IN THE NATURE OF ANTIBODICS (U.S. CLS. 6, 18, 44, 46, 51 AND 52).

SN 78-056,903. BYK GULDEN LOMBERG CHEMISCHE FABRIK GMBH, 78467 KONSTANZ, FED REP GERMANY, FILED 4-5-2001.

**BRIZEN**

FOR PHARMACEUTICAL PREPARATIONS FOR THE TREATMENT OF RESPIRATORY DISEASES AND CONDITIONS (U.S. CLS. 6, 18, 44, 46, 51 AND 52).

SN 78-059,934. JARROW FORMULAS, INC., LOS ANGELES, CA. FILED 4-23-2001.

**CALCI-YUM-YUM**

FOR VITAMINS AND MINERAL SUPPLEMENTS CONTAINING CALCIUM (U.S. CLS. 6, 18, 44, 46, 51 AND 52).  
FIRST USE 12-0-1988; IN COMMERCE 12-0-1988.

SN 78-060,071. RECKITT BENCKISER INC., WAYNE, NJ. FILED 4-24-2001.

**CRYSTAL 'AUTO**

FOR AIR FRESHENING PREPARATIONS (U.S. CLS. 6, 18, 44, 46, 51 AND 52).

**CLASS 5—(Continued).**

SN 78-064,134. NOVARTIS AG, BASEL, SWITZERLAND, FILED 5-17-2001.

**AMDRAY**

OWNER OF U.S. REG. NO. 2,215,815.  
FOR PHARMACEUTICAL PREPARATIONS FOR TREATMENT OF CENTRAL NERVOUS SYSTEM DISEASES AND DISORDERS, IMMUNOLOGICAL DISEASES AND DISORDERS, CARDIOVASCULAR DISEASES AND DISORDERS AND RESPIRATORY DISEASES AND DISORDERS (U.S. CLS. 6, 18, 44, 46, 51 AND 52).

SN 78-070,799. MAHARISHI AYUR-VED PRODUCTS INTERNATIONAL, INC., COLORADO SPRINGS, CO. FILED 6-25-2001.

**FERTILITY PLUS**

NO CLAIM IS MADE TO THE EXCLUSIVE RIGHT TO USE "FERTILITY", APART FROM THE MARK AS SHOWN.  
FOR HERBAL NUTRITIONAL SUPPLEMENTS (U.S. CLS. 6, 18, 44, 46, 51 AND 52).

SN 78-072,295. AEROGEN, INCORPORATED, SUNNYVALE, CA. FILED 7-3-2001.

**PULMOLIN**

FOR INSULIN (U.S. CLS. 6, 18, 44, 46, 51 AND 52).

SN 78-072,392. HERBASWAY LABORATORIES LLC, WALLINGFORD, CT. FILED 7-5-2001.

**VITALITEA**

FOR HERBAL SUPPLEMENT FOR HUMAN CONSUMPTION IN LIQUID FORM, BASED ON TRADITIONAL CHINESE MUSHROOMS (U.S. CLS. 6, 18, 44, 46, 51 AND 52).

SN 78-079,525. MERCOR SERVICES INCORPORATED, CLEARWATER, FL. FILED 8-16-2001.

**BONE PLUS**

NO CLAIM IS MADE TO THE EXCLUSIVE RIGHT TO USE "BONE", APART FROM THE MARK AS SHOWN.  
FOR DIETARY SUPPLEMENT FOR HUMANS (U.S. CLS. 6, 18, 44, 46, 51 AND 52).

**CLASS 5—(Continued).**

SN 78-079,529. PULEO, MARC, POMPAÑO BEACH, FL. FILED 8-16-2001.

**HEARTSHIELD**

FOR ANTIPARASITIC PREPARATION FOR VETERINARY USE IN DOMESTIC ANIMALS (U.S. CLS. 6, 18, 44, 46, 51 AND 52).

SN 78-081,396. RANBAXY LABORATORIES LIMITED, NEW DELHI, INDIA, FILED 8-28-2001.

**CEFAX**

FOR PHARMACEUTICAL AND MEDICINAL PREPARATIONS, NAMELY, TABLETS FOR USE BY HUMANS IN THE TREATMENT OF BACTERIAL INFECTIONS (U.S. CLS. 6, 18, 44, 46, 51 AND 52).

SN 78-081,466. BAYER AKTIENGESELLSCHAFT, LEVERKUSEN-BAYERWERK, FED REP GERMANY, FILED 8-28-2001.

**OBERON**

OWNER OF FED REP GERMANY REG. NO. 39934676, DATED 11-22-1999, EXPIRES 8-31-2009.  
FOR PREPARATIONS FOR KILLING WEEDS AND DESTROYING VERMIN, INSECTICIDES, HERBICIDES, FUNGICIDES (U.S. CLS. 6, 18, 44, 46, 51 AND 52).

SN 78-081,707. PFIZER INC., NEW YORK, NY. FILED 8-29-2001.

**TEFLIC**

FOR PHARMACEUTICAL PREPARATIONS FOR THE TREATMENT OF CARDIOVASCULAR DISEASE, CENTRAL NERVOUS SYSTEM DISEASES AND DISORDERS, NEUROLOGICAL DISORDERS, UROLOGICAL, UROGENITAL AND URINARY DISORDERS, GASTROINTESTINAL DISORDERS, MUSCULOSKELETAL DISORDERS, ALLERGIES, DIABETES, HYPERTENSION, ERECTILE DYSFUNCTION, SEXUAL DYSFUNCTION, STROKE, CANCER, MIGRAINES, PAIN, OBESITY, INFLAMMATION AND INFLAMMATORY DISEASES, RESPIRATORY AND INFECTIOUS DISEASES, AND IMMUNOLOGICAL, BACTERIAL, VIRAL AND FUNGAL DISORDERS; PHARMACEUTICAL PREPARATIONS, NAMELY, CHOLESTEROL PREPARATIONS, SMOKING CESSATION PREPARATIONS, TISSUE AND SKIN REPAIR PREPARATIONS, DERMATOLOGICAL PREPARATIONS, AND GYNECOLOGICAL PREPARATIONS (U.S. CLS. 6, 18, 44, 46, 51 AND 52).

**CLASS 5—(Continued).**

SN 78-083,020. NOVARTIS AG, BASEL, SWITZERLAND,  
FILED 9-7-2001.

**LIL' COMPANIONS**

FOR INFANT AND TODDLER FOOD (U.S. CLS. 6, 18,  
44, 46, 51 AND 52).

SN 78-083,482. ACCERA, INC., AURORA, CO. FILED 9-11-  
2001.

**KETASYN**

FOR PHARMACEUTICALS FOR THE TREATMENT  
OF ALZHEIMER'S DISEASE (U.S. CLS. 6, 18, 44, 46, 51  
AND 52).

SN 78-084,085. CATALYST APPLIED TECHNOLOGIES INC,  
NEW YORK, NY. FILED 9-16-2001.

**VITAMIN BEE**

NO CLAIM IS MADE TO THE EXCLUSIVE RIGHT TO  
USE "VITAMIN B", APART FROM THE MARK AS SHOWN.  
FOR VITAMINS AND NUTRITIONAL SUPPLEMENTS  
(U.S. CLS. 6, 18, 44, 46, 51 AND 52).

SN 78-084,270. LIPTIS PHARMACEUTICALS, BRONX, NY.  
FILED 9-17-2001.

**MICROFEN**

FOR PHARMACEUTICAL PREPARATION TO BE  
USED AS A SUPPLEMENT FOR THE ENHANCEMENT  
OF BODY METABOLISM (U.S. CLS. 6, 18, 44, 46, 51 AND  
52).

SN 78-084,274. LIPTIS PHARMACEUTICALS, BRONX, NY.  
FILED 9-17-2001.

**LITROVIT**

FOR PHARMACEUTICAL PREPARATION TO BE  
USED AS A NUTRITIONAL SUPPLEMENT (U.S. CLS.  
6, 18, 44, 46, 51 AND 52).

**CLASS 5—(Continued).**

SN 78-084,276. LIPTIS PHARMACEUTICALS, BRONX, NY.  
FILED 9-17-2001.

**OB-VIT**

FOR PHARMACEUTICAL PREPARATION TO BE  
USED AS A NUTRITIONAL SUPPLEMENT (U.S. CLS.  
6, 18, 44, 46, 51 AND 52).

SN 78-084,333. SMITHKLINE BEECHAM CORPORATION,  
PHILADELPHIA, PA. FILED 9-18-2001.

**CAPTURE**

FOR ANTACIDS AND CALCIUM SUPPLEMENTS (U.S.  
CLS. 6, 18, 44, 46, 51 AND 52).

SN 78-084,613. X M INTERNATIONAL, L.L.C., PROVO, UT.  
FILED 9-19-2001.

**PEDIALEAN**

FOR DIETARY SUPPLEMENTS, MAINLY FOR CHIL-  
DREN'S WEIGHT LOSS (U.S. CLS. 6, 18, 44, 46, 51 AND  
52).

SN 78-084,705. SPARTAN PRODUCTS, INC., RYE, NY.  
FILED 9-20-2001.

**SURGICSEAL**

FOR ADHESIVE FOR SURGICALLY SEALING AND  
BONDING HUMAN TISSUES, SURFACES, AND OR-  
GANS (U.S. CLS. 6, 18, 44, 46, 51 AND 52).

SN 78-084,862. SMITHKLINE BEECHAM CORPORATION,  
PHILADELPHIA, PA. FILED 9-21-2001.

**CA4 LIFE**

OWNER OF U.S. REG. NO. 2,468,509.  
FOR ANTACIDS AND CALCIUM SUPPLEMENTS (U.S.  
CLS. 6, 18, 44, 46, 51 AND 52).

SN 78-084,863. SMITHKLINE BEECHAM CORPORATION,  
PHILADELPHIA, PA. FILED 9-21-2001.

**CAL4LIFE**

OWNER OF U.S. REG. NO. 2,468,509.  
FOR ANTACIDS AND CALCIUM SUPPLEMENTS (U.S.  
CLS. 6, 18, 44, 46, 51 AND 52).

**CLASS 5—(Continued).**

SN 78-085,464. MALLINCKRODT INC., ST. LOUIS, MO. FILED 9-25-2001.

**DEXTEND**

FOR PHARMACEUTICAL PREPARATIONS FOR THE TREATMENT OF NARCOLEPSY AND BEHAVIORAL DISORDERS (U.S. CLS. 6, 18, 44, 46, 51 AND 52).

---

SN 78-085,473. DDE, INC., BISMARCK, ND. FILED 9-25-2001.

**SOCLE**

FOR NUTRITIONAL SUPPLEMENTS (U.S. CLS. 6, 18, 44, 46, 51 AND 52).

---

SN 78-085,853. WHITMIRE MICRO-GEN RESEARCH LABORATORIES, INC., ST. LOUIS, MO. FILED 9-27-2001.

**HYDROPY-300**

FOR INSECTICIDES FOR DOMESTIC, INSTITUTIONAL AND COMMERCIAL APPLICATIONS (U.S. CLS. 6, 18, 44, 46, 51 AND 52).

---

SN 78-086,538. MUSCLE MARKETING U.S.A., INC., WEST VANCOUVER, BRITISH COLUMBIA, CANADA, FILED 10-2-2001.

**ALLURUS**

FOR DIETARY SUPPLEMENTS AND HEALTH FOODS, NAMELY, NUTRITIONAL FOOD SUPPLEMENTS (U.S. CLS. 6, 18, 44, 46, 51 AND 52).

**CLASS 6—METAL GOODS****CLASS 6—(Continued).**

SN 75-636,407. MICHAEL HEALY, UNBRIDGE, MA. BY ASSIGNMENT HEALY BROTHERS CORPORATION, MANVILLE, RI. FILED 2-8-1999.

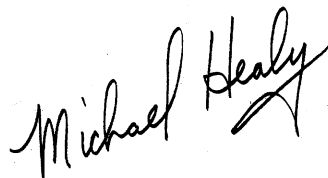

FOR HOUSEHOLD DECORATIVE ITEMS MADE OF NON-PRECIOUS METAL, NAMELY, DOOR KNOCKERS, NON-ELECTRIC DOORBELL RINGERS, ANDIRONS, HANDLES AND PULLS FOR DOORS, NON-ELECTRIC METAL DOOR BELLS, NON-ELECTRIC CHIMES, CANDLE HOLDERS, DECORATIVE TILES; DRAPERY HARDWARE, NAMELY, CURTAIN RODS, TRAVERSE RODS, AND DRAPERY HOOKS; NON-ELECTRIC SIGNBOARDS OF METAL FOR HOUSEHOLD USE; AND NON-ELECTRIC METAL DOOR CHIMES (U.S. CLS. 2, 12, 13, 14, 23, 25 AND 50). FIRST USE 9-0-1997; IN COMMERCE 9-0-1997.

---

SN 75-885,874. ASSOCIATED STEEL COMPANY, INC., CLEVELAND, OH. FILED 1-3-2000.

**MIR 50**

FOR STEEL IN BAR FORM (U.S. CLS. 2, 12, 13, 14, 23, 25 AND 50). FIRST USE 10-0-1998; IN COMMERCE 10-0-1998.

---

SN 75-918,875. FLUID LINE PRODUCTS, INC., WILLOUGHBY, OH. FILED 2-14-2000.

**ANTI BLOCKER**

FOR METAL FITTING, NAMELY, HIGH PRESSURE IN-LINE FLUID FILTER (U.S. CLS. 2, 12, 13, 14, 23, 25 AND 50).

---

SN 76-062,318. KENNEDY MANUFACTURING COMPANY, VAN WERT, OH. FILED 6-2-2000.

**BENCHMARK SERIES**

NO CLAIM IS MADE TO THE EXCLUSIVE RIGHT TO USE "SERIES", APART FROM THE MARK AS SHOWN. FOR METAL TOOL STORAGE CABINETS AND CHESTS (U.S. CLS. 2, 12, 13, 14, 23, 25 AND 50). FIRST USE 11-24-1999; IN COMMERCE 11-24-1999.

**CLASS 6—(Continued).**

SN 76-086,873. L'AIR LIQUIDE, SOCIETE ANONYME POUR L'ETUDE, 75321 PARIS CEDEX, FRANCE, FILED 7-11-2000.

**LEXAL**

FOR WELDING CONSUMABLES, NAMELY, BARE AND COATED WELDING RODS AND WIRES (U.S. CLS. 2, 12, 13, 14, 23, 25 AND 50).  
FIRST USE 3-15-1999; IN COMMERCE 3-14-2000.

---

SN 76-095,258. SCHLUMBERGER TECHNOLOGY CORPORATION, ROSHARON, TX. FILED 7-19-2000.

**RAPIDCONNECT**

OWNER OF U.S. REG. NOS. 2,242,680 AND 2,244,469.  
FOR WELL CONSTRUCTION EQUIPMENT FOR CREATING MULTIPLE BRANCH WELLS FROM A NEW OR EXISTING PARENT SUBTERRANEAN WELL CONSISTING PRIMARILY OF A RETRIEVABLE PREFABRICATED METAL TUBULAR JUNCTION CONTAINING A MATING TEMPLATE AND CONNECTOR THAT MATE DOWNHOLE THEREBY ESTABLISHING A STABLE INTEGRITY BETWEEN THE PARENT AND BRANCH WELLS AND OPTIMIZED PRODUCTION FLOW IN BOTH THE PARENT AND BRANCH WELLS (U.S. CLS. 2, 12, 13, 14, 23, 25 AND 50).  
FIRST USE 2-3-2000; IN COMMERCE 2-3-2000.

---

SN 76-122,577. NATIONAL-STANDARD COMPANY, NILES, MI. FILED 8-30-2000.

**TRU-TRAC**

FOR WELDING WIRE PRODUCTS, NAMELY, CARBON STEEL AND STAINLESS STEEL WELDING WIRE (U.S. CLS. 2, 12, 13, 14, 23, 25 AND 50).  
FIRST USE 1-0-1985; IN COMMERCE 1-0-1985.

**CLASS 6—(Continued).**

SN 76-136,191. NINGBO E.H. VALVES & FITTINGS CO., LTD., NINGBO, ZHEJIANG, CHINA, FILED 9-27-2000.

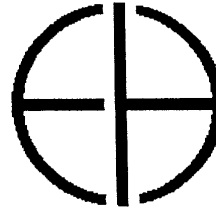

THE MARK CONSISTS OF A STYLIZED DEPICTION OF THE LETTERS "EH."

FOR MANUALLY OPERATED METAL VALVES, NAMELY, BALL VALVES AND CUT-OFF VALVES FOR GAS LEAK PREVENTION, STEEL BOTTLE VALVES FOR LIQUEFIED PETROLEUM GAS, ANGLE VALVES, VALVES FOR PRESSURE REDUCTION, ADJUSTING VALVES, DISCHARGE VALVES FOR SAFETY, VALVES FOR METAL PIPES WHICH PROVIDE AND DISCHARGE WATER, AND VALVES FOR GENERAL USE AND PIPES; PIPES OF METAL, ELBOWS OF METAL FOR PIPES; PIPE WORKS OF METAL, NAMELY, BRASS FLARE FITTINGS, BRASS COMPRESSION FITTINGS, BRASS BAR FITTINGS, BRASS GAS FITTINGS, BRASS HYDRAULIC FITTINGS, STAINLESS FITTINGS, STEEL BARREL FITTINGS, STEEL THREADED FITTINGS, BRASS TUBE AND PIPES, COPPER TUBE AND PIPES, STAINLESS TUBES AND PIPES, STEEL TUBES AND PIPES (U.S. CLS. 2, 12, 13, 14, 23, 25 AND 50).  
FIRST USE 12-0-1997; IN COMMERCE 12-1-1999.

---

SN 76-209,836. BASS & HAYS FOUNDRY, INC., GRAND PRAIRIE, TX. FILED 2-7-2001.

**B H**

FOR MUNICIPAL TYPE MANHOLE RINGS, COVERS, FRAMES AND GRATES CAST OF METAL AND IRON (U.S. CLS. 2, 12, 13, 14, 23, 25 AND 50).  
FIRST USE 0-0-1958; IN COMMERCE 0-0-1958.

---

SN 76-209,844. BASS & HAYS FOUNDRY, INC., GRAND PRAIRIE, TX. FILED 2-7-2001.

**BASS HAYS**

FOR MUNICIPAL TYPE MANHOLE RINGS, COVERS, FRAMES AND GRATES CAST OF METAL AND IRON (U.S. CLS. 2, 12, 13, 14, 23, 25 AND 50).

**CLASS 6—(Continued).**

SN 76-214,674. SRD, INC., PLEASANT GROVE, AL. FILED 2-22-2001.

**ECONODECK**

FOR ROOF DECK SYSTEM COMPRISING THE FOLLOWING COMPONENT COMBINATIONS - METAL ROOF DECK PANELS AND PLYWOOD OR ORIENTED STRAND BOARD; METAL ROOF DECK PANELS, GYPSUM BOARD, AND PLYWOOD OR ORIENTED STRAND BOARD; METAL ROOF DECK PANELS, INSULATION, AND PLYWOOD OR ORIENTED STRAND BOARD; AND METAL ROOF DECK PANELS, GYPSUM BOARD, INSULATION, AND PLYWOOD OR ORIENTED STRAND BOARD (U.S. CLS. 2, 12, 13, 14, 23, 25 AND 50).

SN 76-264,051. VAN DYKE SUPPLY COMPANY, WOON-SOCKET, SD. FILED 5-31-2001.

**RESTORER'S LEGACY**

NO CLAIM IS MADE TO THE EXCLUSIVE RIGHT TO USE "RESTORER'S", APART FROM THE MARK AS SHOWN.

FOR DECORATIVE HARDWARE NAMELY, METAL DOORKNOBS, DOORKNOB SETS, BLACKPLATES, HALL TREE AND COAT HOOKS, SWITCH COVERS, BOLT HOLE COVER, HEAD SCREWS, WINDOW LIFTS AND SASH LOCKS (U.S. CLS. 2, 12, 13, 14, 23, 25 AND 50).

FIRST USE 1-2-2001; IN COMMERCE 1-2-2001.

SN 76-267,872. TOPHAT MAILBOXES, LLC, MURRAY, UT. FILED 6-6-2001.

**TOPHAT MAILBOXES**

NO CLAIM IS MADE TO THE EXCLUSIVE RIGHT TO USE "MAILBOXES", APART FROM THE MARK AS SHOWN.

FOR METAL MAILBOXES (U.S. CLS. 2, 12, 13, 14, 23, 25 AND 50).

FIRST USE 4-0-2001; IN COMMERCE 5-0-2001.

SN 76-269,847. AEROFIT PRODUCTS, INC., BUENA PARK, CA. FILED 6-11-2001.

**CRYOFLARE**

FOR METAL FLUID TUBE COUPLINGS, FITTINGS AND CONNECTORS; HEAT RECOVERABLE METALLIC SLEEVES, NUTS AND COUPLINGS FOR JOINING TUBES (U.S. CLS. 2, 12, 13, 14, 23, 25 AND 50).

FIRST USE 10-0-1999; IN COMMERCE 10-0-1999.

**CLASS 6—(Continued).**

SN 76-276,001. CARDINAL FASTENER & SPECIALTY CO., INC., BEDFORD HEIGHTS, OH. FILED 6-22-2001.

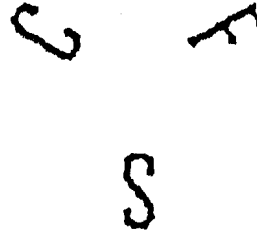

FOR METAL FASTENERS, NAMELY, BOLTS AND CAP SCREWS (U.S. CLS. 2, 12, 13, 14, 23, 25 AND 50). FIRST USE 0-0-1983; IN COMMERCE 0-0-1983.

SN 78-023,988. TEXAS CLASSROOM TEACHERS ASSOCIATION, AUSTIN, TX. FILED 8-31-2000.



SEC. 2(F). FOR METAL KEY CHAINS, METAL KEY RINGS, BUSTS OF NON-PRECIOUS METAL, DESK TOP STATUARY MADE OF NON-PRECIOUS METAL, FIGURINES OF COMMON METAL, JEWELRY BOXES OF METAL, LETTER BOXES OF METAL, METAL CHARMS FOR IDENTIFYING DRINKS, METAL DECORATIVE BOXES, METAL MONEY CLIPS, METAL PIGGY BANKS (U.S. CLS. 2, 12, 13, 14, 23, 25 AND 50).

SN 78-031,201. AP AIR, INC., HUMBOLDT, IA. FILED 10-18-2000.



NO CLAIM IS MADE TO THE EXCLUSIVE RIGHT TO USE "HOSE ASSEMBLIES", APART FROM THE MARK AS SHOWN.

FOR METAL COUPLINGS FOR USE WITH AGRICULTURAL AIR CONDITIONING HOSE ASSEMBLIES (U.S. CLS. 2, 12, 13, 14, 23, 25 AND 50).

FIRST USE 3-1-1999; IN COMMERCE 3-1-1999.

**CLASS 6—(Continued).**

SN 78-037,449. SIDERCA S.A.I.C., BUENOS AIRES, ARGENTINA, FILED 12-1-2000.

**TENARIS**

FOR STEEL AND METAL PIPES AND TUBING, INCLUDING THEIR PARTS AND FITTINGS THEREFOR; METAL PIPE AND TUBE JOINTS; METAL PIPE COLLARS; METAL JUNCTIONS FOR PIPES; SEAMLESS METAL LINE PIPES; WELDED METAL LINE PIPE; METAL MOTHER PIPES; PETROCHEMICAL METAL PIPES; BOILER METAL PIPES; METAL EXCHANGER PIPES AND METAL TUBE EXCHANGER PIPES; METAL DRILLING PIPES; STEEL AND METAL PIPES AND VESSELS USED FOR TRANSPORTING OIL AND FUEL; METAL TUBES USED IN AUTOPARTS AND SAFETY DEVICES (U.S. CLS. 2, 12, 13, 14, 23, 25 AND 50).

SN 78-064,358. BOLTON ALLOYS, L.C., HOUSTON, TX. FILED 5-18-2001.

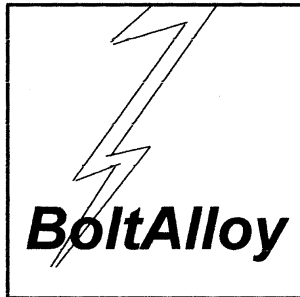

NO CLAIM IS MADE TO THE EXCLUSIVE RIGHT TO USE "BOLT ALLOY", APART FROM THE MARK AS SHOWN.

FOR METAL ALLOYS FOR USE IN WELDING TO PROVIDE WEAR RESISTANCE (U.S. CLS. 2, 12, 13, 14, 23, 25 AND 50).

SN 78-067,289. HMT, INC., HOUSTON, TX. FILED 6-4-2001.

**RASP**

FOR DEVICES FOR USE WITH HYDROCARBON STORAGE TANK FLOATING ROOFS, SPECIFICALLY, REMOTELY ACTUATED PINS FOR LOCKING SUCH ROOFS IN A SET POSITION (U.S. CLS. 2, 12, 13, 14, 23, 25 AND 50).

**CLASS 6—(Continued).**

SN 78-071,665. WATERSAVE, INC., WESTMINSTER, CA. FILED 6-29-2001.

**FINGERLOCK**

FOR KEYLESS OPERATED METAL PADLOCKS, NAMELY PADLOCKS OPERATED BY READING AN AUTHORIZED USER'S FINGERPRINT (U.S. CLS. 2, 12, 13, 14, 23, 25 AND 50).

SN 78-078,153. STEVENS, G/TODD, MATTAWA, WA. FILED 8-8-2001.

**GOTAGS**

FOR METAL PET IDENTIFICATION TAGS (U.S. CLS. 2, 12, 13, 14, 23, 25 AND 50). FIRST USE 11-19-1999; IN COMMERCE 11-20-1999.

SN 78-087,551. PRIMESOURCE BUILDING PRODUCTS, INC., CARROLLTON, TX. FILED 10-9-2001.



FOR METAL FASTENERS, NAMELY SCREWS (U.S. CLS. 2, 12, 13, 14, 23, 25 AND 50).

**CLASS 7—MACHINERY**

**CLASS 7—(Continued).**

SN 75-682,744. SLATER TOOLS, INC., CLINTON TOWNSHIP, MI. FILED 4-15-1999.



OWNER OF U.S. REG. NO. 870,669 AND OTHERS.  
NO CLAIM IS MADE TO THE EXCLUSIVE RIGHT TO USE "TOOLS", APART FROM THE MARK AS SHOWN.  
THE MARK CONSISTS OF A STYLIZED REPRESENTATION OF THE LETTER "S".

FOR TOOLHOLDERS FOR AUTOMATIC SCREW MACHINES, CNC MACHINING CENTERS, TURRET LATHES AND CHUCKERS, NAMELY, BORING, BURNISHING, INTERNAL AND EXTERNAL BROACHING, CENTERS, CHAMFERING, CUT-OFF, DRILLING, DIE, CIRCULAR FORMING, DOVETAIL FORMING, FLAT FORMING, KNURLING, MILLING, POLYGON TURNING, PUNCHING, REAMING, PRECESSING, ROLLER TURNING, SHARPENING, SHAVING, SKIVING, SUPPORTING, AND TAPPING TOOLHOLDERS, AND TOOL BLOCKS; ATTACHMENTS FOR AUTOMATIC SCREW MACHINES, CNC MACHINING CENTERS, TURRET LATHES AND CHUCKERS, NAMELY, DRILLING, INTERNAL AND EXTERNAL BROACHING, MILLING, PICK OFF ATTACHMENTS, POLYGON TURNING, REAMING, STATIONARY AND ROTATING PRECESSING, AND TAPPING ATTACHMENTS; CUTTING TOOLS, NAMELY, BORING, INTERNAL AND EXTERNAL BROACHES, CUT-OFF, CIRCULAR, DIES, DOVETAIL, INSERT, KNURLS, PUNCHES AND RECESS CUTTING TOOLS, TOOL BITS, AND BLANKS FOR EACH THEREOF; AND REPLACEMENT PARTS FOR AUTOMATIC SCREW MACHINES, CNC MACHINING CENTERS, TURRET LATHES AND CHUCKERS, NAMELY, BASES, BEARINGS, BLOCKS, BUSHINGS, CAMS, CHUCKS, CLAMPS, CLUTCHES, COLLARS, COLLETS, DRIVES, DRUMS, FEED TUBES, FINGERS, GEARS, GIBS, HEADS, HOUSING, LEVERS, NUTS, PINS, PLATES, PLUGS, PLUNGERS, PUMPS, PUSHERS, RINGS, RETAINERS, RODS, ROLLS, SCREWS, SHAFTS, SLIDES, SLEEVES, SPACERS, SPINDLES, SPRINGS, SPROCKETS, STOPS, STUDS, WASHERS, AND YOKES (U.S. CLS. 13, 19, 21, 23, 31, 34 AND 35).

FIRST USE 8-31-1993; IN COMMERCE 8-31-1993.

SN 75-716,650. MALISH CORPORATION, THE, WILLOUGHBY, OH. FILED 5-28-1999.

**POWER-PAD**

FOR BRUSHES AND BRUSH DRIVERS FOR FLOOR MAINTENANCE MACHINES (U.S. CLS. 13, 19, 21, 23, 31, 34 AND 35).

FIRST USE 3-15-1999; IN COMMERCE 3-15-1999.

SN 75-818,355. LUBBERING CORP., TROY, PA. FILED 10-12-1999.

**SICOPOINT**

FOR ASSEMBLY LINE SIGN COLOR MACHINE USED FOR APPLYING PAINT FOR CONSPICUOUS MARKINGS FOR USE IN PRODUCTION AND QUALITY CONTROL (U.S. CLS. 13, 19, 21, 23, 31, 34 AND 35).

FIRST USE 6-0-1996; IN COMMERCE 6-0-1996.

**CLASS 7—(Continued).**

SN 75-818,652. OLIN CORPORATION, NORWALK, CT. FILED 10-8-1999.



NO CLAIM IS MADE TO THE EXCLUSIVE RIGHT TO USE "INDUSTRIAL PRODUCTS", APART FROM THE MARK AS SHOWN.

THE LINING IN THE DRAWING IS A FEATURE OF THE MARK BUT NO CLAIM IS MADE AS TO SPECIFIC COLOR.

FOR INDUSTRIAL MANUFACTURING TOOLS AND MACHINES, NAMELY, KILN GUNS AND 8 GAUGE SLUGS FIRED FROM KILN GUNS THAT ARE USED TO CLEAN AND REMOVE NOSE RINGS, BALLS, LOGS, RING PARTS AND OTHER FORMS OF BLOCKAGES AND BUILD UP IN KILNS, FURNACES, SILOS, SMELTERS, AND BOILERS; POWER ACTUATED INDUSTRIAL TOOLS USED FOR FIRING SLUGS FOR CLEANING AND REMOVING BLOCKAGES AND BUILD UP IN KILNS, FURNACES, SILOS, SMELTERS AND BOILERS (U.S. CLS. 13, 19, 21, 23, 31, 34 AND 35).

FIRST USE 8-27-1999; IN COMMERCE 8-27-1999.

SN 75-856,838. APPLIED MATERIALS, INC., SANTA CLARA, CA. FILED 11-23-1999.

**ENABLING THE GIGA-BIT GENERATION**

FOR MACHINES FOR MANUFACTURING SEMICONDUCTOR SUBSTRATES, THIN FILMS, SILICON DISCS AND WAFERS (U.S. CLS. 13, 19, 21, 23, 31, 34 AND 35).

SN 75-876,022. EMHART GLASS S.A., CH-6330, CHAM, SWITZERLAND, FILED 12-20-1999.

**AIS**

FOR GLASS CONTAINER FORMING MACHINES (U.S. CLS. 13, 19, 21, 23, 31, 34 AND 35).

FIRST USE 12-30-1985; IN COMMERCE 12-30-1985.

SN 75-909,234. JOHNSON MATTHEY PUBLIC LIMITED COMPANY, READING RG4 9NH, UNITED KINGDOM, FILED 2-3-2000.

**EGRT**

FOR EXHAUST GAS POLLUTION CONTROL COMPONENTS FOR DIESEL ENGINES USED IN LAND VEHICLE, EXAMPLES OF WHICH ARE SELF-REGENERATING SOOT FILTERS AND TRAPS AND PARTS AND FITTINGS THEREFOR (U.S. CLS. 13, 19, 21, 23, 31, 34 AND 35).



**CLASS 7—(Continued).**

SN 76-023,290. COE MANUFACTURING COMPANY, THE, PAINESVILLE, OH. FILED 4-11-2000.



OWNER OF U.S. REG. NOS. 518,061, 537,343 AND 549,737. FOR MACHINERY FOR CONVEYING, STACKING, PATCHING, GLUING, CUTTING, TRIMMING, PRESSING AND ASSEMBLING LUMBER, VENEER AND COMPOSITE SHEET PRODUCTS FORMED OF THE SAME (U.S. CLS. 13, 19, 21, 23, 31, 34 AND 35). FIRST USE 4-30-1968; IN COMMERCE 4-30-1968.

SN 76-029,716. FOSTER, RAYMOND KEITH, DBA KEITH MANUFACTURING CO., MADRAS, OR. FILED 4-19-2000.

**RUNNING FLOOR II**

NO CLAIM IS MADE TO THE EXCLUSIVE RIGHT TO USE "FLOOR", APART FROM THE MARK AS SHOWN. FOR RECIPROCATING FLOOR CONVEYOR EQUIPMENT COMPRISED OF DRIVE UNITS AND FLOORING, AND REPLACEMENT PARTS THEREFOR (U.S. CLS. 13, 19, 21, 23, 31, 34 AND 35). FIRST USE 10-0-1986; IN COMMERCE 10-0-1986.

SN 76-031,837. BRUNSWICK CORPORATION, LAKE FOREST, IL. FILED 4-20-2000.

**MERCURY PRECISION PARTS**

OWNER OF U.S. REG. NOS. 692,783, 2,394,084 AND OTHERS. NO CLAIM IS MADE TO THE EXCLUSIVE RIGHT TO USE "PRECISION PARTS", APART FROM THE MARK AS SHOWN. FOR PARTS AND ACCESSORIES FOR MARINE PROPULSION UNITS AND MARINE POWER SYSTEMS, NAMELY, FUEL FILTERS, FUEL TANKS AND ELECTRONIC IGNITIONS FOR MOTORS AND ENGINES (U.S. CLS. 13, 19, 21, 23, 31, 34 AND 35). FIRST USE 5-17-1999; IN COMMERCE 5-17-1999.

**CLASS 7—(Continued).**

SN 76-049,281. WIMMER HARTSTAHL GES.M.B.H. & CO. KG, A-5303 THALGAU, AUSTRIA, FILED 5-16-2000.

**W-LOCK**

FOR HEAVY MACHINES AND MACHINE TOOLS, NAMELY, CONSTRUCTION AND EARTH MOVING MACHINES, NAMELY, WHEEL LOADERS, COMPACT BACKHOE LOADERS, BULLDOZERS, GRADERS, EXCAVATORS, MINI EXCAVATORS, AND PARTS THEREFOR; SOIL AND ROCK DRILLING MACHINES AND PARTS THEREFOR; MOTORS, EXCEPT FOR LAND VEHICLES; COUPLINGS AND DEVICES FOR FORCE TRANSFER, EXCEPT FOR LAND VEHICLES, NAMELY, INSTANT COUPLING AND FAST LOCKING SYSTEMS, CONSISTING PRIMARILY OF A STEEL FRAME, PINS, AND HYDRAULIC CYLINDERS FOR CONSTRUCTION MACHINERY; SOIL AND ROCK DRILLING MACHINE EQUIPMENT AND TOOLS (U.S. CLS. 13, 19, 21, 23, 31, 34 AND 35).

SN 76-054,674. AUTUR, S.A., 46988 PATERNA (VALENCIA), SPAIN, FILED 5-23-2000.



OWNER OF SPAIN REG. NO. 2.142.964, DATED 9-7-1998, EXPIRES 2-16-2008. APPLICANT CLAIMS THE COLORS BLUE, RED AND YELLOW AS A FEATURE OF THE MARK. THE TOP TRIANGLE IN THE UPPER RIGHT HAND CORNER IS RED, THE BOTTOM TRIANGLE IN THE UPPER RIGHT HAND CORNER IS YELLOW, THE WORD "AUTUR" IS IN WHITE LETTERING ON A BLUE BACKGROUND. FOR ELEVATORS; MACHINERY AND TOOLS FOR ELEVATORS, NAMELY, PULLEYS, RAILS, GUIDES, COUNTERWEIGHTS, MOTORS AND PARTS THEREFOR (U.S. CLS. 13, 19, 21, 23, 31, 34 AND 35).

SN 76-060,956. AKTIEBOLAGET, ELECTROLUX, S-105-45 STOCKHOLM, SWEDEN, FILED 6-1-2000.

**ELECTROLUX**

OWNER OF U.S. REG. NOS. 195,691, 248,774 AND OTHERS. FOR ELECTRIC AND GASOLINE POWERED BLOWERS AND VACUUMS AND COMBINATION BLOWERS/VACUUMS FOR VACUUMING LEAVES AND OTHER DEBRIS (U.S. CLS. 13, 19, 21, 23, 31, 34 AND 35).

**CLASS 7—(Continued).**

SN 76-064,223. IMPORT PRODUCTS COMPANY, INC., BRIDGEWATER, MA. FILED 6-6-2000.

**CABINAIRE**

FOR AIR FILTERS IMPREGNATED WITH CARBON OR ELECTROSTATICALLY CHARGED PARTICLES FOR USE IN PASSENGER VEHICLES, NAMELY PASSENGER CARS, SPORT UTILITY VEHICLES, VANS AND LIGHT DUTY TRUCKS, AND SOLD OR DISTRIBUTED TO DISTRIBUTORS, RETAILERS AND RESELLERS OF AUTOMOTIVE PRODUCTS AND AUTOMOBILE DEALERSHIPS (U.S. CLS. 13, 19, 21, 23, 31, 34 AND 35).

SN 76-066,073. CHENG POWER SYSTEMS, INC., MOUNTAIN VIEW, CA. FILED 6-7-2000.

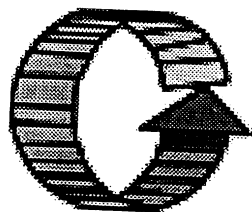

THE STIPLING SHOWN IN THE DRAWING INDICATES A SHADE OF GRAYNESS AND IS NOT INTENDED TO INDICATE COLOR.

THE MARK CONSISTS OF AN ARROW FORMING A CIRCLE. THE CIRCLE IS DIVIDED BY BOLD, BLACK LINES, MAKING SEVERAL RECTANGULAR BOXES IN THE AREA OF THE CIRCLE. THE BOXES ARE PARTLY BLACKENED, FORMING A STIPLING EFFECT.

FOR POWER GENERATION EQUIPMENT, NAMELY, ELECTRONIC GENERATORS, STEAM AND GAS TURBINES, AND PARTS THEREOF (U.S. CLS. 13, 19, 21, 23, 31, 34 AND 35).

SN 76-066,509. HAYES MANUFACTURING, INC., FIFE LAKE, MI. FILED 6-9-2000.

FOR FLEXIBLE, FLYWHEEL, AND DRIVE SHAFT COUPLINGS FOR INDUSTRIAL APPLICATIONS, NAMELY CONNECTORS OF A SHAFT TO A PUMP, SUCH AS A WATER OR HYDRAULIC PUMP (U.S. CLS. 13, 19, 21, 23, 31, 34 AND 35).

FIRST USE 1-1-1990; IN COMMERCE 1-1-1991.

**CLASS 7—(Continued).**

SN 76-072,415. D-M-E COMPANY, MADISON HEIGHTS, MI. FILED 6-5-2000.

**STELLAR**

FOR HOT RUNNER SYSTEMS CONSISTING PRIMARILY OF MANIFOLDS, NOZZLES, NOZZLE TIPS, HEATING ELEMENTS AND TEMPERATURE SENSING DEVICES, SOLD AS A UNIT, USED IN CONVEYING PLASTICS TO INJECTION MOLD CAVITIES (U.S. CLS. 13, 19, 21, 23, 31, 34 AND 35).

SN 76-081,536. MECATOOL AG, 9230 FLAWIL, SWITZERLAND, FILED 6-30-2000.

**MEXCEL**

PRIORITY CLAIMED UNDER SEC. 44(D) ON SWITZERLAND APPLICATION NO. 01409/2000, FILED 2-9-2000, REG. NO. 475727, DATED 2-22-2000, EXPIRES 2-22-2010.

FOR ELECTRODE CLAMPING UNIT FOR HOLDING AN ELECTRODE IN AN ELECTRICAL EROSION MACHINE (U.S. CLS. 13, 19, 21, 23, 31, 34 AND 35).

SN 76-087,778. THOMAS & BETTS INTERNATIONAL, INC., SPARKS, NV. FILED 7-10-2000.

**SHURE STAKE**

FOR POWER OPERATED ELECTRIC TERMINAL CONNECTOR CRIMPING TOOLS (U.S. CLS. 13, 19, 21, 23, 31, 34 AND 35).

FIRST USE 10-31-1949; IN COMMERCE 10-31-1949.

SN 76-093,465. TRACTEL S.A., MONTREUIL 93100, FRANCE, FILED 7-12-2000.

**MINIFOR**

OWNER OF FRANCE REG. NO. 1661564, DATED 5-6-1991, RENEWED AS REG. NO. 1661564, DATED 6-5-2001, EXPIRES 5-6-2011.

FOR CABLE PULLING AND HOISTING MACHINES AND PARTS THEREFOR (U.S. CLS. 13, 19, 21, 23, 31, 34 AND 35).

SN 76-123,947. BREATHE EASY, INC., CARROLLTON, TX. FILED 9-8-2000.

**BENEG**

FOR AIR DUCT CLEANING SYSTEMS COMPRISED; VACUUM BLOWERS THAT REMOVE AIR, DIRT, AND DEBRIS FROM AIR DUCTS, AND EXHAUST THE AIR FROM WHICH DIRT AND DEBRIS HAVE BEEN REMOVED; AND FILTERS THAT REMOVE AND COLLECT DIRT AND DEBRIS FROM AIR REMOVED BY THE BLOWERS (U.S. CLS. 13, 19, 21, 23, 31, 34 AND 35).

**CLASS 7—(Continued).**

SN 76-135,049. AMERICAN ROLLER BEARING COMPANY, PITTSBURGH, PA. FILED 9-25-2000.



NO CLAIM IS MADE TO THE EXCLUSIVE RIGHT TO USE "ROLLER BEARINGS", APART FROM THE MARK AS SHOWN.

SEC. 2(F) AS TO "AMERICAN ROLLER BEARINGS". FOR MACHINE BEARINGS, NAMELY, CAGES, RACES, AND ROLLERS, AND RELATED PARTS NAMELY, RINGS AND SEALS FOR BEARINGS AND BALLS FOR BEARINGS (U.S. CLS. 13, 19, 21, 23, 31, 34 AND 35).

FIRST USE 0-0-1911; IN COMMERCE 0-0-1911.

SN 76-156,022. REICHEL & DREWS, INC., ITASCA, IL. FILED 10-30-2000.

**DIFFERENTIATED LAYER TECHNOLOGY**

NO CLAIM IS MADE TO THE EXCLUSIVE RIGHT TO USE "LAYER TECHNOLOGY", APART FROM THE MARK AS SHOWN.

FOR POWER OPERATED EQUIPMENT, NAMELY, CONTINUOUS WEB FORMING MACHINES FOR MANUFACTURING ROOF SHINGLES (U.S. CLS. 13, 19, 21, 23, 31, 34 AND 35).

SN 76-171,121. NORGRN AUTOMOTIVE, INC., MT. CLEMENS, MI. FILED 11-22-2000.

**NORLOK**

FOR MACHINE PARTS, NAMELY, EXTRUSION MOUNTS, END EFFECTORS, SPLINE RODS, SPLINE BRACKETS, GRIPPER MOUNTINGS, SADDLE MOUNTS, POWERED GRIPPERS, AND POWERED CLAMPS FOR USE ON ASSEMBLY LINES AND ON AUTOMATED MACHINERY IN AN INDUSTRIAL ENVIRONMENT (U.S. CLS. 13, 19, 21, 23, 31, 34 AND 35).

**CLASS 7—(Continued).**

SN 76-185,192. AAR CORP., WOOD DALE, IL. FILED 12-22-2000.

**DOOR SAVER**

NO CLAIM IS MADE TO THE EXCLUSIVE RIGHT TO USE "DOOR", APART FROM THE MARK AS SHOWN.

FOR HYDRAULIC STRUTS AND CYLINDERS FOR ASSISTING IN THE OPENING AND CLOSING OF AN AIRCRAFT DOOR (U.S. CLS. 13, 19, 21, 23, 31, 34 AND 35).

FIRST USE 3-23-1977; IN COMMERCE 3-23-1977.

SN 76-186,323. MEGASONIC SWISS TECHNOLOGY LTD., ZURICH, SWITZERLAND, FILED 12-27-2000.

**SWISSONIC**

FOR ULTRASONIC GOLF CLUB AND GOLF BALL CLEANING MACHINE (U.S. CLS. 13, 19, 21, 23, 31, 34 AND 35).

SN 76-189,904. PAVLATOS, MARINA E., BUFFALO GROVE, IL. FILED 1-4-2001.

**ENSRAAR**

FOR AEROSPACE COMPONENTS, NAMELY, AIRCRAFT AND SPACECRAFT VEHICLE ENGINES, AND REPLACEMENT PARTS THEREFOR (U.S. CLS. 13, 19, 21, 23, 31, 34 AND 35).

SN 76-189,905. PAVLATOS, MARINA E., BUFFALO GROVE, IL. FILED 1-4-2001.

**ENSAAR**

FOR AEROSPACE COMPONENTS, NAMELY, AIRCRAFT AND SPACECRAFT VEHICLE ENGINES, AND REPLACEMENT PARTS THEREFOR (U.S. CLS. 13, 19, 21, 23, 31, 34 AND 35).

SN 76-189,906. PAVLATOS, MARINA E., BUFFALO GROVE, IL. FILED 1-4-2001.

**ENSAAR CCMPC**

FOR AEROSPACE COMPONENTS, NAMELY, AIRCRAFT AND SPACECRAFT VEHICLE ENGINES, AND REPLACEMENT PARTS THEREFOR (U.S. CLS. 13, 19, 21, 23, 31, 34 AND 35).

**CLASS 7—(Continued).**

SN 76-201,677. LILLESBALL PLASTICS AND ENGINEERING LIMITED, NEWBURY, BERKSHIRE, UNITED KINGDOM, FILED 1-30-2001.

**RENCOL**

PRIORITY CLAIMED UNDER SEC. 44(D) ON SPAIN APPLICATION NO. 00178917, FILED 8-3-2000.  
FOR TOLERANCE RINGS (U.S. CLS. 13, 19, 21, 23, 31, 34 AND 35).  
FIRST USE 1-1-1980; IN COMMERCE 1-1-1988.

SN 76-222,998. VETTER, MATTHEW R., CHICAGO, IL. FILED 3-12-2001.

**TURBO DOG**

FOR PUMPS, NAMELY, SUMP PUMPS (U.S. CLS. 13, 19, 21, 23, 31, 34 AND 35).

SN 76-247,920. SEARS, ROEBUCK AND CO., HOFFMAN ESTATES, IL. FILED 4-27-2001.

**SEAL-N-SAVE**

OWNER OF U.S. REG. NO. 1,072,537.  
FOR ELECTRIC POWER OPERATED PACKAGING MACHINE FOR DOMESTIC USES AND PARTS THEREOF (U.S. CLS. 13, 19, 21, 23, 31, 34 AND 35).

SN 76-264,128. BERKELEY PROCESS CONTROL, INC., RICHMOND, CA. FILED 5-29-2001.

**FOUPSERVER**

FOR INTEGRATED SEMICONDUCTOR PRODUCTION MACHINERY, NAMELY, STATIONS FOR STORING WAFER CARRIERS AND ROBOTICS FOR MOVING THE WAFER CARRIERS FROM ONE STATION TO ANOTHER (U.S. CLS. 13, 19, 21, 23, 31, 34 AND 35).

SN 76-264,129. BERKELEY PROCESS CONTROL, INC., RICHMOND, CA. FILED 5-29-2001.

**WAFERSERVER**

FOR INTEGRATED SEMICONDUCTOR WAFER CARRIER AND WAFER HANDLING MACHINERY, NAMELY, STATIONS AND MECHANISMS FOR POSITIONING WAFER CARRIERS AND WAFERS DURING STORAGE AND PROCESSING, AND ROBOTICS FOR MOVING THE WAFER CARRIERS AND WAFERS FROM ONE POSITION TO ANOTHER (U.S. CLS. 13, 19, 21, 23, 31, 34 AND 35).

**CLASS 7—(Continued).**

SN 76-266,019. KENCO CORPORATION, LIGONIER, PA. FILED 6-1-2001.

**SLASH BLADE**

FOR POWER-OPERATED EXCAVATION EQUIPMENT, NAMELY, ATTACHMENT FOR DIGGING, LOADING, GRADING AND SLOPING (U.S. CLS. 13, 19, 21, 23, 31, 34 AND 35).

SN 76-268,251. INGERSOLL CINETIC AUTOMATION CORPORATION, FARMINGTON HILLS, MI. FILED 5-31-2001.

**TRUTIGHT**

FOR INDUSTRIAL FASTENING MACHINES AND TOOLS, NAMELY, NUT RUNNERS AND ELECTRIC CONTROLS FOR NUT RUNNERS (U.S. CLS. 13, 19, 21, 23, 31, 34 AND 35).

SN 76-268,831. DELAWARE CAPITAL FORMATION, INC., WILMINGTON, DE. FILED 6-8-2001.

**SUPER SEAL**

NO CLAIM IS MADE TO THE EXCLUSIVE RIGHT TO USE "SEAL", APART FROM THE MARK AS SHOWN.  
FOR PLUNGER LIFT MACHINES FOR OIL AND GAS LIFT WELLS (U.S. CLS. 13, 19, 21, 23, 31, 34 AND 35).  
FIRST USE 6-6-2001; IN COMMERCE 6-6-2001.

SN 76-271,261. TRI TOOL INC., RANCHO CORDOVA, CA. FILED 6-14-2001.

**BEVELMASTER**

FOR MACHINE TOOLS, NAMELY PORTABLE AND SEMI-PORTABLE MACHINE TOOLS FOR MACHINING AND SHAPING ENDS OF PIPE AND TUBING, FLANGES AND METAL ARTICLES IN PREPARATION FOR WELDING, INCLUDING BEVELING, FACING AND COUNTER BORING, AND SPARE OR REPLACEMENT PARTS FOR SAME (U.S. CLS. 13, 19, 21, 23, 31, 34 AND 35).  
FIRST USE 7-1-1989; IN COMMERCE 7-1-1989.

SN 76-271,263. TRI TOOL INC., RANCHO CORDOVA, CA. FILED 6-14-2001.

**BOILERMASTER**

FOR MACHINE TOOLS, NAMELY PORTABLE AND SEMI-PORTABLE MACHINE TOOLS FOR MACHINING AND SHAPING ENDS OF PIPES AND TUBES TO PREPARE SAME FOR WELDING, IN PARTICULAR BOILER TUBES (U.S. CLS. 13, 19, 21, 23, 31, 34 AND 35).  
FIRST USE 3-11-1996; IN COMMERCE 3-11-1996.

**CLASS 7—(Continued).**

SN 76-271,270. TRI TOOL INC., RANCHO CORDOVA, CA.  
FILED 6-14-2001.

**SEVERMASTER**

FOR MACHINE TOOLS, NAMELY PORTABLE AND SEMI-PORTABLE MACHINE TOOLS FOR SEVERING, FACING AND SQUARING ENDS OF PIPES AND TUBES (U.S. CLS. 13, 19, 21, 23, 31, 34 AND 35).  
FIRST USE 10-1-1989; IN COMMERCE 10-1-1989.

SN 76-276,595. ROLLER BEARING COMPANY OF AMERICA, INC., FAIRFIELD, CT. FILED 6-27-2001.

**DIRTTUFF**

FOR MACHINE PARTS, NAMELY, SPHERICAL PLAIN BEARINGS (U.S. CLS. 13, 19, 21, 23, 31, 34 AND 35).

SN 76-279,355. FLUID RESEARCH CORPORATION, TUSTIN, CA. FILED 7-2-2001.

**PLURASHOT**

FOR MULTI-COMPONENT DISPENSING SYSTEM COMPRISED OF POSITIVE DISPLACEMENT PUMPS, PUMP CONTROLLERS, NOZZLES, TUBING, VALVES, SOLD AS A UNIT (U.S. CLS. 13, 19, 21, 23, 31, 34 AND 35).

SN 76-279,373. FLUID RESEARCH CORPORATION, TUSTIN, CA. FILED 7-2-2001.

**PLURARAM**

FOR MULTI-COMPONENT DISPENSING SYSTEM COMPRISED OF POSITIVE DISPLACEMENT PUMPS, PUMP CONTROLLERS, NOZZLES, TUBING, VALVES, SOLD AS A UNIT (U.S. CLS. 13, 19, 21, 23, 31, 34 AND 35).

SN 78-029,436. COLEMAN POWERMATE, INC., KEARNEY, NE. FILED 10-6-2000.

**WIDE TRACK**

FOR MACHINERY, NAMELY, AIR COMPRESSORS AND STRUCTURAL PARTS THEREFOR AND ELECTRIC GENERATORS AND STRUCTURAL PARTS THEREFOR (U.S. CLS. 13, 19, 21, 23, 31, 34 AND 35).

**CLASS 7—(Continued).**

SN 78-035,924. ULTRASONIC SERVICES INC., HOUSTON, TX. FILED 11-18-2000.

**SONICSENSE**

FOR ULTRASONIC FREQUENCY GENERATORS FOR CLEANING TANKS (U.S. CLS. 13, 19, 21, 23, 31, 34 AND 35).  
FIRST USE 10-23-2000; IN COMMERCE 10-23-2000.

SN 78-060,219. GATES CORPORATION, THE, DENVER, CO. FILED 4-25-2001.

**POWER CURVE**

FOR POWER TRANSMISSION BELTS FOR USE IN INDUSTRIAL APPLICATIONS (U.S. CLS. 13, 19, 21, 23, 31, 34 AND 35).

SN 78-062,419. GATES CORPORATION, THE, DENVER, CO. FILED 5-8-2001.

**GEM**

FOR ENGINE COMPONENTS FOR LAND VEHICLES, NAMELY, TIMING DRIVE MODULES, ACCESSORY DRIVE MODULES, TIMING AND ACCESSORY DRIVE MODULES COMPRISING AN ASSEMBLAGE OF ENGINE PARTS (U.S. CLS. 13, 19, 21, 23, 31, 34 AND 35).

SN 78-077,913. SURFACE COMBUSTION, INC., MAUMEE, OH. FILED 8-7-2001.

**SHUTTLETRAC**

FOR CHARGE CAR COMPRISING AN AUTOMATED CART MOVABLE ON A TRACK HAVING TRANSFER MECHANISMS FOR LOADING AND UNLOADING METAL PARTS INTO AND OUT OF INDUSTRIAL HEAT TREAT FURNACES (U.S. CLS. 13, 19, 21, 23, 31, 34 AND 35).  
FIRST USE 7-11-2001; IN COMMERCE 7-11-2001.

SN 78-079,467. CLEARTRACK SPORTS PROMOTIONS, INC., SAN DIEGO, CA. FILED 8-15-2001.

**AIRHEAD**

FOR PNEUMATIC VALVE SPRINGS (U.S. CLS. 13, 19, 21, 23, 31, 34 AND 35).

**CLASS 7—(Continued).**

SN 78-079,816. LANG, DAMIEN, WATERFORD, OH. FILED 8-17-2001.



OWNER OF U.S. REG. NO. 2,421,996.  
FOR POWER OPERATED TOOL, NAMELY, A COMBI-  
NATION GROUT HOLDER AND DISPENSER (U.S. CLS.  
13, 19, 21, 23, 31, 34 AND 35).  
FIRST USE 9-15-2000; IN COMMERCE 9-15-2000.

SN 78-084,564. SINGER COMPANY LIMITED, THE, DOU-  
GLAS, ISLE OF MAN, FILED 9-19-2001.

## WHERE INNOVATION MEETS IMAGINATION

FOR SEWING MACHINES AND PARTS THEREFORE  
(U.S. CLS. 13, 19, 21, 23, 31, 34 AND 35).

SN 78-085,483. TACONY CORPORATION, FENTON, MO.  
FILED 9-25-2001.

## XQUISIT

FOR SEWING MACHINES (U.S. CLS. 13, 19, 21, 23, 31,  
34 AND 35).

SN 78-085,921. S. C. JOHNSON COMMERCIAL MARKETS,  
INC., STURTEVANT, WI. FILED 9-27-2001.

## JONMASTER

FOR POWER OPERATED MULTI-TASK FLOOR  
CLEANING, SWEEPING, SCRUBBING AND POLISHING  
MACHINES (U.S. CLS. 13, 19, 21, 23, 31, 34 AND 35).

**CLASS 7—(Continued).**

SN 78-085,949. GENERAL ELECTRIC COMPANY, SCHE-  
NECTADY, NY. FILED 9-27-2001.

## TRITON

FOR DISHWASHERS FOR DOMESTIC USE (U.S. CLS.  
13, 19, 21, 23, 31, 34 AND 35).

SN 78-086,146. NUMA TOOL COMPANY, THOMPSON, CT.  
FILED 9-28-2001.

## PATRIOT

FOR PNEUMATIC DOWN HOLE HAMMERS (U.S.  
CLS. 13, 19, 21, 23, 31, 34 AND 35).

**CLASS 8—HAND TOOLS**

SN 75-718,965. SILICON GENESIS CORPORATION, CAMP-  
BELL, CA. FILED 6-4-1999.

## RTCCP

FOR THIN FILM TRANSFER PRODUCTS, NAMELY,  
CLEAVING TOOLS FOR WAFER CLEAVING OR  
BONDED PAIR SEPARATION (U.S. CLS. 23, 28 AND 44).

SN 76-082,460. PETRA AMERICA, INC., DBA PETRA, INC.,  
GLENVIEW, IL. FILED 6-30-2000.

## HANNAH

FOR MANICURE/PEDICURE IMPLEMENTS,  
NAMELY, NAIL FILES, NAIL CLIPPERS, CUTICLE  
PUSHERS, TWEEZERS, NAIL AND CUTICLE SCISSORS  
(U.S. CLS. 23, 28 AND 44).

SN 76-101,026. INDUSTRIA DE DISENO TEXTIL, S.A., AKA  
INDITEX, S.A., 15080 CORUNA, SPAIN, FILED 8-1-2000.

## ZARA

PRIORITY CLAIMED UNDER SEC. 44(D) ON SPAIN  
APPLICATION NO. 2,312,773, FILED 5-3-2000, REG. NO.  
2312773, DATED 5-3-2000, EXPIRES 5-3-2010.

OWNER OF U.S. REG. NOS. 1,922,163, 2,038,110 AND  
OTHERS.

THE ENGLISH TRANSLATION OF "ZARA" IS "MAIZE"  
OR "INDIAN CORN".

FOR CUTLERY, NAMELY, KNIVES, SPOONS, AND  
FORKS; POCKET KNIVES; SPORT KNIVES; RAZORS;  
SHAVING CASES; NAIL CLIPPERS; NAIL FILES; MAN-  
ICURE SETS; HAIR AND BEARD CLIPPERS; DEPILA-  
TION APPLIANCES; NON-ELECTRIC HAND  
IMPLEMENTS FOR HAIR CURLING; SCISSORS; AND  
TWEEZERS (U.S. CLS. 23, 28 AND 44).

**CLASS 8—(Continued).**

SN 76-111,435. HUANG CHIEH METAL INDUSTRY CO., LTD., TAI-SHAN, TAIPEI HSIEN, TAIWAN, FILED 8-17-2000.

**HANS**

FOR HAND TOOLS, NAMELY BLADES FOR UTILITY KNIVES AND CUTTERS, PLIERS, HAMMERS, PRUNING SHEARS, UTILITY KNIVES AND CUTTERS FOR STATIONERY AND INDUSTRIAL APPLICATIONS, SAWS, REAMERS, SHEAR BLADES, SCREWDRIVERS, DRILLS, AND WRENCHES (U.S. CLS. 23, 28 AND 44).

---

SN 76-142,902. POWERNAIL CO., LINCOLNSHIRE, IL. FILED 10-6-2000.

**WEDGEHEAD**

FOR HAND TOOLS, NAMELY, A MALLET FOR WOOD FLOOR INSTALLATION (U.S. CLS. 23, 28 AND 44).

---

SN 76-279,325. WRIGHT TOOL COMPANY, BARBERTON, OH. FILED 7-2-2001.

**WRIGHT STAR**

OWNER OF U.S. REG. NOS. 1,022,945, 2,194,560 AND OTHERS.  
 FOR HAND TOOLS, NAMELY WRENCHES WITH LOBULAR SPLINE OPENINGS FOR ENGAGEMENT WITH FASTENERS (U.S. CLS. 23, 28 AND 44).

---

SN 76-279,534. IRICK & AVERETT LLC, ELKRIDGE, MD. FILED 7-2-2001.



NO CLAIM IS MADE TO THE EXCLUSIVE RIGHT TO USE "LUG NUT", APART FROM THE MARK AS SHOWN. THE STAR BURST IS RED WITH A BLACK SHADOW. FOR HAND TOOLS, NAMELY, LUG NUT ADAPTOR WRENCH (U.S. CLS. 23, 28 AND 44).

**CLASS 8—(Continued).**

SN 78-040,779. AMAR BROTHERS INCORPORATED, HUMBLE, TX. FILED 12-27-2000.

**"DENT OUT" A**

NO CLAIM IS MADE TO THE EXCLUSIVE RIGHT TO USE "DENT", APART FROM THE MARK AS SHOWN. FOR HAND TOOL USED WITH AN ADHESIVE FOR THE REMOVAL OF DOOR DINGS, HAIL DAMAGE AND MINOR DENTS FROM THE SHEET METAL OF A VEHICLE (U.S. CLS. 23, 28 AND 44).

**CLASS 9—ELECTRICAL AND SCIENTIFIC APPARATUS**

---

SN 74-429,552. XENOTRONIX INC., VALENCIA, CA. FILED 8-30-1993.

**INNOVATIONS IN BATTERY CHARGING**

NO CLAIM IS MADE TO THE EXCLUSIVE RIGHT TO USE "BATTERY CHARGING", APART FROM THE MARK AS SHOWN. THE MARK CONSISTS OF THE WORDS "INNOVATIONS IN BATTERY CHARGING", AS SHOWN IN THE DRAWING. FOR BATTERY CHARGERS (U.S. CL. 21).

---

SN 75-184,936. CHYRON CORPORATION, MELVILLE, NY. FILED 10-21-1996.

**TRANSFORM**

OWNER OF U.S. REG. NO. 1,358,925. FOR COMPUTER HARDWARE AND SOFTWARE FOR PERFORMING VIDEO ANIMATION AND EDITING FUNCTIONS (U.S. CLS. 21, 23, 26, 36 AND 38). FIRST USE 6-0-1990; IN COMMERCE 6-0-1990.

**CLASS 9—(Continued).**

SN 75-257,552. HUBBELL INCORPORATED, ORANGE, CT. BY ASSIGNMENT GAI-TRONICS CORPORATION, MOHNTON, PA. FILED 3-14-1997.



NO CLAIM IS MADE TO THE EXCLUSIVE RIGHT TO USE "SMARTSERIES", APART FROM THE MARK AS SHOWN.

THE DRAWING CONSISTS OF STYLIZED, BACK-TO-BACK LETTER "S" AND THE WORD "SMARTSERIES" WITHIN A RECTANGULAR SHAPE.

FOR MICROPROCESSOR-BASED COMMUNICATIONS SYSTEM, COMMUNICATIONS MANAGEMENT SYSTEM, AND EMERGENCY NOTIFICATION SYSTEM, FOR USE IN INDUSTRIAL ENVIRONMENTS AND FEATURING A CONTROL PANEL; TELEPHONE HANDSETS; TELEPHONE RECEIVERS; TELEPHONE INTERFACES; RADIO INTERFACES; SUPERVISED INPUT/OUTPUT DEVICES; SOFTWARE; AMPLIFIERS; ALARMS; MICROPHONES; LOUDSPEAKERS; RECEIVERS; STROBE LIGHTS; AND PRINTERS (U.S. CLS. 21, 23, 26, 36 AND 38).

FIRST USE 1-13-1997; IN COMMERCE 1-13-1997.

SN 75-318,070. BBE SOUND, INC., HUNTINGTON BEACH, CA. FILED 7-1-1997.

**SONIC MAXIMIZER**

NO CLAIM IS MADE TO THE EXCLUSIVE RIGHT TO USE "SONIC", APART FROM THE MARK AS SHOWN.

FOR ELECTRONIC AUDIO SIGNAL PROCESSORS FOR COMPENSATING FOR SOUND DISTORTING CHARACTERISTICS OF SPEAKERS AND OF SPEAKER SYSTEMS (U.S. CLS. 21, 23, 26, 36 AND 38).

FIRST USE 0-0-1986; IN COMMERCE 0-0-1986.

SN 75-430,928. MITEK CORPORATION, DBA MTX, PHOENIX, AZ. FILED 2-9-1998.

**THUNDERLINK**

FOR AUDIO SIGNAL PROCESSORS AND AUDIO SIGNAL INTERCONNECTORS FOR AUDIO EQUIPMENT (U.S. CLS. 21, 23, 26, 36 AND 38).

**CLASS 9—(Continued).**

SN 75-430,948. MITEK CORPORATION, DBA MTX, PHOENIX, AZ. FILED 2-9-1998.

**THUNDERWIRE**

FOR ELECTRICAL AND SCIENTIFIC APPARATUS, NAMELY WIRES FOR CONNECTING AUDIO EQUIPMENT COMPONENTS (U.S. CLS. 21, 23, 26, 36 AND 38).

SN 75-438,717. GATAN, INC., PLEASANTON, CA. FILED 2-23-1998.

**DIGITALMONTAGE**

FOR COMPUTER PROGRAMS FOR USE IN THE ENLARGEMENT OF IMAGES PRODUCED BY A TRANSMISSION ELECTRON MICROSCOPE (U.S. CLS. 21, 23, 26, 36 AND 38).

SN 75-485,059. MEDICALWORKS, INC., SCOTTS VALLEY, CA. FILED 5-14-1998.

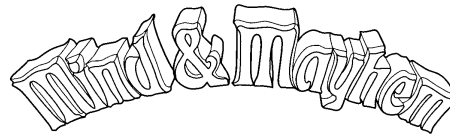

FOR COMPUTER MULTIMEDIA SOFTWARE FOR HEALTH EDUCATION AND COMPUTER GAME SOFTWARE FOR ENTERTAINMENT AND HEALTH EDUCATION (U.S. CLS. 21, 23, 26, 36 AND 38).

SN 75-518,512. OXYGEN MEDIA, INC., NEW YORK, NY. BY CHANGE OF NAME O2, INC., NEW YORK, NY. FILED 7-14-1998.

**OXYGEN**

FOR MOTION PICTURE FILMS, EXPOSED FILM AND NEGATIVES CONTAINING, MOTION PICTURES AND TELEVISION MOVIES FEATURING DRAMAS, COMEDIES, ROMANCES, TELEVISION DRAMA OR COMEDY SERIES, DOCUMENTARIES, NEWS, COMEDY PERFORMANCES, TALK SHOWS, AND ANIMATIONS; CELLS, NAMELY FILM DUPLICATIONS OF INDIVIDUAL FRAMES OF MOTION PICTURES; PRE-RECORDED LASER DISCS AND VIDEOTAPES CONTAINING MOTION PICTURES, TELEVISION MOVIES AND TELEVISION SERIES FEATURING DRAMAS, COMEDIES, ROMANCES, DOCUMENTARIES, NEWS, COMEDY PERFORMANCES, AND TALK SHOWS; AND PRE-RECORDED CD-ROMS AND COMPUTER DISCS CONTAINING ENTERTAINMENT INFORMATION REGARDING MOTION PICTURES, TELEVISION MOVIES AND TELEVISION SERIES FEATURING DRAMAS, COMEDIES, ROMANCES, DOCUMENTARIES, NEWS, COMEDY PERFORMANCES, AND TALK SHOWS (U.S. CLS. 21, 23, 26, 36 AND 38).



**CLASS 9—(Continued).**

SN 75-525,955. DIGITAL GRAFFITI, INC., HAMILTON, ONTARIO, CANADA, FILED 7-27-1998.

**MABANGO**

PRIORITY CLAIMED UNDER SEC. 44(D) ON CANADA APPLICATION NO. 884932, FILED 7-21-1998, REG. NO. TMA527,812, DATED 5-16-2000, EXPIRES 5-16-2015.

FOR COMPUTER SOFTWARE, NAMELY, SOFTWARE FOR GRAPHIC ART DESIGN AND MULTIMEDIA DATABASE MANAGEMENT (U.S. CLS. 21, 23, 26, 36 AND 38).

SN 75-547,901. COMPAQ INFORMATION TECHNOLOGIES GROUP, L.P., HOUSTON, TX. BY ASSIGNMENT DIGITAL EQUIPMENT CORPORATION, MAYNARD, MA. FILED 9-3-1998.

**TRU64**

FOR COMPUTER OPERATING SYSTEM SOFTWARE (U.S. CLS. 21, 23, 26, 36 AND 38).  
FIRST USE 2-1-1999; IN COMMERCE 2-1-1999.

SN 75-555,540. MADACY ENTERTAINMENT GROUP INC., MONTREAL, QUEBEC H3R 3L5, CANADA, FILED 9-21-1998.

**AROMA SOUNDS & SCENTS**

NO CLAIM IS MADE TO THE EXCLUSIVE RIGHT TO USE "SOUNDS", APART FROM THE MARK AS SHOWN.

FOR PRE-RECORDED PHONOGRAPH RECORDS, CASSETTE TAPES, COMPACT DISCS, DIGITAL VIDEO DISCS, VIDEOS AND CD-ROMS FEATURING MUSIC (U.S. CLS. 21, 23, 26, 36 AND 38).

SN 75-555,541. MADACY ENTERTAINMENT GROUP INC., MONTREAL, QUEBEC H3R 3L5, CANADA, FILED 9-21-1998.

**SCENTS & SOUNDS**

NO CLAIM IS MADE TO THE EXCLUSIVE RIGHT TO USE "SOUNDS", APART FROM THE MARK AS SHOWN.

FOR PRE-RECORDED PHONOGRAPH RECORDS, CASSETTE TAPES, COMPACT DISCS, DIGITAL VIDEO DISCS, VIDEOS AND CD-ROMS FEATURING MUSIC (U.S. CLS. 21, 23, 26, 36 AND 38).

**CLASS 9—(Continued).**

SN 75-561,197. ADVANTEST CORPORATION, TOKYO, JAPAN, FILED 9-28-1998.

**OPTSCOPE**

PRIORITY CLAIMED UNDER SEC. 44(D) ON JAPAN APPLICATION NO. 10-54198, FILED 6-29-1998.

FOR TEST SYSTEMS FOR TESTING OPTICAL INSTRUMENTS, APPARATUS, AND DEVICES CONSISTING OF ELECTRONIC AND OPTICAL COMPONENTS, NAMELY, OPTICAL ANALYZERS, OPTICAL REFLECT METERS, CHROMATIC DISPERSION METERS, OPTICAL TRANSFER METERS, OPTICAL INTENSITY BANDPASS METERS, OPTICAL TRANSMISSION AMPLITUDE METERS, FIBER WAVELENGTH DISPERSION METERS, FIBER LENGTH METERS, MICRO-COMPUTERS, COMPUTER FLOPPY DISK DRIVES, COMPUTER KEYBOARDS, OPTICAL CONNECTOR ADAPTORS, AND COMPUTER MONITORS (U.S. CLS. 21, 23, 26, 36 AND 38).

SN 75-585,398. SMITH, DAVID WAYNE, SAN DIMAS, CA. FILED 7-21-1999.

*Love Dimension*

FOR PRERECORDED COMPACT DISCS FEATURING MUSIC (U.S. CLS. 21, 23, 26, 36 AND 38).

SN 75-599,154. IRWIN RESEARCH & DEVELOPMENT, INC., YAKIMA, WA. FILED 12-3-1998.

**BALLERINA**

FOR MACHINE CONTROL SYSTEMS, COMPRISED OF THERMOFORMING MACHINE CONTROLLERS, NAMELY, THERMOFORMER CONTROLLERS, HEAT TUNNEL CONTROLLERS, AND TRIM PRESS CONTROLLERS; MACHINE PROCESS CONTROL SYSTEMS, NAMELY, THERMOFORMING LINE CONTROL SYSTEMS, NAMELY THERMOFORMER CONTROL SYSTEMS, HEAT TUNNEL CONTROL SYSTEMS, AND TRIM PRESS CONTROL SYSTEMS; AND MACHINE CONTROL SOFTWARE, NAMELY, SOFTWARE FOR CONTROLLING COMPONENTS IN A THERMOFORMING LINE (U.S. CLS. 21, 23, 26, 36 AND 38).

FIRST USE 11-11-1996; IN COMMERCE 11-11-1996.

SN 75-605,119. BALLY GAMING INTERNATIONAL, INC., LAS VEGAS, NV. FILED 12-14-1998.

**POOL SHARK**

FOR GAMING DEVICES, NAMELY, SLOT MACHINES WITH OR WITHOUT VIDEO OUTPUT (U.S. CLS. 21, 23, 26, 36 AND 38).

**CLASS 9—(Continued).**

SN 75-609,460. BS & B SAFETY SYSTEMS, INC., TULSA, OK. FILED 8-4-1998.

**SMARTDISK**

FOR ELECTRONIC SENSORS AND RELATED COMPUTER HARDWARE AND SOFTWARE, ALL FOR DETECTING, MONITORING, AND ANALYZING THE CONDITION OF PRESSURE RELIEF EQUIPMENT USED IN CONNECTION WITH PIPES, VESSELS, VALVES, AND TANKS FOR USE IN INDUSTRIES UTILIZING PRESSURE RELIEF EQUIPMENT (U.S. CLS. 21, 23, 26, 36 AND 38).

**CLASS 9—(Continued).**

SN 75-649,358. AVIRT CORPORATION, OREM, UT. FILED 3-1-1999.

**AVIRT**

FOR COMPUTER SOFTWARE TO SET UP AND MAINTAIN A MAIL SERVER PROVIDING EMAIL ACCOUNTS, EMAIL FILTERING, INTERNET ACCESS, AND INTERNET FILTERING (U.S. CLS. 21, 23, 26, 36 AND 38).

FIRST USE 6-1-1998; IN COMMERCE 6-1-1998.

SN 75-629,490. AZALEA TECHNOLOGIES, INC., WOBURN, MA. FILED 1-28-1999.

**CABLYNX**

FOR COMPUTER NETWORKING PRODUCTS, NAMELY, COMPUTER AND COAXIAL CABLES AND CABLE ASSEMBLIES COMPRISING CONNECTORS, BACKSHELLS, AND COAXIAL AND COMPUTER CABLES (U.S. CLS. 21, 23, 26, 36 AND 38).

SN 75-635,732. RAIDER, IRA F.G., DBA RAIDER PRODUCTIONS, WEST CHESTER, PA. FILED 2-5-1999.

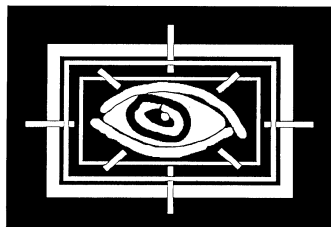

THE MARK CONSISTS OF A STYLIZED EYE. FOR PHOTOGRAPHIC AND CINEMATOGRAPHIC APPARATUS AND INSTRUMENTS, NAMELY, CAMERAS, CAMERA SHUTTERS, CAMERA VIEWFINDERS, CAMERA VIEWFINDER EYECUPS, CAMERA LENSES, CAMERA FILTERS AND CAMERA AND GRIP EQUIPMENT SOLD AS A UNIT (U.S. CLS. 21, 23, 26, 36 AND 38).

FIRST USE 1-26-1999; IN COMMERCE 4-1-1999.

SN 75-674,555. COMPAL ELECTRONICS, INC., TAIPEI, TAIWAN, FILED 4-2-1999.

**COMPAL**

OWNER OF TAIWAN REG. NO. 640875, DATED 5-15-1995, EXPIRES 5-15-2005.

FOR FACSIMILE MACHINES, TELEVISION SETS, PHONOGRAPH RECORD PLAYERS, RADIOS, AUDIO TAPE RECORDERS, VIDEO TAPE RECORDERS, WIRELESS TELEPHONES, MODEMS, FACSIMILE TRANSMITTERS, LCD OR CRT MONITORS, RADIO FREQUENCY CHANGERS, CIRCUIT BOARDS, INTERFACE CARDS, VOICE OR, ELECTRIC CIRCUIT FILTERS, INTEGRATED CIRCUITS, ENCODERS FOR USE IN CONNECTION WITH CIRCUITRY, MICRO-CIRCUITS, ELECTRONIC CIRCUITS, DIODES, LIGHT-EMITTING DIODES, SIGNAL TRANSCIVERS FOR USE IN CONNECTION WITH CIRCUITRY, ELECTRONIC SOUND GENERATOR, DECODERS FOR USE IN CONNECTION WITH CIRCUITRY, COMPUTER RADIATION SHIELDING SCREENS, FLOPPY DISC DRIVES, COMPUTER KEYBOARDS, PRINTERS, CALCULATORS, COMPUTERS (U.S. CLS. 21, 23, 26, 36 AND 38).

SN 75-679,119. INFOLIO, INC., SAN JOSE, CA. BY ASSIGNMENT VADEM, SAN JOSE, CA. FILED 4-9-1999.

**UMID**

FOR COMPUTER SOFTWARE FOR USE IN REMOTELY CONNECTING USERS TO CORPORATE DATA AND APPLICATIONS CONTAINED ON DESKTOP COMPUTERS, WIDE AREA NETWORKS AND LOCAL AREA NETWORKS VIA PORTABLE AND HANDHELD COMMUNICATIONS DEVICES, NAMELY, PERSONAL DATA ASSISTANTS, CELLULAR TELEPHONES, AND LAPTOP COMPUTERS (U.S. CLS. 21, 23, 26, 36 AND 38).

**CLASS 9—(Continued).**

SN 75-717,881. LAIDBACK WE "R" INCORPORATED, ARCHAT, NOVA SCOTIA, B0E1A0, CANADA, FILED 6-1-1999.

**LAPTOP LAIDBACK**

PRIORITY CLAIMED UNDER SEC. 44(D) ON CANADA APPLICATION NO. 898286, FILED 12-2-1998, REG. NO. 529226, DATED 6-15-2000, EXPIRES 6-15-2015.

NO CLAIM IS MADE TO THE EXCLUSIVE RIGHT TO USE "LAPTOP", APART FROM THE MARK AS SHOWN.

FOR ERGONOMIC STANDS SPECIALLY DESIGNED FOR HOLDING A LAPTOP COMPUTER AND OTHER ITEMS SUCH AS READING MATERIALS (U.S. CLS. 21, 23, 26, 36 AND 38).

FIRST USE 4-0-1997; IN COMMERCE 4-0-1997.

SN 75-728,115. APPLIED MATERIALS, INC., SANTA CLARA, CA. FILED 6-14-1999.

**TOOL DISTRIBUTED  
BUFFERING**

NO CLAIM IS MADE TO THE EXCLUSIVE RIGHT TO USE "TOOL" AND "BUFFERING", APART FROM THE MARK AS SHOWN.

FOR SEMICONDUCTOR WAFER PROCESSING EQUIPMENT, AND COMPONENTS, NAMELY, EPITAXIAL REACTORS, CHEMICAL VAPOR DEPOSITION REACTORS, PHYSICAL VAPOR DEPOSITION REACTORS, PLASMA ETCHERS, ION IMPLANTERS, CHEMICAL MECHANICAL POLISHERS, SUPPORTING FRAMES THEREFOR, AND PARTS THEREOF; AND COMPUTER OPERATING PROGRAMS FOR USE THEREWITH (U.S. CLS. 21, 23, 26, 36 AND 38).

SN 75-737,098. MONFARED S., TAHEREH, DAVIS, CA. FILED 6-24-1999.

**TM4&COMPANY**

FOR COMPACT DISCS FEATURING IRANIAN CHILDREN SONGS (U.S. CLS. 21, 23, 26, 36 AND 38).

FIRST USE 2-8-1999; IN COMMERCE 2-8-1999.

SN 75-771,975. DALEEN CANADA CORPORATION, TORONTO, ONTARIO, CANADA, BY CHANGE OF NAME INLOGIC SOFTWARE INC., TORONTO, ONTARIO, CANADA, FILED 8-9-1999.

**E-CARE**

FOR COMPUTER SOFTWARE USED FOR ELECTRONIC COMMERCE AND CUSTOMER SELF-SERVICE THROUGH INTERACTIVE DATABASES, NAMELY, ELECTRONIC BILL PRESENTMENT AND PAYMENT, SERVICE AND ACCOUNT PORTFOLIO MANAGEMENT, WORK FLOW AND MEDIATION, AND MULTI MEDIA PRODUCT CATALOGS ACCESSIBLE BY THE WORLDWIDE COMPUTER NETWORK (U.S. CLS. 21, 23, 26, 36 AND 38).

FIRST USE 6-0-1999; IN COMMERCE 6-0-1999.

**CLASS 9—(Continued).**

SN 75-791,118. POLAROID CORPORATION, CAMBRIDGE, MA. FILED 9-2-1999.

**POLAROID PHOTO ENGINE**

OWNER OF U.S. REG. NOS. 2,036,164, 2,295,786 AND OTHERS.

NO CLAIM IS MADE TO THE EXCLUSIVE RIGHT TO USE "PHOTO", APART FROM THE MARK AS SHOWN.

FOR PHOTOGRAPHIC PRINTERS; DIGITAL COMPUTER PRINTERS; COMPUTER PRINTERS; IMAGE CAPTURING DEVICES, NAMELY, OPTICAL SCANNERS AND PHOTOGRAPHIC PAGERS; PHOTOGRAPHIC CAMERAS; CELLULAR TELEPHONES (U.S. CLS. 21, 23, 26, 36 AND 38).

SN 75-792,530. CHEMA TECHNOLOGY, INC., BROOKFIELD, WI. FILED 9-3-1999.

**POWERSONIC**

FOR ELECTROPLATING MACHINES FOR USE IN THE PRINTING INDUSTRY (U.S. CLS. 21, 23, 26, 36 AND 38).

FIRST USE 1-0-1998; IN COMMERCE 1-0-1998.

SN 75-794,099. SOLIDWORKS CORPORATION, CONCORD, MA. FILED 9-7-1999.



NO CLAIM IS MADE TO THE EXCLUSIVE RIGHT TO USE "EDRAWINGS", APART FROM THE MARK AS SHOWN.

FOR COMPUTER SOFTWARE FOR COMPUTER-AIDED DESIGN (U.S. CLS. 21, 23, 26, 36 AND 38).

FIRST USE 10-4-1999; IN COMMERCE 10-4-1999.

SN 75-807,219. SLIPKNOT, INCORPORATED, LOS ANGELES, CA. FILED 9-23-1999.

The Slipknot logo is rendered in a highly stylized, black, ink-splattered font. The letters are thick and irregular, with many sharp, jagged edges and some internal white space, giving it a chaotic and aggressive appearance.

FOR SERIES OF PRE-RECORDED CD ROMS, COMPACT DISCS, DVDS, AUDIO CASSETTES, PHONOGRAPH ALBUMS AND VIDEOTAPES, FEATURING MUSIC (U.S. CLS. 21, 23, 26, 36 AND 38).

FIRST USE 10-31-1996; IN COMMERCE 10-31-1996.

**CLASS 9—(Continued).**

SN 75-814,932. PIXELTRONIC AG, 3123 BELP, SWITZERLAND, FILED 10-5-1999.



PRIORITY CLAIMED UNDER SEC. 44(D) ON SWITZERLAND APPLICATION NO. 03315/1999, FILED 4-14-1999, REG. NO. 464508, DATED 4-14-1999, EXPIRES 4-14-2009.

THE STIPPLING IN THE DRAWING IS FOR SHADING PURPOSES ONLY.

FOR DEVICES FOR RECORDING, TRANSFER, AND PLAYBACK OF SOUNDS AND PICTURES, NAMELY MULTIMEDIA DEVICES, VIDEO CAMERAS AND RECORDERS, DIGITAL CAMERAS AND RECORDERS, CD- AND DVD-PLAYERS, RADIOS, TELEVISION APPARATUS, OPTICAL SCANNERS, MICROPHONES, HEADPHONES, AND FACSIMILE MACHINES; DATA PROCESSING DEVICES, NAMELY, COMPUTERS, DATA INPUT UNITS, DATA OUTPUT UNITS, DISPLAYS, SCREENS, PRINTERS, KEYBOARDS, AND MICROCOMPUTERS; COMPUTER SOFTWARE FOR ELECTRONIC EXCHANGE OF DATA IMAGES AND SOUNDS FOR USE IN THE FIELD OF DATA PROCESSING AND EDITING OF ELECTRONIC DATA (U.S. CLS. 21, 23, 26, 36 AND 38).

**CLASS 9—(Continued).**

SN 75-828,129. HOUSE OF BLUES BRANDS CORP., HOLLYWOOD, CA. FILED 10-22-1999.



OWNER OF U.S. REG. NOS. 1,772,628 AND 1,933,441. NO CLAIM IS MADE TO THE EXCLUSIVE RIGHT TO USE "ONLINE", APART FROM THE MARK AS SHOWN. FOR PRE-RECORDED AUDIO AND VIDEO TAPES, CASSETTES, CARTRIDGES, COMPACT DISCS, PHONOGRAPH RECORDS, AND OTHER SOUND AND VIDEO RECORDINGS FEATURING MUSIC (U.S. CLS. 21, 23, 26, 36 AND 38).

SN 75-829,652. VIP SWITCH INC., BROSSARD, QUEBEC J4W 3H2, CANADA, FILED 10-22-1999.

**VIPSWITCH**

FOR COMPUTER NETWORK SWITCHES (U.S. CLS. 21, 23, 26, 36 AND 38). FIRST USE 9-0-1997; IN COMMERCE 9-0-1997.

SN 75-818,014. KAYE, GEORGE ALAN JR., NEW YORK, NY. FILED 10-8-1999.



**MOSCODE**

FOR HIGH FIDELITY AUDIO AMPLIFIERS (U.S. CLS. 21, 23, 26, 36 AND 38). FIRST USE 6-1-1984; IN COMMERCE 6-1-1984.

SN 75-857,035. AETHER SYSTEMS, INC., OWINGS MILLS, MD. BY MERGER RIVERBED TECHNOLOGIES, INC., VIENNA, VA. FILED 11-24-1999.

**SCOUTIT**

FOR COMPUTER SOFTWARE FOR USE IN MANAGING THE WIRELESS REMOTE ACCESSIBILITY OF A CORPORATE COMPUTER NETWORK (U.S. CLS. 21, 23, 26, 36 AND 38). FIRST USE 10-15-1999; IN COMMERCE 10-15-1999.

**CLASS 9—(Continued).**

SN 75-857,036. AETHER SYSTEMS, INC., OWINGS MILLS, MD. BY MERGER RIVERBED TECHNOLOGIES, INC., VIENNA, VA. FILED 11-24-1999.

**SCOUTWEB**

FOR COMPUTER SOFTWARE FOR USE IN CONVERTING HTML, XML, OR OTHER MARK-UP LANGUAGE OR WEB-ENABLED APPLICATIONS, DATA OR OTHER INFORMATION FOR DISPLAY ON WIRELESS HANDHELD DEVICES SUCH AS PERSONAL DIGITAL ASSISTANTS, MOBILE PHONES, PAGER DEVICES, PALM-SIZE COMPUTERS, HAND-SIZE COMPUTERS (U.S. CLS. 21, 23, 26, 36 AND 38).

FIRST USE 10-15-1999; IN COMMERCE 10-15-1999.

**CLASS 9—(Continued).**

SN 75-864,529. JET CAPS EUROPE SA, 92100 BOULOGNE BILLANCOURT, FRANCE, FILED 12-4-1999.

**SECUREJET**

PRIORITY CLAIMED UNDER SEC. 44(D) ON FRANCE APPLICATION NO. 99796527, FILED 5-31-1999, REG. NO. 99796527, DATED 5-31-1999, EXPIRES 5-31-2009.

FOR COMPUTER HARDWARE THAT CONNECTS TO PRINTERS TO ENCRYPT DATA AND RESTRICT PAGE DELIVERY (U.S. CLS. 21, 23, 26, 36 AND 38).

FIRST USE 1-1-2000; IN COMMERCE 7-1-2000.

SN 75-857,361. OKI BERING MANAGEMENT CO., CINCINNATI, OH. FILED 11-24-1999.

**COMFORT**

OWNER OF U.S. REG. NOS. 811,336 AND 893,684. FOR EYE PROTECTIVE ITEMS, NAMELY, SAFETY GOGGLES AND LENSES FOR WELDING HELMETS (U.S. CLS. 21, 23, 26, 36 AND 38).

FIRST USE 1-1-1946; IN COMMERCE 1-1-1946.

SN 75-857,650. OKI BERING MANAGEMENT CO., CINCINNATI, OH. FILED 11-24-1999.

**COMFORT**

OWNER OF U.S. REG. NOS. 811,336 AND 893,684. FOR PROTECTIVE CLOTHING ITEMS, NAMELY, WELDING BLANKETS, JACKETS, APRONS, BIBS, SLEEVES, RAINSUITS, GLOVES, ROD BAGS AND CABLE COVERS (U.S. CLS. 21, 23, 26, 36 AND 38).

FIRST USE 1-1-1946; IN COMMERCE 1-1-1946.

SN 75-863,164. SPS STUDIOS, INC., BOULDER, CO. BY CHANGE OF NAME SPS MEDIA, INC., BOULDER, CO. FILED 12-3-1999.

**SPS STUDIOS**

NO CLAIM IS MADE TO THE EXCLUSIVE RIGHT TO USE "STUDIOS", APART FROM THE MARK AS SHOWN.

FOR COMPACT DISCS FEATURING MUSIC, POETRY, AND BOOKS; MAGNETS; AUDIO TAPES FEATURING MUSIC, POETRY, AND BOOKS; COMPUTER SOFTWARE FOR USE IN CREATING CUSTOMIZED GREETING CARDS (U.S. CLS. 21, 23, 26, 36 AND 38).

SN 75-871,241. MEDEA MEDICAL COMMUNICATION SYSTEMS LTD., TEL AVIV, ISRAEL, FILED 12-13-1999.

**DIRECTMD**

FOR MEDICAL COMMUNICATION SYSTEM COMPRISED OF COMPUTER MONITORS, COMPUTERS AND OPERATING SOFTWARE FOR USE AS AN AUTOMATED CALL CENTER WITH A LINK TO THE GLOBAL COMMUNICATIONS NETWORK, HAVING THE ABILITY TO CONNECT WITH MEDICAL DEVICES AND VIDEO CONFERENCING (U.S. CLS. 21, 23, 26, 36 AND 38).

SN 75-871,631. OMNIVATION LLC, NORTHBROOK, IL. FILED 12-14-1999.

**OCCUPANT AWARE**

FOR COMMUNICATIONS NETWORK SYSTEMS COMPRISED OF HARDWARE AND SOFTWARE FOR DATA STORAGE AND TRANSFER; DATA BUS INTERFACE UNITS; WIRELESS AND NON-WIRELESS ELECTRONIC INTEGRATED CONTROL SYSTEMS COMPRISED OF HARDWARE AND SOFTWARE FOR HOME AND OFFICE AUTOMATION, ENTERTAINMENT SYSTEMS COMPRISED OF HARDWARE AND SOFTWARE FOR EFFECTUATING DATA STORAGE AND TRANSFER; AUDIO-VISUAL SYSTEMS COMPRISED OF HARDWARE AND SOFTWARE FOR EFFECTUATING DATA STORAGE AND TRANSFER, LIGHTING SYSTEMS COMPRISED OF HARDWARE AND SOFTWARE FOR EFFECTING TRANSMISSION OF LIGHTING COMMANDS, SECURITY SYSTEMS COMPRISED OF HARDWARE AND SOFTWARE FOR RECORDING, MONITORING AND TRANSMITTING DATA, CLIMATE CONTROL UNITS, TELECOMMUNICATIONS SYSTEMS COMPRISED OF HARDWARE AND SOFTWARE FOR THE TRANSMISSION OF DATA AND COMMUNICATIONS PROTOCOL, PORTS AND WIRING FOR USE IN THE TRANSMISSION OF DATA (U.S. CLS. 21, 23, 26, 36 AND 38).

**CLASS 9—(Continued).**

SN 75-873,213. ENTRADA SOFTWARE, INC., SCOTTSDALE, AZ. FILED 12-17-1999.

**KINNOSA**

FOR COMPUTER SOFTWARE FOR USE IN CAPTURING, MANAGING, DISTRIBUTING TO OTHERS, AND DISPLAYING INFORMATION CONCERNING PRODUCT CONTENT, REQUIREMENTS, DESIGN, INVENTORY, MANUFACTURE, PROCUREMENT, SALES AND DISTRIBUTIONS (U.S. CLS. 21, 23, 26, 36 AND 38).

SN 75-876,329. JAIR ELECTRONICS CORPORATION, MIAMI, FL. FILED 12-21-1999.

**SUMISHI**

FOR FULL LINE OF CONSUMER ELECTRONICS AND COMPUTER HARDWARE (U.S. CLS. 21, 23, 26, 36 AND 38).

SN 75-877,059. CHIP MERCHANT, INC., THE, SAN DIEGO, CA. FILED 12-20-1999.

**HELIX RADE**

OWNER OF U.S. REG. NOS. 1,643,484 AND 1,682,683.  
NO CLAIM IS MADE TO THE EXCLUSIVE RIGHT TO USE "RADE", APART FROM THE MARK AS SHOWN.  
FOR COMPUTER SOFTWARE FOR DATABASE DEVELOPMENT (U.S. CLS. 21, 23, 26, 36 AND 38).  
FIRST USE 3-0-1999; IN COMMERCE 3-0-1999.

SN 75-884,226. NEXTERNA, INC., OMAHA, NE. BY CHANGE OF NAME AUTOMATED MONITORING AND CONTROL INTERNATIONAL, INC., OMAHA, NE. FILED 12-30-1999.

**OptiPath**

FOR COMPUTER SOFTWARE, NAMELY, WIRELESS MIDDLEWARE MESSAGING SOFTWARE FOR USE IN PROVIDING CONNECTIVITY BETWEEN CENTRAL HOST COMPUTER SYSTEMS AND MULTIPLE WIRELESS APPLICATIONS (U.S. CLS. 21, 23, 26, 36 AND 38).

**CLASS 9—(Continued).**

SN 75-888,798. XICOM INCORPORATED, TUXEDO, NY. FILED 12-30-1999.

**XICOM**

OWNER OF U.S. REG. NO. 1,812,339.  
FOR COMPUTER SOFTWARE FOR PSYCHOLOGICAL TESTING AND ANSWER SCORING; COMPUTER SOFTWARE FOR ASSESSING, EVALUATING, TEACHING MANAGEMENT SKILLS, CUSTOMER SERVICE RELATION SKILLS, CORPORATE CULTURE, DIVERSITY, EMPOWERMENT, STRESS RESILIENCY, EMPATHY AND COMMUNICATION SKILLS IN THE FIELD OF BUSINESS; COMPUTER SOFTWARE FOR ASSESSMENT, EVALUATING, TEACHING, AND TRAINING FOR BUSINESS MANAGEMENT THROUGH THE USE OF TECHNOLOGY LEADERSHIP STYLES, PROJECT MANAGEMENT, TEAM BUILDING AND DISPUTE RESOLUTION (U.S. CLS. 21, 23, 26, 36 AND 38).

SN 75-899,491. GLOBALSIGHT CORPORATION, SAN JOSE, CA. FILED 1-18-2000.

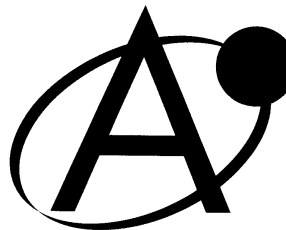

FOR COMPUTER SOFTWARE FOR AUTOMATED DEVELOPMENT, MAINTENANCE AND ADMINISTRATION OF MULTILINGUAL WEB SITES (U.S. CLS. 21, 23, 26, 36 AND 38).  
FIRST USE 9-15-1997; IN COMMERCE 9-15-1997.

SN 75-900,021. MOETTELI, JOHN, GENEVA, SWITZERLAND, FILED 1-16-2000.

**MISSIONTREK**

FOR COMPUTER SOFTWARE FOR IMPROVING EFFICIENCY IN THE FIELD OF INTERNET RESEARCH AND INSTRUCTION MANUALS SOLD AS A UNIT (U.S. CLS. 21, 23, 26, 36 AND 38).

**CLASS 9—(Continued).**

SN 75-900,860. INTERSIL AMERICAS INC., IRVINE, CA. BY ASSIGNMENT INTERSIL CORPORATION, PALM BAY, FL. FILED 1-20-2000.



FOR RADIATION HARDENED INTEGRATED CIRCUITS, NAMELY, CIRCUITS CONTAINING TRANSISTORS OR OTHER SEMICONDUCTOR DEVICES USED IN CIRCUITS FOR WIRELESS COMMUNICATIONS, ELECTRONIC NETWORKS, DIGITAL AND ANALOG ELECTRONIC CIRCUITS, MICROPROCESSORS, MICROCONTROLLERS, DIGITAL SIGNAL PROCESSORS, PROGRAMMABLE LOGIC CIRCUITS, MEMORY CIRCUITS, POWER CONTROL CIRCUITS, AMPLIFIERS AND POWER CONVERTERS, ANALOG AND DIGITAL CONVERTERS; RADIATION HARDENED POWER SEMICONDUCTORS, NAMELY, MOSFETS, IGBTs, AND DISCRETE TRANSISTORS, THYRISTORS, RECTIFIERS, DIODES AND DIODE ARRAYS; RADIATION HARDENED ELECTRONIC CIRCUIT BOARDS AND ASSEMBLED ELECTRONIC MODULES CONTAINING SAID INTEGRATED CIRCUITS, ALL OF THE ABOVE GOODS FOR USE IN MILITARY AND COMMERCIAL SATELLITE APPLICATIONS (U.S. CLS. 21, 23, 26, 36 AND 38).

SN 75-904,640. NSM STORAGE GMBH, 55411 BINGEN/RHEIN, FED REP GERMANY, FILED 1-28-2000.

**NSM2000**

PRIORITY CLAIMED UNDER SEC. 44(D) ON FED REP GERMANY APPLICATION NO. 39946999.0, FILED 8-5-1999, REG. NO. 39946999, DATED 10-19-1999, EXPIRES 8-31-2009.

OWNER OF U.S. REG. NOS. 2,088,514 AND 2,259,007.  
FOR DATA PROCESSING EQUIPMENT; NAMELY, BLANK COMPUTER DISKS FOR OPTICAL MAGNETO-OPTIC AND MAGNETIC DATA STORAGE, COMPUTERS, COMPUTER HARDWARE, AND STAND-ALONE AND NETWORK-ATTACHED COMPUTER HARDWARE CONTAINING BLANK ELECTRONIC ARCHIVES, NAMELY CD AND DVD OPTICAL LIBRARIES FOR THE STORAGE OF COMPUTER SOFTWARE, AUDIO, VIDEO AND OTHER DIGITAL DATA (U.S. CLS. 21, 23, 26, 36 AND 38).

SN 75-905,982. BALBOA INSTRUMENTS, INC., TUSTIN, CA. FILED 1-29-2000.

**M-7 SERIES POWER SYSTEMS**

NO CLAIM IS MADE TO THE EXCLUSIVE RIGHT TO USE "SERIES POWER SYSTEMS", APART FROM THE MARK AS SHOWN.

FOR ELECTRONIC CONTROLS FOR SWIMMING POOLS, SPAS, AND WHIRLPOOL BATHS, NAMELY TRANSUDCERS, SWITCHES, CIRCUIT BOARDS, METERS, AND SENSORS (U.S. CLS. 21, 23, 26, 36 AND 38).  
FIRST USE 9-1-1999; IN COMMERCE 11-30-1999.

**CLASS 9—(Continued).**

SN 75-912,042. LOUDCLOUD, INC., SUNNYVALE, CA. FILED 2-7-2000.

**MAIL CLOUD**

NO CLAIM IS MADE TO THE EXCLUSIVE RIGHT TO USE "MAIL", APART FROM THE MARK AS SHOWN.

FOR COMPUTER HARDWARE; COMPUTER SOFTWARE FOR USE IN DESIGNING AND IMPLEMENTING WEBSITES FOR USE ON LOCAL AND GLOBAL COMPUTER NETWORKS, WIRELESS NETWORKS, BROADBAND NETWORKS AND CABLE NETWORKS; COMPUTER SOFTWARE FOR USE IN THE DESIGN, DEVELOPMENT AND IMPLEMENTATION OF ELECTRONIC COMMERCE SYSTEMS OVER A GLOBAL COMPUTER NETWORK, WIRELESS NETWORK, BROADBAND NETWORK, AND CABLE NETWORK; COMPUTER SOFTWARE USED TO CREATE A TRANSACTION INFRASTRUCTURE FOR ELECTRONIC COMMERCE (U.S. CLS. 21, 23, 26, 36 AND 38).

SN 75-922,622. STARFALL LLC, SUMMIT, NJ. FILED 2-18-2000.

**STARFALL**

FOR COMPUTER SOFTWARE FOR USE IN SEARCHING AND RETRIEVING INFORMATION, SITES, AND OTHER RESOURCES ON THE INTERNET; COMPUTER SOFTWARE CONTAINING OR COMPRISING A DIRECTORY OF INFORMATION, SITES AND RESOURCES ON THE INTERNET; INTERACTIVE COMPUTER GAME SOFTWARE (U.S. CLS. 21, 23, 26, 36 AND 38).

SN 75-928,526. KRF TECH LTD., NETANYA, 42504, ISRAEL, FILED 2-28-2000.

**JUNGO**

PRIORITY CLAIMED UNDER SEC. 44(D) ON ISRAEL APPLICATION NO. 134275, FILED 1-26-2000, REG. NO. 134275, DATED 6-5-2001, EXPIRES 1-26-2007.

"JUNGO" IS A LATIN WORD WHICH HAS THE FOLLOWING MEANINGS IN ENGLISH "JOIN", "UNITE", "BRING TOGETHER", "CLAP (HANDS)", "CONNECT", "YOKE" OR "HARNES".

FOR COMPUTER SOFTWARE DEVELOPMENT TOOLS AND COMPUTER HARDWARE DEVELOPMENT TOOLS FOR EMBEDDED SYSTEMS IN THE FIELDS OF DEVICE DRIVERS DEVELOPMENT, HOT SWAPPABLE HARDWARE, RESIDENTIAL GATEWAYS AND BROADBAND INTEGRATED ACCESS DEVICES, NAMELY, DSL MODEMS, CABLE MODEMS, AND WIRELESS LOCAL LOOP MODEMS (U.S. CLS. 21, 23, 26, 36 AND 38).

**CLASS 9—(Continued).**

SN 75-934,195. EXI WIRELESS SYSTEMS INC., RICHMOND, BRITISH COLUMBIA, CANADA, FILED 3-2-2000.

**ASSETRAC**

FOR WIRELESS SECURITY SYSTEMS COMPRISED OF RADIO FREQUENCY IDENTIFICATION TRANSDUCERS, RADIO FREQUENCY IDENTIFICATION RECEIVERS, AND SOFTWARE FOR CONTROL THEREOF THAT CREATES A MONITORING PERIMETER, IDENTIFY EQUIPMENT THAT RESIDE IN, ENTER, OR EXIT THAT PERIMETER, AND ISSUE ALERTS AND ALARMS WHEN THE IDENTIFIED EQUIPMENT CROSS OR MOVE WITHIN THE PERIMETER (U.S. CLS. 21, 23, 26, 36 AND 38).

SN 75-936,250. MADDUX BAKER ASSOCIATES, INC., FREMONT, CA. FILED 3-6-2000.

**DEPLOYMENT MASTER**

FOR COMPUTER SOFTWARE FOR UNATTENDED INSTALLATION OF OPERATING SYSTEMS AND PROGRAMS (U.S. CLS. 21, 23, 26, 36 AND 38).

SN 75-940,617. MENTOR GRAPHICS CORPORATION, WILSONVILLE, OR. BY ASSIGNMENT HARNESS SOFTWARE LIMITED, ALTRINCHAM, CHESHIRE, WA14 5HX, UNITED KINGDOM, FILED 3-9-2000.

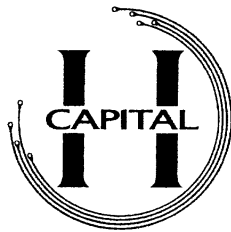

FOR COMPUTER SOFTWARE FOR USE IN THE DESIGN, ENGINEERING, MANUFACTURE, SUPPLY AND USE OF WIRING HARNESSES (U.S. CLS. 21, 23, 26, 36 AND 38).

FIRST USE 0-0-1998; IN COMMERCE 0-0-1998.

SN 75-942,412. GTECH RHODE ISLAND CORPORATION, WEST GREENWICH, RI. FILED 3-13-2000.

**GAME WIZARD**

NO CLAIM IS MADE TO THE EXCLUSIVE RIGHT TO USE "GAME", APART FROM THE MARK AS SHOWN. FOR GAMING MACHINES, NAMELY, VIDEO LOTTERY TERMINALS (U.S. CLS. 21, 23, 26, 36 AND 38).

**CLASS 9—(Continued).**

SN 75-980,616. ZEEKS, INC., WASHINGTON, DC. FILED 5-24-1999.

**'N SYNC**

FOR SERIES OF MUSICAL SOUND RECORDINGS; PRERECORDED RECORDS, AUDIO CASSETTES, COMPACT DISCS AND CD-ROMS FEATURING MUSIC AND LYRICS; PRERECORDED VIDEO TAPES FEATURING MUSICAL ENTERTAINMENT; LASER DISCS FEATURING MUSICAL ENTERTAINMENT; VIDEO DISCS FEATURING MUSICAL ENTERTAINMENT; AND MULTIMEDIA SOFTWARE RECORDED ON CD-ROM FEATURING MUSICAL ENTERTAINMENT (U.S. CLS. 21, 23, 26, 36 AND 38).

FIRST USE 10-0-1995; IN COMMERCE 11-0-1995.

SN 76-000,085. MUZE INC., NEW YORK, NY. FILED 3-14-2000.

**MERCHANT**

FOR COMPUTER SOFTWARE, NAMELY, ELECTRONIC DATA INTERCHANGE SOFTWARE (U.S. CLS. 21, 23, 26, 36 AND 38).

SN 76-000,311. IMANAGE, INC., SAN MATEO, CA. FILED 3-14-2000.

**IMANAGE**

FOR COMPUTER SOFTWARE FOR MANAGING DOCUMENTS, AUDIO, VIDEO, EMAIL, TEXT, DATA, GRAPHICS AND FACSIMILES FOR APPLICATION WITHIN DOCUMENT MANAGEMENT, KNOWLEDGE MANAGEMENT AND BUSINESS-TO-BUSINESS INFORMATION APPLICATIONS VIA LOCAL, WIDE AREA AND GLOBAL NETWORKS (U.S. CLS. 21, 23, 26, 36 AND 38).

FIRST USE 10-0-1995; IN COMMERCE 10-0-1995.

SN 76-001,212. TEXAS INSTRUMENTS INCORPORATED, DALLAS, TX. FILED 3-15-2000.

**TI-OPC**

OWNER OF U.S. REG. NO. 755,376. FOR INTEGRATED CIRCUITS FOR OVERSHOOT PROTECTION (U.S. CLS. 21, 23, 26, 36 AND 38).



**CLASS 9—(Continued).**

SN 76-001,743. HATHERLEIGH COMPANY LTD, INC., LONG ISLAND CITY, NY. FILED 3-16-2000.

**GETFITNOW.COM**

FOR PRE-RECORDED VIDEO TAPES FEATURING FITNESS INSTRUCTION (U.S. CLS. 21, 23, 26, 36 AND 38).

FIRST USE 7-15-2000; IN COMMERCE 7-15-2000.

**CLASS 9—(Continued).**

SN 76-014,073. HART INFO LLC, WILDER, KY. FILED 3-31-2000.

**ORION**

FOR COLLECTION OF SOFTWARE TO ASSIST FORMULATORS AND TECHNOLOGISTS IN MONITORING AND TRACKING CHEMICAL COMPOSITIONS AND PROVIDING FOR THE CALCULATION OF VARIOUS ELEMENTS IN CHEMICAL COMPOSITIONS (U.S. CLS. 21, 23, 26, 36 AND 38).

SN 76-003,289. TIM GORCZYCA, DBA ANDROPOLIS MILLENNIUM SYSTEMS INTERNATIONAL, SAN ANTONIO, TX. FILED 3-17-2000.

**PINONCE**

FOR COMPUTER SOFTWARE FOR USE IN THE FIELD OF BANKING AND FINANCE, NAMELY, COMPUTER SOFTWARE AND NEURAL SOFTWARE FOR USE IN MONITORING PAYMENT CARD TRANSACTIONS AND DETECTING FRAUD, AND USER MANUALS FOR USE THEREWITH, ALL SOLD AS A UNIT (U.S. CLS. 21, 23, 26, 36 AND 38).

SN 76-015,641. I-TECH CORP., EDEN PRAIRIE, MN. FILED 4-3-2000.

SN 76-004,997. SCANCHECK SYSTEMS, INC., PLYMOUTH, MN. FILED 3-20-2000.

**PORTMANN**

FOR COMMUNICATION SYSTEMS COMPRISING BARCODE READERS THAT COLLECT AND TRANSMIT ELECTRONIC INFORMATION BETWEEN COMPUTERS AND/OR DATA COLLECTION DEVICES, NAMELY, BARCODE READERS (U.S. CLS. 21, 23, 26, 36 AND 38).

**SATELLITE**

FOR DIAGNOSTIC EQUIPMENT, NAMELY, SOFTWARE PROGRAM THAT IS A COMPONENT PART OF DIAGNOSTIC EQUIPMENT, AND TESTERS AND ANALYZERS ALL FOR USE WITH SCSI AND FIBRE CHANNEL INTERFACES (U.S. CLS. 21, 23, 26, 36 AND 38).  
FIRST USE 5-5-1999; IN COMMERCE 5-5-1999.

SN 76-005,512. APPLIED INFORMATION SERVICES, INC., SOMERSET, NJ. FILED 3-20-2000.

**DIVCOURT**

FOR TRACKING COMPONENT SOLD AS AN INTEGRATED PART OF COMPUTER SOFTWARE FOR USE IN THE FIELD OF DATABASE MANAGEMENT FOR DIVERSITY SUPPLIER TRACKING AND COUNTING OF MINORITY-OWNED BUSINESSES, AND SMALL BUSINESSES (U.S. CLS. 21, 23, 26, 36 AND 38).  
FIRST USE 12-31-1999; IN COMMERCE 12-31-1999.

SN 76-018,466. CARDINAL HEALTH, INC., DUBLIN, OH. FILED 4-5-2000.

SN 76-008,697. QWEST COMMUNICATIONS INTERNATIONAL INC., DENVER, CO. FILED 3-24-2000.

**QWEST**

FOR COMPUTER SOFTWARE, NAMELY ELECTRONIC MAIL SOFTWARE FOR SENDING, RECEIVING AND MANAGING ELECTRONIC MAIL MESSAGES (U.S. CLS. 21, 23, 26, 36 AND 38).

**ALERXT**

FOR SOFTWARE USED TO MONITOR MEDICATION ORDERS TO PREVENT ADVERSE DRUG EVENTS AND OPTIMIZE DRUG USAGE (U.S. CLS. 21, 23, 26, 36 AND 38).

**CLASS 9—(Continued).**

SN 76-021,389. PROFFITT CENTER, LLC, THE, NASHVILLE, TN. FILED 4-10-2000.

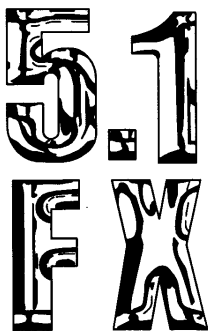

NO CLAIM IS MADE TO THE EXCLUSIVE RIGHT TO USE "5.1 FX", APART FROM THE MARK AS SHOWN.

THE MARK CONSISTS OF THE DIMENSIONAL APPEARANCE OF THE NUMBERS AND LETTERS "5.1 FX", WHICH ARE COMPRISED OF GRADATIONS OF BLACK AND GRAY AND RESEMBLE LIQUID SILVER.

FOR MULTI-CHANNEL AUDIO SOFTWARE DEVELOPED FROM SPECIAL SOUND RECORDINGS AND PRODUCTION MUSIC FOR USE AS AUDIO ELEMENTS OF MULTI-CHANNEL AUDIO PRODUCTIONS (U.S. CLS. 21, 23, 26, 36 AND 38).

FIRST USE 2-10-2000; IN COMMERCE 2-10-2000.

SN 76-022,320. CABLE DESIGN TECHNOLOGIES INC., DBA MOHAWK/CDT, LEOMINSTER, MA. FILED 4-10-2000.

**INST-RULE**

FOR ELECTRICAL WIRE AND CABLE HAVING SPACED MARKERS FORMED THEREON FOR INDICATING THE EXACT LENGTH REMAINING IN THE BOX (U.S. CLS. 21, 23, 26, 36 AND 38).

SN 76-024,098. UNICO, INC., FRANKSVILLE, WI. FILED 4-11-2000.

**FMP**

FOR SOFTWARE FOR AUTOMATED INDUSTRIAL DRIVE AND CONTROL PRODUCTS AND SYSTEMS; NAMELY, DRIVE SYSTEMS SOFTWARE CONTROLLING MOTORS FOR COIL PROCESSING EQUIPMENT (U.S. CLS. 21, 23, 26, 36 AND 38).

**CLASS 9—(Continued).**

SN 76-026,069. QUALCOMM INCORPORATED, SAN DIEGO, CA. FILED 4-13-2000.

**QLINK**

FOR TWO-WAY OR GROUP COMMUNICATION DEVICES, NAMELY, TELEPHONES, WIRELESS TELEPHONES, PERSONAL DATA ASSISTANTS, AND COMPUTERS AND MANUALS PROVIDED THEREWITH (U.S. CLS. 21, 23, 26, 36 AND 38).

SN 76-026,376. CAMBRIDGE INTERACTIVE, INC., CAMBRIDGE, MA. FILED 4-14-2000.

**POWER STEERING**

FOR COMPUTER SOFTWARE, NAMELY, COLLABORATIVE GROUPWARE FOR REAL TIME PROJECT MANAGEMENT THAT ALLOWS USERS TO SHARE, UPDATE, ARCHIVE AND RETRIEVE DATA, TEXT, DOCUMENTS, SCHEDULES, LISTS, MESSAGES AND DISCUSSIONS VIA INTERACTIVE DATABASES (U.S. CLS. 21, 23, 26, 36 AND 38).

SN 76-033,485. MACHEREY, NAGEL GMBH & CO. KG, D-52313 DUREN, FED REP GERMANY, FILED 4-25-2000.

**URYXXON**

PRIORITY CLAIMED UNDER SEC. 44(D) ON ERPNTY TM OFC APPLICATION NO. 1,473,933, FILED 1-14-2000, REG. NO. 1,473,933, DATED 6-6-2001, EXPIRES 1-14-2010.

FOR PHOTOMETER (U.S. CLS. 21, 23, 26, 36 AND 38).

SN 76-033,815. SYMYX TECHNOLOGIES, INC., SANTA CLARA, CA. FILED 4-24-2000.

**POLYVIEW**

FOR COMPUTER SOFTWARE FOR CONTROLLING RESEARCH AND DEVELOPMENT EQUIPMENT IN THE FIELD OF COMBINATORIAL MATERIALS SCIENCE, FOR COMPILING AND CATALOGING RESEARCH AND DEVELOPMENT EXPERIMENT DESIGN, DATA FILES AND RESULTS FOR EXPORTING DATA FILES TO OTHER SOFTWARE PROGRAMS FOR ASSEMBLING DATA AND/OR A COLLECTION OF MATERIALS AND FORMULATIONS FOR USE IN SCIENTIFIC AND ENGINEERING RESEARCH FOR MANAGING DATA FILES AND RESULTS FOR VIEWING DATA FILES AND RESULTS FOR GENERATING DATA FILES DESCRIBING AND DEFINING COLLECTIONS OF MATERIALS AND THE PREPARATION OF MATERIALS FOR USE IN SCIENTIFIC AND ENGINEERING RESEARCH, ALL IN THE FIELD OF COMBINATORIAL MATERIALS SCIENCE (U.S. CLS. 21, 23, 26, 36 AND 38).

**CLASS 9—(Continued).**

SN 76-034,380. SPACESAVER CORPORATION, FORT ATKINSON, WI. FILED 4-25-2000.

**POWER PRO**

NO CLAIM IS MADE TO THE EXCLUSIVE RIGHT TO USE "POWER", APART FROM THE MARK AS SHOWN.  
FOR ELECTRONIC CONTROL FOR MOBILE STORAGE UNITS (U.S. CLS. 21, 23, 26, 36 AND 38).

SN 76-035,175. PIONEER MAGNETICS, INC., SANTA MONICA, CA. FILED 4-26-2000.

**PIONEER PATH**

FOR INDUSTRIAL ELECTRICAL POWER DELIVERY SYSTEM COMPRISED OF INDUSTRIAL POWER REGULATORS, TRANSFORMERS, DISTRIBUTORS, AND RECTIFIERS FOR MONITORING, CONTROLLING, STORING AND DELIVERING ELECTRIC POWER (U.S. CLS. 21, 23, 26, 36 AND 38).

SN 76-037,045. INFINEON TECHNOLOGIES NORTH AMERICA CORP., SAN JOSE, CA. FILED 4-28-2000.

**JXPRESS**

FOR COMPUTER SOFTWARE, NAMELY, COMPUTER SOFTWARE FRAMEWORK FOR USE IN TELECOMMUNICATIONS AND COMPUTER NETWORKS AND SYSTEMS (U.S. CLS. 21, 23, 26, 36 AND 38).

SN 76-038,162. EKA CONSULTING APS, 2613 JG DELFT, NETHERLANDS, FILED 5-1-2000.

**MOSEK**

FOR COMPUTER SOFTWARE FOR GENERAL MATHEMATICAL USE, NAMELY SOFTWARE USED TO SOLVE MATHEMATICAL OPTIMIZATION PROBLEMS, NAMELY, SOLVING LINEAR AND QUADRATIC OPTIMIZATION PROBLEMS (U.S. CLS. 21, 23, 26, 36 AND 38).  
FIRST USE 11-30-1998; IN COMMERCE 11-30-1998.

SN 76-040,580. ADVANCED CASINO SYSTEMS CORPORATION, EGG HARBOR TOWNSHIP, NJ. FILED 5-4-2000.

**TMS**

FOR COMPUTER SOFTWARE FOR USE IN THE MANAGEMENT OF A CASINO WHICH FULLY SUPPORTS PLAYERS EVALUATIONS, TRACKING, CREDIT AND MARKETING FUNCTIONS (U.S. CLS. 21, 23, 26, 36 AND 38).

**CLASS 9—(Continued).**

SN 76-040,875. SHIMADZU CORPORATION, KYOTO, JAPAN, FILED 5-4-2000.

**GCsolution**

FOR SOFTWARE FOR USE IN CHEMICAL ANALYSIS (U.S. CLS. 21, 23, 26, 36 AND 38).

SN 76-041,728. EMOTION, INC., VIENNA, VA. FILED 5-8-2000.



FOR COMPUTER SOFTWARE FOR THE MANAGEMENT OF DIGITAL MEDIA SYSTEMS, NAMELY, CAPTURING, REVIEWING, ANNOTATING, DISPLAYING, MANAGING, STORING, DISTRIBUTING AND TRANSMITTING STORED MULTIMEDIA CONTENT (U.S. CLS. 21, 23, 26, 36 AND 38).

FIRST USE 11-1-1999; IN COMMERCE 11-1-1999.

SN 76-041,732. EMOTION, INC., VIENNA, VA. FILED 5-8-2000.

**Powering Productivity**

FOR COMPUTER SOFTWARE FOR THE MANAGEMENT OF DIGITAL MEDIA SYSTEMS, NAMELY, CAPTURING, REVIEWING, ANNOTATING, DISPLAYING, MANAGING, STORING, DISTRIBUTING AND TRANSMITTING STORED MULTIMEDIA CONTENT (U.S. CLS. 21, 23, 26, 36 AND 38).

FIRST USE 2-0-2000; IN COMMERCE 3-0-2000.

**CLASS 9—(Continued).**

SN 76-042,069. BOSER TECHNOLOGY CO., LTD., HSIN-CHIH, TAIPEI, TAIWAN, FILED 5-5-2000.



FOR MICROCOMPUTERS, INDUSTRIAL COMPUTER SYSTEMS, NAMELY, SOUND EFFECT CARDS, GRAPHIC CARDS, MODEM CARDS, MICRO-COMPUTERS, MAIN BOARDS, MICRO-PROCESSORS, ETHERNET CARDS, COMMUNICATION SERVERS, INTEGRATED CIRCUIT BOARDS, INTERFACE CARDS, INDUSTRIAL COMPUTERS, INDUSTRIAL SINGLE BOARD COMPUTERS, INTERFACE INPUT OUTPUT CARDS, BLANK COMPUTER DISKS, COMPUTER TOUCH MONITOR SCREENS, MULTIMEDIA MPEG CARDS, CPU CARDS, EMBEDDED CHASSES, BACKPLANES, POWER SUPPLIES, AD/DA I/O CARDS (U.S. CLS. 21, 23, 26, 36 AND 38).

FIRST USE 1-1-1998; IN COMMERCE 1-1-1999.

SN 76-044,208. DOT COM GROUP, INC., THE, RESTON, VA. FILED 5-8-2000.

**DUET**

FOR COMPUTER SOFTWARE FOR COLLECTING DATA ON INTERNET-USE PATTERNS (U.S. CLS. 21, 23, 26, 36 AND 38).

FIRST USE 3-0-2000; IN COMMERCE 3-0-2000.

SN 76-047,171. XEROX CORPORATION, STAMFORD, CT. FILED 5-15-2000.

**DIGIFLOW**

FOR LASER PRINTERS, INKJET PRINTERS, COMPUTER PRINTERS, COMPUTER SOFTWARE FOR USE IN THE MANAGEMENT OF PRINTER NETWORKS AND IN THE MANAGEMENT OF PRINTERS (U.S. CLS. 21, 23, 26, 36 AND 38).

SN 76-048,843. ORCHID BIOSCIENCES, INC., PRINCETON, NJ. BY CHANGE OF NAME ORCHID BIOCOMPUTER, INC., PRINCETON, NJ. FILED 5-1-2000.

**SNPWORLD**

FOR COMPUTER HARDWARE FOR GENETIC RESEARCH; COMPUTER SOFTWARE FOR GENETIC DIVERSITY ANALYSIS IN THE FIELD OF GENETIC RESEARCH AND TESTING (U.S. CLS. 21, 23, 26, 36 AND 38).

**CLASS 9—(Continued).**

SN 76-051,551. SMC NETWORKS, IRVINE, CA. FILED 5-18-2000.

**BARRICADE**

FOR LOCAL AREA NETWORK COMPONENTS AND DEVICES, NAMELY, ROUTERS, ADAPTERS (STACKABLE, MANAGED, STAND-ALONE DUALSPEED HUBS, INTERNET HUBS AND ETHERNET HUBS), FAST ETHERNET, LAYER 3 AND GIGABIT ETHERNET SWITCHES, UNIVERSAL SERIAL BUS CONVERTERS, CABLES AND HUBS, WIRELESS PC CARDS AND WIRELESS ACCESS POINTS; HUB DEVICES, NAMELY ACTIVE, MULTI-PORT ACTIVE PASSIVE HUBS AND HARDWARE FOR MOUNTING HUBS; PROCESSORS AND COPROCESSORS, VARIOUS SYSTEM INTERFACES, RECEIVERS, TRANSCIVERS AND TRANSMITTERS, CONTROLLERS, DRIVERS, SCRAMBLERS, DATA SEPARATORS, REPEATERS, BUFFERS, ENCODERS, GENERATORS, CIRCUIT BOARDS, NETWORK TESTERS AND PC SOFTWARE FOR SUCH TESTERS, AND LANS COMPRISING COMPUTERS AND ASSOCIATED LAN-RELATED COMPUTER SOFTWARE (U.S. CLS. 21, 23, 26, 36 AND 38).

FIRST USE 5-1-2000; IN COMMERCE 5-1-2000.

SN 76-052,304. B-BOP ASSOCIATE, INC., BURLINGAME, CA. FILED 5-18-2000.

**B-BOP**

FOR COMPUTER SOFTWARE FOR USE IN MANAGING NETWORK INFRASTRUCTURE ACROSS MULTIPLE SOFTWARE PLATFORMS (U.S. CLS. 21, 23, 26, 36 AND 38).

SN 76-053,478. DATA INDUSTRIAL CORPORATION, MATTAPOISETT, MA. FILED 5-19-2000.

**SDI FLOW SENSORS**

NO CLAIM IS MADE TO THE EXCLUSIVE RIGHT TO USE "FLOW SENSORS", APART FROM THE MARK AS SHOWN.

FOR LIQUID FLOW MEASUREMENT SENSORS FOR WATER OR WATER-CHEMICAL AQUEOUS MIXTURES FOR USE IN THE HVAC MARKET AND IN THE MUNICIPAL AND PUMP/IRRIGATION MARKETS (U.S. CLS. 21, 23, 26, 36 AND 38).

SN 76-054,350. STANDARD TELECOM AMERICA, INC., IRVINE, CA. FILED 5-23-2000.

**X-PRESS**

FOR ELECTRONIC TELECOMMUNICATIONS DEVICES, NAMELY, PAGERS (U.S. CLS. 21, 23, 26, 36 AND 38).

**CLASS 9—(Continued).**

SN 76-055,106. RHS, INC., HIAWATHA, KS. FILED 5-24-2000.

**OUTBACK GUIDANCE**

NO CLAIM IS MADE TO THE EXCLUSIVE RIGHT TO USE "GUIDANCE", APART FROM THE MARK AS SHOWN. FOR ELECTRONIC GUIDANCE SYSTEMS USING VISUAL GUIDANCE FOR FIELD NAVIGATION UTILIZING THE GLOBAL POSITIONING SYSTEM FOR AGRICULTURAL USE (U.S. CLS. 21, 23, 26, 36 AND 38).

SN 76-055,216. ZIBRA CORPORATION, WESTPORT, MA. FILED 5-24-2000.

**MILLISCOPE**

FOR BORESCOPES, NAMELY, NAMELY, RIGID, SEMI-RIGID AND FLEXIBLE MICROBORESOPES AND CUSTOM OPTICS AND ACCESSORIES THEREFOR, NAMELY, VIDEO LENSES, FOR USE IN THE INDUSTRIAL FIELD (U.S. CLS. 21, 23, 26, 36 AND 38). FIRST USE 1-1-1984; IN COMMERCE 1-1-1984.

SN 76-055,466. MOCKINGBIRD NETWORKS, CUPERTINO, CA. FILED 5-24-2000.



NO CLAIM IS MADE TO THE EXCLUSIVE RIGHT TO USE "NETWORKS", APART FROM THE MARK AS SHOWN.

FOR COMPUTER HARDWARE AND SOFTWARE FOR FACILITATING THE CONNECTION OF VOICE AND MULTIMEDIA SERVICES SOLUTIONS, IN THE FIELD OF INTERNET PROTOCOL TELEPHONY (U.S. CLS. 21, 23, 26, 36 AND 38).

FIRST USE 10-21-1999; IN COMMERCE 10-21-1999.

SN 76-055,467. MOCKINGBIRD NETWORKS, CUPERTINO, CA. FILED 5-24-2000.

**MOCKINGBIRD NETWORKS**

NO CLAIM IS MADE TO THE EXCLUSIVE RIGHT TO USE "NETWORKS", APART FROM THE MARK AS SHOWN.

FOR COMPUTER HARDWARE AND SOFTWARE FOR FACILITATING THE CONNECTION OF VOICE AND MULTIMEDIA SERVICES SOLUTIONS, IN THE FIELD OF INTERNET PROTOCOL TELEPHONY (U.S. CLS. 21, 23, 26, 36 AND 38).

FIRST USE 10-21-1999; IN COMMERCE 10-21-1999.

**CLASS 9—(Continued).**

SN 76-058,631. EXTENT TECHNOLOGIES LTD., RESTON, VA. FILED 5-30-2000.

**EXTENT**

FOR COMPUTER SOFTWARE, NAMELY, PROVIDING NETWORK MANAGEMENT AND MARKETING SOLUTIONS TO WIRELESS CARRIERS AND SERVICE PROVIDERS ON A GLOBAL COMPUTER NETWORK AND LAN/WAN DATABASE PROVIDERS (U.S. CLS. 21, 23, 26, 36 AND 38).

SN 76-059,765. SCANCHECK SYSTEMS, INC., PLYMOUTH, MN. FILED 5-31-2000.

**SOLOSHOT**

FOR HAND-HELD LASER SCANNER FOR USE IN DIMENSIONAL WEIGHING (U.S. CLS. 21, 23, 26, 36 AND 38).

SN 76-060,437. SIEMENS AKTIENGESELLSCHAFT, MUNICH, FED REP GERMANY, FILED 5-31-2000.

**SIMARIS**

PRIORITY CLAIMED UNDER SEC. 44(D) ON FED REP GERMANY APPLICATION NO. 30008027.1, FILED 2-3-2000, REG. NO. 30008027, DATED 3-2-2000, EXPIRES 3-2-2010.

FOR COMPUTER SOFTWARE FOR USE IN PLANNING AND CONFIGURATION OF ELECTRICAL POWER SUPPLY AND DISTRIBUTION IN BUILDING; COMPUTER SOFTWARE FOR PROCESSING DATA RELATING TO ELECTRICAL POWER SUPPLY AND DISTRIBUTION IN BUILDINGS AND PROVIDING RELATED TECHNICAL CALCULATIONS, AND GENERATING QUOTES AND ORDERS BASED ON THIS DATA (U.S. CLS. 21, 23, 26, 36 AND 38).

SN 76-060,879. INTERSTATE ELECTRONICS CORPORATION, ANAHEIM, CA. FILED 6-1-2000.



NO CLAIM IS MADE TO THE EXCLUSIVE RIGHT TO USE "DAGR LIGHT", APART FROM THE MARK AS SHOWN.

FOR SATELLITE NAVIGATIONAL SYSTEM, NAMELY, A GLOBAL POSITIONING SYSTEM (U.S. CLS. 21, 23, 26, 36 AND 38).

**CLASS 9—(Continued).**

SN 76-062,323. BIOLINK TECHNOLOGIES INTERNATIONAL, INC., MIRAMAR, FL. FILED 6-2-2000.

## TECHNOLOGY YOU IDENTIFY WITH

FOR COMPUTER HARDWARE AND SOFTWARE FOR BIOMETRIC SECURITY ACCESS CONTROL, NAMELY, SOFTWARE CONTAINING CONTROL ALGORITHMS FOR CONTROLLING ACCESS TO COMPUTERS, COMPUTER FILES, COMPUTER NETWORKS, AND APPLICATIONS BY ANALYZING FINGERPRINTS (U.S. CLS. 21, 23, 26, 36 AND 38).

SN 76-062,516. ROCHESTER GAUGES, INC., DALLAS, TX. FILED 5-31-2000.

## R

FOR GAUGES FOR MEASURING THE LEVEL OF LIQUIDS AND LIQUEFIED COMPRESSED GASES IN VEHICLES, WATERCRAFT, AIRCRAFT, AND STORAGE VESSELS (U.S. CLS. 21, 23, 26, 36 AND 38).  
FIRST USE 7-1-1988; IN COMMERCE 7-1-1988.

SN 76-064,569. JOURNAL OF COMMERCE, INC., NEW YORK, NY. FILED 6-7-2000.

## JOURNAL OF COMMERCE ONLINE

OWNER OF U.S. REG. NOS. 258,747 AND 1,927,514. NO CLAIM IS MADE TO THE EXCLUSIVE RIGHT TO USE "ONLINE", APART FROM THE MARK AS SHOWN. SEC. 2(F).

FOR DOWNLOADABLE ELECTRONIC PUBLICATIONS IN THE NATURE OF NEWSLETTERS AND MAGAZINES PROVIDING NEWS AND ANALYSIS IN THE FIELD OF INTERNATIONAL TRADE AND TRANSPORTATION; CD ROMS BEARING ELECTRONIC PUBLICATIONS IN THE NATURE OF NEWSLETTERS AND MAGAZINES PROVIDING NEWS AND ANALYSIS IN THE FIELD OF INTERNATIONAL TRADE AND TRANSPORTATION (U.S. CLS. 21, 23, 26, 36 AND 38).

SN 76-065,557. BIGCLIX.COM, INC., ATLANTA, GA. FILED 6-8-2000.

## BIGCLIX

FOR WEBSITE DEVELOPMENT SOFTWARE (U.S. CLS. 21, 23, 26, 36 AND 38).

**CLASS 9—(Continued).**

SN 76-066,312. TITUS SOFTWARE CORPORATION, CHATSWORTH, CA. FILED 6-8-2000.

## TITUS

FOR COMPUTER GAME PROGRAMS AND DISKS AND VIDEO GAME CARTRIDGES (U.S. CLS. 21, 23, 26, 36 AND 38).

FIRST USE 1-6-1988; IN COMMERCE 1-6-1988.

SN 76-066,975. SHIN-ETSU HANDOTAI CO., LTD., CHIYODA-KU, TOKYO, JAPAN, FILED 6-9-2000.

## EP-NANA

PRIORITY CLAIMED UNDER SEC. 44(D) ON JAPAN APPLICATION NO. 2000-039517, FILED 4-13-2000, REG. NO. 4466576, DATED 4-13-2001, EXPIRES 4-13-2011.

APPLICANT SUBMITS THAT "NANA" IS A TRANSLITERATION AND MEANS "SEVEN" (7) IN THE JAPANESE LANGUAGE.

FOR SEMICONDUCTOR SILICON WAFERS, SEMICONDUCTOR SILICON INGOTS (U.S. CLS. 21, 23, 26, 36 AND 38).

SN 76-069,148. BROADCAST ELECTRONICS, INC., QUINCY, IL. FILED 6-13-2000.



OWNER OF U.S. REG. NOS. 1,783,908 AND 1,896,823. FOR DIGITAL AUDIO STORAGE AND STUDIO MANAGEMENT COMPUTER SOFTWARE FOR USE IN COMMERCIAL RADIO BROADCASTING (U.S. CLS. 21, 23, 26, 36 AND 38).

FIRST USE 4-0-2000; IN COMMERCE 4-0-2000.

SN 76-070,161. ELLACOYA NETWORKS, INC., MERRIMACK, NH. FILED 6-15-2000.

## OPEN INTELLIGENCE

NO CLAIM IS MADE TO THE EXCLUSIVE RIGHT TO USE "INTELLIGENCE", APART FROM THE MARK AS SHOWN.

FOR NETWORK SERVICE PROVIDER SOFTWARE THAT ENABLES THE PROVIDER TO TAILOR SERVICE PORTALS AND SERVICE OPTIONS TO INDIVIDUAL SUBSCRIBERS AND TO THE PROVIDER'S BUSINESS PARTNERS (U.S. CLS. 21, 23, 26, 36 AND 38).

**CLASS 9—(Continued).**

SN 76-070,294. AUTOLYCUS, INC., CAMP HILL, PA. FILED 6-14-2000.

**SPINOFF TECHNOLOGIES**

NO CLAIM IS MADE TO THE EXCLUSIVE RIGHT TO USE "TECHNOLOGIES", APART FROM THE MARK AS SHOWN.

FOR IMAGING SYSTEM; NAMELY COMPUTER HARDWARE AND SOFTWARE FOR GENERATING AND DISTRIBUTING DIGITAL, TEXT, AND CAD IMAGES AND LITERATURE SOLD TOGETHER AS A UNIT THEREWITH (U.S. CLS. 21, 23, 26, 36 AND 38).

SN 76-070,609. COMVERSE NETWORK SYSTEMS, INC., WAKEFIELD, MA. FILED 6-15-2000.

**COMVERSE NETWORK SYSTEMS**

FOR VOICE MESSAGING AND ENHANCED SERVICES TELECOMMUNICATIONS APPARATUS, NAMELY, COMPUTER HARDWARE FOR USE IN MAKING WIRELINE AND WIRELESS TELECOMMUNICATIONS CONNECTIONS, AND SOFTWARE FOR CONTROLLING THE OPERATION THEREOF (U.S. CLS. 21, 23, 26, 36 AND 38).

FIRST USE 1-14-1998; IN COMMERCE 1-14-1998.

SN 76-070,791. PREFERRED MEDICAL MANAGEMENT, WEST BLOOMFIELD, MI. FILED 6-15-2000.

**APPOINTMED**

FOR COMPUTER SOFTWARE FOR USE IN PRELIMINARY PATIENT ANALYSIS AND PRELIMINARY DIAGNOSIS, AND FOR SCHEDULING OF PATIENT APPOINTMENTS (U.S. CLS. 21, 23, 26, 36 AND 38).

SN 76-071,248. PALL CORPORATION, EAST HILLS, NY. FILED 6-16-2000.

**MUSTANG**

FOR FILTERS, NAMELY FILTER CARTRIDGES AND ION EXCHANGE CHROMATOGRAPHY MODULES FOR BIOCHEMICAL SEPARATIONS (U.S. CLS. 21, 23, 26, 36 AND 38).

FIRST USE 3-15-1999; IN COMMERCE 3-15-1999.

**CLASS 9—(Continued).**

SN 76-071,984. LAC BASKETBALL CLUB, INC., LOS ANGELES, CA. FILED 6-16-2000.



OWNER OF U.S. REG. NO. 2,214,820.  
THE MARK CONSISTS OF THE STYLIZED LETTERS "LAC".

FOR AUDIO, VIDEO, COMPUTER AND LASER DISCS, PRE-RECORDED AUDIO AND VIDEO CASSETTES, PRE-RECORDED AUDIO AND VIDEO TAPES, AND PRE-RECORDED COMPACT DISCS, FEATURING BASKETBALL-THEMED PHOTOS, HIGHLIGHTS, INTERVIEWS OR MUSIC; PRE-RECORDED COMPUTER DISCS, NAMELY COMPUTER GAME SOFTWARE FEATURING BASKETBALL THEMES; COMPUTER ACCESSORIES, NAMELY MOUSE PADS, MICE, DISC CASES, COMPUTER CARRY-ON CASES, KEYBOARD WRIST PADS, COMPUTER MONITOR CARDBOARD FRAMES, ALL RELATED TO BASKETBALL; COMPUTER PROGRAMS FOR DISPLAYING INFORMATION, STATISTICS, TRIVIA ABOUT BASKETBALL; COMPUTER SOFTWARE FEATURING BASKETBALL, NAMELY SCREENSAVERS; VIDEO GAME SOFTWARE; VIDEO GAME CARTRIDGES, AND VIDEO GAME MACHINES FOR USE WITH TELEVISIONS; RADIOS AND TELEPHONES, BINOCULARS, SUNGLASSES, EYEGLASS FRAMES, EYEWEAR STRAPS, CHAINS, EYEGLASS AND SUNGLASS CASES; MAGNETS; MAGNETICALLY ENCODED TELEPHONE CALLING CARDS; MAGNETICALLY ENCODED CREDIT CARDS (U.S. CLS. 21, 23, 26, 36 AND 38).

SN 76-073,247. INTERTRUST TECHNOLOGIES CORPORATION, PALO ALTO, CA. FILED 6-19-2000.

**DTM**

FOR COMPUTER HARDWARE AND COMPUTER SOFTWARE; RECEIVERS AND TRANSMITTERS, NAMELY, RADIOS, TELEPHONES, PAGERS, HAND-HELD REMOTES, TELEVISIONS, AND TELEVISION SET-TOP BOXES; ALL FOR SENDING, RECEIVING, STORING, SECURING AND PROCESSING DIGITAL AND OTHER ELECTRONIC DATA, AND FOR MANAGING SECURE ELECTRONIC EVENTS AND TRANSACTIONS (U.S. CLS. 21, 23, 26, 36 AND 38).

**CLASS 9—(Continued).**

SN 76-074,375. MYND CORPORATION, BLYTHEWOOD, SC. BY CHANGE OF NAME POLICY MANAGEMENT SYSTEMS CORPORATION, DBA MYND CORPORATION, BLYTHEWOOD, SC. FILED 6-21-2000.

**VPMS**

FOR COMPUTER SOFTWARE FOR DEVELOPING INSURANCE PRODUCTS, NAMELY, SOFTWARE FOR DEVELOPING PRODUCT DEFINITION, PLAUSIBILITY TESTING, PRODUCT SIMULATION, DEFINING AND TESTING ACCEPTANCE GUIDELINES, AND DEVELOPING PRODUCT RATES, COMMISSIONS AND COMPENSATION FOR USE IN THE INSURANCE INDUSTRY (U.S. CLS. 21, 23, 26, 36 AND 38).

SN 76-074,648. SHINKO DENSHI COMPANY LIMITED, BUNKYO-KU, TOKYO, JAPAN, FILED 6-21-2000.

**VIBRANCE**

FOR WEIGHT MEASURING SCALES OF THE CONVEYOR TYPE USING LOAD CELLS; LENGTH MEASURING DEVICES, NAMELY, PHOTOELECTRIC SENSORS TO BE USED ON CONVEYORS (U.S. CLS. 21, 23, 26, 36 AND 38).

SN 76-075,246. SPEAKLINK, INC., SEATTLE, WA. FILED 6-21-2000.

**WWW TALK**

NO CLAIM IS MADE TO THE EXCLUSIVE RIGHT TO USE "WWW", APART FROM THE MARK AS SHOWN.

FOR GENERAL PURPOSE CONNECTIVITY SOFTWARE USED TO ESTABLISH AND MANAGE VOICE AND DATA CONNECTIONS (U.S. CLS. 21, 23, 26, 36 AND 38).

SN 76-075,609. IMAGING DEVICES, INC., BURLINGTON, MA. FILED 6-22-2000.

**C NOW 35**

NO CLAIM IS MADE TO THE EXCLUSIVE RIGHT TO USE "35", APART FROM THE MARK AS SHOWN.

FOR PHOTOGRAPHIC CAMERAS, ELECTRONIC STILL CAMERAS, COMBINATION FILM/ELECTRONIC CAMERAS, WEB CAMERAS, VIDEO CAMERAS, AND MOTION PICTURE CAMERAS (U.S. CLS. 21, 23, 26, 36 AND 38).

**CLASS 9—(Continued).**

SN 76-077,109. AMICAS, INC., NEWTON, MA. FILED 6-26-2000.

**AMICAS**

FOR COMPUTER SOFTWARE FOR USE IN ACQUIRING STORING, ARCHIVING, RETRIEVING, DISPLAYING, MANIPULATING, INTEGRATING AND TRANSMITTING IMAGES AND OTHER MEDICAL INFORMATION IN CONJUNCTION WITH Teleradiology PICTURE ARCHIVING AND COMMUNICATIONS SYSTEMS (PACS) TELEMEDICINE AND ENTERPRISE IMAGE DISTRIBUTION (U.S. CLS. 21, 23, 26, 36 AND 38). FIRST USE 6-1-1996; IN COMMERCE 6-1-1996.

SN 76-080,947. HI-REZ PROJECTIONS, INC., BROOKLINE, MA. FILED 6-30-2000.

**HTS**

FOR HOME THEATRE EQUIPMENT NAMELY, TELEVISIONS, ELECTRONIC CINEMA PROJECTORS, HOME THEATRE VIDEO PROJECTORS, VIDEO RECORDERS, LOUDSPEAKERS, AUDIO AMPLIFIERS (U.S. CLS. 21, 23, 26, 36 AND 38).

SN 76-081,358. GUSMER MACHINERY GROUP, INC., LAKEWOOD, NJ. FILED 6-29-2000.

**NC POLARIS**

NO CLAIM IS MADE TO THE EXCLUSIVE RIGHT TO USE "NC", APART FROM THE MARK AS SHOWN.

FOR COMPUTER AIDED MANUFACTURING SOFTWARE, NAMELY, PROGRAMS FOR NUMERICAL CONTROL MILLING, LATHE, PUNCH PRESS, WIREEDM, LASER CUTTER, PLASMA CUTTER, WATERJET CUTTER, OXY CUTTER, AND ROUTER MACHINE APPLICATIONS AND INSTRUCTION MANUALS SOLD THEREWITH (U.S. CLS. 21, 23, 26, 36 AND 38). FIRST USE 9-1-1988; IN COMMERCE 9-1-1988.

SN 76-082,176. NETDECIDE CORP., FALLS CHURCH, VA. FILED 7-3-2000.

**NETDECIDE O.N.E.**

FOR COMPUTER SOFTWARE FOR GLOBAL COMPUTER NETWORKS, LOCAL AREA NETWORKS AND WIDE AREA NETWORKS FOR PROVIDING DECISION SUPPORT TOOLS, INDIVIDUAL FINANCIAL MODELING, MANAGEMENT, PLANNING, AND ONLINE DATA TRANSACTIONS (U.S. CLS. 21, 23, 26, 36 AND 38). FIRST USE 6-28-2000; IN COMMERCE 6-28-2000.



**CLASS 9—(Continued).**

SN 76-082,706. NETDECIDE CORP., FALLS CHURCH, VA.  
FILED 7-3-2000.

**INTELLIDECIDE**

FOR COMPUTER SOFTWARE FOR GLOBAL COMPUTER NETWORKS, LOCAL AREA NETWORKS AND WIDE AREA NETWORKS FOR PROVIDING DECISION SUPPORT TOOLS, INDIVIDUAL FINANCIAL MODELING, MANAGEMENT, PLANNING, AND ONLINE DATA TRANSACTIONS (U.S. CLS. 21, 23, 26, 36 AND 38).  
FIRST USE 8-27-1999; IN COMMERCE 8-27-1999.

---

SN 76-082,709. NETDECIDE CORP., FALLS CHURCH, VA.  
FILED 7-3-2000.

**PLANNERDECIDE**

FOR COMPUTER SOFTWARE FOR GLOBAL COMPUTER NETWORKS, LOCAL AREA NETWORKS AND WIDE AREA NETWORKS FOR PROVIDING DECISION SUPPORT TOOLS, INDIVIDUAL FINANCIAL MODELING, MANAGEMENT, PLANNING, AND ONLINE DATA TRANSACTIONS (U.S. CLS. 21, 23, 26, 36 AND 38).  
FIRST USE 8-27-1999; IN COMMERCE 8-27-1999.

---

SN 76-082,712. NETDECIDE CORP., FALLS CHURCH, VA.  
FILED 7-3-2000.

**NETDECIDE  
DECISIONSERVER**

FOR COMPUTER SOFTWARE FOR GLOBAL COMPUTER NETWORKS, LOCAL AREA NETWORKS AND WIDE AREA NETWORKS FOR PROVIDING DECISION SUPPORT TOOLS, INDIVIDUAL FINANCIAL MODELING, MANAGEMENT, PLANNING, AND ONLINE DATA TRANSACTIONS (U.S. CLS. 21, 23, 26, 36 AND 38).  
FIRST USE 8-27-1999; IN COMMERCE 8-27-1999.

**CLASS 9—(Continued).**

SN 76-083,881. TIME WARNER ENTERTAINMENT COMPANY, L.P., NEW YORK, NY. FILED 7-6-2000.

**GOLDEN SNITCH**

FOR MOTION PICTURE FILMS FEATURING COMEDY, DRAMA, ACTION, ADVENTURE AND/OR ANIMATION, AND MOTION PICTURE FILMS FOR BROADCAST ON TELEVISION FEATURING COMEDY, DRAMA, ACTION, ADVENTURE AND/OR ANIMATION; PRERECORDED VINYL RECORDS, AUDIO TAPES, AUDIO-VIDEO TAPES, AUDIO VIDEO CASSETTES, AUDIO VIDEO DISCS, AND DIGITAL VERSATILE DISCS FEATURING MUSIC, COMEDY, DRAMA, ACTION, ADVENTURE, AND/OR ANIMATION; STEREO HEADPHONES; BATTERIES; CORDLESS TELEPHONES; HAND-HELD CALCULATORS; AUDIO CASSETTE AND CD PLAYERS; CD ROM GAMES; HAND-HELD KARAOKE PLAYERS, TELEPHONE AND/OR RADIO PAGERS; SHORT MOTION PICTURE FILM CASSETTES FEATURING COMEDY, DRAMA, ACTION, ADVENTURE AND/OR ANIMATION TO BE USED WITH HAND-HELD VIEWERS OR PROJECTORS; VIDEO CASSETTE RECORDERS AND PLAYERS, COMPACT DISC PLAYERS, DIGITAL AUDIO TAPE RECORDERS AND PLAYERS, ELECTRONIC DIARIES; RADIOS; MOUSE PADS; EYEGLASSES, SUNGLASSES AND CASES THEREFORE; BOOKLETS SOLD WITH AUDIO TAPES AS A UNIT; COMPUTER PROGRAMS, NAMELY, SOFTWARE LINKING DIGITIZED VIDEO AND AUDIO MEDIA TO A GLOBAL COMPUTER INFORMATION NETWORK; GAME EQUIPMENT SOLD AS A UNIT FOR PLAYING A PARLOR-TYPE COMPUTER GAME; VIDEO AND COMPUTER GAME PROGRAMS; VIDEO GAME CARTRIDGES AND CASSETTES; AND DECORATIVE MAGNETS (U.S. CLS. 21, 23, 26, 36 AND 38).

---

SN 76-085,102. FRX SOFTWARE CORPORATION, DENVER, CO. FILED 7-7-2000.

**FRX ELAUNCH**

OWNER OF U.S. REG. NO. 1,661,555.  
FOR COMPUTER DATABASE MANAGEMENT SOFTWARE USED TO REQUEST, GENERATE AND VIEW ACCOUNTING REPORTS IN THE FIELD OF FINANCE OVER A GLOBAL COMPUTER NETWORK (U.S. CLS. 21, 23, 26, 36 AND 38).

---

SN 76-086,330. CROSSTEAM CORPORATION, BELLEVUE, WA. FILED 7-11-2000.

**CROSSTEAM CAFE**

NO CLAIM IS MADE TO THE EXCLUSIVE RIGHT TO USE "CAFE", APART FROM THE MARK AS SHOWN.

FOR INTERNET PORTAL SOFTWARE DOWNLOADABLE TO AND ACCESSIBLE VIA A DESKTOP COMPUTER FOR FACILITATING AND PERMITTING USERS ON A NETWORK OF PERSONAL COMPUTERS ACCESS TO A SHARED NETWORK TO ENHANCE COMMUNICATIONS, WORKFLOW AND TASK MANAGEMENT, AND DOCUMENT INFORMATION EXCHANGE (U.S. CLS. 21, 23, 26, 36 AND 38).

**CLASS 9—(Continued).**

SN 76-086,495. LECHLER GMBH & CO. KG, D-72555 METZINGEN, FED REP GERMANY, FILED 7-11-2000.

**TWINABSORB**

PRIORITY CLAIMED UNDER SEC. 44(D) ON FED REP GERMANY APPLICATION NO. 30035233.6/0, FILED 5-9-2000, REG. NO. 30035233.6, DATED 8-17-2000, EXPIRES 5-31-2010.

FOR AUTOMATIC SPRAY NOZZLES (U.S. CLS. 21, 23, 26, 36 AND 38).

SN 76-088,129. HAY, JIN C., SANTA BARBARA, CA. FILED 7-14-2000.

**BEATNIX LABS**

FOR MUSICAL SOUND RECORDINGS (U.S. CLS. 21, 23, 26, 36 AND 38).  
FIRST USE 3-31-1999; IN COMMERCE 3-31-1999.

SN 76-088,264. MASTER BRAKE SYSTEMS, INC., DALLAS, TX. FILED 7-12-2000.

**ELECTRABOOST**

FOR ELECTRONIC CONTROLS FOR ENHANCING THE PERFORMANCE OF ELECTRIC BRAKE CONTROLS IN MOTOR VEHICLES BY INCREASING THE POWER TO THE ELECTRIC BRAKE CONTROLS (U.S. CLS. 21, 23, 26, 36 AND 38).

SN 76-088,824. SOTAS, INC., GAITHERSBURG, MD. FILED 7-13-2000.

**SOTAS STATE OF THE ART SYSTEMS**

NO CLAIM IS MADE TO THE EXCLUSIVE RIGHT TO USE "STATE OF THE ART", APART FROM THE MARK AS SHOWN.

FOR COMPUTER OPERATING SYSTEMS, NAMELY, SYSTEMS SOFTWARE FOR USE IN FACILITATING TRACKING AND ACCESSING INFORMATION IN COMMUNICATIONS AND TELEPHONE NETWORKS AND TESTING AND MEASUREMENT EQUIPMENT FOR COMMUNICATIONS AND TELEPHONE NETWORKS (U.S. CLS. 21, 23, 26, 36 AND 38).

**CLASS 9—(Continued).**

SN 76-089,269. LINEO, INC., LINDON, UT. FILED 7-14-2000.



FOR COMPUTER OPERATING SYSTEMS AND COMPUTER SOFTWARE FOR EMBEDDED OPERATING SYSTEMS (U.S. CLS. 21, 23, 26, 36 AND 38).  
FIRST USE 7-1-1999; IN COMMERCE 7-1-1999.

SN 76-092,863. APPLIED MATERIALS, INC., SANTA CLARA, CA. FILED 7-20-2000.

**POLYGEN**

FOR SEMICONDUCTOR WAFER PROCESSING EQUIPMENT, AND COMPONENTS, NAMELY; EPITAXIAL REACTORS, CHEMICAL VAPOR DEPOSITION REACTORS, PHYSICAL VAPOR DEPOSITION REACTORS, PLASMA ETCHERS, ION IMPLANTERS, AND CHEMICAL MECHANICAL POLISHERS (U.S. CLS. 21, 23, 26, 36 AND 38).

SN 76-093,279. KABUSHIKI KAISHA SONY COMPUTER ENTERTAINMENT, TA SONY COMPUTER ENTERTAINMENT, INC., MINATO-KU, TOKYO 107-0052, JAPAN, FILED 7-21-2000.

**SEDECIMUM**

FOR ABACUSES; ACID HYDROMETERS; ACTINOMETERS; ADDING MACHINES; AEROMETERS; AIR TANKS FOR USE IN SCUBA DIVING; ALTIMETERS; AMMETERS; ANEMOMETERS; ANTENNAS; ARM RESTS FOR USE WITH COMPUTERS; AUTOMATIC TELEPHONE DIALERS; AUTOMATIC VALVES; BAR CODE READERS; BAROMETERS; BASEBALL BATTING HELMETS; BATTERIES FOR VEHICLES; BATTERIES; BATTERY CHARGERS; BINOCULARS; BLANK MAGNETIC COMPUTER TAPES; BULLET-PROOF VESTS AND CLOTHING; CALCULATORS; CALIBRATED GLASSWARE; CAMERA CASES; CAMERA FILTERS; CAMERA TRIPODS; CAPACITORS; CASH REGISTERS; CATCHERS' HELMETS; CATHODE RAY TUBES; CHIN STRAPS FOR FOOTBALL HELMETS; CHRONOGRAPHS FOR USE AS SPECIALIZED TIME RECORDING APPARATUS; CIRCUIT BOARDS; CIRCUIT BREAKERS; CLINOMETER; COAXIAL CABLES; COLOR SEPARATION FILM; COMMUTATORS; COMPUTER BUFFERS; COMPUTER CABLES; COMPUTER CARRYING CASES; COMPUTER CHIPS; COMPUTER COLOR PRINTER USING HEAT SENSITIVE DRY PRINTING PROCESS; COMPUTER DISC DRIVES; COMPUTER FAX MODEM CARDS; COMPUTER GAME CARTRIDGES; COMPUTER GAME CASSETTES; COMPUTER GAME DISCS; COM-

**CLASS 9—(Continued).**

PUTER GAME EQUIPMENT CONTAINING MEMORY DEVICES NAMELY, DISCS; COMPUTER GAME JOYSTICKS; COMPUTER GAME PROGRAMS; COMPUTER GAME SOFTWARE; COMPUTER GAME TAPES; COMPUTER HARDWARE; COMPUTER INTERFACE BOARDS; COMPUTER KEYBOARDS; COMPUTER MEMORIES; COMPUTER MONITORS; COMPUTER MOUSE; COMPUTER OPERATING PROGRAMS; COMPUTER OPERATING SYSTEMS; COMPUTER PERIPHERALS; COMPUTER PRINTERS; COMPUTER TERMINALS; COMPUTER UTILITY PROGRAMS; COMPUTERS AND INSTRUCTIONAL MANUALS SOLD AS A UNIT; COMPUTERS; CONDENSERS; CONTACT LENS BLANKS; CONTACT LENS CASES; CONTACT LENSES; CONVERTERS; COVERS FOR ELECTRIC OUTLETS; COVERS FOR TELEPHONE RECEIVERS NOT MADE OF PAPER; CRUISE CONTROLS FOR MOTOR VEHICLES; CYCLOTRONS; DAISY WHEEL PRINTERS; DATA PROCESSORS; DECOMPRESSION CHAMBERS; DECORATIVE REFRIGERATOR MAGNETS; DEMAGNETIZERS FOR MAGNETIC TAPES; DICTATION MACHINES; DIGITAL AUDIO TAPE PLAYERS; DISPOSABLE LATEX GLOVES FOR LABORATORY USE; DISPOSABLE PLASTIC GLOVES FOR LABORATORY USE; DIVING GLOVES; DIVING HELMETS; DIVING SUITS; DOG WHISTLES; DOSIMETERS; DOT MATRIX PRINTERS; DOWNLOADABLE ELECTRONIC PUBLICATIONS; DYNAMOMETERS; EAR PLUGS NOT FOR MEDICAL PURPOSES; ELECTRIC FENCES; ELECTRIC OUTLET COVERS; ELECTRIC SWITCH PLATES; ELECTRICAL POWER EXTENSION CORDS; ELECTRONIC ANIMAL CONFINEMENT SYSTEMS; ELECTRONIC APPARATUS FOR TESTING THE STERILITY OF PHARMACEUTICALS AND INJECTABLE SOLUTIONS; ELECTRONIC APPARATUS FOR TESTING THE STERILITY OF MEDICAL EQUIPMENT; ELECTRONIC EFFECT PEDALS FOR USE WITH SOUND AMPLIFIERS; ELECTRONIC NOTICE BOARDS; ELECTRONIC PERSONAL ORGANIZER; ELECTRONIC SAFES; EMERGENCY WARNING LIGHTS; ENCODERS; EPIDIASCOPES; EVENT RECORDERS; EYEGLASS CASES; EYEGLASS CHAINS; EYEGLASS FRAMES; EYEGLASS LENSES; EYEGLASSES; FACE SHIELDS; FACSIMILE MACHINES; FIBER OPTIC CABLES; FIBER OPTIC LIGHT AND IMAGE CONDUITS; FIBER OPTICS; FILTERS FOR RESPIRATORY MASKS; FIRE ALARMS; FIRE BLANKETS; FIRE EXTINGUISHERS; FIRE HOSE NOZZLES; FIRE SPRINKLERS; FIRE TRUCKS; FOOTBALL HELMETS; FUEL PUMPS FOR SERVICE STATIONS; FUSES FOR AUTOMOBILES; GALVANOMETERS; GAMBLING MACHINES; GAMING EQUIPMENT, NAMELY, SLOT MACHINES WITH OR WITHOUT VIDEO OUTPUT; GAMING MACHINES; GAS CHROMATOGRAPHY APPARATUS; GAS MASK; GAS METERS; GASOMETERS; GLASS TUBES FOR SCIENTIFIC PURPOSES; GRADUATED GLASSWARE; HEADPHONES; HIGHWAY SAFETY CONES; HOCKEY HELMETS; HOLDERS FOR COMPACT DISCS; HUBS FOR TIMING DIALS; HYDROMETERS; HYGROMETERS; IMPACT PRINTERS; INSULATED ELECTRICAL CONNECTORS; INTEGRATED CIRCUITS; INTERACTIVE MULTIMEDIA COMPUTER GAME PROGRAM; INTERACTIVE VIDEO GAME PROGRAMS; INTERACTIVE VIDEO GAMES OF VIRTUAL REALITY COMPRISED OF COMPUTER HARDWARE AND SOFTWARE; INVERTERS; JACKETS FOR COMPUTER DISKS; JACKETS FOR VIDEO CASSETTES; JOYSTICKS FOR VIDEO GAMES; JUMPER CABLES; KALEIDOSCOPIES; KNEE PADS FOR WORKERS; LABORATORY APPARATUS, NAMELY, CENTRIFUGES; LABORATORY GLASSWARE; LASER POINTERS LASER PRINTERS; LASER SCANNERS FOR INDUSTRIAL INSPECTION; LASERS FOR MEASURING PURPOSES; LASERS NOT FOR MEDICAL USE; LETTER SCALES; LIFE BELTS; LIFE JACKETS; LIFE NETS; LIFE PRESERVERS; LIFE-BUOYS; LIFE-SAVING RAFTS; LIGHT EMITTING DIODE DISPLAYS; LIGHT EMITTING DIODES; LIGHTNING BALLASTS; LIGHTNING RODS; LOUDSPEAKER CABINETS; LOUDSPEAKERS; MACHINES FOR PLAYING GAMES OF CHANCE; MAGNETIC CODED CARD READERS; MAGNETIC CODED CARDS; MAGNIFYING GLASSES; MARINE DEPTH FINDERS; MARKER BUOYS; SOUND REPRODUCTION SYSTEM COMPRISING LOUDSPEAKERS, AMPLIFIER AND ONE OR MORE OF THE FOLLOWING - RADIO TUNER, COMPACT DISK PLAYER AND TAPE PLAYER; MEASURING CUPS; MEASURING SPOONS; MEGAPHONES; METAL DETECTORS; METRONOMES; MI-

**CLASS 9—(Continued).**

CRO-PROCESSORS; MICROCOMPUTERS; MICROFICHE; MICROMETERS; MICROPHONES; MICROSCOPES; MICROWAVE OVENS FOR LABORATORY USE; MINICOMPUTERS; MODEMS; MOTION PICTURE CAMERAS; MULTIPLEXERS; MUSICAL SOUND RECORDINGS; MUSICAL VIDEO RECORDINGS; NAVIGATIONAL BUOYS; NEON SIGNS; ODOMETERS; OHMMETERS; OXYGEN MASKS NOT FOR MEDICAL USE; PARKING METERS; PARTICLE ACCELERATORS; Pedometers; PERISCOPES; PERSONAL SECURITY ALARMS; PHONOGRAPH NEEDLES; PHONOGRAPHS; PHOTOCOPYING MACHINES; PLUMB BOBS; PLUMB LEVELS; PLUMB LINES; POCKET CALIPERS FOR MEASURING; POLYGRAPH MACHINES; POWER LINE CONDITIONERS; PRE-PAID TELEPHONE CALLING CARDS, MAGNETICALLY ENCODED; PRESSURE GAUGES; PRESSURE INDICATING PLUGS FOR VALVES; PRINTED CIRCUITS; PRISMS FOR SCIENTIFIC PURPOSES; PROJECTION SCREENS; PROTECTIVE CLOTHING; PROTECTIVE GLOVES FOR INDUSTRIAL USE; PROTRACTORS; PYROMETERS; RADAR DETECTORS; RADAR; RADIO CONTROLLED MINIATURE AERIAL TARGETS; RADIO PAGERS; RADIO TELEPHONES; RADIOS FOR VEHICLES; RADIOS INCORPORATING CLOCKS; RADIOS; RADON DETECTORS; REGULATORS FOR USE IN SCUBA DIVING; REMOTE CURSOR CONTROLS FOR COMPUTERS; RESPIRATORS OTHER THAN FOR ARTIFICIAL RESPIRATION; RESPIRATORY MASK FILTERS; RHEOSTATS; RING BUOYS FOR USE IN WATER RESCUE; SAFETY GOGGLES; SAFETY HARNESSES OTHER THAN FOR VEHICLES OR SPORTS PURPOSES; SAFETY MARKERS; SAFETY OR PROTECTIVE HELMETS; SAFETY PRODUCTS, NAMELY, REFLECTIVE HELMET SKIRTS; SAFETY PRODUCTS, NAMELY, REFLECTIVE SAFETY BANDS TO BE WORN ON THE BODY; SALINOMETERS; SATELLITE PROCESSORS; SATELLITES FOR SCIENTIFIC PURPOSES; SATELLITES; SCALES; SEMICONDUCTOR DEVICES; SEMICONDUCTORS; SEXTANTS; SIGNAL BELLS; SIGNAL PROCESSORS; SIGNAL WHISTLES; SIGNALING BUOYS; SILICON CHIPS; SILICON WAFERS; SIRENS FOR VEHICLES; SIRENS; SLIDE PROJECTORS; SLIDE RULES; SLOT MACHINES; SMOKE DETECTORS; SOLENOID VALVES; SONAR; SPECTACLES; SPEEDOMETERS FOR VEHICLES; SPEEDOMETERS; STEREO AMPLIFIERS; STEREO RECEIVERS; STEREO TUNERS; SUNGLASSES; SUPERCOMPUTERS; SUPERMINI COMPUTERS; SUPPORT BELTS FOR WORKERS; SURVEYING CHAINS; SURVEYORS' LEVELS; TACHOMETERS; TAPE MEASURES; TELEPHONE ANSWERING MACHINES; TELEPHONE APPARATUS, NAMELY INTERCOMS; TELEPHONE EQUIPMENT, NAMELY, CALLER IDENTIFICATION BOXES; TELEPHONES; TELEPROMETERS; TELESCOPES; TELESCOPIC GUN SIGHTS; TELESCOPIC LENS SIGHTS; TELEVISION ANTENNAS; TELEVISION SETS; THEODOLITES; THERMOMETERS NOT FOR MEDICAL USE; THERMOSTATS; TICKET CANCELING MACHINES; TIMING DIALS; TIMING SENSORS; TIRE BALANCING MACHINES FOR LAND VEHICLES; TIRE BALANCING UNITS FOR LAND VEHICLES; TRANSCEIVERS; TRANSPONDERS; TRIPODS FOR CAMERAS; TYPEFACE FONTS RECORDED ON MAGNETIC MEDIA; VEHICLE WHEEL ALIGNMENT MACHINES; VENDING MACHINES; VIDEO CAMERAS; VIDEO CASSETTE RECORDERS; VIDEO GAME CARTRIDGES; VIDEO GAME DISCS; VIDEO GAME INTERACTIVE CONTROL FLOOR PADS OR MATS; VIDEO GAME INTERACTIVE REMOTE CONTROL UNITS; VIDEO GAME JOYSTICKS; VIDEO GAME MACHINES FOR USE WITH TELEVISIONS; VIDEO GAME SOFTWARE; VIDEO GAME TAPE CASSETTES; VIDEO MONITORS; VIDEO TAPE RECORDERS; VIRTUAL REALITY GAME SOFTWARE; VOLTAGE SURGE PROTECTORS; VOLTAGE SURGE SUPPRESSORS; VOLTMETERS; VOTING MACHINES; WALKIE-TALKIES; WARNING TRIANGLES TO INDICATE VEHICLE BREAKDOWNS; WATER METERS; WATER SKI SAFETY VESTS; WELDING ELECTRODES; WORD PROCESSORS; X-Y PLOTTERS; X-RAY PHOTOGRAPHS, OTHER THAN FOR MEDICAL PURPOSES (U.S. CLS. 21, 23, 26, 36 AND 38).

**CLASS 9—(Continued).**

SN 76-094,598. CNC SETUP, INC., SAN CLEMENTE, CA. FILED 7-20-2000.

**SPIN-TRUE**

FOR NON-CONTACT INDICATOR, NAMELY, MEASUREMENT TOOL FOR MEASURING SPINDLE PERPENDICULARITY (U.S. CLS. 21, 23, 26, 36 AND 38).  
FIRST USE 6-15-2000; IN COMMERCE 6-15-2000.

SN 76-095,256. ACCESS COMMERCE, SOCIETE ANONYME, 31674 LABEGE CEDEX, FRANCE, FILED 7-19-2000.



FOR COMPUTER SOFTWARE FOR USE IN ELECTRONIC COMMERCE, NAMELY, TO ENABLE RETAIL TRANSACTIONS OF CUSTOMIZABLE PRODUCTS OVER A GLOBAL COMPUTER NETWORK (U.S. CLS. 21, 23, 26, 36 AND 38).

SN 76-096,492. LINKAIR COMMUNICATIONS (USA), INC., SANTA CLARA, CA. FILED 7-25-2000.

**IP-LAS**

FOR WIRELESS COMMUNICATION DEVICES, NAMELY, CORDLESS TELEPHONES, CELLULAR TELEPHONES, CELLULAR BASE STATIONS, CELLULAR TERMINALS AND INTEGRATED CIRCUITS FOR USE IN SUCH WIRELESS COMMUNICATION DEVICES (U.S. CLS. 21, 23, 26, 36 AND 38).

SN 76-098,675. SBS TECHNOLOGIES, INC., ALBUQUERQUE, NM. FILED 7-28-2000.

**DENALI**

FOR COMPUTER HARDWARE, NAMELY A COMPACT PCI SINGLE BOARD COMPUTER FOR APPLICATIONS REQUIRING SYSTEM/NON-SYSTEM SLOT FUNCTIONALITY AND VERSATILE INPUT/OUTPUT WITH ASYNCHRONOUS TRANSFER MODE (ATM) SEGMENTATION AND REASSEMBLY (SAR) FUNCTIONALITY, PROVIDING LOW POWER AND HIGH PERFORMANCE REAL-TIME PROCESSING CAPABILITIES (U.S. CLS. 21, 23, 26, 36 AND 38).  
FIRST USE 3-0-1998; IN COMMERCE 3-0-1998.

**CLASS 9—(Continued).**

SN 76-099,236. EVERGREEN DESIGN, INC., MAURERTOWN, VA. FILED 7-31-2000.

**AUCPU**

FOR COMPACT, RUGGED COMPUTER WITH DATA STORAGE MEDIA AND/OR DEVICES, I/O (INPUT/OUTPUT) PERIPHERALS AND ELECTRICAL POWER SUPPLIES (U.S. CLS. 21, 23, 26, 36 AND 38).

SN 76-101,434. REDLINE NETWORKS, INC., CAMPBELL, CA. FILED 8-2-2000.

**REDLINE NETWORKS**

NO CLAIM IS MADE TO THE EXCLUSIVE RIGHT TO USE "NETWORKS", APART FROM THE MARK AS SHOWN.

FOR COMPUTER NETWORKING HARDWARE AND SOFTWARE FOR USE IN A DATA CENTER ENVIRONMENT FOR FACILITATING COMMUNICATION BETWEEN CLIENTS AND SERVERS (U.S. CLS. 21, 23, 26, 36 AND 38).

SN 76-103,216. MAGELLAN CORPORATION, SANTA CLARA, CA. FILED 8-3-2000.



OWNER OF U.S. REG. NO. 1,553,520.  
FOR GLOBAL POSITIONING SYSTEM NAVIGATION RECEIVERS, ELECTRONIC NAVIGATION AND DATA INPUT AND DISPLAY EQUIPMENT, NAMELY, GLOBAL POSITIONING SYSTEMS; SOFTWARE THAT FACILITATES GLOBAL POSITIONING SYSTEM NAVIGATION BY INTERPRETING SATELLITE COMMUNICATIONS (U.S. CLS. 21, 23, 26, 36 AND 38).

SN 76-105,723. NIHON COMPUTER KOGYO KABUSHIKI KAISHA, HIGASHI OSAKA-SHI, OSAKA, JAPAN, FILED 8-8-2000.

**JCI FALCON**

FOR INTEGRATED CIRCUITS, ELECTRONIC APPARATUS, NAMELY PRINT SERVER AND COMPUTER OPERATING SYSTEM SOFTWARE FOR SHARING ONE OR MORE HARDCOPY OUTPUT DEVICES ON A NETWORK AND FOR OPERATING AND CONTROLLING COMPUTER PERIPHERALS, PRINTING SYSTEMS, COPIERS AND FACSIMILE MACHINES (U.S. CLS. 21, 23, 26, 36 AND 38).

**CLASS 9—(Continued).**

SN 76-110,742. RAYTHEON COMPANY, LEXINGTON, MA.  
FILED 8-15-2000.

**T-VSAT**

FOR COMMUNICATIONS EQUIPMENT, NAMELY, TERMINALS, ANTENNAS, DATA PROCESSORS AND SOFTWARE, ALL FOR USE IN TRANSMITTING AND RECEIVING DATA, AND MANUALS PROVIDED THEREWITH (U.S. CLS. 21, 23, 26, 36 AND 38).  
FIRST USE 8-0-1998; IN COMMERCE 8-0-1998.

SN 76-111,152. MULTIMEDIA GAMES, INC., AUSTIN, TX.  
FILED 8-11-2000.

**WILD SPINNER**

NO CLAIM IS MADE TO THE EXCLUSIVE RIGHT TO USE "SPINNER", APART FROM THE MARK AS SHOWN.

FOR GAMING MACHINES, NAMELY, SLOT MACHINES WITH OR WITHOUT VIDEO DISPLAY (U.S. CLS. 21, 23, 26, 36 AND 38).

SN 76-111,264. WIND RIVER SYSTEMS, INC., ALAMEDA, CA. FILED 8-17-2000.

**OSEKWORKS**

FOR COMPUTER SOFTWARE OPERATING SYSTEM THAT SERVES AS AN ENVIRONMENT IN WHICH COMPLEX AUTOMOTIVE APPLICATIONS CAN BE DEVELOPED, AND FOR USE IN BUSINESS, EDUCATION, RESEARCH AND SCIENCE IN THE AUTOMOTIVE FIELD, AND INSTRUCTION MANUALS SOLD AS A UNIT (U.S. CLS. 21, 23, 26, 36 AND 38).

SN 76-111,739. RADIO FREQUENCY SYSTEMS, INC., MERIDEN, CT. FILED 8-17-2000.

**RFS SLIMLINE**

OWNER OF U.S. REG. NOS. 1,576,092 AND 2,038,890.  
NO CLAIM IS MADE TO THE EXCLUSIVE RIGHT TO USE "SLIMLINE", APART FROM THE MARK AS SHOWN.  
FOR ANTENNAS USED IN WIRELESS COMMUNICATION SYSTEMS (U.S. CLS. 21, 23, 26, 36 AND 38).  
FIRST USE 1-26-1999; IN COMMERCE 1-26-1999.

**CLASS 9—(Continued).**

SN 76-113,050. RAJAN ENTERPRISES, INC., LOS ANGELES, CA. FILED 8-21-2000.

**POWER-SOUND**

FOR RADIOS, AUDIO CASSETTE AND COMPACT DISC PLAYERS, PORTABLE AND PERSONAL AUDIO CASSETTE AND COMPACT DISC PLAYERS, STEREO RECEIVERS, RADIOS INCORPORATING A CLOCK AND CAR STEREO PLAYERS (U.S. CLS. 21, 23, 26, 36 AND 38).  
FIRST USE 3-0-2000; IN COMMERCE 3-0-2000.

SN 76-113,116. ESFIA, INC., HSIN YI RD., TAIPEI, TAIWAN,  
FILED 8-21-2000.

**ESFIA**

FOR COMPUTERS; COMPUTER PERIPHERALS; OPTICAL DISCS; PRE-RECORDED COMPUTER DISCS FEATURING COMPUTER PROGRAMS FOR USE AS BROWSERS, FOR USE IN PERSONAL INFORMATION MANAGEMENT, FOR ENGLISH HAND WRITING, SYNCHRONOUS COMMUNICATION, WIRELESS COMMUNICATION, FAX, VOICE RECORDING, AND TOUCH PANEL ROTATION, AND FOR USE AS MUSIC DECODER VIA THE INTERNET; PRE-RECORDED COMPACT DISCS FEATURING COMPUTER PROGRAMS FOR USE AS BROWSERS, FOR USE IN PERSONAL INFORMATION MANAGEMENT, FOR ENGLISH HAND WRITING, SYNCHRONOUS COMMUNICATION, WIRELESS COMMUNICATION, FAX, VOICE RECORDING, AND TOUCH PANEL ROTATION, AND FOR USE AS MUSIC DECODER VIA THE INTERNET; PRE-RECORDED MAGNETIC COMPUTER TAPES FEATURING COMPUTER PROGRAMS FOR USE AS BROWSERS, FOR USE IN PERSONAL INFORMATION MANAGEMENT, FOR ENGLISH HAND WRITING, SYNCHRONOUS COMMUNICATION, WIRELESS COMMUNICATION, FAX, VOICE RECORDING, AND TOUCH PANEL ROTATION, AND FOR USE AS MUSIC DECODER VIA THE INTERNET (U.S. CLS. 21, 23, 26, 36 AND 38).

SN 76-113,301. PSC, INC., WEBSTER, NY. FILED 8-18-2000.

**CONFIGURATOR EXPRESS**

NO CLAIM IS MADE TO THE EXCLUSIVE RIGHT TO USE "CONFIGURATOR", APART FROM THE MARK AS SHOWN.

FOR COMPUTER SOFTWARE FOR USE IN PROVIDING GRANULARITY CONTROL IN BAR CODE LASER SCANNERS, AND INTERFACES AND SYMBOLOGY FOR BAR CODE LASER SCANNERS, AND USER MANUALS SOLD AS A UNIT THEREWITH (U.S. CLS. 21, 23, 26, 36 AND 38).  
FIRST USE 9-0-2000; IN COMMERCE 10-0-2000.

**CLASS 9—(Continued).**

SN 76-114,305. STAT SIGNAL SYSTEMS, INC., ATLANTA, GA. FILED 8-22-2000.

**STAT SIGNAL**

FOR WIRELESS DEVICES, NAMELY RF TRANSMITTERS, TRANSCEIVERS, AND RECEIVERS (U.S. CLS. 21, 23, 26, 36 AND 38).

---

SN 76-114,857. SPECTRUM MEDITECH INC., VANCOUVER, BRITISH COLUMBIA, CANADA, FILED 8-21-2000.

**NEEDLYZER**

FOR ELECTRONIC NEEDLE DISINTEGRATION APARATUS (U.S. CLS. 21, 23, 26, 36 AND 38). FIRST USE 6-28-2000; IN COMMERCE 6-28-2000.

---

SN 76-114,936. XSCAPE PROPERTIES, LIMITED, LONDON, UNITED KINGDOM, FILED 8-22-2000.



FOR SUNGLASSES; PARTS AND FITTINGS FOR ALL THE AFORESAID GOODS (U.S. CLS. 21, 23, 26, 36 AND 38).

---

SN 76-115,568. ARAI HELMET, LTD., DBA ARAI HELMET [AMERICAS], LTD., DAYTONA, FL. FILED 8-24-2000.

**VX**

FOR SAFETY HELMETS AND MOTORCYCLE HELMETS (U.S. CLS. 21, 23, 26, 36 AND 38). FIRST USE 0-0-1997; IN COMMERCE 0-0-1997.

---

SN 76-115,572. ARAI HELMET, LTD., DBA ARAI HELMET [AMERICAS], LTD., DAYTONA, FL. FILED 8-24-2000.

**MXC**

FOR SAFETY HELMETS AND MOTORCYCLE HELMETS (U.S. CLS. 21, 23, 26, 36 AND 38). FIRST USE 0-0-1998; IN COMMERCE 0-0-1998.

**CLASS 9—(Continued).**

SN 76-116,477. ACCU-STAR SYSTEMS, INC., MONTREAL, QUEBEC, CANADA, FILED 8-25-2000.

**CARGOPOST**

PRIORITY CLAIMED UNDER SEC. 44(D) ON CANADA APPLICATION NO. 1,064,313, FILED 6-22-2000.

FOR SOFTWARE FOR PROVIDING, MONITORING AND PROCESSING INFORMATION ON CARRYING CAPACITY AND FREIGHT AND OTHER ITEMS IN THE SUPPLY OR DELIVERY CHAIN (U.S. CLS. 21, 23, 26, 36 AND 38).

---

SN 76-116,698. MOLECULAR SENSING PLC, MELKSHAM, WILTSHIRE, UNITED KINGDOM, FILED 8-25-2000.

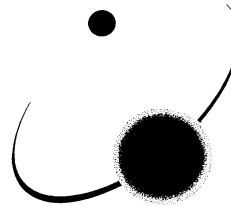

THE STIPLING IN THE DRAWING IS A FEATURE OF THE MARK AND IS NOT INTENDED TO INDICATE COLOR.

FOR COMPUTER SOFTWARE CONTROLLED INSTRUMENT FOR THE AMPLIFICATION OF NUCLEIC ACIDS AND THEIR IDENTIFICATION USING EITHER ELECTRO-CHEMICAL OR OPTICAL MEANS (U.S. CLS. 21, 23, 26, 36 AND 38).

---

SN 76-117,036. HOUSE OF BLUE BRANDS CORP., HOLLYWOOD, CA. FILED 8-25-2000.



FOR PRE-RECORDED AUDIO AND VIDEOTAPES, AUDIO CASSETTES, AUDIO CARTRIDGES USING DIGITAL COMPRESSION TECHNOLOGY, COMPACT DISKS AND PHONOGRAPH RECORDS FEATURING MUSIC (U.S. CLS. 21, 23, 26, 36 AND 38).

**CLASS 9—(Continued).**

SN 76-117,133. QUEST SOFTWARE, INC., IRVINE, CA. FILED 8-28-2000.

**DATAFACTORY**

FOR COMPUTER SOFTWARE FOR DATABASE MANAGEMENT AND DATABASE APPLICATIONS DEVELOPMENT FOR USE BY SOFTWARE DEVELOPERS TO ENABLE THE ACCURATE SUBSETTING, EXTRACTION, AND PROPOGATION OF DATA FOR THE PURPOSES OF DEVELOPMENT AND TESTING OF DATABASES AND DATABASE APPLICATIONS (U.S. CLS. 21, 23, 26, 36 AND 38).

FIRST USE 7-3-2000; IN COMMERCE 8-17-2000.

SN 76-117,330. HOUSE OF BLUE BRANDS CORP., HOLLYWOOD, CA. FILED 8-25-2000.



FOR PRE-RECORDED AUDIO AND VIDEOTAPES, AUDIO CASSETTES, AUDIO CARTRIDGES USING DIGITAL COMPRESSION TECHNOLOGY, COMPACT DISKS, AND PHONOGRAPH RECORDS FEATURING MUSIC (U.S. CLS. 21, 23, 26, 36 AND 38).

SN 76-117,687. STORED ENERGY SYSTEMS, LONGMONT, CO. FILED 8-28-2000.



SEC. 2(F).  
FOR INDUSTRIAL BATTERY CHARGERS (U.S. CLS. 21, 23, 26, 36 AND 38).  
FIRST USE 0-0-1971; IN COMMERCE 0-0-1971.

SN 76-117,730. SERITIS CORPORATION, MILWAUKEE, WI. FILED 8-28-2000.

**FLEXCHANNEL**

FOR COMPUTER SOFTWARE FOR MANAGING, DISTRIBUTING AND REPORTING SALES, FINANCIAL AND OPERATIONAL INFORMATION, NAMELY REPORTING AND BUSINESS INTELLIGENCE SOFTWARE (U.S. CLS. 21, 23, 26, 36 AND 38).

FIRST USE 6-8-2000; IN COMMERCE 6-8-2000.

**CLASS 9—(Continued).**

SN 76-118,026. INTELLOCITY, INC., CAUSEWAY BAY, HONG KONG, FILED 8-28-2000.

**ADHANCED TV**

NO CLAIM IS MADE TO THE EXCLUSIVE RIGHT TO USE "TV", APART FROM THE MARK AS SHOWN.

FOR COMPUTER SOFTWARE FOR USE IN CREATING, DEVELOPING, EDITING AND BROADCASTING INTERACTIVE TELEVISION APPLICATIONS, PACKAGES AND CONTENT (U.S. CLS. 21, 23, 26, 36 AND 38).

SN 76-119,267. SONY ELECTRONICS INC., PARK RIDGE, NJ. FILED 8-30-2000.

**WISP.EAR**

FOR TELEPHONE HEADSETS (U.S. CLS. 21, 23, 26, 36 AND 38).

SN 76-119,378. PLOTNIK, ROD, SAN DIEGO, CA. FILED 8-28-2000.

**POWERLECTURE**

FOR SERIES OF AUDIO RECORDINGS, VIDEO RECORDINGS AND MULTIMEDIA SOFTWARE RECORDINGS ON CD-ROM REGARDING SCIENCES, SOCIAL SCIENCES, MATHEMATICS, HUMANITIES AND LANGUAGES FOR USE IN EDUCATIONAL LECTURES AND AS AN EDUCATIONAL STUDY AIDE AND INSTRUCTIONAL MANUALS RELATED THERETO SOLD AS A UNIT (U.S. CLS. 21, 23, 26, 36 AND 38).

SN 76-123,878. CONEXANT SYSTEMS, INC., NEWPORT BEACH, CA. FILED 9-7-2000.

**MODEMXPRT**

FOR COMPUTER SOFTWARE FOR AUTOMATICALLY DETECTING AND CORRECTING MODEM CONNECTION PROBLEMS IN THE FIELD OF PERSONAL COMPUTERS (U.S. CLS. 21, 23, 26, 36 AND 38).

SN 76-124,324. WESCOR, INC., LOGAN, UT. FILED 9-8-2000.

**KWIKDISK**

FOR SAMPLE HOLDERS FOR VAPOR PRESSURE OSMOMETERS (U.S. CLS. 21, 23, 26, 36 AND 38).

FIRST USE 10-15-1998; IN COMMERCE 10-15-1998.

**CLASS 9—(Continued).**

SN 76-125,757. MICROFOUR, INC., AMARILLO, TX. FILED 9-11-2000.

**SCRIBEMATE**

FOR COMPUTER SOFTWARE, NAMELY, APPLICATIONS FOR USE IN CONJUNCTION WITH COMMERCIALY AVAILABLE VOICE-RECOGNITION SOFTWARE FOR INSERTING DATA INTO COMPUTERIZED FILES IN THE FIELD OF MEDICAL RECORDS AND FORMS, AND INSTRUCTIONAL MANUALS SOLD AS A UNIT THEREWITH (U.S. CLS. 21, 23, 26, 36 AND 38).

FIRST USE 8-21-2000; IN COMMERCE 8-21-2000.

---

SN 76-127,727. SHANDON INC., PITTSBURGH, PA. FILED 9-13-2000.

**PARA-TRIMMER**

FOR LABORATORY EQUIPMENT, NAMELY, A DEVICE WITH A HEATED PLATE FOR REMOVING EXCESS WAX OR PARAFFIN FROM HISTOLOGICAL SAMPLES (U.S. CLS. 21, 23, 26, 36 AND 38).

---

SN 76-127,980. IMAGING RESEARCH INC., ONTARIO, CANADA, FILED 9-14-2000.

**BOREALIS**

FOR TELECENTRIC OPTICAL LENSES (U.S. CLS. 21, 23, 26, 36 AND 38).

---

SN 76-128,373. DISPLAY RESEARCH LABORATORIES, INC., BURLINGAME, CA. FILED 9-12-2000.

**QUANTUMLIGHT**

FOR VACUUM FLUORESCENT DISPLAY PRODUCTS, NAMELY, ACTIVE MATRIX FLAT PANEL DISPLAYS (U.S. CLS. 21, 23, 26, 36 AND 38).

**CLASS 9—(Continued).**

SN 76-128,944. CONCEPT 2000, L.L.C., ST. LOUIS, MO. FILED 9-14-2000.



FOR COMPUTER DATABASES CONTAINING TELEPHONE DIRECTORIES RECORDED ON COMPUTER DISKETTES, CD-ROM AND DVDS (U.S. CLS. 21, 23, 26, 36 AND 38).

---

SN 76-131,216. ITURAN USA, INC., HICKSVILLE, NY. FILED 9-19-2000.

**LIFETRAK**

FOR ELECTRONIC SECURITY, LOCATION, STATUS MONITORING AND SIGNALING SYSTEMS COMPRISED OF A RADIO FREQUENCY TRANSMITTER, ANTENNA, RECEIVER, BATTERY AND PANIC BUTTON FOR MONITORING VEHICLES, PERSONS, ANIMALS AND OBJECTS AND ACCESSORIES THEREFOR (U.S. CLS. 21, 23, 26, 36 AND 38).

---

SN 76-131,220. EXPRESSIONTOOLS, INC., FUKUOKA-SHI FUKUOKA-KEN, JAPAN, FILED 9-19-2000.

**SHADE**

FOR THREE DIMENSIONAL COMPUTER GRAPHICS SOFTWARE (U.S. CLS. 21, 23, 26, 36 AND 38).

---

SN 76-132,512. AB INITIO SOFTWARE CORPORATION, LEXINGTON, MA. FILED 9-20-2000.

**DYNAMIC DATA MART**

NO CLAIM IS MADE TO THE EXCLUSIVE RIGHT TO USE "DYNAMIC DATA", APART FROM THE MARK AS SHOWN.

FOR COMPUTER SOFTWARE, NAMELY, SOFTWARE FOR CREATION, UPDATING, AND MANAGEMENT OF DATABASES BY END-USERS, AND FOR AUTOMATICALLY GENERATING DATABASES FROM END-USER SPECIFICATIONS (U.S. CLS. 21, 23, 26, 36 AND 38).



**CLASS 9—(Continued).**

SN 76-133,280. SUNCEPTS, INC., LOS ANGELES, CA. FILED 9-21-2000.

**HIDES**

FOR EYEGLASS ACCESSORIES, NAMELY, EYEGLASS HOLDERS, EYEGLASS CASES, AND EYEGLASS RETAINERS (U.S. CLS. 21, 23, 26, 36 AND 38).

SN 76-134,782. TRANSMATION, INC., ROCHESTER, NY. FILED 9-25-2000.

**QUIK-DOC**

FOR COMPUTER SOFTWARE FOR USE ON HAND HELD AND OTHER COMPUTERS FOR USE IN THE FIELD OF CALIBRATION OF INSTRUMENTS AND DEVICES FOR CREATING DATA BASES, TRACKING PURPOSES, PROVIDING A GRAPHICAL HUMAN INTERFACE, PROVIDING DOCUMENTING FUNCTIONS, TRANSFERRING INFORMATION BETWEEN HAND HELD AND OTHER COMPUTERS, CONTROLLING INSTRUMENT AND DEVICE CALIBRATORS, CREATING INSTRUMENT RECORDS, AND CREATING CALIBRATOR RECORDS (U.S. CLS. 21, 23, 26, 36 AND 38).

SN 76-134,827. DIGITAL:CONVERGENCE CORPORATION, DALLAS, TX. FILED 9-19-2000.



NO CLAIM IS MADE TO THE EXCLUSIVE RIGHT TO USE "DIGITAL CONVERGENCE", APART FROM THE MARK AS SHOWN.

FOR COMPUTER SOFTWARE WHICH INTERFACES WITH KEYSTROKE AUTOMATION APPARATUS FOR READING CODED IMAGES AND CONVERTING THE IMAGES TO COMPUTER KEYSTROKES; AUDIO OR VIDEO TRANSDUCER FOR RECEIVING ENCODED AUDIO OR VIDEO THAT IS OPERABLE FOR CONNECTING A USER'S COMPUTER TO A LOCATION ON THE INTERNET; HAND-HELD BAR CODE AND PROPRIETARY CODE READER FOR READING MACHINE-READABLE CODES ON MAGAZINES, NEWSPAPERS AND OTHER PUBLICATIONS AND PRODUCTS FOR CONVERTING THE MACHINE-READABLE CODES INTO SPECIFIC INSTRUCTIONS TO INTERFACE WITH A UNIQUE APPLICATION ON A COMPUTER FOR THE PURPOSE OF, IN COMBINATION WITH THE PROGRAM, CONNECTING THE USER'S COMPUTER TO A LOCATION ON THE INTERNET (U.S. CLS. 21, 23, 26, 36 AND 38).

**CLASS 9—(Continued).**

SN 76-136,247. HONEYWELL INTERNATIONAL INC., MORRISTOWN, NJ. FILED 9-28-2000.

**SURVEILLANT**

FOR ELECTRONIC CARD READERS, REMOTE TRANSMITTERS AND RECEIVERS FOR USE WITH ACCESS CONTROL SYSTEMS; COMPUTER HARDWARE AND PERIPHERALS FOR USE WITH ACCESS CONTROL SYSTEMS (U.S. CLS. 21, 23, 26, 36 AND 38).

SN 76-138,569. MICROSYS COMPUTING, INC., YOUNGSTOWN, OH. FILED 10-2-2000.

**DENTIMAX**

FOR DENTAL PRACTICE MANAGEMENT SOFTWARE (U.S. CLS. 21, 23, 26, 36 AND 38). FIRST USE 6-29-2000; IN COMMERCE 6-29-2000.

SN 76-139,701. IVIEW MULTIMEDIA, LIMITED, LONDON, GREAT BRITAIN, FILED 10-3-2000.

**IVIEW**

OWNER OF U.S. REG. NO. 2,390,914.  
FOR COMPUTER SOFTWARE APPLICATION TO VIEW, ANNOTATE, PRESENT AND CATALOG DIGITAL TEXT AND MEDIA FILES OF ANY FORMAT AND CONTENT TYPE, AS WELL AS REPACKAGE AND CONVERT FILES INTO A VARIETY OF MEDIA FORMATS (U.S. CLS. 21, 23, 26, 36 AND 38). FIRST USE 6-1-1995; IN COMMERCE 6-1-1995.

SN 76-139,777. PHYSICAL ELECTRONICS, INC., EDEN PRAIRIE, MN. FILED 10-3-2000.

**PHYSICAL ELECTRONICS**

SEC. 2(F).  
FOR ANALYTICAL INSTRUMENTS, NAMELY, SPECTROMETERS TO BE USED TO ANALYZE A SURFACE OF SOLID MATERIALS (U.S. CLS. 21, 23, 26, 36 AND 38). FIRST USE 0-0-1970; IN COMMERCE 0-0-1970.

SN 76-142,239. BROOKS AUTOMATION, INC., CHELMSFORD, MA. BY MERGER SEMY ENGINEERING, INC., PHOENIX, AZ. FILED 10-6-2000.

**MYPRO**

FOR COMPUTERS, ELECTRONIC CONTROLLERS AND ASSOCIATED SOFTWARE FOR MONITORING AND CONTROLLING SEMICONDUCTOR FABRICATION TOOLS AND EQUIPMENT (U.S. CLS. 21, 23, 26, 36 AND 38). FIRST USE 1-1-1986; IN COMMERCE 1-1-1986.

**CLASS 9—(Continued).**

SN 76-144,189. PRINCE CASTLE INC., CAROL STREAM, IL.  
FILED 10-11-2000.

**MENUVIEW**

SEC. 2(F).  
FOR COMPUTER SOFTWARE PROGRAM FOR  
CREATING AND EDITING RESTAURANT MENUS  
(U.S. CLS. 21, 23, 26, 36 AND 38).  
FIRST USE 0-0-1991; IN COMMERCE 0-0-1991.

SN 76-145,121. BROWN, RONALD J., RED BLUFF, CA.  
FILED 10-13-2000.

**INTELLI-TUNES**

FOR CHILDREN'S PRE-RECORDED AUDIO AND  
VIDEO TAPE CASSETTES, PHONOGRAPH RECORDS,  
VIDEO DISCS AND/OR COMPACT DISCS FEATURING  
STORIES AND MUSIC; CHILDREN'S EDUCATIONAL  
MULTIMEDIA SOFTWARE, INTERACTIVE MULTIME-  
DIA COMPUTER GAME PROGRAM, AND MANUALS  
SOLD THEREWITH (U.S. CLS. 21, 23, 26, 36 AND 38).  
FIRST USE 9-1-2000; IN COMMERCE 9-1-2000.

SN 76-145,540. DIGITAL:CONVERGENCE CORPORATION,  
DALLAS, TX. FILED 9-14-2000.

**Digital:Convergence**

NO CLAIM IS MADE TO THE EXCLUSIVE RIGHT TO  
USE "DIGITAL CONVERGENCE", APART FROM THE  
MARK AS SHOWN.

FOR COMPUTER SOFTWARE WHICH INTERFACES  
WITH KEYSTROKE AUTOMATION APPARATUS FOR  
READING CODED IMAGES AND CONVERTING THE  
IMAGES TO COMPUTER KEYSTROKES; AUDIO OR  
VIDEO TRANSDUCER FOR RECEIVING ENCODED  
AUDIO OR VIDEO THAT IS OPERABLE FOR CON-  
NECTING A USER'S COMPUTER TO A LOCATION ON  
THE INTERNET; HAND-HELD BAR CODE AND PRO-  
PRIETARY CODE READER FOR READING MACHINE-  
READABLE CODES ON MAGAZINES, NEWSPAPERS  
AND OTHER PUBLICATIONS AND PRODUCTS FOR  
CONVERTING THE MACHINE-READABLE CODES  
INTO SPECIFIC INSTRUCTIONS TO INTERFACE WITH  
A UNIQUE APPLICATION ON A COMPUTER FOR THE  
PURPOSE OF, IN COMBINATION WITH THE PRO-  
GRAM, CONNECTING THE USER'S COMPUTER TO A  
LOCATION ON THE INTERNET (U.S. CLS. 21, 23, 26, 36  
AND 38).

**CLASS 9—(Continued).**

SN 76-146,125. ELAN HOME SYSTEMS, LLC, LEXINGTON,  
KY. FILED 10-5-2000.

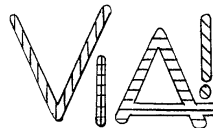

THE MARK INCLUDES COLORS SHOWN BY THE  
LINING IN THE DRAWING AND DESCRIBED AS FOL-  
LWS - THE "V" IS LINED TO INDICATE THE COLOR  
RED, THE "I" IS LINED TO INDICATE THE COLOR  
YELLOW, THE "A" IS LINED TO INDICATE THE COLOR  
BLUE, AND THE "!" IS LINED TO INDICATE THE COLOR  
GREEN.

FOR INTERACTIVE TOUCHSCREEN ELECTRICAL  
CONTROLLERS FOR HOME ELECTRONICS EQUIP-  
MENT; VIDEO DISPLAYS SCREENS FOR HOME AUDIO  
AND VIDEO DEVICE CONTROL AND MONITORING  
(U.S. CLS. 21, 23, 26, 36 AND 38).

FIRST USE 5-14-1999; IN COMMERCE 7-7-1999.

SN 76-146,884. JDA SOFTWARE GROUP, INC., SCOTTS-  
DALE, AZ. FILED 10-13-2000.

**JDA AFFINITY**

OWNER OF U.S. REG. NOS. 1,982,613 AND 2,068,559.  
FOR COMPUTER DATABASE MANAGEMENT SOFT-  
WARE USED IN THE RETAIL BUSINESS INDUSTRY  
FOR CUSTOMER FINANCIAL ANALYSIS, INVEN-  
TORY, MANAGEMENT, CUSTOMER AND BUSINESS  
DATA MANAGEMENT, CUSTOM ORDER PROCES-  
SING, TARGET CUSTOMER MARKETING, CUSTOMER  
BEHAVIORAL ANALYSIS, DATA MINING, REPORT-  
ING, TELEMARKETING, AND CALL-CENTER MAN-  
AGEMENT (U.S. CLS. 21, 23, 26, 36 AND 38).  
FIRST USE 6-14-2000; IN COMMERCE 6-14-2000.

SN 76-147,149. M.J. HARDEN ASSOCIATES, INC., KANSAS  
CITY, MT. FILED 10-17-2000.

**SHEETGEN**

SEC. 2(F).  
FOR COMPUTER SOFTWARE CONSISTING OF AN  
ALIGNMENT SHEET GENERATION APPLICATION  
THAT ENABES PIPELINE ENGINEERS AND DRAFT-  
TERS TO CREATE TRADITIONAL ALIGNMENT  
SHEETS FROM A CONTINUOUS GRAPHIC INFOR-  
MATION SYSTEM DATA SET (U.S. CLS. 21, 23, 26, 36 AND  
38).

FIRST USE 0-0-1988; IN COMMERCE 0-0-1988.

**CLASS 9—(Continued).**

SN 76-149,318. TRIPMASTER CORPORATION, ARLINGTON, TX. FILED 10-18-2000.

**TRIPMASTER ROUTES**

OWNER OF U.S. REG. NO. 1,101,312.  
NO CLAIM IS MADE TO THE EXCLUSIVE RIGHT TO USE "ROUTES", APART FROM THE MARK AS SHOWN.  
FOR COMPUTER SOFTWARE FOR TRANSFERRING DATA IN THE FIELD OF DELIVERY INFORMATION BETWEEN COMPUTERS, AND BETWEEN COMPUTERS AND ON-BOARD VEHICLE INFORMATION RECORDING DEVICES (U.S. CLS. 21, 23, 26, 36 AND 38).

SN 76-149,613. MD/WIN CORPORATION, RALEIGH, NC. FILED 10-19-2000.

**MDROAM**

FOR COMPUTER SOFTWARE, NAMELY, A COMPUTER PROGRAM THAT TRANSFERS INFORMATION AND DATA BETWEEN A COMPUTER NETWORK SYSTEM AND A WIRELESS DEVICE, NAMELY, A PERSONAL DIGITAL ASSISTANT (PDA) (U.S. CLS. 21, 23, 26, 36 AND 38).

SN 76-149,672. TRIPMASTER CORPORATION, ARLINGTON, TX. FILED 10-18-2000.

**TRIPMASTER STANDARDS**

OWNER OF U.S. REG. NO. 1,101,312.  
NO CLAIM IS MADE TO THE EXCLUSIVE RIGHT TO USE "STANDARDS", APART FROM THE MARK AS SHOWN.  
FOR COMPUTER SOFTWARE FOR DEVELOPING, RECORDING, MONITORING AND ANALYZING DELIVERY SCHEDULES, DELIVERY VEHICLE INFORMATION AND DELIVERIES FOR USE IN CONJUNCTION WITH AN ON-BOARD VEHICLE INFORMATION RECORDING DEVICE (U.S. CLS. 21, 23, 26, 36 AND 38).

SN 76-150,474. XYBERNAUT CORPORATION, FAIRFAX, VA. FILED 10-19-2000.



NO CLAIM IS MADE TO THE EXCLUSIVE RIGHT TO USE "RUI", APART FROM THE MARK AS SHOWN.  
FOR SOFTWARE TO GENERATE AND DEPLOY REMOTE USER INTERFACES FOR USER SUPPORTED COMPUTERS (U.S. CLS. 21, 23, 26, 36 AND 38).  
FIRST USE 9-25-2000; IN COMMERCE 9-25-2000.

**CLASS 9—(Continued).**

SN 76-150,514. TRELIS PHOTONICS LTD., YOKNEAM ELITE 20692, ISRAEL, FILED 10-18-2000.

**ELECTROHOLOGRAPHY**

FOR PHOTONIC SWITCHES (U.S. CLS. 21, 23, 26, 36 AND 38).

SN 76-150,670. RADIO CITY TRADEMARKS, LLC, NEW YORK, NY. FILED 10-20-2000.

**RADIO CITY RECORDS**

OWNER OF U.S. REG. NO. 1,223,250.  
NO CLAIM IS MADE TO THE EXCLUSIVE RIGHT TO USE "RECORDS", APART FROM THE MARK AS SHOWN.  
FOR PRE-RECORDED RECORDS, TAPES, CASSETTES, DISCS, COMPACT DISCS, DIGITAL AUDIO TAPES, DIGITAL SOUND AND VIDEO RECORDINGS, ALL FEATURING THEATRICAL, MUSICAL AND CINEMATIC SHOWS AND PERFORMANCES; DOWNLOADABLE AUDIO AND MUSICAL SOUND RECORDINGS (U.S. CLS. 21, 23, 26, 36 AND 38).

SN 76-150,966. YAMATO SEIKO KABUSHIKI KAISHA, DBA YAMATO SCALE CO., LTD., AKASHI, HYOGO, JAPAN, FILED 10-20-2000.

**POKEMINI**

FOR ELECTRONIC DEVICES FOR DETERMINING AND/OR GAUGING BODY FAT, NAMELY CARD-TYPE FAT MEASURING GAUGES OR CALCULATORS (U.S. CLS. 21, 23, 26, 36 AND 38).

SN 76-150,967. YAMATO SEIKO KABUSHIKI KAISHA, DBA YAMATO SCALE CO., LTD., AKASHI, HYOGO, JAPAN, FILED 10-20-2000.

**POKENAVI**

FOR ELECTRONIC DEVICES FOR DETERMINING AND/OR GAUGING BODY FAT, NAMELY CARD-TYPE FAT MEASURING GAUGES OR CALCULATORS (U.S. CLS. 21, 23, 26, 36 AND 38).

**CLASS 9—(Continued).**

SN 76-152,054. DIGITAL PIONEER TECHNOLOGIES CORP., VANCOUVER, BRITISH COLUMBIA, CANADA, FILED 10-19-2000.

**DIGITAL PIONEER**

NO CLAIM IS MADE TO THE EXCLUSIVE RIGHT TO USE "DIGITAL", APART FROM THE MARK AS SHOWN.  
 FOR PARKING EQUIPMENT, NAMELY AUTOMATED PAY STATIONS FOR PARKING LOTS AND PARKING METERS; REVENUE MANAGEMENT SOFTWARE FOR USE IN THE PARKING, PUBLIC TRANSIT AND PRIVATE TRANSIT INDUSTRIES (U.S. CLS. 21, 23, 26, 36 AND 38).  
 FIRST USE 7-15-1998; IN COMMERCE 7-15-1998.

SN 76-152,196. NUVERA FUEL CELLS, INC., CAMBRIDGE, MA. FILED 10-23-2000.

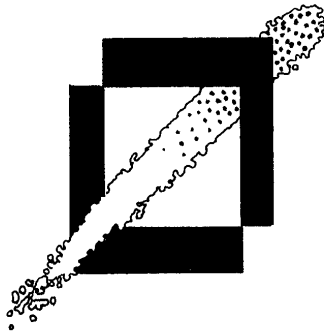

FOR MULTI-FUEL PROCESSORS, NAMELY, FUEL CELL STACKS; POWER MODULES; FUEL CELLS SYSTEMS COMPRISED OF FUEL CELL STACKS, POWER MODULES, FUEL CELLS, FUEL REFORMERS AND FUEL PROCESSORS (U.S. CLS. 21, 23, 26, 36 AND 38).  
 FIRST USE 8-25-2000; IN COMMERCE 8-25-2000.

SN 76-152,635. NATIONAL RAILROAD PASSENGER CORPORATION, WASHINGTON, DC. FILED 10-24-2000.

**AMTRAK**

OWNER OF U.S. REG. NOS. 960,643, 2,021,856 AND OTHERS.  
 FOR ELECTRICAL SIGNALING APPARATUS FOR DETECTING RAILROAD TRAINS AND PROVIDING BI-DIRECTIONAL COMMUNICATIONS THROUGH RAILROAD TRACKS (U.S. CLS. 21, 23, 26, 36 AND 38).

**CLASS 9—(Continued).**

SN 76-154,363. DIRECT ACCESS TRADER CORP., DALLAS, TX. FILED 10-26-2000.

**EXP LITE**

FOR COMPUTER SOFTWARE FOR ANALYZING, QUOTING AND TRADING SECURITIES (U.S. CLS. 21, 23, 26, 36 AND 38).  
 FIRST USE 9-0-2000; IN COMMERCE 9-0-2000.

SN 76-155,096. HOMESTEAD TECHNOLOGIES INC., MENLO PARK, CA. BY CHANGE OF NAME HOMESTEAD-COM INCORPORATED, MENLO PARK, CA. FILED 10-26-2000.

**homestead**

OWNER OF U.S. REG. NO. 2,286,063.  
 FOR COMPUTER SOFTWARE THAT MAY BE DOWNLOADED FROM A GLOBAL COMPUTER NETWORK FOR CREATING, PUBLISHING AND ANIMATING WEB SITES (U.S. CLS. 21, 23, 26, 36 AND 38).

SN 76-155,353. HOMESTEAD TECHNOLOGIES INC., MENLO PARK, CA. BY CHANGE OF NAME HOMESTEAD-COM INCORPORATED, MENLO PARK, CA. FILED 10-26-2000.

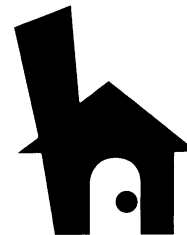

OWNER OF U.S. REG. NO. 2,286,063.  
 FOR COMPUTER SOFTWARE THAT MAY BE DOWNLOADED FROM A GLOBAL COMPUTER NETWORK FOR CREATING, PUBLISHING AND ANIMATING WEB SITES (U.S. CLS. 21, 23, 26, 36 AND 38).

**CLASS 9—(Continued).**

SN 76-155,839. IBRITE, INC., RESTON, VA. FILED 10-30-2000.

**TERMMAKER**

FOR COMPUTER SOFTWARE FOR AUTHORIZING, ORGANIZING, AND DISPLAYING ELECTRONIC INFORMATION, NAMELY TEXT AND MULTIMEDIA CONTENT, ON PORTABLE COMPUTER DEVICES; COMPUTER SOFTWARE FOR DELIVERING ELECTRONIC INFORMATION, NAMELY TEXT AND MULTIMEDIA CONTENT, FROM PERSONAL COMPUTERS AND COMPUTER NETWORKS TO PORTABLE COMPUTER DEVICES (U.S. CLS. 21, 23, 26, 36 AND 38).

FIRST USE 7-15-2000; IN COMMERCE 7-15-2000.

---

SN 76-156,344. GROUP 1 SOFTWARE, INC., LANHAM, MD. FILED 10-30-2000.

**DATAVERSE**

OWNER OF U.S. REG. NO. 2,137,049.  
FOR COMPUTER SOFTWARE THAT VALIDATES, CORRECTS AND FORMATS ADDRESS DATA AND APPENDS RELEVANT DEMOGRAPHIC AND GEOGRAPHIC INFORMATION (U.S. CLS. 21, 23, 26, 36 AND 38).

FIRST USE 9-1-2000; IN COMMERCE 9-1-2000.

---

SN 76-158,555. COLE VISION CORPORATION, TWINSBURG, OH. FILED 11-2-2000.

**LOGONLENZ**

FOR OPHTHALMIC LENSES, NAMELY LENSES FOR EYEGASSES (U.S. CLS. 21, 23, 26, 36 AND 38).

---

SN 76-158,994. FURUNO USA, INC., CAMAS, WA. FILED 11-2-2000.

**NAVNET**

FOR COMPUTER HARDWARE, NAMELY NETWORK INTERFACE FOR MULTIPLE ELECTRONIC DISPLAYS AND SENSORS (U.S. CLS. 21, 23, 26, 36 AND 38).

FIRST USE 5-7-2001; IN COMMERCE 5-7-2001.

**CLASS 9—(Continued).**

SN 76-159,931. SALESPAGE TECHNOLOGIES, INC., KALAMAZOO, MI. FILED 11-3-2000.

**CONSULTING.SPACE**

FOR COMPUTER SOFTWARE PROGRAMS AND USER DOCUMENTATION SOLD AS A UNIT WHICH UTILIZE BROWSERS OVER INTERNAL AND EXTERNAL, GLOBAL, INTERACTIVE COMPUTER COMMUNICATION NETWORKS AND FUNCTION TO AUTOMATE CONTACT MANAGEMENT, CALENDARS, CUSTOMER RELATIONSHIP MANAGEMENT, SALES AND MARKETING ACTIVITIES, LITERATURE FULFILLMENT, CAMPAIGN MANAGEMENT, BUILDING CUSTOM WEB APPLICATIONS, UTILIZATION OF THIRD PARTY DATA FEEDS, SALES REPORTS, MARKET RESEARCH, CALL CENTER ACTIVITIES AND DATA SYNCHRONIZATION IN THE MUTUAL FUND INDUSTRY FOR THE PROFESSIONAL SERVICES INDUSTRY (U.S. CLS. 21, 23, 26, 36 AND 38).

FIRST USE 6-9-2000; IN COMMERCE 6-9-2000.

---

SN 76-161,600. LOGICRAFT CORP., ENGLEWOOD, NJ. FILED 11-8-2000.

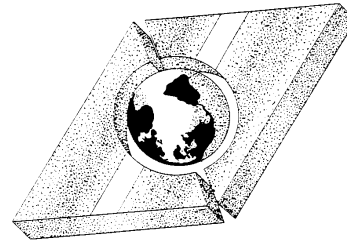

THE STIPLING IN THE DRAWING IS FOR SHADING PURPOSES ONLY.

FOR COMPUTER SOFTWARE FOR USE IN DATABASE MANAGEMENT OPERATION AND SPREADSHEETING APPLICATIONS USED IN THE FIELD OF AIRPORT MANAGEMENT (U.S. CLS. 21, 23, 26, 36 AND 38).

FIRST USE 9-0-1998; IN COMMERCE 9-0-1998.

---

SN 76-162,676. EDULINK, INC., BEVERLY HILLS, CA. FILED 11-9-2000.

**CE TOOL**

NO CLAIM IS MADE TO THE EXCLUSIVE RIGHT TO USE "TOOL", APART FROM THE MARK AS SHOWN.

FOR COMPUTER PROGRAMS; NAMELY AN INTERACTIVE TOOL FOR USE IN THE CREATION AND MODIFICATION OF TEACHING CURRICULA (U.S. CLS. 21, 23, 26, 36 AND 38).

**CLASS 9—(Continued).**

SN 76-163,700. CLIPTRON TECHNOLOGIES, RICHMOND HILL, ONTARIO, CANADA, FILED 11-14-2000.

**CLIPTRON**

FOR ELECTRICAL APPARATUS, NAMELY CIRCUIT BREAKERS, POWER SUPPLIES, NAMELY AC TO DC CONVERTERS, POWER CONVERTERS, NAMELY DC TO DC CONVERTERS AND PROTECTIVE TERMINALS (U.S. CLS. 21, 23, 26, 36 AND 38).

SN 76-164,017. STAR-BAK COMMUNICATIONS, WESTERVILLE, OH. FILED 11-13-2000.



FOR COMPUTER HARDWARE, NAMELY, VIDEO STREAM COMMUNICATION SERVERS (U.S. CLS. 21, 23, 26, 36 AND 38).  
FIRST USE 10-18-2000; IN COMMERCE 1-15-2001.

SN 76-164,027. VIRTMED CORPORATION, CAMBRIDGE, MA. FILED 11-13-2000.

**PATIENTKEEPER**

FOR COMPUTER SOFTWARE TO ENABLE MEDICAL PROFESSIONALS TO CAPTURE AND ORGANIZE PATIENT INFORMATION (U.S. CLS. 21, 23, 26, 36 AND 38).  
FIRST USE 8-11-1999; IN COMMERCE 8-11-1999.

SN 76-164,033. STAR-BAK COMMUNICATIONS, WESTERVILLE, OH. FILED 11-13-2000.

**TORRENT CE**

FOR COMPUTER HARDWARE, NAMELY, VIDEO CONFERENCE ENGINES THAT ENABLES USERS TO TAKE VIDEO CONFERENCES AND TURN INTO OR CONVERT INTO VIDEO STREAM (U.S. CLS. 21, 23, 26, 36 AND 38).

**CLASS 9—(Continued).**

SN 76-165,492. SAS INSTITUTE INC., CARY, NC. FILED 11-15-2000.

**PROCUREMENT VISION**

NO CLAIM IS MADE TO THE EXCLUSIVE RIGHT TO USE "PROCUREMENT", APART FROM THE MARK AS SHOWN.

FOR COMPUTER SOFTWARE FOR DATA ANALYSIS AND REPORT GENERATION IN THE FIELD OF SUPPLIER-RELATIONSHIP MANAGEMENT (U.S. CLS. 21, 23, 26, 36 AND 38).

FIRST USE 9-15-2000; IN COMMERCE 9-15-2000.

SN 76-166,641. RADIO WAVES INC., NORTH BILLERICA, MA. FILED 11-16-2000.



NO CLAIM IS MADE TO THE EXCLUSIVE RIGHT TO USE "RADIO WAVES", APART FROM THE MARK AS SHOWN.

FOR MICROWAVE RADIO EQUIPMENT, NAMELY, ANTENNAS, DIPLEXERS, FREQUENCY GENERATORS, MIXERS, MULTIPLEXERS, OSCILLATORS, POWER SUPPLIES, RADIOS, RF PROTECTION SWITCHES, RADIO TEST SETS, RADIO REPEATERS, RADIO BASE STATIONS AND ELECTRONICS CIRCUITS FOR MANAGING NETWORKS (U.S. CLS. 21, 23, 26, 36 AND 38).

FIRST USE 3-0-1992; IN COMMERCE 3-0-1993.

SN 76-166,882. CHAMELEON SYSTEMS, INC., SAN JOSE, CA. FILED 11-17-2000.

**YOUR COMMUNICATIONS PLATFORM**

NO CLAIM IS MADE TO THE EXCLUSIVE RIGHT TO USE "COMMUNICATIONS PLATFORM", APART FROM THE MARK AS SHOWN.

FOR INTERGRATED CIRCUITS AND ASSOCIATED ELECTRONIC DESIGN AUTOMATION SOFTWARE PROGRAMMING IT, AND INSTRUCTION AND USER MANUALS PROVIDED IN CONNECTION WHEREWITH (U.S. CLS. 21, 23, 26, 36 AND 38).

FIRST USE 2-18-2000; IN COMMERCE 11-13-2000.

**CLASS 9—(Continued).**

SN 76-166,911. CHROME SYSTEM CORPORATION, PORTLAND, OR. FILED 11-15-2000.

**CHROME AUTOBUILDER**

OWNER OF U.S. REG. NOS. 2,330,292, 2,366,377 AND 2,368,629.  
FOR COMPUTER PROGRAMS AND PRINTED INSTRUCTIONAL MATERIAL, SOLD AS A UNIT, CONTAINING INFORMATION AND DATA FOR CREATING CUSTOM COMPUTER SOFTWARE APPLICATIONS WHICH ENABLE USERS TO CONFIGURE, RECEIVE AND SEND REQUESTS FOR VEHICLE QUOTES AND QUOTES FOR AUTOMOBILES, ORDER, PRICE AND PURCHASE AUTOMOBILES VIA A COMPUTER NETWORK (U.S. CLS. 21, 23, 26, 36 AND 38).  
FIRST USE 11-6-2000; IN COMMERCE 11-6-2000.

SN 76-170,129. ZENTEK TECHNOLOGY, INC., LOS ALTOS, CA. FILED 11-15-2000.

**ZENOS**

FOR COMPUTER SOFTWARE, NAMELY EMBEDDED OPERATING SYSTEM SOFTWARE LOCATED ON MICROPROCESSORS THAT IS USED TO CREATE DEVELOPMENT LIBRARIES AND A SOFTWARE DEVELOPMENT ENVIRONMENT (U.S. CLS. 21, 23, 26, 36 AND 38).

**CLASS 9—(Continued).**

SN 76-170,187. WRQ, INC., SEATTLE, WA. FILED 11-22-2000.

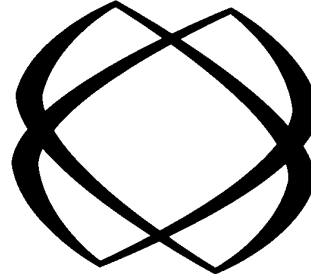

THE MARK CONSISTS OF TWO STYLIZED, INTER-TWINED RECTANGULAR SHAPES ON DIAGONAL PLANES.

FOR COMPUTER SOFTWARE AND INSTRUCTION MANUALS SOLD AS A UNIT TO CONNECT AND CREATE SECURE CHANNELS OF COMMUNICATION BETWEEN REMOTE, MOBILE AND WORK STATION COMPUTERS IN THE FIELDS OF CELLULAR COMMUNICATIONS, INTERCOMPUTER COMMUNICATIONS AND COMMUNICATIONS WITHIN AND BETWEEN COMPUTER NETWORKS; COMPUTER SOFTWARE FOR TERMINAL EMULATION, COMPUTER PROGRAMMING, FILE TRANSFER, GLOBAL NETWORK ACCESS, PRINTING COMPUTER FILES TO PAPER OR DIGITAL FILES; COMPUTER SOFTWARE FOR TRACKING, ANALYZING AND SUMMARIZING BUSINESS PRODUCTIVITY; COMPUTER SOFTWARE FOR CROSS-PLATFORM PROGRAMMING, PASSWORD INTEGRATION, AUTHENTICATION AND ACCESS SECURITY; COMPUTER SOFTWARE FOR INTEGRATING ENTERPRISE SOFTWARE APPLICATIONS AND DATABASES; COMPUTER SOFTWARE AND DEVELOPMENT TOOLS FOR ORGANIZING, EXTRACTING AND ACCESSING DATA FROM MAIN-FRAME COMPUTERS; COMPUTER SOFTWARE FOR CONNECTING, MANAGING, SECURING AND OPTIMIZING WIRELESS AND WIRELINE COMMUNICATIONS BETWEEN COMPUTERS AND COMPUTER NETWORKS (U.S. CLS. 21, 23, 26, 36 AND 38).

SN 76-174,661. WHITEMILLER, ANTHONY F., BOULDER, CO. FILED 12-4-2000.

**ACCU-SCRIBE**

FOR GRAPHITE MARKERS ADAPTED FOR USE WITH TAPE MEASURES, FOR USE IN MARKING CONSTRUCTION MATERIALS (U.S. CLS. 21, 23, 26, 36 AND 38).  
FIRST USE 11-28-2000; IN COMMERCE 11-28-2000.

SN 76-176,956. COLE VISION CORPORATION, TWINSBURG, OH. FILED 12-4-2000.

**LITE LOOKS**

NO CLAIM IS MADE TO THE EXCLUSIVE RIGHT TO USE "LITE", APART FROM THE MARK AS SHOWN.  
FOR OPHTHALMIC LENSES (U.S. CLS. 21, 23, 26, 36 AND 38).

**CLASS 9—(Continued).**

SN 76-177,666. VEDALABS, INC., BATON ROUGE, LA. FILED 12-8-2000.



NO CLAIM IS MADE TO THE EXCLUSIVE RIGHT TO USE "SEARCH & SHARE STREAMS", APART FROM THE MARK AS SHOWN.

THE MARK CONSISTS OF THE STYLIZED WORDS "SEARCH & SHARE STREAMS" WITH TWO DOWNWARD SWISHES EMERGING FROM ABOVE THE WORDS OVER TO THE RIGHT HAND SIDE OF THE WORDS.

FOR COMPUTER SOFTWARE FEATURING PEER-TO-PEER SEARCH AND TRANSMISSION OF MEDIA FILES (U.S. CLS. 21, 23, 26, 36 AND 38).

SN 76-178,689. EXMOD CORPORATION, SAN JOSE, CA. FILED 12-9-2000.



NO CLAIM IS MADE TO THE EXCLUSIVE RIGHT TO USE "CORPORATION", APART FROM THE MARK AS SHOWN.

FOR ELECTROSTATIC CHARGE MONITORING AND MEASURING DEVICES AND ACCESSORIES, NAMELY ELECTROMETERS, WORKSTATION / PROCESS EQUIPMENT MONITORS, AND BODY VOLTAGE / GROUND MONITORS (U.S. CLS. 21, 23, 26, 36 AND 38).

FIRST USE 5-0-2000; IN COMMERCE 5-0-2000.

SN 76-181,486. NEXTSET SOFTWARE, INC., PALO ALTO, CA. FILED 12-15-2000.

**TRADESPACE EXCHANGE**

NO CLAIM IS MADE TO THE EXCLUSIVE RIGHT TO USE "EXCHANGE", APART FROM THE MARK AS SHOWN.

FOR COMPUTER E-COMMERCE SOFTWARE WHICH ENABLES USERS TO PARTICIPATE IN ELECTRONIC BUSINESS EXCHANGE TRANSACTIONS AND AUCTIONS, VIA A GLOBAL COMPUTER NETWORK (U.S. CLS. 21, 23, 26, 36 AND 38).

**CLASS 9—(Continued).**

SN 76-182,133. SHULMAN, JOHN, WAUBUN, MN. AND ALMONOR, JEANNE-MARIE, WAUBUN, MN. FILED 12-18-2000.

**ALIGNOR**

FOR COMPUTER SOFTWARE FOR ANALYZING FACT PATTERNS RELATING TO NEGOTIATION STRATEGIES, COMPLEX DECISION-MAKING, RISK ANALYSIS AND DISPUTE RESOLUTION FOR USE IN THE FIELDS OF BUSINESS, LAW AND MEDIATION (U.S. CLS. 21, 23, 26, 36 AND 38).

SN 76-183,424. IC TECH, INC., OKEMOS, MI. FILED 12-19-2000.



NO CLAIM IS MADE TO THE EXCLUSIVE RIGHT TO USE "LIGHTMOUSE", APART FROM THE MARK AS SHOWN.

FOR COMPUTER SOFTWARE USED FOR PRODUCING VISUAL INTERACTION BETWEEN A PROJECTED IMAGE AND THE APPARATUS PRODUCING THE PROJECTED IMAGE AND THE PROJECTOR OPERATOR USING A LIGHT SOURCE (U.S. CLS. 21, 23, 26, 36 AND 38).

FIRST USE 8-10-2000; IN COMMERCE 8-10-2000.

SN 76-184,667. PICTUREIQ CORPORATION, SEATTLE, WA. FILED 12-20-2000.



FOR COMPUTER SOFTWARE, NAMELY, SERVER SOFTWARE, DISTRIBUTED AS SOFTWARE ONLY AND AS A PRE-INSTALLED OPERATING APPLICATION ON A SPECIALIZED HARDWARE PLATFORM, FOR USE IN THE MANAGEMENT, EDITING, OPTIMIZATION, AND RENDERING OF DIGITAL IMAGES AND VIDEO; COMPUTER SOFTWARE FOR DISPLAYING DIGITAL IMAGES AND VIDEO ON WEB SITES; COMPUTER SOFTWARE FOR TRANSMITTING DIGITAL IMAGES AND VIDEO TO INTERNET-ENABLED DEVICES (U.S. CLS. 21, 23, 26, 36 AND 38).



**CLASS 9—(Continued).**

SN 76-185,873. RITE TRACK EQUIPMENT SERVICES, INC., WEST CHESTER, OH. FILED 12-22-2000.

## **RITE TRACK RECIPE MANAGER**

OWNER OF U.S. REG. NO. 2,402,069.  
NO CLAIM IS MADE TO THE EXCLUSIVE RIGHT TO USE "RECIPE MANAGER", APART FROM THE MARK AS SHOWN.

FOR PROGRAM CONTROLLERS FOR SEMICONDUCTOR PROCESSING EQUIPMENT, NAMELY, SUBSTRATE BAKING, COATING, CLEANING, DEVELOPING, AND DRYING MACHINES (U.S. CLS. 21, 23, 26, 36 AND 38).

FIRST USE 6-0-2000; IN COMMERCE 6-0-2000.

---

SN 76-186,383. WEST MARINE IHC I, INC., WATSONVILLE, CA. FILED 12-21-2000.

## **SEAVOLT**

FOR BATTERIES (U.S. CLS. 21, 23, 26, 36 AND 38).  
FIRST USE 2-0-1993; IN COMMERCE 2-0-1993.

---

SN 76-186,513. CONNER, KEVEN, HOUSTON, TX. FILED 12-26-2000.

## **D - ROCHI**

FOR PRERECORDED AUDIO TAPES FEATURING SOUL ROCK MUSIC; COMPACT DISCS FEATURING SOUL ROCK MUSIC (U.S. CLS. 21, 23, 26, 36 AND 38).

---

SN 76-186,525. INTERTACT CORPORATION, OAKLAND, CA. FILED 12-26-2000.

## **ATOCAAT**

FOR ELECTRONIC CONTROLLERS FOR INTERFACING WITH OR OPERATING ELECTRONIC CIRCUITS (U.S. CLS. 21, 23, 26, 36 AND 38).

---

SN 76-186,532. E-COM.TEL, INC., SAN ANTONIO, TX. FILED 12-27-2000.

## **CYBERLOG, LTD.**

NO CLAIM IS MADE TO THE EXCLUSIVE RIGHT TO USE "LTD.", APART FROM THE MARK AS SHOWN.

FOR TELECOMMUNICATIONS NETWORK EQUIPMENT, NAMELY CALL PROCESSING COMPUTERS AND SWITCHES (U.S. CLS. 21, 23, 26, 36 AND 38).

FIRST USE 12-15-2000; IN COMMERCE 12-15-2000.

**CLASS 9—(Continued).**

SN 76-187,838. GENERAL CABLE TECHNOLOGIES CORPORATION, HIGHLAND HEIGHTS, KY. FILED 12-29-2000.

# **PowerServ**

FOR ELECTRICAL POWER CABLES (U.S. CLS. 21, 23, 26, 36 AND 38).

---

SN 76-195,210. SENIOR TECHNOLOGIES, INC., LINCOLN, NE. FILED 1-17-2001.

## **NEXTCALL**

FOR COMPUTER SOFTWARE FOR USE IN PROGRAMMABLE VERBAL COMMUNICATION SYSTEMS WITHIN HEALTH CARE FACILITIES TO CONNECT CALLERS TO STAFF IN SEQUENCE UNTIL ANSWERED (U.S. CLS. 21, 23, 26, 36 AND 38).

---

SN 76-195,949. RED BROOK SOFTWARE, INC., LATHAM, NY. FILED 1-19-2001.

## **SQL TESTER**

NO CLAIM IS MADE TO THE EXCLUSIVE RIGHT TO USE "SQL", APART FROM THE MARK AS SHOWN.

FOR COMPUTER SOFTWARE FOR EXECUTING STRUCTURED QUERY LANGUAGE (SQL) STATEMENTS BEFORE LOADING THEM FROM FILES OR EMBEDDING THEM IN PROGRAMMING CODE (U.S. CLS. 21, 23, 26, 36 AND 38).

FIRST USE 12-30-2000; IN COMMERCE 12-30-2000.

---

SN 76-197,084. MIGOSOFT CORP., 231 HSIN-TIEN, TAIPEI, TAIWAN, FILED 1-22-2001.

## **WEBMAX**

FOR COMPUTER SOFTWARE AND PROGRAMS USED FOR INTERACTIVE DATABASE MARKETING IN THE FIELD OF ELECTRONIC COMMERCE; AND FLOPPY DISKS AND CD-ROMS WITH COMPUTER PROGRAMS RECORDED THEREON USED FOR INTERACTIVE DATABASE MARKETING IN THE FIELD OF ELECTRONIC COMMERCE (U.S. CLS. 21, 23, 26, 36 AND 38).

**CLASS 9—(Continued).**

SN 76-200,195. SENSORY SCIENCE CORPORATION, SCOTTSDALE, AZ. FILED 1-25-2001.

**iCACHE**

FOR CONSUMER ELECTRONIC DEVICES, NAMELY, MEDIA SERVER DEVICES, NAMELY SOFTWARE AND COMPUTER HARDWARE FOR MANAGING THE VISUAL, AUDIO, AND COMMERCE EXPERIENCE; FOR PROVIDING INTERACTIVE DIGITAL MEDIA, ELECTRONIC COMMERCE AND INFORMATION TO ENABLE CONSUMERS AND CONTENT PROVIDERS TO INTERACT TRANSPARENTLY FOR BOTH ENTERTAINMENT AND COMMERCE; FOR CONCURRENT CONTROL OF MULTIPLE MEDIA FUNCTIONS; FOR SEAMLESS INTEGRATION, INTERCONNECTION, AND MANAGEMENT OF MULTIPLE TRANSPORT MULTIMEDIA; FOR MERGING ELECTRONIC PHOTOGRAPHY, DIGITAL VIDEOS, AND 3D GAME TECHNOLOGY WITH AN ELECTRONIC CATALOG TO ENABLE CUSTOMER INTERACTION WITH PRODUCTS; AND FOR INTEGRATION OF ALL DIGITAL APPLIANCES WITH WAN OR LAN FOR ON-DEMAND HOME MEDIA SERVICE, VIDEO AND SHOPPING (U.S. CLS. 21, 23, 26, 36 AND 38).

SN 76-200,584. SENSORY SCIENCE CORPORATION, SCOTTSDALE, AZ. FILED 1-26-2001.

**iCACHE Inc.**

NO CLAIM IS MADE TO THE EXCLUSIVE RIGHT TO USE "INC.", APART FROM THE MARK AS SHOWN.

FOR CONSUMER ELECTRONIC DEVICES, NAMELY, MEDIA SERVER DEVICES, NAMELY SOFTWARE AND COMPUTER HARDWARE FOR MANAGING THE VISUAL, AUDIO, AND COMMERCE EXPERIENCE; FOR PROVIDING INTERACTIVE DIGITAL MEDIA, ELECTRONIC COMMERCE AND INFORMATION TO ENABLE CONSUMERS AND CONTENT PROVIDERS TO INTERACT TRANSPARENTLY FOR BOTH ENTERTAINMENT AND COMMERCE; FOR CONCURRENT CONTROL OF MULTIPLE MEDIA FUNCTIONS; FOR SEAMLESS INTEGRATION, INTERCONNECTION, AND MANAGEMENT OF MULTIPLE TRANSPORT MULTIMEDIA; FOR MERGING ELECTRONIC PHOTOGRAPHY, DIGITAL VIDEOS, AND 3D GAME TECHNOLOGY WITH AN ELECTRONIC CATALOG TO ENABLE CUSTOMER INTERACTION WITH PRODUCTS; AND FOR INTEGRATION OF ALL DIGITAL APPLIANCES WITH WAN OR LAN FOR ON-DEMAND HOME MEDIA SERVICE, VIDEO AND SHOPPING (U.S. CLS. 21, 23, 26, 36 AND 38).

**CLASS 9—(Continued).**

SN 76-202,356. XYTECH SYSTEMS CORPORATION, BURBANK, CA. FILED 1-30-2001.

**METAVault**

FOR COMPUTER PROGRAMS FOR MEDIA ASSET MANAGEMENT, NAMELY FOR THE STORAGE, SEARCH AND RETRIEVAL OF MEDIA CONTENT, FOR USE BY ENTERTAINMENT-BASED ORGANIZATIONS SUCH AS BROADCAST STUDIOS, TELEVISION NETWORKS, PRODUCTION AND POST PRODUCTION FACILITIES, AND INDEPENDENT-FILM AND VIDEO-TAPE OPERATIONS (U.S. CLS. 21, 23, 26, 36 AND 38).  
FIRST USE 0-0-1998; IN COMMERCE 0-0-1998.

SN 76-204,082. TRIPMASTER CORPORATION, ARLINGTON, TX. FILED 2-2-2001.

**TRIPMASTER DOT**

OWNER OF U.S. REG. NO. 1,101,312.  
NO CLAIM IS MADE TO THE EXCLUSIVE RIGHT TO USE "DOT", APART FROM THE MARK AS SHOWN.  
FOR COMPUTER SOFTWARE FOR ACCESSING, MONITORING AND REPORTING COMPLIANCE WITH TRANSPORTATION REGULATIONS AND FOR PREPARING REPORTS WITH RESPECT THERETO, FOR USE WITH AN ON-BOARD VEHICLE INFORMATION RECORDING DEVICE (U.S. CLS. 21, 23, 26, 36 AND 38).

SN 76-204,085. TRIPMASTER CORPORATION, ARLINGTON, TX. FILED 2-2-2001.

**TRIPMASTER FUEL TAX**

OWNER OF U.S. REG. NO. 1,101,312.  
NO CLAIM IS MADE TO THE EXCLUSIVE RIGHT TO USE "FUEL TAX", APART FROM THE MARK AS SHOWN.  
FOR COMPUTER SOFTWARE FOR THE RECORDING, MONITORING AND ANALYZING OF TRAVEL DISTANCE AND FUEL CONSUMPTION, FOR USE WITH AN ON-BOARD VEHICLE INFORMATION RECORDING DEVICE (U.S. CLS. 21, 23, 26, 36 AND 38).

SN 76-207,387. INGENIX, INC., EDEN PRAIRIE, MN. FILED 2-8-2001.

**MDR**

FOR PRE-RECORDED COMPUTER MEDIA FEATURING ELECTRONIC DATABASES IN THE FIELD OF HEALTH CARE CODING AND HEALTH CARE REIMBURSEMENTS (U.S. CLS. 21, 23, 26, 36 AND 38).  
FIRST USE 5-0-1988; IN COMMERCE 5-0-1988.

**CLASS 9—(Continued).**

SN 76-208,794. DIGISOFT INC., WAYNE, PA. FILED 2-13-2001.

**PICTPOCKET**

FOR COMPUTER SOFTWARE FOR THE POCKET PC FOR USE IN VIEWING MEDICAL IMAGES AND ALLOWING POINT OF CARE ACCESS TO MEDICAL IMAGES SUCH AS MRIS, CAT SCANS, ULTRASOUNDS AND ANGIOGRAMS (U.S. CLS. 21, 23, 26, 36 AND 38).  
FIRST USE 1-31-2001; IN COMMERCE 1-31-2001.

SN 76-210,046. RYMIC SYSTEMS, INC., HUNTSVILLE, AL. FILED 2-14-2001.

**RYMICSIGNAL**

FOR COMPUTER SOFTWARE FOR USE IN DATA ACQUISITION, DATA COLLECTION, DATA MONITORING, AND DATA ANALYSIS IN THE FIELD OF TELECOMMUNICATIONS EQUIPMENT, MEDICAL DEVICES, AND MILITARY AND CIVILIAN VEHICLES, FOR USE IN DIAGNOSTICS, MONITORING, AND CONTROL OF ACTUATORS, MOTORS, SOLENOIDS, AND INDICATOR DEVICES IN SUCH EQUIPMENT, DEVICES, AND VEHICLES IN A COMPUTER NETWORK ENVIRONMENT (U.S. CLS. 21, 23, 26, 36 AND 38).

SN 76-215,008. HAWKWOOD SOFTWARE, LLC, BOSTON, MA. FILED 2-23-2001.

**HAWKWOOD SOFTWARE**

NO CLAIM IS MADE TO THE EXCLUSIVE RIGHT TO USE "SOFTWARE", APART FROM THE MARK AS SHOWN.  
FOR COMPUTER SOFTWARE, NAMELY, INTERACTIVE SOFTWARE USED TO FACILITATE ELECTRIC COMMERCE, NAMELY, DATA EXCHANGE AND SALES TRANSACTIONS, ON A GLOBAL COMPUTER NETWORK (U.S. CLS. 21, 23, 26, 36 AND 38).

SN 76-217,197. AUTODESSYS, INC., COLUMBUS, OH. FILED 2-27-2001.



THE MARK CONSISTS OF A STYLIZED WORD "FORM" AND A STYLIZED "Z" SEPARATED BY A SPHERICAL BULLET, COLOR AND HIGHLIGHTED TO SIMULATE CAST GOLD.  
FOR COMPUTER PROGRAMS FOR COMPUTER AIDED MODELING, DESIGN, AND RENDERING (U.S. CLS. 21, 23, 26, 36 AND 38).  
FIRST USE 2-14-1991; IN COMMERCE 2-14-1991.

**CLASS 9—(Continued).**

SN 76-221,210. UNICCO SERVICE COMPANY, AUBURN-DALE, MA. FILED 3-7-2001.

**UNI-Q**

FOR COMPUTER SOFTWARE FOR THE MANAGEMENT AND INSPECTION OF JANITORIAL, LANDSCAPING AND BUILDING MAINTENANCE AND REPAIR SERVICES (U.S. CLS. 21, 23, 26, 36 AND 38).

SN 76-221,690. HERAEUS ELECTRO-NITE INTERNATIONAL N.V., 3530 HOUTHALEN, BELGIUM, FILED 3-8-2001.

**QUSAS**

PRIORITY CLAIMED UNDER SEC. 44(D) ON BELGIUM APPLICATION NO. 974488, FILED 9-29-2000, REG. NO. 676906, DATED 9-29-2000, EXPIRES 9-29-2010.

FOR MEASUREMENT AND CONTROL INSTRUMENTS AND APPARATUS FOR THE METALLURGICAL INDUSTRY; NAMELY, IMMERSION PROBES AND RELATED MEASUREMENT INSTRUMENTS SOLD AS A UNIT THEREWITH IN THE NATURE OF INDICATORS AND ANALYTICAL INSTRUMENTS FOR THE ANALYSIS OF MOLTEN METAL AND SLAG; IMMERSION PROBES AND MEASURING INSTRUMENTS; NAMELY, SAMPLING PROBES TO DETERMINE THE GAS CONTENT, IN PARTICULAR THE OXYGEN AND NITROGEN LEVEL IN MOLTEN METAL AND SLAG; IMMERSION PROBES, NAMELY, SAMPLING PROBES TO DETERMINE THE PROPERTIES OF SLAG (U.S. CLS. 21, 23, 26, 36 AND 38).

SN 76-221,786. RYMIC SYSTEMS, INC., HUNTSVILLE, AL. FILED 3-8-2001.

**RYMICNET**

FOR MICROCOMPUTERS AND PARTS THEREFOR, AND COMPUTER SOFTWARE FOR USE IN DATA ACQUISITION, DATA COLLECTION, DATA MONITORING, AND DATA ANALYSIS IN THE FIELD OF TELECOMMUNICATIONS EQUIPMENT, MEDICAL DEVICES, AND MILITARY AND CIVILIAN VEHICLES, FOR USE IN DIAGNOSTICS, MONITORING, AND CONTROL OF ACTUATORS, MOTORS, SOLENOIDS, AND INDICATOR DEVICES IN SUCH EQUIPMENT, DEVICES, AND VEHICLES, AND FOR IMPLEMENTING A WEB SERVER TO ALLOW MONITORING AND CONTROL OF SUCH EQUIPMENT, DEVICES, AND VEHICLES OVER A COMPUTER NETWORK AND GLOBAL COMPUTER INFORMATION NETWORK (U.S. CLS. 21, 23, 26, 36 AND 38).

**CLASS 9—(Continued).**

SN 76-224,142. DIGITAL INNOVATIONS, LLC, CHICAGO, IL. FILED 3-13-2001.

**GAMEDR**  
MOTORIZED DISC REPAIR **XMD**

NO CLAIM IS MADE TO THE EXCLUSIVE RIGHT TO USE "MOTORIZED DISC REPAIR", APART FROM THE MARK AS SHOWN.

FOR OPTICAL DIGITAL DISC ACCESSORIES, NAMELY, APPARATUS FOR CLEANING AND REMOVING SCRATCHES FROM OPTICAL DISCS (U.S. CLS. 21, 23, 26, 36 AND 38).

SN 76-227,127. AMERICAN PSYCHOLOGICAL ASSOCIATION, WASHINGTON, DC. FILED 3-20-2001.

## MONITOR ON PSYCHOLOGY

OWNER OF U.S. REG. NO. 2,475,432.  
NO CLAIM IS MADE TO THE EXCLUSIVE RIGHT TO USE "PSYCHOLOGY", APART FROM THE MARK AS SHOWN.

FOR DOWNLOADABLE ELECTRONIC JOURNAL PERIODICALLY PUBLISHED AND DISTRIBUTED TO MEMBERS AND TO OTHER PERSONS IN THE PSYCHOLOGICAL AND SOCIAL SCIENCE COMMUNITIES (U.S. CLS. 21, 23, 26, 36 AND 38).

FIRST USE 1-0-2000; IN COMMERCE 1-0-2000.

SN 76-230,589. BETATHERM CORPORATION, SHREWSBURY, MA. FILED 3-26-2001.

## BETALINK

FOR SIGNAL CONTROLLERS AND CONDITIONERS FOR USE IN TEMPERATURE SENSING AND MEASUREMENT, AND TEMPERATURE-BASED CONTROL (U.S. CLS. 21, 23, 26, 36 AND 38).

SN 76-233,770. UPD CORPORATION, KYUNGGI-DO, REPUBLIC OF KOREA, FILED 4-2-2001.

## KAVO

FOR TELEVISIONS, VIDEO MONITORS, COMPUTER MONITORS (U.S. CLS. 21, 23, 26, 36 AND 38).

**CLASS 9—(Continued).**

SN 76-236,464. HOWELL, CHARLES, HARVEY, IL. FILED 4-2-2001.

## OLANOLOGIC SYSTEMS

NO CLAIM IS MADE TO THE EXCLUSIVE RIGHT TO USE "SYSTEMS", APART FROM THE MARK AS SHOWN.  
FOR COMPUTER DATABASE MANAGEMENT SOFTWARE FOR MANAGING REAL ESTATE PROPERTIES (U.S. CLS. 21, 23, 26, 36 AND 38).

SN 76-236,799. SOKKIA COMPANY, LIMITED, TOKYO, JAPAN, FILED 4-6-2001.

## E-Z TAPE

NO CLAIM IS MADE TO THE EXCLUSIVE RIGHT TO USE "TAPE", APART FROM THE MARK AS SHOWN.

FOR MEASURING APPARATUS AND INSTRUMENTS, NAMELY, ELECTRONIC DISTANCE METER FOR SURVEYING AND INDUSTRIAL MEASUREMENT (U.S. CLS. 21, 23, 26, 36 AND 38).

SN 76-237,602. XPERT IMAGE, INC., COLLEYVILLE, TX. FILED 4-6-2001.



NO CLAIM IS MADE TO THE EXCLUSIVE RIGHT TO USE "EXPERT BILLING", APART FROM THE MARK AS SHOWN.

FOR COMPUTER BILLING SOFTWARE USED IN CONJUNCTION WITH LASER PRINTERS FOR BILLING THE NUMBER OF IMPRESSIONS PRINTED, THE TYPE AND QUANTITY OF PAPER USED, AND FINISHING OPTIONS APPLIED (U.S. CLS. 21, 23, 26, 36 AND 38).

FIRST USE 3-30-2000; IN COMMERCE 3-30-2000.

SN 76-238,166. ROBBINS INDUSTRIES, INC., FLORENCE, AL. FILED 4-10-2001.

## BAKER'S SOLUTION

NO CLAIM IS MADE TO THE EXCLUSIVE RIGHT TO USE "BAKER'S", APART FROM THE MARK AS SHOWN.

FOR ADJUSTABLE MEASURING UTENSILS, NAMELY, ADJUSTABLE MEASURING SPOONS, SCOOPS AND CUPS (U.S. CLS. 21, 23, 26, 36 AND 38).

**CLASS 9—(Continued).**

SN 76-240,065. BELNAVIS, CHERISE LYNN, CHARLOTTE, NC. FILED 4-13-2001.



THE MARK CONSISTS OF 1 BLACK, 1 YELLOW AND 1 RED HUMAN FIGURE WITH THE WORDS "JAMMIN' FOR JESUS" IN BLUE.

FOR PRE-RECORDED EXERCISE VIDEOS; COMPACT DISCS FEATURING MUSIC; CASSETTE TAPES FEATURING MUSIC OR EXERCISES (U.S. CLS. 21, 23, 26, 36 AND 38).

SN 76-241,079. GATEWAY, INC., SAN DIEGO, CA. FILED 4-16-2001.

**GATEWAY**

OWNER OF U.S. REG. NOS. 1,624,580, 2,449,701 AND OTHERS.

FOR TELEPHONES AND MOBILE TELEPHONES (U.S. CLS. 21, 23, 26, 36 AND 38).

SN 76-241,864. PROMINENTE, S.A., CORDOBA CITY, ZIP CODE 5001, ARGENTINA, FILED 4-17-2001.

**PECTRA TECHNOLOGY**

NO CLAIM IS MADE TO THE EXCLUSIVE RIGHT TO USE "TECHNOLOGY", APART FROM THE MARK AS SHOWN.

FOR COMPUTER SOFTWARE USED FOR BUSINESS PROCESSES INTEGRATION AND WORKPLACE EFFICIENCY SOLUTIONS IN THE FIELD OF BUSINESS MANAGEMENT OPERATIONS (U.S. CLS. 21, 23, 26, 36 AND 38).

FIRST USE 9-23-1999; IN COMMERCE 7-17-2000.

**CLASS 9—(Continued).**

SN 76-242,522. DIPIERRO, CHRIS, DURHAM, NC. FILED 4-18-2001.

**STAR PILOT**

FOR COMPUTER SOFTWARE FOR USE IN PLOTTING STARS, PLANETS AND DEEP SKY OBJECTS IN A STANDARD SKYMAP FORMAT IN THE FIELD OF ASTRONOMICAL OBSERVATION (U.S. CLS. 21, 23, 26, 36 AND 38).

FIRST USE 1-1-1998; IN COMMERCE 6-8-1998.

SN 76-243,949. ENVARA, INC., 44269 KFAR SABA, ISRAEL, FILED 4-20-2001.



FOR WIRELESS NETWORKING SYSTEM COMPRISED OF INTEGRATED CIRCUITS AND OPERATING SOFTWARE THEREFOR (U.S. CLS. 21, 23, 26, 36 AND 38).

SN 76-244,431. LECCO TECHNOLOGY (USA) INC., SAN FRANCISCO, CA. FILED 4-19-2001.

**LECCOTECH**

FOR SOFTWARE PROGRAMS AND TOOLS USED IN DEVELOPMENT OF COMPUTER PROGRAMS (U.S. CLS. 21, 23, 26, 36 AND 38).

SN 76-245,845. AMICO, GACTANO A. JR., SALEM, OR. FILED 4-24-2001.

**DIDS-INC.**

FOR VENDING MACHINES FOR COMMUNICATION DEVICES (U.S. CLS. 21, 23, 26, 36 AND 38).

SN 76-246,825. DALBANI CORPORATION OF AMERICA, MIAMI, FL. FILED 4-26-2001.

**ZEALOUS**

FOR SECURITY SYSTEMS COMPRISED OF VCR PLAYERS AND VIDEO MONITORS (U.S. CLS. 21, 23, 26, 36 AND 38).

FIRST USE 3-13-2001; IN COMMERCE 3-13-2001.

**CLASS 9—(Continued).**

SN 76-246,883. U.S. BANCORP LICENSING, INC., MINNEAPOLIS, MN. FILED 4-23-2001.

**PAYGENT**

FOR COMPUTER SOFTWARE FOR PROCESSING AND TRACKING FINANCIAL PAYMENTS IN THE FIELDS OF FINANCIAL SERVICES AND E-COMMERCE, AND USER MANUALS INCLUDED THEREWITH (U.S. CLS. 21, 23, 26, 36 AND 38).

SN 76-247,296. MEMSIC, INC., ANDOVER, MA. FILED 4-27-2001.

**THE FUTURE OF SENSING**

FOR SENSORS FOR DETECTING INERTIAL MOTION, ACCELERATION, GRAVITY, FORCE, VIBRATION AND VELOCITY (U.S. CLS. 21, 23, 26, 36 AND 38).

SN 76-247,315. HUNT VALVE CO. INC., SALEM, OH. FILED 4-27-2001.

**Mega-Flo**

FOR AUTOMATICALLY OPERATED METAL INDUSTRIAL VALVES (U.S. CLS. 21, 23, 26, 36 AND 38). FIRST USE 5-7-1997; IN COMMERCE 5-7-1997.

SN 76-249,174. CRANEL INCORPORATED, COLUMBUS, OH. FILED 5-1-2001.

**PARTNERING FOR SUCCESS**

FOR COMPUTER PERIPHERALS, NAMELY, DOCUMENT IMAGING SCANNERS, DOCUMENT IMAGING SOFTWARE FOR COMMERCIAL USE, COMPUTER MONITORS; KIT CONSISTING OF A LIGHT BULB, PLATEN, CLEANER, SWABS, AND PADS FOR USE WITH DOCUMENT IMAGE SCANNERS; COMPUTER DATA BACKUP DEVICES, NAMELY, STORAGE UNITS FOR MAGNETO-OPTICAL TAPE, CD, DVD, CD-R, AND DVD-R, AND LABEL PRINTERS (U.S. CLS. 21, 23, 26, 36 AND 38).

**CLASS 9—(Continued).**

SN 76-252,050. CLW COMMUNICATIONS GROUP, INC., CHATTANOOGA, TN. FILED 5-7-2001.



NO CLAIM IS MADE TO THE EXCLUSIVE RIGHT TO USE "HISS FREE", APART FROM THE MARK AS SHOWN. FOR BLANK AUDIO CASSETTES (U.S. CLS. 21, 23, 26, 36 AND 38).

SN 76-253,582. CONQUER THE JUNGLE, INC., ALPHARETTA, GA. FILED 5-7-2001.

**CONQUER THE JUNGLE, INC.**

NO CLAIM IS MADE TO THE EXCLUSIVE RIGHT TO USE "INC.", APART FROM THE MARK AS SHOWN. FOR PRERECORDED AUDIO CASSETTES FEATURING INFORMATION IN THE FIELDS OF TRUSTS, BUDGETING, FINANCIAL PLANNING STRATEGIES AND TECHNIQUES, ORGANIZING AND MAINTAINING FINANCIAL DOCUMENTS AND MANUALS SOLD THEREWITH AS A UNIT (U.S. CLS. 21, 23, 26, 36 AND 38).

SN 76-255,554. OLYMPUS OPTICAL CO., LTD., SHIBUYA-KU, TOKYO, JAPAN, FILED 5-11-2001.

**VISIONPLEX**

FOR PROJECTION SYSTEMS COMPRISED OF A COMPUTER, AN IMAGE PROCESSOR, AND MOVIE, PHOTOGRAPHIC AND SLIDE PROJECTORS; COMPUTERS, IMAGE PROCESSORS, AND MOVIE, PHOTOGRAPHIC AND SLIDE PROJECTORS (U.S. CLS. 21, 23, 26, 36 AND 38).

**CLASS 9—(Continued).**

SN 76-255,935. CIRQUE CORPORATION, SALT LAKE CITY, UT. FILED 5-11-2001.

**GLIDEPEN**

OWNER OF U.S. REG. NOS. 1,754,454 AND 1,917,722.  
FOR PEN FOR PROVIDING INPUT TO COMPUTERS, TELEVISION SET-TOP BOXES, PERSONAL DIGITAL ASSISTANTS (PDAS), AND MOBILE TELEPHONES, WHEREIN THE PEN UTILIZES PASSIVE AND ACTIVE MODES FOR ENTERING DATA (U.S. CLS. 21, 23, 26, 36 AND 38).

---

SN 76-255,937. CIRQUE CORPORATION, SALT LAKE CITY, UT. FILED 5-11-2001.

**GLIDETOUGH**

OWNER OF U.S. REG. NOS. 1,754,454 AND 1,917,722.  
FOR DATA INPUT DEVICES, NAMELY, A TOUCHPAD AND A TOUCHPAD SENSOR GRID FOR USE WITH COMPUTERS, PERSONAL DIGITAL ASSISTANTS (PDAS), AND MOBILE TELEPHONES, THE TOUCHPAD UTILIZING TOUCH-SENSITIVE SENSOR TECHNOLOGY (U.S. CLS. 21, 23, 26, 36 AND 38).

---

SN 76-256,117. CIRQUE CORPORATION, SALT LAKE CITY, UT. FILED 5-11-2001.

**GLIDSENSOR**

OWNER OF U.S. REG. NOS. 1,754,454 AND 1,917,722.  
FOR DATA INPUT DEVICES, NAMELY, A TOUCHPAD AND A TOUCHPAD SENSOR GRID FOR USE WITH COMPUTERS, PERSONAL DIGITAL ASSISTANTS (PDAS), AND MOBILE TELEPHONES, THE TOUCHPAD UTILIZING SENSOR TECHNOLOGY THAT UTILIZES PROXIMITY SENSING TO DETECT OBJECTS THROUGH MATERIALS, INCLUDING CURVED AND IRREGULAR SURFACES (U.S. CLS. 21, 23, 26, 36 AND 38).

---

SN 76-256,119. CIRQUE CORPORATION, SALT LAKE CITY, UT. FILED 5-11-2001.

**GLIDEXTEND**

OWNER OF U.S. REG. NOS. 1,754,454 AND 1,917,722.  
FOR TOUCHPAD HARDWARE, NAMELY TOUCHPADS AND TOUCHPAD SENSOR GRIDS, AND SOFTWARE THAT ENABLES A TOUCHPAD TO SELECT AN ICON, DRAG THE ICON, LIFT A FINGER TO A NEW LOCATION ON THE TOUCHPAD WITHOUT DESELECTING THE ICON, AND THEN RESUME DRAGGING THE ICON (U.S. CLS. 21, 23, 26, 36 AND 38).

**CLASS 9—(Continued).**

SN 76-257,380. BALBOA RECORDS, COMPANY, CULVER CITY, CA. FILED 5-14-2001.

**BALBOA RECORDS**

NO CLAIM IS MADE TO THE EXCLUSIVE RIGHT TO USE "RECORDS", APART FROM THE MARK AS SHOWN.  
FOR PHONOGRAPH RECORDS, CASSETTES, COMPACT DISCS AND VIDEO TAPES CONTAINING MUSIC (U.S. CLS. 21, 23, 26, 36 AND 38).  
FIRST USE 10-4-1987; IN COMMERCE 10-4-1987.

---

SN 76-257,496. CAYMAN SYSTEMS, INC., BILLERICA, MA. FILED 5-14-2001.

**CAYMAN SYSTEMS**

OWNER OF U.S. REG. NO. 1,549,946.  
NO CLAIM IS MADE TO THE EXCLUSIVE RIGHT TO USE "SYSTEMS", APART FROM THE MARK AS SHOWN.  
FOR COMPUTER HARDWARE AND SOFTWARE FOR CONTROLLING AN INTERFACE BETWEEN A SINGLE WIDE AREA NETWORK AND MULTIPLE TYPES OF LOCAL AREA NETWORKS (U.S. CLS. 21, 23, 26, 36 AND 38).

---

SN 76-258,059. BAYWATCH PRODUCTION COMPANY, THE, SANTA MONICA, CA. FILED 5-15-2001.

**BAYWATCH**

FOR SLOT MACHINES AND ELECTRONIC GAMING EQUIPMENT (U.S. CLS. 21, 23, 26, 36 AND 38).

---

SN 76-260,107. VECTOR PRODUCTS, INC., FT. LAUDERDALE, FL. FILED 5-21-2001.

**MAXX SST**

FOR POWER INVERTERS (U.S. CLS. 21, 23, 26, 36 AND 38).

**CLASS 9—(Continued).**

SN 76-260,943. CHUN LONG METAL CO., LTD., LU-CHO HSIANG, TAIWAN, FILED 5-23-2001.



FOR CABINETS FOR COMPUTER NETWORKS; PERSONAL COMPUTER CASES; INDUSTRIAL COMPUTER CASES (U.S. CLS. 21, 23, 26, 36 AND 38).  
FIRST USE 3-1-2001; IN COMMERCE 4-1-2001.

SN 76-261,465. CREATIVE LINE INC., WILMINGTON, DE. FILED 5-23-2001.



**AUDIO - ELECTRONIC  
JUKE • CHARACTERS**

NO CLAIM IS MADE TO THE EXCLUSIVE RIGHT TO USE "AUDIO-ELECTRONIC" OR "JUKE.CHARACTERS", APART FROM THE MARK AS SHOWN.

THE MARK CONSISTS OF THE WORDING "AUDIO-ELECTRONIC JUKE.CHARACTERS" AND A STYLIZED DESIGN OF AN ALIEN CHARACTER.

FOR ELECTRONIC ANIMATED FIGURE/JUKEBOX COMBINATIONS AND ELECTRONIC ANIMATED FIGURES FOR OPERATION WITH JUKEBOXES (U.S. CLS. 21, 23, 26, 36 AND 38).

SN 76-261,866. H.T.E. INC., LAKE MARY, FL. FILED 5-25-2001.

**CITYSOFT NT**

FOR COMPUTER SOFTWARE FOR USE IN THE MANAGEMENT OF MUNICIPAL GOVERNMENT SERVICES (U.S. CLS. 21, 23, 26, 36 AND 38).  
FIRST USE 4-1-2001; IN COMMERCE 4-1-2001.

**CLASS 9—(Continued).**

SN 76-261,889. VIZIONAL TECHNOLOGIES, INC., SANTA MONICA, CA. FILED 5-24-2001.

**SYNCHRONIZATION:  
BEYOND VISIBILITY TO  
VALUE**

FOR COMPUTER SOFTWARE FOR THE TRANSLATING, PROCESSING AND EXCHANGE OF LOGISTICS AND MATERIAL DISTRIBUTION INFORMATION; COMPUTER SOFTWARE FOR MANAGEMENT, ANALYSIS FORECASTING AND OPTIMIZATION OF INVENTORY OPERATIONS, NAMELY, ALLOWING FOR REAL TIME, INTERACTIVE USE AND ACCESS TO SUPPLY CHAIN INFORMATION (U.S. CLS. 21, 23, 26, 36 AND 38).

SN 76-263,133. ECHYON CO., LTD., 48-5, 2GA CHUNGMU RO CHUNG GU, SEOUL, REPUBLIC OF KOREA, FILED 5-29-2001.

**ECHYON**

FOR COMPUTER SOFTWARE FOR DOWNLOADING, ACCESSING AND CREATING ELECTRONIC BOOKS (U.S. CLS. 21, 23, 26, 36 AND 38).

SN 76-263,136. BLACK ICE SOFTWARE, INC., AMHERST, NH. FILED 5-29-2001.

**PRINT2EMAIL**

FOR COMPUTER SOFTWARE FOR USE IN ATTACHING TAGGED IMAGE FILE FORMAT FILES OR BIT-MAP FILES TO AN E-MAIL MESSAGE (U.S. CLS. 21, 23, 26, 36 AND 38).

SN 76-265,530. COLWILL, THOMAS R., DBA CONFIGURATION SYSTEMS, BERWYN, PA. FILED 6-1-2001.

**THINGKZ**

FOR COMPUTER SOFTWARE, NAMELY, DEVELOPMENT TOOL SOFTWARE FOR DESIGNING SOPHISTICATED XML AND DHTML STRUCTURES TO BUILD BETTER WEB SITES (U.S. CLS. 21, 23, 26, 36 AND 38).



**CLASS 9—(Continued).**

SN 76-266,972. AUDIO-TECHNICA U.S., INC., STOW, OH. FILED 6-5-2001.



THE MARK CONSISTS OF A STYLIZED DEPICTION OF A HUMAN FIGURE.  
FOR MICROPHONES (U.S. CLS. 21, 23, 26, 36 AND 38).



SN 76-268,413. CHILDREN'S BIBLE HOUR, GRAND RAPIDS, MI. FILED 6-7-2001.

**DOWN GILEAD LANE**

FOR PRERECORDED VIDEO RECORDINGS AND PRERECORDED AUDIO TAPES AND DISCS FEATURING RELIGIOUS MUSIC AND STORIES (U.S. CLS. 21, 23, 26, 36 AND 38).



SN 76-269,627. JAMES, JESSE, LONG BEACH, CA. FILED 6-11-2001.

**JESSE JAMES**

FOR SUNGLASSES (U.S. CLS. 21, 23, 26, 36 AND 38).  
FIRST USE 1-2-2000; IN COMMERCE 1-2-2000.

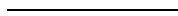

SN 76-270,674. ANTEC CORPORATION, DULUTH, GA. FILED 6-13-2001.



FOR COMPUTER HARDWARE, NAMELY, COMMUNICATIONS SYSTEMS USED IN CENTRAL OFFICE/HEADEND, PLANT, AND CUSTOMER PREMISES FOR VOICE, DATA AND VIDEO APPLICATIONS AND TRANSPORT IN THE CABLE TELEVISION, TELEPHONE AND POWER INDUSTRIES (U.S. CLS. 21, 23, 26, 36 AND 38).

**CLASS 9—(Continued).**

SN 76-271,219. GIVING DRIVE SYSTEMS, INC., NEW YORK, NY. FILED 6-13-2001.



NO CLAIM IS MADE TO THE EXCLUSIVE RIGHT TO USE "TEAMBUILDER", APART FROM THE MARK AS SHOWN.

FOR SOFTWARE, NAMELY - DOWNLOADABLE SOFTWARE FOR CREATING CAMPAIGN TEAMS FOR EMPLOYEE WORKPLACE CAMPAIGNS (U.S. CLS. 21, 23, 26, 36 AND 38).  
FIRST USE 1-1-1997; IN COMMERCE 3-23-2000.



SN 76-272,762. ANALOG DEVICES, INC., NORWOOD, MA. FILED 6-18-2001.

**TIGERSHARC**

OWNER OF U.S. REG. NOS. 2,075,083 AND 2,482,661.  
FOR SEMICONDUCTOR PROCESSORS (U.S. CLS. 21, 23, 26, 36 AND 38).  
FIRST USE 2-15-2001; IN COMMERCE 2-15-2001.

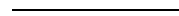

SN 76-273,068. ROLAND DGA CORPORATION, IRVINE, CA. FILED 6-18-2001.

**CUTCHOICE**

FOR COMPUTER SOFTWARE FOR OPERATING VINYL CUTTING MACHINES (U.S. CLS. 21, 23, 26, 36 AND 38).

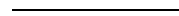

SN 76-274,991. TRIPWIRE, INC., PORTLAND, OR. FILED 6-20-2001.

**TRIPWIRE EVERYWHERE**

OWNER OF U.S. REG. NO. 2,306,881.  
FOR COMPUTER SOFTWARE FOR FILE SYSTEM SECURITY (U.S. CLS. 21, 23, 26, 36 AND 38).

**CLASS 9—(Continued).**

SN 76-276,287. ADVANCED KEYBOARD TECHNOLOGIES, INC., CHICO, CA. FILED 6-25-2001.

**K. I. WRITER**

NO CLAIM IS MADE TO THE EXCLUSIVE RIGHT TO USE "WRITER", APART FROM THE MARK AS SHOWN. FOR COMPUTER HARDWARE AND SOFTWARE FOR TEACHING STUDENTS THE ART OF TYPEWRITING (U.S. CLS. 21, 23, 26, 36 AND 38).

SN 76-276,557. NEARFIELD ACOUSTICS INC., NASHVILLE, TN. FILED 6-26-2001.

**PIPELINERS**

FOR ELECTRICAL CABLE (U.S. CLS. 21, 23, 26, 36 AND 38).

SN 76-279,152. ARCSOFT, INC., FREMONT, CA. FILED 6-27-2001.

**ARCSOFT SHOWBIZ**

OWNER OF U.S. REG. NOS. 2,334,476 AND 2,334,477. FOR COMPUTER SOFTWARE FOR CREATING, EDITING, PLAYING AND TRANSMITTING DIGITAL VIDEOS AND MOVIES (U.S. CLS. 21, 23, 26, 36 AND 38). FIRST USE 6-25-2001; IN COMMERCE 6-25-2001.

SN 76-279,348. TUNNEL RADIO OF AMERICA, INC., CORVALLIS, OR. FILED 7-2-2001.

**TUNNEL RADIO LINK**

NO CLAIM IS MADE TO THE EXCLUSIVE RIGHT TO USE "RADIO LINK", APART FROM THE MARK AS SHOWN.

FOR DISTRIBUTED ANTENNA SYSTEM, SPECIFICALLY FOR RAILROAD AND MASS TRANSIT, THAT EXTENDS TWO WAY WIRELESS DATA AND VOICE SIGNALS IN ZONES THAT ARE NORMALLY SHIELDED FROM COVERAGE BY CONVENTIONAL WIRELESS SYSTEMS (U.S. CLS. 21, 23, 26, 36 AND 38).

SN 76-279,641. AB INITIO SOFTWARE CORPORATION, LEXINGTON, MA. FILED 7-3-2001.

**APPLICATIONS DRAWN TO SCALE**

FOR COMPUTER PROGRAMS FOR DATA WAREHOUSING, BATCH PROCESSING, CLICKSTREAM PROCESSING, DATA MANAGEMENT, DATA TRANSFORMATION, AND ANALYTICS APPLICATIONS (U.S. CLS. 21, 23, 26, 36 AND 38).

**CLASS 9—(Continued).**

SN 76-279,688. STATUS GROUP INTERNATIONAL INC., TORRANCE, CA. FILED 7-2-2001.

**N-JIN**

FOR BLANK RECORDABLE CD'S, MACHINES FOR RECORDING ON CD'S, NAMELY, CD BURNERS; MP3 RECORDING AND PLAYING MACHINES (U.S. CLS. 21, 23, 26, 36 AND 38).

SN 76-279,947. AVENUES IN LEATHER, INC., TINTON FALLS, NJ. FILED 7-2-2001.

**EQUIP**

FOR PERSONAL ELECTRONICS ACCESSORIES, NAMELY, CARRYING CASES SPECIFICALLY DESIGNED FOR CELLULAR PHONES, PALMTOP COMPUTERS, LAPTOP COMPUTERS, PORTABLE AUDIO PLAYERS, PORTABLE GAME PLAYERS AND CAMERAS (U.S. CLS. 21, 23, 26, 36 AND 38).

SN 76-280,879. CHILD SMART, INC., LARCHMONT, NY. FILED 6-25-2001.

**YOUR TINY JUNGLE TOT**

FOR CHILDREN'S VIDEOTAPES, COMPACT DISCS FEATURING CHILDREN'S MUSIC, CASSETTES FEATURING CHILDREN'S MUSIC, CHILDREN'S EDUCATIONAL SOFTWARE (U.S. CLS. 21, 23, 26, 36 AND 38).

SN 76-280,880. CHILD SMART, INC., LARCHMONT, NY. FILED 6-25-2001.

**YOUR TINY MAESTRO**

FOR CHILDREN'S VIDEOTAPES, COMPACT DISCS FEATURING CHILDREN'S MUSIC, CASSETTES FEATURING CHILDREN'S MUSIC, CHILDREN'S EDUCATIONAL SOFTWARE (U.S. CLS. 21, 23, 26, 36 AND 38).

**CLASS 9—(Continued).**

SN 76-281,154. EORIGINAL, INC., BALTIMORE, MD. FILED 7-6-2001.

**PAPER OUT**

FOR COMPUTER SOFTWARE AND HARDWARE FOR THE RETRIEVAL, TRANSMISSION AND TRANSFER OF ORIGINAL ELECTRONIC AUTHENTICATED INFORMATION OBJECTS INTO PAPER OR OTHER TANGIBLE FORM; THE DESTRUCTION OF ORIGINAL ELECTRONIC AUTHENTICATED INFORMATION OBJECTS UPON COMPLETION OF THE RETRIEVAL; TRANSMISSION AND TRANSFER OF ORIGINAL ELECTRONIC AUTHENTICATED INFORMATION OBJECTS INTO PAPER OR OTHER TANGIBLE FORM; AND CERTIFYING THAT THE DESTRUCTION OF THE ORIGINAL ELECTRONIC AUTHENTICATED INFORMATION OBJECTS HAS BEEN UNDERTAKEN; ALL FOR USE IN MORTGAGE, LEASING, HEALTHCARE, SHIPPING/TRANSPORTATION AND OTHER BUSINESS APPLICATIONS (U.S. CLS. 21, 23, 26, 36 AND 38).

SN 76-283,580. ANCHOR GAMING, LAS VEGAS, NV. FILED 7-11-2001.

**CALL & COLLECT**

FOR GAME MACHINES WITH OR WITHOUT VIDEO OUTPUT AND VIDEO GAMES SOLD AS A COMPONENT PART THEREFOR (U.S. CLS. 21, 23, 26, 36 AND 38).

SN 76-285,397. SIERRA VISTA TECHNOLOGY, ALBUQUERQUE, NM. FILED 7-17-2001.



THE MARK CONSISTS OF A STYLIZED ROUND GEAR SHAPE DESIGN WITH THE WORD "KIVA" IN THE CENTER.

FOR COMPUTER SOFTWARE FOR FINITE ELEMENT ANALYSIS OF MANUFACTURED PARTS SUBJECTED TO HEAT TREATMENT USED BY THE INDUSTRIAL HEAT TREATMENT INDUSTRY (U.S. CLS. 21, 23, 26, 36 AND 38).

FIRST USE 5-9-2001; IN COMMERCE 6-19-2001.

**CLASS 9—(Continued).**

SN 76-286,261. AMERITEC CORPORATION, COVINA, CA. FILED 7-16-2001.

**GOLDENMOS**

FOR COMPUTER SOFTWARE FOR TESTING TELEPHONY TESTING SYSTEMS (U.S. CLS. 21, 23, 26, 36 AND 38).

SN 76-286,498. DIGITAL INNOVATIONS, L.L.C., LINCOLNWOOD, IL. FILED 7-17-2001.

**SCRATCH DOCTOR**

OWNER OF U.S. REG. NO. 2,438,800.  
FOR OPTICAL DIGITAL DISC ACCESSORIES, NAMELY, APPARATUS FOR CLEANING AND REPAIRING OPTICAL DISCS (U.S. CLS. 21, 23, 26, 36 AND 38).

SN 76-287,978. FISHER, AMY, CHAPPAQUA, NY. FILED 7-23-2001.



FOR PRERECORDED AUDIOTAPES AND AUDIO-CASSETTES FEATURING EDUCATION IN THE FIELD OF MEDICAL RELAXATION TECHNIQUES (U.S. CLS. 21, 23, 26, 36 AND 38).

SN 76-287,979. FISHER, AMY, CHAPPAQUA, NY. FILED 7-23-2001.



FOR PRERECORDED AUDIOTAPES AND AUDIO-CASSETTES FEATURING EDUCATION IN THE FIELD OF AIRPLANE RELAXATION TECHNIQUES (U.S. CLS. 21, 23, 26, 36 AND 38).

**CLASS 9—(Continued).**

SN 76-288,831. INFINITE VENTURES, INC., PURCELLVILLE, VA. FILED 7-24-2001.

**UNINVITED**

OWNER OF U.S. REG. NO. 1,867,092.  
FOR COMPUTER GAME SOFTWARE (U.S. CLS. 21, 23,  
26, 36 AND 38).

---

SN 76-290,453. EQUILATERAL TECHNOLOGIES, INC., LEXINGTON, MA. FILED 7-25-2001.



NO CLAIM IS MADE TO THE EXCLUSIVE RIGHT TO  
USE "TECHNOLOGIES", APART FROM THE MARK AS  
SHOWN.

FOR COMPUTER SOFTWARE USED TO ENGINEER  
WIRELESS NETWORKS (U.S. CLS. 21, 23, 26, 36 AND 38).  
FIRST USE 6-20-2001; IN COMMERCE 6-20-2001.

---

SN 76-290,736. MEYERS, ROBERT, FT. LAUDERDALE, FL.  
FILED 7-25-2001.

**PULPCHAT**

FOR SOFTWARE FOR ACCESSING, AND OPERATING  
A CHAT ROOM ACCESSIBLE THROUGH A GLOBAL  
COMPUTER NETWORK (U.S. CLS. 21, 23, 26, 36  
AND 38).

---

SN 76-291,949. JOHNSON, CHAD, MCCALLA, AL. FILED 7-  
30-2001.

**TAKEHOLD RECORDS**

NO CLAIM IS MADE TO THE EXCLUSIVE RIGHT TO  
USE "RECORDS", APART FROM THE MARK AS SHOWN.  
FOR MUSICAL SOUND RECORDINGS, MUSICAL  
VIDEO RECORDINGS, DOWNLOADABLE MUSICAL  
SOUND RECORDINGS AND DOWNLOADABLE MUSICAL  
VIDEO RECORDINGS (U.S. CLS. 21, 23, 26, 36 AND  
38).

FIRST USE 10-1-1997; IN COMMERCE 6-1-1998.

**CLASS 9—(Continued).**

SN 76-292,737. EAGLE ENGINEERING OF AMERICA, INC.,  
DESTIN, FL. FILED 7-30-2001.

**DESIGN DEFINITION**

NO CLAIM IS MADE TO THE EXCLUSIVE RIGHT TO  
USE "DESIGN", APART FROM THE MARK AS SHOWN.

FOR DOWNLOADABLE SOFTWARE FOR PROVIDING  
AN INTERACTIVE ELECTRONIC IMAGE, CONTAINING  
BOTH GRAPHICAL REPRESENTATIONS AND INFORMATIONAL  
TEXT, OF AN ARTICLE OR ITEM THAT COMMUNICATES  
NECESSARY INSTRUCTIONS FOR THE PROPER MANUFACTURE  
OF THE ARTICLE OR ITEM (U.S. CLS. 21, 23, 26, 36 AND 38).

---

SN 76-294,895. ALLTRADE INC., LONG BEACH, CA. FILED  
8-4-2001.

**WIDE LOAD**

FOR TAPE MEASURES (U.S. CLS. 21, 23, 26, 36 AND  
38).

FIRST USE 9-1-2000; IN COMMERCE 9-1-2000.

---

SN 76-296,276. SIMAUTHOR, INC., BOULDER, CO. FILED 8-  
7-2001.

**FLIGHTVIZ**

FOR COMPUTER SOFTWARE CREATING GRAPHICAL  
DEPICTIONS OF FLIGHT DATA (U.S. CLS. 21, 23,  
26, 36 AND 38).

FIRST USE 1-0-1997; IN COMMERCE 1-0-1997.

---

SN 76-296,328. CALCULEX, INC., LAS CRUCES, NM. FILED  
8-7-2001.

**CALCULEX**

FOR COMPUTER HARDWARE AND SOFTWARE  
AND ELECTRO-MECHANICAL DEVICES SOLD AS A  
UNIT FOR DATA ACQUISITION, TRANSMISSION,  
PROCESSING, STORAGE, DISPLAY, AND INSTRUCTION  
MANUALS SOLD THEREWITH (U.S. CLS. 21, 23,  
26, 36 AND 38).

FIRST USE 10-10-1989; IN COMMERCE 11-27-1989.

**CLASS 9—(Continued).**

SN 76-296,379. MCDONALD, MICHAEL, SUNNYVALE, CA. FILED 8-9-2001.

**ANIMIST SOFTWARE**

NO CLAIM IS MADE TO THE EXCLUSIVE RIGHT TO USE "SOFTWARE", APART FROM THE MARK AS SHOWN. FOR COMPUTER SOFTWARE WHICH ENABLES COMMUNICATIONS AND TRANSMISSION OF DATA BETWEEN NETWORK ELECTRONIC DEVICES AND COMPUTERS AND TO CREATE WEB DESIGNS (U.S. CLS. 21, 23, 26, 36 AND 38).

---

SN 76-297,053. INNOTEK, INC., GARRETT, IN. FILED 8-8-2001.

**COMMAND SERIES**

NO CLAIM IS MADE TO THE EXCLUSIVE RIGHT TO USE "SERIES", APART FROM THE MARK AS SHOWN. FOR ELECTRICAL ANIMAL BEHAVIOR TRAINING AND CONTROL SYSTEMS, NAMELY REMOTE TRAINING SYSTEMS COMPRISED OF ELECTRICAL RADIO FREQUENCY TRANSMITTERS AND REMOTELY CONTROLLED RECEIVER COLLARS (U.S. CLS. 21, 23, 26, 36 AND 38).  
FIRST USE 1-0-1995; IN COMMERCE 1-0-1995.

---

SN 76-297,210. SOUTH VALLEY, INC., LAS VEGAS, NV. FILED 8-10-2001.

**VALUE DASH**

FOR COMPUTER SOFTWARE ENABLING COMPUTER USERS TO SEND AUTHORIZED E-MAIL TO RECIPIENTS AND ENABLING INTERACTIVE ELECTRONIC COMMUNICATION ON A PRIORITIZED BASIS WITH CONSUMER'S OR MEMBER'S COMPUTERS (U.S. CLS. 21, 23, 26, 36 AND 38).  
FIRST USE 4-12-2001; IN COMMERCE 4-12-2001.

**CLASS 9—(Continued).**

SN 76-299,919. ITALIANO, FRANK, JR., NORTH ARLINGTON, NJ. FILED 8-13-2001.



BOTTLE CAP KID

FOR TOYS AND GAMES, NAMELY, VIDEO GAME SOFTWARE, VIDEO GAME PROGRAMS, VIDEO GAME CARTRIDGES, ELECTRONIC GAME SOFTWARE, ELECTRONIC GAME PROGRAMS AND ELECTRONIC GAME CARTRIDGES (U.S. CLS. 21, 23, 26, 36 AND 38).

---

SN 76-301,171. IGT, RENO, NV. FILED 8-17-2001.

**MULTI-DENOMINATION**

NO CLAIM IS MADE TO THE EXCLUSIVE RIGHT TO USE "MULTI-DENOMINATION", APART FROM THE MARK AS SHOWN. FOR GAMING MACHINES, NAMELY, SLOT MACHINES WITH OR WITHOUT A VIDEO OUTPUT (U.S. CLS. 21, 23, 26, 36 AND 38).  
FIRST USE 1-0-2000; IN COMMERCE 1-0-2000.

---

SN 76-303,988. CASE LOGIC, INC., LONGMONT, CO. FILED 8-22-2001.

**STRONGMAN**

FOR CASES, ALBUMS AND BAGS FOR STORAGE AND TRANSPORTATION, NAMELY, CASES, ALBUMS AND BAGS FOR HAND HELD COMPUTERS, PERSONAL DIGITAL ASSISTANTS, ELECTRONIC ORGANIZERS AND PERSONAL COMMUNICATION DEVICES (U.S. CLS. 21, 23, 26, 36 AND 38).

**CLASS 9—(Continued).**

SN 76-305,270. I/O INTERCONNECT, SANTA ANA, CA. FILED 8-27-2001.

**POCKET READER**

NO CLAIM IS MADE TO THE EXCLUSIVE RIGHT TO USE "READER", APART FROM THE MARK AS SHOWN. FOR UNIVERSAL SERIAL BUS (USB) CARD READER (U.S. CLS. 21, 23, 26, 36 AND 38).

SN 76-306,056. RIVERSONG STUDIOS, LLC, YORK HARBOR, ME. FILED 8-27-2001.

**BLIND DOG RECORDS**

NO CLAIM IS MADE TO THE EXCLUSIVE RIGHT TO USE "RECORDS", APART FROM THE MARK AS SHOWN. FOR PRE-RECORDED COMPACT DISCS FEATURING MUSIC (U.S. CLS. 21, 23, 26, 36 AND 38). FIRST USE 7-30-2001; IN COMMERCE 7-30-2001.

SN 76-306,441. KRUCZYNA, ROGER, 65812 BAD SODEN, DEUTSCHLAND, FED REP GERMANY, FILED 8-30-2001.

**OPTIMEDICS**

FOR CONTACT LENSES (U.S. CLS. 21, 23, 26, 36 AND 38).

SN 76-306,750. APPLIED BEHAVIOR SYSTEMS, LLC., BOULDER, CO. FILED 8-29-2001.

**SPEECHTEACH**

FOR COMPUTER SOFTWARE, NAMELY SOFTWARE FOR TRAINING EXPRESSIVE LANGUAGE BY EVALUATING SPOKEN RESPONSES (U.S. CLS. 21, 23, 26, 36 AND 38).

SN 76-307,421. DRAEGER MEDICAL, INC., TELFORD, PA. FILED 8-30-2001.

**RESPITONE**

FOR COMPUTER SOFTWARE TO PRODUCE A SERIES OF SOUNDS IMPARTING INFORMATION ON PATIENTS UNDERGOING VENTILATION (U.S. CLS. 21, 23, 26, 36 AND 38).

**CLASS 9—(Continued).**

SN 76-308,044. TASCO WORLDWIDE, INC., MIRAMAR, FL. FILED 9-4-2001.



FOR TELESCOPE SIGHTS FOR FIREARMS, NAMELY, RIFLES (U.S. CLS. 21, 23, 26, 36 AND 38). FIRST USE 11-0-2000; IN COMMERCE 1-0-2001.

SN 76-308,614. TRUMP, IVANA, NEW YORK, NY. FILED 9-6-2001.

**IVANA TRUMP**

FOR EYEGLASSES AND SUNGLASSES, EYEGLASS AND SUNGLASS FRAMES, EYEGLASS AND SUNGLASS CHAINS, EYEGLASS AND SUNGLASS CORDS, EYEGLASS AND SUNGLASS CASES (U.S. CLS. 21, 23, 26, 36 AND 38).

SN 76-309,469. ANCHOR COIN, LAS VEGAS, NV. FILED 9-6-2001.

**SPINDAZZLE**

FOR CURRENCY AND/OR CREDIT OPERATED SLOT MACHINES, AND GAMING DEVICES, NAMELY GAMING MACHINES (U.S. CLS. 21, 23, 26, 36 AND 38).

SN 76-309,589. ANCHOR COIN, LAS VEGAS, NV. FILED 9-6-2001.

**WHEEL ESTATE**

FOR CURRENCY AND/OR CREDIT OPERATED SLOT MACHINES, AND GAMING DEVICES, NAMELY GAMING MACHINES (U.S. CLS. 21, 23, 26, 36 AND 38).

**CLASS 9—(Continued).**

SN 76-310,008. XTREMESPECTRUM, INC., VIENNA, VA.  
FILED 9-7-2001.



FOR NETWORK RADIO AND MODEM DEVICES  
CONSISTING OF CHIPS, CHIPSETS OR CORES AND  
PARTS AND FITTINGS THEREFOR (U.S. CLS. 21, 23, 26,  
36 AND 38).

SN 76-310,710. FRANKLIN ELECTRIC CO., INC., BLUFF-  
TON, IN. FILED 9-10-2001.

**QD PUMPTEC**

OWNER OF U.S. REG. NO. 1,558,784.  
FOR ELECTRONIC CONTROL FOR MONITORING  
LOAD OF SUBMERSIBLE PUMP MOTOR AND FOR  
AUTOMATICALLY TURNING MOTOR OFF (U.S. CLS.  
21, 23, 26, 36 AND 38).  
FIRST USE 4-0-1994; IN COMMERCE 4-0-1994.

SN 76-311,062. BALBOA INSTRUMENTS, INC., TUSTIN, CA.  
FILED 9-12-2001.

**FEATHER-TOUCH**

FOR CONTROL PANELS USED IN CONJUNCTION  
WITH ELECTRONIC CONTROLS FOR SWIMMING  
POOLS, SPAS, AND WHIRLPOOL BATHS (U.S. CLS. 21,  
23, 26, 36 AND 38).

SN 76-312,673. TTE, INC., LOS ANGELES, CA. FILED 9-12-  
2001.

**FILTERMAN**

FOR ELECTRONIC COMPONENTS; NAMELY, FIL-  
TERS, INDUCTORS, ATTENUATORS, TERMINATIONS,  
BALUNS, TRANSFORMERS, DIPLEXERS, MULTIPLEX-  
ERS (U.S. CLS. 21, 23, 26, 36 AND 38).  
FIRST USE 10-29-1990; IN COMMERCE 10-29-1990.

**CLASS 9—(Continued).**

SN 76-314,287. DIGITAL EXCHANGE SYSTEMS, INC.,  
TAMPA, FL. FILED 9-19-2001.

**INTELLITRADER**

FOR COMPUTER SOFTWARE, NAMELY, SOFTWARE  
THAT ANALYZES CLIENT INVENTORY AND INTER-  
ACTS WITH AN INTERNET WEB SITE THAT PROVIDES  
INFORMATION REGARDING INVENTORY OF SELL-  
ERS, AND NEEDED PRODUCTS OF BUYERS, TO  
GROCERY AND HEALTH AND BEAUTY CARE  
WHOLESALEERS (U.S. CLS. 21, 23, 26, 36 AND 38).  
FIRST USE 5-6-2001; IN COMMERCE 5-6-2001.

SN 76-314,537. DUAL-LITE INC., CHESHIRE, CT. FILED 9-  
18-2001.

**SEMPRA**

FOR ILLUMINATED EXIT SIGNS (U.S. CLS. 21, 23, 26,  
36 AND 38).

SN 76-315,690. ANCHOR GAMING, LAS VEGAS, NV. FILED  
9-21-2001.

**VANTEDGE**

FOR CENTRAL SYSTEM SOFTWARE FOR MANAGE-  
MENT OF GOVERNMENTAL ON-LINE LOTTERY AND/  
OR GOVERNMENTAL ON-LINE VIDEO WAGERING  
TERMINALS (U.S. CLS. 21, 23, 26, 36 AND 38).

SN 76-315,737. SPECTRA SYSTEMS CORP., PROVIDENCE,  
RI. FILED 9-21-2001.

**VERICAM**

FOR ELECTRONIC TERMINALS FOR READING  
SCANNABLE OPTICAL CODES (U.S. CLS. 21, 23, 26, 36  
AND 38).

**CLASS 9—(Continued).**

SN 76-317,441. ATRONIC INTERNATIONAL GMBH, LUB-  
BECKE, FED REP GERMANY, FILED 9-18-2001.



MYTHOLOGICAL HEAD  
FOR COIN OPERATED GAMING MACHINES, TOKEN  
OPERATED GAMING MACHINES, PAPER MONEY  
OPERATED GAMING MACHINES, MAGNETIC STRIP  
CARD OPERATED GAMING MACHINES, MAGNETIC  
STRIPE CARD OPERATED GAMING MACHINES,  
ELECTRONIC CIRCUIT OPERATED GAMING MA-  
CHINES (U.S. CLS. 21, 23, 26, 36 AND 38).

SN 76-317,709. CHARNIDA, INC., ORLANDO, FL. FILED 9-  
26-2001.

**HOCUS POCUS**

FOR PRERECORDED COMPUTER SOFTWARE FOR  
USE IN THE EVALUATION OF RESTAURANT PER-  
SONNEL PERFORMANCE (U.S. CLS. 21, 23, 26, 36 AND  
38).

SN 76-318,167. DAKTRONICS, INC., BROOKINGS, SD.  
FILED 9-28-2001.

**PanaView**

FOR ELECTRONIC SIGNS AND SCOREBOARDS (U.S.  
CLS. 21, 23, 26, 36 AND 38).

**CLASS 9—(Continued).**

SN 76-320,034. ABIT COMPUTER CORPORATION, TAIPEI  
HSIEN, TAIWAN, FILED 10-1-2001.

**SILURO**

FOR MOTHERBOARDS; INTEGRATED CIRCUITS;  
COMPUTER SYSTEMS, NAMELY, COMPUTER HARD-  
WARE, COMPUTER PERIPHERALS AND OPERATING  
SOFTWARE; COMPUTER SOFTWARE, NAMELY, DE-  
VICE DRIVER SOFTWARE AND UTILITY PROGRAM  
SOFTWARE FOR USE IN OPERATING COMPUTER  
PERIPHERALS; COMPUTER INTERFACE BOARDS;  
VGA CARD (U.S. CLS. 21, 23, 26, 36 AND 38).

SN 76-320,097. JCOR ENTERTAINMENT LLC, NEW YORK,  
NY. FILED 10-1-2001.

**JCOR**

FOR PRERECORDED SOUND RECORDINGS AND  
AUDIO-VISUAL RECORDINGS, NAMELY, AUDIO  
AND VIDEO CASSETTES, CARTRIDGE TAPES, COM-  
PACT DISCS, PHONOGRAPH RECORDS, CD-ROMS,  
VIDEO TAPES, DVDS, AND LASER DISCS (U.S. CLS.  
21, 23, 26, 36 AND 38).  
FIRST USE 11-0-2000; IN COMMERCE 11-0-2000.

SN 76-320,099. AEROTECH, INC., PITTSBURGH, PA. FILED  
10-1-2001.

**AEROVISION**

FOR COMPUTER PROGRAM FOR CONTROLLING  
MULTI-AXIS STAGES FOR VISION ASSISTED POSI-  
TIONING OF PARTS IN THE MANUFACTURING OR  
INSPECTING PROCESS (U.S. CLS. 21, 23, 26, 36 AND 38).

SN 76-321,921. ATMEL CORPORATION, SAN JOSE, CA.  
FILED 10-9-2001.

**TINY11**

FOR SEMICONDUCTOR INTEGRATED CIRCUITS,  
NAMELY MICROCONTROLLER CHIPS (U.S. CLS. 21,  
23, 26, 36 AND 38).



**CLASS 9—(Continued).**

SN 76-321,923. ATMEL CORPORATION, SAN JOSE, CA. FILED 10-9-2001.

**ATTINY10**

FOR SEMICONDUCTOR INTEGRATED CIRCUITS, NAMELY MICROCONTROLLER CHIPS (U.S. CLS. 21, 23, 26, 36 AND 38).

SN 76-321,959. DIOPTICS MEDICAL PRODUCTS, INC., SAN LUIS OBISPO, CA. FILED 10-9-2001.

**COCOON**

FOR SUNGLASSES (U.S. CLS. 21, 23, 26, 36 AND 38).

SN 76-324,917. BONFIGLIO, BARBARA, MOUNT ROYAL, Q.C. H3R 2A6, CANADA, FILED 10-15-2001.

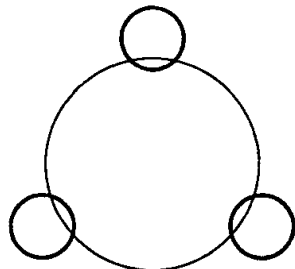

FOR SERIES OF MUSICAL SOUND RECORDINGS, PRE-RECORDED COMPACT DISCS, AUDIO CASSETTES, DIGITAL VIDEO DISCS, PHONOGRAPH RECORDS AND DIGITAL AUDIO FILES FEATURING MUSIC (U.S. CLS. 21, 23, 26, 36 AND 38).  
FIRST USE 7-0-1999; IN COMMERCE 7-0-1999.

SN 78-013,507. WITT, GERALD, ENCINO, CA. FILED 6-20-2000.

**MUSICA VIRTUAL**

NO CLAIM IS MADE TO THE EXCLUSIVE RIGHT TO USE "MUSICA", APART FROM THE MARK AS SHOWN. "MUSICA VIRTUAL" TRANSLATES INTO "VIRTUAL MUSIC".  
FOR DOWNLOADABLE ELECTRONIC PUBLICATIONS IN THE NATURE OF A MAGAZINE IN THE FIELD OF THE LATIN MUSIC INDUSTRY (U.S. CLS. 21, 23, 26, 36 AND 38).  
FIRST USE 0-0-1995; IN COMMERCE 1-1-1997.

**CLASS 9—(Continued).**

SN 78-015,032. GLOBAL EXPORTS USA, INC., DBA MICRO-POWER BATTERY COMPANY, INC., MIAMI, FL. FILED 6-30-2000.

**ATOMIC**

FOR DRY CELL BATTERIES, NAMELY, SILVER OXIDE, ALKALINE MANGANESE, LITHIUM, ZINC AIR, BUTTON AND COIN BATTERIES; ALKALINE MANGANESE, ZINC CARBON, ZINC CHLORIDE BATTERIES, RECHARGEABLE BATTERIES INCLUDING NICKEL CADMIUM, NICKEL METAL HYDRIDE AND LITHIUM ION BATTERIES; BATTERY CHARGERS (U.S. CLS. 21, 23, 26, 36 AND 38).  
FIRST USE 1-8-2001; IN COMMERCE 1-8-2001.

SN 78-018,789. BRATTON, JOHN, NASHUA, NH. FILED 7-28-2000.

**XIXIN**

THE ENGLISH TRANSLATION OF THE WORD "XIXIN" IN THE MARK IS "19 INCHES" OR "NINETEEN INCHES".  
FOR FACE-PLATES, FRONT-PANELS AND FRONT-COVERS FOR COMPUTER MODULES, NAMELY CUSTOM AND STANDARD FACE-PLATES, FRONT-PANELS AND FRONT-COVERS FOR COMPUTER MODULES (U.S. CLS. 21, 23, 26, 36 AND 38).

SN 78-019,126. WERNER B. JOERG, SALT LAKE CITY, UT. FILED 8-1-2000.

**AB-STRACT**

THE TERM IS TO INTENDED AS A MISSPELLING OF THE COMMON ENGLISH NOUN "ABSTRACT".  
FOR COMPUTER SOFTWARE FOR THE INTERACTIVE CONSTRUCTION OF KNOWLEDGE DELIVERY AND PRESENTATION ENVIRONMENTS FOR USE AS FRONT-ENDS TO CORPORATE KNOWLEDGE DATABASES, COMPLEMENTED WITH MEANS FOR SYNCHRONOUS OR ASYNCHRONOUS USER INTERACTION, FOR USE IN GLOBAL COMPUTER NETWORKS (U.S. CLS. 21, 23, 26, 36 AND 38).

SN 78-020,612. ZIONS BANCORPORATION, SALT LAKE CITY, UT. FILED 8-10-2000.

**Net Deposit**

FOR COMPUTER HARDWARE AND SOFTWARE FOR SCANNING CHECKS AND OTHER DOCUMENTS AND PROCESSING AND TRANSMITTING THE DATA SCANNED FROM THE DOCUMENTS (U.S. CLS. 21, 23, 26, 36 AND 38).

**CLASS 9—(Continued).**

SN 78-023,258. KESSELMAN, JOSHUA, PHOENIX, AZ.  
FILED 8-28-2000.

**1 SCALE**

NO CLAIM IS MADE TO THE EXCLUSIVE RIGHT TO USE "SCALE", APART FROM THE MARK AS SHOWN.  
FOR SCALES, NAMELY, SCALES FOR WEIGHING GUNPOWDER AND LETTERS (U.S. CLS. 21, 23, 26, 36 AND 38).  
FIRST USE 6-19-1999; IN COMMERCE 6-20-1999.

SN 78-024,139. YOUNG ELECTRIC SIGN COMPANY, SALT LAKE CITY, UT. FILED 9-1-2000.

**PM VIDEO**

NO CLAIM IS MADE TO THE EXCLUSIVE RIGHT TO USE "VIDEO", APART FROM THE MARK AS SHOWN.  
FOR COMPUTERIZED ELECTRICAL SIGNS (U.S. CLS. 21, 23, 26, 36 AND 38).

SN 78-025,994. HONEYCUTT, JASON, KEN, VICTORVILLE, CA. FILED 9-15-2000.

**HUMANLAB**

FOR PRE-RECORDED AUDIO TAPES FEATURING ORIGINAL MUSIC (U.S. CLS. 21, 23, 26, 36 AND 38).

SN 78-026,004. ORION ENGINEERING CORPORATION, WESTFORD, MA. FILED 9-15-2000.

**DENNIS**

FOR ARTIFICIAL INTELLIGENCE SYSTEM COMPRISING OF SOFTWARE AND COMPUTER HARDWARE TO CONTROL POWER GENERATION FROM DISTRIBUTED RESOURCES AND ENERGY STORAGE DEVICES THAT COORDINATES THE MANAGEMENT AND DISPATCH OF ELECTRIC AND OR THERMAL POWER INTO ENERGY DISTRIBUTION NETWORKS (U.S. CLS. 21, 23, 26, 36 AND 38).

SN 78-026,586. ANIDEA CORPORATION, NEW YORK, NY. FILED 9-19-2000.

**ANIDEA**

FOR COMPUTER PROGRAM USED TO ASSIST IN SALE, LICENSING, TRACKING, AND MARKETING OF INTELLECTUAL ASSETS, AND MANUALS SOLD THEREWITH (U.S. CLS. 21, 23, 26, 36 AND 38).

**CLASS 9—(Continued).**

SN 78-027,003. TONG HO HSING INDUSTRIAL CO., LTD., TAINAN SHIANN, TAIWAN, FILED 9-21-2000.

**NIKKO**

THE ENGLISH TRANSLATION OF THE JAPANESE WORD "NIKKO" IN THE MARK IS "SUNSHINE". THE TWO CHINESE CHARACTERS IN THE MARK TRANSLITERATE TO "JI GONG" AND THIS MEANS "SUNSHINE" IN ENGLISH.

FOR SAFETY HELMETS, NAMELY INDUSTRY AND CONSTRUCTION HELMETS, POLICE HELMETS, MOTORCYCLE HELMETS, CHILDREN'S HELMETS, BICYCLE HELMETS, AND SPORTS HELMETS (U.S. CLS. 21, 23, 26, 36 AND 38).

SN 78-027,366. GARESCHE, CARL E., STREETSBORO, OH. FILED 9-23-2000.

**SILENTHORN**

FOR AUTOMOBILE SAFETY EQUIPMENT, NAMELY A VEHICLE WARNING DEVICE THAT USES EMERGENCY WARNING LIGHTS TO ENHANCE VEHICLE SAFETY (U.S. CLS. 21, 23, 26, 36 AND 38).

SN 78-027,657. CONTENTGUARD HOLDINGS, INC., WILMINGTON, CT. FILED 9-26-2000.



FOR GENERAL USE COMPUTER SOFTWARE FOR INFORMATION MANAGEMENT, NAMELY FACILITATING THE ACCESS, DISTRIBUTION, STORAGE AND RETRIEVAL OF DOCUMENTS, DATA AND IMAGES OVER THE INTERNET AND ON LOCAL NETWORKS, GENERAL USE COMPUTER SOFTWARE FOR COMPUTER NETWORK MANAGEMENT (U.S. CLS. 21, 23, 26, 36 AND 38).

**CLASS 9—(Continued).**

SN 78-028,203. OPNET TECHNOLOGIES, INC., WASHINGTON, DC. FILED 9-28-2000.

**ITGURU**

FOR COMPUTER PROGRAMS FOR USE IN VISUALIZATION, MODELING, AND SIMULATION OF DATA COMMUNICATION NETWORKS AND NETWORKED APPLICATIONS FOR USE IN THE FIELDS OF INFORMATION TECHNOLOGY, TELECOMMUNICATIONS, SOFTWARE DEVELOPMENT, AND SOFTWARE TESTING AND PROGRAM MANUALS SOLD AS A UNIT (U.S. CLS. 21, 23, 26, 36 AND 38).

SN 78-030,046. WILDERNESS INSPIRATIONS, ANCHORAGE, AK. FILED 10-10-2000.

**THE READ, NAME, COLOR, FRAME SERIES**

NO CLAIM IS MADE TO THE EXCLUSIVE RIGHT TO USE "SERIES", APART FROM THE MARK AS SHOWN.

FOR DOWNLOADABLE ELECTRONIC PUBLICATIONS IN THE NATURE OF CHILDREN'S BOOKS (U.S. CLS. 21, 23, 26, 36 AND 38).

SN 78-030,425. CHEMBOURSE.COM, INC., PARSIPPANY, NJ. FILED 10-12-2000.

**SMARTCHEM SYSTEMS**

NO CLAIM IS MADE TO THE EXCLUSIVE RIGHT TO USE "SYSTEMS", APART FROM THE MARK AS SHOWN.

FOR SOFTWARE FOR PROVIDING AN INTERACTIVE AND CUSTOMIZABLE EXPERT SYSTEM THAT SEEKS TO RECONSTRUCT THE DIALOGUE AND QUESTIONS/ANSWERS COMMON IN CHEMICAL TRADING TO ASSIST IN THE IDENTIFICATION OF CHEMICALS FOR TRADING ON A GLOBAL INFORMATION NETWORK (U.S. CLS. 21, 23, 26, 36 AND 38).

SN 78-030,615. LIBERTY GLOVE, INC., IRWINDALE, CA. FILED 10-13-2000.

**DURAGRIP**

FOR PROTECTIVE GLOVES AND APPAREL MADE OF RUBBER, LATEX, POLYURETHANE, VINYL, POLYVINYL CHLORIDE, NEOPRENE, NITRILE, NYLON, POLYESTER AND/OR COTTON FOR INDUSTRIAL USE (U.S. CLS. 21, 23, 26, 36 AND 38).

**CLASS 9—(Continued).**

SN 78-031,348. CABALI, INC., CAMBRIDGE, MA. FILED 10-19-2000.

**OUTERWARE**

FOR COMPUTER SOFTWARE MODULES FOR NETWORK SYSTEM INTEGRATION OF MULTIPLE ENTERPRISE SOFTWARE APPLICATIONS USED WITHIN ONE ENTERPRISE OR ACROSS ENTERPRISES (U.S. CLS. 21, 23, 26, 36 AND 38).

SN 78-031,566. 800-TAX REFUND, INC., CLEVELAND, OH. FILED 10-20-2000.

**POCKETTAX**

FOR DOWNLOADABLE COMPUTER SOFTWARE FOR INCOME TAX PREPARATION AND ELECTRONIC FILING OF TAXES (U.S. CLS. 21, 23, 26, 36 AND 38).

SN 78-032,927. DIGITAL SCOUT LIMITED PARTNERSHIP, COLUMBUS, OH. FILED 10-30-2000.

**DIGITAL STATWARE**

NO CLAIM IS MADE TO THE EXCLUSIVE RIGHT TO USE "DIGITAL", APART FROM THE MARK AS SHOWN.

FOR COMPUTER PROGRAMS FOR HAND-HELD COMPUTERS FOR RECORDING, REPORTING AND UPLOADING STATISTICAL SPORTS DATA (U.S. CLS. 21, 23, 26, 36 AND 38).

SN 78-033,114. O'DONNELL, ROBERT, EDWARD, WOODSTOCK, GA. FILED 10-31-2000.

**BACKUP EXTREME**

NO CLAIM IS MADE TO THE EXCLUSIVE RIGHT TO USE "BACKUP", APART FROM THE MARK AS SHOWN.

FOR COMPUTER SOFTWARE FOR BACKUP PURPOSES (U.S. CLS. 21, 23, 26, 36 AND 38).

SN 78-034,463. GERSTNER, ELI L., BROOKLYN, NY. FILED 11-9-2000.

**THE CHEVRA**

FOR PRE-RECORDED COMPACT DISCS, AUDIO CASSETTES AND VIDEO CASSETTES FEATURING MUSIC (U.S. CLS. 21, 23, 26, 36 AND 38).

**CLASS 9—(Continued).**

SN 78-034,544. TOCCO, DOUGLAS M., WASHINGTON TOWNSHIP, MI. FILED 11-9-2000.



FOR PRERECORDED ENTERTAINMENT VIDEOTAPES AND MOTION PICTURE FILMS IN THE FIELD OF CHILDREN AND FAMILY EDUCATIONAL ENTERTAINMENT (U.S. CLS. 21, 23, 26, 36 AND 38).

SN 78-034,632. IDERA CORPORATION, HOUSTON, TX. FILED 11-9-2000.

**IDERA**

FOR COMPUTER SOFTWARE AND PROGRAMS FOR MANAGING DATA SOURCES, DATABASES, AND DATA COMMUNICATION NAMELY PROVIDING FUNCTIONS FOR DATABASE DEVELOPMENT, DATA MANAGEMENT, DATA INTEGRATION, MIGRATION AND CONVERSION FROM ONE DATABASE TO ANOTHER, AND FOR COLLABORATION AND DATA SHARING ON NETWORKED SYSTEMS; COMPUTER SOFTWARE IS USED INTERACTIVELY BY INFORMATION TECHNOLOGY DEVELOPERS AS WELL AS IN SCHEDULED PROCESSES RUN IN A PRODUCTION ENVIRONMENT (U.S. CLS. 21, 23, 26, 36 AND 38).  
FIRST USE 11-9-2000; IN COMMERCE 11-9-2000.

SN 78-034,724. POLARIS INDUSTRIES INC., MEDINA, MN. FILED 11-10-2000.

**SCRAMBLER 400**

FOR COMPUTER GAME CARTRIDGES (U.S. CLS. 21, 23, 26, 36 AND 38).

SN 78-035,014. INDIGO INVESTMENT SYSTEMS, INC., SARASOTA, FL. FILED 11-13-2000.

**INDIGO 2001**

FOR COMPUTER SOFTWARE FOR INVESTMENT AND STOCK DECISION MAKING, COMPUTER SOFTWARE FOR USE IN THE MANAGEMENT OF INVESTMENT PORTFOLIOS (U.S. CLS. 21, 23, 26, 36 AND 38).

**CLASS 9—(Continued).**

SN 78-038,212. LINJAN, CORP., NAPLES, FL. FILED 12-7-2000.

**AQUA LATCH**

NO CLAIM IS MADE TO THE EXCLUSIVE RIGHT TO USE "AQUA", APART FROM THE MARK AS SHOWN.

FOR ELECTRONIC DEVICES AND SENSORS FOR DETECTING WATER, WATER LEAKS, AND WATER DAMAGE; A MONITORING SYSTEM COMPRISED OF A SENSOR, REPEATER, CONTROLLER, RECEIVER, DIALER, VALVE, COMPUTER SOFTWARE AND PARTS THEREOF, ALL SOLD AS A UNIT FOR DETECTING WATER, WATER LEAKS, AND WATER DAMAGE (U.S. CLS. 21, 23, 26, 36 AND 38).

FIRST USE 8-19-2000; IN COMMERCE 8-19-2000.

SN 78-038,498. MACHOLDA, PAVEL, WEST LINN, OR. FILED 12-8-2000.

**SELFKEY**

FOR COMPUTER SOFTWARE FOR CONTACT INFORMATION MANAGEMENT OF STREET AND WEBSITE ADDRESSES, TELEPHONE, BEEPER AND PAGER NUMBERS, E-MAIL ADDRESSES, AND THE LIKE (U.S. CLS. 21, 23, 26, 36 AND 38).

FIRST USE 2-1-1999; IN COMMERCE 10-19-2000.

SN 78-039,520. DALLAIRE, JACQUES, CONCORD, NJ. BY ASSIGNMENT HUMAN PERFORMANCE INTERNATIONAL, INC., HUNTERSVILLE, NC. FILED 12-15-2000.

**MIND SHAPER**

FOR EDUCATIONAL COMPUTER SOFTWARE FEATURING INSTRUCTION IN HOW TO ENHANCE CONCENTRATION AN PERFORMANCE AND INSTRUCTIONAL MANUALS SOLD AS A UNIT THEREWITH (U.S. CLS. 21, 23, 26, 36 AND 38).

SN 78-039,603. BENASUTTI, MICHAEL, SEAN, SHAMONG, NJ. FILED 12-17-2000.

**DEXTER EXPRESS**

FOR COMPUTER BASED KIOSK SYSTEM COMPOSED OF A CABINET, TOUCH SCREEN COMPUTER DISPLAY, AND COMPUTER, FOR USE IN MERCHANDISING PRODUCTS IN A RETAIL STORE (U.S. CLS. 21, 23, 26, 36 AND 38).

**CLASS 9—(Continued).**

SN 78-039,902. EMERGENT SYSTEMS CORPORATION, DEARBORN, MI. FILED 12-19-2000.

**K-PAC**

FOR COMPUTER PROGRAMS FOR KNOWLEDGE MANAGEMENT, NAMELY, COMPUTER PROGRAMS FOR STORING INFORMATION IN A COMPUTER DATABASE, AND FOR ACCESSING THE INFORMATION IN SAID DATABASE, VIA GLOBAL COMPUTER NETWORKS (U.S. CLS. 21, 23, 26, 36 AND 38).

SN 78-040,468. INFORM SOLUTIONS, INC., SAN DIEGO, CA. FILED 12-22-2000.

**INFORM&ENHANCE**

FOR COMPUTER SOFTWARE PROVIDING INFORMATION REGARDING MEDICAL PROCEDURES (U.S. CLS. 21, 23, 26, 36 AND 38).  
FIRST USE 3-1-1995; IN COMMERCE 3-1-1995.

SN 78-040,508. QYXIS, LLC, EVANSTON, IL. FILED 12-22-2000.

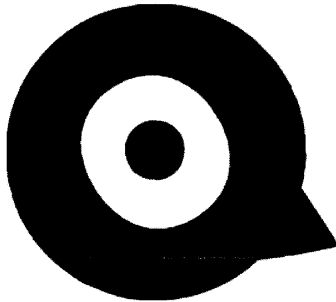

FOR SOFTWARE FOR PASSING SECURE MESSAGES BETWEEN PARTIES WHO ARE EXCHANGING CONFIDENTIAL INFORMATION AND/OR PURCHASING GOODS OR SERVICES (U.S. CLS. 21, 23, 26, 36 AND 38).

SN 78-040,805. GLEN ROAD SYSTEMS, INC., CONSHOHOCKEN, PA. FILED 12-27-2000.

**FastTrak**

FOR AUTOMATION CONTROLS SOFTWARE USED FOR THE CONTROL AND MONITORING OF INDUSTRIAL PRODUCTION AND WAREHOUSE EQUIPMENT AND FACILITIES (U.S. CLS. 21, 23, 26, 36 AND 38).  
FIRST USE 1-1-1999; IN COMMERCE 1-1-1999.

**CLASS 9—(Continued).**

SN 78-042,946. CODETIX LLC, PHILADELPHIA, PA. FILED 1-12-2001.

**ADVANTAGE3D**

FOR COMPUTER SOFTWARE TO ENHANCE THE AUDIO-VISUAL CAPABILITIES OF MULTIMEDIA APPLICATIONS, NAMELY, FOR THE INTEGRATION OF TEXT, AUDIO, GRAPHICS, STILL IMAGES AND MOVING PICTURES (U.S. CLS. 21, 23, 26, 36 AND 38).

SN 78-043,762. LABMETRIC, INC., SCOTTSDALE, AZ. FILED 1-18-2001.

**OHMSOURCE**

FOR ELECTRONIC INSTRUMENTS, NAMELY SUBSTITUTION DECADE BOXES, FOR SUPPLYING A PRECISION ELECTRICAL CHARACTERISTIC, SUCH AS RESISTANCE, CAPACITANCE, AND INDUCTANCE, FOR USE IN THE FIELD OF OR IN CONNECTION WITH ELECTRONIC CIRCUIT DESIGN AND TROUBLESHOOTING (U.S. CLS. 21, 23, 26, 36 AND 38).  
FIRST USE 4-1-2001; IN COMMERCE 4-1-2001.

SN 78-044,276. GOLDBERG, LOREN, DBA LOREN GOLD, WOODLAND HILLS, CA. FILED 1-22-2001.

**LOGORECORDS**

FOR MUSICAL SOUND RECORDINGS (U.S. CLS. 21, 23, 26, 36 AND 38).

SN 78-044,995. ANDES NETWORKS, INC., MOUNTAIN VIEW, CA. BY CHANGE OF NAME BEELINE NETWORKS, INC., MOUNTAIN VIEW, CA. FILED 1-25-2001.

**NEXT LEVEL CONFIDENCE**

FOR COMPUTER HARDWARE AND SOFTWARE FOR ENHANCING, FACILITATING, ENCRYPTING, DECRYPTING, PROCESSING, SECURING, ACCELERATING, AND MANAGING INTERNET TRANSACTIONS, TRAFFIC, AND CONTENT OVER LOCAL AND GLOBAL COMMUNICATION NETWORKS (U.S. CLS. 21, 23, 26, 36 AND 38).

SN 78-046,241. LUCENT TECHNOLOGIES INC., MURRAY HILL, NJ. FILED 2-2-2001.

**NAVIS IENGINEER**

FOR SOFTWARE FOR USE IN CONNECTION WITH THE CONFIGURATION OF TELECOMMUNICATIONS NETWORK ELEMENTS AND WITH ANALYZING TELECOMMUNICATIONS NETWORK AND TELECOMMUNICATIONS NETWORK ELEMENT PERFORMANCE (U.S. CLS. 21, 23, 26, 36 AND 38).

**CLASS 9—(Continued).**

SN 78-048,460. SAVANT SOFTWARE, LLC, CHESAPEAKE, VA. FILED 2-15-2001.

**CLOSE.NET**

FOR COMPUTER SOFTWARE FOR COMPLETING RESIDENTIAL REAL ESTATE TRANSACTIONS (U.S. CLS. 21, 23, 26, 36 AND 38).

SN 78-049,011. BARCODING.COM, INC., BALTIMORE, MD. FILED 2-19-2001.

**FIXED ASSETS IN A BOX**

NO CLAIM IS MADE TO THE EXCLUSIVE RIGHT TO USE "FIXED ASSETS", APART FROM THE MARK AS SHOWN.

FOR COMPUTER SOFTWARE AND BARCODING HARDWARE FOR FIXED ASSETS INVENTORY COUNTING (U.S. CLS. 21, 23, 26, 36 AND 38).

FIRST USE 10-3-2000; IN COMMERCE 12-5-2000.

SN 78-049,819. JAYAWEERA, SURYA, CLAREMONT, CA. FILED 2-22-2001.

**WOLFESTOCK**

OWNER OF U.S. REG. NO. 2,308,717.

FOR EMBEDDED APPLICATION PROGRAMS FOR PAGERS, PERSONAL DIGITAL ASSISTANTS, AND COMPUTERS, USED TO ENABLE USERS TO ACCESS OR INTERACT WITH INFORMATION, CONTENT, AND SERVICES FROM THE GLOBAL COMPUTER NETWORK AND LIMITED COMPUTER NETWORKS (U.S. CLS. 21, 23, 26, 36 AND 38).

FIRST USE 1-7-1997; IN COMMERCE 1-7-1997.

SN 78-050,798. TAO MUSIC, INC., REDWOOD CITY, CA. FILED 3-1-2001.



FOR PRERECORDED KARAOKE MUSIC VIDEO CDS, PLAYERS, MICROPHONES AND MUSIC VIDEO CD TITLE, AND ACCESSORIES, NAMELY HEADSETS, EARPHONES AND ELECTRONIC DANCING PADS (U.S. CLS. 21, 23, 26, 36 AND 38).

**CLASS 9—(Continued).**

SN 78-050,805. EVOLVING SYSTEMS, INC, ENGLEWOOD, CO. FILED 3-1-2001.

**OMNIPRESENCE SERVER**

NO CLAIM IS MADE TO THE EXCLUSIVE RIGHT TO USE "SERVER", APART FROM THE MARK AS SHOWN.

FOR WIRELESS TELECOMMUNICATION SERVER (U.S. CLS. 21, 23, 26, 36 AND 38).

SN 78-051,200. GAETKE, MICHAEL, JAMES, EL CAJON, CA. FILED 3-2-2001.

**MAGPROTECT**

FOR ELECTROMAGNETIC SHIELDING APPARATUS FOR ELECTRICAL TRANSFORMERS (U.S. CLS. 21, 23, 26, 36 AND 38).

SN 78-054,541. JDP CONSULTING, INC., CORAL SPRINGS, FL. FILED 3-22-2001.

**JDP-WORDSMART**

FOR COMPUTER SOFTWARE USED TO MERGE DATABASE FIELD INFORMATION AND WORD PROCESSING FEATURE INTO A COHESIVE FINISHED FORMAT DOCUMENT (U.S. CLS. 21, 23, 26, 36 AND 38).

SN 78-054,544. HERSCH AND COMPANY, LOS ANGELES, CA. FILED 3-22-2001.

**TABOO**

FOR GAMING EQUIPMENT, NAMELY, SLOT MACHINES WITH OR WITHOUT VIDEO OUTPUT (U.S. CLS. 21, 23, 26, 36 AND 38).

SN 78-054,657. ELEMENT K LLC, ROCHESTER, NY. FILED 3-23-2001.

**KNOWLEDGECOACH**

FOR COMPUTER SOFTWARE, NAMELY, INSTRUCTIONAL CD-ROMS IN THE FIELD OF COMPUTER PROFESSIONAL CERTIFICATION TRAINING (U.S. CLS. 21, 23, 26, 36 AND 38).

**CLASS 9—(Continued).**

SN 78-054,689. WINNING EDGE SYSTEMS, INC, ANN ARBOR, MI. FILED 3-23-2001.

**PLAYER POTENTIAL**

NO CLAIM IS MADE TO THE EXCLUSIVE RIGHT TO USE "PLAYER", APART FROM THE MARK AS SHOWN.

FOR COMPUTER SOFTWARE THAT ANALYZES SPORTS RELATED PLAYER PERFORMANCE DATA TO PREDICT FUTURE PERFORMANCE FOR USE IN ATHLETIC CONTESTS AND SPORTS RELATED GAMES (U.S. CLS. 21, 23, 26, 36 AND 38).

---

SN 78-055,192. DIGITAL RANCH, INC., THE, SALT LAKE CITY, UT. FILED 3-27-2001.

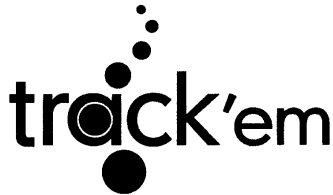

FOR COMPUTER DATABASE MANAGEMENT SOFTWARE FOR USE IN THE SCHEDULING AND MANAGEMENT OF BUSINESS RESOURCES (U.S. CLS. 21, 23, 26, 36 AND 38).

FIRST USE 3-29-2001; IN COMMERCE 6-20-2001.

---

SN 78-056,323. SYSTEMETRICS, INC., CAMBRIDGE, MA. FILED 4-2-2001.

**PAGEMATE**

FOR COMPUTER SOFTWARE USED TO AUTOMATICALLY DELIVER MESSAGES THROUGH A VARIETY OF ELECTRONIC MEDIA, DEVICES AND TECHNOLOGIES, INCLUDING PAGERS, TELEPHONES AND TELEPHONE COMMUNICATIONS DEVICES, VIDEO DISPLAY, FACSIMILE, AND SYNTHESIZED, RECORDED OR COMPUTER-GENERATED SPEECH (U.S. CLS. 21, 23, 26, 36 AND 38).

FIRST USE 10-23-1992; IN COMMERCE 12-4-1992.

**CLASS 9—(Continued).**

SN 78-057,137. SYBASE, INC., EMERYVILLE, CA. FILED 4-6-2001.

**EVERYTHING WORKS  
BETTER WHEN  
EVERYTHING WORKS  
TOGETHER**

FOR COMPUTER SOFTWARE FOR APPLICATIONS DEVELOPMENT IN THE FIELDS OF ELECTRONIC COMMERCE, FINANCIAL SERVICES TRANSACTIONS AND DISTRIBUTED NETWORK COMPUTING; COMPUTER SOFTWARE FOR DATABASE DEVELOPMENT, MANAGEMENT AND MAINTENANCE; COMPUTER SOFTWARE FOR DEVELOPING AND DEPLOYING ENTERPRISE PORTALS; COMPUTER SOFTWARE FOR DELIVERING HYPERTEXT MARKUP LANGUAGE DOCUMENTS VIA COMPUTER NETWORKS; COMPUTER SOFTWARE FOR DATABASE QUERYING AND REPORTING; COMPUTER SOFTWARE FOR ACCESSING AND UPDATING MULTIPLE DATABASE SERVERS; COMPUTER PROGRAMS FOR PERFORMANCE VERIFICATION IN DATABASE MANAGEMENT; COMPUTER PROGRAMS FOR USE IN DISTRIBUTED NETWORK COMPUTING; USER MANUALS SOLD AS UNIT WITH ALL OF THE FOREGOING (U.S. CLS. 21, 23, 26, 36 AND 38).

---

SN 78-057,381. RAUE, KRISTIAN, FREIBURG BADEN-WURTEMBERG, FED REP GERMANY, FILED 4-9-2001.

**JEDOX**

FOR COMPUTER E-COMMERCE SOFTWARE TO ALLOW USERS TO PERFORM ELECTRONIC BUSINESS TRANSACTIONS VIA A GLOBAL COMPUTER NETWORK (U.S. CLS. 21, 23, 26, 36 AND 38).

---

SN 78-060,004. SEQUENCE DESIGN, INC., SANTA CLARA, CA. FILED 4-24-2001.

**PHYSICAL STUDIO**

FOR SOFTWARE USED FOR THE DESIGN OF INTEGRATED CIRCUITS (U.S. CLS. 21, 23, 26, 36 AND 38).

---

SN 78-061,284. AGFA MONOTYPE CORPORATION, ELK GROVE VILAGE, IL. FILED 5-1-2001.

**CUMBERLAND**

FOR COMPUTER SOFTWARE FOR USE IN DISPLAYING AND PRINTING DIGITAL TYPEFACE DESIGNS AND TYPOGRAPHIC ORNAMENTS (U.S. CLS. 21, 23, 26, 36 AND 38).

FIRST USE 1-31-1999; IN COMMERCE 3-6-2000.

**CLASS 9—(Continued).**

SN 78-061,929. ARTLANDIA, INC., CHAMPAIGN, IL. FILED 5-3-2001.

**SYMMETRYWORKS**

FOR COMPUTER SOFTWARE FOR GRAPHIC DESIGN, NAMELY FOR CREATING ILLUSTRATIONS, ARTWORKS, AND ARTISTIC IMAGES (U.S. CLS. 21, 23, 26, 36 AND 38).

FIRST USE 3-12-2001; IN COMMERCE 4-12-2001.

SN 78-065,888. QUIKSILVER, INC., HUNTINGTON BEACH, CA. FILED 5-25-2001.

**ISLAND SOUL**

OWNER OF U.S. REG. NO. 1,946,447.  
FOR EYEWEAR; NAMELY SUNGLASSES (U.S. CLS. 21, 23, 26, 36 AND 38).

SN 78-068,097. LUCENT TECHNOLOGIES INC., MURRAY HILL, NJ. FILED 6-8-2001.

**APX 1000**

FOR COMPUTER HARDWARE, NAMELY REMOTE ACCESS PLATFORMS IN THE FORM OF TELECOMMUNICATIONS SWITCHING EQUIPMENT DESIGNED TO PROVIDE SERVICES RELATED TO THE IDENTIFICATION, PROCESSING, SWITCHING AND TRANSPORT OF HIGH-DENSITY DATA, VOICE AND FACSIMILE CALLS AND PRINTED MATERIALS INCLUDED THEREWITH, SOLD AS A UNIT (U.S. CLS. 21, 23, 26, 36 AND 38).

SN 78-069,187. GREENWAY MEDICAL TECHNOLOGIES, INC., CARROLLTON, GA. FILED 6-14-2001.

**PRIME RESEARCH**

NO CLAIM IS MADE TO THE EXCLUSIVE RIGHT TO USE "RESEARCH", APART FROM THE MARK AS SHOWN.

FOR COMPUTER APPLICATION SOFTWARE FOR USE IN DATABASE MANAGEMENT, IN THE MEDICAL FIELD, TO AGGREGATE DATA FROM DIFFERENT PHYSICIAN PRACTICE'S COMPUTER-BASED PATIENT RECORD SYSTEMS SO THAT THE COMPILED AGGREGATE DATA CAN BE RESEARCHED BY THE PHYSICIANS AND OTHERS (U.S. CLS. 21, 23, 26, 36 AND 38).

**CLASS 9—(Continued).**

SN 78-069,667. ELLIS, JEFFREY, WOODLAND HILLS, CA. FILED 6-18-2001.

**DRUMBEAT**

FOR COMPUTER SOFTWARE FOR USE IN FACILITATING COMMUNICATION BETWEEN USERS VIA FILE EXCHANGE AND FOR USE IN SEARCHING FOR AND DOWNLOADING FILES FROM THE GLOBAL COMPUTER NETWORK (U.S. CLS. 21, 23, 26, 36 AND 38).

SN 78-070,069. PLAYBOY ENTERPRISES INTERNATIONAL, INC., CHICAGO, IL. FILED 6-20-2001.

**PLAYBOY**

OWNER OF U.S. REG. NO. 2,193,907.  
FOR CELLULAR TELEPHONES; CELLULAR TELEPHONE ACCESSORIES; NAMELY CELL PHONE FACEPLATES AND COVERS (U.S. CLS. 21, 23, 26, 36 AND 38).

SN 78-070,782. GENERAL ELECTRIC COMPANY, SCHENECTADY, NY. FILED 6-25-2001.

**CLARUS**

THE ENGLISH TRANSLATION OF THE LATIN WORD "CLARUS" IN THE MARK IS "CLEAR", "BRIGHT", "DISTINCT".

FOR LIGHT EMITTING DIODES AND LIGHTING PRODUCTS AND LIGHTING SYSTEMS, NAMELY LIGHT EMITTING DIODE UNITS, AND POWER SUPPLIES AND PARTS THEREFOR (U.S. CLS. 21, 23, 26, 36 AND 38).

SN 78-071,679. TEXACO INC., WHITE PLAINS, NY. FILED 6-29-2001.

**TEXACO**

OWNER OF U.S. REG. NOS. 57,902, 1,209,440 AND OTHERS.  
FOR BATTERIES (U.S. CLS. 21, 23, 26, 36 AND 38).

SN 78-073,783. MONADNOCK IMAGE SOFTWARE, INC., PETERBOROUGH, NH. FILED 7-13-2001.

**PICDEX**

FOR COMPUTER SOFTWARE DESIGNED TO ASSIST IN IMAGE ORGANIZATION AND EDITING (U.S. CLS. 21, 23, 26, 36 AND 38).

FIRST USE 7-1-2001; IN COMMERCE 7-6-2001.



**CLASS 9—(Continued).**

SN 78-074,319. K & S TRADING INC., HACKENSACK, NJ. FILED 7-17-2001.

**SEGYE**

FOR STEAM IRON FOR DRY CLEANERS (U.S. CLS. 21, 23, 26, 36 AND 38).  
FIRST USE 7-1-2001; IN COMMERCE 7-1-2001.

SN 78-076,220. KOHN, JOEL M, SAN FRANCISCO, CA. FILED 7-27-2001.

**MY GENERATION**

FOR ELECTRIC POWER GENERATION AND STORAGE EQUIPMENT FOR HOME OR OFFICE, NAMELY, SOLAR PHOTOVOLTAIC MODULES, MICRO-WIND-MILLS, CHARGE CONTROLLERS, STORAGE BATTERIES, DC/AC INVERTERS, AND RECEPTACLE OUTLETS FOR AC OR DC ELECTRIC POWER LOADS (U.S. CLS. 21, 23, 26, 36 AND 38).

SN 78-077,712. SURFACE COMBUSTION, INC., MAUMEE, OH. FILED 8-6-2001.

**PROCESSTRAC**

FOR SUPERVISORY CONTROL SOFTWARE FOR INDUSTRIAL HEAT TREAT FURNACES (U.S. CLS. 21, 23, 26, 36 AND 38).  
FIRST USE 7-11-2001; IN COMMERCE 7-11-2001.

SN 78-077,820. KBA CONSULTING GROUP, THE, MELBOURNE, VICTORIA, AUSTRALIA, FILED 8-6-2001.

**MFV**

OWNER OF AUSTRALIA REG. NO. 848885, DATED 7-13-2001, EXPIRES 9-4-2010.  
FOR SOFTWARE SUITE THAT PERFORMS FINANCIAL AND STRATEGIC ANALYSIS AND REPORTING IN SUPPORT OF BUSINESS PLANNING AND PERFORMANCE MANAGEMENT PROCESSES (U.S. CLS. 21, 23, 26, 36 AND 38).  
FIRST USE 9-0-1994; IN COMMERCE 9-0-1994.

SN 78-077,936. LOCKHEED MARTIN GLOBAL TELECOMMUNICATIONS, INC., BETHESDA, MD. FILED 8-7-2001.

**SATCENTER**

FOR SOFTWARE FOR THE PLANNING, MANAGEMENT AND OPERATION OF SATELLITE-BASED COMMUNICATIONS NETWORKS, CONTAINING THE CAPABILITY TO INTEGRATE OTHER SOFTWARE TOOLS WITHIN ITSELF TO FORM A COMBINED PROGRAM FOR PERFORMING THESE FUNCTIONS (U.S. CLS. 21, 23, 26, 36 AND 38).

**CLASS 9—(Continued).**

SN 78-079,553. KUCHMAN, TODD J., HIGHLANDS RANCH, CO. FILED 8-16-2001.

**SCRATCH-LESS**

FOR OPTICAL DISCS, NAMELY, CD'S FEATURING MUSIC OR DATA AND DVD'S (U.S. CLS. 21, 23, 26, 36 AND 38).

SN 78-080,098. DUMA VIDEO, INC, PORTLAND, OR. FILED 8-20-2001.

**DUMA VIDEO**

NO CLAIM IS MADE TO THE EXCLUSIVE RIGHT TO USE "VIDEO", APART FROM THE MARK AS SHOWN.  
FOR VIDEO COMPRESSION SEMICONDUCTOR CHIPS FOR USE IN TELECOMMUNICATIONS AND VIDEO EQUIPMENT (U.S. CLS. 21, 23, 26, 36 AND 38).

SN 78-080,575. CYBERDREAMING NETWORK, INC., THE, LOS ANGELES, CA. FILED 8-22-2001.

**SWIFTSALE**

FOR COMPUTER SOFTWARE TO CONDUCT SECURE ELECTRONIC PAYMENTS USING DIGITAL SIGNATURES AND ENCRYPTION BETWEEN COMPUTERS AND NETWORK SERVERS (U.S. CLS. 21, 23, 26, 36 AND 38).

SN 78-080,718. DEL MAR SCIENTIFIC, LTD., ADDISON, TX. FILED 8-23-2001.

**CHEMFILM**

FOR LEAD ACETATE IMPREGNATED PAPER TAPE FOR USE WITH ELECTRONIC HYDROGEN SULFIDE AND TOTAL SULFUR ANALYZERS FOR USE IN THE NATURAL GAS, SPECIALTY CHEMICAL, AND BEVERAGE INDUSTRIES (U.S. CLS. 21, 23, 26, 36 AND 38).  
FIRST USE 6-4-1990; IN COMMERCE 6-4-1990.

SN 78-080,804. ASPACIA SYSTEMS INC, CHICAGO, IL. FILED 8-23-2001.

**ASPACIA**

FOR COMPUTER ACCOUNTING SOFTWARE AND COMPUTER SOFTWARE FOR USE IN DATABASE MANAGEMENT FOR USE IN THE MANUFACTURING INDUSTRY (U.S. CLS. 21, 23, 26, 36 AND 38).

**CLASS 9—(Continued).**

SN 78-081,058. MICROSOFT CORPORATION, REDMOND, WA. FILED 8-24-2001.

**FASA STUDIO**

NO CLAIM IS MADE TO THE EXCLUSIVE RIGHT TO USE "STUDIO", APART FROM THE MARK AS SHOWN.

FOR COMPUTER PROGRAMS, NAMELY, GAME SOFTWARE FOR USE ON COMPUTERS AND VIDEO GAME PLAYERS (U.S. CLS. 21, 23, 26, 36 AND 38).

---

SN 78-081,121. MBEX, INC., BRICK, NJ. FILED 8-25-2001.

**MBEX**

FOR COMPUTER SOFTWARE FOR USE IN PROVIDING MANAGEMENT BY EXCEPTION FUNCTIONS, NAMELY, RECORDING RANGES OF VALUES AND LEVELS OF IMPORTANCE FOR DATA FIELDS SPECIFIED BY A USER (KNOWN BELOW AS AN "EXCEPTION CHECK") SUCH EXCEPTION CHECKS BEING RECORDED IN A DATABASE AND REPORTING TO THE USER AND/OR A SURROGATE OR SURROGATES FOR THE USER REGARDING THE CURRENT STATUS OF THAT DATA FIELD AS IT CHANGES OVER TIME (KNOWN BELOW AS AN "EXCEPTION STATUS OF A DATA FIELD") BASED UPON COMPARISON WITH DATA IN THE EXCEPTION CHECK; EXCEPTION STATUS OF DATA FIELDS ARE AGGREGATED INTO BALANCED SCORECARDS AND HISTORIC DATA IS MAINTAINED AND REPORTED UPON AS REQUESTED BY THE USERS; SUCH SOFTWARE MAY BE DOWNLOADED FROM A GLOBAL COMPUTER NETWORK (U.S. CLS. 21, 23, 26, 36 AND 38).

FIRST USE 7-2-2001; IN COMMERCE 7-10-2001.

---

SN 78-081,234. REED, RYAN, VENICE, CA. FILED 8-27-2001.

**SPITSHINE RECORDS**

NO CLAIM IS MADE TO THE EXCLUSIVE RIGHT TO USE "RECORDS", APART FROM THE MARK AS SHOWN.

FOR MUSICAL AND THEATRICAL SOUND AND VIDEO RECORDINGS, PRE-RECORDED AUDIO AND VIDEO MAGNETIC MEDIA, NAMELY, AUDIO TAPES AND VIDEO TAPES, COMPACT DISCS, LASER DISCS, AND PHONOGRAPH RECORDS FEATURING MUSIC (U.S. CLS. 21, 23, 26, 36 AND 38).

---

SN 78-081,521. OSTRAM HOLDINGS LIMITED, WASHINGTON, DC. FILED 8-28-2001.

**MIRSAL**

THE TERM "MIRSAL" MEANS MESSENGER OR COURIER IN THE ARABIC LANGUAGE.

FOR COMPUTER SOFTWARE FOR THE AUTOMATION OF CUSTOMS OPERATIONS, NAMELY, CLIENT SERVER APPLICATIONS THAT PROCESS MANIFESTS, CUSTOM DECLARATION, TARIFFS, REVENUE COLLECTIONS AND TRADE STATISTICS (U.S. CLS. 21, 23, 26, 36 AND 38).

**CLASS 9—(Continued).**

SN 78-082,404. AB CARL MUNTERS, SOLLENTUNA, SWEDEN, FILED 9-4-2001.

**CLIMATELINE**

FOR ELECTRONIC INDOOR ENVIRONMENTAL CONTROL UNITS (U.S. CLS. 21, 23, 26, 36 AND 38).

---

SN 78-084,171. ADCON TELEMETRY, INC., BOCA RATON, FL. FILED 9-17-2001.

**A840 TELEMETRY GATEWAY**

NO CLAIM IS MADE TO THE EXCLUSIVE RIGHT TO USE "TELEMETRY GATEWAY", APART FROM THE MARK AS SHOWN.

FOR TELEMETRY EQUIPMENT, NAMELY A CENTRAL PROCESSING UNIT AND A WIRELESS MODEM WHICH CONTROL A NETWORK OF REMOTE TELEMETRY STATIONS (U.S. CLS. 21, 23, 26, 36 AND 38).

FIRST USE 6-30-2001; IN COMMERCE 6-30-2001.

---

SN 78-084,232. ATLANTIC CONSULTANTS, INC., MADISON, CT. FILED 9-17-2001.

**INQUEST**

FOR COMPUTER PROGRAMS FOR AUTOMATING CASE MANAGEMENT IN A MEDICAL EXAMINER'S OFFICE (U.S. CLS. 21, 23, 26, 36 AND 38).

FIRST USE 6-1-1987; IN COMMERCE 6-1-1987.

---

SN 78-084,241. LIGHTSAFER, INC., SAN DIEGO, CA. FILED 9-17-2001.

**KNIGHTEYE**

FOR SECURITY LIGHTING SYSTEM FOR VEHICLES USING RADIO FREQUENCY DEVICE (U.S. CLS. 21, 23, 26, 36 AND 38).

**CLASS 9—(Continued).**

SN 78-084,717. MYREPAIRSHOP, INC., HOUSTON, TX.  
FILED 9-20-2001.



FOR COMPUTER SOFTWARE FOR USE IN BUSINESS  
MANAGEMENT OF INDEPENDENT AUTOMOTIVE  
SERVICE PROVIDERS (U.S. CLS. 21, 23, 26, 36 AND 38).  
FIRST USE 4-0-2001; IN COMMERCE 4-0-2001.

SN 78-084,869. HBE ENGINEERING, INC., THREE RIVERS,  
MI. FILED 9-21-2001.

**AQUARIAN**

FOR ELECTRONIC FLUID LEVEL DETECTORS AND  
INDICATORS (U.S. CLS. 21, 23, 26, 36 AND 38).

SN 78-084,950. BOXER LEARNING, INC., CHARLOTTE-  
VILLE, VA. FILED 9-21-2001.

**BOXERMATH**

OWNER OF U.S. REG. NO. 2,251,451.  
FOR COMPUTER SOFTWARE, NAMELY EDUCA-  
TIONAL SOFTWARE AND TUTORIALS RELATING TO  
MATHEMATICS (U.S. CLS. 21, 23, 26, 36 AND 38).

SN 78-085,279. SAPIEN TECHNOLOGIES, INC., NAPA, CA.  
FILED 9-24-2001.

**PRIMALSCRIPT**

FOR COMPUTER SOFTWARE, NAMELY AN EDITOR  
AND A LANGUAGE-INDEPENDENT INTEGRATED  
DEVELOPMENT ENVIRONMENT FOR USE IN WRIT-  
ING AND EDITING OTHER SOFTWARE, A CODE  
DEVELOPER AND EDITOR (U.S. CLS. 21, 23, 26, 36  
AND 38).

FIRST USE 10-14-1998; IN COMMERCE 10-14-1998.

**CLASS 9—(Continued).**

SN 78-085,453. WMS GAMING INC., WAUKEGAN, IL.  
FILED 9-25-2001.

**HOT TO TROT**

FOR CURRENCY AND CREDIT OPERATED SLOT  
MACHINES AND GAMING DEVICES, NAMELY, GAM-  
ING MACHINES FOR USE IN GAMING ESTABLISH-  
MENTS (U.S. CLS. 21, 23, 26, 36 AND 38).

SN 78-085,855. AETHER SYSTEMS, INC., OWINGS MILLS,  
MD. FILED 9-27-2001.

**AETHER SMART AGENT**

NO CLAIM IS MADE TO THE EXCLUSIVE RIGHT TO  
USE "SMART AGENT", APART FROM THE MARK AS  
SHOWN.

FOR COMPUTER AND COMMUNICATIONS SOFT-  
WARE AND HARDWARE FOR USE IN RECEIVING,  
ANALYZING, AND TRANSMITTING INFORMATION  
TO AND FROM COMPUTER NETWORKS AND WIRE-  
LESS DEVICES, NAMELY HANDHELD COMPUTERS,  
PERSONAL DIGITAL ASSISTANTS, MOBILE TELE-  
PHONES, LAPTOP COMPUTERS, PAGERS (U.S. CLS.  
21, 23, 26, 36 AND 38).

SN 78-086,083. RGE, INC., DANVILLE, IN. FILED 9-28-2001.

**IPSENTRY**

FOR COMPUTER SOFTWARE FOR NETWORK COM-  
MUNICATIONS MONITORING AND MANAGEMENT  
(U.S. CLS. 21, 23, 26, 36 AND 38).  
FIRST USE 3-20-1997; IN COMMERCE 5-5-1997.

SN 78-086,141. ROSEN, DAVID J., NEW YORK, NY. FILED 9-  
28-2001.

**DON'T LEAVE ME**

FOR ELECTRONIC PROXIMITY AND TRACKING  
MONITOR FOR PROTECTION OF PERSONAL PROP-  
ERTY (U.S. CLS. 21, 23, 26, 36 AND 38).

SN 78-086,391. BANDAI AMERICA INCORPORATED, CY-  
PRESS, CA. FILED 10-1-2001.

**RUMBLE ARENA**

FOR VIDEO GAME CARTRIDGES AND DISKS; SOFT-  
WARE FOR TELEVISION GAMES; COMPUTER GAME  
PROGRAMS AND SOFTWARE; VIDEO GAME SOFT-  
WARE; PRE-RECORDED AUDIO AND VIDEO TAPES  
FEATURING ANIMATED STORIES (U.S. CLS. 21, 23, 26,  
36 AND 38).

**CLASS 9—(Continued).**

SN 78-086,543. MOBERG RESEARCH, INC., AMBLER, PA. FILED 10-2-2001.

**BRAINBALL**

FOR APPARATUS WHICH CONTROLS THE MOTION OF A BALL ON A SURFACE USING BRAIN ELECTRICAL ACTIVITY (U.S. CLS. 21, 23, 26, 36 AND 38).

**CLASS 10—MEDICAL APPARATUS**

SN 75-872,812. KI, KWANG JONG, SONGBUK-GU, SEOUL, REPUBLIC OF KOREA, FILED 12-17-1999.



NO CLAIM IS MADE TO THE EXCLUSIVE RIGHT TO USE "MEDICAL", APART FROM THE MARK AS SHOWN. THE LINING SHOWN IN THE DRAWING IS A FEATURE OF THE MARK.

THE MARK CONSISTS OF THE WORDS "VIGEN", "VIGEN MEDICAL", THE KOREAN WORDS FOR "VIGEN MEDICAL IS PROVIDED TO YOU WITH GOODS HEALTH", AND A LOGO CONSISTING OF CONCENTRIC CIRCLES, FIVE INTERSECTING CIRCLES BASED ON THE BASE OF A SEMI-TRIANGLE.

THE KOREAN WORDING IN THE MARK IS TRANSLATED AS "VIGEN MEDICAL IS PROVIDED TO YOU WITH GOOD HEALTH". THE KOREAN CHARACTERS IN THE MARK TRANSLITERATE TO "HAENG BOK KWA KEON KANG I KKOCH PI NEUN VI GEN EUI RYO KI(ZU)" AND THIS MEANS "VIGEN MEDICAL IS PROVIDED TO YOU WITH GOOD HEALTH" IN ENGLISH.

FOR MEDICAL INSTRUMENTS, NAMELY, AUDIO-METERS, STETHOSCOPES, BLOOD TESTING APPARATUS, ANESTHETIC DELIVERY APPARATUS, RADIO THERAPY APPARATUS, PHYSIOTHERAPY APPARATUS, NAMELY A MERCURY ARC LAMP, ULTRAVIOLET RAY LAMP, AND SHORT WAVE DIATHERMY UNIT, AND AN ULTRA SONIC DIAGNOSTIC APPARATUS (U.S. CLS. 26, 39 AND 44).

SN 75-938,957. BIRCH POINT MEDICAL, INC., OAKDALE, MN. FILED 3-8-2000.

**IONTO PATCH**

NO CLAIM IS MADE TO THE EXCLUSIVE RIGHT TO USE "PATCH", APART FROM THE MARK AS SHOWN.

FOR TRANSDERMAL DRUG DELIVERY PATCHES SOLD WITHOUT MEDICATION (U.S. CLS. 26, 39 AND 44).

**CLASS 10—(Continued).**

SN 76-010,046. CORTEK, INC., DEDHAM, MA. FILED 3-27-2000.

**CORTEK**

FOR SPINAL IMPLANTS AND PARTS AND FITTINGS THEREFOR (U.S. CLS. 26, 39 AND 44). FIRST USE 5-6-1998; IN COMMERCE 1-12-2000.

SN 76-022,463. FLOTEC, INC., INDIANAPOLIS, IN. FILED 4-10-2000.

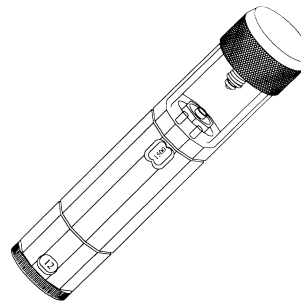

THE MARK CONSISTS OF THE CONFIGURATION OF THE GOODS, NAMELY A PRESSURE REGULATOR HAVING A DODECAGON CROSS-SECTIONAL BODY.

SEC. 2(F). FOR GAS PRESSURE REGULATORS AND COMBINATION GAS PRESSURE REGULATORS WITH FLOW METERING DEVICES FOR MEDICAL USE (U.S. CLS. 26, 39 AND 44). FIRST USE 11-0-1999; IN COMMERCE 11-0-1999.

SN 76-090,150. WITT BIOMEDICAL CORPORATION, MELBOURNE, FL. FILED 7-17-2000.

**"WITTPEDIATRICS"**

OWNER OF U.S. REG. NO. 2,023,596. FOR COMPUTER SOFTWARE SOLD ONLY AS A COMPONENT OF PHYSIOLOGICAL MONITORING SYSTEMS AND DISPLAYS BITMAPS OF PEDIATRIC CONGENITAL ANOMALIES (U.S. CLS. 26, 39 AND 44). FIRST USE 3-1-2000; IN COMMERCE 3-1-2000.

SN 76-093,719. GINGOLD, RUSSELL, UPLAND, CA. FILED 7-24-2000.

**LIBIDOLAND**

FOR ADULT SEXUAL AIDS, NAMELY, ARTIFICIAL PENISES, PENIS ENLARGERS, VIBRATORS, ARTIFICIAL VAGINAS (U.S. CLS. 26, 39 AND 44).

**CLASS 10—(Continued).**

SN 76-104,209. ATOS MEDICAL AB, S-242 22 HORBY, SWEDEN, FILED 8-7-2000.

**PROVOX**  
**ActiValve**

FOR MEDICAL, DENTAL AND VETERINARY INSTRUMENTS AND APPARATUS, NAMELY, FUMIGATORS FOR MEDICAL PURPOSES, RESPIRATORS FOR ARTIFICIAL RESPIRATION; IMPLANTABLE VOICE VENTILATORS AND VOICE PROSTHESES AND PARTS AND ACCESSORIES THEREFOR (U.S. CLS. 26, 39 AND 44).

SN 76-105,131. GENSCI REGENERATION SCIENCES, INC., MISSISSAUGA, ONTARIO, CANADA, FILED 8-8-2000.

**OrthAssist**

THE MARK IS LINED FOR COLOR. THE UPPER PORTION OF THE "O" AND "ASSIST" BEING LINED FOR PURPLE, AND THE LOWER PORTION OF THE "O" AND "RTH" BEING BLACK.

FOR SYSTEM FOR DELIVERING BONE IMPLANT MATERIAL TO THE SITE OF SURGERY, SAID SYSTEM COMPRISED OF CANNULAE, PLUNGERS AND SYRINGES FOR USE IN ORTHOPEDIC PROCEDURES (U.S. CLS. 26, 39 AND 44).  
FIRST USE 3-1-2000; IN COMMERCE 3-1-2000.

SN 76-118,352. SSL PRODUCTS LIMITED, CHESHIRE WA 16 9PD, ENGLAND, FILED 8-28-2000.

**BREVET TX**

FOR ORTHOPEDIC SUPPORTS, SUTURE NEEDLES, STOCKINETTE AND COMPRESSION STOCKINGS AND ANTI-EMBOLISM STOCKINGS (U.S. CLS. 26, 39 AND 44).

SN 76-133,008. REX MEDICAL, L.P., RADNOR, PA. FILED 9-21-2000.

**REX MEDICAL**

NO CLAIM IS MADE TO THE EXCLUSIVE RIGHT TO USE "MEDICAL", APART FROM THE MARK AS SHOWN.  
FOR HOUSEMARK FOR SURGICAL DEVICES, NAMELY VASCULAR DEVICES, BIOPSY DEVICES, MINIMALLY INVASIVE AND PERCUTANEOUS DEVICES, WOUND CLOSURE DEVICES AND SURGICAL IMPLANTS (U.S. CLS. 26, 39 AND 44).

**CLASS 10—(Continued).**

SN 76-137,365. JOHNSON & JOHNSON, NEW BRUNSWICK, NJ. FILED 9-29-2000.

**HYDROSENSE**

FOR MEDICAL DEVICE, NAMELY, HYDROCEPHALUS VALVE WITH IN-LINE TELEMETRIC SENSOR (U.S. CLS. 26, 39 AND 44).

SN 76-179,323. FOREST LABORATORIES, INC., NEW YORK, NY. FILED 12-8-2000.

**AEROSPAN**

FOR INHALERS FOR THERAPEUTIC USE SOLD EMPTY (U.S. CLS. 26, 39 AND 44).

SN 76-199,475. OTOLOGICS LLC, BOULDER, CO. FILED 1-24-2001.

**MET**

FOR HEARING AIDS (U.S. CLS. 26, 39 AND 44).

SN 76-216,762. WHITE KNIGHT HEALTHCARE, INC., ARDEN, NC. FILED 2-27-2001.

**WHITE KNIGHT**

FOR SURGICAL DRAPES (U.S. CLS. 26, 39 AND 44).  
FIRST USE 9-25-1973; IN COMMERCE 9-25-1973.

SN 76-249,404. T-DOC COMPANY, LLC, MT. LAUREL, NJ. FILED 5-1-2001.

**T-DOC**

FOR CATHETERS (U.S. CLS. 26, 39 AND 44).

**CLASS 10—(Continued).**

SN 76-251,240. PACESETTER, INC., DBA ST. JUDE MEDICAL CARDIAC RHYTHM MANAGEMENT DIVISION, SYLMAR, CA. FILED 5-1-2001.

**ST. JUDE MEDICAL**

NO CLAIM IS MADE TO THE EXCLUSIVE RIGHT TO USE "MEDICAL", APART FROM THE MARK AS SHOWN.

FOR CARDIAC PACING SYSTEMS COMPRISED OF PULSE GENERATORS AND EXTERNAL PROGRAMMERS THEREFORE; IMPLANTABLE CARDIO/DEFIBRILLATORS AND EXTERNAL PROGRAMMERS THEREFORE; CARDIAC STIMULATION LEADS FOR USE WITH CARDIAC PACING SYSTEMS, PULSE GENERATORS AND IMPLANTABLE CARDIO/DEFIBRILLATORS; AND ACCESSORIES THEREFORE (U.S. CLS. 26, 39 AND 44).

FIRST USE 4-6-2000; IN COMMERCE 4-6-2000.

SN 76-296,656. PLASTIC MEDICAL SUPPLIES, LTD., WORCESTERSHIRE, ENGLAND, FILED 8-7-2001.

**SECUREGARD**

FOR RETRACTABLE SAFETY MEDICAL SYRINGES (U.S. CLS. 26, 39 AND 44).

SN 76-307,114. C. R. BARD, MURRAY HILL, NJ. FILED 8-31-2001.

**FLUENT**

FOR IMPLANTED PUMPS FOR INTRA-SPINAL DRUG DELIVERY (U.S. CLS. 26, 39 AND 44).

SN 76-310,813. SCIMED LIFE SYSTEMS, INC., MAPLE GROVE, MN. FILED 9-7-2001.

**INFORMER**

FOR DIAGNOSTIC CARDIOVASCULAR PROBE USED ALONE OR AS A MEDICAL GUIDEWIRE (U.S. CLS. 26, 39 AND 44).

SN 76-316,503. GOLD MEDICAL TECHNOLOGIES, INC., ELMWOOD HALL, VALHALLA, NY. FILED 9-24-2001.

**MAGNEVAD**

FOR MEDICAL APPARATUS; NAMELY ARTIFICIAL HEARTS AND ARTIFICIAL LEFT VENTRICULAR ASSIST DEVICES FOR HEARTS (U.S. CLS. 26, 39 AND 44).

**CLASS 10—(Continued).**

SN 76-317,821. HELIO MEDICAL SUPPLIES, INC., SAN JOSE, CA. FILED 9-28-2001.

**MICROCLEAN**

FOR ACUPUNCTURE NEEDLES (U.S. CLS. 26, 39 AND 44).

FIRST USE 4-15-1994; IN COMMERCE 4-15-1994.

SN 76-320,769. UTI CORPORATION, COLLEGEVILLE, PA. FILED 10-3-2001.

**TRIPLEX**

FOR MEDICAL STENTS (U.S. CLS. 26, 39 AND 44).

SN 78-008,279. CALIFORNIA DENTAL SPECIALTIES, INC., BURLINGAME, CA. FILED 5-15-2000.

**MAXMESH**

FOR ORTHODONTIC APPLIANCES, NAMELY, BRACKETS AND BRACELETS FOR TEETH (U.S. CLS. 26, 39 AND 44).

SN 78-008,764. INFUSION DYNAMICS, INC., PLYMOUTH MEETING, PA. FILED 5-18-2000.

**POWER INFUSER**

NO CLAIM IS MADE TO THE EXCLUSIVE RIGHT TO USE "INFUSER", APART FROM THE MARK AS SHOWN.

FOR MEDICAL DEVICE, NAMELY, AN INFUSION PUMP FOR THE RAPID ADMINISTRATION OF INTRAVENOUS FLUIDS (U.S. CLS. 26, 39 AND 44).

FIRST USE 7-30-1999; IN COMMERCE 7-30-1999.

SN 78-008,821. SANARUS MEDICAL, INC., PLEASANTON, CA. FILED 5-18-2000.

**SMARTMARK**

FOR IMAGING MARKERS, NAMELY, PERCUTANEOUSLY IMPLANTABLE TISSUE MARKERS NOT CONTAINING COMPUTING DEVICES, FOR USE IN MEDICAL APPLICATIONS, SPECIFICALLY FOR THE DIAGNOSIS, TREATMENT, ABLATION, REMOVAL AND/OR FOLLOW-UP OF TUMORS (U.S. CLS. 26, 39 AND 44).

**CLASS 10—(Continued).**

SN 78-012,201. PYDA, SOGNY AUX MOULINS, FRANCE, FILED 6-12-2000.

**COMBICATH**

FOR CATHETERS, INTRODUCERS FOR CATHETERS, NEEDLES FOR MEDICAL USES, PROBES FOR MEDICAL USES, MEDICAL AND SURGICAL DRAINS AND DRAIN RECEPTACLES, MEDICAL AND SURGICAL VALVES, MEDICAL BIOPSY AND TISSUE SAMPLERS IN THE FORM OF CATHETERS, MEDICAL PRESSURE TRANSDUCER CUFFS, CATHETER EXTENDERS, CATHETER CONNECTORS, BLOOD FILTERS, FILTERS FOR INTRAVENOUS INFUSIONS, FILTERS FOR EPIDURAL ANAESTHESIA, ROUND ANTI-BACTERIAL FILTERS TO BE CONNECTED IN CATHETERS, UMBILICAL CORD SCISSORS, THORACIC DRAINS, SURGICAL TREPANS AND DRILLS, MEDICAL PRESSURE MANOMETERS, MULTIPOLAR ELECTRODES FOR ELECTRO PHYSIOLOGY, STOP COCKS FOR USE WITH CATHETERS (U.S. CLS. 26, 39 AND 44).

SN 78-021,732. DAGGETT, JONATHAN G., FRESNO, CA. FILED 8-17-2000.

**LUMBALIZER**

FOR MEDICAL DEVICE FOR STRETCHING, STRENGTHENING AND INCREASING RANGE OF MOTION OF THE SPINAL AREAS AND THEIR CORRESPONDING MUSCLE GROUPS TO RELIEVE LOWER BACK PAIN (U.S. CLS. 26, 39 AND 44).

SN 78-021,776. WEKNOW MARKETING, INC., RIVERSIDE, CA. FILED 8-18-2000.

***SalaryCAP***

FOR LATEX CONDOMS (U.S. CLS. 26, 39 AND 44).

SN 78-040,270. MEDICOOL, INC., TORRANCE, CA. FILED 12-21-2000.

**EXERCHIZER**

FOR LEG EXERCISE MACHINE FOR THERAPEUTIC PURPOSES (U.S. CLS. 26, 39 AND 44).  
FIRST USE 2-10-2001; IN COMMERCE 4-20-2001.

**CLASS 10—(Continued).**

SN 78-040,509. UROMETRICS, INC., ST. PAUL, MN. FILED 12-22-2000.

**UROMETRICS**

OWNER OF U.S. REG. NO. 2,111,424.  
FOR MEDICAL DEVICES FOR TREATING AROUSAL DYSFUNCTION, NAMELY, FEMALE GENITALIA SUCTION APPARATUS FOR INDUCING BLOOD FLOW IN THE FEMALE GENITALIA (U.S. CLS. 26, 39 AND 44).  
FIRST USE 12-31-1998; IN COMMERCE 2-28-1999.

SN 78-049,724. 4 AXES LTD., TAIPEI, TAIWAN, FILED 2-22-2001.

**EMEDITRON**

FOR BIPOLAR COAGULATION FORCEPS, DISPOSABLE WIRE PASS DRILLS AND CRANIO BLADES, DISPOSABLE TUNGSTEN MICRO DISSECTION NEEDLES, DISPOSABLE AND REUSABLE ELECTROSURGICAL CORDS, HAND SWITCH PENCIL, FOOT CONTROL PENCIL, ACTIVE ELECTRODES, PAD CLAMP CABLE, AND BIPOLAR DISPOSABLE CABLE FOR USE IN MEDICAL SURGERY (U.S. CLS. 26, 39 AND 44).

SN 78-052,209. REVIVANT CORPORATION, SUNNYVALE, CA. FILED 3-9-2001.



FOR MEDICAL DEVICES AND INSTRUMENTS USED FOR CHEST COMPRESSION IN CARDIAC RESUSCITATION (U.S. CLS. 26, 39 AND 44).

SN 78-078,610. NEWDEAL, VIENNE, FRANCE, FILED 8-10-2001.

**HALLU**

FOR ORTHOPEDIC ARTICLES, NAMELY ORTHOPEDIC JOINT IMPLANT, FOOTWEAR AND SOLE, ORTHOPEDIC SPLINT SUTURES, BONE SCREWS, DRILL, SCREW AND PIN FOR USE IN ORTHOPEDIC SURGICAL PROCEDURES; OSTEOSYNTHESIS PLATES (U.S. CLS. 26, 39 AND 44).

**CLASS 10—(Continued).**

SN 78-079,124. KANE ENTERPRISES, INC., BRANDON, SD.  
FILED 8-14-2001.

**SURGICRYL**

FOR VETERINARY PREPARATIONS, NAMELY ABSORBABLE SYNTHETIC SUTURES FOR USE IN PERFORMING PROCEDURES ON LIVESTOCK (U.S. CLS. 26, 39 AND 44).

FIRST USE 11-16-1999; IN COMMERCE 11-16-1999.

SN 78-080,618. MEDTRONIC INC., MINNEAPOLIS, MN.  
FILED 8-22-2001.

**DECISION CHANNEL**

FOR MEDICAL DEVICES AND INSTRUMENTS, NAMELY CATHETERS AND MEDICAL GUIDEWIRES; IMPLANTABLE DEFIBRILLATORS, CONTROLLERS, AND ELECTRONIC LEADS FOR DEFIBRILLATORS TO REGULATE, CONTROL, AND DIAGNOSE HEART RHYTHMS (U.S. CLS. 26, 39 AND 44).

SN 78-081,248. QUALITY ASPIRATORS, DUNCANVILLE, TX. FILED 8-27-2001.



NO CLAIM IS MADE TO THE EXCLUSIVE RIGHT TO USE "OPTICS", APART FROM THE MARK AS SHOWN.  
FOR SURGICAL/DENTAL MAGNIFYING LOUPES (U.S. CLS. 26, 39 AND 44).

FIRST USE 7-14-2001; IN COMMERCE 8-24-2001.

SN 78-084,402. COLTENE/WHALEDENT, INC., MAHWAH, NJ. FILED 9-18-2001.

**ALPEN**

FOR DENTAL ROTARY INSTRUMENTS WITH DIAMOND ABRASIVES (U.S. CLS. 26, 39 AND 44).

**CLASS 11—ENVIRONMENTAL CONTROL APPARATUS****CLASS 11—(Continued).**

SN 75-533,228. GLEGG WATER CONDITIONING INC.  
GUELPH, ONTARIO, CANADA, FILED 8-5-1998.

**GLEGG REFERENCE DESIGN  
2000**

NO CLAIM IS MADE TO THE EXCLUSIVE RIGHT TO USE "REFERENCE DESIGN", APART FROM THE MARK AS SHOWN.

FOR WATER PURIFICATION UNITS AND SYSTEMS CONSISTING OF CLARIFIERS, ELECTRO DEIONIZATION SYSTEMS, CONDENSATE POLISHERS, VACUUM DEGASIFICATION UNITS, ULTRA FILTRATION UNITS, ULTRAVIOLET STERILIZERS, ION EXCHANGERS, ACID AND CAUSTIC REGENERATION SYSTEMS, REVERSE OSMOSIS SYSTEMS, FORCED DRAFT DECARBONATOR UNITS, FILTERS, CHEMICAL FEED SYSTEMS AND BULK STORAGE UNITS, SOLD WITH AUTOMATIC CONTROLS AND INSTRUMENTS TO MONITOR OPERATING PARAMETERS OF THE UNITS AND SYSTEMS (U.S. CLS. 13, 21, 23, 31 AND 34).

SN 75-554,365. M&I MARSHALL & IISLEY BANK, MILWAUKEE, WI. BY ASSIGNMENT ZERO ZONE, INC., NORTH PRAIRIE, WI. FILED 9-17-1998.

**MAXIMIZER**

FOR COMMERCIAL REFRIGERATORS AND FREEZERS (U.S. CLS. 13, 21, 23, 31 AND 34).

SN 75-621,361. CONSERVATION TECHNOLOGY, LTD., NORTHBROOK, IL. FILED 1-15-1999.

**MICRO/LYTE**

SEC. 2(F).  
FOR ELECTRICAL LIGHTING FIXTURES (U.S. CLS. 13, 21, 23, 31 AND 34).  
FIRST USE 0-0-1989; IN COMMERCE 0-0-1989.

SN 75-770,680. WINDERRA CORPORATION, DANA POINT, CA. FILED 8-6-1999.

**SQUEAKLE**

FOR SHOWER HEADS (U.S. CLS. 13, 21, 23, 31 AND 34).



**CLASS 11—(Continued).**

SN 75-820,401. SYNTRIM INTERNATIONAL CORPORATION,  
TAICHUNG CITY, TAIWAN, FILED 11-2-1999.



日月星辰傳奇

OWNER OF U.S. REG. NO. 1,879,832.  
NO CLAIM IS MADE TO THE EXCLUSIVE RIGHT TO  
USE "SOLAR", APART FROM THE MARK AS SHOWN.  
THE NON-LATIN CHARACTERS IN THE MARK TRANS-  
LITERATE TO "JIH YUEH HSING CHEN CHUAN CHI"  
AND THIS MEANS "SUN, MOON, STAR AND LEGEND" IN  
ENGLISH.

FOR SOLAR-POWERED FLASHLIGHTS; FLASH-  
LIGHTS (U.S. CLS. 13, 21, 23, 31 AND 34).  
FIRST USE 7-29-1993; IN COMMERCE 9-1-1993.

SN 75-828,733. PROMARK MANAGEMENT, INC., CARY, IL.  
FILED 10-22-1999.

**PROMARK PM 2000**

NO CLAIM IS MADE TO THE EXCLUSIVE RIGHT TO  
USE "2000", APART FROM THE MARK AS SHOWN.  
FOR AIR PURIFICATION AND FILTRATION UNITS  
FOR AGRICULTURAL USE; ELECTRICAL AIR PURIFI-  
CATION AND FILTRATION UNITS FOR COMMER-  
CIAL, INDUSTRIAL AND DOMESTIC USE (U.S. CLS.  
13, 21, 23, 31 AND 34).

SN 75-868,070. JOHN MANUFACTURING LTD., KWUN  
TONG, KOWLOON, HONG KONG, FILED 12-10-1999.

**KINGSBRIGHT**

OWNER OF HONG KONG REG. NO. B03713, DATED 12-7-  
1999, EXPIRES 12-7-2006.  
FOR LIGHTING APPARATUS, NAMELY BATTERY  
OPERATED LANTERNS, LAMPS, FLASHLIGHTS,  
ELECTRONIC AND ELECTRICALLY OPERATED LAN-  
THERNS, NEON LIGHTS, FLUORESCENT LAMP TUBES,  
HALOGEN LAMPS, RECHARGEABLE LANTERNS,  
ELECTRICAL TABLE LAMPS, FLASHLIGHTS WITH  
RADIO (U.S. CLS. 13, 21, 23, 31 AND 34).

SN 76-046,507. HON TECHNOLOGY INC., MUSCATINE, IA.  
FILED 5-3-2000.

**TEMPE**

FOR TABLES CAPABLE OF HOLDING A FIREPLACE  
OR GRILL (U.S. CLS. 13, 21, 23, 31 AND 34).

**CLASS 11—(Continued).**

SN 76-049,883. AIR INTERNATIONAL TRANSIT, INC.,  
ADDISON, IL. FILED 5-15-2000.



FOR INDUSTRIAL AIR CONDITIONERS (U.S. CLS.  
13, 21, 23, 31 AND 34).  
FIRST USE 6-0-1982; IN COMMERCE 6-0-1982.

SN 76-060,335. BOTO (LICENSES) LIMITED, DOUGLAS,  
ISLE OF MAN, UNITED KINGDOM, FILED 5-31-2000.

**DRFESTIVE**

FOR ELECTRIC LIGHTS, LAMPS, LANTERNS AND  
TORCHES; ELECTRIC LIGHTS FOR CHRISTMAS  
TREES; AND ELECTRIC LIGHT BULBS (U.S. CLS. 13,  
21, 23, 31 AND 34).

SN 76-075,244. HOBBY HILL LIGHTING, INC., CHICAGO,  
IL. FILED 6-20-2000.

**HOBBY HILL**

FOR PICTURE LIGHTS USING HALOGEN AND  
INCANDESCENT LIGHT BULBS AND HALOGEN, IN-  
CANDESCENT, AND CANDELABRA LIGHT BULBS  
AND LAMPS (U.S. CLS. 13, 21, 23, 31 AND 34).  
FIRST USE 0-0-1968; IN COMMERCE 0-0-1968.

SN 76-076,868. BRON KOBOLD GMBH, 82515 WOLFRAT-  
SHAUSEN, FED REP GERMANY, FILED 6-26-2000.

**KOBOLD**

FOR LIGHTING EQUIPMENT FOR PHOTO, FILM,  
TELEVISION STUDIOS AND THEATER, NAMELY,  
SPOTLIGHTS, FLOODLIGHTS, GLOBES, LIGHT  
STANDS AND LIGHT MOUNTS (U.S. CLS. 13, 21, 23, 31  
AND 34).

**CLASS 11—(Continued).**

SN 76-091,057. INNOWAVE INCORPORATED, OMAHA, NE. FILED 7-18-2000.

**INNOWAVE 270**

OWNER OF U.S. REG. NOS. 2,095,105, 2,349,569 AND OTHERS.

NO CLAIM IS MADE TO THE EXCLUSIVE RIGHT TO USE "270", APART FROM THE MARK AS SHOWN.

FOR WATER DISTILLATION AND WATER FILTERING UNITS TO BE USED TO PURIFY WATER IN DOMESTIC AND FOREIGN HOME, COMMERCIAL AND INDUSTRIAL APPLICATIONS (U.S. CLS. 13, 21, 23, 31 AND 34).

FIRST USE 8-1-1999; IN COMMERCE 8-1-1999.

SN 76-092,107. PENTAIR POOL PRODUCTS, INC., LAGRANVILLE, NY. BY CHANGE OF NAME PAC-FAB, INC., MOOREPARK, CA. FILED 7-20-2000.



NO CLAIM IS MADE TO THE EXCLUSIVE RIGHT TO USE "AQUATIC SYSTEMS", APART FROM THE MARK AS SHOWN.

FOR FILTRATION APPARATUS AND DRIPPER IRRIGATION SYSTEM FOR WATER TREATMENT WHICH IS COMPRISED OF FILTERS, PUMPS, REGULATORS AND HEATERS SOLD IN COMBINATION FOR USE ON SWIMMING POOLS, WATERPARKS, AQUARIUMS, ZOOS CONTAINING WATER AREAS AND AQUACULTURE (U.S. CLS. 13, 21, 23, 31 AND 34).

FIRST USE 7-13-1998; IN COMMERCE 7-13-1998.

SN 76-093,746. ALBATROS, S.L., 28014 MADRID, SPAIN, FILED 7-21-2000.



PRIORITY CLAIMED UNDER SEC. 44(D) ON SPAIN APPLICATION NO. 2,288,486, FILED 2-7-2000, REG. NO. 2288486, DATED 6-20-2000, EXPIRES 6-20-2010.

FOR AIR CONDITIONERS AND HEATERS FOR TRAINS (U.S. CLS. 13, 21, 23, 31 AND 34).

**CLASS 11—(Continued).**

SN 76-102,057. SEA GULL LIGHTING PRODUCTS, INC., RIVERSIDE, NJ. BY ASSIGNMENT ENCON ELECTRIC, L.P., PHILADELPHIA, PA. FILED 8-2-2000.

**ALICANTE**

FOR CEILING FANS (U.S. CLS. 13, 21, 23, 31 AND 34).

SN 76-141,589. AQUAPURITAS CORPORATION, WALTHAM, MA. FILED 10-5-2000.

**AQUAPURITAS**

FOR WATER PURIFICATION UNITS (U.S. CLS. 13, 21, 23, 31 AND 34).

SN 76-141,822. COOPER TECHNOLOGIES COMPANY, HOUSTON, TX. FILED 10-5-2000.

**ETERNALUM**

FOR ELECTRICAL LIGHTING FIXTURES FOR OUTDOOR AREA LIGHTING OR SECURITY LIGHTING (U.S. CLS. 13, 21, 23, 31 AND 34).

SN 76-166,735. TORO COMPANY, THE, BLOOMINGTON, MN. FILED 11-16-2000.

**CLIPPERLINE**

FOR AGRICULTURAL IRRIGATION UNITS COMPRISED OF A PRE-ASSEMBLED HOSE AND RING ASSEMBLY (U.S. CLS. 13, 21, 23, 31 AND 34).

FIRST USE 10-31-2000; IN COMMERCE 10-31-2000.

SN 76-185,497. HUNTER FAN COMPANY, MEMPHIS, TN. FILED 12-21-2000.

**LA PALMA**

THE ENGLISH TRANSLATION OF THE MARK IS "THE PALM".

FOR CEILING FANS (U.S. CLS. 13, 21, 23, 31 AND 34).

**CLASS 11—(Continued).**

SN 76-185,610. MUNTERS CORPORATION, AMESBURY, MA. FILED 12-22-2000.

**DCHP**

FOR COMBINATION AIR CONDITIONING, HEATING AND DEHUMIDIFICATION UNIT (U.S. CLS. 13, 21, 23, 31 AND 34).

FIRST USE 11-1-2000; IN COMMERCE 11-1-2000.

SN 76-193,083. ACRYLINE USA INC., CLIFFWOOD, NJ. FILED 1-12-2001.

**ACRYLINE**

FOR BATHTUBS AND SHOWERS (U.S. CLS. 13, 21, 23, 31 AND 34).

FIRST USE 7-0-1997; IN COMMERCE 7-0-1997.

SN 76-201,214. HEAT RECOVERY TECHNOLOGY, INC., YORK, PA. FILED 1-29-2001.

**CLIMATEPAK**

FOR HEATING, COOLING AND DEHUMIDIFICATION UNITS DESIGNED TO HANDLE VARIABLE QUANTITIES OF OUTSIDE AIR, WHICH CAN BE MOUNTED OUTDOORS AND INDOORS, COME IN A VARIETY OF SIZES AND COMPRESSOR CAPACITIES, INCLUDE A REFRIGERANT DX AND REHEAT COIL, AND MAY BE EQUIPPED WITH A MIXING BOX, EXHAUST BLOWER AND HEAT WHEEL (U.S. CLS. 13, 21, 23, 31 AND 34).

SN 76-201,475. AERATION SYSTEMS, FALMOUTH, ME. FILED 1-29-2001.

**OXYPRO**

FOR WASTEWATER AERATION DEVICE, NAMELY AN UNDERGROUND TANK WITH AIR BLOWER USING FIXED FILM AND SUSPENDED GROWTH PROCESSES FOR SEWAGE TREATMENT (U.S. CLS. 13, 21, 23, 31 AND 34).

FIRST USE 6-0-2000; IN COMMERCE 6-0-2000.

SN 76-209,718. GENX INTERNATIONAL, INCORPORATED, GUILFORD, CT. FILED 2-14-2001.

**CODA TOWER**

FOR FILTRATION SYSTEM FOR REMOVING PARTICULATES, ENVIRONMENTAL CONTAMINATES AND VOLATILE ORGANIC COMPOUNDS FROM THE AIR STREAM OF A LABORATORY ENVIRONMENT (U.S. CLS. 13, 21, 23, 31 AND 34).

FIRST USE 1-15-1997; IN COMMERCE 1-15-1997.

**CLASS 11—(Continued).**

SN 76-212,079. NEW FARM PRODUCTS, INC., MINERAL POINT, WI. FILED 2-20-2001.

**GEOTHERM\***  
Livestock Waterer and Ice Preventer



\*No Electric - No Gas

NO CLAIM IS MADE TO THE EXCLUSIVE RIGHT TO USE "GEOTHERM LIVESTOCK WATERER AND ICE PREVENTER" AND "NO ELECTRIC - NO GAS", APART FROM THE MARK AS SHOWN.

FOR ENERGY-FREE AUTOMATIC LIVESTOCK WATERERS WHICH USE GEOTHERMAL HEAT RECOVERED FROM GROUND WATER TO REMAIN ICE-FREE (U.S. CLS. 13, 21, 23, 31 AND 34).

FIRST USE 0-0-1985; IN COMMERCE 0-0-1985.

SN 76-230,526. ARMSTRONG INTERNATIONAL, INC., STUART, FL. FILED 3-26-2001.

**FLEXI-FLO**

FOR HOT/COLD WATER MIXING VALVES AND THERMOSTATIC WATER TEMPERATURE CONTROLS (U.S. CLS. 13, 21, 23, 31 AND 34).

FIRST USE 3-8-2001; IN COMMERCE 3-8-2001.

SN 76-231,912. LORDAHL MANUFACTURING CO., BUFFALO GROVE, IL. FILED 3-7-2001.

**SLYCLOAN**

FOR PLUMBING FITTINGS, NAMELY, FLAPPERS, FLUSH VALVES, AND REPLACEMENT PARTS THEREFOR; FAUCET VALVES AND REPLACEMENT PARTS THEREFOR AND CARTRIDGES; TOILET REPLACEMENT PARTS, NAMELY, SEALS, DIAPHRAGMS, VACUUM BREAKERS, LEVERS, WASHERS, WATER SAVING DEVICES, TANKS, TANK LIDS, BAILCOCKS, AND REPLACEMENT PARTS THEREFOR, GUIDES, FLOW RESTRICTORS AND REPLACEMENT PARTS THEREFOR; FAUCET REPAIR KITS, COMPRISED OF BALLS, STEMS, CARTRIDGES, BONNETS, CAP NUTS, BIB WASHERS, INLET AND OUTLET SEALS, O-RINGS, CAP GASKETS, PACKINGS, HANDLES AND HANDLE CAPS, ESCUTCHEONS, SLEEVES, ARMS, COVERS, SPOUTS, AERATORS, FLOW HEADS INCLUDING SHOWER HEADS, SUPPLY VALVES AND LINES AND ALL PARTS RELATED THERETO, SOLD AS A UNIT (U.S. CLS. 13, 21, 23, 31 AND 34).

**CLASS 11—(Continued).**

SN 76-237,434. CR/PL, L.L.C., EVANSTON, IL. FILED 4-9-2001.

---

## PREFERRED BY PROFESSIONALS

OWNER OF U.S. REG. NOS. 1,947,765 AND 1,992,212.  
NO CLAIM IS MADE TO THE EXCLUSIVE RIGHT TO USE "PROFESSIONALS", APART FROM THE MARK AS SHOWN.

SEC. 2(F).  
FOR TOILETS, LAVATORIES, SINKS, VANITY SINKS, DRINKING FOUNTAINS, BATHTUBS, SITZ BATHS AND URINALS (U.S. CLS. 13, 21, 23, 31 AND 34).  
FIRST USE 10-0-1994; IN COMMERCE 12-0-1995.

---

SN 76-268,939. INTERNATIONAL ENVIRONMENTAL CORPORATION, OKLAHOMA CITY, OK. FILED 6-8-2001.

## UV ULTRASHIELD

NO CLAIM IS MADE TO THE EXCLUSIVE RIGHT TO USE "UV", APART FROM THE MARK AS SHOWN.

FOR AIR PURIFICATION AND ANTI-MICROBIAL UNIT FOR USE IN AIR CONDITIONING, VENTILATION AND HEATING EQUIPMENT (U.S. CLS. 13, 21, 23, 31 AND 34).

---

SN 76-269,808. HOG ISLAND, INC., DENVER, CO. FILED 6-12-2001.

## HOG ISLAND

FOR CHARCOAL GRILLS, BARBECUE GRILLS, BARBECUES, REFRIGERATED STORAGE CONTAINERS AND STORAGE CONTAINERS AND COVERS FOR ALL OF THE ABOVE, SOLD AS A UNIT (U.S. CLS. 13, 21, 23, 31 AND 34).

---

SN 76-270,581. SCHUSTER, MICHAEL J., JOLIET, IL. FILED 6-13-2001.

## HYDRO CLEAN

NO CLAIM IS MADE TO THE EXCLUSIVE RIGHT TO USE "CLEAN", APART FROM THE MARK AS SHOWN.

FOR PLUMBING FITTINGS, NAMELY, A FILL VALVE FOR TOILETS (U.S. CLS. 13, 21, 23, 31 AND 34).

**CLASS 11—(Continued).**

SN 76-276,677. PRL USA HOLDINGS, INC., WILMINGTON, DE. FILED 6-26-2001.

## RALPH LAUREN

OWNER OF U.S. REG. NOS. 1,671,467, 2,040,831 AND OTHERS.

I HEREBY CONSENT TO THE USE AND REGISTRATION OF MY NAME, "RALPH LAUREN" IN CONNECTION WITH THE ABOVE-REFERENCED TRADEMARK APPLICATION TO REGISTER THE MARK "RALPH LAUREN".

FOR LIGHTING FIXTURES, NAMELY, DESK LAMPS, FLOOR LAMPS, TABLE LAMPS, WALL FIXTURES, HURRICANE LAMPS, LAMP SHADES AND FINIALS (U.S. CLS. 13, 21, 23, 31 AND 34).

FIRST USE 9-0-2000; IN COMMERCE 9-0-2000.

---

SN 76-306,731. WAXMAN CONSUMER PRODUCTS GROUP, INC., BEDFORD HEIGHTS, OH. FILED 8-29-2001.

## BODY MOODS

FOR APPARATUS FOR WATER SUPPLY; NAMELY SHOWERHEADS AND HANDHELD SHOWER MASSAGERS (U.S. CLS. 13, 21, 23, 31 AND 34).

FIRST USE 8-12-2001; IN COMMERCE 8-12-2001.

---

SN 76-310,158. ZABEL INDUSTRIES INTERNATIONAL, LTD., CRESTWOOD, KY. FILED 9-7-2001.

## VERSA-CASE

FOR CASES MADE OF PVC (PLASTIC) FOR WASTE-WATER FILTERS (U.S. CLS. 13, 21, 23, 31 AND 34).

FIRST USE 7-27-2001; IN COMMERCE 7-27-2001.

---

SN 76-312,161. ANGELO BROTHERS COMPANY, PHILADELPHIA, PA. FILED 9-13-2001.

## EZ2FIT

FOR COMPACT FLUORESCENT LIGHT BULBS (U.S. CLS. 13, 21, 23, 31 AND 34).

---

SN 78-023,618. SUNBEAM PRODUCTS, INC., BOCA RATON, FL. FILED 8-30-2000.

## FIBERFINE

FOR WARMING PRODUCTS, NAMELY, ELECTRIC BLANKETS, THROWS, AND MATTRESS PADS NOT FOR MEDICAL USE (U.S. CLS. 13, 21, 23, 31 AND 34).

**CLASS 11—(Continued).**

SN 78-023,620. SUNBEAM PRODUCTS, INC., BOCA RATON, FL. FILED 8-30-2000.

**THERMOFINE**

FOR WARMING PRODUCTS, NAMELY, ELECTRIC BLANKETS, THROWS, AND MATTRESS PADS NOT FOR MEDICAL USE (U.S. CLS. 13, 21, 23, 31 AND 34).

SN 78-028,330. SUNBEAM PRODUCTS, INC., BOCA RATON, FL. FILED 9-29-2000.

**PEAK PERFORMANCE**

FOR BARBECUE GRILLS (U.S. CLS. 13, 21, 23, 31 AND 34).

SN 78-034,969. INTERGLOBAL WASTE MANAGEMENT, INC., CAMARILLO, CA. FILED 11-13-2000.

**BIOLOCK**

FOR ELECTRO-CHEMICAL AGRICULTURAL WASTE MANAGEMENT UNIT TO REMOVE SOLIDS FROM LIQUIDS BY ADDING VARIOUS COMBINATIONS OF CHEMICALS FROM THE METALLIC SALT AND POLYMER FAMILIES TO THE WASTE STREAM AND SUBJECTING THE WASTE STREAM TO AN ELECTRICAL CHARGE, WHICH RESULTS IN THE AGGLOMERATION OF THE SOLIDS AND PERMITS MECHANICAL REMOVAL OF THE CLUSTERS (U.S. CLS. 13, 21, 23, 31 AND 34).

SN 78-034,972. INTERGLOBAL WASTE MANAGEMENT, INC., CAMARILLO, CA. FILED 11-13-2000.

**BIOLOC**

FOR ELECTRO-CHEMICAL AGRICULTURAL WASTE MANAGEMENT UNIT TO REMOVE SOLIDS FROM LIQUIDS BY ADDING VARIOUS COMBINATIONS OF CHEMICALS FROM THE METALLIC SALT AND POLYMER FAMILIES TO THE WASTE STREAM AND SUBJECTING THE WASTE STREAM TO AN ELECTRICAL CHARGE, WHICH RESULTS IN THE AGGLOMERATION OF THE SOLIDS AND PERMITS MECHANICAL REMOVAL OF THE CLUSTERS (U.S. CLS. 13, 21, 23, 31 AND 34).

SN 78-044,838. CONAIR CORPORATION, STAMFORD, CT. FILED 1-25-2001.

**TURBO SAFARI**

OWNER OF U.S. REG. NO. 2,388,751.  
FOR HAIR DRYER (U.S. CLS. 13, 21, 23, 31 AND 34).

**CLASS 11—(Continued).**

SN 78-051,525. HOLIDAY CREATIONS, INC., LITTLETON, CO. FILED 3-6-2001.

**SHEER GLOW LIGHTS**

NO CLAIM IS MADE TO THE EXCLUSIVE RIGHT TO USE "GLOW LIGHTS", APART FROM THE MARK AS SHOWN.

FOR ELECTRIC LIGHTS FOR CHRISTMAS TREES (U.S. CLS. 13, 21, 23, 31 AND 34).

SN 78-073,759. HOMER TLC, INC., CLAYMONT, DE. FILED 7-13-2001.

**AQUADYNE**

FOR SHOWER HEADS, HAND SHOWERS AND SHOWER ACCESSORIES, NAMELY, BODY SPRAYERS, BODY SPRAYER BARS, SHOWER ARMS, SHOWER HOSES; SHOWER FITTINGS, NAMELY, SHOWER VALVES AND SHOWER VOLUME CONTROL VALVES ALL FOR USE IN THE HOME (U.S. CLS. 13, 21, 23, 31 AND 34).

SN 78-086,861. FRESH WATER SYSTEMS, INC., SAN DIEGO, CA. FILED 10-4-2001.

**BIO SCRIPT**

FOR FILTERS FOR WATER CONDITIONING UNITS, WATER COOLERS, WATER DISTILLATION UNITS, DOMESTIC AND COMMERCIAL WATER FILTERING UNITS, AND WATER PURIFICATION AND DISPENSING UNITS (U.S. CLS. 13, 21, 23, 31 AND 34).

**CLASS 12—VEHICLES**

SN 75-806,214. VERINI, NICHOLAS A., LAFAYETTE, CO. FILED 9-23-1999.

**TIRE LAST**

NO CLAIM IS MADE TO THE EXCLUSIVE RIGHT TO USE "TIRE", APART FROM THE MARK AS SHOWN.

FOR POWER-OPERATED DISPENSER FOR INFLATING TIRES WITH NITROGEN GAS (U.S. CLS. 19, 21, 23, 31, 35 AND 44).

**CLASS 12—(Continued).**

SN 75-855,846. ROHLOFF GESELLSCHAFT FUER ANTRIEBSTECHNISCHE ENTWICKLUNGEN MBH, D-3500 KASSEL, FED REP GERMANY, FILED 11-22-1999.

**ROHLOFF**

SEC. 2(F).

FOR PARTS OF MOTORCYCLES AND BICYCLES, NAMELY, GEARS, SPROCKET WHEEL CHANGE SPEED GEARS, SPROCKET WHEELS, CHAIN WHEEL RIMS AND CHAIN SHIFTERS; TIMING CHAINS FOR MOTORCYCLES; STRUCTURAL AND TRANSMISSION PARTS FOR MOTORCYCLES AND BICYCLES, NAMELY, DRIVE CHAINS, DRIVE GEARS, FREE-WHEEL HUBS, MULTIPLE SPEED HUBS AND BOTTOM BRACKET BALL BEARINGS, AND STRUCTURAL PARTS THEREFORE (U.S. CLS. 19, 21, 23, 31, 35 AND 44).  
FIRST USE 0-0-1987; IN COMMERCE 0-0-1990.

SN 75-927,544. BRAUN CORPORATION, THE, WINAMAC, IN. FILED 2-25-2000.

**BRAUNLIFT.COM**

FOR MOBILITY PRODUCTS FOR WHEELCHAIR USERS, NAMELY VEHICLE MOUNTABLE WHEELCHAIR LIFTS AND BARRIER GATES; CONVERTED VANS, BUSES AND PICKUPS, FEATURING LOWERED FLOORS, RAISED ROOFS, LIFTS, RAMPS, AUTOMATIC POWER DOORS, CHAIR TIE DOWNS AND DRIVING CONTROLS; EXTENDING POWER VEHICLE SEATS; VEHICLE TOP WHEELCHAIR CARRIERS AND STRUCTURAL PARTS THEREFOR (U.S. CLS. 19, 21, 23, 31, 35 AND 44).

SN 75-933,536. D. BEN-TOBY, INC., MIAMI, FL. FILED 3-2-2000.



NO CLAIM IS MADE TO THE EXCLUSIVE RIGHT TO USE "GEAR", APART FROM THE MARK AS SHOWN.  
FOR BABY STROLLERS, BABY CARRIAGES, CHILDREN'S CAR SEATS, NAMELY, INFANT CAR SEATS AND CHILDREN'S RESTRAINTS FOR USE IN AUTOMOBILES (U.S. CLS. 19, 21, 23, 31, 35 AND 44).

**CLASS 12—(Continued).**

SN 76-007,812. DUFFEE, TIMOTHY GEORGE, CEREDIGION SA48 8NW, UNITED KINGDOM, FILED 3-17-2000.

**DAVRIAN**

FOR LAND VEHICLES AND STRUCTURAL PARTS THEREFOR; ENGINES FOR LAND VEHICLES; ENGINES FOR AUTOMOBILES; AUTOMOBILE BODIES, AUTOMOBILE CHASSIS; AUTOMOBILE HOODS; SPORTS CARS AND STRUCTURAL PARTS THEREFOR; ENGINES FOR SPORTS CARS; WHEELS FOR AUTOMOBILES AND SPORTS CARS; WHEEL HUBS FOR AUTOMOBILES AND SPORTS CARS (U.S. CLS. 19, 21, 23, 31, 35 AND 44).

SN 76-020,751. BEST BARS LIMITED, MANUREWA, AUCKLAND, NEW ZEALAND, FILED 4-7-2000.

**EZI GRIP**

NO CLAIM IS MADE TO THE EXCLUSIVE RIGHT TO USE "EZI", APART FROM THE MARK AS SHOWN.

FOR BICYCLE RACKS USED TO TRANSPORT CYCLES ON TOP OF AND BEHIND CARS AND PARTS THEREFORE; BICYCLE RACK ACCESSORIES, NAMELY, STABILIZER STRAPS AND EXTENSION BRACKETS FOR USE ON FOUR-WHEEL DRIVE VEHICLES; BICYCLE BEAMS AND CONVERSION TUBES, NAMELY, TOP BARS ON BICYCLES WHICH EXTEND FROM THE HANDLE BARS TO THE SEAT FOR LADIES' BICYCLES, MOUNTAIN BICYCLES AND CHILDREN'S BICYCLES; AND BICYCLE FRAME PROTECTORS (U.S. CLS. 19, 21, 23, 31, 35 AND 44).

SN 76-023,434. WHEEL CONCEPTS, IND., NEWBURY PARK, CA. FILED 4-12-2000.

**WHEEL CONCEPTS**

NO CLAIM IS MADE TO THE EXCLUSIVE RIGHT TO USE "WHEEL", APART FROM THE MARK AS SHOWN.

FOR LAND VEHICLE PARTS, NAMELY, PLATED AUTOMOTIVE WHEELS (U.S. CLS. 19, 21, 23, 31, 35 AND 44).

FIRST USE 6-0-1986; IN COMMERCE 6-0-1986.

SN 76-031,051. TITAN INTERNATIONAL, INC., QUINCY, IL. FILED 4-18-2000.

**MOTOR GRADER II**

NO CLAIM IS MADE TO THE EXCLUSIVE RIGHT TO USE "GRADER", APART FROM THE MARK AS SHOWN.

FOR TIRES (U.S. CLS. 19, 21, 23, 31, 35 AND 44).

FIRST USE 1-1-1994; IN COMMERCE 1-1-1994.

**CLASS 12—(Continued).**

SN 76-044,908. TREADWAYS CORPORATION, NORTH WALES, PA. FILED 5-9-2000.

**GOLDEN FURY**

FOR TIRES (U.S. CLS. 19, 21, 23, 31, 35 AND 44).  
FIRST USE 1-0-1980; IN COMMERCE 1-0-1980.

---

SN 76-063,611. CENTRAL PURCHASING, INC., CAMARILLO, CA. FILED 5-26-2000.

**ESSEX BRASS**

NO CLAIM IS MADE TO THE EXCLUSIVE RIGHT TO USE "BRASS", APART FROM THE MARK AS SHOWN.  
FOR BRASS NOVELTY HORNS, FOR USE AS A BICYCLE OR AUTOMOBILE ACCESSORY, AS A DECORATION, OR AS A NOISE MAKING DEVICE (U.S. CLS. 19, 21, 23, 31, 35 AND 44).  
FIRST USE 3-11-2000; IN COMMERCE 3-11-2000.

---

SN 76-074,196. MUSTO LIMITED, ESSEX, ENGLAND, FILED 6-20-2000.

**MUSTO**

SEC. 2(F).  
FOR BOATS, SAILING BOATS, AND SKIFFS (U.S. CLS. 19, 21, 23, 31, 35 AND 44).

---

SN 76-081,177. FLEET WHOLESALE SUPPLY CO., INC., APPLETON, WI. FILED 6-30-2000.

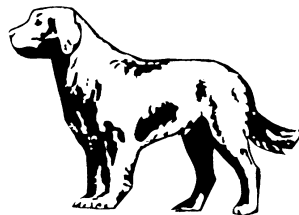

FOR TRAILERS TO BE PULLED BEHIND VEHICLES, NAMELY, TRAVEL TRAILERS, REFRIGERATED TRAILERS, CARGO TRAILERS AND CAMPING TRAILERS (U.S. CLS. 19, 21, 23, 31, 35 AND 44).  
FIRST USE 3-21-1997; IN COMMERCE 3-21-1997.

**CLASS 12—(Continued).**

SN 76-083,788. NELSON-RIGG USA, INC., SANTA ANA, CA. FILED 7-3-2000.

**FALCON DEFENDER**

FOR VEHICLE COVERS, NAMELY, FITTED AND SEMI-FITTED SOFT MOTORCYCLE COVERS (U.S. CLS. 19, 21, 23, 31, 35 AND 44).  
FIRST USE 6-0-1986; IN COMMERCE 6-0-1986.

---

SN 76-097,633. SCOTT JACOBSON, ELIAS DASILVA, AND JAMES KOSTANOS PARTNERSHIPS, THE, FOREST HILLS, NY. FILED 7-28-2000.

**T-REX**

FOR ANTI-THEFT LOCKS FOR MOTOR VEHICLES (U.S. CLS. 19, 21, 23, 31, 35 AND 44).

---

SN 76-131,997. COSCO, INC., COLUMBUS, IN. FILED 9-20-2000.

**TOSCANA**

FOR BABY STROLLERS (U.S. CLS. 19, 21, 23, 31, 35 AND 44).

---

SN 76-136,036. MURRAY, INC., BRENTWOOD, TN. FILED 9-27-2000.

**MURRAY**

OWNER OF U.S. REG. NOS. 1,055,064, 2,299,857 AND OTHERS.  
FOR MOTORIZED SCOOTERS, ELECTRIC SCOOTERS, MOTORIZED MINI BIKES, AND STRUCTURAL PARTS THEREFOR (U.S. CLS. 19, 21, 23, 31, 35 AND 44).

---

SN 76-163,412. TOYOTA JIDOSHA KABUSHIKI KAISHA, DBA TOYOTA MOTOR CORPORATION, AICHI-KEN, JAPAN, FILED 11-9-2000.

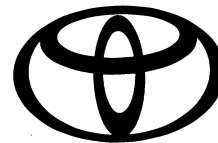

OWNER OF U.S. REG. NOS. 1,797,716 AND 1,895,321.  
FOR AUTOMOBILE AIRBAG SYSTEMS COMPRISING THE AIRBAG COVER, AIRBAG AND INFLATER (U.S. CLS. 19, 21, 23, 31, 35 AND 44).  
FIRST USE 9-0-1992; IN COMMERCE 9-0-1992.

**CLASS 12—(Continued).**

SN 76-177,105. MICHELIN NORTH AMERICA, INC., GREENVILLE, SC. FILED 12-7-2000.

**TWEEL**

FOR INTEGRAL TIRE AND WHEEL (U.S. CLS. 19, 21, 23, 31, 35 AND 44).

SN 76-177,550. JACOVELLI, MATTHEW GEORGE, CEDAR-BROOK, NJ. FILED 12-7-2000.

**WHEEL MATE**

NO CLAIM IS MADE TO THE EXCLUSIVE RIGHT TO USE "WHEEL", APART FROM THE MARK AS SHOWN. FOR TRAY THAT MAY BE ATTACHED TO THE STEERING WHEEL OF A MOTOR VEHICLE; IT CAN SERVE TO HOLD FOOD, BEVERAGE, READING, WRITING AND LAPTOP COMPUTER (U.S. CLS. 19, 21, 23, 31, 35 AND 44).

SN 76-180,796. BCATCO ARL, ST. HELLIER, JERSEY JE 3JW, CHANNEL ISLANDS, FILED 12-14-2000.

**SKID MAULER**

FOR TIRES (U.S. CLS. 19, 21, 23, 31, 35 AND 44).

SN 76-217,556. SCRANTON MANUFACTURING COMPANY INC., SCRANTON, IA. FILED 2-28-2001.

**MAMMOTH**

FOR REFUSE TRUCKS (U.S. CLS. 19, 21, 23, 31, 35 AND 44).  
FIRST USE 6-30-2000; IN COMMERCE 6-30-2000.

SN 76-217,557. SCRANTON MANUFACTURING COMPANY INC., SCRANTON, IA. FILED 2-28-2001.

**HB**

FOR REFUSE TRUCKS (U.S. CLS. 19, 21, 23, 31, 35 AND 44).  
FIRST USE 4-12-1996; IN COMMERCE 4-12-1996.

**CLASS 12—(Continued).**

SN 76-225,444. WEEKEND WARRIOR TRAILERS, INC., PERRIS, CA. FILED 3-16-2001.

**WEEKEND WARRIOR**

FOR TRAVEL TRAILERS, RAMP TRAILERS, NAMELY, CARGO TRAILERS WITH PULL OUT RAMP THAT ARE USED FOR LOADING AND UNLOADING CARGO, AND FIFTH-WHEEL TRAILERS (U.S. CLS. 19, 21, 23, 31, 35 AND 44).  
FIRST USE 4-20-1988; IN COMMERCE 5-10-1988.

SN 76-233,102. MKT, INC., CHAGRIN FALLS, OH. FILED 3-30-2001.

**X-CALIBER**

FOR PARTS FOR TRUCKS, NAMELY, HOODSHIELDS (U.S. CLS. 19, 21, 23, 31, 35 AND 44).  
FIRST USE 8-31-2000; IN COMMERCE 8-31-2000.

SN 76-269,851. LEWIS, WILLIAM K., DRIFTWOOD, TX. FILED 6-11-2001.

**QUATTRO ASSI**

THE ENGLISH TRANSLATION OF "QUATTRO ASSI" IS "FOUR ACES".  
FOR BICYCLE FRAMES AND BICYCLE PARTS, NAMELY, FORKS AND SEATPOSTS (U.S. CLS. 19, 21, 23, 31, 35 AND 44).  
FIRST USE 6-0-1988; IN COMMERCE 9-0-1988.

SN 76-270,222. ACCUFAST INC., WINNIPEG, MB R3J 3X4, CANADA, FILED 6-12-2001.

**GOVAN +**

FOR WHEELCHAIRS (U.S. CLS. 19, 21, 23, 31, 35 AND 44).



**CLASS 12—(Continued).**

SN 76-274,777. WATSON & CHALIN MANUFACTURING, INC., MCKINNEY, TX. FILED 6-21-2001.



OWNER OF U.S. REG. NOS. 2,206,103 AND 2,227,062.  
NO CLAIM IS MADE TO THE EXCLUSIVE RIGHT TO USE "MANUFACTURING INC." AND "SUSPENSION SYSTEMS", APART FROM THE MARK AS SHOWN.  
FOR TRUCK AND TRAILER COMPONENTS, NAMELY, SUSPENSION SYSTEMS COMPRISING AXLES, COIL SPRINGS, LEAF SPRINGS, AIR SPRINGS, BRACKETS, BUSHINGS AND BRAKES (U.S. CLS. 19, 21, 23, 31, 35 AND 44).

SN 76-275,915. VIBRATECH, INC., ALDEN, NY. FILED 6-22-2001.

**FLUIDAMPR**

OWNER OF U.S. REG. NO. 1,449,297.  
FOR CRANKSHAFT DAMPERS FOR HIGH PERFORMANCE ENGINES (U.S. CLS. 19, 21, 23, 31, 35 AND 44).  
FIRST USE 2-12-1986; IN COMMERCE 2-12-1986.

SN 76-275,919. VIBRATECH, INC., ALDEN, NY. FILED 6-22-2001.



OWNER OF U.S. REG. NO. 1,449,297.  
FOR CRANKSHAFT DAMPERS FOR HIGH PERFORMANCE ENGINES (U.S. CLS. 19, 21, 23, 31, 35 AND 44).  
FIRST USE 12-0-1999; IN COMMERCE 12-0-1999.

SN 76-278,052. NISSAN NORTH AMERICA, INC., GARDENA, CA. FILED 6-22-2001.

**VERSANT**

FOR MOTOR VEHICLES, NAMELY, AUTOMOBILES, TRUCKS, VANS, SPORT UTILITY VEHICLES AND STRUCTURAL PARTS THEREFOR (U.S. CLS. 19, 21, 23, 31, 35 AND 44).

**CLASS 12—(Continued).**

SN 76-279,239. MCWILLIAMS, PETER J., CAMARILLO, CA. AND MCWILLIAMS, CLAUDINE R., CAMARILLO, CA. FILED 7-2-2001.

**KID CYBORG DESIGN**

FOR DECORATIVE STRUCTURAL MOTORCYCLE PARTS, NAMELY, AXLE ADJUSTER PLATES, HEADLIGHT ATTACHMENTS, TURN SIGNAL COVERS AND SUSPENSION STRUCTURE COVERS (U.S. CLS. 19, 21, 23, 31, 35 AND 44).

SN 76-279,606. AUTOMANN, INC., MAHWAH, NJ. FILED 7-3-2001.

**AUTOMANN**

OWNER OF U.S. REG. NO. 1,646,776.  
FOR BRAKE, WHEEL, STEERING AND SUSPENSION PARTS FOR TRUCKS AND TRAILERS, NAMELY, AIR SPRINGS, LEAF SPRINGS, SHACKLES AND BRACKETS, SPRING PINS, SHACKLE BOLTS, LOCK PINS, BRAKE ROLL-ERS, ANCHOR PINS, SHACKLE KITS, BUSHINGS AND INSULATORS, TORQUE RODS, DRIVE SHAFTS, MUFFLER CLAMPS AND AXLE NUTS (U.S. CLS. 19, 21, 23, 31, 35 AND 44).  
FIRST USE 0-0-1992, 1967 ; IN COMMERCE 0-0-1992, 1967.

SN 76-283,191. ROLAND DISTRIBUTING CORPORATION, HOUSTON, TX. FILED 7-11-2001.

**NORTH STAR**

OWNER OF U.S. REG. NO. 1,918,794.  
FOR JOGGING STROLLERS (U.S. CLS. 19, 21, 23, 31, 35 AND 44).  
FIRST USE 5-1-2001; IN COMMERCE 5-1-2001.

SN 76-285,185. UNIVERSAL BRASS, INC., AUBURN, WA. FILED 7-16-2001.

**HITCH-DOOR**

FOR AUTOMOBILE ACCESSORIES, NAMELY, FITTED TRAILER HITCH COVERS HAVING SLOGANS AND/OR DESIGNS (U.S. CLS. 19, 21, 23, 31, 35 AND 44).

SN 76-311,207. TOYOTA JIDOSHA KABUSHIKI KAISHA, TA TOYOTA MOTOR CORPORATION, AICHEN-KEN, JAPAN, FILED 9-13-2001.

**JX470**

FOR MOTOR CARS AND STRUCTURAL PARTS THEREOF (U.S. CLS. 19, 21, 23, 31, 35 AND 44).

**CLASS 12—(Continued).**

SN 78-044,025. KELLEY, GARY A., ST PETERSBURG, FL.  
FILED 1-19-2001.

**NEXFLITE**

FOR STRUCTURAL PARTS FOR AIRPLANES (U.S.  
CLS. 19, 21, 23, 31, 35 AND 44).

---

SN 78-060,474. MCCUE CORPORATION, SALEM, MA.  
FILED 4-26-2001.

**BEAN**

FOR SHOPPING CART WITH INTEGRATED CHILD  
CARRIER (U.S. CLS. 19, 21, 23, 31, 35 AND 44).

---

SN 78-081,995. BRANDT, WILLIAM E., ALBUQUERQUE,  
NM. FILED 8-30-2001.

**BIKESAVER**

FOR KICKSTAND SUPPORT PLATE FOR MOTOR-  
CYCLE (U.S. CLS. 19, 21, 23, 31, 35 AND 44).

---

**CLASS 13—FIREARMS**

SN 76-076,762. MICHAELS OF OREGON CO., OREGON  
CITY, OR. FILED 6-26-2000.

**COMFORT STRETCH**

NO CLAIM IS MADE TO THE EXCLUSIVE RIGHT TO  
USE "STRETCH", APART FROM THE MARK AS SHOWN.  
FOR FIREARM SLINGS, NAMELY RIFLE AND SHOT-  
GUN SLINGS (U.S. CLS. 2 AND 9).  
FIRST USE 12-1-1989; IN COMMERCE 12-1-1989.

**CLASS 14—JEWELRY**

SN 75-715,878. MARS, INCORPORATED, MCLEAN, VA.  
FILED 5-26-1999.

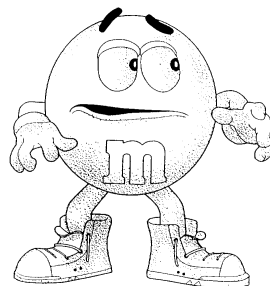

OWNER OF U.S. REG. NOS. 981,235, 983,429 AND  
OTHERS.  
THE STIPPLING IS FOR SHADING PURPOSES ONLY.  
FOR WATCHES (U.S. CLS. 2, 27, 28 AND 50).

---

SN 75-747,722. HILL STREET JEWELERS, INC., LOS AN-  
GELES, CA. FILED 6-17-1999.

**LIQUID DIAMOND**

NO CLAIM IS MADE TO THE EXCLUSIVE RIGHT TO  
USE "DIAMOND", APART FROM THE MARK AS SHOWN.  
FOR JEWELRY SET WITH OR CONTAINING DIA-  
MONDS (U.S. CLS. 2, 27, 28 AND 50).  
FIRST USE 1-15-1999; IN COMMERCE 1-15-1999.

---

SN 75-824,428. CARTIER INTERNATIONAL B.V., 3980 AM-  
STERDAM, NETHERLANDS, FILED 10-18-1999.

**LANIERES**

OWNER OF BENELUX REG. NO. 0638759, DATED 9-14-  
1999, EXPIRES 10-22-2008.  
THE ENGLISH TRANSLATION FOR "LANIERES" IS  
"STRIPS".  
FOR ASHTRAYS, BOXES AND CASES FOR  
WATCHES, JEWELLERY AND CIGARETTES, COFFEE  
AND TEA SERVICES, CANDLESTICKS, CUFF-LINKS,  
PILL-BOXES, POWDER COMPACTS SOLD EMPTY, AND  
SERVING TRAYS, ALL THESE MADE OF PRECIOUS  
METALS OR COATED THEREWITH; JEWELLERY, PRE-  
CIOUS GEM STONES; CHRONOMETERS, CLOCKS AND  
WATCHES (U.S. CLS. 2, 27, 28 AND 50).

---

SN 75-981,330. PARKIN, JOHN P, HAGERSTOWN, MD.  
FILED 8-16-2000.

**GROW IN FAITH**

FOR JEWELRY; JEWELRY WITH A GIFT CARD SOLD  
AS A UNIT (U.S. CLS. 2, 27, 28 AND 50).  
FIRST USE 4-0-2000; IN COMMERCE 4-0-2000.

**CLASS 14—(Continued).**

SN 76-020,643. MAURO ZOPPINI, FLORENCE, ITALY, FILED 4-7-2000.

**ZOPPINI**

PRIORITY CLAIMED UNDER SEC. 44(D) ON ITALY APPLICATION NO. 1360056, FILED 10-21-1999, REG. NO. 1360056, DATED 8-11-2000, EXPIRES 8-11-2010.

FOR JEWELLERY, COSTUME JEWELLERY, WATCHES, CLOCKS, WATCH BANDS (U.S. CLS. 2, 27, 28 AND 50).

FIRST USE 11-0-1998; IN COMMERCE 11-0-1998.

SN 76-055,309. CHIAMPESAN SRL, 36066 SANDRIGO (VI), ITALY, FILED 5-24-2000.

  
**CHIAMPESAN**

FOR JEWELRY, NAMELY, CHAINS, NECKLACES, PENDANTS, BRACELETS, RINGS, BROOCHES, EARRINGS AND WATCHES, ALL MADE OF GOLD, SILVER OR OTHER PRECIOUS METALS; PRECIOUS STONES (U.S. CLS. 2, 27, 28 AND 50).

FIRST USE 9-0-1998; IN COMMERCE 9-0-1998.

SN 76-126,913. TIMEWORKS, INC., BERKELEY, CA. FILED 9-12-2000.

**ACME**  
CLOCK COMPANY

NO CLAIM IS MADE TO THE EXCLUSIVE RIGHT TO USE "CLOCK COMPANY", APART FROM THE MARK AS SHOWN.

FOR HOROLOGICAL INSTRUMENTS (U.S. CLS. 2, 27, 28 AND 50).

FIRST USE 6-0-2000; IN COMMERCE 6-30-2000.

SN 76-134,081. MONTGOMERY WARD, LLC, CHICAGO, IL. FILED 9-22-2000.

**NWB**

OWNER OF U.S. REG. NO. 2,403,794. FOR JEWELRY AND WATCHES (U.S. CLS. 2, 27, 28 AND 50).

FIRST USE 8-0-1999; IN COMMERCE 8-0-1999.

**CLASS 14—(Continued).**

SN 76-164,673. STRINGBEANS ARTWEAR, L.L.C., COVINGTON, LA. FILED 11-14-2000.

**STRINGBEANS ARTWEAR**

NO CLAIM IS MADE TO THE EXCLUSIVE RIGHT TO USE "ARTWEAR", APART FROM THE MARK AS SHOWN. FOR JEWELRY (U.S. CLS. 2, 27, 28 AND 50). FIRST USE 1-0-1998; IN COMMERCE 5-0-1998.

SN 76-165,511. INDUSTRIA DE DISENO TEXTIL, S.A. AKA INDITEX, S.A., 15080 CORUNA, SPAIN, FILED 11-10-2000.

**BERSHKA**

OWNER OF SPAIN REG. NO. 1911576, DATED 6-30-1994, EXPIRES 6-30-2004.

OWNER OF U.S. REG. NOS. 1,868,366, 2,212,573 AND 2,420,464.

FOR JEWELRY; WATCHES AND CLOCKS; AND NAPKIN RINGS OF PRECIOUS METAL (U.S. CLS. 2, 27, 28 AND 50).

SN 76-175,451. HAYASHI, YOSHIKI, LOS ANGELES, CA. FILED 11-30-2000.

**VIOLET UK**

NO CLAIM IS MADE TO THE EXCLUSIVE RIGHT TO USE "UK", APART FROM THE MARK AS SHOWN.

FOR JEWELRY, WATCHES (U.S. CLS. 2, 27, 28 AND 50).

SN 76-182,191. MOVADO LLC, WILMINGTON, DE. BY ASSIGNMENT MOVADO CORPORATION, WILMINGTON, DE. FILED 12-18-2000.

**RILATI**

FOR WATCHES (U.S. CLS. 2, 27, 28 AND 50).

FIRST USE 11-0-1998; IN COMMERCE 11-0-1998.

SN 76-221,525. ERNEST SLOTAR, INC., CHICAGO, IL. FILED 3-9-2001.

**LUCERE**

THE ENGLISH TRANSLATION OF THE LATIN WORD "LUCERE" IS "TO SHINE".

FOR PRECIOUS OR SEMI-PRECIOUS STONES, NAMELY, DIAMONDS (U.S. CLS. 2, 27, 28 AND 50).

**CLASS 14—(Continued).**

SN 76-244,005. LEO SCHACHTER DIAMONDS, L.L.C., NEW YORK, NY. FILED 4-23-2001.

**THE VISIONE DIAMOND**

NO CLAIM IS MADE TO THE EXCLUSIVE RIGHT TO USE "DIAMONDS", APART FROM THE MARK AS SHOWN. FOR DIAMONDS AND FINE JEWELRY MADE IN PART OF DIAMONDS (U.S. CLS. 2, 27, 28 AND 50).

SN 76-245,313. EUGEN SCHOFER GMBH & CO. KG, D-75179 PFORZHEIM, FED REP GERMANY, FILED 4-24-2001.



OWNER OF U.S. REG. NO. 1,474,097.  
FOR JEWELRY (U.S. CLS. 2, 27, 28 AND 50).

SN 76-246,494. AFSHAR, ZOHREH, LOS ANGELES, CA. FILED 4-24-2001.

**AQUA MARIN**

THE ENGLISH TRANSLATION OF "AQUA MARIN" IS "SEA WATER".  
FOR WATCHES, NAMELY, WRISTWATCHES, POCKET WATCHES, DIVING WATCHES; WATCH CASES (U.S. CLS. 2, 27, 28 AND 50).  
FIRST USE 1-1-2001; IN COMMERCE 1-1-2001.

SN 76-255,825. AFSHAR, ZOHREH, LOS ANGELES, CA. FILED 5-11-2001.



THE ENGLISH TRANSLATION OF "AQUA MARIN" IS "SEA WATER".  
FOR WATCHES, NAMELY, WRISTWATCHES, POCKET WATCHES, DIVING WATCHES; WATCH CASES (U.S. CLS. 2, 27, 28 AND 50).  
FIRST USE 1-1-2001; IN COMMERCE 1-1-2001.

**CLASS 14—(Continued).**

SN 76-258,945. TIMEX GROUP B.V., 1075 AD AMSTERDAM, NETHERLANDS, FILED 5-18-2001.

**NATALIE ST. CLAIR**

THE NAME IN THE MARK DOES NOT IDENTIFY A LIVING INDIVIDUAL.  
FOR WATCHES (U.S. CLS. 2, 27, 28 AND 50).

SN 76-260,575. EFRON ENTERPRISES, INC., NEW YORK, NY. FILED 5-22-2001.

**UP MY SLEEVE**

FOR JEWELRY, NAMELY, CUFF LINKS, LAPEL PINS, TIE PINS, TIE CLIPS, PENDANTS, SHIRT STUDS, BUTTON COVERS MADE OF PRECIOUS OR SEMI-PRECIOUS METALS, KEY CHAINS AND FOBS MADE OF PRECIOUS OR SEMI-PRECIOUS METALS, AND COMPONENTS FOR INTERCHANGEABLE CUFF LINKS (U.S. CLS. 2, 27, 28 AND 50).

SN 76-264,496. CINER MANUFACTURING CO., INC., NEW YORK, NY. FILED 5-30-2001.

**SPLASH BY CINER**

OWNER OF U.S. REG. NO. 525,527.  
FOR JEWELRY (U.S. CLS. 2, 27, 28 AND 50).

SN 76-271,363. VALUEVISION INTERNATIONAL, INC., EDEN PRAIRIE, MN. FILED 6-13-2001.

**MOULIN ROUGE**

THE ENGLISH TRANSLATION OF "MOULIN ROUGE" IS "RED MILL".  
FOR JEWELRY (U.S. CLS. 2, 27, 28 AND 50).

**CLASS 14—(Continued).**

SN 76-289,658. BREEDERS' CUP LIMITED, LEXINGTON, KY. FILED 7-24-2001.



OWNER OF U.S. REG. NO. 1,326,857.  
FOR JEWELRY; NAMELY, LAPEL PINS (U.S. CLS. 2, 27, 28 AND 50).

SN 76-291,892. EMANUEL TRADING CORPORATION, EASTHAMPTON, MA. FILED 7-30-2001.

**SILVER PARTY INTERNATIONAL**

NO CLAIM IS MADE TO THE EXCLUSIVE RIGHT TO USE "SILVER" AND "INTERNATIONAL", APART FROM THE MARK AS SHOWN.  
FOR SILVER JEWELRY (U.S. CLS. 2, 27, 28 AND 50).

SN 76-308,616. TRUMP, IVANA, NEW YORK, NY. FILED 9-6-2001.

**IVANA**

FOR JEWELRY (U.S. CLS. 2, 27, 28 AND 50).  
FIRST USE 10-1-1993; IN COMMERCE 10-1-1993.

SN 76-311,704. PACHAUER, WERNER, SAINT CLOUD, FL. FILED 9-14-2001.

**PACHAUER**

FOR JEWELRY (U.S. CLS. 2, 27, 28 AND 50).

**CLASS 14—(Continued).**

SN 76-316,049. PINEHURST, INC., VILLAGE OF PINEHURST, NC. FILED 9-24-2001.

**PINEHURST**

OWNER OF U.S. REG. NOS. 1,517,264, 2,367,370 AND OTHERS.  
FOR WATCHES AND LAPEL PINS (U.S. CLS. 2, 27, 28 AND 50).  
FIRST USE 0-0-1984; IN COMMERCE 0-0-1984.

SN 76-317,192. CIPRIANO, A. ANTHONY, N. ATTLEBORO, MA. AND CIPRIANO, VINCENT J., CUMBERLAND, RI. FILED 9-25-2001.

**THANK YOU GOD ALWAYS**

FOR PRECIOUS METAL AND COSTUME JEWELRY, NAMELY BRACELETS, NECKLACES, EARRINGS, PENDANTS, AND RINGS; AND HOROLOGICAL INSTRUMENTS, NAMELY WATCHES (U.S. CLS. 2, 27, 28 AND 50).

SN 76-320,165. TIMEX GROUP B.V., 1075 AD AMSTERDAM, NETHERLANDS, FILED 10-2-2001.

**LEADER**

FOR WATCHES (U.S. CLS. 2, 27, 28 AND 50).

SN 76-320,167. TIMEX GROUP B.V., 1075 AD AMSTERDAM, NETHERLANDS, FILED 10-2-2001.

**TREAD**

FOR WATCHES (U.S. CLS. 2, 27, 28 AND 50).

SN 76-320,168. TIMEX GROUP B.V., 1075 AD AMSTERDAM, NETHERLANDS, FILED 10-2-2001.

**AGGRESSOR**

FOR WATCHES (U.S. CLS. 2, 27, 28 AND 50).

**CLASS 14—(Continued).**

SN 76-321,484. K&M ASSOCIATES, PROVIDENCE, RI. FILED 10-4-2001.

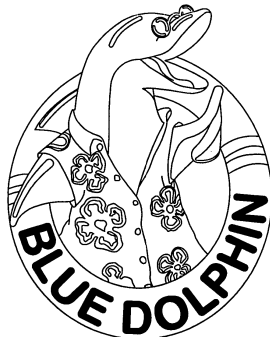

FOR JEWELRY (U.S. CLS. 2, 27, 28 AND 50).  
FIRST USE 9-19-2001; IN COMMERCE 9-19-2001.

SN 76-321,805. MEMOIRE CORPORATION, SKANEATELES, NY. FILED 10-5-2001.

**FELICITY**

FOR JEWELRY AND PRECIOUS STONES (U.S. CLS. 2, 27, 28 AND 50).

SN 78-057,739. A'LOR INTERNATIONAL LTD., LA JOLLA, CA. FILED 4-10-2001.

**CHRONOMARINE**

FOR JEWELRY AND WATCHES (U.S. CLS. 2, 27, 28 AND 50).

SN 78-061,868. HIGH INTENCITY INC., WYCKOFF, NJ. FILED 5-3-2001.

FOR BRACELETS, NECKLACES, ANKLETS, AND JEWELRY ITEMS ATTACHED AND TO BE ATTACHED THERETO (U.S. CLS. 2, 27, 28 AND 50).  
FIRST USE 1-29-2001; IN COMMERCE 1-29-2001.

**CLASS 14—(Continued).**

SN 78-066,931. TWENTIETH CENTURY FOX FILM CORPORATION, LOS ANGELES, CA. FILED 6-1-2001.

OWNER OF U.S. REG. NOS. 2,092,307, 2,442,861 AND OTHERS.

FOR WATCHES, WATCHBANDS; DESK CLOCKS, ALARM CLOCKS, WALL CLOCKS; JEWELRY; LAPEL PINS (U.S. CLS. 2, 27, 28 AND 50).

SN 78-072,536. OLSZEWSKI, EDWARD BRYAN, DENVER, CO. FILED 7-5-2001.

**NAKEDWATCH**

FOR TIME KEEPING DEVICES, NAMELY, WATCHES, POCKETWATCHES, CLOCKS, AND ALARM CLOCKS (U.S. CLS. 2, 27, 28 AND 50).

SN 78-083,320. FORD MODELS, INC., NEW YORK, NY. FILED 9-10-2001.

**FORD MODELS  
SUPERMODEL OF THE  
WORLD**

OWNER OF U.S. REG. NOS. 1,296,761, 2,481,166 AND OTHERS.

FOR JEWELRY, NAMELY, EARRINGS, NECKLACES, PINS, BRACELETS, RINGS, WATCHES (U.S. CLS. 2, 27, 28 AND 50).

SN 78-086,084. COMBINE INTERNATIONAL, INC., TROY, MI. FILED 9-28-2001.

**THE HEART OF AMERICA**

FOR JEWELRY (U.S. CLS. 2, 27, 28 AND 50).

**CLASS 15—MUSICAL INSTRUMENTS**

**CLASS 15—(Continued).**

SN 76-144,544. YOUNG CHANG AKKI CO., LTD., INCHEON, REPUBLIC OF KOREA, FILED 10-11-2000.



**YOUNG CHANG**

OWNER OF U.S. REG. NO. 1,160,869.  
THE MARK DOES NOT IDENTIFY A PARTICULAR LIVING INDIVIDUAL.

THE MARK CONSISTS, IN PART, OF THE LETTERS "Y" AND "C" IN STYLIZED FORM.

FOR MUSICAL INSTRUMENTS, NAMELY, PIANOS, ORGANS, HARMONICAS AND GUITARS; AND ELECTRIC MUSICAL INSTRUMENTS, NAMELY, DIGITAL PIANOS, SYNTHESIZERS, AND KEYBOARDS (U.S. CLS. 2, 21 AND 36).

FIRST USE 5-1-1976; IN COMMERCE 5-1-1976.

SN 76-168,090. HOSHINO GAKKI CO. LTD., NAGOYA, JAPAN, FILED 11-20-2000.

**ACCU-TUNE HOOP**

NO CLAIM IS MADE TO THE EXCLUSIVE RIGHT TO USE "HOOP", APART FROM THE MARK AS SHOWN.

FOR MUSICAL INSTRUMENTS, NAMELY, DRUM HOOPS (U.S. CLS. 2, 21 AND 36).

FIRST USE 4-1-1995; IN COMMERCE 4-1-1995.

SN 76-294,588. AKAI MUSICAL INSTRUMENT CORPORATION, FORT WORTH, TX. FILED 8-3-2001.

**MPC**

FOR ELECTRONIC MUSICAL INSTRUMENTS, NAMELY MIDI (MUSICAL INSTRUMENT DIGITAL INTERFACE) PRODUCTION CENTERS, WHICH COMBINE A DRUM MACHINE AND A DIGITAL SEQUENCER TO PROVIDE PRE-PROGRAMMED PLAYBACK OF DRUM SOUNDS STORED IN MEMORY (U.S. CLS. 2, 21 AND 36).

FIRST USE 12-0-1987; IN COMMERCE 12-0-1987.

**CLASS 15—(Continued).**

SN 76-310,011. TAY-E CO., LTD., TACHIA CHEN, TAIWAN, FILED 9-7-2001.

**Orbitone**

FOR DRUMS, SNARE DRUMS, DRUM STICKS, DRUM HEADS, TIMPANI, JAZZ DRUMS, PERCUSSION INSTRUMENTS NAMELY DRUMS, GONGS, CYMBALS AND COW BELLS, DRUM HOLDERS, MUSICAL INSTRUMENT STANDS, FLUTES, PIANOS, GUITARS, TAMBOURS AND SAXOPHONES (U.S. CLS. 2, 21 AND 36).

SN 78-082,392. MILLER, JAMES ROBERT, SIMI VALLEY, CA. FILED 9-4-2001.

**QUIKSTAND**

FOR MUSICAL INSTRUMENT STANDS (U.S. CLS. 2, 21 AND 36).

FIRST USE 1-13-2001; IN COMMERCE 8-16-2001.

**CLASS 16—PAPER GOODS AND PRINTED MATTER**

SN 74-516,183. TURNER ENTERTAINMENT CO., ATLANTA, GA. FILED 4-25-1994.

**MUNCHKIN**

FOR PAPER ARTICLES, NAMELY LUNCH BAGS, GIFT BAGS, STREAMERS, BANNERS, NAPKINS, GREETING CARDS, POSTCARDS, CALENDARS, STATIONERY, PLAYING CARDS, COLORING BOOKS, POSTERS; PERIODICALS AND BOOKS FEATURING FICTIONAL CHARACTERS AND/OR ELEMENTS FROM THE 1939 MOTION PICTURE CLASSIC IN WHICH A LITTLE GIRL AND HER DOG ARE TRANSPORTED FROM A MIDWESTERN STATE BY A TORNADO TO AN IMAGINARY PLACE WHOSE POPULACE INCLUDES PERSONS KNOWN BY THE TERM SOUGHT TO BE REGISTERED HEREIN, IN WHICH A SONG IS SUNG FEATURING REFERENCE TO BEING SOMEWHERE OVER A COLORFUL METEOROLOGICAL PHENOMENON (U.S. CLS. 2, 5, 22, 23, 29, 37, 38 AND 50).

SN 75-053,751. MARVEL CHARACTERS, INC., CALABASAS, CA. FILED 2-5-1996.

**DOC SAMSON**

FOR PUBLICATIONS, NAMELY COMIC BOOKS AND COMIC MAGAZINES AND PRINTED STORIES IN ILLUSTRATED FORM FEATURED IN BOOKS AND MAGAZINES (U.S. CLS. 2, 5, 22, 23, 29, 37, 38 AND 50).

FIRST USE 11-10-1995; IN COMMERCE 11-10-1995.

**CLASS 16—(Continued).**

SN 75-327,963. TUAN, ROCKY SUNG-CHI, CHESTER SPRINGS, PA. FILED 7-21-1997.

**EMBRYO**

FOR BIOMEDICAL SCIENTIFIC RESEARCH JOURNAL/PERIODICAL (U.S. CLS. 2, 5, 22, 23, 29, 37, 38 AND 50).

SN 75-508,121. DAVDEZ ARTS, INC., DELRAY BEACH, FL. AND BLAIR, BARRY L., DELRAY BEACH, FL. FILED 6-24-1998.

**DEMON HUNTER**

FOR COMIC MAGAZINES (U.S. CLS. 2, 5, 22, 23, 29, 37, 38 AND 50).  
FIRST USE 2-0-1989; IN COMMERCE 2-0-1989.

SN 75-526,150. LC PUBLISHING & STUFF, INC., EVANS, GA. FILED 7-27-1998.

**THRILLSEEKERS**

FOR OUTDOOR ADVENTURE MAGAZINE (U.S. CLS. 2, 5, 22, 23, 29, 37, 38 AND 50).  
FIRST USE 10-1-1997; IN COMMERCE 1-1-1998.

SN 75-589,964. INFORMAT, INC., ST. PAUL, MN. FILED 11-17-1998.

**COUNTRY ROADS**

FOR PRINTED MATTER CONSISTING OF PUBLISHED PROGRAM GUIDES LISTING TIMES AND CONTENT OF RADIO, TELEVISION, INTERNET TECHNOLOGY AND PROGRAMS OF INTEREST TO A RURAL AND AGRICULTURAL AUDIENCE (U.S. CLS. 2, 5, 22, 23, 29, 37, 38 AND 50).

SN 75-591,004. POOCHIE-POMPREECE CO., LTD., SHINAGAWA-KU, TOKYO, JAPAN, FILED 11-23-1998.

**CATPASSPORT**

OWNER OF JAPAN REG. NO. 4127762, DATED 3-27-1998, EXPIRES 3-27-2008.

FOR PAPER IDENTIFICATION CARDS FOR DOGS AND CATS, PAPER IDENTIFICATION RECORDS FOR DOGS AND CATS CONTAINING VETERINARY MEDICAL RECORDS, VACCINATION RECORDS AND PAW PRINTS; BOOKLETS FEATURING PHOTOGRAPHS FOR USE AS A PET PASSPORT; MOUNTED PHOTOGRAPHS AND STATIONERY (U.S. CLS. 2, 5, 22, 23, 29, 37, 38 AND 50).

**CLASS 16—(Continued).**

SN 75-591,005. POOCHIE-POMPREECE CO., LTD., SHINAGAWA-KU, TOKYO, JAPAN, FILED 11-23-1998.

**DOGPASSPORT**

OWNER OF JAPAN REG. NO. 4127763, DATED 3-27-1998, EXPIRES 3-27-2008.

FOR PAPER IDENTIFICATION CARDS FOR DOGS AND CATS, PAPER IDENTIFICATION RECORDS FOR DOGS AND CATS CONTAINING VETERINARY MEDICAL RECORDS, VACCINATION RECORDS AND PAW PRINTS; BOOKLETS FEATURING PHOTOGRAPHS FOR USE AS A PET PASSPORT; MOUNTED PHOTOGRAPHS AND STATIONERY (U.S. CLS. 2, 5, 22, 23, 29, 37, 38 AND 50).

SN 75-718,797. NORTHEAST PUBLISHING INCORPORATED, SOUTH PLAINFIELD, NJ. BY ASSIGNMENT RSC PRODUCTIONS AND PUBLICATIONS, INC., CLINTON TWP, MI. FILED 6-1-1999.

**CONTEMPORARY BRIDE**

OWNER OF U.S. REG. NO. 1,778,526. SEC. 2(F).  
FOR MAGAZINES IN THE FIELD OF WEDDING PLANNING (U.S. CLS. 2, 5, 22, 23, 29, 37, 38 AND 50).  
FIRST USE 12-1-1990; IN COMMERCE 1-1-1991.

SN 75-731,378. ONCOTECH, INC., IRVINE, CA. FILED 6-17-1999.

**DRI**

FOR PRINTED MATTER, NAMELY BROCHURES; PRESENTATION FOLDERS; AND NEWSLETTERS ABOUT CANCER-RELATED TREATMENTS AND SERVICES (U.S. CLS. 2, 5, 22, 23, 29, 37, 38 AND 50).

SN 75-731,379. ONCOTECH, INC., IRVINE, CA. FILED 6-17-1999.

**KNOWLEDGE BRINGS HOPE**

FOR PRINTED MATTER, NAMELY BROCHURES; PRESENTATION FOLDERS; AND NEWSLETTERS ABOUT CANCER-RELATED TREATMENTS AND SERVICES (U.S. CLS. 2, 5, 22, 23, 29, 37, 38 AND 50).

SN 75-731,395. ONCOTECH, INC., IRVINE, CA. FILED 6-17-1999.

**ONCOINDICES**

FOR PRINTED MATTER, NAMELY BROCHURES; PRESENTATION FOLDERS; AND NEWSLETTERS ABOUT CANCER-RELATED TREATMENTS AND SERVICES (U.S. CLS. 2, 5, 22, 23, 29, 37, 38 AND 50).



**CLASS 16—(Continued).**

SN 75-793,249. ASSOCIATION OF RESEARCH LIBRARIES, WASHINGTON, DC. FILED 9-7-1999.

**CNI**

FOR PRINTED MATERIALS, NAMELY, SOUVENIR PROGRAMS, AND CONFERENCE AND SEMINAR PROCEEDINGS, NAMELY, CONFERENCE PROCEEDINGS, TRADE PRESS, WHITE PAPERS, BOOKS, WORK BOOKS, LESSON BOOKS, REFERENCE BOOKS, COMPENDIUMS, ALL IN THE FIELD OF INFORMATION TECHNOLOGY (U.S. CLS. 2, 5, 22, 23, 29, 37, 38 AND 50).

SN 75-833,200. POLESTAR TECHNOLOGIES, INC., NEEDHAM HEIGHTS, MA. FILED 10-27-1999.

**ILLUMINATING QUALITY MEASUREMENTS**

NO CLAIM IS MADE TO THE EXCLUSIVE RIGHT TO USE "MEASUREMENTS", APART FROM THE MARK AS SHOWN.

FOR PUBLICATIONS, NAMELY, INSTRUCTION BROCHURES FOR FLUORESCENCE DETECTION PRODUCTS, BIOREACTORS, FERMENTATION SYSTEMS AND CELL CULTURE SYSTEMS (U.S. CLS. 2, 5, 22, 23, 29, 37, 38 AND 50).

SN 75-842,949. HARRISBURG MAGAZINE, INC., HARRISBURG, PA. BY ASSIGNMENT LEHIGH VALLEY COMMUNICATIONS, INC., BETHLEHEM, PA. FILED 11-8-1999.

**LEHIGH VALLEY MAGAZINE**

NO CLAIM IS MADE TO THE EXCLUSIVE RIGHT TO USE "MAGAZINE", APART FROM THE MARK AS SHOWN. SEC. 2(F).

FOR GENERAL INTEREST MAGAZINES (U.S. CLS. 2, 5, 22, 23, 29, 37, 38 AND 50).

FIRST USE 8-1-1994; IN COMMERCE 8-1-1994.

SN 75-858,115. UPPER DECK COMPANY, LLC, THE, CARLSBAD, CA. FILED 11-24-1999.

**JORDAN BY JORDAN**

FOR AUTOGRAPHED AND NON-AUTOGRAPHED MEMORABILIA AND COLLECTIBLES, NAMELY, MOUNTED PHOTOGRAPHS, MAGAZINE COVERS, TRADING CARDS, LITHOGRAPHS, ART PRINTS, POSTERS, ANIMATION CELLS, NEWSPAPERS FOR GENERAL CIRCULATION, SPORTS BOOKS, PAPER BANNERS, PAPER PENNANTS, PRINTED TICKETS FOR SPORTING EVENTS AND SOUVENIR PROGRAMS FOR SPORTING EVENTS (U.S. CLS. 2, 5, 22, 23, 29, 37, 38 AND 50).

**CLASS 16—(Continued).**

SN 75-887,258. JOHNSON, BARBARA, ARLINGTON HEIGHTS, IL. FILED 1-5-2000.

**CYBER SCRIBBLES**

FOR NOTEBOOKS, CALENDARS, PERSONAL JOURNALS, ASSIGNMENT NOTEBOOKS, PENCILS, PENCIL BOXES, AND VINYL COVERS AND BINDERS USED TO COVER PAPER PRODUCTS (U.S. CLS. 2, 5, 22, 23, 29, 37, 38 AND 50).

FIRST USE 3-0-1999; IN COMMERCE 3-0-1999.

SN 75-896,958. SILICON BALL, SAN FRANCISCO, CA. FILED 1-14-2000.

**BOOKFACE**

FOR SERIES OF FICTION BOOKS AND NON-FICTION BOOKS; PRINTED INSTRUCTIONAL TEACHING MATERIALS AND PRINTED TEACHING MATERIALS, ALL DIRECTED TO THE SUBJECT MATTER OF BOOKS, BOOK REVIEWS, LITERATURE, INFORMATION, LIVE DATA AND LINKS TO WEB SITES, AND ALL RELATING TO BOOKS, BOOK REVIEWS AND LITERATURE (U.S. CLS. 2, 5, 22, 23, 29, 37, 38 AND 50).

SN 75-908,806. SMALL, NICOLE, BIDDEFORD POOL, ME. FILED 2-2-2000.

**JUST THE FACTS**

FOR PRINTED INSTRUCTIONAL MATERIALS, NAMELY, CARD SETS WHICH DETAIL HOW TO USE COMPUTERS, COMPUTER OPERATING SYSTEMS, COMPUTER SOFTWARE AND HOME ELECTRONICS (U.S. CLS. 2, 5, 22, 23, 29, 37, 38 AND 50).

SN 75-915,292. TIME4 MEDIA, INC., NEW YORK, NY. BY CHANGE OF NAME TIMES MIRROR MAGAZINES, INC., NEW YORK, NY. FILED 2-1-2000.

**MOTOR BOATING**

OWNER OF U.S. REG. NOS. 1,006,769, 1,946,214 AND OTHERS.

SEC. 2(F).

FOR PUBLICATIONS, NAMELY, A MAGAZINE IN THE FIELD OF BOATING, SAILING AND YACHTING (U.S. CLS. 2, 5, 22, 23, 29, 37, 38 AND 50).

**CLASS 16—(Continued).**

SN 75-920,208. IVEY, CHARLOTTE ANNE, PARK CITY, UT. FILED 2-4-2000.

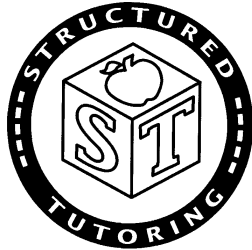

NO CLAIM IS MADE TO THE EXCLUSIVE RIGHT TO USE "STRUCTURED TUTORING", APART FROM THE MARK AS SHOWN.

FOR PRINTED EDUCATIONAL MATERIALS, NAMELY, INSTRUCTIONAL MANUALS, TUTOR'S MANUALS, STUDENT TIME LOGS, AND WORKBOOKS, FOR USE IN TEACHING READING, WRITING, VOCABULARY, READING FLUENCY, READING COMPREHENSION, AND MATHEMATICS (U.S. CLS. 2, 5, 22, 23, 29, 37, 38 AND 50).

FIRST USE 11-1-1999; IN COMMERCE 11-1-1999.

SN 75-922,414. SMITHKLINE BEECHAM CORPORATION, PHILADELPHIA, PA. FILED 2-18-2000.

**INSPIRING TOMORROW'S THERAPIES TODAY**

NO CLAIM IS MADE TO THE EXCLUSIVE RIGHT TO USE "THERAPIES", APART FROM THE MARK AS SHOWN.

FOR PRINTED MATERIAL, NAMELY BROCHURES AND PAMPHLETS RELATING TO THE TREATMENT OF PULMONARY DISEASES AND DISORDERS (U.S. CLS. 2, 5, 22, 23, 29, 37, 38 AND 50).

SN 75-927,658. PEARSON EDUCATION, INC., UPPER SADDLE RIVER, NJ. FILED 2-24-2000.

**DEVELOPING WRITER'S ASSESSMENT**

FOR PRINTED MATERIALS, NAMELY, A SERIES OF TEXTBOOKS, TEACHER'S GUIDES AND WORKBOOKS FOR TEACHING WRITING INSTRUCTION (U.S. CLS. 2, 5, 22, 23, 29, 37, 38 AND 50).

**CLASS 16—(Continued).**

SN 75-936,575. DIORIO, MARY ANN, MILLVILLE, NJ. FILED 3-6-2000.



NO CLAIM IS MADE TO THE EXCLUSIVE RIGHT TO USE "PSALM 96:3 TLB", APART FROM THE MARK AS SHOWN.

THE SCRIPTURE REFERENCE APPEARING UNDER THE LETTERS "NJSCW" IS "PSALM 96:3 TLB".

FOR NEWSLETTERS REGARDING CHRISTIAN FAITH (U.S. CLS. 2, 5, 22, 23, 29, 37, 38 AND 50).

SN 75-942,644. GROOVE TECH, INC., COTTAGE GROVE, MN. FILED 3-13-2000.

**COOKIE**

FOR ADHESIVE BACKED FLEXIBLE SHEET MATERIAL OF REINFORCED PAPER FOR USE IN MASKING SURFACES TO BE COATED (U.S. CLS. 2, 5, 22, 23, 29, 37, 38 AND 50).

SN 75-943,555. MISSOURI EMPLOYERS MUTUAL INSURANCE, COLUMBIA, MO. FILED 3-14-2000.

**WWW.MEM-INS.COM**

FOR PRINTED BROCHURES, INFORMATIONAL FLIERS AND INFORMATIONAL LEAFLETS FEATURING INFORMATION IN THE AREA OF CLAIMS, CLAIMS ADMINISTRATION, CLAIMS MANAGEMENT, DISABILITY MANAGEMENT, LOSS PREVENTION, AND SAFETY AND UNDERWRITING IN THE FIELD OF INSURANCE; PRINTED INSTRUCTIONAL, EDUCATIONAL AND TEACHING MATERIALS FEATURING INFORMATION IN THE AREA OF CLAIMS, CLAIMS ADMINISTRATION, CLAIMS MANAGEMENT, DISABILITY MANAGEMENT, LOSS PREVENTION, AND SAFETY AND UNDERWRITING IN THE FIELD OF INSURANCE (U.S. CLS. 2, 5, 22, 23, 29, 37, 38 AND 50).

**CLASS 16—(Continued).**

SN 76-000,659. PRODUCTION & DISTRIBUTION CORP., MIAMI, FL. FILED 3-13-2000.

## P&C PUBLICIDAD & COMERCIALES

NO CLAIM IS MADE TO THE EXCLUSIVE RIGHT TO USE "PUBLICIDAD & COMERCIALES", APART FROM THE MARK AS SHOWN.

THE ENGLISH TRANSLATION OF "PUBLICIDAD & COMERCIALES" IS "ADVERTISING & COMMERCIALS".

FOR PRINTED MAGAZINES AND NEWSLETTERS IN THE FIELD OF THE SPANISH LANGUAGE ADVERTISING INDUSTRY (U.S. CLS. 2, 5, 22, 23, 29, 37, 38 AND 50). FIRST USE 6-0-1994; IN COMMERCE 6-0-1994.

SN 76-008,950. WOOSTER BRUSH COMPANY, THE, WOOSTER, OH. FILED 3-24-2000.

## SHORTCUT

FOR PAINT BRUSHES FOR PAINTING HOUSEHOLD TRIM, NAMELY, DOORS, CEILING TO WALL ANGLES, CORNERS, CABINETS AND SHELVING (U.S. CLS. 2, 5, 22, 23, 29, 37, 38 AND 50).

FIRST USE 8-26-1999; IN COMMERCE 9-2-1999.

SN 76-010,655. FABRY, THOMAS, NEW CITY, NY. FILED 3-27-2000.

## DOT CALM

OWNER OF U.S. REG. NO. 2,251,814.  
FOR PAPER AND CARDBOARD GOODS, NAMELY, FOLDERS, BOOK COVERS, GREETING CARDS, POSTERS, BAGS, ENVELOPES, COASTERS, COMPUTER PAPER, ENVELOPES, GIFT WRAPPING PAPER, GROCERY BAG PAPER, PLACE MATS, NAPKINS, NOTE PAPER, WRITING PAPER, WALL PAPER, NOTEBOOK COVERS, CALENDARS; NEWSPAPERS, MAGAZINES AND BOOKS IN THE FIELD OF COMPUTER SOFTWARE; CLOTH FOR BOOKBINDING, BOOKBINDING TAPE, BOOKBINDING WIRE, UNMOUNTED AND MOUNTED PHOTOGRAPHS; STATIONERY; ADHESIVE TAPE FOR STATIONERY OR HOUSEHOLD USE; ARTISTS MATERIALS, NAMELY, ACRYLIC PAINTS, OIL PAINTS, PASTELS, PENCILS; PAINT BRUSHES, PAPER TYPEWRITERS; PRINTED INTERNATIONAL, EDUCATIONAL AND TEACHING MATERIALS IN THE FIELD OF COMPUTER SOFTWARE; PLAYING CARDS, PRINTING TYPE AND PRINTERS' CLICHES (U.S. CLS. 2, 5, 22, 23, 29, 37, 38 AND 50).

**CLASS 16—(Continued).**

SN 76-048,483. PFIZER INC., NEW YORK, NY. FILED 5-15-2000.

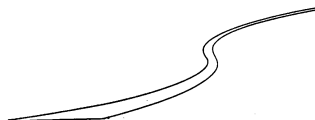

THE MARK CONSISTS OF A WAVY LINE OF VARYING WIDTH EXTENDING DIAGONALLY UPWARD FROM LEFT TO RIGHT ON THE BOTTOM PORTION OF THE GOODS.

FOR PRINTED BROCHURES, LEAFLETS AND INSTRUCTION BOOKLETS, ALL RELATING TO MENTAL HEALTH (U.S. CLS. 2, 5, 22, 23, 29, 37, 38 AND 50).

FIRST USE 10-1-1999; IN COMMERCE 10-1-1999.

SN 76-060,542. OXYGEN MEDIA, LLC, NEW YORK, NY. FILED 5-31-2000.

## BEFEARLESS

FOR PRINTED PUBLICATIONS, NAMELY, BOOKS, PAMPHLETS AND BROCHURES FEATURING NON-FICTION INFORMATION IN THE AREAS OF ELECTIONS, ELECTION PROCEDURES, PUBLIC POLICY, CIVIL ACTION, LOBBYING, GENDER ISSUES, POLLING, ACTIVISM, VOLUNTEERISM, NOT FOR PROFIT ORGANIZATIONS, CHARITIES AND CHARITABLE EFFORTS (U.S. CLS. 2, 5, 22, 23, 29, 37, 38 AND 50).

SN 76-061,967. WEST LICENSING CORPORATION, CLAYMONT, DE. FILED 6-2-2000.

## GOVERNMENT CONTRACTS CITATOR

NO CLAIM IS MADE TO THE EXCLUSIVE RIGHT TO USE "CITATOR", APART FROM THE MARK AS SHOWN. SEC. 2(F).

FOR PRINTED PUBLICATION, NAMELY, A PERIODICALLY ISSUED LISTING OF CASES AND DECISIONS ON GOVERNMENT CONTRACT MATTERS (U.S. CLS. 2, 5, 22, 23, 29, 37, 38 AND 50).

FIRST USE 1-0-1959; IN COMMERCE 1-0-1959.

SN 76-082,920. WATERFALL PUBLICATIONS LTD., LONDON, ENGLAND, FILED 7-5-2000.

## butterfly

FOR MAGAZINE FEATURING LITERATURE AND ARTS (U.S. CLS. 2, 5, 22, 23, 29, 37, 38 AND 50). FIRST USE 7-1-1998; IN COMMERCE 7-1-1998.

**CLASS 16—(Continued).**

SN 76-085,059. PHARMACYCLICS, INC., SUNNYVALE, CA. FILED 7-7-2000.

**CYCLES**

FOR PRINTED PUBLICATIONS, NAMELY, NEWS LETTERS, PAMPHLETS, BROCHURES, JOURNALS, MAGAZINES, IN THE FIELD OF CANCER, ONCOLOGY, AND IN PARTICULAR BRAIN METASTASES (U.S. CLS. 2, 5, 22, 23, 29, 37, 38 AND 50).

FIRST USE 2-18-2000; IN COMMERCE 2-18-2000.

SN 76-087,446. OFFICE PLANNING GROUP, INC., THE, RANCHO CORDOVA, CA. FILED 7-13-2000.

**OFFICE PLANNING GROUP, INC.**

NO CLAIM IS MADE TO THE EXCLUSIVE RIGHT TO USE "OFFICE" AND "GROUP, INC.", APART FROM THE MARK AS SHOWN.

FOR DOCUMENT FILES (U.S. CLS. 2, 5, 22, 23, 29, 37, 38 AND 50).

FIRST USE 10-27-1987; IN COMMERCE 10-27-1987.

SN 76-094,184. RACER COMMUNICATIONS, INC., TUSTIN, CA. FILED 7-20-2000.

**RACER**

OWNER OF U.S. REG. NOS. 1,739,272 AND 2,129,589. SEC. 2(F).

FOR MAGAZINE PUBLISHED FOR THE GENERAL PUBLIC IN THE FIELDS OF AUTO RACING AND MOTOR SPORTS (U.S. CLS. 2, 5, 22, 23, 29, 37, 38 AND 50).

FIRST USE 4-10-1992; IN COMMERCE 4-10-1992.

SN 76-099,733. REINERTSON ASSOCIATES, EAST, INC., FALLS CHURCH, VA. FILED 8-1-2000.

**THE RIGHT QUESTION**

FOR TITLE OR HEADING FOR A COLUMN OR ARTICLE SERIES DEALING WITH NEWS ANALYSIS, SPECIFICALLY IN THE AREA OF DOMESTIC POLITICS, INTERNATIONAL AFFAIRS AND FOREIGN POLITICS (U.S. CLS. 2, 5, 22, 23, 29, 37, 38 AND 50).

FIRST USE 1-10-1990; IN COMMERCE 1-10-1990.

**CLASS 16—(Continued).**

SN 76-100,628. QUEEN AND KING ENTERPRISES, INC., PEORIA, AZ. FILED 8-1-2000.

**TALKING DIRTY WITH THE QUEEN OF CLEAN**

FOR PRINTED MATTER, NAMELY, MAGAZINES, LOOSE-LEAF BINDERS AND LOOSE LEAF NEWSLETTERS, ALL FEATURING INFORMATION ON CLEANING TOPICS, CLEANING SUGGESTIONS AND CLEANING FORMULAS (U.S. CLS. 2, 5, 22, 23, 29, 37, 38 AND 50).

FIRST USE 11-11-1998; IN COMMERCE 11-11-1998.

SN 76-103,085. ANDERSON, DONALD W., OCEANSIDE, CA. FILED 8-7-2000.

**CHRISTICKERS**

FOR STATIONERY AND STATIONARY ACCESSORIES IN THE NATURE OF PAPER CUTTERS, PAPER STAPLERS, DRAWING RULERS, MEMORY AND STICKER ALBUMS, STAMP PADS, WRITING PAPER, TYPING PAPER, STICKERS, RUBBER STAMPS, MARKERS, PENS, PENCILS, AND PAPER TRAYS (U.S. CLS. 2, 5, 22, 23, 29, 37, 38 AND 50).

SN 76-108,484. WILLIAMHOUSE LLC, LONG ISLAND CITY, NY. BY ASSIGNMENT AMERICAN PAD & PAPER COMPANY OF DELAWARE, INC., DALLAS, TX. FILED 8-11-2000.

**FLAKJACKET**

FOR ENVELOPES (U.S. CLS. 2, 5, 22, 23, 29, 37, 38 AND 50).

SN 76-111,051. FORT JAMES OPERATING COMPANY, DEERFIELD, IL. FILED 8-17-2000.

**QUILTED NORTHERN**

OWNER OF U.S. REG. NOS. 1,877,561, 2,059,102 AND 2,209,027.

NO CLAIM IS MADE TO THE EXCLUSIVE RIGHT TO USE "QUILTED", APART FROM THE MARK AS SHOWN.

FOR PRE-MOISTENED CELLULOSIC WIPES (U.S. CLS. 2, 5, 22, 23, 29, 37, 38 AND 50).

**CLASS 16—(Continued).**

SN 76-112,536. ONCE UPON A RECIPE, LLC, MAPLE WOOD, NJ. FILED 8-18-2000.

**ONCE UPON A SNACK**

NO CLAIM IS MADE TO THE EXCLUSIVE RIGHT TO USE "SNACK", APART FROM THE MARK AS SHOWN.

FOR PUBLICATIONS, NAMELY, BOOKS, PERIODICALS, COLUMNS; AND NEWSPAPER, NEWSLETTER, MAGAZINE AND JOURNAL ARTICLES ALL REGARDING COOKING ACTIVITIES (U.S. CLS. 2, 5, 22, 23, 29, 37, 38 AND 50).

SN 76-119,108. PENNWELL CORPORATION, TULSA, OK. FILED 8-29-2000.

**MIDDLE EAST ENERGY  
(MEE)**

NO CLAIM IS MADE TO THE EXCLUSIVE RIGHT TO USE "MIDDLE EAST ENERGY", APART FROM THE MARK AS SHOWN.

FOR PUBLICATIONS, NAMELY MAGAZINES, RELATING TO THE ENERGY INDUSTRY IN THE MIDDLE EAST (U.S. CLS. 2, 5, 22, 23, 29, 37, 38 AND 50).

SN 76-119,783. GUIDEPOSTS, A CHURCH CORPORATION, CARMEL, NY. FILED 8-30-2000.

**HIS MYSTERIOUS WAYS**

SEC. 2(F).

FOR GOODS - PUBLICATIONS, NAMELY, A REGULAR COLUMN IN A MAGAZINE AND A SERIES OF BOOKS, ALL ON RELIGIOUS, INSPIRATIONAL AND SPIRITUAL TOPICS (U.S. CLS. 2, 5, 22, 23, 29, 37, 38 AND 50).

FIRST USE 0-0-1981; IN COMMERCE 0-0-1981.

SN 76-119,924. AMERICAN TRANSLATORS ASSOCIATION, ALEXANDRIA, VA. FILED 8-31-2000.

**THE ATA CHRONICLE**

NO CLAIM IS MADE TO THE EXCLUSIVE RIGHT TO USE "CHRONICLE", APART FROM THE MARK AS SHOWN.

FOR PRINTED PUBLICATIONS, NAMELY, A MAGAZINE FEATURING INFORMATION AND ARTICLES ABOUT THE TRANSLATION AND INTERPRETATION PROFESSIONS (U.S. CLS. 2, 5, 22, 23, 29, 37, 38 AND 50).

FIRST USE 1-0-1972; IN COMMERCE 1-0-1972.

**CLASS 16—(Continued).**

SN 76-121,082. HADDAD, LUZ E., JACKSONVILLE, TX. FILED 9-5-2000.

**THE LUCKY COUSIN CLUB**

FOR PRINTED MATTER, NAMELY MATTED ART PRINTS; NOTE AND GREETING CARDS; SERIES OF NON-FICTION BOOKS IN THE FIELD OF POETRY; AND BOOKLETS IN THE FIELD OF POETRY AND INSPIRATIONAL ESSAYS (U.S. CLS. 2, 5, 22, 23, 29, 37, 38 AND 50).

FIRST USE 4-28-2000; IN COMMERCE 8-10-2000.

SN 76-125,585. TRANSHIELD AS, 0581, OSLO, NORWAY, FILED 9-11-2000.



FOR PLASTIC FILM FOR COMMERCIAL PACKAGING AND WRAPPING (U.S. CLS. 2, 5, 22, 23, 29, 37, 38 AND 50).

FIRST USE 9-0-1998; IN COMMERCE 10-0-1998.

SN 76-130,423. PETOSKEY PLASTICS, INC., PETOSKEY, MI. FILED 9-19-2000.

**TITAN**

FOR TRASH BAGS MADE OF PLASTIC FOR HOUSEHOLD USE (U.S. CLS. 2, 5, 22, 23, 29, 37, 38 AND 50).

FIRST USE 8-30-1980; IN COMMERCE 8-30-1980.

SN 76-132,889. ENNIS BUSINESS FORMS, INC., DESOTO, TX. FILED 9-19-2000.



**SecurePouch**  
DEPOSIT BAGS

NO CLAIM IS MADE TO THE EXCLUSIVE RIGHT TO USE "SECURE POUCH DEPOSIT BAGS", APART FROM THE MARK AS SHOWN.

FOR PLASTIC BAGS FOR BANK DEPOSITS (U.S. CLS. 2, 5, 22, 23, 29, 37, 38 AND 50).

FIRST USE 9-22-1998; IN COMMERCE 9-22-1998.

**CLASS 16—(Continued).**

SN 76-134,775. MORRIS & FELLOWS, INC., ATLANTA, GA. FILED 9-26-2000.

**OPTIMAX**

OWNER OF U.S. REG. NOS. 2,342,906 AND 2,354,877.  
FOR PRINTED MARKET RESEARCH REPORTS CONTAINING COMPILATIONS OF RELEVANT MARKET DATA FOR BUSINESSES ENGAGED IN THE SALE OF PRODUCTS OR THE PROVISION OF SERVICES TO CONSUMERS (U.S. CLS. 2, 5, 22, 23, 29, 37, 38 AND 50).  
FIRST USE 7-15-1998; IN COMMERCE 7-15-1998.

SN 76-136,128. ADMINISTRATORS OF THE TULANE EDUCATIONAL FUND, THE, NEW ORLEANS, LA. FILED 9-27-2000.

**A CENTER FOR EXPLORING RIVER CULTURE, SCIENCE, AND TECHNOLOGY**

FOR PAPER GOODS, NAMELY, POSTCARDS, POSTERS, STATIONERY, CALENDARS, PLAYING CARDS, GREETING CARDS AND NOTEPADS WHICH WILL NOT BE ABOUT A CENTER FOR EXPLORING RIVER CULTURE, SCIENCE AND/OR TECHNOLOGY OR OTHERWISE DEPICT IT OR CONCERN IT; WRITING INSTRUMENTS, NAMELY, BALL POINT PENS AND LEAD PENCILS WHICH WILL NOT BE ABOUT A CENTER FOR EXPLORING RIVER CULTURE, SCIENCE AND/OR TECHNOLOGY OR OTHERWISE DEPICT IT OR CONCERN IT (U.S. CLS. 2, 5, 22, 23, 29, 37, 38 AND 50).

SN 76-136,534. HOMES FOR LIVING, WILMINGTON, DE. FILED 9-28-2000.



FOR PRINTED EDUCATIONAL MATERIALS FOR CHILDREN IN THE FIELD OF DECORATIVE ACCESSORIES, APPAREL, AND FURNITURE; CHILDREN'S EDUCATIONAL BOOKS IN THE FIELD OF CRAFTS, COOKING, NUMBERS, DRAWING, GAMES, ANIMALS AND CHILDREN'S STORYBOOKS (U.S. CLS. 2, 5, 22, 23, 29, 37, 38 AND 50).

**CLASS 16—(Continued).**

SN 76-137,049. PRIMEDIA BUSINESS MAGAZINES & MEDIA INC., OVERLAND PARK, KS. BY CHANGE OF NAME INTERTEC PUBLISHING CORPORATION, OVERLAND PARK, KS. FILED 9-28-2000.



OWNER OF U.S. REG. NOS. 1,887,089, 1,936,401 AND 2,049,294.

NO CLAIM IS MADE TO THE EXCLUSIVE RIGHT TO USE "EDITION", APART FROM THE MARK AS SHOWN.  
THE MARK CONSISTS OF THE WORDS "AMERICAN TRUCKER OVER THE ROAD EDITION" IN STYLIZED LETTERING WITH A ROUTE SIGN IN THE BACKGROUND AND A BANNER BELOW. THE DRAWING HAS BEEN STIPPLED FOR SHADING AND SHADING IS A FEATURE OF THE MARK.

SEC. 2(F).  
FOR PRINTED MAGAZINES FEATURING CLASSIFIED AND INDUSTRY ADVERTISEMENTS FOR THE TRUCKING INDUSTRY (U.S. CLS. 2, 5, 22, 23, 29, 37, 38 AND 50).  
FIRST USE 3-23-2000; IN COMMERCE 3-23-2000.

SN 76-137,749. NATIONAL URBAN LEAGUE, INC., NEW YORK, NY. FILED 10-2-2000.



OWNER OF U.S. REG. NOS. 1,753,021, 2,023,561 AND 2,098,708.

NO CLAIM IS MADE TO THE EXCLUSIVE RIGHT TO USE "JOURNAL", APART FROM THE MARK AS SHOWN.  
SEC. 2(F) AS TO "URBAN LEAGUE" AND "EQUAL OPPORTUNITY".

FOR GENERAL INTEREST MAGAZINE CONTAINING ARTICLES RELATED TO THE CONCERNS AND EXPERIENCES OF PEOPLE OF AFRICAN DESCENT IN THE FIELDS OF BIOGRAPHY, HISTORY, ECONOMICS AND BUSINESS, POLITICS, EDUCATION, THE ARTS AND ENTERTAINMENT, SOCIOLOGY, LEGAL ISSUES, RECREATION AND SPORTS (U.S. CLS. 2, 5, 22, 23, 29, 37, 38 AND 50).  
FIRST USE 8-0-1996; IN COMMERCE 8-0-1996.

SN 76-142,476. FLOORGRAPHICS, INC., PRINCETON, NJ. FILED 10-6-2000.

**STREETALK**

FOR ADHESIVES FOR STATIONERY PURPOSES, ANNOUNCEMENT CARDS, PICTURES, ART PRINTS, CONSTRUCTION PAPER, GENERAL PURPOSE PLASTIC BAGS, PAPER BAGS, PAPER BANNERS, PAPER BOXES, BUMPER STICKERS, PEN AND PENCIL CASES, PRINTED CHARTS, PAPER CONTAINERS, COUPONS, DECALS, ETCHINGS, MEMO PADS, LAMINATED PAPER, ILLUSTRATION PAPER, COLOR PRINTS, AND STICKERS (U.S. CLS. 2, 5, 22, 23, 29, 37, 38 AND 50).

**CLASS 16—(Continued).**

SN 76-142,477. FLOORGRAPHICS, INC., PRINCETON, NJ. FILED 10-6-2000.

**STREETALK PLUS**

FOR ADHESIVES FOR STATIONERY PURPOSES, ANNOUNCEMENT CARDS, PICTURES, ART PRINTS, CONSTRUCTION PAPER, GENERAL PURPOSE PLASTIC BAGS, PAPER BAGS, PAPER BANNERS, PAPER BOXES, BUMPER STICKERS, PEN AND PENCIL CASES, PRINTED CHARTS, PAPER CONTAINERS, COUPONS, DECALS, ETCHINGS, MEMO PADS, LAMINATED PAPER, ILLUSTRATION PAPER, COLOR PRINTS, AND STICKERS (U.S. CLS. 2, 5, 22, 23, 29, 37, 38 AND 50).

SN 76-148,067. GRAND TOYS INTERNATIONAL, INC., DORVAL, QUEBEC H9P 1H7, CANADA, FILED 10-17-2000.

**TWISTEE'S TWIST 2 COLOR**

PRIORITY CLAIMED UNDER SEC. 44(D) ON CANADA APPLICATION NO. 1073916, FILED 9-7-2000.

FOR ACTIVITY ART SETS, NAMELY CRAYONS, ACTIVITY MATS, COMIC STRIPS, COLOURING BOOKS AND COLOURING SHEETS (U.S. CLS. 2, 5, 22, 23, 29, 37, 38 AND 50).

FIRST USE 3-1-2001; IN COMMERCE 3-1-2001.

SN 76-152,975. LIMCO, INC., WILMINGTON, DE. FILED 10-24-2000.



OWNER OF U.S. REG. NOS. 1,492,347, 2,353,539 AND OTHERS.

FOR CRAFTS, NAMELY, PERSONALIZED STATIONARY CRAFT KITS, BUBBLE CHAIR DECORATION CRAFT KITS, JEWELRY CRAFTS KITS, PEN DECORATION CRAFT KITS, LIP BALM CRAFT KITS, COOKIE MAKING KITS AND CLOTHING DECORATION CRAFT KITS (U.S. CLS. 2, 5, 22, 23, 29, 37, 38 AND 50).

**CLASS 16—(Continued).**

SN 76-153,959. ANGEL OF MY OWN, LLC, ST. CHARLES, MO. FILED 10-25-2000.

**GIVING CARDS**

NO CLAIM IS MADE TO THE EXCLUSIVE RIGHT TO USE "CARDS", APART FROM THE MARK AS SHOWN. FOR TRADING CARDS (U.S. CLS. 2, 5, 22, 23, 29, 37, 38 AND 50).

SN 76-155,860. SINGAPORE PRESS HOLDINGS LTD., NEWS CENTRE, SINGAPORE, FILED 10-30-2000.

**STRAITS TIMES INDEX**

OWNER OF U.S. REG. NOS. 2,145,955, 2,337,492 AND OTHERS.

NO CLAIM IS MADE TO THE EXCLUSIVE RIGHT TO USE "INDEX", APART FROM THE MARK AS SHOWN.

FOR NEWSPAPERS, PAMPHLETS, BROCHURES, NEWSLETTERS, JOURNALS, MAGAZINES, ALL FOR GENERAL CIRCULATION AND IN THE FIELD OF BUSINESS AND FINANCE; PRINTED GRAPHIC REPRODUCTIONS, CHARTS, AND INDEXES ABOUT BUSINESS AND FINANCE (U.S. CLS. 2, 5, 22, 23, 29, 37, 38 AND 50).

SN 76-156,922. DELTA TECHNICAL COATINGS, INC., WHITTIER, CA. FILED 10-31-2000.

**STAMP AND FRAME**

NO CLAIM IS MADE TO THE EXCLUSIVE RIGHT TO USE "STAMP", APART FROM THE MARK AS SHOWN.

FOR HANDSTAMP KIT COMPOSED OF DECORATIVE STAMPS AND INK FOR IMPRESSING INK DESIGNS ON STATIONERY (U.S. CLS. 2, 5, 22, 23, 29, 37, 38 AND 50).

FIRST USE 6-0-2000; IN COMMERCE 8-0-2000.

SN 76-157,141. NCPL INC., MISSISSAUGA, ONTARIO, CANADA, FILED 10-31-2000.

**STARPUPPY.COM**

PRIORITY CLAIMED UNDER SEC. 44(D) ON CANADA APPLICATION NO. 1076427, FILED 9-27-2000.

FOR GREETING CARDS (U.S. CLS. 2, 5, 22, 23, 29, 37, 38 AND 50).

**CLASS 16—(Continued).**

SN 76-160,228. SERINDIPITY ENTERPRISES, PEORIA, IL. FILED 11-3-2000.

## WELCOME HOME A JOURNAL DEDICATED TO THE PURSUIT OF THE AMERICAN DREAM

FOR BI-WEEKLY NEWSPAPER IN THE FIELD OF REAL ESTATE FEATURING INFORMATION, ARTICLES AND ADVERTISING (U.S. CLS. 2, 5, 22, 23, 29, 37, 38 AND 50).

FIRST USE 5-1-2000; IN COMMERCE 11-3-2000.

SN 76-167,974. RADIO CITY TRADEMARKS, LLC, NEW YORK, NY. FILED 11-20-2000.

## SHOWPLACE

FOR PRINTED PUBLICATIONS, NAMELY, MAGAZINE CONCERNING LIVE PERFORMANCES, MUSIC, ENTERTAINMENT, SPORTS, CONCERTS, PLAYS, SHOPPING, DINING AND AREA ATTRACTIONS (U.S. CLS. 2, 5, 22, 23, 29, 37, 38 AND 50).

SN 76-174,817. RHYSS PUBLISHING, SAN DIEGO, CA. FILED 12-1-2000.

## ZYSOURCE

FOR PRINTED PUBLICATIONS, NAMELY, DIRECTORIES IN THE FIELD OF PRODUCTS AND SERVICES RELATING TO THE PRACTICE OF MEDICINE (U.S. CLS. 2, 5, 22, 23, 29, 37, 38 AND 50).

SN 76-176,648. CHANDARIA, SACHEN, NAIROBI, KENYA, FILED 12-7-2000.

## Y-NOTE

FOR MEMO PADS WITH A SELF-ADHESIVE BACKING THEREON (U.S. CLS. 2, 5, 22, 23, 29, 37, 38 AND 50).

SN 76-176,682. CHANDARIA, SACHEN, NAIROBI, KENYA, FILED 12-7-2000.

## MEND-IT

FOR ADHESIVE TAPE FOR SCHOOL, HOME AND OFFICE USE (U.S. CLS. 2, 5, 22, 23, 29, 37, 38 AND 50).

**CLASS 16—(Continued).**

SN 76-190,868. AL AMAL INDUSTRIES S.A.O.G., RUSAYL, OMAN, FILED 1-8-2001.

## BUMBUMS

FOR DISPOSABLE DIAPERS (U.S. CLS. 2, 5, 22, 23, 29, 37, 38 AND 50).

SN 76-194,357. MISSION CITY PRESS, INC., SAN ANTONIO, TX. FILED 1-16-2001.

## MILLIE KEITH

THE NAME "MILLIE KEITH" DOES NOT IDENTIFY A LIVING INDIVIDUAL.

FOR PRINTED MATTER, NAMELY, A SERIES OF FICTION BOOKS, STUDY GUIDES, JOURNALS, AGENDAS, AND DIARIES ALL IN THE FIELD OF CHRISTIANITY; STATIONERY (U.S. CLS. 2, 5, 22, 23, 29, 37, 38 AND 50).

SN 76-199,459. COSMOS EUROPEAN TRAVELS, AKTIENGESELLSCHAFT, FUSTENTUM, LIECHTENSTEIN, FILED 1-23-2001.

## TAPESTRY TRAVELS

NO CLAIM IS MADE TO THE EXCLUSIVE RIGHT TO USE "TRAVELS", APART FROM THE MARK AS SHOWN.

FOR BOOKLETS, BROCHURES, GUIDE BOOKS, AND OTHER WRITTEN MATERIALS, NAMELY, CIRCULARS, POSTERS, PAMPHLETS AND PRINTED FORMS ALL CONCERNING TRAVEL (U.S. CLS. 2, 5, 22, 23, 29, 37, 38 AND 50).

SN 76-202,671. GALLAGHER, RAYMOND ROY, SAINT CLAIR SHORES, MI. FILED 1-29-2001.

## WHISPERING LEAVES BOOKS

NO CLAIM IS MADE TO THE EXCLUSIVE RIGHT TO USE "BOOKS", APART FROM THE MARK AS SHOWN.

FOR CHILDREN'S BOOKS, POEM BOOKS, MUSIC BOOKS, HISTORY AND GEOGRAPHY BOOKS AND A SERIES OF FICTION BOOKS (U.S. CLS. 2, 5, 22, 23, 29, 37, 38 AND 50).



**CLASS 16—(Continued).**

SN 76-203,655. MCINTYRE PHOTOGRAPHY, INC., WINSTON-SALEM, NC. FILED 2-1-2001.

**LOOSE ENDS PRESS**

NO CLAIM IS MADE TO THE EXCLUSIVE RIGHT TO USE "PRESS", APART FROM THE MARK AS SHOWN.  
FOR SERIES OF FICTION AND NON-FICTION BOOKS ON A VARIETY OF TOPICS (U.S. CLS. 2, 5, 22, 23, 29, 37, 38 AND 50).  
FIRST USE 9-1-2000; IN COMMERCE 9-1-2000.

---

SN 76-204,738. WALSH, SUSAN MOORE, SHREWSBURY, MA. FILED 2-5-2001.

**LUCI**

FOR BOOKMARKS, PAPER GIFT BOXES, PAPER CANDY BOXES, WRITING PADS, STATIONERY, PAPER GIFT BAGS, GIFT CARDS, AND POSTCARDS, ALL DEPICTING WOMEN PLAYING SPORTS (U.S. CLS. 2, 5, 22, 23, 29, 37, 38 AND 50).

---

SN 76-204,880. DIGITAL DOMAIN, INC., VENICE, CA. FILED 1-22-2001.



OWNER OF U.S. REG. NOS. 2,015,945, 2,018,031 AND 2,260,207.  
FOR PAPERWEIGHTS, PENS, PENCILS, POSTERS AND STATIONERY (U.S. CLS. 2, 5, 22, 23, 29, 37, 38 AND 50).

**CLASS 16—(Continued).**

SN 76-208,560. DAVENPORT, CATHY, PENDLETON, SC. FILED 2-12-2001.



FOR CARDBOARD CONES WITH FOAM INSERTS FOR USE WITH FLORAL ARRANGEMENTS (U.S. CLS. 2, 5, 22, 23, 29, 37, 38 AND 50).  
FIRST USE 8-14-2000; IN COMMERCE 8-14-2000.

---

SN 76-214,611. PHARMACIA & UPJOHN COMPANY, PEAPACK, NJ. FILED 2-23-2001.

**WHAT DO WOMEN WANT?**

FOR PRINTED MATERIALS, NAMELY, EDUCATIONAL AND INSTRUCTION MATERIALS IN THE NATURE OF PAMPHLETS, BROCHURES, NEWSLETTERS AND CARDS RELATING TO ISSUES OF FEMALE HEALTH AND WELLNESS (U.S. CLS. 2, 5, 22, 23, 29, 37, 38 AND 50).  
FIRST USE 2-28-2000; IN COMMERCE 2-28-2000.

---

SN 76-216,934. UHU GMBH & CO. KG, 77815 BUHL, FED REP GERMANY, FILED 2-22-2001.

**UHU mount-it**

THE ENGLISH TRANSLATION OF THE GERMAN WORD "UHU" IS "OWL".  
FOR ADHESIVES FOR HOUSEHOLD AND STATIONERY PURPOSES, NAMELY, MOUNTING TABS AND DOUBLE SIDED FOAM ADHESIVES (U.S. CLS. 2, 5, 22, 23, 29, 37, 38 AND 50).

**CLASS 16—(Continued).**

SN 76-221,621. TRADE PRESS PUBLISHING CORP., MILWAUKEE, WI. FILED 3-2-2001.

**E FACILITIES**

FOR PERIODIC TRADE MAGAZINES CONCERNING THE OPERATION OF FACILITIES, NAMELY, OFFICE, INDUSTRIAL, AND OTHER COMMERCIAL BUILDINGS (U.S. CLS. 2, 5, 22, 23, 29, 37, 38 AND 50).

FIRST USE 10-1-2000; IN COMMERCE 10-1-2000.

**CLASS 16—(Continued).**

SN 76-230,814. AMERICAN NATIONAL RED CROSS, THE, WASHINGTON, DC. FILED 3-27-2001.

**TOGETHER, WE CAN SAVE A LIFE**

FOR PRINTED MATERIALS CONSISTING OF PAPER AND PAPER ARTICLES, PERIODICALS, STATIONARY AND INSTRUCTIONAL AND TEACHING MATERIALS IN THE FIELD OF CHARITABLE FUNDRAISING (U.S. CLS. 2, 5, 22, 23, 29, 37, 38 AND 50).

SN 76-222,560. SMITH, BEVERLY J., DALY CITY, CA. FILED 3-12-2001.

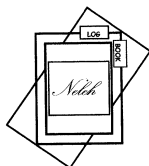

THE NELEH LOGBOOK

NO CLAIM IS MADE TO THE EXCLUSIVE RIGHT TO USE "LOGBOOKS", APART FROM THE MARK AS SHOWN.

THE MARK CONSISTS OF A COMBINATION OF 1 SQUARE AND 3 RECTANGLES. ONE RECTANGLE CONTAINS ANOTHER RECTANGLE INSIDE AND A SQUARE WITH THE WORD "NELEH" INSIDE. THE SQUARE AND THE INNER RECTANGLE IS FILLED IN WITH THE COLOR GOLD. THE OUTER RECTANGLE HAS THE WORD "LOG" AND THE WORD "BOOK" ON TWO SIDES OF THE RECTANGLE WHERE THE TWO WORDS MEET PERPENDICULAR TO EACH OTHER. EACH WORD IS INSIDE A SMALL RECTANGLE-SHAPED BOX. THE THIRD RECTANGLE IS SET AT AN ANGLE AROUND THE OTHER RECTANGLES AND THE SQUARE.

FOR MEDICAL LOGBOOKS TO RECORD HEALTH RELATED INFORMATION (U.S. CLS. 2, 5, 22, 23, 29, 37, 38 AND 50).

SN 76-233,516. WAYNE D. & BARBARA A. CARROLL PARTNERSHIP, THE, LIGONIER, PA. FILED 4-2-2001.

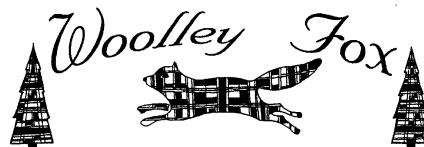

FOR HOOKED RUG PATTERNS (U.S. CLS. 2, 5, 22, 23, 29, 37, 38 AND 50).

FIRST USE 11-0-1993; IN COMMERCE 11-0-1993.

SN 76-235,237. SAM SILVERSTEIN ENTERPRISES, INC., ST. LOUIS, MO. FILED 4-4-2001.



FOR CUSTOM AUDIO/VISUAL TRAINING PROGRAMS FOR CORPORATIONS (U.S. CLS. 2, 5, 22, 23, 29, 37, 38 AND 50).

FIRST USE 1-30-2001; IN COMMERCE 1-30-2001.

SN 76-225,370. INDIANA STAMP CO., INC., FORT WAYNE, IN. FILED 3-16-2001.



OWNER OF U.S. REG. NO. 1,567,072.

FOR MARKING DEVICES, NAMELY, RUBBER STAMPS, SELF-INKING STAMPS AND PRE-INKED STAMPS FOR MAKING PAPER, EMBOSSED SEALS; CORPORATE SEALS; ADDRESS PLATES AND PARKING DECALS (U.S. CLS. 2, 5, 22, 23, 29, 37, 38 AND 50).

SN 76-240,753. VIRCO MGMT. CORP., TORRANCE, CA. FILED 4-16-2001.

**EXPRESS RAIL**

FOR DESK TOP ORGANIZERS CONSISTING OF A HORIZONTAL BEAM THAT IS ATTACHABLE TO A COMPUTER STATION OR DESK (U.S. CLS. 2, 5, 22, 23, 29, 37, 38 AND 50).

**CLASS 16—(Continued).**

SN 76-242,706. BRAMHALL & HAZEL, INC., CONCORD, MA. FILED 4-18-2001.



FOR WRITING INSTRUMENTS, NAMELY, PENS; BOOKMARKS; NOTEBOOKS; STATIONERY; PHOTO-JOURNALS; JOURNALS; STICKERS; ADDRESS BOOKS; NOTEPADS; AND DIARIES (U.S. CLS. 2, 5, 22, 23, 29, 37, 38 AND 50).

**CLASS 16—(Continued).**

SN 76-245,783. LEVENGER COMPANY, DELRAY BEACH, FL. FILED 4-24-2001.



OWNER OF U.S. REG. NOS. 1,682,974, 2,417,331 AND OTHERS.  
FOR STATIONERY AND WRITING INSTRUMENTS (U.S. CLS. 2, 5, 22, 23, 29, 37, 38 AND 50).  
FIRST USE 3-0-1999; IN COMMERCE 3-0-1999.

SN 76-245,208. BIOLNSIGHTS, LLC, CALIFON, NJ. FILED 4-23-2001.

**BIOINSIGHTS, LLC. STATE-OF-THE-INDUSTRY**

NO CLAIM IS MADE TO THE EXCLUSIVE RIGHT TO USE "LLC", APART FROM THE MARK AS SHOWN.  
FOR PRINTED COURSE MATERIALS IN THE FIELD OF BIOSCIENCE (U.S. CLS. 2, 5, 22, 23, 29, 37, 38 AND 50).

SN 76-246,073. CTE PUBLICATIONS, INC., NORTHBROOK, IL. FILED 4-24-2001.



OWNER OF U.S. REG. NO. 1,328,471.  
SEC. 2(F) AS TO "CUTTING TOOL ENGINEERING".  
FOR METALWORKING MAGAZINE (U.S. CLS. 2, 5, 22, 23, 29, 37, 38 AND 50).  
FIRST USE 0-0-1984; IN COMMERCE 0-0-1984.

SN 76-245,714. JACKSON, SUSAN GOODMAN, NORTH-FIELD, NJ. FILED 4-25-2001.

**STAND UP! SPEAK OUT!**

FOR PRINTED INSTRUCTIONAL, EDUCATIONAL AND TEACHING MATERIALS FOR CHILDREN AND THEIR FAMILIES WITH RESPECT TO ISSUES OF PREJUDICE, BULLYING, CHARACTER AND MORAL COURAGE (U.S. CLS. 2, 5, 22, 23, 29, 37, 38 AND 50).  
FIRST USE 4-1-2000; IN COMMERCE 11-14-2000.

SN 76-246,842. BETHEL TRUMPETER, INC., THE, SILVER SPRING, MD. FILED 4-26-2001.

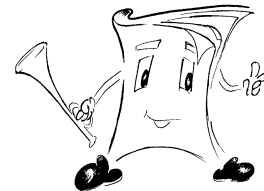

**The Bethel Trumpeter**

NO CLAIM IS MADE TO THE EXCLUSIVE RIGHT TO USE "BETHEL", APART FROM THE MARK AS SHOWN.  
FOR MAGAZINES IN THE FIELD OF CHURCH EVENTS AND CHURCH MINISTRIES (U.S. CLS. 2, 5, 22, 23, 29, 37, 38 AND 50).

**CLASS 16—(Continued).**

SN 76-252,896. HONEYMOON ELEGANCE ETC. INC., BUFFALO, NY. FILED 5-4-2001.

**HONEYMOONELEGANCEET  
C.COM**

FOR STATIONERY, NOTE CARDS, HOLIDAY CARDS, PHOTO POSTCARDS, TRAVEL ITINERARY FORMS, PRINTED BLANK PACKING CHECKLISTS, SPECIAL EVENT COUNTDOWN FORMS, AND PRINTED BLANK GIFT CERTIFICATES (U.S. CLS. 2, 5, 22, 23, 29, 37, 38 AND 50).

---

SN 76-256,322. MEDICAL SUPPLY FOUNDATION, INC., DEERFIELD BEACH, FL. FILED 5-11-2001.

**EVERYDAY DIABETES**

NO CLAIM IS MADE TO THE EXCLUSIVE RIGHT TO USE "DIABETES", APART FROM THE MARK AS SHOWN. FOR SYNDICATED ADVICE COLUMN ON MANAGING DIABETES (U.S. CLS. 2, 5, 22, 23, 29, 37, 38 AND 50).

---

SN 76-257,036. HODGES, WILLIAM, COSTA MESA, CA. FILED 5-15-2001.

**SCARES AND STRIPES**

FOR PARTY FAVORS IN THE NATURE OF PARTY GOODS, NAMELY, NAPKINS, HATS, TABLECLOTHS, BAGS, BANNERS, ENVELOPES, NOTE CARDS AND PARTY DECORATIONS (U.S. CLS. 2, 5, 22, 23, 29, 37, 38 AND 50).

---

SN 76-258,039. NATURAL SCIENCE INDUSTRIES, LTD., WEST HEMPSTEAD, NY. FILED 5-16-2001.

**STRESS PEN**

NO CLAIM IS MADE TO THE EXCLUSIVE RIGHT TO USE "PEN", APART FROM THE MARK AS SHOWN. FOR WRITING INSTRUMENTS, NAMELY PENS (U.S. CLS. 2, 5, 22, 23, 29, 37, 38 AND 50).

**CLASS 16—(Continued).**

SN 76-260,284. RUSCONI EDITORE S.P.A., 20126 MILAN, ITALY, FILED 5-21-2001.

**GENTE**

OWNER OF U.S. REG. NO. 1,627,004.  
THE ENGLISH TRANSLATION OF THE WORD "GENTE" IN THE MARK IS "PEOPLE".  
FOR MAGAZINES AND BOOKS FEATURING ARTICLES, STORIES AND PHOTOGRAPHIC ITEMS ABOUT PUBLIC PERSONALITIES (U.S. CLS. 2, 5, 22, 23, 29, 37, 38 AND 50).  
FIRST USE 9-16-1980; IN COMMERCE 9-16-1980.

---

SN 76-262,722. GROUNDSSWELL, L.L.C., BINGHAM FARMS, MI. FILED 5-29-2001.

**SHEBREW**

FOR ALBUMS, NAMELY, PHOTOGRAPH ALBUMS, SCRAPBOOK ALBUMS; PAPER PARTY BAGS, PLASTIC BAGS, ENVELOPES, AND POUCHES FOR MERCHANDISING PACKAGING, PAPER BAGS, ENVELOPES, AND POUCHES FOR MERCHANDISING PACKAGING; BOOKS, NAMELY ADDRESS BOOKS, APPOINTMENT BOOKS, CHILDREN'S ACTIVITY BOOKS, COLORING BOOKS, DATE BOOKS, MEMORANDUM BOOKS, NOTEBOOKS, PICTURE BOOKS, TELEPHONE NUMBER BOOKS, SCRAPBOOKS BOOK COVERS, BOOK MARKS; BOXES, NAMELY PAPER BOXES, PENCIL BOXES; CALENDARS, NAMELY, DESK CALENDARS, POCKET CALENDARS, WALL CALENDARS, CALENDAR DESK PADS; CARDS, NAMELY, BLANK CARDS, ANNOUNCEMENT CARDS, CHRISTMAS CARDS, GREETING CARDS, PLAYING CARDS; CASES, NAMELY, PEN CASES, PENCIL CASES, PLAYING CARD CASES; GIFT WRAPPING PAPER, METALLIC GIFT WRAP, PAPER GIFT WRAPPING, PAPER RIBBONS FOR GIFT WRAPPING; LOOSE LEAF BINDERS, LOOSE LEAF PAPER; WRITING PADS, SCRATCH PADS; STATIONARY-TYPE PORTFOLIOS; PENS, NAMELY, BALL-POINT PENS, FOUNTAIN PENS, INK PENS, PENCILS, PEN AND PENCIL TRAYS, PEN HOLDERS, PENCIL HOLDERS (U.S. CLS. 2, 5, 22, 23, 29, 37, 38 AND 50).

**CLASS 16—(Continued).**

SN 76-262,914. GROUNDSSWELL, L.L.C., BINGHAM FARMS, MI. FILED 5-29-2001.

**GROUNDS FOR APPEAL**

FOR ALBUMS, NAMELY, PHOTOGRAPH ALBUMS, SCRAPBOOK ALBUMS; PAPER PARTY BAGS, PLASTIC BAGS, ENVELOPES, AND POUCHES FOR MERCHANDISING PACKAGING, PAPER BAGS, ENVELOPES, AND POUCHES FOR MERCHANDISING PACKAGING; BOOKS, NAMELY ADDRESS BOOKS, APPOINTMENT BOOKS, CHILDREN'S ACTIVITY BOOKS, COLORING BOOKS, DATE BOOKS, MEMORANDUM BOOKS, NOTEBOOKS, PICTURE BOOKS, TELEPHONE NUMBER BOOKS, SCRAPBOOKS BOOK COVERS, BOOK MARKS; BOXES, NAMELY PAPER BOXES, PENCIL BOXES; CALENDARS, NAMELY, DESK CALENDARS, POCKET CALENDARS, WALL CALENDARS, CALENDAR DESK PADS; CARDS, NAMELY, BLANK CARDS, ANNOUNCEMENT CARDS, CHRISTMAS CARDS, GREETING CARDS, PLAYING CARDS; CASES, NAMELY, PEN CASES, PENCIL CASES, PLAYING CARD CASES; GIFT WRAPPING PAPER, METALLIC GIFT WRAP, PAPER GIFT WRAPPING, RIBBONS; LOOSE LEAF BINDERS, LOOSE LEAF PAPER, WRITING PADS, SCRATCH PADS; STATIONARY-TYPE PORTFOLIOS; PENS, NAMELY, BALL-POINT PENS, FOUNTAIN PENS, INK PENS, PENCILS, PEN AND PENCIL TRAYS, PEN HOLDERS, PENCIL HOLDERS (U.S. CLS. 2, 5, 22, 23, 29, 37, 38 AND 50).

SN 76-263,251. RUIZ-TOLEDO, LOURDES, MIAMI, FL. FILED 5-29-2001.

**LA RUBIA PELIGROSA**

FOR MAGAZINE COLUMN ON THE SUBJECT OF CELEBRITY NEWS AND GOSSIP (U.S. CLS. 2, 5, 22, 23, 29, 37, 38 AND 50).  
FIRST USE 6-27-2000; IN COMMERCE 6-27-2000.

SN 76-263,504. GROUNDSSWELL, L.L.C., BINGHAM FARMS, MI. FILED 5-30-2001.

**BUMP & GRINDS**

FOR ALBUMS, NAMELY, PHOTOGRAPH ALBUMS, SCRAPBOOK ALBUMS; PAPER PARTY BAGS, PLASTIC BAGS, ENVELOPES, AND POUCHES FOR MERCHANDISING PACKAGING, PAPER BAGS, ENVELOPES, AND POUCHES FOR MERCHANDISING PACKAGING; BOOKS, NAMELY ADDRESS BOOKS, APPOINTMENT BOOKS, CHILDREN'S ACTIVITY BOOKS, COLORING BOOKS, DATE BOOKS, MEMORANDUM BOOKS, NOTEBOOKS, PICTURE BOOKS, TELEPHONE NUMBER BOOKS, SCRAPBOOKS BOOK COVERS, BOOK MARKS; BOXES, NAMELY PAPER BOXES, PENCIL BOXES; CALENDARS, NAMELY, DESK CALENDARS, POCKET CALENDARS, WALL CALENDARS, CALENDAR DESK PADS; CARDS, NAMELY, BLANK CARDS, ANNOUNCEMENT CARDS, CHRISTMAS CARDS, GREETING CARDS, PLAYING CARDS; CASES, NAMELY, PEN CASES, PENCIL CASES, PLAYING CARD CASES; GIFT WRAPPING PAPER, METALLIC GIFT WRAP, PAPER GIFT WRAPPING, RIBBONS; LOOSE LEAF BINDERS, LOOSE LEAF PAPER; WRITING PADS, SCRATCH PADS; STATIONARY-TYPE PORTFOLIOS; PENS, NAMELY, BALL-POINT PENS, FOUNTAIN PENS, INK PENS, PENCILS, PEN AND PENCIL TRAYS, PEN HOLDERS, PENCIL HOLDERS (U.S. CLS. 2, 5, 22, 23, 29, 37, 38 AND 50).

**CLASS 16—(Continued).**

SN 76-265,467. T AND T MARKETING, LLC, BRIGHTON, MI. FILED 6-4-2001.

**PARKING WIZARD**

FOR PRINTED MATERIAL PERTAINING TO CAR PARKING AND PASSENGER SAFETY, NAMELY SIGNS, LABELS, PAMPHLETS, BROCHURES, CATALOGUES, AND NEWSLETTERS (U.S. CLS. 2, 5, 22, 23, 29, 37, 38 AND 50).

SN 76-267,561. HOUGHTON MIFFLIN COMPANY, BOSTON, MA. FILED 6-6-2001.



NO CLAIM IS MADE TO THE EXCLUSIVE RIGHT TO USE "EARLY ASSESSMENT OF READING", APART FROM THE MARK AS SHOWN.

FOR PRINTED MATERIALS, NAMELY TESTS FOR ASSESSMENT OF READING AND LANGUAGE ARTS COMPREHENSION AND SKILLS FOR GRADES K-3 (U.S. CLS. 2, 5, 22, 23, 29, 37, 38 AND 50).

SN 76-272,589. ECOSYNTHETIX INC., LANSING, MI. FILED 6-15-2001.

**GROOVYKIDS**

FOR ARTS AND CRAFT KITS COMPRISED OF GLUE FOR HOUSEHOLD AND STATIONERY USE, ADHESIVES FOR HOUSEHOLD AND STATIONERY USE, PAINTS, AND SELF-ADHESIVE NOTES (U.S. CLS. 2, 5, 22, 23, 29, 37, 38 AND 50).

SN 76-273,579. GOLDWASSER, RICHARD, GLASTONBURY, CT. FILED 6-19-2001.

**VALIDATION: A TEST TO MONITOR MEMORY**

FOR PRINTED BOOKLETS CONTAINING IMAGES USED FOR TESTING MEMORY, MEMORY TEST ANSWER AND SCORING SHEETS, AND BACKGROUND AND INTERPRETATION INFORMATION (U.S. CLS. 2, 5, 22, 23, 29, 37, 38 AND 50).

**CLASS 16—(Continued).**

SN 76-277,376. POTLATCH CORPORATION, SPOKANE, WA. FILED 6-26-2001.

**GABLEPAK**

FOR FLUID IMPERVIOUS PAPER (U.S. CLS. 2, 5, 22, 23, 29, 37, 38 AND 50).

---

SN 76-277,697. SCHOLASTIC INC., NEW YORK, NY. FILED 6-28-2001.



FOR SERIES OF FICTION BOOKS FOR CHILDREN (U.S. CLS. 2, 5, 22, 23, 29, 37, 38 AND 50).

---

SN 76-278,355. DLH DISTRIBUTING AND MARKETING, INC., ALEXANDRIA, VA. FILED 6-20-2001.

**PHONALITY PLUS**

FOR PREPAID LONG DISTANCE TELEPHONE CALLING CARDS, NOT MAGNETICALLY ENCODED (U.S. CLS. 2, 5, 22, 23, 29, 37, 38 AND 50).

---

SN 76-280,733. BEROL CORPORATION, FREEPORT, IL. FILED 7-5-2001.

**TATTOO STICK**

NO CLAIM IS MADE TO THE EXCLUSIVE RIGHT TO USE "TATTOO", APART FROM THE MARK AS SHOWN.  
FOR WRITING INSTRUMENTS FOR DRAWING ON HUMAN SKIN (U.S. CLS. 2, 5, 22, 23, 29, 37, 38 AND 50).

**CLASS 16—(Continued).**

SN 76-281,777. EASTWORD PUBLICATIONS DEVELOPMENT, INC., CLEVELAND, OH. FILED 7-9-2001.

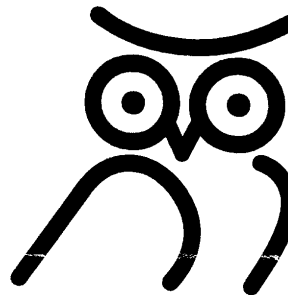

FOR EDUCATIONAL AND REFERENCE BOOKS FOR ADULTS AND CHILDREN, INCLUDING SINGLE AND MULTI-VOLUME SETS, ON A VARIETY OF TOPICS (U.S. CLS. 2, 5, 22, 23, 29, 37, 38 AND 50).  
FIRST USE 9-12-2000; IN COMMERCE 9-12-2000.

---

SN 76-284,617. MORGAN HOUSE PUBLISHING, INC., TUCSON, AZ. FILED 7-6-2001.

**MORGAN HOUSE PUBLISHING**

NO CLAIM IS MADE TO THE EXCLUSIVE RIGHT TO USE "HOUSE PUBLISHING", APART FROM THE MARK AS SHOWN.

FOR PRINTED MATERIAL, NAMELY, NEWSPAPERS, PAMPHLETS, BROCHURES, MAGAZINES, COLORING BOOKS, POSTERS, NOTECARDS, COLLECTIBLE CARDS, AND RUBBER STAMPS ALL DEALING WITH PET ADOPTION AND READING MATERIALS FOR CHILDREN; PRINTED EDUCATIONAL MATERIALS FOR CONSUMERS, SCHOOLS, BUSINESSES, INDUSTRY AND GOVERNMENT AGENCIES, PRIMARILY COMPOSED OF BOOKS, PAMPHLETS, AND BROCHURES (U.S. CLS. 2, 5, 22, 23, 29, 37, 38 AND 50).

---

SN 76-291,035. BARAJAS, LUIS JR., LOS ANGELES, CA. AND TURNER, JAMES, LOS ANGELES, CA. FILED 7-27-2001.

**KEN**

FOR MEN'S LIFESTYLE MAGAZINE (U.S. CLS. 2, 5, 22, 23, 29, 37, 38 AND 50).

**CLASS 16—(Continued).**

SN 76-292,337. CASEY, CAROLE, LAKE OSWEGO, OR. AND LANGSDORF, MARILYN, LAKE OSWEGO, OR. AND MOIR, PATRICIA, LAKE OSWEGO, OR. FILED 7-31-2001.

**COLLEGE IN A BOX**

FOR PAPER ITEMS, NAMELY, NOTE PADS; PRINTED MATERIALS, NAMELY, A KIT COMPRISED OF BOOKS IN THE FIELD OF COLLEGE APPLICATION PLANNING, BOOKLETS IN THE FIELD OF COLLEGE APPLICATION PLANNING, POSTERS, AND PAPER FILES, NAMELY, FILE FOLDERS, HANGING FILES, FILE JACKETS, FILE BOXES, FILE POCKETS, FILE RACKS, FILE TRAYS, AND EXPANDING FILES (U.S. CLS. 2, 5, 22, 23, 29, 37, 38 AND 50).

FIRST USE 9-17-2000; IN COMMERCE 2-14-2001.

SN 76-292,373. I.C.C. USA, CORP., BELL HARBOR, FL. FILED 8-1-2001.

**TELEFELIZ**

THE ENGLISH TRANSLATION OF "TELEFELIZ" IS "HAPPY TELEPHONE".

FOR PREPAID TELEPHONE CALLING CARDS, NOT MAGNETICALLY ENCODED (U.S. CLS. 2, 5, 22, 23, 29, 37, 38 AND 50).

FIRST USE 7-1-2001; IN COMMERCE 7-1-2001.

SN 76-292,572. WEATHER CHANNEL, INC., THE, ATLANTA, GA. FILED 7-31-2001.

**RAYS AWARENESS**

FOR INFORMATIONAL PUBLICATIONS AND BROCHURES REGARDING SUN SAFETY (U.S. CLS. 2, 5, 22, 23, 29, 37, 38 AND 50).

FIRST USE 5-14-2001; IN COMMERCE 5-14-2001.

SN 76-293,774. BROWN, VERNON STEVENS, TAYLORS, SC. FILED 8-3-2001.

**JAMES STUART**

THE NAME "JAMES STUART" DOES NOT IDENTIFY A LIVING INDIVIDUAL.

FOR SERIES OF FICTION BOOKS (U.S. CLS. 2, 5, 22, 23, 29, 37, 38 AND 50).

**CLASS 16—(Continued).**

SN 76-293,832. AMERICAN PHYSIOLOGICAL SOCIETY, THE, BETHESDA, MD. FILED 8-2-2001.

**PHYSIOLOGY IN MEDICINE**

SEC. 2(F).

FOR RECURRING COLUMN APPEARING IN A SERIES OF PUBLICATIONS FEATURING ISSUES RELATING TO PHYSIOLOGY (U.S. CLS. 2, 5, 22, 23, 29, 37, 38 AND 50).

FIRST USE 1-1-1985; IN COMMERCE 1-1-1985.

SN 76-294,656. PAIDEIA,LLC, BLOOMINGTON, MN. FILED 8-6-2001.

**WISDOM OF THE WORLD**

FOR GREETING CARDS, PLAYING CARDS, PERIODICALS, BROCHURES, STATIONERY, CALENDARS, NOTE PADS, DECALS, LEAFLETS, AND JOURNALS ALL CONTAINING QUOTATIONS AND PROVERBS FROM DIVERSE CULTURES (U.S. CLS. 2, 5, 22, 23, 29, 37, 38 AND 50).

SN 76-295,352. WILLIAM EXLINE, INC., CLEVELAND, OH. FILED 8-6-2001.

**CD PASSPORT**

NO CLAIM IS MADE TO THE EXCLUSIVE RIGHT TO USE "CD", APART FROM THE MARK AS SHOWN.

FOR COMPACT DISC DISPLAY FOLDERS MADE OF PAPER (U.S. CLS. 2, 5, 22, 23, 29, 37, 38 AND 50).

SN 76-295,574. SUNSET PUBLISHING CORPORATION, MENLO PARK, CA. FILED 8-6-2001.

**THE SUNSET TRAVEL DIRECTORY**

OWNER OF U.S. REG. NOS. 209,499, 2,087,856 AND OTHERS.

NO CLAIM IS MADE TO THE EXCLUSIVE RIGHT TO USE "TRAVEL DIRECTORY", APART FROM THE MARK AS SHOWN.

FOR MAGAZINE SECTION OFFERING INFORMATION ON HOTELS, RESORTS, MUSEUMS AND LOCAL AND REGIONAL TOURIST ATTRACTIONS (U.S. CLS. 2, 5, 22, 23, 29, 37, 38 AND 50).

FIRST USE 6-0-2001; IN COMMERCE 6-0-2001.

**CLASS 16—(Continued).**

SN 76-296,826. DAINE, KATZ, PITTSBORO, NC. AND BIZZARRI, PHILIP, PITTSBORO, NC. FILED 8-9-2001.

**ROSENBERY BOOKS, ETC.**

NO CLAIM IS MADE TO THE EXCLUSIVE RIGHT TO USE "BOOKS", APART FROM THE MARK AS SHOWN.

FOR CHILDREN'S BOOKS; PRINTED MATERIALS, NAMELY, PRE-PRINTED FICTIONAL LETTERS; ART PRINTS; PAPER CONTAINERS; WRITING STATIONERY, NAMELY, PAPER AND ENVELOPES; ARTS AND CRAFTS PAINT KITS (U.S. CLS. 2, 5, 22, 23, 29, 37, 38 AND 50).

---

SN 76-297,042. CREATIVE TEACHING PRESS, HUNTINGTON BEACH, CA. FILED 8-8-2001.

**TEAMWORKS**

FOR PRINTED EDUCATIONAL CLASSROOM MATERIALS AND MATERIALS FOR ASSISTING PARENTAL INVOLVEMENT IN CHILD READING DEVELOPMENT, NAMELY, BINDERS CONTAINING A PRINTED MANUAL OF WORKSHOPS FOR DEVELOPING READING SKILLS AND HOME ACTIVITY SHEETS, PLASTIC TRANSPARENCIES, PRINTED CHARTS, REWARD SYSTEM COMPONENTS, NAMELY, STICKERS, PRINTED BOOKMARKS, AND PRINTED CERTIFICATES, AND TEACHER TRAINING MATERIALS, NAMELY, BOOKS FOR PROMOTING STAFF AND TEACHER DEVELOPMENT (U.S. CLS. 2, 5, 22, 23, 29, 37, 38 AND 50).  
FIRST USE 9-13-1996; IN COMMERCE 9-13-1996.

---

SN 76-298,274. SUIS FOR FACE AND BODY, PRESCOTT, AZ. FILED 8-13-2001.



DON'T GAMBLE WITH YOUR SKIN

FOR PRINTED EDUCATIONAL AND PROMOTIONAL MATERIALS NAMELY BROCHURES, PAMPHLETS AND LABELS THAT PROVIDE INFORMATION AND RESEARCH ON SKIN CARE PRODUCTS, NAMELY, NON-MEDICATED CLEANSERS, TONERS, MOISTURIZERS, SERUMS, SHAMPOOS AND CONDITIONERS AND PROVIDE INFORMATION ON COSMETIC INGREDIENTS AND HEALTH RELATED TOPICS (U.S. CLS. 2, 5, 22, 23, 29, 37, 38 AND 50).

**CLASS 16—(Continued).**

SN 76-299,307. US WEEKLY LLC, NEW YORK, NY. FILED 8-14-2001.

SEC. 2(F).  
FOR ENTERTAINMENT MAGAZINE SECTION FEATURING PERSONALITIES AND EVENTS, FOCUSING ON THE ENTERTAINMENT INDUSTRY (U.S. CLS. 2, 5, 22, 23, 29, 37, 38 AND 50).  
FIRST USE 7-1-1985; IN COMMERCE 7-1-1985.

---

SN 76-301,317. MERRY THE CRANBERRY, L.L.C., PHOENIX, AZ. FILED 8-17-2001.

**MERRY THE CRANBERRY**

FOR SERIES OF BOOKS (U.S. CLS. 2, 5, 22, 23, 29, 37, 38 AND 50).  
FIRST USE 1-20-2001; IN COMMERCE 8-13-2001.

---

SN 76-301,928. NEW YORK TIMES COMPANY, THE, NEW YORK, NY. FILED 8-17-2001.

**CRITIC'S CHOICE**

OWNER OF U.S. REG. NO. 1,832,731.  
SEC. 2(F).  
FOR NEWSPAPER COLUMN ABOUT THE ARTS (U.S. CLS. 2, 5, 22, 23, 29, 37, 38 AND 50).  
FIRST USE 5-24-1981; IN COMMERCE 5-24-1981.

---

SN 76-302,664. SCHOLASTIC INC., NEW YORK, NY. FILED 8-20-2001.

**BASKETBALL, JR.**

OWNER OF U.S. REG. NO. 1,790,992.  
NO CLAIM IS MADE TO THE EXCLUSIVE RIGHT TO USE "BASKETBALL", APART FROM THE MARK AS SHOWN.  
FOR CONSUMER MAGAZINE RELATED TO BASKETBALL (U.S. CLS. 2, 5, 22, 23, 29, 37, 38 AND 50).



**CLASS 16—(Continued).**

SN 76-303,647. POTLATCH CORPORATION, SPOKANE, WA. FILED 8-20-2001.

**TODAY'S BUY**

FOR PAPER PRODUCTS, NAMELY, BATH AND FACIAL TISSUE, AND PAPER TOWELS (U.S. CLS. 2, 5, 22, 23, 29, 37, 38 AND 50).

SN 76-304,184. STRAVINA OPERATING COMPANY, LLC, CHATSWORTH, CA. FILED 8-24-2001.



The logo for 'Sticker n' Stamp' features the words 'Sticker n'' in a bold, rounded, sans-serif font above the word 'Stamp' in a larger, more stylized font with a drop shadow effect.

FOR STICKERS, PERSONALIZED STICKERS AND INK STAMPER SOLD AS A UNIT (U.S. CLS. 2, 5, 22, 23, 29, 37, 38 AND 50).

SN 76-304,512. SOFTPLAY INC., CHICAGO, IL. FILED 8-27-2001.



The logo for 'Early Language Development' features the text 'Early Language Development' in a bold, sans-serif font. Above the text is a dashed line with two small figures of children holding hands, suggesting a path or journey.

NO CLAIM IS MADE TO THE EXCLUSIVE RIGHT TO USE "EARLY LANGUAGE DEVELOPMENT", APART FROM THE MARK AS SHOWN.

FOR CHILDREN'S CLOTH BOOKS (U.S. CLS. 2, 5, 22, 23, 29, 37, 38 AND 50).  
FIRST USE 7-24-2001; IN COMMERCE 8-16-2001.

SN 76-305,725. CALIFORNIA CEDAR PRODUCTS COMPANY, STOCKTON, CA. FILED 8-27-2001.

**SPANGLE**

FOR PENCILS, PENS, FILE FOLDERS, PENCIL SHARPENERS, LETTER OPENERS, PAPER KNIVES (U.S. CLS. 2, 5, 22, 23, 29, 37, 38 AND 50).

**CLASS 16—(Continued).**

SN 76-305,742. CALIFORNIA CEDAR PRODUCTS COMPANY, STOCKTON, CA. FILED 8-27-2001.

**PROSPECTOR**

FOR PENCILS, PENS, FILE FOLDERS, PENCIL SHARPENERS, LETTER OPENERS, PAPER KNIVES (U.S. CLS. 2, 5, 22, 23, 29, 37, 38 AND 50).

SN 76-305,744. CALIFORNIA CEDAR PRODUCTS COMPANY, STOCKTON, CA. FILED 8-27-2001.

**GOLDEN BEAR**

FOR PENCILS, PENS, FILE FOLDERS, PENCIL SHARPENERS, LETTER OPENERS, PAPER KNIVES (U.S. CLS. 2, 5, 22, 23, 29, 37, 38 AND 50).

SN 76-305,748. CALIFORNIA CEDAR PRODUCTS COMPANY, STOCKTON, CA. FILED 8-27-2001.

**PALOMINO**

FOR PENCILS, PENS, FILE FOLDERS, PENCIL SHARPENERS, LETTER OPENERS, PAPER KNIVES (U.S. CLS. 2, 5, 22, 23, 29, 37, 38 AND 50).

SN 76-306,146. SCRATCH-ART COMPANY, INC., AVON, MA. FILED 8-28-2001.

**BATEEK-O**

FOR COATED WAX SHEET FOR TRANSFERING WAX ONTO A SECOND SHEET WITH THE APPLICATION OF PRESSURE, FOR USE IN THE BATIK TECHNIQUE (U.S. CLS. 2, 5, 22, 23, 29, 37, 38 AND 50).

SN 76-308,170. MCCARTHY, JAMES, WOODINVILLE, WA. AND MCCARTHY, MICHELE, WOODINVILLE, WA. FILED 8-31-2001.

**SOFTWARE FOR YOUR HEAD**

FOR PRINTED PUBLICATIONS, NAMELY BOOKS IN THE FIELD OF BUSINESS ADVICE (U.S. CLS. 2, 5, 22, 23, 29, 37, 38 AND 50).  
FIRST USE 6-28-2001; IN COMMERCE 6-28-2001.

**CLASS 16—(Continued).**

SN 76-308,738. NIVATEL COMMUNICATIONS, INC., ROSLYN HEIGHTS, NY. FILED 9-4-2001.

**SUPREME PHONE CARD**

FOR PREPAID TELEPHONE CALLING CARDS NOT MAGNETICALLY ENCODED (U.S. CLS. 2, 5, 22, 23, 29, 37, 38 AND 50).

FIRST USE 2-1-2001; IN COMMERCE 3-1-2001.

SN 76-309,169. NIVATEL COMMUNICATIONS, INC., ROSLYN HEIGHTS, NY. FILED 9-4-2001.

**JMD PHONE CARD**

NO CLAIM IS MADE TO THE EXCLUSIVE RIGHT TO USE "PHONE CARD", APART FROM THE MARK AS SHOWN.

FOR PREPAID TELEPHONE CALLING CARDS NOT MAGNETICALLY ENCODED (U.S. CLS. 2, 5, 22, 23, 29, 37, 38 AND 50).

FIRST USE 2-1-2001; IN COMMERCE 3-1-2001.

SN 76-309,171. NIVATEL COMMUNICATIONS, INC., ROSLYN HEIGHTS, NY. FILED 9-4-2001.

**UNIQUE PHONE CARD**

NO CLAIM IS MADE TO THE EXCLUSIVE RIGHT TO USE "PHONE CARD", APART FROM THE MARK AS SHOWN.

FOR PREPAID TELEPHONE CALLING CARDS NOT MAGNETICALLY ENCODED (U.S. CLS. 2, 5, 22, 23, 29, 37, 38 AND 50).

FIRST USE 2-1-2001; IN COMMERCE 3-1-2001.

SN 76-309,661. MCINTOSH, MURRAY H., NORTH KINGSTOWN, RI. FILED 9-7-2001.

**SALES LEAD REPORT**

NO CLAIM IS MADE TO THE EXCLUSIVE RIGHT TO USE "SALES" AND "REPORT", APART FROM THE MARK AS SHOWN.

FOR PRINTED MATTER - NAMELY-NEWSLETTER FEATURING TOPICS ON SALES AND MARKETING (U.S. CLS. 2, 5, 22, 23, 29, 37, 38 AND 50).

FIRST USE 3-10-1990; IN COMMERCE 3-10-1990.

SN 76-311,575. AGC, INC., CLEVELAND, OH. FILED 9-10-2001.

**BLUE UMBRELLA**

FOR GREETING CARDS (U.S. CLS. 2, 5, 22, 23, 29, 37, 38 AND 50).

FIRST USE 5-19-2001; IN COMMERCE 5-19-2001.

**CLASS 16—(Continued).**

SN 76-313,711. HEALTH COMMUNICATIONS, INC., DEERFIELD BEACH, FL. FILED 9-18-2001.

**HOW TO BE LIKE**

FOR SERIES OF NON-FICTION BOOKS IN THE FIELD OF INSPIRATION, SELF-AWARENESS AND SELF-IMPROVEMENT (U.S. CLS. 2, 5, 22, 23, 29, 37, 38 AND 50).

SN 76-314,041. TYLER, SUZETTE L., LANSING, MI. FILED 9-18-2001.

**BACKPACKERS**

FOR STATIONARY NOTES CONTAINING ADHESIVE ON ONE SIDE FOR ATTACHMENT TO SURFACES (U.S. CLS. 2, 5, 22, 23, 29, 37, 38 AND 50).

SN 76-318,418. HIKARI HOLDINGS, L.C., ALPINE, UT. FILED 9-28-2001.

**AVORADO KID**

FOR PUBLICATIONS, NAMELY, REFERENCE BOOKS AND PAMPHLETS IN THE FIELD OF HEALTH AND NUTRITION AND CHILDREN'S BOOKS (U.S. CLS. 2, 5, 22, 23, 29, 37, 38 AND 50).

SN 78-017,967. SEGALL, ANITA, L, TURRIALBA, COSTA RICA, FILED 7-22-2000.

**STOP-SNOT**

FOR FACIAL TISSUES (U.S. CLS. 2, 5, 22, 23, 29, 37, 38 AND 50).

SN 78-021,693. GLOBAL NETWORK ACCESS, INC., MIAMI, FL. FILED 8-17-2000.

FOR PRE-PAID LONG DISTANCE TELEPHONE CARDS, NOT MAGNETICALLY ENCODED (U.S. CLS. 2, 5, 22, 23, 29, 37, 38 AND 50).

**CLASS 16—(Continued).**

SN 78-024,173. DE ANDRE, DARROL C., ATLANTA, GA.  
FILED 9-1-2000.

**ALPHA MALE MAGAZINE**

NO CLAIM IS MADE TO THE EXCLUSIVE RIGHT TO USE "MAGAZINE", APART FROM THE MARK AS SHOWN.  
FOR PRINTED MATERIALS, NAMELY PERIODICAL MAGAZINES AND NEWSLETTERS FEATURING INFORMATION OF GENERAL INTEREST TO SAME-GENDER-LOVING AMERICANS OF COLOR IN THE FIELDS OF NEWS, CURRENT EVENTS, COMMENTARY, ENTERTAINMENT, EDUCATION, LIFESTYLE AND PERSONAL RELATIONSHIPS (U.S. CLS. 2, 5, 22, 23, 29, 37, 38 AND 50).

FIRST USE 2-1-2000; IN COMMERCE 5-25-2000.

SN 78-026,595. MODERNA ESCUELA MEDITERRANEA S.L.,  
CARDEDEU BARCELONA, SPAIN, FILED 9-19-2000.

**ADAGIO ART BY GENUINE  
EUROPEAN PORTRAITS**

NO CLAIM IS MADE TO THE EXCLUSIVE RIGHT TO USE "ART BY GENUINE EUROPEAN ARTISTS", APART FROM THE MARK AS SHOWN.

FOR ORIGINAL DRAWINGS AND PORTRAITS IN SEPIA AND CHARCOAL (U.S. CLS. 2, 5, 22, 23, 29, 37, 38 AND 50).

SN 78-027,881. CORNERSTONE ALLIANCE, BENTON HARBOR, MI. FILED 9-27-2000.

**MICHIGAN'S *Great* SOUTHWEST**  
*into the business of life.*

NO CLAIM IS MADE TO THE EXCLUSIVE RIGHT TO USE "MICHIGAN'S GREAT SOUTHWEST", APART FROM THE MARK AS SHOWN.

FOR PRINTED PUBLICATIONS, NAMELY VIEW-BOOK MANUAL IN THE FIELD OF TOURIST GUIDE (U.S. CLS. 2, 5, 22, 23, 29, 37, 38 AND 50).

FIRST USE 7-1-2000; IN COMMERCE 7-1-2000.

**CLASS 16—(Continued).**

SN 78-030,929. GENERAL MOTORS CORPORATION, DETROIT, MI. FILED 10-17-2000.

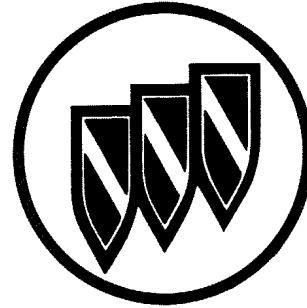

OWNER OF U.S. REG. NOS. 1,037,850, 1,790,402 AND OTHERS.

FOR PRINTED MATERIALS, NAMELY, MANUALS, BROCHURES AND CATALOGS PERTAINING TO THE FEATURES AND CONTROLS, OPERATION, MAINTENANCE, SERVICE AND REPAIR AND TECHNICAL FACTS AND SPECIFICATIONS OF MOTOR VEHICLES (U.S. CLS. 2, 5, 22, 23, 29, 37, 38 AND 50).

FIRST USE 9-1-1981; IN COMMERCE 9-1-1981.

SN 78-032,770. NATURAL AWAKENINGS PUBLISHING CORPORATION, NAPLES, FL. FILED 10-27-2000.

**Natural  
Awakenings**

NO CLAIM IS MADE TO THE EXCLUSIVE RIGHT TO USE "NATURAL", APART FROM THE MARK AS SHOWN.  
FOR MAGAZINES FEATURING NATURAL HEALTH (U.S. CLS. 2, 5, 22, 23, 29, 37, 38 AND 50).

FIRST USE 11-10-1993; IN COMMERCE 1-2-1994.

SN 78-036,533. LUCKY CHARMS ENTERTAINMENT, INC., RAMSEY, NJ. FILED 11-27-2000.

**ROSIE**

OWNER OF U.S. REG. NO. 2,230,599.  
THE NAME "ROSIE O'DONNELL" IDENTIFIES A LIVING INDIVIDUAL WHOSE CONSENT IS OF RECORD.

FOR MAGAZINE FEATURING ARTICLES ON POLITICAL AND SOCIAL ISSUES, CELEBRITIES, HOME AND GARDEN, HOBBIES AND CRAFTS, FOOD, HEALTH, FASHION, PERSONAL WELL-BEING, LIFESTYLES, HUMAN INTEREST STORIES, ADOPTING CHILDREN, AND OTHER TOPICS OF INTEREST GEARED TOWARD WOMEN (U.S. CLS. 2, 5, 22, 23, 29, 37, 38 AND 50).

**CLASS 16—(Continued).**

SN 78-037,835. CONKLIN, GEORGE HENRY, DURHAM, NC. FILED 12-5-2000.

**SOCIATION TODAY**

NO CLAIM IS MADE TO THE EXCLUSIVE RIGHT TO USE "SOCIATION", APART FROM THE MARK AS SHOWN. FOR SOCIOLOGY JOURNALS (U.S. CLS. 2, 5, 22, 23, 29, 37, 38 AND 50).

SN 78-040,547. NEW APPROACH DEVELOPMENT, LLC, BEDFORD, MA. BY ASSIGNMENT NEW APPROACH, INC., BEDFORD, MA. FILED 12-23-2000.

**DOUBLE LOADER**

FOR ARTISTS' MATERIALS IN THE NATURE OF A PALETTE HAVING A RIDGE, TO WHICH PAINTS OF DIFFERENT COLORS MAY BE APPLIED ON EITHER SIDE OF THE RIDGE, FOR USE IN ASSISTING PAINTERS TO ADD PAINT TO THEIR BRUSHES (U.S. CLS. 2, 5, 22, 23, 29, 37, 38 AND 50).  
FIRST USE 8-1-2001; IN COMMERCE 8-1-2001.

SN 78-040,901. VIACOM INTERNATIONAL INC., NEW YORK, NY. FILED 12-28-2000.

**SOO-HYUN**

THE MARK DOES NOT IDENTIFY THE NAME OF A LIVING INDIVIDUAL.

FOR PRINTED MATTER, NAMELY, NOTE PAPER AND LOOSE LEAF PAPER, SERIES OF NON-FICTION BOOKS FEATURING ANIMATION, NOTEBOOKS, PLAYING CARDS, DECALS, STICKERS, BUMPER STICKERS, TRADING CARDS, GREETING CARDS, PHOTO ALBUMS, ADDRESS BOOKS, NOTE CARDS, POSTERS, FOLDERS, PENCILS, PENS, CALENDARS (U.S. CLS. 2, 5, 22, 23, 29, 37, 38 AND 50).

SN 78-041,263. STAR BRIGHT BOOKS, INC., NEW YORK, NY. FILED 1-1-2001.

**STAR BRIGHT BOOKS**

NO CLAIM IS MADE TO THE EXCLUSIVE RIGHT TO USE "BOOKS", APART FROM THE MARK AS SHOWN. FOR CHILDREN'S BOOKS (U.S. CLS. 2, 5, 22, 23, 29, 37, 38 AND 50).  
FIRST USE 5-1-1991; IN COMMERCE 9-1-1995.

**CLASS 16—(Continued).**

SN 78-045,874. SITUATIONAL SERVICES, INCORPORATED, ANN ARBOR, MI. FILED 1-31-2001.

**SITUATIONAL SERVICE**

SEC. 2(F).  
FOR PRINTED EDUCATIONAL, TEACHING AND INSTRUCTIONAL MATERIALS IN THE FIELD OF CORPORATE CUSTOMER RELATIONS TRAINING (U.S. CLS. 2, 5, 22, 23, 29, 37, 38 AND 50).  
FIRST USE 10-10-1989; IN COMMERCE 10-10-1989.

SN 78-049,828. MEDICALMEALS, INC., DELRAY BEACH, FL. FILED 2-22-2001.

**HEALING MEALS**

FOR RECIPE BOOKS FEATURING PHYTOCHEMICAL-SPECIFIC RECIPES FOR FOOD PRODUCTS (U.S. CLS. 2, 5, 22, 23, 29, 37, 38 AND 50).

SN 78-054,852. FULTON, JAMES T., CORONA DEL MAR, CA. FILED 3-24-2001.

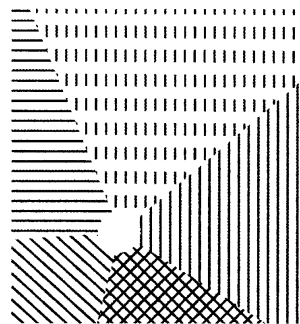

THE DRAWING IS LINED FOR BLUE, GREEN, ORANGE, RED AND VIOLET. THERE IS NO BLACK IN THE MARK. THE UNCOLORED AREA IS SHOWN IN WHITE. THE COLORS ARE SATURATED AT THE PERIPHERY OF THE MARK. THE COLORS BLEND FROM THE CENTRAL RADIUS OF EACH SECTOR NOT SHOWN TO THE CENTRAL RADIUS OF THE ADJOINING SECTOR NOT SHOWN.

THE MARK CONSISTS OF A TWO-DIMENSIONAL RECTANGULAR RAINBOW WITH WHITE LOCATED ALONG A DIAGONAL EXTENDING FROM THE LOWER LEFT TO THE UPPER RIGHT AND AT A DISTANCE OF 25% OF THE DIAGONALS LENGTH FROM THE LOWER LEFT. THE COLORS BLEND FROM BLUE IN THE UPPER LEFT TO GREEN IN THE LOWER LEFT TO RED IN THE LOWER RIGHT TO MAGENTA IN THE UPPER RIGHT TO WHITE AT THE LOCATION SPECIFIED EARLIER.

FOR NON-FICTION BOOKS AND PAMPHLETS FOR INSTRUCTION AND TEACHING ON THE SUBJECTS OF PHYSIOLOGY AND MORPHOLOGY RELATED TO THE SENSORY ORGANS OF BIOLOGICAL ORGANISMS (U.S. CLS. 2, 5, 22, 23, 29, 37, 38 AND 50).  
FIRST USE 9-1-1999; IN COMMERCE 9-1-1999.

**CLASS 16—(Continued).**

SN 78-059,164. REYNOLDS CONSUMER PRODUCTS, INC., APPLETON, WI. FILED 4-19-2001.

**PUREMELT**

FOR RUBBER COMPOUNDING PLASTIC BAGS USED TO CARRY INGREDIENTS INTO BATCHES OF MATERIAL (U.S. CLS. 2, 5, 22, 23, 29, 37, 38 AND 50).

SN 78-064,994. PAPER BALL LLC, NEW YORK, NY. FILED 5-22-2001.

**PAPER BALL**

FOR FICTION AND NON-FICTION BOOKS FEATURING INFORMATION ABOUT FAMOUS ARTISTS AND THEIR ARTWORK; CALENDARS; POSTCARDS; POSTERS; DIARIES; NOTEBOOKS; FOLDERS; NOTE CARDS; WRITING INSTRUMENTS; PAPERWEIGHTS; ALBUMS, NAMELY PHOTO ALBUMS, STAMP ALBUMS AND SCRAPBOOKS; ADDRESS BOOKS; APPOINTMENT BOOKS; ART PRINTS; ART REPRODUCTIONS; PAINT BRUSHES; ARTS AND CRAFTS PAINT KITS; BULLETIN BOARDS; CLIP BOARDS; MEMO BOARDS; BOOKENDS; BOOKMARKS; CHILDREN'S ACTIVITY BOOKS; COLORING BOOKS; GREETING CARDS; PLAYING CARDS; MODELING CLAY; CRAYONS; PAPER PARTY DECORATIONS; PENCILS; PENS; GIFT WRAP; PRINTED INVITATIONS; MARKERS; NOTE PADS; STICKERS (U.S. CLS. 2, 5, 22, 23, 29, 37, 38 AND 50).

SN 78-066,400. VIACOM INTERNATIONAL INC., NEW YORK, NY. FILED 5-30-2001.

**THE WILD THORNBERRYS**

OWNER OF U.S. REG. NOS. 2,241,818, 2,430,173 AND OTHERS.

FOR CALENDARS, RUBBER STAMPS, GREETING CARDS, BOOK COVERS (U.S. CLS. 2, 5, 22, 23, 29, 37, 38 AND 50).

SN 78-069,624. KEYGEAR CORPORATION, WILLOUGHBY, OH. FILED 6-18-2001.

**Smiley Clips**

NO CLAIM IS MADE TO THE EXCLUSIVE RIGHT TO USE "CLIPS", APART FROM THE MARK AS SHOWN.

FOR PAPER CLIPS (U.S. CLS. 2, 5, 22, 23, 29, 37, 38 AND 50).

FIRST USE 3-0-2001; IN COMMERCE 6-0-2001.

**CLASS 16—(Continued).**

SN 78-071,156. LETOURNEAU, DANA, SAN FERNANDO, CA. FILED 6-26-2001.

**KNOTMASTER**

FOR THREE-DIMENSIONAL MODELS FOR EDUCATIONAL PURPOSES, NAMELY, FOR THE PRACTICE OF TYING KNOTS (U.S. CLS. 2, 5, 22, 23, 29, 37, 38 AND 50).

SN 78-071,519. OSTERMEYER, TIM, J. GARLAND, TX. FILED 6-28-2001.

**INSPIRATIONAL IMAGES**

NO CLAIM IS MADE TO THE EXCLUSIVE RIGHT TO USE "IMAGES", APART FROM THE MARK AS SHOWN.

FOR PHOTOGRAPHIC PRINTS (U.S. CLS. 2, 5, 22, 23, 29, 37, 38 AND 50).

SN 78-071,569. SWINGSET PRESS, LLC, VAN NUYS, CA. FILED 6-28-2001.

**STORYCRAFTS**

FOR FICTION BOOKS; BOOK SETS SOLD AS A UNIT COMPRISED OF FICTION AND BLANK BOOKS AND ARTS AND CRAFTS MATERIALS, NAMELY, CRAYONS, PENS, PENCILS, BEADS, YARN, MARKERS, PAINT BRUSHES, JEWELRY MAKING EQUIPMENT, GLUE, POM-POMS AND RIBBON; COLORING BOOKS, NOTE BOOKS; CRAYONS, PENS AND PENCILS; PAINT SETS; CRAFT MATERIALS SOLD AS A UNIT, NAMELY PAPER, BEADS, PAINTS, YARN, GLUE, PAINT BRUSHES, POM-POMS AND RIBBON; AND ARTS AND CRAFTS PAINT KITS (U.S. CLS. 2, 5, 22, 23, 29, 37, 38 AND 50).

SN 78-075,078. COPELAND, P. TAYLOR, SAN LUIS OBISPO, CA. FILED 7-22-2001.

**GRAMMY TIME**

FOR CHILDREN'S BOOKS (U.S. CLS. 2, 5, 22, 23, 29, 37, 38 AND 50).

SN 78-075,351. HANS KOLB WELLPAPPE GMBH & CO., MEMMINGEN, FED REP GERMANY, FILED 7-24-2001.

**CORTRONIC**

FOR CORRUGATED BOARD AND PACKAGING CONTAINERS MADE FROM CORRUGATED BOARD (U.S. CLS. 2, 5, 22, 23, 29, 37, 38 AND 50).

**CLASS 16—(Continued).**

SN 78-080,615. SUPER DUPER INC., DBA SUPER DUPER PUBLICATIONS, GREENVILLE, SC. FILED 8-22-2001.

**TICKLE STORIES**

NO CLAIM IS MADE TO THE EXCLUSIVE RIGHT TO USE "STORIES", APART FROM THE MARK AS SHOWN.

FOR PRINTED MATERIALS FOR PRE-SCHOOL AND ELEMENTARY SCHOOL CHILDREN GRADE PRE-K TO 5TH GRADE, NAMELY WORKBOOKS IN THE FIELD OF SPEECH, ARTICULATION, LANGUAGE, VOICE, FLUENCY, AND HEARING FOR USE BY THE GENERAL PUBLIC, PUBLIC AND PRIVATE TEACHERS, HEALTH PROFESSIONALS OR THERAPISTS (U.S. CLS. 2, 5, 22, 23, 29, 37, 38 AND 50).

SN 78-081,221. LINGLET BRICE, ENCINITAS, CA. AND LINGLET SANDRINE, ENCINITAS, CA. FILED 8-27-2001.

**KENJI MANIA BODY ART.**

NO CLAIM IS MADE TO THE EXCLUSIVE RIGHT TO USE "BODY ART", APART FROM THE MARK AS SHOWN.

FOR PLASTER STAMPS FOR USE IN PLACING TEMPORARY TATTOOS ON SKIN (U.S. CLS. 2, 5, 22, 23, 29, 37, 38 AND 50).

FIRST USE 8-1-2001; IN COMMERCE 8-1-2001.

SN 78-083,323. FORD MODELS, INC., NEW YORK, NY. FILED 9-10-2001.

**FORD MODELS  
SUPERMODEL OF THE  
WORLD**

OWNER OF U.S. REG. NOS. 1,296,761, 2,481,166 AND OTHERS.

FOR POSTERS, CALENDARS, ADDRESS BOOKS, APPOINTMENT BOOKS, PHOTO ALBUMS, SCRAPBOOKS, PENS, PENCILS, NOTE PADS, STATIONERY PAPER AND ENVELOPES (U.S. CLS. 2, 5, 22, 23, 29, 37, 38 AND 50).

SN 78-084,147. ROZYCKI, MARY STECK, ANN ARBOR, MI. FILED 9-17-2001.

**PEACE NOW AND FOREVER**

FOR CHILDREN'S BOOKS (U.S. CLS. 2, 5, 22, 23, 29, 37, 38 AND 50).

**CLASS 16—(Continued).**

SN 78-087,542. SMITHKLINE BEECHAM CORPORATION, PHILADELPHIA, PA. FILED 10-9-2001.

**POWER & SAFETY IN THE  
SAME BREATH.**

FOR PRINTED EDUCATIONAL MATERIALS, NAMELY PAMPHLETS AND BROCHURES CONCERNING INFECTIONS AND TREATMENTS THEREFOR (U.S. CLS. 2, 5, 22, 23, 29, 37, 38 AND 50).

SN 78-087,547. SMITHKLINE BEECHAM CORPORATION, PHILADELPHIA, PA. FILED 10-9-2001.

**XR POWER. AUGMENTIN  
SAFETY.**

OWNER OF U.S. REG. NOS. 1,144,669 AND 1,533,895. NO CLAIM IS MADE TO THE EXCLUSIVE RIGHT TO USE "XR", APART FROM THE MARK AS SHOWN.

FOR PRINTED EDUCATIONAL MATERIALS, NAMELY PAMPHLETS AND BROCHURES CONCERNING INFECTIONS AND TREATMENTS THEREFOR (U.S. CLS. 2, 5, 22, 23, 29, 37, 38 AND 50).

**CLASS 17—RUBBER GOODS**

SN 75-633,283. VALUE PLASTICS, INC., FORT COLLINS, CO. FILED 2-2-1999.

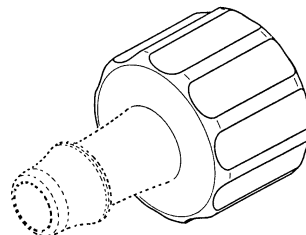

OWNER OF U.S. REG. NOS. 1,817,921, 1,827,467 AND OTHERS.

NO CLAIM IS MADE TO THE EXCLUSIVE RIGHT TO USE "THE DOTTED LINES IN THE DRAWING SHOW THE POSITION OF THE MARK AND NO CLAIM IS MADE TO THEM", APART FROM THE MARK AS SHOWN.

THE LINING IN THE DRAWING IS A FEATURE OF THE MARK AND DOES NOT INDICATE COLOR.

THE MARK CONSISTS OF AN ORNAMENTAL DESIGN AT THE BASE OF AND ENCIRCLING ANY TUBING CONNECTOR PORTION OF THE GOODS.

SEC. 2(F).  
FOR PLASTIC TUBING CONNECTORS FOR FLUID TUBING AND PIPING SYSTEMS (U.S. CLS. 1, 5, 12, 13, 35 AND 50).

FIRST USE 3-31-1987; IN COMMERCE 5-31-1987.

**CLASS 17—(Continued).**

SN 75-871,486. JAKQUMAR AG, 6300 ZUG, SWITZERLAND, FILED 12-14-1999.

**MCKANICA**

FOR CAULKING, CAULKING COMPOUNDS, ADHESIVE SEALANTS FOR GENERAL USE AND FOR AUTOMOTIVE AND MARINE USE, AND GENERAL PURPOSE SILICONE RUBBER SEALANTS (U.S. CLS. 1, 5, 12, 13, 35 AND 50).

FIRST USE 11-0-1999; IN COMMERCE 3-0-2000.

---

SN 75-905,734. PPG INDUSTRIES OHIO, INC., CLEVELAND, OH. FILED 1-29-2000.

**MiST**

FOR MICROPOROUS MATERIAL CONSISTING OF POLY-OLEFIN POLYMERS AND IN THE FORM OF MEMBRANES, SHEETS AND FILMS FOR GENERAL INDUSTRIAL USE (U.S. CLS. 1, 5, 12, 13, 35 AND 50).

---

SN 75-919,303. DENOVUS LLC, EXCELSIOR SPRINGS, MO. FILED 2-15-2000.

**FUNTUFF**

FOR RE-USEABLE AND REMOVABLE ADHESIVE SEALANT COMPOUNDS IN BULK, ROOM TEMPERATURE OR HEAT APPLIED, CAULKS, EXTRUDED, AND SHAPED FORM FOR DECORATION AS STENCILS AND DIE CUT CONFIGURATIONS (U.S. CLS. 1, 5, 12, 13, 35 AND 50).

---

SN 76-020,679. R. A. BROOKS, INC., CAVE CREEK, AZ. FILED 4-10-2000.

**E-Z JOINT SEAL**

NO CLAIM IS MADE TO THE EXCLUSIVE RIGHT TO USE "JOINT SEAL", APART FROM THE MARK AS SHOWN. FOR RUBBER SEALANT FOR CAULKING AND ADHESIVE PURPOSES (U.S. CLS. 1, 5, 12, 13, 35 AND 50).

FIRST USE 11-1-1998; IN COMMERCE 1-1-2000.

**CLASS 17—(Continued).**

SN 76-028,140. KEEPER CO., LTD., TOKYO, JAPAN, FILED 4-14-2000.



FOR PIPE GASKETS; NON-METAL GASKETS FOR USE IN AUTOMOBILES, RAILWAY CARS AND SHIPS, NON-METAL OIL SEALS FOR AUTOMOBILES, RAILWAY CARS, SHIPS, AND HOME ELECTRICAL APPLIANCES, NAMELY LAUNDRY MACHINES AND DRY MACHINES; OIL SEALS AND PACKING MADE PRIMARILY OF RUBBER FOR USE IN SEALING AXLE SHAFTS; INDUSTRIAL RUBBER PRODUCTS, NAMELY SHOCK BUFFERS OF RUBBER FOR INDUSTRIAL MACHINERY, NAMELY AUTOMOBILES, RAILWAY CARS AND SHIPS, INDUSTRIAL RUBBER HOSES FOR AUTOMOBILES, RAILWAY CARS, SHIPS, AND HOME ELECTRICAL APPLIANCES, NAMELY LAUNDRY MACHINES, DRY MACHINES, HOME BAKERY, DISHWASHING MACHINES, ACOUSTIC INSTRUMENTS AND APPARATUS; NONMETAL SEALS, NAMELY CONSTANT VELOCITY JOINT BOOT SEALS FOR USE IN AUTOMOBILES AND INDUSTRIAL MACHINES, STERLING BOOT SEALS FOR USE IN AUTOMOBILES, AND DUST COVERS FOR USE IN AUTOMOBILES, RAILWAY CARS AND INDUSTRIAL MACHINES (U.S. CLS. 1, 5, 12, 13, 35 AND 50).

FIRST USE 6-30-1970; IN COMMERCE 2-18-1988.

---

SN 76-029,050. SOLAR TECHNOLOGY CORPORATION, TAIPEI HSIEN, TAIWAN, CHINA, FILED 4-18-2000.

**INFRATEC**

FOR REFLECTIVE AND NON-REFLECTIVE POLYESTER FILMS, NAMELY, TINTED, METALIZED, SPUTTERED, LAMINATED, COATED, PRINTED, EMBOSSED AND COLORED FILMS; PE (POLYETHYLENE) FILMS AND POP (POLYPROPYLENE) FILMS FOR REJECTING NEAR INFRARED AND ULTRAVIOLET LIGHT, SAVING ENERGY, CONTROLLING GLARE, FADING AND VANDALISM, ALL FOR USE ON COMMERCIAL AND RESIDENTIAL BUILDING GLASS AND AUTOMOBILE GLASS (U.S. CLS. 1, 5, 12, 13, 35 AND 50).

FIRST USE 7-0-1992; IN COMMERCE 7-0-1992.

---

SN 76-078,447. TP COMPOSITES, INC., ASTON, PA. FILED 6-28-2000.

**HIFILL**

FOR INJECTION MOLDING COMPOUNDS CONTAINING HIGH FILLER CONTENTS, NAMELY, PLASTICS IN THE FORM OF PELLETS FOR GENERAL INDUSTRIAL USE AND FOR USE IN MANUFACTURING (U.S. CLS. 1, 5, 12, 13, 35 AND 50).

FIRST USE 11-15-1999; IN COMMERCE 11-15-1999.

**CLASS 17—(Continued).**

SN 76-149,686. SOY WORKS CORPORATION, WOODRIDGE, IL. FILED 10-18-2000.

**SOY WORKS**

NO CLAIM IS MADE TO THE EXCLUSIVE RIGHT TO USE "SOY", APART FROM THE MARK AS SHOWN.

FOR BIODEGRADABLE PLASTICS THAT ARE SOY-DERIVED OR CONTAIN SOY IN THE FORM OF BARS, BLOCKS, PELLETS, RODS, SHEETS, POWDERS, FLAKES OR TUBES FOR USE IN MANUFACTURING (U.S. CLS. 1, 5, 12, 13, 35 AND 50).

---

SN 76-153,955. PACIFIC ECHO, INC., TORRANCE, CA. FILED 10-25-2000.

**POND-FLEX**

FOR PLASTIC HOSES FOR LANDSCAPE PONDS (U.S. CLS. 1, 5, 12, 13, 35 AND 50).

FIRST USE 3-0-2001; IN COMMERCE 3-0-2001.

---

SN 76-156,097. CHRISTIAN, TED G., HYPOLUXO, FL. FILED 10-31-2000.

**TG-55**

FOR POLYURETHANE ADHESIVE CAULK REMOVER (U.S. CLS. 1, 5, 12, 13, 35 AND 50).

FIRST USE 8-1-2000; IN COMMERCE 8-1-2000.

---

SN 76-200,817. ALBANY INTERNATIONAL CORP., ALBANY, NY. FILED 1-26-2001.

**TECHNISHIELD**

FOR CARBON-BASED STRUCTURAL COMPOSITE PART-FORMING MATERIALS CONTAINING SILICON FOR ENHANCED RECEPTION PERFORMANCE IN HIGH TEMPERATURE APPLICATIONS USED FOR INSULATION AND SOUNDPROOFING IN ATMOSPHERIC RE-ENTRY OF SPACE VEHICLES AND IN THE MANUFACTURE OF LAND VEHICLES, YACHTS, SHIPS, AIRCRAFT AND SPACE VEHICLES (U.S. CLS. 1, 5, 12, 13, 35 AND 50).

**CLASS 17—(Continued).**

SN 76-289,366. MANCO, INC., AVON, OH. FILED 7-24-2001.

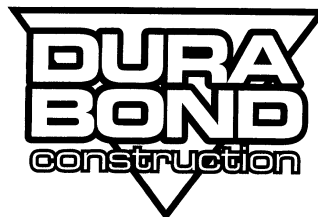

NO CLAIM IS MADE TO THE EXCLUSIVE RIGHT TO USE "BOND" AND "CONSTRUCTION", APART FROM THE MARK AS SHOWN.

FOR DUCT TAPE (U.S. CLS. 1, 5, 12, 13, 35 AND 50).

---

SN 76-289,368. MANCO, INC., AVON, OH. FILED 7-24-2001.

**DURA BOND**

NO CLAIM IS MADE TO THE EXCLUSIVE RIGHT TO USE "BOND", APART FROM THE MARK AS SHOWN.

FOR DUCT TAPE (U.S. CLS. 1, 5, 12, 13, 35 AND 50).

---

SN 76-290,076. ASAHI/AMERICA, INC., MAIDEN, MA. FILED 7-24-2001.

**THE WET PROCESS PEOPLE**

NO CLAIM IS MADE TO THE EXCLUSIVE RIGHT TO USE "WET PROCESS", APART FROM THE MARK AS SHOWN.

FOR THERMOPLASTIC PIPE, VALVES AND FITTINGS FOR FLUID AND CORROSIVE HANDLING APPLICATIONS (U.S. CLS. 1, 5, 12, 13, 35 AND 50).

---

SN 76-293,035. ZEON CHEMICALS L.P., LOUISVILLE, KY. FILED 8-2-2001.

**HYTEMP**

FOR SYNTHETIC RUBBER, NAMELY, POLYACRYLATE ELASTOMERS AND CURATIVES, USED IN THE FURTHER MANUFACTURE OF PARTS USED IN THE AUTOMOTIVE, OIL, AND ENERGY INDUSTRIES AS WELL AS A VARIETY OF OTHER INDUSTRIES (U.S. CLS. 1, 5, 12, 13, 35 AND 50).

FIRST USE 5-0-1988; IN COMMERCE 6-0-1988.



**CLASS 17—(Continued).**

SN 76-297,162. HONEYWELL INTERNATIONAL INC., MORRISTOWN, NJ. FILED 8-10-2001.

**NYLID**

FOR PLASTIC FILM FOR INDUSTRIAL AND COMMERCIAL PACKING USE IN LIDDING APPLICATIONS (U.S. CLS. 1, 5, 12, 13, 35 AND 50).

FIRST USE 1-22-2001; IN COMMERCE 1-22-2001.

SN 78-022,406. FIBERSPAR SPOOLABLE PRODUCTS, INC., WEST WAREHAM, MA. FILED 8-22-2000.

**FIBERSPAR** 

OWNER OF U.S. REG. NOS. 1,607,409, 2,032,398 AND 2,377,068.

FOR PIPES AND TUBES OF COMPOSITE MATERIAL AND CONNECTORS THEREFOR FOR USE IN THE TRANSPORT OF LIQUID AND GASEOUS FLUIDS; PIPES AND TUBES OF COMPOSITE MATERIAL THAT MAY BE STORED IN COILS OR SPOOLS FOR USE IN THE TRANSPORT OF LIQUIDS AND GASEOUS FLUIDS; NON-METAL PIPES AND TUBES OF COMPOSITE MATERIAL THAT MAY BE STORED IN COILS OR SPOOLS FOR USE IN OIL WELLS AND OTHER DEEP SUBTERRANEAN USES (U.S. CLS. 1, 5, 12, 13, 35 AND 50).

SN 78-052,146. GOODYEAR TIRE & RUBBER COMPANY, THE, AKRON, OH. FILED 3-9-2001.

**PLIOGUM**

FOR SYNTHETIC RUBBER IN BALE AND CRUMB FORM FOR USE IN THE MANUFACTURE OF CHEWING GUM AND CHEWING GUM BASE (U.S. CLS. 1, 5, 12, 13, 35 AND 50).

FIRST USE 2-22-2000; IN COMMERCE 2-22-2000.

SN 78-064,752. TSE INDUSTRIES, INC., CLEARWATER, FL. FILED 5-21-2001.

**MAXIPRENE**

FOR THERMOSET ELASTOMER/ RUBBER COMPOUND IN BALE OR SLAB FORM INTENDED FOR EXTREMELY HARSH, DEMANDING AND ABRASIVE APPLICATIONS, INCLUDING; INDUSTRIAL TIRES, LOAD BEARING ROLLERS AND SKID PADS (U.S. CLS. 1, 5, 12, 13, 35 AND 50).

**CLASS 18—LEATHER GOODS****CLASS 18—(Continued).**

SN 75-645,147. EN ROUTE TRAVELWARE FOR WOMEN, A DIVISION OF THE COMPLETE TRAVELER, NICASIO, CA. FILED 2-25-1999.

**EN ROUTE TRAVELWARE**

NO CLAIM IS MADE TO THE EXCLUSIVE RIGHT TO USE "TRAVELWARE", APART FROM THE MARK AS SHOWN.

FOR LUGGAGE, TOTE BAGS, TOILETRY CASES, LUGGAGE TAGS, WALLETS FOR TRAVEL AND SPORTS, FLEXIBLE JEWELRY CASES FOR TRAVEL, TRAVEL PURSES, DAYPACKS, TRAVEL BAGS, SHOE BAGS FOR TRAVEL, AND COLLAPSIBLE LUGGAGE CARTS (U.S. CLS. 1, 2, 3, 22 AND 41).

SN 76-092,909. GOLDBERG, STEPHEN, NEEDHAM, MA. FILED 7-21-2000.

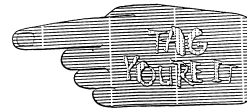

THE DESIGN IS LINED FOR THE COLOR TURQUOISE AND THE LETTERS ARE LINED FOR THE COLOR PURPLE. ALL OUTLINES ARE LINES FOR THE COLOR BLACK.

FOR IDENTIFICATION TAGS MADE OF ONE OR MORE OF THE FOLLOWING MATERIALS, NAMELY LEATHER, RUBBER, CANVAS, FABRIC, YARN, SILK, AND SYNTHETIC ALTERNATIVES FOR USE ON LUGGAGE, BRIEFCASES, KNAPSACKS, HANDBAGS AND PACKAGING (U.S. CLS. 1, 2, 3, 22 AND 41).

SN 76-120,386. THOMPSON, LARRY ANGELO, BEVERLY HILLS, CA. AND THOMPSON, KELLY ANN, BEVERLY HILLS, CA. FILED 8-30-2000.

**BEAMER BAG**

NO CLAIM IS MADE TO THE EXCLUSIVE RIGHT TO USE "BAG", APART FROM THE MARK AS SHOWN.

FOR PURSES, HANDBAGS, SUITCASES, BRIEFCASES, KNAPSACKS, LUGGAGE, BACKPACKS, DUFFLE BAGS, COSMETIC BAGS SOLD EMPTY, CLUTCHES, AND WALLETS (U.S. CLS. 1, 2, 3, 22 AND 41).

SN 76-126,796. XO COMMUNICATIONS, INC., RESTON, VA. BY CHANGE OF NAME NEXTLINK COMMUNICATIONS, INC., MCLEAN, VA. FILED 9-8-2000.

**XOFFERINGS**

FOR LEATHER AND IMITATION LEATHER GOODS, NAMELY BAGS, TRAVELLING BAGS, BILLFOLDS, WALLETS, BRIEFCASES, BRIEFCASE-TYPE PORTFOLIOS, BUSINESS CARD CASES, AND BACKPACKS; TRAVELING BAGS; UMBRELLAS, PARASOLS, AND WALKING STICKS (U.S. CLS. 1, 2, 3, 22 AND 41).

**CLASS 18—(Continued).**

SN 76-130,213. LAWSON, HILARY B., DBA LOTTIE DOTTIE, BOCA RATON, FL. FILED 9-18-2000.

**LOTTIE DOTTIE**

FOR HANDBAGS AND PURSES (U.S. CLS. 1, 2, 3, 22 AND 41).

FIRST USE 2-1-2000; IN COMMERCE 4-1-2000.

SN 76-145,593. SANHE INTERNATIONAL TRAVELLING GOODS CO., LTD., ZHEJIANG, CHINA, FILED 10-12-2000.

**DEGRE**

FOR UNWORKED OR SEMI-WORKED LEATHER SOLD IN BULK; PURSES; GAME BAGS FOR HUNTERS; SCHOOL BAGS; BUSINESS CARD CASES; HAT BOXES OF LEATHER FOR TRAVEL; TRAVELLING TRUNKS; SLING BAGS FOR CARRYING INFANTS; EMPTY TOOL BAGS OF LEATHER; CASES OF LEATHER FOR METAL HARDWARE SPRINGS SOLD EMPTY; BACKPACKS; PURSES NOT OF PRECIOUS METAL; HANDBAG FRAMES; POCKET WALLETS; WHEELED SHOPPING BAGS; ATTACHE CASES; BAGS FOR CLIMBERS; BAGS FOR CAMPERS; BEACH BAGS; HANDBAGS; TRAVELLING BAGS; SHOPPING BAGS; POUCHES OF LEATHER FOR PACKAGING; BRIEFCASES; TRAVELLING SETS OF LEATHER COMPRISED OF CARRY-ON CLOTHES CASES AND SUITCASES; VALISES; SUITCASE HANDLES; BOXES OF LEATHER OR LEATHER BOARD; CHAIN MESH PURSES NOT OF PRECIOUS METAL; TRUNKS FOR TRAVELLING; UNFITTED VANITY CASES SOLD EMPTY; BOXES OF VULCANIZED FIBER FOR USE IN TRAVEL; BAGS FOR TRAVEL, NAMELY, TOTE BAGS, GARMENT BAGS; KEY CASES OF LEATHER; NET BAGS FOR SHOPPING; SUITCASES, CASES OF LEATHEROID, NAMELY IMITATION LEATHER TOILETRY CASES, IMITATION LEATHER BRIEF CASES, IMITATION LEATHER BUSINESS CARD CASES; CASES OF CANVAS, NAMELY TOILETRY CASES; BRIEFCASES; UMBRELLAS; CANES; LEATHER STRAPS FOR LUGGAGE AND HANDBAGS (U.S. CLS. 1, 2, 3, 22 AND 41).

SN 76-175,382. HAYASHI, YOSHIKI, LOS ANGELES, CA. FILED 11-30-2000.

**VIOLET UK**

NO CLAIM IS MADE TO THE EXCLUSIVE RIGHT TO USE "UK", APART FROM THE MARK AS SHOWN.

FOR WALLETS, BILLFOLDS, LUGGAGE, HANDBAGS, PURSES, BRIEFCASES, TRAVELING BAGS, AND UMBRELLAS (U.S. CLS. 1, 2, 3, 22 AND 41).

**CLASS 18—(Continued).**

SN 76-235,600. AMERICAN INTERNATIONAL GROUP, INC., NEW YORK, NY. FILED 3-30-2001.



OWNER OF U.S. REG. NOS. 1,247,313, 2,320,184 AND OTHERS.

FOR ATTACHES, COMPUTER CARRYING CASES, DUFFEL BAGS, LEATHER PORTFOLIOS, SPORTS BAGS, TOTE BAGS AND UMBRELLAS (U.S. CLS. 1, 2, 3, 22 AND 41).

FIRST USE 10-0-1997; IN COMMERCE 10-0-1997.

SN 76-259,709. PRIME TANNING CO., INC., ROCHESTER, NH. FILED 5-21-2001.

**GLO WORM LEATHER**

NO CLAIM IS MADE TO THE EXCLUSIVE RIGHT TO USE "LEATHER", APART FROM THE MARK AS SHOWN. FOR LEATHER SOLD IN BULK (U.S. CLS. 1, 2, 3, 22 AND 41).

FIRST USE 4-3-2001; IN COMMERCE 4-3-2001.

SN 76-269,558. TRAVELPRO INTERNATIONAL, INC., BOCA RATON, FL. FILED 6-11-2001.

**PRO GRIP**

NO CLAIM IS MADE TO THE EXCLUSIVE RIGHT TO USE "GRIP", APART FROM THE MARK AS SHOWN.

FOR HANDLE SYSTEM INCORPORATED INTO LUGGAGE, BAGS, AND CARRYING CASES, COMPRISING A HAND GRIP EXTENDING THEREFROM (U.S. CLS. 1, 2, 3, 22 AND 41).

SN 76-271,960. K-2 CORPORATION, VASHON, WA. FILED 6-15-2001.

**BIOSONIC**

FOR BACKPACKS, HANDBAGS, TOTE BAGS, RUCKSACKS, KNAPSACKS, AND LUGGAGE (U.S. CLS. 1, 2, 3, 22 AND 41).

**CLASS 18—(Continued).**

SN 76-272,164. LIVING UNLIMITED, INC., FAR HILLS, NJ. FILED 6-15-2001.

**THERA-PAW**

FOR PROTECTIVE PET CLOTHING FOR ANIMAL PAWS (U.S. CLS. 1, 2, 3, 22 AND 41).

---

SN 76-316,323. MEIJER, INC., GRAND RAPIDS, MI. FILED 9-24-2001.

**ELLSWORTH HALL**

FOR BACKPACKS (U.S. CLS. 1, 2, 3, 22 AND 41). FIRST USE 6-24-2001; IN COMMERCE 6-24-2001.

---

SN 76-316,424. PINEHURST, INC., VILLAGE OF PINEHURST, NC. FILED 9-24-2001.

**PINEHURST**

OWNER OF U.S. REG. NOS. 1,517,264, 2,367,370 AND OTHERS. FOR ATHLETIC BAGS, UMBRELLAS, GOLF UMBRELLAS AND HANDBAGS (U.S. CLS. 1, 2, 3, 22 AND 41). FIRST USE 0-0-1984; IN COMMERCE 0-0-1984.

---

SN 78-027,059. MAYA WRAP, INC., OMAHA, NE. FILED 9-21-2000.

**MAYA WRAP**

NO CLAIM IS MADE TO THE EXCLUSIVE RIGHT TO USE "WRAP", APART FROM THE MARK AS SHOWN. FOR BABY CARRIERS WORN ON THE BODY (U.S. CLS. 1, 2, 3, 22 AND 41). FIRST USE 0-0-1996; IN COMMERCE 0-0-1996.

**CLASS 18—(Continued).**

SN 78-034,627. RED DRAGON SKATEBOARD CORP., NEW WESTMINSTER, BRITISH COLUMBIA, FILED 11-9-2000.



THE MARK CONSISTS OF A CHINESE LANGUAGE CHARACTER. THE ENGLISH TRANSLATION OF THE MARK IS "CENTER". THE transliteration of the design mark is "ZHONG", FROM THE CHINESE PENION TRANSLATION. FOR WALLETTS AND BACKPACKS (U.S. CLS. 1, 2, 3, 22 AND 41). FIRST USE 3-26-1998; IN COMMERCE 3-26-1998.

---

SN 78-069,614. L. L. BEAN, INC., FREEPORT, ME. FILED 6-18-2001.

**PATCH PACK**

NO CLAIM IS MADE TO THE EXCLUSIVE RIGHT TO USE "PACK", APART FROM THE MARK AS SHOWN. FOR DAY PACKS DESIGNED TO CARRY BOOKS, CLOTHES AND SCHOOL ACCESSORIES (U.S. CLS. 1, 2, 3, 22 AND 41). FIRST USE 7-20-1999; IN COMMERCE 7-20-1999.

---

SN 78-069,623. L. L. BEAN, INC., FREEPORT, ME. FILED 6-18-2001.

**THE BIG EASY**

FOR DAY PACKS DESIGNED TO CARRY BOOKS, CLOTHES, AND SCHOOL ACCESSORIES (U.S. CLS. 1, 2, 3, 22 AND 41). FIRST USE 7-20-1999; IN COMMERCE 7-20-1999.

---

SN 78-080,806. FORD MODELS, INC., NEW YORK, NY. FILED 8-23-2001.

**FORD MODELS**

OWNER OF U.S. REG. NO. 1,296,761. FOR TOTE BAGS; HANDBAGS; WALLETTS; COIN PURSES; COSMETIC BAGS; LUGGAGE TAGS; UMBRELLAS; LEATHER KEY CHAINS; BUSINESS CARD CASES (U.S. CLS. 1, 2, 3, 22 AND 41).

**CLASS 18—(Continued).**

SN 78-083,713. SAMSONITE CORPORATION, DENVER, CO. FILED 9-13-2001.

**RETRIEVER**

FOR LUGGAGE (U.S. CLS. 1, 2, 3, 22 AND 41).

**CLASS 19—NON-METALLIC BUILDING MATERIALS**

SN 75-028,755. BRUCE HARDWOOD FLOORING L.L.C., JACKSON, TN. BY ASSIGNMENT; BY ASSIGNMENT; BY ASSIGNMENT TRIANGLE PACIFIC CORP., DALLAS, TX. FILED 12-1-1995.

**PREMIER**

FOR GOODS, NAMELY WOOD FLOORING (U.S. CLS. 1, 12, 33 AND 50).  
FIRST USE 3-0-1991; IN COMMERCE 3-0-1991.

SN 75-908,108. ROBERTSON, BONNIE K. DAVIS, DBA GRAND RANCH PRODUCTS, CENTERVILLE, TX. FILED 2-2-2000.

**DIG STOPPER**

NO CLAIM IS MADE TO THE EXCLUSIVE RIGHT TO USE "DIG", APART FROM THE MARK AS SHOWN.  
FOR GROUND BARRIER SYSTEMS TO PREVENT DOGS FROM DIGGING, NAMELY, NON-METAL FENCING MATERIAL WHICH ARE ATTACHED ON TO OR BENEATH THE GROUND WITH ANCHORS TO PREVENT PENETRATION DOWNWARDLY BY DIGGING DOGS BUT PERMIT PENETRATION UPWARDLY BY GROWING VEGETATION OR CONCEALMENT (U.S. CLS. 1, 12, 33 AND 50).

SN 76-019,435. PORTABLE FLOORMAKERS, LTD., NOTTINGHAM, ENGLAND, AND EVENT EQUIPMENT SALES, L.P., COUNTRYSIDE, IL. FILED 4-6-2000.

**FLORLOK**

FOR PORTABLE FLOORING COMPOSED PRIMARILY OF NON-METALLIC MATERIALS (U.S. CLS. 1, 12, 33 AND 50).  
FIRST USE 9-0-1989; IN COMMERCE 2-0-1991.

SN 76-073,954. LVTM, INC., ENCINO, CA. FILED 6-20-2000.

**KIRKPATRICK**

SEC. 2(F).  
FOR CONCRETE AND CONCRETE BLOCKS (U.S. CLS. 1, 12, 33 AND 50).  
FIRST USE 2-0-1980; IN COMMERCE 2-0-1980.

**CLASS 19—(Continued).**

SN 76-073,955. LVTM, INC., ENCINO, CA. FILED 6-20-2000.



NO CLAIM IS MADE TO THE EXCLUSIVE RIGHT TO USE "CEMENT COMPANY", APART FROM THE MARK AS SHOWN.  
SEC. 2(F) AS TO "NATIONAL CEMENT COMPANY".  
FOR PORTLAND CEMENT, MASONRY CEMENT (U.S. CLS. 1, 12, 33 AND 50).  
FIRST USE 7-1-1987; IN COMMERCE 7-1-1987.

SN 76-089,032. POLYCON, INC., MADISON, MS. FILED 7-17-2000.

**HARDLINES**

FOR MATERIAL FOR MARKING, COATING AND RESURFACING PAVEMENT, NAMELY, CEMENT MIXES (U.S. CLS. 1, 12, 33 AND 50).

SN 76-093,821. URECOATS INTERNATIONAL, INC., POMPANO BEACH, FL. FILED 7-21-2000.

**URECOATS**

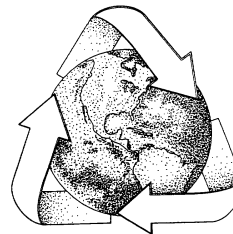

**INDUSTRIES**

NO CLAIM IS MADE TO THE EXCLUSIVE RIGHT TO USE "INDUSTRIES AND THE REPRESENTATION OF THE INTERNATIONAL RECYCLING SYMBOL", APART FROM THE MARK AS SHOWN.  
THE STIPPLING APPEARING IN THE DRAWING IS FOR SHADING PURPOSES ONLY AND IS NOT A FEATURE OF THE MARK.  
FOR ASPHALT BASED SEALANTS AND COATINGS; BITUMEN BASED SEALANTS AND COATINGS FOR ROOFING, WATERPROOFING, LAND FILLS, BRIDGES, WALLS, ASPHALT SURFACES, STEEL AND CONCRETE STRUCTURES (U.S. CLS. 1, 12, 33 AND 50).

**CLASS 19—(Continued).**

SN 76-094,109. URECOATS INTERNATIONAL, INC., POM-PANO BEACH, FL. FILED 7-21-2000.

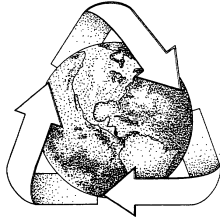

NO CLAIM IS MADE TO THE EXCLUSIVE RIGHT TO USE "REPRESENTATION OF THE INTERNATIONAL RECYCLING SYMBOL", APART FROM THE MARK AS SHOWN.

THE STIPPLING APPEARING IN THE DRAWING IS FOR SHADING PURPOSES ONLY AND IS NOT A FEATURE OF THE MARK.

FOR ASPHALT BASED SEALANTS AND COATINGS; BITUMEN BASED SEALANTS AND COATINGS FOR ROOFING, WATERPROOFING, LAND FILLS, BRIDGES, WALLS, ASPHALT SURFACES, STEEL AND CONCRETE STRUCTURES (U.S. CLS. 1, 12, 33 AND 50).

**CLASS 19—(Continued).**

SN 76-094,890. URECOATS INTERNATIONAL, INC., POM-PANO BEACH, FL. FILED 7-21-2000.

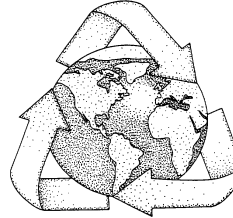

NO CLAIM IS MADE TO THE EXCLUSIVE RIGHT TO USE "REPRESENTATION OF THE INTERNATIONAL RECYCLING SYMBOL", APART FROM THE MARK AS SHOWN.

THE STIPPLING APPEARING IN THE DRAWING IS FOR SHADING PURPOSES ONLY AND IS NOT A FEATURE OF THE MARK.

FOR ASPHALT BASED SEALANTS AND COATINGS; BITUMEN BASED SEALANTS AND COATINGS FOR ROOFING, WATERPROOFING, LAND FILLS, BRIDGES, WALLS ASPHALT SURFACES, STEEL AND CONCRETE STRUCTURES (U.S. CLS. 1, 12, 33 AND 50).

SN 76-094,889. URECOATS INTERNATIONAL, INC., POM-PANO BEACH, FL. FILED 7-21-2000.



**URECOATS INDUSTRIES**

NO CLAIM IS MADE TO THE EXCLUSIVE RIGHT TO USE "INDUSTRIES AND THE REPRESENTATION OF THE INTERNATIONAL RECYCLING SYMBOL", APART FROM THE MARK AS SHOWN.

THE STIPPLING APPEARING IN THE DRAWING IS FOR SHADING PURPOSE ONLY AND IS NOT A FEATURE OF THE MARK.

FOR ASPHALT BASED SEALANTS AND COATINGS; BITUMEN BASED SEALANTS AND COATINGS FOR ROOFING, WATERPROOFING, LAND FILLS, BRIDGES, WALLS, ASPHALT SURFACES, STEEL AND CONCRETE STRUCTURES (U.S. CLS. 1, 12, 33 AND 50).

SN 76-097,895. SOLARIS INTERNATIONAL, L'ANGE-GARDIEN, QUEBEC G0A 2K0, CANADA, FILED 7-27-2000.



NO CLAIM IS MADE TO THE EXCLUSIVE RIGHT TO USE "INTERNATIONAL", APART FROM THE MARK AS SHOWN.

THE BACKGROUND IS DARK GREEN. THE WORDS "SOLARIS" AND "INTERNATIONAL" ARE IN A YELLOW-GOLD COMPLEXION. THE APPEARANCE OF A SUN SEEN THROUGH A WINDOW ON THE LEFT SIDE OF THE DESIGN IS A GRADATION, FROM THE LEFT TO THE RIGHT, FROM ORANGE TO YELLOW.

FOR NON-METAL WINDOWS AND DOORS (U.S. CLS. 1, 12, 33 AND 50).  
FIRST USE 11-25-1997; IN COMMERCE 11-25-1997.

SN 76-112,063. HUNTER DOUGLAS INC., UPPER SADDLE RIVER, NJ. FILED 8-17-2000.

**ALTA**

THE ENGLISH TRANSLATION OF THE WORD "ALTA" IN THE MARK IS "HIGH".  
FOR NON-METAL CORNICES (U.S. CLS. 1, 12, 33 AND 50).

**CLASS 19—(Continued).**

SN 76-175,979. MCCALED, MICHAEL, LOMBARD, IL. FILED 12-5-2000.



NO CLAIM IS MADE TO THE EXCLUSIVE RIGHT TO USE "SHUTTERS" AND THE DESCRIPTIVE DESIGN OF SHUTTERS, APART FROM THE MARK AS SHOWN.

FOR NON-METAL ROLL SHUTTERS, NON-METAL WINDOW SHUTTERS; AND/OR WOODEN PLANTATION STYLE SHUTTERS (U.S. CLS. 1, 12, 33 AND 50).  
FIRST USE 10-19-2000; IN COMMERCE 10-19-2000.

SN 76-188,403. CUSTOM BUILDING PRODUCTS, SEAL BEACH, CA. FILED 1-2-2001.

**RHINOBOARD**

FOR BACKERBOARDS AND FLOORING UNDERLAYMENT FOR USE IN INSTALLING CERAMIC TILE, NATURAL STONE AND RESILIENT FLOORING, AND OTHER TILE, NATURAL STONE AND RESILIENT FLOOR INSTALLATION PRODUCTS (U.S. CLS. 1, 12, 33 AND 50).

SN 76-216,090. DECOSPAN N.V., MENEN, BELGIUM, FILED 2-27-2001.

**FORESTREE**

FOR PARQUET WOOD FLOORING; WOODEN PLANKS AND WOODEN FLOORS; WORKED WOOD AND HALF-WORKED WOOD, NAMELY, VENEERED WOOD USED IN FLOORS AND WALLS; CHIPBOARDS; AND WOOD FOR BUILDING, NAMELY, BEAMS, JOISTS, STUDS AND PANELS (U.S. CLS. 1, 12, 33 AND 50).

SN 76-218,650. PALTOUGH INDUSTRIES (1998) LTD., ISRAEL, FILED 3-5-2001.

**SUNLITE**

FOR THERMOPLASTIC SHEETS FOR USE IN THE BUILDING AND CONSTRUCTION INDUSTRY; NON-LUMINOUS, NON-MECHANICAL SIGNS NOT OF METAL (U.S. CLS. 1, 12, 33 AND 50).

**CLASS 19—(Continued).**

SN 76-268,917. RE-CON BUILDING PRODUCTS INC., ABBOTSFORD, BRITISH COLUMBIA, CANADA, FILED 6-8-2001.

**FIREFREE PLUS**

OWNER OF U.S. REG. NO. 1,930,455.  
FOR FIRE-RETARDANT NON-METAL BUILDING MATERIALS, NAMELY SHINGLES, SHAKES AND SLATE (U.S. CLS. 1, 12, 33 AND 50).  
FIRST USE 11-0-1997; IN COMMERCE 11-0-1997.

SN 76-276,176. J. J. HAINES & COMPANY, INC., GLEN BURNIE, MD. FILED 6-25-2001.

**SIMPLY LISTELI'S**

FOR CERAMIC TILES (U.S. CLS. 1, 12, 33 AND 50).

SN 76-286,054. EXTERIOR SYSTEMS, INC., MACEDONIA, OH. FILED 7-17-2001.

**STONECUT**

FOR VINYL SIDING ACCESSORIES, NAMELY OUTSIDE CORNER POSTS (U.S. CLS. 1, 12, 33 AND 50).

SN 76-292,064. SAROYAN LUMBER COMPANY, HUNTINGTON PARK, CA. FILED 7-30-2001.

**CREMOSO**

THE ENGLISH TRANSLATION OF "CREMOSO" IS "CREAMY".  
FOR WOODEN FLOORING (U.S. CLS. 1, 12, 33 AND 50).  
FIRST USE 3-5-2001; IN COMMERCE 3-5-2001.

SN 76-297,679. EDGETECH I.G., INC., CAMBRIDGE, OH. FILED 8-13-2001.

**HEALTH SMART WINDOWS**

NO CLAIM IS MADE TO THE EXCLUSIVE RIGHT TO USE "WINDOWS", APART FROM THE MARK AS SHOWN.  
FOR NONMETALLIC WINDOWS (U.S. CLS. 1, 12, 33 AND 50).  
FIRST USE 12-31-1999; IN COMMERCE 12-31-1999.

**CLASS 19—(Continued).**

SN 76-306,362. HEPBURN, MARGIE, FOX CHAPEL, PA. FILED 8-29-2001.

**ARF**

FOR NONMETAL GATES AND FENCES, AND NON-METAL FENCE PANELS FOR USE AS PET BARRIERS (U.S. CLS. 1, 12, 33 AND 50).

SN 76-309,993. HALCON CERAMICAS, S.A., 12110 ALCORA, CASTELLON, SPAIN, FILED 9-7-2001.



FOR RAW PRODUCTS FOR CERAMICS, NAMELY, STONEWARE PAVINGS, CERAMIC FLOOR TILES, CERAMIC WALL TILES AND CERAMIC PAVINGS (U.S. CLS. 1, 12, 33 AND 50).

SN 78-031,865. J.M. HUBER CORPORATION, EDISON, NJ. FILED 10-23-2000.

**PERFORMMAX**

FOR ORIENTED STRAND BOARD FOR USE IN CONSTRUCTION (U.S. CLS. 1, 12, 33 AND 50).

SN 78-071,583. ANKAN HOLDINGS LIMITED, ROAD TOWN, TORTOLA, BR.VIRGIN ISLANDS, FILED 6-28-2001.



THE NAME "JILIN" IN THE MARK DOES NOT IDENTIFY A LIVING INDIVIDUAL.

THE MARK CONSISTS OF THE TERMS "JILIN CHIEFTAIN" NEXT TO A DESIGN OF AN INCOMPLETE OVAL AND A RECTANGLE, ALL ON A SOLID RECTANGULAR BACKGROUND.

"JILIN" REPRESENTS THE PRONUNCIATION OF TWO CHINESE CHARACTERS. THESE CHARACTERS REPRESENT A CHINESE PROVINCE AND LITERALLY TRANSLATE AS "LUCKY FOREST".

FOR NON-METAL FLOORING; NON-METAL TRUCK AND CONTAINER FLOORING (U.S. CLS. 1, 12, 33 AND 50).

**CLASS 19—(Continued).**

SN 78-078,279. NAPCO, INC., KEARNEY, MO. FILED 8-8-2001.

**SEVENTY-SIX COLLECTION**

OWNER OF U.S. REG. NO. 2,169,431.

NO CLAIM IS MADE TO THE EXCLUSIVE RIGHT TO USE "COLLECTION", APART FROM THE MARK AS SHOWN.

FOR VINYL SIDING PANELS, VINYL SOFFIT, VINYL WINDOWS, VINYL DOORS AND VINYL SIDING ACCESSORIES, NAMELY, F CHANNEL POSTS, J CHANNEL POSTS, INSIDE AND OUTSIDE CORNER POSTS, AND FINISH TRIM; ALL FOR EXTERIOR SURFACES OF RESIDENTIAL AND COMMERCIAL BUILDINGS (U.S. CLS. 1, 12, 33 AND 50).

FIRST USE 6-25-2001; IN COMMERCE 6-25-2001.

**CLASS 20—FURNITURE AND ARTICLES NOT OTHERWISE CLASSIFIED**

SN 75-418,651. FIGI GRAPHICS, INC., SAN DIEGO, CA. FILED 1-7-1998.

**FIGI GRAPHICS**

NO CLAIM IS MADE TO THE EXCLUSIVE RIGHT TO USE "GRAPHICS", APART FROM THE MARK AS SHOWN.

FOR DECORATIVE ORNAMENTS, NAMELY, FIGURINES AND SCULPTURES OF BONE, IVORY, PLASTER, PLASTIC, WAX AND WOOD; PLAQUES; FURNITURE MIRRORS; AND PICTURE FRAMES (U.S. CLS. 2, 13, 22, 25, 32 AND 50).

FIRST USE 1-1-1986; IN COMMERCE 1-1-1986.

SN 75-651,843. BROYHILL FURNITURE INDUSTRIES, INC., LENOIR, NC. FILED 3-2-1999.

**CONTINENTAL TAPESTRY**

FOR HOUSEHOLD BEDROOM, DINING ROOM AND LIVING ROOM FURNITURE EXCLUDING FURNITURE TO BE USED IN THE BATHROOM AND WOVEN TAPESTRIES (U.S. CLS. 2, 13, 22, 25, 32 AND 50).

FIRST USE 6-17-1999; IN COMMERCE 6-17-1999.

**CLASS 20—(Continued).**

SN 75-664,771. SEALRIGHT COMPANY, INC., DESOTO, KS. FILED 3-22-1999.

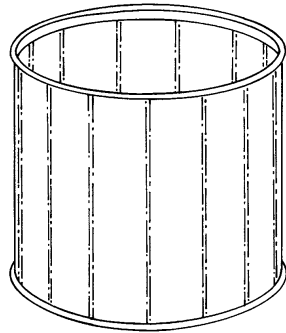

THE MARK CONSISTS OF THE SHAPE OF A ROUND CYLINDRICAL CONTAINER HAVING A GENERALLY FLAT BOTTOM AND A CONTINUOUS SIDEWALL EXTENDING VERTICALLY UPWARD FROM THE BOTTOM TO AN UPPER RIM. THE SHAPE OF THE CONTAINER IS DEFINED BY ITS DIMENSIONS; NAMELY, A SIDEWALL DIAMETER OF ABOUT 9.5 INCHES AND A HEIGHT OF ABOUT 10.3 INCHES. STIFF RING SUPPORTS ENCIRCLE THE SIDEWALL ALONG ITS BOTTOM AND UPPER RIM. THE VERTICAL STRIATIONS IN THE MARK ARE SHOWN IN DOTTED LINES AND ARE NOT CLAIMED AS A FEATURE OF THE MARK.

SEC. 2(F).  
FOR CONTAINER FOR BULK FOOD PRODUCTS, NAMELY, ICE CREAM (U.S. CLS. 2, 13, 22, 25, 32 AND 50).

FIRST USE 3-0-1934; IN COMMERCE 3-0-1934.

SN 75-723,761. MTL'S LIGHTING, INC., NEW YORK, NY. FILED 6-8-1999.

**ADESSO**

OWNER OF U.S. REG. NOS. 1,990,398 AND 2,015,364.  
THE WORD "ADESSO" TRANSLATES TO ENGLISH AS THE WORD "NOW".

FOR READY TO ASSEMBLE TABLES, CHAIRS AND DESKS (U.S. CLS. 2, 13, 22, 25, 32 AND 50).

FIRST USE 10-0-1997; IN COMMERCE 10-0-1997.

**CLASS 20—(Continued).**

SN 75-917,663. OMNIA ITALIAN DESIGN, INC., CHINO, CA. FILED 2-12-2000.

**OMNIA**

**ITALIAN LEATHER FURNITURE**

NO CLAIM IS MADE TO THE EXCLUSIVE RIGHT TO USE "ITALIAN LEATHER FURNITURE", APART FROM THE MARK AS SHOWN.

THE MARK IS LINED FOR THE COLOR PINK.  
THE ENGLISH TRANSLATION OF "OMNIA" IS "ALL THINGS".

FOR FURNITURE, NAMELY, FINE LEATHER COVERED SOFAS, COUCHES, SECTIONALS, CURVED SOFAS, LOVESEATS, CHAISES, CHAIRS AND OTTOMANS (U.S. CLS. 2, 13, 22, 25, 32 AND 50).

FIRST USE 4-1-1989; IN COMMERCE 5-1-1989.

SN 76-014,480. WOHLFAHRT, HARALD, 91541 ROTHENBURG, FED REP GERMANY, FILED 3-30-2000.

**BAVARIAN FEST**

NO CLAIM IS MADE TO THE EXCLUSIVE RIGHT TO USE "BAVARIAN", APART FROM THE MARK AS SHOWN.

FOR DECORATIVE OBJECTS, NAMELY FIGURES OF WOOD, PLASTIC AND PLASTER; DECORATIVE OBJECTS, NAMELY FIGURINES OF WOOD AND WOODEN BACKDROP SCENERY AND STAGES FOR FIGURINES SOLD TOGETHER AS A UNIT THEREWITH (U.S. CLS. 2, 13, 22, 25, 32 AND 50).

SN 76-042,917. MEADOWLANDERS, INC., EAST RUTHERFORD, NJ. FILED 5-8-2000.



OWNER OF U.S. REG. NOS. 1,263,601, 2,265,914 AND OTHERS.

NO CLAIM IS MADE TO THE EXCLUSIVE RIGHT TO USE "NJ", APART FROM THE MARK AS SHOWN.

FOR PILLOWS (U.S. CLS. 2, 13, 22, 25, 32 AND 50).

FIRST USE 11-0-1998; IN COMMERCE 11-0-1998.



**CLASS 20—(Continued).**

SN 76-063,299. SCHIFFINI MOBILI CUCINE S.P.A., 19020 CEPARANA (LA SPEZIA), ITALY, FILED 6-6-2000.

**SCHIFFINI**

OWNER OF ITALY REG. NO. 00805092, DATED 10-8-1999, EXPIRES 10-8-2009.

FOR KITCHEN FURNITURE; HOME AND OFFICE FURNITURE; FURNITURE IN GENERAL; FURNITURE MIRRORS; FRAMES FOR PICTURES; ARTICLES OF WOOD, CORK, REEDS, CANE AND WICKER, NAMELY CHAIRS AND TABLES; ARTICLES MADE OF PLASTIC MATERIALS, NAMELY TABLES AND CHAIRS; FURNITURE OF PLASTIC MATERIAL; METAL FURNITURE; CAMPING FURNITURE; ELASTIC MATTRESSES; PILLOWS (U.S. CLS. 2, 13, 22, 25, 32 AND 50).

SN 76-080,246. AGAM GROUP, LTD., THE, ELKRIDGE, MD. FILED 6-28-2000.

**AGAMSTORE**

OWNER OF U.S. REG. NO. 2,134,191.  
FOR FURNITURE, NAMELY, DISPLAY BOOTHS, DESKS, CHAIRS, TABLES, DISPLAY UNITS AND SHELVING UNITS (U.S. CLS. 2, 13, 22, 25, 32 AND 50).

SN 76-081,716. ARTMAX INC., CHICAGO, IL. FILED 6-30-2000.

**ARTMAX**

FOR FURNITURE, FURNITURE MIRRORS, PICTURE FRAMES, DECORATIVE BOXES, CANDLE HOLDERS, SCULPTURES, AND VASES MADE OR DECORATED WHOLLY OR PARTIALLY OF WOOD OR WICKER (U.S. CLS. 2, 13, 22, 25, 32 AND 50).

FIRST USE 8-30-1991; IN COMMERCE 8-30-1991.

SN 76-107,150. ARM'S REACH CONCEPTS, INC., MALIBU, CA. FILED 8-9-2000.

**BASKETTE**

FOR CHILDREN'S FURNITURE, NOT BEING BASKETS, NAMELY, BASSINETS (U.S. CLS. 2, 13, 22, 25, 32 AND 50).

**CLASS 20—(Continued).**

SN 76-111,548. LUTRON ELECTRONICS CO., INC., COOPERSBURG, PA. FILED 8-17-2000.

**SIVOIA**

FOR WINDOW SHADE SYSTEMS, COMPRISED OF A WINDOW SHADE, A MOTOR DRIVE UNIT, MOUNTING BRACKETS, A TRANSFORMER AND ONE OR MORE OF THE FOLLOWING CONTROLS - HANDHELD INFRARED REMOTE CONTROL, WALL-MOUNTED CONTROLS AND/OR CONTACT CLOSURE INTERFACES; AND REPLACEMENT PARTS THEREFOR (U.S. CLS. 2, 13, 22, 25, 32 AND 50).

FIRST USE 4-12-2000; IN COMMERCE 4-12-2000.

SN 76-119,128. AMERICAN SEATING COMPANY, GRAND RAPIDS, MI. FILED 8-30-2000.

**SEGWAY**

FOR OFFICE FURNITURE SYSTEMS, NAMELY WORKSTATION PANELS, PANEL BASES, PANEL CONNECTORS, PANEL TRIM, PANEL THRUST CHASES, PANEL INSERTS, PANEL FRAMES, SHELVES, DOORS, CABINETS, DRAWERS, WALL CASES, FLOOR CASES, WORK SURFACES, DOORS, DESK TOP SCREENS, TABLES, CREDENZAS, AND PANEL ACCESSORIES SOLD AS A UNIT (U.S. CLS. 2, 13, 22, 25, 32 AND 50).

SN 76-161,051. DISTRIBUTION RICHARD TESSIER INC., NICOLET, QUEBEC, CANADA, FILED 11-8-2000.



NO CLAIM IS MADE TO THE EXCLUSIVE RIGHT TO USE "ERGO", APART FROM THE MARK AS SHOWN.

FOR EXTERIOR SITE FURNISHINGS, NAMELY, CHAIRS AND BENCHES THAT ADAPT TO THE BACK SIDE OF THE BODY ALLOWING FOR HEALTHY AND COMFORTABLE SITTING (U.S. CLS. 2, 13, 22, 25, 32 AND 50).

FIRST USE 10-20-2000; IN COMMERCE 10-20-2000.

SN 76-164,438. DOMINION VETERINARY LABORATORIES LTD., MANITOBA R2W 3N7, CANADA, FILED 11-13-2000.

**FOLLOW THE LEADER**

FOR PLASTIC IDENTIFICATION TAGS FOR LIVESTOCK (U.S. CLS. 2, 13, 22, 25, 32 AND 50).

**CLASS 20—(Continued).**

SN 76-171,854. DESIGN A LINE, INC., SARATOGA SPRINGS, UT. FILED 11-29-2000.

**KREATIVE FOAM**

NO CLAIM IS MADE TO THE EXCLUSIVE RIGHT TO USE "FOAM", APART FROM THE MARK AS SHOWN. FOR MOLDED FOAM SHAPES WITH PAINTABLE SURFACE FOR CRAFTING (U.S. CLS. 2, 13, 22, 25, 32 AND 50).

FIRST USE 9-1-1999; IN COMMERCE 9-0-2001.

---

SN 76-171,855. DESIGN A LINE, INC., SARATOGA SPRINGS, UT. FILED 11-29-2000.



FOR MOLDED FOAM SHAPES WITH PAINTABLE SURFACE FOR CRAFTING (U.S. CLS. 2, 13, 22, 25, 32 AND 50).

FIRST USE 8-0-2000; IN COMMERCE 8-0-2000.

---

SN 76-201,045. STEEL KING INDUSTRIES, INC., STEVENS POINT, WI. FILED 1-26-2001.

**COLUMN CORE**

NO CLAIM IS MADE TO THE EXCLUSIVE RIGHT TO USE "COLUMN", APART FROM THE MARK AS SHOWN. FOR METAL RACK COLUMN REINFORCEMENTS (U.S. CLS. 2, 13, 22, 25, 32 AND 50).

FIRST USE 6-0-2000; IN COMMERCE 6-0-2000.

---

SN 76-209,780. GUANGDONG GOTOP FURNITURE CORPORATION GROUP CO. LTD., ZHONGSHAN GUANGDONG PROVINCE 528400, CHINA, FILED 2-13-2001.

**GOTOP**

FOR BEDS; SOFAS; SIDEBARDS; PLATE RACKS; SHOWCASES, NAMELY, DISPLAY CABINETS; FURNITURE, NAMELY, SALES AND DISPLAY COUNTERS; MATTRESSES; WOOD BEDSTEADS, NAMELY, BED-FRAMES AND HEADBOARDS; SHELVES FOR TYPEWRITERS; FILING CABINETS; BED FITTINGS NOT OF METAL; PILLOWS; WORKBENCHES; FURNITURE CABINETS; CHESTS OF DRAWERS; MIRRORS; FURNITURE SCREENS, NAMELY, ROOM DIVIDERS; DRESSING TABLES; DESKS; SPRING MATTRESSES; CUPBOARDS; RATTAN FURNITURE; PICTURE FRAMES; PICTURE FRAME BRACKETS; WRITING DESKS; CHAIRS; SEATS; BAMBOO FRAME FURNITURE; FURNITURE TABLES; WORKS OF ART, NAMELY, SCULPTURES OF WOOD, WAX, PLASTER OR PLASTIC (U.S. CLS. 2, 13, 22, 25, 32 AND 50).

**CLASS 20—(Continued).**

SN 76-262,109. EUROBIB AB, 22100 LUND, SWEDEN, FILED 5-24-2001.

**EUROBIB**

FOR LIBRARY FURNITURE, NAMELY, SHELVING SYSTEMS, DESK SYSTEMS, BOOK TRUCKS, COMPUTER WORKSTATIONS IN THE NATURE OF FURNITURE, READING TABLES, CHAIRS, STUDY CARRELS, ATLAS CASES, DICTIONARY STANDS, INDEX TABLES, LIGHTED SHELVES, AND DISPLAY STANDS (U.S. CLS. 2, 13, 22, 25, 32 AND 50).

FIRST USE 9-0-1999; IN COMMERCE 1-0-2001.

---

SN 76-262,110. EUROBIB AB, 22100 LUND, SWEDEN, FILED 5-24-2001.

FOR LIBRARY FURNITURE, NAMELY, SHELVING SYSTEMS, DESK SYSTEMS, BOOK TRUCKS, COMPUTER WORKSTATIONS IN THE NATURE OF FURNITURE, READING TABLES, CHAIRS, STUDY CARRELS, ATLAS CASES, DICTIONARY STANDS, INDEX TABLES, LIGHTED SHELVES, AND DISPLAY STANDS (U.S. CLS. 2, 13, 22, 25, 32 AND 50).

FIRST USE 9-0-1999; IN COMMERCE 1-0-2001.

---

SN 76-263,991. PILLOW PATIENTS UNLIMITED, INC., CAMARILLO, CA. FILED 5-30-2001.

**PILLOW PATIENTS**

NO CLAIM IS MADE TO THE EXCLUSIVE RIGHT TO USE "PILLOW", APART FROM THE MARK AS SHOWN.

FOR PILLOWS, NAMELY, PILLOWS FILLED WITH BUCKWHEAT SEED (U.S. CLS. 2, 13, 22, 25, 32 AND 50).

**CLASS 20—(Continued).**

SN 76-273,814. CUSTOM CUSHION COMPANY, SANTA ANA, CA. FILED 6-20-2001.

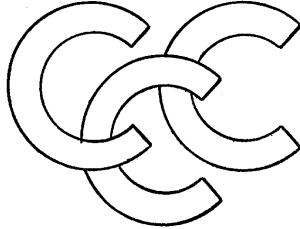

FOR COLLAPSIBLE FOOTREST; SEAT CUSHION WITH INSULATED WEATHER GUARD LEG-WRAP CONTAINED IN THE CUSHION (U.S. CLS. 2, 13, 22, 25, 32 AND 50).

SN 76-292,711. R & D, LLC., OPELIKA, AL. FILED 7-31-2001.

**EZPAY1**

FOR PLASTIC CONTAINER, NAMELY, A PORTABLE COIN CHUTE FOR COLLECTING COINS FROM A SLOT MACHINE (U.S. CLS. 2, 13, 22, 25, 32 AND 50).

SN 76-300,076. PONZIO, CRAIG, EVERGREEN, CO. FILED 8-14-2001.

**CRAIG PONZIO CUSTOM  
FRAME COLLECTION**

OWNER OF U.S. REG. NO. 2,259,495.  
NO CLAIM IS MADE TO THE EXCLUSIVE RIGHT TO USE "CUSTOM FRAME COLLECTION", APART FROM THE MARK AS SHOWN.

FOR PICTURE FRAMES (U.S. CLS. 2, 13, 22, 25, 32 AND 50).  
FIRST USE 2-28-2001; IN COMMERCE 2-28-2001.

SN 78-007,824. PAVE STREET INC., CHARLOTTE AMALIE, US VIRGIN ISLANDS, FILED 5-12-2000.

**PAVE' STREET  
WOODWORKS**

NO CLAIM IS MADE TO THE EXCLUSIVE RIGHT TO USE "WOODWORKS", APART FROM THE MARK AS SHOWN.

FOR FURNITURE, NAMELY, BEDROOM FURNITURE, DINING ROOM FURNITURE, LIVING ROOM FURNITURE, OUTDOOR FURNITURE, OFFICE FURNITURE, TOY BOXES, BLANKET CHESTS, AND FURNITURE PARTS, NAMELY, TABLE TOPS, TABLE LEGS, TABLE LEAVES, CHAIR LEGS, CHAIR ARMS AND CHAIR SEATS AND CABINETS, NAMELY, DISPLAY CABINETS, KITCHEN CABINETS AND BATHROOM CABINETS (U.S. CLS. 2, 13, 22, 25, 32 AND 50).

FIRST USE 3-17-1994; IN COMMERCE 3-17-1994.

**CLASS 20—(Continued).**

SN 78-048,741. BOYD FLOTATION, INC., MARYLAND HEIGHTS, MO. FILED 2-16-2001.

**EXTRAORDINAIRE**

FOR INFLATABLE AIR MATTRESS FOR TEMPORARY SLEEPING ACCOMMODATIONS (U.S. CLS. 2, 13, 22, 25, 32 AND 50).

SN 78-049,162. ALUMINUM DESIGNS, INC., NORTH ATTLEBOROUGH, MA. FILED 2-19-2001.

**TECHNOTABLE**

FOR HANDMADE ALUMINUM TABLES DESIGNED FOR DECORATIVE USE IN RESIDENTIAL AND COMMERCIAL INTERIOR DECOR (U.S. CLS. 2, 13, 22, 25, 32 AND 50).

SN 78-053,285. KLECKA, RICHARD E., CHAPEL HILL, NC. FILED 3-15-2001.

**LOVE SHAKER**

NO CLAIM IS MADE TO THE EXCLUSIVE RIGHT TO USE "SHAKER", APART FROM THE MARK AS SHOWN.

FOR NOVELTY GIFT ITEM, NAMELY, A CERAMIC AND METAL RATTLE WITH BEADS INSIDE (U.S. CLS. 2, 13, 22, 25, 32 AND 50).

SN 78-078,110. DUNCAN, MARK A., BERRYTON, KS. FILED 8-8-2001.



NO CLAIM IS MADE TO THE EXCLUSIVE RIGHT TO USE "WOODS", APART FROM THE MARK AS SHOWN.

THE MARK CONSISTS OF THE WORDS "2ND CHANCE WOODS" ABOVE THE IMAGE OF A TREE.

FOR FURNITURE; WOOD ORNAMENTS, NOT INCLUDING CHRISTMAS TREE ORNAMENTS, MANUFACTURED FROM RECYCLED TREES FOR DECORATION OR DISPLAY (U.S. CLS. 2, 13, 22, 25, 32 AND 50).

FIRST USE 10-8-1998; IN COMMERCE 11-15-1998.

**CLASS 20—(Continued).**

SN 78-081,044. KILEY, BARBARA WEBER, YORBA LINDA, CA. FILED 8-24-2001.

**REMEMBER ME**

FOR FUNERARY URN FOR A PET'S ASHES INCORPORATED INTO MEMORIAL BOOK (U.S. CLS. 2, 13, 22, 25, 32 AND 50).

SN 78-083,617. CLOPAY BUILDING PRODUCTS R&D COMPANY, INC., DBA CLOPAY BUILDING PRODUCTS COMPANY, INC., CINCINNATI, OH. FILED 9-12-2001.

**SAFE-T-TRACK**

FOR NON-METAL GARAGE DOOR HARDWARE, NAMELY PLASTIC GUARD TO PROTECT VERTICAL DROPPING OF GARAGE DOOR (U.S. CLS. 2, 13, 22, 25, 32 AND 50).

SN 78-083,639. CLOPAY BUILDING PRODUCTS R&D COMPANY, INC., DBA CLOPAY BUILDING PRODUCTS COMPANY, INC., CINCINNATI, OH. FILED 9-12-2001.

**SAFE-T-ROLLER**

FOR NON-METAL GARAGE DOOR HARDWARE, NAMELY PLASTIC GUARD TO PROTECT FINGERS FROM BEING PINCHED (U.S. CLS. 2, 13, 22, 25, 32 AND 50).

SN 78-083,945. COMBI INTERNATIONAL CORPORATION, CAROL STREAM, IL. FILED 9-14-2001.



FOR JUVENILE PRODUCTS, NAMELY HIGH CHAIRS AND CHILDREN'S ACTIVITY ROCKERS WITH AUDIO SPEAKERS (U.S. CLS. 2, 13, 22, 25, 32 AND 50).

SN 78-086,112. HICAREX LLC, ALEXANDRIA, VA. FILED 9-28-2001.

**BLUE BANANA TREE**

FOR DISPLAY AND EXHIBITION BOOTH COMPONENTS, COMPRISED OF DISPLAY AND EXHIBITION BOARDS, STANDS, EQUIPMENT, FRAMES AND PANELS; PORTABLE FURNITURE; PORTABLE CABINETS AND SHELVING, ALL FOR USE AT COMMERCIAL TRADE SHOWS AND EXHIBITIONS (U.S. CLS. 2, 13, 22, 25, 32 AND 50).

**CLASS 21—HOUSEWARES AND GLASS**

SN 75-615,773. LUPICA, ROBERT, DBA SMILE INTERNATIONAL TRADING, CHESTERFIELD, VA. FILED 1-5-1999.

**TERRADENT**

FOR TOOTHBRUSHES (U.S. CLS. 2, 13, 23, 29, 30, 33, 40 AND 50).  
FIRST USE 8-20-1998; IN COMMERCE 10-2-1998.

SN 75-826,134. B2K DESIGNS, L.C., FORMERLY D&D DESIGNS, L.C., CAMAS, WA. FILED 10-19-1999.



NO CLAIM IS MADE TO THE EXCLUSIVE RIGHT TO USE "DESIGNS", APART FROM THE MARK AS SHOWN.

FOR HAIR CARE PRODUCTS, NAMELY, COLORING KIT CONSISTING OF A PLASTIC BOWL, PLASTIC LINER FOR THE BOWL, CLIP ON BOWL TO RECEIVE BRUSH FOR APPLICATION OF HAIR COLOR, PLASTIC HANDLE FOR BRUSH USED TO APPLY HAIR COLOR AND VARIOUS BRUSHES USED IN APPLICATION OF HAIR COLOR, ALL SOLD AS A UNIT; HAIR CARE PRODUCT APPLICATION AND MIXING BOWL NOT OF METAL; HAIR CARE PRODUCT APPLICATION AND MIXING BOWL LINER, NOT OF METAL; HAIR COLORING APPLICATION BRUSH, NOT OF METAL; HANDLE FOR BRUSH USED TO APPLY HAIR COLORING, NOT OF METAL; PLASTIC BRUSHES USED IN APPLICATION OF HAIR COLOR, NOT OF METAL; BOWL, NOT OF METAL, FOR USE IN HAIR COLORING, PLASTIC LINER FOR USE IN HAIR COLORING, BRUSH AND HANDLE USED TO APPLY HAIR COLOR; BRUSHES USED IN APPLICATION OF HAIR COLOR (U.S. CLS. 2, 13, 23, 29, 30, 33, 40 AND 50).

SN 75-863,398. TEMKIN, ROBERT, ELMSFORD, NY. FILED 12-6-1999.

**PEAR**

FOR GLOVES OF VINYL FOR HOUSEHOLD USE (U.S. CLS. 2, 13, 23, 29, 30, 33, 40 AND 50).

**CLASS 21—(Continued).**

SN 75-883,941. INTUNE CORPORATION, VENTURA, CA. FILED 12-31-1999.

**6TH MAN**

FOR INSULATED BEVERAGE AND FOOD CONTAINERS THAT ARE PRIMARILY USED TO HOLD BEVERAGES AND FOOD, AND CAN BE USED AS A NOISEMAKER, AND A MEGAPHONE (U.S. CLS. 2, 13, 23, 29, 30, 33, 40 AND 50).

---

SN 75-932,206. H.E. BUTT GROCERY COMPANY, SAN ANTONIO, TX. FILED 2-28-2000.

**BIG COOL BAG**

NO CLAIM IS MADE TO THE EXCLUSIVE RIGHT TO USE "BIG" AND "BAG", APART FROM THE MARK AS SHOWN.

FOR THERMAL INSULATED TOTE BAGS FOR FOOD (U.S. CLS. 2, 13, 23, 29, 30, 33, 40 AND 50). FIRST USE 2-1-2000; IN COMMERCE 2-1-2000.

---

SN 76-030,302. MARS, INCORPORATED, MCLEAN, VA. FILED 4-20-2000.

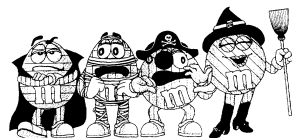

OWNER OF U.S. REG. NOS. 981,235, 983,429 AND OTHERS.

THE DRAWING IS LINED FOR THE COLORS BLUE, YELLOW, RED, GREEN, FLESH AND BROWN. THE STIPLING IS FOR SHADING PURPOSES ONLY AND DOES NOT INDICATE COLOR.

FOR CUPS (U.S. CLS. 2, 13, 23, 29, 30, 33, 40 AND 50).

**CLASS 21—(Continued).**

SN 76-030,500. MARS, INCORPORATED, MCLEAN, VA. FILED 4-20-2000.



OWNER OF U.S. REG. NOS. 981,235 AND 983,429. THE DRAWING IS LINED FOR THE COLORS GREEN, FLESH, YELLOW AND BROWN. THE STIPLING IS FOR SHADING PURPOSES ONLY AND DOES NOT INDICATE COLOR.

FOR CUPS (U.S. CLS. 2, 13, 23, 29, 30, 33, 40 AND 50).

---

SN 76-052,178. SMITHKLINE BEECHAM CORPORATION, PHILADELPHIA, PA. FILED 5-19-2000.

**AQUAFRESH FLEX TIP  
MAXX-ACTIVE**

OWNER OF U.S. REG. NOS. 1,662,981, 1,992,930 AND 2,005,754.

NO CLAIM IS MADE TO THE EXCLUSIVE RIGHT TO USE "TIP", APART FROM THE MARK AS SHOWN.

FOR TOOTHBRUSHES (U.S. CLS. 2, 13, 23, 29, 30, 33, 40 AND 50).

---

SN 76-084,667. ZURICH AMERICAN INSURANCE COMPANY, SCHAUMBURG, IL. FILED 7-7-2000.



FOR PLASTIC COASTERS, MUGS, THERMAL INSULATED CONTAINERS FOR FOOD OR BEVERAGE, NON-METAL MONEY CONTAINERS FOR HOUSEHOLD USE, PLASTIC WATER BOTTLES SOLD EMPTY, LINT REMOVING ROLLERS AND BRUSHES, ELECTRIC LINT REMOVERS, AND HOLDERS FOR PLANTS (U.S. CLS. 2, 13, 23, 29, 30, 33, 40 AND 50).

FIRST USE 1-1-2000; IN COMMERCE 1-1-2000.

**CLASS 21—(Continued).**

SN 76-111,048. SEALRIGHT CO., INC., DESOTO, KS. FILED 8-17-2000.

**MAJESTIK**

FOR CONTAINER LIDS FOR FOOD CONTAINERS (U.S. CLS. 2, 13, 23, 29, 30, 33, 40 AND 50).

SN 76-178,186. L & P PROPERTY MANAGEMENT COMPANY, SOUTH GATE, CA. FILED 12-8-2000.

**ROOFERS' CHOICE**

NO CLAIM IS MADE TO THE EXCLUSIVE RIGHT TO USE "ROOFERS'", APART FROM THE MARK AS SHOWN. FOR CLOTH FOR WIPING AND CLEANING (U.S. CLS. 2, 13, 23, 29, 30, 33, 40 AND 50). FIRST USE 11-1-2000; IN COMMERCE 11-1-2000.

SN 76-180,497. TUCKER, TERENCE, DBA KLEENPAK SYSTEMS, SAN CLEMENTE, CA. AND TUCKER, ROBERT, DBA KLEENPAK SYSTEMS, SAN CLEMENTE, CA. FILED 12-13-2000.

**KLEENPAK**

THE LINING DOES NOT INDICATE COLOR FOR CUTLERY DISPENSERS (U.S. CLS. 2, 13, 23, 29, 30, 33, 40 AND 50). FIRST USE 10-15-2000; IN COMMERCE 10-15-2000.

SN 76-211,819. STEWART, RONALD, EL CAJON, CA. FILED 2-20-2001.

**GROPOT**

FOR HOLDERS FOR FLOWERS AND PLANTS (U.S. CLS. 2, 13, 23, 29, 30, 33, 40 AND 50).

SN 76-217,300. PRODUCT DEVELOPMENT WORKSHOP LLC, NEW YORK, NY. FILED 2-28-2001.

**WOVO**

FOR PLASTIC SALAD BOWLS, CHIP N DIP BOWLS, PLASTIC SERVICE TRAYS, PLASTIC SALAD SERVERS, THERMAL CARAFES, ICE BUCKETS, LAZY SUSANS, WATER PITCHER, DRINKING GLASSES, ICE TONGS, WINE COOLERS, SOAP DISHES, TISSUE BOXES, SOAP DISPENSERS, TOOTHBRUSH HOLDERS, PLASTIC CANISTERS, CORKSCREWS, OLIVE PICKS, BOTTLE OPENERS, AND MARTINI SHAKERS (U.S. CLS. 2, 13, 23, 29, 30, 33, 40 AND 50).

**CLASS 21—(Continued).**

SN 76-225,002. COLEMAN COMPANY, INC., THE, WICHITA, KS. FILED 3-12-2001.

**NIGHTSIGHT**

OWNER OF U.S. REG. NO. 1,882,254. FOR PORTABLE COOLERS (U.S. CLS. 2, 13, 23, 29, 30, 33, 40 AND 50).

SN 76-228,624. INDUSTRIAS MARCA, S.A., BARCELONA, SPAIN, FILED 3-22-2001.

**yak**

FOR SPONGES AND BRUSHES FOR HOUSEHOLD USE; CLEANING MATERIALS IN THE NATURE OF IMPREGNATED ITEMS FOR CLEANING AND POLISHING, NAMELY, IMPREGNATED SPONGES FOR THE CARE OF SHOES, LEATHER, SYNTHETIC AND TEXTILE MATERIALS; DOSING APPARATUS IN THE NATURE OF A COMBINATION SPONGE AND PLASTIC APPLICATOR FOR USE IN CLEANING AND THE CARE OF SHOES AND OTHER LEATHER GOODS (U.S. CLS. 2, 13, 23, 29, 30, 33, 40 AND 50). FIRST USE 1-10-2001; IN COMMERCE 1-10-2001.

SN 76-250,207. INNOVA INC., DAVENPORT, IA. FILED 5-2-2001.

**ULTREX II**

OWNER OF U.S. REG. NOS. 2,277,412, 2,329,192 AND OTHERS.

FOR POTS, METAL COOKING PANS, NON-ELECTRIC GRILLS, NON-ELECTRIC FRYING PANS, BOWLS, SAUTE PANS, MULTI-USE POTS, CLAM POTS, WINDSOR PANS, LASAGNA PANS, PAELLA PANS, TEAKETTLES, NON-ELECTRIC GRIDDLES, STOCKPOTS, NON-ELECTRIC ROASTERS, SAUCEPANS, NON-ELECTRIC CHICKEN FRYERS AND NON-ELECTRIC PRESSURE COOKERS (U.S. CLS. 2, 13, 23, 29, 30, 33, 40 AND 50).

SN 76-260,443. NEWCO ENTERPRISES, INC., ST. CHARLES, MO. FILED 5-22-2001.

**SHURIZJO**

FOR THERMAL INSULATED CONTAINER FOR DISPENSING COFFEE, TEA AND OTHER BEVERAGES (U.S. CLS. 2, 13, 23, 29, 30, 33, 40 AND 50).

**CLASS 21—(Continued).**

SN 76-279,971. WILTON INDUSTRIES, INC., WOODRIDGE, IL. FILED 7-3-2001.

**ULTRA BAKE**

NO CLAIM IS MADE TO THE EXCLUSIVE RIGHT TO USE "BAKE", APART FROM THE MARK AS SHOWN.  
FOR BAKE WARE (U.S. CLS. 2, 13, 23, 29, 30, 33, 40 AND 50).

SN 76-290,093. FTC TECHNOLOGY, INC., EAST RUTHERFORD, NJ. FILED 7-25-2001.

**DIAPER DEKOR**

OWNER OF U.S. REG. NO. 2,454,015.  
NO CLAIM IS MADE TO THE EXCLUSIVE RIGHT TO USE "DIAPER", APART FROM THE MARK AS SHOWN.  
FOR DIAPER WASTE CONTAINERS, AND PLASTIC TUBULAR MATERIAL FOR FORMING BAGS TO HOLD DIAPER WASTE IN THE CONTAINERS (U.S. CLS. 2, 13, 23, 29, 30, 33, 40 AND 50).

SN 76-292,750. MELARD MANUFACTURING CORP., PAS-SIAC, NJ. FILED 8-2-2001.

**OCTAVIO**

FOR BATHROOM ACCESSORIES NAMELY TOWEL BARS, TOWEL RINGS, SOAP DISHES, TISSUE HOLDERS AND TOOTHBRUSH-TUMBLER HOLDERS (U.S. CLS. 2, 13, 23, 29, 30, 33, 40 AND 50).

SN 76-292,752. MELARD MANUFACTURING CORP., PAS-SIAC, NJ. FILED 8-2-2001.

**ASTINA**

FOR BATHROOM ACCESSORIES NAMELY TOWEL BARS, TOWEL RINGS, SOAP DISHES, TISSUE HOLDERS AND TOOTHBRUSH-TUMBLER HOLDERS (U.S. CLS. 2, 13, 23, 29, 30, 33, 40 AND 50).

SN 76-292,760. MELARD MANUFACTURING CORP., PAS-SIAC, NJ. FILED 8-2-2001.

**SATRIA**

FOR BATHROOM ACCESSORIES NAMELY TOWEL BARS, TOWEL RINGS, SOAP DISHES, TISSUE HOLDERS AND TOOTHBRUSH-TUMBLER HOLDERS (U.S. CLS. 2, 13, 23, 29, 30, 33, 40 AND 50).

**CLASS 21—(Continued).**

SN 76-292,763. MELARD MANUFACTURING CORP., PAS-SIAC, NJ. FILED 8-2-2001.

**NOTRA**

FOR BATHROOM ACCESSORIES NAMELY TOWEL BARS, TOWEL RINGS, SOAP DISHES, TISSUE HOLDERS AND TOOTHBRUSH-TUMBLER HOLDERS (U.S. CLS. 2, 13, 23, 29, 30, 33, 40 AND 50).

SN 76-292,764. MELARD MANUFACTURING CORP., PAS-SIAC, NJ. FILED 8-2-2001.

**BAJOU**

FOR BATHROOM ACCESSORIES NAMELY TOWEL BARS, TOWEL RINGS, SOAP DISHES, TISSUE HOLDERS AND TOOTHBRUSH-TUMBLER HOLDERS (U.S. CLS. 2, 13, 23, 29, 30, 33, 40 AND 50).

SN 76-298,423. EVEREADY BATTERY COMPANY, INC., ST. LOUIS, MO. FILED 8-7-2001.

**E-SNAP**

OWNER OF U.S. REG. NOS. 2,418,477 AND 2,448,432.  
FOR RESEALABLE PLASTIC CONTAINERS FOR STORING BATTERIES FOR HOUSEHOLD USE (U.S. CLS. 2, 13, 23, 29, 30, 33, 40 AND 50).  
FIRST USE 6-19-2000; IN COMMERCE 6-19-2000.

SN 78-025,021. DALVEY, JODI, A., WAYZATA, MN. FILED 9-8-2000.

**PLAN IT COOLER**

NO CLAIM IS MADE TO THE EXCLUSIVE RIGHT TO USE "COOLER", APART FROM THE MARK AS SHOWN.  
FOR PORTABLE COOLERS (U.S. CLS. 2, 13, 23, 29, 30, 33, 40 AND 50).  
FIRST USE 1-16-2001; IN COMMERCE 1-16-2001.

SN 78-025,023. DALVEY, JODI, A., WAYZATA, MN. FILED 9-8-2000.

**PLAN-IT COOLER**

NO CLAIM IS MADE TO THE EXCLUSIVE RIGHT TO USE "COOLER", APART FROM THE MARK AS SHOWN.  
FOR PORTABLE COOLERS (U.S. CLS. 2, 13, 23, 29, 30, 33, 40 AND 50).

**CLASS 21—(Continued).**

SN 78-025,031. DALVEY, JODI A., WAYZATA, MN. FILED 9-8-2000.

**PLANET COOLER**

NO CLAIM IS MADE TO THE EXCLUSIVE RIGHT TO USE "COOLER", APART FROM THE MARK AS SHOWN. FOR PORTABLE COOLERS (U.S. CLS. 2, 13, 23, 29, 30, 33, 40 AND 50).  
FIRST USE 1-16-2001; IN COMMERCE 1-16-2001.

SN 78-048,365. COUDERAY DESIGNS, INC., WAYZATA, MN. FILED 2-14-2001.

**STEM GEMS**

FOR STEMWARE ORNAMENTS CONSISTING PRIMARILY OF GLASS AND CONTAINING METAL (U.S. CLS. 2, 13, 23, 29, 30, 33, 40 AND 50).  
FIRST USE 6-0-1999; IN COMMERCE 6-0-1999.

SN 78-076,919. EVANS MANUFACTURING, INC., GARDEN GROVE, CA. FILED 8-1-2001.

**CYBER FLOWER**

NO CLAIM IS MADE TO THE EXCLUSIVE RIGHT TO USE "FLOWER", APART FROM THE MARK AS SHOWN. FOR VASE CONTAINING AN ARTIFICIAL FLOWER WITH HOLDING MEANS FOR SECURING TO COMPUTER MONITORS OR THE LIKE (U.S. CLS. 2, 13, 23, 29, 30, 33, 40 AND 50).

SN 78-076,925. EVANS MANUFACTURING, INC., GARDEN GROVE, CA. FILED 8-1-2001.

**CYBER VASE**

NO CLAIM IS MADE TO THE EXCLUSIVE RIGHT TO USE "VASE", APART FROM THE MARK AS SHOWN. FOR VASE CONTAINING AN ARTIFICIAL FLOWER WITH HOLDING MEANS FOR SECURING TO COMPUTER MONITORS OR THE LIKE (U.S. CLS. 2, 13, 23, 29, 30, 33, 40 AND 50).

SN 78-083,727. PACTIV CORPORATION, LAKE FOREST, IL. FILED 9-13-2001.

**E-Z OVENWARE**

NO CLAIM IS MADE TO THE EXCLUSIVE RIGHT TO USE "OVENWARE", APART FROM THE MARK AS SHOWN. FOR DISPOSABLE PAPERBOARD PANS (U.S. CLS. 2, 13, 23, 29, 30, 33, 40 AND 50).

**CLASS 21—(Continued).**

SN 78-085,436. HOTTOWELS, LLC, MARIETTA, GA. FILED 9-25-2001.

**ABSOLUTE ZERO**

FOR SOFT SIDED COOLERS (U.S. CLS. 2, 13, 23, 29, 30, 33, 40 AND 50).

**CLASS 22—CORDAGE AND FIBERS**

SN 75-786,742. J.A.M. PLASTICS, INC., ANAHEIM, CA. FILED 8-27-1999.

**NEXT LANYARD**

NO CLAIM IS MADE TO THE EXCLUSIVE RIGHT TO USE "LANYARD", APART FROM THE MARK AS SHOWN. FOR NECK STRAPS FOR CARRYING NAME TAGS, NAME BADGES, NAME PLATES AND IDENTIFICATION TAGS (U.S. CLS. 1, 2, 7, 19, 22, 42 AND 50).  
FIRST USE 3-14-2000; IN COMMERCE 3-14-2000.

SN 76-110,006. SMITH, J. PRESTON, KNOXVILLE, TN. FILED 8-15-2000.

**SHEETITES**

FOR TIE DOWN DEVICES FOR BED SHEETS, COMPRISED OF ADJUSTABLE STRAPS AND BUCKLES (U.S. CLS. 1, 2, 7, 19, 22, 42 AND 50).

SN 76-188,636. ALPHA PRODUCTIONS, INC., LOS ANGELES, CA. FILED 1-2-2001.

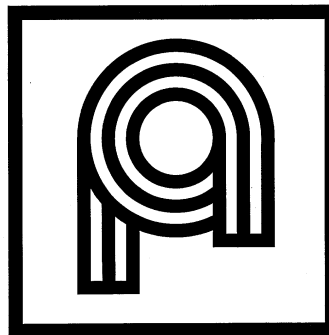

FOR SOLAR CONTROL PRODUCTS FOR BUILDING, NAMELY, AWNINGS MADE OF FIBERGLASS OR FABRIC, COVERED WITH RUBBER, FIBERGLASS OR PLASTIC (U.S. CLS. 1, 2, 7, 19, 22, 42 AND 50).  
FIRST USE 8-0-1978; IN COMMERCE 8-0-1979.



**CLASS 22—(Continued).**

SN 76-212,715. GRANDOE CORPORATION, THE, GLOVERSVILLE, NY. FILED 2-20-2001.

**THERMA DRY**

FOR TEXTILE FIBERS FOR USE AS LINING IN THE FURTHER MANUFACTURE OF CLOTHING (U.S. CLS. 1, 2, 7, 19, 22, 42 AND 50).  
FIRST USE 1-15-2001; IN COMMERCE 1-15-2001.

SN 76-247,408. FUTON EXPRES', INC., ST. LOUIS, MO. FILED 4-30-2001.

**NATURMIX**

FOR STUFFING MATERIAL NOT OF RUBBER OR PLASTIC FOR USE IN FUTONS, MATTRESSES AND CUSHIONS (U.S. CLS. 1, 2, 7, 19, 22, 42 AND 50).

SN 76-263,182. AVID OUTDOOR, L.L.C., LENEXA, KS. FILED 5-29-2001.

**CAMP-WAYS**

OWNER OF U.S. REG. NO. 1,493,149.  
FOR TENTS, DINING CANOPIES AND SPORT TARPULINS (U.S. CLS. 1, 2, 7, 19, 22, 42 AND 50).

**CLASS 23—YARNS AND THREADS**

SN 76-102,208. O'MARA INCORPORATED, DEVON, PA. FILED 8-3-2000.

**O'FLEX II**

NO CLAIM IS MADE TO THE EXCLUSIVE RIGHT TO USE "II", APART FROM THE MARK AS SHOWN.  
FOR FILAMENT YARN COMPRISED IN WHOLE OR IN PART OF POLYESTER AND/OR NYLON (U.S. CL. 43).  
FIRST USE 3-0-2000; IN COMMERCE 3-0-2000.

**CLASS 24—FABRICS**

SN 75-870,859. KABUSHIKI KAISHA SONY COMPUTER ENTERTAINMENT, TA SONY COMPUTER ENTERTAINMENT INC., MINATO-KU, TOKYO, JAPAN, FILED 12-13-1999.

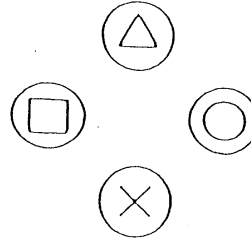

FOR TEXTILES AND TEXTILE GOODS, NAMELY COTTON FABRIC, SILK FABRIC, WOOLEN FABRIC, TOWELS, HANDKERCHIEFS, DISH CLOTHS, GAUZE OF CLOTH; BEDDING, NAMELY PILLOW CASES, SHEETS, QUILTS, BLANKETS, DUVET COVERS, MOSQUITO NETS; TABLE CLOTHS NOT OF PAPER (U.S. CLS. 42 AND 50).

SN 76-032,924. ASIA PACIFIC HI-TECH CO., LTD., FREMONT, CA. FILED 4-21-2000.

**eTEX**

FOR TEXTILES AND TEXTILE GOODS, NAMELY, COTTON, RAYON, LINEN, NYLON, POLYESTER, WOOL CHENILLE, GAUZE AND RAMIE FABRIC, MOLE SKIN, TAFFETA, WOVEN TEXTILE MATERIALS, NAMELY, TEXTILE USED FOR CLOTHING, TEXTILE UPHOLSTERY, KNITTED COTTON, RAYON, LINEN, NYLON, POLYESTER, WOOL, CHENILLE, GAUZE AND RAMIE FABRIC, ALL FOR THE MANUFACTURE OF CLOTHING (U.S. CLS. 42 AND 50).

SN 76-049,761. ASPEN SYSTEMS, INC., MARLBOROUGH, MA. FILED 5-16-2000.

**SPACELOFT**

FOR CLOTH FABRIC CONTAINING AEROGELS USED IN THE FURTHER MANUFACTURE OF WINTER WEAR, SKI WEAR, SPACE SUITS, AND FIREMEN'S OUTERWEAR GARMENTS (U.S. CLS. 42 AND 50).

**CLASS 24—(Continued).**

SN 76-078,430. INDUSTRIAL TECHNOLOGY RESEARCH INSTITUTE, HSINCHU, TAIWAN, FILED 6-27-2000.

**HYDROQUICK**

FOR HYDROPHILIC AND QUICK-DRYING FABRICS, FABRICS OF CHEMICAL FIBERS, FABRICS OF MAN-MADE FIBERS, AND FABRICS OF SYNTHETIC FIBERS, ALL INTENDED FOR USE IN THE MANUFACTURE OF CLOTHING, UPHOLSTERY, AND CURTAINS (U.S. CLS. 42 AND 50).

SN 76-135,554. VICTOR FORSTMANN, INC., NEW YORK, NY. FILED 9-26-2000.

**ARCADE**

FOR WOVEN TEXTILE FABRICS FOR USE IN THE FABRICATION OF BILLIARD TABLE TOPS (U.S. CLS. 42 AND 50).

SN 76-210,720. ABERDEEN ROAD COMPANY, EMIGSVILLE, PA. FILED 2-15-2001.

**SUNDURA**

FOR FABRIC FOR THE MANUFACTURE OF AWNINGS FOR COMMERCIAL AND RESIDENTIAL USE; FABRIC FOR MARINE APPLICATIONS FOR USE IN THE MANUFACTURE OF BOAT COVERS, BIMINI TOPS AND COVERS FOR PLEASURE CRAFTS (U.S. CLS. 42 AND 50).

SN 76-215,381. SAGE COUNTRY, LLC, NAMPA, ID. FILED 2-26-2001.

**SAGE COUNTRY**

FOR TEXTILE FABRIC FOR USE IN THE MANUFACTURE OF CLOTHING (U.S. CLS. 42 AND 50).

SN 76-222,247. ONEIDA LTD., ONEIDA, NY. FILED 3-7-2001.

**ONEIDA**

OWNER OF U.S. REG. NOS. 631,695, 2,425,842 AND OTHERS.

FOR LINENS FOR HOUSEHOLD USE, NAMELY, FABRIC PLACE MATS, FABRIC TABLE CLOTHS AND RUNNERS, FABRIC NAPKINS, POT HOLDERS, OVEN MITTS, AND SETS OF COMBINATIONS OF ANY OF THE ABOVE SOLD AS A UNIT (U.S. CLS. 42 AND 50).

FIRST USE 4-15-1999; IN COMMERCE 4-15-1999.

**CLASS 24—(Continued).**

SN 76-268,662. BI PROPERTIES I INC., GREENSBORO, NC. FILED 6-8-2001.

**AUTHENTECH  
COLLECTION**

NO CLAIM IS MADE TO THE EXCLUSIVE RIGHT TO USE "COLLECTION", APART FROM THE MARK AS SHOWN.

FOR FABRIC FOR USE IN THE MANUFACTURE OF CLOTHING (U.S. CLS. 42 AND 50).

SN 76-280,025. PRECISION FABRICS GROUP, INC., GREENSBORO, NC. FILED 6-27-2001.

**JUMPMASTER**

FOR FABRIC USED IN THE MANUFACTURE OF PARACHUTES (U.S. CLS. 42 AND 50).  
FIRST USE 8-1-1991; IN COMMERCE 8-1-1991.

SN 76-280,079. VYTECH INDUSTRIES, INCORPORATED, ANDERSON, SC. FILED 6-29-2001.

**VAPORNET**

FOR FLEXIBLE VINYL VAPOR RETARDANT LAMINATE MEMBRANE USED IN THE BUILDING CONSTRUCTION INDUSTRY (U.S. CLS. 42 AND 50).

SN 76-290,583. KOREAN SPECIALTY PAPER COMPANY, LOS ANGELES, CA. FILED 7-27-2001.



FOR HOME FURNISHINGS, NAMELY BLANKETS, COMFORTERS, SHEET SETS, BED SPREADS, AND CURTAINS (U.S. CLS. 42 AND 50).

SN 76-294,798. KOHL'S ILLINOIS, INC., AURORA, IL. FILED 8-6-2001.

**THE GREAT ONE**

FOR TOWELS (U.S. CLS. 42 AND 50).

**CLASS 24—(Continued).**

SN 76-294,829. GFD FABRICS, INC., GREENSBORO, NC. FILED 8-6-2001.

**COMFORT IN A BAG**

FOR BEDDING PRODUCTS, NAMELY, COMFORTERS, QUILTS, BEDSPREADS, DUST RUFFLES, PILLOW CASES, PILLOW SHAMS AND BED SHEETS (U.S. CLS. 42 AND 50).

---

SN 76-309,539. NATERRA INTERNATIONAL, INC., DALLAS, TX. FILED 9-6-2001.

**GARDEN'S GATE**

FOR BATH LINENS, FABRIC BATH MATS, BED BLANKETS, BED CANOPIES, BED LINEN, BED PADS, BED SHEETS, BED SPREADS, TABLE LINEN, DUVET COVERS, MATTRESS COVERS, CURTAINS, DRAPERIES, DUST RUFFLES, PILLOW CASES, PILLOW SHAMS, QUILTS, TOWELS, WASH CLOTHES AND WASHING MITTS (U.S. CLS. 42 AND 50).

---

SN 78-051,143. BRADLEY, NANETTE S, SAN ANTONIO, TX. FILED 3-2-2001.

**THE SHEET SCARF**

NO CLAIM IS MADE TO THE EXCLUSIVE RIGHT TO USE "SHEET", APART FROM THE MARK AS SHOWN. FOR BED COVERINGS, NAMELY SHEET AND BEDDING PROTECTORS COMPRISED OF FABRIC AND FLUID-PROOF MATERIALS (U.S. CLS. 42 AND 50).

---

SN 78-057,664. MITCHELL FABRICS, PEORIA, IL. FILED 4-10-2001.

**MITCHELL FABRICS**

NO CLAIM IS MADE TO THE EXCLUSIVE RIGHT TO USE "FABRICS", APART FROM THE MARK AS SHOWN. FOR CURTAIN FABRIC (U.S. CLS. 42 AND 50). FIRST USE 1-1-1965; IN COMMERCE 1-1-1965.

**CLASS 25—CLOTHING**

SN 75-071,018. PHILHOBAR DESIGN CANADA, LTD., MONTREAL, QUEBEC, H2N 1Z2, CANADA, FILED 3-12-1996.

**THE B.C. CLOTHING CO.**

PRIORITY CLAIMED UNDER SEC. 44(D) ON CANADA APPLICATION NO. 799145, FILED 12-7-1995, REG. NO. TMA489601, DATED 2-10-1998, EXPIRES 2-10-2013.

NO CLAIM IS MADE TO THE EXCLUSIVE RIGHT TO USE "CLOTHING CO.", APART FROM THE MARK AS SHOWN.

FOR CLOTHING, NAMELY, MEN'S CASUAL WEAR, NAMELY, T-SHIRTS, SWEATSHIRTS, SHIRTS, SWEATERS, SHORTS, PANTS, JACKETS, VESTS AND BLAZERS, AND LADIES CASUAL WEAR, NAMELY, T-SHIRTS, SWEATSHIRTS, BLOUSES, SWEATERS, VESTS, SHORTS, PANTS, SKIRTS, DRESSES, COATS, JACKETS, BLAZERS, TANK TOPS, OVERALLS, AND JUMPERS (U.S. CLS. 22 AND 39).

---

SN 75-407,177. CHIPMAN-UNION, INC., UNION POINT, GA. FILED 12-17-1997.

**PRO PLUS**

OWNER OF U.S. REG. NO. 1,399,574. FOR HOSEIERY (U.S. CLS. 22 AND 39). FIRST USE 11-21-1975; IN COMMERCE 11-21-1975.

---

SN 75-562,149. MASON SHOE MANUFACTURING CO., CHIPPEWA FALLS, WI. FILED 9-30-1998.

**ENDURA-SPRING**

FOR FOOTWEAR, NAMELY CASUAL FOOTWEAR, DRESS CASUAL FOOTWEAR AND LIGHT DUTY/SERVICE FOOTWEAR (U.S. CLS. 22 AND 39). FIRST USE 6-28-1999; IN COMMERCE 6-28-1999.

---

SN 75-585,268. CRYSTALINE, MISSISSAUGA, ONTARIO, CANADA, FILED 11-9-1998.

**CRYSTALINE**

FOR WOMEN'S APPAREL NAMELY - JACKETS, PANTS, SKIRTS, DRESSES, SWEATERS, BLOUSES, COATS, KNITWEAR NAMELY KNITTED JACKETS, KNITTED SWEATERS, KNITTED PULLOVERS, KNITTED CARDIGANS, KNITTED VESTS, KNITTED TURTLENECKS, KNITTED TOPS, KNITTED SKIRTS, KNITTED DRESSES, AND KNITTED PANTS (U.S. CLS. 22 AND 39).

**CLASS 25—(Continued).**

SN 75-621,951. JOE BOXER COMPANY, LLC, WESTPORT, CT. BY MERGER BOXER HOLDINGS, INC., SAN FRANCISCO, CA. FILED 1-15-1999.

**CHANGE DAILY**

SEC. 2(F).  
FOR CLOTHING, NAMELY, BOXER SHORTS, UNDERWEAR, PAJAMAS, NIGHTGOWNS, ROBES, SHIRTS, PANTS, SHORTS, BRAS, CAMISOLES AND TANK TOPS (U.S. CLS. 22 AND 39).  
FIRST USE 1-1-1995; IN COMMERCE 1-1-1995.

SN 75-623,370. CHICAGO PROFESSIONAL SPORTS LIMITED PARTNERSHIP, CHICAGO, IL. FILED 1-19-1999.

**BULLENNIUM**

FOR CLOTHING, NAMELY, HOSIERY, FOOTWEAR, T-SHIRTS, SWEATSHIRTS, SWEATPANTS, PANTS, TANK TOPS, JERSEYS, SHORTS, PAJAMAS, SPORT SHIRTS, RUGBY SHIRTS, SWEATERS, BELTS, TIES, NIGHTSHIRTS, HATS, WARM-UP SUITS, JACKETS, PARKAS, COATS, CLOTH BIBS, HEAD BANDS, WRIST BANDS, APRONS, BOXER SHORTS, SLACKS, CAPS, EAR MUFFS, GLOVES, WOVEN AND KNIT SHIRTS (U.S. CLS. 22 AND 39).

SN 75-672,287. R.U. OUTSIDE, INC., DRIGGS, ID. FILED 3-31-1999.

**R.U. OUTSIDE**

FOR SHIRTS, T-SHIRTS, SWEATSHIRTS, WARM-UP SUITS, VESTS, JACKETS, PANTS, LONG JOHNS, SOCKS, GLOVES, HATS, BOOTS AND FOOTWEAR (U.S. CLS. 22 AND 39).  
FIRST USE 7-20-1995; IN COMMERCE 8-7-1995.

SN 75-805,265. HASH, JAMES C., JR, WINSTON-SALEM, NC. FILED 10-14-1999.

**IT'S A GOD THING**

FOR CLOTHING, NAMELY, T-SHIRTS, PANTS, SHORTS, FOOTWEAR, HATS, BASEBALL CAPS (U.S. CLS. 22 AND 39).

**CLASS 25—(Continued).**

SN 75-809,047. HELENE DES CHAMPS BVBA, B-9260 SCHELLEBELLE, BELGIUM, FILED 9-27-1999.

**HELENE DES CHAMPS**

OWNER OF BENELUX REG. NO. 492986, DATED 3-22-1991, RENEWED AS REG. NO. 492986, DATED 3-22-2001, EXPIRES 3-22-2011.

THE MARK IS A NAME WHICH DOES NOT IDENTIFY A LIVING INDIVIDUAL.

FOR CORSETRY, NAMELY, BRASSIERES, LINGERIE, LADIES' UNDERWEAR, UNDERWEAR FOR YOUNG GIRLS, BATHING FASHION WEAR FOR CHILDREN, NAMELY, SWIMSUITS, BIKINIS AND SWIMMING TRUNKS (U.S. CLS. 22 AND 39).

FIRST USE 5-0-1987; IN COMMERCE 1-1-1998.

SN 75-828,461. SAMSUNG AMERICA, INC., RIDGEFIELD PARK, NJ. FILED 10-21-1999.

**A S T R A  
CLASSIC**

NO CLAIM IS MADE TO THE EXCLUSIVE RIGHT TO USE "CLASSIC", APART FROM THE MARK AS SHOWN.

FOR CLOTHING NAMELY, COATS, JACKETS, PANTS, SHORTS, SHIRTS, VESTS, SKIRTS, AND SWEATERS (U.S. CLS. 22 AND 39).

FIRST USE 9-11-1999; IN COMMERCE 9-11-1999.

SN 75-835,687. ITC ENTERTAINMENT GROUP LIMITED, LONDON SW1X7R3, ENGLAND, FILED 10-28-1999.

**THUNDERBIRDS**

OWNER OF U.S. REG. NO. 1,879,259.  
FOR CLOTHING, NAMELY SWEATSHIRTS, CAPS, JACKETS, PAJAMAS, SWEATPANTS, SHIRTS, SOCKS, UNDERWEAR, RAIN GEAR, FOOT WEAR AND SLIPPERS (U.S. CLS. 22 AND 39).

SN 75-836,728. K & F WISH COMPANY, INC., ENGLEWOOD, NJ. FILED 11-1-1999.

**WISHWEAR**

FOR CLOTHING, NAMELY CHILDREN'S HATS, SHIRTS, PANTS, SKIRTS, PULLOVERS, JUMPERS, JUMPSUITS, DRESSES, BLOUSES, SOCKS, SHOES, SWEATSHIRTS, SWEATPANTS AND SLEEPWEAR (U.S. CLS. 22 AND 39).

**CLASS 25—(Continued).**

SN 75-851,803. PHILLIPS-VAN HEUSEN CORPORATION, NEW YORK, NY. FILED 11-18-1999.

**PERFORMX**

FOR COLD WEATHER FLEECE TOPS, BOTTOMS, JACKETS AND OUTWEAR, NAMELY, SHIRTS, KNIT SHIRTS, SWEATERS, PANTS, T-SHIRTS, VESTS, JACKETS (U.S. CLS. 22 AND 39).

SN 75-858,113. UPPER DECK COMPANY, LLC, THE, CARLSBAD, CA. FILED 11-24-1999.

**JORDAN BY JORDAN**

FOR AUTOGRAPHED AND NON-AUTOGRAPHED MEMORABILIA, NAMELY, BASEBALL CAPS, JERSEYS, AND SHOES (U.S. CLS. 22 AND 39).

SN 75-898,774. JANE HAMILL, INC., CHICAGO, IL. FILED 1-19-2000.

**JANE HAMILL**

THE NAME "JANE HAMILL" IDENTIFIES A LIVING INDIVIDUAL WHOSE CONSENT IS OF RECORD.

FOR CHILDREN'S WEARING APPAREL AND WOMEN'S WEARING APPAREL NAMELY, BLOUSES, DRESSES, PANTS, SKIRTS, JACKETS, COATS, SWEATERS, T-SHIRTS, TURTLENECKS, HATS, JUMPERS, SCARVES AND SHOES (U.S. CLS. 22 AND 39).

FIRST USE 8-1-1992; IN COMMERCE 10-30-1992.

SN 75-913,615. DURRELL-DANIELS, LORETTA, CHICAGO, IL. FILED 2-10-2000.

**JESUS "THE MILLENNIUM MAN" TODAY...TOMORROW ...FOREVER**

FOR HATS AND T-SHIRTS (U.S. CLS. 22 AND 39).

**CLASS 25—(Continued).**

SN 75-935,141. INFOCHARMS, BEVERLY HILLS, CA. FILED 2-15-2000.

**I-WEAR**

FOR SHIRTS, PANTS, SHOES, JACKETS, SOCKS, AND SCARVES (U.S. CLS. 22 AND 39).

SN 75-955,358. CHIFA LEATHER CORPORATION, TAIPEI, TAIWAN, FILED 3-8-2000.

**CHIFA GENIUS**

PRIORITY CLAIMED UNDER SEC. 44(D) ON TAIWAN APPLICATION NO. 88063115, FILED 12-16-1999, REG. NO. 920731, DATED 12-16-2000, EXPIRES 12-15-2110.

FOR SHOES, SANDALS, SLIPPERS, PLASTIC SLIPPERS, JOGGING SHOES, RIDING BOOTS, SPORT SHOES, SKI BOOTS, GOLF SHOES, SPIKED SHOES, RAIN BOOTS, SOCCER SHOES, BASKETBALL SHOES, AND CANVAS RUBBER SHOES (U.S. CLS. 22 AND 39).

SN 76-010,518. OZ-SOME ENTERPRISES, LLC, INDIANAPOLIS, IN. FILED 3-27-2000.

**OZ-ERCISE**

FOR CLOTHING, NAMELY, SHIRTS, BLOUSES, T-SHIRTS, TOPS, WORK SHIRTS, OUTER SHORTS, BOXER SHORTS, PANTS, TROUSERS, OVERALLS, SLACKS, JEANS, INFANT WEAR, INFANT SLEEPERS, INFANT ROMPERS, BONNETS, SOCKS, TIES, LINGERIE, UNDERWEAR, SLEEPWEAR, SWEATPANTS, SWEATSHIRTS, SKIRTS, DRESSES, SWEATERS AND JACKETS; FOOTWEAR, NAMELY, SNEAKERS AND SANDALS; AND HEAD WEAR, NAMELY, HATS, CAPS, SKI CAPS, HEAD BANDS AND EAR MUFFS (U.S. CLS. 22 AND 39).

SN 76-021,172. VINUALES, MONICA, ST. MARTIN, GUADELOUPE, FILED 4-10-2000.



NO CLAIM IS MADE TO THE EXCLUSIVE RIGHT TO USE "BOLOGNA", APART FROM THE MARK AS SHOWN. THE NAME "ELENA LARDI" DOES NOT IDENTIFY A LIVING INDIVIDUAL.

FOR WOMEN'S SWIMWEAR (U.S. CLS. 22 AND 39).

**CLASS 25—(Continued).**

SN 76-030,040. SASSON, FRIEDA, BROOKLYN, NY. FILED 4-17-2000.

**CLUB WRITE-ON**

NO CLAIM IS MADE TO THE EXCLUSIVE RIGHT TO USE "WRITE-ON", APART FROM THE MARK AS SHOWN. FOR NOVELTY CLOTHING, NAMELY, SHIRTS, TEE-SHIRTS, SWEATERS, PANTS, SWEATSHIRTS, AND CAPS WHICH DISPLAY PRE-INScribed QUERIES FOR PERSONALIZED RESPONSE TO BE INSCRIBED BY THE WEARER (U.S. CLS. 22 AND 39).

SN 76-034,503. VAN BOMMEL SUPERIOR SHOES B.V., WILLEMSTAD, CURACAO, NETHERLD ANTILLES, FILED 4-25-2000.

**VAN BOMMEL**

OWNER OF BENELUX REG. NO. 0004605, DATED 4-20-1971, EXPIRES 4-20-2010. FOR LADIES', GENTLEMEN'S AND CHILDREN'S SHOES; SHOE ACCESSORIES, NAMELY, FOOTBEDS (U.S. CLS. 22 AND 39).

SN 76-034,504. VAN BOMMEL SUPERIOR SHOES B.V., WILLEMSTAD CURACAO, NETHERLD ANTILLES, FILED 4-25-2000.

**FLORIS VAN BOMMEL**

OWNER OF BENELUX REG. NO. 0609250, DATED 3-13-1997, EXPIRES 3-13-2007. THE NAME "FLORIS VAN BOMMEL" IDENTIFIES A LIVING INDIVIDUAL WHOSE CONSENT IS OF RECORD. FOR CLOTHING, NAMELY, TROUSERS, JACKETS, SWEATERS, SOCKS, BLOUSES, SHIRTS, SUITS AND UNDERWEAR; FOOTWEAR; HEADWEAR (U.S. CLS. 22 AND 39).

SN 76-035,438. SELMA K. ENTERPRISES LTD., DBA FAWN CREATIONS, BROOKLYN, NY. FILED 4-26-2000.

**BEYOND COMPARE**

FOR WAIST FITTING GARMENTS COMPOSED OF VERTICAL PLASTIC BONES AND A CLOSURE THAT FITS AROUND THE WAIST TO MAKE THE WAIST APPEAR SMALLER (U.S. CLS. 22 AND 39). FIRST USE 5-30-1990; IN COMMERCE 5-30-1990.

**CLASS 25—(Continued).**

SN 76-039,162. MISKEL, TROY, MUSKEGON HEIGHTS, MI. AND MILES, CHRISTOPHER, MUSKEGON HEIGHTS, MI. FILED 5-3-2000.

**1 ST FIRST PLACE GEAR**

NO CLAIM IS MADE TO THE EXCLUSIVE RIGHT TO USE "GEAR", APART FROM THE MARK AS SHOWN. FOR PANTS, SHIRTS, JACKETS, LEATHER JACKETS, T-SHIRTS, SHORTS, UNDER SHORTS, SWIM TRUNKS, BIKINI, SOCKS, ATHLETIC SHOES, CASUAL SHOES, BELTS, HATS, CAPS, HEADBANDS, WRISTBANDS, SWEAT SUITS, DENIM JEANS, DENIM SHIRTS, DENIM JACKETS, DRESSES, SKIRTS, BLOUSE, SLIPPERS, ROBES, GLASSES, TIES, PURSES, BACK PACKS AND TOTE BAGS (U.S. CLS. 22 AND 39).

SN 76-040,215. VERELA, RAPHAEL, VENICE, CA. FILED 5-1-2000.

**OPTIMUM BOOT CAMP**

FOR EXERCISE AND SHORTS APPAREL, NAMELY, T-SHIRTS, SPORT SHIRTS, SWEATSHIRTS, SWEAT PANTS, WARM-UP SUITS, SHORTS (U.S. CLS. 22 AND 39). FIRST USE 3-1-1999; IN COMMERCE 3-1-1999.

SN 76-042,763. COMINT LEATHER GOODS, INC., CARLSTADT, NJ. FILED 5-8-2000.

**MIREILLE GRANIER**

THE NAME "MIREILLE GRANIER" DOES NOT IDENTIFY A LIVING INDIVIDUAL. FOR CLOTHING, NAMELY, JACKETS, BLAZERS, DRESSES, COATS, BLOUSONS, OVERALLS, VESTS, SKIRTS, SHIRTS, T-SHIRTS, JEANS, PANTS, SHORTS, FOOTWEAR (U.S. CLS. 22 AND 39).

SN 76-047,737. SARAMAR, L.L.C., CHICAGO, IL. FILED 5-11-2000.

**FITTING TRIBUTE**

FOR BRAS, PANTIES, SHAPEWEAR, NAMELY, GIRDLES, SLIPS AND BRIEFS (U.S. CLS. 22 AND 39). FIRST USE 9-15-1999; IN COMMERCE 9-15-1999.

**CLASS 25—(Continued).**

SN 76-054,731. GFSI, INC., LENEXA, KS. FILED 5-22-2000.



OWNER OF U.S. REG. NOS. 1,797,387 AND 2,326,248.  
NO CLAIM IS MADE TO THE EXCLUSIVE RIGHT TO USE "RE-DESIGNED, PRE-SHRUNK WASHED & READY COTTON", APART FROM THE MARK AS SHOWN.  
FOR APPAREL, NAMELY, SWEATSHIRT, POLO SHIRTS, KNIT TOPS, WARMUP SUITS AND PANTS (U.S. CLS. 22 AND 39).

FIRST USE 6-10-2000; IN COMMERCE 6-10-2000.

SN 76-055,795. MGT INDUSTRIES INC., LOS ANGELES, CA.  
FILED 5-24-2000.

**BLUE SKIES AHEAD**

OWNER OF U.S. REG. NO. 1,894,161.  
FOR SLEEPWEAR, LOUNGEWEAR, ROBES AND DAYWEAR, NAMELY, PANTIES, CAMISOLES, BUSTIERS, AND TEDDIES (U.S. CLS. 22 AND 39).  
FIRST USE 2-16-2000; IN COMMERCE 2-16-2000.

SN 76-062,153. FLORSHEIM GROUP INC., CHICAGO, IL.  
FILED 6-2-2000.

**FLORSHEIM**  
**ROYAL IMPERIAL**

OWNER OF U.S. REG. NOS. 204,830, 1,344,691 AND OTHERS.  
FOR FOOTWEAR (U.S. CLS. 22 AND 39).

SN 76-062,363. QUATTRO PIU' S.R.L., MARTINA FRANCA (TARANTO), ITALY, FILED 6-2-2000.

**GIOVANNI MARTELLINI**

THE NAME "GIOVANNI MARTELLINI" IDENTIFIES A LIVING INDIVIDUAL WHOSE CONSENT IS OF RECORD.  
FOR CLOTHING, NAMELY, COATS, JACKETS, SHIRTS, PANTS AND SKIRTS FOR WOMEN (U.S. CLS. 22 AND 39).  
FIRST USE 2-0-2000; IN COMMERCE 2-0-2000.

**CLASS 25—(Continued).**

SN 76-064,069. CANADELLE LIMITED PARTNERSHIP, MONTREAL, QUEBEC, CANADA, FILED 6-5-2000.

**WONDERSHAPE**

FOR STRETCH LINING SOLD AS A COMPONENT PART OF BRASSIERES AND PANTIES (U.S. CLS. 22 AND 39).

FIRST USE 4-30-1998; IN COMMERCE 4-30-1998.

SN 76-066,984. AT LAST SPORTSWEAR INC., SECAUCUS, NJ. FILED 6-9-2000.

**@ LAST**

OWNER OF U.S. REG. NOS. 1,792,692, 2,323,774 AND OTHERS.

FOR MEN'S, WOMEN'S, CHILDREN'S, WEARING APPAREL NAMELY TOPS, SKIRTS, PANTS, BLOUSES, SHORTS, SHIRTS, SWEATERS, DRESSES, PLAYSUITS, JACKETS, VESTS, COATS AND SLEEPWEAR (U.S. CLS. 22 AND 39).

FIRST USE 6-1-2000; IN COMMERCE 6-1-2000.

SN 76-068,326. ABACUS 2000 SRI, VICENTINA VI, ITALY,  
FILED 6-12-2000.

**TEXTRAN**

PRIORITY CLAIMED UNDER SEC. 44(D) ON ITALY APPLICATION NO. TO2000C1717, FILED 5-25-2000, REG. NO. 826,272, DATED 10-5-2000, EXPIRES 5-25-2010.

FOR SPORT AND LEISURE WEAR, NAMELY, JACKETS, COATS, RAINCOATS, SHIRTS, PLUSH SHIRTS, T-SHIRTS, SWEATERS, PANTS, UNDERWEAR, SHORTS, JERSEYS, TRACK SUITS, SPORT UNIFORMS, SOCKS, GLOVES, SUITS, CAPS, HATS AND HEADWEAR, BELTS, SUSPENDERS, TIES, SWEATBANDS, SCARVES, BATHING SUITS, BATHROBES, SPORT SHOES, CYCLING SHOES, TENNIS SHOES, CLIMBING SHOES, GOLF SHOES, SKI BOOTS AND SLIPPERS (U.S. CLS. 22 AND 39).

SN 76-071,055. AHMANSON LAND COMPANY, WEST COVINA, CA. FILED 6-14-2000.

**AHMANSON**

OWNER OF U.S. REG. NOS. 1,422,265 AND 1,454,613.  
FOR CLOTHING, NAMELY, T-SHIRTS, SHORTS, SWEATERS, JACKETS, HATS, VISORS, SWEAT SHIRTS, SWEATSUITS, BATHING SUITS, ATHLETIC WEAR, GOLF APPAREL, RAIN WEAR, HORSEBACK RIDING APPAREL, BICYCLING APPAREL, FOOTWEAR, SHOES, ATHLETIC SHOES, RIDING BOOTS, HIKING BOOTS (U.S. CLS. 22 AND 39).

**CLASS 25—(Continued).**

SN 76-071,966. NORDSTROM, INC., SEATTLE, WA. FILED 6-16-2000.

**NARRATIVE**

FOR MEN'S, WOMEN'S AND CHILDREN'S APPAREL, NAMELY, SHIRTS, PANTS, JEANS, SWEATERS, SKIRTS, DRESSES, SUITS, LINGERIE, SHORTS, COATS, JACKETS, SWIMWEAR AND FOOTWEAR; FASHION ACCESSORIES, NAMELY, HOSIERY, BELTS, HATS, GLOVES AND SCARVES (U.S. CLS. 22 AND 39).

SN 76-072,015. TRABOLSI, ROBERT, TAPPAN, NY. FILED 6-16-2000.

**GEORGETTE TRABOLSI**

FOR LADIES' LINGERIE AND LOUNGE WEAR (U.S. CLS. 22 AND 39).  
FIRST USE 0-0-1990; IN COMMERCE 0-0-1990.

SN 76-075,380. P. PUFF INDUSTRIES INC, ST. PAUL, MN. FILED 6-19-2000.

**STYLE STRETCH**

NO CLAIM IS MADE TO THE EXCLUSIVE RIGHT TO USE "STRETCH", APART FROM THE MARK AS SHOWN.  
FOR CLOTHING, NAMELY BELTS, INCLUDING BELTS MADE FROM RUBBER BANDS (U.S. CLS. 22 AND 39).

SN 76-078,054. LAUGHLIN, NATALIE, NEW YORK, NY. FILED 6-26-2000.

**NATALIE LAUGHLIN**

THE NAME "NATALIE LAUGHLIN" IDENTIFIES A LIVING INDIVIDUAL WHOSE CONSENT IS OF RECORD.  
FOR WOMEN'S PLUS SIZE CLOTHING, NAMELY WOMEN'S BLOUSES, LONG AND SHORT PANTS, DRESSES, SKIRTS, SUITS; UNDERGARMENTS NAMELY PANTIES, BRAS AND BRA CLIPS, ACTIVE WEAR, LOUNGE WEAR NAMELY NIGHTGOWNS, PAJAMAS, AND ROBES, ATHLETIC WEAR NAMELY SWEAT PANTS AND SWEATSHIRTS, SHIRTS, T-SHIRTS, COATS, JACKETS, BELTS, SCARVES, HATS, GLOVES, SOCKS, STOCKINGS, TIGHTS, AND SWIM WEAR (U.S. CLS. 22 AND 39).

**CLASS 25—(Continued).**

SN 76-092,906. ANDRINGA, MICHELLE MARIE FONG, LAGUNA BEACH, CA. FILED 7-21-2000.

**MIMI FONG**

THE NAME "MIMI FONG" IDENTIFIES A LIVING INDIVIDUAL WHOSE CONSENT IS OF RECORD.

FOR MEN'S NECKWEAR, MEN'S SCARVES, MEN'S SHIRTS, MEN'S SUITS, AND MEN'S PANTS (U.S. CLS. 22 AND 39).

FIRST USE 8-1-1987; IN COMMERCE 3-30-1998.

SN 76-098,521. SHANI LIMITED, HERTFORDSHIRE, ENGLAND, FILED 7-27-2000.

**RAINAWAY**

PRIORITY CLAIMED UNDER SEC. 44(D) ON UNITED KINGDOM APPLICATION NO. 2236553, FILED 6-20-2000.

FOR CLOTHING, NAMELY, SHIRTS, COATS, JACKETS, TROUSERS, JEANS, SWEATSHIRTS, T-SHIRTS, VESTS, SHORTS, SKIRTS, BLOUSES, RAINCOATS, RAINWEAR, SWEATERS, PULLOVERS, CARDIGANS, AND HEAD WEAR (U.S. CLS. 22 AND 39).

SN 76-114,329. PATRICK CLARK, L.L.C., NEW YORK, NY. FILED 8-22-2000.

**PATRICK CLARK**

THE MARK DOES NOT IDENTIFY A PARTICULAR LIVING INDIVIDUAL.

FOR CLOTHING, NAMELY, JEANS, T-SHIRTS, JACKETS, SWEATERS, OVERCOATS, UNDERWEAR, DRESSES, HATS AND SCARVES (U.S. CLS. 22 AND 39).

FIRST USE 1-15-2001; IN COMMERCE 1-15-2001.

SN 76-119,078. YICK SANG FAT INTERNATIONAL COMPANY LIMITED, KOWLOON BAY, KOWLOON, HONG KONG, FILED 8-29-2000.



FOR GLOVES FOR CLOTHING; HATS; HEADBANDS FOR CLOTHING; JACKETS; SOCKS; UNDERWEAR; BOOTS; CLOTHING FOR GYMNASTICS AND CLOTHING OF IMITATIONS OF LEATHER, NAMELY PANTS, SHIRTS, T-SHIRTS, SWEATSHIRTS, SHORTS; COATS; DRESS GOWNS; FOOTWEAR UPPERS; KNITWEAR, NAMELY SHIRTS, SWEATERS, SHORTS, PANTS; SHIRTS; SHOES; SUITS; SWEATERS; UNDERCLOTHING; TROUSERS (U.S. CLS. 22 AND 39).



**CLASS 25—(Continued).**

SN 76-121,825. SPORTS AUTHORITY MICHIGAN, INC., THE FORT LAUDERDALE, FL. FILED 9-5-2000.

**PRO V2**

FOR ATHLETIC FOOTWEAR (U.S. CLS. 22 AND 39).

SN 76-122,656. GAULME S.A., 75012 PARIS, FRANCE, FILED 9-5-2000.

**galeriegaultier.com**

PRIORITY CLAIMED UNDER SEC. 44(D) ON FRANCE APPLICATION NO. 003040175, FILED 7-11-2000, REG. NO. 003040175, DATED 7-11-2000, EXPIRES 7-11-2010.

OWNER OF U.S. REG. NOS. 1,314,741, 2,244,101 AND OTHERS.

THE NAME "GAULTIER" IDENTIFIES A LIVING INDIVIDUAL WHOSE CONSENT IS OF RECORD.

THE ENGLISH TRANSLATION OF "GALERIE" IS "GALLERY".

FOR MEN'S AND WOMEN'S CLOTHING, NAMELY, SUITS, VESTS, TROUSERS, SLACKS, SHORTS, SHIRTS, JACKETS, SWEATERS, PAJAMAS, BELTS, SHOES, BOOTS, SLIPPERS, OVERSHOES, OVERCOATS, RAIN COATS, TOP COATS, TRENCH COATS, BOMBER JACKETS, UNDERSHORTS, BRIEFS, TANK TOPS, T-SHIRTS, SWEATSHIRTS, SWEAT PANTS, AND OVERALLS; WOMEN'S BLOUSES, DRESSES, SKIRTS, CULOTTES, TEDDIES, BRASSIERES, PANTIES, PANTYHOSE, SLIPS, CHEMISES AND GIRDLES; MEN'S AND WOMEN'S BATHING SUITS, BATH ROBES, CAPS AND HEADWEAR; SOCKS; SPORTING FOOTWEAR, SHIRTS, SCARVES; GYMNAS TIC AND SPORTS CLOTHES, NAMELY, ATHLETIC UNIFORMS, BODY SUITS, GYM SHORTS, GYM SUITS, JOGGING SUITS, JUMPERS, JUMP SUITS, SWEAT SHORTS, SWEAT SUITS AND WARM UP SUITS (U.S. CLS. 22 AND 39).

SN 76-125,984. NEXTLINK COMMUNICATIONS, INC., MCLEAN, VA. FILED 9-8-2000.

**XOPTIONS**

FOR CLOTHING, NAMELY, SHIRTS, SHORTS, T-SHIRTS, SWEATSHIRTS, SWEATPANTS, AND SOCKS; FOOTWEAR; HEADGEAR, NAMELY, HATS, VISORS, NOVELTY VISORS AND BELTS (U.S. CLS. 22 AND 39).

**CLASS 25—(Continued).**

SN 76-130,167. CREAZIONI MARISTELLA S.R.L., 50041 CALENZANO, FIRENZE, ITALY, FILED 9-15-2000.



NO CLAIM IS MADE TO THE EXCLUSIVE RIGHT TO USE "CREAZIONI", APART FROM THE MARK AS SHOWN.

THE COLORS BLUE AND GREEN ARE CLAIMED. THE WORDS "CREAZIONI" AND "MARISTELLA", THE OUTER CIRCLE AND THE INNER CIRCLE ARE BLUE. THE MIDDLE CIRCLE AND STAR ARE GREEN.

FOR NIGHT-GOWNS, NIGHT-SHIRTS, AND PAJAMAS FOR WOMEN AND CHILDREN (U.S. CLS. 22 AND 39).

SN 76-132,949. GRABITZSOUL, INC., PATERSON, NJ. FILED 9-19-2000.

**GRABITZSOUL**

FOR CLOTHING, NAMELY, COATS, SHORTS, JACKETS, SHIRTS, SWEATERS, PANTS, SCARVES, SOCKS, JEANS, OVERALLS, ANORAK, UNDERSHIRTS, BRIEFS, SWIMMING SUITS, SWEAT SHIRTS, SWEAT PANTS, DRESS SHIRTS, PAJAMAS, UNIFORMS FOR SPORTS, TANKTOPS, TEE-SHIRTS, FOOTWEAR, HEADWEAR/HATS (U.S. CLS. 22 AND 39).

SN 76-134,816. HEIN GERICKE GMBH, DUESSELDORF, FED REP GERMANY, FILED 9-25-2000.



OWNER OF FED REP GERMANY REG. NO. 39947810, DATED 12-14-1999, EXPIRES 8-31-2009.

NO CLAIM IS MADE TO THE EXCLUSIVE RIGHT TO USE "SICHERHEITS-NAHT SAFETY-SEAM", APART FROM THE MARK AS SHOWN.

THE MARK IS LINED FOR THE COLORS RED AND GREEN.

THE ENGLISH TRANSLATION OF "SICHERHEITS-NAHT" IS "SAFETY SEAM".

FOR CLOTHING, NAMELY MOTORCYCLE JACKETS, MOTORCYCLE PANTS, MOTORCYCLE RAINCOATS, MOTORCYCLE RAIN PANTS, THERMAL MOTORCYCLE JACKETS, THERMAL MOTORCYCLE PANTS, MOTORCYCLE COVERALLS, AND THERMAL MOTORCYCLE COVERALLS, GLOVES, SCARVES, SHIRTS, T-SHIRTS, SWEATERS, JERSEYS, NECKTIES, BELTS SHOES, NAMELY MOTORCYCLE BOOTS, HEADGEAR, NAMELY CAPS, HATS (U.S. CLS. 22 AND 39).

**CLASS 25—(Continued).**

SN 76-152,529. JBI, INC, CANTON, MA. FILED 10-23-2000.



OWNER OF U.S. REG. NOS. 1,844,496 AND 1,846,796.  
 NO CLAIM IS MADE TO THE EXCLUSIVE RIGHT TO  
 USE "SPORT", APART FROM THE MARK AS SHOWN.  
 FOR CLOTHING, NAMELY, PANTS, SHIRTS, SOCKS,  
 UNDERWEAR, BELTS, FOOTWEAR, JACKETS, SWIM-  
 WEAR (U.S. CLS. 22 AND 39).  
 FIRST USE 7-1-2000; IN COMMERCE 7-1-2000.

SN 76-157,496. ANAHEIM ANGELS, L.P., ANAHEIM, CA.  
 FILED 11-1-2000.



OWNER OF U.S. REG. NOS. 1,232,818, 1,408,209 AND  
 1,576,459.  
 THE MARK CONSISTS OF A STYLIZED "A" WITH A  
 WING.  
 FOR CLOTHING, NAMELY, CAPS, HATS, HEAD-  
 WEAR, SHIRTS, T-SHIRTS, TURTLENECKS, SHORTS,  
 JERSEYS, SWEATSHIRTS, BOXER SHORTS, ROBES,  
 SLEEP WEAR, JACKETS, INFANTWEAR, CLOTH DIA-  
 PER SETS WITH UNDERSHIRT AND DIAPER COVER,  
 ROMPERS, FOOTWEAR, SOCKS (U.S. CLS. 22 AND 39).  
 FIRST USE 11-19-1996; IN COMMERCE 11-19-1996.

SN 76-158,359. BRYAN MATHEWS AND GREG MATHEWS,  
 PARTNERSHIP, THE, YPSILANTI, MI. FILED 11-2-2000.

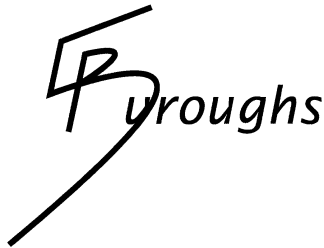

THE MARK CONSISTS OF THE NUMBER "5" ON TOP OF  
 THE LETTER "B" IN THE WORD "BROUGHs". THE  
 MARK IS "5 BROUGHs".  
 FOR CLOTHING, NAMELY, JACKETS, LEATHER  
 JACKETS, DENIM JACKETS, DENIM PANTS, PANTS,  
 SHIRTS, T-SHIRTS, SWEATERS, SWEAT PANTS, SWEAT  
 SHIRTS, HATS, CAPS, UNDERWEAR, LOUNGEWEAR,  
 KNIT SHIRTS, WOVEN SHIRTS, RAINWEAR, SHORTS,  
 AND SWIM WEAR (U.S. CLS. 22 AND 39).  
 FIRST USE 8-15-1998; IN COMMERCE 6-2-2000.

**CLASS 25—(Continued).**

SN 76-158,360. GREG MATHEWS AND BRYAN MATHEWS,  
 PARTNERSHIP, THE, YPSILANTI, MI. FILED 11-2-2000.



THE MARK CONSISTS OF THE NUMBER "5" ON TOP OF  
 THE LETTER "B". THE MARK IS "5B".  
 FOR CLOTHING, NAMELY, JACKETS, LEATHER  
 JACKETS, DENIM JACKETS, DENIM PANTS, PANTS,  
 SHIRTS, T-SHIRTS, SWEATERS, SWEAT PANTS, SWEAT  
 SHIRTS, HATS, CAPS, UNDERWEAR, LOUNGEWEAR,  
 KNIT SHIRTS, WOVEN SHIRTS, RAINWEAR, SHORTS,  
 AND SWIM WEAR (U.S. CLS. 22 AND 39).  
 FIRST USE 8-15-1998; IN COMMERCE 6-2-2000.

SN 76-165,863. FALLON, ROBERT F., TEMECULA, CA.  
 FILED 11-16-2000.



FOR SHIRTS, JACKETS, SWEATSHIRTS, SHORTS,  
 HATS (U.S. CLS. 22 AND 39).

SN 76-175,379. HAYASHI, YOSHIKI, LOS ANGELES, CA.  
 FILED 11-30-2000.

**VIOLET UK**

NO CLAIM IS MADE TO THE EXCLUSIVE RIGHT TO  
 USE "UK", APART FROM THE MARK AS SHOWN.  
 FOR CLOTHING FOR MEN, WOMEN, AND CHIL-  
 DREN, NAMELY, SHIRTS, JACKETS, SWEATERS,  
 PANTS, FOOTWEAR, BELTS, T-SHIRTS, SOCKS, COOR-  
 DINATED SHIRTS, SUITS, TENNIS SHOES, SWEAT  
 SHIRTS, JERSEYS, SHORTS, JOGGING SUITS, SWEAT  
 PANTS, HATS/CAPS, SCARVES, GLOVES, HOSIERY,  
 NECKTIES, RAIN WEAR, PAJAMAS, ROBES, NIGHT  
 SHIRTS, THERMAL UNDERWEAR, HEADBANDS,  
 WRISTBANDS, AND HALLOWEEN COSTUMES (U.S.  
 CLS. 22 AND 39).

**CLASS 25—(Continued).**

SN 76-178,256. SYSTEMS GROUP, INC., THE, MONARCH BEACH, CA. FILED 12-11-2000.

**TRUE FIT TRY ON**

FOR DISPOSABLE, HYGIENIC PAPER PRODUCTS, NAMELY, PANTIES AND FACE MASKS, PROVIDE BY STORES TO SHOPPERS ON A COMPLIMENTARY BASIS FOR USE IN TRYING ON CLOTHING AND SWIMWEAR (U.S. CLS. 22 AND 39).

FIRST USE 10-16-2000; IN COMMERCE 10-16-2000.

SN 76-197,624. TSI BRANDS, INC., WILMINGTON, DE. FILED 1-22-2001.

**WILD RIVER OUTFITTERS**

NO CLAIM IS MADE TO THE EXCLUSIVE RIGHT TO USE "OUTFITTERS", APART FROM THE MARK AS SHOWN.

FOR CLOTHING, NAMELY SLACKS, JEANS, SHORTS, SHIRTS, SKIRTS, SOCKS, KNIT TOPS, KNIT BOTTOMS, DRESSES, JACKETS, VESTS, BELTS AND HATS (U.S. CLS. 22 AND 39).

SN 76-205,234. CHAD KNOX AND ALONZO SMALLEY, DETROIT, MI. FILED 2-6-2001.

**313 GEAR**

NO CLAIM IS MADE TO THE EXCLUSIVE RIGHT TO USE "GEAR", APART FROM THE MARK AS SHOWN.

FOR CLOTHING FOR MEN, WOMEN, AND CHILDREN NAMELY, PANTS, SHIRTS, SHORTS, HATS, SKIRTS, JACKETS, T-SHIRTS, SWEATSHIRTS, BELTS, JERSEYS, HALTER TOPS, TANK TOPS, COATS, DRESSES, VESTS, PULLOVERS, AND SWEATERS (U.S. CLS. 22 AND 39).

SN 76-212,102. GEORGIA BOOT, LLC, FRANKLIN, TN. FILED 2-20-2001.

**ARCTIC TOE**

NO CLAIM IS MADE TO THE EXCLUSIVE RIGHT TO USE "TOE", APART FROM THE MARK AS SHOWN.

FOR FOOTWEAR INCORPORATING AN INSULATED TOE COMPONENT (U.S. CLS. 22 AND 39).

**CLASS 25—(Continued).**

SN 76-214,932. MARCH, SUSAN M., BEDFORD, OH. FILED 2-21-2001.

**SHOECON SHOESAVER**

NO CLAIM IS MADE TO THE EXCLUSIVE RIGHT TO USE "SHOESAVER", APART FROM THE MARK AS SHOWN.

FOR SHOE COVERINGS FOR MEN, WOMEN AND CHILDREN (U.S. CLS. 22 AND 39).

SN 76-233,695. AMERICAN INTERNATIONAL GROUP, INC., NEW YORK, NY. FILED 3-30-2001.



OWNER OF U.S. REG. NOS. 1,247,313, 2,320,184 AND OTHERS.

FOR CAPS, DENIM SHIRTS, HEADBANDS, JACKETS, KNIT SHIRTS, SWEATERS, SWEATSHIRTS, T-SHIRTS AND WIND-RESISTANT JACKETS (U.S. CLS. 22 AND 39).

FIRST USE 2-0-1996; IN COMMERCE 2-0-1996.

SN 76-237,231. THREE GIRLS MUSE, INCORPORATED, RYE, NH. FILED 4-9-2001.

**SHAPE TAPE**

NO CLAIM IS MADE TO THE EXCLUSIVE RIGHT TO USE "TAPE", APART FROM THE MARK AS SHOWN.

FOR BODY TAPE NAMELY A BREATHABLE FABRIC WITH AN ADHESIVE LAYER USED AS A BRA (U.S. CLS. 22 AND 39).

FIRST USE 2-10-2001; IN COMMERCE 2-10-2001.

SN 76-239,079. SIMPLY BLUE, INC., REDMOND, WA. FILED 4-11-2001.

**MC COY INTERNATIONAL**

NO CLAIM IS MADE TO THE EXCLUSIVE RIGHT TO USE "INTERNATIONAL", APART FROM THE MARK AS SHOWN.

FOR SPORTSWEAR, NAMELY, SHIRTS, TOPS, JEANS, PANTS, SHORTS, SWIMWEAR, JACKETS, SHOES (U.S. CLS. 22 AND 39).

**CLASS 25—(Continued).**

SN 76-242,166. SIMPLY BLUE, INC., REDMOND, WA. FILED 4-12-2001.

**MC COY ORIGINAL**

NO CLAIM IS MADE TO THE EXCLUSIVE RIGHT TO USE "ORIGINAL", APART FROM THE MARK AS SHOWN. FOR SPORTSWEAR, NAMELY, SHIRTS, TOPS, JEANS, PANTS, SHORTS, SWIMWEAR, JACKETS, SHOES (U.S. CLS. 22 AND 39).

SN 76-250,254. VAZQUEZ, MANNY, JERSEY CITY, NJ. FILED 5-3-2001.

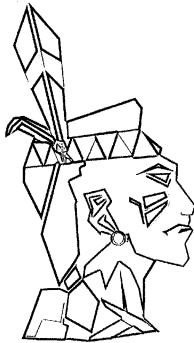

FOR MEN'S, YOUNG MEN'S, AND WOMEN'S CASUAL CLOTHING, ACTIVEWEAR AND SPORTSWEAR WITH EMBROIDERY, NAMELY WOVEN AND KNIT LONG SLEEVE SHIRTS, SHORT SLEEVE SHIRTS, T-SHIRTS, SLACKS, PANTS AND SHORTS (U.S. CLS. 22 AND 39).

FIRST USE 3-19-2001; IN COMMERCE 3-19-2001.

SN 76-250,268. KIDS 2000 INTERNATIONAL, INC., LOS ANGELES, CA. FILED 5-3-2001.

**KIDS 2000**

NO CLAIM IS MADE TO THE EXCLUSIVE RIGHT TO USE "KIDS", APART FROM THE MARK AS SHOWN.

FOR CLOTHING - PANTS, SHORTS, SHIRTS, T-SHIRTS, VESTS, DRESSES, SWEATERS, JACKETS, COATS, UNDERWEAR, UNIFORMS (U.S. CLS. 22 AND 39).

FIRST USE 10-1-1993; IN COMMERCE 10-1-1993.

**CLASS 25—(Continued).**

SN 76-253,584. KING, STEFON W., DBA FIRST ROUND, KANSAS CITY, KS. FILED 5-7-2001.



FOR ATHLETIC CLOTHING, NAMELY, SHIRTS, T-SHIRTS, SHORTS, SWEAT SUITS, PANTS, RUGBY SHIRTS, CAPS AND SOCKS (U.S. CLS. 22 AND 39). FIRST USE 1-31-2000; IN COMMERCE 1-31-2000.

SN 76-255,736. FILODORO CALZE, S.P.A., CASALMORO, MN, ITALY, FILED 5-11-2001.

**PHILIPPE MATIGNON**

OWNER OF U.S. REG. NO. 1,967,299.

THE NAME "PHILIPPE MATIGNON" DOES NOT IDENTIFY A LIVING INDIVIDUAL.

FOR BRAS, SHIRTS, T-SHIRTS, SHORTS, PANTS, PAJAMAS, ROBES, NIGHTGOWNS, PANTIES, LINGERIE, NAMELY BABY DOLLS AND SUSPENDERS, BASQUES, BODICES (U.S. CLS. 22 AND 39).

SN 76-256,689. FEDERATED DEPARTMENT STORES, INC., CINCINNATI, OH. FILED 5-14-2001.

**GLEN ROYAL**

THE NAME IN THE MARK DOES NOT IDENTIFY A LIVING INDIVIDUAL.

FOR MEN'S CLOTHING MADE OF CASHMERE, NAMELY MEN'S CASHMERE SWEATERS (U.S. CLS. 22 AND 39).

SN 76-257,074. PRYOR, JAMES LAFAYETTE, THOUSAND OAKS, CA. FILED 5-15-2001.

**BAJASURFING**

FOR SHIRTS (U.S. CLS. 22 AND 39).

**CLASS 25—(Continued).**

SN 76-257,945. FLYNN, GEORGE THOMAS, III, TUSCARORA, NV. FILED 5-17-2001.

## THE NOT MUCH LAND AND DAMN FEW CATTLE COMPANY

NO CLAIM IS MADE TO THE EXCLUSIVE RIGHT TO USE "COMPANY", APART FROM THE MARK AS SHOWN. FOR SHIRTS, PANTS, SHORTS, DRESSES, SKIRTS, JACKETS, HATS (U.S. CLS. 22 AND 39).

SN 76-258,131. FEROLETO, LEONARD, NEW YORK, NY. FILED 5-17-2001.

## NOHOP

FOR CLOTHING, NAMELY, HEAD WEAR, SWEAT SHIRTS, T-SHIRTS, JACKETS, PANTS, SHORTS, SHIRTS, SOCKS, UNDERWEAR AND FOOTWEAR (U.S. CLS. 22 AND 39).

SN 76-258,151. ROBERTS, ALAN CHARLES, NEW YORK, NY. FILED 5-17-2001.

*hear  
muff*

NO CLAIM IS MADE TO THE EXCLUSIVE RIGHT TO USE "MUFF", APART FROM THE MARK AS SHOWN. FOR FLEECE HEADBANDS (U.S. CLS. 22 AND 39).

SN 76-258,343. EIGHTH AVE TAVERN, INC., NEW YORK, NY. FILED 5-17-2001.

## SCRUFFYWEAR

FOR CLOTHING, NAMELY, T-SHIRTS, SWEATSHIRTS, POLO SHIRTS, CAPS AND JACKETS (U.S. CLS. 22 AND 39).  
FIRST USE 1-0-1999; IN COMMERCE 1-0-1999.

SN 76-259,328. TARDIF, MATT, NEWMARKET, NH. FILED 5-18-2001.

## GOT MANNY?

FOR T-SHIRTS, HATS, SWEATSHIRTS, TANK TOPS, COLLARED SHIRTS, BUTTON DOWN SHIRTS, JACKETS (U.S. CLS. 22 AND 39).

**CLASS 25—(Continued).**

SN 76-263,055. MOMUMA, LOS ANGELES, CA. FILED 5-29-2001.

## MOMUMA

FOR MEN'S SHOES, WOMEN'S SHOES, MEN'S TIES, CLOTHING, NAMELY, UNISEX SOCKS, SCARVES, SHAWLS (U.S. CLS. 22 AND 39).

SN 76-263,056. MOMUMA, LOS ANGELES, CA. FILED 5-29-2001.

## THE WORLD AT YOUR FEET

FOR MEN'S SHOES, WOMEN'S SHOES, MEN'S TIES, CLOTHING, NAMELY, UNISEX SOCKS, SCARVES, SHAWLS (U.S. CLS. 22 AND 39).

SN 76-263,368. JAM VENTURES LLC, NEW YORK, NY. FILED 5-25-2001.

## SWEET RHYTHM

FOR APPAREL, NAMELY, HATS, CAPS, SHIRTS, SWEATERS, T-SHIRTS, JACKETS, SWEATSHIRTS, SHORTS AND SWEATPANTS (U.S. CLS. 22 AND 39).

SN 76-263,693. KENDRICK, EUGENE S., LAWRENCEVILLE, GA. FILED 5-29-2001.

## SURE SOK

NO CLAIM IS MADE TO THE EXCLUSIVE RIGHT TO USE "SOCK", APART FROM THE MARK AS SHOWN. FOR HOSIERY (U.S. CLS. 22 AND 39).

SN 76-264,324. TSI BRANDS, INC., WILMINGTON, DE. FILED 5-29-2001.



Original Khaki Co.

OWNER OF U.S. REG. NO. 2,039,863.  
NO CLAIM IS MADE TO THE EXCLUSIVE RIGHT TO USE "ORIGINAL KHAKI CO.", APART FROM THE MARK AS SHOWN.  
FOR CLOTHING, NAMELY PANTS, JEANS, SHORTS, SHIRTS, AND SKIRTS (U.S. CLS. 22 AND 39).

**CLASS 25—(Continued).**

SN 76-265,391. ZARR MEN L.A., INC., LOS ANGELES, CA. FILED 6-1-2001.

**LORDS**

OWNER OF U.S. REG. NO. 2,358,961.  
FOR CLOTHING, NAMELY, MEN'S AND WOMEN'S SHIRTS, JACKETS, OVERALLS, PANTS, SHORTS, SKIRTS, DRESSES, T-SHIRTS, BLOUSES, VESTS, SCARVES, GLOVES, BELTS, BELTS NOT MADE OF LEATHER, SWIMWEAR, SOCKS, UNDERGARMENTS, MENS AND WOMEN'S SHOES, BOOTS AND SLIPPERS (U.S. CLS. 22 AND 39).

FIRST USE 1-1-1995; IN COMMERCE 1-1-1995.

SN 76-272,780. ROBERTS, ANGELA, LOS ANGELES, CA. FILED 6-15-2001.

**LOVE THAT BABY**

FOR BABY COTTON T-SHIRTS (U.S. CLS. 22 AND 39).

SN 76-275,250. LIZDEN INDUSTRIES INC., NEW YORK, NY. FILED 6-25-2001.

**ISZ LEATHERS**

NO CLAIM IS MADE TO THE EXCLUSIVE RIGHT TO USE "LEATHERS", APART FROM THE MARK AS SHOWN.  
FOR MEN'S, WOMEN'S AND CHILDREN'S CLOTHING NAMELY, JACKETS, PANTS, SKIRTS, SWEATERS, DRESSES, WRAPS AND BELTS, MADE IN WHOLE OR SIGNIFICANT PART OF LEATHER (U.S. CLS. 22 AND 39).

SN 76-277,262. MAXINE SWIM GROUP, INC., LOS ANGELES, CA. FILED 6-25-2001.

**OCEAN AVE SWIMWEAR**

NO CLAIM IS MADE TO THE EXCLUSIVE RIGHT TO USE "SWIMWEAR", APART FROM THE MARK AS SHOWN.

FOR WOMEN'S, JUNIOR'S, AND CHILDREN'S SWIMWEAR (U.S. CLS. 22 AND 39).  
FIRST USE 2-28-1997; IN COMMERCE 2-28-1997.

SN 76-279,074. JOO JOO INTERNATIONAL CORP., SOUTH EL MONTE, CA. FILED 7-2-2001.

**SHOETIME**

FOR SHOES, NAMELY, DRESS SHOES, LOAFERS, TENNIS SHOES, BOOTS, SANDALS, AND WALKING SHOES (U.S. CLS. 22 AND 39).

**CLASS 25—(Continued).**

SN 76-280,278. JENNEY, GEORGE W., MORAINÉ, OH. FILED 7-5-2001.

**MYSLOPS**

FOR T-SHIRTS, SHIRTS, JACKETS, SWEAT SHIRTS, AND PANTS (U.S. CLS. 22 AND 39).

FIRST USE 6-1-2000; IN COMMERCE 11-18-2000.

SN 76-284,615. MORGAN HOUSE PUBLISHING, INC., TUCSON, AZ. FILED 7-6-2001.

**MORGAN THE DOG**

FOR CLOTHING, FOOTWEAR, AND HEADGEAR ASSOCIATED WITH CHARACTER OR THEMES DERIVED FROM STORIES FOR CHILDREN, NAMELY, SHIRTS, BLOUSES, T-SHIRTS, PANTS, HATS, CAPS, SHORTS, SKIRTS, DRESSES, SWEATSHIRTS, SWEAT PANTS, JUMPERS, JACKETS, OVERALLS, RAIN SLICKERS, WARM UP SUITS, SNOW SUITS, SLEEP WEAR, CLOTH BIBS, UNDERWEAR, MASQUERADE AND HALLOWEEN COSTUMES AND MASKS, BOOTS, SHOES, SANDALS AND SLIPPERS (U.S. CLS. 22 AND 39).

SN 76-284,641. SBH, INC., ST. LOUIS, MO. FILED 7-13-2001.

**CLEARFIT**

FOR FOOTWEAR HAVING A WINDOW (U.S. CLS. 22 AND 39).

SN 76-289,466. FOWL PLAY CLOTHING AND ACCESSORIES, LLC., TRAVERSE CITY, MI. FILED 7-25-2001.

**FLY WADER**

NO CLAIM IS MADE TO THE EXCLUSIVE RIGHT TO USE "WADER", APART FROM THE MARK AS SHOWN.

FOR FISHING WADERS FEATURING A WATER-PROOF ZIPPER (U.S. CLS. 22 AND 39).  
FIRST USE 7-0-2000; IN COMMERCE 2-0-2001.

SN 76-294,984. OP-D-OP, INC., ROSEVILLE, CA. FILED 8-3-2001.

**SUNCLICK**

FOR CLOTHING, NAMELY ADJUSTABLE HEADWEAR (U.S. CLS. 22 AND 39).

FIRST USE 1-26-2001; IN COMMERCE 3-29-2001.

**CLASS 25—(Continued).**

SN 76-297,588. MALIBU DREAM GIRL, LOS ANGELES, CA. FILED 8-9-2001.

**OCEAN DREAM**

FOR SWIMWEAR (U.S. CLS. 22 AND 39).

SN 76-307,007. LAND 'N SEA, INC., NEW YORK, NY. FILED 8-30-2001.

**AIR CARGO**

FOR CHILDREN'S CLOTHING, NAMELY, TEE SHIRTS, SHIRTS, SHORTS, PANTS, JACKETS, DRESSES, SKIRTS, AND BLOUSES (U.S. CLS. 22 AND 39).  
FIRST USE 1-0-2000; IN COMMERCE 1-0-2000.

SN 76-309,579. LIP SERVICE COMMUNICATIONS, INC., TROY, MI. FILED 9-7-2001.

**FEED THE URGE**

FOR CLOTHING, NAMELY HATS, SHIRTS, SWEAT-SHIRTS, SHORTS, UNDERWEAR AND JACKETS (U.S. CLS. 22 AND 39).  
FIRST USE 8-28-2001; IN COMMERCE 8-31-2001.

SN 76-311,067. KENNETH COLE PRODUCTIONS (LIC), INC., NASSAU, BAHAMAS, FILED 9-7-2001.

**INQUIRE WITHIN**

FOR CLOTHING, NAMELY, SHIRTS, TOPS, JACKETS, VESTS, HATS, SCARVES, PANTS AND SHORTS (U.S. CLS. 22 AND 39).

SN 76-311,538. E.S. ORIGINALS, INC., NEW YORK, NY. FILED 9-10-2001.

**FEATHER FLEX**

FOR OUTER SOLES FOR FOOTWEAR (U.S. CLS. 22 AND 39).

SN 76-311,935. NEW BALANCE ATHLETIC SHOE, INC., BOSTON, MA. FILED 9-14-2001.

**T-FRAME**

FOR FOOTWEAR (U.S. CLS. 22 AND 39).

**CLASS 25—(Continued).**

SN 76-312,893. SCANTIWEAR, LLC, ADDISON, TX. FILED 9-17-2001.

**GOOBIE**

FOR LINGERIE AND HOSIERY, INCLUDING, PANTIES, PANTYHOSE, TIGHTS, STOCKINGS AND SOCKS (U.S. CLS. 22 AND 39).

SN 76-312,898. SCANTIWEAR, LLC, ADDISON, TX. FILED 9-17-2001.

**GOOBIE SNIFFERS**

FOR LINGERIE AND HOSIERY, INCLUDING, PANTIES, PANTYHOSE, TIGHTS, STOCKINGS AND SOCKS (U.S. CLS. 22 AND 39).

SN 76-313,556. UP-FRONT FOOTWEAR, INC., LEBANON, PA. FILED 9-18-2001.

**DINKLES**

FOR FOOTWEAR, NAMELY, BAND MARCHING SHOES (U.S. CLS. 22 AND 39).  
FIRST USE 4-8-1987; IN COMMERCE 4-8-1987.

SN 76-315,204. U.S. ASIA DIRECT, L.C., ANDOVER, MN. FILED 9-19-2001.

**WALK THE WALK**

FOR FOOTWEAR (U.S. CLS. 22 AND 39).

SN 76-316,455. NEW LIFE INDUSTRIES, INC., SOMERSET, KY. FILED 9-24-2001.

**WORKINTEES.COM**

FOR CLOTHING, NAMELY SHIRTS, SWEAT SHIRTS, SWEAT PANTS, T-SHIRTS, SPORT SHIRTS (U.S. CLS. 22 AND 39).  
FIRST USE 12-27-2000; IN COMMERCE 12-27-2000.

**CLASS 25—(Continued).**

SN 76-317,285. SPRINGER, STEVEN R., SALT LAKE CITY, UT. FILED 9-25-2001.

**DOGWOOD**

FOR CLOTHING, NAMELY SWIM TRUNKS, TURTLE-NECKS, SWEAT PANTS, SWEAT SHIRTS, T-SHIRTS, TANK TOPS, SLACKS, GYM SUITS, PLAY SUITS, POLO SHIRTS, PULLOVERS, ROMPERS, SHIRTS, KNIT SHIRTS, SHORTS, BERMUDA SHORTS, GYM SHORTS, SWEAT SHORTS, PANTS, INFANTWEAR, JACKETS, JERSEYS, JOGGING SUITS, LOUNGEWEAR, HATS, COATS AND CAPS (U.S. CLS. 22 AND 39).

FIRST USE 2-0-1998; IN COMMERCE 8-0-1998.

SN 76-317,444. LA VERN, RODNEY, CORONA, CA. FILED 9-25-2001.

**AIRTIME**

FOR CLOTHING, NAMELY SHIRTS, T-SHIRTS, PANTS, SHORTS, SWIMWEAR, SWEATSHIRTS, JACKETS, SWEATERS, SOCKS, HEADWEAR AND FOOTWEAR (U.S. CLS. 22 AND 39).

SN 76-317,543. IRONCLAD PERFORMANCE WEAR CORP., LOS ANGELES., CA. FILED 9-26-2001.

**WRENCHMEN**

FOR GLOVES (U.S. CLS. 22 AND 39).

SN 76-317,961. SEILER, JOEY T., WESTMINSTER, CO. FILED 9-28-2001.

**UPNYA**

FOR SHOES, PANTS, SHIRTS, BLOUSES, SKIRTS, SHORTS, T-SHIRTS, TANK TOPS, CAPS, VISORS, JACKETS, COATS (U.S. CLS. 22 AND 39).

SN 76-318,018. BEHAR, IAN, NEW YORK, NY. FILED 9-24-2001.

**GROUND HERO**

FOR CLOTHING, NAMELY T-SHIRTS, SHIRTS, SWEATSHIRTS, PANTS, SHORTS, SOCKS, SHOES, JACKETS, COATS, CAPS, AND HATS (U.S. CLS. 22 AND 39).

**CLASS 25—(Continued).**

SN 76-318,271. HELEN WELSH GROUP LLC, THE, NEW YORK, NY. FILED 9-27-2001.

**HARRISON J**

FOR WOMEN'S CLOTHING, NAMELY, SCARVES, SHAWLS AND BELTS (U.S. CLS. 22 AND 39).

SN 76-318,346. GLAMORISE FOUNDATIONS, INC., NEW YORK, NY. FILED 9-27-2001.

**COMFORT PLUS BY  
GLAMORISE**

FOR FOUNDATION GARMENTS (U.S. CLS. 22 AND 39).

SN 76-318,750. KANDY KISS OF CALIFORNIA, INC., PACOIMA, CA. FILED 9-28-2001.

**SAMMI & ME**

FOR CLOTHING, NAMELY DRESSES, TOPS, SKIRTS, PANTS, AND SHORTS (U.S. CLS. 22 AND 39).  
FIRST USE 0-0-1994; IN COMMERCE 0-0-1994.

SN 76-318,769. @TIRE FASHIONS INC., BROOKLYN, NY. FILED 10-1-2001.



FOR WOMEN'S CLOTHING, NAMELY - DENIM JACKETS, DENIM PANTS, DENIM SHORTS, DENIM SKIRTS, JACKETS, TANK TOPS, T-SHIRTS, SWEATERS, SHIRTS, SKIRTS, SWEATSHIRTS, SWEATPANTS, WARMUP SUITS, JOGGING SUITS, JERSEYS, HEADWEAR, VISORS, CAPS (U.S. CLS. 22 AND 39).

SN 76-319,413. N.Y.D.F., INC., NEW YORK, NY. FILED 10-1-2001.

**PATRICK PHILLIP**

THE NAME "PATRICK PHILLIP" DOES NOT IDENTIFY A PARTICULAR INDIVIDUAL.

FOR WEARING APPAREL; NAMELY, SHIRTS, PANTS, SWEATERS, JACKETS, TIES, SHORTS, JEANS, SWEATSUITS, HATS, UNDERWEAR, COATS, SOCKS, BLAZERS, NECKTIES, VESTS, SKIRTS, VESTS, AND TOPS (U.S. CLS. 22 AND 39).

FIRST USE 9-1-2001; IN COMMERCE 9-1-2001.



**CLASS 25—(Continued).**

SN 76-319,433. TIERNEY RIDES, LLC, HOFFMAN ESTATES, IL. FILED 9-28-2001.

**RIDE ME. RIDE ME, NOW.**

FOR CLOTHING, NAMELY, T-SHIRTS, SWEATSHIRTS, SOCKS, CAPS, HATS, VISORS, SHORTS, PANTS, JACKETS, BANDANAS, BOXER SHORTS AND WRISTBANDS; FOOTWEAR, NAMELY, SHOES AND BOOTS (U.S. CLS. 22 AND 39).

---

SN 76-320,039. HUMEAU-BEAUPREAU S.A.S, 49600 BEAUPREAU, FRANCE, FILED 10-1-2001.



FOR FOOTWEAR FOR CHILDREN AND ADOLESCENTS (U.S. CLS. 22 AND 39).  
FIRST USE 12-0-1978; IN COMMERCE 12-31-1978.

---

SN 76-320,084. KANDY KISS OF CALIFORNIA, INC., PACOIMA, CA. FILED 9-28-2001.

**KANDY KISS**

FOR CLOTHING, NAMELY DRESSES, TOPS, SKIRTS, PANTS, AND SHORTS (U.S. CLS. 22 AND 39).  
FIRST USE 0-0-1975; IN COMMERCE 0-0-1975.

---

SN 76-320,757. CASHMERE WEB SALES, LLC, SOUTH NATICK, MA. FILED 10-3-2001.

**SHARE OUR PASSION**

FOR GARMENTS MADE WHOLLY OF CASHMERE AND BLENDS OF CASHMERE, NAMELY, CAPS, GLOVES, PANTS, SCARVES, SHAWLS, SKIRTS, SWEATERS, SWEATSHIRTS, TANK TOPS, TUNICS, VESTS, WRAPS (U.S. CLS. 22 AND 39).

---

SN 76-321,634. FOOTSTAR CORPORATION, WEST NYACK, NY. FILED 10-4-2001.

**MOUNTAIN COUNTRY**

OWNER OF U.S. REG. NO. 1,916,599.  
FOR FOOTWEAR (U.S. CLS. 22 AND 39).  
FIRST USE 10-0-1993; IN COMMERCE 10-0-1993.

**CLASS 25—(Continued).**

SN 76-322,658. PAUL, JEFFREY W., LOS ANGELES, CA. FILED 10-9-2001.

**FREEDOM ROAD**

FOR CLOTHING, NAMELY PANTS, SHIRTS, JACKET AND HATS (U.S. CLS. 22 AND 39).

---

SN 76-324,916. BONFIGLIO, BARBARA, MOUNT ROYAL, Q.C. H3R 2A6, CANADA, FILED 10-15-2001.

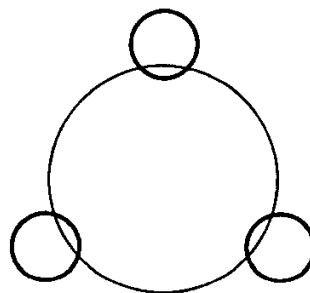

THE MARK CONSISTS OF A PARENT CIRCLE WITH THREE SMALLER CIRCLES PLACED AT TWENTY, FORTY AND SIXTY DEGREES ON THE EDGES OF THE PARENT CIRCLE.

FOR CLOTHING, NAMELY SHIRTS, PANTS, SHORTS, SKIRTS, JACKETS, SWEATSHIRTS, SWEATERS, T-SHIRTS, HATS, FOOTWEAR; AND HEADWEAR (U.S. CLS. 22 AND 39).

---

SN 76-325,057. SCHERING-PLOUGH HEALTHCARE PRODUCTS, INC., MEMPHIS, TN. FILED 10-12-2001.

**COPPERTONE**

OWNER OF U.S. REG. NOS. 567,828, 2,276,242 AND OTHERS.

FOR DISPOSABLE AND LIMITED LIFE CHILDREN'S BEACHWEAR AND SWIMWEAR, NAMELY, DIAPER-PANTS (U.S. CLS. 22 AND 39).

**CLASS 25—(Continued).**

SN 78-016,354. PETRONI, ERIK, B., ATLANTIC BEACH, FL. AND PETRONI, KARINA, B., ATLANTIC BEACH, FL. FILED 7-12-2000.

**SEA PRINCESS**

FOR CLOTHING, NAMELY, BATHING TRUNKS, BELTS, BLOUSES, CHEMISETTES, COATS, DRESSING GOWNS, FLEECE PULLOVERS, FROCKS, GLOVES, HOODS, JACKETS, JUMPERS, LEATHER JACKETS, LEGGINGS, LEOTARDS, OVERALLS, OVERCOATS, PAJAMAS, PANTS, PARKAS, PULLOVERS, SCARVES, SHAWLS, SHIRTS, SINGLETS, SKIRTS, SLIPS, SUSPENDERS, SWEATERS, SWEAT SHIRTS, TANK TOPS, TIGHTS, TOP COATS, TROUSERS, UNDERWEAR, BEACH SHOES, BOOTS, SANDALS, SHOES, BERETS, CAPS, HATS, AND VISORS (U.S. CLS. 22 AND 39).

SN 78-025,393. EDLEIN GROUP, L.C., THE, PLANO, TX. FILED 9-11-2000.

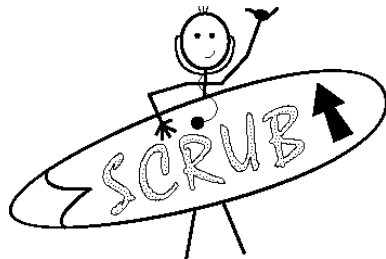

NO CLAIM IS MADE TO THE EXCLUSIVE RIGHT TO USE "SCRUB", APART FROM THE MARK AS SHOWN. FOR CLOTHING, NAMELY, SCRUB TOPS AND PANTS (U.S. CLS. 22 AND 39).

SN 78-025,996. HONEYCUTT, JASON, KEN, VICTORVILLE, CA. FILED 9-15-2000.

**HUMANLAB**

FOR CLOTHING, NAMELY, CAPS, HATS, BELTS, LONG SLEEVED AND SHORT SLEEVED T-SHIRTS, JERSEYS, TOPS, SWEAT PANTS, JEAN PANTS, CORDUROY PANTS (U.S. CLS. 22 AND 39).

**CLASS 25—(Continued).**

SN 78-027,097. MARBLE SPORTSWEAR, INC., BEVERLY HILLS, CA. FILED 9-21-2000.

**NEXT STAR BEVERLY HILLS**

NO CLAIM IS MADE TO THE EXCLUSIVE RIGHT TO USE "BEVERLY HILLS", APART FROM THE MARK AS SHOWN.

FOR BATHING SUITS, BLAZERS, BLOUSES, BOOTS, BRAS, BRIEFS, CAMISOLES, CAPS, COATS, DRESSES, GLOVES, HATS, JACKETS, JEANS, JUMPSUITS, LEOTARDS, NECKTIES, NIGHTGOWNS, OVERALLS, PAJAMAS, PANTS, PANTYHOSE, RAINCOATS, ROBES, SANDALS, SHIRTS, SHOES, SHORTALLS, SHORTS, SKIRTS, SLIPPERS, SLIPS, SOCKS, STOCKINGS, SUITS, SWEATERS, SWEATPANTS, SWEATSHIRTS, T-SHIRTS, TIGHTS, TUXEDOS, VESTS, WARM-UP SUITS (U.S. CLS. 22 AND 39).

SN 78-031,548. HAYES, FREDERICK, H., ROANOKE, VA. FILED 10-19-2000.

**SPORTSZROW**

FOR CLOTHING APPAREL, NAMELY, SWEAT SHIRTS, T-SHIRTS, AND JACKETS (U.S. CLS. 22 AND 39).

SN 78-032,206. BRASSEUR INC., LOS ANGELES, CA. FILED 10-24-2000.

Lisa Rene'

FOR LADIES CLOTHING, NAMELY, SUITS, JACKETS, PANTS, SKIRTS, BLOUSES, DRESSES, SWEATERS, T-SHIRTS, COATS, CAMISOLES (U.S. CLS. 22 AND 39). FIRST USE 9-1-2000; IN COMMERCE 9-1-2000.

SN 78-033,922. WEBVISION, INC., MARLTON, NJ. FILED 11-5-2000.

**SPAGHETTI GEAR**

NO CLAIM IS MADE TO THE EXCLUSIVE RIGHT TO USE "GEAR", APART FROM THE MARK AS SHOWN.

FOR CLOTHING, NAMELY, SHIRTS, IMPRINTED MESSAGES ON SHIRTS, T-SHIRTS, SWEATSHIRTS, PANTS, HATS, SOCKS, DRESSES, JACKETS, NECKTIES, CLOTH BIBS, APRONS, HEADWEAR, INFANTWEAR, LOUNGEWEAR, AND NECKWEAR (U.S. CLS. 22 AND 39).

**CLASS 25—(Continued).**

SN 78-036,031. COLLEGE OF WEST VIRGINIA, THE, BECKLEY, WV. FILED 11-20-2000.

## MOUNTAIN STATE UNIVERSITY

NO CLAIM IS MADE TO THE EXCLUSIVE RIGHT TO USE "UNIVERSITY", APART FROM THE MARK AS SHOWN.

FOR BACKPACKS, BELTS, BLOUSES, BOXER SHORTS, CAPS, COATS, GLASSES, GLOVES, HAIR ACCESSORIES, HATS, JACKETS, JERSEYS, LAPEL PINS, NIGHT SHIRTS, POLO SHIRTS, RAIN GEAR, ROBES, SCARVES, SHIRTS, SHOES, SHORTS, SKIRTS, SLACKS, SOCKS, SWEATERS, SWEATSHIRTS, SWEAT PANTS, T-SHIRTS, TANK TOPS, TIES, TOTE BAGS, UNDERGARMENTS, WIND SUITS, WIND JACKETS (U.S. CLS. 22 AND 39).

SN 78-042,066. GOMES, HELDER, LINDEN, NJ. FILED 1-8-2001.

EuropeanCock



THE MARK CONSISTS, IN PART, OF A ROOSTER WITH THE WORDING "EUROPEANCOCK" ON THE ROOSTER DESIGN.

FOR SHIRTS AND HATS (U.S. CLS. 22 AND 39).  
FIRST USE 10-26-2000; IN COMMERCE 10-26-2000.

SN 78-043,437. STAEHLER, TROY, M, HAWTHORNE, CA. FILED 1-16-2001.

## ROLLERZ ONLY

FOR CLOTHING FOR ADULTS, CHILDREN AND INFANTS, NAMELY, HEAD WEAR, T-SHIRTS, PANTS, DRESSES, BLOUSES, HATS, NECKWEAR, RAINWEAR, SLEEP WEAR, LOUNGEWEAR AND UNDERWEAR (U.S. CLS. 22 AND 39).

**CLASS 25—(Continued).**

SN 78-045,687. MICROSOFT CORPORATION, REDMOND, WA. FILED 1-30-2001.

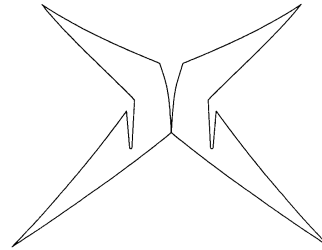

THE MARK CONSISTS OF TWO ANGULAR, CONCAVE REGIONS POSITIONED SIDE-BY-SIDE.

FOR SHIRTS, VESTS, SWEATSHIRTS, SWEATERS, SWEATPANTS, SHORTS, JACKETS, CAPS, BATHROBES, NIGHT SHIRTS, SUSPENDERS, COATS, SWEATBANDS, SCARVES, GLOVES, MITTENS, SOCKS, FOOTWEAR, TIES, VISORS AND WRIST BANDS (U.S. CLS. 22 AND 39).

SN 78-047,063. INTERNATIONAL COMMERCE ONLINE NETWORK, LLC., HASBROUCK HEIGHTS, NJ. FILED 2-7-2001.

ZENDALS

THE MARK CONSISTS IN PART OF CHINESE CHARACTERS.

THE NON-LATIN CHARACTERS IN THE MARK TRANSLITERATE TO "SIEN" AND THIS MEANS "ZEN".

FOR SLIPPERS (U.S. CLS. 22 AND 39).  
FIRST USE 12-1-2000; IN COMMERCE 12-1-2000.

SN 78-050,190. ARCOS S.P.A., TRAVAGLIATO, BRESCIA, ITALY, FILED 2-26-2001.

TRAVELSOX

THE MARK CONSISTS OF THE WORDING "TRAVELSOX" WITH A LOOPING ARROW WITH ITS MIDDLE FORMING THE LETTER "O" IN "SOX".

FOR SOCKS AND STOCKINGS FOR MEN, WOMEN AND CHILDREN (U.S. CLS. 22 AND 39).

**CLASS 25—(Continued).**

SN 78-050,821. SAMSONITE CORPORATION, DENVER, CO.  
FILED 3-1-2001.

## AMERICAN TOURISTER DESTINATION WEAR

OWNER OF U.S. REG. NOS. 750,353, 836,166 AND OTHERS.

NO CLAIM IS MADE TO THE EXCLUSIVE RIGHT TO USE "WEAR", APART FROM THE MARK AS SHOWN.

FOR MEN'S, WOMEN'S AND CHILDREN'S APPAREL NAMELY PANTS, SHIRTS, JACKETS, COATS, SKIRTS, DRESSES, SCARVES AND SUITS (U.S. CLS. 22 AND 39).

SN 78-051,201. BROWN SERVICES, INC., LEXINGTON, KY.  
FILED 3-2-2001.

## KENTUCKY HOT BROWN

NO CLAIM IS MADE TO THE EXCLUSIVE RIGHT TO USE "KENTUCKY", APART FROM THE MARK AS SHOWN.

FOR CLOTHING FOR MEN, WOMEN, CHILDREN, AND INFANTS, NAMELY, SHIRTS, SWEATERS, SWEATSHIRTS, SPORT COATS, PANTS, SWEATPANTS, SHORTS, DRESSES, JEANS, SKIRTS, OVERALLS, SPORT JACKETS, RAINCOATS, PARKAS, OVERCOATS, BATHING SUITS, VESTS, TURTLENECKS, GOLF JACKETS, WIND RESISTANT JACKETS, BLAZERS, BELTS, TIES, SUSPENDERS, HATS, CAPS, SUITS, T-SHIRTS, UNDERSHIRTS, UNDERPANTS, BOXER SHORTS, SOCKS, BATHROBES, LINGERIE AND PAJAMAS, FOOTWEAR, NAMELY, SHOES, BOOTS, SNEAKERS, SANDALS, AND SLIPPERS (U.S. CLS. 22 AND 39).

SN 78-055,196. GANN, CONNIE, JEAN, TENNYSON, IN.  
FILED 3-27-2001.

## SCOPEWEAR

FOR MEDICAL APPAREL, NAMELY, UNIFORMS, PANTS, LAB COATS, NURSE DRESSES, SMOCKS, JUMPSUITS AND COVERALLS WITH THE PATENTED POCKET FOR HOLDING AN UNFOLDED STETHOSCOPE (U.S. CLS. 22 AND 39).

SN 78-057,230. MONTANA CAMO, INC., VICTOR, MT.  
FILED 4-6-2001.

## RIDGE GHOST

OWNER OF U.S. REG. NO. 2,477,598.  
FOR CLOTHING, NAMELY SHIRTS, PANTS, COATS, CAPS, HATS, FOUL WEATHER GEAR, GLOVES, JACKETS, SHORTS, SWEATERS, SWEATSHIRTS, TEE SHIRTS, VESTS, BELTS, BLOUSES, HEAD NETS IN THE NATURE OF VEILS, BOOTS, SHOES, SLIPPERS, COVERALLS, OVERALLS AND JEANS (U.S. CLS. 22 AND 39).

**CLASS 25—(Continued).**

SN 78-057,232. MONTANA CAMO, INC., VICTOR, MT.  
FILED 4-6-2001.

## RIVER GHOST

OWNER OF U.S. REG. NO. 2,477,598.  
FOR CLOTHING, NAMELY SHIRTS, PANTS, COATS, CAPS, HATS, FOUL WEATHER GEAR, GLOVES, JACKETS, SHORTS, SWEATERS, SWEATSHIRTS, TEE SHIRTS, VESTS, BELTS, BLOUSES, HEAD NETS IN THE NATURE OF VEILS, BOOTS, SHOES, SLIPPERS, COVERALLS, OVERALLS AND JEANS (U.S. CLS. 22 AND 39).

SN 78-058,542. CHERRY STIX LTD., NEW YORK, NY. FILED  
4-16-2001.

## TAMMY SUE

THE NAME SHOWN IN THE MARK DOES NOT IDENTIFY A PARTICULAR LIVING INDIVIDUAL.

FOR WOMEN'S CLOTHING NAMELY, SWEATERS, JACKETS, ANORAKS, BLOUSES, TOPS, PULLOVERS, PANTS, JEANS, SHORTS, DRESSES, SKIRTS, SLIPS, UNDERGARMENTS AND SLEEPWEAR (U.S. CLS. 22 AND 39).

SN 78-062,639. HOUSTON MCLANE COMPANY, INC.,  
TEMPLE, TX. FILED 5-9-2001.



FOR CLOTHING; NAMELY, SHIRTS, TEE SHIRTS, POLO SHIRTS, KNIT SHIRTS, GOLF SHIRTS, JACKETS, SWEAT SHIRTS, SWEATERS, JERSEYS, V-NECK PULLOVERS, HATS AND VISORS (U.S. CLS. 22 AND 39).  
FIRST USE 1-5-2001; IN COMMERCE 1-5-2001.

SN 78-063,210. WEIL, SCOTT, PORT WASHINGTON, NY.  
FILED 5-11-2001.

## COOLOSHES

FOR FOOTWEAR, GLOVES, RAIN SUITS, RAINWEAR (U.S. CLS. 22 AND 39).

**CLASS 25—(Continued).**

SN 78-069,916. HOOPS L.P., CHICAGO, IL. FILED 6-19-2001.

**MEMPHIS GRIZZLIES**

OWNER OF U.S. REG. NOS. 2,100,590 AND 2,195,663.  
NO CLAIM IS MADE TO THE EXCLUSIVE RIGHT TO USE "MEMPHIS", APART FROM THE MARK AS SHOWN.  
FOR CLOTHING, NAMELY HOSIERY, FOOTWEAR, T-SHIRTS, SHIRTS, SWEATSHIRTS, SWEATPANTS, PANTS, TANK TOPS, JERSEYS, SHORTS, PAJAMAS, SPORT SHIRTS, RUGBY SHIRTS, SWEATERS, BELTS, TIES, NIGHTSHIRTS, HATS, WARM-UP SUITS, WARM-UP PANTS, WARM-UP TOPS, JACKETS, PARKAS, COATS, CLOTH BIBS, HEAD BANDS, WRIST BANDS, APRONS, BOXER SHORTS, SLACKS, CAPS, EAR MUFFS, GLOVES, MITTENS, WOVEN AND KNIT SHIRTS (U.S. CLS. 22 AND 39).

---

SN 78-072,180. MARTIN, DAVID L., WOODLAND HILLS, CA. FILED 7-3-2001.

**PAJAMA BEACH**

FOR PAJAMAS, LONG JOHNS, BEACHWEAR AND LEISUREWEAR NAMELY, SHIRTS, PANTS AND SHORTS (U.S. CLS. 22 AND 39).

---

SN 78-074,940. L. L. BEAN, INC., FREEPORT, ME. FILED 7-20-2001.

**SNOWFIELD**

FOR CHILDREN'S OUTERWEAR, NAMELY JACKETS, PARKAS AND BIBS (U.S. CLS. 22 AND 39).  
FIRST USE 7-17-2001; IN COMMERCE 7-17-2001.

---

SN 78-077,267. BASS,KENNY,L. DBA CANHEBE RECORDS, LOS ANGELES, CA. FILED 8-2-2001.

**CANHEBE**

FOR SHIRTS (U.S. CLS. 22 AND 39).

---

SN 78-077,787. SUOJANEN, DEBORAH KINDLER, IRVINE, CA. AND AMANI, ARASTEH, IRVINE, CA. FILED 8-6-2001.

**SHOWZ**

FOR CLOTHING, NAMELY, FOOTWEAR, HEADWEAR, SOCKS AND ANKLETS (U.S. CLS. 22 AND 39).

**CLASS 25—(Continued).**

SN 78-077,868. ROTARY INTERNATIONAL, EVANSTON, IL. FILED 8-7-2001.

**INTERACT CLUB**

OWNER OF U.S. REG. NOS. 769,315, 2,467,823 AND OTHERS.

FOR CLOTHING, NAMELY MEN'S, LADIES AND CHILDREN'S JERSEYS, SWEATERS, SWEATSHIRTS, SHIRTS, T-SHIRTS, GOLF SHIRTS, SHORTS, GYM SHORTS, JACKETS, BELTS, SCARVES, BANDANNAS, NECKTIES, BOLO TIES, SOCKS, HATS, CAPS, AND ATHLETIC WEAR, NAMELY, VISORS, WRIST BANDS, AND HEAD BANDS (U.S. CLS. 22 AND 39).  
FIRST USE 1-0-1965; IN COMMERCE 1-0-1965.

---

SN 78-079,634. MCCASLIN, GREG, CANOGA, CA. FILED 8-16-2001.

**MADGUY**

FOR CLOTHING, NAMELY, T-SHIRTS, LONG SLEEVE SHIRTS, SWEAT SHIRTS, HATS AND CAPS (U.S. CLS. 22 AND 39).

FIRST USE 3-24-2000; IN COMMERCE 4-1-2000.

---

SN 78-079,760. HEALTHTEX APPAREL CORP., WILMINGTON, DE. FILED 8-17-2001.

**HEALTHTEX**

OWNER OF U.S. REG. NOS. 1,806,197 AND 1,807,653.  
FOR UNDERWEAR, UNDERSHIRTS AND CAMI-SOLES (U.S. CLS. 22 AND 39).  
FIRST USE 1-1-2000; IN COMMERCE 1-2-2000.

---

SN 78-084,338. NEVADA FEET, INC., WEST NYACK, NY. FILED 9-18-2001.

**NDURE**

FOR FOOTWEAR AND CLOTHING, NAMELY, SHIRTS, T-SHIRTS, TANK TOPS, SWEATSHIRTS, JACKETS, JERSEYS, WIND SUITS, PANTS, SWEATPANTS, SHORTS, SWIMWEAR, HATS, HEADBANDS, SOCKS, AND HOSIERY (U.S. CLS. 22 AND 39).

---

SN 78-084,437. IXSTREME, DALLAS, TX. FILED 9-18-2001.

**THIS IS WHAT I DO**

FOR SHIRTS, HATS, SWEATSHIRTS, SHORTS, JACKETS (U.S. CLS. 22 AND 39).

**CLASS 25—(Continued).**

SN 78-085,429. SURE FOOT CORPORATION, GRAND FORKS, ND. FILED 9-25-2001.

**ICE JOGGER**

OWNER OF U.S. REG. NO. 2,003,779. SEC. 2(F).  
FOR FOOTWEAR ACCESSORIES, NAMELY, REMOVABLE DEVICES FOR NON-SLIP TRACTION WITH CARBIDE SPIKES (U.S. CLS. 22 AND 39).  
FIRST USE 1-27-1995; IN COMMERCE 1-27-1995.

SN 78-085,537. KIRKUP, LOUISE, E, TOPANGA, CA. FILED 9-25-2001.

**VINTAGE VULTURE**

FOR MEN'S, WOMEN'S, AND CHILDREN'S CLOTHING, NAMELY PANTS, JEANS, SHORTS, BIB OVERALLS, COVERALLS, T-SHIRTS, SHIRTS, SWEATSHIRTS, SWEATERS, JACKETS, COATS, DRESSES, SKIRTS, APRONS, CLOTH BIBS, GLOVES, MITTENS, SCARFS, HATS, BANDANNAS, SOCKS, BOOTIES, AND SLEEPWEAR (U.S. CLS. 22 AND 39).  
FIRST USE 8-1-2001; IN COMMERCE 8-1-2001.

SN 78-085,656. HERSCH, CARRIE, YORBA LINDA, CA. FILED 9-26-2001.

**CERELDA**

FOR CLOTHING, NAMELY DRESSES, SKIRTS, BLOUSES, PANTS, SHIRTS, SHOES, JACKETS, LINGERIE (U.S. CLS. 22 AND 39).

SN 78-086,619. GAP (APPAREL) INC., SAN BRUNO, CA. FILED 10-2-2001.

**GIVE YOUR GIFT**

OWNER OF U.S. REG. NOS. 1,129,294, 1,576,510 AND 1,752,562.  
FOR CLOTHING, NAMELY, PANTS, SHORTS, SWEATPANTS, OVERALLS, SHIRTS, TEE-SHIRTS, SWEATSHIRTS, BLOUSES, SKIRTS, DRESSES, JACKETS, VESTS, COATS, RAINWEAR, SHOES, LINGERIE, SLEEPWEAR, LOUNGEWEAR, SWIMWEAR, GLOVES, SOCKS, HOSIERY, BELTS, SCARVES, HATS, TIES, SLIPPERS (U.S. CLS. 22 AND 39).

**CLASS 25—(Continued).**

SN 78-086,622. GAP (APPAREL) INC., SAN BRUNO, CA. FILED 10-2-2001.

**BORN GIFTED**

OWNER OF U.S. REG. NOS. 1,675,154, 1,856,136 AND 1,906,665.  
FOR CLOTHING, NAMELY, SHIRTS, PANTS, SHORTS, JACKETS, ROMPERS, DRESSES, JUMPERS, SWEATERS, DIAPER COVERS, SOCKS, BOOTIES, TIGHTS, SHOES AND SLIPPERS, CLOTH BIBS, HATS, CAPS, BONNETS, BODYSUITS, TEE-SHIRTS, CARDIGANS, SWIMWEAR, PAJAMAS, SLEEPWEAR, NEWBORN AND INFANT WEAR, FLEECE TOPS, APRONS, MITTENS, COATS, JACKETS, SWEATPANTS, SWEATSHIRTS (U.S. CLS. 22 AND 39).

**CLASS 26—FANCY GOODS**

SN 76-069,717. AMAZING WIGS, INC., CANSHOCKEN, PA. FILED 6-12-2000.

**AMAZING WIGS**

NO CLAIM IS MADE TO THE EXCLUSIVE RIGHT TO USE "WIGS", APART FROM THE MARK AS SHOWN.  
FOR WIGS, TOUPEES AND HAIR PIECES (U.S. CLS. 37, 39, 40, 42 AND 50).

SN 76-108,892. DESIGNS BY SKAFFLES, INC., NEW YORK, NY. FILED 8-14-2000.

**HOT STYLES**

FOR HAIR ACCESSORIES, NAMELY, BARRETTES, SCRUNCHIES, BANANA CLIPS, HAIRBANDS, HAIR ORNAMENTS IN THE NATURE OF HAIR WRAPS, TUBAS, CLAWS, PONYTAIL HOLDERS, BOWS, PADDED BARRETTES AND SLEEP CLIPS, NAMELY, HAIRPINS; AND CLOTHING ACCESSORIES, NAMELY, JACKETS CLIPS AND ZIPPER PULLS (U.S. CLS. 37, 39, 40, 42 AND 50).

SN 76-114,509. MODERN HOUSEWARE IMPORTS INC., BURNABY, BRITISH COLUMBIA, CANADA, FILED 8-22-2000.

**SEWING BOX**

NO CLAIM IS MADE TO THE EXCLUSIVE RIGHT TO USE "SEWING", APART FROM THE MARK AS SHOWN.  
FOR NEEDLES, THIMBLES, BUTTONS FOR CLOTHING, SAFETY PINS AND PEARLIZED STRAIGHT PINS (U.S. CLS. 37, 39, 40, 42 AND 50).

**CLASS 26—(Continued).**

SN 76-144,606. TROIKA INTERNATIONAL, INC., LOS ANGELES, CA. FILED 10-11-2000.

**VELVET YAKI**

NO CLAIM IS MADE TO THE EXCLUSIVE RIGHT TO USE "YAKI", APART FROM THE MARK AS SHOWN.  
FOR HAIR EXTENSIONS MADE FROM HUMAN HAIR (U.S. CLS. 37, 39, 40, 42 AND 50).

SN 76-148,993. BOUKEEPS, INC., SAN ANTONIO, TX. FILED 10-18-2000.

**BOUKEEPS**

FOR ARTIFICIAL FLOWER ARRANGEMENTS (U.S. CLS. 37, 39, 40, 42 AND 50).

SN 76-153,903. BOOT FLAP JACK, INC., PRESCOTT, AZ. FILED 10-24-2000.

**FLAP JACK**

NO CLAIM IS MADE TO THE EXCLUSIVE RIGHT TO USE "FLAP", APART FROM THE MARK AS SHOWN.  
FOR ATTACHMENT FOR FOOTWEAR TO ASSIST IN THE REMOVAL OF FOOTWEAR PARTICULARLY BOOTS (U.S. CLS. 37, 39, 40, 42 AND 50).

SN 78-050,834. STJAMES, DEBRA D., VALLEY CENTER, CA. FILED 3-1-2001.

**WONDAR-WANDS**

FOR NON-ELECTRIC HAIR CURLERS (U.S. CLS. 37, 39, 40, 42 AND 50).

**CLASS 27—FLOOR COVERINGS**

SN 75-878,630. TUFENKIAN IMPORT/EXPORT VENTURES, INC., NEW YORK, NY. FILED 12-22-1999.

**DESIGNERS' RESERVE**

NO CLAIM IS MADE TO THE EXCLUSIVE RIGHT TO USE "DESIGNERS'", APART FROM THE MARK AS SHOWN.  
FOR RUGS (U.S. CLS. 19, 20, 37, 42 AND 50).  
FIRST USE 3-1-1996; IN COMMERCE 3-1-1996.

**CLASS 27—(Continued).**

SN 76-054,609. BEST PICTURE SHOW COMPANY PTY. LTD., THE, QUEENSLAND 4000, AUSTRALIA, FILED 5-19-2000.

**THE CROCODILE HUNTER**

FOR WALL COVERINGS OF PLASTIC AND VINYL, WALL HANGINGS, NOT OF TEXTILE, WALL PAPER AND WALL PAPER BORDERS (U.S. CLS. 19, 20, 37, 42 AND 50).

SN 76-068,423. MOHAWK CARPET CORPORATION, CALHOUN, GA. FILED 6-13-2000.

**ANTALYA**

FOR RUGS (U.S. CLS. 19, 20, 37, 42 AND 50).  
FIRST USE 5-1-2000; IN COMMERCE 5-1-2000.

SN 76-153,407. JANITEX RUG SERVICE CORP., BELTSVILLE, MD. FILED 10-20-2000.

**MEKA**

FOR CARPETS, RUGS, AND TEXTILE FLOOR MATS FOR USE IN COMMERCIAL ESTABLISHMENTS (U.S. CLS. 19, 20, 37, 42 AND 50).  
FIRST USE 12-1-1997; IN COMMERCE 12-1-1997.

SN 76-295,228. CHESAPEAKE WALLCOVERINGS CORPORATION, UPPER MARLBORO, MD. FILED 8-6-2001.

**THE GREAT BIG KIDS BOOK**

FOR VINYL WALLCOVERINGS (U.S. CLS. 19, 20, 37, 42 AND 50).

SN 78-026,199. VIRGIN LOOMS INC., CANOGA PARK, CA. FILED 9-16-2000.

**VIRGIN LOOMS**

NO CLAIM IS MADE TO THE EXCLUSIVE RIGHT TO USE "LOOMS", APART FROM THE MARK AS SHOWN.  
FOR CARPET AND RUGS (U.S. CLS. 19, 20, 37, 42 AND 50).  
FIRST USE 8-1-2000; IN COMMERCE 8-1-2000.

**CLASS 27—(Continued).**

SN 78-082,703. VIACOM INTERNATIONAL INC., NEW YORK, NY. FILED 9-5-2001.

## JIMMY NEUTRON BOY GENIUS

FOR RUGS AND WALL HANGINGS NOT OF TEXTILE (U.S. CLS. 19, 20, 37, 42 AND 50).

**CLASS 28—TOYS AND SPORTING GOODS**

SN 75-525,400. IMAGINATION HOLDINGS PTY LTD., NORWOOD, SOUTH, AUSTRALIA, BY ASSIGNMENT YEEND, SHANE A., NORWOOD, AUSTRALIA, FILED 7-24-1998.



FOR TOYS, NAMELY, PARLOR GAMES AND BOARD GAMES (U.S. CLS. 22, 23, 38 AND 50).  
FIRST USE 1-0-1997; IN COMMERCE 9-0-1997.

SN 75-746,182. BENES, DORI M, CHICAGO, IL. FILED 7-8-1999.

**LIFE OF THE**

FOR BOARD GAME PLAYED DURING A PARTY SUCH AS - BIRTHDAY, BABY SHOWER, WEDDING SHOWER (U.S. CLS. 22, 23, 38 AND 50).

**CLASS 28—(Continued).**

SN 75-899,222. JOHN MENZIES (UK) LIMITED, LONDON, EC1N 6TD, ENGLAND, FILED 1-19-2000.

## HAPPY STREET

OWNER OF UNITED KINGDOM REG. NO. 2119499, DATED 7-25-1997, EXPIRES 7-25-2007.

FOR CHILDREN'S TOYS AND GAMES, NAMELY PUZZLES, CARD PUZZLES, RATTLES, MUSICAL TOYS, DOLL HOUSES AND FURNISHINGS, CHILDREN'S PLAYHOUSES, TOY TRAINS, TOY TRUCKS, TOY TRACTORS, TOY TRAILERS, WOODEN BLOCKS, CHILDREN'S WORK BENCHES, CHILDREN'S TOOL BOXES AND TOOLS, CHILDREN'S POTS, PANS, PASTRY SETS AND COFFEE SETS, CHILDREN'S DOCTOR SETS, TOY ANIMALS, BEAD COUNTING FRAMES, TOY FARMS, TOY CLOCKS, TOY HOUSES, TOY VEHICLES, TOY BUILDINGS, TOY MOSAICS, DARTBOARDS, TOY ZOOS; SWIMMING AIDS; PLAYGROUND EQUIPMENT, NAMELY SLIDES, SWINGS, CLIMBING FRAMES, LADDERS, PLAY TUNNELS; TRAMPOLINES; SANDBOXES; TOY CONSTRUCTION SETS; INFLATABLE TOYS; ARTS AND CRAFTS TOYS; TOY ROADS AND STREETS; TOY TOILETS; TOY CRANES; TOY HELICOPTERS; TOY PETROL STATIONS; TOY POLICE STATIONS; TOY SCHOOLS; TOY TELEPHONE BOXES; TOY SHOPS (U.S. CLS. 22, 23, 38 AND 50).

SN 76-001,199. REICHLIN, GAIL, SKOKIE, IL. FILED 3-16-2000.

## THE POCKET PARENT

FOR TOYS, NAMELY, CHILDREN'S DOLLS (U.S. CLS. 22, 23, 38 AND 50).

SN 76-011,782. KONAMI CO, LTD., TOKYO 105-6021, JAPAN, FILED 3-27-2000.

## TACTICAL ESPIONAGE ACTION

NO CLAIM IS MADE TO THE EXCLUSIVE RIGHT TO USE "ESPIONAGE", APART FROM THE MARK AS SHOWN.

FOR STAND ALONE VIDEO OUTPUT GAME MACHINES, STAND ALONE VIDEO MACHINES, HAND-HELD UNIT FOR PLAYING VIDEO GAMES, AND INSTRUCTIONAL MATERIAL SOLD THEREWITH; BOARD GAMES AND INSTRUCTIONS SOLD AS A UNIT; TOYS, NAMELY, PLAY AND ACTION FIGURES AND ACCESSORIES SOLD THEREWITH (U.S. CLS. 22, 23, 38 AND 50).

FIRST USE 5-10-1997; IN COMMERCE 5-10-1997.



**CLASS 28—(Continued).**

SN 76-036,381. MARS, INCORPORATED, MCLEAN, VA. FILED 4-27-2000.

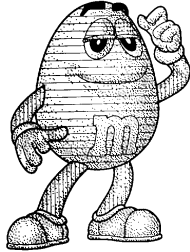

OWNER OF U.S. REG. NOS. 981,235, 983,429 AND OTHERS.

THE DRAWING IS LINED FOR THE COLORS BLUE AND FLESH. THE STIPPLING IS FOR SHADING PURPOSES ONLY.

FOR BOARD GAMES (U.S. CLS. 22, 23, 38 AND 50). FIRST USE 2-25-2000; IN COMMERCE 2-25-2000.

---

SN 76-036,385. MARS, INCORPORATED, MCLEAN, VA. FILED 4-27-2000.

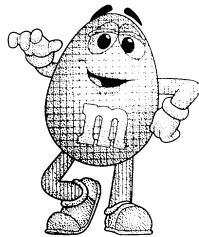

OWNER OF U.S. REG. NOS. 981,235, 983,429 AND OTHERS.

THE DRAWING IS LINED FOR THE COLORS YELLOW AND FLESH. THE STIPPLING IS FOR SHADING PURPOSES ONLY.

FOR BOARD GAMES (U.S. CLS. 22, 23, 38 AND 50). FIRST USE 2-25-2000; IN COMMERCE 2-25-2000.

---

SN 76-051,446. WATERMARK COMMUNITIES, INC., BONITA SPRINGS, FL. FILED 5-18-2000.

**WATERLEFE**

FOR SPORTING GOODS, NAMELY, GOLF BALLS, GOLF BAGS, GOLF GLOVES, GOLF BALL MARKERS AND DIVOT REPAIR TOOLS (U.S. CLS. 22, 23, 38 AND 50).

FIRST USE 3-28-2000; IN COMMERCE 3-28-2000.

**CLASS 28—(Continued).**

SN 76-052,519. THINKBOX MEDIA, INC., HOLLYWOOD, CA. FILED 5-19-2000.

**MYBOOKCLUB**

FOR TOYS, GAMES, AND SPORTING GOODS, NAMELY, ACTION FIGURES AND ACCESSORIES THEREFORE, STUFFED TOY ANIMALS; BABY'S MULTIPLE ACTIVITY TOYS; TOY BAKEWARE AND COOKWARE; BALLOONS; TOY BANKS; BATH TOYS, INFLATABLE BATH TOYS; RIDE-ON TOYS; INFLATABLE AND BUOYANT BATH, SWIMMING AND RIDE-ON TOYS, CARD GAME EQUIPMENT; TOY CARS; DOLLS, BEANBAG DOLLS, PAPER DOLLS, BAG DOLLS, SOFT SCULPTURE DOLLS, DOLLS' ACCESSORIES AND PLAYSETS THEREFOR, INCLUDING DOLL CASES, DOLL CLOTHING, DOLL HOUSE FURNISHINGS, DOLL COSTUMES; STUFFED TOYS; CHECKER SETS; CHESS SETS; CHILDREN'S PLAY COSMETICS; CHILD'S MULTIPLE ACTIVITY TOYS; TOY CONSTRUCTION BLOCKS; INFANT ACTION CRIB TOYS; FLYING DISCS, HAND HELD UNIT FOR PLAYING ELECTRONIC GAMES; ELECTRONIC GAME EQUIPMENT WITH A WATCH FUNCTION; ELECTRONICALLY OPERATED TOY MOTOR VEHICLES; BOARD GAMES AND GAME EQUIPMENT SOLD AS A UNIT FOR PLAYING BOARD GAMES, CARD GAMES, MANIPULATIVE GAMES, PARLOR GAMES, ROLE-PLAYING GAMES AND DRESS UP SETS, ACTION TYPE TARGET GAMES, GAME CARTRIDGES; VIDEO OUTPUT GAME MACHINES FOR USE WITH TELEVISIONS; ROCKING HORSES; JIGSAW PUZZLES; KITES; MANIPULATIVE PUZZLES; PAPER FACE MASKS; TOY MODEL TRAIN SETS; TOY MODEL VEHICLES AND RELATED ACCESSORIES PACKAGES AS A UNIT; ELECTRONICALLY OPERATED TOY MOTOR VEHICLES; ELECTRONIC BATTERY OPERATED ACTION TOYS; TOY TRICK NOISEMAKERS; TOY WHISTLES, PARTY FAVORS IN THE NATURE OF SMALL TOYS, TOY CAP PISTOLS; PLUSH TOYS; SOFT SCULPTURE PLUSH TOYS; THREE DIMENSIONAL PUZZLES IN THE SHAPE OF CUBES; TOY RECORD PLAYER FOR PLAYING TUNES AND CASSETTES AND DISKS THEREFORE; BICYCLES; SKATEBOARDS; ICE SKATES; TOY ROLLER SKATES; TOY IN-LINE SKATES AND ACCESSORIES, INCLUDING KNEE, WRIST AND ELBOW PADS; WATER SQUIRTING TOYS; TEDDY BEARS; WIND UP WALKING TOYS; WIND UP TOYS; NON-MOTORIZED NON-ELECTRONIC MOBILE SELF-PROPELLED RIDING TOYS; TOY TRUCKS; TWIRLING BATONS; BALLS, NAMELY, PLAYGROUND BALLS, SOCCER BALLS, SPORTBALLS, BASEBALLS, BASKETBALLS, FOAM BALLS, BASEBALL GLOVES, SWIMMING FLOATS FOR RECREATIONAL USE; INFLATABLE SWIMMING POOLS FOR RECREATIONAL USE; KICKBOARD FLOATATION DEVICES; GYMNASIAC PARALLEL BARS; WATER SKIS, SNOW SKIS, SNOWBOARDS, SKIPPING ROPES, JUMP ROPES, SNOW SLEDS FOR RECREATIONAL USE; SURF FINS, SURFBOARDS, SWIM BOARDS FOR RECREATIONAL USE; BODYBOARDS; SWIM FINS; MUSICAL TOYS; SQUEEZE TOYS; CHRISTMAS TREE ORNAMENTS, AND PINBALL MACHINES (U.S. CLS. 22, 23, 38 AND 50).

---

SN 76-079,817. 496268 NEW YORK, INC., NORTH BOSTON, NY. FILED 6-28-2000.

**ALL WEATHER**

OWNER OF U.S. REG. NOS. 1,686,518, 1,999,453 AND 2,046,798.

SEC. 2(F).

FOR GLOVES FOR THE PURPOSE OF HORSE RIDING (U.S. CLS. 22, 23, 38 AND 50).

FIRST USE 1-0-1990; IN COMMERCE 1-0-1990.

**CLASS 28—(Continued).**

SN 76-083,063. ICON IP, INC., LOGAN, UT. BY ASSIGNMENT ICON HEALTH & FITNESS, INC., LOGAN, UT. FILED 7-5-2000.



FOR FITNESS AND EXERCISE MACHINES (U.S. CLS. 22, 23, 38 AND 50).  
FIRST USE 11-0-1998; IN COMMERCE 11-0-1998.

SN 76-084,669. ZURICH AMERICAN INSURANCE COMPANY, SCHAUMBURG, IL. FILED 7-7-2000.



OWNER OF U.S. REG. NOS. 1,213,689, 1,823,174 AND 1,941,954.

FOR GOLF BALLS; HEAD COVERS FOR GOLF CLUBS; GOLFER'S KIT CONSISTING PRIMARILY OF MARKERS, SPIKE AND TURF TOOLS AND TEES; STRESS BALL; BALLOONS AND YO-YOS (U.S. CLS. 22, 23, 38 AND 50).

FIRST USE 1-1-2000; IN COMMERCE 1-1-2000.

SN 76-096,214. GUND, INC., EDISON, NJ. FILED 7-25-2000.

## CELEBRATING AMERICA'S TEDDY BEAR...100 YEARS OF HUGS

FOR PLUSH TOYS (U.S. CLS. 22, 23, 38 AND 50).

**CLASS 28—(Continued).**

SN 76-102,061. ADJUSTOTEE LLC, ATKINSON, NH. FILED 8-2-2000.



FOR PRACTICE TEE FOR GOLF BALLS (U.S. CLS. 22, 23, 38 AND 50).  
FIRST USE 3-9-2000; IN COMMERCE 3-9-2000.

SN 76-106,818. BRIO CORPORATION, GERMANTOWN, WI. FILED 8-10-2000.

## DOTTY BUG

NO CLAIM IS MADE TO THE EXCLUSIVE RIGHT TO USE "BUG", APART FROM THE MARK AS SHOWN.

FOR TOY FIGURE, NAMELY A SOFT SCULPTURE TOY (U.S. CLS. 22, 23, 38 AND 50).

SN 76-114,691. XSCAPE PROPERTIES, LIMITED, LONDON, SW-1W 0EN, UNITED KINGDOM, FILED 8-22-2000.



FOR BOARD GAMES; PLUSH TOYS; AND MANIPULATIVE AND JIGSAW PUZZLES (U.S. CLS. 22, 23, 38 AND 50).

SN 76-115,967. CHATTIN BOW COMPANY, INC., NORTH EASTON, MA. FILED 8-24-2000.

## SPEED GUARD

NO CLAIM IS MADE TO THE EXCLUSIVE RIGHT TO USE "GUARD", APART FROM THE MARK AS SHOWN.

FOR ARCHERY ACCESSORIES, NAMELY, BOW GUARDS FOR REDUCING VIBRATIONS AND HAND SHOCK AND FOR IMPROVING STEADINESS (U.S. CLS. 22, 23, 38 AND 50).

**CLASS 28—(Continued).**

SN 76-119,377. BRINKS, JOHN, CARDIFF, CA. FILED 8-28-2000.

**AQUA ANGEL**

NO CLAIM IS MADE TO THE EXCLUSIVE RIGHT TO USE "AQUA", APART FROM THE MARK AS SHOWN.

FOR WATER AND SCUBA EQUIPMENT AND ACCESSORIES, NAMELY, DIVING MASKS, FINS, FLIPPERS, GOGGLES, SPEARGUNS, WATER WING SWIM AIDS, AND SNORKELS (U.S. CLS. 22, 23, 38 AND 50).

SN 76-119,814. BOLLINGER INDUSTRIES, L.P., GRAND PRAIRIE, TX. FILED 8-30-2000.

**AQUAGEAR**

FOR WATER AEROBIC DEVICES, NAMELY, FLOATION DEVICES FOR RECREATIONAL USE, EXERCISE WRIST WEIGHTS, SWIMMING GLOVES, SKIN DIVING MASKS, SNORKELS AND SWIM FINS (U.S. CLS. 22, 23, 38 AND 50).

SN 76-119,922. PENSKE SYSTEM, INC., DETROIT, MI. FILED 8-31-2000.

**PENSKE RACING AUTHENTICS**

OWNER OF U.S. REG. NOS. 987,507, 2,132,515 AND OTHERS.

NO CLAIM IS MADE TO THE EXCLUSIVE RIGHT TO USE "RACING", APART FROM THE MARK AS SHOWN.

FOR TOYS, NAMELY, DIE CAST CARS (U.S. CLS. 22, 23, 38 AND 50).

FIRST USE 8-4-2000; IN COMMERCE 8-4-2000.

SN 76-120,482. BABY EINSTEIN COMPANY, LLC, THE, LITTLETON, CO. FILED 8-31-2000.

**HUMANITIES FOR BABIES**

NO CLAIM IS MADE TO THE EXCLUSIVE RIGHT TO USE "BABIES", APART FROM THE MARK AS SHOWN.

FOR GAMES, PLAYTHINGS AND TOYS FOR CHILDREN, NAMELY PUPPETS, PLUSH TOYS, PULL TOYS, CRIB TOYS, ELECTRONIC ACTION TOYS, BOARD GAMES, HAND-HELD ELECTRONIC GAMES, ROLE-PLAYING GAMES, AND MUSIC, ART, LANGUAGE, POETRY, MATH AND SCIENCE MULTIPLE-ACTIVITY TOYS (U.S. CLS. 22, 23, 38 AND 50).

**CLASS 28—(Continued).**

SN 76-120,849. PRO SELECT, INC., ELMHURST, IL. FILED 9-5-2000.

**ALTRESS**

FOR GOLF CLUBS, GOLF CLUB SHAFTS, GOLF CLUB HEAD COVERS, AND GOLF TEES (U.S. CLS. 22, 23, 38 AND 50).

FIRST USE 0-0-1998; IN COMMERCE 0-0-1998.

SN 76-147,097. LUHR JENSEN & SONS, INC., HOOD RIVER, OR. FILED 10-12-2000.

**RUSH TANGO**

FOR FISHING LURES (U.S. CLS. 22, 23, 38 AND 50).

SN 76-148,935. NATIONAL 4-H COUNCIL, CHEVY CHASE, MD. FILED 10-18-2000.

**HEALTH ROCKS!**

FOR BOARD GAMES AND RUBBER STRESS BALLS DISTRIBUTED IN CONJUNCTION WITH PROMOTION OF LIFE SKILLS TRAINING PROGRAMS DIRECTED TO YOUTH (U.S. CLS. 22, 23, 38 AND 50).

SN 76-150,830. KARSTEN MANUFACTURING CORPORATION, PHOENIX, AZ. FILED 10-16-2000.

**TI 3**

NO CLAIM IS MADE TO THE EXCLUSIVE RIGHT TO USE "TI", APART FROM THE MARK AS SHOWN.

FOR GOLF EQUIPMENT - NAMELY, GOLF CLUBS, WOOD COVERS AND GOLF BAGS (U.S. CLS. 22, 23, 38 AND 50).

FIRST USE 11-4-1999; IN COMMERCE 11-4-1999.

**CLASS 28—(Continued).**

SN 76-152,553. PLAN CREATIONS COMPANY, LTD., SILOM, BANGRAK, BANGKOK 10500, THAILAND, FILED 10-24-2000.



NO CLAIM IS MADE TO THE EXCLUSIVE RIGHT TO USE "TOYS", APART FROM THE MARK AS SHOWN.

FOR TOYS, GAMES AND PLAYTHINGS, NAMELY, WOOD EDUCATIONAL TOYS; SHAPE SORTERS, NAMELY, SHAPE SORTER BOXES AND SHAPE SORTER BOARDS; LACING TOYS; DOLLHOUSES AND DOLLHOUSE FURNITURE; WOOD GAMES, NAMELY, DOMINOS, LOTTO GAMES, AND MEMORY GAMES; WOOD CONSTRUCTION BLOCKS; WOOD SHAPE/COLOR MATCHING TOYS; WOOD PLAY FOOD; WOOD TOY VEHICLES; WOOD TOY MUSICAL INSTRUMENTS; WOOD RIDE-ON TOYS; WOOD PULL TOYS; WOOD IMPULSE TOYS, NAMELY, WOOD WIND UP TOY ANIMALS AND WIND UP TOY VEHICLES; WOOD TOY COMPASSES, TELESCOPES AND MAGNIFIERS; WOOD GARAGE; WOOD GAS STATION; WOOD CAR WASH; WOOD BOAT; WOOD HELICOPTER; WOODEN BRIDE; WOOD TRAFFIC SIGN; WOOD TREE; WOOD SHOP; WOOD PORT; WOOD DOLL FAMILY; WOOD TOYS, NAMELY, WOOD MINIATURE TOYS; AND FABRIC TOYS, NAMELY, DOLLS, DOLL FAMILIES AND STUFFED ANIMALS (U.S. CLS. 22, 23, 38 AND 50).  
FIRST USE 0-0-1994; IN COMMERCE 0-0-1995.

SN 76-153,952. ANGEL OF MY OWN, LLC, ST. CHARLES, MO. FILED 10-25-2000.

**POCKET PROTECTOR**

FOR PLUSH TOYS (U.S. CLS. 22, 23, 38 AND 50).

SN 76-155,232. PROSPORTS TECHNOLOGIES LLC, EL CAJON, CA. FILED 10-27-2000.

**MARK 400**

FOR COMPUTERIZED BASEBALL PITCHING MACHINE FOR USE BY PROFESSIONAL BASEBALL TEAMS (U.S. CLS. 22, 23, 38 AND 50).

**CLASS 28—(Continued).**

SN 76-162,511. TESHER, PATRICIA, TENAFLY, NJ. AND MOLLOY, DEIRDRE, TENAFLY, NJ. FILED 11-9-2000.

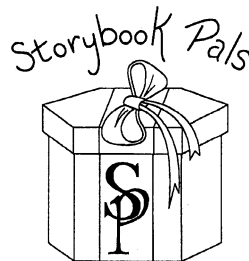

NO CLAIM IS MADE TO THE EXCLUSIVE RIGHT TO USE "STORYBOOK", APART FROM THE MARK AS SHOWN.

FOR PLUSH DOLL STORY KIT INCLUDING A PLUSH DOLL CLOTHED IN A PARTICULAR THEME WITH A HAT AND A SOFT FLEXIBLE STORYBOOK AFFIXED TO THE DOLL, A PRINTED BOOK, A SEPARATE HAT TO BE WORN BY A KIT USER AND A CONTAINER FOR THE KIT (U.S. CLS. 22, 23, 38 AND 50).

SN 76-165,432. CHARLIN PRODUCTIONS INC., RIVER EDGE, NJ. FILED 11-13-2000.

**CLYDE**

FOR PLUSH TOYS (U.S. CLS. 22, 23, 38 AND 50).

SN 76-168,790. TRENDMASTERS, INC., ST. LOUIS, MO. FILED 11-22-2000.

**JOHNNY APPLE BOT**

NO CLAIM IS MADE TO THE EXCLUSIVE RIGHT TO USE "BOT", APART FROM THE MARK AS SHOWN.

FOR TOY ROBOTS; ROBOTIC ACTION TOY FIGURES FEATURING LIGHT AND SOUND EFFECTS; CASES FOR TOY ROBOTS; CASES FOR ROBOTIC ACTION TOY FIGURES; PLAYSETS FEATURING BACKGROUND PANORAMAS FOR TOY ROBOTS; PLAYSETS FEATURING BACKGROUND PANORAMAS FOR ROBOTIC ACTION TOY FIGURES; ACCESSORIES FOR TOY ROBOTS AND ROBOTIC ACTION TOY FIGURES (U.S. CLS. 22, 23, 38 AND 50).

SN 76-173,604. LARAMI LIMITED, PAWTUCKET, RI. FILED 12-1-2000.

**XP**

OWNER OF U.S. REG. NO. 2,241,538.  
FOR WATER SQUIRTING TOYS (U.S. CLS. 22, 23, 38 AND 50).

FIRST USE 2-9-1993; IN COMMERCE 2-9-1993.

**CLASS 28—(Continued).**

SN 76-174,132. ROSE ART INDUSTRIES, INC., LIVINGSTON, NJ. FILED 12-1-2000.

**METAL WORKS**

FOR TOY OVENS AND RELATED ACCESSORIES SOLD AS A UNIT (U.S. CLS. 22, 23, 38 AND 50).

SN 76-174,998. MARY BURNS, INC., NEW YORK, NY. FILED 12-4-2000.

**RED LETTER DAYS**

FOR HOBBY CRAFT KITS FOR CREATING PERSONAL CELEBRATIONS, CONSISTING OF INSTRUCTIONS, JOURNALS, TEACUPS, PLATES AND RELATED ACCESSORIES (U.S. CLS. 22, 23, 38 AND 50).  
FIRST USE 10-0-2000; IN COMMERCE 10-0-2000.

SN 76-183,186. ENTERBRANDS, INCORPORATED, HUNTINGTON BEACH, CA. FILED 12-19-2000.

**WINDTUNNEL SOLE**

NO CLAIM IS MADE TO THE EXCLUSIVE RIGHT TO USE "SOLE", APART FROM THE MARK AS SHOWN.  
FOR GOLF CLUBS (U.S. CLS. 22, 23, 38 AND 50).  
FIRST USE 12-15-1999; IN COMMERCE 1-10-2000.

SN 76-188,955. GARY PLAYER GOLF.COM, INC., GROVER BEACH, CA. FILED 1-3-2001.

**X LOFT II**

NO CLAIM IS MADE TO THE EXCLUSIVE RIGHT TO USE "LOFT", APART FROM THE MARK AS SHOWN.  
FOR GOLF CLUBS (U.S. CLS. 22, 23, 38 AND 50).

SN 76-194,472. KUREHA KAGAKU KOGYO KABUSHIKI KAISHA, TOKYO, JAPAN, FILED 1-16-2001.

**CARBON PRO**

NO CLAIM IS MADE TO THE EXCLUSIVE RIGHT TO USE "CARBON", APART FROM THE MARK AS SHOWN.  
FOR FISHING LINE AND FISHING TACKLE (U.S. CLS. 22, 23, 38 AND 50).  
FIRST USE 8-31-1997; IN COMMERCE 8-31-1997.

**CLASS 28—(Continued).**

SN 76-226,034. BOLDT ENTERTAINMENT, INC., MINNEAPOLIS, MN. FILED 3-16-2001.

**BETTER**

FOR TOYS; NAMELY, SOFT SCULPTURE AND PLUSH TOYS (U.S. CLS. 22, 23, 38 AND 50).  
FIRST USE 3-7-2001; IN COMMERCE 3-7-2001.

SN 76-226,035. BOLDT ENTERTAINMENT, INC., MINNEAPOLIS, MN. FILED 3-16-2001.

**DUCKTAPE**

FOR TOYS, NAMELY, SOFT SCULPTURE AND PLUSH TOYS (U.S. CLS. 22, 23, 38 AND 50).  
FIRST USE 3-7-2001; IN COMMERCE 3-7-2001.

SN 76-226,036. BOLDT ENTERTAINMENT, INC., MINNEAPOLIS, MN. FILED 3-16-2001.

**DUCKSKIN**

FOR TOYS, NAMELY, SOFT SCULPTURE AND PLUSH TOYS (U.S. CLS. 22, 23, 38 AND 50).  
FIRST USE 3-7-2001; IN COMMERCE 3-7-2001.

SN 76-226,039. BOLDT ENTERTAINMENT, INC., MINNEAPOLIS, MN. FILED 3-16-2001.

**COWDUCK**

FOR TOYS, NAMELY, SOFT SCULPTURE AND PLUSH TOYS (U.S. CLS. 22, 23, 38 AND 50).  
FIRST USE 3-7-2001; IN COMMERCE 3-7-2001.

SN 76-229,249. NASCENT INTERNATIONAL, INC., PRAIRIE VILLAGE, KS. FILED 3-22-2001.

**APOGEE FITNESS SYSTEMS**

NO CLAIM IS MADE TO THE EXCLUSIVE RIGHT TO USE "FITNESS SYSTEMS", APART FROM THE MARK AS SHOWN.

FOR EXERCISE AND WEIGHT LIFTING EQUIPMENT, NAMELY, WEIGHT LIFTING BENCHES AND BENCH ACCESSORIES, EXERCISE BENCHES AND BENCH ACCESSORIES, DUMBBELL AND WEIGHT RACKS, SINGLE AND MULTIPLE STATION HOME GYMS, PLATE LOADED/COMBO EXERCISE AND WEIGHT LIFTING MACHINES (U.S. CLS. 22, 23, 38 AND 50).

**CLASS 28—(Continued).**

SN 76-233,316. AMERICAN INTERNATIONAL GROUP, INC., NEW YORK, NY. FILED 3-30-2001.



OWNER OF U.S. REG. NOS. 1,247,313, 2,320,184 AND OTHERS.

FOR FOOTBALLS, GOLF BALLS, GOLF CLUBS, GOLF BAGS, TENNIS BALLS, SOCCER BALLS AND STRESS BALLS (U.S. CLS. 22, 23, 38 AND 50).  
FIRST USE 1-0-1998; IN COMMERCE 1-0-1998.

SN 76-234,438. SUN MOUNTAIN SPORTS, INC., MISSOULA, MT. FILED 4-3-2001.

**SPEED CART**

NO CLAIM IS MADE TO THE EXCLUSIVE RIGHT TO USE "CART", APART FROM THE MARK AS SHOWN.  
FOR PUSH CARTS FOR TRANSPORTING GOLF BAGS (U.S. CLS. 22, 23, 38 AND 50).  
FIRST USE 4-30-2000; IN COMMERCE 4-30-2000.

SN 76-238,850. EARTH & OCEAN SPORTS, INC., REDMOND, WA. FILED 4-11-2001.

**SNOW SURFER**

NO CLAIM IS MADE TO THE EXCLUSIVE RIGHT TO USE "SNOW", APART FROM THE MARK AS SHOWN.  
FOR SNOW SLEDS FOR RECREATIONAL USE (U.S. CLS. 22, 23, 38 AND 50).

SN 76-243,540. MCCARTHY, DAN, STRONGSVILLE, OH. FILED 4-20-2001.

**SEAL ASSURED**

NO CLAIM IS MADE TO THE EXCLUSIVE RIGHT TO USE "SEAL", APART FROM THE MARK AS SHOWN.  
FOR TOYS, NAMELY, STUFFED ANIMALS (U.S. CLS. 22, 23, 38 AND 50).

SN 76-249,716. DOUGLAS PRESS, INC., BELLWOOD, IL. FILED 5-1-2001.

**EZ COUNT**

FOR BINGO PAPER (U.S. CLS. 22, 23, 38 AND 50).

**CLASS 28—(Continued).**

SN 76-252,021. A. SCHRETER, SUSAN A., SEATTLE, WA. FILED 5-7-2001.

**MONKEROOS**

FOR STUFFED TOY ANIMALS, PUPPETS, PLUSH TOYS, AND BATH TOYS (U.S. CLS. 22, 23, 38 AND 50).  
FIRST USE 4-1-2001; IN COMMERCE 4-20-2001.

SN 76-266,021. JAX LTD., INC., PLYMOUTH, MN. FILED 6-1-2001.

**TRAVEL SEQUENCE**

OWNER OF U.S. REG. NO. 1,922,191.  
NO CLAIM IS MADE TO THE EXCLUSIVE RIGHT TO USE "TRAVEL", APART FROM THE MARK AS SHOWN.  
FOR GAMES, NAMELY BOARD AND DICE GAMES (U.S. CLS. 22, 23, 38 AND 50).  
FIRST USE 1-15-1994; IN COMMERCE 5-2-1994.

SN 76-276,362. ZEBCO CORPORATION, TULSA, OK. FILED 6-25-2001.

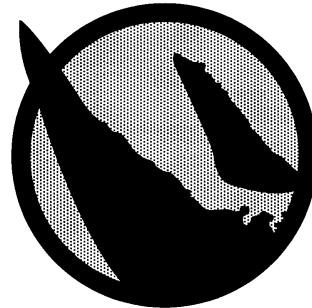

THE STIPPLING IN THE BACKGROUND OF THE DRAWING INDICATES SHADING.  
FOR FISHING RODS AND REELS (U.S. CLS. 22, 23, 38 AND 50).

SN 76-284,308. GEDDES, ANNE, PARNELL, AUCKLAND, NEW ZEALAND, FILED 7-13-2001.



FOR PLUSH TOYS (U.S. CLS. 22, 23, 38 AND 50).

**CLASS 28—(Continued).**

SN 76-286,386. MANHATTAN GROUP, LLC, MINNEAPOLIS, MN. FILED 7-17-2001.

**GROOVY BOYS**

OWNER OF U.S. REG. NO. 2,344,957.  
FOR DOLLS, DOLL CLOTHES AND DOLL ACCESSORIES (U.S. CLS. 22, 23, 38 AND 50).  
FIRST USE 1-0-1999; IN COMMERCE 1-0-1999.

SN 76-289,408. EBSCO INDUSTRIES, INC., BIRMINGHAM, AL. FILED 7-24-2001.



FOR FISHING LURES (U.S. CLS. 22, 23, 38 AND 50).  
FIRST USE 1-0-2001; IN COMMERCE 1-0-2001.

SN 76-290,747. MARSHALL, CURTIS, JAMAICA, NY. FILED 7-27-2001.

**ASTROBABIES**

FOR DOLL FEATURING CONSTELLATION DESIGNS (U.S. CLS. 22, 23, 38 AND 50).

SN 76-290,967. PANLINE USA, NORTHVALE, NJ. FILED 7-27-2001.

**FOOD FOR PLAY**

FOR DIFFERENT SHAPED TOY FOOD ITEMS FOR PLAY (U.S. CLS. 22, 23, 38 AND 50).

**CLASS 28—(Continued).**

SN 76-290,970. PANLINE, NORTHVALE, NJ. FILED 7-27-2001.

**RUB A DUB**

FOR LINE OF BATHTUB ACTIVITY KITS AND ACCESSORIES CONTAINING SUCTION CUP HOOKS, BAGS FOR BATH TUB TOYS, BATH TUB TOYS, INCLUDING PEEL AND STICK TEXTURED APPLIQUES IN THE SHAPE OF DUCKS OR FROGS, FINGER PAINTS, SPONGES IN THE SHAPE OF ANIMALS, PALETTES, BATH TUB FINGER PAINTS, CRAYONS, GLYCERIN TOY, SURPRISE SOAP, BATH PUFF, BATH-TUB CRAYONS, DUCK SPONGE, SOFT FOAM BATH-TUB STICKERS FORMING NUMBERS, SHAPES, FARM ANIMALS, PEOPLE, CLOTHES, BARNS, VEHICLES, AND OTHER INANIMATE ITEMS, AND A REFILL PACK FOR A BATHTUB FINGER PAINTING KIT (U.S. CLS. 22, 23, 38 AND 50).

FIRST USE 2-13-2001; IN COMMERCE 2-13-2001.

SN 76-291,329. BUILD-A-BEAR WORKSHOP, INC., ST. LOUIS, MO. FILED 7-26-2001.

**BEARY TURF SHOE**

NO CLAIM IS MADE TO THE EXCLUSIVE RIGHT TO USE "TURF SHOE", APART FROM THE MARK AS SHOWN. FOR ACCESSORIES FOR STUFFED AND PLUSH TOY ANIMALS (U.S. CLS. 22, 23, 38 AND 50).

FIRST USE 6-16-2000; IN COMMERCE 6-16-2000.

SN 76-291,346. FUNRISE TOYS LTD., TSIMSHATSUI EAST, KOWLOON, HONG KONG, FILED 7-26-2001.

**REAL BEAUTIES**

FOR TOY FIGURINES, NAMELY, PLASTIC HORSES AND ACCESSORIES THEREFORE (U.S. CLS. 22, 23, 38 AND 50).

SN 76-292,546. HASBRO, INC., PAWTUCKET, RI. FILED 8-1-2001.

**JACK DIAMOND**

"JACK DIAMOND" DOES NOT IDENTIFY A LIVING INDIVIDUAL.  
FOR CARD GAMES (U.S. CLS. 22, 23, 38 AND 50).

SN 76-301,969. WHITTLES, DANIEL J., STUART, FL. FILED 8-9-2001.

**TOUR STRETCH**

FOR MANUALLY OPERATED FITNESS AND EXERCISE EQUIPMENT (U.S. CLS. 22, 23, 38 AND 50).  
FIRST USE 9-11-2000; IN COMMERCE 4-23-2001.

**CLASS 28—(Continued).**

SN 76-302,361. UNIMAX TOYS LIMITED, TSIM SHA TSUI, KOWLOON, HONG KONG, FILED 8-20-2001.

**DOUGH KIDZ**

NO CLAIM IS MADE TO THE EXCLUSIVE RIGHT TO USE "KIDS", APART FROM THE MARK AS SHOWN.  
FOR DOLLS AND DOLL ACCESSORIES (U.S. CLS. 22, 23, 38 AND 50).

SN 76-302,416. WELLS FARGO & COMPANY, MINNEAPOLIS, MN. FILED 8-17-2001.

**WELLS FARGO**

OWNER OF U.S. REG. NOS. 779,187, 2,433,473 AND OTHERS.

FOR GOLF ITEMS, NAMELY, GOLF ACCESSORY POUCHES, GOLF BALLS, GOLF TOWELS, GOLF DIVOTS AND MARKERS, GOLF PUTTERS, MINIATURE SOUVENIR GOLF BAGS; COIN BANKS; BALLOONS; STRESS BALLS; FLYING DISCS; YOYO'S; TOY BADGES; SNOW GLOBES; CHRISTMAS TREE ORNAMENTS (U.S. CLS. 22, 23, 38 AND 50).

SN 76-302,670. SCHNEIDER, RICHARD, PACIFIC PALISADES, CA. FILED 8-20-2001.

**KUBB**

FOR PLAYSET FOR A SPORTS GAME WHICH INCLUDES BLOCKS AND BATONS (U.S. CLS. 22, 23, 38 AND 50).

SN 76-303,529. TACKLE TUBES, LLC, PALOS PARK, IL. FILED 8-23-2001.

**TIGER-TOUGH TUBES**

FOR FISHING TACKLE CONTAINERS IN THE NATURE OF PLASTIC TUBES (U.S. CLS. 22, 23, 38 AND 50).

SN 76-303,965. PANLINE USA, INC., NORTHVALE, NY. FILED 8-24-2001.

**GLITTER 'N GLIMMER**

FOR PLAY COSMETIC CASE AND MAKEUP FOR YOUNG GIRLS, WHICH INCLUDES A NYLON CASE, BODY AND HAIR GLITTER GELS, LIPSTICK, LIP GLOSS, NAIL POLISH, NAIL FILE, TOE SEPARATORS, HAIR MASCARA, BODY PENCIL, STICK-ON TATTOOS, AND MAKEUP COLORING SHEETS (U.S. CLS. 22, 23, 38 AND 50).

**CLASS 28—(Continued).**

SN 76-305,233. TANG'S ENTERPRISE, SACRAMENTO, CA. FILED 8-23-2001.

**LITEFISH**

FOR ARTIFICIAL LUMINOUS FISHING LURE (U.S. CLS. 22, 23, 38 AND 50).

SN 76-306,214. PLAYCORE WISCONSIN, INC., JANESVILLE, WI. FILED 8-28-2001.

**PLAYCORE**

FOR PLAYGROUND EQUIPMENT, NAMELY JUMP PANEL, SLIDE, LADDER CRAWL TUBE, CLIMBING POLE, STRETCH PANEL, STEERING WHEEL AND ENCLOSURE, DIP STATION, DECKS, CRUNCH STATION, BUBBLE PANEL, RUNG ENCLOSURE, STAIRS, BRIDGE AND TIC-TAC-TOE PANEL SWINGS, ANIMAL RIDERS, PARALLEL BARS, RINGS, TRAPEZE BAR, TETHERBALL SET, TENNIS NET, SOCCER GOAL, SOCCER NET, BALANCE BEAM, GAME TABLE, VOLLEYBALL NET, BASKETBALL BACKBOARD, WIND-SCREEN, HURDLES, DODGE POSTS, BASEBALL BACKSTOP, PLAYGROUND RAMP, PLAYGROUND PLATFORM, TUBE SLIDE, CIRCUIT TRAINING EXERCISE STATIONS, CYLINDRICAL LOGROLL UNIT, CLIMBER, PLAYGROUND SUSPENSION BRIDGE, CHINNING BAR (U.S. CLS. 22, 23, 38 AND 50).  
FIRST USE 3-1-1998; IN COMMERCE 3-1-1998.

SN 76-307,275. CARTER, JAMES K., DELRAY BEACH, FL. AND TOM, KIMBERLEE LYNN, DELRAY BEACH, FL. FILED 8-31-2001.

**ROLL-LETTE**

FOR TOYS AND GAMES, NAMELY A GAME OF SKILL WHEREIN A BALL IS ROLLED ALONG A U-SHAPED HORIZONTAL TRACK (U.S. CLS. 22, 23, 38 AND 50).

SN 76-307,704. RIVA SPORTS, INC., ROCKVILLE, MD. FILED 8-31-2001.

**ALPINE ROCKET**

OWNER OF U.S. REG. NO. 2,417,912.  
FOR RECREATIONAL PRODUCTS, NAMELY, SNOW SLEDS (U.S. CLS. 22, 23, 38 AND 50).  
FIRST USE 9-1-1999; IN COMMERCE 9-1-1999.



**CLASS 28—(Continued).**

SN 76-308,257. MOOSE MOUNTAIN TOYMAKERS LTD., TSMISHATSUI EAST, KOWLOON, HONG KONG, FILED 8-30-2001.

**CAMP IN PLAYLAND**

FOR INFLATABLE CHILDREN'S PLAY TENTS AND INFLATABLE TOY ACCESSORIES THEREFOR (U.S. CLS. 22, 23, 38 AND 50).

SN 76-308,285. SKIS DYNASTAR INC., WILLISTON, VT. FILED 9-4-2001.

**AUTODRIVE**

FOR ALPINE SKIS (U.S. CLS. 22, 23, 38 AND 50).  
FIRST USE 1-10-2000; IN COMMERCE 1-10-2000.

SN 76-308,809. V & G, L.L.C., SLIDELL, LA. FILED 9-4-2001.

**TERROR TAILS**

FOR FISHING LURES (U.S. CLS. 22, 23, 38 AND 50).

SN 76-308,881. Z-MAN FISHING PRODUCTS, INC., HANAHAN, SC. FILED 9-5-2001.

**CYBER-FLEXXX**

FOR FISHING LURES AND TACKLE (U.S. CLS. 22, 23, 38 AND 50).

SN 76-309,098. POOF PRODUCTS, INC., PLYMOUTH, MI. FILED 9-5-2001.

**QUARTERBACK CHALLENGE**

NO CLAIM IS MADE TO THE EXCLUSIVE RIGHT TO USE "QUARTERBACK", APART FROM THE MARK AS SHOWN.

FOR FOAM FOOTBALLS AND TARGETS FEATURING HOLES THROUGH WHICH THE FOAM FOOTBALLS CAN BE THROWN (U.S. CLS. 22, 23, 38 AND 50).

**CLASS 28—(Continued).**

SN 76-309,136. PATCH PRODUCTS, INC., BELOIT, WI. FILED 9-5-2001.

**SNEAKY PUZZLES**

NO CLAIM IS MADE TO THE EXCLUSIVE RIGHT TO USE "PUZZLES", APART FROM THE MARK AS SHOWN.  
FOR PUZZLES (U.S. CLS. 22, 23, 38 AND 50).

SN 76-310,179. WAL-MART STORES, INC., BENTONVILLE, AR. FILED 9-7-2001.

**NEXT**

FOR POGO STICKS (U.S. CLS. 22, 23, 38 AND 50).

SN 76-310,847. MANHATTAN GROUP, LLC, MINNEAPOLIS, MN. FILED 9-10-2001.

**GROOVY GIRLS**

OWNER OF U.S. REG. NO. 2,344,957.  
FOR DOLL FURNITURE, DOLL CLOTHING, DOLL ACCESSORIES, STUFFED ANIMALS FOR DOLLS, AND TOY PURSES (U.S. CLS. 22, 23, 38 AND 50).  
FIRST USE 2-1-1999; IN COMMERCE 2-1-1999.

SN 76-311,178. X-CONCEPTS, LLC, ESCONDIDO, CA. FILED 9-4-2001.

**TECH DECK MINI**

FOR TOYS, NAMELY, MINIATURE TOY VEHICLES AND ACCESSORIES THEREFOR; TOY ACTION FIGURES, TOY FIGURES, TOY STATUETTES AND DOLLS; MINIATURE TOY STRUCTURES AND ACCESSORIES THEREFOR; INFLATABLE TOYS, INFLATABLE CHILDREN'S TOY FURNITURE AND BEAN BAGS (U.S. CLS. 22, 23, 38 AND 50).  
FIRST USE 12-0-1999; IN COMMERCE 12-0-1999.

SN 76-311,483. CAPITAL GOLF INC. LLC, CHEVY CHASE, MD. FILED 9-13-2001.

**GOLF'S PLANE TRUTH**

FOR SPORTING ARTICLE; NAMELY, A TRAINING DEVICE FOR IMPROVING A GOLFER'S SWING (U.S. CLS. 22, 23, 38 AND 50).

**CLASS 28—(Continued).**

SN 76-312,280. UNIMAX GIFTWARE LTD., TSIM SHA TSUI, KOWLOON, HONG KONG, FILED 9-14-2001.

**MINI HUGS**

FOR DOLLS, DOLL ACCESSORIES, AND PLUSH DOLLS (U.S. CLS. 22, 23, 38 AND 50).

SN 76-313,952. BALBOA MANUFACTURING COMPANY, LLC, SAN DIEGO, CA. FILED 9-19-2001.

**RIOT GEAR**

FOR SKATEBOARDS AND SKATEBOARDS ACCESSORIES, NAMELY, SKATEBOARD WHEELS (U.S. CLS. 22, 23, 38 AND 50).

SN 76-314,085. BUCKSHOT, INC., WILMINGTON, NC. FILED 9-17-2001.

**CENTERSHOT**

FOR HUNTING TREESTANDS (U.S. CLS. 22, 23, 38 AND 50).

SN 78-025,707. SABAN ENTERTAINMENT, INC., LOS ANGELES, CA. FILED 9-13-2000.

**POWER RANGER BABIES**

OWNER OF U.S. REG. NOS. 1,893,768, 2,288,081 AND OTHERS.

FOR TOYS, GAMES, PLAYTHINGS, AND SPORTING GOODS, NAMELY, BASKETBALL BACKBOARDS; TOY AND NON-MOTORIZED SCOOTERS; SKATEBOARDS AND SKATEBOARD BAGS; BENDABLE PLAY FIGURES; TOY ACTION FIGURES AND ACCESSORIES THEREFOR; SPORTS BOARD GAMES; BALLS, NAMELY, BASKETBALLS, PLAYGROUND BALLS, SPORT BALLS, FOAM ACTION BALLS AND TOY HOOP SETS; TOY BANKS; TOY WATCHES; BATH TUB TOYS; CHILDREN'S MULTIPLE ACTIVITY TOYS; TOY MAGIC TRICKS; WATER SQUIRTING TOYS; WIND-UP TOYS; JUMP ROPES; SLING SHOTS; AUDIO AND VISUAL TOYS, NAMELY, TOY WALKIE-TALKIES, ACTION GAMES, TALKING DOLLS, TOY 3-D VIEWERS AND REELS; ACTION SKILL GAMES; BOARD GAMES; CARD GAMES; HAND HELD UNITS FOR PLAYING ELECTRONIC GAMES; STAND ALONE VIDEO GAME MACHINES AND PROGRAMS THEREFOR SOLD AS A UNIT; ELECTRONIC GAME EQUIPMENT WITH A WATCH FUNCTION; HAND HELD LCD GAME MACHINES; COIN AND NON-COIN OPERATED GAME TABLES; PINBALL MACHINES AND PINBALL-TYPE GAMES; JIGSAW PUZZLES; MANIPULATIVE PUZZLES; MECHANICAL ACTION TOYS; BATTERY-OPERATED ACTION TOYS; DOLLS; PUPPETS; PLAYSETS FOR DOLLS; DOLL CLOTHING AND COSTUMES; CHILDREN'S PLAY COSMETICS; ROLE PLAYING GAMES; ACTION-TYPE TARGET SHOOTING GAME SETS COM-

**CLASS 28—(Continued).**

PRISING TOY GUN, TOY SUCTION DARTS AND TARGET; TOY WEAPONS; SQUIRT GUNS; KITES; PAPER AND PLASTIC PARTY FAVORS IN THE NATURE OF SMALL TOYS AND NOISEMAKERS; BALLOONS; STUFFED AND PLUSH TOYS; LATEX SQUEEZE TOY FIGURES; MUSICAL TOYS; INFLATABLE BATH TOYS; SWIMMING AND RIDE-ON TOYS; TOY VEHICLES; TRANSFORMING ROBOTIC TOY VEHICLES; RIDE-IN TOYS; INFLATABLE PLAY SWIMMING POOLS; TOY PLAY HOUSES AND TOY PLAY TENTS; SURF BOARDS, KICK BOARD FLOATATION DEVICES, NAMELY, BODY BOARDS AND LEASHES THEREFOR FOR RECREATIONAL USE; TOY SAND BOXES AND SAND TOYS; SNOW SLEDS, TOBOGGANS, SNOW SAUCERS AND SNOW BOARDS FOR RECREATIONAL USE; TOY BUILDING BLOCKS; MOBILES FOR CHILDREN; CHRISTMAS TREE ORNAMENTS; TOY CRAFT KITS COMPRISING MOLDS AND MOLDING COMPOUND FOR MAKING TOY FIGURES; PLASTIC ACTION FIGURE MODELS; FLYING DISCS; PET TOYS; MARBLES AND YO-YOS (U.S. CLS. 22, 23, 38 AND 50).

SN 78-026,985. LEWIS, CLAYTON C., SOPCHOPPY, FL. FILED 9-21-2000.

**CHUM TO PAPA**

NO CLAIM IS MADE TO THE EXCLUSIVE RIGHT TO USE "CHUM", APART FROM THE MARK AS SHOWN.

FOR FISH ATTRACTANT, NAMELY PACKAGED COMPOSITION FOR ATTRACTING FISH AND OTHER AQUATIC ANIMALS (U.S. CLS. 22, 23, 38 AND 50).

SN 78-040,806. AMMENTORP, LUGENE, JOHANNA, MENOMONEE FALLS, WI. FILED 12-27-2000.

**GOLDBEARLY ORIGINAL MOHAIR BEAR**

NO CLAIM IS MADE TO THE EXCLUSIVE RIGHT TO USE "ORIGINAL MOHAIR BEAR", APART FROM THE MARK AS SHOWN.

FOR TEDDY BEARS MADE ENTIRELY OF MOHAIR WOOL; KIT TO MAKE TEDDY BEARS, CONSISTING OF INSTRUCTIONS, MOHAIR WOOL, FELT, CARDBOARD WASHERS, BOLTS, NUTS, FIBER FILL STUFFING, SHOE BUTTON EYES AND THREAD, ALL SOLD AS A UNIT (U.S. CLS. 22, 23, 38 AND 50).

FIRST USE 10-1-2000; IN COMMERCE 10-1-2000.

SN 78-045,926. MOORE DIONNE, PAMELA, PORT TOWNSEND, WA. FILED 1-31-2001.

**KID SALT:THE GAME**

NO CLAIM IS MADE TO THE EXCLUSIVE RIGHT TO USE "GAME", APART FROM THE MARK AS SHOWN.

FOR EQUIPMENT SOLD AS A UNIT FOR PLAYING A WORD GAME CONSISTING OF INSTRUCTIONS AND RULES FOR PLAY, WORD DISKS, WRITING PADS, PENCILS, ONE-MINUTE TIMER AND SHAKER (U.S. CLS. 22, 23, 38 AND 50).

**CLASS 28—(Continued).**

SN 78-052,309. PMI INDUSTRIES, INC., MARIETTA, GA. FILED 3-9-2001.

**PROEDGE**

FOR SPORTING GOODS, NAMELY, GOLF CLUBS, GOLF BALLS, GOLF BAGS, GOLF CLUB PARTS, NAMELY, GOLF HEADS, GOLF SHAF (U.S. CLS. 22, 23, 38 AND 50).

SN 78-052,318. PMI INDUSTRIES, INC., MARIETTA, GA. FILED 3-9-2001.

**BODYEDGE**

FOR EXERCISE EQUIPMENT, NAMELY, EXERCISE GYM AND WEIGHT MACHINE UNITS, EXERCISE BIKES, AND EXERCISE TREADMILLS; SPORTING GOODS, NAMELY, MINI BICYCLES, BICYCLES, NON-MOTORIZED SCOOTERS, POGO STICKS, AND SKATEBOARDS (U.S. CLS. 22, 23, 38 AND 50).

SN 78-052,729. GARRETT, DONALD TIMOTHY, NASHVILLE, TN. FILED 3-12-2001.

**BUBBA JUG**

NO CLAIM IS MADE TO THE EXCLUSIVE RIGHT TO USE "JUG", APART FROM THE MARK AS SHOWN.

FOR FISHING GOODS, NAMELY, A FREE FLOATING FISHING DEVICE COMPRISED OF A BAITED FLOAT AND ATTACHED FISHING HOOK, LINE AND SINKER SOLD AS A UNIT (U.S. CLS. 22, 23, 38 AND 50).

SN 78-052,973. FIREMAN, ANDREW F., ROCKVILLE, MD. FILED 3-13-2001.

**SNOW SWINGER**

NO CLAIM IS MADE TO THE EXCLUSIVE RIGHT TO USE "SNOW", APART FROM THE MARK AS SHOWN.

FOR SNOW SLEDS FOR RECREATIONAL USE (U.S. CLS. 22, 23, 38 AND 50).

SN 78-060,887. OPHIDIAN INC, FLUSHING, NY. FILED 4-27-2001.

**REAL TIME CARD GAME**

NO CLAIM IS MADE TO THE EXCLUSIVE RIGHT TO USE "CARD GAME", APART FROM THE MARK AS SHOWN.

FOR CARD GAME (U.S. CLS. 22, 23, 38 AND 50).

**CLASS 28—(Continued).**

SN 78-061,541. QUIKPOINT, INC., CONCORD, MA. FILED 5-2-2001.

**ZERO LAUNCHER**

NO CLAIM IS MADE TO THE EXCLUSIVE RIGHT TO USE "LAUNCHER", APART FROM THE MARK AS SHOWN.

FOR TOY THAT LAUNCHES NON TOXIC FOG RINGS (U.S. CLS. 22, 23, 38 AND 50).

SN 78-066,872. WAVE GOLF SYSTEM, INC., FULLERTON, CA. FILED 6-1-2001.

**WAVEGOLF**

FOR GOLF BAGS, GOLF CLUB HEADS, GOLF CLUB SHAFTS, GOLF CLUBS, HAND GRIP FOR GOLF CLUBS, HEAD COVERS FOR GOLF CLUBS, GOLF IRONS, GOLF TEE (U.S. CLS. 22, 23, 38 AND 50). FIRST USE 4-20-2000; IN COMMERCE 4-20-2000.

SN 78-067,840. SPALDING SPORTS WORLDWIDE, INC., CHICOPEE, MA. FILED 6-7-2001.

**TOP-FLITE XL**

OWNER OF U.S. REG. NOS. 505,779, 1,181,280 AND 1,395,892.  
FOR GOLF GLOVES (U.S. CLS. 22, 23, 38 AND 50).

SN 78-071,994. BOLDT ENTERTAINMENT, INC., MINNEAPOLIS, MN. FILED 7-2-2001.

**D. LURE**

FOR TOYS, NAMELY SOFT SCULPTURE AND PLUSH TOYS (U.S. CLS. 22, 23, 38 AND 50).

SN 78-075,039. CREELMAN, KEVIN, KODIAK, AK. AND JACOBS, TERRY G., MOSES LAKE, WA. FILED 7-21-2001.

**QUADMILL**

FOR EXERCISE EQUIPMENT, NAMELY, EXERCISE MACHINES (U.S. CLS. 22, 23, 38 AND 50).

**CLASS 28—(Continued).**

SN 78-076,588. SPALDING SPORTS WORLDWIDE, INC., CHICOPEE, MA. FILED 7-31-2001.

**AC TOUR**

FOR GOLF GLOVES (U.S. CLS. 22, 23, 38 AND 50).

SN 78-076,616. SPALDING SPORTS WORLDWIDE, INC., CHICOPEE, MA. FILED 7-31-2001.

**AC GRIP**

FOR GOLF GLOVES (U.S. CLS. 22, 23, 38 AND 50).

SN 78-076,617. SPALDING SPORTS WORLDWIDE, INC., CHICOPEE, MA. FILED 7-31-2001.

**AC FEEL**

FOR GOLF GLOVES (U.S. CLS. 22, 23, 38 AND 50).

SN 78-077,722. STERN, ERIN, ELYSE, OCALA, FL. FILED 8-6-2001.

**POCKETPONIES**

FOR TOY MINIATURE CLAY HORSES, BARNS, RIDERS, AND TACK ACCESSORIES THEREFOR (U.S. CLS. 22, 23, 38 AND 50).

SN 78-082,702. SUPER DUPER INC., DBA SUPER DUPER PUBLICATIONS, GREENVILLE, SC. FILED 9-5-2001.

**AUDITORY ADVENTURES**

NO CLAIM IS MADE TO THE EXCLUSIVE RIGHT TO USE "AUDITORY", APART FROM THE MARK AS SHOWN.

FOR EDUCATIONAL GAME CONSISTING OF LAMINATED GAME BOARDS, AND WORKBOOK SOLD AS A UNIT IN THE FIELD OF SPEECH, LANGUAGE, VOICE, FLUENCY, AND HEARING, FOR THE USE BY THE GENERAL PUBLIC, PUBLIC AND PRIVATE TEACHERS, HEALTH PROFESSIONALS OR THERAPISTS (U.S. CLS. 22, 23, 38 AND 50).

SN 78-083,643. TRASK, RAIFORD G., III, WRIGHTSVILLE BEACH, NC. FILED 9-12-2001.

**MAN O' WAR**

FOR FISHING TACKLE (U.S. CLS. 22, 23, 38 AND 50).

**CLASS 28—(Continued).**

SN 78-084,692. DAVIS, TODD A., NEWPORT NEWS, VA. FILED 9-20-2001.

*Glamour Shad*

NO CLAIM IS MADE TO THE EXCLUSIVE RIGHT TO USE "SHAD", APART FROM THE MARK AS SHOWN. FOR ARTIFICIAL FISHING LURES (U.S. CLS. 22, 23, 38 AND 50).

SN 78-084,722. CALLAWAY GOLF COMPANY, CARLSBAD, CA. FILED 9-20-2001.

**TLN**

FOR GOLF BALLS, GOLF CLUBS, GOLF BAGS, GOLF CLUB HEADCOVERS (U.S. CLS. 22, 23, 38 AND 50).

SN 78-085,452. DAD'S INK, LTD., MORTON GROVE, IL. FILED 9-25-2001.

**"TOADS OF FUN"**

FOR CHILDREN'S BOARD GAME FOR PRESCHOOL AND PRIMARY GRADES AGE CHILDREN (U.S. CLS. 22, 23, 38 AND 50).

SN 78-085,597. MONTALDO, STUART F, NEEDHAM, MA. FILED 9-26-2001.

**MY LIFE FORM**

FOR BOARD GAMES (U.S. CLS. 22, 23, 38 AND 50).

SN 78-085,658. PANLINE USA, INC., NORTHVALE, NJ. FILED 9-26-2001.

**FASHION PACKED**

FOR SERIES OF ACTIVITY KITS THAT CHILDREN USE TO CREATE VARIOUS ACCESSORIES INCLUDING SLAP BRACELETS, PATCHES, BEADED JEWELRY AND PINS; EACH KIT INCLUDES ALL SUPPLIES NEEDED TO DESIGN THE ASSORTMENT OF ACCESSORIES (U.S. CLS. 22, 23, 38 AND 50).

**CLASS 28—(Continued).**

SN 78-085,663. PANLINE USA, INC., NORTHVALE, NJ.  
FILED 9-26-2001.

**WRAP IT!**

FOR ACTIVITY KIT THAT CHILDREN USE TO DECORATE A SLAP BRACELET AND HAIR ELASTIC; KIT INCLUDES DECORATIVE ACCESSORIES AND ADHESIVE TO AFFIX DECORATIONS (U.S. CLS. 22, 23, 38 AND 50).

SN 78-085,666. PANLINE USA, INC., NORTHVALE, NJ.  
FILED 9-26-2001.

**STRING IT!**

FOR ACTIVITY KIT THAT INCLUDES BEADS AND STRING FOR CHILDREN TO CREATE BEADED JEWELRY (U.S. CLS. 22, 23, 38 AND 50).

SN 78-085,741. BUILD-A-BEAR WORKSHOP, INC., ST. LOUIS, MO. FILED 9-26-2001.

**HOPEFUL WISHES TEDDY**

NO CLAIM IS MADE TO THE EXCLUSIVE RIGHT TO USE "TEDDY", APART FROM THE MARK AS SHOWN.  
FOR STUFFED AND PLUSH TOY ANIMALS (U.S. CLS. 22, 23, 38 AND 50).  
FIRST USE 10-1-2001; IN COMMERCE 10-1-2001.

**CLASS 29—MEATS AND PROCESSED FOODS**

SN 75-689,151. BESSIN CORPORATION, CHICAGO, IL.  
FILED 4-13-1999.

**AMERICAN STAR**

NO CLAIM IS MADE TO THE EXCLUSIVE RIGHT TO USE "AMERICA", APART FROM THE MARK AS SHOWN.  
FOR PROCESSED MEATS (U.S. CL. 46).  
FIRST USE 5-1-1998; IN COMMERCE 5-1-1998.

SN 75-819,834. SUNSWEET GROWERS INC., YUBA CITY, CA. FILED 10-12-1999.

**TASTE THE DIFFERENCE**

FOR DRIED FRUIT; FRUIT BASED SNACK FOOD; FRUIT BASED FILLINGS FOR CAKES AND PIES (U.S. CL. 46).  
FIRST USE 10-4-1999; IN COMMERCE 10-4-1999.

**CLASS 29—(Continued).**

SN 75-866,794. HOUSE OF RAEFORD FARMS, INC., RAEFORD, NC. FILED 12-8-1999.



FOR PROCESSED CHICKEN AND TURKEY (U.S. CL. 46).  
FIRST USE 3-1-1996; IN COMMERCE 3-1-1996.

SN 75-875,974. FLEMING COMPANIES, INC., OKLAHOMA CITY, OK. FILED 12-20-1999.



OWNER OF U.S. REG. NO. 1,531,367.  
NO CLAIM IS MADE TO THE EXCLUSIVE RIGHT TO USE "RIBS ON A STICK" AND "FOODS", APART FROM THE MARK AS SHOWN.  
FOR PREPARED MEATS (U.S. CL. 46).  
FIRST USE 10-14-1991; IN COMMERCE 10-14-1991.

SN 76-026,320. MID-ATLANTIC FOODS, INC., POCOMOKE CITY, MD. FILED 4-14-2000.

**TUCKER'S COVE**

FOR PROCESSED FOODS NAMELY, CLAM CHOWDER, CLAM JUICE AND LAKE TROUT (U.S. CL. 46).  
FIRST USE 1-0-2000; IN COMMERCE 1-0-2000.

**CLASS 29—(Continued).**

SN 76-030,723. PIONEER TRADING, INC., PARAMOUNT, CA. FILED 4-24-2000.



NO CLAIM IS MADE TO THE EXCLUSIVE RIGHT TO USE "HOUSE", APART FROM THE MARK AS SHOWN. THE STIPPLING IN THE DRAWING IS FOR SHADING PURPOSES ONLY.

THE ENGLISH TRANSLATION OF "O'HANA" IS "FAMILY" IN THE HAWAIIAN NATIVE LANGUAGE.

FOR FROZEN ENTREES CONSISTING PRIMARILY OF MEAT, FISH, POULTRY OR VEGETABLES (U.S. CL. 46).

FIRST USE 1-15-2000; IN COMMERCE 1-15-2000.

---

SN 76-040,034. HANNAFORD LICENSING CORP., SCARBOROUGH, ME. FILED 5-3-2000.

**FIRE WORKS ROASTERY**

NO CLAIM IS MADE TO THE EXCLUSIVE RIGHT TO USE "ROASTERY", APART FROM THE MARK AS SHOWN. FOR CHICKEN SOLD IN GROCERY STORES (U.S. CL. 46).

FIRST USE 3-13-2000; IN COMMERCE 3-13-2000.

---

SN 76-048,660. ALASKA SEAFOOD INTERNATIONAL, L.L.C., ANCHORAGE, AK. FILED 5-11-2000.

**GREAT ALASKAN**

NO CLAIM IS MADE TO THE EXCLUSIVE RIGHT TO USE "ALASKAN", APART FROM THE MARK AS SHOWN.

FOR SECONDARY PROCESSED SEAFOOD, NAMELY, SALMON, HALIBUT, COD, SHRIMP, POLLACK AND/OR FROZEN, PREPARED AND PACKAGED MEALS CONSISTING PRIMARILY OF SALMON, HALIBUT, COD, SHRIMP, POLLACK AND/OR FINFISH AND/OR SHELLFISH (U.S. CL. 46).

FIRST USE 7-15-1999; IN COMMERCE 7-15-1999.

---

SN 76-078,039. IRIE FOODS, LLC, WILMINGTON, DE. FILED 6-26-2000.

**IRIE**

THE ENGLISH TRANSLATION OF "IRIE" IS A GREETING OR SALUTATION, AND CONVEYING A MEANING OF PLEASANTNESS OR GOOD FEELING SIMILAR TO HAVE A NICE DAY.

FOR PREPARED FOODS, NAMELY, ENTREES CONSISTING PRIMARILY OF MEAT, FISH, POULTRY OR VEGETABLES (U.S. CL. 46).

FIRST USE 4-10-2000; IN COMMERCE 4-10-2000.

**CLASS 29—(Continued).**

SN 76-086,436. MIKHELSON, BERS, ENCINO, CA. FILED 7-11-2000.



NO CLAIM IS MADE TO THE EXCLUSIVE RIGHT TO USE "CMETAHA", APART FROM THE MARK AS SHOWN. THE ENGLISH TRANSLATION OF "CMETAHA" IS "SOUR CREAM".

FOR DAIRY PRODUCTS NAMELY, SOUR CREAM, SOUR CREAM SUBSTITUTE, COTTAGE CHEESE, WHIPPING CREAM, CREAM CHEESE (U.S. CL. 46).

FIRST USE 12-0-1998; IN COMMERCE 12-0-1998.

---

SN 76-086,692. BUNGE FOODS CORPORATION, BRADLEY, IL. FILED 7-11-2000.



OWNER OF U.S. REG. NO. 1,911,593. NO CLAIM IS MADE TO THE EXCLUSIVE RIGHT TO USE "GARLIC", APART FROM THE MARK AS SHOWN. FOR EDIBLE VEGETABLE BASED OILS (U.S. CL. 46).

FIRST USE 6-19-2000; IN COMMERCE 6-19-2000.

---

SN 76-105,391. MAD MEALS, LLC, BEDFORD, NY. FILED 8-8-2000.

**MAD PACK**

NO CLAIM IS MADE TO THE EXCLUSIVE RIGHT TO USE "PACK", APART FROM THE MARK AS SHOWN.

FOR PREPARED VEGETABLES, CHEESE, CHEESE DIPS, CHEESE SPREADS AND YOGURT DIPS (U.S. CL. 46).

**CLASS 29—(Continued).**

SN 76-105,392. MAD MEALS, LLC., BEDFORD, NY. FILED 8-8-2000.

**MAD SNACK**

NO CLAIM IS MADE TO THE EXCLUSIVE RIGHT TO USE "SNACK", APART FROM THE MARK AS SHOWN.  
FOR PREPARED VEGETABLES, CHEESE, CHEESE DIPS, CHEESE SPREADS AND YOGURT DIPS (U.S. CL. 46).

SN 76-135,375. CAPE MAY FOODS, INC., CAPE MAY, NJ. FILED 9-27-2000.

***"Taking Pride In What We Do"***

FOR SEA FOOD AND SHELL FISH; AND CLAM JUICE (U.S. CL. 46).

SN 76-135,418. CAPE MAY FOODS, INC., CAPE MAY, NJ. FILED 9-27-2000.

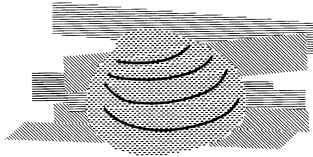

THE DRAWING IS LINED FOR THE COLORS BLUE, GREY AND GREEN.  
THE MARK CONSISTS OF STYLIZED REPRESENTATION OF A CLAM.  
FOR SEA FOOD AND SHELL FISH; AND CLAM JUICE (U.S. CL. 46).  
FIRST USE 1-1-1996; IN COMMERCE 1-1-1996.

SN 76-138,684. LUISSIER S.A., VIROFLAY, FRANCE, FILED 10-2-2000.

**CROC'DORÉ**

FOR MEAT, FISH, CULINARY PREPARATIONS BASED ON SEAFOODS, DELICATESSEN PRODUCTS, NAMELY, PROCESSED MEATS, HAM, SAUSAGES, POTTED MINCE MEAT, LIVER PATE, DUCK MOUSSE, GOOSE LIVER, CHEESE, AND CULINARY PREPARATIONS BASED ON CHEESE (U.S. CL. 46).

**CLASS 29—(Continued).**

SN 76-152,227. CONAGRA BRANDS, INC., OMAHA, NE. FILED 10-23-2000.

**LW PRIVATE RESERVE**

OWNER OF U.S. REG. NOS. 1,631,766 AND 1,668,656.  
FOR FROZEN VEGETABLES (U.S. CL. 46).  
FIRST USE 4-0-1990; IN COMMERCE 4-0-1990.

SN 76-165,150. SMITH PROVISION CO., INC., ERIE, PA. FILED 11-15-2000.

**SMITH'S**

FOR MEAT PRODUCTS, NAMELY, HAM, PORK, POULTRY, LUNCHEON MEATS, MEAT BASED SPREADS AND MEAT PASTE (U.S. CL. 46).  
FIRST USE 7-0-1984; IN COMMERCE 7-0-1984.

SN 76-168,709. J.V. TRADING (GLENDALE) LTD, GLENDALE, NY. FILED 11-17-2000.

美林

**MEI LIN**

THE NON-LATIN CHARACTERS IN THE MARK TRANSLITERATE TO "MAY LIN" OR "MEI LIN" AND THIS MEANS "BEAUTIFUL FOREST" IN ENGLISH.  
FOR CANNED VEGETABLES, CANNED SEAFOOD, NAMELY FISH, CLAMS AND SHRIMPS, AND CANNED LUNCHEON MEAT (U.S. CL. 46).  
FIRST USE 9-18-2000; IN COMMERCE 9-18-2000.

SN 76-213,763. MAY, EDWARD, LAS VEGAS, NV. FILED 2-20-2001.

**TOMASIN RAISIN**

NO CLAIM IS MADE TO THE EXCLUSIVE RIGHT TO USE "RAISIN", APART FROM THE MARK AS SHOWN.  
FOR DRIED GRAPE TOMATOES (U.S. CL. 46).

**CLASS 29—(Continued).**

SN 76-230,725. AMERICAN SKIN, LLC, BURGAW, NC. FILED 3-27-2001.

**LESTER'S CHICHARRONES**

NO CLAIM IS MADE TO THE EXCLUSIVE RIGHT TO USE "CHICHARRONES", APART FROM THE MARK AS SHOWN.

FOR PORK SKINS AND PORK CRACKLINS (U.S. CL. 46).  
FIRST USE 10-0-2000; IN COMMERCE 10-0-2000.

---

SN 76-234,132. JEROME FOODS, INC., BARRON, WI. FILED 4-2-2001.



OWNER OF U.S. REG. NO. 1,919,991.  
NO CLAIM IS MADE TO THE EXCLUSIVE RIGHT TO USE "TURKEY", APART FROM THE MARK AS SHOWN.  
FOR TURKEY AND PROCESSED TURKEY (U.S. CL. 46).  
FIRST USE 12-13-1983; IN COMMERCE 12-13-1983.

---

SN 76-262,231. COMPANIA PESQUERA CAMANCHACA S.A., LAS CONDES, SANTIAGO, CHILE, FILED 5-24-2001.

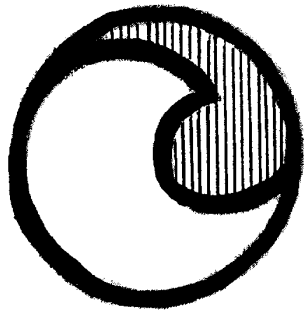

THE DRAWING IS LINED FOR THE COLOR RED.  
FOR SALMON (U.S. CL. 46).  
FIRST USE 3-0-1996; IN COMMERCE 3-0-1996.

**CLASS 29—(Continued).**

SN 76-268,576. GFI HOLDINGS, INC., SAN JOSE, CA. FILED 6-8-2001.



OWNER OF U.S. REG. NOS. 1,408,717, 2,407,232 AND OTHERS.

NO CLAIM IS MADE TO THE EXCLUSIVE RIGHT TO USE "PEMMICAN", APART FROM THE MARK AS SHOWN. THE LINING AND STIPLING ARE FEATURES OF THE MARK AND DO NOT INDICATE COLOR.

THE DEPICTION OF THE NATIVE AMERICAN IN THE MARK DOES NOT IDENTIFY A LIVING INDIVIDUAL.

THE TRADEMARK CONSISTS OF THE HEAD AND NECK OF A NATIVE AMERICAN WITH A HEADDRESS AND ORNAMENTATION ATOP A RECTANGULAR BOX CONTAINING THE WORD "PEMMICAN" IN UPPER CASE BLOCK LETTERS.

FOR SMOKED MEAT SNACKS, NAMELY, BEEFJERKY AND MEAT STICKS (U.S. CL. 46).

---

SN 76-269,975. NEW YUNG WAH TRADING CORP., DBA NYW TRADING CORP., BROOKLYN, NY. FILED 6-13-2001.

**DIAMOND BRAND**

NO CLAIM IS MADE TO THE EXCLUSIVE RIGHT TO USE "BRAND", APART FROM THE MARK AS SHOWN.  
FOR SOYBEAN OIL FOR COOKING (U.S. CL. 46).  
FIRST USE 12-15-2000; IN COMMERCE 12-15-2000.

---

SN 76-276,942. VIENNA SAUSAGE MANUFACTURING COMPANY, CHICAGO, IL. FILED 6-25-2001.

**CHICAGO'S HOT DOG**

OWNER OF U.S. REG. NO. 1,859,330.  
NO CLAIM IS MADE TO THE EXCLUSIVE RIGHT TO USE "HOT DOG", APART FROM THE MARK AS SHOWN. SEC. 2(F).  
FOR WIENERS (U.S. CL. 46).  
FIRST USE 5-0-1989; IN COMMERCE 6-0-1989.

---

SN 76-276,954. LUV JAM INDUSTRIES, L.L.C., ATLANTIC HIGHLANDS, NJ. FILED 6-27-2001.

**SPREAD A LITTLE LOVE!**

FOR JAMS, JELLIES, FRUIT SAUCES AND EDIBLE OILS (U.S. CL. 46).



**CLASS 29—(Continued).**

SN 76-299,059. SARGENTO FOODS INC., PLYMOUTH, WI. FILED 8-13-2001.

## SARGENTO CHEEZE AND PRETZELS

OWNER OF U.S. REG. NOS. 1,196,362, 2,300,230 AND OTHERS.

NO CLAIM IS MADE TO THE EXCLUSIVE RIGHT TO USE "CHEESE AND PRETZELS", APART FROM THE MARK AS SHOWN.

FOR NON-REFRIGERATED SNACK FOOD COMBINATIONS CONSISTING PRIMARILY OF CHEESE BASED DIPS AND ALSO CONTAINING CEREAL-BASED SNACK FOODS (U.S. CL. 46).

FIRST USE 8-6-2001; IN COMMERCE 8-6-2001.

---

SN 78-021,119. SARAMAR, L.L.C., CHICAGO, IL. FILED 8-14-2000.

## E-Z RIBS

NO CLAIM IS MADE TO THE EXCLUSIVE RIGHT TO USE "RIBS", APART FROM THE MARK AS SHOWN.

FOR PROCESSED MEATS (U.S. CL. 46).

---

SN 78-033,729. ROSS, BRIAN, M, BOULDER, CO. FILED 11-3-2000.

## ORGANIC FAMILY

NO CLAIM IS MADE TO THE EXCLUSIVE RIGHT TO USE "ORGANIC", APART FROM THE MARK AS SHOWN.

FOR PACKAGED MEAL COMBINATIONS COMPOSED PRIMARILY OF MEAT AND CHEESE WITH CRACKERS AND DESSERTS; NAMELY, CANDY, BAKERY GOODS, TRAIL MIX AND PUDDING (U.S. CL. 46).

---

SN 78-036,940. PURESOURCE INC., GUELPH ONTARIO, CANADA, FILED 11-29-2000.

## ESSENTIAL 3-6-9

FOR FRUIT- AND SEED-BASED SNACK FOODS (U.S. CL. 46).

**CLASS 29—(Continued).**

SN 78-039,126. BACKWOODS BASKETS, INC., TAHLEQUAH, OK. FILED 12-13-2000.



NO CLAIM IS MADE TO THE EXCLUSIVE RIGHT TO USE "BEST", APART FROM THE MARK AS SHOWN.

FOR GIFT BOXES CONSISTING PRIMARILY OF GOURMET PICKLES, ALSO SOLD WITH RELISHES, SALSA, AND MEAT SEASONING (U.S. CL. 46).

FIRST USE 9-1-1998; IN COMMERCE 9-1-1998.

---

SN 78-044,379. ISNACK, INC., LIBERTY, NY. FILED 1-22-2001.

## CYBER CHIPS

NO CLAIM IS MADE TO THE EXCLUSIVE RIGHT TO USE "CHIPS", APART FROM THE MARK AS SHOWN.

FOR SOY BASED SNACK FOOD (U.S. CL. 46).

FIRST USE 5-4-2001; IN COMMERCE 5-4-2001.

---

SN 78-056,779. MING, WEI, DENVER, CO. FILED 4-4-2001.

## EARTHMILK

FOR SOY-BASED FOOD BEVERAGE USED AS A MILK SUBSTITUTE (U.S. CL. 46).

---

SN 78-061,326. SARAMAR, L.L.C., CHICAGO, IL. FILED 5-1-2001.

## HICKORY GOLD

NO CLAIM IS MADE TO THE EXCLUSIVE RIGHT TO USE "HICKORY", APART FROM THE MARK AS SHOWN.

FOR PROCESSED MEATS (U.S. CL. 46).

**CLASS 30—STAPLE FOODS**

SN 75-638,511. GREENLIGHT FILMPRODUKTION GMBH, 80797 MUNICH, FED REP GERMANY, FILED 2-11-1999.



YOYO

FOR EDIBLE CAKE DECORATIONS, CANDY BREAKFAST CEREALS, CHEWING GUM, COOKIES, POPPED AND CANDY COATED POPCORN, CAKES, FROZEN CONFECTIONS, COCOA, ICE CREAM, PRETZELS AND TORTILLA CHIPS (U.S. CL. 46).

SN 75-809,170. NEXT CEREALS, LLC, CARLSBAD, CA. FILED 9-27-1999.

**NOW THAT'S DIFFERENT**

FOR BREAKFAST CEREALS AND PROCESSED CEREALS; CEREAL BASED SNACK FOODS (U.S. CL. 46).

SN 75-869,581. MARKOVICH, LILLIAN, DIAMOND BAR, CA. FILED 12-13-1999.



NO CLAIM IS MADE TO THE EXCLUSIVE RIGHT TO USE "FRUTTAS", APART FROM THE MARK AS SHOWN. THE ENGLISH TRANSLATION OF "BELLA FRUTTAS" IS "BEAUTIFUL FRUIT".  
FOR COOKIES (U.S. CL. 46).  
FIRST USE 8-15-1998; IN COMMERCE 8-15-1998.

SN 75-897,584. HEILBRUNN, EVA, SAN DIEGO, CA. FILED 1-15-2000.

**CELEBRATION STATION**

FOR GIFT BASKETS CONSISTING OF ASSORTED PRODUCTS OF OTHERS, NAMELY COOKIES, CRACKERS, CANDY AND STUFFED ANIMALS (U.S. CL. 46).  
FIRST USE 12-20-1999; IN COMMERCE 12-20-1999.

**CLASS 30—(Continued).**

SN 75-907,617. EASLEY, MOSES L., III, DBA M & M INDUSTRIES, SAN FRANCISCO, CA. FILED 1-31-2000.

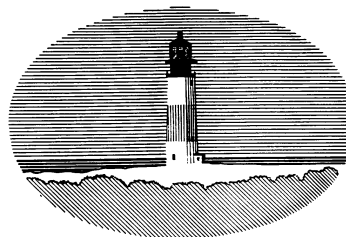

THE MARK IS LINED FOR THE COLORS BLUE, RED AND GREEN.  
FOR BARBEQUE SAUCE AND COOKING AND DIPPING SAUCE (U.S. CL. 46).  
FIRST USE 5-21-1999; IN COMMERCE 9-4-1999.

SN 75-945,486. SANFORD FARADAY, INC., FORT OGLETHORPE, GA. FILED 2-25-2000.

**SQUISH IT! SQUEEZE IT!  
SHAPE IT! EAT IT!**

FOR CANDY (U.S. CL. 46).  
FIRST USE 10-7-1996; IN COMMERCE 6-21-1999.

SN 76-021,858. DEPWEG, ADAM, CUCHARA, CO. AND DEPWEG, JILL, CUCHARA, CO. FILED 4-7-2000.



THE STIPPLING SHOWN IN THE DRAWING IS FOR SHADING PURPOSES ONLY.  
THE PORTRAIT OF THE DRAWING DOES NOT REPRESENT A LIVING INDIVIDUAL.  
FOR MUSTARD, KETCHUP, COOKING AND DIPPING SAUCES, SEASONINGS AND SALAD DRESSINGS (U.S. CL. 46).

**CLASS 30—(Continued).**

SN 76-055,869. SOUTHERN SPECIALTY BRANDS, INC., NASHVILLE, TN. FILED 5-24-2000.



FOR GRITS, CORNMEAL, MILLED RICE (U.S. CL. 46).

SN 76-058,365. SPENCER & FLEETWOOD, EAST HORSLEY, SURREY, GREAT BRITAIN, FILED 5-19-2000.

**SEVERED FINGERS & TOES**

FOR CANDY (U.S. CL. 46).  
FIRST USE 9-1-1997; IN COMMERCE 3-1-1999.

SN 76-058,663. ASIAN BRANDS, INC., ALAMEDA, CA. FILED 5-31-2000.

**TOHFA**

THE ENGLISH TRANSLATION OF "TOHFA" IS "GIFT". FOR RICE, SPICES, SPICE MIXES, SEASONINGS, CONDIMENT SAUCES, NAMELY, SALSA AND RELISHES, FLOUR AND CHUTNEY (U.S. CL. 46).  
FIRST USE 9-4-1995; IN COMMERCE 9-4-1995.

SN 76-106,572. BOYD COFFEE COMPANY, PORTLAND, OR. FILED 8-8-2000.

**ROYALE BLEND**

NO CLAIM IS MADE TO THE EXCLUSIVE RIGHT TO USE "BLEND", APART FROM THE MARK AS SHOWN.  
FOR COFFEE (U.S. CL. 46).

**CLASS 30—(Continued).**

SN 76-124,290. HOTTIE CORPORATION, SALT LAKE CITY, UT. FILED 9-7-2000.

**HOTTIE**

FOR CANDY, NAMELY, BUBBLE GUM, CHEWING GUM, CHOCOLATES, FUDGE, HARD CANDY, MINTS, NON-MEDICATED LOZENGES, SOFT CANDY, TAFFY; BAKERY GOODS, NAMELY, ALL-PURPOSE BAKING MIX, BAGELS, BAKING POWDER, BAKING SODA, BISCUITS, BREAD, BREAD CRUMBS, BREAD MIXES USED FOR BREAD MACHINES, BREADSTICKS, BROWNIE MIX, BROWNIES, CAKE MIXES, CAKES, CHOCOLATE CHIPS, CHOCOLATE-BASED FILLINGS FOR CAKES AND PIES, CONFECTIONERY CHIPS FOR BAKING, COOKIE MIX, COOKIES, CRUMPETS, CUSTARD-BASED FILLINGS FOR CAKES AND PIES, DOUGH, DOUGHNUTS, EDIBLE CAKE DECORATIONS, FLOUR, FRUIT PIES, GINGERBREAD, ICING, ICING MIXES, MARZIPAN, MIXES FOR BAKERY GOODS, MUFFINS, PASTRIES, WAFERS, YEAST; FROZEN CONFECTIONS, NAMELY, BASES FOR MAKING MILKSHAKES, CONES FOR ICE CREAM, FLAVORED ICES, FREEZABLE LIQUID FOR USE IN MAKING FROZEN CONFECTIONS, FROZEN CUSTARDS, FROZEN YOGURT, FRUIT ICE, ICE CREAM, ICE CREAM SUBSTITUTE, ICE MILK, MILKSHAKES, PARFAITS, SHAKES, SHERBET, SORBET; ICE; SNACK FOODS, NAMELY, CANDIED FRUIT SNACKS, CANDY COATED APPLES, CANDY COVERED NUTS, CEREAL-BASED SNACKS, CHEESE FLAVORED PUFFED CORN SNACKS, CHOCOLATE COVERED NUTS, CHOCOLATE TRUFFLES, CORN CHIPS, CORN-BASED SNACKS, CRACKER AND CHEESE COMBINATIONS, GRAIN-BASED SNACKS, GRANOLA-BASED SNACK BARS, MARSHMALLOWS, NACHOS, NUTRITION BARS, PRETZELS, RICE-BASED SNACKS, SANDWICH CRACKERS, SNACK MIX CONSISTING PRIMARILY OF CRACKERS, PRETZELS, CANDIED NUTS AND POPPED POPCORN, TORTILLA CHIPS, WHEAT-BASED SNACKS; POPCORN, NAMELY, CANDY COATED POPCORN, CARAMEL POPCORN, MICROWAVE POPCORN, POPPED POPCORN, PROCESSED UNPOPPED POPCORN; BEVERAGE GOODS, NAMELY, CHOCOLATE FOOD BEVERAGES NOT BEING DAIRY-BASED AND VEGETABLE-BASED, COCOA, COCOA MIXES, COFFEE, COFFEE BEANS, COFFEE-BASED BEVERAGE CONTAINING MILK, GRAIN AND CHICORY BASED COFFEE SUBSTITUTES, GRAIN-BASED FOOD BEVERAGES, HERBAL FOOD BEVERAGES, HERBAL TEA FOR FOOD PURPOSES, ICED TEA, TEA; SWEETENERS, NAMELY, CORN SYRUP, MOLASSES, NATURAL SWEETENER, SUGAR, SUGAR SUBSTITUTES; FLAVORINGS, NAMELY, ALMOND PASTE, BARBECUE SAUCE, CHEESE SAUCE, CHILI POWDERS, CHILI SAUCE, CHILI SEASONING, CHOCOLATE, CHOCOLATE FONDUE, CHOCOLATE POWDER, CHOCOLATE SYRUP, CHOCOLATE TOPPING, DRIED CHILI PEPPERS FOR USE AS A SEASONING, FLAVORING SYRUP, HONEY, HORSERADISH, HOT SAUCE, KETCHUP, MALT FOR FOOD PURPOSES, MAPLE SYRUP, MARINADES, MARSHMALLOW TOPPING, MAYONNAISE, MEAT TENDERIZERS, MUSTARD, NONESSENTIAL OIL FOOD FLAVORINGS, PANCAKE SYRUP, PICANTE SAUCE, PICKLE RELISH, PROCESSED HERBS IN GENERAL, SALAD DRESSING, SALSA, SALT, SAUCES, SEASONED COATING FOR MEAT, FISH AND POULTRY, SEASONINGS IN GENERAL, SPAGHETTI SAUCE, SPICES, TACO SEASONING, TARTAR SAUCE, TERIYAKI SAUCE, TOPPING SYRUP, VANILLA, VINEGAR; MEXICAN FOOD, NAMELY, BURRITOS, CHALUPAS, CHIMICHANGAS, ENCHILADAS, FAJITAS, MEXICAN PIZZA, PREPARED FRIED FLOUR CONFECTIONS, SOPAPILLAS, STUFFED JALAPENOS, TACO SHELLS, TACOS, TAMALES, TAQUITOS, TORTILLAS, TOSTADAS; MISCELLANEOUS FOODS, NAMELY, BREAKFAST CEREALS, CALZONES, CORN DOGS, CRACKERS, CREPES, CROUTONS, CUSTARDS, DESERT SOUFFLES, EGG ROLLS, FLAVORED AND SWEETENED GELATIN DESSERTS, FLAVORED AND SWEETENED GELATINS, FOOD

**CLASS 30—(Continued).**

PACKAGE COMBINATIONS CONSISTING PRIMARILY OF BREAD, CRACKERS AND COOKIES, FROZEN AND PACKAGED ENTREES CONSISTING PRIMARILY OF PASTA OR RICE, GRANOLA, GRAVY MIXES, LASAGNA, MACARONI, MACARONI AND CHEESE, MACARONI SALAD, MEAT PIES, NOODLES, PANCAKE MIXES, PANCAKES, PASTA, PASTA SALAD, PIZZA, POTSTICKERS, PROCESSED GRAINS IN GENERAL, PUDDINGS, QUICHE, RAVIOLI, RICE, SANDWICHES, SPRING ROLLS, STUFFING MIXES CONTAINING BREAD, SWEETMEATS, TAPIOCA, WAFFLES, WON TONS (U.S. CL. 46).

FIRST USE 3-0-1994; IN COMMERCE 3-0-1994.

SN 76-125,520. GROUNDSSWELL, L.L.C., BINGHAM FARMS, MI. FILED 9-11-2000.

**BEAN THINKING OF YOU**

NO CLAIM IS MADE TO THE EXCLUSIVE RIGHT TO USE "BEAN", APART FROM THE MARK AS SHOWN.

FOR COFFEE, COFFEE BEANS, GROUND COFFEE, CAFFEINATED COFFEE, DECAFFEINATED COFFEE, TEA; HERB TEA AND HERBAL TEA FOR FOOD PURPOSES; CAFFEINATED TEA, DECAFFEINATED TEA, TEA BAGS, CAPPUCCINO, 'CAFFE' LATTE', ESPRESSO, COCOA, HOT COCOA, HOT CHOCOLATE (U.S. CL. 46).

SN 76-125,521. GROUNDSSWELL, L.L.C., BINGHAM FARNS, MI. FILED 9-11-2000.

**JINGLE BEANS**

NO CLAIM IS MADE TO THE EXCLUSIVE RIGHT TO USE "BEANS", APART FROM THE MARK AS SHOWN.

FOR COFFEE, COFFEE BEANS, GROUND COFFEE, CAFFEINATED COFFEE, DECAFFEINATED COFFEE; TEA; HERB TEA AND HERBAL TEA FOR FOOD PURPOSES; CAFFEINATED TEA, DECAFFEINATED TEA, TEA BAGS, CAPPUCCINO, 'CAFFE' LATTE', ESPRESSO, COCOA, HOT COCOA, HOT CHOCOLATE (U.S. CL. 46).

SN 76-132,103. IAN'S MONTAIN BAKERY, GRANDBY, CO. FILED 9-20-2000.

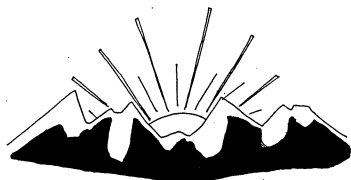

Ian's Mountain Bakery

NO CLAIM IS MADE TO THE EXCLUSIVE RIGHT TO USE "BAKERY", APART FROM THE MARK AS SHOWN.

FOR BAKERY GOODS MADE FROM CEREALS, GRAINS, FRUIT, BREAD, PASTRY AND CONFECTIONERY, NAMELY, CHEESECAKES, PIES, PASTRIES, CAKES, SCONES, BREADS, AND SWEET ROLLS (U.S. CL. 46).

FIRST USE 12-0-1995; IN COMMERCE 12-0-1995.

**CLASS 30—(Continued).**

SN 76-138,685. LUISSIER S.A., 78220 VIROFLAY, FRANCE, FILED 10-2-2000.

**CROC'DORÉ**

FOR FLOUR AND PREPARATIONS MADE FROM CEREAL, NAMELY, BAKERY PRODUCTS AND BISCUITS (U.S. CL. 46).

SN 76-150,072. SONI, DIPTI, SCHAUMBURG, IL. AND SHAH, AJIT, SCHAUMBURG, IL. FILED 10-20-2000.



FOR ICE CREAM (U.S. CL. 46).  
FIRST USE 4-15-2000; IN COMMERCE 4-15-2000.

SN 76-166,018. BOYD COFFEE COMPANY, PORTLAND, OR. FILED 11-14-2000.

**KENYAN ROYALE**

NO CLAIM IS MADE TO THE EXCLUSIVE RIGHT TO USE "KENYAN", APART FROM THE MARK AS SHOWN.  
FOR COFFEE (U.S. CL. 46).

SN 76-171,268. SEO ENTERPRISE, INC., SEATTLE, WA. FILED 11-27-2000.



NO CLAIM IS MADE TO THE EXCLUSIVE RIGHT TO USE "TERIYAKI", APART FROM THE MARK AS SHOWN. THE ENGLISH TRANSLATION OF "SAN" IS "SIR" OR "MISTER".

FOR TERIYAKI SAUCES AND GLAZES (U.S. CL. 46).  
FIRST USE 1-1-1999; IN COMMERCE 1-1-1999.

**CLASS 30—(Continued).**

SN 76-175,519. HARDEE'S FOOD SYSTEMS, INC., ROCKY MOUNT, NC. FILED 12-5-2000.

**BIG TWIN**

NO CLAIM IS MADE TO THE EXCLUSIVE RIGHT TO USE "BIG", APART FROM THE MARK AS SHOWN.  
FOR HAMBURGER SANDWICHES (U.S. CL. 46).

SN 76-194,077. YOHAY BAKING COMPANY INC., BROOKLYN, NY. FILED 1-12-2001.



NO CLAIM IS MADE TO THE EXCLUSIVE RIGHT TO USE "COOKIE GOURMET", APART FROM THE MARK AS SHOWN.  
FOR SPECIALTY BAKERY GOODS (U.S. CL. 46).

SN 76-206,971. SARAH SMITH'S OLD FASHIONED COOKIES, INC., LAS CRUCES, NM. FILED 2-8-2001.

**BASES LOADED**

FOR BAKERY PRODUCTS, NAMELY CAKES, COOKIES AND PIES, SOLD ONLY THROUGH APPLICANT'S STORES AND NOT SOLD THROUGH GENERAL RETAIL OUTLETS (U.S. CL. 46).  
FIRST USE 12-4-2000; IN COMMERCE 12-4-2000.

SN 76-210,692. TEAPORTS, INC., PORTLAND, OR. FILED 2-13-2001.



NO CLAIM IS MADE TO THE EXCLUSIVE RIGHT TO USE "AUTHENTIC KOMBUCHA", APART FROM THE MARK AS SHOWN.  
FOR TEA, HERBAL TEA (U.S. CL. 46).

**CLASS 30—(Continued).**

SN 76-214,888. SPLENDID SPECIALTIES, INC., NOVATO, CA. FILED 2-23-2001.

**SPLENDID SPECIALTIES**

NO CLAIM IS MADE TO THE EXCLUSIVE RIGHT TO USE "SPECIALTIES", APART FROM THE MARK AS SHOWN.

FOR CONFECTIONS, NAMELY CHOCOLATE, CHOCOLATE-COVERED COFFEE BEANS, CHOCOLATE-COVERED GRAHAMS, CHOCOLATE-COVERED CARAMELS, AND TRUFFLES; AND GOURMET AND SPECIALTY FOODS, NAMELY BISCOTTI, BREAD, COOKIES, AND CRACKERS (U.S. CL. 46).

SN 76-222,889. KOBASIC/TOUSHAK INC, ESCANABA, MN. FILED 3-12-2001.

**SAYKLLY'S**

FOR CONFECTIONARY PRODUCTS, NAMELY CHOCOLATES, HARD CANDIES, FUDGE, TAFFIES, ICE CREAMS AND CARAMEL APPLES (U.S. CL. 46).  
FIRST USE 0-0-1906; IN COMMERCE 0-0-1959.

SN 76-231,840. VARRICCHIO, GLORIA A., GARRISON, NY. FILED 3-29-2001.

**MIMA'S INSTANT ZEPPOLE MIX**

NO CLAIM IS MADE TO THE EXCLUSIVE RIGHT TO USE "INSTANT ZEPPOLE MIX", APART FROM THE MARK AS SHOWN.

FOR DRY PASTRY MIX FOR MAKING ZEPPOLES (U.S. CL. 46).  
FIRST USE 6-1-1985; IN COMMERCE 6-1-1985.

SN 76-252,802. CAPTAIN D'S INC., NASHVILLE, TN. FILED 5-4-2001.

**D'S FREEZE**

NO CLAIM IS MADE TO THE EXCLUSIVE RIGHT TO USE "FREEZE", APART FROM THE MARK AS SHOWN.

FOR FROZEN TEA-BASED BEVERAGES CONSISTING OF TEA FLAVORING, AND NATURAL AND ARTIFICIAL FRUIT FLAVORING (U.S. CL. 46).

FIRST USE 7-20-2000; IN COMMERCE 7-20-2000.

**CLASS 30—(Continued).**

SN 76-260,595. WORLD BLACKBELT.COM, INC., TARZANA, CA. FILED 5-22-2001.

**KICKBAR**

FOR GRAIN-BASED NUTRITIONAL FOOD SUPPLEMENTS THAT ARE VITAMIN AND MINERAL FORTIFIED AND FORMED AND PACKAGED AS BARS (U.S. CL. 46).

---

SN 76-264,195. PIZZAPALOOZA, LLC, NEWTON, MA. FILED 5-31-2001.

**PIZZAPALOOZA**

FOR ITALIAN STYLE PIZZA (U.S. CL. 46).  
FIRST USE 4-0-2001; IN COMMERCE 5-21-2001.

---

SN 76-274,771. LA TAPATIA TORTILLERIA, INC., FRESNO, CA. FILED 6-20-2001.

**SOL DE ORO**

OWNER OF U.S. REG. NO. 1,671,953.  
THE ENGLISH TRANSLATION OF "SOL DE ORO" IS "GOLDEN SUN".  
FOR TROTILLAS AND TORTILLA CHIPS (U.S. CL. 46).  
FIRST USE 1-1-1982; IN COMMERCE 1-1-1982.

---

SN 76-280,007. SWEETERY, INC., THE, ANDERSON, SC. FILED 7-6-2001.

**COUPLE CAKES**

NO CLAIM IS MADE TO THE EXCLUSIVE RIGHT TO USE "CAKES", APART FROM THE MARK AS SHOWN.  
FOR BAKERY GOODS (U.S. CL. 46).

---

SN 76-294,219. A TOAST TO BREAD, LTD., ST. PAUL, MN. FILED 8-1-2001.

**MARGIOLINA'S**

FOR DESSERTS, NAMELY, EMPANADAS, CROISSANTS, FLAN, CAKES, PIES, COOKIES, BROWNIES, BISCOTTI, TORTS, TARTS, AND QUICHE (U.S. CL. 46).

**CLASS 30—(Continued).**

SN 76-298,390. POPCORN DEPOT, INC., DBA POPCORN AMERICA, BETHPAGE, NY. FILED 8-10-2001.

**PALM BEACH POPCORN**

NO CLAIM IS MADE TO THE EXCLUSIVE RIGHT TO USE "POPCORN", APART FROM THE MARK AS SHOWN.  
FOR PROCESSED POPCORN, POPPED POPCORN, GLAZED POPCORN, CANDY COATED POPCORN, CHOCOLATE DRIZZLED POPCORN, CARAMEL POPCORN, BUTTERED POPCORN, MICROWAVE POPCORN, OILED POPCORN, SALTED POPCORN, PROCESSED UNPOPPED POPCORN, OILED AND SALTED POPCORN KERNELS (U.S. CL. 46).  
FIRST USE 3-1-2001; IN COMMERCE 3-1-2001.

---

SN 78-027,863. MCDONALD, MARK, A., PHOENIX, AZ. FILED 9-27-2000.

**KETO'S BRAND**

NO CLAIM IS MADE TO THE EXCLUSIVE RIGHT TO USE "BRAND", APART FROM THE MARK AS SHOWN.  
THE NAME "KETO'S" DOES NOT IDENTIFY A PARTICULAR LIVING INDIVIDUAL.  
FOR MEXICAN FOOD, NAMELY, TORTILLA CHIPS (U.S. CL. 46).

---

SN 78-028,310. LIN, JIN-SHOW, DBA UNIVERSAL HERB CO., LTD., SUGAR LAND, TX. FILED 9-29-2000.

**VITA-SHAPE**

FOR HERBAL TEA (U.S. CL. 46).

---

SN 78-030,577. NABISCO BRANDS COMPANY, WILMINGTON, DE. FILED 10-13-2000.

**CAFE COLLECTION**

NO CLAIM IS MADE TO THE EXCLUSIVE RIGHT TO USE "COLLECTION", APART FROM THE MARK AS SHOWN.  
FOR COOKIES (U.S. CL. 46).

---

SN 78-033,718. CENTURA FOODS LIMITED, BUCKINGHAMSHIRE, UNITED KINGDOM, FILED 11-3-2000.

**BISTO**

FOR GRAVY MIXES INCLUDING GRAVY MIXES IN POWDERED AND GRANULE FORM (U.S. CL. 46).

**CLASS 30—(Continued).**

SN 78-034,953. USINAS ITAMARATI S.A., NEW YORK, NY.  
FILED 11-13-2000.

**ITAMARATI**

FOR SUGAR (U.S. CL. 46).

---

SN 78-037,220. MARCELO Y RIVERO, C.A., VALENCIA  
ESTADO CARABOBO, VENEZUELA, FILED 11-30-2000.

**CAFE MADRID**

NO CLAIM IS MADE TO THE EXCLUSIVE RIGHT TO  
USE "CAFE", APART FROM THE MARK AS SHOWN.  
FOR GRIENED AND TOASTED COFFEE (U.S. CL. 46).

---

SN 78-045,400. PET INCORPORATED, MINNEAPOLIS, MN.  
FILED 1-29-2001.

**WILD FOR MILD**

NO CLAIM IS MADE TO THE EXCLUSIVE RIGHT TO  
USE "MILD", APART FROM THE MARK AS SHOWN.  
FOR PICANTE SAUCE AND SALSA (U.S. CL. 46).

---

SN 78-048,963. ASIATIC TRADING CO., LLC, MANCHE-  
STER, CT. FILED 2-18-2001.



NO CLAIM IS MADE TO THE EXCLUSIVE RIGHT TO  
USE "ASIATIC", APART FROM THE MARK AS SHOWN.  
FOR TEAS (U.S. CL. 46).

---

SN 78-052,236. ARBO, INC., LAFAYETTE, CA. FILED 3-9-  
2001.

**ZCOOKIE**

FOR COOKIES (U.S. CL. 46).

**CLASS 30—(Continued).**

SN 78-057,685. TAMALES IMPERIAL COMPANY, HOUS-  
TON, TX. FILED 4-10-2001.

**TAMALES IMPERIAL**

NO CLAIM IS MADE TO THE EXCLUSIVE RIGHT TO  
USE "TAMALES", APART FROM THE MARK AS SHOWN.  
FOR HOMEMADE FROM SCRATCH, READY TO EAT,  
FROZEN AND REFRIDERATED TAMALES, ALL MADE  
FROM DOUGH WITH DIFFERENT FLAVORS AND  
KINDS OF INGREDIENTS (U.S. CL. 46).

---

SN 78-061,568. KRAFT FOODS HOLDINGS, INC., NORTH-  
FIELD, IL. FILED 5-2-2001.

**CLAUSSEN**

OWNER OF U.S. REG. NOS. 919,506 AND 1,474,327.  
SEC. 2(F) AS TO CLAUSSEN.  
FOR RELISH (U.S. CL. 46).  
FIRST USE 5-1-2001; IN COMMERCE 5-1-2001.

---

SN 78-063,944. T.P.C. ENTERPRISES, INC., WALL TOWN-  
SHIP, NJ. FILED 5-16-2001.

**ICEACCINO**

FOR FROZEN CONFECTIONS, NAMELY FLAVORED  
ICES, AND FRUIT JUICE ICES (U.S. CL. 46).

---

SN 78-065,301. SUMMERS, ETHAN, CHARLOTTE, NC.  
FILED 5-23-2001.

**ORIGUMMI**

FOR CHEWING GUM AND BUBBLE GUM (U.S. CL.  
46).

---

SN 78-070,718. EASON, ROBERT ERIC, METAIRIE, LA.  
FILED 6-23-2001.

**BANGING EVERYTHING IN  
SIGHT**

FOR HOT SAUCE (U.S. CL. 46).

**CLASS 30—(Continued).**

SN 78-070,745. PAPARO, ERIC C, SYRACUSE, NY. FILED 6-24-2001.

**PLYOPLEX**

FOR GRAIN BASED FOOD BAR (U.S. CL. 46).

SN 78-073,935. DUPUY, THEODORE R, AUBURN, CA. FILED 7-14-2001.

**MIGHTYMAX**

FOR HAMBURGER SANDWICHES (U.S. CL. 46).  
FIRST USE 8-5-2000; IN COMMERCE 8-5-2000.

SN 78-075,856. ROSZ, THADDEUS, HOLLYWOOD, FL. FILED 7-26-2001.

**TED'S BREAD**

NO CLAIM IS MADE TO THE EXCLUSIVE RIGHT TO USE "BREAD", APART FROM THE MARK AS SHOWN.  
FOR BAKERY TYPE GOODS, NAMELY BREAD AND FLOUR-BASED MIXES (U.S. CL. 46).

SN 78-076,734. CHINA MIST TEA COMPANY, SCOTTSDALE, AZ. FILED 7-31-2001.

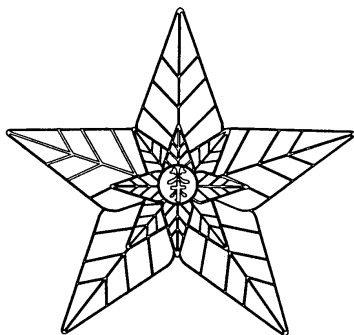

OWNER OF U.S. REG. NO. 2,432,169.  
NO CLAIM IS MADE TO THE EXCLUSIVE RIGHT TO USE THE CHINESE CHARACTER THAT TRANSLATES INTO CHA, WHICH MEANS TEA, APART FROM THE MARK AS SHOWN.

THE MARK CONSISTS OF STAR CONTAINING A CHINESE CHARACTER.

FOR TEA, HERBAL TEA, HERBAL ICED TEA, ICED TEA, TEA-BASED BEVERAGES WITH FRUIT FLAVORING, LOOSE TEA, TEA BAGS AND HOT TEA (U.S. CL. 46).

**CLASS 30—(Continued).**

SN 78-078,486. SPEIDEL, BRIDGET N., KEY BISCAYNE, FL. FILED 8-9-2001.

**HOUSE OF STUART  
SIGNATURE CRACKERS**

NO CLAIM IS MADE TO THE EXCLUSIVE RIGHT TO USE "CRACKERS", APART FROM THE MARK AS SHOWN.  
FOR CRACKERS (U.S. CL. 46).

SN 78-078,570. HANNA-BARBERA PRODUCTIONS, INC., SHERMAN OAKS, CA. FILED 8-9-2001.

**SCOOBY SNACKS**

OWNER OF U.S. REG. NO. 1,579,527.  
NO CLAIM IS MADE TO THE EXCLUSIVE RIGHT TO USE "SNACKS", APART FROM THE MARK AS SHOWN.

FOR COOKIES, BASES FOR MAKING MILKSHAKES, BREAKFAST CEREAL, BUBBLE GUM, CAKE DECORATIONS MADE OF CANDY, CHEWING GUM, FROZEN CONFECTIONS, CRACKERS, FROZEN YOGURT, ICE CREAM, PRETZELS, PEANUT BUTTER CONFECTIONERY CHIPS, MALT FOR FOOD; SOYBEAN MALT; MALT BISCUITS; SUGAR CONFECTIONERY; EDIBLE DECORATIONS FOR CAKE; RICE CAKES; PASTILLES; PASTRIES; BISCUITS AND BREAD; COFFEE BEVERAGES WITH MILK; COCOA BEVERAGES WITH MILK, CHOCOLATE-BASED BEVERAGES, COFFEE AND COFFEE-BASED BEVERAGES, COCOA AND COCOA-BASED BEVERAGES; TEA, NAMELY, GINSENG TEA, BLACK TEA, OOLONG TEA, BARLEY AND BARLEY-LEAF TEA; MEAT TENDERIZERS FOR HOUSEHOLD PURPOSES; BINDING AGENTS FOR ICE-CREAM (U.S. CL. 46).

SN 78-079,827. ANGELIC GOURMET, INC., NAPLES, NY. FILED 8-17-2001.

**THE WORLD'S BEST  
DRESSED PRETZELS**

FOR CHOCOLATE COVERED PRETZELS (U.S. CL. 46).  
FIRST USE 2-2-1999; IN COMMERCE 2-2-1999.

SN 78-084,691. WOLFF, DEENA, SCARSDALE, NY. FILED 9-20-2001.

**ARTMINTS**

FOR CANDY MINTS (U.S. CL. 46).

**CLASS 31—NATURAL AGRICULTURAL PRODUCTS**



**CLASS 31—(Continued).**

SN 75-808,461. MY FAVORITE COMPANY, LLC, THE, WEST CHICAGO, IL. BY ASSIGNMENT ANTHONY TESSELAAR PLANTS PTY LTD, SILVAN VICTORIA 3795, AUSTRALIA, FILED 9-23-1999.

**MY FAVORITE**

FOR LIVE AGRICULTURAL AND HORTICULTURAL SEEDS, LIVE SEEDLINGS, LIVE FLOWER BULBS, LIVE FLOWERS, LIVE PLANTS, LIVE SHRUBS, LIVE BUSHES, LIVE GRASSES, NAMELY DECORATIVE AND NATIVE GRASSES, AND LIVE TREES (U.S. CLS. 1 AND 46).

SN 75-808,462. MY FAVORITE COMPANY, LLC, THE, WEST CHICAGO, IL. BY ASSIGNMENT ANTHONY TESSELAAR PLANTS PTY LTD, SILVAN, VICTORIA 3795, AUSTRALIA, FILED 9-23-1999.

**MY FAVORITES**

FOR LIVE AGRICULTURAL AND HORTICULTURAL SEEDS, LIVE SEEDLINGS, LIVE FLOWER BULBS, LIVE FLOWERS, LIVE PLANTS, LIVE SHRUBS, LIVE BUSHES, LIVE GRASSES, NAMELY DECORATIVE AND NATIVE GRASSES, AND LIVE TREES (U.S. CLS. 1 AND 46).

SN 75-809,505. HAWAIIAN POPCORN, INC., SAN JACINTO, CA. FILED 9-27-1999.

**SWEET AND SALTY TASTE SENSATION**

NO CLAIM IS MADE TO THE EXCLUSIVE RIGHT TO USE "SWEET AND SALTY TASTE", APART FROM THE MARK AS SHOWN.  
FOR SWEET TASTING FLAVORED UNPOPPED POPCORN (U.S. CLS. 1 AND 46).

SN 76-000,271. NUNZA B.V., NETHERLANDS, FILED 3-14-2000.

**ECONUN**

PRIORITY CLAIMED UNDER SEC. 44(D) ON BENELUX APPLICATION NO. 0952839, FILED 12-16-1999, REG. NO. 0659917, DATED 12-16-1999, EXPIRES 12-16-2009.  
FOR SEEDS, NOT INCLUDED IN OTHER CLASSES, NAMELY, VEGETABLE SEEDS (U.S. CLS. 1 AND 46).

**CLASS 31—(Continued).**

SN 76-031,537. PURINA MILLS, INC., ST. LOUIS, MO. FILED 4-24-2000.

**EZ TUB**

NO CLAIM IS MADE TO THE EXCLUSIVE RIGHT TO USE "TUB", APART FROM THE MARK AS SHOWN.  
FOR ANIMAL FEED (U.S. CLS. 1 AND 46).

SN 76-034,911. FRESH AMERICA CORP., DALLAS, TX. FILED 4-26-2000.

**CROWN FRESH**

NO CLAIM IS MADE TO THE EXCLUSIVE RIGHT TO USE "FRESH", APART FROM THE MARK AS SHOWN.  
FOR FRESH PRODUCE, NAMELY, FRESH FRUITS AND VEGETABLES (U.S. CLS. 1 AND 46).

SN 76-047,755. LASS, KARL H., WASHINGTON, DC. AND BARTELS, HERMANN, 48167 HILTRUP-MUNSTER, FED REP GERMANY, FILED 5-12-2000.

**GOLDEN POMMERANIA**

NO CLAIM IS MADE TO THE EXCLUSIVE RIGHT TO USE "GOLDEN", APART FROM THE MARK AS SHOWN.  
FOR UNPROCESSED POTATOES (U.S. CLS. 1 AND 46).

SN 76-074,264. APPLIED SCIENTIFIC CORPORATION, SOUTH SAN FRANCISCO, CA. FILED 6-20-2000.

**JAZZ-MIX**

FOR FOODSTUFFS CONTAINING NUTRIENTS FOR LABORATORY ANIMALS (U.S. CLS. 1 AND 46).  
FIRST USE 4-1-2000; IN COMMERCE 4-1-2000.

**CLASS 31—(Continued).**

SN 76-101,862. QUALITY SALES, LLC, HARTFORD, CT.  
FILED 8-2-2000.



NO CLAIM IS MADE TO THE EXCLUSIVE RIGHT TO USE "SUMMERTIME", APART FROM THE MARK AS SHOWN.

FOR FRESH VEGETABLES AND TOMATOES (U.S. CLS. 1 AND 46).  
FIRST USE 11-0-1995; IN COMMERCE 11-0-1995.

SN 76-111,890. MEREX FOOD CORPORATION, YONKERS, NY. FILED 8-17-2000.

**WINTER GLOW**

FOR PRODUCE COMMON NAMELY FRESH FRUITS AND VEGETABLES PROVIDED TO SUPERMARKETS FOR SALE TO CONSUMERS (U.S. CLS. 1 AND 46).

SN 76-153,833. LANDEC AG, INC., MONTICELLO, IN. BY CHANGE OF NAME INTELICOAT CORPORATION, DBA FIELDER'S CHOICE DIRECT, MONTICELLO, IN. FILED 10-25-2000.

**POLLINATOR PLUS**

NO CLAIM IS MADE TO THE EXCLUSIVE RIGHT TO USE "POLLINATOR", APART FROM THE MARK AS SHOWN.

FOR COATINGS FOR AGRICULTURAL SEEDS TO REGULATE THE GERMINATION OF INBRED HYBRIDS (U.S. CLS. 1 AND 46).

SN 76-157,165. RICHARDSON, GARRY L., ARVIN, CA. FILED 10-30-2000.

**SWEET 16**

FOR FRESH PEACHES, PLUMS AND NECTARINES (U.S. CLS. 1 AND 46).

**CLASS 31—(Continued).**

SN 76-213,513. ROSE OF SHARON NURSERY, INC, MIAMI, FL. FILED 2-22-2001.

**UNIQUE**

FOR LIVING PLANTS, EXCLUDING ROSES, NAMELY SHRUBS AND TREES, AND PARTS THEREOF INCLUDING SCIONS, BUDS, STEM CUTTINGS AND ROOT CUTTINGS (U.S. CLS. 1 AND 46).

SN 76-217,576. FARM SERVICE COOPERATIVE, HARLAN, IA. FILED 2-28-2001.

**PROGRESSIVE NUTRITION**

NO CLAIM IS MADE TO THE EXCLUSIVE RIGHT TO USE "NUTRITION", APART FROM THE MARK AS SHOWN.

FOR ANIMAL FEED (U.S. CLS. 1 AND 46).

SN 76-218,549. DOANE PET CARE COMPANY, BRENTWOOD, TN. FILED 3-1-2001.



NO CLAIM IS MADE TO THE EXCLUSIVE RIGHT TO USE "DOG FOOD", APART FROM THE MARK AS SHOWN. FOR DOG FOOD (U.S. CLS. 1 AND 46).  
FIRST USE 9-30-1999; IN COMMERCE 9-30-1999.

SN 76-235,637. EMERALD FARMS, INC., MIAMI, FL. FILED 4-5-2001.

**EMERALD PRIME**

OWNER OF U.S. REG. NO. 1,593,293.  
FOR CUT FLOWERS AND FLOWERING PLANTS (U.S. CLS. 1 AND 46).

SN 76-288,280. TURF-SEED, INC., HUBBARD, OR. FILED 7-19-2001.

**VENTURE**

FOR GRASS SEED (U.S. CLS. 1 AND 46).

**CLASS 31—(Continued).**

SN 78-035,066. JEDDELOH, HORST, GRESHAM, OR. FILED 11-13-2000.

**PINUS NIGRA BREPO**

NO CLAIM IS MADE TO THE EXCLUSIVE RIGHT TO USE "PINUS NIGRA", APART FROM THE MARK AS SHOWN.

THE ENGLISH TRANSLATION OF THE WORD "PINUS NIGRA BREPO" IN THE MARK IS "BREPO BLACK PINE". FOR LIVE DWARF PINE TREES (U.S. CLS. 1 AND 46).

---

SN 78-044,840. VIGORTONE AG PRODUCTS, INC., CEDAR RAPIDS, IA. FILED 1-25-2001.

**ANIMAL NUTRITION AT ITS BEST**

NO CLAIM IS MADE TO THE EXCLUSIVE RIGHT TO USE "ANIMAL NUTRITION", APART FROM THE MARK AS SHOWN.

FOR ANIMAL FEED FOR LIVESTOCK (U.S. CLS. 1 AND 46).  
FIRST USE 3-0-2000; IN COMMERCE 3-0-2000.

---

SN 78-047,420. MIDDLETON, MICHELE, SHIZUNO, HONOLULU, HI. FILED 2-9-2001.

**FREAKY FELINE**

NO CLAIM IS MADE TO THE EXCLUSIVE RIGHT TO USE "FELINE", APART FROM THE MARK AS SHOWN.

FOR HOME BAKED TREATS FOR CATS (U.S. CLS. 1 AND 46).  
FIRST USE 2-1-2001; IN COMMERCE 2-1-2001.

---

SN 78-057,108. DOW CHEMICAL COMPANY, THE, MIDLAND, MI. FILED 4-6-2001.

**DOW AGROSCIENCES**

OWNER OF U.S. REG. NOS. 294,405, 819,605 AND OTHERS.

FOR AGRICULTURAL SEEDS, NAMELY COTTON SEEDS (U.S. CLS. 1 AND 46).  
FIRST USE 1-1-2000; IN COMMERCE 1-1-2000.

**CLASS 31—(Continued).**

SN 78-074,416. MULCH MANUFACTURING, INC., REYNOLDSBURG, OH. FILED 7-18-2001.

**FARGO ALL BARK CYPRESS MULCH**

NO CLAIM IS MADE TO THE EXCLUSIVE RIGHT TO USE "ALL BARK CYPRESS MULCH", APART FROM THE MARK AS SHOWN.  
FOR MULCH (U.S. CLS. 1 AND 46).

---

SN 78-075,648. HI-TEK RATIONS, INC., DUBLIN, GA. FILED 7-25-2001.



NO CLAIM IS MADE TO THE EXCLUSIVE RIGHT TO USE "PET FOODS", APART FROM THE MARK AS SHOWN.  
FOR DOG FOOD (U.S. CLS. 1 AND 46).

**CLASS 32—LIGHT BEVERAGES**

---

SN 75-047,996. BURRELL, PETER, PETALUMA, CA. FILED 1-24-1996.

**UGLY DOG STOUT**

NO CLAIM IS MADE TO THE EXCLUSIVE RIGHT TO USE "STOUT", APART FROM THE MARK AS SHOWN.  
FOR BEER, ALE AND STOUT (U.S. CLS. 45, 46 AND 48).

**CLASS 32—(Continued).**

SN 75-330,752. ACQUA MINERALE S. BENEDETTO - S.P.A., SCORZE' (VENEZIA), ITALY, FILED 7-25-1997.



THE LINING IN THE DRAWING IS A FEATURE OF THE MARK AND IS NOT INTENDED TO INDICATE COLOR.

THE MARK "SAN BENEDETTO" MEANS "SAINT BENEDICT".

FOR AERATED MINERAL WATER; NON-AERATED MINERAL WATER; CARBONATED SOFT DRINKS; NON-CARBONATED SOFT DRINKS; SYRUPS AND PREPARATIONS FOR MAKING FRUIT DRINKS, SYRUPS AND PREPARATIONS FOR MAKING SOFT DRINKS, MALT SYRUPS FOR BEVERAGES; FRUIT JUICES; AERATED FRUIT JUICES (U.S. CLS. 45, 46 AND 48).

FIRST USE 12-31-1964; IN COMMERCE 12-31-1984.

SN 75-791,626. SOCIETE DES PRODUITS NESTLE, VEVEY 1800, SWITZERLAND, BY ASSIGNMENT SOCIETE DES PRODUITS NESTLE S.A., 1800 VEVEY, SWITZERLAND, FILED 9-3-1999.



OWNER OF U.S. REG. NOS. 1,773,804, 2,068,426 AND OTHERS.

THE LINING AND STIPPLING IS A FEATURE OF THE MARK AND DOES NOT INDICATE COLOR.

FOR SPARKLING FRUIT DRINKS (U.S. CLS. 45, 46 AND 48).

FIRST USE 4-0-1993; IN COMMERCE 4-0-1993.

SN 75-852,004. CHENG, JAMES TEE, DBA J.C. TRADING, PICO RIVERA, CA. FILED 11-18-1999.

**COCO XPRESS**

FOR COCONUT JUICE (U.S. CLS. 45, 46 AND 48).  
FIRST USE 1-0-1998; IN COMMERCE 1-0-1998.

**CLASS 32—(Continued).**

SN 75-865,264. D'LUZANSKY, PATRICK E., APACHE JUNCTION, AZ. FILED 12-17-1999.

**EMERGENCY BEER**

NO CLAIM IS MADE TO THE EXCLUSIVE RIGHT TO USE "BEER", APART FROM THE MARK AS SHOWN.

FOR BEER; BEER MAKING KITS PRIMARILY OF MALTED BARLEY OR MALTED BARLEY EXTRACT, HOPS OR HOPS EXTRACT, YEAST, AND BREWING SUPPLIES AND EQUIPMENT SOLD AS A UNIT; BEER MAKING REFILL KIT CONSISTING PRIMARILY OF MALTED BARLEY OR MALTED BARLEY EXTRACT, HOPS OR HOPS EXTRACT AND YEAST (U.S. CLS. 45, 46 AND 48).

FIRST USE 7-29-1999; IN COMMERCE 10-9-1999.

SN 76-022,846. NATURELAND BIO PRODUCTS LTD., BUR-NABY, BRITISH COLUMBIA, CANADA, FILED 4-11-2000.

**UP BEAT SENSATION**

FOR NON-ALCOHOLIC BEVERAGES CONSISTING PRIMARILY OF WATER AND FRUIT JUICES WITH HERBS; MINERAL WATER; SPORTS DRINKS; FRUIT JUICES; HERB BASED SOFT DRINKS; AND POWDERS, SYRUPS AND CONCENTRATES FOR USE IN THE PREPARATION OF SOFT DRINKS AND SPORTS DRINKS (U.S. CLS. 45, 46 AND 48).

SN 76-032,932. ACQUA & TERME FIUGGI S.P.A., FIUGGI, ITALY, FILED 4-24-2000.

**FONTI DI FIUGGI**

THE ENGLISH TRANSLATION OF THE WORD "FONTI DI FIUGGI" IN THE MARK IS "SPRINGS OF FIUGGI".

SEC. 2(F) AS TO "FIUGGI".

FOR MINERAL WATERS (U.S. CLS. 45, 46 AND 48).

FIRST USE 0-0-1915; IN COMMERCE 1-0-1969.

SN 76-036,033. BIG HOLE BREWING COMPANY, BLOOM-FIELD HILLS, MI. FILED 4-27-2000.

**BIG HOLE WISDOM CREAM ALE**

OWNER OF U.S. REG. NOS. 2,290,055 AND 2,348,132.

NO CLAIM IS MADE TO THE EXCLUSIVE RIGHT TO USE "CREAM ALE", APART FROM THE MARK AS SHOWN.

FOR ALCOHOLIC MALT BEVERAGES, NAMELY, ALE (U.S. CLS. 45, 46 AND 48).

**CLASS 32—(Continued).**

SN 76-044,640. ARBOR HILL ASSOCIATES, INC., NAPLES, NY. FILED 5-10-2000.

**BRISTOL SPRINGS**

FOR CARBONATED NATURALLY GRAPE FLAVORED DRINKING WATER (U.S. CLS. 45, 46 AND 48).

SN 76-059,246. ENERGY BRANDS, INC., WHITESTONE, NY. FILED 5-19-2000.

**GLACEAU SOY WATER**

OWNER OF U.S. REG. NOS. 1,876,824 AND 2,265,015.  
NO CLAIM IS MADE TO THE EXCLUSIVE RIGHT TO USE "SOY" AND "WATER", APART FROM THE MARK AS SHOWN.

FOR NON-ALCOHOLIC BEVERAGES, NAMELY BOTTLED DRINKING WATER CONTAINING SOY PROTEIN AND ISOFLAVONES (U.S. CLS. 45, 46 AND 48).  
FIRST USE 11-19-1999; IN COMMERCE 11-19-1999.

SN 76-084,546. BOSTON BEER CORPORATION, BOSTON, MA. BY ASSIGNMENT BOSTON BEER COMPANY LIMITED PARTNERSHIP, DBA THE BOSTON BEER COMPANY, BOSTON, MA. FILED 7-7-2000.



NO CLAIM IS MADE TO THE EXCLUSIVE RIGHT TO USE "THE WORLD'S MOST AWARD WINNING BEER", APART FROM THE MARK AS SHOWN.

FOR BEVERAGES, NAMELY BEER AND ALE (U.S. CLS. 45, 46 AND 48).  
FIRST USE 1-27-2000; IN COMMERCE 1-27-2000.

SN 76-096,410. 635443 ONTARIO LIMITED, TORONTO, ONTARIO, M6E 1B5, CANADA, FILED 7-26-2000.

**ARTESIAN ARCTIC SIFON**

NO CLAIM IS MADE TO THE EXCLUSIVE RIGHT TO USE "ARTESIAN", APART FROM THE MARK AS SHOWN.  
FOR BOTTLED WATER, MINERAL WATER, CARBONATED WATER (U.S. CLS. 45, 46 AND 48).

**CLASS 32—(Continued).**

SN 76-121,677. FRANCESCA ENTERPRISES, LLC, CRANSTON, RI. FILED 9-5-2000.

**DEL'S ORIGINAL DOUBLE BARREL HARD LEMONADE**

NO CLAIM IS MADE TO THE EXCLUSIVE RIGHT TO USE "ORIGINAL" AND "HARD LEMONADE", APART FROM THE MARK AS SHOWN.

FOR ALCOHOLIC MALT-BASED BEVERAGE, NAMELY, BEER (U.S. CLS. 45, 46 AND 48).  
FIRST USE 7-1-2000; IN COMMERCE 7-1-2000.

SN 76-121,679. FRANCESCA ENTERPRISES, LLC, CRANSTON, RI. FILED 9-5-2000.



NO CLAIM IS MADE TO THE EXCLUSIVE RIGHT TO USE "ORIGINAL" AND "HARD LEMONADE", APART FROM THE MARK AS SHOWN.

FOR ALCOHOLIC MALT-BASED BEVERAGE, NAMELY, BEER (U.S. CLS. 45, 46 AND 48).  
FIRST USE 7-1-2000; IN COMMERCE 7-1-2000.

SN 76-149,112. ANHEUSER-BUSCH, INCORPORATED, ST. LOUIS, MO. FILED 10-17-2000.

**"DOC" OTIS**

THE NAME "DOC" OTIS" DOES NOT IDENTIFY A LIVING INDIVIDUAL.

FOR MALT BEVERAGE IN THE NATURE OF FLAVORED BEER (U.S. CLS. 45, 46 AND 48).  
FIRST USE 4-30-2000; IN COMMERCE 4-30-2000.

**CLASS 32—(Continued).**

SN 76-191,519. RELIANCE ENTERPRISES (USA) CORP.,  
ARCADIA, CA. FILED 1-10-2001.



THE MARK CONSISTS OF TWO RED CHINESE CHARACTERS.

THE NON-LATIN CHARACTERS IN THE MARK TRANSLITERATE TO "TUNG SHUN", AND THIS MEANS "TOGETHER WE LIVE SMOOTHLY AND SUCCESSFULLY" IN ENGLISH.

FOR NON-CARBONATED NON-ALCOHOLIC FRUITS AND VEGETABLES JUICE DRINKS (U.S. CLS. 45, 46 AND 48).

SN 76-247,415. LONG ISLAND LEMONADE COMPANY,  
INC., DIX HILLS, NY. FILED 4-27-2001.

**PINK PARADISE**

NO CLAIM IS MADE TO THE EXCLUSIVE RIGHT TO USE "PINK", APART FROM THE MARK AS SHOWN.

FOR NON-ALCOHOLIC BEVERAGES, NAMELY LEMONADE AND SOFT DRINKS; CARBONATED AND NON-CARBONATED BEVERAGES WITH ADDITIONAL FLAVORS, NAMELY LEMON, LIME AND PINK GRAPEFRUIT (U.S. CLS. 45, 46 AND 48).

SN 76-247,416. LONG ISLAND LEMONADE COMPANY,  
INC., DIX HILLS, NY. FILED 4-27-2001.

**RASPBERRY REEF**

NO CLAIM IS MADE TO THE EXCLUSIVE RIGHT TO USE "RASPBERRY", APART FROM THE MARK AS SHOWN.

FOR NON-ALCOHOLIC BEVERAGES, NAMELY LEMONADE AND SOFT DRINKS; CARBONATED AND NON-CARBONATED BEVERAGES WITH ADDITIONAL FLAVORS, NAMELY LEMON, LIME AND RASPBERRY (U.S. CLS. 45, 46 AND 48).

SN 76-298,794. APPLE & EVE, LLC, PORT WASHINGTON,  
NY. FILED 8-13-2001.

**WATERFRUITS**

FOR FLAVORED WATER BEVERAGES (U.S. CLS. 45, 46 AND 48).

**CLASS 32—(Continued).**

SN 76-313,370. SAVOR THE WILD MARKETING, LLC,  
VINELAND, NJ. FILED 9-14-2001.

**SAVOR THE WILD**

OWNER OF U.S. REG. NO. 1,584,982.

FOR BEER; ALE; SOFT DRINKS AND SYRUPS AND CONCENTRATES FOR THE PREPARATION THEREOF; FRUIT DRINKS AND FRUIT JUICES AND SYRUPS AND CONCENTRATES FOR THE PREPARATION THEREOF (U.S. CLS. 45, 46 AND 48).

SN 78-056,426. KANG, JOHN M., MANHASSET, NY. FILED  
4-2-2001.

**CELADON**

FOR FRUIT-FLAVORED SODA WATER, SODA WATER, MINERAL WATER, PINEAPPLE JUICE, ORANGE JUICE, LEMONADE, SWEET CIDER, GRAPE JUICE, BEER, AND COLA (U.S. CLS. 45, 46 AND 48).  
FIRST USE 3-27-2001; IN COMMERCE 3-27-2001.

SN 78-082,661. TROPICANA PRODUCTS, INC., BRADENTON,  
FL. FILED 9-5-2001.



OWNER OF U.S. REG. NOS. 617,968, 2,229,933 AND OTHERS.

NO CLAIM IS MADE TO THE EXCLUSIVE RIGHT TO USE "HEALTHY IMMUNE SYSTEM", APART FROM THE MARK AS SHOWN.

SEC. 2(F) AS TO "PURE PREMIUM".

FOR FRUIT JUICE AND FRUIT JUICE DRINKS (U.S. CLS. 45, 46 AND 48).

SN 78-083,642. PEPSICO, INC., PURCHASE, NY. FILED 9-12-  
2001.

**ATREVIDAMENTE  
REFRESCANTE**

THE FOREIGN WORDING IN THE MARK TRANSLATES INTO ENGLISH AS "SHOCKINGLY REFRESHING".  
FOR SOFT DRINKS (U.S. CLS. 45, 46 AND 48).

**CLASS 32—(Continued).**

SN 78-084,421. TROPICANA PRODUCTS, INC., BRADENTON, FL. FILED 9-18-2001.

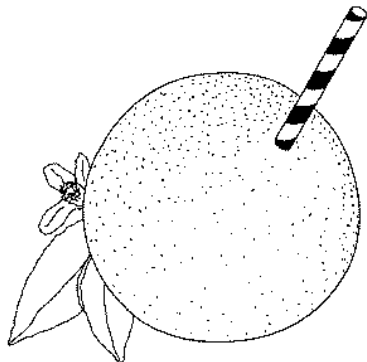

OWNER OF U.S. REG. NO. 1,742,463.  
THE STIPPLING IS A FEATURE OF THE MARK.  
FOR FRUIT JUICE AND FRUIT JUICE DRINKS (U.S. CLS. 45, 46 AND 48).

---

SN 78-084,726. TROPICANA PRODUCTS, INC., BRADENTON, FL. FILED 9-20-2001.

**MANGO TANGERINE  
MAMBO**

NO CLAIM IS MADE TO THE EXCLUSIVE RIGHT TO USE "MANGO TANGERINE", APART FROM THE MARK AS SHOWN.  
FOR FRUIT JUICE AND FRUIT JUICE DRINKS (U.S. CLS. 45, 46 AND 48).

---

SN 78-085,419. PEPSICO, INC., PURCHASE, NY. FILED 9-25-2001.

**WELLSOURCE**

FOR FRUIT-FLAVORED CARBONATED OR NON-CARBONATED DRINKING WATER (U.S. CLS. 45, 46 AND 48).

---

SN 78-085,486. TROPICANA PRODUCTS, INC., BRADENTON, FL. FILED 9-25-2001.

**RUBY RED TANGERINE  
EXTREME**

NO CLAIM IS MADE TO THE EXCLUSIVE RIGHT TO USE "RUBY RED TANGERINE", APART FROM THE MARK AS SHOWN.  
FOR FRUIT JUICE AND FRUIT JUICE DRINKS (U.S. CLS. 45, 46 AND 48).

**CLASS 32—(Continued).**

SN 78-086,533. MUSCLE MARKETING U.S.A., INC., WEST VANCOUVER, BRITISH COLUMBIA, FILED 10-2-2001.

**TIGER'S LEAP**

FOR SPORTS DRINKS AND PREPARATIONS FOR MAKING THE SAME (U.S. CLS. 45, 46 AND 48).

---

SN 78-086,546. MUSCLE MARKETING U.S.A., INC., WEST VANCOUVER, BRITISH COLUMBIA, CANADA, FILED 10-2-2001.

**SECURATINE**

FOR SPORTS DRINKS AND PREPARATIONS FOR MAKING THE SAME (U.S. CLS. 45, 46 AND 48).

---

SN 78-086,768. PEPSICO, INC., PURCHASE, NY. FILED 10-3-2001.

**TOTAL-ACCESS. THE  
ULTIMATE RACING  
EXPERIENCE.**

FOR SOFT DRINKS (U.S. CLS. 45, 46 AND 48).

---

**CLASS 33—WINES AND SPIRITS**

SN 75-638,529. A A FERREIRA S A, 19 VILA NOVA DE GAIA, PORTUGAL, FILED 2-11-1999.

**FERREIRA PORT**

PRIORITY CLAIMED UNDER SEC. 44(D) ON ERPNTY TM OFC APPLICATION NO. 1045111, FILED 1-19-1999, REG. NO. 1045111, DATED 3-6-2000, EXPIRES 3-6-2010.  
NO CLAIM IS MADE TO THE EXCLUSIVE RIGHT TO USE "PORT", APART FROM THE MARK AS SHOWN.  
FOR PORT WINE (U.S. CLS. 47 AND 49).

**CLASS 33—(Continued).**

SN 75-769,861. LUCTOR INTERNATIONAL, L.L.C., RENO, NV. FILED 8-6-1999.



THE MARK CONSISTS OF A BOTTLE THAT CONTAINS THE GOODS IN A STYLIZED SHAPE BOTTLE, HAVING THE CONFIGURATION AS SHOWN IN THE DRAWING. THE STIPPLING IN THE MARK LOCATED AT THE TOP OF THE BOTTLE REPRESENTS THE COLOR RED. THE STIPPLING LOCATED AT THE BOTTOM OF THE BOTTLE REPRESENTS THE COLOR BLUE.

FOR ALCOHOLIC BEVERAGES, NAMELY, GIN AND VODKA (U.S. CLS. 47 AND 49).

SN 75-777,255. FRANCESCO CINZANO CIA S.P.A., 20121 MILANO, ITALY, FILED 8-17-1999.

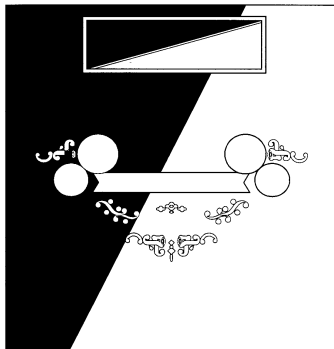

FOR WINES, DISTILLED SPIRITS AND LIQUEURS (U.S. CLS. 47 AND 49).

**CLASS 33—(Continued).**

SN 75-803,706. MORRISON BOWMORE DISTILLERS LIMITED, GLASGOW G21 1EQ, UNITED KINGDOM, FILED 9-17-1999.



NO CLAIM IS MADE TO THE EXCLUSIVE RIGHT TO USE "FINEST BLENDED SCOTCH WHISKY" AND "ROB ROY", APART FROM THE MARK AS SHOWN.

THE LINING SHOWN IN THE TRADEMARK IS A FEATURE OF THE MARK, AND NO CLAIM IS MADE TO COLOR.

FOR ALCOHOLIC BEVERAGES, NAMELY, SCOTCH WHISKY (U.S. CLS. 47 AND 49).

SN 75-854,250. CANTINE RIONDO S.P.A., 37032 MONTEFORTE D'ALPONE (VR), ITALY, BY CHANGE OF NAME DAREG S.P.A., 37032 MONTEFORTE D'ALPONE (VR), ITALY, FILED 11-19-1999.

**RIONDO**

FOR WINES, SPARKLING WINES, PREPARED ALCOHOLIC COCKTAILS AND WINE BASED ALCOHOLIC FLAVORED BEVERAGES (U.S. CLS. 47 AND 49).

SN 75-862,460. S SMITH & SON PTY LTD, ANGASTON, SOUTH AUSTRALIA, AUSTRALIA, FILED 12-2-1999.

**YALUMBA ANTIQUE TAWNY**

OWNER OF U.S. REG. NO. 2,259,268. NO CLAIM IS MADE TO THE EXCLUSIVE RIGHT TO USE "TAWNY", APART FROM THE MARK AS SHOWN.

THE ENGLISH TRANSLATION OF "YALUMBA" IS "ALL THE LAND AROUND".

FOR FORTIFIED WINES (U.S. CLS. 47 AND 49). FIRST USE 10-0-1994; IN COMMERCE 9-0-1997.

SN 75-876,709. CANTINA SOCIALE COOPERATIVA DI LOCOROTONDO SOCIETA COOPERATIVA A RESPONSABILITA LIMITATA, LOCOROTONDO (BARI), ITALY, FILED 12-22-1999.

**TERRE DI DON PEPPE**

THE MARK DOES NOT IDENTIFY A PARTICULAR LIVING INDIVIDUAL.

THE ENGLISH TRANSLATION OF "TERRE DI DON PEPPE" IS "LANDS OF DON PEPPE".

FOR WINES, SPARKLING WINES AND DISTILLED SPIRITS MADE FROM GRAPES (U.S. CLS. 47 AND 49). FIRST USE 4-0-1999; IN COMMERCE 11-0-1999.



**CLASS 33—(Continued).**

SN 75-877,338. S.A. BODEGAS Y VINEDOS SANTIAGO GRAFFIGNA LIMITADA, PROVINCE OF BUENOS AIRES, ARGENTINA, FILED 12-22-1999.

**TULUM VINEYARDS**

NO CLAIM IS MADE TO THE EXCLUSIVE RIGHT TO USE "VINEYARDS", APART FROM THE MARK AS SHOWN.  
FOR WINES (U.S. CLS. 47 AND 49).

SN 75-887,587. STIMSON LANE LTD., WOODINVILLE, WA. FILED 1-5-2000.

**DOMAINE MICHELLE**

OWNER OF U.S. REG. NOS. 1,268,141 AND 1,493,432.  
NO CLAIM IS MADE TO THE EXCLUSIVE RIGHT TO USE "DOMAINE", APART FROM THE MARK AS SHOWN.  
THE ENGLISH TRANSLATION OF "DOMAINE MICHELLE" IS "MICHELLE ESTATE".  
FOR SPARKLING WINE (U.S. CLS. 47 AND 49).

SN 76-007,905. SCHIEFFELIN & CO., NEW YORK, NY. FILED 3-23-2000.

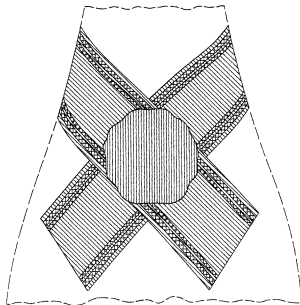

THE MARK IS LINED FOR COLORS GREEN, RED AND GOLD, BUT COLOR IS NOT CLAIMED AS A FEATURE OF THE MARK.  
THE MARK REPRESENTS A BOTTLENECK LABEL.  
FOR CHAMPAGNE (U.S. CLS. 47 AND 49).

SN 76-057,969. LA RURAL VINEDOS Y BODEGAS S.A.L.T.D.A., MAIPU, PROVINCE OF MENDOZA, ARGENTINA, FILED 5-26-2000.

**FELIPE RUTINI**

OWNER OF U.S. REG. NO. 2,040,149.  
THE NAME "FELIPE RUTINI" IN THE MARK DOES NOT IDENTIFY A LIVING INDIVIDUAL.  
FOR WINES (U.S. CLS. 47 AND 49).

**CLASS 33—(Continued).**

SN 76-083,333. DU TOIT, STEPHAN FRANCOIS, JOHANNESBURG, SOUTH AFRICA, FILED 7-5-2000.

**HAWEQUAS**

FOR ALCOHOLIC BEVERAGES, NAMELY, WINES (EXCEPT BEERS) (U.S. CLS. 47 AND 49).

SN 76-099,163. AMERIVINE, INC., SANTA ROSA, CA. FILED 7-28-2000.

**COLD WATER CREEK**

FOR WINE (U.S. CLS. 47 AND 49).  
FIRST USE 0-0-1998; IN COMMERCE 0-0-1998.

SN 76-105,661. GAVIDIA, ARMANDO ANTONIO, PROVINCIA DE BUENOS AIRES, ARGENTINA, FILED 8-9-2000.

**PATAGON**

FOR WINES, (U.S. CLS. 47 AND 49).

SN 76-121,821. TIERS WINE CO (AUST) PTY LTD, THE, SOUTH AUSTRALIA 5171, AUSTRALIA, FILED 9-5-2000.

**RIVERS LANE**

OWNER OF AUSTRALIA REG. NO. 775555, DATED 10-14-1998, EXPIRES 10-14-2008.  
FOR WINES (U.S. CLS. 47 AND 49).

SN 76-122,535. LA COSTA COMPANY LP, THE, ROCKVILLE, MD. FILED 9-5-2000.

**THE LA COSTA SPA**

THE ENGLISH TRANSLATION OF THE WORD "LA COSTA" IN THE MARK IS "THE COAST".  
FOR ALCOHOLIC BEVERAGES, NAMELY, WINES (U.S. CLS. 47 AND 49).

**CLASS 33—(Continued).**

SN 76-140,065. CASTELLI DEL GREVEPESA CANTINA SOCIALE SOC.COOP.A.R.L., FIRENZE, ITALY, FILED 10-3-2000.

**TERRAMARA**

THE MEANING OF THE WORD TERRAMARA IS "TERRA" MEANING "LAND" AND "AMARA" MEANING BITTER.

FOR WINES, SPARKLING WINES (U.S. CLS. 47 AND 49).

SN 76-157,130. FRANCESCO SCRIMAGLIO S.N.C., 14049 NIZZA MONFERRATO, ASTI, ITALY, FILED 10-31-2000.

**SCRIMAGLIO**

FOR WINES (U.S. CLS. 47 AND 49).  
FIRST USE 3-0-1998; IN COMMERCE 5-0-1999.

SN 76-188,731. AFFINITY BEVERAGES, INC., WESTPORT, CT. FILED 1-2-2001.

**CAPTAIN DARK'S STORMY  
BREW**

NO CLAIM IS MADE TO THE EXCLUSIVE RIGHT TO USE "BREW", APART FROM THE MARK AS SHOWN.

FOR ALCOHOLIC BEVERAGE PRODUCED FROM A BREWED MALT BASE WITH NATURAL FLAVORS (U.S. CLS. 47 AND 49).

SN 76-188,752. SOUTH BAY WINE GROUP, PALOS VERDES ESTATES, CA. FILED 1-2-2001.

**CASTLE ROCK**

FOR WINES (U.S. CLS. 47 AND 49).  
FIRST USE 0-0-1994; IN COMMERCE 12-0-1994.

**CLASS 33—(Continued).**

SN 76-189,725. GBL INTERNATIONAL LTD., DERBYSHIRE S45 9NF, ENGLAND, FILED 1-4-2001.

**V ICE**

FOR WINES; DISTILLED SPIRITS; PREPARED ALCOHOLIC COCKTAILS; ALCOHOLIC BEVERAGES, NAMELY VODKA AND PINEAPPLE, VODKA AND WATERMELON, VODKA AND LEMON, VODKA AND LIME, VODKA AND BLACKCURRANT, VODKA AND ORANGE; ALCOHOLIC BEVERAGES CONTAINING FRUIT EXTRACTS (U.S. CLS. 47 AND 49).

SN 76-215,151. GABRIEL MEFFRE - GRANDS VINS DE GIGONDAS - AUGUSTE CHAUVET, 84190 BEAUME DE VENISE, FRANCE, FILED 2-26-2001.

**WILD PIG**

FOR ALCOHOLIC BEVERAGES, NAMELY, WINE (U.S. CLS. 47 AND 49).  
FIRST USE 0-0-1995; IN COMMERCE 0-0-1997.

SN 76-261,192. DE LOACH VINEYARDS, INC., SANTA ROSA, CA. FILED 5-23-2001.

**FLAGSTAFF VINEYARDS &  
WINERY**

NO CLAIM IS MADE TO THE EXCLUSIVE RIGHT TO USE "VINEYARDS & WINERY", APART FROM THE MARK AS SHOWN.

FOR WINE (U.S. CLS. 47 AND 49).

SN 76-283,410. VINA QUEBRADA DE MACUL S.A., SANTIAGO, CHILE, FILED 7-11-2001.

**STELLA AUREA**

OWNER OF U.S. REG. NO. 2,406,609.  
THE ENGLISH TRANSLATION OF "STELLA AUREA" IS "GOLDEN STAR".  
FOR WINES (U.S. CLS. 47 AND 49).

SN 76-283,427. VINA QUEBRADA DE MACUL S.A., SANTIAGO, CHILE, FILED 7-11-2001.

**CASA ALBA**

THE ENGLISH TRANSLATION OF "CASA ALBA" IS "DAWN HOUSE".  
FOR WINES (U.S. CLS. 47 AND 49).

**CLASS 33—(Continued).**

SN 78-048,735. E. & J. GALLO WINERY, MODESTO, CA.  
FILED 2-16-2001.

**MARCELLO**

OWNER OF U.S. REG. NOS. 2,135,078 AND 2,182,555.  
FOR WINES (U.S. CLS. 47 AND 49).

**CLASS 34—SMOKERS' ARTICLES**

SN 76-094,113. CHABA-CHARUTOS DA BAHIA LTDA.,  
48000-000, ALAGOINHAS, BAHIA, BRAZIL, FILED 7-21-  
2000.



NO CLAIM IS MADE TO THE EXCLUSIVE RIGHT TO  
USE "BRASIL AUTENTICOS", "BAHIA" AND THE GEO-  
GRAPHIC OUTLINE OF THE COUNTRY OF BRAZIL,  
APART FROM THE MARK AS SHOWN.

THE WORD "AUTENTICOS" MEANS "AUTHENTIC" IN  
ENGLISH.

FOR CIGARS AND CIGARILLOS (U.S. CLS. 2, 8, 9  
AND 17).

SN 76-133,632. NICKS CIGAR COMPANY, MIAMI, FL.  
FILED 9-18-2000.

**INMENSO**

THE ENGLISH TRANSLATION OF THE WORD "INMEN-  
SO" IN THE MARK IS "IMMENSE".

FOR CIGARS (U.S. CLS. 2, 8, 9 AND 17).

FIRST USE 8-1-1998; IN COMMERCE 8-1-1998.

SN 76-307,793. TWINKLE, INC., DEKALB, IL. FILED 8-31-  
2001.

**TWINKLE**

FOR CLOVE CIGARETTES (U.S. CLS. 2, 8, 9 AND 17).

**CLASS 34—(Continued).**

SN 78-064,077. MARY MILVIA CORPORATION, MIAMI, FL.  
FILED 5-17-2001.

**LOBO CIGARETTES &  
TOBACCO PRODUCTS**

NO CLAIM IS MADE TO THE EXCLUSIVE RIGHT TO  
USE "CIGARETTE & TOBACCO PRODUCTS", APART  
FROM THE MARK AS SHOWN.

FOR CIGARETTES (U.S. CLS. 2, 8, 9 AND 17).

SN 78-077,282. BENGAL TOBACCO CORPORATION, DAVIE,  
FL. FILED 8-3-2001.

**PARK CIGARETTE**

NO CLAIM IS MADE TO THE EXCLUSIVE RIGHT TO  
USE "CIGARETTE", APART FROM THE MARK AS  
SHOWN.

FOR CIGARETTES (U.S. CLS. 2, 8, 9 AND 17).

**SERVICE MARKS****CLASS 35—ADVERTISING AND BUSINESS**

SN 75-420,429. HAQ, NADEEM, ARLINGTON HEIGHTS, IL.  
FILED 1-20-1998.

**IAMUSA IN 2000**

OWNER OF U.S. REG. NO. 2,090,004.

NO CLAIM IS MADE TO THE EXCLUSIVE RIGHT TO  
USE "IN 2000", APART FROM THE MARK AS SHOWN.

FOR RETAIL STORE SERVICES AND WHOLESALE  
DISTRIBUTORSHIPS IN THE FIELD OF CLOTHING  
AND HEADWEAR, NAMELY, SHIRTS, T-SHIRTS, POLO  
SHIRTS, SWEATSHIRTS, HOODED SWEATSHIRTS,  
SHORTS, SWEATPANTS, CAPS, SWEATERS AND JACK-  
ETS (U.S. CLS. 100, 101 AND 102).

**CLASS 35—(Continued).**

SN 75-545,233. TOURNEAU INC., NEW YORK, NY. FILED 8-31-1998.



OWNER OF U.S. REG. NOS. 519,550, 2,139,714 AND OTHERS.

NO CLAIM IS MADE TO THE EXCLUSIVE RIGHT TO USE "CERTIFIED" AND "PRE-OWNED", APART FROM THE MARK AS SHOWN.

FOR DISTRIBUTORSHIP SERVICES IN THE FIELD OF WATCHES (U.S. CLS. 100, 101 AND 102).

FIRST USE 4-0-1997; IN COMMERCE 4-0-1997.

SN 75-623,801. WHITE HOUSE, INC., THE, BALTIMORE, MD. FILED 1-14-1999.

## WHITE HOUSE BLACK MARKET

OWNER OF U.S. REG. NOS. 1,518,965, 2,047,169 AND 2,443,749.

FOR RETAIL STORE SERVICES IN THE FIELD OF CLOTHING, CHINA, BAGS, BELTS, HAIR ACCESSORIES, AND HOUSEWARES (U.S. CLS. 100, 101 AND 102).

FIRST USE 8-0-1997; IN COMMERCE 8-0-1997.

SN 75-632,000. NORSTAN, INC., MINNETONKA, MN. FILED 2-1-1999.



NO CLAIM IS MADE TO THE EXCLUSIVE RIGHT TO USE "CONSULTING", APART FROM THE MARK AS SHOWN.

FOR BUSINESS CONSULTING SERVICES FEATURING STRATEGIC ADVICE, ELECTRONIC COMMERCE, ENTERPRISE RELATIONSHIP MANAGEMENT, ENTERPRISE RESOURCE PLANNING AND INFRASTRUCTURE CONSULTING (U.S. CLS. 100, 101 AND 102).

**CLASS 35—(Continued).**

SN 75-634,945. FOURTH PHASE - PDA INC., THE, SAN FRANCISCO, CA. FILED 2-3-1999.

## GO MOBILE

NO CLAIM IS MADE TO THE EXCLUSIVE RIGHT TO USE "MOBILE", APART FROM THE MARK AS SHOWN.

FOR ARRANGING AND CONDUCTING TRADE SHOW EXHIBITIONS IN THE FIELD OF MOBILE DATA TECHNOLOGY, NAMELY PRESENTING DEMONSTRATIONS, PRESENTATIONS CONCERNING TRENDS IN MOBILE DATA TECHNOLOGY (U.S. CLS. 100, 101 AND 102).

FIRST USE 10-15-1996; IN COMMERCE 10-18-1996.

SN 75-676,805. EDUCATIONAL DIRECTORIES UNLIMITED, INC., ASTON, PA. BY CHANGE OF NAME LIBERTY CITY PROMOTIONS, INC., ASTON, PA. FILED 4-7-1999.

## GRADSCHOOLS.COM

SEC. 2(F).

FOR PROVIDING AN ON-LINE COMPUTER DATABASE CONTAINING DIRECTORIES PERTAINING TO EDUCATION AND EDUCATIONAL PROGRAMS (U.S. CLS. 100, 101 AND 102).

FIRST USE 7-0-1995; IN COMMERCE 9-0-1995.

SN 75-690,754. GREAT ATLANTIC & PACIFIC COMPANY OF CANADA, LIMITED, THE, TORONTO, ONTARIO, M5W 1A6, CANADA, FILED 4-26-1999.

## WE'RE SERVICE OBSESSED

PRIORITY CLAIMED UNDER SEC. 44(D) ON CANADA APPLICATION NO. 894510, FILED 10-26-1998, REG. NO. TMA541353, DATED 2-20-2001, EXPIRES 2-20-2016.

FOR SUPERMARKET AND RETAIL GROCERY STORE SERVICES (U.S. CLS. 100, 101 AND 102).

SN 75-690,756. GREAT ATLANTIC & PACIFIC COMPANY OF CANADA, LIMITED, THE, TORONTO, ONTARIO, M5W 1A6, CANADA, FILED 4-26-1999.

## WE'RE TASTE OBSESSED

PRIORITY CLAIMED UNDER SEC. 44(D) ON CANADA APPLICATION NO. 894,513, FILED 10-26-1998, REG. NO. TMA541355, DATED 2-20-2001, EXPIRES 2-20-2016.

FOR SUPERMARKET AND RETAIL GROCERY STORE SERVICES (U.S. CLS. 100, 101 AND 102).

**CLASS 35—(Continued).**

SN 75-690,757. GREAT ATLANTIC & PACIFIC COMPANY OF CANADA, LIMITED, THE, TORONTO, ONTARIO, M5W 1A6, CANADA, FILED 4-26-1999.

**WE'RE QUALITY OBSESSED**

PRIORITY CLAIMED UNDER SEC. 44(D) ON CANADA APPLICATION NO. 894517, FILED 10-26-1998, REG. NO. TMA541359, DATED 2-20-2001, EXPIRES 2-20-2016.  
FOR SUPERMARKET AND RETAIL GROCERY STORE SERVICES (U.S. CLS. 100, 101 AND 102).

SN 75-690,758. GREAT ATLANTIC & PACIFIC COMPANY OF CANADA, LIMITED, THE, TORONTO, ONTARIO, MSW 1A6, CANADA, FILED 4-26-1999.

**WE'RE BULK OBSESSED**

PRIORITY CLAIMED UNDER SEC. 44(D) ON CANADA APPLICATION NO. 894518, FILED 10-26-1998, REG. NO. TMA541358, DATED 2-20-2001, EXPIRES 2-20-2016.  
FOR SUPERMARKET AND RETAIL GROCERY STORE SERVICES (U.S. CLS. 100, 101 AND 102).

SN 75-690,760. GREAT ATLANTIC & PACIFIC COMPANY OF CANADA, LIMITED, THE, TORONTO, ONTARIO, M5W 1A6, CANADA, FILED 4-26-1999.

**WE'RE BREAKFAST OBSESSED**

PRIORITY CLAIMED UNDER SEC. 44(D) ON CANADA APPLICATION NO. 894519, FILED 10-26-1998, REG. NO. TMA541357, DATED 2-20-2001, EXPIRES 2-20-2016.  
FOR SUPERMARKET AND RETAIL GROCERY STORE SERVICES (U.S. CLS. 100, 101 AND 102).

SN 75-690,762. GREAT ATLANTIC & PACIFIC COMPANY OF CANADA, LIMITED, THE, TORONTO, ONTARIO, M5W 1A6, CANADA, FILED 4-26-1999.

**WE'RE HOLIDAY OBSESSED**

PRIORITY CLAIMED UNDER SEC. 44(D) ON CANADA APPLICATION NO. 894509, FILED 10-26-1998, REG. NO. TMA541315, DATED 2-19-2001, EXPIRES 2-19-2016.  
FOR SUPERMARKET AND RETAIL GROCERY STORE SERVICES (U.S. CLS. 100, 101 AND 102).

**CLASS 35—(Continued).**

SN 75-729,516. MULTEX.COM, INC., NEW YORK, NY. FILED 6-15-1999.



FOR ON-LINE ORDERING SERVICES FEATURING INVESTMENT RESEARCH REPORTS AND RELATED FINANCIAL AND BUSINESS RESEARCH DOCUMENTS IN THE FIELDS OF FINANCIAL RESEARCH AND FINANCIAL INVESTMENT, VIA A WEBSITE ON THE GLOBAL COMPUTER NETWORK (U.S. CLS. 100, 101 AND 102).

FIRST USE 5-6-1999; IN COMMERCE 5-6-1999.

SN 75-746,396. E & H DISTRIBUTING CO., NORTH LAS VEGAS, NV. FILED 7-8-1999.

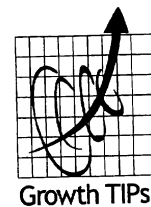

NO CLAIM IS MADE TO THE EXCLUSIVE RIGHT TO USE "GROWTH", APART FROM THE MARK AS SHOWN.

FOR BUSINESS MANAGEMENT CONSULTATION IN THE RETAIL AND FOOD SERVICE INDUSTRIES (U.S. CLS. 100, 101 AND 102).

FIRST USE 8-17-1999; IN COMMERCE 8-17-1999.

SN 75-752,304. FIGI'S INC., MARSHFIELD, WI. FILED 7-15-1999.

**MAPLE STREET PETS**

OWNER OF U.S. REG. NO. 2,269,648.

NO CLAIM IS MADE TO THE EXCLUSIVE RIGHT TO USE "PETS", APART FROM THE MARK AS SHOWN.

FOR ON-LINE RETAIL STORE SERVICES, ON-LINE ORDERING SERVICES, AND MAIL ORDER AND CATALOG SERVICES IN THE FIELD OF PET FOOD, PET TOYS, AND PET RELATED ITEMS (U.S. CLS. 100, 101 AND 102).

**CLASS 35—(Continued).**

SN 75-772,393. GEOFFREY, INC., WILMINGTON, DE.  
FILED 8-10-1999.

**BABIESRUS.COM**

OWNER OF U.S. REG. NOS. 1,995,300, 2,078,910 AND OTHERS.

FOR ON-LINE RETAIL STORE AND RETAIL STORE SERVICES FEATURING PRODUCTS RANGING FROM BOOKS, CASSETTES, VIDEOS, TAPE RECORDERS, MONITORS, HUMIDIFIERS, VAPORIZERS, LAUNDRY DETERGENT, FOOD, UTENSILS AND ACCESSORIES, DIAPERS, MEDICINE, SKIN AND HAIR CARE PRODUCTS, BEDDING, GATES, SAFETY NIGHT LIGHTS, REAR VIEW MIRROR ATTACHMENTS, CAR SEATS, STROLLERS, FURNITURE, CLOTHING AND TOYS, AND AN ON-LINE GIFT REGISTRY AND INFORMATION RESOURCES (U.S. CLS. 100, 101 AND 102).

SN 75-806,236. LATINFOCUS S.L., 08010 BARCELONA, SPAIN, FILED 9-23-1999.

LATIN  
FOCUS

FOR BUSINESS CONSULTATION AND INFORMATION SERVICES CONCERNING ECONOMIC, POLITICAL AND FINANCIAL DEVELOPMENTS AND CONDITIONS IN LATIN AMERICA (U.S. CLS. 100, 101 AND 102).

FIRST USE 1-1-1999; IN COMMERCE 1-1-1999.

SN 75-812,385. AGREVO USA COMPANY, WILMINGTON, DE. FILED 9-30-1999.

**VIRTUAL PAK**

NO CLAIM IS MADE TO THE EXCLUSIVE RIGHT TO USE "PAK", APART FROM THE MARK AS SHOWN.

FOR PROMOTIONAL BUSINESS MARKETING SERVICES FEATURING REBATE PROGRAMS; PROMOTIONAL BUSINESS MARKETING SERVICES PROMOTING THE SALE OF GOODS (U.S. CLS. 100, 101 AND 102).

SN 75-826,204. LAX, MOSHE, BROOKLYN, NY. FILED 10-18-1999.

**GIFTED TRADER**

NO CLAIM IS MADE TO THE EXCLUSIVE RIGHT TO USE "TRADER", APART FROM THE MARK AS SHOWN.

FOR PROMOTING THE GOODS AND SERVICES OF OTHERS THROUGH THE ADMINISTRATION OF INCENTIVE AWARDS PROGRAMS, NAMELY, AWARDS, INCENTIVES AND PRIZES IN THE NATURE OF CASH AWARDS OFFERED TO DAY STOCK TRADERS VIA A GLOBAL COMPUTER NETWORK (U.S. CLS. 100, 101 AND 102).

**CLASS 35—(Continued).**

SN 75-833,328. VAYOO.COM CORP., MONROEVILLE, PA.  
FILED 10-27-1999.

**YOU CLICK. WE LICK.**

FOR COMPUTERIZED ONLINE RETAIL SERVICES FEATURING A WIDE VARIETY OF CONSUMER GOODS AND CASH GIFTS AND GIFT CERTIFICATES (U.S. CLS. 100, 101 AND 102).

SN 75-848,773. MILEPOINT, LLC, EDINA, MN. FILED 11-15-1999.

**MILEPOINT MONEY**

NO CLAIM IS MADE TO THE EXCLUSIVE RIGHT TO USE "MILEPOINT", APART FROM THE MARK AS SHOWN.

FOR PROMOTING THE GOODS AND SERVICES OF OTHERS BY MANAGING FREQUENT Flier MILES CONVERTING FREQUENT Flier MILES INTO A CURRENCY AND REDEEMING SUCH FREQUENT Flier MILES VIA THE CURRENCY; MAIL ORDER CATALOG SERVICES FEATURING CLOTHING, SHOES, COSMETICS, LUGGAGE, HARDWARE, TOOLS, POWER EQUIPMENT, KITCHEN EQUIPMENT, AUTOMOTIVE PARTS, PAINT, JEWELRY, PRINTED PUBLICATIONS AND FURNITURE; ON-LINE ORDER SERVICES FEATURING CLOTHING, SHOES, COSMETICS, LUGGAGE, HARDWARE, TOOLS, POWER EQUIPMENT, KITCHEN EQUIPMENT, AUTOMOTIVE PARTS, PAINT, JEWELRY, PRINTED PUBLICATIONS AND FURNITURE (U.S. CLS. 100, 101 AND 102).

SN 75-874,559. AMN HEALTHCARE, INC., SAN DIEGO, CA.  
FILED 12-18-1999.

AMERICAN MOBILE

OWNER OF U.S. REG. NOS. 2,177,670, 2,408,683 AND OTHERS.

THE LINING SHOWN IN THE DRAWING IS A FEATURE OF THE MARK AND IS NOT INTENDED TO INDICATE COLOR.

SEC. 2(F).

FOR PERSONNEL, PLACEMENT AND RECRUITMENT SERVICES FOR THE HEALTH CARE INDUSTRY; EMPLOYMENT AGENCY SERVICES FOR THE HEALTH CARE INDUSTRY; AND TEMPORARY STAFFING SERVICES FOR THE HEALTH CARE INDUSTRY (U.S. CLS. 100, 101 AND 102).

**CLASS 35—(Continued).**

SN 75-883,330. QTOPICS. INC., SOUTH PLAINFIELD, NJ. FILED 12-30-1999.

**QTOPICS**

FOR COMPUTER SERVICES, NAMELY, PROVIDING POLLING SERVICES FOR BUSINESS OR ADVERTISING PURPOSES VIA GLOBAL AND LOCAL COMPUTER NETWORKS (U.S. CLS. 100, 101 AND 102).

---

SN 75-894,395. DAVIS, SCOTT M., GLENCOE, IL. FILED 1-11-2000.

**BRANDPICTURE**

FOR BUSINESS MANAGEMENT AND MARKETING CONSULTING (U.S. CLS. 100, 101 AND 102).

---

SN 75-897,409. LANG, PHILLIP S., REDMOND, WA. FILED 1-7-2000.

**THE WINE STEWARD**

NO CLAIM IS MADE TO THE EXCLUSIVE RIGHT TO USE "WINE", APART FROM THE MARK AS SHOWN.

FOR ADVERTISING AND MARKETING, NAMELY, CREATING AND PLACING ADVERTISING AND INFORMATIONAL MATERIAL FOR WINE INDUSTRY MEMBERS, FEATURING WINE AND WINE PRODUCTS (U.S. CLS. 100, 101 AND 102).

FIRST USE 6-1-1993; IN COMMERCE 6-1-1993.

---

SN 75-899,318. IFS FINANCIAL CORPORATION, WILMINGTON, DE. FILED 1-19-2000.

**PUEBLO FINANCIAL CORPORATION**

NO CLAIM IS MADE TO THE EXCLUSIVE RIGHT TO USE "FINANCIAL CORPORATION", APART FROM THE MARK AS SHOWN.

FOR MARKETING SERVICES PROMOTING CONSUMER GOODS AND SERVICES OF OTHERS THROUGH DIRECT MAILING, TELEMARKETING, PRINT ADVERTISING, EVENT SPONSORSHIPS, RADIO AND TELEVISION ADVERTISING, AND ADVERTISING ON A GLOBAL COMPUTER NETWORK (U.S. CLS. 100, 101 AND 102).

**CLASS 35—(Continued).**

SN 75-905,944. BANCO BILBAO VIZCAYA ARGENTARIA, S.A., 48005 BILBAO, SPAIN, BY MERGER, BY CHANGE OF NAME BANCO BILBAO VIZCAYA, S.A., 48005 BILBAO, SPAIN, FILED 1-28-2000.

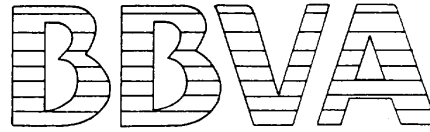

OWNER OF SPAIN REG. NO. 2282263-1, DATED 5-18-2000, EXPIRES 5-18-2010.

THE LINING SHOWN IN THE DRAWING REPRESENTS THE COLOR BLUE WHICH IS A FEATURE OF THE MARK.

THE MARK CONSISTS OF "BBVA" IN COLOR, NAMELY, PANTENE REFLEXIVE BLUE.

FOR BUSINESS MANAGEMENT AND CONSULTATION; MARKET RESEARCH; BUSINESS MARKETING CONSULTING SERVICES; BUSINESS INVESTIGATIONS; FINANCIAL AUDITING; AND PROVIDING COMMERCIAL AND STATISTICAL INFORMATION (U.S. CLS. 100, 101 AND 102).

---

SN 75-911,615. DORA-INTERNATIONAL.COM, LANHAM, MD. FILED 2-7-2000.

**GLOBAL-MAIL-BOXES.COM**

FOR BUSINESS INFORMATION SERVICES, NAMELY PROVISION OF INFORMATION IN THE FIELD OF BUSINESS RELATING TO THE IMPROVEMENT OF BUSINESS OPERATIONS, MARKETING AND SALES, ALL THE AFOREMENTIONED DELIVERED BY MEANS OF A GLOBAL COMPUTER NETWORK (U.S. CLS. 100, 101 AND 102).

---

SN 75-938,755. RICHARD, JENKIN A., MOUNTAIN VIEW, CA. FILED 3-7-2000.

**V2B**

FOR COMPUTER SERVICES, NAMELY, ENABLING THE ON-LINE PURCHASE OF THE GOODS AND SERVICES OF OTHERS BY MEANS OF A VOICE ACTIVATED ELECTRONIC INTERFACE (U.S. CLS. 100, 101 AND 102).

---

SN 75-943,942. MISSOURI EMPLOYERS MUTUAL INSURANCE, COLUMBIA, MO. FILED 3-14-2000.

**MEGA**

FOR BUSINESS MANAGEMENT AND CONSULTING IN THE AREA OF CLAIMS, CLAIMS ADMINISTRATION, CLAIMS MANAGEMENT, DISABILITY MANAGEMENT, LOSS PREVENTION AND SAFETY SERVICES AND UNDERWRITING IN THE FIELD OF INSURANCE (U.S. CLS. 100, 101 AND 102).

FIRST USE 11-1-0096; IN COMMERCE 11-1-0096.

**CLASS 35—(Continued).**

SN 76-001,414. DOBBIN, JAMES M., DBA LOGO IT!, AUSTIN, TX. FILED 3-16-2000.

**Your Logo On <sup>^</sup> Anything.  
almost**

FOR PROMOTING THE GOODS AND SERVICES OF OTHERS THROUGH THE SALE AND SUPPLY OF PROMOTIONAL PRODUCTS BEARING THE CUSTOMER'S LOGO (U.S. CLS. 100, 101 AND 102).  
FIRST USE 3-7-2000; IN COMMERCE 3-7-2000.

SN 76-002,090. MILEPOINT, LLC, EDINA, MN. FILED 3-16-2000.

**E COMMERCE  
REVOLUTION**

NO CLAIM IS MADE TO THE EXCLUSIVE RIGHT TO USE "E COMMERCE", APART FROM THE MARK AS SHOWN.

FOR PROMOTING THE GOODS AND SERVICES OF OTHERS BY MANAGING FREQUENT FLIER MILES, CONVERTING FREQUENT FLIER MILES INTO A CURRENCY IN REDEEMING SUCH FREQUENT FLIER MILES VIA THE CURRENCY; MAIL ORDER CATALOG SERVICES FEATURING CLOTHING, SHOES, COSMETICS, LUGGAGE, HARDWARE, TOOLS, POWER EQUIPMENT, KITCHEN EQUIPMENT, AUTOMOTIVE PARTS, PAINT, JEWELRY, PRINTED PUBLICATIONS AND FURNITURE; ON-LINE ORDERING SERVICES FEATURING CLOTHING, SHOES, COSMETICS, LUGGAGE, HARDWARE, TOOLS, POWER EQUIPMENT, KITCHEN EQUIPMENT, AUTOMOTIVE PARTS, PAINT, JEWELRY, PRINTED PUBLICATIONS AND FURNITURE (U.S. CLS. 100, 101 AND 102).

SN 76-002,401. PACKINGSLIP.COM, INC., ROGERS, MN. FILED 3-16-2000.

**PACKINGSLIP.COM**

FOR COMPUTERIZED TRACKING AND TRACING OF PACKAGES IN TRANSIT (U.S. CLS. 100, 101 AND 102).

**CLASS 35—(Continued).**

SN 76-005,508. MONTE, TODD, HAUPPAUGE, NY. BY ASSIGNMENT TODD MONTE AND KENNETH OLIVER PARTNERSHIP, THE, LINDENHURST, NY. FILED 3-20-2000.

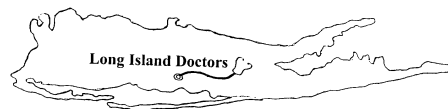

NO CLAIM IS MADE TO THE EXCLUSIVE RIGHT TO USE "LONG ISLAND DOCTORS" AND THE REPRESENTATION OF THE MAP OF LONG ISLAND, APART FROM THE MARK AS SHOWN.

THE MARK CONSISTS THE WORDS "LONG ISLAND DOCTORS" AND A STETHOSCOPE ON THE MAP OF LONG ISLAND.

FOR PROVIDING A WEBSITE FEATURING PHYSICIAN REFERRAL NETWORK SERVICES TO LOCATE DOCTORS IN LONG ISLAND (U.S. CLS. 100, 101 AND 102).

FIRST USE 9-0-1999; IN COMMERCE 9-0-1999.

SN 76-016,849. ADMINISTAFF, INC., KINGWOOD, TX. FILED 4-4-2000.

**BIZZPORT**

FOR ON-LINE COMPUTER SERVICES, NAMELY, PROVIDING INFORMATION REGARDING THE GOODS AND SERVICES OF OTHERS IN THE NATURE OF A BUYERS' GUIDE, BY MEANS OF A COMMUNICATIONS AND COMPUTER NETWORK; PROVIDING A PORTAL THROUGH WHICH BUSINESSES MAY ACCESS INFORMATION AND OUT SOURCE HUMAN RESOURCE SERVICES; DISSEMINATION OF ADVERTISING FOR OTHERS VIA A COMMUNICATIONS AND COMPUTER NETWORK; PROVIDING BUSINESS INFORMATION IN THE FIELDS OF RECRUITING AND SELECTION, EMPLOYEE PERFORMANCE MANAGEMENT, TRAINING AND DEVELOPMENT, BENEFITS MANAGEMENT, EMPLOYER LIABILITY MANAGEMENT, GOVERNMENT COMPLIANCE, EMPLOYMENT ADMINISTRATION, INSURANCE MANAGEMENT, AND FINANCIAL PLANNING SERVICES; DIRECTORY SERVICES TO HELP LOCATE PEOPLE, PLACES, ORGANIZATIONS, PHONE NUMBERS, HOME PAGES, AND ELECTRONIC MAIL ADDRESSES; BUSINESS MANAGEMENT AND CONSULTATION SERVICES (U.S. CLS. 100, 101 AND 102).

SN 76-017,898. SEAMLESSWEB PROFESSIONAL SOLUTIONS, INC., NEW YORK, NY. FILED 4-5-2000.

**SEAMLESSWEB**

FOR ON-LINE FOOD AND GROUND TRANSPORTATION ORDERING AND BILLING SERVICE (U.S. CLS. 100, 101 AND 102).

FIRST USE 11-6-1999; IN COMMERCE 12-7-1999.



**CLASS 35—(Continued).**

SN 76-023,690. HOFFMAN, JON F., OROVILLE, CA. FILED 4-4-2000.

**AZTEC-LIFE**

FOR WHOLESALE DISTRIBUTORSHIP FEATURING MEDICAL DEVICES, NAMELY CHEST HARNESSES (U.S. CLS. 100, 101 AND 102).  
FIRST USE 6-16-1999; IN COMMERCE 6-19-1999.

SN 76-023,759. GONZALES, JOSE IGNACIO ALDAMA, MEXICO, MEXICO, FILED 4-11-2000.

**CALCOS**

FOR BUYING AND SELLING AGENCY SERVICES FEATURING ALL TYPES OF WORKS OF ART, ANTIQUITIES, PAINTINGS, SCULPTURES AND FURNITURE THRU STORES, WAREHOUSES, AND OVER GLOBAL COMPUTER NETWORKS; RETAIL STORE AND ON-LINE RETAIL STORE SERVICES FEATURING ALL TYPES OF WORKS OF ART, ANTIQUITIES, PAINTINGS, SCULPTURES AND FURNITURE (U.S. CLS. 100, 101 AND 102).

SN 76-029,478. ROPA GROUP CORPORATION, THE, HAUPAUGE, NY. FILED 4-19-2000.

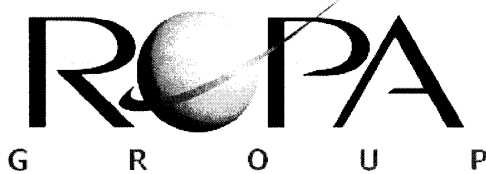

NO CLAIM IS MADE TO THE EXCLUSIVE RIGHT TO USE "GROUP", APART FROM THE MARK AS SHOWN.  
FOR DISTRIBUTORSHIP, PROCUREMENT AND SUPPLIER SERVICES. ALL IN THE FIELD OF MOTOR VEHICLES, AUTOMOBILES, TRUCKS, HAND TOOLS, CONSTRUCTION EQUIPMENT AND SUPPLIES, PORTABLE HOUSING, GENERATORS, TRANSFORMERS, ELECTRIC TOOLS, AIR TOOLS, DRILLING EQUIPMENT, EXCAVATING EQUIPMENT, SAWING EQUIPMENT, ROAD REPAIR EQUIPMENT, HARDWARE, FASTENERS AND ANCHORS (U.S. CLS. 100, 101 AND 102).  
FIRST USE 10-0-1997; IN COMMERCE 10-0-1997.

SN 76-031,748. PRINTCAFE IP MANAGEMENT, INC., PITTSBURGH, PA. FILED 4-20-2000.

**PRINTCAFE PCX**

FOR ONLINE COMPUTER SERVICES, NAMELY PROVIDING A LIST OF SPECIFICATIONS TO ALLOW CUSTOMERS, PRINTERS AND OTHERS TO INTERFACE WITH A WEBSITE FOR COMPUTERIZED ON-LINE ORDERING SERVICES FEATURING PRINTING SERVICES AND PRINTED MATTER (U.S. CLS. 100, 101 AND 102).

**CLASS 35—(Continued).**

SN 76-032,683. EMOTION, INC., VIENNA, VA. FILED 4-25-2000.



FOR COMPUTERIZED ON-LINE ORDERING SERVICES IN THE FIELD OF STOCK PHOTOGRAPHY, DIGITAL IMAGES, DOWNLOADABLE IMAGES AND IMAGES STORED ON CD'S (U.S. CLS. 100, 101 AND 102).  
FIRST USE 2-0-2000; IN COMMERCE 3-0-2000.

SN 76-032,689. EMOTION, INC., VIENNA, VA. FILED 4-25-2000.

eMotion

FOR COMPUTERIZED ON-LINE ORDERING SERVICES IN THE FIELD OF STOCK PHOTOGRAPHY, DIGITAL IMAGES, DOWNLOADABLE IMAGES AND IMAGES STORED ON CD'S (U.S. CLS. 100, 101 AND 102).  
FIRST USE 2-0-2000; IN COMMERCE 3-0-2000.

SN 76-032,696. EMOTION, INC., VIENNA, VA. FILED 4-25-2000.

Powering Productivity

FOR COMPUTERIZED ON-LINE ORDERING SERVICES IN THE FIELD OF STOCK PHOTOGRAPHY, DIGITAL IMAGES, DOWNLOADABLE IMAGES AND IMAGES STORED ON CD'S (U.S. CLS. 100, 101 AND 102).  
FIRST USE 2-0-2000; IN COMMERCE 3-0-2000.

**CLASS 35—(Continued).**

SN 76-034,432. MEDORIS HOLDING CORPORATION, SAN DIEGO, CA. FILED 4-25-2000.



THE STIPPLING IN THE DRAWING IS A FEATURE OF THE MARK AND NOT INTENDED TO REPRESENT COLOR.

FOR PROCUREMENT, NAMELY, PURCHASING MEDICAL GOODS AND DEVICES FOR OTHERS; RETAIL SHOPS, MAIL ORDER SERVICES, TELEPHONE SHOP-AT-HOME, AND ONLINE RETAIL STORE SERVICES FEATURING MEDICAL GOODS AND DEVICES (U.S. CLS. 100, 101 AND 102).

FIRST USE 10-1-1999; IN COMMERCE 10-1-1999.

SN 76-035,586. IRAIL.COM, INC., PARSIPPANY, NJ. FILED 4-27-2000.

**MYRAIL**

FOR BUSINESS SERVICES, NAMELY, PROVIDING A WEBSITE ON THE INTERNET FEATURING A BUSINESS INFORMATION DIRECTED TO THE RAIL INDUSTRY; OPERATING AN ON-LINE MARKETPLACE FOR SELLERS AND BUYERS OF GOODS AND SERVICES IN THE RAIL INDUSTRY (U.S. CLS. 100, 101 AND 102).

FIRST USE 1-27-2000; IN COMMERCE 1-27-2000.

SN 76-037,901. FORD MOTOR COMPANY, DEARBORN, MI. FILED 5-2-2000.

**B-PLAN**

FOR VEHICLE PURCHASE PROGRAM, NAMELY, PROMOTING THE SALE OF AUTOMOBILES THROUGH THE ADMINISTRATION OF INCENTIVE PLANS (U.S. CLS. 100, 101 AND 102).

FIRST USE 0-0-1968; IN COMMERCE 0-0-1968.

**CLASS 35—(Continued).**

SN 76-038,539. A.C. NIELSEN COMPANY, SCHAUMBURG, IL. FILED 4-27-2000.

**ACNIELSEN  
KNOWLEDGEWORKS**

FOR MARKET RESEARCH SERVICES, NAMELY CONDUCTING, ANALYZING, AND REPORTING ADVANCED MODELING, CONSUMER PURCHASE AND PROMOTION RESPONSE BEHAVIOR, PROMOTION EXECUTION, FREQUENT SHOPPER CUSTOMER BEHAVIORS, MARKETING AND CONSUMER PURCHASE AND ADVERTISING RESEARCH, LOYALTY MARKETING PROGRAMS, RETAIL STORE PERFORMANCE ANALYSIS, CUSTOMER LOYALTY ANALYSIS, PRODUCT CATEGORY DATA MINING, AND PROMOTION AND INCENTIVES PROGRAM ANALYSIS; AND CONSULTING SERVICES IN THE AREA OF BUILDING CONSUMER LOYALTY AND PROGRAM MARKETING (U.S. CLS. 100, 101 AND 102).

SN 76-042,373. MEDORIS HOLDING CORPORATION, SAN DIEGO, CA. FILED 4-25-2000.

**MEDORIS**

FOR PROCUREMENT, NAMELY, PURCHASING MEDICAL GOODS AND DEVICES FOR OTHERS; RETAIL SHOPS, MAIL ORDER SERVICES, TELEPHONE SHOP-AT-HOME, AND ONLINE RETAIL STORE SERVICES FEATURING MEDICAL GOODS AND DEVICES (U.S. CLS. 100, 101 AND 102).

FIRST USE 10-1-1999; IN COMMERCE 10-1-1999.

SN 76-042,519. OXFORD LANE, INC., DENVER, CO. FILED 5-5-2000.

**OXFORD LANE**

FOR FRANCHISING, NAMELY TECHNICAL ASSISTANCE IN THE ESTABLISHMENT AND/OR OPERATION OF COMPUTER SYSTEMS TRAINING AND CERTIFICATION BUSINESS CENTERS (U.S. CLS. 100, 101 AND 102).

SN 76-044,028. FREECAR.COM, LLC, BEVERLY HILLS, CA. FILED 5-8-2000.

**FREEWHEELZ.COM**

FOR COOPERATIVE ADVERTISING AND MARKETING, NAMELY, OFFERING CUSTOMERS FREE USE OF AUTOMOBILES BEARING THE CORPORATE ADVERTISING OF OTHERS FOR A LIMITED PERIOD OF TIME (U.S. CLS. 100, 101 AND 102).

**CLASS 35—(Continued).**

SN 76-044,993. PC CLUB, CITY OF INDUSTRY, CA. FILED 5-9-2000.

**STORELINK**

FOR ON-LINE ORDERING SERVICES, FEATURING COMPUTER HARDWARE AND SOFTWARE, ALLOWING THE USER TO PICKUP THEIR PURCHASES AT A USER DESIGNATED RETAIL STORE (U.S. CLS. 100, 101 AND 102).

FIRST USE 9-29-1999; IN COMMERCE 2-19-2000.

SN 76-045,751. TMP WORLDWIDE INC., NEW YORK, NY. FILED 5-11-2000.

**QUICKPOST**

FOR ADVERTISING SERVICES, NAMELY, RECOMMENDING ADVERTISING VENUES AND PLACING JOB LISTINGS FOR OTHERS (U.S. CLS. 100, 101 AND 102).

FIRST USE 1-0-1999; IN COMMERCE 1-0-1999.

SN 76-051,109. WORLD INDUSTRIAL SUPPLY ENTERPRISES, INC., LAKE FOREST, CA. FILED 5-18-2000.



FOR PACKAGING ARTICLES TO THE ORDER AND SPECIFICATION OF OTHERS (U.S. CLS. 100, 101 AND 102).

FIRST USE 2-0-2000; IN COMMERCE 2-0-2000.

SN 76-051,171. B.D. OF NEVADA, RENO, NV. FILED 5-18-2000.



Global Players. World-class Performance.

NO CLAIM IS MADE TO THE EXCLUSIVE RIGHT TO USE "CLASSIC", APART FROM THE MARK AS SHOWN. FOR PROMOTING SPORTING EVENTS OF OTHERS (U.S. CLS. 100, 101 AND 102).

**CLASS 35—(Continued).**

SN 76-051,630. WATERMARK COMMUNITIES, INC., BONITA SPRINGS, FL. FILED 5-18-2000.

**WATERLEFE**

FOR RETAIL GOLF PRO SHOP FEATURING SPORTING GOODS AND APPAREL (U.S. CLS. 100, 101 AND 102).

FIRST USE 3-28-2000; IN COMMERCE 3-28-2000.

SN 76-054,605. CAPITOL CONSULTING, L.L.C., POTOMAC, MD. FILED 5-19-2000.

**THE PRODUCTIVITY CHECKBOOK**

NO CLAIM IS MADE TO THE EXCLUSIVE RIGHT TO USE "PRODUCTIVITY", APART FROM THE MARK AS SHOWN.

FOR BUSINESS ADMINISTRATION SERVICES, NAMELY TO MANAGE LABOR RESOURCES FOR HEALTHCARE PROVIDERS (U.S. CLS. 100, 101 AND 102).

SN 76-058,245. PRINTING INDUSTRY EXCHANGE, LLC, ASHBURN, VA. FILED 5-25-2000.

**PRINTING INDUSTRY EXCHANGE**

SEC. 2(F). FOR SERVICES RELATED TO THE PRINTING INDUSTRY, NAMELY, CONNECTING PRINTING PURCHASERS WITH PRINTING MANUFACTURERS THROUGH THE INTERNET (U.S. CLS. 100, 101 AND 102).

FIRST USE 3-0-1997; IN COMMERCE 10-0-1997.

SN 76-059,099. NEXTPART, INC., EVANSTON, DE. BY CHANGE OF NAME PARTZONE.COM, INC., EVANSTON, IL. FILED 5-31-2000.

**A MILLION MILES OF AUTO PARTS**

FOR MARKETING, NAMELY, ADVERTISING AGENCY FOR THE AUTO PARTS INDUSTRY; DISTRIBUTORSHIPS AND RETAIL STORE SERVICES ALL FEATURING NEW, AFTERMARKET, REMANUFACTURED, AND RECYCLED AUTOMOTIVE PARTS FOR CURRENT AND DISCONTINUED MODELS OF COMMERCIAL VEHICLES, NAMELY, CARS, MOTORCYCLES, AND TRUCKS ALL VIA A GLOBAL COMPUTER NETWORK AND TELEPHONE CALL CENTER (U.S. CLS. 100, 101 AND 102).

**CLASS 35—(Continued).**

SN 76-060,227. NEXTPART, INC., EVANSTON, IL. BY CHANGE OF NAME PARTZONE.COM, INC., EVANSTON, IL. FILED 5-31-2000.

## WHERE THE PROS GO FOR PARTS

FOR MARKETING, NAMELY, ADVERTISING AGENCY FOR THE AUTO PARTS INDUSTRY; DISTRIBUTORSHIPS AND RETAIL STORE SERVICES ALL FEATURING NEW, AFTERMARKET, REMANUFACTURED, AND RECYCLED AUTOMOTIVE PARTS FOR CURRENT AND DISCONTINUED MODELS OF COMMERCIAL VEHICLES, NAMELY, CARS, MOTORCYCLES, AND TRUCKS ALL VIA A GLOBAL COMPUTER NETWORK AND TELEPHONE CALL CENTER (U.S. CLS. 100, 101 AND 102).

SN 76-060,790. VUYNOVICH, DANIEL, HEIDELBERG, FED REP GERMANY, FILED 6-1-2000.

The logo for "lick WASTE" features the word "lick" in a lowercase, sans-serif font with a stylized '@' symbol to its left, followed by the word "WASTE" in a bold, uppercase, sans-serif font.

FOR AUCTIONEERING, FOR OTHERS, BY MEANS OF THE INTERNET, OF WASTE, TOXIC WASTE, GROUND SOILS, AND CONCRETE BUILDING MATERIALS (U.S. CLS. 100, 101 AND 102).

SN 76-065,026. MORIN, ANDREA, BOSTON, MA. FILED 6-5-2000.

## RESOURCIGENT

FOR PERSONNEL MANAGEMENT CONSULTATION SERVICES AND PERSONAL PLACEMENT AND RECRUITMENT SERVICES (U.S. CLS. 100, 101 AND 102).

SN 76-067,688. SEAWEST WINDPOWER, INC., SAN DIEGO, CA. FILED 6-12-2000.

## SEAWEST

FOR OPERATION OF WIND POWER ENERGY PLANTS FOR OTHERS; COMMERCIAL AND INDUSTRIAL MANAGEMENT ASSISTANCE (U.S. CLS. 100, 101 AND 102).

FIRST USE 3-6-1986; IN COMMERCE 3-6-1986.

**CLASS 35—(Continued).**

SN 76-067,925. FREEEATS.COM, INC., HERNDON, VA. FILED 6-12-2000.

## ENTERTAINING AUTOMATED TELEADVERTISING

NO CLAIM IS MADE TO THE EXCLUSIVE RIGHT TO USE "AUTOMATED TELEADVERTISING", APART FROM THE MARK AS SHOWN.

FOR ADVERTISING SERVICES, NAMELY PROVIDING ADVERTISING SPACE VIA A WEBSITE; AND TELEMARKETING SERVICES (U.S. CLS. 100, 101 AND 102).

SN 76-071,576. BORDERFREE LTD., TORONTO, CANADA, BY CHANGE OF NAME ETAIL FACTORY LIMITED, THE, TORONTO, ONTARIO, CANADA, FILED 6-16-2000.

The logo for "borderfree.com" features a stylized hand holding a globe, with the text "borderfree.com" written in a lowercase, sans-serif font below it.

FOR COMPUTER SERVICES, NAMELY, PROCUREMENT SERVICES IN THE NATURE OF FACILITATING THE PURCHASING OF GOODS FOR OTHERS AND PROVIDING REFERENCE INFORMATION FOR PURCHASING AGENTS TO FACILITATE THE INTERNATIONAL PURCHASE OF GOODS FROM THIRD PARTY RETAIL VENDORS ALL VIA THE GLOBAL COMPUTER INFORMATION NETWORK (U.S. CLS. 100, 101 AND 102).

SN 76-071,927. WORLDXPAND, LLC, SACRAMENTO, CA. FILED 6-14-2000.



THE CIRCLE AROUND THE GLOBE AND THE ARROW IN THIS MARK ARE BLUE.

FOR BUSINESS CONSULTING SERVICES FOR HIGH TECHNOLOGY BUSINESSES (U.S. CLS. 100, 101 AND 102).

**CLASS 35—(Continued).**

SN 76-073,502. WISH SOLUTIONS, CAMPBELL, CA. BY CHANGE OF NAME GIFTLOGIC.COM INC., CAMPBELL, CA. FILED 6-19-2000.

**WISH TECHNOLOGY**

NO CLAIM IS MADE TO THE EXCLUSIVE RIGHT TO USE "TECHNOLOGY", APART FROM THE MARK AS SHOWN.

FOR PROVIDING RETAIL STORE SERVICES TO RETAILERS, CONSUMERS AND E-COMMERCE SITES ON A GLOBAL COMPUTER NETWORK IN THE FIELD OF GIFTS, EVENT PLANNING AND SHOPPING (U.S. CLS. 100, 101 AND 102).

FIRST USE 5-15-2000; IN COMMERCE 5-15-2000.

**CLASS 35—(Continued).**

SN 76-082,402. YESMAIL.COM, INC., CHICAGO, IL. FILED 6-30-2000.

**YESMESSAGE**

FOR SUBSCRIPTION ELECTRONIC MARKETING SERVICES, NAMELY, MARKET RESEARCH AND ANALYSIS, CONDUCTING BUSINESS AND MARKETING RESEARCH SURVEYS, AND DISSEMINATION OF ADVERTISING FOR OTHERS VIA ELECTRONIC MAIL OVER A GLOBAL COMPUTER NETWORK (U.S. CLS. 100, 101 AND 102).

SN 76-074,243. BIG SUR WATERBEDS, INC., LAKEWOOD, CO. FILED 6-20-2000.

**WAKE UP. YOU DESERVE BETTER.**

FOR RETAIL STORE SERVICES FEATURING BED-ROOM FURNITURE (U.S. CLS. 100, 101 AND 102).  
FIRST USE 6-3-2000; IN COMMERCE 6-3-2000.

SN 76-075,473. TWO RIVERS MARKETING RESOURCE CORP., DES MOINES, IA. FILED 6-22-2000.

**TWO RIVERS MARKETING RESOURCE GROUP**

NO CLAIM IS MADE TO THE EXCLUSIVE RIGHT TO USE "MARKETING RESOURCE GROUP", APART FROM THE MARK AS SHOWN.

FOR ADVERTISING AND MARKETING SERVICES, NAMELY, CREATING ADVERTISEMENTS AND PROMOTIONAL MATERIAL FOR OTHERS, CONSULTING AND ADVISING OTHERS ON MATTERS OF MARKETING AND ADVERTISING, AND PROMOTING THE GOODS AND SERVICES OF OTHERS BY PREPARING AND PLACING ADVERTISEMENTS ON WEBSITES ACCESSED THROUGH A GLOBAL COMPUTER NETWORK (U.S. CLS. 100, 101 AND 102).

FIRST USE 4-0-2000; IN COMMERCE 4-0-2000.

SN 76-078,510. PREFER.COM, INC., NEW YORK, NY. FILED 6-27-2000.

**PREFER.COM THE E-COMMERCE ACCELERATOR**

NO CLAIM IS MADE TO THE EXCLUSIVE RIGHT TO USE "THE E-COMMERCE ACCELERATOR", APART FROM THE MARK AS SHOWN.

FOR ONLINE RETAIL SERVICES, SPECIFICALLY IN THE FIELDS OF FASHION AND BEAUTY, HOME AND GARDEN, FOOD AND ENTERTAINING, GIFTS, AND APPAREL (U.S. CLS. 100, 101 AND 102).

SN 76-084,288. TIME4 MEDIA, INC., NEW YORK, NY. BY CHANGE OF NAME TIMES MIRROR MAGAZINES, INC., NEW YORK, NY. FILED 7-6-2000.

**FIELD & STREAM CLUB**

OWNER OF U.S. REG. NOS. 1,301,639, 2,311,652 AND OTHERS.

FOR BUYING CLUB FOR OUTDOOR ENTHUSIASTS FEATURING GOODS AND SERVICES RELATED TO THE OUTDOOR INDUSTRY; AND DISCOUNT CLUB SERVICES FOR OUTDOOR ENTHUSIASTS, NAMELY PROMOTING THE GOODS AND SERVICES OF OTHERS THROUGH THE DISTRIBUTION OF DISCOUNT CARDS AND COUPONS (U.S. CLS. 100, 101 AND 102).

FIRST USE 6-30-1998; IN COMMERCE 6-30-1998.

SN 76-087,503. MERKSAMER JEWELERS, INC., PORTLAND, OR. FILED 7-11-2000.

**BARCLAY**

SEC. 2(F).  
FOR RETAIL JEWELRY STORE SERVICES (U.S. CLS. 100, 101 AND 102).  
FIRST USE 6-30-1997; IN COMMERCE 6-30-1997.

SN 76-089,506. MAINLY SECONDS, INC., NORTH HOLLYWOOD, CA. FILED 7-17-2000.

**MAINLY SECONDS**

SEC. 2(F).  
FOR RETAIL STORES FEATURING POTTERY, PLANTS, AND OTHER RELATED NOVELTY GIFT ITEMS (U.S. CLS. 100, 101 AND 102).  
FIRST USE 3-1-1975; IN COMMERCE 3-1-1975.

**CLASS 35—(Continued).**

SN 76-089,527. JMK INTERACTIVE - ELECTROWEB.COM, MIAMI, FL. FILED 7-17-2000.

**ELECTROWEB.COM**

SEC. 2(F).  
FOR RETAIL STORE SERVICES AND ON-LINE RETAIL STORE SERVICES FEATURING CONSUMER ELECTRONICS, NAMELY, COMPACT DISC RECORDERS, DIGITAL CAMERAS, COMPUTER PERIPHERALS, BLANK RECORDING MEDIA AND COMPUTER EQUIPMENT (U.S. CLS. 100, 101 AND 102).  
FIRST USE 9-1-1995; IN COMMERCE 10-1-1995.

SN 76-093,478. TRUCKERSCO-OP.COM, INC., INDIANAPOLIS, IN. FILED 7-12-2000.

**IN-CAB BANKING**

NO CLAIM IS MADE TO THE EXCLUSIVE RIGHT TO USE "BANKING", APART FROM THE MARK AS SHOWN.  
FOR PROVIDING A WEBSITE FEATURING INFORMATION IN THE FIELD OF ELECTRONIC COMMERCE TO FACILITATE BUSINESS-TO-BUSINESS TRANSACTIONS BETWEEN MEMBERS OF THE TRANSPORTATION INDUSTRY (U.S. CLS. 100, 101 AND 102).

SN 76-097,472. DOZUKI, INC., WASHINGTON, DC. FILED 7-24-2000.

**DOZUKI**

FOR ADVERTISING SERVICES, NAMELY, DISSEMINATION OF ADVERTISING FOR OTHERS THROUGH THE DISTRIBUTION OF PERSONALIZED CATALOGUES VIA THE INTERNET (U.S. CLS. 100, 101 AND 102).

SN 76-097,890. PARBEL OF FLORIDA, INC., MIAMI, FL. FILED 7-27-2000.

**THE HR BEAUTY GALLERY**

OWNER OF U.S. REG. NOS. 952,291, 1,866,171 AND OTHERS.

NO CLAIM IS MADE TO THE EXCLUSIVE RIGHT TO USE "BEAUTY GALLERY", APART FROM THE MARK AS SHOWN.

FOR RETAIL STORE SERVICES FEATURING COSMETIC, SKINCARE AND FRAGRANCE PRODUCTS (U.S. CLS. 100, 101 AND 102).

FIRST USE 4-8-1999; IN COMMERCE 4-8-1999.

**CLASS 35—(Continued).**

SN 76-098,483. WESTCO GROUP, INC., DBA MATTRESS WAREHOUSE, AKRON, OH. FILED 7-27-2000.

**MATTRESSWAREHOUSE.COM**

OWNER OF U.S. REG. NO. 1,237,826.  
SEC. 2(F) AS TO "MATTRESS WAREHOUSE".  
FOR ON-LINE RETAIL STORE SERVICES FEATURING BEDDING FURNITURE AND FURNITURE ACCESSORIES; AND PROVIDING GENERAL CONSUMER INFORMATION TO PROSPECTIVE BUYERS IN THE FIELD OF BEDDING FURNITURE AND FURNITURE ACCESSORIES VIA A WEB SITE ON A GLOBAL COMPUTER NETWORK (U.S. CLS. 100, 101 AND 102).  
FIRST USE 6-26-2000; IN COMMERCE 6-26-2000.

SN 76-107,235. VIRTUALPHILANTHROPY, INC., LOS ANGELES, CA. FILED 8-9-2000.

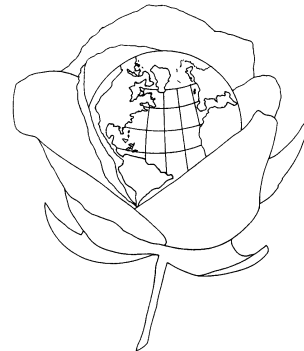

FOR ADVERTISING AND BUSINESS, NAMELY, PROVIDING BUSINESS CONSULTATION TO NON-PROFIT ORGANIZATIONS IN THE AREAS OF ADMINISTRATION, MANAGEMENT AND TECHNICAL SUPPORT; BUSINESS MANAGEMENT PLANNING AND CONSULTATION FOR NON-PROFIT ORGANIZATIONS; AND FRANCHISING, NAMELY, OFFERING TECHNICAL ASSISTANCE IN THE ESTABLISHMENT AND/OR OPERATION OF NON-PROFIT BUSINESS (U.S. CLS. 100, 101 AND 102).

SN 76-107,727. ZAIO.COM, INC., ST. CHARLES, MO. FILED 8-11-2000.

**ZAIO.COM**

FOR FRANCHISING SERVICES, NAMELY, RENDERING TECHNICAL AND ADMINISTRATIVE SUPPORT IN THE ESTABLISHMENT AND OPERATION OF BUSINESSES OFFERING ON-LINE COMPUTER DATABASES, DOWNLOADABLE ELECTRONIC PHOTOGRAPHS, AND COMPUTERIZED ON-LINE ORDERING SERVICES FEATURING PHOTOGRAPHS AND DIGITAL IMAGES OF BUILDINGS AND REAL PROPERTY (U.S. CLS. 100, 101 AND 102).

FIRST USE 1-1-2000; IN COMMERCE 5-31-2000.

**CLASS 35—(Continued).**

SN 76-107,798. HANIF'S INTERNATIONAL FOODS LTD., NORTH DELTA, BRITISH COLUMBIA, FILED 8-11-2000.

**HANIF'S**

FOR IMPORT AGENCY SERVICES IN THE FIELD OF FOOD AND INCENSE; WHOLESALE DISTRIBUTORSHIP FEATURING FOOD AND INCENSE (U.S. CLS. 100, 101 AND 102).

SN 76-112,977. FRENCH, GREGORY M., MUNDELEIN, IL. FILED 8-19-2000.

**XEON**

FOR ADVERTISING, BUSINESS MANAGEMENT, AND BUSINESS ADMINISTRATION SERVICES, NAMELY ADVERTISING AGENCY SERVICES INCLUDING BRAND MANAGEMENT AND BRAND DEVELOPMENT SERVICES, ACCOUNTING SERVICES; MARKET ANALYSIS; MANAGEMENT OF ARTISTS' BUSINESS ACQUISITIONS AND MERGER CONSULTATION; BUSINESS INFORMATION IN THE AREA OF BRAND MANAGEMENT; PREPARING BUSINESS REPORTS; CONDUCTING BUSINESS RESEARCH AND SURVEYS; COPYRIGHT MANAGEMENT CONSULTATION; DISSEMINATION OF ADVERTISING FOR OTHERS VIA AN ON-LINE ELECTRONIC COMMUNICATIONS NETWORK; DISSEMINATION OF ADVERTISING MATTER; PLACING ADVERTISING FOR OTHERS; AND PREPARING MULTI-MEDIA PRESENTATIONS FOR USE IN ADVERTISING (U.S. CLS. 100, 101 AND 102).

SN 76-113,231. 1 (800) TOW-TRUCK, INC., NEWARK, NJ. FILED 8-21-2000.

**1 800 4 JUSTICE**

FOR ADVERTISING AGENCY SERVICES RENDERED TO LAWYERS, AND LAWYER REFERRAL SERVICES (U.S. CLS. 100, 101 AND 102).  
FIRST USE 2-9-2000; IN COMMERCE 3-2-2000.

SN 76-115,511. RICOH SILICON VALLEY, INC., CUPERTINO, CA. FILED 8-24-2000.

**PARTNER-NOW**

FOR PROVIDING INFORMATION ABOUT SALES LEADS AND SALES PROMOTION FOR A MULTI-LEVEL SALES NETWORK THROUGH A GLOBAL COMPUTER NETWORK (U.S. CLS. 100, 101 AND 102).

**CLASS 35—(Continued).**

SN 76-116,781. KEYCORP, CLEVELAND, OH. FILED 8-24-2000.

**KEYPROCURE**

FOR OPERATING AN ELECTRONIC MARKETPLACE VIA A WEBSITE ON THE GLOBAL COMMUNICATIONS NETWORK TO PROMOTE THE PURCHASE AND SALE OF MERCHANDISE AND SUPPLIES OF OTHERS FOR USE BY MERCHANTS (U.S. CLS. 100, 101 AND 102).  
FIRST USE 8-2-2000; IN COMMERCE 8-2-2000.

SN 76-117,418. WRS ENTERPRISES, INC., DBA WILLIAM R. STEVENSON & ASSOCIATES, LOS ANGELES, CA. FILED 8-25-2000.

**INTELLIMARKET**

FOR AUCTIONEERING SERVICES FEATURING THE REAL ESTATE OF OTHERS AND THE DISSEMINATION OF PRINTED ADVERTISING MATTER FOR OTHERS ON THE INTERNET (U.S. CLS. 100, 101 AND 102).

SN 76-118,699. JAGDON, EMMANUEL V., GILBERT, AZ. FILED 6-30-2000.

**VITAMIN GARDEN**

NO CLAIM IS MADE TO THE EXCLUSIVE RIGHT TO USE "VITAMIN", APART FROM THE MARK AS SHOWN.  
FOR MAIL ORDER AND ON-LINE RETAIL STORE SERVICES FEATURING VITAMINS, NUTRITIONAL AND DIETARY SUPPLEMENTS, HERBAL SUPPLEMENTS, MINERAL SUPPLEMENTS, AROMA THERAPY PRODUCTS, COSMETICS, BOOKS RELATING TO HEALTH AND FITNESS, AND FITNESS PRODUCTS (U.S. CLS. 100, 101 AND 102).  
FIRST USE 7-1-1999; IN COMMERCE 7-1-1999.

SN 76-119,603. PLANETJAM MEDIA GROUP, INC., MARIETTA, GA. FILED 8-29-2000.

**READY 4 RADIO**

NO CLAIM IS MADE TO THE EXCLUSIVE RIGHT TO USE "RADIO", APART FROM THE MARK AS SHOWN.  
FOR PROMOTING MUSIC RECORDINGS OF OTHERS BY PLACING MUSIC RECORDINGS IN AN AUDIO FORMAT AT A WEB SITE ACCESSIBLE BY RADIO STATION PROGRAMMERS THROUGH A GLOBAL COMPUTER NETWORK; CONDUCTING MARKET RESEARCH REGARDING PLACEMENT OF MUSIC RECORDINGS OF OTHERS ON RADIO STATION PROGRAMMING (U.S. CLS. 100, 101 AND 102).

**CLASS 35—(Continued).**

SN 76-122,372. JP DAVIS & CO., PORTLAND, OR. FILED 9-5-2000.



NO CLAIM IS MADE TO THE EXCLUSIVE RIGHT TO USE "SMART HOME", APART FROM THE MARK AS SHOWN.

FOR PROMOTING THE SERVICES AND GOODS OF BUSINESSES IN THE INFORMATION TECHNOLOGY INDUSTRY BY ARRANGING, CONDUCTION, HOLDING, AND PROMOTING EVENTS, NAMELY, BUSINESS CONFERENCES AND TRADE SHOW CONFERENCES WHERE SAID BUSINESSES MAY MEET AND INTERACT WITH OTHER INDIVIDUALS AND ORGANIZATIONS INVOLVED IN THE INFORMATION TECHNOLOGY INDUSTRY (U.S. CLS. 100, 101 AND 102).

FIRST USE 8-15-2000; IN COMMERCE 8-15-2000.

SN 76-123,908. INDUSTRIAL FASTENERS INSTITUTE, CLEVELAND, OH. FILED 9-7-2000.



NO CLAIM IS MADE TO THE EXCLUSIVE RIGHT TO USE "INDUSTRIAL FASTENER & FORMING INTERNATIONAL EXHIBITION & CONFERENCE", APART FROM THE MARK AS SHOWN.

FOR PROMOTING TRADE SHOWS FOR THE FASTENER MANUFACTURING AND DISTRIBUTION INDUSTRIES, AND PROVIDING INFORMATION REGARDING THE SALE OF EXHIBIT SPACE AND REGISTRATION SERVICES IN CONNECTION THEREWITH VIA A WEB SITE ON GLOBAL COMPUTER NETWORKS (U.S. CLS. 100, 101 AND 102).

FIRST USE 3-0-2000; IN COMMERCE 3-0-2000.

SN 76-126,918. LINCOLNCREATIVE.COM, INC., NAPERVILLE, IL. FILED 9-12-2000.

**LINCOLNCREATIVE.COM**

FOR DISSEMINATION OF ADVERTISING FOR OTHERS VIA ON-LINE ELECTRONIC COMMUNICATIONS NETWORK; COMPUTERIZED ON-LINE ORDERING SERVICES IN THE FIELD OF ADVERTISING SPECIALTY ITEMS, NAMELY, BASEBALL CAPS, BELT BUCKLES AND HATS (U.S. CLS. 100, 101 AND 102).

**CLASS 35—(Continued).**

SN 76-129,401. PHARMANETWORK.COM, LLC, WOODCLIFF LAKE, NJ. FILED 9-18-2000.

**RXLAUNCHDIRECT**

FOR DISTRIBUTORSHIP AND RETAIL SERVICES FEATURING PHARMACEUTICAL PRODUCTS USING A GLOBAL COMMUNICATIONS NETWORK (U.S. CLS. 100, 101 AND 102).

SN 76-131,548. MARY GREEN ENTERPRISES, SAN FRANCISCO, CA. FILED 9-14-2000.

**MARY GREEN**

OWNER OF U.S. REG. NOS. 1,380,546 AND 1,919,850. THE NAME "MARY GREEN" IDENTIFIES A LIVING INDIVIDUAL WHOSE CONSENT IS OF RECORD.

FOR RETAIL STORES AND FACTORY OUTLETS FEATURING CLOTHING AND ACCESSORIES, NAMELY, MEN AND WOMEN'S SCARVES, SHAWLS, SLEEPWEAR, UNDERWEAR, LINGERIE AND OUTERWEAR (U.S. CLS. 100, 101 AND 102).

FIRST USE 4-0-1983; IN COMMERCE 4-0-1983.

SN 76-133,068. EUREKA! INSTITUTE, INC., NEWTOWN, OH. FILED 9-21-2000.



OWNER OF U.S. REG. NOS. 1,678,769, 2,365,173 AND OTHERS.

THE MARK CONSISTS IN PART OF A REPRESENTATION OF A HUMAN BEING, HOLDING A TELESCOPE LOOKING AT A STAR WHILE STANDING ATOP A PLANET WHICH FEATURES RAYS. THROUGH THE EQUATOR OF THE PLANET IS A BANNER WHICH CONTAINS THE WORDS "PLANET EUREKA". BENEATH THE PLANET ARE THE WORDS "IDEAS FOR A BETTER WORLD".

FOR BUSINESS MARKETING CONSULTING SERVICES TO BENEFIT NON-PROFIT ORGANIZATIONS (U.S. CLS. 100, 101 AND 102).

FIRST USE 4-12-1994; IN COMMERCE 4-12-1994.



**CLASS 35—(Continued).**

SN 76-133,800. POINTS.COM INC., TORONTO, ONTARIO, M5V 2H2, CANADA, FILED 9-22-2000.

**WHERE THEY ALL COUNT!**

FOR PROVIDING A WEB SITE ON THE GLOBAL COMPUTER NETWORK FOR THE TRACKING AND EXCHANGE OF CUSTOMER LOYALTY REWARDS (U.S. CLS. 100, 101 AND 102).

---

SN 76-134,695. FEDERAL NEWS SERVICE, INC., WASHINGTON, DC. FILED 9-25-2000.

**FNS**

FOR INFORMATION SERVICES, NAMELY, VERBATIM TRANSCRIPTS OF HEARINGS, STATEMENTS, BRIEFINGS, STATISTICS AND INTERVIEWS, OF AND RELATING TO GOVERNMENTAL ACTIVITIES (U.S. CLS. 100, 101 AND 102).

FIRST USE 3-0-1989; IN COMMERCE 7-0-1989.

---

SN 76-136,435. EAGLE PARTNERS L.P., HOUSTON, TX. FILED 9-27-2000.



NO CLAIM IS MADE TO THE EXCLUSIVE RIGHT TO USE "GLOBAL LOGISTICS", APART FROM THE MARK AS SHOWN.

FOR COMPUTERIZED TRACKING AND TRACING OF PACKAGES IN TRANSIT; IMPORT AND EXPORT AGENCY SERVICES (U.S. CLS. 100, 101 AND 102).

---

SN 76-136,510. EAGLE PARTNERS L.P., HOUSTON, TX. FILED 9-27-2000.

**EGL EAGLE GLOBAL LOGISTICS**

NO CLAIM IS MADE TO THE EXCLUSIVE RIGHT TO USE "GLOBAL LOGISTICS", APART FROM THE MARK AS SHOWN.

FOR COMPUTERIZED TRACKING AND TRACING OF PACKAGES IN TRANSIT; IMPORT AND EXPORT AGENCY SERVICES (U.S. CLS. 100, 101 AND 102).

FIRST USE 10-1-1999; IN COMMERCE 10-1-1999.

**CLASS 35—(Continued).**

SN 76-137,179. TLP, L.P., DALLAS, TX. FILED 9-29-2000.

**THE LAUNCH POINT**

FOR PROVIDING MARKETING AND CONSULTING ADVISE AND SERVICES CONCERNING ADVERTISING CONCEPTS, MARKET RESEARCH, NEW PRODUCT DEVELOPMENT, PROMOTIONAL ACTIVITIES AND PROVIDING WRITTEN GUIDELINES AND MATERIALS THEREFORE TO OTHERS (U.S. CLS. 100, 101 AND 102).

---

SN 76-137,697. MERISTAR HOTELS & RESORTS, INC., WASHINGTON, DC. FILED 9-29-2000.



FOR MANAGEMENT OF RESTAURANTS, HOTELS, RESORTS, GOLF COURSES AND GOLF PRO SHOPS FOR OTHERS (U.S. CLS. 100, 101 AND 102).

FIRST USE 8-3-1998; IN COMMERCE 8-3-1998.

---

SN 76-137,850. HEAFNER TIRE GROUP, INC., CHARLOTTE, NC. FILED 9-29-2000.

**TRAININGEDGE**

FOR AUTOMOTIVE AND VEHICLE BUSINESS MARKETING CONSULTING, NAMELY, DEVELOPING MARKETING PROGRAMS FOR AUTOMOTIVE AND VEHICLE BUSINESSES IN THE FIELD OF RETAILING TIRES AND AFTER-MARKET ACCESSORIES AND REPLACEMENT PARTS, AND IN THE FIELD OF AUTOMOTIVE AND VEHICLE MAINTENANCE AND REPAIR SERVICES (U.S. CLS. 100, 101 AND 102).

**CLASS 35—(Continued).**

SN 76-138,909. LAN CHILE S.A., SANTIAGO, CHILE, FILED 10-2-2000.



NO CLAIM IS MADE TO THE EXCLUSIVE RIGHT TO USE "USA", APART FROM THE MARK AS SHOWN.

THE MARK IS TO BE USED IN COLOR AND WE CLAIM THE FOLLOWING COLORS: THE LETTERS "LANBOX" ARE IN BLUE, "USA" IS GREY AND THE DESIGN IS RED.

FOR PROVIDING TECHNICAL AID AND ASSISTANCE IN THE OPERATION OF BOX RENTAL AND RECEIPT AND DELIVERY OF GOODS, DOCUMENTS, AND ARTICLES FOR OTHERS FOR STORAGE AND TRANSPORTATION PURPOSES; PURCHASING VIA CATALOGUE OF GOODS, DOCUMENTS AND ARTICLES FOR OTHERS FOR STORAGE AND TRANSPORTATION PURPOSES; COMPUTERIZED ONLINE ORDERING SERVICE FEATURING THE WHOLESALING AND RETAILING OF GOODS, DOCUMENTS AND ARTICLES FOR OTHERS FOR STORAGE AND TRANSPORTATION PURPOSES (U.S. CLS. 100, 101 AND 102).

SN 76-140,566. NEED A PRO, INC., PHOENIX, AZ. FILED 10-3-2000.

**CONSUMER 911**

NO CLAIM IS MADE TO THE EXCLUSIVE RIGHT TO USE "CONSUMER", APART FROM THE MARK AS SHOWN.

FOR COMMERCIAL INFORMATION AND DIRECTORY AGENCY (U.S. CLS. 100, 101 AND 102).

SN 76-141,095. NEXTPART, INC., EVANSTON, IL. FILED 10-4-2000.

**NEXTPART**

FOR DISTRIBUTORSHIPS AND RETAIL STORE SERVICES, ALL FEATURING RECYCLED PARTS FOR CARS, TRUCKS, MOTORCYCLES, BUSES, AND VANS, ALL VIA GLOBAL COMPUTER NETWORK AND TELEPHONE CALL CENTER (U.S. CLS. 100, 101 AND 102).

**CLASS 35—(Continued).**

SN 76-141,413. THANEXUS, INCORPORATED, MANASQUAN, NJ. FILED 10-5-2000.

**THANACARE**

FOR EMPLOYEE LEASING; OUTSOURCING SERVICES OF OTHERS IN THE FIELD OF FUNERAL DIRECTING AND OFFICE ADMINISTRATION TO FUNERAL ESTABLISHMENTS; BUSINESS MANAGEMENT AND CONSULTATION FOR FUNERAL SERVICE ESTABLISHMENTS; FUNERAL PRACTICE MANAGEMENT SERVICES; PERSONNEL MANAGEMENT; PAYROLL PREPARATION; TAX PREPARATION AND FILING; DEVELOPING FUNERAL BUSINESS OPERATIONS METHODS FOR OTHERS; COOPERATIVE ADVERTISING AND MARKETING; ADVERTISING SERVICES, NAMELY, PROMOTING THE SERVICES OF FUNERAL HOMES THROUGH THE DEVELOPMENT AND DISTRIBUTION OF PROMOTIONAL MATERIALS AND BY RENDERING SALES PROMOTION ADVICE (U.S. CLS. 100, 101 AND 102).

SN 76-143,169. SCAN.COM, INC., NEW YORK, NY. FILED 10-10-2000.

**ONE DIAL SHOPPING**

NO CLAIM IS MADE TO THE EXCLUSIVE RIGHT TO USE "SHOPPING", APART FROM THE MARK AS SHOWN.

FOR COMPARATIVE GOODS AND SERVICES PRICING SERVICES PROVIDED BY TELEPHONE AND/OR MOBILE SERVICES AMONG DIFFERENT RETAIL AND INTERNET ENTITIES, AND PROMOTING THE COMPARATIVE PRICING OF THE GOODS AND SERVICES OF OTHERS BY TELEPHONE AND/OR MOBILE SERVICE; TELEPHONE ORDER PROCESSING AND SHOPPING SERVICES PROVIDED BY TELEPHONE AND/OR MOBILE SERVICES; AND INTERACTIVE TELEPHONE AND/MOBILE SERVICES IN THE FIELD OF SHOPPING (U.S. CLS. 100, 101 AND 102).

SN 76-143,243. ZEBORG, INC., NEW YORK, NY. FILED 10-10-2000.

**THE ROCKET SCIENCE  
BEHIND INDIRECT COSTS**

NO CLAIM IS MADE TO THE EXCLUSIVE RIGHT TO USE "INDIRECT COSTS", APART FROM THE MARK AS SHOWN.

FOR BUSINESS TO BUSINESS E-COMMERCE SERVICES, NAMELY, BUSINESS AND MANAGEMENT CONSULTATION TO EVALUATE INDIRECT GOODS AND SERVICES AND TO FACILITATE PROCUREMENT THEREOF (U.S. CLS. 100, 101 AND 102).

FIRST USE 9-13-2000; IN COMMERCE 9-13-2000.

**CLASS 35—(Continued).**

SN 76-143,740. EDGETECH CONSULTING, INC., IRVINE, CA. FILED 10-10-2000.

**EDGETECH**

FOR EMPLOYMENT, HIRING, RECRUITING, PLACEMENT AND STAFFING SERVICES; BUSINESS MANAGEMENT CONSULTATION (U.S. CLS. 100, 101 AND 102).

FIRST USE 7-26-2000; IN COMMERCE 7-26-2000.

SN 76-144,745. SECUREGATE LIMITED, FYSHWICK, ACT, AUSTRALIA, FILED 10-11-2000.

**90EAST**

FOR BUSINESS MANAGEMENT, NAMELY, PROVIDING INFORMATION MANAGEMENT SERVICES FOR CLASSIFIED AND SENSITIVE INFORMATION (U.S. CLS. 100, 101 AND 102).

SN 76-144,844. STEUDLE, ROBERT, APO, AP. FILED 10-12-2000.

**ELDUETS**

FOR MARKETING SERVICES BOTH ON-LINE AND MAIL ORDER FOR MANUFACTURERS WHO WISH TO MARKET OUTSIDE THEIR LOCAL GEOGRAPHIC AREA BUT LACK THE RESOURCES TO DO SO ON THEIR OWN (U.S. CLS. 100, 101 AND 102).

FIRST USE 9-15-2000; IN COMMERCE 9-15-2000.

SN 76-148,032. EFINNET CORPORATION, TROY, MI. FILED 10-13-2000.



FOR ACCOUNTS RECEIVABLE SERVICES, NAMELY, PROVIDING AUTOMATED PROCESSING AND VALIDATION OF ACCOUNTS RECEIVABLE VIA THE INTERNET AND NON-INTERNET SOURCES (U.S. CLS. 100, 101 AND 102).

FIRST USE 3-0-2000; IN COMMERCE 3-0-2000.

**CLASS 35—(Continued).**

SN 76-148,816. INCREDIBLY EZ CORPORATION, TORTOLA, BR.VIRGIN ISLANDS, FILED 10-17-2000.

**EREGALO.COM MAKE YOUR PRESENTS FELT**

NO CLAIM IS MADE TO THE EXCLUSIVE RIGHT TO USE "EREGALO.COM", APART FROM THE MARK AS SHOWN.

THE ENGLISH TRANSLATION OF SPANISH TERM "REGALO" IS "GIFT".

FOR ON-LINE RETAIL OUTLET AND ORDERING SERVICES WHICH FEATURE FLOWERS, GIFT BASKETS, FOOD PRODUCTS, HOME AND ELECTRICAL APPLIANCES, ELECTRONIC DEVICES, BOOKS, VIDEO CASSETTES AND VIDEO COMPACT DISCS, AUDIO COMPACT DISCS, JEWELRY, COSMETICS, SOAPS, SPORTS AND EXERCISE EQUIPMENT, TOYS, CIGARS AND LIQUOR (U.S. CLS. 100, 101 AND 102).

SN 76-149,633. FEDERAL NEWS SERVICE, INC., WASHINGTON, DC. FILED 10-18-2000.



NO CLAIM IS MADE TO THE EXCLUSIVE RIGHT TO USE "NEWS SERVICE", APART FROM THE MARK AS SHOWN.

SEC. 2(F).

FOR INFORMATION SERVICES, NAMELY, VERBATIM TRANSCRIPTS OF HEARINGS, STATEMENTS, BRIEFINGS, STATISTICS AND INTERVIEWS, OF AND RELATING TO GOVERNMENTAL ACTIVITIES (U.S. CLS. 100, 101 AND 102).

FIRST USE 3-0-1989; IN COMMERCE 7-0-1989.

SN 76-151,015. ASHLAND INC., COVINGTON, KY. FILED 10-23-2000.

**GPEZORDER**

FOR COMPUTERIZED ON-LINE ORDERING SERVICES FEATURING THERMOPLASTIC RESIN PRODUCTS FOR USE IN MANUFACTURING, INCLUDING PROVIDING ON-LINE INFORMATION ABOUT THOSE PRODUCTS AND ABOUT EXTRUSION AND MOLDING PROCESSES, INCLUDING INJECTION, ROTATIONAL AND BLOW-MOLDING PROCESSES, IN WHICH SAID PRODUCTS MAY BE USED (U.S. CLS. 100, 101 AND 102).

FIRST USE 11-18-1999; IN COMMERCE 11-18-1999.

**CLASS 35—(Continued).**

SN 76-152,603. UP-STATISTICS CORPORATION, WOODLAND HILLS, CA. FILED 10-25-2000.

**BRILLIANT EXCHANGE**

FOR ONLINE RETAIL STORE FEATURING BOOKS, PAMPHLETS, BROCHURES, AUDIOTAPES, VIDEOTAPES, AUDIO CARTRIDGES AND VIDEO CARTRIDGES, AUDIO DISCS AND VIDEODISCS (U.S. CLS. 100, 101 AND 102).

SN 76-154,127. SITOUR USA, KINGSTON, NY. FILED 10-27-2000.



THE MARK CONSISTS, IN PART, OF THE STYLIZED WORDING "SNOJAM".

FOR PROMOTING SPORTS COMPETITION AND/OR SPORTS EVENTS OF OTHERS (U.S. CLS. 100, 101 AND 102).

FIRST USE 7-1-1999; IN COMMERCE 7-1-1999.

SN 76-154,432. 411SERVICES, INC., WOODLAND HILLS, CA. FILED 10-27-2000.



NO CLAIM IS MADE TO THE EXCLUSIVE RIGHT TO USE "411 I SERVICES", APART FROM THE MARK AS SHOWN.

FOR ONLINE MARKETING SERVICES, NAMELY, DISSEMINATION OF ADVERTISING FOR OTHERS VIA E-MAIL AND PROVIDING INFORMATION IN THE FIELD OF ONLINE DIRECT MARKETING (U.S. CLS. 100, 101 AND 102).

FIRST USE 4-1-2000; IN COMMERCE 4-1-2000.

SN 76-175,630. CONNECTIONS, L.C., WICHITA, KS. FILED 12-6-2000.

**HIRED HANDS**

FOR DATA PROCESSING SERVICES (U.S. CLS. 100, 101 AND 102).

**CLASS 35—(Continued).**

SN 76-179,926. METH COMMUNICATIONS GROUP, LLC, PLYMOUTH MEETING, PA. FILED 12-11-2000.

**Sick Message Syndrome**

NO CLAIM IS MADE TO THE EXCLUSIVE RIGHT TO USE "SYNDROME", APART FROM THE MARK AS SHOWN.

FOR BUSINESS CONSULTATION SERVICES, INCLUDING CONSULTATION SERVICES IN THE FIELD OF EFFECTIVE PUBLIC SPEAKING (U.S. CLS. 100, 101 AND 102).

FIRST USE 10-28-1999; IN COMMERCE 10-28-1999.

SN 76-183,695. FAMILY RECORDS, L.L.C., HOT SPRINGS, AR. FILED 12-21-2000.

**FAMILY RECORDS**

FOR PUBLICITY AGENT SERVICES (U.S. CLS. 100, 101 AND 102).

FIRST USE 11-9-2000; IN COMMERCE 11-9-2000.

SN 76-186,770. PEREGRINE OUTFITTERS, INC., WILLISTON, VT. FILED 12-27-2000.

**PEREGRINE DISTRIBUTION SERVICES**

OWNER OF U.S. REG. NO. 1,865,022.

NO CLAIM IS MADE TO THE EXCLUSIVE RIGHT TO USE "DISTRIBUTION SERVICES", APART FROM THE MARK AS SHOWN.

FOR ORDER FULFILLMENT SERVICES (U.S. CLS. 100, 101 AND 102).

FIRST USE 12-11-2000; IN COMMERCE 12-11-2000.

SN 76-190,481. PROFESSIONAL VETERINARY PRODUCTS, LTD., OMAHA, NE. FILED 1-5-2001.

**PROCONN**

FOR PROVIDING WHOLESALE DISTRIBUTORSHIP SERVICES FOR THE BENEFIT OF OTHERS FEATURING VETERINARY PHARMACEUTICAL PRODUCTS (U.S. CLS. 100, 101 AND 102).

**CLASS 35—(Continued).**

SN 76-190,561. AMERISPEC, INC., MEMPHIS, TN. FILED 1-5-2001.



OWNER OF U.S. REG. NOS. 1,497,266, 1,877,990 AND OTHERS.  
 FOR BUSINESS CONSULTATION AND MANAGEMENT ASSISTANCE RELATING TO THE OPENING AND OPERATION OF HOME AND BUILDING INSPECTION BUSINESSES (U.S. CLS. 100, 101 AND 102).  
 FIRST USE 5-12-2000; IN COMMERCE 5-12-2000.

---

SN 76-190,562. AMERISPEC, INC., MEMPHIS, TN. FILED 1-5-2001.



OWNER OF U.S. REG. NOS. 1,497,266, 1,877,990 AND OTHERS.  
 FOR BUSINESS CONSULTATION AND MANAGEMENT ASSISTANCE RELATING TO THE OPENING AND OPERATION OF HOME AND BUILDING INSPECTION BUSINESSES (U.S. CLS. 100, 101 AND 102).  
 FIRST USE 5-12-2000; IN COMMERCE 5-12-2000.

---

SN 76-192,067. ZEBORG, INC., NEW YORK, NY. FILED 1-10-2001.

**ZEBORG ADVANCED SOURCING**

NO CLAIM IS MADE TO THE EXCLUSIVE RIGHT TO USE "ADVANCED SOURCING", APART FROM THE MARK AS SHOWN.  
 FOR BUSINESS TO BUSINESS CONSULTING SERVICES FOR OTHERS IN THE FIELD OF EVALUATION AND PROCUREMENT OF INDIRECT GOODS AND SERVICES (U.S. CLS. 100, 101 AND 102).  
 FIRST USE 12-5-2000; IN COMMERCE 12-5-2000.

**CLASS 35—(Continued).**

SN 76-192,452. TRANSPORT RECOVERY SERVICES, INC., BILLERICA, MA. FILED 1-10-2001.

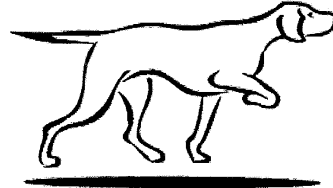

FOR AUDITING SERVICES, NAMELY THE AUDITING OF BILLS FOR FREIGHT, SHIPPING, TELECOMMUNICATIONS, UTILITY AND LEGAL SERVICES; ACCOUNTS PAYABLE RECOVERY AUDITING; LEASE COMPLIANCE AUDITING; TAX AUDITING AND VALUE ADDED TAX RECOVERY AUDITING; CONSULTING SERVICES, NAMELY ADVISING CUSTOMERS ON SUPPLY CHAIN AND LOGISTICS MANAGEMENT INCLUDING CUSTOMER'S CRITICAL SUPPLIER RELATIONSHIPS (U.S. CLS. 100, 101 AND 102).

---

SN 76-197,639. FLORIDA INSTITUTE OF CERTIFIED PUBLIC ACCOUNTANTS, TALLAHASSEE, FL. FILED 1-22-2001.

**FLORIDA CPA NETLINK**

NO CLAIM IS MADE TO THE EXCLUSIVE RIGHT TO USE "FLORIDA CPA", APART FROM THE MARK AS SHOWN.  
 FOR PROVIDING INFORMATION VIA WEB SITE IN THE FIELD OF ACCOUNTING (U.S. CLS. 100, 101 AND 102).  
 FIRST USE 1-1-1997; IN COMMERCE 1-1-1997.

---

SN 76-203,571. AMERICAN EXPRESS COMPANY, NEW YORK, NY. FILED 2-2-2001.

**EXECUTIVE AIR PROGRAM**

NO CLAIM IS MADE TO THE EXCLUSIVE RIGHT TO USE "AIR PROGRAM", APART FROM THE MARK AS SHOWN.  
 FOR PROMOTING THE GOODS AND SERVICES OF AIRLINES BY OFFERING A 2 FOR 1 TRAVEL PROMOTION (U.S. CLS. 100, 101 AND 102).

**CLASS 35—(Continued).**

SN 76-204,294. TOPICAL STORM, INC., WOBURN, MA. FILED 2-2-2001.



FOR ON-LINE ADVERTISING SERVICES FOR OTHERS; PROMOTING THE GOODS AND SERVICES OF OTHERS BY PLACING ADVERTISEMENTS IN ELECTRONIC FORMATS ACCESSED THROUGH GLOBAL COMPUTER NETWORKS (U.S. CLS. 100, 101 AND 102).

SN 76-208,932. PUBLIC INTEREST DATA, INC., ALEXANDRIA, VA. FILED 2-12-2001.



NO CLAIM IS MADE TO THE EXCLUSIVE RIGHT TO USE "PUBLIC INTEREST DATA INCORPORATED", APART FROM THE MARK AS SHOWN.

FOR COMPUTER DATA BASE MANAGEMENT FOR NONPROFIT ORGANIZATIONS (U.S. CLS. 100, 101 AND 102).

SN 76-209,116. EDVENTURE, INC., TUCSON, AZ. FILED 2-12-2001.



FOR BUSINESS AND REAL ESTATE MANAGEMENT SERVICES FOR EDUCATIONAL INSTITUTIONS; BUSINESS CONSULTATION FOR EDUCATIONAL INSTITUTIONS (U.S. CLS. 100, 101 AND 102).

FIRST USE 4-4-1978; IN COMMERCE 4-4-1978.

**CLASS 35—(Continued).**

SN 76-212,207. PRICEWATERHOUSECOOPERS LLP, NEW YORK, NY. FILED 2-15-2001.

**DEALSCENTRAL.COM**

FOR BUSINESS ACQUISITIONS AND MERGER CONSULTATION, NAMELY, FACILITATING THE COLLABORATIVE SHARING OF DOCUMENTS AND RESEARCH RELATED TO MERGERS AND ACQUISITIONS VIA A GLOBAL COMPUTER NETWORK (U.S. CLS. 100, 101 AND 102).

SN 76-212,208. PRICEWATERHOUSECOOPERS LLP, NEW YORK, NY. FILED 2-15-2001.

**DEALSCENTRAL**

FOR BUSINESS ACQUISITIONS AND MERGER CONSULTATION, NAMELY, FACILITATING THE COLLABORATIVE SHARING OF DOCUMENTS AND RESEARCH RELATED TO MERGERS AND ACQUISITIONS VIA A GLOBAL COMPUTER NETWORK (U.S. CLS. 100, 101 AND 102).

SN 76-213,196. PELLEON, L.P., WEXFORD, PA. FILED 2-21-2001.

**CLICK BID BUILD**

FOR PROCUREMENT SERVICES FOR OWNERS OF CONSTRUCTION PROJECTS SEEKING SERVICES OF GENERAL CONTRACTORS IN THE CONSTRUCTION INDUSTRY THROUGH A GLOBAL COMPUTER NETWORK (U.S. CLS. 100, 101 AND 102).

FIRST USE 4-11-2000; IN COMMERCE 9-22-2000.

SN 76-215,347. NEC AMERICA, INC., MELVILLE, NY. FILED 2-21-2001.

**CCDESIGN**

FOR BUSINESS CONSULTATION SERVICES, NAMELY, ASSISTING OTHERS IN THE FACILITATION, PLANNING, IMPLEMENTATION, OPERATION AND MANAGEMENT OF CUSTOMER CONTACT CENTERS (U.S. CLS. 100, 101 AND 102).

**CLASS 35—(Continued).**

SN 76-220,243. NETWORK ENTERPRISES, LLC, BRAINTREE, MA. FILED 3-6-2001.



FOR OFFERING THE OPERATION OF A WORLD-WIDE WEBSITE TO PROVIDE ONLINE NETWORKING OPPORTUNITIES FOR MEMBERS OF LOCAL CHAMBERS OF COMMERCE AND INDUSTRY AND BUSINESS ASSOCIATIONS USING AFFINITY PROFILES (U.S. CLS. 100, 101 AND 102).  
FIRST USE 12-1-2000; IN COMMERCE 12-1-2000.

SN 76-222,393. JATO DYNAMICS, INC., TROY, MI. FILED 3-12-2001.



OWNER OF U.S. REG. NO. 2,205,640.  
FOR MARKETING RESEARCH FOR THE AUTOMOTIVE INDUSTRY RELATING TO THE DESIGN, FEATURES, MANUFACTURE, MARKETING, CUSTOMER INCENTIVES, DISTRIBUTION, PRICING, SALE AND MARKET VOLUME OF MOTOR VEHICLES (U.S. CLS. 100, 101 AND 102).  
FIRST USE 10-0-1997; IN COMMERCE 10-0-1997.

SN 76-229,650. NATURAL'S CLOTHING COMPANY, INC., LAKE OSWEGO, OR. FILED 3-26-2001.

**THERAPY**

FOR RETAIL STORE SERVICES FEATURING WOMEN'S CLOTHING, SHOES, FURNITURE, BOOKS, AND SOAP (U.S. CLS. 100, 101 AND 102).

**CLASS 35—(Continued).**

SN 76-230,401. BOB JONES UNIVERSITY, INC., GREENVILLE, SC. FILED 3-26-2001.



OWNER OF U.S. REG. NOS. 2,146,427 AND 2,223,730.  
NO CLAIM IS MADE TO THE EXCLUSIVE RIGHT TO USE "HOME EDUCATOR'S MARKETPLACE", APART FROM THE MARK AS SHOWN.  
FOR RETAIL STORE SERVICES FOR BOOKS AND HOME EDUCATION MATERIALS AND SUPPLIES (U.S. CLS. 100, 101 AND 102).

SN 76-233,542. EZ-CROSS, INC., MOUNT LAUREL, NJ. FILED 3-29-2001.



FOR INTERNET SERVICE PROVIDING COMPARATIVE PRICING INFORMATION (U.S. CLS. 100, 101 AND 102).

SN 76-236,557. SMITH, KENT, SAN DIEGO, CA. FILED 4-5-2001.

**FASHIONBIZ**

FOR DISSEMINATION OF FASHION RELATED ADVERTISING MATTER FOR OTHERS VIA THE INTERNET; PROVIDING ONLINE DIRECTORY INFORMATION FEATURING A VARIETY OF GOODS AND SERVICES RELATING TO THE FASHION INDUSTRY; ON-LINE; ON-LINE ORDERING SERVICES IN THE FIELD OF CLOTHING (U.S. CLS. 100, 101 AND 102).  
FIRST USE 12-11-1997; IN COMMERCE 12-11-1997.

SN 76-239,978. WORKING MIND COMPANY, THE, DBA BOLD STRATEGIES, ST. LOUIS, MO. FILED 4-12-2001.

**BOLD STRATEGIES**

FOR PROVIDING ONLINE BUSINESS INFORMATION IN THE FIELD OF MANAGEMENT, LEADERSHIP AND EXECUTIVE DEVELOPMENT (U.S. CLS. 100, 101 AND 102).

**CLASS 35—(Continued).**

SN 76-245,759. SELECT AUTO IMPORTS INCORPORATED, ALEXANDRIA, VA. FILED 4-12-2001.



NO CLAIM IS MADE TO THE EXCLUSIVE RIGHT TO USE "AUTO IMPORTS", APART FROM THE MARK AS SHOWN.

FOR AUTOMOBILE DEALERSHIP (U.S. CLS. 100, 101 AND 102).

FIRST USE 1-9-1987; IN COMMERCE 1-9-1987.

---

SN 76-248,000. QVC, INC., WEST CHESTER, PA. FILED 4-27-2001.

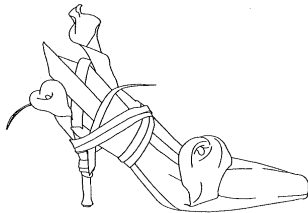

THE MARK CONSISTS OF A HIGH-HEEL SHOE DESIGN. FOR PROVIDING HOME SHOPPING SERVICES IN THE FIELD OF GENERAL MERCHANDISE BY MEANS TELEVISION, TELEPHONE AND THE INTERNET (U.S. CLS. 100, 101 AND 102).

FIRST USE 10-1-1995; IN COMMERCE 10-1-1995.

---

SN 76-248,594. LRF SLATER COMPANIES, INC., LIVINGSTON, NJ. FILED 4-30-2001.

**CHANNEL AUCTIONS**

OWNER OF U.S. REG. NOS. 1,135,339 AND 1,289,413. NO CLAIM IS MADE TO THE EXCLUSIVE RIGHT TO USE "AUCTIONS", APART FROM THE MARK AS SHOWN. FOR ON-LINE TRADING SERVICES TO FACILITATE THE SALE OF GOODS BY OTHERS VIA THE INTERNET (U.S. CLS. 100, 101 AND 102).

---

SN 76-248,640. PMSI-PROJECT MENTORS, INC., ATLANTA, GA. FILED 4-27-2001.

**PM-PROFESSIONALS**

FOR RECRUITING SERVICES TO ACQUIRE PROJECT MANAGERS FOR BUSINESSES (U.S. CLS. 100, 101 AND 102).

**CLASS 35—(Continued).**

SN 76-251,724. MAX COMMUNITY ENTERPRISES INC., MAX, ND. FILED 5-7-2001.

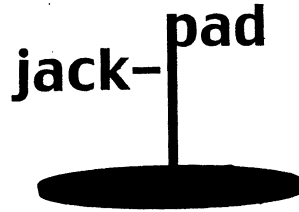

NO CLAIM IS MADE TO THE EXCLUSIVE RIGHT TO USE "JACK-PAD", APART FROM THE MARK AS SHOWN.

FOR WHOLESALE AND RETAIL SHOPS, MAIL ORDER SERVICES, TELEPHONE SHOP-AT-HOME, AND ON-LINE WHOLESALE AND RETAIL STORE SERVICES FEATURING JACK-PADS FOR USE IN THE SUPPORT OF STABILIZING JACKS ON MOTOR HOMES, CAMPER TRAILERS AND OTHER APPLICATIONS (U.S. CLS. 100, 101 AND 102).

---

SN 76-254,965. NEVADA FEET, INC., SUFFERN, NY. FILED 5-10-2001.

**LACE ZONE**

FOR RETAIL STORE SERVICES FEATURING LACES FOR FOOTWEAR (U.S. CLS. 100, 101 AND 102).

FIRST USE 12-1-2000; IN COMMERCE 12-1-2000.

---

SN 76-255,353. LONGHORN POWER, L.P., AUSTIN, TX. FILED 5-9-2001.

**LONGHORN POWER**

NO CLAIM IS MADE TO THE EXCLUSIVE RIGHT TO USE "POWER", APART FROM THE MARK AS SHOWN.

FOR WHOLESALE DISTRIBUTORSHIPS FEATURING ELECTRICITY AND NATURAL GAS (U.S. CLS. 100, 101 AND 102).

---

SN 76-255,808. ON3 DIRECT, SHARON, MA. FILED 5-7-2001.

**YOURGIFTCERTIFICATE.COM**

FOR PROMOTING THE GOODS AND SERVICES OF OTHERS THROUGH THE DISTRIBUTION OF GIFT CERTIFICATES, GIFTS AND DIRECT MARKETING ADVERTISING VIA A NEWSPAPER CARRIER DELIVERY, GLOBAL COMPUTER NETWORK, TELEPHONE AND DIRECT MAIL FOR OTHERS (U.S. CLS. 100, 101 AND 102).



**CLASS 35—(Continued).**

SN 76-256,273. CASTELLON, VICTOR M., HARAHAN, LA.  
FILED 5-14-2001.

**DELIVERIES FOR LIFE**

FOR COMPUTERIZED ON-LINE AND MAIL ORDER  
RETAIL PHARMACY AND DRUGSTORE SERVICES  
FEATURING PHARMACEUTICAL AND PRESCRIPTION  
DRUGS (U.S. CLS. 100, 101 AND 102).  
FIRST USE 4-3-2000; IN COMMERCE 4-3-2000.

SN 76-256,734. DATAMONITOR PLC, LONDON, ENGLAND,  
FILED 5-14-2001.

**SPP**

FOR MARKET RESEARCH SERVICES; PROVIDING  
BUSINESS MARKETING AND CONSULTATION (U.S.  
CLS. 100, 101 AND 102).  
FIRST USE 11-0-1997; IN COMMERCE 11-0-1997.

SN 76-257,991. HOWARD CHRISTENSEN AND ASSOCI-  
ATES, LTD, SCOTTSDALE, AZ. FILED 5-17-2001.

**BEST PRACTICE TO  
MOTIVATE MARKETS**

FOR BUSINESS ADVERTISING RELATED TO PUBLIC  
RELATIONS (U.S. CLS. 100, 101 AND 102).

SN 76-261,199. GLOW MANAGEMENT, LLC, BALDWIN,  
NY. FILED 5-24-2001.

**THE BUSINESS OF  
BEAUTIFUL WOMEN**

FOR MODELING AGENCY THAT SERVES TO PRO-  
VIDE FASHION, ENTERTAINMENT AND CORPORATE  
EMPLOYMENT FOR MODELS (U.S. CLS. 100, 101 AND  
102).  
FIRST USE 5-9-2001; IN COMMERCE 5-9-2001.

SN 76-261,237. TECHROD HOLDINGS INTERNATIONAL  
CORPORATION, ABBOTSFORD, B.C., CANADA, FILED  
5-24-2001.

**LOCAL VIP**

NO CLAIM IS MADE TO THE EXCLUSIVE RIGHT TO  
USE "LOCAL", APART FROM THE MARK AS SHOWN.  
FOR PROMOTING THE GOODS AND SERVICES OF  
OTHERS THROUGH THE DISTRIBUTION OF DIS-  
COUNT CARDS (U.S. CLS. 100, 101 AND 102).  
FIRST USE 2-1-2001; IN COMMERCE 2-1-2001.

**CLASS 35—(Continued).**

SN 76-263,034. WALLBREAKER INC., SANTA ANA, CA.  
FILED 5-23-2001.

**AVANT PREMIERE**

THE FRENCH WORDS "AVANT PREMIERE" TRANS-  
LATE IN ENGLISH TO MEAN "BEFORE THE PREMIERE"  
OR "BEFORE THE FIRST".

FOR RETAIL STORE SERVICES FEATURING MEN'S  
AND WOMEN'S APPAREL PRODUCTS, NAMELY,  
CLOTHING, HEADWEAR, FOOTWEAR, ACCESSORIES,  
BELTS, SCARVES, FRAGRANCES, AND JEWELRY (U.S.  
CLS. 100, 101 AND 102).

SN 76-264,703. RYAN, MOLLY A., SANTA FE, NM. FILED 5-  
31-2001.

**DOUBLE-HELIX**

FOR EXECUTIVE SEARCH AND RECRUITMENT  
SERVICES (U.S. CLS. 100, 101 AND 102).  
FIRST USE 11-0-1996; IN COMMERCE 1-0-1997.

SN 76-268,672. DATATREND TECHNOLOGIES, INC., MIN-  
NETONKA, MN. FILED 6-8-2001.

**E-CONTINUANCE**

FOR BUSINESS MANAGEMENT CONSULTING AND  
CONTINUITY PLANNING SERVICES (U.S. CLS. 100, 101  
AND 102).  
FIRST USE 5-14-2001; IN COMMERCE 5-14-2001.

SN 76-268,820. W. ATLEE BURPEE COMPANY, WARMIN-  
STER, PA. FILED 6-8-2001.

**BURPEE FLORAL**

OWNER OF U.S. REG. NOS. 609,760 AND 680,935.  
NO CLAIM IS MADE TO THE EXCLUSIVE RIGHT TO  
USE "FLORAL", APART FROM THE MARK AS SHOWN.  
FOR ELECTRONIC RETAILING SERVICES VIA COM-  
PUTER AND RETAIL STORE SERVICES, BOTH FEAT-  
URING FLOWERS, PLANTS, AND RELATED  
SUPPLIES; TELEMARKETING SERVICES FOR OTHERS  
FEATURING FLOWERS, PLANTS AND RELATED SUP-  
PLIES (U.S. CLS. 100, 101 AND 102).

**CLASS 35—(Continued).**

SN 76-269,618. WILD CHILD, INC., DALLAS, TX. FILED 6-11-2001.

**WILDCHILDSIGNATORY.COM**

OWNER OF U.S. REG. NO. 2,401,970.  
FOR BUSINESS CONSULTATION SERVICES IN THE FIELD OF SHOW BUSINESS AND TALENT AGENCIES; EMPLOYMENT RECRUITING IN THE NATURE OF HIRING ACTORS FOR ADVERTISING AGENCIES (U.S. CLS. 100, 101 AND 102).

SN 76-270,590. PBI MEDIA, LLC, POTOMAC, MD. FILED 6-13-2001.

**SATELLITE 2001 EUROPE**

NO CLAIM IS MADE TO THE EXCLUSIVE RIGHT TO USE "SATELLITE" AND "EUROPE", APART FROM THE MARK AS SHOWN.

FOR ARRANGING AND CONDUCTING BUSINESS CONFERENCES ON SATELLITE PRODUCTS, TRANSITION SERVICES, AND TECHNICAL SUPPORT SYSTEMS FOR SATELLITE INDUSTRY DECISION MAKERS THROUGH EXHIBITS, DEMONSTRATIONS AND DIRECT EXCHANGES (U.S. CLS. 100, 101 AND 102).

SN 76-271,637. LEVERAGE ENTERPRISES, LLC, FREDERICK, MD. FILED 6-14-2001.



THE MARK CONSISTS OF IN PART, OF THE STYLIZED LETTERS "LE".

FOR BUSINESS MANAGEMENT CONSULTATION, MARKET RESEARCH ANALYSIS AND STRATEGIC BUSINESS PLANNING (U.S. CLS. 100, 101 AND 102).

FIRST USE 10-1-1998; IN COMMERCE 10-1-1998.

**CLASS 35—(Continued).**

SN 76-271,743. TVI, INC., BELLEVUE, WA. FILED 6-16-2001.



NO CLAIM IS MADE TO THE EXCLUSIVE RIGHT TO USE "CASH FOR RECYCLING", APART FROM THE MARK AS SHOWN.

FOR SERVICES CONSISTING OF BUYING WITH CASH USED APPAREL, FURNITURE AND HOUSEHOLD ITEMS FROM THE PUBLIC AND WHOLESALE DISTRIBUTORSHIPS FEATURING USED APPAREL, FURNITURE AND HOUSEHOLD ITEMS, FOR WHOLESALE TO RETAIL THRIFT STORES (U.S. CLS. 100, 101 AND 102).

SN 76-271,970. SIBLEY'S SHOES, INC., WARREN, MI. FILED 6-14-2001.

**SIBLEYS SHOES.COMFORT**

NO CLAIM IS MADE TO THE EXCLUSIVE RIGHT TO USE "SHOES", APART FROM THE MARK AS SHOWN.

FOR ON-LINE RETAIL STORE SERVICES FEATURING MEN AND WOMEN'S SHOES (U.S. CLS. 100, 101 AND 102).

FIRST USE 4-0-2001; IN COMMERCE 4-0-2001.

SN 76-273,189. NORTHLICH, INC., CINCINNATI, OH. FILED 6-18-2001.

**MINDSCAN**

FOR MARKETING SERVICES, NAMELY MARKETING RESEARCH FOR OTHERS WHICH EMPLOYS QUALITATIVE AND QUANTITATIVE RESEARCH METHODS TO ENABLE MARKETERS TO QUICKLY AND EASILY EXPOSE A WIDE RANGE OF MARKETING STIMULI TO LARGE GROUPS OF CONSUMERS AND PROBE FOR DEEPER INSIGHTS AND IMMEDIATE REACTIONS, THUS CONDENSING THE CONSUMER VALIDATION PROCESS FROM MONTHS TO WEEKS; ADVERTISING AGENCY SERVICES, NAMELY CONDUCTING MARKETING RESEARCH AND MARKET ANALYSIS; CONDUCTING MARKETING STUDIES (U.S. CLS. 100, 101 AND 102).

FIRST USE 3-0-2001; IN COMMERCE 3-0-2001.

SN 76-273,286. MORELAND, DAVID, ALISO VIEJO, CA. FILED 6-18-2001.

**REVOLVE**

FOR RETAIL STORE SERVICES FEATURING SPORTSWEAR AND SNOWBOARD CLOTHING AND ON-LINE RETAIL STORE SERVICES FEATURING SPORTSWEAR AND SNOWBOARD CLOTHING (U.S. CLS. 100, 101 AND 102).

**CLASS 35—(Continued).**

SN 76-274,846. ROBERT HALF INCORPORATED, MENLO PARK, CA. FILED 6-21-2001.



OWNER OF U.S. REG. NO. 2,303,618.  
NO CLAIM IS MADE TO THE EXCLUSIVE RIGHT TO USE "MANAGEMENT RESOURCES" AND "PROJECT FINANCIAL PROFESSIONALS", APART FROM THE MARK AS SHOWN.  
FOR PROVIDING TEMPORARY STAFFING AND PERMANENT EMPLOYMENT PLACEMENT SERVICES (U.S. CLS. 100, 101 AND 102).

SN 76-276,754. EVENTREBELS.COM, INC., ELLICOTT CITY, MD. FILED 6-26-2001.

**EVENTREBELS.COM**

FOR BUSINESS EVENT PLANNING SERVICES; BUSINESS EVENT PLANNING CONSULTATION; ARRANGING AND MANAGING CORPORATE MEETINGS; MEETING REGISTRATION SERVICES; INTERACTIVE COMPUTER ON-LINE SERVICES OFFERED VIA A GLOBAL COMPUTER NETWORK IN THE FIELD OF BUSINESS EVENT PLANNING AND CONSULTATION (U.S. CLS. 100, 101 AND 102).

SN 76-277,690. STAFF LEASING, INC., BRADENTON, FL. FILED 6-28-2001.



DESIGN OF LETTER "G" WHEREIN A PORTION OF THE LETTER IS FORMED BY A HUMAN FIGURE WITH ARMS OUTSTRETCHED.  
FOR PERSONNEL PLACEMENT AND RECRUITMENT SERVICES AND BUSINESS CONSULTING SERVICES IN THE FIELD OF HUMAN RESOURCES (U.S. CLS. 100, 101 AND 102).

**CLASS 35—(Continued).**

SN 76-280,396. EXPRESS MEAT COMPANY, INC., OKLAHOMA CITY, OK. FILED 7-5-2001.



**EXPRESS MEAT COMPANY, INC.**

NO CLAIM IS MADE TO THE EXCLUSIVE RIGHT TO USE "EXPRESS MEAT COMPANY", APART FROM THE MARK AS SHOWN.  
FOR DISTRIBUTORSHIP SERVICES FEATURING MEAT PRODUCTS, NAMELY BEEF, CHICKEN AND PORK (U.S. CLS. 100, 101 AND 102).  
FIRST USE 4-19-1991; IN COMMERCE 4-19-1991.

SN 76-280,941. NADEAU TRAIL, INC., DANA POINT, CA. FILED 7-3-2001.

**ZHQ**

FOR ON-LINE BUSINESS DIRECTORY FEATURING A WIDE VARIETY OF PRODUCTS AND SERVICES; ADVERTISING THE PRODUCTS AND SERVICES OF OTHERS BY DISSEMINATION OF SUCH DIRECTORY IN TRADE PUBLICATIONS, NEWSPAPERS AND DIRECT MAILERS, AND ON TELEVISION AND THE INTERNET (U.S. CLS. 100, 101 AND 102).  
FIRST USE 11-19-2000; IN COMMERCE 11-19-2000.

SN 76-281,061. MACCABEE SPORTS, LA VERNE, CA. FILED 7-5-2001.

**WWW.EZFOLDING.COM**

FOR PROVIDING ON-LINE INFORMATION CONCERNING MANUFACTURER'S PRODUCTS, NAMELY, OUTDOOR FOLDING CAMPING FURNITURE (U.S. CLS. 100, 101 AND 102).

SN 76-281,634. NORTHLICH, INC., CINCINNATI, OH. FILED 7-3-2001.

**LIGHTNING RODS**

FOR BRAND DEVELOPMENT SERVICES, NAMELY DEVELOPING BRAND IDENTITY FOR OTHERS USING TOOLS WHICH ASSIST CLIENTS IN MAKING CONNECTIONS BETWEEN THEIR BRANDS AND CONSUMERS; ADVERTISING AGENCY SERVICES, NAMELY CONDUCTING MARKET RESEARCH AND MARKET ANALYSIS; CONDUCTING MARKETING STUDIES (U.S. CLS. 100, 101 AND 102).  
FIRST USE 4-0-2001; IN COMMERCE 4-0-2001.

**CLASS 35—(Continued).**

SN 76-281,823. WOLVERINE TECHNICAL STAFFING, INC., ANN ARBOR, MI. FILED 7-10-2001.



NO CLAIM IS MADE TO THE EXCLUSIVE RIGHT TO USE "TECHNICAL STAFFING INC.", APART FROM THE MARK AS SHOWN.  
 FOR TEMPORARY PERSONNEL PLACEMENT AND STAFFING (U.S. CLS. 100, 101 AND 102).  
 FIRST USE 5-31-2000; IN COMMERCE 5-31-2000.

SN 76-283,249. AUDIT TIME, LLC, LOS ANGELES, CA. FILED 7-12-2001.

**AUDIT TIME**

NO CLAIM IS MADE TO THE EXCLUSIVE RIGHT TO USE "AUDIT", APART FROM THE MARK AS SHOWN.  
 FOR ROYALTY ACCOUNTING AND AUDITING SERVICES DIRECTED TO BUSINESSES, MEMBERS OF THE ENTERTAINMENT INDUSTRY AND OTHERS INCLUDING BUT NOT LIMITED TO RECORDING ARTISTS, PUBLISHERS, SONGWRITERS, RECORD PRODUCERS, MOTION PICTURE PARTICIPANTS, TOUR ORGANIZATIONS AND CONCERT PRODUCERS (U.S. CLS. 100, 101 AND 102).  
 FIRST USE 1-0-2001; IN COMMERCE 1-0-2001.

SN 76-283,470. HOWROYD-WRIGHT EMPLOYMENT AGENCY, INC., GLENDALE, CA. FILED 6-29-2001.

**PRO TRAVEL**

FOR PERSONNEL RECRUITMENT, PLACEMENT AND MANAGEMENT SERVICES (U.S. CLS. 100, 101 AND 102).  
 FIRST USE 10-0-1992; IN COMMERCE 10-0-1992.

SN 76-287,440. POWER BUYING DEALERS, USA, INC., OAKBROOK, IL. FILED 7-19-2001.

**PBD**

FOR RETAIL STORE SERVICES FEATURING CONVENIENCE STORE ITEMS AND GASOLINE (U.S. CLS. 100, 101 AND 102).

**CLASS 35—(Continued).**

SN 76-293,518. STEVENS, MICHAEL D., CLEVELAND, OH. FILED 8-2-2001.

**PAID INFORMANT**

FOR ONLINE POSTING OF REWARDS FOR INFORMATION; DISPLAYING ADVERTISEMENTS FOR OTHERS AND PROVIDING ADVERTISING FOR OTHERS VIA THE INTERNET, DIRECT MAIL ADVERTISING AND TELEVISION ADVERTISING FOR ANY INFORMATION LEADING TO SOLVING CRIMES AND PREVENTION OF CRIMES (U.S. CLS. 100, 101 AND 102).

SN 76-294,068. CITY WINDOWS, L.L.C., NEW YORK, NY. FILED 8-6-2001.

**CITY WINDOWS**

FOR ADVERTISING SERVICES, NAMELY CREATING ILLUMINATED STOREFRONT ADVERTISING DISPLAYS FOR OTHERS (U.S. CLS. 100, 101 AND 102).

SN 76-294,921. HAAS, BRUCE P., CHICAGO, IL. FILED 8-3-2001.

**TAILS IN THE CITY**

FOR RETAIL STORE SERVICES FEATURING PET SUPPLIES AND PET GROOMING SERVICES (U.S. CLS. 100, 101 AND 102).

SN 76-295,534. UNITED WHOLESALE FLORISTS, LLC, LITTLE ROCK, AR. FILED 8-6-2001.

**FIRST PICK, ONE MORE WAY WE PUT OUR CUSTOMERS FIRST**

FOR WHOLESALE IMPORTATION AND WHOLESALE DISTRIBUTORSHIP SERVICES FEATURING FRESH CUT FLOWERS AND CUT GREENS (U.S. CLS. 100, 101 AND 102).

**CLASS 35—(Continued).**

SN 76-297,058. SHERLOCK'S CARPET & TILE, ORLAND PARK, IL. FILED 8-8-2001.



NO CLAIM IS MADE TO THE EXCLUSIVE RIGHT TO USE "CARPET & TILE" AND "YOUR COMPLETE FLOOR COVERING STORE", APART FROM THE MARK AS SHOWN.

FOR RETAIL FLOOR COVERING STORE (U.S. CLS. 100, 101 AND 102).  
FIRST USE 5-31-1997; IN COMMERCE 5-31-1997.

SN 76-310,180. WAL-MART STORES, INC., BENTONVILLE, AR. FILED 9-7-2001.

**GIFT 'N GO**

FOR RETAIL DEPARTMENT STORE SERVICES (U.S. CLS. 100, 101 AND 102).

SN 76-312,154. HEPBURN, BRUCE, LONDON W1A 2GS, UNITED KINGDOM, FILED 9-10-2001.

**IDEAS THAT CREATE NEW REVENUES**

FOR BUSINESS RESEARCH AND CONSULTING SERVICES IN THE FIELD OF BUSINESS MANAGEMENT (U.S. CLS. 100, 101 AND 102).  
FIRST USE 5-0-2000; IN COMMERCE 5-0-2000.

SN 76-313,201. STUPID PRICES FOR SMART SHOPPERS, INC., WEST BLOOMFIELD, MI. FILED 9-17-2001.

**STUPID PRICES FOR SMART SHOPPERS**

FOR RETAIL STORE SERVICES FEATURING HOUSEHOLD GOODS, INCLUDING FOOD PRODUCTS, KITCHEN APPLIANCES, ELECTRONIC PRODUCTS, DINNERWARE, COOKWARE, UTENSILS, BEDDING, AND LINENS (U.S. CLS. 100, 101 AND 102).

**CLASS 35—(Continued).**

SN 76-314,303. MEYNARD DESIGNS, INC., WALTHAM, MA. FILED 9-19-2001.

**EARTH SPIRIT**

FOR RETAIL AND DEPARTMENT STORE SERVICES DEALING PRIMARILY IN APPAREL AND ATHLETIC EQUIPMENT AND APPARATUS (U.S. CLS. 100, 101 AND 102).

SN 76-315,323. JUST JUNIPER, INC., DEERFIELD BEACH, FL. FILED 9-21-2001.

**SIMPLY JUNIPER**

FOR MAIL ORDER CATALOG SERVICES FEATURING HOME, GARDEN AND HOLIDAY GIFT ITEMS (U.S. CLS. 100, 101 AND 102).

FIRST USE 9-0-2001; IN COMMERCE 9-0-2001.

SN 76-316,053. KOGLER, JOHN, TUSTIN, CA. AND KOGLER, CLARE, TUSTIN, CA. FILED 9-21-2001.

**TARMARK**

FOR PROMOTING THE GOODS AND SERVICES OF OTHERS BY MEANS OF DIRECT MARKETING AND ADVERTISING; BUSINESS MARKETING AND DIRECT MARKETING CONSULTING SERVICES (U.S. CLS. 100, 101 AND 102).

SN 76-316,488. PALCOMM, INC., SANTA ANA, CA. FILED 9-24-2001.

**ADVANCEQUITY**

FOR PROMOTING THE SERVICES OF OTHERS BY PROVIDING A WEB SITE AT WHICH USERS CAN LINK TO INFORMATION ABOUT THE MORTGAGE INDUSTRY AND EDUCATIONAL SERVICES TO ENHANCE THE USERS KNOWLEDGE OF THE MORTGAGE INDUSTRY (U.S. CLS. 100, 101 AND 102).

SN 76-321,981. CONSOL PRODUCTIONS INC., NEW YORK, NY. FILED 10-8-2001.

**RENEWYORK**

FOR PROMOTING THE RENEWAL AND REVITALIZATION OF NEW YORK CITY AND NEW YORK STATE AS ATTRACTIVE AND DESIRABLE PLACES TO VISIT, LIVE, WORK AND CONDUCT BUSINESS IN ORDER TO ENHANCE THE IMAGE AND FURTHER THE ECONOMIC DEVELOPMENT AND WELL-BEING OF THE CITY AND STATE AND THEIR INHABITANTS (U.S. CLS. 100, 101 AND 102).

CLASS 35—(Continued).

SN 76-321,982. CONSOL PRODUCTIONS INC., NEW YORK, NY. FILED 10-8-2001.



FOR PROMOTING THE RENEWAL AND REVITALIZATION OF NEW YORK CITY AND NEW YORK STATE AS ATTRACTIVE AND DESIRABLE PLACES TO VISIT, LIVE, WORK AND CONDUCT BUSINESS IN ORDER TO ENHANCE THE IMAGE AND FURTHER THE ECONOMIC DEVELOPMENT AND WELL-BEING OF THE CITY AND STATE AND THEIR INHABITANTS (U.S. CLS. 100, 101 AND 102).

CLASS 35—(Continued).

SN 76-321,985. CONSOL PRODUCTIONS INC., NEW YORK, NY. FILED 10-8-2001.



FOR PROMOTING THE RENEWAL AND REVITALIZATION OF NEW YORK CITY AND NEW YORK STATE AS ATTRACTIVE AND DESIRABLE PLACES TO VISIT, LIVE, WORK AND CONDUCT BUSINESS IN ORDER TO ENHANCE THE IMAGE AND FURTHER THE ECONOMIC DEVELOPMENT AND WELL-BEING OF THE CITY AND STATE AND THEIR INHABITANTS (U.S. CLS. 100, 101 AND 102).

SN 76-321,983. CONSOL PRODUCTIONS INC., NEW YORK, NY. FILED 10-8-2001.



FOR PROMOTING THE RENEWAL AND REVITALIZATION OF NEW YORK CITY AND NEW YORK STATE AS ATTRACTIVE AND DESIRABLE PLACES TO VISIT, LIVE, WORK AND CONDUCT BUSINESS IN ORDER TO ENHANCE THE IMAGE AND FURTHER THE ECONOMIC DEVELOPMENT AND WELL-BEING OF THE CITY AND STATE AND THEIR INHABITANTS (U.S. CLS. 100, 101 AND 102).

SN 76-321,986. CONSOL PRODUCTIONS INC., NEW YORK, NY. FILED 10-8-2001.



FOR PROMOTING THE RENEWAL AND REVITALIZATION OF NEW YORK CITY AND NEW YORK STATE AS ATTRACTIVE AND DESIRABLE PLACES TO VISIT, LIVE, WORK AND CONDUCT BUSINESS IN ORDER TO ENHANCE THE IMAGE AND FURTHER THE ECONOMIC DEVELOPMENT AND WELL-BEING OF THE CITY AND STATE AND THEIR INHABITANTS (U.S. CLS. 100, 101 AND 102).

SN 76-321,984. CONSOL PRODUCTIONS INC., NEW YORK, NY. FILED 10-8-2001.



FOR PROMOTING THE RENEWAL AND REVITALIZATION OF NEW YORK CITY AND NEW YORK STATE AS ATTRACTIVE AND DESIRABLE PLACES TO VISIT, LIVE, WORK AND CONDUCT BUSINESS IN ORDER TO ENHANCE THE IMAGE AND FURTHER THE ECONOMIC DEVELOPMENT AND WELL-BEING OF THE CITY AND STATE AND THEIR INHABITANTS (U.S. CLS. 100, 101 AND 102).

SN 76-321,988. CONSOL PRODUCTIONS INC., NEW YORK, NY. FILED 10-8-2001.



FOR PROMOTING THE RENEWAL AND REVITALIZATION OF NEW YORK CITY AND NEW YORK STATE AS ATTRACTIVE AND DESIRABLE PLACES TO VISIT, LIVE, WORK AND CONDUCT BUSINESS IN ORDER TO ENHANCE THE IMAGE AND FURTHER THE ECONOMIC DEVELOPMENT AND WELL-BEING OF THE CITY AND STATE AND THEIR INHABITANTS (U.S. CLS. 100, 101 AND 102).

**CLASS 35—(Continued).**

SN 76-322,566. PAPERLOOP.COM, INC., SAN FRANCISCO, CA. FILED 10-9-2001.

**CONVERTINGLOOP**

FOR DISSEMINATION OF ADVERTISING FOR OTHERS IN THE FIELD OF CONVERTING AND PACKAGE PRINTING VIA A GLOBAL COMPUTER NETWORK; SHOPPERS GUIDE INFORMATION SERVICES, NAMELY, PROVIDING A DIRECTORY OF SUPPLIERS AND BUYERS IN THE FIELDS OF CONVERTING AND PACKAGE PRINTING VIA A GLOBAL COMPUTER NETWORK (U.S. CLS. 100, 101 AND 102).

FIRST USE 4-0-2001; IN COMMERCE 4-0-2001.

SN 78-016,064. W.W. GRAINGER, INC., LAKE FOREST, IL. FILED 7-10-2000.

**FINDMRO'S INDUSTRIAL PERSONAL SHOPPER**

NO CLAIM IS MADE TO THE EXCLUSIVE RIGHT TO USE "INDUSTRIAL PERSONAL SHOPPER", APART FROM THE MARK AS SHOWN.

FOR SOURCING AND PROCUREMENT SERVICES, NAMELY PURCHASING INDIRECT MATERIALS AND SERVICES FOR BUSINESSES (U.S. CLS. 100, 101 AND 102).

SN 78-016,140. CHRISTIAN & TIMBERS, INC., CLEVELAND, OH. FILED 7-10-2000.

**CANDIDATE CENTRAL**

NO CLAIM IS MADE TO THE EXCLUSIVE RIGHT TO USE "CANDIDATE", APART FROM THE MARK AS SHOWN.

FOR ONLINE EMPLOYMENT INFORMATION SERVICES, NAMELY PROVIDING JOB OPPORTUNITY INFORMATION, COUNSELING AND RECRUITMENT TO INDIVIDUALS AND PROVIDING RESUME INFORMATION TO EMPLOYERS (U.S. CLS. 100, 101 AND 102).

FIRST USE 6-1-2000; IN COMMERCE 6-1-2000.

SN 78-016,725. REACH PUBLISHING SYSTEMS, INC., CINCINNATI, OH. FILED 7-14-2000.

**IN-TOUCH MAGAZINE**

NO CLAIM IS MADE TO THE EXCLUSIVE RIGHT TO USE "MAGAZINE", APART FROM THE MARK AS SHOWN.

FOR PROMOTING THE SALE OF GOODS AND SERVICES OF OTHERS THROUGH THE DISTRIBUTION OF ADVERTISING MATERIAL, DISCOUNT COUPONS AND LOCAL EDITORIAL MATERIAL RELATED TO A TELEVISION OR RADIO STATION (U.S. CLS. 100, 101 AND 102).

FIRST USE 4-7-1997; IN COMMERCE 4-7-1997.

**CLASS 35—(Continued).**

SN 78-019,782. SMITH INTERNATIONAL, INC., HOUSTON, TX. FILED 8-4-2000.

**BITS OFFICE**

NO CLAIM IS MADE TO THE EXCLUSIVE RIGHT TO USE "BITS", APART FROM THE MARK AS SHOWN.

FOR PROVIDING CUSTOMIZED WELL PROPOSALS FOR OTHERS, THE PROPOSALS INCLUDING, NAMELY, ANALYSIS OF OFFSET WELL DATA, DRILLING TIME AND COST ANALYSIS, RECOMMENDED BIT PROGRAM, AND RECOMMENDED BIT OPERATING PARAMETERS FOR OPTIMIZING EACH BIT RUN (U.S. CLS. 100, 101 AND 102).

SN 78-020,601. E-LOCKED DOTCOM, INC., SUNRISE, FL. FILED 8-10-2000.

**E-LOCKED**

FOR ELECTRONIC TRACKING, MONITORING, AND LOCATING OF PERSONS, SHIPMENTS, GOODS IN TRANSIT, AND VEHICLES (U.S. CLS. 100, 101 AND 102).

SN 78-020,928. WALSH, STEVEN M, PAWTUCKET, RI. FILED 8-12-2000.

**MUSICIANSWORLD**

FOR ON-LINE RETAIL SERVICES FEATURING MUSICAL INSTRUMENTS, SHEET MUSIC, DIGITAL MUSIC, MUSIC MERCHANDISE; DISSEMINATION OF ADVERTISING FOR OTHERS VIA AN ON-LINE ELECTRONIC COMMUNICATIONS NETWORK (U.S. CLS. 100, 101 AND 102).

SN 78-022,505. ANDA, INC., FT. LAUDERDALE, FL. FILED 8-23-2000.

**ANDA QUALITY CHECKLIST**

FOR ON-LINE RETAIL STORE SERVICES FEATURING COSMETICS, SKINCARE, NUTRACEUTICALS, VITAMINS, MINERALS DIETARY SUPPLEMENTS, HERBAL TEAS, HERBS, SPICES AND BEVERAGES (U.S. CLS. 100, 101 AND 102).

SN 78-022,991. STAMATS COMMUNICATIONS, INC., CEDAR RAPIDS, IA. FILED 8-25-2000.

**EZPOLL**

FOR CONDUCTING MARKET RESEARCH, OPINION POLLS AND SURVEYS FOR BUSINESS OR ADVERTISING PURPOSES FOR EDUCATIONAL INSTITUTIONS VIA A GLOBAL COMPUTER NETWORK (U.S. CLS. 100, 101 AND 102).

**CLASS 35—(Continued).**

SN 78-024,212. LUPUS FOUNDATION OF AMERICA, INC. SOUTHERN CALIFORNIA CHAPTER, IRVINE, CA. FILED 9-1-2000.



THE CROSSHATCH LINES IN PART OF THE DRAWING ARE TO INDICATE SHADING AND ARE NOT AN INDICATION OF COLOR.

FOR PROMOTING SPORTS COMPETITIONS AND EVENTS OF OTHERS, NAMELY, PROMOTING 5K/10K RUNS FOR CHARITY (U.S. CLS. 100, 101 AND 102).

SN 78-025,958. LTW, INC., LAHAINA, HI. FILED 9-14-2000.

**MAUI MAMA'S**

NO CLAIM IS MADE TO THE EXCLUSIVE RIGHT TO USE "MAUI", APART FROM THE MARK AS SHOWN.

FOR RETAIL OUTLETS FEATURING COFFEE, TEA, ICE CREAM, GIFTS, COFFEE CUPS, COFFEE MUGS, MOUSE PADS, AND T-SHIRTS (U.S. CLS. 100, 101 AND 102).

SN 78-027,429. PERFUME EMPORIUM, INC., IRVINE, CA. FILED 9-24-2000.

**BEAUTY BUCKS**

NO CLAIM IS MADE TO THE EXCLUSIVE RIGHT TO USE "BEAUTY", APART FROM THE MARK AS SHOWN.

FOR ON-LINE RETAIL SERVICES IN THE FIELD OF COSMETICS FEATURING MERCHANDISE DISCOUNTS FOR PREFERRED CUSTOMERS (U.S. CLS. 100, 101 AND 102).

FIRST USE 2-28-2000; IN COMMERCE 7-7-2000.

SN 78-030,395. E-SELEX.COM, SAN DIEGO, CA. FILED 10-12-2000.

**SELEX SUCCESS**

FOR HUMAN RESOURCES MANAGEMENT AND PERSONNEL SELECTION SERVICES (U.S. CLS. 100, 101 AND 102).

FIRST USE 10-5-2000; IN COMMERCE 10-5-2000.

**CLASS 35—(Continued).**

SN 78-031,193. DUANE, MARK W., KENOSHA, WI. FILED 10-18-2000.

**LUNKER.COM**

FOR DISSEMINATION OF ADVERTISING FOR OTHERS VIA ON-LINE ELECTRONIC COMMUNICATIONS NETWORK; ON-LINE TRADING SERVICES TO FACILITATE THE SALE OF GOODS BY OTHERS VIA A COMPUTER NETWORK AND PROVIDING EVALUATIVE FEEDBACK AND RATINGS OF SELLER'S GOODS AND SERVICES, THE VALUE AND PRICES OF SELLERS' GOODS, BUYERS' AND SELLERS' PERFORMANCE, DELIVERY AND OVERALL TRADING EXPERIENCE IN CONNECTION THEREWITH (U.S. CLS. 100, 101 AND 102).

FIRST USE 2-21-2000; IN COMMERCE 2-21-2000.

SN 78-032,552. INTERNATIONAL MASTERS PUBLISHERS AB, MALMO, SWEDEN, FILED 10-26-2000.

**EGIFTOMANIA.COM**

FOR RETAIL SERVICES FEATURING GIFTS ACCESSIBLE BY MEANS OF A GLOBAL NETWORK (U.S. CLS. 100, 101 AND 102).

FIRST USE 11-20-2000; IN COMMERCE 11-20-2000.

SN 78-032,784. D'MELLO, NOEL P, MEMPHIS, TN. FILED 10-28-2000.

NO CLAIM IS MADE TO THE EXCLUSIVE RIGHT TO USE "DOLLAR", APART FROM THE MARK AS SHOWN.

FOR RETAIL VARIETY STORE WHERE ALL ITEMS ARE PRICED AT ONE DOLLAR OR LESS (U.S. CLS. 100, 101 AND 102).

SN 78-035,745. CLEVER IDEAS, INC., CHICAGO, IL. FILED 11-17-2000.

**VALUED MEMBER**

NO CLAIM IS MADE TO THE EXCLUSIVE RIGHT TO USE "MEMBER", APART FROM THE MARK AS SHOWN.

FOR CUSTOMER LOYALTY PROGRAMS FEATURING DIRECT MAIL COMMUNICATIONS, E-MAIL COMMUNICATIONS, POINT ACCUMULATION AND REDEMPTION FOR EITHER FUTURE DISCOUNTS, MERCHANDISE OR AIRLINE MILES, DESIGNED TO INCREASE CONSUMER LOYALTY (U.S. CLS. 100, 101 AND 102).



**CLASS 35—(Continued).**

SN 78-038,727. MARION OFFICE PRODUCTS INC., NASHUA, NH. FILED 12-11-2000.



FOR ON-LINE RETAIL STORE SERVICES FEATURING OFFICE SUPPLIES, AND OFFICE FURNITURE AND PRINTING AND ADVERTISING SERVICES, NAMELY, PREPARING AND DISSEMINATING ADVERTISING FOR OTHERS VIA ON-LINE COMMUNICATIONS NETWORKS (U.S. CLS. 100, 101 AND 102).

SN 78-039,278. KERR, JEAN D., MARIETTA, GA. FILED 12-14-2000.

**FROM TREE TO THEE**

FOR RETAIL STORE SERVICES FEATURING HOME ACCESSORIES, NAMELY, RUGS, ARTWORK, BASKETS, TOWELS, BEDDING, BED LINENS, COMFORTERS, BEDS, BIRD CAGES AND HOUSES, BLANKETS AND QUILTS, BOOKS, NATURE COMPACT DISCS, CALENDARS, CANDLES AND CANDLE STICKS, CERAMICS, WIND CHIMES, CHINA AND CRYSTAL, CLOCKS, DOLLS AND PUPPETS, STATIONERY, DESK SETS, DINNERWARE, TOYS, FLATWARE, FLORAL ARRANGEMENTS, WATER FOUNTAINS, PICTURE FRAMES, FURNITURE, GAMES AND PUZZLES, GARDEN TOOLS, GIFT WRAP AND GREETING CARDS, GLASSWARE, GOURMET FOODS AND CANDY, COOKWARE, LAMPS, MIRRORS, JEWELRY, PILLOWS, POTPOURRI, POTTERY AND STONWARE, SCULPTURE, LINENS AND ARTIFICIAL TREES (U.S. CLS. 100, 101 AND 102).

SN 78-042,221. CEANNAS, INC., WEST HARTFORD, CT. FILED 1-8-2001.

**CEANNAS**

THE WORD "CEANNAS" MEANS "LEADERSHIP, SUPERIORITY, HEADSHIP, CHIEFTAINSHIP, THE UPPER HAND".

FOR EMPLOYMENT PLACEMENT SERVICES (U.S. CLS. 100, 101 AND 102).

**CLASS 35—(Continued).**

SN 78-042,726. CHI COMPUTERS + SOLUTIONS, LLC, PINE BLUFF, AR. FILED 1-11-2001.

**K12DISCOUNT.COM**

FOR RETAIL STORE SERVICES FEATURING COMPUTER HARDWARE, COMPUTER SOFTWARE, COMPUTER PERIPHERALS, COMPUTER ACCESSORIES AND COMPUTER SUPPLIES, NAMELY INK AND TONER CARTRIDGES, BATTERIES AND CHARGERS, PAPER AND TRANSPARENCIES, AND REMOVABLE STORAGE MEDIA, NAMELY, TAPES, BACK-UP TAPES, DISKETTES, AND RECORDABLE CDS (U.S. CLS. 100, 101 AND 102).

FIRST USE 3-9-2000; IN COMMERCE 3-9-2000.

SN 78-043,397. BEELINE SHOPPER, TROY, OH. FILED 1-16-2001.

**SHOP SMART, EAT RIGHT**

NO CLAIM IS MADE TO THE EXCLUSIVE RIGHT TO USE "SHOP", APART FROM THE MARK AS SHOWN.

FOR ELECTRONIC RETAILING SERVICES VIA COMPUTER FEATURING GROCERIES AND FOOD NUTRITIONAL INFORMATION (U.S. CLS. 100, 101 AND 102).

FIRST USE 12-20-2000; IN COMMERCE 12-20-2000.

SN 78-045,879. FIRST MATERIALS & TECHNOLOGY, INC., CAMERON, TX. FILED 1-31-2001.

**TRU-CHEM**

FOR WHOLESALE DISTRIBUTORSHIPS FEATURING THE SOIL STABILIZATION MATERIALS OF OTHERS (U.S. CLS. 100, 101 AND 102).

FIRST USE 1-1-1996; IN COMMERCE 1-1-1996.

SN 78-051,021. INSIGHTS UNLIMITED INC., PAOLI, PA. FILED 3-2-2001.

**MOVE BY MOUSE CHANGE OF ADDRESS SERVICE**

NO CLAIM IS MADE TO THE EXCLUSIVE RIGHT TO USE "CHANGE OF ADDRESS SERVICE", APART FROM THE MARK AS SHOWN.

FOR DISPLAYING ADVERTISEMENTS FOR OTHERS VIA THE INTERNET (U.S. CLS. 100, 101 AND 102).

**CLASS 35—(Continued).**

SN 78-051,794. BENEFIT PLAN AUDIT SERVICES, LLC, SANTA MONICA, CA. FILED 3-7-2001.

**Benefit Plan Audit Services**

NO CLAIM IS MADE TO THE EXCLUSIVE RIGHT TO USE "BENEFIT PLAN AUDIT SERVICES", APART FROM THE MARK AS SHOWN.

FOR BUSINESS AUDITING OF HEALTH AND RETIREMENT BENEFIT PLAN PAYMENTS, PROCEDURES, AND CONTROLS (U.S. CLS. 100, 101 AND 102). FIRST USE 2-9-2001; IN COMMERCE 2-28-2001.

SN 78-055,050. TRUSERV CORPORATION, CHICAGO, IL. FILED 3-26-2001.

**TRUEADVANTAGE**

FOR CONDUCTING A MEMBER INCENTIVE PROGRAM FOR MEMBERS OF A COOPERATIVE TO PROMOTE VOLUNTARY COMPLIANCE WITH PRE-DETERMINED BRAND STANDARDS (U.S. CLS. 100, 101 AND 102).

FIRST USE 11-0-1995; IN COMMERCE 11-0-1995.

SN 78-055,525. BURKE, TOM, LAKESIDE PARK, KY. FILED 3-28-2001.

**HR COUNTRY**

NO CLAIM IS MADE TO THE EXCLUSIVE RIGHT TO USE "HR", APART FROM THE MARK AS SHOWN.

FOR PROVIDING HUMAN RESOURCE INFORMATION VIA A GLOBAL COMPUTER NETWORK (U.S. CLS. 100, 101 AND 102).

SN 78-056,031. WASHINGTON ECONOMICS GROUP, INC., THE, CORAL GABLES, FL. FILED 3-30-2001.

**WEG**

FOR CONSULTING SERVICES IN THE FIELD OF ECONOMICS, NAMELY, ANALYSIS OF BUSINESS CONDITIONS AND REGIONAL ECONOMIC FORECASTS; ECONOMIC IMPACT ASSESSMENTS OF THIRD PARTIES' ACTIVITIES IN GENERATION OF INCOME, OUTPUT AND EMPLOYMENT; PROVIDING CORPORATE AND PUBLIC SECTOR EXTERNAL RELATIONS; PROVIDING CUSTOMIZED ECONOMIC DEVELOPMENT STRATEGIES, MARKETING STRATEGIES AND INVESTMENT STRATEGIES FOR OTHERS; AND CONDUCTING CORPORATE EXPANSION STUDIES (U.S. CLS. 100, 101 AND 102).

FIRST USE 12-29-1992; IN COMMERCE 1-4-1993.

**CLASS 35—(Continued).**

SN 78-056,819. ECOMPANIES WIRELESS LLC, SANTA MONICA, CA. FILED 4-4-2001.

**PACKETCAFE**

FOR BUSINESS SERVICES, NAMELY THE CREATION, MARKETING AND ADMINISTRATION OF AFFILIATION PROGRAMS FOR INDEPENDENT OPERATORS OF WIRELESS NETWORKS (U.S. CLS. 100, 101 AND 102).

SN 78-058,097. HERBAL BAR INDUSTRIES, PHOENIX, AZ. FILED 4-12-2001.

**HBI**

OWNER OF U.S. REG. NO. 2,417,010.

FOR RETAIL STORE SERVICES, MAIL ORDER CATALOGUE SERVICES AND ELECTRONIC CATALOG SERVICES, AND COMPUTERIZED ON-LINE RETAIL STORE SERVICES, ALL FEATURING SMOKER ARTICLES AND ACCESSORIES, NAMELY, TOBACCO, CIGARETTE ROLLING PAPERS, CIGARETTE ROLLING MACHINES, CIGARETTE HOLDERS, PIPES, PIPE CLEANERS, TOBACCO JARS, LIGHTERS, ASH TRAYS, BODY ART, INCENSE, OILS, INCENSE BURNERS, OILS BURNERS, CANDLES, HERBS, JEWELRY, SCALES, POSTERS, STICKERS, T-SHIRTS, HATS, SUNGLASSES, KEY CHAINS, AND AIR FRESHENERS (U.S. CLS. 100, 101 AND 102).

FIRST USE 6-1-1996; IN COMMERCE 6-1-1996.

SN 78-060,389. COMSCORE NETWORKS, INC., RESTON, VA. FILED 4-25-2001.

**NETSCORE TRAFFIC**

FOR PROVIDING MARKET RESEARCH SERVICES REGARDING INTERNET USE ON A GLOBAL NETWORK OF COMPUTERS (U.S. CLS. 100, 101 AND 102).

FIRST USE 3-16-2001; IN COMMERCE 3-28-2001.

SN 78-062,498. LUMINAGROUP LLC, BOULDER, CO. FILED 5-8-2001.

**LUMINAGROUP**

NO CLAIM IS MADE TO THE EXCLUSIVE RIGHT TO USE "GROUP", APART FROM THE MARK AS SHOWN.

FOR BUSINESS CONSULTATION (U.S. CLS. 100, 101 AND 102).

FIRST USE 5-8-2001; IN COMMERCE 5-8-2001.

**CLASS 35—(Continued).**

SN 78-063,234. CIGLER, RENEE, JANE, EMERYVILLE, CA. FILED 5-12-2001.



FOR CARTOON CHARACTER LICENSING AND LICENSING GRAPHIC LOGOS (U.S. CLS. 100, 101 AND 102).

SN 78-063,406. WILSON'S DANICA HOUSE, SANTA BARBARA, CA. FILED 5-14-2001.

**DANICAHOUSE**

FOR RETAIL FURNITURE STORES (U.S. CLS. 100, 101 AND 102).  
FIRST USE 10-15-1961; IN COMMERCE 10-15-1961.

SN 78-063,490. KALEIDOSCOPE SPORTS & ENTERTAINMENT L.L.C., NEW YORK, NY. FILED 5-14-2001.

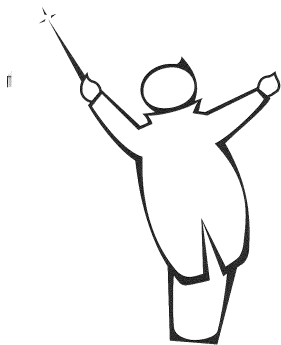

FOR BUSINESS CONSULTATION SERVICES IN THE FIELD OF BUSINESS EVENT PLANNING; BUSINESS EVENT MANAGEMENT, NAMELY, EVENT CONTRACT NEGOTIATION FOR ENTERTAINMENT, FOOD, AND BEVERAGE, DECORATING, ACCOMMODATION AND TRAVEL SERVICES FOR THE EVENTS OF OTHERS (U.S. CLS. 100, 101 AND 102).

SN 78-064,100. DCG CORPLAN CONSULTING LLC, WEST ORANGE, NJ. FILED 5-17-2001.

**ECONOGRAPHICS**

FOR PROVIDING INFORMATION IN THE FIELD OF BUSINESS ECONOMIC DEVELOPMENT COMPILED BASED ON ECONOMIC AND DEMOGRAPHIC FACTORS BY LOCATION (U.S. CLS. 100, 101 AND 102).

**CLASS 35—(Continued).**

SN 78-064,126. ORLANDO/ORANGE COUNTY CONVENTION & VISITORS BUREAU, INC., ORLANDO, FL. FILED 5-17-2001.

**GLOBAL TRAVELVISIONS**

NO CLAIM IS MADE TO THE EXCLUSIVE RIGHT TO USE "GLOBAL", APART FROM THE MARK AS SHOWN.  
FOR CONDUCTING BUSINESS RESEARCH AND SURVEYS, NAMELY INTERNATIONAL TRAVEL RESEARCH AND SURVEYS; PROMOTIONAL SERVICES, NAMELY PROMOTION OF TOURISM AND CONVENTIONS IN THE UNITED STATES (U.S. CLS. 100, 101 AND 102).

SN 78-065,550. PURPLE CAT COMPANY, THE, FENTON, MO. FILED 5-24-2001.

**THE PURPLE CAT COMPANY**

NO CLAIM IS MADE TO THE EXCLUSIVE RIGHT TO USE "COMPANY", APART FROM THE MARK AS SHOWN.  
FOR COMPUTERIZED ON-LINE RETAIL SERVICES FEATURING PAPER GOODS; NAMELY, JOURNALS, NOTECARDS, CALENDARS, ORGANIZERS, PHOTO ALBUMS, STATIONERY, POSTCARDS, WRITING PAPER, ENVELOPES, MEMORY BOOKS, STICKERS, PORTFOLIOS, PICTURE FRAMES, AND RECIPE BOOKS; AND RETAIL STORE SERVICES FEATURING PAPER GOODS; NAMELY, JOURNALS, NOTECARDS, CALENDARS, ORGANIZERS, PHOTO ALBUMS, STATIONERY, POSTCARDS, WRITING PAPER, ENVELOPES, MEMORY BOOKS, STICKERS, PORTFOLIOS, PICTURE FRAMES, AND RECIPE BOOKS (U.S. CLS. 100, 101 AND 102).

SN 78-065,727. D'ALESSANDRO, DAVID F., BOSTON, MA. FILED 5-25-2001.

**10 RULES FOR BUILDING THE KILLER BRAND**

NO CLAIM IS MADE TO THE EXCLUSIVE RIGHT TO USE "BRAND", APART FROM THE MARK AS SHOWN.  
FOR BUSINESS CONSULTATION SERVICES IN THE FIELD OF BRAND MARKETING (U.S. CLS. 100, 101 AND 102).

**CLASS 35—(Continued).**

SN 78-065,728. D'ALESSANDRO, DAVID F., BOSTON, MA. FILED 5-25-2001.

## **BRAND WARFARE:10 RULES FOR BUILDING THE KILLER BRAND**

NO CLAIM IS MADE TO THE EXCLUSIVE RIGHT TO USE "BAND", APART FROM THE MARK AS SHOWN.

FOR BUSINESS CONSULTATION SERVICES IN THE FIELD OF BRAND MARKETING (U.S. CLS. 100, 101 AND 102).

SN 78-069,946. HAZER'S AUTO WRECKING, INC., WEST FARGO, ND. FILED 6-19-2001.

## **HEADLIGHTS TO TAILLIGHTS**

FOR RETAIL ON-LINE STORE SERVICES FEATURING NEW AND USED AUTOMOBILE PARTS (U.S. CLS. 100, 101 AND 102).

FIRST USE 9-1-2000; IN COMMERCE 9-1-2000.

SN 78-070,822. CREATIVE HEALTHCARE SOLUTIONS, L.L.C., SARATOGA SPRINGS, OH. FILED 6-25-2001.

## **NEVER BE FORGOTTEN**

FOR ADVERTISING AGENCY, PUBLIC RELATIONS AND MARKET RESEARCH SERVICES; DIRECT MARKETING ADVERTISING SERVICES FOR OTHERS; SALES PROMOTION SERVICES, NAMELY PROMOTING THE GOODS AND SERVICES OF THE HEALTHCARE AND PHARMACEUTICAL INDUSTRIES THROUGH THE RENDERING OF SALES PROMOTION ADVICE AND THE DISTRIBUTION OF PROMOTIONAL MATERIALS; BUSINESS MARKETING CONSULTING SERVICES; PROVIDING INFORMATION IN THE FIELDS OF PUBLIC RELATIONS, BUSINESS MANAGEMENT AND BUSINESS MARKETING BY MEANS OF A GLOBAL COMPUTER NETWORK; MARKET ANALYSIS; CONDUCTING BUSINESS AND MARKET RESEARCH SURVEYS; CONDUCTING MARKETING STUDIES (U.S. CLS. 100, 101 AND 102).

SN 78-073,171. GENERAL MILLS, INC., MINNEAPOLIS, MN. FILED 7-10-2001.

## **SHOPPER SOLUTIONS**

NO CLAIM IS MADE TO THE EXCLUSIVE RIGHT TO USE "SHOPPER", APART FROM THE MARK AS SHOWN.

FOR CONDUCTING BUSINESS AND MARKET RESEARCH AND PROVIDING ANALYSIS THEREOF RELATING TO THE PURCHASE AND CONSUMPTION OF FOOD (U.S. CLS. 100, 101 AND 102).

**CLASS 35—(Continued).**

SN 78-079,814. TOT STOP, INC., BOCA RATON, FL. FILED 8-17-2001.

## **TOT STOP**

FOR RETAIL DRUG STORE SERVICES (U.S. CLS. 100, 101 AND 102).

SN 78-084,963. NATURAL SLIM, INC., SAN JUAN, PUERTO RICO, FILED 9-21-2001.

## **DIETWAYS**

FOR ON-LINE AND RETAIL STORE SERVICES FEATURING SUGAR FREE AND LOW CARBOHYDRATE FOODS, DESSERTS AND SWEETS (U.S. CLS. 100, 101 AND 102).

FIRST USE 5-15-2001; IN COMMERCE 5-15-2001.

SN 78-087,546. PICKERING & SIMMONS LLC, EDISON, NJ. FILED 10-9-2001.

## **OLD DURHAM ROAD**

FOR MAIL ORDER CATALOG SERVICES AND ON-LINE RETAIL STORE SERVICES FEATURING HOME PRODUCTS AND COLLECTIBLES (U.S. CLS. 100, 101 AND 102).

**CLASS 36—INSURANCE AND FINANCIAL**

SN 74-017,490. NATIONAL DATA INTELLECTUAL PROPERTY CORP., WILMINGTON, DE. BY ASSIGNMENT NATIONAL DATA CORPORATION 03, ATLANTA, GA. FILED 1-9-1990.

## **EAS\$Y-CLAIM**

FOR INSURANCE ELIGIBILITY VERIFICATION BY MEANS OF THIRD PARTY MEMBERSHIP CARDS VIA A GLOBAL COMPUTER NETWORK; INSURANCE CLAIMS ADMINISTRATION (U.S. CLS. 100, 101 AND 102).

FIRST USE 2-1-1988; IN COMMERCE 2-1-1988.

**CLASS 36—(Continued).**

SN 75-423,754. SIT INVESTMENT ASSOCIATES, INC., MINNEAPOLIS, MN. FILED 1-26-1998.

**SIT MUTUAL FUNDS**

NO CLAIM IS MADE TO THE EXCLUSIVE RIGHT TO USE "MUTUAL FUNDS", APART FROM THE MARK AS SHOWN.

FOR MUTUAL FUND INVESTMENT SERVICES; INVESTMENT OF FUNDS FOR OTHERS; FUNDS INVESTMENT SERVICES (U.S. CLS. 100, 101 AND 102).  
FIRST USE 8-1-1996; IN COMMERCE 8-1-1996.

SN 75-562,490. JOHN HANCOCK DISTRIBUTORS, INC., BOSTON, MA. FILED 10-1-1998.

**SFN**

FOR INVESTMENT ADVISORY SERVICES, INVESTMENT MANAGEMENT SERVICES, INVESTMENT OF FUNDS FOR OTHERS, SECURITIES BROKER-DEALER SERVICES, INSURANCE BROKERAGE SERVICES (U.S. CLS. 100, 101 AND 102).

SN 75-604,188. GMAC MORTGAGE CORPORATION, HORSHAM, PA. BY ASSIGNMENT DITECH FUNDING CORPORATION, IRVINE, CA. FILED 12-9-1998.

**DITECH.COM**

OWNER OF U.S. REG. NO. 2,158,800.  
FOR REAL ESTATE MORTGAGE BANKING AND LENDING SERVICES; LOAN ORIGINATION AND FINANCING VIA A GLOBAL COMMUNICATIONS NETWORK (U.S. CLS. 100, 101 AND 102).

SN 75-621,398. UNITED FAMILY LIFE INSURANCE COMPANY, ATLANTA, GA. FILED 1-15-1999.

**FORTISFAMILYLINK**

FOR PROVIDING FUNERAL EXPENSE POLICY SERVICES, NAMELY, PROVIDING FUNERAL EXPENSE POLICY INFORMATION INCLUDING INFORMATION REGARDING PREMIUM PAYMENTS MADE AND INFORMATION REGARDING DEATH BENEFITS AND ELECTRONIC PROCESSING OF INSURANCE CLAIMS AND PAYMENT DATA, ALL PROVIDED VIA A GLOBAL COMPUTER NETWORK (U.S. CLS. 100, 101 AND 102).

FIRST USE 10-0-1998; IN COMMERCE 10-0-1998.

**CLASS 36—(Continued).**

SN 75-727,935. LOMBARD CANADA LTD., TORONTO, ONTARIO M5H 1P9, CANADA, FILED 6-14-1999.



PRIORITY CLAIMED UNDER SEC. 44(D) ON CANADA APPLICATION NO. 899359, FILED 12-14-1998, REG. NO. TMA527179, DATED 4-28-2000, EXPIRES 4-28-2015.

THE STIPPLING SHOWN IN THE DRAWING IS A FEATURE OF THE MARK AND IS NOT INTENDED TO INDICATE COLOR.

FOR INSURANCE BROKERAGE (U.S. CLS. 100, 101 AND 102).

SN 75-795,535. FLOODGARD, INC., COVINGTON, LA. FILED 10-5-1999.

**EZ FLOOD**

NO CLAIM IS MADE TO THE EXCLUSIVE RIGHT TO USE "FLOOD", APART FROM THE MARK AS SHOWN.

FOR INSURANCE ADMINISTRATION IN THE FIELD OF RESIDENTIAL AND COMMERCIAL FLOOD INSURANCE (U.S. CLS. 100, 101 AND 102).

FIRST USE 10-4-1999; IN COMMERCE 10-4-1999.

SN 75-803,725. INTERNATIONAL CATASTROPHE INSURANCE MANAGERS, LLC, BOULDER, CO. FILED 9-17-1999.



OWNER OF U.S. REG. NO. 2,413,923.

NO CLAIM IS MADE TO THE EXCLUSIVE RIGHT TO USE "MANAGERS", APART FROM THE MARK AS SHOWN.

THE STYLIZED "C" IN THE LOGO OF THIS APPLICATION IS SUPPOSED TO BE RED IN COLOR.

FOR INSURANCE SERVICES, NAMELY UNDERWRITING AND ADMINISTRATION OF PROPERTY AND CASUALTY INSURANCE (U.S. CLS. 100, 101 AND 102).

FIRST USE 5-12-1999; IN COMMERCE 5-12-1999.

**CLASS 36—(Continued).**

SN 75-821,084. SOURCENET SOLUTIONS, INC., HOUSTON, TX. FILED 10-11-1999.

## P2P PURCHASE THROUGH PAYMENT

NO CLAIM IS MADE TO THE EXCLUSIVE RIGHT TO USE "P2P", APART FROM THE MARK AS SHOWN.

FOR PROCESSING AND TRANSMISSION OF BILL PAYMENT DATA FOR OTHERS; PAYROLL TAX DEBITING SERVICES (U.S. CLS. 100, 101 AND 102).

---

SN 75-847,485. HARTFORD FIRE INSURANCE COMPANY, HARTFORD, CT. FILED 11-12-1999.

## BUSINESS SERVICES PORTFOLIO

SEC. 2(F).

FOR BUSINESS INSURANCE UNDERWRITING SERVICES (U.S. CLS. 100, 101 AND 102).

FIRST USE 4-15-1991; IN COMMERCE 4-15-1991.

---

SN 75-850,933. ASSET ACCEPTANCE CORP., WARREN, MI. FILED 11-17-1999.

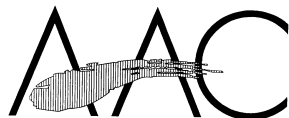

Asset Acceptance Corp.

NO CLAIM IS MADE TO THE EXCLUSIVE RIGHT TO USE "CORP.", APART FROM THE MARK AS SHOWN.

THE MARK IS LINED FOR THE COLOR RED.

SEC. 2(F) AS TO "ASSET ACCEPTANCE CORP."

FOR DEBT ACQUISITION, RECOVERY AND COLLECTION SERVICES; FINANCIAL SERVICES, NAMELY, DEBT BROKERAGE (U.S. CLS. 100, 101 AND 102).

FIRST USE 5-0-1999; IN COMMERCE 5-0-1999.

---

SN 75-858,110. UPPER DECK COMPANY, LLC, THE, CARLSBAD, CA. FILED 11-24-1999.

## JORDAN BY JORDAN

FOR PROVIDING BROKERAGE SERVICES FOR SPORTS COLLECTIBLES AND ATHLETE PARAPHERNALIA AND PROVIDING BROKERAGE SERVICES FOR SPORTS COLLECTIBLES AND ATHLETE PARAPHERNALIA VIA A GLOBAL COMPUTER INFORMATION NETWORK (U.S. CLS. 100, 101 AND 102).

**CLASS 36—(Continued).**

SN 75-870,130. WEISS, ARVIN S., ENGLEWOOD, CO. FILED 12-22-1999.

## FAIRFAX-MORTGAGE.COM

FOR MORTGAGE BANKING AND MORTGAGE BROKERAGE SERVICES PROVIDED VIA A WEB PAGE ON GLOBAL COMPUTER INFORMATION NETWORKS (U.S. CLS. 100, 101 AND 102).

FIRST USE 10-5-1999; IN COMMERCE 10-5-1999.

---

SN 75-917,646. VISIBLE MARKETS, INC., BOSTON, MA. FILED 2-12-2000.

## VISIBLE MARKET

NO CLAIM IS MADE TO THE EXCLUSIVE RIGHT TO USE "MARKET", APART FROM THE MARK AS SHOWN.

FOR FINANCIAL SERVICES, NAMELY PROVIDING AN ON-LINE SECONDARY MARKET FOR THE LISTING AND TRADING OF COMMODITIES; PROVIDING AN ON-LINE COMMODITIES EXCHANGE; AND FINANCIAL ANALYSIS AND CONSULTATION (U.S. CLS. 100, 101 AND 102).

---

SN 75-941,538. IGF INSURANCE COMPANY, DES MOINES, IA. FILED 3-10-2000.

## NURSERYPLUS

FOR UNDERWRITING INSURANCE POLICIES FOR AGRIBUSINESSES THAT RELY ON CROP PRODUCTION (U.S. CLS. 100, 101 AND 102).

FIRST USE 4-10-1997; IN COMMERCE 4-10-1997.

---

SN 76-006,180. BARRINGTON CAPITAL, LLC, SCHAMBURG, IL. FILED 2-3-2000.

## BARRINGTON CAPITAL

FOR INSURANCE SERVICES, NAMELY, PROPERTY AND CASUALTY INSURANCE, UNDERWRITING OTHER LINES OF LIABILITY INSURANCE, AGENCY SERVICES, AND BROKERING REINSURANCE CONTRACTS IN THE FIELDS OF TREATY AND FACULTATIVE PROPERTY INSURANCE, CASUALTY INSURANCE, ACCIDENT INSURANCE, HEALTH INSURANCE, FINITE RISK REINSURANCE AND PROFESSIONAL LIABILITY INSURANCE (U.S. CLS. 100, 101 AND 102).

**CLASS 36—(Continued).**

SN 76-014,457. TCF FINANCIAL CORPORATION, MINNEAPOLIS, MN. FILED 3-30-2000.

**TCF BANK**

NO CLAIM IS MADE TO THE EXCLUSIVE RIGHT TO USE "BANK", APART FROM THE MARK AS SHOWN.  
FOR BANKING SERVICES (U.S. CLS. 100, 101 AND 102).  
FIRST USE 0-0-1997; IN COMMERCE 0-0-1997.

SN 76-016,848. ADMINISTAFF, INC., KINGWOOD, TX. FILED 4-4-2000.

**BIZZPORT**

FOR PROCESSING AND TRANSMISSION OF BILL PAYMENT DATA FOR OTHERS; PAYROLL TAX DEBITING SERVICES; ADMINISTRATION OF EMPLOYEE PENSION AND 401 K PLANS (U.S. CLS. 100, 101 AND 102).

SN 76-026,245. LANDER INSURANCE AGENCY, INC., NEWTON, MA. FILED 4-14-2000.

**SERPSWAP.COM**

FOR SPLIT DOLLAR LIFE INSURANCE PLAN THAT EXCHANGES THE ENTITLEMENT TO NON-QUALIFIED EXECUTIVE BENEFITS TO INCREASE THE ASSET VALUE FOR THE PLAN'S BENEFICIARIES (U.S. CLS. 100, 101 AND 102).  
FIRST USE 5-12-2000; IN COMMERCE 5-12-2000.

SN 76-042,796. ANSWER FINANCIAL INC., ENCINO, CA. FILED 5-8-2000.

**ANSWER CENTER**

FOR INSURANCE AGENCIES (U.S. CLS. 100, 101 AND 102).  
FIRST USE 12-0-1999; IN COMMERCE 12-0-1999.

SN 76-042,923. DLJ LONG TERM INVESTMENT CORPORATION, CHICAGO, IL. FILED 5-8-2000.

**MORTGAGESCENE**

FOR MORTGAGE LENDING, MORTGAGE BANKING, MORTGAGE BROKERAGE (U.S. CLS. 100, 101 AND 102).

**CLASS 36—(Continued).**

SN 76-044,481. TUCKER ANTHONY INCORPORATED, BOSTON, MA. FILED 5-10-2000.

**TUCKER TRADE**

NO CLAIM IS MADE TO THE EXCLUSIVE RIGHT TO USE "TRADE", APART FROM THE MARK AS SHOWN.  
SEC. 2(F) AS TO "TUCKER".  
FOR FINANCIAL SERVICES, NAMELY, ONLINE SECURITIES TRADING AND SECURITIES BROKERAGE SERVICES (U.S. CLS. 100, 101 AND 102).

SN 76-047,377. MHM BUSINESS SERVICES, INC., KANSAS CITY, MO. FILED 5-15-2000.

**EZPOP**

FOR ADMINISTRATION OF EMPLOYEE BENEFIT PLANS FEATURING PRE-TAX PAYMENTS OF INSURANCE PREMIUMS AS SANCTIONED BY INTERNAL REVENUE CODE 125 (U.S. CLS. 100, 101 AND 102).  
FIRST USE 10-1-1998; IN COMMERCE 10-1-1998.

SN 76-051,900. SPOSATO, CHRISTOPHER D., DEVONSHIRE, DV 05, BERMUDA, FILED 5-17-2000.

**PARCELPROTECT**

FOR INSURANCE SERVICES, NAMELY, INSURANCE BROKERAGE; CLAIMS ADJUSTMENT IN THE FIELD OF INSURANCE; INSURANCE AGENCY IN THE FIELDS OF CASUALTY AND LIFE INSURANCE; INSURANCE UNDERWRITING SERVICES, IN THE FIELDS OF PROPERTY, CASUALTY AND RE-INSURANCE UNDERWRITING SERVICES; RISK MANAGEMENT; AND RE-INSURANCE BROKERAGE SERVICES (U.S. CLS. 100, 101 AND 102).

SN 76-051,904. SPOSATO, CHRISTOPHER D., DEVONSHIRE, DV 05, BERMUDA, FILED 5-17-2000.

**PROTECTING YOUR  
INTERNET TRANSACTIONS**

FOR INSURANCE SERVICES, NAMELY, INSURANCE BROKERAGE; CLAIMS ADJUSTMENT IN THE FIELD OF INSURANCE; INSURANCE AGENCY IN THE FIELDS OF CASUALTY AND LIFE INSURANCE; INSURANCE UNDERWRITING SERVICES IN THE FIELDS OF PROPERTY, CASUALTY AND RE-INSURANCE UNDERWRITING SERVICES; RISK MANAGEMENT; AND RE-INSURANCE BROKERAGE SERVICES (U.S. CLS. 100, 101 AND 102).

**CLASS 36—(Continued).**

SN 76-055,248. MOUNTAIN VIEW SOFTWARE CORP., LAYTON, UT. FILED 5-24-2000.

**IFROI**

FOR INSURANCE SERVICES, NAMELY PROCESSING WORKERS' COMPENSATION AND OSHA INJURY REPORTS (U.S. CLS. 100, 101 AND 102).

SN 76-059,470. PPM AMERICA, INC., CHICAGO, IL. FILED 5-30-2000.

**PPM AMERICA** 

OWNER OF U.S. REG. NO. 2,149,113. SEC. 2(F) AS TO "AMERICA".  
FOR FINANCIAL SERVICES, NAMELY, FINANCIAL ANALYSIS AND CONSULTATION, FINANCIAL FORECASTING, FINANCIAL MANAGEMENT, FINANCIAL PLANNING, FINANCIAL PORTFOLIO MANAGEMENT, FINANCIAL RESEARCH (U.S. CLS. 100, 101 AND 102).  
FIRST USE 10-16-1990; IN COMMERCE 10-16-1990.

SN 76-059,670. MID AMERICA MORTGAGE, INC., DALLAS, TX. FILED 5-30-2000.

**MORTGAGEMACHINE**

FOR PROVIDING MORTGAGE APPLICATION PROCESSING SERVICES, NAMELY, REVIEWING CUSTOMER APPLICATION FORMS, CLAIMS PROCESSING, AND MANAGING CUSTOMER ACCOUNTS FOR MORTGAGE BROKERS BY MEANS OF A GLOBAL COMPUTER NETWORK (U.S. CLS. 100, 101 AND 102).  
FIRST USE 5-23-2000; IN COMMERCE 5-4-2000.

SN 76-061,096. CASH TECHNOLOGIES, INC., LOS ANGELES, CA. FILED 6-5-2000.

**ATM-X**

FOR FINANCIAL SERVICES, NAMELY AUTOMATED CREDIT, CHECKING, SAVINGS, BILL, LOAN AND INVESTMENT ACCOUNT SERVICES (U.S. CLS. 100, 101 AND 102).

**CLASS 36—(Continued).**

SN 76-065,253. POPULAR, INC., SAN JUAN, PUERTO RICO, FILED 6-8-2000.

**POPULAR CHECKING**

OWNER OF U.S. REG. NOS. 1,008,477, 2,378,341 AND OTHERS.

NO CLAIM IS MADE TO THE EXCLUSIVE RIGHT TO USE "CHECKING", APART FROM THE MARK AS SHOWN.  
FOR BANKING SERVICES, FINANCIAL SERVICES, NAMELY CHECKING ACCOUNT SERVICES (U.S. CLS. 100, 101 AND 102).

FIRST USE 1-1-1993, THE MARK WAS USED ANYWHERE IN A DIFFERENT FORM OTHER THAN THAT SOUGHT TO BE REGISTERED ON 04/03/1989, AND IN COMMERCE ON 04/03/1989.; IN COMMERCE 1-1-1993, THE MARK WAS USED ANYWHERE IN A DIFFERENT FORM OTHER THAN THAT SOUGHT TO BE REGISTERED ON 04/03/1989, AND IN COMMERCE ON 04/03/1989..

SN 76-066,356. INVESTORFORCE, INC., WAYNE, PA. FILED 6-8-2000.

**I ON INVESTMENTS**

NO CLAIM IS MADE TO THE EXCLUSIVE RIGHT TO USE "INVESTMENTS", APART FROM THE MARK AS SHOWN.

FOR PROVIDING INFORMATION IN THE FIELD OF PENSION FUNDS TO MANAGERS OF LARGE PENSION FUNDS BY MEANS OF MULTIMEDIA PRESENTATIONS OFFERED OVER A GLOBAL COMPUTER NETWORK (U.S. CLS. 100, 101 AND 102).

SN 76-068,108. MORTGAGES LTD., PHOENIX, AZ. FILED 6-12-2000.

**TERM PLUS DEEDS OF TRUST**

NO CLAIM IS MADE TO THE EXCLUSIVE RIGHT TO USE "TERM" AND "DEEDS OF TRUST", APART FROM THE MARK AS SHOWN.

FOR PROVISION OF MORTGAGE BANKING, MORTGAGE LENDING AND MORTGAGE BROKERAGE SERVICES (U.S. CLS. 100, 101 AND 102).

FIRST USE 1-2-1997; IN COMMERCE 1-2-1997.

SN 76-068,286. STOREBRAND ASA, N-0114 OSLO, NORWAY, FILED 6-12-2000.

**PROFITS WITH PRINCIPLE**

FOR FINANCIAL, INVESTMENT AND ASSET MANAGEMENT SERVICES, NAMELY, CONSULTATION, MANAGEMENT, PLANNING AND IMPLEMENTATION OF THE INVESTMENT OF FUNDS IN STOCKS AND SHARES, UNIT TRUSTS, CURRENCIES, GILTS, BONDS AND COMMODITIES; PENSION SERVICES, NAMELY, CONSULTATION, MANAGEMENT, PLANNING, IMPLEMENTATION AND PROVISIONS OF FUNDS TO INDIVIDUALS FOLLOWING RETIREMENT (U.S. CLS. 100, 101 AND 102).



**CLASS 36—(Continued).**

SN 76-078,608. MASSACHUSETTS MUTUAL LIFE INSURANCE COMPANY, SPRINGFIELD, MA. FILED 6-22-2000.

**PERSUMMA FINANCIAL**

NO CLAIM IS MADE TO THE EXCLUSIVE RIGHT TO USE "FINANCIAL", APART FROM THE MARK AS SHOWN.

FOR FINANCIAL SERVICES, NAMELY, ACTUARIAL SERVICES, ANALYSIS AND CONSULTATION, ASSET MANAGEMENT SERVICES, INVESTMENT AND MUTUAL FUND BROKERAGE SERVICES, CREDIT CARD SERVICES, MUTUAL FUND DISTRIBUTION SERVICES, ADMINISTRATION OF EMPLOYEE BENEFIT SERVICES, FIDUCIARY REPRESENTATIVES SERVICES, ELECTRONIC FUNDS TRANSFER SERVICES, INVESTMENT ADVICE SERVICES, INVESTMENT MANAGEMENT SERVICES, MONEY MANAGEMENT SERVICES, ADMINISTRATION OF EMPLOYEE PENSION PLANS SERVICES, RETIREMENT INVESTMENT MANAGEMENT SERVICES, ESTATE TRUST MANAGEMENT SERVICES, SERVICES COMPLEMENTARY, RELATED OR INCIDENTAL TO FINANCIAL ACTIVITY AND OTHER ACTIVITIES OF FINANCIAL SERVICES COMPANIES, NAMELY, FINANCIAL INFORMATION PROVIDED BY ELECTRONIC MEANS (U.S. CLS. 100, 101 AND 102).

SN 76-091,397. ESURANCE INC., SAN FRANCISCO, CA. FILED 7-17-2000.

**INSURANCE. ONLY BETTER**

NO CLAIM IS MADE TO THE EXCLUSIVE RIGHT TO USE "INSURANCE", APART FROM THE MARK AS SHOWN.

FOR QUOTING, UNDERWRITING, AND WRITING OF INSURANCE, NAMELY, PROPERTY AND CASUALTY, LIFE, HEALTH, LIABILITY, COMMERCIAL, TITLE, SURPLUS, FIDELITY, MARINE FIRE, SURETY, DISABILITY, PLATE GLASS, WORKER'S COMPENSATION, COMMON CARRIER LIABILITY, BOILER AND MACHINERY, BURGLARY, CREDIT, SPRINKLER, TEAM AND VEHICLE, MORTGAGE, AIRCRAFT, MORTGAGE GUARANTY, LEGAL INSURANCE, FINANCIAL GUARANTEE; PROVIDING SERVICES, ANCILLARY THERETO, NAMELY, CLAIMS ADMINISTRATION, CLAIMS ADJUSTMENT, BROKERAGE, FINANCIAL PLANNING, CONSULTATION AND RESEARCH IN THE FIELDS OF INSURANCE AND FINANCIAL PLANNING (U.S. CLS. 100, 101 AND 102).  
FIRST USE 12-27-1999; IN COMMERCE 12-27-1999.

SN 76-092,412. FIRST FEDERAL OF LAKEWOOD, LAKEWOOD, OH. FILED 7-20-2000.

**ADVANTAGE55**

FOR BANKING SERVICES FEATURING FREE CHECKING, TRAVEL CLUB WARD SERVICES, AND INCREASED INTEREST RATES ON CERTIFICATES OF DEPOSIT FOR BANK PATRONS AGE 55 AND OLDER (U.S. CLS. 100, 101 AND 102).

FIRST USE 6-1-2000; IN COMMERCE 6-1-2000.

**CLASS 36—(Continued).**

SN 76-092,854. ZURICH AMERICAN INSURANCE COMPANY, SCHAUMBURG, IL. FILED 7-20-2000.

**Z-MED PROPERTY**

NO CLAIM IS MADE TO THE EXCLUSIVE RIGHT TO USE "PROPERTY", APART FROM THE MARK AS SHOWN.

FOR INSURANCE SERVICES, NAMELY PROPERTY UNDERWRITING AND RISK MANAGEMENT SERVICES (U.S. CLS. 100, 101 AND 102).

SN 76-099,429. AMERICAN INVESTMENT BANK, N.A., SALT LAKE CITY, UT. FILED 7-28-2000.

**AMERICAN INVESTMENT BANK, N.A.**

NO CLAIM IS MADE TO THE EXCLUSIVE RIGHT TO USE "BANK, N.A.", APART FROM THE MARK AS SHOWN. SEC. 2(F).

FOR FINANCIAL SERVICES, NAMELY BANKING, SECURITIES INVESTING, AND CONSUMER AND COMMERCIAL LENDING SERVICES; AND INFORMATION SERVICES, NAMELY PROVIDING INFORMATION IN THE FIELD OF FINANCIAL SERVICES, NAMELY BANKING, SECURITIES INVESTING, AND CONSUMER AND COMMERCIAL LENDING (U.S. CLS. 100, 101 AND 102).

FIRST USE 4-2-1984; IN COMMERCE 4-2-1984.

SN 76-117,326. EDISON INTERNATIONAL, ROSEMEAD, CA. FILED 8-25-2000.

**EDISON FUNDING COMPANY**

NO CLAIM IS MADE TO THE EXCLUSIVE RIGHT TO USE "FUNDING COMPANY", APART FROM THE MARK AS SHOWN.

FOR FINANCIAL SERVICES, NAMELY LOAN FINANCING FOR ENERGY RELATED INFRASTRUCTURE PROJECTS, NAMELY COGENERATION, HYDROELECTRIC, NUCLEAR, COAL, NATURAL GAS, ELECTRIC TRANSMISSION AND WASTE-TO-ENERGY PROJECTS; PROVIDING LOAN FINANCING FOR LOW INCOME RESIDENTIAL HOUSING PROJECTS QUALIFYING FOR FEDERAL AND STATE LOW INCOME HOUSING CREDITS (U.S. CLS. 100, 101 AND 102).

FIRST USE 1-29-1996; IN COMMERCE 1-29-1996.

**CLASS 36—(Continued).**

SN 76-119,201. STORM TELECOMMUNICATIONS LIMITED, LONDON, UNITED KINGDOM, FILED 8-30-2000.

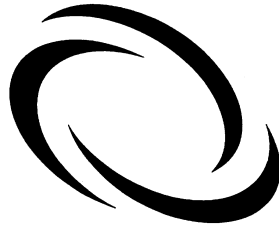

FOR FINANCIAL SERVICES, NAMELY, PROVIDING CHARGE CARD, CREDIT CARD, DEBIT CARD AND PAYMENT CARD SERVICES (U.S. CLS. 100, 101 AND 102).

SN 76-126,195. INVESTOR LIFE SERVICES INC., LIMA, OH. FILED 9-12-2000.

**INVESTORPROTECTOR**

FOR INVESTMENT AND FINANCIAL ADVISORY SERVICES TO ISSUERS AND PURCHASERS OF SECURITIES, GUARANTEE ASSURANCE BROKERAGE AND ADMINISTRATION, IRREVOCABLE TRUST MANAGEMENT, AND TRUST ADMINISTRATION SERVICES (U.S. CLS. 100, 101 AND 102).

FIRST USE 4-28-2000; IN COMMERCE 5-11-2000.

SN 76-127,882. BUYERS ACCEPTANCE CORPORATION, LOUISVILLE, KY. FILED 9-15-2000.



THE LINING IS A FEATURE OF THE MARK AND DOES NOT INDICATE COLOR.

FOR FINANCIAL SERVICES, NAMELY, SERVICING AUTOMOTIVE LOAN CONTRACTS FROM NEW AND USED AUTOMOTIVE DEALERSHIPS (U.S. CLS. 100, 101 AND 102).

FIRST USE 5-20-1999; IN COMMERCE 5-20-1999.

**CLASS 36—(Continued).**

SN 76-128,406. JACKSON NATIONAL LIFE INSURANCE COMPANY, LANSING, MI. FILED 9-15-2000.

**STREAMLINE 200 ANNUITY**

NO CLAIM IS MADE TO THE EXCLUSIVE RIGHT TO USE "ANNUITY", APART FROM THE MARK AS SHOWN. FOR FINANCIAL ANNUITY UNDERWRITING SERVICES (U.S. CLS. 100, 101 AND 102).

SN 76-129,059. IC UNIVERSE, INC., FRUIT HEIGHTS, UT. FILED 9-15-2000.

**1STETECH**

FOR ELECTRONIC PAYMENT SERVICES, NAMELY, ELECTRONIC PROCESSING AND TRANSMISSION OF BILL PAYMENT DATA FOR COMMERCE ENABLED ON A GLOBAL COMPUTER NETWORK (U.S. CLS. 100, 101 AND 102).

SN 76-130,979. BANK ONE CORPORATION, CHICAGO, IL. FILED 9-15-2000.

**BANK ONE EXPRESS LEASE**

OWNER OF U.S. REG. NOS. 1,120,175, 1,502,457 AND OTHERS.

NO CLAIM IS MADE TO THE EXCLUSIVE RIGHT TO USE "EXPRESS LEASE", APART FROM THE MARK AS SHOWN.

FOR BANKING SERVICES (U.S. CLS. 100, 101 AND 102).

SN 76-141,191. 900PENNIES INCORPORATED, SAN DIEGO, CA. FILED 10-5-2000.

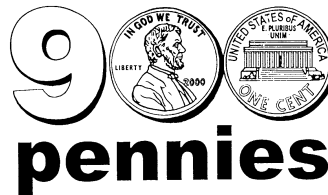

NO CLAIM IS MADE TO THE EXCLUSIVE RIGHT TO USE THE REPRESENTATION OF THE PENNY, ONE-CENT COIN PIECE AND "PENNIES", APART FROM THE MARK AS SHOWN.

FOR ELECTRONIC COMMERCE SERVICES, NAMELY, ESTABLISHMENT OF PREPAID ACCOUNTS, ELECTRONIC TRANSFER OF FUNDS TO EFFECT MONETARY TRANSACTIONS, AND VERIFICATION OF TRANSACTION VERACITY (U.S. CLS. 100, 101 AND 102).

**CLASS 36—(Continued).**

SN 76-144,888. FOX VALLEY SAVINGS AND LOAN ASSOCIATION, FOND DU LAC, WI. FILED 10-11-2000.

**FOX VALLEY SAVINGS  
BANK**

NO CLAIM IS MADE TO THE EXCLUSIVE RIGHT TO USE "SAVINGS BANK", APART FROM THE MARK AS SHOWN.

FOR BANKING SERVICES; COMMERCIAL LENDING, CONSUMER LENDING, AND MORTGAGE LENDING; FINANCIAL PLANNING; ESTATE PLANNING; INVESTMENT ADVICE AND CONSULTATION IN THE FIELDS OF SECURITIES, MUTUAL FUNDS, AND VARIABLE ANNUITIES; BROKERAGE SERVICES IN THE FIELDS OF SECURITIES, MUTUAL FUNDS, AND VARIABLE ANNUITIES; INSURANCE BROKERAGE SERVICES IN THE FIELDS OF CREDIT LIFE AND DISABILITY INSURANCE, HOME INSURANCE, LIFE INSURANCE, HEALTH, DISABILITY, AND LONG-TERM CARE INSURANCE, FIXED ANNUITIES, AND AUTOMOBILE INSURANCE; PROVIDING BANKING, FINANCIAL ADVICE AND INFORMATION, INVESTMENT ADVICE AND BROKERAGE SERVICES, AND INSURANCE BROKERAGE SERVICES, ALL THROUGH ELECTRONIC MEANS (U.S. CLS. 100, 101 AND 102).

**CLASS 36—(Continued).**

SN 76-152,626. 5 STAR FINANCIAL COMPANY, ALEXANDRIA, VA. FILED 10-24-2000.



OWNER OF U.S. REG. NOS. 2,066,255, 2,236,958 AND OTHERS.

NO CLAIM IS MADE TO THE EXCLUSIVE RIGHT TO USE "FUND", APART FROM THE MARK AS SHOWN.

FOR MUTUAL FUND INVESTMENT SERVICES (U.S. CLS. 100, 101 AND 102).

SN 76-145,657. AUTOMATIC PAWN, LTD., CORPUS CHRISTI, TX. FILED 10-12-2000.

**AUTOMATIC PAWN**

NO CLAIM IS MADE TO THE EXCLUSIVE RIGHT TO USE "PAWN", APART FROM THE MARK AS SHOWN.

FOR PAWN SHOPS, PAWN BROKERAGE, CHECK CASHING AND LOAN SERVICES (U.S. CLS. 100, 101 AND 102).

FIRST USE 11-23-1994; IN COMMERCE 11-23-1994.

SN 76-155,318. NATIONWIDE ACCEPTANCE CORPORATION, CHICAGO, IL. FILED 10-27-2000.



FOR LENDING SERVICES, NAMELY MORTGAGE AND COMMERCIAL LENDING SERVICES, CREDIT CARD SERVICES, PERSONAL LOANS, AUTO LOANS, AND SUBPRIME LENDING, NAMELY, SUBPRIME CONSUMER INSTALLMENT LENDING SERVICES, SUBPRIME SALES FINANCE LENDING SERVICES, SUBPRIME MORTGAGE LENDING SERVICES, SUBPRIME CREDIT CARD LENDING SERVICES, SUBPRIME REVOLVING CREDIT LENDING SERVICES AND SUBPRIME COMMERCIAL LENDING SERVICES (U.S. CLS. 100, 101 AND 102).

FIRST USE 6-30-2000; IN COMMERCE 6-30-2000.

SN 76-152,507. JIMMY PETTYJOHN GROUP, INC., DBA JPG, LAS VEGAS, NV. FILED 10-24-2000.

**SERVICE IS OUR SUCCESS**

FOR INSURANCE BROKERAGE IN THE FIELD OF HEALTH, LIFE, DENTAL, VISION, WORKERS' COMPENSATION AND DISABILITY INSURANCE; INVESTMENT BROKERAGE OF MUTUAL FUNDS, ANNUITIES, QUALIFIED PLANS; CONSULTING IN THE FIELD OF EMPLOYEE BENEFITS AND RISK MANAGEMENT (U.S. CLS. 100, 101 AND 102).

FIRST USE 5-0-1999; IN COMMERCE 11-10-1999.

SN 76-157,265. BANK ONE CORPORATION, CHICAGO, IL. FILED 11-1-2000.

**THE ONE PRIVATE  
PORTFOLIOS**

OWNER OF U.S. REG. NOS. 1,120,175, 2,277,143 AND OTHERS.

NO CLAIM IS MADE TO THE EXCLUSIVE RIGHT TO USE "PRIVATE PORTFOLIOS", APART FROM THE MARK AS SHOWN.

FOR BANKING AND FINANCIAL SERVICES, NAMELY FINANCIAL INVESTMENT IN THE FIELD OF SECURITIES AND FINANCIAL MANAGEMENT (U.S. CLS. 100, 101 AND 102).

FIRST USE 10-12-2000; IN COMMERCE 10-12-2000.

**CLASS 36—(Continued).**

SN 76-157,663. NATIONAL CENTER FOR POLICY ANALYSIS, DALLAS, TX. FILED 11-1-2000.

**mysocialsecurity.org**

FOR PROVIDING INFORMATION AND NON-PROFIT ADVISORY SERVICES IN THE FIELD OF RETIREMENT FUNDING AND PROVIDING ONLINE INFORMATION AND NON-PROFIT ADVISORY SERVICES IN THE FIELD OF RETIREMENT FUNDING (U.S. CLS. 100, 101 AND 102).

FIRST USE 5-0-2000; IN COMMERCE 5-0-2000.

SN 76-157,665. NATIONAL CENTER FOR POLICY ANALYSIS, DALLAS, TX. FILED 11-1-2000.

**MYSOCIALESECURITY.ORG**

FOR PROVIDING INFORMATION AND NON-PROFIT ADVISORY SERVICES IN THE FIELD OF RETIREMENT FUNDING AND PROVIDING ONLINE INFORMATION AND NON-PROFIT ADVISORY SERVICES IN THE FIELD OF RETIREMENT FUNDING (U.S. CLS. 100, 101 AND 102).

FIRST USE 5-0-2000; IN COMMERCE 5-0-2000.

SN 76-160,217. PALLETT, GEOFF, ALBERTA, T8H 1T2, CANADA, FILED 11-6-2000.

**THE ACREAGE EXPERT**

NO CLAIM IS MADE TO THE EXCLUSIVE RIGHT TO USE "ACREAGE", APART FROM THE MARK AS SHOWN.

FOR REAL ESTATE SERVICES, NAMELY, RURAL PROPERTY BROKERAGE, SUB-DIVISION AND DEVELOPMENT OF LAND, FINANCING CONSULTATION; PROVIDING INFORMATION IN THE FIELD OF REAL ESTATE THROUGH A WEB SITE VIA THE GLOBAL COMPUTER NETWORK (U.S. CLS. 100, 101 AND 102).

SN 76-161,820. R.V.I. AMERICA CORPORATION, STAMFORD, CT. FILED 11-8-2000.

**GCPI**

FOR UNDERWRITING SERVICES OF INSURANCE-RELATED TO ESCALATION CLAUSES IN REAL ESTATE LEASES (U.S. CLS. 100, 101 AND 102).

**CLASS 36—(Continued).**

SN 76-163,551. KUSHNER COMPANIES, FLORHAM PARK, NJ. FILED 11-13-2000.

**NORCROWN BANK**

NO CLAIM IS MADE TO THE EXCLUSIVE RIGHT TO USE "BANK", APART FROM THE MARK AS SHOWN. FOR BANKING SERVICES (U.S. CLS. 100, 101 AND 102).

FIRST USE 3-0-1985; IN COMMERCE 4-0-1985.

SN 76-164,291. RELIABLE CREDIT ASSOCIATION, INC., PORTLAND, OR. FILED 11-7-2000.



OWNER OF U.S. REG. NO. 925,290.

NO CLAIM IS MADE TO THE EXCLUSIVE RIGHT TO USE "SERVICE", "INTEGRITY" AND "CREDIT ASSOCIATION INC.", APART FROM THE MARK AS SHOWN.

FOR FINANCING SERVICES, NAMELY CONSUMER, COMMERCIAL, AND MORTGAGE MONEY LENDING SERVICES AND PURCHASING OF LOAN CONTRACTS (U.S. CLS. 100, 101 AND 102).

FIRST USE 10-18-2000; IN COMMERCE 10-18-2000.

SN 76-170,302. STOCKMANS BANK, ALTUS, OK. FILED 11-24-2000.



NO CLAIM IS MADE TO THE EXCLUSIVE RIGHT TO USE "ALTUS", "GOULD" OR "BANK", APART FROM THE MARK AS SHOWN.

FOR BANKING (U.S. CLS. 100, 101 AND 102).

FIRST USE 7-7-1998; IN COMMERCE 7-7-1998.

**CLASS 36—(Continued).**

SN 76-173,480. SALOMON SMITH BARNEY INC., NEW YORK, NY. FILED 11-30-2000.

## SSBGEO...THE EQUITY PORTAL

FOR FINANCIAL SERVICES, NAMELY, PROVIDING FINANCIAL RESEARCH, FINANCIAL NEWS, SECURITIES QUOTES AND THE ABILITY TO PERFORM SECURITIES TRADES VIA A GLOBAL COMPUTER NETWORK (U.S. CLS. 100, 101 AND 102).

SN 76-175,643. INSURANCE DESIGNERS OF AMERICA, INC., NEWPORT BEACH, CA. FILED 12-4-2000.

## IDAFS

FOR WHOLESALE LIFE INSURANCE BROKERAGE SERVICES, NAMELY, UNDERWRITING LIFE INSURANCE OF INDEPENDENT BROKERS, PROVIDING NATIONAL CONTRACTS, LICENSING AND DUE DILIGENCE (U.S. CLS. 100, 101 AND 102).

SN 76-180,271. UNITED SERVICES AUTOMOBILE ASSOCIATION, SAN ANTONIO, TX. FILED 12-13-2000.

## USAA CAPITAL GROWTH FUND

OWNER OF U.S. REG. NOS. 806,520, 1,728,691 AND OTHERS.

NO CLAIM IS MADE TO THE EXCLUSIVE RIGHT TO USE "CAPITAL GROWTH FUND", APART FROM THE MARK AS SHOWN.

FOR MUTUAL FUND INVESTMENT SERVICES (U.S. CLS. 100, 101 AND 102).

FIRST USE 10-30-2000; IN COMMERCE 10-30-2000.

SN 76-188,698. DENTAL X CHANGE, INC., IRVINE, CA. FILED 12-28-2000.

## PAYERCONNECT

FOR ELECTRONIC PROCESSING OF INSURANCE CLAIMS AND INSURED DATA; INSURANCE CLAIM ADMINISTRATION (U.S. CLS. 100, 101 AND 102).

FIRST USE 9-9-2000; IN COMMERCE 9-9-2000.

**CLASS 36—(Continued).**

SN 76-190,740. TRUMP, DONALD J., NEW YORK, NY. FILED 1-3-2001.

## THE RESIDENCES AT TRUMP NATIONAL CONDOMINIUM

OWNER OF U.S. REG. NOS. 1,557,303, 2,351,100 AND OTHERS.

NO CLAIM IS MADE TO THE EXCLUSIVE RIGHT TO USE "RESIDENCES" AND "NATIONAL CONDOMINIUM", APART FROM THE MARK AS SHOWN.

FOR REAL ESTATE SERVICES, NAMELY, LISTING, LEASING, AND MANAGING COMMERCIAL AND RESIDENTIAL PROPERTY (U.S. CLS. 100, 101 AND 102).

SN 76-192,998. MOUNTAIN DEVELOPMENT CORPORATION, WEST PATTERSON, NJ. FILED 1-12-2001.

## EASTFIELDMALL.COM

FOR LEASING OF SHOPPING MALL SPACE; SHOPPING CENTER SERVICES (U.S. CLS. 100, 101 AND 102). FIRST USE 12-31-1995; IN COMMERCE 12-31-1995.

SN 76-198,433. ALLIED PILOTS ASSOCIATION FEDERAL CREDIT UNION, NAPERVILLE, IL. FILED 1-24-2001.



FOR BANKING SERVICES, NAMELY CHECKING ACCOUNT, SAVINGS ACCOUNTS, CERTIFICATES OF DEPOSIT, AUTO LOANS, MOTORCYCLE LOANS, BOAT LOANS, RECREATIONAL VEHICLE LOANS, AIRPLANE LOANS, UNSECURED LOANS, RESIDENTIAL REAL ESTATE LOANS, CREDIT CARDS AND BILL PAYMENT SERVICES, AND PROVIDING SUCH SERVICES BY TRADITIONAL METHODS, BY TELEPHONE, AND BY A GLOBAL COMPUTER NETWORK (U.S. CLS. 100, 101 AND 102).

SN 76-198,678. WORLD WIDE WOOD NETWORK, LTD., YELM, WA. FILED 1-23-2001.

## MY FORKLIFT

FOR ON-LINE BROKER SERVICES FOR FACILITATING BUSINESS TRANSACTIONS FOR OTHERS IN THE WOOD PRODUCTS FIELD (U.S. CLS. 100, 101 AND 102).

**CLASS 36—(Continued).**

SN 76-198,709. WORLD WIDE WOOD NETWORK, LTD., YELM, WA. FILED 1-23-2001.

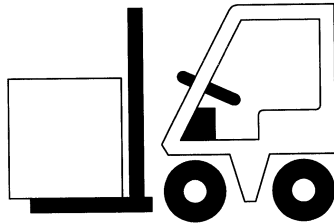

FOR ON-LINE BROKER SERVICES FOR FACILITATING BUSINESS TRANSACTIONS FOR OTHERS IN THE WOOD PRODUCTS FIELD (U.S. CLS. 100, 101 AND 102).

SN 76-223,869. THE TRUSTEE OF THE D. DEAN RHOADS TRUST, A FLORIDA TRUST, THE TRUSTEE COMPRISING D. DEAN RHOADS, A U.S. CITIZEN, NORTH PALM BEACH, FL. FILED 3-9-2001.

**WORLDMARK**

OWNER OF U.S. REG. NO. 1,546,683. FOR FINANCIAL SERVICES, NAMELY, MANAGEMENT, CONSULTATION AND ADVISORY SERVICES IN THE FIELDS OF RISK MANAGEMENT, PORTFOLIO MANAGEMENT AND DEVELOPMENT, INVESTMENTS AND OPERATIONS (U.S. CLS. 100, 101 AND 102). FIRST USE 5-0-1986; IN COMMERCE 5-0-1986.

SN 76-228,203. CITISTREET LLC, QUINCY, MA. FILED 3-21-2001.

**SUCCESS 401K**

NO CLAIM IS MADE TO THE EXCLUSIVE RIGHT TO USE "401K", APART FROM THE MARK AS SHOWN. FOR FINANCIAL SERVICES, NAMELY ADMINISTRATION OF RETIREMENT PLANS (U.S. CLS. 100, 101 AND 102).

**CLASS 36—(Continued).**

SN 76-233,486. ECHOTRADE GROUP, PHOENIX, AZ. FILED 3-30-2001.

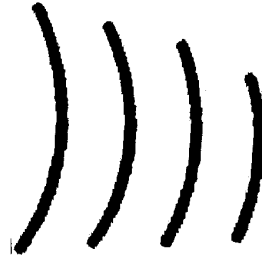

FOR PROVIDING DAY TRADE SERVICES (U.S. CLS. 100, 101 AND 102). FIRST USE 9-28-2000; IN COMMERCE 9-28-2000.

SN 76-235,276. EAST PENN BANK, EMMAUS, PA. FILED 4-5-2001.



NO CLAIM IS MADE TO THE EXCLUSIVE RIGHT TO USE "BANK", APART FROM THE MARK AS SHOWN. FOR BANKING SERVICES (U.S. CLS. 100, 101 AND 102). FIRST USE 10-31-1991; IN COMMERCE 10-31-1991.

SN 76-235,821. FIRST COMMERCIAL CORPORATION, SAN DIEGO, CA. FILED 4-5-2001.

**FIRST COMMERCIAL**

NO CLAIM IS MADE TO THE EXCLUSIVE RIGHT TO USE "COMMERCIAL", APART FROM THE MARK AS SHOWN. FOR FINANCIAL SERVICES, NAMELY, LOAN SERVICES (U.S. CLS. 100, 101 AND 102). FIRST USE 8-23-1993; IN COMMERCE 8-23-1993.

SN 76-240,474. RHEEM MANUFACTURING COMPANY, NEW YORK, NY. FILED 4-16-2001.

**KWIK COMFORT**

FOR FINANCIAL SERVICES, NAMELY FACILITATING AND ARRANGING FOR AIR CONDITIONING PURCHASES (U.S. CLS. 100, 101 AND 102). FIRST USE 12-1-2000; IN COMMERCE 12-9-2000.

**CLASS 36—(Continued).**

SN 76-244,107. SUSAN G. KOMEN BREAST CANCER FOUNDATION, THE, DALLAS, TX. FILED 4-20-2001.

**PLEDGE FOR THE CURE**

OWNER OF U.S. REG. NOS. 1,593,469, 2,484,982 AND OTHERS.

NO CLAIM IS MADE TO THE EXCLUSIVE RIGHT TO USE "PLEDGE", APART FROM THE MARK AS SHOWN, FOR CHARITABLE FUNDRAISING SERVICES, NAMELY, RAISING MONEY FOR BREAST CANCER RESEARCH AND RAISING MONEY FOR LOCAL COMMUNITY BREAST HEALTH AWARENESS PROGRAMS (U.S. CLS. 100, 101 AND 102).  
FIRST USE 6-0-1999; IN COMMERCE 6-0-1999.

**CLASS 36—(Continued).**

SN 76-252,719. PENN SECURITY BANK & TRUST COMPANY, SCRANTON, PA. FILED 5-4-2001.

**SUNNY DAY BANKING**

NO CLAIM IS MADE TO THE EXCLUSIVE RIGHT TO USE "BANKING", APART FROM THE MARK AS SHOWN, FOR BANKING SERVICES (U.S. CLS. 100, 101 AND 102).  
FIRST USE 8-26-1995; IN COMMERCE 8-26-1995.

SN 76-246,394. HARTZ RIVER ROAD LIMITED PARTNERSHIP, SECAUCUS, NJ. FILED 4-25-2001.

**INDEPENDENCE HARBOR**

FOR REAL ESTATE MANAGEMENT AND LEASING OF COMMERCIAL, RESIDENTIAL AND RETAIL STORE PROPERTIES (U.S. CLS. 100, 101 AND 102).  
FIRST USE 0-0-1988; IN COMMERCE 0-0-1988.

SN 76-254,451. THOMAS, MCNERNEY & PARTNERS, MINNEAPOLIS, MN. FILED 5-8-2001.

**THOMAS, MCNERNEY & PARTNERS**

NO CLAIM IS MADE TO THE EXCLUSIVE RIGHT TO USE "PARTNERS", APART FROM THE MARK AS SHOWN, FOR INVESTMENT AND FUNDING SERVICES, NAMELY, PROVIDING VENTURE CAPITAL AND OTHER FUNDING; CAPITAL INVESTMENT CONSULTATION (U.S. CLS. 100, 101 AND 102).

SN 76-248,255. PADCO ADVISORS, INC., DBA RYDEX GLOBAL ADVISORS, INC., ROCKVILLE, MD. FILED 4-30-2001.

**INNOVATION IN INDEXING**

NO CLAIM IS MADE TO THE EXCLUSIVE RIGHT TO USE "INDEXING", APART FROM THE MARK AS SHOWN, FOR FINANCIAL SERVICES, NAMELY, INVESTMENT ADVISEMENT AND MANAGEMENT OF MUTUAL FUNDS (U.S. CLS. 100, 101 AND 102).

SN 76-256,691. TEXAS STAMPEDE, INC., DALLAS, TX. FILED 5-14-2001.

SN 76-250,592. NATIONAL GUARDIAN LIFE INSURANCE COMPANY, MADISON, WI. FILED 5-3-2001.

**CRITICAL HOME PROTECTOR**

FOR INSURANCE UNDERWRITING SERVICES FOR PROVIDING CASH PAYMENT IN EVENT OF SERIOUS ILLNESS (U.S. CLS. 100, 101 AND 102).  
FIRST USE 2-16-2001; IN COMMERCE 2-16-2001.

SN 76-250,593. NATIONAL GUARDIAN LIFE INSURANCE COMPANY, MADISON, WI. FILED 5-3-2001.

**CRITICAL PROTECTOR**

FOR INSURANCE UNDERWRITING SERVICES FOR PROVIDING CASH PAYMENT IN EVENT OF SERIOUS ILLNESS (U.S. CLS. 100, 101 AND 102).



NO CLAIM IS MADE TO THE EXCLUSIVE RIGHT TO USE "TEXAS" AND "COWBOYS CONCERTS KIDS", APART FROM THE MARK AS SHOWN.  
FOR CHARITABLE FUNDRAISER IN THE NATURE OF A RODEO (U.S. CLS. 100, 101 AND 102).  
FIRST USE 1-1-2001; IN COMMERCE 1-1-2001.

**CLASS 36—(Continued).**

SN 76-257,889. JAYWALK INCORPORATED, ALPHARETTA, GA. FILED 5-16-2001.



THE MARK CONSISTS OF A STYLIZED BIRD IN FLIGHT.

FOR FINANCIAL RESEARCH, NAMELY INDEPENDENT RESEARCH CONCERNING FINANCIAL MARKETS AND PUBLIC AND PRIVATE COMPANIES (U.S. CLS. 100, 101 AND 102).

FIRST USE 4-17-2001; IN COMMERCE 4-17-2001.

SN 76-260,100. WESTERN UNION HOLDINGS, INC., ENGLEWOOD, CO. FILED 5-21-2001.

**LA MANERA MÁS RÁPIDA DE ENVIAR Y RECIBIR DINERO EN TODO EL MUNDO**

OWNER OF U.S. REG. NOS. 1,718,726, 2,372,376 AND OTHERS.

THE MARK IS PRESENTED WITHOUT ANY CLAIM AS TO SPECIAL FORM.

THE ENGLISH TRANSLATION OF THE MARK IS "THE FASTEST WAY TO SEND AND RECEIVE MONEY WORLDWIDE".

FOR FINANCIAL SERVICES, NAMELY, MONEY TRANSFER SERVICES AND ELECTRONIC FUNDS TRANSFER SERVICES; ELECTRONIC PAYMENT SERVICES, NAMELY, ELECTRONIC PROCESSING AND TRANSMISSION OF BILL PAYMENT DATA (U.S. CLS. 100, 101 AND 102).

FIRST USE 12-30-1995; IN COMMERCE 12-30-1996.

SN 76-260,164. XL CAPITAL LTD, HAMILTON, HM 11, BERMUDA, FILED 5-22-2001.

**INSURANCE IN A CLICKSTANT**

NO CLAIM IS MADE TO THE EXCLUSIVE RIGHT TO USE "INSURANCE", APART FROM THE MARK AS SHOWN.

FOR INSURANCE UNDERWRITING SERVICES IN THE FIELD OF COMMERCIAL PROPERTY AND CASUALTY; AND INSURANCE CONSULTATION (U.S. CLS. 100, 101 AND 102).

**CLASS 36—(Continued).**

SN 76-260,165. XL CAPITAL LTD, HAMILTON, HM 11, BERMUDA, FILED 5-22-2001.

**CLICKSTANT**

FOR INSURANCE UNDERWRITING SERVICES IN THE FIELD OF COMMERCIAL PROPERTY AND CASUALTY; AND INSURANCE CONSULTATION (U.S. CLS. 100, 101 AND 102).

SN 76-260,377. MEDICAL GROUP INSURANCE SERVICES, INC., SALT LAKE CITY, UT. FILED 5-22-2001.



OWNER OF U.S. REG. NO. 1,686,721. NO CLAIM IS MADE TO THE EXCLUSIVE RIGHT TO USE "COMPANIES", APART FROM THE MARK AS SHOWN.

FOR ADMINISTRATION OF INSURANCE PROGRAMS; INSURANCE BROKERAGE SERVICES (U.S. CLS. 100, 101 AND 102).

FIRST USE 12-31-1972; IN COMMERCE 12-31-1972.

SN 76-260,667. WESTERN FEDERAL CREDIT UNION, LOS ANGELES, CA. FILED 5-22-2001.



FOR CREDIT UNION SERVICES, NAMELY FOR A MINOR'S ACCOUNT (U.S. CLS. 100, 101 AND 102). FIRST USE 5-2-2001; IN COMMERCE 5-2-2001.



**CLASS 36—(Continued).**

SN 76-260,872. DLH DISTRIBUTING AND MARKETING, INC., ALEXANDRIA, VA. FILED 5-21-2001.

**TALKOLA**

FOR PREPAID LONG DISTANCE TELEPHONE CALLING CARD SERVICES (U.S. CLS. 100, 101 AND 102).

SN 76-260,874. DLH DISTRIBUTING AND MARKETING, INC., ALEXANDRIA, VA. FILED 5-21-2001.

**GOLO**

FOR PREPAID LONG DISTANCE TELEPHONE CALLING CARD SERVICES (U.S. CLS. 100, 101 AND 102).

SN 76-265,623. MANDALAY RESORT GROUP, LAS VEGAS, NV. FILED 5-30-2001.

**MANDALAY PLACE**

NO CLAIM IS MADE TO THE EXCLUSIVE RIGHT TO USE "PLACE", APART FROM THE MARK AS SHOWN.  
FOR SHOPPING MALL SERVICES, LEASING OF SPACE IN SHOPPING MALLS (U.S. CLS. 100, 101 AND 102).

SN 76-269,929. AMERICAN FUNDS DISTRIBUTORS, INC., LOS ANGELES, CA. FILED 6-11-2001.

**PLANDIRECT**

OWNER OF U.S. REG. NO. 40,772.  
FOR FINANCIAL SERVICES, NAMELY, RECORD KEEPING AND ADMINISTRATION OF BENEFIT, PENSION AND RETIREMENT PLANS; AND MUTUAL FUND INVESTMENT MANAGEMENT, DISTRIBUTION AND INVESTOR RECORDKEEPING SERVICES AND DISTRIBUTION (U.S. CLS. 100, 101 AND 102).  
FIRST USE 10-31-2000; IN COMMERCE 10-31-2000.

SN 76-269,933. AMERICAN FUNDS DISTRIBUTORS, INC., LOS ANGELES, CA. FILED 6-11-2001.

**PLANPREMIER**

FOR FINANCIAL SERVICES, NAMELY, RECORD KEEPING AND ADMINISTRATION OF BENEFIT, PENSION AND RETIREMENT PLANS; AND MUTUAL FUND INVESTMENT MANAGEMENT, DISTRIBUTION AND INVESTOR RECORDKEEPING SERVICES AND DISTRIBUTION (U.S. CLS. 100, 101 AND 102).  
FIRST USE 10-31-2000; IN COMMERCE 10-31-2000.

**CLASS 36—(Continued).**

SN 76-270,412. LEGACY GROUP INC., THE, BROOKFIELD, WI. FILED 6-12-2001.



NO CLAIM IS MADE TO THE EXCLUSIVE RIGHT TO USE "PHILANTHROPY", APART FROM THE MARK AS SHOWN.

FOR FINANCIAL SERVICES, NAMELY, PROVIDING ADVICE AND CONSULTATION SERVICES TO INDIVIDUALS AND BUSINESSES RELATING TO PHILANTHROPY AND CHARITABLE GIVING, (U.S. CLS. 100, 101 AND 102).  
FIRST USE 8-1-1999; IN COMMERCE 8-1-1999.

SN 76-277,499. TRUSTEES OF THE PENNSYLVANIA REAL ESTATE INVESTMENT TRUST, A PENNSYLVANIA BUSINESS TRUST, THE TRUSTEES COMPRISING SYLVAN M. COHEN, WILLIAM R. DIMELING, ROSEMARIE B. GRECO, LEE H. JAVITCH, LEONARD I. KORMAN, JEFFREY P. ORLEANS, GEORGE F. RUBIN, RONALD RUBIN, AND JONATHAN B. WELLER, ALL CITIZENS OF THE UNITED STATES, PHILADELPHIA, PA. FILED 6-27-2001.

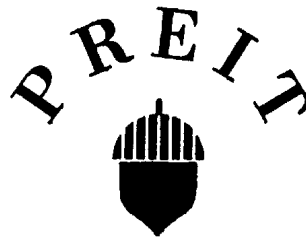

THE LINING IS A FEATURE OF THE MARK AND DOES NOT INDICATE COLOR.  
FOR REAL ESTATE INVESTMENT TRUST SERVICES (U.S. CLS. 100, 101 AND 102).  
FIRST USE 6-0-1966; IN COMMERCE 6-0-1966.

SN 76-277,654. TRUSTEES OF THE PENNSYLVANIA REAL ESTATE INVESTMENT TRUST, A PENNSYLVANIA BUSINESS TRUST, THE TRUSTEES COMPRISING SYLVAN M. COHEN, WILLIAM R. DIMELING, ROSEMARIE B. GRECO, LEE H. JAVITCH, LEONARD I. KORMAN, JEFFREY P. ORLEANS, GEORGE F. RUBIN, RONALD RUBIN, AND JONATHAN B. WELLER, ALL U.S. CITIZENS, PHILADELPHIA, PA. FILED 6-27-2001.

**PREIT**

FOR REAL ESTATE INVESTMENT TRUST SERVICES (U.S. CLS. 100, 101 AND 102).  
FIRST USE 6-0-1966; IN COMMERCE 6-0-1966.

**CLASS 36—(Continued).**

SN 76-277,971. PIONEER INVESTMENT MANAGEMENT, INC., BOSTON, MA. FILED 6-28-2001.

## PIONEER INVESTMENTS PASSEPARTOUT

NO CLAIM IS MADE TO THE EXCLUSIVE RIGHT TO USE "INVESTMENTS", APART FROM THE MARK AS SHOWN.

FOR ONLINE FINANCIAL SERVICES, NAMELY, PROVIDING RECOMMENDATIONS FOR CREATING AND MANAGING INVESTMENT PORTFOLIOS BASED ON A PERSONAL PROFILE AND CUSTOMIZING AND MANAGING INVESTMENT PORTFOLIOS (U.S. CLS. 100, 101 AND 102).

SN 76-278,109. HOPKINS FINANCIAL SERVICES, INC., BOISE, ID. FILED 6-29-2001.



THE MARK CONSISTS OF A STYLIZED "H" FOR REAL ESTATE BROKERAGE AND FINANCIAL SERVICES, NAMELY LENDING MONEY FOR REAL ESTATE TRANSACTIONS (U.S. CLS. 100, 101 AND 102). FIRST USE 1-1-1984; IN COMMERCE 1-1-1984.

SN 76-280,929. WARRANTY CORPORATION OF AMERICA, NORCROSS, GA. FILED 7-5-2001.

## CONSUMERCARE PROTECTION YOU CAN COUNT ON

FOR UNDERWRITING AND ADMINISTRATING WARRANTY PROGRAMS IN THE FIELDS OF APPLIANCES, HOUSEHOLD ELECTRONIC GOODS, COMPUTERS, MOTOR VEHICLES, AND OTHER ITEMS OF PERSONAL PROPERTY (U.S. CLS. 100, 101 AND 102).

**CLASS 36—(Continued).**

SN 76-282,847. ENTERTAINMENT INDUSTRY FOUNDATION, THE, STUDIO CITY, CA. FILED 7-11-2001.

## COURAGE FOR CANCER

FOR CHARITABLE FUND RAISING EVENTS TO FIGHT WOMEN'S CANCERS (U.S. CLS. 100, 101 AND 102).

FIRST USE 5-5-2001; IN COMMERCE 5-5-2001.

SN 76-290,294. HARTFORD LIFE INSURANCE COMPANY, SIMSBURY, CT. FILED 7-26-2001.

## EARNINGS GUARD

NO CLAIM IS MADE TO THE EXCLUSIVE RIGHT TO USE "EARNINGS", APART FROM THE MARK AS SHOWN. FOR DISABILITY INSURANCE UNDERWRITING SERVICES (U.S. CLS. 100, 101 AND 102).

FIRST USE 6-25-2001; IN COMMERCE 6-25-2001.

SN 76-291,359. SOUTHWEST SECURITIES GROUP, INC., DALLAS, TX. FILED 7-27-2001.

## SWS FINANCIAL SERVICES

OWNER OF U.S. REG. NOS. 2,358,973, 2,358,974 AND 2,418,656.

NO CLAIM IS MADE TO THE EXCLUSIVE RIGHT TO USE "FINANCIAL SERVICES", APART FROM THE MARK AS SHOWN.

FOR FINANCIAL SERVICES IN THE FIELD OF INVESTMENT AND SECURITIES BROKERAGE, NAMELY, BROKERAGE SERVICES CONCERNING SECURITIES, MUTUAL FUNDS AND COMMODITIES; FINANCIAL MANAGEMENT SERVICES; SECURITIES AND FINANCIAL CLEARING SERVICES; FINANCIAL ADVISORY SERVICES; FINANCIAL CONSULTATION SERVICES; INVESTMENT ACCOUNT PLANNING (U.S. CLS. 100, 101 AND 102).

SN 76-295,750. CODORUS VALLEY BANCORP, INC., YORK, PA. FILED 8-8-2001.

## PEOPLESINVESTMENTS

FOR INSURANCE AND INVESTMENT BROKERAGE SERVICES (U.S. CLS. 100, 101 AND 102).

**CLASS 36—(Continued).**

SN 76-303,659. NAVY FEDERAL CREDIT UNION, MERRIFIELD, VA. FILED 8-23-2001.

**VETERANS CHOICE**

NO CLAIM IS MADE TO THE EXCLUSIVE RIGHT TO USE "VETERANS", APART FROM THE MARK AS SHOWN. FOR CREDIT UNION SERVICES, NAMELY, MORTGAGE LENDING SERVICES (U.S. CLS. 100, 101 AND 102).

SN 76-304,289. NEW BEGINNINGS AUTO FINANCE, LLC, PROSPECT, CT. FILED 8-24-2001.

**NEW BEGINNINGS AUTO FINANCE**

NO CLAIM IS MADE TO THE EXCLUSIVE RIGHT TO USE "AUTO FINANCE", APART FROM THE MARK AS SHOWN.

FOR FINANCING SERVICES, NAMELY AUTOMOBILE FINANCING FOR INDIVIDUALS WITH POOR AND/OR NO CREDIT (U.S. CLS. 100, 101 AND 102). FIRST USE 6-1-1999; IN COMMERCE 6-1-1999.

SN 76-305,307. NATIONAL WESTERN LIFE INSURANCE COMPANY, AUSTIN, TX. FILED 8-27-2001.

**NWL FEDLIFE ACCUMULATOR**

NO CLAIM IS MADE TO THE EXCLUSIVE RIGHT TO USE "ACCUMULATOR", APART FROM THE MARK AS SHOWN.

FOR LIFE INSURANCE UNDERWRITING SERVICES (U.S. CLS. 100, 101 AND 102).

SN 76-305,308. NATIONAL WESTERN LIFE INSURANCE COMPANY, AUSTIN, TX. FILED 8-27-2001.

**NWL FEDLIFELINE**

FOR LIFE INSURANCE UNDERWRITING SERVICES (U.S. CLS. 100, 101 AND 102).

**CLASS 36—(Continued).**

SN 76-309,021. NIVATEL COMMUNICATIONS, INC., ROSLYN HEIGHTS, NY. FILED 9-4-2001.

**NIVATEL COMMUNICATIONS**

NO CLAIM IS MADE TO THE EXCLUSIVE RIGHT TO USE "COMMUNICATIONS", APART FROM THE MARK AS SHOWN.

FOR PROVIDING PRE-PAID TELEPHONE CALLING CARD SERVICES (U.S. CLS. 100, 101 AND 102). FIRST USE 1-3-2001; IN COMMERCE 3-1-2001.

SN 76-309,458. PAYCAST, LTD., HOUSTON, TX. FILED 9-6-2001.

**PAYCAST**

FOR FINANCIAL SERVICES, NAMELY, HANDLING FINANCIAL TRANSACTIONS BETWEEN PAYORS AND PAYEES THAT ENABLE REAL-TIME DEBITING OF THE PAYEES' ACCOUNTS (U.S. CLS. 100, 101 AND 102).

SN 76-311,549. COLDEN CAPITAL ADVISERS LLC, NEW YORK, NY. FILED 9-10-2001.

**COLDEN**

FOR FINANCIAL SERVICES, NAMELY INVESTMENT MANAGEMENT SERVICES FOR PRIVATE ENTITIES AND ACCOUNTS (U.S. CLS. 100, 101 AND 102). FIRST USE 1-0-2000; IN COMMERCE 4-3-2000.

SN 76-315,005. WELLS FARGO HOME MORTGAGE, INC., DES MOINES, IA. FILED 9-20-2001.

**RAPID VALUE**

FOR MORTGAGE LENDING SERVICES (U.S. CLS. 100, 101 AND 102).

SN 76-322,569. PAPERLOOP.COM, INC., SAN FRANCISCO, CA. FILED 10-9-2001.

**CONVERTINGLOOP**

FOR COMMODITY TRADING FOR OTHERS AND COMMODITY BROKERAGE FOR OTHERS, ALL IN THE FIELDS OF CONVERTING AND PACKAGE PRINTING VIA A GLOBAL COMPUTER NETWORK (U.S. CLS. 100, 101 AND 102).

FIRST USE 4-0-2001; IN COMMERCE 4-0-2001.

**CLASS 36—(Continued).**

SN 76-322,595. KPMG CONSULTING, INC., MCLEAN, VA. FILED 10-3-2001.

**POINT**

FOR CONSULTING SERVICES IN THE FIELD OF PUBLIC PENSION PLANS OF GOVERNMENT AND MUNICIPAL ENTITIES, AND EDUCATIONAL INSTITUTIONS (U.S. CLS. 100, 101 AND 102).  
FIRST USE 5-0-2001; IN COMMERCE 5-0-2001.

---

SN 76-323,423. WELLS FARGO FINANCIAL, INC., DES MOINES, IA. FILED 10-10-2001.

**SPLASH**

FOR CREDIT CARD SERVICES (U.S. CLS. 100, 101 AND 102).

---

SN 76-323,424. WELLS FARGO FINANCIAL, INC., DES MOINES, IA. FILED 10-10-2001.

**FLOORING SOLUTIONS**

FOR CREDIT CARD SERVICES (U.S. CLS. 100, 101 AND 102).

---

SN 78-002,625. HARMAN, HOLLIS PAGE, LOS ANGELES, CA. FILED 4-5-2000.

**KIDS MONEY CLUB (K\$C)**

NO CLAIM IS MADE TO THE EXCLUSIVE RIGHT TO USE "MONEY CLUB", APART FROM THE MARK AS SHOWN.

FOR PROVIDING INFORMATION IN THE FIELDS OF FINANCE, INVESTMENTS AND ECONOMICS VIA THE INTERNET (U.S. CLS. 100, 101 AND 102).

---

SN 78-005,587. FARALLON CAPITAL MANAGEMENT, L.L.C., SAN FRANCISCO, CA. FILED 4-25-2000.

**FARALLON CAPITAL INSTITUTIONAL PARTNERS**

NO CLAIM IS MADE TO THE EXCLUSIVE RIGHT TO USE "CAPITAL INSTITUTIONAL PARTNERS", APART FROM THE MARK AS SHOWN.

FOR FINANCIAL SERVICES, NAMELY, ASSET AND INVESTMENT MANAGEMENT SERVICES (U.S. CLS. 100, 101 AND 102).

FIRST USE 12-6-1989; IN COMMERCE 12-6-1989.

**CLASS 36—(Continued).**

SN 78-015,254. BOSTON ANALYTICS RESEARCH & TRADING LLC, METUCHEN, NJ. FILED 7-2-2000.

**WINNINGSTOCKS.COM**

FOR PROVIDING INVESTMENT INFORMATION VIA A GLOBAL COMPUTER NETWORK, NAMELY A STOCK INFORMATION WEB SITE (U.S. CLS. 100, 101 AND 102).

FIRST USE 4-17-2000; IN COMMERCE 4-17-2000.

---

SN 78-017,290. MASTERCARD INTERNATIONAL INCORPORATED, PURCHASE, NY. FILED 7-18-2000.

**MASTERCARD E-WALLET**

OWNER OF U.S. REG. NOS. 1,186,117, 1,257,853 AND 1,292,519.

NO CLAIM IS MADE TO THE EXCLUSIVE RIGHT TO USE "E-WALLET", APART FROM THE MARK AS SHOWN. FOR FINANCIAL SERVICES; NAMELY, PROVIDING ELECTRONIC BANKING AND PAYMENT CARD SERVICES (U.S. CLS. 100, 101 AND 102).

---

SN 78-022,478. VIRTUAL PURCHASE CARD, INC., ALAMEDA, CA. FILED 8-23-2000.

**VirtualPurchaseConnection**

FOR ELECTRONIC PROCESSING AND TRANSMISSION OF PAYMENT DATA; ELECTRONIC COMMERCE PAYMENT SERVICES, NAMELY, ESTABLISHING AND ADMINISTERING FOR OTHERS OF ACCOUNTS USED TO PURCHASE GOODS AND SERVICES VIA COMMUNICATIONS NETWORKS; FINANCIAL INFORMATION PROVIDED BY ELECTRONIC MEANS; ELECTRONIC FUNDS TRANSFER; BILL PAYMENT SERVICES (U.S. CLS. 100, 101 AND 102).

FIRST USE 8-17-2000; IN COMMERCE 8-27-2001.

---

SN 78-029,404. VENTUREDEBT (US), INC., BOULDER, CO. FILED 10-6-2000.

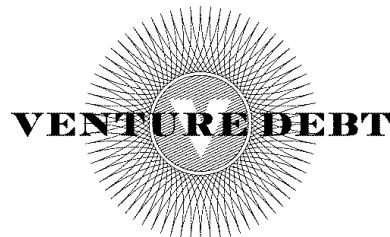

NO CLAIM IS MADE TO THE EXCLUSIVE RIGHT TO USE "VENTURE DEBT", APART FROM THE MARK AS SHOWN.

THE LINING IS A FEATURE OF THE MARK AND DOES NOT INDICATE COLOR.

FOR FINANCIAL SERVICES, NAMELY DEBT CAPITALIZATION FOR EARLY AND EXPANSION STAGE COMPANIES (U.S. CLS. 100, 101 AND 102).

**CLASS 36—(Continued).**

SN 78-030,127. OWENS-CORNING FIBERGLAS TECHNOLOGY INC., SUMMIT, IL. FILED 10-11-2000.

**TRU PROTECTION**

FOR PROVIDING WARRANTIES FEATURING NON-PRORATED COVERAGE FOR REPAIR AND REPLACEMENT SERVICES IN THE FIELD OF BUILDING CONSTRUCTION, INCLUDING PRODUCT AND LABOR (U.S. CLS. 100, 101 AND 102).

SN 78-030,475. TWO AMERICAN LANE CORPORATION, GREENWICH, CT. FILED 10-13-2000.

**UPSTREAM PARTNERS**

NO CLAIM IS MADE TO THE EXCLUSIVE RIGHT TO USE "PARTNERS", APART FROM THE MARK AS SHOWN. FOR FINANCIAL SERVICES, NAMELY, FINANCIAL MANAGEMENT AND INVESTMENT FUNDS (U.S. CLS. 100, 101 AND 102).

SN 78-030,886. STEINBERG, LEONARD, NEW YORK, NY. FILED 10-16-2000.

**LUXURYLOFT**

FOR PROVIDING REAL ESTATE INFORMATION INCLUDING INVESTMENT, FINANCE AND LISTINGS, FEATURING LINKS TO WEBPAGES WITH SIMILAR SUBJECT MATTER VIA A GLOBAL COMPUTER NETWORK (U.S. CLS. 100, 101 AND 102). FIRST USE 9-1-2000; IN COMMERCE 9-25-2000.

SN 78-036,311. THALES FUND MANAGEMENT, LLC, NEW YORK, NY. FILED 11-22-2000.

**THALES FUND  
MANAGEMENT, LLC**

NO CLAIM IS MADE TO THE EXCLUSIVE RIGHT TO USE "FUND MANAGEMENT, LLC", APART FROM THE MARK AS SHOWN.

FOR FINANCIAL SERVICES IN THE NATURE OF FINANCIAL FUND MANAGEMENT (U.S. CLS. 100, 101 AND 102).

FIRST USE 12-1-1998; IN COMMERCE 12-1-1998.

SN 78-048,047. ENRON CORP., HOUSTON, TX. FILED 2-13-2001.

**ENRON ENVEST**

FOR FINANCING SERVICES, BUSINESS CONSULTATION, AND FINANCIAL RISK MANAGEMENT FOR ENERGY-RELATED FACILITIES (U.S. CLS. 100, 101 AND 102).

**CLASS 36—(Continued).**

SN 78-049,512. NEAL PROPERTIES, INC., CHARLOTTE, NC. FILED 2-21-2001.

**SMART INVESTMENTS  
REAL SOLUTIONS**

FOR REAL ESTATE INVESTMENT SERVICES (U.S. CLS. 100, 101 AND 102).

SN 78-057,913. GREENVILLE FINANCIAL CONSULTANTS, INC., GREENVILLE, PA. FILED 4-11-2001.

**THE STRATEGIC LIFESTYLE  
DESIGN**

FOR FINANCIAL PLANNING, INVESTMENT MANAGEMENT, AND LIFE AND HEALTH UNDERWRITING SERVICES (U.S. CLS. 100, 101 AND 102).

SN 78-066,425. CARROT CAPITAL, LLC, NEW YORK, NY. FILED 5-30-2001.

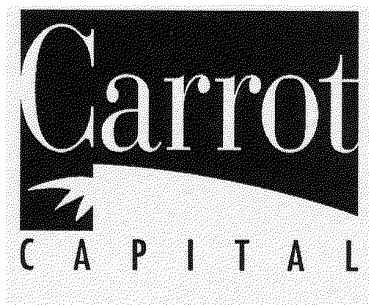

NO CLAIM IS MADE TO THE EXCLUSIVE RIGHT TO USE "CAPITAL", APART FROM THE MARK AS SHOWN.

THE MARK CONSISTS OF A DARK RECTANGULAR BOX, WITHIN THE BOTTOM OF WHICH IS AN OUTLINE OF A CARROT. ABOVE THE CARROT THE WORD "CARROT" IS INSCRIBED AND DIRECTLY BELOW THE CARROT OUTLINE THE WORD "CAPITAL" IS INSCRIBED.

FOR FINANCIAL SERVICES, NAMELY, VENTURE CAPITAL FUNDING SERVICES TO EMERGING AND START-UP COMPANIES, AND INVESTMENT BANKING (U.S. CLS. 100, 101 AND 102).

FIRST USE 4-1-2001; IN COMMERCE 4-1-2001.

SN 78-067,274. ALESSANDRO, BURKE & COMPANY, LLC, CORTE MADERA, CA. FILED 6-4-2001.

**TURNING POINT CAPITAL,  
L.P.**

NO CLAIM IS MADE TO THE EXCLUSIVE RIGHT TO USE "CAPITAL, L.P.", APART FROM THE MARK AS SHOWN.

FOR INVESTMENT MANAGEMENT SERVICES (U.S. CLS. 100, 101 AND 102).

**CLASS 36—(Continued).**

SN 78-067,323. OCASH.COM, INC., WHITE BEAR LAKE, MN. FILED 6-4-2001.

**OCASH**

FOR ELECTRONIC DEBIT TRANSACTION SERVICE FOR PURCHASING GOODS AND SERVICES (U.S. CLS. 100, 101 AND 102).

SN 78-071,719. AMERICAN EXPRESS COMPANY, NEW YORK, NY. FILED 6-29-2001.

**UNDERGRADUATE EXPRESS**

OWNER OF U.S. REG. NOS. 2,450,248, 2,456,439 AND OTHERS.

NO CLAIM IS MADE TO THE EXCLUSIVE RIGHT TO USE "UNDERGRADUATE", APART FROM THE MARK AS SHOWN.

FOR EDUCATIONAL LOANS. (U.S. CLS. 100, 101 AND 102).

FIRST USE 3-0-1999; IN COMMERCE 3-0-1999.

SN 78-072,828. HUNT, KATHLEEN, NASHVILLE, TN. FILED 7-8-2001.

**PULSE CAPITAL PARTNERS**

NO CLAIM IS MADE TO THE EXCLUSIVE RIGHT TO USE "CAPITAL PARTNERS", APART FROM THE MARK AS SHOWN.

FOR PROVIDING VENTURE CAPITAL FUNDING SERVICES TO EMERGING AND START-UP COMPANIES VIA A FUND-OF FUNDS (U.S. CLS. 100, 101 AND 102).

SN 78-074,975. SCIENTIFIC GAMES CORPORATION, NEW YORK, NY. FILED 7-20-2001.

**AUTOBET**

OWNER OF U.S. REG. NOS. 1,276,741 AND 2,282,400. FOR WAGERING SERVICES PROVIDED OVER A GLOBAL COMPUTER NETWORK; AUTOMATED TELEPHONE ACCOUNT WAGERING SERVICES (U.S. CLS. 100, 101 AND 102).

**CLASS 36—(Continued).**

SN 78-080,340. AMERICAN HOME SHIELD OF TEXAS, INC., HOUSTON, TX. FILED 8-21-2001.

**TEXAS HOME WARRANTY**

NO CLAIM IS MADE TO THE EXCLUSIVE RIGHT TO USE "HOME WARRANTY", APART FROM THE MARK AS SHOWN.

SEC. 2(F) AS TO "TEXAS".

FOR WARRANTY SERVICES, NAMELY, ARRANGING FOR REPAIRS AND REPLACEMENT OF UTILITY SYSTEMS, BUILT-IN APPLIANCES AND PARTS THEREOF PURSUANT TO CONTRACTS WITH HOMEOWNERS (U.S. CLS. 100, 101 AND 102).

FIRST USE 0-0-1987; IN COMMERCE 6-29-1989.

SN 78-083,597. INCAPITAL HOLDINGS, LLC, CHICAGO, IL. FILED 9-12-2001.

**BOND OPPORTUNITIES.  
MADE SIMPLE.**

FOR FINANCIAL BROKERAGE SERVICES IN THE FIELD OF BOND NOTES (U.S. CLS. 100, 101 AND 102).

SN 78-084,618. KGF DEVELOPMENT LLC, KIRKLAND, WA. FILED 9-19-2001.

**COPPER RIDGE**

FOR SHOPPING CENTER SERVICES; LEASING OF SHOPPING CENTER SPACE; REAL ESTATE MANAGEMENT SERVICES; LEASING OF APARTMENTS (U.S. CLS. 100, 101 AND 102).

SN 78-085,924. GENERAL ELECTRIC COMPANY, SCHENECTADY, NY. FILED 9-27-2001.

**GE TIMESELECT**

FOR ANNUITY UNDERWRITING SERVICES (U.S. CLS. 100, 101 AND 102).

**CLASS 37—CONSTRUCTION AND REPAIR**

**CLASS 37—(Continued).**

SN 75-746,927. CROSSCOM NATIONAL, INC., BUFFALO GROVE, IL. FILED 7-9-1999.



NO CLAIM IS MADE TO THE EXCLUSIVE RIGHT TO USE "NATIONAL RETAILER COMMUNICATIONS", APART FROM THE MARK AS SHOWN.

FOR INSTALLATION AND MAINTENANCE OF TELECOMMUNICATION EQUIPMENT, NAMELY, TELEPHONES, PAGING SYSTEMS, AND POINT OF SALE DATA SYSTEMS FOR USE IN RETAIL STORES (U.S. CLS. 100, 103 AND 106).

FIRST USE 5-3-1999; IN COMMERCE 5-3-1999.

SN 75-856,132. DRI-EAZ PRODUCTS, INC., BURLINGTON, WA. FILED 10-27-1999.

**DRIZONE**

FOR RESTORATION SERVICES, NAMELY, RESTORATIVE DRYING SERVICES IN THE FIELD OF WATER DAMAGE REMEDIATION IN COMMERCIAL AND RESIDENTIAL BUILDINGS (U.S. CLS. 100, 103 AND 106).

SN 75-861,509. POINTIVITY, INC., SAN DIEGO, CA. BY CHANGE OF NAME LOGIC TECHNOLOGY PARTNERS CORPORATION, SAN DIEGO, CA. FILED 11-30-1999.

**POINTIVITY**

FOR INSTALLATION AND MAINTENANCE OF COMPUTER HARDWARE, COMPUTER SYSTEMS AND COMPUTER NETWORKS (U.S. CLS. 100, 103 AND 106).

SN 75-912,252. LOUDCLOUD, INC., SUNNYVALE, CA. FILED 2-7-2000.

**STRESS CLOUD**

NO CLAIM IS MADE TO THE EXCLUSIVE RIGHT TO USE "STRESS", APART FROM THE MARK AS SHOWN.

FOR REPAIR AND INSTALLATION SERVICES FOR COMPUTER HARDWARE, WIRED AND WIRELESS TELECOMMUNICATIONS EQUIPMENT, TELECOMMUNICATIONS NETWORK EQUIPMENT, AND COMPUTER NETWORK EQUIPMENT USED FOR ONLINE COMMERCE (U.S. CLS. 100, 103 AND 106).

**CLASS 37—(Continued).**

SN 75-913,329. LOUDCLOUD, INC., SUNNYVALE, CA. FILED 2-7-2000.

**PAYMENT CLOUD**

NO CLAIM IS MADE TO THE EXCLUSIVE RIGHT TO USE "PAYMENT", APART FROM THE MARK AS SHOWN.

FOR REPAIR AND INSTALLATION SERVICES FOR COMPUTER HARDWARE, WIRED AND WIRELESS TELECOMMUNICATIONS EQUIPMENT, TELECOMMUNICATIONS NETWORK EQUIPMENT, AND COMPUTER NETWORK EQUIPMENT USED FOR ONLINE COMMERCE (U.S. CLS. 100, 103 AND 106).

SN 76-032,705. DEL WEBB CORPORATION, PHOENIX, AZ. FILED 4-24-2000.



OWNER OF U.S. REG. NOS. 768,006, 1,814,069 AND OTHERS.

NO CLAIM IS MADE TO THE EXCLUSIVE RIGHT TO USE "TEXAS", APART FROM THE MARK AS SHOWN.

THE NAME "DEL WEBB" DOES NOT IDENTIFY A LIVING INDIVIDUAL.

FOR PLANNING AND LAYING OUT OF RESIDENTIAL COMMUNITIES, RECREATIONAL FACILITIES, SOCIAL AND COMMUNITY FACILITIES, OFFICE COMPLEXES, SHOPPING CENTERS AND MEETING AND CONVENTION CENTERS; AND CONSTRUCTION SERVICES, NAMELY CONSTRUCTION OF RESIDENCES, RECREATIONAL FACILITIES, SOCIAL AND COMMUNITY FACILITIES AND COMMERCIAL BUILDINGS (U.S. CLS. 100, 103 AND 106).

FIRST USE 3-22-2000; IN COMMERCE 4-23-2000.

SN 76-039,293. BUZZSAW.COM, SAN FRANCISCO, CA. FILED 4-27-2000.

**BUZZSAW**

FOR CONSTRUCTION MANAGEMENT SERVICES FOR COMMERCIAL AND INDUSTRIAL CONSTRUCTION PROJECTS (U.S. CLS. 100, 103 AND 106).

**CLASS 37—(Continued).**

SN 76-068,788. SEAWEST WINDPOWER, INC., SAN DIEGO, CA. FILED 6-12-2000.

**WINDPOWER FOR A CLEAN FUTURE**

FOR REAL ESTATE SITE SELECTION; LAND DEVELOPMENT, NAMELY, PLANNING AND LAYING OUT OF WIND PARKS; CONSTRUCTION SERVICES, NAMELY, PLANNING, LAYING OUT AND CUSTOM CONSTRUCTION OF WIND PARKS; CONSTRUCTION, MANAGEMENT AND SUPERVISION; MAINTENANCE AND REPAIR OF WIND TURBINES (U.S. CLS. 100, 103 AND 106).

FIRST USE 2-25-1999; IN COMMERCE 2-25-1999.

---

SN 76-095,212. CEPHREN, INC., PALO ALTO, CA. FILED 7-24-2000.



FOR PROVIDING A COMPUTER DATABASE FEATURING INFORMATION ON BUILDING CONSTRUCTION (U.S. CLS. 100, 103 AND 106).

---

SN 76-119,203. STORM TELECOMMUNICATIONS LIMITED, LONDON, UNITED KINGDOM, FILED 8-30-2000.



FOR MAINTENANCE, INSTALLATION AND REPAIR OF TELECOMMUNICATIONS AND COMPUTER NETWORKS (U.S. CLS. 100, 103 AND 106).

---

SN 76-132,672. ESSELSTROM, TYLER, GROVELAND, FL. FILED 9-22-2000.



FOR REPAIR OF COMPUTER HARDWARE SYSTEMS (U.S. CLS. 100, 103 AND 106).

**CLASS 37—(Continued).**

SN 76-134,649. WEBB MECHANICAL & ELECTRICAL CONTRACTORS, TAYLOR, MI. FILED 9-21-2000.

**YOUR SINGLE SOURCE SOLUTION**

FOR MECHANICAL CONTRACTING SERVICES CONSISTING OF INSTALLATION, MAINTENANCE AND REPAIR OF HEATING, VENTILATION, AIR-CONDITIONING, PIPING AND PLUMBING COMPONENTS AND SYSTEMS (U.S. CLS. 100, 103 AND 106).  
FIRST USE 4-20-1999; IN COMMERCE 4-20-1999.

---

SN 76-159,690. WESTERN AND SOUTHERN LIFE INSURANCE COMPANY, THE, DBA WESTERN-SOUTHERN LIFE, CINCINNATI, OH. FILED 11-6-2000.

**QUEEN CITY SQUARE**

NO CLAIM IS MADE TO THE EXCLUSIVE RIGHT TO USE "QUEEN CITY", APART FROM THE MARK AS SHOWN.

FOR CONSTRUCTION AND REPAIR TO OFFICE BUILDINGS (U.S. CLS. 100, 103 AND 106).

---

SN 76-161,229. HILL COUNTRY FABRIC RECOVERY SERVICES, FISCHER, TX. FILED 11-8-2000.



NO CLAIM IS MADE TO THE EXCLUSIVE RIGHT TO USE "FABRIC RECOVERY SERVICES", APART FROM THE MARK AS SHOWN.

FOR TEXTILE CLEANING SERVICES, NAMELY, TEXTILE CLEANING OF FIRE- OR WATER-DAMAGED FABRICS INCLUDING CLOTHING, DRAPERIES AND OTHER FABRICS, FOR INDIVIDUALS, FAMILIES AND BUSINESSES (U.S. CLS. 100, 103 AND 106).

FIRST USE 5-1-2000; IN COMMERCE 5-1-2000.

---

SN 76-185,266. W L HOMES LLC, NEWPORT BEACH, CA. FILED 12-22-2000.

**JOHN LAING HOMES**

NO CLAIM IS MADE TO THE EXCLUSIVE RIGHT TO USE "HOMES", APART FROM THE MARK AS SHOWN. THE NAME "JOHN LAING" DOES NOT IDENTIFY A LIVING INDIVIDUAL.

FOR RESIDENTIAL REAL ESTATE DEVELOPMENT SERVICES (U.S. CLS. 100, 103 AND 106).

FIRST USE 0-0-1984; IN COMMERCE 0-0-1990.



**CLASS 37—(Continued).**

SN 76-187,770. LANDIS CAMPBELL, INC., SALFORDVILLE, PA. FILED 12-29-2000.

**TUFWRAP**

FOR ENVIRONMENTAL REMEDIATION SERVICES, NAMELY, WASTE DISPOSAL BY USE OF AN INTERIOR DEBRIS CONTAINMENT SYSTEM (U.S. CLS. 100, 103 AND 106).

FIRST USE 3-14-2000; IN COMMERCE 3-14-2000.

SN 76-188,960. ON-SITE HYDRAULICS, INC., WHITMORE LAKE, MI. FILED 12-26-2000.

**ON-SITE  
HYDRAULICS**

NO CLAIM IS MADE TO THE EXCLUSIVE RIGHT TO USE "ON-SITE HYDRAULICS", APART FROM THE MARK AS SHOWN.

FOR MOBILE REPAIR SERVICES, NAMELY - HYDRAULIC EQUIPMENT REPAIR SERVICES ON LOCATION (U.S. CLS. 100, 103 AND 106).

FIRST USE 5-15-2000; IN COMMERCE 10-1-1999.

SN 76-211,332. EL PASO CORPORATION, HOUSTON, TX. FILED 2-15-2001.

**elpaso**

OWNER OF U.S. REG. NOS. 1,876,839, 2,201,934 AND OTHERS.

SEC. 2(F) AS TO "EL PASO".

FOR CONSTRUCTION SERVICES, NAMELY, PLANNING, LAYING OUT AND CUSTOM CONSTRUCTION OF ENERGY GENERATING FACILITIES AND PIPELINE SYSTEMS AND RELATED FACILITIES FOR OTHERS; AND, NATURAL GAS DRILLING SERVICES, MAINTENANCE OF PIPELINE SYSTEMS AND ELECTRICITY GENERATION FACILITIES (U.S. CLS. 100, 103 AND 106).

FIRST USE 2-5-2001; IN COMMERCE 2-5-2001.

**CLASS 37—(Continued).**

SN 76-224,714. MAGIC SWEEP CORPORATION, CHESAPEAKE, VA. FILED 3-15-2001.

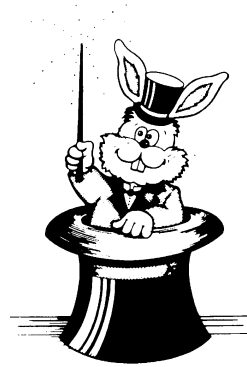

THE STIPPLING IS FOR SHADING PURPOSES ONLY AND IS NOT INTENDED TO INDICATE COLOR.

FOR CHIMNEY, FURNACE AND AIR-DUCT CLEANING AND REPAIR SERVICES; GAS AND ELECTRIC FIREPLACE LOG INSTALLATION REPAIR SERVICES (U.S. CLS. 100, 103 AND 106).

FIRST USE 1-1-1979; IN COMMERCE 1-1-1979.

SN 76-227,818. EL PASO CORPORATION, HOUSTON, TX. FILED 3-20-2001.

**EL PASO EUROPE**

OWNER OF U.S. REG. NOS. 1,876,839, 2,201,934 AND OTHERS.

NO CLAIM IS MADE TO THE EXCLUSIVE RIGHT TO USE "EUROPE", APART FROM THE MARK AS SHOWN.

SEC. 2(F) AS TO "EL PASO".

FOR CONSTRUCTION SERVICES, NAMELY, PLANNING, LAYING OUT AND CUSTOM CONSTRUCTION OF ENERGY GENERATING FACILITIES AND PIPELINE SYSTEMS AND RELATED FACILITIES FOR OTHERS; AND, NATURAL GAS DRILLING SERVICES, MAINTENANCE OF PIPELINE SYSTEMS AND ELECTRICITY GENERATION FACILITIES; AND, CONSTRUCTION AND MAINTENANCE OF COMPRESSED OR LIQUEFIED NATURAL GAS TERMINALS AND FACILITIES FOR THE DELIVERY, PROCESSING AND STORAGE OF LIQUEFIED NATURAL GAS (U.S. CLS. 100, 103 AND 106).

SN 76-255,490. ROCKSOLID GRANIT (USA) INC., ORANGE, CA. FILED 5-14-2001.

**ROCKSOLID GRANIT**

NO CLAIM IS MADE TO THE EXCLUSIVE RIGHT TO USE "GRANITE", APART FROM THE MARK AS SHOWN.

FOR INSTALLATION SERVICES, NAMELY THE INSTALLATION OF RECONSTITUTED GRANITE SLABS AND TILES (U.S. CLS. 100, 103 AND 106).

**CLASS 37—(Continued).**

SN 76-262,645. PALM ISLAND PLANTATION, L.L.C., VERO BEACH, FL. FILED 5-29-2001.

**PALM ISLAND PLANTATION**

NO CLAIM IS MADE TO THE EXCLUSIVE RIGHT TO USE "PALM ISLAND", APART FROM THE MARK AS SHOWN.

FOR REAL ESTATE DEVELOPMENT SERVICES (U.S. CLS. 100, 103 AND 106).

**CLASS 37—(Continued).**

SN 76-280,771. NATIONAL PROPERTIES GROUP CORPORATION, DENVER, CO. FILED 7-2-2001.

**Built Smart**

FOR INSTALLATION OF LOW VOLTAGE DATA WIRING APPARATUS AND CABLE (U.S. CLS. 100, 103 AND 106).

FIRST USE 4-1-1998; IN COMMERCE 4-1-1998.

SN 76-266,982. CIMCON INDUSTRIES, INC., RANCHO CORDOVA, CA. FILED 6-6-2001.

**REINVENTING DESIGN \  
BUILD**

NO CLAIM IS MADE TO THE EXCLUSIVE RIGHT TO USE "DESIGN / BUILD", APART FROM THE MARK AS SHOWN.

FOR RESIDENTIAL AND COMMERCIAL BUILDING CONSTRUCTION (U.S. CLS. 100, 103 AND 106).

SN 76-286,028. AQUILUS, INC., DBA AERO, MT. PLEASANT, SC. FILED 7-16-2001.

**WHEN YOU TRUST THE  
PEOPLE, YOU CAN TRUST  
THE WORK**

FOR AUTOMOBILE REPAIR AND MAINTENANCE (U.S. CLS. 100, 103 AND 106).

FIRST USE 1-0-2000; IN COMMERCE 1-0-2000.

SN 76-271,524. FLOORCOVERINGS INTERNATIONAL, LTD., FOREST PARK, GA. FILED 6-14-2001.

**FIRST**

FOR FLOOR COVERING INSTALLATION AND REPLACEMENT SERVICES (U.S. CLS. 100, 103 AND 106).

FIRST USE 4-0-1998; IN COMMERCE 4-0-1998.

SN 76-301,435. SCHIMENTI CONSTRUCTION COMPANY, PURCHASE, NY. FILED 8-16-2001.



FOR GENERAL CONSTRUCTION OF COMMERCIAL, RETAIL, AND INDUSTRIAL BUILDINGS (U.S. CLS. 100, 103 AND 106).

FIRST USE 1-1-1997; IN COMMERCE 1-1-1997.

SN 76-272,478. BAITY, JAMES J., CARSON CITY, NV. FILED 6-15-2001.

**PRETTY TILE, UGLY  
GROUT?**

NO CLAIM IS MADE TO THE EXCLUSIVE RIGHT TO USE "TILE" AND "GROUT", APART FROM THE MARK AS SHOWN.

FOR GROUTING AND TILE REPAIR SERVICES (U.S. CLS. 100, 103 AND 106).

FIRST USE 5-31-1993; IN COMMERCE 5-31-1993.

SN 76-302,050. HAMILTON SUNDBRAND CORPORATION, WINDSOR LOCKS, CT. FILED 8-15-2001.

**ROBI**

THE NAME IN THE MARK DOES NOT IDENTIFY A LIVING INDIVIDUAL.

FOR REPAIR, MAINTENANCE, AND SUPPORT OF SYSTEMS THAT PROVIDE INERT GAS IN A CONTROLLED AMOUNT TO AN AIRCRAFT FUEL TANK DURING IN-FLIGHT OR GROUND OPERATION (U.S. CLS. 100, 103 AND 106).

**CLASS 37—(Continued).**

SN 76-302,642. HOVNANIAN ENTERPRISES, INC., RED BANK, NJ. FILED 8-21-2001.

**KHOV**

FOR REAL ESTATE DEVELOPMENT SERVICES, NAMELY, DESIGN, CONSTRUCTION AND PROVIDING OF CONDOMINIUMS, HOUSES, RESIDENTIAL PROPERTIES AND COMMERCIAL PROPERTIES IN PLANNED COMMUNITIES (U.S. CLS. 100, 103 AND 106).

SN 76-307,462. EAGLE BUILDING SYSTEMS, INC., ELBERON, NJ. FILED 8-31-2001.

**BUILT THE AMERICAN WAY**

FOR GENERAL CONTRACTOR SERVICES, NAMELY, CONSTRUCTION, REPAIR, RENOVATIONS, AND ADDITIONS TO BUILDINGS AND CONSTRUCTION MANAGEMENT (U.S. CLS. 100, 103 AND 106).  
FIRST USE 6-1-2001; IN COMMERCE 6-1-2001.

SN 78-019,832. KLEENER KING SATELLITES, INC., BRONX, NY. FILED 8-4-2000.

**KLEENER KING**

NO CLAIM IS MADE TO THE EXCLUSIVE RIGHT TO USE "CLEANER", APART FROM THE MARK AS SHOWN.  
FOR DRY CLEANING SERVICES; LAUNDRY SERVICES FOR CLOTH, CLOTHING, FABRIC, LINEN AND TEXTILES (U.S. CLS. 100, 103 AND 106).

SN 78-022,810. INTEGREGX VENTURES, LLC, TOLEDO, OH. FILED 8-24-2000.



FOR RESIDENTIAL MAINTENANCE SERVICES, NAMELY, REPAIR, REMOLDING, IMPROVEMENT AND CONSTRUCTION (U.S. CLS. 100, 103 AND 106).

**CLASS 37—(Continued).**

SN 78-043,406. ZERO WASTE WELL, HOUSTON, TX. FILED 1-16-2001.

**ZERO WASTE WELL**

NO CLAIM IS MADE TO THE EXCLUSIVE RIGHT TO USE "WELL", APART FROM THE MARK AS SHOWN.  
FOR PROVIDING ADVISORY SERVICES RELATING TO DRILLING AND OPERATING OF WELLS; LAYING OF PIPELINES, INSTALLATION, MAINTENANCE AND REPAIR OF COMPUTERS, COMPUTER NETWORKS AND COMPUTER PERIPHERALS; RENTAL OF OIL EXPLORATION MACHINERY AND APPARATUS (U.S. CLS. 100, 103 AND 106).

SN 78-061,066. VILLAGE HABITAT DESIGN, LLC, ATLANTA, GA. FILED 4-30-2001.



NO CLAIM IS MADE TO THE EXCLUSIVE RIGHT TO USE "VILLAGE HABITAT DESIGN", APART FROM THE MARK AS SHOWN.  
THE MARK CONSISTS OF AN IMAGE OF AN ACORN. THE WORDING "VILLAGE HABITAT DESIGN" APPEARS TO THE RIGHT OF THE DESIGN ELEMENT WITHIN THE MARK.  
FOR PLANNING AND LAYING OUT OF RESIDENTIAL COMMUNITIES (U.S. CLS. 100, 103 AND 106).  
FIRST USE 4-0-1998; IN COMMERCE 4-0-1998.

**CLASS 38—COMMUNICATION**

SN 75-092,056. CUG GROUP, INC., DETROIT, MI. FILED 4-22-1996.

**CRN**

FOR TELEVISION BROADCASTING SERVICES (U.S. CLS. 100, 101 AND 104).

**CLASS 38—(Continued).**

SN 75-248,014. WARPSPEED COMMUNICATIONS, PLEASANTON, CA. FILED 2-26-1997.

**WARPSPEED**

FOR TELECOMMUNICATIONS SERVICES, NAMELY, PROVIDING MULTIPLE-USER ACCESS TO A GLOBAL COMMUNICATIONS NETWORK FOR THE TRANSFER AND DISSEMINATION OF A WIDE-RANGE OF INFORMATION AND FOR TELEPHONY COMMUNICATIONS SERVICES (U.S. CLS. 100, 101 AND 104).

---

SN 75-574,075. CITICASTERS CO., BURBANK, CA. FILED 10-21-1998.

**NO DRAWING-SENSORY MARK**

NO CLAIM IS MADE TO THE EXCLUSIVE RIGHT TO USE "FM", APART FROM THE MARK AS SHOWN.

THE MARK CONSISTS OF "KIIS FM" (PRONOUNCED "KISS EF EM") SPOKEN WITH A DISTINCTIVE DELIVERY IN A DISTINCTIVE MALE ANNOUNCER'S VOICE IN A LOW TENOR REGISTER WITH THE EMPHASIS OF DELIVERY ON THE SECOND PORTION OF THE WORDS (I.E., THE "EF EM" [PHONETIC] PORTION), AND WITH A VERY BRIEF, LESS THAN ONE-HALF OF A SECOND, PAUSE BETWEEN THE "KISS" (PHONETIC) AND "EF EM" (PHONETIC) PORTIONS.

FOR RADIO BROADCASTING SERVICES (U.S. CLS. 100, 101 AND 104).

FIRST USE 12-1-1984; IN COMMERCE 12-1-1984.

---

SN 75-747,557. SKYBIZ.COM, INC., TULSA, OK. FILED 6-21-1999.

**SKYBIZ**

FOR PROVIDING TELECOMMUNICATIONS CONNECTIONS TO A GLOBAL COMPUTER NETWORK WHICH ALLOWS USERS TO BUILD WEBSITES AND REPLICATE WEBSITES ACROSS A GLOBAL COMPUTER NETWORK (U.S. CLS. 100, 101 AND 104).

FIRST USE 11-16-1998; IN COMMERCE 11-16-1998.

**CLASS 38—(Continued).**

SN 75-778,384. COLT TELECOM GROUP PLC, LONDON NW1 5JD, UNITED KINGDOM, FILED 8-17-1999.

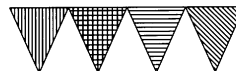

THE DRAWING IS LINED FOR THE COLOR(S) RED, BLUE, GREEN AND YELLOW.

FOR PROVIDING TELECOMMUNICATIONS SERVICES, NAMELY ELECTRONIC AND WIRELESS TRANSMISSION OF VOICE, DATA AND VIDEO; PROVIDING TELECOMMUNICATIONS CONNECTIONS TO A GLOBAL COMPUTER NETWORK; TELECOMMUNICATION SERVICES, NAMELY COLLOCATION AND TESTING SERVICES OF VOICE, DATA AND VIDEO COMMUNICATIONS APPLICATIONS OVER A GLOBAL COMMUNICATION/COMPUTER NETWORK; AND SATELLITE TRANSMISSION SERVICES (U.S. CLS. 100, 101 AND 104).

---

SN 75-841,363. OXYGEN MEDIA, LLC, NEW YORK, NY. FILED 11-5-1999.

**PURE OXYGEN**

FOR PROVIDING COMMUNITY FORUMS IN THE NATURE OF ON-LINE CHAT ROOMS AND ELECTRONIC BULLETIN BOARDS FOR TRANSMISSION OF MESSAGES AMONG COMPUTER USERS CONCERNING CURRENT EVENTS, ATTITUDES, PROFILES AND LIFESTYLES ISSUES INCLUDING HEALTH, FITNESS, MEDICINE, BEAUTY, FAMILY, BUSINESS, MEDIA AND POLITICS (U.S. CLS. 100, 101 AND 104).

---

SN 75-877,969. EMPLOYEE.NET, INC., NEW YORK, NY. FILED 12-22-1999.

**WORKLINKS**

FOR PROVIDING ON-LINE ELECTRONIC BULLETIN BOARDS FOR TRANSMISSION OF MESSAGES AMONG EMPLOYEES AND EMPLOYERS CONCERNING TOPICS OF GENERAL INTEREST (U.S. CLS. 100, 101 AND 104).

---

SN 75-912,598. NEWMARKET COMPANY, INC., THE, WASHINGTON, DC. FILED 2-9-2000.

**ECOUNCILS**

FOR AUDIO-VISUAL WEBCASTING VIA A GLOBAL COMPUTER NETWORK AND TELECONFERENCING BETWEEN BUSINESS GROUPS WITH SHARED INTERESTS (U.S. CLS. 100, 101 AND 104).

**CLASS 38—(Continued).**

SN 75-923,091. ELECTRIC CALIFORNIA WESTERN, INC., SAN DIEGO, CA. FILED 2-18-2000.

**VIRTULINK**

FOR BROADCASTING STILL AND MOVING TELEVISION IMAGES, VIDEO AND COMPUTER GRAPHICS VIA A GLOBAL COMPUTER NETWORK (U.S. CLS. 100, 101 AND 104).

SN 75-937,054. QUICKSTART TECHNOLOGIES, INC., IRVINE, CA. FILED 3-7-2000.

**ETRAINING.COM**

OWNER OF U.S. REG. NO. 2,157,357. SEC. 2(F). FOR TELECOMMUNICATION SERVICES, NAMELY, PROVIDING MULTIPLE-USER ACCESS TO COMPUTER NETWORKS; NETWORK CONFERENCING SERVICES; WEBCASTING AUDIO/VISUAL PROGRAMMING VIA A COMPUTER NETWORK; ELECTRONIC MAIL SERVICES; PROVIDING ON-LINE DISCUSSION FORUMS, LIVE WEB AUDIO/VIDEO CONFERENCES AND CHAT ROOMS FOR TRANSMISSION OF INFORMATION AMONG USERS CONCERNING EDUCATION AND TRAINING IN A WIDE VARIETY OF FIELDS (U.S. CLS. 100, 101 AND 104).

SN 75-942,541. TELERA, INC., CAMPBELL, CA. FILED 3-13-2000.

**THE INTELLIGENCE IN THE NETWORK**

FOR TELECOMMUNICATIONS SERVICES, NAMELY PROVIDING A NETWORK-BASED VOICE TELECOMMUNICATIONS SERVICE THAT ALLOWS USERS TO ACCESS NETWORK AND INTERNET APPLICATIONS BY TELEPHONE (U.S. CLS. 100, 101 AND 104).

**CLASS 38—(Continued).**

SN 76-011,163. LACONNER NEW MEDIA, INC., LACONNER, WA. FILED 3-28-2000.



NO CLAIM IS MADE TO THE EXCLUSIVE RIGHT TO USE "SENIORCENTER.COM", APART FROM THE MARK AS SHOWN.

FOR TELECOMMUNICATION SERVICES, NAMELY, PROVIDING CONNECTIVITY AND ACCESS TO A GLOBAL COMPUTER NETWORK BY MEANS OF HOME TELEVISION SETS, AND EQUIPMENT PERIPHERAL THERETO; PROVIDING COMMUNICATION LINKS TO GLOBAL INTERACTIVE NETWORKS FOR THE TRANSFER AND TRANSMISSION OF WEB SITES COMPUTER FILES, VIDEO, IMAGES AND DOCUMENTS; PROVIDING ONLINE CHAT ROOMS AND ELECTRONIC BULLETIN BOARDS FOR TRANSMISSION OF MESSAGES AMONG COMPUTER USERS CONCERNING SHOPPING, NEWS, SPORTS, BUSINESS NEWS, TECHNOLOGY, ENTERTAINMENT, JOKES, HOROSCOPES, FAITH, HEALTH, FINANCIAL INFORMATION, TRAVEL ON A GLOBAL COMPUTER NETWORK (U.S. CLS. 100, 101 AND 104).

FIRST USE 3-17-2000; IN COMMERCE 3-17-2000.

SN 76-015,224. VIAWEST INTERNET SERVICES, INC., DENVER, CO. FILED 3-31-2000.

**VIAWEST**

FOR PROVIDING MULTIPLE-USER ACCESS TO A GLOBAL COMMUNICATION NETWORK (U.S. CLS. 100, 101 AND 104).

FIRST USE 9-0-1999; IN COMMERCE 9-0-1999.

SN 76-019,311. GEORGES, ALEXANDER J., DBA GEORGES INVESTMENTS, HOUSTON, TX. FILED 4-6-2000.

**HOUSTONNETRADIO**

FOR AUDIO STREAMING TRANSMISSION OF MUSIC AND VOICES VIA COMPUTER TERMINALS; BROADCASTING PROGRAMS VIA A GLOBAL COMPUTER NETWORK; AND TRANSMISSION OF RADIO PROGRAMMING BY MEANS OF A GLOBAL NETWORK (U.S. CLS. 100, 101 AND 104).

**CLASS 38—(Continued).**

SN 76-019,312. GEORGES, ALEXANDER J., DBA GEORGES INVESTMENTS, HOUSTON, TX. FILED 4-6-2000.

**NATIONALNETRADIO**

FOR AUDIO STREAMING TRANSMISSION OF MUSIC AND VOICES VIA COMPUTER TERMINALS; BROADCASTING PROGRAMS VIA A GLOBAL COMPUTER NETWORK; AND TRANSMISSION OF RADIO PROGRAMMING BY MEANS OF A GLOBAL NETWORK (U.S. CLS. 100, 101 AND 104).

---

SN 76-036,711. ONFIBER COMMUNICATIONS, INC., MENLO PARK, CA. FILED 4-28-2000.

**ONFIBER**

FOR TELECOMMUNICATIONS SERVICES, NAMELY, TRANSMISSION OF DATA AND VOICE COMMUNICATIONS (U.S. CLS. 100, 101 AND 104).  
FIRST USE 9-24-1999; IN COMMERCE 10-13-1999.

---

SN 76-044,426. NOVUSAIR, INC., PROSPER, TX. FILED 5-10-2000.

**NOVUSAIR**

FOR PROVIDING BUSINESS TELECOMMUNICATIONS SERVICES, NAMELY, PROVIDING WIRELESS, CELLULAR, TELEPHONE AND INTERNET ACCESS TO THE ONLINE BUSINESS INFORMATION OF THE EMPLOYEES, PARTNERS AND CUSTOMERS OF OTHERS, NAMELY, FINANCIAL AND BUSINESS ACCOUNTS, ELECTRONIC MAIL SYSTEMS, TO-DO LISTS, SALES LEAD DATABASES, EXPENSE INFORMATION, CALENDARS AND ITINERARIES, THROUGH A CENTRALIZED ONLINE HOST (U.S. CLS. 100, 101 AND 104).

---

SN 76-044,427. NOVUSAIR, INC., PROSPER, TX. FILED 5-10-2000.

**RIDE THE WAVES**

FOR PROVIDING BUSINESS TELECOMMUNICATIONS SERVICES, NAMELY, PROVIDING WIRELESS, CELLULAR, TELEPHONE AND INTERNET ACCESS TO THE ONLINE BUSINESS INFORMATION OF THE EMPLOYEES, PARTNERS AND CUSTOMERS OF OTHERS, NAMELY, FINANCIAL AND BUSINESS ACCOUNTS, ELECTRONIC MAIL SYSTEMS, TO-DO LISTS, SALES LEAD DATABASES, EXPENSE INFORMATION, CALENDARS AND ITINERARIES, THROUGH A CENTRALIZED ONLINE HOST (U.S. CLS. 100, 101 AND 104).

**CLASS 38—(Continued).**

SN 76-051,811. BLACK ENTERTAINMENT TELEVISION, INC., WASHINGTON, DC. FILED 5-19-2000.

**NO DRAWING-SENSORY MARK**

OWNER OF U.S. REG. NOS. 1,511,259, 1,665,252 AND OTHERS.

THE MARK CONSISTS OF THE SPOKEN LETTERS "B E T".

FOR CABLE TELEVISION BROADCASTING SERVICES (U.S. CLS. 100, 101 AND 104).

FIRST USE 1-25-1980; IN COMMERCE 1-25-1980.

---

SN 76-057,811. HUGHES ELECTRONICS CORPORATION, EL SEGUNDO, CA. FILED 5-26-2000.

**WE'RE ON A MISSION**

FOR SATELLITE BROADCASTING AND COMMUNICATIONS SERVICES (U.S. CLS. 100, 101 AND 104).

---

SN 76-069,351. TELEZOO.COM, CORPORATION, ARLINGTON, VA. FILED 6-13-2000.

**MYZOO**

FOR PROVIDING INFORMATION REGARDING THE TELECOMMUNICATIONS GOODS AND SERVICES OF OTHERS AND GENERAL NEWS REGARDING THE TELECOMMUNICATIONS INDUSTRY VIA A GLOBAL COMMUNICATIONS NETWORK; PROVIDING INFORMATION IN THE FIELD OF TELECOMMUNICATIONS BY LINKING TO THIRD PARTY WEB SITES (U.S. CLS. 100, 101 AND 104).

FIRST USE 3-0-2000; IN COMMERCE 3-0-2000.

---

SN 76-069,376. TELEZOO.COM, CORPORATION, ARLINGTON, VA. FILED 6-13-2000.

**TAMING TELECOMMUNICATIONS**

NO CLAIM IS MADE TO THE EXCLUSIVE RIGHT TO USE "TELECOMMUNICATIONS", APART FROM THE MARK AS SHOWN.

FOR PROVIDING INFORMATION REGARDING THE TELECOMMUNICATIONS GOODS AND SERVICES OF OTHERS AND GENERAL NEWS REGARDING THE TELECOMMUNICATIONS INDUSTRY VIA A GLOBAL COMMUNICATIONS NETWORK; PROVIDING INFORMATION IN THE FIELD OF TELECOMMUNICATIONS BY LINKING TO THIRD PARTY WEB SITES (U.S. CLS. 100, 101 AND 104).

FIRST USE 5-0-2000; IN COMMERCE 5-0-2000.

**CLASS 38—(Continued).**

SN 76-079,972. GENTEC ENTERPRISES, INC., DBA WESTERN PACIFIC TELECOMMUNICATIONS, CARSON, CA. FILED 6-28-2000.

**WPT**

FOR TELECOMMUNICATION PRODUCTS FOR USE WITH TELEPHONE WIRES, CABLES AND FIBER-OPTIC CABLES, NAMELY - SPLICE CONNECTORS; SPLICE CLOSURES; TERMINALS AND CONNECTORS; POLE LINE DROPWIRE CLAMPS, ELECTRICAL GROUNDING HARDWARE, NAMELY, ELECTRICAL CLIPS, CLAMPS, AND CONDUCTIVE STRAPS; SUBSCRIBER JUNCTIONS, TERMINALS AND JACKS; AND VOLTAGE SURGE PROTECTORS (U.S. CLS. 100, 101 AND 104).  
FIRST USE 3-0-2000; IN COMMERCE 3-0-2000.

SN 76-084,365. PC MANAGEMENT, INC., FORT MYERS, FL. FILED 7-7-2000.

**TELEZONE**

FOR TELECOMMUNICATIONS SERVICES, NAMELY WIRELESS LOCAL LOOP TRANSMISSION OF VOICE, DATA, IMAGES, AUDIO, VIDEO, AND INFORMATION (U.S. CLS. 100, 101 AND 104).  
FIRST USE 7-15-2000; IN COMMERCE 7-15-2000.

SN 76-085,677. CROSSWAVE COMMUNICATIONS INC, TOKYO, JAPAN, FILED 7-7-2000.

**CWC**

FOR TELECOMMUNICATIONS SERVICES, NAMELY, ELECTRONIC TRANSMISSION OF DATA AND DOCUMENTS VIA COMPUTER TERMINALS; PROVIDING MULTIPLE-USER ACCESS TO A GLOBAL COMPUTER INFORMATION NETWORK, PROVIDING INFORMATION ABOUT COMPUTER-AIDED TELECOMMUNICATIONS (U.S. CLS. 100, 101 AND 104).

SN 76-094,736. IHELLO.COM INC., MOUNTAIN VIEW, CA. FILED 7-20-2000.

**IHELLO**

FOR TELECOMMUNICATION SERVICES, NAMELY, ELECTRONIC TRANSMISSION OF FAXES AND VOICE-ENABLED MESSAGES BY A COMPUTER NETWORK; ELECTRONIC MAIL SERVICES; VOICE COMMUNICATION SERVICES NAMELY VOICE AND SPEECH RECOGNITION FOR OPERATION OF A COMPUTER BY MEANS OF VOICE COMMANDS AND FOR SPEECH TO TEXT CONVERSION (U.S. CLS. 100, 101 AND 104).  
FIRST USE 12-17-1999; IN COMMERCE 12-17-1999.

**CLASS 38—(Continued).**

SN 76-097,457. SOURCINGLINK.NET, INC., SAN DIEGO, CA. FILED 7-24-2000.

**SHIPLINK**

FOR PROVIDING MULTIPLE USER ACCESS TO A GLOBAL COMPUTER INFORMATION NETWORK TO ENABLE SUPPLIERS AND BUYERS TO TRACK THE SHIPMENT OF MERCHANDISE (U.S. CLS. 100, 101 AND 104).  
FIRST USE 11-15-1999; IN COMMERCE 11-15-1999.

SN 76-100,039. ALTERNATIVE LEGAL SOLUTIONS, LLC., PORTLAND, OR. FILED 7-31-2000.

**POLIS**

FOR DISSEMINATING EMPLOYMENT INFORMATION, NAMELY ELECTRONIC TRANSMISSION OF EMPLOYMENT DATA VIA A GLOBAL COMPUTER NETWORK (U.S. CLS. 100, 101 AND 104).

SN 76-109,595. ETRANS SAFE, INC., SANTA MONICA, CA. FILED 8-15-2000.

**ETRANS SAFE**

FOR SECURE, CONTINUOUS ELECTRONIC TRANSMISSION OF DATA AND DOCUMENTS VIA COMPUTER TERMINALS FROM ONE COMPANY TO ANOTHER (U.S. CLS. 100, 101 AND 104).

SN 76-132,372. ONFIBER COMMUNICATIONS, INC., CUPERTINO, CA. FILED 9-19-2000.

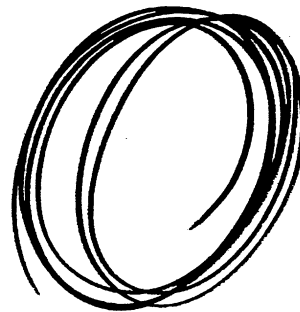

FOR TELECOMMUNICATIONS SERVICES, NAMELY, TRANSMISSION OF DATA AND TELEPHONE COMMUNICATIONS VIA A FIBER OPTIC CABLE NETWORK (U.S. CLS. 100, 101 AND 104).

**CLASS 38—(Continued).**

SN 76-133,287. PATERNOT, STEPHAN, NEW YORK, NY. FILED 9-21-2000.

**GROUP SMS**

NO CLAIM IS MADE TO THE EXCLUSIVE RIGHT TO USE "GROUP", APART FROM THE MARK AS SHOWN. FOR WIRELESS DIGITAL MESSAGING SERVICES (U.S. CLS. 100, 101 AND 104).

SN 76-133,582. GUARANTY BROADCASTING CORPORATION, BATON ROUGE, LA. FILED 9-22-2000.

**GUARANTY SPORTS NETWORK**

NO CLAIM IS MADE TO THE EXCLUSIVE RIGHT TO USE "SPORTS NETWORK", APART FROM THE MARK AS SHOWN.

FOR TELEVISION, RADIO AND INTERNET BROADCASTING (U.S. CLS. 100, 101 AND 104). FIRST USE 5-31-1999; IN COMMERCE 5-31-1999.

SN 76-134,384. PROFLUENT, INC., SAN JOSE, CA. FILED 9-21-2000.

**PROFLUENT**

FOR WIRELESS COMMUNICATION SERVICES, NAMELY WIRELESS PBX SERVICES, WIRELESS DIGITAL MESSAGING SERVICES AND WIRELESS FACSIMILE MAIL SERVICES (U.S. CLS. 100, 101 AND 104).

SN 76-157,725. ENTRAVISION COMMUNICATIONS CORPORATION, WASHINGTON, DC. FILED 11-1-2000.

**ENTRAVISION COMMUNICATIONS CORPORATION**

NO CLAIM IS MADE TO THE EXCLUSIVE RIGHT TO USE "COMMUNICATIONS CORPORATION", APART FROM THE MARK AS SHOWN.

FOR TELEVISION AND RADIO BROADCASTING SERVICES (U.S. CLS. 100, 101 AND 104). FIRST USE 1-30-1996; IN COMMERCE 1-30-1996.

**CLASS 38—(Continued).**

SN 76-157,726. ENTRAVISION COMMUNICATIONS CORPORATION, WASHINGTON, DC. FILED 11-1-2000.

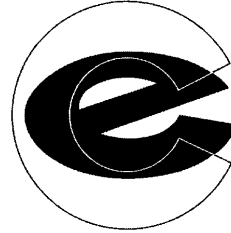

FOR TELEVISION AND RADIO BROADCASTING SERVICES (U.S. CLS. 100, 101 AND 104). FIRST USE 1-30-2000; IN COMMERCE 1-30-2000.

SN 76-161,015. EZGOV, INC., ATLANTA, GA. FILED 11-6-2000.

**EZGOV**

OWNER OF U.S. REG. NO. 2,331,188. FOR TELECOMMUNICATION SERVICES, NAMELY INTERACTIVE VOICE RESPONSE SERVICES (U.S. CLS. 100, 101 AND 104). FIRST USE 7-31-2000; IN COMMERCE 7-31-2000.

SN 76-176,290. PEGASUS COMMUNICATIONS CORPORATION, BALA CYNWYD, PA. FILED 12-6-2000.

**PEGASUS EXPRESS PRO**

FOR TELECOMMUNICATIONS SERVICES, NAMELY, CABLE AND SATELLITE TELEVISION, AUDIO AND INTERNET BROADCASTING SERVICES (U.S. CLS. 100, 101 AND 104).

SN 76-178,695. TALK2 TECHNOLOGY, INC., SALT LAKE CITY, UT. FILED 12-6-2000.

\*WWW

FOR TELECOMMUNICATION SERVICES IN THE NATURE OF PROVIDING INTERACTIVE ACCESS TO COMPUTER INFORMATION NETWORKS USING A TELEPHONY INTERFACE (U.S. CLS. 100, 101 AND 104).



**CLASS 38—(Continued).**

SN 76-193,079. ESINOMED LIMITED, GRAND CAYMAN, CAYMAN ISLANDS, FILED 1-12-2001.

**ESINOMED**

FOR PROVIDING MULTIPLE-USER ACCESS TO A GLOBAL COMPUTER INFORMATION NETWORK (U.S. CLS. 100, 101 AND 104).

---

SN 76-200,219. POSTAL HUT, INC., CRESTWOOD, NY. FILED 1-29-2001.

**CSVS**

FOR ELECTRONIC MAIL SERVICES, NAMELY, PROVIDING RETURN RECEIPTS, CERTIFICATIONS, VERIFICATIONS AND REGISTRATIONS OF TRANSFERS OF INFORMATION ELECTRONICALLY BY MEANS OF ELECTRONIC MAIL MESSAGES (U.S. CLS. 100, 101 AND 104).

---

SN 76-203,086. TECHNICOLOR VIDEOCASSETTE B.V., HELMOND, NETHERLANDS, FILED 1-31-2001.

**TECHNICOLOR**

FOR DIGITAL TRANSMISSION OF FILMS, LIVE EVENTS AND OTHER ENTERTAINMENT MEDIA (U.S. CLS. 100, 101 AND 104).

---

SN 76-203,537. CHOI, JAE K., CERRITOS, CA. FILED 2-1-2001.

**PYONGHWA**

FOR LONG-DISTANCE TELEPHONE SERVICES AND TELEPHONE CALLING CARDS (U.S. CLS. 100, 101 AND 104).

**CLASS 38—(Continued).**

SN 76-211,331. EL PASO CORPORATION, HOUSTON, TX. FILED 2-15-2001.



OWNER OF U.S. REG. NOS. 1,876,839, 2,201,934 AND OTHERS.

SEC. 2(F) AS TO "EL PASO".  
FOR TELECOMMUNICATIONS SERVICES, NAMELY, THE ELECTRONIC TRANSMISSION OF VOICE, FACSIMILE, DATA, VIDEO AND INFORMATION, WIRE AND WIRELESS TELEPHONE SERVICES; AND, MULTIMEDIA AND INTERACTIVE TELECOMMUNICATIONS SERVICES, NAMELY, THE ELECTRONIC TRANSMISSION OF VOICE, DATA, IMAGES AND FACSIMILE (U.S. CLS. 100, 101 AND 104).

FIRST USE 2-5-2001; IN COMMERCE 2-5-2001.

---

SN 76-227,014. EL PASO CORPORATION, HOUSTON, TX. FILED 3-20-2001.

**EL PASO NORTH AMERICA**

OWNER OF U.S. REG. NOS. 1,876,839, 2,201,934 AND OTHERS.

NO CLAIM IS MADE TO THE EXCLUSIVE RIGHT TO USE "NORTH AMERICA", APART FROM THE MARK AS SHOWN.

SEC. 2(F) AS TO "EL PASO".  
FOR TELECOMMUNICATIONS SERVICES, NAMELY, THE ELECTRONIC TRANSMISSION OF VOICE, FACSIMILE, DATA, VIDEO AND INFORMATION, WIRE AND WIRELESS TELEPHONE SERVICES; AND, MULTIMEDIA AND INTERACTIVE TELECOMMUNICATIONS SERVICES, NAMELY, THE ELECTRONIC TRANSMISSION OF VOICE, DATA, IMAGES AND FACSIMILE (U.S. CLS. 100, 101 AND 104).

---

SN 76-227,395. EL PASO CORPORATION, HOUSTON, TX. FILED 3-20-2001.

**EL PASO EUROPE**

OWNER OF U.S. REG. NOS. 1,876,839, 2,201,934 AND OTHERS.

NO CLAIM IS MADE TO THE EXCLUSIVE RIGHT TO USE "EUROPE", APART FROM THE MARK AS SHOWN.

SEC. 2(F) AS TO "EL PASO".  
FOR TELECOMMUNICATIONS SERVICES, NAMELY, THE ELECTRONIC TRANSMISSION OF VOICE, FACSIMILE, DATA, VIDEO AND INFORMATION, WIRE AND WIRELESS TELEPHONE SERVICES; AND, MULTIMEDIA AND INTERACTIVE TELECOMMUNICATIONS SERVICES, NAMELY, THE ELECTRONIC TRANSMISSION OF VOICE, DATA, IMAGES AND FACSIMILE (U.S. CLS. 100, 101 AND 104).

**CLASS 38—(Continued).**

SN 76-229,741. SACRAMENTO KINGS LIMITED PARTNERSHIP, L.P., SACRAMENTO, CA. FILED 3-26-2001.



OWNER OF U.S. REG. NOS. 1,914,185, 1,981,446 AND OTHERS.

SEC. 2(F) AS TO "SACRAMENTO".

FOR CYBERCASTING SERVICES IN THE NATURE OF PROVIDING ON-LINE CHAT ROOMS AND ON-LINE INTERACTIVE CHAT ROOMS WITH GUESTS FOR TRANSMISSION OF MESSAGES AMONG COMPUTER USERS CONCERNING THE FIELD OF BASKETBALL; BROADCASTING PROGRAMS OVER THE INTERNET (U.S. CLS. 100, 101 AND 104).

FIRST USE 10-28-1995; IN COMMERCE 10-28-1995.

SN 76-237,192. UREACH.COM, INC., HOLMDEL, NJ. FILED 4-6-2001.

**UREACH TECHNOLOGIES**

OWNER OF U.S. REG. NO. 2,338,384.

NO CLAIM IS MADE TO THE EXCLUSIVE RIGHT TO USE "TECHNOLOGIES", APART FROM THE MARK AS SHOWN.

FOR COMMUNICATION SERVICES, NAMELY, FACILITATING TELEPHONE CALL MANAGEMENT AND PROVIDING A WEBSITE ON GLOBAL COMPUTER NETWORKS FEATURING INFORMATION IN THE FIELD OF COMMUNICATION SERVICES, FEATURING ELECTRONIC MAIL SERVICES, VOICE APPLICATIONS AND VOICE MAIL SERVICES, AND ELECTRONIC TRANSMISSION OF MESSAGES AND DATA (U.S. CLS. 100, 101 AND 104).

SN 76-269,667. GOLD COAST BROADCASTING COMPANY, VENTURA, CA. FILED 6-11-2001.



OWNER OF U.S. REG. NOS. 1,942,926 AND 1,944,217. NO CLAIM IS MADE TO THE EXCLUSIVE RIGHT TO USE "95.9 FM CLASSIC ROCK", APART FROM THE MARK AS SHOWN.

FOR RADIO BROADCASTING SERVICES (U.S. CLS. 100, 101 AND 104).

FIRST USE 3-1-1995; IN COMMERCE 3-1-1995.

**CLASS 38—(Continued).**

SN 76-275,931. LIBERMAN BROADCASTING INC., BURBANK, CA. FILED 6-21-2001.

**LA NORTEÑA**

THE ENGLISH TRANSLATION OF THE APPLICANT'S IS "THE NORTHERNER" OR "THE NORTHERN ONE" FOR RADIO BROADCASTING SERVICES (U.S. CLS. 100, 101 AND 104).

SN 76-290,888. EMPOWER NET TECHNOLOGIES, INC., RENO, NV. FILED 7-30-2001.

**EMPOWER SYSTEM**

NO CLAIM IS MADE TO THE EXCLUSIVE RIGHT TO USE "SYSTEM", APART FROM THE MARK AS SHOWN.

FOR TELECOMMUNICATIONS, NAMELY ELECTRONICALLY LINKING NETWORK MARKETING COMPANIES WITH THEIR DISTRIBUTORS (U.S. CLS. 100, 101 AND 104).

FIRST USE 3-30-2000; IN COMMERCE 3-30-2000.

SN 76-294,876. WESTERN INTEGRATED NETWORKS, LLC, DENVER, CO. FILED 8-6-2001.

**WINSPACE**

FOR TELECOMMUNICATIONS SERVICES, NAMELY, PROVIDING HIGH SPEED INTERNET ACCESS AND TRANSMISSION OF DATA, AUDIO, VIDEO, AND OTHER SIGNALS OVER TELEPHONE, CABLE, AND FIBER OPTIC NETWORKS (U.S. CLS. 100, 101 AND 104).

SN 76-300,231. BLAZO INC, UPPER SADDLE RIVER, NJ. FILED 8-16-2001.

**BLAZO**

FOR TELECOMMUNICATIONS SERVICES, NAMELY BROADCASTING AND DELIVERY OF AUDIO, VIDEO, AND/OR MULTIMEDIA CONTENT BY MEANS OF COMPUTER NETWORKS, ELECTRONIC COMMUNICATIONS NETWORKS, TELEVISION, CABLE TELEVISION, MOVIE CINEMAS, RADIO, CELLULAR, CLOSED CIRCUIT AND WIRELESS COMMUNICATIONS (U.S. CLS. 100, 101 AND 104).

FIRST USE 7-1-1999; IN COMMERCE 1-6-2000.

**CLASS 38—(Continued).**

SN 76-300,232. BLAZO INC., UPPER SADDLE RIVER, NJ. FILED 8-16-2001.

**LIL' PENGY**

FOR TELECOMMUNICATIONS SERVICES, NAMELY, BROADCASTING AND DELIVERY OF AUDIO, VIDEO, AND/OR MULTIMEDIA CONTENT OF AN ANIMATED SERIES BY MEANS OF COMPUTER NETWORKS, ELECTRONIC COMMUNICATIONS NETWORKS, TELEVISION, CABLE TELEVISION, MOVIE CINEMAS, RADIO, CELLULAR, CLOSED CIRCUIT AND WIRELESS COMMUNICATION (U.S. CLS. 100, 101 AND 104).  
FIRST USE 7-1-1999; IN COMMERCE 1-6-2000.

---

SN 76-301,029. NETGRAM INCORPORATED, ENCINITAS, CA. FILED 8-17-2001.

**E-MAIL BRIDGE**

NO CLAIM IS MADE TO THE EXCLUSIVE RIGHT TO USE "E-MAIL", APART FROM THE MARK AS SHOWN.  
FOR ELECTRONIC MAIL SERVICES (U.S. CLS. 100, 101 AND 104).  
FIRST USE 2-0-1999; IN COMMERCE 2-0-1999.

---

SN 76-305,990. SHOWTIME NETWORKS INC., NEW YORK, NY. FILED 8-28-2001.

**SHO NEXT**

FOR TELECOMMUNICATION SERVICES, NAMELY, CABLE TELEVISION, CABLE RADIO AND SATELLITE TRANSMISSION SERVICES RENDERED THROUGH THE MEDIUMS OF TELEVISION, CABLE TELEVISION AND SATELLITE DELIVERED SYSTEMS IN THE HIGH-DEFINITION FORMAT (U.S. CLS. 100, 101 AND 104).  
FIRST USE 3-1-2001; IN COMMERCE 3-1-2001.

---

SN 76-307,935. STARNET, INC., PALATINE, IL. FILED 8-31-2001.

**WX IS WIRELESS**

FOR PROVIDING WIRELESS INTERNET ACCESS SERVICES (U.S. CLS. 100, 101 AND 104).

**CLASS 38—(Continued).**

SN 76-310,829. PEOPLE FOR THE ETHICAL TREATMENT OF ANIMALS, INC., NORFOLK, VA. FILED 9-10-2001.

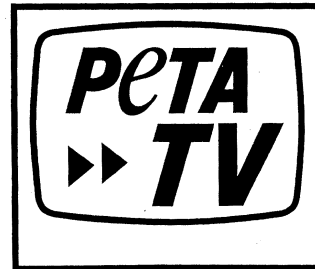

NO CLAIM IS MADE TO THE EXCLUSIVE RIGHT TO USE "TV", APART FROM THE MARK AS SHOWN.  
FOR WEBCASTING SERVICES (U.S. CLS. 100, 101 AND 104).  
FIRST USE 11-18-1999; IN COMMERCE 11-18-1999.

---

SN 76-314,053. DIRECTV, INC., EL SEGUNDO, CA. FILED 9-17-2001.

**FEEL THE JOY**

FOR TELECOMMUNICATION SERVICES, NAMELY, HIGH SPEED TRANSMISSION OF VOICE, VIDEO, DATA AND INFORMATION OVER A GLOBAL COMPUTER INFORMATION NETWORK; TELECOMMUNICATIONS GATEWAY SERVICES; AND EMAIL SERVICES (U.S. CLS. 100, 101 AND 104).  
FIRST USE 8-30-2001; IN COMMERCE 8-30-2001.

---

SN 76-318,869. RAYCOM MEDIA, INC., MONTGOMERY, AL. FILED 9-28-2001.

**KFVE**

FOR TELEVISION BROADCASTING SERVICES (U.S. CLS. 100, 101 AND 104).  
FIRST USE 2-7-1988; IN COMMERCE 2-7-1988.

---

SN 76-320,098. JCOR WIRELESS, LLC, NEW YORK, NY. FILED 10-1-2001.

**JCOR**

FOR TELECOMMUNICATION SERVICES, NAMELY, LOCAL AND LONG DISTANCE TRANSMISSION OF VOICE, DATA, IMAGES, SIGNALS, MESSAGES AND GRAPHICS BY MEANS OF TELEPHONE TRANSMISSION; WIRELESS DIGITAL MESSAGING SERVICES (U.S. CLS. 100, 101 AND 104).

**CLASS 38—(Continued).**

SN 78-020,909. STARBAND COMMUNICATIONS INC., MCLEAN, VA. BY CHANGE OF NAME GILAT-TO-HOME INC., MCLEAN, VA. FILED 8-12-2000.

**STARTANGO**

FOR PROVIDING MULTIPLE-USER ACCESS VIA SATELLITE AND OTHER DATA COMMUNICATIONS FACILITIES TO A GLOBAL COMPUTER INFORMATION NETWORK (U.S. CLS. 100, 101 AND 104).

SN 78-025,710. COREEXPRESS, INC., ST. LOUIS, MO. FILED 9-13-2000.

**COREEXPRESS EXTRANET**

NO CLAIM IS MADE TO THE EXCLUSIVE RIGHT TO USE "EXTRANET", APART FROM THE MARK AS SHOWN. FOR TELECOMMUNICATIONS SERVICES, NAMELY, PROVIDING TELECOMMUNICATIONS CONNECTIONS TO A GLOBAL COMPUTER NETWORK; AND PROVIDING MULTIPLE-USER ACCESS TO A GLOBAL COMPUTER INFORMATION NETWORK (U.S. CLS. 100, 101 AND 104).

SN 78-031,084. TOPE, MICHAEL A., COLUMBIA, MD. FILED 10-17-2000.

**COOPERATIVE DIVERSITY**

FOR WIRELESS TELECOMMUNICATION CONNECTIONS TO A GLOBAL COMPUTER NETWORK; TELECOMMUNICATION SERVICES, NAMELY VOICE AND DATA TRANSMISSION SERVICES (U.S. CLS. 100, 101 AND 104).

SN 78-040,110. NEW SKIES SATELLITES N.V., THE HAGUE, NETHERLANDS, FILED 12-20-2000.



NO CLAIM IS MADE TO THE EXCLUSIVE RIGHT TO USE "SATELLITES", APART FROM THE MARK AS SHOWN.

FOR COLLECTION, TRANSMISSION AND DELIVERY OF VOICE, VIDEO, AUDIO AND DATA SIGNALS VIA SATELLITE; TELECOMMUNICATIONS SERVICES, NAMELY, PROVIDING INTERNET-PROTOCOL BASED NETWORK ACCESS TO GLOBAL COMPUTER NETWORK SERVICE PROVIDERS (U.S. CLS. 100, 101 AND 104).

FIRST USE 1-0-1999; IN COMMERCE 1-0-1999.

**CLASS 38—(Continued).**

SN 78-043,295. AMERICAN LIGHTWAVE COMMUNICATIONS, INC., HOUSTON, TX. FILED 1-16-2001.

**SMART T**

FOR TELECOMMUNICATION SERVICES, NAMELY, PROVIDING LOCAL AND LONG DISTANCE TELEPHONE SERVICES; PROVIDING MULTIPLE USER ACCESS TO A GLOBAL COMPUTER INFORMATION NETWORK; PROVIDING DATA AND PRIVATE LINES WHICH FEATURE DIRECT POINT TO POINT CONNECTIONS (U.S. CLS. 100, 101 AND 104).

SN 78-073,098. RYMAN CONSULTING, INC., DENVER, CO. FILED 7-10-2001.

**E-LEGISLATIVEACTION.COM DEMOCRACY IS JUST A CLICK AWAY.**

FOR PROVIDING ON-LINE ELECTRONIC BULLETIN BOARDS WHEREIN FEDERAL AND STATE LEGISLATIVE PETITION INITIATIVES MAY BE POSTED, AND MESSAGES PERTAINING THERETO MAY BE EXCHANGED (U.S. CLS. 100, 101 AND 104).

**CLASS 39—TRANSPORTATION AND STORAGE**

SN 75-724,148. PRIVATE FUEL STORAGE L.L.C., LA CROSSE, WI. FILED 6-8-1999.

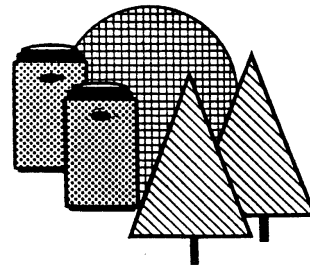

THE MARK AND THE DRAWING THEREOF ARE LINED FOR THE COLORS GREEN AND YELLOW. THE STIPPLING ON THE DRAWING WHICH APPEARS ON THE CANISTER IS FOR SHADING PURPOSES ONLY.

FOR STORAGE OF NUCLEAR FUEL FROM DOMESTIC UTILITIES (U.S. CLS. 100 AND 105).

FIRST USE 5-0-1996; IN COMMERCE 5-0-1996.

**CLASS 39—(Continued).**

SN 75-772,676. TRAVEL LINK SERVICES, INC., VALRICO, FL. FILED 8-10-1999.

**CLASS 39—(Continued).**

SN 76-032,682. EMOTION, INC., VIENNA, VA. FILED 4-25-2000.

**\* CRUISE**



NO CLAIM IS MADE TO THE EXCLUSIVE RIGHT TO USE "CRUISE", APART FROM THE MARK AS SHOWN. FOR TRAVEL AGENCY SERVICES, NAMELY, MAKING RESERVATIONS AND BOOKINGS FOR TRANSPORTATION (U.S. CLS. 100 AND 105).

FOR COMPUTER SERVICES, NAMELY PROVIDING ELECTRONIC STORAGE, SEARCH AND RETRIEVAL OF STOCK PHOTOGRAPHY AND OTHER DIGITAL IMAGES, DOWNLOADABLE IMAGES AND IMAGES STORED ON CD'S (U.S. CLS. 100 AND 105). FIRST USE 2-0-2000; IN COMMERCE 3-0-2000.

SN 75-904,407. HIPERCOR, S.A., 112 28009 MADRID, SPAIN, FILED 1-28-2000.

**HIPERCOR**

OWNER OF SPAIN REG. NO. 1,577,304/3, DATED 3-2-1993, RENEWED AS REG. NO. 1,577,304/3, DATED 3-12-2001, EXPIRES 3-12-2011. FOR PARCEL DELIVERY SERVICES BY TRUCK; MOVING VAN AND FURNITURE STORAGE SERVICES; AND TRANSPORTATION OF PASSENGERS AND GOODS BY BUS (U.S. CLS. 100 AND 105).

SN 76-032,690. EMOTION, INC., VIENNA, VA. FILED 4-25-2000.

SN 75-906,117. KABUSHIKI KAISHA KOBE SEIKO SHO, TA KOBE STEEL, LTD., KOBE, JAPAN, FILED 1-31-2000.

eMotion



FOR TRANSPORTING GOODS BY RAIL, WATER, AIR AND PIPELINE; TRANSPORT BROKERAGE; TRANSPORT RESERVATION; DELIVERY OF GOODS BY TRUCK, AIR OR SHIP; AND PACKAGING OF GOODS FOR TRANSPORTATION (U.S. CLS. 100 AND 105).

FOR COMPUTER SERVICES, NAMELY PROVIDING ELECTRONIC STORAGE, SEARCH AND RETRIEVAL OF STOCK PHOTOGRAPHY AND OTHER DIGITAL IMAGES, DOWNLOADABLE IMAGES AND IMAGES STORED ON CD'S (U.S. CLS. 100 AND 105). FIRST USE 2-0-2000; IN COMMERCE 3-0-2000.

**CLASS 39—(Continued).**

SN 76-034,163. TRANS-GLOBAL SOLUTIONS, INC., HOUSTON, TX. FILED 4-25-2000.



THE MARK CONSISTS, IN PART, OF A STYLIZED DESCRIPTION OF A GLOBE WITH AN ARROW POINTING DOWNWARD ON THE LEFT OF THE GLOBE AND AN ARROW POINTING UPWARD ON THE RIGHT OF THE GLOBE.

FOR LEASING OF LOCOMOTIVES; RAILCAR STORAGE; OPERATION OF BULK TERMINALS; OPERATION OF RIVER TERMINALS, PORT OPERATIONS; OPERATING BULK TERMINAL FACILITIES, OPERATION OF RAIL YARDS, ENGINEERING AND CONVEYING SYSTEMS COMPOSED OF RAIL CARS, RAILROADS, RAIL YARDS, CONVEYORS, CRANES, STORAGE YARDS, RAIL CAR REPAIR FACILITIES, BULK MATERIAL HANDLING EQUIPMENT, FLOATING BULK TERMINALS, BULK TERMINALS, SHIP LOADERS, PORTABLE STACKERS, PORTABLE SCREENING PLANTS, DRAGGABLE CONVEYORS, OVERLAND CONVEYORS, FEEDERS, CLAIMERS, HORIZONTAL CURVE CONVEYORS, RAIL-TO-SHIP BULK TRANSFER SYSTEMS, DOCKS, DUST SUPPRESSION EQUIPMENT, SOUND SUPPRESSION EQUIPMENT, ELEVATING TRUCK DUMPS, OCEAN-GOING BULK CARRIERS, TURN-KEY RAIL PACKAGES COMPOSED OF RAIL CARS, RAILROADS, RAIL YARDS, RAIL CAR REPAIR FACILITIES, RAIL-TO-SHIP BULK TRANSFER SYSTEMS (U.S. CLS. 100 AND 105).

FIRST USE 11-0-1998; IN COMMERCE 11-0-1998.

SN 76-079,553. SUN COUNTRY AIRLINES, INC., MENDOTA HEIGHTS, MN. FILED 6-28-2000.

**AGENT ACCESS**

NO CLAIM IS MADE TO THE EXCLUSIVE RIGHT TO USE "AGENT", APART FROM THE MARK AS SHOWN. FOR AIRLINE TRAVEL RESERVATION SERVICES PROVIDED VIA A GLOBAL COMPUTER NETWORK (U.S. CLS. 100 AND 105).

**CLASS 39—(Continued).**

SN 76-105,020. ETAR, INC., INGLEWOOD, CA. FILED 8-8-2000.

飛洋

THE SERVICE MARK CONSISTS OF A MISCELLANEOUS DESIGN, AS SHOWN IN THE ACCOMPANYING DRAWING, OF TWO (2) CHINESE CHARACTERS, WHICH MAY BE PRONOUNCED AS "FEI YANG" (AS DENOTED BY THE CHINESE PINYIN SYSTEM). THERE IS NO DIRECT ENGLISH TRANSLATION OF THE TWO (2) CHINESE CHARACTERS WORDED TOGETHER BECAUSE EACH CHARACTER HAS MULTIPLE MEANINGS IN CHINESE LANGUAGE.

FOR BROKERAGE AND DELIVERY SERVICES FOR BROKERAGE OF TRANSPORT, SHIP AND FREIGHT, AND FOR DELIVERY BY COURIER AND MESSENGER OF DOCUMENTS, CORRESPONDENCES AND PARCELS (U.S. CLS. 100 AND 105).

FIRST USE 2-1-1995; IN COMMERCE 2-1-1995.

SN 76-110,471. UNITED AIR LINES, INC., CHICAGO, IL. FILED 8-16-2000.

**TALKCARGO**

FOR PROVIDING TRAVEL INFORMATION OVER A GLOBAL COMPUTER NETWORK RELATING TO TRANSPORTATION SERVICES (U.S. CLS. 100 AND 105).

SN 76-121,199. J.P. MCDONALD HOLDINGS, LLC, DEBARY, FL. FILED 8-25-2000.



NO CLAIM IS MADE TO THE EXCLUSIVE RIGHT TO USE "SPACE DEPOT" AND "STORAGE", APART FROM THE MARK AS SHOWN.

FOR RENTAL OF SELF STORAGE SPACE (U.S. CLS. 100 AND 105).

**CLASS 39—(Continued).**

SN 76-131,411. EQUIVEST FINANCE, INC., GREENWICH, CT. FILED 9-19-2000.

**EQUIVEST VACATION AND TRAVEL CLUB**

NO CLAIM IS MADE TO THE EXCLUSIVE RIGHT TO USE "VACATION AND TRAVEL CLUB", APART FROM THE MARK AS SHOWN.  
FOR VACATION CLUB SERVICES (U.S. CLS. 100 AND 105).

SN 76-131,496. AIRLINES COMMERCIAL PARTNER B.V., LOS ANGELES, CA. FILED 9-20-2000.

**AirCP.com**

THE LINING SHOWN IN THE DRAWING IS A FEATURE OF THE MARK.  
FOR TRANSPORTATION AND STORAGE SERVICES, NAMELY, HANDLING CARGO TRANSPORTED BY AIRLINES AND PROVIDING TERMINAL STORAGE, COMPUTERIZED CARGO RESERVATIONS AND BREAK-BULK SERVICES (U.S. CLS. 100 AND 105).

SN 76-141,320. FUGENT, INC., WESTERVILLE, OH. FILED 10-5-2000.

**FUGENT**

FOR MOVING TRANSPORT SERVICES, NAMELY, THE TRANSPORTATION OF DOCUMENTS AND STORAGE THEREOF FOR OTHERS (U.S. CLS. 100 AND 105).

SN 76-167,222. TRAFFIC.COM, INC., WAYNE, PA. FILED 11-16-2000.

**DIGITAL TRAVEL TIME**

NO CLAIM IS MADE TO THE EXCLUSIVE RIGHT TO USE "DIGITAL", APART FROM THE MARK AS SHOWN.  
FOR TRAFFIC INFORMATION SERVICES (U.S. CLS. 100 AND 105).

**CLASS 39—(Continued).**

SN 76-183,953. DOLEMAN, THOMAS H., JR., SAN DIEGO, CA. FILED 12-20-2000.

**COACHAIR INTERNATIONAL**

NO CLAIM IS MADE TO THE EXCLUSIVE RIGHT TO USE "INTERNATIONAL", APART FROM THE MARK AS SHOWN.  
FOR INTERNATIONAL AND DOMESTIC FREIGHT TRANSPORTATION BY AIR (U.S. CLS. 100 AND 105).

SN 76-186,130. ALTERNATIVE DISTRIBUTION SYSTEMS, INC., HOMEWOOD, IL. FILED 12-22-2000.

**LOMAS**

FOR ARRANGEMENT OF TRANSPORTATION AND SHIPPING OF FREIGHT, CARGO, AND RAW MATERIALS BY TRAIN, TRUCK, AND AIR, AND WAREHOUSING, VIA AN INTERNET-BASED EXCHANGE (U.S. CLS. 100 AND 105).  
FIRST USE 10-6-2000; IN COMMERCE 10-6-2000.

SN 76-200,221. K & S HELICOPTERS, INC., DBA TROPICAL HELICOPTERS, KAILUA-KONA, HI. FILED 1-26-2001.



FOR HELICOPTER TOUR SERVICE (U.S. CLS. 100 AND 105).  
FIRST USE 8-0-1998; IN COMMERCE 4-0-1999.

SN 76-227,015. EL PASO CORPORATION, HOUSTON, TX. FILED 3-20-2001.

**EL PASO NORTH AMERICA**

OWNER OF U.S. REG. NOS. 1,876,839, 2,201,934 AND OTHERS.  
NO CLAIM IS MADE TO THE EXCLUSIVE RIGHT TO USE "NORTH AMERICA", APART FROM THE MARK AS SHOWN.  
SEC. 2(F) AS TO "EL PASO".  
FOR TRANSPORTATION AND STORAGE OF NATURAL GAS FOR OTHERS BY PIPELINE; TRANSPORTATION OF LIQUEFIED NATURAL GAS BY SHIP TANKERS AND TANKER TRUCK; AND, STORAGE OF NATURAL GAS AND LIQUEFIED NATURAL GAS (U.S. CLS. 100 AND 105).

**CLASS 39—(Continued).**

SN 76-227,016. EL PASO CORPORATION, HOUSTON, TX. FILED 3-20-2001.

**EL PASO EUROPE**

OWNER OF U.S. REG. NOS. 1,876,839, 2,201,934 AND OTHERS.

NO CLAIM IS MADE TO THE EXCLUSIVE RIGHT TO USE "EUROPE", APART FROM THE MARK AS SHOWN.

SEC. 2(F) AS TO "EL PASO".

FOR TRANSPORTATION AND STORAGE OF NATURAL GAS FOR OTHERS BY PIPELINE; TRANSPORTATION OF LIQUEFIED NATURAL GAS BY SHIP TANKERS AND TANKER TRUCK; AND, STORAGE OF NATURAL GAS AND LIQUEFIED NATURAL GAS (U.S. CLS. 100 AND 105).

SN 76-227,030. TRANSPPLACE.COM, LLC, PLANO, TX. FILED 3-19-2001.

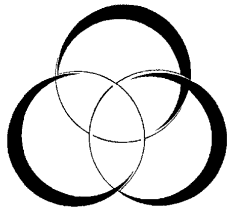

THE MARK CONSISTS OF A STYLIZED DEPICTION OF THREE PARTIALLY OVERLAPPING CIRCLES.

FOR TRANSPORTATION LOGISTIC SERVICES, NAMELY, ARRANGING THE TRANSPORTATION OF GOODS FOR OTHERS; PLANNING AND SCHEDULING SHIPMENTS FOR USERS OF TRANSPORTATION SERVICES (U.S. CLS. 100 AND 105).

SN 76-264,306. PILOT AIR FREIGHT CORP., LIMA, PA. FILED 5-29-2001.

**PILOT HOME DELIVERY**

OWNER OF U.S. REG. NOS. 1,226,948, 2,089,426 AND 2,431,490.

NO CLAIM IS MADE TO THE EXCLUSIVE RIGHT TO USE "HOME DELIVERY", APART FROM THE MARK AS SHOWN.

FOR TRANSPORTATION SERVICES, NAMELY LAND, AIR AND SEA TRANSPORTATION SERVICES AND COORDINATING TRANSPORTATION SERVICES (U.S. CLS. 100 AND 105).

**CLASS 39—(Continued).**

SN 76-266,782. DESPEGAR.COM, INC., MIAMI, FL. FILED 6-5-2001.

**BE YOUR OWN TRAVEL AGENT**

FOR TRAVEL AGENCY SERVICES, NAMELY MAKING RESERVATIONS AND BOOKINGS FOR TRANSPORTATION; TRAVEL BOOKING AGENCIES, TRAVEL GUIDE SERVICES, TRAVEL CLUBS, TRAVEL INFORMATION SERVICES, ARRANGING TRAVEL TOURS, TOUR GUIDE SERVICES, TOURIST AGENCY SERVICES, TRANSPORTATION RESERVATION SERVICES, TRANSPORTATION OF PASSENGERS BY AIR, BOAT, RAIL (U.S. CLS. 100 AND 105).

SN 76-267,976. PRESTIGE VALET, INC., TAMPA, FL. FILED 6-7-2001.



NO CLAIM IS MADE TO THE EXCLUSIVE RIGHT TO USE "VALET", APART FROM THE MARK AS SHOWN.

FOR PARKING LOT, VEHICLE PARKING AND VALET PARKING SERVICES (U.S. CLS. 100 AND 105).

FIRST USE 7-19-1993; IN COMMERCE 7-19-1993.

SN 76-277,238. PRIMO LOGISTICS INC., ATLANTA, GA. FILED 6-25-2001.

**PRIMO LOGISTICS**

NO CLAIM IS MADE TO THE EXCLUSIVE RIGHT TO USE "LOGISTICS", APART FROM THE MARK AS SHOWN.

THE ENGLISH TRANSLATION OF "PRIMO" IS "FIRST".

FOR CARGO TRANSPORT BROKERAGE SERVICES (U.S. CLS. 100 AND 105).

SN 76-284,021. BURLINGTON NORTHERN AND SANTA FE RAILWAY COMPANY, THE, FORT WORTH, TX. FILED 7-12-2001.

**MEXISTACK**

FOR RAILROAD SERVICES, NAMELY RETAIL INTERMODAL SERVICES (U.S. CLS. 100 AND 105).

FIRST USE 6-28-2001; IN COMMERCE 6-28-2001.



**CLASS 39—(Continued).**

SN 76-297,808. ALASKA MARINE HIGHWAY SYSTEM, DBA ALASKA'S MARINE HIGHWAY, JUNEAU, AK. FILED 8-10-2001.

## ALASKA'S MARINE HIGHWAY

NO CLAIM IS MADE TO THE EXCLUSIVE RIGHT TO USE "ALASKA'S", APART FROM THE MARK AS SHOWN. FOR TRANSPORT BY FERRY OF VEHICLES AND PASSENGERS (U.S. CLS. 100 AND 105).  
FIRST USE 1-1-1960; IN COMMERCE 1-1-1960.

SN 76-309,118. NORTH AMERICAN BUSHMAN, INC., OLD FORGE, PA. FILED 9-4-2001.



NO CLAIM IS MADE TO THE EXCLUSIVE RIGHT TO USE "NORTH AMERICAN", APART FROM THE MARK AS SHOWN.

FOR ARRANGING AND CONDUCTING HUNTING AND FISHING EXPEDITIONS; TRAVEL BOOKING AGENCY SERVICES FOR AIR TRAVEL AND HUNTING AND FISHING EXPEDITIONS; PROVIDING TRAVEL INFORMATION AND TRAVEL GUIDE SERVICES; AND CONDUCTING AND ARRANGING SIGHTSEEING TOURS FOR OTHERS (U.S. CLS. 100 AND 105).  
FIRST USE 11-0-2000; IN COMMERCE 11-0-2000.

SN 76-309,119. NORTH AMERICAN BUSHMAN, INC., OLD FORGE, PA. FILED 9-4-2001.

## NORTH AMERICAN BUSHMAN

NO CLAIM IS MADE TO THE EXCLUSIVE RIGHT TO USE "NORTH AMERICAN", APART FROM THE MARK AS SHOWN.

FOR ARRANGING AND CONDUCTING HUNTING AND FISHING EXPEDITIONS; TRAVEL BOOKING AGENCY SERVICES FOR AIR TRAVEL AND HUNTING AND FISHING EXPEDITIONS; PROVIDING TRAVEL INFORMATION AND TRAVEL GUIDE SERVICES; AND CONDUCTING AND ARRANGING SIGHTSEEING TOURS FOR OTHERS (U.S. CLS. 100 AND 105).  
FIRST USE 0-0-1987; IN COMMERCE 2-0-1988.

**CLASS 39—(Continued).**

SN 76-309,120. NORTH AMERICAN BUSHMAN, INC., OLD FORGE, PA. FILED 9-4-2001.

## BUSHMAN OUTFITTERS, REG'D.

NO CLAIM IS MADE TO THE EXCLUSIVE RIGHT TO USE "OUTFITTERS" AND "REG'D", APART FROM THE MARK AS SHOWN.

FOR ARRANGING AND CONDUCTING HUNTING AND FISHING EXPEDITIONS; TRAVEL BOOKING AGENCY SERVICES FOR AIR TRAVEL AND HUNTING AND FISHING EXPEDITIONS; PROVIDING TRAVEL INFORMATION AND TRAVEL GUIDE SERVICES; AND CONDUCTING AND ARRANGING SIGHTSEEING TOURS FOR OTHERS (U.S. CLS. 100 AND 105).  
FIRST USE 2-0-1995; IN COMMERCE 2-0-1995.

SN 78-026,865. TRANSFLO CORPORATION, JACKSONVILLE, FL. BY ASSIGNMENT BULK INTERMODAL DISTRIBUTION SERVICES, INC., JACKSONVILLE, FL. FILED 9-20-2000.

## TRANSNETWORK

FOR FREIGHT TRANSPORTATION, TERMINAL AND WAREHOUSE STORAGE SERVICES FOR OTHERS, NAMELY THE TRANSFER OF BULK FREIGHT BETWEEN RAILCARS, TRUCKS, CONTAINERS AND SHIPS; WAREHOUSE STORAGE OF BULK FREIGHT, AND RAILWAY TRANSFER TERMINAL SERVICES, NAMELY THE LOADING AND UNLOADING OF BULK FREIGHT AND PREPARATION OF GOODS FOR TRANSPORT VIA TRUCK, TRAIN OR SHIP AND TRANSPORTATION RESERVATION AND WAREHOUSE STORAGE SERVICES FOR OTHERS (U.S. CLS. 100 AND 105).

SN 78-047,065. EWAREHOUSELOGISTICS.COM, INC., MIAMI, FL. FILED 2-7-2001.

## EWAREHOUSELOGISTICS.COM

FOR RENTAL OF WAREHOUSE SPACE AND FREIGHT FORWARDING SERVICES (U.S. CLS. 100 AND 105).  
FIRST USE 6-1-2000; IN COMMERCE 6-1-2000.

**CLASS 40—MATERIAL TREATMENT**

**CLASS 40—(Continued).**

SN 75-721,360. HEALEY DISC INC., NEPEAN, ONTARIO K2E 7W6, CANADA, FILED 6-4-1999.

## HEALEY DISC MANUFACTURING

PRIORITY CLAIMED UNDER SEC. 44(D) ON CANADA APPLICATION NO. 899456, FILED 12-10-1998, REG. NO. TMA538046, DATED 11-30-2000, EXPIRES 11-30-2015.

NO CLAIM IS MADE TO THE EXCLUSIVE RIGHT TO USE "DISC MANUFACTURING", APART FROM THE MARK AS SHOWN.

SEC. 2(F).

FOR MANUFACTURE AND DUPLICATION OF MULTIMEDIA PRODUCTS, NAMELY, AUDIO, COMPACT DISCS, CD-ROMS, DIGITAL VERSATILE DISCS (DVD), AUDIO AND VIDEO CASSETTES AND VHS AND TAPE RECORDINGS (U.S. CLS. 100, 103 AND 106).

FIRST USE 5-0-1994; IN COMMERCE 5-0-1994.

---

SN 75-761,904. TYSON TOOL COMPANY LIMITED, WESTON, ONTARIO, CANADA, FILED 7-27-1999.

## QUICKTOOL

PRIORITY CLAIMED UNDER SEC. 44(D) ON CANADA APPLICATION NO. 1012690, FILED 4-21-1999, REG. NO. TMA536245, DATED 10-31-2000, EXPIRES 10-31-2015.

FOR MANUFACTURING OF SPECIALIZED CUTTING TOOLS ACCORDING TO CUSTOMER'S SPECIFICATIONS (U.S. CLS. 100, 103 AND 106).

---

SN 75-834,171. CHANNEL LUMBER COMPANY, RICHMOND, CA. FILED 10-27-1999.



NO CLAIM IS MADE TO THE EXCLUSIVE RIGHT TO USE "LUMBER", APART FROM THE MARK AS SHOWN.

THE LINING IS A FEATURE OF THE MARK AND DOES NOT INDICATE COLOR.

FOR MILL WORKING; ASSEMBLY OF PRODUCTS FOR OTHERS; SAWMILL PLANING; SAWMILL SERVICES; RE-MANUFACTURE OF WOOD FIBER BULLDING MATERIALS AND PRODUCTS TO THE ORDER AND/OR SPECIFICATION OF OTHERS; CUSTOM MANUFACTURE OF WOOD SIDINGS AND OTHER WOOD BUILDING MATERIALS AND PRODUCTS (U.S. CLS. 100, 103 AND 106).

FIRST USE 0-0-1985; IN COMMERCE 0-0-1985.

**CLASS 40—(Continued).**

SN 76-034,893. TELESTREAM, INC., NEVADA CITY, CA. FILED 4-26-2000.

## GIGAFLIP

FOR AUDIO AND VIDEO TRANSFER SERVICES, NAMELY, PROVIDING AN INTERNET WEBSITE FEATURING THE TRANSCODING OF AUDIO AND VIDEO FILE FORMATS TO MATCH THE FILE FORMATS OF USERS' PLAYBACK CAPABILITIES (U.S. CLS. 100, 103 AND 106).

---

SN 76-060,114. SANFORD PROCESS CORPORATION, THE, NATICK, MA. FILED 6-1-2000.

## SANFORD PROCESS

NO CLAIM IS MADE TO THE EXCLUSIVE RIGHT TO USE "PROCESS", APART FROM THE MARK AS SHOWN.

FOR ALUMINUM HARDCOATING SERVICES (U.S. CLS. 100, 103 AND 106).

FIRST USE 12-0-1979; IN COMMERCE 12-0-1979.

---

SN 76-083,013. GROWING FAMILY, INC., ST. CHARLES, MO. FILED 7-5-2000.

## BABIES ARE BEAUTIFUL

FOR PHOTOFINISHING SERVICES; ELECTRONIC IMAGING, SCANNING, DIGITIZING, ALTERATION, AND/OR RETOUCHING OF PHOTOGRAPHIC IMAGES; PHOTOGRAPHIC COMPUTER IMAGING (U.S. CLS. 100, 103 AND 106).

---

SN 76-104,104. INDIANA FURNITURE INDUSTRIES, INC., DBA INDIANA FURNITURE INDUSTRIES AND DBA INDIANA DESK, JASPER, IN. FILED 8-7-2000.

## RELY ON US

FOR CUSTOM MANUFACTURING, NAMELY, PROVIDING BUILT-TO-ORDER FURNITURE FOR OTHERS (U.S. CLS. 100, 103 AND 106).

---

SN 76-104,564. PRICE, VIRGINIA O., HIGHLAND PARK, IL. FILED 8-7-2000.

## PLANET CANIT

FOR CUSTOM MANUFACTURE OF DECORATIVE TINS TO THE ORDER AND/OR SPECIFICATION OF OTHERS (U.S. CLS. 100, 103 AND 106).

**CLASS 40—(Continued).**

SN 76-121,680. FIRSTAR FIBER, INC., OMAHA, NE. FILED 9-5-2000.

**FIRSTAR FIBER**

NO CLAIM IS MADE TO THE EXCLUSIVE RIGHT TO USE "FIBER", APART FROM THE MARK AS SHOWN. FOR PAPER RECYCLING (U.S. CLS. 100, 103 AND 106).

FIRST USE 11-30-1997; IN COMMERCE 11-30-1997.

SN 76-146,997. GALVA-FOAM MARINE INDUSTRIES, INC., CAMDENTON, MT. FILED 10-16-2000.



NO CLAIM IS MADE TO THE EXCLUSIVE RIGHT TO USE "MARINE INDUSTRIES", APART FROM THE MARK AS SHOWN.

GALVA-FOAM WORDS ON TOP OF A SILHOUETTE OF AN ANCHOR SURROUNDED BY ROPE AND THE WORDS "MARINE INDUSTRIES" ENCIRCLING THE ANCHOR

FOR MANUFACTURER OF GALVANIZED STEEL FLOATING DOCKS AND MARINAS AND COMPONENTS THEREOF TO THE ORDER AND SPECIFICATIONS OF OTHERS (U.S. CLS. 100, 103 AND 106).

FIRST USE 9-0-1991; IN COMMERCE 9-0-1991.

SN 76-149,968. DAHLGREN ENTERPRISES, INC., ST. PAUL, MN. FILED 10-20-2000.

**ICE NINE GLASS DESIGN**

NO CLAIM IS MADE TO THE EXCLUSIVE RIGHT TO USE "GLASS DESIGN", APART FROM THE MARK AS SHOWN.

FOR CUSTOM ETCHING ON GLASSWARE (U.S. CLS. 100, 103 AND 106).

FIRST USE 6-1-1985; IN COMMERCE 6-1-1985.

SN 76-227,001. EL PASO CORPORATION, HOUSTON, TX. FILED 3-20-2001.

**EL PASO EUROPE**

OWNER OF U.S. REG. NOS. 1,876,839, 2,201,934 AND OTHERS.

NO CLAIM IS MADE TO THE EXCLUSIVE RIGHT TO USE "EUROPE", APART FROM THE MARK AS SHOWN.

SEC. 2(F) AS TO "EL PASO".

FOR PROCESSING OF NATURAL GAS FOR OTHERS; LIQUEFACTION AND REGASIFICATION OF NATURAL GAS FOR OTHERS; AND, COMPRESSING NATURAL GAS FOR OTHERS (U.S. CLS. 100, 103 AND 106).

**CLASS 40—(Continued).**

SN 76-230,748. ENVIRONMENTAL TECTONICS CORPORATION, SOUTHAMPTON, PA. FILED 3-27-2001.

**THE RIDE WORKS**

FOR MANUFACTURE OF AMUSEMENT AND ENTERTAINMENT RIDES TO THE ORDER AND SPECIFICATION OF OTHERS (U.S. CLS. 100, 103 AND 106).

SN 76-255,228. CAROLINA ENERGY SOLUTIONS, INC., ROCK HILL, SC. FILED 5-11-2001.

**CAROLINA ENERGY SOLUTIONS**

NO CLAIM IS MADE TO THE EXCLUSIVE RIGHT TO USE "CAROLINA ENERGY", APART FROM THE MARK AS SHOWN.

FOR WELDING AND MACHINING SERVICES FOR POWER INDUSTRY (U.S. CLS. 100, 103 AND 106).

SN 78-048,367. ROADWORKS MANUFACTURING, INC., WEST LAFAYETTE, IN. FILED 2-14-2001.

*Do heads turn when you drive by?*

FOR CUSTOM MANUFACTURE OF STAINLESS STEEL ACCESSORIES FOR CLASS 8 SEMI TRUCKS (U.S. CLS. 100, 103 AND 106).

FIRST USE 5-0-2000, THE MARK WAS USED ANYWHERE IN A DIFFERENT FORM OTHER THAN THAT SOUGHT TO BE REGISTERED ON 02/00/2000; IN COMMERCE 6-6-2000, THE MARK WAS USED ANWHERE IN A DIFFERENT FORM OTHER THAN THAT SOUGHT TO BE REGISTERED IN COMMERCE ON 03/00/2000.

SN 78-057,734. SESMARK FOODS, INC., LOVES PARK, IL. FILED 4-10-2001.

**TERRA HARVEST**

FOR MANUFACTURE/BAKING OF SNACK FOODS AND OTHER FOOD PRODUCTS FOR PRIVATE LABEL RESELLERS (U.S. CLS. 100, 103 AND 106).

**CLASS 41—EDUCATION AND ENTERTAINMENT**

**CLASS 41—(Continued).**

SN 74-565,020. HOOPS LP, VANCOUVER, BRITISH COLUMBIA, AND HEISLEY MEMBER, INC., VANCOUVER, BRITISH COLUMBIA, BY CHANGE OF NAME; BY ASSIGNMENT VANCOUVER BASKETBALL LIMITED PARTNERSHIP, THE, VANCOUVER, BRITISH COLUMBIA V6B 2M1, CANADA, FILED 8-24-1994.



PRIORITY CLAIMED UNDER SEC. 44(D) ON CANADA APPLICATION NO. 759408, FILED 7-28-1994, REG. NO. 522667, DATED 2-4-2000, EXPIRES 2-4-2015.

OWNER OF U.S. REG. NO. 2,100,590.

NO CLAIM IS MADE TO THE EXCLUSIVE RIGHT TO USE "VANCOUVER", APART FROM THE MARK AS SHOWN.

THE LINING SHOWN IN THE DRAWING IS A FEATURE OF THE MARK, AND IS NOT INTENDED TO INDICATE COLOR.

FOR ENTERTAINMENT SERVICES IN THE NATURE OF BASKETBALL GAMES AND BASKETBALL EXHIBITIONS RENDERED LIVE AND IN STADIA AND THROUGH THE MEDIA OF RADIO AND TELEVISION BROADCASTS; MASCOT AND DANCE TEAMS PERFORMANCES; CONDUCTING AND ARRANGING BASKETBALL CLINICS (U.S. CLS. 100, 101 AND 107).

SN 75-302,431. INTELQUEST LEARNING SYSTEMS, INC., SALT LAKE CITY, UT. FILED 6-3-1997.

**INTELQUEST UNIVERSITY**

NO CLAIM IS MADE TO THE EXCLUSIVE RIGHT TO USE "UNIVERSITY", APART FROM THE MARK AS SHOWN.

FOR EDUCATIONAL SERVICES, NAMELY, PROVIDING SEMINARS, COURSES, CLASSES, CONFERENCES, AND WORKSHOPS IN THE FIELD OF ACADEMIC SUBJECTS, NAMELY MATHEMATICS, SCIENCE, LITERATURE, LANGUAGE, COMPUTER SCIENCE, BUSINESS MANAGEMENT, HISTORY, ART, AND MUSIC (U.S. CLS. 100, 101 AND 107).

**CLASS 41—(Continued).**

SN 75-469,548. GAME OF VILLAGE, THE, MARLBOROUGH, NH. FILED 4-17-1998.

**THE GAME OF VILLAGE**

NO CLAIM IS MADE TO THE EXCLUSIVE RIGHT TO USE "GAME", APART FROM THE MARK AS SHOWN.

FOR EDUCATIONAL SERVICES, NAMELY CONDUCTING PROGRAMS DURING WHICH PARTICIPANTS CREATE, DEVELOP, OPERATE AND MAINTAIN A FUNCTIONING COMMUNITY ON A MINIATURE SCALE; EDUCATIONAL SERVICES, NAMELY INSTRUCTING OTHERS TO ESTABLISH EDUCATIONAL PROGRAMS DURING WHICH PARTICIPANTS CREATE, DEVELOP, OPERATE AND MAINTAIN A FUNCTIONING COMMUNITY ON A MINIATURE SCALE (U.S. CLS. 100, 101 AND 107).

FIRST USE 0-0-1971; IN COMMERCE 0-0-1988.

SN 75-577,641. NEXT, INC., NEW YORK, NY. FILED 10-26-1998.



FOR ENTERTAINMENT SERVICES, NAMELY, LIVE PERFORMANCES BY A MUSICAL GROUP, DISTRIBUTION AND PRODUCTION OF MUSIC RECORDINGS, MUSIC CONCERTS AND EVENTS BEFORE LIVE AUDIENCES WHICH ARE BROADCAST LIVE OR TAPED FOR LATER BROADCAST (U.S. CLS. 100, 101 AND 107).

FIRST USE 5-1-1997; IN COMMERCE 5-1-1997.

**CLASS 41—(Continued).**

SN 75-621,256. DRAYTON, DRAYTON & LAMAR, INC., AUGUSTA, GA. FILED 1-15-1999.

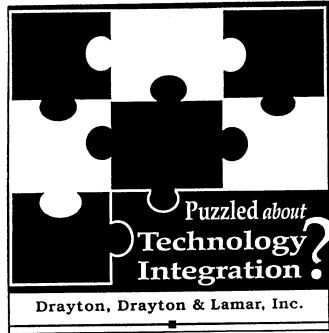

NO CLAIM IS MADE TO THE EXCLUSIVE RIGHT TO USE "TECHNOLOGY INTEGRATION" AND "INC.", APART FROM THE MARK AS SHOWN.

FOR EDUCATIONAL SERVICES, NAMELY, CONDUCTING CLASSES AND HANDS-ON COMPUTER TRAINING FOR CORPORATIONS AN BUSINESSES IN THE FIELD OF INTEGRATING SOFTWARE FOR ELECTRONIC COMMUNICATION, FOLLOW-UP ON-SITE AUDITS OF IMPLEMENTATION OF ELECTRONIC DATA INTERCHANGE, AND PLANNING EXPANSION OF ELECTRONIC COMMUNICATION (U.S. CLS. 100, 101 AND 107).

FIRST USE 8-15-1997; IN COMMERCE 8-15-1997.

SN 75-704,040. 2003 FUND, INC., DBA INVENTING FLIGHT, DAYTON, OH. FILED 5-13-1999.

**WHAT IF?**

FOR ENTERTAINMENT AND EDUCATIONAL SERVICES IN THE NATURE OF ARRANGING, ORGANIZING AND CONDUCTING EDUCATIONAL, CULTURAL AND SOCIAL EXHIBITIONS AND EVENTS, NAMELY, SEMINARS, WORKSHOPS, CONFERENCES, EXPOSITIONS, MUSICAL PERFORMANCES, ART EXHIBITIONS, SPORTING EVENTS, HISTORICAL DISPLAYS AND FESTIVALS FEATURING A VARIETY OF ACTIVITIES, NAMELY SPORTING EVENTS, ARTS AND CRAFTS ACTIVITIES AND EXHIBITS, PARADES, GAMES, RIDES, MOTION PICTURE EXHIBITIONS, CULTURAL ARTS PERFORMANCES, CULTURAL ARTS DISPLAYS AND THE LIKE, ALL IN THE FIELDS OF AVIATION AND COMMUNITY WELFARE, AND PROVIDING EDUCATIONAL MATERIALS IN CONNECTION THEREWITH; EDUCATIONAL SERVICES, NAMELY, SEMINARS, LECTURES, PRESENTATIONS, CLASSES, WORKSHOPS AND CONFERENCES IN THE FIELD OF AVIATION, FOR PROMOTING AWARENESS OF THE HISTORY AND DEVELOPMENT OF AVIATION, AND DISTRIBUTING EDUCATIONAL MATERIALS IN CONNECTION THEREWITH (U.S. CLS. 100, 101 AND 107).

**CLASS 41—(Continued).**

SN 75-795,496. BECKLEY, WALTER, RICHTON PARK, IL. FILED 10-5-1999.

**RADIANT LIVING**

FOR EDUCATIONAL SERVICES, NAMELY TRAINING INDIVIDUALS UTILIZING VARIOUS BREATHING AND EXERCISE TECHNIQUES TO ENHANCE NATURAL BODY PROCESSES AND FUNCTIONS (U.S. CLS. 100, 101 AND 107).

FIRST USE 11-12-1997; IN COMMERCE 11-12-1997.

SN 75-802,073. NATIONAL HOUSEWARES MANUFACTURERS ASSOCIATION, AKA INTERNATIONAL HOUSEWARES ASSOCIATION, ROSEMONT, IL. BY CHANGE OF NAME NATIONAL HOUSEWARES MANUFACTURERS ASSOCIATION, ROSEMONT, IL. FILED 9-17-1999.



NO CLAIM IS MADE TO THE EXCLUSIVE RIGHT TO USE "CHIEF OFFICERS", APART FROM THE MARK AS SHOWN.

FOR EDUCATIONAL SERVICES, NAMELY, CONDUCTING SEMINARS AND WORKSHOPS FOR TOP EXECUTIVES OF THE HOUSEWARES INDUSTRY TO FACILITATE DISCUSSION AND RESOLUTION OF ISSUES AND PROBLEMS FACED BY HOUSEWARES INDUSTRY MEMBERS (U.S. CLS. 100, 101 AND 107).

FIRST USE 6-0-1997; IN COMMERCE 6-0-1997.

SN 75-807,210. SLIPKNOT, INCORPORATED, LOS ANGELES, CA. FILED 9-23-1999.



FOR ENTERTAINMENT SERVICES, NAMELY, LIVE PERFORMANCES BY A MUSICAL GROUP (U.S. CLS. 100, 101 AND 107).

FIRST USE 4-4-1996; IN COMMERCE 4-4-1996.

**CLASS 41—(Continued).**

SN 75-807,262. INDIANAPOLIS ICE L.L.C., INDIANAPOLIS, IN. FILED 9-23-1999.



OWNER OF U.S. REG. NOS. 1,999,301, 2,229,783 AND OTHERS.

NO CLAIM IS MADE TO THE EXCLUSIVE RIGHT TO USE "INDIANAPOLIS", APART FROM THE MARK AS SHOWN.

FOR ENTERTAINMENT SERVICES IN THE NATURE OF PROFESSIONAL HOCKEY COMPETITIONS (U.S. CLS. 100, 101 AND 107).

---

SN 75-829,452. SERIOUS FUN PRODUCTIONS, LLC, LEXINGTON, MA. FILED 10-21-1999.

## SERIOUS FUN PRODUCTIONS

NO CLAIM IS MADE TO THE EXCLUSIVE RIGHT TO USE "PRODUCTIONS", APART FROM THE MARK AS SHOWN.

FOR SERIES OF TELEVISION PROGRAMS AND TELEVISION SEGMENTS; PRODUCTION OF TELEVISION PROGRAMS FOR OTHERS, ALL IN THE FIELD OF SPORTS (U.S. CLS. 100, 101 AND 107).

FIRST USE 6-0-1998; IN COMMERCE 6-0-1998.

---

SN 75-839,562. TRAIN STATION, INCORPORATED, THE, SEYMOUR, TN. FILED 11-3-1999.

## THE TRAIN STATION

FOR EDUCATIONAL SERVICES FOR EMPLOYEES OF BUSINESSES, ORGANIZATIONS, AND UNIVERSITIES IN THE FIELDS OF HUMAN BEHAVIOR, LEADERSHIP, CUSTOMER SERVICE, TIME MANAGEMENT, MOTIVATION, GOAL SETTING, AND PERSONAL AND PROFESSIONAL DEVELOPMENT (U.S. CLS. 100, 101 AND 107).

FIRST USE 4-0-1996; IN COMMERCE 5-15-1996.

**CLASS 41—(Continued).**

SN 75-856,021. PUMP FITNESS, L.L.C., WILMINGTON, DE. FILED 11-22-1999.



NO CLAIM IS MADE TO THE EXCLUSIVE RIGHT TO USE "FITNESS", APART FROM THE MARK AS SHOWN.

THE STIPPLING SHOWN IN THE MARK IS MERELY TO INDICATE SHADING

FOR HEALTH CLUBS, GYMNASIUMS, AND PHYSICAL EDUCATION AND PHYSICAL FITNESS INSTRUCTION (U.S. CLS. 100, 101 AND 107).

FIRST USE 10-1-1999; IN COMMERCE 10-1-1999.

---

SN 75-897,829. TERRAPIN PRESENTS, INC., BROOKFIELD, CT. FILED 1-18-2000.

## TERRAPIN FOUNDATION

NO CLAIM IS MADE TO THE EXCLUSIVE RIGHT TO USE "FOUNDATION", APART FROM THE MARK AS SHOWN.

FOR ENTERTAINMENT, NAMELY TICKETING AND PROMOTION OF MUSIC CONCERTS, ART FESTIVALS AND BENEVOLENT GATHERINGS (U.S. CLS. 100, 101 AND 107).

**CLASS 41—(Continued).**

SN 75-899,405. SUNSHINE KIDS FOUNDATION, THE, HOUSTON, TX. FILED 1-19-2000.



*Dedicated to children with cancer*

OWNER OF U.S. REG. NOS. 1,747,492, 1,748,951 AND 1,748,954.

NO CLAIM IS MADE TO THE EXCLUSIVE RIGHT TO USE "KIDS" AND "DEDICATED TO CHILDREN WITH CANCER", APART FROM THE MARK AS SHOWN.

FOR ENTERTAINMENT SERVICES, NAMELY THE PROVISION OF ACTIVITIES AND PROGRAMS FOR CHILDREN WITH CANCER AND THEIR FAMILIES (U.S. CLS. 100, 101 AND 107).

FIRST USE 10-1-1999; IN COMMERCE 10-1-1999.

SN 75-912,047. LOUDCLOUD, INC., SUNNYVALE, CA. FILED 2-7-2000.

**MAIL CLOUD**

NO CLAIM IS MADE TO THE EXCLUSIVE RIGHT TO USE "MAIL", APART FROM THE MARK AS SHOWN.

FOR EDUCATIONAL SERVICES, NAMELY, CONDUCTING CLASSES, SEMINARS AND WORKSHOPS IN THE FIELDS OF COMPUTER HARDWARE, COMPUTER SOFTWARE, COMPUTER NETWORKING, COMPUTER APPLICATIONS AND ELECTRONIC COMMERCE (U.S. CLS. 100, 101 AND 107).

SN 75-912,262. LOUDCLOUD, INC., SUNNYVALE, CA. FILED 2-7-2000.

**APPLICATION SERVER CLOUD**

NO CLAIM IS MADE TO THE EXCLUSIVE RIGHT TO USE "APPLICATION SERVER", APART FROM THE MARK AS SHOWN.

FOR EDUCATIONAL SERVICES, NAMELY, CONDUCTING CLASSES, SEMINARS AND WORKSHOPS IN THE FIELDS OF COMPUTER HARDWARE, COMPUTER SOFTWARE, COMPUTER NETWORKING, COMPUTER APPLICATIONS AND ELECTRONIC COMMERCE (U.S. CLS. 100, 101 AND 107).

**CLASS 41—(Continued).**

SN 75-913,810. VICTORY ENTERTAINMENT CORP., ORLANDO, FL. FILED 2-9-2000.

**THENEXTBIGSTAR.COM**

FOR ENTERTAINMENT SERVICES, NAMELY CONDUCTING AN ON-GOING TALENT SEARCH CONTEST VIA A GLOBAL COMPUTER NETWORK (U.S. CLS. 100, 101 AND 107).

SN 75-914,007. INTERNET GENERATION TELEVISION, INC., CANOGA PARK, CA. FILED 2-8-2000.

**PULSE POINT**

FOR ENTERTAINMENT SERVICES, NAMELY PROVIDING INTERACTIVE TELEVISION PROGRAMS AND FEATURE FILMS FEATURING DRAMATIC SERIES VIA THE INTERNET (U.S. CLS. 100, 101 AND 107).

SN 75-917,614. POWERHIRING.COM, INC., TUSTIN, CA. FILED 2-14-2000.

**POWERHiring.com**

FOR EDUCATIONAL SERVICES, NAMELY, PROVIDING WORKSHOPS, INTERACTIVE TRAINING TOOLS, AND EDUCATIONAL INFORMATION THROUGH A GLOBAL COMPUTER INFORMATION NETWORK ON THE SUBJECT OF PERSONNEL MANAGEMENT, EMPLOYMENT, AND HIRING PRACTICES, AND PROVIDING INFORMATION RELATING THERETO (U.S. CLS. 100, 101 AND 107).

FIRST USE 1-0-1999; IN COMMERCE 1-0-1999.

SN 75-926,123. 21ST CENTURY ELOQUENCE INC., DBA PALM BEACH ON LINE, WEST PALM BEACH, FL. FILED 2-24-2000.

**PALM BEACH ON LINE**

NO CLAIM IS MADE TO THE EXCLUSIVE RIGHT TO USE "ON LINE", APART FROM THE MARK AS SHOWN. SEC. 2(F).

FOR PROVIDING INFORMATION ON PALM BEACH COUNTY SPORTING, ENTERTAINMENT AND RECREATIONAL FACILITIES VIA A HOME PAGE ON A GLOBAL COMPUTER NETWORK (U.S. CLS. 100, 101 AND 107).

FIRST USE 10-26-1995; IN COMMERCE 10-26-1995.

**CLASS 41—(Continued).**

SN 75-960,964. EWING, EARLY N., ATLANTA, GA. FILED 3-19-2000.

**YOGAMAMA**

FOR YOGA STUDIOS AND YOGA EDUCATIONAL AND INSTRUCTIONAL SERVICES, COURSES AND TRAINING, NAMELY, CONDUCTING AND PRESENTING YOGA CLASSES, INDIVIDUAL INSTRUCTION, WORKSHOPS, SEMINARS, TRAINING PROGRAMS, PRESENTATIONS, DEMONSTRATIONS, AND INSTRUCTION IN YOGA, PRENATAL YOGA, AND POST-NATAL YOGA AND TECHNIQUES FOR MEDITATION, RELAXATION AND PHYSICAL FITNESS (U.S. CLS. 100, 101 AND 107).

FIRST USE 2-5-2000; IN COMMERCE 2-5-2000.

SN 76-016,595. REHABMAX.COM, INC., BALTIMORE, MD. FILED 4-3-2000.

**REHABMAX**

FOR EDUCATIONAL SERVICES, NAMELY, PROVIDING ONLINE TRAINING AND CONTINUING GRADUATE AND EDUCATION CLASSES IN PHYSICAL AND OCCUPATIONAL THERAPY, EXERCISE, AND ATHLETIC TRAINING AND DISTRIBUTION OF EDUCATIONAL INFORMATION IN CONNECTION THEREWITH (U.S. CLS. 100, 101 AND 107).

SN 76-023,527. ELECTRONIC MUSIC FOUNDATION, LTD., ALBANY, NY. FILED 4-13-2000.

**EMF**

FOR PROVIDING INFORMATION ON THE SUBJECT OF THE HISTORY AND CURRENT DEVELOPMENTS OF ELECTRONIC MUSIC (U.S. CLS. 100, 101 AND 107).

FIRST USE 6-1-1994; IN COMMERCE 6-1-1994.

SN 76-032,388. DAVIS, KAREN LYN, LOS ANGELES, CA. FILED 4-24-2000.

**THE NUMBER MONSTER!**

FOR PROVIDING INFORMATION IN THE FIELDS OF ENTERTAINMENT AND EDUCATION RENDERED VIA COMPUTER BY MEANS OF A GLOBAL COMPUTER NETWORK (U.S. CLS. 100, 101 AND 107).

FIRST USE 6-1-1999; IN COMMERCE 6-1-1999.

**CLASS 41—(Continued).**

SN 76-032,782. RWS, INC., TUCSON, AZ. FILED 4-22-2000.

**MOBWORLD.COM**

FOR ENTERTAINMENT SERVICES, NAMELY, PROVIDING AN ON-LINE ROLE PLAYING GAME FOR OTHERS OVER GLOBAL AND LOCAL AREA COMPUTER NETWORKS (U.S. CLS. 100, 101 AND 107).

FIRST USE 4-14-2000; IN COMMERCE 4-14-2000.

SN 76-032,870. JAZZLAND, INC., NEW ORLEANS, LA. FILED 4-24-2000.

**THRILL CLUB CARD**

NO CLAIM IS MADE TO THE EXCLUSIVE RIGHT TO USE "CARD", APART FROM THE MARK AS SHOWN.

FOR AMUSEMENT PARK SERVICES (U.S. CLS. 100, 101 AND 107).

SN 76-037,978. 3D LEARNER, INC., FORT LAUDERDALE, FL. FILED 5-1-2000.

**WE TEACH THE WAY YOU THINK**

FOR TEACHING PROGRAMS, NAMELY, ARRANGING AND CONDUCTING CLASSES, TRAINING PROGRAMS, SEMINARS AND WORKSHOPS IN THE FIELD OF LEARNING DISABILITIES, DIFFERENT LEARNING STYLES, VISION ISSUES AND SELF-CONTROL ISSUES, AND EDUCATIONAL CONSULTING RELATED THERETO; CORPORATE TRAINING PROGRAMS, NAMELY, ARRANGING AND CONDUCTING CLASSES, SEMINARS, WORKSHOPS IN THE FIELD OF LEARNING DISABILITIES, DIFFERENT LEARNING STYLES, VISION ISSUES, SELF-CONTROL FOR PARENTS, STUDENTS AND PROFESSIONALS, AND MANAGING AND TEACHING STUDENTS WITH LEARNING DISABILITIES AND THEIR PARENTS; ARRANGING AND CONDUCTING TRAINING SEMINARS IN THE FIELD OF LEARNING DISABILITIES, DIFFERENT LEARNING STYLES, VISION ISSUES, SELF-CONTROL FOR PARENTS, STUDENTS AND PROFESSIONALS, AND MANAGING AND TEACHING STUDENTS WITH LEARNING DISABILITIES AND THEIR PARENTS; ARRANGING AND CONDUCTING EDUCATIONAL CAMPS IN THE FIELD OF LEARNING DISABILITIES, DIFFERENT LEARNING STYLES, VISION ISSUES, SELF-CONTROL FOR PARENTS, STUDENTS AND PROFESSIONALS, AND MANAGING AND TEACHING STUDENTS WITH LEARNING DISABILITIES AND THEIR PARENTS; ARRANGING AND CONDUCTING RECREATIONAL CAMPS; AND ARRANGING AND CONDUCTING ATHLETIC TRAINING CLASSES IN THE FIELD OF MULTI-SENSORY LEARNING AND LEARNING ASSESSMENT (U.S. CLS. 100, 101 AND 107).

FIRST USE 2-0-1998; IN COMMERCE 2-0-1998.



**CLASS 41—(Continued).**

SN 76-039,581. SUCCESS TRADEMARKS, LLC, RALEIGH, NC. FILED 5-3-2000.

**SUCCESS ONLINE**

NO CLAIM IS MADE TO THE EXCLUSIVE RIGHT TO USE "ONLINE", APART FROM THE MARK AS SHOWN.

FOR PROVIDING EDUCATIONAL INFORMATION IN THE FIELDS OF PROFESSIONAL, PERSONAL AND FINANCIAL ACHIEVEMENT AND ENTREPRENEURIAL MANAGEMENT OVER GLOBAL AND WORLD WIDE WEB NETWORKS (U.S. CLS. 100, 101 AND 107).

---

SN 76-039,695. 410 MUSIC GROUP, BALTIMORE, MD. FILED 5-3-2000.

**410 MUSIC GROUP**

NO CLAIM IS MADE TO THE EXCLUSIVE RIGHT TO USE "MUSIC GROUP", APART FROM THE MARK AS SHOWN.

FOR ENTERTAINMENT SERVICES, NAMELY, RECORD AND RECORD MASTER PRODUCTION; RECORDING STUDIOS (U.S. CLS. 100, 101 AND 107).

FIRST USE 10-0-1999; IN COMMERCE 10-0-1999.

---

SN 76-042,518. OXFORD LANE, INC., DENVER, CO. FILED 5-5-2000.

**OXFORD LANE**

FOR COMPUTER EDUCATION TRAINING IN COMPUTER HARDWARE AND COMPUTER SYSTEMS SOFTWARE, EDUCATIONAL SERVICES, NAMELY CONDUCTING TRAINING CLASSES IN THE FIELD OF COMPUTER HARDWARE AND COMPUTER SYSTEMS SOFTWARE AND DISTRIBUTING COURSE MATERIALS IN CONNECTION THEREWITH (U.S. CLS. 100, 101 AND 107).

---

SN 76-043,957. STONERIDGE GOLF CLUB, INC., MAPLEWOOD, MN. FILED 4-27-2000.

**STONERIDGE**

FOR GOLF CLUB SERVICES, NAMELY, OPERATING A GOLF COURSE, PROVIDING CLUBHOUSE FACILITIES, AND OFFERING INSTRUCTION IN GOLF (U.S. CLS. 100, 101 AND 107).

FIRST USE 2-8-2000; IN COMMERCE 2-28-2000.

**CLASS 41—(Continued).**

SN 76-044,338. CARTOON NETWORK LP, LLLP, THE, ATLANTA, GA. FILED 5-9-2000.



FOR ENTERTAINMENT AND EDUCATION SERVICES IN THE NATURE OF A CONTINUING ANIMATED TELEVISION PROGRAM AND MOTION PICTURE FILM PRODUCTION DIRECTED TOWARD CHILDREN AND YOUNG ADULTS, PROVIDED THROUGH CABLE TELEVISION, BROADCAST TELEVISION, BROADCAST RADIO AND THE GLOBAL COMPUTER INFORMATION NETWORK (U.S. CLS. 100, 101 AND 107).

---

SN 76-049,382. STEIN, DANIEL S., ST. PETERSBURG, FL. FILED 5-9-2000.

**VTP**

FOR EDUCATIONAL SERVICES; NAMELY, A COURSE OF EXERCISE INSTRUCTION FOR EXERCISE OF THE PELVIC FLOOR MUSCLES PROVIDED OVER A GLOBAL COMPUTER NETWORK (U.S. CLS. 100, 101 AND 107).

FIRST USE 4-7-2000; IN COMMERCE 4-7-2000.

---

SN 76-055,291. FIGURE SKATING IN HARLEM, INC., NEW YORK, NY. FILED 5-24-2000.

**SOUL ON ICE**

NO CLAIM IS MADE TO THE EXCLUSIVE RIGHT TO USE "ON ICE", APART FROM THE MARK AS SHOWN.

FOR ENTERTAINMENT SERVICES; NAMELY, PRODUCTION AND PERFORMANCE OF FIGURE SKATING EXHIBITIONS AND COMPETITIONS (U.S. CLS. 100, 101 AND 107).

---

SN 76-057,435. ADVANCED QUANTITATIVE & STRATEGIC SOLUTIONS, LLC, WEST ATLANTIC CITY, NJ. FILED 5-26-2000.

**AQS2**

FOR EDUCATIONAL SERVICES, NAMELY, CONDUCTING SEMINARS, CLASSES, CONFERENCES AND WORKSHOPS IN THE FIELDS OF BUSINESS AND BUSINESS MANAGEMENT, AND THE DISTRIBUTION OF COURSE MATERIALS IN CONNECTION THEREWITH (U.S. CLS. 100, 101 AND 107).

FIRST USE 2-6-2000; IN COMMERCE 2-6-2000.

**CLASS 41—(Continued).**

SN 76-059,357. EROTIC IMAGE, INC., SOUTHFIELD, MI. FILED 5-30-2000.

**EROTIC IMAGE**

NO CLAIM IS MADE TO THE EXCLUSIVE RIGHT TO USE "EROTIC", APART FROM THE MARK AS SHOWN.

FOR ENTERTAINMENT IN THE NATURE OF LIVE, REAL-TIME EROTIC DANCE PERFORMANCES (U.S. CLS. 100, 101 AND 107).

FIRST USE 4-15-1989; IN COMMERCE 4-15-1989.

---

SN 76-075,387. KASSIN, STEVEN, NEW YORK, NY. FILED 6-19-2000.

**SCREAMING SILENCE**

FOR LIVE PERFORMANCES BY A MUSICAL BAND (U.S. CLS. 100, 101 AND 107).

FIRST USE 11-8-1999; IN COMMERCE 11-8-1999.

---

SN 76-075,776. AREL COMMUNICATIONS AND SOFTWARE LTD., YAVNE, 70600, ISRAEL, FILED 6-23-2000.

**AREL CAMPUS**

NO CLAIM IS MADE TO THE EXCLUSIVE RIGHT TO USE "CAMPUS", APART FROM THE MARK AS SHOWN.

FOR EDUCATIONAL SERVICES, NAMELY, TRACKING AND MANAGING COURSES AND LEARNING RESOURCES TO BE USED IN LEARNING PROGRAMS (U.S. CLS. 100, 101 AND 107).

---

SN 76-077,116. AMICAS, INC., NEWTON, MA. FILED 6-26-2000.

**AMICAS**

FOR TRAINING IN THE USE AND OPERATION OF COMPUTER SOFTWARE IN CONJUNCTION WITH TELERADIOLOGY, PICTURE ARCHIVING AND COMMUNICATIONS SYSTEMS (PACS) TELEMEDICINE AND ENTERPRISE IMAGE DISTRIBUTION (U.S. CLS. 100, 101 AND 107).

**CLASS 41—(Continued).**

SN 76-077,606. TRANSACT COMMUNICATIONS, INC., MUKILTEO, WA. FILED 6-26-2000.

**TRANSACT**

FOR COMPUTERIZED INFORMATION SERVICES, NAMELY, PROVIDING AN ONLINE COMPUTER DATABASE TO SEARCH, RETRIEVE, ORGANIZE AND INDEX DATA IN THE FIELD OF EDUCATION, SPECIFICALLY, SCHOOL AND EDUCATION-RELATED DOCUMENTS, RULES, REGULATIONS AND RESOURCES, VIA THE INTERNET, WIDE AREA NETWORKS, AND LOCAL AREA NETWORKS (U.S. CLS. 100, 101 AND 107).

FIRST USE 4-0-1999; IN COMMERCE 6-7-1999.

---

SN 76-084,291. TIME4 MEDIA, INC., NEW YORK, NY. BY CHANGE OF NAME TIMES MIRROR MAGAZINES, INC., NEW YORK, NY. FILED 7-6-2000.

**HALFPIPE JAM**

NO CLAIM IS MADE TO THE EXCLUSIVE RIGHT TO USE "HALFPIPE", APART FROM THE MARK AS SHOWN.

FOR ENTERTAINMENT EXHIBITIONS IN THE NATURE OF A FREESKIING, SKIING AND SNOWBOARDING COMPETITION (U.S. CLS. 100, 101 AND 107).

FIRST USE 12-10-1999; IN COMMERCE 12-10-1999.

---

SN 76-095,967. CERTIFIED MEDICAL REPRESENTATIVES INSTITUTE, INC., THE, ROANOKE, VA. FILED 7-25-2000.

**REP**

FOR PROVIDING ONLINE EDUCATIONAL TESTING IN THE FIELDS OF MEDICINE AND HEALTHCARE (U.S. CLS. 100, 101 AND 107).

FIRST USE 12-6-1999; IN COMMERCE 12-6-1999.

---

SN 76-098,979. SALOMON SMITH BARNEY INC., NEW YORK, NY. FILED 7-28-2000.

**STOCK ADMIN 101**

NO CLAIM IS MADE TO THE EXCLUSIVE RIGHT TO USE "STOCK ADMIN", APART FROM THE MARK AS SHOWN.

FOR EDUCATIONAL SERVICES, NAMELY, CONDUCTING TRAINING CLASSES IN THE FIELD OF STOCK ADMINISTRATION FOR ENTRY LEVEL STOCK ADMINISTRATORS (U.S. CLS. 100, 101 AND 107).

FIRST USE 10-0-1996; IN COMMERCE 10-0-1996.

**CLASS 41—(Continued).**

SN 76-104,623. KING, ROSAMOND S., BROOKLYN, NY.  
FILED 8-7-2000.

**EATING ARTIST**

FOR EDUCATIONAL SERVICES, NAMELY, CONDUCTING SEMINARS, CONFERENCES, CLASSES AND WORKSHOPS IN THE FIELD OF CAREER MANAGEMENT AND DISTRIBUTING COURSE MATERIALS IN CONNECTION THEREWITH; MODE OF INSTRUCTION WILL PRIMARILY BE GROUP AND INDIVIDUAL WORKSHOPS; FIELD OF INSTRUCTION WILL BE HOW TO IMPROVE ARTISTS' LIVES AND CAREERS; PUBLICATION OF BOOKS; PUBLICATION OF MAGAZINES (U.S. CLS. 100, 101 AND 107).

---

SN 76-109,460. NEW FRONTIER MEDIA, INC., BOULDER,  
CO. FILED 8-15-2000.

**PUBLICLY TRADED.  
PRIVATELY WATCHED**

FOR ENTERTAINMENT SERVICES IN THE NATURE OF PRE-RECORDED ADULT-ORIENTED MESSAGES VIA TELEPHONE, ON-GOING SHOWS BROADCAST OVER TELEVISION, CABLE AND SATELLITE IN THE FIELD OF ADULT-ORIENTED ENTERTAINMENT, AND PROVIDING LIVE AND PRE-RECORDED ADULT-ORIENTED ENTERTAINMENT ON-LINE, VIA A WEBSITE (U.S. CLS. 100, 101 AND 107).

---

SN 76-109,461. NEW FRONTIER MEDIA, INC., BOULDER,  
CO. FILED 8-15-2000.

**NEXT TO US, EVERYTHING  
ELSE LOOKS LIKE  
EVERYTHING ELSE**

FOR ENTERTAINMENT SERVICES IN THE NATURE OF PRE-RECORDED ADULT-ORIENTED MESSAGES VIA TELEPHONE, ON-GOING SHOWS BROADCAST OVER TELEVISION, CABLE AND SATELLITE IN THE FIELD OF ADULT-ORIENTED ENTERTAINMENT, AND PROVIDING LIVE AND PRE-RECORDED ADULT-ORIENTED ENTERTAINMENT ON-LINE, VIA A WEBSITE (U.S. CLS. 100, 101 AND 107).

**CLASS 41—(Continued).**

SN 76-110,007. NEW FRONTIER MEDIA, INC., BOULDER,  
CO. FILED 8-15-2000.

**FOR PEOPLE WHO LIKE TO  
WATCH**

FOR ENTERTAINMENT SERVICES IN THE NATURE OF PRE-RECORDED ADULT-ORIENTED MESSAGES VIA TELEPHONE, ON-GOING SHOWS BROADCAST OVER TELEVISION, CABLE AND SATELLITE IN THE FIELD OF ADULT-ORIENTED ENTERTAINMENT, AND PROVIDING LIVE AND PRE-RECORDED ADULT-ORIENTED ENTERTAINMENT ON-LINE, VIA A WEBSITE (U.S. CLS. 100, 101 AND 107).

---

SN 76-111,715. TWENTIETH CENTURY FOX FILM CORPORATION, LOS ANGELES, CA. FILED 8-17-2000.

**SKY FOX**

NO CLAIM IS MADE TO THE EXCLUSIVE RIGHT TO USE "SKY", APART FROM THE MARK AS SHOWN.  
FOR ENTERTAINMENT SERVICES IN THE NATURE OF ONGOING TELEVISION NEWS PROGRAMS DELIVERED VIA HELICOPTER (U.S. CLS. 100, 101 AND 107).  
FIRST USE 3-12-1997; IN COMMERCE 3-12-1997.

---

SN 76-115,547. KNOWLEDGENOW, INC., AUSTIN, TX.  
FILED 8-23-2000.

**KNOWLEDGENOW**

FOR PROVIDING ONLINE CONTINUING EDUCATION COURSES AND CERTIFICATION EXAM REVIEW COURSES IN THE FIELDS OF ACCOUNTING, REAL ESTATE, LAW, INSURANCE, FINANCE AND HUMAN RESOURCES; AND PROVIDING WORKSHOP FOR PROFESSIONALS IN THE FIELDS OF ACCOUNTING, REAL ESTATE, LAW, INSURANCE, FINANCE AND HUMAN RESOURCES, ALL VIA A GLOBAL COMPUTER NETWORK (U.S. CLS. 100, 101 AND 107).

**CLASS 41—(Continued).**

SN 76-116,996. CLASSROOM CONNECT, INC., BRISBANE, CA. FILED 8-28-2000.



NO CLAIM IS MADE TO THE EXCLUSIVE RIGHT TO USE "CHANNEL", APART FROM THE MARK AS SHOWN. FOR EDUCATIONAL SERVICES, NAMELY PROVIDING INTERACTIVE WEBSITES MULTIDISCIPLINARY INTERACTIVE WEBSITES VIA A GLOBAL COMPUTER NETWORK IN THE FIELDS OF GEOGRAPHY, SOCIAL STUDIES, LANGUAGE, ARTS, MATHEMATICS, SCIENCE, TECHNOLOGY AND LIFE/WORK SKILLS (U.S. CLS. 100, 101 AND 107).

FIRST USE 7-0-2000; IN COMMERCE 7-0-2000.

SN 76-118,025. INTELLOCITY, INC., CAUSEWAY BAY, HONG KONG, FILED 8-28-2000.

**ADHANCED TV**

NO CLAIM IS MADE TO THE EXCLUSIVE RIGHT TO USE "TV", APART FROM THE MARK AS SHOWN.

FOR CONSULTATION SERVICES IN THE FIELD OF INTERACTIVE TELEVISION APPLICATIONS, PACKAGES AND CONTENT, NAMELY, CONSULTING OTHERS IN THE DEFINITION, DEVELOPMENT, DEPLOYMENT, MANAGEMENT, CREATION, PRODUCTION, INTEGRATION, ASSEMBLY AND EDITING OF INTERACTIVE TELEVISION APPLICATIONS, PACKAGES AND CONTENT (U.S. CLS. 100, 101 AND 107).

SN 76-118,451. LOWRY, KURT SPENCER, DBA KIDVESTMENTS, CHATSWORTH, CA. AND NAUMANN LOWRY, JANE CAROLE, DBA KIDVESTMENTS, CHATSWORTH, CA. FILED 8-30-2000.

**KIDVESTMENTS**

FOR EDUCATIONAL AND TRAINING SERVICES, NAMELY, CONDUCTING CLASSES, SEMINARS AND WORKSHOPS FOR CHILDREN IN THE AREAS OF FINANCE, INVESTMENT, ETHICS, LEADERSHIP DEVELOPMENT, PERSONAL CHARACTER DEVELOPMENT, ECONOMICS AND CIVICS, AND DISTRIBUTING COURSE MATERIALS IN CONNECTION THEREWITH; EDUCATIONAL AND ENTERTAINMENT SERVICES, NAMELY, PROVIDING MOTIVATIONAL AND INSPIRATIONAL SPEAKERS (U.S. CLS. 100, 101 AND 107).

FIRST USE 3-10-2001; IN COMMERCE 3-10-2001.

**CLASS 41—(Continued).**

SN 76-119,389. AMERICAN SHARED HOSPITAL SERVICES, SAN FRANCISCO, CA. FILED 8-28-2000.

**MEDLEADER.COM**

OWNER OF U.S. REG. NO. 1,367,155. FOR EDUCATIONAL SERVICES, NAMELY, OFFERING SURGICAL TUTORIALS, PROFESSIONAL MEETINGS, LECTURES, SEMINARS AND GRAND ROUNDS AT MEDICAL INSTITUTIONS VIA THE INTERNET (U.S. CLS. 100, 101 AND 107).

SN 76-119,788. JEFFERSON VALLEY RACQUET CLUB, INC., DBA "CLUB FIT", OSSINING, NY. FILED 8-30-2000.

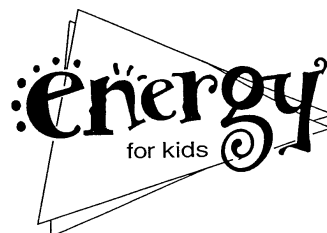

NO CLAIM IS MADE TO THE EXCLUSIVE RIGHT TO USE "FOR KIDS", APART FROM THE MARK AS SHOWN. FOR PROVIDING HEALTH AND FITNESS CLUBS FOR KIDS (U.S. CLS. 100, 101 AND 107).

FIRST USE 12-1-1999; IN COMMERCE 12-1-1999.

SN 76-119,790. JEFFERSON VALLEY RACQUET CLUB, INC., DBA "CLUB FIT", OSSINING, NY. FILED 8-30-2000.

**ENERGY CLUB FIT**

OWNER OF U.S. REG. NOS. 1,605,028 AND 1,606,808. NO CLAIM IS MADE TO THE EXCLUSIVE RIGHT TO USE "CLUB", APART FROM THE MARK AS SHOWN. FOR PROVIDING HEALTH AND FITNESS CLUBS FOR KIDS (U.S. CLS. 100, 101 AND 107).

FIRST USE 12-1-1999; IN COMMERCE 12-1-1999.

SN 76-119,791. JEFFERSON VALLEY RACQUET CLUB, INC., DBA "CLUB FIT", OSSINING, NY. FILED 8-30-2000.

**ENERGY FOR KIDS**

NO CLAIM IS MADE TO THE EXCLUSIVE RIGHT TO USE "FOR KIDS", APART FROM THE MARK AS SHOWN. FOR PROVIDING HEALTH AND FITNESS CLUBS FOR KIDS (U.S. CLS. 100, 101 AND 107).

FIRST USE 12-1-1999; IN COMMERCE 12-1-1999.

**CLASS 41—(Continued).**

SN 76-120,390. TALEGA ASSOCIATES, LLC, SAN CLEMENTE, CA. FILED 8-30-2000.

**TALEGA GOLF CLUB**

NO CLAIM IS MADE TO THE EXCLUSIVE RIGHT TO USE "GOLF CLUB", APART FROM THE MARK AS SHOWN.

THE ENGLISH TRANSLATION OF "TALEGA" IS "SACK OR BAG OR MONEY BAG".

FOR ENTERTAINMENT SERVICES, NAMELY, PROVIDING GOLF CLUB SERVICES AND FACILITIES (U.S. CLS. 100, 101 AND 107).

FIRST USE 2-1-2000; IN COMMERCE 2-1-2000.

---

SN 76-121,071. BROWN, VERNON STEVENS, DBA CHICK SPRINGS PUBLISHING, TAYLORS, SC. FILED 9-1-2000.

**CHICK SPRINGS PUBLISHING**

NO CLAIM IS MADE TO THE EXCLUSIVE RIGHT TO USE "PUBLISHING", APART FROM THE MARK AS SHOWN.

FOR PUBLICATION OF BOOKS (U.S. CLS. 100, 101 AND 107).

FIRST USE 7-15-1999; IN COMMERCE 7-15-1999.

---

SN 76-122,017. BAYLOR COLLEGE OF MEDICINE, HOUSTON, TX. FILED 9-5-2000.

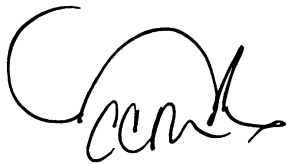

THE MARK CONSISTS OF A STYLIZED DRAWING OF A RODENT WITH THE CURSIVE LETTERING "CCM" UNDERNEATH.

FOR EDUCATIONAL SERVICES, NAMELY, CONDUCTING CLASSES, CONFERENCES, SEMINARS, AND WORKSHOPS IN THE FIELDS OF ANIMAL HUSBANDRY, PATHOLOGY, AND RESEARCH (U.S. CLS. 100, 101 AND 107).

FIRST USE 0-0-1999; IN COMMERCE 2-0-2000.

---

SN 76-122,771. DAVIS MEDIA GROUP, STUDIO CITY, CA. FILED 9-6-2000.

**BOLD**

FOR ENTERTAINMENT SERVICES, NAMELY, ONGOING TELEVISION, RADIO AND WEBCASTING TALK SHOWS FEATURING POLITICAL AND SOCIAL COMMENTARY (U.S. CLS. 100, 101 AND 107).

**CLASS 41—(Continued).**

SN 76-124,338. LIFESPRING NUTRITION, INC., RICHMOND, CA. BY CHANGE OF NAME DOCTORS' CHOICE, INC., RICHMOND, CA. FILED 9-11-2000.



NO CLAIM IS MADE TO THE EXCLUSIVE RIGHT TO USE "HOME NUTRITION", APART FROM THE MARK AS SHOWN.

FOR EDUCATIONAL SERVICES, NAMELY, CONDUCTING CLASSES, SEMINARS, CONFERENCES, AND WORKSHOPS IN THE FIELD OF HEALTH AND WELLNESS (U.S. CLS. 100, 101 AND 107).

---

SN 76-126,875. BOMBAY ENTERTAINMENT, INC., LOS ANGELES, CA. FILED 9-11-2000.

**D.B.A.**

DOING BUSINESS AS...

FOR LIVE MUSIC PERFORMANCE IN THE MANNER OF A RAP GROUP (U.S. CLS. 100, 101 AND 107).

FIRST USE 2-2-1999; IN COMMERCE 3-4-1999.

**CLASS 41—(Continued).**

SN 76-131,898. TIME WARNER ENTERTAINMENT COMPANY, L.P., NEW YORK, NY. FILED 9-19-2000.



NO CLAIM IS MADE TO THE EXCLUSIVE RIGHT TO USE "ENTERTAINMENT", APART FROM THE MARK AS SHOWN.

FOR ENTERTAINMENT SERVICES IN THE NATURE OF LIVE-ACTION, COMEDY, DRAMA AND ANIMATED ON-GOING TELEVISION PROGRAMS; PRODUCTION OF LIVE-ACTION, COMEDY, DRAMA AND ANIMATED TELEVISION PROGRAMS; ENTERTAINMENT SERVICES IN THE NATURE OF LIVE-ACTION, COMEDY, DRAMA AND ANIMATED MOTION PICTURE THEATRICAL FILMS; PRODUCTION OF LIVE-ACTION, COMEDY, DRAMA AND ANIMATED MOTION PICTURE THEATRICAL FILMS; THEATRICAL PERFORMANCES BOTH ANIMATED AND LIVE ACTION; AND PROVIDING AN ON-LINE COMPUTER DATABASE FEATURING ENTERTAINMENT, EDUCATIONAL INFORMATION AND GENERAL INTEREST NEWS (U.S. CLS. 100, 101 AND 107).

SN 76-138,152. VIACOM PRODUCTIONS INC., LOS ANGELES, CA. FILED 9-28-2000.

**STRANGE FREQUENCY**

FOR ENTERTAINMENT SERVICES IN THE NATURE OF A MUSICAL ANTHOLOGY AND SCIENCE FICTION TELEVISION SERIES (U.S. CLS. 100, 101 AND 107).

SN 76-148,975. OWL RECORDS, LLC, BOULDER, CO. FILED 10-19-2000.

**OWL RECORDS**

NO CLAIM IS MADE TO THE EXCLUSIVE RIGHT TO USE "RECORDS", APART FROM THE MARK AS SHOWN. FOR MUSIC PUBLISHING SERVICES (U.S. CLS. 100, 101 AND 107).

FIRST USE 3-1-2000; IN COMMERCE 3-1-2000.

SN 76-153,596. ZONGS, INC., NEW YORK, NY. FILED 10-25-2000.

**ZONGZONE**

FOR COMPUTER SERVICES, NAMELY, PROVIDING INFORMATION IN THE FIELD OF ENTERTAINMENT ONLINE VIA A WEBSITE ON A GLOBAL COMPUTER NETWORK; ENTERTAINMENT SERVICES, NAMELY, PROVIDING ONLINE MUSIC, MOVIES, AND GAMES VIA A WEBSITE (U.S. CLS. 100, 101 AND 107).

**CLASS 41—(Continued).**

SN 76-153,598. ZONGS, INC., NEW YORK, NY. FILED 10-25-2000.

**ZONGS**

FOR COMPUTER SERVICES, NAMELY, PROVIDING INFORMATION IN THE FIELD OF ENTERTAINMENT ONLINE VIA A WEBSITE ON A GLOBAL COMPUTER NETWORK; ENTERTAINMENT SERVICES, NAMELY, PROVIDING MUSIC, MOVIES, AND GAMES VIA A WEBSITE (U.S. CLS. 100, 101 AND 107).

SN 76-158,754. REAL INTERACTIVE, LLC, BRANFORD, CT. FILED 11-3-2000.

**STARPULSE.COM**

FOR ENTERTAINMENT SERVICES, NAMELY, PROVIDING A WEB SITE FEATURING INFORMATION ABOUT MOVIES, TELEVISION, VIDEO AND ENTERTAINMENT; MULTIMEDIA ENTERTAINMENT SOFTWARE PRODUCTION SERVICES (U.S. CLS. 100, 101 AND 107).

FIRST USE 1-1-1999; IN COMMERCE 1-1-1999.

SN 76-159,032. ALLTEL ALABAMA LIMITED PARTNERSHIP, THE, LITTLE ROCK, AR. FILED 11-2-2000.

**PIG PALACE**

FOR ENTERTAINMENT SERVICES, NAMELY, CONDUCTING TAILGATING PARTIES AT SPORTING EVENTS (U.S. CLS. 100, 101 AND 107).

FIRST USE 8-27-2000; IN COMMERCE 8-27-2000.

SN 76-159,470. HARCOURT, INC., ORLANDO, FL. FILED 11-3-2000.

**IDEAL ReferenceWorks**

OWNER OF U.S. REG. NOS. 2,098,351 AND 2,180,373. MARK SOUGHT TO BE REGISTERED IS COMPRISED OF THE WORD "IDEALREFERENCEWORKS" AND THE DESIGN OF AN ARROW FORMING THE LETTER "A".

FOR COMPUTER SERVICES, NAMELY, SUBSCRIPTION ACCESS TO AN ONLINE LIBRARY OF PUBLICATIONS IN THE FIELDS OF SCIENCE, MEDICINE, FORENSICS AND TECHNOLOGY (U.S. CLS. 100, 101 AND 107).

FIRST USE 3-1-2000; IN COMMERCE 3-1-2000.

**CLASS 41—(Continued).**

SN 76-161,702. KIDS AT ART, INC., NEW YORK, NY. FILED 11-9-2000.

**KIDS AT ART**

NO CLAIM IS MADE TO THE EXCLUSIVE RIGHT TO USE "KIDS" AND "ART", APART FROM THE MARK AS SHOWN.

FOR ART CLASSES FOR CHILDREN, AND CONDUCTING CHILDREN'S PARTIES INVOLVING ART ACTIVITIES (U.S. CLS. 100, 101 AND 107).

FIRST USE 9-0-2000; IN COMMERCE 9-0-2000.

---

SN 76-168,457. ENERGIA, INC., ATLANTA, GA. FILED 11-20-2000.

**DREAM IT**

FOR EDUCATIONAL SERVICES, NAMELY, CONDUCTING WORKSHOPS, SEMINARS AND CONFERENCES WITH RESPECT TO THE IMPACT OF COLOR IN CONNECTION WITH PERSONAL GROWTH AND RELATIONSHIPS (U.S. CLS. 100, 101 AND 107).

---

SN 76-168,809. ENERGIA, INC., ATLANTA, GA. FILED 11-20-2000.

**KNOW IT**

FOR EDUCATIONAL SERVICES, NAMELY, CONDUCTING WORKSHOPS, SEMINARS AND CONFERENCES WITH RESPECT TO THE IMPACT OF COLOR IN CONNECTION WITH PERSONAL GROWTH AND RELATIONSHIPS (U.S. CLS. 100, 101 AND 107).

---

SN 76-177,819. RELIGION IN AMERICAN LIFE, STAMFORD, CT. FILED 12-8-2000.

**RELIGION IN AMERICAN LIFE**

NO CLAIM IS MADE TO THE EXCLUSIVE RIGHT TO USE "RELIGION", APART FROM THE MARK AS SHOWN.

FOR RELIGIOUS AND EDUCATIONAL SERVICES, NAMELY CONDUCTING SEMINARS AND EDUCATIONAL PROGRAMS IN PERSON AND VIA THE GLOBAL COMPUTER NETWORK, TELEVISION, AND RADIO, AND DISTRIBUTION OF COURSE MATERIALS IN CONNECTION THEREWITH, DESIGNED TO ENCOURAGE AMERICANS TO ATTEND THE HOUSE OF WORSHIP OF THEIR CHOICE (U.S. CLS. 100, 101 AND 107).

FIRST USE 2-13-1953; IN COMMERCE 2-13-1953.

**CLASS 41—(Continued).**

SN 76-179,015. FREED, KENNETH H., EDINA, MN. FILED 12-11-2000.

**MINA SCALE**

NO CLAIM IS MADE TO THE EXCLUSIVE RIGHT TO USE "SCALE", APART FROM THE MARK AS SHOWN.

FOR MUSIC EDUCATION PROGRAMS AND SERVICES, NAMELY, DISTRIBUTION OF EDUCATIONAL TELEVISION PROGRAMS IN THE FIELD OF MUSIC; EDUCATION SERVICES, NAMELY, CONDUCTING MUSIC CLASSES AND DISTRIBUTING COURSE MATERIAL IN CONNECTION THEREWITH VIA A GLOBAL COMPUTER NETWORK; AND: ENTERTAINMENT, NAMELY, LIVE MUSIC CONCERTS (U.S. CLS. 100, 101 AND 107).

---

SN 76-191,020. HERSHEY CHOCOLATE & CONFECTIONERY CORPORATION, WHEAT RIDGE, CO. FILED 1-9-2001.

**HERSHEYPARK FAIR**

OWNER OF U.S. REG. NOS. 1,297,859, 1,440,229 AND 2,208,822.

NO CLAIM IS MADE TO THE EXCLUSIVE RIGHT TO USE "FAIR", APART FROM THE MARK AS SHOWN.

FOR ENTERTAINMENT IN THE NATURE OF AMUSEMENT PARK SERVICES (U.S. CLS. 100, 101 AND 107).

FIRST USE 5-1-1999; IN COMMERCE 5-1-1999.

---

SN 76-193,797. PROJECT MANAGEMENT INSTITUTE, INC., NEWTOWN SQUARE, PA. FILED 1-12-2001.

**SEMINARS WORLD**

NO CLAIM IS MADE TO THE EXCLUSIVE RIGHT TO USE "SEMINARS", APART FROM THE MARK AS SHOWN.

FOR EDUCATIONAL SERVICES, NAMELY, PROVIDING SEMINARS IN THE FIELD OF PROJECT MANAGEMENT (U.S. CLS. 100, 101 AND 107).

FIRST USE 10-9-1998; IN COMMERCE 10-9-1998.

---

SN 76-194,723. DITTMAN, DAVID, WESTPORT, CT. FILED 1-9-2001.

**PENNINSULA PILOTS**

FOR PRESENTATION AND EXHIBITION OF BASEBALL GAMES (U.S. CLS. 100, 101 AND 107).

FIRST USE 2-1-2000; IN COMMERCE 3-15-2000.

**CLASS 41—(Continued).**

SN 76-198,036. PLAYBOY ENTERPRISES INTERNATIONAL, INC., CHICAGO, IL. FILED 1-23-2001.

**PLAYBOY LOUNGE**

FOR ENTERTAINMENT SERVICES, NAMELY, PROVIDING AN ONLINE WEBSITE FEATURING PRE-RECORDED MUSIC (U.S. CLS. 100, 101 AND 107).  
FIRST USE 11-1-2000; IN COMMERCE 11-1-2000.

SN 76-199,644. YUBET.COM, LOS ANGELES, CA. FILED 1-26-2001.

**YUBET EXPRESS**

OWNER OF U.S. REG. NO. 2,157,307.  
NO CLAIM IS MADE TO THE EXCLUSIVE RIGHT TO USE "EXPRESS", APART FROM THE MARK AS SHOWN.  
FOR ENTERTAINMENT SERVICES, NAMELY, PROVIDING LIVE AUDIO AND VIDEO SIMULCAST TRANSMISSIONS OF HORSE RACES AND RELATED EVENTS AT RACE TRACKS, AND PROVIDING INFORMATION AND DATA REGARDING HORSE RACING; ALL PROVIDED THROUGH TEMPORARY USE OF ONLINE NON-DOWNLOADABLE SOFTWARE VIA THE INTERNET (U.S. CLS. 100, 101 AND 107).

SN 76-209,619. KARAMANOVSKI, EMINA, DALLAS, TX. FILED 2-14-2001.

**STRESS SURFING**

NO CLAIM IS MADE TO THE EXCLUSIVE RIGHT TO USE "STRESS", APART FROM THE MARK AS SHOWN.  
FOR CONDUCTING WORKSHOPS AND SEMINARS TO TEACH SKILLS NECESSARY FOR THE MANAGEMENT OF STRESS (U.S. CLS. 100, 101 AND 107).  
FIRST USE 1-11-2001; IN COMMERCE 1-11-2001.

SN 76-212,411. ELEMENT K LLC, ROCHESTER, NY. FILED 2-20-2001.

**EILT**

FOR EDUCATIONAL SERVICES, NAMELY, CONDUCTING CLASSES IN THE FIELDS OF TECHNOLOGY AND BUSINESS VIA A GLOBAL COMPUTER NETWORK (U.S. CLS. 100, 101 AND 107).

**CLASS 41—(Continued).**

SN 76-215,672. MEDIA HOLDINGS, LLC, AUSTIN, TX. FILED 2-22-2001.

**STANIMALS**

FOR ENTERTAINMENT SERVICES IN THE NATURE OF ILLUSTRATED STORIES FOR CHILDREN PROVIDED BY MEANS OF A GLOBAL COMPUTER NETWORK (U.S. CLS. 100, 101 AND 107).  
FIRST USE 1-26-2001; IN COMMERCE 2-2-2001.

SN 76-226,507. GROUCHO MARX PRODUCTIONS, INC., LOS ANGELES, CA. FILED 3-19-2001.

**GROUCHO MARX**

FOR ENTERTAINMENT SERVICES CONSISTING OF THE LIVE PRESENTATION OF COMEDIC PERFORMANCES (U.S. CLS. 100, 101 AND 107).  
FIRST USE 8-1-1935; IN COMMERCE 10-1-1987.

SN 76-237,029. PATTON, ALEXANDER, WAYNESBORO, MS. FILED 4-9-2001.

**Hali - free****Entertainment**

NO CLAIM IS MADE TO THE EXCLUSIVE RIGHT TO USE "ENTERTAINMENT", APART FROM THE MARK AS SHOWN.

THE MARK CONSISTS IN PART OF A MAN HALF WAY OUT OF THE MISSISSIPPI MAP.

FOR AUDIO RECORDING AND PRODUCTION (U.S. CLS. 100, 101 AND 107).



**CLASS 41—(Continued).**

SN 76-237,383. KURLAND, AMY ELIZABETH, NASHVILLE, TN. FILED 4-10-2001.



NO CLAIM IS MADE TO THE EXCLUSIVE RIGHT TO USE "CAFE", APART FROM THE MARK AS SHOWN.

FOR ENTERTAINMENT SERVICES, NAMELY, PROVIDING LIVE PERFORMANCES BY MUSICAL BANDS AND PROVIDING A VENUE FOR SONGWRITERS TO PERFORM THEIR COMPOSITIONS LIVE (U.S. CLS. 100, 101 AND 107).

FIRST USE 6-2-1989; IN COMMERCE 7-30-1992.

SN 76-237,815. OVERLODE PRODUCTIONS, INC., GRANADA HILLS, CA. FILED 4-9-2001.



THE MARK CONSIST OF AN OVAL WITH LETTERS "SBT" IN STYLIZED TYPE INSIDE THE OVAL.

FOR ENTERTAINMENT SERVICES, NAMELY THE PRODUCTION AND DISTRIBUTION OF MOTION PICTURES; AND PROVIDING A WEBSITE FEATURING ENTERTAINMENT NEWS AND OTHER INFORMATION RELATED TO MOTION PICTURES AND TELEVISION PROGRAMS (U.S. CLS. 100, 101 AND 107).

SN 76-241,858. PROMINENTA, S.A., CORDOBA CITY, ZIP CODE 5001, ARGENTINA, FILED 4-17-2001.

**PECTRA TECHNOLOGY**

NO CLAIM IS MADE TO THE EXCLUSIVE RIGHT TO USE "TECHNOLOGY", APART FROM THE MARK AS SHOWN.

FOR EDUCATIONAL SERVICES, NAMELY CONDUCTING CLASSES, SEMINARS, CONFERENCES AND WORKSHOPS IN THE FIELDS OF COMPUTERS, TECHNOLOGY, BUSINESS OPERATIONS AND MANAGEMENT (U.S. CLS. 100, 101 AND 107).

**CLASS 41—(Continued).**

SN 76-241,872. JAQUES, SUSAN, DBA KEY OF SHE, SKILLMAN, NJ. FILED 4-16-2001.

**KEY OF SHE**

FOR ENTERTAINMENT IN THE NATURE OF CABARET PERFORMANCES AND LIVE PERFORMANCES BY A MUSICAL GROUP (U.S. CLS. 100, 101 AND 107).

SN 76-242,412. THAMES, ZOE ROXANNE, SHINGLE SPRINGS, CA. FILED 4-13-2001.

**MINDMUSCLE FITNESS**

OWNER OF U.S. REG. NO. 1,858,961.

NO CLAIM IS MADE TO THE EXCLUSIVE RIGHT TO USE "FITNESS", APART FROM THE MARK AS SHOWN.

FOR EDUCATIONAL FITNESS/ WELLNESS CLASSES OF INSTRUCTION IN SPORTS, AND ENTERTAINMENT (U.S. CLS. 100, 101 AND 107).

FIRST USE 2-16-1992; IN COMMERCE 2-16-1992.

SN 76-244,733. LINE PUBLICATIONS LLC, LOS ANGELES, CA. FILED 4-18-2001.

**HOLLYWOOD STYLE  
VIRTUAL MUSEUM**

NO CLAIM IS MADE TO THE EXCLUSIVE RIGHT TO USE "VIRTUAL MUSEUM", APART FROM THE MARK AS SHOWN.

FOR PROVIDING A WEB SITE ON A GLOBAL COMPUTER NETWORK FEATURING INFORMATION IN THE FIELD OF AN AWARDS PRESENTATION FOR THE IMAGE OF PERSONALITIES, CHARACTERS AND LOCATIONS APPEARING ON TELEVISION AND IN MOTION PICTURES (U.S. CLS. 100, 101 AND 107).

SN 76-248,685. TIME WARNER ENTERTAINMENT-ADVANCE/NEWHOUSE PARTNERSHIP, STAMFORD, CT. FILED 4-30-2001.

**NUESTROS CANALES**

NO CLAIM IS MADE TO THE EXCLUSIVE RIGHT TO USE "CANALES", APART FROM THE MARK AS SHOWN. "NUESTROS CANALES" IN SPANISH MEANS "OUR CHANNELS".

FOR CABLE TELEVISION PROGRAMMING SERVICES (U.S. CLS. 100, 101 AND 107).

**CLASS 41—(Continued).**

SN 76-250,143. GOODWILL GAMES, INC., ATLANTA, GA. FILED 5-2-2001.



OWNER OF U.S. REG. NOS. 1,587,149 AND 1,669,125.  
 NO CLAIM IS MADE TO THE EXCLUSIVE RIGHT TO USE "GAMES", APART FROM THE MARK AS SHOWN.  
 FOR ENTERTAINMENT SERVICES, NAMELY, THE ORGANIZING AND ARRANGING OF AMATEUR INTERNATIONAL SPORTS COMPETITIONS; THE LIVE AND TELEVISED PRODUCTION AND EXHIBITION OF SPORTING COMPETITIONS AND PROVIDING INFORMATION IN THE FIELD OF SPORTING EVENTS OVER A GLOBAL COMPUTER NETWORK (U.S. CLS. 100, 101 AND 107).  
 FIRST USE 10-2-1992; IN COMMERCE 10-2-1992.

SN 76-251,585. MINISTRY OF ANGELS LTD. CO. L.L.C., SANTA FE, NM. FILED 5-7-2001.

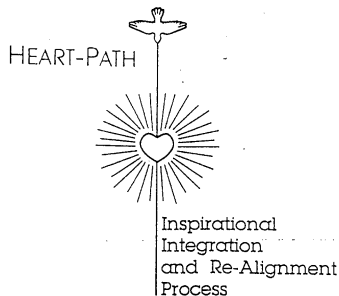

FOR EDUCATIONAL SERVICES, NAMELY, CONDUCTING CLASSES, SEMINARS, CONFERENCES, AND WORKSHOPS IN THE FIELD OF PSYCHO-SPIRITUAL EXPLORATION AND HEALING (U.S. CLS. 100, 101 AND 107).  
 FIRST USE 1-1-1997; IN COMMERCE 1-1-1997.

**CLASS 41—(Continued).**

SN 76-253,719. DALLAS COUNTY COMMUNITY COLLEGE DISTRICT, DALLAS, TX. FILED 5-7-2001.

**NORTH LAKE COLLEGE**

NO CLAIM IS MADE TO THE EXCLUSIVE RIGHT TO USE "COLLEGE", APART FROM THE MARK AS SHOWN.  
 FOR EDUCATIONAL SERVICES, NAMELY, OFFERING COURSES OF INSTRUCTION AT THE COMMUNITY COLLEGE LEVEL (U.S. CLS. 100, 101 AND 107).  
 FIRST USE 9-0-1977; IN COMMERCE 9-0-1977.

SN 76-255,491. ROCKSOLID GRANIT (USA) INC., ORANGE, CA. FILED 5-14-2001.

**ROCKSOLID GRANIT**

NO CLAIM IS MADE TO THE EXCLUSIVE RIGHT TO USE "GRANITE", APART FROM THE MARK AS SHOWN.  
 FOR EDUCATION AND TRAINING SERVICES, NAMELY, TEACHING AND TRAINING OTHERS HOW TO INSTALL RECONSTITUTED GRANITE SLABS AND TILES (U.S. CLS. 100, 101 AND 107).

SN 76-255,662. ST. JEAN, JOLENE C., COTO DE CAZA, CA. FILED 5-11-2001.



NO CLAIM IS MADE TO THE EXCLUSIVE RIGHT TO USE "FREE DELIVERY & PICK-UP DVD MOVIE & GAME RENTALS", APART FROM THE MARK AS SHOWN.  
 THE WORDING "SCENE2U.COM" IS LINED FOR THE COLOR RED.  
 THE MARK CONSISTS OF A SIGNBOARD OF THE KIND COMMONLY ASSOCIATED WITH PRODUCTION SETS FOR MOVIES AND TELEVISION.  
 FOR ON-LINE RENTALS OF VIDEOS, MUSIC, COMPUTER GAMES (U.S. CLS. 100, 101 AND 107).

**CLASS 41—(Continued).**

SN 76-257,715. EDELMAN FINANCIAL SERVICES, INC., FAIRFAX, VA. FILED 5-15-2001.

## EDELMAN CENTER FOR PERSONAL FINANCE EDUCATION

OWNER OF U.S. REG. NO. 1,880,034.  
NO CLAIM IS MADE TO THE EXCLUSIVE RIGHT TO USE "FINANCE EDUCATION", APART FROM THE MARK AS SHOWN.

FOR EDUCATION SERVICES IN THE NATURE OF CLASSES, SEMINARS, CONFERENCES, AND WORKSHOPS; COURSES OF INSTRUCTION RENDERED THROUGH AUDIO, VIDEO, ONLINE AND BROADCAST MEDIA; AND DISTRIBUTING COURSE MATERIALS IN THE NATURE OF BOOKS, NEWSLETTERS, ARTICLES, AND AUDIO-VISUAL MATERIALS IN CONNECTION THEREWITH; ALL IN THE FIELDS OF BUSINESS, FINANCE, INVESTMENT, MONEY MANAGEMENT AND FINANCIAL PLANNING (U.S. CLS. 100, 101 AND 107).

---

SN 76-262,361. KINETIC IMAGEWORKS, INC., IRVINE, CA. FILED 5-25-2001.

## KINETIC IMAGEWORKS

FOR AUDIOVISUAL EDITING SERVICES TO BE PROVIDED IN CONNECTION WITH FILM, VIDEO AND TELEVISION PROJECTS (U.S. CLS. 100, 101 AND 107).

---

SN 76-263,933. MOTORSPORTS ENTERTAINMENT WORLDWIDE, LLC, DAYTONA BEACH, FL. FILED 5-29-2001.

## SPEED LAB

FOR FAMILY ORIENTED ENTERTAINMENT AND AMUSEMENT CENTERS, NAMELY, INTERACTIVE PLAY AREAS (U.S. CLS. 100, 101 AND 107).  
FIRST USE 7-15-2000; IN COMMERCE 7-31-2000.

---

SN 76-264,518. CAMOSY, JOSEPH JR., WEST PALM BEACH, FL. FILED 5-31-2001.

## DIVINE PARADOX

FOR EDUCATIONAL SERVICES, NAMELY, PROVIDING INFORMATION VIA A GLOBAL COMPUTER NETWORK TO HELP INDIVIDUALS LEARN ABOUT THE SPIRITUAL TRUTHS AND HOW TO RECOGNIZE AND APPLY THEM IN EVERYDAY LIFE (U.S. CLS. 100, 101 AND 107).

FIRST USE 6-13-2000; IN COMMERCE 6-13-2000.

**CLASS 41—(Continued).**

SN 76-265,770. PFE PCL BASEBALL LLC, PORTLAND, OR. FILED 5-31-2001.

## PORTLAND BEAVERS

NO CLAIM IS MADE TO THE EXCLUSIVE RIGHT TO USE "PORTLAND", APART FROM THE MARK AS SHOWN. FOR ENTERTAINMENT SERVICES IN THE NATURE OF BASEBALL GAMES AND EXHIBITIONS (U.S. CLS. 100, 101 AND 107).  
FIRST USE 4-5-2001; IN COMMERCE 4-5-2001.

---

SN 76-266,096. KATZ SPORTS & MEDIA, INC., ATLANTA, GA. FILED 6-4-2001.

## GOLF PORTFOLIO

NO CLAIM IS MADE TO THE EXCLUSIVE RIGHT TO USE "GOLF", APART FROM THE MARK AS SHOWN. FOR ENTERTAINMENT IN THE NATURE OF A WEEKLY TELEVISION SERIES FEATURING GOLF AND THE BUSINESS OF GOLF (U.S. CLS. 100, 101 AND 107).

---

SN 76-270,267. VIACOM INTERNATIONAL INC., NEW YORK, NY. FILED 6-11-2001.

## VH1 STORYTELLERS

OWNER OF U.S. REG. NOS. 1,353,809, 2,028,622 AND OTHERS.  
FOR ENTERTAINMENT SERVICES IN THE NATURE OF ON-GOING TELEVISION PROGRAMS IN THE FIELD OF MUSIC; PROVIDING INFORMATION IN THE FIELD OF ENTERTAINMENT AND EDUCATION BY MEANS OF A GLOBAL COMPUTER NETWORK (U.S. CLS. 100, 101 AND 107).  
FIRST USE 6-2-1996; IN COMMERCE 6-2-1996.

---

SN 76-271,017. GOVE-SIEBOLD GROUP, INC., BOYNTON BEACH, FL. FILED 6-14-2001.

## THE BILL GOVE SPEECH WORKSHOP

NO CLAIM IS MADE TO THE EXCLUSIVE RIGHT TO USE "SPEECH WORKSHOP", APART FROM THE MARK AS SHOWN.

FOR EDUCATION IN THE FIELD OF PUBLIC/PROFESSIONAL SPEAKING RENDERED THROUGH LIVE WORKSHOPS AND CORRESPONDENCE COURSES (U.S. CLS. 100, 101 AND 107).

FIRST USE 0-0-1947; IN COMMERCE 0-0-1947.

**CLASS 41—(Continued).**

SN 76-271,385. HARMONY OF THE SPHERES, INC., BUFFALO, NY. FILED 6-14-2001.



NO CLAIM IS MADE TO THE EXCLUSIVE RIGHT TO USE "INTERNATIONAL FESTIVAL OF MUSIC NIAGARA", APART FROM THE MARK AS SHOWN.

THE STIPPLING IS A FEATURE OF THE MARK AND DOES NOT INDICATE COLOR.  
FOR MUSIC FESTIVALS (U.S. CLS. 100, 101 AND 107).

SN 76-271,529. BLOOMINGTON GOLD ENTERPRISES, INC., MARENGO, IL. FILED 6-15-2001.

**THE GOLD SALUTE**

FOR ENTERTAINMENT SERVICES, NAMELY, ORGANIZING AND CONDUCTING AUTOMOBILE EXHIBITIONS (U.S. CLS. 100, 101 AND 107).

SN 76-271,932. CNI HOLDING CORPORATION, CLEARWATER, FL. FILED 6-15-2001.

**ETC SOUL**

NO CLAIM IS MADE TO THE EXCLUSIVE RIGHT TO USE "SOUL", APART FROM THE MARK AS SHOWN.

FOR ENTERTAINMENT SERVICES IN THE NATURE OF A BLOCK OF TELEVISION PROGRAMMING IN THE FIELD OF 'SPIRITUAL, RELIGIOUS AND FAMILY-ORIENTED PROGRAMS' (U.S. CLS. 100, 101 AND 107).  
FIRST USE 6-9-2001; IN COMMERCE 6-9-2001.

SN 76-278,460. PACE UNIVERSITY, NEW YORK, NY. FILED 6-29-2001.

**YOUR FUTURE, IN A WORD**

FOR EDUCATIONAL SERVICES NAMELY OFFERING COURSES AT THE UNIVERSITY LEVEL (U.S. CLS. 100, 101 AND 107).  
FIRST USE 5-0-2000; IN COMMERCE 5-0-2000.

**CLASS 41—(Continued).**

SN 76-280,146. UNDERFASHION CLUB, INC., THE, NEW YORK, NY. FILED 7-2-2001.

**FEMMY**

FOR ORGANIZING AND CONDUCTING AN ANNUAL AWARDS PRESENTATION TO RECOGNIZE EXCELLENCE IN THE FASHION INDUSTRY (U.S. CLS. 100, 101 AND 107).  
FIRST USE 0-0-1963; IN COMMERCE 0-0-1963.

SN 76-280,813. COL. PARKER, WOODLAND HILLS, CA. FILED 7-5-2001.

**COL. PARKER**

THE MARK "COL. PARKER" DOES NOT REFER TO A PARTICULAR LIVING INDIVIDUAL.  
FOR ENTERTAINMENT SERVICES, NAMELY, LIVE PERFORMANCES BY A MUSICAL ARTIST (U.S. CLS. 100, 101 AND 107).

SN 76-288,820. GOTTAGETTACOACH! INC., NORTHBROOK, IL. FILED 7-24-2001.

**GOTTAGETTACOACH!**

FOR EDUCATIONAL SERVICES, NAMELY, PROVIDING PERFORMANCE ENHANCEMENT MENTORING AND COACHING SESSIONS AND WORKSHOPS FOR BUSINESS AND PERSONAL DEVELOPMENT AND DISTRIBUTION WRITTEN MATERIALS USED IN CONNECTION THEREWITH (U.S. CLS. 100, 101 AND 107).  
FIRST USE 7-4-2000; IN COMMERCE 10-14-2000.

SN 76-289,595. SPORTS AUTHORITY MICHIGAN, INC., THE, FORT LAUDERDALE, FL. FILED 7-24-2001.



FOR EDUCATIONAL SERVICES, NAMELY, CONDUCTING CLASSES AND WORKSHOPS IN THE FIELD OF SPORTS AND FITNESS SAFETY AND CONDITIONING, AND PROPER SELECTION AND USE OF SPORTS EQUIPMENT AND ACCESSORIES (U.S. CLS. 100, 101 AND 107).

**CLASS 41—(Continued).**

SN 76-292,965. NATIONAL CREATIVE SOCIETY, INC.,  
ROME, GA. FILED 7-31-2001.

## ROME GEORGIA'S RENAISSANCE MUSIC CAMP

NO CLAIM IS MADE TO THE EXCLUSIVE RIGHT TO USE "ROME GEORGIA'S" AND "MUSIC CAMP", APART FROM THE MARK AS SHOWN.

FOR EDUCATIONAL AND ENTERTAINMENT SERVICES, NAMELY, ORGANIZING AND CONDUCTING CAMPS FEATURING VISUAL ARTS, LITERARY ARTS, AND DRAMATIC ARTS (U.S. CLS. 100, 101 AND 107).

---

SN 76-296,062. SOCCER ASSOCIATION FOR YOUTH, U.S.A.,  
CINCINNATI, OH. FILED 8-6-2001.



OWNER OF U.S. REG. NO. 877,225.  
NO CLAIM IS MADE TO THE EXCLUSIVE RIGHT TO USE "USA" AND "SOCCER", APART FROM THE MARK AS SHOWN.

FOR ORGANIZING AND CONDUCTING SOCCER LEAGUES AND SOCCER PROGRAMS FOR YOUTH (U.S. CLS. 100, 101 AND 107).

FIRST USE 1-0-2000; IN COMMERCE 4-0-2000.

---

SN 76-297,237. SUTOR, BRIAN, BROOKLYN, NY. FILED 8-10-2001.

## HARVEST OF SOULS

FOR ENTERTAINMENT SERVICES IN THE NATURE OF LIVE MUSICAL PERFORMANCES (U.S. CLS. 100, 101 AND 107).

---

SN 76-299,739. EDUCATION CORPORATION OF AMERICA,  
BIRMINGHAM, AL. FILED 8-15-2001.

## CULINARD

OWNER OF U.S. REG. NOS. 2,485,230 AND 2,485,231.  
FOR EDUCATIONAL SERVICES, NAMELY, CONDUCTING SEMINARS AND COURSES OF INSTRUCTION IN THE FIELD OF FOOD PREPARATION (U.S. CLS. 100, 101 AND 107).

FIRST USE 8-1-2000; IN COMMERCE 8-1-2000.

**CLASS 41—(Continued).**

SN 76-301,360. VALLE, DEBRA, LOS ALAMITOS, CA. FILED 8-15-2001.

## SELLING THE BRAND WHEN IT'S YOU

FOR EDUCATIONAL SERVICES, NAMELY, PROVIDING CLASSES, WORKSHOPS AND SEMINARS IN THE FIELDS OF BUSINESS MANAGEMENT, BUSINESS OPERATIONS, AND DEVELOPMENT OF BUSINESS AND PROFESSIONAL PRACTICES VIA LIVE CLASSES, TELEPHONE COMMUNICATIONS AND GLOBAL COMPUTER NETWORKS (U.S. CLS. 100, 101 AND 107).

FIRST USE 6-15-2000; IN COMMERCE 6-15-2000.

---

SN 76-303,417. NEW LIFE MINISTRIES, PLANO, TX. FILED 8-22-2001.

## EVERY MAN'S BATTLE

FOR WORKSHOP FOCUSING ON EDUCATION ABOUT SEXUAL TEMPTATION (U.S. CLS. 100, 101 AND 107).

FIRST USE 10-1-2000; IN COMMERCE 11-1-2000.

---

SN 76-307,255. PROSKAUER ROSE LLP, NEW YORK, NY. FILED 8-29-2001.



NO CLAIM IS MADE TO THE EXCLUSIVE RIGHT TO USE "LAW" AND "WORKPLACE", APART FROM THE MARK AS SHOWN.

FOR EDUCATIONAL SERVICES, NAMELY PROVIDING SEMINARS ON ISSUES RELATING TO LABOR AND EMPLOYMENT LAW AND COURSE MATERIALS DISTRIBUTED THEREWITH (U.S. CLS. 100, 101 AND 107).

FIRST USE 7-10-2001; IN COMMERCE 7-10-2001.

**CLASS 41—(Continued).**

SN 76-309,418. HARVAT, MATTHEW J, CHICAGO, IL. FILED 9-6-2001.

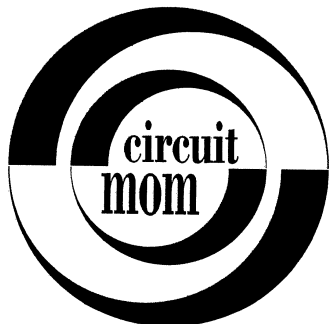

FOR ENTERTAINMENT SERVICES, NAMELY, SHOWS FEATURING FEMALE IMPERSONATORS (U.S. CLS. 100, 101 AND 107).  
FIRST USE 8-0-1996; IN COMMERCE 8-0-1996.

SN 76-309,424. HARVAT, MATTHEW J., CHICAGO, IL. FILED 9-6-2001.

**CIRCUIT MOM**

FOR ENTERTAINMENT SERVICES, NAMELY, SHOWS FEATURING FEMALE IMPERSONATORS (U.S. CLS. 100, 101 AND 107).  
FIRST USE 8-0-1996; IN COMMERCE 8-0-1996.

SN 76-313,867. SCOTT, SUSAN, SAMMAMISH, WA. FILED 9-13-2001.

**TACKLE YOUR TOUGHEST CHALLENGE TODAY**

FOR EDUCATIONAL SERVICES, NAMELY, CONDUCTING CLASSES, SEMINARS, CONFERENCES, AND WORKSHOPS IN THE FIELD OF BUSINESS MANAGEMENT AND INTERPERSONAL COMMUNICATIONS (U.S. CLS. 100, 101 AND 107).

SN 76-313,868. SCOTT, SUSAN, SAMMAMISH, WA. FILED 9-13-2001.

**MASTER THE COURAGE TO INTERROGATE REALITY**

FOR EDUCATIONAL SERVICES, NAMELY, CONDUCTING CLASSES, SEMINARS, CONFERENCES, AND WORKSHOPS IN THE FIELD OF BUSINESS MANAGEMENT AND INTERPERSONAL COMMUNICATIONS (U.S. CLS. 100, 101 AND 107).

**CLASS 41—(Continued).**

SN 76-318,745. JOSTENS, INC., MINNEAPOLIS, MN. FILED 9-28-2001.

**SAFE HAVEN**

FOR SEMINAR FOR EDUCATORS ON HANDLING TODAY'S SCHOOL EMERGENCIES (U.S. CLS. 100, 101 AND 107).  
FIRST USE 11-30-2000; IN COMMERCE 11-30-2000.

SN 76-319,281. KIDS ON ICE, INC., ATLANTA, GA. FILED 9-28-2001.

**KIDS ON ICE**

FOR PROVIDING SPORTS FACILITIES FOR HOCKEY AND EDUCATIONAL INSTRUCTION IN HOCKEY (U.S. CLS. 100, 101 AND 107).

SN 76-320,096. JCOR ENTERTAINMENT LLC, NEW YORK, NY. FILED 10-1-2001.

**JCOR**

FOR ENTERTAINMENT SERVICES, NAMELY LIVE PERFORMANCES BY A MUSICAL GROUP; RECORD PRODUCTION OF MUSICAL PERFORMANCES; PROVIDING INFORMATION ON MUSICAL GROUPS AND OTHER MUSIC AND ENTERTAINMENT SUBJECTS VIA AN ON-LINE GLOBAL COMPUTER NETWORK; MUSIC PUBLISHING SERVICES (U.S. CLS. 100, 101 AND 107).  
FIRST USE 11-0-2000; IN COMMERCE 11-0-2000.

SN 76-321,253. COMMITTEE FOR A RESPONSIBLE FEDERAL BUDGET, WASHINGTON, DC. FILED 10-5-2001.

**EXERCISE IN HARD CHOICES**

FOR EDUCATIONAL SERVICES, NAMELY CONDUCTING SEMINARS AND WORKSHOPS IN WHICH THE PARTICIPANTS EXPERIENCE THE DECISION MAKING PROCESS POLITICIANS UNDERGO IN ESTABLISHING THE NATIONAL BUDGET; APPLICANT DISTRIBUTES COURSE MATERIALS IN CONNECTION THEREWITH (U.S. CLS. 100, 101 AND 107).  
FIRST USE 10-0-1983; IN COMMERCE 10-0-1983.

SN 76-321,915. PARISH, P. WILLIAM, SAN FRANCISCO, CA. FILED 10-5-2001.

**BCUSA**

FOR EDUCATIONAL SERVICES, NAMELY COURSES IN RECYCLING, ALTERNATIVE ENERGY AND CONSERVATION (U.S. CLS. 100, 101 AND 107).  
FIRST USE 2-1-2001; IN COMMERCE 3-1-2001.

**CLASS 41—(Continued).**

SN 76-322,963. POLLAN, STEPHEN M., NEW YORK, NY. FILED 10-9-2001.

**LIFE SCRIPTS**

FOR ENTERTAINMENT SERVICES, NAMELY, A SERIES OF TELEVISION AND RADIO PROGRAMS IN THE FIELD OF NEWS, GENERAL EDUCATION, HEALTH AND SELF-IMPROVEMENT (U.S. CLS. 100, 101 AND 107).

---

SN 78-011,334. LOVE, JEFFREY, MARINE CITY, MI. AND PRESLEY, DANIEL P., PORT HURON, MI. AND ROSE, DANIEL, MARINE CITY, MI. AND SESSOR, DAVID A., JR., PORT HURON, MI. AND TILLY, RYAN, FAIR HAVEN, MI. FILED 6-5-2000.

**I-DEFY**

FOR LIVE PERFORMANCE BY A MUSICAL GROUP (U.S. CLS. 100, 101 AND 107).  
FIRST USE 3-17-1998; IN COMMERCE 8-2-1998.

---

SN 78-023,817. MASTROGIOVANNI, JOHN PAUL, LONG BEACH, CA. FILED 8-30-2000.

**MAMA'S BOYS**

FOR ENTERTAINMENT BY A LIVE MUSICAL GROUP (U.S. CLS. 100, 101 AND 107).  
FIRST USE 12-20-1992; IN COMMERCE 12-20-1992.

---

SN 78-023,903. VIACOM INTERNATIONAL INC., NEW YORK, NY. FILED 8-31-2000.

**NOGGIN'S UP**

OWNER OF U.S. REG. NOS. 2,263,341 AND 2,267,478.  
FOR ENTERTAINMENT SERVICES IN THE NATURE OF TELEVISION PROGRAMS FEATURING LIVE ACTION, COMEDY, AND DRAMA; PROVIDING INFORMATION IN THE FIELD OF ENTERTAINMENT AND EDUCATION RELATING TO TELEVISION PROGRAMS RENDERED VIA A GLOBAL COMPUTER NETWORK (U.S. CLS. 100, 101 AND 107).

---

SN 78-024,300. TORRES, SANDRA, PHILADELPHIA, PA. FILED 9-4-2000.

**TRAININGBUZ.COM**

FOR EDUCATIONAL SERVICES, NAMELY TRAINING IN THE FIELD OF BUSINESS (U.S. CLS. 100, 101 AND 107).

**CLASS 41—(Continued).**

SN 78-026,334. GOMES, CARLO, GIAN, PASADENA, CA. FILED 9-18-2000.

**SIS BOOM BAH**

FOR ENTERTAINMENT SERVICES IN THE NATURE OF PERFORMANCES BY A LIVE MUSICAL GROUP (U.S. CLS. 100, 101 AND 107).  
FIRST USE 0-0-1992; IN COMMERCE 0-0-1992.

---

SN 78-027,363. RESTAINO, STEVEN, OAKLAND, CA. FILED 9-23-2000.

**SUCCESS IS POSSIBLE**

FOR EDUCATIONAL AND ENTERTAINMENT SERVICES, NAMELY PROVIDING MOTIVATIONAL AND EDUCATIONAL SPEAKERS (U.S. CLS. 100, 101 AND 107).

---

SN 78-027,531. SWEET, JULIA E., REHOBOTH, MA. FILED 9-25-2000.

**FITNESS MOM**

NO CLAIM IS MADE TO THE EXCLUSIVE RIGHT TO USE "FITNESS", APART FROM THE MARK AS SHOWN.

FOR ENTERTAINMENT SERVICES IN THE NATURE OF ON-GOING TELEVISION PROGRAMS IN THE FIELD OF FITNESS, HEALTH, AND NUTRITION, EDUCATIONAL SERVICES, NAMELY, PROVIDING COURSES AND SEMINARS IN THE FIELD OF FITNESS, HEALTH, AND NUTRITION (U.S. CLS. 100, 101 AND 107).  
FIRST USE 1-31-2000; IN COMMERCE 1-31-2000.

---

SN 78-028,366. VIACOM INTERNATIONAL INC., NEW YORK, NY. FILED 9-29-2000.

**NICKELODEON GAS PRESENTS SIDELINE HEROES OF THE...**

FOR ENTERTAINMENT SERVICES IN THE NATURE OF A TELEVISION SERIES FEATURING SPORTS; PROVIDING INFORMATION IN THE FIELD OF ENTERTAINMENT, NAMELY SPORTS RENDERED VIA GLOBAL COMPUTER NETWORK (U.S. CLS. 100, 101 AND 107).

**CLASS 41—(Continued).**

SN 78-031,170. FOX FAMILY PROPERTIES, INC., LOS ANGELES, CA. FILED 10-18-2000.

**INSIDE THE COMPETITION**

FOR ENTERTAINMENT SERVICES IN THE NATURE OF A LIVE-ACTION TELEVISION SERIES IN THE FIELDS OF REALITY PROGRAMMING; ON-LINE ENTERTAINMENT SERVICES OFFERED OVER A WORLD-WIDE COMMUNICATION NETWORK FEATURING COMPUTER GAMES, CONTESTS IN THE NATURE OF PRIZE GIVE-AWAYS, WEBISODES, VIDEO CLIPS AND INFORMATION ALL RELATING TO A TELEVISION SERIES IN THE FIELD OF REALITY PROGRAMMING (U.S. CLS. 100, 101 AND 107).

**CLASS 41—(Continued).**

SN 78-039,114. INGRAM, STEPHEN C., DBA "CHILD PRODIGY ENTERTAINMENT", INGLEWOOD, CA. FILED 12-13-2000.

**COMING OUT OF A  
SPEAKER NEAR YOU!**

FOR ENTERTAINMENT SERVICES IN THE NATURE OF LIVE DISC JOCKEY SERVICES FOR PARTIES AND SPECIAL EVENTS, AND AUDIO RECORDING AND PRODUCTION SERVICES (U.S. CLS. 100, 101 AND 107).

SN 78-033,313. EL-DESTRUCTO, EASTON, PA. FILED 11-1-2000.



FOR ENTERTAINMENT SERVICES IN THE NATURE OF LIVE MUSICAL PERFORMANCES (U.S. CLS. 100, 101 AND 107).

SN 78-039,762. GAMETABLE ONLINE, INC., NORTHAMPTON, MA. FILED 12-18-2000.



SN 78-035,063. OSIS, ANDREW, CHICAGO, IL. FILED 11-13-2000.

**LUBRIPHONIC**

FOR ENTERTAINMENT, NAMELY, LIVE MUSIC CONCERTS (U.S. CLS. 100, 101 AND 107).

NO CLAIM IS MADE TO THE EXCLUSIVE RIGHT TO USE "GAME" AND "ONLINE", APART FROM THE MARK AS SHOWN.

FOR ENTERTAINMENT SERVICES, NAMELY, PROVIDING ON-LINE COMPUTER GAMES; PROVIDING INFORMATION IN THE FIELD OF STRATEGY GAME NEWS VIA WEBSITES ON GLOBAL COMPUTER NETWORKS (U.S. CLS. 100, 101 AND 107).

SN 78-036,505. FARRELL, PAUL, A. THORNTON, CO. AND SHAVER, JARROD, C. THORNTON, CO. AND SHAVER, BRANDON, J. DENVER, CO. AND EVERSMA, JUSTIN, J. WESTMINSTER, CO. AND WINTERS, LANCE, J. NORTHGLENN, CO. FILED 11-25-2000.

**NO PARTICULAR ORDER**

FOR ENTERTAINMENT SERVICES, NAMELY, LIVE PERFORMANCES BY A VOCAL AND INSTRUMENTAL GROUP (U.S. CLS. 100, 101 AND 107).  
FIRST USE 3-0-2000; IN COMMERCE 5-20-2000.

SN 78-039,891. HOSTETLER, DANIEL J., TUCSON, AZ. FILED 12-19-2000.

**BIG GALOOT**

FOR ENTERTAINMENT, NAMELY, LIVE PERFORMANCES BY A MUSICAL GROUP (U.S. CLS. 100, 101 AND 107).  
FIRST USE 4-15-1998; IN COMMERCE 11-28-1998.



**CLASS 41—(Continued).**

SN 78-043,430. HOLLINSWORTH, JAY A., NEW ROCHELLE, NY. FILED 1-16-2001.



NO CLAIM IS MADE TO THE EXCLUSIVE RIGHT TO USE "PRODUCTIONS", APART FROM THE MARK AS SHOWN.

FOR PRODUCTION AND DISTRIBUTION OF MOTION PICTURE FILMS; PRODUCTION OF VIDEO CASSETTES (U.S. CLS. 100, 101 AND 107).

SN 78-043,532. CALLAWAY GOLF COMPANY, CARLSBAD, CA. FILED 1-17-2001.

**CALLAWAY CONNECT**

FOR GOLF CLUB SERVICES (U.S. CLS. 100, 101 AND 107).

SN 78-048,098. WORLD PUBLICATIONS, INC., WINTER PARK, FL. FILED 2-13-2001.



NO CLAIM IS MADE TO THE EXCLUSIVE RIGHT TO USE "MARLIN UNIVERSITY", APART FROM THE MARK AS SHOWN.

THE MARK CONSISTS IN PART, OF A STYLIZED DEPICTION OF A MARLIN AND AN EXTERIOR FACADE OF A BUILDING.

FOR EDUCATIONAL SERVICES, NAMELY, CONDUCTING CLASSES, WORKSHOPS, AND CONFERENCES IN THE FIELD OF FISHING WHICH ARE DESIGNED TO TEACH SKILLS IN TACKLE SELECTION, SPECIFIC ANGLING SKILLS, BAIT RIGGING AND PRESENTATION, HANDLING FISH, BOAT OPERATING SKILLS, BASIC NAVIGATION, AND BASIC ELECTRONICS (U.S. CLS. 100, 101 AND 107).  
FIRST USE 8-29-2000; IN COMMERCE 8-29-2000.

**CLASS 41—(Continued).**

SN 78-050,096. NEWELL, WEST JAMES, LAWTON, MI. FILED 2-24-2001.

**SUN NATION**

FOR CONDUCTING WORKSHOPS, SEMINARS AND ONE ON ONE MENTORING INCORPORATING VARIOUS INTERPERSONAL PRINCIPLES, THEORY, DEMONSTRATION AND USE OF SELF ENRICHMENT MODALITIES AND TECHNIQUES, LIKE MEDITATION AND ACUPRESSURE, INSIGHT PRACTICE AND DEVELOPMENT FOR ENHANCEMENT OF PERSONAL AWARENESS (U.S. CLS. 100, 101 AND 107).

SN 78-050,818. SAMMONS, LYNNE A. CASSELBERRY, FL. AND SAMMONS, CHRLES J. CASSELBERRY, FL. FILED 3-1-2001.

**GROUNDHOG BOOKS**

NO CLAIM IS MADE TO THE EXCLUSIVE RIGHT TO USE "BOOKS", APART FROM THE MARK AS SHOWN.

FOR BOOK PUBLISHING SERVICES (U.S. CLS. 100, 101 AND 107).

SN 78-051,482. WEIN, MAX STEVEN, LOS ANGELES, CA. FILED 3-5-2001.

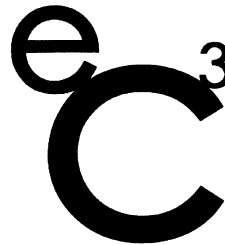

P R O D U C T I O N S

NO CLAIM IS MADE TO THE EXCLUSIVE RIGHT TO USE "PRODUCTIONS", APART FROM THE MARK AS SHOWN.

THE MARK CONSISTS OF A SMALL BLACK LOWER CASE "E" ON THE UPPER LEFT CORNER OF A LARGE RED "C" AND A SMALL BLACK "3" ON THE TOP RIGHT CORNER OF THE RED "C" AND THE WORD "PRODUCTIONS" IS CENTERED DIRECTLY UNDER THE "EC3" LOGO IN GOLD COLOR. THESE COLORS ARE INTENDED TO BE A FEATURE OF THE MARK.

FOR MOTION PICTURE FILM PRODUCTION (U.S. CLS. 100, 101 AND 107).

**CLASS 41—(Continued).**

SN 78-053,745. HETEROCHAT, MARANA, AZ. FILED 3-18-2001.

**HETEROCHAT**

FOR EDUCATIONAL SUPPORT SERVICES, NAMELY, CLASSES AND SEMINARS FOR INDIVIDUALS WHO ARE DIAGNOSED WITH HIV, DESIGNED TO PROVIDE EMOTIONAL SUPPORT AND PROVIDE INFORMATION CONCERNING TREATMENT AND OTHER AVAILABLE BENEFITS (U.S. CLS. 100, 101 AND 107).

SN 78-054,532. MARK IV REALTY GROUP, INC., CHICAGO, IL. FILED 3-22-2001.



NO CLAIM IS MADE TO THE EXCLUSIVE RIGHT TO USE "HOTEL & CASINO", APART FROM THE MARK AS SHOWN.

FOR CASINO AND GAMING SERVICES; PROVIDING GAMING FACILITIES; ENTERTAINMENT, NAMELY, LIVE MUSICAL PERFORMANCES, THEATRICAL PRODUCTIONS AND COMEDY; SPORTING EVENTS, AMUSEMENT CENTERS AND ARCADES; PROVIDING CASINO AND GAMING SERVICES BY MEANS OF WEB SITES AND A GLOBAL COMPUTER NETWORK (U.S. CLS. 100, 101 AND 107).

SN 78-054,815. ROBBINS, KATHLEEN M., INDIANAPOLIS, IN. FILED 3-23-2001.

**THEATRE OF THE CLASSROOM**

FOR EDUCATIONAL SERVICES, NAMELY, CONDUCTING CLASSES; INCLUDING PRIVATE CLASSES, SEMINARS, CONFERENCES, AND WORKSHOPS; IN THE FIELD OF TEACHING AND TRAINING, NAMELY, INSTRUCTING TEACHERS, TRAINERS, AND ANYONE GIVING PUBLIC PRESENTATIONS ON HOW TO IMPROVE THEIR PRESENTATIONS, USING A MODEL FOR INSTRUCTION THE SIX ELEMENTS OF THE DRAMA AS DEFINED BY ARISTOTLE (U.S. CLS. 100, 101 AND 107).

FIRST USE 3-26-1999; IN COMMERCE 3-26-1999.

**CLASS 41—(Continued).**

SN 78-054,823. ROBBINS, KATHLEEN M., INDIANAPOLIS, IN. FILED 3-23-2001.

**THE QUALITY OF MERCY**

FOR EDUCATIONAL SERVICES, NAMELY, CONDUCTING CLASSES, INCLUDING PRIVATE CLASSES, IN THE FIELD OF CUSTOMER SERVICE, TO BE USED IN ANY INDUSTRY OR AT ANY EDUCATIONAL LEVEL, PUBLICLY OR PRIVATELY (U.S. CLS. 100, 101 AND 107).

FIRST USE 6-13-2000; IN COMMERCE 6-13-2000.

SN 78-055,809. VIACOM INTERNATIONAL INC., NEW YORK, NY. FILED 3-29-2001.

**VH1 BANDS ON THE RUN**

OWNER OF U.S. REG. NOS. 1,353,809, 2,028,622 AND OTHERS.

NO CLAIM IS MADE TO THE EXCLUSIVE RIGHT TO USE "BANDS", APART FROM THE MARK AS SHOWN.

FOR ENTERTAINMENT SERVICES IN THE NATURE OF A LIVE ACTION TELEVISION SERIES; PROVIDING INFORMATION IN THE FIELD OF ENTERTAINMENT, MUSIC AND EDUCATION BY MEANS OF A GLOBAL COMPUTER NETWORK (U.S. CLS. 100, 101 AND 107).

SN 78-057,610. CATERPILLAR INC., PEORIA, IL. FILED 4-10-2001.

**DESTINATION TECHNOLOGY**

NO CLAIM IS MADE TO THE EXCLUSIVE RIGHT TO USE "TECHNOLOGY", APART FROM THE MARK AS SHOWN.

FOR EDUCATIONAL SERVICES, NAMELY, PROVIDING CLASSES AND EDUCATIONAL PROGRAMS FOR MIDDLE AND HIGH-SCHOOL STUDENTS DESIGNED TO FOSTER AN INTEREST IN ENGINEERING AND TECHNOLOGICAL CAREER OPPORTUNITIES (U.S. CLS. 100, 101 AND 107).

SN 78-058,234. MARK IV REALTY GROUP, INC., CHICAGO, IL. FILED 4-12-2001.

**GREEK ISLANDS**

FOR CASINO AND GAMING SERVICES; GAMING FACILITIES; ENTERTAINMENT IN THE NATURE OF LIVE MUSICAL PERFORMANCES, THEATRICAL PRODUCTIONS AND COMEDY SHOWS; AMUSEMENT CENTERS AND ARCADES; PROVIDING CASINO AND GAMING SERVICES BY MEANS OF WEB SITES AND A GLOBAL COMPUTER NETWORK (U.S. CLS. 100, 101 AND 107).

**CLASS 41—(Continued).**

SN 78-060,738. ELLEFSON, BRUCE, PHOENIX, AZ. FILED 4-27-2001.

**EARS TO HEAR**

FOR ENTERTAINMENT, NAMELY, LIVE PERFORMANCES BY A MUSICAL BAND (U.S. CLS. 100, 101 AND 107).

---

SN 78-061,343. TM ACQUISITION CORP., PHOENIX, AZ. FILED 5-1-2001.

**C21 TALK RADIO FOR THE REAL WORLD**

OWNER OF U.S. REG. NOS. 1,257,866 AND 2,398,595.  
NO CLAIM IS MADE TO THE EXCLUSIVE RIGHT TO USE "TALK RADIO", APART FROM THE MARK AS SHOWN.  
FOR RADIO PROGRAM IN THE FIELD OF REAL ESTATE (U.S. CLS. 100, 101 AND 107).

---

SN 78-061,703. SILBERBERG, DICKSON COURTNEY, WOODLAND HILLS, CA. AND SILBERBERG, JACQUELYN KINKADE, WOODLAND HILLS, CA. FILED 5-2-2001.

**VANTAGE ENTERTAINMENT**

NO CLAIM IS MADE TO THE EXCLUSIVE RIGHT TO USE "ENTERTAINMENT", APART FROM THE MARK AS SHOWN.

FOR EDUCATION AND ENTERTAINMENT SERVICES, NAMELY, SCRIPT WRITING, PRODUCING AND DIRECTING OF MOTION PICTURE FILMS, TELEVISION SHOWS, VIDEO AND AUDIO RECORDINGS, LIVE PERFORMANCES, THEATER PRODUCTIONS, AND TELEVISION AND RADIO PROGRAMS FOR TRANSMISSION VIA BROADCAST, CABLE, DIGITAL AND GLOBAL COMPUTER NETWORK, AND PUBLICATION OF ACCOMPANYING MATERIALS IN THE FORM OF BOOKS, MAGAZINES AND NEWSLETTERS (U.S. CLS. 100, 101 AND 107).

FIRST USE 1-0-1995; IN COMMERCE 6-0-1995.

**CLASS 41—(Continued).**

SN 78-061,895. LIFE MASK CORP., NEW YORK, NY. FILED 5-3-2001.



THE MARK CONSISTS OF DESIGN OF A FANCIFUL BEE IN A SPOTLIGHT WITH A CITY SKYLINE BACKGROUND COMBINED WITH A STYLIZED "NYNIGHTBUZZ".

FOR ONLINE ENTERTAINMENT INFORMATION SERVICES, NAMELY PROVIDING INFORMATION ON THINGS TO DO AND NIGHTLIFE THROUGH A WEBSITE (U.S. CLS. 100, 101 AND 107).

FIRST USE 2-1-1999; IN COMMERCE 2-1-1999.

---

SN 78-061,907. 3 O'CLOCK CORP. TA THE GREY LODGE PUB, PHILADELPHIA, PA. FILED 5-3-2001.

**FRIDAY THE FIRKINTEENTH**

FOR EDUCATIONAL SERVICES, NAMELY, PROVIDING ENTERTAINMENT IN THE FORM OF A CASK CONDITIONED ALE EVENT (U.S. CLS. 100, 101 AND 107).

---

SN 78-063,410. JOLIET PROFESSIONAL BASEBALL CLUB, LLC, JOLIET, IL. BY ASSIGNMENT BROWN, JEFFREY H., CHICAGO, IL, IL. FILED 5-14-2001.

**JOLIET JACKHAMMERS**

NO CLAIM IS MADE TO THE EXCLUSIVE RIGHT TO USE "JOLIET", APART FROM THE MARK AS SHOWN.

FOR ENTERTAINMENT SERVICES, NAMELY, BASEBALL GAMES AND EXHIBITIONS (U.S. CLS. 100, 101 AND 107).

---

SN 78-065,608. SHOWTIME NETWORKS INC., NEW YORK, NY. FILED 5-24-2001.

**SHOWTIME BOXING: THE NEW GENERATION**

OWNER OF U.S. REG. NOS. 1,075,211 AND 2,180,434.  
NO CLAIM IS MADE TO THE EXCLUSIVE RIGHT TO USE "BOXING", APART FROM THE MARK AS SHOWN.

FOR ENTERTAINMENT SERVICES, NAMELY, PRODUCTION AND DISTRIBUTION OF MOTION PICTURES, COMEDY, MUSICAL AND DRAMATIC SERIES, DOCUMENTARIES, SPORTING EVENTS BY MEANS OF AND FOR CABLE TELEVISION, SATELLITE-DELIVERED AND TELEVISION BROADCASTING (U.S. CLS. 100, 101 AND 107).

**CLASS 41—(Continued).**

SN 78-065,730. D'ALESSANDRO, DAVID F., BOSTON, MA. FILED 5-25-2001.

**BRAND WARFARE**

NO CLAIM IS MADE TO THE EXCLUSIVE RIGHT TO USE "BRAND", APART FROM THE MARK AS SHOWN.

FOR PROVIDING EDUCATION AND TRAINING, NAMELY COURSES, SEMINARS AND LECTURES, IN THE FIELD OF BRAND MARKETING, AND DISTRIBUTING EDUCATIONAL MATERIALS IN CONNECTION THEREWITH (U.S. CLS. 100, 101 AND 107).

SN 78-065,731. D'ALESSANDRO, DAVID F., BOSTON, MA. FILED 5-25-2001.

**10 RULES FOR BUILDING THE KILLER BRAND**

NO CLAIM IS MADE TO THE EXCLUSIVE RIGHT TO USE "BRAND", APART FROM THE MARK AS SHOWN.

FOR PROVIDING EDUCATION AND TRAINING, NAMELY COURSES, SEMINARS AND LECTURES, IN THE FIELD OF BRAND MARKETING, AND DISTRIBUTING EDUCATIONAL MATERIALS IN CONNECTION THEREWITH (U.S. CLS. 100, 101 AND 107).

SN 78-075,828. SHANE, MICHAEL, DUNEDIN, FL. FILED 7-26-2001.

**MICHAEL SHANE**

THE NAME "MICHAEL SHANE" IDENTIFIES A LIVING INDIVIDUAL WHOSE CONSENT IS OF RECORD.

FOR ENTERTAINMENT IN THE NATURE OF WRESTLING CONTESTS (U.S. CLS. 100, 101 AND 107).

SN 78-075,955. GUY, TREY, AUSTIN, TX. FILED 7-26-2001.

**GUYCOM**

FOR TELEVISION PRODUCTION (U.S. CLS. 100, 101 AND 107).

**CLASS 41—(Continued).**

SN 78-083,568. MUSIC TECH MUSICIANS TECHNICAL TRAINING CENTER, INC., DBA MUSIC TECH, MINNEAPOLIS, MN. FILED 9-12-2001.

**MUSICTECH COLLEGE**

OWNER OF U.S. REG. NO. 1,750,471.

NO CLAIM IS MADE TO THE EXCLUSIVE RIGHT TO USE "COLLEGE", APART FROM THE MARK AS SHOWN.

FOR EDUCATIONAL SERVICES, NAMELY, CONDUCTING CLASSES, TRAINING AND MENTORING IN THE FIELDS OF MUSIC, MUSIC RECORDING, MUSIC PRODUCTION AND MUSIC IMAGING (U.S. CLS. 100, 101 AND 107).

FIRST USE 8-15-2001; IN COMMERCE 8-15-2001.

SN 78-084,962. DREXEL UNIVERSITY, PHILADELPHIA, PA. FILED 9-21-2001.

**DRAGONFIRE**

FOR EDUCATIONAL SERVICES, NAMELY, CONDUCTING DISTANCE LEARNING INSTRUCTION AT THE SECONDARY, COLLEGE AND GRADUATE LEVELS (U.S. CLS. 100, 101 AND 107).

SN 78-084,972. GANJO, INC., KINNELON, NJ. FILED 9-21-2001.

**GET A LIFE!!**

FOR ENTERTAINMENT SERVICES, NAMELY, PROVIDING AN ON-LINE COMPUTER GAME (U.S. CLS. 100, 101 AND 107).

SN 78-085,538. TWENTIETH CENTURY FOX FILM CORPORATION, LOS ANGELES, CA. FILED 9-25-2001.

**BOSTON PUBLIC**

FOR ENTERTAINMENT SERVICES IN THE NATURE OF A TELEVISION SERIES FEATURING DRAMA; PROVIDING ON-LINE INFORMATION IN THE FIELD OF TELEVISION, MOTION PICTURE FILM AND VIDEO ENTERTAINMENT VIA A GLOBAL COMMUNICATIONS NETWORK (U.S. CLS. 100, 101 AND 107).

FIRST USE 10-23-2000; IN COMMERCE 10-23-2000.

**CLASS 42—SCIENTIFIC, COMPUTER AND LEGAL SERVICES**

**CLASS 42—(Continued).**

SN 75-557,796. PAKRATS, INC., HOFFMAN ESTATES, IL. FILED 9-21-1998.

**PAKRATS**

FOR DESIGN AND DEVELOPMENT OF COMPUTER SOFTWARE, SOFTWARE FOR WEB SERVERS, COMPUTER OPERATING SYSTEMS, COMPUTER NETWORK SYSTEMS AND COMPUTER APPLICATION PROGRAMS FOR OTHERS; COMPUTER SERVICES, NAMELY, DESIGN AND IMPLEMENTATION OF NETWORK WEB PAGES AND WEB COMPUTER APPLICATION PROGRAMS FOR OTHERS (U.S. CLS. 100 AND 101).

FIRST USE 1-1-1998; IN COMMERCE 1-1-1998.

SN 75-568,564. REILLY, PARKER, BROOKLYN, NY. FILED 10-13-1998.

**BARK**

FOR COMPUTER SERVICES, NAMELY, PROVIDING AN ON-LINE MAGAZINE FEATURING TOPICS OF INTEREST TO TEENAGERS (U.S. CLS. 100 AND 101).

SN 75-626,004. GAMEWARDENS OF VIETNAM ASSN, INC., SAN DIEGO, CA. FILED 1-25-1999.



GAMEWARDENS OF VIETNAM

NO CLAIM IS MADE TO THE EXCLUSIVE RIGHT TO USE "RIVER PATROL FORCE" AND "GAME WARDENS OF VIETNAM", APART FROM THE MARK AS SHOWN.

FOR ASSOCIATION SERVICES; NAMELY, PROMOTING THE INTEREST OF A FRATERNAL ORDER DEVOTED TO THE HISTORY AND REMEMBRANCE OF THE VIETNAM WAR AND MATERIALS DISTRIBUTED IN CONJUNCTION THEREWITH (U.S. CLS. 100 AND 101).

FIRST USE 9-8-1993; IN COMMERCE 9-8-1993.

SN 75-720,689. AMERICA'S SECOND HARVEST, CHICAGO, IL. BY CHANGE OF NAME SECOND HARVEST, CHICAGO, IL. FILED 6-4-1999.

**RELIEF FLEET**

NO CLAIM IS MADE TO THE EXCLUSIVE RIGHT TO USE "RELIEF", APART FROM THE MARK AS SHOWN.

FOR CHARITABLE SERVICES, NAMELY, PROVIDING THE COLLECTION OF SURPLUS AND SALVAGEABLE FOOD AND DISTRIBUTION OF SUCH FOOD TO THE NEEDY VIA DONATED GROUND TRANSPORTATION (U.S. CLS. 100 AND 101).

FIRST USE 5-3-1999; IN COMMERCE 5-3-1999.

**CLASS 42—(Continued).**

SN 75-747,814. WESTERN SKYLAND CORP, SANTA CLARA, CA. FILED 7-12-1999.

**GOTOLUNCH.COM**

FOR PROVIDING AN INTERACTIVE WEB SITE FEATURING INFORMATION ABOUT RESTAURANTS (U.S. CLS. 100 AND 101).

FIRST USE 10-10-1998; IN COMMERCE 10-15-1998.

SN 75-750,016. LCG CONSULTING, LOS ALTOS, CA. FILED 8-4-1999.

**ENERGYONLINE**

SEC. 2(F).

FOR PROVIDING REGULATORY INFORMATION IN THE FIELD OF ENERGY, WITH AN EMPHASIS ON ELECTRIC INDUSTRY RESTRUCTURING TO OTHERS IN THE ENERGY INDUSTRY VIA A GLOBAL COMPUTER NETWORK (U.S. CLS. 100 AND 101).

FIRST USE 3-15-1995; IN COMMERCE 4-1-1995.

SN 75-752,291. HIGH FIVE MANAGEMENT, INC., GREENVILLE, SC. FILED 7-15-1999.

**THE TROPHY CLUB**

NO CLAIM IS MADE TO THE EXCLUSIVE RIGHT TO USE "CLUB", APART FROM THE MARK AS SHOWN. FOR NIGHTCLUB SERVICES (U.S. CLS. 100 AND 101).

FIRST USE 12-24-1997; IN COMMERCE 4-1-1998.

SN 75-784,154. AETNA, INC., BLUE BELL, PA. BY CHANGE OF NAME AETNA U.S. HEALTHCARE INC., BLUE BELL, PA. FILED 8-25-1999.

**DIGITAL DOCFIND**

OWNER OF U.S. REG. NO. 2,075,630.

NO CLAIM IS MADE TO THE EXCLUSIVE RIGHT TO USE "DIGITAL", APART FROM THE MARK AS SHOWN.

FOR PROVIDING INFORMATION REGARDING PHYSICIANS VIA A GLOBAL COMPUTER NETWORK (U.S. CLS. 100 AND 101).

SN 75-813,462. WORKBOX, INC., SAN FRANCISCO, CA. FILED 10-1-1999.

**WORKBOX**

FOR GRAPHIC DESIGN SERVICES FOR OTHERS, NAMELY DEVELOPMENT AND DESIGN OF GLOBAL COMPUTER NETWORK WEBSITES (U.S. CLS. 100 AND 101).

FIRST USE 12-0-1997; IN COMMERCE 12-0-1997.

**CLASS 42—(Continued).**

SN 75-833,967. EMILY'S LIST, WASHINGTON, DC. FILED 10-28-1999.

**EMILY**

FOR POLITICAL ACTION COMMITTEE SERVICES, NAMELY, PROMOTING THE INTEREST OF WOMEN IN THE FIELD OF POLITICS (U.S. CLS. 100 AND 101).

---

SN 75-835,927. WHERE2NET, INC., REDWOOD CITY, CA. FILED 10-29-1999.

**WHERE2NET**

FOR COMPUTER PROGRAMMING FOR OTHERS AND CONSULTING SERVICES TO PERMIT RETAILERS AND THEIR CUSTOMERS TO ACCESS CONTENT OVER A GLOBAL INFORMATION NETWORK, WIRELESS COMMUNICATION NETWORK AND TRADITIONAL TELEPHONE NETWORK (U.S. CLS. 100 AND 101).

---

SN 75-836,388. SODEXHO OPERATIONS, LLC, GAITHERSBURG, MD. BY MERGER SODEXHO MARRIOTT OPERATIONS, INC., GAITHERSBURG, MD. FILED 10-29-1999.



THE MARK CONSISTS IN PART OF THE DESIGN OF A BOWL OF SOUP AND A PIZZA.

FOR PREPARING AND SERVING FOODS IN INSTITUTIONAL DINING FACILITIES (U.S. CLS. 100 AND 101).

FIRST USE 7-1-1999; IN COMMERCE 7-1-1999.

---

SN 75-836,472. HOLBROOK, PHILIP, HOUSTON, TX. FILED 10-29-1999.

**FORCE BALANCED**

FOR CONSULTATION IN THE SCIENCE FIELD, NAMELY PROVIDING INTER-RELATED MATERIAL PROPERTIES COEFFICIENTS AND LOADS FOR SURFACE ENGINEERING OPERATIONS (U.S. CLS. 100 AND 101).

FIRST USE 10-1-1999; IN COMMERCE 10-1-1999.

**CLASS 42—(Continued).**

SN 75-843,341. TRENT, JOHN, SCOTTSDALE, AZ. FILED 11-8-1999.

**STRONGFAMILIES.COM**

FOR PROVIDING INFORMATION, AVAILABLE VIA A GLOBAL COMPUTER NETWORK IN AUDIO OR VIDEO FORMAT IN THE FIELD OF INDIVIDUAL MARRIAGE AND FAMILY RELATIONSHIPS; COMPUTER SERVICES, NAMELY PROVIDING ON-LINE BOOKLETS, WORKBOOKS, NEWSLETTERS IN THE FIELD OF INDIVIDUAL MARRIAGE AND FAMILY RELATIONSHIPS; PROVIDING VIDEO AND AUDIO ON-LINE TRAINING MATERIALS USED BY PASTORS, MARRIAGE COUNSELORS, AND FAMILY COUNSELORS IN THE FIELD OF INDIVIDUAL MARRIAGE AND FAMILY RELATIONSHIPS (U.S. CLS. 100 AND 101).

FIRST USE 10-1-1999; IN COMMERCE 10-1-1999.

---

SN 75-851,499. NGUYEN, THINH V., LOS GATOS, CA. FILED 11-16-1999.

**DENTALCAREWEB**

FOR PROVIDING DATABASES FEATURING NEWS AND INFORMATION, ABOUT DENTISTRY, DENTAL HEALTH, ORAL HYGIENE, ORAL DISEASE, DENTAL CURES, DENTAL MEDICINE, AND DENTAL TREATMENT VIA A GLOBAL COMPUTER NETWORK; DENTAL DIAGNOSIS, TREATMENT, COUNSELING, EDUCATION AND ADVICE VIA A GLOBAL COMPUTER NETWORK; PROVIDING DENTISTRY SERVICES, NAMELY, DENTAL DIAGNOSIS, TREATMENT AND COUNSELING VIA A GLOBAL COMPUTE NETWORK (U.S. CLS. 100 AND 101).

---

SN 75-860,654. LIBERTY HEALTHCARE CORPORATION, BALA CYNWYD, PA. FILED 11-30-1999.

**LIBERTY FAMILY HEALTH CENTER**

OWNER OF U.S. REG. NOS. 1,529,976, 2,234,507 AND OTHERS.

NO CLAIM IS MADE TO THE EXCLUSIVE RIGHT TO USE "FAMILY HEALTH CENTER", APART FROM THE MARK AS SHOWN.

FOR OUTPATIENT MEDICAL SERVICES (U.S. CLS. 100 AND 101).

**CLASS 42—(Continued).**

SN 75-869,116. ENVIROTECH CLEAN AIR, INC., CAMBRIDGE, MA. FILED 12-10-1999.



NO CLAIM IS MADE TO THE EXCLUSIVE RIGHT TO USE "TECH", APART FROM THE MARK AS SHOWN.

THE MARK IS LINED FOR THE COLOR SKY-BLUE. THE MARK CONSISTS OF THE DESIGN OF CLOUDS AND THE WORDS "ENVIROTECH", "ENVIRO" IS ENCLOSED IN A BLOCK.

FOR ENVIRONMENTAL CONSULTATION AND ENVIRONMENTAL MANAGEMENT CONSULTING SERVICES (U.S. CLS. 100 AND 101).

FIRST USE 10-12-1998; IN COMMERCE 10-12-1998.

SN 75-873,163. E-COMMERCE SOLUTIONS, INC., FAIRFAX, VA. FILED 12-17-1999.

**EMPIRE.BUILDER**

FOR COMPUTER CONSULTATION SERVICES, NAMELY, CONSULTING ON THE APPLICATION AND IMPLEMENTATION OF COMPUTER SYSTEMS, INSTALLATION AND MAINTENANCE OF COMPUTER SOFTWARE; CUSTOM DESIGN OF COMPUTER SOFTWARE AND COMPUTER SYSTEMS, AND COMPATIBILITY (U.S. CLS. 100 AND 101).

FIRST USE 10-1-1999; IN COMMERCE 10-1-1999.

SN 75-877,618. FRANCIS, SHANTE', GERMANTOWN, MD. FILED 12-20-1999.



APPLE ON THE TREE, AND THE LETTER "G" IN THE WORD "TANGIBLE" ARE LINED FOR THE COLOR RED.

FOR WRITING SERVICES, NAMELY, COMPOSING POEMS AND SONG LYRICS FOR OTHERS (U.S. CLS. 100 AND 101).

**CLASS 42—(Continued).**

SN 75-877,979. HASSLER & MAIR GMBH, 86167 AUGSBURG, FED REP GERMANY, FILED 12-22-1999.

**HYPERCARRIER**

FOR COMPUTER PROGRAMMING FOR OTHERS (U.S. CLS. 100 AND 101).

SN 75-881,972. KULCHYSKI, ADAM SCOTT, OAKVILLE, ONTARIO, CANADA. FILED 12-27-1999.

**NETINSTINCT**

FOR COMPUTER SERVICES, NAMELY, WEB SITE DESIGN FOR OTHERS; HOSTING THE WEB SITES OF OTHERS ON A GLOBAL COMPUTER NETWORK; REGISTRATION OF DOMAIN NAMES FOR IDENTIFICATION OF USERS ON A GLOBAL COMPUTER NETWORK; AND MAINTENANCE OF WEB SITES FOR OTHERS (U.S. CLS. 100 AND 101).

FIRST USE 8-21-1998; IN COMMERCE 8-21-1998.

SN 75-897,504. SALES ON LINE DIRECT, INC., WORCESTER, MA. FILED 1-18-2000.

**COLLECTING EXCHANGE**

NO CLAIM IS MADE TO THE EXCLUSIVE RIGHT TO USE "EXCHANGE", APART FROM THE MARK AS SHOWN.

FOR PROVIDING ONLINE COMPUTER DATABASES FEATURING INFORMATION ON ANTIQUES AND OTHER COLLECTIBLE ITEMS FOR BUYERS AND SELLERS (U.S. CLS. 100 AND 101).

SN 75-906,648. LASTAR.COM, INC, DAYTON, OH. FILED 2-1-2000.

**SUPPORTING THE EVOLUTION OF EBUSINESS**

NO CLAIM IS MADE TO THE EXCLUSIVE RIGHT TO USE "EBUSINESS", APART FROM THE MARK AS SHOWN. FOR COMPUTER CONSULTATION SERVICES (U.S. CLS. 100 AND 101).

FIRST USE 11-9-1999; IN COMMERCE 11-9-1999.

**CLASS 42—(Continued).**

SN 75-908,031. TOSHIBA AMERICA MEDICAL SYSTEMS, INC., TUSTIN, CA. FILED 2-1-2000.

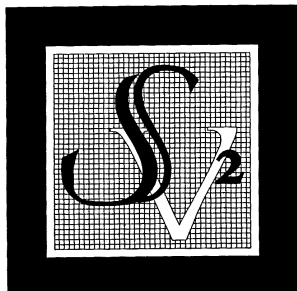

THE LINING IN THE DRAWING IS FOR SHADING PURPOSES ONLY AND DOES NOT INDICATE COLOR.

FOR PROVIDING AN INTERACTIVE WEBSITE FEATURING A VIRTUAL VISIT TO A MEDICAL FACILITY IN WHICH VISITORS CAN SIMULATE THE OPERATION OF MEDICAL DEVICES AND INTERACT WITH HEALTHCARE WORKERS (U.S. CLS. 100 AND 101).

FIRST USE 12-1-1999; IN COMMERCE 12-1-1999.

---

SN 75-910,115. GRANGER TELECOM CORPORATION, SAN ANTONIO, TX. FILED 1-26-2000.

**GRANGER TELECOM**

NO CLAIM IS MADE TO THE EXCLUSIVE RIGHT TO USE "TELECOM", APART FROM THE MARK AS SHOWN.

FOR TELECOMMUNICATION SERVICES, NAMELY, THE DESIGN AND IMPLEMENTATION OF MICROWAVE SYSTEMS, ANTENNA SYSTEMS, CELLULAR ANTENNA SYSTEMS, PCS ANTENNA SYSTEMS, ANALOG RADIO SYSTEMS, MULTIPLEXING SYSTEMS AND COMPUTERS, COMPUTER NETWORKS, DATA CENTERS AND COMPUTER SYSTEMS; COMPUTER CONSULTING RELATED TO THE TELECOMMUNICATION SYSTEM (U.S. CLS. 100 AND 101).

---

SN 75-914,539. GODSPEAKS, INC., ATLANTA, GA. FILED 2-5-2000.

**"NEED DIRECTION?" - GOD**

SEC. 2(F).  
FOR EVANGELISTIC AND MINISTERIAL SERVICES (U.S. CLS. 100 AND 101).

FIRST USE 9-0-1998; IN COMMERCE 9-0-1998.

**CLASS 42—(Continued).**

SN 75-918,139. LOUDCLOUD, INC., SUNNYVALE, CA. FILED 2-14-2000.

**BILLING CLOUD**

NO CLAIM IS MADE TO THE EXCLUSIVE RIGHT TO USE "BILLING", APART FROM THE MARK AS SHOWN.

FOR CONSULTATION IN THE TECHNICAL FACILITATION OF ELECTRONIC COMMERCE AND BUSINESS TRANSACTIONS VIA A GLOBAL COMPUTER NETWORK; CONSULTATION IN THE FIELDS OF COMPUTER SOFTWARE, COMPUTER HARDWARE, COMPUTER HARDWARE DESIGN, INFORMATION TECHNOLOGY AND COMPUTER NETWORKS; COMPUTER SOFTWARE DESIGN FOR OTHERS; TECHNICAL SUPPORT SERVICES, NAMELY, TROUBLESHOOTING, MONITORING AND CONTROLLING COMPUTER HARDWARE AND SOFTWARE VIA A GLOBAL COMPUTER NETWORK; INSTALLATION, OPERATION AND MAINTENANCE OF COMPUTER SOFTWARE; CREATING AND MAINTAINING WEBSITES FOR OTHERS; DESIGNING AND IMPLEMENTING NETWORK WEB PAGES FOR OTHERS; HOSTING THE WEBSITES OF OTHERS ON A COMPUTER SERVER FOR A GLOBAL COMPUTER NETWORK; REPAIR AND INSTALLATION SERVICES FOR COMPUTER SOFTWARE; PROVIDING ONLINE INFORMATION IN THE FIELD OF INTERNET INFRASTRUCTURE, NAMELY, THE LINKING OF COMPUTERS AND COMPUTER NETWORKS, WEBSITE DEVELOPMENT AND MANAGEMENT, COMPUTER HARDWARE AND SOFTWARE FOR THE DESIGN, DEVELOPMENT, MANAGEMENT AND IMPLEMENTATION OF ELECTRONIC COMMERCE SYSTEMS AND WEBSITES (U.S. CLS. 100 AND 101).

---

SN 75-922,794. CAPITAL HOTELS, WASHINGTON, DC. FILED 2-22-2000.

**CAPITAL HOTELS AND SUITES**

NO CLAIM IS MADE TO THE EXCLUSIVE RIGHT TO USE "HOTELS AND SUITES", APART FROM THE MARK AS SHOWN.

FOR HOTEL SERVICES (U.S. CLS. 100 AND 101).

---

SN 75-925,630. HEALTHSYSTEM MINNESOTA, ST. LOUIS PARK, MN. FILED 2-22-2000.

**PARK NICOLLET CLINIC**

OWNER OF U.S. REG. NOS. 1,387,829, 1,397,997 AND 2,001,823.

NO CLAIM IS MADE TO THE EXCLUSIVE RIGHT TO USE "CLINIC", APART FROM THE MARK AS SHOWN.

FOR HEALTH CARE AND MEDICAL RESEARCH SERVICES (U.S. CLS. 100 AND 101).

FIRST USE 4-0-1995; IN COMMERCE 4-0-1995.



**CLASS 42—(Continued).**

SN 75-925,633. PARK NICOLLET HEALTH SERVICES, ST LOUIS PARK, MN. BY CHANGE OF NAME HEALTH-SYSTEM MINNESOTA, ST. LOUIS PARK, MN. FILED 2-22-2000.

**PARK NICOLLET**

OWNER OF U.S. REG. NOS. 1,387,829, 1,397,997 AND 2,001,823.

FOR HEALTH CARE AND MEDICAL RESEARCH SERVICES (U.S. CLS. 100 AND 101).

FIRST USE 8-1-1984; IN COMMERCE 8-1-1984.

SN 75-929,102. TREAT, J. STEVEN, HENDERSON, TX. FILED 2-28-2000.



NO CLAIM IS MADE TO THE EXCLUSIVE RIGHT TO USE "GOOD MEXICAN FOOD", APART FROM THE MARK AS SHOWN.

THE STIPPLING IS A FEATURE OF THE MARK AND IS NOT INTENDED TO INDICATE COLOR.

FOR RESTAURANT AND BAR SERVICES (U.S. CLS. 100 AND 101).

FIRST USE 6-17-1994; IN COMMERCE 6-17-1994.

SN 75-934,564. BAKERY, CONFECTIONERY, TOBACCO WORKERS AND GRAIN MILLERS INTERNATIONAL UNION, KENSINGTON, MD. FILED 3-4-2000.

**BCTGM POWER  
MEMBRECIA TRABAJA  
PARA USTED**

THE ENGLISH TRANSLATION OF "BCTGM POWER MEMBRECIA TRABAJA PARA USTED" IS "BCTGM POWER MEMBERSHIP WORKS FOR YOU".

FOR LABOR UNION SERVICES (U.S. CLS. 100 AND 101).

FIRST USE 7-0-1994; IN COMMERCE 7-0-1994.

SN 75-935,236. IN PHASE INTERNATIONAL, INC., TEMPE, AZ. FILED 2-16-2000.

**LINKUSADENTIST**

FOR PROVIDING MEDICAL INFORMATION VIA THE INTERNET (U.S. CLS. 100 AND 101).

FIRST USE 8-1-1999; IN COMMERCE 8-1-1999.

**CLASS 42—(Continued).**

SN 75-943,314. GODSPEAKS, INC., ATLANTA, GA. FILED 3-15-2000.

**I KNOW WHAT YOU'RE  
GOIN' THROUGH...I HAVE A  
SON - GOD**

NO CLAIM IS MADE TO THE EXCLUSIVE RIGHT TO USE "GOD", APART FROM THE MARK AS SHOWN.

FOR EVANGELICAL, AND MINISTERIAL SERVICES IN THE NATURE OF OFFERING RELIGIOUS INSTRUCTION USING BIBLICALLY-BASED REFERENCES, MESSAGES, AND THOUGHTS TO ENCOURAGE, CHALLENGE, AND SPIRITUALLY STIMULATE READERS AND INDIVIDUALS (U.S. CLS. 100 AND 101).

FIRST USE 3-15-2000; IN COMMERCE 3-15-2000.

SN 75-981,392. RELIANT ENERGY, INCORPORATED, HOUSTON, TX. FILED 1-17-2001.

**RELIANT HALL**

NO CLAIM IS MADE TO THE EXCLUSIVE RIGHT TO USE "HALL", APART FROM THE MARK AS SHOWN.

FOR RESTAURANT AND BAR SERVICES; PROVIDING GENERAL PURPOSE FACILITIES FOR EXHIBITIONS (U.S. CLS. 100 AND 101).

SN 76-000,418. CONNECTED CORPORATION, NATICK, MA. FILED 3-15-2000.



FOR COMPUTER SERVICES, NAMELY ASSISTING CUSTOMERS WITH THE STORAGE AND RETRIEVAL OF NETWORKED FILES VIA A GLOBAL COMPUTER NETWORK (U.S. CLS. 100 AND 101).

SN 76-008,765. ME LICENSING CORPORATION, CLAYMONT, DE. FILED 3-24-2000.

**BIOWORLD SNAPSHOTS**

OWNER OF U.S. REG. NO. 1,650,755.

FOR COMPUTER SERVICES, NAMELY, PROVIDING INFORMATION ON THE BIOTECHNOLOGY INDUSTRY VIA A GLOBAL COMPUTER NETWORK (U.S. CLS. 100 AND 101).

**CLASS 42—(Continued).**

SN 76-024,682. TERRACE SECURITY COMPANY, HOUSTON, TX. FILED 4-13-2000.

**TERRACE SECURITY**

NO CLAIM IS MADE TO THE EXCLUSIVE RIGHT TO USE "SECURITY", APART FROM THE MARK AS SHOWN. FOR SECURITY GUARD SERVICES (U.S. CLS. 100 AND 101).

---

SN 76-026,375. CAMBRIDGE INTERACTIVE, INC., CAMBRIDGE, MA. FILED 4-14-2000.

**POWER STEERING**

FOR PROVIDING TEMPORARY USE OF ON-LINE NON-DOWNLOADABLE COLLABORATIVE GROUPWARE FOR REAL TIME PROJECT MANAGEMENT THAT ALLOWS USERS TO SHARE, UPDATE, ARCHIVE AND RETRIEVE DATA, TEXT, DOCUMENTS, SCHEDULES, LISTS, MESSAGES AND DISCUSSIONS VIA INTERACTIVE DATABASES (U.S. CLS. 100 AND 101). FIRST USE 7-1-1998; IN COMMERCE 1-1-1999.

---

SN 76-026,970. E RESOURCES INC, ROANOKE, TX. FILED 4-17-2000.

**EGROW**

FOR COMPUTER SERVICES, NAMELY, DESIGNING, CREATING, IMPLEMENTING, HOSTING AND MAINTAINING GLOBAL COMPUTER NETWORK SITES FOR OTHERS; DESIGN, HOSTING AND IMPLEMENTING NETWORK WEB PAGES FOR OTHERS; COMPUTER SOFTWARE DESIGN FOR OTHERS (U.S. CLS. 100 AND 101).

---

SN 76-027,837. ESPS, INC., OKEMOS, MI. AND EFFECTIVE SCHOOLS PRODUCTS, LTD., OKEMOS, MI. FILED 4-17-2000.

**EFFECTIVE  
SCHOOLS LEAGUE**

NO CLAIM IS MADE TO THE EXCLUSIVE RIGHT TO USE "LEAGUE", APART FROM THE MARK AS SHOWN.

FOR ASSOCIATION SERVICES, NAMELY, AN ON-LINE ORGANIZATION OF PREDOMINATELY K-12 TEACHERS AND ADMINISTRATORS RESPONSIBLE FOR PLANNING AND IMPLEMENTING PROGRAMS DESIGNED TO IMPROVE STUDENT LEARNING AND STUDENT ACHIEVEMENT (U.S. CLS. 100 AND 101). FIRST USE 2-24-2000; IN COMMERCE 2-24-2000.

**CLASS 42—(Continued).**

SN 76-032,684. EMOTION, INC., VIENNA, VA. FILED 4-25-2000.



FOR COMPUTER CONSULTATION; COMPUTER SYSTEMS ANALYSIS; COMPUTER SERVICES, NAMELY CREATING AND MAINTAINING WEB SITES FOR OTHERS; COMPUTER SERVICES, NAMELY DESIGNING AND IMPLEMENTING WEB SITES FOR OTHERS; COMPUTER SERVICES, NAMELY PROVIDING SEARCH ENGINES FOR OBTAINING DATA ON A GLOBAL COMMUNICATIONS NETWORK (U.S. CLS. 100 AND 101). FIRST USE 2-0-2000; IN COMMERCE 3-0-2000.

---

SN 76-032,685. EMOTION, INC., VIENNA, VA. FILED 4-25-2000.



FOR COMPUTER PROGRAMMING FOR OTHERS; COMPUTER SOFTWARE DESIGN AND CUSTOMIZATION FOR OTHERS (U.S. CLS. 100 AND 101). FIRST USE 2-0-2000; IN COMMERCE 3-0-2000.

---

SN 76-032,687. EMOTION, INC., VIENNA, VA. FILED 4-25-2000.

eMotion

FOR COMPUTER PROGRAMMING FOR OTHERS; COMPUTER SOFTWARE DESIGN AND CUSTOMIZATION FOR OTHERS (U.S. CLS. 100 AND 101). FIRST USE 2-0-2000; IN COMMERCE 3-0-2000.

---

SN 76-034,372. NII COMMUNICATIONS, LTD., SAN ANTONIO, TX. BY MERGER NETWORK INTELLIGENCE, INC., SAN ANTONIO, TX. FILED 4-24-2000.

**NII COMMUNICATIONS**

NO CLAIM IS MADE TO THE EXCLUSIVE RIGHT TO USE "COMMUNICATIONS", APART FROM THE MARK AS SHOWN.

FOR HOSTING WEB SITES OF OTHERS ON A COMPUTER SERVER FOR A GLOBAL COMPUTER NETWORK; DESIGNING AND IMPLEMENTING WEB SITES FOR OTHERS (U.S. CLS. 100 AND 101).

**CLASS 42—(Continued).**

SN 76-034,395. NII COMMUNICATIONS, LTD., SAN ANTONIO, TX. BY MERGER NETWORK INTELLIGENCE, INC., SAN ANTONIO, TX. FILED 4-24-2000.

## TELECOMMUNICATIONS THAT MAKES SENSE

NO CLAIM IS MADE TO THE EXCLUSIVE RIGHT TO USE "TELECOMMUNICATIONS", APART FROM THE MARK AS SHOWN.

FOR HOSTING WEB SITES OF OTHERS ON A COMPUTER SERVER FOR A GLOBAL COMPUTER NETWORK; DESIGNING AND IMPLEMENTING WEB SITES FOR OTHERS (U.S. CLS. 100 AND 101).

SN 76-034,731. TELEDYNAMICS GROUP, INC., CLEARWATER, FL. FILED 4-26-2000.

## MED CENTRAL

NO CLAIM IS MADE TO THE EXCLUSIVE RIGHT TO USE "MED", APART FROM THE MARK AS SHOWN.

FOR PROVIDING INTERACTIVE HEALTHCARE AND DRUG INFORMATION BY TELEPHONE (U.S. CLS. 100 AND 101).

SN 76-034,859. MEDORIS HOLDING CORPORATION, SAN DIEGO, CA. FILED 4-25-2000.



THE STIPPLING IN THE DRAWING IS A FEATURE OF THE MARK AND IS NOT USED TO INDICATE COLORING.

FOR ASSOCIATION SERVICES, NAMELY, PROMOTING THE INTERESTS OF WHOLESALERS, MANUFACTURERS AND GROUP PURCHASING BUSINESS ORGANIZATIONS AND HEALTHCARE PROFESSIONALS (U.S. CLS. 100 AND 101).

SN 76-037,249. KRAFT FOODS HOLDINGS, INC., NORTHFIELD, IL. FILED 4-28-2000.



NO CLAIM IS MADE TO THE EXCLUSIVE RIGHT TO USE "FOODSPEC", APART FROM THE MARK AS SHOWN.

FOR COMPUTER SERVICES, NAMELY, PROVIDING ON-LINE INFORMATION REGARDING VARIOUS FOOD INDUSTRY SPECIFICATIONS (U.S. CLS. 100 AND 101).

**CLASS 42—(Continued).**

SN 76-040,420. WURZER, MARTIN, MUNCHEN, FED REP GERMANY, FILED 5-4-2000.

**eyeQueue**



OWNER OF FED REP GERMANY REG. NO. 39867192, DATED 3-11-1999, EXPIRES 11-30-2008.

THE STIPPLING SHOWN IN THE DRAWING IS A FEATURE OF THE MARK AND IS NOT INTENDED TO INDICATE COLOR.

THE DESIGN PORTION OF THE MARK CONSISTS OF A STYLIZED EYE.

FOR COMPUTER PROGRAMMING SERVICES IN THE FIELD OF MOTION PICTURE CLIP ART (U.S. CLS. 100 AND 101).

SN 76-041,286. PHATRAT TECHNOLOGY, INC., LONGMONT, CO. FILED 5-4-2000.

## SPINRAT

FOR SCIENTIFIC MEASUREMENT SERVICES FOR SPORTING PURPOSES, NAMELY, PROVIDING SCIENTIFIC INFORMATION CONCERNING THE ROTATION OF ATHLETES AND VEHICLES; MEASUREMENT EVALUATION OF ATHLETE AND VEHICLE ROTATION (U.S. CLS. 100 AND 101).

SN 76-044,370. IDYNAMICS INC., OSHKOSH, WI. FILED 5-9-2000.

## IDYNAMICS

FOR COMPUTER CONSULTATION, NAMELY, ANALYSIS OF COMPUTER SYSTEMS AND CUSTOM DESIGN, DEVELOPMENT, INSTALLATION AND IMPLEMENTATION OF BUSINESS E-COMMERCE SOFTWARE (U.S. CLS. 100 AND 101).

SN 76-045,323. NEXEI, INC., EDINA, MN. FILED 5-10-2000.

## NEXEI

FOR COMPUTER SERVICES, NAMELY, AN APPLICATION SERVICE PROVIDER TO HOST WEB-BASED DATA CONTENT MANAGEMENT AND INFORMATION SYSTEMS SOFTWARE APPLICATIONS ON A COMPUTER SERVER IN THE FIELD OF INFORMATION SYSTEMS FOR ENGINEERING-BASED APPLICATION; ONLINE INFORMATION SERVICES, NAMELY, PROVIDING DATABASES, SEARCH ENGINES AND WEB SITE LINKS TO OTHER CONTENT PROVIDERS IN THE FIELD OF INFORMATION SYSTEMS FOR ENGINEERING-BASED APPLICATIONS FOR PROFESSIONALS VIA A GLOBAL COMPUTER NETWORK (U.S. CLS. 100 AND 101).

**CLASS 42—(Continued).**

SN 76-047,291. KASHANI, FAYE, IRVINE, CA. FILED 5-12-2000.

**SPA ÉLAN VITAL**

NO CLAIM IS MADE TO THE EXCLUSIVE RIGHT TO USE "SPA", APART FROM THE MARK AS SHOWN.

THE ENGLISH TRANSLATION OF "ÉLAN VITAL" LOOSELY MEANS IS "VITAL FORCE", OR "IMPULSE OF LIFE", OR "LIFE FORCE".

FOR HEALTH AND BEAUTY SERVICES, NAMELY MASSAGE, MANICURING AND PEDICURING, HAIR STYLING, FACIALS AND MAKE-UP APPLICATION SERVICES; HEALTH AND FITNESS SPA SERVICES; PHYSICAL THERAPY SERVICES FEATURING JACUZZI WATER THERAPY (U.S. CLS. 100 AND 101).

FIRST USE 1-15-2000; IN COMMERCE 1-15-2000.

---

SN 76-051,451. NEW LIGHT CHURCH AND WORLD OUT-REACH AND WORSHIP CENTERS, INC., HOUSTON, TX. FILED 5-18-2000.

## STEADFAST TEENS OF RIGHTEOUS MORALS

FOR PROVIDING RELIGIOUS MINISTERIAL SERVICES FOR TEENAGERS (U.S. CLS. 100 AND 101).  
FIRST USE 2-0-1999; IN COMMERCE 2-0-1999.

---

SN 76-055,031. HORTY, ELVING & ASSOCIATES, INC., MINNEAPOLIS, MN. FILED 5-23-2000.

## THE HEA GROUP

NO CLAIM IS MADE TO THE EXCLUSIVE RIGHT TO USE "GROUP", APART FROM THE MARK AS SHOWN.

FOR ARCHITECTURAL DESIGN FOR OTHERS AND ENGINEERING (U.S. CLS. 100 AND 101).

FIRST USE 1-1-1995; IN COMMERCE 1-1-1995.

---

SN 76-058,570. PENNIE & EDMONDS LLP, NEW YORK, NY. FILED 5-30-2000.

## PENNIE.COM

OWNER OF U.S. REG. NOS. 2,054,266 AND 2,231,029. FOR LEGAL SERVICES (U.S. CLS. 100 AND 101).

**CLASS 42—(Continued).**

SN 76-062,408. NEMEX INC., GREENWICH, CT. FILED 6-5-2000.

## RELIGIOUS CONNECTIONS

FOR APPLICATION SERVICE PROVIDER FEATURING INTERACTIVE SOFTWARE APPLICATIONS FOR USE BY MEMBER BASED ORGANIZATIONS, THEIR MEMBERS AND SUPPLIERS (U.S. CLS. 100 AND 101).

---

SN 76-066,000. FIERCEMARKETS, INC., WASHINGTON, DC. FILED 6-8-2000.

## FIERCEWIRELESS

FOR PROVIDING ONLINE PUBLICATIONS, NAMELY, NEWSLETTERS TO THE WIRELESS AND INTERNET INDUSTRIES FEATURING NEWS, BUSINESS AND GENERAL INTEREST THAT CAN BE ACCESSED VIA ELECTRONIC MAIL; ONLINE INFORMATION SERVICES, NAMELY PROVIDING DATABASES AND INFORMATION FEATURING NEWS, BUSINESS AND GENERAL INTEREST TO THE WIRELESS AND INTERNET INDUSTRIES (U.S. CLS. 100 AND 101).

FIRST USE 2-28-2000; IN COMMERCE 2-28-2000.

---

SN 76-067,689. SEAWEST WINDPOWER, INC., SAN DIEGO, CA. FILED 6-12-2000.

## WINDPOWER FOR A CLEAN FUTURE

FOR SURVEYING AND ENGINEERING SERVICES; TESTING AND COMMISSIONING OF WIND PARKS; ENERGY USAGE MANAGEMENT SERVICES; INSTALLATION, UPDATE AND MAINTENANCE SERVICES FOR COMPUTER SOFTWARE (U.S. CLS. 100 AND 101).  
FIRST USE 2-25-1999; IN COMMERCE 2-25-1999.

---

SN 76-068,886. VORTALLOGIC, INC., ROSWELL, GA. FILED 6-12-2000.



FOR COMPUTER SERVICES, NAMELY, DESIGNING AND IMPLEMENTING WEB SITES FOR OTHERS; COMPUTER SOFTWARE DESIGN FOR OTHERS (U.S. CLS. 100 AND 101).

FIRST USE 1-20-2000; IN COMMERCE 1-20-2000.

**CLASS 42—(Continued).**

SN 76-071,166. GLOBAL CLOUD, LTD., CINCINNATI, OH.  
FILED 6-15-2000.

**GLOBAL CLOUD**

FOR COMPUTER SERVICES, NAMELY, GLOBAL COMPUTER NETWORK DEVELOPMENT, WEB SITE DESIGN, WEB SITE CONSULTING, DATABASE DESIGN DEVELOPMENT, AND COMPUTER MIDDLEWARE DEVELOPMENT (U.S. CLS. 100 AND 101).

FIRST USE 8-0-1997; IN COMMERCE 8-0-1997.

SN 76-072,189. TURIN NETWORKS, INC., PETALUMA, CA.  
FILED 6-12-2000.



NO CLAIM IS MADE TO THE EXCLUSIVE RIGHT TO USE "NETWORKS", APART FROM THE MARK AS SHOWN.

FOR TECHNICAL CONSULTATION IN THE FIELD OF TELECOMMUNICATIONS AND DATA COMMUNICATIONS SERVICES, NAMELY, DESIGNING DISTRIBUTED BROADBAND ACCESS SERVICES (U.S. CLS. 100 AND 101).

SN 76-074,038. GADGETSPACE, INC., CARY, NC. FILED 6-19-2000.

**GADGETSPACE**

FOR COMPUTER SERVICES, NAMELY, PROVIDING ONLINE COMPUTER SOFTWARE APPLICATIONS FOR OTHERS, ENABLING BI-DIRECTIONAL DIALOG BETWEEN INTERNET BASED APPLICATIONS AND MOBILE DEVICES FOR FACILITATING REAL-TIME COMMERCIAL TRANSACTIONS AND INFORMATION EXCHANGE VIA WIRELESS DEVICES, NAMELY, MOBILE TELEPHONES, PERSONAL DIGITAL ASSISTANTS AND HAND HELD ELECTRONIC DEVICES, VIA A GLOBAL COMPUTER NETWORK (U.S. CLS. 100 AND 101).

FIRST USE 1-8-2000; IN COMMERCE 1-8-2000.

SN 76-077,115. AMICAS, INC., NEWTON, MA. FILED 6-26-2000.

**AMICAS**

FOR TECHNICAL CONSULTATION IN THE FIELD OF COMPUTERS, NAMELY THE INSTALLATION, CONFIGURATION, INTEGRATION AND SUPPORT OF COMPUTER SOFTWARE IN CONJUNCTION WITH TELERADIOLOGY, PICTURE ARCHIVING AND COMMUNICATIONS SYSTEMS (PACS) TELEMEDICINE AND ENTERPRISE IMAGE DISTRIBUTION (U.S. CLS. 100 AND 101).

FIRST USE 6-1-1996; IN COMMERCE 6-1-1996.

**CLASS 42—(Continued).**

SN 76-077,282. HAUSER, HILLARY, SANTA BARBARA, CA.  
FILED 6-26-2000.



THE MARK CONSISTS IN PART OF REPRESENTATION OF WAVES, DOLPHINS, SUN.

FOR PROMOTING THE PUBLIC AWARENESS OF THE NEED FOR ENVIRONMENTAL PROTECTION AND MARINE CONSERVATION AS IT RELATES TO THE SANTA BARBARA COUNTY COASTLINE (U.S. CLS. 100 AND 101).

FIRST USE 8-25-1998; IN COMMERCE 8-25-1998.

SN 76-077,582. WESTBROOK VILLAGE ASSOCIATION,  
PEORIA, AZ. FILED 6-26-2000.



NO CLAIM IS MADE TO THE EXCLUSIVE RIGHT TO USE "VILLAGE ASSN.", APART FROM THE MARK AS SHOWN.

FOR HOMEOWNERS ASSOCIATION SERVICES PROMOTING THE INTERESTS OF THE ASSOCIATION HOMEOWNERS, NAMELY, COVENANTS, CONDITIONS AND RESTRICTIONS CC&R COMPLIANCE MANAGEMENT (U.S. CLS. 100 AND 101).

FIRST USE 12-15-1982; IN COMMERCE 12-15-1982.

SN 76-080,256. WAVEBEND SOLUTIONS, L.L.C., CHICAGO,  
IL. FILED 6-29-2000.

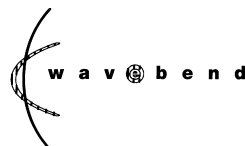

FOR TECHNICAL CONSULTATION IN THE FIELD OF INFORMATION TECHNOLOGY, NAMELY STRATEGY DEVELOPMENT AND ANALYSIS, INTEGRATION, IMPLEMENTATION AND WEB APPLICATION ARCHITECTURE AND CONSTRUCTION (U.S. CLS. 100 AND 101).

FIRST USE 5-9-2000; IN COMMERCE 5-9-2000.

**CLASS 42—(Continued).**

SN 76-080,820. ALACHUA COUNTY FIRE RESCUE, GAINESVILLE, FL. FILED 6-29-2000.



NO CLAIM IS MADE TO THE EXCLUSIVE RIGHT TO USE "ALACHUA COUNTY FIRE RESCUE PUBLIC SAFETY" AND THE CADEUS AND STAR, APART FROM THE MARK AS SHOWN.

FOR FIRE FIGHTING; EMERGENCY MEDICAL ASSISTANCE (U.S. CLS. 100 AND 101).  
FIRST USE 10-1-1992; IN COMMERCE 10-1-1992.

SN 76-081,223. DREAMS ARE FREE, VENICE, FL. FILED 6-30-2000.



FOR PROMOTING PUBLIC AWARENESS OF THE NEED FOR EDUCATING CHILDREN WITH SPECIAL LEARNING NEEDS (U.S. CLS. 100 AND 101).

FIRST USE 7-0-1994; IN COMMERCE 7-0-1994.

SN 76-081,253. THOMPSON, DENNIS, CHARLOTTE, NC. FILED 6-30-2000.

## JOEY D'S OLD-NEIGHBORHOOD ITALIAN

NO CLAIM IS MADE TO THE EXCLUSIVE RIGHT TO USE "ITALIAN", APART FROM THE MARK AS SHOWN.

"JOEY D" IS NOT A LIVING INDIVIDUAL.  
FOR RESTAURANT SERVICES (U.S. CLS. 100 AND 101).

FIRST USE 10-5-2000; IN COMMERCE 10-5-2000.

**CLASS 42—(Continued).**

SN 76-083,397. BAY PARK COMMUNITY HOSPITAL, TOLEDO, OH. FILED 7-5-2000.

## BAY PARK COMMUNITY HOSPITAL

NO CLAIM IS MADE TO THE EXCLUSIVE RIGHT TO USE "COMMUNITY HOSPITAL", APART FROM THE MARK AS SHOWN.

FOR MEDICAL AND HEALTH CARE SERVICES (U.S. CLS. 100 AND 101).  
FIRST USE 5-15-1999; IN COMMERCE 5-15-1999.

SN 76-083,734. QWEST CYBER.SOLUTIONS LLC, DENVER, CO. FILED 7-6-2000.

## PLUG 'N' PLAY

FOR COMPUTER SERVICES, NAMELY PROVIDING APPLICATION MANAGEMENT AND HOSTING SERVICES FOR BUSINESS APPLICATIONS; PROVIDING MAINTENANCE AND SUPPORT FOR BUSINESS APPLICATION SOFTWARE (U.S. CLS. 100 AND 101).  
FIRST USE 5-24-2000; IN COMMERCE 5-24-2000.

SN 76-086,328. LASER SURGE, INC., DBA LSI SOLUTIONS, ROCHESTER, NY. FILED 7-11-2000.

## ACCELERATING PRECISION

FOR CONSULTING SERVICES IN THE FIELD OF MEDICAL INSTRUMENTS. DESIGNING MEDICAL INSTRUMENTS FOR OTHERS (U.S. CLS. 100 AND 101).

SN 76-087,329. HUMMINGBIRD SOCIETY, THE, NEWARK, DE. FILED 7-10-2000.

## HUMMERCARD

FOR PROVIDING TEMPORARY USE OF ON-LINE NON-DOWNLOADABLE SOFTWARE FOR CREATING AND SENDING ELECTRONIC GREETING CARDS VIA A GLOBAL COMPUTER NETWORK (U.S. CLS. 100 AND 101).

FIRST USE 6-20-2000; IN COMMERCE 6-20-2000.

SN 76-089,507. INETSOLUTION, INC., ALMONT, MI. FILED 7-17-2000.

## INETSOLUTION

FOR INTERNET WEB SITE DEVELOPMENT, SOFTWARE DEVELOPMENT FOR OTHERS, INTERNET WEB HOSTING SERVICES, INTERNET CONSULTING SERVICES (U.S. CLS. 100 AND 101).

FIRST USE 6-9-1998; IN COMMERCE 6-9-1998.

**CLASS 42—(Continued).**

SN 76-093,716. GINGOLD, RUSSELL, UPLAND, CA. FILED 7-24-2000.

**DR. LIBIDO**

FOR CONSULTATION IN THE FIELD OF SEX (U.S. CLS. 100 AND 101).

---

SN 76-093,718. GINGOLD, RUSSELL, UPLAND, CA. FILED 7-24-2000.

**LIBIDO LOUNGE**

NO CLAIM IS MADE TO THE EXCLUSIVE RIGHT TO USE "LIBIDO", APART FROM THE MARK AS SHOWN.  
FOR CONSULTATION IN THE FIELD OF SEX (U.S. CLS. 100 AND 101).

---

SN 76-093,745. ALBATROS, S.L., 28014 MADRID, SPAIN, FILED 7-21-2000.



OWNER OF SPAIN REG. NO. 2288488, DATED 6-20-2000, EXPIRES 6-20-2010.

FOR TECHNICAL PROJECT STUDIES IN THE FIELD OF AIR CONDITIONING AND HEATING FOR THE TRAIN INDUSTRY (U.S. CLS. 100 AND 101).

---

SN 76-093,785. JOE'S STONE CRAB DEVELOPMENT COMPANY, LLC, CHICAGO, IL. FILED 7-24-2000.

**JOE'S SEAFOOD, PRIME STEAK & STONE CRAB**

NO CLAIM IS MADE TO THE EXCLUSIVE RIGHT TO USE "SEAFOOD, PRIME STEAK & STONE CRAB", APART FROM THE MARK AS SHOWN.

FOR RESTAURANT SERVICES (U.S. CLS. 100 AND 101).

**CLASS 42—(Continued).**

SN 76-095,744. OPENSTREAM, INC., EDISON, NJ. FILED 7-24-2000.

**OPENSTREAM**

FOR COMPUTER CONSULTING SERVICES, NAMELY CONSULTATION IN THE FIELD OF WIRELESS INFORMATION TRANSMISSION, WEB-TO-WIRELESS TRANSMISSION FEATURING SPEECH COMPONENTS, WEB SITE CONTENT AND INTERACTIVE APPLICATION DEVELOPMENT AND CONVERSION; WEB-TO-WIRELESS CONTENT EXCHANGE SERVICES AND WIRELESS TECHNOLOGY HOSTING SERVICES, NAMELY, PROVIDING WIRELESS TELECOMMUNICATIONS CONNECTIONS TO A GLOBAL COMPUTER NETWORK (U.S. CLS. 100 AND 101).

---

SN 76-096,174. QWEST COMMUNICATIONS INTERNATIONAL INC., DENVER, CO. FILED 7-25-2000.

**PAYSA**

FOR INTEGRATION OF COMPUTER SYSTEMS AND NETWORKS FOR SOFTWARE VENDORS, DEVELOPERS AND APPLICATION SERVICE PROVIDERS; HOSTING THE WEBSITES OF SOFTWARE VENDORS, DEVELOPERS AND APPLICATION SERVICE PROVIDERS ON A COMPUTER SERVER FOR A GLOBAL COMPUTER NETWORK; APPLICATION MANAGEMENT SERVICES FOR SOFTWARE VENDORS, DEVELOPERS AND APPLICATION SERVICE PROVIDERS (U.S. CLS. 100 AND 101).

---

SN 76-100,516. DRUGABUSE SCIENCES, INC., LOS ALTOS, CA. FILED 7-31-2000.

**ALCOPEDIA**

FOR PROVIDING A WEB SITE ON A GLOBAL COMPUTER NETWORK, FEATURING INFORMATION CONCERNING ALCOHOL ABUSE, ALCOHOL ADDICTION AND TREATMENT THEREFORE, INCLUDING LINKS TO OTHER RELATED SITES (U.S. CLS. 100 AND 101).

---

SN 76-102,371. PENINSULA COMMUNITY FOUNDATION, SAN MATEO, CA. FILED 8-2-2000.

**RAISING A READER**

OWNER OF U.S. REG. NO. 2,341,424.  
FOR SOCIAL SERVICES, NAMELY PROVIDING BOOKS TO PARENTS AND CHILD CARE PROVIDERS IN ORDER TO PROMOTE BOOK SHARING AND EMOTIONAL BONDING WITH PRE-SCHOOL CHILDREN (U.S. CLS. 100 AND 101).

**CLASS 42—(Continued).**

SN 76-103,330. STATE STREET CORPORATION, BOSTON, MA. FILED 8-4-2000.

**STATE STREET GLOBAL  
OUTREACH (GO TEAM)**

OWNER OF U.S. REG. NOS. 1,713,605, 2,239,251 AND OTHERS.

NO CLAIM IS MADE TO THE EXCLUSIVE RIGHT TO USE "OUTREACH", APART FROM THE MARK AS SHOWN.

SEC. 2(F) AS TO "GLOBAL".

FOR CHARITABLE SERVICES, NAMELY, ORGANIZING AND CONDUCTING VOLUNTEER PROGRAMS AND COMMUNITY SERVICE PROJECTS; PROMOTING PUBLIC AWARENESS OF THE NEED FOR VOLUNTEER SERVICES (U.S. CLS. 100 AND 101).

SN 76-105,651. SOTAS, INC., GAITHERSBURG, MD. FILED 8-8-2000.



FOR TECHNICAL SUPPORT SERVICE FOR TELEPHONE COMMUNICATIONS PROVIDED BY TELEPHONE, E-MAIL AND IN PERSON (U.S. CLS. 100 AND 101).

SN 76-111,187. PARK NICOLLET INSTITUTE, ST. LOUIS PARK, MN. FILED 8-17-2000.

**PARK NICOLLET HEALTH  
ADVISOR**

OWNER OF U.S. REG. NOS. 1,397,997 AND 2,001,823.

NO CLAIM IS MADE TO THE EXCLUSIVE RIGHT TO USE "HEALTH", APART FROM THE MARK AS SHOWN.

FOR PROVIDING INFORMATION RELATING TO HEALTH THROUGH A GLOBAL COMPUTER NETWORK (U.S. CLS. 100 AND 101).

**CLASS 42—(Continued).**

SN 76-112,758. HEALTHCARE TECHNOLOGY SYSTEMS, LLC, MADISON, WI. FILED 8-18-2000.



**Healthcare  
Technology  
Systems**

NO CLAIM IS MADE TO THE EXCLUSIVE RIGHT TO USE "HEALTHCARE TECHNOLOGY SYSTEMS", APART FROM THE MARK AS SHOWN.

FOR PROMOTING PUBLIC AWARENESS OF MENTAL AND PHYSICAL HEALTH; PROVIDING INFORMATION ABOUT MENTAL AND MEDICAL DISORDERS AND THEIR TREATMENT VIA A GLOBAL COMPUTER INFORMATION NETWORK, VIA TELEPHONE, AND IN PRINTED BOOKLETS (U.S. CLS. 100 AND 101).

FIRST USE 3-0-1998; IN COMMERCE 3-0-1998.

SN 76-112,838. 2NDWAVE, INC., DALLAS, TX. FILED 8-21-2000.

**2WI**

FOR INTEGRATION OF COMPUTER SYSTEMS AND NETWORKS FOR OTHERS; INFORMATION TECHNOLOGY CONSULTATION, NAMELY, IN THE FIELD OF SYSTEMS INTEGRATION (U.S. CLS. 100 AND 101).

SN 76-115,312. TRADEHARBOR, INC., ST. LOUIS, MO. FILED 8-24-2000.

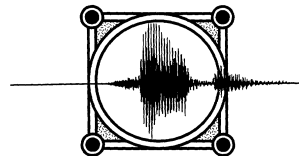

FOR SECURITY SERVICES, NAMELY, VERIFYING ELECTRONIC TRANSACTION PARTICIPANTS BY MEASURING VOICE CHARACTERISTICS (U.S. CLS. 100 AND 101).

FIRST USE 4-0-1999; IN COMMERCE 4-0-1999.



**CLASS 42—(Continued).**

SN 76-115,313. TRADEHARBOR, INC., ST. LOUIS, MO. FILED 8-24-2000.

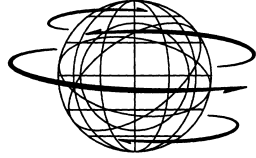

FOR SECURITY SERVICES, NAMELY, VERIFYING ELECTRONIC TRANSACTION PARTICIPANTS BY MEASURING VOICE CHARACTERISTICS (U.S. CLS. 100 AND 101).  
FIRST USE 8-31-1999; IN COMMERCE 8-31-1999.

---

SN 76-115,321. GENETICA DNA LABORATORIES, INC., CINCINNATI, OH. FILED 8-24-2000.



FOR MEDICAL TESTING, NAMELY, DNA TESTING AND ANALYSIS (U.S. CLS. 100 AND 101).  
FIRST USE 4-29-2000; IN COMMERCE 4-29-2000.

---

SN 76-115,403. INTERACTIVE TELECOM NETWORK, INC., SHERMAN OAKS, CA. FILED 8-23-2000.

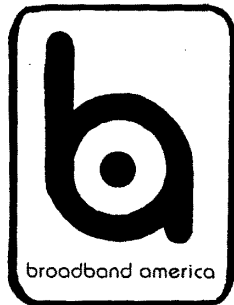

NO CLAIM IS MADE TO THE EXCLUSIVE RIGHT TO USE "AMERICA", APART FROM THE MARK AS SHOWN.  
FOR COMPUTER CONSULTATION SERVICES IN THE FIELD OF CLIENT SERVER TECHNOLOGY, NAMELY SERVER ARCHITECTURE/DESIGN, SYSTEM ADMINISTRATION, E-COMMERCE, SERVER SUPPORT, LOAD BALANCING, FIREWALL SECURITY, BACKUP SOLUTIONS, COMPUTER HOSTING SERVICES AND CO-LOCATION SERVICES (U.S. CLS. 100 AND 101).  
FIRST USE 2-16-2000; IN COMMERCE 2-16-2000.

**CLASS 42—(Continued).**

SN 76-116,307. HEALTHETECH, INC., GOLDEN, CO. FILED 8-24-2000.

**YOUR BODY IS TALKING.  
LISTEN.**

FOR HEALTH, PHYSICAL FITNESS, AND WEIGHT LOSS CONSULTATION, NAMELY, MONITORING PHYSIOLOGICAL MEASUREMENTS AND PROVIDING PATIENTS WITH FEEDBACK AND INFORMATION, AND PROVIDING INFORMATION REGARDING HEALTH, PHYSICAL FITNESS AND WEIGHT LOSS INFORMATION OVER THE INTERNET (U.S. CLS. 100 AND 101).

---

SN 76-117,324. ETC ENTERPRISES, INC., WAITE PARK, MN. FILED 8-25-2000.



FOR HOTELS (U.S. CLS. 100 AND 101).  
FIRST USE 7-23-2000; IN COMMERCE 7-23-2000.

---

SN 76-117,775. VIACORE, INC, ORANGE, CA. FILED 8-28-2000.

**VIRTUAL TRADING  
PARTNER**

NO CLAIM IS MADE TO THE EXCLUSIVE RIGHT TO USE "VIRTUAL", APART FROM THE MARK AS SHOWN.  
FOR COMPUTER SERVICES, NAMELY, COMPUTER TESTING TO INSURE COMPLIANCE WITH DEFINED STANDARDS FOR ELECTRONIC TRANSMISSION AND ROUTING OF MESSAGES AND DATA USED BY BUSINESSES AND THEIR SUPPLIERS OR CUSTOMERS TO PROCESS ORDERS AND IMPLEMENT BUSINESS TRANSACTIONS (U.S. CLS. 100 AND 101).  
FIRST USE 3-31-2000; IN COMMERCE 3-31-2000.

**CLASS 42—(Continued).**

SN 76-120,890. ENGINEERING ANALYSIS ASSOCIATES INC., BINGHAM FARMS, MI. FILED 8-31-2000.



OWNER OF U.S. REG. NO. 1.689,452.  
NO CLAIM IS MADE TO THE EXCLUSIVE RIGHT TO USE "ENGINEERING ANALYSIS ASSOCIATES", APART FROM THE MARK AS SHOWN.

THE MARK CONSISTS OF THE STYLIZED LETTERS "EAA" COMBINED WITH THE WORDS "ENGINEERING ANALYSIS ASSOCIATES".

FOR ENGINEERING SERVICES (U.S. CLS. 100 AND 101).

SN 76-121,740. VITALSTREAM, INC., NEWPORT BEACH, CA. FILED 8-31-2000.

**MEDIACONSOLE**

FOR PROVIDING TEMPORARY USE OF ON-LINE NON-DOWNLOADABLE SOFTWARE FOR WEBSITE MANAGEMENT, MEDIA MANAGEMENT, E-MAIL MANAGEMENT, ACCOUNT MANAGEMENT, AND PAYMENT AND BILLING SERVICES (U.S. CLS. 100 AND 101).

SN 76-123,619. HEALTHSPEED, INC., ENGLEWOOD, NJ. FILED 9-8-2000.

**HEALTHSPEED**

FOR PROVIDING GENERAL HEALTH CARE RELATED INFORMATION (U.S. CLS. 100 AND 101).

SN 76-123,871. HUMAN RESOURCE PROFILE, INC., CINCINNATI, OH. FILED 9-5-2000.

**WHEN INSIGHT IS BETTER THAN HINDSIGHT**

FOR EMPLOYMENT SCREENING SERVICES FOR CLIENTS, NAMELY, PRE-EMPLOYMENT AND EMPLOYMENT BACKGROUND INVESTIGATIONS (U.S. CLS. 100 AND 101).

FIRST USE 11-0-1991; IN COMMERCE 11-0-1991.

**CLASS 42—(Continued).**

SN 76-126,940. CONCEPTIS TECHNOLOGIES INC., MONTREAL, QUEBEC, CANADA, FILED 9-12-2000.



FOR OPERATION OF A WEB SITE SPECIALIZING IN THE FIELD OF MEDICAL SCIENCE (U.S. CLS. 100 AND 101).

FIRST USE 11-11-1999; IN COMMERCE 11-11-1999.

SN 76-128,136. JIMENEZ, VITA, BROOKLYN, NY. FILED 9-13-2000.

**RAINDROP PUBLISHING**

NO CLAIM IS MADE TO THE EXCLUSIVE RIGHT TO USE "PUBLISHING", APART FROM THE MARK AS SHOWN.

FOR CUSTOM WRITING, EDITING, GRAPHIC ART DESIGN AND ILLUSTRATION SERVICES FOR OTHERS, NAMELY, CUSTOM WRITING, EDITING, DESIGNING, AND ILLUSTRATING THE COVERS AND INTERIOR PAGES OF FICTION AND NONFICTION BOOKS, TEACHER ACTIVITY/RESOURCE BOOKS, TEACHER'S GUIDES, CARD PACKS, POSTERS, AND STICKERS ON A VARIETY OF SUBJECTS AND TOPICS FOR THE PRE-KINDERGARTEN THROUGH GRADE 12 MARKET (U.S. CLS. 100 AND 101).

SN 76-129,402. PHARMANETWORK.COM, LLC., WOODCLIFF LAKE, NJ. FILED 9-18-2000.

**RXINTELLISEARCH**

FOR PROVIDING AN ON-LINE DATABASE AND INFORMATION CONCERNING THE PHARMACEUTICAL INDUSTRY VIA A GLOBAL COMMUNICATIONS NETWORK (U.S. CLS. 100 AND 101).

SN 76-129,403. PHARMANETWORK.COM, LLC., WOODCLIFF LAKE, NJ. FILED 9-18-2000.

**PHARMAREFERENCE**

FOR PROVIDING ON-LINE INTERACTIVE DATABASES CONCERNING INFORMATION REGARDING THE PHARMACEUTICAL INDUSTRY USING A GLOBAL COMMUNICATIONS NETWORK (U.S. CLS. 100 AND 101).

**CLASS 42—(Continued).**

SN 76-129,407. PHARMANETWORK.COM, LLC, WOOD-CLIFF LAKE, NJ. FILED 9-18-2000.

**E-MAILPHARMA**

FOR PROVIDING ON-LINE INFORMATION SERVICES VIA A WEBSITE IN THE FIELD OF PHARMACEUTICALS (U.S. CLS. 100 AND 101).

SN 76-130,207. REED ELSEVIER INC., NEWTON, MA. FILED 9-18-2000.

**CHEMICAL EQUIPMENT**

OWNER OF U.S. REG. NO. 1,646,823. SEC. 2(F).  
FOR PROVIDING ONLINE INFORMATION IN THE FIELD OF THE GLOBAL CHEMICAL PROCESSING INDUSTRY VIA A GLOBAL COMPUTER NETWORK (U.S. CLS. 100 AND 101).  
FIRST USE 11-0-1996; IN COMMERCE 11-0-1996.

SN 76-133,129. HORSESHOE GAMING HOLDING CORP., TINLEY PARK, IL. FILED 9-21-2000.

**Yasmin's**

FOR RESTAURANT SERVICES (U.S. CLS. 100 AND 101).  
FIRST USE 12-0-2000; IN COMMERCE 12-0-2000.

SN 76-134,453. AAMBIANCE PRODUCTIONS, INC., BREWSTER, NY. FILED 9-25-2000.



THE MARK CONSISTS OF A STYLIZED "A" DESIGN FOLLOWED BY A HORIZONTAL LINE.  
FOR COMPUTER SERVICES, NAMELY DESIGNING WEB PAGES FOR OTHERS (U.S. CLS. 100 AND 101).  
FIRST USE 1-29-2000; IN COMMERCE 2-19-2000.

**CLASS 42—(Continued).**

SN 76-135,504. HOMES.COM, INC., PALO ALTO, CA. FILED 9-26-2000.

**HOMES.COM  
BROKERADVANTAGE**

OWNER OF U.S. REG. NO. 2,226,864.  
NO CLAIM IS MADE TO THE EXCLUSIVE RIGHT TO USE "HOMES.COM", APART FROM THE MARK AS SHOWN.

FOR COMPUTER SERVICES, NAMELY, CREATING, IMPLEMENTING AND MAINTAINING WEB SITES AND WEB PAGES FOR OTHERS; HOSTING THE WEB SITES AND WEB PAGES OF OTHERS ON A COMPUTER SERVER FOR A GLOBAL COMPUTER NETWORK (U.S. CLS. 100 AND 101).  
FIRST USE 4-0-2000; IN COMMERCE 4-0-2000.

SN 76-135,505. HOMES.COM, INC., MENLO PARK, CA. FILED 9-26-2000.

**HOMES.COM  
AGENTADVANTAGE**

OWNER OF U.S. REG. NO. 2,226,864.  
NO CLAIM IS MADE TO THE EXCLUSIVE RIGHT TO USE "HOMES.COM", APART FROM THE MARK AS SHOWN.

FOR COMPUTER SERVICES, NAMELY, CREATING, IMPLEMENTING AND MAINTAINING WEB SITES AND WEB PAGES FOR OTHERS; HOSTING THE WEB SITES AND WEB PAGES OF OTHERS ON A COMPUTER SERVER FOR A GLOBAL COMPUTER NETWORK (U.S. CLS. 100 AND 101).  
FIRST USE 5-0-2000; IN COMMERCE 5-0-2000.

SN 76-136,127. ADMINISTRATORS OF THE TULANE EDUCATIONAL FUND, THE, NEW ORLEANS, LA. FILED 9-27-2000.

**A CENTER FOR EXPLORING  
RIVER CULTURE, SCIENCE,  
AND TECHNOLOGY**

FOR RESTAURANT SERVICES (U.S. CLS. 100 AND 101).

SN 76-136,983. JOHN GALBRAITH, C. PED, WICHITA, KS. FILED 9-22-2000.

**UNIQUE FEET PEDORTHICS,  
INC.**

NO CLAIM IS MADE TO THE EXCLUSIVE RIGHT TO USE "PEDORTHICS, INC.", APART FROM THE MARK AS SHOWN.

FOR PEDORTHIC MEDICAL SERVICES; DESIGN SERVICES FOR OTHERS IN THE FIELD OF ORTHOTICS (U.S. CLS. 100 AND 101).

**CLASS 42—(Continued).**

SN 76-139,798. PHYSICAL ELECTRONICS, INC., EDEN PRAIRIE, MN. FILED 10-3-2000.

**PHYSICAL ELECTRONICS**

SEC. 2(F).  
FOR SERVICE OF RENDERING FOR OTHERS A PHYSICAL AND CHEMICAL ANALYSIS OF SOLID MATERIALS (U.S. CLS. 100 AND 101).  
FIRST USE 0-0-1970; IN COMMERCE 0-0-1970.

SN 76-140,338. VARSITY LOGISTICS, INC., SAN FRANCISCO, CA. FILED 9-29-2000.

**VARSITY LOGISTICS**

NO CLAIM IS MADE TO THE EXCLUSIVE RIGHT TO USE "LOGISTICS", APART FROM THE MARK AS SHOWN.  
FOR PROVIDING INTEGRATION OF COMPUTER SYSTEMS AND NETWORKS TO BUSINESSES FOR MANAGING SHIPPING AND TRANSPORTATION; PROVIDING TECHNICAL SUPPORT SERVICES IN THE NATURE OF CUSTOMER SERVICE TO BUSINESSES FOR THE PURPOSE OF MANAGING SHIPPING AND TRANSPORTATION, NAMELY, TROUBLESHOOTING OF COMPUTER HARDWARE AND SOFTWARE PROBLEMS VIA TELEPHONE, E-MAIL, ON-LINE, AND IN PERSON (U.S. CLS. 100 AND 101).  
FIRST USE 7-15-1993; IN COMMERCE 7-15-1993.

SN 76-144,953. ALPHASOFT SERVICES CORP., WALNUT CREEK, CA. FILED 10-12-2000.

**ALPHASOFT**  
SERVICES CORPORATION

NO CLAIM IS MADE TO THE EXCLUSIVE RIGHT TO USE "SERVICES CORPORATION", APART FROM THE MARK AS SHOWN.  
FOR COMPUTER CONSULTING SERVICES, NAMELY PROVIDING COMPUTER PROFESSIONALS TO OTHERS FOR COMPUTER PROJECT MANAGEMENT, SYSTEM DESIGN, DEVELOPMENT, TESTING AND QUALITY ASSURANCE, AND TECHNICAL SUPPORT, NAMELY, TROUBLESHOOTING COMPUTER HARDWARE, SOFTWARE AND MANAGEMENT PROBLEMS OF OTHERS (U.S. CLS. 100 AND 101).  
FIRST USE 1-1-2000; IN COMMERCE 1-1-2000.

**CLASS 42—(Continued).**

SN 76-145,518. ALPHASOFT SERVICES CORP., WALNUT CREEK, CA. FILED 10-13-2000.

**ALPHASOFT SERVICES CORPORATION**

NO CLAIM IS MADE TO THE EXCLUSIVE RIGHT TO USE "SERVICES CORPORATION", APART FROM THE MARK AS SHOWN.  
FOR COMPUTER CONSULTING SERVICES, NAMELY PROVIDING COMPUTER PROFESSIONALS TO OTHERS FOR COMPUTER PROJECT MANAGEMENT, SYSTEM DESIGN, DEVELOPMENT, TESTING AND QUALITY ASSURANCE, AND TECHNICAL SUPPORT, NAMELY, TROUBLESHOOTING COMPUTER HARDWARE, SOFTWARE AND MANAGEMENT PROBLEMS OF OTHERS (U.S. CLS. 100 AND 101).  
FIRST USE 1-3-1995; IN COMMERCE 1-3-1995.

SN 76-147,500. CHARLOTTE HORNETS NBA LIMITED PARTNERSHIP, CHARLOTTE, NC. FILED 10-4-2000.



OWNER OF U.S. REG. NOS. 1,642,863, 2,353,316 AND OTHERS.  
THE LINING SHOWN IN THE DRAWING IS A FEATURE OF THE MARK, AND IS NOT INTENDED TO INDICATE COLOR. THE STIPPLING SHOWN IN THE DRAWING IS A FEATURE OF THE MARK, AND IS NOT INTENDED TO INDICATE COLOR.

SEC. 2(F) AS TO "CHARLOTTE".  
FOR COMPUTER SERVICES, NAMELY, PROVIDING ON-LINE MAGAZINES, ON-LINE NEWSLETTERS, AND ON-LINE COLORING BOOKS IN THE NATURE OF DRAWINGS AND PICTURES IN THE FIELD OF BASKETBALL, PROVIDING ON-LINE CATALOGS FEATURING AN ARRAY OF BASKETBALL-THEMED PRODUCTS IN THE FIELD OF BASKETBALL; CONDUCTING PUBLIC OPINION POLL SURVEYS IN THE FIELD OF BASKETBALL FOR NON-BUSINESS, NON-MARKETING PURPOSES; COMPUTER SERVICES, NAMELY, PROVIDING DATABASES FEATURING GENERAL AND LOCAL NEWS AND INFORMATION OF INTEREST TO SPECIFIC GEOGRAPHIC AREAS; PROVIDING TEMPORARY USE OF ON-LINE NON-DOWNLOADABLE SOFTWARE FOR VIEWING TELEVISION HIGHLIGHTS, INTERACTIVE TELEVISION HIGHLIGHTS, VIDEO RECORDINGS, VIDEO STREAM RECORDINGS, INTERACTIVE VIDEO HIGHLIGHT SELECTIONS, RADIO PROGRAMS, RADIO HIGHLIGHTS, AND AUDIO RECORDINGS IN THE FIELD OF BASKETBALL (U.S. CLS. 100 AND 101).  
FIRST USE 10-28-1995; IN COMMERCE 10-28-1995.

**CLASS 42—(Continued).**

SN 76-148,577. BLUE HAMMOCK, INC., PITTSBURGH, PA. FILED 10-16-2000.

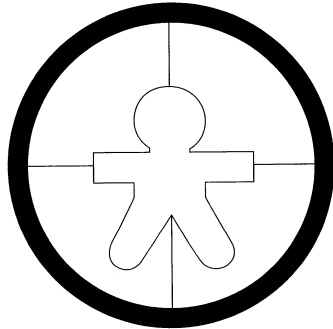

FOR COMPUTER CONSULTATION, NAMELY, CONSULTATION RELATING TO COMPUTER SYSTEM INTEGRATION FOR MARKETING, SALES AND ELECTRONIC COMMERCE SERVICES VIA THE GLOBAL COMMUNICATIONS NETWORK; AND INTEGRATION OF COMPUTER SYSTEMS AND NETWORKS (U.S. CLS. 100 AND 101).

FIRST USE 9-0-2000; IN COMMERCE 9-0-2000.

---

SN 76-149,611. CHOICE HOTELS INTERNATIONAL, INC., SILVER SPRINGS, MD. FILED 10-19-2000.

**LOW RATES, HIGH STANDARDS.**

FOR HOTEL AND MOTEL SERVICES (U.S. CLS. 100 AND 101).

FIRST USE 3-0-1999; IN COMMERCE 3-0-1999.

---

SN 76-153,465. BUSH, SHARON F., PELHAM, NY. FILED 10-25-2000.

**NEUROSMART**

FOR NEUROPSYCHOLOGICAL SERVICES, NAMELY, NEUROPSYCHOLOGICAL TESTING AND NEUROPSYCHOLOGICAL COUNSELING (U.S. CLS. 100 AND 101).

FIRST USE 11-20-1999; IN COMMERCE 8-7-2000.

**CLASS 42—(Continued).**

SN 76-154,534. SPEEDLE LLC, NEW YORK, NY. FILED 10-26-2000.



FOR COMPUTER SERVICES, NAMELY, PROVIDING ON-LINE SERVICE WHICH ALLOWS USERS TO SHARE AND SEARCH HYPERTEXT LINKS AND PROVIDING SEARCH ENGINES FOR OBTAINING DATA ON HYPERTEXT LINKS ON A GLOBAL COMPUTER NETWORK (U.S. CLS. 100 AND 101).

---

SN 76-155,782. INFOPRAG CONSULTING (U.S.) INC., LAS VEGAS, NV. FILED 10-27-2000.

**INFOPRAG**

FOR INFORMATION TECHNOLOGY CONSULTING SERVICES, NAMELY THE DEVELOPMENT, IMPLEMENTATION AND MAINTENANCE OF SYSTEM INTERFACE SOLUTIONS BETWEEN HETEROGENEOUS INFORMATION SYSTEM APPLICATIONS AND DATA CONVERSION SOLUTIONS; MAINTENANCE OF COMPUTER SOFTWARE, NAMELY, THE MAINTENANCE OF SYSTEM INTERFACE SOLUTIONS BETWEEN HETEROGENEOUS INFORMATION SYSTEM APPLICATIONS AND DATA CONVERSION SOLUTIONS (U.S. CLS. 100 AND 101).

FIRST USE 5-13-1996; IN COMMERCE 5-13-1996.

---

SN 76-155,796. LEBOEUF, LAMB, GREENE & MACRAE, L.L.P., NEW YORK, NY. FILED 10-27-2000.

**IBUSINESS SURVIVAL GUIDE**

NO CLAIM IS MADE TO THE EXCLUSIVE RIGHT TO USE "INTERNET BUSINESS" OR "GUIDE", APART FROM THE MARK AS SHOWN.

FOR LEGAL SERVICES (U.S. CLS. 100 AND 101).

---

SN 76-156,145. PCH VENTURES LLC, MALIBU, CA. FILED 10-26-2000.

**HOME OF THE HUACHINANGO**

NO CLAIM IS MADE TO THE EXCLUSIVE RIGHT TO USE "HUACHINANGO", APART FROM THE MARK AS SHOWN.

FOR ON-PREMISE AND CARRY-OUT RESTAURANT SERVICES FEATURING HISPANIC SEAFOOD CUISINE (U.S. CLS. 100 AND 101).

**CLASS 42—(Continued).**

SN 76-156,614. MGAINTERACTIVE, INC., MARIETTA, GA. FILED 10-31-2000.

**MGAI**

FOR APPLICATION SERVICE PROVIDER TO THE INSURANCE INDUSTRY, NAMELY, PROVIDING SOFTWARE TO FACILITATE INSURANCE POLICY ISSUANCE, NAMELY, PROVIDING INSURANCE RATES, QUOTES, AND ISSUING INSURANCE BINDERS AND POLICIES TO SUBSCRIBING INSURANCE CARRIERS, MANAGING GENERAL AGENTS AND THEIR AGENTS (U.S. CLS. 100 AND 101).

SN 76-156,899. UNIVERSAL SERIAL BUS IMPLEMENTERS FORUM, INC., PORTLAND, OR. FILED 10-30-2000.

**USB-IF**

FOR STANDARDIZED TESTING, DIAGNOSIS AND TESTING OF COMPUTER, ELECTRONIC, TELECOMMUNICATIONS AND CABLE AND CONNECTOR PRODUCTS FOR THIRD PARTIES; COMPUTER, ELECTRONIC, TELECOMMUNICATIONS AND CABLE AND CONNECTOR CONSULTATION SERVICES (U.S. CLS. 100 AND 101).

SN 76-159,113. EYERIS, INC., DENVER, CO. FILED 11-3-2000.

**EYEPROFIT**

FOR APPLICATION SERVICE PROVIDER FEATURING SOFTWARE IN THE FIELD OF PROFITABILITY ANALYSIS FOR USE IN HIGHLIGHTING PROFITABILITY ACROSS TIME BY INDIVIDUAL AND AGGREGATE CUSTOMER, MARKET SEGMENT, PRODUCT AND GEOGRAPHY (U.S. CLS. 100 AND 101).  
FIRST USE 8-10-1999; IN COMMERCE 1-1-2000.

SN 76-160,724. EZGOV, INC., ATLANTA, GA. FILED 11-6-2000.



OWNER OF U.S. REG. NO. 2,331,188.  
FOR PROVIDING ONLINE INFORMATION IN THE FIELD OF PUBLIC AGENCIES, PROVIDING INTERNET WEBSITE HOSTING AND PORTAL SERVICES, WEBSITE DESIGN AND DEVELOPMENT SERVICES, AND COMPUTER SOFTWARE INSTALLATION AND CUSTOMIZATION SERVICES, NAMELY CUSTOM DESIGN OF COMPUTER SOFTWARE FOR OTHERS (U.S. CLS. 100 AND 101).  
FIRST USE 7-31-2000; IN COMMERCE 7-31-2000.

**CLASS 42—(Continued).**

SN 76-160,923. EZGOV, INC., ATLANTA, GA. FILED 11-6-2000.

**EZGOV FLEXFOUNDATION**

OWNER OF U.S. REG. NO. 2,332,188.  
FOR COMPUTER SOFTWARE INSTALLATION AND CUSTOMIZATION OF SERVICES, NAMELY CUSTOM DESIGN OF COMPUTER SOFTWARE FOR OTHERS (U.S. CLS. 100 AND 101).  
FIRST USE 9-22-2000; IN COMMERCE 9-22-2000.

SN 76-160,924. EZGOV, INC., ATLANTA, GA. FILED 11-6-2000.

**EZGOV STATESUITE**

OWNER OF U.S. REG. NO. 2,332,188.  
FOR COMPUTER SOFTWARE INSTALLATION AND CUSTOMIZATION SERVICES, NAMELY CUSTOM DESIGN OF COMPUTER SOFTWARE FOR OTHERS (U.S. CLS. 100 AND 101).  
FIRST USE 9-22-2000; IN COMMERCE 9-22-2000.

SN 76-161,008. EZGOV, INC., ATLANTA, GA. FILED 11-6-2000.

**EZGOV LOCALSUITE**

OWNER OF U.S. REG. NO. 2,332,188.  
FOR COMPUTER SOFTWARE INSTALLATION AND CUSTOMIZATION SERVICES, NAMELY CUSTOM DESIGN OF COMPUTE SOFTWARE FOR OTHERS (U.S. CLS. 100 AND 101).  
FIRST USE 9-22-2000; IN COMMERCE 9-22-2000.

SN 76-161,360. HEALTHCOMMUNITIES.COM, INC., NORTHAMPTON, MA. FILED 11-9-2000.



NO CLAIM IS MADE TO THE EXCLUSIVE RIGHT TO USE "NEPHROLOGY NEWS & INFORMATION", APART FROM THE MARK AS SHOWN.

THE MARK CONSISTS OF THE WORDS "NEPHROLOGY WORLD NEPHROLOGY NEWS & INFORMATION" BESIDE OF A CIRCULAR GRAPHIC DESIGN OF A LOWER CASE "n" AND AN UPPER CASE "w" INSIDE OF THE CIRCLE.  
FOR PROVISION OF MEDICAL INFORMATION CONCERNING NEPHROLOGY RELATED TOPICS VIA A GLOBAL COMPUTER NETWORK (U.S. CLS. 100 AND 101).

**CLASS 42—(Continued).**

SN 76-161,362. HEALTHCOMMUNITIES.COM, INC., NORTHAMPTON, MA. FILED 11-9-2000.

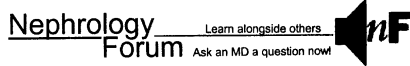

NO CLAIM IS MADE TO THE EXCLUSIVE RIGHT TO USE "NEPHROLOGY FORUM" OR "ASK AN MD A QUESTION NOW!", APART FROM THE MARK AS SHOWN.

THE MARK CONSISTS OF THE WORDS "NEPHROLOGY FORUM LEARN ALONGSIDE OTHERS ASK AN MD A QUESTION!" BESIDE A GRAPHIC OF A MEGAPHONE SHAPE TO THE LEFT OF A LOWER CASE "N" AND AN UPPER CASE "F".

FOR PROVISION OF MEDICAL INFORMATION CONCERNING NEPHROLOGY RELATED TOPICS VIA A GLOBAL COMPUTER NETWORK (U.S. CLS. 100 AND 101).

---

SN 76-161,941. ZEBORG, INC., NEW YORK, NY. FILED 11-8-2000.

**ZEBORG FACILITIES**

NO CLAIM IS MADE TO THE EXCLUSIVE RIGHT TO USE "FACILITIES", APART FROM THE MARK AS SHOWN.

FOR INSTALLATION, MAINTENANCE AND DEVELOPMENT OF SOFTWARE FOR OTHERS FOR ASSISTING IN EVALUATION AND PROCUREMENT OF INDIRECT GOODS AND SERVICES IN THE FACILITIES MANAGEMENT FIELD, INCLUDING AUCTIONING, NEGOTIATION, MANAGEMENT OF PRICE DISCOVERY AND MARKET MONITORING AND ANALYSIS (U.S. CLS. 100 AND 101).

---

SN 76-162,132. BAY CAFE, INC., VIRGINIA BEACH, VA. FILED 11-9-2000.

**HOT TUNA BAR & GRILL**

NO CLAIM IS MADE TO THE EXCLUSIVE RIGHT TO USE "BAR & GRILL", APART FROM THE MARK AS SHOWN.

FOR SERVICES IN THE NATURE OF A RESTAURANT AND BAR (U.S. CLS. 100 AND 101).

FIRST USE 1-15-1992; IN COMMERCE 5-15-1992.

---

SN 76-163,629. SAFEWWW, INC., UNIONDALE, NY. FILED 11-13-2000.

**IDSHIELD**

FOR SECURITY SERVICES FOR OTHERS VIA A WORLD WIDE COMPUTER INFORMATION NETWORK, NAMELY, PROVIDING REAL-TIME, ONLINE AUTHENTICATION OF TRANSACTOR IDENTITY IN PERSONAL AND E-COMMERCE TRANSACTIONS (U.S. CLS. 100 AND 101).

FIRST USE 10-6-1999; IN COMMERCE 10-6-1999.

**CLASS 42—(Continued).**

SN 76-164,510. SOFTCOMM, INC., MELBOURNE BEACH, FL. FILED 11-13-2000.

**MANGROVE.ORG**

FOR PROVIDING INFORMATION IN THE FIELD OF HABITAT CREATION AND RESTORATION, SHORELINE PRESERVATION, POLLUTION CONTROL, AND ESTUARY WATER QUALITY IMPROVEMENT VIA A GLOBAL COMPUTER NETWORK; COMPUTER SERVICES, NAMELY, PROVIDING A WEB SITE VIA A GLOBAL COMPUTER NETWORK FEATURING INFORMATION IN THE FIELD OF HABITAT CREATION AND RESTORATION, SHORELINE PRESERVATION, POLLUTION CONTROL AND ESTUARY WATER QUALITY IMPROVEMENT; PERFORMING RESEARCH IN THE FIELD OF ENVIRONMENTAL REMEDIATION (U.S. CLS. 100 AND 101).

FIRST USE 1-0-1996; IN COMMERCE 12-9-1998.

---

SN 76-165,453. ZEBORG, INC., NEW YORK, NY. FILED 11-14-2000.

**ZEBORG MEDIA**

NO CLAIM IS MADE TO THE EXCLUSIVE RIGHT TO USE "MEDIA", APART FROM THE MARK AS SHOWN.

FOR INSTALLATION, MAINTENANCE, AND DEVELOPMENT OF SOFTWARE FOR OTHERS FOR FACILITATING EVALUATION AND PROCUREMENT OF ADVERTISING AND ADVERTISING-RELATED PRODUCTS AND SERVICES, INCLUDING AUCTIONING, NEGOTIATION, MANAGEMENT OF PRICE DISCOVERY, AND MARKET MONITORING AND ANALYSIS (U.S. CLS. 100 AND 101).

---

SN 76-165,455. ZEBORG, INC., NEW YORK, NY. FILED 11-14-2000.

**ZEBORG COMPUTING**

NO CLAIM IS MADE TO THE EXCLUSIVE RIGHT TO USE "COMPUTING", APART FROM THE MARK AS SHOWN.

FOR INSTALLATION, MAINTENANCE, AND DEVELOPMENT OF SOFTWARE FOR OTHERS FOR FACILITATING EVALUATION AND PROCUREMENT OF COMPUTING-RELATED PRODUCTS AND SERVICES, INCLUDING AUCTIONING, NEGOTIATION, MANAGEMENT OF PRICE DISCOVERY, AND MARKET MONITORING AND ANALYSIS (U.S. CLS. 100 AND 101).

---

SN 76-167,639. CHARTCO LIMITED, LONDON, ENGLAND, FILED 11-17-2000.

**METMANAGER**

FOR PROVIDING METEOROLOGICAL INFORMATION (U.S. CLS. 100 AND 101).

**CLASS 42—(Continued).**

SN 76-169,354. ARCATA ASSOCIATES, INC., NORTH LAS VEGAS, NV. FILED 11-22-2000.

**CLASS 42—(Continued).**

SN 76-170,079. WRQ, INC., SEATTLE, WA. FILED 11-22-2000.

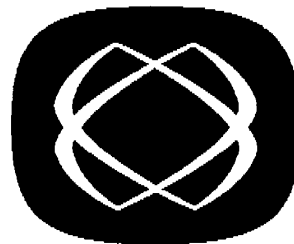

TWO STYLIZED, INTERTWINED RECTANGULAR SHAPES ON DIAGONAL PLANES, WITH A SHADED BACKGROUND.

FOR CONSULTING SERVICES IN THE FIELD OF COMPUTER SOFTWARE FOR INTEGRATING ENTERPRISE SOFTWARE APPLICATIONS; COMPUTER SUPPORT SERVICES, NAMELY, PROVIDING CONSULTATION ON THE USE AND OPERATION OF COMPUTER SOFTWARE PROGRAMS AND THE UPDATING OF COMPUTER SOFTWARE PROGRAMS AND OPERATING SYSTEMS; COMPUTER HARDWARE AND COMPUTER SOFTWARE CONSULTATION SERVICES; TECHNICAL SUPPORT SERVICES, NAMELY TROUBLE SHOOTING SOFTWARE PROBLEMS VIA ONLINE AND OVER THE TELEPHONE; COMPUTER AND SOFTWARE CONSULTATION; DESIGN, DEVELOPMENT AND INSTALLATION OF COMPUTER SOFTWARE; COMPUTER SERVICES, NAMELY, INSTALLATION, INTEGRATION AND NETWORKING OF COMPUTER SOFTWARE PROGRAMS; PROVIDING CUSTOMIZED COMPUTER PROGRAMMING FOR PROVIDING ACCESS TO APPLICATIONS AND INFORMATION ON HOST SYSTEMS USING MOBILE AND WIRELESS COMPUTING DEVICES AND USING COMPUTER NETWORKS AND GLOBAL COMMUNICATIONS NETWORKS; PROVIDING CUSTOMIZED COMPUTER PROGRAMMING FOR COMPUTER NETWORK CONNECTIVITY USING MOBILE AND WIRELESS COMPUTING DEVICES AND USING COMPUTER NETWORKS AND GLOBAL COMMUNICATIONS NETWORKS; COMPUTER PROGRAMMING IN THE FIELD OF ELECTRONIC DATA INTERCHANGE, DATA ENTRY AND APPLICATIONS LINKING; COMPUTER CONSULTING SERVICES IN THE FIELD OF ELECTRONIC DATA INTERCHANGE, DATA ENTRY AND APPLICATIONS LINKING (U.S. CLS. 100 AND 101).

NO CLAIM IS MADE TO THE EXCLUSIVE RIGHT TO USE "ASSOCIATES", APART FROM THE MARK AS SHOWN.

FOR ELECTRONIC ENGINEERING SERVICES (U.S. CLS. 100 AND 101).



**CLASS 42—(Continued).**

SN 76-170,184. WRQ, INC., SEATTLE, WA. FILED 11-22-2000.

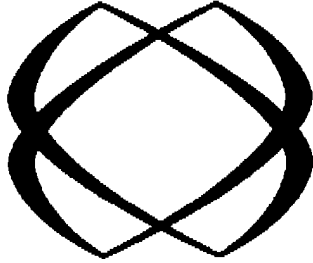

THE MARK CONSISTS OF TWO STYLIZED, INTER-TWINED RECTANGULAR SHAPES ON DIAGONAL PLANES.

FOR CONSULTING SERVICES IN THE FIELD OF COMPUTER SOFTWARE FOR INTEGRATING ENTERPRISE SOFTWARE APPLICATIONS; COMPUTER SUPPORT SERVICES, NAMELY, PROVIDING CONSULTATION ON THE USE AND OPERATION OF COMPUTER SOFTWARE PROGRAMS AND THE UP-DATING OF COMPUTER SOFTWARE PROGRAMS AND OPERATING SYSTEMS; COMPUTER HARDWARE AND COMPUTER SOFTWARE CONSULTATION SERVICES; TECHNICAL SUPPORT SERVICES, NAMELY TROUBLE SHOOTING SOFTWARE PROBLEMS VIA ONLINE AND OVER THE TELEPHONE; COMPUTER AND SOFTWARE CONSULTATION; DESIGN, DEVELOPMENT AND INSTALLATION OF COMPUTER SOFTWARE; COMPUTER SERVICES, NAMELY, INSTALLATION, INTEGRATION AND NETWORKING OF COMPUTER SOFTWARE PROGRAMS; PROVIDING CUSTOMIZED COMPUTER PROGRAMMING FOR PROVIDING ACCESS TO APPLICATIONS AND INFORMATION ON HOST SYSTEMS USING MOBILE AND WIRELESS COMPUTING DEVICES AND USING COMPUTER NETWORKS AND GLOBAL COMMUNICATIONS NETWORKS; PROVIDING CUSTOMIZED COMPUTER PROGRAMMING FOR COMPUTER NETWORK CONNECTIVITY USING MOBILE AND WIRELESS COMPUTING DEVICES AND USING COMPUTER NETWORKS AND GLOBAL COMMUNICATIONS NETWORKS; COMPUTER PROGRAMMING IN THE FIELD OF ELECTRONIC DATA INTERCHANGE, DATA ENTRY AND APPLICATIONS LINKING; COMPUTER CONSULTING SERVICES IN THE FIELD OF ELECTRONIC DATA INTERCHANGE, DATA ENTRY AND APPLICATIONS LINKING (U.S. CLS. 100 AND 101).

SN 76-171,250. SEO ENTERPRISE, INC., SEATTLE, WA. FILED 11-27-2000.



NO CLAIM IS MADE TO THE EXCLUSIVE RIGHT TO USE "TERIYAKI", APART FROM THE MARK AS SHOWN. THE ENGLISH TRANSLATION OF "SAN" IS "SIR" OR "MISTER".

FOR INFORMATION WEBSITE FOR RECIPES, COOKING TIPS, AND HEALTH AND NUTRITION PERTAINING TO TERIYAKI PRODUCTS (U.S. CLS. 100 AND 101). FIRST USE 11-1-1999; IN COMMERCE 11-1-1999.

**CLASS 42—(Continued).**

SN 76-171,347. RABIN, JEFFREY L., WESTON, FL. FILED 11-28-2000.

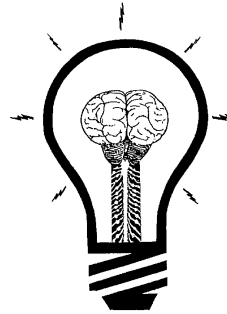

THE STIPPLING AND LINING SHOWN IN THE DRAWING ARE FEATURES OF THE MARK AND NOT INTENDED TO INDICATE COLOR.

FOR PROVIDING CHIROPRACTIC HEALTH CARE SERVICES (U.S. CLS. 100 AND 101).

SN 76-171,956. WEBEBM, INC., NASHVILLE, TN. FILED 11-28-2000.

**EBMPACT**

FOR PROVIDING HEALTHCARE INFORMATION, NAMELY INFORMATION ABOUT DISEASES AND CONDITIONS AND INDIVIDUAL CLINICAL GUIDELINES, VIA INTERNET TO PROVIDERS, PURCHASERS, AND USERS OF HEALTHCARE (U.S. CLS. 100 AND 101).

SN 76-173,623. BALANTZIAN, ESTEBAN EDUARDO, 1636 LA LUCILA, BUENOS AIRES, ARGENTINA, FILED 12-1-2000.

**EL MATE**

THE ENGLISH TRANSLATION OF THE WORD "EL MATE" IN THE MARK IS "CONTAINER IN WHICH ARGENTINEAN TEA IS MADE".

FOR RESTAURANT BAR AND CAFE SERVICES (U.S. CLS. 100 AND 101).

**CLASS 42—(Continued).**

SN 76-174,369. ALATRON CORPORATION, SEATTLE, WA. FILED 12-4-2000.



FOR PROVIDING INFORMATION IN THE FIELD OF ENGINEERING, ELECTRONICS, SEMICONDUCTORS, WIRELESS DEVICES, COMPUTERS AND PRODUCT DEVELOPMENT; PROVIDING TEMPORARY ON-LINE NON-DOWNLOADABLE SOFTWARE FOR PRODUCT DEVELOPMENT AND SAMPLE PROCUREMENT; PROVIDING ON-LINE PRODUCT DEVELOPMENT AND SEARCH TOOLS, NAMELY SOFTWARE FOR USE IN PRODUCT DEVELOPMENT (U.S. CLS. 100 AND 101).

SN 76-175,968. US SEARCH.COM INC., LOS ANGELES, CA. FILED 12-5-2000.

**FRAUDIDENTITY**

FOR COMPUTER SERVICES, NAMELY, DESIGNING AND IMPLEMENTING THE AUTOMATION OF SEARCHING DATABASES TO IDENTIFY INCONSISTENT DATA ELEMENTS, NAMELY, INVALID TELEPHONE NUMBERS, HIGHER RISK ADDRESS LOCATIONS, HIGHER RISK TELEPHONE NUMBERS, INVALID AND DISCONNECTED PHONE NUMBERS, INVALID ADDRESS DATA, IMPOSSIBLE PHONE AND ZIP CODE COMBINATIONS, IMPOSSIBLE ADDRESS COMBINATIONS, INVALID SOCIAL SECURITY NUMBER DATA, AND SOCIAL SECURITY NUMBER DATA BELONGING TO A DECEASED INDIVIDUAL TO REDUCE THE RISKS ASSOCIATED WITH CONDUCTING TRANSACTIONS ON GLOBAL COMPUTER NETWORKS (U.S. CLS. 100 AND 101).

FIRST USE 1-12-2001; IN COMMERCE 3-20-2001.

SN 76-175,969. US SEARCH.COM INC., LOS ANGELES, CA. FILED 12-5-2000.

**TRUSTIDENTITY**

FOR COMPUTER SERVICES, NAMELY, DESIGNING AND IMPLEMENTING THE AUTOMATION OF SEARCHING DATABASES TO CROSS-REFERENCE RECORDS TO VERIFY IDENTIFIES AND REDUCE THE RISKS ASSOCIATED WITH CONDUCTING TRANSACTIONS ON GLOBAL COMPUTER NETWORKS (U.S. CLS. 100 AND 101).

FIRST USE 1-12-2001; IN COMMERCE 3-20-2001.

**CLASS 42—(Continued).**

SN 76-181,925. WILLIAMS, RICHARD D., GRANITE BAY, CA. FILED 12-16-2000.

**HENRY AFRICA**

THE NAME "HENRY AFRICA" DOES NOT IDENTIFY A LIVING INDIVIDUAL.

FOR RESTAURANTS AND BARS (U.S. CLS. 100 AND 101).

SN 76-185,000. UNDERBERG & KESSLER LLP, ROCHESTER, NY. FILED 12-22-2000.

**HELPING YOU MAKE THE MOST OF YOUR OPTIONS**

FOR LEGAL SERVICES (U.S. CLS. 100 AND 101). FIRST USE 12-8-2000; IN COMMERCE 12-8-2000.

SN 76-185,101. GLOBAL PATHOLOGY LABORATORY SERVICES, INC., MIAMI LAKES, FL. FILED 12-20-2000.

**GLOBAL PATHOLOGY**

NO CLAIM IS MADE TO THE EXCLUSIVE RIGHT TO USE "PATHOLOGY", APART FROM THE MARK AS SHOWN.

FOR MEDICAL LABORATORY TESTING (U.S. CLS. 100 AND 101).

SN 76-185,571. MOTHERS ON THE MOVE, INC., BRONX, NY. FILED 12-22-2000.

**MOTHERS ON THE MOVE**

FOR COMMUNITY SERVICES, NAMELY, PROMOTING THE PUBLIC INTEREST IN AND AWARENESS OF THE AREAS OF SAFETY, EDUCATIONAL, HEALTH, GOVERNMENTAL, CULTURAL, AND SOCIAL ISSUES THROUGH COMMUNITY OUTREACH INITIATIVES (U.S. CLS. 100 AND 101).

FIRST USE 1-1-1994; IN COMMERCE 1-1-1994.

**CLASS 42—(Continued).**

SN 76-188,650. MIDWEST SPECIAL SURGERY, PC, ST LOUIS, MO. FILED 1-2-2001.

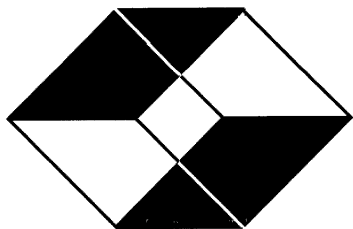

FOR MEDICAL SERVICES, NAMELY, ORTHOPEDIC, PLASTIC, AND HAND SURGERY (U.S. CLS. 100 AND 101).

SN 76-188,697. DENTAL X CHANGE, INC., IRVINE, CA. FILED 12-28-2000.

**PAYERCONNECT**

FOR COMPUTER SERVICES, NAMELY, PROVIDING AN INTERFACE BETWEEN HEALTH CARE PROVIDERS AND INSURANCE COMPANIES TO ENABLE THE ACCESS AND EXCHANGE OF INFORMATION AND INSURANCE CLAIMS VIA THE INTERNET; COMPILING, MAINTAINING AND PROVIDING INFORMATION ON HEALTH CARE PROVIDERS, INSURANCE COMPANIES AND PATIENTS VIA THE INTERNET (U.S. CLS. 100 AND 101).

FIRST USE 9-9-2000; IN COMMERCE 9-9-2000.

SN 76-189,097. PROCARD, INC., GOLDEN, CO. FILED 1-3-2001.

**TRANSPLUS SERVICES**

NO CLAIM IS MADE TO THE EXCLUSIVE RIGHT TO USE "SERVICES", APART FROM THE MARK AS SHOWN.

FOR PROVIDING TEMPORARY USE OF NON-DOWNLOADABLE COMPUTER SOFTWARE FOR REVIEWING AND MANAGING TRANSACTION DATA FOR COMMERCIAL CREDIT CARD PROGRAMS FOR USE IN THE CREDIT CARD AND BANKING INDUSTRY VIA INTERACTIVE GLOBAL COMPUTER NETWORK (U.S. CLS. 100 AND 101).

**CLASS 42—(Continued).**

SN 76-198,620. NATIONAL DATA INTELLECTUAL PROPERTY CORP., ATLANTA, GA. FILED 1-24-2001.

**NDC PRESCRIPTION SALES ANALYZER**

OWNER OF U.S. REG. NOS. 888,836, 1,904,601 AND OTHERS.

NO CLAIM IS MADE TO THE EXCLUSIVE RIGHT TO USE "PRESCRIPTION SALES ANALYZER", APART FROM THE MARK AS SHOWN.

FOR PROVIDING TEMPORARY USE OF ON-LINE NON-DOWNLOADABLE SOFTWARE FOR MONITORING, ANALYZING AND REPORTING OF RETAIL PHARMACY TRANSACTIONS, PRESCRIPTION DRUG TRANSACTIONS AND SALES PATTERNS (U.S. CLS. 100 AND 101).

FIRST USE 6-15-2000; IN COMMERCE 6-15-2000.

SN 76-198,621. NATIONAL DATA INTELLECTUAL PROPERTY CORP., ATLANTA, GA. FILED 1-24-2001.

**NDC PRESCRIPTION PRICE ANALYZER**

OWNER OF U.S. REG. NOS. 888,836, 1,904,601 AND OTHERS.

NO CLAIM IS MADE TO THE EXCLUSIVE RIGHT TO USE "PRESCRIPTION PRICE ANALYZER", APART FROM THE MARK AS SHOWN.

FOR PROVIDING TEMPORARY USE OF ON-LINE NON-DOWNLOADABLE SOFTWARE FOR MONITORING, ANALYZING AND REPORTING OF RETAIL PHARMACY TRANSACTIONS, PRESCRIPTION DRUG TRANSACTIONS, SALES PATTERNS AND PRICING INFORMATION (U.S. CLS. 100 AND 101).

FIRST USE 6-15-2000; IN COMMERCE 6-15-2000.

SN 76-198,622. NATIONAL DATA INTELLECTUAL PROPERTY CORP., ATLANTA, GA. FILED 1-24-2001.

**NDC PHARMACY MARKET ANALYZER**

OWNER OF U.S. REG. NOS. 888,836, 1,904,601 AND OTHERS.

NO CLAIM IS MADE TO THE EXCLUSIVE RIGHT TO USE "PHARMACY MARKET ANALYZER", APART FROM THE MARK AS SHOWN.

FOR PROVIDING TEMPORARY USE OF ON-LINE NON-DOWNLOADABLE SOFTWARE FOR MONITORING, ANALYZING AND REPORTING OF RETAIL PHARMACY TRANSACTIONS, PRESCRIPTION DRUG TRANSACTIONS AND SALES PATTERNS, AND OVERALL BUSINESS PERFORMANCE AND MARKET SHARE (U.S. CLS. 100 AND 101).

FIRST USE 6-15-2000; IN COMMERCE 6-15-2000.

**CLASS 42—(Continued).**

SN 76-200,011. @POS.COM. INC., SAN JOSE, CA. FILED 1-24-2001.

**MOBINETIX SYSTEMS**

NO CLAIM IS MADE TO THE EXCLUSIVE RIGHT TO USE "SYSTEMS", APART FROM THE MARK AS SHOWN.

FOR COMPUTER HARDWARE AND SOFTWARE DESIGN SERVICES FOR OTHERS, NAMELY, DESIGNING POINT-OF-SALE COMPUTER DEVICES AND SOFTWARE TO CAPTURE ELECTRONIC SIGNATURES, READ MAGNETIC STRIPE CARDS, DISPLAY GRAPHICAL ADVERTISEMENTS AND TEXT MESSAGES, AND PLAY SOUNDS (U.S. CLS. 100 AND 101).

SN 76-200,643. SOFTWARE MANAGEMENT CONSULTANTS, INC., GLENDALE, CA. FILED 1-25-2001.

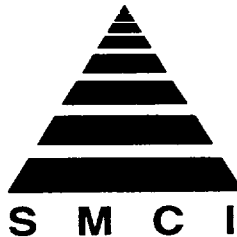

FOR INTEGRATION OF COMPUTER SYSTEMS AND NETWORKS (U.S. CLS. 100 AND 101).  
FIRST USE 11-15-1993; IN COMMERCE 11-15-1993.

SN 76-205,825. PAUL, HASTINGS, JANOFSKY & WALKER LLP, LOS ANGELES, CA. FILED 1-22-2001.

**PaulHastings**

THE NAME SHOWN IN THE MARK DOES NOT IDENTIFY A PARTICULAR LIVING INDIVIDUAL.  
FOR LEGAL SERVICES (U.S. CLS. 100 AND 101).

**CLASS 42—(Continued).**

SN 76-206,275. CALDWELL, RANDY CRAIG, PANORAMA VILLAGE, TX. FILED 2-5-2001.

**PERFECT WISDOM**

FOR INTERNET DEVELOPMENT SERVICES IN THE NATURE OF COMPUTER SERVICES, NAMELY, CREATING, MAINTAINING, AND DESIGNING WEB SITES FOR OTHERS; HOSTING THE WEB SITES OF OTHERS ON A COMPUTER SERVER FOR A GLOBAL COMPUTER NETWORK; REGISTRATION OF DOMAIN NAMES FOR IDENTIFICATION OF USERS ON A GLOBAL COMPUTER NETWORK (U.S. CLS. 100 AND 101).

FIRST USE 4-25-2000; IN COMMERCE 5-17-2000.

SN 76-208,292. KIODEX, INC., NEW YORK, NY. FILED 2-9-2001.

**KIODEX RISK WORKBENCH**

NO CLAIM IS MADE TO THE EXCLUSIVE RIGHT TO USE "RISK WORKBENCH", APART FROM THE MARK AS SHOWN.

FOR PROVIDING TEMPORARY USE OF ON-LINE NON-DOWNLOADABLE SOFTWARE FOR TRADING AND RISK MANAGEMENT ACTIVITIES IN THE FIELDS OF COMMODITIES, COMMODITIES-RELATED PRODUCTS AND OTHER DERIVATIVE INSTRUMENTS (U.S. CLS. 100 AND 101).

SN 76-209,293. VTG RESTAURANT GROUP, LLC, ATLANTA, GA. FILED 2-13-2001.



NO CLAIM IS MADE TO THE EXCLUSIVE RIGHT TO USE "FRESH FOOD FAST", APART FROM THE MARK AS SHOWN.

THE STIPPLING IN THE DRAWING ARE PART OF THE DESIGN AND ARE NOT INTENDED TO INDICATE COLOR.

FOR RESTAURANT SERVICES (U.S. CLS. 100 AND 101).

FIRST USE 1-20-1997; IN COMMERCE 4-1-1998.

SN 76-213,958. PC PITSTOP L.L.C., DAKOTA DUNES, SD. FILED 2-21-2001.

**TECHEXPRESS**

FOR DIAGNOSIS OF COMPUTER PROBLEMS CONDUCTED OVER THE INTERNET; FORWARDING RESULTS OF COMPUTER DIAGNOSTICS TO OTHERS OVER THE INTERNET (U.S. CLS. 100 AND 101).

FIRST USE 2-6-2001; IN COMMERCE 2-6-2001.

**CLASS 42—(Continued).**

SN 76-215,792. DEMEO TEEN CLUB, INC., SANTA ROSA, CA. FILED 2-26-2001.

**CLUB 509**

NO CLAIM IS MADE TO THE EXCLUSIVE RIGHT TO USE "CLUB", APART FROM THE MARK AS SHOWN. FOR RECREATIONAL SERVICES IN THE NATURE OF NIGHTCLUB FOR TEENAGERS (U.S. CLS. 100 AND 101).  
FIRST USE 1-29-2001; IN COMMERCE 1-29-2001.

**CLASS 42—(Continued).**

SN 76-234,331. CYBERDRAWER, INC., DALLAS, TX. FILED 4-2-2001.

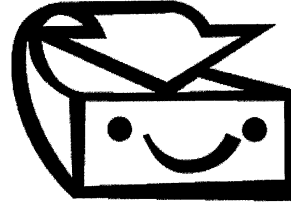

SN 76-216,389. HISPANIC BUSINESS INC., SANTA BARBARA, CA. FILED 2-26-2001.

**SUPERONDA.COM**

OWNER OF U.S. REG. NO. 2,279,149 AND OTHERS. THE ENGLISH LANGUAGE TRANSLATION OF "SUPER ONDA" MEANS "SUPER WAVE".  
FOR COMPUTER SERVICES, NAMELY, PROVIDING ON-LINE MAGAZINES IN THE FIELDS OF GENERAL NEWS, BUSINESS, CAREER DEVELOPMENT, EMPLOYMENT OPPORTUNITIES, EDUCATION, ENTERTAINMENT, SPORTS, MUSIC, THE MILITARY AND ISSUES OF GENERAL INTEREST TO HISPANIC YOUTH AND YOUNG ADULTS (U.S. CLS. 100 AND 101).  
FIRST USE 7-0-1998; IN COMMERCE 7-0-1998.

FOR PROVIDING TEMPORARY USE OF ON-LINE NON-DOWNLOADABLE SOFTWARE FOR THE STORAGE AND RETRIEVAL OF COMMERCIAL AND PROMOTION RECORDS AND DOCUMENTS BY CONSUMERS (U.S. CLS. 100 AND 101).

SN 76-237,018. WAVE DISPERSION TECHNOLOGIES, INC., SUMMIT, NJ. FILED 4-6-2001.

SN 76-218,712. EVISION, LLC, CHICAGO, IL. FILED 3-5-2001.

**VISUAL SHERLOCK**

FOR COMPUTER PROGRAMMING FOR OTHERS AND DEVELOPMENT OF NEW TECHNOLOGY FOR OTHERS IN THE FIELD OF COMPUTER SOFTWARE (U.S. CLS. 100 AND 101).  
FIRST USE 6-1-2000; IN COMMERCE 6-1-2000.

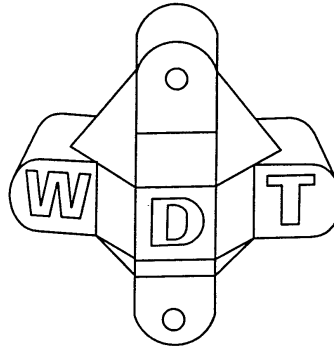

SN 76-231,345. TESTMYHEALTH.COM, LLC, HOUSTON, TX. FILED 3-27-2001.

**TAKE CHARGE OF YOUR HEALTH**

FOR HEALTH SCREENING; HEALTH CARE; LABORATORY TESTING; HEALTH RISK APPRAISAL; HEALTH CONDITION TESTING (U.S. CLS. 100 AND 101).  
FIRST USE 9-0-2000; IN COMMERCE 9-0-2000.

THE MARK CONSISTS OF THE LETTERS "WDT" INSIDE A FOUR-SIDED LOBED MODULE WITH TWO HOLES ON OPPOSING LOBES.  
FOR CONSULTATION IN THE FIELD OF EQUIPMENT TO PREVENT SHORE EROSION AND SCIENTIFIC TESTING AND EVALUATION OF SHORE EROSION AND THE PREVENTION THEREOF; CONSULTATION IN THE FIELD OF EQUIPMENT TO PROTECT HARBORS, MARINAS, ANCHORAGES, AND VESSELS FROM INTRUSION, WAVE ACTION AND BOAT WAKES; CONSULTATION IN THE FIELD OF EQUIPMENT FOR MARINE SECURITY AND DEMARCATION; CONSULTATION IN THE FIELD OF MARINE SIGNAGE AND MARINE WEAPONS PLATFORMS; SCIENTIFIC TESTING AND EVALUATION OF HARBOR AND SHIP SECURITY (U.S. CLS. 100 AND 101).

**CLASS 42—(Continued).**

SN 76-239,318. LSR GROUP, INC., THE, HOUSTON, TX. FILED 4-11-2001.



NO CLAIM IS MADE TO THE EXCLUSIVE RIGHT TO USE "EMERGENCY CAR DOOR UNLOCKING" AND "FREE WHEN CHILD LOCKED INSIDE", APART FROM THE MARK AS SHOWN.  
FOR VEHICLE DOOR UNLOCKING SERVICES (U.S. CLS. 100 AND 101).  
FIRST USE 3-5-1998; IN COMMERCE 3-5-1998.

SN 76-246,293. ZEROSMOKE, INC., ORONO, MN. FILED 4-26-2001.

**ZEROSMOKE**

FOR HEALTH CARE, NAMELY, PROVIDING SMOKING CESSATION SERVICES (U.S. CLS. 100 AND 101).

SN 76-246,481. WEST LICENSING CORPORATION, CLAYMONT, DE. FILED 4-24-2001.

**WEST FIRMSITE**

OWNER OF U.S. REG. NOS. 1,226,635, 1,807,126 AND 2,214,641.  
FOR PROVIDING INFORMATION TO THE LEGAL FIELD VIA A GLOBAL COMPUTER NETWORK; PROVIDING WEB SITE CONSULTATION, DESIGN, DEVELOPMENT AND DESIGN FOR OTHERS; PROVIDING WEB SITE MANAGEMENT IN THE NATURE OF MAINTENANCE AND UPDATES FOR OTHERS (U.S. CLS. 100 AND 101).

SN 76-248,819. ENVIRONMENTAL DEFENSE, INC., NEW YORK, NY. FILED 5-1-2001.

**GET GREEN**

NO CLAIM IS MADE TO THE EXCLUSIVE RIGHT TO USE "GREEN", APART FROM THE MARK AS SHOWN.  
FOR PROMOTING PUBLIC AWARENESS OF THE ACTIONS THE PUBLIC CAN TAKE TO IMPROVE AND ENHANCE THE ENVIRONMENT (U.S. CLS. 100 AND 101).

**CLASS 42—(Continued).**

SN 76-249,500. ELECTRICITY INNOVATION INSTITUTE, THE, PALO ALTO, CA. FILED 4-30-2001.

**EII**

FOR RESEARCH IN THE FIELD OF PRODUCTION, TRANSMISSION, DISTRIBUTION AND UTILIZATION OF ELECTRIC POWER (U.S. CLS. 100 AND 101).

SN 76-252,209. YAKE, WARREN, EDMONTON, ALBERTA T5J 3R8, CANADA, FILED 5-4-2001.

**CRASHGUY**

FOR LEGAL SERVICES IN THE FIELD OF PERSONAL INJURY LAW (U.S. CLS. 100 AND 101).

SN 76-255,742. Z57.COM, INC., SAN DIEGO, CA. FILED 5-11-2001.

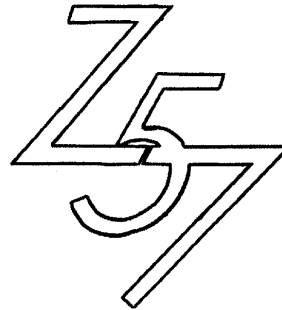

FOR COMPUTER WEBSITE DESIGN SERVICES FOR OTHERS; COMPUTER CONSULTATION; HOSTING WEBSITES OF OTHERS ON A COMPUTER SERVER FOR A GLOBAL COMPUTER NETWORK (U.S. CLS. 100 AND 101).  
FIRST USE 10-0-1999; IN COMMERCE 10-0-1999.

SN 76-256,194. Z57.COM, INC., SAN DIEGO, CA. FILED 5-11-2001.

**Z57**

FOR COMPUTER WEBSITE DESIGN SERVICES FOR OTHERS; COMPUTER CONSULTATION; HOSTING WEBSITES OF OTHERS ON A COMPUTER SERVER FOR A GLOBAL COMPUTER NETWORK (U.S. CLS. 100 AND 101).  
FIRST USE 12-14-1998; IN COMMERCE 12-14-1998.

**CLASS 42—(Continued).**

SN 76-256,590. EDSTIN TECHNOLOGIES, INC., JACKSONVILLE, FL. FILED 5-14-2001.

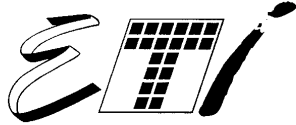

FOR CONSULTING AND ENGINEERING SERVICES IN THE FIELD OF SOLID WASTE DISPOSAL (U.S. CLS. 100 AND 101).

FIRST USE 4-1-2001; IN COMMERCE 4-1-2001.

SN 76-257,763. AURICO REPORTS, INC., ARLINGTON HEIGHTS, IL. FILED 5-16-2001.

**AURICO**

FOR PRE-EMPLOYMENT SCREENING, BACKGROUND CHECKS, AND PUBLIC RECORD SEARCHES (U.S. CLS. 100 AND 101).

FIRST USE 2-1-2001; IN COMMERCE 2-1-2001.

SN 76-258,121. NETWORK ALTERNATIVES, INC., LANGHORNE, PA. FILED 5-17-2001.



FOR PROVIDING E-MAIL COMMUNICATION MONITORING, NAMELY SCANNING AND FILTERING OF E-MAIL TRANSMITTED BETWEEN A LOCAL E-MAIL SYSTEM AND THE INTERNET FOR COMPUTER VIRUSES, UNDESIRABLE CONTENT AND UNSOLICITED COMMUNICATIONS (U.S. CLS. 100 AND 101).

FIRST USE 1-1-2000; IN COMMERCE 1-1-2000.

SN 76-259,386. DO THE HUSTLE, LLC, NEW YORK, NY. FILED 5-18-2001.

**CLUB EXPO**

NO CLAIM IS MADE TO THE EXCLUSIVE RIGHT TO USE "CLUB", APART FROM THE MARK AS SHOWN.

FOR BAR AND NIGHTCLUB SERVICES (U.S. CLS. 100 AND 101).

**CLASS 42—(Continued).**

SN 76-259,392. KAPLAN, BEN, NEW YORK, NY. FILED 5-18-2001.

**CALICAT PRODUCTIONS**

NO CLAIM IS MADE TO THE EXCLUSIVE RIGHT TO USE "PRODUCTIONS", APART FROM THE MARK AS SHOWN.

FOR PEN PAL SUBSCRIPTION SERVICE (U.S. CLS. 100 AND 101).

SN 76-259,654. SIRS MANDARIN, INC., BOCA RATON, FL. FILED 5-21-2001.

**SIRS KNOWLEDGE SOURCE**

OWNER OF U.S. REG. NOS. 1,805,942, 2,146,243 AND OTHERS.

FOR INFORMATION SERVICES, NAMELY, PROVIDING AN ON-LINE PROPRIETARY DATABASE OVER THE GLOBAL COMMUNICATIONS NETWORK FEATURING INFORMATION RELATING TO POLITICAL, SCIENTIFIC, AND SOCIAL ISSUES (U.S. CLS. 100 AND 101).

FIRST USE 1-0-1997; IN COMMERCE 1-0-1997.

SN 76-260,351. VALARAN CORPORATION, PRINCETON, NJ. FILED 5-21-2001.



FOR COMPUTER CONSULTING SERVICES PERTAINING TO SOFTWARE PROGRAMMING, DESIGN, INSTALLATION, CUSTOMIZATION, SALES SUPPORT, AND TRAINING (U.S. CLS. 100 AND 101).

**CLASS 42—(Continued).**

SN 76-261,148. KELASAN, INC., CHANHASSEN, MN. FILED 5-22-2001.



FOR GRIEF SUPPORT SERVICES IN THE NATURE OF PROVIDING INFORMATION IN THE FIELDS OF GRIEF, LOSS, DEATH AND DYING (U.S. CLS. 100 AND 101).  
FIRST USE 1-29-2001; IN COMMERCE 1-29-2001.

**CLASS 42—(Continued).**

SN 76-261,970. DO THE HUSTLE, INC., NEW YORK, NY. FILED 5-24-2001.

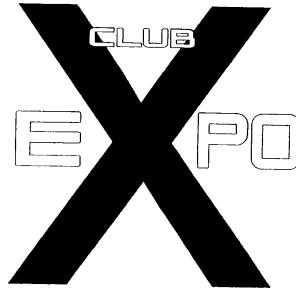

NO CLAIM IS MADE TO THE EXCLUSIVE RIGHT TO USE "CLUB", APART FROM THE MARK AS SHOWN.  
FOR BAR AND NIGHTCLUB SERVICES (U.S. CLS. 100 AND 101).

SN 76-261,607. BEVERLY ENTERPRISES, INC., FORT SMITH, AR. FILED 5-23-2001.

**BEVCARE**

FOR HEALTH CARE REFERRAL SERVICES (U.S. CLS. 100 AND 101).  
FIRST USE 6-30-1999; IN COMMERCE 6-30-1999.

SN 76-262,289. ADAEXPERTS, INC., INVERNESS, FL. FILED 5-22-2001.



SN 76-261,788. HARCOURT, INC., ORLANDO, FL. FILED 5-23-2001.

**IDEALWORLD**

OWNER OF U.S. REG. NOS. 2,098,351 AND 2,180,373.  
FOR ONLINE NEWSLETTER DELIVERED TO SUBSCRIBERS PROVIDING ONLINE ACCESS TO JOURNALS IN THE AREAS OF SCIENCE, MEDICINE, TECHNOLOGY AND PHARMACOLOGY (U.S. CLS. 100 AND 101).  
FIRST USE 6-27-1997; IN COMMERCE 6-27-1997.

NO CLAIM IS MADE TO THE EXCLUSIVE RIGHT TO USE "ADAEXPERT", "STANDARDS", "PRACTICES", "ACCESSIBILITY", "COMPLIANCE" AND "INC.", APART FROM THE MARK AS SHOWN.  
FOR CONSULTING SERVICES FOR DETERMINING WHETHER GOODS AND SERVICES OF OTHERS ARE IN COMPLIANCE WITH FEDERAL AND STATE LAWS THAT GOVERN ACCESSIBILITY BY THE DISABLED (U.S. CLS. 100 AND 101).  
FIRST USE 2-1-2001; IN COMMERCE 2-1-2001.



**CLASS 42—(Continued).**

SN 76-262,484. NLP IP COMPANY, WILMINGTON, DE. FILED 5-25-2001.

**NATIONAL LAW JOURNAL  
EXPERT WITNESSES AND  
CONSULTANTS NETWORK**

OWNER OF U.S. REG. NO. 1,846,695.  
NO CLAIM IS MADE TO THE EXCLUSIVE RIGHT TO USE "EXPERT WITNESSES" AND "CONSULTANTS NETWORK", APART FROM THE MARK AS SHOWN.  
SEC. 2(F) AS TO "NATIONAL LAW JOURNAL".  
FOR COMPUTER SERVICES, NAMELY, PROVIDING AN ONLINE SERIES OF DIRECTORIES PERTAINING TO THE LEGAL FIELD (U.S. CLS. 100 AND 101).  
FIRST USE 3-20-2001; IN COMMERCE 3-20-2001.

---

SN 76-262,648. LIVESKY SOLUTIONS, INC., BOSTON, MA. FILED 5-25-2001.

**LIVESKY**

FOR WIRELESS COMMUNICATION CONSULTING SERVICES (U.S. CLS. 100 AND 101).

---

SN 76-263,366. JAM VENTURES LLC, NEW YORK, NY. FILED 5-25-2001.

**SWEET RHYTHM**

FOR RESTAURANT AND BAR SERVICES; ENTERTAINMENT SERVICES IN THE NATURE OF A NIGHT CLUB FEATURING MUSICAL ENTERTAINMENT (U.S. CLS. 100 AND 101).

---

SN 76-268,590. NATIONAL PAIN FOUNDATION, THE, DENVER, CO. FILED 6-8-2001.



NO CLAIM IS MADE TO THE EXCLUSIVE RIGHT TO USE "THE NATIONAL PAIN FOUNDATION", APART FROM THE MARK AS SHOWN.  
FOR PROVIDING INFORMATION ON TREATMENT OPTIONS FOR PAIN (U.S. CLS. 100 AND 101).  
FIRST USE 7-1-1998; IN COMMERCE 7-1-1998.

**CLASS 42—(Continued).**

SN 76-268,793. PRINTYOU, LLC, DENVER, CO. FILED 6-7-2001.



FOR PROVIDING ON-LINE ELECTRONIC GREETING CARDS (U.S. CLS. 100 AND 101).  
FIRST USE 8-1-2000; IN COMMERCE 5-21-2001.

---

SN 76-269,952. KETTERING MEDICAL CENTER, KETTERING, OH. FILED 6-11-2001.



OWNER OF U.S. REG. NO. 2,431,774.  
FOR GENERAL AND SPECIALIZED HEALTH CARE SERVICES CONSISTING OF INPATIENT AND OUTPATIENT TREATMENT FOR DISEASES AND INJURIES OF ADULTS AND CHILDREN, AS WELL AS NATAL AND PRE-NATAL CARE (U.S. CLS. 100 AND 101).  
FIRST USE 3-0-1981; IN COMMERCE 3-0-1981.

---

SN 76-270,236. KELMSCOTT COMMUNICATIONS, LLC, SAN FRANCISCO, CA. FILED 6-12-2001.

**CEREUS GRAPHICS**

NO CLAIM IS MADE TO THE EXCLUSIVE RIGHT TO USE "GRAPHICS", APART FROM THE MARK AS SHOWN.  
FOR COMMERCIAL-LITHOGRAPHY SERVICES (U.S. CLS. 100 AND 101).

**CLASS 42—(Continued).**

SN 76-272,434. WELLMART HEARTLAB, INC., IRVING, TX. FILED 6-15-2001.

**VIASCAN**

FOR MEDICAL TESTING, NAMELY, DIAGNOSTIC RADIOLOGY AND RELATED TESTING SERVICES FOR SCREENING PATIENTS FOR CORONARY DISEASE USING AN ELECTRON BEAM CT SCANNER (U.S. CLS. 100 AND 101).

SN 76-272,826. TEMPESTA, DARYL, SCOTTS VALLEY, CA. FILED 6-18-2001.

**HOTDOT**

OWNER OF U.S. REG. NO. 2,442,507.  
FOR COMPUTER SERVICES, NAMELY CONSULTATION IN THE FIELD OF WEB SITE DESIGN AND WEB APPLICATION DEVELOPMENT (U.S. CLS. 100 AND 101).  
FIRST USE 8-0-1991; IN COMMERCE 8-0-1991.

SN 76-273,094. MUMMY, PATRICK RAYMOND, SAN DIEGO, CA. FILED 6-18-2001.

**ANATOMICAL  
STRUCTURAL ENGINEER  
(ASE)**

NO CLAIM IS MADE TO THE EXCLUSIVE RIGHT TO USE "ANATOMICAL", APART FROM THE MARK AS SHOWN.

FOR MEDICAL SERVICES, NAMELY, THERAPEUTIC EXERCISE ROUTINES DESIGNED TO RESTORE STRENGTH AND BALANCE TO THE HUMAN BODY SO THAT OPTIMAL POSTURE IS ACHIEVED AND THE PATIENT IS ABLE TO FUNCTION TO THEIR FULL PHYSICAL POTENTIAL, WITHOUT PAIN OR DISCOMFORT (U.S. CLS. 100 AND 101).

SN 76-276,002. GEORGIA'S CIVIL WAR HERITAGE TRAILS, INC., EVANS, GA. FILED 6-22-2001.

**GEORGIA CIVIL WAR  
HERITAGE TRAILS**

NO CLAIM IS MADE TO THE EXCLUSIVE RIGHT TO USE "GEORGIA CIVIL WAR", APART FROM THE MARK AS SHOWN.

FOR PROVIDING HISTORICAL, SOCIAL, POLITICAL AND GEOGRAPHICAL INFORMATION AND ECONOMIC HISTORY RELATED TO THE AMERICAN CIVIL WAR ERA (U.S. CLS. 100 AND 101).

**CLASS 42—(Continued).**

SN 76-277,248. DONAHUE, GALLAGHER, WOODS & WOOD, LLP, OAKLAND, CA. FILED 6-22-2001.

**DONAHUE, GALLAGHER,  
WOODS & WOOD, LLP**

NO CLAIM IS MADE TO THE EXCLUSIVE RIGHT TO USE "LLP", APART FROM THE MARK AS SHOWN.  
FOR LEGAL SERVICES (U.S. CLS. 100 AND 101).  
FIRST USE 6-23-1993; IN COMMERCE 6-23-1993.

SN 76-277,489. TACO BELL CORP., IRVINE, CA. FILED 6-27-2001.

**GET IT AT THE BELL**

OWNER OF U.S. REG. NO. 1,765,386.  
FOR RESTAURANT SERVICES (U.S. CLS. 100 AND 101).

SN 76-281,255. SUMMIT LAW GROUP PLLC, SEATTLE, WA. FILED 7-6-2001.

**SUMMIT LAW GROUP**

NO CLAIM IS MADE TO THE EXCLUSIVE RIGHT TO USE "LAW GROUP", APART FROM THE MARK AS SHOWN.

FOR LEGAL SERVICES (U.S. CLS. 100 AND 101).  
FIRST USE 3-17-1997; IN COMMERCE 5-0-1997.

SN 76-285,730. DOCTOR'S ASSOCIATES INC., FORT LAUDERDALE, FL. FILED 7-16-2001.

**SUBWAY EAT FRESH**

FOR RESTAURANT SERVICES; CATERING SERVICES; EAT-IN AND TAKE-OUT FOOD SERVICES (U.S. CLS. 100 AND 101).

FIRST USE 6-1-2000; IN COMMERCE 6-1-2000.

SN 76-290,982. HONEYWELL INTERNATIONAL INC., MORRISTOWN, NJ. FILED 7-30-2001.

**T.E.A.M.**

FOR CONSULTATION AND ENGINEERING SERVICES IN THE FIELD OF ENERGY MANAGEMENT AND CONSERVATION (U.S. CLS. 100 AND 101).

FIRST USE 3-14-2001; IN COMMERCE 3-14-2001.

**CLASS 42—(Continued).**

SN 76-291,889. ENGINEERED FLUID CONTROLS, INC., CENTRALIA, IL. FILED 7-30-2001.



NO CLAIM IS MADE TO THE EXCLUSIVE RIGHT TO USE "ENGINEERED CONTROL SOLUTIONS", APART FROM THE MARK AS SHOWN.

FOR ENGINEERING SERVICES, NAMELY, IN THE FIELD OF ELECTRONIC AND ELECTRICAL CONTROL SYSTEMS (U.S. CLS. 100 AND 101).

SN 76-292,710. CRITES, KENNETH L., HUNTINGTON BEACH, CA. FILED 7-31-2001.

**OUTRIDERS CAR CLUB**

NO CLAIM IS MADE TO THE EXCLUSIVE RIGHT TO USE "CAR CLUB", APART FROM THE MARK AS SHOWN. FOR AUTOMOBILE CAR CLUB (U.S. CLS. 100 AND 101).

SN 76-295,128. AGGREGATE RESEARCH INDUSTRIES, LLC, RICHMOND, VA. FILED 8-6-2001.

**ARI**

FOR CONSULTING AND RESEARCH SERVICES RELATING TO THE AGGREGATE AND AGGREGATE RELATED INDUSTRIES (U.S. CLS. 100 AND 101). FIRST USE 1-0-2000; IN COMMERCE 1-0-2000.

SN 76-295,187. SOSA BORELLA CATERING LLC, NEW YORK, NY. FILED 8-3-2001.

**SOSA BORELLA**

THE NAME "SOSA BORELLA" DOES NOT IDENTIFY A LIVING INDIVIDUAL. FOR RESTAURANT AND CATERING SERVICES (U.S. CLS. 100 AND 101). FIRST USE 7-0-1995; IN COMMERCE 7-0-1995.

SN 76-296,061. SHOP WELL WITH YOU, NEW YORK, NY. FILED 8-6-2001.

**SHOP WELL WITH YOU**

FOR PERSONAL SHOPPING SERVICE FOR PEOPLE BATTLING CANCER (U.S. CLS. 100 AND 101).

**CLASS 42—(Continued).**

SN 76-296,329. CALCULEX, INC., LAS CRUCES, NM. FILED 8-7-2001.

**CALCULEX**

FOR ENGINEERING SERVICES; CONSULTING SERVICES IN THE FIELD OF DESIGN, SELECTION, IMPLEMENTATION AND USE OF COMPUTER HARDWARE AND SOFTWARE SYSTEMS FOR OTHERS (U.S. CLS. 100 AND 101).

FIRST USE 9-15-1986; IN COMMERCE 5-11-1988.

SN 76-296,568. EXCEL NETWORKS, INCORPORATED, SWARTHMORE, PA. FILED 8-9-2001.

**EXCEL NETWORKS**

NO CLAIM IS MADE TO THE EXCLUSIVE RIGHT TO USE "NETWORKS", APART FROM THE MARK AS SHOWN.

FOR COMPUTER NETWORK DESIGN FOR OTHERS, AND TECHNICAL SUPPORT, NAMELY MONITORING OF NETWORK SYSTEMS (U.S. CLS. 100 AND 101).

SN 76-297,929. SHAKEN BABY ASSOCIATION, INC., DOUSMAN, WI. FILED 8-9-2001.

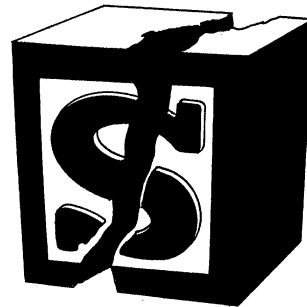

FOR PROMOTING THE PUBLIC AWARENESS OF SHAKEN BABY SYNDROME (U.S. CLS. 100 AND 101). FIRST USE 3-23-1999; IN COMMERCE 3-23-1999.

**CLASS 42—(Continued).**

SN 76-298,674. HODGE, ROBERT A., DBA ALLAMERICAN-WINERIES.COM, PFAFFTOWN, NC. FILED 8-13-2001.

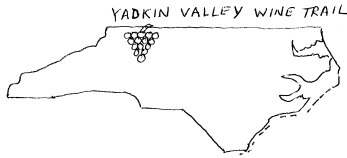

NO CLAIM IS MADE TO THE EXCLUSIVE RIGHT TO USE "YADKIN VALLEY WINE" AND THE REPRESENTATION OF THE STATE OF NORTH CAROLINA, APART FROM THE MARK AS SHOWN.

FOR PROVIDING INFORMATION ABOUT WINE AND WINERIES LOCATED IN THE YADKIN VALLEY AREA OF NORTH CAROLINA (U.S. CLS. 100 AND 101).

SN 76-299,174. NANOBIO CORPORATION, ANN ARBOR, MI. FILED 8-9-2001.

**NANOCURE**

FOR CONSULTING SERVICES IN THE FIELDS OF RESEARCH, FORMULATION, DEVELOPMENT, AND TESTING OF CELL LINES FOR USE IN MEDICAL DIAGNOSTICS, MEDICAL THERAPEUTICS, MEDICAL TREATMENT, AND PRODUCT DEVELOPMENT; RESEARCH, FORMULATION, DEVELOPMENT, AND TESTING OF CELL LINES FOR USE IN PHARMACEUTICAL RESEARCH AND DEVELOPMENT (U.S. CLS. 100 AND 101).

SN 76-299,983. EARL REALTY INC., LANCASTER, PA. FILED 8-16-2001.

**OLD MILL STREAM CAMPING MANOR**

NO CLAIM IS MADE TO THE EXCLUSIVE RIGHT TO USE "CAMPING MANOR", APART FROM THE MARK AS SHOWN.

FOR PROVIDING CAMPGROUND SERVICES (U.S. CLS. 100 AND 101).

FIRST USE 1-1-1967; IN COMMERCE 1-1-1967.

**CLASS 42—(Continued).**

SN 76-300,759. AMERICAN FARMLAND TRUST, INC., WASHINGTON, D.C., DC. FILED 8-17-2001.



NO CLAIM IS MADE TO THE EXCLUSIVE RIGHT TO USE "AMERICAN FARMLAND TRUST", APART FROM THE MARK AS SHOWN.

FOR PROMOTING PUBLIC AWARENESS OF THE NEED FOR CONSERVATION OF FARMLAND, FARMING PRACTICES THAT LEAD TO A HEALTHY ENVIRONMENT, AND PUBLIC POLICIES ON FARMLAND PRESERVATION; ASSOCIATION SERVICES, NAMELY, PROMOTING CONSERVATION OF FARMLAND, FARMING PRACTICES THAT LEAD TO A HEALTHY ENVIRONMENT, AND PUBLIC POLICIES ON FARMLAND PRESERVATION (U.S. CLS. 100 AND 101).

FIRST USE 11-10-1986; IN COMMERCE 11-10-1986.

SN 76-304,473. NATIONAL RESEARCH CORPORATION, LINCOLN, NE. FILED 8-27-2001.

**DOCTORGUIDE**

FOR SURVEYING PATIENTS AND REPORTING THE RESULTS OF PATIENT SATISFACTION AND PERFORMANCE OF MEDICAL DOCTORS (U.S. CLS. 100 AND 101).

FIRST USE 8-0-2000; IN COMMERCE 8-0-2000.

SN 76-304,665. UNITED STATES POSTAL SERVICE, WASHINGTON, DC. FILED 8-24-2001.



OWNER OF U.S. REG. NOS. 2,132,892 AND 2,137,563. NO CLAIM IS MADE TO THE EXCLUSIVE RIGHT TO USE "POSTAL POLICE OFFICER", APART FROM THE MARK AS SHOWN.

SEC. 2(F) AS TO "UNITED STATES POSTAL SERVICE". FOR POLICE PROTECTION SERVICES, NAMELY, PROTECTION OF POSTAL EMPLOYEES, REAL AND PERSONAL PROPERTY; ESCORT SERVICES FOR HIGH VALUE SHIPMENTS OF OTHERS; RESEARCH AND CONSULTING FOR OTHERS IN THE FIELD OF CRIMINAL ACTIVITY; SECURITY GUARD SERVICES (U.S. CLS. 100 AND 101).

FIRST USE 0-0-1981; IN COMMERCE 0-0-1981.

**CLASS 42—(Continued).**

SN 76-305,640. SHORTY SMALL'S DESIGNS, L.C., EDMOND, OK. FILED 8-28-2001.

**SHORTY'S RIBS ON THE RUN**

FOR RESTAURANT AND BAR SERVICES (U.S. CLS. 100 AND 101).  
FIRST USE 8-27-2001; IN COMMERCE 8-27-2001.



SN 76-305,838. SHORTY SMALL'S DESIGNS, L.C., EDMOND, OK. FILED 8-28-2001.

**RIBS ON THE RUN**

FOR RESTAURANT AND BAR SERVICES (U.S. CLS. 100 AND 101).  
FIRST USE 8-27-2001; IN COMMERCE 8-27-2001.



SN 76-306,560. 136 COLLINS AVE., LC, MIAMI BEACH, FL. FILED 8-28-2001.

**TABAC**

THE ENGLISH TRANSLATION OF THE WORD "TABAC IN THE MARK IS "TOBACCO".  
FOR RESTAURANTS (U.S. CLS. 100 AND 101).



SN 76-307,257. PROSKAUER ROSE LLP, NEW YORK, NY. FILED 8-29-2001.



NO CLAIM IS MADE TO THE EXCLUSIVE RIGHT TO USE "LAW" AND "WORKPLACE", APART FROM THE MARK AS SHOWN.

FOR LEGAL SERVICES, NAMELY PROVIDING COUNSELING AND INFORMATION ON ISSUES RELATING TO LABOR AND EMPLOYMENT LAW (U.S. CLS. 100 AND 101).  
FIRST USE 7-10-2001; IN COMMERCE 7-10-2001.

**CLASS 42—(Continued).**

SN 76-307,829. COGNICHECK, INC., LYNCHBURG, VA. FILED 9-4-2001.

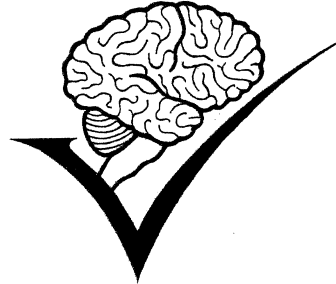

FOR PSYCHOLOGICAL TESTING SERVICE (U.S. CLS. 100 AND 101).



SN 76-308,118. HILBURGER, ALBERT W., NIAN TIC, CT. FILED 9-4-2001.

**TRUTH SQUAD**

FOR PROVIDING INFORMATION ABOUT LIFE ISSUES AND AFFIRMING THE SANCTITY OF ALL HUMAN LIFE (U.S. CLS. 100 AND 101).  
FIRST USE 10-30-1993; IN COMMERCE 4-18-1995.



SN 76-308,613. TRUMP, IVANA, NEW YORK, NY. FILED 9-6-2001.

**IVANA'S**

FOR RESTAURANT SERVICES (U.S. CLS. 100 AND 101).



SN 76-308,684. ALATRON CORPORATION, SEATTLE, WA. FILED 9-5-2001.

**CHANNEL SYNC**

FOR PROVIDING INFORMATION IN THE FIELD OF ENGINEERING, ELECTRONICS, SEMICONDUCTORS, WIRELESS DEVICES, COMPUTERS AND PRODUCT DEVELOPMENT; PROVIDING ON-LINE NON-DOWNLOADABLE SOFTWARE FOR SAMPLE MANAGEMENT, COMPONENT REGISTRATION, ACCOUNT ANALYSIS, COMMISSION TRACKING AND PRODUCT RETURN PROCESSING; APPLICATION SERVICE PROVIDER OF ON-LINE PRODUCT DEVELOPMENT TOOLS, NAMELY SOFTWARE FOR USE IN PRODUCT DEVELOPMENT (U.S. CLS. 100 AND 101).

**CLASS 42—(Continued).**

SN 76-309,373. EDBM, INC., DALLAS, TX. FILED 9-6-2001.

**SWINGING DICKIES**

FOR RESTAURANT AND NIGHT CLUB SERVICES (U.S. CLS. 100 AND 101).

SN 76-312,386. DELJACK, INC., BOISE, ID. FILED 9-14-2001.

**NO LAWYERS**FOR RESTAURANT, BAR AND GRILL SERVICES (U.S. CLS. 100 AND 101).  
FIRST USE 9-0-1986; IN COMMERCE 9-0-1986.

SN 76-313,113. REFRACTEC, INC., IRVINE, CA. FILED 9-10-2001.

**ARE YOU READY?**

FOR OPHTHALMIC SURGICAL SERVICES, NAMELY SERVICES IN CONNECTION WITH CORRECTING VISION WITH AN ELECTRODE (U.S. CLS. 100 AND 101).

SN 76-313,118. CHART HOUSE ENTERPRISES, INC., CHICAGO, IL. FILED 9-10-2001.

**GET IN THE MOOD**FOR RESTAURANT SERVICES (U.S. CLS. 100 AND 101).  
FIRST USE 7-0-2001; IN COMMERCE 7-0-2001.

SN 76-313,226. STAIRWAY TO RECOVERY.COM, INC., MERION, PA. FILED 9-17-2001.

**STAIRWAY TO RECOVERY**

FOR REHABILITATION OF PERSONS ADDICTED TO ALCOHOL, DRUGS, NARCOTICS, AND OTHER ADDICTIONS; PROVIDING INFORMATION TO OTHERS REGARDING ADDICTIONS AND SUBSTANCE ABUSE AND EDUCATIONAL SERVICES REGARDING SUBSTANCE ABUSE AND ADDICTIONS; COUNSELING IN THE FIELDS OF SUBSTANCE ABUSE AND ADDICTIONS (U.S. CLS. 100 AND 101).

**CLASS 42—(Continued).**

SN 76-313,757. SMITHSONIAN INSTITUTION, WASHINGTON, DC. FILED 9-18-2001.

FOR PHOTOGRAPHY SERVICES (U.S. CLS. 100 AND 101).  
FIRST USE 3-30-2001; IN COMMERCE 3-30-2001.

SN 76-315,131. QUIZNO'S CORPORATION, THE, DENVER, CO. FILED 9-20-2001.



FOR RESTAURANT SERVICES (U.S. CLS. 100 AND 101).

SN 76-315,163. KIMPTON HOTEL &amp; RESTAURANT GROUP, LLC, SAN FRANCISCO, CA. FILED 9-20-2001.

**HOTEL VOGUE**NO CLAIM IS MADE TO THE EXCLUSIVE RIGHT TO USE "HOTEL", APART FROM THE MARK AS SHOWN.  
THE MARK CONSISTS OF THE WORDS "HOTEL VOGUE".  
FOR HOTEL SERVICES (U.S. CLS. 100 AND 101).

SN 76-315,265. QUIKBOOK, INC., NEW YORK, NY. FILED 9-21-2001.

**QUIKBOOK.COM**FOR MAKING HOTEL RESERVATIONS FOR OTHERS VIA THE GLOBAL COMPUTER NETWORK (U.S. CLS. 100 AND 101).  
FIRST USE 9-27-2000; IN COMMERCE 9-27-2000.

**CLASS 42—(Continued).**

SN 76-318,069. DOLRIC, INC., SAN FRANCISCO, CA. FILED 9-25-2001.

**B44**

FOR RESTAURANT AND CATERING SERVICES (U.S. CLS. 100 AND 101).  
FIRST USE 11-5-1999; IN COMMERCE 11-5-1999.

SN 76-319,190. CREATIVE HAIRDRESSERS, INC., FALLS CHURCH, VA. FILED 9-28-2001.

**EASY COLOR**

FOR HAIR SALON SERVICES (U.S. CLS. 100 AND 101).

SN 76-321,569. PET STAFF, INC., BEVERLY HILLS, CA. FILED 10-5-2001.

**"WE LOVE 'EM, WHEN YOU HAVE TO LEAVE 'EM"**

FOR PET SITTING (U.S. CLS. 100 AND 101).

SN 76-322,571. PAPERLOOP.COM, INC., SAN FRANCISCO, CA. FILED 10-9-2001.

**CONVERTINGLOOP**

FOR NEWS AGENCY SERVICES, NAMELY, GATHERING AND DISSEMINATION OF NEWS AND NEWS ARTICLES RELATED TO THE FIELDS OF CONVERTING AND PACKAGE PRINTING VIA A GLOBAL COMPUTER NETWORK (U.S. CLS. 100 AND 101).  
FIRST USE 4-0-2001; IN COMMERCE 4-0-2001.

SN 76-323,416. WOMEN IMPACTING PUBLIC POLICY, INC., BLOOMFIELD HILLS, MI. FILED 10-10-2001.

**WIPP**

FOR PROMOTING THE INTERESTS OF WOMEN IN BUSINESS AND POLITICS (U.S. CLS. 100 AND 101).  
FIRST USE 7-0-2001; IN COMMERCE 7-0-2001.

**CLASS 42—(Continued).**

SN 78-010,254. PALMER, ROSEMARY NOBLE, TALLAHASSEE, FL. FILED 5-27-2000.

**FLORIDA LAW LADY**

NO CLAIM IS MADE TO THE EXCLUSIVE RIGHT TO USE "FLORIDA LAW", APART FROM THE MARK AS SHOWN.  
FOR LEGAL SERVICES (U.S. CLS. 100 AND 101).

SN 78-014,886. EVANS, JAMES THOMAS, BALTIMORE, MD. FILED 6-29-2000.

**ILLUME DESIGN**

NO CLAIM IS MADE TO THE EXCLUSIVE RIGHT TO USE "DESIGN", APART FROM THE MARK AS SHOWN.  
FOR GRAPHIC DESIGN, WEB SITE DESIGN, ANIMATION AND ENVIRONMENTAL GRAPHIC DESIGN AND MULTIMEDIA DESIGN SERVICES (U.S. CLS. 100 AND 101).

SN 78-016,942. NETQUIK LLC, LEXINGTON, MA. FILED 7-17-2000.

**FASTSITE.COM**

FOR COMPUTER SERVICES, NAMELY, PROVIDING SEARCH ENGINES FOR OBTAINING GEOGRAPHIC AND BUSINESS INFORMATION DATA ON A GLOBAL COMPUTER NETWORK, FOR USE BY OTHERS ON WEBSITES AND IN BUSINESS ACTIVITIES (U.S. CLS. 100 AND 101).  
FIRST USE 12-4-1999; IN COMMERCE 5-3-2000.

SN 78-023,006. GENZYME CORPORATION, FRAMINGHAM, MA. FILED 8-25-2000.

**A RARE KIND OF CARE**

FOR MEDICAL TESTING; AND MEDICAL COUNSELING IN THE FIELD OF GENETIC DISEASES, INCLUDING BUT NOT LIMITED TO CYSTIC FIBROSIS, POMPE DISEASE, FABRY DISEASE AND GAUCHER DISEASE (U.S. CLS. 100 AND 101).  
FIRST USE 10-1-1999; IN COMMERCE 10-1-1999.

**CLASS 42—(Continued).**

SN 78-023,811. PETROWICH, THEODORE L., BATAVIA, IL.  
FILED 8-30-2000.

**FUND RAISER PLUS**

NO CLAIM IS MADE TO THE EXCLUSIVE RIGHT TO USE "FUND RAISER", APART FROM THE MARK AS SHOWN.

FOR CHARITABLE FUND RAISING SERVICES, NAMELY, PROVIDING NUTRITION BARS FOR ORGANIZATIONS TO SELL AND LITERATURE PROMOTING FUND RAISING FOR SUCH ORGANIZATIONS (U.S. CLS. 100 AND 101).

---

SN 78-023,948. ASK THE GEEK, INC., GREENSBORO, NC.  
FILED 8-31-2000.

**ASK THE GEEK**

FOR COMPUTER CONSULTATION SERVICES (U.S. CLS. 100 AND 101).  
FIRST USE 6-7-1996; IN COMMERCE 6-7-1996.

---

SN 78-023,989. SCHWEGMAN, LUNDBERG, WOESSNER & KLUTH, P.A., MINNEAPOLIS, MN. FILED 8-31-2000.

**BEST DIRECT**

FOR PROFESSIONAL ASSOCIATION SERVICES, NAMELY, PROMOTING THE INTERESTS OF INTELLECTUAL PROPERTY ATTORNEYS; COMPUTER SERVICES, NAMELY, PROVIDING ONLINE INFORMATION AND NEWSLETTERS IN THE FIELD OF INTELLECTUAL PROPERTY LAW (U.S. CLS. 100 AND 101).

---

SN 78-025,232. DR-D-STRESS.COM, INC., SANTA MONICA, CA. FILED 9-10-2000.

**DR-D-STRESS.COM**

FOR PROVIDING INDIVIDUALIZED CONSULTATIONS IN THE FIELD OF STRESS MANAGEMENT (U.S. CLS. 100 AND 101).  
FIRST USE 8-23-2000; IN COMMERCE 8-23-2000.

**CLASS 42—(Continued).**

SN 78-025,907. NG3, CHULA VISTA, CA. FILED 9-14-2000.



FOR COMPUTER SERVICES, NAMELY, CREATING AND MAINTAINING WEB SITES FOR OTHERS (U.S. CLS. 100 AND 101).  
FIRST USE 9-1-1998; IN COMMERCE 9-1-1998.

---

SN 78-026,146. VOLKER, MATHIAS, ALISO VIEJO, CA.  
FILED 9-15-2000.

**TRADEMARK4US**

FOR LEGAL SERVICES; INTELLECTUAL PROPERTY CONSULTATION, NAMELY, TRADEMARK RESEARCHES, TRADEMARK INFORMATION SERVICES, TRADEMARK PROSECUTION; LANGUAGE TRANSLATION SERVICES (U.S. CLS. 100 AND 101).

---

SN 78-026,386. ALASKA SUPPLY CHAIN INTEGRATOR, LLC, ANCHORAGE, AK. FILED 9-18-2000.

**SMARTCOMPETITOR**

FOR PROVIDING TEMPORARY USE OF ON-LINE, NON-DOWNLOADABLE COMPUTER SEARCH ENGINE SOFTWARE THAT ALLOWS SUPPLIERS TO PROVIDE PRICING AND OTHER KEY SERVICE INFORMATION TO CLIENTS FOR PURPOSES OF COMPARISON DURING A COMPETITIVE SELECTION PROCESS (U.S. CLS. 100 AND 101).

---

SN 78-026,966. EHN, MOLLIE, LEE, ENCINITAS, CA. FILED 9-21-2000.

**WORKINGCLASS.COM**

FOR COMPUTER SERVICES, NAMELY, PROVIDING AN ONLINE MAGAZINE FEATURING REVIEWS OF OTHER WEB SITES VIA A GLOBAL COMPUTER NETWORK (U.S. CLS. 100 AND 101).  
FIRST USE 3-7-2000; IN COMMERCE 3-7-2000.



**CLASS 42—(Continued).**

SN 78-027,333. HARD DOLLAR CORPORATION, TEMPE, AZ. FILED 9-22-2000.

**HARD DOLLAR FLEET**

OWNER OF U.S. REG. NO. 1,585,440.  
FOR PROVIDING TEMPORARY USE OF ON-LINE NON-DOWNLOADABLE SOFTWARE FOR EQUIPMENT RESEARCH AND ESTIMATING OWNERSHIP AND OPERATING COSTS FOR USE IN THE FIELD OF INFRA-STRUCTURE CONSTRUCTION MANAGEMENT (U.S. CLS. 100 AND 101).

SN 78-028,460. AQUINAS SOFTWARE, SEA BRIGHT, NJ. FILED 9-30-2000.

**SURFY!**

FOR COMPUTER SERVICES, NAMELY, PROVIDING SOFTWARE INTERFACES AVAILABLE OVER A NETWORK IN ORDER TO CREATE A PERSONALIZED ON-LINE INFORMATION SERVICES; EXTRACTION AND RETRIEVAL OF INFORMATION AND DATA MINING BY MEANS OF GLOBAL COMPUTER NETWORKS; CREATING INDEXES OF INFORMATION, INDEXES OF WEB SITES AND INDEXES OF OTHER INFORMATION SOURCES IN CONNECTION WITH GLOBAL COMPUTER NETWORK; PROVIDING INFORMATION FROM SEARCHABLE INDEXES AND DATABASES OF INFORMATION, INCLUDING TEXT, ELECTRONIC DOCUMENTS, DATABASES, GRAPHICS AND AUDIO VISUAL INFORMATION, BY MEANS OF GLOBAL COMPUTER INFORMATION NETWORKS (U.S. CLS. 100 AND 101).  
FIRST USE 7-23-1998; IN COMMERCE 7-23-1998.

SN 78-029,161. TROMANHAUSER, SCOTT, GLENN, BOSTON, MA. FILED 10-5-2000.

**INTELLIGENT OUTCOMES**

FOR MEDICAL DECISION ANALYSIS SERVICES (U.S. CLS. 100 AND 101).

SN 78-029,679. BOOGIE TV, LLC, MONTCLAIR, NJ. FILED 10-9-2000.

**VIRTUE.TV**

FOR COMPUTER SERVICES, NAMELY, PROVIDING SEARCH ENGINES THAT INDEX LINKS IN THE GENERAL FIELD OF RELIGION AND RELIGIOUS STUDIES; PROVIDING A DISCRIMINATING SEARCH ENGINE FOR OBTAINING INFORMATION AND DATA IN THE FIELDS OF RELIGION AND RELIGIOUS STUDIES (U.S. CLS. 100 AND 101).

**CLASS 42—(Continued).**

SN 78-030,374. RUDE AWAKENING, INC., FAYETTEVILLE, NC. FILED 10-12-2000.

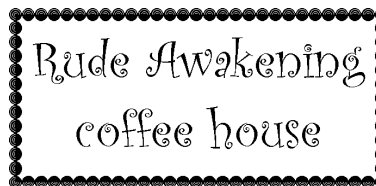

NO CLAIM IS MADE TO THE EXCLUSIVE RIGHT TO USE "COFFEE HOUSE", APART FROM THE MARK AS SHOWN.

FOR RESTAURANT SERVICES, NAMELY COFFEE HOUSE SERVING COFFEE AND FOOD (U.S. CLS. 100 AND 101).

FIRST USE 5-2-1998; IN COMMERCE 12-28-1999.

SN 78-030,575. STEAK MASTERS BRAZILIAN RODIZIO, INC., MIAMI, FL. FILED 10-13-2000.

**STEAKMASTERS EXPRESS**

NO CLAIM IS MADE TO THE EXCLUSIVE RIGHT TO USE "EXPRESS", APART FROM THE MARK AS SHOWN.

FOR RESTAURANT SERVICES FEATURING BRAZILIAN STYLE COOKING (U.S. CLS. 100 AND 101).

SN 78-030,720. BOOGIE TV, LLC, MONTCLAIR, NJ. FILED 10-16-2000.

**ORBIT.TV**

FOR COMPUTER SERVICES, NAMELY, PROVIDING ASTROLOGICAL AND HOROSCOPE FORECASTING VIA WEBSITES ON THE INTERNET; ASTROLOGY AND HOROSCOPE ON-LINE INFORMATION SERVICES, NAMELY, PROVIDING DATABASES AND WEBSITE LINKS TO OTHER CONTENT PROVIDERS IN THE FIELD OF ASTROLOGICAL AND HOROSCOPE FORECASTING; COMPUTER SERVICES, NAMELY, PROVIDING SEARCH ENGINES FOR OBTAINING DATA ON A GLOBAL COMPUTER NETWORK; PROVIDING DATING SERVICES BASED ON HOROSCOPES AND ASTROLOGICAL READINGS VIA WEBSITES ON THE INTERNET (U.S. CLS. 100 AND 101).

SN 78-031,817. WILDENBERG, LYF C, ST PAUL, MN. FILED 10-22-2000.

**MYTECH PARTNERS**

NO CLAIM IS MADE TO THE EXCLUSIVE RIGHT TO USE "PARTNERS", APART FROM THE MARK AS SHOWN.

FOR COMPUTER AND COMPUTER NETWORK CONSULTING SERVICES (U.S. CLS. 100 AND 101).

FIRST USE 10-8-2000; IN COMMERCE 10-8-2000.

**CLASS 42—(Continued).**

SN 78-032,334. RTMEDIA, ATLANTA, GA. FILED 10-25-2000.

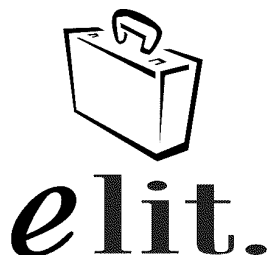

FOR LITIGATION SUPPORT SERVICES AND LEGAL SERVICES IN THE NATURE OF LEGAL CONSULTATION AND TRIAL PRESENTATION SERVICES, NAMELY PRESENTING AUDIO AND VIDEO TESTIMONY AND EXHIBITS IN LEGAL SETTINGS (U.S. CLS. 100 AND 101).

FIRST USE 10-10-2000; IN COMMERCE 10-24-2000.

SN 78-032,375. LUNCHCLUB.NET LLC, CHANDLER, AZ. FILED 10-25-2000.

**LUNCHCLUB**

FOR PROVIDING INFORMATION ON LUNCH SPECIALS VIA E-MAIL (U.S. CLS. 100 AND 101).

FIRST USE 11-0-1999; IN COMMERCE 2-0-2000.

SN 78-033,137. GENERAL MILLS, INC., MINNEAPOLIS, MN. FILED 10-31-2000.

**CEREAL ADVENTURE CAFE**

NO CLAIM IS MADE TO THE EXCLUSIVE RIGHT TO USE "CAFE", APART FROM THE MARK AS SHOWN.

FOR RESTAURANT SERVICES (U.S. CLS. 100 AND 101).

SN 78-035,498. E. R. SQUIBB &amp; SONS, L.L.C., PRINCETON, NJ. FILED 11-16-2000.

**1-800 PRAVACHOL 10**

OWNER OF U.S. REG. NOS. 1,498,284 AND 1,726,619. NO CLAIM IS MADE TO THE EXCLUSIVE RIGHT TO USE "1-800" AND "10", APART FROM THE MARK AS SHOWN.

FOR TELEPHONE INFORMATION SERVICE PROVIDING INFORMATION RELATING TO CARDIOVASCULAR DISEASES (U.S. CLS. 100 AND 101).

**CLASS 42—(Continued).**

SN 78-036,362. APPLIED INTERNET GROUP LLC, EAST HARTFORD, CT. FILED 11-22-2000.

**APPLIED INTERNET**

NO CLAIM IS MADE TO THE EXCLUSIVE RIGHT TO USE "INTERNET", APART FROM THE MARK AS SHOWN. FOR CUSTOM DESIGN FOR OTHERS OF COMPUTER SOFTWARE USED ON WEBSITES; HOSTING THE WEBSITES OF OTHERS ON A COMPUTER SERVER FOR A GLOBAL COMPUTER NETWORK (U.S. CLS. 100 AND 101).

FIRST USE 11-13-2000; IN COMMERCE 11-13-2000.

SN 78-038,694. RIVERLAND LASER, INC., RIVER FALLS, WI. FILED 12-11-2000.



NO CLAIM IS MADE TO THE EXCLUSIVE RIGHT TO USE "LASER, INC.", APART FROM THE MARK AS SHOWN.

FOR LASER MARKING SERVICES (U.S. CLS. 100 AND 101).

SN 78-039,260. TEW, R BURTON, OXFORD, ID. FILED 12-14-2000.

**BREEDERBASE**

FOR COMPUTER SERVICES, NAMELY, PROVIDING AN ON-LINE MAGAZINE IN THE FIELD OF ANIMAL BREEDING (U.S. CLS. 100 AND 101).

SN 78-039,398. BOOGIE TV, LLC, MONTCLAIR, NJ. FILED 12-15-2000.

**ARENA.TV**

FOR COMPUTER SERVICES, NAMELY, PROVIDING SEARCH ENGINES FOR OBTAINING DATA ON A GLOBAL COMPUTE NETWORK IN THE FIELDS OF SPORTS, NEWS AND ENTERTAINMENT (U.S. CLS. 100 AND 101).

SN 78-042,263. ICHANCE, INC., LAS VEGAS, NV. FILED 1-9-2001.



FOR COMPUTER SERVICES, NAMELY, DESIGNING, CREATING, IMPLEMENTING AND MAINTAINING WEB SITES FOR OTHERS IN THE FIELD OF GAMING (U.S. CLS. 100 AND 101).

**CLASS 42—(Continued).**

SN 78-045,706. THREE TREES HOLDINGS II LLC, SAN FRANCISCO, CA. FILED 1-30-2001.

**SNOWSHOES**

FOR RESTAURANT SERVICES (U.S. CLS. 100 AND 101).

**CLASS 42—(Continued).**

SN 78-051,006. BOHNKE, FAITH HOSTETTER, GLEN ALLEN, VA. FILED 3-2-2001.

**WORLDISMYSANDBOX.COM**

FOR PROVIDING A FAMILY WEB SITE WHICH IS USED TO TEACH CHILDREN ABOUT GEOGRAPHICAL AND HISTORICAL PEOPLE AND PLACES OF INTEREST, AND PROVIDES INFORMATION REGARDING THE DATE OF STATEHOOD, BASIC STATE TIMELINE, NATURAL RESOURCES AND FAMOUS CITIZENS OF THE STATE, AND COMPLEMENTS PLANNED FAMILY TRAVEL AS AN EDUCATIONAL TOOL (U.S. CLS. 100 AND 101).

SN 78-048,386. BIZCOM INTERNATIONAL, SALT LAKE CITY, UT. FILED 2-14-2001.

**SMARTCART**

FOR HOSTING THE E-COMMERCE WEB SITES OF OTHERS ON A COMPUTER SERVER FOR A GLOBAL COMPUTER NETWORK (U.S. CLS. 100 AND 101).  
FIRST USE 8-21-1996; IN COMMERCE 8-21-1996.

SN 78-048,973. HERVEY, MARCUS WILLIAM, ORLANDO, FL. FILED 2-18-2001.

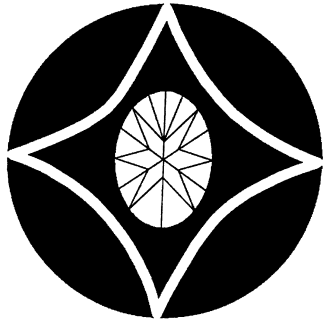

FOR TECHNICAL CONSULTING IN THE FIELD OF COMPUTER SOFTWARE DEVELOPMENT (U.S. CLS. 100 AND 101).

SN 78-051,426. DOCUHOME, LLC, RED BANK, NJ. FILED 3-5-2001.



SN 78-049,016. ENSKY CORPORATION, ROCHESTER, NH. FILED 2-19-2001.



NO CLAIM IS MADE TO THE EXCLUSIVE RIGHT TO USE "CORPORATION", APART FROM THE MARK AS SHOWN.

FOR COMPUTER SERVICES, NAMELY, DESIGNING AND IMPLEMENTING WEB SITES FOR OTHERS (U.S. CLS. 100 AND 101).

FIRST USE 6-10-1997; IN COMMERCE 6-11-1997.

NO CLAIM IS MADE TO THE EXCLUSIVE RIGHT TO USE THE REPRESENTATION OF A CAMERA, APART FROM THE MARK AS SHOWN.

FOR COMPILING INVENTORIES OF PERSONAL PROPERTY FOR INSURANCE PURPOSES AND USE IN LITIGATION FOR OTHERS USING DIGITAL IMAGING, PHOTOGRAPHY, AND VIDEO (U.S. CLS. 100 AND 101).

FIRST USE 11-1-1999; IN COMMERCE 11-17-1999.

**CLASS 42—(Continued).**

SN 78-053,590. COLMANO, MARINO, DBA HARMONY RESORTS, N. HOLLYWOOD, CA. FILED 3-16-2001.



NO CLAIM IS MADE TO THE EXCLUSIVE RIGHT TO USE RESORTS, APART FROM THE MARK AS SHOWN.

THE MARK CONSISTS OF AN INVERSE TRIANGLE CENTERED WITHIN A LARGER TRIANGLE. THE SILHOUETTE OF A LILLY FLOWER APPEARS IN THE CENTER OF THE INVERSE TRIANGLE WITH ITS LEAVES CROSSING INTO THE MAIN TRIANGLE ON EITHER SIDE. THE UPPER HALF OF THE MAIN TRIANGLE ALSO CONTAINS A HALF SUN POSITIONED RESTING ON THE INVERTED TRIANGLE. THE WORDING "HARMONY RESORTS" APPEARS BENEATH THE TRIANGLES WITH TWO WAVE LIKE LINES BELOW THE WORDS.

FOR RESORT HOTELS; HEALTH RESORTS AND HEALTH SPAS (U.S. CLS. 100 AND 101).

SN 78-054,584. SEYKORA, PHILIP J., JENISON, MI. FILED 3-22-2001.

**HOT AIR**

FOR COMPUTER SERVICES, NAMELY, PROVIDING ON-LINE NEWSLETTERS IN THE FIELD OF WIRELESS TELECOMMUNICATIONS (U.S. CLS. 100 AND 101).

SN 78-055,798. KRELL ADVERTISING, INC., FLEMINGTON, NJ. FILED 3-29-2001.

**OPERATION HEALTHY BEACH**

NO CLAIM IS MADE TO THE EXCLUSIVE RIGHT TO USE "BEACH", APART FROM THE MARK AS SHOWN.

FOR PROMOTING PUBLIC AWARENESS OF THE NEED FOR CONCERN OVER LITTER, ENVIRONMENTAL, HEALTH AND SAFETY ISSUES AFFECTING BEACHES AND OTHER RECREATIONAL WATERFRONT AREAS (U.S. CLS. 100 AND 101).

**CLASS 42—(Continued).**

SN 78-056,410. GEEKNET COMMUNICATIONS INC., LAKEVILLE, MN. FILED 4-2-2001.

**COMMUNICATION THROUGH TECHNOLOGY**

FOR COMPUTER SERVICES, NAMELY, CREATING AND MAINTAINING WEB SITES FOR OTHERS; DESIGNING AND IMPLEMENTING NETWORK WEB PAGES FOR OTHERS; DESIGNING AND IMPLEMENTING WEB SITES FOR OTHERS; HOSTING THE WEB SITES OF OTHERS ON A COMPUTER SERVER FOR A GLOBAL COMPUTER NETWORK; REGISTRATION OF DOMAIN NAMES FOR IDENTIFICATION OF USERS ON A GLOBAL COMPUTER NETWORK; INTEGRATION OF COMPUTER SYSTEMS AND NETWORKS; COMPUTER SOFTWARE DESIGN FOR OTHERS; UP-DATING OF COMPUTER SOFTWARE; COMPUTER CONSULTATION; COMPUTER SYSTEMS ANALYSIS; TESTING, ANALYSIS AND EVALUATION OF THE GOODS AND SERVICES OF OTHERS FOR THE PURPOSE OF CERTIFICATION; COMPUTER SITE DESIGN; COMPUTER DISASTER RECOVERY PLANNING; DATABASE DEVELOPMENT SERVICES; PROVIDING SEARCH ENGINES FOR OBTAINING DATA ON A GLOBAL COMPUTER NETWORK; PROVIDING ONLINE DATABASES FEATURING GENERAL AND LOCAL NEWS, AND INFORMATION OF INTEREST TO SPECIFIC GEOGRAPHIC AREAS; COMPUTER PROGRAMMING FOR OTHERS; COMPUTER CODE CONVERSION FOR OTHERS; DATA CONVERSION OF COMPUTER PROGRAM DATA OR INFORMATION; DATA RECOVERY SERVICES; COMPUTER DIAGNOSTIC SERVICES; MONITORING THE COMPUTER SYSTEMS OF OTHERS AND PROVIDING BACK-UP COMPUTER PROGRAMS AND FACILITIES; LEASING COMPUTER FACILITIES (U.S. CLS. 100 AND 101).

FIRST USE 8-2-1999; IN COMMERCE 8-2-1999.

SN 78-056,928. ENRON NET WORKS L.L.C., HOUSTON, TX. FILED 4-5-2001.

**ADMINLOGIC**

FOR COMPUTER SERVICES IN THE NATURE OF A SECURITY CLEARANCE FOR CONTROLLING ACCESS TO AN ON-LINE TRADING PLATFORM (U.S. CLS. 100 AND 101).

SN 78-062,798. REAL TIME ENGINEERING, SPRINGDALE, AR. FILED 5-9-2001.

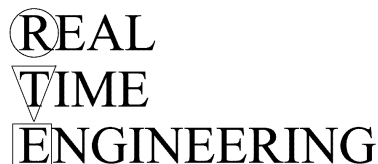

NO CLAIM IS MADE TO THE EXCLUSIVE RIGHT TO USE "REAL TIME ENGINEERING", APART FROM THE MARK AS SHOWN.

FOR ENGINEERING DESIGN (U.S. CLS. 100 AND 101).

**CLASS 42—(Continued).**

SN 78-063,921. MEDICOMPLIANT SOLUTIONS, INC., DEER-FIELD BEACH, FL. FILED 5-16-2001.



NO CLAIM IS MADE TO THE EXCLUSIVE RIGHT TO USE "COMPLIANT" AND "SOLUTIONS", APART FROM THE MARK AS SHOWN.

FOR REVIEWING STANDARDS AND PRACTICES TO ASSURE COMPLIANCE WITH HEALTHCARE LAWS AND REGULATIONS (U.S. CLS. 100 AND 101).  
FIRST USE 4-26-2001; IN COMMERCE 5-5-2001.

SN 78-064,269. MARTENSEN, KIRK M., CHICAGO, IL. FILED 5-17-2001.

**LOGOBRAIN**

FOR APPLICATION SERVICE PROVIDER FEATURING SOFTWARE IN THE FIELD OF NEW LOGO AND NAME ANALYSIS; PROVIDING TECHNICAL SUPPORT SERVICES, NAMELY, TROUBLESHOOTING OF SOFTWARE PROBLEMS VIA THE INTERNET; COMPUTER SERVICES, NAMELY, PROVIDING COMPUTER SOFTWARE SUPPORT SERVICES IN THE FORM OF SOFTWARE UPDATES VIA COMPUTER NETWORKS AND GLOBAL COMMUNICATION NETWORKS; PROVIDING ON-LINE RESEARCH SERVICES FOR OTHERS IN VARIOUS FIELDS; LICENSING OF INTELLECTUAL PROPERTY (U.S. CLS. 100 AND 101).

SN 78-069,827. CARMEL, FRANK J, WASHINGTON, DC. FILED 6-19-2001.



NO CLAIM IS MADE TO THE EXCLUSIVE RIGHT TO USE "P.C." AND "ATTORNEYS AND COUNSELORS AT LAW", APART FROM THE MARK AS SHOWN.

FOR LEGAL SERVICES GENERALLY, LEGAL SERVICES RELATED TO RESORT AND HOSPITALITY, LEGAL SERVICES RELATED TO REAL ESTATE, LEGAL SERVICES RELATED TO BUSINESSES AND LEGAL SERVICES RELATED TO TECHNOLOGY (U.S. CLS. 100 AND 101).  
FIRST USE 1-14-1984; IN COMMERCE 1-14-1984.

**CLASS 42—(Continued).**

SN 78-071,245. DATAPIPE, INC., CHARLOTTE, NC. FILED 6-27-2001.

**DATRIC**

FOR CONSULTING SERVICES IN THE FIELD OF COMPUTERS, COMPUTER SOFTWARE AND COMPUTER DATABASE MAINTENANCE; COMPUTER SOFTWARE DESIGN AND DEVELOPMENT FOR OTHERS; COMPUTER DATABASE MAINTENANCE FOR OTHERS (U.S. CLS. 100 AND 101).

SN 78-072,216. ALLIANCE FOR EXCELLENCE, INC., BLACKSBURG, VA. FILED 7-3-2001.

**ALLIANCE FOR EXCELLENCE**

FOR CHARITABLE SERVICES, NAMELY, ORGANIZING AND CONDUCTING COMMUNITY SERVICE PROGRAMS AND PROJECTS TO ENCOURAGE ACADEMIC AND ECONOMIC ACHIEVEMENT AMONG MINORITY CHILDREN, YOUTH, STUDENTS, AND COMMUNITY PARTICIPANTS (U.S. CLS. 100 AND 101).

SN 78-074,692. QUINTANA, CAROL, LAS CRUCES, NM. FILED 7-19-2001.



FOR COUNSELING IN THE FIELD OF HEALTH (U.S. CLS. 100 AND 101).

**CLASS 42—(Continued).**

SN 78-075,035. HERNANDEZ, ROLANDO, MIAMI, FL. FILED 7-21-2001.

## GOVERNMENT ONLINE INSTEAD OF PEOPLE IN LINE

NO CLAIM IS MADE TO THE EXCLUSIVE RIGHT TO USE "GOVERNMENT ONLINE", APART FROM THE MARK AS SHOWN.

FOR COMPUTER CONSULTATION IN THE FIELD OF ANALYSIS, DESIGN, DEVELOPMENT, AND IMPLEMENTATION OF RULES, NAMELY, POLICIES AND PROCEDURES THAT ARE ENCODED IN COMPUTER SOFTWARE, COMPUTER DATABASES, COMPUTER SOFTWARE APPLICATION PROGRAMS, AND GRAPHICAL USER INTERFACE SOFTWARE FOR USE IN GLOBAL COMPUTER INFORMATION NETWORKS, ELECTRONIC BUSINESS SERVICES, AND ELECTRONIC GOVERNMENT SERVICES (U.S. CLS. 100 AND 101).

SN 78-075,272. HARRIS-SHAPIRO, JON, S, ELKINS PARK, PA. FILED 7-23-2001.

## DESYPHER ANALYTIC SERVICES

NO CLAIM IS MADE TO THE EXCLUSIVE RIGHT TO USE "ANALYTIC SERVICES", APART FROM THE MARK AS SHOWN.

FOR MANAGED HEALTH CARE CONSULTING SERVICES (U.S. CLS. 100 AND 101).

SN 78-076,345. FORMWAY FURNITURE LIMITED, WELLINGTON, NEW ZEALAND, FILED 7-30-2001.

## FDS

FOR DESIGN SERVICES, NAMELY, DESIGN OF FURNITURE FOR OTHERS; DESIGN OF JOINERY FOR OTHERS, DESIGN OF INTERIOR DECOR FOR OTHERS; CONSULTANCY SERVICES IN RELATION TO THE DESIGN OF INTERIOR DECOR, JOINERY AND FURNITURE (U.S. CLS. 100 AND 101).

SN 78-077,455. APLIX CORPORATION, TOKYO, JAPAN, FILED 8-3-2001.

## JBLEND

OWNER OF U.S. REG. NO. 2,436,096.  
FOR COMPUTER PROGRAMMING FOR OTHERS; COMPUTER SOFTWARE DESIGN FOR OTHERS; UPDATING OF COMPUTER SOFTWARE; COMPUTER SYSTEMS ANALYSIS (U.S. CLS. 100 AND 101).

**CLASS 42—(Continued).**

SN 78-079,978. ZIMMERMAN, MICHAEL, R., PLYMOUTH, MA. FILED 8-18-2001.



NO CLAIM IS MADE TO THE EXCLUSIVE RIGHT TO USE "MAGAZINE", APART FROM THE MARK AS SHOWN.  
FOR COMPUTER SERVICES, NAMELY, PROVIDING AN ON-LINE MAGAZINE FEATURING POLITICAL, SPORTS, ENTERTAINMENT, CULTURAL, AND ENVIRONMENTAL INFORMATION (U.S. CLS. 100 AND 101).

SN 78-081,465. SILK ROAD GROUP, LTD., THE, HENDERSONVILLE, TN. FILED 8-28-2001.

## THE POWER OF INTEROPERABILITY

FOR COMPUTER SERVICES, NAMELY, INTERNET AND INTRANET NETWORK DESIGN AND DESIGN OF INTERNET AND INTRANET ARCHITECTURE; COMPUTER NETWORK SECURITY SERVICES; COMPUTER NETWORK MANAGEMENT, NAMELY, MONITORING NETWORK RELIABILITY, INTEROPERABILITY, AND SCALABILITY (U.S. CLS. 100 AND 101).

FIRST USE 3-1-2001; IN COMMERCE 3-1-2001.

SN 78-082,328. MAXWELL, DANIEL S., SEBRING, FL. FILED 9-2-2001.

## MAXWELL COMMUNICATIONS

NO CLAIM IS MADE TO THE EXCLUSIVE RIGHT TO USE "COMMUNICATIONS", APART FROM THE MARK AS SHOWN.

FOR TECHNICAL CONSULTATION AND RESEARCH IN THE FIELD OF BROADCAST RADIO TRANSMITTING SYSTEMS (U.S. CLS. 100 AND 101).

SN 78-082,493. KATZ, REBECCA, FAIRFAX, CA. FILED 9-4-2001.

## THE INNER COOK

FOR DIETITIAN SERVICES, NAMELY, FOOD NUTRITION, FOOD PREPARATION, AND FOOD PROCESSING CONSULTATION AND COUNSELING (U.S. CLS. 100 AND 101).

**CLASS 42—(Continued).**

SN 78-082,495. KATZ, REBECCA, FAIRFAX, CA. FILED 9-4-2001.

**NOURISHING LIFE ONE  
BITE AT A TIME**

FOR DIETITIAN SERVICES, NAMELY, FOOD NUTRITION, FOOD PREPARATION, AND FOOD PROCESSING CONSULTATION AND COUNSELING (U.S. CLS. 100 AND 101).

SN 78-083,472. TAQUET, INC., WAYNE, PA. FILED 9-11-2001.



FOR RESTAURANT SERVICES (U.S. CLS. 100 AND 101).

SN 78-083,574. MARRIOTT INTERNATIONAL, INC., BETHESDA, MD. FILED 9-12-2001.

**YOUR MARRIOTT AWAITS**

OWNER OF U.S. REG. NOS. 899,900, 2,451,587 AND OTHERS.  
FOR HOTEL, RESTAURANT, CATERING, BAR AND LOUNGE SERVICES; PROVISION OF GENERAL PURPOSE FACILITIES FOR MEETINGS, CONFERENCES AND EXHIBITIONS; RESERVATION SERVICES FOR HOTEL ACCOMMODATIONS FOR OTHERS (U.S. CLS. 100 AND 101).  
FIRST USE 6-1-2001; IN COMMERCE 6-1-2001.

**CLASS 42—(Continued).**

SN 78-084,465. ARBY'S IP HOLDER TRUST, FT. LAUDERDALE, FL. FILED 9-19-2001.

**GIVE IN**

FOR RESTAURANT SERVICES (U.S. CLS. 100 AND 101).

SN 78-084,858. PATCH INDUSTRIES, INC., BOONTON TOWNSHIP, NJ. FILED 9-21-2001.

**I-PATCH**

FOR PRINTING SERVICES, NAMELY, PRINTING PRODUCT BROCHURES FOR OTHERS (U.S. CLS. 100 AND 101).

SN 78-086,616. GRANT, RICHARD G., NEW YORK, NY. FILED 10-2-2001.

**SHADOWLAND**

FOR NIGHT CLUB SERVICES (U.S. CLS. 100 AND 101).

SN 78-086,855. PEAK CONNECTIONS, INC., CLEARWATER, FL. FILED 10-4-2001.

**ASK PAM**

FOR CAREER ADVICE (U.S. CLS. 100 AND 101).  
FIRST USE 6-1-1998; IN COMMERCE 6-1-1998.

SN 78-086,858. ROBERT CHAFFIN ENTERPRISES, INC., PHOENIX, AZ. FILED 10-4-2001.

**TASERI**

FOR PROPERTY INSPECTIONS (U.S. CLS. 100 AND 101).

SECTION 4.—PRIOR UNITED STATES CLASSIFICATION

APPLICATION IN ONE CLASS

COLLECTIVE MEMBERSHIP MARKS

SN 76-200,285. GREATER ST. LOUIS AUTOMOTIVE ASSOCIATION, INC., ST. LOUIS, MO. FILED 1-26-2001.

CLASS 200—COLLECTIVE MEMBERSHIP

SN 76-118,474. GRAND BOULE OF THE SIGMA PI PHI, NEW YORK, NY. FILED 8-29-2000.

SIGMA PI PHI

FOR INDICATING MEMBERSHIP IN A FRATERNAL ORGANIZATION UNITED TO PROMOTE CONGENIALITY, TOLERANCE AND CONSTRUCTIVE EFFORT, LEADERSHIP, EDUCATION AND EMPOWERMENT.  
FIRST USE 5-15-1904; IN COMMERCE 5-15-1904.



FOR INDICATING MEMBERSHIP IN ASSOCIATION OF AUTOMOBILE DEALERS.  
FIRST USE 12-1-2000; IN COMMERCE 12-1-2000.

SN 76-153,286. PHI ETA SIGMA NATIONAL HONOR SOCIETY, INC., BOWLING GREEN, KY. FILED 10-23-2000.

CERTIFICATION MARKS

CLASS A—GOODS

SN 75-528,351. AMERICAN SCALLOP ASSOCIATION, INC., NEW BEDFORD, MA. FILED 7-30-1998.



THE ENGLISH TRANSLATION OF "POVIS EOTI SUVAURS" IS "KNOWLEDGE IS POWER".  
FOR INDICATING MEMBERSHIP IN AN ACADEMIC HONOR SOCIETY.  
FIRST USE 3-22-1923; IN COMMERCE 3-22-1923.

NO CLAIM IS MADE TO THE EXCLUSIVE RIGHT TO USE "AMERICAN SCALLOP ASSOCIATION", APART FROM THE MARK AS SHOWN.

THE CERTIFICATION MARK, AS USED BY AUTHORIZED PERSONS IS INTENDED TO CERTIFY THAT THE GOODS ARE PRODUCED BY A PARTICULARLY GROUP AND ARE FRESH AND FROZEN SEAFOOD SHELLFISH AND SCALLOPS.

FOR FRESH AND FROZEN SEAFOOD, SHELLFISH AND SCALLOPS.

\* \* \* \* \*



# TRADEMARK REGISTRATIONS ISSUED

## PRINCIPAL REGISTER

### SECTION 1.— INTERNATIONAL CLASSIFICATION

The short titles associated below with the international class numbers are terms designed merely for quick identification and are not an official part of the international classification. The full names of international classes are given in section 6.1 of the trademark rules of practice.

The designation "U.S. Cl." appearing in this section refers to the U.S. class in effect prior to Sep. 1, 1973 rather than the international class which applies to applications filed on or after that date. For adoption of international classification see notice in the OFFICIAL GAZETTE of Jun. 26, 1973 (911 O.G. TM 210).

#### CLASS 1—CHEMICALS

- 2,537,534. **CHEMSIL**. CHEMCENTRAL CORPORATION, (U.S. CLS. 1, 5, 6, 10, 26 AND 46). SN 75-464,127. PUB. 11-20-2001. FILED 4-7-1998.
- 2,537,543. **BIO-BLOCK**. GENESIS TECHNOLOGIES, (U.S. CLS. 1, 5, 6, 10, 26 AND 46). SN 75-523,517. PUB. 11-20-2001. FILED 7-22-1998.
- 2,537,544. **BIO-BRICK**. GENESIS TECHNOLOGIES, (U.S. CLS. 1, 5, 6, 10, 26 AND 46). SN 75-523,934. PUB. 11-20-2001. FILED 7-22-1998.
- 2,537,560. **RECYCLOMERE**. BELLAND AG, MULTIPLE CLASS, (INT. CLS. 1, 2, 8, 14, 16, 17, 18, 20, 21, 25, 28, 35, 36, 40 AND 42). (U.S. CLS. 1, 2, 3, 5, 6, 10, 11, 12, 13, 16, 22, 23, 25, 26, 27, 28, 29, 30, 32, 33, 35, 37, 38, 39, 40, 41, 44, 46, 50, 100, 101, 102, 103 AND 106). SN 75-602,144. PUB. 11-20-2001. FILED 12-9-1998.
- 2,537,579. **PINNACLE**. NU SALT CORP., MULTIPLE CLASS, (INT. CLS. 1 AND 3), (U.S. CLS. 1, 4, 5, 6, 10, 26, 46, 50, 51 AND 52). SN 75-684,070. PUB. 11-20-2001. FILED 4-15-1999.
- 2,537,582. **MISCELLANEOUS DESIGN**. XI'AN POWER RESIN FACTORY, (U.S. CLS. 1, 5, 6, 10, 26 AND 46). SN 75-702,899. PUB. 8-22-2000. FILED 5-11-1999.
- 2,537,606. **N AND DESIGN**. NOVARTIS AG, MULTIPLE CLASS, (INT. CLS. 1, 5, 31, 35 AND 42), (U.S. CLS. 1, 5, 6, 10, 18, 26, 44, 46, 51, 52, 100, 101 AND 102). SN 75-755,032. PUB. 11-20-2001. FILED 8-12-1999.
- 2,537,640. **TERRACRYSTALS**. HUANG, TAI-HAO, (U.S. CLS. 1, 5, 6, 10, 26 AND 46). SN 75-825,043. PUB. 11-20-2001. FILED 11-4-1999.
- 2,537,778. **NEORESINS AND DESIGN**. AVECIA BV, (U.S. CLS. 1, 5, 6, 10, 26 AND 46). SN 76-014,234. PUB. 11-20-2001. FILED 3-31-2000.
- 2,537,828. **DRI**. KALO, INC., (U.S. CLS. 1, 5, 6, 10, 26 AND 46). SN 76-057,140. PUB. 11-20-2001. FILED 5-25-2000.
- 2,537,909. **US-500**. UNITED SUPPLIERS, INC., (U.S. CLS. 1, 5, 6, 10, 26 AND 46). SN 76-109,422. PUB. 11-20-2001. FILED 8-15-2000.
- 2,537,910. **GUARDIAN III**. GITTO GLOBAL CORPORATION, (U.S. CLS. 1, 5, 6, 10, 26 AND 46). SN 76-109,675. PUB. 11-20-2001. FILED 8-15-2000.
- 2,537,911. **GUARDIAN V**. GITTO GLOBAL CORPORATION, (U.S. CLS. 1, 5, 6, 10, 26 AND 46). SN 76-109,677. PUB. 11-20-2001. FILED 8-15-2000.
- 2,537,912. **GUARDIAN VI**. GITTO GLOBAL CORPORATION, (U.S. CLS. 1, 5, 6, 10, 26 AND 46). SN 76-109,678. PUB. 11-20-2001. FILED 8-15-2000.
- 2,537,913. **GUARDIAN VII**. GITTO GLOBAL CORPORATION, (U.S. CLS. 1, 5, 6, 10, 26 AND 46). SN 76-109,679. PUB. 11-20-2001. FILED 8-15-2000.
- 2,537,914. **GUARDIAN IX**. GITTO GLOBAL CORPORATION, (U.S. CLS. 1, 5, 6, 10, 26 AND 46). SN 76-109,681. PUB. 11-20-2001. FILED 8-15-2000.
- 2,537,915. **GUARDIAN X**. GITTO GLOBAL CORPORATION, (U.S. CLS. 1, 5, 6, 10, 26 AND 46). SN 76-109,682. PUB. 11-20-2001. FILED 8-15-2000.
- 2,537,937. **30 DAY RIDE ASSURANCE GUARANTEE AND DESIGN**. IMI - INTERNATIONAL MARKETING, INC., (U.S. CLS. 1, 5, 6, 10, 26 AND 46). SN 76-129,821. PUB. 11-20-2001. FILED 9-15-2000.
- 2,537,944. **THE POWER TO CLEAN**. ARMOR ALL/STP PRODUCTS COMPANY, THE, (U.S. CLS. 1, 5, 6, 10, 26 AND 46). SN 76-134,237. PUB. 7-3-2001. FILED 9-25-2000.
- 2,538,001. **FLIPSTRIP**. DYNALOY, INC., (U.S. CLS. 1, 5, 6, 10, 26 AND 46). SN 76-163,666. PUB. 11-20-2001. FILED 11-13-2000.
- 2,538,037. **POWER-PAK PELLET**. GREAT LAKES PRODUCTS, (U.S. CLS. 1, 5, 6, 10, 26 AND 46). SN 76-178,805. PUB. 11-20-2001. FILED 12-11-2000.
- 2,538,043. **OXYGANIC AND DESIGN**. LYMAN, CYNTHIA G., (U.S. CLS. 1, 5, 6, 10, 26 AND 46). SN 76-180,876. PUB. 11-20-2001. FILED 12-12-2000.
- 2,538,168. **TAKES THE GUESSWORK OUT OF WATERING! AND DESIGN**. OMS INVESTMENTS, INC., (U.S. CLS. 1, 5, 6, 10, 26 AND 46). SN 76-238,631. PUB. 11-20-2001. FILED 4-9-2001.
- 2,538,200. **DELATABLACK**. BORAL INDUSTRIES INC., (U.S. CLS. 1, 5, 6, 10, 26 AND 46). SN 76-257,589. PUB. 11-20-2001. FILED 4-30-2001.
- 2,538,298. **TIE-GARD**. S-T-N HOLDINGS, INC., (U.S. CLS. 1, 5, 6, 10, 26 AND 46). SN 76-294,130. PUB. 11-20-2001. FILED 7-31-2001.
- 2,538,366. **IRONSAFE**. CENTRAL GARDEN & PET COMPANY, (U.S. CLS. 1, 5, 6, 10, 26 AND 46). SN 76-304,493. PUB. 11-20-2001. FILED 8-27-2001.
- 2,538,414. **D SERIES**. CONOCO INC., (U.S. CLS. 1, 5, 6, 10, 26 AND 46). SN 78-070,388. PUB. 11-20-2001. FILED 6-21-2001.
- 2,538,423. **BIOREMEDY**. SHELL PETROLEUM INC., (U.S. CLS. 1, 5, 6, 10, 26 AND 46). SN 78-072,868. PUB. 11-20-2001. FILED 7-9-2001.

---

#### CLASS 2—PAINTS

- 2,537,560 ( See Class 1 for this trademark).
- 2,537,650. **NEOFLEX**. JONES-BLAIR COMPANY, (U.S. CLS. 6, 11 AND 16). SN 75-842,238. PUB. 11-20-2001. FILED 11-5-1999.
- 2,537,817. **MASTERS OF QUALITY PRESSCAKES AND FLUSHED PIGMENTS**. APOLLO COLORS INC., (U.S. CLS. 6, 11 AND 16). SN 76-048,664. PUB. 11-20-2001. FILED 5-11-2000.
- 2,538,139. **Y104**. XEROX CORPORATION, (U.S. CLS. 6, 11 AND 16). SN 76-229,528. PUB. 11-20-2001. FILED 3-23-2001.
- 2,538,140. **Y103**. XEROX CORPORATION, (U.S. CLS. 6, 11 AND 16). SN 76-229,529. PUB. 11-20-2001. FILED 3-23-2001.
- 2,538,141. **Y102**. XEROX CORPORATION, (U.S. CLS. 6, 11 AND 16). SN 76-229,530. PUB. 11-20-2001. FILED 3-23-2001.
- 2,538,142. **Y101**. XEROX CORPORATION, (U.S. CLS. 6, 11 AND 16). SN 76-229,531. PUB. 11-20-2001. FILED 3-23-2001.
- 2,538,143. **Y100**. XEROX CORPORATION, (U.S. CLS. 6, 11 AND 16). SN 76-229,532. PUB. 11-20-2001. FILED 3-23-2001.
- 2,538,144. **H100X2**. XEROX CORPORATION, (U.S. CLS. 6, 11 AND 16). SN 76-229,533. PUB. 11-20-2001. FILED 3-23-2001.
- 2,538,145. **H100**. XEROX CORPORATION, (U.S. CLS. 6, 11 AND 16). SN 76-229,534. PUB. 11-20-2001. FILED 3-23-2001.

**CLASS 3—COSMETICS AND CLEANING PREPARATIONS**

- 2,537,519. **FERRAGAMO**. SALVATORE FERRAGAMO ITALIA S.P.A., (U.S. CLS. 1, 4, 6, 50, 51 AND 52). SN 74-707,190. PUB. 11-20-2001. FILED 7-28-1995.
- 2,537,542. **AIGLE AND DESIGN**. AIGLE INTERNATIONAL S.A., (U.S. CLS. 1, 4, 6, 50, 51 AND 52). SN 75-523,033. PUB. 11-20-2001. FILED 7-21-1998.
- 2,537,558. **TAHITIAN NONI**. MORINDA, INC., (U.S. CLS. 1, 4, 6, 50, 51 AND 52). SN 75-592,299. PUB. 11-20-2001. FILED 11-19-1998.
- 2,537,579 ( *See Class 1 for this trademark*).
- 2,537,616. **EAU DE PARFUM SUGAR (STYLIZED)**. FRESH, INC., BY MERGER FRESH, INC., (U.S. CLS. 1, 4, 6, 50, 51 AND 52). SN 75-786,152. PUB. 11-20-2001. FILED 10-30-1999.
- 2,537,731. **F (STYLIZED)**. FACES INTERNATIONAL SRL, BY ASSIGNMENT FACES INC., MULTIPLE CLASS, (INT. CLS. 3, 18, 21 AND 42). (U.S. CLS. 1, 2, 3, 4, 6, 13, 22, 23, 29, 30, 33, 40, 41, 50, 51, 52, 100 AND 101). SN 75-928,563. PUB. 11-20-2001. FILED 2-28-2000.
- 2,538,087. **FREDE DAY**. FREDE DAY COSMETICS CO, INC., (U.S. CLS. 1, 4, 6, 50, 51 AND 52). SN 76-203,321. PUB. 8-14-2001. FILED 1-30-2001.
- 2,538,180. **"HAVE A LUCKY DAY!" AND DESIGN**. AT LAST NATURALS, INC., (U.S. CLS. 1, 4, 6, 50, 51 AND 52). SN 76-246,949. PUB. 9-25-2001. FILED 4-26-2001.
- 2,538,196. **BATHINA**. BENEFIT COSMETICS LLC, MULTIPLE CLASS, (INT. CLS. 3 AND 4). (U.S. CLS. 1, 4, 6, 15, 50, 51 AND 52). SN 76-253,242. PUB. 11-20-2001. FILED 5-7-2001.
- 2,538,256. **VERI-CLEAN**. MEREDITH LLC, (U.S. CLS. 1, 4, 6, 50, 51 AND 52). SN 76-287,437. PUB. 11-20-2001. FILED 7-19-2001.
- 2,538,270. **MISCELLANEOUS DESIGN**. SCHROEDER & TREMAYNE, INC., (U.S. CLS. 1, 4, 6, 50, 51 AND 52). SN 76-289,409. PUB. 11-20-2001. FILED 7-24-2001.
- 2,538,276. **BETTY'S NATURAL PRODUCTS**. MAHAN, ELIZABETH M., (U.S. CLS. 1, 4, 6, 50, 51 AND 52). SN 76-290,627. PUB. 11-20-2001. FILED 7-27-2001.
- 2,538,417. **REMOVE**. KAY CHEMICAL COMPANY, (U.S. CLS. 1, 4, 6, 50, 51 AND 52). SN 78-071,288. PUB. 11-20-2001. FILED 6-27-2001.
- 2,538,430. **DREAMCLEANER**. A/C ENTERPRISES, INCORPORATED, (U.S. CLS. 1, 4, 6, 50, 51 AND 52). SN 78-074,572. PUB. 11-20-2001. FILED 7-18-2001.

**CLASS 4—LUBRICANTS AND FUELS**

- 2,538,031. **MEADOW LODGE CANDLES**. MORRISON, JEAN, DBA MEADOW LODGE CREATIONS, (U.S. CLS. 1, 6 AND 15). SN 76-176,728. PUB. 11-20-2001. FILED 12-6-2000.
- 2,538,107. **GOURMET WOOD (STYLIZED)**. GOURMET WOOD PRODUCTS, INC., (U.S. CLS. 1, 6 AND 15). SN 76-212,308. PUB. 11-20-2001. FILED 2-20-2001.
- 2,538,196 ( *See Class 3 for this trademark*).
- 2,538,205. **PRIMITIF AND DESIGN**. XANADU CANDLE INTERNATIONAL, LTD., (U.S. CLS. 1, 6 AND 15). SN 76-264,279. PUB. 11-20-2001. FILED 5-30-2001.
- 2,538,438. **SEVERUS AND DESIGN**. AMSOIL, INC., (U.S. CLS. 1, 6 AND 15). SN 78-077,289. PUB. 11-20-2001. FILED 8-3-2001.

**CLASS 5—PHARMACEUTICALS**

- 2,537,523. **INVICORP**. SENETEK PLC, (U.S. CLS. 6, 18, 44, 46, 51 AND 52). SN 75-175,235. PUB. 11-20-2001. FILED 10-1-1996.
- 2,537,528. **HAIR BUILDER**. HEALTH CENTER FOR BETTER LIVING, INC., (U.S. CLS. 6, 18, 44, 46, 51 AND 52). SN 75-332,031. PUB. 11-20-2001. FILED 7-28-1997.
- 2,537,538. **ZHAN QIAO PAI AND DESIGN**. SHANDONG MEDICINES & HEALTH PRODUCTS IMPORT & EXPORT CORP., (U.S. CLS. 6, 18, 44, 46, 51 AND 52). SN 75-487,233. PUB. 11-20-2001. FILED 5-18-1998.

- 2,537,561. **WANGSON (STYLIZED)**. WANGSON HEALTH PRODUCTS GROUP INC., (U.S. CLS. 6, 18, 44, 46, 51 AND 52). SN 75-611,070. PUB. 11-20-2001. FILED 12-22-1998.
- 2,537,574. **NO BIRD AND DESIGN**. CAMIL, KARAA, MULTIPLE CLASS, (INT. CLS. 5, 6 AND 19). (U.S. CLS. 1, 2, 6, 12, 13, 14, 18, 23, 25, 33, 44, 46, 50, 51 AND 52). SN 75-665,349. PUB. 11-20-2001. FILED 3-22-1999.
- 2,537,576. **STIMULATING EUCALYPTUS**. DIAL BRANDS, INC., (U.S. CLS. 6, 18, 44, 46, 51 AND 52). SN 75-671,968. PUB. 11-20-2001. FILED 3-30-1999.
- 2,537,581. **SANICHEM**. GREAT WESTERN CHEMICAL COMPANY, (U.S. CLS. 6, 18, 44, 46, 51 AND 52). SN 75-701,079. PUB. 11-20-2001. FILED 5-7-1999.
- 2,537,589. **HILTON EQUINE HERBAL SOLUTIONS**. HILTON HERBS, LTD., MULTIPLE CLASS, (INT. CLS. 5 AND 31). (U.S. CLS. 1, 6, 18, 44, 46, 51 AND 52). SN 75-721,660. PUB. 11-20-2001. FILED 6-4-1999.
- 2,537,606 ( *See Class 1 for this trademark*).
- 2,537,609. **WORKOUT FORMULA**. BODY WISE INTERNATIONAL, INC., (U.S. CLS. 6, 18, 44, 46, 51 AND 52). SN 75-761,272. PUB. 11-20-2001. FILED 7-26-1999.
- 2,537,625. **ANIMAL BLOOD BANK**. KAUFMAN, PATRICIA M., MULTIPLE CLASS, (INT. CLS. 5 AND 10). (U.S. CLS. 6, 18, 26, 39, 44, 46, 51 AND 52). SN 75-795,870. PUB. 11-20-2001. FILED 9-3-1999.
- 2,537,665. **SMOCARE**. CARETEC LTD., (U.S. CLS. 6, 18, 44, 46, 51 AND 52). SN 75-865,936. PUB. 11-20-2001. FILED 12-7-1999.
- 2,537,690. **VITAGIANT**. FRIEDMAN, RITA SANDRA, (U.S. CLS. 6, 18, 44, 46, 51 AND 52). SN 75-889,979. PUB. 11-20-2001. FILED 1-5-1999.
- 2,537,730. **ULTRA NAILS**. NATURAL ORGANICS INC., (U.S. CLS. 6, 18, 44, 46, 51 AND 52). SN 75-927,418. PUB. 11-20-2001. FILED 2-25-2000.
- 2,537,732. **MISCELLANEOUS DESIGN**. COGNIS CORPORATION, (U.S. CLS. 6, 18, 44, 46, 51 AND 52). SN 75-928,641. PUB. 11-20-2001. FILED 2-28-2000.
- 2,537,807. **MISCELLANEOUS DESIGN**. LEI YUN SHANG CHINESE MEDICAL WEST LIMITED COMPANY, (U.S. CLS. 6, 18, 44, 46, 51 AND 52). SN 76-041,432. PUB. 11-20-2001. FILED 5-5-2000.
- 2,537,840. **CALDECORT**. INSIGHT PHARMACEUTICALS CORPORATION, BY ASSIGNMENT; BY ASSIGNMENT HERITAGE CONSUMER PRODUCTS, LLC, (U.S. CLS. 6, 18, 44, 46, 51 AND 52). SN 76-060,960. PUB. 11-20-2001. FILED 6-2-2000.
- 2,537,896. **PO CHAI PILLS AND DESIGN**. QUINWOOD LIMITED, (U.S. CLS. 6, 18, 44, 46, 51 AND 52). SN 76-100,720. PUB. 11-20-2001. FILED 8-1-2000.
- 2,537,904. **CANCERTEA**. WILSON, ANDY S., MULTIPLE CLASS, (INT. CLS. 5 AND 30). (U.S. CLS. 6, 18, 44, 46, 51 AND 52). SN 76-104,966. PUB. 11-20-2001. FILED 8-7-2000.
- 2,537,906. **TETRASTARCH**. FRESENIUS KABI AG, (U.S. CLS. 6, 18, 44, 46, 51 AND 52). SN 76-107,678. PUB. 11-20-2001. FILED 8-7-2000.
- 2,537,974. **IMMUNOTEC**. IMMUNOTEC RESEARCH LTD., (U.S. CLS. 6, 18, 44, 46, 51 AND 52). SN 76-148,714. PUB. 11-20-2001. FILED 10-17-2000.
- 2,537,997. **RICEMUCIL**. NUTRASTAR, (U.S. CLS. 6, 18, 44, 46, 51 AND 52). SN 76-162,158. PUB. 11-20-2001. FILED 11-13-2000.
- 2,538,095. **MISCELLANEOUS DESIGN**. VETCO, INC, (U.S. CLS. 6, 18, 44, 46, 51 AND 52). SN 76-207,626. PUB. 8-21-2001. FILED 2-12-2001.
- 2,538,370. **ATOPICA**. NOVARTIS AG, (U.S. CLS. 6, 18, 44, 46, 51 AND 52). SN 78-007,844. PUB. 11-20-2001. FILED 5-12-2000.
- 2,538,419. **SUPERQUIK**. ENTEK CORPORATION, (U.S. CLS. 6, 18, 44, 46, 51 AND 52). SN 78-071,567. PUB. 11-20-2001. FILED 6-28-2001.

**CLASS 6—METAL GOODS**

- 2,537,536. **K AND DESIGN**. KESSEL GMBH, MULTIPLE CLASS, (INT. CLS. 6, 7 AND 19). (U.S. CLS. 1, 2, 12, 13, 14, 19, 21, 23, 25, 31, 33, 34, 35 AND 50). SN 75-474,269. PUB. 11-

- 2-1999. FILED 4-4-1998.  
2,537,574 ( *See Class 5 for this trademark* ).  
2,537,639. **GLASBAU HAHN**. GLASBAU HAHN GMBH + CO. KG, MULTIPLE CLASS, (INT. CLS. 6, 11, 19 AND 20), (U.S. CLS. 1, 2, 12, 13, 14, 21, 22, 23, 25, 31, 32, 33, 34 AND 50). SN 75-820,796. PUB. 11-20-2001. FILED 10-12-1999.  
2,537,657. **SIGNS O' LIFE**. SIGNS O' LIFE INCORPORATED, MULTIPLE CLASS, (INT. CLS. 6, 9 AND 16), (U.S. CLS. 2, 5, 12, 13, 14, 21, 22, 23, 25, 26, 29, 36, 37, 38 AND 50). SN 75-849,927. PUB. 11-20-2001. FILED 11-16-1999.  
2,537,697. **SILFIT**. CHASE-WALTON ELASTOMERS, INC., (U.S. CLS. 2, 12, 13, 14, 23, 25 AND 50). SN 75-897,660. PUB. 11-20-2001. FILED 1-18-2000.  
2,537,719. **TORQUE FORCE**. CANIMEX INC., MULTIPLE CLASS, (INT. CLS. 6, 7, 9, 16, 35, 40 AND 42), (U.S. CLS. 2, 5, 12, 13, 14, 19, 21, 22, 23, 25, 26, 29, 31, 34, 35, 36, 37, 38, 50, 100, 101, 102, 103 AND 106). SN 75-916,166. PUB. 11-20-2001. FILED 2-11-2000.  
2,537,838. **SOUTHWEST DOOR**. SOUTHWEST DOOR COMPANY, INC., MULTIPLE CLASS, (INT. CLS. 6 AND 19), (U.S. CLS. 1, 2, 12, 13, 14, 23, 25, 33 AND 50). SN 76-060,210. PUB. 11-20-2001. FILED 5-31-2000.  
2,538,005. **FORT KNOX MAILBOX**. GRISP, GEROGE, MIKE, (U.S. CLS. 2, 12, 13, 14, 23, 25 AND 50). SN 76-165,169. PUB. 11-20-2001. FILED 11-15-2000.  
2,538,112. **ARCHED-TECH**. UNITED DOMINION INDUSTRIES, INC., DBA CECO DOOR PRODUCTS, (U.S. CLS. 2, 12, 13, 14, 23, 25 AND 50). SN 76-213,733. PUB. 11-20-2001. FILED 2-21-2001.  
2,538,113. **STAINLESS-TECH**. UNITED DOMINION INDUSTRIES, INC., DBA CECO DOOR PRODUCTS, (U.S. CLS. 2, 12, 13, 14, 23, 25 AND 50). SN 76-213,734. PUB. 11-20-2001. FILED 2-21-2001.  
2,538,147. **FANSTEEL WELLMAN DYNAMICS**. FANSTEEL INC., (U.S. CLS. 2, 12, 13, 14, 23, 25 AND 50). SN 76-230,723. PUB. 11-20-2001. FILED 3-27-2001.  
2,538,148. **FANSTEEL WASHINGTON MANUFACTURING**. FANSTEEL INC., (U.S. CLS. 2, 12, 13, 14, 23, 25 AND 50). SN 76-230,724. PUB. 11-20-2001. FILED 3-27-2001.  
2,538,150. **FANSTEEL CALIFORNIA DROP FORGE**. FANSTEEL INC., (U.S. CLS. 2, 12, 13, 14, 23, 25 AND 50). SN 76-230,820. PUB. 11-20-2001. FILED 3-27-2001.  
2,538,172. **STEEL 'N' PEEL**. RASSELSTEIN HOESCH GMBH, (U.S. CLS. 2, 12, 13, 14, 23, 25 AND 50). SN 76-242,594. PUB. 11-20-2001. FILED 4-18-2001.  
2,538,333. **STRONG HOLD AND DESIGN**. FKI INDUSTRIES INC., (U.S. CLS. 2, 12, 13, 14, 23, 25 AND 50). SN 76-299,294. PUB. 11-20-2001. FILED 8-15-2001.  
2,538,352. **DRIFTCLIP**. STEEL NETWORK, INC., THE, (U.S. CLS. 2, 12, 13, 14, 23, 25 AND 50). SN 76-301,285. PUB. 11-20-2001. FILED 8-20-2001.

### CLASS 7—MACHINERY

- 2,537,536 ( *See Class 6 for this trademark* ).  
2,537,554. **IPSO**. SOMFY, SOCIETE ANONYME, (U.S. CLS. 13, 19, 21, 23, 31, 34 AND 35). SN 75-562,384. PUB. 11-20-2001. FILED 9-30-1998.  
2,537,607. **PCI PROCESS CONCEPTION INGENIERIE AND DESIGN**. PROCESS CONCEPTION INGENIERIE SA, MULTIPLE CLASS, (INT. CLS. 7 AND 42), (U.S. CLS. 13, 19, 21, 23, 31, 34, 35, 100 AND 101). SN 75-757,647. PUB. 11-20-2001. FILED 7-21-1999.  
2,537,634. **IVD INTERVAC DESIGN (STYLIZED)**. INTERVAC DESIGN CORP., (U.S. CLS. 13, 19, 21, 23, 31, 34 AND 35). SN 75-808,938. PUB. 11-20-2001. FILED 9-27-1999.  
2,537,719 ( *See Class 6 for this trademark* ).  
2,537,749. **KITCHEN & BATH GALLERIES (STYLIZED)**. KABCORP, INC., MULTIPLE CLASS, (INT. CLS. 7, 11, 20 AND 37), (U.S. CLS. 2, 13, 19, 21, 22, 23, 25, 31, 32, 34, 35, 50, 100, 103 AND 106). SN 75-939,807. PUB. 11-20-2001. FILED 3-9-2000.  
2,537,799. **EXOTAP**. OSG TAP & DIE, INC., (U.S. CLS. 13, 19, 21, 23, 31, 34 AND 35). SN 76-032,857. PUB. 4-17-2001. FILED 4-24-2000.  
2,537,848. **J-STAR**. J-STAR MOTOR INDUSTRIAL CO., LTD.,

- (U.S. CLS. 13, 19, 21, 23, 31, 34 AND 35). SN 76-062,751. PUB. 11-20-2001. FILED 6-5-2000.  
2,538,098. **GORILLA**. GORILLA MANUFACTURING, LLC, (U.S. CLS. 13, 19, 21, 23, 31, 34 AND 35). SN 76-207,920. PUB. 11-20-2001. FILED 2-9-2001.  
2,538,165. **IMT TIRE HANDLER PRODUCTS AND DESIGN**. IOWA MOLD TOOLING CO., INC, (U.S. CLS. 13, 19, 21, 23, 31, 34 AND 35). SN 76-238,433. PUB. 11-20-2001. FILED 4-10-2001.  
2,538,253. **DYNAMAX AND DESIGN**. TENNECO AUTOMOTIVE OPERATING COMPANY INC., (U.S. CLS. 13, 19, 21, 23, 31, 34 AND 35). SN 76-287,113. PUB. 11-20-2001. FILED 7-18-2001.  
2,538,268. **POWERSHOT**. HOLLEY PERFORMANCE PRODUCTS, (U.S. CLS. 13, 19, 21, 23, 31, 34 AND 35). SN 76-288,868. PUB. 11-20-2001. FILED 7-24-2001.  
2,538,321. **TRIM-MAX**. SWISHER MOWER & MACHINE COMPANY, INC., (U.S. CLS. 13, 19, 21, 23, 31, 34 AND 35). SN 76-297,750. PUB. 11-20-2001. FILED 8-13-2001.  
2,538,327. **SUPER SUCKER**. PETELLE, JOSEPH R., (U.S. CLS. 13, 19, 21, 23, 31, 34 AND 35). SN 76-298,824. PUB. 11-20-2001. FILED 8-6-2001.  
2,538,412. **FOR A CLEANER, HEALTHIER HOME..** WHITE CONSOLIDATED INDUSTRIES, INC., (U.S. CLS. 13, 19, 21, 23, 31, 34 AND 35). SN 78-069,311. PUB. 11-20-2001. FILED 6-15-2001.

### CLASS 8—HAND TOOLS

- 2,537,560 ( *See Class 1 for this trademark* ).  
2,537,973. **GREASE BUDDY**. KUSMACK, KEVIN K., (U.S. CLS. 23, 28 AND 44). SN 76-148,380. PUB. 11-20-2001. FILED 10-17-2000.

### CLASS 9—ELECTRICAL AND SCIENTIFIC APPARATUS

- 2,537,526. **LYNETTE JENNINGS HOUSESMART! (STYLIZED)**. NEWCO PRODUCTIONS, L.L.C., MULTIPLE CLASS, (INT. CLS. 9 AND 41), (U.S. CLS. 21, 23, 26, 36, 38, 100, 101 AND 107). SN 75-289,906. PUB. 11-20-2001. FILED 5-12-1997.  
2,537,539. **CHEMSDS +**. CHEMADVISOR, INC., (U.S. CLS. 21, 23, 26, 36 AND 38). SN 75-494,815. PUB. 11-20-2001. FILED 6-2-1998.  
2,537,540. **JASPER PUBLICATIONS**. JASPER PUBLICATIONS, INC., MULTIPLE CLASS, (INT. CLS. 9, 16 AND 35), (U.S. CLS. 2, 5, 21, 22, 23, 26, 29, 36, 37, 38, 50, 100, 101 AND 102). SN 75-495,426. PUB. 3-27-2001. FILED 6-3-1998.  
2,537,545. **CATS**. ROYAL ORDNANCE PLC, (U.S. CLS. 21, 23, 26, 36 AND 38). SN 75-524,169. PUB. 11-20-2001. FILED 7-21-1998.  
2,537,546. **DUAL PRISM**. AIS SOFTWARE, (U.S. CLS. 21, 23, 26, 36 AND 38). SN 75-527,623. PUB. 11-20-2001. FILED 7-28-1998.  
2,537,549. **KWIK-COUPLE**. ALLIED TUBE & CONDUIT CORPORATION, (U.S. CLS. 21, 23, 26, 36 AND 38). SN 75-536,075. PUB. 11-20-2001. FILED 8-17-1998.  
2,537,555. **SKY-WATCHER**. PACIFIC TELESCOPE CORP., (U.S. CLS. 21, 23, 26, 36 AND 38). SN 75-573,082. PUB. 11-20-2001. FILED 10-19-1998.  
2,537,563. **CHEMLINE**. CHEMLINE PLASTICS LIMITED, MULTIPLE CLASS, (INT. CLS. 9 AND 20), (U.S. CLS. 2, 13, 21, 22, 23, 25, 26, 32, 36, 38 AND 50). SN 75-616,133. PUB. 11-20-2001. FILED 1-6-1999.  
2,537,568. **MISCELLANEOUS DESIGN**. BELL ATLANTIC CORPORATION, MULTIPLE CLASS, (INT. CLS. 9, 38 AND 42), (U.S. CLS. 21, 23, 26, 36, 38, 100, 101 AND 104). SN 75-652,370. PUB. 11-20-2001. FILED 3-2-1999.  
2,537,596. **CREATURES ADVENTURES**. CYBERLIFE TECHNOLOGY LIMITED, MULTIPLE CLASS, (INT. CLS. 9 AND 28), (U.S. CLS. 21, 22, 23, 26, 36, 38 AND 50). SN 75-725,918. PUB. 11-20-2001. FILED 6-10-1999.

- 2,537,599. **FFAST-FILL**. FFASTFILL LIMITED, BY CHANGE OF NAME CITY DERIVATIVES SYSTEMS LTD, MULTIPLE CLASS, (INT. CLS. 9 AND 36), (U.S. CLS. 21, 23, 26, 36, 38, 100, 101 AND 102). SN 75-729,780. PUB. 11-20-2001. FILED 6-16-1999.
- 2,537,618. **SYNCHRONET**. SOLID INFORMATION TECHNOLOGY CORPORATION, (U.S. CLS. 21, 23, 26, 36 AND 38). SN 75-789,775. PUB. 11-20-2001. FILED 9-1-1999.
- 2,537,621. **AVIATOR PRO AND DESIGN**. VERTEX STANDARD USA, INC., BY CHANGE OF NAME YAESU MUSEN U.S.A., INC., (U.S. CLS. 21, 23, 26, 36 AND 38). SN 75-790,973. PUB. 11-20-2001. FILED 9-2-1999.
- 2,537,624. **SOCIOMETRICA**. MEDICAL DECISION LOGIC, INC., (U.S. CLS. 21, 23, 26, 36 AND 38). SN 75-795,046. PUB. 11-20-2001. FILED 9-30-1999.
- 2,537,627. **DUALBASE AND DESIGN**. BALL AEROSPACE & TECHNOLOGIES CORP., (U.S. CLS. 21, 23, 26, 36 AND 38). SN 75-798,019. PUB. 11-20-2001. FILED 9-13-1999.
- 2,537,641. **SIW**. SILICON WAVE, INC., (U.S. CLS. 21, 23, 26, 36 AND 38). SN 75-825,825. PUB. 11-20-2001. FILED 10-18-1999.
- 2,537,656. **FLIGHTCOM AND DESIGN**. FLIGHTCOM CORPORATION, (U.S. CLS. 21, 23, 26, 36 AND 38). SN 75-849,570. PUB. 11-20-2001. FILED 11-16-1999.
- 2,537,657 ( See Class 6 for this trademark).
- 2,537,672. **ITEMP**. ENDRESS + HAUSER WETZER GMBH + CO. KG, (U.S. CLS. 21, 23, 26, 36 AND 38). SN 75-871,103. PUB. 8-7-2001. FILED 12-14-1999.
- 2,537,687. **LIGHTHOUSE SUPER SCREENS AND DESIGN**. LIGHTHOUSE TECHNOLOGIES LIMITED, (U.S. CLS. 21, 23, 26, 36 AND 38). SN 75-888,213. PUB. 11-20-2001. FILED 1-6-2000.
- 2,537,703. **HERO**. ROHRER, HELMUT K., (U.S. CLS. 21, 23, 26, 36 AND 38). SN 75-902,586. PUB. 1-16-2001. FILED 1-24-2000.
- 2,537,719 ( See Class 6 for this trademark).
- 2,537,729. **FIRETUF**. DRAKA UK LIMITED, (U.S. CLS. 21, 23, 26, 36 AND 38). SN 75-926,004. PUB. 11-20-2001. FILED 2-23-2000.
- 2,537,733. **ASA (STYLIZED)**. AUDIOVOX SPECIALIZED APPLICATIONS, LLC, (U.S. CLS. 21, 23, 26, 36 AND 38). SN 75-931,479. PUB. 11-20-2001. FILED 2-26-2000.
- 2,537,742. **COOLSTROKE (STYLIZED)**. KONINKLIJKE PHILIPS ELECTRONICS N.V., (U.S. CLS. 21, 23, 26, 36 AND 38). SN 75-934,305. PUB. 11-20-2001. FILED 3-3-2000.
- 2,537,744. **IN THE PAINT**. KOCH ENTERTAINMENT LLC, (U.S. CLS. 21, 23, 26, 36 AND 38). SN 75-936,843. PUB. 11-20-2001. FILED 3-4-2000.
- 2,537,753. **SNAPS SAFE**. SNAPAPPS.COM, INC., (U.S. CLS. 21, 23, 26, 36 AND 38). SN 75-942,195. PUB. 11-20-2001. FILED 3-13-2000.
- 2,537,770. **THE MILK MEN**. KOHN, LORY, MULTIPLE CLASS, (INT. CLS. 9 AND 41), (U.S. CLS. 21, 23, 26, 36, 38, 100, 101 AND 107). SN 76-006,688. PUB. 11-20-2001. FILED 3-22-2000.
- 2,537,777. **CREATE DESIGNS THAT MOVE**. TECHNIKU INCORPORATED, (U.S. CLS. 21, 23, 26, 36 AND 38). SN 76-011,756. PUB. 11-20-2001. FILED 3-22-2000.
- 2,537,786. **SWITCH TIME**. PEAK TIME, MULTIPLE CLASS, (INT. CLS. 9, 35, 37, 38, 41 AND 42), (U.S. CLS. 21, 23, 26, 36, 38, 100, 101, 102, 103, 104, 106 AND 107). SN 76-022,705. PUB. 11-20-2001. FILED 4-11-2000.
- 2,537,790. **VERIPRISE**. VERIPRISE WIRELESS CORPORATION, MULTIPLE CLASS, (INT. CLS. 9, 38 AND 42), (U.S. CLS. 21, 23, 26, 36, 38, 100, 101 AND 104). SN 76-025,608. PUB. 11-20-2001. FILED 4-17-2000.
- 2,537,808. **I-SKIN**. CLAUDIA D. NICHOL, SANDRA B. BRAZIER AND DEIDRA B. JEFFRIES, DBA SPEEDSKIN, LLC, (U.S. CLS. 21, 23, 26, 36 AND 38). SN 76-041,624. PUB. 11-20-2001. FILED 5-4-2000.
- 2,537,810. **WILBUR JR.**. REGISOFT CORPORATION, (U.S. CLS. 21, 23, 26, 36 AND 38). SN 76-042,318. PUB. 11-20-2001. FILED 5-5-2000.
- 2,537,824. **CADMAN**. LOGICAD3D GMBH, (U.S. CLS. 21, 23, 26, 36 AND 38). SN 76-055,998. PUB. 2-20-2001. FILED 5-26-2000.
- 2,537,841. **POLYMEDCO**. POLYMEDCO, INC., (U.S. CLS. 21, 23, 26, 36 AND 38). SN 76-061,361. PUB. 11-20-2001. FILED 6-1-2000.
- 2,537,861. **DISCOVER TAX**. REVENUE SOLUTIONS, INC., (U.S. CLS. 21, 23, 26, 36 AND 38). SN 76-069,014. PUB. 11-20-2001. FILED 6-14-2000.
- 2,537,868. **PROVIDENCE**. YUGEN KAISHA PACIFIX, TA PACIFIX, LTD., (U.S. CLS. 21, 23, 26, 36 AND 38). SN 76-071,898. PUB. 11-20-2001. FILED 6-16-2000.
- 2,537,874. **G DATA AND DESIGN**. G DATA SOFTWARE GMBH, (U.S. CLS. 21, 23, 26, 36 AND 38). SN 76-078,544. PUB. 11-20-2001. FILED 6-27-2000.
- 2,537,878. **ONEDISC**. TAX ANALYSTS, (U.S. CLS. 21, 23, 26, 36 AND 38). SN 76-081,846. PUB. 11-20-2001. FILED 6-30-2000.
- 2,537,880. **BE HIM OR BEAT HIM**. ELECTRONIC ARTS INC., (U.S. CLS. 21, 23, 26, 36 AND 38). SN 76-084,873. PUB. 11-20-2001. FILED 7-8-2000.
- 2,537,883. **PRIMEBASE**. SNAP INNOVATION SOFTWARE-ENTWICKLUNGSGESELLSCHAFT MBH, (U.S. CLS. 21, 23, 26, 36 AND 38). SN 76-085,692. PUB. 11-20-2001. FILED 7-7-2000.
- 2,537,897. **BIOGUARDIAN**. INNOVATEK, INC., (U.S. CLS. 21, 23, 26, 36 AND 38). SN 76-101,580. PUB. 11-20-2001. FILED 8-1-2000.
- 2,537,902. **SANITY: AIKEN'S ARTIFACT**. MONOLITH PRODUCTIONS, INC., (U.S. CLS. 21, 23, 26, 36 AND 38). SN 76-103,369. PUB. 11-20-2001. FILED 8-4-2000.
- 2,537,920. **BIONUMERICS (STYLIZED)**. APPLIED MATHS BVBA, (U.S. CLS. 21, 23, 26, 36 AND 38). SN 76-114,550. PUB. 11-20-2001. FILED 8-21-2000.
- 2,537,929. **PROFIBRE**. JME, INCORPORATED, DBA TMB ASSOCIATES, (U.S. CLS. 21, 23, 26, 36 AND 38). SN 76-123,863. PUB. 11-20-2001. FILED 8-31-2000.
- 2,537,946. **H AND DESIGN**. HYPERCEL CORPORATION, (U.S. CLS. 21, 23, 26, 36 AND 38). SN 76-134,750. PUB. 11-20-2001. FILED 9-25-2000.
- 2,537,948. **BLOBFLOW VORTICITY FOR ALL AND DESIGN**. ROSSI, LOUIS FRANK, (U.S. CLS. 21, 23, 26, 36 AND 38). SN 76-138,125. PUB. 11-20-2001. FILED 10-2-2000.
- 2,537,950. **DATA WRANGLER**. BRIGHT SYSTEMS, INC., (U.S. CLS. 21, 23, 26, 36 AND 38). SN 76-138,571. PUB. 11-20-2001. FILED 10-2-2000.
- 2,537,954. **TELCO SALES**. TELCO SALES, INC., (U.S. CLS. 21, 23, 26, 36 AND 38). SN 76-142,194. PUB. 11-20-2001. FILED 10-5-2000.
- 2,537,977. **COMLITE (STYLIZED)**. HILL-ROM COMPANY, INC., (U.S. CLS. 21, 23, 26, 36 AND 38). SN 76-149,748. PUB. 11-20-2001. FILED 10-20-2000.
- 2,537,986. **CALL-INN**. INNSOFT, INC, MULTIPLE CLASS, (INT. CLS. 9 AND 16), (U.S. CLS. 2, 5, 21, 22, 23, 26, 29, 36, 37, 38 AND 50). SN 76-154,674. PUB. 11-20-2001. FILED 10-27-2000.
- 2,537,993. **C K (STYLIZED)**. PRESTIGE TRADING CORPORATION, MULTIPLE CLASS, (INT. CLS. 9, 14, 20 AND 21), (U.S. CLS. 2, 13, 21, 22, 23, 25, 26, 27, 28, 29, 30, 32, 33, 36, 38, 40 AND 50). SN 76-156,947. PUB. 11-20-2001. FILED 10-29-2000.
- 2,538,011. **MAILSTATION AND DESIGN**. CIDCO INCORPORATED, (U.S. CLS. 21, 23, 26, 36 AND 38). SN 76-167,342. PUB. 11-20-2001. FILED 11-16-2000.
- 2,538,014. **PYROMATE**. PYROMATE, INC., (U.S. CLS. 21, 23, 26, 36 AND 38). SN 76-168,624. PUB. 8-14-2001. FILED 11-20-2000.
- 2,538,022. **FAILSAFE AND DESIGN**. ZF LINUX DEVICES, INC., (U.S. CLS. 21, 23, 26, 36 AND 38). SN 76-172,793. PUB. 11-20-2001. FILED 11-27-2000.
- 2,538,025. **FAILSAFE EMBEDDED**. ZF MICRO DEVICES, INC., BY CHANGE OF NAME ZF LINUX DEVICES, INC., (U.S. CLS. 21, 23, 26, 36 AND 38). SN 76-174,958. PUB. 11-20-2001. FILED 11-28-2000.
- 2,538,089. **REALWORLD IMAGERY**. INTERDIMENSIONAL PUBLISHING, (U.S. CLS. 21, 23, 26, 36 AND 38). SN 76-203,608. PUB. 11-20-2001. FILED 2-2-2001.
- 2,538,090. **NEW ROOTS**. BIOGRAPH RECORDS, INC., (U.S. CLS. 21, 23, 26, 36 AND 38). SN 76-204,231. PUB. 11-20-2001. FILED 2-5-2001.
- 2,538,102. **DEMOIT**. ADVANCED TECHNOLOGY RAMAR LIMITED, (U.S. CLS. 21, 23, 26, 36 AND 38). SN 76-209,804. PUB. 8-14-2001. FILED 2-13-2001.
- 2,538,105. **CYBER SWITCHING**. CYBER SWITCHING, INC.,

(U.S. CLS. 21, 23, 26, 36 AND 38). SN 76-211,423. PUB. 11-20-2001. FILED 2-16-2001.

2,538,166. **FACE RECORDING & MEASUREMENT SYSTEMS.** FACE RECORDING & MEASUREMENT SYSTEMS, INC., MULTIPLE CLASS, (INT. CLS. 9 AND 16), (U.S. CLS. 2, 5, 21, 22, 23, 26, 29, 36, 37, 38 AND 50). SN 76-238,533. PUB. 11-20-2001. FILED 4-10-2001.

2,538,174. **UNIQUITY (STYLIZED).** FASPAC SYSTEMS, INC., (U.S. CLS. 21, 23, 26, 36 AND 38). SN 76-245,218. PUB. 11-20-2001. FILED 4-23-2001.

2,538,179. **CROPTRAX.** SHORT GROUP, INC., THE, (U.S. CLS. 21, 23, 26, 36 AND 38). SN 76-245,942. PUB. 11-20-2001. FILED 4-25-2001.

2,538,188. **URBAN WORKS.** VENTURA DISTRIBUTION, INC., (U.S. CLS. 21, 23, 26, 36 AND 38). SN 76-250,189. PUB. 11-20-2001. FILED 5-1-2001.

2,538,195. **ECLIPSE.** DECCA MUSIC GROUP LIMITED, (U.S. CLS. 21, 23, 26, 36 AND 38). SN 76-252,072. PUB. 11-20-2001. FILED 5-7-2001.

2,538,213. **STAR III.** BLUE-WHITE INDUSTRIES, (U.S. CLS. 21, 23, 26, 36 AND 38). SN 76-269,838. PUB. 11-20-2001. FILED 6-11-2001.

2,538,222. **OG.** DCT FACTORY, INC., (U.S. CLS. 21, 23, 26, 36 AND 38). SN 76-274,884. PUB. 11-20-2001. FILED 6-21-2001.

2,538,237. **KEEPING APPLICATIONS HANDY.** APPREACH, INC., (U.S. CLS. 21, 23, 26, 36 AND 38). SN 76-281,783. PUB. 11-20-2001. FILED 7-9-2001.

2,538,238. **BILLVIEW.** ADVANCED TELECOMMUNICATIONS RESOURCES, INC., (U.S. CLS. 21, 23, 26, 36 AND 38). SN 76-281,807. PUB. 11-20-2001. FILED 7-9-2001.

2,538,273. **SYBA.** SYBA MULTIMEDIA, INC., (U.S. CLS. 21, 23, 26, 36 AND 38). SN 76-290,034. PUB. 11-20-2001. FILED 7-25-2001.

2,538,274. **FAE-OS.** FINE ARTS ENGRAVING COMPANY, (U.S. CLS. 21, 23, 26, 36 AND 38). SN 76-290,259. PUB. 11-20-2001. FILED 7-25-2001.

2,538,288. **ELECTRA-CARE.** ELECTRA-CARE, LLC, (U.S. CLS. 21, 23, 26, 36 AND 38). SN 76-292,961. PUB. 11-20-2001. FILED 7-31-2001.

2,538,306. **SUPERPHOBIC.** CELGARD INC., (U.S. CLS. 21, 23, 26, 36 AND 38). SN 76-295,626. PUB. 11-20-2001. FILED 8-6-2001.

2,538,324. **ULTRAGOLD.** ULTRARF, (U.S. CLS. 21, 23, 26, 36 AND 38). SN 76-298,356. PUB. 11-20-2001. FILED 8-10-2001.

2,538,329. **MISCELLANEOUS DESIGN.** NINTENDO OF AMERICA INC., (U.S. CLS. 21, 23, 26, 36 AND 38). SN 76-299,253. PUB. 11-20-2001. FILED 8-14-2001.

2,538,332. **MXL.** MARSHALL ELECTRONICS, INC., (U.S. CLS. 21, 23, 26, 36 AND 38). SN 76-299,283. PUB. 11-20-2001. FILED 8-15-2001.

2,538,339. **KIDZ BOP.** RAZOR & TIE DIRECT, L.L.C., (U.S. CLS. 21, 23, 26, 36 AND 38). SN 76-299,638. PUB. 11-20-2001. FILED 8-14-2001.

2,538,350. **MISCELLANEOUS DESIGN.** PAULIST NATIONAL CATHOLIC EVANGELIZATION ASSOCIATION, (U.S. CLS. 21, 23, 26, 36 AND 38). SN 76-300,922. PUB. 11-20-2001. FILED 8-17-2001.

2,538,371. **CAPTAIN'S LOG AND DESIGN.** INTUIT COMPUTING, INC., DBA BRAIN TRAIN, (U.S. CLS. 21, 23, 26, 36 AND 38). SN 78-010,762. PUB. 11-20-2001. FILED 6-1-2000.

2,538,374. **SONATA.** SILVERLINE AUDIO TECHNOLOGY, INC., (U.S. CLS. 21, 23, 26, 36 AND 38). SN 78-016,671. PUB. 11-20-2001. FILED 7-13-2000.

2,538,376. **BEAMSTATION.** PISTACHIO CORPORATION, (U.S. CLS. 21, 23, 26, 36 AND 38). SN 78-018,594. PUB. 11-20-2001. FILED 7-27-2000.

2,538,377. **ATM MANAGER PRO.** E-CLASSICSYSTEMS, INC., (U.S. CLS. 21, 23, 26, 36 AND 38). SN 78-021,344. PUB. 11-20-2001. FILED 8-15-2000.

2,538,379. **CATSIM.** HARTMAN, RICHARD J., (U.S. CLS. 21, 23, 26, 36 AND 38). SN 78-023,223. PUB. 11-20-2001. FILED 8-28-2000.

2,538,380. **SEMISIM.** HARTMAN, RICHARD J., (U.S. CLS. 21, 23, 26, 36 AND 38). SN 78-023,224. PUB. 11-20-2001. FILED 8-28-2000.

2,538,424. **G-BROS..** SYA MUSIC GROUP, INC., MULTIPLE CLASS, (INT. CLS. 9 AND 25), (U.S. CLS. 21, 22, 23, 26, 36, 38 AND 39). SN 78-072,879. PUB. 11-20-2001. FILED 7-9-2001.

2,538,432. **WINDOW WASHER.** WEBROOT SOFTWARE INC, (U.S. CLS. 21, 23, 26, 36 AND 38). SN 78-074,803. PUB. 11-20-2001. FILED 7-19-2001.

---

## CLASS 10—MEDICAL APPARATUS

2,537,520. **MACH 16 ULTRAFLX.** TARGET THERAPEUTICS, INC., (U.S. CLS. 26, 39 AND 44). SN 74-726,805. PUB. 11-20-2001. FILED 9-8-1995.

2,537,548. **KONTOUR.** PREMIUM PLASTICS, INC., (U.S. CLS. 26, 39 AND 44). SN 75-533,714. PUB. 11-20-2001. FILED 8-10-1998.

2,537,625 ( *See Class 5 for this trademark*).

2,537,663. **ZOE.** GAUMARD SCIENTIFIC COMPANY INC., (U.S. CLS. 26, 39 AND 44). SN 75-857,632. PUB. 11-20-2001. FILED 11-24-1999.

2,537,686. **THE QUICK FIX RAPID AIRWAY INTRODUCER.** FIX, SHAUN, (U.S. CLS. 26, 39 AND 44). SN 75-888,166. PUB. 11-20-2001. FILED 12-29-1999.

2,537,738. **PROLINE TOOLS.** CASCADE ORTHOPEDIC SUPPLY, INC., (U.S. CLS. 26, 39 AND 44). SN 75-933,041. PUB. 11-20-2001. FILED 3-2-2000.

2,537,843. **GREEN STREAM.** CODAN MEDIZINISCHE GERATE GMBH & CO KG, (U.S. CLS. 26, 39 AND 44). SN 76-061,550. PUB. 11-20-2001. FILED 6-2-2000.

2,537,903. **E-TRODE (STYLIZED).** CONMED CORPORATION, (U.S. CLS. 26, 39 AND 44). SN 76-104,915. PUB. 11-20-2001. FILED 8-9-2000.

2,538,013. **BEAM RAY.** BIORAY, INC., (U.S. CLS. 26, 39 AND 44). SN 76-167,764. PUB. 11-20-2001. FILED 11-17-2000.

2,538,039. **DIVA.** WIDEX APS, (U.S. CLS. 26, 39 AND 44). SN 76-179,373. PUB. 11-20-2001. FILED 12-12-2000.

2,538,099. **FLEXWEAR.** HOLLISTER INCORPORATED, (U.S. CLS. 26, 39 AND 44). SN 76-208,525. PUB. 11-20-2001. FILED 2-12-2001.

2,538,364. **ULTRASOFT.** JOHNSON & JOHNSON, (U.S. CLS. 26, 39 AND 44). SN 76-304,402. PUB. 11-20-2001. FILED 8-27-2001.

2,538,365. **KEEP IN TOUCH.** JOHNSON & JOHNSON, (U.S. CLS. 26, 39 AND 44). SN 76-304,403. PUB. 11-20-2001. FILED 8-27-2001.

2,538,383. **TEMNO.** ALLEGIANCE CORPORATION, (U.S. CLS. 26, 39 AND 44). SN 78-028,825. PUB. 11-20-2001. FILED 10-3-2000.

2,538,422. **STONE INTERCEPTOR.** UROCOR, INC., (U.S. CLS. 26, 39 AND 44). SN 78-071,931. PUB. 11-20-2001. FILED 7-2-2001.

2,538,440. **NICOLET ELITE (STYLIZED).** NICOLET VASCULAR INC., (U.S. CLS. 26, 39 AND 44). SN 78-077,763. PUB. 11-20-2001. FILED 8-6-2001.

---

## CLASS 11—ENVIRONMENTAL CONTROL APPARATUS

2,537,639 ( *See Class 6 for this trademark*).

2,537,683. **POWERMOON.** NOLLE INDUSTRIELLE UMWELTECHNIK GMBH, (U.S. CLS. 13, 21, 23, 31 AND 34). SN 75-887,543. PUB. 11-20-2001. FILED 1-5-2000.

2,537,706. **PHIX AND DESIGN.** GREEN TURTLE TECHNOLOGIES LTD., (U.S. CLS. 13, 21, 23, 31 AND 34). SN 75-904,280. PUB. 11-20-2001. FILED 1-27-2000.

2,537,749 ( *See Class 7 for this trademark*).

2,537,774. **AIRE-FLO.** LENNOX MANUFACTURING INC., (U.S. CLS. 13, 21, 23, 31 AND 34). SN 76-011,249. PUB. 11-20-2001. FILED 3-27-2000.

2,537,941. **SONATA.** LEDALITE ARCHITECTURAL PRODUCTS, (U.S. CLS. 13, 21, 23, 31 AND 34). SN 76-133,054. PUB. 11-20-2001. FILED 9-21-2000.

2,537,960. **AMERICAN STANDARD (STYLIZED).** AMERICAN STANDARD INC., (U.S. CLS. 13, 21, 23, 31 AND 34). SN 76-145,461. PUB. 11-20-2001. FILED 10-13-2000.

2,538,110. **WESTINGHOUSE.** WESTINGHOUSE ELECTRIC CORPORATION, (U.S. CLS. 13, 21, 23, 31 AND 34). SN 76-

- 213,469. PUB. 11-20-2001. FILED 2-21-2001.  
 2,538,173. **PURONEX**. PURE GAS SOLUTIONS, INC., (U.S. CLS. 13, 21, 23, 31 AND 34). SN 76-242,830. PUB. 11-20-2001. FILED 4-18-2001.  
 2,538,258. **ENVIRO-COOL**. PACIFIC DISTRIBUTING, INC., (U.S. CLS. 13, 21, 23, 31 AND 34). SN 76-288,147. PUB. 11-20-2001. FILED 7-12-2001.  
 2,538,356. **AIRPAK**. YORK INTERNATIONAL CORPORATION, (U.S. CLS. 13, 21, 23, 31 AND 34). SN 76-301,999. PUB. 11-20-2001. FILED 8-20-2001.  
 2,538,368. **ARCHEO VENICE DESIGN AND DESIGN**. ARCHEO VENICE DESIGN S.R.L, MULTIPLE CLASS, (INT. CLS. 11 AND 20), (U.S. CLS. 2, 13, 21, 22, 23, 25, 31, 32, 34 AND 50). SN 78-007,323. PUB. 11-20-2001. FILED 5-8-2000.  
 2,538,439. **HI DELTA AND DESIGN**. RAYPAK, INC., (U.S. CLS. 13, 21, 23, 31 AND 34). SN 78-077,302. PUB. 11-20-2001. FILED 8-3-2001.

---

### CLASS 12—VEHICLES

- 2,537,655. **WINNERS CIRCLE**. TMS, INC., (U.S. CLS. 19, 21, 23, 31, 35 AND 44). SN 75-848,566. PUB. 11-20-2001. FILED 11-15-1999.  
 2,537,705. **SAFETYSTEEL**. OAKWOOD ENERGY MANAGEMENT INCORPORATED, (U.S. CLS. 19, 21, 23, 31, 35 AND 44). SN 75-904,006. PUB. 11-20-2001. FILED 1-27-2000.  
 2,537,836. **HANDI HAULER**. NEWMANS' MANUFACTURING, INC., (U.S. CLS. 19, 21, 23, 31, 35 AND 44). SN 76-059,970. PUB. 11-20-2001. FILED 5-30-2000.  
 2,537,844. **CLS 370**. DAIMLERCHRYSLER AG, (U.S. CLS. 19, 21, 23, 31, 35 AND 44). SN 76-062,269. PUB. 11-20-2001. FILED 6-5-2000.  
 2,537,853. **GRANDSLAM 17**. WEBBCO, INC., (U.S. CLS. 19, 21, 23, 31, 35 AND 44). SN 76-066,147. PUB. 11-20-2001. FILED 6-8-2000.  
 2,538,325. **MISCELLANEOUS DESIGN**. MARKEN INTERNATIONAL, INC., (U.S. CLS. 19, 21, 23, 31, 35 AND 44). SN 76-298,488. PUB. 11-20-2001. FILED 8-13-2001.  
 2,538,367. **GAMMA RAY (STYLIZED)**. TREK BICYCLE CORPORATION, (U.S. CLS. 19, 21, 23, 31, 35 AND 44). SN 76-304,678. PUB. 11-20-2001. FILED 8-24-2001.  
 2,538,441. **KFB**. PREMIER AUTOMOTIVE PARTS & ACCESSORIES SUPPLIES LTD., (U.S. CLS. 19, 21, 23, 31, 35 AND 44). SN 78-080,958. PUB. 11-20-2001. FILED 8-24-2001.

---

### CLASS 13—FIREARMS

- 2,538,409. **ROTO-HOLSTER**. FIRST SAMCO INC., (U.S. CLS. 2 AND 9). SN 78-067,448. PUB. 11-20-2001. FILED 6-5-2001.

---

### CLASS 14—JEWELRY

- 2,537,547. **BELIEVE IN YOURSELF !**. PHUN FROM PHOENIX ! INC., (U.S. CLS. 2, 27, 28 AND 50). SN 75-527,978. PUB. 11-20-2001. FILED 7-29-1998.  
 2,537,560 ( *See Class 1 for this trademark* ).  
 2,537,762. **PC POSTAGE**. UNITED STATES POSTAL SERVICE, MULTIPLE CLASS, (INT. CLS. 14 AND 21), (U.S. CLS. 2, 13, 23, 27, 28, 29, 30, 33, 40 AND 50). SN 75-980,125. PUB. 11-20-2001. FILED 8-27-1999.  
 2,537,764. **'N SYNC**. ZEEKS, INC., BY ASSIGNMENT BASS, JAMES LANCE, AND CHASEZ, JOSHUA SCOTT, AND TIMBERLAKE, JUSTIN RANDALL, AND KIRKPATRICK, CHRISTOPHER ALAN, AND FATONE, JOSEPH ANTHONY, JR., MULTIPLE CLASS, (INT. CLS. 14 AND 41), (U.S. CLS. 2, 27, 28, 50, 100, 101 AND 107). SN 75-980,618. PUB. 9-11-2001. FILED 5-24-1999.  
 2,537,993 ( *See Class 9 for this trademark* ).  
 2,538,035. **2200 AL**. EMMEPI DI MANNA & C. SNC, (U.S. CLS. 2, 27, 28 AND 50). SN 76-178,281. PUB. 11-20-2001. FILED 12-11-2000.

- 2,538,036. **2077 AL**. GIACOBBE, GABRIELE, (U.S. CLS. 2, 27, 28 AND 50). SN 76-178,283. PUB. 11-20-2001. FILED 12-11-2000.  
 2,538,046. **LOUISVILLE SLUGGER FIELD AND DESIGN**. HILLERICH & BRADSBY CO., (U.S. CLS. 2, 27, 28 AND 50). SN 76-183,894. PUB. 11-20-2001. FILED 12-19-2000.  
 2,538,047. **LOUISVILLE SLUGGER FIELD**. HILLERICH & BRADSBY CO., (U.S. CLS. 2, 27, 28 AND 50). SN 76-183,895. PUB. 11-20-2001. FILED 12-19-2000.  
 2,538,182. **WOLVERINE BOOTS AND GEAR SINCE 1883**. WOLVERINE WORLD WIDE, INC., (U.S. CLS. 2, 27, 28 AND 50). SN 76-247,026. PUB. 11-20-2001. FILED 4-27-2001.  
 2,538,204. **LUMINOSET**. VERRAGIO LTD., (U.S. CLS. 2, 27, 28 AND 50). SN 76-263,012. PUB. 11-20-2001. FILED 5-29-2001.  
 2,538,334. **BETTINA**. ERWIN PEARL, INC., (U.S. CLS. 2, 27, 28 AND 50). SN 76-299,323. PUB. 11-20-2001. FILED 8-14-2001.

---

### CLASS 15—MUSICAL INSTRUMENTS

- 2,537,671. **GRIPPICK AND DESIGN**. WILKINSON, CLARK ADAMS, DBA GRIPICK, (U.S. CLS. 2, 21 AND 36). SN 75-871,077. PUB. 11-20-2001. FILED 12-14-1999.  
 2,538,114. **MOBIUS MEGATAR**. CRONOS, ARTHUR, (U.S. CLS. 2, 21 AND 36). SN 76-213,853. PUB. 11-20-2001. FILED 2-21-2001.  
 2,538,254. **DAVA**. STOREY, DAVID C., (U.S. CLS. 2, 21 AND 36). SN 76-287,215. PUB. 11-20-2001. FILED 7-18-2001.  
 2,538,269. **NOBLET**. G. LEBLANC CORPORATION, (U.S. CLS. 2, 21 AND 36). SN 76-289,371. PUB. 11-20-2001. FILED 7-24-2001.

---

### CLASS 16—PAPER GOODS AND PRINTED MATTER

- 2,537,540 ( *See Class 9 for this trademark* ).  
 2,537,560 ( *See Class 1 for this trademark* ).  
 2,537,610. **DM DOLAN MEDIA COMPANY AND DESIGN**. DOLAN MEDIA COMPANY, MULTIPLE CLASS, (INT. CLS. 16 AND 42), (U.S. CLS. 2, 5, 22, 23, 29, 37, 38, 50, 100 AND 101). SN 75-765,874. PUB. 11-20-2001. FILED 7-27-1999.  
 2,537,617. **INTERNAL MEDICINE IN-TRAINING EXAMINATION**. AMERICAN COLLEGE OF PHYSICIANS - AMERICAN SOCIETY OF INTERNAL MEDICINE, (U.S. CLS. 2, 5, 22, 23, 29, 37, 38 AND 50). SN 75-786,367. PUB. 11-20-2001. FILED 8-26-1999.  
 2,537,646. **AMERICAN FAIRWAYS**. NELSON, MICHAEL, (U.S. CLS. 2, 5, 22, 23, 29, 37, 38 AND 50). SN 75-835,249. PUB. 11-16-2001. FILED 11-16-1999.  
 2,537,657 ( *See Class 6 for this trademark* ).  
 2,537,662. **EMOTIONAL SMARTS**. DONALDSON, JUNE A., MULTIPLE CLASS, (INT. CLS. 16, 41 AND 42), (U.S. CLS. 2, 5, 22, 23, 29, 37, 38, 50, 100, 101 AND 107). SN 75-857,435. PUB. 10-3-2000. FILED 11-24-1999.  
 2,537,719 ( *See Class 6 for this trademark* ).  
 2,537,728. **BACKPACK BABY**. STAR BRIGHT BOOKS, INC. AND MIRIAM COHEN JOINT VENTURE, THE, (U.S. CLS. 2, 5, 22, 23, 29, 37, 38 AND 50). SN 75-925,585. PUB. 11-20-2001. FILED 2-10-2000.  
 2,537,761. **ASK MIKEY**. SALEM, KAREEM MICHAEL, (U.S. CLS. 2, 5, 22, 23, 29, 37, 38 AND 50). SN 75-951,131. PUB. 11-20-2001. FILED 3-4-2000.  
 2,537,763. **'N SYNC**. ZEEKS, INC., BY ASSIGNMENT BASS, JAMES LANCE, AND CHASEZ, JOSHUA SCOTT, AND TIMBERLAKE, JUSTIN RANDALL, AND KIRKPATRICK, CHRISTOPHER ALAN, AND FATONE, JOSEPH ANTHONY, JR., (U.S. CLS. 2, 5, 22, 23, 29, 37, 38 AND 50). SN 75-980,617. PUB. 9-11-2001. FILED 5-24-1999.  
 2,537,775. **UNDERSTANDING DISABILITIES CREATING OPPORTUNITIES**. UNITED CEREBRAL PALSY ASSOCIATIONS, INC., MULTIPLE CLASS, (INT. CLS. 16, 41 AND 42), (U.S. CLS. 2, 5, 22, 23, 29, 37, 38, 50, 100, 101 AND 107). SN 76-011,280. PUB. 11-20-2001. FILED 3-27-2000.  
 2,537,791. **K.I.S.S.**. K.I.S.S. METHOD, INC., (U.S. CLS. 2, 5, 22,

23, 29, 37, 38 AND 50). SN 76-026,210. PUB. 11-20-2001. FILED 4-13-2000.

2,537,839. **CREATING A WORLD OF SMARTER INVESTORS.** CHARLES SCHWAB & CO., INC., MULTIPLE CLASS, (INT. CLS. 16, 35, 36 AND 41), (U.S. CLS. 2, 5, 22, 23, 29, 37, 38, 50, 100, 101, 102 AND 107). SN 76-060,856. PUB. 11-20-2001. FILED 6-1-2000.

2,537,875. **ULTRAGOLD.** AMERICAN DECAL MFG. CO., (U.S. CLS. 2, 5, 22, 23, 29, 37, 38 AND 50). SN 76-079,233. PUB. 11-20-2001. FILED 6-26-2000.

2,537,877. **HALLO-STIX.** PRINTMARK INDUSTRIES, INC., (U.S. CLS. 2, 5, 22, 23, 29, 37, 38 AND 50). SN 76-080,919. PUB. 11-20-2001. FILED 6-30-2000.

2,537,885. **ENTERTAINMENT ULTIMATE.** ENTERTAINMENT PUBLICATIONS OPERATING COMPANY, INC., (U.S. CLS. 2, 5, 22, 23, 29, 37, 38 AND 50). SN 76-088,351. PUB. 11-20-2001. FILED 7-12-2000.

2,537,894. **M AND DESIGN.** MARS, INCORPORATED, (U.S. CLS. 2, 5, 22, 23, 29, 37, 38 AND 50). SN 76-098,071. PUB. 7-17-2001. FILED 7-27-2000.

2,537,905. **CYBERW@RSWW3.** WEBSHARES, INC., (U.S. CLS. 2, 5, 22, 23, 29, 37, 38 AND 50). SN 76-105,120. PUB. 11-20-2001. FILED 8-9-2000.

2,537,933. **WATER TECHNOLOGY.** NATIONAL TRADE PUBLICATIONS, INC., (U.S. CLS. 2, 5, 22, 23, 29, 37, 38 AND 50). SN 76-128,186. PUB. 5-15-2001. FILED 9-14-2000.

2,537,971. **MISCELLANEOUS DESIGN.** RES MEDIA GROUP, INC., (U.S. CLS. 2, 5, 22, 23, 29, 37, 38 AND 50). SN 76-147,738. PUB. 11-20-2001. FILED 10-16-2000.

2,537,986 ( *See Class 9 for this trademark*).

2,538,130. **BETTA GARDEN.** IMAGINE GOLD, L.L.C., (U.S. CLS. 2, 5, 22, 23, 29, 37, 38 AND 50). SN 76-226,921. PUB. 11-20-2001. FILED 3-20-2001.

2,538,153. **CITRIX.** CITRIX SYSTEMS, INC., (U.S. CLS. 2, 5, 22, 23, 29, 37, 38 AND 50). SN 76-231,739. PUB. 11-20-2001. FILED 3-28-2001.

2,538,166 ( *See Class 9 for this trademark*).

2,538,207. **FRANK'N SNACKERS.** REYNOLDS METALS COMPANY, (U.S. CLS. 2, 5, 22, 23, 29, 37, 38 AND 50). SN 76-268,454. PUB. 11-20-2001. FILED 6-11-2001.

2,538,208. **THE PRESENT-IT.** RIVERSIDE PAPER CORPORATION, (U.S. CLS. 2, 5, 22, 23, 29, 37, 38 AND 50). SN 76-268,767. PUB. 11-20-2001. FILED 6-8-2001.

2,538,214. **SOUTHERN RODDER.** ZUETLAU, DONNA, AND JENNINGS, HOMER F., (U.S. CLS. 2, 5, 22, 23, 29, 37, 38 AND 50). SN 76-271,666. PUB. 11-20-2001. FILED 6-14-2001.

2,538,215. **NORTHERN RODDER.** ZUETLAU, DONNA, AND JENNINGS, HOMER F., (U.S. CLS. 2, 5, 22, 23, 29, 37, 38 AND 50). SN 76-271,668. PUB. 11-20-2001. FILED 6-14-2001.

2,538,219. **FLASH.** GLOBALQUEST, LLC, (U.S. CLS. 2, 5, 22, 23, 29, 37, 38 AND 50). SN 76-273,344. PUB. 11-20-2001. FILED 6-18-2001.

2,538,232. **RE:OLUTIONS.** UNITED SERVICES AUTOMOBILE ASSOCIATION, (U.S. CLS. 2, 5, 22, 23, 29, 37, 38 AND 50). SN 76-280,644. PUB. 11-20-2001. FILED 7-5-2001.

2,538,235. **NEON (STYLIZED).** DR PARTNERS, (U.S. CLS. 2, 5, 22, 23, 29, 37, 38 AND 50). SN 76-281,545. PUB. 11-20-2001. FILED 7-9-2001.

2,538,240. **VOICE MAIL.** VOICE FOR SUCCESS, INC., (U.S. CLS. 2, 5, 22, 23, 29, 37, 38 AND 50). SN 76-283,451. PUB. 11-20-2001. FILED 7-11-2001.

2,538,245. **HEART-CONNECT.** TOWARD EFFECTIVE MANAGEMENT, INC., (U.S. CLS. 2, 5, 22, 23, 29, 37, 38 AND 50). SN 76-284,853. PUB. 11-20-2001. FILED 7-12-2001.

2,538,249. **RHYTHM.** WICOR AMERICAS MANAGEMENT INC., (U.S. CLS. 2, 5, 22, 23, 29, 37, 38 AND 50). SN 76-285,444. PUB. 11-20-2001. FILED 7-13-2001.

2,538,257. **FEEDSTUFFS.** MILLER PUBLISHING COMPANY, THE, (U.S. CLS. 2, 5, 22, 23, 29, 37, 38 AND 50). SN 76-288,079. PUB. 11-20-2001. FILED 7-23-2001.

2,538,260. **MICROLINE.** OKI ELECTRIC INDUSTRY CO., LTD., (U.S. CLS. 2, 5, 22, 23, 29, 37, 38 AND 50). SN 76-288,242. PUB. 11-20-2001. FILED 7-23-2001.

2,538,262. **NUTRITIONALITY.** STEVENS, CLINT D., DBA EMPLOYMENTALITY, (U.S. CLS. 2, 5, 22, 23, 29, 37, 38 AND 50). SN 76-288,582. PUB. 11-20-2001. FILED 7-20-2001.

2,538,279. **ROOM MATES.** PANLINE USA, INC., (U.S. CLS. 2, 5, 22, 23, 29, 37, 38 AND 50). SN 76-290,966. PUB. 11-20-2001.

FILED 7-27-2001.

2,538,291. **HOLIDAY MEMORIES.** LINDY BOWMAN COMPANY, THE, (U.S. CLS. 2, 5, 22, 23, 29, 37, 38 AND 50). SN 76-293,657. PUB. 11-20-2001. FILED 8-1-2001.

2,538,310. **MR. MATCHY.** NATIONAL FIRE SAFETY COUNCIL, (U.S. CLS. 2, 5, 22, 23, 29, 37, 38 AND 50). SN 76-296,088. PUB. 11-20-2001. FILED 8-8-2001.

2,538,320. **JUST TURN & SHARE.** ROBINSON, KATHRYN A., DBA WRITEMATH ENTERPRISES, (U.S. CLS. 2, 5, 22, 23, 29, 37, 38 AND 50). SN 76-297,392. PUB. 11-20-2001. FILED 8-8-2001.

2,538,331. **MYTHS AND FACTS.** NEAR EAST RESEARCH, (U.S. CLS. 2, 5, 22, 23, 29, 37, 38 AND 50). SN 76-299,274. PUB. 11-20-2001. FILED 8-14-2001.

2,538,346. **RED HOUSE PAPERS.** BRENTWOOD INTERNATIONAL, INC., (U.S. CLS. 2, 5, 22, 23, 29, 37, 38 AND 50). SN 76-300,834. PUB. 11-20-2001. FILED 8-15-2001.

2,538,349. **MISCELLANEOUS DESIGN.** PAULIST NATIONAL CATHOLIC EVANGELIZATION ASSOCIATION, (U.S. CLS. 2, 5, 22, 23, 29, 37, 38 AND 50). SN 76-300,921. PUB. 11-20-2001. FILED 8-17-2001.

2,538,413. **MONEY MAP.** MONEY MAP INC., (U.S. CLS. 2, 5, 22, 23, 29, 37, 38 AND 50). SN 78-069,545. PUB. 11-20-2001. FILED 6-17-2001.

2,538,425. **MARKETING BRIEFS.** SALLY SCHMIDT CONSULTING, INC., (U.S. CLS. 2, 5, 22, 23, 29, 37, 38 AND 50). SN 78-072,891. PUB. 11-20-2001. FILED 7-9-2001.

---

## CLASS 17—RUBBER GOODS

2,537,560 ( *See Class 1 for this trademark*).

2,538,069. **ALSIBRONZ.** ENGELHARD CORPORATION, (U.S. CLS. 1, 5, 12, 13, 35 AND 50). SN 76-191,840. PUB. 11-20-2001. FILED 1-10-2001.

---

## CLASS 18—LEATHER GOODS

2,537,560 ( *See Class 1 for this trademark*).

2,537,731 ( *See Class 3 for this trademark*).

2,538,220. **A AND DESIGN.** AIRWALK INTERNATIONAL, LLC, (U.S. CLS. 1, 2, 3, 22 AND 41). SN 76-273,565. PUB. 11-20-2001. FILED 6-19-2001.

2,538,239. **SILVER PLUM.** SMITHSON, CYNTHIA LEIGH, (U.S. CLS. 1, 2, 3, 22 AND 41). SN 76-283,443. PUB. 11-20-2001. FILED 7-11-2001.

2,538,405. **EDUCATION AND DESIGN.** SAN BERNARDINO COUNTY SUPERINTENDENT OF SCHOOLS, MULTIPLE CLASS, (INT. CLS. 18, 21, 25 AND 28), (U.S. CLS. 1, 2, 3, 13, 22, 23, 29, 30, 33, 38, 39, 40, 41 AND 50). SN 78-061,906. PUB. 11-20-2001. FILED 5-3-2001.

2,538,415. **QUIET SPOT AND DESIGN.** SCHAIBLE, SCOTT, E., (U.S. CLS. 1, 2, 3, 22 AND 41). SN 78-071,058. PUB. 11-20-2001. FILED 6-26-2001.

---

## CLASS 19—NON-METALLIC BUILDING MATERIALS

2,537,536 ( *See Class 6 for this trademark*).

2,537,574 ( *See Class 5 for this trademark*).

2,537,639 ( *See Class 6 for this trademark*).

2,537,838 ( *See Class 6 for this trademark*).

2,537,895. **VIKING POOLS.** VIKING POOLS, (U.S. CLS. 1, 12, 33 AND 50). SN 76-098,463. PUB. 11-20-2001. FILED 7-28-2000.

2,538,242. **RETRO TEK.** RETRO TEK I, INC., (U.S. CLS. 1, 12, 33 AND 50). SN 76-283,963. PUB. 11-20-2001. FILED 7-12-2001.

2,538,311. **VIBRANCE.** DURAMAX, INC., (U.S. CLS. 1, 12, 33 AND 50). SN 76-296,322. PUB. 11-20-2001. FILED 8-7-2001.

2,538,361. **SOUND CELL.** BEST BLOCK COMPANY, (U.S. CLS. 1, 12, 33 AND 50). SN 76-302,911. PUB. 11-20-2001.

FILED 8-22-2001.

---

### CLASS 20—FURNITURE AND ARTICLES NOT OTHERWISE CLASSIFIED

- 2,537,560 ( *See Class 1 for this trademark* ).  
 2,537,563 ( *See Class 9 for this trademark* ).  
 2,537,594. **SABRINA**. GLOBAL TOTAL OFFICE, BY ASSIGNMENT GLOBAL UPHOLSTERY COMPANY, (U.S. CLS. 2, 13, 22, 25, 32 AND 50). SN 75-722,960. PUB. 11-20-2001. FILED 6-7-1999.  
 2,537,639 ( *See Class 6 for this trademark* ).  
 2,537,749 ( *See Class 7 for this trademark* ).  
 2,537,797. **THE IMAGE COLLECTION**. NORTH AMERICAN ENCLOSURES, INC., (U.S. CLS. 2, 13, 22, 25, 32 AND 50). SN 76-032,342. PUB. 11-20-2001. FILED 4-24-2000.  
 2,537,865. **GROSFILLEX MAXIMUP**. GROSFILLEX SARL, (U.S. CLS. 2, 13, 22, 25, 32 AND 50). SN 76-070,952. PUB. 11-20-2001. FILED 6-22-1999.  
 2,537,923. **TRAFICOP**. REDWELD RUBBER & PLASTIC LIMITED, (U.S. CLS. 2, 13, 22, 25, 32 AND 50). SN 76-116,765. PUB. 11-20-2001. FILED 8-28-2000.  
 2,537,993 ( *See Class 9 for this trademark* ).  
 2,538,146. **SALUTARE**. MATTRESS DISCOUNTERS CORPORATION, (U.S. CLS. 2, 13, 22, 25, 32 AND 50). SN 76-230,464. PUB. 11-20-2001. FILED 3-26-2001.  
 2,538,149. **YOU'LL FEEL THE DIFFERENCE THE MOMENT YOU LIE DOWN**. SERTA, INC., (U.S. CLS. 2, 13, 22, 25, 32 AND 50). SN 76-231,373. PUB. 11-20-2001. FILED 3-27-2001.  
 2,538,152. **MISCELLANEOUS DESIGN**. BROYHILL FURNITURE INDUSTRIES, INC., (U.S. CLS. 2, 13, 22, 25, 32 AND 50). SN 76-231,373. PUB. 11-20-2001. FILED 3-27-2001.  
 2,538,330. **MYRTLE-MUELLER**. HAWORTH, INC., (U.S. CLS. 2, 13, 22, 25, 32 AND 50). SN 76-299,262. PUB. 11-20-2001. FILED 8-14-2001.  
 2,538,368 ( *See Class 11 for this trademark* ).

---

### CLASS 21—HOUSEWARES AND GLASS

- 2,537,560 ( *See Class 1 for this trademark* ).  
 2,537,652. **CANDOMS**. WEEKEND 2000, INC., (U.S. CLS. 2, 13, 23, 29, 30, 33, 40 AND 50). SN 75-845,177. PUB. 11-20-2001. FILED 11-30-1999.  
 2,537,721. **WICK SNIPPER**. JJI INTERNATIONAL, INC., (U.S. CLS. 2, 13, 23, 29, 30, 33, 40 AND 50). SN 75-917,920. PUB. 11-20-2001. FILED 2-14-2000.  
 2,537,731 ( *See Class 3 for this trademark* ).  
 2,537,734. **WOMEN WITHOUT LIVES**. WOMEN WITHOUT LIVES, INC., MULTIPLE CLASS, (INT. CLS. 21 AND 39). (U.S. CLS. 2, 13, 23, 29, 30, 33, 40, 50, 100 AND 105). SN 75-932,126. PUB. 11-20-2001. FILED 2-29-2000.  
 2,537,758. **THE ANHEUSER-BUSCH COLLECTION**. ANHEUSER-BUSCH, INCORPORATED, (U.S. CLS. 2, 13, 23, 29, 30, 33, 40 AND 50). SN 75-943,825. PUB. 11-20-2001. FILED 3-14-2000.  
 2,537,762 ( *See Class 14 for this trademark* ).  
 2,537,766. **SURE LOCK**. LIBMAN COMPANY, THE, (U.S. CLS. 2, 13, 23, 29, 30, 33, 40 AND 50). SN 76-003,304. PUB. 11-20-2001. FILED 3-17-2000.  
 2,537,864. **LONGABERGER GOLF CLUB**. LONGABERGER COMPANY, THE, (U.S. CLS. 2, 13, 23, 29, 30, 33, 40 AND 50). SN 76-070,721. PUB. 11-20-2001. FILED 6-16-2000.  
 2,537,992. **FUELBELT**. MALIK, VINU PAUL, (U.S. CLS. 2, 13, 23, 29, 30, 33, 40 AND 50). SN 76-156,239. PUB. 11-20-2001. FILED 10-30-2000.  
 2,537,993 ( *See Class 9 for this trademark* ).  
 2,538,000. **TRAC—ATTACKER**. LIZZA, ALLEN C., (U.S. CLS. 2, 13, 23, 29, 30, 33, 40 AND 50). SN 76-163,517. PUB. 11-20-2001. FILED 11-8-2000.  
 2,538,162. **MISCELLANEOUS DESIGN**. MIRACLE CANDLE COMPANY, (U.S. CLS. 2, 13, 23, 29, 30, 33, 40 AND 50). SN 76-236,759. PUB. 11-20-2001. FILED 4-9-2001.  
 2,538,187. **THICK CUT**. DAYDOTS INTERNATIONAL, INC.,

- (U.S. CLS. 2, 13, 23, 29, 30, 33, 40 AND 50). SN 76-249,870. PUB. 11-20-2001. FILED 5-3-2001.  
 2,538,395. **INTERSPACE**. BRAUN GMBH, (U.S. CLS. 2, 13, 23, 29, 30, 33, 40 AND 50). SN 78-053,071. PUB. 11-20-2001. FILED 3-14-2001.  
 2,538,405 ( *See Class 18 for this trademark* ).  
 2,538,435. **GENUINE CHEVROLET**. GENERAL MOTORS CORPORATION, (U.S. CLS. 2, 13, 23, 29, 30, 33, 40 AND 50). SN 78-075,331. PUB. 11-20-2001. FILED 7-24-2001.  
 2,538,436. **MISCELLANEOUS DESIGN**. GENERAL MOTORS CORPORATION, (U.S. CLS. 2, 13, 23, 29, 30, 33, 40 AND 50). SN 78-075,334. PUB. 11-20-2001. FILED 7-24-2001.

---

### CLASS 22—CORDAGE AND FIBERS

- 2,538,252. **TRIAD**. HONEYWELL INTERNATIONAL INC., (U.S. CLS. 1, 2, 7, 19, 22, 42 AND 50). SN 76-286,800. PUB. 11-20-2001. FILED 7-18-2001.

---

### CLASS 24—FABRICS

- 2,537,597. **BABYMANIA**. FARCA, EDUARDO COHEN, AND KAMAJI, ELIAS COHEN, MULTIPLE CLASS, (INT. CLS. 24 AND 25). (U.S. CLS. 22, 39, 42 AND 50). SN 75-726,646. PUB. 11-20-2001. FILED 6-11-1999.  
 2,537,626. **COOLMESH**. COOLEY GROUP HOLDINGS, INC., (U.S. CLS. 42 AND 50). SN 75-797,116. PUB. 11-20-2001. FILED 9-13-1999.  
 2,538,224. **TONKA**. HASBRO, INC., (U.S. CLS. 42 AND 50). SN 76-275,541. PUB. 11-20-2001. FILED 6-21-2001.

---

### CLASS 25—CLOTHING

- 2,537,531. **FACEZECAF (STYLIZED)**. SO FUN, INC., (U.S. CLS. 22 AND 39). SN 75-431,683. PUB. 11-20-2001. FILED 2-10-1998.  
 2,537,541. **ROCK HARD**. RUBIN, HOWARD, DBA THE HOWARD RUBIN ORGANIZATION, (U.S. CLS. 22 AND 39). SN 75-499,900. PUB. 11-20-2001. FILED 6-10-1998.  
 2,537,560 ( *See Class 1 for this trademark* ).  
 2,537,597 ( *See Class 24 for this trademark* ).  
 2,537,612. **3RD COAST VOLLEYBALL CHAMPIONSHIPS**. JUNIOR VOLLEYBALL ASSOCIATION OF AUSTIN, (U.S. CLS. 22 AND 39). SN 75-775,809. PUB. 11-20-2001. FILED 8-6-1999.  
 2,537,693. **TRAVELER'S SUEDE**. NORM THOMPSON OUTFITTERS, INC., (U.S. CLS. 22 AND 39). SN 75-892,181. PUB. 11-20-2001. FILED 1-7-2000.  
 2,537,701. **QUICKEN**. INTUIT INC., (U.S. CLS. 22 AND 39). SN 75-901,298. PUB. 11-20-2001. FILED 1-21-2000.  
 2,537,723. **MEB**. C2 CORPORATION, (U.S. CLS. 22 AND 39). SN 75-919,570. PUB. 10-16-2001. FILED 2-15-2000.  
 2,537,746. **HUCKFEST**. RED BULL GMBH, MULTIPLE CLASS, (INT. CLS. 25 AND 41). (U.S. CLS. 22, 39, 100, 101 AND 107). SN 75-938,198. PUB. 11-20-2001. FILED 3-7-2000.  
 2,537,818. **IMAGINATION CREATIONS**. IMAGINATION CREATIONS, (U.S. CLS. 22 AND 39). SN 76-048,967. PUB. 11-20-2001. FILED 5-15-2000.  
 2,537,881. **DOL SPORTSKIRT AND DESIGN**. DOL SPORTSKIRT, (U.S. CLS. 22 AND 39). SN 76-085,282. PUB. 11-20-2001. FILED 7-10-2000.  
 2,537,982. **BEXY GIRL**. TAYLOR, DONALD D., (U.S. CLS. 22 AND 39). SN 76-153,303. PUB. 11-20-2001. FILED 10-25-2000.  
 2,538,050. **EAT MOR CHIKIN AND DESIGN**. CHICK-FIL-A, INC., (U.S. CLS. 22 AND 39). SN 76-184,298. PUB. 11-20-2001. FILED 12-19-2000.  
 2,538,181. **WOLVERINE BOOTS AND GEAR SINCE 1883**. WOLVERINE WORLD WIDE, INC., (U.S. CLS. 22 AND 39). SN 76-247,025. PUB. 11-20-2001. FILED 4-27-2001.  
 2,538,197. **MISCELLANEOUS DESIGN**. WESTRAY, KENNETH, (U.S. CLS. 22 AND 39). SN 76-253,798. PUB. 11-20-



2001. FILED 5-8-2001.  
 2,538,212. **TRI-MOUNTAIN AND DESIGN**. MOUNTAIN GEAR CORPORATION, (U.S. CLS. 22 AND 39). SN 76-269,827. PUB. 11-20-2001. FILED 6-11-2001.  
 2,538,225. **POLAR SKY**. ZTRYN, S.A. DE C.V., (U.S. CLS. 22 AND 39). SN 76-277,496. PUB. 11-20-2001. FILED 6-27-2001.  
 2,538,227. **ARTIST ART FIRST! (STYLIZED)**. MESA STATE COLLEGE FOUNDATION, (U.S. CLS. 22 AND 39). SN 76-279,372. PUB. 11-20-2001. FILED 7-2-2001.  
 2,538,272. **SAY IT WITH CURECHIEF**. FUZZY FLEECE LLC, (U.S. CLS. 22 AND 39). SN 76-289,630. PUB. 11-20-2001. FILED 7-24-2001.  
 2,538,282. **H HILLWOOD AND DESIGN**. HILLWOOD DEVELOPMENT CORPORATION, (U.S. CLS. 22 AND 39). SN 76-291,503. PUB. 11-20-2001. FILED 7-27-2001.  
 2,538,299. **MISCELLANEOUS DESIGN**. MINT COLLECTION, INC., (U.S. CLS. 22 AND 39). SN 76-294,208. PUB. 11-20-2001. FILED 8-3-2001.  
 2,538,301. **BAHAMA CRUISE**. BAHAMA CRUISE, INC., (U.S. CLS. 22 AND 39). SN 76-294,454. PUB. 11-20-2001. FILED 8-2-2001.  
 2,538,328. **EXIT-ZERO**. EXCELLMODES, INC., (U.S. CLS. 22 AND 39). SN 76-299,231. PUB. 11-20-2001. FILED 8-15-2001.  
 2,538,342. **YABBA-DABBA-DOO**. HANNA-BARBERA PRODUCTIONS, INC., (U.S. CLS. 22 AND 39). SN 76-300,285. PUB. 11-20-2001. FILED 8-14-2001.  
 2,538,359. **NOW EVERYONE GETS TO BE SEXY**. SWEET-FACE FASHION COMPANY, LLC, (U.S. CLS. 22 AND 39). SN 76-302,828. PUB. 11-20-2001. FILED 8-9-2001.  
 2,538,362. **OUTRIGGER CANOE CLUB AND DESIGN**. OUTRIGGER CANOE CLUB, (U.S. CLS. 22 AND 39). SN 76-303,009. PUB. 11-20-2001. FILED 8-20-2001.  
 2,538,375. **FISHGATE AND DESIGN**. RUTTKAY, LYNNE M, (U.S. CLS. 22 AND 39). SN 78-017,347. PUB. 11-20-2001. FILED 7-19-2000.  
 2,538,405 ( *See Class 18 for this trademark*).  
 2,538,424 ( *See Class 9 for this trademark*).  
 2,538,427. **PUNTER**. MILLER, RUSSELL, (U.S. CLS. 22 AND 39). SN 78-073,202. PUB. 11-20-2001. FILED 7-10-2001.  
 2,538,434. **Z06 AND DESIGN**. GENERAL MOTORS CORPORATION, (U.S. CLS. 22 AND 39). SN 78-075,330. PUB. 11-20-2001. FILED 7-24-2001.

---

### CLASS 27—FLOOR COVERINGS

2,537,559. **DOC DESIGNER'S ORIENTAL CARPETS AND DESIGN**. N.V. BOMAT, (U.S. CLS. 19, 20, 37, 42 AND 50). SN 75-599,360. PUB. 11-20-2001. FILED 12-3-1998.  
 2,538,353. **ASTROLAWN**. SOUTHWEST RECREATIONAL INDUSTRIES, INC., MULTIPLE CLASS, (INT. CLS. 27 AND 37), (U.S. CLS. 19, 20, 37, 42, 50, 100, 103 AND 106). SN 76-301,535. PUB. 11-20-2001. FILED 8-20-2001.

---

### CLASS 28—TOYS AND SPORTING GOODS

2,537,560 ( *See Class 1 for this trademark*).  
 2,537,596 ( *See Class 9 for this trademark*).  
 2,537,637. **SUN CHASER**. INTERNATIONAL LEISURE PRODUCTS, INC., (U.S. CLS. 22, 23, 38 AND 50). SN 75-817,772. PUB. 11-20-2001. FILED 10-7-1999.  
 2,538,023. **TONKA JOE**. HASBRO, INC., (U.S. CLS. 22, 23, 38 AND 50). SN 76-173,603. PUB. 11-20-2001. FILED 12-1-2000.  
 2,538,048. **LOUISVILLE SLUGGER FIELD**. HILLERICH & BRADSBY CO., (U.S. CLS. 22, 23, 38 AND 50). SN 76-183,897. PUB. 11-20-2001. FILED 12-19-2000.  
 2,538,132. **JAVA**. KINGMAN INTERNATIONAL CORPORATION, (U.S. CLS. 22, 23, 38 AND 50). SN 76-227,180. PUB. 11-20-2001. FILED 3-21-2001.  
 2,538,203. **FLICK IT & KICK IT!**. CRASNICK, RICHARD M., (U.S. CLS. 22, 23, 38 AND 50). SN 76-261,730. PUB. 11-20-2001. FILED 5-23-2001.  
 2,538,231. **MINDGEAR**. MINDGEAR, (U.S. CLS. 22, 23, 38 AND 50). SN 76-280,619. PUB. 11-20-2001. FILED 7-6-2001.

2,538,305. **SPRI**. SPRI PRODUCTS, INC., (U.S. CLS. 22, 23, 38 AND 50). SN 76-295,005. PUB. 11-20-2001. FILED 8-2-2001.  
 2,538,308. **WHIRL WINGS**. CENTURI CORPORATION, (U.S. CLS. 22, 23, 38 AND 50). SN 76-295,859. PUB. 11-20-2001. FILED 8-6-2001.  
 2,538,313. **PITCH-MATE**. SUNCO DISTRIBUTORS, (U.S. CLS. 22, 23, 38 AND 50). SN 76-296,465. PUB. 11-20-2001. FILED 8-9-2001.  
 2,538,314. **EVOLUTION**. WARRIOR LACROSSE, INC., (U.S. CLS. 22, 23, 38 AND 50). SN 76-296,478. PUB. 11-20-2001. FILED 8-8-2001.  
 2,538,316. **BLADE**. WARRIOR LACROSSE, INC., (U.S. CLS. 22, 23, 38 AND 50). SN 76-296,639. PUB. 11-20-2001. FILED 8-8-2001.  
 2,538,336. **MISCELLANEOUS DESIGN**. ABC INTERNATIONAL TRADERS, INC., DBA MGA ENTERTAINMENT, (U.S. CLS. 22, 23, 38 AND 50). SN 76-299,500. PUB. 11-20-2001. FILED 8-14-2001.  
 2,538,337. **MISCELLANEOUS DESIGN**. ABC INTERNATIONAL TRADERS, INC., DBA MGA ENTERTAINMENT, (U.S. CLS. 22, 23, 38 AND 50). SN 76-299,501. PUB. 11-20-2001. FILED 8-14-2001.  
 2,538,338. **MISCELLANEOUS DESIGN**. ABC INTERNATIONAL TRADERS, INC., DBA MGA ENTERTAINMENT, (U.S. CLS. 22, 23, 38 AND 50). SN 76-299,530. PUB. 11-20-2001. FILED 8-14-2001.  
 2,538,340. **SOL TO GO**. KIDZ SOLUTIONS, (U.S. CLS. 22, 23, 38 AND 50). SN 76-300,201. PUB. 11-20-2001. FILED 8-6-2001.  
 2,538,343. **HANGAR 9**. HORIZON HOBBY, INC., (U.S. CLS. 22, 23, 38 AND 50). SN 76-300,337. PUB. 11-20-2001. FILED 8-16-2001.  
 2,538,344. **CRAWL START**. HASBRO, INC., (U.S. CLS. 22, 23, 38 AND 50). SN 76-300,359. PUB. 11-20-2001. FILED 8-17-2001.  
 2,538,389. **PIG PILE**. R&R GAMES, INC., (U.S. CLS. 22, 23, 38 AND 50). SN 78-035,133. PUB. 11-20-2001. FILED 11-14-2000.  
 2,538,405 ( *See Class 18 for this trademark*).

---

### CLASS 29—MEATS AND PROCESSED FOODS

2,537,518. **ESPUNA AND DESIGN**. ESTEBAN ESPUNA, S.A., (U.S. CL. 46). SN 74-678,323. PUB. 11-20-2001. FILED 5-24-1995.  
 2,537,571. **F FRENCHY'S AND DESIGN**. FRENCHY'S SAUSAGE CO., INC., (U.S. CL. 46). SN 75-664,520. PUB. 11-20-2001. FILED 3-22-1999.  
 2,537,573. **FRENCHY'S (STYLIZED)**. FRENCHY'S SAUSAGE CO., INC., (U.S. CL. 46). SN 75-664,994. PUB. 11-20-2001. FILED 3-22-1999.  
 2,537,575. **FRENCHY'S**. FRENCHY'S SAUSAGE CO., INC., (U.S. CL. 46). SN 75-665,584. PUB. 11-20-2001. FILED 3-22-1999.  
 2,537,638. **CALIFORNIA PARTY**. A.K.A. ELEPHANT, INC., MULTIPLE CLASS, (INT. CLS. 29 AND 30), (U.S. CL. 46). SN 75-818,397. PUB. 11-20-2001. FILED 10-8-1999.  
 2,537,680. **CLUB FRESH**. CLUB FRESH, LLC, MULTIPLE CLASS, (INT. CLS. 29 AND 31), (U.S. CLS. 1 AND 46). SN 75-882,077. PUB. 11-20-2001. FILED 12-28-1999.  
 2,537,712. **GOT A MINUTE? GOT A MEAL!**. CLEMENT, TODD R., (U.S. CL. 46). SN 75-910,876. PUB. 11-20-2001. FILED 2-7-2000.  
 2,537,714. **TENDER N JUICY**. JONMOR INVESTMENTS, INC., (U.S. CL. 46). SN 75-912,712. PUB. 11-20-2001. FILED 2-8-2000.  
 2,537,720. **BOB'S RED MILL**. BOB'S RED MILL NATURAL FOODS, INC., MULTIPLE CLASS, (INT. CLS. 29, 30 AND 31), (U.S. CLS. 1 AND 46). SN 75-916,993. PUB. 11-20-2001. FILED 2-10-2000.  
 2,537,741. **YOSHINOYA RESTAURANTS AND DESIGN**. YOSHINOYA D&C CO., LTD., MULTIPLE CLASS, (INT. CLS. 29, 30 AND 42), (U.S. CLS. 46, 100 AND 101). SN 75-933,523. PUB. 11-20-2001. FILED 3-2-2000.  
 2,537,743. **QUALITY FARMS AND DESIGN**. OPPENHEIMER COMPANIES, INC., (U.S. CL. 46). SN 75-936,819. PUB. 11-20-2001. FILED 3-7-2000.  
 2,537,781. **GREEN VALLEY CERTIFIED ORGANIC AND**

- DESIGN.** CHIQUITA PROCESSED FOODS, LLC, (U.S. CL. 46). SN 76-017,249. PUB. 11-20-2001. FILED 4-4-2000.
- 2,537,796. **KING B FOODS AND DESIGN.** BALL ENTERPRISES, INC., (U.S. CL. 46). SN 76-031,202. PUB. 11-20-2001. FILED 4-24-2000.
- 2,537,890. **MISCELLANEOUS DESIGN.** BANGKOK MARKET, INC., MULTIPLE CLASS, (INT. CLS. 29 AND 30), (U.S. CL. 46). SN 76-093,205. PUB. 11-20-2001. FILED 7-20-2000.
- 2,537,996. **SNACK JACK.** FISCHER PACKING COMPANY, (U.S. CL. 46). SN 76-162,149. PUB. 11-20-2001. FILED 11-9-2000.
- 2,537,998. **LA NINA SIEMPRE CROCANTICOS AND DESIGN.** PRODUCTORA NACIONAL DE ALIMENTOS PRONAL S.A., (U.S. CL. 46). SN 76-162,711. PUB. 11-20-2001. FILED 11-10-2000.
- 2,538,010. **SIMPLY IRRESISTI-BOWL.** VIP SALES COMPANY, INC., MULTIPLE CLASS, (INT. CLS. 29 AND 30), (U.S. CL. 46). SN 76-166,414. PUB. 11-20-2001. FILED 11-16-2000.
- 2,538,012. **TAY HO.** WEST LAKE FOOD CORPORATION, DBA BANH CUON TAY HO RESTAURANT, MULTIPLE CLASS, (INT. CLS. 29 AND 42), (U.S. CLS. 46, 100 AND 101). SN 76-167,460. PUB. 11-20-2001. FILED 11-20-2000.
- 2,538,049. **PUB CHEESE.** RONDELE ACQUISITION, LLC, (U.S. CL. 46). SN 76-184,285. PUB. 11-20-2001. FILED 12-18-2000.
- 2,538,054. **HARVEST CRISP.** READY PAC PRODUCE, INC., (U.S. CL. 46). SN 76-185,580. PUB. 11-20-2001. FILED 12-21-2000.
- 2,538,072. **BAKER'S CORNER.** ALDI INC., MULTIPLE CLASS, (INT. CLS. 29 AND 30), (U.S. CL. 46). SN 76-193,000. PUB. 11-20-2001. FILED 1-12-2001.
- 2,538,093. **COCKTAIL CLAMS.** MID-ATLANTIC FOODS, INC., (U.S. CL. 46). SN 76-206,234. PUB. 11-20-2001. FILED 2-7-2001.
- 2,538,104. **MORALES.** EDDY PACKING CO., INC., (U.S. CL. 46). SN 76-211,402. PUB. 11-20-2001. FILED 2-16-2001.
- 2,538,118. **COWABUNGA AND DESIGN.** SHALVARJIAN, ZACHARY, (U.S. CL. 46). SN 76-218,174. PUB. 11-20-2001. FILED 3-2-2001.
- 2,538,119. **PITTSBURGH PANTHERS AND DESIGN.** UNIVERSITY OF PITTSBURGH OF THE COMMONWEALTH SYSTEM OF HIGHER EDUCATION, (U.S. CL. 46). SN 76-218,652. PUB. 11-20-2001. FILED 3-5-2001.
- 2,538,124. **MVP MOSNER VEAL PACKERS.** DAVID MOSNER INC., (U.S. CL. 46). SN 76-221,501. PUB. 11-20-2001. FILED 3-9-2001.
- 2,538,125. **CASTELLO.** THOLSTRUP CHEESE A/S, (U.S. CL. 46). SN 76-223,442. PUB. 11-20-2001. FILED 3-12-2001.
- 2,538,164. **AIR GOURMET.** AIR GOURMET, INC., (U.S. CL. 46). SN 76-237,926. PUB. 11-20-2001. FILED 4-9-2001.
- 2,538,189. **HEAD OF THE CLASS.** LAND O'LAKES, INC., (U.S. CL. 46). SN 76-251,401. PUB. 11-20-2001. FILED 5-7-2001.
- 2,538,191. **AGRADITO.** NORTHWEST PACKING COMPANY, (U.S. CL. 46). SN 76-251,419. PUB. 11-20-2001. FILED 5-4-2001.
- 2,538,194. **MAKALOA.** SUNTREE, LLC, (U.S. CL. 46). SN 76-251,871. PUB. 11-20-2001. FILED 5-7-2001.
- 2,537,552. **MEXICANO.** DILETTANTE CHOCOLATES, INC., (U.S. CL. 46). SN 75-537,290. PUB. 11-20-2001. FILED 8-17-1998.
- 2,537,562. **CUBIES.** LIFE-LIKE PRODUCTS, INC., (U.S. CL. 46). SN 75-613,691. PUB. 11-20-2001. FILED 1-4-1999.
- 2,537,577. **LC AND DESIGN.** SHE-KOU-CHANG-LI-CHI-PEN-TIEN ENTERPRISE CO., LTD., (U.S. CL. 46). SN 75-675,557. PUB. 11-20-2001. FILED 4-29-1999.
- 2,537,638 ( *See Class 29 for this trademark*).
- 2,537,647. **COMMODORE.** INTERNATIONAL MARKET BRANDS, INC., (U.S. CL. 46). SN 75-836,337. PUB. 11-20-2001. FILED 10-28-1999.
- 2,537,653. **SHAD'S (STYLIZED).** Z & K ASSOCIATES, INC., (U.S. CL. 46). SN 75-846,590. PUB. 11-20-2001. FILED 11-12-1999.
- 2,537,677. **ROLLERSTIX.** CHEF AMERICA, INC., (U.S. CL. 46). SN 75-878,690. PUB. 11-20-2001. FILED 12-20-1999.
- 2,537,685. **BOMOCAF AND DESIGN.** BOMOCAF S.P.A., (U.S. CL. 46). SN 75-887,984. PUB. 11-20-2001. FILED 1-6-2000.
- 2,537,689. **LU AND DESIGN.** GENERALE BISCUIT, (U.S. CL. 46). SN 75-889,242. PUB. 11-20-2001. FILED 1-6-2000.
- 2,537,711. **CARAMEL SIN.** CARAMEL SIN, INC., (U.S. CL. 46). SN 75-910,821. PUB. 11-20-2001. FILED 2-5-2000.
- 2,537,720 ( *See Class 29 for this trademark*).
- 2,537,724. **STAGG (STYLIZED).** HORMEL FOODS, LLC, (U.S. CL. 46). SN 75-920,605. PUB. 11-20-2001. FILED 2-15-2000.
- 2,537,741 ( *See Class 29 for this trademark*).
- 2,537,745. **BISON BRAND.** BISON BRAND, INC., (U.S. CL. 46). SN 75-937,532. PUB. 11-20-2001. FILED 3-7-2000.
- 2,537,765. **ROASTER'S COVE.** E. A. SWEEN COMPANY, MULTIPLE CLASS, (INT. CLS. 30 AND 42), (U.S. CLS. 46, 100 AND 101). SN 76-001,504. PUB. 11-20-2001. FILED 3-15-2000.
- 2,537,779. **GIFF'S ORIGINAL.** GIFF'S ORIGINAL, (U.S. CL. 46). SN 76-015,334. PUB. 11-20-2001. FILED 3-22-2000.
- 2,537,783. **INES ROSALES.** INES ROSALES, S.A., (U.S. CL. 46). SN 76-018,681. PUB. 11-20-2001. FILED 4-6-2000.
- 2,537,805. **VERMONT SUGAR FREE.** MAPLE GROVE FARMS OF VERMONT, INC., (U.S. CL. 46). SN 76-039,480. PUB. 11-20-2001. FILED 5-2-2000.
- 2,537,816. **DON CARLOS AND DESIGN.** DON CARLOS FOODS, INC., (U.S. CL. 46). SN 76-048,612. PUB. 11-20-2001. FILED 5-11-2000.
- 2,537,819. **LACI LE BEAU.** NATROL, INC., (U.S. CL. 46). SN 76-049,096. PUB. 11-20-2001. FILED 5-12-2000.
- 2,537,820. **L'CHAIM FRESH 2000.** BBM CHOCOLATE DISTRIBUTORS, LTD., (U.S. CL. 46). SN 76-051,728. PUB. 11-20-2001. FILED 5-19-2000.
- 2,537,831. **PICKLED BRAINS.** SPENCER & FLEETWOOD, (U.S. CL. 46). SN 76-058,366. PUB. 11-20-2001. FILED 5-19-2000.
- 2,537,890 ( *See Class 29 for this trademark*).
- 2,537,904 ( *See Class 5 for this trademark*).
- 2,537,908. **LONGHORNS.** LAMMES CANDIES SINCE 1885, INC., (U.S. CL. 46). SN 76-109,204. PUB. 11-20-2001. FILED 8-15-2000.
- 2,537,925. **MONSTER MASH SUNDAE.** FRIENDLY ICE CREAM CORPORATION, (U.S. CL. 46). SN 76-116,951. PUB. 11-20-2001. FILED 8-24-2000.
- 2,537,926. **GOOD 'N GOOEY SUNDAE.** FRIENDLY ICE CREAM CORPORATION, (U.S. CL. 46). SN 76-116,952. PUB. 11-20-2001. FILED 8-24-2000.
- 2,537,930. **TAANUG.** LANTEV DISTRIBUTING CORPORATION, (U.S. CL. 46). SN 76-125,078. PUB. 11-20-2001. FILED 9-7-2000.
- 2,537,936. **BAKER'S BREAKFAST COOKIE.** BAKER'S BREAKFAST COOKIE, INC., (U.S. CL. 46). SN 76-129,621. PUB. 11-20-2001. FILED 9-14-2000.
- 2,537,956. **MONSTER CHOCOLATE.** TRUSTEES OF AMERICA'S DRIVE-IN TRUST, THE A PENNSYLVANIA BUSINESS TRUST, THE TRUSTEES COMPRISING KENNETH L. KEYMER, RONALD L. MATLOCK AND JANICE C. GEORGE ALL UNITED STATES CITIZENS, (U.S. CL. 46). SN 76-142,634. PUB. 11-20-2001. FILED 10-6-2000.
- 2,537,957. **SWEETHEART SHAKE.** TRUSTEES OF AMERICA'S DRIVE-IN TRUST A PENNSYLVANIA BUSINESS TRUST, COMPRISING OF KENNETH L. KEYMER, RONALD L. MATLOCK AND JANICE C. GEORGE, ALL

---

### CLASS 30—STAPLE FOODS

- 2,537,521. **BISCOTT CANTUCCI ONE AND DESIGN.** D'AMARIO, PASQUALE, (U.S. CL. 46). SN 75-059,996. PUB. 11-20-2001. FILED 2-20-1996.
- 2,537,522. **STANDARD COFFEE.** STANDARD COFFEE COMPANY, INC., MULTIPLE CLASS, (INT. CLS. 30 AND 42), (U.S. CLS. 46, 100 AND 101). SN 75-114,463. PUB. 9-23-1997. FILED 6-5-1996.
- 2,537,524. **WHOLE MOLE (STYLIZED).** MEXX GROUP, L.L.C., (U.S. CL. 46). SN 75-192,475. PUB. 6-5-2001. FILED 11-4-1996.
- 2,537,527. **MANJARI JIVARA AND DESIGN.** ETABLISSEMENTS DE LOISY & GELET, (U.S. CL. 46). SN 75-294,396. PUB. 11-20-2001. FILED 5-19-1997.

UNITED STATES CITIZENS, (U.S. CL. 46). SN 76-142,635. PUB. 11-20-2001. FILED 10-6-2000.

2,537,961. **LOOKS LIKE A PRETZEL TASTES LIKE A COOKIE.** J&J SNACK FOODS CORP., (U.S. CL. 46). SN 76-145,670. PUB. 11-20-2001. FILED 10-12-2000.

2,537,968. **RED BULLET.** PREMIER NUTRITION, INC., (U.S. CL. 46). SN 76-147,456. PUB. 11-20-2001. FILED 10-17-2000.

2,537,975. **SERVING YOUR SPIRIT.** GOLDEN TEMPLE OF OREGON, INC., (U.S. CL. 46). SN 76-149,284. PUB. 11-20-2001. FILED 10-17-2000.

2,537,983. **LOGO DOUGH.** CROSS CREATIVE CONCEPTS, INC., DBA DBA C3 MARKETING, (U.S. CL. 46). SN 76-153,333. PUB. 11-20-2001. FILED 10-25-2000.

2,538,009. **TURKEY.** GOOD FOOD, INC., (U.S. CL. 46). SN 76-166,321. PUB. 11-20-2001. FILED 11-16-2000.

2,538,010 ( *See Class 29 for this trademark.*).

2,538,024. **RED BULLET AND DESIGN.** PREMIER NUTRITION, INC., (U.S. CL. 46). SN 76-174,374. PUB. 11-20-2001. FILED 12-4-2000.

2,538,041. **PITETTES.** TOUFAYAN BAKERY, INC., (U.S. CL. 46). SN 76-179,721. PUB. 11-20-2001. FILED 12-8-2000.

2,538,042. **AUGUSTO BONA VIA.** D'LISI FOOD SYSTEMS, INC., (U.S. CL. 46). SN 76-179,896. PUB. 11-20-2001. FILED 12-12-2000.

2,538,044. **SCOTTIE MACBEAN ROASTERY AND DESIGN.** SCOTTIE MACBEAN, INC., (U.S. CL. 46). SN 76-183,023. PUB. 11-20-2001. FILED 12-19-2000.

2,538,064. **LA BANDERITA BURRITO GRANDE FLOUR TORTILLAS AND DESIGN.** OLE MEXICAN FOODS, INC., (U.S. CL. 46). SN 76-188,801. PUB. 11-20-2001. FILED 1-3-2001.

2,538,072 ( *See Class 29 for this trademark.*).

2,538,086. **IMPERIAL ORCHID.** LA VENCEDORA E HIJOS, S.A. DE C.V., (U.S. CL. 46). SN 76-202,874. PUB. 11-20-2001. FILED 2-1-2001.

2,538,126. **TEN-LUH.** TEN REN TEA CO., LTD., (U.S. CL. 46). SN 76-224,418. PUB. 11-20-2001. FILED 3-14-2001.

2,538,137. **FARMLAND.** FARMLAND INDUSTRIES, INC., (U.S. CL. 46). SN 76-228,304. PUB. 11-20-2001. FILED 3-21-2001.

2,538,154. **CHOCOLATE ECSTASY INC. AND DESIGN.** CHOCOLATE ECSTASY, INC., (U.S. CL. 46). SN 76-233,403. PUB. 11-20-2001. FILED 3-30-2001.

2,538,160. **BEST OF THE BEST.** CASEY, ALAN J., (U.S. CL. 46). SN 76-236,027. PUB. 11-20-2001. FILED 2-12-2001.

2,538,163. **FOUR STAR GENERAL.** FOUR STAR PIZZA FRANCHISING CORP., (U.S. CL. 46). SN 76-237,761. PUB. 11-20-2001. FILED 4-2-2001.

2,538,176. **SWEET MEADOWS.** NUMI, LLC, (U.S. CL. 46). SN 76-245,255. PUB. 11-20-2001. FILED 4-23-2001.

2,538,177. **TIMELESS CLASSICS.** NUMI, LLC, (U.S. CL. 46). SN 76-245,264. PUB. 11-20-2001. FILED 4-23-2001.

2,538,193. **THE GRATEFUL PALATE.** GRATEFUL PALATE, INC., THE, (U.S. CL. 46). SN 76-251,868. PUB. 11-20-2001. FILED 5-7-2001.

2,538,202. **BOLERO.** GREEK GOURMET, LIMITED, (U.S. CL. 46). SN 76-261,701. PUB. 11-20-2001. FILED 5-23-2001.

2,538,230. **CHANG-TUH.** CHANG-TUH CORPORATION, (U.S. CL. 46). SN 76-280,354. PUB. 11-20-2001. FILED 6-27-2001.

2,538,244. **DANGER MEN COOKING AND DESIGN.** ANDE ROONEY INC., (U.S. CL. 46). SN 76-284,800. PUB. 11-20-2001. FILED 7-12-2001.

2,538,246. **CAFFE APPASSIONATO WHERE A PASSION IS ALWAYS BREWING.** CAFFE APPASSIONATO, INC., (U.S. CL. 46). SN 76-285,148. PUB. 11-20-2001. FILED 7-13-2001.

2,538,263. **JOE'S STUFF.** NOSOC, INC., (U.S. CL. 46). SN 76-288,664. PUB. 11-20-2001. FILED 7-23-2001.

2,538,309. **MELAMPO.** GUALANDI, ALESSANDRO, (U.S. CL. 46). SN 76-295,872. PUB. 11-20-2001. FILED 8-6-2001.

2,538,372. **MISCELLANEOUS DESIGN.** CHIN HU CHUN TEA INDUSTRY CO., LTD., (U.S. CL. 46). SN 78-015,409. PUB. 11-20-2001. FILED 7-5-2000.

2,538,397. **VEGI PIZZA FEAST.** DOMINO'S PIZZA PMC, INC., (U.S. CL. 46). SN 78-057,789. PUB. 11-20-2001. FILED 4-11-2001.

2,538,398. **PEPPERONI PIZZA FEAST.** DOMINO'S PIZZA PMC, INC., (U.S. CL. 46). SN 78-057,790. PUB. 11-20-2001.

FILED 4-11-2001.

2,538,399. **HAWAIIAN PIZZA FEAST.** DOMINO'S PIZZA PMC, INC., (U.S. CL. 46). SN 78-057,791. PUB. 11-20-2001. FILED 4-11-2001.

2,538,400. **DELUXE PIZZA FEAST.** DOMINO'S PIZZA PMC, INC., (U.S. CL. 46). SN 78-057,793. PUB. 11-20-2001. FILED 4-11-2001.

2,538,401. **MEATZZA PIZZA FEAST.** DOMINO'S PIZZA PMC, INC., (U.S. CL. 46). SN 78-057,796. PUB. 11-20-2001. FILED 4-11-2001.

2,538,431. **FATAL ATTRACTION.** ABC INTERNATIONAL, INC., (U.S. CL. 46). SN 78-074,732. PUB. 11-20-2001. FILED 7-19-2001.

### CLASS 31—NATURAL AGRICULTURAL PRODUCTS

2,537,525. **SANTA BARBARA FARMS AND DESIGN.** GUERRA, ROBERT, AND WITT, ROBERT M., (U.S. CLS. 1 AND 46). SN 75-261,944. PUB. 11-20-2001. FILED 3-24-1997.

2,537,557. **CAPESPAN.** CAPESPAN GROUP HOLDINGS LIMITED, BY ASSIGNMENT CAPESPAN INTERNATIONAL PLC, (U.S. CLS. 1 AND 46). SN 75-587,451. PUB. 1-30-2001. FILED 11-12-1998.

2,537,589 ( *See Class 5 for this trademark.*).

2,537,592. **FANTOM (STYLIZED).** SEQUOIA ENTERPRISES, INC., (U.S. CLS. 1 AND 46). SN 75-722,717. PUB. 11-20-2001. FILED 6-7-1999.

2,537,606 ( *See Class 1 for this trademark.*).

2,537,620. **PRADERA.** WILLIAM L. YOUNG FARMS, INC., (U.S. CLS. 1 AND 46). SN 75-789,916. PUB. 11-20-2001. FILED 9-1-1999.

2,537,635. **CHAUMETTE VINEYARD.** M.H. JOHNSON, INC., (U.S. CLS. 1 AND 46). SN 75-809,060. PUB. 11-20-2001. FILED 9-27-1999.

2,537,654. **GRAPE MAN (STYLIZED).** GILFENBAIN, STEVEN L., (U.S. CLS. 1 AND 46). SN 75-848,067. PUB. 11-20-2001. FILED 11-13-1999.

2,537,680 ( *See Class 29 for this trademark.*).

2,537,720 ( *See Class 29 for this trademark.*).

2,537,759. **SURETURF.** NAS INDUSTRIES, INC., (U.S. CLS. 1 AND 46). SN 75-943,867. PUB. 11-20-2001. FILED 3-14-2000.

2,537,812. **SOUTHERN SWEET AND DESIGN.** FARM-WAY PRODUCE INC., (U.S. CLS. 1 AND 46). SN 76-045,077. PUB. 11-20-2001. FILED 5-11-2000.

2,537,869. **COLUMBIA GRAIN.** COLUMBIA GRAIN INTERNATIONAL, INC., (U.S. CLS. 1 AND 46). SN 76-072,276. PUB. 11-20-2001. FILED 6-19-2000.

2,537,899. **SUNFED.** MANDEL MIZOKAMI CORP., (U.S. CLS. 1 AND 46). SN 76-102,853. PUB. 11-20-2001. FILED 7-28-2000.

2,537,900. **SUNDAN.** MANDEL MIZOKAMI CORP., (U.S. CLS. 1 AND 46). SN 76-102,854. PUB. 11-20-2001. FILED 7-28-2000.

2,537,919. **JUPITER.** AGRI SUN NURSERY L.L.C., (U.S. CLS. 1 AND 46). SN 76-113,766. PUB. 8-14-2001. FILED 8-22-2000.

2,537,935. **ZUKE'S.** PERFORMANCE PET NUTRITION, LLC., (U.S. CLS. 1 AND 46). SN 76-129,321. PUB. 11-20-2001. FILED 9-18-2000.

2,537,958. **STAGECOACH SPOKE.** STAGECOACH VINEYARDS LIMITED PARTNERSHIP, (U.S. CLS. 1 AND 46). SN 76-142,670. PUB. 11-20-2001. FILED 10-6-2000.

2,538,033. **KID KUSHION.** OUTDOOR WORLD, (U.S. CLS. 1 AND 46). SN 76-177,825. PUB. 11-20-2001. FILED 12-8-2000.

2,538,034. **WOODY PET.** WOODY PET PRODUCTS INC., (U.S. CLS. 1 AND 46). SN 76-177,840. PUB. 11-20-2001. FILED 12-8-2000.

2,538,040. **HOMESTYLE FAVORITES.** KAL KAN FOODS, INC., (U.S. CLS. 1 AND 46). SN 76-179,642. PUB. 11-20-2001. FILED 12-12-2000.

2,538,084. **SWEET LEGEND (STYLIZED).** LEGEND PRODUCE, LLC, (U.S. CLS. 1 AND 46). SN 76-201,567. PUB. 11-20-2001. FILED 1-29-2001.

2,538,123. **ARM & HAMMER - THE STANDARD OF PURITY AND DESIGN.** CHURCH & DWIGHT COMPANY, (U.S. CLS. 1 AND 46). SN 76-221,146. PUB. 11-20-2001. FILED 3-8-2001.

2,538,135. **KF194.** FIFIELD LAND COMPANY, (U.S. CLS. 1

AND 46). SN 76-227,631. PUB. 11-20-2001. FILED 3-20-2001.  
 2,538,138. **BARNYARD BUDDIES**. NATURE'S ANIMALS, INC., (U.S. CLS. 1 AND 46). SN 76-229,045. PUB. 11-20-2001. FILED 3-23-2001.  
 2,538,156. **ROLLING CAMEL BRAND AND DESIGN**. O. M. CONTRACTING, INC., DBA ROLLING CAMEL RANCHES, (U.S. CLS. 1 AND 46). SN 76-233,755. PUB. 11-20-2001. FILED 4-2-2001.

---

### CLASS 32—LIGHT BEVERAGES

2,537,603. **PEACE MOUNTAIN**. ALDEN, JOHN DAVID, (U.S. CLS. 45, 46 AND 48). SN 75-747,331. PUB. 11-20-2001. FILED 6-24-1999.  
 2,537,700. **MISCELLANEOUS DESIGN**. ARCTIC CHILLER LTD., (U.S. CLS. 45, 46 AND 48). SN 75-900,963. PUB. 11-20-2001. FILED 1-21-2000.  
 2,537,771. **ELOAD**. ELOAD, (U.S. CLS. 45, 46 AND 48). SN 76-008,721. PUB. 11-20-2001. FILED 3-24-2000.  
 2,537,801. **MOZA AND DESIGN**. CERVECERIA CENTRO AMERICANA, S.A., (U.S. CLS. 45, 46 AND 48). SN 76-034,384. PUB. 11-20-2001. FILED 4-25-2000.  
 2,537,823. **WIECKSE WITTE**. BROUWERIJ DE RIDDER B.V., (U.S. CLS. 45, 46 AND 48). SN 76-053,239. PUB. 11-20-2001. FILED 5-22-2000.  
 2,537,879. **M AND DESIGN**. MOLSON CANADA, (U.S. CLS. 45, 46 AND 48). SN 76-083,597. PUB. 11-20-2001. FILED 7-6-2000.  
 2,537,889. **S.U.V.**. SPOETZL BREWERY, INC., (U.S. CLS. 45, 46 AND 48). SN 76-092,971. PUB. 11-20-2001. FILED 7-20-2000.  
 2,538,057. **GRIZZLY WULFF WHEAT**. YELLOWSTONE VALLEY BREWING, LLC, (U.S. CLS. 45, 46 AND 48). SN 76-186,224. PUB. 11-20-2001. FILED 12-26-2000.  
 2,538,063. **180 AND DESIGN**. ANHEUSER-BUSCH, INCORPORATED, (U.S. CLS. 45, 46 AND 48). SN 76-188,263. PUB. 11-20-2001. FILED 1-2-2001.

---

### CLASS 33—WINES AND SPIRITS

2,537,584. **MARINELLA**. BERCU-T-VANDERVOORT & CO., (U.S. CLS. 47 AND 49). SN 75-706,305. PUB. 11-20-2001. FILED 5-14-1999.  
 2,537,586. **MARICOPA VINEYARDS**. BRONCO WINE COMPANY, (U.S. CLS. 47 AND 49). SN 75-711,184. PUB. 11-20-2001. FILED 5-20-1999.  
 2,537,645. **REMY RED AND DESIGN**. E. REMY MARTIN & CO S.A., (U.S. CLS. 47 AND 49). SN 75-829,752. PUB. 11-20-2001. FILED 10-22-1999.  
 2,537,785. **KETEL ONE CITROEN AND DESIGN**. DOUBLE EAGLE B.V., (U.S. CLS. 47 AND 49). SN 76-020,695. PUB. 11-20-2001. FILED 4-10-2000.  
 2,537,822. **GREAT OAKS RANCH**. MICHAEL B. LIPPMAN, INC., DBA GREAT OAKS RANCH, (U.S. CLS. 47 AND 49). SN 76-053,202. PUB. 11-20-2001. FILED 5-22-2000.  
 2,537,943. **VIRTUAL VINEYARDS**. WINE.COM, INC., (U.S. CLS. 47 AND 49). SN 76-133,690. PUB. 11-20-2001. FILED 9-21-2000.  
 2,537,951. **KEOKI**. HAWAIIAN RECTIFIERS, INC., (U.S. CLS. 47 AND 49). SN 76-139,702. PUB. 11-20-2001. FILED 10-3-2000.  
 2,538,065. **ROCKY TERRACE**. HAYWOOD, PETER C., (U.S. CLS. 47 AND 49). SN 76-188,918. PUB. 11-20-2001. FILED 1-2-2001.  
 2,538,116. **NAPA VALLEY HARLAN ESTATE AND DESIGN**. HARLAN ESTATE WINERY, INC., (U.S. CLS. 47 AND 49). SN 76-217,506. PUB. 11-20-2001. FILED 2-28-2001.  
 2,538,117. **NAPA VALLEY THE MAIDEN AND DESIGN**. HARLAN ESTATE WINERY, INC., (U.S. CLS. 47 AND 49). SN 76-217,507. PUB. 11-20-2001. FILED 2-28-2001.  
 2,538,161. **FOR PEOPLE WHO KNOW CHAMPAGNE**. F. KORBEL & BROS., (U.S. CLS. 47 AND 49). SN 76-236,577. PUB. 11-20-2001. FILED 4-4-2001.

2,538,186. **MARTINI & ROSSI AND DESIGN**. MARTINI & ROSSI CORPORATION, (U.S. CLS. 47 AND 49). SN 76-248,593. PUB. 11-20-2001. FILED 4-30-2001.  
 2,538,429. **DIVA**. S. ANDERSON VINEYARD, (U.S. CLS. 47 AND 49). SN 78-074,193. PUB. 11-20-2001. FILED 7-16-2001.

---

### CLASS 34—SMOKERS' ARTICLES

2,537,704. **FLOR DE COPAN**. FABRICA DE TABACOS LA FLOR DE COPAN, S.A. DE C.V., (U.S. CLS. 2, 8, 9 AND 17). SN 75-903,753. PUB. 11-20-2001. FILED 1-27-2000.  
 2,538,103. **BENSON & HEDGES 100'S AND DESIGN**. PHILIP MORRIS INCORPORATED, (U.S. CLS. 2, 8, 9 AND 17). SN 76-210,031. PUB. 11-20-2001. FILED 2-14-2001.

---

### SERVICE MARKS

### CLASS 35—ADVERTISING AND BUSINESS

2,537,533. **COVENANT TRUST COMPANY**. COVENANT TRUST COMPANY, (U.S. CLS. 100, 101 AND 102). SN 75-460,050. PUB. 11-20-2001. FILED 4-1-1998.  
 2,537,535. **CONRAD YELVINGTON DISTRIBUTORS, INC. AND DESIGN**. CONRAD YELVINGTON DISTRIBUTORS, INC., (U.S. CLS. 100, 101 AND 102). SN 75-470,282. PUB. 11-20-2001. FILED 4-20-1998.  
 2,537,540 ( *See Class 9 for this trademark* ).  
 2,537,551. **MISCELLANEOUS DESIGN**. ARUZE CORPORATION, (U.S. CLS. 100, 101 AND 102). SN 75-536,548. PUB. 10-10-2000. FILED 8-12-1998.  
 2,537,560 ( *See Class 1 for this trademark* ).  
 2,537,564. **GIFTECH CORP AND DESIGN**. ROSENBERG, EVA, AND CORDELL, RICK G., (U.S. CLS. 100, 101 AND 102). SN 75-625,039. PUB. 11-20-2001. FILED 1-22-1999.  
 2,537,565. **BRAND GO**. PEACOCK, BRADLEY, (U.S. CLS. 100, 101 AND 102). SN 75-625,656. PUB. 11-20-2001. FILED 10-5-1999.  
 2,537,567. **PEPPER MUSIC NETWORK**. J.W. PEPPER & SON, INC., (U.S. CLS. 100, 101 AND 102). SN 75-651,721. PUB. 11-20-2001. FILED 3-2-1999.  
 2,537,569. **KIDS' UNIVERSE TOYS & SOFTWARE AND DESIGN**. KIDS UNIVERSE, (U.S. CLS. 100, 101 AND 102). SN 75-654,184. PUB. 11-20-2001. FILED 3-5-1999.  
 2,537,572. **F FRENCHY'S AND DESIGN**. FRENCHY'S SAUSAGE CO., INC., (U.S. CLS. 100, 101 AND 102). SN 75-664,521. PUB. 11-20-2001. FILED 3-22-1999.  
 2,537,580. **NEW ENGLAND FITNESS EQUIPMENT AND DESIGN**. NEFITCO, INC., (U.S. CLS. 100, 101 AND 102). SN 75-692,234. PUB. 11-20-2001. FILED 4-26-1999.  
 2,537,585. **INSTINET**. B.D. OF NEVADA, LIMITED PARTNERSHIP, BY MERGER BD OF NEVADA, INC., (U.S. CLS. 100, 101 AND 102). SN 75-706,320. PUB. 7-10-2001. FILED 5-14-1999.  
 2,537,587. **SMI AND DESIGN**. CRESCENT REAL ESTATE EQUITIES, (U.S. CLS. 100, 101 AND 102). SN 75-711,242. PUB. 11-20-2001. FILED 5-20-1999.  
 2,537,588. **I PAGE**. INGRAM CUSTOMER SYSTEMS INC., (U.S. CLS. 100, 101 AND 102). SN 75-717,279. PUB. 11-20-2001. FILED 5-28-1999.  
 2,537,590. **CHESHIRE**. WESTAT, INC., MULTIPLE CLASS, (INT. CLS. 35 AND 42), (U.S. CLS. 100, 101 AND 102). SN 75-722,531. PUB. 11-20-2001. FILED 6-9-1999.  
 2,537,591. **GENETICS FIRST AGRONOMY UP FRONT SERVICE ALWAYS AND DESIGN**. GOLDEN HARVEST SEEDS, INC., (U.S. CLS. 100, 101 AND 102). SN 75-722,705. PUB. 11-20-2001. FILED 6-7-1999.  
 2,537,593. **LIGHTFAIRE**. VIKING ELECTRIC SUPPLY, INC., (U.S. CLS. 100, 101 AND 102). SN 75-722,932. PUB. 11-20-2001. FILED 6-7-1999.  
 2,537,604. **CORPSTART AND DESIGN**. WELLS, JAMESON P., (U.S. CLS. 100, 101 AND 102). SN 75-748,270. PUB. 11-20-2001. FILED 7-12-1999.

- 2,537,606 ( *See Class 1 for this trademark*).
- 2,537,611. **MEDACORP.** MEDACORP, INC., (U.S. CLS. 100, 101 AND 102). SN 75-768,594. PUB. 11-20-2001. FILED 8-5-1999.
- 2,537,615. **E-FULFILLMENT.COM AND DESIGN.** AHL SERVICES, INC., MULTIPLE CLASS, (INT. CLS. 35 AND 39), (U.S. CLS. 100, 101, 102 AND 105). SN 75-784,242. PUB. 11-20-2001. FILED 8-25-1999.
- 2,537,623. **MISCELLANEOUS DESIGN.** LEO BURNETT USA, INC., (U.S. CLS. 100, 101 AND 102). SN 75-794,251. PUB. 11-20-2001. FILED 11-10-1997.
- 2,537,629. **THE CREATIVE LAB AND DESIGN.** MAXWELL, SHERRI, (U.S. CLS. 100, 101 AND 102). SN 75-803,324. PUB. 11-20-2001. FILED 9-20-1999.
- 2,537,633. **FAST IMPLEMENTATION TOOLSET.** DA CONSULTING GROUP, INC., (U.S. CLS. 100, 101 AND 102). SN 75-808,772. PUB. 11-20-2001. FILED 9-27-1999.
- 2,537,644. **WEATHERFORD.** WEATHERFORD HOLDING U.S., INC., MULTIPLE CLASS, (INT. CLS. 35, 37 AND 42), (U.S. CLS. 100, 101, 102, 103 AND 106). SN 75-829,574. PUB. 11-20-2001. FILED 10-21-1999.
- 2,537,648. **CENTRX VETERINARY SUPPLY AND DESIGN.** FRIONA INDUSTRIES, L.P., (U.S. CLS. 100, 101 AND 102). SN 75-838,230. PUB. 11-20-2001. FILED 11-3-1999.
- 2,537,661. **SPALDING AUTO PARTS.** SPALDING AUTO PARTS, INC., MULTIPLE CLASS, (INT. CLS. 35, 37 AND 39), (U.S. CLS. 100, 101, 102, 103, 105 AND 106). SN 75-857,314. PUB. 11-20-2001. FILED 11-24-1999.
- 2,537,666. **INTERNET HORSE CLASSIFIEDS AND DESIGN.** BROMAGEM, AARON, (U.S. CLS. 100, 101 AND 102). SN 75-866,161. PUB. 11-20-2001. FILED 12-7-1999.
- 2,537,667. **CARLSON SYSTEMS.** CARLSON SYSTEMS CORPORATION, MULTIPLE CLASS, (INT. CLS. 35 AND 41), (U.S. CLS. 100, 101, 102 AND 107). SN 75-866,325. PUB. 11-20-2001. FILED 12-7-1999.
- 2,537,668. **FULTONSTREET.COM.** FULTON STREET LOBSTER & SEAFOOD CO., INC., (U.S. CLS. 100, 101 AND 102). SN 75-867,027. PUB. 11-20-2001. FILED 12-8-1999.
- 2,537,670. **DEZZERTS.COM AND DESIGN.** E-TINIAN, L.L.C., (U.S. CLS. 100, 101 AND 102). SN 75-870,909. PUB. 11-20-2001. FILED 12-13-1999.
- 2,537,682. **PARTSBASE.COM.** PARTSBASE.COM, INC., (U.S. CLS. 100, 101 AND 102). SN 75-883,837. PUB. 11-20-2001. FILED 12-31-1999.
- 2,537,684. **1 CACHE STUFF YOU NEED!** 1 CACHE, L.C., (U.S. CLS. 100, 101 AND 102). SN 75-887,724. PUB. 11-20-2001. FILED 1-5-2000.
- 2,537,694. **SECOND SUNDAY.** SECOND SUNDAY PRODUCTIONS LLC, (U.S. CLS. 100, 101 AND 102). SN 75-894,107. PUB. 11-20-2001. FILED 1-7-2000.
- 2,537,708. **WHERE ORIGINALS ORIGINATE..** 5931 BUSINESS TRUST, MULTIPLE CLASS, (INT. CLS. 35 AND 42), (U.S. CLS. 100, 101 AND 102). SN 75-906,748. PUB. 11-20-2001. FILED 1-31-2000.
- 2,537,719 ( *See Class 6 for this trademark*).
- 2,537,727. **DOT.COMPETENCY.** MAGIKBOX, LLC, (U.S. CLS. 100, 101 AND 102). SN 75-925,150. PUB. 11-20-2001. FILED 2-8-2000.
- 2,537,739. **OPTIMAL STORE.** OPTIMAL TELECOM CORPORATION, (U.S. CLS. 100, 101 AND 102). SN 75-933,121. PUB. 11-20-2001. FILED 3-1-2000.
- 2,537,740. **OPTIMAL CITY.** OPTIMAL TELECOM CORPORATION, (U.S. CLS. 100, 101 AND 102). SN 75-933,122. PUB. 11-20-2001. FILED 3-1-2000.
- 2,537,747. **MORGANICS.** MARSH SUPERMARKETS, INC., (U.S. CLS. 100, 101 AND 102). SN 75-938,233. PUB. 11-20-2001. FILED 3-8-2000.
- 2,537,751. **BRAND BUILDING BLUEPRINT.** KILMER & KILMER, INC., (U.S. CLS. 100, 101 AND 102). SN 75-940,715. PUB. 11-20-2001. FILED 3-8-2000.
- 2,537,767. **VENDQUEST AND DESIGN.** VENDQUEST, INC., (U.S. CLS. 100, 101 AND 102). SN 76-003,925. PUB. 11-20-2001. FILED 3-20-2000.
- 2,537,780. **BITTERS CO..** BITTERS CO., (U.S. CLS. 100, 101 AND 102). SN 76-017,225. PUB. 11-20-2001. FILED 4-4-2000.
- 2,537,786 ( *See Class 9 for this trademark*).
- 2,537,787. **BABY HEIRLOOMS.** BABY HEIRLOOMS, CO., (U.S. CLS. 100, 101 AND 102). SN 76-023,131. PUB. 11-20-2001. FILED 4-11-2000.
- 2,537,800. **CYBERNOMICS, INC..** CYBEMOMICS, INC., (U.S. CLS. 100, 101 AND 102). SN 76-034,168. PUB. 11-20-2001. FILED 4-25-2000.
- 2,537,802. **COMMERX.** COMMERX, INC., MULTIPLE CLASS, (INT. CLS. 35 AND 42), (U.S. CLS. 100, 101 AND 102). SN 76-037,397. PUB. 11-20-2001. FILED 5-1-2000.
- 2,537,803. **COMMERX.** COMMERX, INC., MULTIPLE CLASS, (INT. CLS. 35 AND 42), (U.S. CLS. 100, 101 AND 102). SN 76-037,398. PUB. 11-20-2001. FILED 5-1-2000.
- 2,537,804. **X-PLAN.** FORD MOTOR COMPANY, (U.S. CLS. 100, 101 AND 102). SN 76-037,900. PUB. 11-20-2001. FILED 5-2-2000.
- 2,537,809. **GARON.** GARON INDUSTRIES INTERNATIONAL, INC., (U.S. CLS. 100, 101 AND 102). SN 76-041,802. PUB. 11-20-2001. FILED 5-5-2000.
- 2,537,811. **COOL AND DESIGN.** MAGBEE, DAVID JARRET, (U.S. CLS. 100, 101 AND 102). SN 76-042,872. PUB. 11-20-2001. FILED 5-8-2000.
- 2,537,815. **ART 4 BETTER WORLD.** BENDAT, AYA, (U.S. CLS. 100, 101 AND 102). SN 76-046,693. PUB. 11-20-2001. FILED 5-9-2000.
- 2,537,827. **MPOWER.** NETWORK, INC., THE, (U.S. CLS. 100, 101 AND 102). SN 76-056,248. PUB. 11-20-2001. FILED 5-24-2000.
- 2,537,837. **IMETHODS.** INTERNET METHODS, INC., (U.S. CLS. 100, 101 AND 102). SN 76-060,134. PUB. 11-20-2001. FILED 5-30-2000.
- 2,537,839 ( *See Class 16 for this trademark*).
- 2,537,847. **BARGAINBUILDER.COM.** BARGAINBUILDER.COM, INC., (U.S. CLS. 100, 101 AND 102). SN 76-062,733. PUB. 7-3-2001. FILED 6-5-2000.
- 2,537,851. **IBT EXPERT SERVICES PRACTICE.** INTERNATIONAL BANKING TECHNOLOGIES, INC., (U.S. CLS. 100, 101 AND 102). SN 76-064,302. PUB. 9-18-2001. FILED 6-6-2000.
- 2,537,852. **VITAZON.** VITACOST.COM, INC., (U.S. CLS. 100, 101 AND 102). SN 76-065,327. PUB. 11-20-2001. FILED 6-8-2000.
- 2,537,854. **RV NATION AND DESIGN.** RV NATION L.L.C., MULTIPLE CLASS, (INT. CLS. 35 AND 42), (U.S. CLS. 100, 101 AND 102). SN 76-066,511. PUB. 11-20-2001. FILED 6-9-2000.
- 2,537,860. **DISCOVERTAX.** REVENUE SOLUTIONS, INC., (U.S. CLS. 100, 101 AND 102). SN 76-069,008. PUB. 11-20-2001. FILED 6-14-2000.
- 2,537,866. **LAUNCHSQUAD AND DESIGN.** LAUNCHSQUAD, L.L.C., (U.S. CLS. 100, 101 AND 102). SN 76-071,236. PUB. 11-20-2001. FILED 6-15-2000.
- 2,537,887. **BAYBERRY LANE.** SPECIALTY MERCHANDISE CORPORATION, (U.S. CLS. 100, 101 AND 102). SN 76-092,013. PUB. 11-20-2001. FILED 7-19-2000.
- 2,537,891. **WHEN FASHION & MUSIC COLLIDE.** BAMFLEX.COM, INC., (U.S. CLS. 100, 101 AND 102). SN 76-096,105. PUB. 11-20-2001. FILED 7-25-2000.
- 2,537,893. **MOTORCYCLE STUFF.** MOTORCYCLE STUFF, INC., (U.S. CLS. 100, 101 AND 102). SN 76-097,911. PUB. 11-20-2001. FILED 7-27-2000.
- 2,537,898. **DOMINION HOME SYSTEMS DIRECT, INC..** DOMINION VIDEO SATELLITE, INC., (U.S. CLS. 100, 101 AND 102). SN 76-102,832. PUB. 11-20-2001. FILED 8-4-2000.
- 2,537,931. **MISCELLANEOUS DESIGN.** CARLO INC., MULTIPLE CLASS, (INT. CLS. 35, 36 AND 37), (U.S. CLS. 100, 101, 102, 103 AND 106). SN 76-126,056. PUB. 11-20-2001. FILED 9-11-2000.
- 2,537,932. **PUTTING TECHNOLOGY INTO PRACTICE.** MATRIX CONSULTING, INC., MULTIPLE CLASS, (INT. CLS. 35, 41 AND 42), (U.S. CLS. 100, 101, 102 AND 107). SN 76-128,094. PUB. 11-20-2001. FILED 9-14-2000.
- 2,537,938. **CLARION CONCEPTS, INC. AND DESIGN.** CLARION CONCEPTS, INCORPORATED, (U.S. CLS. 100, 101 AND 102). SN 76-130,235. PUB. 11-20-2001. FILED 9-18-2000.
- 2,537,939. **DRIVEN BY IDEAS.** YOUNG & RUBICAM INC., (U.S. CLS. 100, 101 AND 102). SN 76-132,463. PUB. 11-20-2001. FILED 9-21-2000.
- 2,537,947. **CB (STYLIZED).** CHILDBIRTH SOLUTIONS, INC., (U.S. CLS. 100, 101 AND 102). SN 76-137,131. PUB. 11-20-2001. FILED 9-28-2000.

- 2,537,952. **GREAT MEETINGS START HERE.** ORLANDO/ORANGE COUNTY CONVENTION & VISITORS BUREAU, INC., (U.S. CLS. 100, 101 AND 102). SN 76-140,535. PUB. 11-20-2001. FILED 10-4-2000.
- 2,537,953. **TALENT MAPPING.** MASTERYWORKS, INC., (U.S. CLS. 100, 101 AND 102). SN 76-141,641. PUB. 8-28-2001. FILED 10-4-2000.
- 2,537,963. **ROCKETS AND DESIGN.** ROCKET BALL, LTD., (U.S. CLS. 100, 101 AND 102). SN 76-145,989. PUB. 11-20-2001. FILED 10-10-2000.
- 2,537,976. **ROSE FINANCIAL SERVICES.** ROSE FINANCIAL SERVICES, LLC, (U.S. CLS. 100, 101 AND 102). SN 76-149,721. PUB. 11-20-2001. FILED 10-18-2000.
- 2,537,979. **RYDERTRAC.** RYDER SYSTEM, INC, MULTIPLE CLASS, (INT. CLS. 35 AND 42), (U.S. CLS. 100, 101 AND 102). SN 76-150,638. PUB. 11-20-2001. FILED 10-20-2000.
- 2,537,981. **GENERATIONTAX AND DESIGN.** WEINSTEIN, LEWIS A., (U.S. CLS. 100, 101 AND 102). SN 76-152,312. PUB. 11-20-2001. FILED 10-23-2000.
- 2,537,984. **MEDICUS GROUP INTERNATIONAL.** MEDICUS GROUP INTERNATIONAL, INC., MULTIPLE CLASS, (INT. CLS. 35 AND 41), (U.S. CLS. 100, 101, 102 AND 107). SN 76-153,337. PUB. 11-20-2001. FILED 10-24-2000.
- 2,537,987. **REND LAKE MARINA.** REND LAKE MARINA, INC, (U.S. CLS. 100, 101 AND 102). SN 76-154,841. PUB. 11-20-2001. FILED 10-25-2000.
- 2,537,990. **FIRSTESTIMATE.** MITCHELL INTERNATIONAL, INC., (U.S. CLS. 100, 101 AND 102). SN 76-155,790. PUB. 11-20-2001. FILED 10-27-2000.
- 2,537,995. **BUZZ AND DESIGN.** BRAND GO GROUP, LLC, (U.S. CLS. 100, 101 AND 102). SN 76-159,367. PUB. 11-20-2001. FILED 11-3-2000.
- 2,538,002. **SOS SPECIAL OFFSITE SERVICES, INC. AND DESIGN.** SPECIAL OFFSITE SERVICES, INC., (U.S. CLS. 100, 101 AND 102). SN 76-164,387. PUB. 11-20-2001. FILED 11-13-2000.
- 2,538,004. **ANIMAL WORLD AND DESIGN.** FORREST, STEVE, AND FORREST, MARY ANN, (U.S. CLS. 100, 101 AND 102). SN 76-165,065. PUB. 11-20-2001. FILED 11-14-2000.
- 2,538,006. **CENTER CARE AND DESIGN.** COMMONWEALTH HEALTH CORPORATION, DBA CENTER CARE, MULTIPLE CLASS, (INT. CLS. 35 AND 36), (U.S. CLS. 100, 101 AND 102). SN 76-165,314. PUB. 11-20-2001. FILED 11-15-2000.
- 2,538,007. **COMPLETE THE PICTURE.** MAXIM HEALTHCARE SERVICES, INC., (U.S. CLS. 100, 101 AND 102). SN 76-165,855. PUB. 11-20-2001. FILED 11-15-2000.
- 2,538,008. **MAXIM MEDICAL STAFFING.** MAXIM HEALTHCARE SERVICES, INC., (U.S. CLS. 100, 101 AND 102). SN 76-165,874. PUB. 11-20-2001. FILED 11-15-2000.
- 2,538,017. **BUYERSALE.** FRATILLA, BRAD, (U.S. CLS. 100, 101 AND 102). SN 76-169,523. PUB. 11-20-2001. FILED 11-20-2000.
- 2,538,018. **A AND DESIGN.** MORRISON, DAVID ELLSWORTH, (U.S. CLS. 100, 101 AND 102). SN 76-170,028. PUB. 11-20-2001. FILED 11-24-2000.
- 2,538,021. **BRENTWOOD HANGERS.** COURTESY PRODUCTS, L.L.C., (U.S. CLS. 100, 101 AND 102). SN 76-171,574. PUB. 11-20-2001. FILED 11-27-2000.
- 2,538,028. **INTUHEALTH.** MCCOY, DEANNA, DBA INTUHEALTH, (U.S. CLS. 100, 101 AND 102). SN 76-176,128. PUB. 11-20-2001. FILED 12-5-2000.
- 2,538,029. **STYLE AT DISCOUNTED PRICES.** ROBINSON PLUMBING & HEATING SUPPLY CO., INC., (U.S. CLS. 100, 101 AND 102). SN 76-176,465. PUB. 11-20-2001. FILED 12-5-2000.
- 2,538,030. **RB DRUGSTORE.** RB PRODUCTS, LLC, (U.S. CLS. 100, 101 AND 102). SN 76-176,467. PUB. 11-20-2001. FILED 12-5-2000.
- 2,538,032. **MISCELLANEOUS DESIGN.** BRISCOE BURKE & GRIGSBY LLP, (U.S. CLS. 100, 101 AND 102). SN 76-177,640. PUB. 11-20-2001. FILED 12-8-2000.
- 2,538,045. **FOOTBALL FANATICS.** FOOTBALL FANATICS, INC., (U.S. CLS. 100, 101 AND 102). SN 76-183,737. PUB. 11-20-2001. FILED 12-16-2000.
- 2,538,052. **DUMPING.** CHUNG, JI YOUNG, (U.S. CLS. 100, 101 AND 102). SN 76-185,019. PUB. 7-3-2001. FILED 12-22-2000.
- 2,538,080. **PHORTECH.** EBY, MICHAEL J, DBA PHORTECH INTERNATIONAL, (U.S. CLS. 100, 101 AND 102). SN 76-198,428. PUB. 11-20-2001. FILED 1-24-2001.
- 2,538,085. **SNPCHIP.** SNPCHIP, L.L.C., (U.S. CLS. 100, 101 AND 102). SN 76-201,836. PUB. 11-20-2001. FILED 1-30-2001.
- 2,538,091. **PARTNER POINTS AND DESIGN.** POINTS TO PARTNERS, INC., (U.S. CLS. 100, 101 AND 102). SN 76-204,478. PUB. 11-20-2001. FILED 1-30-2001.
- 2,538,100. **NOBODY BRANDS LIKE A TEXAN.** FOGARTY KLEIN MONROE, INC., (U.S. CLS. 100, 101 AND 102). SN 76-208,645. PUB. 11-20-2001. FILED 2-9-2001.
- 2,538,108. **WORK TODAY CASH TODAY.** LABOR READY, INC., (U.S. CLS. 100, 101 AND 102). SN 76-212,584. PUB. 11-20-2001. FILED 2-20-2001.
- 2,538,109. **APRON'S AND DESIGN.** PUBLIX SUPER MARKETS, INC., (U.S. CLS. 100, 101 AND 102). SN 76-213,340. PUB. 11-20-2001. FILED 2-21-2001.
- 2,538,133. **METRO MATTRESS.** METRO MATTRESS CORPORATION, (U.S. CLS. 100, 101 AND 102). SN 76-227,417. PUB. 11-20-2001. FILED 3-20-2001.
- 2,538,134. **PURE PLACEMENT MEDIA.** KEATING MAGEE, (U.S. CLS. 100, 101 AND 102). SN 76-227,511. PUB. 11-20-2001. FILED 3-21-2001.
- 2,538,169. **FAO SCHWARZ FIFTH AVENUE AND DESIGN.** F.A.O. SCHWARZ, (U.S. CLS. 100, 101 AND 102). SN 76-238,883. PUB. 11-20-2001. FILED 4-11-2001.
- 2,538,171. **FOCUSWORKS.** B2BWORKS, INC., (U.S. CLS. 100, 101 AND 102). SN 76-240,893. PUB. 11-20-2001. FILED 4-13-2001.
- 2,538,184. **AEROSPAN.COM AND DESIGN.** AEROSPAN.COM, INC., (U.S. CLS. 100, 101 AND 102). SN 76-247,585. PUB. 11-20-2001. FILED 4-27-2001.
- 2,538,190. **EVERY PROCESS HAS A FLOW.** FLOW MANAGEMENT & ASSOCIATES, INC., MULTIPLE CLASS, (INT. CLS. 35 AND 41), (U.S. CLS. 100, 101, 102 AND 107). SN 76-251,416. PUB. 11-20-2001. FILED 5-4-2001.
- 2,538,206. **MISCELLANEOUS DESIGN.** STORK SYSTEMS, INC., (U.S. CLS. 100, 101 AND 102). SN 76-266,978. PUB. 11-20-2001. FILED 6-6-2001.
- 2,538,226. **FOCUSED THINKING.** INSIGHT GROUP INCORPORATED, THE, (U.S. CLS. 100, 101 AND 102). SN 76-278,464. PUB. 11-20-2001. FILED 6-29-2001.
- 2,538,236. **EQUITEC.** HENRY GROUP, LTD., THE, (U.S. CLS. 100, 101 AND 102). SN 76-281,779. PUB. 11-20-2001. FILED 7-9-2001.
- 2,538,243. **QUILL WWW.QUILL.COM AND DESIGN.** QUILL CORPORATION, (U.S. CLS. 100, 101 AND 102). SN 76-284,222. PUB. 11-20-2001. FILED 7-12-2001.
- 2,538,250. **PROTENTIAL.** PROTENTIAL LLC, (U.S. CLS. 100, 101 AND 102). SN 76-286,243. PUB. 11-20-2001. FILED 7-17-2001.
- 2,538,251. **MAKING THE PROCESS SIMPLE.** PARROS CONSULTING GROUP, L.L.C., (U.S. CLS. 100, 101 AND 102). SN 76-286,670. PUB. 11-20-2001. FILED 7-17-2001.
- 2,538,265. **I'M ON AIR AND DESIGN.** E RESOURCES INC., (U.S. CLS. 100, 101 AND 102). SN 76-288,784. PUB. 11-20-2001. FILED 7-23-2001.
- 2,538,266. **I'M ON AIR.** E RESOURCES INC., (U.S. CLS. 100, 101 AND 102). SN 76-288,785. PUB. 11-20-2001. FILED 7-23-2001.
- 2,538,290. **PANDAGON.** DEL HIERRO, CHARLES, (U.S. CLS. 100, 101 AND 102). SN 76-293,465. PUB. 11-20-2001. FILED 7-31-2001.
- 2,538,293. **IT'S NOT WHAT YOU SELL. IT'S HOW YOU SELL IT.** SALES STRATEGY INSTITUTE, INC., THE, (U.S. CLS. 100, 101 AND 102). SN 76-293,741. PUB. 11-20-2001. FILED 8-2-2001.
- 2,538,296. **PROFIT PLANTATION.** PROFIT PLANTATION, INC., (U.S. CLS. 100, 101 AND 102). SN 76-293,822. PUB. 11-20-2001. FILED 8-2-2001.
- 2,538,304. **FEDCEL.** TIDAL WIRELESS, INC., (U.S. CLS. 100, 101 AND 102). SN 76-294,776. PUB. 11-20-2001. FILED 8-3-2001.
- 2,538,322. **CONNECTHOME.** HOME CONTROLS INCORPORATED, MULTIPLE CLASS, (INT. CLS. 35 AND 37), (U.S. CLS. 100, 101, 102, 103 AND 106). SN 76-298,174. PUB. 11-20-2001. FILED 8-9-2001.
- 2,538,323. **CONNECTHOME AND DESIGN.** HOME CON-

- TROLS INCORPORATED, MULTIPLE CLASS, (INT. CLS. 35 AND 37), (U.S. CLS. 100, 101, 102, 103 AND 106). SN 76-298,200. PUB. 11-20-2001. FILED 8-9-2001.
- 2,538,326. **USE A NOTE, GO TO JAIL.** EVAN M. GREENSPAN, INC., DBA EMG, INC., MULTIPLE CLASS, (INT. CLS. 35 AND 42), (U.S. CLS. 100, 101 AND 102). SN 76-298,765. PUB. 11-20-2001. FILED 8-10-2001.
- 2,538,341. **STAFFAIDE.** STAFFAIDE, INC., (U.S. CLS. 100, 101 AND 102). SN 76-300,282. PUB. 11-20-2001. FILED 8-14-2001.
- 2,538,382. **AOC: (STYLIZED).** ADECCO SA, (U.S. CLS. 100, 101 AND 102). SN 78-028,580. PUB. 11-20-2001. FILED 10-2-2000.
- 2,538,385. **NACE AND DESIGN.** NATIONAL ASSOCIATION OF COLLEGES AND EMPLOYERS, MULTIPLE CLASS, (INT. CLS. 35, 41 AND 42), (U.S. CLS. 100, 101, 102 AND 107). SN 78-032,343. PUB. 11-20-2001. FILED 10-25-2000.
- 2,538,387. **JUST A GAME? I DON'T THINK SO!** VIDEO ADVENTURE, INC., (U.S. CLS. 100, 101 AND 102). SN 78-034,216. PUB. 11-20-2001. FILED 11-7-2000.
- 2,538,392. **PUTYOURLOGOONIT.COM.** IMPAX MARKETING COMMUNICATIONS, INCORPORATED, (U.S. CLS. 100, 101 AND 102). SN 78-041,918. PUB. 11-20-2001. FILED 1-5-2001.
- 2,538,394. **KNOWLEDGE KEEPERS, LTD. PROTECTING INFORMATION AND TRADE SECRETS AND DESIGN.** KNOWLEDGE KEEPERS, LTD., (U.S. CLS. 100, 101 AND 102). SN 78-048,559. PUB. 11-20-2001. FILED 2-15-2001.
- 2,538,410. **RAL ADVANTAGE PLUS.** REGISTERED AGENTS, LTD., (U.S. CLS. 100, 101 AND 102). SN 78-069,125. PUB. 11-20-2001. FILED 6-14-2000.
- 2,538,420. **COMMUNITYID.** BUXTON COMPANY, THE, (U.S. CLS. 100, 101 AND 102). SN 78-071,706. PUB. 11-20-2001. FILED 6-29-2001.
- 2,538,437. **QUALITY YOU CAN PUT YOUR NAME ON.** L. L. BEAN, INC., (U.S. CLS. 100, 101 AND 102). SN 78-076,084. PUB. 11-20-2001. FILED 7-27-2001.

### CLASS 36—INSURANCE AND FINANCIAL

- 2,537,530. **SHOPPING 24.** OTTO-VERSAND (GMBH & CO), MULTIPLE CLASS, (INT. CLS. 36, 38, 39 AND 42), (U.S. CLS. 100, 101, 102, 104 AND 105). SN 75-414,613. PUB. 11-20-2001. FILED 1-7-1998.
- 2,537,532. **PROFITS+PLUS AND DESIGN.** INSURANCE SPECIALIST, INC., (U.S. CLS. 100, 101 AND 102). SN 75-435,067. PUB. 11-20-2001. FILED 2-17-1998.
- 2,537,560 ( *See Class 1 for this trademark.* )
- 2,537,599 ( *See Class 9 for this trademark.* )
- 2,537,619. **OREGON WOMEN LAWYERS FOUNDATION AND DESIGN.** OREGON WOMEN LAWYERS FOUNDATION, (U.S. CLS. 100, 101 AND 102). SN 75-789,833. PUB. 11-20-2001. FILED 9-1-1999.
- 2,537,643. **STUDY HARD. LIVE EASY. (STYLIZED).** AMBLING COMPANIES, INC., (U.S. CLS. 100, 101 AND 102). SN 75-829,102. PUB. 11-20-2001. FILED 10-22-1999.
- 2,537,691. **MISCELLANEOUS DESIGN.** VCH TRADEMARK, INC., MULTIPLE CLASS, (INT. CLS. 36 AND 42), (U.S. CLS. 100, 101 AND 102). SN 75-891,292. PUB. 11-20-2001. FILED 1-7-2000.
- 2,537,698. **CRU & ASSOCIATES AND DESIGN.** CRU & ASSOCIATES, LLC, (U.S. CLS. 100, 101 AND 102). SN 75-898,135. PUB. 11-20-2001. FILED 1-19-2000.
- 2,537,707. **MORTGAGE NATION.** MORTGAGE NATION, (U.S. CLS. 100, 101 AND 102). SN 75-905,250. PUB. 11-20-2001. FILED 1-23-2000.
- 2,537,713. **JDS TIME TALKS PLUS.** J D SERVICES, INCORPORATED, (U.S. CLS. 100, 101 AND 102). SN 75-912,193. PUB. 11-20-2001. FILED 2-8-2000.
- 2,537,717. **CDSTREET.COM.** CD STREET, INC., (U.S. CLS. 100, 101 AND 102). SN 75-915,647. PUB. 11-20-2001. FILED 2-10-2000.
- 2,537,725. **S AND DESIGN.** SYNERGY BANK, (U.S. CLS. 100, 101 AND 102). SN 75-920,878. PUB. 11-20-2001. FILED 2-16-2000.
- 2,537,726. **EQUIPMENT EXPRESS.** WELLS FARGO & COMPANY, (U.S. CLS. 100, 101 AND 102). SN 75-923,181. PUB. 11-20-2001. FILED 2-18-2000.
- 2,537,754. **CLARKSELECT.COM AND DESIGN.** CLARK, GILBERT U., (U.S. CLS. 100, 101 AND 102). SN 75-942,730. PUB. 11-20-2001. FILED 3-3-2000.
- 2,537,755. **LISTINGEXPRESS.COM AND DESIGN.** CLARK, GILBERT U., (U.S. CLS. 100, 101 AND 102). SN 75-942,732. PUB. 11-20-2001. FILED 3-3-2000.
- 2,537,756. **SIGNATURE HILL.** PAPA, ANGELO A., MULTIPLE CLASS, (INT. CLS. 36 AND 42), (U.S. CLS. 100, 101 AND 102). SN 75-943,582. PUB. 11-20-2001. FILED 3-14-2000.
- 2,537,757. **VENSERV.** VENSERV, INC., (U.S. CLS. 100, 101 AND 102). SN 75-943,798. PUB. 11-20-2001. FILED 3-14-2000.
- 2,537,794. **MAGIC MOMENTS.** MAGIC MOMENTS, (U.S. CLS. 100, 101 AND 102). SN 76-026,622. PUB. 11-20-2001. FILED 4-14-2000.
- 2,537,806. **SOUTHTRUST ACCOUNTLINC.** MAUREEN HEARTY, (U.S. CLS. 100, 101 AND 102). SN 76-040,154. PUB. 11-20-2001. FILED 5-4-2000.
- 2,537,839 ( *See Class 16 for this trademark.* )
- 2,537,846. **INSURSCAPE.COM AND DESIGN.** INSURSCAPE.COM, (U.S. CLS. 100, 101 AND 102). SN 76-062,446. PUB. 11-20-2001. FILED 6-5-2000.
- 2,537,849. **C U AT THE DEALER.** INDIRECT SERVICES, INC., (U.S. CLS. 100, 101 AND 102). SN 76-063,289. PUB. 11-20-2001. FILED 6-5-2000.
- 2,537,862. **SMARTONE RATE.** SMARTENERGY.COM, INC., (U.S. CLS. 100, 101 AND 102). SN 76-069,970. PUB. 11-20-2001. FILED 6-14-2000.
- 2,537,863. **SMART FIXED RATE.** SMARTENERGY.COM, INC., (U.S. CLS. 100, 101 AND 102). SN 76-069,971. PUB. 11-20-2001. FILED 6-14-2000.
- 2,537,870. **YOUR MIND. YOUR BODY. YOUR SPIRIT. YOUR HEALTH. AND DESIGN.** BLUE CROSS AND BLUE SHIELD ASSOCIATION, MULTIPLE CLASS, (INT. CLS. 36 AND 42), (U.S. CLS. 100, 101 AND 102). SN 76-073,685. PUB. 11-20-2001. FILED 6-21-2000.
- 2,537,882. **ROAD SERVICE PLUS (STYLIZED).** AMERICAN AUTO GUARDIAN INC., (U.S. CLS. 100, 101 AND 102). SN 76-085,415. PUB. 11-20-2001. FILED 7-10-2000.
- 2,537,931 ( *See Class 35 for this trademark.* )
- 2,537,945. **PROFESSIONAL EFFECTIVE-RATE FINANCING OPTIONS.** FOWLER, STEPHEN F., (U.S. CLS. 100, 101 AND 102). SN 76-134,265. PUB. 11-20-2001. FILED 9-25-2000.
- 2,537,964. **CAPITAL INSURANCE ADJUSTERS, INC. AND DESIGN.** CAPITAL INSURANCE ADJUSTERS, INC., (U.S. CLS. 100, 101 AND 102). SN 76-146,603. PUB. 11-20-2001. FILED 10-16-2000.
- 2,537,965. **VERITAS CAPITAL.** VERITAS CAPITAL MANAGEMENT, L.L.C., (U.S. CLS. 100, 101 AND 102). SN 76-146,668. PUB. 11-20-2001. FILED 10-13-2000.
- 2,537,966. **VERITAS CAPITAL AND DESIGN.** VERITAS CAPITAL MANAGEMENT, L.L.C., (U.S. CLS. 100, 101 AND 102). SN 76-146,670. PUB. 11-20-2001. FILED 10-13-2000.
- 2,537,967. **EDTEST AND DESIGN.** EDFUND, (U.S. CLS. 100, 101 AND 102). SN 76-147,088. PUB. 11-20-2001. FILED 10-16-2000.
- 2,537,969. **MUTUAL BOILER RE AND DESIGN.** FACTORY MUTUAL INSURANCE COMPANY, (U.S. CLS. 100, 101 AND 102). SN 76-147,478. PUB. 11-20-2001. FILED 10-13-2000.
- 2,538,006 ( *See Class 35 for this trademark.* )
- 2,538,016. **NHL ALUMNI.** NATIONAL HOCKEY LEAGUE, (U.S. CLS. 100, 101 AND 102). SN 76-168,990. PUB. 11-20-2001. FILED 11-17-2000.
- 2,538,026. **INAVISIS.** INAVISIS, INC., MULTIPLE CLASS, (INT. CLS. 36 AND 42), (U.S. CLS. 100, 101 AND 102). SN 76-175,144. PUB. 11-20-2001. FILED 12-4-2000.
- 2,538,027. **INAVISIS AND DESIGN.** INAVISIS, INC., MULTIPLE CLASS, (INT. CLS. 36 AND 42), (U.S. CLS. 100, 101 AND 102). SN 76-175,145. PUB. 11-20-2001. FILED 12-4-2000.
- 2,538,051. **BOO BALL.** CHILDREN'S LEUKEMIA FOUNDATION OF MICHIGAN, (U.S. CLS. 100, 101 AND 102). SN 76-184,546. PUB. 11-20-2001. FILED 12-20-2000.
- 2,538,055. **INVESTOR CENTRAL.** FINANCIAL ENGINES, INC., (U.S. CLS. 100, 101 AND 102). SN 76-185,648. PUB. 11-20-2001. FILED 12-22-2000.
- 2,538,056. **EUROGLOBAL TERM LIFE INSURANCE.** INTERNATIONAL MEDICAL GROUP, INC., (U.S. CLS. 100, 101

- AND 102). SN 76-185,717. PUB. 11-20-2001. FILED 12-26-2000.
- 2,538,073. **CYBRCOLLECT, INC. "CASH FLOW AT THE SPEED OF LIGHT"**. CYBRCOLLECT, INC., (U.S. CLS. 100, 101 AND 102). SN 76-193,161. PUB. 11-20-2001. FILED 1-16-2001.
- 2,538,077. **HARRIS NESBITT. HARRIS TRUST AND SAVINGS BANK**, (U.S. CLS. 100, 101 AND 102). SN 76-194,649. PUB. 11-20-2001. FILED 1-17-2001.
- 2,538,078. **"ALUMNI GIVING, ALUMNI GUIDED"**. CASE ALUMNI ASSOCIATION, (U.S. CLS. 100, 101 AND 102). SN 76-195,063. PUB. 11-20-2001. FILED 1-17-2001.
- 2,538,088. **WESTPROP AND DESIGN. PIROZZI, ELIA V.**, (U.S. CLS. 100, 101 AND 102). SN 76-203,525. PUB. 8-28-2001. FILED 2-2-2001.
- 2,538,111. **PBL INSURANCE PROFESSIONAL BUSINESS LIABILITY INSURANCE. BRITAMERICA, INC.**, (U.S. CLS. 100, 101 AND 102). SN 76-213,520. PUB. 11-20-2001. FILED 2-22-2001.
- 2,538,122. **BELCO COMMUNITY CREDIT UNION. BELCO COMMUNITY CREDIT UNION**, (U.S. CLS. 100, 101 AND 102). SN 76-219,559. PUB. 11-20-2001. FILED 3-5-2001.
- 2,538,178. **EBC EMPLOYEE BENEFITS COOPERATIVE AND DESIGN. EMPLOYEE BENEFITS COOPERATIVE**, (U.S. CLS. 100, 101 AND 102). SN 76-245,499. PUB. 11-20-2001. FILED 4-24-2001.
- 2,538,223. **W AND DESIGN. WHITESSELL CONSTRUCTION CO., INC.**, MULTIPLE CLASS, (INT. CLS. 36 AND 37), (U.S. CLS. 100, 101, 102, 103 AND 106). SN 76-275,434. PUB. 11-20-2001. FILED 6-25-2001.
- 2,538,247. **DENTCO. DENT ENTERPRISES, INC.**, MULTIPLE CLASS, (INT. CLS. 36, 37 AND 42), (U.S. CLS. 100, 101, 102, 103 AND 106). SN 76-285,207. PUB. 11-20-2001. FILED 7-13-2001.
- 2,538,248. **ACROFILE. EQUIFAX INC.**, (U.S. CLS. 100, 101 AND 102). SN 76-285,378. PUB. 11-20-2001. FILED 7-14-2001.
- 2,538,255. **FINDERS. EQUIFAX INC.**, (U.S. CLS. 100, 101 AND 102). SN 76-287,383. PUB. 11-20-2001. FILED 7-18-2001.
- 2,538,281. **H HILLWOOD AND DESIGN. HILLWOOD DEVELOPMENT CORPORATION**, (U.S. CLS. 100, 101 AND 102). SN 76-291,502. PUB. 11-20-2001. FILED 7-27-2001.
- 2,538,283. **H HILLWOOD A PEROT COMPANY AND DESIGN. HILLWOOD DEVELOPMENT CORPORATION**, (U.S. CLS. 100, 101 AND 102). SN 76-291,504. PUB. 11-20-2001. FILED 7-27-2001.
- 2,538,286. **ACUSYSTEM. UNITED GUARANTY CORPORATION**, (U.S. CLS. 100, 101 AND 102). SN 76-292,094. PUB. 11-20-2001. FILED 7-25-2001.
- 2,538,292. **4 PAWS FOR A CURE. NATIONAL CHILDHOOD CANCER FOUNDATION**, (U.S. CLS. 100, 101 AND 102). SN 76-293,676. PUB. 11-20-2001. FILED 7-31-2001.
- 2,538,295. **NATIONAL STUDENT LOAN PROGRAM NSLP AND DESIGN. NEBRASKA STUDENT LOAN PROGRAM, INC.**, (U.S. CLS. 100, 101 AND 102). SN 76-293,787. PUB. 11-20-2001. FILED 8-3-2001.
- 2,538,317. **SMARTSERV. SMARTSERV ONLINE, INC.**, (U.S. CLS. 100, 101 AND 102). SN 76-296,679. PUB. 11-20-2001. FILED 7-9-2001.
- 2,538,335. **NEW WAYS, NEW ANSWERS.. SEI INVESTMENTS DEVELOPMENTS, INC.**, (U.S. CLS. 100, 101 AND 102). SN 76-299,377. PUB. 11-20-2001. FILED 8-15-2001.
- 2,538,348. **REMI. ROYAL & SUNALLIANCE USA, INC.**, (U.S. CLS. 100, 101 AND 102). SN 76-300,897. PUB. 11-20-2001. FILED 8-17-2001.
- 2,538,358. **FOCUS ON SUCCESS. J.B. CORBETT AGENCY**, (U.S. CLS. 100, 101 AND 102). SN 76-302,370. PUB. 11-20-2001. FILED 8-20-2001.
- 2,538,363. **MISCELLANEOUS DESIGN. KOLEY LAND COMPANY**, (U.S. CLS. 100, 101 AND 102). SN 76-303,143. PUB. 11-20-2001. FILED 8-22-2001.
- 2,538,421. **SELECT EDITION. JAGUAR CARS LIMITED**, (U.S. CLS. 100, 101 AND 102). SN 78-071,800. PUB. 11-20-2001. FILED 6-29-2001.

**CLASS 37—CONSTRUCTION AND REPAIR**

- 2,537,550. **ARUZE. ARUZE CORPORATION**, (U.S. CLS. 100, 103 AND 106). SN 75-536,547. PUB. 10-3-2000. FILED 8-11-1998.
- 2,537,566. **TAG STAR. KAUTZ, WILLIAM R.**, (U.S. CLS. 100, 103 AND 106). SN 75-649,574. PUB. 11-20-2001. FILED 3-1-1999.
- 2,537,644 ( *See Class 35 for this trademark*).
- 2,537,661 ( *See Class 35 for this trademark*).
- 2,537,669. **COLLECTIVE TECHNOLOGIES AND DESIGN. COLLECTIVE TECHNOLOGIES, INC.**, MULTIPLE CLASS, (INT. CLS. 37 AND 42), (U.S. CLS. 100, 101, 103 AND 106). SN 75-867,102. PUB. 11-20-2001. FILED 12-7-1999.
- 2,537,673. **WARNING CPI SECURITY SYSTEM AND DESIGN. CRIME PREVENTION, INC.**, MULTIPLE CLASS, (INT. CLS. 37 AND 42), (U.S. CLS. 100, 101, 103 AND 106). SN 75-873,186. PUB. 11-20-2001. FILED 12-16-1999.
- 2,537,695. **CI3 (STYLIZED). CONTROL INSTALLATIONS OF IOWA, INC.**, MULTIPLE CLASS, (INT. CLS. 37 AND 42), (U.S. CLS. 100, 101, 103 AND 106). SN 75-896,449. PUB. 11-20-2001. FILED 1-13-2000.
- 2,537,749 ( *See Class 7 for this trademark*).
- 2,537,750. **PERSONAL HOME PRO AND DESIGN. PERSONAL HOME PRO OF THE QUAD CITIES, LLC**, (U.S. CLS. 100, 103 AND 106). SN 75-940,013. PUB. 11-20-2001. FILED 2-18-2000.
- 2,537,786 ( *See Class 9 for this trademark*).
- 2,537,842. **COIT. COIT SERVICES, INC.**, (U.S. CLS. 100, 103 AND 106). SN 76-061,510. PUB. 11-20-2001. FILED 6-2-2000.
- 2,537,931 ( *See Class 35 for this trademark*).
- 2,537,985. **CRANE AMERICA SERVICES. CRANE AMERICA SERVICES, INC.**, (U.S. CLS. 100, 103 AND 106). SN 76-153,979. PUB. 11-20-2001. FILED 10-26-2000.
- 2,537,988. **CAD. CONVEYERED AGGREGATE DELIVERY, INC.**, (U.S. CLS. 100, 103 AND 106). SN 76-155,565. PUB. 11-20-2001. FILED 10-27-2000.
- 2,538,066. **CANDOR. VINCENT ENTERPRISES, INC.**, DBA VINCENT ELECTRICAL ENTERPRISES, INC., (U.S. CLS. 100, 103 AND 106). SN 76-189,351. PUB. 11-20-2001. FILED 1-3-2001.
- 2,538,083. **FROLICKING PONDS. MORRISON, KEITH**, (U.S. CLS. 100, 103 AND 106). SN 76-200,972. PUB. 11-20-2001. FILED 1-26-2001.
- 2,538,211. **HOME ADVANTAGE. MORT & SONS, LLC**, (U.S. CLS. 100, 103 AND 106). SN 76-269,189. PUB. 11-20-2001. FILED 6-11-2001.
- 2,538,223 ( *See Class 36 for this trademark*).
- 2,538,241. **TELCOBUY.COM AND DESIGN. TELCOBUY.COM, LLC**, MULTIPLE CLASS, (INT. CLS. 37 AND 42), (U.S. CLS. 100, 101, 103 AND 106). SN 76-283,925. PUB. 11-20-2001. FILED 7-12-2001.
- 2,538,247 ( *See Class 36 for this trademark*).
- 2,538,277. **TEXAS BIG. HAMMONDS HOMES**, (U.S. CLS. 100, 103 AND 106). SN 76-290,667. PUB. 11-20-2001. FILED 7-27-2001.
- 2,538,280. **H HILLWOOD A PEROT COMPANY AND DESIGN. HILLWOOD DEVELOPMENT CORPORATION**, (U.S. CLS. 100, 103 AND 106). SN 76-291,501. PUB. 11-20-2001. FILED 7-27-2001.
- 2,538,284. **H HILLWOOD (STYLIZED). HILLWOOD DEVELOPMENT CORPORATION**, (U.S. CLS. 100, 103 AND 106). SN 76-291,550. PUB. 11-20-2001. FILED 7-27-2001.
- 2,538,287. **EDG AND DESIGN. ELECTRONICS DESIGN GROUP, INC.**, (U.S. CLS. 100, 103 AND 106). SN 76-292,209. PUB. 11-20-2001. FILED 7-31-2001.
- 2,538,319. **HILLWOOD. HILLWOOD DEVELOPMENT CORPORATION**, (U.S. CLS. 100, 103 AND 106). SN 76-296,902. PUB. 11-20-2001. FILED 8-8-2001.
- 2,538,322 ( *See Class 35 for this trademark*).
- 2,538,323 ( *See Class 35 for this trademark*).
- 2,538,353 ( *See Class 27 for this trademark*).
- 2,538,373. **NO BROKEN PROMISES. MARYLAND WIRE BELTS**, MULTIPLE CLASS, (INT. CLS. 37 AND 40), (U.S. CLS. 100, 103 AND 106). SN 78-016,048. PUB. 11-20-2001. FILED 7-10-2000.
- 2,538,403. **THE LUBE LIZARD. RANDES, TERRY C.**, (U.S. CLS. 100, 103 AND 106). SN 78-060,028. PUB. 11-20-2001.



FILED 4-24-2001.

**CLASS 38—COMMUNICATION**

- 2,537,529. **10123 AND DESIGN**. AMERICATEL CORPORATION, (U.S. CLS. 100, 101 AND 104). SN 75-335,600. PUB. 11-20-2001. FILED 8-4-1997.
- 2,537,530 ( *See Class 36 for this trademark*).
- 2,537,568 ( *See Class 9 for this trademark*).
- 2,537,601. **US ONLINE**. US ONLINE, INC., MULTIPLE CLASS, (INT. CLS. 38 AND 42), (U.S. CLS. 100, 101 AND 104). SN 75-743,565. PUB. 11-20-2001. FILED 7-2-1999.
- 2,537,631. **YA GOTTA EYADA! (STYLIZED)**. EYADA.COM, LLC, (U.S. CLS. 100, 101 AND 104). SN 75-808,657. PUB. 11-20-2001. FILED 9-27-1999.
- 2,537,632. **E EYADA.COM AND DESIGN**. EYADA.COM, LLC, (U.S. CLS. 100, 101 AND 104). SN 75-808,659. PUB. 11-20-2001. FILED 9-27-1999.
- 2,537,660. **ONSHARE AND DESIGN**. ONSHARE, LLC, (U.S. CLS. 100, 101 AND 104). SN 75-857,263. PUB. 11-20-2001. FILED 11-24-1999.
- 2,537,664. **CALMTEL**. CALMTEL COMMUNICATIONS INTERNATIONAL, LLC, (U.S. CLS. 100, 101 AND 104). SN 75-861,332. PUB. 11-20-2001. FILED 12-2-1999.
- 2,537,678. **SIRSI**. SIRSI CORPORATION, MULTIPLE CLASS, (INT. CLS. 38 AND 41), (U.S. CLS. 100, 101, 104 AND 107). SN 75-881,028. PUB. 11-20-2001. FILED 12-27-1999.
- 2,537,692. **DEVILNET**. DUKE UNIVERSITY, MULTIPLE CLASS, (INT. CLS. 38 AND 41), (U.S. CLS. 100, 101, 104 AND 107). SN 75-892,148. PUB. 11-20-2001. FILED 1-7-2000.
- 2,537,702. **ASTROBABY**. TOMORROW, LLC, MULTIPLE CLASS, (INT. CLS. 38 AND 42), (U.S. CLS. 100, 101 AND 104). SN 75-902,134. PUB. 11-20-2001. FILED 1-24-2000.
- 2,537,737. **CAMMUNITY AND DESIGN**. CAMMUNICATIONS.COM, INC., (U.S. CLS. 100, 101 AND 104). SN 75-933,003. PUB. 11-20-2001. FILED 3-2-2000.
- 2,537,752. **SNIP (STYLIZED)**. SNIP HOLDINGS, LLC, (U.S. CLS. 100, 101 AND 104). SN 75-941,467. PUB. 11-20-2001. FILED 3-10-2000.
- 2,537,769. **FUTUR TELECOM**. FUTUR TELECOM OF AMERICA, INC., (U.S. CLS. 100, 101 AND 104). SN 76-006,070. PUB. 11-20-2001. FILED 3-21-2000.
- 2,537,786 ( *See Class 9 for this trademark*).
- 2,537,790 ( *See Class 9 for this trademark*).
- 2,537,829. **ACADEMICPLANET.COM AND DESIGN**. ACADEMIC PLANET.COM, INC., (U.S. CLS. 100, 101 AND 104). SN 76-057,234. PUB. 11-20-2001. FILED 5-25-2000.
- 2,537,830. **API THE ALTERNATIVE PHONE COMPANY AND DESIGN**. ALTERNATIVE PHONE, INC., (U.S. CLS. 100, 101 AND 104). SN 76-057,458. PUB. 11-20-2001. FILED 5-26-2000.
- 2,537,867. **COX BUSINESS SERVICES**. COX COMMUNICATIONS, INC., (U.S. CLS. 100, 101 AND 104). SN 76-071,540. PUB. 11-20-2001. FILED 6-16-2000.
- 2,537,876. **SOAPBOXCOM AND DESIGN**. MOTLEY FOOL, INC, THE, (U.S. CLS. 100, 101 AND 104). SN 76-080,374. PUB. 11-20-2001. FILED 6-29-2000.
- 2,537,934. **CAPS LOCK (STYLIZED)**. CAPS LOCK, INC., MULTIPLE CLASS, (INT. CLS. 38 AND 42), (U.S. CLS. 100, 101 AND 104). SN 76-128,198. PUB. 11-20-2001. FILED 9-14-2000.
- 2,537,972. **WE'RE CHICAGOLAND'S ETHNIC VOICE**. MIGALA COMMUNICATIONS CORPORATION, (U.S. CLS. 100, 101 AND 104). SN 76-147,758. PUB. 11-20-2001. FILED 10-16-2000.
- 2,537,994. **BNN AND DESIGN**. BOSTON COMMUNITY ACCESS AND PROGRAMMING FOUNDATION, (U.S. CLS. 100, 101 AND 104). SN 76-159,215. PUB. 11-20-2001. FILED 11-6-2000.
- 2,538,267. **PUPALERT**. THESCIENTIFICWORLD, INC., (U.S. CLS. 100, 101 AND 104). SN 76-288,842. PUB. 11-20-2001. FILED 7-21-2001.
- 2,538,275. **KDOC-TV**. GOLDEN ORANGE BROADCASTING CO., INC., (U.S. CLS. 100, 101 AND 104). SN 76-290,301. PUB. 11-20-2001. FILED 7-26-2001.
- 2,538,285. **FEEL THE JOY**. DIRECTV, INC., (U.S. CLS. 100, 101 AND 104). SN 76-292,070. PUB. 11-20-2001. FILED 7-30-

- 2001.
- 2,538,345. **EULOGYCAST**. TRIVISION SOLUTIONS, INC., (U.S. CLS. 100, 101 AND 104). SN 76-300,815. PUB. 11-20-2001. FILED 8-16-2001.
- 2,538,396. **LNCNURSE**. SPRING, NICOLE MARIE, (U.S. CLS. 100, 101 AND 104). SN 78-054,869. PUB. 11-20-2001. FILED 3-25-2001.
- 2,538,402. **HIJACK THE NET.COM**. HIJACKTHENET.COM, INC., (U.S. CLS. 100, 101 AND 104). SN 78-057,983. PUB. 11-20-2001. FILED 4-11-2001.
- 2,538,406. **SAFEPLACE AND DESIGN**. FISH5, CORP., (U.S. CLS. 100, 101 AND 104). SN 78-063,284. PUB. 11-20-2001. FILED 5-13-2001.
- 2,538,426. **GET UP TO SPEED AND DESIGN**. SBC COMMUNICATIONS INC., (U.S. CLS. 100, 101 AND 104). SN 78-072,898. PUB. 11-20-2001. FILED 7-9-2001.
- 2,538,428. **STOP WORRYING. START TALKING..** SBC COMMUNICATIONS INC., (U.S. CLS. 100, 101 AND 104). SN 78-073,876. PUB. 11-20-2001. FILED 7-13-2001.

**CLASS 39—TRANSPORTATION AND STORAGE**

- 2,537,530 ( *See Class 36 for this trademark*).
- 2,537,553. **VENETIAN SOCIETY**. SILVERSEA CRUISES LTD., (U.S. CLS. 100 AND 105). SN 75-552,695. PUB. 11-20-2001. FILED 9-9-1998.
- 2,537,578. **RIDE THE RED & GREEN TROLLEYS**. CHICAGO TROLLEY CO., (U.S. CLS. 100 AND 105). SN 75-675,823. PUB. 11-20-2001. FILED 4-6-1999.
- 2,537,615 ( *See Class 35 for this trademark*).
- 2,537,630. **DOMAINCONCIERGE.COM**. PEREGRINITY, INC., MULTIPLE CLASS, (INT. CLS. 39 AND 42), (U.S. CLS. 100, 101 AND 105). SN 75-805,282. PUB. 11-20-2001. FILED 10-14-1999.
- 2,537,661 ( *See Class 35 for this trademark*).
- 2,537,676. **HAND RES**. SYVAX, INC., (U.S. CLS. 100 AND 105). SN 75-877,144. PUB. 11-20-2001. FILED 12-20-1999.
- 2,537,696. **COSTCO.COM**. COSTCO WHOLESALE MEMBERSHIP, INC., BY ASSIGNMENT COSTCO WHOLESALE CORPORATION, (U.S. CLS. 100 AND 105). SN 75-896,641. PUB. 11-20-2001. FILED 1-18-2000.
- 2,537,734 ( *See Class 21 for this trademark*).
- 2,537,772. **HONG KONG SUPERVALUE**. PACIFIC DELIGHT TOURS, INC., (U.S. CLS. 100 AND 105). SN 76-010,485. PUB. 11-20-2001. FILED 3-27-2000.
- 2,537,798. **POWERING PRODUCTIVITY (STYLIZED)**. EMOTION, INC., (U.S. CLS. 100 AND 105). SN 76-032,697. PUB. 11-20-2001. FILED 4-25-2000.
- 2,537,859. **PRIVATE LIMOUSINE, INC. AND DESIGN**. PRIVATE LIMOUSINE, INC, (U.S. CLS. 100 AND 105). SN 76-068,697. PUB. 11-20-2001. FILED 6-14-2000.
- 2,537,928. **C-POP AND DESIGN**. OTS TRAVEL SERVICE, INC., (U.S. CLS. 100 AND 105). SN 76-123,306. PUB. 11-20-2001. FILED 9-6-2000.
- 2,538,019. **RUSH LIMOUSINE**. RUSH LIMOUSINE INC., (U.S. CLS. 100 AND 105). SN 76-170,261. PUB. 11-20-2001. FILED 11-24-2000.
- 2,538,038. **ROCKETSHIP**. ROCKET BUSINESS SERVICES, LLC, (U.S. CLS. 100 AND 105). SN 76-179,257. PUB. 11-20-2001. FILED 12-12-2000.
- 2,538,067. **HEROES IN THE COLD WAR**. BRENT REDMOND TRANSPORTATION, INC., (U.S. CLS. 100 AND 105). SN 76-189,844. PUB. 11-20-2001. FILED 1-5-2001.
- 2,538,101. **YOUR SOURCE FOR SPORTS TRAVEL**. JOHNNYROADTRIP.COM, LLC, (U.S. CLS. 100 AND 105). SN 76-209,144. PUB. 11-20-2001. FILED 2-13-2001.
- 2,538,221. **CITY DASH**. DELTA CORPORATE IDENTITY, INC., (U.S. CLS. 100 AND 105). SN 76-274,111. PUB. 11-20-2001. FILED 6-19-2001.
- 2,538,300. **CRUISE INTO HISTORY**. AMERICAN WEST STEAMBOAT COMPANY LLC, (U.S. CLS. 100 AND 105). SN 76-294,255. PUB. 11-20-2001. FILED 8-3-2001.
- 2,538,315. **AOS**. HILLWOOD DEVELOPMENT CORPORATION, (U.S. CLS. 100 AND 105). SN 76-296,519. PUB. 11-20-2001. FILED 8-8-2001.

2,538,416. **AVIS INTERACTIVE. WIZARD CO., INC.**, (U.S. CLS. 100 AND 105). SN 78-071,071. PUB. 11-20-2001. FILED 6-26-2001.

#### CLASS 40—MATERIAL TREATMENT

2,537,560 ( *See Class 1 for this trademark* ).  
 2,537,719 ( *See Class 6 for this trademark* ).  
 2,537,735. **TRUE-TRADE SUPPLIER. SPANDEX USA INC., DBA CLARKE SYSTEMS**, (U.S. CLS. 100, 103 AND 106). SN 75-932,451. PUB. 11-20-2001. FILED 3-1-2000.  
 2,537,736. **TT AND DESIGN. SPANDEX USA INC., DBA CLARKE SYSTEMS**, (U.S. CLS. 100, 103 AND 106). SN 75-932,452. PUB. 11-20-2001. FILED 3-1-2000.  
 2,537,821. **MCALPIN INDUSTRIES. MCALPIN INDUSTRIES, INC.**, (U.S. CLS. 100, 103 AND 106). SN 76-051,761. PUB. 11-20-2001. FILED 5-19-2000.  
 2,537,871. **FINOSOFT. FINOTEX U.S.A. CORP.**, (U.S. CLS. 100, 103 AND 106). SN 76-074,033. PUB. 11-20-2001. FILED 6-19-2000.  
 2,538,003. **CSM INDUSTRIES METALLURGICAL MATERIALS PROCESSED MATERIALS PERFORMANCE MATERIALS COMPONENTS AND FABRICATIONS AND DESIGN. CSM INDUSTRIES, INC.**, (U.S. CLS. 100, 103 AND 106). SN 76-164,516. PUB. 11-20-2001. FILED 11-13-2000.  
 2,538,155. **RYMIC. RYMIC SYSTEMS, INC.**, (U.S. CLS. 100, 103 AND 106). SN 76-233,514. PUB. 11-20-2001. FILED 4-2-2001.  
 2,538,373 ( *See Class 37 for this trademark* ).  
 2,538,388. **CD-FILM AND DESIGN. HEALTH INFORMATICS TECHNOLOGIES, LLC**, (U.S. CLS. 100, 103 AND 106). SN 78-035,130. PUB. 11-20-2001. FILED 11-14-2000.  
 2,538,404. **VENTEX AND DESIGN. VENTEX, LLC**, (U.S. CLS. 100, 103 AND 106). SN 78-060,232. PUB. 11-20-2001. FILED 4-25-2001.

#### CLASS 41—EDUCATION AND ENTERTAINMENT

2,537,526 ( *See Class 9 for this trademark* ).  
 2,537,556. **ANIMATION. ANIMATION AMERICA, INC.**, (U.S. CLS. 100, 101 AND 107). SN 75-585,073. PUB. 11-20-2001. FILED 11-9-1998.  
 2,537,570. **SF GATE. HEARST COMMUNICATIONS, INC., BY ASSIGNMENT CHRONICLE PUBLISHING COMPANY, THE**, (U.S. CLS. 100, 101 AND 107). SN 75-656,795. PUB. 11-20-2001. FILED 3-9-1999.  
 2,537,600. **VHI MUSIC FIRST. VIACOM INTERNATIONAL INC.**, (U.S. CLS. 100, 101 AND 107). SN 75-734,012. PUB. 11-20-2001. FILED 6-22-1999.  
 2,537,614. **DC 4 AND DESIGN. DC4**, (U.S. CLS. 100, 101 AND 107). SN 75-783,064. PUB. 11-20-2001. FILED 8-24-1999.  
 2,537,628. **SOULSYSTEM. ALEX. STEVEN PAUL**, (U.S. CLS. 100, 101 AND 107). SN 75-800,423. PUB. 11-20-2001. FILED 10-12-1999.  
 2,537,651. **SUSAN SAYS. SOLOVIC, SUSAN WILSON**, (U.S. CLS. 100, 101 AND 107). SN 75-843,828. PUB. 11-20-2001. FILED 11-8-1999.  
 2,537,662 ( *See Class 16 for this trademark* ).  
 2,537,667 ( *See Class 35 for this trademark* ).  
 2,537,678 ( *See Class 38 for this trademark* ).  
 2,537,679. **DEMOCRACY IN PRACTICE. WEEKS, CHRISTIAN B.**, (U.S. CLS. 100, 101 AND 107). SN 75-881,424. PUB. 11-20-2001. FILED 12-28-1999.  
 2,537,692 ( *See Class 38 for this trademark* ).  
 2,537,710. **RESULTS CARD. STANDARDWORK, INC.**, (U.S. CLS. 100, 101 AND 107). SN 75-909,857. PUB. 11-20-2001. FILED 2-4-2000.  
 2,537,715. **CRI CIVIC RESEARCH INSTITUTE AND DESIGN. CIVIC RESEARCH INSTITUTE, INC.**, (U.S. CLS. 100, 101 AND 107). SN 75-913,672. PUB. 11-20-2001. FILED 2-9-2000.  
 2,537,718. **WINNER.COM. WINNER.COM, INC.**, (U.S. CLS.

100, 101 AND 107). SN 75-915,818. PUB. 11-20-2001. FILED 2-10-2000.

2,537,746 ( *See Class 25 for this trademark* ).  
 2,537,760. **PROPHECY AND DESIGN. PARKS II, ALBERT JAMES**, (U.S. CLS. 100, 101 AND 107). SN 75-945,347. PUB. 11-20-2001. FILED 2-24-2000.  
 2,537,764 ( *See Class 14 for this trademark* ).  
 2,537,768. **HIGH SCHOOLED ASSISTANCE DOG. BONNIE BERGIN ASSISTANCE DOG INSTITUTE, THE**, (U.S. CLS. 100, 101 AND 107). SN 76-004,362. PUB. 11-20-2001. FILED 3-20-2000.  
 2,537,770 ( *See Class 9 for this trademark* ).  
 2,537,773. **VELOCITIES. R.K. ASSOCIATES, LLC**, (U.S. CLS. 100, 101 AND 107). SN 76-010,684. PUB. 11-20-2001. FILED 3-27-2000.  
 2,537,775 ( *See Class 16 for this trademark* ).  
 2,537,776. **CORPORATE UNIVERSITY XCHANGE EXCELLENCEAWARDS. CUX, INC.**, (U.S. CLS. 100, 101 AND 107). SN 76-011,408. PUB. 11-20-2001. FILED 3-28-2000.  
 2,537,782. **TRANSFORM THE WAY YOU WORK. INTERACTION ASSOCIATES**, (U.S. CLS. 100, 101 AND 107). SN 76-017,390. PUB. 11-20-2001. FILED 2-16-2000.  
 2,537,784. **REFERRAL MASTERY. CENTER FOR PROFESSIONAL ACHIEVEMENT, INC.**, (U.S. CLS. 100, 101 AND 107). SN 76-018,694. PUB. 11-20-2001. FILED 4-5-2000.  
 2,537,786 ( *See Class 9 for this trademark* ).  
 2,537,789. **NO SNOOZE WORKSHOPS. LAWRENCE K. MCGEHE AND CAROL A. MCGEHE, PARTNERSHIP, THE**, (U.S. CLS. 100, 101 AND 107). SN 76-023,543. PUB. 11-20-2001. FILED 4-13-2000.  
 2,537,792. **LOUISVILLE SLUGGER FIELD AND DESIGN. HILLERICH & BRADSBY CO.**, (U.S. CLS. 100, 101 AND 107). SN 76-026,431. PUB. 11-20-2001. FILED 4-14-2000.  
 2,537,814. **MISCELLANEOUS DESIGN. FMC CORPORATION**, (U.S. CLS. 100, 101 AND 107). SN 76-045,804. PUB. 11-20-2001. FILED 5-10-2000.  
 2,537,825. **MISCELLANEOUS DESIGN. MANAKA, FUMIO**, (U.S. CLS. 100, 101 AND 107). SN 76-056,081. PUB. 11-20-2001. FILED 5-24-2000.  
 2,537,826. **MISCELLANEOUS DESIGN. MANAKA, FUMIO**, (U.S. CLS. 100, 101 AND 107). SN 76-056,083. PUB. 11-20-2001. FILED 5-24-2000.  
 2,537,832. **HWAL-GONG. BR CONSULTING, INC.**, (U.S. CLS. 100, 101 AND 107). SN 76-059,462. PUB. 11-20-2001. FILED 6-2-2000.  
 2,537,833. **UN-KI-SHIM GONG. BR CONSULTING, INC.**, (U.S. CLS. 100, 101 AND 107). SN 76-059,464. PUB. 11-20-2001. FILED 6-2-2000.  
 2,537,834. **HANG-GONG. BR CONSULTING, INC.**, (U.S. CLS. 100, 101 AND 107). SN 76-059,466. PUB. 11-20-2001. FILED 6-2-2000.  
 2,537,835. **JI-GAM EXERCISE. BR CONSULTING, INC.**, (U.S. CLS. 100, 101 AND 107). SN 76-059,467. PUB. 11-20-2001. FILED 6-2-2000.  
 2,537,839 ( *See Class 16 for this trademark* ).  
 2,537,845. **THE ROCK ISLAND BOYS. COOKE, BRUCE E.**, (U.S. CLS. 100, 101 AND 107). SN 76-062,310. PUB. 4-3-2001. FILED 6-2-2000.  
 2,537,850. **THRILLVISION. CREATIVDESIGN GROUP, INC.**, (U.S. CLS. 100, 101 AND 107). SN 76-063,668. PUB. 11-20-2001. FILED 6-6-2000.  
 2,537,856. **BODYSENSE FITNESS AND DESIGN. LUBY, SUE**, (U.S. CLS. 100, 101 AND 107). SN 76-066,753. PUB. 11-20-2001. FILED 6-2-2000.  
 2,537,873. **THE LIVING LEGACY. AMERICAN FRIENDS OF LUBAVITCH**, (U.S. CLS. 100, 101 AND 107). SN 76-077,364. PUB. 11-20-2001. FILED 6-26-2000.  
 2,537,888. **THE HI-FI ROOM. FOX FAMILY PROPERTIES, INC.**, (U.S. CLS. 100, 101 AND 107). SN 76-092,084. PUB. 11-20-2001. FILED 7-19-2000.  
 2,537,892. **MISCELLANEOUS DESIGN. CITYTOBURN INC.**, (U.S. CLS. 100, 101 AND 107). SN 76-096,424. PUB. 11-20-2001. FILED 7-26-2000.  
 2,537,917. **STICKY MAN AND DESIGN. KEEP FLORIDA BEAUTIFUL, INC.**, (U.S. CLS. 100, 101 AND 107). SN 76-113,049. PUB. 11-20-2001. FILED 8-21-2000.  
 2,537,918. **THE INTEGRATED LIFE STRATEGY. FOSTER CAPITAL MANAGEMENT, INC.**, (U.S. CLS. 100, 101 AND

- 107). SN 76-113,127. PUB. 11-20-2001. FILED 8-22-2000.
- 2,537,924. **PLAYBOY BACHELOR PARTY**. PLAYBOY ENTERPRISES INTERNATIONAL, INC., (U.S. CLS. 100, 101 AND 107). SN 76-116,787. PUB. 11-20-2001. FILED 8-24-2000.
- 2,537,932 ( *See Class 35 for this trademark*).
- 2,537,940. **THE CAGE**. WOODWARD CAMP, INC. (U.S. CLS. 100, 101 AND 107). SN 76-132,813. PUB. 11-20-2001. FILED 9-22-2000.
- 2,537,955. **PORTLAND STATE UNIVERSITY**. PORTLAND STATE UNIVERSITY, (U.S. CLS. 100, 101 AND 107). SN 76-142,536. PUB. 11-20-2001. FILED 10-10-2000.
- 2,537,970. **MISCELLANEOUS DESIGN**. REDVECTOR.COM, INC., (U.S. CLS. 100, 101 AND 107). SN 76-147,647. PUB. 11-20-2001. FILED 10-16-2000.
- 2,537,984 ( *See Class 35 for this trademark*).
- 2,537,999. **BUILDING A WEB YOU CAN BELIEVE IN**. TRUSTED UNIVERSAL STANDARDS IN ELECTRONIC TRANSACTIONS, MULTIPLE CLASS, (INT. CLS. 41 AND 42), (U.S. CLS. 100, 101 AND 107). SN 76-163,049. PUB. 11-20-2001. FILED 11-9-2000.
- 2,538,053. **DESIGNABOUT**. INDUSTRIAL DESIGNERS SOCIETY OF AMERICA, (U.S. CLS. 100, 101 AND 107). SN 76-185,259. PUB. 11-20-2001. FILED 12-22-2000.
- 2,538,068. **PLAYBOY.COMVERSATION**. PLAYBOY ENTERPRISES INTERNATIONAL, INC., (U.S. CLS. 100, 101 AND 107). SN 76-191,127. PUB. 11-20-2001. FILED 1-8-2001.
- 2,538,079. **IRONMILL, INC. (STYLIZED)**. IRONMILL, INC., (U.S. CLS. 100, 101 AND 107). SN 76-197,329. PUB. 11-20-2001. FILED 1-17-2001.
- 2,538,082. **A PATH TO YOU**. MARSHALL-ATTLER, FELICIA, (U.S. CLS. 100, 101 AND 107). SN 76-199,594. PUB. 11-20-2001. FILED 1-26-2001.
- 2,538,106. **MISCELLANEOUS DESIGN**. WHIRLY WEST, INC., (U.S. CLS. 100, 101 AND 107). SN 76-211,448. PUB. 11-20-2001. FILED 2-20-2001.
- 2,538,115. **KORNER'S FOLLY**. KORNER'S FOLLY FOUNDATION, (U.S. CLS. 100, 101 AND 107). SN 76-217,355. PUB. 11-20-2001. FILED 2-28-2001.
- 2,538,127. **KASS KIDS ARE SUPER SPECIAL**. O'KEEFE, DOROTHY M., (U.S. CLS. 100, 101 AND 107). SN 76-225,037. PUB. 11-20-2001. FILED 3-13-2001.
- 2,538,129. **DESIGNED TO REMIND**. MEMORY ART, INC., (U.S. CLS. 100, 101 AND 107). SN 76-226,217. PUB. 11-20-2001. FILED 3-19-2001.
- 2,538,131. **CAMP STAR TRAILS AND DESIGN**. BOARD OF REGENTS, THE UNIVERSITY OF TEXAS SYSTEM, (U.S. CLS. 100, 101 AND 107). SN 76-226,969. PUB. 11-20-2001. FILED 3-19-2001.
- 2,538,136. **CAMP STAR TRAILS**. BOARD OF REGENTS, THE UNIVERSITY OF TEXAS SYSTEM, (U.S. CLS. 100, 101 AND 107). SN 76-228,160. PUB. 11-20-2001. FILED 3-19-2001.
- 2,538,157. **VSLIVE!**. FAWCETTE TECHNICAL PUBLICATIONS, INC., (U.S. CLS. 100, 101 AND 107). SN 76-233,892. PUB. 11-20-2001. FILED 3-28-2001.
- 2,538,158. **SUCCESS RULES! AND DESIGN**. SUCCESS RULES!, (U.S. CLS. 100, 101 AND 107). SN 76-234,951. PUB. 11-20-2001. FILED 4-4-2001.
- 2,538,167. **IT'S ALL GOOD**. NBA PROPERTIES, INC., (U.S. CLS. 100, 101 AND 107). SN 76-238,541. PUB. 11-20-2001. FILED 4-10-2001.
- 2,538,170. **CLASSICAL 24**. MINNESOTA PUBLIC RADIO, AND PUBLIC RADIO INTERNATIONAL, INC., (U.S. CLS. 100, 101 AND 107). SN 76-240,520. PUB. 11-20-2001. FILED 4-16-2001.
- 2,538,175. **UNIVERSALCULTURE**. BOJE, HARMONY B., (U.S. CLS. 100, 101 AND 107). SN 76-245,220. PUB. 11-20-2001. FILED 4-23-2001.
- 2,538,183. **NUCCA AND DESIGN**. NATIONAL UPPER CERVICAL CHIROPRACTIC ASSOCIATION, INC., THE, (U.S. CLS. 100, 101 AND 107). SN 76-247,495. PUB. 11-20-2001. FILED 4-27-2001.
- 2,538,190 ( *See Class 35 for this trademark*).
- 2,538,192. **BUNGEERACER**. BUNGEE RACERS, INC., (U.S. CLS. 100, 101 AND 107). SN 76-251,580. PUB. 11-20-2001. FILED 5-7-2001.
- 2,538,201. **B (STYLIZED)**. BALLIERES, ALBERTO, (U.S. CLS. 100, 101 AND 107). SN 76-261,637. PUB. 11-20-2001. FILED 5-23-2001.
- 2,538,209. **MISCELLANEOUS DESIGN**. ESPN, INC., (U.S. CLS. 100, 101 AND 107). SN 76-268,914. PUB. 11-20-2001. FILED 6-8-2001.
- 2,538,210. **GAINING INNER STRENGTH THROUGH OUTDOOR EXPERIENCES AND DESIGN**. OUTERVENTION, INC., MULTIPLE CLASS, (INT. CLS. 41 AND 42), (U.S. CLS. 100, 101 AND 107). SN 76-269,124. PUB. 11-20-2001. FILED 6-11-2001.
- 2,538,264. **FOOLISH THINGS**. JORGENSEN, ISAAC, (U.S. CLS. 100, 101 AND 107). SN 76-288,671. PUB. 11-20-2001. FILED 7-24-2001.
- 2,538,278. **ASTRONAUTS OF ANTIQUITY**. WEINBERG, BRADD, (U.S. CLS. 100, 101 AND 107). SN 76-290,859. PUB. 11-20-2001. FILED 7-27-2001.
- 2,538,294. **THE AMBASSADORS OF COMEDY**. HODGE, JEFFERY, (U.S. CLS. 100, 101 AND 107). SN 76-293,761. PUB. 11-20-2001. FILED 8-1-2001.
- 2,538,312. **RIN TIN TIN**. HEREFORD, DAPHNE, (U.S. CLS. 100, 101 AND 107). SN 76-296,384. PUB. 11-20-2001. FILED 8-8-2001.
- 2,538,318. **FUNIMMERSION**. LANGUAGE STARS, L.L.C., (U.S. CLS. 100, 101 AND 107). SN 76-296,712. PUB. 11-20-2001. FILED 8-7-2001.
- 2,538,347. **ECG**. ENTERTAINMENT & COMMUNICATIONS GROUP, INC., (U.S. CLS. 100, 101 AND 107). SN 76-300,853. PUB. 11-20-2001. FILED 8-15-2001.
- 2,538,351. **HOW COOL IS HOCKEY**. ELMORE SPORTS GROUP, INC., (U.S. CLS. 100, 101 AND 107). SN 76-300,925. PUB. 11-20-2001. FILED 8-20-2001.
- 2,538,355. **SPIRIT OF KWANZAA**. DANCE INSTITUTE OF WASHINGTON, (U.S. CLS. 100, 101 AND 107). SN 76-301,901. PUB. 11-20-2001. FILED 8-17-2001.
- 2,538,378. **SIDHE**. MILLHAM, MICHAEL B., (U.S. CLS. 100, 101 AND 107). SN 78-021,405. PUB. 11-20-2001. FILED 8-15-2000.
- 2,538,385 ( *See Class 35 for this trademark*).
- 2,538,407. **NG NEWGROUND (STYLIZED)**. NEWGROUND RESOURCES, INC., (U.S. CLS. 100, 101 AND 107). SN 78-066,590. PUB. 11-20-2001. FILED 5-31-2001.

---

## CLASS 42—SCIENTIFIC, COMPUTER AND LEGAL SERVICES

- 2,537,522 ( *See Class 30 for this trademark*).
- 2,537,530 ( *See Class 36 for this trademark*).
- 2,537,537. **MCKENZIE METHOD**. TRUSTEES OF THE MCKENZIE INSTITUTE INTERNATIONAL TRUST, A NEW ZEALAND TRUST, THE TRUSTEES COMPRISING VERT MOONEY, A U.S. CITIZEN, ROBIN MCKENZIE, JOY MCKENZIE, JAN MCKENZIE, LAWRENCE DOTT, AND WILLIAM P. JEFFRIES, ALL CITIZENS OF NEW ZEALAND, THE, (U.S. CLS. 100 AND 101). SN 75-486,973. PUB. 11-20-2001. FILED 5-18-1998.
- 2,537,560 ( *See Class 1 for this trademark*).
- 2,537,568 ( *See Class 9 for this trademark*).
- 2,537,583. **THE FAMILY COMPANY**. LEWIS FAMILY COMPANY, INC., THE, (U.S. CLS. 100 AND 101). SN 75-705,920. PUB. 11-20-2001. FILED 5-13-1999.
- 2,537,590 ( *See Class 35 for this trademark*).
- 2,537,595. **MSI**. MARCHESE SERVICES INCORPORATED, (U.S. CLS. 100 AND 101). SN 75-723,373. PUB. 11-20-2001. FILED 6-7-1999.
- 2,537,598. **VENI VIDI VICI**. BUCKHEAD LIFE RESTAURANT GROUP, INC., (U.S. CLS. 100 AND 101). SN 75-727,891. PUB. 11-20-2001. FILED 6-14-1999.
- 2,537,601 ( *See Class 38 for this trademark*).
- 2,537,602. **SIMULATION DYNAMICS AND DESIGN**. SIMULATION DYNAMICS, INC., (U.S. CLS. 100 AND 101). SN 75-743,571. PUB. 11-20-2001. FILED 7-2-1999.
- 2,537,605. **VECO**. VECO CORPORATION, (U.S. CLS. 100 AND 101). SN 75-748,421. PUB. 11-20-2001. FILED 7-12-1999.
- 2,537,606 ( *See Class 1 for this trademark*).
- 2,537,607 ( *See Class 7 for this trademark*).
- 2,537,608. **MISCELLANEOUS DESIGN**. CHIROWISE, INC., (U.S. CLS. 100 AND 101). SN 75-758,287. PUB. 11-20-2001. FILED 7-1-1999.

- 2,537,610 ( *See Class 16 for this trademark*).
- 2,537,613. **SIM2K**. SIM2K, INC., (U.S. CLS. 100 AND 101). SN 75-777,894. PUB. 11-20-2001. FILED 8-17-1999.
- 2,537,622. **NETNODE.NET**. CLIPPINGER, CARYL, (U.S. CLS. 100 AND 101). SN 75-793,871. PUB. 11-20-2001. FILED 9-7-1999.
- 2,537,630 ( *See Class 39 for this trademark*).
- 2,537,636. **WI AND DESIGN**. WIRED INTEGRATIONS, LLC, (U.S. CLS. 100 AND 101). SN 75-817,046. PUB. 11-20-2001. FILED 10-7-1999.
- 2,537,644 ( *See Class 35 for this trademark*).
- 2,537,649. **CLIP2.COM AND DESIGN**. CLIP2.COM, (U.S. CLS. 100 AND 101). SN 75-840,674. PUB. 11-20-2001. FILED 11-3-1999.
- 2,537,658. **CHOP**. CHILDREN'S HOSPITAL OF PHILADELPHIA, THE, (U.S. CLS. 100 AND 101). SN 75-852,087. PUB. 11-20-2001. FILED 11-17-1999.
- 2,537,659. **STARCUTTERS**. DEJOSIA, FRANCESCA, (U.S. CLS. 100 AND 101). SN 75-852,991. PUB. 11-20-2001. FILED 11-18-1999.
- 2,537,662 ( *See Class 16 for this trademark*).
- 2,537,669 ( *See Class 37 for this trademark*).
- 2,537,673 ( *See Class 37 for this trademark*).
- 2,537,674. **MISCELLANEOUS DESIGN**. SPHINX GROUP, INC., (U.S. CLS. 100 AND 101). SN 75-874,758. PUB. 11-20-2001. FILED 12-20-1999.
- 2,537,675. **SPHINX AND DESIGN**. SPHINX RESEARCH GROUP, INC., (U.S. CLS. 100 AND 101). SN 75-875,682. PUB. 11-20-2001. FILED 12-20-1999.
- 2,537,681. **GEMMS**. GATEWAY ELECTRONIC MEDICAL MANAGEMENT SYSTEMS, LLC, (U.S. CLS. 100 AND 101). SN 75-882,817. PUB. 11-20-2001. FILED 12-29-1999.
- 2,537,688. **DRUGMONITOR.COM AND DESIGN**. DRUGMONITOR.COM, INC., (U.S. CLS. 100 AND 101). SN 75-888,307. PUB. 11-20-2001. FILED 1-6-2000.
- 2,537,691 ( *See Class 36 for this trademark*).
- 2,537,695 ( *See Class 37 for this trademark*).
- 2,537,699. **FAITH NEWS NETWORK AND DESIGN**. CHURCH OF GOD, (U.S. CLS. 100 AND 101). SN 75-899,636. PUB. 11-20-2001. FILED 1-20-2000.
- 2,537,702 ( *See Class 38 for this trademark*).
- 2,537,708 ( *See Class 35 for this trademark*).
- 2,537,709. **GRANDE TASTE. LOCO VALUE.** TACO BELL CORP., (U.S. CLS. 100 AND 101). SN 75-908,097. PUB. 11-20-2001. FILED 1-24-2000.
- 2,537,716. **VERTEX INTERNET**. VERTEX INTERNET, INC., (U.S. CLS. 100 AND 101). SN 75-913,864. PUB. 11-20-2001. FILED 2-10-2000.
- 2,537,719 ( *See Class 6 for this trademark*).
- 2,537,722. **JANIS SPINDEL SERIOUS MATCHMAKING**. SPINDEL, JANIS, (U.S. CLS. 100 AND 101). SN 75-919,387. PUB. 11-20-2001. FILED 2-15-2000.
- 2,537,731 ( *See Class 3 for this trademark*).
- 2,537,741 ( *See Class 29 for this trademark*).
- 2,537,748. **M CREATIVE AND DESIGN**. M CREATIVE, INC., (U.S. CLS. 100 AND 101). SN 75-939,052. PUB. 11-20-2001. FILED 3-8-2000.
- 2,537,756 ( *See Class 36 for this trademark*).
- 2,537,765 ( *See Class 30 for this trademark*).
- 2,537,775 ( *See Class 16 for this trademark*).
- 2,537,786 ( *See Class 9 for this trademark*).
- 2,537,788. **TESTING TODAY PROTECTING TOMORROW**. ONTARIO CORPORATION, (U.S. CLS. 100 AND 101). SN 76-023,317. PUB. 11-20-2001. FILED 4-10-2000.
- 2,537,790 ( *See Class 9 for this trademark*).
- 2,537,793. **KAON**. KAON INTERACTIVE INC., (U.S. CLS. 100 AND 101). SN 76-026,454. PUB. 11-20-2001. FILED 4-14-2000.
- 2,537,795. **MISCELLANEOUS DESIGN**. HOMMED, LLC, (U.S. CLS. 100 AND 101). SN 76-027,494. PUB. 11-20-2001. FILED 4-17-2000.
- 2,537,802 ( *See Class 35 for this trademark*).
- 2,537,803 ( *See Class 35 for this trademark*).
- 2,537,813. **MAKE THINGS WORK**. FUNCTION ENGINEERING, INC., (U.S. CLS. 100 AND 101). SN 76-045,711. PUB. 11-20-2001. FILED 5-9-2000.
- 2,537,854 ( *See Class 35 for this trademark*).
- 2,537,855. **NOMYTH ENTERPRISES**. KLIMCZAK, ROBERT J., (U.S. CLS. 100 AND 101). SN 76-066,598. PUB. 11-20-2001. FILED 6-5-2000.
- 2,537,857. **M MENNINGER AND DESIGN**. MENNINGER FOUNDATION, THE, (U.S. CLS. 100 AND 101). SN 76-066,997. PUB. 11-20-2001. FILED 6-9-2000.
- 2,537,858. **THE FUTURE OF HEALTH CARE IN AMERICA**. HOMMED, LLC, (U.S. CLS. 100 AND 101). SN 76-068,608. PUB. 11-20-2001. FILED 6-12-2000.
- 2,537,870 ( *See Class 36 for this trademark*).
- 2,537,884. **FCIA FIBRE CHANNEL INDUSTRY ASSOCIATION AND DESIGN**. FIBRE CHANNEL INDUSTRY ASSOCIATION, (U.S. CLS. 100 AND 101). SN 76-087,800. PUB. 11-20-2001. FILED 7-11-2000.
- 2,537,886. **GENLED.COM THE DIGITAL ACCOUNTANT AND DESIGN**. GENLED.COM, LLC, THE DIGITAL ACCOUNTANT, (U.S. CLS. 100 AND 101). SN 76-088,903. PUB. 11-20-2001. FILED 7-14-2000.
- 2,537,901. **AT THE CROSSROADS OF THE AMERICAS**. MALLOY & MALLOY, P.A., (U.S. CLS. 100 AND 101). SN 76-103,051. PUB. 11-20-2001. FILED 8-4-2000.
- 2,537,907. **ONEIGHTY**. WILLIE GEORGE MINISTRIES, INC., (U.S. CLS. 100 AND 101). SN 76-108,676. PUB. 11-20-2001. FILED 8-14-2000.
- 2,537,916. **CREATIVE INET**. CREATIVE INET, LLC, (U.S. CLS. 100 AND 101). SN 76-110,378. PUB. 11-20-2001. FILED 8-17-2000.
- 2,537,921. **RISKSOLVER COMMUNICATIONS**. CHO, FU LIANG, (U.S. CLS. 100 AND 101). SN 76-114,990. PUB. 11-20-2001. FILED 8-23-2000.
- 2,537,922. **MYWEBBITS (STYLIZED)**. MANNING, GLEN, (U.S. CLS. 100 AND 101). SN 76-115,911. PUB. 11-20-2001. FILED 8-23-2000.
- 2,537,927. **CFLASH**. SEA PORT PRODUCTS CORPORATION, (U.S. CLS. 100 AND 101). SN 76-119,988. PUB. 11-20-2001. FILED 8-31-2000.
- 2,537,932 ( *See Class 35 for this trademark*).
- 2,537,934 ( *See Class 38 for this trademark*).
- 2,537,942. **CARINGROAD.COM**. MINTZ, KAREN L., (U.S. CLS. 100 AND 101). SN 76-133,593. PUB. 11-20-2001. FILED 9-22-2000.
- 2,537,949. **FAZOLI'S AND DESIGN**. FAZOLI'S MANAGEMENT, INC., (U.S. CLS. 100 AND 101). SN 76-138,165. PUB. 11-20-2001. FILED 9-28-2000.
- 2,537,959. **OYONICS @ WORK AND DESIGN**. ENERGY CONVERSION DEVICES, (U.S. CLS. 100 AND 101). SN 76-143,080. PUB. 11-20-2001. FILED 10-10-2000.
- 2,537,962. **THE ORCHID AT MAUNA LANI ISLAND OF HAWAII AND DESIGN**. ML HOTEL INVESTORS, L.P., DBA THE ORCHID AT MAUNA LANI, (U.S. CLS. 100 AND 101). SN 76-145,886. PUB. 11-20-2001. FILED 10-10-2000.
- 2,537,978. **MISCELLANEOUS DESIGN**. JNANA TECHNOLOGIES CORPORATION, (U.S. CLS. 100 AND 101). SN 76-150,160. PUB. 11-20-2001. FILED 10-19-2000.
- 2,537,979 ( *See Class 35 for this trademark*).
- 2,537,980. **SACAGAWEA**. LEWIS AND CLARK BICENTENIAL MARKETING GROUP, INC., (U.S. CLS. 100 AND 101). SN 76-150,880. PUB. 11-20-2001. FILED 10-23-2000.
- 2,537,989. **GIVE US 15 MINUTES...WE'LL GIVE YOU 15YEARS**. CALVIN L. DAY, JR. M.D., P.A., DBA THE LASER HAIR REMOVAL AND MICRODERMABRASION CENTER, (U.S. CLS. 100 AND 101). SN 76-155,726. PUB. 11-20-2001. FILED 10-27-2000.
- 2,537,991. **ENERGY.NET**. FREESE-NOTIS WEATHER, INC., (U.S. CLS. 100 AND 101). SN 76-156,232. PUB. 11-20-2001. FILED 10-30-2000.
- 2,537,999 ( *See Class 41 for this trademark*).
- 2,538,012 ( *See Class 29 for this trademark*).
- 2,538,015. **NHL ALUMNI**. NATIONAL HOCKEY LEAGUE, (U.S. CLS. 100 AND 101). SN 76-168,989. PUB. 11-20-2001. FILED 11-17-2000.
- 2,538,020. **724 FACILITIES**. 724 FACILITIES, INC., (U.S. CLS. 100 AND 101). SN 76-171,136. PUB. 11-20-2001. FILED 11-27-2000.
- 2,538,026 ( *See Class 36 for this trademark*).
- 2,538,027 ( *See Class 36 for this trademark*).
- 2,538,059. **ILS**. INTEGRATED LINEN SYSTEMS, INC., (U.S. CLS. 100 AND 101). SN 76-187,170. PUB. 11-20-2001. FILED 12-28-2000.

- 2,538,060. **LINEN IS MONEY**. INTEGRATED LINEN SYSTEMS, INC., (U.S. CLS. 100 AND 101). SN 76-187,222. PUB. 11-20-2001. FILED 12-28-2000.
- 2,538,061. **INTEGRATED LINEN SYSTEMS**. INTEGRATED LINEN SYSTEMS, INC., (U.S. CLS. 100 AND 101). SN 76-187,270. PUB. 11-20-2001. FILED 12-28-2000.
- 2,538,062. **MCTV**. MINISTRY OF CHRIST THE TRUE VINE, (U.S. CLS. 100 AND 101). SN 76-188,073. PUB. 11-20-2001. FILED 1-2-2001.
- 2,538,070. **EAT MOR CHIKIN AND DESIGN**. CHICK-FIL-A, INC., (U.S. CLS. 100 AND 101). SN 76-192,789. PUB. 11-20-2001. FILED 1-10-2001.
- 2,538,071. **SPRINT E-COMMERCE SOLUTIONS**. SPRINT COMMUNICATIONS COMPANY L.P., (U.S. CLS. 100 AND 101). SN 76-192,929. PUB. 11-20-2001. FILED 1-10-2001.
- 2,538,074. **CITY OF LA QUINTA THE GEM OF THE DESERT CALIFORNIA INCORPORATED 1982 AND DESIGN**. CITY OF LA QUINTA, (U.S. CLS. 100 AND 101). SN 76-193,378. PUB. 11-20-2001. FILED 1-16-2001.
- 2,538,075. **CLAUSIN MILLER EUROPE (STYLIZED)**. CLAUSEN MILLER P.C., (U.S. CLS. 100 AND 101). SN 76-193,388. PUB. 11-20-2001. FILED 1-16-2001.
- 2,538,076. **ALUMNI NHL AND DESIGN**. NATIONAL HOCKEY LEAGUE, (U.S. CLS. 100 AND 101). SN 76-193,967. PUB. 11-20-2001. FILED 1-12-2001.
- 2,538,081. **THE RACE IS ON**. BELO COMPANY, THE, (U.S. CLS. 100 AND 101). SN 76-199,527. PUB. 11-20-2001. FILED 1-23-2001.
- 2,538,092. **CAPITAL BACKUP**. MICRONET, INC., (U.S. CLS. 100 AND 101). SN 76-206,146. PUB. 11-20-2001. FILED 2-8-2001.
- 2,538,094. **THE CUTTING BOARD AND DESIGN**. CUTTING BOARD, INC., THE, (U.S. CLS. 100 AND 101). SN 76-206,901. PUB. 11-20-2001. FILED 2-8-2001.
- 2,538,096. **STRIKENET**. GLOBAL ATMOSPHERICS, INC., (U.S. CLS. 100 AND 101). SN 76-207,835. PUB. 11-20-2001. FILED 2-7-2001.
- 2,538,097. **STRIKENET AND DESIGN**. GLOBAL ATMOSPHERICS, INC., (U.S. CLS. 100 AND 101). SN 76-207,846. PUB. 11-20-2001. FILED 2-7-2001.
- 2,538,120. **MCGEARY'S**. BYNARRY, LTD., (U.S. CLS. 100 AND 101). SN 76-218,662. PUB. 11-20-2001. FILED 3-2-2001.
- 2,538,121. **FAT TOMATOES**. TARA & KYLE, INC., (U.S. CLS. 100 AND 101). SN 76-218,747. PUB. 11-20-2001. FILED 3-2-2001.
- 2,538,128. **PARKLAND MEDICAL CENTER AND DESIGN**. HCA HEALTH SERVICES OF NEW HAMPSHIRE, INC., (U.S. CLS. 100 AND 101). SN 76-225,985. PUB. 11-20-2001. FILED 3-19-2001.
- 2,538,151. **SEXY SCISSORS AND DESIGN**. SEXY SCISSORS, L.L.P., (U.S. CLS. 100 AND 101). SN 76-231,347. PUB. 11-20-2001. FILED 3-27-2001.
- 2,538,159. **AMERICINN MOTEL & SUITES AND DESIGN**. AMERICINN INTERNATIONAL, LLC, (U.S. CLS. 100 AND 101). SN 76-235,935. PUB. 11-20-2001. FILED 4-5-2001.
- 2,538,185. **ONLINEBUDDIES**. ONLINE BUDDIES, INC., (U.S. CLS. 100 AND 101). SN 76-247,638. PUB. 11-20-2001. FILED 4-27-2001.
- 2,538,198. **RADIUS AND DESIGN**. BERGERAC LLC, (U.S. CLS. 100 AND 101). SN 76-255,655. PUB. 11-20-2001. FILED 5-14-2001.
- 2,538,199. **WNI OCEANROUTES AND DESIGN**. WEATHERNEWS INC., (U.S. CLS. 100 AND 101). SN 76-256,944. PUB. 11-20-2001. FILED 5-15-2001.
- 2,538,210 ( *See Class 41 for this trademark*).
- 2,538,216. **MISCELLANEOUS DESIGN**. PER BERGKVIST, (U.S. CLS. 100 AND 101). SN 76-272,512. PUB. 11-20-2001. FILED 6-18-2001.
- 2,538,217. **JEWISHCAFE.COM**. REALCAFES.COM INC., (U.S. CLS. 100 AND 101). SN 76-272,531. PUB. 11-20-2001. FILED 6-15-2001.
- 2,538,218. **MATCHCAFE.COM**. REALCAFES.COM INC., (U.S. CLS. 100 AND 101). SN 76-272,532. PUB. 11-20-2001. FILED 6-15-2001.
- 2,538,228. **POST & SCHELL**. POST & SCHELL, P.C., (U.S. CLS. 100 AND 101). SN 76-280,335. PUB. 11-20-2001. FILED 7-5-2001.
- 2,538,229. **POST & SCHELL AND DESIGN**. POST & SCHELL, P.C., (U.S. CLS. 100 AND 101). SN 76-280,336. PUB. 11-20-2001. FILED 7-5-2001.
- 2,538,233. **AROSE**. NATIONAL BUREAU OF ASIAN RESEARCH, THE, (U.S. CLS. 100 AND 101). SN 76-280,700. PUB. 11-20-2001. FILED 7-5-2001.
- 2,538,234. **MISCELLANEOUS DESIGN**. SUMMIT LAW GROUP, P.L.L.C., (U.S. CLS. 100 AND 101). SN 76-281,256. PUB. 11-20-2001. FILED 7-6-2001.
- 2,538,241 ( *See Class 37 for this trademark*).
- 2,538,247 ( *See Class 36 for this trademark*).
- 2,538,259. **HEALTHINFOSEEKER.COM**. CIGNA INTELLECTUAL PROPERTY, INC., (U.S. CLS. 100 AND 101). SN 76-288,212. PUB. 11-20-2001. FILED 7-23-2001.
- 2,538,261. **NX AND DESIGN**. NETXPOSURE, INC., (U.S. CLS. 100 AND 101). SN 76-288,483. PUB. 11-20-2001. FILED 7-19-2001.
- 2,538,271. **HUB EXPO CENTERS, INC.**. HUB EXPO CENTERS, INC., (U.S. CLS. 100 AND 101). SN 76-289,629. PUB. 11-20-2001. FILED 7-24-2001.
- 2,538,289. **PANDAGON**. DEL HIERRO, CHARLES, (U.S. CLS. 100 AND 101). SN 76-293,464. PUB. 11-20-2001. FILED 7-31-2001.
- 2,538,297. **WAKING AMERICA TO THE IMPORTANCE OF SLEEP**. NATIONAL SLEEP FOUNDATION, (U.S. CLS. 100 AND 101). SN 76-293,884. PUB. 11-20-2001. FILED 8-2-2001.
- 2,538,302. **BK AND DESIGN**. YUILL BLACK, M.D. AND MICHAEL R. KLETZ, M.D., P.C., (U.S. CLS. 100 AND 101). SN 76-294,515. PUB. 11-20-2001. FILED 8-6-2001.
- 2,538,303. **DREAM CHASE**. NEWSON & SONS, INC., (U.S. CLS. 100 AND 101). SN 76-294,571. PUB. 11-20-2001. FILED 8-6-2001.
- 2,538,307. **XRDI**. XRD INC., (U.S. CLS. 100 AND 101). SN 76-295,683. PUB. 11-20-2001. FILED 8-7-2001.
- 2,538,326 ( *See Class 35 for this trademark*).
- 2,538,354. **RAT'S**. PUBLIC ART FOUNDATION, THE, (U.S. CLS. 100 AND 101). SN 76-301,823. PUB. 11-20-2001. FILED 8-20-2001.
- 2,538,357. **CLEARLY SMARTER**. NEW EYEGLASS FACTORY OF MICHIGAN, INC., THE, DBA THE EYEGLASS FACTORY, (U.S. CLS. 100 AND 101). SN 76-302,296. PUB. 11-20-2001. FILED 8-21-2001.
- 2,538,360. **WRMA**. WEATHER RISK MANAGEMENT ASSOCIATION, (U.S. CLS. 100 AND 101). SN 76-302,888. PUB. 11-20-2001. FILED 8-22-2001.
- 2,538,369. **EVITAMINS 101**. WHOLESALE VITAMINS USA, INC., (U.S. CLS. 100 AND 101). SN 78-007,644. PUB. 11-20-2001. FILED 5-11-2000.
- 2,538,381. **THE GRAPHICS DEPT.** GRAPHICS DEPARTMENT INC., THE, (U.S. CLS. 100 AND 101). SN 78-023,788. PUB. 11-20-2001. FILED 8-30-2000.
- 2,538,384. **GOOD HEALTH BEGINS WITH YOU**. OHIO COMMISSION ON MINORITY HEALTH, (U.S. CLS. 100 AND 101). SN 78-030,179. PUB. 11-20-2001. FILED 10-11-2000.
- 2,538,385 ( *See Class 35 for this trademark*).
- 2,538,386. **MISCELLANEOUS DESIGN**. IL VICINO HOLDING COMPANY, INC., (U.S. CLS. 100 AND 101). SN 78-033,578. PUB. 11-20-2001. FILED 11-2-2000.
- 2,538,390. **NAMESTYLES (STYLIZED)**. NAMESTYLES, INCORPORATED, (U.S. CLS. 100 AND 101). SN 78-035,188. PUB. 11-20-2001. FILED 11-14-2000.
- 2,538,391. **CYBERFINA**. CYBERFINA PRODUCTIONS INCORPORATED, (U.S. CLS. 100 AND 101). SN 78-041,408. PUB. 11-20-2001. FILED 1-2-2001.
- 2,538,393. **BJ'S RESTAURANT & BREWHOUSE**. CHICAGO PIZZA & BREWERY, INC., (U.S. CLS. 100 AND 101). SN 78-048,178. PUB. 11-20-2001. FILED 2-13-2001.
- 2,538,408. **NG NEWGROUND (STYLIZED)**. NEWGROUND RESOURCES, INC., (U.S. CLS. 100 AND 101). SN 78-066,593. PUB. 11-20-2001. FILED 5-31-2001.
- 2,538,411. **WHEN IMAGE IS EVERYTHING**. JANESVILLE GROUP LIMITED, (U.S. CLS. 100 AND 101). SN 78-069,234. PUB. 11-20-2001. FILED 6-15-2001.
- 2,538,418. **SUSHITREE**. KIM, YOUNG S., (U.S. CLS. 100 AND 101). SN 78-071,361. PUB. 11-20-2001. FILED 6-27-2001.
- 2,538,433. **GRID IRON GOLD .COM 50 40 30 20 10 AND DESIGN**. STAGLIANO, DENNIS, DBA GRIDIRON GOLD, AND STAGLIANO, SANDRA, DBA GRIDIRON GOLD,

TM 526

OFFICIAL GAZETTE

FEB 12, 2002

(U.S. CLS. 100 AND 101). SN 78-075,220. PUB. 11-20-2001. FILED 7-23-2001.

\* \* \* \* \*

# TRADEMARK REGISTRATIONS ISSUED UNDER SECTION 1(d)

The following marks have registered on the Principal Register pursuant to the intent-to-use provisions of Section 1(d) of the Trademark Act of 1946, as amended.

## SECTION 1.— INTERNATIONAL CLASSIFICATION

The short titles associated below with the international class numbers are terms designed merely for quick identification and are not an official part of the international classification. The full names of international classes are given in section 6.1 of the trademark rules of practice.

The designation "U.S. Cl." appearing in this section refers to the U.S. class in effect prior to Sep. 1, 1973 rather than the international class which applies to applications filed on or after that date. For adoption of international classification see notice in the OFFICIAL GAZETTE of Jun. 26, 1973 (911 O.G. TM 210).

### Application in more than one class

2,538,443. PRINCETON VIDEO IMAGE, INC., PRINCETON, NJ, BY CHANGE OF NAME PRINCETON ELECTRONIC BILLBOARD, INC., PRINCETON, NJ. SN 74-690,734. PUB. 2-18-1997, FILED 6-19-1995.

2,538,450. ARNOLD, PETER B., 6301 ZUG, SWITZERLAND. SN 75-194,188. PUB. 4-27-1999, FILED 11-6-1996.

### L-VIS

#### CLASS 9—ELECTRICAL AND SCIENTIFIC APPARATUS

FOR COMPUTER SOFTWARE FOR USE IN INSERTING ELECTRONIC IMAGES INTO LIVE TELEVISION TRANSMISSIONS, IN REAL TIME, SUCH THAT IMAGES APPEAR TO VIEWERS TO BE PART OF THE ORIGINAL SCENE OR EVENT BEING TELECAST (U.S. CLS. 21, 23, 26, 36 AND 38).

FIRST USE 6-16-1995; IN COMMERCE 6-16-1995.

#### CLASS 40—MATERIAL TREATMENT

FOR ELECTRONIC IMAGING, NAMELY, ALTERATION AND/OR RETOUCHING OF ELECTRONIC IMAGES FOR INSERTION INTO LIVE TELEVISION TRANSMISSIONS, IN REAL TIME, SUCH THAT IMAGES APPEAR TO VIEWERS TO BE PART OF THE ORIGINAL SCENE OR EVENT BEING TELECAST (U.S. CLS. 100, 103 AND 106).

FIRST USE 6-16-1995; IN COMMERCE 6-16-1995.

---

2,538,449. DIMARE ENTERPRISES, INC., NEWMAN, CA. SN 75-186,978. PUB. 7-7-1998, FILED 10-24-1996.

### D'BEST

#### CLASS 29—MEATS AND PROCESSED FOODS

FOR SUN-DRIED TOMATOES (U.S. CL. 46).  
FIRST USE 5-0-1996; IN COMMERCE 5-0-1996.

#### CLASS 31—NATURAL AGRICULTURAL PRODUCTS

FOR FRESH TOMATOES (U.S. CLS. 1 AND 46).  
FIRST USE 5-0-1996; IN COMMERCE 5-0-1996.

### REWATCH

PRIORITY CLAIMED UNDER SEC. 44(D) ON SWITZERLAND APPLICATION NO. 07945/1996, FILED 10-29-1996, REG. NO. 436730, DATED 2-12-1997, EXPIRES 10-29-2016.

#### CLASS 14—JEWELRY

FOR WATCHES (U.S. CLS. 2, 27, 28 AND 50).  
FIRST USE 11-13-1996; IN COMMERCE 11-13-1996.

#### CLASS 18—LEATHER GOODS

FOR LEATHER GOODS, NAMELY, HANDBAGS, WALLETS, PURSES, LUGGAGE AND CHANGE PURSES (U.S. CLS. 1, 2, 3, 22 AND 41).

FIRST USE 11-13-1996; IN COMMERCE 11-13-1996.

#### CLASS 25—CLOTHING

FOR CLOTHING, NAMELY, PANTS, SLACKS, UNDERWEAR, SLEEPWEAR, DRESSES, SUITS, SKIRTS, SCARVES, SHAWLS, TIES, GLOVES, SOCKS, STOCKINGS, SHOES, HATS, CAPS, BELTS AND VISORS (U.S. CLS. 22 AND 39).

FIRST USE 11-13-1996; IN COMMERCE 11-13-1996.

---

2,538,451. IT'S ABOUT TIME, INC., ARMONK, NE. SN 75-215,590. PUB. 8-10-1999, FILED 12-19-1996.

### IT'S ABOUT TIME

#### CLASS 9—ELECTRICAL AND SCIENTIFIC APPARATUS

FOR PRERECORDED CD-ROMS AND AUDIO TAPES FEATURING EDUCATIONAL AND INSTRUCTIONAL SUBJECT MATTER IN THE FIELDS OF MATHEMATICS, SCIENCE AND SOCIAL STUDIES, FOR EDUCATIONAL APPLICATIONS FOR ELEMENTARY SCHOOL THROUGH GRADE TWELVE (U.S. CLS. 21, 23, 26, 36 AND 38).

FIRST USE 5-0-1997; IN COMMERCE 10-0-1997.

**CLASS 16—PAPER GOODS AND PRINTED MATTER**

FOR EDUCATIONAL AND INSTRUCTIONAL BOOKS, BOOKLETS, LEAFLETS AND TEACHING MANUALS FEATURING MATHEMATICS, SCIENCE AND SOCIAL STUDIES FOR EDUCATIONAL APPLICATIONS FOR ELEMENTARY SCHOOL THROUGH GRADE TWELVE (U.S. CLS. 2, 5, 22, 23, 29, 37, 38 AND 50).  
FIRST USE 5-0-1997; IN COMMERCE 6-0-1997.

2,538,455. FOOD CONCEPTS, INC., ENGLEWOOD, CO. SN 75-288,770. PUB. 9-22-1998, FILED 5-8-1997.

**CLASS 29—MEATS AND PROCESSED FOODS**

FOR SALAD DRESSINGS, SAUCES, SALSAS, ENTREES CONSISTING PRIMARILY OF RICE AND PASTA, SALADS CONSISTING PRIMARILY OF RICE AND PASTA (U.S. CL. 46).  
FIRST USE 10-17-1997; IN COMMERCE 9-1-1998.

**CLASS 30—STAPLE FOODS**

FOR SAUCES, SALSAS, ENTREES CONSISTING PRIMARILY OF RICE AND PASTA, SALADS CONSISTING PRIMARILY OF RICE AND PASTA (U.S. CL. 46).  
FIRST USE 10-17-1997; IN COMMERCE 9-1-1998.

**CLASS 40—MATERIAL TREATMENT**

FOR CUSTOM PREPARATION OF FOODS IN VOLUME BATCHES USING COOK/CHILL PROCESSES (U.S. CLS. 100, 103 AND 106).  
FIRST USE 10-17-1997; IN COMMERCE 9-1-1998.

2,538,464. WORD FOR TODAY, INC., THE, SANTA ANA, CA. SN 75-413,857. PUB. 7-18-2000, FILED 1-5-1998.



NO CLAIM IS MADE TO THE EXCLUSIVE RIGHT TO USE REPRESENTATION OF THE CHRISTIAN FISH SYMBOL, APART FROM THE MARK AS SHOWN.

THE MARK CONSISTS OF A HIGHLY STYLIZED DRAWING OF A DOVE COMPRISED OF A CROSS, A FISH, AND THE NUMBER 7.

**CLASS 9—ELECTRICAL AND SCIENTIFIC APPARATUS**

FOR SUNGLASSES, PRE-RECORDED AUDIO CASSETTES, VIDEO CASSETTES, COMPACT DISCS AND RECORD ALBUMS FEATURING CHRISTIAN AND RELIGIOUS MUSIC AND CHRISTIAN AND RELIGIOUS TOPICS (U.S. CLS. 21, 23, 26, 36 AND 38).  
FIRST USE 1-31-2001; IN COMMERCE 12-15-1997.

**CLASS 16—PAPER GOODS AND PRINTED MATTER**

FOR PRINTED MATTER, NAMELY, BUMPER STICKERS, POSTERS, STATIONARY, NOTE PADS, PAMPHLETS AND BROCHURES IN THE FIELD OF CHRISTIAN AND RELIGIOUS MUSIC AND CHRISTIAN AND RELIGIOUS TOPICS, BOOK BINDINGS AND BOOK COVERS (U.S. CLS. 2, 5, 22, 23, 29, 37, 38 AND 50).  
FIRST USE 4-3-2001; IN COMMERCE 4-3-2001.

**CLASS 25—CLOTHING**

FOR CLOTHING, NAMELY, T-SHIRTS, DRESS SHIRTS, SWEATERS, HATS, SHORTS, SHOES, SOCKS, SANDALS, JACKETS, GLOVES (U.S. CLS. 22 AND 39).  
FIRST USE 5-12-2000; IN COMMERCE 5-15-2000.

2,538,482. TIVO, INC., ALVISO, CA. SN 75-530,009. PUB. 5-29-2001, FILED 8-3-1998.

**CLASS 9—ELECTRICAL AND SCIENTIFIC APPARATUS**

FOR COMPUTER HARDWARE, COMPUTER SOFTWARE FOR USE IN CONNECTION WITH PERSONALIZED, INTERACTIVE TELEVISION PROGRAMMING, COMPUTER PERIPHERALS FOR PERSONALIZED, INTERACTIVE TELEVISION PROGRAMMING, TELEVISIONS, TELEVISION PERIPHERAL REMOTE CONTROLS, AND CONTROLS, NAMELY, VIDEO GAME INTERACTIVE REMOTE CONTROL UNITS AND COMPUTER GAME SOFTWARE FOR USE THEREWITH AND ACCOMPANYING MANUALS SOLD AS A UNIT (U.S. CLS. 21, 23, 26, 36 AND 38).  
FIRST USE 6-15-1998; IN COMMERCE 1-7-1999.

**CLASS 35—ADVERTISING AND BUSINESS**

FOR PROMOTING THE SALE OF GOODS AND SERVICES OF OTHERS THROUGH THE DISTRIBUTION OF ON-LINE PROMOTIONAL MATERIALS AND PROMOTIONAL CONTESTS (U.S. CLS. 100, 101 AND 102).

FIRST USE 6-15-1998; IN COMMERCE 1-7-1999.



**CLASS 38—COMMUNICATION**

FOR SUBSCRIPTION TELEVISION BROADCASTING SERVICES; TRANSMISSION OF CABLE TELEVISION AND INTERACTIVE AUDIO AND VIDEO SERVICES, AND CABLE TELEVISION TRANSMISSION OF PERSONALIZED AND INTERACTIVE TELEVISION PROGRAMMING (U.S. CLS. 100, 101 AND 104).

FIRST USE 6-15-1998; IN COMMERCE 1-7-1999.

**CLASS 41—EDUCATION AND ENTERTAINMENT**

FOR ENTERTAINMENT SERVICES, NAMELY, PERSONALIZED AND INTERACTIVE ENTERTAINMENT SERVICES IN THE NATURE OF PROVIDING PERSONALIZED TELEVISION PROGRAMMING, AND INTERACTIVE TELEVISION PROGRAMMING AND GAMES, AND ENTERTAINMENT INFORMATION, NAMELY, AN ON-LINE GUIDE TO PERSONALIZED AND INTERACTIVE TELEVISION PROGRAMMING (U.S. CLS. 100, 101 AND 107).

FIRST USE 6-15-1998; IN COMMERCE 1-7-1999.

---

2,538,497. ICE WINE INTERNATIONAL INC., FLUSHING, NY. SN 75-598,348. PUB. 1-25-2000, FILED 11-30-1998.

佳運時

Clarence

冰酒

NO CLAIM IS MADE TO THE EXCLUSIVE RIGHT TO USE THE CHINESE CHARACTERS, TRANSLITERATE TO "BING JIN" WHICH TRANSLATE TO "ICE WINE", APART FROM THE MARK AS SHOWN.

THE NON-LATIN CHARACTERS IN THE MARK TRANSLITERATE TO "JIA YUN" AND "BING JIN" AND THIS MEANS "CLARENCE" AND "ICE WINE" IN ENGLISH.

**CLASS 32—LIGHT BEVERAGES**

FOR NON-ALCOHOLIC WINE (U.S. CLS. 45, 46 AND 48).

FIRST USE 3-18-2000; IN COMMERCE 3-18-2000.

**CLASS 33—WINES AND SPIRITS**

FOR ALCOHOLIC BEVERAGES, NAMELY, WINE (U.S. CLS. 47 AND 49).

FIRST USE 3-18-2000; IN COMMERCE 3-18-2000.

2,538,501. CORTICEIRA AMORIM S.G.P.S., S.A., 4535 MOZELOS, PORTUGAL. SN 75-604,024. PUB. 5-2-2000, FILED 12-10-1998.

**AMORIM****CLASS 19—NON-METALLIC BUILDING MATERIALS**

FOR CORK AND CORK AGGLOMERATES USED AS AN UNDERLAYMENT TO IMPROVE FLOOR AND WALL COVERINGS AND SUB-PAVEMENT; WOOD PANELS; PLASTER PANEL; PANELBOARD MADE OF CEMENT REINFORCED BY FIBER; CORK PARQUET AND WOOD FLOORS; AND WALL AND FLOOR COVERINGS IN NON-TEXTILE MATERIALS MADE OF CERAMIC AND CORK (U.S. CLS. 1, 12, 33 AND 50).

FIRST USE 1-0-1998; IN COMMERCE 1-0-1998.

**CLASS 20—FURNITURE AND ARTICLES NOT OTHERWISE CLASSIFIED**

FOR CORKS (U.S. CLS. 2, 13, 22, 25, 32 AND 50).

FIRST USE 1-0-1998; IN COMMERCE 1-0-1998.

**CLASS 27—FLOOR COVERINGS**

FOR WALL AND FLOOR COVERINGS IN NON-TEXTILE MATERIALS MADE OF LINOLEUM (U.S. CLS. 19, 20, 37, 42 AND 50).

FIRST USE 1-0-1998; IN COMMERCE 1-0-1998.

---

2,538,508. BAY RIDGE AUTOMOTIVE MANAGEMENT CORP., BROOKLYN, NY. SN 75-655,135. PUB. 12-21-1999, FILED 3-8-1999.

**WORRY FREE PRE-OWNED CARE**

NO CLAIM IS MADE TO THE EXCLUSIVE RIGHT TO USE "PRE-OWNED CARE", APART FROM THE MARK AS SHOWN.

**CLASS 35—ADVERTISING AND BUSINESS**

FOR AUTOMOBILE DEALERSHIP (U.S. CLS. 100, 101 AND 102).

FIRST USE 8-3-2001; IN COMMERCE 8-3-2001.

**CLASS 37—CONSTRUCTION AND REPAIR**

FOR MAINTENANCE AND REPAIR OF AUTOMOBILES (U.S. CLS. 100, 103 AND 106).

FIRST USE 8-3-2001; IN COMMERCE 8-3-2001.

2,538,512. EASTERN U.S. BUDDHA'S STUDY (FALUN DAFA) ASSOCIATION, THE, STATEN ISLAND, NY. SN 75-661,162. PUB. 8-29-2000, FILED 3-16-1999.

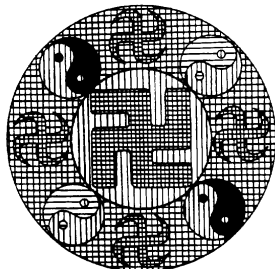

THE LINING SHOWN IN THE MARK IS MERELY TO INDICATE SHADING

THE MARK COMPRISES THE OVERALL DESIGN OF A CIRCLE FEATURING THE ANCIENT SYMBOL OF THE SWASTIKA WHICH IS DERIVED FROM THE SANSKRIT WORD MEANING "BEING FORTUNATE" AT THE CENTER. THE SYMBOL IS ENCIRCLED FURTHER BY VARIOUS DEPICTIONS OF THE YIN-YANG SYMBOLS.

#### CLASS 6—METAL GOODS

FOR METAL BADGES (U.S. CLS. 2, 12, 13, 14, 23, 25 AND 50).  
FIRST USE 5-13-1992; IN COMMERCE 5-13-1992.

#### CLASS 9—ELECTRICAL AND SCIENTIFIC APPARATUS

FOR PRE-RECORDED VIDEOCASSETTES FEATURING THE TEACHING OF BUDDHIST PRINCIPLES (U.S. CLS. 2, 5, 22, 23, 29, 37, 38 AND 50).  
FIRST USE 5-13-1992; IN COMMERCE 5-13-1992.

#### CLASS 16—PAPER GOODS AND PRINTED MATTER

FOR PRINTED MATERIALS, NAMELY BOOKS, PAMPHLETS, FLIERS, NEWSLETTERS, FEATURING THE TEACHING OF BUDDHIST PRINCIPLES (U.S. CLS. 2, 5, 22, 23, 29, 37, 38 AND 50).  
FIRST USE 5-13-1992; IN COMMERCE 5-13-1992.

#### CLASS 24—FABRICS

FOR CLOTH FLAGS (U.S. CLS. 42 AND 50).  
FIRST USE 5-13-1992; IN COMMERCE 5-13-1992.

2,538,520. SADDLEMAN, INC., LOGAN, UT. SN 75-674,246. PUB. 5-30-2000, FILED 4-5-1999.

**LEBRA**

#### CLASS 1—CHEMICALS

FOR FABRIC PROTECTANTS FOR CARPETS, VINYL, RUBBER, PVC AND LEATHER (U.S. CLS. 1, 5, 6, 10, 26 AND 46).  
FIRST USE 7-20-2001; IN COMMERCE 7-20-2001.

#### CLASS 3—COSMETICS AND CLEANING PREPARATIONS

FOR ALL-PURPOSE CLEANING PREPARATIONS; AUTOMOTIVE CLEANING PREPARATIONS AND PROTECTANTS (U.S. CLS. 1, 4, 6, 50, 51 AND 52).  
FIRST USE 7-20-2001; IN COMMERCE 7-20-2001.

2,538,531. OSEM INVESTMENTS LTD., PETACH TIKVA 49517, ISRAEL. SN 75-726,260. PUB. 8-8-2000, FILED 6-10-1999.

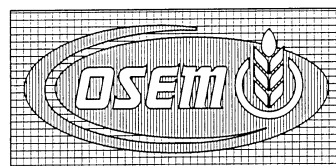

THE TRADEMARK DRAWING IS LINED FOR THE COLORS RED, YELLOW AND WHITE.

THE ENGLISH TRANSLATION OF "OSEM" IS "ABUNDANCE".

#### CLASS 29—MEATS AND PROCESSED FOODS

FOR DRY SOUP MIXES, JELLIES, JAMS, MARMALADES AND PICKLES (U.S. CL. 46).  
FIRST USE 0-0-1997; IN COMMERCE 0-0-1997.

#### CLASS 30—STAPLE FOODS

FOR PACKAGED INSTANT MEALS CONSISTING PRIMARILY OF PASTA, COUSCOUS, RICE OR POTATO PUREE, BISCUITS, CRACKERS, COOKIES, CAKES, BAKED PASTA, FLAFEL, PUDDING, CROUTONS, BREAD CRUMBS, CHOCOLATE POWDER, MATZOS, MEDITERRANEAN KOOS-KOOS, TOASTED PASTA, COUSCOUS, KETCHUP, AND PUDDING (U.S. CL. 46).  
FIRST USE 0-0-1997; IN COMMERCE 0-0-1997.

2,538,534. DORNER MFG. CORP., HARTLAND, WI. SN 75-746,536. PUB. 3-21-2000, FILED 7-9-1999.

**AUTOLOGIK**

#### CLASS 7—MACHINERY

FOR AUTOMATED MATERIAL HANDLING SYSTEMS, NAMELY AUTOMATED CONVEYORS, AUTOMATED SORTERS, AUTOMATED STACKERS, AUTOMATED LABEL APPLICATION EQUIPMENT, AUTOMATED PRODUCT POSITIONING EQUIPMENT, AUTOMATED PACKAGING EQUIPMENT (U.S. CLS. 13, 19, 21, 23, 31, 34 AND 35).  
FIRST USE 2-0-2000; IN COMMERCE 2-0-2000.

#### CLASS 37—CONSTRUCTION AND REPAIR

FOR INSTALLATION OF MATERIAL HANDLING SYSTEMS, INCLUDING INTEGRATION OF MATERIAL HANDLING EQUIPMENT SYSTEMS INTO NEW OR PREVIOUSLY EXISTING SYSTEMS (U.S. CLS. 100, 103 AND 106).  
FIRST USE 2-0-2000; IN COMMERCE 2-0-2000.

**CLASS 40—MATERIAL TREATMENT**

FOR CUSTOM MANUFACTURE OF MATERIAL HANDLING SYSTEMS (U.S. CLS. 100, 103 AND 106).  
FIRST USE 2-0-2000; IN COMMERCE 2-0-2000.

**CLASS 42—SCIENTIFIC, COMPUTER AND LEGAL SERVICES**

FOR DESIGN OF MATERIAL HANDLING SYSTEMS FOR OTHERS (U.S. CLS. 100 AND 101).  
FIRST USE 2-0-2000; IN COMMERCE 2-0-2000.

---

2,538,543. YAMAHA CORPORATION, SHIZUOKA, JAPAN.  
SN 75-788,765. PUB. 5-16-2000, FILED 8-31-1999.

**DIGITAL MUSIC WORLD**

NO CLAIM IS MADE TO THE EXCLUSIVE RIGHT TO USE "DIGITAL MUSIC", APART FROM THE MARK AS SHOWN.

**CLASS 35—ADVERTISING AND BUSINESS**

FOR COMPUTERIZED ON-LINE RETAIL SERVICES IN THE FIELD OF COMPUTER SOFTWARE FOR GAMES AND MUSIC (U.S. CLS. 100, 101 AND 102).  
FIRST USE 8-1-2000; IN COMMERCE 8-1-2000.

**CLASS 41—EDUCATION AND ENTERTAINMENT**

FOR ENTERTAINMENT IN THE NATURE OF CONTESTS IN THE FIELD OF MUSIC AND COMPUTER SERVICES, NAMELY, PROVIDING ONLINE INFORMATION SERVICES IN THE FIELD OF MUSIC (U.S. CLS. 100, 101 AND 107).  
FIRST USE 8-1-2000; IN COMMERCE 8-1-2000.

---

2,538,548. ONFLOW CORPORATION, SAN FRANCISCO, CA. SN 75-800,857. PUB. 11-7-2000, FILED 9-15-1999.

**ONFLOW****CLASS 9—ELECTRICAL AND SCIENTIFIC APPARATUS**

FOR COMPUTER SOFTWARE TO ENHANCE THE AUDIO-VISUAL CAPABILITIES OF MULTIMEDIA APPLICATIONS, NAMELY FOR THE INTEGRATION OF TEXT, AUDIO, GRAPHICS, STILL IMAGES AND MOVING PICTURES; COMPUTER SOFTWARE USED TO CREATE ANIMATION; COMPUTER SOFTWARE USED IN THE FIELD OF ADVERTISING FOR CREATING AND VIEWING INTERACTIVE ADVERTISING; COMPUTER DATABASE SOFTWARE USED IN THE FIELD OF ADVERTISING FOR TRACKING CONSUMER BEHAVIOR; COMPUTER SOFTWARE IN THE FIELD OF IDENTITY AUTHENTICATION AND AUTHORIZATION VERIFICATION (U.S. CLS. 21, 23, 26, 36 AND 38).  
FIRST USE 5-8-2000; IN COMMERCE 12-28-2000.

**CLASS 35—ADVERTISING AND BUSINESS**

FOR ADVERTISING AND PROMOTIONAL SERVICES, NAMELY PREPARING AND PLACING ADVERTISEMENTS FOR OTHERS, PREPARING AUDIO-VISUAL PRESENTATIONS, PLACING ADVERTISEMENTS ON AN ELECTRONIC COMMUNICATIONS NETWORK AND IN ON-LINE MAGAZINES, AND PROMOTING THE GOODS AND SERVICES OF OTHERS BY ARRANGING FOR SPONSORS TO AFFILIATE THEIR GOODS AND SERVICES; RENTAL OF ADVERTISING SPACE; COMMERCIAL INFORMATION AGENCY SERVICES WHICH PROVIDE BUSINESS, MARKETING, DEMOGRAPHIC AND CONSUMER BEHAVIOR DATA FOR OTHERS; MARKET ANALYSIS; MARKET RESEARCH; SALES VOLUME TRACKING FOR OTHERS (U.S. CLS. 100, 101 AND 102).  
FIRST USE 5-8-2000; IN COMMERCE 12-28-2000.

**CLASS 38—COMMUNICATION**

FOR ELECTRONIC TRANSMISSION OF MESSAGES AND DATA (U.S. CLS. 100, 101 AND 104).  
FIRST USE 5-8-2000; IN COMMERCE 12-28-2000.

**CLASS 39—TRANSPORTATION AND STORAGE**

FOR ELECTRONIC STORAGE OF ADVERTISING AND MULTIMEDIA INFORMATION (U.S. CLS. 100 AND 105).  
FIRST USE 5-8-2000; IN COMMERCE 12-28-2000.

**CLASS 41—EDUCATION AND ENTERTAINMENT**

FOR EDUCATIONAL SERVICES, NAMELY PROVIDING CLASSES, SEMINARS, CONFERENCES, AND WORKSHOPS IN THE FIELD OF COMPUTERS AND ON-LINE MULTIMEDIA AUTHORIZING AND DISTRIBUTION OF COURSE MATERIALS IN CONNECTION THEREWITH; ENTERTAINMENT SERVICES, NAMELY PROVIDING AN ON-LINE COMPUTER GAME; MULTIMEDIA ENTERTAINMENT SOFTWARE PRODUCTION SERVICES (U.S. CLS. 100, 101 AND 107).  
FIRST USE 5-8-2000; IN COMMERCE 12-28-2000.

---

2,538,556. NETRAKER CORPORATION, SUNNYVALE, CA. SN 75-811,740. PUB. 1-2-2001, FILED 9-30-1999.

**NETRAKER****CLASS 35—ADVERTISING AND BUSINESS**

FOR BUSINESS CONSULTATION SERVICES IN THE FIELD OF CONDUCTING WEBSITE USABILITY AND MARKET RESEARCH OVER A GLOBAL COMPUTER NETWORK (U.S. CLS. 100, 101 AND 102).  
FIRST USE 11-1-1999; IN COMMERCE 12-1-1999.

**CLASS 42—SCIENTIFIC, COMPUTER AND LEGAL SERVICES**

FOR PROVIDING TEMPORARY USE OF ON-LINE, NON-DOWNLOADABLE SOFTWARE FOR CONDUCTING WEBSITE MARKET RESEARCH OVER A GLOBAL COMPUTER NETWORK (U.S. CLS. 100 AND 101).  
FIRST USE 11-1-1999; IN COMMERCE 12-1-1999.

2,538,560. 4EMPOWERMENT.COM, INC., AUSTIN, TX. SN 75-821,338. PUB. 2-13-2001, FILED 10-12-1999.

## 4EMPOWERMENT.COM

### CLASS 38—COMMUNICATION

FOR PROVIDING ON-LINE CHAT ROOMS AND ON-LINE BULLETIN BOARDS FOR THE TRANSMISSION OF MESSAGES AMONG COMPUTER USERS CONCERNING INFORMATION ABOUT THE FIELDS OF BIOLOGY, SCIENCE, SOCIOLOGY, ANTHROPOLOGY, ENVIRONMENTAL ISSUES, LITERATURE, LANGUAGE ARTS, AND CURRENT EVENTS, AVAILABLE IN A MULTI-LINGUAL FORMAT VIA A GLOBAL COMPUTER NETWORK (U.S. CLS. 100, 101 AND 104).

FIRST USE 8-30-2001; IN COMMERCE 8-30-2001.

### CLASS 42—SCIENTIFIC, COMPUTER AND LEGAL SERVICES

FOR PROVIDING A WEBSITE FEATURING INFORMATION ABOUT THE FIELDS OF BIOLOGY, SCIENCE, SOCIOLOGY, ANTHROPOLOGY, AND ENVIRONMENTAL ISSUES, LITERATURE, LANGUAGE ARTS, AND CURRENT EVENTS, AVAILABLE IN A MULTI-LINGUAL FORMAT VIA A GLOBAL COMPUTER NETWORK, PROVIDING A WEBSITE FEATURING INFORMATION ABOUT FIELD WORK IN THE FIELDS OF BIOLOGY, SCIENCE, SOCIOLOGY, ANTHROPOLOGY AND ENVIRONMENTAL ISSUES, AVAILABLE IN A MULTI-LINGUAL FORMAT VIA A GLOBAL COMPUTER NETWORK, PROVIDING TEMPORARY USE OF ON-LINE NON-DOWNLOADABLE SOFTWARE TO ALLOW USERS TO REPORT, MANIPULATE AND CONDUCT STATISTICAL ANALYSIS OF DATA COLLECTED FROM FIELD WORK CONDUCTED IN THE FIELDS OF BIOLOGY, SCIENCE, SOCIOLOGY, ANTHROPOLOGY AND ENVIRONMENTAL ISSUES VIA A GLOBAL COMPUTER NETWORK, COMPUTER SERVICES, NAMELY PROVIDING ON-LINE NEWSLETTERS AND PAMPHLETS IN THE FIELDS BIOLOGY, SCIENCE, SOCIOLOGY, ANTHROPOLOGY, AND ENVIRONMENTAL ISSUES VIA A GLOBAL COMPUTER NETWORK, COMPUTER CONSULTATION SERVICES, NAMELY, PROVIDING CONSULTATION IN THE FIELD OF WEBSITES AND ON-LINE ELECTRONIC BULLETIN BOARDS FOR TRANSMISSION OF MESSAGES AMONG COMPUTER USERS AND ON-LINE REAL-TIME DISCUSSIONS (U.S. CLS. 100 AND 101).

FIRST USE 8-30-2001; IN COMMERCE 8-30-2001.

2,538,561. 4EMPOWERMENT.COM, INC., AUSTIN, TX. SN 75-821,340. PUB. 2-13-2001, FILED 10-12-1999.

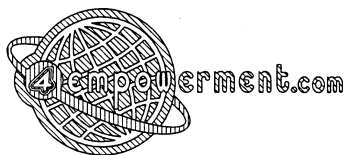

THE MARK IS LINED FOR THE COLORS GREEN, LIGHT GREEN AND MAROON. THE DESIGNATED COLORS GREEN, LIGHT GREEN AND MAROON ARE A FEATURE OF THE MARK.

THE MARK CONSISTS OF A GRIDDED GLOBE DESIGN ENCIRCLED BY A RING, AND THE WORD "4EMPOWERMENT.COM."

### CLASS 38—COMMUNICATION

FOR PROVIDING ON-LINE CHAT ROOMS AND ON-LINE BULLETIN BOARDS FOR THE TRANSMISSION OF MESSAGES AMONG COMPUTER USERS CONCERNING INFORMATION ABOUT THE FIELDS OF BIOLOGY, SCIENCE, SOCIOLOGY, ANTHROPOLOGY, ENVIRONMENTAL ISSUES, LITERATURE, LANGUAGE ARTS, AND CURRENT EVENTS, AVAILABLE IN A MULTI-LINGUAL FORMAT VIA A GLOBAL COMPUTER NETWORK (U.S. CLS. 100, 101 AND 104).

FIRST USE 8-30-2001; IN COMMERCE 8-30-2001.

### CLASS 42—SCIENTIFIC, COMPUTER AND LEGAL SERVICES

FOR PROVIDING A WEBSITE FEATURING INFORMATION ABOUT THE FIELDS OF BIOLOGY, SCIENCE, SOCIOLOGY, ANTHROPOLOGY, AND ENVIRONMENTAL ISSUES, LITERATURE, LANGUAGE ARTS, AND CURRENT EVENTS, AVAILABLE IN A MULTI-LINGUAL FORMAT VIA A GLOBAL COMPUTER NETWORK, PROVIDING A WEBSITE FEATURING INFORMATION ABOUT FIELD WORK IN THE FIELDS OF BIOLOGY, SCIENCE, SOCIOLOGY, ANTHROPOLOGY AND ENVIRONMENTAL ISSUES, AVAILABLE IN A MULTI-LINGUAL FORMAT VIA A GLOBAL COMPUTER NETWORK, PROVIDING TEMPORARY USE OF ON-LINE NON-DOWNLOADABLE SOFTWARE TO ALLOW USERS TO REPORT, MANIPULATE AND CONDUCT STATISTICAL ANALYSIS OF DATA COLLECTED FROM FIELD WORK CONDUCTED IN THE FIELDS OF BIOLOGY, SCIENCE, SOCIOLOGY, ANTHROPOLOGY AND ENVIRONMENTAL ISSUES VIA A GLOBAL COMPUTER NETWORK, COMPUTER SERVICES, NAMELY PROVIDING ON-LINE NEWSLETTERS AND PAMPHLETS IN THE FIELDS BIOLOGY, SCIENCE, SOCIOLOGY, ANTHROPOLOGY, AND ENVIRONMENTAL ISSUES VIA A GLOBAL COMPUTER NETWORK, COMPUTER CONSULTATION SERVICES, NAMELY, PROVIDING CONSULTATION IN THE FIELD OF WEBSITES AND ON-LINE ELECTRONIC BULLETIN BOARDS FOR TRANSMISSION OF MESSAGES AMONG COMPUTER USERS AND ON-LINE REAL-TIME DISCUSSIONS (U.S. CLS. 100 AND 101).

FIRST USE 8-30-2001; IN COMMERCE 8-30-2001.

2,538,574. BRISTOL TECHNOLOGY, INC., DANBURY, CT. SN 75-863,713. PUB. 8-1-2000, FILED 12-1-1999.

## ESLEUTH

### CLASS 9—ELECTRICAL AND SCIENTIFIC APPARATUS

FOR DOWNLOADABLE COMPUTER SOFTWARE FOR USE TO ENABLE COMPANIES UTILIZING NETWORKS OF CONNECTED COMPUTERS OF VARYING TYPES LOCATED IN VARIOUS GEOGRAPHICAL LOCATIONS TO MONITOR THE ACTIVITIES OF REMOTE COMPUTERS AND REMOTE COMPUTER NETWORKS FOR THE PURPOSES OF PREDICTING, DIAGNOSING AND REMEDIATING PROBLEMS WITH COMPUTERS, SOFTWARE AND COMPUTER NETWORKS (U.S. CLS. 21, 23, 26, 36 AND 38).

FIRST USE 12-27-2000; IN COMMERCE 2-28-2001.

**CLASS 42—SCIENTIFIC, COMPUTER AND LEGAL SERVICES**

FOR COMPUTER SOFTWARE PROGRAMMING FOR OTHERS, NAMELY, THE PROGRAMMING OF SOFTWARE FOR USE TO ENABLE COMPANIES UTILIZING NETWORKS OF CONNECTED COMPUTERS OF VARYING TYPES LOCATED IN VARIOUS GEOGRAPHICAL LOCATIONS TO MONITOR THE ACTIVITIES OF REMOTE COMPUTERS AND REMOTE COMPUTER NETWORKS FOR THE PURPOSES OF PREDICTING, DIAGNOSING AND REMEDYING PROBLEMS WITH COMPUTERS, SOFTWARE AND COMPUTER NETWORKS (U.S. CLS. 100 AND 101).

FIRST USE 12-27-2000; IN COMMERCE 2-28-2001.

2,538,584. SUGAR'S MASCOTS.CA INC., TORONTO, ONTARIO, CANADA. SN 75-893,532. PUB. 12-5-2000, FILED 1-10-2000.

## SUGAR'S MASCOT COSTUMES

NO CLAIM IS MADE TO THE EXCLUSIVE RIGHT TO USE "MASCOT COSTUMES", APART FROM THE MARK AS SHOWN.

**CLASS 25—CLOTHING**

FOR MASCOT COSTUMES (U.S. CLS. 22 AND 39).  
FIRST USE 2-27-2001; IN COMMERCE 2-27-2001.

**CLASS 40—MATERIAL TREATMENT**

FOR MANUFACTURE OF MASCOT COSTUMES TO THE ORDER AND SPECIFICATION OF OTHERS (U.S. CLS. 100, 103 AND 106).

FIRST USE 2-27-2001; IN COMMERCE 2-27-2001.

**CLASS 42—SCIENTIFIC, COMPUTER AND LEGAL SERVICES**

FOR MASCOT COSTUME DESIGN FOR OTHERS (U.S. CLS. 100 AND 101).

FIRST USE 2-27-2001; IN COMMERCE 2-27-2001.

2,538,585. SCHEDULE ME, INC., CHICAGO, IL. SN 75-894,705. PUB. 3-20-2001, FILED 1-12-2000.



NO CLAIM IS MADE TO THE EXCLUSIVE RIGHT TO USE "SCHEDULE", APART FROM THE MARK AS SHOWN.

**CLASS 35—ADVERTISING AND BUSINESS**

FOR SCHEDULING AND TIME MANAGING SERVICES RENDERED BY MEANS OF A GLOBAL COMPUTER INFORMATION NETWORK, SPECIFICALLY OFFERING USERS THE ABILITY TO SCHEDULE BUSINESS APPOINTMENTS (U.S. CLS. 100, 101 AND 102).

FIRST USE 1-3-2000; IN COMMERCE 1-1-2001.

**CLASS 42—SCIENTIFIC, COMPUTER AND LEGAL SERVICES**

FOR SCHEDULING AND TIME MANAGING SERVICES RENDERED BY MEANS OF A GLOBAL COMPUTER INFORMATION NETWORK, SPECIFICALLY OFFERING USERS THE ABILITY TO SCHEDULE PERSONAL APPOINTMENTS (U.S. CLS. 100 AND 101).

FIRST USE 1-3-2000; IN COMMERCE 1-1-2001.

2,538,599. SCIHEALTH, INC., ATLANTA, GA. SN 75-930,690. PUB. 12-19-2000, FILED 2-28-2000.

**CLASS 9—ELECTRICAL AND SCIENTIFIC APPARATUS**

FOR COMPUTER SOFTWARE FOR IMPROVING ORGANIZATIONAL MANAGEMENT AND ADMINISTRATION OF HEALTHCARE ORGANIZATIONS (U.S. CLS. 21, 23, 26, 36 AND 38).

FIRST USE 9-0-1999; IN COMMERCE 3-5-2001.

**CLASS 16—PAPER GOODS AND PRINTED MATTER**

FOR PRINTED INSTRUCTIONAL AND TEACHING MATERIAL IN THE FIELD OF HEALTHCARE ORGANIZATIONAL MANAGEMENT (U.S. CLS. 2, 5, 22, 23, 29, 37, 38 AND 50).

FIRST USE 9-0-1999; IN COMMERCE 3-6-2001.

**CLASS 35—ADVERTISING AND BUSINESS**

FOR BUSINESS MANAGEMENT CONSULTATION FOR HEALTHCARE ORGANIZATIONS (U.S. CLS. 100, 101 AND 102).

FIRST USE 9-0-1999; IN COMMERCE 7-20-2001.

**CLASS 41—EDUCATION AND ENTERTAINMENT**

FOR EDUCATIONAL SERVICES, NAMELY, CONDUCTING CLASSES AND TRAINING COURSES FOR DEVELOPING AND IMPLEMENTING BUSINESS STRATEGIES, IMPROVING OPERATIONAL STRUCTURE AND USING EMPIRICAL DATA FOR DECISION MAKING FOR HEALTHCARE ORGANIZATIONS (U.S. CLS. 100, 101 AND 107).

FIRST USE 9-0-1999; IN COMMERCE 3-6-2001.

**CLASS 42—SCIENTIFIC, COMPUTER AND LEGAL SERVICES**

FOR COMPUTER PROGRAMMING SERVICES FOR OTHERS, NAMELY, HEALTHCARE ORGANIZATIONS (U.S. CLS. 100 AND 101).

FIRST USE 9-0-1999; IN COMMERCE 7-20-2001.

2,538,611. BIG HORN VALVE COMPANY, SHERIDAN, WY.  
SN 75-980,873. PUB. 7-25-2000, FILED 1-26-1998.

## VOST

### CLASS 6—METAL GOODS

FOR MANUALLY OPERATED METAL VALVES FOR USE IN LIQUID AND FLUID FLOW SYSTEMS (U.S. CLS. 2, 12, 13, 14, 23, 25 AND 50).

FIRST USE 4-30-1998; IN COMMERCE 7-31-2000.

### CLASS 11—ENVIRONMENTAL CONTROL APPARATUS

FOR PLUMBING FITTINGS, NAMELY, BIBBS, COCKS AND VALVES (U.S. CLS. 13, 21, 23, 31 AND 34).

FIRST USE 4-30-1998; IN COMMERCE 7-31-2000.

### CLASS 20—FURNITURE AND ARTICLES NOT OTHERWISE CLASSIFIED

FOR MANUALLY OPERATED PLASTIC VALVES FOR USE IN LIQUID AND FLUID FLOW SYSTEMS (U.S. CLS. 2, 13, 22, 25, 32 AND 50).

FIRST USE 4-30-1998; IN COMMERCE 7-31-2000.

2,538,612. INTERNATIONAL SPEEDWAY CORPORATION, DAYTONA BEACH, FL. SN 75-981,113. PUB. 2-29-2000, FILED 9-18-1998.



NO CLAIM IS MADE TO THE EXCLUSIVE RIGHT TO USE "KANSAS SPEEDWAY", APART FROM THE MARK AS SHOWN.

### CLASS 21—HOUSEWARES AND GLASS

FOR HOUSEWARES AND GLASS PRODUCTS; NAMELY, MUGS, SHOT GLASSES, DRINKING GLASSES, SALT AND PEPPER SHAKERS, DECANTERS, PORTABLE COOLERS, BEVERAGE INSULATORS AND PLASTIC SPORT BOTTLES (U.S. CLS. 2, 13, 23, 29, 30, 33, 40 AND 50).

FIRST USE 5-6-2001; IN COMMERCE 5-6-2001.

### CLASS 25—CLOTHING

FOR MEN'S, WOMEN'S AND CHILDREN'S CLOTHING; NAMELY, T-SHIRTS, COLLARED SHIRTS, SPORT SHIRTS, SWEATSHIRTS, SLEEVELESS TANK TOPS, JACKETS, SWEATERS, CAPS, HATS, SUN VISORS, SHORTS, PANTS, SHOES, SOCKS AND BELTS (U.S. CLS. 22 AND 39).

FIRST USE 5-6-2001; IN COMMERCE 5-6-2001.

### CLASS 28—TOYS AND SPORTING GOODS

FOR GAMES AND TOYS; NAMELY, COMPUTER VIDEO ARCADE GAMES, DIE CAST AND PLASTIC CARS, TRUCKS, MOTORCYCLES AND OTHER VEHICLES, ELECTRONIC DRIVING AND ROAD RACING GAMES, ELECTRONIC SLOT CARS, ADDITIONAL TRACK FOR RACING GAMES, BOARD GAMES, PUZZLES, PLUSH STUFFED ANIMALS AND RADIO-CONTROLLED CARS, TRUCKS AND OTHER VEHICLES (U.S. CLS. 22, 23, 38 AND 50).

FIRST USE 5-6-2001; IN COMMERCE 5-6-2001.

2,538,615. PRICESMART, INC., SAN DIEGO, CA, BY MERGER, BY CHANGE OF NAME PRICE VENTURES, INC., SAN DIEGO, CA. SN 75-981,336. PUB. 5-12-1998, FILED 3-5-1997.



NO CLAIM IS MADE TO THE EXCLUSIVE RIGHT TO USE "MEMBERSHIP SHOPPING", APART FROM THE MARK AS SHOWN.

### CLASS 16—PAPER GOODS AND PRINTED MATTER

FOR CONSUMER NEWSPAPERS FOR ADVERTISING BUSINESS, PROFESSIONAL AND PERSONAL PRODUCTS; SHOPPING BAGS; PRINTED PLASTIC MEMBERSHIP IDENTIFICATION CARDS (U.S. CLS. 2, 5, 22, 23, 29, 37, 38 AND 50).

FIRST USE 5-4-2001; IN COMMERCE 5-4-2001.

### CLASS 35—ADVERTISING AND BUSINESS

FOR RETAIL DISCOUNT STORE SERVICES, MAIL ORDER SERVICES AND WHOLESALE DISTRIBUTORSHIP SERVICES IN THE FIELD OF GOODS AND ITEMS FOR BUSINESS, PROFESSIONAL AND PERSONAL NEEDS, NAMELY, CIGARETTES AND TOBACCO PRODUCTS, CLOTHING, FOOTWEAR, TOYS, SPORTING GOODS, EXERCISE EQUIPMENT, HOUSEWARES AND HOUSEHOLD GOODS, DETERGENTS, SOAP AND CLEANING PRODUCTS, COSMETICS, GOODS FOR THE CARE OF TEETH, HAIR, NAILS AND OTHER PERSONAL CARE PRODUCTS, OVER-THE-COUNTER MEDICINES AND PHARMACEUTICAL GOODS, LAWN AND GARDEN PRODUCTS AND EQUIPMENT, PET FOOD AND PET CARE PRODUCTS, PAPER GOODS AND PRODUCTS, POWER AND HAND TOOLS, AUTOMOTIVE GOODS; TIRES FOR VEHICLES; FURNITURE, UNFINISHED FURNITURE, OFFICE SUPPLIES AND EQUIPMENT, GROCERIES, DAIRY PRODUCTS, MEATS, BAKED GOODS, COMPUTER HARDWARE, CD ROMS, BOOKS, MAGAZINES, BUILDING SUPPLIES, LARGE AND SMALL ELECTRICAL APPLIANCES, LIGHTING AND ELECTRICAL SUPPLIES AND EQUIPMENT, HARDWARE GOODS, LUMBER, COMPACT DISCS, BLANK AND PRE-RECORDED VIDEO AND AUDIO TAPES, CAMERAS, FILMS, CONSUMER ELECTRONICS, RADIOS, TELEVISIONS, TELEPHONES, LUGGAGE, WATCHES, CLOCKS, STATIONERY, WRITING INSTRUMENTS, SEAFOOD, CANDY, LIQUOR AND ALCOHOLIC BEVERAGES; RETAIL DISCOUNT STORE SERVICES, MAIL ORDER SERVICES AND WHOLESALE DISTRIBUTORSHIP SERVICES IN THE FIELD OF DRUG STORE ITEMS, EYEGLASSES AND SUNGLASSES, AND PARTS AND ACCESSORIES THEREFOR (U.S. CLS. 100, 101 AND 102).

FIRST USE 5-4-2001; IN COMMERCE 5-1-2001.

**CLASS 37—CONSTRUCTION AND REPAIR**

FOR TIRE INSTALLATION SERVICES (U.S. CLS. 100, 103 AND 106).  
FIRST USE 5-4-2001; IN COMMERCE 5-4-2001.

**CLASS 40—MATERIAL TREATMENT**

FOR PHOTOGRAPHIC FILM PROCESSING AND DEVELOPING SERVICES (U.S. CLS. 100, 103 AND 106).  
FIRST USE 5-4-2001; IN COMMERCE 5-4-2001.

**CLASS 42—SCIENTIFIC, COMPUTER AND LEGAL SERVICES**

FOR FITTING OPTICAL LENSES, OPTICIAN AND OPTOMETRY SERVICES; BAKERY DELI AND TAKE-OUT FOOD SERVICES (U.S. CLS. 100 AND 101).  
FIRST USE 5-4-2001; IN COMMERCE 5-4-2001.

2,538,622. LION'S DEN CHRISTIAN MEDIA, INC., NASHVILLE, TN. SN 76-011,070. PUB. 2-6-2001, FILED 3-23-2000.



NO CLAIM IS MADE TO THE EXCLUSIVE RIGHT TO USE "CHRISTIAN MEDIA", APART FROM THE MARK AS SHOWN.

**CLASS 9—ELECTRICAL AND SCIENTIFIC APPARATUS**

FOR PRE-RECORDED AUDIO AND VIDEO TAPES, COMPACT DISCS, DVDS, AND CASSETTES FEATURING MUSIC AND RELIGIOUS THEMES (U.S. CLS. 21, 23, 26, 36 AND 38).  
FIRST USE 3-31-2000; IN COMMERCE 6-19-2001.

**CLASS 16—PAPER GOODS AND PRINTED MATTER**

FOR BOOKS, NEWSLETTERS, MAGAZINES, AND STUDY GUIDES FEATURING RELIGIOUS THEMES (U.S. CLS. 2, 5, 22, 23, 29, 37, 38 AND 50).  
FIRST USE 3-31-2000; IN COMMERCE 6-19-2001.

**CLASS 41—EDUCATION AND ENTERTAINMENT**

FOR EDUCATIONAL SERVICES, NAMELY, CONDUCTING SEMINARS AND CONFERENCES IN THE FIELD OF RELIGION (U.S. CLS. 100, 101 AND 107).  
FIRST USE 3-31-2000; IN COMMERCE 6-19-2001.

2,538,624. DALY, LOUANN, MARBLEHEAD, MA. SN 76-014,772. PUB. 5-15-2001, FILED 3-31-2000.

**O! LAD**

**CLASS 35—ADVERTISING AND BUSINESS**

FOR CONSULTING SERVICES IN THE FIELDS OF BUSINESS ORGANIZATIONAL DEVELOPMENT (U.S. CLS. 100, 101 AND 102).  
FIRST USE 8-0-2000; IN COMMERCE 8-0-2000.

**CLASS 42—SCIENTIFIC, COMPUTER AND LEGAL SERVICES**

FOR CONSULTING SERVICES IN THE FIELDS OF HUMAN DEVELOPMENT AND PERSONAL, INDIVIDUAL ORGANIZATIONAL DEVELOPMENT (U.S. CLS. 100 AND 101).  
FIRST USE 8-0-2000; IN COMMERCE 8-0-2000.

2,538,636. NEXTEC APPLICATIONS, INC., VISTA, CA. SN 76-036,358. PUB. 1-2-2001, FILED 4-27-2000.

**OUTSMART THE OUTDOORS**

**CLASS 24—FABRICS**

FOR TREATED FABRICS FOR USE IN THE MANUFACTURE OF CLOTHING, SLEEPING BAGS, BACKPACKS, LUGGAGE, AND TENTS (U.S. CLS. 42 AND 50).  
FIRST USE 4-27-2000; IN COMMERCE 4-27-2000.

**CLASS 25—CLOTHING**

FOR OUTERWEAR GARMENTS, SPORTSWEAR GARMENTS, APPAREL AND CLOTHING, NAMELY, JACKETS, PARKAS, COATS, PANTS, JUMPSUITS, RAINCOATS, BATHING SUITS, SHORTS, SHIRTS, BLOUSES, UNDERWEAR, UNIFORMS, GLOVES AND SHOES (U.S. CLS. 22 AND 39).  
FIRST USE 4-27-2000; IN COMMERCE 4-27-2000.

\* \* \* \* \*

## SECTION 2.— INTERNATIONAL CLASSIFICATION

The short titles associated below with the international class numbers are terms designed merely for quick identification and are not an official part of the international classification. The full names of international classes are given in section 6.1 of the trademark rules of practice.

The designation "U.S. Cl." appearing in this section refers to the U.S. class in effect prior to Sep. 1, 1973 rather than the international class which applies to applications filed on or after that date. For adoption of international classification see notice in the OFFICIAL GAZETTE of Jun. 26, 1973 (911 O.G. TM 210).

### Application in one class

#### CLASS 1—CHEMICALS

2,538,454. ALEXON-TREND, INC., RAMSEY, MN, BY ASSIGNMENT SERADYN, INC., INDIANAPOLIS, IN. SN 75-286,951. PUB. 2-16-1999, FILED 5-5-1997.

#### OPTIBIND

FOR POLYSTYRENE MICROSPHERES FOR USE AS A SOLIDS PHASE IN BIOMEDICAL RESEARCH AND CLINICAL, VETERINARY, PHARMACEUTICAL, AGRICULTURAL, ENVIRONMENTAL AND INDUSTRIAL DIAGNOSTICS (U.S. CLS. 1, 5, 6, 10, 26 AND 46).  
FIRST USE 3-0-1998; IN COMMERCE 3-0-1998.

2,538,503. COMMONWEALTH BIOTECHNOLOGIES, INC., RICHMOND, VA. SN 75-616,315. PUB. 6-20-2000, FILED 1-6-1999.

#### ACCUTRAC

FOR TRACKING DYES FOR NON-CLINICAL LABORATORY USE IN THE ELUCIDATION OF NUCLEIC ACID SEQUENCES (U.S. CLS. 1, 5, 6, 10, 26 AND 46).  
FIRST USE 2-0-1999; IN COMMERCE 2-0-1999.

2,538,570. BEACON CHEMICAL COMPANY, INC., MT. VERNON, NY. SN 75-851,896. PUB. 5-1-2001, FILED 11-17-1999.

#### TIMBER-GRIP

FOR WOOD GLUE FOR INTERIOR AND EXTERIOR APPLICATIONS, FOR USE BY THE GENERAL PUBLIC AND COMMERCIAL USE (U.S. CLS. 1, 5, 6, 10, 26 AND 46).  
FIRST USE 12-0-1999; IN COMMERCE 7-0-2000.

#### CLASS 1—(Continued).

2,538,617. GARLAND COMPANY, INC., THE, CLEVELAND, OH. SN 76-002,002. PUB. 11-28-2000, FILED 3-16-2000.

#### INSUL-LOCK

FOR ADHESIVES FOR USE IN ROOFING APPLICATIONS (U.S. CLS. 1, 5, 6, 10, 26 AND 46).  
FIRST USE 5-31-2001; IN COMMERCE 5-31-2001.

2,538,623. LEBANON CHEMICAL CORPORATION, LEBANON, PA. SN 76-013,894. PUB. 3-6-2001, FILED 3-30-2000.

#### PERK STRESS RELIEF

OWNER OF U.S. REG. NO. 2,071,127.  
FOR FERTILIZER FOR DOMESTIC AND COMMERCIAL USE (U.S. CLS. 1, 5, 6, 10, 26 AND 46).  
FIRST USE 8-5-1999; IN COMMERCE 8-5-1999.

2,538,625. STRATAGENE, LA JOLLA, CA. SN 76-020,143. PUB. 3-27-2001, FILED 4-7-2000.

#### SURESTART

FOR LABORATORY REAGENTS FOR USE IN SCIENTIFIC RESEARCH AND MOLECULAR BIOLOGY (U.S. CLS. 1, 5, 6, 10, 26 AND 46).  
FIRST USE 5-0-2000; IN COMMERCE 5-0-2000.

2,538,656. SPECIALTY FERTILIZER PRODUCTS, LLC, BELTON, MO. SN 76-090,811. PUB. 5-22-2001, FILED 7-18-2000.

#### NUTRISPHERE

FOR ACIDIFIER COMBINATION TO INCREASE GRANULAR FERTILIZER ABSORPTION (U.S. CLS. 1, 5, 6, 10, 26 AND 46).  
FIRST USE 1-1-2001; IN COMMERCE 1-1-2001.



**CLASS 2—PAINTS**

2,538,590. NANOFILM, LTD., VALLEY VIEW, OH. SN 75-904,256. PUB. 11-7-2000, FILED 1-26-2000.

**PERMASEAL**

FOR PROTECTIVE COATINGS FOR EYEGLASS LENSES, INCLUDING REGULAR, SPORT, SAFETY AND SUNGLASS LENSES (U.S. CLS. 6, 11 AND 16).  
FIRST USE 7-19-2001; IN COMMERCE 7-19-2001.

2,538,647. ABSOLUTE COATINGS, INC., NEW ROCHELLE, NY. SN 76-056,883. PUB. 4-17-2001, FILED 5-25-2000.

**ABSCO**

FOR POLYURETHANE WOOD FLOOR COATINGS AND SEALANTS (U.S. CLS. 6, 11 AND 16).  
FIRST USE 12-13-2000; IN COMMERCE 12-13-2000.

**CLASS 3—COSMETICS AND CLEANING PREPARATIONS**

2,538,457. SALON SCIENCES CORPORATION, FORT LAUDERDALE, FL. SN 75-333,530. PUB. 3-10-1998, FILED 7-31-1997.

**NAIL LAB**

NO CLAIM IS MADE TO THE EXCLUSIVE RIGHT TO USE "NAIL", APART FROM THE MARK AS SHOWN.

FOR NAIL CARE PRODUCTS, NAMELY, NAIL HARDENERS, NAIL POLISH REMOVER, NAIL STRENGTHENERS AND NAIL TIPS (U.S. CLS. 1, 4, 6, 50, 51 AND 52).

FIRST USE 8-15-2000; IN COMMERCE 8-15-2000.

2,538,460. MARK LEES SKIN CARE, INC., PENSACOLA, FL. SN 75-360,738. PUB. 12-1-1998, FILED 9-22-1997.

**SENSITIVE SCIENCE**

FOR SKIN CARE PREPARATIONS, NAMELY, CLEANSERS, TONERS, SUNSCREENS, NIGHT MOISTURIZERS, AND MASKS (U.S. CLS. 1, 4, 6, 50, 51 AND 52).  
FIRST USE 2-0-2000; IN COMMERCE 2-0-2000.

2,538,566. DIAGNOSTICS & DESIGNS, INC., CERRITOS, CA. SN 75-842,438. PUB. 8-15-2000, FILED 11-6-1999.

**OOHS AND AAHS**

FOR HAIR CARE PREPARATIONS (U.S. CLS. 1, 4, 6, 50, 51 AND 52).  
FIRST USE 9-29-2000; IN COMMERCE 9-29-2000.

**CLASS 3—(Continued).**

2,538,602. SEBASTIAN INTERNATIONAL, INC., WOODLAND HILLS, CA. SN 75-934,581. PUB. 10-17-2000, FILED 3-3-2000.

**SLINKY**

FOR HAIR CONDITIONER (U.S. CLS. 1, 4, 6, 50, 51 AND 52).  
FIRST USE 2-25-2000; IN COMMERCE 2-25-2000.

2,538,603. SEBASTIAN INTERNATIONAL, INC., WOODLAND HILLS, CA. SN 75-934,585. PUB. 10-17-2000, FILED 3-3-2000.

**WHAT YOU WEAR BEGINS WITH YOUR HAIR**

FOR NON-MEDICATED HAIR CARE PREPARATIONS, NAMELY, HAIR SHAMPOO, HAIR CONDITIONER, HAIR STYLING GEL, HAIR MOUSSE, HAIR LOTION, HAIR COLORING LOTION, HAIR CRÉMES, HAIR SPRAY, HAIR STRAIGHTENERS, HAIR NEUTRALIZER (U.S. CLS. 1, 4, 6, 50, 51 AND 52).  
FIRST USE 2-25-2000; IN COMMERCE 2-25-2000.

2,538,604. SEBASTIAN INTERNATIONAL, INC., WOODLAND HILLS, CA. SN 75-934,590. PUB. 10-24-2000, FILED 3-3-2000.

**CONTROL TOP**

FOR HAIR STYLING GEL (U.S. CLS. 1, 4, 6, 50, 51 AND 52).  
FIRST USE 3-2-2000; IN COMMERCE 3-2-2000.

**CLASS 3—(Continued).**

2,538,605. SEBASTIAN INTERNATIONAL, INC., WOODLAND HILLS, CA. SN 75-934,592. PUB. 10-31-2000, FILED 3-3-2000.

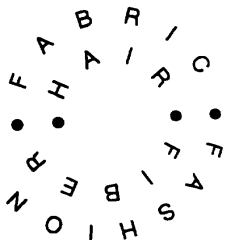

NO CLAIM IS MADE TO THE EXCLUSIVE RIGHT TO USE "HAIR", APART FROM THE MARK AS SHOWN.

FOR NON-MEDICATED HAIR CARE PREPARATIONS, NAMELY, HAIR SHAMPOO, HAIR CONDITIONER, HAIR STYLING GEL, HAIR MOUSSE, HAIR LOTION, HAIR COLORING LOTION, HAIR CRÉMES, HAIR SPRAY, HAIR STRAIGHTENERS, HAIR NEUTRALIZER (U.S. CLS. 1, 4, 6, 50, 51 AND 52).

FIRST USE 2-25-2000; IN COMMERCE 2-25-2000.

2,538,635. STASSI COSMETICS, INC., WESTLAKE VILLAGE, CA. SN 76-036,293. PUB. 1-23-2001, FILED 5-1-2000.



NO CLAIM IS MADE TO THE EXCLUSIVE RIGHT TO USE "SPF", APART FROM THE MARK AS SHOWN.

FOR SUNSCREEN PREPARATIONS (U.S. CLS. 1, 4, 6, 50, 51 AND 52).

FIRST USE 6-1-2000; IN COMMERCE 6-1-2000.

**CLASS 5—PHARMACEUTICALS**

2,538,456. STIEFEL LABORATORIES, INC., CORAL GABLES, FL. SN 75-303,979. PUB. 3-31-1998, FILED 6-5-1997.

**TUPORAL**

FOR DERMATOLOGICAL PREPARATION FOR TREATMENT OF PSORIASIS (U.S. CLS. 6, 18, 44, 46, 51 AND 52).

FIRST USE 1-31-2001; IN COMMERCE 1-31-2001.

**CLASS 5—(Continued).**

2,538,467. CREATION'S OWN, PALM BAY, FL. SN 75-428,995. PUB. 12-8-1998, FILED 2-5-1998.

**CHILDESSENCE**

FOR NUTRITIONAL SUPPLEMENTS (U.S. CLS. 6, 18, 44, 46, 51 AND 52).

FIRST USE 10-0-1998; IN COMMERCE 10-0-1999.

2,538,488. VIVA LIFE SCIENCE, INC., COSTA MESA, CA. BY CHANGE OF NAME VIVA AMERICA MARKETING CORP., COSTA MESA, CA. SN 75-559,951. PUB. 8-10-1999, FILED 9-28-1998.

**SELGUARD**

FOR NUTRITIONAL SUPPLEMENTS (U.S. CLS. 6, 18, 44, 46, 51 AND 52).

FIRST USE 10-1-1999; IN COMMERCE 10-15-1999.

2,538,532. GOLDCAPS, INC., MIAMI, FL. SN 75-732,690. PUB. 12-21-1999, FILED 6-21-1999.

**PHARMASELECT**

FOR DIETARY SUPPLEMENTS (U.S. CLS. 6, 18, 44, 46, 51 AND 52).

FIRST USE 9-12-2000; IN COMMERCE 9-12-2000.

2,538,536. ANABOLIC LABORATORIES, INC., IRVINE, CA. SN 75-757,818. PUB. 1-18-2000, FILED 7-22-1999.

**DIETITIAN'S CHOICE**

FOR DIETARY AND NUTRITIONAL SUPPLEMENTS (U.S. CLS. 6, 18, 44, 46, 51 AND 52).

FIRST USE 9-0-2001; IN COMMERCE 9-0-2001.

2,538,646. SMITHKLINE BEECHAM CORPORATION, PHILADELPHIA, PA. SN 76-052,754. PUB. 4-3-2001, FILED 5-22-2000.

**THINK OXY, THINK OXYGEN. GET IT?**

OWNER OF U.S. REG. NOS. 1,869,207, 2,291,853, AND OTHERS.

FOR ACNE MEDICATION (U.S. CLS. 6, 18, 44, 46, 51 AND 52).

FIRST USE 9-30-2000; IN COMMERCE 9-30-2000.

**CLASS 5—(Continued).**

2,538,653. ASO CORPORATION, SARASOTA, FL. SN 76-078,085. PUB. 5-22-2001, FILED 6-26-2000.

**AWESOME ART**

FOR DECORATED ADHESIVE BANDAGES (U.S. CLS. 6, 18, 44, 46, 51 AND 52).  
FIRST USE 6-0-2000; IN COMMERCE 12-0-2000.

2,538,672. GREAT EARTH COMPANIES, INC., HICKSVILLE, NY. SN 78-030,412. PUB. 7-3-2001, FILED 10-12-2000.

**OPTIPOWERED**

FOR DIETARY AND NUTRITIONAL SUPPLEMENTS (U.S. CLS. 6, 18, 44, 46, 51 AND 52).  
FIRST USE 8-1-2001; IN COMMERCE 8-1-2001.

2,538,673. GREAT EARTH COMPANIE, INC., HICKSVILLE, NY. SN 78-031,070. PUB. 6-26-2001, FILED 10-17-2000.

**WHEY EXCESS**

NO CLAIM IS MADE TO THE EXCLUSIVE RIGHT TO USE "WHEY", APART FROM THE MARK AS SHOWN.  
FOR DIETARY AND NUTRITIONAL SUPPLEMENTS CONTAINING WHEY (U.S. CLS. 6, 18, 44, 46, 51 AND 52).  
FIRST USE 8-1-2001; IN COMMERCE 8-1-2001.

**CLASS 6—METAL GOODS**

2,538,507. WESTERN RAILCO PRODUCTS LTD., SURREY, BRITISH COLUMBIA, CANADA. SN 75-648,754. PUB. 12-7-1999, FILED 2-25-1999.

**RAILCRAFT**

FOR ALUMINUM RAILINGS FOR USE ON BALCONIES, DECKS AND STAIRS AND COMPONENT PARTS THEREOF (U.S. CLS. 2, 12, 13, 14, 23, 25 AND 50).  
FIRST USE 6-11-2000; IN COMMERCE 6-11-2000.

2,538,558. MITEK INDUSTRIES, INC., CHESTERFIELD, MO. SN 75-818,814. PUB. 5-2-2000, FILED 10-12-1999.

**ELIMINATOR**

FOR METAL BRACES FOR ROOF AND FLOOR TRUSS SYSTEMS (U.S. CLS. 2, 12, 13, 14, 23, 25 AND 50).  
FIRST USE 12-17-1999; IN COMMERCE 12-17-1999.

**CLASS 6—(Continued).**

2,538,568. MINERALS TECHNOLOGIES INC., NEW YORK, NY. SN 75-851,106. PUB. 1-16-2001, FILED 11-17-1999.

**ALCACOR**

FOR METAL WIRE, NAMELY, WIRE COMPOSED OF A STEEL COATING AND AN ALUMINUM-CALCIUM COMPOSITE FOR USE IN THE MANUFACTURE OF STEEL (U.S. CLS. 2, 12, 13, 14, 23, 25 AND 50).  
FIRST USE 4-25-2000; IN COMMERCE 4-25-2000.

**CLASS 7—MACHINERY**

2,538,523. MASON GROUP OF COMPANIES LIMITED, MISSISSAUGA, ONTARIO L5T 2G9, CANADA. SN 75-688,756. PUB. 8-29-2000, FILED 4-21-1999.



FOR PORTABLE CARPET AND UPHOLSTERY CLEANING MACHINES WHICH INJECT AND THEN EXTRACT CLEANING SOLUTION AND HOT WATER FROM THE CARPET AND UPHOLSTERY (U.S. CLS. 13, 19, 21, 23, 31, 34 AND 35).  
FIRST USE 3-31-2001; IN COMMERCE 3-31-2001.

2,538,655. LINCOLN GLOBAL, INC., MONTEREY PARK, CA. SN 76-089,756. PUB. 4-17-2001, FILED 7-17-2000.

**V SERIES**

OWNER OF U.S. REG. NOS. 1,983,017 AND 2,126,963.  
NO CLAIM IS MADE TO THE EXCLUSIVE RIGHT TO USE "SERIES", APART FROM THE MARK AS SHOWN.  
FOR GAS WELDING AND CUTTING TORCHES, AND GAS-AIR TORCHES FOR LOW TEMPERATURE BRAZING, ANNEALING AND WELDING, AND PARTS THEREFOR, NAMELY WELDING TIPS, MIXERS FOR WELDING TORCHES, CUTTING ATTACHMENTS FOR WELDING TORCHES, TIP WRENCHES, GAS REGULATORS AND FLAME ARRESTORS FOR GAS REGULATORS AND TORCHES (U.S. CLS. 13, 19, 21, 23, 31, 34 AND 35).  
FIRST USE 0-0-1986; IN COMMERCE 0-0-1986.

2,538,669. HP INTELLECTUAL CORP., WILMINGTON, DE. SN 78-025,056. PUB. 6-26-2001, FILED 9-8-2000.

**MINIPRO PLUS**

FOR ELECTRIC FOOD CHOPPERS/MINCERS FOR DOMESTIC USE (U.S. CLS. 13, 19, 21, 23, 31, 34 AND 35).  
FIRST USE 6-30-2001; IN COMMERCE 6-30-2001.

**CLASS 9—ELECTRICAL AND SCIENTIFIC APPARATUS**

2,538,445. SILVER CREEK TECHNOLOGIES, INC., JOHN-SON CITY, TN. SN 75-039,541. PUB. 11-4-1997, FILED 1-2-1996.

**LEGIS**

FOR LAW OFFICE MANAGEMENT COMPUTER SOFTWARE, NOT INCLUDING SOFTWARE FOR USE IN ACCESS CONTROL, SECURITY, OR IDENTIFICATION (U.S. CLS. 21, 23, 26, 36 AND 38).

FIRST USE 12-31-1997; IN COMMERCE 12-31-1997.

2,538,452. SIEMENS INFORMATION AND COMMUNICATION NETWORKS, INC., BOCO RATON, FL. SN 75-225,637. PUB. 3-9-1999, FILED 1-14-1997.

**PROMPT RESPONSE**

FOR TELECOMMUNICATION AND ELECTRONIC APPARATUS, NAMELY, TELECOMMUNICATION APPARATUS TO AUTOMATICALLY ANSWER AND ROUTE VOICE, VIDEO DATA, FACSIMILE, GLOBAL COMPUTER NETWORK AND MULTIMEDIA COMMUNICATIONS (U.S. CLS. 21, 23, 26, 36 AND 38).

FIRST USE 6-0-1997; IN COMMERCE 6-0-1997.

2,538,458. MARCHON EYEWEAR INC., MELVILLE, NY. SN 75-334,943. PUB. 7-14-1998, FILED 8-4-1997.

**X-FLEX**

OWNER OF U.S. REG. NOS. 1,517,846, 1,544,219, AND 1,747,691.

FOR EYEGLASSES, SUNGLASSES AND SUNGLASS FRAMES (U.S. CLS. 21, 23, 26, 36 AND 38).

FIRST USE 9-26-2001; IN COMMERCE 9-29-2001.

2,538,468. OPTICAL DYNAMICS CORPORATION, LOUISVILLE, KY, BY CHANGE OF NAME; BY ASSIGNMENT RAPID CAST, INC., LOUISVILLE, KY. SN 75-435,687. PUB. 4-11-2000, FILED 2-17-1998.

**PHASES**

OWNER OF U.S. REG. NO. 1,970,912.

FOR EQUIPMENT FOR MAKING AND COATING EYEGLASS LENSES, LENS CURING CHAMBERS, LENS COATING CHAMBERS, LENS MOLDS, LENS MOLD GASKETS, LENS COATING APPLICATORS, LENS CHAMBERS AIR COOLERS AND LENS CHAMBER COOLED AIR DISTRIBUTION DUCTS AND FANS, OPHTHALMIC LENSES, EYEGLASS LENSES, CONTACT LENSES, AND THEIR PARTS AND ACCESSORIES THEREFOR, COMPOSITIONS TO COAT OPHTHALMIC LENSES, COMPOSITIONS TO FORM OPHTHALMIC LENSES, AND COMPOSITIONS APPLIED TO OPHTHALMIC LENSES (U.S. CLS. 21, 23, 26, 36 AND 38).

FIRST USE 3-26-1998; IN COMMERCE 3-26-1998.

**CLASS 9—(Continued).**

2,538,473. US INVESTIGATIONS SERVICES, INC., ANNANDALE, PA. SN 75-464,640. PUB. 10-19-1999, FILED 4-8-1998.

**SWIFTRAK**

FOR COMPUTER PROGRAMS AND RELATED PRINTED DOCUMENTATION IN THE FIELD OF INVESTIGATIONS FOR USE IN EMPLOYMENT BACKGROUND SCREENING, SEARCHING CREDIT AND FINANCIAL INFORMATION, PERFORMING BUSINESS AND INDIVIDUAL IDENTIFICATION AND VERIFICATION, AND SEARCHING FEDERAL, STATE AND COUNTY COURT RECORDS (U.S. CLS. 21, 23, 26, 36 AND 38).

FIRST USE 8-31-1999; IN COMMERCE 1-31-2000.

2,538,476. EXTECH INSTRUMENTS CORPORATION, WALTHAM, MA. SN 75-476,145. PUB. 3-9-1999, FILED 4-28-1998.

**MULTI-SCOPE**

FOR TEST METER FOR MEASURING VOLTAGE, CURRENT AND RESISTANCE (U.S. CLS. 21, 23, 26, 36 AND 38).

FIRST USE 6-30-1998; IN COMMERCE 8-13-1998.

2,538,483. EVERGREEN INTERNET, INC., CHANDLER, AZ. SN 75-540,664. PUB. 8-15-2000, FILED 8-21-1998.

**ECENTIAL**

FOR COMPUTER PROGRAM FOR USE IN FACILITATING NETWORK BASED BUSINESS-TO BUSINESS AND BUSINESS-TO-CONSUMER COMMERCE, NAMELY, A COMPUTER PROGRAM FOR CONDUCTING AND TRACKING THE SALE OF GOODS AND SERVICES BETWEEN BUSINESS ENTITIES AS WELL AS BETWEEN BUSINESSES AND RETAIL CONSUMERS (U.S. CLS. 21, 23, 26, 36 AND 38).

FIRST USE 3-31-1998; IN COMMERCE 4-20-1998.

2,538,485. IMAGE SMITHS, GERMANTOWN, MD. SN 75-544,174. PUB. 10-26-1999, FILED 8-27-1998.

**VERILUM**

FOR GENERAL PURPOSE COMPUTER SOFTWARE FOR VIDEO OUTPUT DISPLAY QUALITY ASSURANCE, NAMELY, TRACKING AND CALIBRATING LUMINOSITY, BRIGHTNESS AND SHARPNESS (U.S. CLS. 21, 23, 26, 36 AND 38).

FIRST USE 9-24-1998; IN COMMERCE 12-3-1998.

**CLASS 9—(Continued).**

2,538,486. MATSUSHITA ELECTRIC CORPORATION OF AMERICA, SECAUCUS, NJ. SN 75-549,037. PUB. 6-13-2000, FILED 9-8-1998.

## EVOLVING TECHNOLOGY FOR TOMORROW'S VEHICLES

FOR AUTOMOTIVE ELECTRONIC PRODUCTS, NAMELY, RADIOS, CD CHANGERS, AUDIO SPEAKERS, IN-VEHICLE GLOBAL POSITIONING SYSTEMS COMPRISED OF A PROCESSING UNIT WITH A DISPLAY SCREEN, A RECEIVER, A MAP DATA BASE AND A MAP MATCHING PROGRAM; AND BATTERIES FOR ELECTRIC VEHICLES (U.S. CLS. 21, 23, 26, 36 AND 38).  
FIRST USE 6-9-1999; IN COMMERCE 6-9-1999.

2,538,487. GENERAL ATOMICS, SAN DIEGO, CA. SN 75-557,266. PUB. 11-14-2000, FILED 9-23-1998.

## LYNX

FOR APPARATUS FOR RECORDING, TRANSMISSION OR REPRODUCTION OF IMAGES, NAMELY, AIRBORNE RADAR SYSTEMS COMPOSED OF A SYNTHETIC APERTURE RADAR, DIGITAL MODULE, SIGNAL PROCESSOR AND ANTENNA ASSEMBLY, FOR USE IN CREATING MAPS AND MAPPING TARGETS (U.S. CLS. 21, 23, 26, 36 AND 38).  
FIRST USE 5-6-1998; IN COMMERCE 5-6-1998.

2,538,489. INTERLOGIX, INC., TUALATIN, OR, BY MERGER; BY CHANGE OF NAME SLC TECHNOLOGIES, INC., TUALATIN, OR. SN 75-559,993. PUB. 2-8-2000, FILED 9-28-1998.

## SAFEAIR

FOR STATIONARY ELECTRONIC GAS DETECTION APPARATUS USED IN CONNECTION WITH A CENTRAL CONTROL UNIT OF ELECTRONIC SECURITY AND FIRE ALARM SYSTEMS FOR RESIDENTIAL AND NON-INDUSTRIAL COMMERCIAL BUILDINGS, NAMELY, DETECTORS AND ALARM CONDITION SENSORS USED FOR DETECTING AND REPORTING THE PRESENCE OF HAZARDOUS GASES THROUGH THE CENTRAL CONTROL UNIT (U.S. CLS. 21, 23, 26, 36 AND 38).  
FIRST USE 8-0-1998; IN COMMERCE 8-0-1998.

**CLASS 9—(Continued).**

2,538,502. EDUCITY OF SALAURA INC., GREENSBORO, NY. SN 75-608,479. PUB. 11-16-1999, FILED 12-21-1998.

## EDUCITY

FOR EDUCATIONAL SOFTWARE FEATURING THE SUBJECTS OF MATHEMATICS, SCIENCE, LANGUAGES, GEOGRAPHY, HISTORY, AND RELIGIOUS STUDIES; GENERAL USE SOFTWARE FOR CALENDAR MAKING, GREETING CARD MAKING, BUSINESS CARD MAKING, COMPUTER-AIDED DESIGN, AND FOR DESIGNING AND DELIVERING ONLINE PROMOTIONAL INFORMATION; SCREEN SAVER SOFTWARE; SOFTWARE FOR BUSINESSES FOR PROJECT MANAGEMENT AND RESOURCE ALLOCATION (U.S. CLS. 21, 23, 26, 36 AND 38).  
FIRST USE 1-1-1999; IN COMMERCE 3-1-2000.

2,538,510. FBTC, LLC, PRINCETON, NJ. SN 75-660,357. PUB. 1-4-2000, FILED 3-15-1999.

## FUNNY BITS FROM YOUR TALKING CHIPS

FOR COMPUTER SOFTWARE, NAMELY, COMPUTER SCREEN SAVER SOFTWARE AND SOFTWARE FOR USE IN ACCESSING A DATABASE OF JOKES AND HUMOROUS STORIES (U.S. CLS. 21, 23, 26, 36 AND 38).  
FIRST USE 8-29-2001; IN COMMERCE 8-29-2001.

2,538,511. CTI LIMITED, INC., DALLAS, TX. SN 75-661,109. PUB. 1-11-2000, FILED 3-16-1999.

## SSLE

FOR REAL ESTATE MANAGEMENT SOFTWARE (U.S. CLS. 21, 23, 26, 36 AND 38).  
FIRST USE 3-14-1994; IN COMMERCE 3-14-1994.

2,538,516. SOPHISTICATED CIRCUITS, INC., BOTHELL, WA. SN 75-671,466. PUB. 4-25-2000, FILED 3-29-1999.

## KICK-OFF!

FOR COMPUTER HARDWARE; COMPUTER UTILITY PROGRAMS FOR MONITORING AND SUPERVISING THE OPERATION OF A DIGITAL PROCESSING SYSTEM, AND FOR PERFORMING MAINTENANCE OPERATIONS SUCH AS RESTART OPERATIONS AUTOMATICALLY ON THE DIGITAL PROCESSING SYSTEM (U.S. CLS. 21, 23, 26, 36 AND 38).  
FIRST USE 1-5-1999; IN COMMERCE 11-3-1999.

**CLASS 9—(Continued).**

2,538,519. JAI A/S, 2600 GLOSTRUP, DENMARK. SN 75-674,103. PUB. 7-4-2000, FILED 4-5-1999.



OWNER OF U.S. REG. NO. 2,313,030.  
FOR CAMERAS, NAMELY, CCD CAMERAS AND  
ICCD CAMERAS (U.S. CLS. 21, 23, 26, 36 AND 38).  
FIRST USE 12-31-1988; IN COMMERCE 12-31-1991.

2,538,525. BMC SOFTWARE, INC., HOUSTON, TX. SN 75-691,980. PUB. 3-13-2001, FILED 4-26-1999.

**ASSURING BUSINESS  
AVAILABILITY**

FOR COMPUTER SOFTWARE, PROGRAMS AND  
USER MANUALS SOLD AS A UNIT FOR MANAGING  
COMPUTER SYSTEMS, DATABASES AND APPLICA-  
TIONS, NAMELY PROVIDING DATA MANAGEMENT,  
APPLICATION MANAGEMENT AND PERFORMANCE  
OPTIMIZATION AND RECOVERY, NAMELY, RESTOR-  
ING AND RESTARTING OF MAINFRAME AND DIS-  
TRIBUTED SYSTEMS COMPUTERS AND THE  
BUSINESS APPLICATIONS, PROGRAMS AND SYSTEMS  
THAT OPERATE THEREIN (U.S. CLS. 21, 23, 26, 36 AND  
38).

FIRST USE 4-26-1999; IN COMMERCE 4-26-1999.

2,538,528. SPRING HOUSE, INC., ALEXANDRIA, IN. SN 75-708,519. PUB. 10-3-2000, FILED 5-18-1999.

**COUNTRY HOMECOMING**

NO CLAIM IS MADE TO THE EXCLUSIVE RIGHT TO  
USE "COUNTRY", APART FROM THE MARK AS SHOWN.  
FOR PRE-RECORDED AUDIO TAPES, VIDEO TAPES,  
COMPACT DISCS, DIGITAL AUDIO DISCS, DIGITAL  
VIDEO DISCS, AND RECORDS FEATURING MUSIC  
AND MUSICAL PERFORMANCES (U.S. CLS. 21, 23, 26,  
36 AND 38).

FIRST USE 10-5-1999; IN COMMERCE 10-5-1999.

**CLASS 9—(Continued).**

2,538,540. CRYSTALLIZE, INC., ANN ARBOR, MI. SN 75-772,400. PUB. 4-25-2000, FILED 8-10-1999.

**CRYSTALLIZE**

FOR BUSINESS COMPUTER SOFTWARE FOR USE IN  
DATABASE MANAGEMENT, NAMELY, TO MERGE  
DATA AS A RESULT OF INTEGRATION OR DIVESTI-  
TURE OF A BUSINESS ENTITY (U.S. CLS. 21, 23, 26, 36  
AND 38).

FIRST USE 7-1-1999; IN COMMERCE 7-1-1999.

2,538,545. AIRNET COMMUNICATIONS CORPORATION,  
MELBOURNE, FL. SN 75-794,122. PUB. 4-11-2000, FILED  
9-7-1999.

**ADAPTACELL**

FOR ELECTRONIC BASE STATION EQUIPMENT  
AND SOFTWARE FOR CELLULAR AND PERSONAL  
COMMUNICATION SERVICES (PCS) TELEPHONES,  
NAMELY, POWER AMPLIFIERS, RECEIVER MULTI  
COUPLERS, RADIO FREQUENCY (RF) SIGNAL  
TRANSMIT AND RECEIVE FILTERS, RADIO FRE-  
QUENCY (RF) TRANSCEIVERS, SIGNAL PROCESSORS,  
DIGITAL SIGNAL COMBINERS, DIGITAL SIGNAL  
CHANNELIZERS, SWITCHED BEAM ANTENNAS,  
ADAPTIVE ANTENNAS, GENERAL PURPOSE PACKET  
DATA SWITCHES, ASYNCHRONOUS TRANSFER  
MODE (ATM) PACKET DATA SWITCHES, WIRELESS  
DATA COMMUNICATIONS EQUIPMENT, HOST COM-  
PUTERS, LINE INTERFACE CARDS AND ELECTRICAL  
POWER SUPPLIES (U.S. CLS. 21, 23, 26, 36 AND 38).

FIRST USE 9-20-1999; IN COMMERCE 9-20-1999.

2,538,564. COLEMAN CABLE SYSTEMS, INC., WAUKEGAN,  
IL. SN 75-832,592. PUB. 5-8-2001, FILED 10-26-1999.

**MAXIMUM ENERGY**

FOR UNIVERSAL LEAD-FREE BATTERY CABLES  
(U.S. CLS. 21, 23, 26, 36 AND 38).

FIRST USE 10-0-1999; IN COMMERCE 1-0-2000.

**CLASS 9—(Continued).**

2,538,565. CHROME HEARTS, INC., HOLLYWOOD, CA. SN 75-836,232. PUB. 9-5-2000, FILED 10-29-1999.

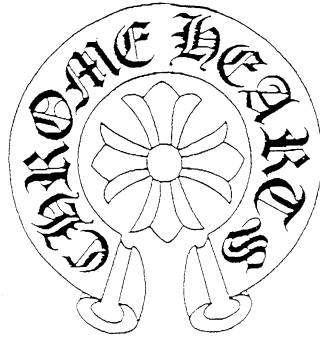

THE MARK IS COMPRISED OF A HORSESHOE AND FLOWER DESIGN AND THE WORDING "CHROME HEARTS".

FOR EYEWEAR; NAMELY, EYEGASSES, SUNGLASSES, EYEGASS CASES AND SUNGLASS CASES (U.S. CLS. 21, 23, 26, 36 AND 38).

FIRST USE 12-0-1999; IN COMMERCE 12-0-1999.

2,538,581. MINE SAFETY APPLIANCES COMPANY, PITTSBURGH, PA. SN 75-877,236. PUB. 1-23-2001, FILED 12-21-1999.

**BUTTON**

FOR ELECTROCHEMICAL GAS SENSORS (U.S. CLS. 21, 23, 26, 36 AND 38).

FIRST USE 8-14-2001; IN COMMERCE 8-14-2001.

2,538,592. AGFA-GEVAERT, MORTSEL, BELGIUM. SN 75-908,304. PUB. 9-26-2000, FILED 2-2-2000.

**IMPAX BASIX**

FOR COMPUTERS, COMPUTER PERIPHERALS AND COMPUTER PROGRAMS AND INSTRUCTION MANUALS SOLD AS A UNIT FOR USE IN DIGITAL IMAGE MANAGEMENT AND ARCHIVING IN THE FIELD OF MEDICAL RADIOGRAPHY (U.S. CLS. 21, 23, 26, 36 AND 38).

FIRST USE 11-0-1999; IN COMMERCE 11-0-1999.

**CLASS 9—(Continued).**

2,538,595. NEW ENERGY ASSOCIATES, L.L.C., ATLANTA, GA. SN 75-921,622. PUB. 5-8-2001, FILED 2-17-2000.



OWNER OF U.S. REG. NO. 2,348,036.  
FOR COMPUTER SOFTWARE PROVIDING INFORMATION IN THE AREAS OF SUPPLY, DELIVERY, CUSTOMER DATA, MARKET, FINANCIAL, AND RISK ALTERNATIVES FOR GENERATION AND TRANSMISSION PLANNING AND ANALYSIS FOR UTILITY COMPANIES (U.S. CLS. 21, 23, 26, 36 AND 38).  
FIRST USE 4-0-2000; IN COMMERCE 5-0-2000.

2,538,618. ANATEL COMMUNICATIONS CORPORATION, PEABODY, MA. SN 76-007,106. PUB. 11-21-2000, FILED 3-22-2000.

**MEDIABEARER**

FOR TELECOMMUNICATIONS COMPUTER HARDWARE AND SOFTWARE FOR TRANSMITTING PACKETIZED DIGITAL DATA OVER INTERNET PROTOCOL NETWORKS (U.S. CLS. 21, 23, 26, 36 AND 38).  
FIRST USE 3-15-2001; IN COMMERCE 3-15-2001.

2,538,637. EQUITRAC CORPORATION, CORAL GABLES, FL. SN 76-036,936. PUB. 1-30-2001, FILED 4-28-2000.

**ACCOUNTRAC**

OWNER OF U.S. REG. NO. 1,747,696.  
FOR COMPUTER HARDWARE IN THE NATURE OF DATA RECORDERS FOR MONITORING, RECORDING AND REPORTING THE USE MADE OF OFFICE EQUIPMENT; COMPUTER SOFTWARE FOR MONITORING, RECORDING AND REPORTING THE USE MADE OF OFFICE EQUIPMENT (U.S. CLS. 21, 23, 26, 36 AND 38).  
FIRST USE 6-25-2000; IN COMMERCE 6-25-2000.

2,538,654. SHOPKO STORES, INC., GREEN BAY, WI. SN 76-078,671. PUB. 4-10-2001, FILED 6-22-2000.

**WONDERLIGHT PLUS**

OWNER OF U.S. REG. NO. 1,931,250.  
FOR POLYCARBONATE EYEGASS LENSES WITH A PREMIUM SCRATCH RESISTANT SURFACE (U.S. CLS. 21, 23, 26, 36 AND 38).  
FIRST USE 4-5-2000; IN COMMERCE 4-5-2000.

**CLASS 9—(Continued).**

2,538,659. HART SPECIALTIES, INC., AMITYVILLE, NY. SN 76-103,947. PUB. 5-1-2001, FILED 8-4-2000.

**JUBILEE**

FOR EYEGLASS FRAMES, SUNGLASSES AND EYEGLASSES (U.S. CLS. 21, 23, 26, 36 AND 38).  
FIRST USE 8-1-2000; IN COMMERCE 10-6-2000.

2,538,661. GIVEMEPower, INC., CALGARY, ALBERTA, CANADA. SN 76-159,331. PUB. 6-19-2001, FILED 11-6-2000.

**POWERCAD**

FOR PRODUCT DEVELOPMENT SOFTWARE FOR END USERS (U.S. CLS. 21, 23, 26, 36 AND 38).  
FIRST USE 4-18-2000; IN COMMERCE 6-20-2001.

2,538,662. NAVITAR, INC., ROCHESTER, NY. SN 78-003,871. PUB. 12-5-2000, FILED 4-12-2000.

**EASY READER**

FOR VIDEO INSPECTION SYSTEM CONSISTING OF AN AUTO-FOCUSING VIDEO INSPECTION LENS, CAMERA AND LIGHTS FOR USE IN QUALITY CONTROL INSPECTION IN THE FIELD OF MANUFACTURING (U.S. CLS. 21, 23, 26, 36 AND 38).  
FIRST USE 7-1-2001; IN COMMERCE 7-1-2001.

2,538,666. PIXEL ARCHITECTURE, LLC, ROSELLE, IL. SN 78-016,898. PUB. 3-13-2001, FILED 7-16-2000.

**MARKETTRACER**

FOR COMPUTER SOFTWARE WHICH ENABLES USERS TO (1) TRACK THE PRICES OF THE USER'S PRODUCTS ADVERTISED ON INTERNET RESELLER'S WEB SITES, (2) TRACK THE PRICES OF COMPETITORS' PRODUCTS ON RESELLER'S WEB SITES, AND (3) COMPARE PRICES FOR ADVERTIZED GOODS AND SERVICES AMONG MULTIPLE VENDERS (U.S. CLS. 21, 23, 26, 36 AND 38).  
FIRST USE 8-1-2000; IN COMMERCE 1-1-2001.

2,538,668. WILL TO LEARN INCORPORATED, BILOXI, MS. SN 78-020,888. PUB. 7-3-2001, FILED 8-11-2000.

**WILL TO LEARN**

FOR COMPUTER TRAINING SOFTWARE FOR IT INFORMATION TECHNOLOGY (U.S. CLS. 21, 23, 26, 36 AND 38).  
FIRST USE 1-10-2001; IN COMMERCE 1-15-2001.

**CLASS 10—MEDICAL APPARATUS**

2,538,658. JOHNSON & JOHNSON, NEW BRUNSWICK, NJ. SN 76-098,203. PUB. 4-24-2001, FILED 7-28-2000.

**ONE TOUCH ULTRA**

OWNER OF U.S. REG. NO. 1,484,999.  
FOR BLOOD GLUCOSE MONITORING DEVICES, AND PARTS AND ACCESSORIES THEREFOR (U.S. CLS. 26, 39 AND 44).  
FIRST USE 1-15-2001; IN COMMERCE 1-15-2001.

**CLASS 12—VEHICLES**

2,538,620. HONDA GIKEN KOGYO KABUSHIKI KAISHA (HONDA MOTOR CO., LTD.), MINATO-KU, TOKYO 107, JAPAN. SN 76-008,588. PUB. 1-2-2001, FILED 3-23-2000.

**VTX**

FOR MOTORCYCLES AND STRUCTURAL PARTS (U.S. CLS. 19, 21, 23, 31, 35 AND 44).  
FIRST USE 3-0-2001; IN COMMERCE 3-0-2001.

**CLASS 14—JEWELRY**

2,538,474. BJ&J, LTD., BOULDER, CO. SN 75-465,675. PUB. 11-16-1999, FILED 4-10-1998.

**ARCTIC ICE**

NO CLAIM IS MADE TO THE EXCLUSIVE RIGHT TO USE "ICE", APART FROM THE MARK AS SHOWN.  
FOR PRECIOUS GEMSTONES (U.S. CLS. 2, 27, 28 AND 50).  
FIRST USE 3-21-2001; IN COMMERCE 3-21-2001.

2,538,537. BJ&J, LTD., BOULDER, CO. SN 75-757,870. PUB. 12-5-2000, FILED 7-22-1999.

**PURE ICE**

NO CLAIM IS MADE TO THE EXCLUSIVE RIGHT TO USE "ICE", APART FROM THE MARK AS SHOWN.  
FOR DIAMONDS (U.S. CLS. 2, 27, 28 AND 50).  
FIRST USE 3-19-2001; IN COMMERCE 3-19-2001.



**CLASS 14—(Continued).**

2,538,549. CASIO KEISANKI KABUSHIKI KAISHA, DBA CASIO COMPUTER CO., LTD., SHIBUYA-KU, TOKYO, JAPAN. SN 75-803,052. PUB. 10-3-2000, FILED 9-17-1999.



THE MARK CONSISTS OF AN OCEAN WAVE. FOR ELECTRONIC WATCHES (U.S. CLS. 2, 27, 28 AND 50).  
FIRST USE 3-0-2000; IN COMMERCE 3-0-2000.

**CLASS 16—PAPER GOODS AND PRINTED MATTER**

2,538,442. SKYTECH, INC., CHASKA, MN. SN 74-515,338. PUB. 12-13-1994, FILED 4-22-1994.

**SKYTRIBUNE**

FOR GENERAL CIRCULATION NEWSPAPERS DISTRIBUTED ELECTRONICALLY TO SUBSCRIBERS (U.S. CLS. 2, 5, 22, 23, 29, 37, 38 AND 50).  
FIRST USE 4-0-1994; IN COMMERCE 12-0-2000.

2,538,463. SEA WORLD, INC., ST. LOUIS, MO. SN 75-398,795. PUB. 7-28-1998, FILED 12-2-1997.



OWNER OF U.S. REG. NOS. 1,195,498, 1,907,329, AND OTHERS.

THE DESIGN ELEMENT OF THE MARK CONSISTS OF A STYLIZED REPRESENTATION OF A DORSAL FIN.

FOR PRINTED MATTER, NAMELY, POSTCARDS, POSTERS AND STICKERS (U.S. CLS. 2, 5, 22, 23, 29, 37, 38 AND 50).

FIRST USE 2-18-1999; IN COMMERCE 2-18-1999.

**CLASS 16—(Continued).**

2,538,572. TIME WARNER ENTERTAINMENT COMPANY, L.P., NEW YORK, NY. SN 75-858,831. PUB. 11-7-2000, FILED 11-24-1999.

**NIMBUS TWO THOUSAND**

FOR PRINTED MATTER AND PAPER GOODS NAMELY, BOOKS FEATURING CHARACTERS FROM ANIMATED, ACTION ADVENTURE, COMEDY AND DRAMA FEATURES, COMIC BOOKS, CHILDREN'S BOOKS, MAGAZINES FEATURING CHARACTERS FROM ANIMATED, ACTION ADVENTURE, COMEDY AND DRAMA FEATURES, COLORING BOOKS, CHILDREN'S ACTIVITY BOOKS; STATIONERY, WRITING PAPER, ENVELOPES, NOTEBOOKS, DIARIES, NOTE CARDS, GREETING CARDS TRADING CARDS; LITHOGRAPHS; PENS, PENCILS, CASES THEREFOR, ERASERS, CRAYONS, MARKERS, COLORED PENCILS, PAINTING SETS, CHALK AND CHALKBOARDS FOR SCHOOL AND HOME USE; DECALS, IRON-ON TRANSFERS; POSTERS; MOUNTED AND UNMOUNTED PHOTOGRAPHS; BOOK COVERS, BOOK MARKS, CALENDARS, GIFT WRAPPING PAPER; PAPER PARTY DECORATIONS—NAMELY, PAPER NAPKINS, PAPER DOILIES, PAPER PLACE MATS, CREPE PAPER, PAPER HATS, INVITATIONS, PAPER TABLE CLOTHS, PAPER CAKE DECORATIONS; PRINTED TRANSFERS FOR EMBROIDERY OR FABRIC APPLIQUES; PRINTED PATTERNS FOR COSTUMES, PAJAMAS, SWEATSHIRTS AND T-SHIRTS; PAPER PHOTO FRAMES (U.S. CLS. 2, 5, 22, 23, 29, 37, 38 AND 50).  
FIRST USE 11-15-2000; IN COMMERCE 11-15-2000.

2,538,575. E.K. SUCCESS, LTD., CLIFTON, NJ. SN 75-866,147. PUB. 8-1-2000, FILED 12-7-1999.

**A CHILD'S BEST FIRST MARKER**

FOR MARKERS AND PENS (U.S. CLS. 2, 5, 22, 23, 29, 37, 38 AND 50).  
FIRST USE 11-8-1999; IN COMMERCE 11-8-1999.

2,538,586. TYCO PLASTICS LP, MINNEAPOLIS, MN, BY CHANGE OF NAME CARLISLE PLASTICS LP, MINNEAPOLIS, MN. SN 75-897,078. PUB. 2-6-2001, FILED 1-14-2000.

**METALLO-TUFF**

FOR PLASTIC BAGS FOR USE AS CAN LINERS (U.S. CLS. 2, 5, 22, 23, 29, 37, 38 AND 50).  
FIRST USE 7-31-2000; IN COMMERCE 7-31-2000.

2,538,589. PRO-INNOVATIVE CONCEPTS, INC., PHOENIX, AZ. SN 75-903,754. PUB. 9-26-2000, FILED 1-27-2000.

**GUMMY PEN**

NO CLAIM IS MADE TO THE EXCLUSIVE RIGHT TO USE "PEN", APART FROM THE MARK AS SHOWN.  
FOR PENS (U.S. CLS. 2, 5, 22, 23, 29, 37, 38 AND 50).  
FIRST USE 6-13-2000; IN COMMERCE 6-13-2000.

**CLASS 16—(Continued).**

2,538,609. MORGAN STANLEY DEAN WITTER & CO., NEW YORK, NY. SN 75-941,359. PUB. 10-31-2000, FILED 3-10-2000.

**SECTORSCOPE**

FOR PRINTED PUBLICATION, NAMELY, A NEWSLETTER IN THE FIELDS OF FINANCE, BUSINESS, AND ECONOMICS (U.S. CLS. 2, 5, 22, 23, 29, 37, 38 AND 50).

FIRST USE 3-0-2000; IN COMMERCE 3-0-2000.

**CLASS 18—(Continued).**

2,538,494. PHAT FASHIONS LLC, NEW YORK, NY. SN 75-587,603. PUB. 11-30-1999, FILED 11-9-1998.

**BABY PHAT**

OWNER OF U.S. REG. NO. 2,240,881.  
FOR BACKPACKS, MESSENGER BAGS, HANDBAGS, PURSES, LUGGAGE, ATHLETIC BAGS, TOTE BAGS, TOILET CASES SOLD EMPTY, BRIEFCASES, UMBRELLAS, KEY CASES, AND WALLETS (U.S. CLS. 1, 2, 3, 22 AND 41).

FIRST USE 3-15-2001; IN COMMERCE 3-15-2001.

2,538,663. NEW ENGLAND PACKAGING CO., INC., FAIRFIELD, CT. SN 78-004,654. PUB. 1-23-2001, FILED 4-18-2000.

**ZERO-CONTACT**

FOR CORRUGATED PAPER CONTAINERS FOR HAZARDOUS MATERIALS (U.S. CLS. 2, 5, 22, 23, 29, 37, 38 AND 50).

FIRST USE 1-1-2001; IN COMMERCE 1-1-2001.

**CLASS 17—RUBBER GOODS**

2,538,530. OWENS CORNING FIBERGLAS TECHNOLOGY, INC., TOLEDO, OH. SN 75-720,332. PUB. 12-21-1999, FILED 6-28-1999.

**VAPORWICK**

FOR GLASS FIBER INSULATION USED IN COMMERCIAL AND MECHANICAL INSULATION (U.S. CLS. 1, 5, 12, 13, 35 AND 50).

FIRST USE 6-29-2001; IN COMMERCE 6-29-2001.

**CLASS 18—LEATHER GOODS**

2,538,484. BETESH GROUP HOLDING CORPORATION, GENERATION SPORT DIVISION, THE, NEW YORK, NY. SN 75-542,272. PUB. 10-12-1999, FILED 8-25-1998.

**KIDZ GENERATION**

OWNER OF U.S. REG. NO. 2,003,235.  
FOR ALL-PURPOSE SPORT BAGS, BACKPACKS, TOTE BAGS, CARRY-ON BAGS, HANDBAGS, LUGGAGE, AND BARREL BAGS (U.S. CLS. 1, 2, 3, 22 AND 41).

FIRST USE 1-0-1999; IN COMMERCE 1-0-1999.

2,538,563. PHAT FASHIONS LLC, NEW YORK, NY. SN 75-822,587. PUB. 4-25-2000, FILED 10-13-1999.



FOR BACKPACKS, SHOULDERS BAGS, HANDBAGS, PURSES, LUGGAGE, ATHLETIC BAGS, TOTE BAGS, TOILET CASES SOLD EMPTY, BRIEFCASES, UMBRELLAS, KEY CASES, AND WALLETS (U.S. CLS. 1, 2, 3, 22 AND 41).

FIRST USE 3-15-2001; IN COMMERCE 3-15-2001.

2,538,594. KONTOS, GEORGE VLASIOS, HARVEY, LA. SN 75-916,395. PUB. 12-19-2000, FILED 10-30-1999.



...Because you want everyone to see your pet

FOR NON-METAL, GLOW IN THE DARK IDENTIFICATION BAND TO BE WORN ON THE PAW OF A PET (U.S. CLS. 1, 2, 3, 22 AND 41).

FIRST USE 9-28-1999; IN COMMERCE 1-1-2000.

**CLASS 18—(Continued).**

2,538,606. BARREIRO, SARAIVELYS, NEW YORK, NY. SN 75-935,222. PUB. 1-9-2001, FILED 2-16-2000.



FOR HANDBAGS (U.S. CLS. 1, 2, 3, 22 AND 41).  
FIRST USE 2-12-2001; IN COMMERCE 2-12-2001.

2,538,633. TRAVELPRO INTERNATIONAL, INC., BOCA RATON, FL. SN 76-030,905. PUB. 11-21-2000, FILED 4-19-2000.

**SYMPHONY**

FOR LUGGAGE (U.S. CLS. 1, 2, 3, 22 AND 41).  
FIRST USE 4-0-2000; IN COMMERCE 4-0-2000.

2,538,650. JANSPOUT APPAREL CORP., WILMINGTON, DE. SN 76-060,861. PUB. 4-24-2001, FILED 6-1-2000.

**WHEN THE ROAD CALLS...**

FOR LUGGAGE, BACKPACKS, BRIEFCASES, WALLET, DUFFEL BAGS AND TRAVEL BAGS (U.S. CLS. 1, 2, 3, 22 AND 41).  
FIRST USE 10-9-2000; IN COMMERCE 10-9-2000.

2,538,667. SAMSONITE CORPORATION, DENVER, CO. SN 78-018,313. PUB. 3-20-2001, FILED 7-25-2000.

**RESPONSE**

FOR LUGGAGE (U.S. CLS. 1, 2, 3, 22 AND 41).  
FIRST USE 10-1-2000; IN COMMERCE 10-1-2000.

**CLASS 19—NON-METALLIC BUILDING MATERIALS**

**CLASS 19—(Continued).**

2,538,495. TREX COMPANY, LLC, WINCHESTER, VA. SN 75-589,330. PUB. 2-22-2000, FILED 11-13-1998.

**THE DECK OF A LIFETIME**

FOR NON-METAL BUILDING MATERIALS FOR OUTDOOR DECK CONSTRUCTION, NAMELY, WOOD FIBER AND POLYETHYLENE COMPOSITE FLOORING (U.S. CLS. 1, 12, 33 AND 50).  
FIRST USE 11-0-1998; IN COMMERCE 11-0-1998.

2,538,559. NEW ENGLAND CLASSIC INTERIORS, INC., PORTLAND, ME. SN 75-819,520. PUB. 5-2-2000, FILED 10-12-1999.

**CUSTOM CLASSIC**

NO CLAIM IS MADE TO THE EXCLUSIVE RIGHT TO USE "CUSTOM", APART FROM THE MARK AS SHOWN.  
FOR NON-METAL BUILDING MATERIALS, NAMELY, PANELING AND MILLWORK, EXCLUSIVE OF CABINETS, IN A VARIETY OF ARCHITECTURAL STYLES MADE OF WOOD, WOOD-BASED MATERIAL OR WOOD SUBSTITUTES, NAMELY, POLYVINYL CHLORIDE, PAPER OR FOIL SYNTHETICS (U.S. CLS. 1, 12, 33 AND 50).  
FIRST USE 3-0-2000; IN COMMERCE 10-0-2000.

**CLASS 20—FURNITURE AND ARTICLES NOT OTHERWISE CLASSIFIED**

2,538,517. MILL'S PRIDE LIMITED PARTNERSHIP, WEST PALM BEACH, FL. SN 75-671,739. PUB. 7-25-2000, FILED 3-31-1999.

**MONTROSE**

FOR WOODEN KITCHEN CABINET DOORS (U.S. CLS. 2, 13, 22, 25, 32 AND 50).  
FIRST USE 4-1-2000; IN COMMERCE 4-1-2000.

2,538,526. UNIVERSAL FURNITURE LIMITED, DBA BENCHCRAFT, BLUE MOUNTAIN, MS, BY MERGER UNIVERSAL FURNITURE INDUSTRIES, INC., DBA BENCHCRAFT FURNITURE, BLUE MOUNTAIN, MS. SN 75-698,733. PUB. 6-27-2000, FILED 5-5-1999.



OWNER OF U.S. REG. NOS. 1,225,071, 2,014,506, AND OTHERS.  
FOR FURNITURE (U.S. CLS. 2, 13, 22, 25, 32 AND 50).  
FIRST USE 10-0-1999; IN COMMERCE 10-0-1999.

**CLASS 20—(Continued).**

2,538,591. POTTS, DEBRA L., SOLANA BEACH, CA. AND POTTS, KENNETH L., SOLANA BEACH, CA. SN 75-905,452. PUB. 4-17-2001, FILED 1-25-2000.

**PROFOUND PRODUCTS**

NO CLAIM IS MADE TO THE EXCLUSIVE RIGHT TO USE "PRODUCTS", APART FROM THE MARK AS SHOWN. FOR AUTOMOTIVE ACCESSORY, NAMELY, STORAGE ORGANIZERS FOR USE IN VEHICLES (U.S. CLS. 2, 13, 22, 25, 32 AND 50).  
FIRST USE 4-7-2000; IN COMMERCE 4-7-2000.

2,538,600. GLOBAL TOTAL OFFICE, DOWNSVIEW, ONTARIO, CANADA. SN 75-934,273. PUB. 12-5-2000, FILED 3-2-2000.

**NUCAS**

FOR OFFICE FURNITURE (U.S. CLS. 2, 13, 22, 25, 32 AND 50).  
FIRST USE 6-0-2000; IN COMMERCE 6-0-2000.

2,538,657. LEXINGTON FURNITURE INDUSTRIES, INC., LEXINGTON, NC. SN 76-095,654. PUB. 5-8-2001, FILED 7-11-2000.

**SOPHIE'S ATTIC**

FOR FURNITURE (U.S. CLS. 2, 13, 22, 25, 32 AND 50).  
FIRST USE 10-0-2000; IN COMMERCE 10-0-2000.

**CLASS 21—HOUSEWARES AND GLASS**

2,538,601. ROBERT WHOLEY & CO., INC., PITTSBURGH, PA. SN 75-934,343. PUB. 12-5-2000, FILED 3-3-2000.

**BALCONY  
COOKWARE**

NO CLAIM IS MADE TO THE EXCLUSIVE RIGHT TO USE "COOKWARE", APART FROM THE MARK AS SHOWN.

FOR COOKWARE, NAMELY, POTS, PANS, CUTTING BOARDS AND KITCHEN GADGETS, NAMELY, KITCHEN LADLES, SPATULAS AND ROLLING PINS (U.S. CLS. 2, 13, 23, 29, 30, 33, 40 AND 50).  
FIRST USE 0-0-1989; IN COMMERCE 0-0-1989.

**CLASS 21—(Continued).**

2,538,648. ZEPHYR DESIGN, INC., ALAMEDA, CA. SN 76-058,508. PUB. 4-17-2001, FILED 5-30-2000.

**GOTTA HABIT**

FOR BATTERY OPERATED AND/OR ELECTRIC TOOTHBRUSHES (U.S. CLS. 2, 13, 23, 29, 30, 33, 40 AND 50).  
FIRST USE 12-14-2000; IN COMMERCE 12-14-2000.

**CLASS 25—CLOTHING**

2,538,466. WARNACO U.S., INC., BRIDGEPORT, CT, BY ASSIGNMENT WARNACO, INC., NEW YORK, NY. SN 75-424,724. PUB. 10-13-1998, FILED 1-28-1998.

**WARNER'S PURE  
BRILLIANCE**

OWNER OF U.S. REG. NOS. 50,062, 1,524,600, AND OTHERS.

FOR INTIMATE APPAREL AND FIGURE ENHANCING GARMENTS, NAMELY, BRAS, PANTIES, UNDERWEAR, UNDERPANTS, UNDERGARMENTS, UNDERCLOTHES, TEDDIES, SLIPS, SARONGS, NEGLIGES, LINGERIE, FOUNDATION GARMENTS, GIRDLES, CORSETS, CAMISOLES, BODY SLIPS AND BODY SUITS, SLEEPWEAR AND NIGHTGOWNS (U.S. CLS. 22 AND 39).  
FIRST USE 6-15-2001; IN COMMERCE 6-15-2001.

2,538,471. BOOT ROYALTY COMPANY, L.P., FORT WORTH, TX. SN 75-455,725. PUB. 11-24-1998, FILED 3-24-1998.

**J-FLEX**

FOR FOOTWEAR INSOLE AND OUTSOLE COMBINATION (U.S. CLS. 22 AND 39).  
FIRST USE 1-0-2001; IN COMMERCE 1-0-2001.

2,538,493. MOTHERS IN MOTION, INC., ROUND ROCK, TX. SN 75-575,948. PUB. 11-30-1999, FILED 10-23-1998.

**BIOENGINEERED  
PERFORMANCE SYSTEM**

NO CLAIM IS MADE TO THE EXCLUSIVE RIGHT TO USE "BIOENGINEERED" AND "SYSTEM", APART FROM THE MARK AS SHOWN.

FOR EXERCISE GARMENTS FOR EXPECTANT WOMEN, NAMELY, LEOTARDS, UNITARDS, LEGGINGS, BIKE SHORTS, RUNNING SHORTS, SHORT SHORTS, JOGGING BRAS, SWEATPANTS, T-SHIRTS, SWIMSUITS AND UNDERWEAR (U.S. CLS. 22 AND 39).  
FIRST USE 1-0-1999; IN COMMERCE 1-0-1999.

**CLASS 25—(Continued).**

2,538,499. EGGERT, WALLACE MARTIN, ST. PETERSBURG, FL. SN 75-599,339. PUB. 12-7-1999, FILED 12-3-1998.

**HOW YOU LIKE ME NOW?**

FOR MEN'S, WOMEN'S, AND CHILDREN'S WEARING APPAREL, NAMELY SHIRTS, T-SHIRTS, SWEATSHIRTS, TANKTOPS, MUSCLE SHIRTS, PANTS, JEANS, COATS, DUSTERS, VESTS, UNDERWEAR, SCARVES, BANDANNAS, TIES, CAPS, FOOTWEAR AND HEADWEAR (U.S. CLS. 22 AND 39).

FIRST USE 11-30-1998; IN COMMERCE 4-6-2000.

2,538,521. PRAK PRODUCTIONS, INC., CHAPPAQUA, NY. SN 75-686,666. PUB. 7-25-2000, FILED 4-19-1999.

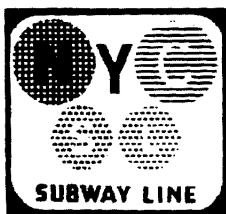

NO CLAIM IS MADE TO THE EXCLUSIVE RIGHT TO USE "NYC", APART FROM THE MARK AS SHOWN.

THE DRAWING IS LINED FOR THE COLORS YELLOW, BLUE AND GREY.

FOR MEN'S, WOMEN'S AND CHILDREN'S CLOTHING, NAMELY T-SHIRTS, SWEATSHIRTS, KNITTED SHIRTS, WOVEN SHIRTS, DENIM SHIRTS, HATS, JACKETS AND PANTS (U.S. CLS. 22 AND 39).

FIRST USE 7-0-1999; IN COMMERCE 7-0-1999.

2,538,535. KLAUS STEILMANN GMBH & CO. KG, 44867 BOCHUM-WATTENSCHIED, FED REP GERMANY. SN 75-747,233. PUB. 6-6-2000, FILED 7-9-1999.

**WOLFGANG KAISER**

THE NAME "WOLFGANG KAISER" DOES NOT IDENTIFY A LIVING INDIVIDUAL.

FOR CLOTHING FOR MEN WOMEN AND CHILDREN, NAMELY COATS, JACKETS, SUITS, PANTS, SKIRTS, BLOUSES, SHIRTS, SWEATERS AND DRESSES (U.S. CLS. 22 AND 39).

FIRST USE 8-0-1999; IN COMMERCE 8-0-1999.

**CLASS 25—(Continued).**

2,538,542. ROCKY SHOES & BOOTS, INC., NELSONVILLE, OH. SN 75-786,424. PUB. 2-29-2000, FILED 8-27-1999.

**AQUA GUARD**

FOR FOOTWEAR, NAMELY SHOES AND BOOTS (U.S. CLS. 22 AND 39).

FIRST USE 10-31-1999; IN COMMERCE 10-31-1999.

2,538,546. EAST TEXAS DISTRIBUTING INC., HOUSTON, TX. SN 75-797,004. PUB. 12-12-2000, FILED 9-10-1999.

**AUSTIN GOLF**

NO CLAIM IS MADE TO THE EXCLUSIVE RIGHT TO USE "GOLF", APART FROM THE MARK AS SHOWN.

FOR MEN'S AND WOMEN'S GOLF APPAREL, NAMELY, KNIT AND WOVEN SHIRTS, SHORTS AND PANTS, OUTERWEAR, NAMELY, NYLON JACKETS, DENIM JACKETS, CANVAS JACKETS, FLEECE VESTS, PULLOVERS AND JACKETS, RAIN JACKETS, BELTS, AND HEADWEAR (U.S. CLS. 22 AND 39).

FIRST USE 3-22-2000; IN COMMERCE 3-25-2000.

2,538,555. JEFFERY L. MILLER AND WILLIAM HINDS PARTNERSHIP, THE, HOUSTON, TX. SN 75-808,502. PUB. 5-9-2000, FILED 9-25-1999.

**TANK McNAMARA**

OWNER OF U.S. REG. NO. 1,124,020.

THE NAME IN THE MARK DOES NOT IDENTIFY A LIVING INDIVIDUAL.

FOR T-SHIRTS, SWEAT SHIRTS (U.S. CLS. 22 AND 39).

FIRST USE 1-26-2001; IN COMMERCE 1-26-2001.

2,538,571. CROCKER, MICHAEL W., BURLINGTON, MA. AND ENGEL, STEPHEN, STRATHAM, NH. SN 75-853,095. PUB. 5-30-2000, FILED 11-19-1999.

**DID THE MOUNTAIN**

FOR CLOTHING, NAMELY, SWEAT BANDS, ATHLETIC UNIFORMS, SWIMWEAR, BOOTS, UNDERWEAR, COATS, DRESSES, FOOTWEAR, BOOTS, SHOES, JACKETS, SHORTS, HATS, HEADWEAR, NECKWEAR, JEANS, PANTS, JOGGING SUITS, PAJAMAS, SHIRTS, SUITS, SOCKS, SWEAT PANTS, SWEAT SHIRTS, LEOTARDS AND LEGGINGS, GLOVES, T-SHIRTS, AND TOPS (U.S. CLS. 22 AND 39).

FIRST USE 8-22-2001; IN COMMERCE 8-22-2001.

**CLASS 25—(Continued).**

2,538,573. LINDROS, ERIC, TORONTO, ONTARIO M5N LV4, CANADA. SN 75-861,617. PUB. 8-29-2000, FILED 12-1-1999.



FOR CLOTHING, NAMELY, FOOTWEAR, ATHLETIC SHOES, ATHLETIC UNIFORMS, HEADBANDS, BATHING SUITS, BELTS, SHORTS, BOOTS, BOXER SHORTS, UNDERWEAR, COATS, VESTS, FISHING WADERS, FLIGHT SUITS, FOUL WEATHER GEAR, GOLF SHIRTS, GYM SUITS, HATS, JACKETS, JEANS, JERSEYS, JOGGING SUITS, NECKTIES, PANTS, SWEAT PANTS, RAINWEAR, SHIRTS, SWEAT SHIRTS, SOCKS, SUITS, BODY SUITS, SWEAT SUITS, WARM-UP SUITS, SUN VISORS, SWEATERS, SWIM TRUNKS, STOCKINGS, TROUSERS, AND BATHING TRUNKS (U.S. CLS. 22 AND 39).

FIRST USE 12-31-1999; IN COMMERCE 12-31-1999.

2,538,577. NATORI COMPANY INCORPORATED, THE, NEW YORK, NY. SN 75-869,652. PUB. 12-19-2000, FILED 12-13-1999.

**JOSIE**

OWNER OF U.S. REG. NOS. 1,710,136, 1,798,793, AND 1,858,186.

THE NAME "JOSIE" IDENTIFIES A LIVING INDIVIDUAL WHOSE CONSENT IS OF RECORD.

FOR SHIRTS, PANTS, JACKETS AND (U.S. CLS. 22 AND 39).

FIRST USE 0-0-1985; IN COMMERCE 0-0-1985.

2,538,613. P & A INTERNATIONAL, COSTA MESA, CA. SN 75-981,121. PUB. 3-14-2000, FILED 9-20-1999.

**DEVELOPMENT**

FOR WOMEN'S SKIRTS, DRESSES, COATS, JACKETS, PANTS, TROUSERS, KNIT TOPS, WOVEN SHIRTS AND HEADWEAR (U.S. CLS. 22 AND 39).

FIRST USE 2-1-2000; IN COMMERCE 5-1-2000.

**CLASS 25—(Continued).**

2,538,614. LION LICENSING, LTD., WILMINGTON, DE. SN 75-981,238. PUB. 12-5-2000, FILED 4-13-2000.

ANNE <sup>2</sup>KLEIN

OWNER OF U.S. REG. NOS. 1,006,943, 1,876,539, AND OTHERS.

THE STIPPLING IN THE DRAWING IS INTENDED TO REPRESENT SHADING.

THE NAME "ANNE KLEIN" IN THE MARK DOES NOT IDENTIFY A LIVING INDIVIDUAL.

FOR COATS, OVERCOATS, TRENCH COATS, RAINCOATS, ANORAKS, PARKAS, BLAZERS, JACKETS, CARDIGANS, BOLEROS, SPORT COATS, WIND RESISTANT JACKETS, FUR STOLE, SUITS, VESTS, DRESSES, EVENING GOWNS, JUMPERS, SKIRTS, PANTS, SLACKS, TROUSERS, JEANS, DUNGAREES, SWEATERS, PULLOVERS, JERSEYS, SHIRTS, FORMAL SHIRTS, BLOUSES, TUNICS, SWEATSHIRTS, T-SHIRTS, HALTER TOPS, TANK TOPS, BODYSUITS, LINGERIE, NIGHTGOWNS, NIGHT SHIRTS, NEGLIGEEES, ROBES, PAJAMAS, HANDKERCHIEFS, SCARVES, SHAWLS, NECKERCHIEFS, GLOVES, MITTENS, BELTS, SASHES, CUMMERBUNDS, HEADWEAR, FOOTWEAR (U.S. CLS. 22 AND 39).

FIRST USE 2-0-2000; IN COMMERCE 7-5-2000.

2,538,621. SIMPLY FASHION STORES, LTD., BIRMINGHAM, AL. SN 76-008,604. PUB. 12-5-2000, FILED 3-24-2000.

**SIMPLY SECRETS**

OWNER OF U.S. REG. NOS. 1,532,425, 2,065,611, AND OTHERS.

FOR CLOTHING, NAMELY BRAS, PANTIES, UNDERWEAR, UNDERPANTS, UNDERGARMENTS, UNDERCLOTHES, LINGERIE, BRIEFS, SLIPS, CAMISOLES AND SLEEPWEAR, ALL FOR WOMEN (U.S. CLS. 22 AND 39).

FIRST USE 8-0-2000; IN COMMERCE 8-0-2000.

2,538,638. JILLMERICA, LLC, PHOENIX, AZ. SN 76-036,978. PUB. 11-28-2000, FILED 4-28-2000.

**DIPUC**

FOR CLOTHING, NAMELY MEN'S AND WOMEN'S UNDERGARMENTS (U.S. CLS. 22 AND 39).

FIRST USE 7-30-2001; IN COMMERCE 7-30-2001.

**CLASS 25—(Continued).**

2,538,651. CARON, YVES MARIE, 38620 ST GEOIRE EN VALDAINE, FRANCE. AND BIBOLLET, JEAN CLAUDE, 74230 THONES, FRANCE. SN 76-065,051. PUB. 4-3-2001, FILED 6-7-2000.

**POWERCROSS**

OWNER OF FRANCE REG. NO. 99818209, DATED 10-13-1999, EXPIRES 10-13-2009.

FOR SOLES AND INNER SOLES AS A COMPONENT OF FOOTWEAR (U.S. CLS. 22 AND 39).

FIRST USE 7-0-2001; IN COMMERCE 7-0-2001.

**CLASS 27—FLOOR COVERINGS**

2,538,478. INTERFACE, INC., ATLANTA, GA. SN 75-514,265. PUB. 4-18-2000, FILED 7-7-1998.

**IDEAS IN CONTRAST**

FOR CARPETING (U.S. CLS. 19, 20, 37, 42 AND 50).  
FIRST USE 7-7-1998; IN COMMERCE 7-7-1998.

**CLASS 28—TOYS AND SPORTING GOODS**

2,538,505. SHIMANO AMERICAN CORPORATION, IRVINE, CA. SN 75-635,600. PUB. 12-7-1999, FILED 2-8-1999.

**DARTAINIUM**

FOR DRAG WASHERS SOLD AS AN INTEGRAL COMPONENT OF FISHING REELS (U.S. CLS. 22, 23, 38 AND 50).

FIRST USE 3-0-1998; IN COMMERCE 3-0-1998.

2,538,533. MATTEL, INC., EL SEGUNDO, CA. SN 75-735,073. PUB. 7-4-2000, FILED 7-15-1999.

**FRIENDSHIP CHARM**

NO CLAIM IS MADE TO THE EXCLUSIVE RIGHT TO USE "CHARM", APART FROM THE MARK AS SHOWN.

FOR TOY PLAYSETS FEATURING DOLLS, DOLL ACCESSORIES, DOLL FURNITURE AND DOLL FURNITURE ACCESSORIES (U.S. CLS. 22, 23, 38 AND 50).

FIRST USE 2-0-2000; IN COMMERCE 2-0-2000.

**CLASS 28—(Continued).**

2,538,547. SPERRY CORP., TAIPEI, TAIWAN. SN 75-798,727. PUB. 5-16-2000, FILED 9-13-1999.



FOR HAND-HELD UNIT FOR PLAYING ELECTRONIC GAMES; COIN-OPERATED STAND-ALONE VIDEO-GAME MACHINES (U.S. CLS. 22, 23, 38 AND 50).

FIRST USE 1-6-1999; IN COMMERCE 6-17-1999.

2,538,557. HONG KONG CITY TOYS FACTORY LIMITED, KOWLOON, HONG KONG. SN 75-816,619. PUB. 5-9-2000, FILED 10-7-1999.

**AMANDA**

FOR DOLLS, DOLL CLOTHING AND DOLL ACCESSORIES (U.S. CLS. 22, 23, 38 AND 50).

FIRST USE 6-21-1992; IN COMMERCE 8-1-1992.

2,538,610. LEE'S AQUARIUM & PET PRODUCTS, SAN MARCOS, CA. SN 75-941,729. PUB. 3-13-2001, FILED 3-10-2000.

**KOMET KRAWLER**

FOR PET TOYS, NAMELY, GLOW IN THE DARK EXERCISE CONTAINERS OF VARIOUS SHAPES MADE OF POLYMERIC MATERIAL (U.S. CLS. 22, 23, 38 AND 50).

FIRST USE 6-29-2000; IN COMMERCE 6-26-2001.

2,538,627. RAPID DISPLAYS, INC., CHICAGO, IL. SN 76-021,671. PUB. 12-12-2000, FILED 4-10-2000.

**SVENGALI'S ROPE ESCAPE**

NO CLAIM IS MADE TO THE EXCLUSIVE RIGHT TO USE "ROPE ESCAPE", APART FROM THE MARK AS SHOWN.

FOR MAGIC TRICKS (U.S. CLS. 22, 23, 38 AND 50).

FIRST USE 3-21-2000; IN COMMERCE 3-21-2000.

**CLASS 28—(Continued).**

2,538,628. RAPID DISPLAYS, INC., CHICAGO, IL. SN 76-021,673. PUB. 12-12-2000, FILED 4-10-2000.

**SIBERIAN POST ESCAPE**

NO CLAIM IS MADE TO THE EXCLUSIVE RIGHT TO USE "POST ESCAPE", APART FROM THE MARK AS SHOWN.

FOR MAGIC TRICKS (U.S. CLS. 22, 23, 38 AND 50).  
FIRST USE 3-21-2000; IN COMMERCE 3-21-2000.

2,538,629. ZOBMONDO ENTERTAINMENT, LLC, LOS ANGELES, CA. SN 76-025,181. PUB. 12-5-2000, FILED 4-14-2000.

**THE OUTRAGEOUS GAME OF BIZARRE CHOICES**

FOR BOARD GAMES (U.S. CLS. 22, 23, 38 AND 50).  
FIRST USE 3-0-2000; IN COMMERCE 3-0-2000.

2,538,630. ECHO TOYS LTD., TAI PO, NEW TERRITORIES, HONG KONG. SN 76-025,421. PUB. 12-5-2000, FILED 4-14-2000.

**CARBOT**

FOR RADIO-CONTROLLED TOY VEHICLES (U.S. CLS. 22, 23, 38 AND 50).  
FIRST USE 1-1-2000; IN COMMERCE 10-7-2000.

2,538,640. NORCYN, LLC, FORT WAYNE, IN. SN 76-040,718. PUB. 11-7-2000, FILED 5-4-2000.



FOR MANUALLY OPERATED EXERCISE EQUIPMENT (U.S. CLS. 22, 23, 38 AND 50).  
FIRST USE 4-11-2000; IN COMMERCE 4-11-2000.

**CLASS 28—(Continued).**

2,538,670. PETERSON, DAVID P., ORLAND PARK, IL. SN 78-025,793. PUB. 6-26-2001, FILED 9-13-2000.

**SOCCERQUET**

THE MARK CONSISTS OF THE NAME "SOCCERQUET" WITH A SOCCER BALL AS THE "O".

FOR SPORTING GOODS, NAMELY AN ACTION-TYPE TARGET GAME FOR DEVELOPING SOCCER SKILLS, CONSISTING OF SOCCER BALLS AND PLASTIC ARCHES (U.S. CLS. 22, 23, 38 AND 50).

FIRST USE 9-13-2000; IN COMMERCE 5-4-2001.

2,538,671. CALHOUN, DARLENE J., DBA CHUCKLE GAMES, ROCKLIN, CA. SN 78-026,661. PUB. 7-3-2001, FILED 9-19-2000.

**BRAINSTRAIN**

FOR BOARD GAMES (U.S. CLS. 22, 23, 38 AND 50).  
FIRST USE 9-19-2000; IN COMMERCE 2-8-0201.

**CLASS 29—MEATS AND PROCESSED FOODS**

2,538,444. ALQUIMIA MARINA S.A., GUAYAQUIL, ECUADOR. SN 74-728,427. PUB. 6-2-1998, FILED 9-13-1995.

**SEAJOY**

OWNER OF U.S. REG. NO. 1,577,958.  
FOR SEAFOOD (U.S. CL. 46).  
FIRST USE 8-0-1999; IN COMMERCE 8-20-2001.

2,538,524. CACIQUE, INC., CITY OF INDUSTRY, CA. SN 75-690,763. PUB. 8-22-2000, FILED 4-26-1999.



THE STIPLING IS A FEATURE OF THE MARK, AND DOES NOT INDICATE COLOR.  
FOR CHEESE AND SOUR CREAM (U.S. CL. 46).  
FIRST USE 2-28-1999; IN COMMERCE 2-28-1999.



**CLASS 29—(Continued).**

2,538,527. BREWSTER DAIRY, INC., BREWSTER, OH. SN 75-702,342. PUB. 12-7-1999, FILED 5-10-1999.

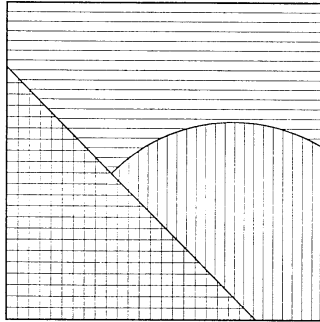

OWNER OF U.S. REG. NO. 1,342,944.  
THE MARK IS LINED FOR THE COLORS YELLOW, BLUE AND RED.  
FOR CHEESE AND CHEESE FOOD (U.S. CL. 46).  
FIRST USE 10-1-1998; IN COMMERCE 10-1-1998.

2,538,644. LAMB-WESTON, INC., KENNEWICK, WA. SN 76-049,447. PUB. 5-22-2001, FILED 5-17-2000.

**FLAMETHROWER FRIES**

NO CLAIM IS MADE TO THE EXCLUSIVE RIGHT TO USE "FRIES", APART FROM THE MARK AS SHOWN.  
FOR FROZEN VEGETABLES (U.S. CL. 46).  
FIRST USE 5-24-2001; IN COMMERCE 5-31-2001.

**CLASS 30—STAPLE FOODS**

2,538,498. FIELDBROOK FARMS, INC., DUNKIRK, NY. SN 75-598,530. PUB. 8-24-1999, FILED 12-3-1998.

**FIELDBROOK FARMS**

NO CLAIM IS MADE TO THE EXCLUSIVE RIGHT TO USE "FARMS", APART FROM THE MARK AS SHOWN.  
FOR FROZEN CONFECTIONS, NAMELY, ICE CREAM, ICE CREAM NOVELTIES, FROZEN YOGURT, FLAVORED ICE POPS; FROZEN JUICE BARS, PUD-  
DING AND FRUIT BARS (U.S. CL. 46).  
FIRST USE 6-15-2001; IN COMMERCE 6-15-2001.

**CLASS 30—(Continued).**

2,538,539. CHOCOLATES GAROTO S.A., ESPIRITO SANTO, BRAZIL. SN 75-761,067. PUB. 11-14-2000, FILED 7-26-1999.

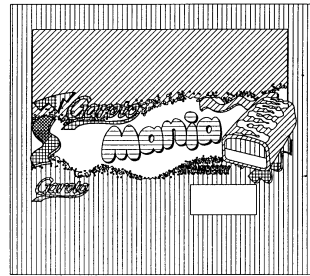

OWNER OF U.S. REG. NOS. 1,226,096, 1,826,510, AND OTHERS.  
NO CLAIM IS MADE TO THE EXCLUSIVE RIGHT TO USE "STRAWBERRY", APART FROM THE MARK AS SHOWN.  
THE MARK IS LINED FOR THE COLORS RED, PINK, ORANGE, YELLOW, BLUE, AND BROWN.  
THE ENGLISH TRANSLATION OF "GAROTO" IS "BOY" OR "KID".  
FOR CHOCOLATES (U.S. CL. 46).  
FIRST USE 8-0-1999; IN COMMERCE 8-0-1999.

2,538,643. HARBOR SWEETS, INC., SALEM, MA. SN 76-049,386. PUB. 3-6-2001, FILED 5-5-2000.

**FOX TROT**

FOR CANDY (U.S. CL. 46).  
FIRST USE 9-15-2000; IN COMMERCE 9-15-2000.

2,538,645. GONZALEZ AND TAPANES FOODS, INC., NORTH BERGEN, NJ. SN 76-052,750. PUB. 2-27-2001, FILED 5-22-2000.

**ROA**

FOR RICE (U.S. CL. 46).  
FIRST USE 3-1-2001; IN COMMERCE 3-1-2001.

**CLASS 30—(Continued).**

2,538,664. ARNETT, JAMES A., DULUTH, GA. SN 78-015,733.  
PUB. 1-9-2001, FILED 7-6-2000.

**SMACK YO MAMA**  
**AWESOME**

**BARBECUE SAUCE**  
**THE TASTE THAT'S IN YOUR FACE!**

NO CLAIM IS MADE TO THE EXCLUSIVE RIGHT TO USE "BARBECUE SAUCE", APART FROM THE MARK AS SHOWN.

FOR BARBECUE SAUCE (U.S. CL. 46).  
FIRST USE 3-25-1997; IN COMMERCE 3-27-2000.

**CLASS 31—NATURAL AGRICULTURAL PRODUCTS**

2,538,492. NUTRO PRODUCTS, INC., CITY OF INDUSTRY, CA. SN 75-571,174. PUB. 7-6-1999, FILED 10-15-1998.

**BETTER HEALTH**  
**THROUGH BETTER**  
**NUTRITION**

FOR PET FOODS (U.S. CLS. 1 AND 46).  
FIRST USE 8-0-1999; IN COMMERCE 8-0-1999.

**CLASS 32—LIGHT BEVERAGES**

2,538,448. MILLEA, JAMES S., JR., RENSSELAER, NY. AND GUPTILL, WILLIAM R., MACHIAS, ME. SN 75-181,353. PUB. 2-10-1998, FILED 10-15-1996.

**MAINE WOODS**

NO CLAIM IS MADE TO THE EXCLUSIVE RIGHT TO USE "MAINE", APART FROM THE MARK AS SHOWN.

FOR BOTTLED SPRING WATER (U.S. CLS. 45, 46 AND 48).  
FIRST USE 3-17-2001; IN COMMERCE 3-17-2001.

2,538,490. PAINT ROCK ARTESIAN WATER, INC., WORLAND, WY. SN 75-562,649. PUB. 6-8-1999, FILED 9-30-1998.

**REVITA**

FOR NATURAL SPRING WATER AND DRINKING WATER (U.S. CLS. 45, 46 AND 48).  
FIRST USE 8-22-2001; IN COMMERCE 8-22-2001.

**CLASS 32—(Continued).**

2,538,491. NEKTA INTERNATIONAL LIMITED, MT WELLINGTON, AUCKLAND, NEW ZEALAND. SN 75-568,103. PUB. 5-23-2000, FILED 10-8-1998.

**NEKTA**

OWNER OF U.S. REG. NOS. 2,058,513, 2,133,435, AND 2,164,198.

FOR FRUIT DRINKS AND FRUIT FLAVORED SOFT DRINKS; FRUIT DRINKS AND FRUIT FLAVORED SOFT DRINKS CONTAINING ADDED VITAMINS, MINERALS, NUTRIENTS AND/OR HERBS; SMOOTHIES; PARTIALLY FROZEN SLUSH-TYPE FRUIT DRINKS AND SOFT DRINKS; ISOTONIC DRINKS AND SPORTS DRINKS (U.S. CLS. 45, 46 AND 48).

FIRST USE 5-0-1997; IN COMMERCE 5-0-1998.

2,538,514. SIMPLY FOOD DISTRIBUTORS, INC., BROOKLYN, NY. SN 75-662,469. PUB. 10-5-1999, FILED 3-18-1999.

**PINE GROVE**

FOR BOTTLED SPRING WATER (U.S. CLS. 45, 46 AND 48).

FIRST USE 5-4-1999; IN COMMERCE 5-4-1999.

**CLASS 33—WINES AND SPIRITS**

2,538,583. EAST-SIDE WINERY, LODI, CA. SN 75-882,749. PUB. 12-12-2000, FILED 12-28-1999.

**SILK OAK ESTATE**  
**VINEYARDS**

NO CLAIM IS MADE TO THE EXCLUSIVE RIGHT TO USE "VINEYARDS", APART FROM THE MARK AS SHOWN.

FOR WINES (U.S. CLS. 47 AND 49).  
FIRST USE 4-6-2000; IN COMMERCE 6-6-2000.

**SERVICE MARKS**

**CLASS 35—ADVERTISING AND BUSINESS**

2,538,453. HOME BUYER'S FAIR, INC., SCOTTSDALE, AZ. SN 75-230,258. PUB. 10-12-1999, FILED 1-23-1997.

**THE MOVING ON CONTEST**

NO CLAIM IS MADE TO THE EXCLUSIVE RIGHT TO USE "CONTEST", APART FROM THE MARK AS SHOWN.

FOR PROMOTING VIA GLOBAL COMPUTER INFORMATION NETWORK THE GOODS AND SERVICES OF OTHERS BY CONDUCTING PERIODIC SWEEPSTAKES CONTESTS DIRECTED TO CONSUMERS INTERESTED IN RELOCATING THEIR RESIDENCES (U.S. CLS. 100, 101 AND 102).

FIRST USE 0-0-1998; IN COMMERCE 0-0-1998.

**CLASS 35—(Continued).**

2,538,459. BRIERLEY, HAROLD, DALLAS, TX, BY ASSIGNMENT TARGETED MARKETING SYSTEMS, INC., DALLAS, TX. SN 75-351,865. PUB. 4-6-1999, FILED 9-4-1997.

**E-LATIONSHIP**

FOR PROMOTING THE GOODS AND SERVICES OF OTHERS THROUGH LOYALTY REWARDS PROGRAMS TO EARN AND/OR REDEEM MILES, POINTS OR OTHER PROGRAM CURRENCY FOR MERCHANDISE OR SERVICES VIA A GLOBAL COMPUTER INFORMATION NETWORK AND INTERACTIVE TELEVISION (U.S. CLS. 100, 101 AND 102).  
FIRST USE 7-23-1999; IN COMMERCE 7-23-1999.

2,538,470. EYEWEB, INC., NEW YORK, NY, BY ASSIGNMENT PF HOLDING, INC, NEW YORK, NY. SN 75-438,878. PUB. 12-28-1999, FILED 2-23-1998.

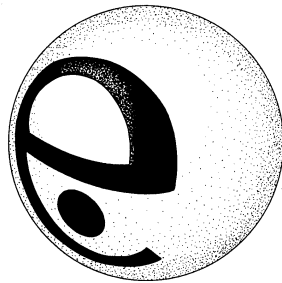
**EYEWEB**

FOR COMPUTERIZED ON-LINE RETAIL SERVICES IN THE FIELD OF COSMETICS AND JEWELRY (U.S. CLS. 100, 101 AND 102).  
FIRST USE 8-0-1999; IN COMMERCE 8-0-1999.

2,538,496. TRIAD HOSPITALS HOLDINGS, INC., DALLAS, TX. SN 75-594,616. PUB. 6-20-2000, FILED 11-23-1998.

**TRIAD HOSPITALS**

NO CLAIM IS MADE TO THE EXCLUSIVE RIGHT TO USE "HOSPITALS", APART FROM THE MARK AS SHOWN. FOR MANAGEMENT OF HOSPITALS AND OTHER HEALTH CARE PROVIDER INSTITUTIONS (U.S. CLS. 100, 101 AND 102).  
FIRST USE 5-11-1999; IN COMMERCE 5-11-1999.

**CLASS 35—(Continued).**

2,538,500. BRANDOW COMPANY, INC., CAMP HILL, PA. SN 75-602,610. PUB. 10-12-1999, FILED 12-10-1998.

**BIZMINER**

FOR BUSINESS CONSULTATION AND RESEARCH (U.S. CLS. 100, 101 AND 102).  
FIRST USE 10-7-1998; IN COMMERCE 10-7-1998.

2,538,551. O'FARRELL, EDWARD, NEW YORK, NY. SN 75-804,677. PUB. 3-14-2000, FILED 9-21-1999.

**10AFTER.COM**

FOR BUSINESS SERVICES IN THE FIELD OF NEW PRODUCT PROMOTIONS AND DEMONSTRATIONS (U.S. CLS. 100, 101 AND 102).  
FIRST USE 2-28-2000; IN COMMERCE 2-28-2000.

2,538,553. ICSO MALLS, LLC, MUSKEGO, WI. SN 75-806,846. PUB. 1-2-2001, FILED 9-23-1999.



FOR ON-LINE COMMERCE SERVICES, NAMELY, PROMOTING THE GOODS AND SERVICES OF OTHERS THROUGH ADVERTISEMENTS AND LISTINGS OF RETAIL STORES AND THEIR GOODS, AND SERVICE PROVIDERS AND THEIR SERVICES, VIA THE INTERNET; AND ON-LINE RETAIL AND DEPARTMENT STORE SERVICES FEATURING SPORTING GOODS, FURNITURE, MATTRESSES AND BOX SPRINGS, FUTONS, HOME APPLIANCES, GIFTS, HOME DECORATING PRODUCTS, CLOCKS, WATCHES, WATCHBANDS, SUNGLASSES, WALLETTS AND LEATHER ACCESSORIES, PURSES, BACKPACKS, TOYS AND PLUSH ANIMALS, MUSICAL INSTRUMENTS, KNIVES AND CUTLERY, NOTECARDS AND STATIONERY, GROCERIES AND SPECIALTY FOODS, BEER AND LIQUOR, WINE AND WINE FLASKS, ARTWORK, BOOKS, PRE-RECORDED MUSIC, CLOTHING AND SHOES, OFFICE SUPPLIES, COMPUTER HARDWARE AND SOFTWARE, PETS AND PET SUPPLIES, CUT FLOWERS AND LIVE PLANTS, FLORAL ARRANGEMENTS, TELEPHONES, AND MOTORCYCLES (U.S. CLS. 100, 101 AND 102).  
FIRST USE 11-18-1999; IN COMMERCE 11-18-1999.

2,538,567. MANAGEMENT RECRUITERS INTERNATIONAL, INC., CLEVELAND, OH. SN 75-849,854. PUB. 8-8-2000, FILED 11-16-1999.

**BANISTER INTERNATIONAL**

NO CLAIM IS MADE TO THE EXCLUSIVE RIGHT TO

**CLASS 35—(Continued).**

USE "INTERNATIONAL", APART FROM THE MARK AS SHOWN.

FOR EMPLOYMENT AGENCY SERVICES (U.S. CLS. 100, 101 AND 102).  
FIRST USE 8-1-1999; IN COMMERCE 8-1-1999.

---

2,538,578. VIBA FIMA, INC., BUFFALO GROVE, IL. SN 75-876,733. PUB. 2-13-2001, FILED 12-21-1999.

**BAZAH!**

FOR PROVIDING GENERAL COMMERCIAL INFORMATION AND DIRECTORY SERVICES WITHIN SPECIFIC LOCAL GEOGRAPHIC AREAS VIA A GLOBAL COMPUTER INFORMATION NETWORK (U.S. CLS. 100, 101 AND 102).

FIRST USE 7-4-2001; IN COMMERCE 7-4-2001.

---

2,538,579. VIBA FIMA, INC., BUFFALO GROVE, IL. SN 75-876,799. PUB. 1-30-2001, FILED 12-21-1999.

**PERCSUITE**

FOR PROVIDING GENERAL COMMERCIAL INFORMATION AND DIRECTORY SERVICES WITHIN SPECIFIC LOCAL GEOGRAPHIC AREAS VIA A GLOBAL COMPUTER INFORMATION NETWORK (U.S. CLS. 100, 101 AND 102).

FIRST USE 7-4-2001; IN COMMERCE 7-4-2001.

---

2,538,580. VIBA FIMA, INC., BUFFALO GROVE, IL. SN 75-876,976. PUB. 1-30-2001, FILED 12-21-1999.

**FENZPOST**

FOR PROVIDING GENERAL COMMERCIAL INFORMATION AND DIRECTORY SERVICES WITHIN SPECIFIC LOCAL GEOGRAPHIC AREAS VIA A GLOBAL COMPUTER INFORMATION NETWORK (U.S. CLS. 100, 101 AND 102).

FIRST USE 7-4-2001; IN COMMERCE 7-4-2001.

---

2,538,588. MATHEWS & CLARK COMMUNICATIONS, INC., REDWOOD CITY, CA. SN 75-902,850. PUB. 11-7-2000, FILED 1-24-2000.

**POSITIO**

FOR PUBLIC RELATION SERVICES (U.S. CLS. 100, 101 AND 102).

FIRST USE 7-11-2000; IN COMMERCE 7-11-2000.

**CLASS 35—(Continued).**

2,538,593. LAPODIS, INC., NEW YORK, NY, BY ASSIGNMENT DECORATION.COM, NEW YORK, NY. SN 75-910,920. PUB. 12-26-2000, FILED 2-5-2000.

the  
e@world  
of style

FOR INTERNET MARKETING AND PROMOTION OF HOME DECORATING ITEMS OF OTHERS (U.S. CLS. 100, 101 AND 102).

FIRST USE 2-12-2001; IN COMMERCE 2-12-2001.

---

2,538,596. NEXTMED SYSTEMS, INC., CLEVELAND, OH. SN 75-921,719. PUB. 12-26-2000, FILED 2-17-2000.

**NEXTMED**

FOR BUSINESS MANAGEMENT SERVICES, NAMELY, MEDICAL PRACTICE MANAGEMENT SERVICES VIA AN INTRANET COMPUTER NETWORK AND GLOBAL COMPUTER NETWORKS (U.S. CLS. 100, 101 AND 102).

FIRST USE 2-22-2000; IN COMMERCE 2-22-2000.

---

2,538,626. CAROUSEL FARMS, L.L.C., MARCUS, IA. SN 76-020,799. PUB. 11-28-2000, FILED 4-3-2000.

**VIRTUAL FREEZER**

FOR RETAIL STORE SERVICES, AVAILABLE THROUGH COMPUTER COMMUNICATIONS AND INTERACTIVE TELEVISION FEATURING MEAT (U.S. CLS. 100, 101 AND 102).

FIRST USE 8-20-2000; IN COMMERCE 7-6-2001.

---

2,538,641. USC CONSULTING GROUP, LLC, BROOMALL, PA. SN 76-043,821. PUB. 5-8-2001, FILED 5-8-2000.

**DELTASCAN**

FOR BUSINESS MANAGEMENT CONSULTATION SERVICES (U.S. CLS. 100, 101 AND 102).

FIRST USE 4-1-2000; IN COMMERCE 5-15-2000.

**CLASS 36—INSURANCE AND FINANCIAL**

**CLASS 36—(Continued).**

2,538,465. BANK OF AMERICA CORPORATION, CHARLOTTE, NC, BY MERGER; BY MERGER, BY CHANGE OF NAME; BY CHANGE OF NAME NATIONSBANK CORPORATION, CHARLOTTE, NC. SN 75-415,111. PUB. 9-15-1998, FILED 1-8-1998.

**ROARS**

FOR BANKING SERVICES, FINANCIAL MANAGEMENT, INVESTMENT BROKERAGE AND INVESTMENT ADVICE (U.S. CLS. 100, 101 AND 102).  
FIRST USE 6-16-1998; IN COMMERCE 6-16-1998.

2,538,469. CREDIT BUREAU OF GREATER GREENSBORO, DBA CREDIT BUREAU INFORMATION SERVICES, GREENSBORO, NC. SN 75-437,143. PUB. 8-1-2000, FILED 2-19-1998.

**RENTFACTS**

FOR INFORMATION SERVICES, NAMELY PROVIDING INFORMATION TO APARTMENT OWNERS ABOUT POTENTIAL RENTERS (U.S. CLS. 100, 101 AND 102).  
FIRST USE 6-25-2001; IN COMMERCE 6-25-2001.

2,538,472. ATLANTIC CAPITAL MANAGEMENT, L.L.C., RICHMOND, VA. SN 75-464,527. PUB. 5-22-2001, FILED 4-8-1998.



ATLANTIC CAPITAL MANAGEMENT, LLC

NO CLAIM IS MADE TO THE EXCLUSIVE RIGHT TO USE "CAPITAL MANAGEMENT, LLC", APART FROM THE MARK AS SHOWN.

FOR INVESTMENT ADVISORY SERVICES (U.S. CLS. 100, 101 AND 102).  
FIRST USE 3-0-1998; IN COMMERCE 3-0-1998.

**CLASS 36—(Continued).**

2,538,479. AMERICAN RE-INSURANCE COMPANY, PRINCETON, NJ. SN 75-520,616. PUB. 10-24-2000, FILED 7-17-1998.

**A WORLD OF SERVICES  
UNDER ONE REMARKABLE  
ROOF**

OWNER OF U.S. REG. NOS. 1,795,249 AND 1,911,768.  
FOR RISK MANAGEMENT SERVICES; AND CAPTIVE RISK RETENTION MANAGEMENT SERVICES; REINSURANCE INTERMEDIARY SERVICES, NAMELY, PLACEMENT OF TREATY AND FACULTATIVE REINSURANCE, PROPERTY CATASTROPHE EXPOSURE ANALYSIS, MASSIVE INJURY CLAIM MANAGEMENT, RUN-OFF INSURANCE CLAIM HANDLING, INSURANCE AND REINSURANCE UNDERWRITING, RISK ANALYSIS, AND ACTUARIAL AND INSURANCE CONTRACT EVALUATION SERVICES; INSURANCE AND REINSURANCE BROKERAGE; INSURANCE SERVICES, NAMELY, RISK MANAGEMENT ANALYSIS AND CONSULTING SERVICES, ALTERNATIVE FUNDING CONSULTING SERVICES, INSURANCE BROKERAGE SERVICES, INSURANCE CONSULTING SERVICES, SELF-INSURANCE CONSULTING SERVICES, AND TAX AND INSURANCE CONTRACT EVALUATION (U.S. CLS. 100, 101 AND 102).  
FIRST USE 8-31-1998; IN COMMERCE 8-31-1998.

2,538,513. INSTIPRO, INC., NORTHBROOK, IL. SN 75-661,619. PUB. 12-28-1999, FILED 3-16-1999.

**INSTIPRO**

FOR BROKERAGE SERVICES FEATURING SECURITIES, OPTIONS AND FUTURE CONTRACTS (U.S. CLS. 100, 101 AND 102).  
FIRST USE 1-1-2001; IN COMMERCE 1-1-2001.

2,538,552. EXPERIAN INFORMATION SOLUTIONS, INC., ORANGE, CA. SN 75-804,881. PUB. 10-31-2000, FILED 9-21-1999.

**DETECT**

FOR FINANCIAL AND CREDIT INFORMATION PROVIDED BY ELECTRONIC MEANS; CREDIT INQUIRY AND CONSULTATION; FINANCIAL ANALYSIS AND CONSULTATION; COMPUTER SERVICES, NAMELY, PROVIDING A COMPUTER DATABASE CONTAINING INFORMATION CONCERNING COMPUTERIZED PRINT AND DATA SELECTION, ARRANGEMENT, PRESENTATION AND DISTRIBUTION IN THE FIELD OF EVALUATION OF RISK FACTORS IN APPLICATIONS FOR CREDIT; PROVIDING AN INTERACTIVE COMPUTER DATABASE IN THE FIELD OF EVALUATION OF RISK FACTORS IN APPLICATIONS FOR CREDIT; AND COMPUTER SERVICES, NAMELY, PROVIDING A COMPUTER DATABASE IN THE FIELD OF EVALUATION OF RISK FACTORS IN APPLICATIONS FOR CREDIT; COMPUTER SERVICES, NAMELY, PROVIDING ONLINE ACCESS TO DATABASE CONTAINING INFORMATION IN THE FIELD OF EVALUATION OF RISK FACTORS IN APPLICATIONS FOR CREDIT (U.S. CLS. 100, 101 AND 102).  
FIRST USE 3-28-2000; IN COMMERCE 3-28-2000.

**CLASS 36—(Continued).**

2,538,554. BEAR BRAND RANCH CO., NEWPORT BEACH, CA. SN 75-807,389. PUB. 12-12-2000, FILED 9-27-1999.

**THE YACHT CHANNEL**

NO CLAIM IS MADE TO THE EXCLUSIVE RIGHT TO USE "YACHT", APART FROM THE MARK AS SHOWN. FOR YACHT AND YACHT ACCESSORIES BROKERAGE SERVICES (U.S. CLS. 100, 101 AND 102). FIRST USE 12-0-1998; IN COMMERCE 12-0-1998.

2,538,608. DISTRICT BOARD OF TRUSTEES, MIAMI-DADE COMMUNITY COLLEGE, THE, MIAMI, FL. SN 75-941,106. PUB. 11-28-2000, FILED 3-10-2000.

**M-DCCARD**

FOR DIRECT DEPOSIT SERVICES, NAMELY ELECTRONIC DISBURSEMENT OF FINANCIAL AID AWARDS, STUDENT PAYROLL, AND EMPLOYEE PAYROLL DIRECTLY INTO BANK ACCOUNTS, VIA AN INTEGRATED CIRCUIT CHIP CARD (U.S. CLS. 100, 101 AND 102). FIRST USE 10-8-1999; IN COMMERCE 10-8-1999.

2,538,649. COMMERCEFIRST BANCORP, INC., ANNAPOLIS, MD. SN 76-060,144. PUB. 4-3-2001, FILED 5-30-2000.



THE LINING IS A FEATURE OF THE MARK AND DOES NOT INDICATE COLOR. FOR BANKING (U.S. CLS. 100, 101 AND 102). FIRST USE 6-30-2000; IN COMMERCE 6-30-2000.

**CLASS 37—CONSTRUCTION AND REPAIR**

2,538,518. JG NORTH RALEIGH L.L.C., CLEVELAND, OH. SN 75-672,645. PUB. 12-19-2000, FILED 4-1-1999.

**TRIANGLE TOWN CENTER**

NO CLAIM IS MADE TO THE EXCLUSIVE RIGHT TO USE "TOWN CENTER", APART FROM THE MARK AS SHOWN. FOR REAL ESTATE DEVELOPMENT SERVICES (U.S. CLS. 100, 103 AND 106). FIRST USE 5-31-2001; IN COMMERCE 5-31-2001.

**CLASS 37—(Continued).**

2,538,587. JDC ELECTRIC, INC., SAN FRANCISCO, CA. SN 75-899,187. PUB. 3-20-2001, FILED 1-18-2000.



NO CLAIM IS MADE TO THE EXCLUSIVE RIGHT TO USE "ELECTRIC", APART FROM THE MARK AS SHOWN. FOR ELECTRICAL CONTRACTING SERVICES (U.S. CLS. 100, 103 AND 106). FIRST USE 1-0-1995; IN COMMERCE 1-0-1999.

**CLASS 38—COMMUNICATION**

2,538,597. TRAIL BLAZERS INC., PORTLAND, OR. SN 75-928,405. PUB. 11-21-2000, FILED 2-25-2000.

**RIPCITY**

FOR PROVIDING ACCESS TO A GLOBAL COMMUNICATIONS NETWORK, WIDE-AREA NETWORK(S) AND/OR LOCAL AREA NETWORK(S); TELEVISION, RADIO, CABLE TELEVISION AND SATELLITE BROADCASTING SERVICES; DIGITAL AND ELECTRONIC MESSAGING SERVICES; ELECTRONIC MAIL SERVICES; COMPUTER BULLETIN BOARD SERVICES IN THE FIELD OF SPORTS AND ENTERTAINMENT (U.S. CLS. 100, 101 AND 104). FIRST USE 12-1-1999; IN COMMERCE 12-1-1999.

2,538,634. AT&T CORP., NEW YORK, NY. SN 76-034,387. PUB. 12-26-2000, FILED 4-25-2000.

**WIRELESS FROM AT&T.  
YOUR WORLD. CLOSE AT  
HAND.**

FOR WIRELESS ELECTRONIC TRANSMISSION OF VOICE, DATA, FACSIMILE AND WIRELESS ACCESS TO GLOBAL COMPUTER NETWORKS (U.S. CLS. 100, 101 AND 104). FIRST USE 3-0-2000; IN COMMERCE 3-0-2000.

**CLASS 39—TRANSPORTATION AND STORAGE**

**CLASS 39—(Continued).**

2,538,447. TALKING CAR, INC., CHICAGO, IL. SN 75-129,048. PUB. 10-28-1997, FILED 7-2-1996.

**CARS TALK, WHEELS WALK.**

FOR INFORMATION SERVICES, NAMELY, PROVIDING ENCODED DATA PERTAINING TO CARS TO AUTOMOBILE DEALERS (U.S. CLS. 100 AND 105).  
FIRST USE 7-18-2000; IN COMMERCE 7-18-2000.

2,538,481. PETROLEUM HEAT & POWER CO., INC., STAMFORD, CT. SN 75-525,853. PUB. 10-19-1999, FILED 7-27-1998.

**OIL DIRECT GET THAT WARM FEELING FOR LESS.**

FOR DELIVERY OF RESIDENTIAL HOME HEATING OIL BY TRUCK (U.S. CLS. 100 AND 105).  
FIRST USE 8-0-1998; IN COMMERCE 7-0-1999.

**CLASS 41—EDUCATION AND ENTERTAINMENT**

2,538,475. ODS TECHNOLOGIES, L.P., BROOMFIELD, CO. SN 75-466,905. PUB. 5-2-2000, FILED 4-13-1998.

**RACENIGHT**

FOR ENTERTAINMENT SERVICES, NAMELY, AN INTERACTIVE ONGOING TELEVISION PROGRAM IN THE FIELD OF ANIMAL RACING (U.S. CLS. 100, 101 AND 107).  
FIRST USE 11-1-2000; IN COMMERCE 11-1-2000.

2,538,477. KGS INC., BROWNSBURG, IN. SN 75-511,385. PUB. 8-17-1999, FILED 6-29-1998.

**GET OVER IT!**

FOR CONDUCTING WORKSHOPS AND SEMINARS IN THE FIELD OF SELF-HELP, SELF-ASSURANCE, ORGANIZATIONAL CHANGE, AND MOTIVATION (U.S. CLS. 100, 101 AND 107).  
FIRST USE 6-1-1998; IN COMMERCE 6-1-1998.

**CLASS 41—(Continued).**

2,538,550. BLACK ENTERTAINMENT TELEVISION, INC., WASHINGTON, DC. SN 75-803,792. PUB. 11-28-2000, FILED 9-17-1999.

**RAP CITY: THA BASSMENT**

OWNER OF U.S. REG. NO. 1,653,933.  
FOR ENTERTAINMENT SERVICES IN THE NATURE OF ON-GOING TELEVISION PROGRAMS IN THE FIELD OF MUSIC (U.S. CLS. 100, 101 AND 107).  
FIRST USE 8-1-1999; IN COMMERCE 8-1-1999.

2,538,562. PAULSTARR ENTERPRISES, INC., CHANHASSEN, MN. SN 75-822,304. PUB. 8-1-2000, FILED 10-13-1999.

**COVERALL MUSIC**

NO CLAIM IS MADE TO THE EXCLUSIVE RIGHT TO USE "MUSIC", APART FROM THE MARK AS SHOWN.  
FOR PRODUCTION OF MUSICAL RECORDINGS (U.S. CLS. 100, 101 AND 107).  
FIRST USE 10-0-1999; IN COMMERCE 10-0-1999.

2,538,576. LIFEWAY CHRISTIAN RESOURCES OF THE SOUTHERN BAPTIST CONVENTION, NASHVILLE, TN, BY CHANGE OF NAME SUNDAY SCHOOL BOARD OF THE SOUTHERN BAPTIST CONVENTION, THE, NASHVILLE, TN. SN 75-866,992. PUB. 11-7-2000, FILED 12-8-1999.



NO CLAIM IS MADE TO THE EXCLUSIVE RIGHT TO USE "CONFERENCE CENTER", APART FROM THE MARK AS SHOWN.

FOR ARRANGING AND CONDUCTING EDUCATIONAL AND RELIGIOUS CONFERENCES, SEMINARS AND WORKSHOPS IN THE FIELD OF RELIGION (U.S. CLS. 100, 101 AND 107).  
FIRST USE 5-15-2000; IN COMMERCE 5-15-2000.

**CLASS 41—(Continued).**

2,538,598. TRAIL BLAZERS INC., PORTLAND, OR. SN 75-928,469. PUB. 12-12-2000, FILED 2-25-2000.

**RIPCITYONLINE**

NO CLAIM IS MADE TO THE EXCLUSIVE RIGHT TO USE "ONLINE", APART FROM THE MARK AS SHOWN.

FOR ENTERTAINMENT SERVICES, NAMELY, BASKETBALL GAMES AND EXHIBITIONS RENDERED LIVE AND THROUGH THE MEDIA OF RADIO, TELEVISION, CABLE TELEVISION AND SATELLITE BROADCASTS, AND VIA ONLINE MEANS VIA A GLOBAL COMMUNICATIONS NETWORK; PRODUCTION OF TELEVISION, RADIO AND CABLE TELEVISION PROGRAMMING; SPORTS AND ENTERTAINMENT INFORMATION PROVIDED BY ELECTRONIC MEANS; PROVIDING FACILITIES FOR SPORTING EVENTS, EXHIBITIONS, CONCERTS, AND OTHER FORMS OF PUBLIC ENTERTAINMENT OF OTHERS; PROVIDING INFORMATION SERVICES VIA A GLOBAL COMPUTER NETWORK, WIDE AREA NETWORKS AND LOCAL AREA NETWORKS IN THE FIELDS OF ENTERTAINMENT AND SPORTS (U.S. CLS. 100, 101 AND 107).

FIRST USE 12-1-1999; IN COMMERCE 12-1-1999.

---

2,538,631. SCRIPPS NETWORKS, INC., KNOXVILLE, TN, BY ASSIGNMENT SCRIPPS HOWARD BROADCASTING COMPANY, DBA HOME & GARDEN TELEVISION, KNOXVILLE, TN. SN 76-027,344. PUB. 12-12-2000, FILED 4-17-2000.

**OUR PLACE**

FOR ENTERTAINMENT SERVICES, NAMELY, A TELEVISION SERIES FEATURING INTERIOR DESIGN, HOME RENOVATION AND DECORATING IDEAS (U.S. CLS. 100, 101 AND 107).

FIRST USE 10-2-2000; IN COMMERCE 10-2-2000.

---

2,538,632. SCRIPPS NETWORKS, INC., KNOXVILLE, TN, BY ASSIGNMENT SCRIPPS HOWARD BROADCASTING COMPANY, DBA HOME & GARDEN TELEVISION, KNOXVILLE, TN. SN 76-027,345. PUB. 12-12-2000, FILED 4-17-2000.

**WEEKEND WARRIORS**

FOR ENTERTAINMENT SERVICES, NAMELY, A TELEVISION SERIES FEATURING INTERIOR DESIGN HOME RENOVATION AND DECORATING IDEAS (U.S. CLS. 100, 101 AND 107).

FIRST USE 10-3-2000; IN COMMERCE 10-3-2000.

**CLASS 41—(Continued).**

2,538,642. UNIVERSITY OF THE INCARNATE WORD, SAN ANTONIO, TX. SN 76-047,442. PUB. 11-28-2000, FILED 5-12-2000.

**BRAINPOWER ONLINE**

NO CLAIM IS MADE TO THE EXCLUSIVE RIGHT TO USE "ONLINE", APART FROM THE MARK AS SHOWN.

FOR EDUCATIONAL SERVICES, NAMELY, PROVIDING COURSES OF INSTRUCTION AT THE COLLEGE LEVEL (U.S. CLS. 100, 101 AND 107).

FIRST USE 8-17-2001; IN COMMERCE 8-17-2001.

---

2,538,660. ADVANCE MAGAZINE PUBLISHERS INC., NEW YORK, NY. SN 76-112,592. PUB. 5-22-2001, FILED 8-21-2000.

**PARADE CLASSROOM**

OWNER OF U.S. REG. NO. 508,181 AND OTHERS.

NO CLAIM IS MADE TO THE EXCLUSIVE RIGHT TO USE "CLASSROOM", APART FROM THE MARK AS SHOWN.

FOR EDUCATIONAL SERVICES, NAMELY DEVELOPMENT AND DISSEMINATION OF EDUCATIONAL MATERIALS FOR OTHERS FOR USE IN CONNECTION WITH TEACHING SECONDARY-SCHOOL-AGE CHILDREN, NAMELY TEACHERS GUIDES, LESSON PLANS AND OTHER PRINTED MATERIALS (U.S. CLS. 100, 101 AND 107).

FIRST USE 9-1-2000; IN COMMERCE 9-1-2000.

---

2,538,665. KOHN, JOEL, M. SAN FRANCISCO, CA. SN 78-016,490. PUB. 4-10-2001, FILED 7-12-2000.

**TRADER KID**

FOR ENTERTAINMENT SERVICES, NAMELY, LIVE MUSICAL PERFORMANCES (U.S. CLS. 100, 101 AND 107).

FIRST USE 10-20-2000; IN COMMERCE 10-20-2000.

**CLASS 42—SCIENTIFIC, COMPUTER AND LEGAL SERVICES**

---

2,538,446. GENE LOGIC, INC., NEW HAVEN, CT. SN 75-069,997. PUB. 1-6-1998, FILED 3-11-1996.

**READS**

FOR TECHNICAL RESEARCH AND CONSULTING SERVICES IN THE FIELD OF GENETIC ANALYSIS, USING A SCIENTIFIC TECHNIQUE FOR RAPID IDENTIFICATION OF QUALITATIVE AND QUANTITATIVE GENE EXPRESSION PROFILES (U.S. CLS. 100 AND 101).

FIRST USE 5-27-1997; IN COMMERCE 5-27-1997.



**CLASS 42—(Continued).**

2,538,461. FANCY PUBLICATIONS, INC., LOS ANGELES, CA. SN 75-383,358. PUB. 6-30-1998, FILED 11-3-1997.

**PET HEALTH NEWS**

OWNER OF U.S. REG. NO. 1,725,546.  
NO CLAIM IS MADE TO THE EXCLUSIVE RIGHT TO USE "NEWS", APART FROM THE MARK AS SHOWN. SEC. 2(F).

FOR COMPUTER SERVICES, NAMELY, OFFERING AN ON LINE MAGAZINE AND INFORMATION RELATING TO PET CARE (U.S. CLS. 100 AND 101).  
FIRST USE 3-0-1998; IN COMMERCE 3-0-1998.

2,538,462. RUBENFELD, ILANA, NEW YORK, NY. SN 75-384,309. PUB. 5-18-1999, FILED 11-4-1997.

**CRS**

FOR PSYCHOLOGICAL COUNSELING, NAMELY, BODY-ORIENTED PSYCHOTHERAPY (U.S. CLS. 100 AND 101).

FIRST USE 5-0-1997; IN COMMERCE 5-0-1997.

2,538,504. REMEDI CONSULTING COMPANY, REYNOLDSBURG, OH. SN 75-616,916. PUB. 10-17-2000, FILED 1-7-1999.

**REMEDY ELECTRONIC  
COMMERCE GROUP**

NO CLAIM IS MADE TO THE EXCLUSIVE RIGHT TO USE "ELECTRONIC COMMERCE GROUP", APART FROM THE MARK AS SHOWN.

FOR CONSULTING SERVICES IN THE FIELD OF DATA TRANSFER, NAMELY, THE TRANSMISSION OF ELECTRONIC DATA VIA COMPUTERS (U.S. CLS. 100 AND 101).

FIRST USE 4-27-2001; IN COMMERCE 4-27-2001.

2,538,506. CLINICAL REFERENCE LABORATORY, LENEXA, KS. SN 75-636,538. PUB. 5-29-2001, FILED 2-9-1999.



OWNER OF U.S. REG. NO. 2,096,624.  
THE STIPPLING IN THE DRAWING IS FOR SHADING PURPOSES.

FOR LABORATORY TESTING SERVICES IN THE MEDICAL FIELDS (U.S. CLS. 100 AND 101).  
FIRST USE 8-16-1999; IN COMMERCE 8-16-1999.

**CLASS 42—(Continued).**

2,538,509. RESPONSYS, INC., SANTA CLARA, CA. SN 75-660,101. PUB. 1-16-2001, FILED 3-15-1999.

**RESPONYS INTERACT**

NO CLAIM IS MADE TO THE EXCLUSIVE RIGHT TO USE "INTERACT", APART FROM THE MARK AS SHOWN.

FOR PROVIDING TEMPORARY USE OF ON-LINE NON-DOWNLOADABLE SOFTWARE FOR AUTOMATING AND ENHANCING MARKETING, SALES, SUPPORT, AND ELECTRONIC COMMERCE FUNCTIONS, NAMELY, ORDERING PROCESSING, ORDER CONFIRMATION, CREDIT CARD PROCESSING, SHOPPING CART INTEGRATION, AND SHIPPING NOTIFICATION, TO ENABLE COMMERCIAL TRANSACTIONS OVER A GLOBAL COMPUTER INFORMATION NETWORK, AND CONSULTING SERVICES ASSISTING IN THE USE OF SUCH SOFTWARE (U.S. CLS. 100 AND 101).

FIRST USE 11-0-1998; IN COMMERCE 11-0-1999.

2,538,515. VALLEY LASER EYE CENTRE INC., ABBOTSFORD, BRITISH COLUMBIA, CANADA. SN 75-671,460. PUB. 4-25-2000, FILED 3-29-1999.

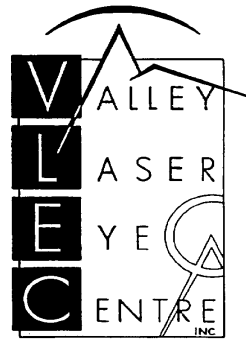

PRIORITY CLAIMED UNDER SEC. 44(D) ON CANADA APPLICATION NO. 895,116, FILED 11-6-1998, REG. NO. TMA530223, DATED 7-18-2000, EXPIRES 7-18-2015.

NO CLAIM IS MADE TO THE EXCLUSIVE RIGHT TO USE "LASER EYE CENTRE INC", APART FROM THE MARK AS SHOWN.

FOR MEDICAL SERVICES, NAMELY, EYE SURGERY TO CORRECT VISION DEFICIENCIES (U.S. CLS. 100 AND 101).

FIRST USE 2-24-1999; IN COMMERCE 2-24-1999.

2,538,522. GARLAND, RONALD C., SALT LAKE CITY, UT. SN 75-688,100. PUB. 8-8-2000, FILED 4-21-1999.

**GEEK UNIVERSITY**

FOR ASSOCIATION SERVICES, NAMELY, PROMOTING THE INTERESTS OF SOCIAL CLUB MEMBERS; SOCIAL CLUBS (U.S. CLS. 100 AND 101).

FIRST USE 4-5-2001; IN COMMERCE 4-5-2001.

**CLASS 42—(Continued).**

2,538,529. JRP TECHNOLOGIES, INC., SAN ANTONIO, TX. SN 75-716,292. PUB. 6-13-2000, FILED 5-27-1999.

**PINWHEEL CREATIONS**

NO CLAIM IS MADE TO THE EXCLUSIVE RIGHT TO USE "CREATIONS", APART FROM THE MARK AS SHOWN.

FOR CONSULTATION IN THE FIELD OF CUSTOM SOFTWARE DESIGN; CUSTOM DESIGN OF EDUCATIONAL SOFTWARE FOR OTHERS (U.S. CLS. 100 AND 101).

FIRST USE 10-0-1999; IN COMMERCE 10-0-1999.

**CLASS 42—(Continued).**

2,538,582. HURST, GEORGIA L., ESCONDIDO, CA. SN 75-881,110. PUB. 8-15-2000, FILED 12-27-1999.

**HABITAT WEST**

NO CLAIM IS MADE TO THE EXCLUSIVE RIGHT TO USE "HABITAT", APART FROM THE MARK AS SHOWN. FOR HABITAT RESTORATION SERVICES FOR ENDANGERED SPECIES OF ANIMALS (U.S. CLS. 100 AND 101).

FIRST USE 5-23-2001; IN COMMERCE 5-23-2001.

2,538,538. WATCHGUARD TECHNOLOGIES, INC., SEATTLE, WA. SN 75-758,631. PUB. 1-11-2000, FILED 8-25-1998.

**LIVESECURITY**

FOR COMPUTER SERVICES, NAMELY, PROVIDING SECURITY MONITORING, INFORMATION FLOW CONTROL AND ACCESS CONTROL FOR THE PURPOSE OF CONTROLLING AND MONITORING USE AND ACCESS BY USERS OF LOCAL AREA, WIDE AREA AND GLOBAL COMPUTER NETWORKS (U.S. CLS. 100 AND 101).

FIRST USE 2-8-1999; IN COMMERCE 2-8-1999.

2,538,607. CROWD CONTROL INTERACTIVE GROUP, ATLANTA, GA. SN 75-939,632. PUB. 1-23-2001, FILED 3-9-2000.

**VIRTUALPREMISE**

FOR PROVIDING TEMPORARY USE OF ON-LINE NON-DOWNLOADABLE SOFTWARE FOR INFORMATION AND DATABASE MANAGEMENT IN THE FIELD OF REAL ESTATE (U.S. CLS. 100 AND 101).

FIRST USE 3-0-2000; IN COMMERCE 4-0-2000.

2,538,544. HAMPTON CARES, INC., SAG HARBOR, NY. SN 75-793,802. PUB. 5-9-2000, FILED 9-7-1999.

**RCK**

FOR PHYSICAL THERAPY SERVICES FEATURING A PHYSICAL THERAPY TECHNIQUE, NAMELY, RE-CREATING KINESTHETICS (U.S. CLS. 100 AND 101).

FIRST USE 5-0-2001; IN COMMERCE 5-0-2001.

2,538,616. SHEEHAN, ANDREA L., PIERRE, SD. SN 75-981,417. PUB. 6-29-1999, FILED 2-23-1998.

**RANGE COUNTRY**

FOR PROVIDING TEMPORARY HOUSING ACCOMMODATIONS (U.S. CLS. 100 AND 101).

FIRST USE 6-2-1999; IN COMMERCE 6-2-1999.

2,538,569. PHILYRA RESEARCH LLC, WESTPORT, CT. SN 75-851,621. PUB. 4-17-2001, FILED 11-17-1999.

**PHILYRA**

FOR CONSULTING SERVICES, SCIENTIFIC RESEARCH AND TECHNICAL WRITING FOR OTHERS, ALL IN THE MEDICAL AND PHARMACEUTICAL FIELDS (U.S. CLS. 100 AND 101).

FIRST USE 10-25-2000; IN COMMERCE 10-25-2000.

2,538,619. ZAUDERER, DAVID, ATLANTA, GA. SN 76-007,312. PUB. 11-21-2000, FILED 3-21-2000.

**THE .COM BEFORE THE STORM**

FOR PROVIDING INFORMATION ON WEATHER FORECASTS BY MEANS OF A GLOBAL COMPUTER NETWORK (U.S. CLS. 100 AND 101).

FIRST USE 7-15-2001; IN COMMERCE 7-15-2001.

FEB 12, 2002

U.S. PATENT AND TRADEMARK OFFICE

TM 563

**CLASS 42—(Continued).**

2,538,639. HEALTHMEDIA, INC., ANN ARBOR, MI. SN 76-037,346. PUB. 1-23-2001, FILED 5-1-2000.

**REVOLUTIONIZING  
CHANGE**

FOR CONSULTING SERVICES IN THE FIELDS OF HEALTH CARE, WELLNESS, DISEASE MANAGEMENT, HEALTH RISK ASSESSMENT, HEALTH BEHAVIOR CHANGE AND HEALTH BEHAVIOR ASSESSMENT (U.S. CLS. 100 AND 101).  
FIRST USE 4-9-2000; IN COMMERCE 4-9-2000.

**CLASS 42—(Continued).**

2,538,652. DUNKIN' DONUTS USA, INC., PLYMOUTH, MI. SN 76-065,682. PUB. 2-13-2001, FILED 6-7-2000.

**LOOSEN UP A LITTLE**

FOR RESTAURANT SERVICES (U.S. CLS. 100 AND 101).  
FIRST USE 9-5-2000; IN COMMERCE 9-5-2000.

\* \* \* \* \*

PRIOR UNITED STATES CLASSIFICATION

APPLICATION IN MORE THAN ONE CLASS

2,538,480. INTERACTIVE DIGITAL SOFTWARE ASSOCIATION, WASHINGTON, DC. SN 75-522,995. PUB. 12-26-2000, FILED 7-21-1998.

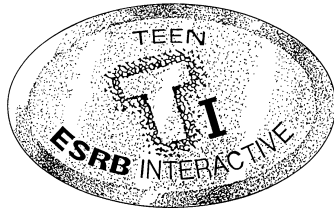

OWNER OF U.S. REG. NOS. 1,992,753, 2,152,076, AND OTHERS.

NO CLAIM IS MADE TO THE EXCLUSIVE RIGHT TO USE "TEEN" AND "INTERACTIVE", APART FROM THE MARK AS SHOWN.

THE STIPPLING IN THE DRAWING IS A FEATURE OF THE MARK AND IS NOT INTENDED TO CLAIM ANY PARTICULAR COLOR.

THE CERTIFICATION MARK, USED BY PERSONS AUTHORIZED BY THE CERTIFIER, CERTIFIES THAT IN THE OPINION OF THE CERTIFIER'S PANEL OF JUDGES, THAT THE CONTENT OF THE INTERACTIVE DIGITAL SOFTWARE, WEBSITES AND WEBPAGES ARE SUITABLE FOR PERSONS AGES THIRTEEN AND OLDER AND MAY CONTAIN VIOLENT CONTENT, MILD OR STRONG LANGUAGE AND/OR SUGGESTIVE THEMES.

**CLASS A—GOODS**

FOR CERTIFICATION OF THE CONTENT OF INTERACTIVE VIDEO AND COMPUTER GAMES (U.S. CL. A). FIRST USE 2-6-2001; IN COMMERCE 2-6-2001.

**CLASS B—SERVICES**

FOR CERTIFICATION OF THE CONTENT OF ONLINE ENTERTAINMENT SERVICES RENDERED VIA INTERACTIVE VIDEO AND COMPUTER GAMES ACCESSED THROUGH WEB SITES AND WEB PAGES (U.S. CL. B).

FIRST USE 1-6-1998; IN COMMERCE 1-6-1998.

\* \* \* \* \*

PRIOR UNITED STATES CLASSIFICATION

APPLICATION IN ONE CLASS

CERTIFICATION MARKS

CLASS B—SERVICES  
2,538,541. SUPACHILL USA, INC., HOUSTON, TX. SN 75-  
778,936. PUB. 7-4-2000, FILED 8-19-1999.

**SUPACHILL**

THE CERTIFICATION MARK, AS INTENDED TO BE USED BY AUTHORIZED PERSONS, IS INTENDED TO CERTIFY THAT MEDICAL SERVICES THAT ARE ADVERTISED IN CONJUNCTION WITH THE CERTIFICATION MARK OR MEDICAL SERVICES THAT USED THE CERTIFICATION MARK IN ANY WAY ARE PROPERLY USING THE APPLICANT'S QUICK FREEZING METHOD AND MEET THE APPLICANT'S SPECIFIED QUALITY STANDARDS.

FOR MEDICAL SERVICES (U.S. CL. B).  
FIRST USE 6-30-1999; IN COMMERCE 6-30-1999.

\* \* \* \* \*

# SUPPLEMENTAL REGISTER

These registrations are not subject to opposition.

## SECTION 1.— INTERNATIONAL CLASSIFICATION

The short titles associated below with the international class numbers are terms designed merely for quick identification and are not an official part of the international classification. The full names of international classes are given in section 6.1 of the trademark rules of practice.

The designation "U.S. Cl." appearing in this section refers to the U.S. class in effect prior to Sep. 1, 1973 rather than the international class which applies to applications filed on or after that date. For adoption of international classification see notice in the OFFICIAL GAZETTE of Jun. 26, 1973 (911 O.G. TM 210).

### Application in more than one class

2,538,676. SLOAN'S, INC., WEST PALM BEACH, FL. SN 75-633,303. FILED P.R. 2-3-1999; AM. S.R. 7-3-2001.

#### **CLASS 42—SCIENTIFIC, COMPUTER AND LEGAL SERVICES**

FOR CARRY OUT AND EAT-IN RESTAURANTS FEATURING ICE CREAM, DESSERTS AND SNACK FOODS (U.S. CLS. 100 AND 101).  
FIRST USE 11-3-1999; IN COMMERCE 11-3-1999.

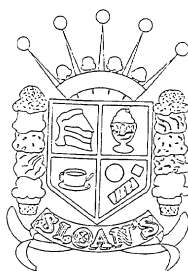

2,538,683. UNITED STATES POSTAL SERVICE, WASHINGTON, DC. SN 75-761,437. FILED P.R. 7-27-1999; AM. S.R. 6-8-2000.

THE LINING AND STIPPLING IN THE DRAWING ARE FEATURES OF THE MARK AND DO NOT INDICATE COLOR OR SHADING.

### **PC POSTAGE**

#### **CLASS 25—CLOTHING**

FOR T-SHIRTS, CAPS, SWEATSHIRTS AND APRONS (U.S. CLS. 22 AND 39).  
FIRST USE 11-3-1999; IN COMMERCE 11-3-1999.

NO CLAIM IS MADE TO THE EXCLUSIVE RIGHT TO USE "POSTAGE" INTERNATIONAL CLASSES 9,35,38 AND 40, APART FROM THE MARK AS SHOWN.

#### **CLASS 30—STAPLE FOODS**

FOR FROZEN DESSERTS, NAMELY ICE CREAM, FROZEN YOGURT AND FRUIT ICE AND OTHER FLAVORED ICES; BAKED GOODS, NAMELY MUFFINS, SCONES, BISCUITS, COOKIES, PASTRIES, CAKES; CREPES; CANDY; CARAMEL POPCORN; CHOCOLATE; CHOCOLATE COVERED NUTS; PRETZELS (U.S. CL. 46).  
FIRST USE 11-3-1999; IN COMMERCE 11-3-1999.

#### **CLASS 9—ELECTRICAL AND SCIENTIFIC APPARATUS**

FOR COMPUTER SOFTWARE FOR THE APPLICATION OF POSTAGE INDICIA AND FOR PREPARING DOCUMENTS AND PACKAGES FOR DELIVERY THAT MAY BE DOWNLOADABLE FROM A GLOBAL COMPUTER NETWORK (U.S. CLS. 21, 23, 26, 36 AND 38).  
FIRST USE 3-31-1998; IN COMMERCE 3-31-1998.

#### **CLASS 35—ADVERTISING AND BUSINESS**

FOR RETAIL STORE SERVICES LOCATED ON THE PREMISES OF A RESTAURANT, FEATURING GIFTS (U.S. CLS. 100, 101 AND 102).  
FIRST USE 11-3-1999; IN COMMERCE 11-3-1999.

#### **CLASS 35—ADVERTISING AND BUSINESS**

FOR ONLINE RETAIL SERVICES IN THE FIELD OF POSTAGE; PREPARING MAIL FOR DEPOSIT WITH A POSTAL AUTHORITY AND MAILING LIST RENTAL SERVICES (U.S. CLS. 100, 101 AND 102).  
FIRST USE 3-31-1998; IN COMMERCE 3-31-1998.

**CLASS 36—INSURANCE AND FINANCIAL**

FOR FINANCIAL SERVICES, NAMELY PROVIDING ONLINE STORED VALUE ACCOUNTS IN CLOSED ENVIRONMENTS; CLEARING AND RECONCILING FINANCIAL TRANSACTIONS VIA A GLOBAL COMPUTER NETWORK; ELECTRONIC CASH TRANSACTIONS; ELECTRONIC CREDIT CARD TRANSACTIONS; ELECTRONIC CREDIT AND DEBIT TRANSACTIONS; ELECTRONIC FUNDS TRANSFERS; FINANCIAL INFORMATION PROVIDED BY ELECTRONIC MEANS; ON-LINE FINANCIAL TRANSACTION SERVICES IN THE FIELD OF MONETARY EXCHANGE IN DIGITAL FORMAT AND COMMUNICATION OF INFORMATION REGARDING CREDIT AND DEBIT INFORMATION VIA COMPUTER NETWORKS (U.S. CLS. 100, 101 AND 102).

FIRST USE 3-31-1998; IN COMMERCE 3-31-1998.

**CLASS 38—COMMUNICATION**

FOR ELECTRONIC TELECOMMUNICATIONS SERVICES IN THE NATURE OF ELECTRONIC DELIVERY OF DOCUMENTS AND MAIL BY ELECTRONIC TRANSMISSION; ELECTRONIC TRANSMISSION OF POSTAGE (U.S. CLS. 100, 101 AND 104).

FIRST USE 3-31-1998; IN COMMERCE 3-31-1998.

**CLASS 39—TRANSPORTATION AND STORAGE**

FOR MAILING SERVICES, NAMELY, PARCEL DELIVERY AND PACKAGING ARTICLES FOR TRANSPORTATION; MAIL DELIVERY SERVICES (U.S. CLS. 100 AND 105).

FIRST USE 3-31-1998; IN COMMERCE 3-31-1998.

**CLASS 40—MATERIAL TREATMENT**

FOR DIGITAL IMAGING SERVICES IN THE FIELD OF POSTAGE; DIGITAL COMPRESSION OF FILES REPRESENTING MONETARY VALUE (U.S. CLS. 100, 103 AND 106).

FIRST USE 3-31-1998; IN COMMERCE 3-31-1998.

**CLASS 42—SCIENTIFIC, COMPUTER AND LEGAL SERVICES**

FOR TESTING, ANALYSIS AND EVALUATION OF THE GOODS AND SERVICES OF OTHERS FOR THE PURPOSE OF CERTIFICATION; DIGITAL CERTIFICATE CERTIFICATION AUTHORITY; INSTALLATION OF COMPUTER SOFTWARE FOR OTHERS; CONSULTING SERVICES IN THE FIELD OF COMPUTERS, COMPUTER SOFTWARE AND POSTAGE AND TECHNICAL SUPPORT SERVICES, NAMELY, TROUBLESHOOTING OF COMPUTER HARDWARE AND SOFTWARE PROBLEMS VIA TELEPHONE, E-MAIL AND IN PERSON TO OTHERS; PROVIDING INFORMATION IN THE FIELD OF COMPUTER TECHNOLOGY VIA THE GLOBAL COMPUTER NETWORK; COMPUTER SERVICES, NAMELY, PROVIDING ON-LINE PUBLICATIONS, NAMELY, BOOKS, BROCHURES, WHITE PAPERS, CATALOGS AND PAMPHLETS IN THE FIELDS OF COMPUTER AND INFORMATION TECHNOLOGY; COMPUTER SERVICES, NAMELY, DESIGNING AND DEVELOPING STANDARDS FOR OTHERS IN THE DESIGN AND IMPLEMENTATION OF COMPUTER SOFTWARE, COMPUTER HARDWARE AND TELECOMMUNICATIONS EQUIPMENT; COMPUTER SERVICES, NAMELY, DESIGNING COMPUTER SOFTWARE, COMPUTER HARDWARE AND COMPUTER NETWORKS FOR OTHERS; COMPUTER SERVICES, NAMELY, PROVIDING DATABASES FEATURING INFORMATION IN THE FIELD OF POSTAGE VALUE AND ALLOWING DOWNLOADING OF SUCH SOFTWARE, ACCESSED VIA A GLOBAL COMPUTER NETWORK (U.S. CLS. 100 AND 101).

FIRST USE 3-31-1998; IN COMMERCE 3-31-1998.

2,538,694. DELANEY COMPANY, INC. THE, CUMMING, GA. SN 76-005,760. FILED P.R. 3-21-2000; AM. S.R. 7-16-2001.

**CALLAN****CLASS 6—METAL GOODS**

FOR METAL LOCKS, HINGES, DOOR STOPS, HINGE STOPS FOR COMMERCIAL AND RESIDENTIAL DOORS; METAL HANDRAIL BRACKETS FOR HANDRAILS; METAL HOUSE NUMBERS; METAL KICK PLATES FOR COMMERCIAL AND RESIDENTIAL DOORS; METAL DOOR KNOCKERS; DOOR CLOSERS, NAMELY, HANDLES USED TO CLOSE DOORS; CABINET HARDWARE, NAMELY, HINGES AND HANDLES; METAL HINGES FOR INTERIOR AND EXTERIOR SHUTTERS; METAL BOLTS AND METAL LATCHES; METAL HOOKS FOR BATHROBES (U.S. CLS. 2, 12, 13, 14, 23, 25 AND 50).

FIRST USE 7-14-2000; IN COMMERCE 8-25-2000.

**CLASS 21—HOUSEWARES AND GLASS**

FOR TOWEL BARS AND RINGS; SOAP DISHES; TOOTHBRUSH HOLDERS (U.S. CLS. 2, 13, 23, 29, 30, 33, 40 AND 50).

FIRST USE 7-14-2000; IN COMMERCE 8-25-2000.

2,538,702. MEDEO LIMITED, DUBLIN 2, IRELAND. SN 76-117,837. FILED P.R. 8-23-2000; AM. S.R. 8-16-2001.

**SUPERNUMBERS**

OWNER OF ERPN CMNTY TM OFC REG. NO. 001530823, DATED 4-3-2001, EXPIRES 4-3-2011.

**CLASS 16—PAPER GOODS AND PRINTED MATTER**

FOR PRINTED MATTER, NAMELY COUPONS, TOKENS, PUBLICATIONS, MAGAZINES, NEWSPAPERS, JOURNALS AND BOOKS IN THE FIELD OF GAMING, PRINTED PLAYING CARDS AND GAME CARDS (U.S. CLS. 2, 5, 22, 23, 29, 37, 38 AND 50).

**CLASS 28—TOYS AND SPORTING GOODS**

FOR LOTTERY TICKETS; SCRATCH CARD GAMES (U.S. CLS. 22, 23, 38 AND 50).

**CLASS 35—ADVERTISING AND BUSINESS**

FOR PROMOTING THE GOODS AND SERVICES OF OTHERS THROUGH GAMING AND LOTTERIES (U.S. CLS. 100, 101 AND 102).

**CLASS 41—EDUCATION AND ENTERTAINMENT**

2,538,703. INSTITUTIONAL INVESTOR, INC., NEW YORK, NY. SN 76-123,108. FILED P.R. 9-6-2000; AM. S.R. 8-8-2001.

FOR ENTERTAINMENT SERVICES IN THE GAMING AND LOTTERY FIELD, NAMELY CONDUCTING LOTTERIES, RAFFLE DRAWINGS, AND GAMES OF CHANCE FOR OTHERS; ENTERTAINMENT IN THE NATURE OF TELEVISION QUIZ SHOWS AND COMPETITIONS INVOLVING GAMES OF CHANCE; PROVIDING AN ON-LINE COMPUTER DATABASE IN THE FIELD OF LOTTERIES, RAFFLE DRAWINGS, GAMES OF CHANCE, COMPETITIONS, AND QUIZ SHOWS VIA A GLOBAL COMPUTER NETWORK (U.S. CLS. 100, 101 AND 107).

**STRATEGIC INVESTOR  
RELATIONS**

**CLASS 16—PAPER GOODS AND PRINTED MATTER**

FOR FINANCIAL JOURNALS (U.S. CLS. 2, 5, 22, 23, 29, 37, 38 AND 50).  
FIRST USE 3-14-2001; IN COMMERCE 3-14-2001.

**CLASS 42—SCIENTIFIC, COMPUTER AND LEGAL SERVICES**

FOR PROVIDING ON-LINE FINANCIAL JOURNALS (U.S. CLS. 100 AND 101).  
FIRST USE 8-1-2001; IN COMMERCE 8-1-2001.

\* \* \* \* \*



## SECTION 2.— INTERNATIONAL CLASSIFICATION

The short titles associated below with the international class numbers are terms designed merely for quick identification and are not an official part of the international classification. The full names of international classes are given in section 6.1 of the trademark rules of practice.

The designation "U.S. Cl." appearing in this section refers to the U.S. class in effect prior to Sep. 1, 1973 rather than the international class which applies to applications filed on or after that date. For adoption of international classification see notice in the OFFICIAL GAZETTE of Jun. 26, 1973 (911 O.G. TM 210).

### Application in one class

#### CLASS 3—COSMETICS AND CLEANING PREPARATIONS

2,538,701. HALLOWELL II, ROBERT LEROY, LOS ANGELES, CA. SN 76-115,079. FILED P.R. 8-24-2000; AM. S.R. 6-22-2001.

#### SUPER VOLUMIZING TONIC

NO CLAIM IS MADE TO THE EXCLUSIVE RIGHT TO USE "VOLUMIZING TONIC", APART FROM THE MARK AS SHOWN.

FOR HAIR VOLUMIZING SPRAY (U.S. CLS. 1, 4, 6, 50, 51 AND 52).  
FIRST USE 10-1-1999; IN COMMERCE 10-1-1999.

2,538,707. JOHN PAUL MITCHELL SYSTEMS, SANTA CLARITA, CA. SN 76-158,171. FILED P.R. 11-2-2000; AM. S.R. 9-24-2001.

#### TEA TREE LIQUID HAND SOAP

NO CLAIM IS MADE TO THE EXCLUSIVE RIGHT TO USE "LIQUID HAND SOAP", APART FROM THE MARK AS SHOWN.

FOR SKIN CARE PRODUCTS, NAMELY SOAP FOR THE SKIN (U.S. CLS. 1, 4, 6, 50, 51 AND 52).  
FIRST USE 1-15-2001; IN COMMERCE 1-15-2001.

2,538,715. PROCTER & GAMBLE COMPANY, THE, CINCINNATI, OH. SN 78-033,302. FILED P.R. 11-1-2000; AM. S.R. 7-5-2001.

#### APPLE BLOSSOM

FOR LIQUID DISHWASHING DETERGENT (U.S. CLS. 1, 4, 6, 50, 51 AND 52).  
FIRST USE 4-30-2001; IN COMMERCE 4-30-2001.

#### CLASS 9—ELECTRICAL AND SCIENTIFIC APPARATUS

#### CLASS 9—(Continued).

2,538,675. HUMMINGBIRD COMMUNICATIONS LTD., AKA HUMMINGBIRD LTD., NORTH YORK, ONTARIO M2H 2W1, CANADA. SN 75-515,992. FILED P.R. 7-9-1998; AM. S.R. 7-31-2001.

#### BI QUERY

FOR COMPUTER PROGRAMS, NAMELY COMPUTER SOFTWARE BUNDLE FOR DESKTOP AD HOC QUERY AND REPORTING APPLICATIONS (U.S. CLS. 21, 23, 26, 36 AND 38).

FIRST USE 10-0-1998; IN COMMERCE 10-0-1998.

#### CLASS 16—PAPER GOODS AND PRINTED MATTER

2,538,681. LEVY, MENACHEM M., BROOKLYN, NY. SN 75-733,995. FILED P.R. 6-22-1999; AM. S.R. 7-31-2001.

#### KOSHER SHOPPER

FOR PUBLICATIONS, NAMELY, SUPPLEMENTS FOR INSERTION IN NEWSPAPERS CONTAINING INFORMATION OF INTEREST TO THE JEWISH COMMUNITY, SPECIFICALLY, INFORMATION CONCERNING RELIGIOUS OBSERVANCE (U.S. CLS. 2, 5, 22, 23, 29, 37, 38 AND 50).

FIRST USE 5-0-2000; IN COMMERCE 5-0-2000.

2,538,689. TRANSAMERICA LIFE INSURANCE AND ANNUITY COMPANY, LOS ANGELES, CA. SN 75-868,574. FILED P.R. 12-8-1999; AM. S.R. 11-17-2000.

#### THE BOOK: YOUR GUIDE TO SELLING RETIREMENT PLANS

FOR PERIODIC PUBLICATION, NAMELY, BOOKLETS AND MANUALS RELATING TO MARKETING IN THE INSURANCE AND FINANCIAL FIELDS (U.S. CLS. 2, 5, 22, 23, 29, 37, 38 AND 50).

FIRST USE 9-15-1999; IN COMMERCE 9-15-1999.

**CLASS 16—(Continued).**

2,538,692. DOW CORNING CORPORATION, MIDLAND, MI. SN 75-942,559. FILED P.R. 3-13-2000; AM. S.R. 2-20-2001.

## CONSTRUCTION MATERIALS NEWS

OWNER OF U.S. REG. NOS. 851,225, 2,022,858, AND OTHERS.

NO CLAIM IS MADE TO THE EXCLUSIVE RIGHT TO USE "CONSTRUCTION" AND "NEWS", APART FROM THE MARK AS SHOWN.

FOR PRINTED MAGAZINE CONTAINING ARTICLES REGARDING THE USE OF THE PUBLISHER'S SILICONE PRODUCTS IN THE BUILDING AND CONSTRUCTION INDUSTRY (U.S. CLS. 2, 5, 22, 23, 29, 37, 38 AND 50).

FIRST USE 3-1-1999; IN COMMERCE 3-1-1999.

2,538,696. CONVERSIONS MADE EASY, INC., MANCHESTER, MO. SN 76-052,887. FILED P.R. 5-22-2000; AM. S.R. 5-21-2001.

## CONVERSIONS MADE EASY

FOR CARD FOR PROVIDING MATHEMATICAL CALCULATIONS (U.S. CLS. 2, 5, 22, 23, 29, 37, 38 AND 50). FIRST USE 4-15-2000; IN COMMERCE 4-15-2000.

2,538,714. THAI, KHI V., BOCA RATON, FL. SN 78-025,273. FILED P.R. 9-11-2000; AM. S.R. 7-18-2001.

## PRACADEMICS PRESS

NO CLAIM IS MADE TO THE EXCLUSIVE RIGHT TO USE "PRESS", APART FROM THE MARK AS SHOWN.

FOR ACADEMIC JOURNALS IN SOCIAL SCIENCES IN THE FIELD OF PUBLIC BUDGETING AND PUBLIC PROCUREMENT (U.S. CLS. 2, 5, 22, 23, 29, 37, 38 AND 50).

FIRST USE 1-1-1995; IN COMMERCE 1-1-1995.

**CLASS 24—FABRICS**

2,538,697. HOLLINGSWORTH & VOSE COMPANY, EAST WALPOLE, MA. SN 76-053,980. FILED P.R. 5-23-2000; AM. S.R. 5-16-2001.

## SOFT 'N' STABLE

FOR WET-LAID, SOFT CUTAWAY EMBROIDERY BACKING USED FOR STABILIZING HOOPED FABRIC DURING MACHINE EMBROIDERY (U.S. CLS. 42 AND 50).

FIRST USE 7-14-2000; IN COMMERCE 7-14-2000.

**CLASS 26—FANCY GOODS****CLASS 26—(Continued).**

2,538,693. ARMOR ESTATE, LLC, SADDLE BROOK, NJ. SN 75-980,323. FILED P.R. 1-28-1999; AM. S.R. 5-14-2001.

## DON'T SERVE ME

FOR ORNAMENTAL NOVELTY BUTTONS, ORNAMENTAL NOVELTY PINS (U.S. CLS. 37, 39, 40, 42 AND 50).

FIRST USE 12-2-1999; IN COMMERCE 12-2-1999.

**CLASS 30—STAPLE FOODS**

2,538,680. JELLY BELLY CANDY COMPANY, FAIRFIELD, CA, BY MERGER; BY CHANGE OF NAME HERMAN GOELITZ CANDY CO., INC., FAIRFIELD, CA. SN 75-712,756. FILED P.R. 5-24-1999; AM. S.R. 1-18-2000.

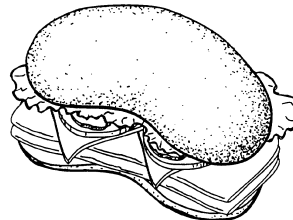

NO CLAIM IS MADE TO THE EXCLUSIVE RIGHT TO USE THE REPRESENTATION OF LETTUCE, TOMATO SLICES, CHEESE SLICES, PICKLE SLICES, AND MEAT SLICES, APART FROM THE MARK AS SHOWN.

THE LINING IN THE DRAWING IS A FEATURE OF THE MARK AND DEPICTS LETTUCE, TOMATO SLICES, PICKLE SLICES, CHEESE SLICES, AND MEAT SLICES. THE STIPPLING IN THE DRAWING IS FOR SHADING PURPOSES ONLY AND DOES NOT INDICATE COLOR.

THE MARK CONSISTS OF THE GOODS, NAMELY A THREE DIMENSIONAL CONFIGURATION OF A DISTINCTIVELY SHAPED SANDWICH IN THE FORM OF A STYLIZED JELLY BEAN.

FOR PREPARED SANDWICHES FOR CONSUMPTION ON OR OFF THE PREMISES (U.S. CL. 46).

FIRST USE 5-1-1999; IN COMMERCE 5-1-1999.

2,538,712. KRAFT FOODS HOLDINGS, INC., NORTHFIELD, IL. SN 78-023,004. FILED P.R. 8-25-2000; AM. S.R. 8-13-2001.

## SWEET RECIPES

FOR BARBECUE SAUCE (U.S. CL. 46). FIRST USE 2-1-2001; IN COMMERCE 2-1-2001.

**CLASS 33—WINES AND SPIRITS**

**CLASS 33—(Continued).**

2,538,677. PEDRO DOMECA MEXICO, S.A. DE C.V., COLONIA DEL CARMEN COYOACAN, 04100, MEXICO. SN 75-652,893. FILED P.R. 3-3-1999; AM. S.R. 12-20-1999.



OWNER OF MEXICO REG. NO. 579608, DATED 3-4-1998, EXPIRES 3-4-2008.

THE BROKEN LINES REPRESENTS THE CONFIGURATION OF THE BOTTLE CONTAINER FOR THE GOODS AND ARE MEANT TO SHOW THE POSITION OF THE MARK ON THE GOODS.

THE MARK CONSISTS OF A CONFIGURATION FOR A BOTTLE CONTAINER WITH A RAISED QUADRILATERAL ARCH.

FOR ALCOHOLIC LIQUORS, NAMELY RUM (U.S. CLS. 47 AND 49).

**SERVICE MARKS****CLASS 35—ADVERTISING AND BUSINESS**

2,538,691. TELESIAN TECHNOLOGY, INC., WORCESTER, MA. SN 75-921,027. FILED P.R. 2-11-2000; AM. S.R. 1-29-2001.

**THE E-BUSINESS  
IMPERATIVE**

NO CLAIM IS MADE TO THE EXCLUSIVE RIGHT TO USE "E-BUSINESS", APART FROM THE MARK AS SHOWN.

FOR BUSINESS MARKETING CONSULTING SERVICES, NAMELY, STRATEGIC BUSINESS TECHNIQUES AND PLANNING RELATING TO E-COMMERCE (U.S. CLS. 100, 101 AND 102).

FIRST USE 12-0-1999; IN COMMERCE 12-0-1999.

**CLASS 35—(Continued).**

2,538,700. WEBDATAMINER, INC., NEW YORK, NY. SN 76-088,406. FILED P.R. 7-13-2000; AM. S.R. 6-29-2001.

**WEBMINER**

FOR MARKETING SERVICES, NAMELY, ASSISTING COMPANIES ON THE INTERNET BY UTILIZING INFORMATION GENERATED BY THEIR AND OTHER WEBSITES TO PROVIDE DETAILED PROFILES OF CURRENT AND POTENTIAL CUSTOMERS FOR PREDICTING ONLINE INTERESTS AND BEHAVIOR ENABLING THE CREATION OF PERSONALIZED E-COMMERCE PROGRAMS (U.S. CLS. 100, 101 AND 102).  
FIRST USE 10-3-2000; IN COMMERCE 10-3-2000.

**CLASS 36—INSURANCE AND FINANCIAL**

2,538,686. HARRIS, LEE D., DBA HARRIS INTERNATIONAL REAL ESTATE, MEMPHIS, TN. SN 75-817,219. FILED P.R. 10-7-1999; AM. S.R. 4-24-2001.

**INDUSTRIALSITES.COM**

FOR PROVIDING REAL ESTATE INFORMATION BY MEANS OF COMPUTER NETWORK; REAL ESTATE LEASING, AGENCY, AND MANAGEMENT SERVICES AND CONSULTATION SERVICES RENDERED IN CONNECTION THEREWITH (U.S. CLS. 100, 101 AND 102).  
FIRST USE 10-4-1999; IN COMMERCE 10-4-1999.

2,538,687. HARRIS, LEE D., DBA HARRIS INTERNATIONAL REAL ESTATE, MEMPHIS, TN. SN 75-817,221. FILED P.R. 10-7-1999; AM. S.R. 4-24-2001.

**WAREHOUSEsites.COM**

FOR PROVIDING REAL ESTATE INFORMATION BY MEANS OF A GLOBAL COMPUTER NETWORK; REAL ESTATE LEASING, AGENCY, AND MANAGEMENT SERVICES AND CONSULTATION SERVICES RENDERED IN CONNECTION THEREWITH (U.S. CLS. 100, 101 AND 102).  
FIRST USE 10-4-1999; IN COMMERCE 10-4-1999.

2,538,690. KRATZ, JOSEPH R., HOUSTON, TX. SN 75-872,415. FILED P.R. 12-15-1999; AM. S.R. 1-16-2001.

**STOCKTOURNAMENT.COM**

FOR INVESTMENT CONSULTATION, NAMELY, PROVIDING AN ONLINE TOURNAMENT FOR INVESTORS TO BUILD AND TEST THEIR INVESTMENT STRATEGIES (U.S. CLS. 100, 101 AND 102).  
FIRST USE 11-21-1998; IN COMMERCE 11-21-1998.

**CLASS 36—(Continued).**

2,538,698. MILLION DOLLAR ROUND TABLE FOUNDATION, PARK RIDGE, IL. SN 76-065,799. FILED P.R. 6-7-2000; AM. S.R. 2-1-2001.

**GLOBAL GIFT FUND**

NO CLAIM IS MADE TO THE EXCLUSIVE RIGHT TO USE "GIFT FUND", APART FROM THE MARK AS SHOWN. FOR CHARITABLE FUND RAISING (U.S. CLS. 100, 101 AND 102).

FIRST USE 4-29-2000; IN COMMERCE 4-29-2000.

**CLASS 39—TRANSPORTATION AND STORAGE**

2,538,705. HOMES.COM, INC., PALO ALTO, CA. SN 76-135,603. FILED P.R. 9-26-2000; AM. S.R. 8-20-2001.

**HOMES.COM**

OWNER OF U.S. REG. NO. 2,226,864. FOR PROVIDING MOVING AND RELOCATION INFORMATION FOR INDIVIDUALS AND FAMILIES VIA A GLOBAL COMPUTER NETWORK (U.S. CLS. 100 AND 105).

FIRST USE 10-0-1999; IN COMMERCE 10-0-1999.

2,538,709. NORTHWEST AIRLINES, INC., ST. PAUL, MN. SN 76-211,653. FILED P.R. 2-16-2001; AM. S.R. 10-16-2001.

**BIZ PERKS**

OWNER OF U.S. REG. NOS. 2,365,494 AND 2,367,286. FOR AIRLINES SERVICES, NAMELY, MAKING AIR TRANSPORTATION RESERVATIONS BY MEANS OF A GLOBAL COMPUTER NETWORK (U.S. CLS. 100 AND 105).

FIRST USE 3-1-2001; IN COMMERCE 3-1-2001.

**CLASS 40—MATERIAL TREATMENT**

2,538,711. DVDTRANSFER.COM, L.L.C., MINNEAPOLIS, MN. SN 78-001,370. FILED P.R. 3-28-2000; AM. S.R. 10-12-2001.

**DVD** *Transfer.com*

FOR CUSTOM MANUFACTURING OF DVDS TO THE ORDER AND/OR SPECIFICATION OF OTHERS (U.S. CLS. 100, 103 AND 106).

FIRST USE 1-15-1998; IN COMMERCE 10-28-1999.

**CLASS 41—EDUCATION AND ENTERTAINMENT**

2,538,674. CREATIVE MARKETING TECHNIQUES, INC., PLANTATION, FL. SN 75-302,956. FILED 6-4-1997.

**CREATIVE COOKING EXPO**

NO CLAIM IS MADE TO THE EXCLUSIVE RIGHT TO USE "EXPO", APART FROM THE MARK AS SHOWN.

FOR ENTERTAINMENT SERVICES, NAMELY, ARRANGING AND ORGANIZING CULINARY EXPOSITIONS (U.S. CLS. 100, 101 AND 107).

FIRST USE 5-1-1996; IN COMMERCE 5-1-1996.

2,538,678. HOB CONCERTS COMPANY, UNIVERSAL CITY, CA, BY CHANGE OF NAME UNIVERSAL CITY STUDIOS, INC., UNIVERSAL CITY, CA. SN 75-681,788. FILED P.R. 4-12-1999; AM. S.R. 2-5-2001.

**BOXSUITES**

FOR ENTERTAINMENT SERVICES, PROVIDING PREFERRED BENEFITS AND PRIVILEGES FOR ENTERTAINMENT EVENTS (U.S. CLS. 100, 101 AND 107).

FIRST USE 3-0-1998; IN COMMERCE 3-0-1998.

2,538,679. HUMETRICS, INC., HOUSTON, TX. SN 75-708,150. FILED P.R. 5-17-1999; AM. S.R. 8-6-2001.

**BLUEPRINT FOR SUCCESSFUL HIRING**

NO CLAIM IS MADE TO THE EXCLUSIVE RIGHT TO USE "SUCCESSFUL HIRING", APART FROM THE MARK AS SHOWN.

FOR CONDUCTING WORKSHOPS AND SEMINARS IN HUMAN RESOURCES, EMPLOYMENT, RECRUITING, EMPLOYEE IDENTIFICATION, EMPLOYEE SELECTION, EMPLOYEE SCREENING, EMPLOYEE PERFORMANCE APPRAISAL, AND EMPLOYMENT SKILLS, AND WRITTEN MATERIAL DISTRIBUTED THEREWITH (U.S. CLS. 100, 101 AND 107).

FIRST USE 2-0-1999; IN COMMERCE 2-0-1999.

2,538,688. NTN COMMUNICATIONS, INC., CARLSBAD, CA. SN 75-848,256. FILED P.R. 11-11-1999; AM. S.R. 8-22-2001.

**WORLD TRIVIA LEAGUE**

NO CLAIM IS MADE TO THE EXCLUSIVE RIGHT TO USE "TRIVIA LEAGUE", APART FROM THE MARK AS SHOWN.

FOR ENTERTAINMENT IN THE NATURE OF COMPETITIONS AMONG PLAYERS IN GAMES, TESTING THE PLAYERS' SKILL AND KNOWLEDGE OF VARIOUS SUBJECT MATTER AREAS, WHICH GAMES ARE PLAYED VIA INTERACTIVE TELEVISION AND VIA A GLOBAL COMPUTER NETWORK (U.S. CLS. 100, 101 AND 107).

FIRST USE 8-17-2001; IN COMMERCE 8-17-2001.

**CLASS 41—(Continued).**

2,538,710. NATIONAL ACADEMY OF RECORDING ARTS & SCIENCES, SANTA MONICA, CA. SN 76-252,235. FILED P.R. 5-7-2001; AM. S.R. 9-21-2001.

## LATIN MUSIC HALL OF FAME

FOR EDUCATIONAL SERVICES FOR PROVIDING EDUCATIONAL PROGRAMS, NAMELY, SEMINARS AND CLASSES IN THE FIELD OF MUSIC (U.S. CLS. 100, 101 AND 107).

FIRST USE 4-5-2001; IN COMMERCE 4-5-2001.

---

2,538,713. MC CARTNEY, FRANCESCA A., MILL VALLEY, CA. SN 78-025,143. FILED P.R. 9-8-2000; AM. S.R. 11-30-2001.

## INTUITION MEDICINE

FOR PROVIDING CLASSES, SEMINARS, AND WORKSHOPS IN THE FIELD OF INTUITIVE MEDICINE, AND DISTRIBUTING COURSE MATERIALS AND AUDIO TAPES IN CONNECTION THEREWITH (U.S. CLS. 100, 101 AND 107).

FIRST USE 5-9-1999; IN COMMERCE 5-9-1999.

---

## CLASS 42—SCIENTIFIC, COMPUTER AND LEGAL SERVICES

2,538,682. PROSKAUER ROSE LLP, NEW YORK, NY. SN 75-748,047. FILED P.R. 7-12-1999; AM. S.R. 12-7-2000.

## IPRACTICE

FOR PROVISION OF LEGAL SERVICES IN THE AREAS OF TECHNOLOGY, NEW MEDIA, LICENSING AND INTELLECTUAL PROPERTY CONSULTATION (U.S. CLS. 100 AND 101).

FIRST USE 9-27-1999; IN COMMERCE 9-27-1999.

---

2,538,684. BOX OFFICE MANAGEMENT INT'L, DBA THE INTERNATIONAL TICKETING ASSOCIATION, NEW YORK, NY. SN 75-776,305. FILED P.R. 8-16-1999; AM. S.R. 11-24-2000.

## THE INTERNATIONAL TICKETING ASSOCIATION

NO CLAIM IS MADE TO THE EXCLUSIVE RIGHT TO USE "ASSOCIATION", APART FROM THE MARK AS SHOWN.

FOR ASSOCIATION SERVICES, NAMELY, PROMOTING THE INTERESTS OF TICKETING PROFESSIONALS (U.S. CLS. 100 AND 101).

FIRST USE 1-30-1997; IN COMMERCE 1-30-1997.

**CLASS 42—(Continued).**

2,538,685. SG COWEN SECURITIES CORPORATION, NEW YORK, NY. SN 75-793,025. FILED P.R. 9-7-1999; AM. S.R. 10-6-2000.

## SEMICONDUCTOR EQUIPMENT: INTERCONNECT

FOR PROVIDING ON-LINE PUBLICATIONS, NAMELY, NEWSLETTERS, JOURNALS AND RESEARCH REPORTS CONTAINING ADVICE, ARTICLES AND INFORMATION ABOUT SEMICONDUCTOR EQUIPMENT OFFERED OVER A GLOBAL COMPUTER NETWORK (U.S. CLS. 100 AND 101).

FIRST USE 7-8-1997; IN COMMERCE 7-8-1997.

---

2,538,695. JOHNSON CONTROLS, INC., MILWAUKEE, WI. SN 76-044,885. FILED P.R. 5-9-2000; AM. S.R. 12-28-2000.

## TOTAL ENERGY MANAGEMENT

NO CLAIM IS MADE TO THE EXCLUSIVE RIGHT TO USE "ENERGY MANAGEMENT", APART FROM THE MARK AS SHOWN.

FOR ENERGY ENGINEERING AND TECHNICAL CONSULTATION SERVICES RELATING TO THE USE, PURCHASE, CONTROL, AND CONSERVATION OF ENERGY FOR OWNERS AND OPERATORS OF INDUSTRIAL, COMMERCIAL, AND GOVERNMENTAL FACILITIES (U.S. CLS. 100 AND 101).

FIRST USE 6-0-1998; IN COMMERCE 6-0-1998.

---

2,538,699. WORKOUT.COM, INC., MILPITAS, CA. SN 76-067,426. FILED P.R. 6-9-2000; AM. S.R. 6-25-2001.

## WORKOUT.COM

FOR PROVIDING INFORMATION ABOUT EXERCISE PROGRAMS, PHYSICAL FITNESS DIETING, HEALTH, AND WEIGHT TRAINING VIA A GLOBAL COMPUTER NETWORK; PHYSICAL FITNESS CONSULTATION AND NUTRITION CONSULTATION (U.S. CLS. 100 AND 101).

FIRST USE 12-24-1997; IN COMMERCE 2-6-1999.

---

2,538,704. HOMES.COM, INC., PALO ALTO, CA. SN 76-135,602. FILED P.R. 9-26-2000; AM. S.R. 8-20-2001.

## HOMES.COM

OWNER OF U.S. REG. NO. 2,226,864.  
FOR PROVIDING GENERAL INFORMATION ABOUT SCHOOLS, WEATHER, COMMUTING, DEMOGRAPHICS, AND CRIME IN LOCAL COMMUNITIES VIA A GLOBAL COMPUTER NETWORK (U.S. CLS. 100 AND 101).

FIRST USE 10-0-1999; IN COMMERCE 10-0-1999.

**CLASS 42—(Continued).**

2,538,706. LOCKWOOD LEADERSHIP INTERNATIONAL, HOLDEN BEACH, NC. SN 76-147,631. FILED P.R. 10-16-2000; AM. S.R. 6-23-2001.

**INTERACTION SYTLE  
PROFILE**

NO CLAIM IS MADE TO THE EXCLUSIVE RIGHT TO USE "PROFILE", APART FROM THE MARK AS SHOWN.  
FOR PROVIDING PROFESSIONAL BUSINESS CONSULTATIONS IN THE AREA OF MANAGEMENT LEADERSHIP ASSESSMENT THAT INCLUDE BUSINESS EVALUATIONS AND REPORTS (U.S. CLS. 100 AND 101).  
FIRST USE 1-1-1999; IN COMMERCE 1-1-1999.

**CLASS 42—(Continued).**

2,538,708. SCHNEIDER, DAVID L., SAN DIEGO, CA. SN 76-172,389. FILED P.R. 11-22-2000; AM. S.R. 10-9-2001.

**COUPONUSER**

FOR COMPUTER SERVICES, NAMELY, PROVIDING SEARCH ENGINES FOR OBTAINING DATA ON A GLOBAL COMPUTER NETWORK (U.S. CLS. 100 AND 101).  
FIRST USE 6-6-2001; IN COMMERCE 6-6-2001.

\* \* \* \* \*

# TRADEMARK REGISTRATIONS RENEWED

The designation "U.S. Cl." appearing in this section refers to the U.S. class in effect prior to Sep. 1, 1973 rather than the international class which applies to applications filed on or after that date. For adoption of international classification see notice in the OFFICIAL GAZETTE of Jun. 26, 1973 (911 O.G. TM 210).

83,793.	UTICA AND DESIGN. U.S. CL. 23. (INT. CL. 8). REG. 10-10-1911.	921,823.	HANG-ON. U.S. CL. 13. (INT. CL. 6). REG. 10-12-1971.
84,057.	URSA (STYLIZED). U.S. CL. 15. (INT. CL. 4). REG. 10-31-1911.	921,857.	TENSOR (STYLIZED). U.S. CL. 21. (INT. CLS. 9 AND 11). REG. 10-12-1971.
84,344.	SELAS. U.S. CL. 23. (INT. CL. 7). REG. 11-28-1911.	921,922.	DAMPP-CHASER. U.S. CLS. 26 AND 34. (INT. CLS. 9 AND 11). REG. 10-12-1971.
144,382.	PRESTO. U.S. CL. 23. (INT. CL. 7). REG. 7-5-1921.	921,942.	CYCLO-WASH (STYLIZED). U.S. CL. 34. (INT. CL. 11). REG. 10-12-1971.
147,322.	GTD AND DESIGN. U.S. CL. 23. (INT. CLS. 6, 7, 8, 9, 11, 12, 16, 21 AND 28). REG. 10-11-1921.	921,954.	FILMOPLAST. U.S. CL. 37. (INT. CL. 16). REG. 10-12-1971.
285,941.	MISCELLANEOUS DESIGN. U.S. CL. 46. (INT. CL. 29). REG. 8-11-1931.	921,955.	FILMOLUX. U.S. CL. 37. (INT. CL. 16). REG. 10-12-1971.
530,305.	ESTEE LAUDER (STYLIZED). U.S. CL. 51. (INT. CLS. 3 AND 5). REG. 9-5-1950.	922,045.	MISCELLANEOUS DESIGN. U.S. CL. 100. (INT. CL. 42). REG. 10-12-1971.
547,397.	MACBETH (STYLIZED). U.S. CL. 26 ONLY. (INT. CL. 9). REG. 9-4-1951.	922,087.	WYOBOND. INT. CL. 1. (U.S. CL. 1). REG. 10-19-1971.
549,293.	GLOCOIL. U.S. CL. 21. (INT. CL. 9). REG. 10-9-1951.	922,364.	IH (STYLIZED). U.S. CL. 26. (INT. CL. 9). REG. 10-19-1971.
551,228.	SIC-SAC AND DESIGN. U.S. CL. 2. (INT. CL. 16). REG. 11-27-1951.	922,524.	SANI-FLUSH. U.S. CL. 52. (INT. CLS. 3 AND 5). REG. 10-19-1971.
553,791.	CONOLITE. U.S. CL. 12. (INT. CL. 19). REG. 1-22-1952.	922,533.	GEO DATA AND DESIGN. U.S. CL. 100. (INT. CL. 42). REG. 10-19-1971.
559,346.	DUB-L-COP. U.S. CL. 16. (INT. CL. 2). REG. 5-27-1952.	923,036.	EDELMANN. U.S. CLS. 2, 13 AND 35 ONLY. (INT. CLS. 6, 17 AND 20). REG. 11-2-1971.
562,912.	MONT LA SALLE (STYLIZED). U.S. CL. 47. (INT. CL. 33). REG. 8-19-1952.	923,201.	JIFFY-JACK. U.S. CL. 26. (INT. CL. 9). REG. 11-2-1971.
562,913.	MONT LA SALLE ALTAR WINE AND DESIGN. U.S. CL. 47. (INT. CL. 33). REG. 8-19-1952.	923,416.	PENNLON. U.S. CL. 13. (INT. CL. 6). REG. 11-9-1971.
713,371.	ATLANTIC 33 (STYLIZED). U.S. CL. 14. (INT. CL. 6). REG. 4-4-1961.	923,560.	HARVARD. U.S. CL. 46. (INT. CLS. 1, 5, 29, 30, 31 AND 32). REG. 11-9-1971.
714,062.	BS (STYLIZED). U.S. CL. 13. (INT. CL. 6). REG. 4-18-1961.	924,003.	MISS MODEL OF MODELS. U.S. CL. 101. (INT. CL. 35). REG. 11-16-1971.
714,821.	E.Z.EST. U.S. CL. 52. (INT. CL. 3). REG. 5-2-1961.	924,312.	UNDERSHAPERS. U.S. CL. 39. (INT. CL. 25). REG. 11-23-1971.
715,001.	DAIDO (STYLIZED). U.S. CL. 23. (INT. CLS. 6 AND 7). REG. 5-9-1961.	924,952.	ANTIGENE. U.S. CL. 6. (INT. CL. 1). REG. 12-7-1971.
716,626.	MIDAS AND DESIGN. U.S. CL. 103. (INT. CL. 37). REG. 6-6-1961.	925,158.	BATA (STYLIZED). U.S. CL. 39. (INT. CL. 25). REG. 12-7-1971.
716,627.	MIDAS MUFFLER SHOPS. U.S. CL. 103. (INT. CL. 37). REG. 6-6-1961.	926,512.	LA FLOR. U.S. CL. 46. (INT. CL. 30). REG. 1-4-1972.
721,291.	GP AND DESIGN. U.S. CL. 23. (INT. CL. 7). REG. 9-12-1961.	927,471.	BLACK & BEAUTIFUL. U.S. CL. 51. (INT. CL. 3). REG. 1-18-1972.
722,454.	CONVERTAINER (STYLIZED). U.S. CL. 2. (INT. CL. 6). REG. 10-10-1961.	927,573.	ASHLAND AND DESIGN. INT. CL. 1. (U.S. CL. 1). REG. 1-25-1972.
722,714.	MRS. BUTTERWORTH'S. U.S. CL. 46. (INT. CL. 30). REG. 10-10-1961.	928,114.	DYNA BRAKE. U.S. CL. 13. (INT. CL. 9). REG. 2-1-1972.
725,709.	NEWPORT. U.S. CL. 49. (INT. CL. 33). REG. 12-26-1961.	930,109.	MOONLIGHT. U.S. CL. 46. (INT. CL. 31). REG. 2-29-1972.
726,143.	NELSON. U.S. CL. 12. (INT. CL. 19). REG. 1-9-1962.	930,894.	THE CHURCH AROUND THE WORLD. U.S. CL. 38. (INT. CL. 16). REG. 3-14-1972.
727,244.	STAT-TITE. U.S. CL. 35. (INT. CL. 17). REG. 2-6-1962.	932,281.	THE JOURNAL OF UROLOGY (STYLIZED). U.S. CL. 38. (INT. CL. 16). REG. 4-11-1972.
728,857.	"REDI-SET". U.S. CL. 37. (INT. CL. 16). REG. 3-20-1962.	935,861.	DOWEX. U.S. CL. 6. (INT. CL. 1). REG. 6-20-1972.
737,180.	ROCKY MOUNTAIN NEWS. U.S. CL. 38. (INT. CL. 16). REG. 9-4-1962.	937,017.	SHIELD. U.S. CL. 22. (INT. CL. 28). REG. 7-4-1972.
891,729.	TURTLE CREEK. U.S. CL. 101. (INT. CLS. 35, 36, 38, 41 AND 42). REG. 5-26-1970.	943,541.	EPSEAL. U.S. CL. 12. (INT. CL. 17). REG. 9-26-1972.
900,038.	SHELFERS. U.S. CL. 13. (INT. CLS. 6, 7, 11, 17, 20 AND 21). REG. 10-6-1970.	1,118,172.	T-TAPE AND DESIGN. INT. CL. 11. (U.S. CL. 13). REG. 5-15-1979.
905,053.	ETHAN ALLEN. U.S. CL. 21. (INT. CLS. 9 AND 11). REG. 12-29-1970.	1,141,495.	PARMALAT. INT. CLS. 29, 30 AND 32 ONLY. (U.S. CLS. 45, 46 AND 48). REG. 11-18-1980.
911,455.	AMISH ACRES AND DESIGN. U.S. CL. 107. (INT. CL. 41). REG. 4-13-1971.	1,150,103.	S 500 SURACTIV. INT. CL. 1. (U.S. CL. 6). REG. 4-7-1981.
912,928.	G-T. U.S. CL. 23. (INT. CL. 7). REG. 6-8-1971.	1,150,240.	XT. INT. CL. 7. (U.S. CL. 23). REG. 4-7-1981.
920,309.	GERKENS. U.S. CL. 46. (INT. CL. 30). REG. 9-14-1971.	1,150,439.	CEMBONIT. INT. CLS. 19 AND 37. (U.S. CLS. 1, 12, 33, 50, 100, 103 AND 106). REG. 4-7-1981.
921,478.	SHURE. U.S. CL. 21. (INT. CL. 9). REG. 10-5-1971.	1,152,482.	NURSERY RHYME (STYLIZED). INT. CL. 25. (U.S. CL. 39). REG. 4-28-1981.
921,748.	DENVER BRONCOS. U.S. CL. 107. (INT. CL. 41). REG. 10-5-1971.	1,153,855.	THE CLASSIC AMERICAN SILVER. INT. CL. 14. (U.S. CLS. 2, 27, 28 AND 50). REG. 5-12-1981.
921,750.	BRONCOS. U.S. CL. 107. (INT. CL. 41). REG. 10-5-1971.		

- 1,154,194. A/O. INT. CLS. 37 AND 42. (U.S. CLS. 100 AND 103). REG. 5-12-1981.
- 1,155,497. MCS. INT. CL. 12. (U.S. CL. 35). REG. 5-26-1981.
- 1,158,764. WIZARD. INT. CL. 5. (U.S. CL. 6). REG. 6-30-1981.
- 1,158,871. SFIM AND DESIGN. INT. CL. 9. (U.S. CLS. 21 AND 26). REG. 6-30-1981.
- 1,160,734. POURMATIC. INT. CL. 9. (U.S. CL. 26). REG. 7-14-1981.
- 1,160,967. EASYUP. INT. CL. 20. (U.S. CL. 32). REG. 7-14-1981.
- 1,162,004. POLY PLUS. INT. CL. 24. (U.S. CL. 50). REG. 7-21-1981.
- 1,162,990. A PINCH IS ALL IT TAKES. INT. CL. 34. (U.S. CL. 17). REG. 7-28-1981.
- 1,163,486. KULDUCKIE (STYLIZED). INT. CL. 9. (U.S. CL. 21). REG. 8-4-1981.
- 1,164,356. BLISS. INT. CL. 7. (U.S. CL. 23). REG. 8-11-1981.
- 1,165,496. NEC. INT. CL. 16. (U.S. CL. 38). REG. 8-18-1981.
- 1,166,448. FAMILY (STYLIZED). INT. CL. 13. (U.S. CL. 9). REG. 8-25-1981.
- 1,166,878. AUTOGEL. INT. CL. 1. (U.S. CL. 6). REG. 9-1-1981.
- 1,167,243. PURITAN AND DESIGN. INT. CL. 16. (U.S. CL. 38). REG. 9-1-1981.
- 1,168,051. PORT-O-COILER (STYLIZED). INT. CL. 7. (U.S. CL. 23). REG. 9-8-1981.
- 1,169,578. MISCELLANEOUS DESIGN. INT. CLS. 36, 37 AND 41. (U.S. CLS. 102, 103 AND 107). REG. 9-15-1981.
- 1,169,744. SUPER BONDER. INT. CL. 1. (U.S. CL. 5). REG. 9-15-1981.
- 1,169,785. BINNEY & SMITH AND DESIGN. INT. CLS. 2 AND 16. (U.S. CLS. 16 AND 37). REG. 9-22-1981.
- 1,170,556. BMW AND DESIGN. INT. CLS. 37 AND 42. (U.S. CLS. 101 AND 103). REG. 9-22-1981.
- 1,170,824. 07. INT. CL. 3. (U.S. CLS. 51 AND 52). REG. 9-29-1981.
- 1,171,228. GELBOND (STYLIZED). INT. CL. 17. (U.S. CLS. 1 AND 50). REG. 9-29-1981.
- 1,171,423. THANK GOODNESS IT FITS. INT. CL. 25. (U.S. CL. 39). REG. 9-29-1981.
- 1,171,639. GYP-CRETE. INT. CLS. 37 AND 41. (U.S. CLS. 103 AND 107). REG. 9-29-1981.
- 1,171,818. KENYON AND DESIGN. INT. CL. 1. (U.S. CLS. 5 AND 6). REG. 10-6-1981.
- 1,171,828. AQUAQUEST. INT. CL. 1. (U.S. CL. 6). REG. 10-6-1981.
- 1,171,874. CC-500. INT. CL. 3. (U.S. CLS. 51 AND 52). REG. 10-6-1981.
- 1,171,997. SAXMAYER AND DESIGN. INT. CL. 7. (U.S. CL. 23). REG. 10-6-1981.
- 1,172,118. HEALTH BIKE. INT. CLS. 10 AND 28. (U.S. CLS. 22 AND 44). REG. 10-6-1981.
- 1,172,272. CLARK. INT. CL. 19. (U.S. CL. 12). REG. 10-6-1981.
- 1,172,321. WEXFORD (STYLIZED). INT. CL. 21. (U.S. CL. 33). REG. 10-6-1981.
- 1,172,334. GOODY. INT. CL. 21. (U.S. CL. 29). REG. 10-6-1981.
- 1,172,448. GOLD CREST. INT. CL. 29. (U.S. CL. 46). REG. 10-6-1981.
- 1,172,552. MORTGAGE MASTER. INT. CL. 36. (U.S. CLS. 100, 101 AND 102). REG. 10-6-1981.
- 1,172,579. MAZDA (STYLIZED). INT. CL. 37. (U.S. CL. 103). REG. 10-6-1981.
- 1,172,749. A-B-C. INT. CL. 1. (U.S. CL. 6). REG. 10-13-1981.
- 1,172,863. M AND DESIGN. INT. CLS. 7, 8 AND 9. (U.S. CLS. 23 AND 26). REG. 10-13-1981.
- 1,172,960. WIDE-GARD. INT. CL. 9. (U.S. CLS. 26 AND 50). REG. 10-13-1981.
- 1,172,970. SIDECOM (STYLIZED). INT. CL. 9. (U.S. CL. 26). REG. 10-13-1981.
- 1,173,015. HANDYMAN. INT. CL. 9. (U.S. CL. 26). REG. 10-13-1981.
- 1,173,073. SKY-TRACKER. INT. CL. 11. (U.S. CL. 21). REG. 10-13-1981.
- 1,173,135. JACMEL. INT. CL. 14. (U.S. CL. 28). REG. 10-13-1981.
- 1,173,311. CHIVALRY. INT. CL. 21. (U.S. CL. 33). REG. 10-13-1981.
- 1,173,359. ELITE. INT. CL. 25. (U.S. CL. 39). REG. 10-13-1981.
- 1,173,381. RIFLE AND DESIGN. INT. CL. 25. (U.S. CL. 39). REG. 10-13-1981.
- 1,173,448. STRIKE-GUARD. INT. CL. 28. (U.S. CL. 22). REG. 10-13-1981.
- 1,173,468. ENERGEE NUGGETS. INT. CL. 29. (U.S. CL. 46). REG. 10-13-1981.
- 1,173,576. CIS. INT. CLS. 35 AND 41. (U.S. CLS. 101 AND 107). REG. 10-13-1981.
- 1,173,623. PLACON. INT. CL. 37. (U.S. CL. 103). REG. 10-13-1981.
- 1,173,624. PLACON (STYLIZED). INT. CL. 37. (U.S. CL. 103). REG. 10-13-1981.
- 1,173,708. PIZZA MAN "HE DELIVERS" AND DESIGN. INT. CL. 42. (U.S. CL. 100). REG. 10-13-1981.
- 1,173,720. BYERLY'S. INT. CL. 42. (U.S. CL. 101). REG. 10-13-1981.
- 1,173,729. WE TREAT YOU RIGHT. INT. CL. 42. (U.S. CL. 100). REG. 10-13-1981.
- 1,173,788. OLYMPIC WEATHER SCREEN. INT. CL. 2. (U.S. CL. 16). REG. 10-20-1981.
- 1,173,804. ADCO DETERGENT. INT. CL. 3. (U.S. CL. 52). REG. 10-20-1981.
- 1,173,830. LASHLITES. INT. CL. 3. (U.S. CL. 40). REG. 10-20-1981.
- 1,173,871. TIME-C. INT. CL. 5. (U.S. CL. 18). REG. 10-20-1981.
- 1,173,935. NEWCOMER. INT. CL. 7. (U.S. CL. 23). REG. 10-20-1981.
- 1,173,945. HOE. INT. CL. 7. (U.S. CL. 23). REG. 10-20-1981.
- 1,174,030. SCF. INT. CL. 10. (U.S. CL. 44). REG. 10-20-1981.
- 1,174,277. CHICOPEE (STYLIZED). INT. CL. 21. (U.S. CL. 29). REG. 10-20-1981.
- 1,174,279. REMEMBER. INT. CL. 22. (U.S. CL. 1). REG. 10-20-1981.
- 1,174,355. PLAYTEX. INT. CL. 25. (U.S. CL. 39). REG. 10-20-1981.
- 1,174,478. P AND DESIGN. INT. CL. 34. (U.S. CL. 8). REG. 10-20-1981.
- 1,174,479. OMEGA AND DESIGN. INT. CL. 34. (U.S. CL. 17). REG. 10-20-1981.
- 1,174,517. SEABROOK ISLAND. INT. CLS. 36, 37 AND 41. (U.S. CLS. 101, 102 AND 107). REG. 10-20-1981.
- 1,174,686. FELTMASTER. INT. CL. 1. (U.S. CL. 6). REG. 10-27-1981.
- 1,174,851. MEAD (STYLIZED). INT. CL. 7. (U.S. CL. 23). REG. 10-27-1981.
- 1,174,924. Z8. INT. CL. 9. (U.S. CL. 26). REG. 10-27-1981.
- 1,175,126. MEAD (STYLIZED). INT. CL. 16. (U.S. CL. 37). REG. 10-27-1981.
- 1,175,308. STARTER. INT. CL. 25. (U.S. CL. 39). REG. 10-27-1981.
- 1,175,337. P (STYLIZED). INT. CL. 28. (U.S. CL. 22). REG. 10-27-1981.
- 1,175,474. CHINA EXPERIENCE. INT. CL. 39. (U.S. CL. 105). REG. 10-27-1981.
- 1,175,505. MODERN FARM. INT. CL. 42. (U.S. CL. 101). REG. 10-27-1981.
- 1,175,538. BYERLY'S (STYLIZED). INT. CL. 42. (U.S. CL. 101). REG. 10-27-1981.
- 1,175,557. PRODUCTS DESIGNED FOR FLORISTS BY FLORISTS. INT. CL. 1. (U.S. CLS. 1, 5 AND 6). REG. 10-27-1981.
- 1,175,656. SPECTROMELT. INT. CL. 1. (U.S. CL. 6). REG. 11-3-1981.
- 1,175,738. ZEC (STYLIZED). INT. CL. 3. (U.S. CL. 4). REG. 11-3-1981.
- 1,175,840. VIVATOOL. INT. CLS. 7 AND 8. (U.S. CL. 23). REG. 11-3-1981.
- 1,175,855. VIBRANETICS AND DESIGN. INT. CL. 7. (U.S. CL. 23). REG. 11-3-1981.
- 1,176,445. STONE CREEK. INT. CL. 33. (U.S. CL. 47). REG. 11-3-1981.
- 1,176,791. UNI DERM. INT. CL. 5. (U.S. CL. 18). REG. 11-10-1981.
- 1,176,900. FREUND. INT. CL. 7. (U.S. CL. 23). REG. 11-10-1981.
- 1,177,128. YELLOW JACKET. INT. CL. 13. (U.S. CL. 9). REG. 11-10-1981.
- 1,177,212. PLASTAZOTE. INT. CL. 17. (U.S. CL. 1). REG. 11-10-1981.
- 1,177,236. HUSKY PLYWOOD AND DESIGN. INT. CL. 19. (U.S. CL. 12). REG. 11-10-1981.
- 1,177,272. PLACON (STYLIZED). INT. CL. 20. (U.S. CL. 2). REG. 11-10-1981.
- 1,177,380. SPORTS STUF (STYLIZED). INT. CL. 25. (U.S. CL. 39). REG. 11-10-1981.
- 1,178,179. PLACON. INT. CL. 20. (U.S. CLS. 2 AND 50). REG. 11-17-1981.



- 1,179,451. LIVINGSTON CELLARS (STYLIZED). INT. CL. 33. (U.S. CL. 47). REG. 11-24-1981.
- 1,179,978. MISCELLANEOUS DESIGN. INT. CL. 10. (U.S. CL. 44). REG. 12-1-1981.
- 1,180,446. BIAS. INT. CLS. 35 AND 42. (U.S. CLS. 100 AND 101). REG. 12-1-1981.
- 1,181,697. ZWITTERGENT. INT. CL. 1. (U.S. CL. 6). REG. 12-15-1981.
- 1,181,841. ECKOLD AND DESIGN. INT. CLS. 7 AND 8. (U.S. CL. 23). REG. 12-15-1981.
- 1,182,109. JOS. A. BANK. INT. CLS. 18 AND 25. (U.S. CLS. 3, 39 AND 41). REG. 12-15-1981.
- 1,182,602. SUMIREZ. INT. CL. 1. (U.S. CL. 1). REG. 12-22-1981.
- 1,182,713. BIBBY. INT. CLS. 7 AND 12. (U.S. CL. 23). REG. 12-22-1981.
- 1,182,937. PERGUT. INT. CL. 17. (U.S. CL. 1). REG. 12-22-1981.
- 1,183,748. LINN'S STAMP NEWS. INT. CL. 16. (U.S. CL. 38). REG. 12-29-1981.
- 1,184,515. VEGA AND DESIGN. INT. CL. 9 ONLY. (U.S. CL. 21). REG. 1-5-1982.
- 1,185,239. BAR STEEL SERVICE CENTER AND DESIGN. INT. CL. 42. (U.S. CL. 101). REG. 1-5-1982.
- 1,186,372. OMNIFLEX. INT. CL. 5. (U.S. CL. 44). REG. 1-19-1982.
- 1,187,400. THERMO BLEND (STYLIZED). INT. CL. 7. (U.S. CL. 23). REG. 1-26-1982.
- 1,188,384. CIG. INT. CL. 7. (U.S. CL. 23). REG. 2-2-1982.
- 1,191,378. COLLEGE BOWL. INT. CL. 41. (U.S. CL. 107). REG. 3-2-1982.
- 1,192,142. VI VULCAN INDUSTRIES AND DESIGN. INT. CL. 20. (U.S. CL. 32). REG. 3-16-1982.
- 1,192,531. COMPANY. INT. CL. 16. (U.S. CL. 38). REG. 3-23-1982.
- 1,194,328. ULTRASTAK. INT. CL. 16. (U.S. CL. 2). REG. 4-27-1982.
- 1,195,923. THE CHARLEY HORSE AND DESIGN. INT. CL. 42. (U.S. CL. 100). REG. 5-18-1982.
- 1,201,124. FORTY KARAT. INT. CL. 20. (U.S. CL. 32). REG. 7-13-1982.
- 1,201,345. BONKERS!. INT. CL. 30. (U.S. CL. 46). REG. 7-13-1982.
- 1,201,562. MW THE MAT WORKS AND DESIGN. INT. CL. 42. (U.S. CL. 101). REG. 7-13-1982.
- 1,202,446. KASOLV. INT. CL. 1. (U.S. CL. 6). REG. 7-27-1982.
- 1,204,268. ULTRA SKIN (STYLIZED). INT. CL. 5. (U.S. CL. 18). REG. 8-10-1982.
- 1,209,010. MISCELLANEOUS DESIGN. INT. CLS. 37 AND 42. (U.S. CLS. 101 AND 103). REG. 9-14-1982.
- 1,209,322. MISCELLANEOUS DESIGN. U.S. CL. 200. REG. 9-14-1982.
- 1,209,937. FRUIT-A-FREEZE. INT. CL. 30. (U.S. CL. 46). REG. 9-21-1982.
- 1,210,015. KIRBY (STYLIZED). INT. CL. 37. (U.S. CL. 103). REG. 9-21-1982.
- 1,210,016. KIRBY. INT. CL. 37. (U.S. CL. 103). REG. 9-21-1982.
- 1,210,017. KIRBY (STYLIZED). INT. CL. 37. (U.S. CL. 103). REG. 9-21-1982.
- 1,212,118. VERIN. INT. CL. 5. (U.S. CL. 18). REG. 10-12-1982.
- 1,573,521. GIORDANA (STYLIZED). INT. CL. 25. (U.S. CLS. 22 AND 39). REG. 12-26-1989.
- 1,579,562. PERIDATA. INT. CL. 42. (U.S. CL. 100). REG. 1-23-1990.
- 1,585,434. AUTOBOND. INT. CL. 9. (U.S. CLS. 21, 26 AND 38). REG. 3-6-1990.
- 1,597,536. ENERGIE BI CURRANTS. INT. CL. 25. (U.S. CLS. 22 AND 39). REG. 5-22-1990.
- 1,604,012. COMBINED HEALTH APPEAL AND DESIGN. INT. CL. 36. (U.S. CL. 102). REG. 6-26-1990.
- 1,616,474. BASE STATION. INT. CL. 9. (U.S. CLS. 21, 23, 26, 36 AND 38). REG. 10-9-1990.
- 1,617,767. JUGGLEBUG. INT. CL. 28. (U.S. CL. 22). REG. 10-16-1990.
- 1,618,233. S.C.I. SERVICE CHEMICAL INCORPORATED AND DESIGN. INT. CL. 1. (U.S. CLS. 1, 5, 6, 10, 26 AND 46). REG. 10-23-1990.
- 1,623,359. KILLER LOOP. INT. CL. 9. (U.S. CL. 26). REG. 11-20-1990.
- 1,623,361. ENTER PHONE AND DESIGN. INT. CL. 9. (U.S. CL. 21). REG. 11-20-1990.
- 1,626,000. MARBLE MASTER (STYLIZED). INT. CL. 19. (U.S. CL. 12). REG. 12-4-1990.
- 1,626,001. GTS. INT. CL. 19. (U.S. CL. 12). REG. 12-4-1990.
- 1,626,242. MISCELLANEOUS DESIGN. INT. CL. 35. (U.S. CLS. 100, 101 AND 102). REG. 12-4-1990.
- 1,626,437. DAVIS LAY. INT. CL. 42. (U.S. CL. 101). REG. 12-4-1990.
- 1,626,511. NATURALL AND DESIGN. INT. CL. 1. (U.S. CL. 10). REG. 12-11-1990.
- 1,626,522. FREEDOM. INT. CL. 2. (U.S. CL. 11). REG. 12-11-1990.
- 1,633,487. CUERVO GOLD CROWN. INT. CL. 41. (U.S. CL. 107). REG. 1-29-1991.
- 1,635,416. A.Y.M. INC. AND DESIGN. INT. CL. 11. (U.S. CL. 13). REG. 2-19-1991.
- 1,636,250. PURE & NATURAL (STYLIZED). INT. CL. 29. (U.S. CL. 46). REG. 2-26-1991.
- 1,636,277. CAREERPATH. INT. CL. 35. (U.S. CL. 101). REG. 2-26-1991.
- 1,638,302. RAILWALKER. INT. CL. 12. (U.S. CL. 19). REG. 3-19-1991.
- 1,639,198. MIDWAY. INT. CL. 28. (U.S. CLS. 22 AND 23). REG. 3-26-1991.
- 1,639,635. PASAR. INT. CL. 9. (U.S. CLS. 21 AND 26). REG. 4-2-1991.
- 1,639,763. STAGING CONCEPTS. INT. CL. 19. (U.S. CL. 12). REG. 4-2-1991.
- 1,640,240. ENDLEVEL II. INT. CL. 7. (U.S. CL. 23). REG. 4-9-1991.
- 1,641,346. TOUGH BY BRUNO VALENTI. INT. CL. 25. (U.S. CL. 39). REG. 4-16-1991.
- 1,641,680. DIVI RESORTS. INT. CL. 42. (U.S. CLS. 100, 101 AND 107). REG. 4-16-1991.
- 1,643,312. ECHINACEA-POWER. INT. CL. 5. (U.S. CL. 18). REG. 5-7-1991.
- 1,643,717. BLACK GOLD (STYLIZED). INT. CL. 28. (U.S. CL. 22). REG. 5-7-1991.
- 1,644,578. PP PITTI IMMAGINE (STYLIZED). INT. CL. 35. (U.S. CL. 101). REG. 5-14-1991.
- 1,645,095. AMWAY AND DESIGN. INT. CL. 16 ONLY. (U.S. CLS. 2, 5, 22, 23, 29, 37, 38 AND 50). REG. 5-21-1991.
- 1,645,258. STONCRETE. INT. CL. 19. (U.S. CL. 12). REG. 5-21-1991.
- 1,645,448. PP PITTI IMMAGINE (STYLIZED). INT. CL. 35. (U.S. CL. 101). REG. 5-21-1991.
- 1,649,076. GROW TRUTH CHARACTER FRIENDSHIP AND DESIGN. INT. CL. 42. (U.S. CL. 100). REG. 6-25-1991.
- 1,649,276. VIBRECON. INT. CL. 7. (U.S. CLS. 23 AND 34). REG. 7-2-1991.
- 1,651,199. CHIP'S CHALLENGE. INT. CL. 28. (U.S. CLS. 22 AND 38). REG. 7-16-1991.
- 1,651,900. BEAMBENDER. INT. CL. 9. (U.S. CL. 21). REG. 7-23-1991.
- 1,652,866. GLUCOPHAGE. INT. CL. 5. (U.S. CL. 18). REG. 8-6-1991.
- 1,653,217. R & B REALTY GROUP AND DESIGN. INT. CL. 36. (U.S. CLS. 100, 101 AND 102). REG. 8-6-1991.
- 1,653,257. PARK PAL AND DESIGN. INT. CL. 41. (U.S. CL. 107). REG. 8-6-1991.
- 1,653,295. COLTER'S WORLD CLASS CATERING. INT. CL. 42. (U.S. CL. 100). REG. 8-6-1991.
- 1,653,416. FAST BREAK AND DESIGN. INT. CL. 3. (U.S. CL. 4). REG. 8-13-1991.
- 1,653,451. GUIDE-RITE. INT. CL. 6. (U.S. CL. 13). REG. 8-13-1991.
- 1,653,460. JCB AND DESIGN. INT. CL. 7. (U.S. CL. 23). REG. 8-13-1991.
- 1,654,722. DEL MAR. INT. CLS. 6, 20 AND 24. (U.S. CLS. 12, 32 AND 42). REG. 8-27-1991.
- 1,654,920. LOUVERDRAPE. INT. CL. 20. (U.S. CL. 32). REG. 8-27-1991.
- 1,655,711. MISCELLANEOUS DESIGN. INT. CL. 31. (U.S. CL. 1). REG. 9-3-1991.
- 1,655,924. LINEA ROMA. INT. CL. 9. (U.S. CL. 26). REG. 9-3-1991.
- 1,657,078. RADCURE AND DESIGN. INT. CL. 1. (U.S. CL. 6). REG. 9-17-1991.
- 1,657,103. PRECIOUS PINK. INT. CL. 3. (U.S. CL. 51). REG. 9-17-1991.
- 1,657,145. CRYOLIVE (STYLIZED). INT. CL. 6. (U.S. CL. 13). REG. 9-17-1991.
- 1,657,308. DELINEATORS. INT. CL. 11. (U.S. CL. 21). REG. 9-17-1991.
- 1,657,602. ZOLD. INT. CL. 36. (U.S. CLS. 101 AND 102). REG. 9-17-1991.

- 1,658,020. CLOSE DOSE. INT. CL. 7. (U.S. CL. 23). REG. 9-24-1991.
- 1,658,638. SOFF-T-CUT. INT. CL. 7. (U.S. CL. 23). REG. 9-24-1991.
- 1,658,968. PRISMA FILM. INT. CL. 16. (U.S. CLS. 37 AND 50). REG. 10-1-1991.
- 1,659,140. CHILDREN'S DISCOVERY CENTERS. INT. CLS. 41 AND 42. (U.S. CLS. 100 AND 107). REG. 10-1-1991.
- 1,659,324. SMS. INT. CL. 1. (U.S. CL. 6). REG. 10-8-1991.
- 1,659,415. HEARTH MAGIC. INT. CLS. 6 AND 21 ONLY. (U.S. CLS. 2 AND 13). REG. 10-8-1991.
- 1,659,433. STANLEY FILTER. INT. CL. 7. (U.S. CLS. 23 AND 31). REG. 10-8-1991.
- 1,659,452. MEGA TOOL. INT. CLS. 7 AND 8. (U.S. CL. 23). REG. 10-8-1991.
- 1,659,512. AUSPEX. INT. CL. 9. (U.S. CLS. 26 AND 38). REG. 10-8-1991.
- 1,659,547. PICRITE. INT. CL. 9. (U.S. CLS. 26 AND 38). REG. 10-8-1991.
- 1,659,551. EASY DENTAL. INT. CL. 9. (U.S. CL. 38). REG. 10-8-1991.
- 1,659,582. STARPAC. INT. CL. 9. (U.S. CL. 26). REG. 10-8-1991.
- 1,659,754. HEAT MASTER. INT. CL. 17. (U.S. CL. 35). REG. 10-8-1991.
- 1,659,763. ROMA. INT. CL. 18. (U.S. CL. 3). REG. 10-8-1991.
- 1,659,772. F (STYLIZED). INT. CL. 19. (U.S. CL. 12). REG. 10-8-1991.
- 1,659,902. THE BEAN PEOPLE. INT. CL. 29. (U.S. CL. 46). REG. 10-8-1991.
- 1,659,969. VELVEETA. INT. CL. 30. (U.S. CL. 46). REG. 10-8-1991.
- 1,660,149. COLORES!. INT. CL. 41. (U.S. CL. 107). REG. 10-8-1991.
- 1,660,160. PAIDINC. INT. CL. 41. (U.S. CL. 107). REG. 10-8-1991.
- 1,660,313. OXOR. INT. CL. 9. (U.S. CL. 26). REG. 10-8-1991.
- 1,660,342. CANNU-FLEX. INT. CL. 10. (U.S. CL. 44). REG. 10-8-1991.
- 1,660,477. HANNA'S INGLENOOK AND DESIGN. INT. CL. 3. (U.S. CLS. 1 AND 50). REG. 10-15-1991.
- 1,660,603. CONTEC AND DESIGN. INT. CL. 9. (U.S. CLS. 21 AND 26). REG. 10-15-1991.
- 1,660,607. CRIMPFLEX. INT. CL. 9. (U.S. CLS. 21, 23, 26, 36 AND 38). REG. 10-15-1991.
- 1,660,628. GILBARCO. INT. CL. 9. (U.S. CL. 26). REG. 10-15-1991.
- 1,660,661. KEYSERVER (STYLIZED). INT. CL. 9. (U.S. CL. 38). REG. 10-15-1991.
- 1,660,726. TRAIL MASTER. INT. CL. 12. (U.S. CLS. 19, 21, 23, 31, 35 AND 44). REG. 10-15-1991.
- 1,660,732. KINGQUAD (STYLIZED). INT. CL. 12. (U.S. CL. 19). REG. 10-15-1991.
- 1,660,762. THUMPER. INT. CL. 14. (U.S. CL. 27). REG. 10-15-1991.
- 1,660,768. ACOUSTALON-LITE. INT. CL. 15. (U.S. CL. 36). REG. 10-15-1991.
- 1,660,772. PACKAGING DEPOT. INT. CL. 39 ONLY. (U.S. CL. 105). REG. 10-15-1991.
- 1,660,775. PHILLIES. INT. CLS. 16 AND 25. (U.S. CLS. 2, 5, 22, 23, 29, 37, 38, 39 AND 50). REG. 10-15-1991.
- 1,660,840. SUPER-STRETCH. INT. CL. 19. (U.S. CL. 12). REG. 10-15-1991.
- 1,660,875. PERFECTION BRAND FELTS (STYLIZED). INT. CL. 24. (U.S. CL. 42). REG. 10-15-1991.
- 1,660,879. WILTON COURT. INT. CL. 24. (U.S. CL. 42). REG. 10-15-1991.
- 1,660,882. C CROWN CRAFTS AND DESIGN. INT. CL. 24. (U.S. CL. 42). REG. 10-15-1991.
- 1,660,883. C CROWN CRAFTS AND DESIGN. INT. CL. 24. (U.S. CL. 42). REG. 10-15-1991.
- 1,660,911. NICKELODEON STUDIOS AND DESIGN. INT. CLS. 25 AND 41. (U.S. CLS. 39 AND 107). REG. 10-15-1991.
- 1,660,926. WORK KING. INT. CL. 25. (U.S. CL. 39). REG. 10-15-1991.
- 1,661,025. CHILKOOT-CHARLIE'S SOURDOUGH ALE AND DESIGN. INT. CL. 32. (U.S. CL. 48). REG. 10-15-1991.
- 1,661,044. PINPOINT. INT. CL. 35. (U.S. CLS. 100 AND 101). REG. 10-15-1991.
- 1,661,054. INFINITE HORIZONS, INC. AND DESIGN. INT. CL. 35. (U.S. CL. 101). REG. 10-15-1991.
- 1,661,062. AMERICAN INTERNATIONAL COMPANIES. INT. CL. 36. (U.S. CLS. 100, 101 AND 102). REG. 10-15-1991.
- 1,661,069. SIGNATURE FINANCIAL GROUP. INT. CL. 36. (U.S. CLS. 101 AND 102). REG. 10-15-1991.
- 1,661,105. GRASSLANDS GOLF & COUNTRY CLUB AND DESIGN. INT. CL. 37. (U.S. CL. 103). REG. 10-15-1991.
- 1,661,169. NICKELODEON STUDIOS. INT. CL. 41. (U.S. CL. 107). REG. 10-15-1991.
- 1,661,187. LIFELINE HOME HEALTH CARE. INT. CL. 42. (U.S. CLS. 100 AND 107). REG. 10-15-1991.
- 1,661,237. COOKIN' UP DOWN-HOME COOKIN'. INT. CL. 42. (U.S. CL. 100). REG. 10-15-1991.
- 1,661,310. ORANGE COUNTY INSIGHTS. INT. CL. 16. (U.S. CL. 38). REG. 10-15-1991.
- 1,661,429. GREEN AND WHITE STRAND. INT. CL. 6. (U.S. CL. 7). REG. 10-22-1991.
- 1,661,464. WERNER AND DESIGN. INT. CL. 9. (U.S. CLS. 21 AND 50). REG. 10-22-1991.
- 1,661,510. YO YO EXTRAVAGANZA. INT. CLS. 9 AND 41. (U.S. CLS. 21 AND 107). REG. 10-22-1991.
- 1,661,590. GAMOW. INT. CL. 10. (U.S. CL. 44). REG. 10-22-1991.
- 1,661,596. TOUGHWEAVE. INT. CL. 10. (U.S. CL. 44). REG. 10-22-1991.
- 1,661,623. COUGAR. INT. CL. 12. (U.S. CL. 19). REG. 10-22-1991.
- 1,661,734. MISCELLANEOUS DESIGN. INT. CL. 18. (U.S. CL. 41). REG. 10-22-1991.
- 1,661,918. WHAT STATE ARE YOUR TAXES IN?. INT. CL. 35. (U.S. CL. 101). REG. 10-22-1991.
- 1,661,948. SORENSEN CONSTRUCTION ALBAN DEVELOPMENT AND DESIGN. INT. CL. 37. (U.S. CLS. 100, 103 AND 106). REG. 10-22-1991.
- 1,661,952. MISCELLANEOUS DESIGN. INT. CLS. 37 AND 42. (U.S. CLS. 101 AND 103). REG. 10-22-1991.
- 1,661,996. CALIFORNIA YACHT CLUB AND DESIGN. INT. CL. 41. (U.S. CL. 107). REG. 10-22-1991.
- 1,662,074. DIAMOND MICRO SOLUTIONS. INT. CL. 42. (U.S. CL. 101). REG. 10-22-1991.
- 1,662,182. MINTRATE MSP 10/41. INT. CL. 5. (U.S. CLS. 18 AND 46). REG. 10-29-1991.
- 1,662,194. TALON SCREWS AND DESIGN. INT. CL. 6. (U.S. CLS. 2, 12, 13, 14, 23, 25 AND 50). REG. 10-29-1991.
- 1,662,197. XTRA FLEX. INT. CL. 6. (U.S. CL. 13). REG. 10-29-1991.
- 1,662,206. DOUBLE FRAME. INT. CL. 7. (U.S. CL. 23). REG. 10-29-1991.
- 1,662,304. BLUE STAR. INT. CL. 9. (U.S. CLS. 21 AND 34). REG. 10-29-1991.
- 1,662,481. M.C.A.. INT. CL. 19. (U.S. CL. 12). REG. 10-29-1991.
- 1,662,539. CLASS CLUB. INT. CL. 25. (U.S. CL. 39). REG. 10-29-1991.
- 1,662,638. CURLY BREAD. INT. CL. 30. (U.S. CL. 46). REG. 10-29-1991.
- 1,662,724. ABC PLATINUM RADIO NETWORK. INT. CL. 35. (U.S. CLS. 101 AND 104). REG. 10-29-1991.
- 1,662,747. JCB PLAZA. INT. CL. 36. (U.S. CL. 102). REG. 10-29-1991.
- 1,662,776. MISCELLANEOUS DESIGN. INT. CLS. 37 AND 42. (U.S. CLS. 101 AND 103). REG. 10-29-1991.
- 1,662,892. PREP'N SIZE (STYLIZED). INT. CL. 2. (U.S. CL. 6). REG. 10-29-1991.
- 1,662,977. STARPHIRE. INT. CL. 21. (U.S. CL. 33). REG. 10-29-1991.
- 1,663,063. APPLIED LABORATORIES. INT. CLS. 35 AND 40. (U.S. CLS. 100, 101, 102, 103 AND 106). REG. 10-29-1991.
- 1,663,341. VET BASE. INT. CL. 10. (U.S. CL. 44). REG. 11-5-1991.
- 1,663,609. ABC GALAXY RADIO NETWORK. INT. CL. 35. (U.S. CLS. 101 AND 104). REG. 11-5-1991.
- 1,663,719. NIXON'S DELI. INT. CL. 42. (U.S. CL. 100). REG. 11-5-1991.
- 1,663,796. SPRINGHOUSE GOLF CLUB. INT. CL. 25. (U.S. CL. 39). REG. 11-5-1991.
- 1,663,871. OWENS ONLINE. INT. CL. 35. (U.S. CL. 101). REG. 11-5-1991.
- 1,663,950. FIELD MASTER. INT. CL. 7. (U.S. CL. 23). REG. 11-12-1991.
- 1,664,141. OLD MISSION BLEND. INT. CL. 19. (U.S. CL. 12). REG. 11-12-1991.

- 1,664,325. SEAL STOCKHOLM AND DESIGN. INT. CL. 34. (U.S. CL. 17). REG. 11-12-1991.
- 1,664,392. LEISURE CLASS. INT. CL. 36. (U.S. CL. 102). REG. 11-12-1991.
- 1,664,404. NICCA U.S.A.. INT. CL. 37. (U.S. CLS. 103 AND 106). REG. 11-12-1991.
- 1,664,408. WE CAN TAKE THE HEAT. INT. CL. 37. (U.S. CL. 103). REG. 11-12-1991.
- 1,664,649. THERAHEAT. INT. CL. 1. (U.S. CLS. 6 AND 44). REG. 11-19-1991.
- 1,664,935. THERMO-CONTROL. INT. CLS. 12 AND 21 ONLY. (U.S. CLS. 19 AND 33). REG. 11-19-1991.
- 1,665,176. DAIRY QUEEN AND DESIGN. INT. CL. 30. (U.S. CL. 46). REG. 11-19-1991.
- 1,665,193. MARTELL FONDEE EN 1715 J.F. MARTELL CORDON BLEU OLD CLASSIC COGNAC AND DESIGN. INT. CL. 33. (U.S. CL. 49). REG. 11-19-1991.
- 1,665,205. ABC GENESIS RADIO NETWORK. INT. CL. 35. (U.S. CLS. 101 AND 104). REG. 11-19-1991.
- 1,665,322. CUSTOMERFIRST (STYLIZED). INT. CL. 42. (U.S. CL. 100). REG. 11-19-1991.
- 1,665,646. RV (STYLIZED). INT. CL. 6. (U.S. CL. 14). REG. 11-26-1991.
- 1,666,089. MISCELLANEOUS DESIGN. INT. CL. 37. (U.S. CL. 103). REG. 11-26-1991.
- 1,666,090. THE ENTERPRISE FOUNDATION. INT. CL. 37. (U.S. CL. 103). REG. 11-26-1991.
- 1,666,152. THE VARSITY SPORT OF THE MIND. INT. CL. 41. (U.S. CL. 107). REG. 11-26-1991.
- 1,666,273. ASSOCIATION OF COLLEGIATE LICENSING ADMINISTRATORS. INT. CL. 16. (U.S. CL. 38). REG. 11-26-1991.
- 1,666,334. SUPER-TRETE. INT. CL. 1. (U.S. CL. 6). REG. 12-3-1991.
- 1,666,420. ENHANCE. INT. CLS. 5 AND 10. (U.S. CLS. 18 AND 44). REG. 12-3-1991.
- 1,666,423. LBS II. INT. CL. 5. (U.S. CL. 18). REG. 12-3-1991.
- 1,666,849. M (STYLIZED). INT. CL. 28. (U.S. CL. 22). REG. 12-3-1991.
- 1,667,083. VICTORY AWARDS. INT. CL. 42. (U.S. CL. 100). REG. 12-3-1991.
- 1,667,195. QUIK-SEMBL. INT. CL. 20. (U.S. CL. 32). REG. 12-3-1991.
- 1,667,351. CUSIN-1 ABA. INT. CL. 6. (U.S. CL. 14). REG. 12-10-1991.
- 1,667,957. BRM BUTLER REFRIGERATED MEATS, INC. AND DESIGN. INT. CL. 42. (U.S. CL. 101). REG. 12-10-1991.
- 1,668,930. ONCE UPON A CHILD. INT. CL. 42. (U.S. CL. 101). REG. 12-17-1991.
- 1,669,303. SEPTI-SEAL. INT. CL. 11. (U.S. CL. 13). REG. 12-24-1991.
- 1,669,359. EB AND DESIGN. INT. CL. 14. (U.S. CL. 28). REG. 12-24-1991.
- 1,669,648. MOORE-CLARK. INT. CL. 31. (U.S. CL. 46). REG. 12-24-1991.
- 1,669,678. MARTELL V-S-O-P MEDALLION OLD FINE COGNAC AND DESIGN. INT. CL. 33. (U.S. CL. 49). REG. 12-24-1991.
- 1,670,844. C-LIFE. INT. CL. 25. (U.S. CL. 39). REG. 12-31-1991.
- 1,671,053. BUSHMASTER. INT. CL. 11. (U.S. CL. 21). REG. 1-7-1992.
- 1,671,744. CONCEPT. INT. CL. 16. (U.S. CL. 38). REG. 1-14-1992.
- 1,672,678. PEARLDIVE AND DESIGN. INT. CL. 28. (U.S. CL. 22). REG. 1-21-1992.
- 1,672,760. REDIRECTIONS. INT. CL. 35. (U.S. CL. 101). REG. 1-21-1992.
- 1,674,863. THE DONUT MAN. INT. CLS. 9 AND 41. (U.S. CLS. 36 AND 107). REG. 2-11-1992.
- 1,674,897. STAT! -REF AND DESIGN. INT. CL. 9. (U.S. CL. 38). REG. 2-11-1992.
- 1,675,448. STRAWBERRIES. INT. CL. 42. (U.S. CL. 101). REG. 2-11-1992.
- 1,675,618. CERAC/PURE. INT. CL. 1. (U.S. CL. 6). REG. 2-18-1992.
- 1,675,664. GREAT LAKES AND DESIGN. INT. CL. 4. (U.S. CL. 1). REG. 2-18-1992.
- 1,675,803. VL. INT. CL. 14. (U.S. CL. 28). REG. 2-18-1992.
- 1,676,551. PROTECTWALL. INT. CL. 6. (U.S. CLS. 12 AND 13). REG. 2-25-1992.
- 1,676,944. MADNESS. INT. CL. 31. (U.S. CL. 1). REG. 2-25-1992.
- 1,677,049. MISCELLANEOUS DESIGN. INT. CL. 37. (U.S. CL. 103). REG. 2-25-1992.
- 1,678,013. SUITE SYSTEMS. INT. CL. 42. (U.S. CLS. 100 AND 101). REG. 3-3-1992.
- 1,678,211. STYLE PLUS. INT. CL. 3. (U.S. CLS. 51 AND 52). REG. 3-10-1992.
- 1,678,249. PHARMACIST FORMULA AND DESIGN. INT. CL. 5. (U.S. CL. 18). REG. 3-10-1992.
- 1,678,274. BEAM AND DESIGN. INT. CL. 7. (U.S. CLS. 21 AND 23). REG. 3-10-1992.
- 1,678,431. WILDCAT. INT. CL. 13. (U.S. CL. 9). REG. 3-10-1992.
- 1,678,518. BABY-SITTER'S LITTLE SISTER. INT. CL. 16. (U.S. CL. 38). REG. 3-10-1992.
- 1,678,702. MAGIC MITTS. INT. CL. 28. (U.S. CL. 22). REG. 3-10-1992.
- 1,679,044. LOG CABIN LITE. INT. CL. 30. (U.S. CL. 46). REG. 3-10-1992.
- 1,679,244. MIL-E-QUAL. INT. CL. 9. (U.S. CLS. 21, 23, 26, 36 AND 38). REG. 3-17-1992.
- 1,679,368. THE MONEYPAPER. INT. CL. 16. (U.S. CL. 38). REG. 3-17-1992.
- 1,679,371. CONVERTING. INT. CL. 16. (U.S. CL. 38). REG. 3-17-1992.
- 1,679,574. OLD BAY. INT. CL. 30. (U.S. CL. 46). REG. 3-17-1992.
- 1,680,706. TERRI LYNN. INT. CL. 42. (U.S. CL. 101). REG. 3-24-1992.
- 1,681,680. MOCHA-FREEZE. INT. CL. 30. (U.S. CL. 46). REG. 3-31-1992.
- 1,682,059. YA/YA. INT. CL. 20. (U.S. CL. 32). REG. 4-7-1992.
- 1,682,065. SATIN. INT. CL. 21. (U.S. CL. 50). REG. 4-7-1992.
- 1,682,182. DEL'S AND DESIGN. INT. CL. 32. (U.S. CL. 45). REG. 4-7-1992.
- 1,683,029. WILDLIFE REFUGE. INT. CL. 25. (U.S. CL. 39). REG. 4-14-1992.
- 1,683,653. PERFUSION CHROMATOGRAPHY. INT. CL. 9. (U.S. CL. 26). REG. 4-21-1992.
- 1,686,294. L.A. EXPRESS. INT. CL. 14. (U.S. CL. 27). REG. 5-12-1992.
- 1,688,989. ACQUA (STYLIZED). INT. CL. 14. (U.S. CL. 27). REG. 5-26-1992.
- 1,689,217. ON TOP. INT. CL. 31. (U.S. CL. 1). REG. 5-26-1992.
- 1,689,886. THE INSTRUCTOR'S CHOICE. INT. CLS. 9 AND 28. (U.S. CLS. 9, 22 AND 26). REG. 6-2-1992.
- 1,690,235. FANTAGRAPH AND DESIGN. INT. CL. 24. (U.S. CL. 42). REG. 6-2-1992.
- 1,690,236. FANTAGRAPH AND DESIGN. INT. CLS. 24 AND 37. (U.S. CLS. 42 AND 103). REG. 6-2-1992.
- 1,691,446. ELITE. INT. CL. 16. (U.S. CLS. 2, 5, 22, 23, 29, 37, 38 AND 50). REG. 6-9-1992.
- 1,692,594. AGMS. INT. CL. 9. (U.S. CLS. 26 AND 38). REG. 6-9-1992.
- 1,693,838. DOWEX MARATHON. INT. CL. 1. (U.S. CL. 1). REG. 6-16-1992.
- 1,695,570. BROOKFIELDS. INT. CL. 42. (U.S. CL. 100). REG. 6-16-1992.
- 1,696,244. GENUS G E H AL SN SL G E H AL SN SL AND DESIGN. INT. CL. 28. (U.S. CL. 22). REG. 6-23-1992.
- 1,696,494. CAPITAL GBS COMMUNICATIONS AND DESIGN. INT. CL. 37. (U.S. CL. 103). REG. 6-23-1992.
- 1,698,527. WEAR TREND PLUS. INT. CL. 42. (U.S. CL. 100). REG. 6-30-1992.
- 1,699,293. SWEET STREET. INT. CL. 30. (U.S. CL. 46). REG. 7-7-1992.
- 1,700,702. CARAMEL APPLE GRANNY. INT. CL. 30. (U.S. CL. 46). REG. 7-14-1992.
- 1,701,270. CYTOLYT. INT. CL. 1. (U.S. CLS. 1, 5, 6, 10, 26 AND 46). REG. 7-21-1992.
- 1,701,426. CD. INT. CL. 7. (U.S. CL. 23). REG. 7-21-1992.
- 1,701,970. PACKED FROM FRESH TOMATOES! AND DESIGN. INT. CLS. 29 AND 30. (U.S. CL. 46). REG. 7-21-1992.
- 1,702,057. ABC PRIME RADIO NETWORK. INT. CL. 35. (U.S. CLS. 101 AND 104). REG. 7-21-1992.
- 1,702,102. JUSTCHECKING. INT. CL. 36. (U.S. CLS. 100, 101 AND 102). REG. 7-21-1992.
- 1,702,123. BANK ONE. INT. CL. 36. (U.S. CL. 102). REG. 7-21-1992.
- 1,702,142. WASH ME. INT. CL. 37. (U.S. CL. 103). REG. 7-21-1992.
- 1,703,154. GREETINGS FROM HELL. INT. CL. 16. (U.S. CLS. 37 AND 38). REG. 7-28-1992.

- 1,705,021. DANDI LINERS AND DESIGN. INT. CL. 20. (U.S. CL. 2). REG. 8-4-1992.
- 1,706,170. 2000 FLUSHES BLUE. INT. CL. 3. (U.S. CL. 51). REG. 8-11-1992.
- 1,708,325. LIQUID ALOHA. INT. CL. 25. (U.S. CL. 39). REG. 8-18-1992.
- 1,710,180. MISCELLANEOUS DESIGN. INT. CL. 28. (U.S. CL. 22). REG. 8-25-1992.
- 1,710,605. PERFORMANCE SUPPORT SYSTEMS. INT. CL. 42. (U.S. CL. 100). REG. 8-25-1992.
- 1,711,908. TRIVIAL PURSUIT AND DESIGN. INT. CL. 28. (U.S. CL. 22). REG. 9-1-1992.
- 1,712,057. DOC HOLIDAY. INT. CL. 32. (U.S. CL. 45). REG. 9-1-1992.
- 1,712,208. MISCELLANEOUS DESIGN. INT. CL. 36. (U.S. CL. 102). REG. 9-1-1992.
- 1,712,949. HAIR SYSTEMS INC. PROCESSORS & PACKAGERS OF QUALITY HAIR CARE PRODUCTS AND DESIGN. INT. CLS. 3 AND 42. (U.S. CLS. 51, 52 AND 101). REG. 9-8-1992.
- 1,714,071. MEDPROBE. INT. CLS. 35 AND 42. (U.S. CLS. 100 AND 101). REG. 9-8-1992.
- 1,714,795. GIRLS INC. (STYLIZED). INT. CL. 42. (U.S. CLS. 100 AND 101). REG. 9-8-1992.
- 1,715,431. INSCRUB. INT. CL. 11. (U.S. CL. 23). REG. 9-15-1992.
- 1,716,803. THE DOG HOUSE HOT DOGS AND DESIGN. INT. CL. 42. (U.S. CL. 100). REG. 9-15-1992.
- 1,718,838. NORTHWEST AIRLINES. INT. CL. 39. (U.S. CL. 105). REG. 9-22-1992.
- 1,719,790. EARTHSPAN. INT. CL. 5. (U.S. CL. 18). REG. 9-29-1992.
- 1,720,181. HAWK. INT. CL. 16. (U.S. CL. 38). REG. 9-29-1992.
- 1,720,647. WE TAKE CARE OF YOUR PEOPLE. SO YOU CAN TAKE CARE OF YOUR BUSINESS.. INT. CL. 35. (U.S. CL. 101). REG. 9-29-1992.

\* \* \* \* \*

# TRADEMARK REGISTRATIONS CANCELED

The designation "U.S. Cl." appearing in this section refers to the U.S. class in effect prior to Sep. 1, 1973 rather than the international class which applies to applications filed on or after that date. For adoption of international classification see notice in the OFFICIAL GAZETTE of Jun. 26, 1973 (911 O.G. TM 210).

## SECTION 7(D)

- 741,112. BALL ARMOR. U.S. CL. 4. REG. 11-27-1962.  
787,838. IZOD THE CHOICE OF CHAMPIONS (STYLIZED). U.S. CL. 39. REG. 4-6-1965.  
842,921. IZOD THE CHOICE OF CHAMPIONS. U.S. CL. 39. REG. 1-23-1968.  
1,311,843. ZAP-IT. INT. CL. 3. REG. 1-1-1985.  
1,650,367. HARSCO CORPORATION AND DESIGN. INT. CL. 40. REG. 7-9-1991.  
1,669,149. HARSCO CORPORATION AND DESIGN. INT. CLS. 7 AND 9. REG. 12-24-1991.  
1,893,286. SAVE-ON SELECT PLUS AND DESIGN. INT. CLS. 35 AND 42. REG. 5-9-1995.  
1,906,966. NATIONAL BOARD CERTIFIED TEACHER. INT. CL. 42. REG. 7-18-1995.  
1,940,365. 1ST ADE. INT. CLS. 30 AND 32. REG. 12-12-1995.  
1,948,056. IKELIA. INT. CLS. 3 AND 5. REG. 1-16-1996.  
1,961,923. TRANSFORMING THE PRESENT—DISCOVERING THE FUTURE. INT. CL. 41. REG. 3-12-1996.  
1,968,964. PRICERITE OPTICAL. INT. CL. 42. REG. 4-16-1996.  
2,351,045. PITTSBURGH FISH MARKET RESTAURANT. INT. CL. 42. REG. 5-16-2000.  
2,370,545. PRECISIONSTAFFING. INT. CL. 35 ONLY. REG. 7-25-2000.  
2,469,122. EMPACTHEALTH.COM. INT. CL. 35. REG. 7-17-2001.  
2,480,292. SAMSON MUSIC AND DESIGN. INT. CL. 9. REG. 8-21-2001.  
2,486,565. ZAP! AND DESIGN. INT. CL. 3. REG. 9-11-2001.  
2,486,568. ZAP. INT. CL. 3. REG. 9-11-2001.  
2,492,823. ZAP! PAD. INT. CL. 21. REG. 9-25-2001.
- 708,614. KILD. U.S. CL. 6. REG. 12-20-1960.  
708,616. FERMCOZYME. U.S. CL. 6. REG. 12-20-1960.  
708,621. AMITY. U.S. CL. 8. REG. 12-20-1960.  
708,625. TRIMLINE (STYLIZED). U.S. CL. 12. REG. 12-20-1960.  
708,631. TRUSS-O-MATIC AND DESIGN. U.S. CL. 12. REG. 12-20-1960.  
708,639. SHEF-TY. U.S. CL. 14. REG. 12-20-1960.  
708,640. LOW AMP. U.S. CL. 14. REG. 12-20-1960.  
708,644. OIL-UP (STYLIZED). U.S. CL. 15. REG. 12-20-1960.  
708,645. CONOPLEX. U.S. CL. 15. REG. 12-20-1960.  
708,647. UNICO FOUNTAIN OF COLOR. U.S. CL. 16. REG. 12-20-1960.  
708,649. GALAXY. U.S. CL. 17. REG. 12-20-1960.  
708,665. COSA-SIGNEBON. U.S. CL. 18. REG. 12-20-1960.  
708,666. FERONATED OPTIMS AND DESIGN. U.S. CL. 18. REG. 12-20-1960.  
708,670. DECTON. U.S. CL. 18. REG. 12-20-1960.  
708,677. HI-THERM AND DESIGN. U.S. CL. 18. REG. 12-20-1960.  
708,687. ADMIRAL. U.S. CL. 21. REG. 12-20-1960.  
708,688. GO FISH. U.S. CL. 22. REG. 12-20-1960.  
708,702. STRACO (STYLIZED). U.S. CL. 22. REG. 12-20-1960.  
708,705. GRAVITROL. U.S. CL. 23. REG. 12-20-1960.  
708,707. TRU-THREAD. U.S. CL. 23. REG. 12-20-1960.  
708,708. DUOTROL. U.S. CL. 23. REG. 12-20-1960.  
708,711. HEEL WHEEL. U.S. CL. 23. REG. 12-20-1960.  
708,712. HI CAP AND DESIGN. U.S. CL. 23. REG. 12-20-1960.  
708,714. TAB-O-MATIC. U.S. CL. 23. REG. 12-20-1960.  
708,727. CLIMATE EYE (STYLIZED). U.S. CL. 26. REG. 12-20-1960.  
708,728. MEDALIST. U.S. CL. 26. REG. 12-20-1960.  
708,734. ADMIRAL. U.S. CL. 31. REG. 12-20-1960.  
708,742. ROAD TRAC (STYLIZED). U.S. CL. 35. REG. 12-20-1960.  
708,744. AD-4-EVER. U.S. CL. 37. REG. 12-20-1960.  
708,770. WHISPER SMOOTH. U.S. CL. 40. REG. 12-20-1960.  
708,774. CHERUB. U.S. CL. 42. REG. 12-20-1960.  
708,775. STARWEAVE. U.S. CL. 42. REG. 12-20-1960.  
708,776. ORIOLE. U.S. CL. 42. REG. 12-20-1960.  
708,777. SUNDOWN. U.S. CL. 42. REG. 12-20-1960.  
708,778. SLEEPING BEAUTY. U.S. CL. 42. REG. 12-20-1960.  
708,782. VAN-GARD. U.S. CL. 44. REG. 12-20-1960.  
708,783. MISCELLANEOUS DESIGN. U.S. CL. 44. REG. 12-20-1960.  
708,784. ACHATITE. U.S. CL. 44. REG. 12-20-1960.  
708,792. UNITY. U.S. CL. 46. REG. 12-20-1960.  
708,793. KENT AND DESIGN. U.S. CL. 46. REG. 12-20-1960.  
708,804. MANDALAY (STYLIZED). U.S. CL. 46. REG. 12-20-1960.  
708,812. PEASANT. U.S. CL. 46. REG. 12-20-1960.  
708,817. WINN DIXIE AND DESIGN. U.S. CL. 46. REG. 12-20-1960.  
708,818. WRITE-A-CAKE. U.S. CL. 46. REG. 12-20-1960.  
708,826. ICEAROONS. U.S. CL. 46. REG. 12-20-1960.  
708,828. HEDGES & BUTLER (STYLIZED). U.S. CL. 47. REG. 12-20-1960.  
708,831. VIBRANT. U.S. CL. 51. REG. 12-20-1960.  
708,832. EQUIDERM. U.S. CL. 51. REG. 12-20-1960.  
708,836. BIRKIN. U.S. CL. 51. REG. 12-20-1960.  
708,839. BRECKSET. U.S. CL. 51. REG. 12-20-1960.

## SECTION 8

- 138,291. MASCO. U.S. CL. 29. REG. 12-21-1920.  
383,598. DAMPABASE. U.S. CL. 50. REG. 12-17-1940.  
383,643. SEXTET. U.S. CL. 46. REG. 12-17-1940.  
383,668. SPARE-TIME (STYLIZED). U.S. CL. 22. REG. 12-17-1940.  
541,762. HY-RAIL. U.S. CL. 19. REG. 5-1-1951.  
708,565. RIB MOUNTAIN. INT. CL. 1. REG. 12-20-1960.  
708,566. BALLERINA. INT. CL. 1. REG. 12-20-1960.  
708,568. MELLO TOUCH. U.S. CL. 1. REG. 12-20-1960.  
708,570. AUTO-SET. U.S. CL. 1. REG. 12-20-1960.  
708,586. EMBERS BRAND AND DESIGN. U.S. CL. 1. REG. 12-20-1960.  
708,592. COTE. U.S. CL. 6. REG. 12-20-1960.  
708,597. DISPERSOL. INT. CL. 2. REG. 12-20-1960.  
708,606. NELSONITE. U.S. CL. 6. REG. 12-20-1960.  
708,607. SANI-CLOR. U.S. CL. 6. REG. 12-20-1960.  
708,608. STERI-MAGIC (STYLIZED). U.S. CL. 6. REG. 12-20-1960.  
708,611. FIBROS. U.S. CL. 6. REG. 12-20-1960.  
708,613. SABITHANE. U.S. CL. 6. REG. 12-20-1960.

- 708,847. LANO-MOIST. U.S. CL. 51. REG. 12-20-1960.  
708,852. IRSA. U.S. CL. 52. REG. 12-20-1960.  
708,853. SULFRIN. U.S. CL. 52. REG. 12-20-1960.  
708,856. USAPON. U.S. CL. 52. REG. 12-20-1960.  
708,863. TC AND DESIGN. U.S. CL. 105. REG. 12-20-1960.  
708,864. BESHARIZING. U.S. CL. 106. REG. 12-20-1960.  
708,867. CLEAN 'N TUNE. U.S. CL. 15. REG. 12-20-1960.  
923,036. EDELMANN. U.S. CLS. 19, 23 AND 26, ONLY. REG. 11-2-1971.  
1,128,894. STENODATA. INT. CL. 9. REG. 1-8-1980.  
1,130,261. VARI-DAMP. INT. CL. 9. REG. 2-5-1980.  
1,143,807. AUTOSOL. INT. CLS. 1, 3, 5 AND 21. REG. 12-23-1980.  
1,143,809. VALCHEM. INT. CL. 1. REG. 12-23-1980.  
1,143,813. D AND DESIGN. INT. CL. 1. REG. 12-23-1980.  
1,143,814. SARET. INT. CL. 1. REG. 12-23-1980.  
1,143,815. BETA PAK. INT. CL. 1. REG. 12-23-1980.  
1,143,817. MISCELLANEOUS DESIGN. INT. CL. 1. REG. 12-23-1980.  
1,143,824. ROYAL PURPLE (STYLIZED). INT. CL. 3. REG. 12-23-1980.  
1,143,825. ULTRA BODY. INT. CL. 3. REG. 12-23-1980.  
1,143,829. DELIVERANCE. INT. CL. 3. REG. 12-23-1980.  
1,143,831. PLAIMAR. INT. CL. 3. REG. 12-23-1980.  
1,143,833. PUREX SYMBOL OF VALUE AND DESIGN. INT. CL. 3. REG. 12-23-1980.  
1,143,836. POSH. INT. CL. 3. REG. 12-23-1980.  
1,143,840. ULTRA-D M MARATHON AND DESIGN. INT. CL. 4. REG. 12-23-1980.  
1,143,856. BEACH GUARD. INT. CL. 5. REG. 12-23-1980.  
1,143,857. CONDRANOL. INT. CL. 5. REG. 12-23-1980.  
1,143,863. SUNASU AND DESIGN. INT. CL. 5. REG. 12-23-1980.  
1,143,864. SPECTRO-VITE. INT. CL. 5. REG. 12-23-1980.  
1,143,866. AQUA-HOOF. INT. CL. 5. REG. 12-23-1980.  
1,143,867. NOVACORT. INT. CL. 5. REG. 12-23-1980.  
1,143,868. SULCOSYN. INT. CL. 5. REG. 12-23-1980.  
1,143,877. GINSAVENA. INT. CL. 5. REG. 12-23-1980.  
1,143,878. AUROFORCE. INT. CL. 5. REG. 12-23-1980.  
1,143,879. PHYLLLO-TAB. INT. CL. 5. REG. 12-23-1980.  
1,143,886. JOINTS. INT. CL. 6. REG. 12-23-1980.  
1,143,889. LU METAL (STYLIZED). INT. CL. 6. REG. 12-23-1980.  
1,143,892. POLLUSTOP. INT. CL. 6. REG. 12-23-1980.  
1,143,894. GG (STYLIZED). INT. CL. 6. REG. 12-23-1980.  
1,143,895. CERRODUCT. INT. CL. 6. REG. 12-23-1980.  
1,143,897. TOOLHEAD (STYLIZED). INT. CL. 6. REG. 12-23-1980.  
1,143,900. KARRO. INT. CL. 6. REG. 12-23-1980.  
1,143,902. KORNS. INT. CL. 6. REG. 12-23-1980.  
1,143,906. MALTESE. INT. CL. 6. REG. 12-23-1980.  
1,143,907. NOBLE. INT. CL. 6. REG. 12-23-1980.  
1,143,918. ARRASATE. INT. CL. 7. REG. 12-23-1980.  
1,143,921. SPEEDMASTER 150. INT. CL. 7. REG. 12-23-1980.  
1,143,925. SARCLAD. INT. CL. 7. REG. 12-23-1980.  
1,143,926. WL (STYLIZED). INT. CLS. 7 AND 11. REG. 12-23-1980.  
1,143,929. R RADER AND DESIGN. INT. CL. 7. REG. 12-23-1980.  
1,143,931. TOMATO CHEF. INT. CL. 7. REG. 12-23-1980.  
1,143,932. TOMATO CHEF SLICER AND DESIGN. INT. CL. 7. REG. 12-23-1980.  
1,143,933. HUSHH-PUP. INT. CL. 7. REG. 12-23-1980.  
1,143,935. HESSAPP. INT. CL. 7. REG. 12-23-1980.  
1,143,938. YIELDMASTER. INT. CL. 7. REG. 12-23-1980.  
1,143,941. CORTEZ. INT. CL. 7. REG. 12-23-1980.  
1,143,942. GENUINE VILTER PART AND DESIGN. INT. CLS. 7 AND 11. REG. 12-23-1980.  
1,143,944. FLEXIGAS. INT. CL. 7. REG. 12-23-1980.  
1,143,955. LIBRA. INT. CL. 8. REG. 12-23-1980.  
1,143,957. FLASH. INT. CL. 9. REG. 12-23-1980.  
1,143,964. MEGABUS. INT. CL. 9. REG. 12-23-1980.  
1,143,965. TELEMITTER. INT. CL. 9. REG. 12-23-1980.  
1,143,967. VECTORIZER. INT. CL. 9. REG. 12-23-1980.  
1,143,977. HMC AND DESIGN. INT. CLS. 9 AND 42. REG. 12-23-1980.  
1,143,984. GG (STYLIZED). INT. CL. 9. REG. 12-23-1980.  
1,143,989. ACS AND DESIGN. INT. CL. 9. REG. 12-23-1980.  
1,143,990. APPLIED COLOR SYSTEMS. INT. CL. 9. REG. 12-23-1980.  
1,143,996. HISTO-PLATE. INT. CL. 9. REG. 12-23-1980.  
1,143,998. AUTOPIPETTER. INT. CL. 9. REG. 12-23-1980.  
1,144,007. SPECULATOR. INT. CL. 9. REG. 12-23-1980.  
1,144,013. ACCUTIG 300 (STYLIZED). INT. CL. 9. REG. 12-23-1980.  
1,144,014. UNL (STYLIZED). INT. CL. 9. REG. 12-23-1980.  
1,144,015. SUNDRIFTER. INT. CL. 9. REG. 12-23-1980.  
1,144,016. QUAD MOUNT. INT. CL. 9. REG. 12-23-1980.  
1,144,020. PANELSPOTTER AND DESIGN. INT. CL. 9. REG. 12-23-1980.  
1,144,025. DIESCOPE. INT. CL. 9. REG. 12-23-1980.  
1,144,034. ISO-CUBE. INT. CL. 9. REG. 12-23-1980.  
1,144,039. HIC-CUP AND DESIGN. INT. CL. 10. REG. 12-23-1980.  
1,144,041. CLASSIC. INT. CL. 10. REG. 12-23-1980.  
1,144,043. BANTAM-2. INT. CL. 10. REG. 12-23-1980.  
1,144,051. BIOPOD. INT. CL. 11. REG. 12-23-1980.  
1,144,057. GALILEO. INT. CL. 11. REG. 12-23-1980.  
1,144,060. GLO-GRATE. INT. CL. 11. REG. 12-23-1980.  
1,144,061. Q-BEAM (STYLIZED). INT. CL. 11. REG. 12-23-1980.  
1,144,064. MISCELLANEOUS DESIGN. INT. CL. 11. REG. 12-23-1980.  
1,144,066. MATCH-NON. INT. CL. 11. REG. 12-23-1980.  
1,144,070. SPRINGTIME. INT. CL. 11. REG. 12-23-1980.  
1,144,072. MELITTA PERSONAL COFFEEMAKER. INT. CL. 11. REG. 12-23-1980.  
1,144,073. TOLOTTI AIRTITE HOME HEATER AND DESIGN. INT. CL. 11. REG. 12-23-1980.  
1,144,078. DAILY. INT. CL. 12. REG. 12-23-1980.  
1,144,079. SUPERSTAR AND DESIGN. INT. CL. 12. REG. 12-23-1980.  
1,144,081. BROWNING. INT. CL. 12. REG. 12-23-1980.  
1,144,082. MAMMOTH. INT. CL. 12. REG. 12-23-1980.  
1,144,110. FUNKY (STYLIZED). INT. CL. 15. REG. 12-23-1980.  
1,144,113. ROSE FOR FRIENDSHIP. INT. CLS. 16 AND 42. REG. 12-23-1980.  
1,144,115. EDITIONES HERDER AND DESIGN. INT. CL. 16. REG. 12-23-1980.  
1,144,119. KNOWLEDGE SERVICE. INT. CL. 16. REG. 12-23-1980.  
1,144,122. MISCELLANEOUS DESIGN. INT. CL. 16. REG. 12-23-1980.  
1,144,123. THE SEA. INT. CL. 16. REG. 12-23-1980.  
1,144,124. MATH PATH. INT. CL. 16. REG. 12-23-1980.  
1,144,128. MISCELLANEOUS DESIGN. INT. CLS. 16, 41 AND 42. REG. 12-23-1980.  
1,144,141. SHOPPER'S FRIEND. INT. CL. 16. REG. 12-23-1980.  
1,144,144. WILD & WONDERFUL (STYLIZED). INT. CL. 16. REG. 12-23-1980.  
1,144,148. SUNSHINE MUSIC MOUNTAIN AND DESIGN. INT. CL. 16. REG. 12-23-1980.  
1,144,151. FUNNY FREIGHT (STYLIZED). INT. CL. 16. REG. 12-23-1980.  
1,144,153. GATES AND DESIGN. INT. CL. 16. REG. 12-23-1980.  
1,144,169. RED DEVIL. INT. CL. 17. REG. 12-23-1980.  
1,144,173. ESLON. INT. CL. 17. REG. 12-23-1980.  
1,144,182. WW (STYLIZED). INT. CL. 18. REG. 12-23-1980.  
1,144,183. MISCELLANEOUS DESIGN. INT. CL. 19. REG. 12-23-1980.  
1,144,184. MODAR. INT. CLS. 19 AND 20. REG. 12-23-1980.  
1,144,187. THE RUSTICS OF LINDBERGH LAKE. INT. CL. 19. REG. 12-23-1980.  
1,144,193. EMINENCE (STYLIZED). INT. CLS. 20, 21 AND 26. REG. 12-23-1980.  
1,144,201. BULK FILE. INT. CL. 20. REG. 12-23-1980.  
1,144,202. MISCELLANEOUS DESIGN. INT. CL. 20. REG. 12-23-1980.  
1,144,203. OAK-LIN. INT. CL. 20. REG. 12-23-1980.  
1,144,205. FLEXI-SETTE AND DESIGN. INT. CL. 20. REG. 12-23-1980.  
1,144,206. ROPER REEL. INT. CL. 20. REG. 12-23-1980.

- 1,144,208. STAXUP (STYLIZED). INT. CL. 20. REG. 12-23-1980.
- 1,144,209. BRAIN FLOSS. INT. CL. 20. REG. 12-23-1980.
- 1,144,211. CLASSIC ROSE COLLECTION. INT. CLS. 21 AND 34. REG. 12-23-1980.
- 1,144,215. ULTRAEASE. INT. CL. 21. REG. 12-23-1980.
- 1,144,216. SONIC SENSOR (STYLIZED). INT. CL. 21. REG. 12-23-1980.
- 1,144,217. STRATA-LINE. INT. CL. 21. REG. 12-23-1980.
- 1,144,230. SUPER YARN MART! AND DESIGN. INT. CL. 23. REG. 12-23-1980.
- 1,144,235. FILTRA. INT. CL. 24. REG. 12-23-1980.
- 1,144,236. CHIFFONSHEEN. INT. CL. 24. REG. 12-23-1980.
- 1,144,238. BODY SACK. INT. CL. 24. REG. 12-23-1980.
- 1,144,246. PROTECT-O-KICK. INT. CL. 25. REG. 12-23-1980.
- 1,144,252. FEELIN' GREAT. INT. CL. 25. REG. 12-23-1980.
- 1,144,260. JEROLDS AND DESIGN. INT. CLS. 25 AND 42. REG. 12-23-1980.
- 1,144,262. COLMAR AND DESIGN. INT. CL. 25. REG. 12-23-1980.
- 1,144,274. SNOW SNAKE AND DESIGN. INT. CL. 25. REG. 12-23-1980.
- 1,144,277. LAWMAN. INT. CL. 25. REG. 12-23-1980.
- 1,144,290. SNEAKERS. INT. CL. 25. REG. 12-23-1980.
- 1,144,297. SHARILOVE AND DESIGN. INT. CL. 25. REG. 12-23-1980.
- 1,144,299. TURNUPS AND DESIGN. INT. CL. 25. REG. 12-23-1980.
- 1,144,300. ANGEL LITE. INT. CL. 25. REG. 12-23-1980.
- 1,144,314. ESPRIT DECOR. INT. CL. 27. REG. 12-23-1980.
- 1,144,319. HALSTEAD CONDUCTIVE (STYLIZED). INT. CL. 27. REG. 12-23-1980.
- 1,144,322. INDRAHMA BY RAHMANAN (STYLIZED). INT. CL. 27. REG. 12-23-1980.
- 1,144,325. NATURALUSTER. INT. CL. 27. REG. 12-23-1980.
- 1,144,328. CAPITOL CARPETS CC AND DESIGN. INT. CL. 27. REG. 12-23-1980.
- 1,144,332. SKI KEEP. INT. CL. 28. REG. 12-23-1980.
- 1,144,346. BUBBLO'S AND DESIGN. INT. CL. 28. REG. 12-23-1980.
- 1,144,351. MISCELLANEOUS DESIGN. INT. CL. 28. REG. 12-23-1980.
- 1,144,354. E99 RADIAL. INT. CL. 28. REG. 12-23-1980.
- 1,144,362. CLONE. INT. CL. 28. REG. 12-23-1980.
- 1,144,371. SHELLY SEA WEE. INT. CL. 28. REG. 12-23-1980.
- 1,144,372. SANDY SEA WEE. INT. CL. 28. REG. 12-23-1980.
- 1,144,374. CORAL SEA WEE. INT. CL. 28. REG. 12-23-1980.
- 1,144,383. TOUGHS. INT. CL. 28. REG. 12-23-1980.
- 1,144,385. AHI (STYLIZED). INT. CL. 28. REG. 12-23-1980.
- 1,144,387. SOFTLITE. INT. CL. 28. REG. 12-23-1980.
- 1,144,389. IMAGE. INT. CL. 28. REG. 12-23-1980.
- 1,144,391. SNYDER'S OF BERLIN. INT. CLS. 29 AND 30. REG. 12-23-1980.
- 1,144,394. MISCELLANEOUS DESIGN. INT. CL. 29. REG. 12-23-1980.
- 1,144,401. MISCELLANEOUS DESIGN. INT. CL. 29. REG. 12-23-1980.
- 1,144,403. FLEISCHMANN'S AND DESIGN. INT. CL. 29. REG. 12-23-1980.
- 1,144,404. TACO-LOVER (STYLIZED). INT. CL. 29. REG. 12-23-1980.
- 1,144,406. MISCELLANEOUS DESIGN. INT. CL. 29. REG. 12-23-1980.
- 1,144,407. MISCELLANEOUS DESIGN. INT. CL. 29. REG. 12-23-1980.
- 1,144,410. MISCELLANEOUS DESIGN. INT. CL. 29. REG. 12-23-1980.
- 1,144,416. PARIZOT. INT. CL. 30. REG. 12-23-1980.
- 1,144,417. PIZZA PATIO. INT. CL. 30. REG. 12-23-1980.
- 1,144,422. CAP 'N KID. INT. CL. 30. REG. 12-23-1980.
- 1,144,425. NBA SLAM DUNK AND DESIGN. INT. CL. 30. REG. 12-23-1980.
- 1,144,435. YOGHURT DREAMS (STYLIZED). INT. CL. 30. REG. 12-23-1980.
- 1,144,440. MONO-DRI. INT. CL. 30. REG. 12-23-1980.
- 1,144,441. MICROWAVE PANTRY. INT. CL. 30. REG. 12-23-1980.
- 1,144,442. MICROWAVERS. INT. CL. 30. REG. 12-23-1980.
- 1,144,443. MICROWAVE CUPBOARD. INT. CL. 30. REG. 12-23-1980.
- 1,144,444. MICROWAVE KITCHEN. INT. CL. 30. REG. 12-23-1980.
- 1,144,446. SEVEN (STYLIZED). INT. CL. 32. REG. 12-23-1980.
- 1,144,449. ELAN. INT. CL. 32. REG. 12-23-1980.
- 1,144,458. NORDVIK. INT. CL. 33. REG. 12-23-1980.
- 1,144,459. FOURCROY AND DESIGN. INT. CL. 33. REG. 12-23-1980.
- 1,144,464. REGIS. INT. CL. 33. REG. 12-23-1980.
- 1,144,466. VR THE CELEBRATED AND DESIGN. INT. CL. 34. REG. 12-23-1980.
- 1,144,470. THE CHEESE SHOP AND DESIGN. INT. CLS. 35 AND 42. REG. 12-23-1980.
- 1,144,475. MISCELLANEOUS DESIGN. INT. CL. 35. REG. 12-23-1980.
- 1,144,479. THORP AND DESIGN. INT. CLS. 35 AND 36. REG. 12-23-1980.
- 1,144,484. HEALTHFORCE. INT. CL. 35. REG. 12-23-1980.
- 1,144,487. SUN BANK. INT. CL. 36. REG. 12-23-1980.
- 1,144,490. MID CONTINENT MINI CARD AND DESIGN. INT. CL. 36. REG. 12-23-1980.
- 1,144,502. MISCELLANEOUS DESIGN. INT. CL. 36. REG. 12-23-1980.
- 1,144,503. CIA AND DESIGN. INT. CL. 36. REG. 12-23-1980.
- 1,144,513. OCEAN-AIR INTERNATIONAL INC. OA AND DESIGN. INT. CL. 39. REG. 12-23-1980.
- 1,144,517. AFI AND DESIGN. INT. CL. 39. REG. 12-23-1980.
- 1,144,522. MISCELLANEOUS DESIGN. INT. CL. 39. REG. 12-23-1980.
- 1,144,524. DOLLAR RENT-A-CAR SYSTEMS AND DESIGN. INT. CL. 39. REG. 12-23-1980.
- 1,144,525. SPACE AND DESIGN. INT. CL. 39. REG. 12-23-1980.
- 1,144,531. SQUARE FOOT GARDENING. INT. CL. 41. REG. 12-23-1980.
- 1,144,540. MISCELLANEOUS DESIGN. INT. CL. 41. REG. 12-23-1980.
- 1,144,541. JAZZ.ER.CISE AND DESIGN. INT. CL. 41. REG. 12-23-1980.
- 1,144,544. TRANSMEET. INT. CL. 41. REG. 12-23-1980.
- 1,144,548. MISCELLANEOUS DESIGN. INT. CL. 41. REG. 12-23-1980.
- 1,144,554. GRANDMA LEE'S BAKERY & EATING PLACE. INT. CL. 42. REG. 12-23-1980.
- 1,144,562. HOME OF THE LAUGHING FISH AND DESIGN. INT. CL. 42. REG. 12-23-1980.
- 1,144,563. VAUN. GARDE (STYLIZED). INT. CL. 42. REG. 12-23-1980.
- 1,144,564. ONE DAY AT A TIME MINISTRIES, INC. AND DESIGN. INT. CL. 42. REG. 12-23-1980.
- 1,144,565. AD-2000. INT. CL. 42. REG. 12-23-1980.
- 1,144,566. PORTA-PRINTER PPS AND DESIGN. INT. CL. 42. REG. 12-23-1980.
- 1,144,577. PEACHTREE QUALITY SALVAGE STORES. INT. CL. 42. REG. 12-23-1980.
- 1,144,578. CHEF CHU'S. INT. CL. 42. REG. 12-23-1980.
- 1,144,582. COUNTRY CHARM AND DESIGN. INT. CL. 42. REG. 12-23-1980.
- 1,144,585. LAMB. INT. CL. 42. REG. 12-23-1980.
- 1,144,598. F.P.S. FIRE PROTECTION SPECIALIST AND DESIGN. U.S. CL. B. REG. 12-23-1980.
- 1,571,525. PINKE DINKS (STYLIZED). INT. CL. 3. REG. 12-19-1989.
- 1,572,776. BOUNCIN N' BEHAVIN (STYLIZED). INT. CL. 3. REG. 12-26-1989.
- 1,574,681. THORN AND DESIGN. INT. CL. 11. REG. 1-2-1990.
- 1,582,506. HEARING INSTRUMENTS. INT. CL. 16. REG. 2-13-1990.
- 1,627,866. FACTOR-TEST (STYLIZED). INT. CL. 1. REG. 12-18-1990.
- 1,627,876. BONEBUMPER. INT. CL. 1. REG. 12-18-1990.
- 1,627,881. TRIM CUT. INT. CL. 1. REG. 12-18-1990.
- 1,627,885. HONEST PRODUCTS HONEST PRICES AND DESIGN. INT. CL. 2. REG. 12-18-1990.
- 1,627,889. LANDMARK. INT. CL. 2. REG. 12-18-1990.

- 1,627,900. SUPRA NOVA AND DESIGN. INT. CL. 3. REG. 12-18-1990.
- 1,627,905. TOTAL CONTROL. INT. CL. 3. REG. 12-18-1990.
- 1,627,915. VAXA (STYLIZED). INT. CL. 3. REG. 12-18-1990.
- 1,627,921. MISCELLANEOUS DESIGN. INT. CLS. 3 AND 7. REG. 12-18-1990.
- 1,627,922. GRAF. INT. CL. 3. REG. 12-18-1990.
- 1,627,924. MISCELLANEOUS DESIGN. INT. CL. 3. REG. 12-18-1990.
- 1,627,932. VIBAX-5 (STYLIZED). INT. CL. 5. REG. 12-18-1990.
- 1,627,936. EVERDRI. INT. CL. 5. REG. 12-18-1990.
- 1,627,938. MISCELLANEOUS DESIGN. INT. CL. 5. REG. 12-18-1990.
- 1,627,939. DEXTROLYTE. INT. CL. 5. REG. 12-18-1990.
- 1,627,946. BOLT ENERGY. INT. CL. 5. REG. 12-18-1990.
- 1,627,952. RATHBONE. INT. CL. 6. REG. 12-18-1990.
- 1,627,961. JET BLASTER AND DESIGN. INT. CL. 7. REG. 12-18-1990.
- 1,627,970. SRECO FLEXIBLE. INT. CL. 7. REG. 12-18-1990.
- 1,627,971. ROTO-DISC. INT. CL. 7. REG. 12-18-1990.
- 1,627,980. MISCELLANEOUS DESIGN. INT. CL. 7. REG. 12-18-1990.
- 1,627,998. ADLER-ROYAL. INT. CLS. 9, 16 AND 37. REG. 12-18-1990.
- 1,628,002. PRO-LINE. INT. CL. 9. REG. 12-18-1990.
- 1,628,008. ERO (STYLIZED). INT. CL. 9. REG. 12-18-1990.
- 1,628,033. MISCELLANEOUS DESIGN. INT. CL. 9. REG. 12-18-1990.
- 1,628,042. IBS. INT. CL. 9. REG. 12-18-1990.
- 1,628,047. DATA MAGIC. INT. CL. 9. REG. 12-18-1990.
- 1,628,049. VIA SMARTTEST. INT. CL. 9. REG. 12-18-1990.
- 1,628,051. AUTO-LOCK. INT. CL. 9. REG. 12-18-1990.
- 1,628,055. STEAMSCAN. INT. CL. 9. REG. 12-18-1990.
- 1,628,061. PHOTOPHONE. INT. CL. 9. REG. 12-18-1990.
- 1,628,062. SHIP MATE. INT. CL. 9. REG. 12-18-1990.
- 1,628,063. SALON CREATIONS. INT. CLS. 9 AND 11. REG. 12-18-1990.
- 1,628,068. ETI AND DESIGN. INT. CL. 9. REG. 12-18-1990.
- 1,628,072. WHISPER 1.3. INT. CL. 9. REG. 12-18-1990.
- 1,628,077. BRIKO AND DESIGN. INT. CLS. 9, 25 AND 28. REG. 12-18-1990.
- 1,628,078. SPEAK TO ME. INT. CLS. 9 AND 16. REG. 12-18-1990.
- 1,628,090. ULTRALAB. INT. CL. 9. REG. 12-18-1990.
- 1,628,091. RAPIDLAB. INT. CL. 9. REG. 12-18-1990.
- 1,628,096. PCPI. INT. CL. 9. REG. 12-18-1990.
- 1,628,116. POWER R. INT. CL. 9. REG. 12-18-1990.
- 1,628,122. WHO WORKS WHEN. INT. CL. 9. REG. 12-18-1990.
- 1,628,127. ARE. INT. CL. 9. REG. 12-18-1990.
- 1,628,129. NET-SET. INT. CL. 9. REG. 12-18-1990.
- 1,628,136. TECHMATE. INT. CL. 9. REG. 12-18-1990.
- 1,628,138. FIRST RATE. INT. CLS. 9 AND 35. REG. 12-18-1990.
- 1,628,144. ETHERGATE. INT. CL. 9. REG. 12-18-1990.
- 1,628,153. TELECOM MANAGER. INT. CL. 9. REG. 12-18-1990.
- 1,628,162. SUN KIDS. INT. CL. 9. REG. 12-18-1990.
- 1,628,164. BGS. INT. CL. 9. REG. 12-18-1990.
- 1,628,169. QUANTUM. INT. CL. 10. REG. 12-18-1990.
- 1,628,171. SONASSAGE. INT. CL. 10. REG. 12-18-1990.
- 1,628,172. PE 600. INT. CL. 10. REG. 12-18-1990.
- 1,628,173. ANNA-DOTE (STYLIZED). INT. CL. 10. REG. 12-18-1990.
- 1,628,179. AUTOVENT-SP. INT. CL. 10. REG. 12-18-1990.
- 1,628,181. APOLLO. INT. CL. 11. REG. 12-18-1990.
- 1,628,191. SUNFAMILY. INT. CL. 11. REG. 12-18-1990.
- 1,628,196. WOLFARD GLASSBLOWING CO. AND DESIGN. INT. CL. 11. REG. 12-18-1990.
- 1,628,202. T589 LP RADIAL. INT. CL. 12. REG. 12-18-1990.
- 1,628,216. ATX 780. INT. CL. 12. REG. 12-18-1990.
- 1,628,217. ATX 760. INT. CL. 12. REG. 12-18-1990.
- 1,628,222. DOME' PEARL (STYLIZED). INT. CL. 14. REG. 12-18-1990.
- 1,628,226. PALOMAR AND DESIGN. INT. CL. 14. REG. 12-18-1990.
- 1,628,241. DANA (STYLIZED). INT. CL. 15. REG. 12-18-1990.
- 1,628,257. GREAT GOALIES. INT. CL. 16. REG. 12-18-1990.
- 1,628,265. BAY AREA LABELS AND DESIGN. INT. CL. 16. REG. 12-18-1990.
- 1,628,269. TAYLOR'S POCKET GUIDE. INT. CL. 16. REG. 12-18-1990.
- 1,628,277. SONOCO WASTE PAK AND DESIGN. INT. CL. 16. REG. 12-18-1990.
- 1,628,278. TAKING CHARGE PLANNER. INT. CL. 16. REG. 12-18-1990.
- 1,628,279. FAT FACTS FAT COUNTER (STYLIZED). INT. CL. 16. REG. 12-18-1990.
- 1,628,280. THE BRIDAL PATH. INT. CL. 16. REG. 12-18-1990.
- 1,628,289. TO LIFE! INT. CL. 16. REG. 12-18-1990.
- 1,628,295. RETROSPECTIVE. INT. CL. 16. REG. 12-18-1990.
- 1,628,304. DEAR DIARY. INT. CL. 16. REG. 12-18-1990.
- 1,628,306. THE VIKING SMORGASBOARD. INT. CL. 16. REG. 12-18-1990.
- 1,628,311. GIVE BUT GIVE WISELY. INT. CL. 16. REG. 12-18-1990.
- 1,628,316. A NOTCH ABOVE THE OTHERS. INT. CL. 16. REG. 12-18-1990.
- 1,628,326. ELIM-A-TRIM. INT. CL. 17. REG. 12-18-1990.
- 1,628,345. PORTAPATH. INT. CL. 20. REG. 12-18-1990.
- 1,628,347. PERMAPAK. INT. CL. 20. REG. 12-18-1990.
- 1,628,348. SHOPPING CADDY. INT. CL. 20. REG. 12-18-1990.
- 1,628,349. INFOLINE. INT. CL. 20. REG. 12-18-1990.
- 1,628,354. VINYL-FLX AND DESIGN. INT. CL. 20. REG. 12-18-1990.
- 1,628,357. SNAP HAPPY (STYLIZED). INT. CL. 20. REG. 12-18-1990.
- 1,628,382. LANIFICIO TITANUS. INT. CL. 24. REG. 12-18-1990.
- 1,628,386. BODY-BANNER. INT. CL. 24. REG. 12-18-1990.
- 1,628,404. BERNARD WEATHERILL. INT. CL. 25. REG. 12-18-1990.
- 1,628,407. MESSMASTER. INT. CL. 25. REG. 12-18-1990.
- 1,628,410. OBEX SPORT. INT. CL. 25. REG. 12-18-1990.
- 1,628,418. BODY ALIVE AND DESIGN. INT. CL. 25. REG. 12-18-1990.
- 1,628,420. MISCELLANEOUS DESIGN. INT. CL. 25. REG. 12-18-1990.
- 1,628,433. LITTLE PLAYER PIANO. INT. CL. 28. REG. 12-18-1990.
- 1,628,434. MUNARI TECH & COLORS (STYLIZED). INT. CL. 28. REG. 12-18-1990.
- 1,628,436. "BEAT THE COMPETITION!". INT. CL. 28. REG. 12-18-1990.
- 1,628,437. BESTSELL'R - THE JAMES A. MICHENER GAME. INT. CL. 28. REG. 12-18-1990.
- 1,628,440. SUPERTOYS AND DESIGN. INT. CL. 28. REG. 12-18-1990.
- 1,628,447. REVOLVERS AND DESIGN. INT. CL. 28. REG. 12-18-1990.
- 1,628,462. TOP SHOT. INT. CL. 28. REG. 12-18-1990.
- 1,628,468. TIP-IT. INT. CL. 28. REG. 12-18-1990.
- 1,628,484. GILYONE. INT. CL. 29. REG. 12-18-1990.
- 1,628,489. R AND DESIGN. INT. CL. 29. REG. 12-18-1990.
- 1,628,492. GOLD'S. INT. CLS. 29 AND 30. REG. 12-18-1990.
- 1,628,506. PIZZALAPAN. INT. CL. 30. REG. 12-18-1990.
- 1,628,508. ROCO. INT. CL. 30. REG. 12-18-1990.
- 1,628,509. SUNSWEET CALIFORNIA AND DESIGN. INT. CL. 30. REG. 12-18-1990.
- 1,628,512. MIA TIA AND DESIGN. INT. CL. 30. REG. 12-18-1990.
- 1,628,513. AMICO (STYLIZED). INT. CL. 30. REG. 12-18-1990.
- 1,628,519. MISCELLANEOUS DESIGN. INT. CL. 30. REG. 12-18-1990.
- 1,628,523. FAST AID KIT. INT. CL. 30. REG. 12-18-1990.
- 1,628,528. WALTER PREMIUM KENDALL HOT MEALS AND DESIGN. INT. CL. 31. REG. 12-18-1990.
- 1,628,532. PETPAL. INT. CL. 31. REG. 12-18-1990.
- 1,628,542. THE LEGENDARY BOONVILLE BEER ANDERSON VALLEY BREWING CO. AND DESIGN. INT. CL. 32. REG. 12-18-1990.
- 1,628,547. MISCELLANEOUS DESIGN. INT. CL. 33. REG. 12-18-1990.
- 1,628,553. TRE FONTANI. INT. CL. 33. REG. 12-18-1990.



- 1,628,560. D DROUOT AND DESIGN. INT. CL. 35. REG. 12-18-1990.
- 1,628,569. SELECTIVE MARKET COVERAGE. INT. CL. 35. REG. 12-18-1990.
- 1,628,571. CAREER TALK 976-5772 AND DESIGN. INT. CL. 35. REG. 12-18-1990.
- 1,628,575. CLUB HOLLYWOOD. INT. CL. 35. REG. 12-18-1990.
- 1,628,579. SCA PROMOTIONS AND DESIGN. INT. CL. 35. REG. 12-18-1990.
- 1,628,585. OUR BUSINESS IS GROWING COMPANIES. INT. CL. 35. REG. 12-18-1990.
- 1,628,586. FANNIE MAE THE USA'S HOUSING PARTNER. INT. CL. 36. REG. 12-18-1990.
- 1,628,599. LEAMINGTON. INT. CLS. 36 AND 37. REG. 12-18-1990.
- 1,628,601. CHILD CARE PLUS AND DESIGN. INT. CL. 36. REG. 12-18-1990.
- 1,628,630. AMFAB AND DESIGN. INT. CL. 37. REG. 12-18-1990.
- 1,628,635. GETTY...THE VALUE LEADER IN FINE GASOLINES...AND MORE!. INT. CL. 37. REG. 12-18-1990.
- 1,628,640. TAURUS AND DESIGN. INT. CL. 38. REG. 12-18-1990.
- 1,628,642. DISCOM. INT. CL. 38. REG. 12-18-1990.
- 1,628,644. PSEG AND DESIGN. INT. CL. 39. REG. 12-18-1990.
- 1,628,645. PSEG AND DESIGN. INT. CL. 39. REG. 12-18-1990.
- 1,628,648. AFF (STYLIZED). INT. CLS. 39, 40 AND 42. REG. 12-18-1990.
- 1,628,649. BUTTERWORTH. INT. CLS. 39 AND 42. REG. 12-18-1990.
- 1,628,652. EAASY SABRE. INT. CLS. 39 AND 42. REG. 12-18-1990.
- 1,628,655. SHARP EDGE, INC.. INT. CL. 40. REG. 12-18-1990.
- 1,628,659. BERNARD WEATHERILL. INT. CL. 40. REG. 12-18-1990.
- 1,628,670. THE 90'S. INT. CL. 41. REG. 12-18-1990.
- 1,628,671. N AND DESIGN. INT. CL. 41. REG. 12-18-1990.
- 1,628,672. V.A.R.I.O.U.S. AND DESIGN. INT. CL. 41. REG. 12-18-1990.
- 1,628,682. DATABASE WORLD. INT. CL. 41. REG. 12-18-1990.
- 1,628,684. MISCELLANEOUS DESIGN. INT. CL. 41. REG. 12-18-1990.
- 1,628,691. CHEYENNE SALOON & OPERA HOUSE. INT. CLS. 41 AND 42. REG. 12-18-1990.
- 1,628,693. ORCHID GARDEN BALLROOM. INT. CLS. 41 AND 42. REG. 12-18-1990.
- 1,628,694. THE MOREHOUSE MP PUBLISHING GROUP (STYLIZED). INT. CL. 41. REG. 12-18-1990.
- 1,628,702. PHINEAS PHOGG'S BALLOON WORKS PURVEYORS OF BALLOONS BURGERS AND BOOGIE AND DESIGN. INT. CLS. 41 AND 42. REG. 12-18-1990.
- 1,628,704. SOUTHBOUND U.S.A. AND DESIGN. INT. CL. 41. REG. 12-18-1990.
- 1,628,707. HAROLD'S ARMY-NAVY. INT. CL. 42. REG. 12-18-1990.
- 1,628,718. SONIC AMERICA'S DRIVE-IN AND DESIGN. INT. CL. 42. REG. 12-18-1990.
- 1,628,723. PHOENIX GARDEN. INT. CL. 42. REG. 12-18-1990.
- 1,628,733. THUIA. INT. CL. 42. REG. 12-18-1990.
- 1,628,740. DOLLAR DEALS. INT. CL. 42. REG. 12-18-1990.
- 1,628,758. LET'S FACE IT. INT. CL. 42. REG. 12-18-1990.
- 1,628,762. THE BUMBY EMPORIUM. INT. CL. 42. REG. 12-18-1990.
- 1,628,764. SPAGHETTI ALREADY PASTA AND PIZZA TO GO "TAKE OUT OFTEN" AND DESIGN. INT. CL. 42. REG. 12-18-1990.
- 1,628,769. MISCELLANEOUS DESIGN. INT. CL. 42. REG. 12-18-1990.
- 1,628,784. RIGHT DIRECTIONS. INT. CL. 42. REG. 12-18-1990.
- 1,628,786. MISCELLANEOUS DESIGN. INT. CL. 42. REG. 12-18-1990.
- 1,628,788. CALIFORNIA DATES AND DESIGN. U.S. CL. A. REG. 12-18-1990.
- 1,628,790. EXPERT MANAGER. INT. CL. 9. REG. 12-18-1990.
- 1,628,803. MALL MADNESS. INT. CL. 28. REG. 12-18-1990.
- 1,628,804. HEADSPIN. INT. CL. 28. REG. 12-18-1990.
- 1,628,806. TEE PLUS. INT. CL. 28. REG. 12-18-1990.
- 1,628,811. PEACH ROSE BOUQUET. INT. CL. 3. REG. 12-18-1990.
- 1,628,812. ONE PUMP (STYLIZED). INT. CL. 3. REG. 12-18-1990.
- 1,628,821. THE MARK OF QUALITY AND VALUE. INT. CL. 16. REG. 12-18-1990.
- 1,628,829. MISCELLANEOUS DESIGN. INT. CL. 30. REG. 12-18-1990.
- 1,628,830. HOT MEALS. INT. CL. 31. REG. 12-18-1990.
- 1,628,833. WORLDWIDE INSURANCE SERVICES FOR EXPORTERS. INT. CL. 36. REG. 12-18-1990.
- 1,628,836. PERFORMANCE PROFILE. INT. CL. 42. REG. 12-18-1990.
- 1,645,095. AMWAY AND DESIGN. INT. CLS. 10, 11 AND 20 ONLY. REG. 5-21-1991.
- 1,659,415. HEARTH MAGIC. INT. CL. 8 ONLY. REG. 10-8-1991.
- 1,660,772. PACKAGING DEPOT. INT. CLS. 16, 17, 36 AND 42 ONLY. REG. 10-15-1991.
- 1,806,867. THE HEALTHCARE FORUM. INT. CL. 35 ONLY. REG. 11-23-1993.
- 1,867,891. LAB IN A BAG. INT. CL. 1. REG. 12-20-1994.
- 1,867,893. TYNEC (STYLIZED). INT. CL. 1. REG. 12-20-1994.
- 1,867,894. GREASE MONKEY AND DESIGN. INT. CL. 1. REG. 12-20-1994.
- 1,867,897. AQUACOAT. INT. CL. 2. REG. 12-20-1994.
- 1,867,901. COLLODEX. INT. CLS. 3 AND 5. REG. 12-20-1994.
- 1,867,903. DERMACLAIR (STYLIZED). INT. CL. 3. REG. 12-20-1994.
- 1,867,905. EMERALD AND DESIGN. INT. CL. 3. REG. 12-20-1994.
- 1,867,906. MEDUSA. INT. CL. 3. REG. 12-20-1994.
- 1,867,908. CASTALIA. INT. CL. 3. REG. 12-20-1994.
- 1,867,910. PREVALENCE (STYLIZED). INT. CL. 3. REG. 12-20-1994.
- 1,867,911. MISCELLANEOUS DESIGN. INT. CL. 3. REG. 12-20-1994.
- 1,867,916. WET 'N' WILD. INT. CL. 3. REG. 12-20-1994.
- 1,867,917. INTERFUSE AND DESIGN. INT. CL. 3. REG. 12-20-1994.
- 1,867,918. BODY ROK. INT. CL. 3. REG. 12-20-1994.
- 1,867,922. NUTRISEVE. INT. CL. 3. REG. 12-20-1994.
- 1,867,928. NO MORE GERMIES AND DESIGN. INT. CL. 3. REG. 12-20-1994.
- 1,867,929. THE ENVIRONMENTAL WAY. INT. CL. 4. REG. 12-20-1994.
- 1,867,933. CHEVRON ECO. INT. CL. 4. REG. 12-20-1994.
- 1,867,935. ENDO-MILK. INT. CL. 4. REG. 12-20-1994.
- 1,867,936. MENICON PROGENT. INT. CL. 5. REG. 12-20-1994.
- 1,867,940. ROTSTOP. INT. CL. 5. REG. 12-20-1994.
- 1,867,943. DAFLOX. INT. CL. 5. REG. 12-20-1994.
- 1,867,945. 24K B.C.. INT. CL. 5. REG. 12-20-1994.
- 1,867,947. ALLELIX. INT. CL. 5. REG. 12-20-1994.
- 1,867,948. NOREX. INT. CL. 5. REG. 12-20-1994.
- 1,867,952. SILVERLOID COLLOIDAL SILVER AND DESIGN. INT. CL. 5. REG. 12-20-1994.
- 1,867,954. MISCELLANEOUS DESIGN. INT. CL. 5. REG. 12-20-1994.
- 1,867,957. YEAST-X. INT. CL. 5. REG. 12-20-1994.
- 1,867,962. UNI-CHARM AND DESIGN. INT. CL. 5. REG. 12-20-1994.
- 1,867,964. RHINATHIOL. INT. CL. 5. REG. 12-20-1994.
- 1,867,968. NO MORE BURN AND DESIGN. INT. CL. 5. REG. 12-20-1994.
- 1,867,971. ATEC AND DESIGN. INT. CL. 6. REG. 12-20-1994.
- 1,867,973. ACCU-SPOUT. INT. CL. 6. REG. 12-20-1994.
- 1,867,975. ESTIMATE PLUS. INT. CL. 6. REG. 12-20-1994.
- 1,867,977. CUPRUM. INT. CL. 6. REG. 12-20-1994.

- 1,867,979. KWIKI STIK-FIT NOKOAT (STYLIZED). INT. CL. 6. REG. 12-20-1994.
- 1,867,980. STRUT-LOK. INT. CL. 6. REG. 12-20-1994.
- 1,867,988. SENTRUM AND DESIGN. INT. CL. 6. REG. 12-20-1994.
- 1,867,990. KQDC & DIE CART SYSTEM. INT. CL. 7. REG. 12-20-1994.
- 1,867,991. MAGNUM. INT. CL. 7. REG. 12-20-1994.
- 1,867,994. COMPETITOR (STYLIZED). INT. CL. 7. REG. 12-20-1994.
- 1,867,995. EQUALIZER. INT. CL. 7. REG. 12-20-1994.
- 1,868,003. CHOICE AND DESIGN. INT. CL. 7. REG. 12-20-1994.
- 1,868,017. HI-SEAS. INT. CLS. 8 AND 28. REG. 12-20-1994.
- 1,868,021. THE GRIP. INT. CL. 8. REG. 12-20-1994.
- 1,868,022. LUCKY. INT. CL. 8. REG. 12-20-1994.
- 1,868,024. CLASSIC-ADA (STYLIZED). INT. CL. 9. REG. 12-20-1994.
- 1,868,027. HIGH PRODUCTIVITY SYSTEMS (STYLIZED). INT. CL. 9. REG. 12-20-1994.
- 1,868,028. ANIMATION WORKS. INT. CL. 9. REG. 12-20-1994.
- 1,868,029. MISCELLANEOUS DESIGN. INT. CL. 9. REG. 12-20-1994.
- 1,868,030. SMART FLOW. INT. CL. 9. REG. 12-20-1994.
- 1,868,032. FLOWPOWER AND DESIGN. INT. CL. 9. REG. 12-20-1994.
- 1,868,036. ANALYZER. INT. CL. 9. REG. 12-20-1994.
- 1,868,039. MICROSCAN AND DESIGN. INT. CL. 9. REG. 12-20-1994.
- 1,868,040. MAX. INT. CL. 9. REG. 12-20-1994.
- 1,868,043. Z ZORTEC, INC. AND DESIGN. INT. CL. 9. REG. 12-20-1994.
- 1,868,045. MAPIX. INT. CL. 9. REG. 12-20-1994.
- 1,868,046. BENCHCOM. INT. CLS. 9, 16, 35, 41 AND 42. REG. 12-20-1994.
- 1,868,047. WET GRIP. INT. CLS. 9 AND 10. REG. 12-20-1994.
- 1,868,049. AM AMAZING MEDIA AND DESIGN. INT. CL. 9. REG. 12-20-1994.
- 1,868,053. CASESERV. INT. CL. 9. REG. 12-20-1994.
- 1,868,061. GRAPHIC PILOT. INT. CL. 9. REG. 12-20-1994.
- 1,868,062. MISCELLANEOUS DESIGN. INT. CLS. 9 AND 41. REG. 12-20-1994.
- 1,868,063. REALTIME VISION AND DESIGN. INT. CL. 9. REG. 12-20-1994.
- 1,868,064. WSU. INT. CL. 9. REG. 12-20-1994.
- 1,868,065. HAZCAD APEX ENVIRONMENTAL, INC. AND DESIGN. INT. CL. 9. REG. 12-20-1994.
- 1,868,067. GAMESTAR. INT. CLS. 9 AND 28. REG. 12-20-1994.
- 1,868,068. MATCH BALANCE. INT. CL. 9. REG. 12-20-1994.
- 1,868,069. SOFTSCREEN. INT. CL. 9. REG. 12-20-1994.
- 1,868,072. EXPRESSBUNDLE (STYLIZED). INT. CL. 9. REG. 12-20-1994.
- 1,868,074. ENTERPRISE SELF-SERVICE. INT. CLS. 9 AND 42. REG. 12-20-1994.
- 1,868,078. MONTANA AND DESIGN. INT. CL. 9. REG. 12-20-1994.
- 1,868,081. ESTEEM. INT. CLS. 9 AND 16. REG. 12-20-1994.
- 1,868,085. CHOOSESMArt!. INT. CL. 9. REG. 12-20-1994.
- 1,868,086. TRANSITION. INT. CL. 9. REG. 12-20-1994.
- 1,868,087. TAGWARE. INT. CL. 9. REG. 12-20-1994.
- 1,868,089. CAMP TV VIDEO PRODUCTIONS, INC. AND DESIGN. INT. CL. 9. REG. 12-20-1994.
- 1,868,090. SEVENTHSIGN. INT. CLS. 9 AND 41. REG. 12-20-1994.
- 1,868,092. Q-SKILLS (STYLIZED). INT. CL. 9. REG. 12-20-1994.
- 1,868,094. BEER-GUARD AND DESIGN. INT. CL. 9. REG. 12-20-1994.
- 1,868,095. LANPHARAOH (STYLIZED). INT. CL. 9. REG. 12-20-1994.
- 1,868,096. MOUSE TAMER. INT. CL. 9. REG. 12-20-1994.
- 1,868,098. PARSONS TECHNOLOGY. INT. CL. 9. REG. 12-20-1994.
- 1,868,100. SPARTON MARINE. INT. CL. 9. REG. 12-20-1994.
- 1,868,103. WORKPRO. INT. CL. 9. REG. 12-20-1994.
- 1,868,109. DA BOMB RECORDS. INT. CL. 9. REG. 12-20-1994.
- 1,868,110. RESEARCHSTATION. INT. CL. 9. REG. 12-20-1994.
- 1,868,111. MPOWER. INT. CL. 9. REG. 12-20-1994.
- 1,868,112. SPECTRUM CONNECTED AND DESIGN. INT. CL. 9. REG. 12-20-1994.
- 1,868,113. Z-STATION. INT. CL. 9. REG. 12-20-1994.
- 1,868,114. AKH. INT. CL. 9. REG. 12-20-1994.
- 1,868,117. SYSCON AND DESIGN. INT. CL. 9. REG. 12-20-1994.
- 1,868,118. SYSCON. INT. CL. 9. REG. 12-20-1994.
- 1,868,123. RC/MIGRATOR. INT. CL. 9. REG. 12-20-1994.
- 1,868,125. LOGISTOP. INT. CL. 9. REG. 12-20-1994.
- 1,868,135. DIVE-IN THEATRE. INT. CL. 9. REG. 12-20-1994.
- 1,868,139. BABYPORT. INT. CL. 10. REG. 12-20-1994.
- 1,868,141. BREAST MARKER I. INT. CL. 10. REG. 12-20-1994.
- 1,868,142. MISCELLANEOUS DESIGN. INT. CL. 10. REG. 12-20-1994.
- 1,868,144. DIAGNOSTEC 2000. INT. CL. 10. REG. 12-20-1994.
- 1,868,146. SUZIKIT. INT. CL. 10. REG. 12-20-1994.
- 1,868,149. EPAMP (STYLIZED). INT. CL. 10. REG. 12-20-1994.
- 1,868,150. MY. INT. CL. 10. REG. 12-20-1994.
- 1,868,152. ENDPOINT. INT. CL. 10. REG. 12-20-1994.
- 1,868,157. K LOK AND DESIGN. INT. CL. 10. REG. 12-20-1994.
- 1,868,158. KSMF. INT. CL. 11. REG. 12-20-1994.
- 1,868,159. MARLEY. INT. CLS. 11, 17 AND 19. REG. 12-20-1994.
- 1,868,160. THE INNOVATIVE SOLUTIONS COMPANY. INT. CLS. 11, 22 AND 40. REG. 12-20-1994.
- 1,868,163. TYKRON. INT. CL. 11. REG. 12-20-1994.
- 1,868,167. FM MATTSSON AND DESIGN. INT. CL. 11. REG. 12-20-1994.
- 1,868,170. ESP. INT. CL. 11. REG. 12-20-1994.
- 1,868,174. TEXAS MATCH. INT. CL. 11. REG. 12-20-1994.
- 1,868,175. AQUA GOLD (STYLIZED). INT. CL. 11. REG. 12-20-1994.
- 1,868,177. SUNSPORT. INT. CL. 12. REG. 12-20-1994.
- 1,868,179. CHILD-SAFER. INT. CL. 12. REG. 12-20-1994.
- 1,868,180. GRAYLINE AND DESIGN. INT. CL. 12. REG. 12-20-1994.
- 1,868,182. ROCK POINT. INT. CLS. 12 AND 18. REG. 12-20-1994.
- 1,868,183. WATER OTTER INC. AND DESIGN. INT. CL. 12. REG. 12-20-1994.
- 1,868,188. ACCU-CUT. INT. CL. 13. REG. 12-20-1994.
- 1,868,194. MISCELLANEOUS DESIGN. INT. CL. 14. REG. 12-20-1994.
- 1,868,195. ACE RAY AND DESIGN. INT. CL. 14. REG. 12-20-1994.
- 1,868,196. LOUIS PION. INT. CL. 14. REG. 12-20-1994.
- 1,868,200. EMC. INT. CL. 14. REG. 12-20-1994.
- 1,868,203. ONE FINGER AD-LIB (STYLIZED). INT. CL. 15. REG. 12-20-1994.
- 1,868,206. SALEM. INT. CL. 16. REG. 12-20-1994.
- 1,868,207. SUPER PRINT AND DESIGN. INT. CL. 16. REG. 12-20-1994.
- 1,868,208. THE FAMILY CIRCLE DIET AMERICA CHALLENGE AND DESIGN. INT. CLS. 16 AND 41. REG. 12-20-1994.
- 1,868,209. EXPERT EXPRESS. INT. CL. 16. REG. 12-20-1994.
- 1,868,211. THE WORLD'S FINEST NEW ZEALAND KIWI-FRUIT AND DESIGN. INT. CLS. 16, 29, 31 AND 32. REG. 12-20-1994.
- 1,868,212. PABLO COMBO. INT. CL. 16. REG. 12-20-1994.
- 1,868,213. TELEROUTE AND DESIGN. INT. CLS. 16, 35, 38, 39 AND 41. REG. 12-20-1994.
- 1,868,214. NOTHING VENTURED NOTHING GAINED AND DESIGN. INT. CL. 16. REG. 12-20-1994.
- 1,868,220. LIGHTING RESEARCH INSTITUTE. INT. CLS. 16 AND 42. REG. 12-20-1994.
- 1,868,221. GOL! AND DESIGN. INT. CL. 16. REG. 12-20-1994.
- 1,868,223. CPR CRITICAL PROBLEM RESPONSE AND DESIGN. INT. CL. 16. REG. 12-20-1994.

- 1,868,224. ADVOCATE'S EDGE CPA LITIGATION SERVICES FOR LAWYERS AND DESIGN. INT. CL. 16. REG. 12-20-1994.
- 1,868,227. PETRO SYSTEMS WORLD (STYLIZED). INT. CL. 16. REG. 12-20-1994.
- 1,868,229. SILVER SPORTS. INT. CL. 16. REG. 12-20-1994.
- 1,868,230. NUEVO ESTILO. INT. CL. 16. REG. 12-20-1994.
- 1,868,236. TFCB AND DESIGN. INT. CL. 16. REG. 12-20-1994.
- 1,868,237. SECRET KEEPERS. INT. CL. 16. REG. 12-20-1994.
- 1,868,240. U.S. NEW IMMIGRATION LAW AND DESIGN. INT. CL. 16. REG. 12-20-1994.
- 1,868,243. CARS FROM THE MOON. INT. CL. 16. REG. 12-20-1994.
- 1,868,244. A SQUIRREL'S TALE. INT. CL. 16. REG. 12-20-1994.
- 1,868,245. TEXAS ARKANSAS LOUISIANA OKLAHOMA TRUCKER. INT. CL. 16. REG. 12-20-1994.
- 1,868,246. RUGBY UNION AND DESIGN. INT. CL. 16. REG. 12-20-1994.
- 1,868,247. ACTION ART. INT. CL. 16. REG. 12-20-1994.
- 1,868,248. BIRTHDAY GAZETTE. INT. CL. 16. REG. 12-20-1994.
- 1,868,249. TURN OFF THE VIOLENCE AND DESIGN. INT. CLS. 16 AND 42. REG. 12-20-1994.
- 1,868,250. MOTORCYCLE TOUR & TRAVEL ADVENTURE IN STYLE (STYLIZED). INT. CL. 16. REG. 12-20-1994.
- 1,868,252. SKEIN DOMAIN AND DESIGN. INT. CLS. 16 AND 42. REG. 12-20-1994.
- 1,868,253. FORBES MEDIACRITIC. INT. CL. 16. REG. 12-20-1994.
- 1,868,254. THE SAVING TIMES. INT. CL. 16. REG. 12-20-1994.
- 1,868,255. SLAG. INT. CL. 16. REG. 12-20-1994.
- 1,868,259. LULAC. INT. CL. 16. REG. 12-20-1994.
- 1,868,260. NEWS BRAKE. INT. CL. 16. REG. 12-20-1994.
- 1,868,261. TUFF STUFF'S COLLECT!. INT. CL. 16. REG. 12-20-1994.
- 1,868,262. THE MACROSCOPE. INT. CL. 16. REG. 12-20-1994.
- 1,868,266. GNOME. INT. CL. 16. REG. 12-20-1994.
- 1,868,268. VOZ Y DATOS. INT. CL. 16. REG. 12-20-1994.
- 1,868,269. ERISA-EXTRA. INT. CLS. 16 AND 36. REG. 12-20-1994.
- 1,868,271. RESOURCES. INT. CL. 16. REG. 12-20-1994.
- 1,868,273. VORTEX. INT. CL. 16. REG. 12-20-1994.
- 1,868,274. NATIONAL POLY PRODUCTS, INC.. INT. CLS. 17, 24 AND 25. REG. 12-20-1994.
- 1,868,280. PIRELLI BEDDING AND DESIGN. INT. CLS. 17, 20, 22 AND 24. REG. 12-20-1994.
- 1,868,281. MISCELLANEOUS DESIGN. INT. CL. 17. REG. 12-20-1994.
- 1,868,283. TUFF CO. SINCE 1939 TUFF CO. DIV. OF YANCEY COMPANY AND DESIGN. INT. CL. 17. REG. 12-20-1994.
- 1,868,284. SPECTRUM (STYLIZED). INT. CL. 17. REG. 12-20-1994.
- 1,868,293. QUICK-TRIP. INT. CL. 18. REG. 12-20-1994.
- 1,868,294. THE BAKERY BOYS AND DESIGN. INT. CL. 18. REG. 12-20-1994.
- 1,868,296. MISCELLANEOUS DESIGN. INT. CL. 18. REG. 12-20-1994.
- 1,868,297. BB AND DESIGN. INT. CL. 18. REG. 12-20-1994.
- 1,868,299. VITESSE. INT. CL. 18. REG. 12-20-1994.
- 1,868,300. MACLEO SPORTS MANIAC. INT. CL. 18. REG. 12-20-1994.
- 1,868,301. MACLEO. INT. CL. 18. REG. 12-20-1994.
- 1,868,302. SPORTS MANIAC. INT. CL. 18. REG. 12-20-1994.
- 1,868,303. MODAN. INT. CL. 18. REG. 12-20-1994.
- 1,868,307. MANCHESTER. INT. CL. 19. REG. 12-20-1994.
- 1,868,309. GERPLAN. INT. CL. 19. REG. 12-20-1994.
- 1,868,310. SOLAR SHIELD. INT. CL. 19. REG. 12-20-1994.
- 1,868,311. BEL-DECK. INT. CL. 19. REG. 12-20-1994.
- 1,868,315. SAXON PAVING. INT. CL. 19. REG. 12-20-1994.
- 1,868,319. EXTOL CORPORATION. INT. CL. 41. REG. 12-20-1994.
- 1,868,321. NERD TESTER. INT. CL. 20. REG. 12-20-1994.
- 1,868,323. CAP-TURE!. INT. CL. 20. REG. 12-20-1994.
- 1,868,324. WORLD HANGERS INC. HANG ALL AND DESIGN. INT. CL. 20. REG. 12-20-1994.
- 1,868,327. PROKART. INT. CL. 20. REG. 12-20-1994.
- 1,868,329. CUSH'N TOTE (STYLIZED). INT. CL. 20. REG. 12-20-1994.
- 1,868,330. ALBERTASaurus. INT. CL. 20. REG. 12-20-1994.
- 1,868,331. LAFAYETTE. INT. CL. 20. REG. 12-20-1994.
- 1,868,332. GLOW-BENCH AND DESIGN. INT. CLS. 20 AND 35. REG. 12-20-1994.
- 1,868,333. THE TALE OF TWO BAD MICE. INT. CL. 20. REG. 12-20-1994.
- 1,868,336. SAFE T LOCK AND DESIGN. INT. CL. 20. REG. 12-20-1994.
- 1,868,337. WINGFIELD AND DESIGN. INT. CL. 21. REG. 12-20-1994.
- 1,868,339. CARE CAGES AND DESIGN. INT. CL. 21. REG. 12-20-1994.
- 1,868,340. NU BORN TIME CAPSULES AND DESIGN. INT. CL. 21. REG. 12-20-1994.
- 1,868,342. SQUEEK-EAZE AND DESIGN. INT. CL. 21. REG. 12-20-1994.
- 1,868,347. MLT AND DESIGN. INT. CL. 21. REG. 12-20-1994.
- 1,868,349. VANITIES. INT. CL. 21. REG. 12-20-1994.
- 1,868,350. QUICK SCOOP. INT. CL. 21. REG. 12-20-1994.
- 1,868,352. ALL STAR (STYLIZED). INT. CL. 25. REG. 12-20-1994.
- 1,868,353. MADRE INTERNATIONAL. INT. CL. 25. REG. 12-20-1994.
- 1,868,354. VENTANA. INT. CL. 25. REG. 12-20-1994.
- 1,868,355. MISCELLANEOUS DESIGN. INT. CL. 25. REG. 12-20-1994.
- 1,868,357. A LA MODE. INT. CL. 25. REG. 12-20-1994.
- 1,868,359. CHEAP & CHIC AND DESIGN. INT. CL. 25. REG. 12-20-1994.
- 1,868,361. LADY GEL EPIRUS. INT. CL. 25. REG. 12-20-1994.
- 1,868,362. SPIRIT LAKE OUTFITTERS. INT. CL. 25. REG. 12-20-1994.
- 1,868,364. SUBITO AND DESIGN. INT. CL. 25. REG. 12-20-1994.
- 1,868,365. G AND DESIGN. INT. CL. 25. REG. 12-20-1994.
- 1,868,367. PLAY BY PLAY. INT. CL. 25. REG. 12-20-1994.
- 1,868,371. AM-FM. INT. CL. 25. REG. 12-20-1994.
- 1,868,373. TOP DOG GYM AND DESIGN. INT. CL. 25. REG. 12-20-1994.
- 1,868,374. SUPERBODIES. INT. CL. 25. REG. 12-20-1994.
- 1,868,378. SEMPRE UNICORN AND DESIGN. INT. CL. 25. REG. 12-20-1994.
- 1,868,379. CAREER MOVES. INT. CL. 25. REG. 12-20-1994.
- 1,868,380. MATRIX ESSENTIALS. INT. CL. 25. REG. 12-20-1994.
- 1,868,381. MISSPENT YOUTH AND DESIGN. INT. CL. 25. REG. 12-20-1994.
- 1,868,382. IMENTO. INT. CL. 25. REG. 12-20-1994.
- 1,868,383. INDIGO ME. INT. CL. 25. REG. 12-20-1994.
- 1,868,385. DEAL WITH IT. INT. CL. 25. REG. 12-20-1994.
- 1,868,386. SLADE CASUALS EST. 1991 AND DESIGN. INT. CL. 25. REG. 12-20-1994.
- 1,868,388. MADISON WELLS. INT. CL. 25. REG. 12-20-1994.
- 1,868,390. III SETS. INT. CL. 25. REG. 12-20-1994.
- 1,868,391. RETRO AND DESIGN. INT. CL. 25. REG. 12-20-1994.
- 1,868,392. KAJOL AND DESIGN. INT. CL. 25. REG. 12-20-1994.
- 1,868,394. PRET'E AND DESIGN. INT. CL. 25. REG. 12-20-1994.
- 1,868,397. DSS AND DESIGN. INT. CL. 25. REG. 12-20-1994.
- 1,868,398. UNITED DESIGN SOFT GOODS AND DESIGN. INT. CL. 25. REG. 12-20-1994.
- 1,868,399. RAGG MAPPS AND DESIGN. INT. CL. 25. REG. 12-20-1994.
- 1,868,402. SCENIC SPECIALTEES. INT. CL. 25. REG. 12-20-1994.
- 1,868,403. MISCELLANEOUS DESIGN. INT. CL. 25. REG. 12-20-1994.
- 1,868,404. CLASSIC DESIGNS AND DESIGN. INT. CL. 25. REG. 12-20-1994.

- 1,868,406. I [LOVE] SLOWER LOWER DELAWARE AND DESIGN. INT. CL. 25. REG. 12-20-1994.
- 1,868,407. KHI AND DESIGN. INT. CL. 25. REG. 12-20-1994.
- 1,868,408. CRITTERS AND DESIGN. INT. CL. 25. REG. 12-20-1994.
- 1,868,410. MATERNITY MOODS BY MARLA. INT. CL. 25. REG. 12-20-1994.
- 1,868,411. NORTH SHORE UNDERGROUND HAWAII AND DESIGN. INT. CL. 25. REG. 12-20-1994.
- 1,868,413. LUCIANO GATTI. INT. CL. 25. REG. 12-20-1994.
- 1,868,416. RUOK ?. INT. CL. 25. REG. 12-20-1994.
- 1,868,417. BAXIS (STYLIZED). INT. CL. 25. REG. 12-20-1994.
- 1,868,419. SEASON TICKET. INT. CL. 25. REG. 12-20-1994.
- 1,868,420. MOOSE CREEK JUNO OF CALIFORNIA AND DESIGN. INT. CL. 25. REG. 12-20-1994.
- 1,868,421. VOTRE NOM...PARIS. INT. CL. 25. REG. 12-20-1994.
- 1,868,422. PRINT THE PLANET. INT. CL. 25. REG. 12-20-1994.
- 1,868,425. MIND FLARE AND DESIGN. INT. CL. 25. REG. 12-20-1994.
- 1,868,428. OUR LEAGUE. INT. CL. 25. REG. 12-20-1994.
- 1,868,429. WPC (STYLIZED). INT. CL. 25. REG. 12-20-1994.
- 1,868,430. FRANCESCA BOTTA. INT. CL. 25. REG. 12-20-1994.
- 1,868,433. I AND DESIGN. INT. CL. 25. REG. 12-20-1994.
- 1,868,434. SIERRA ORIGINALS. INT. CL. 25. REG. 12-20-1994.
- 1,868,436. IT'S ABOUT TIME. INT. CL. 25. REG. 12-20-1994.
- 1,868,439. FLIP-ONS. INT. CL. 25. REG. 12-20-1994.
- 1,868,441. L'ORNA. INT. CL. 26. REG. 12-20-1994.
- 1,868,442. THE NEEDLECRAFT SHOP. INT. CL. 26. REG. 12-20-1994.
- 1,868,443. YELLOWHAIR BUCKLES AND DESIGN. INT. CL. 26. REG. 12-20-1994.
- 1,868,444. SKYWALKER RANCH. INT. CL. 26. REG. 12-20-1994.
- 1,868,445. WONDERFULLY CUDDLY AND DESIGN. INT. CLS. 27 AND 42. REG. 12-20-1994.
- 1,868,446. THE SAFE HARBOUR J.G. HOOK COLLECTION. INT. CL. 27. REG. 12-20-1994.
- 1,868,450. OODLES. INT. CL. 28. REG. 12-20-1994.
- 1,868,451. WORLD SPORTS INTERNATIONAL. INT. CL. 28. REG. 12-20-1994.
- 1,868,453. SPY'S (STYLIZED). INT. CL. 28. REG. 12-20-1994.
- 1,868,455. THUNDERBALL. INT. CL. 28. REG. 12-20-1994.
- 1,868,458. HYDRACISER (STYLIZED). INT. CL. 28. REG. 12-20-1994.
- 1,868,460. MIDI. INT. CL. 28. REG. 12-20-1994.
- 1,868,461. MIDWOOD. INT. CL. 28. REG. 12-20-1994.
- 1,868,463. WHERE IN THE USA IS CARMEN SANDIEGO? DELUXE. INT. CL. 28. REG. 12-20-1994.
- 1,868,464. ANGELICA. INT. CL. 28. REG. 12-20-1994.
- 1,868,465. THE MS. FINICKY SEAL OF APPROVAL AND DESIGN. INT. CL. 28. REG. 12-20-1994.
- 1,868,468. THE ELIZABETH CAROLE COLLECTION. INT. CL. 28. REG. 12-20-1994.
- 1,868,469. BIG RED BLITZ. INT. CL. 28. REG. 12-20-1994.
- 1,868,472. ARROW ALLEY. INT. CL. 28. REG. 12-20-1994.
- 1,868,473. ALLEY COURT. INT. CL. 28. REG. 12-20-1994.
- 1,868,474. TRILENE BERKLEY ULTRATHIN SUPER STRONG TOUGH AND THIN FISHING LINE AND DESIGN. INT. CL. 28. REG. 12-20-1994.
- 1,868,475. TRILENE BERKLEY XL EXTRA LIMP CASTABLE SUPER STRONG WORLD RECORD FISHING LINE AND DESIGN. INT. CL. 28. REG. 12-20-1994.
- 1,868,476. CAP WAVES. INT. CL. 28. REG. 12-20-1994.
- 1,868,478. JUNGLE KING AND DESIGN. INT. CL. 28. REG. 12-20-1994.
- 1,868,480. TALKING SWEETIE. INT. CL. 28. REG. 12-20-1994.
- 1,868,481. GIGGLES. INT. CL. 28. REG. 12-20-1994.
- 1,868,482. IMANI. INT. CL. 28. REG. 12-20-1994.
- 1,868,483. AEROFLY. INT. CL. 28. REG. 12-20-1994.
- 1,868,486. THIARA RANCHES ESTAB. IN U.S. 1907 "WE'RE FRUITS & NUTS!" AND DESIGN. INT. CLS. 29 AND 31. REG. 12-20-1994.
- 1,868,487. MISCELLANEOUS DESIGN. INT. CLS. 29, 30, 31 AND 32. REG. 12-20-1994.
- 1,868,490. NATURES VALUE AND DESIGN. INT. CL. 29. REG. 12-20-1994.
- 1,868,491. CAFE REY TARRAZU (STYLIZED). INT. CL. 30. REG. 12-20-1994.
- 1,868,493. MISCELLANEOUS DESIGN. INT. CL. 30. REG. 12-20-1994.
- 1,868,496. MOUNTAIN SHINE INT'L. AND DESIGN. INT. CL. 30. REG. 12-20-1994.
- 1,868,498. SHOCKIN' SHERBET. INT. CL. 30. REG. 12-20-1994.
- 1,868,500. STATEMINTS. INT. CL. 30. REG. 12-20-1994.
- 1,868,503. ULTIMATE ECLAIR. INT. CL. 30. REG. 12-20-1994.
- 1,868,506. THE BREAD MOMS AND KIDS CAN AGREE ON. INT. CL. 30. REG. 12-20-1994.
- 1,868,510. HARMONY. INT. CL. 31. REG. 12-20-1994.
- 1,868,511. PA-PA'S. INT. CL. 31. REG. 12-20-1994.
- 1,868,512. SUNRAY. INT. CL. 31. REG. 12-20-1994.
- 1,868,513. TROPICAL FRUIT KOLA INDIA. INT. CL. 32. REG. 12-20-1994.
- 1,868,514. SUNSATIONAL AND DESIGN. INT. CL. 32. REG. 12-20-1994.
- 1,868,515. VIP AND DESIGN. INT. CL. 33. REG. 12-20-1994.
- 1,868,517. PAPA'S VINEYARD. INT. CL. 33. REG. 12-20-1994.
- 1,868,518. PAGEPRO AND DESIGN. INT. CL. 35. REG. 12-20-1994.
- 1,868,519. AR AND DESIGN. INT. CLS. 35, 36, 41 AND 42. REG. 12-20-1994.
- 1,868,520. DESIGN BRIDGE AND DESIGN. INT. CLS. 35 AND 42. REG. 12-20-1994.
- 1,868,521. SUREFIND. INT. CL. 35. REG. 12-20-1994.
- 1,868,523. PROJECT HEALTHVISION. INT. CLS. 35 AND 42. REG. 12-20-1994.
- 1,868,526. LEGALSOURCE. INT. CL. 35. REG. 12-20-1994.
- 1,868,527. ADVANCED REHAB SYSTEMS. INT. CLS. 35 AND 42. REG. 12-20-1994.
- 1,868,529. TECHNIK DEVELOPMENT INTERNATIONAL. INT. CL. 35. REG. 12-20-1994.
- 1,868,531. SMARTWORK STUDIO INC. (STYLIZED). INT. CLS. 35 AND 42. REG. 12-20-1994.
- 1,868,532. THE COUPON CHANNEL (STYLIZED). INT. CL. 35. REG. 12-20-1994.
- 1,868,533. SCANNER APPLICATIONS AND DESIGN. INT. CL. 35. REG. 12-20-1994.
- 1,868,534. ROPHARMEX. INT. CL. 35. REG. 12-20-1994.
- 1,868,535. THE AMERICAN ROAD (STYLIZED). INT. CL. 35. REG. 12-20-1994.
- 1,868,536. VISCOMM. INT. CL. 35. REG. 12-20-1994.
- 1,868,538. STOR REPORTS (STYLIZED). INT. CL. 35. REG. 12-20-1994.
- 1,868,541. INNOVATE AND DESIGN. INT. CL. 35. REG. 12-20-1994.
- 1,868,542. MISCELLANEOUS DESIGN. INT. CL. 35. REG. 12-20-1994.
- 1,868,543. REAL ESTATE SOLUTIONS, INC.. INT. CLS. 35 AND 36. REG. 12-20-1994.
- 1,868,544. T.L.I.. INT. CL. 35. REG. 12-20-1994.
- 1,868,545. DE DIRECT EFFECT (STYLIZED). INT. CL. 35. REG. 12-20-1994.
- 1,868,546. THE DOUGLAS JOHN TRADING COMPANY (STYLIZED). INT. CLS. 35 AND 42. REG. 12-20-1994.
- 1,868,548. AD IN THE HOLE. INT. CL. 35. REG. 12-20-1994.
- 1,868,550. PRIVILEGEFLYER (STYLIZED). INT. CL. 35. REG. 12-20-1994.
- 1,868,551. MONEY PLUS GUARANTEE. INT. CLS. 35 AND 39. REG. 12-20-1994.
- 1,868,553. CHAMPION RESUME SERVICE. INT. CLS. 35 AND 42. REG. 12-20-1994.
- 1,868,554. NAME EXCHANGE (STYLIZED). INT. CLS. 35 AND 36. REG. 12-20-1994.
- 1,868,555. EURO/PRODUCTS 21ST CENTURY AND DESIGN. INT. CL. 35. REG. 12-20-1994.
- 1,868,556. INTELLIMAP. INT. CL. 35. REG. 12-20-1994.
- 1,868,557. ARDEN TIME PROGRAMS AND DESIGN. INT. CL. 35. REG. 12-20-1994.

- 1,868,558. WHERE RADIO MEETS TV. INT. CL. 35. REG. 12-20-1994.
- 1,868,559. SERVICE CHECK. INT. CL. 35. REG. 12-20-1994.
- 1,868,560. ALERT. INT. CL. 35. REG. 12-20-1994.
- 1,868,561. PEACE OF MIND. IT COMES WITH EVERY PIECE OF THE ROCK.. INT. CLS. 35, 36, 37 AND 42. REG. 12-20-1994.
- 1,868,562. NETWORKD. INT. CL. 35. REG. 12-20-1994.
- 1,868,563. THE INTERFACE FINANCIAL GROUP. INT. CL. 36. REG. 12-20-1994.
- 1,868,567. CHECKKEEPER. INT. CL. 36. REG. 12-20-1994.
- 1,868,568. PERPETUITY FORTRESS. INT. CL. 36. REG. 12-20-1994.
- 1,868,571. THE PLATINUM SUPREME PLAN. INT. CL. 36. REG. 12-20-1994.
- 1,868,572. THE PLATINUM PLAN. INT. CL. 36. REG. 12-20-1994.
- 1,868,573. CREDIT UNION ETC EXPRESS TRANSACTION CENTER AND DESIGN. INT. CL. 36. REG. 12-20-1994.
- 1,868,575. 100% HOME EQUITY LINE AND DESIGN. INT. CL. 36. REG. 12-20-1994.
- 1,868,576. CHARITY PLUS AND DESIGN. INT. CL. 36. REG. 12-20-1994.
- 1,868,578. CUT COSTS NOT CARE. INT. CL. 36. REG. 12-20-1994.
- 1,868,579. BASE "+". INT. CL. 36. REG. 12-20-1994.
- 1,868,581. CONCERN-BASED. INT. CL. 36. REG. 12-20-1994.
- 1,868,584. MLC AND DESIGN. INT. CL. 36. REG. 12-20-1994.
- 1,868,585. NATIONAL BANK OF THE REDWOODS AND DESIGN. INT. CL. 36. REG. 12-20-1994.
- 1,868,588. LEADER NATIONAL. INT. CL. 36. REG. 12-20-1994.
- 1,868,589. HOUSECLEVELAND. INT. CL. 36. REG. 12-20-1994.
- 1,868,591. ANALYSTS GROUP OF FUNDS AND DESIGN. INT. CL. 36. REG. 12-20-1994.
- 1,868,592. AD-EXCESS RISK. INT. CL. 36. REG. 12-20-1994.
- 1,868,595. CENTERPOINT. INT. CL. 36. REG. 12-20-1994.
- 1,868,596. VENWEST. INT. CLS. 36 AND 37. REG. 12-20-1994.
- 1,868,597. 1-800-7-REWARD. INT. CL. 36. REG. 12-20-1994.
- 1,868,605. BIO-SPRAY AND DESIGN. INT. CLS. 37, 40 AND 42. REG. 12-20-1994.
- 1,868,609. FACELIFT (STYLIZED). INT. CL. 37. REG. 12-20-1994.
- 1,868,614. PAGE ASSIST. INT. CL. 38. REG. 12-20-1994.
- 1,868,615. FRIENDS AROUND THE WORLD ANYTIME. INT. CL. 38. REG. 12-20-1994.
- 1,868,616. NETFACTS. INT. CL. 38. REG. 12-20-1994.
- 1,868,617. ECR 1000. INT. CL. 38. REG. 12-20-1994.
- 1,868,618. ECR 2000. INT. CL. 38. REG. 12-20-1994.
- 1,868,621. GREEN OASIS AND DESIGN. INT. CLS. 39, 41 AND 42. REG. 12-20-1994.
- 1,868,622. ALERT. INT. CL. 39. REG. 12-20-1994.
- 1,868,623. IEXC (STYLIZED). INT. CL. 39. REG. 12-20-1994.
- 1,868,624. FTI (STYLIZED). INT. CL. 39. REG. 12-20-1994.
- 1,868,626. MATT'S MAILING CENTER. INT. CL. 39. REG. 12-20-1994.
- 1,868,628. MEMBERS PREFERENCE AND DESIGN. INT. CL. 39. REG. 12-20-1994.
- 1,868,629. ADVENTURE DELIVERY. INT. CL. 39. REG. 12-20-1994.
- 1,868,633. WORLDCLASS PROCESSING, INC.. INT. CL. 40. REG. 12-20-1994.
- 1,868,634. ASPEN AND DESIGN. INT. CL. 40. REG. 12-20-1994.
- 1,868,636. WORTHINGTON. INT. CL. 40. REG. 12-20-1994.
- 1,868,637. MISCELLANEOUS DESIGN. INT. CLS. 40 AND 42. REG. 12-20-1994.
- 1,868,638. U UNITED TESTING GROUP AND DESIGN. INT. CL. 40. REG. 12-20-1994.
- 1,868,642. WE TAKE THE WORST PICTURES. (AND TURN THEM INTO THE BEST.). INT. CL. 40. REG. 12-20-1994.
- 1,868,644. WATER POINT SYSTEMS. INT. CLS. 40 AND 42. REG. 12-20-1994.
- 1,868,646. MINNESOTA CONTINUING LEGAL EDUCATION. INT. CL. 41. REG. 12-20-1994.
- 1,868,647. CMG COLOR DIRECTIONS BRIGHTER LIGHTER WARMER GRAYER DARKER COOLER AND DESIGN. INT. CLS. 41 AND 42. REG. 12-20-1994.
- 1,868,648. NATICK RACQUET CLUB. INT. CL. 41. REG. 12-20-1994.
- 1,868,651. PAN AM INTERNATIONAL FLIGHT ACADEMY AND DESIGN. INT. CL. 41. REG. 12-20-1994.
- 1,868,653. APPLE ASSURANCE. INT. CL. 41. REG. 12-20-1994.
- 1,868,659. TYKESTOWN USA AND DESIGN. INT. CLS. 41 AND 42. REG. 12-20-1994.
- 1,868,660. PLAY POINTS. INT. CL. 41. REG. 12-20-1994.
- 1,868,664. WELLSTAFF. INT. CL. 41. REG. 12-20-1994.
- 1,868,665. CST. INT. CL. 41. REG. 12-20-1994.
- 1,868,666. THE BRADDOCK BODY PROCESS AND DESIGN. INT. CL. 41. REG. 12-20-1994.
- 1,868,667. SRO MOTORSPORTS. INT. CL. 41. REG. 12-20-1994.
- 1,868,668. MISCELLANEOUS DESIGN. INT. CL. 41. REG. 12-20-1994.
- 1,868,669. DUG-OUT TRIVIA AND DESIGN. INT. CL. 41. REG. 12-20-1994.
- 1,868,672. MYSTERY BY DESIGN. INT. CL. 41. REG. 12-20-1994.
- 1,868,673. MISCELLANEOUS DESIGN. INT. CL. 41. REG. 12-20-1994.
- 1,868,677. MAS. INT. CL. 41. REG. 12-20-1994.
- 1,868,678. RAW PRODUCTION BAND AND DESIGN. INT. CL. 41. REG. 12-20-1994.
- 1,868,680. TEDDY BEAR PRODUCTIONS AND DESIGN. INT. CL. 41. REG. 12-20-1994.
- 1,868,681. FLYCATCHER. INT. CL. 41. REG. 12-20-1994.
- 1,868,682. IZZY MORPHIC. INT. CL. 41. REG. 12-20-1994.
- 1,868,683. L.U.L.A.C. AND DESIGN. INT. CLS. 41 AND 42. REG. 12-20-1994.
- 1,868,684. BENESTROPHE. INT. CL. 41. REG. 12-20-1994.
- 1,868,685. ONE VOICE. INT. CL. 41. REG. 12-20-1994.
- 1,868,688. SCOFFLAWS. INT. CL. 41. REG. 12-20-1994.
- 1,868,691. GODSPEED. INT. CL. 41. REG. 12-20-1994.
- 1,868,693. CHOICE CARE (STYLIZED). INT. CL. 42. REG. 12-20-1994.
- 1,868,695. COVERS (STYLIZED). INT. CL. 42. REG. 12-20-1994.
- 1,868,696. NAPA AUTOCARE CENTER WE INSTALL QUALITY NAPA PARTS AND DESIGN. INT. CL. 42. REG. 12-20-1994.
- 1,868,698. IVF AMERICA (STYLIZED). INT. CL. 42. REG. 12-20-1994.
- 1,868,699. CAPE COD CRAFTERS OUTLET AND DESIGN. INT. CL. 42. REG. 12-20-1994.
- 1,868,700. EDUCATIVE COUNSELING (STYLIZED). INT. CL. 42. REG. 12-20-1994.
- 1,868,703. FLORIDA EYE CENTER AND DESIGN. INT. CL. 42. REG. 12-20-1994.
- 1,868,705. WHINE. INT. CL. 42. REG. 12-20-1994.
- 1,868,706. PICTURE BOOK PREVIEW. INT. CL. 42. REG. 12-20-1994.
- 1,868,707. TREGO SYSTEMS. INT. CL. 42. REG. 12-20-1994.
- 1,868,708. FIELD STATION. INT. CL. 42. REG. 12-20-1994.
- 1,868,709. GOOD DOGGY CLUB. INT. CL. 42. REG. 12-20-1994.
- 1,868,710. SYEX EXPRESS. INT. CL. 42. REG. 12-20-1994.
- 1,868,712. SOLUTIONIST. INT. CL. 42. REG. 12-20-1994.
- 1,868,713. SPRINGSHIRE INN. INT. CL. 42. REG. 12-20-1994.
- 1,868,714. RAISING SECURITY PROFESSIONAL COUNCIL AWARENESS AND DESIGN. INT. CL. 42. REG. 12-20-1994.
- 1,868,715. TOLCO FLOORS TO CEILINGS WORLDWIDE LIQUIDATORS AND DESIGN. INT. CL. 42. REG. 12-20-1994.
- 1,868,719. GENESYS. INT. CL. 42. REG. 12-20-1994.
- 1,868,720. JERK MACHINE RESTAURANT. INT. CL. 42. REG. 12-20-1994.
- 1,868,722. THE FOUNDATION FOR INTERNATIONAL UNDERSTANDING AND DESIGN. INT. CL. 42. REG. 12-20-1994.

- 1,868,725. PETS "&" US (STYLIZED). INT. CL. 42. REG. 12-20-1994.
- 1,868,727. MISCELLANEOUS DESIGN. INT. CL. 42. REG. 12-20-1994.
- 1,868,731. U IN VIEW (STYLIZED). INT. CL. 42. REG. 12-20-1994.
- 1,868,732. AMERICA'S CHOICE FOR HOME-STYLE COOKING. INT. CL. 42. REG. 12-20-1994.
- 1,868,735. MANAGED HEALTHCARE SERVICES AND DESIGN. INT. CL. 42. REG. 12-20-1994.
- 1,868,736. AMERICAN QUALITY REGISTRARS A.Q.R. CERTIFIED QUALITY SYSTEMS AND DESIGN. INT. CL. 42. REG. 12-20-1994.
- 1,868,737. AMERICAN WHOLESALE FLORAL AND DESIGN. INT. CL. 42. REG. 12-20-1994.
- 1,868,738. FSI (STYLIZED). INT. CL. 42. REG. 12-20-1994.
- 1,868,740. WSD WATERSOFT DEVELOPMENT CO. AND DESIGN. INT. CL. 42. REG. 12-20-1994.
- 1,868,743. ROTACARE. INT. CL. 42. REG. 12-20-1994.
- 1,868,745. BRING HOME THE DIFFERENCE. INT. CL. 42. REG. 12-20-1994.
- 1,868,747. MICROAPEX AND DESIGN. INT. CL. 42. REG. 12-20-1994.
- 1,868,749. MARK PI'S FEAST OF CHINA BUFFET. INT. CL. 42. REG. 12-20-1994.
- 1,868,754. ATS. INT. CL. 42. REG. 12-20-1994.
- 1,868,756. TRIVENTCARE (STYLIZED). INT. CL. 42. REG. 12-20-1994.
- 1,868,758. THE COFFEE GROUNDS AND DESIGN. INT. CL. 42. REG. 12-20-1994.
- 1,868,762. SOUND EXCHANGE AND DESIGN. INT. CL. 42. REG. 12-20-1994.
- 1,868,763. SADIE'S CAFETERIA FAMILY DINING FROM MORRISON'S (STYLIZED). INT. CL. 42. REG. 12-20-1994.
- 1,868,765. PSD AND DESIGN. INT. CL. 42. REG. 12-20-1994.
- 1,868,766. TOUCHTALK. INT. CL. 42. REG. 12-20-1994.
- 1,868,771. BIO-TECH HEALTH SYSTEMS. INT. CL. 42. REG. 12-20-1994.
- 1,868,772. MISCELLANEOUS DESIGN. INT. CL. 42. REG. 12-20-1994.
- 1,868,773. HH (STYLIZED). INT. CL. 42. REG. 12-20-1994.
- 1,868,784. ETHOCYN. INT. CLS. 3 AND 5. REG. 12-20-1994.
- 1,868,785. MEDIS. INT. CLS. 1, 3 AND 5. REG. 12-20-1994.
- 1,868,790. "TCBY" AND DESIGN. INT. CLS. 29 AND 30. REG. 12-20-1994.
- 1,868,791. DECA. INT. CLS. 11 AND 21. REG. 12-20-1994.
- 1,868,792. LATA. INT. CLS. 14, 25 AND 26. REG. 12-20-1994.
- 1,868,793. ACCUWARE. INT. CLS. 9 AND 41. REG. 12-20-1994.
- 1,868,795. REFRACTIVEHORIZONS. INT. CLS. 35 AND 41. REG. 12-20-1994.
- 1,868,799. LIPOCEUTICAL. INT. CL. 1. REG. 12-20-1994.
- 1,868,802. LADY ASHFORD. INT. CL. 3. REG. 12-20-1994.
- 1,868,803. HERBAL SYNERGY COMPLEX (STYLIZED). INT. CL. 3. REG. 12-20-1994.
- 1,868,804. CITRUS NAUTICAL SHEEN. INT. CL. 3. REG. 12-20-1994.
- 1,868,805. HOTWIPE. INT. CL. 3. REG. 12-20-1994.
- 1,868,810. SHAKLEE ESSENTIALS. INT. CL. 3. REG. 12-20-1994.
- 1,868,811. GENESA. INT. CL. 5. REG. 12-20-1994.
- 1,868,813. OAPI (STYLIZED). INT. CL. 5. REG. 12-20-1994.
- 1,868,815. PISCINE-PLUS TRAITEMENT DE L'EAU POUR PISCINE ALGICIDE POOL-PLUS SWIMMING POOL WATER TREATMENT ALGAECIDE AND DESIGN. INT. CL. 5. REG. 12-20-1994.
- 1,868,818. CORROSION GARD. INT. CL. 6. REG. 12-20-1994.
- 1,868,819. WHEEL CUFF. INT. CL. 6. REG. 12-20-1994.
- 1,868,820. INTERLAM. INT. CL. 7. REG. 12-20-1994.
- 1,868,821. AUTO-AIM. INT. CL. 7. REG. 12-20-1994.
- 1,868,822. OXYMAX. INT. CL. 7. REG. 12-20-1994.
- 1,868,824. GRIND-ALL. INT. CL. 7. REG. 12-20-1994.
- 1,868,825. EMX100 (STYLIZED). INT. CL. 7. REG. 12-20-1994.
- 1,868,826. TRUX. INT. CL. 7. REG. 12-20-1994.
- 1,868,827. MILLZILLA. INT. CL. 7. REG. 12-20-1994.
- 1,868,830. CAPS. INT. CL. 9. REG. 12-20-1994.
- 1,868,831. POEMS. INT. CL. 9. REG. 12-20-1994.
- 1,868,833. VOICE-MATE (STYLIZED). INT. CL. 9. REG. 12-20-1994.
- 1,868,834. WALLIS HIVOLT. INT. CL. 9. REG. 12-20-1994.
- 1,868,836. "LIBERATED...CMM". INT. CL. 9. REG. 12-20-1994.
- 1,868,837. VARIVUE. INT. CL. 9. REG. 12-20-1994.
- 1,868,838. STARFIRE. INT. CL. 9. REG. 12-20-1994.
- 1,868,839. PFTREND. INT. CL. 9. REG. 12-20-1994.
- 1,868,842. MYO-LOGIC. INT. CL. 9. REG. 12-20-1994.
- 1,868,843. LANPOINT SYSTEMS. INT. CL. 9. REG. 12-20-1994.
- 1,868,844. TRITECH. INT. CL. 9. REG. 12-20-1994.
- 1,868,845. SNITCH. INT. CL. 9. REG. 12-20-1994.
- 1,868,846. DUOMATE. INT. CL. 9. REG. 12-20-1994.
- 1,868,847. TOT TRACKER. INT. CL. 9. REG. 12-20-1994.
- 1,868,850. PIGGY VAC. INT. CL. 9. REG. 12-20-1994.
- 1,868,851. REV-UP. INT. CL. 9. REG. 12-20-1994.
- 1,868,854. MADMATE. INT. CL. 9. REG. 12-20-1994.
- 1,868,855. LL-2000. INT. CL. 9. REG. 12-20-1994.
- 1,868,856. MUSIC LINK (STYLIZED). INT. CL. 9. REG. 12-20-1994.
- 1,868,857. RENAISSANCE. INT. CL. 10. REG. 12-20-1994.
- 1,868,860. JYROS. INT. CL. 10. REG. 12-20-1994.
- 1,868,862. AGIL. INT. CL. 10. REG. 12-20-1994.
- 1,868,867. CM MONTALTO AND DESIGN. INT. CL. 11. REG. 12-20-1994.
- 1,868,868. CLIMATE CARE. INT. CL. 11. REG. 12-20-1994.
- 1,868,870. ECOMOTION. INT. CL. 12. REG. 12-20-1994.
- 1,868,872. FIDDLE FISH. INT. CL. 15. REG. 12-20-1994.
- 1,868,873. CHROME-DOME. INT. CL. 15. REG. 12-20-1994.
- 1,868,875. VALUE-QUEST. INT. CL. 16. REG. 12-20-1994.
- 1,868,876. MEDIAMATCH. INT. CL. 16. REG. 12-20-1994.
- 1,868,877. AVIALEX. INT. CL. 16. REG. 12-20-1994.
- 1,868,878. GYMTIPS FOR KIDS ON THE GROW. INT. CL. 16. REG. 12-20-1994.
- 1,868,879. SNICKERDOODLES. INT. CL. 16. REG. 12-20-1994.
- 1,868,882. AMBYTES. INT. CL. 16. REG. 12-20-1994.
- 1,868,883. PLAYRIGHT. INT. CL. 16. REG. 12-20-1994.
- 1,868,885. ULTRAMAN. INT. CL. 16. REG. 12-20-1994.
- 1,868,886. YOUNGBLOOD. INT. CL. 16. REG. 12-20-1994.
- 1,868,889. HEAVY METAL. INT. CL. 20. REG. 12-20-1994.
- 1,868,890. M AND DESIGN. INT. CL. 20. REG. 12-20-1994.
- 1,868,891. NEWHORIZONS (STYLIZED). INT. CL. 20. REG. 12-20-1994.
- 1,868,892. "LE PLUG". INT. CL. 20. REG. 12-20-1994.
- 1,868,895. SHETLAND. INT. CL. 20. REG. 12-20-1994.
- 1,868,896. HIDE-A-REST. INT. CL. 20. REG. 12-20-1994.
- 1,868,897. BUG-N-BUFF AND DESIGN. INT. CL. 21. REG. 12-20-1994.
- 1,868,898. PLASTI-SPRAY. INT. CL. 21. REG. 12-20-1994.
- 1,868,899. STUDIO COLLAGE. INT. CL. 24. REG. 12-20-1994.
- 1,868,901. LOOK RIGHT. INT. CL. 25. REG. 12-20-1994.
- 1,868,902. AIR 21 TURF. INT. CL. 25. REG. 12-20-1994.
- 1,868,903. MUSIC FOR YOUR EYES. INT. CL. 25. REG. 12-20-1994.
- 1,868,906. GINA GABRIEL. INT. CL. 25. REG. 12-20-1994.
- 1,868,910. KIDS ALL KIDS ARE NUMBER ONE (STYLIZED). INT. CL. 25. REG. 12-20-1994.
- 1,868,912. MISE AU GREEN. INT. CL. 25. REG. 12-20-1994.
- 1,868,914. SPEED DEMON. INT. CL. 25. REG. 12-20-1994.
- 1,868,915. SPEED DEVIL. INT. CL. 25. REG. 12-20-1994.
- 1,868,916. MEDIBACK-PLUS. INT. CL. 27. REG. 12-20-1994.
- 1,868,919. SANDMAN. INT. CL. 28. REG. 12-20-1994.
- 1,868,920. INTERPLANETARY LIZARDS. INT. CL. 28. REG. 12-20-1994.
- 1,868,921. SUCK UP. INT. CL. 28. REG. 12-20-1994.
- 1,868,923. WASHR' TOSSR'. INT. CL. 28. REG. 12-20-1994.
- 1,868,924. GREAT WEEKEND. INT. CL. 28. REG. 12-20-1994.
- 1,868,925. BIG NICKEL. INT. CL. 28. REG. 12-20-1994.
- 1,868,926. POWER COURT. INT. CL. 28. REG. 12-20-1994.
- 1,868,928. LANCE AND DESIGN. INT. CL. 28. REG. 12-20-1994.
- 1,868,930. FIT STRIP. INT. CL. 28. REG. 12-20-1994.
- 1,868,931. STREETBOARD. INT. CL. 28. REG. 12-20-1994.
- 1,868,932. HOPPIN' CHECKERS. INT. CL. 28. REG. 12-20-1994.
- 1,868,933. AQUASAUROUS. INT. CL. 28. REG. 12-20-1994.

- 1,868,934. LATITUDE. INT. CL. 28. REG. 12-20-1994.  
 1,868,935. GULF CITY SEAFOODS. INT. CL. 29. REG. 12-20-1994.  
 1,868,939. GOOD & SIMPLE (STYLIZED). INT. CL. 29. REG. 12-20-1994.  
 1,868,940. INTERNATIONAL CUISINE. INT. CL. 29. REG. 12-20-1994.  
 1,868,945. PURPLE PASSIONS. INT. CL. 30. REG. 12-20-1994.  
 1,868,946. IT'S HOW STEAK IS DONE, SPICY (STYLIZED). INT. CL. 30. REG. 12-20-1994.  
 1,868,947. THE ROMAN BAR AND DESIGN. INT. CL. 30. REG. 12-20-1994.  
 1,868,953. MEX TO THE MAX. INT. CL. 30. REG. 12-20-1994.  
 1,868,954. COACHELLA JOE. INT. CL. 31. REG. 12-20-1994.  
 1,868,956. QUALITY BREEDS CUSTOMER SATISFACTION. INT. CL. 31. REG. 12-20-1994.  
 1,868,957. A START 200 AND DESIGN. INT. CL. 31. REG. 12-20-1994.  
 1,868,960. THOMPSON'S PASTA BONES. INT. CL. 31. REG. 12-20-1994.  
 1,868,961. KIT'N KABOODLE. SO MANY SHAPES AND FLAVORS IT MAKES OTHER MEALS SEEM DOWNRIGHT. INT. CL. 31. REG. 12-20-1994.  
 1,868,962. NUTTY BONE. INT. CL. 31. REG. 12-20-1994.  
 1,868,964. HOMEBOY. INT. CL. 32. REG. 12-20-1994.  
 1,868,965. CACTI. INT. CL. 33. REG. 12-20-1994.  
 1,868,966. GUILLOT. INT. CL. 33. REG. 12-20-1994.  
 1,868,968. SCOTTISH LEADER AND DESIGN. INT. CL. 33. REG. 12-20-1994.  
 1,868,969. KRISTAL CZARSKAYA. INT. CL. 33. REG. 12-20-1994.  
 1,868,971. COASTAL OAKS. INT. CL. 33. REG. 12-20-1994.  
 1,868,973. X AND DESIGN. INT. CL. 34. REG. 12-20-1994.  
 1,868,974. OCEANBRIDGE. INT. CL. 35. REG. 12-20-1994.  
 1,868,975. ERRAND CENTER. INT. CL. 35. REG. 12-20-1994.  
 1,868,976. STRATEGY-BASED PAY. INT. CL. 35. REG. 12-20-1994.  
 1,868,981. BUILDING RELATIONSHIPS FOR LIFE. INT. CL. 36. REG. 12-20-1994.  
 1,868,982. THE ART OF MAKING MONEY WORK. INT. CL. 36. REG. 12-20-1994.  
 1,868,987. ENVIRONMENTAL PARTNERSHIP PROGRAM. INT. CL. 37. REG. 12-20-1994.  
 1,868,988. MCI PREFERRED HOMEWORKS. INT. CL. 38. REG. 12-20-1994.  
 1,868,989. PEEK A VIEW. INT. CL. 38. REG. 12-20-1994.  
 1,868,990. FLEETPOINT. INT. CL. 39. REG. 12-20-1994.  
 1,868,991. SPONTANEOUS GOLD. INT. CL. 39. REG. 12-20-1994.  
 1,868,995. FITNESS PLUS. INT. CL. 41. REG. 12-20-1994.  
 1,868,996. PUTTERS WORLD. INT. CL. 41. REG. 12-20-1994.  
 1,868,997. 1-900-773-LSMA. INT. CL. 42. REG. 12-20-1994.  
 1,868,998. REMTEST. INT. CL. 42. REG. 12-20-1994.  
 1,868,999. GUARDIAN ANGEL. INT. CL. 42. REG. 12-20-1994.  
 1,869,003. ENVISION VACATIONS. INT. CL. 42. REG. 12-20-1994.  
 1,869,004. VISION USA VOLUNTEERS IN SERVICE IN OUR NATION AND DESIGN. INT. CL. 42. REG. 12-20-1994.  
 1,869,005. ELITE. INT. CL. 42. REG. 12-20-1994.  
 1,869,006. LA PLAZA DEL HOGAR. INT. CL. 42. REG. 12-20-1994.  
 1,869,007. COURT SERVE. INT. CL. 42. REG. 12-20-1994.  
 1,869,008. SHARPEN YOUR POINT OF PURCHASE. INT. CL. 42. REG. 12-20-1994.  
 1,869,009. REHABILITY CORPORATION. INT. CL. 42. REG. 12-20-1994.  
 1,869,010. REHABILITY CENTER. INT. CL. 42. REG. 12-20-1994.  
 1,869,011. PLANWARE. INT. CL. 42. REG. 12-20-1994.  
 1,869,012. REFRESHED & REJUVENATED R & R AND DESIGN. INT. CL. 42. REG. 12-20-1994.  
 1,869,013. WE HELP YOU BUILD ON YOUR IMAGINATION. INT. CL. 42. REG. 12-20-1994.  
 1,869,016. THE ONLINE JOURNAL OF CURRENT CLINICAL TRIALS. INT. CLS. 9, 16, 35, 41 AND 42. REG. 12-20-1994.  
 1,869,017. PRIMARY JOURNALS ONLINE. INT. CLS. 16, 35, 41 AND 42. REG. 12-20-1994.  
 1,869,018. DONGLE. INT. CLS. 9, 16 AND 28. REG. 12-20-1994.  
 1,869,020. STANDARDNEWS. INT. CLS. 41 AND 42. REG. 12-20-1994.  
 1,869,021. QUICK NEWS-LINK. INT. CLS. 16, 35, 36, 38 AND 42. REG. 12-20-1994.  
 1,869,023. U.S. WATER. INT. CLS. 37 AND 40. REG. 12-20-1994.  
 1,869,025. ENVIRONMENTAL HEALTH FOUNDATION. INT. CLS. 41 AND 42. REG. 12-20-1994.  
 1,869,026. TALLINN. INT. CLS. 32 AND 33. REG. 12-20-1994.  
 1,869,027. BEAUTIFUL PLANTS BRAND. INT. CL. 1. REG. 12-20-1994.  
 1,869,028. BERING. INT. CL. 3. REG. 12-20-1994.  
 1,869,029. CLEAN BREATH. INT. CL. 3. REG. 12-20-1994.  
 1,869,032. OIL OF EMU AND DESIGN. INT. CL. 3. REG. 12-20-1994.  
 1,869,033. TREE GUARD. INT. CL. 5. REG. 12-20-1994.  
 1,869,034. KID ESSENTIALS. INT. CL. 5. REG. 12-20-1994.  
 1,869,035. TEEN ESSENTIALS. INT. CL. 5. REG. 12-20-1994.  
 1,869,037. AIR BRAKE. INT. CL. 7. REG. 12-20-1994.  
 1,869,038. DENTAL TECHNOLOGIES. INT. CL. 9. REG. 12-20-1994.  
 1,869,039. LEAK TRACKER. INT. CL. 9. REG. 12-20-1994.  
 1,869,040. CONTEMPORARY MUSIC TEACHING GOD'S WORD. INT. CL. 9. REG. 12-20-1994.  
 1,869,042. THE CAROLING KIDS (STYLIZED). INT. CL. 9. REG. 12-20-1994.  
 1,869,044. INTERACTIVE PRODUCT SELECTOR. INT. CL. 9. REG. 12-20-1994.  
 1,869,048. WARM WRAP GRIPS. INT. CL. 12. REG. 12-20-1994.  
 1,869,049. UNDEEZ. INT. CL. 16. REG. 12-20-1994.  
 1,869,050. SPORT AVIATION FOR KIDS. INT. CL. 16. REG. 12-20-1994.  
 1,869,051. BIKINI ILLUSTRATED. INT. CL. 16. REG. 12-20-1994.  
 1,869,052. MANOR ESTATES. INT. CL. 16. REG. 12-20-1994.  
 1,869,053. CONTEMPORARY MUSIC TEACHING GOD'S WORD. INT. CL. 16. REG. 12-20-1994.  
 1,869,055. IMAGING ECONOMICS. INT. CL. 16. REG. 12-20-1994.  
 1,869,056. WHO'S WHO IN PIPELINING. INT. CL. 16. REG. 12-20-1994.  
 1,869,058. PHILANTHROPY JOURNAL OF NORTH CAROLINA. INT. CL. 16. REG. 12-20-1994.  
 1,869,059. THE JOURNAL OF FINANCIAL ENGINEERING. INT. CL. 16. REG. 12-20-1994.  
 1,869,060. SUPERMARKET FROZENS. INT. CL. 16. REG. 12-20-1994.  
 1,869,061. WIRELESS COMMUNICATIONS FORUM. INT. CL. 16. REG. 12-20-1994.  
 1,869,062. LOUISIANA FARMER. INT. CL. 16. REG. 12-20-1994.  
 1,869,064. HOME GYM AND FITNESS. INT. CL. 16. REG. 12-20-1994.  
 1,869,066. ROCKY MOUNTAIN MAGAZINE. INT. CL. 16. REG. 12-20-1994.  
 1,869,067. EXPERT GRAPHICS. INT. CL. 16. REG. 12-20-1994.  
 1,869,068. CASUAL DECOR A GUIDE TO OUTDOOR/INDOOR FURNISHINGS. INT. CL. 16. REG. 12-20-1994.  
 1,869,072. THE INTERNATIONAL DEFENSE ELECTRONICS SYSTEMS HANDBOOK. INT. CL. 16. REG. 12-20-1994.  
 1,869,074. UTILITY MAINTENANCE. INT. CL. 16. REG. 12-20-1994.  
 1,869,077. AMERICAN BUILDER MAGAZINE. INT. CL. 16. REG. 12-20-1994.  
 1,869,081. DESIGNER KITCHENS A WHO'S WHO IN KITCHEN DESIGN. INT. CL. 16. REG. 12-20-1994.  
 1,869,082. THE GOLF ANNUAL. INT. CL. 16. REG. 12-20-1994.

- 1,869,084. MARINE TECHNOLOGY NEWS. INT. CL. 16. REG. 12-20-1994.
- 1,869,086. WINDSHIELD REPAIR JOURNAL. INT. CL. 16. REG. 12-20-1994.
- 1,869,087. SNAP EDGE. INT. CL. 19. REG. 12-20-1994.
- 1,869,088. ANY SIDE UP ANY SIDE UP AND DESIGN. INT. CL. 20. REG. 12-20-1994.
- 1,869,089. U.S. STICK. INT. CL. 20. REG. 12-20-1994.
- 1,869,091. GRAND CASINO GULFPORT MISSISSIPPI. INT. CL. 25. REG. 12-20-1994.
- 1,869,093. DIG A LITTLE DEEPER. INT. CL. 25. REG. 12-20-1994.
- 1,869,094. EASY WEAVE (STYLIZED). INT. CL. 26. REG. 12-20-1994.
- 1,869,095. MISCELLANEOUS DESIGN. INT. CL. 28. REG. 12-20-1994.
- 1,869,096. 4 LANE RACING. INT. CL. 28. REG. 12-20-1994.
- 1,869,098. BEAUTIFUL BEADS!. INT. CL. 28. REG. 12-20-1994.
- 1,869,099. BOWHUNTER'S ORGANIZER. INT. CL. 28. REG. 12-20-1994.
- 1,869,100. MID-OVERSIZED. INT. CL. 28. REG. 12-20-1994.
- 1,869,101. SUPER TEE. INT. CL. 28. REG. 12-20-1994.
- 1,869,102. MISCELLANEOUS DESIGN. INT. CL. 30. REG. 12-20-1994.
- 1,869,103. WE BAKE IT BETTER. INT. CL. 30. REG. 12-20-1994.
- 1,869,104. COFFEE FOR A CAUSE. INT. CL. 30. REG. 12-20-1994.
- 1,869,106. PUBLICIDAD FERRER. INT. CL. 35. REG. 12-20-1994.
- 1,869,107. THE MEMPHIS FLEA MARKET. INT. CL. 35. REG. 12-20-1994.
- 1,869,112. SOUTH FLORIDA'S BANK. INT. CL. 36. REG. 12-20-1994.
- 1,869,115. MISCELLANEOUS DESIGN. INT. CL. 38. REG. 12-20-1994.
- 1,869,116. FLORIDA FAX!. INT. CL. 38. REG. 12-20-1994.
- 1,869,118. TRAVEL JUDAICA. INT. CL. 39. REG. 12-20-1994.
- 1,869,119. PREPARING FOR MEDIATION. INT. CL. 41. REG. 12-20-1994.
- 1,869,120. ORIENTAL ARTS TRAINING CENTER. INT. CL. 41. REG. 12-20-1994.
- 1,869,122. THE U.S. AMATEUR. INT. CL. 41. REG. 12-20-1994.
- 1,869,125. PEARL HARBOR H-O-B-B-I-E-S (STYLIZED). INT. CL. 42. REG. 12-20-1994.
- 1,869,126. AMERICAN TELECOMMUTING ASSOCIATION. INT. CL. 42. REG. 12-20-1994.
- 1,869,127. JENSEN ALE HOUSE AND RAW BAR. INT. CL. 42. REG. 12-20-1994.
- 1,934,934. LIL' DRUG STORE. INT. CL. 3 ONLY. REG. 11-14-1995.
- 1,934,943. THE ORIGINAL LIL' DRUG STORE AND DESIGN. INT. CL. 3 ONLY. REG. 11-14-1995.
- 1,937,790. PREMIER INTERIORS. INT. CL. 35 ONLY. REG. 11-28-1995.
- 1,958,259. IMO. INT. CLS. 9 AND 12 ONLY. REG. 2-27-1996.
- 1,962,235. CVP. INT. CLS. 29 AND 31 ONLY. REG. 3-12-1996.

---

**SECTION 18**

- 1,166,235. INFRACON. INT. CL. 9. REG. 8-25-1981.

- 1,424,150. KINGSFORD. INT. CL. 30. REG. 1-6-1987.
- 1,691,031. TECHNOLOGY CONSULTING CORPORATION. INT. CL. 42. REG. 6-2-1992.
- 1,997,472. FUTURE EYESTIK. INT. CL. 3. REG. 8-27-1996.
- 2,228,729. ORKESTRA AND DESIGN. INT. CL. 25. REG. 3-2-1999.
- 2,254,160. CRYSTAL BREATH SYSTEM. INT. CLS. 3 AND 5. REG. 6-15-1999.

---

**SECTION 37**

- 1,602,929. PILATES STUDIO. INT. CL. 41. REG. 6-19-1990.

---

**INADVERTENTLY ISSUED REGISTRATION NUMBERS**

- 2,306,153. THIS OLD HOUSE ONLINE. INT. CL. 37. REG. 1-4-2000. RESTORED TO SN 75-600,856.
- 2,387,542. SEXYADS. INT. CL. 42. REG. 9-19-2000. RESTORED TO SN 75-746,967.
- 2,403,170. PARVEST. INT. CL. 36. REG. 11-14-2000. RESTORED TO SN 75-484,026.
- 2,426,009. OS W-E AND DESIGN. INT. CLS. 1, 2, 6, 7, 8, 9 AND 21. REG. 2-6-2001. RESTORED TO SN 75-412,033.
- 2,426,270. MIXSTAR (STYLIZED). INT. CL. 10. REG. 2-6-2001. RESTORED TO SN 75-709,555.
- 2,453,561. T THOMAS AND DESIGN. INT. CL. 7. REG. 5-22-2001. RESTORED TO SN 75-510,414.
- 2,464,837. HYFEN 85 CXF. INT. CL. 7. REG. 7-3-2001. RESTORED TO SN 75-494,183.
- 2,464,951. POWER T.I.E.. INT. CLS. 9, 35 AND 42. REG. 7-3-2001. RESTORED TO SN 75-675,746.
- 2,490,954. CHOICE PLAZA. INT. CL. 35. REG. 9-18-2001. RESTORED TO SN 78-013,695.
- 2,492,622. BARMAG. INT. CL. 9. REG. 9-25-2001. RESTORED TO SN 76-165,306.
- 2,494,148. JAGUAR AND DESIGN. INT. CL. 5. REG. 10-2-2001. RESTORED TO SN 76-050,679.
- 2,497,620. SOUTHWEST RESEARCH INSTITUTE. INT. CL. 41. REG. 10-16-2001. RESTORED TO SN 75-824,628.
- 2,499,793. ALL ABOARD THE RIGHT BRAIN TRAIN THE CREATION STATION FINE ART STUDIO AND DESIGN. INT. CLS. 35 AND 41. REG. 10-23-2001. RESTORED TO SN 75-928,992.



# TRADEMARK REGISTRATIONS AMENDED, CORRECTED, ETC.

The designation "U.S. Cl." appearing in this section refers to the U.S. class in effect prior to Sep. 1, 1973 rather than the international class which applies to applications filed on or after that date. For adoption of international classification see notice in the OFFICIAL GAZETTE of Jun. 26, 1973 (911 O.G. TM 210).

Any change to the registration will be indicated at the bottom of each entry under ELEMENTS AMENDED, CORRECTED OR RESTRICTED. With the exception of changes to the goods and services, additions to the registration will appear in asterisks and deletions of the registration will appear in brackets. Elements which are only changed will be listed with no punctuation. As to the goods/services statement, amendments to the goods/services will appear in asterisks and deletions will appear in brackets. In addition if any change to the goods/services occurs, the element "Goods/Services" will be listed under ELEMENTS AMENDED, CORRECTED OR RESTRICTED.

1,149,920. REG. 3-31-1981. COMBE INCORPORATED (DELAWARE CORPORATION), 1101 WESTCHESTER AVE., WHITE PLAINS, NY, 106043597, SN 73-230,338. FILED 9-6-1979. PRINCIPAL REGISTER.

FOR MULTIPLE REPEATER FIREWORKS.  
FIRST USE 4-0-1994; IN COMMERCE 4-0-1994.

## ODOR-EATERS

ELEMENTS CORRECTED  
OWNER NAME

OWNER OF U.S. REG. NOS. 988,715, 1,090,583 AND OTHERS.

INT. CL. 25/U.S. CLS. 22 AND 39

FOR [ FOOT ] DEODORIZING PRODUCTS—NAMELY, [ DEODORANT ] \* DEODORIZING \* SOCKS.  
FIRST USE 7-3-1979; IN COMMERCE 7-3-1979.

1,914,373. REG. 8-22-1995. TURKISH AIRLINES, INC. (TURKEY CORPORATION), 821 UNITED NATIONS PLAZA, 4TH FLOOR, NEW YORK, NY, 10017, SN 74-452,524. FILED P.R. 10-29-1993; AM. S.R. 5-12-1995. SUPPLEMENTAL REGISTER.

ELEMENTS AMENDED  
\*GOODS/SERVICES\*

## CORPORATE CLUB

1,661,335. REG. 10-22-1991. VARN PRODUCTS CO., INC. (NEW JERSEY CORPORATION), 8 ALLERMAN RD., OAKLAND, NJ, 07436, SN 74-039,417. FILED 3-19-1990. PRINCIPAL REGISTER.

INT. CL. 39/U.S. CLS. 100 AND 105

FOR HOSPITALITY SERVICES IN THE NATURE OF PROVIDING REFRESHMENTS, LOUNGING ACCOMMODATIONS AND TRAVEL ASSISTANCE TO TICKETED AIRLINE PASSENGERS.

FIRST USE 9-15-1993; IN COMMERCE 9-15-1993.

## OVERNITE

ELEMENTS CORRECTED  
OWNER NAME

INT. CL. 1/U.S. CL. 6

FOR LIQUID CHEMICAL CONDITIONER FOR PRINTING PRESS ROLLS AND BLANKETS.  
FIRST USE 12-15-1989; IN COMMERCE 12-18-1989.

ELEMENTS CORRECTED  
OWNER NAME

1,916,215. REG. 9-5-1995. NIIT (USA), INC. (GEORGIA CORPORATION), 400 PERIMETER CTR. TERRACE, N.E., SUITE 900, ATLANTA, GA, 303461260, SN 74-557,855. FILED 8-5-1994. PRINCIPAL REGISTER.

## NIIT

1,859,148. REG. 10-18-1994. B. J. ALAN COMPANY (OHIO CORPORATION), 555 MARTIN LUTHER KING BLVD., YOUNGSTOWN, OH, 45502, SN 74-382,288. FILED 4-26-1993. PRINCIPAL REGISTER.

INT. CL. 9/U.S. CLS. 21, 23, 26, 36 AND 38

FOR COMPUTER SOFTWARE, NAMELY SOFTWARE USED TO TRAIN OTHERS IN THE USE OF COMPUTERS SUCH AS INTERACTIVE VIDEO SOFTWARE, MULTIMEDIA SOFTWARE AND PERFORMANCE SOFTWARE AND INSTRUCTION MANUALS SOLD AS A UNIT.

FIRST USE 7-1-1991; IN COMMERCE 7-1-1991.

## 19 SHOT MACHINE GUN SHELL

NO CLAIM IS MADE TO THE EXCLUSIVE RIGHT TO USE "19 SHOT", APART FROM THE MARK AS SHOWN.  
INT. CL. 13/U.S. CL. 9

ELEMENTS CORRECTED  
OWNER NAME

1,940,149. REG. 12-5-1995. ENGELHARD CORPORATION (DELAWARE CORPORATION), 101 WOOD AVENUE, ISELIN, NJ, 08830, SN 74-654,576. FILED 4-3-1995. PRINCIPAL REGISTER.

**ATTASORB**

INT. CL. 1/U.S. CLS. 1  
FOR LOW VOLATILE FULLERS EARTH.  
FIRST USE 5-16-1951; IN COMMERCE 7-8-1952.

ELEMENTS CORRECTED  
OWNER NAME

---

2,285,706. REG. 10-12-1999. EXPERIENCE LEARNING COMMUNITY (WASHINGTON NON-PROFIT CORPORATION), FORMERLY EXPERIENCE LEARNING PROJECT, 2901 THIRD AVENUE, SUITE 400, SEATTLE, WA, 98121, BY CHANGE OF NAME EXPERIENCE MUSIC PROJECT (WASHINGTON), BELLEVUE, WA, SN 74-649,993. FILED 3-22-1995. PRINCIPAL REGISTER.

**EMP**

INT. CL. 18/U.S. CLS. 1, 2, 3, 22 AND 41  
FOR TOTE BAGS.  
FIRST USE 11-3-1998; IN COMMERCE 11-3-1998.

ELEMENTS CORRECTED  
\*ASSIGNMENT/NAME CHANGE\*

---

2,299,038. REG. 12-7-1999. KABUSHIKI KAISHA NTT DATA (JAPAN CORPORATION), DBA NTT DATA CORPORATION, 3-3, TOYOSU 3-CHOME, KOTO-KU, TOKYO, JAPAN., BY CHANGE OF NAME KABUSHIKI KAISHA NTT DATA (JAPAN CORPORATION), DBA NTT DATA CORPORATION, TOKYO, JAPAN, SN 75-978,361. FILED 3-26-1996. PRINCIPAL REGISTER.

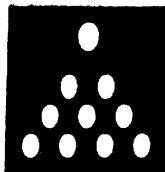

INT. CL. 9/U.S. CLS. 21, 23, 26, 36 AND 38  
FOR COMPUTER SOFTWARE FOR USE IN THE FOLLOWING BUSINESS APPLICATIONS - GENERAL LEDGER, ACCOUNT MANAGEMENT, CASH MANAGEMENT AND INVENTORY CONTROL.  
FIRST USE 7-0-1988; IN COMMERCE 10-0-1990.

ELEMENTS CORRECTED  
OWNER NAME

2,344,066. REG. 4-18-2000. GOEPEL ELECTRONICS, LLC (TEXAS LIMITED LIABILITY COMPANY) 9600 GREAT HILLS, SUITE 150W, AUSTIN, TX, 78759, BY ASSIGNMENT GOEPEL ELECTRONICS, LLC (IDAHO), AUSTIN, TX, SN 75-465,752. FILED 4-9-1998. PRINCIPAL REGISTER.

**INTELLIGENT BOUNDARY  
SCAN SOLUTIONS**

NO CLAIM IS MADE TO THE EXCLUSIVE RIGHT TO USE "INTELLIGENT BOUNDARY SCAN", APART FROM THE MARK AS SHOWN.

INT. CL. 9/U.S. CLS. 21, 23, 26, 36 AND 38  
FOR COMPUTER SOFTWARE AND COMPUTER HARDWARE BOTH FOR TESTING ELECTRONIC CIRCUITRY.  
FIRST USE 1-0-1999; IN COMMERCE 1-0-1999.

ELEMENTS CORRECTED  
\*ASSIGNMENT/NAME CHANGE\*

---

2,351,763. REG. 5-23-2000. NATIONAL ASSOCIATION FOR STOCK CAR AUTO RACING, INC. (FLORIDA CORPORATION), P. O. BOX 2875, DAYTONA BEACH, FL, 321202875, SN 75-717,667. FILED 5-28-1999. PRINCIPAL REGISTER.

**INSIDE NASCAR**

OWNER OF U.S. REG. NOS. 990,987, 1,908,112 AND OTHERS.

INT. CL. 25/U.S. CLS. 22 AND 39  
FOR CLOTHING, NAMELY, T-SHIRTS, GOLF SHIRTS, CAPS, AND HATS.

FIRST USE 7-1-1996; IN COMMERCE 7-1-1996.  
INT. CL. 41/U.S. CLS. 100, 101 AND 107  
FOR ENTERTAINMENT [ OF ] SERVICES, NAMELY, [ AND ] \*AN \* ONGOING TELEVISION PROGRAM FEATURING STOCK CAR AND STOCK TRUCK RACING.  
FIRST USE 7-1-1996; IN COMMERCE 7-1-1996.

ELEMENTS CORRECTED  
GOODS/SERVICES  
OWNER NAME

---

2,381,550. REG. 8-29-2000. MYCITY.COM, INC. (FLORIDA CORPORATION), 169 E. FLAGLER STREET, 2ND FLOOR, MIAMI BEACH, FL, 33131, SN 75-833,230. FILED 10-27-1999. PRINCIPAL REGISTER.

**MYCITY**

INT. CL. 35/U.S. CLS. 100, 101 AND 102  
FOR PROMOTING THE GOODS AND SERVICES OF OTHERS BY PREPARING AND PLACING ADVERTISEMENTS IN AN ELECTRONIC FORMAT ACCESSED THROUGH A GLOBAL COMPUTER NETWORK; AND PREPARING AND DISTRIBUTING AUDIO, VISUAL AND DATA PRESENTATIONS ON ELECTRONIC MEDIA FOR OTHERS .  
FIRST USE 10-20-1995; IN COMMERCE 10-20-1995.

ELEMENTS CORRECTED  
CITIZENSHIP

2,388,943. REG. 9-26-2000. CRONOS GROUP SA, THE (LUXEMBOURG CORPORATION), 7, RUE D'AMSTERDAM, L-1126 LUXEMBOURG, UNITED KINGDOM., ASSIGNEE OF; ASSIGNEE OF; ASSIGNEE OF C G HOLDING S.A. (LUXEMBOURG CORPORATION), L-1126 LUXEMBOURG, LUXEMBOURG. SN 74-802,526. FILED 12-13-1991. PRINCIPAL REGISTER.



PRIORITY CLAIMED UNDER SEC. 44(D) ON UNITED KINGDOM APPLICATION NO. 1477375, FILED 9-17-1991, REG. NO. 1477375, DATED 3-26-1993, EXPIRES 9-17-2008. INT. CL. 36/U.S. CLS. 100, 101 AND 102

FOR FINANCIAL SERVICES, NAMELY, FINANCIAL MANAGEMENT AND PLANNING SERVICES; LEASE PURCHASE FINANCING; FINANCIAL INFORMATION AND ADVISORY SERVICES AND BROKERAGE OF INSURANCE RELATED INVESTMENT SECURITIES.

FIRST USE ; IN COMMERCE .

ELEMENTS CORRECTED  
FOREIGN COUNTRY OF ORIGIN  
PRIORITY CLAIMED STATEMENT

2,389,501. REG. 9-26-2000. GUERLAIN S.A. (FRANCE CORPORATION), 68, AVENUE DES CHAMPS-ELYSEES, 75008 PARIS, FRANCE., SN 75-694,680. FILED 4-29-1999. PRINCIPAL REGISTER.

## ISSIMAT

OWNER OF FRANCE REG. NO. 98759502, DATED 11-9-1998, EXPIRES 11-9-2008.

OWNER OF U.S. REG. NO. 1,235,987 AND OTHERS.  
INT. CL. 3/U.S. CLS. 1, 4, 6, 50, 51 AND 52

FOR SKIN MOISTURIZER, SKIN CREAM, SKIN CLARIFIERS, SKIN TONERS, SKIN MOUSSE, SKIN LOTION.

ELEMENTS CORRECTED  
\*PRIORITY CLAIMED STATEMENT\*

2,401,194. REG. 11-7-2000. SAIC (DELAWARE CORPORATION), 10260 CAMPUS POINT DRIVE MS F3, SAN DIEGO, CA. 92121, SN 75-388,888. FILED 11-12-1997. PRINCIPAL REGISTER.

## EPICWEB

INT. CL. 9/U.S. CLS. 21, 23, 26, 36 AND 38

FOR COMPUTER SOFTWARE, NAMELY A WIDE AREA COMPUTER BASED SOFTWARE PROCESS AND AUTOMATION TOOL FOR WORK MANAGEMENT; INCLUDING MANAGING, TRACKING AND INITIATING TASKS \*BUT NOT FOR USE IN THE HEALTH-CARE INDUSTRY\*.

FIRST USE 1-27-1997; IN COMMERCE 1-27-1997.

ELEMENTS CORRECTED  
GOODS/SERVICES

2,419,721. REG. 1-9-2001. CONSTRUCTION COOPERATION AND EDUCATION TRUST, A NEW YORK NOT FOR PROFIT LABOR MANAGEMENT TRUST, THE TRUSTEES COMPRISINGSTEPHEN REMINTON, JOHN CASEY, RONALD POMMERENING, THOMAS J. MCCADDEN, FRANK WIRT, MARTIN POTTER, ROBERT BROWN, GARY ROTH, RICHARD T. HARDY AND GARY SQUIRES, ALL U.S. CITIZENS, THE (NEW YORK NOT FOR PROFIT LABOR MANAGEMENT TRUST) 180 LINDEN OAKS, ROCHESTER, NY, 14625, SN 75-543,431. FILED 8-27-1998. PRINCIPAL REGISTER.

## UNICON

INT. CL. 42/U.S. CLS. 100 AND 101  
FOR ASSOCIATION SERVICES, NAMELY, PROMOTING THE INTERESTS OF UNIONS AND CONTRACTORS IN THE BUILDING TRADES.

FIRST USE 9-7-1998; IN COMMERCE 10-31-1998.

ELEMENTS CORRECTED  
NAME/PORTRAIT DESCRIPTION OR CONSENT

2,422,495. REG. 1-23-2001. CORDIANT COMMUNICATIONS GROUP PLC (UNITED STATES CORPORATION), 121-141 WESTBOURNE TERRACE, LONDON W1A 6JR, ENGLAND, BY CHANGE OF NAME; BY CHANGE OF NAME; BY CHANGE OF NAME CORDIANT COMMUNICATIONS GROUP PLC (UNITED KINGDOM CORPORATION), LONDON W1A 4XA, ENGLAND, SN 75-404,700. FILED 12-12-1997. PRINCIPAL REGISTER.

## CCG

PRIORITY CLAIMED UNDER SEC. 44(D) ON UNITED KINGDOM APPLICATION NO. 2147975, FILED 10-15-1997, REG. NO. 2147975, DATED 10-15-1997, EXPIRES 10-15-2007. INT. CL. 35/U.S. CLS. 100, 101 AND 102

FOR ADVERTISING AGENCY SERVICES, DIRECT MAIL ADVERTISING SERVICES, PUBLIC RELATIONS SERVICES AND CREATION OF MULTI-MEDIA PRESENTATIONS FOR OTHERS FOR USE IN ADVERTISING.

FIRST USE ; IN COMMERCE .

ELEMENTS CORRECTED  
OWNER ADDRESS

2,449,143. REG. 5-8-2001. MYCITY.COM, INC. (FLORIDA CORPORATION), 169 E. FLAGLER STREET, 2ND FLOOR, MIAMI BEACH, FL, 33131, SN 76-029,210. FILED 4-19-2000. PRINCIPAL REGISTER.



INT. CL. 35/U.S. CLS. 100, 101 AND 102  
 FOR PROMOTING THE GOODS AND SERVICES OF OTHERS BY PREPARING AND PLACING ADVERTISEMENTS IN AN ELECTRONIC FORMAT ACCESSED THROUGH A GLOBAL COMPUTER NETWORK; AND PREPARING AND DISTRIBUTING AUDIO, VISUAL AND DATA PRESENTATIONS ON ELECTRONIC MEDIA FOR OTHERS .  
 FIRST USE 10-20-1995; IN COMMERCE 10-20-1995.

ELEMENTS CORRECTED  
 CITIZENSHIP

2,449,379. REG. 5-8-2001. FLOWMASTER, INC. (NEVADA CORPORATION), 2975 DUTTON AVENUE, UNIT 3, SANTA ROSA, CA, 95407, SN 75-188,228. FILED 10-28-1996. PRINCIPAL REGISTER.

**DELTA SERIES**

NO CLAIM IS MADE TO THE EXCLUSIVE RIGHT TO USE "SERIES", APART FROM THE MARK AS SHOWN.  
 INT. CL. 16/U.S. CLS. 2, 5, 22, 23, 29, 37, 38 AND 50  
 FOR POSTERS FOR USE IN PROMOTING HIGH-PERFORMANCE MUFFLERS AND TAILPIPES.  
 FIRST USE 7-9-2000; IN COMMERCE 7-10-2000.

ELEMENTS CORRECTED  
 [INTERNATIONAL CLASS(ES)]

2,451,346. REG. 5-15-2001. TEKNION FURNITURE SYSTEMS LIMITED (CANADA CORPORATION), 1150 FLINT ROAD, TORONTO, ONTARIO, CANADA, M3J M6. BY ASSIGNMENT TEKNION FURNITURE SYSTEMS (PARTNERSHIP), DOWNSVIEW, ONTARIO M3J 2J5, CANADA, SN 75-477,102. FILED 4-30-1998. PRINCIPAL REGISTER.

**KITTEN**

PRIORITY CLAIMED UNDER SEC. 44(D) ON CANADA APPLICATION NO. 875994, FILED 4-22-1998.  
 INT. CL. 20/U.S. CLS. 2, 13, 22, 25, 32 AND 50  
 FOR OFFICE FURNITURE.  
 FIRST USE 6-0-1998; IN COMMERCE 6-0-1998.

ELEMENTS CORRECTED  
 OWNER NAME

2,453,536. REG. 5-22-2001. UNION STATION KANSAS CITY, INC (MISSOURI CORPORATION), 30 WEST PERSHING, KANSAS CITY, MO, 64108, BY MERGER UNION STATION ASSISTANCE CORPORATION (MISSOURI CORPORATION), KANSAS CITY, MO, SN 75-484,789. FILED 5-14-1998. PRINCIPAL REGISTER.



NO CLAIM IS MADE TO THE EXCLUSIVE RIGHT TO USE "KANSAS CITY UNION STATION" AND "SINCE 1914", APART FROM THE MARK AS SHOWN.  
 INT. CL. 16/U.S. CLS. 2, 5, 22, 23, 29, 37, 38 AND 50  
 FOR SOUVENIR ITEMS, NAMELY, INK PENS, POSTER AND POSTCARDS.  
 FIRST USE 12-1-1999; IN COMMERCE 12-1-1999.  
 INT. CL. 21/U.S. CLS. 2, 13, 23, 29, 30, 33, 40 AND 50  
 FOR COFFEE MUGS.  
 FIRST USE 11-5-1999; IN COMMERCE 11-5-1999.  
 INT. CL. 25/U.S. CLS. 22 AND 39  
 FOR CLOTHING, NAMELY BALL CAPS AND T-SHIRTS.  
 FIRST USE 12-1-1999; IN COMMERCE 12-1-1999.  
 INT. CL. 36/U.S. CLS. 100, 101 AND 102  
 FOR LEASING OF SHOPPING MALL SPACE FEATURING MUSEUM STORE SERVICES, MUSEUMS AND EDUCATIONAL EXHIBITS OFFERED, THEATERS AND RESTAURANT AND BUSINESS OFFICES IN AN EDUCATIONAL COMPLEX.  
 FIRST USE 11-10-1999; IN COMMERCE 11-10-1999.

ELEMENTS CORRECTED  
 OWNER NAME  
 OWNER ADDRESS

2,457,341. REG. 6-5-2001. GRANT PRIDECO, L.P. (DELAWARE LIMITED PARTNERSHIP), 1450 LAKE ROBBINS DR., SUITE 600, THE WOODLANDS, TX, 77380, BY MERGER GRANT PRIDECO TECHNOLOGY, INC. (DELAWARE CORPORATION), WILMINGTON, DE, SN 76-073,362. FILED 6-19-2000. PRINCIPAL REGISTER.

**ANJO**

INT. CL. 6/U.S. CLS. 2, 12, 13, 14, 23, 25 AND 50  
 FOR METAL THREADED CONNECTIONS FOR CONNECTING TUBULAR MEMBERS SUCH AS TUBING AND CASING USED IN THE OIL AND GAS INDUSTRY.  
 FIRST USE 4-3-2000; IN COMMERCE 4-3-2000.

ELEMENTS AMENDED  
 \*ASSIGNMENT/NAME CHANGE\*

2,463,190. REG. 6-26-2001. KNIT-RITE, INC. (DELAWARE CORPORATION), 120 OSAGE, KANSAS CITY, KS, 661030900, SN 75-607,067. FILED 12-17-1998. PRINCIPAL REGISTER.

2,468,063. REG. 7-10-2001. MAVETY MEDIA GROUP LTD. (NEW YORK CORPORATION), 462 BROADWAY, SUITE 4000, NEW YORK, NY, 10013, SN 75-233,289. FILED 1-29-1997. PRINCIPAL REGISTER.

## GELBO

INT. CL. 10/U.S. CLS. 26, 39 AND 44  
FOR HEEL AND ELBOW PADS FOR MEDICAL USE.  
FIRST USE 9-0-1998; IN COMMERCE 9-0-1998.

ELEMENTS CORRECTED  
[INTERNATIONAL CLASS(ES)]

---

2,465,991. REG. 7-3-2001. GALE PACIFIC PTY. LTD. (AUSTRALIA CORPORATION), 145 WOODLANDS DRIVE, BRAESIDE, VICTORIA, AUSTRALIA., BY ASSIGNMENT; BY ASSIGNMENT GALE AUSTRALIA PTY. LTD. (AUSTRALIA COMPANY), BRAESIDE, VICTORIA 3195, AUSTRALIA, SN 75-439,065. FILED 2-23-1998. PRINCIPAL REGISTER.

## COOLAROO

OWNER OF U.S. REG. NOS. 2,017,652, 2,182,678 AND OTHERS.

INT. CL. 18/U.S. CLS. 1, 2, 3, 22 AND 41  
FOR OUTSIDE STRUCTURES FOR SHADING, SHELTERING AND PROTECTION, NAMELY, FREESTANDING UMBRELLAS AND MARKET UMBRELLAS.

FIRST USE 6-30-1998; IN COMMERCE 8-30-1998.

INT. CL. 20/U.S. CLS. 2, 13, 22, 25, 32 AND 50

FOR INDOOR AND OUTDOOR BLINDS FOR WINDOWS, [ WINDOW BLINDS OF TEXTILE AND CLOTH, ] WINDOW BLINDS OF TEXTILE AND CLOTH, WINDOW BLINDS OF PLASTIC WOVEN, NON-WOVEN AND KNITTED MESH FABRIC.

FIRST USE 6-30-1998; IN COMMERCE 8-30-1998.

INT. CL. 22/U.S. CLS. 1, 2, 7, 19, 22, 42 AND 50

FOR FREESTANDING SHADE, SHELTERING AND PROTECTION TENT STRUCTURES, NAMELY, PERMANENT, PORTABLE AND DEMOUNTABLE SHADE, SHELTERING AND PROTECTION STRUCTURES HAVING A METAL FRAMEWORK SUPPORTING COVERING FABRIC FORMING A ROOF AND ANY SIDE WALLS; OUTSIDE STRUCTURES FOR SHADING, SHELTERING AND PROTECTION, NAMELY, AWNINGS, CANOPIES AND PRIVACY SHELTERS; WOVEN, NON-WOVEN AND KNITTED MESH SHEET MATERIAL FOR SCREENING, SHELTERING, SHADING, PROTECTION AND WINDBREAK PURPOSES; PLASTIC WOVEN, NON-WOVEN AND KNITTED MESH SHEET MATERIAL FOR SCREENING, SHELTERING, SHADING, PROTECTION AND WINDBREAK PURPOSES; AND PLASTIC WOVEN, NON-WOVEN AND KNITTED MESH FABRICS AND SHEETS FOR SCREENING, SHELTERING, SHADING, PROTECTION AND WINDBREAK PURPOSES; PLASTIC CLOTH FOR SCREENING, SHELTERING, SHADING, PROTECTION AND WINDBREAK PURPOSES.

FIRST USE 6-30-1998; IN COMMERCE 8-30-1998.

ELEMENTS CORRECTED  
GOODS/SERVICES

## TIGHT

INT. CL. 41/U.S. CLS. 100, 101 AND 107

FOR ENTERTAINMENT SERVICES, NAMELY, PROVIDING ADULT ENTERTAINMENT VIA A GLOBAL COMPUTER NETWORK; ENTERTAINMENT SERVICES, NAMELY, PROVIDING VISUAL IMAGES AND ARTICLES FOR ADULT ENTERTAINMENT VIA A GLOBAL COMPUTER NETWORK.

FIRST USE 4-29-1997; IN COMMERCE 4-29-1997.

INT. CL. 42/U.S. CLS. 100 AND 101

FOR COMPUTER SERVICES, NAMELY, PROVIDING AN ON-LINE BULLETIN BOARD IN THE FIELD OF ADULT ENTERTAINMENT; COMPUTER SERVICES, NAMELY, PROVIDING ON-LINE MAGAZINES IN THE FIELD OF ADULT ENTERTAINMENT.

FIRST USE 4-29-1997; IN COMMERCE 4-29-1997.

ELEMENTS CORRECTED  
[DISCLAIMER]

---

2,471,071. REG. 7-24-2001. CHF INDUSTRIES, INC. (DELAWARE CORPORATION), ONE PARK AVENUE, NEW YORK, NY, 10016, SN 75-818,178. FILED 10-8-1999. PRINCIPAL REGISTER.

## MY ROOM

OWNER OF U.S. REG. NO. 2,133,025.

INT. CL. 20/U.S. CLS. 2, 13, 22, 25, 32 AND 50

FOR PILLOWS.

FIRST USE 0-0-1985; IN COMMERCE 0-0-1985.

INT. CL. 24/U.S. CLS. 42 AND 50

FOR TEXTILE GOODS, NAMELY, PILLOW CASES, SHEETS, COMFORTERS, DUST RUFFLES, TABLE CLOTHS, CURTAINS, DRAPERIES, VALANCES, AND CURTAIN TIE BACKS.

FIRST USE 0-0-1985; IN COMMERCE 0-0-1985.

ELEMENTS CORRECTED  
PRIOR U.S. REGS.

2,471,949. REG. 7-24-2001. AEA TECHNOLOGY PLC (UNITED KINGDOM COMPANY), 329 HARWELL, DIDCOT, OXFORDSHIRE, OX11 0RA, UNITED KINGDOM., SN 75-529,053. FILED 7-29-1998. PRINCIPAL REGISTER.

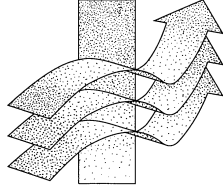

OWNER OF UNITED KINGDOM REG. NO. 2156742, DATED 1-29-1998, EXPIRES 1-29-2008.

THE STIPPLING IN THE DRAWING IS FOR SHADING PURPOSES ONLY AND DOES NOT INDICATE COLOR.

THE MARK CONSISTS OF A STYLIZED DESIGN OF THREE PARALLEL WAVY ARROWS CROSSING A RECTANGULAR BAR.

INT. CL. 9/U.S. CLS. 21, 23, 26, 36 AND 38

FOR COMPUTER PROGRAMS FOR PERFORMING ENGINEERING ANALYSIS, SIMULATION OF PROCESSES IN FLUIDS, FLUID DYNAMICS ANALYSIS, AND HEAT TRANSFER ANALYSIS, FOR USE IN THE FIELDS OF ENGINEERING, MEDICAL RESEARCH, METEOROLOGY, HYDRODYNAMICS, AND THERMODYNAMICS.

FIRST USE 6-0-1997; IN COMMERCE 6-0-1997.

INT. CL. 42/U.S. CLS. 100 AND 101

FOR PROFESSIONAL CONSULTANCY SERVICES RELATING TO ENGINEERING DESIGN, ENGINEERING ANALYSIS, SIMULATION OF PROCESSES IN FLUIDS, FLUID DYNAMICS, AND HEAT TRANSFER ANALYSIS.

FIRST USE 6-0-1997; IN COMMERCE 6-0-1997.

ELEMENTS CORRECTED  
PRIORITY CLAIMED STATEMENT

2,472,251. REG. 7-24-2001. QUINTESSENT COMMUNICATIONS, INC. (DELAWARE CORPORATION), 18200 NE UNION HILL ROAD, SUITE 200, REDMOND, WA, 98052-333, SN 75-778,758. FILED 8-17-1999. PRINCIPAL REGISTER.

## QUINTESSENT

INT. CL. 9/U.S. CLS. 21, 23, 26, 36 AND 38

FOR COMPUTER GATEWAY SOFTWARE FOR USE IN THE TELECOMMUNICATION FIELD.

FIRST USE 2-2-1998; IN COMMERCE 9-16-1998.

ELEMENTS AMENDED  
OWNER ADDRESS

2,477,784. REG. 8-14-2001. MARRIAGE BUILDERS, INC. (MINNESOTA CORPORATION), 12568 ETHAN AVENUE, WHITE BEAR LAKE, MN, 55110, SN 76-057,058. FILED 5-25-2000. PRINCIPAL REGISTER.

## MARRIAGE BUILDERS

NO CLAIM IS MADE TO THE EXCLUSIVE RIGHT TO USE "MARRIAGE", APART FROM THE MARK AS SHOWN. SEC. 2(F).

INT. CL. 35/U.S. CLS. 100, 101 AND 102

FOR ONLINE RETAIL STORE SERVICES FEATURING BOOKS AND AUDIO TAPES IN THE FIELDS OF MARRIAGE AND FAMILY MATTERS.

FIRST USE 1-0-1996; IN COMMERCE 8-5-1996.

INT. CL. 42/U.S. CLS. 100 AND 101

FOR MARRIAGE COUNSELING; MARRIAGE COACHING; AND PROVIDING INFORMATION ABOUT MARRIAGE, MARRIAGE ENRICHMENT, MARRIAGE COUNSELING, MARRIAGE COACHING AND FAMILY MATTERS IN TEXT AND AUDIO FORMATS VIA A GLOBAL COMPUTER NETWORK.

FIRST USE 1-0-1996; IN COMMERCE 8-5-1996.

ELEMENTS CORRECTED  
DATE OF FIRST USE  
DATE OF FIRST USE IN COMMERCE

2,478,834. REG. 8-21-2001. ELSICON, INCORPORATED (DELAWARE CORPORATION), DELAWARE TECHNOLOGY PARK, 5100 INNOVATION WAY, NEWARK, DE, 19711, SN 75-517,044. FILED 7-10-1998. PRINCIPAL REGISTER.

## OPTOALIGN

OWNER OF U.S. REG. NO. 2,196,161.

INT. CL. 9/U.S. CLS. 21, 23, 26, 36 AND 38

FOR OPTICAL LIGHT EXPOSURE DEVICE, NAMELY, A COMBINATION OF PROCESSING LAMPS AND LIGHT POLARIZING OPTICAL ELEMENTS FOR PROCESSING ALIGNMENT LAYERS BY EXPOSURE TO TREATMENT LIGHT.

FIRST USE 4-13-1998; IN COMMERCE 4-13-1998.

ELEMENTS AMENDED  
\*OWNER ADDRESS\*

2,478,959. REG. 8-21-2001. HORIZONT GERATEWERK GMBH (FED REP GERMANY LIMITED LIABILITY COMPANY) HOMBERGER WEG 4-6, 34497 KORBACH, FED REP GERMANY., SN 75-670,928. FILED 3-30-1999. PRINCIPAL REGISTER.

## HORIZONT

PRIORITY CLAIMED UNDER SEC. 44(D) ON FED REP GERMANY APPLICATION NO. 000944843, FILED 10-1-1998, REG. NO. 944843, DATED 11-16-1999, EXPIRES 11-16-2009.

INT. CL. 9/U.S. CLS. 21, 23, 26, 36 AND 38

FOR ELECTRONIC TRAFFIC AND SAFETY EQUIPMENT, NAMELY, WARNING LAMPS, BEACON LIGHTS, ELECTRONIC FLASHING LIGHTS, TRAFFIC GUIDE LIGHTS, TRAFFIC SIGNALS, WARNING TRAILERS AND TROLLEYS, BATTERIES AND BATTERY CHARGERS; ELECTRIC FENCING COMPONENTS, NAMELY, ELECTRIFIED WIRES, ROPES AND TWINE, ELECTRICAL CONDUCTORS, BATTERIES, CONNECTORS, INSULATORS, ELECTRICAL FENCE POSTS AND GATE [ HANDLERS ] \* HANDLES \*.

FIRST USE ; IN COMMERCE .

ELEMENTS CORRECTED  
GOODS/SERVICES

2,480,495. REG. 8-21-2001. IDENTIX INCORPORATED (DELAWARE CORPORATION), 510 NORTH PASTORIA AVE., SUNNYVALE, CA, 84086, BY ASSIGNMENT; BY ASSIGNMENT IDENTIFICATOR TECHNOLOGY INC. (DELAWARE CORPORATION), SAN BRUNO, CA, SN 75-653,705. FILED 3-4-1999. PRINCIPAL REGISTER.

## BIOSHIELD

INT. CL. 9/U.S. CLS. 21, 23, 26, 36 AND 38

FOR COMPUTER SOFTWARE FOR USE IN CONTROLLING SECURITY ACCESS TO OTHER SOFTWARE APPLICATIONS AND FEATURES/COMMANDS WITHIN OTHER SOFTWARE APPLICATIONS UTILIZING BIOMETRIC FINGER IMAGING TO IDENTIFY INDIVIDUALS.

FIRST USE 5-1-1998; IN COMMERCE 8-1-1998.

ELEMENTS CORRECTED  
OWNER NAME

2,489,893. REG. 9-18-2001. CONTROLLED F.O.R.C.E. INC. (ILLINOIS CORPORATION), 303 W. STATE STREET, GENEVA, IL, 60134, SN 75-683,986. FILED 4-15-1999. PRINCIPAL REGISTER.

## CONTROLLED F.O.R.C.E.

SEC. 2(F).

INT. CL. 9/U.S. CLS. 21, 23, 26, 36 AND 38

FOR PRE-RECORDED VIDEOTAPES FEATURING INSTRUCTION IN SELF-DEFENSE, COMMUNICATION AND RESTRAINING TECHNIQUES FOR LAW ENFORCEMENT AND SECURITY OFFICIALS; MOTION PICTURES FEATURING INDIVIDUALS DEMONSTRATING SELF-DEFENSE AND RETRAINING TECHNIQUES.

FIRST USE 1-0-1994; IN COMMERCE 1-0-1994.

INT. CL. 41/U.S. CLS. 100, 101 AND 107

FOR WORKSHOPS AND SEMINARS IN THE FIELD OF LAW ENFORCEMENT AND SELF-DEFENSE TRAINING.

FIRST USE 1-0-1994; IN COMMERCE 1-0-1994.

ELEMENTS CORRECTED  
MARK

2,493,042. REG. 9-25-2001. AMADA COMPANY LIMITED (JAPAN CORPORATION), 200, ISHIDA, ISEHARA-SHI, KANAGAWA-KEN, JAPAN., BY MERGER AMADA METRECS COMPANY, LIMITED (JAPAN CORPORATION), KANAGAWA-KEN, 259-1196, JAPAN, SN 75-555,178. FILED 9-17-1998. PRINCIPAL REGISTER.

## AP100

INT. CL. 9/U.S. CLS. 21, 23, 26, 36 AND 38

FOR SOFTWARE AND HARDWARE FOR DESIGNING AND MODELING SHEET METAL PARTS, AND/OR FOR DEVELOPING AND IMPLEMENTING BENDING PLANS TO MANUFACTURE SUCH SHEET METAL PARTS, AND INSTRUCTION MANUALS SOLD AS A UNIT THEREWITH.

FIRST USE 6-4-1998; IN COMMERCE 7-29-1999.

ELEMENTS CORRECTED  
\*ASSIGNMENT/NAME CHANGE\*

2,494,339. REG. 10-2-2001. SCRIPPS NETWORKS, INC. (DELAWARE CORPORATION), 9821 SHERRILLS BOULEVARD, KNOXVILLE, TN, 37932, BY ASSIGNMENT; BY ASSIGNMENT; BY ASSIGNMENT SCRIPPS HOWARD BROADCASTING COMPANY (OHIO CORPORATION), DBA HOME & GARDEN TELEVISION, KNOXVILLE, TN, SN 76-140,251. FILED 10-4-2000. PRINCIPAL REGISTER.

## GREAT FALL FIX-UP

INT. CL. 38/U.S. CLS. 100, 101 AND 104

FOR CABLE TELEVISION BROADCASTING SERVICES.

FIRST USE 10-27-1997; IN COMMERCE 10-27-1997.

ELEMENTS CORRECTED  
OWNER NAME

2,494,892. REG. 10-2-2001. DELCO REMY AMERICA, INC. (DELAWARE CORPORATION), 2902 ENTERPRISE DRIVE, ANDERSON, IN, 46013, SN 75-765,887. FILED 8-2-1999. PRINCIPAL REGISTER.

## ROAD GANG

OWNER OF U.S. REG. NO. 1,953,001 AND OTHERS.

INT. CL. 9/U.S. CLS. 21, 23, 26, 36 AND 38

FOR BATTERIES [ FOR ] \* AND \* LOW VOLTAGE DISCONNECTS [ AND ] \* FOR \* MOTOR VEHICLES.

FIRST USE 12-20-1999; IN COMMERCE 12-20-1999.

ELEMENTS CORRECTED  
GOODS/SERVICES

2,494,916. REG. 10-2-2001. BROADVIEW NETWORKS HOLDINGS, INC. (DELAWARE CORPORATION), 59 MAIDEN LANE, NEW YORK, NY, 10038, BY ASSIGNMENT COAXICOM, INC. (DELAWARE CORPORATION), LONG ISLAND CITY, NY, SN 75-785,828. FILED 8-26-1999. PRINCIPAL REGISTER.

## BROADVIEW NETWORKS

NO CLAIM IS MADE TO THE EXCLUSIVE RIGHT TO USE "NETWORKS", APART FROM THE MARK AS SHOWN.

INT. CL. 38/U.S. CLS. 100, 101 AND 104

FOR TELECOMMUNICATION SERVICES, NAMELY, TELEPHONE, PAGING, AND CELLULAR TELECOMMUNICATIONS; PROVIDING TELECOMMUNICATIONS CONNECTIONS TO A GLOBAL COMPUTER NETWORK; AND ELECTRONIC TRANSMISSION OF DATA.

FIRST USE 9-1-1999; IN COMMERCE 10-1-1999.

ELEMENTS CORRECTED  
\*ASSIGNMENT/NAME CHANGE\*

2,500,579. REG. 10-23-2001. ERGON CORPORATION (CALIFORNIA CORPORATION), 695 DELONG AVENUE, NOVATO, CA, 94945, BY ASSIGNMENT; BY ASSIGNMENT BACK DESIGNS, INC. (CALIFORNIA CORPORATION), BERKELEY, CA, SN 75-097,742. FILED 5-2-1996. PRINCIPAL REGISTER.

## HEALTH BY DESIGN

INT. CL. 35/U.S. CLS. 100, 101 AND 102

FOR RETAIL STORE DEPARTMENTS AND MAIL ORDER CATALOG SERVICES FEATURING ERGONOMIC, THERAPEUTIC AND ORTHOPEDIC FURNITURE AND DEVICES; COMPUTERIZED ON-LINE RETAIL SERVICES IN THE FIELD OF ERGONOMIC, THERAPEUTIC AND ORTHOPEDIC FURNITURE AND DEVICES.

FIRST USE 3-0-1998; IN COMMERCE 3-0-1998.

ELEMENTS CORRECTED

\*ASSIGNMENT/NAME CHANGE\*

\* \* \* \* \*



# INDEX OF REGISTRANTS

FEB 12, 2002

(Registered; Renewed; Canceled; Amended, Corrected, etc.; New Certificates; 12c Publications.)

The designation "U.S. Cl." appearing in this section refers to the U.S. class in effect prior to Sep. 1, 1973 rather than the international class which applies to applications filed on or after that date. For adoption of international classification see notice in the OFFICIAL GAZETTE of Jun. 26, 1973 (911 O.G. TM 210).

- A. BESHAR & CO., INC., NEW YORK, NY:  
708,864, CANC. U.S. CL. 106.
- A. Y. MCDONALD INDUSTRIES, INC., DUBUQUE, IA:  
1,635,416. REN. 12-31-01. INT. CL. 11.
- A.K.A. ELEPHANT, INC., NOVATO, CA:  
2,537,638, PUB. 11-20-2001. MULTIPLE CLASS, INT. CLS.  
29 AND 30.
- A/C ENTERPRISES, INCORPORATED, COUNCIL GROVE,  
KS:  
2,538,430, PUB. 11-20-2001. INT. CL. 3.
- A/E/C SYSTEMS, INC., NEWINGTON, CT:  
1,868,556, CANC. INT. CL. 35.
- ABC INTERNATIONAL TRADERS, INC., NORTH HILLS,  
CA, DBA MGA ENTERTAINMENT:  
2,538,336, PUB. 11-20-2001. INT. CL. 28.  
2,538,337, PUB. 11-20-2001. INT. CL. 28.  
2,538,338, PUB. 11-20-2001. INT. CL. 28.
- ABC INTERNATIONAL, INC., PLAYA DEL REY, CA:  
2,538,431, PUB. 11-20-2001. INT. CL. 30.
- ABC RADIO NETWORK, INC., NEW YORK, NY, DBA ABC  
RADIO NETWORKS:  
1,662,724. REN. 1-4-02. INT. CL. 35.  
1,663,609. REN. 1-4-02. INT. CL. 35.  
1,665,205. REN. 1-4-02. INT. CL. 35.  
1,702,057. REN. 1-4-02. INT. CL. 35.
- ABE SHAPIRO'S TOOLS & SUPPLIES FOR JEWELERS CO.,  
INC., NEW YORK, NY, DBA A&M JEWEL CO.:  
1,659,452. REN. 1-4-02. MULTIPLE CLASS, INT. CLS. 7  
AND 8.
- ABEX CORPORATION, NEW YORK, NY:  
1,144,016, CANC. INT. CL. 9.
- ABSOLUTE COATINGS, INC., NEW ROCHELLE, NY:  
2,538,647, INT. CL. 2.
- ACADEMIC PLANET.COM, INC., HOUSTON, TX:  
2,537,829, PUB. 11-20-2001. INT. CL. 38.
- ACCIDENT INSURANCE SERVICES, INC., DALLAS, TX:  
1,868,592, CANC. INT. CL. 36.
- ACCUWARE, INC., PITTSBURGH, PA:  
1,868,793, CANC. MULTIPLE CLASS, INT. CLS. 9 AND  
41.
- ACE GREEN PRODUCTS CORPORATION, LOS ANGELES,  
CA:  
1,868,195, CANC. INT. CL. 14.
- ACME CHEMICAL COMPANY, MILWAUKEE, WI:  
708,614, CANC. U.S. CL. 6.
- ACTS II ENTERPRISES, INC., TAMPA, FL:  
1,867,918, CANC. INT. CL. 3.
- ACUCOTE, INC., GRAHAM, NC:  
1,868,876, CANC. INT. CL. 16.
- AD IN THE HOLE INTERNATIONAL, INC., ST. LOUIS, MO:  
1,868,548, CANC. INT. CL. 35.
- ADAMS APPLE DISTRIBUTING L.P., CHICAGO, IL:  
1,868,321, CANC. INT. CL. 20.
- ADCO SIGN CORPORATION, CLEARWATER, FL:  
1,628,354, CANC. INT. CL. 20.
- ADCO, INC., SEDALIA, MO:  
1,173,804. REN. 1-4-02. INT. CL. 3.
- ADECCO SA, 1275 CHESEREX, SWITZERLAND:  
2,538,382, PUB. 11-20-2001. INT. CL. 35.
- ADMINISTAFF, INC., KINGWOOD, TX:  
1,720,647. REN. 1-4-02. INT. CL. 35.
- ADOBE SYSTEMS INCORPORATED, SAN JOSE, CA, AL-  
DUS CORPORATION, SEATTLE, WA:  
1,665,322. REN. 1-4-02. INT. CL. 42.
- ADVANCE MAGAZINE PUBLISHERS INC., NEW YORK,  
NY:  
2,538,660, INT. CL. 41.
- ADVANCED CARDIOVASCULAR SYSTEMS, INC., SANTA  
CLARA, CA:  
1,628,172, CANC. INT. CL. 10.
- ADVANCED ESTIMATING CONCEPTS, INC., HUBBARD,  
OR:  
1,868,838, CANC. INT. CL. 9.
- ADVANCED REHAB SYSTEMS, INC., BOSTON, MA:  
1,868,527, CANC. MULTIPLE CLASS, INT. CLS. 35 AND  
42.
- ADVANCED TECHNOLOGY RAMAR LIMITED,  
CHRISTCHURCH, DORSET, UNITED KINGDOM:  
2,538,102, PUB. 8-14-2001. INT. CL. 9.
- ADVANCED TELECOMMUNICATIONS RESOURCES, INC.,  
WORTHINGTON, OH:  
2,538,238, PUB. 11-20-2001. INT. CL. 9.
- ADVANSTAR COMMUNICATIONS INC., CLEVELAND,  
OH:  
1,582,506, CANC. INT. CL. 16.
- ADVERTISING EXCHANGE, INC., LOS ANGELES, CA:  
1,144,141, CANC. INT. CL. 16.
- AEA TECHNOLOGY PLC, OXFORDSHIRE, OX11 0RA,  
UNITED KINGDOM:  
2,471,949, COR. MULTIPLE CLASS, INT. CLS. 9 AND 42.
- AEGIS ENTERTAINMENT, INC., LA JOLLA, CA, DBA  
WILDSTORM PRODUCTIONS:  
1,868,255, CANC. INT. CL. 16.  
1,868,266, CANC. INT. CL. 16.
- AEROFIT PRODUCTS, INC., BUENA PARK, CA, RAY-  
CHEM CORPORATION, MENLO PARK, CA:  
1,657,145. REN. 1-2-02. INT. CL. 6.
- AERONAUTICS FORWARDERS, INC., GREAT NECK, NY:  
1,144,517, CANC. INT. CL. 39.
- AEROSPAN.COM, INC., WOOD DALE, IL:  
2,538,184, PUB. 11-20-2001. INT. CL. 35.
- AETNA FINANCE COMPANY, MINNEAPOLIS, MN:  
1,144,479, CANC. MULTIPLE CLASS, INT. CLS. 35 AND  
36.
- AGC, INC., CLEVELAND, OH:  
1,869,008, CANC. INT. CL. 42.
- AGFA-GEVAERT, MORTSEL, BELGIUM:  
2,538,592, INT. CL. 9.
- AGGRESSIVE INDUSTRIES, INC., SPRING LAKE PARK,  
MN:  
1,868,327, CANC. INT. CL. 20.
- AGRI SUN NURSERY L.L.C., SELMA, CA:  
2,537,919, PUB. 8-14-2001. INT. CL. 31.
- AHL SERVICES, INC., ATLANTA, GA:  
2,537,615, PUB. 11-20-2001. MULTIPLE CLASS, INT. CLS.  
35 AND 39.
- AIGLE INTERNATIONAL S.A., 75116 PARIS, FRANCE:  
2,537,542, PUB. 11-20-2001. INT. CL. 3.
- AIR GOURMET, INC., LOS ANGELES, CA:  
2,538,164, PUB. 11-20-2001. INT. CL. 29.
- AIR MARIN FLUGREISEN GMBH, 5300 BONN 1, FED REP  
GERMANY:  
1,868,621, CANC. MULTIPLE CLASS, INT. CLS. 39, 41

- AND 42.
- AIRNET COMMUNICATIONS CORPORATION, MELBOURNE, FL:  
2,538,545, INT. CL. 9.
- AIRWALK INTERNATIONAL, LLC, GOLDEN, CO:  
2,538,220, PUB. 11-20-2001. INT. CL. 18.
- AIS SOFTWARE, 54000 NANCY, FRANCE:  
2,537,546, PUB. 11-20-2001. INT. CL. 9.
- ALADAN CORPORATION, DOTHAN, AL:  
1,868,047, CANC. MULTIPLE CLASS, INT. CLS. 9 AND 10.
- ALAN JUDE SUMMA AND GLENN BOYD, MOSCOW, PA, DBA LEADBELLY PRODUCTIONS:  
1,868,920, CANC. INT. CL. 28.
- ALBERTASaurus CORPORATION, LITTLE ROCK, AR:  
1,868,330, CANC. INT. CL. 20.
- ALCATEL TITN ANSWARE, 75008 PARIS, FRANCE:  
1,868,046, CANC. MULTIPLE CLASS, INT. CLS. 9, 16, 35, 41 AND 42.
- ALCON LABORATORIES, INC., FT. WORTH, TX:  
708,832, CANC. U.S. CL. 51.
- ALCON LABORATORIES, INC., FORT WORTH, TX:  
1,868,795, CANC. MULTIPLE CLASS, INT. CLS. 35 AND 41.  
1,868,857, CANC. INT. CL. 10.
- ALDEN, JOHN DAVID, LONGMEADOW, MA:  
2,537,603, PUB. 11-20-2001. INT. CL. 32.
- ALDI INC., BATAVIA, IL:  
2,538,072, PUB. 11-20-2001. MULTIPLE CLASS, INT. CLS. 29 AND 30.
- ALEX, STEVEN PAUL, CLEARWATER, FL:  
2,537,628, PUB. 11-20-2001. INT. CL. 41.
- ALEXON-TREND, INC., RAMSEY, MN FROM SERADYN, INC., INDIANAPOLIS, IN:  
2,538,454, INT. CL. 1.
- ALFRED DUNHILL PIPES LIMITED, LONDON, SWIY 6DL, ENGLAND, DUNHILL PIPES LIMITED, ST. JAMES, LONDON, ENGLAND, AKA PARKER HARDCASTLE:  
1,174,478, REN. 1-4-02. INT. CL. 34.
- ALL OUTDOORS, INC., UNDERHILL, VT:  
1,868,296, CANC. INT. CL. 18.
- ALLAUDIN'S DESIGNS, INC., LOS ANGELES, CA:  
1,868,413, CANC. INT. CL. 25.
- ALLEGHENY POWER SERVICE CORPORATION, GREENSBURG, PA:  
1,868,870, CANC. INT. CL. 12.
- ALLEGIANCE CORPORATION, MCGAW PARK, IL:  
2,538,383, PUB. 11-20-2001. INT. CL. 10.
- ALLELIX BIOPHARMACEUTICALS INC., MISSISSAUGA, ONTARIO, CANADA:  
1,867,947, CANC. INT. CL. 5.
- ALLEN, KENNETH D., BOONVILLE, CA, DBA ANDERSON VALLEY BREWING COMPANY:  
1,628,542, CANC. INT. CL. 32.
- ALLIED AVIATION SUPPLIES CO., OKLAHOMA CITY, OK:  
551,228, REN. 1-3-02. U.S. CL. 2 (INT. CL. 16).
- ALLIED CORPORATION, MORRISTOWN, NJ:  
1,144,325, CANC. INT. CL. 27.
- ALLIED PAPER INCORPORATED, KALAMAZOO, MI:  
1,144,153, CANC. INT. CL. 16.
- ALLIED TUBE & CONDUIT CORPORATION, HARVEY, IL:  
2,537,549, PUB. 11-20-2001. INT. CL. 9.
- ALPHARMA INC., FORT LEE, NJ, AMERICAN CYANAMID COMPANY, WAYNE, NJ:  
1,658,020, REN. 1-4-02. INT. CL. 7.
- ALQUIMIA MARINA S.A., GUAYAQUIL, ECUADOR FROM CORPTHOR S.A., CORAL GABLES, FL:  
2,538,444, INT. CL. 29.
- ALTERNATIVE PHONE, INC., OCALA, FL:  
2,537,830, PUB. 11-20-2001. INT. CL. 38.
- ALTICOR INC., ADA, MI, AMWAY CORPORATION, ADA, MI:  
1,645,095, REN. 1-3-02. INT. CL. 16.
- AMADA METRECS COMPANY, LIMITED, KANAGAWA-KEN, 259-1196, JAPAN TO AMADA METRECS COMPANY, LIMITED, KANAGAWA-KEN, 259-1196, JAPAN:  
2,493,042, COR. INT. CL. 9.
- AMAZING MEDIA, INC., SAN ANSELMO, CA:  
1,868,049, CANC. INT. CL. 9.
- AMBLING COMPANIES, INC., VALDOSTA, GA:  
2,537,643, PUB. 11-20-2001. INT. CL. 36.
- AMCOL INTERNATIONAL CORPORATION, ARLINGTON HEIGHTS, IL, FEDERAL BENTONITE COMPANY, CLEVELAND, OH:  
922,087, REN. 1-3-02. U.S. CL. 1 (INT. CL. 1).
- AMERICA'S DRIVE-IN TRUST ("ADIT"), RENO, NV:  
1,628,718, CANC. INT. CL. 42.
- AMERICAN AIRLINES, INC., DALLAS/FORT WORTH AIRPORT, TX:  
1,628,652, CANC. MULTIPLE CLASS, INT. CLS. 39 AND 42.
- AMERICAN ASSOCIATION FOR THE ADVANCEMENT OF SCIENCE ("AAAS"), THE, WASHINGTON, DC:  
1,869,016, CANC. MULTIPLE CLASS, INT. CLS. 9, 16, 35, 41 AND 42.  
1,869,017, CANC. MULTIPLE CLASS, INT. CLS. 16, 35, 41 AND 42.
- AMERICAN AUTO GUARDIAN INC., MT. PROSPECT, IL:  
2,537,882, PUB. 11-20-2001. INT. CL. 36.
- AMERICAN BEVERAGE CORPORATION, VERONA, PA:  
1,940,365, CANC. MULTIPLE CLASS, INT. CLS. 30 AND 32.
- AMERICAN BUSINESS CONCEPTS, INC., DALLAS, TX:  
1,868,096, CANC. INT. CL. 9.
- AMERICAN CAN COMPANY, GREENWICH, CT:  
708,611, CANC. U.S. CL. 6.
- AMERICAN COLLEGE OF PHYSICIANS - AMERICAN SOCIETY OF INTERNAL MEDICINE, PHILADELPHIA, PA:  
2,537,617, PUB. 11-20-2001. INT. CL. 16.
- AMERICAN DAIRY QUEEN CORPORATION, EDINA, MN:  
1,173,729, REN. 1-4-02. INT. CL. 42.
- AMERICAN DAIRY QUEEN CORPORATION, EDNA, MN:  
1,665,176, REN. 1-2-02. INT. CL. 30.
- AMERICAN DECAL MFG. CO., CHICAGO, IL:  
2,537,875, PUB. 11-20-2001. INT. CL. 16.
- AMERICAN DISTRICT TELEGRAPH COMPANY, NEW YORK, NY:  
1,143,965, CANC. INT. CL. 9.
- AMERICAN FINE FOODS, INC., PAYETTE, ID:  
1,628,648, CANC. MULTIPLE CLASS, INT. CLS. 39, 40 AND 42.
- AMERICAN FOOD SERIVE DISTRIBUTORS, COMMERCE, CA, DAVIS LAY, INC., MODESTO, CA:  
1,626,437, REN. 1-4-02. INT. CL. 42.
- AMERICAN FRIENDS OF LUBAVITCH, WASHINGTON, D.C., DC:  
2,537,873, PUB. 11-20-2001. INT. CL. 41.
- AMERICAN INTERNATIONAL GROUP, INC., NEW YORK, NY:  
1,628,833, CANC. INT. CL. 36.  
1,661,062, REN. 12-30-01. INT. CL. 36.
- AMERICAN METAL FABRICATORS, INC., TEMPLE HILLS, MD:  
1,628,630, CANC. INT. CL. 37.
- AMERICAN NUT & CHOCOLATE COMPANY, SOUTH BOSTON, MA:  
923,560, REN. 1-3-02. U.S. CL. 46 (INT. CLS. 1, 5, 29, 30, 31 AND 32).
- AMERICAN OPTOMETRIC ASSOCIATION, ST. LOUIS, MO:  
1,869,004, CANC. INT. CL. 42.
- AMERICAN PARK 'N SWAP, INC., PHOENIX, AZ:  
1,869,107, CANC. INT. CL. 35.
- AMERICAN POOLPLAYERS ASSOCIATION, LAKE SAINT LOUIS, MO:  
1,869,122, CANC. INT. CL. 41.
- AMERICAN PROMOTIONAL EVENTS, INC., FLORENCE, AL, BRDD OF INDIANA, INC., GAS CITY, IN:  
1,166,448, REN. 1-4-02. INT. CL. 13.
- AMERICAN RE-INSURANCE COMPANY, PRINCETON, NJ:  
2,538,479, INT. CL. 36.
- AMERICAN STANDARD INC., PISCATAWAY, NJ:  
2,537,960, PUB. 11-20-2001. INT. CL. 11.

AMERICAN STERILIZER COMPANY, ERIE, PA, DBA AMSCO:  
1,628,169, CANC. INT. CL. 10.

AMERICAN TELEPHONE AND TELEGRAPH COMPANY, NEW YORK, NY:  
1,868,597, CANC. INT. CL. 36.  
1,868,989, CANC. INT. CL. 38.

AMERICAN THREAD COMPANY, THE, STAMFORD, CT:  
1,144,205, CANC. INT. CL. 20.

AMERICAN UROLOGICAL ASSOCIATION, INC., BALTIMORE, MD, WILLIAMS & WILKINS COMPANY, THE, BALTIMORE, MD:  
932,281. REN. 1-4-02. U.S. CL. 38 (INT. CL. 16).

AMERICAN VIDEO LANGUAGE INSTITUTE, INC., NORTH MIAMI BEACH, FL:  
1,628,078, CANC. MULTIPLE CLASS, INT. CLS. 9 AND 16.

AMERICAN WEST STEAMBOAT COMPANY LLC, PORTLAND, OR:  
2,538,300, PUB. 11-20-2001. INT. CL. 39.

AMERICAN WHOLESALE FLORAL, INC., ROCKVILLE, MD:  
1,868,737, CANC. INT. CL. 42.

AMERICATEL CORPORATION, MIAMI, FL:  
2,537,529, PUB. 11-20-2001. INT. CL. 38.

AMERICINN INTERNATIONAL, LLC, CHANHASSEN, MN:  
2,538,159, PUB. 11-20-2001. INT. CL. 42.

AMISH ACRES, LLC, NAPPANEE, IN, AMISH ACRES, INC., NAPPANEE, IN, DBA AMISH ACRES:  
911,455. REN. 1-4-02. U.S. CL. 107 (INT. CL. 41).

AMITEE COSMETICS, INC., COSTA MESA, CA:  
1,627,924, CANC. INT. CL. 3.

AMITY LEATHER PRODUCTS CO., WEST BEND, WI:  
708,621, CANC. U.S. CL. 8.

AMOS PRESS, INC., SIDNEY, OH:  
1,183,748. REN. 12-30-01. INT. CL. 16.

AMSOIL, INC., SUPERIOR, WI:  
2,538,438, PUB. 11-20-2001. INT. CL. 4.

AMWAY CORPORATION, ADA, MI TO ALTICOR INC., ADA, MI:  
1,645,095, CANC. MULTIPLE CLASS, INT. CLS. 10, 11 AND 20.

AMWAY CORPORATION, ADA, MI:  
1,868,882, CANC. INT. CL. 16.

ANABOLIC LABORATORIES, INC., IRVINE, CA:  
2,538,536, INT. CL. 5.

ANACONDA COMPANY, THE, DENVER, CO:  
708,625, CANC. U.S. CL. 12.

ANATEL COMMUNICATIONS CORPORATION, PEABODY, MA:  
2,538,618, INT. CL. 9.

ANCHOR HOCKING CORPORATION, FREEPORT, IL:  
1,172,321. REN. 1-4-02. INT. CL. 21.

ANDE ROONEY INC., HIGHLAND, NY:  
2,538,244, PUB. 11-20-2001. INT. CL. 30.

ANDERSON BROS. & JOHNSON CO., WAUSAU, WI:  
708,565, CANC. U.S. CL. 1.

ANDERSONS, THE, MAUMEE, OH:  
1,868,579, CANC. INT. CL. 36.

ANDREW EASTON COMPANY, THE, BEVERLY HILLS, CA:  
1,868,803, CANC. INT. CL. 3.

ANHEUSER-BUSCH, INCORPORATED, ST. LOUIS, MO:  
2,537,758, PUB. 11-20-2001. INT. CL. 21.  
2,538,063, PUB. 11-20-2001. INT. CL. 32.

ANIMATION AMERICA, INC., TOPANGA, CA:  
2,537,556, PUB. 11-20-2001. INT. CL. 41.

ANKEL INTERNATIONAL, INC., SAN DIEGO, CA:  
1,868,114, CANC. INT. CL. 9.

ANNA-DOTE, INC., WEST MIDDLESEX, PA:  
1,628,173, CANC. INT. CL. 10.

ANOZIRA DOOR SYSTEMS, INC., TEMPE, AZ:  
1,867,988, CANC. INT. CL. 6.

ANY SIDE UP INC., HORSHAM, PA:  
1,869,088, CANC. INT. CL. 20.

APEX ENVIRONMENTAL, INC., ROCKVILLE, MD:  
1,868,065, CANC. INT. CL. 9.

APL INTERNATIONAL, INC., BROKEN ARROW, OK:  
1,868,465, CANC. INT. CL. 28.

APOLLO COLORS INC., ROCKDALE, IL:  
2,537,817, PUB. 11-20-2001. INT. CL. 2.

APPLE COMPUTER, INC., CUPERTINO, CA:  
1,868,653, CANC. INT. CL. 41.

APPLETON ELECTRIC LLC, SKOKIE, IL, APPLETON ELECTRIC COMPANY, CHICAGO, IL:  
921,823. REN. 1-2-02. U.S. CL. 13 (INT. CL. 6).

APPLIED COLOR SYSTEMS, INC., PRINCETON, NJ:  
1,143,989, CANC. INT. CL. 9.  
1,143,990, CANC. INT. CL. 9.

APPLIED DATA RESEARCH, INC., PRINCETON, NJ:  
1,143,967, CANC. INT. CL. 9.

APPLIED LABORATORIES, INC., COLUMBUS, IN:  
1,663,063. REN. 1-3-02. MULTIPLE CLASS, INT. CLS. 35 AND 40.

APPLIED MATHS BVBA, 8511 KORTRIJK, BELGIUM:  
2,537,920, PUB. 11-20-2001. INT. CL. 9.

APPLIED POWER INC., BROOKFIELD, WI:  
1,143,933, CANC. INT. CL. 7.

APPLIED TECHNOLOGY PUBLICATIONS, INC., BARRINGTON, IL:  
1,869,074, CANC. INT. CL. 16.

APPREACH, INC., BALTIMORE, MD:  
2,538,237, PUB. 11-20-2001. INT. CL. 9.

ARCHEO VENICE DESIGN S.R.L, VENICE, ITALY:  
2,538,368, PUB. 11-20-2001. MULTIPLE CLASS, INT. CLS. 11 AND 20.

ARCHER DANIELS MIDLAND COMPANY, DECATUR, IL, MOORMAN MANUFACTURING COMPANY, QUINCY, IL:  
1,662,182. REN. 1-4-02. INT. CL. 5.

ARCTIC CAT INC., THIEF RIVER FALLS, MN, ARCTCO, INC., THIEF RIVER FALLS, MN:  
1,661,623. REN. 1-3-02. INT. CL. 12.

ARCTIC CHILLER LTD., ALBERTA, CANADA:  
2,537,700, PUB. 11-20-2001. INT. CL. 32.

ARDELL INTERNATIONAL, INC., LOS ANGELES, CA, ARDELL INCORPORATED, SOLON, OH:  
1,173,830. REN. 1-3-02. INT. CL. 3.

ARDEN INDUSTRIAL PRODUCTS, INC., ST. PAUL, MN, DBA ARDEN FASTENERS:  
1,868,557, CANC. INT. CL. 35.

ARGUS ASSET MANAGEMENT, INC., WILMINGTON, DE:  
1,868,268, CANC. INT. CL. 16.  
1,869,072, CANC. INT. CL. 16.

ARIZONA DOJA, INC., TUCSON, AZ, GRYCZKOWSKI, EDWARD, TUCSON, AZ:  
1,705,021. REN. 1-4-02. INT. CL. 20.

ARKWRIGHT TECHNICAL SERVICES, INC., WALTHAM, MA:  
1,868,754, CANC. INT. CL. 42.

ARMCO INC., MIDDLETOWN, OH:  
708,639, CANC. U.S. CL. 14.

ARMOR ALL/STP PRODUCTS COMPANY, THE, OAKLAND, CA:  
2,537,944, PUB. 7-3-2001. INT. CL. 1.

ARMOR ESTATE, LLC, SADDLE BROOK, NJ:  
2,538,693, INT. CL. 26.

ARMOUR AND COMPANY, PHOENIX, AZ:  
708,793, CANC. U.S. CL. 46.

ARNETT, JAMES A., DULUTH, GA:  
2,538,664, INT. CL. 30.

ARNOLD, PETER B., 6301 ZUG, SWITZERLAND:  
2,538,450, MULTIPLE CLASS, INT. CLS. 14, 18 AND 25.

ARRASATE, C.I. TACI, MONDRAGON (GUIPUZCOA), SPAIN:  
1,143,918, CANC. INT. CL. 7.

ARTHUR ANDERSEN LLP, CHICAGO, IL, ARTHUR ANDERSEN & CO., CHICAGO, IL:  
1,661,918. REN. 1-3-02. INT. CL. 35.

ARUZE CORPORATION, KOTOKU, TOKYO, JAPAN:  
2,537,550, PUB. 10-3-2000. INT. CL. 37.  
2,537,551, PUB. 10-10-2000. INT. CL. 35.

ASH HANDKERCHIEF CORP., NEW YORK, NY:  
1,868,434, CANC. INT. CL. 25.

ASHLAND INC., COVINGTON, KY, ASHLAND OIL, INC., COLUMBUS, OH:  
927,573. REN. 1-4-02. U.S. CL. 1 (INT. CLS. 1, 2 AND 19).

- ASICS CORPORATION, CHUO-KU, KOBE 650, JAPAN:  
1,868,361, CANC. INT. CL. 25.
- ASO CORPORATION, SARASOTA, FL:  
2,538,653, INT. CL. 5.
- ASPIRA ASSOCIATION, INC., WASHINGTON, DC:  
1,868,677, CANC. INT. CL. 41.
- ASSOCIATION OF COLLEGIATE LICENSING ADMINISTRATORS, INC., WEST HARTFORD, CT:  
1,666,273, REN. 12-30-01. INT. CL. 16.
- ASTRA ASSOCIATES, INC., TROY, MI:  
1,130,261, CANC. INT. CL. 9.
- AT LAST NATURALS, INC., VALHALLA, NY:  
2,538,180, PUB. 9-25-2001. INT. CL. 3.
- AT&T CORP., NEW YORK, NY:  
2,538,634, INT. CL. 38.
- ATHENA INTERNATIONAL, INC., GARDNERVILLE, NV,  
E-Z-EST PRODUCTS CO., INC., OAKLAND, CA:  
714,821, REN. 1-4-02. U.S. CL. 52 (INT. CL. 3).
- ATLANTA RICHFIELD COMPANY, PHILADELPHIA, PA:  
1,143,814, CANC. INT. CL. 1.
- ATLANTIC CAPITAL MANAGEMENT, L.L.C., RICHMOND, VA:  
2,538,472, INT. CL. 36.
- ATLANTIC STEEL CORPORATION, ASTORIA, NY,  
ATLANTIC STEEL CORP., NEW YORK, NY:  
713,371, REN. 1-3-02. U.S. CL. 14 (INT. CL. 6).
- ATX TELECOM SYSTEMS, INC., NAPERVILLE, IL:  
1,628,072, CANC. INT. CL. 9.
- AU, LAWRENCE, LIVONIA, MI:  
1,868,925, CANC. INT. CL. 28.
- AUDIOVOX SPECIALIZED APPLICATIONS, LLC, ELKHART, IN:  
2,537,733, PUB. 11-20-2001. INT. CL. 9.
- AUGUSTUS WEINKELLEREI GMBH, AM OCKENHEIMER GRABEN 35, FED REP GERMANY:  
1,628,547, CANC. INT. CL. 33.
- AURORA FOODS INC., ST. LOUIS, MO, LEVER BROTHERS COMPANY, NEW YORK, NY:  
722,714, REN. 12-29-01. U.S. CL. 46 (INT. CL. 30).
- AURORA FOODS INC., ST. LOUIS, MO, KRAFT GENERAL FOODS, INC., GLENVIEW, IL:  
1,679,044, REN. 12-30-01. INT. CL. 30.
- AUSPEX SYSTEMS, INC., SANTA CLARA, CA:  
1,659,512, REN. 1-3-02. INT. CL. 9.
- AUSTENAL, INC., CHICAGO, IL:  
1,868,150, CANC. INT. CL. 10.
- AUTOBOND, INC., NEW YORK, NY:  
1,585,434, REN. 1-4-02. INT. CL. 9.
- AUTOMATED BUILDING COMPONENTS, INC., MIAMI, FL:  
708,631, CANC. U.S. CL. 12.
- AUTOMATIC DEVICES COMPANY, ALLENTOWN, PA:  
1,868,125, CANC. INT. CL. 9.
- AUTOMOTIVE SERVICE COUNCILS, INC., ELMHURST, IL:  
1,144,544, CANC. INT. CL. 41.
- AUTOTYPE AMERICAS, INC., SCHAUMBURG, IL, NOR-FILM CORPORATION, SCHAUMBURG, IL:  
1,166,878, REN. 1-3-02. INT. CL. 1.
- AVALON HILL GAME COMPANY, THE, BALTIMORE, MD:  
1,144,389, CANC. INT. CL. 28.
- AVECIA BV, NL5140AC WAALWIJK, NETHERLANDS:  
2,537,778, PUB. 11-20-2001. INT. CL. 1.
- AVIMAR, INCORPORATED, VOORHEES, NJ:  
1,868,921, CANC. INT. CL. 28.
- AVNET, INC., GREAT NECK, NY:  
1,868,773, CANC. INT. CL. 42.
- AVON PRODUCTS, INC., NEW YORK, NY:  
708,847, CANC. U.S. CL. 51.  
1,869,034, CANC. INT. CL. 5.  
1,869,035, CANC. INT. CL. 5.
- AXEL SPRINGER PUBLICACIONES, S.L. Y COMPANIA, SOCIEDAD EN COMANDITA, 28020 MADRID, SPAIN:  
1,868,230, CANC. INT. CL. 16.
- AZRAK-HAMWAY INTERNATIONAL INC., NEW YORK, NY:  
1,144,385, CANC. INT. CL. 28.
- AZURE TECHNOLOGIES, INC., HOPKINTON, MA:  
1,868,095, CANC. INT. CL. 9.
- B. C. ROGERS POULTRY, INC., MORTON, MS:  
1,628,489, CANC. INT. CL. 29.
- B. J. ALAN COMPANY, YOUNGSTOWN, OH:  
1,859,148, COR. INT. CL. 13.
- B.D. OF NEVADA, LIMITED PARTNERSHIP, RENO, NV FROM BD OF NEVADA, INC., RENO, NV:  
2,537,585, PUB. 7-10-2001. INT. CL. 35.
- B.G. PRODUCTS, INC., WICHITA, KS:  
1,698,527, REN. 1-2-02. INT. CL. 42.
- B-17 FLY TACKEL LIMITED, REDFORD, MI:  
1,628,804, CANC. INT. CL. 28.
- BABY HEIRLOOMS, CO., SALT LAKE CITY, UT:  
2,537,787, PUB. 11-20-2001. INT. CL. 35.
- BACHARACH, INC., PITTSBURGH, PA:  
1,660,313, REN. 1-4-02. INT. CL. 9.
- BACK DESIGNS, INC., BERKELEY, CA TO BACK DESIGNS, INC., BERKELEY, CA:  
2,500,579, COR. INT. CL. 35.
- BAEKWHA CO., LTD., CHOLLABUK-DO, REPUBLIC OF KOREA:  
1,868,772, CANC. INT. CL. 42.
- BAHAMA CRUISE, INC., PEMBROKE PINES, FL:  
2,538,301, PUB. 11-20-2001. INT. CL. 25.
- BAKER'S BREAKFAST COOKIE, INC., BELLINGHAM, WA:  
2,537,936, PUB. 11-20-2001. INT. CL. 30.
- BALL AEROSPACE & TECHNOLOGIES CORP., BOULDER, CO:  
2,537,627, PUB. 11-20-2001. INT. CL. 9.
- BALL ENTERPRISES, INC., IDAHO FALLS, ID:  
2,537,796, PUB. 11-20-2001. INT. CL. 29.
- BALL HORTICULTURAL COMPANY, WEST CHICAGO, IL, GEO. J. BALL, INC., WEST CHICAGO, IL, AKA BALL SEED CO.:  
1,676,944, REN. 1-3-02. INT. CL. 31.
- BALL INDUSTRIES, EL SEGUNDO, CA:  
741,112, CANC. U.S. CL. 4.
- BALLANTYNE OF OMAHA, INC., OMAHA, NE, PICHEL INDUSTRIES, RANCHO, CA:  
1,173,073, REN. 1-2-02. INT. CL. 11.
- BALLIERES, ALBERTO, SECCION PALMAS 11450 MEXICO, D.F., MEXICO:  
2,538,201, PUB. 11-20-2001. INT. CL. 41.
- BAMFLEX.COM, INC., CULVER CITY, CA:  
2,537,891, PUB. 11-20-2001. INT. CL. 35.
- BANGKOK MARKET, INC., MAYWOOD, CA:  
1,869,102, CANC. INT. CL. 30.  
2,537,890, PUB. 11-20-2001. MULTIPLE CLASS, INT. CLS. 29 AND 30.
- BANK OF AMERICA CORPORATION, CHARLOTTE, NC FROM NATIONSBANK CORPORATION, CHARLOTTE, NC:  
2,538,465, INT. CL. 36.
- BANK ONE CORPORATION, CHICAGO, IL, BANC ONE CORPORATION, COLUMBUS, OH:  
1,702,123, REN. 1-3-02. INT. CL. 36.
- BANQUE PARIBAS, 75002, PARIS, FRANCE:  
2,403,170, CANC. IIRN. RESTORED TO S.N. 75-484,026.
- BARGAINBUILDER.COM, INC., DURHAM, NC:  
2,537,847, PUB. 7-3-2001. INT. CL. 35.
- BARREIRO, SARAIVELYS, NEW YORK, NY:  
2,538,606, INT. CL. 18.
- BARRIE HOUSE COFFEE CO., INC., CASTLETON, NY:  
1,869,104, CANC. INT. CL. 30.
- BARTHOLOMEW; MEL, OLDFIELD, NY:  
1,144,531, CANC. INT. CL. 41.
- BASS, JAMES LANCE AND CHASEZ, JOSHUA SCOTT AND TIMBERLAKE, JUSTIN RANDALL AND KIRKPATRICK, CHRISTOPHER ALAN AND FATONE, JOSEPH ANTHONY, JR.:  
*See—ZEEKS, INC..*
- BASS, JAMES LANCE AND CHASEZ, JOSHUA SCOTT AND TIMBERLAKE, JUSTIN RANDALL AND KIRKPATRICK, CHRISTOPHER ALAN AND FATONE, JOSEPH ANTHONY, JR.:  
*See—ZEEKS, INC..*
- BATA LIMITED, TORONTO, CANADA, BATA SHOE COMPANY, INC., BELCAMP, MD:  
925,158, REN. 1-3-02. U.S. CL. 39 (INT. CL. 25).

- BATTLE CREEK EQUIPMENT CO., BATTLE CREEK, MI:  
1,172,118. REN. 1-2-02. MULTIPLE CLASS, INT. CLS. 10  
AND 28.
- BAUER & SCHAURTE KARCHER GMBH, D-4040 NEUSS/  
RHEIN, FED REP GERMANY:  
1,143,900, CANC. INT. CL. 6.
- BAXIS INC., LOS ANGELES, CA:  
1,868,417, CANC. INT. CL. 25.
- BAY AREA LABELS, SAN JOSE, CA:  
1,628,265, CANC. INT. CL. 16.
- BAY MILLS LIMITED, OAKVILLE, ONTARIO, CANADA:  
1,628,347, CANC. INT. CL. 20.
- BAY RIDGE AUTOMOTIVE MANAGEMENT CORP.,  
BROOKLYN, NY:  
2,538,508, MULTIPLE CLASS, INT. CLS. 35 AND 37.
- BAYER AKTIENGESELLSCHAFT, LEVERKUSEN-BAYER-  
WERK, FED REP GERMANY:  
1,182,937. REN. 1-3-02. INT. CL. 17.
- BAYERISCHE MOTOREN WERKE AKTIENGE-  
SELLSCHAFT, MUNCHEN, FED REP GERMANY:  
1,170,556. REN. 1-3-02. MULTIPLE CLASS, INT. CLS. 37  
AND 42.
- BBM CHOCOLATE DISTRIBUTORS, LTD., NEW YORK,  
NY:  
2,537,820, PUB. 11-20-2001. INT. CL. 30.
- BD OF NEVADA, INC.:  
*See— B.D. OF NEVADA, LIMITED PARTNERSHIP.*
- BEACON CHEMICAL COMPANY, INC., MT. VERNON, NY:  
2,538,570, INT. CL. 1.
- BEAR BRAND RANCH CO., NEWPORT BEACH, CA:  
2,538,554, INT. CL. 36.
- BEAUTIFUL PLANTS BRAND, WEST LINN, OR:  
1,869,027, CANC. INT. CL. 1.
- BECTON, DICKINSON AND COMPANY, FRANKLIN  
LAKES, NJ:  
1,174,030. REN. 1-4-02. INT. CL. 10.
- BELCO, TACOMA, WA:  
1,868,311, CANC. INT. CL. 19.
- BELCO COMMUNITY CREDIT UNION, HARRISBURG, PA:  
2,538,122, PUB. 11-20-2001. INT. CL. 36.
- BELL AND READING ENGINEERING LIMITED, WEST  
VANCOUVER, BRITISH COLUMBIA, CANADA:  
1,144,051, CANC. INT. CL. 11.
- BELL ATLANTIC CORPORATION, NEW YORK, NY:  
2,537,568, PUB. 11-20-2001. MULTIPLE CLASS, INT. CLS.  
9, 38 AND 42.
- BELLAND AG, 4500 SOLOTHURN, SWITZERLAND:  
2,537,560, PUB. 11-20-2001. MULTIPLE CLASS, INT. CLS.  
1, 2, 8, 14, 16, 17, 18, 20, 21, 25, 28, 35, 36, 40 AND 42.
- BELO COMPANY, THE, WILMINGTON, DE:  
2,538,081, PUB. 11-20-2001. INT. CL. 42.
- BENARD WEATHERILL LTD., LONDON, ENGLAND:  
1,628,404, CANC. INT. CL. 25.
- BENCKISER CONSUMER PRODUCTS INC., DANBURY,  
CT:  
1,867,973, CANC. INT. CL. 6.
- BENDAT, AYA, NEW YORK, NY:  
2,537,815, PUB. 11-20-2001. INT. CL. 35.
- BENEFIT COSMETICS LLC, SAN FRANCISCO, CA:  
2,538,196, PUB. 11-20-2001. MULTIPLE CLASS, INT. CLS.  
3 AND 4.
- BENESTROPHE, INC., STUART, FL:  
1,868,684, CANC. INT. CL. 41.
- BENETTON SPORTSYSTEM USA, INC., BORDENTOWN,  
NJ, PRINCE MANUFACTURING, INC., PRINCETON, NJ:  
1,175,337. REN. 12-30-01. INT. CL. 28.
- BENTLEY LINGERIE, INC., JERSEY CITY, NJ:  
1,868,912, CANC. INT. CL. 25.
- BERCUT-VANDERVOORT & CO., SAN FRANCISCO, CA:  
2,537,584, PUB. 11-20-2001. INT. CL. 33.
- BERGERAC LLC, BOSTON, MA:  
2,538,198, PUB. 11-20-2001. INT. CL. 42.
- BERKLEY INC., SPIRIT LAKE, IA:  
1,868,474, CANC. INT. CL. 28.  
1,868,475, CANC. INT. CL. 28.
- BERNARD WEATHERILL, LTD., LONDON, ENGLAND:  
1,628,659, CANC. INT. CL. 40.
- BESCO USA INTERNATIONAL, ORANGE, CA:  
1,868,460, CANC. INT. CL. 28.  
1,868,461, CANC. INT. CL. 28.
- BEST BLOCK COMPANY, MENOMONEE FALLS, WI:  
2,538,361, PUB. 11-20-2001. INT. CL. 19.
- BETESH GROUP HOLDING CORPORATION, GENERA-  
TION SPORT DIVISION, THE, NEW YORK, NY:  
2,538,484, INT. CL. 18.
- BEUCHAT USA, INC., FT. LAUDERDALE, FL:  
1,628,462, CANC. INT. CL. 28.
- BGS SYSTEMS, WALTHAM, MA:  
1,628,164, CANC. INT. CL. 9.
- BIBBY TRANSMISSIONS LIMITED, DEWSBURY, WEST  
YORKSHIRE, ENGLAND, WELLMAN BIBBY COMPANY  
LIMITED, THE, DEWSBURY, WEST YORKSHIRE, ENG-  
LAND:  
1,182,713. REN. 1-2-02. MULTIPLE CLASS, INT. CLS. 7  
AND 12.
- BIEN PRODUCTIONS, INC., BROOKLYN, NY:  
1,868,244, CANC. INT. CL. 16.
- BIG HORN VALVE COMPANY, SHERIDAN, WY:  
2,538,611, MULTIPLE CLASS, INT. CLS. 6, 11 AND 20.
- BIK PRO, INC., PHOENIX, AZ, DBA ROCK POINT OUT-  
FITTERS:  
1,868,182, CANC. MULTIPLE CLASS, INT. CLS. 12 AND  
18.
- BINNEY & SMITH INC., EASTON, PA:  
708,688, CANC. U.S. CL. 22.  
1,169,785. REN. 1-3-02. MULTIPLE CLASS, INT. CLS. 2  
AND 16.
- BIO-SPRAY, INC., GREENLAND, NH:  
1,868,605, CANC. MULTIPLE CLASS, INT. CLS. 37, 40  
AND 42.
- BIO-TEC COSMETICS LTD., TORONTO, ONTARIO, CANA-  
DA:  
1,868,802, CANC. INT. CL. 3.
- BIO-TECH HEALTH SYSTEMS, LTD., CHICAGO, IL:  
1,868,771, CANC. INT. CL. 42.
- BIO/DATA CORPORATION, HATBORO, PA:  
1,143,815, CANC. INT. CL. 1.
- BIOFARMA, S.A., 92201 NEUILLY-SUR-SEINE, FRANCE:  
1,867,943, CANC. INT. CL. 5.
- BIOFORCE AG ROGGWIL TG, AU, 9325 ROGGWIL, SWIT-  
ZERLAND:  
1,143,877, CANC. INT. CL. 5.  
1,143,878, CANC. INT. CL. 5.
- BIOGRAPH RECORDS, INC., SOMERVILLE, MA:  
2,538,090, PUB. 11-20-2001. INT. CL. 9.
- BIOMED RESEARCH, INC., LOS ANGELES, CA:  
1,143,857, CANC. INT. CL. 5.
- BIORAY, INC., BIRMINGHAM, AL:  
2,538,013, PUB. 11-20-2001. INT. CL. 10.
- BIOZONE LABORATORIES, INC., MARTINEZ, CA:  
1,868,799, CANC. INT. CL. 1.
- BISON BRAND, INC., NORTH PALM BEACH, FL:  
2,537,745, PUB. 11-20-2001. INT. CL. 30.
- BITTERS CO., SEATTLE, WA:  
2,537,780, PUB. 11-20-2001. INT. CL. 35.
- BJ&J, LTD., BOULDER, CO:  
2,538,474, INT. CL. 14.  
2,538,537, INT. CL. 14.
- BLACK ENTERTAINMENT TELEVISION, INC., WASHING-  
TON, DC:  
2,538,550, INT. CL. 41.
- BLACK PRINCE DISTILLERY, INC., THE, CLIFTON, NJ:  
1,868,965, CANC. INT. CL. 33.
- BLACK-CLAWSON COMPANY, THE, HAMILTON, OH:  
708,708, CANC. U.S. CL. 23.
- BLACKTHORN, INC., CLAYTON, OH, DBA DURA TECH:  
1,669,303. REN. 12-29-01. INT. CL. 11.
- BLITZ MANUFACTURING COMPANY, INC., RIVERSIDE,  
CA:  
1,868,350, CANC. INT. CL. 21.
- BLOCK DRUG COMPANY, INC., JERSEY CITY, NJ:  
1,706,170. REN. 1-2-02. INT. CL. 3.
- BLUE CROSS AND BLUE SHIELD ASSOCIATION, CHICA-  
GO, IL:  
2,537,870, PUB. 11-20-2001. MULTIPLE CLASS, INT. CLS.

- 36 AND 42.  
**BLUE CROSS AND BLUE SHIELD OF MINNESOTA, ST. PAUL, MN:**  
 1,868,523, CANC. MULTIPLE CLASS, INT. CLS. 35 AND 42.  
**BLUE-WHITE INDUSTRIES, WESTMINSTER, CA:**  
 2,538,213, PUB. 11-20-2001. INT. CL. 9.  
**BMC INDUSTRIES, INC., MINNEAPOLIS, MN:**  
 1,868,837, CANC. INT. CL. 9.  
**BMC SOFTWARE, INC., HOUSTON, TX:**  
 2,538,525, INT. CL. 9.  
**BNA ASSOCIATES, INC., NASHVILLE, TN:**  
 2,469,122, CANC. INT. CL. 35.  
**BOARD OF REGENTS, THE UNIVERSITY OF TEXAS SYSTEM, AUSTIN, TX:**  
 2,538,131, PUB. 11-20-2001. INT. CL. 41.  
 2,538,136, PUB. 11-20-2001. INT. CL. 41.  
**BOARD OF TRUSTEES OF THE UNIVERSITY OF ILLINOIS, THE, URBANA, IL:**  
 1,868,673, CANC. INT. CL. 41.  
**BOATHOUSE ROW SPORTS, LTD., PHILADELPHIA, PA:**  
 1,628,420, CANC. INT. CL. 25.  
**BOB'S RED MILL NATURAL FOODS, INC., MILWAUKIE, OR:**  
 2,537,720, PUB. 11-20-2001. MULTIPLE CLASS, INT. CLS. 29, 30 AND 31.  
**BODY ALIVE, SANTA MONICA, CA:**  
 1,628,418, CANC. INT. CL. 25.  
**BODY WISE INTERNATIONAL, INC., TUSTIN, CA:**  
 2,537,609, PUB. 11-20-2001. INT. CL. 5.  
**BOJE, HARMONY B., DECATUR, GA:**  
 2,538,175, PUB. 11-20-2001. INT. CL. 41.  
**BOMOCAF S.P.A., I-20080 BINASCO [MI], ITALY:**  
 2,537,685, PUB. 11-20-2001. INT. CL. 30.  
**BONNIE BERGIN ASSISTANCE DOG INSTITUTE, THE, ROHNERT PARK, CA:**  
 2,537,768, PUB. 11-20-2001. INT. CL. 41.  
**BOOT ROYALTY COMPANY, L.P., FORT WORTH, TX:**  
 2,538,471, INT. CL. 25.  
**BORAL INDUSTRIES INC., ROSWELL, GA:**  
 2,538,200, PUB. 11-20-2001. INT. CL. 1.  
**BORDEN, INC., COLUMBUS, OH:**  
 708,570, CANC. U.S. CL. 1.  
**BOSTIK INC., MIDDLETON, MA:**  
 1,868,450, CANC. INT. CL. 28.  
**BOSTON COMMUNITY ACCESS AND PROGRAMMING FOUNDATION, BOSTON, MA:**  
 2,537,994, PUB. 11-20-2001. INT. CL. 38.  
**BOX OFFICE MANAGEMENT INT'L, NEW YORK, NY, DBA THE INTERNATIONAL TICKETING ASSOCIATION:**  
 2,538,684, INT. CL. 42.  
**BOY SCOUTS OF AMERICA, IRVING, TX:**  
 1,209,322, REN. 1-3-02. U.S. CL. 200.  
**BR CONSULTING, INC, MESA, AZ:**  
 2,537,835, PUB. 11-20-2001. INT. CL. 41.  
**BR CONSULTING, INC., MESA, AZ:**  
 2,537,832, PUB. 11-20-2001. INT. CL. 41.  
 2,537,833, PUB. 11-20-2001. INT. CL. 41.  
 2,537,834, PUB. 11-20-2001. INT. CL. 41.  
**BRAND GO GROUP, LLC, CHICAGO, IL:**  
 2,537,995, PUB. 11-20-2001. INT. CL. 35.  
**BRANDOW COMPANY, INC., CAMP HILL, PA:**  
 2,538,500, INT. CL. 35.  
**BRAUEREI FELDSCHESSCHEN, RHEINFELDEN, SWITZERLAND:**  
 1,144,449, CANC. INT. CL. 32.  
**BRAUN GMBH, KRONBERG IM TAUNUS, FED REP GERMANY:**  
 2,538,395, PUB. 11-20-2001. INT. CL. 21.  
**BREADSHOP, INC., THE, SANTA CRUZ, CA:**  
 1,628,512, CANC. INT. CL. 30.  
**BREDDO INC., KANSAS CITY, KS:**  
 1,144,440, CANC. INT. CL. 30.  
**BREEDER'S CHOICE PET FOODS, INC., IRWINDALE, CA:**  
 1,628,528, CANC. INT. CL. 31.  
 1,628,830, CANC. INT. CL. 31.  
**BRENT REDMOND TRANSPORTATION, INC., HOLLISTER, CA:**  
 2,538,067, PUB. 11-20-2001. INT. CL. 39.  
**BRENTWOOD INTERNATIONAL, INC., CAMPBELLSVILLE, KY:**  
 2,538,346, PUB. 11-20-2001. INT. CL. 16.  
**BREWSTER DAIRY, INC., BREWSTER, OH:**  
 2,538,527, INT. CL. 29.  
**BRI PRODUCTION S.A., 38610 GIERES, FRANCE:**  
 1,868,355, CANC. INT. CL. 25.  
**BRICO S.R.L., DORMELLETO NO, ITALY:**  
 1,628,077, CANC. MULTIPLE CLASS, INT. CLS. 9, 25 AND 28.  
**BRIDGESTONE/FIRESTONE, INC., AKRON, OH:**  
 1,628,202, CANC. INT. CL. 12.  
**BRIERLEY, HAROLD, DALLAS, TX FROM TARGETED MARKETING SYSTEMS, INC., DALLAS, TX:**  
 2,538,459, INT. CL. 35.  
**BRIGGS, GEORGE LEONARD, LAMPE, MO:**  
 1,628,279, CANC. INT. CL. 16.  
**BRIGHT SYSTEMS, INC., RENO, NV:**  
 2,537,950, PUB. 11-20-2001. INT. CL. 9.  
**BRIMMS INCORPORATED, TONAWANDA, NY:**  
 937,017, REN. 1-2-02. U.S. CL. 22 (INT. CL. 28).  
**BRISCOE BURKE & GRIGSBY LLP, TULSA, OK:**  
 2,538,032, PUB. 11-20-2001. INT. CL. 35.  
**BRISTOL TECHNOLOGY, INC., DANBURY, CT:**  
 2,538,574, MULTIPLE CLASS, INT. CLS. 9 AND 42.  
**BRITAMERICA, INC., HARLINGEN, TX:**  
 2,538,111, PUB. 11-20-2001. INT. CL. 36.  
**BROADCAST EQUITIES, INC., VIRGINIA BEACH, VA:**  
 1,869,020, CANC. MULTIPLE CLASS, INT. CLS. 41 AND 42.  
**BRODERBUND SOFTWARE, INC., NOVATO, CA:**  
 1,868,463, CANC. INT. CL. 28.  
**BROMAGEM, AARON, SAN JOSE, CA:**  
 2,537,666, PUB. 11-20-2001. INT. CL. 35.  
**BRONCO WINE COMPANY, CERES, CA:**  
 2,537,586, PUB. 11-20-2001. INT. CL. 33.  
**BROOK INDUSTRIES, INC., OKLAHOMA CITY, OK:**  
 1,867,894, CANC. INT. CL. 1.  
**BROOKHAVEN ENTERPRISES, INC., NORCROSS, GA:**  
 1,144,577, CANC. INT. CL. 42.  
**BROOKS, RICHARD, HUNTINGTON STATION, NY:**  
 1,868,688, CANC. INT. CL. 41.  
**BROUWERIJ DE RIDDER B.V., 6221 EN MAASTRICHT, NETHERLANDS:**  
 2,537,823, PUB. 11-20-2001. INT. CL. 32.  
**BROYHILL COMPANY, THE, DAKOTA CITY, NE:**  
 1,663,950, REN. 12-30-01. INT. CL. 7.  
**BROYHILL FURNITURE INDUSTRIES, INC., LENOIR, NC:**  
 2,538,152, PUB. 11-20-2001. INT. CL. 20.  
**BRUNSWICK CORPORATION, SKOKIE, IL:**  
 1,867,991, CANC. INT. CL. 7.  
**BUCCIARELLI, SUZANNE, RESTON, VA, DBA PAGEPRO:**  
 1,868,518, CANC. INT. CL. 35.  
**BUCK STOVES WEST, INC., BENICIA, CA, DBA BSW, INC.:**  
 1,659,415, REN. 1-2-02. MULTIPLE CLASS, INT. CLS. 6 AND 21.  
 1,659,415, CANC. INT. CL. 8.  
**BUCKHEAD LIFE RESTAURANT GROUP, INC., ATLANTA, GA:**  
 2,537,598, PUB. 11-20-2001. INT. CL. 42.  
**BUILDERS SQUARE, INC., SAN ANTONIO, TX:**  
 1,869,006, CANC. INT. CL. 42.  
**BULL, S.A., PARIS, FRANCE:**  
 1,628,733, CANC. INT. CL. 42.  
**BUNGEE RACERS, INC., GREENVILLE, MS:**  
 2,538,192, PUB. 11-20-2001. INT. CL. 41.  
**BURN STEWART DISTILLERS PLC, BARRHEAD, GLASGOW, UNITED KINGDOM:**  
 1,868,968, CANC. INT. CL. 33.  
**BURNS PHILP FOOD INC., SAN FRANCISCO, CA:**  
 1,628,532, CANC. INT. CL. 31.  
**BURNS, ANTHONY D., QUEENSCLIFF, NEW SOUTH WALES 2096, AUSTRALIA, DBA MICROMULTIMEDIA:**  
 1,868,092, CANC. INT. CL. 9.

BURR-BROWN CORPORATION, TUCSON, AZ:  
1,868,843, CANC. INT. CL. 9.

BURROUGHS WELLCOME CO., RESEARCH TRIANGLE PARK, NC:  
708,670, CANC. U.S. CL. 18.

BURROUGHS; MIGGS, WESTPORT, CT:  
1,144,007, CANC. INT. CL. 9.

BUTTERWORTH HEALTH CORPORATION, GRAND RAPIDS, MI:  
1,628,649, CANC. MULTIPLE CLASS, INT. CLS. 39 AND 42.

BUXTON COMPANY, THE, FORT WORTH, TX:  
2,538,420, PUB. 11-20-2001. INT. CL. 35.

BYERLY'S, INC., EDINA, MN:  
1,173,720, REN. 1-4-02. INT. CL. 42.  
1,175,538, REN. 1-4-02. INT. CL. 42.

BYNARRY, LTD., ALBANY, NY:  
2,538,120, PUB. 11-20-2001. INT. CL. 42.

B2BWORKS, INC., CHICAGO, IL:  
2,538,171, PUB. 11-20-2001. INT. CL. 35.

C. C. KORNS COMPANY, JOHNSTOWN, PA:  
1,143,902, CANC. INT. CL. 6.

C. F. MARTIN ORGANISATION, THE, NAZARETH, PA:  
1,144,110, CANC. INT. CL. 15.

C.B. FLEET INVESTMENT CORPORATION, WILMINGTON, DE:  
1,867,957, CANC. INT. CL. 5.

C.R. BARD, INC., MURRAY HILL, NJ:  
1,868,862, CANC. INT. CL. 10.

C.R. GIBSON COMPANY, THE, NORWALK, CT:  
1,868,237, CANC. INT. CL. 16.

C-LIFE CORPORATION, NEW YORK, NY:  
1,670,844, REN. 1-2-02. INT. CL. 25.

CACIQUE, INC., CITY OF INDUSTRY, CA:  
2,538,524, INT. CL. 29.

CAFE EL REY, S.A., SAN JOSE, COSTA RICA:  
1,868,491, CANC. INT. CL. 30.

CAFFE APPASSIONATO, INC., SEATTLE, WA:  
2,538,246, PUB. 11-20-2001. INT. CL. 30.

CALBIOCHEM-NOVABIOCHEM CORP., SAN DIEGO, CA, CALBIOCHEM-BEHRING CORP., LA JOLLA, CA:  
1,181,697, REN. 1-4-02. INT. CL. 1.

CALDOR CORPORATION, THE, NORWALK, CT:  
1,868,745, CANC. INT. CL. 42.

CALHOUN, DARLENE J., ROCKLIN, CA, DBA CHUCKLE GAMES:  
2,538,671, INT. CL. 28.

CALIFORNIA AMPLIFIER, INC., CAMARILLO, CA:  
1,651,900, REN. 12-30-01. INT. CL. 9.

CALIFORNIA BUFF COMPANY, INC., LOS ANGELES, CA:  
1,627,921, CANC. MULTIPLE CLASS, INT. CLS. 3 AND 7.

CALIFORNIA DATE ADMINISTRATIVE COMMITTEE, INDIO, CA:  
1,628,788, CANC. U.S. CL. A.

CALIFORNIA MILLING CORPORATION, LOS ANGELES, CA:  
708,812, CANC. U.S. CL. 46.

CALIFORNIA PRODUCTS CORPORATION, ANDOVER, MA:  
1,662,892, REN. 1-2-02. INT. CL. 2.

CALMTEL COMMUNICATIONS INTERNATIONAL, LLC, VIENNA, VA:  
2,537,664, PUB. 11-20-2001. INT. CL. 38.

CALVIN L. DAY, JR. M.D., P.A., SAN ANTONIO, TX, DBA THE LASER HAIR REMOVAL AND MICRODERMABRASION CENTER:  
2,537,989, PUB. 11-20-2001. INT. CL. 42.

CAMIL, KARAA, 92200 NEUILLY SUR SEINE, FRANCE:  
2,537,574, PUB. 11-20-2001. MULTIPLE CLASS, INT. CLS. 5, 6 AND 19.

CAMMUNICATIONS.COM, INC., ATLANTA, GA:  
2,537,737, PUB. 11-20-2001. INT. CL. 38.

CAMP TV VIDEO PRODUCTIONS, INC., DALLAS, TX:  
1,868,089, CANC. INT. CL. 9.

CAMPBELL TAGGART, INC., ST. LOUIS, MO:  
1,868,506, CANC. INT. CL. 30.

CAMPUS FUND RAISERS, INC., W. TRENTON, NJ:  
1,628,523, CANC. INT. CL. 30.

CAMUS LA GRANDE MARQUE, 16100 COGNAC, FRANCE:  
1,868,966, CANC. INT. CL. 33.

CANADIAN AGING AND REHABILITATION PRODUCT DEVELOPMENT CORPORATION, WINNIPEG, MANITOBA, CANADA:  
1,868,519, CANC. MULTIPLE CLASS, INT. CLS. 35, 36, 41 AND 42.

CANIMEX INC., QUEBEC, CANADA:  
2,537,719, PUB. 11-20-2001. MULTIPLE CLASS, INT. CLS. 6, 7, 9, 16, 35, 40 AND 42.

CANTY, LLOYD, SACRAMENTO, CA, DBA LFI-THE ULTIMATE HEALTH COMPANY:  
1,867,952, CANC. INT. CL. 5.

CAPE COD CRAFTERS, INC., MYSTIC, CT:  
1,868,699, CANC. INT. CL. 42.

CAPESPAN GROUP HOLDINGS LIMITED, BELLVILLE, SOUTH AFRICA FROM CAPESPAN INTERNATIONAL PLC, SOUTH BUCKS, SL2 3RQ, ENGLAND:  
2,537,557, PUB. 1-30-2001. INT. CL. 31.

CAPESPAN INTERNATIONAL PLC:  
*See—CAPESPAN GROUP HOLDINGS LIMITED.*

CAPITAL BANK, MIAMI, FL:  
1,869,112, CANC. INT. CL. 36.

CAPITAL CITIES MEDIA, INC., NEW YORK, NY:  
1,869,060, CANC. INT. CL. 16.

CAPITAL COMMUNICATIONS CORPORATION, KANSAS CITY, MO:  
1,696,494, REN. 1-2-02. INT. CL. 37.

CAPITAL INSURANCE ADJUSTERS, INC., DOVER, DE:  
2,537,964, PUB. 11-20-2001. INT. CL. 36.

CAPS LOCK, INC., MONROEVILLE, PA:  
2,537,934, PUB. 11-20-2001. MULTIPLE CLASS, INT. CLS. 38 AND 42.

CARAMEL SIN, INC., LOS ANGELES, CA:  
2,537,711, PUB. 11-20-2001. INT. CL. 30.

CARE COMPUTER SYSTEMS, INC., BELLEVUE, WA, DBA NEWPORT SYSTEMS:  
1,628,122, CANC. INT. CL. 9.

CAREER EMPLOYMENT SERVICES, INC., WESTBURY, NY:  
1,144,484, CANC. INT. CL. 35.

CAREERPATH.COM, INC., LOS ANGELES, CA, SILICON PRAIRIE TECHNOLOGY ASSN., LENEXA, KS:  
1,636,277, REN. 12-31-01. INT. CL. 35.

CARETEC LTD., ROSH HA'AYIN, ISRAEL:  
2,537,665, PUB. 11-20-2001. INT. CL. 5.

CARL S. AKEY, INC., LEWISBURG, OH:  
1,868,957, CANC. INT. CL. 31.

CARLO INC., ALBUQUERQUE, NM:  
2,537,931, PUB. 11-20-2001. MULTIPLE CLASS, INT. CLS. 35, 36 AND 37.

CARLO MONTALTO INDUSTRIA E COMERCIO LTDA., CEP 04.299 SAO PAULO SP, BRAZIL:  
1,868,867, CANC. INT. CL. 11.

CARLSON SYSTEMS CORPORATION, OMAHA, NE:  
2,537,667, PUB. 11-20-2001. MULTIPLE CLASS, INT. CLS. 35 AND 41.

CAROLINA DOOR CONTROLS INCORPORATED, DURHAM, NC:  
1,677,049, REN. 1-4-02. INT. CL. 37.

CAROLYN J. BRADDOCK, M.A., P.C., LAKEWOOD, CO:  
1,868,666, CANC. INT. CL. 41.

CARON, YVES MARIE, 38620 ST GEOIRE EN VALDAINE, FRANCE AND BIBOLLET, JEAN CLAUDE, 74230 THONES, FRANCE:  
2,538,651, INT. CL. 25.

CAROUSEL FARMS, L.L.C., MARCUS, IA:  
2,538,626, INT. CL. 35.

CARRIER VIBRATING EQUIPMENT, INC., LOUISVILLE, KY:  
1,175,855, REN. 1-4-02. INT. CL. 7.

CARSON SALES COMPANY, INC., PHOENIX, AZ:  
1,662,194, REN. 12-29-01. INT. CL. 6.

CARTER ELECTRIC CORPORATION, PHOENIX, AZ:  
1,144,206, CANC. INT. CL. 20.

CARTER-WALLACE, INC., NEW YORK, NY:  
1,867,911, CANC. INT. CL. 3.

- CASCADE ORTHOPEDIC SUPPLY, INC., CHICO, CA:  
2,537,738, PUB. 11-20-2001. INT. CL. 10.
- CASE ALUMNI ASSOCIATION, CLEVELAND, OH:  
2,538,078, PUB. 11-20-2001. INT. CL. 36.
- CASE CORPORATION, RACINE, WI, INTERNATIONAL  
HARVESTER COMPANY, CHICAGO, IL:  
922,364. REN. 1-2-02. U.S. CL. 26 (INT. CL. 9).
- CASEY, ALAN J., CHANTILLY, VA:  
2,538,160, PUB. 11-20-2001. INT. CL. 30.
- CASHTON FARM SUPPLY, CASHTON, WI:  
1,626,511. REN. 1-2-02. INT. CL. 1.
- CASIO KEISANKI KABUSHIKI KAISHA, SHIBUYA-KU,  
TOKYO, JAPAN, DBA CASIO COMPUTER CO., LTD.:  
2,538,549, INT. CL. 14.
- CASS INFORMATION SYSTEMS, INC., BRIDGETON, MO:  
1,628,138, CANC. MULTIPLE CLASS, INT. CLS. 9 AND  
35.
- CAYMUS VINEYARDS, RUTHERFORD, CA:  
1,868,971, CANC. INT. CL. 33.
- CD STREET, INC., DALLAS, TX:  
2,537,717, PUB. 11-20-2001. INT. CL. 36.
- CELEX GROUP, INC., LOMBARD, IL, DBA CELEBRATING  
EXCELLENCE, INC.:  
1,868,247, CANC. INT. CL. 16.
- CELGARD INC., CHARLOTTE, NC:  
2,538,306, PUB. 11-20-2001. INT. CL. 9.
- CELLULAR FOUNDATION, THE, WASHINGTON, DC:  
1,869,061, CANC. INT. CL. 16.
- CELLULOID S.A., SELESTAT, FRANCE:  
1,144,193, CANC. MULTIPLE CLASS, INT. CLS. 20, 21  
AND 26.
- CELSA LG (SOCIETE ANONYME), 86360 CHASSENEUIL  
DU POITOU, FRANCE:  
1,868,139, CANC. INT. CL. 10.
- CENTER FOR PROFESSIONAL ACHIEVEMENT, INC.,  
CHAGRIN FALLS, OH:  
2,537,784, PUB. 11-20-2001. INT. CL. 41.
- CENTERPOINT BANK, BEDFORD, NH:  
1,868,595, CANC. INT. CL. 36.
- CENTRAL GARDEN & PET COMPANY, LAFAYETTE, CA:  
2,538,366, PUB. 11-20-2001. INT. CL. 1.
- CENTURI CORPORATION, PENROSE, CO:  
2,538,308, PUB. 11-20-2001. INT. CL. 28.
- CERAC, INCORPORATED, MILWAUKEE, WI:  
1,675,618. REN. 1-3-02. INT. CL. 1.
- CERTIFIED TOURS, INC., FORT LAUDERDALE, FL:  
1,868,551, CANC. MULTIPLE CLASS, INT. CLS. 35 AND  
39.
- CERVECERIA CENTRO AMERICANA, S.A., GUATEMALA  
CITY, GUATEMALA:  
2,537,801, PUB. 11-20-2001. INT. CL. 32.
- CERVECERIA INDIA, INC., MAYAGUEZ, PUERTO RICO:  
1,868,513, CANC. INT. CL. 32.
- CHAMBRE DE DISCIPLINE DE LA COMPAGNIE DES  
COMMISSAIRES PRISEURS DE PARIS, PARIS, FRANCE:  
1,628,560, CANC. INT. CL. 35.
- CHAMPION CHEMICAL CO., INC., WHITTIER, CA TO  
SIRIUS PRODUCTS, INC., NORTHRIDGE, CA:  
1,311,843, CANC. INT. CL. 3.
- CHANG-TUH CORPORATION, SOUTH SALEM, OR:  
2,538,230, PUB. 11-20-2001. INT. CL. 30.
- CHANTAL PHARMACEUTICAL CORPORATION, LOS AN-  
GELES, CA:  
1,868,784, CANC. MULTIPLE CLASS, INT. CLS. 3 AND 5.
- CHARLES SCHWAB & CO., INC., SAN FRANCISCO, CA:  
2,537,839, PUB. 11-20-2001. MULTIPLE CLASS, INT. CLS.  
16, 35, 36 AND 41.
- CHASE-WALTON ELASTOMERS, INC., HUDSON, MA:  
2,537,697, PUB. 11-20-2001. INT. CL. 6.
- CHATEAU DE FONTPINOT, 16130 SEGONZAC, FRANCE:  
1,868,515, CANC. INT. CL. 33.
- CHATHAM MANUFACTURING COMPANY, ELKIN, NC:  
708,774, CANC. U.S. CL. 42.  
708,775, CANC. U.S. CL. 42.  
708,776, CANC. U.S. CL. 42.  
708,777, CANC. U.S. CL. 42.  
708,778, CANC. U.S. CL. 42.
- CHATTEM, INC., CHATTANOOGA, TN:  
708,677, CANC. U.S. CL. 18.
- CHEESE SHOP INTERNATIONAL, INC., GREENWICH, CT:  
1,144,470, CANC. MULTIPLE CLASS, INT. CLS. 35 AND  
42.
- CHEF AMERICA, INC., ENGLEWOOD, CO:  
2,537,677, PUB. 11-20-2001. INT. CL. 30.
- CHEF CHU'S, INC., LOS ALTOS, CA:  
1,144,578, CANC. INT. CL. 42.
- CHEMADVISOR, INC., PITTSBURGH, PA:  
2,537,539, PUB. 11-20-2001. INT. CL. 9.
- CHEMCENTRAL CORPORATION, BEDFORD PARK, IL:  
2,537,534, PUB. 11-20-2001. INT. CL. 1.
- CHEMLINE PLASTICS LIMITED, THORNHILL, ONTARIO  
L3T 6L2, CANADA:  
2,537,563, PUB. 11-20-2001. MULTIPLE CLASS, INT. CLS.  
9 AND 20.
- CHERRY TREE PRODUCTS COMPANY, THE, PROVI-  
DENCE, RI:  
1,868,403, CANC. INT. CL. 25.
- CHEVRON CORPORATION, SAN FRANCISCO, CA:  
1,867,933, CANC. INT. CL. 4.
- CHF INDUSTRIES, INC., NEW YORK, NY:  
2,471,071, COR. MULTIPLE CLASS, INT. CLS. 20 AND  
24.
- CHICAGO PIZZA & BREWERY, INC., HUNTINGTON  
BEACH, CA:  
2,538,393, PUB. 11-20-2001. INT. CL. 42.
- CHICAGO TROLLEY CO., CHICAGO, IL:  
2,537,578, PUB. 11-20-2001. INT. CL. 39.
- CHICK-FIL-A, INC., ATLANTA, GA:  
2,538,050, PUB. 11-20-2001. INT. CL. 25.  
2,538,070, PUB. 11-20-2001. INT. CL. 42.
- CHICOPEE, INC., NORTH CHARLESTON, SC, JOHNSON &  
JOHNSON, NEW BRUNSWICK, NJ:  
1,174,277. REN. 1-2-02. INT. CL. 21.
- CHILDBIRTH SOLUTIONS, INC., THE PLAINS, VA:  
2,537,947, PUB. 11-20-2001. INT. CL. 35.
- CHILDREN'S HOSPITAL OF PHILADELPHIA, THE, PHI-  
LADELPHIA, PA:  
2,537,658, PUB. 11-20-2001. INT. CL. 42.
- CHILDREN'S DISCOVERY CENTERS OF AMERICA, INC.,  
SAN RAFAEL, CA:  
1,659,140. REN. 12-30-01. MULTIPLE CLASS, INT. CLS.  
41 AND 42.
- CHILDREN'S LEUKEMIA FOUNDATION OF MICHIGAN,  
SOUTHFIELD, MI:  
2,538,051, PUB. 11-20-2001. INT. CL. 36.
- CHIN HU CHUN TEA INDUSTRY CO., LTD., NANTOU  
HSIEN, TAIWAN:  
2,538,372, PUB. 11-20-2001. INT. CL. 30.
- CHINA TUHSU ZHEJIANG TEA IMPORT & EXPORT  
CORPORATION, HANGZHOU, CHINA:  
1,868,493, CANC. INT. CL. 30.
- CHIQUITA PROCESSED FOODS, LLC, CINCINNATI, OH:  
2,537,781, PUB. 11-20-2001. INT. CL. 29.
- CHIROWISE, INC., JONESBORO, GA:  
2,537,608, PUB. 11-20-2001. INT. CL. 42.
- CHIU, DAVID H., NORTHRIDGE, CA:  
1,868,402, CANC. INT. CL. 25.
- CHN, INC., NEW ORLEANS, LA, DBA NADW:  
1,868,223, CANC. INT. CL. 16.
- CHO, FU LIANG, IRVINE, CA:  
2,537,921, PUB. 11-20-2001. INT. CL. 42.
- CHOCOLATE ECSTASY, INC., AKRON, OH:  
2,538,154, PUB. 11-20-2001. INT. CL. 30.
- CHOCOLATES GAROTO S.A., ESPIRITO SANTO, BRAZIL:  
2,538,539, INT. CL. 30.
- CHOICE CORPORATION, CHESTERFIELD, MI:  
1,868,003, CANC. INT. CL. 7.
- CHRISTOPHER CHARLES ROPE PAMELA ANITA ROPE,  
CARBROOKE, WATTON, NORFOLK, ENGLAND TO  
PORTAPATH INTERNATIONAL LIMITED, LONDON  
EC2M7AY, UNITED KINGDOM:  
1,628,345, CANC. INT. CL. 20.
- CHROME HEARTS, INC., HOLLYWOOD, CA:  
2,538,565, INT. CL. 9.



- CHRONICLE PUBLISHING COMPANY, THE:  
*See— HEARST COMMUNICATIONS, INC..*
- CHU, VICTOR, NEW YORK, NY:  
 1,628,723, CANC. INT. CL. 42.
- CHUNG, JI YOUNG, YON SOO-KU IN CHON, REPUBLIC OF KOREA:  
 2,538,052, PUB. 7-3-2001. INT. CL. 35.
- CHURCH & DWIGHT COMPANY, GREEN RIVER, WY:  
 2,538,123, PUB. 11-20-2001. INT. CL. 31.
- CHURCH FOR SPIRITUAL DISCOVERY, THE, FAIRFAX, CA, DBA ASSOCIATION OF EDUCATIVE COUNSELORS:  
 1,868,700, CANC. INT. CL. 42.
- CHURCH OF GOD, CLEVELAND, TN:  
 2,537,699, PUB. 11-20-2001. INT. CL. 42.
- CIDCO INCORPORATED, MORGAN HILL, CA:  
 2,538,011, PUB. 11-20-2001. INT. CL. 9.
- CIGNA INTELLECTUAL PROPERTY, INC., WILMINGTON, DE:  
 2,538,259, PUB. 11-20-2001. INT. CL. 42.
- CITIZENS COMMUNICATIONS COMPANY, STANFORD, CT, HIGHLAND TELEPHONE COMPANY, MONROE, NY:  
 1,661,310, REN. 1-4-02. INT. CL. 16.
- CITRIX SYSTEMS, INC., FT. LAUDERDALE, FL:  
 2,538,153, PUB. 11-20-2001. INT. CL. 16.
- CITY DERIVATIVES SYSTEMS LTD:  
*See— FFASTFILL LIMITED.*
- CITY OF LA QUINTA, LA QUINTA, CA:  
 2,538,074, PUB. 11-20-2001. INT. CL. 42.
- CITYTOBURN INC., NEW YORK, NY:  
 2,537,892, PUB. 11-20-2001. INT. CL. 41.
- CIVIC RESEARCH INSTITUTE, INC., NEW YORK, NY:  
 2,537,715, PUB. 11-20-2001. INT. CL. 41.
- CLARIN CORPORATION, LAKE BLUFF, IL:  
 1,868,889, CANC. INT. CL. 20.
- CLARION CONCEPTS, INCORPORATED, SLEEPY HOLLOW, NY:  
 2,537,938, PUB. 11-20-2001. INT. CL. 35.
- CLARK DOOR INC., CONCORD, ONTARIO, CLARK DOOR COMPANY, INC., CRANFORD, NJ:  
 1,172,272, REN. 1-2-02. INT. CL. 19.
- CLARK, GILBERT U., BURKE, VA:  
 2,537,754, PUB. 11-20-2001. INT. CL. 36.  
 2,537,755, PUB. 11-20-2001. INT. CL. 36.
- CLAUDIA D. NICHOL, SANDRA B. BRAZIER AND DELDRA B. JEFFRIES, AROURA HILLS, CA, DBA SPEEDSKIN, LLC:  
 2,537,808, PUB. 11-20-2001. INT. CL. 9.
- CLAUSEN MILLER P.C., CHICAGO, IL:  
 2,538,075, PUB. 11-20-2001. INT. CL. 42.
- CLEMENT, TODD R., REXBURG, ID:  
 2,537,712, PUB. 11-20-2001. INT. CL. 29.
- CLINICAL REFERENCE LABORATORY, LENEXA, KS:  
 2,538,506, INT. CL. 42.
- CLIPPINGER, CARYL, FAIRFAX, VA:  
 2,537,622, PUB. 11-20-2001. INT. CL. 42.
- CLIP2.COM, SAN JOSE, CA:  
 2,537,649, PUB. 11-20-2001. INT. CL. 42.
- CLUB AT SEABROOK ISLAND, INC., JOHNS ISLAND, SC, SEABROOK ISLAND COMPANY, CHARLESTON, SC:  
 1,169,578, REN. 1-4-02. MULTIPLE CLASS, INT. CLS. 36, 37 AND 41.
- CLUB FRESH, LLC, WEST SACRAMENTO, CA:  
 2,537,680, PUB. 11-20-2001. MULTIPLE CLASS, INT. CLS. 29 AND 31.
- COASTAL AMUSEMENT DISTRIBUTORS, INC., LAKEWOOD, NJ:  
 1,868,472, CANC. INT. CL. 28.
- COASTAL INDUSTRIES, INC., CARLSTADT, NJ:  
 1,143,817, CANC. INT. CL. 1.
- COATES BROTHERS PLC, LONDON, ENGLAND:  
 1,626,522, REN. 1-3-02. INT. CL. 2.
- COAXICOM, INC., LONG ISLAND CITY, NY TO COAXICOM, INC., LONG ISLAND CITY, NY:  
 2,494,916, COR. INT. CL. 38.
- CODAN MEDIZINISCHE GERATE GMBH & CO KG, HOLSTEIN, FED REP GERMANY:  
 2,537,843, PUB. 11-20-2001. INT. CL. 10.
- COGNIS CORPORATION, CINCINNATI, OH:  
 2,537,732, PUB. 11-20-2001. INT. CL. 5.
- COIT SERVICES, INC., BURLINGAME, CA:  
 2,537,842, PUB. 11-20-2001. INT. CL. 37.
- COLD ICE CORPORATION, OAKLAND, CA:  
 1,664,649, REN. 1-3-02. INT. CL. 1.
- COLE-PARMER INSTRUMENT COMPANY, VERNON HILLS, IL:  
 923,201, REN. 1-2-02. U.S. CL. 26 (INT. CL. 9).
- COLEMAN CABLE SYSTEMS, INC., WAUKEGAN, IL:  
 2,538,564, INT. CL. 9.
- COLLECTIVE TECHNOLOGIES, INC., AUSTIN, TX:  
 2,537,669, PUB. 11-20-2001. MULTIPLE CLASS, INT. CLS. 37 AND 42.
- COLLEGE BOWL COMPANY, INC., WOODLAND HILLS, CA:  
 1,191,378, REN. 1-2-02. INT. CL. 41.  
 1,666,152, REN. 1-2-02. INT. CL. 41.
- COLOR MARKETING GROUP, INC., ARLINGTON, VA:  
 1,868,647, CANC. MULTIPLE CLASS, INT. CLS. 41 AND 42.
- COLUMBIA DRY CLEANING MACHINE CORP., WEST BABYLON, NY:  
 1,627,971, CANC. INT. CL. 7.
- COLUMBIA GRAIN INTERNATIONAL, INC., PORTLAND, OR:  
 2,537,869, PUB. 11-20-2001. INT. CL. 31.
- COLUMBIA TRISTAR HOME VIDEO, CULVER CITY, CA:  
 1,628,575, CANC. INT. CL. 35.
- COMBE INCORPORATED, WHITE PLAINS, NY:  
 1,149,920, AM. INT. CL. 25.
- COMMERCEFIRST BANCORP, INC., ANNAPOLIS, MD:  
 2,538,649, INT. CL. 36.
- COMMERX, INC., CHICAGO, IL:  
 2,537,802, PUB. 11-20-2001. MULTIPLE CLASS, INT. CLS. 35 AND 42.  
 2,537,803, PUB. 11-20-2001. MULTIPLE CLASS, INT. CLS. 35 AND 42.
- COMMONWEALTH BIOTECHNOLOGIES, INC., RICHMOND, VA:  
 2,538,503, INT. CL. 1.
- COMMONWEALTH HEALTH CORPORATION, BOWLING GREEN, KY, DBA CENTER CARE:  
 2,538,006, PUB. 11-20-2001. MULTIPLE CLASS, INT. CLS. 35 AND 36.
- COMMONWEALTH PLYWOOD CIE LTEE/CO. LTD., STE. THERESE, QUEBEC, CANADA:  
 1,177,236, REN. 1-2-02. INT. CL. 19.
- COMMUNITY HEALTH CHARITIES, INC., ARLINGTON, VA, COMBINED HEALTH APPEAL OF AMERICA, ATLANTA, GA:  
 1,604,012, REN. 12-30-01. INT. CL. 36.
- COMPAGNIE GERVAIS DANONE, LEVALLOIS-PERRET, FRANCE:  
 1,144,416, CANC. INT. CL. 30.
- COMPAQ COMPUTER CORPORATION, HOUSTON, TX:  
 1,868,541, CANC. INT. CL. 35.
- COMPASS PPA INCORPORATED, CHICAGO, IL:  
 1,868,578, CANC. INT. CL. 36.
- COMPU SOFT OF N.J. INC., OLD BRIDGE, NJ:  
 1,628,062, CANC. INT. CL. 9.
- CONAIR CORPORATION, STAMFORD, CT:  
 1,628,171, CANC. INT. CL. 10.
- CONCEPTS DIRECT, INC., LONGMONT, CO:  
 1,868,248, CANC. INT. CL. 16.
- CONGRESSIONAL INFORMATION SERVICE, INC., BETHESDA, DC:  
 1,173,576, REN. 1-2-02. MULTIPLE CLASS, INT. CLS. 35 AND 41.
- CONMED ANDOVER MEDICAL, INC., UTICA, NY, AND-OVER MEDICAL INCORPORATED, LOWELL, MA:  
 1,179,978, REN. 1-3-02. INT. CL. 10.
- CONMED CORPORATION, UTICA, NY:  
 2,537,903, PUB. 11-20-2001. INT. CL. 10.
- CONNER, PRESTON LEE, KANSAS CITY, MO:  
 1,868,553, CANC. MULTIPLE CLASS, INT. CLS. 35 AND 42.

- CONOCO INC., PONCA CITY, OK:  
708,645, CANC. U.S. CL. 15.
- CONOCO INC., HOUSTON, TX:  
2,538,414, PUB. 11-20-2001. INT. CL. 1.
- CONRAD YELVINGTON DISTRIBUTORS, INC., DAYTONA BEACH, FL:  
2,537,535, PUB. 11-20-2001. INT. CL. 35.
- CONSOLIDATED CHEMICAL, INC., ST. LOUIS, MO:  
1,171,874, REN. 1-4-02. INT. CL. 3.
- CONSOLIDATED SPECIALTY RESTAURANTS, INC., INDIANAPOLIS, IN, SNAK'S FIFTH AVE., INC., ORLAND PARK, IL, AKA THE CHARLEY HORSE:  
1,195,923, REN. 1-4-02. INT. CL. 42.
- CONSTRUCTION COOPERATION AND EDUCATION TRUST, A NEW YORK NOT FOR PROFIT LABOR MANAGEMENT TRUST, THE TRUSTEES COMPRISING STEPHEN REMINTON, JOHN CASEY, RONALD POMERENING, THOMAS J. MCCADDEN, FRANK WIRT, MARTIN POTTER, ROBERT BROWN, GARY ROTH, RICHARD T. HARDY AND GARY SQUIRES, ALL U.S. CITIZENS, THE, ROCHESTER, NY:  
2,419,721, COR. INT. CL. 42.
- CONTEC CO. LTD., NISHIYODOGAWA-KU, OSAKA 555, JAPAN, DBA CONTROL TECHNOLOGY CO. LTD.:  
1,660,603, REN. 1-4-02. INT. CL. 9.
- CONTINENTAL AUTOMOTIVE LICENSING CORP, AUBURN HILLS, MI, GENERAL TIRE & RUBBER COMPANY, THE, AKRON, OH:  
1,155,497, REN. 1-3-02. INT. CL. 12.
- CONTROL INSTALLATIONS OF IOWA, INC., DES MOINES, IA:  
2,537,695, PUB. 11-20-2001. MULTIPLE CLASS, INT. CLS. 37 AND 42.
- CONTROLLED F.O.R.C.E. INC., GENEVA, IL:  
2,489,893, COR. MULTIPLE CLASS, INT. CLS. 9 AND 41.
- CONVERSE, INC., NORTH READING, MA:  
1,868,352, CANC. INT. CL. 25.
- CONVERSIONS MADE EASY, INC., MANCHESTER, MO:  
2,538,696, INT. CL. 16.
- CONVERTO MFG. CO., INC., CAMBRIDGE CITY, IN, GOLAY & CO., CAMBRIDGE CITY, IN:  
722,454, REN. 1-2-02. U.S. CL. 2 (INT. CL. 6).
- CONVEYERED AGGREGATE DELIVERY, INC., EUGENE, OR:  
2,537,988, PUB. 11-20-2001. INT. CL. 37.
- CONXALL CORPORATION, VILLA PARK, IL:  
1,679,244, REN. 1-4-02. INT. CL. 9.
- COOKE, BRUCE E., REDONDO BEACH, CA:  
2,537,845, PUB. 4-3-2001. INT. CL. 41.
- COOLEY GROUP HOLDINGS, INC., PAWTUCKET, RI:  
2,537,626, PUB. 11-20-2001. INT. CL. 24.
- COOPER INDUSTRIES, INC., HOUSTON, TX:  
708,707, CANC. U.S. CL. 23.
- COOPER TECHNOLOGIES COMPANY, HOUSTON, TX, B-LINE SYSTEMS, INC., HIGHLAND, IL:  
1,653,451, REN. 1-3-02. INT. CL. 6.
- CORDIANT COMMUNICATIONS GROUP PLC, SAN RAFAEL, CA TO CORDIANT COMMUNICATIONS GROUP PLC, LONDON W1A 4XA, ENGLAND:  
2,422,495, COR. INT. CL. 35.
- CORNING INCORPORATED, CORNING, NY, CORNING GLASS WORKS, CORNING, NY:  
547,397, REN. 1-4-02. U.S. CL. 26 (INT. CL. 9).
- CORNS, STEVEN R., WINSTON-SALEM, NC:  
1,868,404, CANC. INT. CL. 25.
- CORTICEIRA AMORIM S.G.P.S., S.A., 4535 MOZELOS, PORTUGAL:  
2,538,501, MULTIPLE CLASS, INT. CLS. 19, 20 AND 27.
- COSMEBEL SPRL. CO., 1030 BRUSSELS, BELGIUM:  
1,867,903, CANC. INT. CL. 3.
- COSTCO WHOLESALE CORPORATION:  
*See— COSTCO WHOLESALE MEMBERSHIP, INC.*
- COSTCO WHOLESALE MEMBERSHIP, INC., ISSAQUAH, WA FROM COSTCO WHOLESALE CORPORATION, ISSAQUAH, WA:  
2,537,696, PUB. 11-20-2001. INT. CL. 39.
- COTEE INDUSTRIES INC., PORT RICHEY, FL:  
1,628,468, CANC. INT. CL. 28.
- COUNCIL OF BETTER BUSINESS BUREAUS, INC., ARLINGTON, VA:  
1,628,311, CANC. INT. CL. 16.
- COUNTRY CHARM, LTD., RICHMOND, VA:  
1,144,582, CANC. INT. CL. 42.
- COURTESY PRODUCTS, L.L.C., ST. LOUIS, MO:  
2,538,021, PUB. 11-20-2001. INT. CL. 35.
- COVENANT TRUST COMPANY, CHICAGO, IL:  
2,537,533, PUB. 11-20-2001. INT. CL. 35.
- COX COMMUNICATIONS, INC., ATLANTA, GA:  
2,537,867, PUB. 11-20-2001. INT. CL. 38.
- COX ENTERPRISES, INC., ATLANTA, GA:  
1,628,571, CANC. INT. CL. 35.
- CPI CHURCH STREET, INC., BALTIMORE, MD:  
1,628,691, CANC. MULTIPLE CLASS, INT. CLS. 41 AND 42.  
1,628,693, CANC. MULTIPLE CLASS, INT. CLS. 41 AND 42.  
1,628,702, CANC. MULTIPLE CLASS, INT. CLS. 41 AND 42.  
1,628,762, CANC. INT. CL. 42.
- CRANE AMERICA SERVICES, INC, DAYTON, OH:  
2,537,985, PUB. 11-20-2001. INT. CL. 37.
- CRASNICK, RICHARD M., SANTA MONICA, CA:  
2,538,203, PUB. 11-20-2001. INT. CL. 28.
- CREATION STATION FINE ART STUDIO, LLC, THE, VANCOUVER, WA:  
2,499,793, CANC. IIRN. RESTORED TO S.N. 75-928,992.
- CREATION'S OWN, PALM BAY, FL:  
2,538,467, INT. CL. 5.
- CREATIVDESIGN GROUP, INC., REDANDO BEACH, CA:  
2,537,850, PUB. 11-20-2001. INT. CL. 41.
- CREATIVE INET, LLC, HANFORD, CA:  
2,537,916, PUB. 11-20-2001. INT. CL. 42.
- CREATIVE MARKETING TECHNIQUES, INC., PLANTATION, FL:  
2,538,674, INT. CL. 41.
- CREDIT BUREAU OF GREATER GREENSBORO, GREENSBORO, NC, DBA CREDIT BUREAU INFORMATION SERVICES:  
2,538,469, INT. CL. 36.
- CREEKSIDE MUSHROOMS LTD, WORTHINGTON, PA, BUTLER COUNTY MUSHROOM FARM, INC., WEST WINFIELD, PA:  
930,109, REN. 1-2-02. U.S. CL. 46 (INT. CL. 31).
- CRESCENT REAL ESTATE EQUITIES, FORT WORTH, TX:  
2,537,587, PUB. 11-20-2001. INT. CL. 35.
- CRESSET CHEMICAL COMPANY, WESTON, OH:  
1,666,334, REN. 12-29-01. INT. CL. 1.
- CRIME PREVENTION, INC., CHARLOTTE, NC:  
2,537,673, PUB. 11-20-2001. MULTIPLE CLASS, INT. CLS. 37 AND 42.
- CROCKER, MICHAEL W., BURLINGTON, MA AND ENGEL, STEPHEN, STRATHAM, NH:  
2,538,571, INT. CL. 25.
- CRONOS GROUP SA, THE, L-1126 LUXEMBOURG, LUXEMBOURG TO C G HOLDING S.A., L-1126 LUXEMBOURG, LUXEMBOURG:  
2,388,943, COR. INT. CL. 36.
- CRONOS, ARTHUR, FAIRFAX, VA:  
2,538,114, PUB. 11-20-2001. INT. CL. 15.
- CROSS CREATIVE CONCEPTS, INC., ATLANTA, GA, DBA DBA C3 MARKETING:  
2,537,983, PUB. 11-20-2001. INT. CL. 30.
- CROWD CONTROL INTERACTIVE GROUP, ATLANTA, GA:  
2,538,607, INT. CL. 42.
- CROWN CRAFTS, INC., ATLANTA, GA, CCLR, INC., WILMINGTON, DE:  
1,660,882, REN. 1-2-02. INT. CL. 24.  
1,660,883, REN. 1-2-02. INT. CL. 24.
- CRU & ASSOCIATES, LLC, TOWSON, MD:  
2,537,698, PUB. 11-20-2001. INT. CL. 36.
- CRYSTAL BREATH, INCORPORATED, BURBANK, CA:  
2,254,160, CANC. MULTIPLE CLASS, INT. CLS. 3 AND 5.
- CRYSTALLIZE, INC., ANN ARBOR, MI:  
2,538,540, INT. CL. 9.

CSM INDUSTRIES, INC., CLEVELAND, OH:  
2,538,003, PUB. 11-20-2001. INT. CL. 40.

CTI LIMITED, INC., DALLAS, TX:  
2,538,511, INT. CL. 9.

CUPRUM, S.A. DE C.V. NUEVO LEON, MEXICO:  
1,867,977, CANC. INT. CL. 6.

CURTICE-BURNS, INC., ROCHESTER, NY:  
1,144,391, CANC. MULTIPLE CLASS, INT. CLS. 29 AND 30.

CUSTARD INSURANCE ADJUSTERS, INC., FT. WAYNE, IN:  
1,144,503, CANC. INT. CL. 36.

CUSTOM BUILDING PRODUCTS, SEAL BEACH, CA,  
MONTGOMERY, JAMES D., JR., FT. LAUDERDALE, FL:  
1,626,000. REN. 1-4-02. INT. CL. 19.  
1,626,001. REN. 1-4-02. INT. CL. 19.

CUSTOM COALS CORPORATION, PITTSBURGH, PA:  
1,868,637, CANC. MULTIPLE CLASS, INT. CLS. 40 AND 42.

CUTTING BOARD, INC., THE, BURLINGTON, NC:  
2,538,094, PUB. 11-20-2001. INT. CL. 42.

CUX, INC., NEW YORK, NY:  
2,537,776, PUB. 11-20-2001. INT. CL. 41.

CYBEMOMICS, INC., CHICAGO, IL:  
2,537,800, PUB. 11-20-2001. INT. CL. 35.

CYBER SWITCHING, INC., SANTA CLARA, CA:  
2,538,105, PUB. 11-20-2001. INT. CL. 9.

CYBERFINA PRODUCTIONS INCORPORATED, MCLEAN, VA:  
2,538,391, PUB. 11-20-2001. INT. CL. 42.

CYBERLIFE TECHNOLOGY LIMITED, CAMBRIDGE CB5 8AB, UNITED KINGDOM:  
2,537,596, PUB. 11-20-2001. MULTIPLE CLASS, INT. CLS. 9 AND 28.

CYBRCOLLECT, INC., LACROSSE, WI:  
2,538,073, PUB. 11-20-2001. INT. CL. 36.

CYCLOX CORPORATION, SAN FRANCISCO, CA:  
1,868,819, CANC. INT. CL. 6.

CYTYC CORPORATION, BOXBOROUGH, MA:  
1,701,270. REN. 12-30-01. INT. CL. 1.

C2 CORPORATION, TAICHUNG, TAIWAN:  
2,537,723, PUB. 10-16-2001. INT. CL. 25.

C3 COMMUNICATIONS, INC., AUSTIN, TX:  
2,464,951, CANC. IIRN. RESTORED TO S.N. 75-675,746.

D'AMARIO, PASQUALE, 64032 ATRI (PROVINCE OF TERAMO), ITALY:  
2,537,521, PUB. 11-20-2001. INT. CL. 30.

D'LSI FOOD SYSTEMS, INC., CANANDAIGUA, NY:  
2,538,042, PUB. 11-20-2001. INT. CL. 30.

DA BOMB ENTERTAINMENT GROUP, INC., LOS ANGELES, CA:  
1,868,109, CANC. INT. CL. 9.

DA CONSULTING GROUP, INC., HOUSTON, TX:  
2,537,633, PUB. 11-20-2001. INT. CL. 35.

DAIDO CORPORATION, SOMERSET, NJ:  
715,001. REN. 1-4-02. U.S. CL. 23 (INT. CLS. 6 AND 7).

DAIHEN CORPORATION, YODOGAWA-KU, OSAKA-SHI, JAPAN:  
1,144,013, CANC. INT. CL. 9.

DAIMLERCHRYSLER AG, 70567 STUTTGART, FED REP GERMANY:  
2,537,844, PUB. 11-20-2001. INT. CL. 12.

DAISY BRAND, INC., DALLAS, TX:  
1,636,250. REN. 12-31-01. INT. CL. 29.

DALY, LOUANN, MARBLEHEAD, MA:  
2,538,624, MULTIPLE CLASS, INT. CLS. 35 AND 42.

DAMPP-CHASER ELECTRONICS CORPORATION, HENDERSONVILLE, NC, DAMPP-CHASER ELECTRONICS, INC., HENDERSONVILLE, NC:  
921,922. REN. 1-4-02. MULTIPLE CLASS, U.S. CLS. 26 (INT. CL. 9) AND 34 (INT. CL. 11).

DANCE INSTITUTE OF WASHINGTON, WASHINGTON, DC:  
2,538,355, PUB. 11-20-2001. INT. CL. 41.

DANSK ETERNIT A/S, DK-9000 AALBORG, DENMARK,  
DANSK ETERNIT-FABRIK A/S, AALBORG, DENMARK:  
1,150,439. REN. 1-3-02. MULTIPLE CLASS, INT. CLS. 19 AND 37.

DARROW PRODUCTION COMPANY, EL RENO, OK:  
1,868,879, CANC. INT. CL. 16.

DAVID MOSNER INC., BRONX, NY:  
2,538,124, PUB. 11-20-2001. INT. CL. 29.

DAVOX CORPORATION, BILLERICA, MA:  
1,868,030, CANC. INT. CL. 9.

DAWSON HOME FASHIONS, INC., NEW YORK, NY:  
1,868,899, CANC. INT. CL. 24.

DAYDOTS INTERNATIONAL, INC., FORT WORTH, TX:  
2,538,187, PUB. 11-20-2001. INT. CL. 21.

DCT FACTORY, INC., WALNUT, CA:  
2,538,222, PUB. 11-20-2001. INT. CL. 9.

DC4, SANTA CLARITA, CA:  
2,537,614, PUB. 11-20-2001. INT. CL. 41.

DE SOTO CLOTHING CO., INC., SAN DIEGO, CA:  
1,868,397, CANC. INT. CL. 25.

DECCA MUSIC GROUP LIMITED, LONDON W4 4HS, ENGLAND:  
2,538,195, PUB. 11-20-2001. INT. CL. 9.

DECKER RESEARCH SERVICES, INCORPORATED, LAKE-LAND, FL:  
1,868,766, CANC. INT. CL. 42.

DEERY AMERICAN CORPORATION, GRAND JUNCTION, CO:  
1,660,840. REN. 1-3-02. INT. CL. 19.

DEGRAEVE, DIRK G.A., AGOURA HILLS, CA:  
1,868,532, CANC. INT. CL. 35.

DEJORIA, BELLA, OXNARD, CA:  
1,628,811, CANC. INT. CL. 3.

DEJOSIA, FRANCESCA, NEW YORK CITY, NY:  
2,537,659, PUB. 11-20-2001. INT. CL. 42.

DEL HIERRO, CHARLES, TUCSON, AZ:  
2,538,289, PUB. 11-20-2001. INT. CL. 42.  
2,538,290, PUB. 11-20-2001. INT. CL. 35.

DEL MONTE CORPORATION, SAN FRANCISCO, CA:  
1,144,394, CANC. INT. CL. 29.

DEL'S LEMONADE & REFRESHMENTS, INC., CRANSTON, RI:  
1,681,680. REN. 1-3-02. INT. CL. 30.  
1,682,182. REN. 1-2-02. INT. CL. 32.

DEL'S SEAWAY SHRIMP & OYSTER CO., INC., BILOXI, MS:  
1,144,406, CANC. INT. CL. 29.  
1,144,407, CANC. INT. CL. 29.

DELANEY COMPANY, INC, THE, CUMMING, GA:  
2,538,694, MULTIPLE CLASS, INT. CLS. 6 AND 21.

DELCO REMY AMERICA, INC., ANDERSON, IN:  
2,494,892, COR. INT. CL. 9.

DELICATO VINEYARDS, MANTECA, CA, DBA PALOMA WINE COMPANY:  
1,628,553, CANC. INT. CL. 33.

DELTA CORPORATE IDENTITY, INC., ATLANTA, GA:  
2,538,221, PUB. 11-20-2001. INT. CL. 39.

DELTA DATA SYSTEMS, INC., PICAYUNE, MS:  
1,868,045, CANC. INT. CL. 9.

DENT ENTERPRISES, INC., DEWITT, MI:  
2,538,247, PUB. 11-20-2001. MULTIPLE CLASS, INT. CLS. 36, 37 AND 42.

DENTSPLY RESEARCH & DEVELOPMENT CORP., MILFORD, DE:  
1,144,041, CANC. INT. CL. 10.

DENTSPLY RESEARCH & DEVELOPMENT CORP., LOS ANGELES, CA, DENTSPLY INTERNATIONAL INC., YORK, PA:  
1,666,420. REN. 1-3-02. MULTIPLE CLASS, INT. CLS. 5 AND 10.

DENVER PUBLISHING COMPANY, THE, DENVER, CO:  
737,180. REN. 1-4-02. U.S. CL. 38 (INT. CL. 16).

DESIGN BRIDGE LIMITED, LONDON EC1R 0AA, UNITED KINGDOM:  
1,868,520, CANC. MULTIPLE CLASS, INT. CLS. 35 AND 42.

DEVRY, INC., EVANSTON, IL:  
1,144,119, CANC. INT. CL. 16.

DEXTRAN PRODUCTS LIMITED, SCARBOROUGH, ONTARIO, CANADA:  
1,867,901, CANC. MULTIPLE CLASS, INT. CLS. 3 AND 5.

DIAGNOSTICS & DESIGNS, INC., CERRITOS, CA:  
2,538,566, INT. CL. 3.

- DIAL BRANDS, INC., SCOTTSDALE, AZ:  
2,537,576, PUB. 11-20-2001. INT. CL. 5.
- DIAMOND MICRO SOLUTIONS, INC., SAN LEANDRO, CA:  
1,662,074. REN. 1-3-02. INT. CL. 42.
- DICAMILLO BAKING COMPANY, INC., NIAGARA FALLS, NY:  
1,662,638. REN. 1-4-02. INT. CL. 30.
- DIET CENTER, INC., PITTSBURGH, PA:  
1,868,940. CANC. INT. CL. 29.
- DIGIFILM SERVICES, INC., FLUSHING, NY:  
1,868,642. CANC. INT. CL. 40.
- DIGITAL CONSULTING, INC., ANDOVER, MA:  
1,628,682. CANC. INT. CL. 41.
- DILETTANTE CHOCOLATES, INC., SEATTLE, WA:  
2,537,552, PUB. 11-20-2001. INT. CL. 30.
- DILLARD'S, INC., LITTLE ROCK, AR, DILLARD DEPARTMENT STORES, INC., LITTLE ROCK, AR:  
1,662,539. REN. 1-2-02. INT. CL. 25.
- DIMARE ENTERPRISES, INC., NEWMAN, CA:  
2,538,449, MULTIPLE CLASS, INT. CLS. 29 AND 31.
- DIRECT COMMUNICATION SERVICE, INC., DENVER, CO, INFINITIVE HORIZONS, INC., ST. LOUIS, MO:  
1,661,054. REN. 1-4-02. INT. CL. 35.
- DIRECTV, INC., EL SEGUNDO, CA:  
2,538,285, PUB. 11-20-2001. INT. CL. 38.
- DISPATCH COMMUNICATIONS, INC., RUTHERFORD, NJ:  
1,628,642. CANC. INT. CL. 38.
- DISTRICT BOARD OF TRUSTEES, MIAMI-DADE COMMUNITY COLLEGE, THE, MIAMI, FL:  
2,538,608, INT. CL. 36.
- DIVERSEY CORPORATION, THE, NORTHBROOK, IL:  
708,592, CANC. U.S. CL. 6.
- DIVI HOTELS MARKETING, INC., CHAPEL HILL, NC:  
1,641,680. REN. 12-30-01. INT. CL. 42.
- DIXON, ARNE, BOTHELL, WA:  
1,661,510. REN. 1-4-02. MULTIPLE CLASS, INT. CLS. 9 AND 41.
- DMA GROUP, INC., EXETER, NH:  
1,628,585, CANC. INT. CL. 35.
- DOL SPORTSKIRT, SAN ANSELMO, CA:  
2,537,881, PUB. 11-20-2001. INT. CL. 25.
- DOLAN MEDIA COMPANY, MINNEAPOLIS, MN:  
2,537,610, PUB. 11-20-2001. MULTIPLE CLASS, INT. CLS. 16 AND 42.
- DOLLAR RENT-A-CAR SYSTEMS, INC., LOS ANGELES, CA:  
1,144,524, CANC. INT. CL. 39.
- DOLLAR TREE STORES, INC., NORFOLK, VA:  
1,628,740, CANC. INT. CL. 42.
- DOMINION VIDEO SATELLITE, INC., NAPLES, FL:  
2,537,898, PUB. 11-20-2001. INT. CL. 35.
- DOMINO'S PIZZA PMC, INC., ANN ARBOR, MI:  
2,538,397, PUB. 11-20-2001. INT. CL. 30.  
2,538,398, PUB. 11-20-2001. INT. CL. 30.  
2,538,399, PUB. 11-20-2001. INT. CL. 30.  
2,538,400, PUB. 11-20-2001. INT. CL. 30.  
2,538,401, PUB. 11-20-2001. INT. CL. 30.
- DON CARLOS FOODS, INC., HIALEAH, FL:  
2,537,816, PUB. 11-20-2001. INT. CL. 30.
- DON FOSHER, INC., CLAYTON, MO:  
1,144,208, CANC. INT. CL. 20.
- DONALDSON, JUNE A., CALGARY, ALBERTA T2S 1 W4, CANADA:  
2,537,662, PUB. 10-3-2000. MULTIPLE CLASS, INT. CLS. 16, 41 AND 42.
- DONOHUE INC., QUEBEC, CANADA:  
1,143,813, CANC. INT. CL. 1.
- DONOHUE, NANCY, EAST NORWALK, CT:  
1,144,122, CANC. INT. CL. 16.
- DOO, RODNEY, HONOLULU, HI:  
1,708,325. REN. 1-4-02. INT. CL. 25.
- DORNER MFG. CORP., HARTLAND, WI:  
2,538,534, MULTIPLE CLASS, INT. CLS. 7, 37, 40 AND 42.
- DOUBLE EAGLE B.V., CURACAO, NETHERLD ANTILLES:  
2,537,785, PUB. 11-20-2001. INT. CL. 33.
- DOUGLAS JOHN TRADING COMPANY, JACKSONVILLE, FL:  
1,868,546, CANC. MULTIPLE CLASS, INT. CLS. 35 AND 42.
- DOW CHEMICAL COMPANY, THE, MIDLAND, MI:  
935,861. REN. 12-31-01. U.S. CL. 6 (INT. CL. 1).  
1,693,838. REN. 12-31-01. INT. CL. 1.
- DOW CORNING CORPORATION, MIDLAND, MI:  
2,538,692, INT. CL. 16.
- DR PARTNERS, FORT SMITH, AR:  
2,538,235, PUB. 11-20-2001. INT. CL. 16.
- DRAKA UK LIMITED, WASHINGTON, TYNE & WEAR WE38 0AQ, UNITED KINGDOM:  
2,537,729, PUB. 11-20-2001. INT. CL. 9.
- DREEBEN; DAN STERN, SAN ANTONIO, TX:  
1,144,209, CANC. INT. CL. 20.
- DRUGMONITOR.COM, INC., BETHESDA, MD:  
2,537,688, PUB. 11-20-2001. INT. CL. 42.
- DRUMMOND COMPANY, INC., LAKELAND, FL:  
1,661,105. REN. 12-29-01. INT. CL. 37.
- DRUSTAR, INC., GROVE CITY, OH:  
1,628,051, CANC. INT. CL. 9.
- DUDLEY PRODUCTS, INC., GREENSBORO, NC:  
1,627,905, CANC. INT. CL. 3.
- DUKE UNIVERSITY, DURHAM, NC:  
2,537,692, PUB. 11-20-2001. MULTIPLE CLASS, INT. CLS. 38 AND 41.
- DUNKIN' DONUTS USA, INC., PLYMOUTH, MI:  
2,538,652, INT. CL. 42.
- DURAMAX, INC., MIDDLEFIELD, OH:  
2,538,311, PUB. 11-20-2001. INT. CL. 19.
- DURATEX S/A, SAO PAULO, BRAZIL:  
1,144,183, CANC. INT. CL. 19.
- DURATEX S/A, (01311) SAO PAULO SP, BRAZIL:  
1,868,791, CANC. MULTIPLE CLASS, INT. CLS. 11 AND 21.
- DURILON BRAKE COMPANY, INC., LONGVIEW, TX:  
1,868,260, CANC. INT. CL. 16.
- DURSOL-FABRIK OTTO DURST GMBH & CO. KG., 5650 SOLINGEN-WALD, FED REP GERMANY:  
1,143,807, CANC. MULTIPLE CLASS, INT. CLS. 1, 3, 5 AND 21.
- DVDTRANSFER.COM, L.L.C., MINNEAPOLIS, MN:  
2,538,711, INT. CL. 40.
- DWORKIN, MICHAEL L., SAN FRANCISCO, CA:  
1,868,877, CANC. INT. CL. 16.
- DYNALLOY, INC., INDIANAPOLIS, IN:  
2,538,001, PUB. 11-20-2001. INT. CL. 1.
- DYNAMIC ANALYSIS, INC., HUNTSVILLE, AL:  
1,868,087, CANC. INT. CL. 9.
- DYNAPOINT, INC., CITY OF INDUSTRY, CA:  
1,868,067, CANC. MULTIPLE CLASS, INT. CLS. 9 AND 28.
- DYNATECH LABORATORIES INCORPORATED, CHANTILLY, VA:  
1,143,996, CANC. INT. CL. 9.  
1,143,998, CANC. INT. CL. 9.
- DYNIX CORPORATION, PROVO, UT:  
1,868,719, CANC. INT. CL. 42.
- E RESOURCES INC., ROANOKE, TX:  
2,538,265, PUB. 11-20-2001. INT. CL. 35.  
2,538,266, PUB. 11-20-2001. INT. CL. 35.
- E. & J. GALLO WINERY, MODESTO, CA, AKA GALLO LIVINGSTON CELLARS:  
1,179,451. REN. 12-31-01. INT. CL. 33.
- E. A. SWEEN COMPANY, EDEN PRAIRIE, MN:  
2,537,765, PUB. 11-20-2001. MULTIPLE CLASS, INT. CLS. 30 AND 42.
- E. EDELMANN & CO., CHICAGO, IL TO EPICOR INDUSTRIES, INC., NORTHBROOK, IL:  
923,036, CANC. MULTIPLE CLASS, U.S. CLS. 19, 23 AND 26.
- E. REMY MARTIN & CO S.A., 16100 COGNAC, FRANCE:  
2,537,645, PUB. 11-20-2001. INT. CL. 33.
- E. T. BROWNE DRUG CO., INC., ENGLEWOOD CLIFFS, NJ, LEMUR LABORATORIES, INC., NEW YORK, NY:  
927,471. REN. 1-2-02. U.S. CL. 51 (INT. CL. 3).
- E. W. BLISS COMPANY, INC., HASTINGS, MI:  
1,164,356. REN. 1-2-02. INT. CL. 7.
- E.K. SUCCESS, LTD., CLIFTON, NJ:  
2,538,575, INT. CL. 16.

E.S. ORIGINALS, INC., NEW YORK, NY:  
1,868,914, CANC. INT. CL. 25.  
1,868,915, CANC. INT. CL. 25.

E-CLASSICSYSTEMS, INC., NORWOOD, MA:  
2,538,377, PUB. 11-20-2001. INT. CL. 9.

E-TINIAN, L.L.C., HEATHROW, FL:  
2,537,670, PUB. 11-20-2001. INT. CL. 35.

EAGLE ELECTRIC MFG. CO., INC., HOUSTON, TX:  
549,293. REN. 1-2-02. U.S. CL. 21 (INT. CL. 9).

EAST TEXAS DISTRIBUTING INC., HOUSTON, TX:  
2,538,546, INT. CL. 25.

EAST-SIDE WINERY, LODI, CA:  
2,538,583, INT. CL. 33.

EASTERBROOK ALLCARD & CO. LIMITED, SHEFFIELD, ENGLAND:  
144,382. REN. 1-3-02. U.S. CL. 23 (INT. CL. 7).

EASTERN MERCHANDISE CO., INC., SEATTLE, WA:  
1,868,200, CANC. INT. CL. 14.

EASTERN U.S. BUDDHA'S STUDY (FALUN DAFA) ASSOCIATION, THE, STATEN ISLAND, NY:  
2,538,512, MULTIPLE CLASS, INT. CLS. 6, 9, 16 AND 24.

EASTMAN KODAK COMPANY, ROCHESTER, NY:  
708,728, CANC. U.S. CL. 26.  
1,868,111, CANC. INT. CL. 9.

EBSO INDUSTRIES, INC., BIRMINGHAM, AL, AKA VULCAN INDUSTRIES:  
1,192,142. REN. 1-2-02. INT. CL. 20.

EBY, MICHAEL J, SAN CARLOS, CA, DBA PHORTECH INTERNATIONAL:  
2,538,080, PUB. 11-20-2001. INT. CL. 35.

ECHO TOYS LTD., TAI PO, NEW TERRITORIES, HONG KONG:  
2,538,630, INT. CL. 28.

ECKOLD AG, TRIMMIS, SWITZERLAND, W. ECKOLD AG, TRIMMIS-STATION, SWITZERLAND:  
1,181,841. REN. 1-4-02. MULTIPLE CLASS, INT. CLS. 7 AND 8.

ECONOMICS AND TECHNOLOGY, INC., BOSTON, MA:  
1,628,068, CANC. INT. CL. 9.

ECONOTECH, INC., LAMBERTVILLE, NJ:  
1,628,129, CANC. INT. CL. 9.

EDDY PACKING CO., INC., YOAKUM, TX:  
2,538,104, PUB. 11-20-2001. INT. CL. 29.

EDFUND, RANCHO CORDOVA, CA:  
2,537,967, PUB. 11-20-2001. INT. CL. 36.

EDUCITY OF SALAURA INC., GREENSBORO, NY:  
2,538,502, INT. CL. 9.

EGGERT, WALLACE MARTIN, ST. PETERSBURG, FL:  
2,538,499, INT. CL. 25.

EKCO HOUSEWARES, INC., FRANKLIN PARK, IL:  
1,144,215, CANC. INT. CL. 21.  
1,144,216, CANC. INT. CL. 21.

EL CENTRO FOODS, INC., NORTH HOLLYWOOD, CA:  
1,173,708. REN. 1-4-02. INT. CL. 42.

ELECTRA-CARE, LLC, TOPEKA, KS:  
2,538,288, PUB. 11-20-2001. INT. CL. 9.

ELECTRONIC ARTS INC., REDWOOD CITY, CA:  
2,537,880, PUB. 11-20-2001. INT. CL. 9.

ELECTRONIC DATA SYSTEMS CORPORATION, PLANO, TX:  
1,628,127, CANC. INT. CL. 9.  
1,868,875, CANC. INT. CL. 16.

ELECTRONICS DESIGN GROUP, INC., PISCATAWAY, NJ:  
2,538,287, PUB. 11-20-2001. INT. CL. 37.

ELLIOTT, TIM H., BAYTOWN, TX:  
1,868,458, CANC. INT. CL. 28.

ELMORE SPORTS GROUP, INC., WEST VALLEY CITY, UT:  
2,538,351, PUB. 11-20-2001. INT. CL. 41.

ELOAD, TORONTO, CANADA:  
2,537,771, PUB. 11-20-2001. INT. CL. 32.

ELSICON, INCORPORATED, NEWARK, DE:  
2,478,834, AM. INT. CL. 9.

ELTRA CORPORATION, TOLEDO, OH:  
708,727, CANC. U.S. CL. 26.

EMERSON ELECTRIC COMPANY, ST. LOUIS, MO:  
1,868,824, CANC. INT. CL. 7.

EMERSON POWER TRANSMISSION MANUFACTURING, LP, MAYSVILLE, KY, EMERSON ELECTRIC CO., ST. LOUIS, MO:  
1,150,240. REN. 1-2-02. INT. CL. 7.

EMMEPI DI MANNA & C. SNC, 15048 VALENZA (AL), ITALY:  
2,538,035, PUB. 11-20-2001. INT. CL. 14.

EMOTION, INC., VIENNA, VA:  
2,537,798, PUB. 11-20-2001. INT. CL. 39.

EMPIRE ENTERPRISES, INC., SHELBYVILLE, TN:  
1,144,151, CANC. INT. CL. 16.

EMPIRE KOSHER POULTRY, INC., MIFFLINTOWN, PA:  
1,144,401, CANC. INT. CL. 29.

EMPLOYEE BENEFITS COOPERATIVE, MADISON, WI:  
2,538,178, PUB. 11-20-2001. INT. CL. 36.

ENCODA SYSTEMS, INC., DENVER, CO, DATA COMMUNICATIONS CORPORATION, MEMPHIS, TN:  
1,180,446. REN. 1-2-02. MULTIPLE CLASS, INT. CLS. 35 AND 42.

ENDRESS + HAUSER WETZER GMBH + CO. KG, D-87481 NESSELWANG, FED REP GERMANY:  
2,537,672, PUB. 8-7-2001. INT. CL. 9.

ENERGY CONVERSION DEVICES, TROY, MI:  
2,537,959, PUB. 11-20-2001. INT. CL. 42.

ENERGY EXPRESS, LTD., CHICAGO, IL:  
1,868,682, CANC. INT. CL. 41.

ENGEL BROTHERS, NEW YORK, NY:  
1,669,359. REN. 12-30-01. INT. CL. 14.

ENGELHARD CORPORATION, ISELIN, NJ:  
1,940,149, COR. INT. CL. 1.  
2,538,069, PUB. 11-20-2001. INT. CL. 17.

ENPROTECH CORPORATION, NEW YORK, NY:  
1,868,998, CANC. INT. CL. 42.

ENTEK CORPORATION, ELKRIDGE, MD:  
2,538,419, PUB. 11-20-2001. INT. CL. 5.

ENTERPRISE FOUNDATION, THE, COLUMBIA, MD:  
1,666,089. REN. 12-30-01. INT. CL. 37.  
1,666,090. REN. 12-30-01. INT. CL. 37.

ENTERTAINMENT & COMMUNICATIONS GROUP, INC., NORTH MIAMI, FL:  
2,538,347, PUB. 11-20-2001. INT. CL. 41.

ENTERTAINMENT PUBLICATIONS OPERATING COMPANY, INC., TROY, MI:  
2,537,885, PUB. 11-20-2001. INT. CL. 16.

ENVIRONMENTAL RESOURCES MANAGEMENT, INC., EXTON, PA:  
1,868,271, CANC. INT. CL. 16.

EPICOR INDUSTRIES, INC., NORTHBROOK, IL, E. EDELMANN & CO., CHICAGO, IL:  
923,036. REN. 1-2-02. MULTIPLE CLASS, U.S. CLS. 2 (INT. CL. 20), 13 (INT. CL. 6) AND 35 (INT. CL. 17).

EQUIFAX INC., ATLANTA, GA:  
2,538,248, PUB. 11-20-2001. INT. CL. 36.  
2,538,255, PUB. 11-20-2001. INT. CL. 36.

EQUITRAC CORPORATION, CORAL GABLES, FL:  
2,538,637, INT. CL. 9.

ERMANCO INCORPORATED, SPRING LAKE, MI:  
1,868,825, CANC. INT. CL. 7.

ERNST MUHLBAUER KG, D-22547 HAMBURG, FED REP GERMANY:  
2,426,270, CANC. IIRN. RESTORED TO S.N. 75-709,555.

ERWIN PEARL, INC., NEW YORK, NY:  
2,538,334, PUB. 11-20-2001. INT. CL. 14.

ESPN, INC., BRISTOL, CT:  
2,538,209, PUB. 11-20-2001. INT. CL. 41.

ESPRIT DE CORP., SAN FRANCISCO, CA:  
1,144,314, CANC. INT. CL. 27.

ESSENSE SYSTEMS, INC., PEABODY, MA:  
1,868,074, CANC. MULTIPLE CLASS, INT. CLS. 9 AND 42.

ESSIE COSMETICS, LTD., ASTORIA, NY:  
1,657,103. REN. 12-30-01. INT. CL. 3.

ESTEBAN ESPUNA, S.A., 17800 - OLOT (GERONA), SPAIN:  
2,537,518, PUB. 11-20-2001. INT. CL. 29.

ESTEE LADER INC., NEW YORK, NY, LAUDER, ESTEE, NEW YORK, NY, DBA ESTEE LAUDER COSMETIC CO.:  
530,305. REN. 1-3-02. U.S. CL. 51 (INT. CLS. 3 AND 5).

- ETABLISSEMENT VIVADENT, SCHAAN, LIECHTENSTEIN:  
708,783, CANC. U.S. CL. 44.  
708,784, CANC. U.S. CL. 44.
- ETABLISSEMENTS DE LOISY & GELET, 2660 TAIN L'HERMITAGE, FRANCE:  
2,537,527, PUB. 11-20-2001. INT. CL. 30.
- ETABLISSEMENTS FOURCROY S.A., BRUSSELS, BELGIUM:  
1,144,459, CANC. INT. CL. 33.
- ETHAN ALLEN MARKETING CORPORATION, DANBURY, CT, BAUMRITTER CORPORATION, NEW YORK, NY:  
905,053. REN. 1-4-02. U.S. CL. 21 (INT. CLS. 9 AND 11).
- EURO-PRODUCTS 21ST CENTURY, LAS VEGAS, NV:  
1,868,555, CANC. INT. CL. 35.
- EUTECTIC CORPORATION, FLUSHING, NY:  
708,640, CANC. U.S. CL. 14.
- EVAN M. GREENSPAN, INC., STUDIO CITY, CA, DBA EMG, INC.:  
2,538,326, PUB. 11-20-2001. MULTIPLE CLASS, INT. CLS. 35 AND 42.
- EVANS, ROBERT C., BEACH HAVEN, NJ:  
1,674,863. REN. 12-31-01. MULTIPLE CLASS, INT. CLS. 9 AND 41.
- EVERGREEN INTERNET, INC., CHANDLER, AZ:  
2,538,483, INT. CL. 9.
- EXCELLMODES, INC., NEW YORK, NY:  
2,538,328, PUB. 11-20-2001. INT. CL. 25.
- EXPERIAN INFORMATION SOLUTIONS, INC., ORANGE, CA:  
2,538,552, INT. CL. 36.
- EXPERIENCE MUSIC PROJECT, BELLEVUE, WA TO EXPERIENCE MUSIC PROJECT, BELLEVUE, WA:  
2,285,706, COR. INT. CL. 18.
- EXPERIMENTAL AIRCRAFT ASSOCIATION, INC., OSHKOSH, WI:  
1,869,050, CANC. INT. CL. 16.
- EXPERT BUYING SYSTEMS, INC., VANCOUVER, WA:  
1,868,085, CANC. INT. CL. 9.
- EXPRESS SHIPPING CENTERS, INC., FAIRFIELD, IA:  
1,868,975, CANC. INT. CL. 35.
- EXTECH INSTRUMENTS CORPORATION, WALTHAM, MA:  
2,538,476, INT. CL. 9.
- EXTOL CORPORATION, BETHEL, CT:  
1,868,319, CANC. INT. CL. 41.
- EYADA.COM, LLC, NEW YORK, NY:  
2,537,631, PUB. 11-20-2001. INT. CL. 38.  
2,537,632, PUB. 11-20-2001. INT. CL. 38.
- EYEWEB, INC., NEW YORK, NY FROM PF HOLDING, INC, NEW YORK, NY:  
2,538,470, INT. CL. 35.
- F M MATTSSON AB, S-792 27 MORA, SWEDEN:  
1,868,167, CANC. INT. CL. 11.
- F. J. STRAUSS CO., INC., NEW YORK, NY:  
708,702, CANC. U.S. CL. 22.
- F. KORBEL & BROS., GUERNEVILLE, CA:  
2,538,161, PUB. 11-20-2001. INT. CL. 33.
- F.A.O. SCHWARZ, NEW YORK, NY:  
2,538,169, PUB. 11-20-2001. INT. CL. 35.
- FABRICA DE TABACOS LA FLOR DE COPAN, S.A. DE C.V., SANTA ROSA DE COPAN, HONDURAS:  
2,537,704, PUB. 11-20-2001. INT. CL. 34.
- FACE RECORDING & MEASUREMENT SYSTEMS, INC., TOPEKA, KS:  
2,538,166, PUB. 11-20-2001. MULTIPLE CLASS, INT. CLS. 9 AND 16.
- FACELIFT INTERNATIONAL INC., COLUMBIA, MD:  
1,868,609, CANC. INT. CL. 37.
- FACES INC.:  
*See— FACES INTERNATIONAL SRL.*
- FACES INTERNATIONAL SRL, BRIDGETOWN, BARBADOS FROM FACES INC., TORONTO, ONTARIO M4P 1E4, CANADA:  
2,537,731, PUB. 11-20-2001. MULTIPLE CLASS, INT. CLS. 3, 18, 21 AND 42.
- FACTORY MUTUAL INSURANCE COMPANY, JOHNSTON, RI:  
2,537,969, PUB. 11-20-2001. INT. CL. 36.
- FAIREST MADE FOODS, INC., BALDWIN, WI:  
1,868,939, CANC. INT. CL. 29.
- FAIRMONT RAILWAY MOTORS, INCORPORATED, FAIRMONT, MN TO HARSCO CORPORATION, CAMP HILL, PA:  
541,762, CANC. U.S. CL. 19.
- FAMILY CIRCLE, INC., THE, NEW YORK, NY:  
1,868,208, CANC. MULTIPLE CLASS, INT. CLS. 16 AND 41.
- FANCY PUBLICATIONS, INC., LOS ANGELES, CA:  
2,538,461, INT. CL. 42.
- FANSTEEL INC., NORTH CHICAGO, IL:  
2,538,147, PUB. 11-20-2001. INT. CL. 6.  
2,538,148, PUB. 11-20-2001. INT. CL. 6.  
2,538,150, PUB. 11-20-2001. INT. CL. 6.
- FARCA, EDUARDO COHEN, COLONIA GRANJAS MEXICO, MEXICO AND KAMAJI, ELIAS COHEN, COLONIA GRANJAS MEXICO, MEXICO:  
2,537,597, PUB. 11-20-2001. MULTIPLE CLASS, INT. CLS. 24 AND 25.
- FARM-WEY PRODUCE INC., LAKELAND, FL:  
2,537,812, PUB. 11-20-2001. INT. CL. 31.
- FARMLAND INDUSTRIES, INC., KANSAS CITY, MO:  
2,538,137, PUB. 11-20-2001. INT. CL. 30.
- FARNAM COMPANIES, INC., THE, PHOENIX, AZ:  
1,143,824, CANC. INT. CL. 3.
- FARNAM, FRANKLIN C., ASHEVILLE, NC:  
1,869,048, CANC. INT. CL. 12.
- FARNELL ELECTRONICS PLC, LEEDS LS12 2NE, UNITED KINGDOM:  
1,868,834, CANC. INT. CL. 9.
- FARO TECHNOLOGIES, INC., LAKE MARY, FL:  
1,868,836, CANC. INT. CL. 9.
- FARZANEGAN, SHAHAB, DUNDEE, NY:  
1,868,425, CANC. INT. CL. 25.
- FASPAC SYSTEMS, INC., LA JOLLA, CA:  
2,538,174, PUB. 11-20-2001. INT. CL. 9.
- FAWCETTE TECHNICAL PUBLICATIONS, INC., PALO ALTO, CA:  
2,538,157, PUB. 11-20-2001. INT. CL. 41.
- FAZOLI'S MANAGEMENT, INC., LEXINGTON, KY:  
2,537,949, PUB. 11-20-2001. INT. CL. 42.
- FBTC, LLC, PRINCETON, NJ:  
2,538,510, INT. CL. 9.
- FEDERAL NATIONAL MORTGAGE ASSOCIATION, WASHINGTON, DC, DBA FANNIE MAE:  
1,628,586, CANC. INT. CL. 36.  
1,868,589, CANC. INT. CL. 36.
- FEDERAL RESERVE BANK OF ST. LOUIS, THE, ST. LOUIS, MO:  
1,868,567, CANC. INT. CL. 36.
- FEF IMPORTS CO., INC., FLUSHING, NY, DBA JOHNSON T & C, INC.:  
1,867,905, CANC. INT. CL. 3.
- FENNER U.S., INC., WILMINGTON, DE:  
2,464,837, CANC. IIRN. RESTORED TO S.N. 75-494,183.
- FERMCO BIOCHEMICS, INC., ELK GROVE VILLAGE, IL:  
708,616, CANC. U.S. CL. 6.
- FFASTFILL LIMITED, LONDON, UNITED KINGDOM FROM CITY DERIVATIVES SYSTEMS LTD, LONDON EC4N 6HH, UNITED KINGDOM:  
2,537,599, PUB. 11-20-2001. MULTIPLE CLASS, INT. CLS. 9 AND 36.
- FIBERLOCK TECHNOLOGIES, INC., ANDOVER, MA, LEHMAN BROS. CORP., JERSEY CITY, NJ:  
1,172,749. REN. 1-2-02. INT. CL. 1.
- FIBRE CHANNEL INDUSTRY ASSOCIATION, SAN FRANCISCO, CA:  
2,537,884, PUB. 11-20-2001. INT. CL. 42.
- FIELDBROOK FARMS, INC., DUNKIRK, NY:  
2,538,498, INT. CL. 30.
- FIFIELD LAND COMPANY, BRAWLEY, CA:  
2,538,135, PUB. 11-20-2001. INT. CL. 31.
- FILMOLUX (USA) INCORPORATED, SEATTLE, WA:  
1,868,820, CANC. INT. CL. 7.

- FILTER SALES CORPORATION, NASHVILLE, TN:  
1,868,826, CANC. INT. CL. 7.
- FINAMARK, INC., WILMINGTON, DE, FINA OIL AND CHEMICAL COMPANY, DALLAS, TX:  
1,661,952. REN. 1-4-02. MULTIPLE CLASS, INT. CLS. 37 AND 42.  
1,662,776. REN. 1-4-02. MULTIPLE CLASS, INT. CLS. 37 AND 42.
- FINANCIAL DESIGN EDUCATION CORP., LARKSPUR, CA:  
1,868,581, CANC. INT. CL. 36.
- FINANCIAL ENGINES, INC., PALO ALTO, CA:  
2,538,055, PUB. 11-20-2001. INT. CL. 36.
- FINE ARTS ENGRAVING COMPANY, BURR RIDGE, IL:  
2,538,274, PUB. 11-20-2001. INT. CL. 9.
- FINNIGAN, III, OLIVER D., KISSIMMEE, FL, JUGGLEBUG, INC., EDMONDS, WA:  
1,617,767. REN. 1-4-02. INT. CL. 28.
- FINOTEX U.S.A. CORP., MIAMI, FL:  
2,537,871, PUB. 11-20-2001. INT. CL. 40.
- FIRE PROTECTION SPECIALIST CERTIFICATION BOARD, SWARTHMORE, PA:  
1,144,598, CANC. U.S. CL. B.
- FIRMA NUFER-OPTIK NEOSTYLE WALTER A. NUFER, DIESELSTRASSE 19-25, FED REP GERMANY:  
1,143,957, CANC. INT. CL. 9.
- FIRST HEALTH ASSOCIATES-SUPPORTING PHYSICIANS OF PENNSYLVANIA HOSPITAL, PHILADELPHIA, PA:  
1,628,786, CANC. INT. CL. 42.
- FIRST SAMCO INC., SOUTHAMPTON, PA:  
2,538,409, PUB. 11-20-2001. INT. CL. 13.
- FISCHER GESELLSCHAFT M.B.H., RIED IM INNKREIS, AUSTRIA:  
1,144,354, CANC. INT. CL. 28.
- FISCHER GESELLSCHAFT M.B.H., A-4910 RIED IM INNKREIS, AUSTRIA:  
1,144,387, CANC. INT. CL. 28.
- FISCHER PACKING COMPANY, LOUISVILLE, KY:  
2,537,996, PUB. 11-20-2001. INT. CL. 29.
- FISH5, CORP., WORCESTER, PA:  
2,538,406, PUB. 11-20-2001. INT. CL. 38.
- FITE, JAMES H., MIAMI, FL:  
1,868,332, CANC. MULTIPLE CLASS, INT. CLS. 20 AND 35.
- FIX, SHAUN, PORT ST. LUCIE, FL:  
2,537,686, PUB. 11-20-2001. INT. CL. 10.
- FKI INDUSTRIES INC., FAIRFIELD, CT:  
2,538,333, PUB. 11-20-2001. INT. CL. 6.
- FLEETWOOD SNACKS INCORPORATED, FLEETWOOD, PA:  
1,869,103, CANC. INT. CL. 30.
- FLIGHT SYSTEMS INDUSTRIAL PRODUCTS, MECHANICSBURG, PA, FLIGHT SYSTEMS, INC., MECHANICSBURG, PA:  
1,173,015. REN. 1-4-02. INT. CL. 9.
- FLIGHTCOM CORPORATION, PORTLAND, OR:  
2,537,656, PUB. 11-20-2001. INT. CL. 9.
- FLORALIFE, INC., WALTERBORO, SC:  
1,175,557. REN. 1-4-02. INT. CL. 1.
- FLORIDA EYE CENTER, P.A., ST. PETERSBURG, FL:  
1,868,703, CANC. INT. CL. 42.
- FLORIDA ONLINE, INC., PANAMA CITY BEACH, FL:  
1,869,116, CANC. INT. CL. 38.
- FLOW MANAGEMENT & ASSOCIATES, INC., DALLAS, TX:  
2,538,190, PUB. 11-20-2001. MULTIPLE CLASS, INT. CLS. 35 AND 41.
- FLOWMASTER, INC., SANTA ROSA, CA:  
2,449,379, COR. INT. CL. 16.
- FLOWSERVE MANAGEMENT COMPANY, IRVING, TX, VALTEK INCORPORATED, SPRINGVILLE, UT:  
1,659,582. REN. 12-31-01. INT. CL. 9.
- FMC CORPORATION, PHILADELPHIA, PA:  
1,171,228. REN. 1-3-02. INT. CL. 17.
- FMC CORPORATION, CHICAGO, IL:  
1,868,068, CANC. INT. CL. 9.
- FMC CORPORATION, PHILADELPHIA, PA:  
2,537,814, PUB. 11-20-2001. INT. CL. 41.
- FOGARTY KLEIN MONROE, INC., HOUSTON, TX:  
2,538,100, PUB. 11-20-2001. INT. CL. 35.
- FOOD CONCEPTS, INC., ENGLEWOOD, CO:  
2,538,455, MULTIPLE CLASS, INT. CLS. 29, 30 AND 40.
- FOOTBALL FANATICS, INC., ORANGE PARK, FL:  
2,538,045, PUB. 11-20-2001. INT. CL. 35.
- FOOTE, JOHN, SEATTLE, WA, DBA MARKET MAGIC:  
1,628,047, CANC. INT. CL. 9.
- FORBES INC., NEW YORK, NY:  
1,868,253, CANC. INT. CL. 16.
- FORD LABORATORIES, INC., MOONACHIE, NJ:  
1,143,864, CANC. INT. CL. 5.
- FORD MOTOR COMPANY, DEARBORN, MI:  
1,868,177, CANC. INT. CL. 12.  
2,537,804, PUB. 11-20-2001. INT. CL. 35.
- FORETHOUGHT LIFE INSURANCE COMPANY, BATESVILLE, IN:  
1,868,560, CANC. INT. CL. 35.
- FORGOTTEN WOMAN, INC., THE, LONG ISLAND CITY, NY:  
1,868,383, CANC. INT. CL. 25.
- FORMICA CORPORATION, CINCINNATI, OH:  
1,659,772. REN. 12-30-01. INT. CL. 19.
- FORMS AND SUPPLIES, INC., MEMPHIS, TN:  
1,868,738, CANC. INT. CL. 42.
- FORREST, STEVE, CHESAPEAKE, VA AND FORREST, MARY ANN, CHESAPEAKE, VA:  
2,538,004, PUB. 11-20-2001. INT. CL. 35.
- FOSTER CAPITAL MANAGEMENT, INC., WEST DES MOINES, IA:  
2,537,918, PUB. 11-20-2001. INT. CL. 41.
- FOUNDATION FOR ENVIRONMENTAL HEALTH RESEARCH, TUCSON, AZ:  
1,869,025, CANC. MULTIPLE CLASS, INT. CLS. 41 AND 42.
- FOUNDATION FOR INTERNATIONAL UNDERSTANDING, THE, SAN DIEGO, CA:  
1,868,722, CANC. INT. CL. 42.
- FOUR STAR PIZZA FRANCHISING CORP., CLAYSVILLE, PA:  
2,538,163, PUB. 11-20-2001. INT. CL. 30.
- FOWLER, STEPHEN F., SCOTTSDALE, AZ:  
2,537,945, PUB. 11-20-2001. INT. CL. 36.
- FOX FAMILY PROPERTIES, INC., LOS ANGELES, CA:  
2,537,888, PUB. 11-20-2001. INT. CL. 41.
- FOX VALLEY SYSTEMS, INC., CARY, IL:  
1,627,885, CANC. INT. CL. 2.
- FRANCESCA BOTTA DESIGNS, LTD., NEW YORK, NY:  
1,868,430, CANC. INT. CL. 25.
- FRANKFORD-QUAKER GROCERY COMPANY, PHILADELPHIA, PA:  
708,792, CANC. U.S. CL. 46.
- FRATILLA, BRAD, LEBANON, OH:  
2,538,017, PUB. 11-20-2001. INT. CL. 35.
- FREDE DAY COSMETICS CO, INC., BROWNWOOD, TX:  
2,538,087, PUB. 8-14-2001. INT. CL. 3.
- FREDERICK FREIGHT, INC., MOLINE, IL:  
1,868,624, CANC. INT. CL. 39.
- FREDERICK WARNE & CO., INC., NEW YORK, NY:  
1,868,333, CANC. INT. CL. 20.
- FRESE-NOTIS WEATHER, INC., DES MOINES, IA:  
2,537,991, PUB. 11-20-2001. INT. CL. 42.
- FRENCHY'S SAUSAGE CO., INC., HOUSTON, TX:  
2,537,571, PUB. 11-20-2001. INT. CL. 29.  
2,537,572, PUB. 11-20-2001. INT. CL. 35.  
2,537,573, PUB. 11-20-2001. INT. CL. 29.  
2,537,575, PUB. 11-20-2001. INT. CL. 29.
- FRESENIUS KABI AG, 61352 BAD HOMBURG, FED REP GERMANY:  
2,537,906, PUB. 11-20-2001. INT. CL. 5.
- FRESH MARK, INC., CANTON, OH:  
1,868,636, CANC. INT. CL. 40.
- FRESH, INC., BOSTON, MA FROM FRESH, INC., BOSTON, MA:  
2,537,616, PUB. 11-20-2001. INT. CL. 3.
- FRESH, INC.:  
*See—FRESH, INC..*

- FREUND INDUSTRIAL CO., LTD., SHINJYUKU-KU, TOKYO 160, JAPAN:  
1,176,900. REN. 1-4-02. INT. CL. 7.
- FRIEDMAN, EISENSTEIN, RAEMER & SCHWARTZ, CHICAGO, IL:  
1,868,224. CANC. INT. CL. 16.
- FRIEDMAN, RITA SANDRA, AVENTURA, FL:  
2,537,690. PUB. 11-20-2001. INT. CL. 5.
- FRIENDLY ICE CREAM CORPORATION, WILBRAHAM, MA:  
2,537,925. PUB. 11-20-2001. INT. CL. 30.  
2,537,926. PUB. 11-20-2001. INT. CL. 30.
- FRIONA INDUSTRIES, L.P., AMARILLO, TX:  
2,537,648. PUB. 11-20-2001. INT. CL. 35.
- FRITZ, WAYNE L., OMAHA, NE:  
1,628,357. CANC. INT. CL. 20.
- FRUIT-A-FREEZE, INC., NORWALK, CA:  
1,209,937. REN. 1-3-02. INT. CL. 30.
- FRY'S METALS, INC., PROVIDENCE, RI:  
1,867,971. CANC. INT. CL. 6.
- FUGITIVE EMISSIONS CONTROL, INC., LONG BEACH, CA:  
1,869,039. CANC. INT. CL. 9.
- FULL CIRCLE MEDIA CORPORATION, NORWALK, CT:  
1,868,536. CANC. INT. CL. 35.
- FULTON STREET LOBSTER & SEAFOOD CO., INC., NEW YORK, NY:  
2,537,668. PUB. 11-20-2001. INT. CL. 35.
- FUNCTION ENGINEERING, INC., PALO ALTO, CA:  
2,537,813. PUB. 11-20-2001. INT. CL. 42.
- FUNG SENG INDUSTRIAL CO. LTD., TSUEN WAN, HONG KONG:  
1,868,480. CANC. INT. CL. 28.
- FUTUR TELECOM OF AMERICA, INC., HOBOKEN, NJ:  
2,537,769. PUB. 11-20-2001. INT. CL. 38.
- FUZZY FLEECE LLC, CHESHIRE, CT:  
2,538,272. PUB. 11-20-2001. INT. CL. 25.
- G DATA SOFTWARE GMBH, D-44793 BOCHUM, FED REP GERMANY:  
2,537,874. PUB. 11-20-2001. INT. CL. 9.
- G. LEBLANC CORPORATION, KENOSHA, WI:  
2,538,269. PUB. 11-20-2001. INT. CL. 15.
- G. W. ONTHANK COMPANY, DES MOINES, IA:  
1,144,328. CANC. INT. CL. 27.
- G.S.U.S.A., INC., AHOSKIE, NC, GOLDEN SKILLET INTERNATIONAL, INC., MINNEAPOLIS, MN:  
1,661,237. REN. 1-3-02. INT. CL. 42.
- GALE PACIFIC PTY. LTD., BRAESIDE, VICTORIA, AUSTRALIA TO GALE AUSTRALIA PTY. LTD., BRAESIDE, VICTORIA 3195, AUSTRALIA:  
2,465,991. COR. MULTIPLE CLASS, INT. CLS. 18, 20 AND 22.
- GARDNER MERCHANT FOOD SERVICES, INC., TRUMBULL, CT:  
1,869,012. CANC. INT. CL. 42.
- GARLAND COMMERCIAL RANGES LIMITED, MISSISSAUGA, ONTARIO, CANADA, INDUSTRIAL INDUSTRIES, INC., CYPRESS, TX:  
921,942. REN. 1-2-02. U.S. CL. 34 (INT. CL. 11).
- GARLAND COMPANY, INC., THE, CLEVELAND, OH:  
2,538,617. INT. CL. 1.
- GARLAND, RONALD C., SALT LAKE CITY, UT:  
2,538,522. INT. CL. 42.
- GARON INDUSTRIES INTERNATIONAL, INC., MOSINEE, WI:  
2,537,809. PUB. 11-20-2001. INT. CL. 35.
- GATES RUBBER COMPANY, THE, DENVER, CO:  
1,144,169. CANC. INT. CL. 17.
- GATEWAY ELECTRONIC MEDICAL MANAGEMENT SYSTEMS, LLC, INDIANAPOLIS, IN:  
2,537,681. PUB. 11-20-2001. INT. CL. 42.
- GAUMARD SCIENTIFIC COMPANY INC., MIAMI, FL:  
2,537,663. PUB. 11-20-2001. INT. CL. 10.
- GAY, HOWARD, WEST BROOKFIELD, MA:  
1,868,451. CANC. INT. CL. 28.
- GAYLORD ENTERTAINMENT COMPANY, NASHVILLE, TN, OPRYLAND USA INC, NASHVILLE, TN:  
1,663,796. REN. 1-4-02. INT. CL. 25.
- GC AMERICA INC., ALSIP, IL, COE LABORATORIES, INC., CHICAGO, IL:  
1,186,372. REN. 1-2-02. INT. CL. 5.
- GCR PUBLISHING GROUP, INC., NEW YORK, NY:  
1,869,051. CANC. INT. CL. 16.
- GENCORP INC., FAIRLAWN, OH:  
1,868,281. CANC. INT. CL. 17.
- GENE LOGIC, INC., NEW HAVEN, CT:  
2,538,446. INT. CL. 42.
- GENERAL ATOMICS, SAN DIEGO, CA:  
2,538,487. INT. CL. 9.
- GENERAL MILLS, INC., MINNEAPOLIS, MN:  
787,838. CANC. U.S. CL. 39.
- GENERAL MOTORS CORPORATION, DETROIT, MI:  
2,538,434. PUB. 11-20-2001. INT. CL. 25.  
2,538,435. PUB. 11-20-2001. INT. CL. 21.  
2,538,436. PUB. 11-20-2001. INT. CL. 21.
- GENERAL PACKAGING EQUIPMENT CO., HOUSTON, TX:  
721,291. REN. 1-3-02. U.S. CL. 23 (INT. CL. 7).
- GENERALE BISCUIT, 91200 ATHIS MONS, FRANCE:  
2,537,689. PUB. 11-20-2001. INT. CL. 30.
- GENESIS TECHNOLOGIES, NORCROSS, GA:  
2,537,543. PUB. 11-20-2001. INT. CL. 1.  
2,537,544. PUB. 11-20-2001. INT. CL. 1.
- GENESPORT INDUSTRIES LTD./LES INDUSTRIES GENE-SPORT LTEE, MONTREAL, QUEBEC, CANADA:  
1,144,246. CANC. INT. CL. 25.
- GENLED.COM, LLC, THE DIGITAL ACCOUNTANT, PRINCETON, NJ:  
2,537,886. PUB. 11-20-2001. INT. CL. 42.
- GENSIA, INC., SAN DIEGO, CA:  
1,868,811. CANC. INT. CL. 5.
- GENZYME CORPORATION, CAMBRIDGE, MA:  
1,627,866. CANC. INT. CL. 1.
- GEODATA CORPORATION, TULSA, OK:  
922,533. REN. 1-2-02. U.S. CL. 100 (INT. CL. 42).
- GEORG DRALLE, HAMBURG, FED REP GERMANY:  
708,836. CANC. U.S. CL. 51.  
708,852. CANC. U.S. CL. 52.  
708,853. CANC. U.S. CL. 52.
- GEORGIA-PACIFIC CORPORATION, PORTLAND, OR:  
708,607. CANC. U.S. CL. 6.
- GEORGIA-PACIFIC CORPORATION, ATLANTA, GA, OWENS-ILLINOIS, INC., TOLEDO, OH:  
1,194,328. REN. 1-4-02. INT. CL. 16.
- GEORGIA-PACIFIC CORPORATION, ATLANTA, GA:  
1,869,013. CANC. INT. CL. 42.
- GERKENS CACAO B.V., 1531 MA WORMER, NETHERLANDS, GERKENS CACAO INDUSTRIE N.V., WORMER, NETHERLANDS:  
920,309. REN. 1-4-02. U.S. CL. 46 (INT. CL. 30).
- GERLAND, 69100 VILLEURBANNE, FRANCE:  
1,868,309. CANC. INT. CL. 19.
- GEROY; ROBERT DOVING, NAPLES, FL, DBA DOVING GEROY LTD.:  
1,144,015. CANC. INT. CL. 9.
- GETTY PETROLEUM CORP., JERICHO, NY:  
1,628,635. CANC. INT. CL. 37.
- GIACOBBE, GABRIELE, 15048 VALENZA (AL), ITALY:  
2,538,036. PUB. 11-20-2001. INT. CL. 14.
- GIANNI VERSACE SPA, 20121 MILANO, ITALY:  
1,867,906. CANC. INT. CL. 3.
- GIANT BICYCLE, INC., RANCHO DOMINGUEZ, CA:  
1,628,216. CANC. INT. CL. 12.  
1,628,217. CANC. INT. CL. 12.
- GIEL MILLNER, ANDOVER, NJ:  
1,628,484. CANC. INT. CL. 29.
- GIFF'S ORIGINAL, CHESHIRE, CT:  
2,537,779. PUB. 11-20-2001. INT. CL. 30.
- GILFENBAIN, STEVEN L., BEVERLY HILLS, CA:  
2,537,654. PUB. 11-20-2001. INT. CL. 31.
- GIRLS INCORPORATED, NEW YORK, NY:  
1,714,795. REN. 12-31-01. INT. CL. 42.
- GITA SPORTS, LTD., CHARLOTTE, NC, DBA GITA SPORTING GOODS, LTD.:  
1,573,521. REN. 1-3-02. INT. CL. 25.



- GITTO GLOBAL CORPORATION, LUNENBERG, MA:  
2,537,910, PUB. 11-20-2001. INT. CL. 1.  
2,537,911, PUB. 11-20-2001. INT. CL. 1.  
2,537,912, PUB. 11-20-2001. INT. CL. 1.  
2,537,913, PUB. 11-20-2001. INT. CL. 1.  
2,537,914, PUB. 11-20-2001. INT. CL. 1.  
2,537,915, PUB. 11-20-2001. INT. CL. 1.
- GIVEMEPower, INC., CALGARY, ALBERTA, CANADA:  
2,538,661, INT. CL. 9.
- GLASBAU HAHN GMBH + CO. KG, D-60314 FRANKFURT AM MAIN, FED REP GERMANY:  
2,537,639, PUB. 11-20-2001. MULTIPLE CLASS, INT. CLS. 6, 11, 19 AND 20.
- GLOBAL ADVANCED TECHNOLOGY CORP., NEW YORK, NY:  
1,628,042, CANC. INT. CL. 9.
- GLOBAL ATMOSPHERICS, INC., TUCSON, AZ:  
2,538,096, PUB. 11-20-2001. INT. CL. 42.  
2,538,097, PUB. 11-20-2001. INT. CL. 42.
- GLOBAL TOTAL OFFICE, DOWNSVIEW, ONTARIO, CANADA FROM GLOBAL UPHOLSTERY COMPANY, DOWNSVIEW, ONTARIO, CANADA:  
2,537,594, PUB. 11-20-2001. INT. CL. 20.
- GLOBAL TOTAL OFFICE, DOWNSVIEW, ONTARIO, CANADA:  
2,538,600, INT. CL. 20.
- GLOBAL UPHOLSTERY COMPANY:  
*See—GLOBAL TOTAL OFFICE.*
- GLOBALQUEST, LLC, PRINCETON, NJ:  
2,538,219, PUB. 11-20-2001. INT. CL. 16.
- GLYNLYON, INC., LAUGHLIN, NV, ATARI CORPORATION, SUNNYVALE, CA:  
1,651,199, REN. 1-3-02. INT. CL. 28.
- GODFREY ROLLER COMPANY, PHILADELPHIA, PA:  
383,598, CANC. U.S. CL. 50.
- GODSPEED, NEW YORK, NY:  
1,868,691, CANC. INT. CL. 41.
- GOEPEL ELECTRONICS, LLC, AUSTIN, TX TO GOEPEL ELECTRONICS, LLC, AUSTIN, TX:  
2,344,066, COR. INT. CL. 9.
- GOLD CIRCLE ENTERTAINMENT, INC., OMAHA, NE:  
2,480,292, CANC. INT. CL. 9.
- GOLD DISK INC., MISSISSAUGA, ONTARIO, CANADA:  
1,868,028, CANC. INT. CL. 9.
- GOLD PURE FOOD PRODUCTS CO., INC., BROOKLYN, NY:  
1,628,492, CANC. MULTIPLE CLASS, INT. CLS. 29 AND 30.
- GOLD; IRWIN L., BRENTWOOD, MD:  
1,144,404, CANC. INT. CL. 29.
- GOLDCAPS, INC., MIAMI, FL:  
2,538,532, INT. CL. 5.
- GOLDEN HARVEST SEEDS, INC., BLOOMINGTON, IL:  
2,537,591, PUB. 11-20-2001. INT. CL. 35.
- GOLDEN ORANGE BROADCASTING CO., INC., IRVINE, CA:  
2,538,275, PUB. 11-20-2001. INT. CL. 38.
- GOLDEN STATE BULB GROWERS, INC., WATSONVILLE, CA:  
1,689,217, REN. 1-4-02. INT. CL. 31.
- GOLDEN TEMPLE OF OREGON, INC., LOS ANGELES, CA:  
2,537,975, PUB. 11-20-2001. INT. CL. 30.
- GOLF ANNUAL, INC., THE, DENVER, CO:  
1,869,082, CANC. INT. CL. 16.
- GONZALEZ AND TAPANES FOODS, INC., NORTH BERGEN, NJ:  
2,538,645, INT. CL. 30.
- GOOD FOOD, INC, HONEY BROOK, PA:  
2,538,009, PUB. 11-20-2001. INT. CL. 30.
- GOODBODY, INC, JUNO, FL:  
1,868,365, CANC. INT. CL. 25.
- GOODHOPE BAGS INDUSTRIES, LA PUENTE, CA:  
1,868,293, CANC. INT. CL. 18.
- GOODSON, R. DWAYNE, FRISCO, CO:  
1,868,399, CANC. INT. CL. 25.
- GOODVIEW ENTERPRISES, LTD., CHINO, CA:  
1,868,416, CANC. INT. CL. 25.
- GOODY PRODUCTS, INC., PEACHTREE CITY, GA:  
1,172,334, REN. 12-29-01. INT. CL. 21.
- GORILLA MANUFACTURING, LLC, NILES, MI:  
2,538,098, PUB. 11-20-2001. INT. CL. 7.
- GOSHEN CONSTRUCTION, INC., GOSHEN, CT:  
1,868,503, CANC. INT. CL. 30.
- GOUGH HOLDINGS (ENGINEERING) LIMITED, STOKE ON TRENT, STAFFORDSHIRE, UNITED KINGDOM:  
1,649,276, REN. 1-4-02. INT. CL. 7.
- GOURMET WOOD PRODUCTS, INC., ARLINGTON, TX:  
2,538,107, PUB. 11-20-2001. INT. CL. 4.
- GOYA FOODS, INC., SECAUCUS, NJ, GOYA FOODS, INC., SECAUCUS, NJ:  
1,659,902, REN. 1-4-02. INT. CL. 29.
- GRACE, EDWARD P., III, BRISTOL, RI:  
1,868,705, CANC. INT. CL. 42.
- GRAND CASINOS, INC., PLYMOUTH, MN:  
1,869,091, CANC. INT. CL. 25.
- GRANDMA LEE'S INTERNATIONAL HOLDINGS LIMITED, MISSISSAUGA, ONTARIO, CANADA:  
1,144,554, CANC. INT. CL. 42.
- GRANT PRIDECO TECHNOLOGY, INC., WILMINGTON, DE TO GRANT PRIDECO, L.P., THE WOODLANDS, TX:  
2,457,341, AM. INT. CL. 6.
- GRAPHICS DEPARTMENT INC., THE, ANAHEIM, CA:  
2,538,381, PUB. 11-20-2001. INT. CL. 42.
- GRATEFUL PALATE, INC., THE, OXNARD, CA:  
2,538,193, PUB. 11-20-2001. INT. CL. 30.
- GRAY, NANCY S., WEST LEBANON, NH, DBA THE BRIDAL PATH:  
1,628,280, CANC. INT. CL. 16.
- GREAT EARTH COMPANIE, INC., HICKSVILLE, NY:  
2,538,673, INT. CL. 5.
- GREAT EARTH COMPANIES, INC., HICKSVILLE, NY, GREAT EARTH INTERNATIONAL, INC., HICKSVILLE, NY:  
1,719,790, REN. 1-4-02. INT. CL. 5.
- GREAT EARTH COMPANIES, INC., HICKSVILLE, NY:  
2,538,672, INT. CL. 5.
- GREAT LAKES PRODUCTS, INDIANAPOLIS, IN:  
2,538,037, PUB. 11-20-2001. INT. CL. 1.
- GREAT PACIFIC INDUSTRIES INC., VANCOUVER, BRITISH COLUMBIA V6E 2H2, CANADA, DBA OVERWATEA FOOD GROUP:  
1,893,286, CANC. MULTIPLE CLASS, INT. CLS. 35 AND 42.
- GREAT WESTERN CHEMICAL COMPANY, PORTLAND, OR:  
2,537,581, PUB. 11-20-2001. INT. CL. 5.
- GREEK GOURMET, LIMITED, HINGHAM, MA:  
2,538,202, PUB. 11-20-2001. INT. CL. 30.
- GREEN TURTLE TECHNOLOGIES LTD., ETOBICOKE, ONTARIO M9C SK1, CANADA:  
2,537,706, PUB. 11-20-2001. INT. CL. 11.
- GREENFIELD INDUSTRIES, INC., EVANS, GA, GREENFIELD TAP AND DIE CORPORATION, GREENFIELD, MA:  
147,322, REN. 1-2-02. U.S. CL. 23 (INT. CLS. 6, 7, 8, 9, 11, 12, 16, 21 AND 28).
- GREENLEAF NURSERY COMPANY, PARK HILL, OK:  
1,868,512, CANC. INT. CL. 31.
- GRISP, GEROGE, MIKE, GRANTS PASS, OR:  
2,538,005, PUB. 11-20-2001. INT. CL. 6.
- GROENING, MATT, LOS ANGELES, CA:  
1,703,154, REN. 12-31-01. INT. CL. 16.
- GROSFILLEX SARL, 01610 ARBENT, FRANCE:  
2,537,865, PUB. 11-20-2001. INT. CL. 20.
- GROW (INTERNATIONAL), MANICKVILLE, AUSTRALIA:  
1,649,076, REN. 1-3-02. INT. CL. 42.
- GROW BIZ INTERNATIONAL, INC., MINNEAPOLIS, MN, BLUM, LYNN, DUBLIN, OH, DBA ONCE UPON A CHILD:  
1,668,930, REN. 1-4-02. INT. CL. 42.
- GT MFG., INC., CLAY CENTER, KS, GILMORE-TATGE MANUFACTURING COMPANY, INC., CLAY CENTER, KS:  
912,928, REN. 1-4-02. U.S. CL. 23 (INT. CL. 7).
- GUALANDI, ALESSANDRO, NEW YORK, NY:  
2,538,309, PUB. 11-20-2001. INT. CL. 30.

- GUARANTEE MUTUAL LIFE COMPANY, OMAHA, NE:  
1,868,981, CANC. INT. CL. 36.
- GUARD-TECH INDUSTRIES, INC., FARMINGTON HILLS, MI:  
1,868,845, CANC. INT. CL. 9.
- GUARDIAN ANGEL, INC., MEMPHIS, TN:  
1,868,999, CANC. INT. CL. 42.
- GUCCI SHOPS INC., NEW YORK, NY:  
1,143,894, CANC. INT. CL. 6.
- GUCCI SHOPS, INC., NEW YORK, NY:  
1,143,984, CANC. INT. CL. 9.
- GUERLAIN S.A., 75008 PARIS, FRANCE:  
2,389,501, COR. INT. CL. 3.
- GUERRA, ROBERT, LOMPOC, CA AND WITT, ROBERT M., LOMPOC, CA:  
2,537,525, PUB. 11-20-2001. INT. CL. 31.
- GULF & WESTERN MANUFACTURING COMPANY, SOUTHFIELD, MI:  
708,712, CANC. U.S. CL. 23.
- GULF CITY SEAFOODS, INC., PASCAGOULA, MS:  
1,868,935, CANC. INT. CL. 29.
- GUYER, J. PAUL, SACRAMENTO, CA:  
1,868,243, CANC. INT. CL. 16.
- GYMBOREE CORPORATION, THE, BURLINGAME, CA:  
1,868,878, CANC. INT. CL. 16.
- HACKETT, LAYNE, LOS GATOS, CA:  
1,868,229, CANC. INT. CL. 16.
- HAINES, ROBERT G., ORANGE PARK, FL:  
1,868,262, CANC. INT. CL. 16.
- HAIR SYSTEMS INC., ENGLISHTOWN, NJ:  
1,712,949. REN. 1-4-02. MULTIPLE CLASS, INT. CLS. 3 AND 42.
- HALLIBURTON ENERGY SERVICES, INC., CARROLLTON, TX, HALLIBURTON COMPANY, DUNCAN, OK:  
943,541. REN. 1-2-02. U.S. CL. 12 (INT. CL. 17).
- HALLMARK CARDS, INCORPORATED, KANSAS CITY, MO:  
1,144,123, CANC. INT. CL. 16.
- HALLOWELL II, ROBERT LEROY, LOS ANGELES, CA:  
2,538,701, INT. CL. 3.
- HAMMONDS HOMES, HOUSTON, TX:  
2,538,277, PUB. 11-20-2001. INT. CL. 37.
- HAMPTON CARES, INC., SAG HARBOR, NY:  
2,538,544, INT. CL. 42.
- HAMPTON ROADS ADMIRALS, INC., NORFOLK, VA:  
1,628,684, CANC. INT. CL. 41.
- HANNA-BARBERA PRODUCTIONS, INC., SHERMAN OAKS, CA:  
2,538,342, PUB. 11-20-2001. INT. CL. 25.
- HANNA'S POTPOURRI SPECIALTIES, INC., FAYETTEVILLE, AR:  
1,660,477. REN. 12-30-01. INT. CL. 3.
- HARBOR SWEETS, INC., SALEM, MA:  
2,538,643, INT. CL. 30.
- HARLAN ESTATE WINERY, INC, OAKVILLE, CA:  
2,538,116, PUB. 11-20-2001. INT. CL. 33.
- HARLAN ESTATE WINERY, INC., OAKVILLE, CA:  
2,538,117, PUB. 11-20-2001. INT. CL. 33.
- HARLYN PRODUCTS, INC., LOS ANGELES, CA, DBA THE PALOMAR CORPORATION:  
1,628,226, CANC. INT. CL. 14.
- HARMONY PRODUCTS, INC., CHESAPEAKE, VA:  
1,868,510, CANC. INT. CL. 31.
- HAROLD'S DIST. OF ELMIRA CORPORATION, HORSEHEADS, NY:  
1,628,707, CANC. INT. CL. 42.
- HARRIS TRUST AND SAVINGS BANK, CHICAGO, IL:  
2,538,077, PUB. 11-20-2001. INT. CL. 36.
- HARRIS, DENNIS, FLAGSTAFF, AZ:  
1,868,408, CANC. INT. CL. 25.
- HARRIS, LEE D., MEMPHIS, TN, DBA HARRIS INTERNATIONAL REAL ESTATE:  
2,538,686, INT. CL. 36.  
2,538,687, INT. CL. 36.
- HARSCO CORPORATION, CAMP HILL, PA:  
1,650,367, CANC. INT. CL. 40.  
1,669,149, CANC. MULTIPLE CLASS, INT. CLS. 7 AND 9.
- HART PUBLICATIONS, INC., DENVER, CO:  
1,868,227, CANC. INT. CL. 16.  
1,869,056, CANC. INT. CL. 16.
- HART SPECIALTIES, INC., AMITYVILLE, NY:  
2,538,659, INT. CL. 9.
- HARTMAN, RICHARD J., SANTA BARBARA, CA:  
2,538,379, PUB. 11-20-2001. INT. CL. 9.  
2,538,380, PUB. 11-20-2001. INT. CL. 9.
- HARTWELL CORPORATION, THE, PLACENTIA, CA:  
1,867,980, CANC. INT. CL. 6.
- HASBRO, INC., PAWTUCKET, RI:  
1,628,803, CANC. INT. CL. 28.  
1,868,932, CANC. INT. CL. 28.  
1,869,098, CANC. INT. CL. 28.  
2,538,023, PUB. 11-20-2001. INT. CL. 28.  
2,538,224, PUB. 11-20-2001. INT. CL. 24.  
2,538,344, PUB. 11-20-2001. INT. CL. 28.
- HASSETT, KATHRYN L., SAN JOSE, CA, DBA MYSTERY BY DESIGN:  
1,868,672, CANC. INT. CL. 41.
- HAWAIIAN RECTIFIERS, INC., MIRA LOMA, CA:  
2,537,951, PUB. 11-20-2001. INT. CL. 33.
- HAWORTH, INC., HOLLAND, MI:  
2,538,330, PUB. 11-20-2001. INT. CL. 20.
- HAYWOOD, PETER C., SONOMA, CA:  
2,538,065, PUB. 11-20-2001. INT. CL. 33.
- HCA HEALTH SERVICES OF NEW HAMPSHIRE, INC., DERRY, NH:  
2,538,128, PUB. 11-20-2001. INT. CL. 42.
- HEALTH CENTER FOR BETTER LIVING, INC., NAPLES, FL:  
2,537,528, PUB. 11-20-2001. INT. CL. 5.
- HEALTH INFORMATICS TECHNOLOGIES, LLC, MAHWAH, NJ:  
2,538,388, PUB. 11-20-2001. INT. CL. 40.
- HEALTHCARE FORUM, THE, SAN FRANCISCO, CA TO AMERICAN HOSPITAL ASSOCIATION, CHICAGO, IL:  
1,806,867, CANC. INT. CL. 35.
- HEALTHMEDIA, INC., ANN ARBOR, MI:  
2,538,639, INT. CL. 42.
- HEARST COMMUNICATIONS, INC., NEW YORK, NY FROM CHRONICLE PUBLISHING COMPANY, THE, SAN FRANCISCO, CA:  
2,537,570, PUB. 11-20-2001. INT. CL. 41.
- HEAVEN ON EARTH, INC., WASHINGTON, DC:  
1,868,464, CANC. INT. CL. 28.
- HEDGES & BUTLER LIMITED, LONDON, ENGLAND:  
708,828, CANC. U.S. CL. 47.
- HEEP TUNG MANUFACTORY LTD., FO TAN, SHATIN, N.T., HONG KONG:  
1,868,933, CANC. INT. CL. 28.
- HELIX SYSTEMS, INC., PALO ALTO, CA:  
1,868,110, CANC. INT. CL. 9.
- HENDEE ENTERPRISES, INC., HOUSTON, TX:  
1,868,160, CANC. MULTIPLE CLASS, INT. CLS. 11, 22 AND 40.
- HENDERSON, JOHN D., DOVE CANYON, CA:  
1,869,007, CANC. INT. CL. 42.
- HENRY GROUP, LTD., THE, CLEVELAND, OH:  
2,538,236, PUB. 11-20-2001. INT. CL. 35.
- HENRY HOLT AND COMPANY, INC., NEW YORK, NY:  
1,868,236, CANC. INT. CL. 16.
- HENRY SCHEIN INC, MELVILLE, NY, DENTAL PLAN, INC., GARLAND, TX:  
1,659,551. REN. 1-4-02. INT. CL. 9.
- HENRY SCHEIN INC., MELVILLE, NY, HENRY SCHEIN INC., PORT WASHINGTON, NY:  
1,663,341. REN. 1-4-02. INT. CL. 10.
- HEREFORD, DAPHNE, HOUSTON, TX:  
2,538,312, PUB. 11-20-2001. INT. CL. 41.
- HERITAGE CONSUMER PRODUCTS, LLC:  
*See—INSIGHT PHARMACEUTICALS CORPORATION.*
- HERITAGE ORGANIZATION, INC., THE, DALLAS, TX:  
1,868,568, CANC. INT. CL. 36.
- HERMAN GOELITZ CANDY CO., INC.:  
*See—JELLY BELLY CANDY COMPANY.*
- HESS AND ASSOCIATES, INC., NORCROSS, GA:  
1,868,490, CANC. INT. CL. 29.

HESSISCHE APPARATEBAU GMBH, 6204 TAUNUSSTEIN 1, FED REP GERMANY:  
1,143,935, CANC. INT. CL. 7.

HI-SEAS INDUSTRIES, INC., NEW YORK, NY:  
1,868,017, CANC. MULTIPLE CLASS, INT. CLS. 8 AND 28.

HIAWATHA LOG HOMES, INC., MUNISING, MI:  
1,628,316, CANC. INT. CL. 16.

HIGHLAND SUPPLY CORPORATION, HIGHLAND, IL:  
1,658,968, REN. 12-31-01, INT. CL. 16.  
1,682,065, REN. 1-3-02, INT. CL. 21.

HIJACK THENET.COM, INC., ALTA LOMA, CA:  
2,538,402, PUB. 11-20-2001, INT. CL. 38.

HILL-ROM COMPANY, INC., BATESVILLE, IN:  
2,537,977, PUB. 11-20-2001, INT. CL. 9.

HILL-ROM SERVICES, INC., BATESVILLE, IN, HILL-ROM COMPANY, INC., BATESVILLE, IN:  
1,172,970, REN. 1-3-02, INT. CL. 9.

HILLERICH & BRADSBY CO., LOUISVILLE, KY:  
2,537,792, PUB. 11-20-2001, INT. CL. 41.  
2,538,046, PUB. 11-20-2001, INT. CL. 14.  
2,538,047, PUB. 11-20-2001, INT. CL. 14.  
2,538,048, PUB. 11-20-2001, INT. CL. 28.

HILLWOOD DEVELOPMENT CORPORATION, DALLAS, TX:  
2,538,280, PUB. 11-20-2001, INT. CL. 37.  
2,538,281, PUB. 11-20-2001, INT. CL. 36.  
2,538,282, PUB. 11-20-2001, INT. CL. 25.  
2,538,283, PUB. 11-20-2001, INT. CL. 36.  
2,538,284, PUB. 11-20-2001, INT. CL. 37.  
2,538,315, PUB. 11-20-2001, INT. CL. 39.  
2,538,319, PUB. 11-20-2001, INT. CL. 37.

HILTON HERBS, LTD., CREWKERNE SOMERSET, UNITED KINGDOM:  
2,537,589, PUB. 11-20-2001, MULTIPLE CLASS, INT. CLS. 5 AND 31.

HMJ CLOTHING COMPANY LTD., LITTLE FERRY, NJ:  
1,868,394, CANC. INT. CL. 25.

HOB CONCERTS COMPANY, UNIVERSAL CITY, CA FROM UNIVERSAL CITY STUDIOS, INC., UNIVERSAL CITY, CA:  
2,538,678, INT. CL. 41.

HODGE, JEFFERY, LOS ANGELES, CA:  
2,538,294, PUB. 11-20-2001, INT. CL. 41.

HOFFMAN MARITIME CONSULTANTS, INC., GLEN HEAD, NY:  
1,143,977, CANC. MULTIPLE CLASS, INT. CLS. 9 AND 42.

HOLLEY PERFORMANCE PRODUCTS, BOWLING GREEN, KY:  
2,538,268, PUB. 11-20-2001, INT. CL. 7.

HOLLINGSWORTH & VOSE COMPANY, EAST WALPOLE, MA:  
2,538,697, INT. CL. 24.

HOLLISTER INCORPORATED, LIBERTYVILLE, IL:  
2,538,099, PUB. 11-20-2001, INT. CL. 10.

HOLMES PRODUCTS CORP., MILFORD, MA:  
1,868,868, CANC. INT. CL. 11.

HOME BEVERAGES, SAFFORD, AZ:  
1,712,057, REN. 1-4-02, INT. CL. 32.

HOME BUYER'S FAIR, INC., SCOTTSDALE, AZ FROM FAS HOTLINE, INC., SCOTTSDALE, AZ:  
2,538,453, INT. CL. 35.

HOME CONTROLS INCORPORATED, SAN DIEGO, CA:  
2,538,322, PUB. 11-20-2001, MULTIPLE CLASS, INT. CLS. 35 AND 37.  
2,538,323, PUB. 11-20-2001, MULTIPLE CLASS, INT. CLS. 35 AND 37.

HOME PLACE LTD., EDISON, NJ:  
1,868,669, CANC. INT. CL. 41.

HOMES.COM, INC., PALO ALTO, CA:  
2,538,704, INT. CL. 42.  
2,538,705, INT. CL. 39.

HOMMED, LLC, BROOKFIELD, WI:  
2,537,795, PUB. 11-20-2001, INT. CL. 42.  
2,537,858, PUB. 11-20-2001, INT. CL. 42.

HONDA GIKEN KOGYO KABUSHIKI KAISHA (HONDA MOTOR CO., LTD.), MINATO-KU, TOKYO 107, JAPAN:  
2,538,620, INT. CL. 12.

HONEYWELL INC., MINNEAPOLIS, MN:  
1,143,964, CANC. INT. CL. 9.

HONEYWELL INTERNATIONAL INC., MORRISTOWN, NJ:  
2,538,252, PUB. 11-20-2001, INT. CL. 22.

HONG KONG CITY TOYS FACTORY LIMITED, KOW-LOON, HONG KONG:  
2,538,557, INT. CL. 28.

HORAN AND HORAN OF SYRACUSE, INC., SYRACUSE, NY:  
1,868,758, CANC. INT. CL. 42.

HORIZON HOBBY, INC., CHAMPAIGN, IL:  
2,538,343, PUB. 11-20-2001, INT. CL. 28.

HORIZONT GERATEWERK GMBH, 34497 KORBACH, FED REP GERMANY:  
2,478,959, COR. INT. CL. 9.

HORMEL FOODS, LLC, AUSTIN, MN:  
2,537,724, PUB. 11-20-2001, INT. CL. 30.

HORN ABBOT LTD., TORONTO, ONTARIO, CANADA:  
1,696,244, REN. 1-4-02, INT. CL. 28.  
1,711,908, REN. 1-4-02, INT. CL. 28.

HORSE & RIDER, INC., DENVER, CO:  
1,869,066, CANC. INT. CL. 16.

HOUGHTON MIFFLIN COMPANY, BOSTON, MA:  
1,628,269, CANC. INT. CL. 16.

HOY, J. B., NORTH WEBSTER, IN, DBA ROSE FOR FRIENDSHIP SOCIETY:  
1,144,113, CANC. MULTIPLE CLASS, INT. CLS. 16 AND 42.

HP INTELLECTUAL CORP., WILMINGTON, DE:  
2,538,669, INT. CL. 7.

HTM SPORT S.P.A., BARGHETTO 37, 160, ITALY:  
1,628,434, CANC. INT. CL. 28.

HUANG, TAI-HAO, NASHVILLE, TN:  
2,537,640, PUB. 11-20-2001, INT. CL. 1.

HUB DISTRIBUTING, INC., ONTARIO, CA:  
1,628,410, CANC. INT. CL. 25.

HUB EXPO CENTERS, INC., BOSTON, MA:  
2,538,271, PUB. 11-20-2001, INT. CL. 42.

HUBBARD ISA LLC, WILMINGTON, DE, HUBBARD FARMS, INC., WALPOLE, NH:  
1,655,711, REN. 1-4-02, INT. CL. 31.

HUDSON, WILLIAM, LAS VEGAS, NV, DBA WILLIAM HUDSON & ASSOCIATES:  
1,868,021, CANC. INT. CL. 8.

HUMETRICS, INC., HOUSTON, TX:  
2,538,679, INT. CL. 41.

HUMMINGBIRD COMMUNICATIONS LTD., NORTH YORK, ONTARIO M2H 2W1, CANADA, AKA HUMMINGBIRD LTD.:  
2,538,675, INT. CL. 9.

HUNKAR LABORATORIES, INC., CINCINNATI, OH:  
1,628,790, CANC. INT. CL. 9.

HURRICANE SPORTS, INC., SARASOTA, FL:  
1,868,919, CANC. INT. CL. 28.

HURST, GEORGIA L., ESCONDIDO, CA:  
2,538,582, INT. CL. 42.

HYPERCEL CORPORATION, SAN FERNANDO, CA:  
2,537,946, PUB. 11-20-2001, INT. CL. 9.

I. KRUGER, INC., CARY, NC, AIR PRODUCTS AND CHEMICALS, INC., ALLENTOWN, PA:  
1,154,194, REN. 1-4-02, MULTIPLE CLASS, INT. CLS. 37 AND 42.

I.E. INDUSTRIES FASHIONS, INC., NEW YORK, NY:  
1,868,436, CANC. INT. CL. 25.

I.G. TOURS, INC., MIAMI BEACH, FL:  
1,869,118, CANC. INT. CL. 39.

IAG FEDERAL CREDIT UNION, RYE, NY:  
1,868,573, CANC. INT. CL. 36.

ICE WINE INTERNATIONAL INC., FLUSHING, NY:  
2,538,497, MULTIPLE CLASS, INT. CLS. 32 AND 33.

ICSO MALLS, LLC, MUSKEGO, WI:  
2,538,553, INT. CL. 35.

IDENTIX INCORPORATED, SUNNYVALE, CA TO IDENTIFCATOR TECHNOLOGY INC., SAN BRUNO, CA:  
2,480,495, COR. INT. CL. 9.

- IEXC EXPRESS COURIER LTD., CH-6330 CHAM, SWITZERLAND:  
1,868,623, CANC. INT. CL. 39.
- IL VICINO HOLDING COMPANY, INC., ALBUQUERQUE, NM:  
2,538,386, PUB. 11-20-2001. INT. CL. 42.
- ILLINOIS TOOL WORKS INC., GLENVIEW, INDIA, MILLER ELECTRIC MFG. CO., A MILLER GROUP, LTD. COMPANY, APPLETON, WI:  
1,662,304, REN. 1-4-02. INT. CL. 9.
- IMAGE DATA CORPORATION, SAN ANTONIO, TX TO E-SYSTEMS MEDICAL ELECTRONICS, INC., SAN ANTONIO, TX:  
1,628,061, CANC. INT. CL. 9.
- IMAGE OF THE MOON, LIMITED, WESTMINSTER, MD:  
1,628,769, CANC. INT. CL. 42.
- IMAGE SMITHS, GERMANTOWN, MD:  
2,538,485, INT. CL. 9.
- IMAGINATION CREATIONS, JUPITER, FL:  
2,537,818, PUB. 11-20-2001. INT. CL. 25.
- IMAGINE GOLD, L.L.C., SOUTH HACKENSACK, NJ:  
2,538,130, PUB. 11-20-2001. INT. CL. 16.
- IMI - INTERNATIONAL MARKETING, INC., CHAMBERSBURG, PA:  
2,537,937, PUB. 11-20-2001. INT. CL. 1.
- IMMUNOTEC RESEARCH LTD., QUEBEC J7V 5V5, CANADA:  
2,537,974, PUB. 11-20-2001. INT. CL. 5.
- IMO INDUSTRIES INC., LAWRENCEVILLE, NJ, TRANSMERICA DELAVAL INC., PRINCETON, NJ:  
1,188,384, REN. 12-29-01. INT. CL. 7.
- IMO INDUSTRIES INC., LAWRENCEVILLE, NJ:  
1,958,259, CANC. MULTIPLE CLASS, INT. CLS. 9 AND 12.
- IMPAX MARKETING COMMUNICATIONS, INCORPORATED, PHILADELPHIA, PA:  
2,538,392, PUB. 11-20-2001. INT. CL. 35.
- IMPERIAL CHEMICAL INDUSTRIES LIMITED, MILLBANK, LONDON, S.W.1, ENGLAND:  
708,597, CANC. U.S. CL. 2.
- INAVISIS, INC., SAN DIEGO, CA:  
2,538,026, PUB. 11-20-2001. MULTIPLE CLASS, INT. CLS. 36 AND 42.  
2,538,027, PUB. 11-20-2001. MULTIPLE CLASS, INT. CLS. 36 AND 42.
- INDIAN INDUSTRIES, INC., EVANSVILLE, IN:  
1,868,473, CANC. INT. CL. 28.
- INDIANA WIRE DIE COMPANY, INC., FT. WAYNE, IN:  
1,144,025, CANC. INT. CL. 9.
- INDIRECT SERVICES, INC., SALT LAKE CITY, UT:  
2,537,849, PUB. 11-20-2001. INT. CL. 36.
- INDUSTRIAL DESIGNERS SOCIETY OF AMERICA, GREAT FALLS, VA:  
2,538,053, PUB. 11-20-2001. INT. CL. 41.
- INES ROSALES, S.A., SEVILLA, SPAIN:  
2,537,783, PUB. 11-20-2001. INT. CL. 30.
- INGRAM CUSTOMER SYSTEMS INC., LAVERGNE, TN:  
2,537,588, PUB. 11-20-2001. INT. CL. 35.
- INNOVATEK, INC., RICHLAND, WA:  
2,537,897, PUB. 11-20-2001. INT. CL. 9.
- INNSOFT, INC, BEAVERTON, OR:  
2,537,986, PUB. 11-20-2001. MULTIPLE CLASS, INT. CLS. 9 AND 16.
- INSIDE SPORTS, INC., EVANSTON, IL:  
1,869,064, CANC. INT. CL. 16.
- INSIGHT GROUP INCORPORATED, THE, TEMPE, AZ:  
2,538,226, PUB. 11-20-2001. INT. CL. 35.
- INSIGHT PHARMACEUTICALS CORPORATION, SAN FRANCISCO, CA FROM HERITAGE CONSUMER PRODUCTS, LLC, PLYMOUTH MEETING, PA:  
2,537,840, PUB. 11-20-2001. INT. CL. 5.
- INSTIPRO, INC., NORTHBROOK, IL:  
2,538,513, INT. CL. 36.
- INSTITUTIONAL INVESTOR, INC., NEW YORK, NY:  
2,538,703, MULTIPLE CLASS, INT. CLS. 16 AND 42.
- INSTRUCTIONAL TELECOMMUNICATIONS FOUNDATION, INC., BOULDER, CO:  
1,628,670, CANC. INT. CL. 41.
- INSURANCE SPECIALIST, INC, WHEAT RIDGE, CO:  
2,537,532, PUB. 11-20-2001. INT. CL. 36.
- INSURSCAPE.COM, OXNARD, CA:  
2,537,846, PUB. 11-20-2001. INT. CL. 36.
- INTEGRATED LINEN SYSTEMS, INC., ARLINGTON, TX:  
2,538,059, PUB. 11-20-2001. INT. CL. 42.  
2,538,060, PUB. 11-20-2001. INT. CL. 42.  
2,538,061, PUB. 11-20-2001. INT. CL. 42.
- INTEGRITY MUSIC, INC., MOBILE, AL:  
1,869,040, CANC. INT. CL. 9.  
1,869,053, CANC. INT. CL. 16.
- INTEGRITY SYSTEMS, INC., PHOENIX, AZ, INTEGRITY TRAINING SYSTEMS, INC., BRADY, TX:  
1,660,160, REN. 1-2-02. INT. CL. 41.
- INTER-CITY PRODUCTS CORPORATION (USA), LAVERGNE, TN:  
1,868,170, CANC. INT. CL. 11.
- INTER-CITY RELOCATION SERVICE, INC., CHICAGO, IL:  
1,869,052, CANC. INT. CL. 16.
- INTER-STATE NURSERIES, INCORPORATED, HAMBURG, IA:  
708,566, CANC. U.S. CL. 1.
- INTERACTION ASSOCIATES, SAN FRANCISCO, CA:  
2,537,782, PUB. 11-20-2001. INT. CL. 41.
- INTERACTIVE DIGITAL SOFTWARE ASSOCIATION, WASHINGTON, DC:  
2,538,480, MULTIPLE CLASS, U.S. CLS. A AND B.
- INTERDIMENSIONAL PUBLISHING, CAPITAN, NM:  
2,538,089, PUB. 11-20-2001. INT. CL. 9.
- INTERFACE GROUP LTD., THE, MARKHAM, ONTARIO, L3R 0C8, CANADA:  
1,868,563, CANC. INT. CL. 36.
- INTERFACE, INC., ATLANTA, GA:  
2,538,478, INT. CL. 27.
- INTERFUSE NATURAL PRODUCTS, INC., LODI, CA:  
1,867,917, CANC. INT. CL. 3.
- INTERLOGIX, INC., TUALATIN, OR FROM SLC TECHNOLOGIES, INC., TUALATIN, OR:  
2,538,489, INT. CL. 9.
- INTERNATIONAL ASSOCIATION OF FINANCIAL ENGINEERS, INC., STONY BROOK, NY:  
1,869,059, CANC. INT. CL. 16.
- INTERNATIONAL BANKING TECHNOLOGIES, INC., NORCROSS, GA:  
2,537,851, PUB. 9-18-2001. INT. CL. 35.
- INTERNATIONAL DATA GROUP, INC., FRAMINGHAM, MA:  
1,868,883, CANC. INT. CL. 16.  
1,869,067, CANC. INT. CL. 16.
- INTERNATIONAL FAMILY ENTERTAINMENT, INC., VIRGINIA BEACH, VA:  
1,868,995, CANC. INT. CL. 41.
- INTERNATIONAL LEISURE PRODUCTS, INC., EDGEWOOD, NY:  
2,537,637, PUB. 11-20-2001. INT. CL. 28.
- INTERNATIONAL MARKET BRANDS, INC., ERIE, PA:  
2,537,647, PUB. 11-20-2001. INT. CL. 30.
- INTERNATIONAL MEDICAL GROUP, INC., INDIANAPOLIS, IN:  
2,538,056, PUB. 11-20-2001. INT. CL. 36.
- INTERNATIONAL PAPER COMPANY, TUXEDO, NY:  
1,671,744, REN. 1-3-02. INT. CL. 16.
- INTERNATIONAL PAPER COMPANY, PURCHASE, NY, DBA ANCHOR:  
1,867,897, CANC. INT. CL. 2.
- INTERNATIONAL SELF-ESTEEM, INC., TAMPA, FL:  
1,868,081, CANC. MULTIPLE CLASS, INT. CLS. 9 AND 16.
- INTERNATIONAL SPEEDWAY CORPORATION, DAYTONA BEACH, FL:  
2,538,612, MULTIPLE CLASS, INT. CLS. 21, 25 AND 28.
- INTERNATIONAL TECHNIDYNE CORPORATION, EDISON, NJ:  
1,868,152, CANC. INT. CL. 10.
- INTERNET METHODS, INC., PHOENIX, AZ:  
2,537,837, PUB. 11-20-2001. INT. CL. 35.
- INTERVAC DESIGN CORP., JUPITER, FL:  
2,537,634, PUB. 11-20-2001. INT. CL. 7.

INTUIT COMPUTING, INC., RICHMOND, VA, DBA BRAIN TRAIN:  
2,538,371, PUB. 11-20-2001. INT. CL. 9.

INTUIT INC., MOUNTAIN VIEW, CA:  
2,537,701, PUB. 11-20-2001. INT. CL. 25.

IOWA MOLD TOOLING CO., INC, GARNER, IA:  
2,538,165, PUB. 11-20-2001. INT. CL. 7.

IRONMILL, INC., FORT COLLINS, CO:  
2,538,079, PUB. 11-20-2001. INT. CL. 41.

IRVING PULP & PAPER LIMITED, ST. JOHN, NEW BRUNSWICK, CANADA:  
1,868,206, CANC. INT. CL. 16.

ISLAND PEN MANUFACTURING CORP., BROOKLYN, NY:  
708,744, CANC. U.S. CL. 37.

ISOLYSER CO., INC., NORCROSS, GA:  
1,659,324, REN. 12-30-01. INT. CL. 1.

IT'S ABOUT TIME, INC., ARMONK, NE:  
2,538,451, MULTIPLE CLASS, INT. CLS. 9 AND 16.

IVECO INDUSTRIAL VEHICLES CORPORATION B.V., AMSTELVEEN (AMSTERDAM), NETHERLANDS:  
1,144,078, CANC. INT. CL. 12.

IVEY, MICHAEL KEVIN, WASHINGTON, DC:  
1,868,680, CANC. INT. CL. 41.

IVF AMERICA, INC., GREENWICH, CT:  
1,868,698, CANC. INT. CL. 42.

IZOD, LTD., NEW YORK, NY:  
842,921, CANC. U.S. CL. 39.

J D SERVICES, INCORPORATED, SALT LAKE CITY, UT:  
2,537,713, PUB. 11-20-2001. INT. CL. 36.

J. C. BAMFORD EXCAVATORS LIMITED, STAFFORDSHIRE, ENGLAND:  
1,653,460, REN. 1-4-02. INT. CL. 7.

J. R. CARLSON LABORATORIES, INC., ARLINGTON HEIGHTS, IL:  
1,173,871, REN. 1-2-02. INT. CL. 5.

J.B. CORBETT AGENCY, FORT MITCHELL, KY:  
2,538,358, PUB. 11-20-2001. INT. CL. 36.

J.G. HOOK, INC., PHILADELPHIA, PA:  
1,868,446, CANC. INT. CL. 27.

J.W. PEPPER & SON, INC., PAOLI, PA:  
2,537,567, PUB. 11-20-2001. INT. CL. 35.

J&J SNACK FOODS CORP., PENNSAUKEN, NJ:  
2,537,961, PUB. 11-20-2001. INT. CL. 30.

J-I-T INSTITUTE OF TECHNOLOGY, INC., ENGLEWOOD, CO:  
1,868,032, CANC. INT. CL. 9.

J-STAR MOTOR INDUSTRIAL CO., LTD., SAN CHUNG CITY, TAIPEI HSIEN, TAIWAN:  
2,537,848, PUB. 11-20-2001. INT. CL. 7.

JACMEL JEWELRY, INC., LONG ISLAND CITY, NY:  
1,173,135, REN. 1-4-02. INT. CL. 14.

JACOBSON, GEORGE D/B/A/ PACIFIC HOE SAW & KNIFE COMPANY, PORTLAND, OR, R. HOE & CO., INC., SCARSDALE, NY:  
1,173,945, REN. 1-4-02. INT. CL. 7.

JADON, INC., ANCHORAGE, AK:  
1,661,025, REN. 1-2-02. INT. CL. 32.

JAGUAR CARS LIMITED, ALLESLEY, ENGLAND:  
2,538,421, PUB. 11-20-2001. INT. CL. 36.

JAI A/S, 2600 GLOSTRUP, DENMARK:  
2,538,519, INT. CL. 9.

JAMES B. RUSSELL, INC., ENGLEWOOD, NJ:  
1,144,466, CANC. INT. CL. 34.

JAMES HALSTEAD LIMITED, WHITEFIELD, MANCHESTER, LANCASHIRE, ENGLAND:  
1,144,319, CANC. INT. CL. 27.

JAMES J. DUFFY, INC., CHARLESTOWN, MA:  
1,868,973, CANC. INT. CL. 34.

JAMES RIVER PAPER COMPANY, INC., OAKLAND, CA:  
1,869,044, CANC. INT. CL. 9.

JAMISON, J. SCOTT, OREM, UT:  
1,869,099, CANC. INT. CL. 28.

JANESVILLE GROUP LIMITED, JANESVILLE, WI:  
2,538,411, PUB. 11-20-2001. INT. CL. 42.

JANITEX RUG SERVICE CORP., BELTSVILLE, MD:  
1,201,562, REN. 1-4-02. INT. CL. 42.

JANSPORT APPAREL CORP., WILMINGTON, DE:  
2,538,650, INT. CL. 18.

JAQUITH INDUSTRIES, INC., SYRACUSE, NY:  
1,184,515, REN. 1-2-02. INT. CL. 9.

JASPER PUBLICATIONS, INC., WOODLAND HILLS, CA:  
2,537,540, PUB. 3-27-2001. MULTIPLE CLASS, INT. CLS. 9, 16 AND 35.

JAZZERCISE, INC., CARLSBAD, CA:  
1,144,541, CANC. INT. CL. 41.

JCB INTERNATIONAL CREDIT CARD CO., LTD., LOS ANGELES, CA:  
1,662,747, REN. 1-4-02. INT. CL. 36.

JDC ELECTRIC, INC., SAN FRANCISCO, CA:  
2,538,587, INT. CL. 37.

JDR ENTERPRISES INC., MOORHEAD, MN:  
1,868,897, CANC. INT. CL. 21.

JEFFERY L. MILLER AND WILLIAM HINDS PARTNERSHIP, THE, HOUSTON, TX:  
2,538,555, INT. CL. 25.

JELD-WEN, INC., KLAMATH FALLS, OR:  
1,868,307, CANC. INT. CL. 19.

JELLY BELLY CANDY COMPANY, FAIRFIELD, CA FROM HERMAN GOELITZ CANDY CO., INC., FAIRFIELD, CA:  
2,538,680, INT. CL. 30.

JENSEN ALE HOUSE AND RAW BAR, INC., JENSEN BEACH, FL:  
1,869,127, CANC. INT. CL. 42.

JERI-JO KNITWEAR, INC., NEW YORK, NY, JERI-JO, KNITWEAR, INC., NEW YORK, NY:  
1,597,536, REN. 1-3-02. INT. CL. 25.

JEROLD'S, INC., CHICAGO, IL:  
1,144,260, CANC. MULTIPLE CLASS, INT. CLS. 25 AND 42.

JG NORTH RALEIGH L.L.C., CLEVELAND, OH:  
2,538,518, INT. CL. 37.

JILLMERICA, LLC, PHOENIX, AZ:  
2,538,638, INT. CL. 25.

JJI INTERNATIONAL, INC., WARWICK, RI:  
2,537,721, PUB. 11-20-2001. INT. CL. 21.

JME, INCORPORATED, BURBANK, CA, DBA TMB ASSOCIATES:  
2,537,929, PUB. 11-20-2001. INT. CL. 9.

JNANA TECHNOLOGIES CORPORATION, NEW YORK, NY:  
2,537,978, PUB. 11-20-2001. INT. CL. 42.

JOHN BROWN CUSTOM SPORTING EQUIPMENT LIMITED, COLLINGWOOD, ONTARIO, CANADA:  
1,868,455, CANC. INT. CL. 28.

JOHN GROSS & CO., BALTIMORE, MD:  
1,144,464, CANC. INT. CL. 33.

JOHN PAUL MITCHELL SYSTEMS, SANTA CLARITA, CA:  
2,538,707, INT. CL. 3.

JOHNNYROADTRIP.COM, LLC, TOWSON, MD:  
2,538,101, PUB. 11-20-2001. INT. CL. 39.

JOHNS, WILLIAM FRANK, PENSACOLA, FL:  
1,868,542, CANC. INT. CL. 35.

JOHNSON & JOHNSON, NEW BRUNSWICK, NJ:  
1,867,928, CANC. INT. CL. 3.  
1,867,968, CANC. INT. CL. 5.  
2,538,364, PUB. 11-20-2001. INT. CL. 10.  
2,538,365, PUB. 11-20-2001. INT. CL. 10.  
2,538,658, INT. CL. 10.

JOHNSON CONTROLS, INC., MILWAUKEE, WI:  
2,538,695, INT. CL. 42.

JOHNSON PRODUCTS CO., INC., CHICAGO, IL:  
1,143,829, CANC. INT. CL. 3.

JOHNSON, JAMES, CLEARWATER, FL:  
1,868,174, CANC. INT. CL. 11.

JONBIL, INC., NEW YORK, NY:  
1,144,299, CANC. INT. CL. 25.

JONES MEDICAL INSTRUMENT COMPANY, OAK BROOK, IL:  
1,616,474, REN. 1-3-02. INT. CL. 9.

JONES-BLAIR COMPANY, DALLAS, TX:  
2,537,650, PUB. 11-20-2001. INT. CL. 2.

JONES, STEVEN W., ATLANTA, GA:  
1,868,735, CANC. INT. CL. 42.

- JONMOR INVESTMENTS, INC., WILMINGTON, DE:  
2,537,714, PUB. 11-20-2001. INT. CL. 29.
- JORGENSEN, ISAAC, AURORA, CO:  
2,538,264, PUB. 11-20-2001. INT. CL. 41.
- JRP TECHNOLOGIES, INC., SAN ANTONIO, TX:  
2,538,529, INT. CL. 42.
- JUN MA, MARK WEI, SOUTH SAN FRANCISCO, CA, DBA  
OCEANBRIDGE ENTERPRISES:  
1,868,974, CANC. INT. CL. 35.
- JUNG PRODUCTS, INC., CINCINNATI, OH:  
708,782, CANC. U.S. CL. 44.
- JUNIOR VOLLEYBALL ASSOCIATION OF AUSTIN, AUS-  
TIN, TX:  
2,537,612, PUB. 11-20-2001. INT. CL. 25.
- JUNO OF CALIFORNIA, LOS ANGELES, CA:  
1,868,420, CANC. INT. CL. 25.
- K.I.S.S. METHOD, INC., TAYLORSVILLE, UT:  
2,537,791, PUB. 11-20-2001. INT. CL. 16.
- K-LOK, INC., BOCA RATON, FL:  
1,868,157, CANC. INT. CL. 10.
- KABCORP, INC., RALEIGH, NC:  
2,537,749, PUB. 11-20-2001. MULTIPLE CLASS, INT. CLS.  
7, 11, 20 AND 37.
- KABUSHIKI KAISHA NTT DATA, TOKYO, JAPAN, DBA  
NTT DATA CORPORATION TO KABUSHIKI KAISHA  
NTT DATA, TOKYO, JAPAN, DBA NTT DATA COR-  
PORATION:  
2,299,038, COR. INT. CL. 9.
- KAHN, STEVEN, MANHASSET HILLS, NY, DBA MANNIX  
CO., LTD.:  
1,868,478, CANC. INT. CL. 28.
- KAISER COMPUTER SYSTEMS, EDEN PRAIRIE, MN:  
1,868,847, CANC. INT. CL. 9.
- KAL KAN FOODS, INC., VERNON, CA:  
2,538,040, PUB. 11-20-2001. INT. CL. 31.
- KALO, INC., OVERLAND PARK, KS:  
2,537,828, PUB. 11-20-2001. INT. CL. 1.
- KAON INTERACTIVE INC., CAMBRIDGE, MA:  
2,537,793, PUB. 11-20-2001. INT. CL. 42.
- KARTRIDG PAK CO., THE, DAVENPORT, IA:  
1,143,938, CANC. INT. CL. 7.
- KASMAR PUBLICATIONS, INC., PALM DESERT, CA:  
1,869,081, CANC. INT. CL. 16.
- KAUFMAN, PATRICIA M., DIXON, CA:  
2,537,625, PUB. 11-20-2001. MULTIPLE CLASS, INT. CLS.  
5 AND 10.
- KAUTZ, WILLIAM R., GENEVA, IL:  
2,537,566, PUB. 11-20-2001. INT. CL. 37.
- KAWAI MUSICAL INST. MFG. CO., LTD., SHIZUOKA-  
PREF. 430, JAPAN:  
1,868,203, CANC. INT. CL. 15.
- KAY CHEMICAL COMPANY, GREENSBORO, NC:  
2,538,417, PUB. 11-20-2001. INT. CL. 3.
- KDW ENTERPRISES, INC., FRANKLIN PARK, IL:  
1,627,961, CANC. INT. CL. 7.
- KEATING MAGEE, NEW ORLEANS, LA:  
2,538,134, PUB. 11-20-2001. INT. CL. 35.
- KEEP FLORIDA BEAUTIFUL, INC., TALLAHASSEE, FL:  
2,537,917, PUB. 11-20-2001. INT. CL. 41.
- KEITH HARRIS & CO., LTD., THORNLEIGH, AUSTRALIA:  
1,143,831, CANC. INT. CL. 3.
- KEITH, JON, NEW YORK, NY:  
1,144,540, CANC. INT. CL. 41.
- KELLWOOD COMPANY, CHESTERFIELD, MO:  
1,144,252, CANC. INT. CL. 25.
- KELLY-SPRINGFIELD TIRE COMPANY, THE, CUMBER-  
LAND, MD:  
708,742, CANC. U.S. CL. 35.
- KEMIRA OY, SF-00180 HELSINKI, FINLAND:  
1,867,940, CANC. INT. CL. 5.
- KENNER PARKER TOYS INC., BEVERLY, MA:  
1,144,371, CANC. INT. CL. 28.  
1,144,372, CANC. INT. CL. 28.  
1,144,374, CANC. INT. CL. 28.
- KENYON CONSUMER PRODUCTS, INC., WEST KING-  
STON, RI, KENYON PIECE DYEWORKS, INC., THE,  
KENYON, RI, AKA KENYON INDUSTRIES:  
1,171,818, REN. 1-4-02. INT. CL. 1.
- KESSEL GMBH, D-85101 LENTING, FED REP GERMANY:  
2,537,536, PUB. 11-2-1999. MULTIPLE CLASS, INT. CLS.  
6, 7 AND 19.
- KGS INC., BROWNSBURG, IN:  
2,538,477, INT. CL. 41.
- KIDS UNIVERSE, BEVERLY HILLS, CA:  
2,537,569, PUB. 11-20-2001. INT. CL. 35.
- KIDZ SOLUTIONS, HAMPTON, VA:  
2,538,340, PUB. 11-20-2001. INT. CL. 28.
- KILLER LOOP EYEWEAR S.P.A., 31040 PEDEROBBA (TRE-  
VISO), ITALY, MODA SOLARIS S.P.A., PEDEROBBA,  
TREVISO, ITALY:  
1,623,359, REN. 1-4-02. INT. CL. 9.
- KILMER & KILMER, INC., ALBUQUERQUE, NM:  
2,537,751, PUB. 11-20-2001. INT. CL. 35.
- KIM, K. H., AURORA, IL:  
1,869,120, CANC. INT. CL. 41.
- KIM, YOUNG S., SAN FRANCISCO, CA:  
2,538,418, PUB. 11-20-2001. INT. CL. 42.
- KIMBERLY-CLARK CORPORATION, NEENAH, WI:  
1,628,289, CANC. INT. CL. 16.
- KIN HING INTERNATIONAL, INC., POMONA, CA:  
1,868,407, CANC. INT. CL. 25.
- KING PUTT ASSOCIATES, VIRGINIA BEACH, VA:  
1,868,996, CANC. INT. CL. 41.
- KINGMAN INTERNATIONAL CORPORATION, BALDWIN  
PARK, CA:  
2,538,132, PUB. 11-20-2001. INT. CL. 28.
- KINGS & POTTER, MIAMI, FL:  
1,628,437, CANC. INT. CL. 28.
- KINGSFORD PRODUCTS COMPANY, THE, OAKLAND,  
CA:  
1,424,150, CANC. INT. CL. 30.
- KINZE MANUFACTURING, INC., WILLIAMSBURG, IA:  
1,662,206, REN. 1-4-02. INT. CL. 7.
- KITCHEN INVESTMENT GROUP, INC., MADISON, WI,  
COUNTRY KITCHEN INCORPORATED, OF MIDDLE-  
TOWN OHIO, CINCINNATI, OH:  
922,045, REN. 1-3-02. U.S. CL. 100 (INT. CL. 42).
- KLAUS STEILMANN GMBH & CO. KG, 44867 BOCHUM-  
WATTENSCHIED, FED REP GERMANY:  
2,538,535, INT. CL. 25.
- KLEER-VU PLASTICS CORPORATION, BROWNSVILLE,  
TN:  
1,628,002, CANC. INT. CL. 9.
- KLIMCZAK, ROBERT J., INDEPENDENCE, OH:  
2,537,855, PUB. 11-20-2001. INT. CL. 42.
- KNIT-RITE, INC., KANSAS CITY, KS:  
2,463,190, COR. INT. CL. 10.
- KNME-TV, ALBUQUERQUE, NM:  
1,660,149, REN. 1-2-02. INT. CL. 41.
- KNOWLEDGE KEEPERS, LTD., ARLINGTON HEIGHTS,  
IL:  
2,538,394, PUB. 11-20-2001. INT. CL. 35.
- KNUTSON, KIRBY, ROCKFORD, IL:  
1,868,476, CANC. INT. CL. 28.
- KOBAYASHI HANSOKIKI CO., LTD., NAGOYA-SHI, AI-  
CHI-KEN, JAPAN:  
1,867,990, CANC. INT. CL. 7.
- KOCH ENTERTAINMENT LLC, NEW YORK, NY:  
2,537,744, PUB. 11-20-2001. INT. CL. 9.
- KOHN, JOEL, M, SAN FRANCISCO, CA:  
2,538,665, INT. CL. 41.
- KOHN, LORY, TOMS RIVER, NJ:  
2,537,770, PUB. 11-20-2001. MULTIPLE CLASS, INT. CLS.  
9 AND 41.
- KOLEY LAND COMPANY, LEMARS, IA:  
2,538,363, PUB. 11-20-2001. INT. CL. 36.
- KONINKLIJKE PHILIPS ELECTRONICS N.V., EINDHO-  
VEN, NETHERLANDS:  
2,537,742, PUB. 11-20-2001. INT. CL. 9.
- KONTOS, GEORGE VLASIOS, HARVEY, LA:  
2,538,594, INT. CL. 18.
- KORNER'S FOLLY FOUNDATION, KERNERSVILLE, NC:  
2,538,115, PUB. 11-20-2001. INT. CL. 41.
- KRAFT FOODS HOLDINGS, INC., NORTH FIELD, IL,  
KRAFT GENERAL FOODS, INC., GLENVIEW, IL:  
1,659,969, REN. 12-31-01. INT. CL. 30.

KRAFT FOODS HOLDINGS, INC., NORTHFIELD, IL:  
2,538,712, INT. CL. 30.

KRAFT, INC., GLENVIEW, IL:  
1,144,441, CANC. INT. CL. 30.  
1,144,442, CANC. INT. CL. 30.  
1,144,443, CANC. INT. CL. 30.  
1,144,444, CANC. INT. CL. 30.

KRANSON INDUSTRIES, INC., ST. LOUIS, MO:  
1,868,898, CANC. INT. CL. 21.

KRATZ, JOSEPH R., HOUSTON, TX:  
2,538,690, INT. CL. 36.

KUBOTA CORPORATION, NANIWA-KU, OSAKA-SHI, JAPAN:  
1,868,158, CANC. INT. CL. 11.

KUDO, KENNETH MASAJI, PAHOA, HI:  
1,868,323, CANC. INT. CL. 20.

KUSMACK, KEVIN K., DECATUR, MI:  
2,537,973, PUB. 11-20-2001. INT. CL. 8.

L C 3 S, INC., RANCHO CORDOVA, CA:  
1,695,570, REN. 1-3-02. INT. CL. 42.

L. L. BEAN, INC, FREEPORT, ME:  
2,538,437, PUB. 11-20-2001. INT. CL. 35.

LA FLOR PRODUCTS CO., INC., RIDGEWOOD, NY:  
926,512, REN. 1-3-02. U.S. CL. 46 (INT. CL. 30).

LA FOURMI, 49510 JALLAIS, FRANCE:  
1,868,392, CANC. INT. CL. 25.

LA VENCEDORA E HIJOS, S.A. DE C.V., SAN LUIS POTOSI, S.L.P., MEXICO:  
2,538,086, PUB. 11-20-2001. INT. CL. 30.

LAACO, LTD., LOS ANGELES, CA:  
1,661,996, REN. 1-3-02. INT. CL. 41.

LABOR READY, INC., TACOMA, WA:  
2,538,108, PUB. 11-20-2001. INT. CL. 35.

LABORATOIRE C.C.D., 75008 PARIS, FRANCE:  
1,868,146, CANC. INT. CL. 10.

LABORATORY TECHNOLOGIES CORPORATION, WILMINGTON, MA:  
1,868,063, CANC. INT. CL. 9.

LACKENBACH SIEGEL MARZULLO & ARONSON, P.C., SCARSDALE, NY:  
1,868,997, CANC. INT. CL. 42.

LAMB-WESTON, INC., KENNEWICK, WA:  
2,538,644, INT. CL. 29.

LAMB, W. C., LAFAYETTE, LA, DBA LAMB ENTERPRISES:  
1,144,585, CANC. INT. CL. 42.

LAMBDA PHARMA S.A., 1204 GENEVA, SWITZERLAND:  
1,867,908, CANC. INT. CL. 3.

LAMBERT, THOMAS J., MANITOWOC, WI:  
1,628,326, CANC. INT. CL. 17.

LAMMES CANDIES SINCE 1885, INC., AUSTIN, TX:  
2,537,908, PUB. 11-20-2001. INT. CL. 30.

LAMY S.A., 75490 PARIS CEDEX 10, FRANCE:  
1,868,213, CANC. MULTIPLE CLASS, INT. CLS. 16, 35, 38, 39 AND 41.

LAN-O-SHEEN, INC., ST. PAUL, MN:  
708,608, CANC. U.S. CL. 6.

LANCE INDUSTRIES, SYLMAR, CA:  
1,628,033, CANC. INT. CL. 9.

LANCOME PARFUMS ET BEAUTE & CIE, 75008 PARIS, FRANCE:  
1,867,910, CANC. INT. CL. 3.  
1,867,922, CANC. INT. CL. 3.

LAND O'LAKES, INC., ARDEN HILLS, MN:  
2,538,189, PUB. 11-20-2001. INT. CL. 29.

LANGUAGE STARS, L.L.C., CHICAGO, IL:  
2,538,318, PUB. 11-20-2001. INT. CL. 41.

LANTEV DISTRIBUTING CORPORATION, BROOKLYN, NY:  
2,537,930, PUB. 11-20-2001. INT. CL. 30.

LAPODIS, INC., NEW YORK, NY FROM DECORATION.-COM, NEW YORK, NY:  
2,538,593, INT. CL. 35.

LASALLE NATIONAL TRUST, N.A., CHICAGO, IL:  
1,868,982, CANC. INT. CL. 36.

LATA EXPORT & IMPORT, INC., LOS ANGELES, CA:  
1,868,792, CANC. MULTIPLE CLASS, INT. CLS. 14, 25 AND 26.

LATENDRESSE, JOHN R., CAMDEN, TN, DBA AMERICAN PEARL CREATIONS:  
1,628,222, CANC. INT. CL. 14.

LAUNCHSQUAD, L.L.C., SAN FRANCISCO, CA:  
2,537,866, PUB. 11-20-2001. INT. CL. 35.

LAWMAN INTERNATIONAL LIMITED, KWUN TONG, KOWLOON, HONG KONG:  
1,144,277, CANC. INT. CL. 25.

LAWRENCE K. MCGEHE AND CAROL A. MCGEHE, PARTNERSHIP, THE, DAYTON BEACH SHORES, FL:  
2,537,789, PUB. 11-20-2001. INT. CL. 41.

LCC INCORPORATED, ARLINGTON, VA:  
1,868,855, CANC. INT. CL. 9.

LEADER NATIONAL INSURANCE COMPANY, INDEPENDENCE, OH:  
1,868,588, CANC. INT. CL. 36.

LEAGUE OF UNITED LATIN AMERICAN CITIZENS, LAS VEGAS, NV:  
1,868,259, CANC. INT. CL. 16.  
1,868,683, CANC. MULTIPLE CLASS, INT. CLS. 41 AND 42.

LEAMINGTON ASSOCIATION, INC., GREENWOOD, SC:  
1,628,599, CANC. MULTIPLE CLASS, INT. CLS. 36 AND 37.

LEAPS & BOUNDS, INC., OAK BROOK, IL:  
1,868,660, CANC. INT. CL. 41.

LEBANON CHEMICAL CORPORATION, LEBANON, PA:  
2,538,623, INT. CL. 1.

LECTRA SYSTEMES, 33610 CESTAS, FRANCE:  
1,868,061, CANC. INT. CL. 9.

LEDALITE ARCHITECTURAL PRODUCTS, LANGLEY, BRITISH COLUMBIA, CANADA:  
2,537,941, PUB. 11-20-2001. INT. CL. 11.

LEE'S AQUARIUM & PET PRODUCTS, SAN MARCOS, CA:  
2,538,610, INT. CL. 28.

LEGALSOURCE, INC., LOS ANGELES, CA:  
1,868,526, CANC. INT. CL. 35.

LEGEND PRODUCE, LLC, MENDOTA, CA:  
2,538,084, PUB. 11-20-2001. INT. CL. 31.

LEGENT CORPORATION, PITTSBURGH, PA:  
1,868,072, CANC. INT. CL. 9.

LEI YUN SHANG CHINESE MEDICAL WEST LIMITED COMPANY, HONG KONG, PRC, CHINA:  
2,537,807, PUB. 11-20-2001. INT. CL. 5.

LENCO, INC., JACKSON, MO:  
1,144,020, CANC. INT. CL. 9.

LENMAR, INC., BALTIMORE, MD:  
1,627,889, CANC. INT. CL. 2.

LENNOX MANUFACTURING INC., MARSHALLTOWN, IA:  
2,537,774, PUB. 11-20-2001. INT. CL. 11.

LEO BURNETT USA, INC., CHICAGO, IL:  
2,537,623, PUB. 11-20-2001. INT. CL. 35.

LESLIE ANN LAPIDAKIS, EASTON, PA:  
1,868,214, CANC. INT. CL. 16.

LET'S FACE IT, INC., SUFFERN, NY:  
1,628,758, CANC. INT. CL. 42.

LEVY, MENACHEM M., BROOKLYN, NY:  
2,538,681, INT. CL. 16.

LEWIS AND CLARK BICENTENIAL MARKETING GROUP, INC., LAKESIDE, MT:  
2,537,980, PUB. 11-20-2001. INT. CL. 42.

LEWIS FAMILY COMPANY, INC., THE, MOORESTOWN, NJ:  
2,537,583, PUB. 11-20-2001. INT. CL. 42.

LEXINGTON FURNITURE INDUSTRIES, INC., LEXINGTON, NC:  
2,538,657, INT. CL. 20.

LIBBEY GLASS INC., TOLEDO, OH, OWENS-ILLINOIS, INC., TOLEDO, OH:  
1,173,311, REN. 1-3-02. INT. CL. 21.

LIBERTY CENTER VENTURE, PITTSBURGH, PA:  
2,351,045, CANC. INT. CL. 42.

LIBERTY FABRICS OF NEW YORK, NEW YORK, NY:  
1,144,236, CANC. INT. CL. 24.

LIBERTY RESEARCH GROUP, INC., GREAT FALLS, MT:  
1,868,078, CANC. INT. CL. 9.

- LIBMAN COMPANY, THE, ARCOLA, IL:  
2,537,766, PUB. 11-20-2001. INT. CL. 21.
- LICO BRANDS, INC., STOCKTON, CA:  
1,701,970. REN. 1-3-02. MULTIPLE CLASS, INT. CLS. 29 AND 30.
- LIFE-LIKE PRODUCTS, INC., BALTIMORE, MD:  
2,537,562, PUB. 11-20-2001. INT. CL. 30.
- LIFELINE HEALTH CARE, INC., SOMERSET, KY:  
1,661,187. REN. 1-2-02. INT. CL. 42.
- LIFETIME PRODUCTS, INC., CLEARFIELD, UT:  
1,868,926, CANC. INT. CL. 28.
- LIFEWAY CHRISTIAN RESOURCES OF THE SOUTHERN BAPTIST CONVENTION, NASHVILLE, TN FROM SUNDAY SCHOOL BOARD OF THE SOUTHERN BAPTIST CONVENTION, THE, NASHVILLE, TN:  
2,538,576, INT. CL. 41.
- LIGHTHOUSE TECHNOLOGIES LIMITED, KOWLOON TONG, HONG KONG:  
2,537,687, PUB. 11-20-2001. INT. CL. 9.
- LIGHTING RESEARCH INSTITUTE, INC., NEW YORK, NY:  
1,868,220, CANC. MULTIPLE CLASS, INT. CLS. 16 AND 42.
- LIL' DRUG STORE PRODUCTS, INC., CEDAR RAPIDS, IA:  
1,934,934, CANC. INT. CL. 3.  
1,934,943, CANC. INT. CL. 3.
- LILLEHAMMER OLYMPISKE ORGANISASJONSKOMITE AS, 2600 LILLEHAMMER, NORWAY:  
1,868,487, CANC. MULTIPLE CLASS, INT. CLS. 29, 30, 31 AND 32.
- LINCOLN GLOBAL, INC., MONTEREY PARK, CA:  
2,538,655, INT. CL. 7.
- LINDROS, ERIC, TORONTO, ONTARIO M5N LV4, CANADA:  
2,538,573, INT. CL. 25.
- LINDY BOWMAN COMPANY, THE, ELLICOTT CITY, MD:  
2,538,291, PUB. 11-20-2001. INT. CL. 16.
- LINER HEALTH SERVICES CORP., CARSON, CA, P. LEINER NUTRITIONAL PRODUCTS, INC., CARSON, CA:  
1,678,249. REN. 1-3-02. INT. CL. 5.
- LION LICENSING, LTD., WILMINGTON, DE:  
2,538,614, INT. CL. 25.
- LION'S DEN CHRISTIAN MEDIA, INC., NASHVILLE, TN:  
2,538,622, MULTIPLE CLASS, INT. CLS. 9, 16 AND 41.
- LIONEL L.L.C., CHESTERFIELD, MI:  
1,628,447, CANC. INT. CL. 28.
- LIPHA, 69008 LYON, FRANCE, LIPHA, LYONNAISE INDUSTRIELLE PHARMACEUTIQUE, 69008 LYON, FRANCE:  
1,652,866. REN. 1-3-02. INT. CL. 5.
- LITELAB CORPORATION, BUFFALO, NY:  
1,657,308. REN. 1-4-02. INT. CL. 11.
- LITERARISCHES INSTITUT AG, BASEL, SWITZERLAND:  
1,144,115, CANC. INT. CL. 16.
- LITTLE RAPIDS CORPORATION, GREEN BAY, WI:  
1,869,089, CANC. INT. CL. 20.
- LIZZA, ALLEN C., GALVESTON, TX:  
2,538,000, PUB. 11-20-2001. INT. CL. 21.
- LJEPAVA, JOHN WILLIAM, CONCORD, CA:  
1,868,094, CANC. INT. CL. 9.
- LOCKWOOD LEADERSHIP INTERNATIONAL, HOLDEN BEACH, NC:  
2,538,706, INT. CL. 42.
- LOCOMOTOR U.S.A., INC., LOS ANGELES, CA:  
1,868,300, CANC. INT. CL. 18.  
1,868,301, CANC. INT. CL. 18.  
1,868,302, CANC. INT. CL. 18.
- LOCTITE CORPORATION, ROCK HILL, CT:  
1,169,744. REN. 1-4-02. INT. CL. 1.
- LOGICAD3D GMBH, D-82229 SEEFELD, FED REP GERMANY:  
2,537,824, PUB. 2-20-2001. INT. CL. 9.
- LOMI SCHOOL FOUNDATION, MILL VALLEY, CA:  
1,144,548, CANC. INT. CL. 41.
- LONDON PUBLISHING CO., AMBLER, PA:  
1,628,257, CANC. INT. CL. 16.
- LONGABERGER COMPANY, THE, NEWARK, OH:  
2,537,864, PUB. 11-20-2001. INT. CL. 21.
- LONGS DRUG STORES CALIFORNIA, INC., WALNUT CREEK, CA:  
1,144,458, CANC. INT. CL. 33.
- LOOK RIGHT (H.K.) LIMITED, TSIMSHATSUI, KOWLOON, HONG KONG:  
1,868,901, CANC. INT. CL. 25.
- LOUMEL, INC., NEW YORK, NY:  
1,868,428, CANC. INT. CL. 25.
- LUBRI-LOY COMPANY, THE, ST. LOUIS, MO:  
708,867, CANC. U.S. CL. 15.
- LUBY, SUE, ANDOVER, MA:  
2,537,856, PUB. 11-20-2001. INT. CL. 41.
- LUCAS INDUSTRIES PUBLIC LIMITED COMPANY, BIRMINGHAM, ENGLAND:  
1,144,064, CANC. INT. CL. 11.
- LUCASFILM LTD., NICASIO, CA:  
1,868,444, CANC. INT. CL. 26.
- LUCKY STORES, INC., DUBLIN, CA:  
1,868,022, CANC. INT. CL. 8.
- LUDI & CIE. AG, FLAWIL (ST. GALL), SWITZERLAND:  
1,143,889, CANC. INT. CL. 6.
- LYDALL, INC., MANCHESTER, CT:  
1,144,235, CANC. INT. CL. 24.
- LYMAN, CYNTHIA G., EL PASO, TX:  
2,538,043, PUB. 11-20-2001. INT. CL. 1.
- M CREATIVE, INC., WINSTON-SALEM, NC:  
2,537,748, PUB. 11-20-2001. INT. CL. 42.
- M. PAGANO & SONS, INC., BROOKLYN, NY:  
1,868,511, CANC. INT. CL. 31.
- M.H. JOHNSON, INC., ST. LOUIS, MO:  
2,537,635, PUB. 11-20-2001. INT. CL. 31.
- M.S. MANAGEMENT ASSOCIATES, INC., INDIANAPOLIS, IN:  
1,868,254, CANC. INT. CL. 16.
- M.Z. BERGER & CO., INC., LONG ISLAND CITY, NY:  
1,686,294. REN. 12-29-01. INT. CL. 14.
- M&FC HOLDING COMPANY, INC., WILMINGTON, DE:  
1,665,646. REN. 1-4-02. INT. CL. 6.
- MACDERMID GRAPHIC ARTS, INC., ATLANTA, GA, W. R. GRACE & CO., CAMBRIDGE, MA:  
1,162,004. REN. 1-4-02. INT. CL. 24.
- MADE IN HEAVEN ENTERTAINMENT, INC., CHICAGO, IL:  
1,868,558, CANC. INT. CL. 35.
- MAGBEE, DAVID JARRET, BEAUFORT, SC:  
2,537,811, PUB. 11-20-2001. INT. CL. 35.
- MAGIC CHEF, INC., CLEVELAND, TN:  
708,687, CANC. U.S. CL. 21.  
708,734, CANC. U.S. CL. 31.
- MAGIC MOMENTS, BIRMINGHAM, AL:  
2,537,794, PUB. 11-20-2001. INT. CL. 36.
- MAGIKBOX, LLC, COS COB, CT:  
2,537,727, PUB. 11-20-2001. INT. CL. 35.
- MAHAN, ELIZABETH M., BREMERTON, WA:  
2,538,276, PUB. 11-20-2001. INT. CL. 3.
- MALCOLM, CATHERINE J.A., MIAMI, FL AND MALCOLM, DESMOND A., MIAMI, FL:  
1,868,720, CANC. INT. CL. 42.
- MALIBU COMICS ENTERTAINMENT, INC. AND GOLD MOUNTAIN ENTERTAINMENT JOINT VENTURE, THE, CALABASAS, CA:  
1,868,903, CANC. INT. CL. 25.
- MALIK, VINU PAUL, CAMBRIDGE, MA:  
2,537,992, PUB. 11-20-2001. INT. CL. 21.
- MALLOY & MALLOY, P.A., MIAMI, FL:  
2,537,901, PUB. 11-20-2001. INT. CL. 42.
- MANAGEMENT RECRUITERS INTERNATIONAL, INC., CLEVELAND, OH:  
2,538,567, INT. CL. 35.
- MANAKA, FUMIO, NODA-SHI CHIBA-KEN, JAPAN:  
2,537,825, PUB. 11-20-2001. INT. CL. 41.  
2,537,826, PUB. 11-20-2001. INT. CL. 41.
- MANDALAY FOOD PRODUCTS CORPORATION, BURLINGAME, CA:  
708,804, CANC. U.S. CL. 46.
- MANDEL MIZOKAMI CORP, RIO RICO, AZ:  
2,537,899, PUB. 11-20-2001. INT. CL. 31.



- MANDEL MIZOKAMI CORP, RIO RICO, AZ:  
2,537,900, PUB. 11-20-2001. INT. CL. 31.
- MANIFATTURA MARIO COLOMBO & C. S.P.A., MONZA (MILAN), ITALY:  
1,144,262, CANC. INT. CL. 25.
- MANN & HUMMEL ADVANCED FILTRATION CONCEPTS, INC., LOUISVILLE, KY:  
2,492,622, CANC. IIRN. RESTORED TO S.N. 76-165,306.
- MANNING, GLEN, MARIETTA, GA:  
2,537,922, PUB. 11-20-2001. INT. CL. 42.
- MANSOUR RAHMANAN, NEW YORK, NY:  
1,144,322, CANC. INT. CL. 27.
- MANUFACTURING AND CONSULTING SERVICES, INC., COSTA MESA, CA:  
1,144,565, CANC. INT. CL. 42.
- MAPLE GROVE FARMS OF VERMONT, INC., ST. JOHNSBURY, VT:  
2,537,805, PUB. 11-20-2001. INT. CL. 30.
- MAPLES, MARLA, NEW YORK, NY:  
1,868,410, CANC. INT. CL. 25.
- MARATHON PETROLEUM COMPANY, FINDLAY, OH:  
1,143,840, CANC. INT. CL. 4.
- MARCH PRODUCTS, INC., SOUTH EL MONTE, CA, CROWN LEISURE PRODUCTS, INC., OWOSSO, MI:  
1,661,734. REN. 1-3-02. INT. CL. 18.
- MARCHESE SERVICES INCORPORATED, SUNRISE, FL:  
2,537,595, PUB. 11-20-2001. INT. CL. 42.
- MARCHON EYEWEAR INC., MELVILLE, NY:  
2,538,458, INT. CL. 9.
- MARCIANO, CHARLY, 93500, PANTIN, FRANCE:  
1,868,421, CANC. INT. CL. 25.
- MARCONI COMMERCE SYSTEMS, GREENSBORO, NC, GILBARCO INC., GREENSBORO, NC:  
1,660,628. REN. 1-3-02. INT. CL. 9.
- MARGARET VILLA, INC., ORONO, ME:  
1,627,922, CANC. INT. CL. 3.
- MARIGOLD FOODS, INC., MINNEAPOLIS, MN:  
1,628,829, CANC. INT. CL. 30.
- MARIN FOOD SPECIALTIES, INC., BYRON, CA:  
1,173,468. REN. 1-4-02. INT. CL. 29.
- MARK LEES SKIN CARE, INC., PENSACOLA, FL:  
2,538,460, INT. CL. 3.
- MARK PI'S FRANCHISE CORPORATION, HILLIARD, OH:  
1,868,749, CANC. INT. CL. 42.
- MARKEN INTERNATIONAL, INC., PEWAUKEE, WI:  
2,538,325, PUB. 11-20-2001. INT. CL. 12.
- MARLEY (U.K.) LIMITED, SEVENOAKS, KENT TN13 2DS, ENGLAND:  
1,868,159, CANC. MULTIPLE CLASS, INT. CLS. 11, 17 AND 19.
- MARMON GROUP, INC., THE, WILMINGTON, DE:  
1,143,895, CANC. INT. CL. 6.
- MARRIAGE BUILDERS, INC., WHITE BEAR LAKE, MN:  
2,477,784, COR. MULTIPLE CLASS, INT. CLS. 35 AND 42.
- MARS, INCORPORATED, MCLEAN, VA:  
1,666,849. REN. 12-29-01. INT. CL. 28.  
2,537,894, PUB. 7-17-2001. INT. CL. 16.
- MARSH SUPERMARKETS, INC., INDIANAPOLIS, IN:  
2,537,747, PUB. 11-20-2001. INT. CL. 35.
- MARSHALL ELECTRONICS, INC., EL SEGUNDO, CA:  
2,538,332, PUB. 11-20-2001. INT. CL. 9.
- MARSHALL-ATTLE, FELICIA, LINDENWOLD, NJ:  
2,538,082, PUB. 11-20-2001. INT. CL. 41.
- MARTELL S.A., 16100 COGNAC, FRANCE, J. & F. MARTELL, INC., NEW YORK, NY:  
1,665,193. REN. 1-4-02. INT. CL. 33.  
1,669,678. REN. 1-4-02. INT. CL. 33.
- MARTINI & ROSSI CORPORATION, MIAMI, FL:  
2,538,186, PUB. 11-20-2001. INT. CL. 33.
- MARUHACHI CERAMICS OF AMERICA, INC., CORONA, CA:  
1,662,481. REN. 1-2-02. INT. CL. 19.  
1,664,141. REN. 1-2-02. INT. CL. 19.
- MARYLAND WIRE BELTS, CHURCH CREEK, MD:  
2,538,373, PUB. 11-20-2001. MULTIPLE CLASS, INT. CLS. 37 AND 40.
- MASCO BUILDING PRODUCTS CORP., TAYLOR, MI:  
1,143,906, CANC. INT. CL. 6.  
1,143,907, CANC. INT. CL. 6.
- MASON GROUP OF COMPANIES LIMITED, MISSISSAUGA, ONTARIO L5T 2G9, CANADA:  
2,538,523, INT. CL. 7.
- MASON, REYNOLD E., BREMERTON, WA, DBA RENNY MASON COMPANY:  
1,868,483, CANC. INT. CL. 28.
- MASTERCARD INTERNATIONAL INCORPORATED, NEW YORK, NY:  
1,868,991, CANC. INT. CL. 39.
- MASTERPIECE ACCESSORIES, INC., SANTA FE SPRINGS, CA:  
1,868,890, CANC. INT. CL. 20.
- MASTERYWORKS, INC., ANNANDALE, VA:  
2,537,953, PUB. 8-28-2001. INT. CL. 35.
- MATHEWS & CLARK COMMUNICATIONS, INC., REDWOOD CITY, CA:  
2,538,588, INT. CL. 35.
- MATRIA HEALTHCARE, INC., MARIETTA, GA, HEALTHDYNE, INC., MARIETTA, GA, DBA HEALTHDYNE PERINATAL SERVICES:  
1,579,562. REN. 1-2-02. INT. CL. 42.
- MATRIX CONSULTING, INC., DUBUN, OH:  
2,537,932, PUB. 11-20-2001. MULTIPLE CLASS, INT. CLS. 35, 41 AND 42.
- MATRIX ESSENTIALS, INC., SOLON, OH:  
1,868,380, CANC. INT. CL. 25.
- MATSUSHITA ELECTRIC CORPORATION OF AMERICA, SECAUCUS, NJ:  
2,538,486, INT. CL. 9.
- MATT'S MAILING CENTER, INC., SANTA ANA, CA:  
1,868,626, CANC. INT. CL. 39.
- MATTEL, INC., EL SEGUNDO, CA:  
1,868,924, CANC. INT. CL. 28.  
2,538,533, INT. CL. 28.
- MATRESS DISCOUNTERS CORPORATION, UPPER MARLBORO, MD:  
2,538,146, PUB. 11-20-2001. INT. CL. 20.
- MAUREEN HEGARTY, BIRMINGHAM, AL:  
2,537,806, PUB. 11-20-2001. INT. CL. 36.
- MAVETY MEDIA GROUP LTD., NEW YORK, NY:  
2,468,063, COR. MULTIPLE CLASS, INT. CLS. 41 AND 42.
- MAXIM HEALTHCARE SERVICES, INC., COLUMBIA, MD:  
2,538,007, PUB. 11-20-2001. INT. CL. 35.  
2,538,008, PUB. 11-20-2001. INT. CL. 35.
- MAXWELL, SHERRI, BROOKLYN, NY:  
2,537,629, PUB. 11-20-2001. INT. CL. 35.
- MAXXON CORPORATION, HAMEL, MN, GYP-CRETE CORPORATION, HAMEL, MN:  
1,171,639. REN. 1-4-02. MULTIPLE CLASS, INT. CLS. 37 AND 41.
- MAZDA MOTOR CORPORATION, AKI-GUN, HIROSHIMAKEN, JAPAN, TOYO KOGYO CO., LTD., AKI-GUN, HIROSHIMA-KEN, JAPAN:  
1,172,579. REN. 1-4-02. INT. CL. 37.
- MC CARTNEY, FRANCESCA A., MILL VALLEY, CA:  
2,538,713, INT. CL. 41.
- MCALPIN INDUSTRIES, INC., ROCHESTER, NY:  
2,537,821, PUB. 11-20-2001. INT. CL. 40.
- McCLEAVE, ROBERT, CHARLOTTE, NC:  
1,868,379, CANC. INT. CL. 25.
- MCCOWEN, PAMELA, PENSACOLA, FL:  
1,869,119, CANC. INT. CL. 41.
- MCCOY, DEANNA, KIRKLAND, WA, DBA INTUHEALTH:  
2,538,028, PUB. 11-20-2001. INT. CL. 35.
- MCCOY, HAROLD G., KIRKLAND, WA:  
1,868,842, CANC. INT. CL. 9.
- MCGRW-HILL, INC., NEW YORK, NY, DBA EDUCATIONAL DEVELOPMENTAL LABORATORIES:  
1,144,124, CANC. INT. CL. 16.
- MCGUIRE FINANCIAL MANAGEMENT, INC., DALLAS, TX:  
1,653,295. REN. 1-4-02. INT. CL. 42.

- MCI COMMUNICATIONS CORPORATION, WASHINGTON, DC:  
1,868,615, CANC. INT. CL. 38.  
1,868,617, CANC. INT. CL. 38.  
1,868,618, CANC. INT. CL. 38.  
1,868,988, CANC. INT. CL. 38.
- MCLANE COMPANY, INC., TEMPLE, TX:  
1,962,235, CANC. MULTIPLE CLASS, INT. CLS. 29 AND 31.
- MCNEIL (OHIO) CORPORATION, ST. PAUL, MN:  
1,869,037, CANC. INT. CL. 7.
- MDY ADVANCED TECHNOLOGIES, INC., FAIR LAWN, NJ:  
1,868,851, CANC. INT. CL. 9.
- MEAD CORPORATION, THE, DAYTON, OH:  
1,174,851, REN. 1-4-02, INT. CL. 7.  
1,175,126, REN. 1-3-02, INT. CL. 16.
- MECHANICAL SERVICE COMPANY, ALLENTOWN, PA:  
1,868,821, CANC. INT. CL. 7.
- MEDACORP, INC., BOSTON, MA:  
2,537,611, PUB. 11-20-2001, INT. CL. 35.
- MEDEO LIMITED, DUBLIN 2, IRELAND:  
2,538,702, MULTIPLE CLASS, INT. CLS. 16, 28, 35 AND 41.
- MEDICAL DECISION LOGIC, INC., BALTIMORE, MD:  
2,537,624, PUB. 11-20-2001, INT. CL. 9.
- MEDICUS GROUP INTERNATIONAL, INC., NEW YORK, NY:  
2,537,984, PUB. 11-20-2001, MULTIPLE CLASS, INT. CLS. 35 AND 41.
- MEDIS CORPORATION, GUAYNABO, PUERTO RICO:  
1,868,785, CANC. MULTIPLE CLASS, INT. CLS. 1, 3 AND 5.
- MEDOS WESTERN (MEDICAL PRODUCTS) B.V., 1102 BR AMSTERDAM, NETHERLANDS:  
1,868,860, CANC. INT. CL. 10.
- MEDPROBE, INC., MINNEAPOLIS, MN:  
1,714,071, REN. 1-4-02, MULTIPLE CLASS, INT. CLS. 35 AND 42.
- MEIJER, INC., GRAND RAPIDS, MI:  
1,671,053, REN. 1-2-02, INT. CL. 11.
- MEINOLF SCHNEIDER, 6903 NECKARGEMUND, FED REP GERMANY:  
1,869,018, CANC. MULTIPLE CLASS, INT. CLS. 9, 16 AND 28.
- MELITTA-WERKE BENTZ & SOHN KOMMANDITGESELLSCHAFT, MINDEN, WESTFALEN 1, FED REP GERMANY:  
1,144,072, CANC. INT. CL. 11.
- MEMORY ART, INC., SCOTTSDALE, AZ:  
2,538,129, PUB. 11-20-2001, INT. CL. 41.
- MENEGUS, ALFRED B., WALNUT CREEK, CA, DBA PAPA'S VINEYARD:  
1,868,517, CANC. INT. CL. 33.
- MENICON CO., LTD., NAGOYA-SHI, AICHI-KEN, JAPAN:  
1,867,936, CANC. INT. CL. 5.
- MENNINGER FOUNDATION, THE, TOPEKA, KS:  
2,537,857, PUB. 11-20-2001, INT. CL. 42.
- MERCK KGAA, DARMSTADT, FED REP GERMANY, E. MERCK, DARMSTADT 1, FED REP GERMANY:  
1,175,656, REN. 1-2-02, INT. CL. 1.
- MEREDITH LLC, RICHMOND, IN:  
2,538,256, PUB. 11-20-2001, INT. CL. 3.
- MERILLAT INDUSTRIES, INC., ADRIAN, MI:  
1,868,895, CANC. INT. CL. 20.
- MESA STATE COLLEGE FOUNDATION, GRAND JUNCTION, CO:  
2,538,227, PUB. 11-20-2001, INT. CL. 25.
- METRO MATTRESS CORPORATION, LIVERPOOL, NY:  
2,538,133, PUB. 11-20-2001, INT. CL. 35.
- MEUSER'S WINCHESTER FARMS, INC., CANAL WINCHESTER, OH:  
1,144,410, CANC. INT. CL. 29.
- MEWBORN, MICHAEL KEITH, SAN DIEGO, CA:  
1,868,385, CANC. INT. CL. 25.
- MEXX GROUP, L.L.C., CHICAGO, IL:  
2,537,524, PUB. 6-5-2001, INT. CL. 30.
- MICHAEL B. LIPPMAN, INC., SANTA YNEZ, CA, DBA GREAT OAKS RANCH:  
2,537,822, PUB. 11-20-2001, INT. CL. 33.
- MICHAEL WERDIGER, INC., NEW YORK, NY, NOVA STYLINGS, INC., VAN NUYS, CA:  
1,675,803, REN. 1-4-02, INT. CL. 14.
- MICO BEAUTY PRODUCTS CO., STOW, OH:  
1,143,825, CANC. INT. CL. 3.
- MICRON DESIGN TECHNOLOGY LTD., TAIPEI HSIEN, TAIWAN:  
1,868,928, CANC. INT. CL. 28.
- MICRONET, INC., SCHENECTADY, NY:  
2,538,092, PUB. 11-20-2001, INT. CL. 42.
- MICROSCAN SYSTEMS INCORPORATED, TUKWILA, WA:  
1,868,039, CANC. INT. CL. 9.
- MID CONTINENT SYSTEMS, INC., WEST MEMPHIS, AR:  
1,144,490, CANC. INT. CL. 36.
- MID-ATLANTIC FOODS, INC., POCOMOKE CITY, MD:  
2,538,093, PUB. 11-20-2001, INT. CL. 29.
- MIDAS INTERNATIONAL CORPORATION, ITASCA, IL:  
716,626, REN. 1-2-02, U.S. CL. 103 (INT. CL. 37).  
716,627, REN. 1-2-02, U.S. CL. 103 (INT. CL. 37).
- MIDWAY AMUSEMENT GAMES, LLC, CHICAGO, IL, MIDWAY MANUFACTURING COMPANY, CHICAGO, IL:  
1,639,198, REN. 1-3-02, INT. CL. 28.
- MIDWEST FOUNDATION INDEPENDENT PHYSICIANS ASSOCIATION, CINCINNATI, OH:  
1,868,693, CANC. INT. CL. 42.
- MIGALA COMMUNICATIONS CORPORATION, CHICAGO, IL:  
2,537,972, PUB. 11-20-2001, INT. CL. 38.
- MILL'S PRIDE LIMITED PARTNERSHIP, WEST PALM BEACH, FL:  
2,538,517, INT. CL. 20.
- MILLEA, JAMES S., JR., RENSSELAER, NY AND GUPTILL, WILLIAM R., MACHIAS, ME:  
2,538,448, INT. CL. 32.
- MILLENNIUM MANAGEMENT TOOLS, INC., EVERGREEN, CO:  
1,868,976, CANC. INT. CL. 35.
- MILLER HARNESS COMPANY, L.L.C., WASHINGTON, NC, MILLER HARNESS COMPANY, INC., EAST RUTHERFORD, NJ:  
1,659,763, REN. 1-4-02, INT. CL. 18.
- MILLER PUBLISHING COMPANY, THE, MINNETONKA, MN:  
2,538,257, PUB. 11-20-2001, INT. CL. 16.
- MILLER, JOHN L., CHARDON, OH:  
1,868,736, CANC. INT. CL. 42.
- MILLER, RUSSELL, LOS ANGELES, CA:  
2,538,427, PUB. 11-20-2001, INT. CL. 25.
- MILLHAM, MICHAEL B., SPOKANE, WA:  
2,538,378, PUB. 11-20-2001, INT. CL. 41.
- MILLION DOLLAR ROUND TABLE FOUNDATION, PARK RIDGE, IL:  
2,538,698, INT. CL. 36.
- MILLNER, GIEL, ANDOVER, NJ:  
1,628,513, CANC. INT. CL. 30.
- MILTCO CORPORATION, HARRISBURG, PA:  
1,628,694, CANC. INT. CL. 41.
- MINARICH GROUP, INC., THE, BARRINGTON, IL:  
1,868,538, CANC. INT. CL. 35.
- MINDGEAR, SAN MATEO, CA:  
2,538,231, PUB. 11-20-2001, INT. CL. 28.
- MINE SAFETY APPLIANCES COMPANY, PITTSBURGH, PA:  
2,538,581, INT. CL. 9.
- MINER HOUSEWARES, INC., KANSAS CITY, MO:  
1,868,336, CANC. INT. CL. 20.
- MINERALS TECHNOLOGIES INC., NEW YORK, NY:  
2,538,568, INT. CL. 6.
- MINISTRY OF CHRIST THE TRUE VINE, SIGNAL HILL, CA:  
2,538,062, PUB. 11-20-2001, INT. CL. 42.
- MINNESOTA CITIZENS COUNCIL ON CRIME AND JUSTICE, MINNEAPOLIS, MN:  
1,868,249, CANC. MULTIPLE CLASS, INT. CLS. 16 AND

42.  
MINNESOTA PUBLIC RADIO, ST. PAUL, MN AND PUBLIC RADIO INTERNATIONAL, INC., MINNEAPOLIS, MN: 2,538,170, PUB. 11-20-2001. INT. CL. 41.
- MINNESOTA STATE BAR ASSOCIATION, THE, ST. PAUL, MN: 1,868,646, CANC. INT. CL. 41.
- MINT COLLECTION, INC., NEW YORK, NY: 2,538,299, PUB. 11-20-2001. INT. CL. 25.
- MINTZ, KAREN L., NEW HOPE, PA: 2,537,942, PUB. 11-20-2001. INT. CL. 42.
- MIRACLE CANDLE COMPANY, LAREDO, TX: 2,538,162, PUB. 11-20-2001. INT. CL. 21.
- MITCHEL & SCOTT MACHINE COMPANY, INC., INDIA-NAPOLIS, IN: 1,185,239, REN. 1-3-02. INT. CL. 42.
- MITCHELL INTERNATIONAL, INC., SAN DIEGO, CA: 2,537,990, PUB. 11-20-2001. INT. CL. 35.
- MITEK INDUSTRIES, INC., CHESTERFIELD, MO: 2,538,558, INT. CL. 6.
- ML HOTEL INVESTORS, L.P., LOS ANGELES, CA, DBA THE ORCHID AT MAUNA LANI: 2,537,962, PUB. 11-20-2001. INT. CL. 42.
- MLC LIMITED, THE, NORTH SYDNEY, NEW SOUTH WALES 2060, AUSTRALIA: 1,868,584, CANC. INT. CL. 36.
- MO OCH DOMSJO AKTIEBOLAG, S-891 80 ORNSKOLDSVIK, SWEDEN: 1,868,207, CANC. INT. CL. 16.
- MOBILE PAINT MANUFACTURING COMPANY OF DELAWARE, INC., THEODORE, AL: 559,346, REN. 1-2-02. U.S. CL. 16 (INT. CL. 2).
- MODAN INDUSTRIES (1983) LTD., TEL AVIV 66550, ISRAEL: 1,868,303, CANC. INT. CL. 18.
- MODAR, INCORPORATED, BENTON HARBOR, MI: 1,144,184, CANC. MULTIPLE CLASS, INT. CLS. 19 AND 20.
- MODERN INDUSTRIES, INC., HASTINGS, MN: 1,867,954, CANC. INT. CL. 5.
- MODERN MUZZLE LOADING, INC., CENTERVILLE, IA: 1,868,188, CANC. INT. CL. 13.
- MOGI COMPANY, ANKOV, MN: 1,868,453, CANC. INT. CL. 28.
- MOHAWK DISTILLED PRODUCTS, L.P., NORTH MIAMI, FL, MCKESSON & ROBBINS, INCORPORATED, NEW YORK, NY: 725,709, REN. 1-4-02. U.S. CL. 49 (INT. CL. 33).
- MOLLAND, BERNARD, 92200 NEUILLY SUR SEINE, FRANCE: 1,868,712, CANC. INT. CL. 42.
- MOLSON CANADA, TORONTO, ONTARIO, CANADA: 2,537,879, PUB. 11-20-2001. INT. CL. 32.
- MONEY MAP INC., BROOKLYN, NY: 2,538,413, PUB. 11-20-2001. INT. CL. 16.
- MONOLITH PRODUCTIONS, INC., KIRKLAND, WA: 2,537,902, PUB. 11-20-2001. INT. CL. 9.
- MOONSHADOW S.P.A., 20122 MILAN, ITALY: 1,868,359, CANC. INT. CL. 25.
- MOORE ENTERPRISES, INC., MCDONOUGH, GA: 1,868,468, CANC. INT. CL. 28.
- MORGAN CRUCIBLE COMPANY PLC, THE, BERKSHIRE SL4 1EP, GREAT BRITAIN, GTE PRODUCTS CORPORATION, STAMFORD, CT: 1,667,351, REN. 1-4-02. INT. CL. 6.
- MORGAN STANLEY DEAN WITTER & CO., NEW YORK, NY: 2,538,609, INT. CL. 16.
- MORINDA, INC., PROVO, UT: 2,537,558, PUB. 11-20-2001. INT. CL. 3.
- MORRISON RESTAURANTS INC., MOBILE, AL: 1,868,763, CANC. INT. CL. 42.
- MORRISON, DAVID ELLSWORTH, CONCORD, NH: 2,538,018, PUB. 11-20-2001. INT. CL. 35.
- MORRISON, JEAN, UNION DALE, PA, DBA MEADOW LODGE CREATIONS: 2,538,031, PUB. 11-20-2001. INT. CL. 4.
- MORRISON, KEITH, SEA CLIFF, NY: 2,538,083, PUB. 11-20-2001. INT. CL. 37.
- MORT & SONS, LLC, BLOOMINGTON, IN: 2,538,211, PUB. 11-20-2001. INT. CL. 37.
- MORTGAGE MASTER SERVICE CORPORATION, KENT, WA: 1,172,552, REN. 1-2-02. INT. CL. 36.
- MORTGAGE NATION, LIGHTHOUSE POINT, FL: 2,537,707, PUB. 11-20-2001. INT. CL. 36.
- MOSKOWITZ, ROBERT A., WOODLAND HILLS, CA: 1,869,126, CANC. INT. CL. 42.
- MOTHERS IN MOTION, INC., ROUND ROCK, TX: 2,538,493, INT. CL. 25.
- MOTLEY FOOL, INC, THE, ALEXANDRIA, VA: 2,537,876, PUB. 11-20-2001. INT. CL. 38.
- MOTOMCO LTD., MADISON, WI: 2,494,148, CANC. IIRN. RESTORED TO S.N. 76-050,679.
- MOTORCYCLE STUFF, INC., CAPE GIRARDEAU, MO: 2,537,893, PUB. 11-20-2001. INT. CL. 35.
- MOUNTAIN GEAR CORPORATION, BALDWIN PARK, CA: 2,538,212, PUB. 11-20-2001. INT. CL. 25.
- MOUNTAIN SHINE INTERNATIONAL CORPORATION, LAKE OSWEGO, OR: 1,868,496, CANC. INT. CL. 30.
- MOUNTZ, INC., SAN JOSE, CA: 1,172,863, REN. 1-4-02. MULTIPLE CLASS, INT. CLS. 7, 8 AND 9.
- MSG (ILLINOIS) INC., LOMBARD, IL, DBA SRO MOTORSPORTS: 1,868,667, CANC. INT. CL. 41.
- MULTISPIRO, INC., IRVINE, CA: 1,868,839, CANC. INT. CL. 9.
- MURRAY BAKERY PRODUCTS, INC., AUGUSTA, GA: 1,144,422, CANC. INT. CL. 30.
- MUSIC SOUND EXCHANGE, NEW YORK, NY: 1,868,762, CANC. INT. CL. 42.
- MYCITY.COM, INC., MIAMI BEACH, FL: 2,381,550, COR. INT. CL. 35.
- 2,449,143, COR. INT. CL. 35.
- MYCOGEN CORPORATION, SAN DIEGO, CA: 1,627,938, CANC. INT. CL. 5.
- N.S.U. NORTH SHORE UNDERGROUND CORP., HONOLULU, HI: 1,868,411, CANC. INT. CL. 25.
- N.V. BOMAT, B-9800 DEINZE, BELGIUM: 2,537,559, PUB. 11-20-2001. INT. CL. 27.
- NABISCO, INC., EAST HANOVER, NJ: 1,144,403, CANC. INT. CL. 29.
- NABISCO, INC., PARSIPPANY, NJ: 1,868,946, CANC. INT. CL. 30.
- 1,868,953, CANC. INT. CL. 30.
- NADEAU, WILLIAM C., UNIVERSITY HEIGHTS, OH: 1,144,039, CANC. INT. CL. 10.
- NAK CORPORATION, HAYWARD, CA: 1,868,367, CANC. INT. CL. 25.
- NAMESTYLES, INCORPORATED, BENICIA, CA: 2,538,390, PUB. 11-20-2001. INT. CL. 42.
- NANOFILM, LTD., VALLEY VIEW, OH: 2,538,590, INT. CL. 2.
- NANWANI INTERNATIONAL LTD., NORTH BERGEN, NJ: 1,868,391, CANC. INT. CL. 25.
- NAPA VALLEY SECIALTY WINES, INC., ST. HELENA, CA, DE LA SALLE INSTITUTE, NAPA, CA, DBA MONT LA SALLE VINEYARDS: 562,913, REN. 1-2-02. U.S. CL. 47 (INT. CL. 33).
- NAPA VALLEY SPECIALTY WINES, INC., ST. HELENA, CA, DE LA SALLE INSTITUTE, NAPA, CA, DBA MONT LA SALLE VINEYARDS: 562,912, REN. 1-2-02. U.S. CL. 47 (INT. CL. 33).
- NAS INDUSTRIES, INC, NEW YORK, NY: 2,537,759, PUB. 11-20-2001. INT. CL. 31.
- NATHAN SCHECTER & SONS, PHILADELPHIA, PA, DBA WYNNE NOVELTY CO.: 1,144,057, CANC. INT. CL. 11.
- NATIONAL ACADEMY OF RECORDING ARTS & SCIENCES, SANTA MONICA, CA: 2,538,710, INT. CL. 41.

- NATIONAL ASSOCIATION FOR STOCK CAR AUTO RACING, INC., DAYTONA BEACH, FL:  
2,351,763, COR. MULTIPLE CLASS, INT. CLS. 25 AND 41.
- NATIONAL ASSOCIATION OF COLLEGES AND EMPLOYERS, BETHLEHEM, PA:  
2,538,385, PUB. 11-20-2001. MULTIPLE CLASS, INT. CLS. 35, 41 AND 42.
- NATIONAL AUTOMOTIVE PARTS ASSOCIATION, ATLANTA, GA:  
1,868,696, CANC. INT. CL. 42.
- NATIONAL BANK OF THE REDWOODS, SANTA ROSA, CA:  
1,868,585, CANC. INT. CL. 36.
- NATIONAL BOARD FOR PROFESSIONAL TEACHING STANDARDS, SOUTHFIELD, MI:  
1,906,966, CANC. INT. CL. 42.
- NATIONAL BUREAU OF ASIAN RESEARCH, THE, SEATTLE, WA:  
2,538,233, PUB. 11-20-2001. INT. CL. 42.
- NATIONAL CHILDHOOD CANCER FOUNDATION, ARCADIA, CA:  
2,538,292, PUB. 11-20-2001. INT. CL. 36.
- NATIONAL COUNCIL OF STATE BOARDS OF NURSING, INC., CHICAGO, IL:  
1,868,665, CANC. INT. CL. 41.
- NATIONAL FIRE PROTECTION ASSOCIATION, INC., QUINCY, MA:  
1,165,496, REN. 1-3-02. INT. CL. 16.
- NATIONAL FIRE SAFETY COUNCIL, MICHIGAN CENTER, MI:  
2,538,310, PUB. 11-20-2001. INT. CL. 16.
- NATIONAL HOCKEY LEAGUE, NEW YORK, NY:  
2,538,015, PUB. 11-20-2001. INT. CL. 42.  
2,538,016, PUB. 11-20-2001. INT. CL. 36.  
2,538,076, PUB. 11-20-2001. INT. CL. 42.
- NATIONAL MAGAZINE COMPANY LIMITED, THE, LONDON, ENGLAND:  
1,192,531, REN. 1-2-02. INT. CL. 16.
- NATIONAL MANUFACTURING CO., STERLING, IL:  
900,038, REN. 1-4-02. U.S. CL. 13 (INT. CLS. 6, 7, 11, 17, 20 AND 21).
- NATIONAL NONWOVENS, INC., EASTHAMPTON, MA, NATIONAL FELT COMPANY, INC., EASTHAMPTON, MA:  
1,660,875, REN. 1-3-02. INT. CL. 24.
- NATIONAL POLY PRODUCTS, INC., CARTERSVILLE, GA:  
1,868,274, CANC. MULTIPLE CLASS, INT. CLS. 17, 24 AND 25.
- NATIONAL REHABILITATION HOSPITAL, INC., WASHINGTON, DC, MEDLANTIC HEALTHCARE GROUP, WASHINGTON, DC:  
1,667,083, REN. 1-4-02. INT. CL. 42.
- NATIONAL SLEEP FOUNDATION, WASHINGTON, DC:  
2,538,297, PUB. 11-20-2001. INT. CL. 42.
- NATIONAL SPINNING CO., INC., NEW YORK, NY:  
1,869,094, CANC. INT. CL. 26.
- NATIONAL SUPER SERVICE COMPANY, THE, TOLEDO, OH:  
1,868,850, CANC. INT. CL. 9.
- NATIONAL TRADE PUBLICATIONS, INC., LATHAM, NY:  
2,537,933, PUB. 5-15-2001. INT. CL. 16.
- NATIONAL UPPER CERVICAL CHIROPRACTIC ASSOCIATION, INC., THE, MONROE, MI:  
2,538,183, PUB. 11-20-2001. INT. CL. 41.
- NATORI COMPANY INCORPORATED, THE, NEW YORK, NY:  
2,538,577, INT. CL. 25.
- NATROL, INC., CHATSWORTH, CA:  
2,537,819, PUB. 11-20-2001. INT. CL. 30.
- NATURAL ORGANICS INC., FARMINGDALE, NY:  
1,204,268, REN. 1-2-02. INT. CL. 5.
- NATURAL ORGANICS INC., MELVILLE, NY:  
2,537,730, PUB. 11-20-2001. INT. CL. 5.
- NATURE COMPANY, THE, BERKELEY, CA:  
1,868,708, CANC. INT. CL. 42.
- NATURE'S ANIMALS, INC., ALBANY, NY:  
2,538,138, PUB. 11-20-2001. INT. CL. 31.
- NATURE'S SUNSHINE PRODUCTS, INC., PROVO, UT:  
1,666,423, REN. 1-3-02. INT. CL. 5.
- NAVITAR, INC., ROCHESTER, NY:  
2,538,662, INT. CL. 9.
- NBA PROPERTIES, INC., NEW YORK, NY:  
1,144,425, CANC. INT. CL. 30.  
2,538,167, PUB. 11-20-2001. INT. CL. 41.
- NEAR EAST RESEARCH, WASHINGTON, DC:  
2,538,331, PUB. 11-20-2001. INT. CL. 16.
- NEBRASKA STUDENT LOAN PROGRAM, INC., LINCOLN, NE:  
2,538,295, PUB. 11-20-2001. INT. CL. 36.
- NEEDLECRAFT SHOP, INC., THE, BIG SANDY, TX:  
1,868,442, CANC. INT. CL. 26.
- NEFITCO, INC., BRATTLEBORO, VT:  
2,537,580, PUB. 11-20-2001. INT. CL. 35.
- NEKTA INTERNATIONAL LIMITED, MT WELLINGTON, AUCKLAND, NEW ZEALAND:  
2,538,491, INT. CL. 32.
- NELSON STUD WELDING, INC., ELYRIA, OH, GREGORY INDUSTRIES, INC., LORAIN, OH:  
726,143, REN. 1-4-02. U.S. CL. 12 (INT. CL. 19).
- NELSON, MICHAEL, LAWRENCEVILLE, NJ:  
2,537,646, PUB. 1-16-2001. INT. CL. 16.
- NELSONITE CHEMICAL PRODUCTS, INC., GRAND RAPIDS, MI:  
708,606, CANC. U.S. CL. 6.
- NESCHEN INTERNATIONAL B.V., NL-4824 AB BRED, NETHERLANDS, HANS NESCHEN, KOMMANDITGESELLSCHAFT, BUCKEBURG, FED REP GERMANY:  
921,955, REN. 1-4-02. U.S. CL. 37 (INT. CL. 16).
- NESCHEN INTERNATIONAL BV, NL-4824 AB BRED, NETHERLANDS, HANS NESCHEN, KOMMANDITGESELLSCHAFT, BUCKEBURG, FED REP GERMANY:  
921,954, REN. 1-4-02. U.S. CL. 37 (INT. CL. 16).
- NESTE OIL SERVICES, INC., SAN DIEGO, CA:  
1,868,310, CANC. INT. CL. 19.
- NETRAKER CORPORATION, SUNNYVALE, CA:  
2,538,556, MULTIPLE CLASS, INT. CLS. 35 AND 42.
- NETWORK, INC., THE, NORCROSS, GA:  
2,537,827, PUB. 11-20-2001. INT. CL. 35.
- NETXPOSURE, INC., PORTLAND, OR:  
2,538,261, PUB. 11-20-2001. INT. CL. 42.
- NEW BRUNSWICK SCIENTIFIC CO., INC., EDISON, NJ:  
1,160,734, REN. 1-4-02. INT. CL. 9.
- NEW ENERGY ASSOCIATES, L.L.C., ATLANTA, GA:  
2,538,595, INT. CL. 9.
- NEW ENGLAND CLASSIC INTERIORS, INC., PORTLAND, ME:  
2,538,559, INT. CL. 19.
- NEW ENGLAND PACKAGING CO., INC., FAIRFIELD, CT:  
2,538,663, INT. CL. 16.
- NEW ERA, INC., CLARKSVILLE, TN:  
1,144,217, CANC. INT. CL. 21.
- NEW EYEGLASS FACTORY OF MICHIGAN, INC., THE, FERNDALE, MI, DBA THE EYEGLASS FACTORY:  
2,538,357, PUB. 11-20-2001. INT. CL. 42.
- NEW HORIZONS INTERNATIONAL CORPORATION, TAIPEI, TAIWAN:  
1,868,891, CANC. INT. CL. 20.
- NEW WATER PRODUCTS, LLC, AUBURN, WA:  
1,868,175, CANC. INT. CL. 11.
- NEW YORK STATE BUSINESS GROUP, INC., LATHAM, NY:  
1,868,571, CANC. INT. CL. 36.  
1,868,572, CANC. INT. CL. 36.
- NEW ZEALAND KIWIFRUIT MARKETING BOARD, NEW-MARKET, AUCKLAND, NEW ZEALAND:  
1,868,211, CANC. MULTIPLE CLASS, INT. CLS. 16, 29, 31 AND 32.
- NEWCO PRODUCTIONS, L.L.C., ATLANTA, GA:  
2,537,526, PUB. 11-20-2001. MULTIPLE CLASS, INT. CLS. 9 AND 41.
- NEWCOMER PRODUCTS, INC., LATROBE, PA:  
1,173,935, REN. 1-3-02. INT. CL. 7.

- NEWELL OPERATING COMPANY, FREEPORT, IL, HOME FASHIONS, INC., SANTA MONICA, CA, DBA INTER ALIA, DEL MAR:  
1,654,722. REN. 1-4-02. MULTIPLE CLASS, INT. CLS. 6, 20 AND 24.
- NEWELL OPERATING COMPANY, FREEPORT, IL, HOME FASHIONS, INC., SANTA MONICA, CA:  
1,654,920. REN. 1-4-02. INT. CL. 20.
- NEWGROUND RESOURCES, INC., MANCHESTER, MO:  
2,538,407. PUB. 11-20-2001. INT. CL. 41.  
2,538,408. PUB. 11-20-2001. INT. CL. 42.
- NEWHOUSE SPECIALTY CO., INC., SANTA ANA, CA:  
1,868,805. CANC. INT. CL. 3.
- NEWMANS' MANUFACTURING, INC., ROYALTON, MN:  
2,537,836. PUB. 11-20-2001. INT. CL. 12.
- NEWS AND OBSERVER FOUNDATION, THE, RALEIGH, NC:  
1,869,058. CANC. INT. CL. 16.
- NEWSON & SONS, INC., FORT PIERCE, FL:  
2,538,303. PUB. 11-20-2001. INT. CL. 42.
- NEXTEC APPLICATIONS, INC., VISTA, CA:  
2,538,636. MULTIPLE CLASS, INT. CLS. 24 AND 25.
- NEXTMED SYSTEMS, INC., CLEVELAND, OH:  
2,538,596. INT. CL. 35.
- NICCA U.S.A., INC., FOUNTAIN INN, SC:  
1,664,404. REN. 1-3-02. INT. CL. 37.
- NICHOLS, JEROME SMITH III, IRVINE, CA:  
1,868,381. CANC. INT. CL. 25.
- NICOLET VASCULAR INC., GOLDEN, CO:  
2,538,440. PUB. 11-20-2001. INT. CL. 10.
- NICOMATIC, 74890 BONS-EN-CHABLAIS, FRANCE:  
1,660,607. REN. 1-4-02. INT. CL. 9.
- NIGRELLI SYSTEMS INC., KIEL, WI:  
1,868,822. CANC. INT. CL. 7.
- NIIT (USA), INC., ATLANTA, GA:  
1,916,215. COR. INT. CL. 9.
- NIKE, INC., BEAVERTON, OR, BRS, INC., BEAVERTON, OR:  
1,173,359. REN. 12-29-01. INT. CL. 25.
- NIKE, INC., BEAVERTON, OR:  
1,868,902. CANC. INT. CL. 25.
- NINTENDO OF AMERICA INC., REDMOND, WA:  
2,538,329. PUB. 11-20-2001. INT. CL. 9.
- NIPPON ELECTRIC GLASS CO., LTD., SHIGA-KEN, JAPAN:  
1,628,191. CANC. INT. CL. 11.
- NIPPON GAS KABUSHIKI KAISHA (NIPPON GAS CO., LTD.), CHUO-KU, TOKYO 104, JAPAN:  
1,144,066. CANC. INT. CL. 11.
- NISSAN, PAUL, TORRANCE, CA, DBA THE COMING DAY:  
1,868,727. CANC. INT. CL. 42.
- NIXON'S FRANCHISES, INC., KNOXVILLE, TN:  
1,663,719. REN. 1-2-02. INT. CL. 42.
- NMC MEDICAL PRODUCTS, INC., LEXINGTON, MA:  
1,627,939. CANC. INT. CL. 5.
- NOLLE INDUSTRIELLE UMWELTECHNIK GMBH, D-47495 RHEINBERG, FED REP GERMANY:  
2,537,683. PUB. 11-20-2001. INT. CL. 11.
- NOLTIE, KEITH G., MISSISSAUGA, ONTARIO L5E 2E2, CANADA:  
1,868,804. CANC. INT. CL. 3.
- NORCYN, LLC, FORT WAYNE, IN:  
2,538,640. INT. CL. 28.
- NORLAB, INC., MISSISSAUGA, ONTARIO, CANADA:  
1,628,090. CANC. INT. CL. 9.  
1,628,091. CANC. INT. CL. 9.
- NORM THOMPSON OUTFITTERS, INC., HILLSBORO, OR:  
2,537,693. PUB. 11-20-2001. INT. CL. 25.
- NORTECH FOREST PRODUCTS, INC., EDEN PRAIRIE, MN:  
1,869,033. CANC. INT. CL. 5.
- NORTH AMERICAN ENCLOSURES, INC., CENTRAL ISLIP, NY:  
2,537,797. PUB. 11-20-2001. INT. CL. 20.
- NORTH AMERICAN MARKETING CORPORATION, THE, MANCHESTER, CT:  
1,672,678. REN. 1-3-02. INT. CL. 28.
- NORTH AMERICAN RUGBY PUBLISHING, INC., DENVER, CO:  
1,868,246. CANC. INT. CL. 16.
- NORTHEASTERN UNIVERSITY, BOSTON, MA:  
1,628,671. CANC. INT. CL. 41.
- NORTHWEST AIRLINES, INC., ST. PAUL, MN:  
1,718,838. REN. 1-2-02. INT. CL. 39.  
2,538,709. INT. CL. 39.
- NORTHWEST PACKING COMPANY, VANCOUVER, WA:  
2,538,191. PUB. 11-20-2001. INT. CL. 29.
- NORTHWOOD ANIMAL HOSPITAL, TALLAHASSEE, FL:  
1,868,725. CANC. INT. CL. 42.
- NOSOC, INC., NEW ORLEANS, LA:  
2,538,263. PUB. 11-20-2001. INT. CL. 30.
- NOUVELLES IMAGES S. A., VILLEMAMDEUR, FRANCE:  
1,628,295. CANC. INT. CL. 16.
- NOVAPET, INC., FORT LAUDERDALE, FL:  
1,868,294. CANC. INT. CL. 18.
- NOVARTIS AG, BASEL, SWITZERLAND:  
2,537,606. PUB. 11-20-2001. MULTIPLE CLASS, INT. CLS. 1, 5, 31, 35 AND 42.  
2,538,370. PUB. 11-20-2001. INT. CL. 5.
- NOVELL, INC., PROVO, UT:  
1,868,562. CANC. INT. CL. 35.
- NTN COMMUNICATIONS, INC., CARLSBAD, CA:  
2,538,688. INT. CL. 41.
- NU SALT CORP., SASKATOON, SASKATCHEWAN, CANADA:  
2,537,579. PUB. 11-20-2001. MULTIPLE CLASS, INT. CLS. 1 AND 3.
- NUMI, LLC, OAKLAND, CA:  
2,538,176. PUB. 11-20-2001. INT. CL. 30.  
2,538,177. PUB. 11-20-2001. INT. CL. 30.
- NUTRASTAR, EL DORADO HILLS, CA:  
2,537,997. PUB. 11-20-2001. INT. CL. 5.
- NUTRO PRODUCTS, INC., CITY OF INDUSTRY, CA:  
2,538,492. INT. CL. 31.
- O. M. CONTRACTING, INC., THERMAL, CA, DBA ROLLING CAMEL RANCHES:  
2,538,156. PUB. 11-20-2001. INT. CL. 31.
- O'FARRELL, EDWARD, NEW YORK, NY:  
2,538,551. INT. CL. 35.
- O'KEEFE, DOROTHY M., NEWTOWN SQUARE, PA:  
2,538,127. PUB. 11-20-2001. INT. CL. 41.
- OAK, EUGENE, LOS ANGELES, CA:  
1,868,240. CANC. INT. CL. 16.
- OAKWOOD ENERGY MANAGEMENT INCORPORATED, DEARBORN, MI:  
2,537,705. PUB. 11-20-2001. INT. CL. 12.
- OCEAN-AIR INTERNATIONAL, INC., BURGETTSTOWN, PA:  
1,144,513. CANC. INT. CL. 39.
- ODS TECHNOLOGIES, L.P., BROOMFIELD, CO:  
2,538,475. INT. CL. 41.
- OFFICAL STARTER LLC, COLUMBUS, OH, STARTER SPORTSWEAR, INC., NEW HAVEN, CT:  
1,175,308. REN. 1-2-02. INT. CL. 25.
- OHIO COMMISSION ON MINORITY HEALTH, COLUMBUS, OH:  
2,538,384. PUB. 11-20-2001. INT. CL. 42.
- OKI ELECTRIC INDUSTRY CO., LTD., MINATO-KU, TOKYO, JAPAN:  
2,538,260. PUB. 11-20-2001. INT. CL. 16.
- OKLAHOMA TOURISM AND RECREATION DEPARTMENT, OKLAHOMA CITY, OK:  
1,653,257. REN. 12-29-01. INT. CL. 41.
- OLD BAY COMPANY, INC., HUNT VALLEY, MD:  
1,679,574. REN. 12-31-01. INT. CL. 30.
- OLD WORLD FOODS, INC., PORTLAND, OR:  
1,628,764. CANC. INT. CL. 42.
- OLE MEXICAN FOODS, INC., ATLANTA, GA:  
2,538,064. PUB. 11-20-2001. INT. CL. 30.
- OLEM SHOE CORPORATION, MIAMI, FL:  
1,641,346. REN. 1-3-02. INT. CL. 25.
- OLIN CORPORATION, NORWALK, CT:  
1,678,431. REN. 1-2-02. INT. CL. 13.
- OLMEC TOYS, INC., NEW YORK, NY:  
1,868,482. CANC. INT. CL. 28.

- OMS INVESTMENTS, INC., WILMINGTON, DE:  
2,538,168, PUB. 11-20-2001. INT. CL. 1.
- ONDEOP NALCO COMPANY, NAPERVILLE, IL, DIAMOND SHAMROCK CORPORATION, DALLAS, TX:  
1,171,828. REN. 1-4-02. INT. CL. 1.
- ONDEOP NALCO COMPANY, NAPERVILLE, IL, DIAMOND SHAMROCK CORPORATION, DALLAS, TX:  
1,174,686. REN. 1-4-02. INT. CL. 1.
- ONE DAY AT A TIME PRISON MINISTRIES, INC., COSTA MESA, CA:  
1,144,564, CANC. INT. CL. 42.
- ONFLOW CORPORATION, SAN FRANCISCO, CA:  
2,538,548, MULTIPLE CLASS, INT. CLS. 9, 35, 38, 39 AND 41.
- ONLINE BUDDIES, INC., CAMBRIDGE, MA:  
2,538,185, PUB. 11-20-2001. INT. CL. 42.
- ONSHARE, LLC, ITHACA, NY:  
2,537,660, PUB. 11-20-2001. INT. CL. 38.
- ONTARIO CORPORATION, MUNCIE, IN:  
2,537,788, PUB. 11-20-2001. INT. CL. 42.
- OPAL COMMUNICATIONS, INC., NEW YORK, NY:  
1,720,181. REN. 1-4-02. INT. CL. 16.
- OPPENHEIMER COMPANIES, INC., BOISE, ID:  
2,537,743, PUB. 11-20-2001. INT. CL. 29.
- OPTICAL DYNAMICS CORPORATION, LOUISVILLE, KY FROM RAPID CAST, INC., LOUISVILLE, KY:  
2,538,468, INT. CL. 9.
- OPTICAL MEDIA INTERNATIONAL, LOS GATOS, CA:  
1,868,062, CANC. MULTIPLE CLASS, INT. CLS. 9 AND 41.
- OPTIMAL TELECOM CORPORATION, TAMPA, FL:  
2,537,739, PUB. 11-20-2001. INT. CL. 35.  
2,537,740, PUB. 11-20-2001. INT. CL. 35.
- ORBIT INDUSTRIES, INC., HELEN, GA:  
1,868,419, CANC. INT. CL. 25.
- OREGON WOMEN LAWYERS FOUNDATION, BEND, OR:  
2,537,619, PUB. 11-20-2001. INT. CL. 36.
- ORIEL INCORPORATED, MADISON, WI, JOINER ASSOCIATES INC., MADISON, WI:  
1,626,242. REN. 12-29-01. INT. CL. 35.
- ORKESTRA, NEW YORK, NY:  
2,228,729, CANC. INT. CL. 25.
- ORLANDO/ORANGE COUNTY CONVENTION & VISITORS BUREAU, INC., ORLANDO, FL:  
2,537,952, PUB. 11-20-2001. INT. CL. 35.
- ORTRONICS, INC., PAWCATUCK, CT:  
1,868,064, CANC. INT. CL. 9.
- OSEM INVESTMENTS LTD., PETACH TIKVA 49517, ISRAEL:  
2,538,531, MULTIPLE CLASS, INT. CLS. 29 AND 30.
- OSG TAP & DIE, INC., GLENDALE HEIGHTS, IL:  
2,537,799, PUB. 4-17-2001. INT. CL. 7.
- OSPREY BIOTECHNICS, INC., SARASOTA, FL:  
1,867,891, CANC. INT. CL. 1.
- OTS TRAVEL SERVICE, INC., NEW YORK, NY:  
2,537,928, PUB. 11-20-2001. INT. CL. 39.
- OTSUKA AMERICA PHARMACEUTICAL, INC., SEATTLE, WA:  
1,868,813, CANC. INT. CL. 5.
- OTTO-VERSAND (GMBH & CO), 22172 HAMBURG, FED REP GERMANY:  
2,537,530, PUB. 11-20-2001. MULTIPLE CLASS, INT. CLS. 36, 38, 39 AND 42.
- OUTDOOR WORLD, PEMBROKE, NH:  
2,538,033, PUB. 11-20-2001. INT. CL. 31.
- OUTERVENTION, INC., SAN FRANCISCO, CA:  
2,538,210, PUB. 11-20-2001. MULTIPLE CLASS, INT. CLS. 41 AND 42.
- OUTRIGGER CANOE CLUB, HONOLULU, HI:  
2,538,362, PUB. 11-20-2001. INT. CL. 25.
- OVERSEAS CHRISTIAN SERVICEMEN'S CENTERS, INC., ENGLEWOOD, CO:  
1,144,128, CANC. MULTIPLE CLASS, INT. CLS. 16, 41 AND 42.
- OWENBY COMPANY, THE, BLAIRSVILLE, GA, OWENBY MANUFACTURING CO., INC., MARIETTA, GA:  
1,177,380. REN. 12-29-01. INT. CL. 25.
- OWENS CORNING FIBERGLAS TECHNOLOGY, INC., TOLEDO, OH:  
2,538,530, INT. CL. 17.
- OWENS ONLINES, INC., TAMPA, FL, OWENS INTERNATIONAL CREDIT, INC., CLEARWATER, FL:  
1,663,871. REN. 1-3-02. INT. CL. 35.
- OZARK HONEY-DEW FARMS, INC., ELKLAND, MO:  
1,868,339, CANC. INT. CL. 21.
- P & A INTERNATIONAL, COSTA MESA, CA FROM P & A INTERNATIONAL, COSTA MESA, CA:  
2,538,613, INT. CL. 25.
- PACIFIC DELIGHT TOURS, INC., NEW YORK, NY:  
1,175,474. REN. 1-4-02. INT. CL. 39.  
2,537,772, PUB. 11-20-2001. INT. CL. 39.
- PACIFIC DISTRIBUTING, INC., FRESNO, CA:  
2,538,258, PUB. 11-20-2001. INT. CL. 11.
- PACIFIC SALES ASSOCIATES, INC., BURLINGAME, CA, DBA PACIFIC SALES AND IMPORTS:  
1,868,969, CANC. INT. CL. 33.
- PACIFIC TELESCOPE CORP., RICHMOND, BRITISH COLUMBIA, V7E 1J7, CANADA:  
2,537,555, PUB. 11-20-2001. INT. CL. 9.
- PACKAGING DEPOT INC., NORTH VANCOUVER, BRITISH COLUMBIA, CANADA:  
1,660,772. REN. 1-2-02. INT. CL. 39.  
1,660,772, CANC. MULTIPLE CLASS, INT. CLS. 16, 17, 36 AND 42.
- PAFFRATH, RONALD A., MADISON, CT, JOHNSON; DOUGLAS M., ARMONK, NY, DBA STRIKE GUARD CO.:  
1,173,448. REN. 12-29-01. INT. CL. 28.
- PAINWEBBER INC., NEW YORK, NY:  
1,868,269, CANC. MULTIPLE CLASS, INT. CLS. 16 AND 36.
- PAINT ROCK ARTESIAN WATER, INC., WORLAND, WY:  
2,538,490, INT. CL. 32.
- PALL CORPORATION, EAST HILLS, NY:  
1,628,179, CANC. INT. CL. 10.
- PAMA-LAMA CORPORATION, CHICAGO, IL:  
1,628,348, CANC. INT. CL. 20.
- PAN AM INTERNATIONAL FLIGHT ACADEMY INC., MIAMI, FL:  
1,868,651, CANC. INT. CL. 41.
- PANLINE USA, INC., NORTHVALE, NJ:  
2,538,279, PUB. 11-20-2001. INT. CL. 16.
- PAPA, ANGELO A., NEW CASTLE, PA:  
2,537,756, PUB. 11-20-2001. MULTIPLE CLASS, INT. CLS. 36 AND 42.
- PARFUMS GUY LAROCHE, 75001 PARIS, FRANCE:  
1,869,028, CANC. INT. CL. 3.
- PARKPLACE FAMILY SERVICES, INC., INDIANAPOLIS, IN:  
1,868,659, CANC. MULTIPLE CLASS, INT. CLS. 41 AND 42.
- PARKS II, ALBERT JAMES, NORTH RICHLAND HILLS, TX:  
2,537,760, PUB. 11-20-2001. INT. CL. 41.
- PARMALAT S.P.A., COLLECCHIO, PARMA, ITALY:  
1,141,495. REN. 1-3-02. MULTIPLE CLASS, INT. CLS. 29, 30 AND 32.
- PARROS CONSULTING GROUP, L.L.C., SUMNER, WI:  
2,538,251, PUB. 11-20-2001. INT. CL. 35.
- PARSONS TECHNOLOGY, INC., HIAWATHA, IA:  
1,868,098, CANC. INT. CL. 9.
- PARTSBASE.COM, INC., BOCA RATON, FL:  
2,537,682, PUB. 11-20-2001. INT. CL. 35.
- PASAR, INC., DENVER, CO:  
1,639,635. REN. 12-31-01. INT. CL. 9.
- PATH FOUNDATION, INC., THE, KINGWOOD, TX:  
1,868,664, CANC. INT. CL. 41.
- PATZ SALES, INC., POUND, WI:  
1,667,195. REN. 1-3-02. INT. CL. 20.
- PAUL JOURNEE S.A., 92400 COURBEVOIE, FRANCE:  
1,143,892, CANC. INT. CL. 6.
- PAUL W. DAVIS SYSTEMS, INC., JACKSONVILLE, FL:  
1,937,790, CANC. INT. CL. 35.

PAULIST NATIONAL CATHOLIC EVANGELIZATION ASSOCIATION, WASHINGTON, DC:  
2,538,349, PUB. 11-20-2001. INT. CL. 16.  
2,538,350, PUB. 11-20-2001. INT. CL. 9.

PAULSEN, TYLER G., MENASHA, WI:  
1,868,629, CANC. INT. CL. 39.

PAULSTARR ENTERPRISES, INC., CHANHASSEN, MN:  
2,538,562, INT. CL. 41.

PAVER SYSTEMS, INC., WEST PALM BEACH, FL:  
1,868,315, CANC. INT. CL. 19.

PAVION LTD., NYACK-ON-HUDSON, NY:  
1,867,916, CANC. INT. CL. 3.

PAZ SYSTEMS INC., FARMINGDALE, NY:  
1,676,551. REN. 1-3-02. INT. CL. 6.

PBI-GORDON CORPORATION, KANSAS CITY, MO:  
1,627,881, CANC. INT. CL. 1.

PDB SPORTS, LTD., ENGLEWOOD, CO, DBA DENVER BRONCOS, EMPIRE SPORTS, INC., DENVER, CO:  
921,748. REN. 1-4-02. U.S. CL. 107 (INT. CL. 41).  
921,750. REN. 1-4-02. U.S. CL. 107 (INT. CL. 41).

PEACOCK, BRADLEY, NEW YORK, NY:  
2,537,565, PUB. 11-20-2001. INT. CL. 35.

PEAKTIME, 75726 PARIS, CEDEX, FRANCE:  
2,537,786, PUB. 11-20-2001. MULTIPLE CLASS, INT. CLS. 9, 35, 37, 38, 41 AND 42.

PEARL HARBOR HOBBIES, MORROW, GA:  
1,869,125, CANC. INT. CL. 42.

PEARSON, DURK, TONOPAH, NE AND SHAW, SANDY, TONOPAH, NE:  
1,867,945, CANC. INT. CL. 5.

PEDRO DOMECA MEXICO, S.A. DE C.V., COLONIA DEL CARMEN COYOACAN, 04100, MEXICO:  
2,538,677, INT. CL. 33.

PEERLESS CARPET CORPORATION, WESTMOUNT, QUEBEC, CANADA:  
1,868,445, CANC. MULTIPLE CLASS, INT. CLS. 27 AND 42.

PEN-TAB INDUSTRIES, INC., GLENDALE, NY:  
1,868,209, CANC. INT. CL. 16.

PENA, MANUEL, NAPA, CA:  
1,868,892, CANC. INT. CL. 20.

PENNWALT CORPORATION, PHILADELPHIA, PA:  
708,705, CANC. U.S. CL. 23.

PENTECH INTERNATIONAL INC., EDISON, NJ:  
1,997,472, CANC. INT. CL. 3.

PER BERGKVIST, ASTORIA, NY:  
2,538,216, PUB. 11-20-2001. INT. CL. 42.

PEREGRINITY, INC., SAN FRANCISCO, CA:  
2,537,630, PUB. 11-20-2001. MULTIPLE CLASS, INT. CLS. 39 AND 42.

PERFECT FIT INDUSTRIES, INC., NEW YORK, NY:  
1,144,238, CANC. INT. CL. 24.

PERFORMANCE DYNAMICS, INC., COLUMBUS, OH:  
2,370,545, CANC. INT. CL. 35.

PERFORMANCE PET NUTRITION, LLC., ALBUQUERQUE, NM:  
2,537,935, PUB. 11-20-2001. INT. CL. 31.

PERFORMANCE SUPPORT SYSTEMS, NEWPORT NEWS, VA:  
1,710,605. REN. 1-2-02. INT. CL. 42.

PERNOD RICARD, 75008 PARIS, FRANCE:  
1,869,026, CANC. MULTIPLE CLASS, INT. CLS. 32 AND 33.

PERRI, GREGORY, MT. LAUREL, NJ, DBA PINKE DINKS:  
1,571,525, CANC. INT. CL. 3.

PERSEPTIVE BIOSYSTEMS, INC., FRAMINGHAM, MA:  
1,683,653. REN. 1-3-02. INT. CL. 9.

PERSONAL COMPUTER PRODUCTS, INC., SAN DIEGO, CA:  
1,628,096, CANC. INT. CL. 9.

PERSONAL HOME PRO OF THE QUAD CITIES, LLC, BETTENDORF, IA:  
2,537,750, PUB. 11-20-2001. INT. CL. 37.

PET SUPPLY DEPOT, INC., CANTON, MA:  
1,868,765, CANC. INT. CL. 42.

PETELLE, JOSEPH R., KNOXVILLE, TN:  
2,538,327, PUB. 11-20-2001. INT. CL. 7.

PETERSEN, C. ALLEN, FAIR HAVEN, NJ, DBA COMPETE! GAMES:  
1,628,436, CANC. INT. CL. 28.

PETERSON, DAVID P., ORLAND PARK, IL:  
2,538,670, INT. CL. 28.

PETRO PSC, L.P., EL PASO, TX:  
1,868,732, CANC. INT. CL. 42.

PETROLEUM HEAT & POWER CO., INC., STAMFORD, CT:  
2,538,481, INT. CL. 39.

PETTIBONE CORPORATION, CHICAGO, IL:  
1,143,944, CANC. INT. CL. 7.

PFIZER INC., NEW YORK, NY:  
708,665, CANC. U.S. CL. 18.  
708,831, CANC. U.S. CL. 51.  
1,143,856, CANC. INT. CL. 5.

PHAT FASHIONS LLC, NEW YORK, NY:  
2,538,494, INT. CL. 18.  
2,538,563, INT. CL. 18.

PHILIP MORRIS INCORPORATED, NEW YORK, NY:  
708,649, CANC. U.S. CL. 17.  
2,538,103, PUB. 11-20-2001. INT. CL. 34.

PHILIPS ELECTRONICS N.V., EINDHOVEN, NETHERLANDS:  
1,868,856, CANC. INT. CL. 9.

PHILLIES, THE, PHILADELPHIA, PA:  
1,660,775. REN. 1-4-02. MULTIPLE CLASS, INT. CLS. 16 AND 25.

PHILLIPS PUBLISHING INTERNATIONAL, INC., POTOMAC, MD:  
1,869,084, CANC. INT. CL. 16.

PHILMAC PTY. LTD., NORTH PLYMPTON, SOUTH AUSTRALIA, AUSTRALIA:  
1,868,337, CANC. INT. CL. 21.

PHILYRA RESEARCH LLC, WESTPORT, CT:  
2,538,569, INT. CL. 42.

PHOENIX INTANGIBLES HOLDING COMPANY, WILMINGTON, DE, BUTLER REFRIGERATED MEATS, INC., HARMONY, PA:  
1,667,957. REN. 1-2-02. INT. CL. 42.

PHUN FROM PHOENIX INC., TEMPE, AZ:  
2,537,547, PUB. 11-20-2001. INT. CL. 14.

PHYSICIANS WORLD COMMUNICATIONS GROUP, SECAUCUS, NJ:  
1,869,055, CANC. INT. CL. 16.

PIERRE FABRE S.A., 92100 BOULOGNE, FRANCE:  
1,948,056, CANC. MULTIPLE CLASS, INT. CLS. 3 AND 5.

PILARCIK, ERIC R., CLARKSTON, MI:  
1,868,500, CANC. INT. CL. 30.

PILATES, INC., NEW YORK, NY:  
1,602,929, CANC. INT. CL. 41.

PINNACLE MICRO, INC., IRVINE, CA:  
1,868,029, CANC. INT. CL. 9.

PION, 75002 PARIS, FRANCE:  
1,868,196, CANC. INT. CL. 14.

PIONEER HI-BRED INTERNATIONAL, INC., DES MOINES, IA:  
1,628,836, CANC. INT. CL. 42.

PIONEER PLASTICS CORPORATION, SHELTON, CT, CONTINENTAL CAN COMPANY INC., NEW YORK, NY:  
553,791. REN. 1-4-02. U.S. CL. 12 (INT. CL. 19).

PIRELLI S.P.A., MILANO, ITALY:  
1,868,280, CANC. MULTIPLE CLASS, INT. CLS. 17, 20, 22 AND 24.

PIROZZI, ELIA V., ONTARIO, CA:  
2,538,088, PUB. 8-28-2001. INT. CL. 36.

PISTACHIO CORPORATION, PORTLAND, OR:  
2,538,376, PUB. 11-20-2001. INT. CL. 9.

PITTI IMMAGINE S.R.L., 50123 FLORENCE, ITALY:  
1,644,578. REN. 1-3-02. INT. CL. 35.

PITTI IMMAGINE S.R.L., 50123 FIRENZE, ITALY:  
1,645,448. REN. 1-3-02. INT. CL. 35.

PITTSBURGH TAG COMPANY, PITTSBURGH, PA:  
1,868,040, CANC. INT. CL. 9.

PIXEL ARCHITECTURE, LLC, ROSELLE, IL:  
2,538,666, INT. CL. 9.

PIZZA PATIO MANAGEMENT LTD., VANCOUVER, BRITISH COLUMBIA, CANADA:  
1,144,417, CANC. INT. CL. 30.

- PLACON CORPORATION, MADISON, WI:  
1,173,623. REN. 1-3-02. INT. CL. 37.  
1,173,624. REN. 1-4-02. INT. CL. 37.  
1,177,272. REN. 1-4-02. INT. CL. 20.  
1,178,179. REN. 1-4-02. INT. CL. 20.
- PLAN B, INC., VALPARAISO, IN:  
1,627,876. CANC. INT. CL. 1.
- PLATINUM TECHNOLOGY, INC., OAKBROOK TERRACE, IL:  
1,868,123. CANC. INT. CL. 9.
- PLAYBOY ENTERPRISES INTERNATIONAL, INC., CHICAGO, IL:  
2,537,924. PUB. 11-20-2001. INT. CL. 41.  
2,538,068. PUB. 11-20-2001. INT. CL. 41.
- PLAYTEX APPAREL, INC., STAMFORD, CT, INTERNATIONAL PLAYTEX, INC., STAMFORD, CT:  
1,171,423. REN. 12-31-01. INT. CL. 25.
- PLAYTEX MARKETING CORPORATION, NEW YORK, NY, INTERNATIONAL PLAYTEX, INC., STAMFORD, CT:  
1,174,355. REN. 1-4-02. INT. CL. 25.
- POINTS TO PARTNERS, INC., BRENTWOOD, TN:  
2,538,091. PUB. 11-20-2001. INT. CL. 35.
- POLYMEDCO, INC., CORTLANDT MANOR, NY:  
1,868,141. CANC. INT. CL. 10.  
2,537,841. PUB. 11-20-2001. INT. CL. 9.
- POPSICLE INDUSTRIES, INC., ENGLEWOOD, NJ:  
383,643. CANC. U.S. CL. 46.
- PORPOISE POOL & PATIO, INC., CLEARWATER, FL:  
1,868,135. CANC. INT. CL. 9.
- PORTA-PRINTER SYSTEMS INC., LARGO, FL:  
1,144,566. CANC. INT. CL. 42.
- PORTABLE HYPERBARICS, INC., ILION, NY:  
1,661,590. REN. 12-29-01. INT. CL. 10.
- PORTER ATHLETIC EQUIPMENT COMPANY, BROADVIEW, IL:  
1,868,931. CANC. INT. CL. 28.
- PORTLAND STATE UNIVERSITY, PORTLAND, OR:  
2,537,955. PUB. 11-20-2001. INT. CL. 41.
- POSH, INC., MIAMI, FL:  
1,143,836. CANC. INT. CL. 3.
- POST & SCHELL, P.C., PHILADELPHIA, PA:  
2,538,228. PUB. 11-20-2001. INT. CL. 42.  
2,538,229. PUB. 11-20-2001. INT. CL. 42.
- POTTS, DEBRA L., SOLANA BEACH, CA AND POTTS, KENNETH L., SOLANA BEACH, CA:  
2,538,591. INT. CL. 20.
- POWER R, INC., SEATTLE, WA:  
1,628,116. CANC. INT. CL. 9.
- PPG ARCHITECTURAL FINISHES, INC., PITTSBURGH, PA, COMERCO, INC., TACOMA, WA:  
1,173,788. REN. 1-2-02. INT. CL. 2.
- PPG INDUSTRIES OHIO, INC., CLEVELAND, OH, PPG INDUSTRIES, INC., PITTSBURGH, PA:  
1,662,977. REN. 1-2-02. INT. CL. 21.
- PPG INDUSTRIES, INC., PITTSBURGH, PA:  
1,867,975. CANC. INT. CL. 6.
- PQ CORPORATION, VALLEY FORGE, PA:  
1,202,446. REN. 1-2-02. INT. CL. 1.
- PRAK PRODUCTIONS, INC., CHAPPAQUA, NY:  
2,538,521. INT. CL. 25.
- PRECEPT MINISTRIES OF REACH OUT, INC., CHATTANOOGA, TN:  
1,868,668. CANC. INT. CL. 41.
- PRECIOUS TIMES FASHIONS INC./MODES PRECIOUS TIMES INC., MONTREAL, QUEBEC, CANADA:  
1,868,353. CANC. INT. CL. 25.
- PREMIER AUTOMOTIVE PARTS & ACCESSORIES SUPPLIES LTD., HONG KONG, HONG KONG:  
2,538,441. PUB. 11-20-2001. INT. CL. 12.
- PREMIER NUTRITION, INC., CARLSBAD, CA:  
2,537,968. PUB. 11-20-2001. INT. CL. 30.  
2,538,024. PUB. 11-20-2001. INT. CL. 30.
- PREMIUM PLASTICS, INC., CHICAGO, IL:  
2,537,548. PUB. 11-20-2001. INT. CL. 10.
- PRESTIGE TRADING CORPORATION, LOS ANGELES, CA:  
2,537,993. PUB. 11-20-2001. MULTIPLE CLASS, INT. CLS. 9, 14, 20 AND 21.
- PRICESMART, INC., SAN DIEGO, CA FROM PRICE VENTURES, INC., SAN DIEGO, CA:  
2,538,615. MULTIPLE CLASS, INT. CLS. 16, 35, 37, 40 AND 42.
- PRIDE BEVERAGES LTD., BRITISH COLUMBIA, CANADA:  
1,868,514. CANC. INT. CL. 32.
- PRIMESITE OUTDOOR ADVERTISING (PROPRIETARY) LIMITED, JOHANNESBURG, SOUTH AFRICA:  
1,868,844. CANC. INT. CL. 9.
- PRINCE CASTLE, INC., CAROL STREAM, IL:  
1,143,931. CANC. INT. CL. 7.  
1,143,932. CANC. INT. CL. 7.
- PRINCE STREET HOLDING COMPANY, ATLANTA, GA:  
1,868,916. CANC. INT. CL. 27.
- PRINCETON VIDEO IMAGE, INC., PRINCETON, NJ FROM PRINCETON ELECTRONIC BILLBOARD, INC., PRINCETON, NJ:  
2,538,443. MULTIPLE CLASS, INT. CLS. 9 AND 40.
- PRINCIPLE PLASTICS, INC., GARDENA, CA:  
1,869,095. CANC. INT. CL. 28.
- PRINT THE PLANET, INC., HOUSTON, TX:  
1,868,422. CANC. INT. CL. 25.
- PRINTMARK INDUSTRIES, INC., HAZLETON, PA:  
2,537,877. PUB. 11-20-2001. INT. CL. 16.
- PRIVATE LIMOUSINE, INC, UNION, NJ:  
2,537,859. PUB. 11-20-2001. INT. CL. 39.
- PRO KENNEX, INC., SAN DIEGO, CA:  
1,869,100. CANC. INT. CL. 28.
- PRO-INNOVATIVE CONCEPTS, INC., PHOENIX, AZ:  
2,538,589. INT. CL. 16.
- PROCESS CONCEPTION INGENIERIE SA, 92190 - MEUDON, FRANCE:  
2,537,607. PUB. 11-20-2001. MULTIPLE CLASS, INT. CLS. 7 AND 42.
- PROCTER & GAMBLE COMPANY, THE, CINCINNATI, OH:  
2,538,715. INT. CL. 3.
- PRODUCT ORIGINATORS, INC., OXNARD, CA:  
1,144,346. CANC. INT. CL. 28.
- PRODUCTORA NACIONAL DE ALIMENTOS PRONAL S.A., RISARALDA, COLOMBIA:  
2,537,998. PUB. 11-20-2001. INT. CL. 29.
- PROFESSIONAL MEDICAL PRODUCTS, INC., GREENWOOD, SC:  
1,628,821. CANC. INT. CL. 16.
- PROFIT PLANTATION, INC., MESA, AZ:  
2,538,296. PUB. 11-20-2001. INT. CL. 35.
- PROSKAUER ROSE LLP, NEW YORK, NY:  
2,538,682. INT. CL. 42.
- POTENTIAL LLC, OAKBROOK TERRACE, IL:  
2,538,250. PUB. 11-20-2001. INT. CL. 35.
- PRUDENTIAL INSURANCE COMPANY OF AMERICA, THE, NEWARK, NJ:  
1,868,561. CANC. MULTIPLE CLASS, INT. CLS. 35, 36, 37 AND 42.  
1,868,576. CANC. INT. CL. 36.
- PRUDENTIAL-FELDCO OF CALIFORNIA, INC., INDUSTRY, CA:  
1,144,144. CANC. INT. CL. 16.
- PRUDHOMME; DON, GRANADA HILLS, CA:  
1,144,475. CANC. INT. CL. 35.
- PUBLIC ART FOUNDATION, THE, HAMILTON, NJ:  
2,538,354. PUB. 11-20-2001. INT. CL. 42.
- PUBLIC SERVICE ENTERPRISE GROUP INCORPORATED, NEWARK, NJ:  
1,628,644. CANC. INT. CL. 39.  
1,628,645. CANC. INT. CL. 39.
- PUBLICIDAD FERRER Y ASOCIADOS, S.A. DE C.V., 01050 MEXICO CITY, MEXICO:  
1,869,106. CANC. INT. CL. 35.
- PUBLIX SUPER MARKETS, INC., LAKELAND, FL:  
2,538,109. PUB. 11-20-2001. INT. CL. 35.
- PURATOS N.V., 1720 GROOT-BIJGAARDEN, BELGIUM:  
1,150,103. REN. 1-2-02. INT. CL. 1.
- PURDUE FREDERICK COMPANY, THE, NORWALK, CT:  
1,143,879. CANC. INT. CL. 5.
- PURE GAS SOLUTIONS, INC., WILMINGTON, DE:  
2,538,173. PUB. 11-20-2001. INT. CL. 11.



PUREX CORPORATION, LAKEWOOD, CA:  
1,143,833, CANC. INT. CL. 3.

PURITAN INTERNATIONAL, LTD., ALLENTOWN, PA,  
GULF STREAM LOGOS LTD., GEORGE TOWN, GRAND  
CAYMAN ISLAND, CAYMAN ISLANDS:  
1,167,243, REN. 1-4-02. INT. CL. 16.

PYROMATE, INC., PETERBOROUGH, NH:  
2,538,014, PUB. 8-14-2001. INT. CL. 9.

Q-BEAM CORPORATION, DALLAS, TX:  
1,144,061, CANC. INT. CL. 11.

QCOMMERCE INC., BELLEVUE, WA:  
2,490,954, CANC. IIRN. RESTORED TO S.N. 78-013,695.

QUAKER OATS COMPANY, THE, CHICAGO, IL:  
1,868,709, CANC. INT. CL. 42.

QUICK CORP., CHIYODA-KU, TOKYO 100, JAPAN:  
1,869,021, CANC. MULTIPLE CLASS, INT. CLS. 16, 35, 36,  
38 AND 42.

QUILL CORPORATION, LINCOLNSHIRE, IL:  
2,538,243, PUB. 11-20-2001. INT. CL. 35.

QUINTESSENT COMMUNICATIONS, INC., REDMOND,  
WA:  
2,472,251, AM. INT. CL. 9.

QUINTON ELECTROPHYSIOLOGY CORPORATION,  
MARKHAM, ONTARIO, CANADA:  
1,868,149, CANC. INT. CL. 10.

QUINTUS CORPORATION, PALO ALTO, CA:  
1,868,103, CANC. INT. CL. 9.

QUINWOOD LIMITED, CHANNEL ISLANDS, UNITED  
KINGDOM:  
2,537,896, PUB. 11-20-2001. INT. CL. 5.

R & B REALTY GROUP, LOS ANGELES, CA:  
1,653,217, REN. 1-4-02. INT. CL. 36.

R. G. BARRY CORPORATION, PICKERINGTON, OH:  
1,144,300, CANC. INT. CL. 25.

R.C.D. PRODUCTS INC./PRODUITS R.C.D. INC., LAVAL  
P.Q., CANADA:  
1,868,815, CANC. INT. CL. 5.

R.K. ASSOCIATES, LLC, CHAPEL HILL, NC:  
2,537,773, PUB. 11-20-2001. INT. CL. 41.

R&R GAMES, INC., TAMPA, FL:  
2,538,389, PUB. 11-20-2001. INT. CL. 28.

RA BRANDS L.L.C., MADISON, NC, REMINGTON ARMS  
COMPANY, INC., BRIDGEPORT, CT:  
1,177,128, REN. 1-4-02. INT. CL. 13.

RACIK, STEPHEN J., FREMONT, CA, DBA NU BORN TIME  
CAPSULES:  
1,868,340, CANC. INT. CL. 21.

RADAR COMPANIES, INC., PORTLAND, OR:  
1,143,929, CANC. INT. CL. 7.

RADIALL ANTENNA TECHNOLOGIES, INC., VANCOU-  
VER, WA, LARSEN ELECTRONICS, INC., VANCOUVER,  
WA:  
1,163,486, REN. 1-4-02. INT. CL. 9.

RAH-RAH, INC., MT. PLEASANT, SC:  
1,628,386, CANC. INT. CL. 24.

RAINBOW PLAY SYSTEMS, INC., BROOKINGS, SD:  
1,710,180, REN. 12-30-01. INT. CL. 28.

RALSTON PURINA COMPANY, ST. LOUIS, MO:  
1,868,961, CANC. INT. CL. 31.

RAN DECISIONS, INC., COLORADO SPRINGS, CO:  
1,868,550, CANC. INT. CL. 35.

RANGLES, TERRY C., CHANDLER, AZ:  
2,538,403, PUB. 11-20-2001. INT. CL. 37.

RANIR/DCP CORPORATION, GRAND RAPIDS, MI:  
1,869,029, CANC. INT. CL. 3.

RAPID DISPLAYS, INC., CHICAGO, IL:  
2,538,627, INT. CL. 28.  
2,538,628, INT. CL. 28.

RASSELSTEIN HOESCH GMBH, D-56626 ANDERNACH,  
FED REP GERMANY:  
2,538,172, PUB. 11-20-2001. INT. CL. 6.

RASTEROPS CORPORATION, SANTA CLARA, CA:  
1,868,846, CANC. INT. CL. 9.

RATHBONE PRECISION METALS, INC., PALMER, MA:  
1,627,952, CANC. INT. CL. 6.

RAYPAK, INC., OXNARD, CA:  
2,538,439, PUB. 11-20-2001. INT. CL. 11.

RAYS APPAREL, INC., BELL GARDENS, CA:  
1,868,371, CANC. INT. CL. 25.

RAZOR & TIE DIRECT, L.L.C., NEW YORK, NY:  
2,538,339, PUB. 11-20-2001. INT. CL. 9.

RB PRODUCTS, LLC, PHOENIX, AZ:  
2,538,030, PUB. 11-20-2001. INT. CL. 35.

READY PAC PRODUCE, INC., IRWINDALE, CA:  
2,538,054, PUB. 11-20-2001. INT. CL. 29.

REAL ESTATE SOLUTIONS, INC., WASHINGTON, DC:  
1,868,543, CANC. MULTIPLE CLASS, INT. CLS. 35 AND  
36.

REALCAFES.COM INC., TORONTO, ONTARIO, CANADA:  
2,538,217, PUB. 11-20-2001. INT. CL. 42.  
2,538,218, PUB. 11-20-2001. INT. CL. 42.

RECKITT & COLMAN SUBSIDIARY CORPORATION, WIL-  
MINGTON, DE, AMERICAN HOME PRODUCTS COR-  
PORATION, NEW YORK, NY:  
922,524, REN. 1-2-02. U.S. CL. 52 (INT. CLS. 3 AND 5).  
1,158,764, REN. 1-4-02. INT. CL. 5.

RED BULL GMBH, 5330 FUSCHL AM SEE, AUSTRIA:  
2,537,746, PUB. 11-20-2001. MULTIPLE CLASS, INT. CLS.  
25 AND 41.

REDIRECTIONS, INC., CARMEL, IN:  
1,672,760, REN. 1-2-02. INT. CL. 35.

REDVECTOR.COM, INC., TAMPA, FL:  
2,537,970, PUB. 11-20-2001. INT. CL. 41.

REDWELD RUBBER & PLASTIC LIMITED, ALTON HAMP-  
SHIRE GU342QR, ENGLAND:  
2,537,923, PUB. 11-20-2001. INT. CL. 20.

REED AND BARTON CORPORATION, TAUNTON, MA:  
1,153,855, REN. 1-3-02. INT. CL. 14.

REED ELSEVIER INC, NEWTON, MA, DELTA COMMU-  
NICATIONS, INC., CHICAGO, IL:  
1,679,371, REN. 1-4-02. INT. CL. 16.

REED PUBLISHING (USA) INC., NEWTON, MA:  
1,868,830, CANC. INT. CL. 9.

REFLECT-TECH, INC., DALLAS, TX:  
1,868,284, CANC. INT. CL. 17.

REGIS CORPORATION, MINNEAPOLIS, MN:  
1,627,900, CANC. INT. CL. 3.

REGISOFT CORPORATION, NEW YORK, NY:  
2,537,810, PUB. 11-20-2001. INT. CL. 9.

REGISTERED AGENTS, LTD., WILMINGTON, DE:  
2,538,410, PUB. 11-20-2001. INT. CL. 35.

REHABILITATION CORPORATION, BRENTWOOD, TN:  
1,869,009, CANC. INT. CL. 42.  
1,869,010, CANC. INT. CL. 42.

REICHDRIILL, INC., PHILIPSBURG, PA:  
1,627,980, CANC. INT. CL. 7.

REL ENTERPRISES, CINCINNATI, OH:  
1,144,562, CANC. INT. CL. 42.

REMEDI CONSULTING COMPANY, REYNOLDSBURG,  
OH:  
2,538,504, INT. CL. 42.

RENAISSANCE GOLF PRODUCTS, INC., HUNTINGTON  
BEACH, CA, DBA FILA GOLF:  
1,868,934, CANC. INT. CL. 28.

REND LAKE MARINA, INC, BENTON, IL:  
2,537,987, PUB. 11-20-2001. INT. CL. 35.

REPUBLIC CONTROLS CORPORATION, SYRACUSE, NY:  
1,868,036, CANC. INT. CL. 9.

RES MEDIA GROUP, INC., NEW YORK, NY:  
2,537,971, PUB. 11-20-2001. INT. CL. 16.

RESHETYLO, STEPHAN, ALLENTOWN, PA:  
1,868,747, CANC. INT. CL. 42.

RESOURCE ENTERPRISE COLLECTIVE, INC., BROOK-  
LYN, NY:  
1,868,964, CANC. INT. CL. 32.

RESPONSYS, INC., SANTA CLARA, CA:  
2,538,509, INT. CL. 42.

RETRO TEK I, INC., MADISON, WI:  
2,538,242, PUB. 11-20-2001. INT. CL. 19.

REVENUE SOLUTIONS, INC., PEMBROKE, MA:  
2,537,860, PUB. 11-20-2001. INT. CL. 35.  
2,537,861, PUB. 11-20-2001. INT. CL. 9.

REYNOLDS METALS COMPANY, RICHMOND, VA:  
2,538,207, PUB. 11-20-2001. INT. CL. 16.

- REZ, DONALD H. AND BETTY REZ, NEWPORT BEACH, CA:  
1,144,060, CANC. INT. CL. 11.
- RIBA, ABBY, CLEARWATER, FL:  
1,868,441, CANC. INT. CL. 26.
- RICHARDSON BRANDS COMPANY, SOUTH MIAMI, FL, LIFE SAVERS, INC., NEW YORK, NY:  
1,201,345, REN. 1-3-02. INT. CL. 30.
- RICHARDSON-SHAW PROPRIETARY, LTD., WODONGA, VICTORIA 3690, AUSTRALIA:  
2,387,542, CANC. IIRN. RESTORED TO S.N. 75-746,967.
- RICHES, KENT A., OCEANSIDE, CA, DBA AIRTECH:  
1,868,180, CANC. INT. CL. 12.
- RIVERSIDE PAPER CORPORATION, APPLETON, WI:  
1,868,212, CANC. INT. CL. 16.  
2,538,208, PUB. 11-20-2001. INT. CL. 16.
- ROB LIEFELD, INC., ANAHEIM, CA:  
1,868,886, CANC. INT. CL. 16.
- ROBERT WHOLEY & CO., INC., PITTSBURGH, PA:  
2,538,601, INT. CL. 21.
- ROBERTS-GORDON, INC., BUFFALO, NY:  
1,868,163, CANC. INT. CL. 11.
- ROBERTS, JEFFREY, APPLE VALLEY, MN:  
1,868,873, CANC. INT. CL. 15.
- ROBINSON PLUMBING & HEATING SUPPLY CO., INC., FALL RIVER, MA:  
2,538,029, PUB. 11-20-2001. INT. CL. 35.
- ROBINSON, KATHRYN A., VALRICO, FL, DBA WRITE-MATH ENTERPRISES:  
2,538,320, PUB. 11-20-2001. INT. CL. 16.
- ROCKET BALL, LTD., HOUSTON, TX:  
2,537,963, PUB. 11-20-2001. INT. CL. 35.
- ROCKET BUSINESS SERVICES, LLC, MILWAUKEE, WI:  
2,538,038, PUB. 11-20-2001. INT. CL. 39.
- ROCKY MOUNTAIN SUNROOF, DENVER, CO:  
1,868,634, CANC. INT. CL. 40.
- ROCKY SHOES & BOOTS, INC., NELSONVILLE, OH:  
2,538,542, INT. CL. 25.
- ROCO FOODS, INC., CASTRO VALLEY, CA:  
1,628,508, CANC. INT. CL. 30.
- ROEDERSTEIN SPEZIALFABRIKEN FUR BAUELEMENTE DER ELEKTRONIK UND KONDENSATOREN DER STARKSTROMTECHNIK GESELLSCHAFT MIT BESCHRANKTER HAFTUNG, D-84034 LANDSHUT, FED REP GERMANY:  
1,628,008, CANC. INT. CL. 9.
- ROFFLER INDUSTRIES, INC., CORAOPOLIS, PA:  
708,644, CANC. U.S. CL. 15.
- ROHM AND HAAS COMPANY:  
708,613, CANC. U.S. CL. 6.
- ROHRER, HELMUT K., 81479 MUNCHEN, FED REP GERMANY:  
2,537,703, PUB. 1-16-2001. INT. CL. 9.
- ROMAX, INC., MIDDLETOWN, NJ:  
1,868,521, CANC. INT. CL. 35.
- RONDELE ACQUISITION, LLC, MERRILL, WI:  
2,538,049, PUB. 11-20-2001. INT. CL. 29.
- RONLEE APPAREL COMPANY L.P., LYNDBURST, NJ:  
1,868,906, CANC. INT. CL. 25.
- ROOS, ANDREAS, 1024 ECUBLENS, SWITZERLAND:  
1,868,534, CANC. INT. CL. 35.
- ROQUEFORT ASSOCIATION, INC., NEW YORK, NY, DOUGLAS, BERNARD M., NEW YORK, NY:  
285,941, REN. 1-3-02. U.S. CL. 46 (INT. CL. 29).
- ROSE FINANCIAL SERVICES, LLC, ROCKVILLE, MD:  
2,537,976, PUB. 11-20-2001. INT. CL. 35.
- ROSE MANUFACTURING COMPANY, ENGLEWOOD, CO, ROSE MANUFACTURING COMPANY, KANSAS CITY, MO:  
928,114, REN. 1-4-02. U.S. CL. 13 (INT. CL. 9).
- ROSEMEAD BOULEVARD CORPORATION, SOUTH EL MONTE, CA:  
1,868,388, CANC. INT. CL. 25.
- ROSEN, PETER H., SAN FRANCISCO, CA, DBA V.A.R.-I.O.U.S. MEDIA:  
1,628,672, CANC. INT. CL. 41.
- ROSENBERG, EVA, ENCINO, CA AND CORDELL, RICK G., ENCINO, CA:  
2,537,564, PUB. 11-20-2001. INT. CL. 35.
- ROSENTHAL AKTIENGESELLSCHAFT, SELB, BAVARIA, FED REP GERMANY:  
1,144,211, CANC. MULTIPLE CLASS, INT. CLS. 21 AND 34.
- ROSS, KLAUS, PORT COQUITLAM, BRITISH COLUMBIA, CANADA, DBA K.D. ROSS & ASSOCIATES:  
1,628,349, CANC. INT. CL. 20.
- ROSSI, LOUIS FRANK, LOWELL, MA:  
2,537,948, PUB. 11-20-2001. INT. CL. 9.
- ROTACARE INTERNATIONAL, INC., SAN JOSE, CA:  
1,868,743, CANC. INT. CL. 42.
- ROUGH NOTES COMPANY, INC., THE, CARMEL, IN:  
728,857, REN. 1-4-02. U.S. CL. 37 (INT. CL. 16).
- ROUX LABORATORIES, INC., JACKSONVILLE, FL, SYNTEX (U.S.A.) INC., PALO ALTO, CA:  
1,170,824, REN. 1-2-02. INT. CL. 3.
- ROYAL & SUNALLIANCE USA, INC., CHARLOTTE, NC:  
2,538,348, PUB. 11-20-2001. INT. CL. 36.
- ROYAL BUSINESS MACHINES, INC., HARTFORD, CT:  
708,714, CANC. U.S. CL. 23.
- ROYAL INTERNATIONAL OPTICAL, INC., DALLAS, TX:  
1,968,964, CANC. INT. CL. 42.
- ROYAL MANUFACTURING COMPANY, INC., NEW YORK, NY, AKA HAMILTON MFG. CO.:  
1,144,290, CANC. INT. CL. 25.
- ROYAL OAK ENTERPRISES, INC., ROSWELL, GA, IMPERIAL PRODUCTS CORPORATION, ST. LOUIS, MO:  
1,675,664, REN. 1-2-02. INT. CL. 4.
- ROYAL ORDNANCE PLC, LANCASHIREPR7 6AD, ENGLAND:  
2,537,545, PUB. 11-20-2001. INT. CL. 9.
- RS SERVICING CO., INC., WILMINGTON, DE, JOS. A. BANK CLOTHIERS, INC., BALTIMORE, MD:  
1,182,109, REN. 1-4-02. MULTIPLE CLASS, INT. CLS. 18 AND 25.
- RUBENFELD, ILANA, NEW YORK, NY:  
2,538,462, INT. CL. 42.
- RUBIN, HOWARD, NEW YORK, NY, DBA THE HOWARD RUBIN ORGANIZATION:  
2,537,541, PUB. 11-20-2001. INT. CL. 25.
- RUD-KETTENFABRIK RIEGER & DIETZ GMBH. & CO., AALEN 1, FED REP GERMANY:  
1,144,082, CANC. INT. CL. 12.
- RURAL PRESS USA, INC., RALEIGH, NC:  
1,869,062, CANC. INT. CL. 16.
- RUSH LIMOUSINE INC., CHICAGO, IL:  
2,538,019, PUB. 11-20-2001. INT. CL. 39.
- RUSSELL-NEWMAN, INC., DENTON, TX:  
1,868,354, CANC. INT. CL. 25.
- RUSTICS OF LINDBERGH LAKE, INC., THE, CONDON, MT:  
1,144,187, CANC. INT. CL. 19.
- RUTTKAY, LYNNE M, ESCONDIDO, CA:  
2,538,375, PUB. 11-20-2001. INT. CL. 25.
- RV NATION L.L.C., LAKELAND, FL:  
2,537,854, PUB. 11-20-2001. MULTIPLE CLASS, INT. CLS. 35 AND 42.
- RYDER SYSTEM, INC, MIAMI, FL:  
2,537,979, PUB. 11-20-2001. MULTIPLE CLASS, INT. CLS. 35 AND 42.
- RYMIC SYSTEMS, INC., HUNTSVILLE, AL:  
2,538,155, PUB. 11-20-2001. INT. CL. 40.
- S & D COFFEE, INC., CONCORD, NC:  
1,678,013, REN. 12-31-01. INT. CL. 42.
- S. ANDERSON VINEYARD, YOUNTVILLE, CA:  
2,538,429, PUB. 11-20-2001. INT. CL. 33.
- S.B. SCHMIDT PAPER CO., BURNSVILLE, MN:  
1,691,446, REN. 1-3-02. INT. CL. 16.
- S-T-N HOLDINGS, INC., LAS VEGAS, NV:  
2,538,298, PUB. 11-20-2001. INT. CL. 1.
- SADDLEMAN, INC., LOGAN, UT:  
2,538,520, MULTIPLE CLASS, INT. CLS. 1 AND 3.
- SADOWSKI, JOHN E., DEARBORN HEIGHTS, MI:  
1,628,806, CANC. INT. CL. 28.

- SAFETY-KLEEN CANADA INC., TORONTO, ONTARIO M5C 1K9, CANADA:  
1,867,929, CANC. INT. CL. 4.
- SAGEM SA, 75116 PARIS, FRANCE, SOCIETE DE FABRICATION D'INSTRUMENTS DE MESURE SFIM, MASSY, FRANCE:  
1,158,871. REN. 12-30-01. INT. CL. 9.
- SAIC, SAN DIEGO, CA:  
2,401,194, COR. INT. CL. 9.
- SAINT GERMAIN GOBAIN GLASS FRANCE, 92400 COURBEVOIE, FRANCE, SAINT-GOBAIN VITRAGE INTERNATIONAL, 92400 COURBEVOIE, FRANCE:  
1,664,935. REN. 1-4-02. MULTIPLE CLASS, INT. CLS. 12 AND 21.
- SAINT-GOBAIN PERFORMANCE PLASTICS CORPORATION, WAYNE, NJ, DIXON CORPORATION, BRISTOL, RI:  
923,416. REN. 1-4-02. U.S. CL. 13 (INT. CL. 6).
- SALEM, KAREEM MICHAEL, LUBBOCK, TX:  
2,537,761, PUB. 11-20-2001. INT. CL. 16.
- SALES STRATEGY INSTITUTE, INC., THE, HERNDON, VA:  
2,538,293, PUB. 11-20-2001. INT. CL. 35.
- SALLY SCHMIDT CONSULTING, INC., ALBANY, NY:  
2,538,425, PUB. 11-20-2001. INT. CL. 16.
- SALON SCIENCES CORPORATION, FORT LAUDERDALE, FL:  
2,538,457, INT. CL. 3.
- SALVATORE FERRAGAMO ITALIA S.P.A., FLORENCE, ITALY:  
2,537,519, PUB. 11-20-2001. INT. CL. 3.
- SAMSONITE CORPORATION, DENVER, CO:  
2,538,667, INT. CL. 18.
- SAN BERNARDINO COUNTY SUPERINTENDENT OF SCHOOLS, SAN BERNARDINO, CA:  
2,538,405, PUB. 11-20-2001. MULTIPLE CLASS, INT. CLS. 18, 21, 25 AND 28.
- SANDERS, ERIC D., SAN FRANCISCO, CA, DBA DIRECT EFFECT MARKETING:  
1,868,545, CANC. INT. CL. 35.
- SARATOGA TURF REMEDIES, INC., GANSEVOORT, NY:  
1,143,866, CANC. INT. CL. 5.
- SARCLAD INTERNATIONAL LIMITED, SHEFFIELD, YORKSHIRE, ENGLAND:  
1,143,925, CANC. INT. CL. 7.
- SASSAFRAS SOFTWARE, INC., HANOVER, NH:  
1,660,661. REN. 1-2-02. INT. CL. 9.
- SAXMAYER CORPORATION, BLISSFIELD, MI:  
1,171,997. REN. 1-2-02. INT. CL. 7.
- SBC COMMUNICATIONS INC., SAN ANTONIO, TX:  
2,538,426, PUB. 11-20-2001. INT. CL. 38.  
2,538,428, PUB. 11-20-2001. INT. CL. 38.
- SCA PROMOTIONS, INC., DALLAS, TX:  
1,628,579, CANC. INT. CL. 35.
- SCANNER APPLICATIONS, INC., MILFORD, OH:  
1,868,533, CANC. INT. CL. 35.
- SCHAIBLE, SCOTT, E., DENVER, CO:  
2,538,415, PUB. 11-20-2001. INT. CL. 18.
- SCHEDULE ME, INC., CHICAGO, IL:  
2,538,585, MULTIPLE CLASS, INT. CLS. 35 AND 42.
- SCHNEIDER COMMUNICATIONS, INC., GREEN BAY, WI:  
1,869,115, CANC. INT. CL. 38.
- SCHNEIDER, DAVID L., SAN DIEGO, CA:  
2,538,708, INT. CL. 42.
- SCHOLASTIC INC., NEW YORK, NY:  
1,628,304, CANC. INT. CL. 16.  
1,678,518. REN. 12-31-01. INT. CL. 16.  
1,868,706, CANC. INT. CL. 42.
- SCHROEDER & TREMAYNE, INC., ST. LOUIS, MO:  
2,538,270, PUB. 11-20-2001. INT. CL. 3.
- SCHULTE HILLEN, WOLF JOCHEN, 4400 MUNSTER, FED REP GERMANY:  
1,868,382, CANC. INT. CL. 25.
- SCHULZE AND BURCH BISCUIT CO., CHICAGO, IL:  
708,826, CANC. U.S. CL. 46.
- SCHWARZ LEATHER CORP., EDGEWATER, NJ:  
708,568, CANC. U.S. CL. 1.
- SCIHEALTH, INC., ATLANTA, GA:  
2,538,599, MULTIPLE CLASS, INT. CLS. 9, 16, 35, 41 AND 42.
- SCM CORPORATION, CLEVELAND, OH:  
708,818, CANC. U.S. CL. 46.
- SCOTT FETZER COMPANY, THE, WESTLAKE, OH, SCOTT & FETZER COMPANY, THE, LAKEWOOD, OH:  
1,210,015. REN. 12-29-01. INT. CL. 37.  
1,210,016. REN. 12-29-01. INT. CL. 37.  
1,210,017. REN. 12-29-01. INT. CL. 37.
- SCOTT MEDICAL PRODUCTS, PLUMSTEADVILLE, PA:  
1,867,948, CANC. INT. CL. 5.
- SCOTTIE MACBEAN, INC., WORTHINGTON, OH:  
2,538,044, PUB. 11-20-2001. INT. CL. 30.
- SCRIPPS NETWORKS, INC., KNOXVILLE, TN TO SCRIPPS HOWARD BROADCASTING COMPANY, KNOXVILLE, TN, DBA HOME & GARDEN TELEVISION:  
2,494,339, COR. INT. CL. 38.
- SCRIPPS NETWORKS, INC., KNOXVILLE, TN FROM SCRIPPS HOWARD BROADCASTING COMPANY, KNOXVILLE, TN, DBA HOME & GARDEN TELEVISION:  
2,538,632, INT. CL. 41.
- SCRIPPS NETWORKS, INC., KNOXVILLE, TN FROM SCRIPPS HOWARD BROADCASTING COMPANY, KNOXVILLE, TN, DBA HOME & GARDEN TELEVISION:  
2,538,631, INT. CL. 41.
- SEA PORT PRODUCTS CORPORATION, SAN MATEO, CA:  
2,537,927, PUB. 11-20-2001. INT. CL. 42.
- SEA WORLD, INC., ST. LOUIS, MO:  
2,538,463, INT. CL. 16.
- SEATTLE STEAM CO., SEATTLE, WA:  
1,628,055, CANC. INT. CL. 9.
- SEBASTIAN INTERNATIONAL, INC., WOODLAND HILLS, CA:  
2,538,602, INT. CL. 3.  
2,538,603, INT. CL. 3.  
2,538,604, INT. CL. 3.  
2,538,605, INT. CL. 3.
- SECOND SUNDAY PRODUCTIONS LLC, SAN FRANCISCO, CA:  
2,537,694, PUB. 11-20-2001. INT. CL. 35.
- SECURITY PROFESSIONAL COUNCIL, INC., PHILADELPHIA, PA:  
1,868,714, CANC. INT. CL. 42.
- SEE, CHARLIE, OF CHARLIE SEE & ASSOCIATES, HOLLYWOOD, CA, SEE, CHARLIE, HOLLYWOOD, CA, DBA CHARLIE SEE & ASSOCIATES:  
924,003. REN. 1-2-02. U.S. CL. 101 (INT. CL. 35).
- SEER TECHNOLOGIES, INC., NEW YORK, NY:  
1,868,027, CANC. INT. CL. 9.
- SEI INVESTMENTS DEVELOPMENTS, INC., OAKS, PA:  
2,538,335, PUB. 11-20-2001. INT. CL. 36.
- SEKISUI KAGAKU KOGYO KABUSHIKI KAISHA, KITA-KU, OSAKA, JAPAN, AKA SEKISUI CHEMICAL CO. LTD.:  
1,144,173, CANC. INT. CL. 17.
- SELAS CORPORATION OF AMERICA, DRESHER, PA, "SELAS" GESELLSCHAFT MIT BESCHRANKTER HAF-TUNG, BERLIN, FED REP GERMANY:  
84,344. REN. 1-3-02. U.S. CL. 23 (INT. CL. 7).
- SELLSTROM MANUFACTURING COMPANY, PALATINE, IL, RESEARCH & TRADING CORPORATION, WILMINGTON, DE:  
1,638,302. REN. 1-2-02. INT. CL. 12.
- SEMPRE INTERNATIONAL, INC., TAIPEI, TAIWAN:  
1,868,378, CANC. INT. CL. 25.
- SENETEK PLC, LONDON SW1E 5HW, ENGLAND:  
2,537,523, PUB. 11-20-2001. INT. CL. 5.
- SEQUOIA ENTERPRISES, INC., EXETER, CA:  
2,537,592, PUB. 11-20-2001. INT. CL. 31.
- SERTA, INC., ITASCA, IL:  
2,538,149, PUB. 11-20-2001. INT. CL. 20.
- SERVICE CHECK CORPORATION, ORLANDO, FL:  
1,868,559, CANC. INT. CL. 35.
- SERVICE CHEMICAL, INC., HATFIELD, PA:  
1,618,233. REN. 1-3-02. INT. CL. 1.
- SEVEN-UP COMPANY, THE, ST. LOUIS, MO:  
1,144,446, CANC. INT. CL. 32.

- SEVENSTRAND TACKLE CORPORATION, HUNTINGTON BEACH, CA:  
1,144,362, CANC. INT. CL. 28.
- SEVENTHSIGN MUSIC GROUP, ALBUQUERQUE, NM:  
1,868,090, CANC. MULTIPLE CLASS, INT. CLS. 9 AND 41.
- SEXY SCISSORS, L.L.P., AUSTIN, TX:  
2,538,151, PUB. 11-20-2001. INT. CL. 42.
- SG COWEN SECURITIES CORPORATION, NEW YORK, NY:  
2,538,685, INT. CL. 42.
- SHAFFER, MARK, SEATTLE, WA:  
1,868,342, CANC. INT. CL. 21.
- SHAKLEE CORPORATION, SAN FRANCISCO, CA:  
1,868,810, CANC. INT. CL. 3.
- SHALVARJIAN, ZACHARY, NORTH HIGHLANDS, CA:  
2,538,118, PUB. 11-20-2001. INT. CL. 29.
- SHANDONG MEDICINES & HEALTH PRODUCTS IMPORT & EXPORT CORP., QINGDAO, SHANDONG, CHINA:  
2,537,538, PUB. 11-20-2001. INT. CL. 5.
- SHARILOVE FASHIONS, PATERSON, NJ:  
1,144,297, CANC. INT. CL. 25.
- SHARPEDGE INC., WINN, MI:  
1,628,655, CANC. INT. CL. 40.
- SHARPER IMAGE CORPORATION, SAN FRANCISCO, CA:  
1,868,299, CANC. INT. CL. 18.
- SHARPER IMAGE LOOK, INC., GARFIELD, NJ:  
1,868,930, CANC. INT. CL. 28.
- SHE-KOU-CHANG-LI-CHI-PEN-TIEN ENTERPRISE CO., LTD., TAICHUNG HSIEN, TAIWAN:  
2,537,577, PUB. 11-20-2001. INT. CL. 30.
- SHEEHAN, ANDREA L., PIERRE, SD:  
2,538,616, INT. CL. 42.
- SHELL PETROLEUM INC., HOUSTON, TX:  
2,538,423, PUB. 11-20-2001. INT. CL. 1.
- SHEPHERD, RONALD L., DEERFIELD BEACH, FL:  
1,868,194, CANC. INT. CL. 14.
- SHERWOOD PRODUCTS, INC., SAN ANTONIO, TX:  
1,172,960, REN. 1-3-02. INT. CL. 9.
- SHIMANO AMERICAN CORPORATION, IRVINE, CA:  
2,538,505, INT. CL. 28.
- SHIVA CORPORATION, BEDFORD, MA:  
1,628,144, CANC. INT. CL. 9.
- SHOPKO STORES, INC., GREEN BAY, WI:  
2,538,654, INT. CL. 9.
- SHORT GROUP, INC., THE, AMES, IA:  
2,538,179, PUB. 11-20-2001. INT. CL. 9.
- SHURE INCORPORATED, EVANSTON, IL, SHURE BROTHERS INCORPORATED, EVANSTON, IL:  
921,478, REN. 12-30-01. U.S. CL. 21 (INT. CL. 9).
- SID PATERSON ADVERTISING, INC., NEW YORK, NY, DBA GOLI PUBLISHING:  
1,868,221, CANC. INT. CL. 16.
- SIEMENS INFORMATION AND COMMUNICATION NETWORKS, INC., BOCO RATON, FL FROM SIEMENS BUSINESS COMMUNICATION SYSTEMS, INC., SANTA CLARA, CA:  
2,538,452, INT. CL. 9.
- SIGNATURE FINANCIAL GROUP, INC., BOSTON, MA:  
1,661,069, REN. 1-2-02. INT. CL. 36.
- SIGNS O' LIFE INCORPORATED, BOSTON, MA:  
2,537,657, PUB. 11-20-2001. MULTIPLE CLASS, INT. CLS. 6, 9 AND 16.
- SILAS, CYNTHIA, ARLINGTON, VA:  
1,628,407, CANC. INT. CL. 25.
- SILICON WAVE, INC., SAN DIEGO, CA:  
2,537,641, PUB. 11-20-2001. INT. CL. 9.
- SILVER CREEK TECHNOLOGIES, INC., JOHNSON CITY, TN:  
2,538,445, INT. CL. 9.
- SILVERLINE AUDIO TECHNOLOGY, INC., CONCORD, CA:  
2,538,374, PUB. 11-20-2001. INT. CL. 9.
- SILVERSEA CRUISES LTD., FORT LAUDERDALE, FL:  
2,537,553, PUB. 11-20-2001. INT. CL. 39.
- SIMON LEVI COMPANY, LTD., KENWOOD, CA, BEDFORD WINE CO., INC., SOUTH SAN FRANCISCO, CA, DBA STONE CREEK CELLARS:  
1,176,445, REN. 1-3-02. INT. CL. 33.
- SIMPLY FASHION STORES, LTD., BIRMINGHAM, AL:  
2,538,621, INT. CL. 25.
- SIMPLY FOOD DISTRIBUTORS, INC., BROOKLYN, NY:  
2,538,514, INT. CL. 32.
- SIMULATION DYNAMICS, INC., MARYVILLE, TN:  
2,537,602, PUB. 11-20-2001. INT. CL. 42.
- SIM2K, INC., INDIANAPOLIS, IN:  
2,537,613, PUB. 11-20-2001. INT. CL. 42.
- SIQUEIROS, DAVID MICHAEL, EL PASO, TX:  
1,868,910, CANC. INT. CL. 25.
- SIRIUS PRODUCTS, INC., WOODLAND HILLS, CA:  
2,486,565, CANC. INT. CL. 3.  
2,486,568, CANC. INT. CL. 3.  
2,492,823, CANC. INT. CL. 21.
- SIRSI CORPORATION, HUNTSVILLE, AL:  
2,537,678, PUB. 11-20-2001. MULTIPLE CLASS, INT. CLS. 38 AND 41.
- SKEIN DOMAIN, INC., BURLINGTON, VT:  
1,868,252, CANC. MULTIPLE CLASS, INT. CLS. 16 AND 42.
- SKI KEEP, INC., WILKES-BARRE, PA:  
1,144,332, CANC. INT. CL. 28.
- SKUTTLE MFG. CO., MARIETTA, OH:  
1,144,070, CANC. INT. CL. 11.
- SKYTECH, INC., CHASKA, MN:  
2,538,442, INT. CL. 16.
- SLADE, ALAN, MATAWAN, NJ:  
1,868,386, CANC. INT. CL. 25.
- SLOAN'S, INC., WEST PALM BEACH, FL:  
2,538,676, MULTIPLE CLASS, INT. CLS. 25, 30, 35 AND 42.
- SLOWER LOWER DELAWARE, INC., MILLSBORO, DE:  
1,868,406, CANC. INT. CL. 25.
- SMARTENERGY.COM, INC., NEW YORK, NY:  
2,537,862, PUB. 11-20-2001. INT. CL. 36.  
2,537,863, PUB. 11-20-2001. INT. CL. 36.
- SMARTSERV ONLINE, INC., STAMFORD, CT:  
2,538,317, PUB. 11-20-2001. INT. CL. 36.
- SMARTWORK STUDIO, INC., MORELAND HILLS, OH:  
1,868,531, CANC. MULTIPLE CLASS, INT. CLS. 35 AND 42.
- SMITH & NEPHEW, INC., MEMPHIS, TN, HOWMEDICA, INC., NEW YORK, NY:  
1,176,791, REN. 1-4-02. INT. CL. 5.
- SMITH & NEPHEW, INC., MEMPHIS, TN, ACUFEX MICRO-SURGICAL, INC., NORWOOD, MA:  
1,660,342, REN. 1-4-02. INT. CL. 10.
- SMITHKLINE BEECHAM CORPORATION, PHILADELPHIA, PA:  
2,538,646, INT. CL. 5.
- SMITHSON, CYNTHIA LEIGH, BRENTWOOD, TN:  
2,538,239, PUB. 11-20-2001. INT. CL. 18.
- SNAP EDGE CORPORATION, PALATINE, IL:  
1,869,087, CANC. INT. CL. 19.
- SNAP INNOVATION SOFTWAREENTWICKLUNGSGESSELLSCHAFT MBH, 22767 HAMBURG, FED REP GERMANY:  
2,537,883, PUB. 11-20-2001. INT. CL. 9.
- SNAPAPPS.COM, INC., MISSOULA, MT:  
2,537,753, PUB. 11-20-2001. INT. CL. 9.
- SNIP HOLDINGS, LLC, PENNSAUKEN, NJ:  
2,537,752, PUB. 11-20-2001. INT. CL. 38.
- SNOW SNAKE PRODUCTS, VISTA, CA:  
1,144,274, CANC. INT. CL. 25.
- SNOWDEN-PENCER, INC., TUCKER, GA:  
1,867,935, CANC. INT. CL. 4.
- SNPCHIP, L.L.C., SAN ANTONIO, TX:  
2,538,085, PUB. 11-20-2001. INT. CL. 35.
- SO FUN, INC., BRIDGEPORT, PA:  
2,537,531, PUB. 11-20-2001. INT. CL. 25.
- SOFT-CUT INTERNATIONAL, INC., CORONA, CA, CHIU-MINATTA CONCRETE CONCEPTS, RIVERSIDE, CA:  
1,658,638, REN. 12-31-01. INT. CL. 7.
- SOFTWARE PRODUCTIVITY SOLUTIONS, INC., INDIAN LANTIC, FL:  
1,868,024, CANC. INT. CL. 9.

SOLID INFORMATION TECHNOLOGY CORPORATION, MOUNTAIN VIEW, CA:  
2,537,618, PUB. 11-20-2001. INT. CL. 9.

SOLOVIC, SUSAN WILSON, ST. LOUIS, MO:  
2,537,651, PUB. 11-20-2001. INT. CL. 41.

SOLUTIA, ST. LOUIS, MO, MONSANTO COMPANY, ST. LOUIS, MO:  
1,174,279. REN. 1-4-02. INT. CL. 22.

SOMEDAY BABY, INC., NASHVILLE, TN:  
1,869,042, CANC. INT. CL. 9.

SOMFY, SOCIETE ANONYME, 74300 CLUSES, FRANCE:  
2,537,554, PUB. 11-20-2001. INT. CL. 7.

SONTAG, SHELDON, NEW YORK, NY:  
1,868,439, CANC. INT. CL. 25.

SOPHISTICATED CIRCUITS, INC., BOTHELL, WA:  
2,538,516, INT. CL. 9.

SORENSEN CONSTRUCTION CORP., WOODBRIDGE, VA:  
1,661,948. REN. 1-4-02. INT. CL. 37.

SOTAK-COOPER, DAN, SPRINGFIELD, MA:  
1,868,681, CANC. INT. CL. 41.

SOUTHAM BUSINESS COMMUNICATIONS, USA, INC., INDIANAPOLIS, IN:  
1,868,245, CANC. INT. CL. 16.

SOUTHBOUND U.S.A., CHANTILLY, VA:  
1,628,704, CANC. INT. CL. 41.

SOUTHCO, INC., CONCORDVILLE, PA:  
1,143,897, CANC. INT. CL. 6.

SOUTHEAST FOOD SYSTEMS, INC., DURHAM, NC:  
1,716,803. REN. 1-3-02. INT. CL. 42.

SOUTHERN WIRE CORPORATION, OLIVE BRANCH, MS:  
1,661,429. REN. 1-2-02. INT. CL. 6.

SOUTHTRUST CORPORATION, BIRMINGHAM, AL:  
1,702,102. REN. 1-4-02. INT. CL. 36.

SOUTHWEST DOOR COMPANY, INC., TUCSON, AZ:  
2,537,838, PUB. 11-20-2001. MULTIPLE CLASS, INT. CLS. 6 AND 19.

SOUTHWEST RECREATIONAL INDUSTRIES, INC., LEANDER, TX:  
2,538,353, PUB. 11-20-2001. MULTIPLE CLASS, INT. CLS. 27 AND 37.

SOUTHWEST RESEARCH INSTITUTE, SAN ANTONIO, TX:  
2,497,620, CANC. IIRN. RESTORED TO S.N. 75-824,628.

SPACE & LEISURE TIME, LTD., NEW YORK, NY:  
1,144,525, CANC. INT. CL. 39.

SPALDING & EVENFLO COMPANIES, INC., TAMPA, FL:  
1,144,351, CANC. INT. CL. 28.

SPALDING AUTO PARTS, INC., SPOKANE, WA:  
2,537,661, PUB. 11-20-2001. MULTIPLE CLASS, INT. CLS. 35, 37 AND 39.

SPANDEX USA INC., ALLENTOWN, PA, DBA CLARKE SYSTEMS:  
2,537,735, PUB. 11-20-2001. INT. CL. 40.  
2,537,736, PUB. 11-20-2001. INT. CL. 40.

SPAR GROUP INC., WEST VANCOUVER, BRITISH COLUMBIA, CANADA:  
1,867,979, CANC. INT. CL. 6.

SPARE-TIME PRODUCTS, INC., MINNEAPOLIS, MN:  
383,668, CANC. U.S. CL. 22.

SPARKS, TONNEY, HOUSTON, TX:  
1,869,093, CANC. INT. CL. 25.

SPARTON CORPORATION, JACKSON, MI:  
1,868,100, CANC. INT. CL. 9.

SPC RESOURCES, INC., WILMINGTON, DE:  
1,628,277, CANC. INT. CL. 16.

SPECIAL OFFSITE SERVICES, INC., NAPERVILLE, IL:  
2,538,002, PUB. 11-20-2001. INT. CL. 35.

SPECIALTY FERTILIZER PRODUCTS, LLC, BELTON, MO:  
2,538,656, INT. CL. 1.

SPECIALTY MARKETING, INC., GILFORD, NH:  
1,869,068, CANC. INT. CL. 16.

SPECIALTY MERCHANDISE CORPORATION, CHATSWORTH, CA:  
2,537,887, PUB. 11-20-2001. INT. CL. 35.

SPECTRUM CELLULAR CORPORATION, DALLAS, TX:  
1,868,112, CANC. INT. CL. 9.

SPECTRUM SPECIALTIES, INC., CINCINNATI, OH:  
1,143,886, CANC. INT. CL. 6.

SPENCER & FLEETWOOD, EAST HORSLEY, SURREY, GREAT BRITAIN:  
2,537,831, PUB. 11-20-2001. INT. CL. 30.

SPERRY CORP., TAIPEI, TAIWAN:  
2,538,547, INT. CL. 28.

SPHINX GROUP, INC., AGOURA HILLS, CA:  
2,537,674, PUB. 11-20-2001. INT. CL. 42.

SPHINX RESEARCH GROUP, INC., AGOURA HILLS, CA:  
2,537,675, PUB. 11-20-2001. INT. CL. 42.

SPINDEL, JANIS, NEW YORK, NY:  
2,537,722, PUB. 11-20-2001. INT. CL. 42.

SPOETZL BREWERY, INC., SAN ANTONIO, TX:  
2,537,889, PUB. 11-20-2001. INT. CL. 32.

SPORT CHALET INC., LA CANADA, CA:  
1,868,390, CANC. INT. CL. 25.

SPORTCRAFT, LTD., MT. OLIVE, NJ, GENERAL SPORT-CRAFT COMPANY, LTD., BERGENFIELD, NJ:  
1,678,702. REN. 12-31-01. INT. CL. 28.

SPRI PRODUCTS, INC., MUNDELEIN, IL:  
2,538,305, PUB. 11-20-2001. INT. CL. 28.

SPRING HOUSE, INC., ALEXANDRIA, IN:  
2,538,528, INT. CL. 9.

SPRING WINDOW FASHION LP, MIDDLETON, WI, GRABER INDUSTRIES, INC., MIDDLETON, WI:  
1,160,967. REN. 1-3-02. INT. CL. 20.

SPRING, NICOLE MARIE, RUSSELL, OH:  
2,538,396, PUB. 11-20-2001. INT. CL. 38.

SPRINGSHIRE INN, INC., WOODSTOCK, IL:  
1,868,713, CANC. INT. CL. 42.

SPRINT COMMUNICATIONS COMPANY L.P., OVERLAND PARK, KS:  
2,538,071, PUB. 11-20-2001. INT. CL. 42.

SPX CORPORATION, MUSKEGON, MI, DBA TRUTH DIVISION OF SPX CORPORATION:  
1,868,818, CANC. INT. CL. 6.

SRECO-FLEXIBLE INC., LIMA, OH:  
1,627,970, CANC. INT. CL. 7.

STAFFAIDE, INC., ORANGE, CA:  
2,538,341, PUB. 11-20-2001. INT. CL. 35.

STAGECOACH VINEYARDS LIMITED PARTNERSHIP, NAPA, CA:  
2,537,958, PUB. 11-20-2001. INT. CL. 31.

STAGING CONCEPTS, INC., BROOKLYN PARK, MN:  
1,639,763. REN. 1-4-02. INT. CL. 19.

STAGLIANO, DENNIS, ALIQUIPPA, PA, DBA GRIDIRON GOLD AND STAGLIANO, SANDRA, ALIQUIPPA, PA, DBA GRIDIRON GOLD:  
2,538,433, PUB. 11-20-2001. INT. CL. 42.

STANDARD COFFEE COMPANY, INC., TROY, MI:  
2,537,522, PUB. 9-23-1997. MULTIPLE CLASS, INT. CLS. 30 AND 42.

STANDARD TEXTILE CO. INC., CINCINNATI, OH, STANDARD TEXTILE CO. INC., CINCINNATI, OH:  
1,661,596. REN. 1-2-02. INT. CL. 10.

STANDARD TEXTILE CO., INC., CINCINNATI, OH:  
1,690,235. REN. 12-31-01. INT. CL. 24.  
1,690,236. REN. 12-31-01. MULTIPLE CLASS, INT. CLS. 24 AND 37.

STANDARD-THOMSON CORPORATION, STANDARD-THOMSON CORPORATION, WALTHAM, MA:  
727,244. REN. 1-4-02. U.S. CL. 35 (INT. CL. 17).

STANDARD-THOMSON CORPORATION, WALTHAM, MA:  
1,187,400. REN. 1-2-02. INT. CL. 7.

STANDARDSWORK, INC., WASHINGTON, DC:  
2,537,710, PUB. 11-20-2001. INT. CL. 41.

STANICO, INC., SHREWSBURY, NJ:  
1,868,945, CANC. INT. CL. 30.

STANLEY FILTER COMPANY, SKIATOOK, OK:  
1,659,433. REN. 1-3-02. INT. CL. 7.

STAR BRIGHT BOOKS, INC. AND MIRIAM COHEN JOINT VENTURE, THE, NEW YORK, NY:  
2,537,728, PUB. 11-20-2001. INT. CL. 16.

STARNO, BEVERLY, SAN RAFAEL, CA, DBA BEVERLY PRODUCTIONS:  
1,868,947, CANC. INT. CL. 30.

STASSI COSMETICS, INC., WESTLAKE VILLAGE, CA:  
2,538,635, INT. CL. 3.

- STATE INDUSTRIES, INC., ASHLAND CITY, TN:  
1,628,181, CANC. INT. CL. 11.
- STEEL NETWORK, INC., THE, RALEIGH, NC:  
2,538,352, PUB. 11-20-2001. INT. CL. 6.
- STENOGRAPH CORPORATION, SKOKIE, IL:  
1,128,894, CANC. INT. CL. 9.
- STERLING DRUG INC., NEW YORK, NY:  
708,856, CANC. U.S. CL. 52.
- STEVENS, CLINT D., HOUSTON, TX, DBA EMPLOYMENTALITY:  
2,538,262, PUB. 11-20-2001. INT. CL. 16.
- STIEFEL LABORATORIES, INC., CORAL GABLES, FL:  
2,538,456, INT. CL. 5.
- STOCKHAUSEN, INC., GREENSBORO, NC:  
1,628,812, CANC. INT. CL. 3.
- STOLLE MACHINERY, INC., NORTH CANTON, OH, DBA REDICON METAL FORMING SYSTEMS, REDICON CORPORATION, CANTON, OH:  
1,640,240, REN. 1-4-02. INT. CL. 7.
- STONHARD, INC., MAPLE SHADE, NJ:  
1,645,258, REN. 1-3-02. INT. CL. 19.
- STOREY, DAVID C., CARROLLTON, GEORGIA:  
2,538,254, PUB. 11-20-2001. INT. CL. 15.
- STORK SYSTEMS, INC., SUGAR HILL, GA:  
2,538,206, PUB. 11-20-2001. INT. CL. 35.
- STRATAGENE, LA JOLLA, CA:  
2,538,625, INT. CL. 1.
- STROMBECKER CORPORATION, CHICAGO, IL:  
1,144,383, CANC. INT. CL. 28.
- SUBITO SPORT, 412 52 GOTEBOURG, SWEDEN:  
1,868,364, CANC. INT. CL. 25.
- SUCCESS RULES!, CALABASAS, CA:  
2,538,158, PUB. 11-20-2001. INT. CL. 41.
- SUGAR'S MASCOTS.CA INC., TORONTO, ONTARIO, CANADA:  
2,538,584, MULTIPLE CLASS, INT. CLS. 25, 40 AND 42.
- SULTON, INC., WAYNE, NJ:  
708,839, CANC. U.S. CL. 51.
- SUMITOMO CHEMICAL CO., LTD., CHUO-KU, OSAKA, JAPAN:  
924,952, REN. 1-3-02. U.S. CL. 6 (INT. CL. 1).  
1,182,602, REN. 1-3-02. INT. CL. 1.
- SUMITOMO ELECTRIC CARBIDE, INC., MT. PROSPECT, IL:  
1,868,827, CANC. INT. CL. 7.
- SUMMIT LAW GROUP, P.L.L.C., SEATTLE, WA:  
2,538,234, PUB. 11-20-2001. INT. CL. 42.
- SUN BANKS, INC., ORLANDO, FL:  
1,144,487, CANC. INT. CL. 36.
- SUN SPORTSWEAR, INC., KENT, WA:  
1,868,362, CANC. INT. CL. 25.
- SUN STYLE INTERNATIONAL INC., NEW YORK, NY:  
1,628,162, CANC. INT. CL. 9.
- SUN WORLD, INC., INDIO, CA:  
1,868,954, CANC. INT. CL. 31.
- SUNASU INTERNATIONAL, INC., SAN DIEGO, CA:  
1,143,863, CANC. INT. CL. 5.
- SUNCO DISTRIBUTORS, JUPITER, FL:  
2,538,313, PUB. 11-20-2001. INT. CL. 28.
- SUNSWEET GROWERS INC., STOCKTON, CA:  
1,628,509, CANC. INT. CL. 30.
- SUNTREE, LLC, OROSI, CA:  
2,538,194, PUB. 11-20-2001. INT. CL. 29.
- SUPACHILL USA, INC., HOUSTON, TX:  
2,538,541, U.S. CL. B.
- SUPER RIFLE SOCIETA PER AZIONI, FLORENCE, ITALY:  
1,173,381, REN. 1-4-02. INT. CL. 25.
- SUPER SAGLESS CORPORATION, TUPELO, MS:  
1,868,896, CANC. INT. CL. 20.
- SUPER TEE, INC., CLEVELAND, OH:  
1,869,101, CANC. INT. CL. 28.
- SUPER YARN MART, THE, LOS ANGELES, CA:  
1,144,230, CANC. INT. CL. 23.
- SUPERBODIES, INC., MILWAUKEE, WI:  
1,868,374, CANC. INT. CL. 25.
- SUPERTOYS U.S.A., INC., ISLAND HEIGHTS, NJ:  
1,628,440, CANC. INT. CL. 28.
- SUSAN BATES INC., STAMFORD, CT:  
708,770, CANC. U.S. CL. 40.
- SUTCLIFFE, CHARLES DANA, NEWARK, DE:  
1,628,241, CANC. INT. CL. 15.
- SUZUKI MOTOR CORPORATION, HAMANATSU-SHI, SHIZUOKA-KEN, JAPAN:  
1,660,732, REN. 1-3-02. INT. CL. 12.
- SWEET STREET DESSERTS, INC., READING, PA:  
1,699,293, REN. 1-4-02. INT. CL. 30.  
1,700,702, REN. 1-4-02. INT. CL. 30.
- SWEETFACE FASHION COMPANY, LLC, NEW YORK, NY:  
2,538,359, PUB. 11-20-2001. INT. CL. 25.
- SWEETLAND NORTHLAND HEALTH GROUP, THE, SOUTH PORTLAND, ME:  
1,869,011, CANC. INT. CL. 42.
- SWIFT-ECKRICH, INC., DOWNERS GROVE, IL, SWIFT & COMPANY, CHICAGO, IL:  
1,172,448, REN. 1-2-02. INT. CL. 29.
- SWISHER MOWER & MACHINE COMPANY, INC., WARRENSBURG, MO:  
2,538,321, PUB. 11-20-2001. INT. CL. 7.
- SWIZZELS MATLOW LTD., NEW MILLS, NEAR STOCKPORT, DERBYSHIRE, ENGLAND:  
1,144,435, CANC. INT. CL. 30.
- SYA MUSIC GROUP, INC., SAVANNAH, GA:  
2,538,424, PUB. 11-20-2001. MULTIPLE CLASS, INT. CLS. 9 AND 25.
- SYBA MULTIMEDIA, INC., MONTCLAIR, CA:  
2,538,273, PUB. 11-20-2001. INT. CL. 9.
- SYEX EXPRESS, INC., HOUSTON, TX:  
1,868,710, CANC. INT. CL. 42.
- SYNERGY BANK, HOUMA, LA:  
2,537,725, PUB. 11-20-2001. INT. CL. 36.
- SYNTEX (U.S.A.) INC., PALO ALTO, CA:  
1,143,867, CANC. INT. CL. 5.  
1,143,868, CANC. INT. CL. 5.  
1,144,043, CANC. INT. CL. 10.
- SYNTHELABO, 92350 LE PLESSIS ROBINSON, FRANCE:  
1,867,964, CANC. INT. CL. 5.
- SYSCON CORPORATION, WASHINGTON, DC:  
1,868,117, CANC. INT. CL. 9.  
1,868,118, CANC. INT. CL. 9.
- SYVAX, INC., OAK RIDGE, NJ:  
2,537,676, PUB. 11-20-2001. INT. CL. 39.
- T. S. RAGSDALE COMPANY, INCORPORATED, LAKE CITY, SC:  
708,586, CANC. U.S. CL. 1.
- T.C.M. LIMITED, DOUGLAS, ISLE OF MAN, IMI 3DA, BR.VIRGIN ISLANDS:  
1,572,776, CANC. INT. CL. 3.
- T.L.I. INTERNATIONAL CORP., CHICAGO, IL:  
1,868,544, CANC. INT. CL. 35.
- T-SYSTEMS INTERNATIONAL, INC., SAN DIEGO, CA, TRICKLE SYSTEMS CORPORATION, SAN DIEGO, CA:  
1,118,172, REN. 1-3-02. INT. CL. 11.
- TA TRIUMPH-ADLER AKTIENGESELLSCHAFT, NURNBERG 90449, FED REP GERMANY:  
1,627,998, CANC. MULTIPLE CLASS, INT. CLS. 9, 16 AND 37.
- TABACALERA BRANDS, INC., WILMINGTON, DE, LOEW'S THEATRES, INC., NEW YORK, NY:  
1,174,479, REN. 1-3-02. INT. CL. 34.
- TACO BELL CORP., IRVINE, CA:  
2,537,709, PUB. 11-20-2001. INT. CL. 42.
- TAKING CHARGE, INC., BAYFIELD, CO:  
1,628,278, CANC. INT. CL. 16.
- TALKING CAR, INC., CHICAGO, IL:  
2,538,447, INT. CL. 39.
- TAM COMMUNICATIONS, INC., NORWALK, CT:  
1,868,250, CANC. INT. CL. 16.
- TAMIRSON, INC., MIAMI, FL:  
1,628,506, CANC. INT. CL. 30.
- TAPCO INTERNATIONAL CORPORATION, PLYMOUTH, MI, TAPCO PRODUCTS COMPANY, INC., DETROIT, MI:  
1,168,051, REN. 1-2-02. INT. CL. 7.
- TARA & KYLE, INC., SAN DIEGO, CA:  
2,538,121, PUB. 11-20-2001. INT. CL. 42.

- TARGET THERAPEUTICS, INC., FREMONT, CA:  
2,537,520, PUB. 11-20-2001. INT. CL. 10.
- TAURUS COMMUNICATIONS, INC., FRAMINGHAM, MA:  
1,628,640, CANC. INT. CL. 38.
- TAX ANALYSTS, ARLINGTON, VA:  
2,537,878, PUB. 11-20-2001. INT. CL. 9.
- TAYLOR, DONALD D., DEL MAR, CA:  
2,537,982, PUB. 11-20-2001. INT. CL. 25.
- TCBY ENTERPRISES, INC., LITTLE ROCK, AR:  
1,868,790, CANC. MULTIPLE CLASS, INT. CLS. 29 AND 30.
- TDH LAFAYETTE INDUSTRIES, INC., BROOKLYN, NY:  
1,868,331, CANC. INT. CL. 20.
- TECHNIK DEVELOPMENT INTERNATIONAL, SAN DIEGO, CA:  
1,868,529, CANC. INT. CL. 35.
- TECHNIKU INCORPORATED, DENVER, CO:  
2,537,777, PUB. 11-20-2001. INT. CL. 9.
- TECHNOLOGY CONSULTING CORPORATION, WAUKESHA, WI:  
1,691,031, CANC. INT. CL. 42.
- TEKNION FURNITURE SYSTEMS, DOWNSVIEW, ONTARIO M3J 2J5, CANADA TO TEKNION FURNITURE SYSTEMS, DOWNSVIEW, ONTARIO M3J 2J5, CANADA:  
2,451,346, COR. INT. CL. 20.
- TELCO SALES, INC., CLINTON, MS:  
2,537,954, PUB. 11-20-2001. INT. CL. 9.
- TELCOBUY.COM, LLC, ST. LOUIS, MO:  
2,538,241, PUB. 11-20-2001. MULTIPLE CLASS, INT. CLS. 37 AND 42.
- TELECOMMUNICATIONS SOFTWARE, INC., WESTBURY, NY:  
1,628,153, CANC. INT. CL. 9.
- TELEDYNE INDUSTRIES, INC., LOS ANGELES, CA:  
1,144,034, CANC. INT. CL. 9.  
1,144,203, CANC. INT. CL. 20.
- TELESIAN TECHNOLOGY, INC., WORCESTER, MA:  
2,538,691, INT. CL. 35.
- TEN REN TEA CO., LTD., TAIPEI, TAIWAN:  
2,538,126, PUB. 11-20-2001. INT. CL. 30.
- TENEX CORPORATION, ELK GROVE, IL:  
1,868,349, CANC. INT. CL. 21.
- TENNECO AUTOMOTIVE OPERATING COMPANY INC., LAKE FOREST, IL:  
2,538,253, PUB. 11-20-2001. INT. CL. 7.
- TENNESSEE TEACHER'S CREDIT UNION, NASHVILLE, TN:  
1,664,392, REN. 12-30-01. INT. CL. 36.
- TENNIS CORPORATION OF AMERICA, CHICAGO, IL:  
1,868,648, CANC. INT. CL. 41.
- TENSOR CORPORATION, CHELSEA, MA, TENSOR CORPORATION, BROOKLYN, NY:  
921,857, REN. 1-3-02. U.S. CL. 21 (INT. CLS. 9 AND 11).
- TEQUILA CUERVO LA ROJENA, S.A. DE C.V., ZAPOCAN JALISCO, CODIGO 45070, MEXICO, TEQUILA CUERVO S.A., GUADALAJARA, JALISCO, MEXICO:  
1,633,487, REN. 1-3-02. INT. CL. 41.
- TERRI LYNN, INC., ELGIN, IL:  
1,680,706, REN. 12-29-01. INT. CL. 42.
- TETON DATA SYSTEMS, JACKSON, WY:  
1,674,897, REN. 1-4-02. INT. CL. 9.
- TEXACO INC., WHITE PLAINS, NY, TEXAS COMPANY, THE, HOUSTON, TX:  
84,057, REN. 1-2-02. U.S. CL. 15 (INT. CL. 4).
- TEXTRON INC., PROVIDENCE, RI:  
708,711, CANC. U.S. CL. 23.
- TEXTRON VERBINDUNGSTECHNIK GMBH & CO. OHG, D-41462 NEUSS, FED REP GERMANY, BAUER & SCHAURTE, NEUSS (RHINE), FED REP GERMANY:  
714,062, REN. 1-4-02. U.S. CL. 13 (INT. CL. 6).
- THAI, KHI V., BOCA RATON, FL:  
2,538,714, INT. CL. 16.
- THE CLUB AT SEABROOK ISLAND, INC., JOHN'S ISLAND, SC, SEABROOK ISLAND COMPANY, CHARLESTON, SC:  
1,174,517, REN. 1-4-02. MULTIPLE CLASS, INT. CLS. 36, 37 AND 41.
- THE GATES CORPORATION, DENVER, CO, GATES RUBBER COMPANY, THE, DENVER, CO:  
1,659,754, REN. 12-29-01. INT. CL. 17.
- THE LAMAUR CORPORATION, FRIDLEY, MN, DOW-BRANDS INC., INDIANAPOLIS, IN:  
1,678,211, REN. 12-31-01. INT. CL. 3.
- THE MONEYPAPER, INC., NEW YORK, NY, TEMPER OF THE TIMES COMMUNICATIONS, INC., MAMARONECK, NY:  
1,679,368, REN. 1-3-02. INT. CL. 16.
- THER-A-PEDIC ASSOCIATES, INC., MIDDLESEX, NJ:  
1,201,124, REN. 1-3-02. INT. CL. 20.
- THERMO JARRELL ASH CORPORATION, FRANKLIN, MA:  
1,868,831, CANC. INT. CL. 9.
- THESCIANTIFICWORLD, INC., BOYNTON BEACH, FL:  
2,538,267, PUB. 11-20-2001. INT. CL. 38.
- THIARA, HARSEV S., SR., LIVE OAK, CA AND THIARA, MOHINDERJIT K., LIVE OAK, CA AND THIARA, HARSEV S., JR., LIVE OAK, CA:  
1,868,486, CANC. MULTIPLE CLASS, INT. CLS. 29 AND 31.
- THOLSTRUP CHEESE A/S, 1254 KOBENHAVN K, DENMARK:  
2,538,125, PUB. 11-20-2001. INT. CL. 29.
- THOMAS EQUIPMENT LTD., CENTERVILLE, NEW BRUNSWICK, CANADA:  
2,453,561, CANC. IIRN. RESTORED TO S.N. 75-510,414.
- THOMPSON CREATIVE MARKETING GROUP, INC., THE, SPRINGFIELD, VA:  
1,868,554, CANC. MULTIPLE CLASS, INT. CLS. 35 AND 36.
- THOMPSON'S PET PASTA PRODUCTS, INC., FT. LAUDERDALE, FL:  
1,868,960, CANC. INT. CL. 31.
- THORN EMI PLC, LONDON, ENGLAND:  
1,574,681, CANC. INT. CL. 11.
- TIDAL WIRELESS, INC., DUBLIN, OH:  
2,538,304, PUB. 11-20-2001. INT. CL. 35.
- TIDI PRODUCTS, INC., RIALTO, CA:  
1,868,142, CANC. INT. CL. 10.
- TIME WARNER ENTERTAINMENT COMPANY, L.P., NEW YORK, NY:  
2,538,572, INT. CL. 16.
- TIMELY ENTERPRISES, INC., GARLAND, TX:  
1,868,329, CANC. INT. CL. 20.
- TIMES MIRROR COMPANY, THE, LOS ANGELES, CA:  
1,628,569, CANC. INT. CL. 35.
- TIMEX CORPORATION, MIDDLEBURY, CT:  
1,688,989, REN. 12-31-01. INT. CL. 14.
- TISHMAN RESEARCH COMPANY, NEW YORK, NY:  
1,166,235, CANC. INT. CL. 9.
- TITANUS S.P.A., THIENE (VICENZA), ITALY:  
1,628,382, CANC. INT. CL. 24.
- TIVO, INC., ALVISO, CA FROM TELEWORLD INC., SUNNYVALE, CA:  
2,538,482, MULTIPLE CLASS, INT. CLS. 9, 35, 38 AND 41.
- TM ACQUISITION CORP., PARSIPPANY, NJ:  
1,868,535, CANC. INT. CL. 35.
- TMS, INC., CHICAGO, IL:  
2,537,655, PUB. 11-20-2001. INT. CL. 12.
- TNH LEASING AG, LEIDSEPLEIN 29, AMSTERDAM, NETHERLANDS:  
1,868,833, CANC. INT. CL. 9.
- TOLCO CORPORATION, MIAMI, FL:  
1,868,715, CANC. INT. CL. 42.
- TOLOTTI MANUFACTURING, INC., SPARKS, NV:  
1,144,073, CANC. INT. CL. 11.
- TOMORROW, LLC, GREENWICH, CT:  
2,537,702, PUB. 11-20-2001. MULTIPLE CLASS, INT. CLS. 38 AND 42.
- TOMY AMERICA INC., SOUTHPORT, CT:  
1,628,433, CANC. INT. CL. 28.
- TOP DOG ENTERPRISE, INC., AUBURN, WA:  
1,868,373, CANC. INT. CL. 25.
- TOUFAYAN BAKERY, INC., NORTH BERGEN, NJ:  
2,538,041, PUB. 11-20-2001. INT. CL. 30.

- TOWARD EFFECTIVE MANAGEMENT, INC., SARASOTA, FL:  
2,538,245, PUB. 11-20-2001. INT. CL. 16.
- TOWLE MANUFACTURING COMPANY, BOSTON, MA:  
1,143,955, CANC. INT. CL. 8.
- TRAIL BLAZERS INC., PORTLAND, OR:  
2,538,597, INT. CL. 38.  
2,538,598, INT. CL. 41.
- TRAILMASTERS PRODUCTS, INC., CORONA, CA, TRAIL MASTER PRODUCTS, INC., COLDWATER, MI:  
1,660,726, REN. 1-4-02. INT. CL. 12.
- TRANS WORLD NEW YORK, LLC, ALBANY, NY, STRAWBERRIES INC., MILFORD, MA:  
1,675,448, REN. 1-2-02. INT. CL. 42.
- TRANSAMERICA LIFE INSURANCE AND ANNUITY COMPANY, LOS ANGELES, CA:  
2,538,689, INT. CL. 16.
- TRANSCONTINENTAL PUBLISHING, INC., PHOENIX, AZ:  
1,869,077, CANC. INT. CL. 16.
- TRANSITION SYSTEMS, INC., BOSTON, MA:  
1,868,086, CANC. INT. CL. 9.
- TRANSPORT CLEARINGS OF TWIN CITIES, INC., ST. PAUL, MN, DBA TRANSPORT CLEARINGS OF TWIN CITIES:  
708,863, CANC. U.S. CL. 105.
- TRAVEL CONSULTANTS, INC., GRAND RAPIDS, MI:  
1,869,003, CANC. INT. CL. 42.
- TRAVEL INCORPORATED, ATLANTA, GA:  
1,868,628, CANC. INT. CL. 39.
- TRAVEL INDUSTRY COUNCIL, INC., ROCHESTER, NY, DBA INDEPENDENT TRAVEL AGENCIES ASSOCIATION, ITAA:  
1,868,622, CANC. INT. CL. 39.
- TRAVELPRO INTERNATIONAL, INC., BOCA RATON, FL:  
2,538,633, INT. CL. 18.
- TREGO SYSTEMS, WALNUT CREEK, CA:  
1,868,053, CANC. INT. CL. 9.  
1,868,707, CANC. INT. CL. 42.
- TREK BICYCLE CORPORATION, WATERLOO, WI:  
2,538,367, PUB. 11-20-2001. INT. CL. 12.
- TREX COMPANY, LLC, WINCHESTER, VA:  
2,538,495, INT. CL. 19.
- TRI-COUNTY HOME HEALTH CARE SERVICES, INC., CORAL SPRINGS, FL:  
1,868,756, CANC. INT. CL. 42.
- TRI-MER CORPORATION, OWOSSO, MI:  
1,715,431, REN. 1-3-02. INT. CL. 11.
- TRIAD HOSPITALS HOLDINGS, INC., DALLAS, TX FROM C/HCA, INC., NASHVILLE, TN:  
2,538,496, INT. CL. 35.
- TRIVISION SOLUTIONS, INC., SOLVANG, CA:  
2,538,345, PUB. 11-20-2001. INT. CL. 38.
- TROUW INTERNATIONAL B.V., NL-5831 JL BOXMEER, NETHERLANDS:  
1,669,648, REN. 12-31-01. INT. CL. 31.
- TRUE TEMPER SPORTS, INC., MEMPHIS, TN, EMHART INDUSTRIES, INC., TOWSON, MD:  
1,643,717, REN. 1-3-02. INT. CL. 28.
- TRUSTED UNIVERSAL STANDARDS IN ELECTRONIC TRANSACTIONS, SAN JOSE, CA:  
2,537,999, PUB. 11-20-2001. MULTIPLE CLASS, INT. CLS. 41 AND 42.
- TRUSTEES OF AMERICA'S DRIVE-IN TRUST A PENNSYLVANIA BUSINESS TRUST, COMPRISING OF KENNETH L. KEYMER, RONALD L. MATLOCK AND JANICE C. GEORGE, ALL UNITED STATES CITIZENS, RENO, NV:  
2,537,957, PUB. 11-20-2001. INT. CL. 30.
- TRUSTEES OF AMERICA'S DRIVE-IN TRUST, THE A PENNSYLVANIA BUSINESS TRUST, THE TRUSTEES COMPRISING KENNETH L. KEYMER, RONALD L. MATLOCK AND JANICE C. GEORGE ALL UNITED STATES CITIZENS, RENO, NV:  
2,537,956, PUB. 11-20-2001. INT. CL. 30.
- TRUSTEES OF THE ANALYSTS TRUST, THE, CINCINNATI, OH:  
1,868,591, CANC. INT. CL. 36.
- TRUSTEES OF THE MCKENZIE INSTITUTE INTERNATIONAL TRUST, A NEW ZEALAND TRUST, THE TRUSTEES COMPRISING VERT MOONEY, A U.S. CITIZEN, ROBIN MCKENZIE, JOY MCKENZIE, JAN MCKENZIE, LAWRENCE DOTT, AND WILLIAM P. JEFFRIES, ALL CITIZENS OF NEW ZEALAND, THE, WAIKANAE, NEW ZEALAND:  
2,537,537, PUB. 11-20-2001. INT. CL. 42.
- TSI BRANDS, INC., WILMINGTON, DE, TROPICAL GARMENT MANUFACTURING CO., TAMPA, FL:  
1,683,029, REN. 12-29-01. INT. CL. 25.
- TSP, INC., RICHMOND, VA:  
1,868,261, CANC. INT. CL. 16.
- TSUBURAYA PRODUCTIONS CO., LTD., SETAGAYA-KU, TOKYO, 157, JAPAN:  
1,868,885, CANC. INT. CL. 16.
- TURKISH AIRLINES, INC., NEW YORK, NY:  
1,914,373, COR. INT. CL. 39.
- TURNER, JAMES L., JR., FT WASHINGTON, MD:  
1,868,678, CANC. INT. CL. 41.
- TURTLE CREEK MANAGEMENT, INC., INDIANAPOLIS, IN:  
891,729, REN. 1-3-02. U.S. CL. 101 (INT. CLS. 35, 36, 38, 41 AND 42).
- TUTHILL CORPORATION, HINSDALE, IL:  
1,867,994, CANC. INT. CL. 7.  
1,867,995, CANC. INT. CL. 7.
- TWIN LABORATORIES INC., AMERICAN FORK, UT, NATUR-PHARMA, INC., OREM, UT:  
1,643,312, REN. 1-3-02. INT. CL. 5.
- TYCO INDUSTRIES, INC., MOUNT LAUREL, NJ:  
1,869,096, CANC. INT. CL. 28.
- TYCO PLASTICS LP, MINNEAPOLIS, MN FROM CARLISLE PLASTICS LP, MINNEAPOLIS, MN:  
2,538,586, INT. CL. 16.
- TYNDALE HOUSE PUBLISHERS, INC., WHEATON, IL, TYNDALE HOUSE PUBLISHERS, WHEATON, IL:  
930,894, REN. 1-4-02. U.S. CL. 38 (INT. CL. 16).
- TYNE POLYMERS, INC., BURLINGTON, CT:  
1,867,893, CANC. INT. CL. 1.
- U S WEST BUSINESS RESOURCES, INC., ENGLEWOOD, CO:  
1,868,990, CANC. INT. CL. 39.
- U S WEST ENTERPRISES, INC., OMAHA, NE:  
1,628,136, CANC. INT. CL. 9.
- U S WEST NEWVECTOR GROUP, INC., BELLEVUE, WA:  
1,868,614, CANC. INT. CL. 38.
- U.S. WATER INC., SOMERVILLE, NJ:  
1,869,023, CANC. MULTIPLE CLASS, INT. CLS. 37 AND 40.
- UCB CHEMICALS CORPORATION, SMYRNA, GA, RAD-CURE SPECIALTIES, INC., ATLANTA, GA:  
1,657,078, REN. 1-3-02. INT. CL. 1.
- ULTRA BOND, INC., RIVERSIDE, CA:  
1,869,086, CANC. INT. CL. 16.
- ULTRARF, SUNNYVALE, CA:  
2,538,324, PUB. 11-20-2001. INT. CL. 9.
- UNDERWATER DIVING INC., CHATSWORTH, CA:  
1,689,886, REN. 12-31-01. MULTIPLE CLASS, INT. CLS. 9 AND 28.
- UNI-CHARM CORPORATION, KAWANOE-SHI, EHIME-KEN, JAPAN:  
1,867,962, CANC. INT. CL. 5.
- UNION STATION ASSISTANCE CORPORATION, KANSAS CITY, MO TO UNION STATION ASSISTANCE CORPORATION, KANSAS CITY, MO:  
2,453,536, COR. MULTIPLE CLASS, INT. CLS. 16, 21, 25 AND 36.
- UNITED BUSINESS EQUIPMENT CORP., BUFFALO, NY:  
1,144,201, CANC. INT. CL. 20.
- UNITED CEREBRAL PALSY ASSOCIATIONS, INC., WASHINGTON, DC:  
2,537,775, PUB. 11-20-2001. MULTIPLE CLASS, INT. CLS. 16, 41 AND 42.
- UNITED DESIGN CORPORATION, NOBLE, OK:  
1,868,398, CANC. INT. CL. 25.



- UNITED DOMINION INDUSTRIES, INC., CHARLOTTE, NC, DBA CECO DOOR PRODUCTS:  
2,538,112, PUB. 11-20-2001. INT. CL. 6.  
2,538,113, PUB. 11-20-2001. INT. CL. 6.
- UNITED GUARANTY CORPORATION, GREENSBORO, NC:  
2,538,286, PUB. 11-20-2001. INT. CL. 36.
- UNITED MERCHANTS AND MANUFACTURERS, INC., NEW YORK, NY:  
1,143,809, CANC. INT. CL. 1.
- UNITED POSTAL SAVINGS ASSOCIATION, ST. LOUIS, MO:  
1,868,575, CANC. INT. CL. 36.
- UNITED SERVICES AUTOMOBILE ASSOCIATION, SAN ANTONIO, TX:  
2,538,232, PUB. 11-20-2001. INT. CL. 16.
- UNITED STATES PIPE AND FOUNDRY COMPANY, INC., BIRMINGHAM, AL, UNITED STATES PIPE AND FOUNDRY COMPANY, BIRMINGHAM, AL:  
1,662,197, REN. 1-4-02. INT. CL. 6.
- UNITED STATES POSTAL SERVICE, WASHINGTON, DC:  
2,537,762, PUB. 11-20-2001. MULTIPLE CLASS, INT. CLS. 14 AND 21.  
2,538,683, MULTIPLE CLASS, INT. CLS. 9, 35, 36, 38, 39, 40 AND 42.
- UNITED STATES TOBACCO COMPANY, GREENWICH, CT:  
1,664,325, REN. 1-3-02. INT. CL. 34.
- UNITED STATES TOBACCO MANUFACTURING LP, NASHVILLE, TN, UNITED STATES TOBACCO COMPANY, GREENWICH, CT:  
1,162,990, REN. 1-2-02. INT. CL. 34.
- UNITED SUPPLIERS, INC., ELDORA, IA:  
2,537,909, PUB. 11-20-2001. INT. CL. 1.
- UNITED TESTING GROUP, INC., ATLANTA, GA:  
1,868,638, CANC. INT. CL. 40.
- UNITOOL INC., MONTREAL QUEBEC, CANADA, UNITED TOOLS COMPANY (MONTREAL) LTD., MONTREAL, QUEBEC, CANADA:  
1,175,840, REN. 1-3-02. MULTIPLE CLASS, INT. CLS. 7 AND 8.
- UNIVERSAL CITY STUDIOS, INC.:  
*See—HOB CONCERTS COMPANY.*
- UNIVERSAL COOPERATIVES, INC., MINNEAPOLIS, MN:  
708,647, CANC. U.S. CL. 16.
- UNIVERSAL FURNITURE LIMITED, BLUE MOUNTAIN, MS, DBA BENCHCRAFT FROM UNIVERSAL FURNITURE INDUSTRIES, INC., BLUE MOUNTAIN, MS, DBA BENCHCRAFT FURNITURE:  
2,538,526, INT. CL. 20.
- UNIVERSAL HEALTH CARE PRODUCTS (CANADA) INC., POINTE-CLAIRE, QUEBEC, CANADA:  
1,627,936, CANC. INT. CL. 5.
- UNIVERSITY OF CHICAGO HOSPITALS, CHICAGO, IL:  
1,628,784, CANC. INT. CL. 42.
- UNIVERSITY OF PITTSBURGH OF THE COMMONWEALTH SYSTEM OF HIGHER EDUCATION, PITTSBURGH, PA:  
1,961,923, CANC. INT. CL. 41.  
2,538,119, PUB. 11-20-2001. INT. CL. 29.
- UNIVERSITY OF THE INCARNATE WORD, SAN ANTONIO, TX:  
2,538,642, INT. CL. 41.
- UNL INCORPORATED, WEBSTER, NY:  
1,144,014, CANC. INT. CL. 9.
- UROCOR, INC., OKLAHOMA CITY, OK:  
2,538,422, PUB. 11-20-2001. INT. CL. 10.
- US INVESTIGATIONS SERVICES, INC., ANNANDALE, PA:  
2,538,473, INT. CL. 9.
- US ONLINE, INC., WENATCHEE, WA:  
2,537,601, PUB. 11-20-2001. MULTIPLE CLASS, INT. CLS. 38 AND 42.
- USC CONSULTING GROUP, LLC, BROOMALL, PA:  
2,538,641, INT. CL. 35.
- UTICA TOOL COMPANY, INC., ORANGEBURG, SC:  
83,793, REN. 1-4-02. U.S. CL. 23 (INT. CL. 8).
- UTILITY TRAILER MANUFACTURING COMPANY, CITY OF INDUSTRY, CA:  
1,144,079, CANC. INT. CL. 12.
- V.I. PREWETT & SON, INC., FORT PAYNE, AL, BELK STORES SERVICES, INC., CHARLOTTE, NC:  
1,152,482, REN. 1-4-02. INT. CL. 25.
- VALLEY LASER EYE CENTRE INC., ABBOTSFORD, BRITISH COLUMBIA, CANADA:  
2,538,515, INT. CL. 42.
- VANITY FAIR, INC., WILMINGTON, DE, MUNSINGWEAR, INC., MINNEAPOLIS, MN:  
924,312, REN. 1-2-02. U.S. CL. 39 (INT. CL. 25).
- VARN PRODUCTS CO., INC., OAKLAND, NJ:  
1,661,335, COR. INT. CL. 1.
- VAUGHAN INDUSTRIES, INC., DETROIT, MI:  
1,653,416, REN. 1-3-02. INT. CL. 3.
- VAUNGARDE, INCORPORATED, OWOSSO, MI:  
1,144,563, CANC. INT. CL. 42.
- VAXA INTERNATIONAL, INC., SAN DIEGO, CA:  
1,627,915, CANC. INT. CL. 3.
- VCH TRADEMARK, INC., ORLANDO, FL:  
2,537,691, PUB. 11-20-2001. MULTIPLE CLASS, INT. CLS. 36 AND 42.
- VECO CORPORATION, ANCHORAGE, AK:  
2,537,605, PUB. 11-20-2001. INT. CL. 42.
- VENDQUEST, INC., MURRAY HILL, NJ:  
2,537,767, PUB. 11-20-2001. INT. CL. 35.
- VENSERV, INC., AGOURA HILLS, CA:  
2,537,757, PUB. 11-20-2001. INT. CL. 36.
- VENTEX, LLC, TAMPA, FL:  
2,538,404, PUB. 11-20-2001. INT. CL. 40.
- VENTURA DISTRIBUTION, INC., THOUSAND OAKS, CA:  
2,538,188, PUB. 11-20-2001. INT. CL. 9.
- VENTURE STORES, INC., O'FALLON, MO:  
1,868,357, CANC. INT. CL. 25.
- VENTURE WEST GROUP, INC., THE, TUCSON, AZ:  
1,868,596, CANC. MULTIPLE CLASS, INT. CLS. 36 AND 37.
- VEREX LABORATORIES, INC., ENGLEWOOD, CO:  
1,212,118, REN. 1-4-02. INT. CL. 5.
- VERIPRISE WIRELESS CORPORATION, ALPHARETTA, GA:  
2,537,790, PUB. 11-20-2001. MULTIPLE CLASS, INT. CLS. 9, 38 AND 42.
- VERITAS CAPITAL MANAGEMENT, L.L.C., NEW YORK, NY:  
2,537,965, PUB. 11-20-2001. INT. CL. 36.  
2,537,966, PUB. 11-20-2001. INT. CL. 36.
- VERRAGIO LTD., NEW YORK, NY:  
2,538,204, PUB. 11-20-2001. INT. CL. 14.
- VERRONNEAU, MARK R., NEW BEDFORD, MA AND O'NEIL, MARK A., NEW BEDFORD, MA AND SBORDONE, THOMAS D., JR., NEW BEDFORD, MA AND VERRONNEAU, MARGARET E., NEW BEDFORD, MA, DBA STEW PRODUCTIONS:  
1,868,923, CANC. INT. CL. 28.
- VERTEX INTERACTIVE, INC., SOUTH PLAINFIELD, NJ, DATA CONTROL SYSTEMS, INC., MIDDLESEX, NJ:  
1,659,547, REN. 1-4-02. INT. CL. 9.
- VERTEX INTERNET, INC., LITITZ, PA:  
2,537,716, PUB. 11-20-2001. INT. CL. 42.
- VERTEX STANDARD USA, INC., CERRITOS, CA FROM YAESU MUSEN U.S.A., INC., CERRITOS, CA:  
2,537,621, PUB. 11-20-2001. INT. CL. 9.
- VETCO, INC, MELVILLE, NY:  
2,538,095, PUB. 8-21-2001. INT. CL. 5.
- VIACOM INTERNATIONAL INC., NEW YORK, NY, VIACOM INTERNATIONAL INC., NEW YORK, NY:  
1,660,911, REN. 1-3-02. MULTIPLE CLASS, INT. CLS. 25 AND 41.  
1,661,169, REN. 1-3-02. INT. CL. 41.
- VIACOM INTERNATIONAL INC., NEW YORK, NY:  
2,537,600, PUB. 11-20-2001. INT. CL. 41.
- VIAISOFT, INC., PHOENIX, AZ:  
1,628,049, CANC. INT. CL. 9.
- VIBA FIMA, INC., BUFFALO GROVE, IL:  
2,538,578, INT. CL. 35.  
2,538,579, INT. CL. 35.  
2,538,580, INT. CL. 35.
- VIBACIDE RESEARCH, INC., LANSING, IL:  
1,627,932, CANC. INT. CL. 5.

- VIBROSYSTEM INC., LONGUEUIL, PROVINCE OF QUEBEC, CANADA, VIBRO-METER CORPORATION INC., LONGUEUIL, QUEBEC, CANADA:  
1,692,594. REN. 12-31-01. INT. CL. 9.
- VICTOR R. BROWNING & COMPANY, INC., WILLOUGHBY, OH:  
1,144,081. CANC. INT. CL. 12.
- VIDEO ADVENTURE, INC., DUBUQUE, IA:  
2,538,387. PUB. 11-20-2001. INT. CL. 35.
- VIDEO DENTAL CONCEPTS, INC., ORMOND BEACH, FL:  
1,868,144. CANC. INT. CL. 10.
- VIDEO-DENT, INC., AURORA, MO:  
1,869,038. CANC. INT. CL. 9.
- VIKING CONTROLS, INC., NASHUA, NH:  
1,628,306. CANC. INT. CL. 16.
- VIKING ELECTRIC SUPPLY, INC., MINNEAPOLIS, MN:  
2,537,593. PUB. 11-20-2001. INT. CL. 35.
- VIKING POOLS, MIDLAND, TX:  
2,537,895. PUB. 11-20-2001. INT. CL. 19.
- VILTER MANUFACTURING CORPORATION, MILWAUKEE, WI:  
1,143,942. CANC. MULTIPLE CLASS, INT. CLS. 7 AND 11.
- VINCENT ENTERPRISES, INC., CHICAGO, IL, DBA VINCENT ELECTRICAL ENTERPRISES, INC.:  
2,538,066. PUB. 11-20-2001. INT. CL. 37.
- VIP SALES COMPANY, INC., TULSA, OK:  
2,538,010. PUB. 11-20-2001. MULTIPLE CLASS, INT. CLS. 29 AND 30.
- VISCOUNT COMMUNICATIONS & CONTROL SYSTEMS, BURNABY, BRITISH COLUMBIA, CANADA, VISCOUNT INDUSTRIES LIMITED, VANCOUVER, BRITISH COLUMBIA, CANADA:  
1,623,361. REN. 1-4-02. INT. CL. 9.
- VISION DESIGN EYEWEAR, INC., NO. MIAMI, FL:  
1,655,924. REN. 1-2-02. INT. CL. 9.
- VISTA DMS, INC., SANTA BARBARA, CA, MOORE BUSINESS FORMS, INC., GRAND ISLAND, NY:  
1,661,044. REN. 1-4-02. INT. CL. 35.
- VITACOST.COM, INC., SPRINGFIELD, IL:  
2,537,852. PUB. 11-20-2001. INT. CL. 35.
- VITAMIN QUOTA, INC., WEST CALDWELL, NJ:  
708,666. CANC. U.S. CL. 18.
- VIVA LIFE SCIENCE, INC., COSTA MESA, CA FROM VIVA AMERICA MARKETING CORP., COSTA MESA, CA:  
2,538,488. INT. CL. 5.
- VOICE FOR SUCCESS, INC., COLUMBIA, MD:  
2,538,240. PUB. 11-20-2001. INT. CL. 16.
- VORTEX COMICS, INCORPORATED, SANBORN, NY:  
1,868,273. CANC. INT. CL. 16.
- W-C IMPORTS, INC., ANAHEIM, CA:  
1,660,879. REN. 1-2-02. INT. CL. 24.
- WANGSON HEALTH PRODUCTS GROUP INC., CUDAHY, CA:  
2,537,561. PUB. 11-20-2001. INT. CL. 5.
- WARDWELL BRAIDING MACHINE COMPANY, CENTRAL FALLS, RI:  
1,143,921. CANC. INT. CL. 7.
- WARNACO U.S., INC., BRIDGEPORT, CT FROM WARNACO, INC., NEW YORK, NY:  
2,538,466. INT. CL. 25.
- WARNER-LAMBERT COMPANY, MORRIS PLAINS, NJ:  
1,868,498. CANC. INT. CL. 30.
- WARRIOR LACROSSE, INC., WARREN, MI:  
2,538,314. PUB. 11-20-2001. INT. CL. 28.  
2,538,316. PUB. 11-20-2001. INT. CL. 28.
- WASH ME CORPORATION, MINNEAPOLIS, MN:  
1,702,142. REN. 1-4-02. INT. CL. 37.
- WATCHGUARD TECHNOLOGIES, INC., SEATTLE, WA:  
2,538,538. INT. CL. 42.
- WATER OTTER INC., HAMILTON, MT:  
1,868,183. CANC. INT. CL. 12.
- WATER POINT SYSTEMS, INC., FORT WORTH, TX:  
1,868,644. CANC. MULTIPLE CLASS, INT. CLS. 40 AND 42.
- WATERSOFT DEVELOPMENT COMPANY, DOWNERS GROVE, IL:  
1,868,740. CANC. INT. CL. 42.
- WEATHER RISK MANAGEMENT ASSOCIATION, WASHINGTON, DC:  
2,538,360. PUB. 11-20-2001. INT. CL. 42.
- WEATHERFORD HOLDING U.S., INC., HOUSTON, TX:  
2,537,644. PUB. 11-20-2001. MULTIPLE CLASS, INT. CLS. 35, 37 AND 42.
- WEATHERNEWS INC., SUNNYVALE, CA:  
2,538,199. PUB. 11-20-2001. INT. CL. 42.
- WEAVER, C. W. BILL, HOUSTON, TX AND WEAVER, BEVERLY, HOUSTON, TX, DBA TRANSMEX SUPPLY CO., INC.:  
1,869,032. CANC. INT. CL. 3.
- WEBBCO, INC., NEW YORK, NY:  
2,537,853. PUB. 11-20-2001. INT. CL. 12.
- WEBDATAMINER, INC., NEW YORK, NY:  
2,538,700. INT. CL. 35.
- WEBROOT SOFTWARE INC, BOULDER, CO:  
2,538,432. PUB. 11-20-2001. INT. CL. 9.
- WEBSHARES, INC., COSTA MESA, CA:  
2,537,905. PUB. 11-20-2001. INT. CL. 16.
- WEEKEND 2000, INC., AUSTIN, TX:  
2,537,652. PUB. 11-20-2001. INT. CL. 21.
- WEEKS, CHRISTIAN B., TEMPLE, NH:  
2,537,679. PUB. 11-20-2001. INT. CL. 41.
- WEINBERG, BRADD, EFLAND, NC:  
2,538,278. PUB. 11-20-2001. INT. CL. 41.
- WEINSTEIN, LEWIS A., NEEDHAM, MA:  
2,537,981. PUB. 11-20-2001. INT. CL. 35.
- WELD-EQUIP B.V., 5705 AE HELMOND, NETHERLANDS:  
2,426,009. CANC. IIRN. RESTORED TO S.N. 75-412,033.
- WELL-MADE TOY MANUFACTURING CORPORATION, HOLLIS, NY:  
1,868,481. CANC. INT. CL. 28.
- WELLS FARGO & COMPANY, MINNEAPOLIS, MN:  
2,537,726. PUB. 11-20-2001. INT. CL. 36.
- WELLS, JAMESON P., CHARLOTTE, NC:  
2,537,604. PUB. 11-20-2001. INT. CL. 35.
- WERNER LEHARA INC., GRAND RAPIDS, MI:  
1,143,926. CANC. MULTIPLE CLASS, INT. CLS. 7 AND 11.
- WERNER TOOL & MANUFACTURING CO., INC., DETROIT, MI:  
1,661,464. REN. 1-3-02. INT. CL. 9.
- WEST LAKE FOOD CORPORATION, SANTA ANA, CA, DBA BANH CUON TAY HO RESTAURANT:  
2,538,012. PUB. 11-20-2001. MULTIPLE CLASS, INT. CLS. 29 AND 42.
- WESTAT, INC., ROCKVILLE, MD:  
2,537,590. PUB. 11-20-2001. MULTIPLE CLASS, INT. CLS. 35 AND 42.
- WESTECH INNOVATIONS INC., BAIE D'URFE, PROVINCE OF QUEBEC, CANADA:  
1,868,179. CANC. INT. CL. 12.
- WESTERN ATLAS INTERNATIONAL, INC., HOUSTON, TX:  
1,869,005. CANC. INT. CL. 42.
- WESTERN AUTO SUPPLY COMPANY, ROANOKE, MO:  
1,209,010. REN. 1-4-02. MULTIPLE CLASS, INT. CLS. 37 AND 42.
- WESTERN LUMBER COMPANY, INC., NATIONAL CITY, CA:  
1,144,502. CANC. INT. CL. 36.
- WESTERN RAILCO PRODUCTS LTD., SURREY, BRITISH COLUMBIA, CANADA:  
2,538,507. INT. CL. 6.
- WESTINGHOUSE ELECTRIC CORPORATION, PITTSBURGH, PA:  
2,538,110. PUB. 11-20-2001. INT. CL. 11.
- WESTRAY, KENNETH, WASHINGTON, DC:  
2,538,197. PUB. 11-20-2001. INT. CL. 25.
- WGBH EDUCATIONAL FOUNDATION, BOSTON, MA:  
2,306,153. CANC. IIRN. RESTORED TO S.N. 75-600,856.
- WHEEL TRUEING TOOL COMPANY, COLUMBIA, SC:  
1,143,941. CANC. INT. CL. 7.
- WHIRLY WEST, INC., CHICAGO, IL:  
2,538,106. PUB. 11-20-2001. INT. CL. 41.

- WHITE CONSOLIDATED INDUSTRIES, INC., CLEVELAND, OH:  
1,678,274, REN. 12-31-01. INT. CL. 7.  
2,538,412, PUB. 11-20-2001. INT. CL. 7.
- WHITESSELL CONSTRUCTION CO., INC., DELRAN, NJ:  
2,538,223, PUB. 11-20-2001. MULTIPLE CLASS, INT. CLS. 36 AND 37.
- WHOLESALE VITAMINS USA, INC., FOREST HILLS, NY:  
2,538,369, PUB. 11-20-2001. INT. CL. 42.
- WICOR AMERICAS MANAGEMENT INC., HANOVER, NH:  
2,538,249, PUB. 11-20-2001. INT. CL. 16.
- WIDEX APS, DK-3500 VERLOSE, DENMARK:  
2,538,039, PUB. 11-20-2001. INT. CL. 10.
- WILHELM BOFINGER, ILLSFELD, WURTTENBERG, FED REP GERMANY:  
1,144,202, CANC. INT. CL. 20.
- WILKINSON, CLARK ADAMS, WHITETHORN, CA, DBA GRIPIICK:  
2,537,671, PUB. 11-20-2001. INT. CL. 15.
- WILL TO LEARN INCORPORATED, BILOXI, MS:  
2,538,668, INT. CL. 9.
- WILLIAM L. YOUNG FARMS, INC., HINDBORO, IL:  
2,537,620, PUB. 11-20-2001. INT. CL. 31.
- WILLIAMSBURG FOODS, INC., WILLIAMSBURG, VA:  
1,868,962, CANC. INT. CL. 31.
- WILLIE GEORGE MINISTRIES, INC., TULSA, OK:  
2,537,907, PUB. 11-20-2001. INT. CL. 42.
- WILNOR FOODS, INC., ENGLEWOOD, NJ, DBA WILDS BAKING COMPANY TO AMERIFOODS BAKERY COMPANIES, INC., PARAMUS, NJ:  
1,628,519, CANC. INT. CL. 30.
- WILSON, ANDY S., ARROYO GRANDE, CA:  
2,537,904, PUB. 11-20-2001. MULTIPLE CLASS, INT. CLS. 5 AND 30.
- WILSON, LORNA J., SALEM, OR:  
1,868,685, CANC. INT. CL. 41.
- WINDMERE CORPORATION, MIAMI LAKES, FL:  
1,628,063, CANC. MULTIPLE CLASS, INT. CLS. 9 AND 11.
- WINDOW & BED COVERS INC., LONDON, ONTARIO, CANADA N6L 1A8, CANADA:  
1,868,695, CANC. INT. CL. 42.
- WINE.COM, INC., NAPA, CA:  
2,537,943, PUB. 11-20-2001. INT. CL. 33.
- WINN-DIXIE STORES, INC., JACKSONVILLE, FL:  
708,817, CANC. U.S. CL. 46.
- WINNER.COM, INC., WILMINGTON, DE:  
2,537,718, PUB. 11-20-2001. INT. CL. 41.
- WINNIPEG PANTS & SPORTSWEAR MFG. LTD., WINNIPEG, MANITOBA, CANADA, DBA RICHLU SPORTSWEAR:  
1,660,926, REN. 1-3-02. INT. CL. 25.
- WINTER PARK CONSTRUCTION COMPANY, MAITLAND, FL:  
1,868,429, CANC. INT. CL. 25.
- WIRED INTEGRATIONS, LLC, PLEASANTON, CA:  
2,537,636, PUB. 11-20-2001. INT. CL. 42.
- WIZARD CO., INC., GARDEN CITY, NY:  
2,538,416, PUB. 11-20-2001. INT. CL. 39.
- WM. E. HOOPER & SONS COMPANY, BALTIMORE, MD:  
138,291, CANC. U.S. CL. 29.
- WOLFARD GLASSBLOWING COMPANY, SANTA ROSA, CA:  
1,628,196, CANC. INT. CL. 11.
- WOLVERINE WORLD WIDE, INC., ROCKFORD, MI:  
2,538,181, PUB. 11-20-2001. INT. CL. 25.  
2,538,182, PUB. 11-20-2001. INT. CL. 14.
- WOMEN WITHOUT LIVES, INC., SOPRINA, TX:  
2,537,734, PUB. 11-20-2001. MULTIPLE CLASS, INT. CLS. 21 AND 39.
- WONDER WHIP COMPANY, INC., FOSTORIA, IA:  
1,144,182, CANC. INT. CL. 18.
- WOODWARD CAMP, INC, WOODWARD, PA:  
2,537,940, PUB. 11-20-2001. INT. CL. 41.
- WOODY PET PRODUCTS INC., WHITE ROCK, BRITISH COLUMBIA, CANADA:  
2,538,034, PUB. 11-20-2001. INT. CL. 31.
- WORD FOR TODAY, INC., THE, SANTA ANA, CA:  
2,538,464, MULTIPLE CLASS, INT. CLS. 9, 16 AND 25.
- WORK/FAMILY DIRECTIONS, INC., WATERTOWN, MA:  
1,628,601, CANC. INT. CL. 36.
- WORKOUT.COM, INC., MILPITAS, CA:  
2,538,699, INT. CL. 42.
- WORLD DELIGHT TOURS, INC., NEW YORK, NY:  
1,144,522, CANC. INT. CL. 39.
- WORLD HANGERS, INC., LODI, NJ:  
1,868,324, CANC. INT. CL. 20.
- WORLD WIDE PRESS, INC., GREAT FALLS, MT:  
1,868,469, CANC. INT. CL. 28.
- WORLDCLASS PROCESSING, INC., AMBRIDGE, PA:  
1,868,633, CANC. INT. CL. 40.
- WUNDIES ENTERPRISES, INC., NEW YORK, NY:  
1,869,049, CANC. INT. CL. 16.
- XANADU CANDLE INTERNATIONAL, LTD., ROAD TOWN, TORTOLA, BR.VIRGIN ISLANDS:  
2,538,205, PUB. 11-20-2001. INT. CL. 4.
- XEDIA CORPORATION, WILMINGTON, MA:  
1,868,854, CANC. INT. CL. 9.
- XEROX CORPORATION, STAMFORD, CT:  
1,868,987, CANC. INT. CL. 37.  
2,538,139, PUB. 11-20-2001. INT. CL. 2.  
2,538,140, PUB. 11-20-2001. INT. CL. 2.  
2,538,141, PUB. 11-20-2001. INT. CL. 2.  
2,538,142, PUB. 11-20-2001. INT. CL. 2.  
2,538,143, PUB. 11-20-2001. INT. CL. 2.  
2,538,144, PUB. 11-20-2001. INT. CL. 2.  
2,538,145, PUB. 11-20-2001. INT. CL. 2.
- XI'AN POWER RESIN FACTORY, XI'AN, SHAANXI PROVINCE, CHINA:  
2,537,582, PUB. 8-22-2000. INT. CL. 1.
- XRD INC., BEAUFORT, SC:  
2,538,307, PUB. 11-20-2001. INT. CL. 42.
- XYCOM, INC., SALINE, MI:  
1,868,069, CANC. INT. CL. 9.
- Y-TEX CORPORATION, CODY, WY, AKA MODERN FARM:  
1,175,505, REN. 1-2-02. INT. CL. 42.
- YAESU MUSEN U.S.A., INC.:  
*See— VERTEX STANDARD USA, INC..*
- YAMAHA CORPORATION, HAMAMATSU-SHI, SHIZUOKA-KEN, JAPAN:  
1,660,768, REN. 1-3-02. INT. CL. 15.
- YAMAHA CORPORATION, SHIZUOKA, JAPAN:  
2,538,543, MULTIPLE CLASS, INT. CLS. 35 AND 41.
- YANCEY COMPANY, SACRAMENTO, CA:  
1,868,283, CANC. INT. CL. 17.
- YELLOWHAIR, LOREN, TAYLOR, AZ:  
1,868,443, CANC. INT. CL. 26.
- YELLOWSTONE VALLEY BREWING, LLC, BILLINGS, MT:  
2,538,057, PUB. 11-20-2001. INT. CL. 32.
- YORK CHILDREN'S FOUNDATION, THE, HOUSTON, TX:  
1,712,208, REN. 1-3-02. INT. CL. 36.
- YORK INTERNATIONAL CORPORATION,, YORK, PA:  
2,538,356, PUB. 11-20-2001. INT. CL. 11.
- YOSHINOYA D&C CO., LTD., TOKYO, JAPAN:  
2,537,741, PUB. 11-20-2001. MULTIPLE CLASS, INT. CLS. 29, 30 AND 42.
- YOU IN VIEW, INC., SOUTH EASTON, MA:  
1,868,731, CANC. INT. CL. 42.
- YOUNG & RUBICAM INC., NEW YORK, NY:  
2,537,939, PUB. 11-20-2001. INT. CL. 35.
- YOUNG ASPIRATIONS/YOUNG ARTISTS, INC., NEW ORLEANS, LA:  
1,682,059, REN. 1-3-02. INT. CL. 20.
- YUEJIN STAINLESS STEEL PRODUCTS (GROUP) CORPORATION, SHANGHAI, CHINA:  
1,868,347, CANC. INT. CL. 21.
- YUGEN KAISHA PACIFIX, YOKOHAMA, KANAGAWA, JAPAN, TA PACIFIX, LTD.:  
2,537,868, PUB. 11-20-2001. INT. CL. 9.
- YUILL BLACK, M.D. AND MICHAEL R. KLETZ, M.D., P.C., MCLEAN, VA:  
2,538,302, PUB. 11-20-2001. INT. CL. 42.
- Z & K ASSOCIATES, INC., MIAMI, FL:  
2,537,653, PUB. 11-20-2001. INT. CL. 30.

- ZAMPELL REFRACTORIES, INC., NEWBURYPORT, MA:  
1,664,408. REN. 1-3-02. INT. CL. 37.
- ZAUDERER, DAVID, ATLANTA, GA:  
2,538,619. INT. CL. 42.
- ZAVERL, FRANK, JR., ALBANY, NY, DBA BB SYSTEMS PRODUCTS:  
1,868,297. CANC. INT. CL. 18.
- ZEC S.P.A., CINISELLO BALSAMO, MILANO, ITALY:  
1,175,738. REN. 1-2-02. INT. CL. 3.
- ZEEKS, INC., WASHINGTON, DC FROM BASS, JAMES LANCE, BRANDON, MS AND CHASEZ, JOSHUA SCOTT, ORLANDO, FL AND TIMBERLAKE, JUSTIN RANDALL, MILLINGTON, TN AND KIRKPATRICK, CHRISTOPHER ALAN, ORLANDO, FL AND FATONE, JOSEPH ANTHONY, JR., ORLANDO, FL:  
2,537,763. PUB. 9-11-2001. INT. CL. 16.  
2,537,764. PUB. 9-11-2001. MULTIPLE CLASS, INT. CLS. 14 AND 41.
- ZELCO INDUSTRIES, INC., MOUNT VERNON, NY:  
1,660,762. REN. 1-3-02. INT. CL. 14.
- ZELINA CRAMER AND DEBORAH MESZAROS PARTNERSHIP, THE, STATE COLLEGE, PA:  
1,868,872. CANC. INT. CL. 15.
- ZENITH DATA SYSTEMS CORPORATION, BUFFALO GROVE, IL:  
1,868,113. CANC. INT. CL. 9.
- ZEPHYR DESIGN, INC., ALAMEDA, CA:  
2,538,648. INT. CL. 21.
- ZERO-MAX, INC., PLYMOUTH, MN:  
1,701,426. REN. 1-3-02. INT. CL. 7.
- ZF LINUX DEVICES, INC., PALO ALTO, CA:  
2,538,022. PUB. 11-20-2001. INT. CL. 9.
- ZF LINUX DEVICES, INC.:  
*See— ZF MICRO DEVICES, INC..*
- ZF MICRO DEVICES, INC., PALO ALTO, CA FROM ZF LINUX DEVICES, INC., PALO ALTO, CA:  
2,538,025. PUB. 11-20-2001. INT. CL. 9.
- ZIG-ZAG IMPORTS, INC., SUNRISE, FL, DBA SOCCER MADNESS:  
1,868,433. CANC. INT. CL. 25.
- ZILOG, INC., CAMPBELL, CA:  
1,174,924. REN. 1-2-02. INT. CL. 9.
- ZITTEL REALTORS, INC., HARWOOD HEIGHTS, IL, DBA CENTURY 21 ZITTEL:  
1,657,602. REN. 1-3-02. INT. CL. 36.
- ZOBMONDO ENTERTAINMENT, LLC, LOS ANGELES, CA:  
2,538,629. INT. CL. 28.
- ZONDERVAN CORPORATION, THE, GRAND RAPIDS, MI:  
1,144,148. CANC. INT. CL. 16.
- ZORTEC, INC., NASHVILLE, TN:  
1,868,043. CANC. INT. CL. 9.
- ZOTEOFAMS PLC, CROYDON, SURREY, ENGLAND, BXL PLASTICS LIMITED, LONDON, ENGLAND:  
1,177,212. REN. 1-2-02. INT. CL. 17.
- ZTRYN, S.A. DE C.V., MONTERREY, N.L., MEXICO:  
2,538,225. PUB. 11-20-2001. INT. CL. 25.
- ZUETLAU, DONNA, ANNISTON, AL AND JENNINGS, HOMER F., ANNISTON, AL:  
2,538,214. PUB. 11-20-2001. INT. CL. 16.  
2,538,215. PUB. 11-20-2001. INT. CL. 16.
- 1 CACHE, L.C., LOGAN, UT:  
2,537,684. PUB. 11-20-2001. INT. CL. 35.
- 206 MACOPIN CORP., BLOOMINGDALE, NJ:  
1,627,946. CANC. INT. CL. 5.
- 3COM CORPORATION, SANTA CLARA, CA:  
1,868,616. CANC. INT. CL. 38.
- 4EMPOWERMENT.COM, INC., AUSTIN, TX:  
2,538,560. MULTIPLE CLASS, INT. CLS. 38 AND 42.  
2,538,561. MULTIPLE CLASS, INT. CLS. 38 AND 42.
- 5931 BUSINESS TRUST, WILMINGTON, DE:  
2,537,708. PUB. 11-20-2001. MULTIPLE CLASS, INT. CLS. 35 AND 42.
- 724 FACILITIES, INC., ELKHORN, NE:  
2,538,020. PUB. 11-20-2001. INT. CL. 42.

\* \* \* \* \*