

MARKS PUBLISHED FOR OPPOSITION

The following marks are published in compliance with section 12(a) of the Trademark Act of 1946. Applications for the registration of marks in more than one class have been filed as provided in section 30 of said act as amended by Public Law 772, 87th Congress, approved Oct. 9, 1962, 76 Stat. 769. Opposition under section 13 may be filed within thirty days of the date of this publication. See rules 2.101 to 2.105.

A separate fee of two hundred dollars for opposing each mark in each class must accompany the opposition.

SECTION 1.— INTERNATIONAL CLASSIFICATION

The short titles associated below with the international class numbers are terms designed merely for quick identification and are not an official part of the international classification. The full names of international classes are given in section 6.1 of the trademark rules of practice.

The designation "U.S. Cl." appearing in this section refers to the U.S. class in effect prior to Sep. 1, 1973 rather than the international class which applies to applications filed on or after that date. For adoption of international classification see notice in the OFFICIAL GAZETTE of Jun. 26, 1973 (911 O.G. TM 210).

Application in more than one class

SN 75-146,147. PHARMALYTICS, INC., UPPER MON-
TCLAIR, NJ. FILED 7-26-1996.



NO CLAIM IS MADE TO THE EXCLUSIVE RIGHT TO
USE "INC.", APART FROM THE MARK AS SHOWN.

CLASS 35—ADVERTISING AND BUSINESS

FOR COMPUTER SERVICES, NAMELY LICENSING
OF COMPUTER SOFTWARE (U.S. CLS. 100, 101 AND
102).
FIRST USE 6-14-1996; IN COMMERCE 6-14-1999.

CLASS 42—SCIENTIFIC, COMPUTER AND LEGAL SERVICES

FOR COMPUTER SERVICES, NAMELY COMPUTER
SOFTWARE DESIGN FOR OTHERS AND CONSULTA-
TION SERVICES (U.S. CLS. 100 AND 101).
FIRST USE 6-14-1996; IN COMMERCE 6-14-1996.

CLASS 5—PHARMACEUTICALS

FOR CLINICAL MEDICAL REAGENTS FOR USE IN
GENE THERAPY; PHARMACEUTICAL PREPARATIONS
FOR USE IN GENE THERAPY; THERAPEUTIC COM-
POSITIONS CONTAINING LIPID REAGENTS SUITA-
BLE FOR GENE THERAPY; THERAPEUTIC
COMPOSITIONS CONTAINING NUCLEIC ACID FOR
GENE THERAPY; PHARMACEUTICAL PREPARATIONS
CONTAINING NUCLEIC ACIDS FOR USE IN THE
TREATMENT OF VIRAL AND BACTERIAL INFEC-
TIONS, CANCER, HIV AND AIDS RELATED INFEC-
TIONS AND BODILY CONDITIONS ASSOCIATED WITH
IMPAIRED IMMUNOSYSTEMS; PHARMACEUTICAL
PREPARATIONS IN THE FIELD OF GENE THERAPY;
PHARMACEUTICAL PREPARATIONS FOR THE
TREATMENT OF CANCER (U.S. CLS. 6, 18, 44, 46, 51
AND 52).

CLASS 10—MEDICAL APPARATUS

FOR INSTRUMENTS AND APPARATUS FOR THE
ADMINISTRATION OF GENE THERAPY, NAMELY,
SYRINGES, SCALPELS, CATHETERS, TUBES FOR THE
ADMINISTRATION OF GENE THERAPY PRODUCTS;
SURGICAL AND MEDICAL APPARATUS AND INSTRU-
MENTS FOR THE ADMINISTRATION OF GENE THER-
APY PRODUCTS, NAMELY, SYRINGES, SCALPELS,
INJECTORS, CATHETERS, TUBES FOR THE ADMINIS-
TRATION OF GENE THERAPY PRODUCTS (U.S. CLS.
26, 39 AND 44).

SN 75-354,210. OXFORD BIOMEDICA PLC, OXFORD, OX4
4GA, UNITED KINGDOM, FILED 9-9-1997.

CORECTOGEN

OWNER OF UNITED KINGDOM REG. NO. 2117732,
DATED 6-20-1997, EXPIRES 12-4-2006.

CLASS 1—CHEMICALS

FOR CHEMICAL COMPOSITIONS CONTAINING NU-
CLEIC ACIDS FOR USE IN THE MANUFACTURE OF
PHARMACEUTICALS AND RETROVIRAL VECTOR
PREPARATIONS (U.S. CLS. 1, 5, 6, 10, 26 AND 46).

SN 75-388,333. FOREMOST FARMS USA, COOPERATIVE,
BARABOO, WI. FILED 11-12-1997.

TASTE THE PRIDE INSIDE.

CLASS 29—MEATS AND PROCESSED FOODS

FOR MILK, FLAVORED MILK, BUTTERMILK, SOUR
CREAM, DAIRY-BASED SNACK DIPS, HALF AND
HALF, WHIPPED CREAM, DAIRY BASED CREAMERS,
COTTAGE CHEESE, YOGURT, EGGS, CHEESE, BUT-
TER, AND EGG NOG (U.S. CL. 46).
FIRST USE 7-1-1997; IN COMMERCE 7-1-1997.

CLASS 30—STAPLE FOODS

FOR ICE CREAM, ICE MILK MIXES AND ICE MILK (U.S. CL. 46).
FIRST USE 7-1-1997; IN COMMERCE 7-1-1997.

CLASS 32—LIGHT BEVERAGES

FOR FRUIT JUICES, FRUIT DRINKS, FRUIT PUNCH, LEMONADE AND MINERAL WATER (U.S. CLS. 45, 46 AND 48).
FIRST USE 7-1-1997; IN COMMERCE 7-1-1997.

SN 75-525,991. THE SSI GROUP, INC., MOBILE, AL. FILED 7-27-1998.



The SSI Group, Inc.

NO CLAIM IS MADE TO THE EXCLUSIVE RIGHT TO USE "GROUP, INC.", APART FROM THE MARK AS SHOWN.

THE LINING SHOWN IN THE DRAWING IS A FEATURE OF THE MARK AND NOT INTENDED TO INDICATE COLOR.

CLASS 9—ELECTRICAL AND SCIENTIFIC APPARATUS

FOR COMPUTER SOFTWARE USED FOR BILLING, APPOINTMENT SCHEDULING AND MEDICAL RECORD ORGANIZATION IN THE HEALTH CARE FIELD (U.S. CLS. 21, 23, 26, 36 AND 38).

FIRST USE 1-1-1993; IN COMMERCE 1-1-1993.

CLASS 42—SCIENTIFIC, COMPUTER AND LEGAL SERVICES

FOR COMPUTER CONSULTATION IN THE HEALTH CARE FIELD, NAMELY, ASSISTING CUSTOMERS WITH ELECTRONIC MEDICAL CLAIMS PROCESSING (U.S. CLS. 100 AND 101).

FIRST USE 1-1-1993; IN COMMERCE 1-1-1993.

SN 75-530,190. RICHTREE MARKETS INC., TORONTO, ONTARIO, CANADA, FILED 8-3-1998.

**NOTHING GROWS LIKE A
FRESH IDEA**

PRIORITY CLAIMED UNDER SEC. 44(D) ON CANADA APPLICATION NO. 868,404, FILED 2-3-1998, REG. NO. TMA569871, DATED 10-29-2002, EXPIRES 10-29-2017.

CLASS 16—PAPER GOODS AND PRINTED MATTER

FOR PUBLICATIONS; NAMELY, STAFF TRAINING MANUALS FOR USE IN THE RESTAURANT INDUSTRY; BROCHURES ON THE SUBJECT OF GROUP SALES, FRANCHISE INFORMATION, INVESTORS, POTENTIAL LANDLORDS, AND FRANCHISE EXPANSION; AND TRAINING MATERIALS, NAMELY, BOOKS, PAMPHLETS, AND MANUALS FEATURING INFORMATION REGARDING FOOD SERVICE MANAGEMENT PRACTICES, FOOD AND BEVERAGE SERVICE TECHNIQUES, FOOD HANDLING AND PREPARATION SKILLS, BASICS OF CUSTOMER SATISFACTION, FOOD SAFETY AND SANITATION, SALES TECHNIQUES IN A RESTAURANT ENVIRONMENT, AND USE AND MAINTENANCE OF FOOD SERVICES EQUIPMENT, POINT OF SALE SYSTEMS, AND COMPUTERS (U.S. CLS. 2, 5, 22, 23, 29, 37, 38 AND 50).

CLASS 35—ADVERTISING AND BUSINESS

FOR FRANCHISING SERVICES; NAMELY OFFERING TECHNICAL ASSISTANCE IN THE ESTABLISHMENT, OPERATION AND LICENSING OF RESTAURANTS; AND RESTAURANT MANAGEMENT SERVICES PROVIDED FOR OTHERS (U.S. CLS. 100, 101 AND 102).

CLASS 41—EDUCATION AND ENTERTAINMENT

FOR TRAINING SERVICES IN THE FIELD OF FOOD SERVICE MANAGEMENT PRACTICES, FOOD AND BEVERAGE SERVICE TECHNIQUES, FOOD HANDLING AND PREPARATION SKILLS, MENU DEVELOPMENT, BASICS OF CUSTOMER SATISFACTION, FOOD SAFETY AND SANITATION, SALES TECHNIQUES IN A RESTAURANT ENVIRONMENT, AND USE AND MAINTENANCE OF FOOD SERVICES EQUIPMENT, POINT OF SALE SYSTEMS AND COMPUTERS (U.S. CLS. 100, 101 AND 107).

CLASS 42—SCIENTIFIC, COMPUTER AND LEGAL SERVICES

FOR CARRY-OUT RESTAURANT SERVICES; AND RESTAURANT CONSULTING SERVICES PROVIDED FOR OTHERS (U.S. CLS. 100 AND 101).

SN 75-566,016. SEGRETS, INC., WAKEFIELD, MA. BY ASSIGNMENT SEGRETS, INC., WAKEFIELD, MA. FILED 10-7-1998.

SIGRID OLSEN

OWNER OF U.S. REG. NOS. 1,774,702 AND 1,869,689.
THE NAME "SIGRID OLSEN" IDENTIFIES A LIVING INDIVIDUAL WHOSE CONSENT IS OF RECORD.

CLASS 3—COSMETICS AND CLEANING PREPARATIONS

FOR SCENTED SOAPS; SCENTED BATH GEL; PERFUME; EAU DE COLOGNE; ESSENTIAL OILS FOR PERSONAL USE; HAND LOTION; BODY LOTION (U.S. CLS. 1, 4, 6, 50, 51 AND 52).

CLASS 9—ELECTRICAL AND SCIENTIFIC APPARATUS

FOR SUNGLASSES (U.S. CLS. 21, 23, 26, 36 AND 38).

CLASS 14—JEWELRY

FOR JEWELRY (U.S. CLS. 2, 27, 28 AND 50).

CLASS 18—LEATHER GOODS

FOR BACKPACKS; TOTE BAGS; ALL-PURPOSE ATHLETIC BAGS; PURSES; HANDBAGS; CREDIT CARD CASES; WALLET; WAIST PACKS (U.S. CLS. 1, 2, 3, 22 AND 41).

SN 75-571,352. DFS GROUP L.P., SAN FRANCISCO, CA.
FILED 10-15-1998.

PLEASURE ISLAND**CLASS 3—COSMETICS AND CLEANING PREPARATIONS**

FOR BATH, BEAUTY AND AROMATHERAPY PRODUCTS, NAMELY, BODY WASH, SKIN SOAP, NON-MEDICATED BATH SALTS, SKIN LOTION, MASSAGE OIL, SHAMPOO AND CONDITIONER; POTPOURRI, AND GIFTS SETS COMPRISING OF COMBINATIONS OF THE ABOVE AS WELL AS BATH GEL, CANDLES AND SACHETS, SOLD AS A UNIT (U.S. CLS. 1, 4, 6, 50, 51 AND 52).

CLASS 4—LUBRICANTS AND FUELS

FOR CANDLES (U.S. CLS. 1, 6 AND 15).

CLASS 6—METAL GOODS

FOR METAL KEY CHAINS, METAL DECORATIVE BOXES (U.S. CLS. 2, 12, 13, 14, 23, 25 AND 50).

CLASS 9—ELECTRICAL AND SCIENTIFIC APPARATUS

FOR DECORATIVE MAGNETS (U.S. CLS. 21, 23, 26, 36 AND 38).

CLASS 14—JEWELRY

FOR JEWELRY, WATCHES, CLOCKS (U.S. CLS. 2, 27, 28 AND 50).

CLASS 16—PAPER GOODS AND PRINTED MATTER

FOR PENS; MARKERS; CRAYONS; PENCILS; COLORING BOOKS; STATIONERY; POST CARDS; PLAYING CARDS; DECALS; TRAVEL ACCESSORIES, NAMELY, MAPS, TELEPHONE CALLING CARDS NOT MAGNETICALLY ENCODED; PAPER TABLE ACCESSORIES, NAMELY, TABLE CLOTHS AND NAPKINS (U.S. CLS. 2, 5, 22, 23, 29, 37, 38 AND 50).

CLASS 18—LEATHER GOODS

FOR LARGE LEATHER AND IMITATION LEATHER BAGS, NAMELY, TOTE BAGS, BACKPACKS; TRAVEL ACCESSORY BAGS SOLD EMPTY, ROLL BAGS; SMALL LEATHER AND IMITATION LEATHER BAGS AND ACCESSORIES, NAMELY WALLET, COIN PURSES, COSMETIC CASES SOLD EMPTY, KEYFOBS; NON-MOTORIZED COLLAPSIBLE LUGGAGE CARTS (U.S. CLS. 1, 2, 3, 22 AND 41).

CLASS 20—FURNITURE AND ARTICLES NOT OTHERWISE CLASSIFIED

FOR NON METAL KEY CHAINS, NAMELY, PLASTIC, PLUSH, AND INTERACTIVE KEY CHAINS; FIGURINES MADE OF BONE, IVORY, PLASTIC, WAX AND WOOD; PICTURE FRAMES; TABLE ACCESSORIES, NAMELY, SNOW GLOBES, WATER GLOBES; DRINKING STRAWS (U.S. CLS. 2, 13, 22, 25, 32 AND 50).

CLASS 21—HOUSEWARES AND GLASS

FOR DINNERWARE SERVING PIECES, NAMELY, PLATES, WICKER BASKETS, STRAW BASKETS, PANDAN BASKETS, AND BAMBOO BASKETS, BOWLS, SERVING TRAYS NOT OF PRECIOUS METAL, TRIVETS, SERVINGS PLATTERS NOT OF PRECIOUS METAL, BASTING SPOONS, MIXING SPOONS, SERVING SPOONS, AND SLOTTED SPOONS, BOTTLE OPENERS, PLASTIC COASTERS, BEVERAGE GLASSES, TUMBLERS, SHOT GLASSES, MUGS, CUPS, COFFEE POTS NOT OF PRECIOUS METAL, TEA POTS NOT MADE OF PRECIOUS METAL, PLATES, DECORATIVE WALL PLATES, LUNCH BOXES, TRAVEL ACCESSORIES, NAMELY, CANTEENS, KITCHEN LADLES; BEVERAGEWARE SIPPERS; VASES, WINDCHIMES, PAPER PLATES, PAPER CUPS, NONMETAL DECORATIVE BOXES (U.S. CLS. 2, 13, 23, 29, 30, 33, 40 AND 50).

CLASS 24—FABRICS

FOR KITCHEN TEXTILES, NAMELY, POTHOLDERS, OVEN MITTS, KITCHEN TOWELS, TIE TOWELS, MAGIC TOWELS; HOT PADS; TEXTILE PLACEMATS; BATH ACCESSORIES, NAMELY, BATH, FACE, AND HAND TOWELS, BEACH AND GOLF TOWELS; WALL DECOR, NAMELY, TEXTILE WALL HANGINGS; PRINTED FABRICS IN RAYON, COTTON AND SILK (U.S. CLS. 42 AND 50).

CLASS 25—CLOTHING

FOR CLOTHING, NAMELY, T-SHIRTS AND ALOHA SHIRTS, SHORTS, TWO PIECE SETS OF SHORTS AND SHIRTS, SKIRTS, SOCKS, SCARVES, SWEATSHIRTS, HEADWEAR, DRESSES, FOOTWEAR, COVERUPS/PAREOS, BATHING SUITS, ROMPERS, POLO SHIRTS, APRONS (U.S. CLS. 22 AND 39).

CLASS 30—STAPLE FOODS

FOR FOOD, NAMELY, CANDIES, CHOCOLATES, COOKIES; COFFEE; TEA; CONDIMENTS, NAMELY, MUSTARD, KETCHUP AND MAYONNAISE; SALSA (U.S. CL. 46).

CLASS 34—SMOKERS' ARTICLES

FOR CIGARETTE LIGHTERS NOT OF PRECIOUS METAL, CIGARETTE CASES MADE OF LEATHER OR OTHER MATERIAL NOT PRECIOUS METAL (U.S. CLS. 2, 8, 9 AND 17).

SN 75-585,380. NEW YORKER S.H.K. JEANS, GMBH, D-38112 BRAUNSCHWEIG, FED REP GERMANY, FILED 11-9-1998.



PRIORITY CLAIMED UNDER SEC. 44(D) ON FED REP GERMANY APPLICATION NO. 39826089.3, FILED 5-9-1998, REG. NO. 39826089, DATED 8-10-1998, EXPIRES 5-31-2008.

THE STIPPLING IN THE MARK IS FOR SHADING PURPOSES AND IS NOT INTENDED AS AN INDICATOR OF COLOR.

CLASS 3—COSMETICS AND CLEANING PREPARATIONS

FOR PERFUME AND ESSENTIAL OILS FOR PERSONAL USE; PERSONAL HYGIENE AND BEAUTY CARE, NAMELY, LIPSTICK, EYESHADOW, BLUSH, FOUNDATION POWDER, MASCARA, EYELINER, LIPLINER; HAIR SHAMPOO AND HAIR CONDITIONER, HAIR SPRAY, HAIR COLOR; NAIL POLISH, NAIL POLISH THINNER, NAIL POLISH REMOVER; HAIR GELS; NON-MEDICATED HAIR PREPARATIONS FOR THICKENING HAIR; SKIN LOTION; FACE CREAMS AND FACE MOISTURIZERS; BATH SOAPS; BATH GELS AND BUBBLE BATH (U.S. CLS. 1, 4, 6, 50, 51 AND 52).

CLASS 9—ELECTRICAL AND SCIENTIFIC APPARATUS

FOR PRERECORDED AUDIO TAPES FEATURING MUSIC AND EDUCATIONAL INSTRUCTION IN THE FIELDS OF LANGUAGE TEACHING AND CULTURAL TRAINING; AUDIO-VISUAL EQUIPMENT, NAMELY, TAPE CASSETTE PLAYERS, VIDEO CASSETTE PLAYERS; VIDEO CAMERAS; CAMERA TRIPODS AND MICROPHONES; FOOTBALL HELMETS AND HOCKEY HELMETS (U.S. CLS. 21, 23, 26, 36 AND 38).

CLASS 14—JEWELRY

FOR WATCHES; PINS, NAMELY, ORNAMENTAL PINS, JEWELRY PINS, TIE PINS AND BROOCHES (U.S. CLS. 2, 27, 28 AND 50).

CLASS 18—LEATHER GOODS

FOR LEATHER GOODS, NAMELY, LEATHER BAGS, ENVELOPES AND POUCHES FOR MERCHANDISE PACKAGING, LEATHER SHOPPING BAGS; SMALLER LEATHER GOODS, NAMELY, LEATHER KEY FOBS, PURSES, AND TOILETRY CASES SOLD EMPTY (U.S. CLS. 1, 2, 3, 22 AND 41).

CLASS 25—CLOTHING

FOR SKI BOOTS, CLIMBING SHOES, FOOTBALL SHOES, BASEBALL SHOES, BOXING SHOES, CYCLING SHOES, GOLF SHOES, WATER SHOES, CROSS-COUNTRY SKIING SHOES, HIKING SHOES, SPECIAL BAGS FOR STORING AND TRANSPORTING SPORTS EQUIPMENT, NAMELY, BAGS FOR SKIING SHOES (U.S. CLS. 22 AND 39).

CLASS 28—TOYS AND SPORTING GOODS

FOR SPORTING ARTICLES AND SPORTS APPARATUS, NAMELY, GOLF ARTICLES, NAMELY, GOLF BALLS, GOLF CLUBS, GOLF SHAFTS, GOLF BAGS, NON-MOTORIZED GOLF PULL-CARTS, GOLF GLOVES; SWIM FINNS; SAIL BOARDS AND PARTS THEREFOR, NAMELY, BOOMS, FINNS, HARNESS-LINES FOR SECURING RIDER, FOOT-STRAPS, PROTECTIVE JACKETS FOR MASTS, SPREADER BARS AND MASTS, DAGGER-BOARDS; SNOWBOARDS, SURFBOARDS, SKIS, SKI STICKS, SKI EQUIPMENT, NAMELY, SKI POLES AND WAX; SPECIAL BAGS FOR STORING AND TRANSPORTING SPORTS EQUIPMENT, NAMELY, BAGS FOR SKI GEAR, SNOWBOARDS (U.S. CLS. 22, 23, 38 AND 50).

CLASS 32—LIGHT BEVERAGES

FOR NON-ALCOHOLIC MALT BEVERAGES AND MINERAL WATER (U.S. CLS. 45, 46 AND 48).

SN 75-595,949. BALCOM CHEMICALS, INC., GREELEY, CO. FILED 11-23-1998.

MPOWER3**CLASS 35—ADVERTISING AND BUSINESS**

FOR COMPUTER DATABASE MANAGEMENT IN THE FIELDS OF AGRICULTURE, FIELD CONDITIONS, VEGETATION, FIELD MANAGEMENT, WEATHER, CHEMICALS, PESTICIDE APPLICATION, FERTILIZER APPLICATION, TILLAGE PRACTICES, SOIL EROSION, INSECTS, DISEASE, SOIL CONDITIONS AND/OR CROP YIELDS (U.S. CLS. 100, 101 AND 102).

CLASS 36—INSURANCE AND FINANCIAL

FOR FINANCIAL CONSULTING SERVICES, NAMELY, PROVIDING FARMERS AND RANCHERS WITH INFORMATION AND RECOMMENDATIONS FOR MAXIMIZING THE PROFITABILITY OF FARMING AND RANCHING OPERATIONS (U.S. CLS. 100, 101 AND 102).

CLASS 42—SCIENTIFIC, COMPUTER AND LEGAL SERVICES

FOR PROVIDING A WIDE RANGE OF USER-SPECIFIC INFORMATION AND FORECASTING CAPABILITIES VIA A WEB SITE, AN ON-LINE COMPUTER DATABASE, COMPUTER DISC, E-MAIL, OR DOWNLOAD FROM A WEB SITE IN THE FIELDS OF AGRICULTURE, FIELD CONDITIONS, VEGETATION, FIELD MANAGEMENT, WEATHER, CHEMICALS, PESTICIDE APPLICATION, FERTILIZER APPLICATION, TILLAGE PRACTICES, SOIL EROSION, INSECTS, DISEASES, SOIL CONDITIONS, AND CROP YIELDS (U.S. CLS. 100 AND 101).

SN 75-619,560. KINGSPAN GROUP PLC, CO. CAVAN, IRELAND, FILED 1-12-1999.



OWNER OF IRELAND REG. NO. 165436, DATED 2-9-1995, EXPIRES 2-9-2002.

OWNER OF IRELAND REG. NO. 165435, DATED 2-9-1995, EXPIRES 2-9-2002.

OWNER OF IRELAND REG. NO. 165434, DATED 2-9-1995, EXPIRES 2-9-2002.

CLASS 6—METAL GOODS

FOR METAL BUILDING MATERIALS, NAMELY, WINDOWS, DOORS, MOLDINGS, SIDINGS, AND STRUCTURAL PARTS THEREFOR; METAL SHEETING AND METAL CLADDING FOR ROOFS AND WALLS; METAL GUTTERS; METAL LOUVRES; TRANSPORTABLE METAL BUILDINGS; METAL CLADDING FOR DOORS; METAL HARDWARE, NAMELY, LOCKS, HANDLES, HINGES, METAL FASTENERS, NAMELY, DRILLED STRIP FASTENERS, ALL FOR WINDOWS, DOORS AND GATES; METAL PIPES AND TUBES AND PARTS THEREFOR; IRONMONGERY IN THE NATURE OF SMALL ITEMS OF METAL HARDWARE, NAMELY, CORNICES, LOCKS, TACKS, WASHERS, BOLTS; PIPES AND TUBES OF METAL (U.S. CLS. 2, 12, 13, 14, 23, 25 AND 50).

CLASS 17—RUBBER GOODS

FOR PACKING MATERIALS OF RUBBER AND PLASTIC FOR SHIPPING CONTAINERS, RUBBER FOR USE IN THE MANUFACTURE SEALS AND GASKETS, RUBBER SHOCK ABSORBERS FOR INDUSTRIAL MACHINERY; RIGID INSULATION BOARDS FOR USE IN COMMERCIAL AND RESIDENTIAL BUILDING CONSTRUCTION; NON-METAL STOPPING MATERIALS, NAMELY, INSULATING RINGS, DISCS, CORD, TAPE, SPACING SHEETS AND SPACERS, INCANDESCENT PLATES AND SHEETS; INSULATING MATERIALS MADE OF POLYURETHANE FOAM, PAPER AND FABRIC IN THE FORM OF PANELS, BATTIS, SHEETS AND TUBES; EXTRUDED PLASTIC IN THE FORMS OF SPHERES AND PELLETS FOR USE IN THE MANUFACTURE OF GENERAL COMMERCIAL PRODUCTS; NON-METALLIC FLEXIBLE PIPES; AND PARTS THEREFOR (U.S. CLS. 1, 5, 12, 13, 35 AND 50).

CLASS 19—NON-METALLIC BUILDING MATERIALS

FOR NON-METAL BUILDING MATERIALS, NAMELY, WOOD TRUSSES AND LAMINATED COLUMNS; NON-METAL TRANSPORTABLE BUILDINGS; NON-METAL RIGID PIPES FOR BUILDING; AND PARTS THEREFOR (U.S. CLS. 1, 12, 33 AND 50).

SN 75-638,470. BALCOM CHEMICALS, INC., DBA MPO-WER3, INC., GREELEY, CO. FILED 2-10-1999.

NFORM

CLASS 35—ADVERTISING AND BUSINESS

FOR COMPUTER DATABASE MANAGEMENT IN THE FIELDS OF AGRICULTURE, FIELD CONDITIONS, VEGETATION, FIELD MANAGEMENT, WEATHER, CHEMICALS, PESTICIDE APPLICATION, FERTILIZER APPLICATION, TILLAGE PRACTICES, SOIL EROSION, INSECTS, DISEASE, SOIL CONDITIONS AND/OR CROP YIELDS (U.S. CLS. 100, 101 AND 102).

CLASS 42—SCIENTIFIC, COMPUTER AND LEGAL SERVICES

FOR PROVIDING A WIDE RANGE OF USER-SPECIFIC INFORMATION AND FORECASTING CAPABILITIES VIA A WEB SITE, AN ON-LINE COMPUTER DATABASE, COMPUTER DISC, E-MAIL, OR DOWNLOAD FROM A WEB SITE IN THE FIELDS OF AGRICULTURE, FIELD CONDITIONS, VEGETATION, FIELD MANAGEMENT, WEATHER, CHEMICALS, PESTICIDE APPLICATIONS, FERTILIZER APPLICATION, TILLAGE PRACTICES, SOIL EROSION, INSECTS, DISEASES, SOIL CONDITIONS, AND CROP YIELDS (U.S. CLS. 100 AND 101).

SN 75-652,074. BIOFEM, INC., IRVINE, CA. FILED 3-2-1999.

PHARMADOPHILUS

CLASS 3—COSMETICS AND CLEANING PREPARATIONS

FOR PRODUCTS CONTAINING MICRO-ENCAPSULATED LACTOBACIHI OR OTHER ORGANISMS, NAMELY, NON-MEDICATED SKIN CARE PREPARATIONS AND COSMETIC PREPARATIONS, NAMELY LOTIONS, CREAMS, POWDERS, GELS AND OINTMENTS (U.S. CLS. 1, 4, 6, 50, 51 AND 52).

CLASS 5—PHARMACEUTICALS

FOR NUTRITIONAL PRODUCTS, NAMELY, VITAMINS FOR HUMAN USE AND FOR ANIMAL USE, NAMELY PETS AND LIVESTOCK CONTAINING MICRO-ENCAPSULATED LACTOBACILHI OR OTHER RELATED ORGANISMS, IN POWDER, CAPLET, CAPSULE OR TABLET FORM (U.S. CLS. 6, 18, 44, 46, 51 AND 52).

SN 75-661,780. KARAGEORGE, DIMITRI, NEW YORK, NY. FILED 3-16-1999.

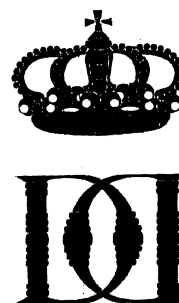
**CLASS 14—JEWELRY**

FOR CUFFLINKS, TIE CLIPS AND OTHER ASSORTED JEWELRY (U.S. CLS. 2, 27, 28 AND 50).

CLASS 16—PAPER GOODS AND PRINTED MATTER

FOR PRINTED MATTER, NAMELY, MAIL ORDER CATALOGS, FEATURING CUFFLINKS, TIE CLIPS AND OTHER ASSORTED JEWELRY (U.S. CLS. 2, 5, 22, 23, 29, 37, 38 AND 50).

CLASS 25—CLOTHING

FOR CLOTHING, NAMELY, SHIRTS, BLOUSES, PANTS, SHORTS, SKIRTS, DRESSES, JACKETS, COATS, HOSIERY, SWEATERS, CARDIGANS, JUMPERS, SUITS, TROUSERS, CHEMISES, SLIPS, PETTICOATS, CORSETS, BRASSIERES, NEGLIGEEES, NIGHTGOWNS, NECKTIES, SCARVES, APRONS, OVERCOATS, STOCKINGS, GLOVES, TEE SHIRTS, HEADWEAR, FOOTWEAR, SWIMSUITS, UNDERSHIRTS, EVENING DRESSES, AND BELTS (U.S. CLS. 22 AND 39).

CLASS 35—ADVERTISING AND BUSINESS

FOR MAIL ORDER SERVICES FEATURING CUFFLINKS, TIE CLIPS AND OTHER ASSORTED JEWELRY (U.S. CLS. 100, 101 AND 102).

SN 75-668,141. C.P. HALL COMPANY, THE, CHICAGO, IL.
FILED 3-25-1999.

HALLSERV

CLASS 35—ADVERTISING AND BUSINESS

FOR INVENTORY CONTROL SERVICES, NAMELY, INVENTORY MONITORING AND INVENTORY MANAGEMENT (U.S. CLS. 100, 101 AND 102).

CLASS 37—CONSTRUCTION AND REPAIR

FOR INSTALLATION OF INFORMATION TECHNOLOGY COMPUTER SYSTEMS FOR OTHERS WHICH PROVIDE SPECIFIC ELECTRONIC LINKAGES FOR CUSTOMERS VIA EXTRANETS, EDI, AND CUSTOMER SPECIFIC AREAS ON A WEBSITE (U.S. CLS. 100, 103 AND 106).

CLASS 38—COMMUNICATION

FOR ELECTRONIC TRANSMISSION OF ACCOUNTING AND SHIPPING DOCUMENT SUCH AS PURCHASE ORDERS, INVOICES, AND BILLS OF SALE VIA COMPUTER TERMINALS (U.S. CLS. 100, 101 AND 104).

CLASS 39—TRANSPORTATION AND STORAGE

FOR JOINT WAREHOUSING SERVICES (U.S. CLS. 100 AND 105).

CLASS 42—SCIENTIFIC, COMPUTER AND LEGAL SERVICES

FOR PROVIDING JOINT TECHNICAL AND CHEMICAL PRODUCTS RESEARCH AND TESTING FOR OTHERS; DESIGN AND INSTALLATION OF INFORMATION TECHNOLOGY COMPUTER SOFTWARE FOR OTHERS AND DESIGN OF INFORMATION TECHNOLOGY COMPUTER SYSTEMS FOR OTHERS WHICH PROVIDE ELECTRONIC LINKAGES FOR CUSTOMERS VIA EXTRANETS, EDI, AND CUSTOMER SPECIFIC AREAS ON A WEBSITE (U.S. CLS. 100 AND 101).

SN 75-672,879. KEY CORPORATE CAPITAL INC., PORTLAND, ME. BY ASSIGNMENT ACORN PRODUCTS CO., INC., LEWISTON, ME. FILED 4-1-1999.

ACORN

CLASS 24—FABRICS

FOR BED BLANKETS AND THROWS (U.S. CLS. 42 AND 50).
FIRST USE 12-16-1996; IN COMMERCE 12-16-1996.

CLASS 25—CLOTHING

FOR FOOTGEAR AND HEADWEAR, NAMELY, BOOTS, SHOES, SLIPPERS, SOCKS, HATS AND SCARVES (U.S. CLS. 22 AND 39).
FIRST USE 9-14-1976; IN COMMERCE 9-14-1976.

SN 75-672,880. KEY CORPORATE CAPITAL INC., PORTLAND, ME. BY ASSIGNMENT ACORN PRODUCTS CO., INC., LEWISTON, ME. FILED 4-1-1999.



CLASS 24—FABRICS

FOR BED BLANKETS AND THROWS (U.S. CLS. 42 AND 50).
FIRST USE 6-30-1998; IN COMMERCE 6-30-1998.

CLASS 25—CLOTHING

FOR FOOTGEAR AND HEADWEAR, NAMELY, BOOTS, SHOES, SLIPPERS, SOCKS, HATS AND SCARVES (U.S. CLS. 22 AND 39).
FIRST USE 6-30-1998; IN COMMERCE 6-30-1998.

SN 75-683,159. ARIBA, INC., SUNNYVALE, CA. FILED 4-15-1999.

ARIBALIVE

OWNER OF U.S. REG. NOS. 2,202,102, 2,405,389 AND OTHERS.

CLASS 16—PAPER GOODS AND PRINTED MATTER

FOR INSTRUCTION MANUALS FOR THE INSTALLATION AND USE OF COMPUTER SOFTWARE (U.S. CLS. 2, 5, 22, 23, 29, 37, 38 AND 50).

CLASS 42—SCIENTIFIC, COMPUTER AND LEGAL SERVICES

FOR COMPUTER PROGRAMMING FOR OTHERS AND COMPUTER CONSULTING SERVICES REGARDING THE USE AND MODIFICATION OF COMPUTER SOFTWARE (U.S. CLS. 100 AND 101).

SN 75-691,296. KIM, JONG SUK, KANGNAM-GU, SEOUL, REPUBLIC OF KOREA, FILED 4-21-1999.



THE STYLIZED KOREAN WORD IN THE MARK TRANSLITERATES TO "JAMBANGEE", WHICH HAS NO MEANING IN MODERN DAY KOREAN.

CLASS 25—CLOTHING

FOR CLOTHING AND APPAREL, NAMELY LEATHER SHOES, RUBBER SHOES, BOOTS FOR SPORTS, FOOTBALL SHOES, LOW SHOES, BOOTS, SANDALS, SLIPPERS, WOODEN SHOES, BEACH SHOES, SPORTS JERSEYS, LIVERIES, NAMELY, UNIFORMS, SCHOOL UNIFORMS, SKIRTS, CHILDREN'S WEARS, NAMELY, JUMPERS, JEANS, PANTS, VESTS, SHIRTS, BATHING SUITS, BATHING TRUNKS, AND BEACH WEAR, HATS, GARTER BELTS, GAITERS, BELTS, FUR HATS, SUSPENDERS, EVENING DRESSES, KOREAN GARTER BELTS, SUITS, OVERCOATS, HALF-COATS, RAIN COATS, MANTLES, SWEATERS, CARDIGANS, COLLARS, CUFFS, BLOUSES, SPORTS SHIRTS, POLO-SHIRTS, UNDER SHIRTS, UNDERWEAR, UNDERPANTS, CHEMISETTES, SLIPS, PETTICOATS, CORSETS, BRASSIERES, BATHING CAPS, APRONS, INFANT CLOTH DIAPERS, PAJAMAS, SPORT STOCKINGS, NAMELY SWEAT SOCKS, NEGLIGEEES, CLOTH BIBS, NIGHT GOWNS, SPORTS UNIFORMS, TIGHTS, NIGHT CAPS, SOCKS, FULL DRESSES, STOCKINGS, SUITS, SOCKS, SOCK SUSPENDERS, TROUSERS, DRESS, GLOVES, BOW TIES AND NECKTIES (U.S. CLS. 22 AND 39).

CLASS 26—FANCY GOODS

FOR DECORATIVE AND FANCY WEARING ARTICLES, WIGS MADE OF SYNTHETIC AND HUMAN HAIR AND HAIR PIECES, HAIR BANDS, HAIR NETS, HAIR PINS, ZIPPERS, HOOK AND LOOP FASTENING TAPE, BUTTONS FOR CLOTHING, EYELETS FOR CLOTHING, LACES, NAMELY SHOE LACES, HOOKS FOR CLOTHING, EMBROIDERIES, BOWS FOR THE HAIR, PRESS BUTTONS, CLOTH PATCHES FOR CLOTHING, BROOCHES NOT OF PRECIOUS METAL AND NOT IMITATION JEWELRY, CLOTHING BUCKLES, SLIDE FASTENERS, ORNAMENTAL RIBBONS MADE OF TEXTILE, HAIR RIBBONS, HAIR CLOTH PINS AND ORNAMENTAL NOVELTY CLOTH PINS NOT OF PRECIOUS METAL (U.S. CLS. 37, 39, 40, 42 AND 50).

SN 75-701,762. BERNARDAUD PORCELAINES DE LIMOGES, S.A., 87000 LIMOGES, FRANCE, FILED 5-10-1999.

BERNARDAUD

OWNER OF U.S. REG. NOS. 1,550,195, 2,139,170 AND OTHERS.

CLASS 4—LUBRICANTS AND FUELS

FOR CANDLES (U.S. CLS. 1, 6 AND 15).
FIRST USE 1-0-1995; IN COMMERCE 1-0-1995.

CLASS 21—HOUSEWARES AND GLASS

FOR CANDLE HOLDERS NOT OF PRECIOUS METAL (U.S. CLS. 2, 13, 23, 29, 30, 33, 40 AND 50).
FIRST USE 1-0-1995; IN COMMERCE 1-0-1995.

SN 75-735,561. PAIN NET, INC., COLUMBUS, OH. FILED 7-21-1999.

PAIN NET

SEC. 2(F).

CLASS 35—ADVERTISING AND BUSINESS

FOR BUSINESS MANAGEMENT SERVICES FOR MEDICAL OFFICES, INCLUDING BUSINESS MANAGEMENT AND CONSULTATION IN THE FIELD OF MEDICAL OFFICE OPERATIONAL PROTOCOLS; AND COOPERATIVE ADVERTISING AND MARKETING SERVICES FOR MEDICAL OFFICES (U.S. CLS. 100, 101 AND 102).

FIRST USE 8-1-1985; IN COMMERCE 8-1-1985.

CLASS 41—EDUCATION AND ENTERTAINMENT

FOR EDUCATIONAL SERVICES, NAMELY, PROVIDING ON-LINE TRAINING IN THE MEDICAL AND SURGICAL TECHNIQUES OF PAIN MANAGEMENT; AND CONDUCTING SEMINARS IN ADVANCE LABORATORY TRAINING WORKSHOPS, IN THE FIELD OF MEDICAL AND SURGICAL TECHNIQUES RELATING TO PAIN MANAGEMENT; AND DEVELOPING AND DISTRIBUTING MATERIALS IN CONNECTION THEREWITH (U.S. CLS. 100, 101 AND 107).

FIRST USE 8-1-1985; IN COMMERCE 8-1-1985.

CLASS 42—SCIENTIFIC, COMPUTER AND LEGAL SERVICES

FOR PROVIDING GENERAL CLINICAL MEDICAL SERVICES AND PROVIDING SPECIALIZED CLINICAL AND SURGICAL SERVICES IN THE FIELD OF PAIN MEDICINE AND PAIN MANAGEMENT; MEDICAL RESEARCH SERVICES IN THE FIELD OF PAIN MEDICINE AND PAIN MANAGEMENT; PROVIDING MEDICAL INFORMATION IN PAIN MEDICINE AND PAIN MANAGEMENT (U.S. CLS. 100 AND 101).

FIRST USE 8-1-1985; IN COMMERCE 8-1-1985.

SN 75-742,821. GREMLIN INTERACTIVE LIMITED, SHEFFIELD, S1 4HA, ENGLAND, FILED 7-2-1999.

GEKIDO

PRIORITY CLAIMED UNDER SEC. 44(D) ON UNITED KINGDOM APPLICATION NO. 2187858, FILED 2-4-1999, REG. NO. 2187858, DATED 7-3-1999, EXPIRES 2-4-2009.

CLASS 9—ELECTRICAL AND SCIENTIFIC APPARATUS

FOR COMPUTER GAMES SOFTWARE; COMPUTER GAMES AND VIDEO GAMES RECORDED ON CARTRIDGES, CASSETTES, DISCS, CD-ROMS AND TAPES; MULTIMEDIA COMPUTER GAMES RECORDED ON CD-ROMS; VIDEO GAME MACHINES FOR USE WITH COMPUTERS AND TELEVISION MONITORS; AND INTERACTIVE VIDEO GAMES OF VIRTUAL REALITY COMPRISED OF COMPUTER HARDWARE AND SOFTWARE (U.S. CLS. 21, 23, 26, 36 AND 38).

CLASS 28—TOYS AND SPORTING GOODS

FOR ELECTRONICS GAMES, NAMELY, HANDHELD UNITS FOR PLAYING ELECTRONIC GAMES AND ELECTRONIC EDUCATIONAL GAMES FOR CHILDREN (U.S. CLS. 22, 23, 38 AND 50).

SN 75-760,070. KUNDAN FOODS, INC., LOS ANGELES, CA. FILED 8-17-1999.



NO CLAIM IS MADE TO THE EXCLUSIVE RIGHT TO USE "BRAND" AND "AUTHENTIC INDIAN PRODUCTS", APART FROM THE MARK AS SHOWN.

THE FOREIGN WORD "RANI" TRANSLATE INTO "QUEEN" IN THE LANGUAGE OF HINDI AND URDU.

CLASS 29—MEATS AND PROCESSED FOODS

FOR INDIAN PRODUCTS, NAMELY, DRIED BEANS, LENTILS, CLARIFIED BUTTER, NAMELY, GHEE, EDIBLE OILS, NAMELY, CORN OIL, SESAME OIL, ALMOND OIL AND COCONUT OIL, AND PICKLES (U.S. CL. 46).

FIRST USE 2-15-1999; IN COMMERCE 6-20-1999.

CLASS 30—STAPLE FOODS

FOR INDIAN PRODUCTS, NAMELY, 70 VARIETIES OF DRIED SPICES, GROUND FLOUR, DURUM WHEAT FLOUR, AND FRUIT CHUTNEY (U.S. CL. 46).

FIRST USE 2-15-1999; IN COMMERCE 6-20-1999.

SN 75-766,459. SEB S.A., F-69134 ECULLY CEDEX, FRANCE, BY ASSIGNMENT MOULINEX S.A., F-14123 CORMELLES LE ROYAL, FRANCE, FILED 8-2-1999.



PRIORITY CLAIMED UNDER SEC. 44(D) ON FRANCE APPLICATION NO. 99/773566, FILED 2-4-1999, REG. NO. 99/773566, DATED 2-4-1999, EXPIRES 2-4-2009.

NO CLAIM IS MADE TO THE EXCLUSIVE RIGHT TO USE "MEXICAN DINNER", APART FROM THE MARK AS SHOWN.

THE DRAWING IS LINED FOR THE COLORS YELLOW AND ORANGE.

CLASS 11—ENVIRONMENTAL CONTROL APPARATUS

FOR ELECTRIC APPARATUS FOR COOKING FOOD, NAMELY OVENS, MICROWAVE OVENS, ROTISSERIES, SPIT-ROASTERS, MEAT BROILERS, TOASTERS, WAFFLE BAKING OVENS; DEEP FAT FRYERS, COOKING STOVES, FOOD WARMERS, PLATE WARMERS, BABY BOTTLE WARMERS, ELECTRIC PANS, ELECTRIC SAUCE-PANS, CREPE COOKERS, EGG COOKERS AND BARBECUE GRILLS (U.S. CLS. 13, 21, 23, 31 AND 34).

CLASS 21—HOUSEWARES AND GLASS

FOR COOKING SKEWERS AND COOKING UTENSILS, NAMELY, GRILLS FOR SUPPORTING FOODS DURING COOKING (U.S. CLS. 2, 13, 23, 29, 30, 33, 40 AND 50).

SN 75-778,774. BENEFIT COSMETICS LLC, SAN FRANCISCO, CA. BY ASSIGNMENT BENEFIT COSMETICS, INC., SAN FRANCISCO, CA. FILED 8-18-1999.

BENEFIT

OWNER OF U.S. REG. NOS. 1,582,141, 1,772,618 AND 1,772,620.

CLASS 3—COSMETICS AND CLEANING PREPARATIONS

FOR COSMETICS; NAMELY, SKIN CLEANSING CREAMS; NIGHT CREAMS; FACIAL CREAMS; SKIN FRESHENERS; ASTRINGENTS; MASQUES OR FACIAL PACKS; BATH OILS; PERFUMED BATH OILS; COLOGNES; EYE SHADOW; MASCARA; LIPSTICK; LIP GLOSS; ROUGE; LIQUID ROUGE; BODY LOTIONS; SUN TAN LOTION AND SUN TAN ULTRAVIOLET BLOCK (U.S. CLS. 1, 4, 6, 50, 51 AND 52).

FIRST USE 10-5-1988; IN COMMERCE 10-5-1988.

CLASS 35—ADVERTISING AND BUSINESS

FOR RETAIL STORE AND DISTRIBUTORSHIP SERVICES IN THE FIELD OF COSMETICS (U.S. CLS. 100, 101 AND 102).

FIRST USE 2-2-1992; IN COMMERCE 2-2-1992.

SN 75-779,397. JOSHUA EMIL ACQUISITION CORPORATION, HOUSTON, TX. FILED 8-18-1999.

ROADLINK USA

OWNER OF U.S. REG. NOS. 1,420,457 AND 1,454,644. NO CLAIM IS MADE TO THE EXCLUSIVE RIGHT TO USE "USA", APART FROM THE MARK AS SHOWN.

CLASS 35—ADVERTISING AND BUSINESS

FOR ARRANGING FOR THE TRANSPORTATION OF FREIGHT BY GROUND FOR OTHERS (U.S. CLS. 100, 101 AND 102).

CLASS 39—TRANSPORTATION AND STORAGE

FOR FREIGHT TRANSPORTATION BY TRUCK; FREIGHT FORWARDING (U.S. CLS. 100 AND 105).

SN 75-796,196. EBERHARDT, USA, INC., BYRON, CA. FILED 9-9-1999.

EBERHARDT, USA

NO CLAIM IS MADE TO THE EXCLUSIVE RIGHT TO USE "USA", APART FROM THE MARK AS SHOWN.

CLASS 7—MACHINERY

FOR COMMERCIAL BAKING EQUIPMENT, NAMELY, SEMI-INDUSTRIAL DOUGH PROCESSING EQUIPMENT, NAMELY, MIXERS, DIVIDER ROUNDERS, ROLL LINES, MOLDING MACHINES, INTERMEDIATE PROOFERS, AND KAISER ROLL STAMPING MACHINES (U.S. CLS. 13, 19, 21, 23, 31, 34 AND 35).

CLASS 11—ENVIRONMENTAL CONTROL APPARATUS

FOR COMMERCIAL BAKING EQUIPMENT, NAMELY, OVENS (U.S. CLS. 13, 21, 23, 31 AND 34).

SN 75-806,968. WEDDINGCHANNEL.COM, INC., LOS ANGELES, CA. BY CHANGE OF NAME WEDCOM INC., LOS ANGELES, CA. FILED 9-23-1999.

WeddingChannel.com

NO CLAIM IS MADE TO THE EXCLUSIVE RIGHT TO USE "WEDDING", APART FROM THE MARK AS SHOWN. THE WORD WEDDING IS LINED FOR THE COLOR BLACK AND THE WORDS CHANNEL.COM SHOULD BE CONSIDERED LINED FOR THE COLOR LIGHT PURPLE OR LAVENDER.
SEC. 2(F).

CLASS 35—ADVERTISING AND BUSINESS

FOR ADVERTISING AGENCIES AND BUSINESS MARKETING CONSULTING SERVICES; COMPUTERIZED ON-LINE SEARCH AND ORDERING SERVICE FEATURING RETAIL DISTRIBUTORSHIP OF A FULL LINE OF HOUSEWARE PRODUCTS, INCLUDING FORMAL DINNERWARE, CASUAL DINING, FLATWARE, CRYSTAL, HOUSEWARES, GLASSES AND MUGS, BAKEWARE, KITCHEN, HOUSE DECOR, AND OTHER SERVEWARE (U.S. CLS. 100, 101 AND 102).
FIRST USE 5-1-1999; IN COMMERCE 5-1-1999.

CLASS 39—TRANSPORTATION AND STORAGE

FOR TRAVEL INFORMATION SERVICES (U.S. CLS. 100 AND 105).
FIRST USE 5-1-1999; IN COMMERCE 5-1-1999.

SN 75-828,146. NEWS INTERNATIONAL PLC., LONDON E19XY, UNITED KINGDOM, FILED 10-22-1999.

EPARTNERS

PRIORITY CLAIMED UNDER SEC. 44(D) ON ERPN CMNTY TM OFC APPLICATION NO. 1154681, FILED 4-22-1999, REG. NO. 1154681, DATED 5-12-2000, EXPIRES 4-22-2009.

CLASS 35—ADVERTISING AND BUSINESS

FOR PREPARING AND PLACING ADVERTISEMENTS FOR OTHERS; BUSINESS MANAGEMENT; BUSINESS ADMINISTRATION CONSULTATION, NAMELY, LAUNCHING BUSINESSES, CONDUCTING MARKET ANALYSIS, DEVELOPING BUSINESS PLANS, DEVELOPING INFRASTRUCTURE, IDENTIFYING POTENTIAL PARTNERS AND INVESTORS, DEVELOPING OPERATIONAL STRUCTURES AND PROCESSES, RECRUITING PERSONNEL AND OBTAINING GENERAL ADMINISTRATIVE SERVICES; BUSINESS CONSULTATION IN THE FIELDS OF NEW TECHNOLOGIES, THE INTERNET AND NEW MEDIA (U.S. CLS. 100, 101 AND 102).

CLASS 36—INSURANCE AND FINANCIAL

FOR FINANCIAL SERVICES, NAMELY, VENTURE CAPITAL FUNDS; INCUBATOR SERVICES, NAMELY, FINANCING SERVICES, FINANCIAL CONSULTING, AND FINANCIAL VALUATION; MORTGAGE BROKERING SERVICES PROVIDED VIA THE INTERNET; INVESTMENT AND VENTURE CAPITAL CONSULTATION SERVICES; INVESTMENT AND VENTURE CAPITAL ADVISORY SERVICES; OBTAINING AND INVESTING IN FUNDING FOR NEW BUSINESSES IN THE FIELDS OF NEW TECHNOLOGY, THE INTERNET AND NEW MEDIA; FINANCIAL GUARANTEE AND SURETY SERVICES; INVESTMENT MANAGEMENT SERVICES; FINANCIAL ANALYSIS AND CONSULTATION (U.S. CLS. 100, 101 AND 102).

CLASS 42—SCIENTIFIC, COMPUTER AND LEGAL SERVICES

FOR SCIENTIFIC AND INDUSTRIAL RESEARCH, NAMELY, RESEARCH AND DEVELOPMENT FOR NEW PRODUCTS FOR OTHERS, RESEARCH WITH RESPECT TO CONSUMER ATTITUDES AND PURCHASE BEHAVIORS AND RESEARCH WITH RESPECT TO NEW TECHNOLOGIES, THE INTERNET AND NEW MEDIA (U.S. CLS. 100 AND 101).

SN 75-842,350. MOBO HOLDINGS (UK) LIMITED, WINCHMORE HILL, LONDON, N21 3RE, ENGLAND, FILED 11-8-1999.



PRIORITY CLAIMED UNDER SEC. 44(D) ON UNITED KINGDOM APPLICATION NO. 2196449, FILED 5-6-1999, REG. NO. 2196449, DATED 12-13-2002, EXPIRES 5-6-2009.

CLASS 9—ELECTRICAL AND SCIENTIFIC APPARATUS

FOR PHONOGRAPH RECORDS, PRE-RECORDED COMPACT DISCS AND PRE-RECORDED AUDIO TAPES, ALL FEATURING MUSIC; BLANK VIDEO TAPES; PRE-RECORDED VIDEO TAPES FEATURING MUSIC AWARDS CEREMONIES, MUSIC, MOTION PICTURES, TELEVISION SHOWS, CARTOONS AND DOCUMENTARIES; MOTION PICTURE FILMS, NAMELY, ACTION MOVIES, ROMANCES, COMEDIES, ROMANTIC COMEDIES, DRAMAS, THRILLERS AND HORROR MOVIES; MUSICAL SOUND RECORDINGS; DVDS FEATURING MUSIC, TELEVISION SHOWS AND MOVIES; COMPUTER GAME PROGRAMS (U.S. CLS. 21, 23, 26, 36 AND 38).

CLASS 16—PAPER GOODS AND PRINTED MATTER

FOR PRINTED MATTER AND PRINTED PUBLICATIONS, NAMELY, MAGAZINES REGARDING THE MUSIC INDUSTRY AND MUSIC; BOOKS REGARDING THE MUSIC INDUSTRY AND MUSIC; POSTERS; ART AND PICTORIAL PRINTS; STATIONERY; MERCHANDISE BAGS, PAPER BAGS; WRITING SETS CONSISTING OF WRITING INSTRUMENTS, WRITING PADS, AND PAPER; CALENDARS; POSTCARDS; IRON-ON AND PLASTIC TRANSFERS; PHOTOGRAPH ALBUMS, STAMP ALBUMS; GREETING CARDS; PENS; PENCILS; ERASERS; DRAFTING RULERS, DRAWING RULERS; DIARIES; STICKERS; BINDERS; FOLDERS; BOOKMARKS; UNMOUNTED PHOTOGRAPHS; MOUNTED PHOTOGRAPHS; PAPERWEIGHTS; PEN CASES; SCRAP BOOKS (U.S. CLS. 2, 5, 22, 23, 29, 37, 38 AND 50).

CLASS 25—CLOTHING

FOR ARTICLES OF CLOTHING, NAMELY, T-SHIRTS, TOPS, HALTER NECK TOPS, SWEATSHIRTS, SHIRTS, SWEATERS, CARDIGANS, JACKETS, BODYWARMERS IN THE NATURE OF SLEEVELESS JACKETS, BLOUSES, RAINCOATS, COATS, SHORTS, PANTS, DRESSING GOWNS, BATHROBES, TRACKSUITS, SKIRTS, DRESSES, CULOTTES, SUITS, TUXEDOS, UNDERWEAR, HOSIERY, SOCKS, PANTYHOSE, STOCKINGS, KNICKERS, UNDERPANTS, VESTS, BRAS, BUSTIERS, SLIPS, JEANS, GIRDLES, PAJAMAS, NIGHTSHIRTS, NIGHTDRESSES, NIGHTWEAR, SPORTSWEAR IN THE NATURE OF SWEATPANTS, SWEATSHIRTS, BRA TOPS, CYCLING SHORTS, JOGGING PANTS, LEOTARDS, TENNIS SKIRTS, TENNIS DRESSES, SWIMMING TRUNKS, SWIMSUITS, BIKINIS, SARONGS, WAISTCOATS, TIES, GLOVES; FOOTWEAR; HEADGEAR, NAMELY, HATS, CAPS, AND VISORS; SCARVES; BELTS (U.S. CLS. 22 AND 39).

CLASS 35—ADVERTISING AND BUSINESS

FOR ADVERTISING AGENCY SERVICES; BUSINESS MARKETING CONSULTANCY SERVICES; MARKET RESEARCH; CONDUCTING MARKETING STUDIES; PUBLICITY AGENCY SERVICES; PUBLIC RELATIONS; PROMOTING THE GOODS AND SERVICES OF OTHERS BY ARRANGING FOR SPONSORS TO AFFILIATE THEIR GOODS AND SERVICES WITH SPORTING, CULTURAL, EDUCATIONAL AND ENTERTAINMENT EVENTS; PROVIDING TELEVISION, RADIO AND DIRECT MAIL ADVERTISING FOR OTHERS; BUSINESS MANAGEMENT AND CONSULTATION RELATING TO BROADCASTING AND ADVERTISING; MANAGEMENT OF PERFORMING ARTISTS, ACTORS, ACTRESSES, COMEDIANS, COMEDIENNES, PHOTOGRAPHERS, ANIMATORS, FILM, RADIO AND TELEVISION PRODUCERS AND DIRECTORS, MUSICIANS, PERFORMING ANIMALS (U.S. CLS. 100, 101 AND 102).

CLASS 38—COMMUNICATION

FOR TELEVISION AND RADIO BROADCASTING; CABLE TELEVISION BROADCASTING; SATELLITE TRANSMISSION SERVICES; DIGITAL TELEVISION AND RADIO TRANSMISSION SERVICES; PAY-PER-VIEW TELEVISION TRANSMISSION SERVICES; WEBCASTING SERVICES, NAMELY, REAL-TIME TRANSMISSION OF ENCODED VIDEO OVER A GLOBAL COMPUTER NETWORK (U.S. CLS. 100, 101 AND 104).

CLASS 41—EDUCATION AND ENTERTAINMENT

FOR ENTERTAINMENT IN THE NATURE OF ONGOING RADIO AND TELEVISION PROGRAMS IN THE FIELDS OF NEWS, COMEDY, VARIETY, ROMANCE, HORROR, THRILLERS AND DRAMAS; ENTERTAINMENT, NAMELY, PRODUCTION OF MUSIC AWARD CEREMONIES, MUSICAL CONCERTS, MUSICALS, PLAYS, THEATRICAL PERFORMANCES, TELEVISION PROGRAMS, RADIO PROGRAMS, MOTION PICTURE FILMS AND NIGHT CLUB ENTERTAINMENT; ENTERTAINMENT IN THE NATURE OF AN INFORMATION AND ADVISORY SERVICES REGARDING STAGE, SCREEN, SHOW BUSINESS, TELEVISION, RADIO, MUSIC, POPULAR CULTURE, NIGHTCLUBS, CONCERTS AND AWARD CEREMONIES PROVIDED ON-LINE FROM A COMPUTER DATABASE OR THE GLOBAL COMMUNICATIONS NETWORK; ORGANIZING AWARD CEREMONIES AND MUSIC COMPETITIONS FOR ENTERTAINMENT PURPOSES; RECORDING STUDIOS FOR FILM, VIDEO, TELEVISION AND MUSIC; MUSIC PUBLISHING SERVICES; PUBLICATION OF MAGAZINES AND BOOKS (U.S. CLS. 100, 101 AND 107).

CLASS 42—SCIENTIFIC, COMPUTER AND LEGAL SERVICES

FOR NIGHTCLUBS; RESTAURANTS; BARS; CAFES; CAFETERIAS; PROVIDING FACILITIES FOR AWARD CEREMONIES, EXHIBITIONS AND CONFERENCES; DESIGN AND PRODUCTION OF ARTWORK FOR COMMERCIAL PURPOSES; PORTRAIT AND STILL LIFE PHOTOGRAPHY; TYPESETTING; PRINTING (U.S. CLS. 100 AND 101).

SN 75-842,980. USI INSURANCE SERVICES, INC., SAN FRANCISCO, CA. FILED 11-10-1999.

EZUSI**CLASS 35—ADVERTISING AND BUSINESS**

FOR MANAGING THE OPERATIONS OF INSURANCE AGENCIES AND BROKERS ON AN OUTSOURCING BASIS (U.S. CLS. 100, 101 AND 102).

CLASS 36—INSURANCE AND FINANCIAL

FOR FINANCIAL SERVICES, NAMELY, BROKERAGE SERVICES IN THE FIELD OF INSURANCE; INSURANCE ADMINISTRATION (U.S. CLS. 100, 101 AND 102).

SN 75-846,464. CONTINUING MEDICAL IMPLEMENTATION INC., OTTAWA, ON, CANADA, FILED 11-11-1999.

CONTINUING MEDICAL IMPLEMENTATION

PRIORITY CLAIMED UNDER SEC. 44(D) ON CANADA APPLICATION NO. 1015159, FILED 5-11-1999, REG. NO. TMA575066, DATED 2-19-2003, EXPIRES 2-19-2018.

NO CLAIM IS MADE TO THE EXCLUSIVE RIGHT TO USE "CONTINUING MEDICAL", APART FROM THE MARK AS SHOWN.

CLASS 16—PAPER GOODS AND PRINTED MATTER

FOR PRINTED INSTRUCTIONAL, EDUCATIONAL, AND TEACHING MATERIALS IN THE FIELD OF CARDIOLOGY AND VASCULAR MEDICINE (U.S. CLS. 2, 5, 22, 23, 29, 37, 38 AND 50).

CLASS 41—EDUCATION AND ENTERTAINMENT

FOR EDUCATIONAL SERVICES, NAMELY, CONDUCTING CLASSES, SEMINARS, WORKSHOPS, CONFERENCES IN THE FIELD OF CARDIOLOGY AND CARDIOVASCULAR MEDICINE (U.S. CLS. 100, 101 AND 107).

CLASS 39—TRANSPORTATION AND STORAGE

FOR LEASING OR RENTAL OF AUTOMOBILES, RAILWAY CARS, AIRCRAFT AND WATER CRAFT (U.S. CLS. 100 AND 105).

CLASS 42—SCIENTIFIC, COMPUTER AND LEGAL SERVICES

FOR TECHNICAL MANAGEMENT FOR FACILITIES THAT REPAIR AND MAINTAIN AUTOMOBILES AND MOTORS, AS WELL AS TECHNICAL SUPERVISION OF THEIR INSTALLATIONS AND EQUIPMENT; TECHNICAL CONSULTING AND ADVISORY ACTIVITIES CONCERNING THE REPAIR OF AUTOMOBILES AND MOTORS; ENGINEERING SERVICES; DEVELOPMENT AND MAINTENANCE OF SOFTWARE PROGRAMS FOR DATA PROCESSING (U.S. CLS. 100 AND 101).

SN 75-860,832. DAIMLERCHRYSLER AG, 70567 STUTTGART, FED REP GERMANY, FILED 11-30-1999.

PROSPER

PRIORITY CLAIMED UNDER SEC. 44(D) ON FED REP GERMANY APPLICATION NO. 39944437.812, FILED 7-27-1999, REG. NO. 39944437, DATED 8-31-1999, EXPIRES 7-31-2009.

CLASS 7—MACHINERY

FOR INTERNAL COMBUSTION ENGINES FOR MACHINE OPERATION (U.S. CLS. 13, 19, 21, 23, 31, 34 AND 35).

CLASS 9—ELECTRICAL AND SCIENTIFIC APPARATUS

FOR SOFTWARE PROGRAMS STORED ON DATA BASED CARRIERS FOR DATA AND TEXT PROCESSING CONCERNING THE AUTOMOTIVE FIELD, ELECTRICAL AND ELECTRONIC SENSORS, HYDRAULIC ACTIVATORS FOR VEHICLE SUSPENSION AND DISPLAYS FOR MEASURING FUEL EFFICIENCY OF DEVICES POWERED BY INTERNAL COMBUSTION ENGINES, IN THE AUTOMOTIVE FIELD (U.S. CLS. 21, 23, 26, 36 AND 38).

CLASS 12—VEHICLES

FOR PASSENGER CARS, COMMERCIAL VEHICLES, NAMELY, TRUCKS, TROLLYS, TRAINS AND VANS, BUSES, BOATS, RAILWAY LOCOMOTIVES, AIRCRAFT AND THEIR STRUCTURAL PARTS; INTERNAL COMBUSTION ENGINES FOR AUTOMOBILES; CLUTCHES FOR AUTOMOBILES AND DEVICES FOR POWER TRANSMISSIONS FOR AUTOMOBILES, NAMELY, GEAR BOXES, HYDRAULIC TORQUE CONVERTERS, POWER TRANSMISSION SHAFTS, DRIVEN AXLES, DIFFERENTIAL GEARS AND LOCKS THEREFOR (U.S. CLS. 19, 21, 23, 31, 35 AND 44).

CLASS 35—ADVERTISING AND BUSINESS

FOR BUSINESS MANAGEMENT AND ORGANIZATIONAL PLANNING FOR FACILITIES THAT REPAIR AND MAINTAIN AUTOMOBILES AND MOTORS (U.S. CLS. 100, 101 AND 102).

CLASS 37—CONSTRUCTION AND REPAIR

FOR REPAIR AND SERVICE OF AUTOMOBILES, RAILWAY CARS, AIRCRAFT AND WATER CRAFT (U.S. CLS. 100, 103 AND 106).

SN 75-871,684. GREENLAND ICE CAP PRODUCTION APS, 3921 NARSAQ, GREENLAND, FILED 12-14-1999.



NO CLAIM IS MADE TO THE EXCLUSIVE RIGHT TO USE "GREENLAND", APART FROM THE MARK AS SHOWN.

CLASS 30—STAPLE FOODS

FOR COFFEE, TEA, COCOA, SUGAR, RICE, TAPIOCA, SAGO, ARTIFICIAL COFFEE; CEREALS GOODS, NAMELY CEREAL BASED SNACK FOOD, READY-TO-EAT CEREAL DERIVED FOOD BARS, BREAKFAST CEREALS; PROCESSED CEREALS, FLOUR; BREAD, PASTRY, AND PREPARATION MIXES FOR MAKING BAKERY GOODS, NAMELY MIXES FOR BREAD AND PASTRY; CONFECTIONERY GOODS, NAMELY CONFECTIONERY CHIPS FOR BAKING, PEANUT BUTTER CONFECTIONERY CHIPS; FROZEN CONFECTIONS; FREEZABLE LIQUIDS FOR USE IN MAKING FROZEN CONFECTIONS; ICE CREAM; ICES, NAMELY GLACIER ICE, ICE CUBES, FLAVORED ICES; HONEY, TREACLE; YEAST; BAKING POWDER; CONDIMENTS, NAMELY SALT, MUSTARD AND SPICES (U.S. CL. 46).

CLASS 32—LIGHT BEVERAGES

FOR BEERS; MINERAL AND AERATED WATERS AND OTHER NON-ALCOHOLIC DRINKS, NAMELY FRUIT DRINKS AND FRUIT JUICES; SYRUPS FOR MAKING LEMONADE; MALT SYRUP FOR BEVERAGES; SYRUPS FOR MAKING SOFT DRINKS (U.S. CLS. 45, 46 AND 48).

CLASS 33—WINES AND SPIRITS

FOR ALCOHOLIC BEVERAGES, NAMELY WINE, BRANDY, GIN, COGNAC; DISTILLED SPIRITS (U.S. CLS. 47 AND 49).

SN 75-894,678. ZADRO PRODUCTS, INC., HUNTINGTON BEACH, CA. FILED 1-7-2000.

FOR MY EYES ONLY

CLASS 9—ELECTRICAL AND SCIENTIFIC APPARATUS

FOR (BASED ON INTENT TO USE) MAGNIFYING LENSES (U.S. CLS. 21, 23, 26, 36 AND 38).

CLASS 20—FURNITURE AND ARTICLES NOT OTHERWISE CLASSIFIED

FOR (BASED ON USE IN COMMERCE) MAGNIFYING MIRRORS AND MAGNIFYING MIRRORS HAVING AN ATTACHED FOLD-OUT MAGNIFYING LENS (U.S. CLS. 2, 13, 22, 25, 32 AND 50).
FIRST USE 7-0-1999; IN COMMERCE 7-0-1999.

SN 75-897,863. THE NATIONAL URBAN TECHNOLOGY CENTER, INC., NEW YORK, NY. FILED 1-18-2000.

SEEDTECH

CLASS 37—CONSTRUCTION AND REPAIR

FOR INSTALLATION OF COMPUTER NETWORKS IN INNER-CITY COMMUNITIES (U.S. CLS. 100, 103 AND 106).
FIRST USE 5-0-1996; IN COMMERCE 5-0-1996.

CLASS 42—SCIENTIFIC, COMPUTER AND LEGAL SERVICES

FOR TECHNICAL SUPPORT SERVICES, NAMELY, TROUBLE SHOOTING OF COMPUTER HARDWARE AND SOFTWARE PROBLEMS VIA TELEPHONE, EMAIL AND IN PERSON, FOR COMPUTER TRAINING CENTERS IN INNER-CITY COMMUNITIES (U.S. CLS. 100 AND 101).
FIRST USE 5-0-1996; IN COMMERCE 5-0-1996.

SN 75-907,822. SFCC, INC., OVERLAND PARK, KS. FILED 2-2-2000.

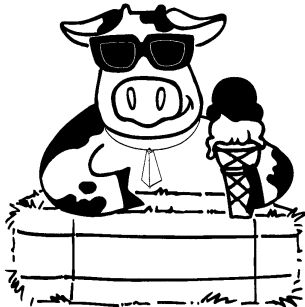

THE LINING IS A FEATURE OF THE MARK AND DOES NOT INDICATE COLOR.

CLASS 35—ADVERTISING AND BUSINESS

FOR RETAIL FROZEN CUSTARD STORE SERVICES; RETAIL ICE CREAM CONFECTIONERY STORE SERVICES (U.S. CLS. 100, 101 AND 102).
FIRST USE 10-21-1997; IN COMMERCE 10-21-1997.

CLASS 42—SCIENTIFIC, COMPUTER AND LEGAL SERVICES

FOR RESTAURANT SERVICES (U.S. CLS. 100 AND 101).
FIRST USE 10-21-1997; IN COMMERCE 10-21-1997.

SN 75-912,006. EDITIONS ODILE JACOB, 75005 PARIS, FRANCE, FILED 2-7-2000.

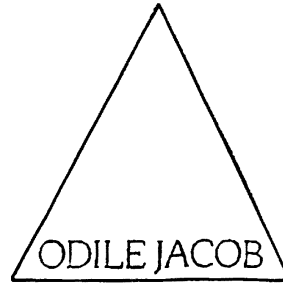

PRIORITY CLAIMED UNDER SEC. 44(D) ON ERP N CMNTY TM OFC APPLICATION NO. 001424548, FILED 11-29-1999, REG. NO. 1424548, DATED 2-6-2001, EXPIRES 11-29-2009.

THE NAME "ODILE JACOB" IDENTIFIES A LIVING INDIVIDUAL WHOSE CONSENT IS OF RECORD.

CLASS 9—ELECTRICAL AND SCIENTIFIC APPARATUS

FOR APPARATUS FOR RECORDING, TRANSMISSION, OR REPRODUCTION OF SOUND OR IMAGES, NAMELY, CASSETTE PLAYERS, DVD PLAYERS, VCR, CD ROM ENGRAVER, TAPE RECORDERS, TELEVISIONS, COMPUTERS, AND PHOTOCOPIERS; MAGNETIC CARRIERS, RECORDING DISCS, COMPACT DISCS, INTERACTIVE COMPACT DISCS, READ-ONLY MEMORY COMPACT DISCS, OPTICAL DISCS CONTAINING MUSIC, INFORMATION, DOCUMENTS AND DATA IN THE FIELD OF SCIENCE, MEDICINE, HEALTH, LIFESTYLES, HUMANITIES, SOCIAL SCIENCE, AND LITERATURE; TEACHING APPARATUS AND INSTRUMENTS, NAMELY, CASSETTE RECORDERS, TAPE RECORDERS, COMPUTERS, AND CD ROMS; RECORDED COMPUTER PROGRAMS, NAMELY, SOFTWARE CONTAINING DOCUMENTS AND DATA IN THE FIELD OF SCIENCE, MEDICINE, HEALTH, LIFESTYLES, HUMANITIES, SOCIAL SCIENCE, AND LITERATURE; DATA PROCESSORS AND DATA PROCESSING COMPUTERS (U.S. CLS. 21, 23, 26, 36 AND 38).

CLASS 16—PAPER GOODS AND PRINTED MATTER

FOR PRINTED MATTER, NAMELY, PERIODICALS, JOURNALS, NEWSLETTERS, BROCHURES, NEWSPAPERS, BOOKLETS, MAGAZINES, PRINTED PAPER, IN THE FIELDS OF PRINTING, SCIENCE, MEDICINE, HEALTH, LIFESTYLES, HUMANITIES, SOCIAL SCIENCE, AND LITERATURE; BOOKS IN ALL FIELDS, BOOKBINDING MATERIALS, NAMELY, BOOKBINDING WIRE, BOOKBINDING TAPE, CLOTH FOR BOOKBINDING; MOUNTED AND UNMOUNTED PHOTOGRAPHS; STATIONERY; ADHESIVES FOR STATIONERY OR HOUSEHOLD PURPOSES; PAINT BRUSHES; TYPEWRITERS; PRINTED INSTRUCTIONAL AND TEACHING MATERIAL IN THE FIELD OF SCIENCE; PLAYING CARDS; PRINTERS' TYPE; PRINTING BLOCKS (U.S. CLS. 2, 5, 22, 23, 29, 37, 38 AND 50).

CLASS 38—COMMUNICATION

FOR TELECOMMUNICATION SERVICES PROVIDED BY RADIO AND TELEGRAPH; ELECTRONIC VOICE MESSAGING, NAMELY, THE RECORDING, STORAGE AND SUBSEQUENT TRANSMISSION OF VOICE MESSAGES BY TELEPHONE; TELEPHONE VOICE MESSAGING SERVICES; WIRELESS DIGITAL MESSAGING SERVICES; ELECTRONIC MAIL SERVICES; ELECTRONIC TRANSMISSION OF DATA AND DOCUMENTS VIA COMPUTER TERMINALS AND COMPUTER NETWORKS; TELEGRAM TRANSMISSION; ONLINE MESSAGING SERVICES; ELECTRONIC COMMUNICATION SERVICES AND SERVICES OF COMMUNICATIONS BY COMPUTER, NAMELY, ELECTRONIC MAIL, VIDEO CAM TRANSFER VIA A GLOBAL COMPUTER NETWORK, INSTANT MESSAGING SERVICES; PROVIDING ELECTRONIC DATA EXCHANGE SERVICES AND DATA TRANSMISSION; PROVIDING TELECOMMUNICATIONS INFORMATION; RENTAL OF MODEMS AND MESSAGE TRANSMISSION EQUIPMENT; CABLE TELEVISION TRANSMISSION; BROADCASTING OF TELEVISION PROGRAMS, PROVIDING TELECOMMUNICATION CONNECTIONS TO A GLOBAL COMPUTER NETWORK (U.S. CLS. 100, 101 AND 104).

CLASS 41—EDUCATION AND ENTERTAINMENT

FOR EDUCATION, NAMELY, PROVIDING INSTRUCTION AND TRAINING IN THE FIELD OF SCIENCE, MEDICINE, HEALTH, LIFESTYLES, HUMANITIES AND SOCIAL SCIENCE, LITERATURE, NEWS; ENTERTAINMENT SERVICE NAMELY LIVE LITERARY READING EVENTS AND FILM AND VIDEO PRESENTATIONS; ARRANGING AND CONDUCTING COLLOQUIUMS, CONFERENCES, CONGRESSES, SEMINARS AND SYMPOSIUMS IN THE FIELD OF SCIENCE; ORGANIZATION OF EXHIBITIONS FOR CULTURAL OR EDUCATIONAL PURPOSES IN THE FIELD OF SCIENCE; LENDING LIBRARIES; PUBLICATION OF BOOKS; EDITING; EDITING OF BOOKS; ENTERTAINMENT SERVICES, NAMELY, RADIO PROGRAMS AND TELEVISION PROGRAMS IN THE FIELD OF NEWS, COMEDY, TALK AND SCIENCE; PROVIDING INFORMATION IN THE FIELD OF LITERATURE FROM A DATABASE VIA THE INTERNET, INTERACTIVELY (U.S. CLS. 100, 101 AND 107).

CLASS 42—SCIENTIFIC, COMPUTER AND LEGAL SERVICES

FOR HOSTING A WEBSITE OF OTHERS; PROVIDING INFORMATION IN THE FIELD OF SCIENCE, LIFESTYLES, HUMANITIES AND SOCIAL SCIENCE FROM A DATABASE VIA THE INTERNET, INTERACTIVELY; RENTAL OF COMPUTERS, COMPUTER TERMINALS AND PRINTERS (U.S. CLS. 100 AND 101).

SN 75-922,791. ALPHABLOX CORPORATION, MOUNTAIN VIEW, CA. FILED 2-22-2000.

PERSONALIZED INFOAPPS**CLASS 9—ELECTRICAL AND SCIENTIFIC APPARATUS**

FOR COMPUTER SOFTWARE DEVELOPMENT TOOLS; WEB SITE DEVELOPMENT SOFTWARE; COMPUTER SOFTWARE FOR USE BY OTHERS TO DEVELOP SOFTWARE MODULES THAT CAN BE EASILY LINKED TOGETHER (U.S. CLS. 21, 23, 26, 36 AND 38).

CLASS 42—SCIENTIFIC, COMPUTER AND LEGAL SERVICES

FOR COMPUTER SOFTWARE DEVELOPMENT FOR OTHERS; COMPUTER PROGRAMMING FOR OTHERS; COMPUTER CONSULTATION (U.S. CLS. 100 AND 101).

SN 75-981,724. ALCYONE LIMITED, NASSAU, BAHAMAS, FILED 5-25-1999.

ANCIENT FUTURE

OWNER OF UNITED KINGDOM REG. NO. 949834, DATED 12-22-2000, EXPIRES 10-7-2008.

CLASS 3—COSMETICS AND CLEANING PREPARATIONS

FOR NON-MEDICATED TOILET PREPARATIONS, NAMELY ANTI-PERSPIRANTS, DEODORANTS FOR PERSONAL USE, PRE-SHAVE LOTIONS, SHAVING LOTIONS, AFTER-SHAVE LOTIONS, SKIN CREAMS AND LOTIONS, SCALP CARE CREAMS AND LOTIONS, BODY CARE CREAMS AND LOTIONS; COSMETICS, NAMELY MAKE-UP FOUNDATION, EYE SHADOW, BLUSH, MASCARA, NAIL VARNISH, LIPSTICK; PERFUMERY, HAIR CARE PREPARATIONS; ESSENTIAL OILS FOR PERSONAL USE; SKIN SOAPS; DENTIFRICES (U.S. CLS. 1, 4, 6, 50, 51 AND 52).

CLASS 5—PHARMACEUTICALS

FOR PHARMACEUTICAL PREPARATIONS AND SUBSTANCES FOR THE TREATMENT OF PSYCHOSOMATIC AND STRESS RELATED AILMENTS; FOOD SUPPLEMENTS, VITAMINS, HERBAL SUPPLEMENTS; HERBAL TEA FOR MEDICINAL PURPOSES (U.S. CLS. 6, 18, 44, 46, 51 AND 52).

CLASS 9—ELECTRICAL AND SCIENTIFIC APPARATUS

FOR RADIOS; TELEVISION SETS; AUDIO TAPE RECORDERS AND PLAYERS; COMPACT DISC RECORDERS AND PLAYERS; DVD RECORDERS AND PLAYERS; SCALES; BIORHYTHM MONITORS; CALCULATORS; COIN-OPERATED VENDING MACHINES; MICROPHONES, HEADPHONES, STEREO AMPLIFIERS AND SOUND AMPLIFIERS; LOUDSPEAKERS, KARAOKE MACHINES; MUSICAL JUKE BOXES; COMPUTERS, COMPUTER PERIPHERALS; COMPUTER SOFTWARE FOR USE IN DATABASE MANAGEMENT IN THE FIELD HEALTHCARE; COMPUTER SOFTWARE, NAMELY A DATABASE OF INFORMATION RELATING TO HEALTHCARE ISSUES, TOPICS AND ADVICE; ELECTRONIC PERSONAL ORGANIZERS; TELEPHONES, CELLULAR TELEPHONES; MUSICAL SOUND RECORDINGS, MUSICAL VIDEO RECORDINGS; PRERECORDED VIDEO TAPES, DISCS AND CINEMATOGRAPHIC FILMS ALL FEATURING MUSICAL, POETRY AND DANCE PERFORMANCES AND CULTURAL AND HEALTHCARE INFORMATION AND ADVICE; PHOTOGRAPHIC SLIDE TRANSPARENCIES; BLANK AUDIO TAPES, BLANK VIDEOTAPES, BLANK COMPUTER DISCS, BLANK COMPACT DISCS AND BLANK DVDS; PHOTOGRAPHIC CAMERAS; SUNGLASSES, SPECTACLES AND CASES THEREFOR; SAFETY EYESHADES; PERISCOPE, BINOCULARS AND MONOCULAR; PROTECTIVE CLOTHING AND PROTECTIVE HELMETS; BATTERIES; FIRE-EXTINGUISHERS; ELECTRIC DOOR BELLS AND ELECTRIC DOOR OPENERS; FIRE ALARMS; PERSONAL SECURITY ALARMS; ELECTRICAL SECURITY SYSTEMS FOR MAINTAINING THE SECURITY OF HOMES, OFFICES AND VEHICLES, COMPRISED OF CAMERAS AND SENSORS (U.S. CLS. 21, 23, 26, 36 AND 38).

CLASS 16—PAPER GOODS AND PRINTED MATTER

FOR PRINTED MATTER, PRINTED PUBLICATIONS, AND PRINTED PERIODICAL PUBLICATIONS, NAMELY BOOKS, PRINTED MANUALS, MAGAZINES, BOOKLETS, AND PRINTED GUIDES ALL ABOUT LIFESTYLE, ALTERNATIVE HEALTHCARE, EMOTIONAL WELL-BEING AND CULTURAL MATTERS; POSTERS, LEAFLETS ABOUT LIFESTYLE, ALTERNATIVE HEALTHCARE, EMOTIONAL WELL-BEING AND CULTURAL MATTERS; PRINTED TICKETS, MOUNTED OR UNMOUNTED PHOTOGRAPHS, DECALOMANIAS, CALENDARS, GREETING CARDS, PRINTED INSTRUCTIONAL AND TEACHING MATERIALS ABOUT PERSONAL AND EMOTIONAL WELL-BEING; STATIONERY; WRITING AND DRAWING IMPLEMENTS NAMELY PENS AND PENCILS; WRAPPING AND PACKAGING MATERIALS MADE FROM PAPER OR CARDBOARD; PLASTIC BUBBLE WRAP FOR WRAPPING OR PACKAGING; WRAPPING AND PACKAGING MATERIALS MADE FROM COMBINATIONS OF PAPER OR CARDBOARD OR PLASTIC BUBBLE WRAP FOR WRAPPING OR PACKAGING (U.S. CLS. 2, 5, 22, 23, 29, 37, 38 AND 50).

CLASS 42—SCIENTIFIC, COMPUTER AND LEGAL SERVICES

FOR HEALTH AND BEAUTY CARE SERVICES, NAMELY HOLISTIC HEALTH CARE SERVICES; HAIRDRESSING SALONS; BEAUTY SALONS (U.S. CLS. 100 AND 101).

SN 75-982,950. PNC FINANCIAL SERVICES GROUP, INC., THE, FORMERLY PNC BANK CORP., PITTSBURGH, PA. FILED 7-26-1999.

ISITES@PNCBANK

OWNER OF U.S. REG. NOS. 1,813,131, 1,863,311 AND OTHERS.

CLASS 35—ADVERTISING AND BUSINESS

FOR OFFERING TECHNICAL ASSISTANCE IN THE ESTABLISHMENT AND OPERATION OF ONLINE RETAIL STORES, PROVIDING E-COMMERCE TECHNICAL INFRASTRUCTURE AND DATABASES OF SERVICES AND MERCHANDISE CONTENT, AND WEBSITE MARKETING SERVICES (U.S. CLS. 100, 101 AND 102).

FIRST USE 10-1-1999; IN COMMERCE 10-1-1999.

CLASS 36—INSURANCE AND FINANCIAL

FOR BANKING SERVICES AND CREDIT CARD TRANSACTION PROCESSING SERVICES (U.S. CLS. 100, 101 AND 102).

FIRST USE 10-1-1999; IN COMMERCE 10-1-1999.

SN 76-006,107. DECISION MANAGEMENT INTERNATIONAL, INC., BRADENTON, FL. FILED 3-21-2000.

REGULUS

CLASS 9—ELECTRICAL AND SCIENTIFIC APPARATUS

FOR ELECTRONIC INTERFACING EQUIPMENT AND SOFTWARE FOR AUTOMATING AND IMPROVING BATCH AND LOT HISTORY RECORDS KEEPING; NAMELY, INTRANET SERVERS, RADIO FREQUENCY TRANSMITTERS AND RECEIVERS, AND COMPUTER SOFTWARE FOR WORD PROCESSING FOR CREATING DOCUMENT TEMPLATES FOR ISSUANCE OF BATCH RECORDS, BILLS OF MATERIALS, ROOM AND EQUIPMENT PREPARATION AND STATUS REPORTS, MATERIAL CHECK-IN, IDENTIFICATION, AND VERIFICATION REPORTS, EQUIPMENT CLEANING REPORTS, EQUIPMENT SET-UP REPORTS, INGREDIENTS ADDING REPORTS, EQUIPMENT OPERATION REPORTS, MATERIAL CRYSTALLIZATION, CENTRIFUGATION, DRYING, AND SAMPLING REPORTS, INTERMEDIATE PACKAGING REPORTS, TESTING WORKSHEETS, TEMPERATURE RECORDING, SUPERVISORY APPROVALS, AND RECONCILIATION/YIELD REPORTS FOR USE IN THE PHARMACEUTICAL INDUSTRIES, TO BE USED WITH ASEPTIC MANUFACTURING SUITES COMPRISED OF, ELECTRONIC WEIGH SCALES, COMPOUND MIXING MACHINES, CHEMICAL AND BIOLOGICAL REACTORS, TABLET COMPRESSING MACHINES, IMPRINTING AND LABELING MACHINES, COATING MACHINES, AND PACKAGING MACHINES TO ENSURE COMPLIANCE TO CFR PART 21 OF THE FOOD AND DRUG ADMINISTRATION REGULATIONS INCLUDING COMPLIANCE TO PART II, ELECTRONIC SIGNATURE COMPLIANCE, TRACKING AND MONITORING THE BATCH OR LOT HISTORY REQUIRED FOR SUCH COMPLIANCE THROUGH THE USE OF RADIO FREQUENCY WAVES AND ELECTRONIC SIGNATURES, AND MAINTAINING LOG BOOKS FOR THE CLEANING, CALIBRATION AND HISTORY OF MACHINES, USED IN THE FIELD OF PHARMACEUTICALS, BIOTECHNOLOGY, AND MEDICAL DEVICE MANUFACTURING (U.S. CLS. 21, 23, 26, 36 AND 38).

CLASS 35—ADVERTISING AND BUSINESS

FOR BUSINESS PROCESS RE-ENGINEERING SERVICES FOR REDESIGN, STORAGE AND CHANGE CONTROL PROCEDURES ASSOCIATED WITH THE DOCUMENTATION AND CREATION OF BATCH AND LOT HISTORY RECORDS FOR THE PHARMACEUTICAL, BIOTECHNOLOGY, AND MEDICAL DEVICE INDUSTRIES (U.S. CLS. 100, 101 AND 102).

SN 76-011,121. AQUAFIL S.P.A., ARCO (TRENTO), ITALY,
FILED 3-28-2000.

SN 76-024,407. BURNS, MARVIN LOUIS, NEW YORK, NY.
FILED 4-13-2000.

AND GROUP'S HIP HOP HALL OF FAME

AQUAFIL

PRIORITY CLAIMED UNDER SEC. 44(D) ON ITALY
APPLICATION NO. VR99C000478, FILED 9-30-1999, REG.
NO. 00801904, DATED 1-26-2000, EXPIRES 9-30-2009.

CLASS 1—CHEMICALS

FOR UNPROCESSED PLASTICS AND SYNTHETIC RESINS IN THE NATURE OF POLYAMIDES, ACETAL RESINS, POLYESTERS, POLYCARBONATES, POLYPHENYLENE OXIDES, ACRYLONITRILE-BUTADIENE-STYRENE POLYMERS AND BLENDS CONTAINING SAME FOR INJECTION, MOLDING AND EXTRUSION OF ARTICLES IN THE FIELD OF ELECTRICAL APPLIANCES, ELECTRICAL INDUSTRIAL PRODUCTS, ELECTRICAL HOUSEHOLD PRODUCTS AND AUTOMOTIVE PRODUCTS; INTERMEDIATES FOR THE CHEMICAL INDUSTRY, NAMELY, CAPROLACTAM, AMMONIUM SULPHATE, CYCLOHEXANE, CYCLOHEXANONE, CYCLOHEXANOL, CARBON DIOXIDE, SODIUM CARBONATE, AND NITROGEN (U.S. CLS. 1, 5, 6, 10, 26 AND 46).

CLASS 17—RUBBER GOODS

FOR UNPROCESSED MASTER BATCH IN PELLET FORM, NAMELY, BLENDS OF UNPROCESSED PLASTICS IN THE NATURE OF POLYAMIDES, ACETAL RESINS, POLYESTERS, POLYCARBONATES, POLYPHENYLENE OXIDES, ACRYLONITRILE-BUTADIENE-STYRENE POLYMERS TOGETHER WITH PIGMENTS, DYES AND PLASTICIZERS, PLASTICS AND SYNTHETIC RESINS IN PELLET FORM, NAMELY, POLYAMIDES, ACETALS, POLYCARBONATES, POLYPHENYLENE OXIDES, POLYPHENYL ETHERS, POLYBUTALENETEREPHTHALATES, POLYESTERS, ACRYLONITRILE-BUTADIENE-STYRENES AND BLENDS THEREOF FOR INJECTION, MOLDING AND EXTRUSION OF ARTICLES IN THE FIELD OF ELECTRICAL APPLIANCES, ELECTRICAL INDUSTRIAL PRODUCTS AND ELECTRICAL HOUSEHOLD PRODUCTS, AND AUTOMOTIVE PRODUCTS (U.S. CLS. 1, 5, 12, 13, 35 AND 50).

CLASS 22—CORDAGE AND FIBERS

FOR TEXTILE FIBERS, PLASTIC FIBERS FOR TEXTILE USE, CARBON FIBERS FOR TEXTILE USE, FIBERS OF VITREOUS SILICA FOR TEXTILE USE, GLASS FIBERS FOR TEXTILE USE, TWINE OR NETS; SYNTHETIC FIBERS (U.S. CLS. 1, 2, 7, 19, 22, 42 AND 50).

CLASS 23—YARNS AND THREADS

FOR YARNS, NAMELY COLORED OR UNCOLORED ELASTIC, SYNTHETIC AND PLASTIC YARNS FOR TEXTILE AND CARPETING USE; THREADS, NAMELY COLORED OR UNCOLORED ELASTIC, SYNTHETIC AND PLASTIC THREADS FOR TEXTILE AND CARPETING USE; INDIA RUBBER TREADS FOR TEXTILE USE, FIBERGLASS THREADS FOR TEXTILE USE, WOOLEN THREADS AND YARNS; SPUN WOOL, COTTON THREADS AND YARNS AND SPUN SILK (U.S. CL. 43).

NO CLAIM IS MADE TO THE EXCLUSIVE RIGHT TO USE "HIP HOP HALL OF FAME", APART FROM THE MARK AS SHOWN.

CLASS 9—ELECTRICAL AND SCIENTIFIC APPARATUS

FOR PRE-RECORDED AUDIO AND VIDEO CASSETTE TAPES, PHONOGRAPH RECORDS, COMPACT DISCS, MINI-DISCS, AND DVDS FEATURING HIP-HOP, RAP, URBAN, R AND B AND POP MUSIC AND CULTURE (U.S. CLS. 21, 23, 26, 36 AND 38).

CLASS 25—CLOTHING

FOR CLOTHING, NAMELY CAPS, HATS, SCARVES, T-SHIRTS, SWEATSHIRTS, SWEATPANTS, SWEATERS, PANTS, JEANS, JACKETS, BLAZERS, SUITS, SHORTS, SLEEPWEAR, SWIMWEAR, LINGERIE, HOSIERY, PAJAMAS, GLOVES, COATS, BANDANAS, CLOTH BIBS, SHIRTS, VESTS, DRESSES, GOWNS, OVERALLS, TIES, SUSPENDERS, BELTS, SOCKS, UNDERWEAR, SNEAKERS, SLIPPERS, SHOES AND BOOTS (U.S. CLS. 22 AND 39).

CLASS 42—SCIENTIFIC, COMPUTER AND LEGAL SERVICES

FOR CAFE AND RESTAURANT (U.S. CLS. 100 AND 101).

SN 76-026,953. MONKEY WORLD LIMITED, DORSET BH20
6HH, ENGLAND, FILED 4-17-2000.



PRIORITY CLAIMED UNDER SEC. 44(D) ON ERP
CMNTY TM OFC APPLICATION NO. 1348903, FILED 10-
18-1999, REG. NO. 1348903, DATED 12-18-2000, EXPIRES 10-
18-2009.

NO CLAIM IS MADE TO THE EXCLUSIVE RIGHT TO USE "MONKEY" AND "APE RESCUE CENTRE", APART FROM THE MARK AS SHOWN.

CLASS 6—METAL GOODS

FOR METAL BADGES; METAL KEY RINGS (U.S. CLS. 2, 12, 13, 14, 23, 25 AND 50).

CLASS 9—ELECTRICAL AND SCIENTIFIC APPARATUS

FOR PRE-RECORDED VIDEO CASSETTES IN THE FIELD OF NON-HUMAN PRIMATES; VIDEO GAME CARTRIDGES, DISCS AND SOFTWARE; DIGITAL VIDEO DISCS IN THE FIELD OF NON-HUMAN PRIMATES; MAGNETS (U.S. CLS. 21, 23, 26, 36 AND 38).

CLASS 16—PAPER GOODS AND PRINTED MATTER

FOR BOOKS, PERIODICALS, NEWSLETTERS, BROCHURES, PAMPHLETS, NEWSPAPERS, MAGAZINES, JOURNALS, BOOKLETS, ALL IN THE FIELD OF NON-HUMAN PRIMATES; EXERCISE BOOKS; MOUNTED AND UNMOUNTED PHOTOGRAPHS; POSTERS; STATIONERY GOODS, NAMELY, NOTE PADS, ADDRESS BOOKS, PENCILS, PENS, CRAYONS, UNGRADUATED RULERS, RUBBER ERASERS, PENCIL CASES, PENCIL SHARPENERS, POSTCARDS, FELT TIP MARKERS, GREETING CARDS, NOTELETS, CARDBOARD BOOKMARKS, ROLLERPENS, FELT PENS, FOUNTAIN PENS, PAPER TABLE NAPKINS, PAPER TABLECLOTHS, COASTERS AND TABLE MATS MADE OF PAPER, PAPER BADGES, BALL POINT PENS, WRITING PAPER, ENVELOPES, LOOSE LEAF BINDERS, BLOTTERS, WRAPPING PAPER, BOTTLE ENVELOPES MADE OF PAPER, FOLDERS FOR PAPERS, INK AND PENCIL HOLDERS; ADHESIVE TAPE FOR STATIONERY OR HOUSEHOLD PURPOSES; GLUE FOR STATIONERY OR HOUSEHOLD PURPOSES; ARTISTS' MATERIALS, NAMELY, DRAWING BOOKS, PENCILS, CHARCOAL PENCILS, CRAYONS, PASTELS, PAINTING SETS, PAINTING PALETTES, CANVAS FOR PAINTING, CHALK, COMPASSES FOR DRAWING, DRAWING PADS, DRAWING PENS, PAINTERS' EASELS, MODELING CLAY, MODELING MATERIALS, NAMELY, MODELING COMPOUNDS, MODELING WAX NOT FOR DENTAL PURPOSES, PAINT BRUSHES, PAINT BOXES, AND STENCILS; DIARIES, CALENDARS, STICKERS; PRINTED INSTRUCTIONAL MATERIAL NAMELY, BOOKS, BROCHURES, PAMPHLETS, JOURNALS, NEWSLETTERS, NEWSPAPERS, MAGAZINES, BOOKLETS IN THE FIELD OF NON-HUMAN PRIMATES; METAL BOOKMARKS; GLASS PAPERWEIGHTS (U.S. CLS. 2, 5, 22, 23, 29, 37, 38 AND 50).

CLASS 20—FURNITURE AND ARTICLES NOT OTHERWISE CLASSIFIED

FOR PICTURE FRAMES, ORNAMENTS AND FIGURINES, ALL MADE OF WOOD, CORK, REED, CANE, WICKER, HORN, BONE, IVORY, WHALEBONE, SHELL, AMBER, MOTHER OF PEARL, MEERSCHAUM, OR OF PLASTICS, ALL FOR PERSONAL USE OR FOR USE IN THE HOME; PLASTIC NAME BADGES AND PLASTIC KEY RINGS, ALL FOR PERSONAL USE; TEXTILE WINDOW BLINDS (U.S. CLS. 2, 13, 22, 25, 32 AND 50).

CLASS 21—HOUSEWARES AND GLASS

FOR DECORATIVE ORNAMENTS AND FIGURINES ALL MADE OF GLASS, PORCELAIN, CHINA OR EARTHENWARE, ALL FOR USE IN THE HOME; PLATES, MUGS, CUPS, SAUCERS, BOWLS AND VASES ALL MADE OF CHINA OR GLASS, ALL FOR USE IN THE HOME; HAIR COMBS AND COMB CASES; COASTERS OF WOOD, CORK, REED, CANE, WICKER, HORN, BONE, IVORY, WHALEBONE, SHELL, AMBER, MOTHER OF PEARL, MEERSCHAUM, PLASTIC, CHINA OR GLASS, ALL FOR USE IN THE HOME (U.S. CLS. 2, 13, 23, 29, 30, 33, 40 AND 50).

CLASS 24—FABRICS

FOR TEXTILE COASTERS, UPHOLSTERY FABRICS, TEXTILE FABRICS FOR MANUFACTURING INTO CLOTHING; TEXTILE FABRICS FOR CURTAINS, TEXTILE FLAGS, TEXTILE HANDKERCHIEFS, TEXTILE PIECE GOODS FOR MAKING CUSHION COVERS, TEXTILE TABLE MATS; BED LINEN; TABLE LINEN, NAMELY, NAPKINS AND PLACE MATS; TOWELS; TABLE MATS OF WOOD, CORK, REED, CANE, WICKER, HORN, BONE, IVORY, WHALEBONE, SHELL, AMBER, MOTHER OF PEARL, MEERSCHAUM, PLASTIC, CHINA OR GLASS, ALL FOR USE IN THE HOME (U.S. CLS. 42 AND 50).

CLASS 25—CLOTHING

FOR PAJAMAS, RAINCOATS, T-SHIRTS, SWEATSHIRTS, SWEATERS, APRONS AS ARTICLES OF CLOTHING, BATHROBES, GLOVES, PULLOVERS, SCARFS, SHIRTS, POLO SHIRTS, RUGBY SHIRTS, SHORTS, SUN VISORS, HATS AND SOCKS (U.S. CLS. 22 AND 39).

CLASS 26—FANCY GOODS

FOR BADGES MADE FROM TEXTILE MATERIAL; THIMBLES MADE OF CHINA OR GLASS, FOR USE IN THE HOME (U.S. CLS. 37, 39, 40, 42 AND 50).

CLASS 28—TOYS AND SPORTING GOODS

FOR GAMES, NAMELY, BOARD GAMES, CARD GAMES, DOMINOES, PUZZLES, PARLOUR GAMES, HAND-HELD VIDEO GAMES; CHRISTMAS TREE DECORATIONS; PLAYING CARDS (U.S. CLS. 22, 23, 38 AND 50).

CLASS 38—COMMUNICATION

FOR TELEVISION BROADCASTING (U.S. CLS. 100, 101 AND 104).

CLASS 41—EDUCATION AND ENTERTAINMENT

FOR EDUCATIONAL SERVICES IN THE NATURE OF SEMINARS, CONFERENCES, SYMPOSIUMS, CLASSES, WORKSHOPS, LECTURES, VIDEOS, FILMS AND TELEVISION PROGRAMS RELATING TO NON-HUMAN PRIMATES AND RESCUE AND REHABILITATION OF NON-HUMAN PRIMATES; NON-HUMAN PRIMATE EXHIBITS (U.S. CLS. 100, 101 AND 107).

SN 76-027,428. LOCUS DIALOGUE INC., MONTREAL, QUEBEC H3B 1A7, CANADA, FILED 4-17-2000.

LOCUSCARE

PRIORITY CLAIMED UNDER SEC. 44(D) ON CANADA APPLICATION NO. 1,032,681, FILED 10-15-1999, REG. NO. TMA569284, DATED 10-22-2002, EXPIRES 10-22-2017.

CLASS 37—CONSTRUCTION AND REPAIR

FOR INSTALLATION AND MAINTENANCE OF AUTOMATIC SYSTEMS HARDWARE FOR THE TRANSFER OF TELEPHONE CALLS USING VOICE RECOGNITION TECHNOLOGY (U.S. CLS. 100, 103 AND 106).

CLASS 42—SCIENTIFIC, COMPUTER AND LEGAL SERVICES

FOR INSTALLATION AND MAINTENANCE OF SOFTWARE ENABLING THE OPERATION OF SYSTEMS HARDWARE USING THE VOICE RECOGNITION TECHNOLOGY; TECHNICAL SUPPORT SERVICES, NAMELY TROUBLESHOOTING PROBLEMS OF SOFTWARE ENABLING THE OPERATION OF SYSTEMS HARDWARE USING THE VOICE RECOGNITION TECHNOLOGY; CONSULTING SERVICES RELATING AUTOMATIC VOICE ACTIVATED SYSTEMS HARDWARE FOR THE TRANSFER OF TELEPHONE CALLS USING VOICE RECOGNITION TECHNOLOGY AND SOFTWARE ENABLING THE OPERATION OF SYSTEMS HARDWARE USING THE VOICE RECOGNITION TECHNOLOGY; TECHNICAL SUPPORT SERVICES, NAMELY, TROUBLESHOOTING PROBLEMS OF AUTOMATIC VOICE ACTIVATED SYSTEMS HARDWARE FOR THE TRANSFER OF TELEPHONE CALLS USING VOICE RECOGNITION TECHNOLOGY (U.S. CLS. 100 AND 101).

SN 76-031,845. FRANCHISE OPPORTUNITIES.COM, LLC, FOREST PARK, GA. FILED 4-20-2000.

REDEFINING THE FRANCHISE MARKETPLACE

NO CLAIM IS MADE TO THE EXCLUSIVE RIGHT TO USE "FRANCHISE MARKETPLACE", APART FROM THE MARK AS SHOWN.

CLASS 35—ADVERTISING AND BUSINESS

FOR PROVIDING ONLINE DIRECTORIES, INDICES AND SEARCHABLE DATABASES RELATING TO A VARIETY OF INFORMATION AND DATA AVAILABLE ON A GLOBAL COMPUTER NETWORK IN THE FIELD OF BUSINESS VENTURES (U.S. CLS. 100, 101 AND 102). FIRST USE 12-16-1999; IN COMMERCE 12-16-1999.

CLASS 42—SCIENTIFIC, COMPUTER AND LEGAL SERVICES

FOR PROVIDING INFORMATION SERVICES ON A WIDE VARIETY OF SUBJECTS (U.S. CLS. 100 AND 101). FIRST USE 12-16-1999; IN COMMERCE 12-16-1999.

SN 76-034,082. SIMON, UDO, 90409 NURNBERG, FED REP GERMANY, FILED 4-25-2000.

es-q-lab

PRIORITY CLAIMED UNDER SEC. 44(D) ON FED REP GERMANY APPLICATION NO. 39968176.0, FILED 10-30-1999, REG. NO. 39968176, DATED 2-14-2000, EXPIRES 10-30-2009.

CLASS 35—ADVERTISING AND BUSINESS

FOR ADVERTISING SERVICES, NAMELY, SERVICES OF ADVERTISING AGENCIES, DIRECT MAIL ADVERTISING, ELECTRONIC BILLBOARD ADVERTISING, DISSEMINATION OF ADVERTISING MATTER, PREPARATION OF ADVERTISEMENTS FOR OTHERS; ADVERTISING SERVICES FOR OTHERS, NAMELY, PROMOTING THE GOODS AND SERVICES OF OTHERS VIA RADIO, TELEVISION AND THE INTERNET; BUSINESS MANAGEMENT SERVICES, NAMELY, BUSINESS MANAGEMENT AND BUSINESS CONSULTATION, MANAGEMENT OF A COMMERCIAL UNDERTAKING; CORPORATE ADMINISTRATION SERVICES, NAMELY, PROVIDING BUSINESS INFORMATION IN THE MEDICAL FIELD, BUSINESS APPRAISALS, BUSINESS INVESTIGATIONS, PROVIDING STATISTICAL INFORMATION; BUSINESS SUPERVISION; COST ACCOUNTING, ACCOUNT AUDITING, PAYROLL PREPARATION, AND OFFICE TASKS, NAMELY, CLERICAL SERVICES, WORD PROCESSING, TYPING, TELEPHONE ANSWERING, PREPARING BUSINESS REPORTS, PHOTOCOPYING; MARKET RESEARCH AND ANALYSIS IN THE FIELD OF MEDICAL TECHNOLOGY; BUSINESS CONSULTATION SERVICES FOR GENERATING NEW PRODUCT IDEAS; BUSINESS CONSULTING, NAMELY, CUSTOMER RELATIONSHIP MANAGEMENT (U.S. CLS. 100, 101 AND 102).

CLASS 38—COMMUNICATION

FOR TELECOMMUNICATIONS SERVICES, NAMELY, TRANSMISSION OF NEWS AND PICTURES VIA NARROW AND BROADBAND INTERNET CONNECTIONS; CONDUCTING TELEPHONE COMMUNICATION SERVICES; TELETXT SERVICES; COMMUNICATION VIA COMPUTER TERMINALS, NAMELY, ELECTRONIC TRANSMISSION OF VOICE, DATA AND IMAGES VIA LOCAL AND GLOBAL COMPUTER NETWORKS; ELECTRONIC TRANSFER OF DATA, TEXT, SOUND AND PICTURES; AND COMPUTER-AIDED TRANSMISSION OF NEWS AND PICTURES; PROVIDING MULTIPLE-USER ACCESS TO THE INTERNET AND PROVIDING ON-LINE ELECTRONIC BULLETIN BOARDS FOR TRANSMISSION OF MESSAGES AMONG COMPUTER USERS CONCERNING ISSUES RELATED TO THE MEDICAL FIELD (U.S. CLS. 100, 101 AND 104).

CLASS 41—EDUCATION AND ENTERTAINMENT

FOR EDUCATIONAL SERVICES, NAMELY, PROVIDING TRAINING CLASSES AND THE ORGANIZATION OF SEMINARS, WORKSHOPS AND CONGRESSES IN THE FIELD OF MEDICAL TECHNOLOGY FOR DOCTORS, PHARMACEUTICAL REPRESENTATIVES, SIMILAR CONSULTANTS AND PATIENTS; PROVIDING INFORMATION IN THE MEDICAL FIELD VIA THE INTERNET; ENTERTAINMENT SERVICES, NAMELY, ORGANIZING SPORTS AND CULTURAL ACTIVITIES; PUBLICATION OF SUPPLEMENTARY PRINTED MEDIA, CATALOGUES, BOOKS, NEWSPAPERS, JOURNALS AND INFORMATION BROCHURES (U.S. CLS. 100, 101 AND 107).

CLASS 42—SCIENTIFIC, COMPUTER AND LEGAL SERVICES

FOR ENGINEERING SERVICES; SERVICES OF AN ENGINEER; PHYSICIST SERVICES; PHARMACIST SERVICES; INTELLECTUAL PROPERTY CONSULTATION, LICENSING OF INTELLECTUAL PROPERTY AND PATENT AGENCY CONSULTATION; COMPUTER SOFTWARE DEVELOPMENT IN THE FIELD OF DATA PROCESSING; TELEPHONE HOT LINE, E-MAIL AND RADIO COUNSELING, NAMELY OFFERING ADVICE REGARDING SAFE, PROTECTED TRANSMISSION OF DATA, THE USE OF ENCODING SOFTWARE, THE USE OF PROTECTION MECHANISMS AND FIREWALLS; PROVIDING ELECTRONIC VERIFICATION OF ONLINE ORDERS OF DIGITAL CONTENT AND GENERATING ELECTRONIC PERMISSION CODES WHICH THEN ALLOW USERS TO ACCESS SAID DIGITAL CONTENT; ANY OF THE AFOREMENTIONED SERVICES ON THE INTERNET AS WELL AS THE INTERNET; COMPUTER SERVICES, NAMELY, CREATING WEB SITES FOR

OTHERS; PROVIDING INFORMATION, NAMELY, PROVIDING EXPERT REPORTS IN THE MEDICAL FIELD, ADVICE AND EXPERT SERVICES IN THE MEDICAL FIELD; NEWS REPORTING SERVICES, NAMELY, GATHERING AND DISSEMINATION OF NEWS VIA COMPUTER DATABASES; DEVELOPMENT OF COMPUTER DATABASES FOR OTHERS; LEASING OF COMPUTERS AND DATA PROCESSING PERIPHERALS AND SOFTWARE; COMPUTER CONSULTING SERVICES IN THE FIELD OF COMPUTER NETWORK DEVELOPMENT, COMPUTER NETWORK INSTALLATIONS, COMPUTER NETWORK EXTENSION AND COMPUTER NETWORK OPERATION; MEDICAL AND SCIENTIFIC RESEARCH, NAMELY, CONDUCTING CLINICAL TRIALS; PROVIDING DATABASES IN THE MEDICAL FIELD (U.S. CLS. 100 AND 101).

SN 76-042,179, VBH REALM B.V., 1079 LH AMSTERDAM, NETHERLANDS, FILED 5-5-2000.



PRIORITY CLAIMED UNDER SEC. 44(D) ON BENELUX APPLICATION NO. 0949929, FILED 11-10-1999, REG. NO. 0661570, DATED 11-10-1999, EXPIRES 11-10-2009.

CLASS 18—LEATHER GOODS

FOR BASED ON INTENT TO USE— ANIMAL HARNESSES; BARREL BAGS; CATALOG CASES; CREDIT CARD CASES; DAYPACKS; DOCUMENT CASES; LIP-STICK HOLDERS; LUGGAGE TAGS; SCRATCHING POSTS, BASED ON 44(E)— ANIMAL CARRIERS; ANIMAL GAME BAGS; ANIMAL SKINS AND HIDES; ATHLETIC BAGS; ALL PURPOSE ATHLETIC BAGS; ATTACHE CASES; BABY BACKPACKS; BACKPACKS; BANDOLIERS; BEACH BAGS; BEACH UMBRELLAS; BILLFOLDS; BOOK BAGS; BOSTON BAGS; BRIEFBAGS; BRIEFCASES; BUSINESS CASES; BUSINESS CARD CASES; CALLING CARD CASES; CANVAS WOOD CARRIERS; CANES; CARRY-ON BAGS; CHANGE PURSES; CLUTCH BAGS; CLUTCH PURSES; COIN PURSES; COSMETIC CASES SOLD EMPTY; DIAPER BAGS; DOG CLOTHING; DOG COLLARS; DOG LEASHES; DRAW-STRING POUCHES; DUFFEL BAGS; FANNY PACKS; FELT POUCHES; FUR PELTS; GARMENT BAGS FOR TRAVEL; GOLF UMBRELLAS; GYM BAGS; HANDBAGS; HARNESS STRAPS; HARNESSES; HAT BOXES FOR TRAVEL; HAVERSACKS; HORSE BLANKETS; HUNTERS GAME BAGS; INFANT CARRIERS WORN ON THE BODY; KEY CASES; KNAPSACKS; LEASHES FOR ANIMALS; LEATHER BAGS FOR MERCHANDISE PACKAGING; LEATHER SOLD IN BULK; IMITATION LEATHER SOLD IN BULK; LUGGAGE; NON-MOTORIZED COLLAPSIBLE LUGGAGE CARTS; OVERNIGHT BAGS; OVERNIGHT CASES; PARASOLS; PATIO UMBRELLAS; PELTS; PET CUSHIONS; POCKETBOOKS; BRIEFCASE-TYPE PORTFOLIOS; PORTMANTEAUS; PULLMANS; PURSES; REINS; ROLL BAGS; RUCKSACKS; SADDLERY; SADDLES; SACHELS; SCHOOL BAGS; SCHOOL BOOK BAGS; SHAVING BAGS SOLD EMPTY; SHOE BAGS FOR TRAVEL; LEATHER SHOPPING BAGS; MESH SHOPPING BAGS; TEXTILE SHOPPING BAGS; SHOPPING BAGS WITH WHEELS ATTACHED; SHOULDER BAGS; ALL PURPOSE SPORTS BAGS; SPORTSMAN'S HUNTING BAGS; STRAPS FOR HANDBAGS; STRAPS FOR LUGGAGE; SUIT BAGS; SUITCASES; THONGS; TOILETRY CASES SOLD EMPTY; TOOL BAGS SOLD EMPTY; TOTE BAGS; TRAVEL BAGS; TRAVELING BAGS; TRUNKS FOR TRAVELING; LUGGAGE, NAMELY, TRUNKS; UMBRELLA COVERS; UMBRELLAS; VALISES; VANITY CASES SOLD EMPTY; WAIST PACKS; WALKING STICKS; WALLETS; WHIPS; WRIST MOUNTED CARRYALL BAGS; WRIST MOUNTED PURSES (U.S. CLS. 1, 2, 3, 22 AND 41).

CLASS 25—CLOTHING

FOR BASED ON INTENT TO USE— BABY BUNTING; COMBINATIONS; PAREU; SKI BOOT BAGS; SKORTS; SLEEP MASKS; CLOTHING, NAMELY, TIES; TIGHTS; ZOOT SUITS; BASED ON 44(E)— AFTER SKI BOOTS; APRONS; ASCOTS; ATHLETIC FOOTWEAR; ATHLETIC UNIFORMS; BANDANNAS; BATHING CAPS; BATHROBES; BEACH COVER-UPS; BEACHWEAR; CLOTHING, NAMELY, BELTS; BERETS; BERMUDA SHORTS; BIKINIS; BLAZERS; BLOUSES; BLOUSONS; BOAS; BODY SUITS; BOLEROS; BOOTS; BOTTOMS; BOW TIES; BOXER SHORTS; BRAS; BRASSIERES; UNDERWEAR, NAMELY, BRIEFS; BUSTIERS; CAFTANS; CAMISOLES; CAPES; CLOTHING, NAMELY, CAPS; CARDIGANS; CASSOCKS; CHAPS; CHEMISETTES; CHEMISES; CLOGS; CLOTH BIBS; COATS; COLLARS; COVERALLS; COVERUPS; CRAVATS; CUFFS; CULOTTES; CUMMERBUNDS; DICKIES; DRESSES; DRESSING GOWNS; DRESS SHIELDS; CLOTHING, NAMELY, DUSTERS; EAR MUFFS; ESPADRILLES; EVENING GOWNS; FISHING VESTS; FISHING WADERS; FOOTWEAR; FOUL WEATHER GEAR; FOUNDATION GARMENTS; FUR CLOAKS; FUR COATS; FUR JACKETS; FUR STOLE; GABARDINES; GALOSHES; GAUCHOS; GLOVES; GOLF SHIRTS; GOLF SHOES; GREATCOATS; GYM SHORTS; HALTER TOPS; HATS; HEAD BANDS; HEAD WEAR; HEEL INSERTS; HEELS; CLOTHING, NAMELY, HOODS; HOSIERY; INFANTWEAR; JACKETS; JEANS; CLOTHING, NAMELY, JERSEYS; JODHPURS; JOGGING SUITS; JUMPSUITS; KERCHIEFS; KILTS; KIMONOS; KNICKERS; KNIT SHIRTS; LAYETTES; LEATHER COATS; LEATHER JACKETS; LEG WARMER; LEGGINGS; LEOTARDS; LIGHT-REFLECTING COATS; LIGHT-REFLECTING JACKETS; LINGERIE; LOUNGEWEAR; MAILLOTS; MASQUERADE COSTUMES AND MASKS SOLD IN CONNECTION THEREWITH; MINISKIRTS; MITTENS; MOCCASINS; MONEY BELTS; MUFFS; EAR MUFFS; NECK BANDS; NECKERCHIEFS; NECKTIES; NECKWEAR; NEGLIGES; NIGHT GOWNS; NIGHT SHIRTS; OVERCOATS; OVERSHOES; PAJAMAS; PANTIES; PANTS; PANTSUITS; PANTYHOSE; PARKAS; PEDAL PUSHERS; PEIGNOIRS; POCKET SQUARES; POLO SHIRTS; PONCHOS; PULLOVERS; RAIN COATS; RAIN SUITS; RAINWEAR; ROBES; RUBBERS; SANDALS; SARIS; SARONGS; SASHERS; SCARVES; SHAWLS; SHIRTS; SHOES; CLOTHING, NAMELY, SHORT SETS; SHORTS; SINGLET; SKI BOOTS; SKI GLOVES; SKI MASKS; SKI PANTS; SKI SUITS; SKI WEAR; SKIRTS; SLACKS; SLEEPWEAR; SLIPPERS; SLIPS; SOCKS; SPORT COATS; SPORT SHIRTS; STOCKINGS; STOLE; SUIT COATS; SUITS; SUNSUITS; SUNVISORS; SUSPENDERS; SWEAT BANDS; SWEAT PANTS; SWEAT SHIRTS; SWEAT SUITS; SWEATERS; SWIM WEAR; SWIMSUITS; T-SHIRTS; TAILLEURS; TANGAS; TANK TOPS; TENNIS WEAR; FOOTWEAR, NAMELY, THONGS; CLOTHING, NAMELY, TOGAS; CLOTHING, NAMELY, TOPS; TUNICS; TURBANS; TURTLENECKS; TUXEDOS; UNDERCLOTHES; UNDERGARMENTS; UNDERPANTS; UNDERSHIRTS; UNDERWEAR; UNIFORMS; V-NECK SWEATERS; VEILS; VESTS; VISORS; WARM UP SUITS; WEDDING GOWNS; WET SUITS; WIND RESISTANT JACKETS; WINDSHIRTS; CLOTHING, NAMELY, WRAPS; WRIST BANDS (U.S. CLS. 22 AND 39).

CLASS 35—ADVERTISING AND BUSINESS

FOR BASED ON INTENT TO USE— RETAIL APPAREL STORES; RETAIL CLOTHING BOUTIQUES; COMPUTERIZED ON-LINE ORDERING SERVICES IN THE FIELD OF APPAREL, ACCESSORIES, WORKS OF ART, JEWELRY, PERFUME, COSMETICS, HOUSEHOLD ITEMS; COMPUTERIZED ON-LINE RETAIL SERVICES IN THE FIELD OF APPAREL, ACCESSORIES, WORKS OF ART, JEWELRY, PERFUME, COSMETICS, HOUSEHOLD ITEMS; RETAIL DEPARTMENT STORES; DISCOUNT STORES IN THE FIELD OF APPAREL, ACCESSORIES, WORKS OF ART, JEWELRY, PERFUME, COSMETICS, HOUSEHOLD ITEMS; SAMPLE DISTRIBUTION; WHOLESALE DISTRIBUTORSHIPS FEATURING APPAREL, ACCESSORIES, WORKS OF ART, JEWELRY, PERFUME, COSMETICS, HOUSEHOLD ITEMS; DISTRIBUTORSHIPS IN THE FIELD OF APPAREL, ACCESSORIES, WORKS OF ART, JEWELRY, PERFUME, COSMETICS, HOUSEHOLD ITEMS; ELECTRONIC RETAILING SERVICES VIA COMPUTER FEATURING APPAREL, ACCESSORIES, WORKS OF ART, JEWELRY, PERFUME, COSMETICS, HOUSEHOLD ITEMS; RETAIL

FUR STORES; RETAIL FURNITURE STORES; SHOPPER'S GUIDE INFORMATION; RETAIL GIFT SHOPS; LICENSING OF APPAREL, ACCESSORIES, WORKS OF ART, JEWELRY, PERFUME, COSMETICS, HOUSEHOLD ITEMS; RETAIL OUTLETS FEATURING APPAREL, ACCESSORIES, WORKS OF ART, JEWELRY, PERFUME, COSMETICS, HOUSEHOLD ITEMS; PROVIDING HOME SHOPPING SERVICES IN THE FIELD OF APPAREL, ACCESSORIES, WORKS OF ART, JEWELRY, PERFUME, COSMETICS, HOUSEHOLD ITEMS BY MEANS OF TELEVISION; PROCUREMENT, NAMELY PURCHASING LUXURY GOODS FOR OTHERS; RETAIL APPAREL, ACCESSORIES, WORKS OF ART, JEWELRY, PERFUME, COSMETICS, HOUSEHOLD ITEMS STORES; RETAIL SERVICES, AVAILABLE THROUGH COMPUTER COMMUNICATIONS AND INTERACTIVE TELEVISION, FEATURING APPAREL, ACCESSORIES, WORKS OF ART, JEWELRY, PERFUME, COSMETICS, HOUSEHOLD ITEMS; RETAIL VARIETY STORES; WHOLESALE STORES FEATURING APPAREL, ACCESSORIES, WORKS OF ART, JEWELRY, PERFUME, COSMETICS, HOUSEHOLD ITEMS; BASED ON 44(E)- ADVERTISING AGENCIES; ARRANGING AND CONDUCTING TRADE SHOW EXHIBITIONS IN THE FIELD OF APPAREL, ACCESSORIES, WORKS OF ART, JEWELRY, COSMETICS, PERFUME, HOUSEHOLD ITEMS; ART GALLERIES; AUCTIONEERING; BUSINESS INFORMATION IN THE NATURE OF LUXURY GOODS; BUSINESS MANAGEMENT; BUSINESS SUPERVISION; CATALOG SERVICES FEATURING APPAREL, ACCESSORIES, WORKS OF ART, PERFUME, COSMETICS, JEWELRY, MAIL ORDER HOUSEHOLD ITEMS; DEVELOPING PROMOTIONAL CAMPAIGNS FOR BUSINESS; DIRECT MAIL ADVERTISING; RETAIL SHOP WINDOW DISPLAY ARRANGEMENT SERVICES; WINDOW DRESSING AND DISPLAY ARRANGEMENT SERVICES; BUSINESS MERCHANDISING DISPLAY SERVICES; DISSEMINATION OF ADVERTISING MATTER; ELECTRONIC BILLBOARD ADVERTISING; EXPORT AND IMPORT AGENCIES; FRANCHISING, NAMELY OFFERING TECHNICAL ASSISTANCE IN THE ESTABLISHMENT AND/OR OPERATION OF DESIGNER RETAILS STORES; RETAIL JEWELRY STORES; MAIL ORDER SERVICES FEATURING APPAREL, ACCESSORIES, WORKS OF ART, JEWELRY, PERFUME, COSMETICS, HOUSEHOLD ITEMS, MANAGEMENT ASSISTANCE; MODELING AGENCIES; MODELING FOR ADVERTISING OR SALES PROMOTION; PRODUCT MERCHANDISING; PROMOTING THE GOODS AND SERVICES OF OTHERS BY ARRANGING FOR SPONSORS TO AFFILIATE THEIR GOODS AND SERVICES WITH DESIGNER FASHION ITEMS; DEVELOPING PROMOTIONAL CAMPAIGNS FOR BUSINESSES; PUBLIC RELATIONS; RESTAURANT FRANCHISING; RETAIL SHOP WINDOW DISPLAY ARRANGEMENT SERVICES; TELEPHONE SHOP-AT-HOME SERVICES IN THE FIELD OF APPAREL, ACCESSORIES, WORKS OF ART, JEWELRY, PERFUME, COSMETICS, HOUSEHOLD ITEMS; WINDOW DISPLAY ARRANGEMENT SERVICES; WINDOW DRESSING AND DISPLAY ARRANGEMENT SERVICES (U.S. CLS. 100, 101 AND 102).

SN 76-051,058. TRAFFICMASTER PLC., BUCKINGHAMSHIRE, MK14 6DX, UNITED KINGDOM, FILED 5-18-2000.

TRAFFICMASTER

CLASS 9—ELECTRICAL AND SCIENTIFIC APPARATUS

FOR ELECTRICAL AND ELECTRONIC APPARATUS AND INSTRUMENTS FOR PROVISION OF ROAD TRAFFIC INFORMATION, FOR PROVISION OF INFORMATION AS TO ROAD TRAFFIC CONGESTION AND SPEED AND ABOUT INDIVIDUAL ROAD VEHICLES, FOR ROAD TRAFFIC MONITORING, AND FOR MONITORING OF ROAD TRAFFIC CONGESTION AND SPEED AND OF INDIVIDUAL ROAD VEHICLES; ELECTRICAL AND ELECTRONIC APPARATUS AND INSTRUMENTS LOCATABLE IN VEHICLE INTERIORS FOR PROVIDING VISUAL AND ORAL INFORMATION RELATING TO ROAD TRAFFIC CONDITIONS; ELECTRONIC EQUIPMENT IN THE NATURE OF NUMERIC, GRAPHIC AND TEXTUAL DATA PROCESSORS, WIRELESS AND FIXED ELECTRONIC TRANSMITTERS AND RECEIVERS, AND CENTRAL ELECTRONIC GRAPHICAL DISPLAY SYSTEMS FOR MONITORING AND COMMUNICATING WITH INDIVIDUAL ROAD VEHICLES; CONTROL CENTERS FOR PERFORMING NUMERIC, GRAPHIC AND TEXTUAL DATA PROCESSING, WIRELESS AND FIXED ELECTRONIC TRANSMISSION AND RECEPTION AND CENTRAL ELECTRONIC GRAPHICAL DISPLAYING FOR MONITORING AND COMMUNICATING WITH INDIVIDUAL ROAD VEHICLES (U.S. CLS. 21, 23, 26, 36 AND 38).

CLASS 39—TRANSPORTATION AND STORAGE

FOR PROVISION OF ROAD TRAFFIC INFORMATION; PROVISION OF INFORMATION AS TO ROAD TRAFFIC CONGESTION AND SPEED AND ABOUT INDIVIDUAL ROAD VEHICLES; ROAD TRAFFIC MONITORING; MONITORING OF ROAD TRAFFIC CONGESTION AND SPEED AND OF INDIVIDUAL ROAD VEHICLES, AND CONSULTATION WITH REGARD TO THE PROVISION OF SUCH INFORMATION AND THE PERFORMING OF SUCH MONITORING AND THE RELATED EQUIPMENT USED IN CONNECTION THEREWITH (U.S. CLS. 100 AND 105).

SN 76-054,833. VECTOR, INC., WESTMINSTER, CA. FILED 5-22-2000.

VECTOR

CLASS 41—EDUCATION AND ENTERTAINMENT

FOR COUNSELING IN THE FIELD OF VOCATIONAL REHABILITATION, VOCATIONAL EVALUATION AND VOCATIONAL GUIDANCE (U.S. CLS. 100, 101 AND 107). FIRST USE 7-1-1975; IN COMMERCE 9-0-1980.

CLASS 42—SCIENTIFIC, COMPUTER AND LEGAL SERVICES

FOR CONDUCTING MEDICAL EVALUATION RESEARCH IN THE FIELD OF DISABILITY; CONDUCTING VOCATIONAL RESEARCH IN THE FIELD OF DISABILITY; PROVIDING FORENSIC EXPERT SERVICES, NAMELY, DISABILITY ASSESSMENTS AND OPINIONS; PROVIDING CASE MANAGEMENT SERVICES, NAMELY, MANAGING DISABILITY CASES; PROVIDING EXPERT TESTIMONY IN THE FIELDS OF PERSONAL INJURY, WRONGFUL DEATH, WRONGFUL EMPLOYMENT TERMINATION, AMERICAN DISABILITIES ACT ISSUES, DIVORCE, DISCRIMINATION AND SEXUAL HARASSMENT (U.S. CLS. 100 AND 101).
FIRST USE 7-1-1975; IN COMMERCE 9-0-1980.

SN 76-060,239. H.M. PUBLISHERS HOLDINGS LIMITED, HAMPSHIRE, UNITED KINGDOM, FILED 5-31-2000.

PALGRAVE**CLASS 41—EDUCATION AND ENTERTAINMENT**

FOR INFORMATION SERVICES, NAMELY, PROVIDING INFORMATION RELATING TO MUSIC, MUSICIANS, MUSICAL INSTRUMENTS, CULTURE, LITERARY WORKS, ECOLOGY, AND ENVIRONMENT IN THE ACADEMIC, EDUCATIONAL, INSTRUCTIONAL AND TEACHING FIELDS; HOUSE MARK FOR EDUCATIONAL SERVICES, NAMELY, CONDUCTING INTERACTIVE MEDIA-BASED CLASSES AND SEMINARS; ENTERTAINMENT SERVICES IN THE NATURE OF ON-GOING TELEVISION PROGRAMS, FILMS, AND MULTIMEDIA PROGRAMS IN THE ACADEMIC, EDUCATIONAL, INSTRUCTIONAL, AND TEACHING FIELDS; PUBLISHING SERVICES, NAMELY PUBLICATION OF BOOKS, MAGAZINES, LEAFLETS, PAMPHLETS, JOURNALS, TEACHING AND INSTRUCTIONAL MATERIALS IN PRINTED FORM; ELECTRONIC PUBLISHING SERVICES, NAMELY PUBLICATIONS OF TEXT, GRAPHIC, AUDIO AND AUDIOVISUAL WORKS OF OTHERS ON COMPACT DISCS, AUDIO TAPES, VIDEO TAPES, AUDIO-VIDEO TAPES, DIGITAL VIDEO DISCS; ARRANGING AND CONDUCTING EDUCATIONAL CONFERENCES, WORKSHOPS, SEMINARS, FOCUS GROUPS AND STUDY GROUPS (U.S. CLS. 100, 101 AND 107).

SN 76-057,678. GLOBAL EXECUTIVE TRAVEL SELECTIONS, INC., NEW YORK, NY. FILED 5-26-2000.

**CLASS 42—SCIENTIFIC, COMPUTER AND LEGAL SERVICES**

FOR COMPUTER SERVICES, NAMELY PROVIDING ON-LINE BOOKS, MAGAZINES, LEAFLETS, PAMPHLETS, JOURNALS, TEACHING AND INSTRUCTIONAL MATERIALS IN THE FIELD OF MUSIC, MUSICIANS, MUSICAL INSTRUMENTS, CULTURE, LITERARY WORKS, SCIENCE, MEDICINE, ECOLOGY, BUSINESS, HISTORY AND ENVIRONMENT; INFORMATION SERVICES, NAMELY, PROVIDING INFORMATION IN THE FIELD OF HISTORY AND SCIENCE (U.S. CLS. 100 AND 101).

SN 76-063,640. SOLUTIONS PHARMACY, INC., TOA BAJA, PUERTO RICO, FILED 6-5-2000.

SOLUTIONS PHARMACY

NO CLAIM IS MADE TO THE EXCLUSIVE RIGHT TO USE "PHARMACY", APART FROM THE MARK AS SHOWN.

CLASS 39—TRANSPORTATION AND STORAGE

FOR TRAVEL SERVICES, NAMELY, MAKING TRANSPORTATION ARRANGEMENTS BY OFFERING BUSINESS CLASS AIR TICKETS AT DISCOUNTED PRICES AND VOUCHERS FOR CAR RENTALS, LIMOUSINE TRANSFERS AND AIRLINE TICKETS (U.S. CLS. 100 AND 105).

FIRST USE 12-31-2000; IN COMMERCE 12-31-2000.

CLASS 35—ADVERTISING AND BUSINESS

FOR RETAIL STORE SERVICES, MAIL ORDER SERVICES, TELEPHONE ORDERING SERVICES, AND COMPUTERIZED ON-LINE ORDERING SERVICES IN THE FIELD OF PHARMACEUTICAL PRODUCTS (U.S. CLS. 100, 101 AND 102).

FIRST USE 4-26-1999; IN COMMERCE 4-29-1999.

CLASS 42—SCIENTIFIC, COMPUTER AND LEGAL SERVICES

FOR TRAVEL SERVICES, NAMELY, MAKING ARRANGEMENTS FOR LODGING BY PROVIDING VOUCHERS FOR LODGING AT HOTELS (U.S. CLS. 100 AND 101).

FIRST USE 12-31-2000; IN COMMERCE 12-31-2000.

CLASS 39—TRANSPORTATION AND STORAGE

FOR DELIVERY BY COURIER OF PHARMACEUTICAL PRODUCTS TO OTHERS (U.S. CLS. 100 AND 105).

FIRST USE 4-26-1999; IN COMMERCE 4-29-1999.

SN 76-069,751. OPTX CORPORATION, DENVER, CO. FILED 6-14-2000.

SN 76-071,739. NOVOMIND AG, 22305 HAMBURG, FED REP GERMANY, FILED 6-15-2000.

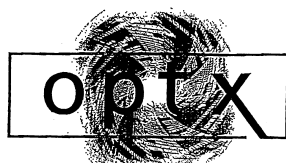

PRIORITY CLAIMED UNDER SEC. 44(D) ON CANADA APPLICATION NO. 1056505, FILED 4-25-2000.

OWNER OF U.S. REG. NO. 2,217,503.

THE STIPPLING SHOWN IN THE DRAWING IS A FEATURE OF THE MARK AND IS NOT INTENDED TO INDICATE COLOR.

CLASS 9—ELECTRICAL AND SCIENTIFIC APPARATUS

FOR COMPUTER SOFTWARE USED IN THE PLANNING, MANAGING AND ANALYZING OF PATIENT HEALTHCARE TREATMENT (U.S. CLS. 21, 23, 26, 36 AND 38).

CLASS 35—ADVERTISING AND BUSINESS

FOR BUSINESS CONSULTATION SERVICES, NAMELY, OPERATIONAL REVIEW OF PATIENT TREATMENT; BUSINESS PROJECT PLANNING AND PLANNING AND IMPLEMENTATION OF ELECTRONIC PATIENT TREATMENT MANAGEMENT PROGRAM; BUSINESS PROCESS RE-ENGINEERING SERVICES; BUSINESS CONSULTATION SERVICES IN THE FIELD OF CHANGE MANAGEMENT; COMPUTER SERVICES, NAMELY, INFORMATION SYSTEMS PLANNING FOR OTHERS; MEDICAL BILLING; AND BUSINESS CONSULTATION SERVICES IN THE FIELD OF CHANGE STRATEGY DEVELOPMENT (U.S. CLS. 100, 101 AND 102).

CLASS 36—INSURANCE AND FINANCIAL

FOR FINANCIAL ANALYSIS; FINANCIAL ANALYSIS OF PATIENT REIMBURSEMENT PROGRAMS (U.S. CLS. 100, 101 AND 102).

CLASS 42—SCIENTIFIC, COMPUTER AND LEGAL SERVICES

FOR DESIGN AND DEVELOPMENT FOR OTHERS OF MEDICAL TREATMENT GUIDELINES, DRUG TREATMENT REGIMENS, CLINICAL TRIALS AND MEDICAL TREATMENT PROTOCOLS; CONSULTING SERVICES IN THE FIELD OF SELECTION, IMPLEMENTATION, AND USE OF COMPUTER SOFTWARE SYSTEMS IN PATIENT TREATMENT; ANALYSIS OF PATIENT TREATMENT DATA; PATIENT OUTCOME ANALYSIS (U.S. CLS. 100 AND 101).

NOVO MIND

PRIORITY CLAIMED UNDER SEC. 44(D) ON FED REP GERMANY APPLICATION NO. 30008303.3/0, FILED 2-4-2000, REG. NO. 30008303, DATED 1-15-2001, EXPIRES 2-28-2010.

CLASS 9—ELECTRICAL AND SCIENTIFIC APPARATUS

FOR DATABASE MANAGEMENT INFORMATION SOFTWARE RECORDED ON DVD, CD-ROM, PRE-RECORDED DIGITAL AUDIO TAPES FEATURING DATABASE MANAGEMENT INFORMATION SOFTWARE (U.S. CLS. 21, 23, 26, 36 AND 38).

CLASS 38—COMMUNICATION

FOR TELECOMMUNICATION SERVICES, NAMELY, PERSONAL COMMUNICATION SERVICES OFFERED VIA THE INTERNET (U.S. CLS. 100, 101 AND 104).

CLASS 42—SCIENTIFIC, COMPUTER AND LEGAL SERVICES

FOR PROVIDING INFORMATION VIA A GLOBAL COMPUTER NETWORK CONCERNING GLOBAL COMPUTER NETWORK APPLICATIONS DEVELOPMENT IN CONNECTION WITH INFORMATION STORAGE AND INFORMATION TECHNOLOGY; COMPUTER SOFTWARE DESIGN AND DEVELOPMENT SERVICES FOR OTHERS (U.S. CLS. 100 AND 101).

SN 76-075,792. MSK VERPACKUNGS SYSTEME GESELLSCHAFT MIT BESCHRANKTER HAFTUNG, 47533 KLEVE, FED REP GERMANY, FILED 6-22-2000.

FLOWTECH

PRIORITY CLAIMED UNDER SEC. 44(D) ON FED REP GERMANY APPLICATION NO. 30012043.5, FILED 2-17-2000, REG. NO. 30012043, DATED 7-18-2000, EXPIRES 7-18-2010.

CLASS 7—MACHINERY

FOR PACKAGING MACHINES AND CONVEYORS USING PACKAGING FOIL AND PACKAGING FILMS, BELT CONVEYORS AND ROLLER CONVEYORS, FOR PACKAGING HOME APPLIANCES IN THE NATURE OF WASHING MACHINES, WASH-UP MACHINES, CLOTHES DRYERS, REFRIGERATORS, FREEZERS, AIR-CONDITIONERS, FOR PACKAGING CONTAINERS MADE OF PAPER, CARDBOARD, GLASS, AND FOR PACKAGING STONE, BUILDING MATERIALS AND BUILDING FITTINGS (U.S. CLS. 13, 19, 21, 23, 31, 34 AND 35).

CLASS 8—HAND TOOLS

FOR HAND-HELD AND HAND-OPERATED DEVICES FOR THE PACKAGING INDUSTRY FOR USE IN PACKAGING WITH FOILS OR FILMS FOR PACKAGING HOME APPLIANCES IN THE NATURE OF WASHING MACHINES, WASH-UP MACHINES, CLOTHES DRYERS, REFRIGERATORS, FREEZERS, AIR-CONDITIONERS, FOR PACKAGING CONTAINERS MADE OF PAPER, CARDBOARD, GLASS, AND FOR PACKAGING STONE, BUILDING MATERIALS AND BUILDING FITTINGS (U.S. CLS. 23, 28 AND 44).

SN 76-084,995. SYNAVANT INC., ATLANTA, GA. BY CHANGE OF NAME ST SPIN, INC., WESTPORT, CT. FILED 7-7-2000.

SYNAVANT**CLASS 9—ELECTRICAL AND SCIENTIFIC APPARATUS**

FOR COMPUTER SOFTWARE FOR THE PHARMACEUTICAL AND HEALTH CARE INDUSTRIES, NAMELY, FOR SALES PROMOTION, ADMINISTRATION, MANAGEMENT, DATABASE MANAGEMENT, TO PROVIDE DATA AND INFORMATION, IN COMPUTER READABLE FORMAT, CLIENT RELATIONSHIP MANAGEMENT SYSTEMS AND SALE FORCE AUTOMATION SYSTEMS, AND ACCOMPANYING USER MANUALS SOLD AS A UNIT (U.S. CLS. 21, 23, 26, 36 AND 38).

CLASS 35—ADVERTISING AND BUSINESS

FOR PROMOTIONAL AND MARKETING SERVICES FOR THE PHARMACEUTICAL AND HEALTH CARE INDUSTRIES, NAMELY, PROMOTING THE GOODS AND SERVICES OF OTHERS THROUGH THE DISTRIBUTION OF SAMPLES AND PROMOTIONAL MATERIALS AND MESSAGES; MANAGEMENT OF CIRCULATION LISTS OF OTHERS OF HEALTH CARE AND PHARMACEUTICAL TRADE MAGAZINES AND NEWSLETTERS (U.S. CLS. 100, 101 AND 102).

CLASS 42—SCIENTIFIC, COMPUTER AND LEGAL SERVICES

FOR MAINTENANCE OF COMPUTER SOFTWARE USED IN THE PHARMACEUTICAL AND HEALTH CARE INDUSTRIES; INTEGRATION OF COMPUTER SALES FORCE AUTOMATION, INFORMATION COMMUNICATION AND DATA MANAGEMENT SYSTEMS AND NETWORKS TO ORGANIZE AND MANAGE SALES AND MARKETING INFORMATION IN THE PHARMACEUTICAL AND HEALTH CARE INDUSTRIES; TECHNICAL SUPPORT AND TROUBLESHOOTING SERVICES FOR COMPUTER SOFTWARE VIA IN PERSON, ON-LINE, EMAIL AND TELEPHONE; CONSULTING SERVICES FOR THE PHARMACEUTICAL AND HEALTH CARE INDUSTRIES IN THE FIELD OF SALE FORCE AUTOMATION, INFORMATION COMMUNICATIONS, AND DATA MANAGEMENT (U.S. CLS. 100 AND 101).

SN 76-086,715. FEDERAL MOGUL WIESBADEN GMBH, D-65201 WIESBADEN, FED REP GERMANY, FILED 7-11-2000.

GLYCO ELBEC

PRIORITY CLAIMED UNDER SEC. 44(D) ON FED REP GERMANY APPLICATION NO. 30007866.6, FILED 2-3-2000, REG. NO. 30007866, DATED 5-15-2000, EXPIRES 2-28-2010.

CLASS 6—METAL GOODS

FOR SEMI-FINISHED METALS FOR USE IN THE MANUFACTURE OF BEARINGS (U.S. CLS. 2, 12, 13, 14, 23, 25 AND 50).

CLASS 7—MACHINERY

FOR MACHINE PARTS, NAMELY PLAIN METAL BEARINGS (U.S. CLS. 13, 19, 21, 23, 31, 34 AND 35).

SN 76-087,439. JACKSON INTERNATIONAL TRADING COMPANY KURT D. BRUHL GESELLSCHAFT MBH & CO., GRAZ, AUSTRIA, FILED 7-12-2000.



OWNER OF AUSTRIA REG. NO. 157747, DATED 2-13-1995, EXPIRES 2-13-2005.

OWNER OF U.S. REG. NOS. 1,844,016, 1,928,828 AND 1,931,817.

NO CLAIM IS MADE TO THE EXCLUSIVE RIGHT TO USE "SIMPLY THE BEST FOR MEN", APART FROM THE MARK AS SHOWN.

THE MARK CONSISTS OF A DRAWING OF A LION ABOVE THE WORDING "ADONIS SIMPLY THE BEST FOR MEN".

CLASS 3—COSMETICS AND CLEANING PREPARATIONS

FOR COSMETICS, NAMELY, FACE AND BODY CREAMS AND MOISTURIZERS, FACE AND BODY CLEANSERS, BODY AND FACE SOAPS, SHOWER GELS, HAIR AND BODY SHAMPOO AND HAIR AND BODY CONDITIONING LOTIONS AND OILS, PERFUMES, AFTERSHAVE LOTIONS AND CREAMS, DEODORANTS, MEN'S PERFUMES (U.S. CLS. 1, 4, 6, 50, 51 AND 52).

CLASS 18—LEATHER GOODS

FOR LEATHER GOODS, NAMELY, WALLETS, BRIEF-CASES, TRAVEL BAGS, COSMETIC BAGS SOLD EMPTY, BUSINESS CARD CASES, CREDIT CARD CASES, KEY CASES, UMBRELLAS (U.S. CLS. 1, 2, 3, 22 AND 41).

CLASS 25—CLOTHING

FOR MEN'S CLOTHING, NAMELY, SHIRTS, JACKETS, TROUSERS, PANTS, OVERCOATS, SPORTSCOATS, UNDERWEAR, SOCKS, TIES, HATS, SHOES, KERICHS, MUFFLERS, GLOVES (U.S. CLS. 22 AND 39).

SN 76-099,712. DOLPHIN CAPITAL AG, 81679 MUNCHEN, FED REP GERMANY, BY ASSIGNMENT; BY ASSIGNMENT FUNWORLD AG, 80333 MUNCHEN, FED REP GERMANY, FILED 7-31-2000.

funPl@yce

PRIORITY CLAIMED UNDER SEC. 44(D) ON FED REP GERMANY APPLICATION NO. 30007331.3/4, FILED 2-1-2000, REG. NO. 300073313, DATED 4-20-2000, EXPIRES 2-28-2010.

CLASS 9—ELECTRICAL AND SCIENTIFIC APPARATUS

FOR VENDING MACHINES, KARAOKE MACHINES, DVD PLAYERS, SLOT MACHINES; AUDIO MIXERS, AUDIO ENTERTAINMENT SYSTEMS COMPRISING RECEIVER, AUDIO TAPE PLAYER, CD PLAYER AND SPEAKERS; VIDEO GAME MACHINES AND PINBALL MACHINES; COIN HANDLING MECHANISMS FOR COIN-OPERATED MACHINES; COMPACT DISC ROMS FEATURING MUSIC AND GAMES; COMPACT DISCS FEATURING SOUND AND VIDEO DATA; COMPUTERS; COMPUTER SOFTWARE TO OPERATE GAME AND MUSIC MACHINES; COMPUTER OPERATING PROGRAMS; COMPUTER PERIPHERAL DEVICES; MAGNETIC AND OPTICAL SOFTWARE IN THE NATURE OF DISCS FEATURING SOFTWARE TO OPERATE GAME AND MUSIC MACHINES; SLIDE PROJECTORS; BLANK COMPUTER MAGNETIC DATA STORAGE DISKETTES; TELEVISION SETS; COIN-OPERATED MECHANISMS FOR TELEVISION SETS; INTERFACES NAMELY FOR GAME AND MUSIC MACHINES; LAPTOP COMPUTERS; LASERS, NOT FOR MEDICAL PURPOSES; MODEMS; COMPUTER MONITORS; MUSICAL JUKE BOXES; COIN-OPERATED MUSICAL JUKE BOXES; VIDEO PROJECTION APPARATUS, NAMELY PROJECTION TELEVISION AND COMPUTER SETS; PROJECTION SCREENS; PHOTOGRAPHIC PROJECTORS; SLIDE PROJECTORS' RADIO; VIDEO GAMES FOR USE WITH TELEVISION SETS; SOUND RECORDING APPARATUS, NAMELY TAPE RECORDERS; SOUND RECORDING CARRIERS, NAMELY AUDIO CASSETTES RECORDERS, CD RECORDERS, PHONOGRAPHIC RECORDERS; SOUND REPRODUCTION APPARATUS, NAMELY AUDIO CASSETTE PLAYERS (U.S. CLS. 21, 23, 26, 36 AND 38).

CLASS 35—ADVERTISING AND BUSINESS

FOR ECONOMIC FORECASTING AND ANALYSIS; CONSULTATION IN CONNECTION WITH ORGANIZING AND MANAGING BUSINESS ENTERPRISES COUNSELING WITH ORGANIZING AND MANAGING ENTERPRISES; PROVIDING TELEVISION ADVERTISING FOR OTHERS; MARKET RESEARCH; DISSEMINATION OF ADVERTISING FOR OTHERS; MODELING SERVICES FOR ADVERTISING AND SALES PROMOTING PURPOSES; PUBLIC OPINION POLLING FOR BUSINESS OR ADVERTISING PURPOSES; PUBLICITY AGENCY SERVICES; PUBLIC RELATIONS; RENDERING SALES PROMOTION ADVICE; MAIL ORDER SERVICES FEATURING MUSIC TAPES, COMPUTER GAMES, GAMES, MAGAZINES AND CLOTHES; DISTRIBUTION OF FREE SAMPLES FOR PROMOTION PURPOSES; DEMONSTRATION OF GOODS FOR PROMOTION PURPOSES; ADVERTISING AGENCY SERVICES; RENTAL OF ADVERTISING SPACE; DISSEMINATION OF ADVERTISING BROCHURES; PROMOTING THE LIVE CONCERT EVENTS OF OTHERS; ARRANGING BUSINESS CONFERENCES (U.S. CLS. 100, 101 AND 102).

CLASS 41—EDUCATION AND ENTERTAINMENT

FOR ORGANIZING EXHIBITIONS AND FAIRS FOR ENTERTAINMENT; ENTERTAINMENT CLUBS; PROVIDING CASINO FACILITIES, PROVIDING SPORTING EVENT FACILITIES; AMUSEMENT PARKS; DISCOTHEQUES; RENTAL OF TELEVISION SETS AND RADIOS; PRODUCTION OF TELEVISION ENTERTAINMENT PROGRAMS; MOTION PICTURE FILM PRODUCTION; ORGANIZING SPARE TIME ACTIVITIES, NAMELY, ORGANIZING COMMUNITY FESTIVALS FEATURING SPORTING EVENTS, ART EXHIBITIONS, FLEA MARKETS, ETHNIC DANCES AND THE LIKE; GOLF COURSES; PROVIDING COURSES OF INSTRUCTION AT THE KINDERGARTEN LEVEL; RENTAL OF CINEMATIC MOTION PICTURE FILMS; CINEMA THEATERS; REALIZING LIVE CONCERT EVENTS; LOTTERY SERVICES; ARRANGING AND CONDUCTING EDUCATIONAL CONFERENCES; ARRANGING FOR TICKET RESERVATIONS FOR ENTERTAINMENT EVENTS; SCHEDULING OF RADIO AND TELEVISION PROGRAMS; ENTERTAINMENT IN THE NATURE OF BEAUTY PAGEANTS; PRODUCTION OF ENTERTAINMENT SHOWS, NAMELY, OPERA, CONCERTS, LIVE MUSIC SHOWS, TELEVISION SHOWS, RADIO PROGRAMS, PLAYS AND THEATER PRODUCTIONS; PROVIDING SPORT CAMP FACILITIES; ORGANIZING AND CONDUCTING EDUCATIONAL SYMPOSIUMS IN THE FIELDS OF ENTERTAINMENT SERVICES, ADVERTISING, PUBLIC RELATIONS, ECONOMIC FORECASTING AND ANALYSIS, MARKET RESEARCH AND BUSINESS PROMOTION; RENTAL OF SOUND RECORDINGS; SOUND RECORDING STUDIOS; VIDEO FILM PRODUCTION (U.S. CLS. 100, 101 AND 107).

SN 76-107,532. ORCA VISION, INC., CHIYODA-KU, TOKYO, JAPAN, FILED 8-10-2000.

ORCA VISION

PRIORITY CLAIMED UNDER SEC. 44(D) ON JAPAN APPLICATION NO. 2000-033326, FILED 3-31-2000, REG. NO. 4515382, DATED 10-19-2001, EXPIRES 10-19-2011.

NO CLAIM IS MADE TO THE EXCLUSIVE RIGHT TO USE "VISION", APART FROM THE MARK AS SHOWN.

CLASS 9—ELECTRICAL AND SCIENTIFIC APPARATUS

FOR COMPUTERS AND COMPUTER SOFTWARE FOR PRODUCING AND DISTRIBUTING DIGITAL IMAGES AND EDUCATION; PHOTOGRAPHIC SLIDE TRANSPARENCIES; SLIDE FILM MOUNTS; PRE-RECORDED VIDEO DISCS AND VIDEO TAPES FEATURING INFORMATION TECHNOLOGY, EDUCATION AND WEB CONTENT (U.S. CLS. 21, 23, 26, 36 AND 38).

CLASS 35—ADVERTISING AND BUSINESS

FOR DISSEMINATION OF ADVERTISING FOR OTHERS; PROMOTING THE SALE OF GOODS AND SERVICES OF OTHERS THROUGH THE DISTRIBUTION OF PRINTED MATERIALS; PROVIDING AUCTION SERVICES (U.S. CLS. 100, 101 AND 102).

CLASS 36—INSURANCE AND FINANCIAL

FOR PROVIDING ELECTRONIC FUNDS TRANSFER SERVICES; PROVIDING STOCK QUOTATIONS (U.S. CLS. 100, 101 AND 102).

CLASS 38—COMMUNICATION

FOR TELEVISION BROADCASTING VIA THE INTERNET; ELECTRONIC TRANSMISSION OF IMAGES VIA COMPUTER TERMINALS; TELEVISION BROADCASTING; CABLE TELEVISION BROADCASTING; RADIO BROADCASTING; MOBILE TELEPHONE COMMUNICATION SERVICES; COMMUNICATIONS BY COMPUTER TERMINALS, NAMELY, ELECTRONIC TRANSMISSION OF DATA AND DOCUMENTS VIA COMPUTER TERMINALS; COMMUNICATIONS BY TELEGRAPH; TELEPHONE COMMUNICATION; COMMUNICATIONS BY FACSIMILE; PAGING BY RADIO; TRANSMITTING STREAMING AUDIO VIA THE INTERNET; COMMUNICATIONS VIA TELEPRINTER EXCHANGE (U.S. CLS. 100, 101 AND 104).

CLASS 39—TRANSPORTATION AND STORAGE

FOR MAKING RESERVATIONS AND BOOKINGS FOR TRANSPORTATION VIA THE INTERNET (U.S. CLS. 100 AND 105).

CLASS 41—EDUCATION AND ENTERTAINMENT

FOR PRODUCTION OF TELEVISION PROGRAMS INCLUDING PROGRAMS BROADCAST VIA THE INTERNET; DISTRIBUTION OF TELEVISION PROGRAMS FOR OTHERS; EDUCATIONAL SERVICES, NAMELY, CONDUCTING CLASSES, SEMINARS, CONFERENCES, WORKSHOPS IN THE FIELD OF ARTS AND SPORTS; EDUCATIONAL SERVICES, NAMELY CONDUCTING LECTURES, PRESENTATIONS, DEBATES, STUDIES AND TRAINING CLASSES OR COURSES RELATING TO OPERATION AND MANAGEMENT OF THE INTERNET AND TECHNICAL CONTENTS THEREOF; PROVIDING CONCERT BOOKING SERVICES (U.S. CLS. 101 AND 107).

SN 76-114,023. IEC LOGISTICS, INC., LAVERGNE, TN. FILED 8-22-2000.



NO CLAIM IS MADE TO THE EXCLUSIVE RIGHT TO USE "THE GLOBAL LOGISTICS COMPANY", APART FROM THE MARK AS SHOWN.

CLASS 35—ADVERTISING AND BUSINESS

FOR BUSINESS MANAGEMENT SERVICES, NAMELY, MANAGING GLOBAL CARGO SERVICES FOR OTHERS; SUPPLY CHAIN MANAGEMENT; BUSINESS MANAGEMENT CONSULTATION NAMELY DEVELOPING VALUE-ADDED LOGISTICS SOLUTIONS FOR OTHERS USING INFORMATION TECHNOLOGY; CUSTOMERS CLEARANCE SERVICES (U.S. CLS. 100, 101 AND 102).

FIRST USE 9-23-1999; IN COMMERCE 9-23-1999.

CLASS 39—TRANSPORTATION AND STORAGE

FOR FREIGHT FORWARDING SERVICES INCLUDING AIR FREIGHT, EXPRESS DISTRIBUTION, OVERLAND DISTRIBUTION, OCEAN FREIGHT, AND SPECIALIZED DISTRIBUTION SERVICES (U.S. CLS. 100 AND 105).

FIRST USE 9-23-1999; IN COMMERCE 9-23-1999.

SN 76-122,397. DT SWISS AG, CH-2504 BIEL, SWITZERLAND, FILED 9-5-2000.



PRIORITY CLAIMED UNDER SEC. 44(D) ON SWITZERLAND APPLICATION NO. 02529/2000, FILED 3-3-2000, REG. NO. 476268, DATED 9-4-2000, EXPIRES 3-3-2010.

OWNER OF U.S. REG. NOS. 1,631,512, 2,121,337 AND OTHERS.

NO CLAIM IS MADE TO THE EXCLUSIVE RIGHT TO USE "COMPETITION", APART FROM THE MARK AS SHOWN.

CLASS 12—VEHICLES

FOR BICYCLES AND PARTS THEREOF, NAMELY, EXPANDERS, STANDS, BAR ENDS, SEAT POSTS, HUBS, SPOKES, SPOKE NIPPLES, RIMS, RIM TAPES, CRANKS, TIRES, HANDLE BARS, STEMS, MUD GUARDS, MUD GUARD FASTENING RODS, AND LUGGAGE CARRIERS; MOTORCYCLES AND PARTS THEREOF, NAMELY, HUBS, SPOKES AND SPOKE NIPPLES, RIMS, RIM TAPES, CRANKS, TIRES, HANDLE BARS, STEMS, MUD GUARDS, MUD GUARD FASTENING RODS, AND LUGGAGE CARRIERS; HUBS FOR WHEELCHAIRS (U.S. CLS. 19, 21, 23, 31, 35 AND 44).

CLASS 25—CLOTHING

FOR SPORTS AND LEISURE CLOTHING, NAMELY T-SHIRTS, TRACK SUITS, SPORTS TROUSERS, SPORTS SHOES, BASEBALL CAPS, SPORTS SUITS, SPORTS UNDERWEAR, STOCKINGS AND TRICOTS, NAMELY, SPORTS SHIRTS (U.S. CLS. 22 AND 39).

SN 76-124,208. MOTT METALLURGICAL CORPORATION, FARMINGTON, CT. FILED 9-7-2000.

**THINK OF THE
POSSIBILITIES****CLASS 6—METAL GOODS**

FOR DISCS, TUBES, CUPS, SHEETS AND BUSHINGS, ALL MADE OF POROUS METAL, FOR USE IN INDUSTRIAL AND LABORATORY PROCESSES IN THE CHEMICAL, PETROCHEMICAL, SEMICONDUCTOR, FOOD AND BEVERAGE, PHARMACEUTICAL, POWER GENERATION, AEROSPACE, PULP AND PAPER, INSTRUMENTATION AND TEXTILE INDUSTRIES (U.S. CLS. 2, 12, 13, 14, 23, 25 AND 50).

CLASS 11—ENVIRONMENTAL CONTROL APPARATUS

FOR AUTOMATED FILTRATION SYSTEMS COMPRISED OF HOUSINGS, VESSELS, CONTROLS, VALVES, PIPING AND ONE OR MORE OF GAS, LIQUID AND FILTERS, THE FILTERS BEING MADE OF POROUS METAL, THE AUTOMATED FILTRATION SYSTEMS BEING FOR USE IN INDUSTRIAL AND LABORATORY PROCESSES IN THE CHEMICAL, PETROCHEMICAL, SEMICONDUCTOR, FOOD AND BEVERAGE, PHARMACEUTICAL, POWER GENERATION, AEROSPACE, PULP AND PAPER, INSTRUMENTATION AND TEXTILE INDUSTRIES, AND REPLACEMENT PARTS FOR THE AUTOMATED FILTRATION SYSTEMS (U.S. CLS. 13, 21, 23, 31 AND 34).

SN 76-125,136. BRYAN CAVE LLP, ST. LOUIS, MO. FILED 9-8-2000.

SN 76-134,863. DT SWISS AG, BIEL, SWITZERLAND, FILED 9-25-2000.

IP ZONE



NO CLAIM IS MADE TO THE EXCLUSIVE RIGHT TO USE "IP", APART FROM THE MARK AS SHOWN.

CLASS 41—EDUCATION AND ENTERTAINMENT

FOR PROVIDING INTERACTIVE ONLINE CLASSES AND TRAINING REGARDING INTELLECTUAL PROPERTY, LEGAL RESEARCH, LEGAL RESOURCES AND LEGAL SERVICES; PROVIDING ONLINE INFORMATION IN THE FIELD OF INTELLECTUAL PROPERTY TRAINING (U.S. CLS. 100, 101 AND 107).

CLASS 42—SCIENTIFIC, COMPUTER AND LEGAL SERVICES

FOR INTELLECTUAL PROPERTY CONSULTATION PROVIDED ONLINE, NAMELY, PROVIDING ANALYTICAL PROCESSES, METHODS, DECISION TREES AND INFORMATION IN THE FIELDS OF LEGAL DECISION MAKING (U.S. CLS. 100 AND 101).

PRIORITY CLAIMED UNDER SEC. 44(D) ON SWITZERLAND APPLICATION NO. 08487/2000, FILED 7-17-2000, REG. NO. 480767, DATED 9-5-2002, EXPIRES 9-5-2012.

OWNER OF U.S. REG. NOS. 1,631,512, 2,121,337 AND OTHERS.

CLASS 12—VEHICLES

FOR BICYCLES AND PARTS THEREOF, EXPANDERS, STANDS, BAR ENDS, SEAT POSTS, HUBS, SPOKES, SPOKE NIPPLES, RIMS, RIM TAPES, CRANKS, TIRES, HANDLE BARS, STEMS, MUD GUARDS, MUD GUARD FASTENING RODS, SPOKE CLIPS FOR WHEELS, AND LUGGAGE CARRIERS; MOTORCYCLES AND PARTS THEREOF, NAMELY, HUBS, SPOKES AND SPOKE NIPPLES, RIMS, RIM TAPES, CRANKS, TIRES, HANDLE BARS, STEMS, MUD GUARDS, MUD GUARD FASTENING RODS, SPOKE CLIPS FOR WHEELS, AND LUGGAGE CARRIERS (U.S. CLS. 19, 21, 23, 31, 35 AND 44).

CLASS 25—CLOTHING

FOR SPORTS AND LEISURE CLOTHING, NAMELY, T-SHIRTS, TRACK SUITS, SPORT TROUSERS, SPORT SHOES, BASKETBALL CAPS, SPORTS SUITS, SPORTS UNDERWEAR, STOCKINGS AND TRICOTS, NAMELY, SPORTS SHIRTS (U.S. CLS. 22 AND 39).

SN 76-130,062. STARGAZER GROUP, LLC, MCLEAN, VA. FILED 9-18-2000.

SN 76-135,524. NEILL CORPORATION, HAMMOND, LA. FILED 9-26-2000.

DOT.COMMONS

CLASS 35—ADVERTISING AND BUSINESS

FOR COMPUTER SERVICES, NAMELY, PROMOTING THE GOODS AND SERVICES OF OTHERS BY PROVIDING HYPOERTEXT LINKS TO THE WEBSITES OF OTHERS PROVIDED BY WEBSITE USERS (U.S. CLS. 100, 101 AND 102).

CLASS 38—COMMUNICATION

FOR COMPUTER SERVICES, NAMELY, PROVIDING ON-LINE COLLABORATION FACILITIES OVER A GLOBAL COMPUTER NETWORK COMPRISING MESSAGE BOARDS, VIRTUAL CONFERENCE ROOMS AND MODERATED REAL TIME DISCUSSIONS (U.S. CLS. 100, 101 AND 104).

HAIR ESSENTIALS

NO CLAIM IS MADE TO THE EXCLUSIVE RIGHT TO USE "HAIR", APART FROM THE MARK AS SHOWN.

CLASS 11—ENVIRONMENTAL CONTROL APPARATUS

FOR HAND HELD ELECTRIC HAIR DRYERS (U.S. CLS. 13, 21, 23, 31 AND 34).
FIRST USE 1-1-1999; IN COMMERCE 1-1-1999.

CLASS 21—HOUSEWARES AND GLASS

FOR HAIR BRUSHES (U.S. CLS. 2, 13, 23, 29, 30, 33, 40 AND 50).
FIRST USE 1-1-1999; IN COMMERCE 1-1-1999.

SN 76-137,618. OAKSTONE PUBLISHING LLC, BIRMINGHAM, AL. FILED 9-29-2000.

SN 76-157,144. M' LIS COMPANY, INC., THE, SALT LAKE CITY, UT. FILED 10-31-2000.

OAKSTONE

CLASS 9—ELECTRICAL AND SCIENTIFIC APPARATUS

FOR PRE-RECORDED AUDIO CASSETTES FEATURING MEDICAL, LEGAL AND EDUCATIONAL INFORMATION; MULTIMEDIA SOFTWARE RECORDED ON CD-ROM FEATURING INSTRUCTIONAL VIDEOS, SLIDES AND TEXT FOR USE IN THE MEDICAL, LEGAL AND EDUCATIONAL INDUSTRIES (U.S. CLS. 21, 23, 26, 36 AND 38).

FIRST USE 12-0-1998; IN COMMERCE 12-0-1998.

CLASS 16—PAPER GOODS AND PRINTED MATTER

FOR BOOKS, BOOKLETS AND NEWSLETTERS FEATURING MEDICAL, LEGAL AND EDUCATIONAL INFORMATION (U.S. CLS. 2, 5, 22, 23, 29, 37, 38 AND 50).

FIRST USE 1-0-1999; IN COMMERCE 1-0-1999.

CLASS 35—ADVERTISING AND BUSINESS

FOR COMPUTERIZED ONLINE RETAIL SERVICES IN THE FIELD OF PRINTED PUBLICATIONS AND DATA RECORDED ON CD-ROM'S AND AUDIO CASSETTES FEATURING MEDICAL, LEGAL AND EDUCATIONAL INFORMATION (U.S. CLS. 100, 101 AND 102).

FIRST USE 10-8-1998; IN COMMERCE 10-8-1998.

SN 76-144,314. PRODUCTION FINANCE INTERNATIONAL L.L.C., SPOKANE, WA. BY ASSIGNMENT; BY ASSIGNMENT; BY ASSIGNMENT SWAG INDUSTRIES, CARLSBAD, CA. FILED 10-11-2000.

TWIST

OWNER OF U.S. REG. NO. 2,433,990.

CLASS 9—ELECTRICAL AND SCIENTIFIC APPARATUS

FOR PROTECTIVE HELMETS FOR SNOWBOARDERS (U.S. CLS. 21, 23, 26, 36 AND 38).

CLASS 25—CLOTHING

FOR FOOTWEAR (U.S. CLS. 22 AND 39).

M' LIS

CLASS 3—COSMETICS AND CLEANING PREPARATIONS

FOR FACIAL CREAM; FACIAL CLEANSING CREAM; FACIAL CLEANSING LOTION; FACIAL CLEANSER; FACIAL SCRUBS; FACIAL EMOLLIENTS; FACIAL SCRUBS, NAMELY, FACIAL EXFOLIANTS; FACIAL LOTION; FACIAL MOISTURIZER; FACIAL EMOLLIENTS, NAMELY FACIAL SOFTENERS; FACIAL TONER; FACIAL SOAP; ESSENTIAL OILS FOR PERSONAL USE, NAMELY, FACIAL OIL; FACIAL NOURISHING CREAM; FACE POWDER; FACE LIFT POWDER; FACIAL CREAM, NAMELY, FACE LIFT GLYCOLIC ACID TREATMENT; FACIAL LOTION, NAMELY, FACE LIFE GLYCOLIC ACID TREATMENT; FACIAL MASKS; FACE LIFT MASKS; FACIAL MASK ACTIVATORS; SKIN CREAM; SKIN CLEANSING CREAM; SKIN CLEANSING LOTION; SKIN CLEANSER; SKIN EMOLLIENTS; SKIN SCRUBS, NAMELY, SKIN EXFOLIANTS; SKIN LOTION; SKIN MOISTURIZER; SKIN EMOLLIENTS, NAMELY, SKIN SOFTENERS; SKIN TONER; SKIN SOAP; ESSENTIAL OILS FOR PERSONAL USE, NAMELY, SKIN OIL; SKIN NOURISHING CREAM; SKIN CELLULITE CREAM; SKIN POWDER; BODY MASKS; BODY MASK ACTIVATORS; BODY WRAP CREAM; ESSENTIAL OILS FOR PERSONAL USE, NAMELY, BODY OIL; BODY POWDER; BATH OIL; AND MASSAGE OIL (U.S. CLS. 1, 4, 6, 50, 51 AND 52).

FIRST USE 2-25-1993; IN COMMERCE 2-25-1993.

CLASS 5—PHARMACEUTICALS

FOR NUTRITIONAL SUPPLEMENTS; HERBAL SUPPLEMENTS; VITAMIN SUPPLEMENTS; MINERAL SUPPLEMENTS; VITAMINS; MINERALS; AMINO ACIDS FOR USE AS DIETARY SUPPLEMENTS; DIETARY SUPPLEMENTS, NAMELY, NATURAL OILS; HERBAL SUPPLEMENTS, NAMELY, NATURAL OILS; DETOXIFICATION FORMULATIONS AND HERBAL CLEANSERS; AND DIETARY SUPPLEMENTS, NAMELY NATURALLY OCCURRING SUBSTANCES AND PREPARATIONS FOR USE IN DETOXIFICATION, CLEANSING, RESTORING HEALTH AND CONTOURING OF THE BODY, AND IN THE TREATMENT OF DRY SKIN, WRINKLED SKIN, PREMATURE WRINKLING, DAMAGED SKIN, ACNE, BLACKHEADS, BLEMISHES, ENLARGED PORES, CLOGGING OF THE PORE, DEAD SKIN CELLS, EXCESS OILS, OXIDATION CONDITIONS, FACIAL CONDITIONS, SKIN CONDITIONS, SCAR TISSUE FORMATION, DAMAGED HAIR, HAIR CONDITIONS, SCALP CONDITIONS, BACTERIA CONDITIONS, FUNGUS CONDITIONS, EXCESS WEIGHT, EXCESS FAT, WATER-WEIGHT GAIN, WATER RETENTION, EXCESS CELLULITE, HEADACHES, NASAL CONGESTION, ALLERGIES, MENTAL CONFUSION, STRESS, NERVOUS TENSION, CHEMICAL DEPENDENCIES, ABDOMINAL CRAMPS, STOMACH DISTRESS, INTESTINAL DISTRESS, GASTROINTESTINAL PRESSURE, BLOOD CONDITIONS, LYMPHATIC CONDITIONS, COLON CONDITIONS, BOWEL CONDITIONS, INTESTINE CONDITIONS, DIGESTIVE IRREGULARITIES, DIGESTIVE CONDITIONS, CONSTIPATION, DIETARY DEFICIENCIES, NUTRITIONAL DEFICIENCIES, WASTE ELIMINATION CONDITIONS, BODY TOXINS, BODY ODOR, BLOOD CIRCULATORY CONDITIONS, CHOLESTEROL, EDEMA, SWELLING, INFLAMMATION, INFECTIONS, YEAST INFECTIONS, PARASITES, PREMENSTRUAL CONDITIONS, MENSTRUAL CONDITIONS, POST MENSTRUAL SYNDROME, HORMONAL IMBALANCE, INFLAMMATION OF THE JOINTS, ARTHRITIS, OSTEOPOROSIS, CONDITIONS OF THE JOINTS, INSUFFICIENT GROWTH, METABOLIC CONDITIONS, PREMATURE AGING, CONDITIONS ASSOCIATED WITH AGING, LOW ENERGY, AND POOR HEALTH (U.S. CLS. 6, 18, 44, 46, 51 AND 52).

FIRST USE 2-25-1993; IN COMMERCE 2-25-1993.

SN 76-159,969. ENGENDERHEALTH, NEW YORK, NY. BY CHANGE OF NAME AVSC INTERNATIONAL, NEW YORK, NY. FILED 11-7-2000.

ENGENDERHEALTH

CLASS 41—EDUCATION AND ENTERTAINMENT

FOR EDUCATIONAL SERVICES, NAMELY, CONDUCTING CLASSES, SEMINARS, CONFERENCES, WORKSHOPS AND ONE-ON-ONE INSTRUCTION IN THE FIELD OF WOMEN'S REPRODUCTIVE HEALTH, FAMILY PLANNING AND COMMUNITY HEALTH (U.S. CLS. 100, 101 AND 107).

CLASS 42—SCIENTIFIC, COMPUTER AND LEGAL SERVICES

FOR MEDICAL CONSULTATION IN THE FIELDS OF WOMEN'S REPRODUCTIVE HEALTH, FAMILY PLANNING AND COMMUNITY HEALTH (U.S. CLS. 100 AND 101).

SN 76-162,662. RJMF, PARIS, FRANCE, BY CHANGE OF NAME LA TECHNIQUE FRANCAISE DU NETTOYAGE, 75019 PARIS, FRANCE, FILED 11-10-2000.



OWNER OF FRANCE REG. NO. 003007507, DATED 2-15-2000, EXPIRES 2-15-2010.

NO CLAIM IS MADE TO THE EXCLUSIVE RIGHT TO USE "GROUPE AND "SERVICE GLOBAL", APART FROM THE MARK AS SHOWN.

THE WORD "GROUPE" TRANSLATES INTO ENGLISH AS "GROUP".

CLASS 35—ADVERTISING AND BUSINESS

FOR ADVERTISING AGENCIES; PREPARING AND PLACING ADVERTISEMENTS FOR OTHERS; DISSEMINATION OF ADVERTISING FOR OTHERS VIA ONLINE ELECTRONIC COMMUNICATIONS NETWORKS; DIRECT MAIL ADVERTISING; COMMERCIAL BUSINESS MANAGEMENT; BUSINESS MANAGEMENT ADMINISTRATION, OFFICE FUNCTIONS, NAMELY, PREPARING BUSINESS REPORTS, SAMPLE AND HANDBILL DISTRIBUTION, ACCOUNTING SERVICES, DOCUMENT REPRODUCTION, EMPLOYMENT AGENCIES, COMPUTERIZED FILE MANAGEMENT; ARRANGING NEWSPAPER SUBSCRIPTIONS FOR THE PUBLICATIONS OF OTHERS; BUSINESS CONSULTANCY; BUSINESS INFORMATION ON IMPORT/EXPORT AND PRODUCT SALES; ORGANIZING EXHIBITIONS FOR COMMERCIAL OR ADVERTISING PURPOSES IN THE FIELDS OF CLEANING OF BUILDINGS, SECURITY, BUILDING MAINTENANCE, NAMELY, MAINTENANCE OF HEATING, AIR-CONDITIONING, VENTILATION, ROOFING, ELECTRICAL SYSTEMS AND PLUMBING INSTALLATIONS, AS WELL AS MAINTENANCE OF WATER AND AIR TIGHTNESS SYSTEMS; RENTAL OF VENDING MACHINES (U.S. CLS. 100, 101 AND 102).

CLASS 36—INSURANCE AND FINANCIAL

FOR INSURANCE ADMINISTRATION; INSURANCE UNDERWRITING IN THE FIELD OF LIFE, HEALTH, ACCIDENT, FIRE; FINANCIAL AFFAIRS, NAMELY, FINANCIAL ANALYSIS AND CONSULTATION; FINANCIAL MANAGEMENT; FINANCIAL RESEARCH; FINANCIAL PLANNING; MONETARY AFFAIRS, NAMELY, MONETARY EXCHANGE, BANKING SERVICES, FUNDS INVESTMENT; REAL ESTATE AFFAIRS, NAMELY, REAL ESTATE INVESTMENT, REAL ESTATE BROKERAGE, REAL ESTATE AGENCIES; SAVINGS BANK SERVICES; TRAVEL AGENCY SERVICES, NAMELY, ISSUING TRAVELERS' CHECKS; ISSUING LETTERS OF CREDIT FOR OTHERS; APARTMENT HOUSE MANAGEMENT (U.S. CLS. 100, 101 AND 102).

CLASS 37—CONSTRUCTION AND REPAIR

FOR BUILDING CONSTRUCTION AND REPAIR, INSTALLATION OF ELECTRICAL SYSTEMS, AIR CONDITIONING SYSTEMS, APPLIANCES, WINDOWS, ROOFING, PIPELINES, BUILDING INSULATION; PUBLIC AND RURAL WORKS, NAMELY, EXCAVATION SERVICES, INSTALLATION AND REPAIR OF IRRIGATION SYSTEMS, INSTALLING SEPTIC TANKS, ROAD CONSTRUCTION; DRILLING OF WELLS; RENTAL OF CONSTRUCTION AND BUILDING EQUIPMENT, BULLDOZERS AND EXCAVATORS OF TREES; MAINTENANCE AND CLEANING OF BUILDINGS, INCLUDING ROOMS AND FLOORS; APPLICATION OF PROTECTIVE COATINGS TO FACADES OF STRUCTURES; DISINFECTING; PEST CONTROL; LAUNDERING OF CLOTH, CLOTHING, FABRIC, LINEN, TEXTILES; REPAIR AND TRANSFORMATION OF CLOTHING; RETREADING OF TIRES; SHOE REPAIR; INSTALLATION, MAINTENANCE AND REPAIR OF AIR CONDITIONING APPARATUS AND OF ELECTRIC APPARATUS, NAMELY, MOTORS, HEATING APPARATUS, RETINNING (U.S. CLS. 100, 103 AND 106).

CLASS 38—COMMUNICATION

FOR ELECTRONIC TRANSMISSION OF DATA AND DOCUMENTS VIA COMPUTER TERMINALS (U.S. CLS. 100, 101 AND 104).

CLASS 39—TRANSPORTATION AND STORAGE

FOR TRANSPORT BY ROAD, FERRY, BOAT, RAIL, AIR; PACKAGING OF GOODS FOR TRANSPORTATION; STORAGE OF GOODS; TRAVEL AGENCY SERVICES, NAMELY, MAKING RESERVATIONS AND BOOKINGS FOR TRANSPORTATION; TRAVEL BOOKING AGENCIES; ARRANGING TRAVEL TOURS; DELIVERY OF NEWSPAPERS; PUBLIC UTILITY SERVICES IN THE NATURE OF WATER AND ELECTRICITY DISTRIBUTION; OPERATION OF TRANSPORTER BRIDGES; MARITIME TOWING, UNLOADING AND RELOADING OF SHIPS; STORAGE OF CLOTHING; FROZEN-FOOD LOCKER RENTAL; RENTAL OF GARAGE SPACE; BOOKING OF SEATS FOR TRAVEL AND TRANSPORTATION (U.S. CLS. 100 AND 105).

CLASS 40—MATERIAL TREATMENT

FOR TREATMENT OF METAL, PAPER, FUEL; TRANSFORMATION OF OTHERS' AGRICULTURAL GOODS, NAMELY, FOOD PROCESSING, VINIFICATION, DISTILLATION, THRESHING, FRUIT PRESSING AND FLOUR-MILLING; SAWMILL PLANING; EMBROIDERING; DRESSMAKING; CUTTING OF CLOTH, FABRIC, TEXTILES; POLISHING OF METAL, GLASS; APPLYING PROTECTIVE COATINGS TO METAL; DYEING OF FABRICS AND CLOTHING; ANTI-MOTH TREATMENT OF FABRICS; WATERPROOFING OF FABRICS; BINDING OF DOCUMENTS; AIR PURIFICATION AND REGENERATION; VULCANIZATION IN THE NATURE OF MATERIAL TREATMENT; TIRE VULCANIZATION; PHOTOGRAPHIC PRINTING, PRINTING (U.S. CLS. 100, 103 AND 106).

CLASS 42—SCIENTIFIC, COMPUTER AND LEGAL SERVICES

FOR RESTAURANT SERVICES; PROVIDING TEMPORARY HOUSING ACCOMMODATION; MEDICAL SERVICES, HYGIENIC AND BEAUTY CARE, NAMELY, BEAUTY SALONS, HEALTH SPAS; VETERINARY SERVICES; AGRICULTURAL ADVICE; LEGAL SERVICES; SCIENTIFIC AND INDUSTRIAL RESEARCH; COMPUTER PROGRAMMING FOR OTHERS; CONVALESCENT HOMES; NURSERIES AND DAY CARE CENTERS; MARRIAGE BUREAUS; UNDERTAKING; ENGINEERING, TECHNICAL CONSULTATION AND PLANNING IN THE FIELD OF ENGINEERING; ENGINEERING DRAWING, NOT FOR CONSTRUCTION; GEOLOGICAL PROSPECTING; MATERIAL TESTING; MEDICAL, OPTICAL, CHEMICAL AND DENTAL LABORATORIES; RENTAL OF FARMING EQUIPMENT, CLOTHING AND BEDDING; NEWS AGENCIES, NAMELY, GATHERING AND DISSEMINATION OF NEWS; NEWS REPORTING SERVICES; PROVIDING FACILITIES FOR EXHIBITIONS; LAWN CARE; AND CARE TAKING, NAMELY, NURSING CARE, CHILD CARE, REAL ESTATE EXPERT LAND SURVEYING SERVICES (U.S. CLS. 100 AND 101).

SN 76-170,269. ATLANTES SERVES, INC., MENLO PARK, CA. BY CHANGE OF NAME @LANTES.COM SERVICES, INC., DBA ATLANTES, MENLO PARK, CA. FILED 11-22-2000.

ATLANTES**CLASS 9—ELECTRICAL AND SCIENTIFIC APPARATUS**

FOR COMPUTER SOFTWARE AND HARDWARE FOR USE IN CONNECTION WITH MANAGING AND TRACKING PEOPLE, GOODS, INVENTORY AND ACCESS TO AND FROM SECURED AND UNSECURED LOCATIONS (U.S. CLS. 21, 23, 26, 36 AND 38).

CLASS 42—SCIENTIFIC, COMPUTER AND LEGAL SERVICES

FOR COMPUTER SERVICES, NAMELY, PROVIDING A CUSTOMIZED DATABASE FOR MANAGING AND TRACKING PEOPLE, GOODS, INVENTORY AND ACCESS TO AND FROM SECURED AND UNSECURED LOCATIONS (U.S. CLS. 100 AND 101).

SN 76-173,182. ER&P GMBH, D07745 JENA, FED REP GERMANY, FILED 11-28-2000.

GODYO**CLASS 35—ADVERTISING AND BUSINESS**

FOR BUSINESS CONSULTING SERVICES REGARDING THE ORGANIZATION AND MANAGEMENT OF ENTERPRISES (U.S. CLS. 100, 101 AND 102).

CLASS 42—SCIENTIFIC, COMPUTER AND LEGAL SERVICES

FOR COMPUTER CONSULTATION SERVICE, DESIGN AND UPDATING OF COMPUTER SOFTWARE (U.S. CLS. 100 AND 101).

SN 76-173,745. HONEYWELL INTERNATIONAL INC., MORRISTOWN, NJ. FILED 12-1-2000.

AVIENT**CLASS 9—ELECTRICAL AND SCIENTIFIC APPARATUS**

FOR COMPUTER SOFTWARE FOR USE IN ORGANIZATION, COORDINATION AND SCHEDULING IN THE FIELDS OF AVIATION SYSTEM OPERATIONS, AVIATION MAINTENANCE AND ENGINEERING, AVIATION STATION OPERATIONS, AVIATION AIR TRAFFIC CONTROL COORDINATION, AVIATION DISPATCH OPERATIONS, AVIATION RAMP OPERATIONS, AVIATION SCHEDULING, AVIATION DECISION SUPPORT, AIRPORT LANDING SYSTEMS, AIRPORT RAMP OPERATIONS, AIRPORT OPERATIONS SUPPORT, AIRPORT INTEGRATED SYSTEMS, AIR TRAFFIC CONTROL OPERATIONS SUPPORT, AND TRANSPORTATION OPERATIONS SUPPORT (U.S. CLS. 21, 23, 26, 36 AND 38).

CLASS 35—ADVERTISING AND BUSINESS

FOR PROVIDING BUSINESS MANAGEMENT INFORMATION ON AVIATION SYSTEM OPERATIONS, AVIATION STATION OPERATIONS, AVIATION DISPATCH OPERATIONS, AVIATION DECISION SUPPORT (U.S. CLS. 100, 101 AND 102).

CLASS 39—TRANSPORTATION AND STORAGE

FOR PROVIDING INFORMATION IN THE FIELD OF AIRPORT SERVICES, NAMELY, AVIATION AIR TRAFFIC CONTROL COORDINATION, AVIATION RAMP OPERATIONS, AVIATION SCHEDULING, AIRPORT LANDING SYSTEMS, AIRPORT RAMP OPERATIONS, AIRPORT OPERATIONS SUPPORT, AIR TRAFFIC CONTROL OPERATIONS SUPPORT, TRANSPORTATION OPERATIONS SUPPORT (U.S. CLS. 100 AND 105).

CLASS 42—SCIENTIFIC, COMPUTER AND LEGAL SERVICES

FOR AVIATION ENGINEERING INFORMATION SERVICES, NAMELY, PROVIDING TECHNICAL, ANALYTICAL, AND OPERATIONAL INFORMATION OF AVIATION SYSTEMS, NAMELY, ON AVIATION MAINTENANCE AND ENGINEERING, AIRPORT INTEGRATED SYSTEMS; CONSULTING SERVICES IN THE FIELDS OF AVIATION SYSTEM OPERATIONS, AVIATION MAINTENANCE AND ENGINEERING, AVIATION STATION OPERATIONS, AVIATION AIR TRAFFIC CONTROL COORDINATION, AVIATION DISPATCH OPERATIONS, AVIATION RAMP OPERATIONS, AVIATION SCHEDULING, AVIATION DECISION SUPPORT, AIRPORT LANDING SYSTEMS, AIRPORT RAMP OPERATIONS, AIRPORT OPERATIONS SUPPORT, AIRPORT INTEGRATED SYSTEMS, AIR TRAFFIC CONTROL OPERATIONS SUPPORT, TRANSPORTATION OPERATIONS SUPPORT (U.S. CLS. 100 AND 101).

SN 76-176,164. CAA, INC., DETROIT, MI. FILED 12-5-2000.

CAA

CLASS 9—ELECTRICAL AND SCIENTIFIC APPARATUS

FOR AUTOMOTIVE ON-BOARD COMPUTER AND NETWORK CONTROLS, NAMELY CENTRAL PROCESSING UNITS, CD DRIVES, DC TUNERS, DVD DRIVES, VISUAL DISPLAY SCREENS, VISUAL DISPLAY SCREENS, DIGITAL SIGNAL PROCESSOR CONTROLLERS, COMPUTER MULTIMEDIA SOUND CHIPS, VIDEO CONTROLLER CHIPS, AND SPEED SENSORS; GLOBAL POSITIONING SYSTEMS, NAMELY, RECEIVERS WITH ANTENNA AND SMART CARD INTERFACE BOARDS; ELECTRONIC ROAD MAP AND REAR VISION DISPLAYS, NAMELY VIDEO MONITORS AND LCD SCREENS; VOICE, AUDIO AND DATA MESSAGING HARDWARE, DISPLAYS, SWITCHES, SPEAKERS, AND VOICE CONTROLS FOR THE TRANSMISSION, RECEIPT, AND MANIPULATION OF AUDIO AND VIDEO SIGNALS AND DATA CONTAINED THEREIN; COMPUTER SOFTWARE FOR USE IN COMMUNICATION SYSTEMS, NAMELY IMPLEMENTATION, OPERATION, AND CUSTOMIZATION OF VOICE, DATA AND PAGING FUNCTIONS; COMPUTER SOFTWARE FOR USE IN WIRELESS INTERNET ACCESS; ELECTRONIC NAVIGATION SYSTEMS FOR MOTOR VEHICLES, NAMELY COMPUTER HARDWARE, ON-BOARD COMPUTERS, SERVER COMPUTERS, COMPUTING OPERATING SOFTWARE, CELLULAR TELEPHONES AND SENSORS TO MONITOR VEHICLE STATE AND VEHICLE POSITIONS; AND, REMOTE CONTROLS FOR LIGHTING, HEATING, STEAM GENERATING, COOKING, REFRIGERATING, DRYING, VENTILATING, WATER SUPPLY AND SANITARY DISPOSAL FOR USE IN MOTOR VEHICLE INFORMATION SYSTEMS; APPARATUS FOR USE IN LOCOMOTION FOR LAND, AIR, AND WATER EQUIPMENT, NAMELY AUTOMOBILES, TRUCKS, SUVs, MOTORCYCLES, TANKS, AIRPLANES, TRAINS, BOATS, AND SHIPS, NAMELY AUTOMOBILE AUDIO NAVIGATION AID COMPRISING AN OPTICAL DISK ON WHICH DIGITIZED MAPS, COMPRESSED VOICE RECORDS AND COMPUTER PROGRAMS ARE STORED AND AN OPTICAL DISK PLAYER WHICH OPERATES AN INTERACTIVE COMPUTER SOFTWARE, NAMELY AN ARTIFICIAL INTELLIGENCE ROUTING ALGORITHM THAT INTERFACES WITH THE DRIVER OF THE AUTOMOBILE VOICE INPUT AND OUTPUT AND AUTOMOTIVE AUDIO SYSTEMS COMPRISING RADIOS, AUDIO PROCESSORS, LOUD-SPEAKERS, AMPLIFIERS AND AUTOMOBILE CROSS-OVER CIRCUITS (U.S. CLS. 21, 23, 26, 36 AND 38).

CLASS 35—ADVERTISING AND BUSINESS

FOR PROVIDING ONLINE DATABASE SERVICES IN THE FIELD OF VEHICLE LOCATION TRACKING AND ON LINE BUSINESS DIRECTORY SERVICES FEATURING FUEL STATIONS, CAR REPAIR BUSINESSES AND EMERGENCY AUTOMOBILE SERVICE BUSINESSES (U.S. CLS. 100, 101 AND 102).

CLASS 37—CONSTRUCTION AND REPAIR

FOR PROVIDING ONLINE VEHICLE DIAGNOSTIC INFORMATION (U.S. CLS. 100, 103 AND 106).

CLASS 38—COMMUNICATION

FOR COMMUNICATION SERVICES, NAMELY PROVIDING TELECOMMUNICATIONS CONNECTIONS VIA A GLOBAL COMPUTER NETWORK FOR TELEVISION RECEPTION, RADIO RECEPTION, TELEPHONE, FAX AND MESSAGING SERVICES (U.S. CLS. 100, 101 AND 104).

CLASS 42—SCIENTIFIC, COMPUTER AND LEGAL SERVICES

FOR CONSULTING SERVICES FOR OTHERS IN THE FOLLOWING FIELDS— 1 MOTOR VEHICLE COCKPIT INTERIOR ART AND DESIGN, NAMELY, GRAPHICS, STYLING, TEXTURE, FABRIC, COLOR, COMPONENT SHAPES, SWITCHES, VIDEO DISPLAYS, AND CONTROLS; 2 MOTOR VEHICLE COMMUNICATION CAPABILITIES; 3 MOTOR VEHICLE ON-BOARD COMPUTER SYSTEMS, NAMELY COMPUTER SOFTWARE, COMPUTER SOFTWARE DEVELOPMENT TOOLS, AND ELECTRONIC NAVIGATION TOOLS; 4 ELECTRONIC MULTIMEDIA NETWORKS FOR MOTOR VEHICLE, NAMELY, WIRELESS VOICE, DATA, VIDEO, AND GLOBAL COMPUTER NETWORK ACCESS; AND 5 DEVELOPMENT OF VEHICLE OPERATION CONTROLS, GRAPHICS, DESIGN, AND ERGONOMICS, INCLUDING SELECTION AND LAYOUT OF CONTROLS AND DISPLAYS, TESTING AND VALIDATION OF INTERFACE DESIGN, MEASUREMENT PROCEDURES, AND CRITERION VALUES (U.S. CLS. 100 AND 101).

SN 76-176,205. AEX- INDICES B.V., 1012 JW AMSTERDAM, NETHERLANDS, FILED 12-5-2000.

NEXT ECONOMY INDEX

PRIORITY CLAIMED UNDER SEC. 44(D) ON BENELUX APPLICATION NO. 0966498, FILED 6-7-2000, REG. NO. 0670752, DATED 6-7-2000, EXPIRES 6-7-2010.

NO CLAIM IS MADE TO THE EXCLUSIVE RIGHT TO USE "ECONOMY INDEX", APART FROM THE MARK AS SHOWN.

CLASS 35—ADVERTISING AND BUSINESS

FOR ADVERTISING SERVICES, NAMELY, PLACING ADVERTISING FOR OTHERS IN THE FIELD OF STOCKS, BONDS, AND OTHER FINANCIAL INSTRUMENTS; BUSINESS INFORMATION, NAMELY, PROVIDING STATISTICAL INFORMATION, TRADE INFORMATION, AND MARKET RESEARCH AND ANALYSIS IN THE FIELD OF STOCKS, BONDS, AND OTHER FINANCIAL INSTRUMENTS (U.S. CLS. 100, 101 AND 102).

CLASS 36—INSURANCE AND FINANCIAL

FOR BROKERAGE SERVICES IN THE FIELD OF STOCKS, BONDS, MUTUAL FUNDS AND DEBT INSTRUMENTS; PRICE QUOTATIONS FOR STOCKS, BONDS, MUTUAL FUNDS, COMMODITIES, AND OTHER FINANCIAL INSTRUMENTS; FINANCIAL ANALYSIS AND CONSULTING SERVICES; OPERATION OF A STOCK EXCHANGE; COMPILATION, MAINTAINING AND OPERATING A STOCK INDEX (U.S. CLS. 100, 101 AND 102).

CLASS 41—EDUCATION AND ENTERTAINMENT

FOR PUBLICATION OF BOOKS, MAGAZINES, PERIODICALS, NEWSLETTERS, DAILY LISTS FEATURING FINANCIAL STATISTICS, TRADE INFORMATION, MARKET RESEARCH AND ANALYSIS (U.S. CLS. 100, 101 AND 107).

SN 76-176,741. NAPCO, INC, BATAVIA, IL. FILED 12-6-2000.

PAPA•POINTS

NO CLAIM IS MADE TO THE EXCLUSIVE RIGHT TO USE "POINTS", APART FROM THE MARK AS SHOWN.

CLASS 30—STAPLE FOODS

FOR COFFEE (U.S. CL. 46).
FIRST USE 9-8-1998; IN COMMERCE 9-8-1998.

CLASS 35—ADVERTISING AND BUSINESS

FOR PROMOTING THE SALE OF COFFEE THROUGH THE ADMINISTRATION OF INCENTIVE AWARD PROGRAMS (U.S. CLS. 100, 101 AND 102).
FIRST USE 9-8-1998; IN COMMERCE 9-8-1998.

SN 76-177,641. KEMSLEY, SANDRA G., BLOOMFIELD HILLS, MI. FILED 12-8-2000.

ABCTEACH

CLASS 38—COMMUNICATION

FOR PROVIDING ON-LINE ELECTRONIC BULLETIN BOARDS FOR TRANSMISSION OF MESSAGES AMONG COMPUTER USERS CONCERNING IDEAS, SUGGESTIONS, LESSON PLANS, PROJECTS, WORK PRODUCT, IMAGES, PUZZLES, STORIES, POEMS, AND GAMES IN THE FIELD OF EDUCATION; PROVIDING ON-LINE FORUMS FOR TRANSMISSION OF MESSAGES AMONG COMPUTER USERS CONCERNING IDEAS, SUGGESTIONS, LESSON PLANS, PROJECTS, WORK PRODUCT, IMAGES, PUZZLES, STORIES, POEMS, AND GAMES IN THE FIELD OF EDUCATION (U.S. CLS. 100, 101 AND 104).
FIRST USE 2-21-2000; IN COMMERCE 2-21-2000.

CLASS 41—EDUCATION AND ENTERTAINMENT

FOR PROVIDING A WEBSITE ON A GLOBAL COMPUTER NETWORK FEATURING AN ONLINE DATABASE WITH IDEAS, SUGGESTIONS, LESSON PLANS, PROJECTS, WORK PRODUCT, IMAGES, PUZZLES, STORIES, POEMS, AND GAMES IN THE FIELD OF EDUCATION (U.S. CLS. 100, 101 AND 107).
FIRST USE 2-21-2000; IN COMMERCE 2-21-2000.

SN 76-178,038. CASH MONEY CHEQUE CASHING INC., ETOBICOKE, ONTARIO M9R 3G1, CANADA, FILED 12-8-2000.



PRIORITY CLAIMED UNDER SEC. 44(D) ON CANADA APPLICATION NO. 10787110, FILED 10-12-2000, REG. NO. TMA571942, DATED 12-9-2002, EXPIRES 12-9-2017.

CLASS 16—PAPER GOODS AND PRINTED MATTER

FOR PENS (U.S. CLS. 2, 5, 22, 23, 29, 37, 38 AND 50).

CLASS 36—INSURANCE AND FINANCIAL

FOR FINANCIAL SERVICES, NAMELY, CHECK CASHING SERVICES, MONEY ORDER SERVICES, PAY-DAY ADVANCE SERVICES, CURRENCY EXCHANGE SERVICES, MONEY TRANSFER SERVICES, BILL PAYMENT SERVICES, AUTOMATED TELLER MACHINE SERVICES; PREPAID DEBIT CARD AND CREDIT CARD SERVICES, INSURANCE BROKERAGE SERVICES (U.S. CLS. 100, 101 AND 102).

CLASS 38—COMMUNICATION

FOR CELLULAR TELEPHONE SERVICES, PREPAID LOCAL PHONE SERVICES AND PREPAID TELEPHONE CARD SERVICES, PAGING SERVICES AND FAX SERVICES (U.S. CLS. 100, 101 AND 104).

CLASS 39—TRANSPORTATION AND STORAGE

FOR MAILBOX RENTALS (U.S. CLS. 100 AND 105).

SN 76-180,290. ADVANCED ENGINE MANAGEMENT, INC., HAWTHORNE, CA. FILED 12-13-2000.

AEM

CLASS 7—MACHINERY

FOR UNDERDRIVE PULLEY KITS FOR LAND VEHICLES COMPRISED OF PULLEYS AND BELTS; AUTOMOBILE INTAKE SYSTEMS COMPRISED OF INTAKE PIPES, AIR FILTERS, BRACKETS AND MOUNTS; BRAKE PADS FOR LAND VEHICLES; BIG ROTOR BRAKE SYSTEM COMPRISED OF ROTORS, ROTOR HATS, CALIPER REPOSITIONING BRACKETS AND MOUNTING HARDWARE; FUEL SYSTEMS COMPRISED OF HIGH VOLUME FUEL RAILS, FUEL PRESSURE REGULATORS AND FUEL FILTERS; AND ENGINE DRESS UP ACCESSORIES FOR LAND VEHICLES, NAMELY, SPARK PLUG WIRE COVER (U.S. CLS. 13, 19, 21, 23, 31, 34 AND 35).
FIRST USE 10-0-1997; IN COMMERCE 10-0-1997.

CLASS 12—VEHICLES

FOR ADJUSTABLE CAM GEARS FOR LAND VEHICLES; AND OIL FILLER CAPS (U.S. CLS. 19, 21, 23, 31, 35 AND 44).
FIRST USE 10-0-1997; IN COMMERCE 10-0-1997.

SN 76-180,294. FUJITSU LIMITED, KANAGAWA 211-8588, JAPAN, FILED 12-13-2000.



PRIORITY CLAIMED UNDER SEC. 44(D) ON JAPAN APPLICATION NO. 2000-065223, FILED 6-13-2000, REG. NO. 4525477, DATED 11-30-2001, EXPIRES 11-30-2011.

CLASS 9—ELECTRICAL AND SCIENTIFIC APPARATUS

FOR COMPUTERS; COMPUTER HARDWARE, NAMELY, CENTRAL PROCESSING UNITS (CPUS); PROGRAMMED ELECTRONIC DATA-CARRYING CIRCUITS; BLANK MAGNETIC COMPUTER DISKS AND BLANK MAGNETIC COMPUTER TAPES; COMPUTER MONITORS, LIGHT EMITTING DIODES (LEDS) DISPLAYS, LIQUID CRYSTAL DISPLAYS (LCDS), CATHOD-RAY TUBE DISPLAYS; COMPUTER KEYBOARDS; COMPUTER PRINTERS; MAGNETIC DISK DRIVES AND MAGNETIC TAPE DRIVES; BLANK MAGNETO-OPTICAL DISKS; COMPUTER PERIPHERALS; SEMICONDUCTOR DEVICES; ELECTRONIC CIRCUITS, NAMELY, INTEGRATED CIRCUITS, LARGE SCALE INTEGRATED CIRCUITS AND MICROPROCESSORS; ELECTRIC AND ELECTRONIC PARTS AND COMPONENTS, NAMELY, CONNECTORS, SWITCHES, RELAYS, AND SWITCHRELAYS (U.S. CLS. 21, 23, 26, 36 AND 38).

CLASS 42—SCIENTIFIC, COMPUTER AND LEGAL SERVICES

FOR PROVIDING INFORMATION REGARDING THE DESIGN OF COMPUTERS AND THE DESIGN, DEVELOPMENT AND MAINTENANCE OF COMPUTER PROGRAMS; PROVIDING CONSULTATION SERVICES REGARDING THE DESIGN OF COMPUTERS, COMPUTER SYSTEMS AND COMPUTER NETWORKS; CONSULTATION SERVICES REGARDING THE DESIGN, DEVELOPMENT AND MAINTENANCE OF COMPUTER PROGRAMS AND COMPUTER SYSTEMS; THE DESIGN, DEVELOPMENT AND MAINTENANCE OF COMPUTER PROGRAMS; THE DESIGN AND DEVELOPMENT OF COMPUTER NETWORKS; REMOTE MONITORING OF COMPUTER SYSTEMS; COMPUTER SYSTEMS ANALYSIS, NAMELY, ESTABLISHING ENVIRONMENTS AND LEVELS OF FUNCTIONS AND CAPABILITIES FOR COMPUTERS AND PROGRAMS AND THE RENTAL AND LEASING OF COMPUTERS (U.S. CLS. 100 AND 101).

CLASS 35—ADVERTISING AND BUSINESS

FOR PROVIDING COMMERCIAL SALES INFORMATION; COMPUTERIZED DATABASE MANAGEMENT SERVICES, NAMELY, COMPILING INFORMATION INTO COMPUTER DATABASES AND SYSTEMIZING INFORMATION INTO COMPUTER DATABASES AND DATA PROCESSING SERVICES (U.S. CLS. 100, 101 AND 102).

SN 76-180,419. M'LIS COMPANY, INC., THE, SALT LAKE CITY, UT. FILED 12-13-2000.

CLASS 36—INSURANCE AND FINANCIAL

FOR PROVIDING FINANCIAL AND INSURANCE INFORMATION (U.S. CLS. 100, 101 AND 102).

CLASS 37—CONSTRUCTION AND REPAIR

FOR REPAIR AND MAINTENANCE OF COMPUTERS (U.S. CLS. 100, 103 AND 106).

**CLASS 38—COMMUNICATION**

FOR ELECTRONIC TRANSMISSION OF DATA AND DOCUMENTS VIA COMPUTER TERMINALS (U.S. CLS. 100, 101 AND 104).

CLASS 3—COSMETICS AND CLEANING PREPARATIONS

FOR FACIAL CREAM; FACIAL CLEANSING CREAM; FACIAL CLEANSING LOTION; FACIAL CLEANSER; FACIAL SCRUBS; FACIAL EMOLLIENTS; FACIAL SCRUBS, NAMELY, FACIAL EXFOLIANTS; FACIAL LOTION; FACIAL MOISTURIZER; FACIAL EMOLLIENTS, NAMELY FACIAL SOFTENERS; FACIAL TONER; FACIAL SOAP; ESSENTIAL OILS FOR PERSONAL USE, NAMELY, FACIAL OIL; FACIAL NOURISHING CREAM; FACIAL CREAM, NAMELY, FACE LIFT GLYCOLIC ACID TREATMENT; FACIAL LOTION, NAMELY, FACE LIFT GLYCOLIC ACID TREATMENT; FACIAL MASKS; FACE LIFT MASKS; FACIAL MASK ACTIVATORS; SKIN CREAM; SKIN CLEANSING CREAM; SKIN CLEANSING LOTION; SKIN CLEANSER; SKIN EMOLLIENTS; SKIN SCRUBS, NAMELY, SKIN EXFOLIANTS; SKIN LOTION; SKIN MOISTURIZER; SKIN EMOLLIENTS, NAMELY, SKIN SOFTENERS; SKIN TONER; SKIN SOAP; ESSENTIAL OILS FOR PERSONAL USE, NAMELY, SKIN OIL; SKIN NOURISHING CREAM; SKIN CELLULITE CREAM; BODY MASKS; BODY MASK ACTIVATORS; BODY WRAP CREAM; ESSENTIAL OILS FOR PERSONAL USE, NAMELY, BODY OIL; BATH OIL; AND MASSAGE OIL (U.S. CLS. 1, 4, 6, 50, 51 AND 52).

FIRST USE 2-25-1993; IN COMMERCE 2-25-1993.

CLASS 39—TRANSPORTATION AND STORAGE

FOR PROVIDING FREIGHT BROKERAGE SERVICES FOR TRAVEL CONTRACTS NOT INCLUDING LODGING (U.S. CLS. 100 AND 105).

CLASS 41—EDUCATION AND ENTERTAINMENT

FOR EDUCATIONAL SERVICES, NAMELY, CONDUCTING TRAINING COURSES AND WORKSHOPS FOR SOFTWARE DEVELOPERS IN THE FIELD OF PROGRAMMING, SOFTWARE DEVELOPMENT AND GLOBAL INFORMATION NETWORK TECHNOLOGY (U.S. CLS. 100, 101 AND 107).

CLASS 5—PHARMACEUTICALS

FOR NUTRITIONAL SUPPLEMENTS; HERBAL SUPPLEMENTS; VITAMIN SUPPLEMENTS; MINERAL SUPPLEMENTS; VITAMINS; MINERALS; AMINO ACIDS FOR USE AS DIETARY SUPPLEMENTS; DIETARY SUPPLEMENTS, NAMELY, NATURAL OILS; HERBAL SUPPLEMENTS, NAMELY, DETOXIFICATION FORMULATIONS, AND HERBAL CLEANSERS; AND DIETARY SUPPLEMENTS, NAMELY NATURALLY OCCURRING SUBSTANCES AND PREPARATIONS FOR USE IN DETOXIFICATION, CLEANSING, RESTORING HEALTH AND CONTOURING OF THE BODY, AND IN THE TREATMENT OF DRY SKIN, WRINKLED SKIN, PREMATURE WRINKLING, DAMAGED SKIN, ACNE, BLACKHEADS, BLEMISHES, ENLARGED PORES, CLOGGING OF THE PORES, DEAD SKIN CELLS, EXCESS OILS, OXIDATION CONDITIONS, FACIAL CONDITIONS, SKIN CONDITIONS, SCAR TISSUE FORMATION, DAMAGED HAIR, HAIR CONDITIONS, SCALP CONDITIONS, BACTERIA CONDITIONS, FUNGUS CONDITIONS, EXCESS WEIGHT, EXCESS FAT, WATER-WEIGHT GAIN, WATER RETENTION, EXCESS CELLULITE, HEADACHES, NASAL CONGESTION, ALLERGIES, MENTAL CONFUSION, STRESS, NERVOUS TENSION, CHEMICAL DEPENDENCIES, ABDOMINAL CRAMPS, STOMACH DISTRESS, INTESTINAL DISTRESS, GASTROINTESTINAL PRESSURE, BLOOD CONDITIONS, LYMPHATIC CONDITIONS, COLON CONDITIONS, BOWEL CONDITIONS, INTESTINE CONDITIONS, DIGESTIVE IRREGULARITIES, DIGESTIVE CONDITIONS, CONSTIPATION, DIETARY DEFICIENCIES, NUTRITIONAL DEFICIENCIES, WASTE ELIMINATION CONDITIONS, BODY TOXINS, BODY ODOR, BLOOD CIRCULATORY CONDITIONS, CHOLESTEROL, EDEMA, SWELLING, INFLAMMATION, INFECTIONS, YEAST INFECTIONS, PARASITES, PREMENSTRUAL CONDITIONS, MENSTRUAL CONDITIONS, POST MENSTRUAL SYNDROME, HORMONAL IMBALANCE, INFLAMMATION OF THE JOINTS, ARTHRITIS, OSTEOPOROSIS, CONDITIONS OF THE JOINTS, INSUFFICIENT GROWTH, METABOLIC CONDITIONS, PREMATURE AGING, CONDITIONS ASSOCIATED WITH AGING, LOW ENERGY, AND POOR HEALTH (U.S. CLS. 6, 18, 44, 46, 51 AND 52).

FIRST USE 2-25-1993; IN COMMERCE 2-25-1993.

CLASS 9—ELECTRICAL AND SCIENTIFIC APPARATUS

FOR COMPUTER PERIPHERAL DEVICES; MOUSE MATS; OPTICAL SCANNERS; COPIERS AND TEACHING APPARATUS AND INSTRUMENTS, NAMELY, AUDIOVISUAL TEACHING APPARATUS, NAMELY, PHOTOGRAPHIC SLIDE TRANSPARENCIES, PROJECTORS, DATA PROJECTORS, AND VIDEO AND PROJECTION SCREENS; ELECTRONIC TEACHING GUIDES, NAMELY, INFRARED LASER POINTERS; PRE-RECORDED VIDEO CASSETTES FEATURING INFORMATION AND TRAINING IN RELATION TO THE INTERNET, INFORMATION AND ADVICE REGARDING REGISTRATION OF DOMAIN NAMES, AND DOMAIN NAME DISPUTE RESOLUTIONS; COMPACT DISCS FEATURING INFORMATION AND TRAINING IN RELATION TO THE INTERNET, INFORMATION AND ADVICE REGARDING REGISTRATION OF DOMAIN NAMES, AND DOMAIN NAME DISPUTE RESOLUTIONS; COMPUTER HARDWARE; COMPUTER FIRMWARE FOR USE IN DATABASE MANAGEMENT, FOR USE IN THE OPERATION AND MAINTENANCE OF A REGISTER OF DOMAIN NAMES, AND FOR USE IN REGISTERING DOMAIN NAMES; COMPUTER SOFTWARE FOR USE IN RELATION TO ACCESSING THE INTERNET; COMPUTER SOFTWARE FOR USE IN RELATION TO DATABASE MANAGEMENT, FOR USE IN RELATION TO THE OPERATION AND MAINTENANCE OF A REGISTER OF DOMAIN NAMES, AND FOR USE IN RELATION TO REGISTRATION OF DOMAIN NAMES, ALL FOR USE IN RELATION TO THE INTERNET; MAGNETIC DATA CARRIERS BEARING RECORDED DATA AND SOFTWARE, FEATURING INFORMATION AND TRAINING IN RELATION TO THE INTERNET, INFORMATION AND ADVICE REGARDING REGISTRATION OF DOMAIN NAMES, AND DOMAIN NAME DISPUTE RESOLUTIONS; DOWNLOADABLE ELECTRONIC PUBLICATIONS FROM DATABASES OR FROM FACILITIES PROVIDED ON THE INTERNET IN THE FIELD OF THE MAINTENANCE OF A REGISTER OF DOMAIN NAMES, DOMAIN NAME WATCHING AND SEARCHING, REGISTRATION OF DOMAIN NAMES, AND DOMAIN NAME DISPUTE RESOLUTIONS (U.S. CLS. 21, 23, 26, 36 AND 38).

CLASS 16—PAPER GOODS AND PRINTED MATTER

FOR PRINTED MATTER, NAMELY, STATIONERY; PRINTED INSTRUCTIONAL AND TEACHING MATERIALS, NAMELY, NEWSLETTERS, NON-FICTION BOOKS, PERIODICALS, BOOKLETS, BROCHURES, AND MANUALS, ALL RELATING TO COMPUTERS, COMPUTER TECHNOLOGY, THE INTERNET, DATABASE MANAGEMENT, THE OPERATION AND MAINTENANCE OF A REGISTER OF DOMAIN NAMES, REGISTERING DOMAIN NAMES, DOMAIN NAME WATCHING AND SEARCHING, DOMAIN NAME DISPUTE RESOLUTIONS, AND DESIGN AND COMPILATION OF WEB PAGES; PRINTED FORMS; PAPER BEER MATS; PAPER COASTERS; PENS; PENCILS; CLIPBOARDS; CALENDARS; DIARIES; DOMAIN NAME, BUSINESS AND COMMERCIAL INFORMATION DIRECTORIES; POSTERS; MAPS; UNMOUNTED PHOTOGRAPHS; LEAFLETS AND INFORMATIONAL FLYERS TO EDUCATE THE PUBLIC ABOUT COMPUTERS, COMPUTER TECHNOLOGY, THE INTERNET, DATABASE MANAGEMENT, THE OPERATION AND MAINTENANCE OF A REGISTER OF DOMAIN NAMES, REGISTERING DOMAIN NAMES, DOMAIN NAME WATCHING AND SEARCHING, DOMAIN NAME DISPUTE RESOLUTIONS, AND DESIGN AND COMPILATION OF WEB PAGES; WEB PAGES IN THE FORM OF PRINTED MATTER, NAMELY IN RESPECT OF COMPUTERS, COMPUTER TECHNOLOGY, THE INTERNET, DATABASE MANAGEMENT, THE OPERATION AND MAINTENANCE OF A REGISTER OF DOMAIN NAMES, REGISTERING DOMAIN NAMES, DOMAIN NAME WATCHING AND SEARCHING, DOMAIN NAME DISPUTE RESOLUTIONS AND DESIGN AND COMPILATION OF WEB PAGES (U.S. CLS. 2, 5, 22, 23, 29, 37, 38 AND 50).

SN 76-180,828. NOMINET UK, OXFORD OX4 6LB, UNITED KINGDOM, FILED 12-14-2000.

NOMINET UK

OWNER OF UNITED KINGDOM REG. NO. 2233095, DATED 11-3-2000, EXPIRES 5-18-2010.

NO CLAIM IS MADE TO THE EXCLUSIVE RIGHT TO USE "UK", APART FROM THE MARK AS SHOWN.

CLASS 35—ADVERTISING AND BUSINESS

FOR ADVERTISING AND PUBLICITY SERVICES, NAMELY, PROVISION OF ADVERTISING SPACE IN MAGAZINES, COMPILATION OF ADVERTISEMENTS FOR USE AS WEB PAGES ON THE INTERNET, DISSEMINATION OF ADVERTISING FOR OTHERS VIA A WEB PAGE; ADVISORY AND CONSULTANCY SERVICES RELATING TO THE FOREGOING; DISTRIBUTION OF PRINTED ADVERTISING MATTER, AND DISSEMINATION OF ADVERTISING MATTER; COMPUTERIZED AND ON-LINE DATABASE MANAGEMENT SERVICES; PROVISION OF ADVERTISEMENT AND PUBLICITY SERVICES IN RELATION TO THE INTERNET; ADVISORY AND CONSULTANCY SERVICES RELATING TO THE FOREGOING; BUSINESS ADVISORY, CONSULTANCY, RESEARCH AND INFORMATION SERVICES; COMPILATION, PROVISION, AND RETRIEVAL OF BUSINESS AND COMMERCIAL INFORMATION; COMPILATION OF BUSINESS DIRECTORIES AND PREPARATION OF BUSINESS REPORTS (U.S. CLS. 100, 101 AND 102).

CLASS 38—COMMUNICATION

FOR TELECOMMUNICATION SERVICES, NAMELY, PROVIDING WIRELESS, TELECOMMUNICATIONS SERVICES, NAMELY, PROVIDING ELECTRONIC, ELECTRIC, WIRELESS AND DIGITAL TRANSMISSION OF VOICE, DATA, IMAGES AND SIGNALS AND PROVIDING MULTIPLE USER ACCESS TO THE INTERNET, AND PROVIDING CONTINUOUS ACCESS TO THE INTERNET FOR MULTIPLE USERS; BROADCASTING INFORMATION, VIA GLOBAL COMPUTER NETWORKS; PROVIDING MULTIPLE-USER ACCESS TO A GLOBAL COMPUTER INFORMATION NETWORK; DATA COMMUNICATION SERVICES, NAMELY, PROVIDING TELECOMMUNICATIONS CONNECTIONS TO A GLOBAL COMPUTER NETWORK; COMMUNICATION BY COMPUTER TERMINALS, NAMELY, ELECTRONIC TRANSMISSION OF DATA, MESSAGES, INFORMATION AND IMAGES; SERVICES FOR THE COLLECTION AND TRANSMISSION OF MESSAGES FROM A COMPUTER DATABASE OR VIA THE INTERNET, ALL FOR BUSINESS OR DOMESTIC PURPOSES (U.S. CLS. 100, 101 AND 104).

CLASS 41—EDUCATION AND ENTERTAINMENT

FOR PROVIDING EDUCATIONAL INFORMATION AND TRAINING, NAMELY, LECTURES, PRESENTATIONS, SEMINARS, AND WORKSHOPS, IN THE FIELD OF COMPUTERS, COMPUTER TECHNOLOGY, THE INTERNET, DATABASE MANAGEMENT, THE OPERATION AND MAINTENANCE OF A REGISTER OF DOMAIN NAMES, REGISTERING DOMAIN NAMES, DOMAIN NAME WATCHING AND SEARCHING, DOMAIN NAME DISPUTE RESOLUTIONS, AND DESIGN AND COMPILATION OF WEB PAGES; CONDUCTING AND ORGANIZING SEMINARS AND EDUCATIONAL AND INSTRUCTIONAL CONVENTIONS, CONFERENCES, CONGRESSES, EXHIBITIONS AND DEMONSTRATIONS IN THE FIELD OF COMPUTERS, COMPUTER TECHNOLOGY, THE INTERNET, DATABASE MANAGEMENT, THE OPERATION AND MAINTENANCE OF A REGISTER OF DOMAIN NAMES, REGISTERING DOMAIN NAMES, DOMAIN NAME WATCHING AND SEARCHING, AND DOMAIN NAME DISPUTE RESOLUTIONS; PROVIDING TRAINING IN RELATION TO THE INTERNET, NAMELY, TRAINING IN RELATION TO DOMAIN NAME REGISTRATION, DOMAIN NAME WATCHING AND SEARCHING SERVICES, AND DESIGN AND COMPILATION OF WEB PAGES; PROVIDING AN INTERACTIVE DATABASE OF INFORMATION RELATING TO EDUCATION AND TRAINING (U.S. CLS. 100, 101 AND 107).

CLASS 42—SCIENTIFIC, COMPUTER AND LEGAL SERVICES

FOR OPERATION AND MAINTENANCE OF A REGISTER OF DOMAIN NAMES FOR IDENTIFICATION OF USERS ON A GLOBAL COMPUTER NETWORK; PROVISION OF COMPUTER SERVICES FOR THE ALLOCATION OF DOMAIN NAMES; DOMAIN NAME WATCHING AND SEARCHING SERVICES, NAMELY, IDENTIFYING, MONITORING AND REPORTING DOMAIN NAME APPLICATIONS AND REGISTRATIONS, AND OBTAINING DOMAIN NAME REGISTRATION INFORMATION; INFORMATION AND ADVICE REGARDING THE REGISTRATION OF DOMAIN NAMES; PROVIDING COMPUTER INFORMATION IN RELATION TO THE INTERNET, NAMELY, INFORMATION ON DOMAIN NAMES, DOMAIN NAME REGISTRATION, DOMAIN NAME WATCHING AND SEARCHING SERVICES, DESIGN AND COMPILATION OF WEB PAGES; ADVISORY SERVICES RELATING TO EDUCATION AND TRAINING; ADVISORY AND CONSULTANCY SERVICES RELATING TO COMPUTERS, COMPUTER TECHNOLOGY, THE INTERNET, DATABASE MANAGEMENT, THE OPERATION AND MAINTENANCE OF A REGISTER OF DOMAIN NAMES, REGISTERING DOMAIN NAMES, DOMAIN NAME WATCHING AND SEARCHING, DOMAIN NAME DISPUTE RESOLUTIONS, AND DESIGN AND COMPILATION OF WEB PAGES; DOMAIN NAME TECHNICAL PROJECT STUDIES, NAMELY, IMPLEMENTING, INTEGRATING AND TESTING OF DOMAIN NAMES ON LOCAL AREA NETWORKS; DESIGN AND COMPILATION OF WEB PAGES; PROVIDING COMPUTER DATABASES IN THE FIELD OF COMPUTER TECHNOLOGY AND ON-LINE COMPUTER SERVICES; AND PROVISION OF ADVICE AND ASSISTANCE IN RESPECT OF DOMAIN NAME DISPUTE RESOLUTIONS; PROVIDING CUSTOMIZED ON-LINE WEB PAGES FEATURING USER-DEFINED INFORMATION, WHICH INCLUDES SEARCH ENGINES AND ONLINE WEB LINKS TO OTHER WEB SITES; PROVIDING AN ON-LINE COMPUTER DATABASE, NAMELY, FOR MAINTAINING A REGISTER OF DOMAIN NAMES, DOMAIN WATCHING AND SEARCHING, RETAINING INFORMATION RELATING TO DOMAIN NAME DISPUTE RESOLUTION, AND RETAINING INFORMATION RELATING TO DOMAIN NAMES, AND REGISTERING DOMAIN NAMES (U.S. CLS. 100 AND 101).

SN 76-182,022. PIPER-HEIDSIECK - ANCIENNE MAISON HEIDSIECK FONDEE EN, 51100 REIMS, FRANCE, FILED 12-15-2000.

CLUB PIPER

NO CLAIM IS MADE TO THE EXCLUSIVE RIGHT TO USE "CLUB", APART FROM THE MARK AS SHOWN.

CLASS 16—PAPER GOODS AND PRINTED MATTER

FOR PAPER PRODUCTS AND PRINTED MATTERS NAMELY TABLE NAPKINS OF PAPER, TABLE LINENS OF PAPER, TABLE CLOTHS OF PAPER, TABLE MATS OF PAPER, PRINTED MENUS, BAGS OF PAPER OR PLASTIC FOR PACKAGING, PAPER AND CARDBOARD BAGS, PRINTED PRICE LISTS, COASTERS OF PAPER, PERIODICALS, NAMELY PERIODICALS REGARDING WINE, OENOLOGY, WINE MAKING AND RESTAURANTS, POSTERS, PRINTED PROSPECTUSES, STICKERS, CONICAL PAPER BAGS, PICTURES, PHOTOGRAPHS, BOTTLE WRAPPERS OF CARDBOARD OR PAPER, SIGNBOARDS OF PAPER OR CARDBOARD, PLACE MATS OF PAPER (U.S. CLS. 2, 5, 22, 23, 29, 37, 38 AND 50).

CLASS 42—SCIENTIFIC, COMPUTER AND LEGAL SERVICES

FOR HOTEL SERVICES; RESTAURANT SERVICES, CAFE SERVICES, CAFETERIA SERVICES; SNACK BAR SERVICES; COCKTAIL LOUNGE SERVICES; CATERING; AND PROVIDING INFORMATION AND CONSULTATION IN THE FIELD OF GASTRONOMY (U.S. CLS. 100 AND 101).

SN 76-182,406. COVANSYS CORPORATION, FARMINGTON HILLS, MI. BY CHANGE OF NAME COMPLETE BUSINESS SOLUTIONS, INC., FARMINGTON HILLS, MI. FILED 12-18-2000.

WEI**CLASS 35—ADVERTISING AND BUSINESS**

FOR BUSINESS CONSULTATION FOR ELECTRONIC COMMERCE AND ELECTRONIC BUSINESS (U.S. CLS. 100, 101 AND 102).

FIRST USE 8-29-2000; IN COMMERCE 8-29-2000.

CLASS 42—SCIENTIFIC, COMPUTER AND LEGAL SERVICES

FOR COMPUTER CONSULTATION IN THE FIELDS OF COMPUTER SYSTEMS AND COMPUTER SOFTWARE; CUSTOM COMPUTER SOFTWARE DESIGN FOR OTHERS; ENGINEERING SERVICES IN THE FIELD OF COMPUTER SYSTEMS; INTEGRATION OF COMPUTER SYSTEMS WITH COMPUTER SOFTWARE FOR ELECTRONIC COMMERCE AND ELECTRONIC BUSINESS (U.S. CLS. 100 AND 101).

FIRST USE 8-29-2000; IN COMMERCE 8-29-2000.

SN 76-182,411. MEMOREC STOFFEL GMBH-MEDIZINISCH-MOLEKULARE ENTWICKLUNG, KOLN, D-50829 KOLN, FED REP GERMANY, FILED 12-18-2000.

PIQOR

OWNER OF FED REP GERMANY REG. NO. 39916209, DATED 8-13-1999, EXPIRES 3-31-2009.

THE LETTERS "PIQOR" IS AN ACRONYM WHICH STANDS FOR "PARALLEL IDENTIFICATIONS AND QUANTIFICATION OF RNA'S".

CLASS 1—CHEMICALS

FOR CHEMICAL SUBSTANCES, NAMELY DNA FOR SCIENTIFIC OR RESEARCH USE IN THE FIELDS OF IMMUNOLOGY, ONCOLOGY, TOXICOLOGY, APOPTOSIS, NEUROLOGY; CHEMICALS, NAMELY BUFFERS FOR HYBRIDIZATION OF NUCLEIC ACIDS FOR SCIENTIFIC OR RESEARCH USE (U.S. CLS. 1, 5, 6, 10, 26 AND 46).

CLASS 9—ELECTRICAL AND SCIENTIFIC APPARATUS

FOR ELECTRONIC APPARATUS FOR DETECTING AND DIAGNOSING GENE PROFILES IN LABORATORY RESEARCH; SUPPORTS, NAMELY GENE CHIPS MADE FROM PLASTIC OR GLASS FOR PERFORMING HYBRIDIZATION REACTIONS (U.S. CLS. 21, 23, 26, 36 AND 38).

CLASS 10—MEDICAL APPARATUS

FOR ELECTRONIC APPARATUS FOR DETECTING AND DIAGNOSING GENE PROFILES IN CLINICAL OR MEDICAL LABORATORY; SUPPORTS, NAMELY CHIPS MADE FROM PLASTIC OR GLASS FOR PERFORMING HYBRIDIZATION REACTIONS FOR MEDICAL PURPOSES (U.S. CLS. 26, 39 AND 44).

CLASS 42—SCIENTIFIC, COMPUTER AND LEGAL SERVICES

FOR LABORATORY RESEARCH IN THE FIELDS OF IMMUNOLOGY, ONCOLOGY, TOXICOLOGY, APOPTOSIS AND NEUROLOGY (U.S. CLS. 100 AND 101).

SN 76-183,805. MOSOCO CORPORATION, CHANG HUA CITY, TAIWAN, FILED 12-21-2000.

MOSOCO**CLASS 7—MACHINERY**

FOR COMPONENT PARTS OF MACHINES, NAMELY AIR IONIZERS FOR USE IN ELECTRIC GENERATORS, FANS FOR MACHINES, MOTORS AND ENGINES, MICROMOTORS, AND MOTORS FOR MACHINES, PUMPS, ENGINES, GENERATORS, MECHANICAL CONTROLLERS FOR MOTORS AND ENGINES, MICROMOTORS FOR USE IN MACHINERY FOR MEDICAL USE, NAMELY ELECTRIC TOOTHBRUSHES, BLOOD PRESSURE MEASURING APPARATUS, DENTAL SYRINGES, ELECTRICAL MASSAGER APPARATUS, OPTICAL MACHINERY, NAMELY CAMERAS, PROJECTORS, DIGITAL STILL CAMERAS, DIGITAL CAM-CORDERS, PHOTO PRINTERS, AND INDUSTRIAL AIR PURIFICATION MACHINES (U.S. CLS. 13, 19, 21, 23, 31, 34 AND 35).

CLASS 9—ELECTRICAL AND SCIENTIFIC APPARATUS

FOR MICROMOTORS FOR USE IN COMPUTER PERIPHERALS AND AUDIO EQUIPMENT, NAMELY DISC PLAYERS FOR ELECTRONIC DATA PROCESSING APPARATUS, NAMELY DIGITAL VIDEO DISC PLAYERS, VIDEO COMPACT DISC PLAYERS, COMPACT DISC PLAYERS, DATA STORAGE APPARATUS FOR COMPUTERS, SCANNERS, PRINTERS, ELECTRIC MICROWAVES, MICRORELAYS, ELECTRIC TRANSFORMERS, TRIGGERING CIRCUITS, COMMUTATORS, ELECTRIC COILS, CONVERTERS, INVERTERS, ELECTRIC OZONE GENERATORS OTHER THAN FOR MEDICAL USE, AIR IONIZERS FOR USE IN ELECTRIC OZONE GENERATORS, TIME RECORDING APPARATUS, NAMELY HYBRID-TIME RECORDERS, VOLTAGE-TIME RECORDERS, TEMPERATURE-TIME RECORDERS, ELECTRONIC BUZZERS FOR OFFICE EQUIPMENT, NAMELY FAX MACHINES, COPY MACHINES, SHREDDERS, PENCIL SHARPENERS, COMMUNICATIONS EQUIPMENT, NAMELY, MOBILE PHONES, PDA'S, COMPUTERS, AUTOMOBILES, ELECTRIC HOME APPLIANCES, NAMELY AIR CONDITIONERS, HOT-WATER HEATERS, AND CLOCKS, ELECTRIC CONTROLLERS FOR MOTORS AND ENGINES, FANS FOR COOLING ELECTRONIC APPARATUS FOR USE IN POWER SUPPLIES, CENTRAL PROCESSING UNITS, I/O CARDS (U.S. CLS. 21, 23, 26, 36 AND 38).

SN 76-187,677. H. J. RASHTI & COMPANY, INC., NEW YORK, NY. FILED 12-29-2000.

SN 76-188,536. BEICIP-FRANLAB, RUEIL MALMAISON, FRANCE, FILED 12-29-2000.



THE LINING IS A FEATURE OF THE MARK AND DOES NOT INDICATE COLOR.

CLASS 8—HAND TOOLS

FOR SILVERPLATED SPOONS AND FORKS (U.S. CLS. 23, 28 AND 44).
FIRST USE 11-1-2000; IN COMMERCE 11-1-2000.

CLASS 10—MEDICAL APPARATUS

FOR NIPPLES FOR BABY BOTTLES; BABY BOTTLES (U.S. CLS. 26, 39 AND 44).
FIRST USE 11-1-2000; IN COMMERCE 11-1-2000.

CLASS 14—JEWELRY

FOR SILVERPLATED NURSERY ACCESSORIES, NAMELY, PICTURE FRAMES, PHOTO ALBUMS, RATTLES, PIGGY BANKS, COMBS AND BRUSHES, DISHES AND CUPS AND BIRTH CERTIFICATE ANNOUNCEMENTS (U.S. CLS. 2, 27, 28 AND 50).
FIRST USE 11-1-2000; IN COMMERCE 11-1-2000.

CLASS 16—PAPER GOODS AND PRINTED MATTER

FOR BAGS FOR BABY BOTTLES (U.S. CLS. 2, 5, 22, 23, 29, 37, 38 AND 50).
FIRST USE 11-1-2000; IN COMMERCE 11-1-2000.

CLASS 20—FURNITURE AND ARTICLES NOT OTHERWISE CLASSIFIED

FOR NURSERY ROOM DECORATIONS NAMELY, CLOTHES HANGERS, PICTURE FRAMES, SNOW GLOBES (U.S. CLS. 2, 13, 22, 25, 32 AND 50).
FIRST USE 11-1-2000; IN COMMERCE 11-1-2000.

CLASS 24—FABRICS

FOR BED BLANKETS, TOWELS, WASH CLOTHS, BATH MITTS; NEWBORN AND INFANT FEEDING ITEMS, NAMELY, BURP CLOTHS (U.S. CLS. 42 AND 50).
FIRST USE 11-1-2000; IN COMMERCE 11-1-2000.

CLASS 25—CLOTHING

FOR NEWBORN AND INFANT APPAREL AND ACCESSORIES, NAMELY, CLOTH BIBS, SWEATERS, SHOES, SOCKS, SLEEPERS, BODYSUITS, CREEPERS, SHORTS, PANTS AND SHIRTS (U.S. CLS. 22 AND 39).
FIRST USE 11-1-2000; IN COMMERCE 11-1-2000.

CLASS 28—TOYS AND SPORTING GOODS

FOR PLASTIC TOYS FOR CHILDREN, NAMELY, RATTLES, TEETHERS, AND DEVELOPMENTAL TOYS, PLUSH TOYS, FOAM JIGSAW PUZZLES, TOY MOBILES (U.S. CLS. 22, 23, 38 AND 50).
FIRST USE 11-1-2000; IN COMMERCE 11-1-2000.

GEOSURF

PRIORITY CLAIMED UNDER SEC. 44(D) ON FRANCE APPLICATION NO. 3069978, FILED 11-30-2000, REG. NO. 003069978, DATED 11-30-2000, EXPIRES 11-30-2010.

CLASS 9—ELECTRICAL AND SCIENTIFIC APPARATUS

FOR COMPUTER SOFTWARE, NAMELY SOFTWARE IN THE FIELD OF RESERVOIR GEOLOGY USED FOR DEVELOPMENT AND CONSTRUCTION OF RESERVOIR STRUCTURES (U.S. CLS. 21, 23, 26, 36 AND 38).

CLASS 35—ADVERTISING AND BUSINESS

FOR BUSINESS MANAGEMENT CONSULTING, PROFESSIONAL BUSINESS CONSULTATION SERVICES RELATED TO THE DEVELOPMENT AND CONSTRUCTION OF RESERVOIR STRUCTURES, COMPUTERIZED DATABASE MANAGEMENT SERVICES IN THE FIELD OF GEOLOGY (U.S. CLS. 100, 101 AND 102).

CLASS 42—SCIENTIFIC, COMPUTER AND LEGAL SERVICES

FOR DESIGN AND DEVELOPMENT OF SOFTWARE IN THE FIELD OF RESERVOIR GEOLOGY FOR OTHERS, TECHNICAL CONSULTING SERVICES IN THE FIELD OF RESERVOIR GEOLOGY, PREPARING DRAWINGS BY COMPUTER FOR CONSTRUCTING AND BUILDING RESERVOIR STRUCTURES, CONDUCTING TECHNICAL PROJECT STUDIES, PERFORMING INDUSTRIAL RESEARCH AND DEVELOPMENT FOR OTHERS, PREPARING ENGINEERING STUDIES AND WORK, NAMELY EXPERT REPORTS, EVALUATIONS, ESTIMATES, RESEARCH, PREPARATION OF REPORTS IN THE FIELD OF RESERVOIR GEOLOGY (U.S. CLS. 100 AND 101).

SN 76-190,732. X-CONCEPTS, LLC, ESCONDIDO, CA. FILED 1-3-2001.

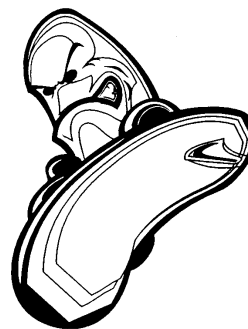

THE MARK CONSISTS OF A THUMB DESIGN FIGURE ON A WAKE BOARD.

CLASS 25—CLOTHING

FOR SHIRTS, T-SHIRTS, TANK TOPS, JERSEYS, TURTLENECKS, PANTS, JEANS, OVERALLS, DRESSES, JUMPERS, SKIRTS, SKORTS, SHORTS, SWEATSHIRTS, SWEAT PANTS, SWEATERS, VESTS, JACKETS, CARDIGANS, PARKAS, COATS, RAIN COATS, GLOVES, MITTENS, HATS, CAPS, HEADWEAR, EARMUFFS, SCARVES, THERMAL UNDERWEAR, UNDERWEAR BOXER SHORTS, SOCKS, BATHING SUITS, SWIM TRUNKS, SWIMSUITS, SWIMSUIT COVERS, BEACH COVER-UPS, NIGHT SHIRTS, NIGHT GOWNS, PAJAMAS, BLANKET SLEEPERS, BATHROBES, SHOES, SNEAKERS, BOOTS SANDALS, SLIPPERS, BELTS, HEAD BANDS, BANDANNAS, NECKTIES, SUSPENDERS (U.S. CLS. 22 AND 39).

CLASS 28—TOYS AND SPORTING GOODS

FOR TOY ACTION FIGURES, CASES FOR ACTION FIGURES, TOY WEAPONS, TOY ARMOR, TOY SWORDS, MECHANICAL ACTION TOYS, TOY CAP PISTOLS, TOY VEHICLES, RADIO CONTROLLED TOY VEHICLES, TOY VEHICLE TRACK SETS, TOY VEHICLE PLAY SETS, TOY AIRPLANES, COLLECTIBLE TOY FIGURES, STUFFED TOY ANIMALS, PLUSH TOYS, DRAWING TOYS, PUPPETS, TOY BANKS, TALKING TOYS, TOY MOBILES, MUSICAL TOYS, TOY CONSTRUCTION BLOCKS, TOY BUILDING BLOCKS, JIGSAW PUZZLES, SLIDE PUZZLES, MANIPULATIVE PUZZLES, OUTDOOR PLAY EQUIPMENT, NAMELY SWING SET AND CLIMBING UNITS, CONSISTING OF SWINGS, CLIMBING ROPES, CLIMBING LADDERS, TRAPEZES, SLIDES, BRIDGES, LADDERS, SLIDING POLES, PLAY DECKS, PIRATE'S LADDER, TARPAULIN, MONKEY BARS, AND SAND BOXES, BUBBLE MAKING WAND AND SOLUTION SETS, BODY BOARDS, FLYING DISCS, YO-YOS, PADDLE BALL GAMES, FOOTBAGS USED IN KICKING GAMES, ROLLER SKATES, IN-LINE SKATES, ICE SKATES, RIDE-ON TOYS, SKATEBOARDS, MINIATURE SKATEBOARDS, PLASTIC TOY HOOPS, PINWHEELS, KITES, FOOTBALLS, BASKETBALLS, SOCCER BALLS, SPORT BALLS, PLAY TENTS, PLAY HOUSES, ELBOW, KNEE, WRIST AND SHIN GUARDS FOR ATHLETIC USE, PLAY SWIMMING POOLS, SWIM GOGGLES, SWIM MASKS, SNORKELS, WATER-SQUIRTING TOYS, SAND TOYS, SAND BOX TOYS, BATH TOYS, BALLOONS, PARTY FAVORS IN THE NATURE OF CRACKERS OR NOISEMAKERS, PARTY FAVORS IN THE NATURE OF SMALL TOYS, ADULT AND CHILDREN PARTY GAMES, CARD GAMES, BOARD GAMES, ROLE-PLAYING GAMES, ACTION-TYPE TARGET GAMES, COIN-OPERATED ARCADE GAMES, ELECTRONIC HANDHELD GAMES, CHRISTMAS TREE ORNAMENTS, CHRISTMAS TREE SKIRTS, CHRISTMAS STOCKINGS (U.S. CLS. 22, 23, 38 AND 50).

SN 76-192,201. PAUL HARTMANN AG, HEIDENHEIM, FED REP GERMANY, FILED 1-10-2001.

VAMEDIS

PRIORITY CLAIMED UNDER SEC. 44(D) ON FED REP GERMANY APPLICATION NO. 30060074.7/0, FILED 8-11-2000, REG. NO. 30060074, DATED 1-16-2001, EXPIRES 8-31-2010.

CLASS 9—ELECTRICAL AND SCIENTIFIC APPARATUS

FOR APPARATUS FOR RECORDING, TRANSMISSION OR REPRODUCTION OF SOUND OR IMAGES, NAMELY SCANNERS AND FACSIMILE MACHINES THAT CAN STORE AND TRANSMIT HEALTHCARE DATA; BLANK MAGNETIC DATA CARRIERS, NAMELY, FLOPPY DISCS, PRE-RECORDED PHONOGRAPH RECORDS FEATURING MUSIC; CALCULATING MACHINES, NAMELY, CALCULATORS AND COMPUTERS; DATA PROCESSING EQUIPMENT, NAMELY, COMPUTERS AND SERVERS FOR HEALTHCARE APPLICATIONS; DATA PROCESSING COMPUTER SOFTWARE, FOR ANALYZING AND GENERATING REPORTS REGARDING ILLNESS, HEALTH AND MEDICINE DATA, SOFTWARE FOR DATABASE MANAGEMENT, NAMELY, ORDER MANAGEMENT, INVOICE MANAGEMENT, PROCUREMENT MANAGEMENT, DISEASE MANAGEMENT, AND CLINICAL RECORD MANAGEMENT SOFTWARE; VIDEO CONFERENCING SYSTEMS, COMPRISING COMPUTER HARDWARE AND OPERATING SOFTWARE; COMPUTERS, LCD SCREENS, MODEMS AND SOFTWARE FOR TRANSMITTING SOUND, IMAGES AND MULTIMEDIA DATA VIA THE GLOBAL COMPUTER NETWORK; MULTIMEDIA APPARATUS, NAMELY, SERVERS AND PCS THAT ENABLE STORAGE AND VISUALIZATION OF WEB-BASED ELECTRONIC CATALOGS, COMMUNITY AND CONTENT SECTIONS (U.S. CLS. 21, 23, 26, 36 AND 38).

CLASS 35—ADVERTISING AND BUSINESS

FOR ADVERTISING SERVICES, NAMELY PROMOTING THE HEALTHCARE GOODS AND SERVICES OF OTHERS BY RENTAL OF ADVERTISING SPACE IN AN ELECTRONIC MAGAZINE ACCESSED THROUGH THE INTERNET; DISSEMINATION OF INSURANCE ADVERTISING MATTER FOR OTHERS; BUSINESS INFORMATION SERVICES, NAMELY, PROVIDING BUSINESS INFORMATION IN THE FIELD OF HEALTHCARE; MARKET DATA ANALYSIS IN THE FIELD OF HEALTHCARE; PROVIDING CONSUMER PRODUCT INFORMATION VIA THE INTERNET RELATED TO HEALTH AND MEDICINE; BUSINESS MANAGEMENT SERVICES FOR OTHERS; CONDUCTING MARKETING STUDIES FOR OTHERS; PROVIDING BUSINESS MARKETING INFORMATION IN THE FIELDS OF HEALTH, MEDICINE AND PROCUREMENT; BUSINESS CONSULTING SERVICES IN THE FIELD OF HEALTHCARE; OPERATION OF TELEPHONE CALL CENTERS FOR OTHERS FOR USERS OF ELECTRONIC DATA PROCESSING MACHINES; PROCUREMENT OF HEALTHCARE GOODS AND SERVICES FOR OTHERS; ON-LINE RETAIL STORE SERVICES FEATURING HEALTHCARE GOODS AND SERVICES; ON-LINE ORDER FULFILLMENT SERVICES; COMPUTERIZED TRACKING AND MANAGEMENT OF COMMERCIAL TRANSACTIONS ON A GLOBAL COMPUTER NETWORK; INVOICING SERVICES FOR BOTH PAYERS AND PROVIDERS OF HEALTHCARE PRODUCTS AND SERVICES; PACKAGING ARTICLES TO ORDER AND SPECIFICATION OF OTHERS; COMPUTERIZED DATABASE MANAGEMENT, NAMELY ORGANIZING AND MANAGING COMPUTERIZED DATABASE FOR OTHERS; FACILITATING THE EXCHANGE OF NEEDED INFORMATION FOR FINANCIAL TRANSACTIONS VIA THE INTERNET AND EDI-BASED INFRASTRUCTURE OF INFORMATION RELATED TO PROCUREMENT AND HEALTHCARE (U.S. CLS. 100, 101 AND 102).

CLASS 36—INSURANCE AND FINANCIAL

FOR INSURANCE UNDERWRITING AND BROKERAGE SERVICES IN THE FIELD OF HEALTHCARE; FACTORING SERVICES TO BOTH PAYERS AND PROVIDERS OF HEALTHCARE PRODUCTS AND SERVICES; ELECTRONIC PAYMENT, NAMELY ELECTRONIC PROCESSING AND TRANSMISSION OF BILL PAYMENT DATA (U.S. CLS. 100, 101 AND 102).

CLASS 38—COMMUNICATION

FOR PROVIDING MULTIPLE USER ACCESS TO THE GLOBAL COMPUTER NETWORK; ELECTRONIC TRANSMISSION OF VOICE, MESSAGES, DRAWINGS, IMAGES, DOCUMENTS AND DATA, VIA COMPUTER TERMINALS; ELECTRONIC MAIL MESSAGING; E-MAIL MESSAGING; E-MAIL FORWARDING SERVICES; PROVIDING ON-LINE ELECTRONIC BULLETIN BOARDS FOR TRANSMISSION OF MESSAGES AMONG COMPUTER USERS CONCERNING ILLNESSES, HEALTH AND MEDICAL TOPICS; ELECTRONIC TRANSMISSION OF E-MAIL MESSAGES BY COMPUTER USERS IN THE FIELD OF HEALTHCARE; ELECTRONIC DATA INTERCHANGE, OR EDI, SERVICES (U.S. CLS. 100, 101 AND 104).

CLASS 39—TRANSPORTATION AND STORAGE

FOR TRANSPORT SERVICES, NAMELY THE BROKERAGE, CONSOLIDATION AND TRANSPORTATION OF HEALTHCARE-RELEVANT GOODS VIA AIR, RAIL AND TRUCK, BETWEEN BUYERS AND SELLERS OF HEALTHCARE-RELEVANT GOODS AND SERVICES; PACKAGING GOODS FOR TRANSPORT; STORAGE OF PRODUCTS RELEVANT TO THE HEALTHCARE INDUSTRY AND HEALTHCARE PROVIDERS (U.S. CLS. 100 AND 105).

CLASS 41—EDUCATION AND ENTERTAINMENT

FOR EDUCATION SERVICES, NAMELY, ARRANGING AND CONDUCTING CONFERENCES, SEMINARS, SYMPOSIA AND WORKSHOPS IN THE FIELD OF HEALTH, MEDICINE, PROCUREMENT AND SUPPLY CHAIN; TRAINING SERVICES IN THE FIELD OF HEALTHCARE INDUSTRY RELATED ELECTRONIC PROCUREMENT AND COMMUNICATION; ON-LINE PUBLICATION OF BOOKS, MAGAZINES AND JOURNALS IN THE FIELDS OF ILLNESSES, HEALTH AND MEDICINE; AND COMPUTER SERVICES, NAMELY, PROVIDING ON-LINE, NON-DOWNLOADABLE BOOKS, MAGAZINES, AND JOURNALS IN THE FIELD OF ILLNESSES, HEALTH AND MEDICINE VIA THE INTERNET (U.S. CLS. 100, 101 AND 107).

CLASS 42—SCIENTIFIC, COMPUTER AND LEGAL SERVICES

FOR CATERING AND RESTAURANT SERVICES TO THE HEALTHCARE INDUSTRY; INSTALLATION AND MAINTENANCE OF SOFTWARE; RENTAL OF DATA PROCESSING EQUIPMENT, NAMELY, COMPUTERS; PROVIDING AN ONLINE DATABASE FEATURING INFORMATION ON THE HEALTHCARE INDUSTRY; COMPUTER PROJECT MANAGEMENT SERVICE FOR OTHERS; HEALTHCARE CONSULTING SERVICES; SUPPORT SERVICES, NAMELY PROVIDING TROUBLESHOOTING OF COMPUTER HARDWARE AND SOFTWARE PROBLEMS VIA THE INTERNET; ONLINE WEBSITE FEATURING INFORMATION REGARDING THE HEALTHCARE INDUSTRY (U.S. CLS. 100 AND 101).

SN 76-195,547. PABU SERVICES, INC., WILMINGTON, DE.
FILED 1-18-2001.

FLEXPACK**CLASS 1—CHEMICALS**

FOR SPECIALTY CHEMICALS AND CHEMICAL BLENDS USED AS POLYMER ADDITIVES, NAMELY, ANTI-STATIC COMPOUNDS, FLAME RETARDANTS, ANTI-MICROBIAL COMPOUNDS, ANTI-BLOCKING COMPOUNDS, ANTI-SLIP COMPOUNDS, CLARIFIERS, NUCLEATING COMPOUNDS, LIGHT STABILIZERS, ULTRA VIOLET LIGHT ABSORBERS, NICKEL QUENCHERS, ACID SCAVENGERS, CROSS-LINKING AGENTS, AGING INHIBITORS, ANTIOXIDANTS, ANTI-OZONANTES, WAXES, SYNTHETIC RESINS FOR MANUFACTURING, ALL FOR USE IN THE MANUFACTURE OF FIBERS, FILMS, EXTRUSIONS, CO-EXTRUSIONS, MOLDED ARTICLES, THERMO-FORMED ARTICLES, AND SIMILAR TANGIBLE ARTICLES OR THE RAW MATERIAL FROM WHICH SAID ARTICLES ARE MADE (U.S. CLS. 1, 5, 6, 10, 26 AND 46).

CLASS 2—PAINTS

FOR PIGMENTS AND NATURAL RESINS FOR MANUFACTURING FOR USE IN THE MANUFACTURE OF FIBERS, FILMS, EXTRUSIONS, CO-EXTRUSIONS, MOLDED ARTICLES, THERMO-FORMED ARTICLES, AND SIMILAR TANGIBLE ARTICLES OR THE RAW MATERIAL FROM WHICH SAID ARTICLES ARE MADE (U.S. CLS. 6, 11 AND 16).

SN 76-195,904. PABU SERVICES, INC., WILMINGTON, DE.
FILED 1-18-2001.

POLYPACK**CLASS 1—CHEMICALS**

FOR SPECIALTY CHEMICALS AND CHEMICAL BLENDS USED AS POLYMER ADDITIVES, NAMELY, ANTI-STATIC COMPOUNDS, FLAME RETARDANTS, ANTI-BLOCKING COMPOUNDS, CLARIFIERS, NUCLEATING COMPOUNDS, LIGHT STABILIZERS, ULTRA VIOLET LIGHT ABSORBERS, NICKEL QUENCHERS, ACID SCAVENGERS, CROSS-LINKING AGENTS, AGING INHIBITORS, ANTIOXIDANTS, ANTI-OZONANTES, WAXES, SYNTHETIC RESINS FOR MANUFACTURING, ALL FOR USE IN THE MANUFACTURE OF FIBERS, FILMS, EXTRUSIONS, CO-EXTRUSIONS, MOLDED ARTICLES, THERMO-FORMED ARTICLES, AND SIMILAR TANGIBLE ARTICLES OR THE RAW MATERIAL FROM WHICH SAID ARTICLES ARE MADE (U.S. CLS. 1, 5, 6, 10, 26 AND 46).

CLASS 2—PAINTS

FOR PIGMENTS AND NATURAL RESINS FOR MANUFACTURING FOR USE IN THE MANUFACTURE OF FIBERS, FILMS, EXTRUSIONS, CO-EXTRUSIONS, MOLDED ARTICLES, THERMO-FORMED ARTICLES, AND SIMILAR TANGIBLE ARTICLES OR THE RAW MATERIAL FROM WHICH SAID ARTICLES ARE MADE (U.S. CLS. 6, 11 AND 16).

SN 76-198,020. TOKYO SEIMITSU CO., LTD., TOKYO, JAPAN, FILED 1-22-2001.



THE STIPPLING SHOWN IN THE DRAWING IS A FEATURE OF THE MARK.

CLASS 9—ELECTRICAL AND SCIENTIFIC APPARATUS

FOR PRECISION MEASURING MACHINES, NAMELY WAFER THICKNESS MEASURING MACHINE, NON-CONTACT FLATNESS MEASURING MACHINE, DIGITAL LENGTH MEASURING MACHINE, LASER INTERFERENCE LENGTH MEASURING SENSOR, OPTICAL FIBER LASER INTERFEROMETER MEASURING MACHINE, SURFACE TEXTURE MEASURING MACHINE, THREE-DIMENSIONAL MEASURING MACHINE, SURFACE TEXTURE AND CONTOUR MEASURING MACHINE, CONTOUR MEASURING MACHINE, ROUNDNESS MEASURING MACHINE, ROUNDNESS AND CYLINDRICAL/FLAT PROFILE ANALYSIS MACHINE, COORDINATE MEASURING MACHINE; DATA PROCESSING MACHINES FOR USE IN PROCESSING COORDINATE MEASURING DATA, MACHINE CONTROL GAUGE, DISPLACEMENT SENSOR, ELECTRIC MICROMETER, PNEUMATIC MICROMETER; COMPUTER CONTROLLED DISCRETE DEVICE TESTER; AUTOMATIC DIE SELECTOR, NAMELY COMPUTERIZED EQUIPMENT FOR TESTING SEMICONDUCTORS AND FOR SELECTION OF DIES FOR SEMICONDUCTOR MANUFACTURE; ELECTRIC OR MAGNETIC MEASURING MACHINES/INSTRUMENTS, NAMELY ELECTRIC CURRENT OR VOLTAGE DETECTORS, MAGNETIC MEASURING APPARATUS NAMELY MAGNETIC SENSORS, CAPACITY MEASURES; OPTICAL APPARATUS/INSTRUMENTS, NAMELY MICROSCOPES; ELECTRONIC MACHINES AND INSTRUMENTS AND THEIR PARTS AND FITTINGS, NAMELY ULTRASONIC DEPTH SOUNDERS; AUTOMATIC DISTRIBUTION VENDING MACHINES; NETWORK SYSTEM COMPRISED OF COMPUTER HARDWARE AND SOFTWARE FOR WAFER PROBING MACHINES; WAFER INSPECTION UNITS (U.S. CLS. 21, 23, 26, 36 AND 38).

CLASS 37—CONSTRUCTION AND REPAIR

FOR REPAIR AND MAINTENANCE SERVICE FOR MANUFACTURING AND MEASURING APPARATUS, NAMELY—METAL WORKING MACHINES AND TOOLS, NAMELY GRINDING MACHINES, METAL CUTTING MACHINES; CHEMICAL MACHINES/APPARATUS, NAMELY SEMICONDUCTOR WAFER DRYING MACHINES, SEMICONDUCTOR WAFER SCRUBBING AND WASHING MACHINE; SEMICONDUCTOR MANUFACTURING EQUIPMENT, NAMELY WIRE SLICING MACHINE, WAFER SLICING MACHINE, SLICING MACHINES FOR NON-SILICON WAFERS, SLICED WAFER CARBON DEMOUNTING AND CLEANING MACHINE, WAFER EDGE GRINDING MACHINE, WAFER PROBING MACHINE, WAFER DICING MACHINE, DICING MACHINE, CHEMICAL MECHANICAL PLANARIZERS, AND CHEMICAL MECHANICAL GRINDERS AND BACK GRINDERS; AND PRECISION MEASURING MACHINES AND INSTRUMENTS USED FOR PRODUC-

TION OF SEMICONDUCTOR, LIQUID CRYSTAL AND ELECTRONIC COMPONENTS, NAMELY WAFER THICKNESS MEASURING INSTRUMENT, NON-CONTACT FLATNESS MEASURING INSTRUMENT, MACHINES CONTROL GAGE, AUTOMATIC MEASURING MACHINE, DISPLACEMENT SENSOR, ELECTRIC MICROMETER, PNEUMATIC MICROMETER, DIGITAL LENGTH MEASURING INSTRUMENT, LASER INTERFERENCE LENGTH MEASURING SENSOR, OPTICAL FIBER LASER INTERFEROMETER MEASURING UNIT, SURFACE TEXTURE MEASURING INSTRUMENT, THREE-DIMENSIONAL MEASURING INSTRUMENT, SURFACE TEXTURE AND CONTOUR MEASURING INSTRUMENT, CONTOUR MEASURING INSTRUMENT, ROUNDNESS MEASURING INSTRUMENT, ROUNDNESS AND CYLINDRICAL/FLAT PROFILE ANALYSIS UNIT, COORDINATE MEASURING MACHINES; REPAIR AND MAINTENANCE OF DATA PROCESSING MACHINES FOR USE IN PROCESSING COORDINATE MEASURING DATA; COMPUTER CONTROLLED DISCRETE DEVICE TESTER; AUTOMATIC DIE SELECTOR, NAMELY COMPUTERIZED EQUIPMENT FOR TESTING SEMICONDUCTORS AND FOR SELECTION OF DIES FOR SEMICONDUCTOR MANUFACTURE; WAFER INSPECTION UNITS; ELECTRIC OR MAGNETIC MEASURING MACHINES/INSTRUMENTS, NAMELY ELECTRIC CURRENT OR VOLTAGE DETECTORS, MAGNETIC MEASURING APPARATUS NAMELY MAGNETIC SENSORS, CAPACITY MEASURES; OPTICAL APPARATUS/INSTRUMENTS, NAMELY MICROSCOPES; ELECTRONIC MACHINES/INSTRUMENTS AND THEIR PARTS/FITTINGS, NAMELY ULTRASONIC DEPTH SOUNDERS; AUTOMATIC DISTRIBUTION VENDING MACHINES (U.S. CLS. 100, 103 AND 106).

SN 76-200,786. WILDFUN XTREME SPORTS, LAS VEGAS, NV, FILED 1-29-2001.

WILDFUN

CLASS 39—TRANSPORTATION AND STORAGE

FOR ARRANGING EXCURSIONS AND MAKING RESERVATION FOR TRANSPORTATION FOR OTHERS ON EXCURSION TO NIGHT CLUBS, BARS AFTER HOUR LOUNGES, LIVE CONCERT PERFORMANCES OF MUSIC OR DANCING, AND RELATED ENTERTAINMENT AND SPORTING EVENTS; ARRANGING EXCURSIONS AND MAKING RESERVATION FOR TRANSPORTATION FOR OTHERS ON EXCURSIONS WHERE PEOPLE CAN RIDE AND UTILIZE PERSONAL WATERCRAFTS, BOATS, WATER-SKIS, WAKEBOARDS, KNEEBOARDS, RAFTS, AND RELATED EQUIPMENT; ALL TERRAIN VEHICLES (ATVS), DIRTBIKES, MOUNTAIN BIKES, OFF-ROADING VEHICLES AND EQUIPMENT; HANGGLIDERS, PARAGLIDING, PARASAILING, SKYDIVING, BALLONING, HELICOPTERS, AND RELATED EQUIPMENT; BEACH EQUIPMENT, CAMPING EQUIPMENT, SNOW EQUIPMENT, SNOWBOARDS, SNOWSKIS, AND RELATED EQUIPMENT (U.S. CLS. 100 AND 105).

FIRST USE 4-6-2000; IN COMMERCE 4-6-2000.

CLASS 41—EDUCATION AND ENTERTAINMENT

FOR ARRANGING AND ORGANIZING ENTERTAINMENT, SPORTING AND CULTURAL ACTIVITIES FOR OTHERS WHO ENGAGE IN RIDING AND UTILIZING PERSONAL WATERCRAFTS, BOATS, WATER-SKIS, WAKEBOARDS, KNEEBOARDS, RAFTS, AND RELATED EQUIPMENT; ALL TERRAIN VEHICLES (ATVS), DIRTBIKES, MOUNTAIN BIKES, OFF-ROADING VEHICLES AND EQUIPMENT; HANGGLIDERS, PARAGLIDING, PARASAILING, SKYDIVING, BALLONING, HELICOPTERS, AND RELATED EQUIPMENT; BEACH EQUIPMENT, CAMPING EQUIPMENT, SNOW EQUIPMENT, SNOWBOARDS, SNOWSKIS, AND RELATED EQUIPMENT; ARRANGING AND ORGANIZING ENTERTAINMENT, SPORTING AND CULTURAL ACTIVITIES FOR OTHERS WHO ATTEND NIGHT CLUBS, BARS, AFTER HOUR LOUNGES, LIVE CONCERT PERFORMANCES OF MUSIC OR DANCING, AND RELATED ENTERTAINMENT AND SPORTING EVENTS (U.S. CLS. 100, 101 AND 107).

FIRST USE 4-6-2000; IN COMMERCE 4-6-2000.

CLASS 42—SCIENTIFIC, COMPUTER AND LEGAL SERVICES

FOR MAKING RESERVATIONS AND BOOKINGS FOR TEMPORARY LODGING FOR OTHERS ENGAGED IN ENTERTAINMENT, SPORTING AND CULTURAL ACTIVITIES (U.S. CLS. 100 AND 101).

FIRST USE 4-6-2000; IN COMMERCE 4-6-2000.

SN 76-202,813. VERSATA, INC., OAKLAND, CA. FILED 1-31-2001.



versata

THE ENGLISH TRANSLATION OF "VERSATA" IS "VERSED".

CLASS 9—ELECTRICAL AND SCIENTIFIC APPARATUS

FOR COMPUTER SOFTWARE, NAMELY, SOFTWARE FOR THE DEVELOPMENT AND MANAGEMENT OF SOFTWARE APPLICATIONS, AND MANUALS THEREFOR SOLD AS A UNIT (U.S. CLS. 21, 23, 26, 36 AND 38).

FIRST USE 12-0-1999; IN COMMERCE 12-0-1999.

CLASS 42—SCIENTIFIC, COMPUTER AND LEGAL SERVICES

FOR COMPUTER SOFTWARE AND COMPUTER HARDWARE DESIGN AND CONSULTATION SERVICES FOR OTHERS AND TECHNICAL SUPPORT RELATING THERETO, NAMELY, MONITORING OF COMPUTER NETWORK SYSTEMS AND TROUBLESHOOTING OF COMPUTER SOFTWARE AND HARDWARE PROBLEMS (U.S. CLS. 100 AND 101).

FIRST USE 12-0-1999; IN COMMERCE 12-0-1999.

SN 76-203,798. ING. ERICH PFEIFFER GMBFH, 78315 RADOLFZELL, FED REP GERMANY, FILED 2-2-2001.

SmartPump

PRIORITY CLAIMED UNDER SEC. 44(D) ON FED REP GERMANY APPLICATION NO. 30058460, FILED 8-7-2000, REG. NO. 30058460.1, DATED 1-23-2001, EXPIRES 8-31-2010.

CLASS 9—ELECTRICAL AND SCIENTIFIC APPARATUS

FOR DISPENSERS, NOT CONTAINING MICROPROCESSORS, THAT COUNT OR MEASURE DOSAGE OR OUTPUT, FOR USE WITH COSMETICS AND PHARMACEUTICAL PRODUCTS, AND PARTS THEREOF (U.S. CLS. 21, 23, 26, 36 AND 38).

CLASS 10—MEDICAL APPARATUS

FOR DISPENSERS AND SPRAYERS FOR MEDICAL USE, NOT CONTAINING MICROPROCESSORS, NAMELY, SPRAYERS FOR USE IN TREATING ASTHMA, PUMP-ACTION SPRAYERS FOR ADMINISTERING TOPICAL PHARMACEUTICALS SOLD EMPTY, MEDICAL SPRAYERS FOR LIQUID MEDICINES, AND PARTS THEREOF (U.S. CLS. 26, 39 AND 44).

CLASS 21—HOUSEWARES AND GLASS

FOR PERFUME SPRAYERS SOLD EMPTY, DISPENSERS FOR LIQUID SOAP AND SIMILAR HOUSEHOLD PRODUCTS, NOT MADE FROM METAL, AND PARTS THEREOF, NONE OF THE AFOREMENTIONED GOODS CONTAINING MICROPROCESSORS (U.S. CLS. 2, 13, 23, 29, 30, 33, 40 AND 50).

SN 76-204,433. SINTERAMA S.P.A., 13876 SANDIGLIANO (BIELLA), ITALY, FILED 2-2-2001.

ZERBION

OWNER OF ITALY REG. NO. 361,595, DATED 10-11-2000, EXPIRES 10-11-2010.

CLASS 23—YARNS AND THREADS

FOR CHENILLE YARN, COTTON THREAD AND YARN, DARNING THREAD AND YARN, ELASTIC THREAD AND YARN FOR TEXTILE USE, EMBROIDERY THREAD AND YARN, FIBER-GLASS THREAD FOR TEXTILE USE, HEMP THREAD AND YARN, JUTE THREAD AND YARN, LINEN THREAD AND YARN, RAYON THREAD AND YARN, RUBBER THREAD FOR TEXTILE USE, SEWING THREAD AND YARN, SILK THREAD AND YARN, SPUN COTTON, SPUN SILK, SPUN THREAD AND YARN, SPUN WOOL, THREAD, THREADS OF PLASTIC MATERIALS FOR TEXTILE USE, SPUN WOOL, WOOLEN THREAD AND YARN AND WORSTED (U.S. CL. 43).

CLASS 24—FABRICS

FOR ADHESIVE FABRIC FOR APPLICATION BY HEAT; BATH LINEN, BED BLANKETS, BED LINEN, TABLE LINEN COASTERS, COTTON FABRICS, CURTAINS OF TEXTILE OR PLASTIC, DAMASK, FABRIC FOR BOOTS AND SHOES, FABRIC OF IMITATION ANIMAL SKINS, FLANNEL, UNFITTED FABRIC FURNITURE COVERS, FUSTIAN, FABRIC GAUZE, GLASS CLOTH, GUMMED CLOTH FOR TEXTILE PURPOSES, HANDKERCHIEFS OF TEXTILE, HAT LININGS OF TEXTILE, HEMP CLOTH, HOUSEHOLD LINEN, JERSEY FABRIC MATERIAL, JUTE CLOTH, CLOTH LABELS, LINEN, PILLOW CASES RAYON FABRIC; SILK CLOTH, SILK FABRICS FOR PRINTING PATTERNS; TABLE CLOTHS NOT OF PAPER, TABLE LINEN, TAPESTRIES OF TEXTILE FOR WALL HANGINGS, TOWELS OF TEXTILE, VELVET, WALL HANGINGS OF TEXTILE, WOOLEN CLOTH AND WOOLEN FABRIC (U.S. CLS. 42 AND 50).

SN 76-204,679. EBBON-DACS LIMITED, OXFORD OX2 2QY, ENGLAND, FILED 2-2-2001.



SN 76-204,549. EBBON-DACS LIMITED, OXFORD OX2 2QY, ENGLAND, FILED 2-2-2001.

EBBON DACS**CLASS 9—ELECTRICAL AND SCIENTIFIC APPARATUS**

FOR COMPUTER SOFTWARE FOR USE IN THE AUTOMOTIVE AND MOTOR INDUSTRIES, NAMELY, A PROGRAM FOR USE IN DATABASE MANAGEMENT AND FOR USE AS A SPREAD SHEET TO FACILITATE BUSINESS MANAGEMENT, ADMINISTRATION AND PLANNING; COMMUNICATION SOFTWARE FOR USE THE AUTOMOTIVE AND MOTOR INDUSTRIES TO CONNECT COMPUTER NETWORK USERS AND CUSTOMERS; COMPUTER SOFTWARE FOR USE IN DATABASE MANAGEMENT AND FOR USE AS A SPREAD SHEET TO FACILITATE THE MANAGEMENT OF BUSINESS SALES INFORMATION; COMPUTER SOFTWARE FOR USE IN DATABASE MANAGEMENT AND FOR USE AS A SPREAD SHEET TO ENABLE THE MANAGEMENT OF AUTOMOTIVE SALES CHANNELS AND BUSINESS MONITORING, NAMELY, BUSINESS MANAGEMENT AND REPORTING SYSTEMS; COMPUTER SOFTWARE FOR USE IN DATABASE MANAGEMENT AND FOR USE AS A SPREAD SHEET IN THE FIELD OF CUSTOMER SERVICES; COMPUTER SOFTWARE FOR TRACKING VEHICLES, SALES OF AUTOMOTIVE VEHICLES AND PRODUCTS AND PARTS AND ACCESSORIES AS PART OF THE SUPPLY CHAIN LOGISTICS; COMPUTER SOFTWARE FOR USE IN DATABASE MANAGEMENT AND FOR USE AS A SPREAD SHEET TO FACILITATE THE MANAGEMENT OF SUPPLY CHAIN LOGISTICS; ALL THE AFOREMENTIONED SOFTWARE IN DOWNLOADABLE AND CD-ROM FORM (U.S. CLS. 21, 23, 26, 36 AND 38).

CLASS 9—ELECTRICAL AND SCIENTIFIC APPARATUS

FOR COMPUTER SOFTWARE FOR USE IN THE AUTOMOTIVE AND MOTOR INDUSTRIES, NAMELY, A PROGRAM FOR USE IN DATABASE MANAGEMENT AND FOR USE AS A SPREAD SHEET TO FACILITATE BUSINESS MANAGEMENT, ADMINISTRATION AND PLANNING; COMMUNICATION SOFTWARE FOR USE THE AUTOMOTIVE AND MOTOR INDUSTRIES TO CONNECT COMPUTER NETWORK USERS AND CUSTOMERS; COMPUTER SOFTWARE FOR USE IN DATABASE MANAGEMENT AND FOR USE AS A SPREAD SHEET TO FACILITATE THE MANAGEMENT OF BUSINESS SALES INFORMATION; COMPUTER SOFTWARE FOR USE IN DATABASE MANAGEMENT AND FOR USE AS A SPREAD SHEET TO ENABLE THE MANAGEMENT OF AUTOMOTIVE SALES CHANNELS AND BUSINESS MONITORING, NAMELY, BUSINESS MANAGEMENT AND REPORTING SYSTEMS; COMPUTER SOFTWARE FOR USE IN DATABASE MANAGEMENT AND FOR USE AS A SPREAD SHEET IN THE FIELD OF CUSTOMER SERVICES; COMPUTER SOFTWARE FOR TRACKING VEHICLES, SALES OF AUTOMOTIVE VEHICLES AND PRODUCTS AND PARTS AND ACCESSORIES AS PART OF THE SUPPLY CHAIN LOGISTICS; COMPUTER SOFTWARE FOR USE IN DATABASE MANAGEMENT AND FOR USE AS A SPREAD SHEET TO FACILITATE THE MANAGEMENT OF SUPPLY CHAIN LOGISTICS; ALL THE AFOREMENTIONED SOFTWARE IN DOWNLOADABLE AND CD-ROM FORM (U.S. CLS. 21, 23, 26, 36 AND 38).

CLASS 35—ADVERTISING AND BUSINESS

FOR BUSINESS MANAGEMENT; PROVIDING CONSULTATION AND ADVICE IN THE FIELD OF PROCESS MANAGEMENT RELATING TO TRACKING AND MONITORING SALES PROCESSES, SUPPLY CHAIN PROCESSES AND CUSTOMER RELATIONS PROCESSES WITHIN THE AUTOMOTIVE AND MOTOR INDUSTRIES; ALL PROVIDED IN-PERSON AND OVER A GLOBAL COMPUTER NETWORK (U.S. CLS. 100, 101 AND 102).

CLASS 35—ADVERTISING AND BUSINESS

FOR BUSINESS MANAGEMENT; PROVIDING CONSULTATION AND ADVICE IN THE FIELD OF PROCESS MANAGEMENT RELATING TO TRACKING AND MONITORING SALES PROCESSES, SUPPLY CHAIN PROCESSES AND CUSTOMER RELATIONS PROCESSES WITHIN THE AUTOMOTIVE AND MOTOR INDUSTRIES; ALL PROVIDED IN-PERSON AND OVER A GLOBAL COMPUTER NETWORK (U.S. CLS. 100, 101 AND 102).

CLASS 42—SCIENTIFIC, COMPUTER AND LEGAL SERVICES

FOR COMPUTER SOFTWARE DESIGN AND DEVELOPMENT FOR OTHERS; LEASING ACCESS TIME TO A COMPUTER DATABASE IN THE FIELD OF AUTOMOTIVE AND MOTOR INDUSTRIES (U.S. CLS. 100 AND 101).

CLASS 42—SCIENTIFIC, COMPUTER AND LEGAL SERVICES

FOR COMPUTER SOFTWARE DESIGN AND DEVELOPMENT FOR OTHERS; LEASING ACCESS TIME TO A COMPUTER DATABASE IN THE FIELD OF AUTOMOTIVE AND MOTOR INDUSTRIES (U.S. CLS. 100 AND 101).

SN 76-205,538. SKEEZIKS LTD. CO., ALBUQUERQUE, NM.
FILED 2-6-2001.

JONATHAN LARSON

CLASS 36—INSURANCE AND FINANCIAL

FOR CHARITABLE FUND RAISING SERVICES; PROVIDING GRANTS TO ORGANIZATIONAL AND INDIVIDUALS THAT PROMOTE THE PERFORMING ARTS; AND LOAN FINANCING SERVICE (U.S. CLS. 100, 101 AND 102).

CLASS 41—EDUCATION AND ENTERTAINMENT

FOR AWARD PROGRAM FOR CORPORATION AND INDIVIDUALS WHO HAVE MADE SIGNIFICANT CHARITABLE CONTRIBUTIONS; AND PROVIDING INFORMATION VIA THE INTERNET IN THE FIELD OF THE PERFORMING ARTS (U.S. CLS. 100, 101 AND 107).

CLASS 42—SCIENTIFIC, COMPUTER AND LEGAL SERVICES

FOR CHARITABLE SERVICES, NAMELY, PROVIDING EQUIPMENT AND FACILITIES IN THE FIELD OF THE PERFORMING ARTS (U.S. CLS. 100 AND 101).

CLASS 9—ELECTRICAL AND SCIENTIFIC APPARATUS

FOR PROTECTIVE HEADGEAR, HELMETS, GLOVES, AND GOGGLES, NAMELY, HELMETS FOR PROTECTION AGAINST ACCIDENT AND INJURY, HELMETS FOR USE IN SPORTS; PROTECTIVE GLOVES FOR INDUSTRIAL USE; GOGGLES FOR PROTECTION AGAINST ACCIDENT OR INJURY, SKIING GOGGLES, GOGGLES FOR EYE PROTECTION; GOGGLES FOR USE IN AUTORACING; LUMINOUS AND MECHANICAL SIGNS; SUN GLASSES, SPECTACLES AND CASES THEREFORE; MAGNETICALLY CODED CREDIT CARDS, TELEPHONE CARDS, BONUS CARDS, CHARGE CARDS; COMPUTER SOFTWARE FOR THE OPERATION OF MAGNETICALLY ENCODED CARDS; BATTERIES; PRERECORDED VIDEO CASSETTES FOR EDUCATION, DOCUMENTARIES, AND ENTERTAINMENT IN THE FIELD OF AUTO RACING; PRERECORDED COMPACT DISCS FOR EDUCATION, DOCUMENTARIES, AND ENTERTAINMENT IN THE FIELD OF AUTO RACING; SOFTWARE FOR COMPUTERS AND DOWNLOADABLE COMPUTER SOFTWARE IN THE FIELDS OF EDUCATION AND ENTERTAINMENT ON THE SUBJECT OF AUTO RACING; COMPUTER SOFTWARE FEATURING GAMES; PHOTOGRAPHIC APPARATUS NAMELY CAMERAS AND CAMCORDERS; BINOCULARS; DOWNLOADABLE ON-LINE ELECTRONIC PUBLICATIONS, NAMELY BOOKS, CATALOGUES, FACT SHEETS, NEWSPAPERS, AND MAGAZINES IN THE FIELD OF AUTO RACING; COMPUTER DATABASES CONTAINING ENTERTAINMENT INFORMATION ON THE SUBJECT OF AUTO RACING, RECORDED ON COMPUTER MEDIA; EDUCATIONAL DATABASES CONTAINING INFORMATION OF THE SUBJECT OF AUTO RACING RECORDED ON COMPUTER MEDIA (U.S. CLS. 21, 23, 26, 36 AND 38).

CLASS 16—PAPER GOODS AND PRINTED MATTER

FOR STATIONERY; PICTURES; MOUNTED PHOTOGRAPHS; UNMOUNTED PHOTOGRAPHS; POSTERS; RUBBER STAMPS; BOOK COVERS AND BINDINGS; STATIONERY-TYPE PORTFOLIOS; NEWSPAPERS AND MAGAZINES FEATURING AUTO RACING; COMIC BOOKS; CATALOGUES FEATURING AUTO RACING; ANNUAL PUBLICATIONS NAMELY BOOKS ON AUTO RACING; LEAFLETS AND PRINTED MAILERS FEATURING AUTO RACING; ADDRESS BOOKS; PHOTO ALBUMS; AUTOGRAPH BOOKS; DIARIES; SCRAP BOOKS; WRITING PADS AND WRITING TABLETS; BINDERS; CALENDARS; PERSONAL PLANNERS AND ORGANIZERS; GREETING CARDS; ROUTE MAPS; PRINTING, PAINTING AND DRAWING SETS; LETTER OPENERS; COMPUTER GAME INSTRUCTION MANUALS; STICKERS; STENCILS; PLASTIC TRANSFERS; IRON-ON TRANSFERS; GIFT WRAPPING PAPER AND STATIONERY; STATIONERY BAGS MADE OF PAPER, PLASTIC SANDWICH BAGS, PAPER PARTY BAGS; CHECKBOOK WALLETS AND PASSPORT WALLETS; PAPER BAGS FOR MERCHANDISE PACKAGING; PAPER NAME BADGES; PAPER PLACEMATS; BUSTS, FIGURINES, AND ORNAMENTS MADE OF CARDBOARD, PAPER AND PAPER MACHE, PAPERWEIGHTS; AND PAPER PARTY DECORATIONS, NAMELY, STREAMERS (U.S. CLS. 2, 5, 22, 23, 29, 37, 38 AND 50).

CLASS 24—FABRICS

FOR CLOTH BANNERS AND FLAGS; TOWELS; FACE FLANNELS, NAMELY CLOTHS FOR WASHING AND CLEANING FACES; BED LINEN; DUVET COVERS; CURTAINS; LINEN TABLE CLOTHS; LINEN NAPKINS; CLOTH BADGES NOT TO BE APPLIED TO CLOTHING, AND CLOTH LABELS; HANDKERCHIEFS; FRIEZES; TABLE LINEN NAMELY COASTERS, PRINTED TEXTILE LABELS; PARTS AND FITTINGS FOR ALL THE AFORESAID GOODS (U.S. CLS. 42 AND 50).

SN 76-205,601. FORMULA MANAGEMENT LTD., ST. HELIER, JERSEY, CHANNEL ISLANDS, BY ASSIGNMENT RAIKKONEN RACING LTD., SOUTHAMPTON, UNITED KINGDOM, FILED 2-6-2001.



THE NAME "KIMI RAIKKONEN" IDENTIFIES A LIVING INDIVIDUAL WHOSE CONSENT IS OF RECORD.

CLASS 25—CLOTHING

FOR AUTOMOBILE RACING GLOVES, UNDERWEAR; TRACKSUITS; SHELL SUITS, NAMELY, BODY SUITS AND JOGGING SUITS; OVERALLS; COATS; MANTLES; SUITS; JACKETS; WAIST COATS; BATH ROBES; JUMPERS; TROUSERS; SHORTS; SHIRTS; POLO SHIRTS; T-SHIRTS; SWEAT SHIRTS; SWEAT BANDS; FOOTWEAR; SKI BOOTS; GAITERS AND BAGS FOR SKI BOOTS; SOCKS; HEADGEAR, NAMELY CAP PEAKS, VISORS, AND BASEBALL CAPS; VISORS; BASEBALL CAPS; NECKWEAR; SCARVES; GLOVES USED FOR CASUAL DRIVING OF AUTOMOBILES; CLOTHING BELTS; BRACES FOR CLOTHING, NAMELY, SUSPENDERS; HEADBANDS; HATS (U.S. CLS. 22 AND 39).

CLASS 26—FANCY GOODS

FOR TEXTILE AND EMBROIDERED BADGES AND PATCHES TO BE SEWN ON OR IRONED ONTO CLOTHING; EMBROIDERY; NAME LETTERING AND MONOGRAM LETTERING FOR APPLICATION TO FABRICS; ROSETTES IN THE NATURE OF FABRIC TRIMMING AND FRINGES; RIBBONS; HAIR RIBBONS AND BOWS; SHIRT AND ORNAMENTAL NOVELTY BUTTONS (U.S. CLS. 37, 39, 40, 42 AND 50).

CLASS 28—TOYS AND SPORTING GOODS

FOR BALLOONS; BATH TOYS; BOARD GAMES; CARD GAMES; TOY CONSTRUCTION SETS; DICE GAMES; HAND HELD UNIT FOR PLAYING ELECTRONIC GAMES; ELECTRONIC DART BOARDS; TOY FIGURINES; SPORT GLOVES FOR RECREATIONAL BICYCLING; EXERCISE EQUIPMENT, NAMELY, ROWING MACHINES, POWERED TREADMILLS FOR RUNNING, AND WEIGHT LIFTING MACHINES; INFLATABLE TOYS; JIGSAW PUZZLES; KITES; TOY MODEL VEHICLES; TOY GARAGES; PAPER TOYS, NAMELY PAPER AIRPLANES, PAPER DOLLS AND PAPER FACEMASKS; PLASTIC TOY MODELS, NAMELY, CARS, TRAINS, AIRPLANES, AND FAMOUS BUILDINGS; PLAY TENTS; SOFT SCULPTURED TOYS; STUFFED ANIMALS; PUZZLES; RIDE ON TOYS NAMELY TOY BICYCLES AND TOY VEHICLES; IN-LINE SKATES AND ROLLER SKATES; SKATE BOARDS; SAIL AND SURF BOARDS; SNOW SLEDS FOR RECREATIONAL USE; TOY VEHICLE TRACKS AND RACING SETS; TOY MONEY BOXES; HOME PLATES; PARTY FAVORS IN THE NATURE OF SMALL TOYS; BEAN BAGS; TOY BANK NOTES (U.S. CLS. 22, 23, 38 AND 50).

SN 76-207,319. LIGHTARCHITECTURE LTD., LONDON W1J 5AE, UNITED KINGDOM, FILED 2-9-2001.

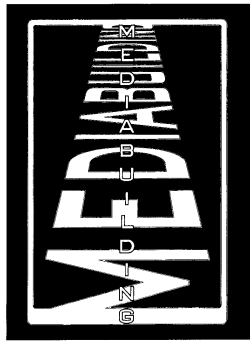

PRIORITY CLAIMED UNDER SEC. 44(D) ON ITALY APPLICATION NO. RM2000C00509, FILED 8-11-2000.

THE MARK IS IN COLOR WHEREIN THE BLACK DESIGNATES A DARK SHADE OF BLUE AND THE WHITE CONTAINED WITHIN THE BLACK BACKGROUND INDICATES A LIGHTER SHADE OF BLUE.

CLASS 38—COMMUNICATION

FOR ELECTRONIC TRANSMISSION OF IMAGES VIA COMPUTER TERMINALS FOR PROJECTION ONTO BUILDING FACADES; CABLE TELEVISION BROADCASTING; TELEVISION BROADCASTING; CELLULAR TELEPHONE SERVICES; ELECTRONIC MAIL SERVICES; ELECTRONIC VOICE MESSAGING, NAMELY, THE RECORDING AND SUBSEQUENT TRANSMISSION OF VOICE MESSAGES BY TELEPHONE; RENTAL OF TELECOMMUNICATIONS EQUIPMENT, NAMELY, MESSAGE SENDING MACHINES (U.S. CLS. 100, 101 AND 104).

CLASS 42—SCIENTIFIC, COMPUTER AND LEGAL SERVICES

FOR CONSULTATION SERVICES IN THE FIELDS OF ARCHITECTURE, ENGINEERING AND COMPUTER PROGRAMMING; PRINTING AND GRAPHIC ART DESIGN; AND RENTAL OF COMPUTERS AND SOFTWARE (U.S. CLS. 100 AND 101).

SN 76-208,890. EADS DEUTSCHLAND GMBH, D-85521 OTTOBRUNN B. MUNCHEN, FED REP GERMANY, FILED 2-13-2001.

PLANET AEROSPACE

NO CLAIM IS MADE TO THE EXCLUSIVE RIGHT TO USE "AEROSPACE", APART FROM THE MARK AS SHOWN.

CLASS 9—ELECTRICAL AND SCIENTIFIC APPARATUS

FOR DATA PROCESSING APPARATUS, NAMELY, COMPUTERS AND COMPUTER SERVERS AND PARTS THEREFOR; ELECTRONIC COMMUNICATION AND VIDEO APPARATUS, NAMELY, RADAR AND VIDEO PHONES; COMPUTER WORKSTATIONS COMPRISING MONITORS, HARD DISK DRIVES AND KEYBOARDS, PERSONAL COMPUTERS, LAPTOPS AND PARTS THEREFOR; ELECTRONIC, OPTICAL, AND MAGNETIC DATA CARRIERS AND RECORDING APPARATUS, NAMELY, CD ROMS, DVDS, FLOPPY DISKS, BLANK AND PRE-RECORDED WITH ADVERTISEMENTS AND PROGRAMS FOR VIRTUAL REALITY AND MULTIMEDIA PRESENTATIONS AND INFORMATION OF A TRAVEL AGENCY; CD ROM, DVD AND FLOPPY DISK DRIVES; TELEVISIONS; COMPUTER PROGRAMS FOR VIRTUAL REALITY, INTERNET AND MULTIMEDIA PRESENTATIONS; COMPUTER SOFTWARE FOR TECHNICAL WRITING FOR OTHERS, COORDINATION OF SUBMISSIONS TO PUBLICATIONS BY A PLURALITY OF AUTHORS; COMPUTER SOFTWARE FOR WRITTEN TEXT AND IMAGE EDITING; COMPUTER SOFTWARE FOR SERVICES OF A TRAVEL AGENCY, NAMELY, PLANNING, COLLECTING AND ARRANGING OF TRAVEL ROUTES AND TOURIST EVENTS FOR OTHERS AND MAKING RESERVATIONS AND BOOKINGS FOR TRANSPORT AND TEMPORARY LODGING PARTICULARLY VIA LOCAL AND GLOBAL COMPUTER NETWORKS; COMPUTER SOFTWARE FOR SOFTWARE DESIGN FOR OTHERS PARTICULARLY VIA LOCAL AND GLOBAL COMPUTER NETWORKS; COMPUTER SOFTWARE FOR WEB DESIGN AND MULTIMEDIA DESIGN VIA LOCAL AND GLOBAL COMPUTER NETWORKS; COMPUTER SOFTWARE FOR LEASING OF ACCESS TIME VIA LOCAL AND GLOBAL COMPUTER NETWORKS; COMPUTER SOFTWARE FOR TECHNICAL CONSULTATION IN THE FIELD OF COMPUTER HARDWARE AND SOFTWARE AND TECHNICAL SUPPORT SERVICES, NAMELY, TROUBLESHOOTING OF COMPUTER HARDWARE AND SOFTWARE AND E-MAIL PROBLEMS (U.S. CLS. 21, 23, 26, 36 AND 38).

CLASS 16—PAPER GOODS AND PRINTED MATTER

FOR PRINTED MATTER, NAMELY, REGIONAL, NATIONWIDE, AND WORLDWIDE PERIODICAL AND NON-PERIODICAL PUBLICATIONS, NAMELY, NEWSPAPERS, MAGAZINES, HANDBOOKS, BOOKS, AND BROCHURES RELATING TO TECHNICAL, ECONOMIC, GEOGRAPHICAL AND CULTURAL TOPICS, IN THE FIELD OF TRAVEL AND TOURISM; MOUNTED AND UNMOUNTED PHOTOGRAPHS; MATERIALS FOR PACKAGING, NAMELY, PAPER AND PLASTIC BAGS FOR MERCHANDISE PACKAGING; PRINTED PAPER SIGNS AND LABELS; POSTERS, POSTCARDS, DRAWINGS, PAINTINGS; PLAYING CARDS (U.S. CLS. 2, 5, 22, 23, 29, 37, 38 AND 50).

CLASS 42—SCIENTIFIC, COMPUTER AND LEGAL SERVICES

FOR TECHNICAL WRITING FOR OTHERS, COORDINATION OF SUBMISSIONS TO PUBLICATIONS BY A PLURALITY OF AUTHORS; WRITTEN TEXT EDITING; SERVICES OF A TRAVEL AGENCY, NAMELY, MAKING RESERVATIONS AND BOOKING AND TEMPORARY LODGING PARTICULARLY VIA LOCAL AND GLOBAL COMPUTER NETWORKS; SOFTWARE DESIGN FOR OTHERS PARTICULARLY VIA LOCAL AND GLOBAL COMPUTER NETWORKS; WEB DESIGN AND MULTIMEDIA DESIGN, COMPUTER CONSULTANCY; DESIGN, REDESIGN AND UPDATING OF COMPUTER SOFTWARE AND DATABASES FOR OTHERS; DESIGNING SOFTWARE FOR ONLINE ADVERTISING AND MULTIMEDIA PRESENTATIONS PARTICULARLY VIA LOCAL AND GLOBAL COMPUTER NETWORKS; LEASING OF COMPUTER SOFTWARE FOR ONLINE MULTIMEDIA PRESENTATIONS; PROVIDING TEMPORARY USE OF ONLINE NON-DOWNLOADABLE SOFTWARE FOR USE IN DATABASE MANAGEMENT AND BROWSING AND FOR USE AS A SPREADSHEET PARTICULARLY IN THE FIELD OF TRAVEL AND TOURISM; TECHNICAL CONSULTATION IN THE FIELD OF COMPUTER HARDWARE AND SOFTWARE AND TECHNICAL SUPPORT SERVICES, NAMELY, TROUBLESHOOTING OF COMPUTER HARDWARE AND SOFTWARE PROBLEMS VIA TELEPHONE, E-MAIL, AND IN PERSON (U.S. CLS. 100 AND 101).

SN 76-210,153. ROYAL & SUN ALLIANCE INSURANCE GROUP PLC, LONDON, UNITED KINGDOM, FILED 2-12-2001.



THE MARK CONSISTS OF THE WORDS "MORE TH>N & NAVIGATOR DEVICE" WITH BORDER AND THE WORDS "FROM ROYAL & SUN ALLIANCE".

CLASS 35—ADVERTISING AND BUSINESS

FOR TAX CONSULTATION; AUCTIONEERING; DIRECT MAIL ADVERTISING; DISSEMINATION OF ADVERTISING MATTER; DOCUMENT REPRODUCTION BUSINESS MANAGEMENT (U.S. CLS. 100, 101 AND 102).

CLASS 36—INSURANCE AND FINANCIAL

FOR INSURANCE ADMINISTRATION, BROKERAGE AND CONSULTATION; GUARANTEE ASSURANCE UNDERWRITING; UNDERWRITING OF ALL TYPES OF INSURANCE; FINANCIAL ANALYSIS, CONSULTATION, MANAGEMENT, PLANNING AND RESEARCH; ACTUARIAL SERVICES; INVESTMENT ADVICE AND BROKERAGE; FINANCING SERVICES; MORTGAGE BROKERAGE AND LENDING; TEMPORARY LOANS; ADMINISTRATION OF EMPLOYEE PENSION PLANS; ADMINISTRATION OF ANNUITIES AND RETIREMENT PLANS; TRUST SERVICES, NAMELY, INVESTMENT AND TRUST COMPANY SERVICES; MUTUAL FUND RETIREMENT PLANS; TRUST SERVICES, NAMELY, INVESTMENT AND TRUST COMPANY SERVICES; MUTUAL FUND BROKERAGE AND INVESTMENT; ESTATE PLANNING; REAL ESTATE APPRAISAL, BROKERAGE, LEASING AND MANAGEMENT; RENTAL OF APARTMENTS; FINANCIAL VALUATION OF PERSONAL PROPERTY AND REAL ESTATE; ESTATE TRUST MANAGEMENT; HOUSING AGENCIES; RENT COLLECTION AGENCIES (U.S. CLS. 100, 101 AND 102).

CLASS 42—SCIENTIFIC, COMPUTER AND LEGAL SERVICES

FOR STANDARDIZED TESTING; QUALITY CONTROL FOR OTHERS; LEGAL SERVICES; CAREER, HEALTH, MARRIAGE, MEDICAL, NUTRITION AND PSYCHOLOGICAL COUNSELING; HEALTH CARE; LAND SURVEYING (U.S. CLS. 100 AND 101).

SN 76-210,985. DINICTA S.R.L., 31049 VALDOBBIADENE, TREVISO, ITALY, FILED 2-16-2001.

GELPAD BY DINICTA

PRIORITY CLAIMED UNDER SEC. 44(D) ON ITALY APPLICATION NO. 1,988,575, FILED 12-7-2000, REG. NO. 001988575, DATED 3-20-2002, EXPIRES 12-7-2010.

OWNER OF U.S. REG. NO. 2,370,399.

NO CLAIM IS MADE TO THE EXCLUSIVE RIGHT TO USE "GELPAD", APART FROM THE MARK AS SHOWN.

CLASS 9—ELECTRICAL AND SCIENTIFIC APPARATUS

FOR MOUSE PADS, JOYSTICK ERGONOMIC GRIPS; ARM-RESTS FOR USE WITH COMPUTERS (U.S. CLS. 21, 23, 26, 36 AND 38).

CLASS 10—MEDICAL APPARATUS

FOR ANTI-SHOCK SEAT CUSHIONS AND PADS FOR MEDICAL PURPOSES (U.S. CLS. 26, 39 AND 44).

CLASS 20—FURNITURE AND ARTICLES NOT OTHERWISE CLASSIFIED

FOR PILLOWS, ARMCHAIRS, PADDED FURNITURE AND MATTRESSES; FURNITURE PARTS, NAMELY, ARM RESTS (U.S. CLS. 2, 13, 22, 25, 32 AND 50).

SN 76-213,287. INTERNATIONAL AMATEUR ATHLETIC FEDERATION, MC 98000 MONTE CARLO, MONACO, FILED 2-21-2001.

PURE COMPETITION

PRIORITY CLAIMED UNDER SEC. 44(D) ON MONACO APPLICATION NO. 22089, FILED 9-13-2000, REG. NO. 01.22085, DATED 2-27-2001, EXPIRES 9-13-2010.

CLASS 6—METAL GOODS

FOR METAL KEY CHAINS; METAL MONEY CLIPS; FIGURINES OF COMMON METALS, PEWTER FIGURINES; TROPHIES OF COMMON METALS, STATUES OF NON-PRECIOUS METALS; SCULPTURES MADE OF COMMON METAL; AND COLLECTIBLE MILK CAPS MADE OF COMMON METALS (U.S. CLS. 2, 12, 13, 14, 23, 25 AND 50).

CLASS 9—ELECTRICAL AND SCIENTIFIC APPARATUS

FOR MAGNETS; DECORATIVE REFRIGERATOR MAGNETS; EYEGLASSES; SUNGLASSES; CASES AND CHAINS FOR EYEGLASSES AND SUNGLASSES, BINOCULARS; APPARATUS FOR RECORDING, TRANSMITTING AND REPRODUCING OF SOUND AND IMAGES, NAMELY, VIDEO CAMERAS, MOTION PICTURE CAMERAS, VIDEO RECORDERS, COMPACT DISK PLAYERS, DIGITAL DISK PLAYERS, TELEVISION RECEIVERS AND RADIO RECEIVERS; BLANK AUDIO TAPES; BLANK DIGITAL AUDIO TAPES; BLANK AUDIO DISCS; BLANK AUDIO CASSETTES; PRERECORDED AUDIO TAPES, DISCS, COMPACT DISCS, OPTICAL DISCS, CD-ROMS AND CASSETTES ALL FEATURING MUSIC; BLANK VIDEO TAPES; BLANK VIDEO DISCS; BLANK OPTICAL DISCS; BLANK COMPACT DISCS; BLANK VIDEO CASSETTES; PRERECORDED VIDEO TAPES, MAGNETIC TAPES, MAGNETIC DISKS, DIGITAL TAPES, DISCS, COMPACT DISCS, FLOPPY DISKS, OPTICAL DISKS, CD-ROMS, DVDS AND CASSETTES ALL FEATURING ANIMATION, IMAGES AND SPORTING EVENTS; VIDEO CASSETTE RECORDERS; VIDEO TAPE RECORDERS; COMPUTERS; MODEMS; ELECTRONIC POCKET TRANSLATORS; ELECTRONIC PERSONAL ORGANIZERS; OPTICAL SCANNERS; COMPUTER PRINTERS; CALCULATORS; DATA PROCESSORS; AUTOMATED TELLER MACHINES; CASH EXCHANGING MACHINES; PERSONAL SECURITY ALARMS; LOUDSPEAKERS; CAMCORDERS; FACSIMILE MACHINES; TELEPHONES; TELEPHONE ANSWERING MACHINES; VIDEO TELEPHONES; PHOTOCOPYING MACHINES, PHOTOGRAPHIC EQUIPMENT, NAMELY, PHOTOGRAPHIC CAMERAS, 35MM CAMERAS, PROJECTORS, EXPOSED CAMERA FILM, FLASH BULBS, CAMERA CASES AND BATTERIES FOR CAMERAS; WIND SOCKS FOR INDICATING WIND DIRECTION AND INTENSITY; VIDEO GAME CARTRIDGES; CD ROMS, COMPUTER GAME SOFTWARE; BLANK MAGNETIC COMPUTER TAPES; MAGNETIC CODED CARDS; COMPUTER HARDWARE, NAMELY, MEMORY CARDS AND MICROCHIPS; VENDING MACHINES; DIRECTIONAL COMPASSES; MAGNETICALLY ENCODED CREDIT CARDS; MAGNETICALLY ENCODED PHONE CARDS; MAGNETICALLY ENCODED AUTOMATED TELLER MACHINE CARDS; MAGNETICALLY ENCODED TRAVEL AND ENTERTAINMENT CARDS; MAGNETICALLY ENCODED CHECK GUARANTEE CARDS; MAGNETICALLY ENCODED DEBIT CARDS; VIDEOTAPES AND VIDEO DISKS RECORDED WITH ANIMATION, MAGNETIC TAPES, MAGNETIC DISKS, AND ELECTRICAL IRONS (U.S. CLS. 21, 23, 26, 36 AND 38).

CLASS 12—VEHICLES

FOR BICYCLES; MOTORCYCLES; AUTOMOBILES; TRUCKS; VANS; BUSES; AIRPLANES; BOATS; VEHICULAR BALLOONS; AIRSHIPS; PRAMS; BABY STROLLERS; CHILDREN'S CAR SEATS; AUTOMOBILE ACCESSORIES, NAMELY, AUTOMOBILE WINDSHIELD SUN SCREENS, SKI RACKS FOR VEHICLES, BICYCLE RACKS FOR VEHICLES, SPORTING EQUIPMENT RACKS FOR VEHICLES, TIRE COVERS, VEHICLE SEAT COVERS, FITTED COVERS FOR VEHICLES, ENGINES FOR LAND VEHICLES, NAMELY, AUTOMOBILES; AND TIRES (U.S. CLS. 19, 21, 23, 31, 35 AND 44).

CLASS 14—JEWELRY

FOR JEWELRY; WATCHES; CLOCKS; MEDALLIONS; ORNAMENTAL PINS; PENDANTS; TANKARDS OF PRECIOUS METAL; TROPHIES OF PRECIOUS METAL; STATUES OF PRECIOUS METAL; SCULPTURES MADE OF PRECIOUS METAL; TEA POTS OF PRECIOUS METAL; TIE CLIPS; TIE PINS; ASHTRAYS OF PRECIOUS METAL; CIGARETTE CASES OF PRECIOUS METALS; NON-MONETARY COINS; PINS BEING JEWELRY; FIGURINES MADE OF PRECIOUS METALS; HAT ORNAMENTS OF PRECIOUS METAL; SHOE ORNAMENTS OF PRECIOUS METAL; AND COLLECTIBLE MILK CAPS OF PRECIOUS METAL (U.S. CLS. 2, 27, 28 AND 50).

CLASS 16—PAPER GOODS AND PRINTED MATTER

FOR HOLOGRAMS; GIFT AND PARTY SUPPLIES MADE OF PAPER, NAMELY, NAPKINS TABLE CLOTHS, PAPER BAGS, PRINTED INVITATIONS, GIFT WRAP, COASTERS AND PLACE MATS; PAPER TABLE LINENS; CREPE PAPER; PAPER GARBAGE BAGS; PLASTIC GARBAGE BAGS; FOOD WRAPPERS; PRINTED PAPER LABELS, FLAGS, PENNANTS AND HANDKERCHIEFS; TYPEWRITER PAPER; PLASTIC COATED COPYING PAPER; PAPER FILTERS FOR COFFEE MAKERS; PAPER TOWELS; DISPOSABLE PAPER WIPES NOT IMPREGNATED WITH CHEMICALS OR COMPOUNDS; TOILET PAPER; ENVELOPES; DISPOSABLE DIAPERS; STATIONERY AND SCHOOL SUPPLIES, NAMELY, THEME PADS, NOTEBOOKS, NOTEBOOK PAPER AND BINDERS; WRITING INSTRUMENTS, NAMELY, PENS, PENCILS, BALL-POINT PENS, PEN AND PENCIL SETS, POROUS TIP PENS, ROLLER BALL PENS AND MARKERS; PEN AND PENCIL HOLDERS; PRINTING BLOCKS; CORRECTION FLUIDS; ERASERS; BOOKENDS; PENCIL SHARPENERS; CALENDARS; ADHESIVE NOTE PAPER; POSTERS; GREETING CARDS; DECALS; HEAT TRANSFER PAPER; IRON-ON TRANSFERS; COLORING BOOKS; CHILDREN'S ACTIVITY BOOKS; MAGAZINES, NEWSPAPERS, PICTURE BOOKS AND JOURNALS FEATURING ATHLETES AND SPORTING EVENTS; MAPS; PLAYING CARDS; PRINTED TICKETS; BANK CHECKS; PRINTED TIMETABLES; SPORTS TRADING CARDS; BUMPER STICKERS; MOUNTED PHOTOGRAPHS; UNMOUNTED PHOTOGRAPHS; PHOTOGRAPH ALBUMS; STATIONERY; OFFICE REQUISITES, NAMELY, CORRECTING FLUID FOR TYPE PAPER, EMBOSSERS, PUNCHES, RUBBER BANDS AND STAPLERS; RUBBER STAMPS; CREDIT CARDS WITHOUT MAGNETIC CODING; PREPAID PHONE CARDS WITHOUT MAGNETIC CODING; DEBIT CARDS WITHOUT MAGNETIC CODING; AUTOMATED TELLER MACHINE CARDS WITHOUT MAGNETIC CODING; TRAVEL AND ENTERTAINMENT CARDS WITHOUT MAGNETIC CODING; CHECK GUARANTEE CARDS WITHOUT MAGNETIC CODING; AUTOGRAPH BOOKS; BOOK COVERS; CONFETTI; CHALK; DOCUMENT HOLDERS; PAPER CLIPS; DRAWING PENS AND PENCILS; WRITING INK; INKING PADS; RUBBER STAMPS; ADDRESS BOOKS; DESK STANDS AND HOLDERS FOR PENS, PENCILS AND INK; DRAFTING RULERS; PAINT BOXES; PAPER KITCHEN TOWELS; WRITING PAPER; SCRIBBLE PADS; CLIP BOARDS; NOTEPAD HOLDERS; DECORATIONS FOR PENCILS; SCORE BOOK SCHEDULES FOR RECORDING RESULTS; ADHESIVE TAPE FOR STATIONERY; OFFICE DISPENSERS FOR ADHESIVE TAPE; STAPLERS; STENCILS; LUMINOUS PAPER; EVENT PROGRAMS; EVENT ALBUMS; CARDBOARD BOXES FOR TISSUES; TEMPORARY TATTOOS,

NAMELY, DECORATIVE TRANSFERS FOR COSMETIC PURPOSES; PASSPORT HOLDERS; PLASTIC KEY CARDS THAT ARE NOT MAGNETICALLY ENCODED; AND DISPLAY STANDS MADE OF CARDBOARD (U.S. CLS. 2, 5, 22, 23, 29, 37, 38 AND 50).

CLASS 18—LEATHER GOODS

FOR UMBRELLAS; PARASOLS; ALL PURPOSE SPORT BAGS; TRAVELLING BAGS; BACKPACKS; TOTE BAGS; SCHOOL BAGS; HAND BAGS; BEACH BAGS; SUIT CASES; VANITY CASES SOLD EMPTY; KEY CASES; SUIT BAGS; BELT BAGS; SOCCER BALL SHAPED BAGS FOR USE AS NOVELTY ITEMS; WALLET; PURSES; AND BRIEF CASES (U.S. CLS. 1, 2, 3, 22 AND 41).

CLASS 25—CLOTHING

FOR CLOTHING, NAMELY, SHIRTS; KNIT SHIRTS; JERSEYS, TANK TOPS, T-SHIRTS, DRESSES, SKIRTS, UNDERWEAR, SWIM WEAR, SHORTS, PANTS, SWEATERS, CAPS, HATS, SCARVES, VISORS, WARM-UP SUITS, SWEATSHIRTS, JACKETS, UNIFORMS, NECKTIES, WRIST BANDS, HEADBANDS, GLOVES, APRONS, CLOTH BIBS, PAJAMAS, SOCKS, HOSE, BELTS, SUSPENDERS; FOOTWEAR; AND HEADWEAR (U.S. CLS. 22 AND 39).

CLASS 28—TOYS AND SPORTING GOODS

FOR GAMES AND PLAYTHINGS, NAMELY, SPORT BALLS, BOARD GAMES, STUFFED DOLLS, STUFFED ANIMALS, TOY VEHICLES, JIGSAW PUZZLES, BALLOONS AND INFLATABLE TOYS; BATTING GLOVES; BASEBALL GLOVES; GOLF GLOVES; BICYCLING GLOVES; SOCCER EQUIPMENT, NAMELY, BALLS, GLOVES, KNEE PADS, ELBOW PADS AND SHOULDER PADS; SOCCER GOALS; TOY PARTY HATS; AND HAND-HELD UNITS FOR PLAYING ELECTRONIC GAMES; PLAY TOYS, NAMELY, FOAM HANDS; AND CHRISTMAS TREE ORNAMENTS (U.S. CLS. 22, 23, 38 AND 50).

CLASS 32—LIGHT BEVERAGES

FOR SOFT DRINKS; SYRUPS AND POWDERS FOR USE IN THE PREPARATION OF SOFT DRINKS; MINERAL WATER; AERATED WATERS; FRUIT DRINKS; VEGETABLE JUICES; BEER; ALE; AND ISOTONIC DRINKS (U.S. CLS. 45, 46 AND 48).

CLASS 35—ADVERTISING AND BUSINESS

FOR EMPLOYMENT AGENCIES; PERSONNEL EMPLOYMENT AGENCIES RECRUITMENT; ADVERTISING FOR OTHERS VIA THE INTERNET; DISSEMINATION OF ADVERTISING MATTER FOR OTHERS; CARTOON CHARACTER LICENSING; OUTDOOR ADVERTISING SERVICES FOR OTHERS, NAMELY, RENTAL OF ADVERTISING SPACE ON OUTDOOR BILLBOARDS; TELEVISION ADVERTISING SERVICES FOR OTHERS; PROMOTION AGENCY SERVICES, NAMELY, PROMOTING THE GOODS AND SERVICES OF OTHERS THROUGH THE DISTRIBUTION OF PRINTED AND AUDIO PROMOTIONAL MATERIALS AND BY RENDERING SALES PROMOTION ADVICE; ADVERTISING FOR OTHERS IN THE FORM OF ANIMATION; MARKET RESEARCH; PUBLIC OPINION POLLING FOR BUSINESS OR ADVERTISING PURPOSES; PROMOTION AND ORGANIZATION OF COMMERCIAL EXHIBITIONS OF OTHERS; COMPUTERIZED DATABASE MANAGEMENT; BUSINESS MANAGEMENT; PROVIDING STATISTICAL INFORMATION FOR SPORTS AND SPORTS TEAMS; ON-LINE RETAIL

STORE SERVICES FEATURING CLOTHING, SPORTING GOODS AND MEMORABILIA; AUCTIONEERING; BUSINESS ADMINISTRATION SERVICES FOR OTHERS, NAMELY, PROCESSING OF SALES OF GOODS AND SERVICES MADE VIA THE INTERNET; DATA PROCESSING SERVICES; PROMOTING SPORTING COMPETITIONS, SPORT EXHIBITIONS AND SPORTING EVENTS OF OTHERS; RETAIL APPAREL STORES; AND PREFERRED CUSTOMER BENEFIT PROGRAM IN THE NATURE OF SUPPORTER FIDELITY CARDS FOR USE IN CONJUNCTION WITH SPORTING EVENTS (U.S. CLS. 100, 101 AND 102).

CLASS 36—INSURANCE AND FINANCIAL

FOR CREDIT CARD SERVICES; ISSUANCE OF CREDIT CARDS; TRAVELERS CHECK ISSUANCE; FINANCING SERVICES; BANKING; INSURANCE UNDERWRITING IN THE FIELD OF LIFE, HEALTH, ACCIDENT, PROPERTY AND CASUALTY; FINANCIAL SPONSORSHIP OF SPORTING EVENTS AND SPORTING EXHIBITIONS; AND FINANCIAL AND INSURANCE INFORMATION PROVIDED BY ELECTRONIC MEANS (U.S. CLS. 100, 101 AND 102).

CLASS 38—COMMUNICATION

FOR TELECOMMUNICATIONS GATEWAY SERVICES; TELECOMMUNICATIONS SERVICES, NAMELY, PERSONAL COMMUNICATION SERVICES; CELLULAR TELEPHONE SERVICES; TELEX COMMUNICATIONS SERVICES; ELECTRONIC TRANSMISSION OF DATA AND DOCUMENTS VIA COMPUTER TERMINALS; TELEGRAPH SERVICES; TELEPHONE COMMUNICATION; FACSIMILE TRANSMISSIONS; PAGING SERVICES; VIDEO TELECONFERENCING; TELEVISION BROADCASTING; CABLE TELEVISION BROADCASTING; RADIO BROADCASTING; BROADCASTING PROGRAMS VIA THE INTERNET; LEASING OF TELEPHONE; LEASING OF FACSIMILE MACHINES; RENTAL OF TELECOMMUNICATION EQUIPMENT; ELECTRONIC MAIL SERVICES; PROVIDING MULTIPLE USER ACCESS TO THE INTERNET; PROVIDING TELECOMMUNICATIONS CONNECTIONS TO THE INTERNET; AND PROVIDING ON-LINE CHAT ROOMS FOR TRANSMISSION OF MESSAGES AMONG COMPUTER USERS CONCERNING SPORTS (U.S. CLS. 100, 101 AND 104).

CLASS 41—EDUCATION AND ENTERTAINMENT

FOR ADMINISTRATION OF LOTTERIES FOR OTHERS; ORGANIZING EXHIBITIONS FOR SPORTING AND CULTURAL EVENTS; ENTERTAINMENT SERVICES IN THE NATURE OF BEAUTY PAGEANTS; PROVIDING FACILITIES FOR TRACK AND FIELD TOURNAMENTS; RENTAL OF AUDIO AND VIDEO EQUIPMENT; PRODUCTION OF RADIO AND TELEVISION PROGRAMS; ANIMATION PRODUCTION SERVICES; ARRANGING FOR TICKET RESERVATIONS FOR SHOWS AND SPORTING EVENTS; ORGANIZING COMMUNITY FESTIVALS FEATURING RAFFLE DRAWINGS; ENTERTAINMENT SERVICES, NAMELY, PROVIDING ON-LINE COMPUTER GAMES; LEASING OF PHOTOGRAPHS, PHOTOGRAPHIC PRINTS, SLIDES, TRANSPARENCIES, MOTION PICTURE FILMS, VIDEO TAPES, VIDEO DISCS, COMPACT DISCS, AUDIO TAPES AND AUDIO DISCS; AUDIO RECORDING AND PRODUCTION (U.S. CLS. 100, 101 AND 107).

CLASS 42—SCIENTIFIC, COMPUTER AND LEGAL SERVICES

FOR CONTRACT FOOD SERVICES; CATERING; TRAVEL AGENCY SERVICES, NAMELY, MAKING RESERVATIONS AND BOOKS FOR TEMPORARY LODGING; LANGUAGE TRANSLATION; COMPUTER CONSULTING SERVICES; SECURITY GUARD SERVICES; MEDICAL SERVICES; DENTISTRY; HOSPITALS; DRUG TESTING FOR SUBSTANCE ABUSE; HAIR STYLING; HAIR CUTTING; BEAUTY SALONS; RENTAL OF CLOTHING, NAMELY, UNIFORMS; COMPUTER SOFTWARE DESIGN FOR OTHERS; HOSTING THE WEB SITES OF OTHERS ON THE INTERNET; LICENSING OF INTELLECTUAL PROPERTY RIGHTS; COMPUTER RENTAL; COMPUTER SERVICES, NAMELY, CREATING AND MAINTAINING WEB SITES FOR OTHERS; COMPUTER SERVICES, NAMELY, PROVIDING DATABASES FEATURING GENERAL AND LOCAL NEWS AND INFORMATION OF INTEREST TO SPECIFIC GEOGRAPHIC LOCATIONS; COMPUTER SERVICES, NAMELY, INSTALLATION AND MAINTENANCE OF COMPUTER SOFTWARE; COMPUTER SERVICES, NAMELY, LEASING ACCESS TIME TO A COMPUTER DATABASE IN THE FIELD OF SPORTS; ARCHIVING SERVICES FOR STILL IMAGE PHOTOGRAPHS AND MOTION PICTURES; NEWS AGENCIES, NAMELY, GATHERING AND DISSEMINATION OF NEWS; COMPUTER SERVICES, NAMELY, PROVIDING SEARCH ENGINES FOR OBTAINING DATA ON A GLOBAL COMPUTER NETWORK; VIDEOTAPING; PROVIDING ON-LINE ELECTRONIC PUBLICATIONS IN THE FIELDS OF SPORTS; PROVIDING ON-LINE PUBLICATION OF ELECTRONIC BOOKS AND JOURNALS IN THE FIELD OF SPORTS; COMPUTER SERVICES, NAMELY, PROVIDING ON-LINE DIRECTORIES IN THE FIELDS OF SPORTS; AND STOCK PHOTOGRAPHY SERVICES, NAMELY, LEASING REPRODUCTION RIGHTS OF PHOTOGRAPHS TO OTHERS (U.S. CLS. 100 AND 101).

SN 76-217,128. BOMBARDIER-ROTAX GMBH, A-4623 GUNSKIRCHEN, AUSTRIA, FILED 2-28-2001.

4-TEC**CLASS 1—CHEMICALS**

FOR FUEL STABILIZERS FOR USE WITH GASOLINE AND DIESEL FUELS (U.S. CLS. 1, 5, 6, 10, 26 AND 46).

CLASS 2—PAINTS

FOR PAINTS FOR USE IN THE MANUFACTURE OF RECREATIONAL VEHICLES, NAMELY, SNOWMOBILES, PERSONAL WATERCRAFT, ALL-TERRAIN VEHICLES, CARTS, LIGHT AIRCRAFT, AND MOTORCYCLES (U.S. CLS. 6, 11 AND 16).

CLASS 3—COSMETICS AND CLEANING PREPARATIONS

FOR CLEANERS FOR USE ON RECREATIONAL VEHICLES, NAMELY, SNOWMOBILES, PERSONAL WATERCRAFT, ALL-TERRAIN VEHICLES, CARTS, LIGHT AIRCRAFT, AND MOTORCYCLES (U.S. CLS. 1, 4, 6, 50, 51 AND 52).

CLASS 4—LUBRICANTS AND FUELS

FOR GASOLINE AND DIESEL FUELS, FUEL OIL, GENERAL PURPOSE GREASES AND LUBRICANTS ALL FOR RECREATIONAL VEHICLES NAMELY SNOWMOBILES, PERSONAL WATERCRAFT, ALL-TERRAIN VEHICLES, CARTS, LIGHT AIRCRAFT AND MOTORCYCLES (U.S. CLS. 1, 6 AND 15).

CLASS 7—MACHINERY

FOR HYDRAULIC VEHICLE JACKS, POWER OPERATED LIFTS FOR MOVING, PARKING AND STORING LAND AND NON-LAND VEHICLES; MOTORS AND ENGINES FOR NON-LAND VEHICLES, AND STRUCTURAL PARTS THEREFOR; SNOW BLOWERS; AND SNOW GROOMERS AND STRUCTURAL PARTS THEREOF (U.S. CLS. 13, 19, 21, 23, 31, 34 AND 35).

CLASS 12—VEHICLES

FOR RECREATIONAL VEHICLES, NAMELY, SNOWMOBILES, PERSONAL WATERCRAFT, NAMELY, RECREATIONAL JET-POWERED BOATS, ALL-TERRAIN VEHICLES, MOTORIZED CARTS, NAMELY, GO-CARTS, LIGHT AIRCRAFT, MOTORCYCLES AND STRUCTURAL PARTS THEREFOR; TRACKED UTILITY VEHICLES, NAMELY, SNOW GROOMERS AND STRUCTURAL PARTS THEREFOR; ENGINES FOR LAND VEHICLES; VEHICLE ACCESSORIES, NAMELY, PICK-UP TRUCK CAPS AND LINERS, BUG DEFLECTORS, ROCK DEFLECTORS, MUD FLAPS FOR VEHICLES, BUMP GUARD FOR VEHICLES, VEHICLE ROLL BARS, ROOF RACKS, NAMELY, ROOF RACK STORAGE CONTAINERS FOR LAND VEHICLES, TAIL GATE PROTECTORS, SALT SHIELDS AND STRUCTURAL PARTS OF VEHICLES, FENDER TRIM, AILERONS, LICENSE PLATE HOLDERS, VEHICLE STORAGE CONTAINERS AND CARGO CARRIERS, SKI RACKS, BICYCLE RACKS, TIRE COVERS, NAMELY, FITTED AND SEMI-FITTED VEHICLE COVERS; HAND TRUCKS, DOLLIES; CHILDREN'S STROLLERS; TRAILERS, TRACTOR TRAILERS, AND TRAVEL TRAILERS; AND VEHICLE TIRES (U.S. CLS. 19, 21, 23, 31, 35 AND 44).

CLASS 25—CLOTHING

FOR CLOTHING, WEARING APPAREL, AND ACCESSORIES, NAMELY, SHIRTS, SWEATSHIRTS, T-SHIRTS, JERSEYS, SWEATERS, PULLOVERS, PANTS, SWEAT-PANTS, JEANS, SHORTS, BOXER SHORTS, BATHROBES, NIGHT-SHIRTS, PAJAMAS, JACKETS, COATS, WIND-RESISTANT JACKETS, VESTS, DRESSES, SKIRTS, BLOUSES, UNDERWEAR, BOXER SHORTS, SWIMWEAR, RAINCOATS, CAPES, TIES, ASCOTS, BELTS, SCARVES, GLOVES; FOOTWEAR, NAMELY, SHOES, BOOTS, SANDALS, SOCKS; HEADGEAR, NAMELY, HATS, CAPS, RAIN HATS; SNOW-SPORTSWEAR, NAMELY, HIGHPANTS, PANTS, JACKETS, GLOVES, MITTS, HATS, DICKEYS, BALACLAVAS, TUBE TOPS, BANDANNAS, SKI MASKS, BOOTS, RACING SUITS, WRIST BANDS, REFLECTIVE ARM BANDS; WATER-SPORTSWEAR, NAMELY, BODY SUITS, TOPS, BOTTOMS, SHORTS, SHIRTS, JACKETS, SOCKS, HOODS, BATHING SUITS, SARONGS, SHOES, BOOTS, SANDALS, GLOVES, AND APRONS (U.S. CLS. 22 AND 39).

SN 76-224,745. BIOTONIX INC., MONTREAL, QUEBEC, CANADA, FILED 3-15-2001.

BIOTONIX

PRIORITY CLAIMED UNDER SEC. 44(D) ON CANADA APPLICATION NO. 1081574, FILED 11-6-2000.

CLASS 9—ELECTRICAL AND SCIENTIFIC APPARATUS

FOR COMPUTER SOFTWARE THAT UTILIZES BIO-MECHANICAL, WEB-BASED TECHNOLOGY TO DETECT POSTURAL DEVIATIONS OF PATIENTS AND AUTOMATICALLY GENERATES PERSONALIZED CORRECTIVE EXERCISE PROGRAMS (U.S. CLS. 21, 23, 26, 36 AND 38).

FIRST USE 4-0-2000; IN COMMERCE 4-0-2000.

CLASS 42—SCIENTIFIC, COMPUTER AND LEGAL SERVICES

FOR MEDICAL TESTING AND SERVICES, NAMELY, ASSESSING AND DETECTING POSTURAL DEVIATIONS OF PATIENTS BY MEANS OF WEB-BASED TECHNOLOGY; PHYSICAL FITNESS CONSULTATION, NAMELY, PROVIDING PERSONALIZED CORRECTIVE EXERCISE PROGRAMS TO OTHERS WHICH ARE AUTOMATICALLY GENERATED USING WEB-BASED TECHNOLOGY (U.S. CLS. 100 AND 101).

FIRST USE 4-0-2000; IN COMMERCE 4-0-2000.

SN 76-231,932. BOEHRINGER INGELHEIM PHARMA KG, 55216 INGELHEIM AM RHEIN, FED REP GERMANY, FILED 3-28-2001.

HANDIHALER

OWNER OF FED REP GERMANY REG. NO. 39813444, DATED 5-19-1998, EXPIRES 3-31-2008.

CLASS 5—PHARMACEUTICALS

FOR INSTRUMENTS AND APPARATUS FILLED WITH RESPIRATORY PHARMACEUTICAL PREPARATIONS (U.S. CLS. 6, 18, 44, 46, 51 AND 52).

CLASS 10—MEDICAL APPARATUS

FOR INHALERS SOLD EMPTY FOR THE INHALATION OF MEDICINE (U.S. CLS. 26, 39 AND 44).

SN 76-225,941. CLEVELAND FREE TIMES MEDIA, INC., CLEVELAND, OH. FILED 3-16-2001.

FREE TIMES**CLASS 16—PAPER GOODS AND PRINTED MATTER**

FOR NEWSPAPERS IN THE FIELDS OF POLITICS, CULTURE, ENTERTAINMENT AND CLASSIFIED ADVERTISEMENTS; GUIDES TO RESTAURANTS AND MENUS IN THE CLEVELAND, OHIO AREA; ANNUAL SUPPLEMENTS TO NEWSPAPERS ON THE SUBJECTS OF SUMMER EVENTS AND ACTIVITIES, THE ARTS AND HOLIDAY GIFTS (U.S. CLS. 2, 5, 22, 23, 29, 37, 38 AND 50).

FIRST USE 9-30-1992; IN COMMERCE 9-30-1992.

CLASS 42—SCIENTIFIC, COMPUTER AND LEGAL SERVICES

FOR COMPUTER SERVICES, NAMELY, PROVIDING ONLINE NEWSPAPERS IN THE FIELDS OF POLITICS AND CULTURE, ENTERTAINMENT AND CLASSIFIED ADVERTISEMENTS; PROVIDING AN ONLINE COMPUTER DATABASE IN THE FIELD OF POLITICS AND CULTURE (U.S. CLS. 100 AND 101).

FIRST USE 9-30-1992; IN COMMERCE 9-30-1992.

SN 76-237,607. TYR SPORT, INC., HUNTINGTON BEACH, CA. FILED 4-6-2001.

PREDATOR**CLASS 9—ELECTRICAL AND SCIENTIFIC APPARATUS**

FOR SWIM GOGGLES (U.S. CLS. 21, 23, 26, 36 AND 38).

FIRST USE 7-0-1998; IN COMMERCE 7-0-1998.

CLASS 25—CLOTHING

FOR CLOTHING, NAMELY WATER POLO SUITS, AND SWIM CAPS (U.S. CLS. 22 AND 39).

FIRST USE 7-0-1998; IN COMMERCE 7-0-1998.

SN 76-243,007. PROMOTIONAL BROADCAST NETWORK, INC., SANTEE, CA. FILED 4-17-2001.

SPEEDWAY

SN 76-231,098. EASYWAY AG, 40789 MONHEIM, FED REP GERMANY, FILED 3-28-2001.

BMI 23**CLASS 5—PHARMACEUTICALS**

FOR DIETARY SUPPLEMENTS FOR WEIGHT REDUCTION (U.S. CLS. 6, 18, 44, 46, 51 AND 52).

CLASS 16—PAPER GOODS AND PRINTED MATTER

FOR PAPER GOODS AND PRINTED MATTER RELATING TO DIETARY SUPPLEMENTS FOR WEIGHT REDUCTION, NAMELY, LEAFLETS, INSTRUCTIONAL AND TEACHING MATERIALS, MAGAZINES, NEWSPAPERS, BROCHURES, PHOTOGRAPHS AND STATIONERY (U.S. CLS. 2, 5, 22, 23, 29, 37, 38 AND 50).

CLASS 35—ADVERTISING AND BUSINESS

FOR PROMOTING THE BUSINESSES OF RADIO AND TELEVISION BROADCAST STATIONS AND THE SALE OF GOODS AND SERVICES OF THEIR SPONSORS BY PROVIDING SIMULATED AUTOMOBILE RACING GAME CONTESTS PLAYED BY RADIO LISTENERS AND TELEVISION VIEWERS VIA RADIO, TELEVISION, TELEPHONE AND OVER THE INTERNET (U.S. CLS. 100, 101 AND 102).

CLASS 41—EDUCATION AND ENTERTAINMENT

FOR ENTERTAINMENT IN THE NATURE OF PROVIDING SIMULATED AUTOMOBILE RACING GAME CONTESTS PLAYED BY RADIO LISTENERS AND TELEVISION VIEWERS VIA RADIO, TELEVISION, TELEPHONE AND OVER THE INTERNET (U.S. CLS. 100, 101 AND 107).

SN 76-243,322. MAVESA, S.A., CARACAS 1010, VENEZUELA, AND GERBER PRODUCTS COMPANY, FREMONT, MI. BY ASSIGNMENT GERBER PRODUCTS COMPANY, FREMONT, MI. AND LEBLON INVESTMENTS LIMITED, CARACAS, VENEZUELA, FILED 4-19-2001.

SN 76-249,768. CARWASH CELL, INC., THE, PORT CHESTER, NY. FILED 4-27-2001.

YUKERY

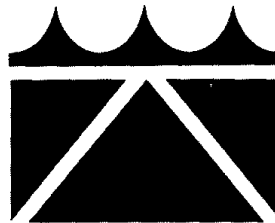

CLASS 5—PHARMACEUTICALS

FOR BABY FOOD (U.S. CLS. 6, 18, 44, 46, 51 AND 52).

CLASS 32—LIGHT BEVERAGES

FOR FRUIT DRINKS AND FRUIT JUICES; MINERAL WATERS, SYRUPS AND OTHER PREPARATIONS FOR MAKING BEVERAGES (U.S. CLS. 45, 46 AND 48).

CLASS 7—MACHINERY

FOR SELF-CONTAINED VEHICLE WASHING UNITS COMPRISING VEHICLE WASHING MACHINES, VEHICLE DRYING MACHINES AND VEHICLE POLISHING MACHINES (U.S. CLS. 13, 19, 21, 23, 31, 34 AND 35).
FIRST USE 5-1-2001; IN COMMERCE 5-1-2001.

CLASS 35—ADVERTISING AND BUSINESS

FOR FRANCHISING, NAMELY, OFFERING TECHNICAL ASSISTANCE IN THE ESTABLISHMENT AND/OR OPERATION OF CARWASHES (U.S. CLS. 100, 101 AND 102).
FIRST USE 5-1-2001; IN COMMERCE 5-1-2001.

CLASS 37—CONSTRUCTION AND REPAIR

FOR VEHICLE WASHING AND DETAILING SERVICES (U.S. CLS. 100, 103 AND 106).
FIRST USE 5-1-2001; IN COMMERCE 5-1-2001.

SN 76-245,509. APB FINANCIAL LLC, LOUISVILLE, KY. BY ASSIGNMENT TRUE QUOTE LLC, LOUISVILLE, KY. FILED 4-24-2001.

SN 76-250,628. PROCEDES CHENEL INTERNATIONAL, 92170 VANVES, FRANCE, FILED 5-3-2001.

TRUE CONTROL

PROCÉDÉS CHÉNEL

CLASS 35—ADVERTISING AND BUSINESS

FOR PROVIDING BUSINESS INFORMATION IN THE NATURE OF DATA AND RESEARCH IN THE FIELD OF ENERGY COMMODITIES, NAMELY, ELECTRICITY, COAL, NATURAL GAS, CRUDE OIL, REFINED PETROLEUM PRODUCTS AND OTHER ENERGY-RELATED COMMODITIES, AS WELL AS WEATHER DERIVATIVES, EMISSIONS CREDITS, AND ENERGY OPTIONS, FORWARD CONTRACTS AND OTHER FINANCIAL DERIVATIVES VIA A WEBSITE ON A MULTI-USER GLOBAL COMPUTER INFORMATION NETWORK (U.S. CLS. 100, 101 AND 102).

OWNER OF FRANCE REG. NO. 97/664343, DATED 2-18-1997, EXPIRES 2-18-2007.

THE ENGLISH TRANSLATION OF THE WORD "PROCEDES" IN THE MARK IS "PROCESS".

CLASS 36—INSURANCE AND FINANCIAL

FOR FINANCIAL AND BROKERAGE TRANSACTION SERVICES, NAMELY PROVIDING ONLINE INFORMATION AND TRADING OF ENERGY COMMODITIES, NAMELY, ELECTRICITY, COAL, NATURAL GAS, CRUDE OIL, REFINED PETROLEUM PRODUCTS AND OTHER ENERGY-RELATED COMMODITIES, AS WELL AS WEATHER DERIVATIVES, EMISSIONS CREDITS, AND ENERGY OPTIONS, FORWARD CONTRACTS AND OTHER FINANCIAL DERIVATIVES VIA A WEBSITE ON A MULTI-USER GLOBAL COMPUTER INFORMATION NETWORK (U.S. CLS. 100, 101 AND 102).

CLASS 6—METAL GOODS

FOR METAL BUILDING MATERIALS, NAMELY, TEMPORARY METAL BUILDING SYSTEMS CONSISTING PRIMARILY OF EXPOSITION PARTITION SYSTEMS CONSISTING OF WALL PANELS, ROOF PANELS, DOORS AND WINDOWS; SUSPENDED STRETCHED SECURITY CEILING SYSTEMS CONSISTING OF PANELS ASSEMBLED TO CONSTITUTE A CEILING INSIDE OF AN EXPOSITION BUILDING MADE OF ONE OR MORE PANELS (U.S. CLS. 2, 12, 13, 14, 23, 25 AND 50).

CLASS 16—PAPER GOODS AND PRINTED MATTER

FOR SPECIAL REINFORCED PAPER FOR TEMPORARY PARTITIONS AND VISUAL SCREENS (U.S. CLS. 2, 5, 22, 23, 29, 37, 38 AND 50).

CLASS 19—NON-METALLIC BUILDING MATERIALS

FOR NON METAL BUILDING MATERIALS, NAMELY, STRETCHED SECURITY CANOPY FOR USE AS A TEMPORARY CEILING (U.S. CLS. 1, 12, 33 AND 50).

CLASS 20—FURNITURE AND ARTICLES NOT OTHERWISE CLASSIFIED

FOR TEMPORARY PAPER PARTITIONS (U.S. CLS. 2, 13, 22, 25, 32 AND 50).

CLASS 24—FABRICS

FOR NON-WOVEN TEXTILE FABRICS FOR PARTITION PANELS, CEILING PANELS AND SIGN PANELS (U.S. CLS. 42 AND 50).

SN 76-254,293. LIFEASSAYS AB, SE-223 70 LUND, SWEDEN, FILED 5-9-2001.

LIFEASSAYS**CLASS 5—PHARMACEUTICALS**

FOR DIAGNOSTIC REGENT PREPARATIONS FOR CLINICAL AND MEDICAL USE (U.S. CLS. 6, 18, 44, 46, 51 AND 52).

CLASS 9—ELECTRICAL AND SCIENTIFIC APPARATUS

FOR COMPUTER SOFTWARE FOR ANALYSIS AND DIAGNOSIS INVOLVING THE MEASUREMENTS OF PROTEINS, VIRUSES AND CELLS IN BODY FLUID SAMPLES IN THE MEDICAL, VETERINARY, LIFE SCIENCE AND PHARMACEUTICAL FIELDS (U.S. CLS. 21, 23, 26, 36 AND 38).

CLASS 10—MEDICAL APPARATUS

FOR MEDICAL APPARATUS AND INSTRUMENTS, NAMELY, MICROPROCESSOR-BASED MAGNETIC PERMEABILITY METERS FOR DIAGNOSIS AND ANALYSIS INVOLVING THE MEASUREMENTS OF PROTEINS, VIRUSES AND CELLS IN BODY FLUID SAMPLES (U.S. CLS. 26, 39 AND 44).

SN 76-256,191. SKLAN, HAROLD, NEW YORK, NY. FILED 5-11-2001.

WITH LIBERTY AND INJUSTICE FOR ALL**CLASS 41—EDUCATION AND ENTERTAINMENT**

FOR PRODUCTION OF FILM, TELEVISION SHOWS AND PLAYS (U.S. CLS. 100, 101 AND 107).

CLASS 42—SCIENTIFIC, COMPUTER AND LEGAL SERVICES

FOR PROVIDING INFORMATION TO THE PUBLIC CONCERNING THE AMERICAN JUSTICE SYSTEM (U.S. CLS. 100 AND 101).

SN 76-262,163. W. MOORCROFT P.L.C., STAFFORDSHIRE, UNITED KINGDOM, FILED 5-23-2001.

**CLASS 11—ENVIRONMENTAL CONTROL APPARATUS**

FOR LAMPS (U.S. CLS. 13, 21, 23, 31 AND 34).

CLASS 14—JEWELRY

FOR BROACHES AND CLOCKS (U.S. CLS. 2, 27, 28 AND 50).

CLASS 16—PAPER GOODS AND PRINTED MATTER

FOR WRAPPING PAPER; PLASTIC BAGS FOR GENERAL USE; CARDBOARD BOXES; POSTCARDS AND GREETING CARDS; SOCIAL STATIONARY; BOOKS ABOUT ART AND POTTERY; MAGAZINES ABOUT ENAMELS, COMPANY DESIGNERS, NEW DESIGNS AND SHAPES OF PRODUCTS AND AUCTION NEWS; NEWSLETTERS TO MEMBERS OF THE COLLECTORS CLUBS; POSTERS; CALENDARS; DOCUMENT FILES; PHOTOGRAPH ALBUMS; PENS AND PENCILS; EMBROIDERY DESIGN PATTERNS; ARTIST MATERIALS, NAMELY INK TRACING PAPER AND CLAY SLIPS; WATER COLOR PAINTINGS AND PRINTS; COMPANY STORE CARD, NAMELY, CARDS INDICATING THAT A PERSON IS A MEMBER OF THE COLLECTOR'S CLUB; BLANK OR PARTIALLY PRINTED LABELS FOR MARKET ADVERTISING AND PUBLICITY (U.S. CLS. 2, 5, 22, 23, 29, 37, 38 AND 50).

CLASS 19—NON-METALLIC BUILDING MATERIALS

FOR NON-METAL TILES, NAMELY DECORATED CERAMIC TILES; POTTERY WARE, NAMELY TILES (U.S. CLS. 1, 12, 33 AND 50).

CLASS 21—HOUSEWARES AND GLASS

FOR POTTERY WARE, NAMELY, JUGS, BOWLS, VASES, CROCKS, PLATES, CHARGERS, EGG CUPS, TEA CUPS, SUGAR AND CREAM HOLDERS, TEA CUP AND SAUCERS, TEA PLATES, MUGS, CAKE STANDS, TRAYS, COASTERS, NAME STANDS, GINGER JARS, BOXES, CANDLE STICKS, PLANT HOLDERS, AND TWO-HANDLED LOVING CUPS; AND DECORATIVE ENAMEL WARE, NAMELY, MINIATURE VASES, TRINKET BOXES, NAPKIN HOLDERS, EGG CUPS, EGGS, MINIATURE JUGS, HIP FLASKS, PERFUME BOTTLES, MINATORY GINGER JARS; MODELS, NAMELY, THREE-DIMENSIONAL PIECES OF ART POTTERY (U.S. CLS. 2, 13, 23, 29, 30, 33, 40 AND 50).

CLASS 24—FABRICS

FOR PATTERNED TEXTILES AND TEXTILE GOODS, NAMELY, CLOTH NAPKINS AND SILK HANDKERCHIEFS (U.S. CLS. 42 AND 50).

SN 76-263,116. DESIGN DIMENSION EDUCATIONAL TRUST, WEST YORKSHIRE, UNITED KINGDOM, FILED 5-24-2001.



PRIORITY CLAIMED UNDER SEC. 44(D) ON UNITED KINGDOM APPLICATION NO. 2254459, FILED 11-29-2000, REG. NO. 2254459, DATED 12-13-2002, EXPIRES 11-29-2010. NO CLAIM IS MADE TO THE EXCLUSIVE RIGHT TO USE "FOOD", APART FROM THE MARK AS SHOWN.

CLASS 16—PAPER GOODS AND PRINTED MATTER

FOR PRINTED MATTER, NAMELY, BOOKS, BOOKLETS, LEAFLETS, POSTERS, STICKERS, TRANSFERS, SPECIFICALLY, IRON-ON, PLASTIC AND ADHESIVE, PERIODICALS, DECALCOMANIAS, PICTURES, PHOTOGRAPHS, STATIONERY, BLANK CARDS, FLASH CARDS, INDEX CARDS, NOTE CARDS AND PLACE CARDS, ALL FEATURING ISSUES PERTAINING TO FOOD AND BEVERAGE (U.S. CLS. 2, 5, 22, 23, 29, 37, 38 AND 50).

CLASS 41—EDUCATION AND ENTERTAINMENT

FOR PROVIDING EDUCATIONAL INFORMATION REGARDING COOKING, MENU PREPARATION AND FOODS AND DRINK RELATED BUDGETARY AND PURCHASING ISSUES; AND PROVIDING EDUCATION SERVICES, NAMELY, PROVIDING CLASSES, SEMINARS, WORKSHOPS, LECTURES IN THE FIELDS OF COOKING, MENU PREPARATION, AND FOOD DRINK RELATED BUDGETARY AND PURCHASING ISSUES (U.S. CLS. 100, 101 AND 107).

SN 76-264,954. BURGMANN DICHTUNGSWERKE GMBH & CO. KG, 82515 WOLFRTATSHAUSEN, FED REP GERMANY, FILED 5-31-2001.

BURGMANN

OWNER OF U.S. REG. NO. 1,156,909.
SEC. 2(F).

CLASS 4—LUBRICANTS AND FUELS

FOR INDUSTRIAL OILS AND GREASES, LUBRICANTS (U.S. CLS. 1, 6 AND 15).

CLASS 6—METAL GOODS

FOR BASE METALS AND THEIR ALLOYS IN PARTICULAR FOR USE IN THE FIELD OF PROTECTION OF PERSONAL PROTECTION, PROTECTION OF VEHICLES, AIRCRAFT AND OTHER OBJECTS AGAINST IMPACT, STABBING, PRESSURE WAVES, PROJECTILES AND SPLINTERS; METAL SAFES; SAFETY DEPOSIT BOXES, IN PARTICULAR MADE OF METAL; METAL BELLOWS-TYPE SLIDING RING SEALS; ROTARY JOINTS, IN PARTICULAR ROTARY WATER JOINTS MADE OF METAL; AND ARMOR PLATES FOR BALLISTIC AND BLAST PROTECTION FOR MOTOR VEHICLES, HELICOPTERS, AIRCRAFT, AND NAVAL VESSELS (U.S. CLS. 2, 12, 13, 14, 23, 25 AND 50).

CLASS 7—MACHINERY

FOR PUMPS, NAMELY PUMPS FOR PUMPING FLUIDS AWAY FROM OR TO SEALS, FOR EXAMPLE CARTRIDGE-TYPE SEALS; FILTERS, NAMELY, BUFFER FLUID FILTERS AND MAGNETIC FILTERS; CYCLONE SEPARATORS; THERMOSIPHON AND PARTS THEREFOR FOR SEALS, IN PARTICULAR FOR SLIDING RING SEALS; PRESSURE BOOSTER FOR SLIDING RING SEALS; MECHANICAL SPLIT SEALS, IN PARTICULAR RADIAL SPLIT SEALS, AND LABYRINTH SEALS; SEALS FOR ROTARY KILNS (U.S. CLS. 13, 19, 21, 23, 31, 34 AND 35).

CLASS 9—ELECTRICAL AND SCIENTIFIC APPARATUS

FOR CONTROL AND MONITORING APPARATUS FOR MEASURING PRESSURE, TEMPERATURE, FLOW RATES, FILLING LEVELS, AND QUENCH SYSTEMS FOR SEALS USED IN SUPPLY SYSTEMS, CIRCULATION SYSTEMS, FLUSHING SYSTEMS, QUENCH SYSTEMS, QUENCHING FLUID SYSTEMS, BUFFER SYSTEMS, SPA BUFFER SYSTEMS, OPEN-CIRCUIT BUFFER FLUID SYSTEMS, THERMOSIPHON SYSTEMS, STERILE-OPERATION SUPPLY SYSTEMS, AND PRESSURE BOOSTER SYSTEMS; FLEXIBLE, WATER-REPELLANT, AIR-PERMEABLE, BALLISTIC PROTECTIVE VESTS FOR PRIVATE AND PUBLIC SECURITY AND PROTECTION SERVICES; PROTECTING DEVICES FOR PERSONAL USE, NAMELY HIGHLY FLEXIBLE, BALLISTIC PROTECTION TO BE WORN UNDER WORK WEAR NAMELY BALLISTIC ARMOR PROTECTION FABRICS AND PLATES FOR SHOCK ABSORPTION, SPLINTER PROTECTION, AND STAB PROTECTION (U.S. CLS. 21, 23, 26, 36 AND 38).

CLASS 11—ENVIRONMENTAL CONTROL APPARATUS

FOR HEAT EXCHANGERS; ELECTRICAL WATER PUMPS FOR PUMPING FLUIDS TO OR AWAY FROM SEALS, SUCH AS CARTRIDGE-TYPE SEALS; MAGNETIC FILTERS; PLUMBING FITTINGS, NAMELY, VALVES AND COCKS IN PARTICULAR BALL COCKS; GAS SUPPLY SYSTEM COMPRISING OF VALVES, METERS, PIPES, FILTERS, RESERVOIRS AND PARTS THEREOF FOR SUPPLYING, CIRCULATING, FILTERING, MONITORING, REGULATING, AND DISCHARGING LUBRICANT GAS FOR USE IN CONNECTION WITH GAS LUBRICATED MECHANICAL SEALS (U.S. CLS. 13, 21, 23, 31 AND 34).

CLASS 12—VEHICLES

FOR VEHICLE PARTS, NAMELY, ARTICULATED SEALING, ISOLATING AND DAMPENING APPARATUS FOR INTEGRATION INTO EXHAUST SYSTEMS FOR VEHICLES ARMORED VEHICLE PARTS, NAMELY ARTICULATION SEALING OR NOISE DAMPENING APPARATUS (U.S. CLS. 19, 21, 23, 31, 35 AND 44).

CLASS 17—RUBBER GOODS

FOR FLANGE SEALS, MANHOLE SEALS, RING SEALS, LIP SEALS AND O-RINGS "SEALING RINGS" OF ELASTOMERIC; SEALING COMPOUNDS FOR COVERING GASKETS AND MOLDED PARTS, PLASTIC STUFFING BOX PACKINGS AND STUFFING BOX PACKING RINGS; NON-METAL SLIDING RING SEALS, IN PARTICULAR HYDROSTATIC AND HYDRODYNAMIC SLIDING RING SEALS, NON-METAL GAS-LUBRICATED SLIDING RING SEALS, ELASTOMERIC BELLOWS-TYPE SLIDING RING SEALS, NON-METAL CARTRIDGE-TYPE SLIDING RING SEALS AS WELL AS NON-METAL SLIDING RING SEALS HAVING INTEGRATED PUMP MEANS FOR MECHANICAL SEALS; MAGNETIC COUPLING SEALS; SEALING MATS MADE OF PLASTIC OR RUBBER FOR SEALING POLLUTANTS OUT OF THE SURROUNDING ENVIRONMENT; NON-METAL SEALING BELLOWS, NON-METAL SEALING SLEEVES, CORDS, BANDS, FABRICS, MESHES, FELTS, SHEETS AND PLATES MADE OF GRAPHITE, COMPRESSED EXPANDED GRAPHITE, MICA, COMPRESSED EXPANDED MICA, PLASTICS, RUBBER,

METAL WIRES, GLASS, MINERAL OR CERAMIC FIBRES, OR A COMBINATION OF THESE MATERIALS INTENDED FOR MANUFACTURING SEALS, PACKINGS AND COMPENSATORS; PLASTIC MATERIAL IN THE FORM OF PLATES, FABRICS AND FIBRES, IN PARTICULAR ARAMIDES AND POLYETHYLENE, FOR MANUFACTURING SOFT AND HARD PROTECTIVE MATERIALS FOR PROTECTING PEOPLE, VEHICLES, AIRCRAFT AND OTHER OBJECTS AGAINST IMPACT, STABBING, PRESSURE WAVES, PROJECTILES, AND SPLINTERS; MAGNETIC COUPLINGS FOR SEALING PURPOSES; HERMETICALLY SEALING MAGNETIC COUPLINGS; EXPANSION JOINTS, IN PARTICULAR SOFT MATERIAL EXPANSION JOINTS, NAMELY, EXPANSION JOINTS FOR CONNECTIONS IN AIR PIPE AND FLUE GAS PIPE AND DUCT SYSTEMS TO COMPENSATE FOR THERMAL EXPANSION, VIBRATIONS AND MISALIGNMENTS (U.S. CLS. 1, 5, 12, 13, 35 AND 50).

CLASS 42—SCIENTIFIC, COMPUTER AND LEGAL SERVICES

FOR DEVELOPMENT OF SOFTWARE FOR USE IN THE FIELD OF SEALING TECHNOLOGY, IN PARTICULAR IN THE FIELD OF SLIDING RING SEALS AND FOR THE EDP-ASSISTED SELECTION OF POTENTIAL TYPES OF SEALS (U.S. CLS. 100 AND 101).

SN 76-265,169. SCIGENIC CO., LTD., SEOUL, REPUBLIC OF KOREA, FILED 6-1-2001.

SCIZEC

CLASS 35—ADVERTISING AND BUSINESS

FOR MARKETING SERVICES FOR OTHERS; IMPORT AND EXPORT AGENCIES; RETAIL STORE SERVICES FEATURING HEALTH-GIVING FOODS (U.S. CLS. 100, 101 AND 102).

CLASS 36—INSURANCE AND FINANCIAL

FOR BROKERAGE IN THE FIELD OF MEDICINES AND COOKED FOOD, AND BROKERAGE IN THE FIELD OF HEALTH FOODS (U.S. CLS. 100, 101 AND 102).

CLASS 42—SCIENTIFIC, COMPUTER AND LEGAL SERVICES

FOR RESEARCH AND DEVELOPMENT FOR OTHERS, PROVIDING MEDICINE INFORMATION, TECHNOLOGICAL INFORMATION SERVICES FOR SELECTION OF MEDICINES, TECHNICAL RESEARCH, FOOD INSTRUCTION SERVICE, ENVIRONMENTAL RESEARCH, PROFESSIONAL CONSULTANCY RELATED TO NON-BUSINESS, BIOLOGICAL RESEARCH, CHEMISTRY SERVICES, CHEMICAL RESEARCH AND ANALYSIS (U.S. CLS. 100 AND 101).

SN 76-265,510. TUSTIN BARBEQUES, INC., IRVINE, CA, FILED 6-1-2001.

NATURAL BORN GRILLERS

NO CLAIM IS MADE TO THE EXCLUSIVE RIGHT TO USE "GRILLERS", APART FROM THE MARK AS SHOWN.

CLASS 11—ENVIRONMENTAL CONTROL APPARATUS

FOR BARBEQUE GRILLS AND ACCESSORIES, NAMELY, BARBEQUE GRILL COVERS AND REPLACEMENT PARTS THEREFOR; LAVA ROCKS FOR USE IN BARBEQUE GRILLS (U.S. CLS. 13, 21, 23, 31 AND 34).

CLASS 16—PAPER GOODS AND PRINTED MATTER

FOR PRINTED MATTER, NAMELY, PAPER SIGNS, PAPER SIGNS FOR ATTACHMENT TO VEHICLES, POSTERS, PAPER BANNERS, BUMPER STICKERS, AND PAPER SIGN BOARDS FOR POINT OF SALE ADVERTISING (U.S. CLS. 2, 5, 22, 23, 29, 37, 38 AND 50).

CLASS 21—HOUSEWARES AND GLASS

FOR UTENSILS FOR BARBEQUES, NAMELY, FORKS, TONGS, TURNERS, SPATULAS; BARBEQUE UTENSIL SETS, CONSISTING OF COMBINATIONS OF SPATULAS, TONGS, TURNERS, FORK AND BRUSHES FOR BASTING MEAT AND VEGETABLES (U.S. CLS. 2, 13, 23, 29, 30, 33, 40 AND 50).

CLASS 25—CLOTHING

FOR CLOTHING, NAMELY, ADULT AND JUVENILE SHIRTS, HATS, HEAD WEAR, APRONS, JACKETS, SWEATSHIRTS, AND UNIFORMS (U.S. CLS. 22 AND 39).

CLASS 29—MEATS AND PROCESSED FOODS

FOR PREPACKAGED FOODS, NAMELY, PREPACKAGED BEEF, POULTRY, PORK, VEAL, VEGETABLES, VEGETABLE AND MEAT COMBINATIONS, FROZEN MEAT, PREMARINATED MEAT, SLICED FRESH VEGETABLES AND MARINATED VEGETABLES (U.S. CL. 46).

SN 76-269,651. CLOVER MFG. CO., LTD., OSAKA, JAPAN, FILED 6-11-2001.



OWNER OF U.S. REG. NO. 1,256,573 AND OTHERS. NO CLAIM IS MADE TO THE EXCLUSIVE RIGHT TO USE "MFG. CO., LTD. JAPAN", APART FROM THE MARK AS SHOWN.

THE MARK CONSISTS OF TWO DARK GREEN STRIPS, THE TOP STRIP CONTAINING THE WORD "CLOVER" AND THE DESIGN OF A CLOVER. THE TWO STRIPS ARE

PLACED ABOVE A DESIGN OF SEVERAL CLOVERS IN VARYING SHADES OF GREEN AND IN DIFFERENT SIZES OVER THE WORDING "CLOVER MFG. CO., LTD. JAPAN". THE OUTLINE OF THE PACKAGING IS SHOWN IN BROKEN LINES AND IS NOT PART OF THE MARK SOUGHT TO BE REGISTERED. THE BROKEN LINING SHOWN ON THE DRAWING IS FOR THE PURPOSE OF SHOWING THE POSITION OF THE MARK IN RELATION TO THE PACKAGING; NO CLAIM IS MADE TO THE RIGHT TO THE SHAPE OF THE PACKAGING ITSELF.

CLASS 8—HAND TOOLS

FOR BUTTON-HOLE CUTTERS; EYELET PUNCHES; TAILOR'S AWLS; SEAM RIPPERS; SCISSORS; SHEARS; TAILOR'S SHEARS; PINKING SHEARS; THREAD CLIPPERS; SLASH CUTTERS; NAIL CLIPPERS; NAIL FILES; KITCHEN KNIVES; CARVING KNIVES; HAND TOOLS, NAMELY, SAWS, HAMMERS, SPANNERS, SCREWDRIVERS, NAIL PULLERS, NIPPERS, PINNERS AND SCOOPS; HOES; HAND-OPERATED BRAIDED CORD MAKERS; SHAVING CASES; PEDICURE SETS; MANICURE SETS; NON-ELECTRIC CAN OPENERS; SPOONS; FORKS; SHARPENING INSTRUMENTS FOR TAILOR'S CHALK; PALETTE KNIVES; HAND OPERATED SPRAY PUMPS FOR HOUSEHOLD USE; TROWELS; NON-ELECTRIC SOLDERING IRONS; PLIERS; PLIERS FOR PRESS FASTENERS; CUTTING PLIERS; SHOVELS; TWEEZERS AND NON-ELECTRIC KNIVES (U.S. CLS. 23, 28 AND 44).

FIRST USE 2-15-2000; IN COMMERCE 2-15-2000.

CLASS 16—PAPER GOODS AND PRINTED MATTER

FOR HEAT TRANSFER PAPERS FOR TAILORING AND DRESSMAKING; TAILOR'S CHALK; CHALK FOR USE WITH TRACING WHEELS; DRESSMAKER'S MARKING PENCILS; ADHESIVE TAPES FOR USE BY TAILORS AND DRESSMAKERS; NOTEBOOKS FOR DRAWING, SKETCHING, DESIGNING AND THE LIKE IN THE FIELD OF DRESSMAKING, TAILORING AND HANDICRAFT WORKS; PASTES AND OTHER ADHESIVES FOR HANDICRAFT WORKS; DRAWING INSTRUMENTS; DRAWING RULERS FOR USE IN DRESSMAKING; TRIANGULAR REDUCING RULERS FOR DRESSMAKING; TRACING IMPLEMENTS OF BALL POINT PEN-TYPE FOR USE WITH DRESSMAKING AND TAILORING WITHOUT INK; HEAT-ADHESIVE SHEETS FOR DRESSMAKING, TAILORING AND HANDICRAFTS; TRACING PAPER; CARBON PAPER; HEAT TRANSFER PAPERS; LETTER OPENERS; ADHESIVE GLUE FOR STATIONERY AND HOUSEHOLD USE; PAINT BRUSHES; PALETTES FOR PAINTING AND THERMO-TRANSFER DECALCOMANIA (U.S. CLS. 2, 5, 22, 23, 29, 37, 38 AND 50).

FIRST USE 2-15-2000; IN COMMERCE 2-15-2000.

CLASS 26—FANCY GOODS

FOR KNITTING NEEDLES; CIRCULAR KNITTING NEEDLES; CROCHET HOOKS; NEEDLES; SEWING NEEDLES; HANDICRAFT NEEDLES; EMBROIDERY PUNCH NEEDLES; PUNCH NEEDLES; SEWING MACHINE NEEDLES; LATCHED HOOKS; EMBROIDERY NEEDLES; TAPESTRY NEEDLES; BEADING NEEDLES; QUILTING NEEDLES; LEATHER NEEDLES; REPAIR NEEDLES; APPLIQUE NEEDLES; FILET-LACING TOOLS, NAMELY, NEEDLES AND HOOKS; BOBBIN-LACING TOOLS, NAMELY BOBBIN PINS; HAIRPIN CROCHET LOOMS; FLOWER LOOMS; TATTING SHUTTLES; CASES AND CONTAINERS FOR SEWING NEEDLES, KNITTING NEEDLES AND/OR CROCHET HOOKS; SEWING BOXES; SEWING BASKETS; NEEDLE CUSHIONS; CAPS FOR KNITTING NEEDLES; KNITTING BOBBINS; CABLE STITCH HOLDERS; SAFETY PIN-TYPE STITCH HOLDERS; MARKING RINGS FOR KNITTING; YARN GUIDES; CIRCULAR AND SEMI-CIRCULAR CORE ELEMENTS FOR MAKING POM-POMS; SEWING THIMBLES; BODKINS; LOOP TURNERS; HAND TOOLS USED IN SEWING FOR MAKING BIAS TAPE; TRACING SPATULAS; MACRAME BOARDS; HANDICRAFT BOARDS; MAGNET MARKER BOARDS FOR KNITTING; SEWING CLAMPS; HEM CLIPS; SAFETY PINS; PINS USED FOR MAKING MACRAME; STRAIGHT PINS FOR SEWING, DRESS-

MAKING AND HANDICRAFTS; HOOKS AND EYES; BUTTONS FOR CLOTHING; FABRIC APPLIQUES; RIBBONS; ELASTIC AND NON-ELASTIC TAPES FOR USE WITH GARMENTS; BRAIDS; WOVEN FABRIC TAPE TYPE FASTENERS; EDGING AND HEMMING TAPES FOR GARMENTS; BIAS TAPE; ARTIFICIAL FLOWERS; NON-ELECTRIC HAIR CURLERS; HAIR NETS; HAIR BANDS; HAIR PINS; SEW-IN NAME TAGS; TRACING WHEELS; NEEDLE THREADERS; THREAD TWEEZERS; LINE DRAWING AND DOTTING PLATES FOR MAKING PATCHWORK PIECES; TEMPLATES FOR MAKING PATCHWORK OF DIFFERENT SIZES AND SHAPES; TEMPLATES FOR FORMING ROUND CORNERS OF POCKETS AND SLEEVES (U.S. CLS. 37, 39, 40, 42 AND 50).

FIRST USE 2-15-2000; IN COMMERCE 2-15-2000.

SN 76-270,024. OSRAM SYLVANIA INC., DANVERS, MA. FILED 6-11-2001.

SEE THE WORLD IN A NEW LIGHT

CLASS 9—ELECTRICAL AND SCIENTIFIC APPARATUS

FOR ELECTRONIC CONTROLS FOR LIGHTING SYSTEMS; ELECTRONIC BALLAST; STARTERS FOR FLUORESCENT LAMPS, PHOTOFLASH LIGHTING PRODUCTS, POWER SUPPLIES; LIGHTING SYSTEMS COMPRISED OF BALLASTS FOR FLUORESCENT LAMPS; ELECTRIC LAMPS FOR USE IN MICROSCOPES; SEMICONDUCTOR ETCHING LIGHTS (U.S. CLS. 21, 23, 26, 36 AND 38).

CLASS 11—ENVIRONMENTAL CONTROL APPARATUS

FOR LINE OF ELECTRIC LAMPS AND ELECTRIC LIGHTING PRODUCTS, NAMELY INCANDESCENT LAMPS, FLUORESCENT LAMPS, HALOGEN LAMPS, ARC DISCHARGE LAMPS, HIGH INTENSITY DISCHARGE LAMPS, ELECTRON-LUMINESCENT LAMPS, TUNGSTEN LAMPS, PHOTO OPTIC LAMPS, SPECIALTY LIGHTING, NAMELY, ELECTRIC LIGHTS FOR AIRPORT RUNWAYS, MEDICAL OPERATING AND EXAMINING ROOMS, HOUSEHOLD APPLIANCES, STAGE LIGHTING, ARENAS, SUNTAN MACHINES, AQUARIUMS, AIRPLANE INTERIORS, MOVIE PROJECTION, MOVIE AND TELEVISION PRODUCTION, PLANT GROWING; ANTIBACTERIAL ELECTRIC LIGHTS; AND COMPONENT PARTS THEREOF (U.S. CLS. 13, 21, 23, 31 AND 34).

CLASS 35—ADVERTISING AND BUSINESS

FOR COMPUTERIZED ON-LINE RETAIL SERVICES FEATURING LIGHTING PRODUCTS AND BALLASTS; ECONOMIC ANALYSIS IN THE FIELDS OF LIGHTING AND RELAMPING (U.S. CLS. 100, 101 AND 102).

CLASS 37—CONSTRUCTION AND REPAIR

FOR CUSTOM INSTALLATION AND MAINTENANCE OF LAMPS, AND LIGHTING PRODUCTS; (U.S. CLS. 100, 103 AND 106).

CLASS 42—SCIENTIFIC, COMPUTER AND LEGAL SERVICES

FOR CONSULTING SERVICES ON THE WORLD WIDE WEB IN THE FIELDS OF LIGHTING AND RELAMPING; CUSTOM DESIGN OF LIGHTING SYSTEMS; PROVIDING ON-LINE INFORMATION IN THE FIELD OF LIGHTING TECHNOLOGY, DESIGN, THEORY, AND APPLICATIONS (U.S. CLS. 100 AND 101).

SN 76-273,716. SPARKNOTES LLC, NEW YORK, NY. FILED 6-19-2001.

SN 76-275,627. SAAB AUTOMOBILE AB, 461 80 TROLLHATTAN, SWEDEN, FILED 6-21-2001.



9-6

OWNER OF U.S. REG. NO. 2,490,292.
THE MARK CONSISTS IN PART OF A STYLIZED DESIGN OF A SPARK.

CLASS 16—PAPER GOODS AND PRINTED MATTER

FOR PUBLICATIONS, NAMELY, STUDY GUIDES IN THE FIELD OF LITERATURE (U.S. CLS. 2, 5, 22, 23, 29, 37, 38 AND 50).

CLASS 41—EDUCATION AND ENTERTAINMENT

FOR ON-LINE EDUCATIONAL SERVICES, NAMELY, PROVIDING INFORMATION AND ANALYSIS OF LITERARY WORKS (U.S. CLS. 100, 101 AND 107).

CLASS 42—SCIENTIFIC, COMPUTER AND LEGAL SERVICES

FOR COMPUTER SERVICES, NAMELY, PROVIDING ON-LINE STUDY GUIDES IN THE FIELD OF LITERATURE (U.S. CLS. 100 AND 101).

SN 76-275,597. DIREX IMAGE LLC, ORLANDO, FL. FILED 6-22-2001.

XOOM

CLASS 35—ADVERTISING AND BUSINESS

FOR ADVERTISING AGENCY SERVICES FOR NETWORKED INTERACTIVE DIGITAL FLAT-PANEL DISPLAYS, BILLBOARDS AND KIOSKS; MARKET RESEARCH; CONSULTATION IN THE FIELDS OF MARKETING AND ADVERTISING (U.S. CLS. 100, 101 AND 102).

CLASS 37—CONSTRUCTION AND REPAIR

FOR INSTALLATION, MAINTENANCE AND REPAIR OF NETWORKED DIGITAL FLAT-PANEL DISPLAYS, BILLBOARDS AND KIOSKS AND SOFTWARE THEREFOR (U.S. CLS. 100, 103 AND 106).

CLASS 38—COMMUNICATION

FOR ELECTRONIC, ELECTRIC, AND DIGITAL TRANSMISSION OF VOICE, DATA, INFORMATION, IMAGES, SIGNALS (U.S. CLS. 100, 101 AND 104).

CLASS 41—EDUCATION AND ENTERTAINMENT

FOR ENTERTAINMENT SERVICES, NAMELY PRODUCTION OF PROGRAMMING FOR NETWORKED DIGITAL FLAT-PANEL DISPLAYS, BILLBOARDS AND KIOSKS (U.S. CLS. 100, 101 AND 107).

PRIORITY CLAIMED UNDER SEC. 44(D) ON SWEDEN APPLICATION NO. 01-00963, FILED 2-8-2001, REG. NO. 350555, DATED 11-30-2001, EXPIRES 11-30-2011.

CLASS 9—ELECTRICAL AND SCIENTIFIC APPARATUS

FOR SCIENTIFIC, PHOTOGRAPHIC AND OPTICAL APPARATUS AND INSTRUMENTS AS WELL AS INSPECTION, WEIGHING, MEASURING, SIGNALING, CHECKING AND SUPERVISION, LIFE-SAVING AND TEACHING APPARATUS AND INSTRUMENTS, NAMELY CRUISE CONTROL APPARATUS FOR PASSENGER CARS, SPEED CONTROL APPARATUS FOR PASSENGER CARS, ELECTRICAL AND ELECTRONIC MEASURING, CONTROLLING AND REGULATING DEVICES FOR TRACTION CONTROL AND BRAKING SYSTEMS IN AUTOMOBILES, REAR VIEW MIRROR AUTOMATIC DE-BLINDER, DIMMING CONTROL DEVICES FOR DASH PANEL LIGHTING, AUTOMATIC RAIN SENSORS AND BURGLARY ALARMS, APPARATUS FOR RECORDING TRANSMISSION OF SOUND AND IMAGES, NAMELY, VIDEO CASSETTE RECORDERS, AUDIO TAPE RECORDERS, RADIO AND TELEPHONE TRANSMITTERS, COMPACT DISC PLAYERS AND GLOBAL POSITIONING SATELLITE NAVIGATORS, BLANK MAGNETIC DATA CARRIERS, DATA PROCESSORS AND COMPUTERS, FIRE EXTINGUISHING APPARATUS, ELECTRIC APPARATUS AND INSTRUMENTS, NAMELY RELAYS, BATTERIES, JUMP START CABLES, SWITCHES, FUSES, SPEED INDICATORS, REVOLUTION COUNTERS, ALL AFORESAID ARTICLES FOR USE IN PASSENGER CARS AND THE PASSENGER CAR MANUFACTURING INDUSTRY (U.S. CLS. 21, 23, 26, 36 AND 38).

CLASS 12—VEHICLES

FOR AUTOMOBILES, NAMELY PASSENGER CARS AS WELL AS PARTS AND FITTINGS THERETO, NAMELY ENGINES, GEAR BOXES, CAR BODIES, CHASSIS, STEERING SUSPENSIONS, RIMS, BRAKES, WHEELS, TIRES, HUB CAPS, SEATS, ALARM AND ANTI-THEFT DEVICES, SEAT COVERS, HEAD RESTS, AIR BAGS, REARVIEW MIRRORS, STEERING WHEELS, TOWING HOOKS, ROOF RACKS, CAR-TOP LUGGAGE CARRIERS, CAR SAFETY-SEATS AND WINDSHIELD WIPERS AND BLADES; POWER STEERING, SAFETY DEVICES FOR PASSENGER VEHICLES, NAMELY SUPPORTS FOR BACK OF HEAD AND NECK, AIR BAGS, SAFETY BELT STRETCHERS/HOLDERS, ABS BRAKES; TURBO CHARGERS AND SUPER CHARGERS FOR ENGINES OF LAND VEHICLES (U.S. CLS. 19, 21, 23, 31, 35 AND 44).

CLASS 37—CONSTRUCTION AND REPAIR

FOR INSTALLATION OF AUTOMOBILE COMPONENTS AND DEVICES, NAMELY ENGINES, GEAR BOXES, CAR BODIES, CHASSIS, STEERING SUSPENSIONS, RIMS, BRAKES, WHEELS, TIRES, HUB CAPS, SEATS, ALARM AND ANTI-THEFT DEVICES, SEAT COVERS, REAR-VIEW MIRRORS, STEERING WHEELS, TOWING HOOKS, ROOF RACKS, CAR-TOP LUGGAGE CARRIERS, CAR SAFETY-SEATS, WINDSHIELD WIPERS AND BLADES, AUTOMATIC STEERING APPARATUS, SPEED CONTROL APPARATUS, AND OTHER SAFETY DEVICES, NAMELY SUPPORTS FOR BACK OF HEAD AND NECK, AIR BAGS, SAFETY BELT STRETCHERS/HOLDERS, ANTI-SPINNING SYSTEMS FOR TIRES, SO-CALLED NIGHT PANEL FUNCTIONS, ABS BRAKES, REAR VIEW MIRROR AUTOMATIC DE-BLINDER, AUTOMATIC RAIN SENSORS, APPARATUS FOR RECORDING TRANSMISSION OF SOUND AND IMAGES, NAMELY, VIDEO CASSETTE RECORDERS,

AUDIO TAPE RECORDERS, RADIO AND TELEPHONE TRANSMITTERS, COMPACT DISC PLAYERS AND GLOBAL POSITIONING SATELLITE NAVIGATORS, BLANK MAGNETIC DATA CARRIERS, DATA PROCESSING EQUIPMENT AND COMPUTERS, FIRE EXTINGUISHING APPARATUS, ELECTRIC APPARATUSES AND INSTRUMENTS, NAMELY RELAYS, BATTERIES, SWITCHES, FUSES, SPEED INDICATORS, REVOLUTION COUNTERS, AND FUEL, IGNITION AND ENGINE REINFORCING SYSTEMS FOR PASSENGER CARS, AND MAINTENANCE AND REPAIR SERVICES FOR PASSENGER CARS (U.S. CLS. 100, 103 AND 106).

CLASS 37—CONSTRUCTION AND REPAIR

FOR INSTALLATION OF AUTOMOBILE COMPONENTS AND DEVICES, NAMELY ENGINES, GEAR BOXES, CAR BODIES, CHASSIS, STEERING SUSPENSIONS, RIMS, BRAKES, WHEELS, TIRES, HUB CAPS, SEATS, ALARM AND ANTI-THEFT DEVICES, SEAT COVERS, REAR-VIEW MIRRORS, STEERING WHEELS, TOWING HOOKS, ROOF RACKS, CAR-TOP LUGGAGE CARRIERS, CAR SAFETY-SEATS, WINDSHIELD WIPERS AND BLADES, AUTOMATIC STEERING APPARATUS, SPEED CONTROL APPARATUS, AND OTHER SAFETY DEVICES, NAMELY SUPPORTS FOR BACK OF HEAD AND NECK, AIR BAGS, SAFETY BELT STRETCHERS/HOLDERS, ANTI-SPINNING SYSTEMS FOR TIRES, SO-CALLED NIGHT PANEL FUNCTIONS, ABS BRAKES, REAR VIEW MIRROR AUTOMATIC DEBLINDER, AUTOMATIC RAIN SENSORS, APPARATUS FOR RECORDING TRANSMISSION OF SOUND AND IMAGES, NAMELY, VIDEO CASSETTE RECORDERS, AUDIO TAPE RECORDERS, RADIO AND TELEPHONE TRANSMITTERS, COMPACT DISC PLAYERS AND GLOBAL POSITIONING SATELLITE NAVIGATORS, BLANK MAGNETIC DATA CARRIERS, DATA PROCESSING EQUIPMENT AND COMPUTERS, FIRE EXTINGUISHING APPARATUS, ELECTRIC APPARATUSES AND INSTRUMENTS, NAMELY RELAYS, BATTERIES, SWITCHES, FUSES, SPEED INDICATORS, REVOLUTION COUNTERS, AND FUEL, IGNITION AND ENGINE REINFORCING SYSTEMS FOR PASSENGER CARS, AND MAINTENANCE AND REPAIR SERVICES FOR PASSENGER CARS (U.S. CLS. 100, 103 AND 106).

SN 76-275,707. SAAB AUTOMOBILE AB, SWEDEN, FILED 6-21-2001.

9-5

PRIORITY CLAIMED UNDER SEC. 44(D) ON SWEDEN APPLICATION NO. 01-00962, FILED 2-8-2001, REG. NO. 350554, DATED 11-30-2001, EXPIRES 11-30-2011.
OWNER OF U.S. REG. NO. 2,339,033.

CLASS 9—ELECTRICAL AND SCIENTIFIC APPARATUS

FOR SCIENTIFIC, PHOTOGRAPHIC AND OPTICAL APPARATUS AND INSTRUMENTS AS WELL AS INSPECTION, WEIGHING, MEASURING, SIGNALING, CHECKING AND SUPERVISION, LIFE-SAVING AND TEACHING APPARATUS AND INSTRUMENTS, NAMELY CRUISE CONTROL APPARATUS FOR PASSENGER CARS, SPEED CONTROL APPARATUS FOR PASSENGER CARS, ELECTRICAL AND ELECTRONIC MEASURING, CONTROLLING AND REGULATING DEVICES FOR TRACTION CONTROL AND BRAKING SYSTEMS IN AUTOMOBILES, REAR VIEW MIRROR AUTOMATIC DE-BLINDER, DIMMING CONTROL DEVICES FOR DASH PANEL LIGHTING, AUTOMATIC RAIN SENSORS AND BURGLARY ALARMS, APPARATUS FOR RECORDING TRANSMISSION OF SOUND AND IMAGES, NAMELY, VIDEO CASSETTE RECORDERS, AUDIO TAPE RECORDERS, RADIO AND TELEPHONE TRANSMITTERS, COMPACT DISC PLAYERS AND GLOBAL POSITIONING SATELLITE NAVIGATORS, BLANK MAGNETIC DATA CARRIERS, DATA PROCESSORS AND COMPUTERS, FIRE EXTINGUISHING APPARATUS, ELECTRIC APPARATUSES AND INSTRUMENTS, NAMELY RELAYS, BATTERIES, JUMP START CABLES, SWITCHES, FUSES, SPEED INDICATORS, REVOLUTION COUNTERS, ALL AFORESAID ARTICLES FOR USE IN PASSENGER CARS AND THE PASSENGER CAR MANUFACTURING INDUSTRY (U.S. CLS. 21, 23, 26, 36 AND 38).

CLASS 12—VEHICLES

FOR AUTOMOBILES, NAMELY PASSENGER CARS AS WELL AS PARTS AND FITTINGS THERETO, NAMELY ENGINES, GEAR BOXES, CAR BODIES, CHASSIS, STEERING SUSPENSIONS, RIMS, BRAKES, WHEELS, TIRES, HUB CAPS, SEATS, ALARM AND ANTI-THEFT DEVICES, SEAT COVERS, HEAD RESTS, AIR BAGS, REARVIEW MIRRORS, STEERING WHEELS, TOWING HOOKS, ROOF RACKS, CAR-TOP LUGGAGE CARRIERS, CAR SAFETY-SEATS AND WINDSHIELD WIPERS AND BLADES; POWER STEERING, SAFETY DEVICES FOR PASSENGER VEHICLES, NAMELY SUPPORTS FOR BACK OF HEAD AND NECK, AIR BAGS, SAFETY BELT STRETCHERS/HOLDERS, ABS BRAKES; TURBO CHARGERS AND SUPER CHARGERS FOR ENGINES OF LAND VEHICLES (U.S. CLS. 19, 21, 23, 31, 35 AND 44).

SN 76-276,498. MAPAL FABRIK FUR PRAZISIONSWERKZEUGE DR. KRESS KG, AALEN, FED REP GERMANY, FILED 6-26-2001.

CTS

PRIORITY CLAIMED UNDER SEC. 44(D) ON FED REP GERMANY APPLICATION NO. 30094260.5/3, FILED 12-28-2000, REG. NO. 30094260, DATED 5-15-2001, EXPIRES 12-31-2010.

CLASS 37—CONSTRUCTION AND REPAIR

FOR SETTING OF MACHINE TOOLS FOR MACHINING METAL AND OTHER MATERIALS; INSTALLATION, SETTING AND MAINTENANCE OF MEASURING AND TESTING INSTRUMENTS, AS WELL AS OF CHUCKING TOOLS AND TOOLS; REPAIRING AND RESTORING OF MEASURING AND TESTING INSTRUMENTS AS WELL AS OF CHUCKING TOOLS AND TOOLS; RENTAL OF MEASURING AND TESTING INSTRUMENTS AS WELL AS OF CHUCKING TOOLS AND TOOLS (U.S. CLS. 100, 103 AND 106).

CLASS 38—COMMUNICATION

FOR ELECTRONIC TRANSMISSION OF MESSAGES AND DATA IN THE NATURE OF TEXTS, DRAWINGS AND IMAGES (U.S. CLS. 100, 101 AND 104).

CLASS 39—TRANSPORTATION AND STORAGE

FOR PICKUP AND DELIVERY OF TOOLS BY AIR, LAND AND SEA; STORAGE OF TOOLS (U.S. CLS. 100 AND 105).

CLASS 42—SCIENTIFIC, COMPUTER AND LEGAL SERVICES

FOR ENGINEERING; INFORMATION TECHNOLOGY SERVICES, NAMELY, PROVIDING INFORMATION IN THE FIELD OF SCIENCE; TECHNICAL CONSULTATION IN THE FIELD OF INDUSTRIAL ENGINEERING FOR USING MACHINE TOOLS; PRODUCT RESEARCH AND DEVELOPMENT IN THE FIELD OF MACHINE TOOL MANUFACTURE; ON-SITE AND REMOTE TECHNICAL SUPERVISION AND INSPECTION IN THE FIELD OF WORKING PROCESSES IN MECHANICAL PRODUCTION BY RUNNING DIAGNOSTICS ON EQUIPMENT; TECHNICAL SUPERVISION AND INSPECTION IN THE FIELD OF PLACING PRODUCTION PLANTS INTO OPERATION; TECHNICAL ANALYSIS, TECHNICAL DESIGN AND TECHNICAL CONSULTATION IN THE FIELD OF OPTIMIZATION OF PROCESS FLOW IN MECHANICAL PRODUCTION; INDUSTRIAL DESIGN IN THE FIELD OF TECHNICAL OPERATION FOR MECHANICAL PRODUCTION PLANTS; PROVIDING INFORMATION IN THE FIELD OF COMPUTER DESIGN AIDS FOR PRODUCTION PLANTS; HOSTING THE WEBSITES OF OTHERS ON A COMPUTER SERVER FOR A GLOBAL APPLICATION SERVICE PROVIDER (ASP), NAMELY, HOSTING COMPUTER SOFTWARE APPLICATIONS OF OTHERS (U.S. CLS. 100 AND 101).

SN 76-278,934. B BRAUN MEDICAL INC., BETHLEHEM, PA. FILED 6-29-2001.

THE SAFETY COMPANY IN HEALTHCARE**CLASS 5—PHARMACEUTICALS**

FOR PHARMACEUTICAL AND SANITARY SUBSTANCES, NAMELY NUTRITION PREPARATIONS FOR ENTERAL AND PARENTERAL FEEDING; ADMIXING SOLUTIONS AND ADDITIVES, NAMELY STERILE WATER, POTASSIUM CHLORIDE INJECTIONS, AMINO ACID INJECTIONS, IV FAT EMULSIONS, ELECTROLYTE CONCENTRATES, AND SODIUM HYDROCHLORIDE INJECTIONS; IV SOLUTIONS, NAMELY, DEXTROSE INJECTIONS, SODIUM CHLORIDE INJECTIONS, POTASSIUM CHLORIDE INJECTIONS, STERILE WATER, SALINE, RINGERS INJECTIONS, LACTATED RINGERS INJECTIONS, MULTI-ELECTROLYTE INJECTIONS, ALCOHOL INJECTIONS, AMINO ACID INJECTIONS, PLASMA VOLUME MANAGEMENT INJECTIONS, DEXTRAN INJECTIONS, MANNITOL INJECTIONS, PERITONEAL DIALYSIS SOLUTIONS; PHARMACEUTICAL PREPARATIONS FOR TREATMENT OF PAIN; MEDICATED PREPARATIONS FOR SKIN CLEANSING, CARE AND PROTECTION FOR MEDICAL USE; TOPICAL ANALGESICS AND ANESTHETICS; ANTI-INFECTIVES; ANTI-INFLAMMATORIES; ANTI-BIOTIC HAND WASH AND OINTMENTS; ANTISEPTICS; WOUND BANDAGES, PLASTERS AND DRESSINGS; MEDICAL AND ALL PURPOSE DISINFECTANTS; INCONTINENCE PADS AND GARMENTS (U.S. CLS. 6, 18, 44, 46, 51 AND 52).

CLASS 10—MEDICAL APPARATUS

FOR SURGICAL, MEDICAL, DENTAL AND VETERINARY INSTRUMENTS AND APPLIANCES, NAMELY, INTRAVENOUS ADMINISTRATION SETS COMPRISED OF IV TUBING, CLAMPS, IV FLOW REGULATORS, LUER SLIPS, LUER LOCKS, STOPCOCKS, VALVES, INJECTION SITES, ACCESS PORTS, FLASHTUBES, BURETTE CHAMBERS, DRIP CHAMBERS, PUMP CHAMBERS, SPIKES, FLUID FILTERS, PARTICULATE MATTER FILTERS, NEEDLES, BLOOD WARMING COILS, IN-LINE VENOUS PRESSURE MONITORS, MANOMETERS, CATHETERS, CATHETER PLUGS AND CAPS, ADAPTERS AND/OR CONNECTORS FOR THE ADMINISTRATION OF INTRAVENOUS SOLUTIONS; PUMP SETS COMPRISED OF INFUSION PUMPS, CASSETTES FOR INFUSION PUMPS, IV TUBING, CLAMPS, IV FLOW REGULATORS, FREE-FLOW PROTECTOR CLIPS, LUER SLIPS, STOPCOCKS, VALVES, INJECTION SITES, ACCESS PORTS, SPIKES, FILTERS, BURETTE CHAMBERS, DRIP CHAMBERS, NEEDLES, ADAPTERS AND/OR CONNECTORS FOR THE INFUSION OF INTRAVENOUS SOLUTIONS; NEEDLE-FREE INTRAVENOUS PRODUCTS, NAMELY VALVES, INJECTION SITES, ACCESS PORTS, DISPENSING PINS, ACCESS PINS, MANIFOLDS, PROTECTED NEEDLES AND IV CATHETERS, SPIKES, ADAPTERS AND/OR CONNECTORS; ANESTHESIA INTRAVENOUS PRODUCTS, NAMELY, TUBING, FLASHTUBES AND FLASHBULBS, DRIP CHAMBERS, VALVES, CLAMPS, INJECTION SITES, ACCESS PORTS, PORT COVERS, MANIFOLDS, STOPCOCKS, SPIKES, ADAPTERS AND/OR CONNECTORS; IRRIGATION AND UROLOGY PRODUCTS, NAMELY, IRRIGATION CONTAINERS, IRRIGATION CONTAINER POLES/STANDS, TUBING, DRIP CHAMBERS, DRAINAGE BAGS AND TUBES, CLAMPS, CATHETERS, MANIFOLDS, SPIKES, ADAPTERS AND/OR CONNECTORS; DIALYSIS PRODUCTS, NAMELY, HEMODIALYSIS APPARATUS, BLOOD PRESSURE MONITORS AND CUFFS, CONCENTRATE SOLUTION CONTAINERS, DISPOSAL BUCKETS AND HOLDERS, ARTIFICIAL KIDNEY HOLDERS, DRAINAGE BAGS, DRIP CHAMBERS, IV TUBING, INJECTION SITES, ACCESS PORTS, SPIKES, CLAMPS, FILTERS, SYRINGES, CANNULAS, NEEDLES, TRANSDUCER PROTECTORS, DISPENSING PINS, ADAPTERS AND/OR CONNECTORS; IV SOLUTION CONTAINERS; ADMIXTURE PRODUCTS, NAMELY, DISPENSING PINS, SYRINGES, CANNULAS, NEEDLES, SYRINGES CAPS, ADMIXTURE COMPOUNDERS, VALVES, IV TUBING,

SN 76-276,866. WARREN GROUP, LLC, THE, COLUMBIA, SC. FILED 6-27-2001.

WHO ELSE OWNS THIS LOSS**CLASS 16—PAPER GOODS AND PRINTED MATTER**

FOR NEWSLETTERS FEATURING INVOLVEMENT MATRICES FOR IDENTIFYING THE CAUSES OF THE PARTIES RESPONSIBLE FOR INSURED BODILY INJURY AND/OR PROPERTY LOSSES (U.S. CLS. 2, 5, 22, 23, 29, 37, 38 AND 50).

CLASS 36—INSURANCE AND FINANCIAL

FOR INSURANCE CONSULTING SERVICES AND FINANCIAL CONSULTING SERVICES (U.S. CLS. 100, 101 AND 102).

SOLUTION CONTAINERS, MIXING CONTAINERS MANIFOLDS, CLAMPS, VOLUME ADJUSTMENT DEVICES, FILTERS, SPIKES, ADAPTER AND/OR CONNECTORS; INFUSION SYSTEMS COMPRISED OF INFUSION PUMPS, IV POLES AND STANDS, IV TUBING, CLAMPS, INJECTION SITES, VALVES, ADAPTERS AND/OR CONNECTORS; PAIN CONTROL PRODUCTS, NAMELY, CATHETERS, SYRINGES, NEEDLES, FILTERS, NERVE STIMULATORS, MANOMETERS, VALVES, INJECTION SITES, ACCESS PORTS, ADAPTERS AND/OR CONNECTORS; VASCULAR ACCESS PRODUCTS, NAMELY, CATHETERS AND CATHETER GUARDS, ANCHORS AND CAPS, INTRODUCERS, DILATORS, SHEATHS, GUIDEWIRES AND GUIDEWIRE DISPENSERS, SYRINGES, NEEDLES, VALVES, INJECTION SITES, ACCESS PORTS, FILTERS, ECG CABLES, TRANSDUCERS, STOPCOCKS, CLAMPS, IV TUBING, SCALPELS, OBTURATORS, ADAPTERS AND/OR CONNECTOR; AND INTERVENTIONAL PRODUCTS, NAMELY, FILTERS, SYRINGES, NEEDLES, ACCESS PORTS, CATHETER INFLATION DEVICES, SPIKES, STOPCOCKS, VALVES, BURETTES, IV TUBING, OBTURATORS, TRANSDUCERS, INTRODUCERS, DILATORS, SHEATHS, RADIOLOGY FLUID COLLECTION BAGS, DRAINAGE BAGS, GUIDEWIRES AND GUIDEWIRE DISPENSERS, CLAMPS, DRIP CHAMBERS, ADAPTERS AND/OR CONNECTORS (U.S. CLS. 26, 39 AND 44).

CLASS 42—SCIENTIFIC, COMPUTER AND LEGAL SERVICES

FOR HEALTHCARE SERVICES; ADMIXTURE PHARMACY SERVICES, HOME NURSING SERVICES AND OUTPATIENT HEALTHCARE SERVICES (U.S. CLS. 100 AND 101).

SN 76-281,401. OSMOSE, INC., BUFFALO, NY. FILED 7-6-2001.

OSMOSE

THE ENGLISH TRANSLATION OF THE WORD "OSMOSE" IN THE MARK IS "OSMOSIS".

CLASS 1—CHEMICALS

FOR CHEMICAL COMPOSITIONS FOR USE ON WOOD AND OTHER CELLULOSIC MATERIALS TO RENDER THE SAME FIRE RETARDANT, INSECT AND DECAY RESISTANT; SYNTHETIC PHENOLIC RESOLE RESINS AND CATALYSTS FOR USE IN REPAIRING VOIDS IN WOOD; SYNTHETIC EPOXY RESINS, EPOXY ADHESIVES, AND EPOXY HARDENERS FOR USE WITH WOOD AND OTHER CELLULOSIC MATERIALS; CHEMICALS FOR USE IN MANUFACTURING INSECTICIDES, NAMELY, ARSENIC; CHEMICAL ADDITIVES FOR USE IN ADDING COLOR AND WATER REPELLANT FEATURES TO WOOD PRESERVATIVES; WATER REPELLANT ADDITIVES FOR WOOD PRESERVATIVES, NAMELY, WATERPROOFING COMPOSITIONS THAT ARE MIXED WITH WOOD PRESERVATIVES FOR USE ON WOOD AND OTHER CELLULOSIC MATERIALS (U.S. CLS. 1, 5, 6, 10, 26 AND 46).
FIRST USE 1-18-1935; IN COMMERCE 1-18-1935.

CLASS 2—PAINTS

FOR WOOD PRESERVATIVE COMPOSITIONS FOR CONTROLLING DECAY IN WOOD; PRESERVATIVE CARTRIDGE FOR CONTROLLING DECAY IN WOOD; WOOD PRESERVATIVE BANDAGES; PRIMER-SEALERS FOR APPLICATION ON FIRE RETARDANT, TREATED WOOD; WOOD STAINS AND WOOD TONERS; WOOD, MASONRY, AND STUCCO SEALERS; WOOD POLE RESTORATION SYSTEMS COMPRISED OF FIBER-GLASS WRAP AND POLYETHYLENE SOAKING FLUID; COLOR ADDITIVE COMPOSITIONS FOR USE WITH WOOD PRESERVATIVES, NAMELY, WOOD STAINS THAT ARE MIXED WITH WOOD PRESERVATIVES; CHEMICAL COMPOSITIONS FOR PRESERVING WOOD AND OTHER MATERIALS OF CELLULOSE ORIGIN; WOOD PRESERVATIVES FOR PRESSURE PLANT USE ONLY; CORROSION INHIBITING COATINGS FOR PROTECTING STEEL PILINGS FROM CORROSION; WOOD PRESERVATIVES FOR PRESSURE PLANT USE ONLY (U.S. CLS. 6, 11 AND 16).

FIRST USE 1-18-1935; IN COMMERCE 1-18-1935.

CLASS 3—COSMETICS AND CLEANING PREPARATIONS

FOR CLEANING COMPOUNDS FOR WEATHERED WOOD (U.S. CLS. 1, 4, 6, 50, 51 AND 52).

FIRST USE 1-18-1935; IN COMMERCE 1-18-1935.

CLASS 5—PHARMACEUTICALS

FOR FUNGICIDES FOR DOMESTIC AND COMMERCIAL USE IN CONTROLLING DECAY IN WOOD IN LARGE STRUCTURAL TIMBERS; FUMIGANTS PESTICIDES FOR DOMESTIC AND COMMERCIAL USE IN CONTROLLING DECAY AND INSECTS IN WOOD; INSECT REPELLANTS FOR PROTECTION OF MARINE PILING FROM MARINE BORERS; INSECTICIDES FOR DOMESTIC AND COMMERCIAL USE, NAMELY, ARSENIC (U.S. CLS. 6, 18, 44, 46, 51 AND 52).

FIRST USE 1-18-1935; IN COMMERCE 1-18-1935.

CLASS 6—METAL GOODS

FOR METAL WOOD SCREWS; PREPACKAGED METAL HARDWARE FOR CONSTRUCTING WOOD DECKS NAMELY, BRACKETS AND FASTENERS; METAL TRUSSES FOR UTILITY POLES (U.S. CLS. 2, 12, 13, 14, 23, 25 AND 50).

FIRST USE 1-18-1935; IN COMMERCE 1-18-1935.

CLASS 9—ELECTRICAL AND SCIENTIFIC APPARATUS

FOR MEASURING APPARATUS AND INSTRUMENTS, NAMELY, ELECTRONIC INSTRUMENTS FOR MEASURING PULSE RESISTANCE USED IN DETECTION OF ACTIVE DISCOLORATION IN LIVING TREES AND UTILITY POLES; COMPUTER SOFTWARE PROGRAMS FOR USE IN DETERMINING LOADS FOR INSERVICE UTILITY POLES (U.S. CLS. 21, 23, 26, 36 AND 38).

FIRST USE 1-18-1935; IN COMMERCE 1-18-1935.

CLASS 17—RUBBER GOODS

FOR PROTECTIVE PLASTIC WRAP FOR USE WITH WOODEN AND STEEL PILINGS TO PROTECT SUCH PILINGS AGAINST MARINE BORER AND CORROSION DAMAGE (U.S. CLS. 1, 5, 12, 13, 35 AND 50).

FIRST USE 1-18-1935; IN COMMERCE 1-18-1935.

CLASS 19—NON-METALLIC BUILDING MATERIALS

FOR NON-METAL PROTECTIVE COVERS FOR PROTECTING THE UPPER ENDS OF EXPOSED TIMBER (U.S. CLS. 1, 12, 33 AND 50).

FIRST USE 1-18-1935; IN COMMERCE 1-18-1935.

CLASS 35—ADVERTISING AND BUSINESS

FOR MANAGEMENT SERVICES NAMELY MANAGING THIRD PARTY JOINT USE REQUESTS ON UTILITY POLES AND CONTROLLING USAGE OF UTILITY POLES (U.S. CLS. 100, 101 AND 102).
FIRST USE 1-18-1935; IN COMMERCE 1-18-1935.

CLASS 37—CONSTRUCTION AND REPAIR

FOR CONSTRUCTION SERVICES; NAMELY, RESTORATION IN THE FIELD OF UTILITY POLES; PROVIDING PREVENTATIVE MAINTENANCE SERVICES TO OTHERS WHO OWN UTILITY POLES, NAMELY, POLE INSPECTION, TREATMENT AND RESTORATION PROVIDER, FIELD DATA ACQUISITION FOR AM/FM/GIS PROJECTS, GROUNDING SYSTEMS INSPECTIONS, PAD MOUNTED TRANSFORMER CABINET MAINTENANCE, AND VEGETATION MANAGEMENT; PROVIDING PREVENTATIVE MAINTENANCE SERVICES TO OTHERS WHO OWN RAILROAD BRIDGES, NAMELY, INSPECTING, ENGINEERING, DESIGNING, REPAIRING AND REPORTING ON RAILROAD BRIDGES (U.S. CLS. 100, 103 AND 106).
FIRST USE 1-18-1935; IN COMMERCE 1-18-1935.

CLASS 40—MATERIAL TREATMENT

FOR APPLYING CHEMICAL PRESERVATIVES TO THE WOOD PRODUCTS OF OTHERS (U.S. CLS. 100, 103 AND 106).
FIRST USE 1-18-1935; IN COMMERCE 1-18-1935.

CLASS 42—SCIENTIFIC, COMPUTER AND LEGAL SERVICES

FOR TECHNICAL CONSULTATION SERVICES RENDERED IN THE PREPARATION, USE AND APPLICATION OF WOOD PRESERVATIVES AND IN APPLYING PRESERVATIVES TO THE WOODEN PRODUCTS OF OTHERS; TECHNICAL CONSULTATION SERVICES RENDERED IN THE PREPARATION, USE AND APPLICATION OF PLASTIC MESH WRAPS TO IN-PLACE WOODEN AND STEEL PILINGS OF OTHERS; CONSULTING SERVICES RELATING TO THE INSPECTION, TREATMENT, AND REPAIR OF STANDING POLES (U.S. CLS. 100 AND 101).
FIRST USE 1-18-1935; IN COMMERCE 1-18-1935.

SN 76-283,861. CAIN SECURITY SYSTEMS, INC., DBA CAIN INTEGRATED SYSTEMS, ALEXANDRIA, VA. FILED 7-10-2001.



NO CLAIM IS MADE TO THE EXCLUSIVE RIGHT TO USE "INTEGRATED SYSTEMS", APART FROM THE MARK AS SHOWN.

CLASS 37—CONSTRUCTION AND REPAIR

FOR INSTALLATION, MAINTENANCE AND REPAIR OF RESIDENTIAL AND COMMERCIAL FIRE AND INTRUSION ALARM SYSTEMS, CLOSED CIRCUIT TELEVISION SYSTEMS, AUDIO/VIDEO SYSTEMS, HOME THEATER SYSTEMS, LIGHTING SYSTEMS, AUDIO/VISUAL RECORDING AND CATALOGING SYSTEMS, ACCESS CONTROL SYSTEMS, VIDEO DISTRIBUTION SYSTEMS, AUDIO DISTRIBUTION SYSTEMS, AND INTERCOM AND TELEPHONE SYSTEMS (U.S. CLS. 100, 103 AND 106).
FIRST USE 6-0-2000; IN COMMERCE 6-0-2000.

CLASS 42—SCIENTIFIC, COMPUTER AND LEGAL SERVICES

FOR DESIGN FOR OTHERS, AND ELECTRONIC MONITORING SERVICES, IN THE FIELD RESIDENTIAL AND COMMERCIAL FIRE AND INTRUSION ALARM SYSTEMS, CLOSED CIRCUIT TELEVISION SYSTEMS, AUDIO/VIDEO SYSTEMS, HOME THEATER SYSTEMS, LIGHTING SYSTEMS, AUDIO/VISUAL RECORDING AND CATALOGING SYSTEMS, ACCESS CONTROL SYSTEMS, VIDEO DISTRIBUTION SYSTEMS, AUDIO DISTRIBUTION SYSTEMS, AND INTERCOM AND TELEPHONE SYSTEMS (U.S. CLS. 100 AND 101).
FIRST USE 6-0-2000; IN COMMERCE 6-0-2000.

SN 76-283,862. CAIN SECURITY SYSTEMS, INC., ALEXANDRIA, VA. FILED 7-10-2001.

CAIN SECURITY SYSTEMS, INC.

NO CLAIM IS MADE TO THE EXCLUSIVE RIGHT TO USE "SECURITY SYSTEMS INC.", APART FROM THE MARK AS SHOWN.
SEC. 2(F).

CLASS 37—CONSTRUCTION AND REPAIR

FOR INSTALLATION, MAINTENANCE AND REPAIR OF RESIDENTIAL AND COMMERCIAL FIRE AND INTRUSION ALARM SYSTEMS, CLOSED CIRCUIT TELEVISION SYSTEMS, AUDIO/VIDEO SYSTEMS, HOME THEATER SYSTEMS, LIGHTING SYSTEMS, AUDIO/VISUAL RECORDING AND CATALOGING SYSTEMS, ACCESS CONTROL SYSTEMS, VIDEO DISTRIBUTION SYSTEMS, AUDIO DISTRIBUTION SYSTEMS, AND INTERCOM AND TELEPHONE SYSTEMS (U.S. CLS. 100, 103 AND 106).
FIRST USE 0-0-1977; IN COMMERCE 0-0-1977.

CLASS 42—SCIENTIFIC, COMPUTER AND LEGAL SERVICES

FOR DESIGN FOR OTHERS, AND ELECTRONIC MONITORING SERVICES, IN THE FIELD RESIDENTIAL AND COMMERCIAL FIRE AND INTRUSION ALARM SYSTEMS, CLOSED CIRCUIT TELEVISION SYSTEMS, AUDIO/VIDEO SYSTEMS, HOME THEATER SYSTEMS, LIGHTING SYSTEMS, AUDIO/VISUAL RECORDING AND CATALOGING SYSTEMS, ACCESS CONTROL SYSTEMS, VIDEO DISTRIBUTION SYSTEMS, AUDIO DISTRIBUTION SYSTEMS, AND INTERCOM AND TELEPHONE SYSTEMS (U.S. CLS. 100 AND 101).
FIRST USE 0-0-1977; IN COMMERCE 0-0-1977.

SN 76-285,894. ZANER-BLOSER, INC., COLUMBUS, OH.
FILED 7-16-2001.

ZANER-BLOSER

CLASS 16—PAPER GOODS AND PRINTED MATTER

FOR EDUCATIONAL TEXTBOOKS FOCUSING ON READING, HANDWRITING, PHONICS, STUDY SKILLS, AND SPELLING (U.S. CLS. 2, 5, 22, 23, 29, 37, 38 AND 50).
FIRST USE 12-1-1895; IN COMMERCE 12-1-1904.

CLASS 41—EDUCATION AND ENTERTAINMENT

FOR EDUCATIONAL SERVICES, NAMELY, PROVIDING COURSES OF INSTRUCTION IN KINDERGARTEN THROUGH HIGH SCHOOL STUDENTS IN THE AREAS OF READING, HANDWRITING, PHONICS, STUDY SKILLS, AND SPELLING; PUBLICATION OF BOTH HARD AND SOFT COVER CONSUMABLE AND NON-CONSUMABLE TEXTBOOKS FOR KINDERGARTEN THROUGH HIGH SCHOOL STUDENTS IN THE AREAS OF READING, HANDWRITING, PHONICS, STUDY SKILLS AND SPELLING (U.S. CLS. 100, 101 AND 107).
FIRST USE 12-1-1895; IN COMMERCE 12-1-1904.

SN 76-286,788. MARTYNEC, ANDREA M., DOYLESTOWN, PA. FILED 7-17-2001.



NO CLAIM IS MADE TO THE EXCLUSIVE RIGHT TO USE THE REPRESENTATION OF INTERNATIONAL RECYCLING SYMBOL WITH THE ROTATING ARROW, APART FROM THE MARK AS SHOWN.

THE STIPPLING IS A FEATURE OF THE MARK AND IS NOT INTENDED TO INDICATE COLOR.

CLASS 35—ADVERTISING AND BUSINESS

FOR CONSERVATION SERVICES, NAMELY, PROMOTING PUBLIC AWARENESS IN THE NEED TO MAINTAIN AND CONSERVE LAND AND RESOURCES AND PARTICULARLY THE PRISTINE CONDITION OF NATURAL OUTDOOR SPACES (U.S. CLS. 100, 101 AND 102).

CLASS 40—MATERIAL TREATMENT

FOR RECYCLING SERVICES (U.S. CLS. 100, 103 AND 106).

SN 76-289,892. GOTTLIEB BINDER GMBH & CO, D-71088 HOLZGERLINGEN, FED REP GERMANY, FILED 7-25-2001.

PRINTED HOOKS ON DEMAND

NO CLAIM IS MADE TO THE EXCLUSIVE RIGHT TO USE "HOOKS", APART FROM THE MARK AS SHOWN.

CLASS 17—RUBBER GOODS

FOR PLASTIC FILM FOR INDUSTRIAL AND COMMERCIAL USE; PLASTIC TAPE, PLASTIC FLAT TAPE, AND ADHESIVE PLASTIC TAPE FOR INDUSTRIAL AND COMMERCIAL USE; PLASTIC ADHESIVE BANDS AND FILM FOR SEALING CARTONS; PLASTIC ADHESIVE BANDS AND FILM FOR SEALING PHARMACEUTICAL CONTAINERS; PLASTIC ADHESIVE PACKING TAPE FOR INDUSTRIAL OR COMMERCIAL USE; AND CELLULOSE ACETATE FILM USED IN THE MANUFACTURE OF PRESSURE SENSITIVE ADHESIVE TAPE (U.S. CLS. 1, 5, 12, 13, 35 AND 50).

CLASS 20—FURNITURE AND ARTICLES NOT OTHERWISE CLASSIFIED

FOR NON-METAL HOOK AND LOOP ADHESIVE FASTENERS AND NON-METAL ADHESIVE FASTENERS FOR A WIDE VARIETY OF COMMERCIAL AND INDUSTRIAL APPLICATIONS; FASTENERS CONSISTING OF EXTRUDED PLASTIC IN THE FORM OF STRIPS, RIBBONS AND BARS FOR ATTACHING, AFFIXING, FASTENING, SECURING, ADJOINING, CLAMPING, CLIPPING, CONNECTING, SECURING, HANGING AND HOLDING PURPOSES FOR MANUFACTURING AND GENERAL INDUSTRIAL USE (U.S. CLS. 2, 13, 22, 25, 32 AND 50).

CLASS 26—FANCY GOODS

FOR HOOK AND LOOP FASTENING TAPE (U.S. CLS. 37, 39, 40, 42 AND 50).

SN 76-289,987. BB TECHNOLOGIES, INC., WILMINGTON, DE. FILED 7-25-2001.

ONE SOURCE FOR WORLDWIDE INFRASTRUCTURE SERVICES

NO CLAIM IS MADE TO THE EXCLUSIVE RIGHT TO USE "WORLDWIDE INFRASTRUCTURE SERVICES", APART FROM THE MARK AS SHOWN.

CLASS 37—CONSTRUCTION AND REPAIR

FOR INSTALLATION AND MAINTENANCE OF TELECOMMUNICATION AND COMPUTER NETWORK INFRASTRUCTURE SYSTEMS (U.S. CLS. 100, 103 AND 106).

FIRST USE 6-21-2001; IN COMMERCE 6-21-2001.

CLASS 42—SCIENTIFIC, COMPUTER AND LEGAL SERVICES

FOR TELECOMMUNICATION AND COMPUTER NETWORK INFRASTRUCTURE DESIGN FOR OTHERS; TECHNICAL SUPPORT FOR TELECOMMUNICATION AND COMPUTER NETWORK INFRASTRUCTURE SYSTEMS (U.S. CLS. 100 AND 101).

FIRST USE 6-21-2001; IN COMMERCE 6-21-2001.

SN 76-290,024. ALTEER CORPORATION, IRVINE, CA. FILED 7-25-2001.

ALTEER**CLASS 9—ELECTRICAL AND SCIENTIFIC APPARATUS**

FOR COMPUTER HARDWARE AND PERIPHERALS; PERSONAL DIGITAL ASSISTANTS; COMPUTER SOFTWARE AND APPLICATIONS FOR MEDICAL PRACTICES FOR THE PURPOSE OF SCHEDULING, CHARTING, BILLING AND PATIENT MESSAGING (U.S. CLS. 21, 23, 26, 36 AND 38).

FIRST USE 0-0-1996; IN COMMERCE 0-0-1996.

CLASS 42—SCIENTIFIC, COMPUTER AND LEGAL SERVICES

FOR COMPUTER SERVICES, NAMELY COMPUTER CONSULTATION AND INTEGRATION OF COMPUTER SYSTEMS; COMPUTER PROGRAMMING SERVICES FOR OTHERS; COMPUTER SYSTEMS ANALYSIS; COMPUTER SOFTWARE DESIGN AND DEVELOPMENT FOR OTHERS; COMPUTER TECHNICAL SUPPORT SERVICES, NAMELY, TROUBLESHOOTING OF COMPUTER HARDWARE AND SOFTWARE PROBLEMS; HOSTING A WEB-SITE FOR OTHERS TO USE FOR ACCESS TO DATA, HEALTHCARE SERVICES AND INFORMATION IN THE FIELD OF HEALTHCARE (U.S. CLS. 100 AND 101).

FIRST USE 0-0-1996; IN COMMERCE 0-0-1996.

SN 76-290,987. GREAT STUFF, INC., SAN LEANDRO, CA. FILED 7-26-2001.

ROBOREEL**CLASS 6—METAL GOODS**

FOR HAND OPERATED GARDEN HOSE REELS MADE PRIMARILY OF METAL (U.S. CLS. 2, 12, 13, 14, 23, 25 AND 50).

CLASS 7—MACHINERY

FOR POWER OPERATED REELS FOR WINDING AND STORING LINEAR MATERIALS, NAMELY, HOSES, GARDEN HOSES, AIR AND PNEUMATIC HOSES, AND NON-METAL TWINE (U.S. CLS. 13, 19, 21, 23, 31, 34 AND 35).

CLASS 9—ELECTRICAL AND SCIENTIFIC APPARATUS

FOR REELS FOR WINDING AND STORING LINEAR MATERIALS, NAMELY, ELECTRICAL CORDS, EXTENSION CORDS AND ELECTRICAL CABLES (U.S. CLS. 21, 23, 26, 36 AND 38).

SN 76-295,554. MONOGEN, INC., VERNON HILLS, IL. FILED 8-6-2001.

MONOPREP**CLASS 5—PHARMACEUTICALS**

FOR REAGENTS FOR DISEASE DETECTION AND DIAGNOSIS, AND THERAPEUTIC MONITORING OF PATIENTS; FLUIDS FOR PRESERVATION OF CELLULAR SPECIMENS FOR MEDICAL DIAGNOSTIC AND SCREENING PURPOSES; SPECIMEN AND MICROSCOPE SLIDE TREATMENT PREPARATIONS, NAMELY, STAINERS AND COVER SLIPPERS, ALL FOR MEDICAL DIAGNOSTIC AND SCREENING PURPOSES (U.S. CLS. 6, 18, 44, 46, 51 AND 52).

CLASS 9—ELECTRICAL AND SCIENTIFIC APPARATUS

FOR MICROSCOPE SLIDE EVALUATION APPARATUS IN THE NATURE OF AUTOMATED AND COMPUTER ASSISTED MICROSCOPES AND ACCESSORIES THEREFOR, MICROSCOPE SLIDES AND TEST TUBES, ALL FOR BIOMEDICAL SCREENING, DIAGNOSTIC AND THERAPEUTIC MONITORING PURPOSES (U.S. CLS. 21, 23, 26, 36 AND 38).

CLASS 10—MEDICAL APPARATUS

FOR SUPPLIES, ACCESSORIES AND APPARATUS, NAMELY VIALS AND FLUIDS FOR PRESERVATION OF CELLULAR SPECIMENS, SOLD TOGETHER AS A UNIT, MICROSCOPE SLIDES, MICROSCOPE SLIDE-PREPARATION INSTRUMENTS, SPECIMEN ALIQUOTING MACHINES, AND SPECIMEN AND MICROSCOPE SLIDE TREATMENT DEVICES, NAMELY, STAINERS AND COVER SLIPPERS, ALL FOR BIOMEDICAL SCREENING, DIAGNOSTIC AND THERAPEUTIC MONITORING PURPOSES (U.S. CLS. 26, 39 AND 44).

SN 76-295,811. CONSTRUTODO, INC., HOUSTON, TX. FILED 8-6-2001.

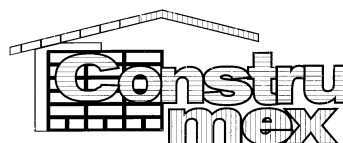

IN THE DRAWING THE RIGHT HAND PORTION OF THE ROOF AND "MEX" ARE LINED FOR RED AND CONSTRU IS LINED FOR BLUE.

CLASS 35—ADVERTISING AND BUSINESS

FOR RETAIL STORE SERVICES FEATURING A WIDE VARIETY OF CONSUMER CONSTRUCTION-RELATED GOODS AND SERVICES OF OTHERS, WHICH ARE MADE AVAILABLE BY MEANS OF SAMPLE DISPLAYS IN THE NATURE OF DEPICTIONS IN CATALOGS AND OF DESCRIPTIONS OF SUCH CONSTRUCTION-RELATED GOODS AND SERVICES AND BY ARRANGING IN THE U.S. FOR PURCHASE OF SUCH GOODS AND SERVICES FROM MEXICAN SUPPLIERS AND SERVICE PROVIDERS BY U.S. BASED CUSTOMERS, FOR DELIVERY IN MEXICO FROM SUPPLIERS AND FROM SERVICE PROVIDERS IN MEXICO (U.S. CLS. 100, 101 AND 102).

FIRST USE 7-10-2001; IN COMMERCE 7-10-2001.

CLASS 36—INSURANCE AND FINANCIAL

FOR CURRENCY EXCHANGE ADVICE IN THE FIELD OF CONSTRUCTION, ENGINEERING AND ARCHITECTURAL MATERIALS AND SERVICES; CONSULTATION IN CONNECTION WITH THE FINANCIAL ASPECTS OF CHOOSING, CONTACTING, PLACING ORDERS WITH, CONFIRMING ACCEPTANCE OF ORDERS BY, AND ARRANGING FOR PAYMENTS TO MEXICAN SUPPLIERS AND SERVICE PROVIDERS FOR U.S. BASED CUSTOMERS IN THE FIELD OF CONSTRUCTION, ENGINEERING AND ARCHITECTURAL MATERIALS AND SERVICES (U.S. CLS. 100, 101 AND 102).

FIRST USE 7-10-2001; IN COMMERCE 7-10-2001.

CLASS 37—CONSTRUCTION AND REPAIR

FOR CONSULTATION IN THE FIELD OF CONSTRUCTION, ENGINEERING AND ARCHITECTURAL PLANNING (U.S. CLS. 100, 103 AND 106).

FIRST USE 7-10-2001; IN COMMERCE 7-10-2001.

SN 76-299,545. KAI CORPORATION, CHIYODA-KU, TOKYO, JAPAN, FILED 8-14-2001.

和寂
W A S A B I

THE CHINESE CHARACTERS IN THE MARK TRANSLATE PHONETICALLY AS "WA" (MEANING "JAPAN" IN JAPANESE) AND "SABI" (MEANING "ANTIQUÉ LOOK" IN JAPANESE).

CLASS 8—HAND TOOLS

FOR HAND TOOLS AND INSTRUMENTS, NAMELY, BUSH HAMMERS, MALLETs, GAVELS, HAMMERS, SCREW DRIVERS, SPANNERS, WRENCHES, MONKEY WRENCHES, TROWELS, BRANDING IRONS, VISES, NAIL PULLERS AND NAIL EXTRACTORS, NIPPERS, PLIERS, CUTTING PLIERS, PINCERS, PICKAXES, TAMPING PICKS, SHOVELS, SCOOPS, SPADES, SNOW SHOVELS, LEATHER STROPS, SHARPENING STEELS AND WHETSTONES; SHARP-EDGED HAND TOOLS AND INSTRUMENTS, NAMELY, SCISSORS, SHEARS, NAIL CLIPPERS, NAIL SCISSORS, SCISSORS BLADES, PUNCHES, HAIRDRESSING SCISSORS, GARDENING SCISSORS, AND SHEARS, CLOTH SHEARS, KNIVES, NAMELY, PARING KNIVES, STEAK KNIVES, COOKING KNIVES, SANTOKU KNIVES, BONING KNIVES, ORIENTAL CHEF'S KNIVES, ARMY KNIVES, HUNTING KNIVES, MOUNTAINEERING KNIVES, LIGHTWEIGHT KNIVES, DOUBLE BLADED KNIVES, BREAD KNIVES, POCKET KNIVES, SPORTSMAN'S SHEARS, DOUBLE-EDGED BLADE KNIVES, TROUT KNIVES, BIRD KNIVES, AND ELK SKINNER KNIVES, HAND CUTTERS, KITCHEN KNIVES, STRAW CUTTERS, FOLDING KNIVES, GLASS CUTTERS, GLAZIERS' DIAMONDS, FRUIT KNIVES, SCALING KNIVES, PARING IRONS, FLOOR MAT CHOPPERS, CARVING KNIVES, DRAWING KNIVES, VEGETABLE KNIVES, MEAT CHOPPERS, TABLE KNIVES, RAZORS, RAZOR BLADES, NON-ELECTRIC HAIR CLIPPERS, GAFFS, CHISELS, PLANES, DRILLS, SAWS, AXES, SICKLES, HATCHETS, CENTER PUNCHES, DIES, TAPS, DRILLS, MILLING CUTTERS, FILES, REAMERS, SWORDS AND SABERS; HOES AND MATTOCKS; HAND TOOLS, NAMELY, RAKES AND ABRADERS; SHOEMAKERS' HAND TOOLS, NAMELY, LASTS; ELECTRIC RAZORS AND ELECTRIC HAIR CLIPPERS; SHAVING CASES COMPOSED OF RAZORS, RAZOR BLADES AND SHAVING CREAM OR SHAVING GEL; PEDICURE SETS; MANICURE SETS; SUGAR TONGS; NON-ELECTRIC CAN OPENERS; NUTCRACKERS NOT OF PRECIOUS METAL; FORKS FOR COOKING, TABLEWARE, NAMELY, FORKS, KNIVES, AND SPOONS; DRESSMAKERS' CHALK SHARPENERS; DIVING KNIVES; DIVING KNIFE HOLDERS; ICE PICKS; FIRE SHOVELS; PALETTE KNIVES; WOODEN PESTLES; EARTHENWARE MORTARS; CHOPSTICKS; CHOPSTICK CASES; AND TWEEZERS (U.S. CLS. 23, 28 AND 44).

CLASS 21—HOUSEWARES AND GLASS

FOR SCOOPS; HOUSEHOLD AND KITCHEN AND COOKING CONTAINERS NOT OF PRECIOUS METAL; PANS; NON-ELECTRIC COFFEE POTS NOT OF PRECIOUS METAL; CAST IRON KETTLES; NON-ELECTRIC TEA KETTLES; ICE PAILS; NON-ELECTRIC HOUSEHOLD WHISKS; COOKING SKEWERS; PORTABLE COOLERS; STRAINERS, PEPPER POTS, SUGAR BOWLS AND SALT SHAKERS NOT OF PRECIOUS METAL; EGG CUPS; NAPKIN HOLDERS/NAPKIN RINGS NOT OF PRECIOUS METAL; SERVING TRAYS NOT OF PRECIOUS METAL; TOOTHPICK HOLDERS NOT OF PRECIOUS METAL; RICE CHESTS; BAMBOO BOWLS; SHAKERS; RICE SCOOPS; HAND OPERATED COFFEE GRINDERS AND PEPPER MILLS; FUNNELS; GLASS STORAGE JARS; DRINKING FLASKS; DINING MEAL TRAYS AND STANDS; BOTTLE OPENERS; GRATERS; TART SCOOPS; KITCHEN LADLES AND DIPPERS; SIEVES AND FLOUR SIFTERS; WOOD CHOPPING BOARDS FOR KITCHEN USE; INSULATING FLASKS AND VACUUM BOTTLES SOLD EMPTY; ROLLING PINS; COOKING UTENSILS, NAMELY, GRILLS; TOOTHPICKS; LEMON SQUEEZERS; NON ELECTRIC WAFFLE IRONS; CLEANING AND LAUNDRY EQUIPMENT, NAMELY, WASHING BOARDS, CLOTHES PINS, WASHING BRUSHES, WASH BASINS, DUSTING CLOTHS, CLOTHS FOR CLEANING, WASH TUBS, SCRUBBING BRUSHES, WASTE BASKETS, DUST PANS, BUCKETS, DUSTERS, CLOTH STRETCH-DRYING BOARDS, BROOMS, MOPS, RODS FOR DRYING CLOTHES, CLOTHES DRYING HANGERS; GLOVES FOR HOUSEHOLD PURPOSES; COMBS, COMB CASES, CREAM CASES, FITTED VANITY CASES, SPONGES, TOILET BRUSHES, PERFUME SPRAYERS, NAMELY, VAPORIZERS SOLD EMPTY, SOAP HOLDERS, NAIL BRUSHES, POWDER PUFFS, TOOTHBRUSHES, TOOTHBRUSH CONTAINERS, SHAVING BRUSH STANDS, HAIR BRUSHES, LIPSTICK BRUSHES, EYELASH CUR-

TERS, EYEBROW BRUSHES; TUB BRUSHES; METAL WIRE BRUSHES NOT BEING PART OF MACHINES; BRUSHES FOR PIPES; INDUSTRIAL BRUSHES; SHIP SCRUBBING BRUSHES, PIG BRISTLES FOR BRUSHES; CLOTHES BRUSHES; SHOE BRUSHES; SHOE HORNS; SHOE SHINE CLOTHS; HANDY SHOE SHINERS; SHOE TREES; PACKAGING CONTAINERS OF GLASS OR CERAMIC; TROUGHS FOR LIVESTOCK; POULTRY RINGS; IRONING BOARDS; FEEDING VESSELS FOR PETS; BRUSHES FOR PETS; FLOWER POTS; CINDER SHIFTERS FOR HOUSEHOLD USE; BOXES OF METAL FOR DISPENSING PAPER TOWELS; SPRAYER FOR GENERAL HOUSEHOLD USE SOLD EMPTY; IRONING STANDS; BIRD CAGES; BIRD BATHS NOT BEING STRUCTURES; WATERING CANS, CHAMBER POTS; COAL SCUTTLES; SOAP DISPENSERS; NONMETAL PIGGY BANKS; TOILET PAPER HOLDERS; MOUSE TRAPS; FLY SWATTERS; TAILORS' TRACING SPATULA BOARDS, NAMELY, HERA-DAI; BATH WATER STIRRERS; BATHROOM PAILS; CANDLE SNUFFERS AND CANDLESTICKS NOT OF PRECIOUS METAL; VASES NOT OF PRECIOUS METAL; INCENSE BURNERS AND PERFUME BURNERS FOR DOMESTIC USE; FLOWER BOWLS NOT OF PRECIOUS METAL; WIND CHIMES; COSMETIC POWDER COMPACTS NOT OF PRECIOUS METAL, SOLD EMPTY (U.S. CLS. 2, 13, 23, 29, 30, 33, 40 AND 50).

SN 76-301,058. WEICHERT RELOCATION CO, INC., MORRIS PLAINS, NJ. FILED 8-17-2001.



WeichertRelocation

OWNER OF U.S. REG. NOS. 1,454,583, 2,409,239 AND OTHERS.

CLASS 35—ADVERTISING AND BUSINESS

FOR BUSINESS AND PERSONNEL RELOCATION SERVICES; REFERRALS FOR DISCOUNTED SERVICES IN THE FIELDS OF RECREATION AND LEISURE SERVICES, TRAVEL SERVICES, CONSTRUCTION SERVICES, AND CONTRACTOR SERVICES (U.S. CLS. 100, 101 AND 102).

CLASS 36—INSURANCE AND FINANCIAL

FOR REAL ESTATE BROKERAGE, RENTAL OF APARTMENTS, TOWN HOMES, HOUSES AND CONDOMINIUMS; REAL ESTATE MANAGEMENT, NAMELY, MANAGEMENT OF COMMERCIAL AND RESIDENTIAL PROPERTIES, REAL ESTATE INVESTMENT, INSURANCE BROKERAGE, MORTGAGE BROKERAGE AND FINANCIAL SERVICES, NAMELY, INVESTMENT SECURITIES (U.S. CLS. 100, 101 AND 102).

SN 76-302,640. ADVANTEK, INC., MINNETONKA, MN. FILED 8-21-2001.

ADVANTEK

OWNER OF U.S. REG. NO. 1,506,963.

CLASS 7—MACHINERY

FOR MACHINES FOR THE ELECTRONIC INDUSTRY FOR PACKAGING ELECTRONIC COMPONENTS AND SMALL PARTS IN EMBOSSED CARRIER TAPE AND COVER TAPE (U.S. CLS. 13, 19, 21, 23, 31, 34 AND 35).
FIRST USE 11-12-1978; IN COMMERCE 11-12-1978.

CLASS 9—ELECTRICAL AND SCIENTIFIC APPARATUS

FOR REELS FOR FLEXIBLE LAMINATED BANDS AND EMBOSSED CARRIER TAPE FOR CARRYING ELECTRONIC COMPONENTS AND SMALL PARTS, AND INSULATING EQUIPMENT FOR APPLYING INSULATING TAPE INCLUDING REELS AND SUPPORTS FOR SUPPORTING THE REELS AND SUPPORTS FOR SUPPORTING THE REELS WITH RESPECT TO A WORK SURFACE; TAPE WINDERS FOR APPLYING TAPE-TYPE PACKAGING FOR ELECTRONIC COMPONENTS; TESTING EQUIPMENT FOR EVALUATING THE PERFORMANCE OF ELECTRONIC COMPONENT PACKAGING, AND TAPING MACHINES FOR APPLYING TAPE-TYPE PACKAGING FOR ELECTRONIC COMPONENTS (U.S. CLS. 21, 23, 26, 36 AND 38).
FIRST USE 11-12-1978; IN COMMERCE 11-12-1978.

CLASS 16—PAPER GOODS AND PRINTED MATTER

FOR PLASTIC ANTISTATIC BAGS FOR PACKAGING ELECTRICAL COMPONENTS AND MICROCHIPS, PLASTIC CONDUCTIVE GAGS FOR PACKAGING ELECTRICAL COMPONENTS AND MICROCHIPS, AND PLASTIC MOISTURE RESISTANT BAGS FOR PACKAGING ELECTRICAL COMPONENTS AND MICROCHIPS (U.S. CLS. 2, 5, 22, 23, 29, 37, 38 AND 50).
FIRST USE 11-1-1995; IN COMMERCE 11-1-1995.

CLASS 17—RUBBER GOODS

FOR PLASTIC TAPE, PRESSURE SENSITIVE TAPE, HEAT ACTIVATED TAPE, INSULATIVE TAPE, AND ANTISTATIC TAPE FOR INDUSTRIAL AND COMMERCIAL USE, EMBOSSED CARRIER TAPE FOR PROTECTING ELECTRONIC COMPONENTS FROM PHYSICAL AND ELECTRO-STATIC DISCHARGE DAMAGE DURING SHIPPING AND STORAGE, TAPE COVERS FOR THE EMBOSSED CARRIER TAPE TO MAINTAIN ELECTRONIC COMPONENTS IN DESIRED POSITIONS DURING SHIPPING AND STORAGE; PLASTIC VACUUM INSULATION PANELS FOR USE IN PACKAGING; PLASTIC PACKING MATERIALS PROVIDING THERMAL INSULATION; PACKAGING MATERIALS FABRICATED FROM PLASTIC IN SHEET OR ROLL FORM (U.S. CLS. 1, 5, 12, 13, 35 AND 50).
FIRST USE 3-16-1999; IN COMMERCE 3-16-1999.

CLASS 37—CONSTRUCTION AND REPAIR

FOR REPAIR, ADJUSTMENT AND MAINTENANCE OF TAPE EMBOSsing MACHINES AND PACKAGING EQUIPMENT, INCLUDING EQUIPMENT FOR PACKAGING OF ELECTRONIC COMPONENTS (U.S. CLS. 100, 103 AND 106).
FIRST USE 4-1-1999; IN COMMERCE 4-1-1999.

CLASS 40—MATERIAL TREATMENT

FOR MANUFACTURE TO THE ORDER AND SPECIFICATION OF OTHERS OF PACKAGING EQUIPMENT, SURFACE MOUNT TAPING MACHINES, PACKAGING MATERIALS, AND PLASTIC BAGS (U.S. CLS. 100, 103 AND 106).
FIRST USE 4-1-1999; IN COMMERCE 4-1-1999.

CLASS 42—SCIENTIFIC, COMPUTER AND LEGAL SERVICES

FOR TECHNICAL SUPPORT SERVICES IN THE NATURE OF CONSULTATION REGARDING PACKAGING PRODUCTS FOR OTHERS; ENGINEERING CONSULTATION REGARDING SELECTION AND USE OF INSULATIVE MATERIALS, PACKAGING OF INSULATIVE MATERIALS AND ELECTRONIC COMPONENTS, AND DESIGN OF INSULATIVE MATERIALS FOR PARTICULAR APPLICATIONS; AND DESIGN FOR OTHERS OF EQUIPMENT FOR PACKAGING OF ELECTRONIC COMPONENTS (U.S. CLS. 100 AND 101).

FIRST USE 4-1-1999; IN COMMERCE 4-1-1999.

SN 76-305,104. BRITISH AIRWAYS PLC., WEST DRAYTON, UNITED KINGDOM, FILED 8-24-2001.

FLYTHROUGH

PRIORITY CLAIMED UNDER SEC. 44(D) ON ERPN CMNTY TM OFC APPLICATION NO. 2323368, FILED 7-31-2001, REG. NO. 2323368, DATED 7-31-2001, EXPIRES 7-31-2011.

CLASS 35—ADVERTISING AND BUSINESS

FOR AIRPORT BAGGAGE CHECK-IN SERVICES; AIRPORT PASSENGER CHECK-IN SERVICES (U.S. CLS. 100, 101 AND 102).

CLASS 39—TRANSPORTATION AND STORAGE

FOR AIRLINE TRANSPORTATION SERVICES; TRAVEL AGENCY SERVICES, NAMELY, MAKING RESERVATIONS AND BOOKINGS FOR TRANSPORTATION; TRAVEL BOOKING AGENCIES; TRAVEL INFORMATION SERVICES; RENTAL OF VEHICLES; VEHICLE PARKING; COURIER SERVICES; CARGO STORAGE AND HANDLING; AIRPLANE CHARTERING; PACKAGING HOLIDAY ARTICLES FOR TRANSPORTATION; ARRANGING TRAVEL TOURS (U.S. CLS. 100 AND 105).

SN 76-304,061. FIRST CURRENCY CHOICE SVERIGE AB, 434 21 KUNGSBACKA, SWEDEN, FILED 8-24-2001.



PRIORITY CLAIMED UNDER SEC. 44(D) ON SWEDEN APPLICATION NO. 01-01493, FILED 3-2-2001, REG. NO. 350199, DATED 11-16-2001, EXPIRES 11-16-2011.

NO CLAIM IS MADE TO THE EXCLUSIVE RIGHT TO USE "CURRENCY", APART FROM THE MARK AS SHOWN.

THE STIPPLING IN THE DRAWING IS USED FOR SHADING PURPOSES, AND DOES NOT INDICATE COLOR.

CLASS 9—ELECTRICAL AND SCIENTIFIC APPARATUS

FOR RECORDED COMPUTER SOFTWARE FOR USE IN DATABASE MANAGEMENT FOR ELECTRONIC CREDIT AND DEBIT PAYMENT FINANCIAL TRANSACTIONS; COMPUTER HARDWARE; RECORDED COMPUTER PROGRAMS FOR USE IN DATABASE MANAGEMENT FOR ELECTRONIC CREDIT AND DEBIT PAYMENT FINANCIAL TRANSACTIONS (U.S. CLS. 21, 23, 26, 36 AND 38).

CLASS 36—INSURANCE AND FINANCIAL

FOR FINANCIAL SERVICES, NAMELY BANKING SERVICES IN THE NATURE OF PAYMENT SERVICES, NAMELY BILL PAYMENT SERVICES, CREDIT SERVICES, NAMELY CREDIT CONSULTATION, DEBIT SERVICES, NAMELY DEBIT ACCOUNT SERVICES FEATURING A COMPUTER READABLE CARD, BANK CARD SERVICES, NAMELY DEBIT CARD SERVICES, PAYMENT TERMINAL AND TERMINAL TRANSACTION SERVICES, NAMELY PROVIDING MULTIPLE PAYMENT OPTIONS BY MEANS OF CUSTOMER-OPERATED ELECTRONIC TERMINALS AVAILABLE ON-SITE IN RETAIL STORES, HOTELS, CAR RENTAL FACILITIES AND AMUSEMENT AND THEME PARKS, AND ELECTRONIC FINANCIAL TRANSACTIONS, NAMELY ELECTRONIC DEBIT TRANSACTIONS AND ELECTRONIC CREDIT TRANSACTIONS (U.S. CLS. 100, 101 AND 102).

SN 76-305,920. DKH ENTERPRISES, INC., MIDLOTHIAN, TX, FILED 8-23-2001.

HOODWINKER'S**CLASS 9—ELECTRICAL AND SCIENTIFIC APPARATUS**

FOR VIDEOTAPE RECORDINGS FEATURING MAGIC (U.S. CLS. 21, 23, 26, 36 AND 38).

CLASS 16—PAPER GOODS AND PRINTED MATTER

FOR PHOTOGRAPHS, BUMPER STICKERS PRINTED ON PAPER ASSOCIATED WITH APPLICANT'S ENTERTAINMENT AND RESTAURANT AND BAR SERVICES (U.S. CLS. 2, 5, 22, 23, 29, 37, 38 AND 50).

CLASS 21—HOUSEWARES AND GLASS

FOR GLASS BEVERAGE WARE AND MUGS (U.S. CLS. 2, 13, 23, 29, 30, 33, 40 AND 50).

CLASS 25—CLOTHING

FOR T-SHIRTS AND CAPS BEARING THE MARK ASSOCIATED WITH APPLICANT'S ENTERTAINMENT, RESTAURANT AND BAR SERVICES, DISTRIBUTED AS SOUVENIRS THROUGH APPLICANT'S ENTERTAINMENT, RESTAURANT AND BAR LOCATIONS (U.S. CLS. 22 AND 39).

CLASS 28—TOYS AND SPORTING GOODS

FOR EQUIPMENT FOR AMATEUR USE IN PERFORMING TRICKS OF ILLUSION OR MAGIC AND PLAYING CARDS (U.S. CLS. 22, 23, 38 AND 50).

CLASS 41—EDUCATION AND ENTERTAINMENT

FOR ENTERTAINMENT SERVICES IN THE NATURE OF ILLUSIONIST OR MAGIC PERFORMANCES (U.S. CLS. 100, 101 AND 107).

CLASS 42—SCIENTIFIC, COMPUTER AND LEGAL SERVICES

FOR RESTAURANT AND BAR SERVICES (U.S. CLS. 100 AND 101).

SN 76-307,453. JEFFREY MILLER CATERING CO., LANSDOWNE, PA. FILED 8-30-2001.

PARTYSPACE

SEC. 2(F).

CLASS 35—ADVERTISING AND BUSINESS

FOR ON-LINE BUSINESS DIRECTORIES FEATURING PARTY PLANNING, NAMELY INFORMATION ABOUT BANDS, CATERERS, PHOTOGRAPHERS, FLORIST, DJ AND WEDDING GIFT OPTIONS FOR EVENTS AT HOTELS, MUSEUMS, COUNTRY CLUBS, PRIVATE RESIDENCES AND HISTORIC FACILITIES (U.S. CLS. 100, 101 AND 102).

FIRST USE 11-1-1996; IN COMMERCE 11-1-1996.

CLASS 41—EDUCATION AND ENTERTAINMENT

FOR PARTY PLANNING AND SPECIAL EVENT PLANNING (U.S. CLS. 100, 101 AND 107).

FIRST USE 11-1-1996; IN COMMERCE 11-1-1996.

SN 76-308,763. OREGON HEALTH AND SCIENCE UNIVERSITY, PORTLAND, OR. FILED 9-4-2001.

DANGEROUS DECIBELS**CLASS 9—ELECTRICAL AND SCIENTIFIC APPARATUS**

FOR EAR PLUGS NOT FOR MEDICAL PURPOSES; INTERACTIVE MULTIMEDIA COMPUTER GAME PROGRAMS; ELECTRONIC TEACHING APPARATUS AND INSTRUMENTS, NAMELY TESTING AND DISPLAY EQUIPMENT NAMELY SOUND LEVEL METERS, OSCILLOSCOPES, AND VIDEO DISPLAY MONITORS (U.S. CLS. 21, 23, 26, 36 AND 38).

CLASS 16—PAPER GOODS AND PRINTED MATTER

FOR PRINTED INSTRUCTIONAL, EDUCATIONAL, AND TEACHING MATERIALS IN THE FIELD OF PREVENTION AND TREATMENT OF HEARING LOSS AND TINNITUS (U.S. CLS. 2, 5, 22, 23, 29, 37, 38 AND 50).

CLASS 25—CLOTHING

FOR CLOTHING, NAMELY, EARMUFFS, SHIRTS AND CAPS (U.S. CLS. 22 AND 39).

CLASS 41—EDUCATION AND ENTERTAINMENT

FOR EDUCATIONAL SERVICES, NAMELY PROVIDING INTERACTIVE MUSEUM EXHIBITS IN THE FIELD OF HEARING HEALTH AND PREVENTION AND TREATMENT OF HEARING LOSS; CONDUCTING EDUCATIONAL CLASSES, SEMINARS, CONFERENCES AND WORKSHOPS, AND ORGANIZING LIVE EVENTS TO EDUCATE THE PUBLIC ABOUT HEARING HEALTH AND THE PREVENTION AND TREATMENT OF HEARING LOSS, AND DISTRIBUTING EDUCATIONAL AND COURSE MATERIALS IN CONNECTION THEREWITH (U.S. CLS. 100, 101 AND 107).

CLASS 42—SCIENTIFIC, COMPUTER AND LEGAL SERVICES

FOR PROMOTING PUBLIC AWARENESS OF HEARING HEALTH AND THE PREVENTION AND TREATMENT OF HEARING LOSS THROUGH PUBLIC SERVICE ANNOUNCEMENTS; PROVIDING A WEBSITE FEATURING INFORMATION ABOUT THE FIELD OF HEARING HEALTH AND THE PREVENTION AND TREATMENT OF HEARING LOSS (U.S. CLS. 100 AND 101).

SN 76-309,843. LANCASTER COUNTY NATURAL GAS AUTHORITY, LANCASTER, SC. AND CHESTER COUNTY NATURAL GAS AUTHORITY, CHESTER, SC. AND YORK COUNTY NATURAL GAS AUTHORITY, ROCK HILL, SC. FILED 9-6-2001.



NO CLAIM IS MADE TO THE EXCLUSIVE RIGHT TO USE "ENERGY GROUP", APART FROM THE MARK AS SHOWN.

THE MARK CONSISTS OF A DESIGN WITH ALTERNATING RED AND WHITE STRIPES STARTING WITH THE COLOR RED. A BLACK PALMETTO TREE IS ALSO SUPERIMPOSED OVER THE BASE OF THE DESIGN WHICH IS BLUE WITH WHITE STARS. TO THE RIGHT OF THE DESIGN ARE THE WORDS "PATRIOTS ENERGY GROUP" WHICH ARE IN ALL BLUE LETTERS.

CLASS 6—METAL GOODS

FOR NON-LUMINOUS AND NON-MECHANICAL METAL SIGNS AND METAL KEY CHAINS OR KEY RINGS (U.S. CLS. 2, 12, 13, 14, 23, 25 AND 50).

CLASS 9—ELECTRICAL AND SCIENTIFIC APPARATUS

FOR ELECTRICAL, LUMINOUS, BACKLIT AND NEON SIGNS AND DECORATIVE MAGNETS (U.S. CLS. 21, 23, 26, 36 AND 38).

CLASS 16—PAPER GOODS AND PRINTED MATTER

FOR ADDRESS BOOKS, ADDRESS LABELS, ANNIVERSARY BOOKS, ANNOUNCEMENT CARDS, APPOINTMENT BOOKS, PAPER BAGS, PLASTIC BAGS, BUMPER STICKERS, BUSINESS CARDS, BUSINESS FORMS, CALENDARS, COUPON BOOKS, DECALS, MEMO PADS, PAPER NAPKINS, NEWSLETTERS RELATED TO NATURAL GAS, PENCILS, PENS, DESK STANDS FOR PENS AND PENCILS, POSTCARDS, PRICE TAGS, STATIONARY WRITING PAPER AND ENVELOPES, POSTERS, BOOKS RELATED TO NATURAL GAS, PLAYING CARDS, PRINTED PAPER SIGNS, BROCHURES RELATED TO NATURAL GAS, AND PRINT ADVERTISEMENT RELATED TO NATURAL GAS (U.S. CLS. 2, 5, 22, 23, 29, 37, 38 AND 50).

CLASS 18—LEATHER GOODS

FOR BAGS, NAMELY, ALL PURPOSE SPORT BAGS, BACKPACKS, BEACH BAGS, DAYPACKS, DUFFEL BAGS, FANNY PACKS, HANDBAGS, POCKETBOOKS, SCHOOL BAGS, LUGGAGE, SOUVENIR BAGS, TOTE BAGS, AND UMBRELLAS, LEATHER KEY CHAINS AND LUGGAGE TAGS (U.S. CLS. 1, 2, 3, 22 AND 41).

CLASS 19—NON-METALLIC BUILDING MATERIALS

FOR NON-LUMINOUS, NON-METAL AND NON-MECHANICAL SIGNS (U.S. CLS. 1, 12, 33 AND 50).

CLASS 20—FURNITURE AND ARTICLES NOT OTHERWISE CLASSIFIED

FOR WOODEN SIGNBOARDS, PLASTIC BANNERS, NON-METAL CLOSURES FOR CONTAINERS AND NON-METAL KEY CHAINS OR KEY RINGS (U.S. CLS. 2, 13, 22, 25, 32 AND 50).

CLASS 21—HOUSEWARES AND GLASS

FOR CUPS, NAMELY, PLASTIC CUPS, BEVERAGE GLASSWARE, BEER MUGS, COFFEE CUPS, AND EARTHENWARE MUGS, COMMEMORATIVE PLATES, BOTTLE OPENERS, BOTTLE SQUEEGEES, CORK SCREWS, AND FOAM DRINK HOLDERS (U.S. CLS. 2, 13, 23, 29, 30, 33, 40 AND 50).

CLASS 25—CLOTHING

FOR CLOTHING, NAMELY, FOOTWEAR, V-NECK SWEATERS, SOCKS, APRONS, JACKETS, GOLF SHIRTS, POLO SHIRTS, HEADBANDS, T-SHIRTS, AND HEADGEAR, NAMELY, HATS (U.S. CLS. 22 AND 39).

CLASS 35—ADVERTISING AND BUSINESS

FOR PROCUREMENT, NAMELY, PURCHASING NATURAL GAS AND ARRANGING FOR PICKUP, DELIVERY, STORAGE, TRANSPORTATION AND RESELLING OF NATURAL GAS (U.S. CLS. 100, 101 AND 102).

CLASS 39—TRANSPORTATION AND STORAGE

FOR TRANSMISSION OF NATURAL GAS THROUGH PIPELINES; PUBLIC UTILITY SERVICES IN THE NATURE OF NATURAL GAS DISTRIBUTION; FREIGHT TRANSPORTATION AND DELIVERY OF NATURAL GAS BY PIPE, RAIL, OR TRUCK; STORAGE OF NATURAL GAS (U.S. CLS. 100 AND 105).

SN 76-310,007. SIMSURGERY AS, 0161 OSLO, NORWAY, FILED 9-7-2001.

SIMMENTOR

PRIORITY CLAIMED UNDER SEC. 44(D) ON NORWAY APPLICATION NO. 200105608, FILED 4-30-2001, REG. NO. 212358, DATED 12-13-2001, EXPIRES 12-13-2011.

CLASS 9—ELECTRICAL AND SCIENTIFIC APPARATUS

FOR DATA PROCESSORS AND COMPUTERS; COMPUTER PERIPHERALS; DIGITAL SIMULATORS COMPRISED OF SOFTWARE SIMULATING A VISUAL SCENE SIMILAR TO THE SURROUNDINGS EXPERIENCED BY SURGEONS PERFORMING CORONARY ANASTOMIS SURGERY; COMPUTER PROGRAMS USED FOR IMAGE GUIDED SURGERY AND IMAGE GUIDED INTERVENTIONAL PROCEDURES, AND FOR SUPERVISING SURGERY, AND FOR THE TEACHING IN SURGERY AND INTERVENTIONAL PROCEDURES (U.S. CLS. 21, 23, 26, 36 AND 38).

CLASS 10—MEDICAL APPARATUS

FOR SURGICAL, MEDICAL, DENTAL, AND VETERINARY APPARATUS AND INSTRUMENTS USED FOR IMAGE GUIDED SURGERY AND IMAGE GUIDED INTERVENTIONAL PROCEDURES NAMELY, FLEXIBLE AND RIGID OPTICAL SYSTEMS, NAMELY, CAMERA ENDOSCOPES AND LIGHT SOURCES; SURGICAL INSTRUMENTS, NAMELY NEEDLES, FORCEPS, ELECTROCAUTERY INSTRUMENTS, NEEDLE HOLDERS, SCISSORS, SCALPELS, CLIP APPLIERS, AND TROCARS; ENDOVASCULAR INSTRUMENTS, NAMELY CATHETERS, GUIDEWIRES, SHEATH INTRODUCERS AND INTRODUCER SETS; TUBES FOR LIQUID INFUSION ELECTRODES (U.S. CLS. 26, 39 AND 44).

CLASS 41—EDUCATION AND ENTERTAINMENT

FOR EDUCATIONAL SERVICES, NAMELY CONDUCTING CLASSES, CONFERENCES, SEMINARS AND WORKSHOPS IN THE FIELD OF IMAGE GUIDED SURGERY AND IMAGE GUIDED INTERVENTIONAL PROCEDURES; PROVIDING TRAINING IN THE USE OF COMPUTER PROGRAMS FOR IMAGE-GUIDED SURGERY AND IMAGE GUIDED INTERVENTIONAL PROCEDURES (U.S. CLS. 100, 101 AND 107).

CLASS 42—SCIENTIFIC, COMPUTER AND LEGAL SERVICES

FOR MEDICAL TREATMENT SERVICE; SCIENTIFIC AND INDUSTRIAL RESEARCH DEVELOPMENT, UPDATING AND MAINTENANCE OF COMPUTER PROGRAMS AND OTHER SOFTWARE FOR OTHERS; PROVIDING AN INTERACTIVE COMPUTER DATABASE IN THE FIELD OF IMAGE GUIDED SURGERY AND IMAGE GUIDED INTERVENTIONAL PROCEDURES; LEASING OF SOFTWARE PROGRAMS USED FOR IMAGE GUIDED SURGERY AND IMAGE GUIDED INTERVENTIONAL PROCEDURES OR PROVIDING TEMPORARY USE OF ON-LINE NON-DOWNLOADABLE SOFTWARE FOR IMAGE GUIDED SURGERY AND IMAGE GUIDED INTERVENTIONAL PROCEDURES (U.S. CLS. 100 AND 101).

SN 76-314,046. ELECTRONICS TECHNICIANS ASSOCIATION INTERNATIONAL INC., THE, GREENCASTLE, IN. FILED 9-18-2001.

SN 76-316,875. KIRON (SARL), PARIS, FRANCE, FILED 9-19-2001.

**ELECTRONICS
TECHNICIANS
ASSOCIATION,
INTERNATIONAL**



GRAND VENETIAN

SEC. 2(F).

CLASS 41—EDUCATION AND ENTERTAINMENT

FOR EDUCATIONAL SERVICES, NAMELY, CONDUCTING SEMINARS, CONFERENCES, WORKSHOPS AND EDUCATIONAL TESTING SERVICES IN THE FIELD OF ELECTRONICS FOR THE HIGH TECHNOLOGY INDUSTRY (U.S. CLS. 100, 101 AND 107).
FIRST USE 11-0-1978; IN COMMERCE 11-0-1978.

PRIORITY CLAIMED UNDER SEC. 44(D) ON FRANCE APPLICATION NO. 20013089643, FILED 3-19-2001, REG. NO. 013089646, DATED 3-19-2001, EXPIRES 3-19-2011.

CLASS 35—ADVERTISING AND BUSINESS

FOR BUSINESS MANAGEMENT AND CONSULTATION (U.S. CLS. 100, 101 AND 102).

CLASS 42—SCIENTIFIC, COMPUTER AND LEGAL SERVICES

FOR TESTING, ANALYSIS AND EVALUATION OF THE SERVICES OF OTHERS IN THE FIELD OF ELECTRONICS FOR THE PURPOSE OF CERTIFICATION (U.S. CLS. 100 AND 101).
FIRST USE 11-0-1978; IN COMMERCE 11-0-1978.

CLASS 36—INSURANCE AND FINANCIAL

FOR REAL ESTATE BROKERAGE; FINANCIAL INVESTMENT IN THE FIELD OF REAL ESTATE; REAL ESTATE MANAGEMENT; LEASING OF REAL ESTATE, REAL ESTATE SYNDICATION (U.S. CLS. 100, 101 AND 102).

CLASS 37—CONSTRUCTION AND REPAIR

FOR RESIDENTIAL, COMMERCIAL, COMMUNITY ASSOCIATION AND INDUSTRIAL BUILDING CONSTRUCTION AND REPAIR; REAL ESTATE DEVELOPMENT; REAL ESTATE SITE SELECTION (U.S. CLS. 100, 103 AND 106).

SN 76-315,718. NAUTILUS, INC., VANCOUVER, WA. FILED 9-21-2001.

NAUTILUS UNIVERSITY

NO CLAIM IS MADE TO THE EXCLUSIVE RIGHT TO USE "UNIVERSITY", APART FROM THE MARK AS SHOWN.

CLASS 42—SCIENTIFIC, COMPUTER AND LEGAL SERVICES

FOR FACILITIES ENGINEERING SERVICES; CONSULTATION IN THE FIELD OF ENVIRONMENTAL MANAGEMENT OF COMMERCIAL FACILITIES AND REAL ESTATE (U.S. CLS. 100 AND 101).

CLASS 9—ELECTRICAL AND SCIENTIFIC APPARATUS

FOR VIDEOTAPES, AUDIO TAPES, DVD'S AND CD-ROM'S FEATURING HEALTH AND FITNESS, EXERCISE ROUTINES, DIET AND NUTRITION, AND HEALTH AND FITNESS COUNSELING (U.S. CLS. 21, 23, 26, 36 AND 38).

SN 76-317,001. SPRING COMMUNICATIONS, INC., SALT LAKE CITY, UT. FILED 9-25-2001.

CLASS 16—PAPER GOODS AND PRINTED MATTER

FOR EDUCATIONAL PUBLICATIONS, NAMELY, TRAINING MANUALS IN THE FIELD OF HEALTH AND FITNESS, EXERCISE ROUTINES, DIET AND NUTRITION, AND HEALTH AND FITNESS COUNSELING (U.S. CLS. 2, 5, 22, 23, 29, 37, 38 AND 50).



CLASS 41—EDUCATION AND ENTERTAINMENT

FOR EDUCATIONAL AND TRAINING SERVICES, NAMELY, CONDUCTING CLASSES, WORKSHOPS, SEMINARS, TRAINING AND DEVELOPMENT IN THE FIELD OF HEALTH AND FITNESS, EXERCISE ROUTINES, DIET AND NUTRITION, AND FITNESS COUNSELING AND TRAINING (U.S. CLS. 100, 101 AND 107).

NO CLAIM IS MADE TO THE EXCLUSIVE RIGHT TO USE "COMMUNICATIONS", APART FROM THE MARK AS SHOWN.

CLASS 9—ELECTRICAL AND SCIENTIFIC APPARATUS

FOR COMMUNICATION PRODUCTS AND ACCESSORIES, NAMELY, WIRELESS TELEPHONES, PAGERS, EMAIL DEVICES, INTERNET CONNECTIVITY DEVICES, HAND HELD COMPUTERS; ACCESSORIES FOR WIRELESS COMMUNICATION DEVICES, NAMELY, CASES AND HOLSTERS, CHARGERS, ADAPTERS, EAR SPEAKERS, MICROPHONES, HANDS FREE KITS, DOCKING STATIONS, MEMORY CARDS, FACE PLATES, ANTENNAS, MODEMS, COMPUTER GAME SOFTWARE AND COMPUTER SEARCH ENGINE SOFTWARE BOTH FOR USE IN WIRELESS TELEPHONES, PAGERS AND EMAIL DEVICES (U.S. CLS. 21, 23, 26, 36 AND 38).

CLASS 35—ADVERTISING AND BUSINESS

FOR RETAIL STORE SERVICES IN THE FIELD OF WIRELESS COMMUNICATION SERVICES, NAMELY, VOICE, DATA, CELLULAR, PCS, BROADBAND, AND INTERNET CONNECTIVITY (U.S. CLS. 100, 101 AND 102).

CLASS 37—CONSTRUCTION AND REPAIR

FOR INSTALLATION SERVICES FOR WIRELESS COMMUNICATION PRODUCTS (U.S. CLS. 100, 103 AND 106).

SN 76-317,002. SPRING COMMUNICATIONS, INC., SALT LAKE CITY, UT. FILED 9-25-2001.

SPRING COMMUNICATIONS

NO CLAIM IS MADE TO THE EXCLUSIVE RIGHT TO USE "COMMUNICATIONS", APART FROM THE MARK AS SHOWN.

CLASS 9—ELECTRICAL AND SCIENTIFIC APPARATUS

FOR COMMUNICATION PRODUCTS AND ACCESSORIES, NAMELY, WIRELESS TELEPHONES, PAGERS, EMAIL DEVICES, INTERNET CONNECTIVITY DEVICES, HAND HELD COMPUTERS; ACCESSORIES FOR WIRELESS COMMUNICATION DEVICES, NAMELY, CASES AND HOLSTERS, CHARGERS, ADAPTERS, EAR SPEAKERS, MICROPHONES, HANDS FREE KITS, DOCKING STATIONS, MEMORY CARDS, FACE PLATES, ANTENNAS, MODEMS, COMPUTER GAME SOFTWARE AND COMPUTER SEARCH ENGINE SOFTWARE BOTH FOR USE IN WIRELESS TELEPHONES, PAGERS AND EMAIL DEVICES (U.S. CLS. 21, 23, 26, 36 AND 38).

CLASS 35—ADVERTISING AND BUSINESS

FOR RETAIL STORE SERVICES IN THE FIELD OF WIRELESS COMMUNICATION SERVICES, NAMELY, VOICE, DATA, CELLULAR, PCS, BROADBAND, AND INTERNET CONNECTIVITY (U.S. CLS. 100, 101 AND 102).

CLASS 37—CONSTRUCTION AND REPAIR

FOR INSTALLATION SERVICES FOR WIRELESS COMMUNICATION PRODUCTS (U.S. CLS. 100, 103 AND 106).

SN 76-317,461. CERTAS PLC, REIGATE, SURREY, UNITED KINGDOM, BY CHANGE OF NAME EVE GROUP PLC, GUILDFORD, SURREY, UNITED KINGDOM, FILED 9-25-2001.

EVE**CLASS 6—METAL GOODS**

FOR PREFABRICATED PORTABLE ROADS MADE OF METAL; METAL ACCESS SYSTEMS COMPRISED OF INTERLOCKING PANELS, PLANKS, OR TILES USED AS TEMPORARY ROADS TO PROVIDE STABLE ACCESS OVER EXISTING SURFACES; METAL STADIUM TURF PROTECTION SYSTEMS COMPRISED OF INTERLOCKING TILES USED AS TEMPORARY SURFACES TO PROTECT EXISTING TURF; METAL SURFACING CONSISTING OF PANELS, PLANKS OR TILING, USED AS TEMPORARY ROADS TO PROVIDE ACCESS OVER EXISTING SURFACES; METAL PANELS USED AS TEMPORARY ROADS TO PROVIDE ACCESS OVER EXISTING SURFACES; METAL CRASH BARRIERS FOR ROADS, NAMELY, WHEEL RETARDING BARRIERS; PORTABLE SLIPWAYS MADE OF METAL USED TO PROVIDE ACCESS OVER EXISTING SURFACES TO VEHICLES OR PEDESTRIANS; METAL SUPPORT STRUCTURES USED TO PROVIDE ACCESS OVER EXISTING SURFACES TO VEHICLES OR PEDESTRIANS; TOWERS AND MASTS MADE OF METAL USED FOR PROVIDING ACCESS OVER EXISTING SURFACES TO VEHICLES OR PEDESTRIANS; METAL CONSTRUCTION MATERIALS, NAMELY, PANELS, FIXINGS, FENCING, MESH, JOINTS, SPOOLS, HYDRAULICS, BARRIERS, SCAFFOLDING, GATES, PLANKS OR TILING, NON-ELECTRIC CABLES AND WIRES OF COMMON METAL; CRASH BARRIERS OF METAL FOR ROADS; PREFABRICATED METAL BRIDGES; PREFABRICATED MOBILE AND FIXED WALKWAYS, PATHWAYS, BOARDING STAIRS AND RAMPS, ALL MADE OF METAL; METAL FENCES; METAL GATES; METAL GUARD RAILS; METAL SCAFFOLDING; METAL ROPES; METAL HARDWARE, NAMELY, PULLEYS, TELEGRAPH POLES; PORTABLE BARRIERS FOR CROWD AND TRAFFIC CONTROL AND EVENT MANAGEMENT; FENCING AND GATES; PREFABRICATED ROADS; METAL HARDWARE, NAMELY, SHUTTERING WIRE STRETCHERS AND TENSION LINKS (U.S. CLS. 2, 12, 13, 14, 23, 25 AND 50).

CLASS 19—NON-METALLIC BUILDING MATERIALS

FOR PREFABRICATED NON-METAL PORTABLE ROADS; NON-METAL ACCESS SYSTEMS COMPRISED OF INTERLOCKING PANELS, PLANKS, OR TILES USED AS TEMPORARY ROADS TO PROVIDE STABLE ACCESS OVER EXISTING SURFACES; NON-METAL STADIUM TURF PROTECTION SYSTEMS COMPRISED OF INTERLOCKING TILES USED AS TEMPORARY SURFACES TO PROTECT EXISTING TURF; NON-METAL SURFACING MADE OF PANELS, PLANKS OR TILING USED AS TEMPORARY ROADS TO PROVIDE ACCESS OVER EXISTING SURFACES; PREFABRICATED NON-METAL BUILDING STRUCTURES; NON-METAL PANELS USED AS TEMPORARY SURFACING TO PROTECT AND PROVIDE ACCESS OVER EXISTING SURFACES; CONSTRUCTION ELEMENTS NOT MADE OF METAL, NAMELY, SUPPORTS FOR USE WITH CRANES; WHEEL RETARDING BARRIERS, NAMELY, CRASH BARRIERS OF CONCRETE, WOOD OR PLASTIC FOR ROADS; NON-METAL PORTABLE SLIPWAYS FOR USE BY VEHICLES OR PEDESTRIANS; NONMETALLIC RIGID PIPES FOR BUILDING CONSTRUCTION; NON-METALLIC PREFABRICATED PORTABLE BUILDINGS; PREFABRICATED NON-METAL BRIDGES, WALKWAYS, PATHWAYS AND BOARDING STAIRS AND RAMPS, BOTH MOBILE AND FIXED; MOBILE TURF PROTECTION SURFACING COMPRISING NON-METAL INTERLOCKING PANELS, PLANKS, OR TILES USED TO PROTECT OR PROVIDE ACCESS OVER EXISTING TURF; NON-METAL FLOATING AND FIXED DOCKS; NON-METAL FENCES AND GATES; PORTABLE BARRIERS OF CONCRETE, WOOD OR PLASTIC FOR CROWD CONTROL AND EVENT MANAGEMENT (U.S. CLS. 1, 12, 33 AND 50).

CLASS 20—FURNITURE AND ARTICLES NOT OTHERWISE CLASSIFIED

FOR NON-METAL HOOKS AND NON-METAL CLIPS FOR PIPES USED IN THE PREPARATION, CONSTRUCTION AND MAINTENANCE OF BARRIERS, FENCING, GATES OR TEMPORARY SURFACES USED TO COVER ALREADY EXISTING SURFACES; FURNITURE, NAMELY, SEATS (U.S. CLS. 2, 13, 22, 25, 32 AND 50).

CLASS 27—FLOOR COVERINGS

FOR FLOOR COVERINGS USED FOR THE PURPOSE OF PROTECTING THE EXISTING FLOOR OR FOR THE PURPOSE OF PROVIDING SUPPORT FOR VEHICLES AND/OR PEDESTRIANS (U.S. CLS. 19, 20, 37, 42 AND 50).

CLASS 37—CONSTRUCTION AND REPAIR

FOR CONSTRUCTION, ERECTION AND DISMANTLING OF TEMPORARY AND PORTABLE ROADS, PATHWAYS, FOUNDATIONS, BRIDGES, WALKWAYS, ROAD BARRIERS AND CROWD CONTROL BARRIERS, FENCES, BUILDINGS, INFRASTRUCTURE AND TEMPORARY HARD SURFACES, TEMPORARY FENCING, HOARDING, LOOK-OUT TOWERS, GATES, AND SEATING STANDS; INSTALLATION, REPAIR, MAINTENANCE, REFURBISHMENT, MODIFICATION AND MAINTENANCE OF SUPPORT STRUCTURES, MASTS, AERIALS AND FOUNDATIONS FOR SUPPORT STRUCTURES; RENTAL OF CONSTRUCTION EQUIPMENT, CRANES, DRILLS, PLATFORMS AND SCAFFOLDING; CONSULTING AND PROVIDING INFORMATION IN THE FIELD OF CONSTRUCTION, ERECTION AND DISMANTLING OF TEMPORARY AND PORTABLE ROADS, PATHWAYS, FOUNDATIONS, BRIDGES, WALKWAYS, ROAD BARRIERS, AND CROWD CONTROL BARRIERS, FENCES, BUILDINGS, INFRASTRUCTURE AND TEMPORARY HARD SURFACES, TEMPORARY FENCING, HOARDING, LOOK-OUT TOWERS, GATES AND SEATING STANDS; CONSULTING AND PROVIDING INFORMATION IN THE FIELD OF INSTALLATION, REPAIR, MAINTENANCE, REFURBISHMENT, MODIFICATION AND MAINTENANCE OF SUPPORT STRUCTURES, MASTS, AERIALS AND FOUNDATIONS FOR SUPPORT STRUCTURES; CONSULTING AND PROVIDING INFORMATION IN THE FIELD OF RENTAL OF CONSTRUCTION EQUIPMENT; AND CONSTRUCTION, REPAIR AND MAINTENANCE OF RAILWAY AND RAILWAY TRACKS (U.S. CLS. 100, 103 AND 106).

CLASS 42—SCIENTIFIC, COMPUTER AND LEGAL SERVICES

FOR CIVIL ENGINEERING SERVICES; CONSULTATION SERVICES AND PROVIDING INFORMATION IN THE FIELD OF CIVIL ENGINEERING (U.S. CLS. 100 AND 101).

CLASS 35—ADVERTISING AND BUSINESS

FOR BUSINESS MANAGEMENT SERVICES; BUSINESS MANAGEMENT CONSULTATION SERVICES; BUSINESS ADMINISTRATION, NAMELY PROVIDING COMPANY SECRETARIAL SERVICES; MARKET RESEARCH AND ANALYSIS; BUSINESS CONSULTATION SERVICES; PREPARING BUSINESS REPORTS, PROMOTIONAL SERVICES NAMELY, THE PROMOTION OF BUSINESSES AND INVESTMENT PRODUCTS THROUGH THE PREPARATION AND PLACEMENT OF ADVERTISING AND MARKETING MATERIAL, THE DISSEMINATION OF ADVERTISING AND MARKETING MATERIAL, THE PREPARATION AND DISSEMINATION OF PROSPECTUSES, THE ISSUANCE OF PROSPECTUSES AND INFORMATION MEMORANDA AND THE PREPARATION AND DISSEMINATION OF PROMOTIONAL MATERIAL; REAL ESTATE ADVERTISING SERVICES; PROVIDING AN ON-LINE COMPUTER DATABASE IN THE FIELDS OF BUSINESS MANAGEMENT AND CONSULTANCY; INFORMATION, ADVISORY AND CONSULTANCY SERVICES RELATING TO THE AFORESAID (U.S. CLS. 100, 101 AND 102).

CLASS 36—INSURANCE AND FINANCIAL

FOR FINANCIAL, PRIVATE EQUITY AND VENTURE CAPITAL CONSULTATION SERVICES; FINANCIAL, PRIVATE EQUITY AND VENTURE CAPITAL MANAGEMENT CONSULTATION SERVICES; CONSULTATION IN THE FIELD OF CORPORATE FINANCING; BANKING SERVICES; VENTURE CAPITAL AND PRIVATE EQUITY SERVICES, NAMELY PROVIDING BUSINESS FINANCING AND BUSINESS FINANCING CONSULTATION SERVICES; FINANCIAL SERVICES, NAMELY FINANCIAL INTERMEDIATION AND CAPITAL MANAGEMENT SERVICES; THE PROVISION OF INSTALLMENT, INTEREST FREE, INTEREST BEARING, SHAREHOLDER, CONVERTIBLE, SHORT TERM AND BRIDGING LOANS; INVESTMENT BANKING SERVICES; INVESTMENT, PRIVATE EQUITY, VENTURE CAPITAL, HEDGE FUND AND DEBT FUND MANAGEMENT, ADMINISTRATION AND FINANCIAL ADVICE SERVICES; TRUST SERVICES, NAMELY INVESTMENT AND TRUST COMPANY SERVICES; BANKING SERVICES, NAMELY TRADING OF FOREIGN EXCHANGE; CAPITAL BROKERAGE SERVICES; TRUSTEE SERVICES RELATING TO PRIVATE EQUITY AND VENTURE CAPITAL; LEASE PURCHASE FINANCING; REAL ESTATE INVESTMENT AND MANAGEMENT AND ANALYSIS; PROVIDING VENTURE CAPITAL AND PRIVATE EQUITY FINANCING SERVICES; PROVIDING AN ON-LINE COMPUTER DATABASE IN THE FIELD OF FINANCIAL SERVICE, BANKING SERVICES, PRIVATE EQUITY AND VENTURE CAPITAL; AND INFORMATION, ADVISORY AND CONSULTANCY SERVICES RELATING TO THE AFORESAID (U.S. CLS. 100, 101 AND 102).

SN 76-320,663. CARIBE IMPORTED CIGARS, INC., MIAMI, FL. FILED 10-3-2001.

TABACALERA EIROA

NO CLAIM IS MADE TO THE EXCLUSIVE RIGHT TO USE "TABACALERA", APART FROM THE MARK AS SHOWN.

THE WORD "TABACALERA" MAY MEAN ONE OR MORE OF THE FOLLOWING, "FACTORY", "TOBACCO GROWER", "CIGAR DEALERSHIP", AND/OR "SPANISH STATE TOBACCO MONOPOLY".

CLASS 34—SMOKERS' ARTICLES

FOR CIGARS AND CIGAR TOBACCO LEAF; ACCESSORIES, NAMELY, CIGARETTE AND CIGAR LIGHTERS NOT OF PRECIOUS METAL, ASHTRAYS NOT OF PRECIOUS METAL, CIGAR CUTTERS, AND HUMIDORS (U.S. CLS. 2, 8, 9 AND 17).

SN 76-320,340. PERMIRA ADVISERS LIMITED, LONDON WC2E 7QG, UNITED KINGDOM, BY CHANGE OF NAME SVA LIMITED, LONDON WC2E7QG, UNITED KINGDOM, FILED 10-1-2001.



PRIORITY CLAIMED UNDER SEC. 44(D) ON UNITED KINGDOM APPLICATION NO. 2278599, FILED 5-21-2001, REG. NO. 2278599, DATED 3-8-2002, EXPIRES 8-21-2011.

CLASS 35—ADVERTISING AND BUSINESS

FOR DISTRIBUTORSHIP SERVICES IN THE FIELD OF CIGARS AND TOBACCO PRODUCTS AND RELATED ACCESSORIES (U.S. CLS. 100, 101 AND 102).

SN 76-321,375. CALIFORNIA FAUCETS, HUNTINGTON BEACH, CA. FILED 10-2-2001.



NO CLAIM IS MADE TO THE EXCLUSIVE RIGHT TO USE "CALIFORNIA FAUCETS", APART FROM THE MARK AS SHOWN.

THE MARK CONSISTS, IN PART, OF A STYLIZED DEPICTION OF THE LETTERS "C" AND "F".

CLASS 11—ENVIRONMENTAL CONTROL APPARATUS

FOR PLUMBING FITTINGS AND FIXTURES MADE PRIMARILY OF BRASS, NAMELY, FAUCETS, HANDLES, FLANGES, TUB AND SHOWER SETS COMPRISED OF FAUCETS, HANDLES, FLANGES, SHOWERHEADS AND SPOUTS, HAND-HELD SHOWERHEADS; BIDETS AND FITTINGS FOR THEIR INSTALLATION; PLUMBING FITTINGS, NAMELY, PRESSURE BALANCE VALVES AND THERMOSTATIC VALVES (U.S. CLS. 13, 21, 23, 31 AND 34).

FIRST USE 6-1-1991; IN COMMERCE 6-1-1991.

CLASS 21—HOUSEWARES AND GLASS

FOR BATHROOM ACCESSORIES MADE PRIMARILY OF BRASS, NAMELY, TOWEL BARS, TOWEL RINGS, AND TOILET TISSUE HOLDERS (U.S. CLS. 2, 13, 23, 29, 30, 33, 40 AND 50).

FIRST USE 6-1-1991; IN COMMERCE 6-1-1991.

SN 76-322,434. SPECK INDUSTRIAL CONTROLS, INC., MOORESTOWN, NJ. FILED 10-9-2001.



NO CLAIM IS MADE TO THE EXCLUSIVE RIGHT TO USE "INDUSTRIAL CONTROLS, INC." AND "REPAIR & SUPPLY", APART FROM THE MARK AS SHOWN.

CLASS 35—ADVERTISING AND BUSINESS

FOR DISTRIBUTORSHIP IN THE FIELD OF ELECTRICAL EQUIPMENT (U.S. CLS. 100, 101 AND 102). FIRST USE 8-1-2001; IN COMMERCE 8-1-2001.

CLASS 37—CONSTRUCTION AND REPAIR

FOR ELECTRICAL REPAIRS AND INSTALLATION OF ELECTRONIC EQUIPMENT (U.S. CLS. 100, 103 AND 106).

FIRST USE 8-1-2001; IN COMMERCE 8-1-2001.

SN 76-322,646. ONTARIO PAINT & WALLPAPER LIMITED, CONCORD, ON L4K 3S8, CANADA. FILED 10-9-2001.

HUGS & KISSES

PRIORITY CLAIMED UNDER SEC. 44(D) ON CANADA APPLICATION NO. 1,099,433, FILED 4-12-2001, REG. NO. TMA573544, DATED 1-14-2003, EXPIRES 1-14-2018.

CLASS 16—PAPER GOODS AND PRINTED MATTER

FOR WALL COVERING SAMPLE BOOKS; WALLPAPER SAMPLE BOOKS (U.S. CLS. 2, 5, 22, 23, 29, 37, 38 AND 50).

CLASS 27—FLOOR COVERINGS

FOR CLOTH WALL COVERINGS; PLASTIC WALL COVERINGS; VINYL WALL COVERINGS AND WALL PAPER (U.S. CLS. 19, 20, 37, 42 AND 50).

SN 76-323,323. AFRICAN ECHOES INC., SOMERSET, NJ. FILED 10-11-2001.

HEAR VOICES CALLING YOU TO THE EAST



NO CLAIM IS MADE TO THE EXCLUSIVE RIGHT TO USE "INC", APART FROM THE MARK AS SHOWN.

CLASS 16—PAPER GOODS AND PRINTED MATTER

FOR ART PRINTS AND EMBROIDERY DESIGN PATTERNS (U.S. CLS. 2, 5, 22, 23, 29, 37, 38 AND 50).

CLASS 25—CLOTHING

FOR SWEATSHIRTS AND T-SHIRTS (U.S. CLS. 22 AND 39).

SN 76-323,882. KIRKBI AG, CH-6340, BAAR, SWITZERLAND, FILED 10-11-2001.

SN 76-323,897. KIRKBI AG, CH-6340, BAAR, SWITZERLAND, FILED 10-11-2001.



CLASS 9—ELECTRICAL AND SCIENTIFIC APPARATUS

FOR ELECTRONIC INTERACTIVE MULTIMEDIA SYSTEMS FOR USE BY CHILDREN TO COMPOSE MUSIC AND STORIES BY FITTING ACTUATORS INTO RECEIVERS; PRERECORDED MAGNETIC DATA CARRIERS FEATURING SOUND AND IMAGES FOR THE COMPOSING OF MUSIC AND STORIES; GAME CARTRIDGES FOR COMPUTER VIDEO GAMES, COMPUTER GAME CASSETTES, COMPUTER GAME PROGRAMS, VIDEO GAME PROGRAMS, CD-ROM GAME PROGRAMS, COMPUTER VIDEO GAME PROGRAMS, MUSICAL SOUND RECORDINGS AND MUSICAL VIDEO RECORDINGS, CHILDREN'S MOTION PICTURE FILMS, CHILDREN'S ANIMATED FILMS (U.S. CLS. 21, 23, 26, 36 AND 38).

CLASS 16—PAPER GOODS AND PRINTED MATTER

FOR PAPER AND CARDBOARD BOXES, CARTONS AND CONTAINERS; PRINTED MATTER, NAMELY BUILDING INSTRUCTIONS FOR TOYS AND PLAYTHINGS, INSTRUCTIONS FOR USE AND MAINTENANCE OF TOYS AND PLAYTHINGS AND EDUCATIONAL PUBLICATIONS, NAMELY BOOKS, MAGAZINES AND LEAFLETS ON CHILDREN AND HOW TO DEVELOP CHILDREN THROUGH PLAY; PHOTOGRAPHS; STATIONERY; ARTISTS' MATERIALS, NAMELY ARTISTS' PEN, BRUSHES, COLOURS, PAPER, CANVAS AND EASEL; PAINT BRUSHES; PRINTED INSTRUCTIONAL MATERIALS FOR USING TOYS AND PLAYTHINGS AND PRINTED TEACHING MATERIALS FOR DEVELOPING CHILDREN THROUGH PLAY; PLAYING CARDS (U.S. CLS. 2, 5, 22, 23, 29, 37, 38 AND 50).

CLASS 25—CLOTHING

FOR CLOTHING, NAMELY PANTS, CLOTH BIBS, BABIES DIAPERS OF TEXTILE, BATHROBES, DRESSING GOWNS, SWIM WEAR, PAJAMAS, SLEEPWEAR, NIGHT GOWNS, COATS, JACKETS, PONCHOS, RAIN COATS, ROMPERS, JUMPERS, PULLOVERS, SWEATERS, SWEATSHIRT AND SWEATPANTS, SHIRTS, T-SHIRTS, TROUSERS, JEANS, LEGGINGS, SKIRT AND DRESSES, UNDERCLOTHES, BELTS, SUSPENDERS, GLOVES, SCARVES, NECKWEAR, SOCKS AND STOCKINGS, FOOTWEAR, HEAD WEAR (U.S. CLS. 22 AND 39).

CLASS 28—TOYS AND SPORTING GOODS

FOR GAMES AND PLAYTHINGS, NAMELY BOARD GAMES, CARD GAMES, HAND HELD UNIT FOR PLAYING VIDEO GAMES AND HAND HELD UNIT FOR PLAYING ELECTRONIC GAMES, CONSTRUCTIONS TOYS, TOY BUILDING ELEMENTS AND CONNECTING LINKS, TOY CONSTRUCTION KITS, TOY BUILDINGS, TOY THEATRE, TOY FURNITURE, TOY FIGURES, TOY VEHICLES, PLANES, TRAINS AND BOATS, PLUSH TOYS, RATTLES, BALLS, TEETHING RINGS AND MUSICAL TOYS; CHRISTMAS TREE DECORATIONS (U.S. CLS. 22, 23, 38 AND 50).



CLASS 9—ELECTRICAL AND SCIENTIFIC APPARATUS

FOR ELECTRONIC INTERACTIVE MULTIMEDIA SYSTEMS FOR USE BY CHILDREN TO COMPOSE MUSIC AND STORIES BY FITTING ACTUATORS INTO RECEIVERS; PRERECORDED MAGNETIC DATA CARRIERS FEATURING SOUND AND IMAGES FOR THE COMPOSING OF MUSIC AND STORIES; GAME CARTRIDGES FOR COMPUTER VIDEO GAMES, COMPUTER GAME CASSETTES, COMPUTER GAME PROGRAMS, VIDEO GAME PROGRAMS; CD-ROM GAME PROGRAMS, COMPUTER VIDEO GAME PROGRAMS, MUSICAL SOUND RECORDINGS AND MUSICAL VIDEO RECORDINGS, CHILDREN'S MOTION PICTURE FILMS, CHILDREN'S ANIMATED FILMS (U.S. CLS. 21, 23, 26, 36 AND 38).

CLASS 16—PAPER GOODS AND PRINTED MATTER

FOR PAPER AND CARDBOARD BOXES, CARTONS AND CONTAINERS; PRINTED MATTER, NAMELY BUILDING INSTRUCTIONS FOR TOYS AND PLAYTHINGS, INSTRUCTIONS FOR USE AND MAINTENANCE OF TOYS AND PLAYTHINGS AND EDUCATIONAL PUBLICATIONS, NAMELY BOOKS, MAGAZINES AND LEAFLETS ON CHILDREN AND HOW TO DEVELOP CHILDREN THROUGH PLAY; PHOTOGRAPHS; STATIONERY; ARTISTS' MATERIALS, NAMELY ARTISTS' PEN, BRUSHES, COLOURS, PAPER, CANVAS AND EASEL; PAINT BRUSHES; PRINTED INSTRUCTIONAL MATERIALS FOR USING TOYS AND PLAYTHINGS AND PRINTED TEACHING MATERIALS FOR DEVELOPING CHILDREN THROUGH PLAY; PLAYING CARDS (U.S. CLS. 2, 5, 22, 23, 29, 37, 38 AND 50).

CLASS 25—CLOTHING

FOR CLOTHING, NAMELY PANTS, CLOTH BIBS, BABIES DIAPERS OF TEXTILE, BATHROBES, DRESSING GOWNS, SWIM WEAR, PAJAMAS, SLEEPWEAR, NIGHT GOWNS, COATS, JACKETS, PONCHOS, RAIN COATS, ROMPERS, JUMPERS, PULLOVERS, SWEATERS, SWEATSHIRT AND SWEATPANTS, SHIRTS, T-SHIRTS, TROUSERS, JEANS, LEGGINGS, SKIRT AND DRESSES, UNDERCLOTHES, BELTS, SUSPENDERS, GLOVES, SCARVES, NECKWEAR, SOCKS AND STOCKINGS, FOOTWEAR, HEAD WEAR (U.S. CLS. 22 AND 39).

CLASS 28—TOYS AND SPORTING GOODS

FOR GAMES AND PLAYTHINGS, NAMELY BOARD GAMES, CARD GAMES, HAND HELD UNIT FOR PLAYING VIDEO GAMES AND HAND HELD UNIT FOR PLAYING ELECTRONIC GAMES, CONSTRUCTIONS TOYS, TOY BUILDING ELEMENTS AND CONNECTING LINKS, TOY CONSTRUCTION KITS, TOY BUILDINGS, TOY THEATRE, TOY FURNITURE, TOY FIGURES, TOY VEHICLES, PLANES, TRAINS AND BOATS, PLUSH TOYS, RATTLES, BALLS, TEETHING RINGS AND MUSICAL TOYS; CHRISTMAS TREE DECORATIONS (U.S. CLS. 22, 23, 38 AND 50).

SN 76-323,898. KIRKBI AG, CH-6340, BAAR, SWITZERLAND, FILED 10-11-2001.

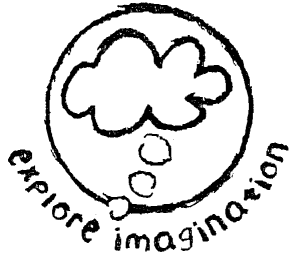
**CLASS 9—ELECTRICAL AND SCIENTIFIC APPARATUS**

FOR ELECTRONIC INTERACTIVE MULTIMEDIA SYSTEMS FOR USE BY CHILDREN TO COMPOSE MUSIC AND STORIES BY FITTING ACTUATORS INTO RECEIVERS; PRERECORDED MAGNETIC DATA CARRIERS FEATURING SOUND AND IMAGES FOR THE COMPOSING OF MUSIC AND STORIES; GAME CARTRIDGES FOR COMPUTER VIDEO GAMES, COMPUTER GAMES CASSETTES, COMPUTER GAME PROGRAMS, VIDEO GAME PROGRAMS, CD-ROM GAME PROGRAMS, COMPUTER VIDEO GAME PROGRAMS, MUSICAL SOUND RECORDINGS AND MUSICAL VIDEO RECORDINGS, CHILDREN'S MOTION PICTURE FILMS, CHILDREN'S ANIMATED FILMS (U.S. CLS. 21, 23, 26, 36 AND 38).

CLASS 16—PAPER GOODS AND PRINTED MATTER

FOR PAPER AND CARDBOARD BOXES, CARTONS AND CONTAINERS; PRINTED MATTER, NAMELY BUILDING INSTRUCTIONS FOR TOYS AND PLAYTHINGS, INSTRUCTIONS FOR USE AND MAINTENANCE OF TOYS AND PLAYTHINGS AND EDUCATIONAL PUBLICATIONS, NAMELY BOOKS, MAGAZINES AND LEAFLETS ON CHILDREN AND HOW TO DEVELOP CHILDREN THROUGH PLAY; PHOTOGRAPHS; STATIONERY; ARTISTS' MATERIALS, NAMELY ARTISTS' PEN, BRUSHES, COLOURS, PAPER, CANVAS AND EASEL; PAINT BRUSHES; PRINTED INSTRUCTIONAL MATERIALS FOR USING TOYS AND PLAYTHINGS AND PRINTED TEACHING MATERIALS FOR DEVELOPING CHILDREN THROUGH PLAY; PLAYING CARDS (U.S. CLS. 2, 5, 22, 23, 29, 37, 38 AND 50).

CLASS 25—CLOTHING

FOR CLOTHING, NAMELY PANTS, CLOTH BIBS, BABIES DIAPERS OF TEXTILE, BATHROBES, DRESSING GOWNS, SWIM WEAR, PAJAMAS, SLEEPWEAR, NIGHT GOWNS, COATS, JACKETS, PONCHOS, RAIN COATS, ROMPERS, JUMPERS, PULLOVERS, SWEATERS, SWEATSHIRT AND SWEATPANTS, SHIRTS, T-SHIRTS, TROUSERS, JEANS, LEGGINGS, SKIRT AND DRESSES, UNDERCLOTHES, BELTS, SUSPENDERS, GLOVES, SCARVES, NECKWEAR, SOCKS AND STOCKINGS, FOOTWEAR, HEAD WEAR (U.S. CLS. 22 AND 39).

CLASS 28—TOYS AND SPORTING GOODS

FOR GAMES AND PLAYTHINGS, NAMELY BOARD GAMES, CARD GAMES, HAND HELD UNIT FOR PLAYING VIDEO GAMES AND HAND HELD UNIT FOR PLAYING ELECTRONIC GAMES, CONSTRUCTIONS TOYS, TOY BUILDING ELEMENTS AND CONNECTING LINKS, TOY CONSTRUCTION KITS, TOY BUILDINGS, TOY THEATRE, TOY FURNITURE, TOY FIGURES, TOY VEHICLES, PLANES, TRAINS AND BOATS, PLUSH TOYS, RATTLES, BALLS, TEETHING RINGS AND MUSICAL TOYS; CHRISTMAS TREE DECORATIONS (U.S. CLS. 22, 23, 38 AND 50).

SN 76-323,899. KIRKBI AG, CH-6340, BAAR, SWITZERLAND, FILED 10-11-2001.

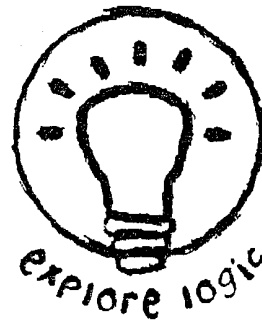
**CLASS 9—ELECTRICAL AND SCIENTIFIC APPARATUS**

FOR ELECTRONIC INTERACTIVE MULTIMEDIA SYSTEMS FOR USE BY CHILDREN TO COMPOSE MUSIC AND STORIES BY FITTING ACTUATORS INTO RECEIVERS; PRERECORDED MAGNETIC DATA CARRIERS FEATURING SOUND AND IMAGES FOR THE COMPOSING OF MUSIC AND STORIES; GAME CARTRIDGES FOR COMPUTER VIDEO GAMES, COMPUTER GAME CASSETTES, COMPUTER GAME PROGRAMS, VIDEO GAME PROGRAMS, CD-ROM GAME PROGRAMS, COMPUTER VIDEO GAME PROGRAMS, MUSICAL SOUND RECORDINGS AND MUSICAL VIDEO RECORDINGS, CHILDREN'S MOTION PICTURE FILMS, CHILDREN'S ANIMATED FILMS (U.S. CLS. 21, 23, 26, 36 AND 38).

CLASS 16—PAPER GOODS AND PRINTED MATTER

FOR PAPER AND CARDBOARD BOXES, CARTONS AND CONTAINERS; PRINTED MATTER, NAMELY BUILDING INSTRUCTIONS FOR TOYS AND PLAYTHINGS, INSTRUCTIONS FOR USE AND MAINTENANCE OF TOYS AND PLAYTHINGS AND EDUCATIONAL PUBLICATIONS, NAMELY BOOKS, MAGAZINES AND LEAFLETS ON CHILDREN AND HOW TO DEVELOP CHILDREN THROUGH PLAY; PHOTOGRAPHS; STATIONERY; ARTISTS' MATERIALS, NAMELY ARTISTS' PEN, BRUSHES, COLOURS, PAPER, CANVAS AND EASEL; PAINT BRUSHES; PRINTED INSTRUCTIONAL MATERIALS FOR USING TOYS AND PLAYTHINGS AND PRINTED TEACHING MATERIALS FOR DEVELOPING CHILDREN THROUGH PLAY; PLAYING CARDS (U.S. CLS. 2, 5, 22, 23, 29, 37, 38 AND 50).

CLASS 25—CLOTHING

FOR CLOTHING, NAMELY PANTS, CLOTH BIBS, BABIES DIAPERS OF TEXTILE, BATHROBES, DRESSING GOWNS, SWIM WEAR, PAJAMAS, SLEEPWEAR, NIGHT GOWNS, COATS, JACKETS, PONCHOS, RAIN COATS, ROMPERS, JUMPERS, PULLOVERS, SWEATERS, SWEATSHIRT AND SWEATPANTS, SHIRTS, T-SHIRTS, TROUSERS, JEANS, LEGGINGS, SKIRT AND DRESSES, UNDERCLOTHES, BELTS, SUSPENDERS, GLOVES, SCARVES, NECKWEAR, SOCKS AND STOCKINGS, FOOTWEAR, HEAD WEAR (U.S. CLS. 22 AND 39).

CLASS 28—TOYS AND SPORTING GOODS

FOR GAMES AND PLAYTHINGS, NAMELY BOARD GAMES, CARD GAMES, HAND HELD UNIT FOR PLAYING VIDEO GAMES AND HAND HELD UNIT FOR PLAYING ELECTRONIC GAMES, CONSTRUCTIONS TOYS, TOY BUILDING ELEMENTS AND CONNECTING LINKS, TOY CONSTRUCTION KITS, TOY BUILDINGS, TOY THEATRE, TOY FURNITURE, TOY FIGURES, TOY VEHICLES, PLANES, TRAINS AND BOATS, PLUSH TOYS, RATTLES, BALLS, TEETHING RINGS AND MUSICAL TOYS; CHRISTMAS TREE DECORATIONS (U.S. CLS. 22, 23, 38 AND 50).

SN 76-324,952. VADILAL INTERNATIONAL LIMITED, AHMEDABAD, GUJARAT, INDIA, FILED 10-16-2001.



PRIORITY CLAIMED UNDER SEC. 44(D) ON INDIA APPLICATION NO. 1009515, FILED 5-15-2001.

PRIORITY CLAIMED UNDER SEC. 44(D) ON INDIA APPLICATION NO. 1009516, FILED 5-15-2001.

NO CLAIM IS MADE TO THE EXCLUSIVE RIGHT TO USE "QUICK TREAT", APART FROM THE MARK AS SHOWN.

THE MARK CONSISTS OF THE WORD "VADILAL" PRINTED IN WHITE STYLIZED LETTERS ON A RED BACKGROUND AND, ON THE NEXT LINE, THE WORDS "QUICK TREAT" PRINTED IN WHITE BLOCK LETTERS ON A BLUE BACKGROUND. THESE COLORS ARE A FEATURE OF THE MARK.

CLASS 29—MEATS AND PROCESSED FOODS

FOR READY-TO-EAT FOODS, NAMELY, FROZEN AND CANNED ENTREES AND SIDE DISHES CONSISTING PRIMARILY OF VEGETABLES; AND FROZEN AND CANNED FRUITS AND VEGETABLES (U.S. CL. 46).

CLASS 30—STAPLE FOODS

FOR FROZEN DESSERTS, NAMELY, ICE CREAM; AND READY-TO-EAT FROZEN AND CANNED ENTREES AND SIDE DISHES CONSISTING PRIMARILY OF PASTA OR RICE (U.S. CL. 46).

SN 76-325,881. PIKE MANAGEMENT GROUP, INC., LETHBRIDGE, ALBERTA, CANADA, FILED 10-15-2001.

AGCOACH

PRIORITY CLAIMED UNDER SEC. 44(D) ON CANADA APPLICATION NO. 1,100,932, FILED 4-26-2001, REG. NO. 1,100,932, DATED 1-21-2003, EXPIRES 1-21-2018.

CLASS 35—ADVERTISING AND BUSINESS

FOR AGRI-BUSINESS MANAGEMENT SERVICES, NAMELY, OFFERING PEER-TO-PEER MANAGEMENT, ADVISORY AND CONSULTING SERVICES AND INFORMATION SHARING SERVICES IN THE NATURE OF PROVIDING AN ON-LINE COMPUTER DATABASE, TELEPHONE INFORMATION SERVICE IN THE FIELD OF BUSINESS AND AGRI-BUSINESS MANAGEMENT, MARKET COMMENTARY AND SALES RECOMMENDATIONS IN THE NATURE OF MARKETING ANALYSIS, AND BUSINESS MARKETING INFORMATION VIA THE INTERNET TO FARMERS AND FARM BUSINESSES TO ASSIST IN IMPROVING THE INTEGRATION OF MARKETING, AGRONOMY AND BUSINESS MANAGEMENT (U.S. CLS. 100, 101 AND 102).

CLASS 36—INSURANCE AND FINANCIAL

FOR INFORMATION SHARING SERVICES IN THE NATURE OF PROVIDING AN ON-LINE COMPUTER DATABASE IN THE FIELD OF MARKET COMMENTARY AND SALES RECOMMENDATIONS NAMELY COMMODITY INVESTMENT ADVICE, INVESTMENT ADVICE, CAPITAL INVESTMENT CONSULTATION TO FARMERS AND FARM BUSINESSES TO ASSIST IN IMPROVING THE INTEGRATION OF MARKETING, AGRONOMY AND BUSINESS MANAGEMENT (U.S. CLS. 100, 101 AND 102).

CLASS 41—EDUCATION AND ENTERTAINMENT

FOR EDUCATION SERVICES, NAMELY, ONE-ON-ONE MENTORING IN THE FIELD OF MARKETING, AGRONOMY AND BUSINESS MANAGEMENT TO FARMERS AND FARM BUSINESSES (U.S. CLS. 100, 101 AND 107).

SN 76-326,086. HANSE CHEMIE GMBH, D-21502 GEESTHACHT, FED REP GERMANY, FILED 10-16-2001.

NANOPOX

OWNER OF FED REP GERMANY REG. NO. 30040748, DATED 8-14-2000, EXPIRES 5-31-2010.

CLASS 1—CHEMICALS

FOR CHEMICAL COMPOUNDS FOR USE IN THE MANUFACTURE OF LACQUERS AND ADHESIVES; UNPROCESSED ARTIFICIAL RESINS FOR USE IN THE MANUFACTURE OF THERMOSETTING PLASTICS; LIQUID OR LIQUEFIABLE UNPROCESSED SYNTHETIC RESINS MODIFIED BY AN AMORPHOUS SILICON DIOXIDE HAVING PARTICLE SIZES LESS THAN 100 NM FOR USE AS CASTING RESINS (U.S. CLS. 1, 5, 6, 10, 26 AND 46).

CLASS 17—RUBBER GOODS

FOR THERMOSETTING PLASTIC RESINS IN LIQUID FORM FOR USE IN THE MANUFACTURE OF MOLDED PLASTIC ARTICLES (U.S. CLS. 1, 5, 12, 13, 35 AND 50).

SN 76-326,537. DRAGOCO GERBERDING & CO. AG, 37603 HOLZMINDEN, FED REP GERMANY, FILED 10-16-2001.

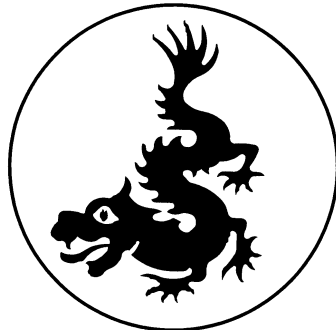

OWNER OF U.S. REG. NO. 1,150,130.

CLASS 1—CHEMICALS

FOR CHEMICALS, NAMELY, ODORANTS, FRAGRANCES, PERFUME COMPOSITIONS, ACTIVE INGREDIENTS AND RAW MATERIALS FOR USE IN THE MANUFACTURE OF COSMETIC PRODUCTS (U.S. CLS. 1, 5, 6, 10, 26 AND 46).

FIRST USE 0-0-1921; IN COMMERCE 0-0-1956.

CLASS 2—PAINTS

FOR DYES AND COLORANTS FOR USE IN THE MANUFACTURE OF FOODSTUFFS, NAMELY, ALL FOOD ITEMS, LUXURY FOODS AND TOBACCO, FOR BEVERAGES, PHARMACEUTICAL AND COSMETIC PREPARATIONS (U.S. CLS. 6, 11 AND 16).

FIRST USE 0-0-1945; IN COMMERCE 0-0-1956.

CLASS 3—COSMETICS AND CLEANING PREPARATIONS

FOR ESSENTIAL OILS FOR FOOD FLAVORINGS, INDUSTRIAL USE IN THE COSMETICS INDUSTRY AND FOR USE IN MANUFACTURING COSMETICS AND FOR PERSONAL USE; PERFUME; ROOM FRAGRANCES; SKIN CLEANSERS; BODY SOAPS; FACIAL SOAPS; SKIN LOTIONS; LAUNDRY DETERGENT; DEODORANT SOAP; DETERGENT SOAP; HAIR COLOR; HAIR SHAMPOO; HAIR CONDITIONER; HAIR STYLING GEL; NON MEDICATED HAIR CARE PREPARATIONS; HAIR MOUSSE; HAIR SPRAY; SKIN LOTION; PERSONAL DEODORANTS AND ANTIPERSPIRANTS; SHOWER GEL; BATH GEL; ALL PURPOSE CLEANING PREPARATIONS; HOUSEHOLD CLEANING PREPARATIONS; NON STATIC DRYER SHEETS; TOILET SOAP; TOILET DEODORANT; DISHWASHING DETERGENTS; POTPOURRI; COSMETICS, NAMELY, FOUNDATIONS, CONCEALERS, LIPSTICKS, POWDER, BLUSHER, BRONZER, EYE SHADOW, EYELINER, LIP LINER, LIP GLOSS; CARPET CLEANERS; CLEANER FOR USE ON TILES, WOOD, PLASTIC, GLASS; FOOD FLAVORINGS, BEING ESSENTIAL OILS (U.S. CLS. 1, 4, 6, 50, 51 AND 52).

FIRST USE 0-0-1921; IN COMMERCE 0-0-1956.

CLASS 29—MEATS AND PROCESSED FOODS

FOR DRIED FRUITS AND VEGETABLES; DRIED FRUITS AND VEGETABLES IN POWDER FORM (U.S. CL. 46).

FIRST USE 0-0-1930; IN COMMERCE 0-0-1956.

CLASS 30—STAPLE FOODS

FOR EXTRACTS USED AS FLAVORING; IMITATION AND NATURAL FLAVORINGS FOR FOOD (U.S. CL. 46).

FIRST USE 0-0-1930; IN COMMERCE 0-0-1956.

SN 76-328,407. CHELO PUBLISHING, INC., NEW YORK, NY, FILED 10-23-2001.

MR. EXERCISE

CLASS 16—PAPER GOODS AND PRINTED MATTER

FOR PERIODICAL PUBLICATIONS, NAMELY, SECTION OF MAGAZINES DEALING WITH MEN'S BODYBUILDING AND EXERCISE (U.S. CLS. 2, 5, 22, 23, 29, 37, 38 AND 50).

FIRST USE 3-0-1992; IN COMMERCE 3-0-1992.

CLASS 41—EDUCATION AND ENTERTAINMENT

FOR ENTERTAINMENT SERVICES IN THE NATURE OF FITNESS SPORTING EVENTS AND CONTESTS; NAMELY, BODYBUILDING OR FITNESS CHAMPIONSHIPS FOR ATHLETES, AND BODYBUILDING OR FITNESS EXHIBITIONS (U.S. CLS. 100, 101 AND 107).

FIRST USE 3-0-1992; IN COMMERCE 3-0-1992.

SN 76-329,120. AGPRO, INC., PARIS, TX, FILED 10-23-2001.

BIODELTA

OWNER OF U.S. REG. NO. 1,051,718.

CLASS 7—MACHINERY

FOR FLUID PUMPS AND MECHANICAL FLUID SPRAYERS FOR USE IN WASTEWATER MANAGEMENT SYSTEMS (U.S. CLS. 13, 19, 21, 23, 31, 34 AND 35).

CLASS 11—ENVIRONMENTAL CONTROL APPARATUS

FOR WASTEWATER MANAGEMENT SYSTEMS FOR MUNICIPAL AND INDUSTRIAL USE, SOLD AS A UNIT, COMPRISING SOLID SEPARATORS, SCRAPERS, FLOOR FLUSHERS, SPRAYERS, HOSES AND PUMPS; REPLACEMENT COMPONENTS FOR MUNICIPAL AND INDUSTRIAL WASTEWATER MANAGEMENT SYSTEMS, NAMELY, SOLID SEPARATORS, SCRAPERS AND FLOOR FLUSHERS (U.S. CLS. 13, 21, 23, 31 AND 34).

CLASS 42—SCIENTIFIC, COMPUTER AND LEGAL SERVICES

FOR ENGINEERING AND TECHNICAL CONSULTING SERVICES FOR WASTEWATER MANAGEMENT SYSTEMS IN MUNICIPAL AND INDUSTRIAL APPLICATIONS (U.S. CLS. 100 AND 101).

CLASS 9—ELECTRICAL AND SCIENTIFIC APPARATUS

FOR SCIENTIFIC APPARATUS AND INSTRUMENTS FOR LABORATORY RESEARCH, NAMELY, SCALES, CAMERAS, MICROSCOPES, OPTICAL CHARACTER RECOGNITION APPARATUS, LASERS FOR MEASURING PURPOSES, OSCILLOSCOPES, SPECTROSCOPES, SIGNAL PROCESSORS, TRANSCEIVERS; NAUTICAL SURVEYING APPARATUS AND INSTRUMENTS, NAMELY, SONAR, MARINE DEPTH FINDERS; EQUIPMENT FOR REPRODUCING SOUND, NAMELY, AUDIO TAPE PLAYERS, COMPACT DISC PLAYERS, DVD PLAYERS, MP3 PLAYERS, PHONOGRAPHS, AUDIO RECEIVERS; CASH REGISTERS, CALCULATING MACHINES; DATA PROCESSING EQUIPMENT, NAMELY, COMPUTERS WITH GRAPHICAL AND/OR COLOUR DISPLAY CAPABILITY, PERIPHERAL EQUIPMENT FOR COMPUTER SYSTEMS, NAMELY DATA INPUT, OUTPUT, STORAGE AND TRANSMISSION EQUIPMENT AND APPARATUS; COMPUTER CHIPS; COMPUTER OPERATING PROGRAMMES; COMPUTER OPERATING SYSTEMS; CENTRAL PROCESSING UNITS; COMPUTERS AND SYSTEMS CONSISTING ENTIRELY OR ESSENTIALLY THEREOF, IN PARTICULAR NOTEBOOK COMPUTERS AND DESKTOP COMPUTERS; COMPUTER PERIPHERALS, NAMELY, COMPUTER MOUSE, PRINTERS, PLOTTERS, TERMINALS, MONITORS, SCANNERS; FLOPPY DISK DRIVES; TEXT PROCESSING EQUIPMENT; DATA STORAGE MEMORIES, NAMELY BLANK FLOPPY DISKS, MAGNETIC HARD DISKS AND MAGNETIC TAPES, COMPACT DISCS (ROM, READ-ONLY MEMORIES) SOLID STATE MEMORY DEVICES, TAPE DRIVES, OPTICAL DATA CARRIERS, NAMELY, STORAGE MEMORIES FOR DATA PROCESSING SYSTEMS; COMPUTER HARDWARE, NAMELY, SOUND CARDS FOR COMPUTERS, MOTHERBOARDS, INTERFACE CARDS, PLUG-IN CARDS AND FLOPPY DISKS; INSTRUMENTS AND APPARATUS FOR SPEECH INPUT AND OUTPUT AND FOR VOICE RECOGNITION; INSTRUMENTS AND APPARATUS FOR PLAIN TEXT RECOGNITION; INSTRUMENTS AND EQUIPMENT FOR RECORDING, TRANSMITTING AND REPRODUCING SOUND, IMAGE AND DATA, NAMELY, TELEPHONES, AUDIO/VIDEO RECORDING DEVICES, AND PROJECTORS; PHOTOCOPYING EQUIPMENT AND MACHINES, INCLUDING ELECTROSTATIC AND THERMAL (U.S. CLS. 21, 23, 26, 36 AND 38).

SN 76-329,579. GUTZEN, CHRISTIAN, 53115 BONN, FED REP GERMANY, AND SCHWARTZ, STEPHAN, 53115 BONN, FED REP GERMANY, FILED 10-23-2001.

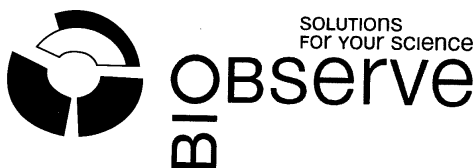
**CLASS 42—SCIENTIFIC, COMPUTER AND LEGAL SERVICES**

FOR CREATION, UPDATING, UPGRADING AND MAINTENANCE OF PROGRAMMES FOR DATA PROCESSING; DEVELOPMENT OF SOFTWARE FOR AUTOMATING COMPLEX BEHAVIORAL TESTS WITH ANIMALS FOR THE RESEARCH AND PHARMACEUTICAL SECTORS; COMPILATION, MANIPULATION, STORAGE, EVALUATION AND ANALYSIS OF SCIENTIFIC DATA FOR OTHERS; CONSULTANCY IN THE FIELD OF DATA PROCESSING FOR BUILDING AND ORGANIZING DATA PROCESSING SYSTEMS, INCLUDING NETWORKS; DESIGN OF EDP SYSTEMS; LEASING OF COMPUTER SOFTWARE; LEASING OF DATA PROCESSING EQUIPMENT; CONSULTANCY RELATING TO AND PLANNING OF TEST PACKAGES FOR BEHAVIORAL RESEARCH AND OTHER TESTS ON ANIMALS, INCLUDING TEST PACKAGES OF PHARMACEUTICAL APPLICATIONS; PREPARATION OF MEDICAL, BIOLOGICAL AND TECHNICAL REPORTS; TECHNICAL CONSULTANCY AND REPORTING (U.S. CLS. 100 AND 101).

OWNER OF FED REP GERMANY REG. NO. 30126116, DATED 7-18-2001, EXPIRES 4-30-2011.

SN 76-331,138. HOTHAND, INC., LAKE FOREST, CA. FILED 10-29-2001.

SN 76-332,141. PRIMAL ELEMENTS, INC., GARDEN GROVE, CA. FILED 10-30-2001.

HOTHAND

CLASS 9—ELECTRICAL AND SCIENTIFIC APPARATUS

FOR COMPUTER SOFTWARE USED FOR MARKETING BY DISPLAYING PRODUCT AND SERVICE ORDERING INFORMATION AND ADVERTISEMENTS ON THE SCREENS OF WIRELESS COMMUNICATION DEVICES (U.S. CLS. 21, 23, 26, 36 AND 38).

CLASS 35—ADVERTISING AND BUSINESS

FOR BUSINESS MARKETING RESEARCH AND CONSULTATION SERVICES IN THE FIELD OF POINT OF COMMERCE TELECOMMUNICATIONS SERVICES AND WIRELESS COMMUNICATIONS COMMERCE (U.S. CLS. 100, 101 AND 102).

SN 76-331,387. VECTOR ESP, INC., HOUSTON, TX. FILED 10-30-2001.

ENTERPRISE SERVICES PARTNER

NO CLAIM IS MADE TO THE EXCLUSIVE RIGHT TO USE "ENTERPRISE SERVICES", APART FROM THE MARK AS SHOWN.

CLASS 41—EDUCATION AND ENTERTAINMENT

FOR EDUCATIONAL SERVICES, NAMELY, COMPUTER TRAINING (U.S. CLS. 100, 101 AND 107). FIRST USE 10-23-2001; IN COMMERCE 10-23-2001.

CLASS 42—SCIENTIFIC, COMPUTER AND LEGAL SERVICES

FOR COMPUTER SERVICES, NAMELY, INFORMATION TECHNOLOGY CONSULTING FOR IMPROVING AND ENHANCING COMPUTER SYSTEMS AND APPLICATIONS TO GAIN SEAMLESS ACCESS TO COMPUTER APPLICATIONS AND INFORMATION ON A SHARED COMPUTER SYSTEM; COMPUTER ENTERPRISE INTEGRATION, NAMELY, IMPROVING AND ENHANCING COMPUTER SYSTEMS AND APPLICATIONS TO GAIN SEAMLESS ACCESS TO COMPUTER APPLICATIONS AND INFORMATION ON A SHARED COMPUTER SYSTEM; INTEGRATION OF COMPUTER HARDWARE AND SOFTWARE; TECHNICAL SUPPORT SERVICES, NAMELY, TROUBLESHOOTING OF COMPUTER HARDWARE AND SOFTWARE PROBLEMS; AND CUSTOM SOFTWARE APPLICATION DEVELOPMENT, NAMELY, FOR IMPLEMENTING DESIGNS, IMPROVEMENTS AND ENHANCEMENTS OF COMPUTER SYSTEMS AND APPLICATIONS IN ORDER TO GAIN SEAMLESS ACCESS TO COMPUTER APPLICATIONS AND INFORMATION ON A SHARED COMPUTER SYSTEM (U.S. CLS. 100 AND 101).

FIRST USE 8-0-2000; IN COMMERCE 8-0-2001.

CUPCAKE

CLASS 3—COSMETICS AND CLEANING PREPARATIONS

FOR PERSONAL SOAP FOR HANDS, FACE AND BODY; PERFUME; COLOGNE, TOILET WATER; ESSENTIAL OILS FOR PERSONAL USE (U.S. CLS. 1, 4, 6, 50, 51 AND 52).

CLASS 4—LUBRICANTS AND FUELS

FOR CANDLES (U.S. CLS. 1, 6 AND 15).

SN 76-333,024. LAVIPHARM LABORATORIES INC., EAST WINDSOR, NJ. FILED 11-2-2001.

ENCAP-X

CLASS 7—MACHINERY

FOR MANUFACTURING EQUIPMENT, NAMELY, MACHINES USED IN RESEARCHING, DEVELOPING AND MANUFACTURING PHARMACEUTICALS, NUTRACEUTICALS, CHEMICALS, PROTEINS, PEPTIDES, OLIGONUCLEOTIDES, DNA, VACCINES, OTHER BIOTECHNOLOGY-DERIVED PRODUCTS, AND OTHER PRODUCTS USING SUPERCRITICAL FLUID TECHNOLOGY (U.S. CLS. 13, 19, 21, 23, 31, 34 AND 35).

CLASS 9—ELECTRICAL AND SCIENTIFIC APPARATUS

FOR LABORATORY EQUIPMENT FOR USE IN RESEARCHING, DEVELOPING AND MANUFACTURING PHARMACEUTICALS, NUTRACEUTICALS, CHEMICALS, PROTEINS, PEPTIDES, OLIGONUCLEOTIDES, DNA, VACCINES, OTHER BIOTECHNOLOGY-DERIVED PRODUCTS, AND OTHER PRODUCTS USING SUPERCRITICAL FLUID TECHNOLOGY (U.S. CLS. 21, 23, 26, 36 AND 38).

CLASS 40—MATERIAL TREATMENT

FOR CUSTOM MANUFACTURING OF PHARMACEUTICALS, NUTRACEUTICALS, CHEMICALS, PROTEINS, PEPTIDES, OLIGONUCLEOTIDES, DNA, VACCINES, OTHER BIOTECHNOLOGY-DERIVED PRODUCTS, AND OTHER PRODUCTS USING SUPERCRITICAL FLUID TECHNOLOGY (U.S. CLS. 100, 103 AND 106).

CLASS 42—SCIENTIFIC, COMPUTER AND LEGAL SERVICES

FOR CONDUCTING FEASIBILITY STUDIES FOR OTHERS ON THE USE OF SUPERCRITICAL FLUIDS IN THE FORMULATION OF PHARMACEUTICALS, NUTRACEUTICALS, CHEMICALS, PROTEINS, PEPTIDES, OLIGONUCLEOTIDES, DNA, VACCINES, OTHER BIOTECHNOLOGY-DERIVED PRODUCTS, AND OTHER PRODUCTS; LICENSING OF SUPERCRITICAL FLUID TECHNOLOGY; DEVELOPING PHARMACEUTICALS, NUTRACEUTICALS, CHEMICALS, PROTEINS, PEPTIDES, OLIGONUCLEOTIDES, DNA, VACCINES, OTHER BIOTECHNOLOGY-DERIVED PRODUCTS, AND OTHER PRODUCTS FOR OTHERS USING SUPERCRITICAL FLUID TECHNOLOGY (U.S. CLS. 100 AND 101).

SN 76-333,491. AUSSIE BODIES PTY LTD., MELBOURNE VIC 3000, AUSTRALIA, FILED 11-1-2001.



OWNER OF AUSTRALIA REG. NO. 635903, DATED 7-27-1994, EXPIRES 7-27-2004.

OWNER OF AUSTRALIA REG. NO. 679,374, DATED 11-28-1995, EXPIRES 11-28-2005.

OWNER OF AUSTRALIA REG. NO. 659913, DATED 5-2-1995, EXPIRES 5-2-2005.

CLASS 25—CLOTHING

FOR SWEATSHIRTS, T-SHIRTS, AND SINGLET TOPS (U.S. CLS. 22 AND 39).

CLASS 29—MEATS AND PROCESSED FOODS

FOR MILK POWDERS, WHEY PROTEIN POWDERS, PROTEIN FOR USE AS A FOOD ADDITIVE OR FOOD FILLER, WHEY AND SOY PROTEIN BASES FOR ADDITION TO MILK TO MAKE A MILK BEVERAGE, YOGURT, HIGH PROTEIN MUESLI SNACK BARS, HIGH PROTEIN CONFECTIONARY SNACK BARS, HIGH PROTEIN SNACK CHIPS, AND HIGH PROTEIN PANCAKES (U.S. CL. 46).

CLASS 30—STAPLE FOODS

FOR ICE CREAM, ICE CREAM MIX, PREPARATIONS FOR MAKING ICE CREAM, AND MUESLI-BASED SNACK BARS (U.S. CL. 46).

CLASS 32—LIGHT BEVERAGES

FOR SPORTS DRINKS, AMINO ACID FORTIFIED SPORTS DRINKS, ACRATED SPORTS DRINKS, ISOTONIC DRINKS, AND DRINK BASES (U.S. CLS. 45, 46 AND 48).

SN 76-333,677. MOVING EYES PRODUCTIONS INC., FAIRFIELD, NJ. FILED 11-5-2001.

MOVING EYES PRODUCTIONS

NO CLAIM IS MADE TO THE EXCLUSIVE RIGHT TO USE "PRODUCTIONS", APART FROM THE MARK AS SHOWN.

CLASS 41—EDUCATION AND ENTERTAINMENT

FOR MULTIMEDIA ENTERTAINMENT SOFTWARE PRODUCTION SERVICES; ENTERTAINMENT, NAMELY, PRODUCTION OF TELEVISION SHOWS; AUDIO RECORDING AND PRODUCTION; DISTRIBUTION OF TELEVISION PROGRAMS FOR OTHERS (U.S. CLS. 100, 101 AND 107).

CLASS 42—SCIENTIFIC, COMPUTER AND LEGAL SERVICES

FOR DESIGNING INTERNET CONTENT, NAMELY, DESIGNING WEBSITES FOR OTHERS; COMPUTER GRAPHIC DESIGN SERVICES (U.S. CLS. 100 AND 101).

SN 76-334,683. PEAK LEARNING, INC., SAN LUIS OBISPO, CA. FILED 11-6-2001.

AQ

CLASS 35—ADVERTISING AND BUSINESS

FOR CONSULTING SERVICES IN THE FIELD OF LEADERSHIP PERFORMANCE AND PROFESSIONAL DEVELOPMENT (U.S. CLS. 100, 101 AND 102).
FIRST USE 1-1-1987; IN COMMERCE 1-1-1987.

CLASS 41—EDUCATION AND ENTERTAINMENT

FOR EDUCATIONAL SERVICES, NAMELY CONDUCTING PROGRAMS, PRESENTATIONS AND SEMINARS IN THE FIELD OF LEADERSHIP PERFORMANCE AND PROFESSIONAL DEVELOPMENT (U.S. CLS. 100, 101 AND 107).
FIRST USE 1-1-1987; IN COMMERCE 1-1-1987.

SN 76-334,718. FAIGLE KUNSTSTOFFE GESELLSCHAFT M.B.H., A-6971 HARD, AUSTRIA, FILED 11-6-2001.

FAIGLE

PRIORITY CLAIMED UNDER SEC. 44(D) ON AUSTRIA APPLICATION NO. AM4153/2001, FILED 6-7-2001, REG. NO. 199940, DATED 10-22-2001, EXPIRES 10-31-2011.
SEC. 2(F).

CLASS 1—CHEMICALS

FOR PLASTICS AND FIBER REINFORCED PLASTICS, FOR THE MANUFACTURE OF COMPONENTS OF VEHICLES, MACHINES, DEVICES, AND APPARATUS, NAMELY, PLASTIC-MOLDING COMPOUNDS FOR USE IN THE MANUFACTURE OF MOLDED PLASTIC ARTICLES (U.S. CLS. 1, 5, 6, 10, 26 AND 46).

CLASS 7—MACHINERY

FOR MACHINE PARTS MADE OF PLASTICS AND FIBER REINFORCED PLASTICS, NAMELY, BEARINGS AND BUSHINGS, NOZZLES WHICH ARE PARTS OF POWER- OPERATED SPRAYERS, BEARINGS AND BUSHINGS; MACHINE PARTS MADE OF PLASTICS AND FIBER REINFORCED PLASTICS, NAMELY, GEAR WHEELS, BEARINGS, SLIDING BLOCKS, SLIDE BRAKE LINING FOR MACHINES, ROLLER BEARINGS, ROPE PULLEYS, WHEELS, ROPE PULLEY INSETS, CYLINDERS, BUSHINGS, POINTS BUSHINGS, EC-CENTRICS, CAM SHAFTS, CAM DISKS AND COUPLINGS; INSULATING MATERIALS MADE OF PLASTICS AGAINST ACOUSTIC AND MECHANICAL VIBRATIONS AND FOR SHOCK ABSORBING, NAMELY, SHOCK ABSORBERS FOR MACHINES (U.S. CLS. 13, 19, 21, 23, 31, 34 AND 35).

CLASS 17—RUBBER GOODS

FOR NON-METAL PIPE COLLARS; RUBBER SLEEVES FOR PROTECTING PARTS OF MACHINERY, PLASTIC IN THE FORM OF BARS, BLOCKS, PELLETS, RODS, SHEETS AND TUBES FOR USE IN MANUFACTURING; PLASTIC COMPOSITE MATERIAL IN THE FORM OF GRANULES FOR USE IN MANUFACTURING OF GOODS MADE OF THERMOPLASTIC PLASTICS (U.S. CLS. 1, 5, 12, 13, 35 AND 50).

SN 76-335,416. STIFTUNG CAESAR, 53111 BONN, FED REP GERMANY, FILED 11-7-2001.

GoVisual

PRIORITY CLAIMED UNDER SEC. 44(D) ON FED REP GERMANY APPLICATION NO. 30146392.1/4, FILED 8-2-2001, REG. NO. 30146392, DATED 1-3-2002, EXPIRES 8-31-2011.

CLASS 9—ELECTRICAL AND SCIENTIFIC APPARATUS

FOR COMPUTERS; DATA PROCESSORS; COMPUTER SOFTWARE USED TO DESIGN TECHNICAL DIAGRAMS FOR USE IN A VARIETY OF FIELDS AND APPLICATIONS, SUCH AS MATHEMATICS, NETWORK DOCUMENTATION, NETWORK MANAGEMENT, BUSINESS PROCESSES, TELECOMMUNICATIONS NETWORKS, CHEMICAL INTERACTIONS AND BIOCHEMICAL PATHWAYS; DOWNLOADABLE ELECTRONIC PUBLICATIONS IN THE NATURE OF MANUALS IN THE FIELD OF COMPUTER SOFTWARE; MULTIMEDIA SOFTWARE RECORDED ON CD-ROM'S FEATURING COMPUTER INSTRUCTION MANUALS (U.S. CLS. 21, 23, 26, 36 AND 38).

CLASS 16—PAPER GOODS AND PRINTED MATTER

FOR COMPUTER SOFTWARE INSTRUCTION MANUALS; PRINTED MANUALS IN THE FIELD OF HOW TO USE AND OPERATE COMPUTER SOFTWARE; PRINTED INSTRUCTION SHEETS FOR USE IN IMPLEMENTATION, MAINTENANCE, TEACHING, OPERATING AND INSTALLING COMPUTER SOFTWARE (U.S. CLS. 2, 5, 22, 23, 29, 37, 38 AND 50).

CLASS 42—SCIENTIFIC, COMPUTER AND LEGAL SERVICES

FOR DESIGN AND UPDATING COMPUTER SOFTWARE FOR OTHERS (U.S. CLS. 100 AND 101).

SN 76-336,300. FRINGE COMMUNICATIONS, GRAND RAPIDS, MI. FILED 11-9-2001.

FRINGE**CLASS 9—ELECTRICAL AND SCIENTIFIC APPARATUS**

FOR VIDEO CASSETTES, MOTION PICTURE FILMS AND DVDS PERTAINING TO SPIRITUALITY, SELF HELP, INSPIRATION, HEALTH, LIFESTYLE, PHILOSOPHY, RELIGION AND CHRISTIANITY (U.S. CLS. 21, 23, 26, 36 AND 38).

CLASS 16—PAPER GOODS AND PRINTED MATTER

FOR PRINTED MATTER, NAMELY BOOKS AND BOOKLETS PERTAINING TO SPIRITUALITY, SELF HELP, INSPIRATION, HEALTH, LIFESTYLE, PHILOSOPHY, RELIGION AND CHRISTIANITY (U.S. CLS. 2, 5, 22, 23, 29, 37, 38 AND 50).

SN 76-337,325. ILLINOIS TOOL WORKS INC., GLENVIEW, IL. FILED 11-14-2001.

DELPRO**CLASS 9—ELECTRICAL AND SCIENTIFIC APPARATUS**

FOR PLASTIC COMPONENTS OF BATTERIES, NAMELY, INDICATORS AND VENTS (U.S. CLS. 21, 23, 26, 36 AND 38).
FIRST USE 12-0-1998; IN COMMERCE 12-0-1998.

CLASS 11—ENVIRONMENTAL CONTROL APPARATUS

FOR PLASTIC COMPONENTS OF VEHICLE HEADLAMPS, NAMELY, ADJUSTORS, PIVOTS, AND VENTS (U.S. CLS. 13, 21, 23, 31 AND 34).
FIRST USE 12-0-1998; IN COMMERCE 12-0-1998.

CLASS 12—VEHICLES

FOR INJECTED MOLDED PLASTIC COMPONENTS AND ASSEMBLIES FOR VEHICLES, NAMELY, DAMPERS AND GEARS (U.S. CLS. 19, 21, 23, 31, 35 AND 44).
FIRST USE 12-0-1998; IN COMMERCE 12-0-1998.

CLASS 20—FURNITURE AND ARTICLES NOT OTHERWISE CLASSIFIED

FOR NON-METAL LATCHES (U.S. CLS. 2, 13, 22, 25, 32 AND 50).
FIRST USE 12-0-1998; IN COMMERCE 12-0-1998.

SN 76-338,611. ENVISIONAL TECHNOLOGY LIMITED,
CAMBRIDGE, UNITED KINGDOM, FILED 11-16-2001.



CLASS 9—ELECTRICAL AND SCIENTIFIC APPARATUS

FOR COMPUTERS; COMPUTER SOFTWARE FOR USE IN THE SEARCH AND RETRIEVAL OF DATA, KNOWLEDGE MANAGEMENT, INTERNET RESEARCH AND ARTIFICIAL INTELLIGENCE APPLICATIONS IN THE FIELD OF ONLINE INTELLECTUAL PROPERTY MANAGEMENT; COMPUTER PROGRAMS; COMPUTER HARDWARE; COMPUTER MEMORIES; COMPUTER PERIPHERAL DEVICES; BLANK MAGNETIC COMPUTER TAPES; BLANK MAGNETIC DATA CARRIERS, NAMELY, COMPACT DISCS; DOWNLOADABLE ELECTRONIC PUBLICATIONS IN THE NATURE OF E-MAIL NEWSLETTERS, ONLINE NEWSLETTERS AND REPORTS IN THE FIELD OF DATA SEARCH AND RETRIEVAL, KNOWLEDGE MANAGEMENT AND ARTIFICIAL INTELLIGENCE; DOWNLOADABLE MUSICAL SOUND RECORDINGS (U.S. CLS. 21, 23, 26, 36 AND 38).

CLASS 16—PAPER GOODS AND PRINTED MATTER

FOR PRINTED MATTER AND PUBLICATIONS, NAMELY, BOOKS, PROSPECTUSES, MANUALS, BOOKLETS AND DIAGRAMS RELATING TO INFORMATION TECHNOLOGY, COMPUTERS, COMPUTER SYSTEMS, COMPUTER PROGRAMS, COMPUTER PROGRAMMING, COMPUTER HARDWARE AND COMPUTER SOFTWARE; INSTRUCTION BOOKS AND MANUALS SOLD WITH COMPUTERS, COMPUTER PROGRAMS, COMPUTER HARDWARE AND COMPUTER SOFTWARE; INFORMATION REPORTS AND PRINTED REPORTS ABOUT DATA SEARCH, DATA RETRIEVAL, KNOWLEDGE MANAGEMENT AND ARTIFICIAL INTELLIGENCE; POSTERS; STATIONERY; STATIONERY COVERS; CARD FILES, DOCUMENT FOLDERS, PAPER EXPANDING FILES, ENVELOPES AND PRINTING TYPE; BLANK PAPER TAPES AND CARDS FOR THE RECORDING OF COMPUTER PROGRAMS (U.S. CLS. 2, 5, 22, 23, 29, 37, 38 AND 50).

CLASS 35—ADVERTISING AND BUSINESS

FOR BUSINESS SERVICES, NAMELY BUSINESS RESEARCH AND SURVEYS, CONSUMER RESEARCH, MARKET ANALYSIS AND PROVIDING BUSINESS INFORMATION; PREPARATION OF BUSINESS REPORTS; PROVIDING AN ON-LINE COMPUTER DATABASE IN THE FIELD OF BUSINESS INFORMATION AND PROVIDING BUSINESS INFORMATION VIA THE INTERNET; COPYRIGHT MANAGEMENT SERVICES; PROVIDING AND ANALYZING STATISTICAL BUSINESS INFORMATION; COMPUTERIZED DATABASE MANAGEMENT IN THE FIELD OF ONLINE INTELLECTUAL PROPERTY MANAGEMENT (U.S. CLS. 100, 101 AND 102).

CLASS 42—SCIENTIFIC, COMPUTER AND LEGAL SERVICES

FOR COMPUTER SERVICES, NAMELY COMPUTER PROGRAMMING FOR OTHERS; DESIGN OF COMPUTER SYSTEMS, COMPUTER PROGRAMS, COMPUTER HARDWARE AND COMPUTER SOFTWARE FOR OTHERS; UPDATING OF COMPUTER HARDWARE AND SOFTWARE FOR OTHERS; PROVIDING ONLINE COMPUTER DATABASES FEATURING RESULTS OBTAINED IN CARRYING OUT ONLINE RESEARCH FOR THE PURPOSES OF MANAGING INTELLECTUAL PROPERTY ONLINE; RENTAL AND LEASING OF COMPUTERS, COMPUTER HARDWARE AND SOFTWARE; CONSULTATION SERVICES RELATING TO COMPUTERS, COMPUTER SYSTEMS, COMPUTER NETWORKS, COMPUTER PROGRAMS, COMPUTER PROGRAMMING, COMPUTER HARDWARE, AND COMPUTER SOFTWARE; CONSULTATION SERVICES RELATING TO THE DESIGN OF COMPUTER SYSTEMS; COMPUTERS; COMPUTER PROGRAMS; COMPUTER HARDWARE AND COMPUTER SOFTWARE; CONSULTATION SERVICES RELATING TO THE RENTAL OF COMPUTERS, COMPUTER PROGRAMS, COMPUTER HARDWARE AND COMPUTER SOFTWARE; COMPUTER DATABASE CONSULTANT SERVICES; INTELLECTUAL PROPERTY MANAGEMENT CONSULTATION; LICENSING OF INTELLECTUAL PROPERTY; LEGAL RESEARCH SERVICES COMPRISING DATA SEARCH, DATA RETRIEVAL, KNOWLEDGE MANAGEMENT AND ARTIFICIAL INTELLIGENCE IN THE FIELD OF ONLINE INTELLECTUAL PROPERTY MANAGEMENT; RESEARCH AND DEVELOPMENT FOR NEW PRODUCTS FOR OTHERS; PROVIDING INFORMATION ABOUT THE SEARCH AND RETRIEVAL OF DATA, KNOWLEDGE MANAGEMENT AND ARTIFICIAL INTELLIGENCE IN THE FIELD OF ONLINE INTELLECTUAL PROPERTY MANAGEMENT (U.S. CLS. 100 AND 101).

SN 76-339,628. HATRAK, ROBERT STEPHEN, LAS VEGAS,
NV. FILED 11-19-2001.

RELIEF FACTOR MANAGEMENT SYSTEMS RFMS

NO CLAIM IS MADE TO THE EXCLUSIVE RIGHT TO USE "MANAGEMENT SYSTEMS", APART FROM THE MARK AS SHOWN.
SEC. 2(F).

CLASS 9—ELECTRICAL AND SCIENTIFIC APPARATUS

FOR COMPUTER SOFTWARE FOR MANAGING STAFFING, NAMELY, TIMEKEEPING SOFTWARE FOR CONTROLLING OVERTIME IN PRISONS, JAILS, DETENTION CENTERS, POLICE DEPARTMENTS, FIRE DEPARTMENTS AND ANY OTHER AGENCY THAT OPERATES 365-DAYS PER YEAR, FROM EIGHT TO 24 HOURS PER DAY AND ONE TO SEVEN DAYS PER WEEK (U.S. CLS. 21, 23, 26, 36 AND 38).
FIRST USE 7-1-1982; IN COMMERCE 7-1-1982.

CLASS 35—ADVERTISING AND BUSINESS

FOR BUSINESS MANAGEMENT SUPERVISION, NAMELY, MANAGING STAFFING, PREPARING RELIEF FACTOR AND BUDGET BASED DUTY SCHEDULES, AND CONTROLLING OVERTIME IN PRISONS, JAILS, DETENTION CENTERS, POLICE DEPARTMENTS, FIRE DEPARTMENTS AND ANY OTHER AGENCY THAT OPERATES 365-DAY PER YEAR, FROM EIGHT TO 24 HOURS PER DAY AND ONE TO SEVEN DAYS PER WEEK (U.S. CLS. 100, 101 AND 102).
FIRST USE 7-1-1982; IN COMMERCE 7-1-1982.

SN 76-339,688. WACKER POLYMER SYSTEMS GMBH & CO. KG, D-84489 BURGHAUSEN, FED REP GERMANY, FILED 11-13-2001.

VINNACOAT

PRIORITY CLAIMED UNDER SEC. 44(D) ON FED REP GERMANY APPLICATION NO. 30131149.8, FILED 8-20-2001, REG. NO. 30131149, DATED 8-20-2001, EXPIRES 5-31-2011.

OWNER OF U.S. REG. NOS. 1,943,617, 2,282,429 AND 2,508,776.

CLASS 1—CHEMICALS

FOR UNPROCESSED PLASTICS FOR USE IN THE CHEMICAL, PLASTICS, METALLURGICAL, GLASS, PAPER, CERAMIC, PHOTOGRAPHY, AGRICULTURAL, HORTICULTURAL, FORESTRY, COMMERCIAL AND RESIDENTIAL BUILDING, CONSTRUCTION, AUTOMOBILE, AUTOMOTIVE, INSULATION, PACKAGING, ENGINEERING, ENERGY, ELECTRONICS, PHARMACEUTICAL, COSMETIC, FRAGRANCE, TEXTILE, LEATHER, SYNTHETIC RUBBER, HEALTHCARE, FOOD, PAINT, MOULD MAKING, SEMI-CONDUCTOR, MICROCHIP AND TERRESTRIAL PHOTOVOLTAIC INDUSTRIES; CHEMICAL COMPOUNDS THAT CROSS-LINK TO FORM PLASTICS; CHEMICALS IN THE FORM OF RAW MATERIALS, AUXILIARIES, ADDITIVES AND CATALYSTS USED IN PLASTICS PRODUCTION; CHEMICALS, NAMELY, POLYVINYL CHLORIDE, POLYVINYL ACETATE, POLYVINYL ALCOHOL, POLYVINYL ACETALS, ACRYLATES, STYRENES, VINYL ESTER, THEIR MIXTURES, BLENDS, ALLOYS, COPOLYMERS, GRAFT COPOLYMERS AND BLOCK COPOLYMERS BASED ON THEM AND ON OTHER POLYMERS FOR USE IN THE ABOVE-MENTIONED INDUSTRIES; CHEMICAL EMBEDDING COMPOUNDS AND MOLDING COMPOUNDS FOR USE IN THE ABOVE-MENTIONED INDUSTRIES; CHEMICAL AGENTS FOR IMPREGNATING, BINDING AND COATING OF TEXTILES, FIBERS, FURS, LEATHERS, NON-WOVENS, FABRICS AND WOOD; CHEMICAL COATING AGENTS FOR USE IN THE MANUFACTURE OF RELEASE PAPERS, NAMELY, SELF-ADHESIVE LABELS, ADHESIVE FILMS AND ADHESIVE TAPES; CHEMICALS, NAMELY, THICKENING AND THIXOTROPIC AGENTS FOR USE IN THE ABOVE-MENTIONED INDUSTRIES; CHEMICAL IMPREGNATING AGENTS FOR BUILDING MATERIALS, WOOD ARTIFICIAL AND NATURAL STONE, MORTAR, CEMENT, CONCRETE, GASSED CONCRETE, GYPSUM, MASONRY, FACADES; CHEMICAL STONE STRENGTHENER; CHEMICAL POLYMER COATING AGENTS FOR PAPER, MINERAL MATERIALS, FILLERS AND PIGMENTS; ANTI-BLOCKING AGENTS FOR YARNS; CHEMICALS FOR USE IN BINDING PAINTS, LACQUERS, GLUES, PUHESIRES AND FOR USE IN BINDING CHEMICALS USED IN THE BUILDING INDUSTRY; CHEMICAL FOR BINDING NON-WOVEN MATERIALS, FILTERS, LAMINATES, FIBERS, FIBER DRESSINGS, CARPET FINISHES, NEEDLES FELTS, PAPER COATING, PAPER IMPREGNANTS, FLAME PROTECTION FINISHES AND RF WELDABLE FINISHES; CHEMICAL BINDERS AND ADDITIVES FOR USE IN THE MANUFACTURING OF CERAMIC COMPOUNDS; CHEMICAL ADDITIVES FOR USE IN THE MANUFACTURE OF COSMETIC PREPARATIONS; CHEMICAL PLASTICIZERS FOR PLASTICS; CHEMICAL ADHESION PROMOTORS FOR GENERAL INDUSTRIAL USE; CHEMICAL ANTISTATIC AGENTS; CHEMICALS, NAMELY, VINYL ACETATE AND VINYL CHLORIDE FOR USE IN THE ABOVE-MENTIONED INDUSTRIES; CHEMICALS FOR USE IN MAINTAINING THE FRESHNESS AND KEEPING QUALITIES OF FOODSTUFFS; ADHESIVES FOR INDUSTRIAL PURPOSES FOR USE IN THE ABOVE-MENTIONED INDUSTRIES; CATALYSTS FOR CHEMICAL PROCESS FOR USE IN THE ABOVE-MENTIONED INDUSTRIES; ORGANIC CHEMICAL INTERMEDIATES FOR THE PROCESSING INDUSTRY, NAMELY, FOR USE IN THE ABOVE-MENTIONED INDUSTRIES; RAW MATERIALS IN THE NATURE OF ORGANIC CHEMICAL COMPOUNDS FOR USE IN THE ABOVE-MENTIONED INDUSTRIES; ACTIVE CHEMICAL SUBSTANCES AND AUXILIARIES FOR USE IN THE MANUFACTURE OF PHARMACEUTICALS AND PESTICIDES; CHEMICAL PRODUCTS CONTAINING AND MADE OF PLASTICS IN THE FORM OF SOLUTIONS

AND GRADULES FOR USE IN THE ABOVE-MENTIONED INDUSTRIES; CHEMICAL RAW MATERIALS, AUXILIARIES AND CHEMICAL ADDITIVES FOR USE IN THE MANUFACTURE OF LACQUERS, POWDERED LACQUERS AND PRINTING INKS; CHEMICAL FLOW CONTROL AGENTS AND BINDERS FOR USE IN THE MANUFACTURE OF LACQUERS AND PAINTS; CHEMICALS, NAMELY, BACTERICIDAL, FIREPROOF, AND HAMMER FINISH ADDITIVES FOR USE IN THE MANUFACTURE OF LACQUERS (U.S. CLS. 1, 5, 6, 10, 26 AND 46).

CLASS 2—PAINTS

FOR PAINTS USED BY ARTISTS; PAINTS FOR INTERIOR AND EXTERIOR OF HOUSES, CONCRETE, MASONRY, INDUSTRIAL EQUIPMENT AND MACHINERY, AUTOMOBILES, CERAMICS AND FURNITURE; VARNISH AND LACQUERS IN THE NATURE OF A COATING; WOOD PRESERVATIVES; ANTI-RUST OILS; COLOR PIGMENTS; PAINT THINNER; LACQUERS FOR COATING ELECTRICAL, ELECTRONIC PAINTS AND COMPONENTS; COATING LACQUERS IN THE NATURE OF COATING FOR GENERAL INDUSTRIAL USE (U.S. CLS. 6, 11 AND 16).

CLASS 16—PAPER GOODS AND PRINTED MATTER

FOR ADHESIVES FOR STATIONARY ARTICLES; ADHESIVES FOR HOUSEHOLD PURPOSES; BOOK-BINDING PASTE; ARTISTS' MODELING COMPOUNDS AND DO-IT-YOURSELF MATERIALS FOR MODELING IN THE NATURE OF ORGANIC CHEMICALS (U.S. CLS. 2, 5, 22, 23, 29, 37, 38 AND 50).

CLASS 17—RUBBER GOODS

FOR SEMI PROCESSED PLASTICS AND PLASTIC GOODS FOR USE IN THE CHEMICAL, PLASTICS, METALLURGICAL, GLASS, PAPER, CERAMIC, PHOTOGRAPHY, AGRICULTURAL, HORTICULTURAL, FORESTRY, COMMERCIAL AND RESIDENTIAL BUILDING, CONSTRUCTION, AUTOMOBILE, AUTOMOTIVE, INSULATION, PACKAGING, ENGINEERING, ENERGY, ELECTRONICS, PHARMACEUTICAL, COSMETIC, FRAGRANCE, TEXTILE, LEATHER, SYNTHETIC RUBBER, HEALTHCARE, FOOD, PAINT, MOULD MAKING, SEMI-CONDUCTOR, MICROCHIP AND TERRESTRIAL PHOTOVOLTAIC INDUSTRIES; PRODUCTS CONTAINING AND MADE OF PLASTICS IN THE FORM OF BLOCKS, EXTRUDATES, SHEETS, FILMS, RODS, FLEXIBLE PIPES AND FIBERS FOR USE IN THE ABOVE-MENTIONED INDUSTRIES AND NOT FOR TEXTILE USE; SEALANTS FOR JOINTS, PLASTIC GASKETS, INSULATING OILS, AND INSULATING PAINTS AND LACQUERS FOR GENERAL INDUSTRIAL USE; PLASTIC SOLDERING THREADS NOT FOR TEXTILE USE (U.S. CLS. 1, 5, 12, 13, 35 AND 50).

SN 76-341,264. ALDIVIA S.A., SAINT-GENIS-LAVAL CEDEX, FRANCE, FILED 11-26-2001.

VIAMERINE

PRIORITY CLAIMED UNDER SEC. 44(D) ON FRANCE APPLICATION NO. 013103176, FILED 5-25-2001, REG. NO. 013103176, DATED 5-25-2001, EXPIRES 5-25-2011.

CLASS 1—CHEMICALS

FOR EMOLLIENT OLEO CHEMICAL ADDITIVES FOR USE IN THE MANUFACTURE OF COSMETICS, HYDRATING OLEO CHEMICAL ADDITIVES FOR USE IN THE MANUFACTURE OF COSMETICS, CHEMICAL ADDITIVES IN THE NATURE OF ANIMAL WAX SUBSTITUTES FOR USE IN THE MANUFACTURE OF COSMETICS, CHEMICAL ADDITIVES IN THE NATURE OF LANOLIN SUBSTITUTES FOR USE IN THE MANUFACTURE OF COSMETICS (U.S. CLS. 1, 5, 6, 10, 26 AND 46).

CLASS 3—COSMETICS AND CLEANING PREPARATIONS

FOR COSMETICS, ANTI-BACTERIAL SOAP, DEODORANT SOAP, MEDICATED SOAP, BODY AND FACE SKIN SOAP, TOILET SOAP, LAUNDRY DETERGENT, DISH DETERGENT MADE WITH VEGETABLE EXTRACTS, VEGETABLE OILS, ESSENTIAL OILS, EXCEPT OF PERFUME COMPOSITIONS AND COLOGNES IN THE NATURE OF VEGETABLE EXTRACTS, VEGETABLE OILS, ESSENTIAL OILS (U.S. CLS. 1, 4, 6, 50, 51 AND 52).

CLASS 5—PHARMACEUTICALS

FOR VEGETABLE EXTRACTS, VEGETABLE OILS, ESSENTIAL OILS FOR MEDICAL AND VETERINARY USE FOR USE IN THE TREATMENT OF DERMATOLOGICAL AFFECTIONS, IN THE TREATMENT OF HAIR LOSS, HAIR DRYNESS, HAIR BRITTLENESS, AND HAIR FINENESS, AND IN THE TREATMENT OF ANIMAL COAT HAIR LOSS, ANIMAL COAT HAIR DRYNESS, ANIMAL COAT HAIR BRITTLENESS, AND ANIMAL COAT HAIR FINENESS, VEGETABLE EXTRACTS INTENDED FOR SUPPLEMENTING FOOD MEDICALLY RESTRICTED DIETS (U.S. CLS. 6, 18, 44, 46, 51 AND 52).

CLASS 7—MACHINERY

FOR MACHINES AND MACHINE TOOLS, NAMELY LATHES, MILLING MACHINES AND POWER DRILLS; MACHINING CENTERS WHICH CONSIST OF LATHES, MILLING MACHINES, AND/OR POWER DRILLS; NUMERICALLY CONTROLLED MACHINING EQUIPMENT FOR CONTROLLING THE AFOREMENTIONED MACHINES; MACHINE-OPERATED TOOLS, NAMELY DRILLS, MILLING CUTTERS, TURNING TOOLS, GRINDERS; COMPONENT PARTS AND ACCESSORIES FOR THE AFOREMENTIONED MACHINES, NAMELY, MACHINE TOOL TABLES, MOTOR-DRIVEN HANDLING DEVICES FOR HANDLING TOOLS AND WORKPIECES, FIXTURES FOR CLAMPING WORKPIECES, NAMELY, METAL CLAMPS USED FOR HOLDING PIECE PARTS ON MACHINE TOOL TABLES, MOTOR-DRIVEN CONVEYORS FOR CONVEYING WORKPIECES, INDUSTRIAL ROBOTS, AND TOOLS FOR THE AFOREMENTIONED MACHINES, NAMELY TOOL CHANGERS FOR CHANGING TOOLS BETWEEN TOOL MAGAZINES AND TOOL SPINDLES, TOOL MAGAZINES CONTAINING TOOLS FOR MILLING AND DRILLING, WORKPIECE MAGAZINES, TOOL SPINDLES (U.S. CLS. 13, 19, 21, 23, 31, 34 AND 35).

CLASS 9—ELECTRICAL AND SCIENTIFIC APPARATUS

FOR ELECTRICAL AND ELECTRONIC CONTROLS USED WITH LATHES, MILLING MACHINES, AND POWER DRILLS (U.S. CLS. 21, 23, 26, 36 AND 38).

CLASS 20—FURNITURE AND ARTICLES NOT OTHERWISE CLASSIFIED

FOR WORK BENCHES FOR MILLING MACHINES, NON-METAL PALLETS CONTAINING MACHINED WORKPIECES (U.S. CLS. 2, 13, 22, 25, 32 AND 50).

SN 76-342,129. MASCHINENFABRIK BERTHOLD HERMLE AG, D-78599 GOSHEIM, FED REP GERMANY, FILED 11-28-2001.



PRIORITY CLAIMED UNDER SEC. 44(D) ON FED REP GERMANY APPLICATION NO. 30136574.1/0, FILED 6-15-2001, REG. NO. 30136574, DATED 9-21-2001, EXPIRES 6-30-2011.

CLASS 6—METAL GOODS

FOR METAL PALLETS CONTAINING MACHINED WORKPIECES (U.S. CLS. 2, 12, 13, 14, 23, 25 AND 50).

SN 76-342,130. MASCHINENFABRIK BERTHOLD HERMLE AG, D-78599 GOSHEIM, FED REP GERMANY, FILED 11-28-2001.

HERMLE

PRIORITY CLAIMED UNDER SEC. 44(D) ON FED REP GERMANY APPLICATION NO. 30136545.8/0, FILED 6-15-2001, REG. NO. 30136545, DATED 8-13-2001, EXPIRES 6-30-2011.

CLASS 6—METAL GOODS

FOR METAL PALLETS CONTAINED MACHINED WORKPIECES (U.S. CLS. 2, 12, 13, 14, 23, 25 AND 50).

CLASS 7—MACHINERY

FOR MACHINES AND MACHINE TOOLS, NAMELY LATHES, MILLING MACHINES AND POWER DRILLS; MACHINING CENTERS WHICH CONSIST OF LATHES, MILLING MACHINES, AND/OR POWER DRILLS; NUMERICALLY CONTROLLED MACHINING EQUIPMENT FOR CONTROLLING THE AFOREMENTIONED MACHINES; MACHINE-OPERATED TOOLS, NAMELY DRILLS, MILLING CUTTERS, TURNING TOOLS, GRINDERS; COMPONENT PARTS AND ACCESSORIES FOR THE AFOREMENTIONED MACHINES, NAMELY, MACHINE TOOL TABLES, MOTOR-DRIVEN HANDLING DEVICES FOR HANDLING TOOLS AND WORKPIECES, FIXTURES FOR CLAMPING WORKPIECES, NAMELY, METAL CLAMPS USED FOR HOLDING PIECE PARTS ON MACHINE TOOL TABLES, MOTOR-DRIVEN CONVEYORS FOR CONVEYING WORKPIECES, INDUSTRIAL ROBOTS, AND TOOLS FOR THE AFOREMENTIONED MACHINES, NAMELY TOOL CHANGERS FOR CHANGING TOOLS BETWEEN TOOL MAGAZINES AND TOOL SPINDLES, TOOL MAGAZINES CONTAINING TOOLS FOR MILLING AND DRILLING, WORKPIECE MAGAZINES, TOOL SPINDLES (U.S. CLS. 13, 19, 21, 23, 31, 34 AND 35).

CLASS 9—ELECTRICAL AND SCIENTIFIC APPARATUS

FOR ELECTRICAL AND ELECTRONIC CONTROLS USED WITH LATHES, MILLING MACHINES, AND POWER DRILLS (U.S. CLS. 21, 23, 26, 36 AND 38).

CLASS 20—FURNITURE AND ARTICLES NOT OTHERWISE CLASSIFIED

FOR WORK BENCHES FOR MILLING MACHINES, NON-METAL PALLETS CONTAINING MACHINED WORKPIECES (U.S. CLS. 2, 13, 22, 25, 32 AND 50).

SN 76-342,737. FISCHER, ADDISON M, NAPLES, FL. FILED 11-29-2001.



THE ENGLISH TRANSLATION OF THE WORD "LAS ALTURAS" IN THE MARK IS "THE HEIGHTS".

CLASS 25—CLOTHING

FOR CLOTHING, NAMELY, SHIRTS, SHORTS, PANTS, SWEATSHIRTS, HATS AND FOOTWEAR (U.S. CLS. 22 AND 39).

CLASS 29—MEATS AND PROCESSED FOODS

FOR DRIED AND COOKED FRUITS AND VEGETABLES, DRIED BEANS, MEATS, FISH, POULTRY AND GAME, MILK AND CHEESE (U.S. CL. 46).

CLASS 30—STAPLE FOODS

FOR COFFEE, TEA, COCOA, GRAIN AND CHICORY BASED COFFEE SUBSTITUTES, SUGAR, RICE, TAPIOCA, SAGO, FLOUR, BREAKFAST CEREALS, BREAD, BISCUITS, CAKES, PASTRIES AND CONFECTIONERY, FLAVORED ICE, HONEY, TREACLE, YEAST, BAKING POWDER, SALT, MUSTARD, VEGETABLE PEPPER, SPICE PEPPER, VINEGAR, SAUCES, SPICES AND ICE (U.S. CL. 46).

CLASS 31—NATURAL AGRICULTURAL PRODUCTS

FOR FRESH FRUITS, FRESH VEGETABLES, FRESH OR RAW BEANS, FRESH OR RAW HERBS, FRESH OR RAW MUSHROOMS, FRESH OR RAW NUTS, FRESH OR RAW GRAINS, DRIED PLANTS (U.S. CLS. 1 AND 46).

CLASS 32—LIGHT BEVERAGES

FOR MINERAL AND AERATED WATERS AND OTHER NONALCOHOLIC DRINKS, NAMELY, FRUIT DRINKS (U.S. CLS. 45, 46 AND 48).

CLASS 42—SCIENTIFIC, COMPUTER AND LEGAL SERVICES

FOR HOTEL SERVICES, NAMELY, SERVICES FOR PROVIDING FOOD, DRINK AND TEMPORARY ACCOMMODATIONS; HEALTH RESORT SERVICES, NAMELY, PROVIDING LODGING THAT SPECIALIZE IN PROMOTING PATRONS' GENERAL HEALTH AND WELL-BEING (U.S. CLS. 100 AND 101).

SN 76-342,176. THE SPORTS NETWORK INC., TORONTO, ONTARIO, CANADA, FILED 11-28-2001.

OFF THE RECORD

PRIORITY CLAIMED UNDER SEC. 44(D) ON CANADA APPLICATION NO. 1105570, FILED 6-5-2001, REG. NO. TMA576,070, DATED 2-20-2003, EXPIRES 2-20-2018.

CLASS 38—COMMUNICATION

FOR TELEVISION BROADCASTING (U.S. CLS. 100, 101 AND 104).

CLASS 41—EDUCATION AND ENTERTAINMENT

FOR TELEVISION SHOW PRODUCTION (U.S. CLS. 100, 101 AND 107).

SN 76-343,374. FABASOFT AG, A-4040 PUCHENAU, AUSTRIA, FILED 11-29-2001.

RELATIONVIEWER

OWNER OF AUSTRIA REG. NO. 192240, DATED 11-17-2000, EXPIRES 11-17-2010.

CLASS 9—ELECTRICAL AND SCIENTIFIC APPARATUS

FOR COMPUTER SOFTWARE FOR BUSINESS PROCESS MANAGEMENT AND WORKFLOW MANAGEMENT, NAMELY, AUTOMATING, SYSTEMATIZING AND STRUCTURING THE ADMINISTRATION AND MANAGEMENT OF LARGE INDUSTRIAL ENTERPRISES AND PUBLIC AUTHORITIES, TELECOMMUNICATION ENTERPRISES, AND THE SERVICES INVOLVED WITH FINANCIAL AND PLANNING SERVICES; COMPUTER SOFTWARE FOR DOCUMENT AND INFORMATION MANAGEMENT, STORAGE, ARCHIVING AND RETRIEVAL; DATA PROCESSING EQUIPMENT, NAMELY, COMPUTER HARDWARE, KEYBOARDS, MONITORS, MOUSE, PRINTERS, SCANNERS AND COMPUTER PERIPHERALS; MAGNETIC DATA CARRIERS, NAMELY, PRE-RECORDED COMPACT DISCS FOR BUSINESS PROCESS MANAGEMENT AND WORKFLOW MANAGEMENT, NAMELY, AUTOMATING, SYSTEMATIZING AND STRUCTURING THE ADMINISTRATION AND MANAGEMENT OF LARGE INDUSTRIAL ENTERPRISES AND PUBLIC AUTHORITIES, TELECOMMUNICATION ENTERPRISES, AND THE SERVICES INVOLVED WITH FINANCIAL AND PLANNING SERVICES; COMPACT DISCS AND DVDS CONTAINING SOFTWARE FOR DATA PROCESSING; COMPUTERS; COMPUTER SOFTWARE FOR USE IN DATABASE MANAGEMENT AND FOR WORD PROCESSING IN THE FIELDS OF BUSINESS PROCESS MANAGEMENT AND WORKFLOW MANAGEMENT, NAMELY, AUTOMATING, SYSTEMATIZING AND STRUCTURING THE ADMINISTRATION AND MANAGEMENT OF LARGE INDUSTRIAL ENTERPRISES AND PUBLIC AUTHORITIES, TELECOMMUNICATION ENTERPRISES, AND THE SERVICES INVOLVED WITH FINANCIAL AND PLANNING SERVICES (U.S. CLS. 21, 23, 26, 36 AND 38).

CLASS 41—EDUCATION AND ENTERTAINMENT

FOR EDUCATION SERVICES, NAMELY, CLASSES, SEMINARS, CONFERENCES AND WORKSHOPS IN THE FIELD OF COMPUTER AND SOFTWARE TRAINING, WORD AND DATA PROCESSING (U.S. CLS. 100, 101 AND 107).

CLASS 42—SCIENTIFIC, COMPUTER AND LEGAL SERVICES

FOR PROFESSIONAL CONSULTATION IN THE FIELD OF INFORMATION TECHNOLOGY; COMPUTER CONSULTATION; COMPUTER PROGRAMMING FOR OTHERS (U.S. CLS. 100 AND 101).

SN 76-343,503. MCKESSON CORPORATION, SAN FRANCISCO, CA. FILED 11-28-2001.

MCKESSON EMPOWERING HEALTHCARE

OWNER OF U.S. REG. NOS. 1,382,620, 2,231,955 AND OTHERS.

NO CLAIM IS MADE TO THE EXCLUSIVE RIGHT TO USE "HEALTHCARE", APART FROM THE MARK AS SHOWN.

CLASS 35—ADVERTISING AND BUSINESS

FOR WHOLESALE DISTRIBUTORSHIP BUSINESS MANAGEMENT CONSULTING SERVICES IN THE NATURE OF SUPPLY CHAIN SERVICES FOR THE HEALTHCARE INDUSTRY, NAMELY, MANAGING THE PROCESSES INVOLVED IN PRODUCING, ORDERING, SHIPPING, AND DISTRIBUTING PHARMACEUTICAL AND MEDICAL AND SURGICAL GOODS; BUSINESS MANAGEMENT CONSULTATION IN THE SUPPLY CHAIN FIELD IN THE NATURE OF PHARMACEUTICAL AND MEDICAL AND SURGICAL PRODUCT SELECTION AND INVENTORY CONTROL; PHARMACY MANAGEMENT SERVICES; BUSINESS MARKETING AND BUSINESS MARKETING CONSULTING SERVICES FOR PHARMACEUTICAL MANUFACTURERS (U.S. CLS. 100, 101 AND 102).

FIRST USE 7-31-2001; IN COMMERCE 7-31-2001.

CLASS 42—SCIENTIFIC, COMPUTER AND LEGAL SERVICES

FOR TECHNICAL CONSULTATION SERVICES IN THE FIELD OF PHARMACY AUTOMATION, NAMELY, CONSULTING IN THE FIELD OF EQUIPMENT USED TO AUTOMATE DISPENSING OF MEDICATION IN PHARMACIES (U.S. CLS. 100 AND 101).

FIRST USE 7-31-2002; IN COMMERCE 7-31-2002.

SN 76-345,060. HEB GROCERY COMPANY, LP, SAN ANTONIO, TX. FILED 12-4-2001.

HELPING. HERE.

NO CLAIM IS MADE TO THE EXCLUSIVE RIGHT TO USE "HELPING", APART FROM THE MARK AS SHOWN.

CLASS 36—INSURANCE AND FINANCIAL

FOR CHARITABLE FUNDRAISING; PHILANTHROPIC SERVICES CONCERNING MONETARY DONATIONS (U.S. CLS. 100, 101 AND 102).

CLASS 42—SCIENTIFIC, COMPUTER AND LEGAL SERVICES

FOR PROVIDING CHARITABLE SERVICES TO COMMUNITIES, NAMELY, EMERGENCY DISTRIBUTION OF FOOD, CLOTHING AND SUPPLIES TO VICTIMS OF DISASTER, AND ORGANIZING AND COORDINATING VOLUNTEERS FOR COMMUNITY SERVICE PROJECTS (U.S. CLS. 100 AND 101).

SN 76-349,738. CHENE DEVELOPPEMENT, 75008 PARIS, FRANCE, FILED 12-18-2001.

XTRACHENE

PRIORITY CLAIMED UNDER SEC. 44(D) ON FRANCE APPLICATION NO. 013106415, FILED 6-19-2001, REG. NO. 013106415, DATED 6-19-2001, EXPIRES 6-19-2011.

CLASS 30—STAPLE FOODS

FOR AROMATIC PREPARATIONS FOR USE IN FOOD, NAMELY, ADDITIVES FOR NON-NUTRITIONAL PURPOSES FOR USE AS WINE FLAVORING; EXTRACT USED AS FLAVORING, BEING NON-ESSENTIAL OILS (U.S. CL. 46).

CLASS 31—NATURAL AGRICULTURAL PRODUCTS

FOR WOOD SHAVINGS USED TO PROVIDE FLAVOR IN THE PRODUCTION OF WINE (U.S. CLS. 1 AND 46).

SN 76-349,800. HEIMANN SYSTEMS, 94150 RUNGIS, FRANCE, FILED 12-18-2001.

HCV**CLASS 9—ELECTRICAL AND SCIENTIFIC APPARATUS**

FOR ELECTRIC AND ELECTRONIC APPARATUS AND INSTRUMENTS FOR SECURITY AND MONITORING, NAMELY, SCANNERS FOR LETTERS, PARCELS, LUGGAGE, FREIGHT, CARGO; SCANNERS FOR DETECTING EXPLOSIVES, METALS, WEAPONS AND ORGANIC MATTER; IMAGE AMPLIFIERS, NAMELY, ELECTRONIC ZOOM LENSES; INFRARED AND ULTRAVIOLET IMAGE CONVERTERS; DETECTORS USING INFRARED RAYS FOR DETECTING HIDDEN GOODS IN PARCELS, LUGGAGE, FREIGHT CARGO; SCANNERS NOT FOR MEDICAL USE; X-RAY SCANNERS FOR INSPECTING TRUCKS AND TRANSPORT CONTAINERS; SURVEILLANCE SYSTEMS COMPRISED OF THE AFOREMENTIONED SCANNERS (U.S. CLS. 21, 23, 26, 36 AND 38).

CLASS 37—CONSTRUCTION AND REPAIR

FOR INSTALLATION, MAINTENANCE AND REPAIR OF INSPECTION, SURVEILLANCE AND SECURITY SYSTEMS COMPRISED OF SCANNERS, IMAGE AMPLIFIERS, NAMELY, ELECTRONIC ZOOM LENSES, INFRARED AND ULTRAVIOLET IMAGE CONVERTERS, DETECTORS USING INFRARED RAYS FOR DETECTING HIDDEN GOODS IN PARCELS, LUGGAGE, FREIGHT CARGO, SCANNERS NOT FOR MEDICAL USE, AND X-RAY SCANNERS FOR INSPECTING TRUCKS AND TRANSPORT CONTAINERS (U.S. CLS. 100, 103 AND 106).

CLASS 42—SCIENTIFIC, COMPUTER AND LEGAL SERVICES

FOR PRODUCT DEVELOPMENT, NAMELY, DEVELOPMENT OF INSPECTION, SURVEILLANCE AND SECURITY SYSTEMS FOR OTHERS (U.S. CLS. 100 AND 101).

SN 76-349,807. HEIMANN SYSTEMS, 94150 RUNGIS, FRANCE, FILED 12-18-2001.

HEIMANN CARGO VISION

NO CLAIM IS MADE TO THE EXCLUSIVE RIGHT TO USE "CARGO" OR "VISION", APART FROM THE MARK AS SHOWN.

CLASS 9—ELECTRICAL AND SCIENTIFIC APPARATUS

FOR ELECTRIC AND ELECTRONIC APPARATUS AND INSTRUMENTS FOR SECURITY AND MONITORING, NAMELY, SCANNERS FOR LETTERS, PARCELS, LUGGAGE, FREIGHT, CARGO; SCANNERS FOR DETECTING EXPLOSIVES, METALS, WEAPONS AND ORGANIC MATTER; IMAGE AMPLIFIERS, NAMELY, ELECTRONIC ZOOM LENSES; INFRARED AND ULTRAVIOLET IMAGE CONVERTERS; DETECTORS USING INFRARED RAYS FOR DETECTING HIDDEN GOODS IN PARCELS, LUGGAGE, FREIGHT CARGO; SCANNERS NOT FOR MEDICAL USE; X-RAY SCANNERS FOR INSPECTING TRUCKS AND TRANSPORT CONTAINERS; SURVEILLANCE SYSTEMS COMPRISED OF THE AFOREMENTIONED SCANNERS (U.S. CLS. 21, 23, 26, 36 AND 38).

CLASS 37—CONSTRUCTION AND REPAIR

FOR INSTALLATION, MAINTENANCE AND REPAIR OF INSPECTION, SURVEILLANCE AND SECURITY SYSTEMS COMPRISED OF SCANNERS, IMAGE AMPLIFIERS, NAMELY, ELECTRONIC ZOOM LENSES, INFRARED AND ULTRAVIOLET IMAGE CONVERTERS, DETECTORS USING INFRARED RAYS FOR DETECTING HIDDEN GOODS IN PARCELS, LUGGAGE, FREIGHT CARGO, SCANNERS NOT FOR MEDICAL USE, AND X-RAY SCANNERS FOR INSPECTING TRUCKS AND TRANSPORT CONTAINERS (U.S. CLS. 100, 103 AND 106).

CLASS 42—SCIENTIFIC, COMPUTER AND LEGAL SERVICES

FOR PRODUCT DEVELOPMENT, NAMELY, DEVELOPMENT OF INSPECTION, SURVEILLANCE AND SECURITY SYSTEMS FOR OTHERS (U.S. CLS. 100 AND 101).

SN 76-350,455. TAKATA KABUSHIKI KAISHA, TA TAKATA CORPORATION, TOKYO, JAPAN, FILED 12-20-2001.

TIRER

PRIORITY CLAIMED UNDER SEC. 44(D) ON JAPAN APPLICATION NO. 2001-72654, FILED 8-9-2001, REG. NO. 4610207, DATED 10-4-2002, EXPIRES 10-4-2012.

PRIORITY CLAIMED UNDER SEC. 44(D) ON JAPAN APPLICATION NO. 2001-105931, FILED 11-27-2001, REG. NO. 4573389, DATED 5-31-2002, EXPIRES 5-31-2012.

CLASS 18—LEATHER GOODS

FOR (BASE ON JAPAN REGISTRATION 4573389) FOLDING BRIEFCASES, SHOULDER BAGS, GLADSTONE BAGS, WICKER TRUNKS, BRIEFCASE-TYPE PORTFOLIOS, SUITCASES, CARRY-ON BAGS, TOTE BAGS, TRUNKS, HANDBAGS, BOSTON BAGS, SCHOOL KNAPSACKS, BACKPACKS, RUCKSACKS, PASS CARD CASES, NAME CARD CASES, CREDIT CARD CASES, CALLING CARD CASES, BUSINESS CARD CASES, LEATHER, SYNTHETIC LEATHER, MESH AND/OR TEXTILE SHOPPING BAG, SHOPPING BAGS WITH WHEELS ATTACHED, PURSES, KEY CASES, WALLET, BILLFOLDS AND CLOTH POUCHES (U.S. CLS. 1, 2, 3, 22 AND 41).

CLASS 25—CLOTHING

FOR (BASE ON JAPAN REGISTRATION 4610207) BELTS (U.S. CLS. 22 AND 39).

SN 76-350,945. HEIDELBERGER DRUCKMASCHINEN AG, 69115 HEIDELBERG, FED REP GERMANY, FILED 12-19-2001.

ZAPF ESSENTIALS

PRIORITY CLAIMED UNDER SEC. 44(D) ON FED REP GERMANY APPLICATION NO. 30142007.6/1, FILED 7-11-2001, REG. NO. 30142007, DATED 12-18-2001, EXPIRES 7-31-2011.

NO CLAIM IS MADE TO THE EXCLUSIVE RIGHT TO USE "ZAPF", APART FROM THE MARK AS SHOWN.

CLASS 9—ELECTRICAL AND SCIENTIFIC APPARATUS

FOR TYPOGRAPHICAL CHARACTERS STORED ON DATA CARRIERS; BLANK DATA CARRIERS; ELECTRONIC DATABASE OF DIGITALLY STORED TYPOGRAPHICAL CHARACTERS RECORDED ON COMPUTER MEDIA (U.S. CLS. 21, 23, 26, 36 AND 38).

CLASS 16—PAPER GOODS AND PRINTED MATTER

FOR FONTS OF TYPOGRAPHICAL CHARACTERS (U.S. CLS. 2, 5, 22, 23, 29, 37, 38 AND 50).

SN 76-351,633. CUMMINS WEST, INC., SAN LEANDRO, CA. FILED 12-21-2001.

clēaire

ADVANCED EMISSION CONTROLS

NO CLAIM IS MADE TO THE EXCLUSIVE RIGHT TO USE "ADVANCED EMISSION CONTROLS", APART FROM THE MARK AS SHOWN.

THE MARK CONSISTS OF THE WORD "CLEAIRE" IN PANTONE 660 BLUE, A WAVE-LIKE LINE IN PANTONE 660 BLUE, AND THE WORDS "ADVANCED EMISSION CONTROLS" IN PANTONE COOL GREY 9. THE COLOR IS CLAIMED AS A FEATURE OF THE MARK.

CLASS 7—MACHINERY

FOR EMISSION REDUCTION SYSTEMS FOR DIESEL ENGINES, COMPRISING CATALYTIC CONVERTERS, PARTICULATE MATTER COLLECTORS, COMBINED CATALYTIC MUFFLERS, EMISSION CONTROLS SYSTEM MONITORS, EMISSION CONTROL SYSTEM DATA LOGGERS AND EMISSION CONTROL SYSTEM CONTROLLERS; EXHAUST AFTER TREATMENT SYSTEMS FOR DIESEL ENGINES, COMPRISED OF CATALYTIC CONVERTERS, PARTICULATE FILTERS, AND HOUSING FOR THESE COMPONENTS; PARTS OF AIR POLLUTION CLEAN UP UNITS FOR ENGINES, NAMELY, NITROGEN OXIDE REDUCTION CATALYSTS, OXIDATION CATALYSTS, AND PARTICULATE FILTERS, AND COMBINED CATALYTIC MUFFLERS (U.S. CLS. 13, 19, 21, 23, 31, 34 AND 35).

FIRST USE 11-9-2001; IN COMMERCE 9-9-2002.

CLASS 9—ELECTRICAL AND SCIENTIFIC APPARATUS

FOR AUTOMATED CONTROL SYSTEMS FOR MONITORING AND CONTROLLING SYSTEMS FOR EMISSION REDUCTION IN DIESEL AND INTERNAL COMBUSTION ENGINES COMPRISING ELECTRONIC CONTROLS, REAGENT TANKS, REAGENT INJECTORS, ELECTRONIC SENSORS AND HOUSINGS FOR THESE COMPONENTS (U.S. CLS. 21, 23, 26, 36 AND 38).

FIRST USE 11-9-2001; IN COMMERCE 9-9-2002.

SN 76-351,904. TILLOTTS PHARMA AG, 4417 ZIEFEN, SWITZERLAND, FILED 12-21-2001.

TILLOTTS

PRIORITY CLAIMED UNDER SEC. 44(D) ON SWITZERLAND APPLICATION NO. 06790/2001, FILED 7-9-2001, REG. NO. 494757, DATED 7-9-2001, EXPIRES 7-9-2011.

CLASS 5—PHARMACEUTICALS

FOR PHARMACEUTICAL PREPARATIONS, NAMELY, PREPARATIONS FOR TREATING DISORDERS OF THE GASTRO-INTESTINAL TRACT (U.S. CLS. 6, 18, 44, 46, 51 AND 52).

CLASS 42—SCIENTIFIC, COMPUTER AND LEGAL SERVICES

FOR PHARMACEUTICAL DRUG DEVELOPMENT SERVICES; CONSULTING SERVICES, NAMELY, PROVIDING ASSISTANCE WITH THE REGULATORY APPROVAL PROCESS FOR DRUGS; CONSULTING SERVICES, NAMELY, PROVIDING ASSISTANCE AND ADVICE IN THE FIELD OF DRUG MANUFACTURING (U.S. CLS. 100 AND 101).

SN 76-352,183. HERITAGE BATHROOMS PLC, BRISTOL BS3 4AG, ENGLAND, FILED 12-21-2001.

AGELESS

CLASS 6—METAL GOODS

FOR ANTI-TARNISH FINISH COMPONENT OF CABINET AND DOOR METAL HARDWARE, NAMELY METAL CABINET HINGES, METAL KNOBS AND METAL PULLS, METAL TOILET SEAT HINGES, METAL TOILET HOLD DOWN NUTS, METAL TOILET FLUSH LEVERS, METAL ROBE HOOKS, METAL MIRROR ARMS AND METAL SUPPORTS (U.S. CLS. 2, 12, 13, 14, 23, 25 AND 50).

CLASS 11—ENVIRONMENTAL CONTROL APPARATUS

FOR ANTI-TARNISH FINISH COMPONENT OF PLUMBING FIXTURES AND PLUMBING FITTINGS, NAMELY FAUCETS, FAUCET HANDLES, FAUCET LEVERS, BIDET VALVES, BATHTUB DRAIN VALVES, LAVATORY DRAIN VALVES, LAVATORY POP-UPS, BATHTUB POP-UPS AND BATHTUB OVERFLOW ESCUTCHEONS, TUB SPOUTS, SHOWER HEADS, SHOWER ARMS, AND HAND HELD SHOWERS (U.S. CLS. 13, 21, 23, 31 AND 34).

CLASS 20—FURNITURE AND ARTICLES NOT OTHERWISE CLASSIFIED

FOR ANTI-TARNISH FINISH COMPONENT OF BATHROOM FURNITURE, NAMELY MIRROR FRAMES, SHELF SUPPORTS, AND SHELF RAILS (U.S. CLS. 2, 13, 22, 25, 32 AND 50).

CLASS 21—HOUSEWARES AND GLASS

FOR BATH ACCESSORIES, NAMELY TOWEL BARS, TOWEL RINGS, TOILET ROLL HOLDERS, SOAP DISHES, TOOTHBRUSH HOLDERS, TUMBLER HOLDERS (U.S. CLS. 2, 13, 23, 29, 30, 33, 40 AND 50).

SN 76-352,373. NATIONAL PETCARE CENTERS, INC., FORT COLLINS, CO. FILED 12-26-2001.



CLASS 35—ADVERTISING AND BUSINESS

FOR RETAIL VETERINARY PHARMACY SERVICES; RETAIL STORE SERVICES FEATURING PET PRODUCTS AND VETERINARY PHARMACEUTICAL PRODUCTS; BUSINESS MANAGEMENT SERVICES, BUSINESS OPERATIONS MANAGEMENT SERVICES, MARKETING AND ACCOUNTING SERVICES, ALL IN THE FIELD OF VETERINARY MANAGEMENT SERVICES (U.S. CLS. 100, 101 AND 102).

CLASS 36—INSURANCE AND FINANCIAL

FOR TRAINING SERVICES IN THE FIELD OF PET OBEDIENCE AND BEHAVIOR (U.S. CLS. 100, 101 AND 102).

CLASS 44—MEDICAL, BEAUTY AND AGRICULTURAL SERVICES

FOR VETERINARY SERVICES; PET GROOMING AND PET BOARDING SERVICES; CONSULTING SERVICES IN THE FIELD OF PET CARE; INFORMATION SERVICES IN THE FIELD OF PET CARE (U.S. CLS. 100 AND 101).

SN 76-352,519. CUMMINS WEST, INC., SAN LEANDRO, CA. FILED 12-21-2001.

CLÉAIRE ADVANCED EMISSION CONTROLS

NO CLAIM IS MADE TO THE EXCLUSIVE RIGHT TO USE "ADVANCED EMISSION CONTROLS", APART FROM THE MARK AS SHOWN.

CLASS 7—MACHINERY

FOR EMISSION REDUCTION SYSTEMS FOR DIESEL ENGINES, COMPRISING CATALYTIC CONVERTERS, PARTICULATE MATTER COLLECTORS, COMBINED CATALYTIC MUFFLERS, EMISSION CONTROLS SYSTEM MONITORS, EMISSION CONTROL SYSTEM DATA LOGGERS AND EMISSION CONTROL SYSTEM CONTROLLERS; EXHAUST AFTER TREATMENT SYSTEMS FOR DIESEL ENGINES, COMPRISED OF CATALYTIC CONVERTERS, PARTICULATE FILTERS, AND HOUSINGS FOR THESE COMPONENTS; PARTS OF AIR POLLUTION CLEAN UP UNITS FOR ENGINES, NAMELY, NITROGEN OXIDE REDUCTION CATALYSTS, OXIDATION CATALYSTS, AND PARTICULATE FILTERS, AND COMBINED CATALYTIC MUFFLERS (U.S. CLS. 13, 19, 21, 23, 31, 34 AND 35).

FIRST USE 11-9-2001; IN COMMERCE 9-9-2002.

CLASS 9—ELECTRICAL AND SCIENTIFIC APPARATUS

FOR AUTOMATED CONTROL SYSTEMS FOR MONITORING AND CONTROLLING SYSTEMS FOR EMISSION REDUCTION IN DIESEL AND INTERNAL COMBUSTION ENGINES COMPRISING ELECTRONIC CONTROLS, REAGENT TANKS, REAGENT INJECTORS, ELECTRONIC SENSORS AND HOUSINGS FOR THESE COMPONENTS (U.S. CLS. 21, 23, 26, 36 AND 38).

FIRST USE 11-9-2001; IN COMMERCE 9-9-2002.

SN 76-352,720. NATIONAL PETCARE CENTERS, INC., FORT COLLINS, CO. FILED 12-26-2001.



CLASS 35—ADVERTISING AND BUSINESS

FOR RETAIL VETERINARY PHARMACY SERVICES; RETAIL STORE SERVICES FEATURING PET PRODUCTS AND VETERINARY PHARMACEUTICAL PRODUCTS; BUSINESS MANAGEMENT SERVICES, BUSINESS OPERATIONS MANAGEMENT SERVICES, MARKETING AND ACCOUNTING SERVICES, ALL IN THE FIELD OF VETERINARY MANAGEMENT SERVICES (U.S. CLS. 100, 101 AND 102).

CLASS 36—INSURANCE AND FINANCIAL

FOR TRAINING SERVICES IN THE FIELD OF PET OBEDIENCE AND BEHAVIOR (U.S. CLS. 100, 101 AND 102).

CLASS 44—MEDICAL, BEAUTY AND AGRICULTURAL SERVICES

FOR VETERINARY SERVICES; PET GROOMING AND PET BOARDING SERVICES; CONSULTING SERVICES IN THE FIELD OF PET CARE; INFORMATION SERVICES IN THE FIELD OF PET CARE (U.S. CLS. 100 AND 101).

SN 76-353,549. UNITED STATES POSTAL SERVICE, WASHINGTON, DC. FILED 12-26-2001.



OWNER OF U.S. REG. NOS. 2,132,892, 2,295,478 AND OTHERS.

THE MARK CONSISTS, IN PART, OF THE STYLIZED HEAD OF AN EAGLE INSIDE A STAR.

SEC. 2(F) AS TO "UNITED STATES POSTAL INSPECTION SERVICE".

CLASS 35—ADVERTISING AND BUSINESS

FOR CONDUCTING BUSINESS INVESTIGATIONS FOR FRAUD, WASTE, AND CRIMINAL ACTIVITY (U.S. CLS. 100, 101 AND 102).

FIRST USE 6-0-1997; IN COMMERCE 6-0-1997.

CLASS 42—SCIENTIFIC, COMPUTER AND LEGAL SERVICES

FOR POLICE PROTECTION SERVICES, NAMELY, PROTECTION OF POSTAL EMPLOYEES, REAL AND PERSONAL PROPERTY; RESEARCH AND CONSULTING FOR OTHERS IN THE FIELD OF CRIMINAL ACTIVITY (U.S. CLS. 100 AND 101).

FIRST USE 6-0-1997; IN COMMERCE 6-0-1997.

SN 76-354,577. JFC INTERNATIONAL INC, SOUTH SAN FRANCISCO, CA. FILED 1-4-2002.

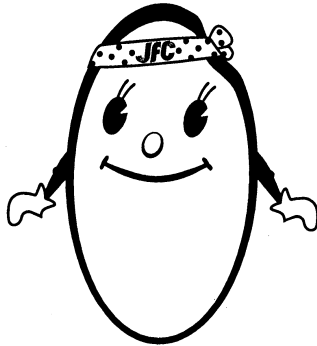

OWNER OF U.S. REG. NOS. 1,220,203 AND 2,172,204. THE CUTIE CHARACTER IS INTENDED TO REPRESENT A FRIENDLY GRAIN OF RICE.

CLASS 29—MEATS AND PROCESSED FOODS

FOR MEAT; FISH; POULTRY; GAME; FROZEN MEAT; FROZEN FISH; FROZEN POULTRY; FROZEN GAME; CANNED MEAT; CANNED FISH; CANNED POULTRY; CANNED GAME; CHONG-SAUSAGE; CHICKEN STOCK; NOT LIVE, EDIBLE BABY CLAMS AND OYSTERS; PROCESSED, EDIBLE SEAWEED; IMITATION CRAB MEAT; FROZEN IMITATION CRAB MEAT; FISH CAKES; FROZEN FISH CAKES; FRIED FISH CAKES; DRIED SQUID; BEEF JERKY; MEAT EXTRACTS; PRESERVED, DRIED AND COOKED FRUITS AND VEGETABLES; PICKLED FRUITS; PICKLED VEGETABLES; DRIED MUSHROOMS; DRIED FISH; DRIED SEAFOOD; DRIED BEANS; DRIED, EDIBLE SEAWEED; CANNED BEANS; CANNED FRUITS; CANNED VEGETABLES; SEAFOOD; FROZEN SEAFOOD; CANNED SEAFOOD; PROCESSED BEANS; PROCESSED MUNG BEANS; PROCESSED RED BEANS; DRIED SOYBEAN; FROZEN SOYBEAN; SOYBEAN MILK; SOYBEAN PASTE; BLACK, DRIED SOYBEAN; BLACK, PROCESSED AND EDIBLE SESAME SEEDS; CANNED CHINESE STIR-FRY VEGETABLES; CANNED, EDIBLE BAMBOO SHOOTS; CANNED WATER CHESTNUTS; CANNED MUSHROOMS; JELLIES; JAMS; FRUIT SAUCES; EDIBLE OILS AND FATS; SESAME OIL; CHILI OIL; CHINESE STIR-FRY OIL; SESAME CHILI OIL; HOT CHILI OIL; VEGETABLE OIL; COTTON SEED OIL; PROCESSED NUTS; BOILED GINGKO NUTS; CANNED AND DRIED LYCHEE NUTS; SOUP BROTH OR MIXES AND PREPARATION FOR MAKING SOUP; SOUPS; TOFU; MILK; POTATO CRISPS; POTATO YAM CAKES; PREPARED WHITE MELON WITH SAKE-LEES; BEAN CURD; ALIMENTARY PASTES; EDIBLE, PROCESSED BAMBOO SHOOTS; FRUIT AND SOY BASED SNACK FOOD; POTATO-BASED SNACK FOODS; PROTEIN BASED, NUTRIENT-DENSE SNACK BARS; SNACK FOOD DIPS; SNACK MIX CONSISTING PRIMARILY OF PROCESSED FRUITS, PROCESSED NUTS AND/OR RAISINS; POTATO CHIPS; PROCESSED SESAME SEEDS CONSISTING PRIMARILY OF BATTER MIXES; POTATO CRISPS; DRY SHRIMP CRISPS; VEGETABLE CRISPS; PROCESSED, EDIBLE SESAME SEEDS (U.S. CL. 46).

CLASS 30—STAPLE FOODS

FOR DRIED CHILI PEPPERS; PREPARED HORSE-RADISHES; CANNED CURRY; CANNED NOODLES; CANNED BABY SWEET CORN; GRANOLA-BASED SNACK BARS; CEREAL BASED SNACK FOOD; PUFFED CORN SNACKS; RICE-BASED SNACK FOODS; SNACK MIX CONSISTING PRIMARILY OF CRACKERS, PRETZELS, CANDIED NUTS AND/OR POPPED POPCORN; WHEAT-BASED SNACK FOODS; NACHO AND TORTILLA CHIPS; COFFEE; TEA; SUGAR; RICE; COFFEE SUBSTITUTES, NAMELY, ARTIFICIAL COFFEE; GINSENG TEA; GREEN TEA; JASMINE TEA; OOLONG TEA; CANNED TEA; COCOA; TAPIOCA; SAGO; SWEET RICE; SHORT GRAIN RICE; MEDIUM GRAIN RICE; LONG GRAIN RICE; FLOUR; RICE FLOUR; SOYBEAN FLOUR; SOY CRACKERS; PROCESSED CEREALS; BREAD; PASTRY; FROZEN CONFECTIONS; CANDIES; CAKES; CRACKERS; BISCUITS; COOKIES; PASTRIES; PUDDINGS; RICE CRACKERS; PRESSED WHEAT; PRESSED WHEAT CAKES; BREAD; BREAD CRUMBS; MIXES FOR BAKERY GOODS, NAMELY, BATTER MIX FOR BAKERY GOODS AND TEMPURA BATTER MIX FOR BAKERY GOODS; FOOD STARCH; CRUSHED OR HUSKED BARLEY; PROCESSED BARLEY MEAL; SOYBEAN PASTE; RICE VINEGAR; PASTA, NOODLE, WANTON AND EGG ROLL BASED GOODS, NAMELY, EGG ROLL SKINS, GYOZA SKINS, SHU MAI SKINS, WONTON SKINS, WONTON WITH CHICKEN DUMPLING, WONTON WITH PORK DUMPLING, ALMOND COOKIES; SUGAR GINGER; CANDY; NOODLES; DRIED NOODLES; FRESH NOODLES; WET NOODLES; SAIFUN NOODLES; MAIFUN NOODLES; CHOW MEIN NOODLES; CHOW FUNN NOODLES; MOLASSES; MUSTARD; VINEGAR; SAUCES; CONDIMENTS, NAMELY, KETCHUP, MUSTARD AND RELISH; TABLE SYRUPS; ORIENTAL STYLE SAUCES; HOISIN SAUCES; PLUM SAUCES; OYSTER SAUCES; SWEET AND SOUR SAUCES; CHINESE BARBECUE SAUCES; SZECHWAN CHILI SAUCES; THAI PEANUT SATAY SAUCES; BLACK BEAN SAUCES; CHINESE STIR-FRY SAUCES; GOLDEN PLUM SAUCES; ORIENTAL MARINADE SAUCES; ORIENTAL SALAD DRESSING SAUCES;

KUNG PAO SAUCES; CHINESE DUCK SAUCES; SOY SAUCES; SPICES; SEASONING MIXES; CURRY SAUCES; CHINESE WONTON SEASONING MIX; POT-STICKER SEASONING MIX; BEEF AND BROCCOLI SEASONING MIX; FRIED RICE SEASONING MIX; HOT AND SPICY SEASONING MIX; STIR-FRY SEASONING MIX; SWEET AND SOUR SEASONING MIX; CHAR SIU SEASONING MIX; CHOP SUEY SEASONING MIX; CHOW MEIN SEASONING MIX (U.S. CL. 46).

CLASS 21—HOUSEWARES AND GLASS

FOR [BASED ON SECTION 44(E) AND 1(B)] NON ELECTRIC HOUSEHOLD UTENSILS, NAMELY SPATULAS, STRAINERS, GRATERS, BUTTER DISH COVERS, CHEESE-DISH COVERS, TRIVETS, MANUALLY OPERABLE FRUIT PRESSES FOR HOUSEHOLD PURPOSES, COOKERY MOLDS; CONTAINERS FOR HOUSEHOLD OR KITCHEN USE, NOT MADE OF PRECIOUS METAL; UNWROUGHT GLASS, EXCEPT GLASS USED IN BUILDING; BEVERAGE GLASSWARE; PORCELAIN AND EARTHENWARE, NAMELY, MUGS, JARS FOR JAMS AND JELLIES, TABLE PLATES NOT OF PRECIOUS METAL, CUPS NOT OF PRECIOUS METAL, SOUP BOWLS NOT OF PRECIOUS METAL, SALAD BOWLS NOT OF PRECIOUS METAL, SALT CELLARS NOT OF PRECIOUS METAL, BUTTER DISHES NOT OF PRECIOUS METAL, SOUP HOLDERS, FLOWER POTS, NON-METAL PIGGY BANKS; NON ELECTRIC CANDLABRAS NOT OF PRECIOUS METAL; FLOWER POT COVERS NOT MADE OF PAPER; FIGURINES OF PORCELAIN, GLASS OR TERRA COTTA; VASES NOT OF PRECIOUS METAL; TABLEWARE OTHER THAN KNIVES, FORKS AND SPOONS, NAMELY, BUTTER DISHES, SERVING DISHES, PLATES, AND SUGAR BOWLS NOT OF PRECIOUS METAL; DRINKING GLASSES; FLASKS; DOOR-HANDLES OF PORCELAIN; BOWLS, VASES AND JUGS MADE OF POTTERY (U.S. CLS. 2, 13, 23, 29, 30, 33, 40 AND 50).

SN 76-355,495. CHAMBRE SYNDICALE DES CERAMISTES ET ATELIERS D'ARTS DE FRANCE, 75017 PARIS, FRANCE, FILED 1-7-2002.



PRIORITY CLAIMED UNDER SEC. 44(D) ON FRANCE APPLICATION NO. 013124063, FILED 10-3-2001, REG. NO. 013124063, DATED 10-3-2001, EXPIRES 10-3-2011.

NO CLAIM IS MADE TO THE EXCLUSIVE RIGHT TO USE "CREATEDINFRANCE.COM", APART FROM THE MARK AS SHOWN.

THE MARK CONSISTS OF THREE OVERLAPPING SQUARES ABOVE THE WORDING "CREATEDINFRANCE.COM". THE SQUARE ON THE RIGHT SIDE WITH A WHITE PARTIAL VASE OUTLINE IS PURPLE, THE SQUARE ON THE LEFT SIDE WITH A WHITE PARTIAL CHAIR OUTLINE IS GOLD, AND THE CENTER SQUARE WITH A WHITE BRANCH AND LEAF OUTLINE IS GREEN. ALL LETTERING IN THE MARK IS PURPLE. COLOR IS CLAIMED AS A FEATURE OF THE MARK.

CLASS 16—PAPER GOODS AND PRINTED MATTER

FOR [BASED ON SECTION 44(E) AND 1(B)] PRINTED MATTER, NAMELY LEAFLETS, PROSPECTUS, PAMPHLETS, FLYERS, NEWSPAPERS, PERIODICALS, MAGAZINES, BOOKS, ENCYCLOPAEDIAS, GUIDES, BROCHURES, CATALOGS IN THE FIELDS OF FASHION, ART, POTTERY, AND EARTHENWARE (U.S. CLS. 2, 5, 22, 23, 29, 37, 38 AND 50).

CLASS 35—ADVERTISING AND BUSINESS

FOR [BASED ON SECTION 1(B) ALONE] ORGANIZATION OF EXHIBITIONS FOR COMMERCIAL OR ADVERTISING PURPOSES, IN THE FIELDS OF CERAMICS, POTTERY, CHINA, AND EARTHENWARE; BUSINESS MANAGEMENT FOR PERFORMING ARTISTS; IMPORT-EXPORT AGENCIES; DISSEMINATION OF ADVERTISING MATTER; SHOW WINDOW DRESSING AND DISPLAY ARRANGEMENT SERVICES; DIRECT MAIL ADVERTISING, FEATURING TRACTS, PROSPECTUS, PRINTED MATTER AND SAMPLES; AUCTIONEERING; ARRANGING AND CONDUCTING TRADE SHOWS IN THE FIELDS OF CERAMICS, CHINAS, POTTERIES, EARTHENWARE, AND ARTS; COMMERCIAL AND INDUSTRIAL MANAGEMENT ASSISTANCE; CONDUCTING BUSINESS AND MARKETING RESEARCH SURVEYS; BUSINESS ORGANIZATION CONSULTATION; ADVERTISING AGENCIES, NAMELY, PROMOTING THE SERVICES OF EARTHENWARE FACTORIES, POTTERIES, AND CERAMISTS THROUGH THE DISTRIBUTION OF PRINTED AND AUDIO PROMOTIONAL MATERIAL AND BY RENDERING SALES PROMOTION ADVICE; PUBLICATION OF PUBLICITY TEXTS; PUBLIC RELATIONS (U.S. CLS. 100, 101 AND 102).

CLASS 38—COMMUNICATION

FOR [BASED ON SECTION 44(E) AND 1(B)] TELECOMMUNICATION SERVICES, NAMELY, LOCAL AND LONG-DISTANCE TRANSMISSION OF VOICE, DATA, AND GRAPHICS, BY MEANS OF TELEPHONES, TELEGRAPHS, CABLE AND SATELLITE TRANSMISSION; PROVIDING TELECOMMUNICATIONS INFORMATION; PROVIDING TELECOMMUNICATION CONSULTATION (U.S. CLS. 100, 101 AND 104).

SN 76-357,194. LA GIARA S.P.A., 88071 CIRO (CROTONE), ITALY, FILED 1-10-2002.

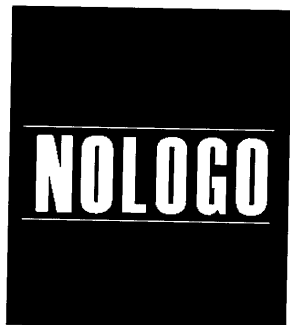

PRIORITY CLAIMED UNDER SEC. 44(D) ON ITALY APPLICATION NO. 2295095, FILED 7-10-2001, REG. NO. 2295095, DATED 10-2-2002, EXPIRES 7-10-2011.

CLASS 29—MEATS AND PROCESSED FOODS

FOR MEAT; FISH; POULTRY AND GAME; MEAT EXTRACTS; PRESERVED, DRIED AND COOKED FRUITS AND VEGETABLES; JELLIES; JAMS; FRUIT SAUCES; EGGS; MILK; EDIBLE OILS AND FATS (U.S. CL. 46).

CLASS 30—STAPLE FOODS

FOR COFFEE; TEA; COCOA; SUGAR; RICE; TAPIOCA; SAGO; ARTIFICIAL COFFEE; FLOURS AND PREPARATIONS MADE FROM CEREALS, NAMELY, BREAD, PASTRIES; HONEY, TREACLE; YEAST, BAKING-POWDER; SALT, MUSTARD; VINEGAR; SAUCES; SPICES; ICE (U.S. CL. 46).

CLASS 33—WINES AND SPIRITS

FOR WINE AND ALCOHOLIC BEVERAGES, EXCEPT BEER, NAMELY, RED WINE, WHITE WINE, COO KING SHERRY, SPIRITS, CORDIALS, WHISKEY, VODKA, RUM AND GIN (U.S. CLS. 47 AND 49).

SN 76-358,345. INFLATABLE IMAGE TECHNOLOGIES, PTY. LIMITED, SYDNEY, AUSTRALIA, FILED 1-15-2002.



Unique Inflatable Technologies

NO CLAIM IS MADE TO THE EXCLUSIVE RIGHT TO USE "AIR", "UNIQUE INFLATABLE TECHNOLOGIES" AND "USA", APART FROM THE MARK AS SHOWN.

CLASS 19—NON-METALLIC BUILDING MATERIALS

FOR INFLATABLE STRUCTURES, NAMELY, PORTABLE NON-METAL BUILDINGS IN THE NATURE OF INFLATABLE PORTABLE PROTECTIVE ENCLOSURES (U.S. CLS. 1, 12, 33 AND 50).

FIRST USE 12-30-2001; IN COMMERCE 5-26-2002.

CLASS 20—FURNITURE AND ARTICLES NOT OTHERWISE CLASSIFIED

FOR INFLATABLE PUBLICITY OBJECTS (U.S. CLS. 2, 13, 22, 25, 32 AND 50).

FIRST USE 12-30-2001; IN COMMERCE 5-26-2002.

CLASS 22—CORDAGE AND FIBERS

FOR INFLATABLE STRUCTURES IN THE NATURE OF INFLATABLE TENTS AND ORNATE TENTS, NAMELY, PAVILIONS (U.S. CLS. 1, 2, 7, 19, 22, 42 AND 50).

FIRST USE 12-30-2001; IN COMMERCE 5-26-2002.

SN 76-359,518. VENABLE, BAETJER AND HOWARD, L.L.P., BALTIMORE, MD. FILED 1-17-2002.

VALUE ADDED, VALUES DRIVEN

CLASS 35—ADVERTISING AND BUSINESS

FOR POLITICAL LOBBYING SERVICES IN THE FIELDS OF ADMINISTRATIVE LAWS AND REGULATIONS, ADMIRALTY AND MARITIME LAWS AND REGULATIONS, ANTITRUST LAWS AND REGULATIONS, LAWS AND REGULATIONS AFFECTING APPELLATE PRACTICE, BANKING LAWS AND REGULATIONS, BANKRUPTCY AND CREDITOR'S RIGHTS LAWS AND REGULATIONS, BUSINESS LAWS AND REGULATIONS, LAWS AND REGULATIONS AFFECTING CIVIL TRIAL PRACTICE, COMMUNICATIONS LAWS AND REGULATIONS, CONSUMER FINANCIAL SERVICES LAWS AND REGULATIONS, CONSTRUCTION LAWS AND REGULATIONS, LAWS AND REGULATIONS AFFECTING CORPORATIONS, CORPORATE FINANCE AND SECURITIES LAWS AND REGULATIONS, ELECTRONIC MARKETING AND DISTRIBUTION LAWS AND REGULATIONS, EMPLOYEE BENEFITS LAWS AND REGULATIONS, ENVIRONMENTAL LAWS AND REGULATIONS, ESTATES AND TRUSTS LAWS AND REGULATIONS, GOVERNMENT CONTRACTS LAWS AND REGULATIONS, HEALTH CARE LAWS AND REGULATIONS, HEALTH SERVICES LAWS AND REGULATIONS, IMMIGRATION LAWS AND REGULATIONS, LAWS AND REGULATIONS AFFECTING INFORMATION LAW, INSURANCE LAWS AND REGULATIONS, INTELLECTUAL PROPERTY LAWS AND REGULATIONS, INTERNATIONAL LAWS AND REGULATIONS, LABOR AND EMPLOYMENT LAWS AND REGULATIONS, LITIGATION LAWS AND REGULATIONS, LAWS AND REGULATIONS AFFECTING CIVIL LAW, LAWS AND REGULATIONS AFFECTING COMMERCIAL LAW, LAWS AND REGULATIONS AFFECTING CRIMINAL LAW, NATURAL RESOURCES LAWS AND REGULATIONS, PRODUCTS LIABILITY LAWS AND REGULATIONS, PUBLIC FINANCE LAWS AND REGULATIONS, REAL ESTATE LAWS AND REGULATIONS, TAXATION LAWS AND REGULATIONS, LAWS AND REGULATIONS AFFECTING TAX CONTROVERSIES LITIGATION, TECHNOLOGY LAWS AND REGULATIONS, TRANSPORTATION LAWS AND REGULATIONS, HOSPITALITY LAWS AND REGULATIONS, TERRORISM LIABILITY INSURANCE LAWS AND REGULATIONS, LAWS AND REGULATIONS AFFECTING FOREIGN GOVERNMENTS, HOUSING FINANCE LAWS AND REGULATIONS, MEDICAL RESEARCH LAWS AND REGULATIONS, NATIVE AMERICAN AFFAIRS LAWS AND REGULATIONS, HOMELAND SECURITY

LAWS AND REGULATIONS, EDUCATION LAWS AND REGULATIONS, AND APPROPRIATIONS LAWS AND REGULATIONS (U.S. CLS. 100, 101 AND 102).

CLASS 42—SCIENTIFIC, COMPUTER AND LEGAL SERVICES

FOR LEGAL SERVICES (U.S. CLS. 100 AND 101).

SN 76-359,645. DAIMLERCHRYSLER AG, 70567 STUTTGART, FED REP GERMANY, FILED 1-16-2002.

SLK 350

PRIORITY CLAIMED UNDER SEC. 44(D) ON FED REP GERMANY APPLICATION NO. 30143749.1/1, FILED 7-18-2001, REG. NO. 30143749, DATED 8-21-2001, EXPIRES 7-31-2011.

OWNER OF U.S. REG. NOS. 2,230,053, 2,238,159 AND OTHERS.

NO CLAIM IS MADE TO THE EXCLUSIVE RIGHT TO USE "350", APART FROM THE MARK AS SHOWN.

CLASS 12—VEHICLES

FOR AUTOMOBILES AND STRUCTURAL PARTS THEREOF (U.S. CLS. 19, 21, 23, 31, 35 AND 44).

CLASS 28—TOYS AND SPORTING GOODS

FOR TOY MODEL AUTOMOBILES (U.S. CLS. 22, 23, 38 AND 50).

CLASS 37—CONSTRUCTION AND REPAIR

FOR REPAIR AND MAINTENANCE OF AUTOMOBILES (U.S. CLS. 100, 103 AND 106).

SN 76-359,971. PULL-A-PART, INC., NORCROSS, GA. FILED 1-9-2002.



PULL-A-PART

THE STIPPLING IS FOR SHADING PURPOSES ONLY, AND IS NOT INTENDED TO INDICATE COLOR.

THE MARK CONSISTS OF, IN PART, OF THE WORDS, "PULL-A-PART", THE FANCIFUL DESIGN OF A WOMAN HOLDING TOOLS AND VEHICLE PARTS, AND MISCELLANEOUS DESIGN. THE COLOR RED APPEARS ON THE CLOTHING, SHOES, BELT, NECKBAND, HEADBAND,

AND LIPS OF THE WOMAN. THE COLOR PINK APPEARS ON THE FACE, HAND AND LEGS OF THE WOMAN. THE COLOR BEIGE APPEARS ON THE SKIN OF THE WOMAN. THE COLOR BROWN APPEARS ON THE WOMAN'S HAIR. THE COLOR YELLOW APPEARS ON THE WOMAN'S CLOTHING. THE COLOR BLUE APPEARS ON THE TOOLS, AUTOMOBILE PARTS, THE BELT BUCKLE AND SHOES OF THE WOMAN. THE COLOR GREEN APPEARS ON THE WOMAN'S EYES. THE COLOR BLACK APPEARS ON THE TOOLS AND AUTOMOBILE PARTS.

CLASS 35—ADVERTISING AND BUSINESS

FOR RETAIL STORE SERVICES AND DISTRIBUTORSHIP IN THE FIELD OF NEW AND USED AUTOMOBILE PARTS (U.S. CLS. 100, 101 AND 102).

FIRST USE 1-31-2001; IN COMMERCE 1-31-2001.

CLASS 39—TRANSPORTATION AND STORAGE

FOR PURCHASING USED AUTOMOBILES, NAMELY, AUTOMOBILE SALVAGE SERVICES (U.S. CLS. 100 AND 105).

FIRST USE 1-31-2001; IN COMMERCE 1-31-2001.

SN 76-362,102. ALTUS BIOLOGICS, INC., CAMBRIDGE, MA. FILED 1-23-2002.

ALTUS PHARMACEUTICALS

OWNER OF U.S. REG. NO. 2,416,022 AND OTHERS.

NO CLAIM IS MADE TO THE EXCLUSIVE RIGHT TO USE "PHARMACEUTICALS", APART FROM THE MARK AS SHOWN.

CLASS 1—CHEMICALS

FOR PROTEINS AND CHEMICALS, NAMELY, ANTIBODIES, ENZYMES, ENZYME PREPARATIONS, GLYCOPROTEINS, HORMONES AND PEPTIDES FOR GENERAL INDUSTRIAL AND MANUFACTURING USE AND FOR SCIENTIFIC, MEDICAL RESEARCH, AND AGRICULTURAL PURPOSES (U.S. CLS. 1, 5, 6, 10, 26 AND 46).

CLASS 5—PHARMACEUTICALS

FOR PROTEINS AND CHEMICALS, NAMELY, ANTIBODIES, ENZYMES, ENZYME PREPARATIONS, GLYCOPROTEINS, HORMONES AND PEPTIDES FOR MEDICAL AND VETERINARY CLINICAL AND DIAGNOSTIC USE; AND PROTEINS AND CHEMICALS, NAMELY ANTIBODIES, ENZYMES, ENZYME PREPARATIONS, GLYCOPROTEINS, HORMONES AND PEPTIDES FOR MEDICAL AND THERAPEUTIC USE IN THE TREATMENT OF INFECTIOUS AND PARASITIC DISEASES, NEOPLASMS, ENDOCRINE DISEASES, NUTRITIONAL DEFICIENCIES, METABOLIC DISEASES AND DISORDERS, GASTROINTESTINAL DISEASES AND DISORDERS, IMMUNITY DISORDERS, DISEASES OF THE BLOOD AND BLOOD-FORMING ORGANS, DISEASES AND DISORDERS OF THE CIRCULATORY SYSTEM, DISEASES AND DISORDERS OF THE RESPIRATORY SYSTEM, DISEASES AND DISORDERS OF THE DIGESTIVE SYSTEM, DISEASES AND DISORDERS OF THE GENITOURINARY SYSTEM, DISEASES AND CONDITIONS OF THE SKIN AND SUBCUTANEOUS TISSUE, DISEASES AND DISORDERS OF THE MUSCULOSKELETAL SYSTEM AND CONNECTIVE TISSUE, CONGENITAL ANOMALIES, INJURIES, AND POISONING, IN HUMANS, LIVESTOCK, DOMESTIC PETS, AND EXOTIC ANIMALS (U.S. CLS. 6, 18, 44, 46, 51 AND 52).

CLASS 10—MEDICAL APPARATUS

FOR HOUSE MARK FOR MEDICAL DEVICES, MEDICAL APPARATUS AND DRUG DELIVERY DEVICES (U.S. CLS. 26, 39 AND 44).

CLASS 40—MATERIAL TREATMENT

FOR CUSTOM MANUFACTURE AND MODIFICATION OF PROTEINS AND CHEMICALS AND ENZYME PREPARATIONS FOR OTHERS FOR GENERAL INDUSTRIAL AND MANUFACTURING USE, MEDICAL AND VETERINARY CLINICAL, DIAGNOSTIC AND THERAPEUTIC USE, AND FOR USE IN SCIENTIFIC FIELDS, THE MEDICAL FIELD, AND THE FOOD, PHARMACEUTICAL AND AGRICULTURAL INDUSTRIES (U.S. CLS. 100, 103 AND 106).

CLASS 42—SCIENTIFIC, COMPUTER AND LEGAL SERVICES

FOR PHARMACEUTICAL DRUG RESEARCH, DESIGN, AND DEVELOPMENT SERVICES FOR OTHERS; RESEARCH, DESIGN, DEVELOPMENT, AND TESTING OF PROTEINS, CHEMICALS AND ENZYME PREPARATIONS FOR OTHERS; PROVIDING TECHNICAL ADVICE AND CONSULTATION SERVICES IN THE FIELD OF CHEMISTRY (U.S. CLS. 100 AND 101).

SN 76-362,201. ALTUS BIOLOGICS, INC., CAMBRIDGE, MA. FILED 1-23-2002.

ALTUS

OWNER OF U.S. REG. NO. 2,416,022 AND OTHERS.

CLASS 1—CHEMICALS

FOR PROTEINS AND CHEMICALS, NAMELY, ANTIBODIES, ENZYMES, GLYCOPROTEINS, HORMONES AND PEPTIDES FOR GENERAL INDUSTRIAL AND MANUFACTURING USE AND FOR SCIENTIFIC, MEDICAL RESEARCH, AND AGRICULTURAL PURPOSES (U.S. CLS. 1, 5, 6, 10, 26 AND 46).

CLASS 5—PHARMACEUTICALS

FOR PROTEINS AND CHEMICALS, NAMELY, ANTIBODIES, ENZYMES, GLYCOPROTEINS, HORMONES AND PEPTIDES FOR MEDICAL AND VETERINARY CLINICAL AND DIAGNOSTIC USE; AND PROTEINS AND CHEMICALS, NAMELY ANTIBODIES, ENZYMES, GLYCOPROTEINS, HORMONES AND PEPTIDES FOR MEDICAL AND THERAPEUTIC USE IN THE TREATMENT OF INFECTIOUS AND PARASITIC DISEASES, NEOPLASMS, ENDOCRINE DISEASES, NUTRITIONAL DEFICIENCIES, METABOLIC DISEASES AND DISORDERS, GASTROINTESTINAL DISEASES AND DISORDERS, IMMUNITY DISORDERS, DISEASES OF THE BLOOD AND BLOOD-FORMING ORGANS, DISEASES AND DISORDERS OF THE CIRCULATORY SYSTEM, DISEASES AND DISORDERS OF THE RESPIRATORY SYSTEM, DISEASES AND DISORDERS OF THE DIGESTIVE SYSTEM, DISEASES AND DISORDERS OF THE GENITOURINARY SYSTEM, DISEASES AND CONDITIONS OF THE SKIN AND SUBCUTANEOUS TISSUE, DISEASES AND DISORDERS OF THE MUSCULOSKELETAL SYSTEM AND CONNECTIVE TISSUE, CONGENITAL ANOMALIES, INJURIES, AND POISONING, IN HUMANS, LIVESTOCK, DOMESTIC PETS, AND EXOTIC ANIMALS (U.S. CLS. 6, 18, 44, 46, 51 AND 52).

CLASS 10—MEDICAL APPARATUS

FOR HOUSE MARK FOR MEDICAL DEVICES, MEDICAL APPARATUS AND DRUG DELIVERY DEVICES (U.S. CLS. 26, 39 AND 44).

CLASS 40—MATERIAL TREATMENT

FOR CUSTOM MANUFACTURE AND MODIFICATION OF PROTEINS AND CHEMICALS FOR OTHERS FOR GENERAL INDUSTRIAL AND MANUFACTURING USE, MEDICAL AND VETERINARY CLINICAL, DIAGNOSTIC AND THERAPEUTIC USE, AND FOR USE IN SCIENTIFIC FIELDS, THE MEDICAL FIELD, AND THE FOOD, PHARMACEUTICAL AND AGRICULTURAL INDUSTRIES (U.S. CLS. 100, 103 AND 106).

CLASS 42—SCIENTIFIC, COMPUTER AND LEGAL SERVICES

FOR PHARMACEUTICAL DRUG RESEARCH, DESIGN, AND DEVELOPMENT SERVICES FOR OTHERS; RESEARCH, DESIGN, DEVELOPMENT, AND TESTING OF PROTEINS AND CHEMICALS FOR OTHERS; PROVIDING TECHNICAL ADVICE AND CONSULTATION SERVICES IN THE FIELD OF CHEMISTRY (U.S. CLS. 100 AND 101).

SN 76-362,876. KABUSHIKI KAISHA SEGA. DBA SEGA CORPORATION, OHTA-KU, TOKYO 144-0043, JAPAN, AND KABUSHIKI KAISHA HITMAKER, DBA HITMAKER CO., LTD., OHTA-KU, TOKYO 144-0033, JAPAN, FILED 1-25-2002.

THE MAZE OF THE KINGS

PRIORITY CLAIMED UNDER SEC. 44(D) ON JAPAN APPLICATION NO. 2001-107546, FILED 12-3-2001, REG. NO. 4642467, DATED 1-31-2003, EXPIRES 1-31-2013.

CLASS 9—ELECTRICAL AND SCIENTIFIC APPARATUS

FOR VIDEO GAME SOFTWARE; COMPUTER GAME PROGRAMS; COMPUTER GAME DISCS; VIDEO COMPUTER GAME PROGRAMS; HOME VIDEO COMPUTER GAME DISCS; GAME DISCS AND CIRCUIT BOARDS CONTAINING GAME PROGRAMS FOR USE WITH HAND-HELD OR ARCADE VIDEO GAME MACHINES WITH BUILT-IN SCREENS (U.S. CLS. 21, 23, 26, 36 AND 38).

CLASS 28—TOYS AND SPORTING GOODS

FOR HAND-HELD VIDEO GAME MACHINES; STAND ALONE VIDEO GAME MACHINES; ARCADE GAME MACHINES WITH BUILT-IN SCREENS (U.S. CLS. 22, 23, 38 AND 50).

CLASS 41—EDUCATION AND ENTERTAINMENT

FOR PROVIDING RECREATION FACILITIES, AMUSEMENT CENTERS, AMUSEMENT ARCADES AND AMUSEMENT PARKS (U.S. CLS. 100, 101 AND 107).

SN 76-365,604. ZIAJA LTD. ZAKLAD PRODUKCJI LEKOW SPOLKA Z O.O., GDANSK-MATAMIA, POLAND, FILED 2-1-2002.

MINTPERFEKT

PRIORITY CLAIMED UNDER SEC. 44(D) ON POLAND APPLICATION NO. 239628, FILED 8-14-2001.

CLASS 3—COSMETICS AND CLEANING PREPARATIONS

FOR CLEANING PREPARATIONS, NAMELY, BODY SOAPS, LIQUID BODY SOAPS, TOILET SOAP, DISINFECTANT SOAPS, BATH SOAP, BATH FOAM, SHOWER GEL; DEODORANTS FOR PERSONAL USE, ANTIPERSPIRANTS; NON-MEDICATED DENTIFRICES, NAMELY, TOOTH GEL, TOOTH PASTE, TOOTH POLISH, TOOTH POWDERS, NON-MEDICATED MOUTHWASH AND RINSE, NON-MEDICATED BREATH FRESHENER, DENTURE CLEANERS, DENTURE CLEANING PREPARATIONS; PRE-MOISTENED COSMETIC TISSUES, PRE-MOISTENED COSMETIC TOWELETTES, PRE-MOISTENED COSMETIC WIPES (U.S. CLS. 1, 4, 6, 50, 51 AND 52).

FIRST USE 0-0-1999; IN COMMERCE 0-0-2001.

CLASS 5—PHARMACEUTICALS

FOR MEDICATED SKIN CARE PREPARATIONS, NAMELY, CREAMS, BALMS, TONIC LOTIONS, MASKS, MILKS, GELS; SANITARY PRODUCTS, NAMELY, SANITARY SPRAYS; MEDICATED DENTIFRICES, NAMELY, MEDICATED TOOTH GELS, MEDICATED TOOTH PASTE, MEDICATED MOUTHWASH, MEDICATED BREATH FRESHENER, DENTAL BLEACHING GELS, DENTAL RINSE, DENTAL POLISH; MEDICATED PRE-MOISTENED TISSUES, MEDICATED PRE-MOISTENED TOWELETTES, MEDICATED PRE-MOISTENED COSMETIC WIPES (U.S. CLS. 6, 18, 44, 46, 51 AND 52).

FIRST USE 0-0-1999; IN COMMERCE 0-0-2001.

SN 76-365,779. ADM KAO LLC, DECATUR, IL. FILED 2-4-2002.

ENOVA**CLASS 1—CHEMICALS**

FOR CHEMICAL ADDITIVES FOR USE IN THE MANUFACTURE OF FOOD, BEVERAGES AND DIETARY SUPPLEMENTS (U.S. CLS. 1, 5, 6, 10, 26 AND 46).

CLASS 29—MEATS AND PROCESSED FOODS

FOR COOKING OILS AND FATS; EDIBLE OILS AND FATS; EDIBLE OILS AND FATS FOR USE AS INGREDIENTS IN THE MANUFACTURE OF BEVERAGES AND FOODS, NAMELY, SOUPS, MAYONNAISE, DRESSINGS, SNACK FOOD DIPS, SPREADS, ICINGS, FROSTINGS, SAUCES, FROZEN MEALS CONSISTING PRIMARILY OF MEAT, FISH, POULTRY OR VEGETABLES; POTATO CHIPS; POTATO CRACKERS; POTATO-BASED SNACK FOODS; AND PROTEIN-BASED, NUTRIENT DENSE SNACK BARS; RICE AND CORN-BASED SNACK CHIPS, CRACKERS AND SNACK FOODS; BREADS, PASTRIES, COOKIES; FROZEN MEALS CONSISTING PRIMARILY OF PASTA OR RICE; FROZEN PIZZAS; AND CANDIES AND CANDY BARS (U.S. CL. 46).

SN 76-366,421. ALTUS BIOLOGICS, INC., CAMBRIDGE, MA. FILED 2-1-2002.

ALTUS BIOLOGICS

OWNER OF U.S. REG. NO. 2,416,022 AND OTHERS. NO CLAIM IS MADE TO THE EXCLUSIVE RIGHT TO USE "BIOLOGICS", APART FROM THE MARK AS SHOWN.

CLASS 1—CHEMICALS

FOR PROTEINS AND CHEMICALS, NAMELY, ANTIBODIES, ENZYMES, ENZYME PREPARATIONS, GLYCOPROTEINS, HORMONES AND PEPTIDES FOR GENERAL INDUSTRIAL AND MANUFACTURING USE AND FOR SCIENTIFIC, MEDICAL RESEARCH, AND AGRICULTURAL PURPOSES (U.S. CLS. 1, 5, 6, 10, 26 AND 46).

CLASS 5—PHARMACEUTICALS

FOR PROTEINS AND CHEMICALS, NAMELY, ANTIBODIES, ENZYMES, ENZYME PREPARATIONS, GLYCOPROTEINS, HORMONES AND PEPTIDES FOR MEDICAL AND THERAPEUTIC USE IN THE TREATMENT OF INFECTIOUS AND PARASITIC DISEASES, NEOPLASMS, ENDOCRINE DISEASES, NUTRITIONAL DEFICIENCIES, METABOLIC DISEASES AND DISORDERS, GASTROINTESTINAL DISEASES AND DISORDERS, IMMUNITY DISORDERS, DISEASES OF THE BLOOD AND BLOOD-FORMING ORGANS, DISEASES AND DISORDERS OF THE CIRCULATORY SYSTEM, DISEASES AND DISORDERS OF THE RESPIRATORY SYSTEM, DISEASES AND DISORDERS OF THE DIGESTIVE SYSTEM, DISEASES AND DISORDERS OF THE GENITOURINARY SYSTEM, DISEASES AND CONDITIONS OF THE SKIN AND SUBCUTANEOUS TISSUE, DISEASES AND DISORDERS OF THE MUSCULOSKELETAL SYSTEM AND CONNECTIVE TISSUE, CONGENITAL ANOMALIES, INJURIES, AND POISONING, IN HUMANS, LIVESTOCK, DOMESTIC PETS, AND EXOTIC ANIMALS (U.S. CLS. 6, 18, 44, 46, 51 AND 52).

CLASS 10—MEDICAL APPARATUS

FOR HOUSE MARK FOR MEDICAL DEVICES, MEDICAL APPARATUS AND DRUG DELIVERY DEVICES (U.S. CLS. 26, 39 AND 44).

CLASS 40—MATERIAL TREATMENT

FOR CUSTOM MANUFACTURE AND MODIFICATION OF PROTEINS AND CHEMICALS AND ENZYME PREPARATIONS FOR OTHERS FOR GENERAL INDUSTRIAL AND MANUFACTURING USE, MEDICAL AND VETERINARY CLINICAL, DIAGNOSTIC AND THERAPEUTIC USE, AND FOR USE IN SCIENTIFIC FIELDS, THE MEDICAL FIELD, AND THE FOOD, PHARMACEUTICAL AND AGRICULTURAL INDUSTRIES (U.S. CLS. 100, 103 AND 106).

CLASS 42—SCIENTIFIC, COMPUTER AND LEGAL SERVICES

FOR PHARMACEUTICAL DRUG RESEARCH, DESIGN, AND DEVELOPMENT SERVICES FOR OTHERS; RESEARCH, DESIGN, DEVELOPMENT, AND TESTING OF PROTEINS, CHEMICALS AND ENZYME PREPARATIONS FOR OTHERS; PROVIDING TECHNICAL ADVICE AND CONSULTATION SERVICES IN THE FIELD OF CHEMISTRY (U.S. CLS. 100 AND 101).

SN 76-367,145. PAC TEAM S.A., 1052 LE MONT SUR LAUSANNE, SWITZERLAND, BY ASSIGNMENT BORLE, ALAIN, 1009 PULLY, SWITZERLAND, FILED 2-6-2002.

PAC TEAM**CLASS 40—MATERIAL TREATMENT**

FOR CUSTOM CONSTRUCTION OF RETAIL POINT OF SALE DISPLAYS FOR WATCHES AND JEWELRY (U.S. CLS. 100, 103 AND 106).

CLASS 42—SCIENTIFIC, COMPUTER AND LEGAL SERVICES

FOR CUSTOM DESIGN FOR OTHERS OF RETAIL POINT OF SALE DISPLAYS FOR WATCHES AND JEWELRY (U.S. CLS. 100 AND 101).

SN 76-367,190. NATIONAL COLLEGIATE ATHLETIC ASSOCIATION, INDIANAPOLIS, IN. FILED 2-5-2002.

FINAL FOUR FRIDAY

OWNER OF U.S. REG. NOS. 1,488,836, 1,786,019 AND 2,377,720.

CLASS 35—ADVERTISING AND BUSINESS

FOR PRODUCTION AND DISTRIBUTION OF MULTI MEDIA PROJECTS, NAMELY, COMMERCIAL AND ADVERTISING SPOTS, AND PREPARING AUDIO AND VIDEO PRESENTATIONS FOR USE IN ADVERTISING (U.S. CLS. 100, 101 AND 102).

CLASS 41—EDUCATION AND ENTERTAINMENT

FOR ENTERTAINMENT SERVICES IN THE NATURE OF ATHLETIC CONTESTS, GAMES, TOURNAMENTS, EXHIBITIONS AND EVENTS AT THE COLLEGE LEVEL; PROVIDING LIVE ATHLETIC CONTESTS, GAMES, TOURNAMENTS AND EXHIBITIONS; PRODUCTION OF RADIO, TELEVISION, AND GLOBAL COMPUTER COMMUNICATIONS PROGRAMS AND NETWORK BROADCAST PROGRAMS FEATURING NEWS HIGHLIGHTS, ATHLETIC CONTESTS, GAMES, TOURNAMENTS, EXHIBITIONS AND EVENTS AT THE COLLEGE LEVEL; DISTRIBUTION OF RADIO, TELEVISION, AND GLOBAL COMPUTER COMMUNICATIONS PROGRAMS AND NETWORK BROADCAST PROGRAMS FOR OTHERS FEATURING NEWS HIGHLIGHTS, ATHLETIC CONTESTS, GAMES, TOURNAMENTS, EXHIBITIONS AND EVENTS AT THE COLLEGE LEVEL; PRODUCTION OF MULTI MEDIA PROJECTS, NAMELY, RADIO AND TELEVISION PRESENTATIONS, PRESENTATIONS FOR DISTRIBUTION OVER GLOBAL COMPUTER NETWORKS AND WIRELESS COMMUNICATION SYSTEMS, AND CONSUMER-TARGETED VIDEO DISCS AND VIDEO CASSETTES; DISTRIBUTION OF MULTI MEDIA PROJECTS, NAMELY, AUDIO AND VIDEO PRESENTATIONS, RADIO AND TELEVISION PRESENTATIONS, PRESENTATIONS FOR DISTRIBUTION OVER GLOBAL COMPUTER NETWORKS, AND WIRELESS COMMUNICATION SYSTEMS AND CONSUMER-TARGETED VIDEO DISKS AND VIDEO CASSETTES FOR OTHERS (U.S. CLS. 100, 101 AND 107).

SN 76-367,566. PPG INDUSTRIES OHIO, INC., CLEVELAND, OH. FILED 2-6-2002.

POWERX**CLASS 1—CHEMICALS**

FOR OXIDIZING CHEMICALS FOR INDUSTRIAL USE IN TREATING WASTEWATER, PROCESS WATER AND COATINGS AND CHEMICAL ANALYSIS TEST KITS FOR USE THEREWITH, COMPOSED OF CHEMICAL TEST STRIPS TO MEASURE FREE AND TOTAL CHLORINE, BACTERIA AND FUNGUS LEVELS (U.S. CLS. 1, 5, 6, 10, 26 AND 46).

CLASS 11—ENVIRONMENTAL CONTROL APPARATUS

FOR PLASTIC BUOYANT UNITS FOR DISPENSING OXIDIZING AND CHLORINATING CHEMICALS FOR INDUSTRIAL USE IN TREATING WASTEWATER, PROCESS WATER AND COATINGS (U.S. CLS. 13, 21, 23, 31 AND 34).

SN 76-367,678. PPG INDUSTRIES OHIO, INC., CLEVELAND, OH. FILED 2-6-2002.

CLASS 1—CHEMICALS

FOR OXIDIZING CHEMICALS FOR INDUSTRIAL USE IN TREATING WASTEWATER, PROCESS WATER AND COATINGS AND CHEMICAL ANALYSIS TEST KITS FOR USE THEREWITH, COMPOSED OF CHEMICAL TEST STRIPS TO MEASURE FREE AND TOTAL CHLORINE, BACTERIA AND FUNGUS LEVELS (U.S. CLS. 1, 5, 6, 10, 26 AND 46).

CLASS 11—ENVIRONMENTAL CONTROL APPARATUS

FOR PLASTIC BUOYANT UNITS FOR DISPENSING OXIDIZING AND CHLORINATING CHEMICALS FOR INDUSTRIAL USE IN TREATING WASTEWATER, PROCESS WATER AND COATINGS (U.S. CLS. 13, 21, 23, 31 AND 34).

SN 76-367,981. SMARTPOOL INC., LAKEWOOD, NJ. FILED 2-7-2002.

SOLARTRON**CLASS 3—COSMETICS AND CLEANING PREPARATIONS**

FOR CHEMICALS FOR CLEANING SWIMMING POOLS (U.S. CLS. 1, 4, 6, 50, 51 AND 52).

CLASS 9—ELECTRICAL AND SCIENTIFIC APPARATUS

FOR SWIMMING POOL APPARATUS FOR MONITORING AND DISPENSING THE RELEASE OF CHEMICALS INTO SWIMMING POOL WATER (U.S. CLS. 21, 23, 26, 36 AND 38).

SN 76-371,212. ROSSI INDUSTRIES S.R.L., VENEZIA, ITALY,
FILED 2-14-2002.

SN 76-374,704. SUSS MICROTEC AG, D-GARCHING 85748,
FED REP GERMANY, FILED 2-22-2002.



PRIORITY CLAIMED UNDER SEC. 44(D) ON ITALY
APPLICATION NO. PD2002C00003, FILED 1-30-2002, REG.
NO. 862924, DATED 12-4-2002, EXPIRES 1-30-2022.

CLASS 9—ELECTRICAL AND SCIENTIFIC APPARATUS

FOR OPTICAL APPARATUS AND INSTRUMENTS, NAMELY SPECTACLES AND SUNGLASSES; FRAMES, CASES, HINGES TEMPLES AND LENSES FOR SPECTACLES AND SUNGLASSES AND PARTS AND ACCESSORIES THEREOF; EYESHADES, SKI-GOGGLES, PROTECTIVE HELMETS AND PROTECTIVE GOGGLES NAMELY SAFETY GOGGLES AND SPORTS GOGGLES FOR USE IN CYCLING, MOTOR-SPORTS, WATER-SPORTS, SNOW AND WINTER SPORTS, AND PARTS AND ACCESSORIES THEREOF; BEING ALL OF THE AFORE MENTIONED PRODUCTS FOR LEISURE AND SPORT; BINOCULARS AND CONTAINERS THEREFOR (U.S. CLS. 21, 23, 26, 36 AND 38).

CLASS 18—LEATHER GOODS

FOR LEATHER AND IMITATIONS OF LEATHER SOLD IN BULK; GOODS MADE OF LEATHER AND IMITATION OF LEATHER, NAMELY CASES, KEY CASES, POCKETBOOKS, WALLETS AND PURSES; ANIMAL SKINS, HIDES, TRUNKS AND BAGS, HANDBAGS AND TRAVELING BAGS, SPORTS BAGS, UMBRELLAS, PARASOLS, AND WALKING STICKS, AND PARTS OF THE AFORESAID GOODS; WHIPS, ANIMAL HARNESSSES, AND SADDLERY (U.S. CLS. 1, 2, 3, 22 AND 41).

CLASS 25—CLOTHING

FOR CLOTHING ARTICLES FOR LEISURE AND SPORT, NAMELY, SHIRTS, T-SHIRTS, SHORTS, PANTS, SWEATSHIRTS, SWEATPANTS, TANK TOPS, SWEATERS, VESTS, JACKETS, SOCKS STOCKINGS, BANDANAS, SUSPENDERS, GLOVES, BATHROBES, SWIMSUITS, JERSEYS, UNDERWEAR, OVERALLS, SKIRTS, JEANS, TROUSERS, COATS, RAINCOATS, LEOTARDS, AND BELTS; FOOTWEAR FOR LEISURE AND SPORTS, NAMELY SHOES, SANDALS, BOOTS, SPORT SHOES; AND HEADWEAR FOR LEISURE AND SPORTS, NAMELY HATS, VISORS AND CAPS (U.S. CLS. 22 AND 39).



PRIORITY CLAIMED UNDER SEC. 44(D) ON FED REP GERMANY APPLICATION NO. 30151317.1/0, FILED 8-24-2001, REG. NO. 30151317, DATED 1-30-2002, EXPIRES 8-31-2011.

COLOR APPEARS IN THE MARK AS FOLLOWS: THE LETTERS AND PLUS SIGN ARE BLUE, AND THE BOX ENCOMPASSING THE LETTERS "SUSS" IS ORANGE, THERE BEING NO BLACK IN THE MARK.

THE ENGLISH TRANSLATION OF THE WORD "SUSS" IN THE MARK IS "SWEET".

CLASS 7—MACHINERY

FOR MACHINES FOR THE PRODUCTION, PROCESSING AND TESTING OF ELECTRONIC, MICROMECHANICAL AND OPTICAL COMPONENTS (U.S. CLS. 13, 19, 21, 23, 31, 34 AND 35).

CLASS 9—ELECTRICAL AND SCIENTIFIC APPARATUS

FOR OPTICAL, ELECTRIC AND ELECTRONIC EQUIPMENT FOR THE PRODUCTION, PROCESSING AND TESTING OF ELECTRONIC, MICROMECHANICAL AND OPTOMECHANICAL COMPONENTS AND IN PARTICULAR SEMI-CONDUCTORS AND MICRO-MECHANICAL COMPONENTS IN THE NATURE OF MASK ADJUSTING DEVICES, WAFER SAMPLERS, BONDERS, COATERS, AND INTERLINKED SYSTEMS, NAMELY, MASK ALIGNERS COMPRISING EYEPIECES OR DUAL VIDEO, MICROSCOPES AND MONITORS, LITHOGRAPHY CLUSTERS COMPRISING MASK ALIGNER MODULES LINKED TO A SPIN-COATING APPARATUS DESIGNED FOR WAFER BUMPING AND WAFER LEVEL PACKAGING, BONDERS COMPRISING CENTRE PUSH-INS, DISPOSABLE AND EXCHANGEABLE PLATES, ELECTRODES, MONITORS; CLEANERS, COMPRISING MEGASONIC NOZZLES AND OPTICAL-CHEMICAL CLEANERS, CHUCKS, INFRA-RED LIGHT SOURCES, CCD CAMERA; WAFER MOUNTING APPARATUS, COMPRISING PROCESS MODULES WHICH CAN BE USED FOR PROCESSES SUCH AS PRE-CLEANING, ADHESIVE COATING, HEATING, WAFER MOUNTING, COOLING AND FINAL CLEANING; PROBED APPARATUS EQUIPPED WITH A LASER CUTTER OR EMISSION MICROSCOPES AND WORKING WITH SOFTWARE; TEST DEVICES FOR OPTO-ELECTRONICS COMPRISING SPECIAL FIBER POSITIONING APPARATUS, INTEGRATING SPHERES, CHUCK FIXTURES FOR LASER BAR HANDLING, GRAPHICAL USER INTERFACES, PHYSICAL SENSORS, ACCELEROMETERS AND MICROPHONES, SOFTWARE AND FLEXIBLE TOOLS FOR PATTERN RECOGNITION (U.S. CLS. 21, 23, 26, 36 AND 38).

CLASS 37—CONSTRUCTION AND REPAIR

FOR INSTALLATION, REPAIR AND MAINTENANCE OF THE MACHINES FOR THE PRODUCTION, PROCESSING AND TESTING OF ELECTRONIC, MICROMECHANICAL AND OPTICAL COMPONENTS, AND OF THE OPTICAL, ELECTRICAL AND ELECTRONIC EQUIPMENT FOR THE PRODUCTION, PROCESSING AND TESTING OF ELECTRONIC, MICROMECHANICAL AND OPTOMECHANICAL COMPONENTS AND, IN PARTICULAR, SEMI-CONDUCTORS AND MICRO-MECHANICAL COMPONENTS IN THE NATURE OF MASK ADJUSTING DEVICES, WAFER SAMPLERS, BONDERS, COATERS, AND INTERLINKED SYSTEMS, NAMELY, MASK ALIGNERS COMPRISING EYEPIECES OR DUAL VIDEO, MICROSCOPES AND MONITORS, LITHOGRAPHY CLUSTERS COMPRISING MASK ALIGNER MODULES LINKED TO A SPIN-COATING

APPARATUS DESIGNED FOR WAFER BUMPING AND WAFER LEVEL PACKAGING, BONDERS COMPRISING CENTRE PUSH-INS, DISPOSABLE AND EXCHANGEABLE PLATES, ELECTRODES, MONITORS; CLEANERS, COMPRISING MEGASONIC NOZZLES AND OPTICAL-CHEMICAL CLEANERS, CHUCKS, INFRA-RED LIGHT SOURCES, CCD CAMERA; WAFER MOUNTING APPARATUS, COMPRISING PROCESS MODULES WHICH CAN BE USED FOR PROCESSES SUCH AS PRE-CLEANING, ADHESIVE COATING, HEATING, WAFER MOUNTING, COOLING AND FINAL CLEANING; PROBED APPARATUS EQUIPPED WITH A LASER CUTTER OR EMISSION MICROSCOPES AND WORKING WITH SOFTWARE; TEST DEVICES FOR OPTOELECTRONICS COMPRISING SPECIAL FIBER POSITIONING APPARATUS, INTEGRATING SPHERES, CHUCK FIXTURES FOR LASER BAR HANDLING, GRAPHICAL USER INTERFACES, PHYSICAL SENSORS, ACCELEROMETERS AND MICROPHONES, SOFTWARE AND FLEXIBLE TOOLS FOR PATTERN RECOGNITION; INSTALLATION, MAINTENANCE, UPGRADING, REPAIR OF GOODS IN THE FIELD OF MICROT TECHNOLOGY (U.S. CLS. 100, 103 AND 106).

SN 76-376,136. INFRA SOURCE INCORPORATED, MORTON, PA. FILED 2-25-2002.

EMPOWERING THE PEOPLE WHO POWER THE WORLD

CLASS 42—SCIENTIFIC, COMPUTER AND LEGAL SERVICES

FOR TECHNICAL SUPPORT SERVICES, NAMELY DEVELOPMENT OF NEW TECHNOLOGY FOR OTHERS IN THE FIELD OF MICROT TECHNOLOGY; DESIGN AND TESTING FOR NEW PRODUCT DEVELOPMENT (U.S. CLS. 100 AND 101).

CLASS 35—ADVERTISING AND BUSINESS

FOR BUILDING CONTRACT ADMINISTRATION FOR OTHERS; PROCUREMENT SERVICES, NAMELY PURCHASING CONSTRUCTION MATERIALS FOR OTHERS; BUSINESS RECORDS MAINTENANCE; OPERATING TELEPHONE CALL CENTERS FOR OTHERS (U.S. CLS. 100, 101 AND 102).

CLASS 36—INSURANCE AND FINANCIAL

FOR RIGHT-OF-WAY ACQUISITIONS; PROCURING SITE LOCATIONS FOR PUBLIC UTILITY AND TELECOMMUNICATION FACILITIES; TITLE TRANSFER AND RECORDING IN CONNECTION WITH THE DESIGN AND CONSTRUCTION OF UTILITY AND TELECOMMUNICATION FACILITIES (U.S. CLS. 100, 101 AND 102).

CLASS 37—CONSTRUCTION AND REPAIR

FOR CONSTRUCTION SERVICES IN THE FIELD OF PUBLIC UTILITY AND TELECOMMUNICATION FACILITIES, NAMELY, PLANNING, LAYING OUT, CUSTOM CONSTRUCTION, RENOVATION, INSTALLATION, MAINTENANCE, AND REPAIR OF PUBLIC UTILITY AND TELECOMMUNICATION FACILITIES, BUILDING, ROADS, STREETS, PAVEMENTS, DUCTS, MANHOLES, UTILITY LINES, UTILITY EQUIPMENT, ELECTRIC LINES, ELECTRICAL EQUIPMENT, GAS LINES, OUTDOOR LIGHTING, WATER LINES, SEWER LINES, PIPELINES, CABLE LINES, TELEPHONE LINES, TELECOMMUNICATION LINES, TELECOMMUNICATION EQUIPMENT AND TELECOMMUNICATION TOWERS, GAS AND ELECTRIC METERS, TELEPHONE AND TELECOMMUNICATION CALL CENTERS; EARTH MOVING AND EXCAVATION; DIGGING OF TRENCHES; BORING DRILLING AND PLOWING OF EARTH; INSTALLATION OF BRIDGES AND RIVER CROSSINGS; AND REAL ESTATE DEVELOPMENT (U.S. CLS. 100, 103 AND 106).

CLASS 38—COMMUNICATION

FOR TELECOMMUNICATION SERVICES, NAMELY, OPERATING TELEPHONE CALL CENTERS FOR OTHERS (U.S. CLS. 100, 101 AND 104).

SN 76-375,906. FATHAMMER OY, 00100 HELSINKI, FINLAND, FILED 2-27-2002.

X-FORGE

OWNER OF ERPN CMNTY TM OFC REG. NO. 002232288, DATED 9-25-2002, EXPIRES 5-25-2011.

CLASS 9—ELECTRICAL AND SCIENTIFIC APPARATUS

FOR COMPUTER GAME PROGRAMS; COMPUTER GAME PROGRAMS FOR USE IN MOBILE DEVICES; COMPUTER GAME PROGRAMS EMBEDDED IN MOBILE DEVICES (U.S. CLS. 21, 23, 26, 36 AND 38).

CLASS 38—COMMUNICATION

FOR MOBILE TELEPHONE COMMUNICATION SERVICES; PROVIDING MULTIPLE-USER ACCESS TO GLOBAL COMPUTER INFORMATION NETWORKS (U.S. CLS. 100, 101 AND 104).

CLASS 42—SCIENTIFIC, COMPUTER AND LEGAL SERVICES

FOR COMPUTER PROGRAMMING FOR MOBILE ENTERTAINMENT; COMPUTER GAME PROGRAMMING; DEVELOPMENT, DESIGN AND UPDATING OF COMPUTER GAME PROGRAMS (U.S. CLS. 100 AND 101).

CLASS 42—SCIENTIFIC, COMPUTER AND LEGAL SERVICES

FOR DESIGN FOR OTHERS IN THE FIELD OF PUBLIC UTILITY AND TELECOMMUNICATION FACILITIES, ENGINEERING SERVICES, AND CONDUCTING FEASIBILITY STUDIES AND ENVIRONMENTAL IMPACT ASSESSMENTS FOR OTHERS, ALL IN CONNECTION WITH UTILITY AND TELECOMMUNICATION FACILITIES; AND UTILITY METER READING SERVICES (U.S. CLS. 100 AND 101).

SN 76-376,618. COMMONWEALTH OF PENNSYLVANIA, ACTING THROUGH THE PENNSYLVANIA DEPARTMENT OF TRANSPORTATION, HARRISBURG, PA. FILED 2-27-2002.

SN 76-377,385. GODDESS NETWORK, INC., THE, TROY, MI. FILED 2-28-2002.



THE LINING IS NOT A FEATURE OF THE MARK, BUT WAS MERELY TO INDICATE SHADING.

CLASS 14—JEWELRY

FOR JEWELRY, NAMELY, LAPEL PINS (U.S. CLS. 2, 27, 28 AND 50).
FIRST USE 3-9-2001; IN COMMERCE 3-9-2001.

CLASS 16—PAPER GOODS AND PRINTED MATTER

FOR PROMOTIONAL NOVELTY ITEMS, NAMELY, ADVERTISING SPECIALTIES IN THE NATURE OF OFFICE SUPPLIES, NAMELY, PENS, PENCILS, STICKERS, AND PAPER NAPKINS (U.S. CLS. 2, 5, 22, 23, 29, 37, 38 AND 50).
FIRST USE 3-9-2001; IN COMMERCE 3-9-2001.

CLASS 18—LEATHER GOODS

FOR PROMOTIONAL AND NOVELTY ITEMS, NAMELY, LUGGAGE TAGS (U.S. CLS. 1, 2, 3, 22 AND 41).
FIRST USE 3-9-2001; IN COMMERCE 3-9-2001.

CLASS 20—FURNITURE AND ARTICLES NOT OTHERWISE CLASSIFIED

FOR PROMOTIONAL AND NOVELTY ITEMS, NAMELY, NON-METAL KEY CHAINS AND BANDAGE HOLDERS (U.S. CLS. 2, 13, 22, 25, 32 AND 50).
FIRST USE 3-9-2001; IN COMMERCE 3-9-2001.

CLASS 25—CLOTHING

FOR WEARING APPAREL, NAMELY, HATS AND SHIRTS (U.S. CLS. 22 AND 39).
FIRST USE 3-9-2001; IN COMMERCE 3-9-2001.

CLASS 26—FANCY GOODS

FOR PROMOTIONAL AND NOVELTY ITEMS, NAMELY, CLOTH PATCHES FOR CLOTHING (U.S. CLS. 37, 39, 40, 42 AND 50).
FIRST USE 3-9-2001; IN COMMERCE 3-9-2001.

CLASS 28—TOYS AND SPORTING GOODS

FOR PROMOTIONAL AND NOVELTY ITEMS, NAMELY, TOYS, NAMELY, MINIATURE HARD HATS (U.S. CLS. 22, 23, 38 AND 50).
FIRST USE 3-9-2001; IN COMMERCE 3-9-2001.



THE STIPPLING IS A FEATURE OF THE MARK AND DOES NOT INDICATE COLOR.

CLASS 9—ELECTRICAL AND SCIENTIFIC APPARATUS

FOR COMPUTER SHAREWARE FOR USE WITH SIMULATION GAMES THAT WILL BE PLAYED ON THE INTERNET; INTERACTIVE VIDEO GAME PROGRAMS (U.S. CLS. 21, 23, 26, 36 AND 38).

CLASS 28—TOYS AND SPORTING GOODS

FOR BOARD GAMES AND ROLE-PLAYING GAMES IN THE FIELD OF SELF-ACTUALIZATION OF WOMEN IN THE WORKPLACE (U.S. CLS. 22, 23, 38 AND 50).

CLASS 38—COMMUNICATION

FOR ONLINE FORUMS AND CHAT ROOMS IN THE FIELD OF SELF-ACTUALIZATION OF WOMEN IN THE WORKPLACE VIA A WORLDWIDE NETWORK (U.S. CLS. 100, 101 AND 104).

CLASS 41—EDUCATION AND ENTERTAINMENT

FOR EDUCATIONAL SERVICES, NAMELY CONDUCTING SEMINARS, CONFERENCES, RETREATS IN THE FIELD OF SOUL DEVELOPMENT, CORPORATE SPIRITUALITY AND SELF-ACTUALIZATION; PROVIDING SEMINARS IN THE FIELD OF SELF-ACTUALIZATION OF WOMEN IN THE WORKPLACE (U.S. CLS. 100, 101 AND 107).

CLASS 45—PERSONAL SERVICES

FOR PROVIDING INFORMATION IN THE FIELD OF SELF-ACTUALIZATION OF WOMEN IN THE WORKPLACE (U.S. CLS. 100 AND 101).

SN 76-378,294. MWH-METALLWERK HELMSTADT GMBH, D-74921 HELMSTADT-BARGEN, FED REP GERMANY, FILED 3-1-2002.

SN 76-379,879. TO SERVE MAN, INC., DALLAS, TX. FILED 3-7-2002.



PRIORITY CLAIMED UNDER SEC. 44(D) ON FED REP GERMANY APPLICATION NO. 30153282.6., FILED 9-5-2001, REG. NO. 30153282.6, DATED 12-4-2001, EXPIRES 9-30-2011.

NO CLAIM IS MADE TO THE EXCLUSIVE RIGHT TO USE "GARDEN", APART FROM THE MARK AS SHOWN.

THE MARK CONSISTS OF THE STYLIZED WORDING "ROYAL GARDEN" IN AN OVAL DESIGN WITH THE DESIGN OF THE CROWN PLACED ABOVE THE WORDING "ROYAL GARDEN". THE DESIGN OF THE CROWN IS CENTERED HALF-WAY IN THE OVAL DESIGN, WHILE THE TOP HALF IS ABOVE THE OVAL DESIGN.

CLASS 20—FURNITURE AND ARTICLES NOT OTHERWISE CLASSIFIED

FOR FURNITURE, NAMELY GARDEN AND OUTDOOR FURNITURE; PILLOWS AND MATTRESSES FOR USE WITH OUTDOOR SEATS AND LOUNGERS (U.S. CLS. 2, 13, 22, 25, 32 AND 50).

CLASS 24—FABRICS

FOR TEXTILE GOODS, NAMELY SEAT COVERS AND COVERS FOR MATTRESSES AND CUSHIONS USED WITH OUTDOOR AND GARDEN FURNITURE (U.S. CLS. 42 AND 50).

SN 76-379,200. SALONI PORTUGAL-MATERIAIS DE CONSTRUÇÃO LDA., 2795 CARNAXIRE (LISBOA), PORTUGAL, FILED 3-5-2002.

SALONI

OWNER OF U.S. REG. NO. 2,357,038.
THE ENGLISH TRANSLATION OF THE ITALIAN WORD "SALONI" IS "HALLS".

CLASS 19—NON-METALLIC BUILDING MATERIALS

FOR WALL TILES; NON-METAL FLOOR TILES; CERAMIC, STONEWARE AND PORCELAIN WALL TILES AND FLOOR PAVING TILES (U.S. CLS. 1, 12, 33 AND 50).

FIRST USE 12-31-1972; IN COMMERCE 9-25-2001.

CLASS 35—ADVERTISING AND BUSINESS

FOR RETAIL STORE SERVICES AND COMPUTERIZED ON-LINE RETAIL SERVICES IN THE FIELD OF WALL TILES, FLOOR TILES, CERAMIC, STONEWARE AND PORCELAIN WALL COVERINGS AND FLOOR PAVINGS (U.S. CLS. 100, 101 AND 102).

FIRST USE 12-31-1972; IN COMMERCE 9-25-2001.

SuperStars

CLASS 28—TOYS AND SPORTING GOODS

FOR COLLECTIBLE AND TRADEABLE INTERLOCKING GAME PIECES THAT CAN FORM VARIOUS TWO-DIMENSIONAL SHAPES AND THREE-DIMENSIONAL SHAPES IN THE COURSE OF SOLVING A PUZZLE OR PLAYING A GAME; TOY BUILDING BLOCKS (U.S. CLS. 22, 23, 38 AND 50).

CLASS 35—ADVERTISING AND BUSINESS

FOR PROMOTING THE GOODS AND SERVICES OF OTHERS BY MEANS OF WEBSITES AND COLLECTIBLE AND TRADEABLE INTERLOCKING GAME PIECES (U.S. CLS. 100, 101 AND 102).

SN 76-380,476. NAFCU SERVICE CORPORATION, ARLINGTON, VA. FILED 3-12-2002.

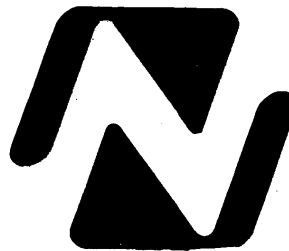

CLASS 16—PAPER GOODS AND PRINTED MATTER

FOR PRINTED MATTER, NAMELY, QUARTERLY NEWSLETTER AND JOURNALS IN THE NATURE OF ADDRESSING ISSUES OF IMPORTANCE TO FEDERAL CREDIT UNIONS AND CREDIT UNION STAFF AND PROFESSIONALS (U.S. CLS. 2, 5, 22, 23, 29, 37, 38 AND 50).

FIRST USE 1-23-2002; IN COMMERCE 1-23-2002.

CLASS 36—INSURANCE AND FINANCIAL

FOR FINANCIAL SPONSORING AND FUNDING EDUCATIONAL SEMINARS AND PROGRAMS RELATED TO TOPICS AND ISSUES OF IMPORTANCE TO FEDERAL CREDIT UNIONS AND CREDIT UNION STAFF AND PROFESSIONALS (U.S. CLS. 100, 101 AND 102).

FIRST USE 1-23-2002; IN COMMERCE 1-23-2002.

SN 76-380,520. SHABBY CHIC, INC., LOS ANGELES, CA.
FILED 3-11-2002.

SN 76-380,628. FRANCO TYP-POSTALIA AG & CO., D-16547
BIRKENWERDER, FED REP GERMANY, FILED 3-11-
2002.



OWNER OF U.S. REG. NO. 2,315,476.

CLASS 21—HOUSEWARES AND GLASS

FOR TOOTHBRUSH HOLDERS; TOOTHBRUSHES; TUMBLERS; MEAL TRAYS; LOTION DISPENSERS AND PUMPS; SOAP DISHES; FITTED VANITY CASES; WASTEBASKETS; SHOWER HOOKS; TOWEL BARS; SHOWER CADDIES; PERFUME SPRAYERS SOLD EMPTY; MUGS; MUG TREES; GLASS AND PORCELAIN FABRIC MITTS FOR CLEANING; NAPKIN HOLDERS; NAIL BRUSHES; HAIR COMBS; HAIR BRUSHES; BOTTLE OPENERS; CERAMIC AND GLASS HOLIDAY ORNAMENTS; MOPS; BROOMS; DINNERWARE; CHINA DINNERWARE; DISHES; CUPS; DRINKING GLASSES; GLASS BOWLS; GLASS PANS; PAPER CUPS AND PLATES; PITCHERS; PLATES; SALT AND PEPPER SHAKERS; SERVING SPOONS; SPICE RACKS; LUNCH BOXES; JUGS; NON-METAL KEEPSAKE BOXES; NON-METAL DECORATIVE BOXES; DECORATIVE GLASS BOXES; NON-METAL TRINKET BOXES; CANDLE HOLDERS NOT OF PRECIOUS METAL; CANDLE STICKS NOT OF PRECIOUS METAL (U.S. CLS. 2, 13, 23, 29, 30, 33, 40 AND 50).

FIRST USE 11-0-1999; IN COMMERCE 11-0-1999.

CLASS 24—FABRICS

FOR FABRICS, LINENS AND TEXTILES FOR THE FURTHER MANUFACTURE OF HOUSEWARES; FABRIC, LINEN AND TEXTILE PIECE GOODS FOR THE FURTHER MANUFACTURE OF HOUSEWARES; FABRICS, LINENS AND TEXTILES FOR BEDDING, BATHWARE, FURNITURE, HOME FURNISHINGS, HOUSEHOLD GOODS, WINDOW TREATMENTS AND CLOTHING; BED SPREADS; BED SHEETS; FITTED BED SHEETS; FLAT BED SHEETS; POPLIN AND T-SHIRT BED SHEETS; BED BLANKETS; RECEIVING BLANKETS; BED CANOPIES; DUVETS; DUVET COVERS; BED PADS; BEDDING LINEN; DUST RUFFLES; PILLOW CASES; PILLOW SHAMS; POTATOSACK PILLOW CASES; PILLOW CASES WITH RUFFLES; PILLOW SHAMS WITH RUFFLES; RUFFLED BEDSKIRTS; BEDSKIRTS; COMFORTERS; TOWELS; HOODED TOWELS; BATH LINENS; CLOTH BANNERS; FABRIC CURTAINS; DRAPERIES; DRAPERY PANELS; DISH CLOTHS; CLOTH DOILIES; CLOTH AND TEXTILE NAPKINS; WASH CLOTHS; CLOTH AND TEXTILE PLACEMATS; PUFFS FOR WINDOW TREATMENTS; FABRIC TABLE RUNNERS; SHROUDS; TABLE CLOTHS NOT OF PAPER; TEXTILE TAPESTRIES; FABRIC VALANCES; FABRIC CHAIR PADS; QUILTS; QUILTED SHAMS; SHOWER CURTAINS; TOWELS; BATHROOM TOWELS; HAND TOWELS; WASH TOWELS; KITCHEN TOWELS; POT HOLDERS; AND MATTRESS PADS (U.S. CLS. 42 AND 50).

FIRST USE 11-0-1999; IN COMMERCE 11-0-1999.

MYMAIL

OWNER OF FED REP GERMANY REG. NO. 30106446,
DATED 3-26-2001, EXPIRES 1-31-2011.

CLASS 9—ELECTRICAL AND SCIENTIFIC APPARATUS

FOR POSTAGE METERS; AND POSTAGE METERING MACHINES (U.S. CLS. 21, 23, 26, 36 AND 38).

CLASS 16—PAPER GOODS AND PRINTED MATTER

FOR FRANKING MACHINES, NAMELY, DESKTOP FRANKING MACHINES AND PERSONAL USE FRANKING MACHINES (U.S. CLS. 2, 5, 22, 23, 29, 37, 38 AND 50).

SN 76-381,648. NORWOOD, WILLIE, JR., AKA RAY J., LOS ANGELES, CA. FILED 3-12-2002.

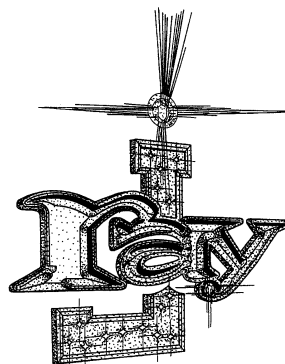

THE STIPPLING IS FOR SHADING PURPOSES ONLY AND DOES NOT INDICATE COLOR.

CLASS 9—ELECTRICAL AND SCIENTIFIC APPARATUS

FOR (BASED ON INTENT TO USE) MUSICAL SOUND RECORDINGS; MUSICAL VIDEO RECORDINGS; DOWNLOADABLE MUSICAL SOUND RECORDINGS; DOWNLOADABLE MUSICAL VIDEO RECORDINGS (U.S. CLS. 21, 23, 26, 36 AND 38).

CLASS 16—PAPER GOODS AND PRINTED MATTER

FOR (BASED ON USE IN COMMERCE) POSTERS; (BASED ON INTENT TO USE) STICKERS, SOUVENIR PROGRAMS AND SOUVENIR BOOKS CONCERNING CONCERTS, MUSICAL PERFORMANCES, AND A PERFORMER AND RECORDING ARTIST (U.S. CLS. 2, 5, 22, 23, 29, 37, 38 AND 50).

FIRST USE 0-0-2001; IN COMMERCE 0-0-2001.

CLASS 25—CLOTHING

FOR (BASED ON INTENT TO USE) SHIRTS, HATS, TANK TOPS, HEADWEAR, NAMELY, DO RAGS AND BANDANAS (U.S. CLS. 22 AND 39).

CLASS 38—COMMUNICATION

FOR (BASED ON USE IN COMMERCE) STREAMING OF AUDIO AND AUDIO VISUAL INFORMATION ON THE INTERNET FEATURING MUSIC AND MUSICAL BASED ENTERTAINMENT; PROVIDING ONLINE CHATROOMS FOR TRANSMISSION OF MESSAGES AMONG COMPUTER USERS AND PROVIDING ONLINE ELECTRONIC BULLETIN BOARDS FOR TRANSMISSION OF MESSAGES AMONG COMPUTER USERS ALL CONCERNING A MUSICAL ARTIST AND SUCH ARTIST'S MUSIC, SOUND AND VIDEO RECORDINGS, PICTURES, NEWS, SPECIAL PROJECTS, TOURS, PERSONAL APPEARANCES AND BIOGRAPHY (U.S. CLS. 100, 101 AND 104).

FIRST USE 0-0-2001; IN COMMERCE 0-0-2001.

CLASS 41—EDUCATION AND ENTERTAINMENT

FOR (BASED ON USE IN COMMERCE) PROVIDING INFORMATION ON A MUSICAL ARTIST AND SUCH ARTIST'S MUSIC, SOUND AND VIDEO RECORDINGS, PICTURES, NEWS, SPECIAL PROJECTS, TOURS, PERSONAL APPEARANCES AND BIOGRAPHY VIA A WEBSITE ON A GLOBAL COMPUTER NETWORK; (BASED ON INTENT TO USE) ENTERTAINMENT SERVICES NAMELY, LIVE MUSICAL PERFORMANCES (U.S. CLS. 100, 101 AND 107).

FIRST USE 0-0-2001; IN COMMERCE 0-0-2001.

SN 76-381,735. SAFESEC CORPORATION, FORMERLY REVOLVING DOOR CONTROL, INC., ONTARIO, CA. FILED 3-12-2002.

SAFESEC

OWNER OF U.S. REG. NO. 1,356,243.

CLASS 6—METAL GOODS

FOR METAL REVOLVING DOORS; METAL GATES (U.S. CLS. 2, 12, 13, 14, 23, 25 AND 50).

FIRST USE 11-15-1982; IN COMMERCE 3-23-1983.

CLASS 7—MACHINERY

FOR ELECTRIC MOTORS FOR MACHINES (U.S. CLS. 13, 19, 21, 23, 31, 34 AND 35).

FIRST USE 11-15-1982; IN COMMERCE 3-23-1983.

CLASS 9—ELECTRICAL AND SCIENTIFIC APPARATUS

FOR ELECTRIC REVOLVING DOOR OPERATORS, ELECTRIC CONTROLLERS FOR REVOLVING DOORS; ELECTRIC SENSORS AND REPLACEMENT PARTS THEREFOR FOR ELECTRICALLY OPERATED REVOLVING DOORS; ELECTRIC SECURITY GATE OPERATORS (U.S. CLS. 21, 23, 26, 36 AND 38).

FIRST USE 11-15-1982; IN COMMERCE 3-23-1983.

CLASS 19—NON-METALLIC BUILDING MATERIALS

FOR NON-METAL REVOLVING DOORS; NON-METAL GATES (U.S. CLS. 1, 12, 33 AND 50).

FIRST USE 11-15-1982; IN COMMERCE 3-23-1983.

SN 76-382,776. NOVO NORDISK A/S, DK-2880 BAGSVAERD, DENMARK, FILED 3-13-2002.

WWW.HEIGHTMATTERS.COM

PRIORITY CLAIMED UNDER SEC. 44(D) ON DENMARK APPLICATION NO. 200103436, FILED 9-13-2001, REG. NO. VR200104101, DATED 10-5-2001, EXPIRES 10-5-2011.

CLASS 9—ELECTRICAL AND SCIENTIFIC APPARATUS

FOR COMPUTER SOFTWARE FOR RECORDING MEDICAL INFORMATION; COMPUTER SOFTWARE FOR RECORDING DATA FROM EDUCATIONAL PRESENTATIONS AND FOR RECORDING ATTENDANCE OF SAID PRESENTATIONS; COMPUTER SOFTWARE FOR USE IN ACCESSING WEBSITES, INTRANETS AND THE INTERNET; ELECTRONIC PUBLICATIONS, NAMELY, BOOKS, MAGAZINES, AND MANUALS FEATURING MEDICAL INFORMATION RECORDED ON COMPUTER MEDIA (U.S. CLS. 21, 23, 26, 36 AND 38).

CLASS 42—SCIENTIFIC, COMPUTER AND LEGAL SERVICES

FOR MEDICAL RESEARCH SERVICES RELATED TO HUMAN GROWTH HORMONE PREPARATIONS AND OTHER PHARMACEUTICALS; AND CONSULTATION SERVICES IN THE FIELD OF IT SYSTEM DEVELOPMENT, IMPLEMENTATION, AND MAINTENANCE (U.S. CLS. 100 AND 101).

CLASS 44—MEDICAL, BEAUTY AND AGRICULTURAL SERVICES

FOR PROVIDING AN ON-LINE COMPUTER DATABASE IN THE FIELD OF DATA CONCERNING MEDICAL ANALYSIS AND TREATMENT; MEDICAL COUNSELING SERVICES; MEDICAL CLINICAL SERVICES; PROVIDING INFORMATION AND ADVICE RELATING TO PERSONAL MANAGEMENT OF MEDICAL CONDITIONS (U.S. CLS. 100 AND 101).

SN 76-383,103. TIME AND PLACE WORLD, LLC, WASHINGTON, DC. FILED 3-14-2002.

TIME & PLACE**CLASS 35—ADVERTISING AND BUSINESS**

FOR IN-HOME RETAIL SERVICES FEATURING ART, FURNITURE, CLOTHING, HOUSEHOLD ITEMS AND FURNISHINGS (U.S. CLS. 100, 101 AND 102).

CLASS 36—INSURANCE AND FINANCIAL

FOR LEASING AND MANAGEMENT OF REAL ESTATE PROPERTIES TO OTHERS; REAL ESTATE PROPERTY MANAGEMENT SERVICES; REAL ESTATE BROKERAGE (U.S. CLS. 100, 101 AND 102).

CLASS 41—EDUCATION AND ENTERTAINMENT

FOR SPECIAL EVENT SERVICES, NAMELY SPECIAL EVENT PLANNING (U.S. CLS. 100, 101 AND 107).

CLASS 45—PERSONAL SERVICES

FOR CONCIERGE SERVICES FOR OTHERS COMPRISING MAKING REQUESTED PERSONAL ARRANGEMENTS AND RESERVATIONS AND PROVIDING CUSTOMER-SPECIFIC INFORMATION TO MEET INDIVIDUAL NEEDS RENDERED TOGETHER IN A LEASED REAL ESTATE ENVIRONMENT (U.S. CLS. 100 AND 101).

SN 76-384,593. CHURCH OF GOD IN CHRIST, INC., MEMPHIS, TN. FILED 3-20-2002.



SN 76-383,401. CORE SDI, INC., NEW YORK, NY. FILED 3-14-2002.

CORE IMPACT**CLASS 9—ELECTRICAL AND SCIENTIFIC APPARATUS**

FOR COMPUTER SECURITY SOFTWARE, NAMELY, SOFTWARE FOR ENCRYPTING AND PROTECTING THE INTEGRITY OF DATA AND ELECTRONIC COMMUNICATIONS OVER COMPUTER NETWORKS; COMPUTER SOFTWARE FOR AUTHENTICATION, ACCESS CONTROL AND OTHER SECURITY FEATURES WITHIN COMPUTER NETWORKS AND THROUGH EXTERNAL CONNECTIONS; COMPUTER SOFTWARE FOR IMPLEMENTING SECURITY METHODOLOGY INVOLVING ENCRYPTION OF PAYMENT CARD NUMBERS OVER A GLOBAL COMPUTER NETWORK (U.S. CLS. 21, 23, 26, 36 AND 38).

NO CLAIM IS MADE TO THE EXCLUSIVE RIGHT TO USE "THE SEAL OF THE CHURCH OF GOD IN CHRIST, INC., ORGANIZED 1907" AND "MEMPHIS, TENNESSEE", APART FROM THE MARK AS SHOWN.

CLASS 9—ELECTRICAL AND SCIENTIFIC APPARATUS

FOR AUDIO TAPES, VIDEO TAPES, COMPACT DISCS, AND DIGITAL VIDEO DISCS FEATURING RELIGIOUS SUBJECT MATTER (U.S. CLS. 21, 23, 26, 36 AND 38).
FIRST USE 3-31-1973; IN COMMERCE 3-31-1973.

CLASS 42—SCIENTIFIC, COMPUTER AND LEGAL SERVICES

FOR COMPUTER CONSULTATION SERVICES INVOLVING THE CREATION AND DEVELOPMENT OF COMPUTER SECURITY SOFTWARE PROGRAMS FOR OTHERS AND SECURITY PRINTING, NAMELY ENCODING IDENTIFICATION INFORMATION, NON-VALUABLE DOCUMENTS AND PRODUCTS (U.S. CLS. 100 AND 101).

CLASS 16—PAPER GOODS AND PRINTED MATTER

FOR BOOKS, BOOKLETS, AND PAMPHLETS FEATURING RELIGIOUS SUBJECT MATTER (U.S. CLS. 2, 5, 22, 23, 29, 37, 38 AND 50).
FIRST USE 3-31-1973; IN COMMERCE 3-31-1973.

CLASS 41—EDUCATION AND ENTERTAINMENT

FOR EDUCATIONAL SERVICES IN THE NATURE OF RELIGIOUS INSTRUCTION (U.S. CLS. 100, 101 AND 107).
FIRST USE 3-31-1973; IN COMMERCE 3-31-1973.

SN 76-383,556. SPRINGBOARD NON-PROFIT CONSUMER CREDIT MANAGEMENT, INC., RIVERSIDE, CA. FILED 3-18-2002.

SPRINGNET**CLASS 9—ELECTRICAL AND SCIENTIFIC APPARATUS**

FOR COMPUTER SOFTWARE USED IN CONNECTION WITH CREDIT, DEBT, AND BANKRUPTCY MANAGEMENT FOR FINANCIAL EDUCATION AND CLIENT COUNSELING, INCLUDING FOR PURPOSES OF RECORDING PERSONAL AND FINANCIAL DATA, DOCUMENTING INFORMATION ON THE ORIGINATION OF APPOINTMENTS, CREATING SPENDING BUDGETS, AND TRACKING THE RECEIPT AND DISBURSEMENT OF FUNDS (U.S. CLS. 21, 23, 26, 36 AND 38).

CLASS 45—PERSONAL SERVICES

FOR MINISTERIAL SERVICES (U.S. CLS. 100 AND 101).
FIRST USE 3-31-1973; IN COMMERCE 3-31-1973.

SN 76-384,625. HELLERMANNTYTON CORPORATION, MILWAUKEE, WI. FILED 3-19-2002.

HellermannTyton
A SPIRENT Company
Network Sciences

CLASS 36—INSURANCE AND FINANCIAL

FOR PROVIDING DEBT MANAGEMENT SERVICES CONSISTING OF THE COMPILATION AND MAINTENANCE OF PERSONAL INFORMATION AND FINANCIAL TRANSACTIONS (U.S. CLS. 100, 101 AND 102).

NO CLAIM IS MADE TO THE EXCLUSIVE RIGHT TO USE "COMPANY" AND "NETWORK", APART FROM THE MARK AS SHOWN.

CLASS 6—METAL GOODS

FOR FASTENERS, NAMELY METAL BUNDLING AND SECURING PRODUCTS, NAMELY CABLE TIES, NAIL CLIPS, MASONRY CLIPS, SIDING CLIPS, AND CLAMPS, METAL PROTECTIVE TUBING FOR ELECTRICAL WIRING, AND METAL FASTENERS IN THE NATURE OF GROMMETS (U.S. CLS. 2, 12, 13, 14, 23, 25 AND 50).

CLASS 9—ELECTRICAL AND SCIENTIFIC APPARATUS

FOR STRUCTURAL CABLING PRODUCTS FOR COMMERCIAL AND RESIDENTIAL TELECOMMUNICATIONS NETWORK INSTALLATIONS, NAMELY PATCH PANELS, MODULAR AND OPTICAL FIBER AND ELECTRICAL JACKS, PATCH CORDS, FACEPLATES FOR USE WITH OUTLETS, FIBER CONNECTORS, OPTICAL FIBER ENCLOSURES NAMELY ELECTRICAL AND OPTICAL JUNCTION BOXES AND CABLING EQUIPMENT, CONTROL PANELS, AND EQUIPMENT RACKS AND SHELVES FOR TELECOMMUNICATIONS EQUIPMENT (U.S. CLS. 21, 23, 26, 36 AND 38).

CLASS 16—PAPER GOODS AND PRINTED MATTER

FOR BLANK COMPUTER PRINTABLE LABELS, HEAT TRANSFER LABELS, TAGS AND MARKERS, PRINTED LABELS FOR USE ON TELECOMMUNICATIONS EQUIPMENT, AND WARNING LABELS (U.S. CLS. 2, 5, 22, 23, 29, 37, 38 AND 50).

CLASS 20—FURNITURE AND ARTICLES NOT OTHERWISE CLASSIFIED

FOR NON-METAL FASTENERS IN THE NATURE OF GROMMETS AND NON-METAL BUNDLING AND SECURING PRODUCTS, NAMELY CABLE TIES AND CLAMPS, AND RACEWAYS NAMELY PLASTIC CHANNELS, FITTINGS, AND CONNECTORS FOR SECURING, ROUTING, AND CONNECTING POWER, VOICE, DATA, VIDEO, OR FIBER OPTIC CABLES (U.S. CLS. 2, 13, 22, 25, 32 AND 50).

CLASS 5—PHARMACEUTICALS

FOR PHARMACEUTICAL PREPARATIONS FOR USE IN THE TREATMENT OF HEART DISEASE AND HEART CONDITIONS, DIABETES, MENSTRUAL DISORDERS, BLOOD PRESSURE PROBLEMS, CARDIOVASCULAR PROBLEMS, LIPID METABOLISM DISORDERS, ASTHMA, ARTHRITIS, ARTHROSIS, TINNITUS, AND PERIODONTOSIS; VITAMINS AND MINERALS FOR MEDICAL PURPOSES; FOOD SUPPLEMENTS FOR NON-MEDICAL PURPOSES, CONSISTING PRIMARILY OF VITAMINS, AMINO ACIDS AND TRACE ELEMENTS; DIETETIC DIETARY SUPPLEMENTS FOR NON-MEDICAL USE, NAMELY AMINO ACIDS AND TRACE ELEMENTS; NUTRITIONALLY FORTIFIED BEVERAGES (U.S. CLS. 6, 18, 44, 46, 51 AND 52).

CLASS 30—STAPLE FOODS

FOR CANDY; CANDY IN THE NATURE OF EFFERVESCENT STICKS AND EFFERVESCENT TABLETS; PASTILLES; JELLIED FRUITS (U.S. CL. 46).

CLASS 32—LIGHT BEVERAGES

FOR MINERAL AND CARBONATED WATER; OTHER NON-ALCOHOLIC BEVERAGES, NAMELY FRUIT DRINKS AND FRUIT JUICES; PREPARATIONS, NAMELY SYRUPS, POWDERS, AND TABLETS FOR MAKING FORTIFIED BEVERAGES (U.S. CLS. 45, 46 AND 48).

SN 76-385,310. VIRGINIA HOSPITAL CENTER ARLINGTON HEALTH SYSTEM, ARLINGTON, VA. FILED 3-18-2002.

VIRGINIA HOSPITAL CENTER - ARLINGTON

NO CLAIM IS MADE TO THE EXCLUSIVE RIGHT TO USE "HOSPITAL CENTER", APART FROM THE MARK AS SHOWN.

SEC. 2(F).

SN 76-384,756. RATH, MATTHIAS, NL-7609 KL ALMELO, NETHERLANDS, FILED 3-20-2002.

DR. RATH'S SPORT FORMULA

PRIORITY CLAIMED UNDER SEC. 44(D) ON ERPN CMNTY TM OFC APPLICATION NO. 002407609, FILED 10-11-2001, REG. NO. 002407609, DATED 10-17-2001, EXPIRES 10-11-2011.

NO CLAIM IS MADE TO THE EXCLUSIVE RIGHT TO USE "SPORT FORMULA", APART FROM THE MARK AS SHOWN.

APPLICANT SUBMITS A CONSENT OF THE LIVING INDIVIDUAL WHOSE NAME APPEARS AS PART OF THE MARK.

CLASS 9—ELECTRICAL AND SCIENTIFIC APPARATUS

FOR DOWNLOADABLE ELECTRONIC PUBLICATIONS IN THE NATURE OF ARTICLES AND FEATURES REGARDING HEALTHCARE, WELLNESS, EXERCISE, AND HEALTH SERVICES; DOWNLOADABLE ELECTRONIC PUBLICATIONS IN THE NATURE OF SCHEDULES OF PROGRAMS AND CLASSES OFFERED BY A HOSPITAL IN THE FIELD OF HEALTHCARE, WELLNESS, EXERCISE AND HEALTH SERVICES (U.S. CLS. 21, 23, 26, 36 AND 38).

FIRST USE 11-19-2001; IN COMMERCE 11-19-2001.

CLASS 16—PAPER GOODS AND PRINTED MATTER

FOR PRINTED PUBLICATIONS, NAMELY, BROCHURES AND NEWSLETTERS REGARDING HEALTHCARE, WELLNESS, EXERCISE, HEALTH SERVICES, HOSPITAL INFORMATION, INFORMATION ABOUT PHYSICIANS, PATIENT INFORMATION, AND SCHEDULES OF PROGRAMS AND CLASSES OFFERED BY A HOSPITAL (U.S. CLS. 2, 5, 22, 23, 29, 37, 38 AND 50).

FIRST USE 8-16-2001; IN COMMERCE 8-16-2001.

CLASS 44—MEDICAL, BEAUTY AND AGRICULTURAL SERVICES

FOR HEALTHCARE SERVICES; PROVIDING A WEB SITE FEATURING INFORMATION REGARDING HEALTHCARE, WELLNESS, HEALTH SERVICES, HOSPITAL INFORMATION, INFORMATION ABOUT PHYSICIANS, AND PATIENT INFORMATION (U.S. CLS. 100 AND 101).

FIRST USE 7-25-2001; IN COMMERCE 7-25-2001.

SN 76-385,311. VIRGINIA HOSPITAL CENTER ARLINGTON HEALTH SYSTEM, ARLINGTON, VA. FILED 3-18-2002.



APPLICANT CLAIMS THE COLOR BLUE AS FEATURE OF THE MARK.

THE MARK CONSISTS OF FOUR DIAGONAL LINES OF VARYING WIDTHS COMPRISING A STYLIZED LETTER "V".

CLASS 9—ELECTRICAL AND SCIENTIFIC APPARATUS

FOR DOWNLOADABLE ELECTRONIC PUBLICATIONS IN THE NATURE OF ARTICLES AND FEATURES REGARDING HEALTHCARE, WELLNESS, EXERCISE, AND HEALTH SERVICES; DOWNLOADABLE ELECTRONIC PUBLICATIONS IN THE NATURE OF SCHEDULES OF PROGRAMS AND CLASSES OFFERED BY A HOSPITAL IN THE FIELD OF HEALTHCARE, WELLNESS, EXERCISE AND HEALTH SERVICES (U.S. CLS. 21, 23, 26, 36 AND 38).

FIRST USE 11-19-2001; IN COMMERCE 11-19-2001.

CLASS 16—PAPER GOODS AND PRINTED MATTER

FOR PRINTED PUBLICATIONS, NAMELY, BROCHURES AND NEWSLETTERS REGARDING HEALTHCARE, WELLNESS, EXERCISE, HEALTH SERVICES, HOSPITAL INFORMATION, INFORMATION ABOUT PHYSICIANS PATIENT INFORMATION, AND SCHEDULES OF PROGRAMS AND CLASSES OFFERED BY A HOSPITAL (U.S. CLS. 2, 5, 22, 23, 29, 37, 38 AND 50).

FIRST USE 8-16-2001; IN COMMERCE 8-16-2001.

CLASS 44—MEDICAL, BEAUTY AND AGRICULTURAL SERVICES

FOR HEALTHCARE SERVICES; PROVIDING A WEB SITE FEATURING INFORMATION REGARDING HEALTHCARE, WELLNESS, HEALTH SERVICES, HOSPITAL INFORMATION, INFORMATION ABOUT PHYSICIANS, AND PATIENT INFORMATION (U.S. CLS. 100 AND 101).

FIRST USE 7-25-2001; IN COMMERCE 7-25-2001.

SN 76-385,446. ELBO INC., WILMINGTON, DE. FILED 3-19-2002.

EB GAMES

OWNER OF U.S. REG. NOS. 1,906,173, 2,433,190 AND 2,433,191.

NO CLAIM IS MADE TO THE EXCLUSIVE RIGHT TO USE "GAMES", APART FROM THE MARK AS SHOWN.

CLASS 35—ADVERTISING AND BUSINESS

FOR MAIL ORDER, ONLINE AND RETAIL STORE SERVICES FEATURING CHILDREN'S TOYS AND BOOKS, CHILDREN'S VIDEO TAPES, CD'S AND AUDIO TAPES, INTERACTIVE TOYS, PUZZLES AND BOARD GAMES, PLUSH TOYS, DRESS UP CLOTHING, CHILDREN'S ARTS AND CRAFTS, SCIENCE AND NATURE ITEMS, COMPUTER HARDWARE, SOFTWARE AND PERIPHERALS, COMPUTER-RELATED FURNITURE, VIDEO GAME HARDWARE, SOFTWARE AND ACCESSORIES, ELECTRONIC BOARD GAMES, HAND-HELD ENTERTAINMENT HARDWARE AND SOFTWARE, CONSUMER-RELATED DISC HARDWARE AND SOFTWARE, CONSUMER ELECTRONICS, AND RELATED ACCESSORIES, BOOKS AND MAGAZINES (U.S. CLS. 100, 101 AND 102).

CLASS 41—EDUCATION AND ENTERTAINMENT

FOR RENTAL OF VIDEO AND COMPUTER GAMES; ON-LINE RENTAL OF COMPUTER GAMES (U.S. CLS. 100, 101 AND 107).

SN 76-387,504. PAXSON PRODUCTIONS, INC., LOS ANGELES, CA. FILED 3-27-2002.

JUST CAUSE**CLASS 9—ELECTRICAL AND SCIENTIFIC APPARATUS**

FOR PRERECORDED AUDIO AND VIDEOTAPES, COMPACT DISCS AND RECORDS FEATURING AN ONGOING DRAMATIC TELEVISION SERIES (U.S. CLS. 21, 23, 26, 36 AND 38).

CLASS 35—ADVERTISING AND BUSINESS

FOR RETAIL STORE SERVICES IN THE FIELD OF GENERAL MERCHANDISE; PROVIDING HOME SHOPPING SERVICES IN THE FIELD OF GENERAL MERCHANDISE VIA TELEVISION; RETAIL STORE SERVICES FEATURING GENERAL MERCHANDISE VIA A GLOBAL COMPUTER NETWORK (U.S. CLS. 100, 101 AND 102).

CLASS 41—EDUCATION AND ENTERTAINMENT

FOR ENTERTAINMENT IN THE NATURE OF AN ONGOING DRAMATIC TELEVISION SERIES (U.S. CLS. 100, 101 AND 107).

SN 76-388,019. PINKERTON SERVICE CORPORATION, WESTLAKE VILLAGE, CA. FILED 3-28-2002.

SN 76-388,491. INTERMED ADVISORS, INC., BELMONT, MA. FILED 3-28-2002.



OWNER OF U.S. REG. NO. 2,077,466.

CLASS 36—INSURANCE AND FINANCIAL

FOR CREDIT CHECKING SERVICES; ASSET SEARCHING SERVICES (U.S. CLS. 100, 101 AND 102).

CLASS 45—PERSONAL SERVICES

FOR GUARD SERVICES, SECURITY PATROL SERVICES, AND INVESTIGATION SERVICES, NAMELY, SERVICE QUALITY INVESTIGATIONS, PRE-EMPLOYMENT BACKGROUND INVESTIGATIONS, FACT VERIFICATION INVESTIGATIONS, CIVILIAN PERSONAL PROTECTION, SURVEILLANCE, AND UNDERCOVER INVESTIGATION (U.S. CLS. 100 AND 101).

SN 76-388,224. CRANE CO., STAMFORD, CT. FILED 3-26-2002.

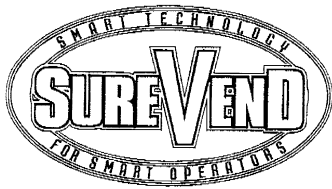

NO CLAIM IS MADE TO THE EXCLUSIVE RIGHT TO USE "SMART TECHNOLOGY", APART FROM THE MARK AS SHOWN.

CLASS 9—ELECTRICAL AND SCIENTIFIC APPARATUS

FOR VENDING MACHINES (U.S. CLS. 21, 23, 26, 36 AND 38).

CLASS 42—SCIENTIFIC, COMPUTER AND LEGAL SERVICES

FOR VENDING MACHINE QUALITY CONTROL SERVICES (U.S. CLS. 100 AND 101).

I MED

NO CLAIM IS MADE TO THE EXCLUSIVE RIGHT TO USE "MED", APART FROM THE MARK AS SHOWN.

CLASS 9—ELECTRICAL AND SCIENTIFIC APPARATUS

FOR WIRELESS DEVICES, NAMELY, PERSONAL DIGITAL ASSISTANTS (U.S. CLS. 21, 23, 26, 36 AND 38).

CLASS 44—MEDICAL, BEAUTY AND AGRICULTURAL SERVICES

FOR MEDICAL SERVICES, NAMELY, MONITORING AND SUPERVISION FOR DIABETIC AND HYPERTENSIVE PATIENTS CONDUCTED THROUGH PERSONAL DIGITAL ASSISTANTS (U.S. CLS. 100 AND 101).

SN 76-388,885. KIDS VOTING USA, INC., TEMPE, AZ. FILED 3-28-2002.



OWNER OF U.S. REG. NO. 2,033,341.
NO CLAIM IS MADE TO THE EXCLUSIVE RIGHT TO USE "KIDS VOTING" AND "USA", APART FROM THE MARK AS SHOWN.

CLASS 16—PAPER GOODS AND PRINTED MATTER

FOR EDUCATIONAL PUBLICATIONS, NAMELY, TRAINING MANUALS IN THE FIELD OF VOTING RIGHTS AND RESPONSIBILITIES; BOOKS AND PRINTED EDUCATIONAL MATERIALS IN THE FIELD OF VOTING RIGHTS AND RESPONSIBILITIES (U.S. CLS. 2, 5, 22, 23, 29, 37, 38 AND 50).
FIRST USE 6-1-1988; IN COMMERCE 6-1-1988.

CLASS 35—ADVERTISING AND BUSINESS

FOR PROMOTING THE EDUCATION OF CHILDREN ON VOTING RIGHTS AND RESPONSIBILITIES (U.S. CLS. 100, 101 AND 102).
FIRST USE 6-1-1988; IN COMMERCE 6-1-1988.

SN 76-389,782. PACIFIC BRANDS RETAIL GROUP 1, INC.,
IRVINE, CA. FILED 4-2-2002.

CENTRAL RIDE SHOP

NO CLAIM IS MADE TO THE EXCLUSIVE RIGHT TO USE "RIDE SHOP", APART FROM THE MARK AS SHOWN.

CLASS 25—CLOTHING

FOR WEARING APPAREL, NAMELY, T-SHIRTS, SHIRTS, SHORTS, PANTS, SWEATSHIRTS, SWEAT-PANTS, HATS, VISORS, SHOES AND BELTS (U.S. CLS. 22 AND 39).

CLASS 35—ADVERTISING AND BUSINESS

FOR RETAIL STORE SERVICES IN THE FIELD OF WEARING APPAREL; DISTRIBUTORSHIPS IN THE FIELD OF WEARING APPAREL (U.S. CLS. 100, 101 AND 102).

SN 76-389,874. SHAUN PALMER LTD., CH-8865- BILTEN,
SWITZERLAND, FILED 4-2-2002.



OWNER OF SWITZERLAND REG. NO. 492,786, DATED
10-12-2001, EXPIRES 10-12-2011.

OWNER OF U.S. REG. NO. 1,977,636.
THE STIPPLING IS A FEATURE OF THE MARK AND
DOES NOT INDICATE COLOR.

THE NAME "SHAUN PALMER" IDENTIFIES A LIVING
INDIVIDUAL WHOSE CONSENT IS OF RECORD.

CLASS 3—COSMETICS AND CLEANING PREPARATIONS

FOR LAUNDRY BLEACH; GENERAL PURPOSE CLEANING, POLISHING, SCOURING, AND ABRASIVE LIQUIDS AND POWDERS; SKIN SOAPS, BODY SOAPS, DEODORANT SOAPS, AND TOILET SOAPS; PERFUME, ESSENTIAL OILS FOR PERSONAL USE; COSMETICS, HAIR LOTIONS; DENTIFRICE (U.S. CLS. 1, 4, 6, 50, 51 AND 52).

CLASS 9—ELECTRICAL AND SCIENTIFIC APPARATUS

FOR OPTICAL APPARATUS, INSTRUMENTS, AND SPORTING ARTICLES, NAMELY, SUNGLASSES; SPORTING ARTICLES, NAMELY, SNOWBOARDING HELMETS; COMPUTER GAME CARTRIDGES; COMPUTER GAME CASSETTES; COMPUTER GAME SOFTWARE; COMPUTER GAME DISCS; COMPUTER AND ELECTRONIC GAME PROGRAMS; COMPUTER GAME TAPES; COMPUTERIZED VIDEO TABLE GAMES FOR GAMING PURPOSES; VIDEO GAME DISCS; VIDEO GAME SOFTWARE; VIDEO GAME CARTRIDGES; VIDEO GAME TAPE CASSETTES; VIDEO GAME MACHINES FOR USE WITH TELEVISIONS; BLANK MAGNETIC DATA CARRIERS; PRERECORDED MAGNETIC DATA CARRIERS FEATURING VIDEO GAMES; BLANK COMPUTER DISCS; AUDIO DISCS FEATURING MUSIC; AUTOMATIC VENDING MACHINES AND MECHANISMS FOR COIN OPERATED APPARATUS; CASH REGISTERS; CALCULATORS; DATA PROCESSORS; COMPUTERS; COMPUTER GAME SOFTWARE; FIRE-EXTINGUISHERS; SPORTING ARTICLES, NAMELY, SPORTS GOGGLES FOR USE IN SNOWBOARDING, SKIING, MOUNTAIN BIKING, MOTOCROSS, AND SNOWMOBILING; AND PARTS FOR ALL OF THE AFORESAID GOODS (U.S. CLS. 21, 23, 26, 36 AND 38).

CLASS 14—JEWELRY

FOR PRECIOUS METALS AND THEIR ALLOYS SOLD IN BULK; JEWELRY; PRECIOUS GEMSTONES; HOROLOGICAL INSTRUMENTS, NAMELY, WATCHES AND CLOCKS; AND CHRONOMETERS (U.S. CLS. 2, 27, 28 AND 50).

CLASS 16—PAPER GOODS AND PRINTED MATTER

FOR PRINTED MATTER, NAMELY, BOOKS AND MAGAZINES FEATURING VIDEO GAMES; BOOK BINDINGS; BOOKBINDING TAPE; BOOKBINDING WIRE; PHOTOGRAPHS, STICKERS; SCHOOL SUPPLIES, NAMELY, POCKET FOLDERS, BINDERS, RINGED BINDERS, STATIONERY-TYPE PORTFOLIOS, NOTEBOOKS, SPIRAL BOUND NOTEBOOKS, BLANK AND PRINTED THEME BOOKS, PENCILS, PENS, MARKERS, NOTE PADS, PAPER PADS, NOTEBOOK PAPER, PENCIL TOPPERS, ERASERS, RUBBER STAMPS, STAMP PADS, RUBBER STAMP KITS CONSISTING OF THEME-ORIENTED RUBBER STAMPS AND INK PADS, PENCIL SHARPENERS, DAILY PLANNERS, DESK TOP PLANNERS, CALENDARS, WALL CALENDARS AND DAILY CALENDAR DESK PADS; STATIONERY; ADHESIVES FOR STATIONERY OR HOUSEHOLD PURPOSES; ARTISTS' BRUSHES, PASTELS, PENCILS, PENS, CANVAS PANELS AND PAINTING SETS; PAINT BRUSHES; ELECTRIC AND NON-ELECTRIC TYPEWRITERS; OFFICE REQUISITES, NAMELY, CORRECTING FLUID FOR TYPE, PAPER EMBOSSERS, PUNCHES, RUBBER BANDS, STAPLERS; PLASTIC BUBBLE PACKS FOR PACKAGING; PLASTIC BAGS FOR PACKAGING; PRINTING TYPE; AND PRINTING BLOCKS (U.S. CLS. 2, 5, 22, 23, 29, 37, 38 AND 50).

CLASS 18—LEATHER GOODS

FOR BAGS, TRUNKS AND SUITCASES MADE OF LEATHER AND IMITATION LEATHER; ANIMAL SKINS AND HIDES; UMBRELLAS, PARASOLS AND WALKING STICKS; WHIPS AND SADDLERY (U.S. CLS. 1, 2, 3, 22 AND 41).

CLASS 25—CLOTHING

FOR CLOTHING, NAMELY, SNOWBOARD BOOTS, SOCKS, PANTS, T-SHIRTS, SWEATERS, JACKETS, AND JERSEYS; HATS; CAPS; GLOVES; FOOTWEAR; AND HEADWEAR (U.S. CLS. 22 AND 39).

CLASS 28—TOYS AND SPORTING GOODS

FOR GAMES, NAMELY, HAND HELD UNIT FOR PLAYING ELECTRONIC GAMES AND STAND ALONE VIDEO GAME MACHINES; GYMNASIAC APPARATUS; AND SPORTING ARTICLES, NAMELY, SNOWBOARDS AND PARTS AND FITTINGS FOR SNOWBOARDS; PLAYTHINGS, NAMELY, MINIATURE TOY SNOW PARKS AND ACCESSORIES THEREFORE; AND CHRISTMAS TREE DECORATIONS NOT INCLUDING CONFECTIONERY OR ILLUMINATION ARTICLES; AND PLAYING CARDS (U.S. CLS. 22, 23, 38 AND 50).

SN 76-391,788. NEXTEL COMMUNICATIONS, INC., RESTON, VA. FILED 4-5-2002.

**DISCOVER THE NEXTEL
ADVANTAGE**

CLASS 9—ELECTRICAL AND SCIENTIFIC APPARATUS

FOR EQUIPMENT USED IN PROVIDING TELECOMMUNICATIONS SERVICES, NAMELY, MOBILE RADIOS, TWO-WAY RADIOS, CELLULAR TELEPHONES, DIGITAL CELLULAR TELEPHONES, MOBILE TELEPHONES, DISPATCH RADIOS, PAGERS, MOBILE DISPATCH RADIOS, MOBILE DATA RECEIVERS; HARDWARE AND SOFTWARE FOR USE IN COMMUNICATIONS NETWORKS, NAMELY, INTERNET PROTOCOL AND TELECOMMUNICATIONS NETWORK TRANSMITTERS, RECEIVERS, CONVERTERS, AND ROUTERS WHICH ALLOW THE USER TO SEND VOICE, DATA, PICTURES, MUSIC AND VIDEO OVER WIRELESS NETWORKS (U.S. CLS. 21, 23, 26, 36 AND 38).

SN 76-390,147. ABP HOLDINGS, INC., BOSTON, MA. FILED 4-2-2002.



OWNER OF U.S. REG. NOS. 1,134,895, 2,203,593 AND OTHERS.

NO CLAIM IS MADE TO THE EXCLUSIVE RIGHT TO USE "PAIN", APART FROM THE MARK AS SHOWN.

THE WORDS "AU BON PAIN" ARE IN THE COLOR WHITE AND THE RECTANGLE DESIGN IS IN THE COLOR YELLOW.

THE ENGLISH TRANSLATION OF THE WORDING "AU BON PAIN" IS "AT" OR "TO THE GOOD BREAD".

CLASS 38—COMMUNICATION

FOR TELECOMMUNICATION SERVICES, NAMELY, PROVIDING VOICE, DATA, PICTURES, MUSIC AND VIDEO VIA WIRELESS NETWORKS AND TWO-WAY RADIO DISPATCHING SERVICES, ELECTRONIC TRANSMISSION OF VOICE, TEXT, IMAGES, DATA AND INFORMATION BY MEANS OF TWO-WAY RADIOS, MOBILE RADIOS, CELLULAR TELEPHONES, DIGITAL CELLULAR TELEPHONES, MOBILE TELEPHONES, DISPATCH RADIOS, PAGERS; PAGING SERVICES; MOBILE TELEPHONE COMMUNICATION SERVICES; WIRELESS INTERNET ACCESS SERVICES; AND WIRELESS DATA SERVICES FOR MOBILE DEVICES VIA A WIRELESS NETWORK FOR THE PURPOSE OF SENDING AND RECEIVING ELECTRONIC MAIL, FACSIMILES, DATA, IMAGES, INFORMATION, TEXT, NUMERIC MESSAGING AND TEXT MESSAGING AND FOR ACCESSING A GLOBAL COMMUNICATIONS NETWORK (U.S. CLS. 100, 101 AND 104).

CLASS 35—ADVERTISING AND BUSINESS

FOR RETAIL BAKERY SHOPS (U.S. CLS. 100, 101 AND 102).

CLASS 43—HOTEL AND RESTAURANT SERVICES

FOR RESTAURANT SERVICES AND CATERING SERVICES (U.S. CLS. 100 AND 101).

SN 76-392,085. TOUCHCREDIT FINANCIAL SERVICES, INC., MARINA DEL REY, CA. FILED 4-8-2002.

**(TVC) TRANSACTION
VERIFICATION
CERTIFICATE**

NO CLAIM IS MADE TO THE EXCLUSIVE RIGHT TO USE "TRANSACTION VERIFICATION CERTIFICATE", APART FROM THE MARK AS SHOWN.

SN 76-391,669. JOHNSON, GARY, BOISE, ID. FILED 4-4-2002.

GLIDETEXT

CLASS 9—ELECTRICAL AND SCIENTIFIC APPARATUS

FOR COMPUTER SOFTWARE FOR USE IN MANIPULATING ELECTRONIC TEXT FOR DESKTOP AND COMMERCIAL PUBLISHING (U.S. CLS. 21, 23, 26, 36 AND 38).

CLASS 9—ELECTRICAL AND SCIENTIFIC APPARATUS

FOR COMPUTER SOFTWARE IN THE FIELD OF COMPUTER NETWORK SECURITY FOR USE IN BANKING AND CREDIT ISSUANCE FEATURING BIOMETRIC IDENTIFICATION, VERIFICATION AND AUTHENTICATION OF CUSTOMERS DATA, FOR IDENTIFICATION, VERIFICATION AND AUTHENTICATION OF PHYSICAL PERSONS BY MEANS OF ELECTRONIC OR BIOMETRIC DATA, NAMELY FINGERPRINTS, FOR THE PURPOSE OF CONTROLLING ACCESS TO COMPUTER NETWORKS AND INFORMATION (U.S. CLS. 21, 23, 26, 36 AND 38).

CLASS 35—ADVERTISING AND BUSINESS

FOR LICENSING OF COMPUTER SOFTWARE THAT GENERATES TEXT IN WHICH THE WORD SEQUENCE IS REVERSED IN ALTERNATING LINES OF TEXT (U.S. CLS. 100, 101 AND 102).

CLASS 42—SCIENTIFIC, COMPUTER AND LEGAL SERVICES

FOR COMPUTER CONSULTING SERVICES IN THE FIELD OF COMPUTER NETWORK SECURITY AND IN THE FIELD OF COMPUTER SOFTWARE FOR USE IN BANKING AND CREDIT ISSUANCE FEATURING BIOMETRIC IDENTIFICATION, VERIFICATION AND AUTHENTICATION OF CUSTOMERS DATA, FOR IDENTIFICATION, VERIFICATION AND AUTHENTICATION OF PHYSICAL PERSONS BY MEANS OF ELECTRONIC OR BIOMETRIC DATA, NAMELY FINGERPRINTS, FOR THE PURPOSE OF CONTROLLING ACCESS TO COMPUTER NETWORKS AND INFORMATION (U.S. CLS. 100 AND 101).

CLASS 11—ENVIRONMENTAL CONTROL APPARATUS

FOR STEAM TABLES FOR WARMING FOOD (U.S. CLS. 13, 21, 23, 31 AND 34).
FIRST USE 8-30-2001; IN COMMERCE 8-30-2001.

CLASS 21—HOUSEWARES AND GLASS

FOR CATERING FOOD RACKS AND ALUMINUM PANS (U.S. CLS. 2, 13, 23, 29, 30, 33, 40 AND 50).
FIRST USE 8-30-2001; IN COMMERCE 8-30-2001.

SN 76-392,763. VALLEY PACKAGING CORP., PULASKI, TN. FILED 4-5-2002.

VALLEY PACKAGING

NO CLAIM IS MADE TO THE EXCLUSIVE RIGHT TO USE "PACKAGING", APART FROM THE MARK AS SHOWN.

CLASS 16—PAPER GOODS AND PRINTED MATTER

FOR PACKAGING MATERIALS, NAMELY, PAPER, CARDBOARD AND CORRUGATED BOXES, CONTAINERS, CARTONS, LABELS, LINERBOARDS, SHEETS, TRAYS AND INSERTS; CORRUGATED MATERIALS, NAMELY, POINT OF SALE DISPLAYS, MARKETING DISPLAYS AND PRODUCT DISPLAYS (U.S. CLS. 2, 5, 22, 23, 29, 37, 38 AND 50).

FIRST USE 8-14-1984; IN COMMERCE 8-14-1984.

CLASS 20—FURNITURE AND ARTICLES NOT OTHERWISE CLASSIFIED

FOR PACKAGING MATERIALS, NAMELY, PLASTIC BOXES, CONTAINERS, CARTONS, LABELS, LINERBOARDS, SHEETS, TRAYS AND INSERTS; PLASTIC CORRUGATED MATERIALS, NAMELY POINT OF SALE DISPLAYS, MARKETING DISPLAYS AND PRODUCT DISPLAYS (U.S. CLS. 2, 13, 22, 25, 32 AND 50).

FIRST USE 8-14-1984; IN COMMERCE 8-14-1984.

SN 76-392,857. PICK-UP-PAN, INC., ELIZABETH, NJ. FILED 4-5-2002.



NO CLAIM IS MADE TO THE EXCLUSIVE RIGHT TO USE "CLASSIC CATERER", APART FROM THE MARK AS SHOWN.

SN 76-393,769. GAZ DE FRANCE, SERVICE NATIONAL, 75017 PARIS, FRANCE, FILED 4-11-2002.

Hiérapipe

OWNER OF FRANCE REG. NO. 01/3124519, DATED 10-5-2001, EXPIRES 10-5-2012.

CLASS 9—ELECTRICAL AND SCIENTIFIC APPARATUS

FOR COMPUTER SOFTWARE FOR CALCULATING PRIORITY INDEXES TO STRUCTURE METALLIC DISTRIBUTION PIPES INTO HIERARCHY (U.S. CLS. 21, 23, 26, 36 AND 38).

CLASS 16—PAPER GOODS AND PRINTED MATTER

FOR INSTRUCTION MANUALS FOR USE WITH COMPUTER SOFTWARE FOR CALCULATING PRIORITY INDEXES TO STRUCTURE METALLIC DISTRIBUTION PIPES INTO HIERARCHY (U.S. CLS. 2, 5, 22, 23, 29, 37, 38 AND 50).

CLASS 35—ADVERTISING AND BUSINESS

FOR COMPILING AND PROVIDING STATISTICAL INFORMATION IN THE NATURE OF MATHEMATIC DATA AND STATISTICS RELATED TO CALCULATING PRIORITY INDEXES TO STRUCTURE METALLIC DISTRIBUTION PIPES INTO HIERARCHY; BUSINESS CONSULTANCY, INFORMATION AND INQUIRIES RELATED TO THE CALCULATION OF PRIORITY INDEXES TO STRUCTURE METALLIC DISTRIBUTION PIPES INTO HIERARCHY (U.S. CLS. 100, 101 AND 102).

CLASS 38—COMMUNICATION

FOR TELECOMMUNICATIONS, NAMELY, LOCAL AND LONG DISTANCE TRANSMISSION OF VOICE, DATA, GRAPHICS BY MEANS OF TELEPHONE, TELEGRAPHIC, CABLE, AND SATELLITE TRANSMISSIONS; PROVIDING FIBER OPTIC NETWORK SERVICES; ELECTRONIC TRANSMISSION OF DATA AND DOCUMENTS VIA COMPUTER TERMINALS; TELECOMMUNICATION SERVICES VIA THE INTERNET, NAMELY, PROVIDING TELECOMMUNICATIONS CONNECTIONS TO A GLOBAL COMPUTER NETWORK; ELECTRONIC MAIL SERVICES VIA INTRANET; ELECTRONIC TRANSMISSION OF INFORMATION VIA TELEMATICS; ALL THE AFORESAID SERVICES RENDERED IN THE FIELD OF CALCULATING PRIORITY INDEXES TO STRUCTURE METALLIC DISTRIBUTION PIPES INTO HIERARCHY (U.S. CLS. 100, 101 AND 104).

CLASS 42—SCIENTIFIC, COMPUTER AND LEGAL SERVICES

FOR DEVELOPMENT AND DESIGN FOR OTHERS OF COMPUTER SOFTWARE RELATED TO THE FIELD OF FLUID DISTRIBUTION VIA PIPES, TECHNICAL CONSULTATION FOR THE DEVELOPMENT OF DIGITAL PRODUCTS (U.S. CLS. 100 AND 101).

SN 76-394,593. HPL TECHNOLOGIES, INC., SAN JOSE, CA. FILED 4-11-2002.

**CLASS 9—ELECTRICAL AND SCIENTIFIC APPARATUS**

FOR COMPUTER SOFTWARE FOR YIELD MANAGEMENT, ELECTRONIC DESIGN AUTOMATION AND FACTORY AUTOMATION IN THE FIELD OF DESIGN, FABRICATION AND TESTING OF SEMICONDUCTORS, INTEGRATED CIRCUITS AND MICROELECTRONICS (U.S. CLS. 21, 23, 26, 36 AND 38).

FIRST USE 2-0-1999; IN COMMERCE 4-0-1999.

CLASS 41—EDUCATION AND ENTERTAINMENT

FOR EDUCATIONAL SERVICES, NAMELY, CONDUCTING WORKSHOPS IN THE FIELD OF MANUFACTURING OF SEMICONDUCTORS, INTEGRATED CIRCUITS, INTEGRATED CIRCUIT DEVICES AND MICROELECTRONICS (U.S. CLS. 100, 101 AND 107).

FIRST USE 2-0-1999; IN COMMERCE 4-0-1999.

CLASS 42—SCIENTIFIC, COMPUTER AND LEGAL SERVICES

FOR INSTALLATION AND MAINTENANCE OF SOFTWARE FOR OTHERS IN THE FIELD OF DESIGN, FABRICATION AND TESTING OF SEMICONDUCTORS, INTEGRATED CIRCUITS AND MICROELECTRONICS; TECHNICAL SUPPORT SERVICES, NAMELY TROUBLESHOOTING OF COMPUTER SOFTWARE PROBLEMS; PROVIDING ON-LINE TECHNICAL AND ENGINEERING INFORMATION IN THE FIELD OF DESIGN, FABRICATION AND TESTING OF SEMICONDUCTORS, INTEGRATED CIRCUITS AND MICROELECTRONICS; ENGINEERING SERVICES AND CONSULTATION SERVICES IN THE FIELD OF DESIGN, FABRICATION AND TESTING OF SEMICONDUCTORS, INTEGRATED CIRCUITS AND MICROELECTRONICS (U.S. CLS. 100 AND 101).

FIRST USE 2-0-1999; IN COMMERCE 4-0-1999.

SN 76-393,781. SCANCOM INTERNATIONAL A/S, 4220 KORSOR, DENMARK, FILED 4-11-2002.

PETAN

PRIORITY CLAIMED UNDER SEC. 44(D) ON DENMARK APPLICATION NO. VA200103865, FILED 10-12-2001, REG. NO. VR200105071, DATED 12-17-2001, EXPIRES 12-17-2011.

CLASS 17—RUBBER GOODS

FOR PLASTIC FIBERS FOR USE IN WEAVING IN THE MANUFACTURE OF FURNITURE, EXCLUDING USE IN TEXTILES (U.S. CLS. 1, 5, 12, 13, 35 AND 50).

CLASS 20—FURNITURE AND ARTICLES NOT OTHERWISE CLASSIFIED

FOR FURNITURE (U.S. CLS. 2, 13, 22, 25, 32 AND 50).

SN 76-394,168. TAYLOR CORPORATION, NORTH MANKATO, MN. BY ASSIGNMENT NOWDOCS, INC., ALISO VIEJO, CA. FILED 4-10-2002.

NOWDOCS

OWNER OF U.S. REG. NO. 2,433,544.

CLASS 9—ELECTRICAL AND SCIENTIFIC APPARATUS

FOR COMPUTER SOFTWARE, NAMELY, SOFTWARE THAT ALLOWS SUBMISSION OF PRINT JOB ORDERS AND FULFILLMENT OF PRINT JOB ORDERS VIA THE INTERNET AND INTRANETS (U.S. CLS. 21, 23, 26, 36 AND 38).

FIRST USE 2-28-2001; IN COMMERCE 2-28-2001.

CLASS 42—SCIENTIFIC, COMPUTER AND LEGAL SERVICES

FOR PROVIDING TEMPORARY USE OF NON-DOWNLOADABLE COMPUTER SOFTWARE THAT ALLOWS SUBMISSION OF PRINT JOB ORDERS AND FULFILLMENT OF PRINT JOB ORDERS VIA THE INTERNET AND INTRANETS (U.S. CLS. 100 AND 101).

FIRST USE 2-28-2001; IN COMMERCE 2-28-2001.

SN 76-395,427. ENCORUS HOLDINGS LIMITED, DUBLIN 1, IRELAND, FILED 4-15-2002.

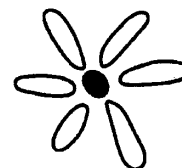

encorus
TECHNOLOGIES

NO CLAIM IS MADE TO THE EXCLUSIVE RIGHT TO USE "TECHNOLOGIES", APART FROM THE MARK AS SHOWN.

CLASS 9—ELECTRICAL AND SCIENTIFIC APPARATUS

FOR SOFTWARE, NAMELY, COMPUTER SOFTWARE THAT ENABLES MOBILE POINT OF SALE TERMINALS AND DEVICES TO FACILITATE SECURE METHODS OF PAYMENT, DIGITAL SIGNATURE TECHNOLOGY, AUTHENTICATION, ENCRYPTION AND REPUDIATION FOR USE BY MERCHANTS AND FINANCIAL INSTITUTIONS; COMPUTER DATA PROCESSING SOFTWARE THAT FACILITATES MOBILE ELECTRONIC TRANSACTION VERIFICATION AND ACQUISITION FOR USE BY MERCHANTS AND FINANCIAL INSTITUTIONS; AND COMPUTER SOFTWARE FOR SECURE INTEGRATION AND APPLICATION DEVELOPMENT, NAMELY THE SECURE TRANSMISSION OF DATA, FRAUD DETECTION, ENCRYPTION AND DIGITAL SIGNATURE TECHNOLOGY FOR USE BY MERCHANTS AND FINANCIAL INSTITUTIONS, AND USER MANUALS SOLD THEREWITH; AND DATA STORAGE MEDIA IN THE NATURE OF BLANK FLOPPY DISKS, BLANK CD-ROMS AND DISK DRIVES (U.S. CLS. 21, 23, 26, 36 AND 38).

FIRST USE 9-0-2001; IN COMMERCE 9-0-2001.

CLASS 42—SCIENTIFIC, COMPUTER AND LEGAL SERVICES

FOR COMPUTER SOFTWARE DESIGN, DEVELOPMENT AND MAINTENANCE SERVICES FOR OTHERS FOR THE CREATION AND MAINTENANCE OF PROGRAMS FOR DATA PROCESSING, PARTICULARLY FOR FINANCIAL SERVICE COMPANIES; COMPUTER SOFTWARE CONSULTATION RELATING TO MAINTENANCE AND OPERATION OF PROGRAMS FOR DATA PROCESSING; COMPUTER NETWORK AND SYSTEM DESIGN FOR OTHERS, NAMELY, INTERACTIVE NETWORKS AND DATA PROCESSING SYSTEMS FOR THE TRANSMISSION OF DATA AND INFORMATION; COMPUTER CONSULTATION, NAMELY, CONSULTATION SERVICES RELATING TO THE MAINTENANCE AND OPERATION OF NETWORKS AND DATA-PROCESSING SERVICES; MAINTENANCE AND REPAIR OF COMPUTER SOFTWARE; COMPUTER CONSULTATION SERVICES RELATING TO SETTING UP INTERACTIVE MARKETING NETWORKS AND DATA PROCESSING SYSTEMS FOR THE TRANSMISSION OF DATA (U.S. CLS. 100 AND 101).

FIRST USE 11-0-2001; IN COMMERCE 11-0-2001.

CLASS 35—ADVERTISING AND BUSINESS

FOR PROVIDING ONLINE BUSINESS SERVICES AND BUSINESS CONSULTING SERVICES, NAMELY ORGANIZATION AND CARRYING OUT OF BUSINESS TRANSACTIONS (U.S. CLS. 100, 101 AND 102).

FIRST USE 11-0-2001; IN COMMERCE 11-0-2001.

SN 76-395,647. VIANOR HOLDING OY, 37100 NOKIA, FINLAND, FILED 4-15-2002.

CLASS 36—INSURANCE AND FINANCIAL

FOR ELECTRONIC PAYMENT, NAMELY, ELECTRONIC PROCESSING AND TRANSMISSION OF BILL PAYMENT DATA, NAMELY PAYMENT VERIFICATION, AUTHENTICATION, AUTHORIZATION, SETTLEMENT AND PROCESSING SERVICES VIA MOBILE POINT OF SALE TERMINALS AND DEVICES AND A GLOBAL COMPUTER NETWORK; FINANCIAL INFORMATION PROVIDED BY ELECTRONIC MEANS, NAMELY, ONLINE, ELECTRONIC STATEMENT GENERATION SERVICES (U.S. CLS. 100, 101 AND 102).

FIRST USE 11-0-2001; IN COMMERCE 11-0-2001.



PRIORITY CLAIMED UNDER SEC. 44(D) ON FINLAND APPLICATION NO. T200200129, FILED 1-15-2002, REG. NO. 225882, DATED 11-29-2002, EXPIRES 11-29-2012.

THE ENGLISH TRANSLATION OF "VIANOR" IS "NORTHERN ROAD".

CLASS 37—CONSTRUCTION AND REPAIR

FOR MAINTENANCE AND REPAIR OF COMPUTER HARDWARE; AND INSTALLATION OF COMPUTER SYSTEMS AND NETWORKS; INSTALLATION, MAINTENANCE AND REPAIR OF COMPUTER NETWORKS AND SYSTEMS, NAMELY, INTERACTIVE NETWORKS AND DATA-PROCESSING SYSTEMS FOR THE TRANSMISSION OF DATA AND INFORMATION (U.S. CLS. 100, 103 AND 106).

FIRST USE 11-0-2001; IN COMMERCE 11-0-2001.

CLASS 12—VEHICLES

FOR (BASED ON INTENT TO USE) VEHICLE TIRES AND INNER TUBES (U.S. CLS. 19, 21, 23, 31, 35 AND 44).

CLASS 35—ADVERTISING AND BUSINESS

FOR (BASED ON 44(E)) RETAIL STORE SERVICES FEATURING VEHICLES, THEIR PARTS, FITTINGS AND SPARE PARTS; FRANCHISING, NAMELY, OFFERING TECHNICAL ASSISTANCE IN THE ESTABLISHMENT AND/OR OPERATION OF AUTOMOBILE PARTS STORES AND AUTOMOBILE REPAIR SHOPS (U.S. CLS. 100, 101 AND 102).

CLASS 41—EDUCATION AND ENTERTAINMENT

FOR INSTRUCTION IN THE FIELD OF DATA PROCESSING, COMPUTER SOFTWARE AND COMPUTER SYSTEMS (U.S. CLS. 100, 101 AND 107).

FIRST USE 11-0-2001; IN COMMERCE 11-0-2001.

CLASS 37—CONSTRUCTION AND REPAIR

FOR (BASED ON INTENT TO USE) MAINTENANCE, REPAIR AND INSTALLATION OF VEHICLES, THEIR PARTS, FITTINGS AND SPARE PARTS (U.S. CLS. 100, 103 AND 106).

SN 76-396,330. TECMO, LIMITED, TOKYO, JAPAN, FILED 4-17-2002.

DIGITAL VENUS

NO CLAIM IS MADE TO THE EXCLUSIVE RIGHT TO USE "DIGITAL", APART FROM THE MARK AS SHOWN.

CLASS 9—ELECTRICAL AND SCIENTIFIC APPARATUS

FOR COMPUTER, ELECTRONIC OR VIDEO GAME EQUIPMENT FOR PLAYING GAMES, NAMELY COMPUTER GAME SOFTWARE; COMPUTER, ELECTRONIC OR VIDEO GAME EQUIPMENT FOR USE WITH TELEVISIONS, NAMELY COMPUTER GAME SOFTWARE FOR USE WITH TELEVISIONS; ELECTRONIC GAME PROGRAMS ADAPTED FOR USE WITH TELEVISION RECEIVERS; VIDEO GAME SOFTWARE FOR USE ON ELECTRONIC GAME EQUIPMENT; VIDEO GAME SOFTWARE FOR USE WITH COIN-OPERATED ELECTRONIC GAME EQUIPMENT; VIDEO GAME PROGRAM SOFTWARE FOR USE WITH CELLULAR TELEPHONE; VIDEO GAME SOFTWARE; COMPUTERS; COMPUTER SOFTWARE GAME CARTRIDGES; VIDEO GAME CARTRIDGES, DISKS, CASSETTES AND SOFTWARE; HAND HELD JOY STICKS, MOUSE CONTROLLERS AND TRACKER BALL CONTROLLERS, ALL FOR USE WITH TELEVISION GAME APPARATUS, VIDEO GAME APPARATUS OR COMPUTER OR ELECTRONIC GAME APPARATUS; FLOOR PADS OR MATS FOR INTERACTIVE CONTROL OF COMPUTER, ELECTRONIC OR VIDEO GAMES; REMOTE CONTROLLERS FOR INTERACTIVE CONTROL OF COMPUTER, ELECTRONIC OR VIDEO GAMES; INTERACTIVE MULTIMEDIA COMPUTER, ELECTRONIC AND VIDEO GAME PROGRAMS; INTERACTIVE COMPUTER AND VIDEO GAMES OF VIRTUAL REALITY COMPRISED OF COMPUTER HARDWARE AND COMPUTER SOFTWARE; CINEMATOGRAPHIC FILMS; DOWNLOADABLE COMPUTER GAME SOFTWARE; DOWNLOADABLE MUSICAL SOUND RECORDINGS; DOWNLOADABLE VIDEO RECORDINGS FEATURING MUSIC; DOWNLOADABLE ELECTRONIC PUBLICATIONS IN THE NATURE OF MAGAZINE IN THE FIELD OF GAME SOFTWARE (U.S. CLS. 21, 23, 26, 36 AND 38).

CLASS 41—EDUCATION AND ENTERTAINMENT

FOR EDUCATION OR INSTRUCTION SERVICES, NAMELY SEMINARS IN THE FIELD OF ARTS/CRAFTS; MOVIE FILM PRODUCTION; MOVIE FILM DISTRIBUTION; PRODUCTION OF RADIO AND TELEVISION PROGRAMS; PROVIDING COMPUTER GAMES VIA COMPUTER NETWORK; PROVIDING A COMPUTER GAME THAT MAY BE ACCESSED NETWORK-WIDE BY NETWORK USERS; ENTERTAINMENT SERVICES, NAMELY, PROVIDING AN ON-LINE COMPUTER GAME; RENTAL OF COMPUTER GAME PROGRAMS; PROVIDING AMUSEMENT FACILITIES; BOOKING OF SEATS FOR SHOWING MOVIES, SHOWS, PLAYS OR MUSICAL PERFORMANCE; RENTAL AND LEASING OF TOYS; RENTAL AND LEASING OF MACHINES AND INSTRUMENTS, NAMELY, SLOT MACHINES FOR USE IN AMUSEMENT PARKS; RENTAL AND LEASING OF GAME MACHINES; PROVIDING INFORMATION IN RELATION TO MOVIES; PROVIDING INFORMATION IN RELATION TO PERFORMANCE OF SHOWS; PROVIDING INFORMATION IN RELATION TO PLAYS; PROVIDING INFORMATION IN RELATION TO MUSIC (CONCERTS); PROVIDING INFORMATION IN RELATION TO RADIO AND TELEVISION PROGRAMS; PROVIDING INFORMATION IN RELATION TO SPORTS; PROVIDING INFORMATION IN RELATION TO HORSE RACES; PROVIDING INFORMATION IN RELATION TO BICYCLE RACES; PROVIDING INFORMATION IN RELATION TO GO-CART RACES; PROVIDING INFORMATION IN RELATION TO BOAT RACES; PROVIDING

INFORMATION IN RELATION TO LOTTERY TICKETS; PROVIDING INFORMATION IN RELATION TO GAMES VIA COMPUTER NETWORKS; PROVIDING INFORMATION IN RELATION TO VIDEO GAME APPARATUS FOR PERSONAL USE AND PROGRAMS THEREOF; PROVIDING INFORMATION IN RELATION TO VIDEO GAME APPARATUS FOR COMMERCIAL USE AND PROGRAMS THEREOF; PROVIDING INFORMATION IN RELATION TO AMUSEMENT FACILITIES; PROVIDING INFORMATION IN RELATION TO ENTERTAINMENT BOOKING FOR CONCERTS (U.S. CLS. 100, 101 AND 107).

SN 76-396,742. PREMIER SHEEP SUPPLIES, LTD., WASHINGTON, IA. FILED 4-16-2002.



CLASS 7—MACHINERY

FOR BLADES AND BRUSHES FOR ELECTRIC CLIPPERS FOR SHEARING LIVESTOCK; POWER OPERATED SHEARS FOR SHEARING OR TRIMMING LIVESTOCK; AND MECHANIZED LIVESTOCK FEEDERS (U.S. CLS. 13, 19, 21, 23, 31, 34 AND 35).

CLASS 8—HAND TOOLS

FOR CLIPPERS AND HAND OPERATED SHEARS FOR SHEARING OR TRIMMING LIVESTOCK (U.S. CLS. 23, 28 AND 44).

CLASS 9—ELECTRICAL AND SCIENTIFIC APPARATUS

FOR ELECTRIC FENCES FOR LIVESTOCK (U.S. CLS. 21, 23, 26, 36 AND 38).

SN 76-397,245. LA ROCHE-POSAY LABORATOIRE PHARMACEUTIQUE, LA ROCHE-POSAY, FRANCE, FILED 4-18-2002.

HOME PEEL

PRIORITY CLAIMED UNDER SEC. 44(D) ON FRANCE APPLICATION NO. 02/3.156.420, FILED 3-28-2002, REG. NO. 023156420, DATED 3-28-2002, EXPIRES 3-28-2012.

CLASS 3—COSMETICS AND CLEANING PREPARATIONS

FOR PERFUME, TOILET WATER; GELS AND SALTS FOR THE BATH AND THE SHOWER NOT FOR MEDICAL PURPOSES; TOILET SOAPS; BODY DEODORANTS; COSMETICS, NAMELY CREAMS, MILKS, LOTIONS, GELS AND POWDERS FOR THE FACE, THE BODY AND THE HANDS; COSMETICS, NAMELY NON-MEDICATED SUN BLOCK AND SUN SCREEN PREPARATIONS; MAKE-UP PREPARATIONS; HAIR SHAMPOOS; GELS, SPRAYS, MOUSSES AND BALMS FOR HAIR STYLING AND HAIR CARE; HAIR LACQUERS; HAIR COLOURING AND HAIR DECOLORANT PREPARATIONS; PERMANENT WAVING AND CURLING PREPARATIONS; ESSENTIAL OILS FOR PERSONAL USE (U.S. CLS. 1, 4, 6, 50, 51 AND 52).

CLASS 5—PHARMACEUTICALS

FOR PHARMACEUTICAL PREPARATIONS FOR TREATMENT OF THE SKIN; SANITARY PREPARATIONS FOR MEDICAL PURPOSES, NAMELY, MEDICAL PLASTERS; SKIN WOUND AND BURN DRESSINGS; AND SKIN DISINFECTANTS FOR MEDICAL PURPOSES (U.S. CLS. 6, 18, 44, 46, 51 AND 52).

SN 76-397,980. VILLARI, PETER M., LANSDALE, PA. FILED 4-18-2002.

**THE I.D.E.A. LAWYERS
"PROTECTING YOUR
CHILD'S EDUCATIONAL
RIGHTS"**

NO CLAIM IS MADE TO THE EXCLUSIVE RIGHT TO USE "LAWYERS" AND "EDUCATIONAL", APART FROM THE MARK AS SHOWN.

CLASS 41—EDUCATION AND ENTERTAINMENT

FOR PROVIDING EDUCATIONAL SERVICES, NAMELY, ASSISTING CHILDREN WITH DISABILITIES AND/OR DEVELOPMENTAL DELAYS IN OBTAINING APPROPRIATE PRIVATE OR PUBLIC EDUCATION UNDER STATE AND FEDERAL LAWS (U.S. CLS. 100, 101 AND 107).

CLASS 42—SCIENTIFIC, COMPUTER AND LEGAL SERVICES

FOR LEGAL SERVICES, NAMELY, PROVIDING ASSISTANCE TO PARENTS WITH CHILDREN WITH DISABILITIES AND/OR DEVELOPMENTAL DELAYS (U.S. CLS. 100 AND 101).

SN 76-398,472. FISCHER, HARVEY, AKA JACK DIAMOND, GAITHERSBURG, MD. FILED 4-19-2002.

JACK DIAMOND

CLASS 41—EDUCATION AND ENTERTAINMENT

FOR NIGHT CLUBS AND OTHER ENTERTAINMENT FACILITIES, NAMELY DINNER THEATERS, CASINOS, BILLIARD CLUBS (U.S. CLS. 100, 101 AND 107).

CLASS 43—HOTEL AND RESTAURANT SERVICES

FOR RESTAURANT AND TAKE-OUT RESTAURANT SERVICES, COCKTAIL LOUNGES (U.S. CLS. 100 AND 101).

SN 76-399,111. CYTOS BIOTECHNOLOGY AG, 8952 ZURICH-SCHLIEREN, SWITZERLAND, FILED 4-23-2002.



PRIORITY CLAIMED UNDER SEC. 44(D) ON SWITZERLAND APPLICATION NO. 10375/2001. FILED 10-26-2001, REG. NO. 497625, DATED 4-11-2002, EXPIRES 10-26-2021.

CLASS 5—PHARMACEUTICALS

FOR PHARMACEUTICAL AND VETERINARY PREPARATIONS, NAMELY, ANTIBIOTICS, VACCINES AND MEDICINES FOR THE TREATMENT OF IMMUNOLOGICAL AND HEMATOLOGICAL DISORDERS, DISEASES AFFECTING THE IMMUNE SYSTEM, ALLERGIES, INFLAMMATIONS, CANCER, CARDIOVASCULAR, AND METABOLIC DISEASES, NERVOUS SYSTEM DISORDERS, INFECTIOUS DISEASES, RESPIRATORY DISEASES, BONE DISEASES, AND AILMENTS ASSOCIATED WITH TRANSPLANTATION, ALL FOR USE BY HUMANS AND ANIMALS, NAMELY, DOMESTIC, FARM AND WILD ANIMALS; DIETARY SUPPLEMENTS FOR MEDICAL USE; SANITARY PREPARATIONS FOR MEDICAL USE, NAMELY, ANTIBACTERIAL, ANTIVIRAL AND ANTIFUNGAL AGENTS FOR THE ELIMINATION OR REDUCTION OF GERMS, BACTERIA, VIRUSES AND FUNGI (U.S. CLS. 6, 18, 44, 46, 51 AND 52).

CLASS 42—SCIENTIFIC, COMPUTER AND LEGAL SERVICES

FOR SCIENTIFIC RESEARCH IN THE FIELD OF BIOTECHNOLOGY; TECHNICAL CONSULTATION AND RESEARCH IN THE FIELD OF BIOTECHNOLOGY; INDUSTRIAL RESEARCH IN THE FIELD OF BIOTECHNOLOGY, NAMELY, FOR THE IDENTIFICATION AND PRODUCTION OF PROTEINS AND VACCINES; DEVELOPMENT OF NEW TECHNOLOGIES FOR OTHERS IN THE FIELD OF BIOTECHNOLOGY (U.S. CLS. 100 AND 101).

SN 76-399,569. STUFFY BEAR FACTORY, LAS VEGAS, NV. FILED 4-24-2002.

STUFFY BEAR FACTORY

NO CLAIM IS MADE TO THE EXCLUSIVE RIGHT TO USE "BEAR FACTORY", APART FROM THE MARK AS SHOWN.

CLASS 28—TOYS AND SPORTING GOODS

FOR STUFFED TOY ANIMALS; CLOTHING FOR STUFFED TOY ANIMALS, SPECIFICALLY DRESSES, PANTS, SKIRTS, SHIRTS, HATS, VESTS, SUITS, AND BRIDAL GOWNS AND VEILS; AND TOY ACCESSORIES FOR STUFFED TOY ANIMALS, SPECIFICALLY, PURSES, SUN GLASSES, SURF BOARDS, HEADBANDS, BELTS, SHOES, TOY MUSICAL INSTRUMENTS, JEWELRY, AND ADOPTION CERTIFICATES (U.S. CLS. 22, 23, 38 AND 50).

FIRST USE 11-23-2000; IN COMMERCE 11-23-2000.

CLASS 35—ADVERTISING AND BUSINESS

FOR RETAIL STORE SERVICES WHEREIN CUSTOMERS PICK UP AN UNSTUFFED ANIMAL, PLACE IT ON A CONVEYOR SYSTEM AND FOLLOW ALONG IN CONSTRUCTING THE STUFFED ANIMAL, BY STUFFING, STITCHING, ADOPTING, SPRUCING AND DRESSING THEIR CREATION (U.S. CLS. 100, 101 AND 102).

FIRST USE 11-23-2000; IN COMMERCE 11-23-2000.

SN 76-399,591. MIDAX, 92230 GENNEVILLIERS, FRANCE, FILED 4-25-2002.



PRIORITY CLAIMED UNDER SEC. 44(D) ON FRANCE APPLICATION NO. 013129829, FILED 10-31-2001, REG. NO. 013129829, DATED 10-31-2001, EXPIRES 10-31-2011.

NO CLAIM IS MADE TO THE EXCLUSIVE RIGHT TO USE "TAROT", APART FROM THE MARK AS SHOWN.

CLASS 28—TOYS AND SPORTING GOODS

FOR GAMES AND PLAYTHINGS, NAMELY, BOARD GAMES, MARBLES FOR GAMES, DICE AND COUNTERS FOR GAMES (U.S. CLS. 22, 23, 38 AND 50).

CLASS 43—HOTEL AND RESTAURANT SERVICES

FOR RESTAURANT, BAR AND CAFE SERVICES (U.S. CLS. 100 AND 101).

SN 76-399,657. HARRINGTON & KING PERFORATING CO., INC., THE, CHICAGO, IL. FILED 4-23-2002.

**CLASS 6—METAL GOODS**

FOR SHEETS AND COILS OF PERFORATED COMMON METALS AND ORNAMENTAL METAL GRILLE STOCK AND PANELS OF COMMON METALS (U.S. CLS. 2, 12, 13, 14, 23, 25 AND 50).

FIRST USE 0-0-1963; IN COMMERCE 0-0-1963.

CLASS 40—MATERIAL TREATMENT

FOR CUSTOM MANUFACTURE OF PERFORATED STRIPS AND SHEETS FOR CONSTRUCTION USES (U.S. CLS. 100, 103 AND 106).

FIRST USE 0-0-1962; IN COMMERCE 0-0-1962.

SN 76-399,899. WOODSTREAM CORPORATION, LITITZ, PA. FILED 4-24-2002.



OWNER OF U.S. REG. NOS. 622,813, 2,494,915 AND OTHERS.

CLASS 5—PHARMACEUTICALS

FOR REPELLENTS, NAMELY, LIQUID COMPOSITIONS FOR CONTAINMENT, EXCLUSION AND TRAINING OF PETS AND SMALL ANIMALS, NAMELY BIRDS, DOGS, CATS, RACCOONS, DEER, SQUIRRELS, GEESE, RABBITS AND MOLES (U.S. CLS. 6, 18, 44, 46, 51 AND 52).

FIRST USE 7-26-1999; IN COMMERCE 7-26-1999.

CLASS 6—METAL GOODS

FOR METAL RODS AND POSTS FOR SUPPORTING BIRD AND SQUIRREL FEEDERS AND HOUSES; PET SUPPLIES, NAMELY METAL TIE-OUT STAKES, METAL PET LEADS, METAL HALTER CHAINS, METAL RUNNER AND TIE-OUT CHAINS, METAL ANIMAL TRAPS FOR SQUIRRELS, RABBITS, RODENTS, RACCOONS AND CATS; METAL ANIMAL HOUSES FOR SQUIRRELS, RABBITS, DOGS, CATS, CHICKENS, GEESE AND RACCOONS (U.S. CLS. 2, 12, 13, 14, 23, 25 AND 50).

FIRST USE 10-27-1980; IN COMMERCE 10-27-1980.

CLASS 9—ELECTRICAL AND SCIENTIFIC APPARATUS

FOR COLLAR-MOUNTED ELECTRICAL RECEIVERS FOR PETS RESPONSIVE TO SOUND AND/OR HAND-HELD TRANSMITTERS TO INITIATE AN AUDIBLE OR LOW LEVEL ELECTRICAL STIMULATION TO MINIMIZE BARKING, CONTAINMENT AND EXCLUSIONARY PRODUCTS AND TRAINING DEVICES, NAMELY ELECTRIC ANIMAL CONTAINMENT AND EXCLUSIONARY CONTROL FENCES, HAND-HELD TRAINING DEVICES FOR SELECTIVELY EMITTING PLEASANT AND UNPLEASANT AUDIBLE TONES, TRANSMITTERS RESPONSIVE TO THE PRESENCE OF RECEIVERS ON A PET'S COLLAR TO INITIATE AN AUDIBLE WARNING AND/OR ELECTRICAL STIMULATION, ELECTRONIC LEASHES, SHORT AND LONG DISTANCE MONITORS ON PET COLLARS, PET CONTAINMENT BARRIERS FOR USE IN VEHICLES, ELECTRONIC POSTS TO PROVIDE A LOW LEVEL ELECTRICAL STIMULATION TO REPEL ANIMALS, MOTION-ACTIVATED WATER SPRAY DEVICES TO REPEL ANIMALS; INDOOR BOUNDARY DEVICES IN THE NATURE OF AUDIBLE AND LOW LEVEL ELECTRICAL STIMULATION PRODUCING DEVICES, AND VIBRATION RESPONSIVE SENSORS TO DETECT THE PRESENCE OF AN ANIMAL AND TRIGGER AN ALARM CIRCUIT (U.S. CLS. 21, 23, 26, 36 AND 38).

FIRST USE 8-30-1999; IN COMMERCE 8-30-1999.

CLASS 18—LEATHER GOODS

FOR PET AND SMALL ANIMAL CARRIERS (U.S. CLS. 1, 2, 3, 22 AND 41).

FIRST USE 0-0-1995; IN COMMERCE 0-0-1995.

CLASS 19—NON-METALLIC BUILDING MATERIALS

FOR PREFABRICATED AND MODULAR PET AND SMALL ANIMAL HOUSES (U.S. CLS. 1, 12, 33 AND 50). FIRST USE 0-0-1994; IN COMMERCE 0-0-1994.

CLASS 21—HOUSEWARES AND GLASS

FOR RODENT TRAPS, PLASTIC LITTER PANS, BIRD FEEDERS, BUTTERFLY FEEDERS, SQUIRREL CHAIRS FOR FEEDING SQUIRRELS, SQUIRREL POLE AND POST BAFFLES FOR DISCOURAGING SQUIRRELS FROM ACCESS TO BIRD FEEDERS, RODS AND POSTS FOR SUPPORTING BIRD AND SQUIRREL FEEDERS AND HOUSES; SEED CATCHERS, SEED TRAY CATCHERS; BIRD HOUSES, BAT HOUSES; PET AND SMALL ANIMAL CAGES; LITTER PANS AND LITTER PAN LINERS; ANIMAL FEEDERS; METAL NESTS; URINE GUARDS; WATER BOTTLES AND SALT SPOOL HANGERS ALL FOR USE IN PET AND SMALL ANIMAL CARRIERS, HOUSES AND CAGES, AND CAGE CLIPS AND CAGE CLIP PLIERS FOR ASSEMBLING PET AND SMALL ANIMAL CARRIERS, HOUSES AND CAGES AND SOLD TOGETHER AS A UNIT; AND STRAY CAT RESCUE KITS CONSISTING PRIMARILY OF CAT CAGES AND DIVIDERS (U.S. CLS. 2, 13, 23, 29, 30, 33, 40 AND 50).

FIRST USE 0-0-1985; IN COMMERCE 0-0-1985.

SN 76-400,458. KONAMI CORPORATION, TOKYO, JAPAN, FILED 4-26-2002.

CONTRA ADVANCE

OWNER OF U.S. REG. NOS. 1,455,536, 1,876,017 AND OTHERS.

CLASS 9—ELECTRICAL AND SCIENTIFIC APPARATUS

FOR VIDEO GAME SOFTWARE; VIDEO GAME PROGRAMS; VIDEO GAME CD-ROMS; VIDEO GAME DIGITAL VERSATILE DISC-ROMS; COMPUTER GAME PROGRAMS; COMPUTER GAME CD-ROMS; COMPUTER GAME DIGITAL VERSATILE DISC-ROMS; ELECTRONIC GAME PROGRAMS; ELECTRONIC GAME CD-ROMS; ELECTRONIC GAME DIGITAL VERSATILE DISC-ROMS; COMPUTER GAME CARTRIDGES AND COMPUTER GAME CASSETTES FOR PLAYING ELECTRONIC GAMES ON HAND-HELD UNITS; CIRCUIT BOARDS CONTAINING GAME PROGRAMS FOR USE WITH HAND-HELD VIDEO GAME MACHINE; VIDEO OUTPUT GAME MACHINES FOR USE WITH TELEVISIONS; DOWNLOADABLE ELECTRONIC GAME SOFTWARE, DOWNLOADABLE COMPUTER GAME SOFTWARE AND DOWNLOADABLE VIDEO GAME SOFTWARE (U.S. CLS. 21, 23, 26, 36 AND 38).

CLASS 28—TOYS AND SPORTING GOODS

FOR STAND-ALONE VIDEO GAME MACHINES; HAND-HELD VIDEO GAME MACHINES; HAND-HELD UNITS FOR PLAYING ELECTRONIC GAMES; TOYS NAMELY ACTION FIGURES, DOLLS, AND PLAYSETS THEREFORE (U.S. CLS. 22, 23, 38 AND 50).

CLASS 41—EDUCATION AND ENTERTAINMENT

FOR ENTERTAINMENT SERVICES, NAMELY PROVIDING ON-LINE COMPUTER GAMES; PROVIDING ON-LINE COMPUTER DATABASE IN THE FIELD OF COMPUTER GAMES; PROVIDING INFORMATION TO GAME PLAYERS ABOUT THE RANKING OF THEIR SCORES OF GAMES THROUGH THE WEB SITES; PROVIDING INFORMATION ABOUT COMPUTER GAMES THROUGH THE WEB SITES (U.S. CLS. 100, 101 AND 107).

SN 76-401,317. KABUSHIKI KAISHA MARY CHOCOLATE COMPANY, DBA MARY CHOCOLATE CO., LTD., OTAKU, TOKYO, JAPAN, FILED 4-29-2002.

Setsuko

PRIORITY CLAIMED UNDER SEC. 44(D) ON JAPAN APPLICATION NO. 2002-7716, FILED 2-4-2002, REG. NO. 4600655, DATED 8-30-2002, EXPIRES 8-30-2012.

THE ENGLISH TRANSLATION OF "SETSUKO" IS "MODERATE CHILD" OR "RESTRAINED CHILD".

CLASS 29—MEATS AND PROCESSED FOODS

FOR FRUIT JELLIES (U.S. CL. 46).

CLASS 30—STAPLE FOODS

FOR CHOCOLATE CANDY; COOKIES; ICE-CREAM; WAFER; SPONGE CAKES; CARAMELS; SHERBET; TAFY; DROP; NOUGAT; PIES; BISCUITS; PUDDINGS; MOUSSE; MARRON GLACES (U.S. CL. 46).

SN 76-402,032. PHILLIPS CHEVROLET, INC., FRANKFORT, IL. FILED 5-1-2002.

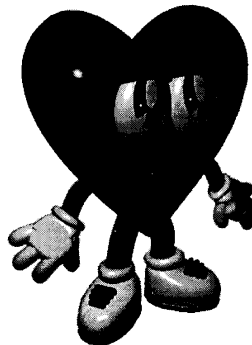
**CLASS 25—CLOTHING**

FOR CLOTHING, NAMELY, SHIRTS, T-SHIRTS, HATS AND JACKETS (U.S. CLS. 22 AND 39). FIRST USE 2-10-2002; IN COMMERCE 3-15-2002.

CLASS 35—ADVERTISING AND BUSINESS

FOR AUTOMOBILE DEALERSHIPS FEATURING AUTOMOBILES, SPORT UTILITY VEHICLES AND LIGHT TRUCKS (U.S. CLS. 100, 101 AND 102).
FIRST USE 2-10-2002; IN COMMERCE 3-15-2002.

CLASS 37—CONSTRUCTION AND REPAIR

FOR REPAIR OF AUTOMOBILES, SPORT UTILITY VEHICLES AND LIGHT TRUCKS (U.S. CLS. 100, 103 AND 106).
FIRST USE 2-10-2002; IN COMMERCE 3-15-2002.

CLASS 39—TRANSPORTATION AND STORAGE

FOR LEASING OF AUTOMOBILES, SPORT UTILITY VEHICLES AND LIGHT TRUCKS (U.S. CLS. 100 AND 105).
FIRST USE 2-10-2002; IN COMMERCE 3-15-2002.

SN 76-402,225. VORMETRIC, INC., SAN JOSE, CA. BY CHANGE OF NAME AES NETWORKS, INC., SAN JOSE, CA. FILED 4-29-2002.

VORMETRIC**CLASS 9—ELECTRICAL AND SCIENTIFIC APPARATUS**

FOR COMPUTER HARDWARE; COMMUNICATIONS SERVERS; COMPUTER NETWORK HUBS, SWITCHES AND ROUTERS; TELECOMMUNICATION SWITCHES; COMPUTER SOFTWARE FOR USE IN NETWORK MANAGEMENT AND SECURITY, DATA STORAGE, DATA ENCRYPTION AND DATA SECURITY; DATABASE MANAGEMENT SOFTWARE FOR GENERAL USE; COMMUNICATIONS SOFTWARE FOR CONNECTING COMMUNICATIONS NETWORKS; COMPUTER SOFTWARE DEVELOPMENT TOOLS; MANUALS DISTRIBUTED AS A UNIT FOR THE FOREGOING (U.S. CLS. 21, 23, 26, 36 AND 38).

CLASS 35—ADVERTISING AND BUSINESS

FOR LICENSING OF COMPUTER SOFTWARE (U.S. CLS. 100, 101 AND 102).

CLASS 42—SCIENTIFIC, COMPUTER AND LEGAL SERVICES

FOR COMPUTER HARDWARE DESIGN; COMPUTER HARDWARE DEVELOPMENT; COMPUTER SOFTWARE DEVELOPMENT; COMPUTER SOFTWARE DESIGN FOR OTHERS; COMPUTER SOFTWARE CONSULTATION; COMPUTER NETWORK DESIGN FOR OTHERS; INTEGRATION OF COMPUTER SYSTEMS AND NETWORKS; LICENSING OF INTELLECTUAL PROPERTY (U.S. CLS. 100 AND 101).

CLASS 45—PERSONAL SERVICES

FOR MONITORING OF DIGITAL DATA AND COMPUTER SYSTEMS FOR SECURITY PURPOSES (U.S. CLS. 100 AND 101).

SN 76-402,375. PHARMAPLAN INTERNATIONAL GMBH, OBERURSEL 61440, FED REP GERMANY, FILED 4-29-2002.

PHARMAPLAN

OWNER OF U.S. REG. NO. 2,402,363.

CLASS 35—ADVERTISING AND BUSINESS

FOR BUSINESS MANAGEMENT CONSULTATION IN THE FIELD OF PLANNING AND COMPLETION OF CONSTRUCTION OF MACHINERY, INSTALLATIONS AND EQUIPMENT FOR THE PHARMACEUTICAL AND CHEMICAL BUSINESS (U.S. CLS. 100, 101 AND 102).
FIRST USE 9-0-1999; IN COMMERCE 9-0-1999.

CLASS 36—INSURANCE AND FINANCIAL

FOR FINANCIAL ANALYSIS AND CONSULTATION IN THE FIELD OF PLANNING AND COMPLETION OF CONSTRUCTION OF MACHINERY, INSTALLATIONS AND EQUIPMENT FOR THE PHARMACEUTICAL AND CHEMICAL INDUSTRIES (U.S. CLS. 100, 101 AND 102).
FIRST USE 9-0-1999; IN COMMERCE 9-0-1999.

CLASS 37—CONSTRUCTION AND REPAIR

FOR CONSTRUCTION PLANNING SERVICES, NAMELY, TECHNICAL AND ORGANIZATIONAL PLANNING FOR THE CONSTRUCTION AND COMPLETION OF HOSPITAL AND PARTS THEREOF (U.S. CLS. 100, 103 AND 106).
FIRST USE 9-0-1999; IN COMMERCE 9-0-1999.

CLASS 42—SCIENTIFIC, COMPUTER AND LEGAL SERVICES

FOR TECHNICAL CONSULTATION IN THE FIELD OF PLANNING AND COMPLETION OF CONSTRUCTION OF MACHINERY, INSTALLATIONS AND EQUIPMENT FOR THE PHARMACEUTICAL AND CHEMICAL INDUSTRIES (U.S. CLS. 100 AND 101).
FIRST USE 9-0-1999; IN COMMERCE 9-0-1999.

SN 76-402,716. SX BUOWAREN PRODUKTIONS UND HANDELS GMBH, A-1231 VIENNA, AUSTRIA, FILED 5-1-2002.

KRAUSE HANDLER

PRIORITY CLAIMED UNDER SEC. 44(D) ON AUSTRIA APPLICATION NO. 1226/2002, FILED 2-22-2002, REG. NO. 203477, DATED 5-3-2002, EXPIRES 5-3-2012.

CLASS 6—METAL GOODS

FOR SMALL ITEMS OF METAL HARDWARE, NAMELY RIVETS, CRAMPS AND NAILS (U.S. CLS. 2, 12, 13, 14, 23, 25 AND 50).

CLASS 7—MACHINERY

FOR RIVETING MACHINES (U.S. CLS. 13, 19, 21, 23, 31, 34 AND 35).

CLASS 16—PAPER GOODS AND PRINTED MATTER

FOR LOOSE LEAF BINDERS, LEVER ARCH MECHANISM, NAMELY, LOOSE LEAF BOOK BINDERS; WIRE PAPER CLIPS TO HOLD WRITTEN AND PRINTED MATTER IN OFFICE FILES; DESKTOP AND PERSONAL ORGANIZERS; A FULL LINE OF OFFICE REQUISITES; STAPLERS; PUNCHERS; DOCUMENT FILES AND FOLDERS; JACKETS FOR PAPER; STACKING TRAYS FOR COMPUTER PRINTOUTS; RACKS FOR LETTERS AND PRINTED FORMS; AND LETTER TRAYS AND SHELVES (U.S. CLS. 2, 5, 22, 23, 29, 37, 38 AND 50).

CLASS 16—PAPER GOODS AND PRINTED MATTER

FOR PRINTED MATERIALS, NAMELY, NEWSLETTERS, BOOKLETS, BROCHURES, PRINTED INSTRUCTIONAL AND TEACHING MATERIALS, WORKSHEETS, AND WORKBOOKS, ALL IN THE FIELDS OF INVESTMENT, FINANCE, ECONOMICS, BUSINESS, FINANCIAL PLANNING, PORTFOLIO MANAGEMENT, RETIREMENT PLANNING, MONEY MANAGEMENT, INVESTMENT STRATEGY AND ASSET ALLOCATION; PERIODICAL PUBLICATIONS, NAMELY, MAGAZINES AND JOURNALS, IN THE FIELDS OF INVESTMENT, FINANCE, ECONOMICS, BUSINESS, FINANCIAL PLANNING, PORTFOLIO MANAGEMENT, RETIREMENT PLANNING, MONEY MANAGEMENT, INVESTMENT STRATEGY AND ASSET ALLOCATION (U.S. CLS. 2, 5, 22, 23, 29, 37, 38 AND 50).

SN 76-402,718. SX BUROWAREN PRODUKTIONS UND HANDELS GMBH, A-1231 VIENNA, AUSTRIA, FILED 5-1-2002.

KOLOMAN HANDLER

OWNER OF AUSTRIA REG. NO. 189163, DATED 6-15-2000, EXPIRES 6-15-2010.

CLASS 6—METAL GOODS

FOR SMALL ITEMS OF METAL HARDWARE, NAMELY RIVETS, CRAMPS AND NAILS (U.S. CLS. 2, 12, 13, 14, 23, 25 AND 50).

CLASS 7—MACHINERY

FOR RIVETING MACHINES (U.S. CLS. 13, 19, 21, 23, 31, 34 AND 35).

CLASS 16—PAPER GOODS AND PRINTED MATTER

FOR LOOSE LEAF BINDERS, LEVER ARCH MECHANISM, NAMELY, LOOSE LEAF BOOK BINDERS; WIRE PAPER CLIPS TO HOLD WRITTEN AND PRINTED MATTER IN OFFICE FILES; DESKTOP AND PERSONAL ORGANIZERS; A FULL LINE OF OFFICE REQUISITES; STAPLERS; PUNCHERS; DOCUMENT FILES AND FOLDERS; JACKETS FOR PAPER; STACKING TRAYS FOR COMPUTER PRINTOUTS; RACKS FOR LETTERS AND PRINTED FORMS; AND LETTER TRAYS AND SHELVES (U.S. CLS. 2, 5, 22, 23, 29, 37, 38 AND 50).

CLASS 36—INSURANCE AND FINANCIAL

FOR BROKERAGE SERVICES IN THE FIELDS OF FINANCIAL SECURITIES, STOCKS, BONDS, MUTUAL FUNDS, MONEY MARKET FUNDS, COMMODITIES, FUTURES, STOCK OPTIONS, AND INDICES OF FINANCIAL SECURITIES; INVESTMENT SERVICES IN THE FIELDS OF FINANCIAL SECURITIES, STOCKS, BONDS, MUTUAL FUNDS, MONEY MARKET FUNDS, COMMODITIES, FUTURES, STOCK OPTIONS, AND INDICES OF FINANCIAL SECURITIES; INVESTMENT ADVICE AND MANAGEMENT IN THE FIELDS OF FINANCIAL SECURITIES, STOCKS, BONDS, MUTUAL FUNDS, MONEY MARKET FUNDS, COMMODITIES, FUTURES, STOCK OPTIONS, AND INDICES OF FINANCIAL SECURITIES; SECURITIES BROKERAGE ACCOUNT SERVICES THAT FEATURE AN INTEREST-BEARING FEATURE FOR CASH BETWEEN INVESTMENTS, ELECTRONIC CASH TRANSACTIONS, AND MARGIN LOAN SERVICES; BANKING SERVICES; CREDIT CARD AND DEBIT CARD SERVICES; CHECK PROCESSING AND BILL PAYMENT SERVICES; ANNUITY INVESTMENT SERVICES; FINANCIAL INVESTMENT IN THE FIELD OF VARIABLE INSURANCE; FINANCIAL INFORMATION PROVIDED BY ELECTRONIC MEANS; ADMINISTRATION OF EMPLOYEE PENSION PLANS; FINANCIAL PLANNING; INSURANCE BROKERAGE; CASH MANAGEMENT ACCOUNT SERVICES; FIXED INCOME INVESTMENT SERVICES; ELECTRONIC FUNDS TRANSFER; PROVIDING INFORMATION AND ANALYSIS IN THE FIELDS OF FINANCE, ECONOMICS, INVESTMENT, BUSINESS, FINANCIAL PLANNING, AND INVESTMENT STRATEGY; PROVIDING PORTFOLIO MANAGEMENT SERVICES; PROVIDING AN INTERACTIVE ONLINE COMPUTER DATABASE IN THE FIELD OF FINANCIAL PORTFOLIO MANAGEMENT, FINANCIAL DECISION MAKING, INVESTMENT RESEARCH, MONITORING INVESTMENT VALUE AND PERFORMANCE OF INVESTMENTS, ANALYZING INVESTMENT PERFORMANCE, EVALUATING ASSET ALLOCATION, RISK TOLERANCE, FINANCIAL ALTERNATIVE PLANS AND INVESTMENT TIME FRAMES; PROVIDING INFORMATION BY PHONE AND BY ONLINE MEANS IN THE FIELD OF INVESTMENT ACCOUNT INFORMATION AND FINANCIAL RESEARCH; PROVIDING AN ONLINE COMPUTER DATABASE IN THE FIELDS OF INVESTING, FINANCE, FINANCIAL PLANNING, FINANCIAL NEWS, FINANCIAL INFORMATION, AND ANALYSIS IN THE FIELDS OF INVESTING, FINANCE AND FINANCIAL PLANNING (U.S. CLS. 100, 101 AND 102).

SN 76-403,195. CHARLES SCHWAB & CO., INC., SAN FRANCISCO, CA. FILED 5-1-2002.

SCHWAB SIGNATURE CLIENT

OWNER OF U.S. REG. NOS. 1,703,692, 2,462,502 AND OTHERS.

CLASS 41—EDUCATION AND ENTERTAINMENT

FOR EDUCATIONAL SERVICES, NAMELY, CONDUCTING SEMINARS, CLASSES, CONFERENCES, AND WORKSHOPS IN THE FIELDS OF FINANCIAL INVESTMENTS, FINANCE, FINANCIAL PLANNING, PORTFOLIO MANAGEMENT, RETIREMENT PLANNING, MONEY MANAGEMENT, INVESTMENT STRATEGY, AND ASSET ALLOCATION, AND EDUCATIONAL MATERIALS DISTRIBUTED THEREWITH (U.S. CLS. 100, 101 AND 107).

SN 76-403,485. ABN AMRO NORTH AMERICA, INC., CHICAGO, IL. FILED 5-3-2002.



CLASS 6—METAL GOODS

FOR METAL KEY CHAINS (U.S. CLS. 2, 12, 13, 14, 23, 25 AND 50).

CLASS 14—JEWELRY

FOR LAPEL PINS (U.S. CLS. 2, 27, 28 AND 50).

CLASS 18—LEATHER GOODS

FOR LUGGAGE TAGS AND ATHLETIC AND TOTE BAGS (U.S. CLS. 1, 2, 3, 22 AND 41).

CLASS 21—HOUSEWARES AND GLASS

FOR MUGS AND GLASSES (U.S. CLS. 2, 13, 23, 29, 30, 33, 40 AND 50).

CLASS 40—MATERIAL TREATMENT

FOR FOOD PROCESSING SERVICES, NAMELY MILK AND DAIRY PROCESSING (U.S. CLS. 100, 103 AND 106).

SN 76-403,695. DAIMLERCHRYSLER SERVICES NORTH AMERICA LLC, SOUTHFIELD, MI. FILED 5-3-2002.

DCISI

CLASS 35—ADVERTISING AND BUSINESS

FOR CONSUMER AND COMMERCIAL VEHICLE, AUTOMOBILE AND TRUCK DEALERSHIPS (U.S. CLS. 100, 101 AND 102).

CLASS 36—INSURANCE AND FINANCIAL

FOR CREDIT CARD REVOLVING LINES OF CREDIT; FINANCIAL PORTFOLIO MANAGEMENT; RISK MANAGEMENT; LEASE PURCHASE FINANCING OF CONSUMER AND COMMERCIAL MOTOR VEHICLES, AUTOMOBILES AND TRUCKS; UNDERWRITING INSURANCE IN THE FIELD OF CONSUMER AND COMMERCIAL VEHICLES, AUTOMOBILE SAND TRUCKS; INSURANCE ADMINISTRATION (U.S. CLS. 100, 101 AND 102).

CLASS 39—TRANSPORTATION AND STORAGE

FOR LEASING OF CONSUMER AND COMMERCIAL MOTOR VEHICLES, AUTOMOBILES AND TRUCKS (U.S. CLS. 100 AND 105).

SN 76-403,686. MIDLAND FARMS, INC., NORTH EASTON, MA. FILED 5-3-2002.



NO CLAIM IS MADE TO THE EXCLUSIVE RIGHT TO USE "FARMS", APART FROM THE MARK AS SHOWN.

CLASS 29—MEATS AND PROCESSED FOODS

FOR MILK; DAIRY PRODUCTS EXCLUDING ICE CREAM, ICE MILK AND FROZEN YOGURT (U.S. CL. 46).

CLASS 35—ADVERTISING AND BUSINESS

FOR RETAIL GROCERY STORE SERVICES, FEATURING MILK AND DAIRY PRODUCTS; DISTRIBUTORSHIPS IN THE FIELD OF MILK AND DAIRY PRODUCTS; SUPERMARKETS, NAMELY RETAIL SUPERMARKET SERVICES (U.S. CLS. 100, 101 AND 102).

SN 76-403,696. DAIMLERCHRYSLER SERVICES NORTH AMERICA LLC, SOUTHFIELD, MI. FILED 5-3-2002.

DCIC

CLASS 35—ADVERTISING AND BUSINESS

FOR CONSUMER AND COMMERCIAL VEHICLE, AUTOMOBILE AND TRUCK DEALERSHIPS (U.S. CLS. 100, 101 AND 102).

CLASS 36—INSURANCE AND FINANCIAL

FOR CREDIT CARD REVOLVING LINES OF CREDIT; FINANCIAL PORTFOLIO MANAGEMENT; RISK MANAGEMENT; LEASE PURCHASE FINANCING OF CONSUMER AND COMMERCIAL MOTOR VEHICLES, AUTOMOBILES AND TRUCKS; UNDERWRITING INSURANCE IN THE FIELD OF CONSUMER AND COMMERCIAL VEHICLES, AUTOMOBILES AND TRUCKS; INSURANCE ADMINISTRATION (U.S. CLS. 100, 101 AND 102).

CLASS 39—TRANSPORTATION AND STORAGE

FOR LEASING OF CONSUMER AND COMMERCIAL MOTOR VEHICLES AUTOMOBILES AND TRUCKS (U.S. CLS. 100 AND 105).

SN 76-404,213. WELLSOURCE, INC., CLACKAMAS, OR.
FILED 4-30-2002.

WELLSOURCE

CLASS 9—ELECTRICAL AND SCIENTIFIC APPARATUS

FOR COMPUTER SOFTWARE FOR PERFORMING HEALTH AND LIFESTYLE ASSESSMENTS; COMPUTER SOFTWARE FEATURING LIFESTYLE INVENTORY AND HEALTH SCREEN TESTS, EXPLANATION OF RISKS, AND RECOMMENDATIONS FOR RISK REDUCTION; COMPUTER SOFTWARE FOR TRACKING PERSONAL LIFESTYLE CHANGES, FITNESS ACTIVITIES AND HEALTH GOALS AND FOR MEASURING EFFECTIVENESS OF WELLNESS PROGRAMS (U.S. CLS. 21, 23, 26, 36 AND 38).

FIRST USE 4-2-1983; IN COMMERCE 4-2-1983.

CLASS 16—PAPER GOODS AND PRINTED MATTER

FOR PRINTED INSTRUCTIONAL MATERIALS, NAMELY, BROCHURES, NEWSLETTERS, POSTERS, NOTEBOOKS, GUIDES, HANDOUTS, MANUALS, AND WORKBOOKS IN THE FIELDS OF HEALTH, NUTRITION, EXERCISE, WELLNESS, AND DISEASE MANAGEMENT OR PREVENTION; PRINTED EDUCATIONAL AND TEACHING MATERIALS, NAMELY, BROCHURES, NEWSLETTERS, GUIDES, HANDOUTS, AND WORKBOOKS IN THE FIELDS OF HEALTH, NUTRITION, EXERCISE, WELLNESS AND DISEASE MANAGEMENT; PRINTED CONSUMER INFORMATION MATERIALS, NAMELY, BROCHURES, NEWSLETTERS, POSTERS, NOTEBOOKS, GUIDES, HANDOUTS, MANUALS, AND WORKBOOKS IN THE FIELDS OF HEALTH, NUTRITION, EXERCISE, WELLNESS, AND DISEASE MANAGEMENT OF PREVENTION (U.S. CLS. 2, 5, 22, 23, 29, 37, 38 AND 50).

FIRST USE 4-2-1983; IN COMMERCE 4-2-1983.

CLASS 35—ADVERTISING AND BUSINESS

FOR PROVIDING BUSINESS SERVICES TO OTHERS IN THE HEALTH CARE FIELD, NAMELY, DESIGNING, DEVELOPMENT AND IMPLEMENTING MANAGEMENT SYSTEMS AND PROGRAMS SO THAT OTHERS CAN PROACTIVELY MANAGE, EVALUATE OUTCOMES OF, EDUCATE, ASSESS AND TRACK PATIENTS, CLIENTS, MEMBERS AND OTHER INDIVIDUALS IN THE FIELDS OF HEALTH, NUTRITION, EXERCISE, WELLNESS AND DISEASE MANAGEMENT; BUSINESS MANAGEMENT CONSULTING SERVICES IN THE FIELD OF HEALTH MANAGEMENT SYSTEMS (U.S. CLS. 100, 101 AND 102).

FIRST USE 12-31-1983; IN COMMERCE 12-31-1983.

CLASS 41—EDUCATION AND ENTERTAINMENT

FOR MEDICAL EDUCATION SERVICES, NAMELY, CONDUCTING SEMINARS, WORKSHOPS, COURSES AND EDUCATIONAL DEMONSTRATIONS IN THE FIELDS OF PLANNING, DESIGNING, AND MARKETING WELLNESS PROGRAMS, DOCUMENTING THE OUTCOMES OF SUCH WELLNESS PROGRAMS, EVALUATING THEIR COSTS AND BENEFITS, AND REVIEWING AND EVALUATING RESULTS OF SUCH WELLNESS PROGRAMS (U.S. CLS. 100, 101 AND 107).

FIRST USE 12-31-1992; IN COMMERCE 12-31-1992.

CLASS 42—SCIENTIFIC, COMPUTER AND LEGAL SERVICES

FOR PROVIDING TEMPORARY USE OF NON-DOWNLOADABLE SOFTWARE FOR PERFORMING HEALTH ASSESSMENTS; PROVIDING TEMPORARY USE OF NON-DOWNLOADABLE SOFTWARE FEATURING HEALTH TOPICS FOR USE IN PROMOTIONAL CAMPAIGNS IN THE FIELD OF HEALTH EDUCATION AND HEALTHCARE; PROVIDING TEMPORARY USE OF NON-DOWNLOADABLE SOFTWARE FEATURING LIFESTYLE INVENTORY AND HEALTH SCREENING TESTS, EXPLANATIONS OF RISKS, AND RECOMMENDATIONS FOR RISK REDUCTION; PROVIDING TEMPORARY USE OF NON-DOWNLOADABLE SOFTWARE FOR TRACKING PERSONAL LIFESTYLE CHANGES, FITNESS ACTIVITIES AND HEALTH GOALS, AND FOR MEASURING EFFECTIVENESS OF WELLNESS PROGRAMS; PROVIDING TEMPORARY USE OF NON-DOWNLOADABLE SOFTWARE FOR EDUCATING OTHERS ON WAYS TO IMPROVE THEIR HEALTH, PREVENT DISEASE, MANAGE CHRONIC HEALTH PROBLEMS, AND OBTAIN RELIABLE INSTRUCTIONS FOR IMPROVING QUALITY OF LIFE; DESIGNING, DEVELOPING, AND IMPLEMENTING COMPUTER SOFTWARE PROGRAMS FOR OTHERS IN THE FIELDS OF PLANNING, DESIGNING, AND MARKETING WELLNESS PROGRAMS, DOCUMENTING THE OUTCOMES OF SUCH WELLNESS PROGRAMS, EVALUATING THEIR COSTS AND BENEFITS, AND REVIEWING AND EVALUATING RESULTS OF SUCH WELLNESS PROGRAMS (U.S. CLS. 100 AND 101).

FIRST USE 4-2-1983; IN COMMERCE 4-2-1983.

CLASS 44—MEDICAL, BEAUTY AND AGRICULTURAL SERVICES

FOR MEDICAL AND HEALTH EVALUATION SERVICES, NAMELY, PERFORMING HEALTH AND WELLNESS ASSESSMENTS AND HEALTH SCREENING TESTS; WELLNESS PROMOTION SERVICES, NAMELY, PROVIDING INFORMATION IN THE FIELDS OF LIFESTYLE CHANGES, HEALTH GOALS, PROVIDING EXPLANATIONS OF HEALTH RISKS AND RECOMMENDATIONS FOR RISK REDUCTION, PREVENTION, AND DISEASE MANAGEMENT FOR IMPROVING THE QUALITY OF LIFE (U.S. CLS. 100 AND 101).

FIRST USE 12-31-1983; IN COMMERCE 12-31-1983.

SN 76-404,558. INVERCAP, S.A. DE C. V., COL. VALLE OTE., MEXICO D.F, MEXICO, FILED 5-7-2002.



OWNER OF MEXICO REG. NO. 564505, DATED 10-17-1997, EXPIRES 10-17-2007.

OWNER OF MEXICO REG. NO. 565555, DATED 10-17-1997, EXPIRES 10-17-2007.

CLASS 35—ADVERTISING AND BUSINESS

FOR ADMINISTRATION OF BUSINESS PAYROLL FOR COMMERCIAL AND INDUSTRIAL BUSINESSES (U.S. CLS. 100, 101 AND 102).

CLASS 36—INSURANCE AND FINANCIAL

FOR FINANCIAL SERVICES, NAMELY MONEY LENDING, INVESTMENT FUND TRANSFER AND TRANSACTION SERVICES; BANKING SERVICES; AND CREDIT REPORTING AGENCY (U.S. CLS. 100, 101 AND 102).

SN 76-405,067. HERBA ENTERPRISE, INC., SAN FRANCISCO, CA. FILED 5-8-2002.

CHRYSMORI

THERE IS NO ENGLISH TRANSLATION OF THE MARK. THE MARK IS A COINED WORD.

CLASS 5—PHARMACEUTICALS

FOR DIETARY SUPPLEMENTS (U.S. CLS. 6, 18, 44, 46, 51 AND 52).
FIRST USE 0-0-1996; IN COMMERCE 0-0-1996.

CLASS 30—STAPLE FOODS

FOR BEVERAGE, NAMELY TEA (U.S. CL. 46).
FIRST USE 0-0-1996; IN COMMERCE 0-0-1996.

SN 76-405,089. BLAUPUNKT-WERKE GMBH, 31139 HILDESHEIM, FED REP GERMANY, FILED 5-6-2002.



OWNER OF FED REP GERMANY REG. NO. 39723441, DATED 8-1-1997, EXPIRES 5-31-2007.
OWNER OF U.S. REG. NO. 2,320,171.

CLASS 9—ELECTRICAL AND SCIENTIFIC APPARATUS

FOR APPARATUS AND INSTRUMENTS FOR THE NAVIGATION OF LAND-BOUND VEHICLES FOR PASSENGER TRANSPORT AND TRAFFIC AND FOR GOODS TRANSPORT AND TRAFFIC, NAMELY, COMPUTERS, MONITORS AND ELECTRICAL CONTROLLERS; ELECTRONIC MEMORY CARDS, AND ELECTRONIC CHIP CARDS; DATA MEDIA FOR INFORMATION AND CONTROL SYSTEMS ON CD-ROM, ALL THE AFOREMENTIONED GOODS CONTAINING DIGITAL ROAD MAPS (U.S. CLS. 21, 23, 26, 36 AND 38).

CLASS 16—PAPER GOODS AND PRINTED MATTER

FOR PAPER PRODUCTS, NAMELY, CODE CARDS AND CONTROL CARDS (U.S. CLS. 2, 5, 22, 23, 29, 37, 38 AND 50).

SN 76-405,534. ABC INVESTMENT CORP., WILMINGTON, DE. FILED 5-10-2002.



OWNER OF U.S. REG. NOS. 2,355,033, 2,497,552 AND 2,497,553.
NO CLAIM IS MADE TO THE EXCLUSIVE RIGHT TO USE "RADIO", APART FROM THE MARK AS SHOWN.

CLASS 9—ELECTRICAL AND SCIENTIFIC APPARATUS

FOR (BASED ON INTENT TO USE) SOUND RECORDINGS OF OLD-TIME NOSTALGIC RADIO PROGRAMS FEATURING MUSIC AND DRAMATIC ENTERTAINMENT (U.S. CLS. 21, 23, 26, 36 AND 38).

CLASS 35—ADVERTISING AND BUSINESS

FOR (BASED ON INTENT TO USE) RETAIL MAIL ORDER SERVICES OF RECORDED RADIO PROGRAMS FOR AUDIO PRESENTATION (BASED ON INTENT TO USE) ELECTRONIC RETAILING SERVICES OF RECORDED RADIO PROGRAMS FOR AUDIO PRESENTATION (U.S. CLS. 100, 101 AND 102).
FIRST USE 4-1-2002; IN COMMERCE 4-1-2002.

SN 76-405,792. HEALY & CO, SAN RAMON, CA. FILED 4-4-2002.

HELPING YOU CONNECT

CLASS 35—ADVERTISING AND BUSINESS

FOR BUSINESS ANALYSIS AND PLANNING; BUSINESS NETWORK PLANNING (U.S. CLS. 100, 101 AND 102).
FIRST USE 6-15-2002; IN COMMERCE 6-15-2002.

CLASS 42—SCIENTIFIC, COMPUTER AND LEGAL SERVICES

FOR TECHNICAL IMPLEMENTATION OF SERVICES FOR COMMUNICATIONS NETWORKS (U.S. CLS. 100 AND 101).
FIRST USE 6-15-2000; IN COMMERCE 6-15-2000.

SN 76-405,952. JAC INVESTMENTS INC., ELK GROVE VILLAGE, IL. FILED 5-10-2002.

PREMIUMS. PROMOTIONS. PARTNERSHIPS.

CLASS 35—ADVERTISING AND BUSINESS

FOR DEVELOPMENT OF PHILANTHROPIC INTEGRATED PROMOTIONAL CAMPAIGNS AIMED AT CHILDREN (U.S. CLS. 100, 101 AND 102).
FIRST USE 2-1-2002; IN COMMERCE 2-1-2002.

CLASS 40—MATERIAL TREATMENT

FOR CUSTOM MANUFACTURE OF CHILDREN'S TOYS, COLORING BOOKS, CHILDREN'S ACTIVITY BOOKS, TRADING CARDS, TEMPORARY TATTOOS, DECALS AND PRESS ON STICKERS (U.S. CLS. 100, 103 AND 106).
FIRST USE 2-1-2002; IN COMMERCE 2-1-2002.

CLASS 42—SCIENTIFIC, COMPUTER AND LEGAL SERVICES

FOR CUSTOM DESIGN OF CHILDREN'S TOYS, COLORING BOOKS, CHILDREN'S ACTIVITY BOOKS, TRADING CARD, TEMPORARY TATTOOS, DECALS AND PRESS ON STICKERS' CUSTOM DESIGN OF PACKAGING OF PROCESSED FOODS PRODUCTS, CHILDREN'S TOYS, COLORING BOOKS, CHILDREN'S ACTIVITY BOOKS, CHILDREN'S PRINTED EDUCATIONAL MATERIALS, TRADING CARDS, TEMPORARY TATTOOS, DECALS AND PRESS ON STICKERS (U.S. CLS. 100 AND 101).

FIRST USE 2-1-2002; IN COMMERCE 2-1-2002.

SN 76-406,716. IO INTERACTIVE A/S, DENMARK, FILED 4-29-2002.

FREEDOM: THE BATTLE FOR LIBERTY ISLAND**CLASS 9—ELECTRICAL AND SCIENTIFIC APPARATUS**

FOR COMPUTER PROGRAMS, NAMELY COMPUTER SOFTWARE, FOR USE IN ELECTRONIC GAMES FOR USE AS ENTERTAINMENT OR EDUCATION, THAT MAY BE DOWNLOADED FROM A GLOBAL COMPUTER NETWORK; ELECTRONIC GAME PROGRAMS; COMPUTER GAME SOFTWARE; VIDEO GAME SOFTWARE; VIDEO GAMES, NAMELY VIDEO GAME DISCS, VIDEO GAME DVDS AND VIDEO GAME CASSETTES; COMPUTER GAMES SOFTWARE, DOWNLOADABLE ELECTRONIC PUBLICATIONS IN THE NATURE OF MAGAZINES, BOOK, INSTRUCTION MANUALS IN THE FIELD OF COMPUTER GAMES SOFTWARE AND COMPUTER GAMES SUPPLIED ON-LINE FROM ELECTRONIC DATABASES AND PROVIDED THROUGH A GLOBAL COMPUTER NETWORK; ALL MEDIA UPON WHICH COMPUTER GAME SOFTWARE AND VIDEO GAME SOFTWARE IS STORED, NAMELY VIDEO GAME AND COMPUTER GAME TAPES, CD-ROMS, DVDS, CASSETTES, WHERE SUCH MEDIA CONTAINS PRE-RECORDED VIDEO GAME SOFTWARE WHEN SOLD; PRERECORDED VIDEO CASSETTES AND DVDS FEATURING GAMES AND GAMES SOFTWARE; PRERECORDED COMPACT DISCS FEATURING GAMES, GAMES SOFTWARE, FILMS AND MUSIC; CINEMATOGRAPHIC AND TELEVISION FILMS FEATURING COMPUTER GAME PLOTS AND CHARACTERS; MOTION PICTURE FILMS, CARTOON FILMS, AND ANIMATED FILMS FEATURING COMPUTER GAME PLOTS AND CHARACTERS; INSTRUCTION MANUALS RECORDED ON ELECTRONIC MEDIA, NAMELY CD-ROMS, COMPACT DISCS, DVDS, AND CASSETTES (U.S. CLS. 21, 23, 26, 36 AND 38).

SN 76-406,023. ITW GEMA AG, CH-9015 ST. GALLEN, SWITZERLAND, FILED 5-10-2002.

OPTIGUN

OWNER OF SWITZERLAND REG. NO. 492691, DATED 12-12-2001, EXPIRES 12-12-2012.

CLASS 7—MACHINERY

FOR AUTOMATIC SPRAY COATING DEVICES, NAMELY, SPRAY GUNS FOR SPRAYING COATING LIQUID OR COATING POWDER ONTO AN ARTICLE TO BE COATED (U.S. CLS. 13, 19, 21, 23, 31, 34 AND 35).

CLASS 8—HAND TOOLS

FOR MANUAL SPRAY COATING DEVICES, NAMELY, SPRAY GUNS FOR SPRAYING COATING LIQUID OR COATING POWDER ONTO AN ARTICLE TO BE COATED (U.S. CLS. 23, 28 AND 44).

CLASS 9—ELECTRICAL AND SCIENTIFIC APPARATUS

FOR ELECTRONIC CONTROLLERS AND REGULATORS FOR CONTROLLING OR REGULATING THE FEEDING OF COATING LIQUID OR COATING POWDER TO A COATING DEVICE FOR SPRAYING SAID COATING LIQUID OR COATING POWDER ONTO AN ARTICLE TO BE COATED (U.S. CLS. 21, 23, 26, 36 AND 38).

CLASS 28—TOYS AND SPORTING GOODS

FOR TOYS, GAMES AND PLAYTHINGS, NAMELY MODEL CARS, PUPPETS; BOARD GAMES; HAND HELD UNITS FOR PLAYING ELECTRONIC GAMES; TOY MODEL HOBBY CRAFT KITS; PLAY FIGURES AND ACTION FIGURES; COIN-OPERATED VIDEO GAMES (U.S. CLS. 22, 23, 38 AND 50).

CLASS 41—EDUCATION AND ENTERTAINMENT

FOR ENTERTAINMENT SERVICES, NAMELY LIVE MUSICAL SHOWS AND PERFORMANCES BY MUSICAL BANDS, PROVIDING ON-LINE COMPUTER GAMES; ELECTRONIC PUBLISHING NAMELY PUBLICATION OF TEXT AND GRAPHIC WORKS OF OTHERS ON CD-ROMS, COMPACT DISCS, DVDS AND CASSETTE FEATURING INFORMATION ABOUT ELECTRONIC GAMES; MOTION PICTURE FILM PRODUCTION; PRODUCTION OF VIDEO CASSETTES; PRODUCTION OF VIDEO AND TELEVISION SHOWS; RENTAL OF CINEMA FILMS; RENTAL OF MOTION PICTURES; RENTAL OF VIDEO CASSETTES AND DVDS; TELEVISION ENTERTAINMENT, NAMELY ENTERTAINMENT IN THE NATURE OF ON-GOING PROGRAMS IN THE FIELD OF ELECTRONIC GAMES; PRODUCTION OF TELEVISION PROGRAMS (U.S. CLS. 100, 101 AND 107).

CLASS 42—SCIENTIFIC, COMPUTER AND LEGAL SERVICES

FOR COMPUTER SOFTWARE GAME DESIGN FOR OTHERS; ELECTRONIC GAME DESIGN FOR OTHERS; COMPUTER GAME PROGRAMMING FOR OTHERS; UPDATING AND MAINTENANCE OF COMPUTER SOFTWARE GAMES FOR OTHERS (U.S. CLS. 100 AND 101).

SN 76-406,931. OMNIMOUNT SYSTEMS, INC., PHOENIX, AZ. FILED 5-9-2002.

EVERYTHING FROM A TO V

CLASS 9—ELECTRICAL AND SCIENTIFIC APPARATUS

FOR AUDIO SPEAKERS, STANDS, MOUNTS, AND BRACKETS, ALL FOR USE IN AUDIO/VIDEO EQUIPMENT FIELD (U.S. CLS. 21, 23, 26, 36 AND 38).
FIRST USE 4-1-2002; IN COMMERCE 4-1-2002.

CLASS 20—FURNITURE AND ARTICLES NOT OTHERWISE CLASSIFIED

FOR FURNITURE FOR USE WITH AUDIO/VIDEO PRODUCTS (U.S. CLS. 2, 13, 22, 25, 32 AND 50).
FIRST USE 4-1-2002; IN COMMERCE 4-1-2002.

SN 76-407,022. SLINGO, INC., RIDGEWOOD, NJ. FILED 5-10-2002.

BRASIL SLINGO

OWNER OF U.S. REG. NOS. 2,063,768, 2,566,904 AND 2,591,818.

NO CLAIM IS MADE TO THE EXCLUSIVE RIGHT TO USE "BRASIL", APART FROM THE MARK AS SHOWN.

THE ENGLISH TRANSLATION OF THE WORD "BRASIL" IN THE MARK IS "BRAZIL".

CLASS 9—ELECTRICAL AND SCIENTIFIC APPARATUS

FOR SOFTWARE USED TO ACCESS ON-LINE INTERACTIVE COMPUTER GAMES (U.S. CLS. 21, 23, 26, 36 AND 38).

CLASS 41—EDUCATION AND ENTERTAINMENT

FOR PROVIDING ON-LINE INTERACTIVE COMPUTER GAMES (U.S. CLS. 100, 101 AND 107).

SN 76-407,919. MTS PRODUCTS, NORTHRIDGE, CA. FILED 5-14-2002.



OWNER OF U.S. REG. NO. 2,405,556.

THE NAME SHOWN IN THE MARK IS MERELY FANCIFUL AND DOES NOT IDENTIFY A PARTICULAR INDIVIDUAL.

J.MASON (STYLIZED) AND DESIGN, WHEREIN THE MARK CONSIST OF THE WORD "J.MASON" IN A STYLIZED FORMAT AND THE ENTIRE WORDING IS ENCIRCLED WITHIN AN ECLIPSE.

SEC. 2(F).

CLASS 12—VEHICLES

FOR BABY STROLLERS, SKEDDABLE STROLLER, MULTIPLE STROLLER, TRANSPORT STROLLER, UMBRELLA STROLLER, STROLLER JOGGERS, BICYCLES, TRICYCLES, BICYCLE RIMS, BICYCLE SPOKES, BICYCLE BELLS, BICYCLE SADDLES BICYCLE STANDS, SADDLE COVER FOR BICYCLES, WHEELS FOR BICYCLES, BICYCLE FRAMES, BABY CARRIAGES, HAND CARS, WAGONS, AND SAFETY SEATS FOR CHILDREN FOR AUTOMOBILES (U.S. CLS. 19, 21, 23, 31, 35 AND 44).

FIRST USE 11-0-2001; IN COMMERCE 11-0-2001.

CLASS 18—LEATHER GOODS

FOR TOYS AND RECREATIONAL EQUIPMENT, NAMELY, BABY BACKPACKS AND CONVERTIBLE BABY BACKPACK STROLLERS; BRIEFCASES, BACKPACKS, LUGGAGE, AND RELATED ACCESSORIES, NAMELY, PURSES, HANDBAGS, TRAVEL BAGS, CARRY-ON BAGS, AND PASSPORT CASES, EXPANDABLE PULL-MAN, ROLLING LUGGAGE, ROLLING GARMENT BAG, COMPACT GARMENT COVER, ROLLING DUFFLE, CABIN DUFFLE, ROLLER PILOT CASE, BUSINESS BRIEFCASE, AND DELUXE BOARDING TOTE (U.S. CLS. 1, 2, 3, 22 AND 41).

FIRST USE 11-0-2001; IN COMMERCE 11-0-2001.

CLASS 20—FURNITURE AND ARTICLES NOT OTHERWISE CLASSIFIED

FOR FURNITURE, NAMELY, BABY WALKERS, HIGH CHAIRS, BEDS, TABLES, PORTABLE CARRIER SEATS FOR INFANTS AND SMALL CHILDREN, BABY CRIBS, AND BABY WALKERS; CHANGING TABLES, DRESSER, PORTABLE CRIBS; GLIDES, MOSES BASKETS, TODDLER BED, ARMORIES, CO-SLEEPER, ROCKERS, BASSINETS, CRADLES, PLAY YARDS, AND ACTIVITIES CHAIRS (U.S. CLS. 2, 13, 22, 25, 32 AND 50).

FIRST USE 11-0-2001; IN COMMERCE 11-0-2001.

CLASS 28—TOYS AND SPORTING GOODS

FOR PUSH-PEDAL AND RIDE-UPON TOYS; TOY VEHICLES; SWINGS, BOUNCERS, ACTIVITIES MATS (U.S. CLS. 22, 23, 38 AND 50).

FIRST USE 11-0-2001; IN COMMERCE 11-0-2001.

SN 76-408,111. UNITED PARCEL SERVICE OF AMERICA, INC., ATLANTA, GA. FILED 5-13-2002.

MARKET DRIVER

NO CLAIM IS MADE TO THE EXCLUSIVE RIGHT TO USE "DRIVER", APART FROM THE MARK AS SHOWN.

CLASS 35—ADVERTISING AND BUSINESS

FOR BUSINESS MANAGEMENT CONSULTING SERVICES IN THE FIELD OF LICENSING AND INTELLECTUAL PROPERTY MANAGEMENT (U.S. CLS. 100, 101 AND 102).

CLASS 39—TRANSPORTATION AND STORAGE

FOR TRANSPORTATION AND DELIVERY OF PERSONAL PROPERTY BY AIR, RAIL, BOAT AND MOTOR VEHICLE (U.S. CLS. 100 AND 105).

SN 76-409,325. MEDICA HEALTH PLANS, MINNETONKA, MN. FILED 5-17-2002.

MEDICA

OWNER OF U.S. REG. NOS. 1,761,828, 2,392,584 AND OTHERS.

CLASS 35—ADVERTISING AND BUSINESS

FOR PHYSICIAN, DENTAL, HOSPITAL, CLINIC AND PHARMACY REFERRAL SERVICES PROVIDED VIA A GLOBAL COMPUTER NETWORK (U.S. CLS. 100, 101 AND 102).

CLASS 36—INSURANCE AND FINANCIAL

FOR DENTAL HEALTH INSURANCE UNDERWRITING AND ADMINISTRATION (U.S. CLS. 100, 101 AND 102).

CLASS 38—COMMUNICATION

FOR PROVIDING ON-LINE MESSAGING AMONG COMPUTER USERS CONCERNING HEALTH AND MEDICAL INFORMATION; TRANSMISSION OF SECURE ELECTRONIC MESSAGING BETWEEN DOCTORS, NURSES, MEDICAL STAFF AND PATIENTS; PROVIDING ON-LINE TRANSMISSION OF MEDICAL AND INSURANCE RECORDS (U.S. CLS. 100, 101 AND 104).

CLASS 44—MEDICAL, BEAUTY AND AGRICULTURAL SERVICES

FOR MEDICAL CONSULTING SERVICES, MEDICAL INFORMATION SERVICES AND MEDICAL DIAGNOSIS AND TREATMENT RESOURCES SERVICES AVAILABLE VIA TELEPHONE; TELEPHONIC ASSESSMENT AND REFERRAL SERVICES FOR MENTAL HEALTH, SUBSTANCE ABUSE AND DAILY LIVING MEDICAL PROBLEMS; PROVIDING A WEB SITE ON A GLOBAL COMPUTER NETWORK FEATURING MEDICAL, DRUG AND HEALTH INFORMATION, NAMELY, DIAGNOSTIC ADVICE, SYMPTOMS, CONDITIONS, TREATMENT, PREVENTION, MEDICAL NEWS, TIPS AND ADVICE ON HEALTH TOPICS, HEALTH RISKS, FITNESS EXERCISES, NUTRITION AND IMMUNIZATION; PROVIDING DENTAL HEALTH CARE BY DENTISTS; DENTIST SERVICES; CHIROPRACTIC SERVICES (U.S. CLS. 100 AND 101).

SN 76-409,362. ALORICA INC., CHINO, CA. FILED 5-20-2002.

HELIX BY ALORICA

CLASS 9—ELECTRICAL AND SCIENTIFIC APPARATUS

FOR COMPUTER SOFTWARE AND PROGRAMS FOR SUPPORTING AND INTEGRATING CUSTOMER RELATIONSHIP MANAGEMENT, SUPPLY CHAIN MANAGEMENT AND DATA ANALYSIS AND ENABLING E-BUSINESS, SERVICE AND SALES AUTOMATION (U.S. CLS. 21, 23, 26, 36 AND 38).

FIRST USE 10-1-1999; IN COMMERCE 10-1-1999.

CLASS 35—ADVERTISING AND BUSINESS

FOR COMPUTER SERVICES NAMELY MANAGEMENT OF WEBSITES, COMPUTER SOFTWARE AND RELATIONAL DATABASES IN THE FIELD OF BUSINESS E-COMMERCE, WARRANTY ADMINISTRATION, LOGISTICS, TELEPHONE CALL CENTER SERVICES; RETAIL STORE SERVICES, ONLINE COMPUTER COMMUNICATIONS, SOFTWARE, COMPUTER PERIPHERALS AND COMPUTER RELATED PARTS (U.S. CLS. 100, 101 AND 102).

FIRST USE 10-1-1999; IN COMMERCE 10-1-1999.

CLASS 42—SCIENTIFIC, COMPUTER AND LEGAL SERVICES

FOR COMPUTER SERVICE NAMELY DEVELOPMENT, INTEGRATION OF RELATIONAL DATABASES, COMPUTER SOFTWARE AND WEBSITES IN THE FIELD OF BUSINESS E-COMMERCE, WARRANTY ADMINISTRATION, LOGISTICS, TELEPHONE CALL CENTER SERVICES, RETAIL STORE SERVICES, ONLINE COMPUTER COMMUNICATIONS, SOFTWARE, COMPUTER PERIPHERALS AND COMPUTER RELATED PARTS NAMELY COMPUTER SOFTWARE, AND PROGRAM APPLICATIONS FOR ENABLING, SUPPORTING AND INTEGRATING DATABASE AND DATABASE MANAGEMENT, CUSTOMER RELATIONSHIP MANAGEMENT, WARRANTY SERVICE, E-MAIL CORRESPONDENCE, LOGISTICS, AND DISTRIBUTION MANAGEMENT; PROVIDING INFORMATION REGARDING CONSULTING WITH RESPECT TO INFORMATION TECHNOLOGY AND USE AND APPLICATION OF COMPUTER AND COMPUTER SYSTEMS; TECHNICAL SUPPORT, NAMELY TROUBLESHOOTING OF COMPUTER DATABASE, APPLICATION, SOFTWARE, COMPUTER HARDWARE, COMPUTER SYSTEM ERRORS AND PERFORMANCE (U.S. CLS. 100 AND 101).

FIRST USE 10-1-1999; IN COMMERCE 10-1-1999.

SN 76-409,409. GARDEN-FRESH FOODS, INC., MILWAUKEE, WI. FILED 5-16-2002.

GRANDPA'S

CLASS 29—MEATS AND PROCESSED FOODS

FOR PREPARED SALADS, NAMELY POTATO SALADS, COLE SLAWS; PREPARED DIPS AND BAKED BEANS (U.S. CL. 46).

FIRST USE 10-0-1998; IN COMMERCE 10-0-1998.

CLASS 30—STAPLE FOODS

FOR PASTA SALAD (U.S. CL. 46).

FIRST USE 4-0-1999; IN COMMERCE 4-0-1999.

SN 76-409,447. MEDICA HEALTH PLANS, MINNETONKA, MN. FILED 5-17-2002.

MEDICA .COM

OWNER OF U.S. REG. NOS. 1,761,828, 2,392,584 AND OTHERS.

CLASS 38—COMMUNICATION

FOR PROVIDING ON-LINE MESSAGING AMONG COMPUTER USERS CONCERNING HEALTH AND MEDICAL INFORMATION; TRANSMISSION OF SECURE ELECTRONIC MESSAGING BETWEEN DOCTORS, NURSES, MEDICAL STAFF AND PATIENTS; PROVIDING ON-LINE TRANSMISSION OF MEDICAL AND INSURANCE RECORDS (U.S. CLS. 100, 101 AND 104).

CLASS 44—MEDICAL, BEAUTY AND AGRICULTURAL SERVICES

FOR PROVIDING A WEB SITE ON A GLOBAL COMPUTER NETWORK FEATURING MEDICAL, DENTAL, DRUG AND HEALTH INFORMATION, NAMELY, DIAGNOSTIC ADVICE, SYMPTOMS, CONDITIONS, TREATMENT, PREVENTION, MEDICAL NEWS, TIPS AND ADVICE ON HEALTH TOPICS, HEALTH RISKS, FITNESS EXERCISES, NUTRITION AND IMMUNIZATION; PROVIDING A DATABASE OF MEDICAL PROVIDERS (U.S. CLS. 100 AND 101).

CLASS 44—MEDICAL, BEAUTY AND AGRICULTURAL SERVICES

FOR HEALTHCARE IN THE NATURE OF HEALTH MAINTENANCE ORGANIZATIONS; MEDICAL CONSULTING SERVICES, MEDICAL INFORMATION SERVICES AND MEDICAL DIAGNOSIS AND TREATMENT RESOURCES SERVICES AVAILABLE VIA TELEPHONE; TELEPHONIC ASSESSMENT AND REFERRAL SERVICES FOR MENTAL HEALTH, SUBSTANCE ABUSE AND DAILY LIVING MEDICAL PROBLEMS; PROVIDING A WEB SITE ON A GLOBAL COMPUTER NETWORK FEATURING MEDICAL, DRUG AND HEALTH INFORMATION, NAMELY, DIAGNOSTIC ADVICE, SYMPTOMS, CONDITIONS, TREATMENT, PREVENTION, MEDICAL NEWS, TIPS AND ADVICE ON HEALTH TOPICS, HEALTH RISKS, FITNESS EXERCISES, NUTRITION AND IMMUNIZATION; PROVIDING DENTAL HEALTH CARE BY DENTISTS; DENTIST SERVICES; CHIROPRACTIC SERVICES (U.S. CLS. 100 AND 101).

SN 76-409,614. DONE DEAL ADHESIVES LAB., INC., HUDSON, MA. FILED 5-16-2002.

DoneDeal
ADHESIVES LAB

SN 76-409,448. MEDICA HEALTH PLANS, MINNETONKA, MN. FILED 5-17-2002.

MEDICA

OWNER OF U.S. REG. NOS. 1,761,828, 2,392,584 AND OTHERS.

THE MARK CONSISTS OF THE WORD "MEDICA" WITH ALL THE LETTERS IN THE COLOR BLUE.

CLASS 35—ADVERTISING AND BUSINESS

FOR PHYSICIAN, DENTAL, HOSPITAL, CLINIC AND PHARMACY REFERRAL SERVICES PROVIDED VIA A GLOBAL COMPUTER NETWORK (U.S. CLS. 100, 101 AND 102).

CLASS 36—INSURANCE AND FINANCIAL

FOR ADMINISTRATION OF PREPAID HEALTHCARE PLANS, HEALTHCARE PLAN INSURANCE ADMINISTRATION SERVICES, UNDERWRITING HEALTHCARE PLANS; UNDERWRITING INSURANCE FOR PREPAID HEALTHCARE; DENTAL HEALTH INSURANCE UNDERWRITING AND ADMINISTRATION (U.S. CLS. 100, 101 AND 102).

CLASS 38—COMMUNICATION

FOR PROVIDING ON-LINE MESSAGING AMONG COMPUTER USERS CONCERNING HEALTH AND MEDICAL INFORMATION; TRANSMISSION OF SECURE ELECTRONIC MESSAGING BETWEEN DOCTORS, NURSES, MEDICAL STAFF AND PATIENTS; PROVIDING ON-LINE TRANSMISSION OF MEDICAL AND INSURANCE RECORDS (U.S. CLS. 100, 101 AND 104).

CLASS 1—CHEMICALS

FOR FULL LINE OF INDUSTRIAL ADHESIVES FOR GENERAL INDUSTRIAL USE; EPOXY PUTTY GLUE FOR USE IN THE AUTOMOBILE INDUSTRY; EPOXY GOUGE FOR GENERAL BONDING AND REPAIR PURPOSES; GLUE FOR INDUSTRIAL PURPOSES; EPOXY ADHESIVE FOR REPAIRING METAL, GLASS, CERAMIC, PLASTIC, LEATHER, WOOD, FIBERGLASS; GENERAL PURPOSE ADHESIVES; CYANOACRYLATE ADHESIVES FOR AUTOMOTIVE AFTERMARKET REPAIRING AND GENERAL INDUSTRIAL USES; SILICONE ADHESIVES FOR AUTOMOTIVE AFTERMARKET REPAIRING AND GENERAL INDUSTRIAL USES; ADHESIVES FOR USE WITH THREADED AND CYLINDRICAL ASSEMBLIES; ADHESIVES FOR USE IN HOME REPAIR AND IMPROVEMENT; ADHESIVE FOR USE BY HOBBYISTS IN ARTS AND CRAFTS; ADHESIVE SEALANTS FOR USE IN BRAKE AND POWER STEERING SYSTEM LEAKS; A FULL LINE OF CHEMICAL PREPARATIONS FOR USE IN THE MANUFACTURE OF AUTOMOTIVE REPAIR AND MAINTENANCE PRODUCTS; AUTOMOTIVE ADHESIVES, NAMELY, GASKET CEMENT; AUTOMOTIVE BRAKE SYSTEM LEAK ADHESIVE SEALANTS OF THE FAST DRYING AND HARD SETTING TYPE AND OF THE NON-HARDENING AND PLIABLE TYPE FOR KEEPING GASKETS IN PLACE AS WELL AS FOR REPLACING GASKET MATERIALS ON PARTING SURFACES AS INTERFACIAL SEALANTS; AUTOMOTIVE MULTI-PURPOSE CEMENT FOR SEALING CRACKS AND OPENINGS BETWEEN WINDOWS AND WINDSHIELDS, GLASS, WOOD, AND LEATHER PARTS; ADHESIVE CEMENT FOR HOBBYISTS; GENERAL INDUSTRIAL ADHESIVES; ADHESIVES FOR APPLYING FLOOR TILES; ADHESIVES FOR APPLYING WALL COVERINGS; ADHESIVES FOR USE IN THE MANUFACTURE OF FURNITURE; ADHESIVES FOR USE IN THE MANUFACTURE OF PLYWOOD; ADHESIVES FOR USE IN THE MANUFACTURE OF SURGICAL BANDAGES; ADHESIVES FOR USE IN THE MANUFACTURE OF

NO CLAIM IS MADE TO THE EXCLUSIVE RIGHT TO USE "ADHESIVES LAB", APART FROM THE MARK AS SHOWN.

WALL COVERINGS; PURE NON-METALLIC SILICON SOLD IN GEL, INGOTS OR SLICES FORM (U.S. CLS. 1, 5, 6, 10, 26 AND 46).
FIRST USE 1-8-2002; IN COMMERCE 1-8-2002.

SN 76-409,673, AIRE SERV HEATING & AIR CONDITIONING, INC., WACO, TX. FILED 5-17-2002.

CLASS 17—RUBBER GOODS

FOR ADHESIVE SEALANTS FOR GENERAL USE; RUBBER AND SILICONE ADHESIVE SEALANTS FOR SEALING BROKEN GASKETS, CRACKED BATTERIES, AIR DUCKS AND FURNACE LEAKS ALL FOR IN BUILDING; ADHESIVE SEALANT AND CAULKING COMPOUND; RUBBER GASKET SEALANT FOR ADHESIVE PURPOSE; RUBBER AND SILICONE GASKET SEALER FOR USE IN PLUMBING; SEALING COMPOUND FOR SEALING UNIONS IN ENGINES; ADHESIVE SEALANT AND CAULKING COMPOUND IN A PUTTY-LIKE PASTE FOR SEALING WINDSHIELDS AND MOLDINGS; SEALING COMPOUND FOR PIPE JOINTS; SEALANTS FOR BUILDINGS; SEALANTS FOR PAVEMENT JOINTS; RUBBER SEALANT FOR CAULKING AND ADHESIVE PURPOSES; GENERAL PURPOSE SILICONE RUBBER SEALANT; PIPE JOINT SEALANT; ADHESIVE-BACKED PLASTIC FILMS FOR USE IN THE MANUFACTURE OF DURABLE LABELS AND NAMEPLATES; ADHESIVE TAPE FOR SEALING CARTONS FOR INDUSTRIAL AND COMMERCIAL USE (U.S. CLS. 1, 5, 12, 13, 35 AND 50).
FIRST USE 1-8-2002; IN COMMERCE 1-8-2002.

AIRE SERV

OWNER OF U.S. REG. NOS. 1,818,574, 1,890,475 AND 1,927,783.

CLASS 9—ELECTRICAL AND SCIENTIFIC APPARATUS

FOR ENERGY-SAVING THERMOSTATS (U.S. CLS. 21, 23, 26, 36 AND 38).
FIRST USE 10-14-1994; IN COMMERCE 10-14-1994.

CLASS 11—ENVIRONMENTAL CONTROL APPARATUS

FOR RESIDENTIAL AND COMMERCIAL HEATING AND AIR CONDITIONING EQUIPMENT, NAMELY, FURNACES, AIR CONDITIONERS, HUMIDIFIERS, AND DEHUMIDIFIERS, AND REPLACEMENT PARTS THEREFOR; AND AIR FILTERS FOR FURNACES, AIR CONDITIONERS, HUMIDIFIERS, AND DEHUMIDIFIERS (U.S. CLS. 13, 21, 23, 31 AND 34).
FIRST USE 10-14-1994; IN COMMERCE 10-14-1994.

CLASS 37—CONSTRUCTION AND REPAIR

FOR INSTALLATION, MAINTENANCE, AND REPAIR OF RESIDENTIAL AND COMMERCIAL HEATING AND AIR CONDITIONING EQUIPMENT; RESIDENTIAL AND COMMERCIAL AIR DUCT CLEANING AND REPAIR SERVICES; RESIDENTIAL AND COMMERCIAL ENERGY LOSS AND AIR QUALITY BUILDING INSPECTION SERVICES (U.S. CLS. 100, 103 AND 106).
FIRST USE 10-14-1994; IN COMMERCE 10-14-1994.

SN 76-409,656, SKIN AN APOTHECARY, INC., DAYTON, OH. FILED 5-17-2002.



SN 76-409,674, AIRE SERV HEATING & AIR CONDITIONING, INC., WACO, TX. FILED 5-17-2002.

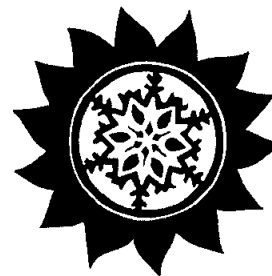

NO CLAIM IS MADE TO THE EXCLUSIVE RIGHT TO USE "SKIN" AND "APOTHECARY", APART FROM THE MARK AS SHOWN.

OWNER OF U.S. REG. NO. 1,927,783.

CLASS 3—COSMETICS AND CLEANING PREPARATIONS

FOR SALT GLOWS; BATH GELS; BEAUTY MASKS; BODY AND FACIAL MASKS; BODY AND FACIAL SCRUBS; SKIN CONDITIONERS; FACE, BODY, HAND, EYE AND SKIN CREAMS; FACE, BODY, HAND, EYE AND SKIN LOTIONS; SKIN MOISTURIZERS; FACIAL AND SKIN CLEANSERS; HAIR GELS; HAIR SHAMPOOS AND CONDITIONERS; MASSAGE AND BODY OILS (U.S. CLS. 1, 4, 6, 50, 51 AND 52).
FIRST USE 12-0-1988; IN COMMERCE 12-0-1988.

CLASS 35—ADVERTISING AND BUSINESS

FOR RETAIL STORE AND DISTRIBUTORSHIP SERVICES IN THE FIELD OF SKIN, BEAUTY, PERSONAL CARE AND HAIR CARE PRODUCTS (U.S. CLS. 100, 101 AND 102).
FIRST USE 12-0-1988; IN COMMERCE 12-0-1988.

CLASS 9—ELECTRICAL AND SCIENTIFIC APPARATUS

FOR ENERGY-SAVING THERMOSTATS (U.S. CLS. 21, 23, 26, 36 AND 38).
FIRST USE 12-0-2002; IN COMMERCE 12-0-2002.

CLASS 11—ENVIRONMENTAL CONTROL APPARATUS

SN 76-409,743. ALORICA INC., CHINO, CA. FILED 5-20-2002.

FOR RESIDENTIAL AND COMMERCIAL HEATING AND AIR CONDITIONING EQUIPMENT, NAMELY, FURNACES, AIR CONDITIONERS, HUMIDIFIERS, AND DEHUMIDIFIERS, AND REPLACEMENT PARTS THEREFOR; AND AIR FILTERS FOR FURNACES, AIR CONDITIONERS, HUMIDIFIERS, AND DEHUMIDIFIERS (U.S. CLS. 13, 21, 23, 31 AND 34).

FIRST USE 12-0-1992; IN COMMERCE 12-0-1992.

CLASS 37—CONSTRUCTION AND REPAIR

FOR INSTALLATION, MAINTENANCE, AND REPAIR OF RESIDENTIAL AND COMMERCIAL HEATING AND AIR CONDITIONING EQUIPMENT; RESIDENTIAL AND COMMERCIAL AIR DUCT CLEANING AND REPAIR SERVICES; RESIDENTIAL AND COMMERCIAL ENERGY LOSS AND AIR QUALITY BUILDING INSPECTION SERVICES (U.S. CLS. 100, 103 AND 106).

FIRST USE 12-0-1992; IN COMMERCE 12-0-1992.



SN 76-409,693. ART HOLDINGS, INC., ST. MICHAEL, BARBADOS, FILED 5-17-2002.

CLASS 9—ELECTRICAL AND SCIENTIFIC APPARATUS

FOR COMPUTER SOFTWARE AND PROGRAMS FOR SUPPORTING AND INTEGRATING CUSTOMER RELATIONSHIP MANAGEMENT, SUPPLY CHAIN MANAGEMENT AND DATA ANALYSIS AND ENABLING E-BUSINESS, SERVICE AND SALES AUTOMATION (U.S. CLS. 21, 23, 26, 36 AND 38).

FIRST USE 10-1-1999; IN COMMERCE 10-1-1999.

**CLASS 35—ADVERTISING AND BUSINESS**

FOR COMPUTER SERVICES NAMELY MANAGEMENT OF WEBSITES, COMPUTER SOFTWARE AND RELATIONAL DATABASES, IN THE FIELD OF BUSINESS E-COMMERCE, WARRANTY ADMINISTRATION, LOGISTIC, TELEPHONE CALL CENTER SERVICES; RETAIL STORE SERVICES, ONLINE COMPUTER COMMUNICATIONS, SOFTWARE, COMPUTER PERIPHERALS AND COMPUTER RELATED PARTS (U.S. CLS. 100, 101 AND 102).

FIRST USE 10-1-1999; IN COMMERCE 10-1-1999.

CLASS 42—SCIENTIFIC, COMPUTER AND LEGAL SERVICES

FOR COMPUTER SERVICES NAMELY DEVELOPMENT, INTEGRATION OF RELATIONAL DATABASES, COMPUTER SOFTWARE AND WEBSITES IN THE FIELD OF BUSINESS E-COMMERCE, WARRANTY ADMINISTRATION, LOGISTICS, TELEPHONE CALL CENTER SERVICES, RETAIL STORE SERVICES, ONLINE COMPUTER COMMUNICATIONS, SOFTWARE, COMPUTER PERIPHERALS AND COMPUTER RELATED PARTS NAMELY COMPUTER SOFTWARE AND PROGRAM APPLICATIONS FOR ENABLING, SUPPORTING AND INTEGRATING DATABASE AND DATABASE MANAGEMENT, CUSTOMER RELATIONSHIP MANAGEMENT, WARRANTY SERVICE, E-MAIL CORRESPONDENCE, LOGISTICS, AND DISTRIBUTION MANAGEMENT; PROVIDING INFORMATION REGARDING CONSULTING WITH RESPECT TO INFORMATION TECHNOLOGY AND USE AND APPLICATION OF COMPUTER AND COMPUTER SYSTEMS; TECHNICAL SUPPORT, NAMELY TROUBLESHOOTING OF COMPUTER DATABASE, APPLICATION, SOFTWARE, COMPUTER HARDWARE, COMPUTER SYSTEM ERRORS AND PERFORMANCE (U.S. CLS. 100 AND 101).

FIRST USE 10-1-1999; IN COMMERCE 10-1-1999.

NO CLAIM IS MADE TO THE EXCLUSIVE RIGHT TO USE "AUTOMOTIVE ART", APART FROM THE MARK AS SHOWN.

CLASS 2—PAINTS

FOR PAINTS FOR AUTOMOBILES, PAINT SEALERS AND COATINGS IN THE NATURE OF AUTOMOBILE FINISHING (U.S. CLS. 6, 11 AND 16).

CLASS 35—ADVERTISING AND BUSINESS

FOR FRANCHISING, NAMELY, OFFERING TECHNICAL ASSISTANCE IN THE ESTABLISHMENT AND/OR OPERATION OF AUTOMOBILE ACCESSORY AND PARTS STORES (U.S. CLS. 100, 101 AND 102).

SN 76-410,806. BAYERISCHE MOTOREN WERKE AKTIENGESELLSCHAFT, D-80788 MUENCHEN, FED REP GERMANY, FILED 5-15-2002.

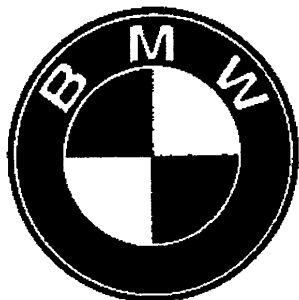

OWNER OF ERPN CMNTY TM OFC REG. NO. 91884, DATED 3-23-1999, EXPIRES 4-1-2006.

OWNER OF U.S. REG. NOS. 611,710, 1,627,241 AND OTHERS.

CLASS 3—COSMETICS AND CLEANING PREPARATIONS

FOR CLEANING PREPARATIONS FOR USE IN THE AUTOMOTIVE FIELD; POLISH, NAMELY, CHROME, AUTOMOBILE POLISH; CAR CARE PRODUCTS, NAMELY, INTERIOR CLEANER, WHEEL CLEANER, CAR SHAMPOO, LEATHER CARE, RUBBER CARE AND CAR WAX (U.S. CLS. 1, 4, 6, 50, 51 AND 52).

CLASS 4—LUBRICANTS AND FUELS

FOR ENGINE OILS (U.S. CLS. 1, 6 AND 15).

CLASS 6—METAL GOODS

FOR METAL KEY RINGS; METAL MONEY CLIPS (U.S. CLS. 2, 12, 13, 14, 23, 25 AND 50).

CLASS 7—MACHINERY

FOR VEHICLE PARTS, NAMELY, ENGINE COVERS (U.S. CLS. 13, 19, 21, 23, 31, 34 AND 35).

CLASS 9—ELECTRICAL AND SCIENTIFIC APPARATUS

FOR COMPACT DISC PLAYERS; CELLULAR PHONES AND PARTS THEREOF; MOUSE PADS; GLOBAL POSITIONING SYSTEMS CONSISTING PRIMARILY OF COMPUTERS, COMPUTER SOFTWARE, TRANSMITTERS, RECEIVERS AND NETWORK INTERFACE DEVICES; ODOMETER/TACHOMETER DISPLAYS (U.S. CLS. 21, 23, 26, 36 AND 38).

CLASS 11—ENVIRONMENTAL CONTROL APPARATUS

FOR SPOT LAMPS; MAP LIGHTS; LIGHTS FOR VEHICLES (U.S. CLS. 13, 21, 23, 31 AND 34).

CLASS 12—VEHICLES

FOR WHEEL STUD LOCKS; VALVE STEM CAPS; BICYCLES; BICYCLES STANDS FOR STATIONARY TRAINING; BICYCLE BAGS, NAMELY, BAGS MADE TO FIT BICYCLES; BULK HAULING TRAILERS; TRAILER HITCH KITS (U.S. CLS. 19, 21, 23, 31, 35 AND 44).

CLASS 14—JEWELRY

FOR WATCHES; CLOCKS (U.S. CLS. 2, 27, 28 AND 50).

CLASS 16—PAPER GOODS AND PRINTED MATTER

FOR PENS (U.S. CLS. 2, 5, 22, 23, 29, 37, 38 AND 50).

CLASS 18—LEATHER GOODS

FOR BACKPACKS; CARRY-ALL BAGS; DUFFEL BAGS; FANNY PACKS (U.S. CLS. 1, 2, 3, 22 AND 41).

CLASS 20—FURNITURE AND ARTICLES NOT OTHERWISE CLASSIFIED

FOR NON-METAL KEY RINGS (U.S. CLS. 2, 13, 22, 25, 32 AND 50).

CLASS 21—HOUSEWARES AND GLASS

FOR CUPS (U.S. CLS. 2, 13, 23, 29, 30, 33, 40 AND 50).

CLASS 25—CLOTHING

FOR GLOVES; DRESSES; SHIRTS; SCARVES; SWEAT-SHIRTS; TIES; WIND RESISTANT JACKETS (U.S. CLS. 22 AND 39).

CLASS 28—TOYS AND SPORTING GOODS

FOR GOLF BAGS; GOLF BALLS; SNOWBOARDS; SKATEBOARDS; TOY MOTORCYCLES; MINIATURE TOY VEHICLES (U.S. CLS. 22, 23, 38 AND 50).

SN 76-410,841. CH. BEHA GMBH TECHNISCHE NEUENTWICKLUNGEN, D-79286 GLOTTERTAL, FED REP GERMANY, FILED 5-16-2002.

Black Forest
BFK
 Knives

NO CLAIM IS MADE TO THE EXCLUSIVE RIGHT TO USE "BLACK FOREST KNIVES", APART FROM THE MARK AS SHOWN.

CLASS 8—HAND TOOLS

FOR KNIVES, NAMELY, HUNTING KNIVES, FOLDING KNIVES, KITCHEN KNIVES, BUTCHER KNIVES, PARING KNIVES, FISHING KNIVES, SPORT KNIVES; SCISSORS; MANUALLY OPERATED HAND TOOLS, NAMELY, SCREWDRIVERS, FILES AND SAWS; TWEEZERS; PLIERS; AXES; FLATWARE (U.S. CLS. 23, 28 AND 44).

CLASS 11—ENVIRONMENTAL CONTROL APPARATUS

FOR FLASHLIGHTS (U.S. CLS. 13, 21, 23, 31 AND 34).

CLASS 18—LEATHER GOODS

FOR BAGS, NAMELY, ATHLETIC BAGS, BOOK BAGS, CARRY-ON BAGS, DUFFEL BAGS, GARMENT BAGS FOR TRAVEL, SHOULDER BAGS, TOTE BAGS; SUITCASES (U.S. CLS. 1, 2, 3, 22 AND 41).

CLASS 21—HOUSEWARES AND GLASS

FOR CORKSCREWS, COOKING POTS; PANS, NAMELY, METAL COOKING PANS, FRYING PANS, ROASTING PANS, GLASS PANS, CAKE PANS (U.S. CLS. 2, 13, 23, 29, 30, 33, 40 AND 50).

SN 76-411,354. SELECT AUTOMATION, INC., HOLLY SPRINGS, NC. FILED 5-21-2002.

CHOICE AUTOMATION

NO CLAIM IS MADE TO THE EXCLUSIVE RIGHT TO USE "AUTOMATION", APART FROM THE MARK AS SHOWN.

SN 76-411,116. MUSTAD INTERNATIONAL GROUP B.V., NL-1017 CG AMSTERDAM, NETHERLANDS, FILED 5-23-2002.

CONTINENTAL

PRIORITY CLAIMED UNDER SEC. 44(D) ON ERPN CMNTY TM OFC APPLICATION NO. 002486116, FILED 11-30-2001.

CLASS 6—METAL GOODS

FOR HORSESHOES OF METAL; METAL NAILS FOR HORSESHOES (U.S. CLS. 2, 12, 13, 14, 23, 25 AND 50). FIRST USE 12-16-2002; IN COMMERCE 12-16-2002.

CLASS 35—ADVERTISING AND BUSINESS

FOR RETAIL STORE SERVICES FEATURING SECURITY SYSTEMS, COMPUTER SYSTEMS AND COMPUTER NETWORKS, LIGHTING, HEATING AND AIR CONDITIONING SYSTEMS, AUDIO AND VIDEO SYSTEMS; DISTRIBUTORSHIPS IN THE FIELD OF SECURITY SYSTEMS, COMPUTER SYSTEMS AND COMPUTER NETWORKS, LIGHTING, HEATING AND AIR CONDITIONING SYSTEMS, AUDIO AND VIDEO SYSTEMS (U.S. CLS. 100, 101 AND 102).

CLASS 17—RUBBER GOODS

FOR HORSESHOES, NOT OF METAL (U.S. CLS. 1, 5, 12, 13, 35 AND 50). FIRST USE 12-16-2002; IN COMMERCE 12-16-2002.

CLASS 37—CONSTRUCTION AND REPAIR

FOR INSTALLATION OF SECURITY SYSTEMS, LIGHTING, HEATING AND AIR CONDITIONING SYSTEMS, AUDIO AND VIDEO SYSTEMS; INSTALLATION OF COMPUTER NETWORKS (U.S. CLS. 100, 103 AND 106).

CLASS 42—SCIENTIFIC, COMPUTER AND LEGAL SERVICES

FOR COMPUTER NETWORK DESIGN FOR OTHERS; DESIGN FOR OTHERS IN THE FIELD OF HOME AND OFFICE AUTOMATION SYSTEMS; PROVIDING TEMPORARY USE ON ONLINE NON-DOWNLOADABLE SOFTWARE WHICH ALLOWS USERS TO DESIGN AND DEVELOP THEIR OWN HOME AND OFFICE AUTOMATION SYSTEMS (U.S. CLS. 100 AND 101).

SN 76-411,332. THE SHERATON CORPORATION, WHITE PLAINS, NY. FILED 5-21-2002.

SWEET SLEEPER**CLASS 20—FURNITURE AND ARTICLES NOT OTHERWISE CLASSIFIED**

FOR FURNITURE, NAMELY, BEDS, CRIBS, MATTRESSES, BASSINETS AND CRADLES, THROW PILLOWS, BOLSTER PILLOWS, FITTED FURNITURE COVERS (U.S. CLS. 2, 13, 22, 25, 32 AND 50).

SN 76-411,355. SELECT AUTOMATION, INC., HOLLY SPRINGS, NC. FILED 5-21-2002.

SELECTAUTOMATION**CLASS 35—ADVERTISING AND BUSINESS**

FOR RETAIL STORE SERVICES FEATURING SECURITY SYSTEMS, COMPUTER SYSTEMS AND COMPUTER NETWORKS, LIGHTING, HEATING AND AIR CONDITIONING SYSTEMS, AUDIO AND VIDEO SYSTEMS; DISTRIBUTORSHIPS IN THE FIELD OF SECURITY SYSTEMS, COMPUTER SYSTEMS AND COMPUTER NETWORKS, LIGHTING, HEATING AND AIR CONDITIONING SYSTEMS, AUDIO AND VIDEO SYSTEMS (U.S. CLS. 100, 101 AND 102).

CLASS 24—FABRICS

FOR BED LINEN, BED BLANKETS, BED CANOPIES, BED PADS, BED SHEETS, BED SPREADS, CRIB BUMPERS, CRIB CANOPIES, PILLOW CASES, CLOTH DOILIES, WASH CLOTHS, COMFORTERS, DUVET COVERS, MATTRESS COVERS, CURTAINS, DUST RUFFLES, DUVETS, EIDERDOWNS, UNFITTED FABRIC FURNITURE COVERS, HOUSEHOLD LINENS, MATTRESS PADS, PILLOW SHAMS, QUILTS, TOWELS, WASHING MITTS, SHAMS, BOX SPRING COVERS, BED SKIRTS, SHAMS, COVERLET, BOLSTER SLIPCOVERS, AND SHOWER CURTAINS (U.S. CLS. 42 AND 50).

CLASS 37—CONSTRUCTION AND REPAIR

FOR INSTALLATION OF SECURITY SYSTEMS, LIGHTING, HEATING AND AIR CONDITIONING SYSTEMS, AUDIO AND VIDEO SYSTEMS; INSTALLATION OF COMPUTER NETWORKS (U.S. CLS. 100, 103 AND 106).

CLASS 43—HOTEL AND RESTAURANT SERVICES

FOR HOTEL, MOTEL, AND MOTOR INN LODGING SERVICES; RESORT LODGING SERVICES; CONSULTING SERVICES IN THE FIELD OF HOSPITALITY (U.S. CLS. 100 AND 101).

CLASS 42—SCIENTIFIC, COMPUTER AND LEGAL SERVICES

FOR COMPUTER NETWORK DESIGN FOR OTHERS; DESIGN FOR OTHERS IN THE FIELD OF HOME AND OFFICE AUTOMATION SYSTEMS; PROVIDING TEMPORARY USE OF ONLINE NON-DOWNLOADABLE SOFTWARE WHICH ALLOWS USERS TO DESIGN AND DEVELOP THEIR OWN HOME AND OFFICE AUTOMATION SYSTEMS (U.S. CLS. 100 AND 101).

SN 76-411,490. CHAMBERS, KRISTYN, AUSTIN, TX. FILED 5-20-2002.

KRISTYN CHAMBERS AUSTIN

NO CLAIM IS MADE TO THE EXCLUSIVE RIGHT TO USE "AUSTIN", APART FROM THE MARK AS SHOWN.

THE NAME "KRISTYN CHAMBERS AUSTIN" IDENTIFIES A LIVING INDIVIDUAL WHOSE CONSENT IS OF RECORD.

CLASS 18—LEATHER GOODS

FOR PURSE (U.S. CLS. 1, 2, 3, 22 AND 41).
FIRST USE 4-1-2002; IN COMMERCE 4-1-2002.

CLASS 25—CLOTHING

FOR BELTS AND SANDALS (U.S. CLS. 22 AND 39).
FIRST USE 4-1-2002; IN COMMERCE 4-1-2002.

SN 76-411,713. MARICAL, INC., PORTLAND, MA. BY ASSIGNMENT MARICAL, LLC, PORTLAND, ME. FILED 5-24-2002.

MARICAL

CLASS 5—PHARMACEUTICALS

FOR NUTRIENT AND MINERAL FISH FOOD SUPPLEMENTS TO PROMOTE FISH GROWTH (U.S. CLS. 6, 18, 44, 46, 51 AND 52).

CLASS 44—MEDICAL, BEAUTY AND AGRICULTURAL SERVICES

FOR TECHNICAL CONSULTATION IN THE FIELDS OF AQUACULTURE, BREEDING AND GROWING FISH, PRODUCING FISH HAVING PARTICULAR CHARACTERISTICS, PEARL FORMATION, CAVIAR AND/OR ROE PRODUCTION, SOFT SHELL CRUSTACEAN PRODUCTION, FISH PRODUCTION WITH TOXINS, CONTAMINANTS AND/OR PARASITES REMOVED, AND PROVIDING INSTRUCTIONS FOR THE PRODUCTION OF FISH PRODUCTS (U.S. CLS. 100 AND 101).

SN 76-412,041. THE COLOR SOURCE INC., ST. LOUIS, MO. FILED 5-24-2002.

INDOX SERVICES

NO CLAIM IS MADE TO THE EXCLUSIVE RIGHT TO USE "SERVICES", APART FROM THE MARK AS SHOWN.

CLASS 35—ADVERTISING AND BUSINESS

FOR BUSINESS RECORDS MANAGEMENT SERVICES, NAMELY DOCUMENT INDEXING FOR OTHERS, AND PHOTOCOPYING SERVICES (U.S. CLS. 100, 101 AND 102).

CLASS 39—TRANSPORTATION AND STORAGE

FOR STORAGE AND DELIVERY OF BUSINESS RECORDS (U.S. CLS. 100 AND 105).

CLASS 40—MATERIAL TREATMENT

FOR PRINTING SERVICES, AND DOCUMENT DATA TRANSFER AND PHYSICAL CONVERSION SERVICES FROM ONE MEDIA TO ANOTHER (U.S. CLS. 100, 103 AND 106).

SN 76-412,474. ALCAN ALUMINUM CORPORATION, CLEVELAND, OH. FILED 5-24-2002.

SELECTMC

CLASS 37—CONSTRUCTION AND REPAIR

FOR CONSULTATION SERVICES IN THE FIELD OF CABLE INSTALLATION (U.S. CLS. 100, 103 AND 106).

CLASS 41—EDUCATION AND ENTERTAINMENT

FOR TRAINING AND EDUCATION SERVICES RELATING TO THE USE OF ELECTRICAL CABLE IN COMMERCIAL, INDUSTRIAL AND RESIDENTIAL MARKETS (U.S. CLS. 100, 101 AND 107).

SN 76-412,623. ABN AMRO LEASE HOLDING N.V., 1314 CJ ALMERE-STAD, NETHERLANDS, FILED 5-21-2002.



PRIORITY CLAIMED UNDER SEC. 44(D) ON BENELUX APPLICATION NO. 1007495, FILED 3-18-2002, REG. NO. 0704605, DATED 3-18-2002, EXPIRES 3-18-2012.

THE MARK CONSISTS OF THE COLORS RED AND BLUE ARE CLAIMED AS FEATURES OF THE MARK. THE TRIANGULAR SHAPE IS DEPICTED IN RED AND THE SQUARE SHAPE AND THE WORD "NETWORK" IS DEPICTED IN BLUE.

CLASS 35—ADVERTISING AND BUSINESS

FOR BUSINESS SERVICES RELATED TO VEHICLE LEASING AND FLEET MANAGEMENT, NAMELY, MANAGING MAINTENANCE REQUIREMENTS, WINDOW REPAIR AND BREAKDOWN SERVICES FOR VEHICLES; ADMINISTRATION SERVICES RENDERED TO THIRD PARTIES RELATED TO VEHICLE LEASING AND FLEET MANAGEMENT (U.S. CLS. 100, 101 AND 102).

CLASS 36—INSURANCE AND FINANCIAL

FOR COMPILING FINANCING REPORTS RELATED TO THE USE OF LEASED VEHICLES; FINANCIAL ADVICE RELATED TO VEHICLE LEASING; CREDIT CARD SERVICES FOR USE WITH LEASED VEHICLES FOR THE PURCHASE OF FUELS, LUBRICANTS, AND AUTOMOTIVE ACCESSORIES; VEHICLE INSURANCE SERVICES (U.S. CLS. 100, 101 AND 102).

CLASS 39—TRANSPORTATION AND STORAGE

FOR RENTAL AND LEASING OF VEHICLES (U.S. CLS. 100 AND 105).

SN 76-413,005. WILD FLAVORS, INC., ERLANGER, KY. FILED 5-29-2002.



OWNER OF U.S. REG. NO. 2,634,982.

THE WORD "COLORS" APPEARS IN A GRADUAL SUCCESSION FROM LEFT TO RIGHT OF THE COLORS GREEN, YELLOW, ORANGE, RED, PURPLE AND BLUE. THE WORDS "FROM NATURE" APPEAR IN GREEN. THE UNDERSCORE APPEARS IN A GRADUAL SUCCESSION FROM LEFT TO RIGHT OF THE COLORS GREEN, YELLOW, ORANGE, RED, PURPLE AND BLUE.

CLASS 3—COSMETICS AND CLEANING PREPARATIONS

FOR ESSENTIAL OILS FOR FOOD FLAVORING AND ESSENTIAL OILS FOR FLAVORING OF NON-ALCOHOLIC BEVERAGES; ESSENTIAL OILS FOR USE IN THE MANUFACTURING OF NON-ALCOHOLIC BEVERAGES AND FOOD PRODUCTS; ESSENTIAL OILS FOR USE IN THE MANUFACTURE OF SCENTED FOOD PRODUCTS AND SCENTED NON-ALCOHOLIC BEVERAGES (U.S. CLS. 1, 4, 6, 50, 51 AND 52).

CLASS 30—STAPLE FOODS

FOR EXTRACTS USED AS FLAVORING FOR NON-ALCOHOLIC BEVERAGES AND FOOD PRODUCTS; NON-ESSENTIAL OILS USED IN FOOD FLAVORING AND FLAVORING OF NON-ALCOHOLIC BEVERAGES; FOOD FLAVORINGS (U.S. CL. 46).

CLASS 32—LIGHT BEVERAGES

FOR NECTARS AND CONCENTRATES, USED IN MAKING NON-ALCOHOLIC BEVERAGES, NAMELY, FRUIT DRINKS AND SOFT DRINKS (U.S. CLS. 45, 46 AND 48).

SN 76-413,761. ANY DESIGN MONOGRAM EMBROIDERY, INC., MELROSE, MA. FILED 5-30-2002.

GNAWTY DOG

SEC. 2(F).

CLASS 24—FABRICS

FOR GOLF TOWELS AND BEACH TOWELS (U.S. CLS. 42 AND 50).
FIRST USE 3-25-1996; IN COMMERCE 8-31-1996.

CLASS 25—CLOTHING

FOR CLOTHING FOR MEN, WOMEN AND CHILDREN, NAMELY, SHIRTS, SWEATERS, SHORTS, SOCKS, NECKTIES, SWIMMING SUITS, HATS, SCARVES, JACKETS (U.S. CLS. 22 AND 39).
FIRST USE 3-25-1996; IN COMMERCE 8-27-1996.

SN 76-414,195. DAUGHTERS OF HEAVEN MINISTRIES, INC., TULSA, OK. FILED 6-5-2002.

DAUGHTERS OF HEAVEN**CLASS 41—EDUCATION AND ENTERTAINMENT**

FOR RELIGIOUS CONFERENCES FOR WOMEN AND GIRLS (U.S. CLS. 100, 101 AND 107).
FIRST USE 8-4-1995; IN COMMERCE 8-4-1995.

CLASS 45—PERSONAL SERVICES

FOR EVANGELISTIC AND MINISTERIAL SERVICES (U.S. CLS. 100 AND 101).
FIRST USE 8-4-1995; IN COMMERCE 8-4-1995.

SN 76-414,622. DEY SYSTEMS, INC., LOUISVILLE, KY. FILED 5-31-2002.

**CLASS 35—ADVERTISING AND BUSINESS**

FOR INFORMATION SERVICES, NAMELY, PROVIDING SURVEY SERVICES FOR OTHERS VIA MAILED AND INTERNET SURVEY PRODUCTS IN ORDER TO MEASURE CUSTOMER AND EMPLOYEE SATISFACTION (U.S. CLS. 100, 101 AND 102).

CLASS 44—MEDICAL, BEAUTY AND AGRICULTURAL SERVICES

FOR CLINICAL OUTCOME SERVICES, NAMELY, TRACKING THE RECOVERY STATUS OF INDIVIDUALS RECEIVING MEDICAL AND SURGICAL PROCEDURES (U.S. CLS. 100 AND 101).

SN 76-414,900. IBERDROLA, S.A., 48008 BILBAO, SPAIN, FILED 5-30-2002.

**IBERDROLA**

THE STIPPLING IS FOR SHADING PURPOSES ONLY AND DOES NOT INDICATE COLOR.

CLASS 37—CONSTRUCTION AND REPAIR

FOR INSTALLATION, REPAIR AND MAINTENANCE OF ELECTRICITY POWER STATIONS, ELECTRICITY DISTRIBUTION NETWORKS AND POWER TRANSFORMATION STATIONS; BUILDING CONSTRUCTION AND REPAIR SERVICES (U.S. CLS. 100, 103 AND 106).

CLASS 39—TRANSPORTATION AND STORAGE

FOR PUBLIC UTILITY SERVICES IN THE NATURE OF NATURAL GAS, WATER AND ELECTRICITY DISTRIBUTION; WATER TRANSPORT BY PIPELINES FOR PUBLIC UTILITY PURPOSES (U.S. CLS. 100 AND 105).

CLASS 40—MATERIAL TREATMENT

FOR SERVICES OF RECYCLING OF WASTE AND RUBBISH; TREATMENT AND PROCESSING OF WASTE BY MECHANICAL AND CHEMICAL MEANS AND ITS CLASSIFICATION, MECHANICAL AND CHEMICAL TREATMENT OR PROCESSING OF ALL KINDS OF FLUIDS; WATER TREATMENT; PRODUCTION OF POWER (U.S. CLS. 100, 103 AND 106).

CLASS 41—EDUCATION AND ENTERTAINMENT

FOR VOCATIONAL GUIDANCE; TRANSLATION SERVICES (U.S. CLS. 100, 101 AND 107).

CLASS 42—SCIENTIFIC, COMPUTER AND LEGAL SERVICES

FOR ENGINEERING SERVICES; TECHNICAL RESEARCH AND TECHNICAL PROJECT RESEARCH IN THE FIELD OF ELECTRICITY SOURCES; RESEARCH AND DEVELOPMENT OF NEW PRODUCTS FOR OTHERS; PHYSICISTS SERVICES, COMPUTER CONSULTATION SERVICES (U.S. CLS. 100 AND 101).

CLASS 44—MEDICAL, BEAUTY AND AGRICULTURAL SERVICES

FOR PSYCHOLOGICAL TESTING (U.S. CLS. 100 AND 101).

SN 76-415,206. MISSONI S.P.A., SUMIRAGO (VARESE), ITALY, FILED 6-6-2002.



MISSONI

PRIORITY CLAIMED UNDER SEC. 44(D) ON ITALY APPLICATION NO. M12001C01295, FILED 12-24-2001, REG. NO. 00861162, DATED 11-6-2002, EXPIRES 6-1-2021.

PRIORITY CLAIMED UNDER SEC. 44(D) ON ITALY APPLICATION NO. M12001C01295, FILED 12-24-2001, REG. NO. 828406, DATED 11-8-2000, EXPIRES 11-8-2010.

CLASS 3—COSMETICS AND CLEANING PREPARATIONS

FOR (BASED ON FOREIGN REGISTRATION NO 861162) PERFUMES, TOILET WATER, PERSONAL DEODORANTS, ESSENTIAL OILS FOR PERSONAL USE, BODY LOTIONS, SHOWER GEL, BUBBLE BATH, BATH OILS, BATH PEARLS, SKIN SOAPS, SHAVING BALMS, SHAVING CREAM, AFTERSHAVE LOTIONS, COSMETIC PENCILS, FOUNDATION MAKE-UP, FACE POWDERS, TALCUM POWDER, ROUGES, LIPSTICKS, MASCARAS, SKIN CLEANSING CREAMS, SKIN CLEANSING LOTIONS, SUN SCREEN PREPARATION, NAIL POLISH, BEAUTY MASKS, FACIAL SCRUBS, FACE CREAMS, BODY CREAMS, HAIR SHAMPOOS, HAIR SPRAYS, HAIR LOTIONS, DENTIFRICES (U.S. CLS. 1, 4, 6, 50, 51 AND 52).

CLASS 18—LEATHER GOODS

FOR (BASED ON FOREIGN REGISTRATION NO. 861162) HANDBAGS, LUGGAGE, SHOULDER BAGS, BEACH BAGS, CLUTCH BAGS, ALL PURPOSE SPORTS BAGS, ATTACHE CASES, SCHOOL BAGS, TOTE BAGS, TRAVELLING BAGS, CREDIT CARD CASES, DOCUMENT CASES, PASSPORT CASES, COSMETIC CASES SOLD EMPTY, KEYCASES, KNAPSACKS, RUCKSACKS, BRIEFCASES, PURSES, WALLETTS, TRAVELLING TRUNKS, SUITCASES, UMBRELLAS, PARASOLS, WALKING STICKS (U.S. CLS. 1, 2, 3, 22 AND 41).

CLASS 25—CLOTHING

FOR (BASED ON FOREIGN REGISTRATION NO. 828406) PULLOVERS, GLOVES, CARDIGANS, JERSEYS, NECKWEAR, SWEATERS, SOCKS, STOCKINGS, TIGHTS, TROUSERS, LEGGINGS, SKIRTS, JACKETS, JERKINS, SHIRTS, VESTS, WAISTCOATS, JUMPERS, TRACK SUITS, BLOUSES, BLOUSONS, JEANS, SWEAT PANTS, GYM SUITS, KNICKERS, PANTS, SHORTS, T-SHIRTS, SWEAT-SHIRTS, SUITS AND DRESSES, OVERCOATS, COATS, ANORAKS, RAINCOATS, BELTS, SUSPENDERS, LOUNGEWEAR, UNDERWEAR, BEACHWEAR, SLEEPWEAR, FOOTWEAR, HEADWEAR (U.S. CLS. 22 AND 39).

SN 76-415,554. ROI SOLUTIONS, INC., SOUTH LAKE, TX, FILED 6-4-2002.

ADDITIONS**CLASS 9—ELECTRICAL AND SCIENTIFIC APPARATUS**

FOR ACCESSORY KITS FOR COMPUTER PRINTERS, SCANNERS, PERSONAL DIGITAL ASSISTANTS, DIGITAL CAMERAS, CAMCORDERS, CELLULAR TELEPHONES AND LAPTOP COMPUTERS CONTAINING ONE OR MORE OF THE FOLLOWING - CLEANING FLUID; CLEANING WIPES; CANNED AIR; PRINTER CABLES; CABLE TIES; POWER SURGE PROTECTORS; SCREEN PROTECTION SHIELDS; PHOTO IMAGING SOFTWARE FOR USE WITH PERSONAL DIGITAL ASSISTANTS; PERSONAL DIGITAL ASSISTANT AND PHOTO IMAGING SOFTWARE; CASES FOR PERSONAL DIGITAL ASSISTANTS, DIGITAL CAMERAS, LAPTOP COMPUTERS AND DISKETTES; DISKETTES; STYLUSES FOR PERSONAL DIGITAL ASSISTANTS; PHOTO TEMPLATES FOR SCANNERS; MINI-TRIPOD FOR DIGITAL CAMERAS; CELLULAR TELEPHONE MOUNTS FOR VEHICLES, VEHICLE MOUNT KIT, BELT CLIP, EAR BUD, ANTENNA BOOSTER AND CIGARETTE LIGHTER ADAPTER FOR CELLULAR TELEPHONES (U.S. CLS. 21, 23, 26, 36 AND 38).

CLASS 16—PAPER GOODS AND PRINTED MATTER

FOR LOST AND FOUND DECALS (U.S. CLS. 2, 5, 22, 23, 29, 37, 38 AND 50).

SN 76-415,602. SUMITOMO CHEMICAL CO., LTD., CHUOKU, OSAKA, JAPAN, FILED 6-4-2002.

SHURIKEN

THE ENGLISH TRANSLATION OF "SHURIKEN" IS "THROWING STAR".

CLASS 1—CHEMICALS

FOR CHEMICALS FOR USE IN THE MANUFACTURE OF INSECTICIDES, FUNGICIDES AND HERBICIDES (U.S. CLS. 1, 5, 6, 10, 26 AND 46).

CLASS 5—PHARMACEUTICALS

FOR INSECTICIDES, FUNGICIDES AND HERBICIDES FOR KILLING WEEDS AND DESTROYING VERMIN FOR AGRICULTURAL, DOMESTIC AND INDUSTRIAL (U.S. CLS. 6, 18, 44, 46, 51 AND 52).

SN 76-415,603. SUMITOMO CHEMICAL CO., LTD., OSAKA, JAPAN, FILED 6-4-2002.

GOKISTAR**CLASS 1—CHEMICALS**

FOR CHEMICALS FOR USE IN THE MANUFACTURE OF INSECTICIDES, FUNGICIDES AND HERBICIDES (U.S. CLS. 1, 5, 6, 10, 26 AND 46).

CLASS 5—PHARMACEUTICALS

FOR INSECTICIDES FOR AGRICULTURAL, DOMESTIC AND INDUSTRIAL USE; FUNGICIDES FOR AGRICULTURAL, DOMESTIC AND INDUSTRIAL USE; HERBICIDES FOR AGRICULTURAL, DOMESTIC AND INDUSTRIAL USE; WEED KILLERS FOR AGRICULTURAL, DOMESTIC AND INDUSTRIAL USE; AND PREPARATIONS FOR DESTROYING VERMIN (U.S. CLS. 6, 18, 44, 46, 51 AND 52).

SN 76-415,743. BRADLEY, SUSAN K., PALM BEACH GARDENS, FL. FILED 6-5-2002.

WOMEN, MEANING & MONEY

NO CLAIM IS MADE TO THE EXCLUSIVE RIGHT TO USE "WOMEN" AND "MONEY", APART FROM THE MARK AS SHOWN.

CLASS 9—ELECTRICAL AND SCIENTIFIC APPARATUS

FOR PRERECORDED VIDEO AND AUDIO TAPES FEATURING MOTIVATIONAL TECHNIQUES FOR PERSONAL ENHANCEMENT (U.S. CLS. 21, 23, 26, 36 AND 38).

FIRST USE 9-5-2001; IN COMMERCE 9-5-2001.

CLASS 41—EDUCATION AND ENTERTAINMENT

FOR EDUCATIONAL SERVICES, NAMELY CONDUCTING PROGRAMS IN MOTIVATIONAL TECHNIQUES AND PERSONAL ENHANCEMENT (U.S. CLS. 100, 101 AND 107).

FIRST USE 9-5-2001; IN COMMERCE 9-5-2001.

SN 76-416,092. A.D. SUTTON & SONS, INC., NEW YORK, NY. FILED 6-6-2002.

FRIDGE PAK

NO CLAIM IS MADE TO THE EXCLUSIVE RIGHT TO USE "PAK", APART FROM THE MARK AS SHOWN.

CLASS 18—LEATHER GOODS

FOR BAGS, NAMELY, BACK PACKS, BOOK BAGS, TRAVEL BAGS, TOTE BAGS, ALL PURPOSE SPORT BAGS, SHOULDER BAGS AND WALLETS (U.S. CLS. 1, 2, 3, 22 AND 41).

FIRST USE 6-1-1997; IN COMMERCE 6-1-1997.

CLASS 21—HOUSEWARES AND GLASS

FOR INSULATED LUNCH BAGS, NAMELY, THERMAL INSULATED TOTE BAGS FOR FOOD OR BEVERAGE (U.S. CLS. 2, 13, 23, 29, 30, 33, 40 AND 50).

FIRST USE 6-1-1997; IN COMMERCE 6-1-1997.

SN 76-416,342. STRING YARNS, LLC, NEW YORK, NY. FILED 6-3-2002.

STRING YARNS

NO CLAIM IS MADE TO THE EXCLUSIVE RIGHT TO USE "YARNS", APART FROM THE MARK AS SHOWN.

CLASS 35—ADVERTISING AND BUSINESS

FOR RETAIL STORE SERVICES FEATURING YARNS, KNITTING TOOLS, KNITTING ACCESSORIES, PATTERNS, BUTTONS, ZIPPERS, AND FINISHED KNIT GOODS (U.S. CLS. 100, 101 AND 102).

CLASS 41—EDUCATION AND ENTERTAINMENT

FOR EDUCATIONAL SERVICES, NAMELY, CONDUCTING CLASSES, SEMINARS AND WORKSHOPS IN THE FIELD OF KNITTING (U.S. CLS. 100, 101 AND 107).

SN 76-416,562. SAKAR INTERNATIONAL INC., EDISON, NJ. FILED 5-23-2002.

SAKAR

OWNER OF U.S. REG. NOS. 1,203,445 AND 1,678,355.

CLASS 9—ELECTRICAL AND SCIENTIFIC APPARATUS

FOR PDA ACCESSORIES, NAMELY, BATTERY CHARGERS, UNIVERSAL SERIAL BUS CABLES, NAMELY, NON-ELECTRICAL CABLES CONNECTING A COMPUTER TO PDA ACCESSORIES; COMPUTER ACCESSORIES, NAMELY, KEYBOARDS, MICE, SPEAKERS AND JOYSTICKS; DIGITAL CAMERA ACCESSORIES, NAMELY, LENSES, TRIPODS, BATTERIES AND CHARGERS; RADIOS, CASSETTE PLAYERS, CD PLAYERS, TELEPHONES, DATABANKS, CALCULATORS, TELESCOPES, MICROSCOPES, AND WALKIE TALKIES (U.S. CLS. 21, 23, 26, 36 AND 38).

FIRST USE 0-0-1996; IN COMMERCE 0-0-1996.

CLASS 28—TOYS AND SPORTING GOODS

FOR TOYS, NAMELY, TOY BINOCULARS, TOY TELESCOPES, TOY CAMERAS, TOY RADIOS, TOY TELEPHONES, AND TOY WALKIE TALKIES (U.S. CLS. 22, 23, 38 AND 50).

FIRST USE 0-0-1996; IN COMMERCE 0-0-1996.

SN 76-417,419. UNCLE BEN'S, INC., VERNON, CA. FILED 6-5-2002.

VEG-A-FULLS

CLASS 29—MEATS AND PROCESSED FOODS

FOR PREPARED FOODS CONSISTING PRIMARILY OF EGGS OR MEAT TOGETHER WITH VEGETABLES, CHEESE, SAUCE AND/OR BREAD (U.S. CL. 46).

CLASS 30—STAPLE FOODS

FOR PREPARED FOODS CONSISTING PRIMARILY OF PASTA OR RICE TOGETHER WITH VEGETABLES, MEAT, CHEESE, SAUCE AND/OR BREAD (U.S. CL. 46).

SN 76-417,420. UNCLE BEN'S, INC., VERNON, CA. FILED 6-5-2002.

UNCLE BEN'S VEG-A-FULLS

OWNER OF U.S. REG. NOS. 437,176, 1,888,708 AND OTHERS.

CLASS 29—MEATS AND PROCESSED FOODS

FOR PREPARED FOODS CONSISTING PRIMARILY OF EGGS OR MEAT TOGETHER WITH VEGETABLES, CHEESE, SAUCE AND/OR BREAD (U.S. CL. 46).

CLASS 30—STAPLE FOODS

FOR PREPARED FOODS CONSISTING PRIMARILY OF PASTA OR RICE TOGETHER WITH VEGETABLES, MEAT, CHEESE, SAUCE AND/OR BREAD (U.S. CL. 46).

SN 76-417,590. ROCHE DIAGNOSTICS GMBH, 68305 MANNHEIM, FED REP GERMANY, FILED 6-5-2002.

MELLIBASE

OWNER OF FED REP GERMANY REG. NO. 30157289, DATED 11-20-2001, EXPIRES 9-30-2011.

CLASS 9—ELECTRICAL AND SCIENTIFIC APPARATUS

FOR COMPUTER SOFTWARE FOR PROGNOSIS AND CALCULATION OF RISKS AND COSTS OF LONG-TERM COMPLICATIONS AND SECONDARY ILLNESS EMANATING FROM DIABETES (U.S. CLS. 21, 23, 26, 36 AND 38).

CLASS 36—INSURANCE AND FINANCIAL

FOR INSURANCE CONSULTING, NAMELY, GENERATING OF RISK PROFILES FOR HEALTH INSURANCE (U.S. CLS. 100, 101 AND 102).

CLASS 41—EDUCATION AND ENTERTAINMENT

FOR COACHING OF DIABETIC PATIENTS IN THE MEDICAL FIELD (U.S. CLS. 100, 101 AND 107).

CLASS 44—MEDICAL, BEAUTY AND AGRICULTURAL SERVICES

FOR MEDICAL MONITORING OF THERAPY VIA THE INTERNET (U.S. CLS. 100 AND 101).

SN 76-418,092. SIG TECHNOLOGY AG (SIG TECHNOLOGY LTD.), 8212 NEUHAUSEN AM RHEINFALL, SWITZERLAND, FILED 6-14-2002.

Systemgra

PRIORITY CLAIMED UNDER SEC. 44(D) ON SWITZERLAND APPLICATION NO. 03045/2002, FILED 4-5-2002, REG. NO. 499135, DATED 5-14-2002, EXPIRES 4-5-2012.

CLASS 7—MACHINERY

FOR MACHINES, NAMELY PACKAGING AND FILLING MACHINES; ELECTRIC MOTORS FOR MACHINES (U.S. CLS. 13, 19, 21, 23, 31, 34 AND 35).

CLASS 35—ADVERTISING AND BUSINESS

FOR BUSINESS CONSULTATION IN THE FIELD OF INDUSTRIAL PACKAGING; CONDUCTING MARKETING PROJECT STUDIES IN THE FIELD OF INDUSTRIAL PACKAGING (U.S. CLS. 100, 101 AND 102).

CLASS 42—SCIENTIFIC, COMPUTER AND LEGAL SERVICES

FOR DESIGN OF NEW PRODUCTS FOR OTHERS IN THE FIELD OF INDUSTRIAL PACKAGING (U.S. CLS. 100 AND 101).

SN 76-418,534. COMPUTER AIDED DEVELOPMENT CORPORATION LIMITED, STEVENAGE, HERTFORDSHIRE SG1 2JY, UNITED KINGDOM, FILED 6-7-2002.

SN 76-418,612. MASSACHUSETTS HOSPITAL ASSOCIATION, INC., BURLINGTON, MA. FILED 6-7-2002.

MSIS

PRIORITY CLAIMED UNDER SEC. 44(D) ON UNITED KINGDOM APPLICATION NO. 2288221, FILED 12-14-2001, REG. NO. 2288221, DATED 6-21-2002, EXPIRES 12-14-2011.

CLASS 9—ELECTRICAL AND SCIENTIFIC APPARATUS

FOR COMPUTER SOFTWARE FOR GEOGRAPHICAL INFORMATION SYSTEMS, MAPPING SYSTEMS, DIGITAL MAPPING, COMPUTER AIDED DESIGN AND THE CREATION OF GRAPHIC IMAGES ON A COMPUTER (U.S. CLS. 21, 23, 26, 36 AND 38).

CLASS 16—PAPER GOODS AND PRINTED MATTER

FOR COMPUTER OPERATING MANUALS FOR USE IN CONNECTION WITH COMPUTER SOFTWARE FOR GEOGRAPHICAL INFORMATION SYSTEMS, MAPPING SYSTEMS, DIGITAL MAPPING, COMPUTER AIDED DESIGN AND THE CREATION OF GRAPHIC IMAGES ON A COMPUTER (U.S. CLS. 2, 5, 22, 23, 29, 37, 38 AND 50).

CLASS 42—SCIENTIFIC, COMPUTER AND LEGAL SERVICES

FOR COMPUTER CONSULTATION AND TECHNICAL SUPPORT SERVICES, NAMELY, TROUBLESHOOTING OF COMPUTER HARDWARE AND SOFTWARE PROBLEMS (U.S. CLS. 100 AND 101).



CLASS 35—ADVERTISING AND BUSINESS

FOR PROMOTING PUBLIC AWARENESS OF THE NEED TO ADVANCE HEALTH CARE POLICIES TOWARDS AN ACCESSIBLE, HIGH QUALITY HEALTH CARE SYSTEM (U.S. CLS. 100, 101 AND 102).

CLASS 41—EDUCATION AND ENTERTAINMENT

FOR EDUCATIONAL SERVICES, NAMELY, PROVIDING SEMINARS AND PROGRAMS RELATING TO HEALTH CARE POLICIES AND THE NEED FOR AN ACCESSIBLE, HIGH QUALITY HEALTH CARE SYSTEM (U.S. CLS. 100, 101 AND 107).

SN 76-418,611. MASSACHUSETTS HOSPITAL ASSOCIATION, INC., BURLINGTON, MA. FILED 6-7-2002.



SN 76-418,753. DRIVECON, INC., GURNEE, IL. FILED 6-7-2002.

NO CLAIM IS MADE TO THE EXCLUSIVE RIGHT TO USE "MASSACHUSETTS HOSPITALS", APART FROM THE MARK AS SHOWN.

DRIVECON

CLASS 35—ADVERTISING AND BUSINESS

FOR PROMOTING PUBLIC AWARENESS OF THE NEED TO ADVANCE HEALTH CARE POLICIES TOWARDS AN ACCESSIBLE, HIGH QUALITY HEALTH CARE SYSTEM (U.S. CLS. 100, 101 AND 102).

CLASS 7—MACHINERY

FOR ELECTRIC MOTORS FOR MACHINES (U.S. CLS. 13, 19, 21, 23, 31, 34 AND 35).
FIRST USE 6-1-1983; IN COMMERCE 6-1-1983.

CLASS 41—EDUCATION AND ENTERTAINMENT

FOR EDUCATIONAL SERVICES, NAMELY, PROVIDING SEMINARS AND PROGRAMS RELATING TO HEALTH CARE POLICIES AND THE NEED FOR AN ACCESSIBLE, HIGH QUALITY HEALTH CARE SYSTEM (U.S. CLS. 100, 101 AND 107).

CLASS 9—ELECTRICAL AND SCIENTIFIC APPARATUS

FOR ELECTRONIC CONTROLS FOR USE WITH MACHINES, NAMELY, REMOTE CONTROLS, VARIABLE SPEED DRIVES AND OPERATOR CONTROLS (U.S. CLS. 21, 23, 26, 36 AND 38).
FIRST USE 6-1-1983; IN COMMERCE 6-1-1983.

SN 76-418,809. KOLYNICZ, MARK, TROY, MI. FILED 6-7-2002.

SN 76-418,984. TAIWAN SEMICONDUCTOR MANUFACTURING CO., LTD., HSINCHU, TAIWAN, FILED 6-7-2002.



THE PORTRAIT DOES NOT DEPICT A LIVING PERSON. THE ENGLISH TRANSLATION OF "POLSKA KROLEWNA" IS "POLISH PRINCESS".

CLASS 29—MEATS AND PROCESSED FOODS

FOR PICKLES, SAUERKRAUT, PICKLES IN BRINE, PROCESSED PEPPERS, JAMS AND JELLIES, PROCESSED MUSHROOMS, CHEESES, SMOKED MEATS, CANNED MEATS AND SOUPS (U.S. CL. 46).
FIRST USE 1-2-2002; IN COMMERCE 1-2-2002.

CLASS 30—STAPLE FOODS

FOR PIEROGIS, CREPES, FRUIT SYRUP, TABLE SYRUP, AND PASTA (U.S. CL. 46).
FIRST USE 1-2-2002; IN COMMERCE 1-2-2002.

SN 76-418,866. KOSE CORPORATION, TOKYO, JAPAN, FILED 6-12-2002.



CLASS 3—COSMETICS AND CLEANING PREPARATIONS

FOR COSMETICS, PERFUMES, COSMETIC SOAPS AND HAIR LOTIONS (U.S. CLS. 1, 4, 6, 50, 51 AND 52).

CLASS 21—HOUSEWARES AND GLASS

FOR EYEBROW BRUSHES, CHEEK BRUSHES, EYE SHADOW BRUSHES, MASCARA COMBS, COMPACTS SOLD EMPTY, LIP BRUSHES, POWDER PUFFS, COSMETIC BRUSHES AND FOUNDATION SPONGES FOR APPLYING MAKEUP; COSMETIC UTENSILS, NAMELY POWDER COMPACT NOT OF PRECIOUS METAL, POWDER PUFFS AND TOILET SPONGES (U.S. CLS. 2, 13, 23, 29, 30, 33, 40 AND 50).

EMB1TRAM

CLASS 40—MATERIAL TREATMENT

FOR CUSTOM MANUFACTURE OF SEMICONDUCTORS, WAFERS SUCH AS SILICON SLICES, AND INTEGRATED CIRCUITS FOR USE IN PROCESSING OR PACKAGING OF INTEGRATED CIRCUITS, TESTING OF ELECTRONIC CHIP INTEGRATED CIRCUITS AND MANUFACTURING OF SEMICONDUCTORS AND INTEGRATED CIRCUITS; ASSEMBLY OF INTEGRATED CIRCUITS FOR OTHERS; CONSULTATION SERVICES IN THE FIELD OF CUSTOM MANUFACTURE OF SOFTWARE CHIPS AND INTEGRATED CIRCUIT CARDS (U.S. CLS. 100, 103 AND 106).

CLASS 42—SCIENTIFIC, COMPUTER AND LEGAL SERVICES

FOR CONSULTATION SERVICES IN THE FIELD OF DESIGN TECHNIQUE AND DEVELOPMENT OF SEMICONDUCTORS CHIPS, INTEGRATED CIRCUIT AND PROCESSING EQUIPMENT VIA GLOBAL COMMUNICATION NETWORK; DESIGN OF SEMICONDUCTORS AND INTEGRATED CIRCUITS FOR OTHERS; LICENSING OF COMPUTER DATABASES OF A SEMICONDUCTOR CHIP PROCESS SYSTEM AND INTEGRATED CIRCUIT DESIGNS; PROVIDING INFORMATION RELATING TO THE DESIGN OF SEMICONDUCTOR WAFERS, SILICON SLICES, VIA GLOBAL COMMUNICATION NETWORK; PROVIDING INFORMATION RELATING TO SOFTWARE FOR DESIGNING INTEGRATED CIRCUIT PROCESS SYSTEMS, INTEGRATED CIRCUIT PARTS AND INTEGRATED CIRCUITS VIA GLOBAL COMMUNICATION NETWORK; SOFTWARE DESIGNS FOR USE IN THE PROCESSING OF ELECTRONIC CHIPS, SEMICONDUCTORS, WAFERS SUCH AS SILICON SLICES, INTEGRATED CIRCUITS AND THEIR COMPONENT PARTS, MACHINE OPERATION SYSTEMS, AND OTHER COMPUTER APPLICATIONS; DESIGN OF ELECTRONIC CHIPS, SEMICONDUCTORS, WAFERS SUCH AS SILICON SLICES, INTEGRATED CIRCUITS AND THEIR COMPONENTS; CONSULTATION SERVICES OF INTEGRATED CIRCUIT COMPUTER AID AND DESIGN TECHNIQUES; RESEARCH AND ANALYSIS OF THE MANUFACTURE AND DETECTION TECHNIQUES OF SOFTWARE CHIPS AND INTEGRATED CIRCUIT CARDS; AND CONSULTATION SERVICES IN THE FIELD OF DETECTION TECHNIQUES OF SOFTWARE CHIPS AND INTEGRATED CIRCUIT CARDS (U.S. CLS. 100 AND 101).

SN 76-419,229. HOLSCHER, KELLY SOLE, PACIFIC PALISADES, CA. FILED 6-11-2002.

CANBEES

CLASS 9—ELECTRICAL AND SCIENTIFIC APPARATUS

FOR PRERECORDED AUDIO CASSETTES AND COMPACT DISCS FEATURING MUSIC, STORIES, ACTIVITIES AND EDUCATIONAL AND ENTERTAINMENT TOPICS REGARDING OCCUPATIONS, FOR CHILDREN; VIDEO CASSETTES AND DIGITAL VIDEO DISCS FEATURING ENTERTAINMENT FOR CHILDREN; COMPUTER SOFTWARE FEATURING MUSIC, STORIES, ACTIVITIES AND EDUCATIONAL AND ENTERTAINMENT TOPICS REGARDING OCCUPATIONS, FOR CHILDREN; ANIMATED AND LIVE ACTION MOTION PICTURE FILMS FEATURING EDUCATIONAL AND ENTERTAINMENT TOPICS FOR CHILDREN; INTERACTIVE VIDEO GAMES COMPRISED OF COMPUTER HARDWARE AND SOFTWARE; COMPUTER GAME SOFTWARE (U.S. CLS. 21, 23, 26, 36 AND 38).

CLASS 16—PAPER GOODS AND PRINTED MATTER

FOR PRINTED MATTER AND PAPER GOODS—NAMESLY, STORY BOOKS, CHILDREN'S BOOKS, MAGAZINES FEATURING EDUCATIONAL AND ENTERTAINMENT TOPICS FOR CHILDREN, COLORING BOOKS, CHILDREN'S ACTIVITY BOOKS; STATIONERY, WRITING PAPER, ENVELOPES, ADDRESS BOOKS, NOTEBOOKS, BINDERS, DIARIES, NOTE CARDS, GREETING CARDS, TRADING CARDS; LITHOGRAPHS; PENS, PENCILS, CASES THEREFOR, ERASERS, CRAYONS, MARKERS, COLORED PENCILS, PAINTING SETS, CHALK AND CHALKBOARDS; DECALS, HEAT TRANSFERS; POSTERS; MOUNTED AND UNMOUNTED PHOTOGRAPHS; BOOK COVERS, BOOK MARKS, CALENDARS, GIFT WRAPPING PAPER; PAPER PARTY FAVORS AND PAPER PARTY DECORATIONS, NAMESLY, PAPER NAPKINS, PAPER DOILIES, PAPER PLACE MATS, CREPE PAPER, PAPER HATS, INVITATIONS, PAPER TABLE CLOTHS, PAPER CAKE DECORATIONS; PRINTED TRANSFERS FOR EMBROIDERY OR FABRIC APPLIQUES; PRINTED PATTERNS FOR COSTUMES, PAJAMAS, SWEATSHIRTS AND T-SHIRTS; DESK ACCESSORIES, NAMESLY, DESK PADS, PEN AND PENCIL HOLDERS, NOTEPAD HOLDERS, AND DESK SETS, PEN AND PENCIL CASES; RUBBER STAMP SETS AND STICKERS; BUMPER STICKERS; STATIONERY PORTFOLIOS AND LUNCH BAGS (U.S. CLS. 2, 5, 22, 23, 29, 37, 38 AND 50).

CLASS 25—CLOTHING

FOR CLOTHING FOR MEN, WOMEN AND CHILDREN - NAMESLY, SHIRTS, T-SHIRTS, SWEATSHIRTS, JOGGING SUITS, TROUSERS, PANTS, SHORTS, TANK TOPS, RAINWEAR, CLOTH BABY BIBS, SKIRTS, BLOUSES, DRESSES, SUSPENDERS, SWEATERS, JACKETS, COATS, RAINCOATS, SNOW SUITS, TIES, ROBES, HATS, CAPS, SUNVISORS, BELTS, SCARVES, SLEEPWEAR, PAJAMAS, LINGERIE, UNDERWEAR, BOOTS, SHOES, SNEAKERS, SANDALS, BOOTIES, SLIPPER SOCKS, SWIMWEAR AND MASQUERADE AND HALLOWEEN COSTUMES AND MASKS SOLD IN CONNECTION THEREWITH (U.S. CLS. 22 AND 39).

CLASS 28—TOYS AND SPORTING GOODS

FOR TOYS AND SPORTING GOODS, INCLUDING GAMES AND PLAYTHINGS - NAMESLY, ACTION FIGURES AND ACCESSORIES THEREFOR; PLUSH TOYS; BALLOONS; BATHTUB TOYS; RIDE-ON TOYS; CARD GAMES; TOY VEHICLES; DOLLS; FLYING DISCS; ELECTRONIC HAND-HELD GAME UNIT; A BOARD GAMES, MANIPULATIVE GAMES, PARLOR GAMES, PARLOR-TYPE COMPUTER GAMES, ACTION TYPE TARGET GAMES; STAND ALONE VIDEO OUTPUT GAME MACHINES; JIGSAW AND MANIPULATIVE PUZZLES; PAPER FACE MASKS; SKATEBOARDS; ICE SKATES; WATER SQUIRTING TOYS; BALLS - NAMESLY, PLAYGROUND BALLS, SOCCER BALLS, BASEBALLS, BASKETBALLS; BASEBALL GLOVES; SWIMMING FLOATS FOR RECREATIONAL USE; KICKBOARD FLOTATION DEVICES FOR RECREATIONAL USE; SURFBOARDS; SWIM BOARDS FOR RECREATIONAL USE; SWIM FINS; TOY BAKEWARE AND TOY COOKWARE; TOY BANKS; AND CHRISTMAS TREE ORNAMENTS (U.S. CLS. 22, 23, 38 AND 50).

SN 76-419,792. DANNY'S BAR-B-QUE, INC., CARY, NC. FILED 6-12-2002.



NO CLAIM IS MADE TO THE EXCLUSIVE RIGHT TO USE "LEAN MEAT, GREAT SAUCE" AND "BAR-B-QUE", APART FROM THE MARK AS SHOWN.

CLASS 30—STAPLE FOODS

FOR BAR-B-QUE SAUCE (U.S. CL. 46).
FIRST USE 6-1-2000; IN COMMERCE 6-1-2000.

CLASS 43—HOTEL AND RESTAURANT SERVICES

FOR BAR-B-QUE RESTAURANT (U.S. CLS. 100 AND 101).
FIRST USE 6-1-2000; IN COMMERCE 6-1-2000.

SN 76-420,088. GILMORE ENTERPRISES WINDOW COVERINGS, INC., CHATSWORTH, CA. FILED 5-31-2002.

GILMORE

SEC. 2(F).

CLASS 17—RUBBER GOODS

FOR POLYVINYL CHLORIDE (PVC) IN SEMI-FINISHED FORM USED IN THE MANUFACTURE OF VERTICAL BLIND VANES, HORIZONTAL BLIND SLATS AND PLEATED SHADES (U.S. CLS. 1, 5, 12, 13, 35 AND 50).

FIRST USE 12-31-1980; IN COMMERCE 12-31-1980.

CLASS 20—FURNITURE AND ARTICLES NOT OTHERWISE CLASSIFIED

FOR VERTICAL AND HORIZONTAL WINDOW BLINDS AND COMPONENTS AND PARTS THEREOF; WINDOW BLIND TRACKS AND PARTS THEREOF; ROLLER WINDOW SHADES AND PARTS THEREOF; PLEATED WINDOW SHADES AND PARTS THEREOF; WINDOW BLIND HEADRAILS AND COMPONENTS THEREOF; WINDOW SLATS; INTERIOR WINDOW SHUTTERS AND PARTS AND FITTINGS THEREOF (U.S. CLS. 2, 13, 22, 25, 32 AND 50).

FIRST USE 12-31-1980; IN COMMERCE 12-31-1980.

CLASS 24—FABRICS

FOR DRAPERIES; DRAPERY FABRICS USED FOR THE MANUFACTURE OF VERTICAL BLIND VANES, HORIZONTAL BLIND VANES, HORIZONTAL BLIND SLATS AND PLEATED SHADES (U.S. CLS. 42 AND 50).

FIRST USE 12-31-1980; IN COMMERCE 12-31-1980.

SN 76-420,244. SUNDAY RIVER SKIWAY CORPORATION, BETHEL, ME. FILED 6-3-2002.

SUNDAY RIVER**CLASS 41—EDUCATION AND ENTERTAINMENT**

FOR SKI RESORTS (U.S. CLS. 100, 101 AND 107).
FIRST USE 11-1-1971; IN COMMERCE 11-1-1971.

CLASS 43—HOTEL AND RESTAURANT SERVICES

FOR RESORT LODGING SERVICES AND RESTAURANT SERVICES (U.S. CLS. 100 AND 101).
FIRST USE 11-1-1971; IN COMMERCE 11-1-1971.

SN 76-420,341. THERION BIOLOGICS CORPORATION, CAMBRIDGE, MA. FILED 6-7-2002.

THERION BIOLOGICS

NO CLAIM IS MADE TO THE EXCLUSIVE RIGHT TO USE "BIOLOGICS", APART FROM THE MARK AS SHOWN.

CLASS 5—PHARMACEUTICALS

FOR PHARMACEUTICAL PREPARATIONS FOR THE TREATMENT OF HIV, CANCERS, INCLUDING LEUKEMIA, LYMPHOMAS, CARCINOMAS, COLON CANCER, BREAST CANCER, LUNG CANCER, PANCREATIC CANCER, HEPATOCELLULAR CARCINOMA, KIDNEY CANCER, MELANOMA AND METASTATIC CANCERS; VACCINES AND RECOMBINANT VECTORS OF POX AND COMPONENT IMMUNE-STIMULATORY AGENTS USED IN SAID VACCINES TO PRODUCE BIOLOGICAL IMMUNOGENS FOR USE IN HUMANS (U.S. CLS. 6, 18, 44, 46, 51 AND 52).

FIRST USE 8-19-1993; IN COMMERCE 8-19-1993.

CLASS 42—SCIENTIFIC, COMPUTER AND LEGAL SERVICES

FOR PHARMACEUTICAL RESEARCH AND DEVELOPMENT (U.S. CLS. 100 AND 101).
FIRST USE 8-19-1993; IN COMMERCE 8-19-1993.

SN 76-420,581. ROBIN INDUSTRIES, INC., CLEVELAND, OH. FILED 6-12-2002.

VIBRANT TECHNOLOGIES

NO CLAIM IS MADE TO THE EXCLUSIVE RIGHT TO USE "TECHNOLOGIES", APART FROM THE MARK AS SHOWN.

CLASS 40—MATERIAL TREATMENT

FOR CONTRACT MANUFACTURING OF POLYMERS AND ELASTOMERIC COMPONENTS; PARTS MOLDING; CUSTOM MANUFACTURE OF MOLDS FOR USE WITH POLYMERS (U.S. CLS. 100, 103 AND 106).

CLASS 42—SCIENTIFIC, COMPUTER AND LEGAL SERVICES

FOR DESIGN FOR OTHERS IN THE FIELD OF POLYMERS, NAMELY, THERMOPLASTIC AND ELASTOMERIC COMPONENTS; DESIGN AND TESTING FOR NEW PRODUCT DEVELOPMENT; TECHNICAL CONSULTATION AND RESEARCH IN THE FIELD OF POLYMER, THERMOPLASTIC AND ELASTOMERIC MATERIAL ENGINEERING (U.S. CLS. 100 AND 101).

SN 76-421,003. LABEL MAKERS, INC., PLEASANT PRAIRIE, WI. FILED 6-13-2002.

ease
peel

NO CLAIM IS MADE TO THE EXCLUSIVE RIGHT TO USE "PEEL", APART FROM THE MARK AS SHOWN.

CLASS 6—METAL GOODS

FOR METAL CAPS FOR CONTAINERS (U.S. CLS. 2, 12, 13, 14, 23, 25 AND 50).

CLASS 20—FURNITURE AND ARTICLES NOT OTHERWISE CLASSIFIED

FOR PLASTIC CAPS FOR CONTAINERS (U.S. CLS. 2, 13, 22, 25, 32 AND 50).

SN 76-422,410. JOLLYBABY INTERNATIONAL LIMITED, KOWLOON, HONG KONG, FILED 6-19-2002.

SN 76-423,277. BR 111 IMPORTS & EXPORTS, INC., LAUREL, MD. FILED 6-20-2002.



OWNER OF U.S. REG. NO. 2,148,770.
NO CLAIM IS MADE TO THE EXCLUSIVE RIGHT TO USE "EXOTIC HARDWOOD FLOORING", APART FROM THE MARK AS SHOWN.

CLASS 24—FABRICS

FOR FABRICS FOR THE MANUFACTURE OF BUILDINGS, CLOTHING, FURNITURE, SOFT TOYS, SHOES AND CURTAINS; BEDDING, NAMELY, BLANKETS, BED SHEETS, PILLOWCASES, PILLOW SHAMS, COMFORTERS, BED SPREADS, DUVET COVERS, CRIB AND COT BUMPERS, MATTRESS PROTECTORS (U.S. CLS. 42 AND 50).

CLASS 28—TOYS AND SPORTING GOODS

FOR BUILDING BLOCKS; DOLLS CLOTHES; DOLL HOUSES; MARIONETTES; TOY MOBILES; PUPPETS; INFANTS RATTLES; PLAYMATS; TEDDY BEARS; SOFT TOYS IN THE SHAPE OF ANIMALS, MOONS, CLOUDS, SUNS, STARS, CLOWNS, TRAINS, AND DOLLS; MUSICAL SOFT TOYS IN THE SHAPE OF ANIMALS, MOONS, CLOUDS, SUNS, STARS, CLOWNS, TRAINS, AND DOLLS; SOFT TOYS WITH SQUEAKERS IN THE SHAPE OF ANIMALS, MOONS, CLOUDS, SUNS, STARS, CLOWNS, TRAINS, AND DOLLS (U.S. CLS. 22, 23, 38 AND 50).

CLASS 19—NON-METALLIC BUILDING MATERIALS

FOR HARDWOOD AND ENGINEERED HARDWOOD PRODUCTS, NAMELY, FLOORING, MOLDING, WOOD ACCESSORIES, NAMELY, FEATURE STRIPS, REDUCER STRIPS, STAIR NOSINGS, SHOE MOLDINGS, STAIR TREADS, STAIR RISERS, T-MOLDINGS, THRESHOLD TRANSITIONS, AND DOORS (U.S. CLS. 1, 12, 33 AND 50).
FIRST USE 4-1-2001; IN COMMERCE 4-1-2001.

CLASS 35—ADVERTISING AND BUSINESS

FOR DISTRIBUTORSHIPS FEATURING HARDWOOD AND ENGINEERED HARDWOOD PRODUCTS, INCLUDING FLOORING, MOLDING, WOOD ACCESSORIES AND DOORS (U.S. CLS. 100, 101 AND 102).
FIRST USE 4-1-2001; IN COMMERCE 4-1-2001.

SN 76-422,491. MRA INTERNATIONAL, INC., PHILADELPHIA, PA. FILED 6-18-2002.

EVENTS CAFE

NO CLAIM IS MADE TO THE EXCLUSIVE RIGHT TO USE "CAFE", APART FROM THE MARK AS SHOWN.

CLASS 35—ADVERTISING AND BUSINESS

FOR RETAIL STORE SERVICES FEATURING RESTAURANT AND BAR PROMOTIONAL ITEMS SUCH AS CLOTHING, ACCESSORIES AND GENERAL GOODS (U.S. CLS. 100, 101 AND 102).

CLASS 43—HOTEL AND RESTAURANT SERVICES

FOR RESTAURANT AND BAR SERVICES (U.S. CLS. 100 AND 101).

SN 76-423,419. CME TELEMETRIX INC., WATERLOO, ONTARIO, CANADA, FILED 6-20-2002.

LIPRONIR

PRIORITY CLAIMED UNDER SEC. 44(D) ON CANADA APPLICATION NO. 1,138,272, FILED 4-23-2002.

CLASS 9—ELECTRICAL AND SCIENTIFIC APPARATUS

FOR COMPUTER SOFTWARE FOR USE IN CONTROLLING MEDICAL INSTRUMENTS FOR USE IN MEASURING LIPID PROFILES (U.S. CLS. 21, 23, 26, 36 AND 38).

CLASS 10—MEDICAL APPARATUS

FOR MEDICAL INSTRUMENTS, NAMELY SPECTROPHOTOMETRIC INSTRUMENTS, FOR USE IN MEASURING LIPID PROFILES (U.S. CLS. 26, 39 AND 44).

SN 76-423,638. TMW MARKETING COMPANY, INC., FREMONT, CA. FILED 6-24-2002.

TWINHILL

OWNER OF U.S. REG. NOS. 2,165,445 AND 2,165,447.

CLASS 18—LEATHER GOODS

FOR ATHLETIC BAGS, GOLF UMBRELLAS, OVERNIGHT BAGS, ATTACHE CASES, SHOE BAGS FOR TRAVEL, SUITCASES, TOILETRY CASES SOLD EMPTY AND WALLETS (U.S. CLS. 1, 2, 3, 22 AND 41).

CLASS 24—FABRICS

FOR GOLF TOWELS (U.S. CLS. 42 AND 50).

CLASS 25—CLOTHING

FOR GOLF WEARING APPAREL, NAMELY, KNIT SHIRTS AND LONG SLEEVE SHIRTS; RAINWEAR, RAIN JACKETS, RAIN SUITS, COATS AND JACKETS, SCARVES, PULLOVERS, TURTLENECKS, VESTS; SHOES, NAMELY, CASUAL FOOTWEAR AND ATHLETIC FOOTWEAR; NECKTIES AND GLOVES (U.S. CLS. 22 AND 39).

CLASS 28—TOYS AND SPORTING GOODS

FOR SPORTING GOODS, NAMELY, GOLF BALLS, GOLF TEES, TEE MARKERS, GOLF CLUB HEADS, BALL MARKERS, DIVOT REPAIR TOOLS, GOLF GLOVES, GOLF CLUBS, GOLF BAGS, GOLF BAGS COVERS, GOLF BAGS TAGS AND GOLF ACCESSORY POUCHES (U.S. CLS. 22, 23, 38 AND 50).

SN 76-425,002. SILVER SADDLE RANCH & CLUB, INC., CALIFORNIA CITY, CA. FILED 6-24-2002.



Silver Saddle Ranch & Spa

OWNER OF U.S. REG. NOS. 1,401,620 AND 2,642,439.
NO CLAIM IS MADE TO THE EXCLUSIVE RIGHT TO USE "RANCH & SPA", APART FROM THE MARK AS SHOWN.

THE STIPPLING IS A FEATURE OF THE MARK AND DOES NOT INDICATE COLOR.

CLASS 41—EDUCATION AND ENTERTAINMENT

FOR COUNTRY CLUB SERVICES (U.S. CLS. 100, 101 AND 107).
FIRST USE 4-15-2002; IN COMMERCE 4-15-2002.

CLASS 44—MEDICAL, BEAUTY AND AGRICULTURAL SERVICES

FOR RESORT SERVICES, NAMELY, HEALTH AND SPA SERVICES, MASSAGE SERVICES AND BEAUTY SALON SERVICES (U.S. CLS. 100 AND 101).
FIRST USE 4-15-2002; IN COMMERCE 4-15-2002.

SN 76-425,172. ABS SMOOTHIES USA, LLC, MARSHALL, MI. FILED 6-26-2002.

YA-MAKIN SMOOTHIES

NO CLAIM IS MADE TO THE EXCLUSIVE RIGHT TO USE "SMOOTHIES", APART FROM THE MARK AS SHOWN.

CLASS 29—MEATS AND PROCESSED FOODS

FOR FRUIT PUREE BASES FOR USE IN FRUIT TOPPING AND FRUIT SAUCES (U.S. CL. 46).

CLASS 32—LIGHT BEVERAGES

FOR FRUIT PUREE BASES FOR USE IN SMOOTHIES (U.S. CLS. 45, 46 AND 48).

SN 76-425,947. BREAD & CIE, INC., SAN DIEGO, CA. FILED 6-27-2002.

BREAD & CIE

NO CLAIM IS MADE TO THE EXCLUSIVE RIGHT TO USE "BREAD", APART FROM THE MARK AS SHOWN.

CLASS 35—ADVERTISING AND BUSINESS

FOR RETAIL BAKERY SHOPS (U.S. CLS. 100, 101 AND 102).
FIRST USE 12-16-1994; IN COMMERCE 12-0-1996.

CLASS 43—HOTEL AND RESTAURANT SERVICES

FOR RESTAURANT SERVICES (U.S. CLS. 100 AND 101).
FIRST USE 12-16-1994; IN COMMERCE 12-0-1995.

SN 76-427,765. GENSCI ORTHOBIOLOGICS, INC., IRVINE, CA. FILED 7-5-2002.

DBM100**CLASS 5—PHARMACEUTICALS**

FOR SURGICAL IMPLANTS COMPRISING LIVING TISSUE, NAMELY, BONE REGENERATION ALLOGRAFT TISSUE (U.S. CLS. 6, 18, 44, 46, 51 AND 52).
FIRST USE 2-13-2002; IN COMMERCE 2-13-2002.

CLASS 10—MEDICAL APPARATUS

FOR SURGICAL IMPLANTS COMPRISING ARTIFICIAL MATERIAL, NAMELY, BONE REGENERATION ALLOGRAFT TISSUE (U.S. CLS. 26, 39 AND 44).
FIRST USE 2-13-2002; IN COMMERCE 2-13-2002.

SN 76-427,849. BAXTER INTERNATIONAL INC., ROUND LAKE, IL. FILED 6-28-2002.

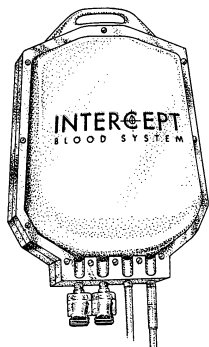

NO CLAIM IS MADE TO THE EXCLUSIVE RIGHT TO USE "BLOOD SYSTEM", APART FROM THE MARK AS SHOWN.

THE STIPPLING IS A FEATURE OF THE MARK AND DOES NOT INDICATE COLOR.

CLASS 16—PAPER GOODS AND PRINTED MATTER

FOR PAMPHLETS, BROCHURES, NEWSLETTERS AND CATALOGS IN THE FIELD OF TRANSFUSION MEDICINE (U.S. CLS. 2, 5, 22, 23, 29, 37, 38 AND 50).

CLASS 44—MEDICAL, BEAUTY AND AGRICULTURAL SERVICES

FOR PROVIDING INFORMATION IN THE FIELD OF TRANSFUSION MEDICINE (U.S. CLS. 100 AND 101).

SN 76-428,507. MZM, INC., WASHINGTON, DC. FILED 7-8-2002.



THE STIPPLING SHOWN IN THE DRAWING IS A FEATURE OF THE MARK AND IS NOT INTENDED TO INDICATE COLOR.

CLASS 35—ADVERTISING AND BUSINESS

FOR STRATEGIC BUSINESS PLANNING AND TRANSFORMATION SERVICES, NAMELY IN THE NATURE OF BUSINESS PROCESS RE-ENGINEERING SERVICES; AND COMPUTERIZED MANAGEMENT OF ENTERPRISE DATABASES (U.S. CLS. 100, 101 AND 102). FIRST USE 7-1-2002; IN COMMERCE 7-1-2002.

CLASS 39—TRANSPORTATION AND STORAGE

FOR STORAGE SERVICES FOR ARCHIVING DATABASES, IMAGES AND OTHER ELECTRONIC DATA (U.S. CLS. 100 AND 105). FIRST USE 7-1-2002; IN COMMERCE 7-1-2002.

CLASS 42—SCIENTIFIC, COMPUTER AND LEGAL SERVICES

FOR NATIONAL SECURITY CONSULTING, NAMELY, CONSULTING SERVICES IN THE FIELD OF DESIGN, SELECTION, IMPLEMENTATION AND USE OF HARDWARE AND SOFTWARE SYSTEMS FOR OTHERS; DATA MINING; AND CREATING INDICES OF INFORMATION, SITES AND OTHER RESOURCES AVAILABLE ON COMPUTER NETWORKS (U.S. CLS. 100 AND 101). FIRST USE 7-1-2002; IN COMMERCE 7-1-2002.

SN 76-428,869. NIPPON DENKI KABUSHIKI KAISHA, DBA NEC CORPORATION, TOKYO, JAPAN, FILED 7-5-2002.

NEC LCD TECHNOLOGIES

OWNER OF U.S. REG. NOS. 1,688,830, 1,908,239 AND OTHERS. NO CLAIM IS MADE TO THE EXCLUSIVE RIGHT TO USE "LCD TECHNOLOGIES", APART FROM THE MARK AS SHOWN.

CLASS 9—ELECTRICAL AND SCIENTIFIC APPARATUS

FOR TELEPHONES, MULTIPLEXERS, PERSONAL DIGITAL ASSISTANTS, FACSIMILE MACHINES, CORDLESS TELEPHONE SETS, ELECTRONIC COMPUTER, MAINFRAME COMPUTERS, SMALL BUSINESS COMPUTERS, PERSONAL COMPUTERS, NOTEBOOK COMPUTERS, SUPERCOMPUTERS, COMPUTER PERIPHERALS AND TERMINALS, COMPUTER KEYBOARDS, COMPUTER MOUSE, MOUSE PADS, WORD PROCESSORS, COMPUTER OUTPUT PRINTERS, CD-ROM DRIVES, CD-RECORDABLE DRIVES, CD-RWRITEABLE DRIVES, DVD-ROM DRIVES, REWRITEABLE DVD DRIVES, COMPUTER MONITORS, MOVIE AND PHOTOGRAPHIC PROJECTORS, COLOR PLASMA DISPLAY PANELS, MODEMS, OPTICAL DISK PLAYERS, INDUSTRIAL ROBOTS, MICROCOMPUTERS, SEMICONDUCTORS, INTEGRATED CIRCUITS (ICS), HYBRID INTEGRATED CIRCUITS APPLICATION SPECIFIC INTEGRATED CIRCUITS (ASICS), READ ONLY MEMORIES (ROMS), RANDOM ACCESS MEMORIES (RAMS), STATIC RANDOM ACCESS MEMORIES (SRAMS), DYNAMIC RANDOM ACCESS MEMORIES (DRAMs), PROGRAMMABLE READ ONLY MEMORIES (PROMS), ERASABLE PROGRAMMABLE READ ONLY MEMORIES (EPROMS), ELECTRICALLY ERASABLE PROGRAMMABLE READ ONLY MEMORIES (EEPROMS), FIELD PROGRAMMABLE READ ONLY MEMORIES (FPGAs), MICROCOMPUTERS, CENTRAL PROCESSING UNITS (CPUS), TRANSISTORS, GALLIUM ARSENIDE FIELD-EFFECT TRANSISTORS, FLUORESCENT INDICATOR PANELS, ELECTROLUMINESCENT LIGHTING PANELS, LIQUID CRYSTAL DISPLAYS (LCD), LIGHT EMITTING DIODE DISPLAYS, PRINTED WIRING BOARDS (PWBS), CAPACITORS, VARIABLE RESISTORS, ELECTRICAL CONNECTORS, TELEVISION RECEIVERS, MOVIE AND PHOTOGRAPHIC PROJECTORS, COLOR PLASMA DISPLAY PANELS, DIRECT BROADCASTING SATELLITE RECEIVERS, EXTENDED-DEFINITION TELEVISION AND RADIO RECEIVERS, VIDEO CASSETTE RECORDERS, COMPACT DISK PLAYERS, SURROUND AMPLIFIERS/DECODERS, BATTERIES; PARTS AND FITTING FOR ALL THE AFORESAID GOODS (U.S. CLS. 21, 23, 26, 36 AND 38).

CLASS 42—SCIENTIFIC, COMPUTER AND LEGAL SERVICES

FOR TECHNICAL SUPPORT SERVICES AND TECHNICAL CONSULTING SERVICES FOR CREATING, DESIGNING AND MAINTAINING WEB SITE FOR OTHERS, TECHNICAL SUPPORT SERVICES AND TECHNICAL CONSULTATION FOR COMPUTER PROGRAMMING AND COMPUTER HARDWARE; CONSULTATION AND ADVISORY SERVICES IN THE FIELD OF LIQUID CRYSTAL DISPLAYS AND IN THE FIELD OF DESIGN OF LIQUID CRYSTAL DISPLAYS; DESIGN OF COMPUTER HARDWARE, COMPUTER SOFTWARE, WEB SITES AND COMPUTER NETWORK SYSTEM FOR OTHERS; DESIGN OF LIQUID CRYSTAL DISPLAYS; PROVIDING OTHERS WITH INFORMATION RELATING TO COMPUTER HARDWARE AND COMPUTER SOFTWARE; PROVIDING OTHERS WITH INFORMATION RELATING TO COMPUTER HARDWARE AND COMPUTER SOFTWARE VIA LOCAL AND GLOBAL COMPUTER INFORMATION NETWORKS; PROVIDING OTHERS WITH THE INFORMATION IN THE FIELD OF LIQUID CRYSTAL DISPLAYS AND IN THE FIELD OF DESIGN OF LIQUID CRYSTAL DISPLAYS; PROVIDING OTHERS WITH THE INFORMATION IN THE FIELD OF DESIGN OF LIQUID CRYSTAL DISPLAYS VIA LOCAL AND GLOBAL COMPUTER INFORMATION NETWORKS; MAINTENANCE AND UPDATING OF COMPUTER SOFTWARE AND WEB SITES FOR OTHERS; COMPUTER NETWORK SYSTEMS ANALYSIS; SERVICES RELATING TO THE TECHNICAL SUPERVISION AND INSPECTION OF ELECTRONIC APPARATUS AND INSTRUMENTS INCLUDING ELECTRONIC COMPUTERS; REPAIR SERVICES OF COMPUTER SOFTWARE PROGRAM AND MAINTENANCE AND MANAGEMENT OF WEB SITES OF OTHERS (U.S. CLS. 100 AND 101).

SN 76-430,393. SUNWEST SCREEN GRAPHICS LTD., WINNIPEG, MANITOBA, CANADA, FILED 7-15-2002.

SUNWEST SCREEN GRAPHICS

OWNER OF CANADA REG. NO. TMA557,529, DATED 2-7-2002. EXPIRES 2-7-2012.

NO CLAIM IS MADE TO THE EXCLUSIVE RIGHT TO USE "SCREEN GRAPHICS", APART FROM THE MARK AS SHOWN.

CLASS 16—PAPER GOODS AND PRINTED MATTER

FOR DECALS (U.S. CLS. 2, 5, 22, 23, 29, 37, 38 AND 50). FIRST USE 10-31-1989; IN COMMERCE 10-31-1989.

CLASS 40—MATERIAL TREATMENT

FOR SCREEN PRINTING SERVICES (U.S. CLS. 100, 103 AND 106). FIRST USE 10-31-1989; IN COMMERCE 10-31-1989.

SN 76-430,411. THE J. M. SMUCKER COMPANY, ORRVILLE, OH. FILED 7-15-2002.

SN 76-429,215. UMG ABS, LTD., TOKYO, JAPAN, FILED 7-11-2002.

UMG ALLOY

NO CLAIM IS MADE TO THE EXCLUSIVE RIGHT TO USE "ALLOY", APART FROM THE MARK AS SHOWN.

CLASS 1—CHEMICALS

FOR UNPROCESSED SYNTHETIC RESINS AND RESIN MOLDING MATERIALS FOR USE IN A WIDE VARIETY OF FIELDS; UNPROCESSED PLASTICS FOR USE IN A WIDE VARIETY OF FIELDS; CHEMICALS FOR USE IN THE MANUFACTURE OF A WIDE VARIETY OF GOODS (U.S. CLS. 1, 5, 6, 10, 26 AND 46).

CLASS 17—RUBBER GOODS

FOR RESINS IN SHEETS, TUBES, BLOCKS, AND RODS FOR GENERAL INDUSTRIAL USE; PLASTICS IN SHEETS, TUBES, BLOCKS, AND RODS FOR GENERAL INDUSTRIAL USE (U.S. CLS. 1, 5, 12, 13, 35 AND 50).

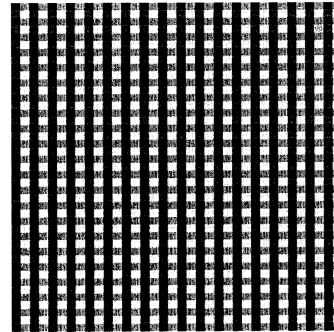

OWNER OF U.S. REG. NOS. 1,254,673, 2,655,608 AND OTHERS. SEC. 2(F).

CLASS 29—MEATS AND PROCESSED FOODS

FOR PACKAGED LUNCH COMBINATIONS CONSISTING PRIMARILY OF FRUIT SPREADS, JAMS, JELLIES, PRESERVES, PEANUT BUTTER, AND CRACKER COMBINATIONS (U.S. CL. 46). FIRST USE 6-0-2000; IN COMMERCE 6-0-2000.

CLASS 30—STAPLE FOODS

FOR SANDWICHES—NAMELY PEANUT BUTTER AND JELLY SANDWICHES, PEANUT BUTTER AND JAM SANDWICHES, PEANUT BUTTER AND FRUIT PRESERVES SANDWICHES, AND PEANUT BUTTER AND FRUIT SPREAD SANDWICHES; AND PACKAGED LUNCH COMBINATIONS CONSISTING PRIMARILY OF CRACKERS (U.S. CL. 46). FIRST USE 6-0-2000; IN COMMERCE 6-0-2000.

SN 76-430,614. INPHOMATCH, INC., CHANTILLY, VA.
FILED 7-11-2002.

INPHOMATCH

CLASS 38—COMMUNICATION

FOR ELECTRONIC TRANSMISSION OF TEXT AND DATA MESSAGES VIA WIRELESS COMMUNICATION NETWORKS (U.S. CLS. 100, 101 AND 104).
FIRST USE 8-0-2000; IN COMMERCE 9-0-2000.

CLASS 42—SCIENTIFIC, COMPUTER AND LEGAL SERVICES

FOR CROSS-PLATFORM CONVERSION OF DIGITAL CONTENT INTO OTHER FORMS OF DIGITAL CONTENT FOR TRANSMISSION OVER WIRELESS COMMUNICATIONS NETWORKS (U.S. CLS. 100 AND 101).
FIRST USE 8-0-2000; IN COMMERCE 9-0-2000.

SN 76-430,688. STROUD, JAMES M., TRAVELERS REST, SC.
FILED 7-12-2002.

DR. BUCK

THE NAME "DR. BUCK" DOES NOT IDENTIFY A LIVING INDIVIDUAL.

CLASS 5—PHARMACEUTICALS

FOR MINERAL SUPPLEMENTS AND FEED SUPPLEMENTS FOR RUMINANT ANIMALS SUCH AS DEER AND COWS IN GRANULAR, PELLET, LIQUID, AND BLOCK FORM WITH INSECT REPELLANT, AND MINERAL SUPPLEMENTS AND FEED SUPPLEMENTS FOR RUMINANT ANIMALS SUCH AS DEER AND COWS IN GRANULAR, PELLET, LIQUID, AND BLOCK FORM WITHOUT INSECT REPELLANT (U.S. CLS. 6, 18, 44, 46, 51 AND 52).

CLASS 28—TOYS AND SPORTING GOODS

FOR HUNTING LURES IN THE NATURE OF ANIMAL SCENT PREPARATIONS (U.S. CLS. 22, 23, 38 AND 50).

CLASS 31—NATURAL AGRICULTURAL PRODUCTS

FOR ANIMAL FEED (U.S. CLS. 1 AND 46).

SN 76-430,772. VOICELINK COMMUNICATIONS, LLC,
MANCHESTER, CT. FILED 7-12-2002.

HOMELAND DEFENSE NETWORK

NO CLAIM IS MADE TO THE EXCLUSIVE RIGHT TO USE "NETWORK", APART FROM THE MARK AS SHOWN.

CLASS 9—ELECTRICAL AND SCIENTIFIC APPARATUS

FOR CELLULAR TELEPHONES, DIGITAL CELLULAR PHONES, DISPATCH RADIOS, MOBILE RADIOS, RADIOS FOR VEHICLES, TWO-WAY RADIOS, DIGITAL PHONES, WIRELESS TELEPHONES, RADIO PAGERS, MOBILE DATA RECEIVERS, MOBILE RADIOS, MOBILE TELEPHONES (U.S. CLS. 21, 23, 26, 36 AND 38).

CLASS 35—ADVERTISING AND BUSINESS

FOR MANAGEMENT OF TELEPHONE CALL CENTERS FOR OTHERS (U.S. CLS. 100, 101 AND 102).

CLASS 38—COMMUNICATION

FOR CELLULAR TELEPHONE SERVICES; ELECTRONIC, ELECTRIC, AND DIGITAL TRANSMISSION OF VOICE, DATA, IMAGES, SIGNALS, AND MESSAGES; MOBILE RADIO COMMUNICATION SERVICES; PROVIDING TELECOMMUNICATIONS CONNECTIONS TO A GLOBAL COMPUTER NETWORK; RADIO COMMUNICATION SERVICES; TELECOMMUNICATION SERVICES, NAMELY, LOCAL AND LONG DISTANCE TRANSMISSION OF VOICE, DATA, AND GRAPHICS BY MEANS OF TELEPHONE, TELEGRAPH SERVICES, CABLE, AND SATELLITE TRANSMISSIONS; TELEPHONE VOICE MESSAGING SERVICES; TEXT AND NUMERIC WIRELESS DIGITAL MESSAGING SERVICES; WIRELESS PBX SERVICES; WIRELESS VOICE MAIL SERVICES; TELECOMMUNICATIONS CONSULTATION COMMUNICATION SERVICES (U.S. CLS. 100, 101 AND 104).

CLASS 45—PERSONAL SERVICES

FOR MONITORING TELEPHONE CALLS FROM SUBSCRIBERS AND NOTIFYING EMERGENCY FACILITIES (U.S. CLS. 100 AND 101).

SN 76-431,132. WHITMAN-WALKER, INC., WASHINGTON,
DC. FILED 7-1-2002.

TASTE OF DUPONT

NO CLAIM IS MADE TO THE EXCLUSIVE RIGHT TO USE "DUPONT", APART FROM THE MARK AS SHOWN.

CLASS 36—INSURANCE AND FINANCIAL

FOR CHARITABLE FUNDRAISING SERVICES (U.S. CLS. 100, 101 AND 102).

CLASS 41—EDUCATION AND ENTERTAINMENT

FOR ENTERTAINMENT SERVICES, NAMELY, ORGANIZING COMMUNITY FESTIVALS WITH FACILITIES FOR FOOD, REFRESHMENT, ENTERTAINMENT AND CRAFTS (U.S. CLS. 100, 101 AND 107).

SN 76-431,543. DEGUSSA AG, 40474 DUSSELDORF, FED
REP GERMANY, FILED 7-11-2002.

AMINOSCREEN

OWNER OF FED REP GERMANY REG. NO. 30081372,
DATED 9-3-2001, EXPIRES 11-30-2010.

CLASS 9—ELECTRICAL AND SCIENTIFIC APPARATUS

FOR COMPUTER SOFTWARE FOR USE IN ANIMAL NUTRITION, NAMELY, FOR USE BY POULTRY PRODUCERS TO OPTIMIZE AMINO ACID NUTRITION AND TO ASSIST IN ENABLING ANIMAL NUTRITIONISTS TO DETERMINE THE BEST AMINO ACID SPECIFICATIONS OF LIVESTOCK DIETS IN THE FIELD OF ANIMAL NUTRITION (U.S. CLS. 21, 23, 26, 36 AND 38).

CLASS 41—EDUCATION AND ENTERTAINMENT

FOR EDUCATIONAL SERVICES FOR ANIMAL NUTRITIONISTS, SPECIFICALLY, CONDUCTING CLASSES, SEMINARS, CONFERENCES, WORKSHOPS IN THE FIELD OF ANIMAL NUTRITION (U.S. CLS. 100, 101 AND 107).

CLASS 42—SCIENTIFIC, COMPUTER AND LEGAL SERVICES

FOR RESEARCH IN THE FIELD OF ANIMAL PRODUCTION (U.S. CLS. 100 AND 101).

SN 76-432,279. PFIZER INC., NEW YORK, NY. FILED 7-19-2002.



OWNER OF U.S. REG. NOS. 626,088, 2,565,654 AND OTHERS.

CLASS 16—PAPER GOODS AND PRINTED MATTER

FOR PRINTED MATERIALS, NAMELY, INFORMATIONAL BOOKLETS, BROCHURES, PAMPHLETS, PHOTOGRAPHIC SLIDES, COLORING SHEETS AND NEWSLETTERS ON THE SUBJECTS OF ARTHRITIS, DIABETES AND CARDIO-VASCULAR DISEASES (U.S. CLS. 2, 5, 22, 23, 29, 37, 38 AND 50).

CLASS 44—MEDICAL, BEAUTY AND AGRICULTURAL SERVICES

FOR MEDICAL INFORMATION SERVICES, NAMELY, PROVIDING INFORMATION ON THE SUBJECTS OF ARTHRITIS, DIABETES AND CARDIO-VASCULAR DISEASES (U.S. CLS. 100 AND 101).

SN 76-432,614. PATTERSON, CHARLENE, MENIFEE, AR. FILED 7-18-2002.

ONCE NEW**CLASS 3—COSMETICS AND CLEANING PREPARATIONS**

FOR COSMETICS, PERFUME, COLOGNE, BODY LOTION, LIPSTICK AND AFTERSHAVE (U.S. CLS. 1, 4, 6, 50, 51 AND 52).

CLASS 25—CLOTHING

FOR JEANS, DRESSES, SHIRTS, SKIRTS, SHORTS, SHORTS SETS, PANTS, BLOUSES, SWEATERS, TOPS, CARDIGANS, JACKETS, VESTS, OVERALLS, HATS, CAPS, UNDERSHIRTS, UNDERWEAR, T-SHIRTS, BANDANAS, SCARVES, PAJAMAS, NIGHTSHIRTS, NIGHTGOWNS, SWEAT SUITS, BODY SUITS, SUSPENDERS, BELTS, BOOTS, SANDALS, SOCKS, HOSIERY, SHOES, TROUSERS AND NECKTIES (U.S. CLS. 22 AND 39).

SN 76-432,915. RICOLA AG, 4242 LAUFEN, SWITZERLAND, FILED 7-2-2002.

NATURE'S PROTECTION

PRIORITY CLAIMED UNDER SEC. 44(D) ON SWITZERLAND APPLICATION NO. 04443/2002, FILED 5-16-2002, REG. NO. 504990, DATED 11-15-2002, EXPIRES 5-16-2012.

CLASS 5—PHARMACEUTICALS

FOR DIETARY SUPPLEMENTS IN THE FORM OF CONFECTIONERY LOZENGES (U.S. CLS. 6, 18, 44, 46, 51 AND 52).

CLASS 30—STAPLE FOODS

FOR CONFECTIONERY IN THE FORM OF LOZENGES FOR NON-MEDICATED PURPOSES (U.S. CL. 46).

SN 76-433,394. COMPUTER EMPLOYMENT APPLICATIONS, INC., MILWAUKEE, WI. FILED 7-23-2002.



THE LINING IS A FEATURE OF THE MARK AND DOES NOT INDICATE COLOR.

CLASS 9—ELECTRICAL AND SCIENTIFIC APPARATUS

FOR COMPUTER SOFTWARE FOR USE IN INTERVIEWING AND SCREENING EMPLOYMENT APPLICANTS (U.S. CLS. 21, 23, 26, 36 AND 38).

FIRST USE 8-26-1987; IN COMMERCE 1-19-1991.

CLASS 35—ADVERTISING AND BUSINESS

FOR CONDUCTING COMPUTERIZED SCREENING OF EMPLOYMENT APPLICANTS FOR TESTING EMPLOYMENT SKILLS AND QUALIFICATIONS; PROVIDING DATABASE OF EMPLOYMENT APPLICANT'S DATA (U.S. CLS. 100, 101 AND 102).

FIRST USE 8-26-1987; IN COMMERCE 1-19-1991.

CLASS 45—PERSONAL SERVICES

FOR CONDUCTING PRE-EMPLOYMENT BACKGROUND CHECKS AND PROVIDING SUMMARIES OF DATA OBTAINED FROM PRE-EMPLOYMENT BACKGROUND CHECKS (U.S. CLS. 100 AND 101).

FIRST USE 8-26-1987; IN COMMERCE 1-19-1991.

SN 76-433,943. TBAC INVESTMENT TRUST, ARLINGTON, TX, AND SUPERBA, INC., LOS ANGELES, CA. FILED 7-24-2002.

**CLASS 9—ELECTRICAL AND SCIENTIFIC APPARATUS**

FOR BEEPER CARRYING CASES MADE OF LEATHER (U.S. CLS. 21, 23, 26, 36 AND 38).

FIRST USE 0-0-1980; IN COMMERCE 0-0-1980.

CLASS 16—PAPER GOODS AND PRINTED MATTER

FOR POCKET SIZE LEATHER PERSONAL ACCESSORY CASES FOR PENS AND PENCILS; LEATHER CHECKBOOK AND PASSPORT CASES (U.S. CLS. 2, 5, 22, 23, 29, 37, 38 AND 50).

FIRST USE 0-0-1960; IN COMMERCE 0-0-1960.

CLASS 18—LEATHER GOODS

FOR LEATHER GOODS, NAMELY, WALLETS, KEY HOLDERS, CARD HOLDERS, AND POCKET SIZE LEATHER PERSONAL ACCESSORY CASES FOR ITEMS SUCH AS MONEY, RECEIPTS, PAPER, CARDS, TISSUES, AND NAIL CLIPPERS (U.S. CLS. 1, 2, 3, 22 AND 41).

FIRST USE 0-0-1960; IN COMMERCE 0-0-1960.

CLASS 20—FURNITURE AND ARTICLES NOT OTHERWISE CLASSIFIED

FOR NON-METAL MONEY CLIPS MADE OF LEATHER (U.S. CLS. 2, 13, 22, 25, 32 AND 50).

FIRST USE 0-0-1980; IN COMMERCE 0-0-1980.

CLASS 25—CLOTHING

FOR BELTS FOR CLOTHING (U.S. CLS. 22 AND 39).

FIRST USE 0-0-1946; IN COMMERCE 0-0-1948.

SN 76-435,454. AUTOZONE, INC., MEMPHIS, TN. FILED 7-25-2002.

DURALAST GOLD

OWNER OF U.S. REG. NOS. 1,467,999, 1,607,305 AND 1,740,870.

CLASS 7—MACHINERY

FOR AUTOMOTIVE ALTERNATORS (U.S. CLS. 13, 19, 21, 23, 31, 34 AND 35).

FIRST USE 1-0-1996; IN COMMERCE 1-0-1996.

CLASS 9—ELECTRICAL AND SCIENTIFIC APPARATUS

FOR AUTOMOTIVE BATTERIES (U.S. CLS. 21, 23, 26, 36 AND 38).

FIRST USE 1-0-1996; IN COMMERCE 1-0-1996.

SN 76-435,806. HYDRO-GEAR LIMITED PARTNERSHIP, SULLIVAN, IL. FILED 7-30-2002.

WE SET THE WHEELS IN MOTION**CLASS 7—MACHINERY**

FOR HYDRAULIC PUMPS AND HYDRAULIC MOTORS FOR MACHINES, GEAR MOTORS FOR MACHINES, WHEEL MOTORS FOR MACHINES, HYDRAULIC TRANSMISSIONS FOR MACHINES, HYDROSTATIC TRANSMISSIONS FOR MACHINES, HYDRAULIC TRANSAXLES FOR MACHINES, HYDROSTATIC TRANSAXLES FOR MACHINES AND GEAR BOXES FOR MACHINES; HYDRAULIC PUMPS (U.S. CLS. 13, 19, 21, 23, 31, 34 AND 35).

FIRST USE 1-5-1998; IN COMMERCE 1-5-1998.

CLASS 12—VEHICLES

FOR LAND VEHICLE PARTS, NAMELY, HYDRAULIC MOTORS, GEAR MOTORS, WHEEL MOTORS, HYDRAULIC TRANSMISSIONS, HYDROSTATIC TRANSMISSIONS, HYDRAULIC TRANSAXLES, HYDROSTATIC TRANSAXLES, AND GEAR BOXES (U.S. CLS. 19, 21, 23, 31, 35 AND 44).

FIRST USE 1-15-1998; IN COMMERCE 1-15-1998.

CLASS 41—EDUCATION AND ENTERTAINMENT

FOR CONSULTING SERVICES IN THE FIELD OF TRAINING IN THE OPERATION OF PUMPS, TRANSMISSIONS, TRANSAXLES, GEAR BOXES, AND MOTORS (U.S. CLS. 100, 101 AND 107).

FIRST USE 1-15-1998; IN COMMERCE 1-15-1998.

CLASS 42—SCIENTIFIC, COMPUTER AND LEGAL SERVICES

FOR CONSULTING SERVICES AND TECHNICAL CONSULTATION RELATING TO THE DESIGN AND MATERIALS TESTING IN THE FIELD OF PUMPS, TRANSMISSIONS, TRANSAXLES, GEAR BOXES AND MOTORS (U.S. CLS. 100 AND 101).

FIRST USE 1-5-1998; IN COMMERCE 1-5-1998.

SN 76-438,117. MEREDITH CORPORATION, DES MOINES, IA. FILED 8-5-2002.

SN 76-438,647. REPKING, MARY C., WAUSAU, WI. FILED 8-8-2002.

ALL AROUND THE WEB

CLASS 16—PAPER GOODS AND PRINTED MATTER

FOR PRINTED PUBLICATIONS, NAMELY A SECTION OF A MAGAZINE FEATURING ARTICLES PERTAINING TO WEBSITES OF GENERAL INTEREST SUBJECT MATTER (U.S. CLS. 2, 5, 22, 23, 29, 37, 38 AND 50).

FIRST USE 11-2-2001; IN COMMERCE 11-2-2001.

CLASS 44—MEDICAL, BEAUTY AND AGRICULTURAL SERVICES

FOR PROVIDING INFORMATION VIA THE INTERNET ABOUT THE WEBSITES OF OTHERS IN THE FIELD OF AGRICULTURE, FARMING AND FARMER INTERESTS (U.S. CLS. 100 AND 101).

FIRST USE 11-2-2001; IN COMMERCE 11-2-2001.

SN 76-438,285. CIMCITIES, LLC, ATLANTA, GA. FILED 8-6-2002.

OSO.COM

CLASS 35—ADVERTISING AND BUSINESS

FOR ON-LINE BUSINESS DIRECTORIES FEATURING RETAILERS AND SHOPPING CENTERS; PROMOTING THE GOODS AND SERVICES OF OTHERS BY MEANS OF OPERATING AN ON-LINE SHOPPING MALL WITH LINKS TO RETAIL WEB SITES OF OTHERS (U.S. CLS. 100, 101 AND 102).

FIRST USE 9-0-1998; IN COMMERCE 9-0-1998.

CLASS 41—EDUCATION AND ENTERTAINMENT

FOR PROVIDING INTERACTIVE INFORMATION IN THE FIELD OF GENERAL AND LOCAL, NATIONAL AND INTERNATIONAL NEWS, INFORMATION ON MOVIES, THEATER, TELEVISION AND RADIO PROGRAMS, SPORTING EVENTS, CONCERTS, MUSEUMS, EXHIBITIONS AND FESTIVALS, AND INFORMATION ON SIGHTS AND ATTRACTIONS OF INTEREST TO TOURISTS AND VISITORS TO RHODE ISLAND, VIA THE INTERNET (U.S. CLS. 100, 101 AND 107).

FIRST USE 9-0-1998; IN COMMERCE 9-0-1998.

CLASS 42—SCIENTIFIC, COMPUTER AND LEGAL SERVICES

FOR PROVIDING INTERACTIVE INFORMATION IN THE FIELD OF WEATHER REPORTING VIA THE INTERNET (U.S. CLS. 100 AND 101).

FIRST USE 9-0-1998; IN COMMERCE 9-0-1998.

CLASS 43—HOTEL AND RESTAURANT SERVICES

FOR PROVIDING INTERACTIVE INFORMATION ON RESTAURANTS, BARS AND HOTELS VIA THE INTERNET (U.S. CLS. 100 AND 101).

FIRST USE 9-0-1998; IN COMMERCE 9-0-1998.

TRI-STRETCH

CLASS 10—MEDICAL APPARATUS

FOR LEG STRETCHING DEVICES FOR THERAPEUTIC AND POST SURGERY USES, AND STANDS THEREFORE; MEDICAL APPARATUS, NAMELY, STRETCHING DEVICES AND TENSION CORDS FOR USE IN REHABILITATION OF PATENTS SUFFERING FROM ACUTE UPPER AND LOWER EXTREMITY COMPLICATIONS (U.S. CLS. 26, 39 AND 44).

CLASS 28—TOYS AND SPORTING GOODS

FOR LEG STRETCHING DEVICES FOR FITNESS AND EXERCISE USES, AND STANDS THEREFORE (U.S. CLS. 22, 23, 38 AND 50).

SN 76-440,998. PROGRESSIVE SUSPENSION INC., HESPERIA, CA. FILED 8-16-2002.

PROGRESSIVE SUSPENSION

OWNER OF U.S. REG. NO. 2,372,257.

NO CLAIM IS MADE TO THE EXCLUSIVE RIGHT TO USE "SUSPENSION", APART FROM THE MARK AS SHOWN.

CLASS 8—HAND TOOLS

FOR HAND TOOLS, NAMELY SPANNERS, WRENCHES, COILED SPRING COMPRESSORS, AIR FORK BALANCERS, SPOKE TRUERS, SAFETY WIRE STARTERS, FLUID FILLERS AND ADJUSTERS, LEVER LOCKS, BUNGEE NUTS, AND BRAKE SNAKES (U.S. CLS. 23, 28 AND 44).

FIRST USE 12-0-1988; IN COMMERCE 12-0-1988.

CLASS 12—VEHICLES

FOR LAND VEHICLE SUSPENSION PARTS, NAMELY, SHOCK ABSORBERS, COILED SPRINGS, DAMPERS, DAMPER RODS, TRAVEL LIMITERS, SHOCK COVERS, DUST BOOTS, AND SEALS; TIRE REPAIR KITS COMPRISED OF TIRE INFLATORS, TIRE PATCHES, TIRE PLUGS, TUBE BUFFERS, REAMERS, AND TIRE SEALING COMPOUNDS; AND HAND OPERATED TIRE AIR PUMPS (U.S. CLS. 19, 21, 23, 31, 35 AND 44).

FIRST USE 12-0-1988; IN COMMERCE 12-0-1988.

SN 76-443,538. HEALTHTEX APPAREL CORP., WILMINGTON, DE. FILED 8-26-2002.

EASY ANSWERS

CLASS 18—LEATHER GOODS

FOR BACKPACKS, TOTE BAGS AND DIAPER BAGS (U.S. CLS. 1, 2, 3, 22 AND 41).

CLASS 25—CLOTHING

FOR BEACH COVER-UPS, BABY BIBS NOT OF PAPER, BOOTIES, BRIEFS, CASUAL PANTS, COATS, COVERALLS, CREEPERS, DRESSES, FOOTWEAR, GLOVES, HATS, HEADBANDS, HOSE, JACKETS, JEANS, JUMPERS, LAYETTES, LEGGINGS, MITTENS, NIGHTGOWNS, NIGHTSHIRTS, OVERALLS, PAJAMAS, PANTIES, PARKAS, PULLOVERS, RAINGEAR, ROBES, ROMPERS, BUTTON-FRONT SHIRTS, CREW SHIRTS, KNIT SHIRTS, PULLOVER SHIRTS, V-NECK SHIRTS, SHORTS, SHORTS, SKIRTS, SLEEPERS, SOCKS, SWEATSUITS, SWEATERS, SWIMSUITS, T-SHIRTS, VESTS, VISORS AND WIND-RESISTANT JACKETS (U.S. CLS. 22 AND 39).

CLASS 16—PAPER GOODS AND PRINTED MATTER

FOR FILLER PAPER; TYPING PAPER; NOTE PADS; FOLDERS; PAPER PARTY BAGS; MERCHANDISE BAGS; LOOSE LEAF BINDERS; THREE RING BINDERS; BOOK COVERS; ANIMATION CELS; BALL POINT PENS; CARTOON PRINTS; CARTOON STRIPS; FABRIC GIFT BAGS; FELT PENS; GIFT WRAPPING PAPER; GENERAL PURPOSE PLASTIC BAGS; GROCERY BAGS; ILLUSTRATIONS; INK PENS; LUNCH BAGS; MECHANICAL PENCILS; NEWSPAPER CARTOONS; PAPER BAGS; PAPER GIFT BAGS; PAPER GIFT WRAPPING RIBBONS; PAPER SHOPPING BAGS; PENCILS; PENS; PLASTIC OR PAPER BAGS FOR HOUSEHOLD USE; PLASTIC SANDWICH BAGS; PLASTIC SHOPPING BAGS; POROUS TIP PENS; ROLLER BALL PENS; SANDWICH BAGS; WRAPPING PAPER (U.S. CLS. 2, 5, 22, 23, 29, 37, 38 AND 50).

SN 76-444,049. AGRI LABORATORIES, LTD., ST. JOSEPH, MO. FILED 8-23-2002.

NO CLAIM IS MADE TO THE EXCLUSIVE RIGHT TO USE "PIN 45", APART FROM THE MARK AS SHOWN.

CLASS 18—LEATHER GOODS

FOR FANNY PACKS; WAIST PACKS; BACKPACKS; ALL PURPOSE LEATHER SPORTS BAGS; ATHLETIC BAGS; BABY BACKPACKS; BEACH BAGS; BOOK BAGS; CARRY-ON BAGS; DUFFEL BAGS; GARMENT BAGS FOR TRAVEL; GYM BAGS; LUGGAGE; LUGGAGE TAGS; SCHOOL BAGS; SCHOOL BOOK BAGS; SHOULDER BAGS; SUITCASES; TOOL BAGS SOLD EMPTY; TOTE BAGS; WRIST MOUNTED CARRY ALL BAGS; LEATHER ACCESSORIES, NAMELY, LEATHER BELTS AND HANDBAGS (U.S. CLS. 1, 2, 3, 22 AND 41).

CLASS 16—PAPER GOODS AND PRINTED MATTER

FOR EDUCATIONAL NEWSLETTERS CONCERNING VACCINATION OF CATTLE (U.S. CLS. 2, 5, 22, 23, 29, 37, 38 AND 50).

FIRST USE 8-7-2002; IN COMMERCE 8-7-2002.

CLASS 21—HOUSEWARES AND GLASS

FOR THERMAL INSULATED BAGS FOR FOOD OR BEVERAGES (U.S. CLS. 2, 13, 23, 29, 30, 33, 40 AND 50).

CLASS 44—MEDICAL, BEAUTY AND AGRICULTURAL SERVICES

FOR VETERINARY SERVICES IN THE NATURE OF VACCINATION OF CATTLE (U.S. CLS. 100 AND 101).

FIRST USE 8-7-2002; IN COMMERCE 8-7-2002.

CLASS 25—CLOTHING

FOR BATHING SUITS; BATHING CAPS; TANK TOPS; SHIRTS; T-SHIRTS; PANTS; SHORTS; WATER SHORTS; CROP TOPS; BRA TOPS; JACKETS; BRIEFS; HATS; CAPS; LEOTARDS; LEGGINGS; COATS; DRESSES; SKIRTS; SWEATERS; SWEAT SHIRTS; BABY BIBS NOT OF PAPER; BOXER SHORTS; JOGGING SUITES; PLASTIC BABY BIBS; SWEAT PANTS; SUN VISORS; TEXTILE BABY BIBS; VISORS (U.S. CLS. 22 AND 39).

SN 76-444,062. FREER, CHARLES D., REDFORD, MI. FILED 8-27-2002.

WILLIE J. BLUZE

"WILLIE J. BLUZE" DOES NOT IDENTIFY A LIVING INDIVIDUAL.

CLASS 10—MEDICAL APPARATUS

FOR PACIFIERS FOR BABIES (U.S. CLS. 26, 39 AND 44).

CLASS 14—JEWELRY

FOR JEWELRY, NAMELY, BRACELETS, NECKLACES, RINGS, WATCHES, WRIST WATCHES, AND POCKET WATCHES (U.S. CLS. 2, 27, 28 AND 50).

CLASS 28—TOYS AND SPORTING GOODS

FOR BOWLING BAGS; BLOW-OUTS, BALLOONS, PARTY FAVORS, NAMELY, NOISEMAKERS AND SNAPPERS; TOY HORNS; DOLLS; PAPER DOLLS; TALKING DOLLS; PORCELAIN DOLLS; SOFT SCULPTURE DOLLS; WOODEN TOY DOLLS; ELECTRIC ACTION TOYS; MECHANICAL ACTION TOYS; ADULT AND CHILDREN'S PARTY GAMES; BEAN BAGS; BEAN BAG DOLLS; BOARD GAMES; DOLLS AND ACCESSORIES THEREFOR; GOLF BAGS; HAND PUPPETS; MARIONETTES PUPPETS; PARLOR GAMES; PLASTIC CHARACTER TOYS; PULL TOYS; PUSH TOYS; RAG DOLLS; RIDE-ON TOYS; SOFT SCULPTURE TOYS; TALKING TOYS; TOY BANKS; TOY BOXES; TOY ACTION FIGURES; TOY FIGURES; TOY WATCHES; YO-YOS (U.S. CLS. 22, 23, 38 AND 50).

SN 76-444,172. TRICKPIC PRODUCTIONS, INC., MONTGOMERY, IL. FILED 8-23-2002.

SN 76-444,311. DAVISON OIL COMPANY, INC., MOBILE, AL. FILED 8-23-2002.

MORPHABLES

CLASS 16—PAPER GOODS AND PRINTED MATTER

FOR PRINTED IMAGES ON LENTICULAR SCREENS; GRAPHIC AND PHOTOGRAPHIC PRINTED IMAGES ON LENTICULAR IMAGE ANNOUNCEMENTS, BASEBALL CARDS, CARDS, INVITATIONS, PICTURES, POSTERS, AND POSTCARDS (U.S. CLS. 2, 5, 22, 23, 29, 37, 38 AND 50).

CLASS 40—MATERIAL TREATMENT

FOR ELECTRONIC DIGITIZING, ALTERATION AND RE-TOUCHING OF PHOTOGRAPHIC IMAGES AND LENTICULAR PRINTING SERVICES (U.S. CLS. 100, 103 AND 106).

SN 76-444,250. SENSITECH, INC., BEVERLY, MA. FILED 3-25-2002.

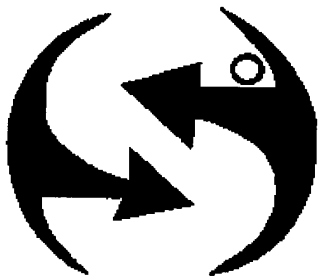

THE MARK CONSISTS OF A STYLIZED CAPITAL LETTER "S" OUTLINING INSET SILHOUETTES OF ARROWS.

CLASS 9—ELECTRICAL AND SCIENTIFIC APPARATUS

FOR DEVICES FOR MONITORING TEMPERATURE, HUMIDITY AND OTHER CONDITIONS FOR GOODS IN PROCESS, IN TRANSIT, IN STORAGE OR ON DISPLAY, NAMELY ELECTRONIC THERMOMETERS, HUMIDITY MONITORS AND ANALOG RECORDERS; AND WEB-ENABLED AND WIRELESS DATA COLLECTION, MONITORING AND MANAGEMENT SYSTEMS COMPRISED OF COMPUTER SOFTWARE AND THERMAL PRINTERS FOR MONITORING AND REPORTING OF ENVIRONMENTAL CONDITIONS OF GOODS IN TRANSIT (U.S. CLS. 21, 23, 26, 36 AND 38).

FIRST USE 9-30-1997; IN COMMERCE 9-30-1997.

CLASS 42—SCIENTIFIC, COMPUTER AND LEGAL SERVICES

FOR DATA MANAGEMENT AND ANALYSIS SERVICES, NAMELY MONITORING, RETRIEVING, COLLECTING, STORING, COMPILING, TRACKING, ANALYZING AND REPORTING TEMPERATURE AND COLD CHAIN DATA AND OTHER DATA PROVIDED BY CUSTOMERS (U.S. CLS. 100 AND 101).

FIRST USE 9-30-1997; IN COMMERCE 9-30-1997.

MAJESTIC

CLASS 1—CHEMICALS

FOR ANTIFREEZE (U.S. CLS. 1, 5, 6, 10, 26 AND 46). FIRST USE 8-5-2002; IN COMMERCE 8-5-2002.

CLASS 4—LUBRICANTS AND FUELS

FOR MOTOR OIL, FUEL OIL AND INDUSTRIAL OILS (U.S. CLS. 1, 6 AND 15). FIRST USE 8-5-2002; IN COMMERCE 8-5-2002.

SN 76-445,463. MAY DEPARTMENT STORES INTERNATIONAL, INC., ST. LOUIS, MO. FILED 8-30-2002.

SUN COUNTRY KIDS

OWNER OF U.S. REG. NO. 1,555,787.
NO CLAIM IS MADE TO THE EXCLUSIVE RIGHT TO USE "KIDS", APART FROM THE MARK AS SHOWN.

CLASS 8—HAND TOOLS

FOR STAINLESS STEEL FLATWARE, NAMELY, FORKS AND SPOONS (U.S. CLS. 23, 28 AND 44).

CLASS 18—LEATHER GOODS

FOR FANNY PACKS (U.S. CLS. 1, 2, 3, 22 AND 41).

CLASS 28—TOYS AND SPORTING GOODS

FOR OUTDOOR GAMES, NAMELY, HORSESHOES, TWO MITTS WITH BALL HAVING COMPLEMENTARY PARTS WHICH ADHERE TO EACH OTHER, TWO SCOOPERS WITH BALL, BADMINTON SETS AND TOY FLYING SAUCERS FOR TOSS GAMES; AND TOYS, NAMELY, SQUIRT GUN SETS, BUBBLE MAKING TOYS, INSECT SETS, POOL TOYS AND CROQUET SETS (U.S. CLS. 22, 23, 38 AND 50).

SN 76-445,910. FRATERNAL ORDER OF POLICE, NASHVILLE, TN. FILED 8-29-2002.

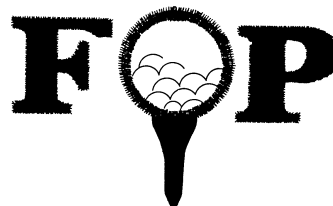

OWNER OF U.S. REG. NOS. 644,560 AND 1,527,776.

CLASS 18—LEATHER GOODS

FOR GOLF SHOE BAGS FOR TRAVEL (U.S. CLS. 1, 2, 3, 22 AND 41). FIRST USE 0-0-1998; IN COMMERCE 0-0-1998.

CLASS 25—CLOTHING

FOR CLOTHING, NAMELY SHIRTS AND HATS;
GOLF SHOE BAGS (U.S. CLS. 22 AND 39).
FIRST USE 0-0-1998; IN COMMERCE 0-0-1998.

SN 76-448,094. LAKIN, GAY, KITTERY, ME. FILED 9-9-2002.

THE JELLY MAKER'S DAUGHTER

CLASS 29—MEATS AND PROCESSED FOODS

FOR JAMS, JELLIES AND FRUIT SPREADS (U.S. CL. 46).
FIRST USE 9-0-1996; IN COMMERCE 9-0-1996.

SN 76-447,312. RACHAEL STEPHENS, INC., SARASOTA, FL.
FILED 9-5-2002.

RACHAEL STEPHENS

THE NAME(S), PORTRAIT(S), AND/OR SIGNATURE(S)
SHOWN IN THE MARK DOES NOT IDENTIFY A PARTICULAR
LIVING INDIVIDUAL.

CLASS 30—STAPLE FOODS

FOR RELISHES (U.S. CL. 46).
FIRST USE 9-0-1996; IN COMMERCE 9-0-1996.

CLASS 8—HAND TOOLS

FOR MANICURE AND PEDICURE IMPLEMENTS,
NAMELY NAIL FILES, NAIL CLIPPERS, CUTICLE
PUSHERS, TWEEZERS, NAIL AND CUTICLE SCISSORS
(U.S. CLS. 23, 28 AND 44).

SN 76-448,358. PILGRIM PARTNERS, INC., DBA THE
VIRGINIAN RESTAURANT, ALEXANDRIA, VA. FILED
9-6-2002.

THE VIRGINIAN

CLASS 21—HOUSEWARES AND GLASS

FOR HAIR ACCESSORIES, NAMELY HAIR COMBS
AND BRUSHES (U.S. CLS. 2, 13, 23, 29, 30, 33, 40 AND
50).

CLASS 25—CLOTHING

FOR CLOTHING, NAMELY, SHIRTS (U.S. CLS. 22
AND 39).
FIRST USE 3-0-1936; IN COMMERCE 3-0-1936.

SN 76-447,479. NATIONAL FOUNDATION FOR CANCER
RESEARCH, INC., BETHESDA, MD. FILED 8-8-2002.

CLASS 43—HOTEL AND RESTAURANT SERVICES

FOR RESTAURANT SERVICES (U.S. CLS. 100 AND
101).
FIRST USE 0-0-1923; IN COMMERCE 0-0-1923.



SN 76-448,384. EVERSOF, INC., LONG BEACH, CA. FILED
9-10-2002.

**CLASS 35—ADVERTISING AND BUSINESS**

FOR PROMOTING PUBLIC AWARENESS IN THE
FIELD OF CANCER PREVENTION, DIAGNOSIS AND
TREATMENT AND THE NEED TO FUND RESEARCH
IN DEVELOPING CURES FOR CANCER (U.S. CLS. 100,
101 AND 102).
FIRST USE 6-15-2002; IN COMMERCE 6-15-2002.

CLASS 11—ENVIRONMENTAL CONTROL APPARATUS

FOR WATER CONDITIONING UNITS AND FILTERS
FOR PURIFYING WATER (U.S. CLS. 13, 21, 23, 31 AND
34).
FIRST USE 1-1-1976; IN COMMERCE 1-1-1990.

CLASS 36—INSURANCE AND FINANCIAL

FOR CHARITABLE FUND RAISING SERVICES (U.S.
CLS. 100, 101 AND 102).
FIRST USE 6-15-2002; IN COMMERCE 6-15-2002.

CLASS 37—CONSTRUCTION AND REPAIR

FOR MAINTENANCE AND REPAIR OF WATER
TREATMENT CONDITIONING UNITS (U.S. CLS. 100,
103 AND 106).
FIRST USE 1-1-1976; IN COMMERCE 1-1-1990.

SN 76-448,892. SMITH, CHRISTOPHER J., JAMESTOWN, NC.
FILED 9-12-2002.



NO CLAIM IS MADE TO THE EXCLUSIVE RIGHT TO USE "DIABETIC CHEF", APART FROM THE MARK AS SHOWN.

CLASS 16—PAPER GOODS AND PRINTED MATTER

FOR COOKBOOKS AND BOOKS ABOUT CULINARY ARTS (U.S. CLS. 2, 5, 22, 23, 29, 37, 38 AND 50).

CLASS 30—STAPLE FOODS

FOR SPICES (U.S. CL. 46).

CLASS 41—EDUCATION AND ENTERTAINMENT

FOR EDUCATIONAL SERVICES, NAMELY CONDUCTING SEMINARS AND INSTRUCTION IN THE CULINARY ARTS (U.S. CLS. 100, 101 AND 107).

SN 76-450,349. MOBILE CENTREX, INC., RICHARDSON, TX. FILED 9-17-2002.



NO CLAIM IS MADE TO THE EXCLUSIVE RIGHT TO USE "MOBILE", APART FROM THE MARK AS SHOWN.

THE MARK CONSISTS OF THE WORDS "MOBILE CENTREX" SURROUNDED BY AN ELLIPSE OPEN ABOVE AND BELOW THE WORDS, WITH THE ELLIPSE BEGINNING AS AN EXTENSION OF THE "X" IN "CENTREX", AND WITH A SHADED CIRCLE CONTAINING THE LETTER "M" APPEARING AT THE END OF THE PORTION OF THE ELLIPSE ENDING ABOVE THE "M" IN "MOBILE".

CLASS 38—COMMUNICATION

FOR WIRELESS TELECOMMUNICATIONS SERVICES FOR USE IN BUSINESS, WHICH ALLOWS INSIDE AND OUTSIDE SERVICE PERSONNEL TO COMMUNICATE VIA A SEAMLESS DATA COMPATIBILITY LINK, FOR HANDLING WORK ORDERS, LOGGING AND TRACKING, PARTS ORDERS, SCHEDULING, REVIEW OF SERVICE LEVEL AGREEMENTS (SLAS) AND OTHER CONTRACT MANAGEMENT INFORMATION, INCLUDING WARRANTIES AND ENTITLEMENTS, BY UTILIZING A WIRELESS NETWORK WITH GRAPHICAL USER INTERFACES AT BOTH THE INSIDE SERVICE PERSONNEL DATA PROCESSING SYSTEM TERMINALS AND THE OUTSIDE SERVICE PERSONNEL WIRELESS MOBILE DEVICES (U.S. CLS. 100, 101 AND 104).

FIRST USE 8-9-2002; IN COMMERCE 8-9-2002.

CLASS 42—SCIENTIFIC, COMPUTER AND LEGAL SERVICES

FOR COMPUTER SERVICES, NAMELY, INTEGRATION OF COMPUTER SYSTEMS AND NETWORKS TO CREATE WIRELESS TELECOMMUNICATIONS SERVICES FOR USE IN BUSINESS, WHICH ALLOWS INSIDE AND OUTSIDE SERVICE PERSONNEL TO COMMUNICATE VIA A SEAMLESS DATA COMPATIBILITY LINK, FOR HANDLING WORK ORDERS, LOGGING AND TRACKING, PARTS ORDERS, SCHEDULING, REVIEW OF SERVICE LEVEL AGREEMENTS (SLAS) AND OTHER CONTRACT MANAGEMENT INFORMATION, INCLUDING WARRANTIES AND ENTITLEMENTS, BY UTILIZING A WIRELESS NETWORK WITH GRAPHICAL USER INTERFACES AT BOTH THE INSIDE SERVICE PERSONNEL DATA PROCESSING SYSTEM TERMINALS AND THE OUTSIDE SERVICE PERSONNEL WIRELESS MOBILE DEVICES (U.S. CLS. 100 AND 101).

FIRST USE 8-9-2002; IN COMMERCE 8-9-2002.

SN 76-450,499. BRAZIL INTERNATIONAL, INC., DBA JD LIGHT INTERNATIONAL, NEW YORK, NY. FILED 9-11-2002.

FLEECE WORLD

NO CLAIM IS MADE TO THE EXCLUSIVE RIGHT TO USE "FLEECE", APART FROM THE MARK AS SHOWN.

CLASS 18—LEATHER GOODS

FOR TOTE BAGS (U.S. CLS. 1, 2, 3, 22 AND 41).

CLASS 24—FABRICS

FOR BLANKETS, SHEETS AND PILLOWCASES (U.S. CLS. 42 AND 50).

CLASS 25—CLOTHING

FOR MENS AND WOMEN'S JACKETS, PANTS, SHORTS, SWEATSHIRTS, SOCKS, GLOVE, FOOTWEAR, PAJAMAS, NIGHTSHIRTS, LOUNGEWEAR, BATHROBES, UNDERWEAR, WARM-UP SUITS, HATS AND CAPS, WRISTBANDS, HEADBANDS (U.S. CLS. 22 AND 39).

SN 76-451,337. GEORGIA CANCER COALITION, ATLANTA, GA. FILED 9-13-2002.

MOBILIZING GEORGIA, IMMOBILIZING CANCER

CLASS 16—PAPER GOODS AND PRINTED MATTER

FOR PRINTED INSTRUCTIONAL, EDUCATIONAL AND TEACHING MATERIALS, NAMELY, BRIEFING PAPERS, SYMPOSIA, BROCHURES, AND REPORTS IN THE FIELD OF CANCER RESEARCH, EARLY DETECTION, PREVENTION AND TREATMENT (U.S. CLS. 2, 5, 22, 23, 29, 37, 38 AND 50).

FIRST USE 9-15-2001; IN COMMERCE 9-15-2001.

CLASS 35—ADVERTISING AND BUSINESS

FOR PROMOTING PUBLIC AWARENESS OF THE NEED FOR CANCER RESEARCH, EARLY DETECTION, PREVENTION AND TREATMENT (U.S. CLS. 100, 101 AND 102).

FIRST USE 3-1-2001; IN COMMERCE 3-1-2001.

CLASS 36—INSURANCE AND FINANCIAL

FOR PROVIDING FINANCIAL GRANTS TO HEALTH AGENCIES AND HOSPITALS FOR CANCER RESEARCH, EARLY DETECTION, PREVENTION AND TREATMENT; AND CHARITABLE FUNDRAISING SERVICES (U.S. CLS. 100, 101 AND 102).

FIRST USE 3-1-2001; IN COMMERCE 3-1-2001.

CLASS 41—EDUCATION AND ENTERTAINMENT

FOR EDUCATIONAL SERVICES, NAMELY, CONDUCTING CLASSES, SEMINARS, CONFERENCES, AND WORKSHOPS IN THE FIELD OF CANCER RESEARCH, EARLY DETECTION, PREVENTION AND TREATMENT, AND DISSEMINATING COURSE MATERIALS IN CONNECTION THEREWITH (U.S. CLS. 100, 101 AND 107).

FIRST USE 3-1-2001; IN COMMERCE 3-1-2001.

SN 76-451,373. HUMANA, INC., LOUISVILLE, KY. FILED 9-17-2002.

GUIDANCE WHEN YOU NEED IT MOST

CLASS 35—ADVERTISING AND BUSINESS

FOR MANAGEMENT FOR THE HEALTH BENEFIT PLANS FOR OTHERS; HEALTH CARE COST CONTAINMENT; HEALTH CARE COST REVIEW; HEALTH CARE UTILIZATION AND REVIEW SERVICES; MANAGED CARE SERVICES, NAMELY, ELECTRONIC PROCESSING OF HEALTH CARE INFORMATION; PHYSICIAN REFERRALS; AND SUPPLYING PRESCRIPTION DRUGS TO HEALTH PLAN PARTICIPANTS FOR THE FUNDING ORGANIZATIONS (U.S. CLS. 100, 101 AND 102).

CLASS 36—INSURANCE AND FINANCIAL

FOR UNDERWRITING, ORGANIZING AND ADMINISTRATION OF PRE-PAID HEALTH CARE SERVICES AND PLANS; HEALTH AND LIFE INSURANCE UNDERWRITING SERVICES; DENTAL INSURANCE UNDERWRITING SERVICES; UNDERWRITING, ORGANIZING AND ADMINISTRATION OF PRE-PAID HEALTH CARE SERVICES AND PLANS, HEALTH AND LIFE INSURANCE UNDERWRITING SERVICES, AND DENTAL INSURANCE UNDERWRITING SERVICES ALL PROVIDED VIA AN ON-LINE COMPUTER NETWORK OR COMMUNICATIONS MEANS; ELECTRONIC PROCESSING OF INSURANCE AND PREPAID HEALTH CARE PLAN CLAIMS; PROVIDING FINANCIAL ANALYSIS AND INFORMATION REGARDING EMPLOYEE BENEFIT AND INSURANCE PROGRAMS ELECTRONICALLY OR VIA A GLOBAL COMPUTER NETWORK (U.S. CLS. 100, 101 AND 102).

CLASS 44—MEDICAL, BEAUTY AND AGRICULTURAL SERVICES

FOR HEALTH CARE SERVICES; HEALTH CARE SERVICES IN THE NATURE OF HEALTH MAINTENANCE AND PREFERRED PROVIDER ORGANIZATIONS FEATURING MEDICAL, DENTAL, AND VISION CARE; HEALTH CARE SERVICES, HEALTH CARE SERVICES IN THE NATURE OF HEALTH MAINTENANCE AND PREFERRED PROVIDER ORGANIZATIONS FEATURING MEDICAL, DENTAL, AND VISION CARE ALL PROVIDED VIA AN ON-LINE COMPUTER NETWORK, ELECTRONICALLY, AND VIA THE INTERNET; PROVIDING HEALTH CARE INFORMATION BY TELEPHONE, ELECTRONICALLY, AND VIA THE INTERNET; AND PROVIDING HEALTH INFORMATION (U.S. CLS. 100 AND 101).

SN 76-452,073. AMERICAN PAYROLL INSTITUTE, INC., NEW YORK, NY. FILED 9-19-2002.

KNOWLEDGE ASSESSMENT CALCULATOR

CLASS 9—ELECTRICAL AND SCIENTIFIC APPARATUS

FOR COMPUTER SOFTWARE USED TO COLLECT INFORMATION FROM USERS IN ORDER TO PROVIDE APPROPRIATE TRAINING OPTIONS AND PRODUCTS TO USERS IN VARIOUS FIELDS (U.S. CLS. 21, 23, 26, 36 AND 38).

CLASS 41—EDUCATION AND ENTERTAINMENT

FOR PROVIDING AND COLLECTING INFORMATION REGARDING PAYROLL TRAINING AND PAYROLL TRAINING RELATED GOODS; PROVIDING CONSULTATION AND ADVICE REGARDING PAYROLL TRAINING (U.S. CLS. 100, 101 AND 107).

SN 76-452,105. SCOTT HAZELCORN MEMORIAL CHILDREN'S FOUNDATION, NEW YORK, NY. FILED 9-24-2002.

SCOTT HAZELCORN MEMORIAL CHILDREN'S FOUNDATION

NO CLAIM IS MADE TO THE EXCLUSIVE RIGHT TO USE "MEMORIAL CHILDREN'S FOUNDATION", APART FROM THE MARK AS SHOWN.

"SCOTT HAZELCORN" IS NOT THE NAME OF A LIVING INDIVIDUAL

CLASS 36—INSURANCE AND FINANCIAL

FOR CHARITABLE FUNDRAISING (U.S. CLS. 100, 101 AND 102).

FIRST USE 9-23-2001; IN COMMERCE 10-0-2001.

CLASS 41—EDUCATION AND ENTERTAINMENT

FOR SUMMER CAMP SERVICES (U.S. CLS. 100, 101 AND 107).

FIRST USE 10-0-2001; IN COMMERCE 10-0-2001.

SN 76-452,772. SYPRIS SOLUTIONS, INC, LOUISVILLE, KY. FILED 9-23-2002.

SYPRIS

OWNER OF U.S. REG. NOS. 2,374,001 AND 2,384,257.

CLASS 40—MATERIAL TREATMENT

FOR CUSTOM MANUFACTURE OF ELECTRONIC PRODUCTS TO THE ORDER AND SPECIFICATION OF OTHERS, NAMELY, CIRCUIT CARD ASSEMBLIES, SUBSYSTEMS AND END-USER PRODUCTS; CUSTOM MANUFACTURE OF FORGED PRODUCTS AND PROPRIETARY PIPING COMPONENTS TO THE ORDER AND SPECIFICATION OF OTHERS, NAMELY, TRUCK AXLES, AIRCRAFT ENGINE CYLINDERS AND SHAFTS, HIGH PRESSURE CLOSURES FOR STORAGE TANKS, AND INSULATED JOINTS FOR UNDERGROUND PIPING, FOR USE IN THE ENERGY, POWER TRAIN AND AEROSPACE INDUSTRIES (U.S. CLS. 100, 103 AND 106).

FIRST USE 3-31-1998; IN COMMERCE 3-31-1998.

CLASS 42—SCIENTIFIC, COMPUTER AND LEGAL SERVICES

FOR ENGINEERING AND DESIGN OF ELECTRONIC PRODUCTS, NAMELY, CIRCUIT CARD ASSEMBLIES, SUBSYSTEMS, SOFTWARE AND END-USER PRODUCTS FOR OTHERS; ELECTRONIC TESTING AND CALIBRATIONS SERVICES (U.S. CLS. 100 AND 101).

FIRST USE 3-31-1998; IN COMMERCE 3-31-1998.

SN 76-452,911. GEORGIA CANCER COALITION, ATLANTA, GA. FILED 9-19-2002.

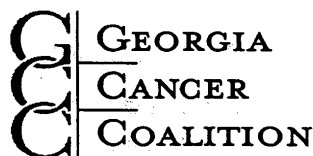

NO CLAIM IS MADE TO THE EXCLUSIVE RIGHT TO USE "GEORGIA CANCER COALITION", APART FROM THE MARK AS SHOWN.

CLASS 16—PAPER GOODS AND PRINTED MATTER

FOR PRINTED INSTRUCTIONAL, EDUCATIONAL AND TEACHING MATERIALS, NAMELY, BRIEFING PAPERS, SYMPOSIA, BROCHURES, AND REPORTS IN THE FIELD OF CANCER RESEARCH, EARLY DETECTION, PREVENTION AND TREATMENT (U.S. CLS. 2, 5, 22, 23, 29, 37, 38 AND 50).

FIRST USE 9-15-2001; IN COMMERCE 9-15-2001.

CLASS 35—ADVERTISING AND BUSINESS

FOR PROMOTING PUBLIC AWARENESS OF THE NEED FOR CANCER RESEARCH, EARLY DETECTION, PREVENTION AND TREATMENT (U.S. CLS. 100, 101 AND 102).

FIRST USE 3-1-2001; IN COMMERCE 3-1-2001.

CLASS 36—INSURANCE AND FINANCIAL

FOR PROVIDING FINANCIAL GRANTS TO HEALTH AGENCIES AND HOSPITALS FOR CANCER RESEARCH, EARLY DETECTION, PREVENTION AND TREATMENT; AND CHARITABLE FUNDRAISING SERVICES (U.S. CLS. 100, 101 AND 102).

FIRST USE 3-1-2001; IN COMMERCE 3-1-2001.

CLASS 41—EDUCATION AND ENTERTAINMENT

FOR EDUCATIONAL SERVICES, NAMELY, CONDUCTING CLASSES, SEMINARS, CONFERENCES, AND WORKSHOPS IN THE FIELD OF CANCER RESEARCH, EARLY DETECTION, PREVENTION AND TREATMENT, AND DISSEMINATING COURSE MATERIALS IN CONNECTION THEREWITH (U.S. CLS. 100, 101 AND 107).

FIRST USE 3-1-2001; IN COMMERCE 3-1-2001.

SN 76-454,735. UNITED PARCEL SERVICE OF AMERICA, INC., ATLANTA, GA. FILED 10-2-2002.

WORLDPORT

CLASS 35—ADVERTISING AND BUSINESS

FOR CONSULTING SERVICES IN THE FIELD OF LOGISTICS PLANNING, TRANSPORTATION, CENTRAL PARTS DISTRIBUTION, RETURNS MANAGEMENT AND REVERSE LOGISTICS (U.S. CLS. 100, 101 AND 102).

CLASS 37—CONSTRUCTION AND REPAIR

FOR CONSULTING SERVICES IN THE FIELD OF FIELD REPAIR AND DEPOT REPAIR (U.S. CLS. 100, 103 AND 106).

CLASS 39—TRANSPORTATION AND STORAGE

FOR TRANSPORTATION AND DELIVERY OF PERSONAL PROPERTY BY AIR, RAIL, BOAT, AND MOTOR VEHICLE; CONSULTING SERVICES IN THE FIELD OF WAREHOUSING (U.S. CLS. 100 AND 105).

SN 76-455,962. TOMASSO BROTHERS, INC., NEW BRITAIN, CT. FILED 10-7-2002.

SN 76-454,928. RODALE INC., EMMAUS, PA. FILED 9-25-2002.

SPOT THE SKINNY**CLASS 16—PAPER GOODS AND PRINTED MATTER**

FOR PUBLICATION, NAMELY, MAGAZINE COLUMN IN THE FIELD OF HEALTH, FITNESS, DIET, EXERCISE AND LIFESTYLE (U.S. CLS. 2, 5, 22, 23, 29, 37, 38 AND 50).

CLASS 44—MEDICAL, BEAUTY AND AGRICULTURAL SERVICES

FOR PROVIDING INFORMATION IN THE FIELD OF HEALTH, DIET, AND A HEALTHY LIFESTYLE VIA A WEB SITE VIA THE INTERNET (U.S. CLS. 100 AND 101).

SN 76-455,310. AEROSPACE PRODUCTS INTERNATIONAL, INC., MEMPHIS, TN. FILED 10-1-2002.

WE STOCK SOLUTIONS**CLASS 7—MACHINERY**

FOR RADIATOR CONNECTING HOSES; HOSES AND FIRESLEEVES FOR AIRCRAFT; FITTED COOLANT HOSES FOR AIRCRAFT ENGINES; AND SPARK PLUGS (U.S. CLS. 13, 19, 21, 23, 31, 34 AND 35).

CLASS 12—VEHICLES

FOR AIRCRAFT PARTS AND ACCESSORIES, NAMELY, TIRES, BRAKES, WINDSHIELDS, COCKPIT CANOPIES, WINDOWS AND SEATS; AIRPORT GROUND SUPPORT EQUIPMENT, NAMELY, MOTORIZED BAGGAGE CARTS, MOTORIZED BAGGAGE TUGS, AND FUEL TRUCKS (U.S. CLS. 19, 21, 23, 31, 35 AND 44).

CLASS 35—ADVERTISING AND BUSINESS

FOR BUSINESS SERVICES, NAMELY, INVENTORY MANAGEMENT FOR AIRLINES, FIXED BASED AND FLEET OPERATORS, AND CORPORATE AVIATION DEPARTMENTS (U.S. CLS. 100, 101 AND 102).

CLASS 37—CONSTRUCTION AND REPAIR

FOR OVERHAUL AND REPAIR SERVICES FOR BRAKES AND STARTER GENERATORS FOR AIRCRAFT (U.S. CLS. 100, 103 AND 106).

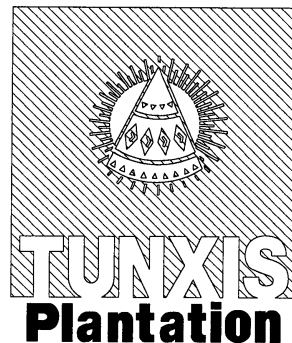

OWNER OF U.S. REG. NOS. 2,471,522 AND 2,482,100.
THE DRAWING CONTAINS LININGS DESIGNATING THE COLOR GREEN, BUT NO CLAIM IS MADE TO COLOR WHICH IS NOT A FEATURE OF THE MARK.
"TUNXIS" IS THE NAME OF AN INDIAN TRIBE THAT ONCE LIVED IN THE CONNECTICUT AREA AT SOME TIME IN THE PAST

CLASS 41—EDUCATION AND ENTERTAINMENT

FOR GOLF CLUB SERVICES (U.S. CLS. 100, 101 AND 107).

FIRST USE 10-16-2001; IN COMMERCE 10-16-2001.

CLASS 43—HOTEL AND RESTAURANT SERVICES

FOR RESTAURANT SERVICES AND PROVIDING BANQUET, PICNIC AND SOCIAL FUNCTION FACILITIES FOR SPECIAL OCCASIONS (U.S. CLS. 100 AND 101).

FIRST USE 10-16-2001; IN COMMERCE 10-16-2001.

SN 76-456,355. TIKIGAQ CORPORATION, ANCHORAGE, AK. FILED 9-30-2002.

NANIQ

"NANIQ" IS A INUPIAQ WORD MEANING "BRIGHT LIGHT" OR "LAMP."

CLASS 37—CONSTRUCTION AND REPAIR

FOR INSTALLATION OF COMPUTER NETWORKS AND SYSTEMS (U.S. CLS. 100, 103 AND 106).

FIRST USE 3-19-2002; IN COMMERCE 3-19-2002.

CLASS 42—SCIENTIFIC, COMPUTER AND LEGAL SERVICES

FOR CONSULTING SERVICES IN THE FIELD OF DESIGN, SELECTION, IMPLEMENTATION AND USE OF COMPUTER HARDWARE AND SOFTWARE SYSTEMS FOR OTHERS (U.S. CLS. 100 AND 101).

FIRST USE 3-19-2002; IN COMMERCE 3-19-2002.

SN 76-456,641. PEPSICO, INC., PURCHASE, NY. FILED 10-1-2002.

INCLUSION IS YOUR BUSINESS

CLASS 29—MEATS AND PROCESSED FOODS

FOR POTATO-BASED SNACKS, NAMELY, POTATO CHIPS, TORTILLA CHIPS AND CHEESE FLAVORED PUFFED CORN SNACKS; CANDIED POPCORN; MULTI-GRAIN CHIPS; PRETZELS (U.S. CL. 46).

CLASS 30—STAPLE FOODS

FOR CORN-BASED SNACK FOODS, NAMELY, CORN CHIPS, TORTILLA CHIPS AND CHEESE FLAVORED PUFFED CORN SNACKS; CANDIED POPCORN; MULTI-GRAIN CHIPS; PRETZELS (U.S. CL. 46).

CLASS 32—LIGHT BEVERAGES

FOR SOFT DRINKS, JUICES AND DRINKING WATER (U.S. CLS. 45, 46 AND 48).

CLASS 35—ADVERTISING AND BUSINESS

FOR EMPLOYMENT COUNSELING AND RECRUITING (U.S. CLS. 100, 101 AND 102).

SN 76-457,453. MCELHANEY, TAMMY, SAVANNAH, GA. FILED 10-10-2002.

TAM-E

CLASS 25—CLOTHING

FOR WOMEN'S CLOTHING, NAMELY, TOPS, BOTTOMS, SHORTS, SHIRTS, DRESSES, SWEATERS, TEE-SHIRTS, PANTS, BATHING SUITS, COVER-UPS, AND UNDERGARMENTS (U.S. CLS. 22 AND 39).

CLASS 28—TOYS AND SPORTING GOODS

FOR EXERCISE EQUIPMENT, NAMELY, HAND WEIGHTS, EXERCISE BALLS, UPPER AND LOWER BODY EXTENSION MACHINES, AND UPPER AND LOWER BODY PRESS MACHINES (U.S. CLS. 22, 23, 38 AND 50).

SN 76-457,807. MCC EVENTS, LLC, AUGUSTA, GA. FILED 10-11-2002.

NBHA

OWNER OF U.S. REG. NO. 2,050,383.

CLASS 35—ADVERTISING AND BUSINESS

FOR ASSOCIATION SERVICES, NAMELY, PROMOTING THE ADVANCEMENT OF HORSEMANSHIP, AND EQUESTRIAN COMPETITION (U.S. CLS. 100, 101 AND 102).

FIRST USE 9-1-1993; IN COMMERCE 9-1-1993.

CLASS 41—EDUCATION AND ENTERTAINMENT

FOR EDUCATIONAL SERVICES, NAMELY, PROVIDING INCENTIVES FOR RIDERS TO DEMONSTRATE EXCELLENCE IN THE FIELD OF HORSEMANSHIP AND EQUESTRIAN COMPETITION THROUGH THE ISSUANCE OF AWARDS; AND ORGANIZING AND PRESENTING SPORTS COMPETITIONS (U.S. CLS. 100, 101 AND 107).

FIRST USE 9-1-1993; IN COMMERCE 9-1-1993.

SN 76-459,674. HIRA COLLECTION INC., WALNUT, CA. FILED 10-21-2002.

BRIDAL HOME

NO CLAIM IS MADE TO THE EXCLUSIVE RIGHT TO USE "BRIDAL", APART FROM THE MARK AS SHOWN.

CLASS 25—CLOTHING

FOR EVENING GOWNS AND DRESSES; LEATHER COATS, JACKETS, PANTS, SKIRTS, AND RIDING GLOVES; MEN'S SUITS AND TUXEDOS; CHILDREN'S CLOTHES, NAMELY, BOYS TUXEDOS, JACKETS AND SUITS, GIRLS EVENING, PROM, BRIDAL AND GRADUATION DRESSES AND GOWNS (U.S. CLS. 22 AND 39).

FIRST USE 1-1-2001; IN COMMERCE 1-1-2001.

CLASS 35—ADVERTISING AND BUSINESS

FOR COMPUTERIZED ON-LINE RETAIL SERVICES IN THE FIELD OF EVENING GOWNS AND DRESSES; LEATHER COATS, JACKETS, PANTS, SKIRTS AND RIDING GLOVES; MEN'S SUITS AND TUXEDOS; CHILDREN'S CLOTHES, PERFUMES AND FASHION ACCESSORIES (U.S. CLS. 100, 101 AND 102).

FIRST USE 1-1-2001; IN COMMERCE 1-1-2001.

SN 76-460,264. MUSAIC, INC., NOVATO, CA. FILED 10-16-2002.

MUSAIC

CLASS 41—EDUCATION AND ENTERTAINMENT

FOR MUSIC PRODUCTION SERVICES, NAMELY, MUSIC COMPOSITION AND MUSIC ARRANGEMENT FOR OTHERS (U.S. CLS. 100, 101 AND 107).

CLASS 42—SCIENTIFIC, COMPUTER AND LEGAL SERVICES

FOR LEGAL SERVICES, LICENSING OF INTELLECTUAL PROPERTY (U.S. CLS. 100 AND 101).

SN 76-460,729. NACHNANI, GOBIND H., VIRGINIA BEACH, VA. FILED 10-23-2002.

COASTAL EDGE

CLASS 25—CLOTHING

FOR CLOTHING, NAMELY BEACH WEAR, BATHING SUITS AND TRUNKS, BEACH SHOES, SURF WEAR, T-SHIRTS, TANK TOPS, SWEAT SHIRTS, SHORTS, PANTS, SHIRTS, BOXER SHORTS, SOCKS, BASEBALL CAPS, AND SUN VISORS (U.S. CLS. 22 AND 39).
FIRST USE 3-31-1986; IN COMMERCE 5-31-1990.

CLASS 35—ADVERTISING AND BUSINESS

FOR RETAIL CLOTHING AND SPORTING GOODS STORES (U.S. CLS. 100, 101 AND 102).
FIRST USE 3-31-1986; IN COMMERCE 5-31-1990.

SN 76-460,769. CORAM, INC., DENVER, CO. FILED 10-16-2002.

CORAM HEALTHCARE

OWNER OF U.S. REG. NO. 2,152,708.
NO CLAIM IS MADE TO THE EXCLUSIVE RIGHT TO USE "HEALTHCARE", APART FROM THE MARK AS SHOWN.

CLASS 35—ADVERTISING AND BUSINESS

FOR PROCUREMENT, NAMELY, PURCHASING PHARMACEUTICALS FOR OTHERS; SUPPLYING PRESCRIPTION DRUGS TO HEALTH PLAN PARTICIPANTS FOR THE FUNDING ORGANIZATIONS (U.S. CLS. 100, 101 AND 102).

FIRST USE 7-0-1994; IN COMMERCE 7-0-1994.

CLASS 40—MATERIAL TREATMENT

FOR CUSTOM MANUFACTURE OF PHARMACEUTICALS, NAMELY MIXING OF PHARMACEUTICALS AND NUTRITIONAL PRODUCTS FOR HOSPITALS AND HEALTHCARE FACILITIES (U.S. CLS. 100, 103 AND 106).

FIRST USE 7-0-1994; IN COMMERCE 7-0-1994.

CLASS 44—MEDICAL, BEAUTY AND AGRICULTURAL SERVICES

FOR MEDICAL SERVICES, NAMELY IN-HOME INFUSION AND NUTRITIONAL SERVICES (U.S. CLS. 100 AND 101).

FIRST USE 7-0-1994; IN COMMERCE 7-0-1994.

SN 76-460,770. CORAM, INC., DENVER, CO. FILED 10-16-2002.

CORAM

OWNER OF U.S. REG. NO. 2,152,708.

CLASS 35—ADVERTISING AND BUSINESS

FOR PROCUREMENT, NAMELY, PURCHASING PHARMACEUTICALS FOR OTHERS; SUPPLYING PRESCRIPTION DRUGS TO HEALTH PLAN PARTICIPANTS FOR THE FUNDING ORGANIZATIONS (U.S. CLS. 100, 101 AND 102).

FIRST USE 7-0-1994; IN COMMERCE 7-0-1994.

CLASS 40—MATERIAL TREATMENT

FOR CUSTOM MANUFACTURE OF PHARMACEUTICALS, NAMELY MIXING OF PHARMACEUTICALS AND NUTRITIONAL PRODUCTS FOR HOSPITALS AND HEALTHCARE FACILITIES (U.S. CLS. 100, 103 AND 106).

FIRST USE 7-0-1994; IN COMMERCE 7-0-1994.

CLASS 44—MEDICAL, BEAUTY AND AGRICULTURAL SERVICES

FOR MEDICAL SERVICES, NAMELY IN-HOME INFUSION AND NUTRITIONAL SERVICES (U.S. CLS. 100 AND 101).

FIRST USE 7-0-1994; IN COMMERCE 7-0-1994.

SN 76-460,895. ALISETH HOLDINGS, INC., LAWRENCE, NY. FILED 10-22-2002.

MOE GINSBURG

THE NAME(S), PORTRAIT(S), AND/OR SIGNATURE(S) SHOWN IN THE MARK DOES NOT IDENTIFY A PARTICULAR LIVING INDIVIDUAL.

CLASS 25—CLOTHING

FOR SUITS, SHIRTS, PANTS, TIES, JACKETS, COATS, TIES, BELTS, UNDERGARMENTS (U.S. CLS. 22 AND 39).

FIRST USE 8-1-1977; IN COMMERCE 8-1-1977.

CLASS 35—ADVERTISING AND BUSINESS

FOR RETAIL CLOTHING STORE (U.S. CLS. 100, 101 AND 102).

FIRST USE 8-1-1977; IN COMMERCE 8-1-1977.

SN 76-460,968. RED HOT & BLUE RESTAURANTS, INC., ARLINGTON, VA. FILED 10-18-2002.

SN 76-461,825. KORAN, LINDA H., WESTERVILLE, OH. FILED 10-28-2002.



OWNER OF U.S. REG. NOS. 1,603,066, 1,706,908 AND 1,813,800.

NO CLAIM IS MADE TO THE EXCLUSIVE RIGHT TO USE "A SOUTHERN GRILL & BAR", APART FROM THE MARK AS SHOWN.

CLASS 25—CLOTHING

FOR T-SHIRTS, HATS, GOLF HATS, GOLF SHIRTS AND APRONS (U.S. CLS. 22 AND 39).

CLASS 30—STAPLE FOODS

FOR BARBECUE SAUCE AND SPICE MIX (U.S. CL. 46).

CLASS 43—HOTEL AND RESTAURANT SERVICES

FOR RESTAURANT SERVICES, CARRY-OUT RESTAURANT SERVICES AND CATERING SERVICES (U.S. CLS. 100 AND 101).

SN 76-461,099. BAM! ENTERTAINMENT, INC., SAN JOSE, CA. FILED 10-9-2002.

CRUSHED BASEBALL

NO CLAIM IS MADE TO THE EXCLUSIVE RIGHT TO USE "BASEBALL", APART FROM THE MARK AS SHOWN.

CLASS 9—ELECTRICAL AND SCIENTIFIC APPARATUS

FOR VIDEO GAME CARTRIDGES AND DISCS (U.S. CLS. 21, 23, 26, 36 AND 38).

CLASS 41—EDUCATION AND ENTERTAINMENT

FOR ENTERTAINMENT SERVICES, NAMELY, PROVIDING AN ON-LINE COMPUTER VIDEO GAME AND PROVIDING ENTERTAINMENT INFORMATION ABOUT VIDEO GAMES VIA A WEBSITE ON THE INTERNET (U.S. CLS. 100, 101 AND 107).

ENGLISH ON A ROLL

CLASS 9—ELECTRICAL AND SCIENTIFIC APPARATUS

FOR SET OF SIX-SIDED CUBES USED AS AN EDUCATIONAL TOOL FOR TEACHING ENGLISH AS A LANGUAGE TO NATIVE OR NON-NATIVE SPEAKERS OF ENGLISH, BASIC LITERACY STUDENTS OR STUDENTS WITH LEARNING DISABILITIES (U.S. CLS. 21, 23, 26, 36 AND 38).

FIRST USE 10-9-2002; IN COMMERCE 10-9-2002.

CLASS 16—PAPER GOODS AND PRINTED MATTER

FOR PRINTED MATTER, NAMELY, BOOKS, MANUALS, PAMPHLETS, BROCHURES, POSTERS, PRINTED INSTRUCTIONAL TEACHING MATERIALS, ALL IN THE FIELD OF TEACHING ENGLISH AS A LANGUAGE TO NATIVE OR NON-NATIVE SPEAKERS OF ENGLISH, BASIC LITERACY STUDENTS OR STUDENTS WITH LEARNING DISABILITIES (U.S. CLS. 2, 5, 22, 23, 29, 37, 38 AND 50).

FIRST USE 10-9-2002; IN COMMERCE 10-9-2002.

CLASS 41—EDUCATION AND ENTERTAINMENT

FOR EDUCATIONAL SERVICES, NAMELY, CLASSES, CONFERENCES, SEMINARS, STUDY GROUPS, WORKSHOPS, ALL IN THE FIELD OF TEACHING ENGLISH AS A LANGUAGE TO NATIVE OR NON-NATIVE SPEAKERS OF ENGLISH, BASIC LITERACY STUDENTS OR STUDENTS WITH LEARNING DISABILITIES (U.S. CLS. 100, 101 AND 107).

FIRST USE 10-9-2002; IN COMMERCE 10-9-2002.

SN 76-465,708. U.S. GREEN BUILDING COUNCIL, WASHINGTON, DC. FILED 11-12-2002.

LEED

OWNER OF U.S. REG. NO. 2,274,505.

CLASS 41—EDUCATION AND ENTERTAINMENT

FOR DEVELOPMENT AND DISSEMINATION OF EDUCATIONAL MATERIALS FOR OTHERS IN THE FIELD OF ENVIRONMENTAL DESIGN, CONSTRUCTION, AND OPERATION OF BUILDINGS AND REAL ESTATE; EDUCATIONAL SERVICES, NAMELY, CONDUCTING CLASSES, SEMINARS, CONFERENCES AND WORKSHOPS IN THE FIELD OF ENVIRONMENTAL DESIGN, CONSTRUCTION, AND OPERATION OF BUILDINGS AND REAL ESTATE (U.S. CLS. 100, 101 AND 107).

FIRST USE 4-30-1996; IN COMMERCE 4-30-1996.

CLASS 42—SCIENTIFIC, COMPUTER AND LEGAL SERVICES

FOR SERVICES INVOLVING THE FORMULATION OF STANDARDS AND BEST PRACTICES FOR THE ENVIRONMENTAL DESIGN, CONSTRUCTION, AND OPERATION OF BUILDINGS AND REAL ESTATE; TESTING, ANALYSIS AND EVALUATION OF THE SERVICES OF OTHERS FOR THE PURPOSE OF CERTIFICATION (U.S. CLS. 100 AND 101).

FIRST USE 4-30-1996; IN COMMERCE 4-30-1996.

SN 76-465,715. U.S. GREEN BUILDING COUNCIL, WASHINGTON, DC. FILED 11-12-2002.

SN 76-467,312. PHYSICIANS COMMITTEE FOR RESPONSIBLE MEDICINE, INC., WASHINGTON, DC. FILED 11-15-2002.

USGBC

CLASS 41—EDUCATION AND ENTERTAINMENT

FOR DEVELOPMENT AND DISSEMINATION OF EDUCATIONAL MATERIALS FOR OTHERS IN THE FIELD OF ENVIRONMENTAL DESIGN, CONSTRUCTION, AND OPERATION OF BUILDINGS AND REAL ESTATE; EDUCATIONAL SERVICES, NAMELY, CONDUCTING CLASSES, SEMINARS, CONFERENCES AND WORKSHOPS IN THE FIELD OF ENVIRONMENTAL DESIGN, CONSTRUCTION, AND OPERATION OF BUILDINGS AND REAL ESTATE (U.S. CLS. 100, 101 AND 107).

FIRST USE 4-30-1993; IN COMMERCE 4-30-1993.

CLASS 42—SCIENTIFIC, COMPUTER AND LEGAL SERVICES

FOR SERVICES INVOLVING THE FORMULATION OF STANDARDS AND BEST PRACTICES FOR THE ENVIRONMENTAL DESIGN, CONSTRUCTION, AND OPERATION OF BUILDINGS AND REAL ESTATE; TESTING, ANALYSIS, AND EVALUATION OF THE SERVICES OF OTHERS FOR THE PURPOSE OF CERTIFICATION (U.S. CLS. 100 AND 101).

FIRST USE 4-30-1993; IN COMMERCE 4-30-1993.

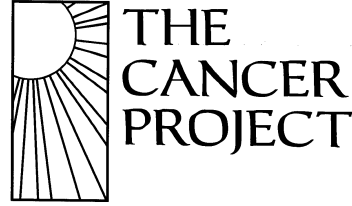

NO CLAIM IS MADE TO THE EXCLUSIVE RIGHT TO USE "THE CANCER PROJECT", APART FROM THE MARK AS SHOWN.

THE LINING IS A FEATURE OF THE MARK NOT INTENDED TO INDICATE COLOR.

CLASS 16—PAPER GOODS AND PRINTED MATTER

FOR BOOKLETS, BROCHURES, AND PRINTED INSTRUCTIONAL, EDUCATIONAL, AND TEACHING MATERIALS ALL IN THE FIELD OF NUTRITION AND HEALTH (U.S. CLS. 2, 5, 22, 23, 29, 37, 38 AND 50).

FIRST USE 6-0-1999; IN COMMERCE 6-0-1999.

CLASS 35—ADVERTISING AND BUSINESS

FOR PROMOTING PUBLIC AWARENESS OF THE NEED FOR A HEALTHY DIET TO PREVENT AND TREAT CANCER (U.S. CLS. 100, 101 AND 102).

FIRST USE 6-0-1999; IN COMMERCE 6-0-1999.

SN 76-467,033. NATIONAL ACADEMY OF RECORDING ARTS & SCIENCES, INC., SANTA MONICA, CA. FILED 11-5-2002.



CLASS 36—INSURANCE AND FINANCIAL

FOR CHARITABLE FINANCIAL ASSISTANCE SERVICES, NAMELY, PROVIDING FUNDS TO MUSICIANS IN TIMES OF NEED (U.S. CLS. 100, 101 AND 102).

FIRST USE 11-0-1991; IN COMMERCE 11-0-1991.

CLASS 44—MEDICAL, BEAUTY AND AGRICULTURAL SERVICES

FOR COUNSELING SERVICES IN THE FIELD OF SUBSTANCE ABUSE TREATMENT (U.S. CLS. 100 AND 101).

FIRST USE 11-0-1991; IN COMMERCE 11-0-1991.

CLASS 41—EDUCATION AND ENTERTAINMENT

FOR EDUCATIONAL SERVICES, NAMELY, PROVIDING PROGRAMS AND SEMINARS ON THE SUBJECT OF NUTRITION TO PREVENT AND TREAT CANCER (U.S. CLS. 100, 101 AND 107).

FIRST USE 6-0-1999; IN COMMERCE 6-0-1999.

CLASS 42—SCIENTIFIC, COMPUTER AND LEGAL SERVICES

FOR MEDICAL RESEARCH IN THE FIELD OF NUTRITION AND CANCER (U.S. CLS. 100 AND 101).

FIRST USE 6-0-1999; IN COMMERCE 6-0-1999.

SN 76-467,315. PHYSICIANS COMMITTEE FOR RESPONSIBLE MEDICINE, INC., WASHINGTON, DC. FILED 11-15-2002.

PCRM

CLASS 16—PAPER GOODS AND PRINTED MATTER

FOR BOOKS, BROCHURES, BOOKLETS, POSTERS, MAGAZINES, NEWSLETTERS, AND PRINTED INSTRUCTIONAL, EDUCATIONAL, AND TEACHING MATERIALS IN THE FIELDS OF FOOD, NUTRITION, HEALTH, MEDICAL RESEARCH, AND MEDICAL EDUCATION; STATIONERY WRITING PAPER AND ENVELOPES, POSTCARDS, BUMPER STICKERS (U.S. CLS. 2, 5, 22, 23, 29, 37, 38 AND 50).

FIRST USE 0-0-1985; IN COMMERCE 0-0-1985.

CLASS 35—ADVERTISING AND BUSINESS

FOR PROMOTING PUBLIC AWARENESS OF THE NEED FOR A HEALTHY DIET AND HIGHER STANDARDS IN MEDICAL RESEARCH AND EDUCATION (U.S. CLS. 100, 101 AND 102).

FIRST USE 0-0-1985; IN COMMERCE 0-0-1985.

CLASS 42—SCIENTIFIC, COMPUTER AND LEGAL SERVICES

FOR MEDICAL RESEARCH IN THE FIELD OF HEALTH AND NUTRITION; LEGAL SERVICES RELATED TO FOOD, NUTRITION, MEDICAL RESEARCH, AND MEDICAL EDUCATION (U.S. CLS. 100 AND 101).

FIRST USE 0-0-1985; IN COMMERCE 0-0-1985.

SN 76-467,392. INTERNATIONAL CHEMICAL COMPANY, PHILADELPHIA, PA. FILED 11-15-2002.

INTERNATIONAL PRODUCTS

OWNER OF U.S. REG. NOS. 155,619 AND 161,749.
NO CLAIM IS MADE TO THE EXCLUSIVE RIGHT TO USE "PRODUCTS", APART FROM THE MARK AS SHOWN. SEC. 2(F).

CLASS 2—PAINTS

FOR METALWORKING COATING COMPOUNDS FOR DRAWING AND STAMPING, ROLL-FORMING, RUST PREVENTION, MACHINING AND GRINDING, MASS FINISHING, CLEANING AND LUBRICATION (U.S. CLS. 6, 11 AND 16).

FIRST USE 1-0-1922; IN COMMERCE 1-0-1922.

CLASS 3—COSMETICS AND CLEANING PREPARATIONS

FOR METALWORKING CLEANING COMPOUNDS FOR DRAWING AND STAMPING, ROLL-FORMING, RUST PREVENTION, MACHINING AND GRINDING, MASS FINISHING, CLEANING AND LUBRICATION (U.S. CLS. 1, 4, 6, 50, 51 AND 52).

FIRST USE 12-0-1920; IN COMMERCE 12-0-1920.

CLASS 4—LUBRICANTS AND FUELS

FOR METALWORKING LUBRICATING COMPOUNDS FOR DRAWING AND STAMPING, ROLL-FORMING, RUST PREVENTION, MACHINING AND GRINDING, MASS FINISHING, CLEANING AND LUBRICATION (U.S. CLS. 1, 6 AND 15).

FIRST USE 1-0-1921; IN COMMERCE 1-0-1921.

SN 76-467,412. UNITED PARCEL SERVICE OF AMERICA, INC., ATLANTA, GA. FILED 11-15-2002.

UPS C.O.D. SELECT

OWNER OF U.S. REG. NOS. 2,485,945 AND 2,652,138.
NO CLAIM IS MADE TO THE EXCLUSIVE RIGHT TO USE "C.O.D.", APART FROM THE MARK AS SHOWN.

CLASS 36—INSURANCE AND FINANCIAL

FOR FINANCIAL SERVICES, NAMELY CASH MANAGEMENT SERVICES (U.S. CLS. 100, 101 AND 102).

CLASS 39—TRANSPORTATION AND STORAGE

FOR TRANSPORTATION AND DELIVERY OF PERSONAL PROPERTY BY AIR, RAIL, BOAT, AND MOTOR VEHICLE (U.S. CLS. 100 AND 105).

SN 76-467,674. DENARDIS, TIMOTHY M., NAPLES, FL. FILED 11-7-2002.



NO CLAIM IS MADE TO THE EXCLUSIVE RIGHT TO USE "RACE CLOTHING GENUINE", APART FROM THE MARK AS SHOWN.
THE MARK CONSISTS IN PART OF STYLIZED BACK TO BACK LETTER "D'S".

CLASS 4—LUBRICANTS AND FUELS

FOR PETROLEUM PRODUCTS, NAMELY, MOTOR OIL (U.S. CLS. 1, 6 AND 15).

CLASS 12—VEHICLES

FOR STRUCTURAL PARTS FOR MOTORCYCLES (U.S. CLS. 19, 21, 23, 31, 35 AND 44).

CLASS 25—CLOTHING

FOR CLOTHING, NAMELY, PANTS, T-SHIRTS, JERSEYS, GLOVES, AND BOOTS (U.S. CLS. 22 AND 39).

SN 76-468,668. ENJOY THE JOURNEY, LLC, RIVER VALE, NJ. FILED 11-20-2002.

THE UNEXPECTED JOURNEY

CLASS 16—PAPER GOODS AND PRINTED MATTER

FOR PRINTED INSTRUCTIONAL, EDUCATIONAL, AND TEACHING MATERIALS USED IN SEMINARS FOR FAMILIES WITH CHILDREN HAVING SPECIAL NEEDS (U.S. CLS. 2, 5, 22, 23, 29, 37, 38 AND 50).

CLASS 41—EDUCATION AND ENTERTAINMENT

FOR EDUCATIONAL SERVICES, NAMELY, CONDUCTING WORKSHOPS AND SEMINARS FOR FAMILIES WITH CHILDREN HAVING SPECIAL NEEDS (U.S. CLS. 100, 101 AND 107).

SN 76-468,893. EAGLE RESEARCH CORPORATION, SCOTT DEPOT, WV. FILED 11-21-2002.



THE STYLIZED PROFILE OF THE HEAD OF AN EAGLE ENCLOSED WITHIN A SUBSTANTIALLY SQUARE BOX HAVING ROUNDED CORNERS.

CLASS 37—CONSTRUCTION AND REPAIR

FOR INSTALLATION, CONFIGURING, START UP AND CHECKOUT OF SUPERVISORY CONTROL AND DATA ACQUISITION (SCADA) SYSTEMS FOR UTILITY COMPANIES (U.S. CLS. 100, 103 AND 106).
FIRST USE 5-0-1998; IN COMMERCE 5-0-1998.

CLASS 42—SCIENTIFIC, COMPUTER AND LEGAL SERVICES

FOR CUSTOM COMPUTER PROGRAMMING, AND DESIGN OF SUPERVISORY CONTROL AND DATA ACQUISITION (SCADA) SYSTEMS FOR UTILITY COMPANIES (U.S. CLS. 100 AND 101).
FIRST USE 5-0-1998; IN COMMERCE 5-0-1998.

SN 76-470,039. HTZ INVESTMENT CORP., WILMINGTON, DE. FILED 11-25-2002.



CLASS 1—CHEMICALS

FOR WATER FILTERING MATERIALS, NAMELY, FIBER FLOSS AND FILTER CHARCOAL; AND ADDITIVES FOR AQUARIUM WATER, NAMELY, SALT; WATER PURIFYING CHEMICALS FOR AQUARIUMS IN TABLETS, LIQUID AND/OR SPRAY FORM (U.S. CLS. 1, 5, 6, 10, 26 AND 46).

CLASS 3—COSMETICS AND CLEANING PREPARATIONS

FOR DETERGENT FOR REMOVING STAINS FROM RUGS AND CARPETS HAVING INCIDENTAL DEODORANT PROPERTIES; SHAMPOOS, SOAPS AND CONDITIONERS FOR PETS (U.S. CLS. 1, 4, 6, 50, 51 AND 52).

CLASS 5—PHARMACEUTICALS

FOR VITAMINS FOR PETS; FLEA KILLING COLLAR FOR PETS; FLEA AND TICK DIP, FLEA AND TICK SPRAY, POWDER, AND REPELLENTS FOR PETS, INSECTICIDAL SHAMPOOS AND SOAPS FOR PETS, FLEA AND TICK CARPET POWDER, WORMERS FOR PETS, NAMELY, MEDICATED PREPARATIONS TO RID PETS OF DIGESTIVE TRACT PARASITES, HAIR BALL REMEDIES FOR CATS AND ANTI-ITCH MEDICINE FOR AQUARIUM FISH, FLEA AND TICK ERADICATION PRODUCT CAPSULE FORM TO BE INGESTED BY DOGS; FLEA AND TICK TOPICAL ERADICATION PREPARATION; FLEA AND TICK DROPS FOR CATS; FLEA AND TICK DROPS FOR DOGS; VITAMINS FOR CATS AND DOGS; WORMERS FOR CATS AND DOGS; INSECTICIDAL SHAMPOOS FOR DOGS (U.S. CLS. 6, 18, 44, 46, 51 AND 52).

CLASS 6—METAL GOODS

FOR METAL STAKES FOR PETS (U.S. CLS. 2, 12, 13, 14, 23, 25 AND 50).

CLASS 7—MACHINERY

FOR AQUARIUM PUMPS (U.S. CLS. 13, 19, 21, 23, 31, 34 AND 35).

CLASS 8—HAND TOOLS

FOR HAND TOOLS FOR PICKING UP PET ANIMAL'S EXCREMENTS, NAIL FILES FOR ANIMAL PETS, PET PEDICURE INSTRUMENTS; HAND TOOLS, NAMELY, AQUARIUM SCRAPERS (U.S. CLS. 23, 28 AND 44).

CLASS 9—ELECTRICAL AND SCIENTIFIC APPARATUS

FOR PET ACCESSORIES, NAMELY, WHISTLES USED FOR CALLING DOGS; AQUARIUM THERMOMETERS; ELECTRIC MECHANISM FOR ATTRACTING AND TRAPPING FLEAS (U.S. CLS. 21, 23, 26, 36 AND 38).

CLASS 11—ENVIRONMENTAL CONTROL APPARATUS

FOR WATER FILTERS; AQUARIUM HEATERS, AND AQUARIUM LIGHTS, INSTALLATIONS FOR LIGHTING, HEATING, STEAM GENERATING, COOKING, REFRIGERATING, DRYING, VENTILATING, WATER SUPPLY AND SANITARY PURPOSES; LIGHT REFLECTORS FOR ATTACHMENTS TO TANKS AND WATER EJECTING SYPHONS (U.S. CLS. 13, 21, 23, 31 AND 34).

CLASS 16—PAPER GOODS AND PRINTED MATTER

FOR AQUARIUM TANKS; AQUARIUM NETS, AQUARIUM NETS FOR MOVING FISH, DECORATIVE BACKGROUNDS, AQUARIUM FITTINGS AND ACCESSORIES, NAMELY, STANDS, AIR RELEASE STONES, FIBRE FLOSS, ARTIFICIAL LANDSCAPE, CREATING STONE AND ORNAMENTS, BREEDING TRAPS AND ARTIFICIAL BREEDING GRASS, AND SCREEN COVERS OF AQUARIUMS; GRAVEL PAPER FOR BIRD CAGES, LINER BAGS FOR CAT LITTER PANS; PUBLICATIONS, NAMELY, INFORMATIONAL PAMPHLETS ABOUT AQUARIUMS, AQUARIUM FISH, BIRDS, HAMSTERS, GERBILS AND GUINEA PIGS; NON-ABRASIVE LINE BAGS FOR CAT LITTER PANS (U.S. CLS. 2, 5, 22, 23, 29, 37, 38 AND 50).

CLASS 17—RUBBER GOODS

FOR AQUARIUM SEALANTS AND PLASTIC PIPES, VALVES AND PIPE CONNECTORS FOR AQUARIUMS (U.S. CLS. 1, 5, 12, 13, 35 AND 50).

CLASS 18—LEATHER GOODS

FOR DOG ACCESSORIES, NAMELY, COLLARS, LEADS AND HARNESSSES; CLOTHING FOR PET ANIMALS; PET PILLOWS AND RAWHIDE CHEWS FOR DOGS; RAWHIDE CHEWS FOR PETS, COLLARS, LEADS AND HARNESSSES FOR PETS, CHAIN LEADS, CHOKE COLLARS, TIE-OUT CHAINS AND STAKES FOR PETS (U.S. CLS. 1, 2, 3, 22 AND 41).

CLASS 20—FURNITURE AND ARTICLES NOT OTHERWISE CLASSIFIED

FOR PORTABLE BEDS FOR PETS; BEDS AND PILLOWS FOR PETS; NON-METAL STAKES FOR PETS (U.S. CLS. 2, 13, 22, 25, 32 AND 50).

CLASS 21—HOUSEWARES AND GLASS

FOR PET BRUSHES AND COMBS; CAT LITTER PANS, PET FEEDING DISHES, WATER BOTTLES FOR SMALL ANIMAL PETS, PET FOOD CAN COVERS, BIRD BATH, BIRD FOOD AND WATER CUPS, BIRD CAGES AND THE STANDS THEREFOR; CAGES FOR PETS, NAMELY, HOUSING/PLAYING ENVIRONMENT FOR SMALL ANIMAL PETS AND PARTS THEREFOR (U.S. CLS. 2, 13, 23, 29, 30, 33, 40 AND 50).

CLASS 26—FANCY GOODS

FOR ARTIFICIAL PLANTS FOR AQUARIUMS AND PET RESTRAINING STAKE (U.S. CLS. 37, 39, 40, 42 AND 50).

CLASS 28—TOYS AND SPORTING GOODS

FOR DOG CHEW TOYS MADE OF ANIMAL HIDE FOR EXERCISING TEETH AND THE GUMS AND DOG SQUEAK TOYS; PET TOYS, NAMELY, TOYS FOR DOGS, CATS, BIRDS, HAMSTERS, AND GERBILS (U.S. CLS. 22, 23, 38 AND 50).

CLASS 31—NATURAL AGRICULTURAL PRODUCTS

FOR FOOD FOR ANIMAL PETS, NAMELY, DOGS, CATS, HAMSTERS, GERBILS, GUINEA PIGS, RABBITS, CUTTLEBONE FOR BIRDS, BIRDS, TROPICAL AND AQUARIUM FISH AND CEDAR SHAVINGS FOR SMALL PETS (U.S. CLS. 1 AND 46).

CLASS 42—SCIENTIFIC, COMPUTER AND LEGAL SERVICES

FOR PROVIDING TECHNICAL INFORMATION IN THE FIELD OF PET PRODUCTS RENDERED BY MEANS OF A COMPUTER INFORMATION NETWORK (U.S. CLS. 100 AND 101).

SN 76-470,069. TANIMURA & ANTLE, INC., SALINAS, CA. FILED 11-25-2002.

GROWN WITH FAMILY PRIDE FOR 3 GENERATIONS

CLASS 29—MEATS AND PROCESSED FOODS

FOR PRE-CUT FRESH FRUITS AND VEGETABLES AND PRE-CUT GARDEN SALADS (U.S. CL. 46).

CLASS 31—NATURAL AGRICULTURAL PRODUCTS

FOR FRESH FRUITS AND VEGETABLES (U.S. CLS. 1 AND 46).

SN 76-470,232. HARTMANN-LAUSANNE, INC., ADDISON, TX. FILED 11-25-2002.

HARTMANN-LAUSANNE

CLASS 42—SCIENTIFIC, COMPUTER AND LEGAL SERVICES

FOR MEDIATION SERVICES (U.S. CLS. 100 AND 101).

CLASS 44—MEDICAL, BEAUTY AND AGRICULTURAL SERVICES

FOR HEALTH CARE CONSULTATION (U.S. CLS. 100 AND 101).

SN 76-470,464. FRIEDHOFF, RICHARD M., SAN FRANCISCO, CA. FILED 11-27-2002.

TANDENT

CLASS 35—ADVERTISING AND BUSINESS

FOR BUSINESS STRATEGY CONSULTING (U.S. CLS. 100, 101 AND 102).

CLASS 42—SCIENTIFIC, COMPUTER AND LEGAL SERVICES

FOR TECHNOLOGY CONSULTING (U.S. CLS. 100 AND 101).

SN 76-471,043. CORAM, INC., DENVER, CO. FILED 11-25-2002.

**CLASS 35—ADVERTISING AND BUSINESS**

FOR WHOLESALE DISTRIBUTORSHIPS FEATURING PHARMACEUTICAL AND NUTRITIONAL PRODUCTS FOR HOSPITALS AND HEALTHCARE FACILITIES (U.S. CLS. 100, 101 AND 102).

CLASS 40—MATERIAL TREATMENT

FOR MIXING OF PHARMACEUTICAL AND NUTRITIONAL PRODUCTS TO THE ORDER AND SPECIFICATION OF HOSPITALS AND HEALTHCARE FACILITIES (U.S. CLS. 100, 103 AND 106).

SN 76-471,399. HARVARD INVESTMENTS, INC., SCOTTS-DALE, AZ. FILED 11-18-2002.

SN 76-473,266. NYC2012, INC., NEW YORK, NY. FILED 12-4-2002.

**THERE'S A CERTAIN SPIRIT
HERE**

**THE WORLD'S SECOND
HOME**

CLASS 36—INSURANCE AND FINANCIAL

FOR REAL ESTATE AGENCY SERVICES (U.S. CLS. 100, 101 AND 102).
FIRST USE 12-18-2002; IN COMMERCE 12-18-2002.

CLASS 35—ADVERTISING AND BUSINESS

FOR PROMOTING BUSINESS AND TOURISM IN CITY AND STATE OF NEW YORK; PROMOTING THE ECONOMIC DEVELOPMENT OF THE CITY AND STATE OF NEW YORK; PROMOTING THE CITY AND STATE OF NEW YORK AS A SITE FOR CULTURAL EVENTS, ENTERTAINMENT EXHIBITIONS AND SPORT COMPETITIONS AND GAMES (U.S. CLS. 100, 101 AND 102).

CLASS 37—CONSTRUCTION AND REPAIR

FOR CONSTRUCTION AND LAND DEVELOPMENT SERVICES, NAMELY, PLANNING, LAYING OUT AND BUILDING OF RESIDENTIAL AND MULTI-USE COMMUNITIES AND COMMERCIAL BUILDINGS FEATURING NEW RESIDENCES, RECREATIONAL FACILITIES, SOCIAL AND COMMUNITY FACILITIES, AND MEETING AND CONVENTION CENTERS (U.S. CLS. 100, 103 AND 106).
FIRST USE 12-18-2002; IN COMMERCE 12-18-2002.

CLASS 41—EDUCATION AND ENTERTAINMENT

FOR ORGANIZING EDUCATIONAL AND CULTURAL EVENTS, PROGRAMS, AND EXHIBITIONS RELATING TO THE PAST, PRESENT AND FUTURE OF THE CITY AND STATE OF NEW YORK AND DESIGNED TO FOSTER CIVIC PRIDE; PUBLICATION OF BOOKS, NEWSPAPERS, AND MAGAZINES; CONDUCTING ENTERTAINMENT EXHIBITIONS IN THE NATURE OF PARADES; CONDUCTING ENTERTAINMENT EXHIBITIONS IN THE NATURE OF THEME PARKS; ORGANIZING SPORT COMPETITIONS AND GAMES; ORGANIZING CULTURAL EVENTS, NAMELY MUSICAL, THEATRICAL, DANCE, ART AND CRAFT EXHIBITIONS; MOTION PICTURE FILM PRODUCTION SERVICES; ORGANIZING LIVE PERFORMANCES BY MUSICAL BANDS, THEATRICAL GROUPS, AND SPORTS AND ENTERTAINMENT PERSONALITIES (U.S. CLS. 100, 101 AND 107).

SN 76-472,171. PEP PRODUCTIONS, L.L.C., EDMOND, OK. FILED 12-3-2002.

OSAAT

CLASS 16—PAPER GOODS AND PRINTED MATTER

FOR PRINTED COURSE MATERIALS IN THE FIELD OF HEALTH AND NUTRITION (U.S. CLS. 2, 5, 22, 23, 29, 37, 38 AND 50).
FIRST USE 10-18-2002; IN COMMERCE 10-18-2002.

SN 76-474,506. LES HUILERIES DE LA CROIX VERTE ET LA TOURANGELLE, SARL, SAUMUR, FRANCE, FILED 12-10-2002.

LA TOURANGELLE

CLASS 41—EDUCATION AND ENTERTAINMENT

FOR EDUCATIONAL SERVICES, NAMELY, CONDUCTING COURSES AND WORKSHOPS IN THE FIELD OF HEALTH AND NUTRITION (U.S. CLS. 100, 101 AND 107).
FIRST USE 10-18-2002; IN COMMERCE 10-18-2002.

CLASS 29—MEATS AND PROCESSED FOODS

FOR EDIBLE OILS (U.S. CL. 46).

SN 76-472,735. HARVARD INVESTMENTS, INC., SCOTTS-DALE, AZ. FILED 12-9-2002.

TALKING ROCK

CLASS 30—STAPLE FOODS

FOR SALAD DRESSINGS (U.S. CL. 46).

CLASS 36—INSURANCE AND FINANCIAL

FOR REAL ESTATE AGENCY SERVICES (U.S. CLS. 100, 101 AND 102).
FIRST USE 8-30-2000; IN COMMERCE 1-3-2001.

SN 76-474,653. PETROBRAS DISTRIBUIDORA S.A., MARACANA, RIO DE JANEIRO, BRAZIL, FILED 12-13-2002.

CLASS 37—CONSTRUCTION AND REPAIR

FOR CONSTRUCTION AND LAND DEVELOPMENT SERVICES, NAMELY, PLANNING, LAYING OUT AND BUILDING OF RESIDENTIAL AND MULTI-USE COMMUNITIES AND COMMERCIAL BUILDINGS FEATURING NEW RESIDENCES, RECREATIONAL FACILITIES, SOCIAL AND COMMUNITY FACILITIES, AND MEETING AND CONVENTION CENTERS (U.S. CLS. 100, 103 AND 106).
FIRST USE 8-30-2000; IN COMMERCE 1-3-2001.

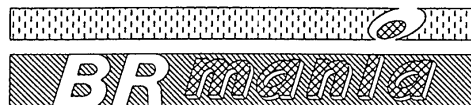

THE LINING IN THE MARK IS AN INDICATOR FOR THE COLORS PURPLE, GREEN AND ORANGE.

CLASS 16—PAPER GOODS AND PRINTED MATTER

FOR STATIONERY, FOLDERS, LABELS, NOTEBOOKS, WRITING PADS, PAPER SHEETS, ADVERTISEMENT BOARDS MADE OF PAPER OR PLASTIC, BOOKMARKERS, CALENDARS, CARDBOARD ARTICLES FOR OFFICE AND SCHOOL PURPOSES, DECAL-COMANIA, NAMELY, PREPARED PAPER PRINTS OR DESIGNS TO BE FIXED IN CHINA, GLASS OR MARBLE, GIFT PENS AND PENCILS, BOXES FOR PENS AND PENCILS, BOXES OF CARDBOARD, COASTERS OF PAPER, PAPER KNIVES, PENHOLDERS, CARDBOARD TUBES FOR DOCUMENTS, AND PLASTIC AND PAPER BAGS (U.S. CLS. 2, 5, 22, 23, 29, 37, 38 AND 50).

CLASS 43—HOTEL AND RESTAURANT SERVICES

FOR RESTAURANT SERVICES, NAMELY CAFE, CAFETERIA, FAST FOOD AND SNACK BAR SERVICES (U.S. CLS. 100 AND 101).

SN 76-477,798. POST-TENSIONING INSTITUTE, PHOENIX, AZ. FILED 12-24-2002.

**CLASS 16—PAPER GOODS AND PRINTED MATTER**

FOR BOOKS, BROCHURES, BULLETINS, MANUALS, NEWSLETTERS, PAMPHLETS, AND SLIDE PRESENTATIONS IN THE FIELD OF POST-TENSIONING DESIGN AND CONSTRUCTION TECHNOLOGY; DIRECTORIES OF COMPANIES ENGAGED IN POST-TENSIONED CONSTRUCTION OR PROVIDING RELATED GOODS OR SERVICES (U.S. CLS. 2, 5, 22, 23, 29, 37, 38 AND 50).

FIRST USE 7-0-1976; IN COMMERCE 7-0-1976.

CLASS 35—ADVERTISING AND BUSINESS

FOR PROMOTING THE SERVICES OF COMPANIES ENGAGED IN POST-TENSIONED CONSTRUCTION THROUGH THE DISTRIBUTION OF PRINTED AND VIDEO PROMOTION MATERIALS; PROMOTING THE SERVICES OF COMPANIES ENGAGED IN POST-TENSIONED CONSTRUCTION THROUGH AN INTERNET WEBSITE (U.S. CLS. 100, 101 AND 102).

FIRST USE 7-0-1976; IN COMMERCE 7-0-1976.

SN 76-481,499. INTERNET CORPORATION FOR ASSIGNED NAMES AND NUMBERS, MARINA DEL REY, CA. FILED 1-10-2003.

INTERNET ASSIGNED NUMBERS AUTHORITY

OWNER OF U.S. REG. NO. 2,620,519.
SEC. 2(F).

CLASS 35—ADVERTISING AND BUSINESS

FOR ADMINISTRATION, MANAGEMENT, AND COORDINATION OF PARAMETERS AND GUIDELINES FOR FACILITATING INTERNET COMMUNICATIONS; AND THE ADMINISTRATION, MANAGEMENT, AND COORDINATION OF TOP-LEVEL DOMAIN NAMES OR ADDRESSES ON THE INTERNET (U.S. CLS. 100, 101 AND 102).

FIRST USE 1-1-1989; IN COMMERCE 1-1-1989.

CLASS 42—SCIENTIFIC, COMPUTER AND LEGAL SERVICES

FOR PROVIDING INFORMATION IN THE FIELD OF STANDARDS AND GUIDELINES FOR THE INTERNET AND DOMAIN NAME REGISTRATION; DOMAIN NAME REGISTRY SERVICES IN THE NATURE OF CREATION OF, ESTABLISHING PROVISIONS FOR AND DEVELOPMENT AND MAINTENANCE OF PARAMETERS AND GUIDELINES FOR FACILITATING INTERNET COMMUNICATIONS; AND THE CREATION OF, ESTABLISHING PROVISIONS FOR AND MONITORING AND MAINTENANCE OF TOP-LEVEL DOMAIN NAMES OR ADDRESSES ON THE INTERNET (U.S. CLS. 100 AND 101).

FIRST USE 1-1-1989; IN COMMERCE 1-1-1989.

SN 76-485,266. DISCOVERY PARTNERS INTERNATIONAL, INC., SAN DIEGO, CA. FILED 1-24-2003.

MICROARCS**CLASS 1—CHEMICALS**

FOR CHEMICAL AND BIOLOGICAL REAGENTS FOR SCIENTIFIC USE IN THE FORM OF GELS, FILMS, MEMBRANES, FILTERS, AND SOLID MATRIX MATERIALS USED AS VEHICLES FOR CARRYING CHEMICAL AND BIOLOGICAL REAGENTS; CHEMICAL COMPOUND LIBRARIES FOR USE IN CHEMICAL AND BIOLOGICAL SYNTHESIS AND ASSAY SCREENING; KITS FOR SCIENTIFIC USE COMPRISED OF REAGENTS, PROCESSING CHEMICALS, ARRAY PLATES, SLIDES CONTAINERS, GELS, FILMS, MEMBRANES, FILTERS AND SOLID MATRIX MATERIALS FOR USE IN CHEMICAL AND BIOLOGICAL SYNTHESIS, AND ASSAY SCREENING (U.S. CLS. 1, 5, 6, 10, 26 AND 46).

CLASS 9—ELECTRICAL AND SCIENTIFIC APPARATUS

FOR LABORATORY EQUIPMENT, NAMELY APPARATUS FOR SCREENING SAMPLES, NAMELY, ASSAY PLATES AND SLIDES, SCREENING PLATES AND SLIDES, ARRAY PLATES AND SLIDES, FOR THE SCREENING OF BIOLOGICAL OR BIOCHEMICAL ACTIVITY, DETECTING THE PRESENCE OF ANALYTES IN SAMPLES, AND IDENTIFYING SAMPLE TYPE; AND MOLECULAR ARRAY SCREENING AND PATTERN MEASURING EQUIPMENT, NAMELY, DETECTORS FOR DETECTING FLUORESCENCE, CHEMILUMINESCENCE, ABSORBANCE, ALPHA SCREENING, AND RADIOISOTOPE EMISSION (U.S. CLS. 21, 23, 26, 36 AND 38).

CLASS 42—SCIENTIFIC, COMPUTER AND LEGAL SERVICES

FOR GENETIC AND PHARMACEUTICAL RESEARCH AND TESTING SERVICES FEATURING COMBINATORIAL AND MEDICINAL CHEMISTRY TECHNOLOGIES FOR THE PURPOSES OF CREATING DRUG LEADS; GENETIC PROFILING FOR THE PURPOSES OF TOXICOLOGY SCREENING AND CREATING AND TESTING DRUG LEADS; RESEARCH AND DEVELOPMENT SERVICES FOR OTHERS IN THE FIELDS OF COMBINATORIAL AND MEDICINAL CHEMICALS, COMPOUNDS AND DEVICES, MEASURING APPARATUS FOR USE IN COMBINATORIAL AND MEDICINAL RESEARCH AND DEVELOPMENT OF DRUG LEADS; CHEMICAL AND BIOLOGICAL SCREENING ANALYSIS AND ASSAY SERVICES FOR OTHERS (U.S. CLS. 100 AND 101).

SN 76-486,015. RICOLA AG, 4242 LAUFEN, SWITZERLAND, FILED 1-30-2003.

RICOLA REFRESHERS

OWNER OF U.S. REG. NOS. 2,025,925, 2,364,824 AND OTHERS.

CLASS 5—PHARMACEUTICALS

FOR MEDICATED CANDY FOR RELIEF OF THE COMMON COLD, SORE THROATS AND COUGHS; COUGH DROPS (U.S. CLS. 6, 18, 44, 46, 51 AND 52).

CLASS 30—STAPLE FOODS

FOR NON-MEDICATED CANDY (U.S. CL. 46).

SN 76-492,300. CHAMPION IMPORTS, INC., SUGARLAND, TX. FILED 2-25-2003.

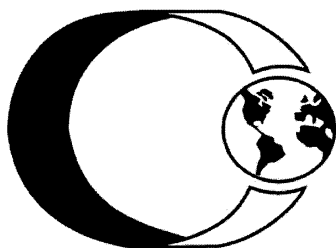

THE MARK CONSISTS OF A STYLIZED LETTER "C", AND A GLOBE.

CLASS 8—HAND TOOLS

FOR TABLEWARE MADE OF PRECIOUS METAL, NAMELY, KNIVES, FORKS, AND SPOONS; NON-ELECTRIC CAN OPENERS, NON-ELECTRIC FRUIT AND VEGETABLE PEELERS (U.S. CLS. 23, 28 AND 44).

CLASS 14—JEWELRY

FOR ASHTRAYS AND CANDLEHOLDERS, BOTH MADE OF PRECIOUS METAL, SERVING TRAYS MADE OF PRECIOUS METAL (U.S. CLS. 2, 27, 28 AND 50).

CLASS 21—HOUSEWARES AND GLASS

FOR SALT AND PEPPER SHAKERS, TEA POTS NOT OF PRECIOUS METAL, CORK SCREWS AND BEVERAGE GLASSWARE, BOTTLE OPENERS, ICE BUCKETS, VASES, TEA SETS, COCKTAIL SHAKERS, MEAL TRAYS, BOWLS (U.S. CLS. 2, 13, 23, 29, 30, 33, 40 AND 50).

SN 76-975,105. COMITE INTERNATIONAL OLYMPIQUE, LAUSANNE, SWITZERLAND, FILED 9-19-2000.

BEIJING 2008

PRIORITY CLAIMED UNDER SEC. 44(D) ON SWITZERLAND APPLICATION NO. 03544/2000, FILED 3-23-2000, REG. NO. 476466, DATED 3-23-2000, EXPIRES 3-23-2010.

CLASS 1—CHEMICALS

FOR UNEXPOSED AND SENSITIZED PHOTOGRAPHIC FILMS AND PHOTOSENSITIVE PAPER (U.S. CLS. 1, 5, 6, 10, 26 AND 46).

CLASS 3—COSMETICS AND CLEANING PREPARATIONS

FOR LAUNDRY BLEACH AND LAUNDRY DETERGENT; HAND AND BODY SOAPS; PERFUME, EAU DE TOILETTE AND AFTER-SHAVE; COSMETICS, NAMELY, CREAMS AND GELS FOR FACIAL AND BODY USE; AND TOOTH PASTES (U.S. CLS. 1, 4, 6, 50, 51 AND 52).

CLASS 4—LUBRICANTS AND FUELS

FOR DIESEL FUEL AND GASOLINE (U.S. CLS. 1, 6 AND 15).

CLASS 5—PHARMACEUTICALS

FOR DIETARY SUPPLEMENTS; CONTACT LENS DISINFECTANTS; CONTACT LENS CLEANING SOLUTIONS AND CONTACT LENS WETTING SOLUTIONS (U.S. CLS. 6, 18, 44, 46, 51 AND 52).

CLASS 6—METAL GOODS

FOR METAL KEYCHAINS; METAL KEYRINGS; METAL MONEYCLIPS; AND METAL NAME BADGES TO BE WORN TO SUPPORT THE APPLICANT'S ACTIVITIES (U.S. CLS. 2, 12, 13, 14, 23, 25 AND 50).

CLASS 9—ELECTRICAL AND SCIENTIFIC APPARATUS

FOR EYEGLASSES; SUNGLASSES; RADIOS; TELEVISIONS; AUDIO AND VIDEO RECORDING APPARATUS NAMELY, OPTICAL DISKS, DISKETTES AND PLAYERS THEREFOR; VIDEO CAMERAS; CAMCORDERS; VIDEO CASSETTE RECORDERS; BLANK AUDIO AND VIDEO TAPES AND CASSETTES; FACSIMILE TRANSMISSION MACHINES; PHOTOGRAPHIC EQUIPMENT, NAMELY CAMERAS AND PROJECTORS; CALCULATORS; BATTERIES; COMPACT DISC PLAYERS; COMPUTERS; COMPUTER OPERATING PROGRAMS AND SYSTEMS; EYEGGLASS FRAMES; FLASH BULBS FOR CAMERAS; TELEPHONES, TELEPHONE RECEIVERS AND TELEPHONE TRANSMITTERS; PHOTOCOPYING MACHINES; CAMERA STRAPS; FASHION EYEGLASSES; EYEGGLASS LENSES; EYEGGLASS CASES; EYEGGLASS CORDS; MAGNETS; BINOCULARS; GRADUATED RULERS; SAFETY GOGGLES; PEDOMETERS; ELECTRIC LIGHT SWITCH PLATES; NEON SIGNS; MAGNIFYING GLASSES; LIFE PRESERVERS; AND SPORTS HELMETS FOR USE IN SOFTBALL, BASEBALL, ROLLER SKATING, IN-LINE ROLLER SKATING, HIKING, MOUNTAIN CLIMBING AND KAYAKING (U.S. CLS. 21, 23, 26, 36 AND 38).

CLASS 12—VEHICLES

FOR VEHICLES, NAMELY, AUTOMOBILES, TRUCKS, BICYCLES, MOTORCYCLES, AND BOATS; AND METAL LICENSE PLATE HOLDERS (U.S. CLS. 19, 21, 23, 31, 35 AND 44).

CLASS 14—JEWELRY

FOR BELT BUCKLES OF PRECIOUS METAL FOR CLOTHING; TIE PINS; TIE CLIPS; TIE-TACKS; ORNAMENTAL LAPEL PINS; JEWELRY, NAMELY CHARMS, PENDANTS, BRACELETS, PINS, CUFF LINKS, NECKLACES, EARRINGS AND RINGS; MEDALLIONS; NON-MONETARY COINS OF PRECIOUS METAL; CLOCKS, WATCHES; CHRONOGRAPHS FOR USE AS WATCHES; STOP WATCHES; WOVEN BRACELETS; MEDALS FOR USE AS AWARDS; NAPKIN RINGS OF PRECIOUS METAL AND GOLD-PLATED OR GOLD-KARAT REPLICAS; BADGES OF PRECIOUS METAL TO BE WORN TO SUPPORT THE APPLICANT'S ACTIVITIES; HAT PINS OF PRECIOUS METALS; AND ORNAMENTAL LAPEL PINS NOT OF PRECIOUS METAL, TO BE WORN TO SUPPORT THE APPLICANT'S ACTIVITIES (U.S. CLS. 2, 27, 28 AND 50).

CLASS 16—PAPER GOODS AND PRINTED MATTER

FOR REPOSITIONABLE NOTE PAPER; ELECTRIC AND NON-ELECTRIC TYPEWRITERS; PRINTED INSTRUCTIONAL AND TEACHING MATERIALS IN THE FIELD OF SPORTS ENTERTAINMENT; NOTE PAPER DISPENSERS; GENERAL FEATURE, COMPUTER, TRAVEL, SPORTS AND FASHION MAGAZINES; NEWSPAPERS FOR GENERAL CIRCULATION; GENERAL PURPOSE PLASTIC BAGS; CALENDARS; ROADMAPS; CATALOGS IN THE FIELD OF SPORTS APPAREL, SPORTS EQUIPMENT, PENS AND STATIONERY SETS, HOUSEHOLD FURNISHING AND CLOTHING CATALOGS; ENVELOPES; CARDBOARD AND PAPER CARTONS; BLANK AND PICTURE POSTCARDS; NOTE CARDS; NOTE PADS; GREETING CARDS; COOKBOOKS; CHILDREN'S ACTIVITY AND COLORING BOOKS; PUFFY STICKERS; ADHESIVE STICKERS, PHOTOGRAPH ALBUMS; MEMORANDUM BOOKS; PENS; PENCILS; FOLDERS AND STATIONERY-TYPE PORTFOLIOS FOR PAPER; NOTEBOOKS AND BINDERS; LETTER OPENERS; MEMO HOLDERS; DIARIES; CLIPBOARDS; BOOK COVERS; BULLETIN BOARDS; ERASABLE MEMO BOARDS; PEN AND PENCIL HOLDERS; PAPER CLIP HOLDERS; PAPER NAPKINS AND TOWELS; TISSUE AND TOILET PAPER; POSTERS; WRITING PAPER AND STATIONERY; GRAPHICS PAPER; NEWSPRINT PAPER; PAPER BANNERS, DECALS AND WINDSHIELD DECAL STRIPS; DRAWING SETS COMPRISED OF PAINTS AND BRUSHES; PAPERWEIGHTS; PENCIL CADDIES; MEMO PADS; ERASERS; STATIONERY HOLDERS; MAPS; DISPOSABLE PAPER

BABY BIBS; DESK SETS; STICKER BOOKS; POSTCARD BOOKS; HOLOGRAPHIC GREETING CARDS; BOOKS TO COLLECT COINS; PENCIL BAGS; PENCIL SHARPENERS; SCORE BOOKS; GIFT WRAP SETS COMPRISED OF WRAPPING PAPER, PAPER BOWS AND GIFT CARDS; CARDBOARD GIFT BOXES; COMIC BOOKS; BOOKMARKS; POSTER BOOKS; PARTY GOODS, NAMELY, PAPER NAPKINS, PAPER PARTY HATS, PAPER PARTY HORNS AND PRINTED INVITATIONS; PAPER PRINTED PARTY SIGNS AND PAPER PRINTED LAWN SIGNS; STAMP PADS; PAPER GROCERY BAGS; AND PAPERWEIGHTS IN THE FORM OF JUMBO-SIZED REPLICAS; RINGS; AND PAPER LUGGAGE TAGS (U.S. CLS. 2, 5, 22, 23, 29, 37, 38 AND 50).

CLASS 18—LEATHER GOODS

FOR KNAPSACKS; ALL-PURPOSE SPORTS BAGS; BACK PACKS; TOTE BAGS; HANDBAGS; PURSES; WALLETS; CREDIT CARD CASES; BRIEFCASE-TYPE LEATHER BUSINESS FOLDERS; BRIEF CASES; ATTACHE CASES OF LEATHER AND VINYL; GARMENT BAGS FOR TRAVEL; GYM BAGS; ALL-PURPOSE SPORTS GEAR CARRYING BAGS; UMBRELLAS; LUGGAGE TRUNKS FOR TRAVELING; PARASOLS, WALKING STICKS; WHIPS; HARNESSSES; SADDLERY; BARREL BAGS; FANNY PACKS; DOG LEASHES; TRAVEL BAGS AND SHOE BAGS FOR TRAVEL; DUFFEL BAGS; SUIT BAGS FOR TRAVEL; SCHOOL BAGS; GYM BAGS SHAPED TO FIT INTO FOOTLOCKERS; PET COLLARS, IDENTIFICATION TAGS NOT MADE OF METAL FOR PETS (U.S. CLS. 1, 2, 3, 22 AND 41).

CLASS 20—FURNITURE AND ARTICLES NOT OTHERWISE CLASSIFIED

FOR FOOT LOCKERS, PILLOWS AND SEAT CUSHIONS; STADIUM SEATS; NONMETAL MONEY CHAINS, NON-METAL KEY RINGS, NON-METAL KEY CHAINS; PICTURE FRAMES; HAND-HELD MIRRORS; ROLLER SHADES FOR WINDOWS WITH SUCTION CUPS; MAGAZINE CADDIES; PLAQUES; SOFT SCULPTURE WALL DECORATIONS; NON-METAL REUSABLE BOTTLE CAPS; NON-METAL CLIPS FOR TABLECLOTHS; HARD PLASTIC BOBBLE-HEAD FIGURINES AND PLASTIC BOBBLE-CAP STATUES; DECORATIVE MOBILES; DECORATIVE MINIATURE STADIUM REPRODUCTIONS, NAMELY, SMALL PLASTIC MODELS OF A STADIUM USED FOR AN INTERNATIONAL ATHLETIC EVENT; STEEL FURNITURE; CHAIRS AND STOOLS; TABLES, FOLDING SPORTS SEATS AND STOOLS; FOOTSTOOLS; CLOTHES HANGERS AND COAT HANGERS; NON-METAL TROPHY CUPS; BEAN BAG CHAIRS; NON-METAL STANDS FOR HOLDING AND DISPLAYING VARIOUS TYPES OF BALLS; PLASTIC FIGURINES; PLASTIC WATER-FILLED SNOW GLOBES; AND WOODEN LETTER BOXES (U.S. CLS. 2, 13, 22, 25, 32 AND 50).

CLASS 21—HOUSEWARES AND GLASS

FOR BOTTLES SOLD EMPTY MADE OF PLASTIC AND GLASS; PAPER AND PLASTIC DRINKING CUPS AND GLASSES; JUGS; DECORATIVE AND COMMEMORATIVE PLATES; DINNERWARE; FIGURINES MADE OF CHINA, CRYSTAL, EARTHENWARE, GLASS, PORCELAIN AND TERRA COTTA; MUGS MADE OF EARTHENWARE, GLASS AND PORCELAIN; LUNCH BOXES AND PAILS; PAPER PLATES; TANKARDS NOT OF PRECIOUS METAL; MEAL TRAYS, WASTEPAPER BASKETS (U.S. CLS. 2, 13, 23, 29, 30, 33, 40 AND 50).

CLASS 25—CLOTHING

FOR BELTS, NECKTIES; SUSPENDERS; BANDANAS; BEACH SANDALS; INFANT AND TODDLER SLEEPWEAR; BATHROBES; NIGHTSHIRTS, PAJAMAS AND LOUNGEWEAR; BEACH COVER-UP DRESSES; CLOTH DIAPER SETS; TODDLER SHORT AND TOP SETS; GIRLS KNIT DRESSES WITH PANTS SETS; BOYS SHORTS AND TOP SETS; GIRLS SKIRT/PANTY COMBINATIONS; SOCKS; PLAYSUITS; COVERALLS; UNION SUITS; COLLARLESS SHIRTS; SHORTS; PANTS AND SLACKS; SHIRTS; JACKETS; JUDGES, TEAM, REFEREE AND UMPIRE UNIFORMS; SWEATERS; PARKAS; TURTLENECKS; MITTENS; GLOVES; UNDERWEAR; ROMPERS; JERSEYS; MATERNITY TOPS; BOWTIES; HEADWEAR AND SCARVES; EAR MUFFS, EARBANDS AND HEADBANDS; HOSIERY; RAINWEAR, NAMELY, RAIN PONCHOS AND JACKETS; FOOTWEAR, NAMELY SHOES, BOOTS AND SLIPPERS; BATH THONGS; NYLON SHELLS; HATS; CAPS; VISORS; APRONS; SKI AND CLOTH BIBS; UNIFORM REPRODUCTIONS; CANVAS FOOTWEAR; KNICKERS; WIND-RESISTANT JACKETS; T-SHIRTS; SWEATSHIRTS; SWEATPANTS; BASEBALL CAPS; COATS; PULLOVERS; ONE-PIECE SKI SUITS; GOLF SHIRTS AND HATS; BLAZERS; LEGWARMERS; SEQUINED EVENING TOPS; JEANS; LEOTARDS; WORKOUT AND SPORTS APPAREL, NAMELY, SHORTS, JACKETS, SLACKS AND SKIRTS; AND SKI MASKS (U.S. CLS. 22 AND 39).

CLASS 26—FANCY GOODS

FOR CLOTH PATCHES FOR CLOTHING; EMBROIDERED EMBLEMS; BOWS AND RIBBONS FOR GIFT WRAPPING; HAT ORNAMENTS NOT OF PRECIOUS METAL; AND PLASTIC, ORNAMENTAL NOVELTY BUTTONS (U.S. CLS. 37, 39, 40, 42 AND 50).

CLASS 28—TOYS AND SPORTING GOODS

FOR DOLLS AND STUFFED TOY ANIMALS; TOY SCALE MODEL VEHICLES; JIGSAW PUZZLES; CHRISTMAS TREE ORNAMENTS AND CHRISTMAS TREE DECORATIONS, BUT EXCLUDING CONFECTIONERY AND ILLUMINATION ARTICLES; COMMEMORATIVE SPORTS BALLS WITH THE LOGO OF AN INTERNATIONAL ATHLETIC EVENT ON THEM; ACTION PUPPETS; TOY PLASTIC MINI-HELMETS; BLOW-UP TOYS, NAMELY BEACH BALLS, NOVELTY FLOTATION DEVICES FOR RECREATIONAL USE AND COMMEMORATIVE MASCOT DOLLS; BOBBLE-HEAD DOLLS; HAND PUPPETS; TEDDY BEARS; DARTBOARD CABINETS AND DARTS; CHRISTMAS STOCKINGS; BASKETBALL BACKBOARDS; GOLF BAG COVERS; SHOULDER STRAP PADS FOR GOLF BAGS; PLASTIC YO-YOS; ACTION FIGURES AND ACCESSORIES TO BE USED WITH ACTION FIGURES; AERODYNAMIC DISCS FOR PLAYING BOARD GAMES; MARBLES; KITES; ARCHERY SETS; TOY TRUCKS; RUBBER AND WOODEN SPORTS BALLS; JUMP ROPES; ATHLETIC SUPPORTERS; TENNIS, BADMINTON, VOLLEY BALL AND GOALIE NETS; FIELD HOCKEY STICKS; PLASTIC TOY HOOPS; IRON SHOTS SPECIFICALLY FOR USE IN THE SHOT PUT COMPETITION; TENNIS, RACQUETBALL AND BADMINTON RACKETS; TABLE TENNIS PADDLES; BASEBALL AND CRICKET BATS; GYMNASIAC EQUIPMENT, NAMELY, BOTTLE-SHAPED CLUBS; BALLOONS; BASEBALL, SAILING, BOXING, SKI, KARATE, SOFTBALL AND HOCKEY GLOVES; BOWLING BALL BAGS; TOY MODEL TRAIN SETS; RADIO-OPERATED TOY VEHICLES; TOYS FOR PETS; COIN AND NON-COIN OPERATED PINBALL MACHINES; FISHING LURES; DISCUSES; EXERCISE EQUIPMENT, NAMELY, BARBELLS AND WEIGHT-LIFT BENCHES; SPORTS GOGGLES FOR USE IN SKIING RACQUETBALL, SWIMMING, SNORKELING AND SCUBA DIVING; PAPER CHRISTMAS TREE DECORATIONS; ATHLETIC EQUIPMENT SHAPED NYLON BAGS FOR CARRYING TENNIS RACKETS; SKIS AND SQUASH RACKETS; AND HAND-HELD UNITS FOR PLAYING VIDEO GAMES; TOY PLASTIC MINI-HELMETS (U.S. CLS. 22, 23, 38 AND 50).

CLASS 29—MEATS AND PROCESSED FOODS

FOR MEAT, FISH, POULTRY AND GAME; MEAT EXTRACTS; PRESERVED, DRIED AND COOKED FRUITS AND VEGETABLES; JELLIES, JAMS, FRUIT SAUCES; EGGS, MILK, CHEESE AND YOGURT; AND EDIBLE OILS AND EDIBLE FATS (U.S. CL. 46).

CLASS 30—STAPLE FOODS

FOR COFFEE, TEA, COCOA, SUGAR, RICE, TAPIOCA AND SAGO; FLOUR, BISCUITS AND COOKIES; FLAVORED ICES; HONEY AND TREACLE; YEAST, BAKING-POWDER; SALT, MUSTARD; VINEGAR; SAUCES; CONDIMENTS, NAMELY, MAYONNAISE, KETCHUP AND RELISH; SPICES; AND ICE CREAM; ICE MILK AND FROZEN YOGURT (U.S. CL. 46).

CLASS 32—LIGHT BEVERAGES

FOR BEERS; MINERAL AND AERATED WATERS; FRUIT DRINKS AND FRUIT JUICE CONCENTRATES; CARBONATED, LOW CALORIE, AND NON-CARBONATED SOFT DRINKS AND SYRUPS FOR THE PREPARATION OF SOFT DRINKS (U.S. CLS. 45, 46 AND 48).

CLASS 35—ADVERTISING AND BUSINESS

FOR ADVERTISING SERVICES, NAMELY, DIRECT MAIL ADVERTISING (U.S. CLS. 100, 101 AND 102).

CLASS 36—INSURANCE AND FINANCIAL

FOR FINANCIAL MANAGEMENT, FINANCING SERVICES, CREDIT CARD SERVICES, AND INSURANCE UNDERWRITING IN THE FIELDS OF ACCIDENT, LIFE AND FIRE (U.S. CLS. 100, 101 AND 102).

CLASS 38—COMMUNICATION

FOR RADIO AND TELEVISION BROADCASTING, AND BROADCASTING PROGRAMS VIA A GLOBAL COMPUTER NETWORK (U.S. CLS. 100, 101 AND 104).

CLASS 39—TRANSPORTATION AND STORAGE

FOR COURIER SERVICES (U.S. CLS. 100 AND 105).

CLASS 42—SCIENTIFIC, COMPUTER AND LEGAL SERVICES

FOR RESTAURANT SERVICES, LEGAL SERVICES, AND THE LICENSING OF INTELLECTUAL PROPERTY (U.S. CLS. 100 AND 101).

SN 76-975,309. TREVIRA GMBH, FRANKFURT AM MAIN, FED REP GERMANY, FILED 8-2-2001.

SN 78-020,916. BLACKHEART RECORDS, INC., NEW YORK, NY, FILED 8-12-2000.



CLASS 22—CORDAGE AND FIBERS

FOR RAW FIBROUS TEXTILE MATERIALS, FIBER AND FILAMENTS, FOR TEXTILE USE (U.S. CLS. 1, 2, 7, 19, 22, 42 AND 50).

CLASS 23—YARNS AND THREADS

FOR YARNS AND THREADS, FOR TEXTILE USE (U.S. CL. 43).

CLASS 24—FABRICS

FOR WOVEN AND KNITTED FABRICS FOR THE MANUFACTURE OF CLOTHING (U.S. CLS. 42 AND 50).

SN 76-975,408. AMERICAN INSTITUTE FOR MANAGING DIVERSITY, INC., ATLANTA, GA. FILED 7-1-2002.

DIVERSITY LEADERSHIP ACADEMY

CLASS 14—JEWELRY

FOR LAPEL PINS (U.S. CLS. 2, 27, 28 AND 50).
FIRST USE 1-0-2001; IN COMMERCE 1-0-2001.

CLASS 16—PAPER GOODS AND PRINTED MATTER

FOR WRITING PENS AND NOTEBOOKS (U.S. CLS. 2, 5, 22, 23, 29, 37, 38 AND 50).
FIRST USE 1-0-2001; IN COMMERCE 1-0-2001.

CLASS 18—LEATHER GOODS

FOR TOTE BAGS AND BUSINESS CARD CASES (U.S. CLS. 1, 2, 3, 22 AND 41).
FIRST USE 1-0-2001; IN COMMERCE 1-0-2001.

THE RUNAWAYS

CLASS 25—CLOTHING

FOR SHIRTS AND T-SHIRTS (BASED ON USE IN COMMERCE); HATS, CAPS, BASEBALL CAPS AND JACKETS (BASED ON INTENT TO USE) (U.S. CLS. 22 AND 39).

FIRST USE 12-1-1990; IN COMMERCE 12-1-1990.

CLASS 41—EDUCATION AND ENTERTAINMENT

FOR ENTERTAINMENT SERVICES, NAMELY, LIVE PERFORMANCES BY A MUSICAL AND SINGING GROUP (BASED UPON INTENT TO USE) (U.S. CLS. 100, 101 AND 107).

SN 78-026,408. GPC BIOTECH AG, MUNICH, FED REP GERMANY, FILED 9-18-2000.



NO CLAIM IS MADE TO THE EXCLUSIVE RIGHT TO USE "BIOTECH", APART FROM THE MARK AS SHOWN.

CLASS 5—PHARMACEUTICALS

FOR PHARMACEUTICAL PREPARATIONS AND FORMULATIONS, DIAGNOSTIC PREPARATIONS AND MEDICATED HEALTH PREPARATIONS FOR USE IN THE DIAGNOSIS AND TREATMENT OF HUMAN DISEASES AND DISORDERS, NAMELY, CIRCULATORY, RESPIRATORY, ENDOCRINE, NEUROLOGIC, CARDIOVASCULAR, ALIMENTARY, ONCOLOGIC, AUTO-IMMUNE OR IMMUNE-RELATED, PULMONARY, MUSCULOSKELETAL, LYMPHATIC, GASTROINTESTINAL, BONE SENSORY, VIRAL, URINARY, RENAL INFECTIOUS, METABOLIC OR CENTRAL NERVOUS SYSTEM DISEASES OR DISORDERS; VETERINARY VACCINES FOR BIRDS AND MAMMALS, NAMELY, LIVESTOCK, CATS, DOGS AND RODENTS; INSECTICIDES, FUNGICIDES AND HERBICIDES FOR COMMERCIAL, AGRICULTURAL AND DOMESTIC USE (U.S. CLS. 6, 18, 44, 46, 51 AND 52).

CLASS 9—ELECTRICAL AND SCIENTIFIC APPARATUS

FOR SCIENTIFIC APPARATUS, NAMELY AN APPARATUS FOR SCREENING PHARMACEUTICAL, DIAGNOSTIC, CHEMICAL, BIOCHEMICAL, BIOLOGICAL AND BIOTECHNOLOGICAL SAMPLES, IDENTIFYING THE CONTENT OF SUCH SAMPLES, MEASURING PATTERNS AND EQUIPMENT, NAMELY PICKING ROBOTS, SPOTTING ROBOTS, ARRAYING AND RE-ARRAYING ROBOTS, AUTOMATED PIPETTING, MICROPIPETTING AND CELL SORTING DEVICES, SCANNERS, READERS, DETECTORS AND PLACE HANDLERS, FOR MAKING AND SCREENING MOLECULAR ARRAYS, AND PARTS THEREFOR; DATA PROCESSORS; COMPUTERS; COMPUTER PROGRAMS FOR DATA MANAGEMENT, MANIPULATION AND ANALYSIS FOR USE IN THE FIELD OF GENOMICS AND DRUG DEVELOPMENT (U.S. CLS. 21, 23, 26, 36 AND 38).

CLASS 42—SCIENTIFIC, COMPUTER AND LEGAL SERVICES

FOR SCIENTIFIC RESEARCH; INDUSTRIAL RESEARCH AND CONTRACT RESEARCH SERVICES FOR OTHERS IN THE FIELD OF ANALYTICAL CHEMISTRY, BIOCHEMISTRY, MEDICINAL CHEMISTRY, DRUG DEVELOPMENT, BIOTECHNOLOGY, MICROBIOLOGY AND MOLECULAR BIOLOGY, AND CHEMICAL, BIOCHEMICAL AND BIOTECHNOLOGICAL ANALYSIS; MEDICAL RESEARCH; COMPUTER SOFTWARE DESIGN FOR OTHERS (U.S. CLS. 100 AND 101).

SN 78-030,006. NUPI S.P.A., IMOLA (BOLOGNA), ITALY, FILED 10-10-2000.

CHEMPEX**CLASS 11—ENVIRONMENTAL CONTROL APPARATUS**

FOR PIPES BEING PART OF SANITARY FACILITIES, NAMELY, NON-METAL PIPES, NON-METAL PIPE FITTINGS AND NON-METAL JUNCTIONS AND NON-METAL LINERS FOR METAL PIPES FOR CONVEYING HOT AND COLD WATER, WASTE WATER, GEOTHERMAL WATER AND AQUEOUS SLURRIES AND SUSPENSIONS FOR USE IN WATER SUPPLY SYSTEMS AND WASTE WATER TREATMENT (U.S. CLS. 13, 21, 23, 31 AND 34).

FIRST USE 5-1-2000; IN COMMERCE 7-4-2000.

SN 78-026,717. LAUREN-WAWRZYNIAK, GREG, SAN DIEGO, CA. FILED 9-19-2000.



THE LINING IS A FEATURE OF THE MARK AND DOES NOT INDICATE COLOR.

CLASS 35—ADVERTISING AND BUSINESS

FOR PRODUCT MARKETING SERVICES, NAMELY, PROMOTING GOODS AND SERVICES OF OTHERS THROUGH THE DISTRIBUTION OF PRINTED MATERIALS AND COMMERCIAL, AND PRODUCT MERCHANDISING (U.S. CLS. 100, 101 AND 102).

CLASS 42—SCIENTIFIC, COMPUTER AND LEGAL SERVICES

FOR NEW PRODUCT DESIGN AND DEVELOPMENT FOR OTHERS (U.S. CLS. 100 AND 101).

CLASS 17—RUBBER GOODS

FOR NON-METAL PIPES, NON-METAL PIPE FITTINGS AND NON-METAL JUNCTIONS AND NON-METAL LINERS FOR METAL PIPES FOR PURPOSES OF PLUMBING AND CONVEYING NATURAL GAS, NAMELY, CONVEYING HOT AND COLD WATER, WASTE WATER, GEOTHERMAL WATER, SLURRIES AND SUSPENSIONS, LIQUID HYDROCARBONS, NATURAL GAS, GASEOUS FUELS, AND CHEMICAL PROCESS GAS SUCH AS WATER VAPOR CONTAINING OTHER VAPOR AND SOLIDS FOR USE IN POWER PLANTS, INDUSTRIAL HOT AND COLD WATER CONVEYANCE PIPE WORK, PUBLIC UTILITIES FOR WATER HEATING, OIL FIELD RE-INJECTION, CONVEYANCE SYSTEM FOR GASEOUS FUELS, PIPING SYSTEMS FOR CONVEYING SLURRIES, AND GEOTHERMAL PIPING SYSTEMS (U.S. CLS. 1, 5, 12, 13, 35 AND 50).

FIRST USE 5-1-2000; IN COMMERCE 7-4-2000.

CLASS 19—NON-METALLIC BUILDING MATERIALS

FOR NON-METAL WATER PIPES, NON-METAL WATER PIPE FITTINGS AND NON-METAL JUNCTIONS AND NONMETAL LINERS FOR METAL WATER PIPES FOR CONVEYING HOT AND COLD WATER, WASTE WATER, GEOTHERMAL WATER, FOR USE IN WATER SUPPLY SYSTEMS, POWER PLANTS, INDUSTRIAL HOT AND COLD WATER CONVEYANCE PIPE WORK, WASTE WATER TREATMENT, PUBLIC UTILITIES FOR WATER HEATING, OIL FIELD RE-INJECTION, CONVEYANCE SYSTEM FOR GASEOUS FUELS, PIPING SYSTEM FOR CONVEYING SLURRIES, AND GEOTHERMAL PIPING SYSTEMS (U.S. CLS. 1, 12, 33 AND 50).

FIRST USE 5-1-2000; IN COMMERCE 7-4-2000.

SN 78-028,187. ONSHORE, INC., CHICAGO, IL. FILED 9-28-2000.

COMPLETEIT**CLASS 37—CONSTRUCTION AND REPAIR**

FOR GLOBAL COMPUTER MANAGEMENT SERVICES FOR OTHERS, NAMELY AN INTEGRATED SET OF SERVICES COMPRISING COMPUTER NETWORK INSTALLATION (U.S. CLS. 100, 103 AND 106).

CLASS 42—SCIENTIFIC, COMPUTER AND LEGAL SERVICES

FOR GLOBAL COMPUTER MANAGEMENT SERVICES FOR OTHERS, NAMELY AN INTEGRATED SET OF SERVICES COMPRISING COMPUTER NETWORK DESIGN AND MANAGEMENT (U.S. CLS. 100 AND 101).

SN 78-033,567. AT&T CORP., NEW YORK, NY. FILED 11-2-2000.

VENTARIS**CLASS 35—ADVERTISING AND BUSINESS**

FOR ON-LINE RETAIL PURCHASING CLUB; WHOLESALE AND RETAIL DISTRIBUTORSHIP OF BOOKS; RETAIL BOOK STORE SERVICES; COMPUTERIZED ON-LINE RETAIL AND WHOLESALE ORDERING SERVICES FEATURING BOOKS, CLOTHING, SHOES, CONSUMER ELECTRONIC PRODUCTS, TOYS, FOOD, BEVERAGES, PHONORECORDS, VIDEOS, TAPES, COMPACT DISCS AND COMPUTER SOFTWARE; AND ON-LINE DIRECTORY SERVICES, NAMELY, PROVIDING LINKS TO ALUMNI AND PROFESSIONAL GROUPS (U.S. CLS. 100, 101 AND 102).

CLASS 36—INSURANCE AND FINANCIAL

FOR BILL PAYMENT SERVICES, NAMELY PAYMENT PROCESSING, BY MEANS OF A GLOBAL COMPUTER NETWORK, BY MAIL, COURIER, TELEPHONE AND FACSIMILE (U.S. CLS. 100, 101 AND 102).

SN 78-045,712. GENERAL ELECTRIC COMPANY, SCHE-NECTADY, NY. FILED 1-30-2001.

CLASS 37—CONSTRUCTION AND REPAIR

FOR INSTALLATION OF COMPUTER NETWORKS (U.S. CLS. 100, 103 AND 106).

CLASS 38—COMMUNICATION

FOR PROVIDING MULTIPLE-USER ACCESS TO INFORMATION NETWORK; PROFESSIONAL CONSULTANCY SERVICES RELATING TO COMMUNICATIONS (U.S. CLS. 100, 101 AND 104).

CLASS 39—TRANSPORTATION AND STORAGE

FOR TRAVEL BOOKING AGENCY SERVICES BY ELECTRONIC AND NON-ELECTRONIC MEANS, NAMELY, BY COMPUTER, BY MAIL, COURIER, TELEPHONE, AND FACSIMILE; PROVIDING INFORMATION REGARDING TRANSPORTATION BOOKINGS THROUGH NON-ELECTRONIC MEANS AND AN ELECTRONIC DATABASE; ELECTRONIC STORAGE OF MESSAGES AND DATA (U.S. CLS. 100 AND 105).

CLASS 42—SCIENTIFIC, COMPUTER AND LEGAL SERVICES

FOR MAKING RESERVATIONS AND BOOKINGS FOR TEMPORARY LODGING; PROVIDING INFORMATION IN CONNECTION WITH TEMPORARY LODGING; PRINTING TICKETS FOR AIR TRAVEL AND LODGING FOR OTHERS; PROVIDING AN INTERACTIVE DATABASE FEATURING AUTOMATICALLY UPDATING ADDRESS BOOK, PERSONAL PLANNER, DATE REMINDER ALL VIA A GLOBAL COMPUTER NETWORK; PROVIDING TEMPORARY USE OF ON-LINE NON-DOWNLOADABLE SOFTWARE FOR EVENT SCHEDULING AND FOR SORTING, CREATING, VIEWING AND EDITING ADDRESS BOOKS AND OTHER PERSONAL AND PROFESSIONAL CONTACT INFORMATION; COMPUTER SERVICES, NAMELY, PROVIDING SEARCH ENGINES FOR LOCATING INFORMATION, RESOURCES, AND THE ELECTRONIC GREETING CARDS VIA A GLOBAL COMPUTER NETWORK; PROFESSIONAL CONSULTANCY SERVICES RELATING TO THE INTERNET; HIRE, RENTAL AND LEASING OF COMPUTER AND DATA PROCESSING APPARATUS; COMPUTER PROGRAMMING FOR OTHERS; INSTALLATION AND MAINTENANCE OF COMPUTER SOFTWARE; INTEGRATION OF COMPUTER SYSTEMS AND NETWORKS; COMPUTER SERVICES, NAMELY, DESIGNING AND IMPLEMENTING NETWORK WEBPAGES FOR OTHERS; COMPUTER SERVICES, NAMELY, DESIGNING AND IMPLEMENTING WEBSITES FOR OTHERS; AND HOSTING THE WEB SITES OF OTHERS (U.S. CLS. 100 AND 101).

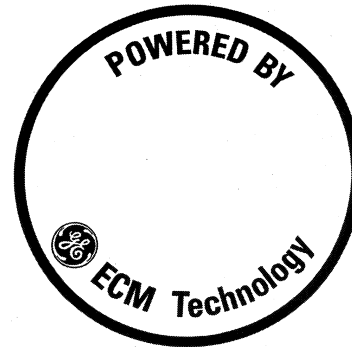

NO CLAIM IS MADE TO THE EXCLUSIVE RIGHT TO USE "TECHNOLOGY", APART FROM THE MARK AS SHOWN.

CLASS 7—MACHINERY

FOR DC MOTOR CONTROLLERS, BRUSHLESS DC MOTORS, BRUSHLESS DC MOTORS AND CONTROLLERS SOLD AS A UNIT (U.S. CLS. 13, 19, 21, 23, 31, 34 AND 35).

FIRST USE 0-0-1984; IN COMMERCE 0-0-1984.

CLASS 42—SCIENTIFIC, COMPUTER AND LEGAL SERVICES

FOR PROMOTING PUBLIC AWARENESS OF THE USER OF DC MOTORS, BRUSHLESS DC MOTORS AND DC MOTOR CONTROLLERS (U.S. CLS. 100 AND 101).

FIRST USE 0-0-1984; IN COMMERCE 0-0-1984.

SN 78-049,641. INTERNATIONAL DATA GROUP, INC., FRAMINGHAM, MA. FILED 2-22-2001.

PLAYSMART**CLASS 16—PAPER GOODS AND PRINTED MATTER**

FOR PRINT PUBLICATIONS, NAMELY, NEWSLETTERS, MAGAZINES, AND SUPPLEMENTS SOLD THEREWITH, JOURNALS AND NEWSPAPERS IN THE FIELDS OF INTERACTIVE ENTERTAINMENT, COMPUTERS, COMPUTER SOFTWARE, ONLINE SERVICES, HIGH TECHNOLOGY, COMMUNICATIONS, INFORMATION TECHNOLOGY AND INFORMATION SERVICES (U.S. CLS. 2, 5, 22, 23, 29, 37, 38 AND 50).

FIRST USE 6-0-2001; IN COMMERCE 6-0-2001.

CLASS 42—SCIENTIFIC, COMPUTER AND LEGAL SERVICES

FOR PROVIDING A WEBSITE OF INFORMATION IN THE FIELDS OF INTERACTIVE ENTERTAINMENT, COMPUTERS, COMPUTER SOFTWARE, ONLINE SERVICES, COMMUNICATIONS, INFORMATION TECHNOLOGY AND INFORMATION SERVICES; PROVIDING ONLINE PUBLICATIONS, NAMELY, NEWSLETTERS, MAGAZINES, AND SUPPLEMENTS SOLD THEREWITH, JOURNALS AND NEWSPAPERS IN THE FIELDS OF INTERACTIVE ENTERTAINMENT, COMPUTERS, COMPUTER SOFTWARE, ONLINE SERVICES, HIGH TECHNOLOGY, COMMUNICATIONS, INFORMATION TECHNOLOGY AND INFORMATION SERVICES (U.S. CLS. 100 AND 101).

FIRST USE 11-0-2001; IN COMMERCE 11-0-2001.

SN 78-050,856. FUNDA N.V., 1097 DN AMSTERDAM, NETHERLANDS, FILED 3-1-2001.

FUNDA

PRIORITY CLAIMED UNDER SEC. 44(D) ON BENELUX APPLICATION NO. 972029, FILED 2-24-2001, REG. NO. 0685680, DATED 8-24-2000, EXPIRES 8-24-2010.

CLASS 35—ADVERTISING AND BUSINESS

FOR ADVERTISING AGENCIES; DISSEMINATION OF ADVERTISING MATTER; PLACEMENT OF ADVERTISEMENTS FOR OTHERS; COMMERCIAL INFORMATION AGENCIES; COMMERCIAL INFORMATION IN THE FIELD OF REAL ESTATE AND RELATED PRODUCTS AND SERVICES; ORGANIZATION OF EXHIBITIONS FOR OTHERS FOR COMMERCIAL PURPOSES; DIRECT MAIL MARKETING SERVICES; BUSINESS MARKETING SERVICES PROVIDED IN THE REAL ESTATE INDUSTRY; COOPERATIVE ADVERTISING AND MARKETING; PROVIDING BUSINESS MARKETING INFORMATION; CONDUCTING MARKETING STUDIES, MULTI-LEVEL MARKETING BUSINESS SERVICES; BUSINESS MARKETING CONSULTING SERVICES RELATING TO DOING BUSINESS VIA THE INTERNET WITH E-COMMERCE; PUBLIC RELATIONS; BUSINESS CONSULTATION; BUSINESS ADMINISTRATION AND INFORMATION RELATED THERETO IN THE FIELD OF REAL ESTATE; BUSINESS MANAGEMENT CONSULTATION; BUSINESS ORGANIZATIONAL CONSULTATION; MARKETING AND DIRECT MARKETING SERVICES OF A DATABASE, NAMELY, DATABASE MANAGEMENT; PROMOTING THE GOODS AND SERVICES OF OTHERS THAT ARE DIRECTLY OR INDIRECTLY RELATED TO THE REAL ESTATE MARKET BY PREPARING AND PLACING ADVERTISEMENTS IN AN ELECTRONIC MAGAZINE ACCESSED THROUGH A GLOBAL COMPUTER NETWORK, BY PROVIDING A WEBSITE AT WHICH USERS CAN LINK TO REAL ESTATE MARKET INFORMATION, AND THROUGH ON-LINE ORDERING AND CATALOGING OF THOSE GOODS AND SERVICES; PROVISION OF INFORMATION IN THE FIELD OF REAL ESTATE CONCERNING LIVING, HOUSES AND MERCHANDISING VIA A GLOBAL COMPUTER NETWORK; AUCTIONS VIA AN INTERACTIVE ON-LINE BULLETIN BOARD ON A GLOBAL COMPUTER NETWORK; PROVIDING COMMERCIAL INFORMATION IN THE FIELD OF LIVING VIA A GLOBAL COMPUTER NETWORK; PROVIDING HOME SHOPPING SERVICES IN THE FIELD OF GOODS AND SERVICES THAT ARE DIRECTLY OR INDIRECTLY RELATED TO REAL ESTATE MARKET BY MEANS OF TELEVISION; MAIL ORDER CATALOG SERVICES FEATURING GOODS AND SERVICES THAT ARE DIRECTLY OR INDIRECTLY RELATED TO REAL ESTATE MARKET; MAILING LIST PREPARATION; MARKET CANVASSING, BUSINESS RESEARCH AND ANALYSIS, VIA A GLOBAL COMPUTER NETWORK; FRANCHISING, NAMELY, OFFERING TECHNICAL ASSISTANCE IN THE ESTABLISHMENT AND/OR OPERATION OF REAL ESTATE AGENTS AND THEIR POTENTIAL PARTNERS (U.S. CLS. 100, 101 AND 102).

CLASS 36—INSURANCE AND FINANCIAL

FOR PROVIDING CONSULTATION IN THE FIELD OF MORTGAGES, INSURANCE, PENSIONS, SAVINGS, CREDIT, FINANCIAL AFFAIRS AND BANKING; PROVIDING ASSISTANCE, NAMELY, INFORMATION PROVISION, INTERMEDIARY IN THE FIELD OF MORTGAGES, INSURANCE, PENSIONS, SAVINGS, CREDIT, FINANCIAL AFFAIRS AND BANKING; REAL ESTATE AGENCIES, THE AFORE-MENTIONED SERVICES RENDERED VIA A GLOBAL COMPUTER NETWORK (U.S. CLS. 100, 101 AND 102).

CLASS 39—TRANSPORTATION AND STORAGE

FOR ELECTRONIC STORAGE OF DATA, ORDER PLACEMENTS AND WEBSITE USERS BEHAVIOR (U.S. CLS. 100 AND 105).

CLASS 42—SCIENTIFIC, COMPUTER AND LEGAL SERVICES

FOR CONSULTANCY ABOUT THE USE AND APPLICATION OF THE INTERNET WITH REGARD TO E-COMMERCE; RENTAL OF ACCESS TIME TO COMPUTER DATA BASES VIA THE INTERNET AND OTHER ELECTRONIC MEANS; RESEARCH AND CONSULTANCY CONCERNING LEGAL MATTERS; DESIGN OF COMPUTER INFORMATION SYSTEMS FOR OTHERS; PROGRAMMING AND IMPLEMENTATION OF COMPUTER INFORMATION SYSTEMS FOR OTHERS, THE AFORE-MENTIONED SERVICES OFFERED OR RENDERED VIA A GLOBAL COMPUTER NETWORK OR OTHERWISE (U.S. CLS. 100 AND 101).

SN 78-056,280. MASTERWIN INTERNATIONAL HOLDINGS LIMITED, TSUEN WAN, NEW TERRITORIES, HONG KONG, FILED 4-2-2001.

**CLASS 6—METAL GOODS**

FOR NON-ELECTRIC CABLES AND WIRES OF COMMON METAL; PIPES AND TUBES OF METAL; METAL SAFES; GOODS OF COMMON METAL NOT INCLUDED IN OTHER CLASSES, NAMELY KEY RINGS AND TOOL BOXES (U.S. CLS. 2, 12, 13, 14, 23, 25 AND 50).

CLASS 14—JEWELRY

FOR PRECIOUS METALS AND THEIR ALLOYS; GOODS IN PRECIOUS METAL OR COATED THEREWITH NOT INCLUDED IN OTHER CLASSES NAMELY, JEWELRY; PRECIOUS STONE; HOROLOGICAL AND CHRONOMETRIC INSTRUMENTS, NAMELY, DESK CLOCKS AND WALL CLOCKS; PEN HOLDERS OF PRECIOUS METAL; NAME CARD HOLDERS OF PRECIOUS METAL; PAPER CLIPS HOLDERS OF PRECIOUS METAL; ASHTRAYS MADE OF PRECIOUS METAL; TIE CLIPS, CUFFLINKS, BELT-BUCKLES OF PRECIOUS METAL; PILL CASES MADE OF PRECIOUS METAL; AND CIGARETTE CASES OF PRECIOUS METAL (U.S. CLS. 2, 27, 28 AND 50).

CLASS 16—PAPER GOODS AND PRINTED MATTER

FOR PAPER, CARDBOARD AND GOODS MADE FROM THESE MATERIALS NOT INCLUDED IN OTHER CLASSES, NAMELY, PACKAGING BOXES OF PAPER AND CARDBOARD; BOOKBINDING MATERIAL; PHOTOGRAPHS, STATIONERY; ADHESIVES FOR STATIONERY OR HOUSEHOLD PURPOSES; ARTISTS' MATERIALS, NAMELY, PENCILS, PAINTS; PAINT BRUSHES; TYPEWRITERS AND OFFICE REQUISITES NOT INCLUDING FURNITURE, NAMELY, STAPLES, RUBBER BANDS; PLASTIC MATERIALS FOR PACKAGING, NAMELY WRAPPERS, BAGS; PLAYING CARDS; PRINTERS' TYPE; PRINTING BLOCKS; BUSINESS CARD HOLDERS, LETTER OPENERS, TAPE DISPENSERS, PENS, PEN STANDS, BOOKMARKS, MEMO PAD HOLDERS, PEN HOLDERS NOT OF PRECIOUS METAL (U.S. CLS. 2, 5, 22, 23, 29, 37, 38 AND 50).

CLASS 40—MATERIAL TREATMENT

FOR MANUFACTURE OF DESKTOPS, DESKTOP SETS, NAME CARD HOLDERS, MEMO PAD HOLDERS, NAME CARD CASES, MONEY CLIPS, BOOKMARKS, PHOTO FRAMES, CLOCKS, KEY HOLDERS, LETTER OPENERS, WINE AND CIGAR ACCESSORIES, MEN'S WEAR ACCESSORIES, ORGANIZERS AND WALLETS TO THE ORDER AND SPECIFICATION OF OTHERS (U.S. CLS. 100, 103 AND 106).

CLASS 42—SCIENTIFIC, COMPUTER AND LEGAL SERVICES

FOR DESIGN OF DESKTOP PRODUCTS, DESKTOP SETS, GOLF SERIES, NAME CARD HOLDERS, HOLDERS FOR DESK ACCESSORIES, NAMELY CARD CASES, MONEY CLIPS, BOOKMARKS, PHOTO FRAMES, CLOCKS, KEY HOLDERS, LETTER OPENERS, WINE AND CIGAR ACCESSORIES, MEN'S WEAR ACCESSORIES, ORGANIZERS AND WALLETS; JEWELRY DESIGNING IN THE NATURE OF TRINKET DESIGN, PACKAGING DESIGN SERVICES (U.S. CLS. 100 AND 101).

SN 78-059,302. NOVO INTERNATIONAL COMPANY LIMITED, NEW TERRITORIES, HONG KONG, FILED 4-19-2001.

NoVo

THE ENGLISH TRANSLATION OF THE SUBJECT MARK IS "NEW".

CLASS 6—METAL GOODS

FOR TRANSPORTABLE BUILDING OF METAL; NON-ELECTRIC CABLES AND WIRES OF COMMON METAL; PIPES AND TUBES OF METAL, METAL SAFES, METAL GOODS, NAMELY METAL KEY RINGS AND TOOL BOXES AND EXCLUDING PARTS OF MACHINERY, NAMELY, FORMS OF METAL AND PLASTIC FOR PRINTING, COATING OR STAMPING OF STRIP SHAPED METAL (U.S. CLS. 2, 12, 13, 14, 23, 25 AND 50).

CLASS 14—JEWELRY

FOR PEN HOLDERS OF PRECIOUS METAL; NAME CARD HOLDERS OF PRECIOUS METAL; CIGARETTE CASES OF PRECIOUS METAL; ASHTRAYS OF PRECIOUS METAL (U.S. CLS. 2, 27, 28 AND 50).

CLASS 16—PAPER GOODS AND PRINTED MATTER

FOR PAPER, CARDBOARD AND GOODS MADE FROM THESE MATERIALS, NAMELY, PAPER AND CARDBOARD BOXES; PHOTOGRAPHS; STATIONARY; ADHESIVES FOR STATIONARY OR HOUSEHOLD PURPOSES; ARTISTS' MATERIALS, NAMELY, PENCILS, PAINTS AND PAINTBRUSHES; OFFICE REQUISITES, NAMELY, STAPLERS AND RUBBER BANDS; PLASTIC BAGS FOR PACKAGING; PLASTIC WRAP; PLAYING CARDS; PRINTERS' FONTS; PRINTING BLOCKS; LETTER OPENERS; ADHESIVE TAPE DISPENSERS FOR HOUSEHOLD OR STATIONARY USE; PENS; PEN STANDS; BOOK MARKS; MEMO PAD HOLDERS; PEN HOLDERS NOT OF PRECIOUS METAL (U.S. CLS. 2, 5, 22, 23, 29, 37, 38 AND 50).

CLASS 40—MATERIAL TREATMENT

FOR MANUFACTURE OF DESKTOP PRODUCTS, DESKTOP SETS, BUSINESS CARD HOLDERS AND MEMO PAD HOLDERS, BUSINESS CARD CASES, MONEY CLIPS, BOOKMARKS, PHOTO FRAMES, KEY HOLDERS, LETTER OPENERS, WINE AND CIGAR ACCESSORIES, ORGANIZERS AND WALLETS TO THE ORDER AND SPECIFICATION OF OTHERS (U.S. CLS. 100, 103 AND 106).

CLASS 42—SCIENTIFIC, COMPUTER AND LEGAL SERVICES

FOR DESIGN FOR OTHERS IN THE FIELD OF DESKTOP PRODUCTS, DESKTOP SETS, GOLF SERIES, NAME CARD HOLDERS, HOLDERS FOR DESK ACCESSORIES, MONEY CLIPS, NAME CARD CASES, PHOTO FRAMES, BOOKMARKS, KEY HOLDERS, LETTER OPENERS, WINE AND CIGAR ACCESSORIES, ORGANIZERS AND WALLETS; PACKAGING DESIGN FOR OTHERS (U.S. CLS. 100 AND 101).

SN 78-059,862. SIX CONTINENTS PLC, LONDON, UNITED KINGDOM, BY CHANGE OF NAME BASS PUBLIC LIMITED COMPANY, LONDON, UNITED KINGDOM, FILED 4-23-2001.



PRIORITY CLAIMED UNDER SEC. 44(D) ON UNITED KINGDOM APPLICATION NO. 2264140, FILED 3-13-2001, REG. NO. 2264140, DATED 3-13-2001, EXPIRES 3-13-2011. OWNER OF U.S. REG. NO. 1,726,099. THE STIPLING IS FOR SHADING PURPOSES ONLY.

CLASS 16—PAPER GOODS AND PRINTED MATTER

FOR PAPER, NAMELY COMPUTER PAPER AND FLIP PAPER CHARTS; CARDS, NAMELY, PLAYING CARDS, BUSINESS CARDS AND NAME PLACE CARDS; POSTCARDS; PRINTED MATTER, NAMELY, BROCHURES AND LEAFLETS ON THE SUBJECTS OF HOTELS, BARS, PUBLIC HOUSES, CAFES, RESTAURANTS, SNACK BARS, NIGHT CLUBS, DISCOTHEQUES, DANCE HALLS, TEN PIN BOWLING ALLEYS, SNOOKER AND POOL FACILITIES AND CINEMAS; STATIONERY, WRITING PAPER, ENVELOPES AND NOTE PADS; WRITING INSTRUMENTS, NAMELY, PENS, PENCILS, MARKER PENS, ROLLER BALL PENS AND CRAYONS; HOTEL AND LOCAL INFORMATION DIRECTORIES; HOTEL AND ENTERTAINMENT INFORMATION MAGAZINES; AND PRINTED PAPER MENUS (U.S. CLS. 2, 5, 22, 23, 29, 37, 38 AND 50).

CLASS 35—ADVERTISING AND BUSINESS

FOR BUSINESS MANAGEMENT SERVICES; PROVIDING FACILITIES FOR BUSINESS MEETINGS; COMMERCIAL INFORMATION SERVICES, NAMELY, PROVIDING MARKETING AND DEMOGRAPHIC DATA; BUSINESS CONSULTATION SERVICES CONCERNING FRANCHISING; ADVERTISING SERVICES, NAMELY DISSEMINATION OF ADVERTISING FOR OTHERS, ALL SUCH SERVICES ALSO BEING PROVIDED VIA ON-LINE COMPUTER DATA BASED AND VIA THE INTERNET; BUSINESS ADMINISTRATION SERVICES, NAMELY, ELECTRONIC PROCESSING AND TRANSMISSION OF BILL PAYMENT DATA FOR TRANSACTIONS MADE ON THE INTERNET; PERSONNEL PLACEMENT AND RECRUITMENT; EMPLOYMENT VERIFICATION AND PERSONNEL MANAGEMENT SERVICES; PUBLIC RELATIONS SERVICES; PROMOTING THE GOODS AND SERVICES OF OTHERS BY OPERATION AND SUPERVISION OF LOYALTY SCHEMES AND INCENTIVE SCHEMES, NAMELY, SCHEMES INTENDED AND DESIGNED TO REWARD FREQUENT CUSTOMERS; BUSINESS INFORMATION (U.S. CLS. 100, 101 AND 102).

CLASS 41—EDUCATION AND ENTERTAINMENT

FOR ENTERTAINMENT IN THE NATURE OF VISUAL AND AUDIO PERFORMANCES, NAMELY, PROVIDING DANCE MUSIC AND LIVE MUSIC CONCERTS; TEN PIN BOWLING ALLEY SERVICES, PROVIDING CINEMA THEATER FACILITIES; DISCOTHEQUE; PROVIDING PLAY ROOMS AND GAME ROOMS FOR PLAYING CARDS, BACKGAMMON, AND ELECTRONIC, SLOT MACHINE AND BOARD GAMES; PROVISION OF SNOOKER AND POOL FACILITIES; PROVISION OF LEISURE AND RECREATION FACILITIES; AMUSEMENT SERVICES NAMELY PROVISION OF AMUSEMENT CENTERS; ORGANIZATION OF COMPETITIONS, NAMELY ARRANGING AND CONDUCTING ATHLETIC, CARD AND OTHER GAME COMPETITIONS; ENTERTAINMENT SERVICES, IN THE NATURE OF ONGOING THEATRICAL AND MUSICAL SHOWS; PARTY PLANNING SERVICES, NAMELY, ORGANIZATION OF PARTIES AND PROVISION OF PARTY FACILITIES (U.S. CLS. 100, 101 AND 107).

CLASS 42—SCIENTIFIC, COMPUTER AND LEGAL SERVICES

FOR HOTEL SERVICES, MOTEL SERVICES, HOTEL RESERVATION SERVICES, ARRANGING TEMPORARY HOUSING ACCOMMODATIONS; HOTEL CONCIERGE; BAR SERVICES, PUBLIC HOUSE SERVICES, CAFE SERVICES, RESTAURANT AND SNACK BAR SERVICES; CATERING SERVICES FOR THE PROVISION OF FOOD AND DRINK; PROVISION OF CONVENTION FACILITIES; NIGHT CLUBS; HOTEL SERVICES FEATURING A SPECIAL BENEFITS PROGRAM FOR FREQUENT TRAVELERS (U.S. CLS. 100 AND 101).

SN 78-067,227. GUINNESS UDV NORTH AMERICA, INC., STAMFORD, CT. FILED 6-4-2001.

ICE CAP

CLASS 32—LIGHT BEVERAGES

FOR NON-ALCOHOLIC BREWED MALT BEVERAGES (U.S. CLS. 45, 46 AND 48).

CLASS 33—WINES AND SPIRITS

FOR ALCOHOLIC BEVERAGE PRODUCED FROM A BREWED MALT BASE WITH NATURAL FLAVORS, DISTILLED SPIRITS (U.S. CLS. 47 AND 49).

SN 78-068,670. SAMARATNE, MILES, LONDON, UNITED KINGDOM, FILED 6-12-2001.

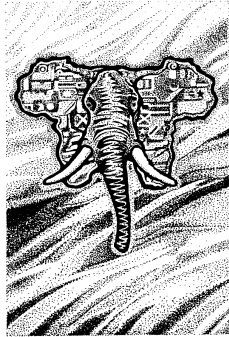

THE STIPPLING IN THE DRAWING IS FOR SHADING PURPOSED ONLY.

CLASS 6—METAL GOODS

FOR NAME BADGES, KEY FOBS, KEY RINGS, AND KEY CHAINS, ALL BEING METALLIC; METAL BOXES AND METAL CASH BOXES; METAL GAS CONTAINERS (U.S. CLS. 2, 12, 13, 14, 23, 25 AND 50).

CLASS 9—ELECTRICAL AND SCIENTIFIC APPARATUS

FOR PRERECORDED VIDEO AND AUDIO CASSETTES FEATURING MUSIC AND MOTION PICTURE FILMS FEATURING COMEDY, DRAMA, ACTION, ADVENTURE, ANIMATION, AND DOCUMENTARIES; VIDEO DISCS AND COMPACT DISCS FEATURING MUSIC AND MOTION PICTURE FILMS FEATURING COMEDY, DRAMA, ACTION, ADVENTURE, ANIMATION, DOCUMENTARIES, AND TRAILERS; CD-ROM DRIVES; COMPUTER AND VIDEO GAMES SOFTWARE AND DISCS; TELECOMMUNICATIONS APPARATUS AND INSTRUMENTS, NAMELY, TELEPHONES; COMPUTER SOFTWARE FOR USE IN TELECOMMUNICATIONS, NAMELY, COMPUTER SOFTWARE FOR THE ISSUING AND THE USE OF TELEPHONE CALLING CARDS, COMPUTER SOFTWARE FOR CREATING AND PROCESSING MAGNETIC ENCODING ON TELEPHONE CALLING CARDS, AND FOR THE DEVELOPMENT DATA WHICH TELEPHONE CALLING CARDS BEAR, AND PLAYING VIRTUAL REALITY GAMES, AND PUBLICATIONS IN ELECTRONIC FORM THAT MAY BE DOWNLOADED FROM A GLOBAL COMPUTER NETWORK AND DOWNLOADABLE ELECTRONIC PUBLICATIONS IN THE FIELD OF ENTERTAINMENT; TELECOMMUNICATION COMPUTER SOFTWARE AND HARDWARE TO ENABLE CONNECTION TO DATABASES AND THE INTERNET; PRE-PAID TELEPHONE CALLING CARDS, MAGNETICALLY ENCODED; TELEPHONES; TELEPHONE ANSWERING MACHINES; SUNGLASSES (U.S. CLS. 21, 23, 26, 36 AND 38).

CLASS 16—PAPER GOODS AND PRINTED MATTER

FOR POSTERS; DIARIES; BOOKS IN THE FIELD OF TELECOMMUNICATIONS, NEWS, CURRENT EVENTS, CARTOONS, CINEMA, VIDEO GAMES, AND COMPUTER GAMES; SERIES OF FICTION BOOKS; BROCHURES IN THE FIELD OF TELECOMMUNICATIONS, COMPUTER GAMES, NEWS, VIDEO GAMES, AND CURRENT EVENTS; MANUALS, NAMELY, COMPUTER GAME INSTRUCTION MANUALS, TELECOMMUNICATION HARDWARE AND SOFTWARE INSTRUCTION MANUALS; MAGAZINES, NAMELY, TELECOMMUNICATIONS, NEWS, AND COMPUTER AND VIDEO GAMES; PERIODICAL PUBLICATIONS IN THE FIELD OF TELECOMMUNICATIONS, NEWS, COMPUTER AND VIDEO GAMES, CARTOONS, AND CINEMA; CALENDARS; NOTEBOOKS; GREETING CARDS; POSTCARDS; STICKERS; STATIONERY; PAPER BAGS AND GENERAL PURPOSE PLASTIC BAGS; PLAYING CARDS (U.S. CLS. 2, 5, 22, 23, 29, 37, 38 AND 50).

CLASS 20—FURNITURE AND ARTICLES NOT OTHERWISE CLASSIFIED

FOR KEY FOBS, NOT OF METAL; FURNITURE; MIRRORS; PICTURE FRAMES; JEWELRY AND ACCESSORY BOXES NOT OF METAL; LETTER BOXES NOT OF METAL; NON-METAL LOCK BOXES; NON-METAL MAIL BOXES; NON-METAL MONEY BOXES; NON-METAL TOOL BOXES; TOY BOXES, NOT OF METAL; WOOD BOXES (U.S. CLS. 2, 13, 22, 25, 32 AND 50).

CLASS 21—HOUSEWARES AND GLASS

FOR HOUSEHOLD OR KITCHEN UTENSILS, NAMELY, POT AND PAN SCRAPERS, ROLLING PINS, SPATULAS, TURNERS, WHISKS; MUGS; CROCKERY, NAMELY, MUGS, FIGURINES, PLATES, BOWLS AND SERVING DISHES; BEVERAGE GLASSWARE; PORCELAIN, EARTHENWARE AND CHINAWARE, NAMELY, MUGS, FIGURINES, PLATES, BOWLS AND SERVING DISHES; AND CUPS (U.S. CLS. 2, 13, 23, 29, 30, 33, 40 AND 50).

CLASS 24—FABRICS

FOR TOWELS OF TEXTILES; PLACE MATS OF TEXTILE; LINEN; CLOTH BANNERS; BED LINEN; CLOTH COASTERS; UNFITTED FABRIC FURNITURE COVERS; TEXTILE NAPKINS; LAP RUGS; CLOTH HANDKERCHIEFS FOR USE WITH SNUFF (U.S. CLS. 42 AND 50).

CLASS 25—CLOTHING

FOR CLOTHING, NAMELY, T-SHIRTS, SWEATSHIRTS, SWEATPANTS, TRACKSUITS, CARDIGANS, JEANS, FLEECE TOPS, GOLF-TYPE PLACKET SHIRTS, HOCKEY SHIRTS, HOODED KNIT TOPS, JACKETS, JERSEY TOPS AND BOTTOMS, JUMPERS, PANTS, PEDAL PUSHERS, POLO SHIRTS, PULLOVERS, RUGBY SHIRTS, SWEATERS, SHORTS, SPORT SHIRTS, COVERALLS, TANK TOPS, HALTER TOPS, BATHING SUITS, BATHING TRUNKS, COVER-UPS, OVERALLS, SHAWLS, APRONS, SLEEP SHIRTS, PAJAMAS, NIGHTSHIRTS, ROBES, SLEEP SHORTS, RAINCOATS, RAIN HATS, RAIN CAPES, PONCHOS, BELTS, SCARVES, MITTENS, GLOVES, VISORS, WRIST BANDS, AND SOCKS; FOOTWEAR; HEADWEAR (U.S. CLS. 22 AND 39).

CLASS 26—FANCY GOODS

FOR ORNAMENTAL NOVELTY BADGES; RIBBONS AND BRAID; ARTIFICIAL FLOWERS (U.S. CLS. 37, 39, 40, 42 AND 50).

CLASS 27—FLOOR COVERINGS

FOR RUGS (U.S. CLS. 19, 20, 37, 42 AND 50).

CLASS 28—TOYS AND SPORTING GOODS

FOR TOYS, GAMES AND PLAYTHINGS, NAMELY, BOARD GAMES, BATTERY-POWERED COMPUTER GAMES WITH LCD SCREEN WHICH FEATURES ANIMATION AND SOUND EFFECTS, DOLLS, TOY FIGURES, TOY ACTION FIGURES, STUFFED TOY ANIMALS, TEDDY BEARS, BOUNCING BALLS FOR FOOTBALL, BASKETBALL, SOCCER, TENNIS, AND FOR PLAYING INDOORS, FLYING DISCS, AND YO-YOS; GYMNAS TIC APPARATUS; ATHLETIC SPORTING GOODS, NAMELY, SPORTS RACKETS FOR TENNIS AND SQUASH, BASE BALLS, SOFTBALLS, AND BATS FOR BASEBALL AND SOFTBALL (U.S. CLS. 22, 23, 38 AND 50).

CLASS 30—STAPLE FOODS

FOR CONFECTIONERY, NAMELY, CANDY, CAKES, PIES, MIXES FOR BAKERY GOODS; CONFECTIONERY CHIPS FOR BAKING; COFFEE; GRAIN-BASED COFFEE SUBSTITUTES; CHICORY-BASED COFFEE SUBSTITUTES; TEA, COCOA, SUGAR, RICE, TAPIOCA, SEMOLINA, SAGO; FLOUR AND PREPARATIONS MADE FROM CEREALS, NAMELY, PROCESSED CEREALS; NOODLES; BREAD, BISCUITS, PASTRY; ICES; HONEY; TREA CLE; MUSTARD; VINEGAR; SAUCES; SPICES; CONDIMENTS, NAMELY, PIMIENTO, KETCHUP, MAYONNAISE, SALAD DRESSINGS, HORSERADISH AND RELISH; BEVERAGES, NAMELY, CHOCOLATE FOOD BEVERAGES NOT BEING DAIRY-BASED OR VEGETABLE BASED, GRAIN-BASED BEVERAGES, HERBAL FOOD BEVERAGES, TEA-BASED BEVERAGES WITH FRUIT FLAVORING, HERBAL TEA, AND ICED TEA; FROZEN CONFECTIONS; ICE CREAM PRODUCTS, NAMELY, ICE CREAM, CONES FOR ICE CREAM, AND ICE CREAM DRINKS; ICE; SYRUPS, NAMELY, PANCAKE, CHOCOLATE, CORN, FLAVORING, MAPLE, CHOCOLATE TOPPING, MARSHMALLOW TOPPING, TABLE AND TOPPING (U.S. CL. 46).

CLASS 32—LIGHT BEVERAGES

FOR MINERAL AND AERATED WATERS; NON-ALCOHOLIC BEVERAGES, NAMELY, SOFT DRINKS, FRUIT DRINKS, AND FRUIT JUICES; BEER AND NON-ALCOHOLIC BEER; SYRUPS, CONCENTRATES, AND POWDERS FOR MAKING BEVERAGES, NAMELY, FRUIT DRINKS, AND SOFT DRINKS (U.S. CLS. 45, 46 AND 48).

CLASS 34—SMOKERS' ARTICLES

FOR RAW AND MANUFACTURED TOBACCO; TOBACCO PRODUCTS, NAMELY, PIPE TOBACCO, CIGARETTE TOBACCO, AND CHEWING TOBACCO; SMOKERS' ARTICLES, NAMELY, PIPE FILTERS, FILTER TIPS, CLEANERS, RACKS, STANDS, TRAYS, STEMS AND TOOLS; MATCHES; SNUFF CIGARETTES; CIGARS; CIGARILLOS; SMOKING PIPES; HUMIDORS; CIGARETTE PAPERS; CIGARETTE ROLLING PAPERS; CIGAR TUBES; WICKS FOR LIGHTERS; FLINTS AND FIRE STONES FOR LIGHTERS; CIGAR, CIGARETTE, PIPE, SNUFF AND TOBACCO BOXES AND POUCHES; ASHTRAYS, NOT OF PRECIOUS METAL; SNUFF DISPENSERS; HERBS FOR SMOKING; TOBACCO JARS NOT OF PRECIOUS METAL; NON-METAL LIGHTER FLUID CONTAINER SOLD EMPTY; POCKET CIGARETTE LIGHTERS NOT OF PRECIOUS METAL; CIGAR AND CIGARETTE CASES NOT OF PRECIOUS METAL, CIGAR CUTTERS AND SCISSORS; PARTS AND FITTINGS FOR ALL THE AFORESAID GOODS (U.S. CLS. 2, 8, 9 AND 17).

CLASS 36—INSURANCE AND FINANCIAL

FOR TELEPHONE CALLING CARD SERVICES; TELECOMMUNICATIONS AIR TIME BROKERAGE SERVICES (U.S. CLS. 100, 101 AND 102).

SN 78-071,725. GENERAL ELECTRIC COMPANY, SCHE-NECTADY, NY. FILED 6-29-2001.

REVIVE**CLASS 35—ADVERTISING AND BUSINESS**

FOR WHOLESALE STORES AND RETAIL STORE SERVICES FEATURING PRE-OWNED MEDICAL DIAGNOSTIC IMAGING EQUIPMENT; WHOLESALE DISTRIBUTORSHIPS FEATURING PRE-OWNED MEDICAL DIAGNOSTIC IMAGING EQUIPMENT (U.S. CLS. 100, 101 AND 102).

CLASS 37—CONSTRUCTION AND REPAIR

FOR REFURBISHING AND INSTALLATION OF PRE-OWNED MEDICAL DIAGNOSTIC IMAGING EQUIPMENT (U.S. CLS. 100, 103 AND 106).

CLASS 39—TRANSPORTATION AND STORAGE

FOR TRANSPORT OF PRE-OWNED MEDICAL DIAGNOSTIC IMAGING EQUIPMENT BY TRUCK, AUTOMOBILE, RAIL, BOAT OR AIR (U.S. CLS. 100 AND 105).

CLASS 42—SCIENTIFIC, COMPUTER AND LEGAL SERVICES

FOR ON-SITE EQUIPMENT EVALUATION OF PRE-OWNED MEDICAL DIAGNOSTIC IMAGING EQUIPMENT (U.S. CLS. 100 AND 101).

SN 78-072,312. SHARED BASE LIMITED, BELLSHILL, UNITED KINGDOM, FILED 7-4-2001.

SHARED BASE

PRIORITY CLAIMED UNDER SEC. 44(D) ON UNITED KINGDOM APPLICATION NO. 2273558, FILED 6-26-2001, REG. NO. 2273558, DATED 11-1-2002, EXPIRES 6-26-2011.

CLASS 9—ELECTRICAL AND SCIENTIFIC APPARATUS

FOR COMPUTER SOFTWARE, APPLICATION SOFTWARE, APPLICATION PROGRAMS, APPLICATION PROGRAMMING INTERFACES, COMPUTER PROGRAMS, ALL RELATING TO PROVIDING WEBSITE DEVELOPMENT AND WEB ENABLING TOOLS FOR USE IN BUSINESS DEVELOPMENT; ELECTRONIC DATABASES IN THE FIELD OF PROVIDING WEBSITE DEVELOPMENT AND WEB ENABLING TOOLS FOR USE IN BUSINESS DEVELOPMENT RECORDED ON COMPUTER MEDIA; COMPUTER DATABASE PROGRAMS, COMPUTER DATABASE TOOLS, AND COMPUTER INTERFACES FOR PROVIDING WEBSITE DEVELOPMENT AND WEB ENABLING TOOLS FOR USE IN BUSINESS DEVELOPMENT; COMPUTER SOFTWARE PROGRAMS FOR USE IN DATABASE MANAGEMENT; ELECTRONIC PUBLICATIONS, NAMELY, MANUALS PROVIDING INFORMATION ON WEBSITE DEVELOPMENT AND WEB ENABLING TOOLS FOR USE IN BUSINESS DEVELOPMENT, RECORDED ON COMPUTER MEDIA; CDS, CD-ROMS AND INTERACTIVE CD-ROMS FOR STORAGE OF COMPUTER DATA; ELECTRONIC, OPTICAL AND MAGNETIC BLANK TAPES FOR STORAGE OF COMPUTER DATA; SOUND, VIDEO, AND DATA RECORDINGS; RECORDS, DISCS, TAPES, CASSETTES, CARTRIDGES, AND CARDS, ALL BEARING OR FOR USE IN BEARING DATA, SOUND, IMAGES, GAMES, GRAPHICS, TEXT, PROGRAMS OR INFORMATION IN THE FIELD OF PROVIDING WEBSITE DEVELOPMENT AND WEB ENABLING TOOLS FOR USE IN BUSINESS DEVELOPMENT (U.S. CLS. 21, 23, 26, 36 AND 38).

CLASS 38—COMMUNICATION

FOR COMPUTER NETWORK COMMUNICATION SERVICES, NAMELY, PROVIDING MULTIPLE USER ACCESS TO A GLOBAL COMPUTER INFORMATION NETWORK; INTERNET SERVICE PROVIDER SERVICES (U.S. CLS. 100, 101 AND 104).

CLASS 42—SCIENTIFIC, COMPUTER AND LEGAL SERVICES

FOR CONSULTATION SERVICES RELATING TO INTERNET SERVICE PROVIDERS AND COMPUTER NETWORK COMMUNICATION SERVICES; COMPUTER SERVICES, NAMELY, CREATING NETWORKS IN THE NATURE OF APPLICATION PROGRAMMING INTERFACES; COMPUTER SERVICES, NAMELY, CREATING AND MAINTAINING WEB SITES FOR OTHERS; COMPUTER CONSULTATION SERVICES; DESIGN, DEVELOPMENT, INSTALLATION AND MAINTENANCE OF COMPUTER SOFTWARE; DESIGN OF COMPUTER SOFTWARE APPLICATION SOLUTIONS; DESIGN AND PROGRAMMING, ALL FOR THE CREATION OF APPLICATION PROGRAMMING INTERFACES; CONSULTATION SERVICES RELATING TO CREATING AND MAINTAINING WEB SITES, DESIGN, DEVELOPMENT, INSTALLATION, AND MAINTENANCE OF COMPUTER SOFTWARE; DESIGN OF COMPUTER SOFTWARE APPLICATION SOLUTIONS AND APPLICATION PROGRAMMING INTERFACES (U.S. CLS. 100 AND 101).

SN 78-072,766, IMAGE LINE BVBA, SINT MARTENS LATHEM, BELGIUM, FILED 7-7-2001.

FRUITYLOOPS

PRIORITY CLAIMED UNDER SEC. 44(D) ON NETHERLANDS APPLICATION NO. 0982531, FILED 1-30-2001, REG. NO. 0982531, DATED 1-30-2001, EXPIRES 1-30-2011.

PRIORITY CLAIMED UNDER SEC. 44(D) ON NETHERLANDS APPLICATION NO. 0690458, FILED 4-25-2001, REG. NO. 0988579, DATED 4-25-2001, EXPIRES 4-25-2011.

CLASS 9—ELECTRICAL AND SCIENTIFIC APPARATUS

FOR COMPUTER SOFTWARE USED TO COMPOSE MUSIC AND EDIT MUSICAL COMPOSITIONS; COMPUTER SOFTWARE USED TO CONTROL MUSICAL INSTRUMENTS; DOWNLOADABLE AND NON-DOWNLOADABLE MUSICAL SOUND RECORDINGS; DOWNLOADABLE AND NON-DOWNLOADABLE COMPUTER SOFTWARE USED TO CONTROL AND IMPROVE SOUND QUALITY OF COMPUTERS AND AUDIO EQUIPMENT; MIDI CONTROLLERS, NAMELY, COMPUTER HARDWARE FOR FACILITATING DIGITAL INTERFACING WITH MUSICAL INSTRUMENTS; VOCODERS, NAMELY, COMPUTER HARDWARE THAT ALTERS MUSICAL SOUNDS TO SOUND AS IF THEY ARE MADE BY ROBOTS (U.S. CLS. 21, 23, 26, 36 AND 38).

CLASS 15—MUSICAL INSTRUMENTS

FOR MUSIC EQUIPMENT, NAMELY, SYNTHESIZERS, SAMPLERS, PIANOS, KEYBOARDS, DRUMS, DRUM MACHINES, GUITARS (U.S. CLS. 2, 21 AND 36).

CLASS 35—ADVERTISING AND BUSINESS

FOR COMPUTERIZED ON-LINE ORDERING AND RETAIL STORE SERVICES IN THE FIELD OF MUSIC AND MUSICAL INSTRUMENTS; PROMOTING THE GOODS AND SERVICES OF OTHERS BY MEANS OF OPERATING AN ON-LINE SHOPPING MALL WITH LINKS TO THE RETAIL WEB SITES OF OTHERS; PROMOTING THE GOODS AND SERVICES OF OTHERS THROUGH ON-LINE ORDERING AND CATALOGING OF THOSE GOODS AND SERVICES; PROVIDING ON-LINE REGISTRATION SERVICES FOR MUSICAL EXHIBITIONS AND MUSIC INSTRUCTIONAL CLASSES; PROVIDING SPACE AT A WEB SITE FOR THE ADVERTISEMENT OF THE GOODS AND SERVICES OF OTHERS (U.S. CLS. 100, 101 AND 102).

SN 78-079,208, XPLANE CORP., ST. LOUIS, MO, FILED 8-14-2001.

**CLASS 16—PAPER GOODS AND PRINTED MATTER**

FOR PRINTED VISUALS IN THE NATURE OF INFORMATION GRAPHICS (U.S. CLS. 2, 5, 22, 23, 29, 37, 38 AND 50).

CLASS 42—SCIENTIFIC, COMPUTER AND LEGAL SERVICES

FOR GRAPHIC ART AND TEXT DESIGN (U.S. CLS. 100 AND 101).

SN 78-079,860. PIATTO DOPPIO, INC., NEW YORK, NY.
FILED 8-17-2001.

SN 78-081,160. LURGI AG, FRANKFURT AM MAIN, FED
REP GERMANY, FILED 8-26-2001.



THE MARK IS COMPOSED OF TWO SQUARES WITH CONCENTRIC CIRCLES INSIDE AND THE INSCRIPTION "PIATTO DOPPIO" BELOW. THE LEFT SQUARE IS BLACK WITH TWO GREY CIRCLES AND ONE WHITE CIRCLE. THE RIGHT SQUARE IS GREY WITH ONE BLACK CIRCLE, ONE WHITE CIRCLE AND ONE GREY CIRCLE. THE BELOW INSCRIPTION IS BLACK.

THE ENGLISH TRANSLATION OF THE WORD "PIATTO DOPPIO" IN THE MARK IS "DOUBLE PLATE".

CLASS 41—EDUCATION AND ENTERTAINMENT

FOR ENTERTAINMENT IN THE NATURE OF LIVE MUSICAL GROUP AND DJ (U.S. CLS. 100, 101 AND 107).
FIRST USE 8-15-2001; IN COMMERCE 8-15-2001.

CLASS 42—SCIENTIFIC, COMPUTER AND LEGAL SERVICES

FOR RESTAURANT SERVICES, NAMELY, PROVIDING FOOD AND DRINK (U.S. CLS. 100 AND 101).
FIRST USE 8-15-2001; IN COMMERCE 8-15-2001.

SN 78-080,185. LES ENTREPRISES MICROTEC INC., SAINT-AUGUSTIN DE DESMAURES, QUEBEC, FILED 8-20-2001.

MICROTEC SECURI-T

NO CLAIM IS MADE TO THE EXCLUSIVE RIGHT TO USE "SECURITY", APART FROM THE MARK AS SHOWN.

CLASS 9—ELECTRICAL AND SCIENTIFIC APPARATUS

FOR SECURITY SYSTEMS COMPRISING SECURITY ALARMS, COMPUTER HARDWARE, TRANSMITTERS AND RECEIVERS, TELEPHONES, CIRCUITS, LAMPS, TRANSISTORS, AND BATTERIES FOR RESIDENCES, INDUSTRIAL AND COMMERCIAL ESTABLISHMENTS (U.S. CLS. 21, 23, 26, 36 AND 38).

CLASS 35—ADVERTISING AND BUSINESS

FOR RETAIL STORE SERVICES, COMPUTERIZED ONLINE RETAIL SERVICES, ONLINE ORDERING SERVICES, CATALOG SERVICES AND MAIL ORDER SERVICES, AND TELEPHONE ORDERING SERVICES ALL FEATURING SECURITY SYSTEMS FOR PREVENTING THEFT, NAMELY, FOR RESIDENCE, INDUSTRIAL AND COMMERCIAL ESTABLISHMENTS (U.S. CLS. 100, 101 AND 102).

LURGI EUROFUEL

PRIORITY CLAIMED UNDER SEC. 44(D) ON FED REP GERMANY APPLICATION NO. 30112798.001, FILED 2-26-2001, REG. NO. 30112798, DATED 11-21-2001, EXPIRES 2-28-2011.

OWNER OF U.S. REG. NOS. 670,186, 1,005,940 AND 1,991,016.

CLASS 1—CHEMICALS

FOR CHEMICAL PRODUCTS FOR COMMERCIAL AND SCIENTIFIC USE, NAMELY, ALKYLATES (U.S. CLS. 1, 5, 6, 10, 26 AND 46).

CLASS 4—LUBRICANTS AND FUELS

FOR FUELS, NAMELY, MOTOR FUELS, AIRCRAFT FUELS, ROCKET FUELS AND RACING FUELS (U.S. CLS. 1, 6 AND 15).

CLASS 11—ENVIRONMENTAL CONTROL APPARATUS

FOR APPARATUS, INSTALLATIONS AND DEVICES FOR THE PRODUCTION OF ALKYLATES, NAMELY, CRACK-REACTORS, DISTILLERS, CONDENSERS, ROTARY-EVAPORATORS, AUTOCLAVES, DEHYDROGENATION UNITS AND ADSORPTION UNITS (U.S. CLS. 13, 21, 23, 31 AND 34).

CLASS 37—CONSTRUCTION AND REPAIR

FOR BUILDING, INSTALLATION AND MAINTENANCE OF INDUSTRIAL PLANTS AND FACILITIES (U.S. CLS. 100, 103 AND 106).

CLASS 42—SCIENTIFIC, COMPUTER AND LEGAL SERVICES

FOR RESEARCH AND DEVELOPMENT IN THE FIELD OF CHEMISTRY, ESPECIALLY IN THE FIELD OF ALKYLATION; ENGINEERING SERVICES; DEVELOPMENT, PLANNING, AND PROJECTING FOR OTHERS OF DEVICES, APPARATUS AND METHODS IN THE FIELDS OF ANALYSIS AND SYNTHESIS AS WELL AS RELATED CONSULTING SERVICES, ESPECIALLY IN THE FIELD OF ALKYLATION; CHEMICAL ANALYSES AND INTERPRETATION OF THE RESULTS; CHEMICAL SYNTHESSES AND INTERPRETATION OF THE RESULTS; AND TECHNICAL CONSULTATION IN THE FIELD OF ALL CHEMISTRY (U.S. CLS. 100 AND 101).

SN 78-082,430. PRIME FOOD PROCESSING CORP., BROOKLYN, NY. FILED 9-4-2001.



OWNER OF U.S. REG. NO. 2,154,674.
THE NON-LATIN CHARACTERS IN THE MARK TRANSLITERATE TO "JIA JIA" OR "KA KA" AND THIS MEANS "GOOD BOY" OR "GOOD GIRL" IN ENGLISH.
SEC. 2(F).

CLASS 29—MEATS AND PROCESSED FOODS

FOR FROZEN AND REFRIGERATED MEALS AND PACKAGED PRECOOKED MEALS CONSISTING OF PROCESSED MEATS, SEAFOOD, POULTRY AND VEGETABLES; DIM SUMS CONTAINING PROCESSED MEATS SEAFOOD, POULTRY AND VEGETABLES; DUMPLINGS CONTAINING PROCESSED MEATS, SEAFOOD, POULTRY AND VEGETABLES (U.S. CL. 46).

CLASS 30—STAPLE FOODS

FOR FROZEN ENTREES AND PACKAGED ENTREES CONSISTING PRIMARILY OF PASTA OR RICE; PASTA AND NOODLES (U.S. CL. 46).

SN 78-085,905. ROSENUIST-GESTAO E SERVICOS SOCIADE UNIPESSOAL LDA, 9000-051 FUNCHAL-MADEIRA, PORTUGAL, FILED 9-27-2001.

CALLIOPE

CLASS 18—LEATHER GOODS

FOR ALL PURPOSE ATHLETIC BAGS, BEACH BAGS, BOOK BAGS, CARRY-ON BAGS, GYM BAGS, LEATHER SHOPPING BAGS, OVERNIGHT BAGS, SHOULDER BAGS, TOTE BAGS, TRAVEL BAGS, HANDBAGS, PURSES, WALLETS, SUITCASES, TRUNKS, COSMETIC CASES SOLD EMPTY, DOCUMENT-CASES, UMBRELLAS (U.S. CLS. 1, 2, 3, 22 AND 41).

CLASS 25—CLOTHING

FOR DRESSES, SKIRTS, TROUSERS, SHIRTS, JACKETS, OVERCOATS, RAINCOATS, COATS AND PULL-OVERS, JERKINS, HATS, SCARVES, FOULARDS, HOSIERY, NECKERCHIEVES, GLOVES, BELTS FOR CLOTHING, SHOES, BOOTS, SANDALS, CLOGS, SLIPPERS (U.S. CLS. 22 AND 39).

FIRST USE 3-8-2001; IN COMMERCE 3-8-2001.

SN 78-087,631. HODGES TRANSPORTATION, DBA NATC, CARSON CITY, NV. FILED 10-9-2001.

REAL TIME, REAL WORLD SOLUTIONS

CLASS 9—ELECTRICAL AND SCIENTIFIC APPARATUS

FOR (BASED ON INTENT TO USE) ELECTRICAL AND SCIENTIFIC APPARATUS, NAMELY ELECTRICAL CONTROL SYSTEMS FOR MOTOR VEHICLES COMPRISED OF MICROPROCESSORS AND ELECTRONIC CIRCUITRY; AND COMPUTER SOFTWARE FOR ALLOWING USER TO ACCUMULATE DATA REGARDING MOTOR VEHICLE AND MOTOR VEHICLE COMPONENTRY PERFORMANCE FOR EVALUATION PURPOSES; AND COMPUTER HARDWARE, NAMELY DEVICES AND APPLICATIONS ALLOWING USER TO ACCUMULATE DATA REGARDING MOTOR VEHICLE AND MOTOR VEHICLE COMPONENTRY PERFORMANCE FOR EVALUATION PURPOSES (U.S. CLS. 21, 23, 26, 36 AND 38).

FIRST USE 12-30-1991; IN COMMERCE 12-30-1991.

CLASS 42—SCIENTIFIC, COMPUTER AND LEGAL SERVICES

FOR (BASE ON USE IN COMMERCE) TECHNICAL CONSULTATION AND RESEARCH IN THE FIELD OF TRANSPORTATION; REVIEWING STANDARDS AND PRACTICES TO ASSURE COMPLIANCE WITH GOVERNMENTAL REGULATIONS OF MOTOR VEHICLES AND COMPONENTRY, NAMELY TESTING AND EVALUATION OF ENVIRONMENTAL PERFORMANCE, VEHICLE PERFORMANCE, VEHICLE COMPONENTRY PERFORMANCE ELECTROMAGNETIC COMPATIBILITY/INTERFERENCE AND WINTER PERFORMANCE (U.S. CLS. 100 AND 101).

FIRST USE 12-30-1991; IN COMMERCE 12-30-1991.

SN 78-088,212. INFOSPACE, INC., BELLEVUE, WA. FILED 10-12-2001.

DISCOVER WHAT YOU CAN DO

CLASS 35—ADVERTISING AND BUSINESS

FOR COMPUTER SERVICES, NAMELY, PROVIDING INFORMATION AND DATABASES IN THE FIELDS OF BUSINESS, CITY GUIDES, CLASSIFIEDS AND DIRECTORY INFORMATION, SHOPPING AND DIRECTORIES VIA WIRED AND WIRELESS COMMUNICATIONS AND NETWORKS; COMPUTER SERVICES, NAMELY, PROVIDING PERSONAL INFORMATION MANAGEMENT, CALENDAR MANAGEMENT, ADDRESS MANAGEMENT, COMMUNITY INFORMATION MANAGEMENT, GROUP MANAGEMENT, AND COMMUNICATION DEVICE MANAGEMENT ON WIRED AND WIRELESS COMMUNICATIONS AND COMPUTER NETWORKS; CUSTOMER SUPPORT SERVICES, NAMELY ANSWERING CUSTOMER INQUIRIES, AND PROVIDING INFORMATION TO CUSTOMERS REGARDING THE PRIVACY AND USE OF THEIR PERSONAL AND FINANCIAL INFORMATION; COMPUTER SERVICES, NAMELY, PROVIDING ELECTRONIC COMMERCE SERVICES, NAMELY, GIFT REGISTRY SERVICES, PROVIDING AN ONLINE BUSINESS-TO-BUSINESS MARKETPLACE WHERE BUSINESSES CAN BUY AND SELL EXCESS INVENTORY AND IDLE ASSETS, AND ONLINE AUCTION SERVICES; PROVIDING ONLINE RETAIL, MAIL ORDER, AND AUCTION BUSINESS MANAGEMENT (U.S. CLS. 100, 101 AND 102).

CLASS 36—INSURANCE AND FINANCIAL

FOR COMPUTER SERVICES, NAMELY, PROVIDING INFORMATION AND DATABASES IN THE FIELDS OF FINANCE AND INSURANCE VIA WIRED AND WIRELESS COMMUNICATIONS AND NETWORKS AND FINANCIAL CONSULTATION SERVICES (U.S. CLS. 100, 101 AND 102).

SN 78-091,074. I3 MOBILE, INC., STAMFORD, CT. FILED 10-31-2001.

CLASS 38—COMMUNICATION

FOR COMPUTER SERVICES, NAMELY, PROVIDING ON-LINE ELECTRONIC BULLETIN BOARDS FOR TRANSMISSION OF MESSAGES AMONG COMPUTER USERS CONCERNING GENERAL INFORMATION IN THE FIELDS OF GEOGRAPHIC REGIONAL CONCERNS, HEALTH, SOCIETY, SHOPPING, BUSINESS AND MONEY, COMPUTERS AND THE WEB, NEWS AND EVENTS, AND ENTERTAINMENT; PROVIDING ON-LINE CHAT ROOMS FOR TRANSMISSION OF MESSAGES AMONG COMPUTER USERS CONCERNING GENERAL INFORMATION IN THE FIELD OF GEOGRAPHIC REGIONAL CONCERNS, HEALTH, SOCIETY, SHOPPING, BUSINESS AND MONEY, COMPUTERS AND THE WEB, NEWS AND EVENTS; NETWORK CONFERENCING SERVICES; ELECTRONIC MAIL VOICE MAIL, TEXT, FAX MESSAGES BY TELEPHONE AND TELEPHONE VOICE MESSAGE SERVICES (U.S. CLS. 100, 101 AND 104).

The New Mobile Experience**CLASS 38—COMMUNICATION**

FOR PROVIDING MULTIPLE-USER ACCESS TO A GLOBAL COMPUTER NETWORK VIA COMPUTERS, WIRELESS DEVICES, RADIO PAGERS, CELLULAR TELEPHONES, AND PERSONAL DIGITAL ASSISTANTS (U.S. CLS. 100, 101 AND 104).

FIRST USE 2-1-2001; IN COMMERCE 2-15-2001.

CLASS 39—TRANSPORTATION AND STORAGE

FOR COMPUTER SERVICES, PROVIDING INFORMATION AND DATABASES IN THE FIELD OF TRAVEL VIA WIRED AND WIRELESS COMMUNICATIONS AND NETWORKS (U.S. CLS. 100 AND 105).

CLASS 41—EDUCATION AND ENTERTAINMENT

FOR ENTERTAINMENT SERVICES, NAMELY PROVIDING GAMES, JOKES, HOROSCOPES, ANIMATED GRAPHICS, RINGTONES AND AUDIO ENTERTAINMENT PRODUCTS VIA WIRELESS DEVICES AND THE GLOBAL COMPUTER NETWORK (U.S. CLS. 100, 101 AND 107).

FIRST USE 2-1-2001; IN COMMERCE 2-15-2001.

CLASS 41—EDUCATION AND ENTERTAINMENT

FOR COMPUTER SERVICES, PROVIDING INFORMATION AND DATABASES IN THE FIELD OF SPORTS AND ENTERTAINMENT VIA WIRED AND WIRELESS COMMUNICATIONS AND NETWORKS (U.S. CLS. 100, 101 AND 107).

CLASS 42—SCIENTIFIC, COMPUTER AND LEGAL SERVICES

FOR PROVIDING CUSTOMIZED AND PERSONALIZED INFORMATION ON A WIDE VARIETY OF TOPICS VIA THE GLOBAL COMPUTER NETWORK AND WIRELESS DEVICES (U.S. CLS. 100 AND 101).

FIRST USE 2-1-2001; IN COMMERCE 2-15-2001.

CLASS 42—SCIENTIFIC, COMPUTER AND LEGAL SERVICES

FOR COMPUTER SERVICES, PROVIDING INFORMATION AND DATABASES IN THE FIELD OF NEWS AND WEATHER VIA WIRED AND WIRELESS COMMUNICATIONS AND NETWORKS; COMPUTER SERVICES, NAMELY, PROVIDING SEARCH ENGINES FOR OBTAINING DATA ON WIRED AND WIRELESS COMMUNICATIONS AND COMPUTER NETWORKS; CONSULTING AND DESIGN IN THE FIELDS OF DATA WAREHOUSING, DATABASES, AND WEB AND DATABASE INTEGRATION; COMPUTER SOFTWARE DEVELOPMENT SERVICES; COMPUTER SERVICES, NAMELY, DESIGNING AND IMPLEMENTING WEB PAGES FOR OTHERS; COMPUTER SERVICES, NAMELY, DEVELOPING ELECTRONIC COMMERCE WEB SITES FOR OTHERS; COMPUTER SERVICES, NAMELY, PROVIDING ON-LINE FACILITIES FOR THE COLLECTION, STORAGE, QUERYING, AND REPORTING OF DATA; COMPUTER CONSULTING SERVICES, TESTING, ANALYSIS, AND VALUATION OF THE ELECTRONIC COMMERCE WEB SITES FOR OTHERS FOR THE PURPOSES OF CERTIFICATION; REGISTRATION OF DOMAIN NAMES FOR THE IDENTIFICATION OF USERS (U.S. CLS. 100 AND 101).

SN 78-092,057. CHANNING L. BETE CO., INC., SOUTH DEERFIELD, MA. FILED 11-7-2001.

CHANNING BETE COMPANY

NO CLAIM IS MADE TO THE EXCLUSIVE RIGHT TO USE "COMPANY", APART FROM THE MARK AS SHOWN. THE NAME "CHANNING BETE" DOES NOT IDENTIFY A LIVING INDIVIDUAL.

CLASS 9—ELECTRICAL AND SCIENTIFIC APPARATUS

FOR PRERECORDED AUDIO CASSETTES, VIDEO TAPES, DVDS, MULTIMEDIA SOFTWARE RECORDED ON CD-ROM, AND COMPUTER DISCS RELATING TO HEALTH, WELLNESS, PARENTING, YOUTH DEVELOPMENT, EDUCATION, SOCIAL ISSUES, COGNITIVE AND BEHAVIORAL CHANGE, ELDER ISSUES, SAFETY, ELECTRICITY, ENERGY AND CONSERVATION, EMERGENCY PREPAREDNESS, RECREATION AND LEISURE, ANIMAL WELFARE AND RELIGION; STAFF TRAINING IN THE AREA OF HEALTH, SAFETY, PERSONAL DEVELOPMENT, CLASSROOM MANAGEMENT AND COGNITIVE AND BEHAVIORAL CHANGE; EDUCATIONAL CURRICULUM IN THE AREA OF HEALTH, WELLNESS, YOUTH DEVELOPMENT, SOCIAL ISSUES, COGNITIVE AND BEHAVIORAL CHANGE, CLASSROOM MANAGEMENT AND PARENTING; INDUSTRY IN THE AREA OF HEALTH, SAFETY AND PERSONAL DEVELOPMENT; GOVERNMENT IN THE AREA OF HEALTH, WELLNESS, PARENTING, YOUTH DEVELOPMENT, EDUCATION, SOCIAL ISSUES, COGNITIVE AND BEHAVIORAL CHANGE, ELDER ISSUES, SAFETY, ELECTRICITY, ENERGY AND CONSERVATION, EMERGENCY PREPAREDNESS, RECREATION AND LEISURE AND ANIMAL WELFARE; AND BUSINESS IN THE AREA OF HEALTH, SAFETY AND PERSONAL DEVELOPMENT; COMPUTER SOFTWARE CONSISTING OF AN ELECTRONIC DATABASE RELATED TO HUMAN BEHAVIOR AND COGNITION, EDUCATION, AND EDUCATIONAL CURRICULUM IN THE AREA OF HEALTH, WELLNESS, YOUTH DEVELOPMENT, SOCIAL ISSUES, COGNITIVE AND BEHAVIORAL CHANGE, CLASSROOM MANAGEMENT AND PARENTING; AND RELATED PRINTED INSTRUCTIONAL MANUALS SOLD AS A UNIT (U.S. CLS. 21, 23, 26, 36 AND 38).

CLASS 16—PAPER GOODS AND PRINTED MATTER

FOR PRINTED MATTER, NAMELY, COLORING BOOKS, BROCHURES, PAMPHLETS, LEADER'S GUIDES, POSTERS, CALENDARS, AND CURRICULUM COURSE MATERIALS, NAMELY BOOKS, BROCHURES, PAMPHLETS, POSTERS AND CALENDARS ALL RELATING TO HEALTH, WELLNESS, PARENTING, YOUTH DEVELOPMENT, EDUCATION, SOCIAL ISSUES, COGNITIVE AND BEHAVIORAL CHANGE, ELDER ISSUES, SAFETY, ELECTRICITY, ENERGY AND CONSERVATION, EMERGENCY PREPAREDNESS, RECREATION AND LEISURE, ANIMAL WELFARE AND RELIGION; STAFF TRAINING IN THE AREA OF HEALTH, SAFETY, PERSONAL DEVELOPMENT, CLASSROOM MANAGEMENT AND COGNITIVE AND BEHAVIORAL CHANGE; EDUCATIONAL CURRICULUM IN THE AREA OF HEALTH, WELLNESS, YOUTH DEVELOPMENT, SOCIAL ISSUES, COGNITIVE AND BEHAVIORAL CHANGE, CLASSROOM MANAGEMENT AND PARENTING; INDUSTRY IN THE AREA OF HEALTH, SAFETY AND PERSONAL DEVELOPMENT; GOVERNMENT IN THE AREA OF HEALTH, WELLNESS, PARENTING, YOUTH DEVELOPMENT, EDUCATION, SOCIAL ISSUES, COGNITIVE AND BEHAVIORAL CHANGE, ELDER ISSUES, SAFETY, ELECTRICITY, ENERGY AND CONSERVATION, EMERGENCY PREPAREDNESS, RECREATION AND LEISURE AND ANIMAL WELFARE; AND BUSINESS IN THE AREA OF HEALTH, SAFETY AND PERSONAL DEVELOPMENT (U.S. CLS. 2, 5, 22, 23, 29, 37, 38 AND 50).

CLASS 35—ADVERTISING AND BUSINESS

FOR ADVERTISING SERVICES FOR OTHERS, NAMELY, CONDUCTING DIRECT MAIL CAMPAIGNS FOR OTHERS; TELEMARKETING SERVICES (U.S. CLS. 100, 101 AND 102).

CLASS 41—EDUCATION AND ENTERTAINMENT

FOR EDUCATIONAL AND TRAINING SERVICES, AND ONLINE EDUCATIONAL AND TRAINING SERVICES, NAMELY, EDUCATIONAL PROGRAMS AND THE CONDUCTING OF WORKSHOPS AND TRAINING PROGRAMS IN THE AREAS OF HEALTH, WELLNESS, PARENTING, YOUTH DEVELOPMENT, EDUCATION, SOCIAL ISSUES, COGNITIVE AND BEHAVIORAL CHANGE, ELDER ISSUES, SAFETY, ELECTRICITY, ENERGY AND CONSERVATION, EMERGENCY PREPAREDNESS, RECREATION AND LEISURE, ANIMAL WELFARE AND RELIGION; EDUCATIONAL CURRICULUM IN THE AREAS OF HEALTH, WELLNESS, YOUTH DEVELOPMENT, SOCIAL ISSUES, COGNITIVE AND BEHAVIORAL CHANGE, ELDER ISSUES, SAFETY, ELECTRICITY, ENERGY AND CONSERVATION, EMERGENCY PREPAREDNESS, RECREATION AND LEISURE AND ANIMAL WELFARE; AND BUSINESS IN THE AREA OF HEALTH, SAFETY AND PERSONAL DEVELOPMENT; TRAINING SERVICES, NAMELY, TRAINING TEACHERS, PROFESSIONALS, PARENTS AND OTHER ADULTS IN THE AREAS OF PREVENTION SCIENCE, RISK ASSESSMENT AND PROTECTIVE FACTORS RELATING TO YOUTH IN THE AREAS OF ALCOHOL AND OTHER DRUGS, DELINQUENCY, SOCIAL ISSUES, FAMILY ISSUES, COMMUNITY ISSUES, AND SCHOOL ISSUES; THE MOBILIZATION OF COMMUNITY RESOURCES, AND THE PLANNING AND IMPLEMENTATION OF PREVENTION SCIENCE PROGRAMS; PUBLICATION OF BOOKS, BOOKLETS, EDUCATIONAL MATERIALS, AND CATALOGS; PRODUCTION AND EDITING OF VIDEOTAPES, VIDEO CASSETTES, AND AUDIO CASSETTES PROVIDING ONLINE EDUCATIONAL AND TRAINING COMPUTER DATABASE IN THE AREA OF THE FIELD OF EDUCATION, RECREATION AND LEISURE, AND RELIGION; EDUCATIONAL CURRICULUM IN THE AREAS OF HEALTH, WELLNESS, YOUTH DEVELOPMENT, SOCIAL ISSUES, COGNITIVE AND BEHAVIORAL CHANGE, CLASSROOM MANAGEMENT, PARENTING, DRUG ABUSE AND PREVENTION; STAFF TRAINING IN THE AREA OF HEALTH, SAFETY, PERSONAL DEVELOPMENT, CLASSROOM MANAGEMENT AND COGNITIVE AND BEHAVIORAL CHANGE; HEALTH, SAFETY AND PERSONAL DEVELOPMENT OF WORKERS IN INDUSTRIAL ENVIRONMENTS; GOVERNMENT IN THE AREA OF HEALTH, WELLNESS, PARENTING, YOUTH DEVELOPMENT, EDUCATION, SOCIAL ISSUES, COGNITIVE AND BEHAVIORAL CHANGE, ELDER ISSUES, SAFETY, ELECTRICITY, ENERGY AND CONSERVATION, EMERGENCY PREPAREDNESS, RECREATION AND LEISURE AND ANIMAL WELFARE AND BUSINESS IN THE AREA OF HEALTH, SAFETY AND PERSONAL DEVELOPMENT ONLINE INFORMATION SERVICES IN THE FIELD OF RECREATION AND LEISURE (U.S. CLS. 100, 101 AND 107).

CLASS 42—SCIENTIFIC, COMPUTER AND LEGAL SERVICES

FOR ONLINE INFORMATION SERVICES, NAMELY, PROVIDING INFORMATION RELATING TO HEALTH, WELLNESS, PARENTING, YOUTH DEVELOPMENT, SOCIAL ISSUES, COGNITIVE AND BEHAVIORAL CHANGE, ELDER ISSUES, CHILD SAFETY, OCCUPATIONAL SAFETY, HOME SAFETY, PERSONAL SAFETY, ENERGY AND CONSERVATION, EMERGENCY PREPAREDNESS, ANIMAL WELFARE AND RELIGION; HEALTH, SAFETY AND PERSONAL DEVELOPMENT OF WORKERS IN INDUSTRIAL ENVIRONMENTS; GOVERNMENT IN THE AREA OF HEALTH, WELLNESS, PARENTING, YOUTH DEVELOPMENT, SOCIAL ISSUES, COGNITIVE AND BEHAVIORAL CHANGE, ELDER ISSUES, SAFETY, ENERGY AND CONSERVATION, EMERGENCY PREPAREDNESS, AND ANIMAL WELFARE; DESIGNING AND IMPLEMENTING WEB PAGES FOR OTHERS, CONSULTING SERVICES IN THE AREA OF COGNITIVE AND BEHAVIORAL CHANGE; AND LANGUAGE TRANSLATION SERVICES (U.S. CLS. 100 AND 101).

CLASS 9—ELECTRICAL AND SCIENTIFIC APPARATUS

FOR PRERECORDED AUDIO CASSETTES, VIDEO TAPES, DVDS, MULTIMEDIA SOFTWARE RECORDED ON CD-ROM, AND COMPUTER DISCS RELATING TO HEALTH, WELLNESS, PARENTING, YOUTH DEVELOPMENT, EDUCATION, SOCIAL ISSUES, COGNITIVE AND BEHAVIORAL CHANGE, ELDER ISSUES, SAFETY, ELECTRICITY, ENERGY AND CONSERVATION, EMERGENCY PREPAREDNESS, RECREATION AND LEISURE, ANIMAL WELFARE AND RELIGION; STAFF TRAINING IN THE AREA OF HEALTH, SAFETY, PERSONAL DEVELOPMENT, CLASSROOM MANAGEMENT AND COGNITIVE AND BEHAVIORAL CHANGE; EDUCATIONAL CURRICULUM IN THE AREA OF HEALTH, WELLNESS, YOUTH DEVELOPMENT, SOCIAL ISSUES, COGNITIVE AND BEHAVIORAL CHANGE, CLASSROOM MANAGEMENT AND PARENTING; INDUSTRY IN THE AREA OF HEALTH, SAFETY AND PERSONAL DEVELOPMENT; GOVERNMENT IN THE AREA OF HEALTH, WELLNESS, PARENTING, YOUTH DEVELOPMENT, EDUCATION, SOCIAL ISSUES, COGNITIVE AND BEHAVIORAL CHANGE, ELDER ISSUES, SAFETY, ELECTRICITY, ENERGY AND CONSERVATION, EMERGENCY PREPAREDNESS, RECREATION AND LEISURE AND ANIMAL WELFARE; AND BUSINESS IN THE AREA OF HEALTH, SAFETY AND PERSONAL DEVELOPMENT; COMPUTER SOFTWARE CONSISTING OF AN ELECTRONIC DATABASE RELATED TO HUMAN BEHAVIOR AND COGNITION, EDUCATION, AND EDUCATIONAL CURRICULUM IN THE AREA OF HEALTH, WELLNESS, YOUTH DEVELOPMENT, SOCIAL ISSUES, COGNITIVE AND BEHAVIORAL CHANGE, CLASSROOM MANAGEMENT AND PARENTING; AND RELATED PRINTED INSTRUCTIONAL MANUALS SOLD AS A UNIT (U.S. CLS. 21, 23, 26, 36 AND 38).

SN 78-092,066, CHANNING L. BETE CO., INC., SOUTH DEERFIELD, MA. FILED 11-7-2001.



THE MARK CONSISTS OF A FANCIFUL DEPICTION OF A PERSON RUNNING.

CLASS 16—PAPER GOODS AND PRINTED MATTER

FOR PRINTED MATTER, NAMELY, COLORING BOOKS, BROCHURES, PAMPHLETS, LEADER'S GUIDES, POSTERS, CALENDARS, AND CURRICULUM COURSE MATERIALS, NAMELY BOOKS, BROCHURES, PAMPHLETS, POSTERS AND CALENDARS ALL RELATING TO HEALTH, WELLNESS, PARENTING, YOUTH DEVELOPMENT, EDUCATION, SOCIAL ISSUES, COGNITIVE AND BEHAVIORAL CHANGE, ELDER ISSUES, SAFETY, ELECTRICITY, ENERGY AND CONSERVATION, EMERGENCY PREPAREDNESS, RECREATION AND LEISURE, ANIMAL WELFARE AND RELIGION; STAFF TRAINING IN THE AREA OF HEALTH, SAFETY, PERSONAL DEVELOPMENT, CLASSROOM MANAGEMENT AND COGNITIVE AND BEHAVIOR CHANGE; EDUCATIONAL CURRICULUM IN THE AREA OF HEALTH, WELLNESS, YOUTH DEVELOPMENT, SOCIAL ISSUES, COGNITIVE AND BEHAVIORAL CHANGE, CLASSROOM MANAGEMENT AND PARENTING; INDUSTRY IN THE AREA OF HEALTH, SAFETY AND PERSONAL DEVELOPMENT; GOVERNMENT IN THE AREA OF HEALTH, WELLNESS, PARENTING, YOUTH DEVELOPMENT, EDUCATION, SOCIAL ISSUES, COGNITIVE AND BEHAVIORAL CHANGE, ELDER ISSUES, SAFETY, ELECTRICITY, ENERGY AND CONSERVATION, EMERGENCY PREPAREDNESS, RECREATION AND LEISURE AND ANIMAL WELFARE; AND BUSINESS IN THE AREA OF HEALTH, SAFETY AND PERSONAL DEVELOPMENT (U.S. CLS. 2, 5, 22, 23, 29, 37, 38 AND 50).

CLASS 35—ADVERTISING AND BUSINESS

FOR ADVERTISING SERVICES FOR OTHERS, NAMELY, CONDUCTING DIRECT MAIL CAMPAIGNS FOR OTHERS; TELEMARKETING SERVICES (U.S. CLS. 100, 101 AND 102).

CLASS 41—EDUCATION AND ENTERTAINMENT

FOR EDUCATIONAL AND TRAINING SERVICES, AND ONLINE EDUCATIONAL AND TRAINING SERVICES, NAMELY, EDUCATIONAL PROGRAMS AND THE CONDUCTING OF WORKSHOPS AND TRAINING PROGRAMS IN THE AREAS OF HEALTH, WELLNESS, PARENTING, YOUTH DEVELOPMENT, EDUCATION, SOCIAL ISSUES, COGNITIVE AND BEHAVIORAL CHANGE, ELDER ISSUES, SAFETY, ELECTRICITY, ENERGY AND CONSERVATION, EMERGENCY PREPAREDNESS, RECREATION AND LEISURE, ANIMAL WELFARE AND RELIGION; EDUCATIONAL CURRICULUM IN THE AREAS OF HEALTH, WELLNESS, YOUTH DEVELOPMENT, SOCIAL ISSUES, COGNITIVE AND BEHAVIORAL CHANGE, CLASSROOM MANAGEMENT, PARENTING, DRUG ABUSE AND PREVENTION; STAFF TRAINING IN THE AREA OF HEALTH, SAFETY, PERSONAL DEVELOPMENT, CLASSROOM MANAGEMENT AND COGNITIVE AND BEHAVIORAL CHANGE, HEALTH, SAFETY AND PERSONAL DEVELOPMENT OF WORKERS IN INDUSTRIAL ENVIRONMENTS, GOVERNMENT IN THE AREA OF HEALTH, WELLNESS, PARENTING, YOUTH DEVELOPMENT, EDUCATION, SOCIAL ISSUES, COGNITIVE AND BEHAVIORAL CHANGE, ELDER ISSUES, SAFETY, ELECTRICITY, ENERGY AND CONSERVATION, EMERGENCY PREPAREDNESS, RECREATION AND LEISURE AND ANIMAL WELFARE; AND BUSINESS IN THE AREA OF HEALTH, SAFETY AND PERSONAL DEVELOPMENT; TRAINING SERVICES, NAMELY, TRAINING TEACHERS, PROFESSIONALS, PARENTS AND OTHER ADULTS IN THE AREAS OF PREVENTION SCIENCE, RISK ASSESSMENT AND PROTECTIVE FACTORS RELATING TO YOUTH IN THE AREAS OF ALCOHOL AND OTHER DRUGS, DELINQUENCY, SOCIAL ISSUES, FAMILY ISSUES, COMMUNITY ISSUES, AND SCHOOL ISSUES; THE MOBILIZATION OF COMMUNITY RESOURCES, AND THE PLANNING AND IMPLEMENTATION OF PREVENTION SCIENCE PROGRAMS; PUBLICATION OF BOOKS, BOOKLETS, EDUCATIONAL MATERIALS, AND CATALOGS; PRODUCTION AND EDITING OF VIDEOTAPES, VIDEO CASSETTES, AND AUDIO CASSETTES PROVIDING ONLINE EDUCATIONAL AND TRAINING COMPUTER DATABASE IN THE AREA OF THE FIELD OF EDUCATION, RECREATION AND LEISURE, AND RELIGION; EDUCATIONAL CURRICULUM IN THE AREAS OF HEALTH, WELLNESS, YOUTH DEVELOPMENT, SOCIAL ISSUES, COGNITIVE AND BEHAVIORAL CHANGE, CLASSROOM MANAGEMENT, PARENTING, DRUG ABUSE AND PREVENTION; STAFF TRAINING IN THE AREA OF HEALTH, SAFETY, PERSONAL DEVELOPMENT, CLASSROOM MANAGEMENT AND COGNITIVE AND BEHAVIORAL CHANGE; HEALTH, SAFETY AND PERSONAL DEVELOPMENT OF WORKERS IN INDUSTRIAL ENVIRONMENTS; GOVERNMENT IN THE AREA OF HEALTH, WELLNESS, PARENTING, YOUTH DEVELOPMENT, EDUCATION, SOCIAL ISSUES, COGNITIVE AND BEHAVIORAL CHANGE, ELDER ISSUES, SAFETY, ELECTRICITY, ENERGY AND CONSERVATION, EMERGENCY PREPAREDNESS, RECREATION AND LEISURE AND ANIMAL WELFARE AND BUSINESS IN THE AREA OF HEALTH, SAFETY AND PERSONAL DEVELOPMENT ONLINE INFORMATION SERVICES IN THE FIELD OF RECREATION AND LEISURE (U.S. CLS. 100, 101 AND 107).

CLASS 42—SCIENTIFIC, COMPUTER AND LEGAL SERVICES

FOR ONLINE INFORMATION SERVICES, NAMELY, PROVIDING INFORMATION RELATING TO HEALTH, EVILNESS, PARENTING, YOUTH DEVELOPMENT, SOCIAL ISSUES, COGNITIVE AND BEHAVIORAL CHANGE, ELDER ISSUES, CHILD SAFETY, OCCUPATIONAL SAFETY, HOME SAFETY, PERSONAL SAFETY, ENERGY AND CONSERVATION, EMERGENCY PREPAREDNESS, ANIMAL WELFARE AND RELIGION; HEALTH, SAFETY AND PERSONAL DEVELOPMENT OF WORKERS IN INDUSTRIAL ENVIRONMENTS; GOVERNMENT IN THE AREA OF HEALTH, WELLNESS, PARENTING, YOUTH DEVELOPMENT, SOCIAL ISSUES, COGNITIVE AND BEHAVIORAL CHANGE, ELDER ISSUES, SAFETY, ENERGY AND CONSERVATION, EMERGENCY PREPAREDNESS, AND ANIMAL WELFARE; DESIGNING AND IMPLEMENTING WEB PAGES FOR OTHERS, CONSULTING SERVICES IN THE AREA OF COGNITIVE AND BEHAVIORAL CHANGE; AND LANGUAGE TRANSLATION SERVICES (U.S. CLS. 100 AND 101).

SN 78-092.068. CHANNING L. BETE CO., INC., SOUTH DEERFIELD, MA. FILED 11-7-2001.



NO CLAIM IS MADE TO THE EXCLUSIVE RIGHT TO USE "COMPANY", APART FROM THE MARK AS SHOWN. THE NAME "CHANNING BETE" DOES NOT IDENTIFY A LIVING INDIVIDUAL.

THE MARK CONSISTS OF A FANCIFUL DEPICTION OF A PERSON RUNNING WITHIN TEXT.

CLASS 9—ELECTRICAL AND SCIENTIFIC APPARATUS

FOR PRERECORDED AUDIO CASSETTES, VIDEO TAPES, DVDS, MULTIMEDIA SOFTWARE RECORDED ON CD-ROM, AND COMPUTER DISCS RELATING TO HEALTH, WELLNESS, PARENTING, YOUTH DEVELOPMENT, EDUCATION, SOCIAL ISSUES, COGNITIVE AND BEHAVIORAL CHANGE, ELDER ISSUES, SAFETY, ELECTRICITY, ENERGY AND CONSERVATION, EMERGENCY PREPAREDNESS, RECREATION AND LEISURE, ANIMAL WELFARE AND RELIGION; STAFF TRAINING IN THE AREA OF HEALTH, SAFETY, PERSONAL DEVELOPMENT, CLASSROOM MANAGEMENT AND COGNITIVE AND BEHAVIORAL CHANGE; EDUCATIONAL CURRICULUM IN THE AREA OF HEALTH, WELLNESS, YOUTH DEVELOPMENT, SOCIAL ISSUES, COGNITIVE AND BEHAVIORAL CHANGE, CLASSROOM MANAGEMENT AND PARENTING; INDUSTRY IN THE AREA OF HEALTH, SAFETY AND PERSONAL DEVELOPMENT; GOVERNMENT IN THE AREA OF HEALTH, WELLNESS, PARENTING, YOUTH DEVELOPMENT, EDUCATION, SOCIAL ISSUES, COGNITIVE AND BEHAVIORAL CHANGE, ELDER ISSUES, SAFETY, ELECTRICITY, ENERGY AND CONSERVATION, EMERGENCY PREPAREDNESS, RECREATION AND LEISURE AND ANIMAL WELFARE; AND BUSINESS IN THE AREA OF HEALTH, SAFETY AND PERSONAL DEVELOPMENT; COMPUTER SOFTWARE CONSISTING OF AN ELECTRONIC DATABASE RELATED TO HUMAN BEHAVIOR AND COGNITION, EDUCATION, AND EDUCATIONAL CURRICULUM IN THE AREA OF HEALTH, WELLNESS, YOUTH DEVELOPMENT, SOCIAL ISSUES, COGNITIVE AND BEHAVIORAL CHANGE, CLASSROOM MANAGEMENT AND PARENTING; AND RELATED PRINTED INSTRUCTIONAL MANUALS SOLD AS A UNIT (U.S. CLS. 21, 23, 26, 36 AND 38).

CLASS 16—PAPER GOODS AND PRINTED MATTER

FOR PRINTED MATTER, NAMELY, COLORING BOOKS, BROCHURES, PAMPHLETS, LEADER'S GUIDES, POSTERS, CALENDARS, AND CURRICULUM COURSE MATERIALS, NAMELY BOOKS, BROCHURES, PAMPHLETS, POSTERS AND CALENDARS ALL RELATING TO HEALTH, WELLNESS, PARENTING, YOUTH DEVELOPMENT, EDUCATION, SOCIAL ISSUES, COGNITIVE AND BEHAVIORAL CHANGE, ELDER ISSUES, SAFETY, ELECTRICITY, ENERGY AND CONSERVATION, EMERGENCY PREPAREDNESS, RECREATION AND LEISURE, ANIMAL WELFARE AND RELIGION; STAFF TRAINING IN THE AREA OF HEALTH, SAFETY, PERSONAL DEVELOPMENT, CLASSROOM MANAGEMENT AND COGNITIVE AND BEHAVIORAL CHANGE; EDUCATIONAL CURRICULUM IN THE AREA OF HEALTH, WELLNESS, YOUTH DEVELOPMENT, SOCIAL ISSUES, COGNITIVE AND BEHAVIORAL CHANGE, CLASSROOM MANAGEMENT AND PARENTING; INDUSTRY IN THE AREA OF HEALTH, SAFETY AND PERSONAL DEVELOPMENT; GOVERNMENT IN THE AREA OF HEALTH, WELLNESS, PARENTING, YOUTH DEVELOPMENT, EDUCATION, SOCIAL ISSUES, COGNITIVE AND BEHAVIORAL CHANGE, ELDER ISSUES, SAFETY, ELECTRICITY, ENERGY AND CONSERVATION, EMERGENCY PREPAREDNESS, RECREATION AND LEISURE AND ANIMAL WELFARE; AND BUSINESS IN THE AREA OF HEALTH, SAFETY AND PERSONAL DEVELOPMENT (U.S. CLS. 2, 5, 22, 23, 29, 37, 38 AND 50).

CLASS 35—ADVERTISING AND BUSINESS

FOR ADVERTISING SERVICES FOR OTHERS, NAMELY, CONDUCTING DIRECT MAIL CAMPAIGNS FOR OTHERS; TELEMARKETING SERVICES (U.S. CLS. 100, 101 AND 102).

CLASS 41—EDUCATION AND ENTERTAINMENT

FOR EDUCATIONAL AND TRAINING SERVICES, AND ONLINE EDUCATIONAL AND TRAINING SERVICES, NAMELY, EDUCATIONAL PROGRAMS AND THE CONDUCTING OF WORKSHOPS AND TRAINING PROGRAMS IN THE AREAS OF HEALTH, WELLNESS, PARENTING, YOUTH DEVELOPMENT, EDUCATION, SOCIAL ISSUES, COGNITIVE AND BEHAVIORAL CHANGE, ELDER ISSUES, SAFETY, ELECTRICITY, ENERGY AND CONSERVATION, EMERGENCY PREPAREDNESS, RECREATION AND LEISURE, ANIMAL WELFARE AND RELIGION; EDUCATIONAL CURRICULUM IN THE AREAS OF HEALTH, WELLNESS, YOUTH DEVELOPMENT, SOCIAL ISSUES, COGNITIVE AND BEHAVIORAL CHANGE, ELDER ISSUES, SAFETY, ELECTRICITY, ENERGY AND CONSERVATION, EMERGENCY PREPAREDNESS, RECREATION AND LEISURE AND ANIMAL WELFARE; AND BUSINESS IN THE AREA OF HEALTH, SAFETY AND PERSONAL DEVELOPMENT; TRAINING SERVICES, NAMELY, TRAINING TEACHERS, PROFESSIONALS, PARENTS AND OTHER ADULTS IN THE AREAS OF PREVENTION SCIENCE, RISK ASSESSMENT AND PROTECTIVE FACTORS RELATING TO YOUTH IN THE AREAS OF ALCOHOL AND OTHER DRUGS, DELINQUENCY, SOCIAL ISSUES, FAMILY ISSUES, COMMUNITY ISSUES, AND SCHOOL ISSUES; THE MOBILIZATION OF COMMUNITY RESOURCES, AND THE PLANNING AND IMPLEMENTATION OF PREVENTION SCIENCE PROGRAMS; PUBLICATION OF BOOKS, BOOKLETS, EDUCATIONAL MATERIALS, AND CATALOGS; PRODUCTION AND EDITING OF VIDEOTAPES, VIDEO CASSETTES, AND AUDIO CASSETTES PROVIDING ONLINE EDUCATIONAL AND TRAINING COMPUTER DATABASE IN THE AREA OF THE FIELD OF EDUCATION, RECREATION AND LEISURE, AND RELIGION; EDUCATIONAL CURRICULUM IN THE AREAS OF HEALTH, WELLNESS, YOUTH DEVELOPMENT, SOCIAL ISSUES, COGNITIVE AND BEHAVIORAL CHANGE, CLASSROOM MANAGEMENT, PARENTING, DRUG ABUSE AND PREVENTION; STAFF TRAINING IN THE AREA OF HEALTH, SAFETY, PERSONAL DEVELOPMENT, CLASSROOM MANAGEMENT AND COGNITIVE AND BEHAVIORAL CHANGE; HEALTH, SAFETY AND PERSONAL DEVELOPMENT OF WORKERS IN INDUSTRIAL ENVIRONMENTS; GOVERNMENT IN THE AREA OF HEALTH, WELLNESS, PARENTING, YOUTH DEVELOPMENT, EDUCATION, SOCIAL ISSUES, COGNITIVE AND BEHAVIORAL CHANGE, ELDER ISSUES, SAFETY, ELECTRICITY, ENERGY AND CONSERVATION, EMERGENCY PREPAREDNESS, RECREATION AND LEISURE AND ANIMAL WELFARE AND BUSINESS IN THE AREA OF HEALTH, SAFETY AND PERSONAL DEVELOPMENT ONLINE INFORMATION SERVICES IN THE FIELD OF RECREATION AND LEISURE (U.S. CLS. 100, 101 AND 107).

CLASS 42—SCIENTIFIC, COMPUTER AND LEGAL SERVICES

FOR ONLINE INFORMATION SERVICES, NAMELY, PROVIDING INFORMATION RELATING TO HEALTH, WELLNESS, PARENTING, YOUTH DEVELOPMENT, SOCIAL ISSUES, COGNITIVE AND BEHAVIORAL CHANGE, ELDER ISSUES, CHILD SAFETY, OCCUPATIONAL SAFETY, HOME SAFETY, PERSONAL SAFETY, ENERGY AND CONSERVATION, EMERGENCY PREPAREDNESS, ANIMAL WELFARE AND RELIGION; HEALTH, SAFETY AND PERSONAL DEVELOPMENT OR WORKERS IN INDUSTRIAL ENVIRONMENTS; GOVERNMENT IN THE AREA OF HEALTH, WELLNESS, PARENTING, YOUTH DEVELOPMENT OR WORKERS IN INDUSTRIAL ENVIRONMENTS, SOCIAL ISSUES, COGNITIVE AND BEHAVIORAL CHANGE, ELDER ISSUES, SAFETY, ENERGY AND CONSERVATION, EMERGENCY PREPAREDNESS, AND ANIMAL WELFARE; DESIGNING AND IMPLEMENTING WEB PAGES FOR OTHERS, CONSULTING SERVICES IN THE AREA OF COGNITIVE AND BEHAVIORAL CHANGE; AND LANGUAGE TRANSLATION SERVICES (U.S. CLS. 100 AND 101).

SN 78-092,071. CHANNING L. BETE CO., INC., SOUTH DEERFIELD, MA. FILED 11-7-2001.

Channing Bete
COMPANY



NO CLAIM IS MADE TO THE EXCLUSIVE RIGHT TO USE "COMPANY", APART FROM THE MARK AS SHOWN. THE NAME "CHANNING BETE" DOES NOT IDENTIFY A LIVING INDIVIDUAL.

THE MARK CONSISTS OF FANCIFUL DEPICTION OF A PERSON RUNNING WITHIN TEXT.

CLASS 9—ELECTRICAL AND SCIENTIFIC APPARATUS

FOR PRERECORDED AUDIO CASSETTES, VIDEO TAPES, DVDS, MULTIMEDIA SOFTWARE RECORDED ON CD-ROM, AND COMPUTER DISCS RELATING TO HEALTH, WELLNESS, PARENTING, YOUTH DEVELOPMENT, EDUCATION, SOCIAL ISSUES, COGNITIVE AND BEHAVIORAL CHANGE, ELDER ISSUES, SAFETY, ELECTRICITY, ENERGY AND CONSERVATION, EMERGENCY PREPAREDNESS, RECREATION AND LEISURE, ANIMAL WELFARE AND RELIGION; STAFF TRAINING IN THE AREA OF HEALTH, SAFETY, PERSONAL DEVELOPMENT, CLASSROOM MANAGEMENT AND COGNITIVE AND BEHAVIORAL CHANGE; EDUCATIONAL CURRICULUM IN THE AREA OF HEALTH, WELLNESS, YOUTH DEVELOPMENT, SOCIAL ISSUES, COGNITIVE AND BEHAVIORAL CHANGE, CLASSROOM MANAGEMENT AND PARENTING; INDUSTRY IN THE AREA OF HEALTH, SAFETY AND PERSONAL DEVELOPMENT; GOVERNMENT IN THE AREA OF HEALTH, WELLNESS, PARENTING, YOUTH DEVELOPMENT, EDUCATION, SOCIAL ISSUES, COGNITIVE AND BEHAVIORAL CHANGE, ELDER ISSUES, SAFETY, ELECTRICITY, ENERGY AND CONSERVATION, EMERGENCY PREPAREDNESS, RECREATION AND LEISURE AND ANIMAL WELFARE; AND BUSINESS IN THE AREA OF HEALTH, SAFETY AND PERSONAL DEVELOPMENT; COMPUTER SOFTWARE CONSISTING OF AN ELECTRONIC DATABASE RELATED TO HUMAN BEHAVIOR AND COGNITION, EDUCATION, AND EDUCATIONAL CURRICULUM IN THE AREA OF HEALTH, WELLNESS, YOUTH DEVELOPMENT, SOCIAL ISSUES, COGNITIVE AND BEHAVIORAL CHANGE, CLASSROOM MANAGEMENT AND PARENTING; AND RELATED PRINTED INSTRUCTIONAL MANUALS SOLD AS A UNIT (U.S. CLS. 21, 23, 26, 36 AND 38).

CLASS 16—PAPER GOODS AND PRINTED MATTER

FOR PRINTED MATTER, NAMELY, COLORING BOOKS, BROCHURES, PAMPHLETS, LEADER'S GUIDES, POSTERS, CALENDARS, AND CURRICULUM COURSE MATERIALS, NAMELY BOOKS, BROCHURES, PAMPHLETS, POSTERS AND CALENDARS ALL RELATING TO HEALTH, WELLNESS, PARENTING, YOUTH DEVELOPMENT, EDUCATION, SOCIAL ISSUES, COGNITIVE AND BEHAVIORAL CHANGE, ELDER ISSUES, SAFETY, ELECTRICITY, ENERGY AND CONSERVATION, EMERGENCY PREPAREDNESS, RECREATION AND LEISURE, ANIMAL WELFARE AND RELIGION; STAFF TRAINING IN THE AREA OF HEALTH, SAFETY, PERSONAL DEVELOPMENT, CLASSROOM MANAGEMENT AND COGNITIVE AND BEHAVIORAL CHANGE; EDUCATIONAL CURRICULUM IN THE AREA OF HEALTH, WELLNESS, YOUTH DEVELOPMENT, SOCIAL ISSUES, COGNITIVE AND BEHAVIORAL CHANGE, CLASSROOM MANAGEMENT AND PARENTING; INDUSTRY IN THE AREA OF HEALTH, SAFETY AND PERSONAL DEVELOPMENT; GOVERNMENT IN THE AREA OF HEALTH, WELLNESS, PARENTING, YOUTH DEVELOPMENT, EDUCATION, SOCIAL ISSUES, COGNITIVE AND BEHAVIORAL CHANGE, ELDER ISSUES, SAFETY, ELECTRICITY, ENERGY AND CONSERVATION, EMERGENCY PREPAREDNESS, RECREATION AND LEISURE AND ANIMAL WELFARE; AND BUSINESS IN THE AREA OF HEALTH, SAFETY AND PERSONAL DEVELOPMENT (U.S. CLS. 2, 5, 22, 23, 29, 37, 38 AND 50).

CLASS 35—ADVERTISING AND BUSINESS

FOR ADVERTISING SERVICES FOR OTHERS, NAMELY, CONDUCTING DIRECT MAIL CAMPAIGNS FOR OTHERS; TELEMARKETING SERVICES (U.S. CLS. 100, 101 AND 102).

CLASS 41—EDUCATION AND ENTERTAINMENT

FOR EDUCATIONAL AND TRAINING SERVICES, AND ONLINE EDUCATIONAL AND TRAINING SERVICES, NAMELY, EDUCATIONAL PROGRAMS AND THE CONDUCTING OF WORKSHOPS AND TRAINING PROGRAMS IN THE AREAS OF HEALTH, WELLNESS, PARENTING, YOUTH DEVELOPMENT, EDUCATION, SOCIAL ISSUES, COGNITIVE AND BEHAVIORAL CHANGE, ELDER ISSUES, SAFETY, ELECTRICITY, ENERGY AND CONSERVATION, EMERGENCY PREPAREDNESS, RECREATION AND LEISURE, ANIMAL WELFARE AND RELIGION; EDUCATIONAL CURRICULUM IN THE AREAS OF HEALTH, WELLNESS, YOUTH DEVELOPMENT, SOCIAL ISSUES, COGNITIVE AND BEHAVIORAL CHANGE, CLASSROOM MANAGEMENT, PARENTING, DRUG ABUSE AND PREVENTION; STAFF TRAINING IN THE AREA OF HEALTH, SAFETY, PERSONAL DEVELOPMENT, CLASSROOM MANAGEMENT AND COGNITIVE AND BEHAVIORAL CHANGE, HEALTH, SAFETY AND PERSONAL DEVELOPMENT OF WORKERS IN INDUSTRIAL ENVIRONMENTS, GOVERNMENT IN THE AREA OF HEALTH, WELLNESS, PARENTING, YOUTH DEVELOPMENT, EDUCATION, SOCIAL ISSUES, COGNITIVE AND BEHAVIORAL CHANGE, ELDER ISSUES, SAFETY, ELECTRICITY, ENERGY AND CONSERVATION, EMERGENCY PREPAREDNESS, RECREATION AND LEISURE AND ANIMAL WELFARE; AND BUSINESS IN THE AREA OF HEALTH, SAFETY AND PERSONAL DEVELOPMENT; TRAINING SERVICES, NAMELY, TRAINING TEACHERS, PROFESSIONALS, PARENTS AND OTHER ADULTS IN THE AREAS OF PREVENTION SCIENCE, RISK ASSESSMENT AND PROTECTIVE FACTORS RELATING TO YOUTH IN THE AREAS OF ALCOHOL AND OTHER DRUGS, DELINQUENCY, SOCIAL ISSUES, FAMILY ISSUES, COMMUNITY ISSUES, AND SCHOOL ISSUES; THE MOBILIZATION OF COMMUNITY RESOURCES, AND THE PLANNING AND IMPLEMENTATION OF PREVENTION SCIENCE PROGRAMS; PUBLICATION OF BOOKS, BOOKLETS, EDUCATIONAL MATERIALS, AND CATALOGS; PRODUCTION AND EDITING OF VIDEOTAPES, VIDEO CASSETTES, AND AUDIO CASSETTES PROVIDING ONLINE EDUCATIONAL AND TRAINING COMPUTER DATABASE IN THE AREA OF THE FIELD OF EDUCA-

TION, RECREATION AND LEISURE, AND RELIGION; EDUCATIONAL CURRICULUM IN THE AREAS OF HEALTH, WELLNESS, YOUTH DEVELOPMENT, SOCIAL ISSUES, COGNITIVE AND BEHAVIORAL CHANGE, CLASSROOM MANAGEMENT, PARENTING, DRUG ABUSE AND PREVENTION; STAFF TRAINING IN THE AREA OF HEALTH, SAFETY, PERSONAL DEVELOPMENT, CLASSROOM MANAGEMENT AND COGNITIVE AND BEHAVIORAL CHANGE; HEALTH, SAFETY AND PERSONAL DEVELOPMENT OF WORKERS IN INDUSTRIAL ENVIRONMENTS; GOVERNMENT IN THE AREA OF HEALTH, WELLNESS, PARENTING, YOUTH DEVELOPMENT, EDUCATION, SOCIAL ISSUES, COGNITIVE AND BEHAVIORAL CHANGE, ELDER ISSUES, SAFETY, ELECTRICITY, ENERGY AND CONSERVATION, EMERGENCY PREPAREDNESS, RECREATION AND LEISURE AND ANIMAL WELFARE AND BUSINESS IN THE AREA OF HEALTH, SAFETY AND PERSONAL DEVELOPMENT ONLINE INFORMATION SERVICES IN THE FIELD OF RECREATION AND LEISURE (U.S. CLS. 100, 101 AND 107).

CLASS 42—SCIENTIFIC, COMPUTER AND LEGAL SERVICES

FOR ONLINE INFORMATION SERVICES, NAMELY, PROVIDING INFORMATION RELATING TO HEALTH, WELLNESS, PARENTING, YOUTH DEVELOPMENT, SOCIAL ISSUES, COGNITIVE AND BEHAVIORAL CHANGE, ELDER ISSUES, CHILD SAFETY, OCCUPATIONAL SAFETY, HOME SAFETY, PERSONAL SAFETY, ENERGY AND CONSERVATION, EMERGENCY PREPAREDNESS, ANIMAL WELFARE AND RELIGION; HEALTH, SAFETY AND PERSONAL DEVELOPMENT OF WORKERS IN INDUSTRIAL ENVIRONMENTS; GOVERNMENT IN THE AREA OF HEALTH, WELLNESS, PARENTING, YOUTH DEVELOPMENT, SOCIAL ISSUES, COGNITIVE AND BEHAVIORAL CHANGE, ELDER ISSUES, SAFETY, ENERGY AND CONSERVATION, EMERGENCY PREPAREDNESS, AND ANIMAL WELFARE; DESIGNING AND IMPLEMENTING WEB PAGES FOR OTHERS, CONSULTING SERVICES IN THE AREA OF COGNITIVE AND BEHAVIORAL CHANGE; AND LANGUAGE TRANSLATION SERVICES (U.S. CLS. 100 AND 101).

SN 78-093,099. CHARACTER ARTS, LLC, WILTON, CT. FILED 11-13-2001.

CHARACTER ARTS

NO CLAIM IS MADE TO THE EXCLUSIVE RIGHT TO USE "ARTS", APART FROM THE MARK AS SHOWN.

CLASS 35—ADVERTISING AND BUSINESS

FOR MANAGEMENT SERVICES, NAMELY, COPYRIGHT MANAGEMENT, MANAGEMENT OF COPYRIGHT AND TRADEMARK LICENSEES, MANAGEMENT OF CREATIVE SERVICE PROVIDERS, NAMELY, MANAGEMENT OF PERFORMING ARTISTS AND MANAGEMENT OF WRITERS IN THE FIELD OF ENTERTAINMENT (U.S. CLS. 100, 101 AND 102).

CLASS 41—EDUCATION AND ENTERTAINMENT

FOR ENTERTAINMENT NAMELY, PRODUCTION AND DISTRIBUTION OF THEATRICAL MOTION PICTURES; TELEVISION SHOW PRODUCTION; DISTRIBUTION OF TELEVISION PROGRAMMING FOR OTHERS; PRODUCING LIVE THEATRICAL EVENTS; PRODUCTION OF VIDEO DISCS FOR OTHERS, AUDIO RECORDING AND PRODUCTION (U.S. CLS. 100, 101 AND 107).

SN 78-096,883. HYMITE APS, 2800 LYNGBY, DENMARK, FILED 12-6-2001.

HYMITE

PRIORITY CLAIMED UNDER SEC. 44(D) ON DENMARK APPLICATION NO. VA200104008, FILED 10-24-2001, REG. NO. VA20014600, DATED 11-14-2001, EXPIRES 11-14-2011.

CLASS 9—ELECTRICAL AND SCIENTIFIC APPARATUS

FOR COMPONENTS FOR OPTICAL COMMUNICATION, NAMELY, OPTICAL AMPLIFIERS, ATTENUATORS, DEMULTIPLEXERS, INTEGRATED CIRCUIT CHIPS FOR USE AS LASER DIODE DRIVERS, INTEGRATED CIRCUIT CHIPS FOR USE AS TRANSMITTANCE AMPLIFIERS FOR PHOTO DETECTORS, LASERS NOT FOR MEDICAL USE BUT FOR TELECOMMUNICATION AND AMPLIFICATION, LIGHT EMITTING DIODES, MULTIPLEXERS, OPTICAL FILTERS, OPTICAL LENSES, RECEIVERS TO RECEIVE LIGHT, NAMELY PHOTO DETECTORS, SEMICONDUCTOR CHIPS, SEMICONDUCTOR DEVICES, SEMICONDUCTORS, TELECOMMUNICATION SWITCHES, TRANSCEIVERS, SEMICONDUCTOR OPTICAL AMPLIFIERS, LINEAR OPTICAL AMPLIFIERS, COUPLERS, SPLITTERS, ARRAYED WAVEGUIDE GRATINGS (U.S. CLS. 21, 23, 26, 36 AND 38).

CLASS 40—MATERIAL TREATMENT

FOR ASSEMBLY AND ENCAPSULATION OF OPTICAL COMMUNICATIONS COMPONENTS FOR OTHERS (U.S. CLS. 100, 103 AND 106).

SN 78-098,576. SITE59.COM, INC., NYC, NY. FILED 12-16-2001.

AGENT59

OWNER OF U.S. REG. NO. 2,535,497.

CLASS 39—TRANSPORTATION AND STORAGE

FOR ARRANGING FOR RESERVATIONS AND BOOKING FOR TRANSPORTATION SERVICES; PROVIDING INFORMATION IN THE FIELD OF TRAVEL VIA THE INTERNET (U.S. CLS. 100 AND 105).

CLASS 42—SCIENTIFIC, COMPUTER AND LEGAL SERVICES

FOR ARRANGING FOR RESERVATIONS AND BOOKING FOR TEMPORARY LODGING (U.S. CLS. 100 AND 101).

SN 78-100,283. EDIBA, INC., OKLAHOMA CITY, OK. FILED 12-28-2001.

EDIBA

CLASS 16—PAPER GOODS AND PRINTED MATTER

FOR PRINTED EDUCATIONAL MATERIAL, NAMELY PROFESSIONAL AND PATIENT HANDBOOKS AND GUIDE BOOKS IN THE FIELD OF DIABETES, MANAGEMENT OF DIABETES AND CARE OF INDIVIDUALS WITH DIABETES (U.S. CLS. 2, 5, 22, 23, 29, 37, 38 AND 50).

FIRST USE 8-9-2001; IN COMMERCE 8-17-2001.

CLASS 41—EDUCATION AND ENTERTAINMENT

FOR EDUCATIONAL SERVICES, NAMELY, CONDUCTING CLASSES, SEMINARS, CONFERENCES AND WORKSHOPS IN THE FIELD OF DIABETES, MANAGEMENT OF DIABETES AND CARE OF INDIVIDUALS WITH DIABETES AND DISTRIBUTING COURSE MATERIALS IN CONNECTION THEREWITH (U.S. CLS. 100, 101 AND 107).

FIRST USE 8-9-2001; IN COMMERCE 8-17-2001.

SN 78-100,478. NORTON, TIM R., COLORADO SPRINGS, CO. FILED 12-31-2001.

SIMALYTIC

CLASS 9—ELECTRICAL AND SCIENTIFIC APPARATUS

FOR COMPUTER SOFTWARE FOR ANALYZING THE PERFORMANCE AND CAPACITY OF COMPUTER SYSTEMS, APPLICATIONS AND ENVIRONMENTS (U.S. CLS. 21, 23, 26, 36 AND 38).

CLASS 42—SCIENTIFIC, COMPUTER AND LEGAL SERVICES

FOR COMPUTER SERVICES, NAMELY, ANALYZING THE PERFORMANCE AND/OR CAPACITY OF COMPUTER SYSTEMS AND/OR COMPUTER APPLICATIONS AND/OR COMPUTER ENVIRONMENTS FOR OTHERS; PROVIDING COMPUTER SYSTEMS ANALYSIS OF COMPUTER TECHNOLOGY FOR OTHERS; MODELING COMPUTER SYSTEM AND/OR COMPUTER PROGRAM BEHAVIOR FOR OTHERS (U.S. CLS. 100 AND 101).

FIRST USE 3-0-2000; IN COMMERCE 3-0-2000.

SN 78-100,728. SOURCECHECK, LLC., HENDERSON, NV. FILED 1-3-2002.

SOURCECHECK

CLASS 35—ADVERTISING AND BUSINESS

FOR COMPUTERIZED DATABASE MANAGEMENT SERVICES, NAMELY UPDATING AND CORRECTING CUSTOMER AND CONSUMER INFORMATION FOR THE RETAIL, CREDIT PROVIDER, TELECOMMUNICATIONS, E-COMMERCE, FINANCIAL SERVICES AND COLLECTION AGENCY INDUSTRIES (U.S. CLS. 100, 101 AND 102).

FIRST USE 2-6-2001; IN COMMERCE 1-2-2002.

CLASS 42—SCIENTIFIC, COMPUTER AND LEGAL SERVICES

FOR FRAUD PREVENTION SERVICES, NAMELY AUTHENTICATION AND VERIFICATION OF PERSONAL IDENTIFICATION DATA AND INFORMATION PROVIDED BY CREDIT APPLICANTS, LOAN APPLICANTS AND POTENTIAL CUSTOMERS (U.S. CLS. 100 AND 101).

FIRST USE 12-6-2001; IN COMMERCE 1-2-2002.

CLASS 45—PERSONAL SERVICES

FOR FRAUD DETECTION SERVICES IN THE FIELD OF CREDIT CARD ISSUANCE AND TRANSACTIONS FOR RETAIL, CREDIT PROVIDER, TELECOMMUNICATIONS, E-COMMERCE, FINANCIAL SERVICES AND COLLECTION AGENCY INDUSTRIES (U.S. CLS. 100 AND 101).

FIRST USE 2-6-2002; IN COMMERCE 1-2-2002.

SN 78-101,532. INTERLOG USA, INC., SOUTH MINNEAPOLIS, MN. FILED 1-8-2002.

INTERLOG USA, INC.

NO CLAIM IS MADE TO THE EXCLUSIVE RIGHT TO USE "USA INC.", APART FROM THE MARK AS SHOWN.

CLASS 35—ADVERTISING AND BUSINESS

FOR FREIGHT LOGISTICS MANAGEMENT IN THE FIELDS OF OCEAN FREIGHT, AIR FREIGHT, TRUCKING, RAIL, WAREHOUSING, CARTAGE, AND DISTRIBUTION (U.S. CLS. 100, 101 AND 102).

FIRST USE 3-6-1995; IN COMMERCE 6-1-1995.

CLASS 39—TRANSPORTATION AND STORAGE

FOR TRANSPORTATION FREIGHT FORWARDING, FREIGHT BROKERAGE, FREIGHT LOGISTICS, AND STORAGE AND WAREHOUSE SERVICES FOR TRANSPORTATION BY AIR CARRIER, TRUCK, RAILWAY, AND OCEAN CARRIER (U.S. CLS. 100 AND 105).

FIRST USE 3-6-1995; IN COMMERCE 6-1-1995.

SN 78-102,507. I.S. ASSOCIATES, INC., TROY, MI. FILED 1-14-2002.

CLASS 9—ELECTRICAL AND SCIENTIFIC APPARATUS

FOR COMPUTER HARDWARE AND SOFTWARE FOR USE OF TELEMAGEMENT OF VOICE, DATA, AND VIDEO NETWORKS, CALL ACCOUNTING, USAGE ACCOUNTING, CUSTOMER BILLING, CUSTOMER RELATIONSHIP MANAGEMENT, TOLL FRAUD AND NETWORK MANAGEMENT IN THE FIELD OF VOICE, DATA, AND VIDEO TELECOMMUNICATIONS AND NETWORKS (U.S. CLS. 21, 23, 26, 36 AND 38).

FIRST USE 10-0-1997; IN COMMERCE 10-0-1997.

CLASS 42—SCIENTIFIC, COMPUTER AND LEGAL SERVICES

FOR COMPUTER SOFTWARE DEVELOPMENT FOR OTHERS IN THE FIELD OF TELEMAGEMENT, CALL ACCOUNTING, USAGE ACCOUNTING, BILLING, CUSTOMER RELATIONSHIP MANAGEMENT, TOLL FRAUD AND NETWORK MANAGEMENT (U.S. CLS. 100 AND 101).

FIRST USE 10-0-1997; IN COMMERCE 10-0-1997.

SN 78-102,543. TEXAS MEDICAL FOUNDATION, AUSTIN, TX. FILED 1-14-2002.

TEXAS MEDICAL FOUNDATION

NO CLAIM IS MADE TO THE EXCLUSIVE RIGHT TO USE "MEDICAL FOUNDATION", APART FROM THE MARK AS SHOWN.

SEC. 2(F).

CLASS 35—ADVERTISING AND BUSINESS

FOR PROMOTING PUBLIC AWARENESS OF THE NEED FOR HEALTH CARE SERVICE QUALITY AND UTILIZATION (U.S. CLS. 100, 101 AND 102).

FIRST USE 12-27-1971; IN COMMERCE 12-27-1971.

CLASS 44—MEDICAL, BEAUTY AND AGRICULTURAL SERVICES

FOR MEDICAL SERVICES IN THE NATURE OF MEDICAL PEER REVIEW FOR PRIVATE INDUSTRY, GOVERNMENTAL AGENCIES, AND STATE AND FEDERAL GOVERNMENT; HEALTH CARE CONSULTATION SERVICES (U.S. CLS. 100 AND 101).

FIRST USE 12-27-1971; IN COMMERCE 12-27-1971.

SN 78-103,008. YK AMERICA INTERNATIONAL, INC., EL MONTE, CA. FILED 1-16-2002.

SPINE-FLEX**CLASS 10—MEDICAL APPARATUS**

FOR EXERCISE MACHINE FOR THERAPEUTIC PURPOSES (U.S. CLS. 26, 39 AND 44).

FIRST USE 1-0-2002; IN COMMERCE 1-0-2002.

CLASS 28—TOYS AND SPORTING GOODS

FOR MANUAL EXERCISE EQUIPMENT; MANUAL EXERCISE EQUIPMENT FOR BACK AND MUSCLE STRETCHING (U.S. CLS. 22, 23, 38 AND 50).

FIRST USE 1-0-2002; IN COMMERCE 1-0-2002.

SN 78-104,772. WESTINGHOUSE ELECTRIC CORPORATION, NEW YORK, NY. FILED 1-25-2002.

WESTINGHOUSE

OWNER OF U.S. REG. NOS. 299,083, 989,527 AND OTHERS.

CLASS 9—ELECTRICAL AND SCIENTIFIC APPARATUS

FOR ELECTRIC GATE AND GARAGE DOOR OPENERS AND PARTS AND ACCESSORIES THEREFOR; ELECTRIC GATE AND GARAGE DOOR OPENERS ACCESSORIES, NAMELY, REMOTE CONTROLS, TRANSMITTERS, RECEIVERS AND KEYPADS; THERMOSTATS (U.S. CLS. 21, 23, 26, 36 AND 38).

CLASS 11—ENVIRONMENTAL CONTROL APPARATUS

FOR HEATING AND AIR CONDITIONING CENTRAL SYSTEMS FOR BUILDINGS, INCLUDING COMMERCIAL BUILDINGS; SPLIT AIR HANDLERS, DUCTLESS SPLIT SYSTEM AND PACKAGED AIR CONDITIONING AND HEAT PUMP UNITS, FORCED AIR FURNACES, AIR HANDLERS, NON-PORTABLE ELECTRONIC AIR CLEANERS, AND RELATED PARTS THEREFOR; ACCESSORIES OF THE AFOREMENTIONED GOODS, NAMELY, HUMIDIFIERS, INDOOR COILS, AND ELECTRONIC AIR FILTERS (U.S. CLS. 13, 21, 23, 31 AND 34).

SN 78-104,776. WESTINGHOUSE ELECTRIC CORPORATION, NEW YORK, NY. FILED 1-25-2002.

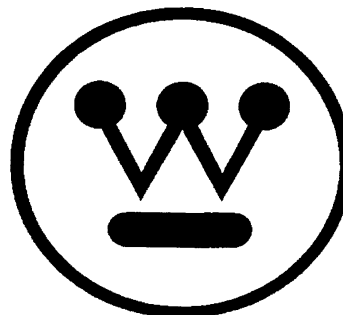

OWNER OF U.S. REG. NOS. 858,162, 985,838 AND 2,106,668.

CLASS 9—ELECTRICAL AND SCIENTIFIC APPARATUS

FOR ELECTRIC GATE AND GARAGE DOOR OPENERS AND PARTS AND ACCESSORIES THEREFOR; ELECTRIC GATE AND GARAGE DOOR OPENERS ACCESSORIES, NAMELY, REMOTE CONTROLS, TRANSMITTERS, RECEIVERS, KEYPADS AND THERMOSTATS (U.S. CLS. 21, 23, 26, 36 AND 38).

CLASS 11—ENVIRONMENTAL CONTROL APPARATUS

FOR HEATING AND AIR CONDITIONING CENTRAL SYSTEMS FOR BUILDINGS, INCLUDING COMMERCIAL BUILDINGS; SPLIT AIR HANDLERS, DUCTLESS SPLIT SYSTEM AND PACKAGED AIR CONDITIONING AND HEAT PUMP UNITS, FORCED AIR FURNACES, AIR HANDLERS, NON-PORTABLE ELECTRONIC AIR CLEANERS, AND RELATED PARTS THEREFOR; ACCESSORIES OF THE AFOREMENTIONED GOODS, NAMELY, HUMIDIFIERS, INDOOR COILS, AND ELECTRONIC AIR FILTERS (U.S. CLS. 13, 21, 23, 31 AND 34).

SN 78-106,102. HEARTLAND PREMIUM BEEF, INC., HUTCHINSON, KS. FILED 1-31-2002.



SN 78-104,834. DEUTSCHE BANK AG, FRANKFURT AM MAIN, FED REP GERMANY, FILED 1-25-2002.

GLOBIS

PRIORITY CLAIMED UNDER SEC. 44(D) ON FED REP GERMANY APPLICATION NO. 30145158.3/3, FILED 7-26-2001, REG. NO. 30145158, DATED 9-8-2001, EXPIRES 7-31-2011.

CLASS 36—INSURANCE AND FINANCIAL

FOR FINANCIAL SERVICES, NAMELY, FINANCIAL EXCHANGE SERVICES, FINANCIAL FORECASTING AND MONEY LENDING (U.S. CLS. 100, 101 AND 102).

CLASS 42—SCIENTIFIC, COMPUTER AND LEGAL SERVICES

FOR DESIGN AND DEVELOPMENT OF COMPUTER SOFTWARE PROGRAMS FOR OTHERS FOR USE IN DATA PROCESSING, AND IN THE TRANSMISSION OF INFORMATION AND DATA ONLINE AND/OR VIA THE INTERNET (U.S. CLS. 100 AND 101).

NO CLAIM IS MADE TO THE EXCLUSIVE RIGHT TO USE "PREMIUM BEEF, INC.", APART FROM THE MARK AS SHOWN.

CLASS 29—MEATS AND PROCESSED FOODS

FOR BEEF, PROCESSED BEEF AND HAMBURGER (U.S. CL. 46).
FIRST USE 10-1-2001; IN COMMERCE 10-1-2001.

CLASS 31—NATURAL AGRICULTURAL PRODUCTS

FOR CATTLE (U.S. CLS. 1 AND 46).
FIRST USE 10-1-2001; IN COMMERCE 10-1-2001.

CLASS 35—ADVERTISING AND BUSINESS

FOR BUSINESS MANAGEMENT SERVICES (U.S. CLS. 100, 101 AND 102).
FIRST USE 10-1-2001; IN COMMERCE 10-1-2001.

CLASS 44—MEDICAL, BEAUTY AND AGRICULTURAL SERVICES

FOR AGRICULTURAL CONSULTATION IN THE FIELD OF LIVESTOCK MANAGEMENT AND CONSULTATION IN THE FIELDS OF ANIMAL CHARACTERISTICS, ANIMAL CARCASS CHARACTERISTICS, ANIMAL GROWTH, ANIMAL BREEDING AND ANIMAL GENETICS (U.S. CLS. 100 AND 101).
FIRST USE 10-1-2001; IN COMMERCE 10-1-2001.

SN 78-104,964. BAROUH EATON (CANADA) LTD., MISSISSAUGA, ONTARIO, FILED 1-25-2002.

FILLZ-ALL**CLASS 2—PAINTS**

FOR PRINTING SUPPLIES, NAMELY, INK JET CARTRIDGES, RECYCLED INK JET CARTRIDGES, INK JET PRINTER INK WITH TOOLS FOR REFILLING INK JET CARTRIDGES, PHOTOCOPIER LIQUID AND POWDERED TONERS, LASER TONER CARTRIDGES, RECYCLED LASER TONER CARTRIDGES, DIGITAL PRINTER TONER CARTRIDGES (U.S. CLS. 6, 11 AND 16).

CLASS 16—PAPER GOODS AND PRINTED MATTER

FOR COMPUTER PRINTER AND TYPEWRITER RIBBONS, CORRECTING TAPE FOR TYPE, INK ROLLERS FOR OFFICE MACHINES, CORRECTING FLUID FOR TYPE, CORRECTING FILM FOR TYPE, THERMAL FAX MACHINE RIBBONS (U.S. CLS. 2, 5, 22, 23, 29, 37, 38 AND 50).

SN 78-106,468. GLENWOOD DESIGNS, RANCHO DOMINGUEZ, CA. FILED 2-4-2002.



NO CLAIM IS MADE TO THE EXCLUSIVE RIGHT TO USE "DESIGNS", APART FROM THE MARK AS SHOWN.

CLASS 11—ENVIRONMENTAL CONTROL APPARATUS

FOR ELECTRIC LIGHTING FIXTURES, INFRARED LIGHTING FIXTURES, LAMPS AND LAMP ACCESSORIES, NAMELY LAMP SHADES (U.S. CLS. 13, 21, 23, 31 AND 34).

FIRST USE 12-18-2001; IN COMMERCE 12-28-2001.

CLASS 21—HOUSEWARES AND GLASS

FOR SCULPTURES, STATUES, GLASS STORAGE JARS, FLOWER POTS, VASES, OR MUGS MADE OF PORCELAIN, CRYSTAL, CHINA, GLASS OR EARTHENWARE FOR HOUSEHOLD USE OR DECORATION (U.S. CLS. 2, 13, 23, 29, 30, 33, 40 AND 50).

FIRST USE 12-18-2001; IN COMMERCE 12-28-2001.

SN 78-107,235. TOGETHER FOR FREEDOM, INC., WASHINGTON, DC. BY CHANGE OF NAME UNITED WE STAND, INC., WASHINGTON, DC. FILED 2-6-2002.

TOGETHER FOR FREEDOM**CLASS 36—INSURANCE AND FINANCIAL**

FOR CHARITABLE FUND RAISING FOR PATRIOTIC CAUSES (U.S. CLS. 100, 101 AND 102).

CLASS 41—EDUCATION AND ENTERTAINMENT

FOR ENTERTAINMENT NAMELY, PRODUCTION OF PATRIOTIC SPEECHES, PANEL DISCUSSIONS AND MUSICAL PERFORMANCES (U.S. CLS. 100, 101 AND 107).

SN 78-107,205. RODALE INC., EMMAUS, PA. FILED 2-6-2002.

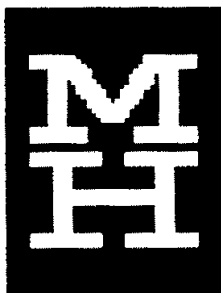

THE MARK CONSISTS OF THE STYLIZED LETTERS "M" AND "H" ON A RED BACKGROUND.

CLASS 16—PAPER GOODS AND PRINTED MATTER

FOR MAGAZINE PUBLISHED PERIODICALLY IN THE FIELD OF HEALTH, FITNESS, DIET, EXERCISE, AND LIFESTYLE (U.S. CLS. 2, 5, 22, 23, 29, 37, 38 AND 50).

CLASS 41—EDUCATION AND ENTERTAINMENT

FOR PUBLICATION OF AN ON-LINE MAGAZINE CONTAINING COLUMNS AND ARTICLES IN THE FIELD OF HEALTH, FITNESS, DIET, EXERCISE, AND LIFESTYLE; AND PROVIDING INFORMATION IN THE FIELD OF FITNESS AND EXERCISE VIA A WEB SITE ON THE MULTI-USER GLOBAL COMPUTER INFORMATION NETWORK (U.S. CLS. 100, 101 AND 107).

CLASS 44—MEDICAL, BEAUTY AND AGRICULTURAL SERVICES

FOR PROVIDING INFORMATION IN THE FIELD OF HEALTH, DIET, AND LIFESTYLE VIA A WEB SITE ON THE MULTI-USER GLOBAL COMPUTER INFORMATION NETWORK (U.S. CLS. 100 AND 101).

SN 78-108,022. GDT GARABET DERMA TECHNOLOGY GMBH, HAMBURG, FED REP GERMANY, FILED 2-11-2002.

WOUNDEL

PRIORITY CLAIMED UNDER SEC. 44(D) ON FED REP GERMANY APPLICATION NO. 30149930.605, FILED 8-14-2001, REG. NO. 30149930, DATED 5-30-2002, EXPIRES 8-31-2011.

CLASS 5—PHARMACEUTICALS

FOR MEDICAL PLASTERS; WOUND AND SURGICAL DRESSINGS; DRESSING MEANS, NAMELY HYDROCOLLOID DRESSINGS AND WET AND DRY WOUND DRESSINGS; WOUND CARE ARTICLES, NAMELY CREAMS AND OINTMENTS, WOUND ANTIBACTERIAL GAUZE AND PURIFIED COTTON; MEDICATED CREAMS FOR MEDICAL SKIN CARE SUBSTANCES; MEDICATED WOUND FIXING PREPARATIONS, NAMELY OINTMENTS, CLEANING LIQUIDS, DISINFECTANTS; MEDICATED CLEANING LIQUIDS AND OINTMENTS; ALL PURPOSE DISINFECTANTS; VACCINES; MEDICATED SERUM FOR USE ON WOUNDS; MEDICATED COMPRESSES; BANDAGES FOR SKIN WOUNDS; WOUND GAUZE; COTTON FOR MEDICAL PURPOSES; WOUND DRAINAGE SPONGES NOT FOR SURGICAL USE; SEDATIVES AND ANALGESICS (U.S. CLS. 6, 18, 44, 46, 51 AND 52).

CLASS 10—MEDICAL APPARATUS

FOR SURGICAL COMPRESSES; SURGICAL SPONGES; INCONTINENCE BED PADS; HOSPITAL BEDS FOR USE BY BURN PATIENTS; BANDAGES FOR ANATOMICAL JOINTS (U.S. CLS. 26, 39 AND 44).

SN 78-109,204. RED DEVIL INTERNATIONAL S.A., LUXEMBOURG, LUXEMBOURG, FILED 2-15-2002.

ONE SUN**CLASS 5—PHARMACEUTICALS**

FOR FOOD SUPPLEMENTS; NUTRITIONAL SUPPLEMENTS FOR USE IN FOOD AND BEVERAGES (U.S. CLS. 6, 18, 44, 46, 51 AND 52).

CLASS 32—LIGHT BEVERAGES

FOR BEVERAGES, NAMELY, CARBONATED AND NON-CARBONATED MINERAL WATER AND TABLE WATER; ISOTONIC DRINKS, HYPERTONIC DRINKS, HYPOTONIC DRINKS, FRUIT DRINKS, SMOOTHIES, FRUIT JUICES, FRUIT NECTARS, SOFT DRINKS, COLAS, POP, LEMONADE, ISOTONIC ENERGY DRINKS AND SPORTS DRINKS; NON-ALCOHOLIC PREPARED COCKTAIL MIXES; SYRUPS FOR MAKING BEVERAGES, NAMELY, FRUIT DRINKS, FRUIT JUICES, FRUIT NECTARS, FRUIT PUNCH, FRUIT-FLAVORED SOFT DRINKS, SOFT DRINKS, POP, LEMONADE, AND SPORTS DRINKS; VEGETABLE JUICE; POWDERS AND CONCENTRATES USED IN THE PREPARATION OF BEVERAGES; ESSENCES AND NON-ALCOHOLIC FRUIT EXTRACTS USED IN THE PREPARATION OF BEVERAGES; FRUIT PUREE BASED SYRUP FOR USE IN THE PREPARATION OF BEVERAGES; BEER-BASED COOLERS; FLAVORED BREWED MALT-BASED ALCOHOLIC BEVERAGES IN THE NATURE OF BEER (U.S. CLS. 45, 46 AND 48).

SN 78-109,816. FOOD EQUIPMENT TECHNOLOGIES COMPANY, INC., LINCOLNSHIRE, IL. FILED 2-19-2002.

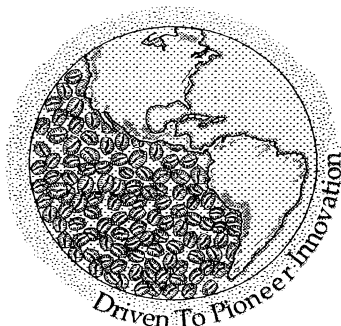

THE STIPPLING IS FOR SHADING PURPOSES ONLY. THE MARK CONSISTS OF A FANCIFUL GLOBE SHOWING THE NORTH AND SOUTH AMERICAN CONTINENTS AND THE PACIFIC OCEAN COVERED WITH COFFEE BEANS WITH STEAM OR CLOUDS RISING OFF AND SURROUNDING THE GLOBE AND THE CONTINENTS, ALL LOCATED ABOVE THE WORDS "DRIVEN TO PIONEER INNOVATION".

CLASS 7—MACHINERY

FOR ELECTRICAL COFFEE BEAN GRINDERS SOLD TO RESTAURANTS, CATERERS AND THE LIKE FOR COMMERCIAL USE (U.S. CLS. 13, 19, 21, 23, 31, 34 AND 35).

CLASS 11—ENVIRONMENTAL CONTROL APPARATUS

FOR COMMERCIAL COFFEE BREWERS, TEA BREWERS AND FRESH ICED TEA BREWERS; REFRIGERATED INSULATED BEVERAGE DISPENSERS; HIGH VOLUME COFFEE BREWING AND TEA BREWING SYSTEMS COMPOSED OF MODULAR BREWERS, STORAGE TANKS AND MOBILE DISPENSERS THAT INTERCONNECT AND WORK TOGETHER AS A SINGLE SYSTEM; HOT WATER DISPENSERS HAVING ELECTRICALLY-ACTUATED HEATING APPARATUS FOR READY-TO-MIX FOOD AND BEVERAGES, AND HOT SYRUP DISPENSING UNITS HAVING ELECTRICALLY-ACTUATED HEATING APPARATUS, ALL SOLD TO RESTAURANTS, CATERERS AND THE LIKE FOR COMMERCIAL USE (U.S. CLS. 13, 21, 23, 31 AND 34).

CLASS 21—HOUSEWARES AND GLASS

FOR PORTABLE INSULATED BEVERAGE DISPENSERS (U.S. CLS. 2, 13, 23, 29, 30, 33, 40 AND 50).

SN 78-111,233. FREEMAN, VIVIAN V., NEWSOMS, VA. FILED 2-26-2002.

SOWER OF THE WORD

NO CLAIM IS MADE TO THE EXCLUSIVE RIGHT TO USE "THE WORD", APART FROM THE MARK AS SHOWN.

CLASS 9—ELECTRICAL AND SCIENTIFIC APPARATUS

FOR PRE-RECORDED AUDIO AND VIDEO CASSETTES FEATURING CHRISTIAN RELIGIOUS SUBJECTS (U.S. CLS. 21, 23, 26, 36 AND 38).

CLASS 16—PAPER GOODS AND PRINTED MATTER

FOR TRACTS, BROCHURES, BOOKS AND BOOKLETS FEATURING CHRISTIAN RELIGIOUS SUBJECTS (U.S. CLS. 2, 5, 22, 23, 29, 37, 38 AND 50).

SN 78-111,515. KAON INTERACTIVE INC., MAYNARD, MA. FILED 2-27-2002.



OWNER OF U.S. REG. NOS. 2,537,793 AND 2,539,374.

CLASS 9—ELECTRICAL AND SCIENTIFIC APPARATUS

FOR COMPUTER SOFTWARE FOR THE CREATION, EDITING, DISPLAY AND MANIPULATION OF THREE-DIMENSIONAL DIGITAL IMAGES OVER THE GLOBAL WORLDWIDE WEB AND OTHER COMPUTER NETWORKS (U.S. CLS. 21, 23, 26, 36 AND 38).
FIRST USE 2-19-2002; IN COMMERCE 2-19-2002.

CLASS 42—SCIENTIFIC, COMPUTER AND LEGAL SERVICES

FOR COMPUTER PROGRAMMING FOR OTHERS, NAMELY CREATION OF THREE-DIMENSIONAL DIGITAL IMAGES USING COMPUTER SOFTWARE FOR DISPLAY OVER THE GLOBAL WORLDWIDE WEB (U.S. CLS. 100 AND 101).
FIRST USE 2-19-2002; IN COMMERCE 2-19-2002.

SN 78-112,953. MIDWAY AMUSEMENT GAMES, LLC,
CHICAGO, IL. FILED 3-6-2002.



OWNER OF U.S. REG. NOS. 1,883,678 AND 1,912,104.
THE MARK CONSISTS OF A DRAGON DESIGN IN A
CIRCLE, INSIDE A TRIANGULAR SHIELD DESIGN.

**CLASS 9—ELECTRICAL AND SCIENTIFIC
APPARATUS**

FOR PRERECORDED MOTION PICTURE AND TELEVISION FILMS, AUDIO TAPES, VIDEO TAPES AND COMPACT DISCS FEATURING MOVIES, DOWNLOADABLE SOFTWARE FOR USE IN PLAYING ONLINE COMPUTER GAMES, DOWNLOADABLE COMPUTER GAMES, COMPUTER AND VIDEO GAME PROGRAMS IN THE FORM OF CARTRIDGES, DISCS, CD-ROMS, CASSETTES, TAPES, AND MINI DISCS; VIDEO GAME CARTRIDGES AND DISKS, SOFTWARE PROGRAMS FOR VIDEO GAMES (U.S. CLS. 21, 23, 26, 36 AND 38).

CLASS 14—JEWELRY

FOR JEWELRY, CLOCKS, WATCHES, CHRONOMETERS, AND PINS (U.S. CLS. 2, 27, 28 AND 50).

**CLASS 16—PAPER GOODS AND PRINTED
MATTER**

FOR PAPER GOODS, NAMELY, COMIC BOOKS, BOOKS IN THE FORM OF STRATEGY GUIDES FOR VIDEO GAMES, TRADING CARDS, POSTERS AND TRADING CARD MILK BOTTLE CAPS; PEN AND PENCIL TRAYS, HOLDERS, BOXES AND CASES; PENCIL SHARPENERS AND DECORATIVE PENCIL ORNAMENTS; PENCILS AND PENS; NOTEBOOKS; NOTEPADS; TEMPORARY TATTOOS AND STICKERS; CALENDARS AND STATIONERY (U.S. CLS. 2, 5, 22, 23, 29, 37, 38 AND 50).

CLASS 21—HOUSEWARES AND GLASS

FOR LUNCH BOXES, VACUUM FLASKS AND THERMALLY INSULATED CONTAINERS FOR FOOD AND BEVERAGES (U.S. CLS. 2, 13, 23, 29, 30, 33, 40 AND 50).

CLASS 25—CLOTHING

FOR CLOTHING, NAMELY, GLOVES, BANDANNAS, PAJAMAS, PANTS, SHIRTS, SWEATSUITS; SHOES; SHORTS, SOCKS, SWEATERS, JACKETS AND HATS (U.S. CLS. 22 AND 39).

CLASS 28—TOYS AND SPORTING GOODS

FOR HAND-HELD VIDEO GAMES, TOY ACTION FIGURES AND ACTION FIGURE ACCESSORIES (U.S. CLS. 22, 23, 38 AND 50).

CLASS 41—EDUCATION AND ENTERTAINMENT

FOR ENTERTAINMENT SERVICES IN THE NATURE OF A TV SHOW, AND TELEVISION MOVIES FEATURING LIVE ACTION AND ANIMATION; PROVIDING ONLINE COMPUTER GAMES (U.S. CLS. 100, 101 AND 107).

SN 78-114,088. WORKING SOLO, INC., NEW PALTZ, NY.
FILED 3-11-2002.

WORKING SOLO

SEC. 2(F).

**CLASS 16—PAPER GOODS AND PRINTED
MATTER**

FOR BOOKS, NEWSLETTERS, MAGAZINES AND PRINTED REPORTS IN THE FIELD OF SMALL BUSINESS MANAGEMENT (U.S. CLS. 2, 5, 22, 23, 29, 37, 38 AND 50).

FIRST USE 12-8-1986; IN COMMERCE 2-19-1993.

CLASS 35—ADVERTISING AND BUSINESS

FOR CONSULTING SERVICES IN THE FIELD OF SMALL BUSINESS MANAGEMENT (U.S. CLS. 100, 101 AND 102).

FIRST USE 12-8-1986; IN COMMERCE 2-19-1993.

SN 78-118,053. INDIGOVISION LIMITED, EDINBURGH, UNITED KINGDOM. FILED 3-28-2002.

SN 78-119,658. WINDHAM BRANNON, P.C., ATLANTA, GA. FILED 4-4-2002.

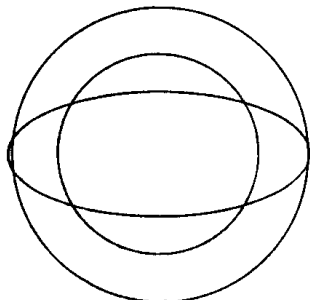

CLASS 9—ELECTRICAL AND SCIENTIFIC APPARATUS

FOR PHOTOGRAPHIC CAMERAS, NAMELY, DIGITAL CAMERAS AND VIDEO CAMERAS; APPARATUS FOR PROCESSING ANALOG AND DIGITAL DATA, NAMELY, DIGITAL VIDEO CAMERAS, DIGITAL VIDEO ENCODING UNITS, DIGITAL VIDEO DISPLAYS AND MONITORS, DIGITAL VIDEO RECORDERS, APPLICATION SPECIFIC INTEGRATED CIRCUITS, AND ANALOG AND DIGITAL IMAGE DATA PROCESSORS; ANALOG AND DIGITAL VIDEO APPARATUS FOR USE WITH COMPUTERS AND COMPUTER NETWORKS, NAMELY, DIGITAL VIDEO CAMERAS, DIGITAL VIDEO ENCODING UNITS, DIGITAL VIDEO DISPLAYS AND MONITORS, DIGITAL VIDEO RECORDERS AND APPLICATION SPECIFIC INTEGRATED CIRCUITS; APPARATUS FOR PROCESSING VIDEO SIGNALS, NAMELY, DIGITAL VIDEO CAMERAS, DIGITAL VIDEO ENCODING UNITS, DIGITAL VIDEO DISPLAYS AND MONITORS, DIGITAL VIDEO RECORDERS AND APPLICATION SPECIFIC INTEGRATED CIRCUITS; COMPUTER HARDWARE AND SOFTWARE FOR STORING, RETRIEVING, DISPLAYING, MANIPULATING, TRANSMITTING, PRINTING, REPRODUCING, ENCRYPTING AND COMPRESSING LIVE AND RECORDED DIGITAL IMAGES AND RELATED DATA OBTAINED FROM NETWORKED VIDEO CAMERAS; CDS AND CD-ROMS, NAMELY, PRE-RECORDED AUDIO AND VIDEO RECORDINGS FEATURING INFORMATION ON THE SUBJECT OF DIGITAL IMAGING; COMPUTER PROGRAMS IN PRINTED FORM FOR USE IN DIGITAL IMAGING PROCESSES (U.S. CLS. 21, 23, 26, 36 AND 38).

CLASS 16—PAPER GOODS AND PRINTED MATTER

FOR PRINTED PUBLICATIONS, NAMELY, BOOKS, MAGAZINES, PERIODICALS AND SUPPLEMENTS, BROCHURES, CATALOGS, FACT SHEETS, PAMPHLETS AND LEAFLETS ALL RELATING TO DIGITAL IMAGING (U.S. CLS. 2, 5, 22, 23, 29, 37, 38 AND 50).

CLASS 40—MATERIAL TREATMENT

FOR PHOTOGRAPHIC IMAGE PROCESSING, NAMELY, CORRECTION, MANIPULATION, RESTORATION AND ENHANCEMENT OF PHOTOGRAPHIC FILM; PROCESSING OF DIGITAL IMAGES, NAMELY, CORRECTION, RESTORATION AND ENHANCEMENT SERVICES FOR DIGITAL IMAGES AND VIDEOS; DUPLICATION OF DIGITAL IMAGES, NAMELY, MEDIA DUPLICATION OF DATA AND DIGITAL INFORMATION; PRINTING AND MANIPULATION, NAMELY, REPRODUCTION, REDUCTION AND ENLARGEMENT OF DIGITAL IMAGES (U.S. CLS. 100, 103 AND 106).

GREAT PEOPLE GREAT CLIENTS

CLASS 35—ADVERTISING AND BUSINESS

FOR TAX PLANNING, SALES TAX RECOVERY ACCOUNTING SERVICES, STRATEGIC BUSINESS PLANNING AND BUSINESS ADVICE FOR START-UP COMPANIES (U.S. CLS. 100, 101 AND 102).
FIRST USE 10-0-2001; IN COMMERCE 10-0-2001.

CLASS 36—INSURANCE AND FINANCIAL

FOR INVESTMENT PLANNING, PERSONAL FINANCIAL PLANNING, FINANCIAL ADVICE FOR START-UP COMPANIES, ESTATE PLANNING (U.S. CLS. 100, 101 AND 102).
FIRST USE 10-0-2001; IN COMMERCE 10-0-2001.

CLASS 42—SCIENTIFIC, COMPUTER AND LEGAL SERVICES

FOR LITIGATION SUPPORT SERVICES (U.S. CLS. 100 AND 101).
FIRST USE 10-0-2001; IN COMMERCE 10-0-2001.

SN 78-119,699. HARBOR ELECTRONICS, INC., SANTA CLARA, CA. FILED 4-4-2002.



OWNER OF U.S. REG. NO. 2,513,864.
NO CLAIM IS MADE TO THE EXCLUSIVE RIGHT TO USE "ELECTRONICS, INC.," APART FROM THE MARK AS SHOWN.

CLASS 9—ELECTRICAL AND SCIENTIFIC APPARATUS

FOR PRINTED CIRCUIT BOARDS USED IN THE TESTING OF INTEGRATED CIRCUITS (U.S. CLS. 21, 23, 26, 36 AND 38).

CLASS 40—MATERIAL TREATMENT

FOR ASSEMBLY OF PRINTED CIRCUIT BOARDS FOR OTHERS (U.S. CLS. 100, 103 AND 106).

CLASS 42—SCIENTIFIC, COMPUTER AND LEGAL SERVICES

FOR DESIGN FOR OTHERS IN THE FIELD OF PRINTED CIRCUIT BOARDS (U.S. CLS. 100 AND 101).

SN 78-119,922. HYDER, TRACIE, D., HOLLADAY, UT.
FILED 4-5-2002.

EZEVENTS

CLASS 35—ADVERTISING AND BUSINESS

FOR BUSINESS SUPPORT SERVICES, NAMELY, PROVIDING A CORPORATE PRESENCE FOR OTHERS AT TRADE SHOWS (U.S. CLS. 100, 101 AND 102).
FIRST USE 6-27-2001; IN COMMERCE 6-27-2001.

CLASS 41—EDUCATION AND ENTERTAINMENT

FOR EVENT PLANNING CONSULTATION, NAMELY, PLANNING SPECIAL CORPORATE EVENTS FOR OTHERS (U.S. CLS. 100, 101 AND 107).
FIRST USE 6-27-2001; IN COMMERCE 6-27-2001.

SN 78-120,218. WILD PLANET TOYS, INC., SAN FRANCISCO, CA. FILED 4-8-2002.

OUTDOOR ANTICS

NO CLAIM IS MADE TO THE EXCLUSIVE RIGHT TO USE "OUTDOOR", APART FROM THE MARK AS SHOWN.

CLASS 9—ELECTRICAL AND SCIENTIFIC APPARATUS

FOR FLOATING WATERPROOF FM RADIO, SWIM MASKS AND SNORKELS (U.S. CLS. 21, 23, 26, 36 AND 38).

CLASS 28—TOYS AND SPORTING GOODS

FOR OUTDOOR WATER SQUIRTING TOYS AND GAMES, NAMELY TOY PERISCOPES FOR USE UNDER WATER; ACTION SKILL GAMES FOR USE IN WATER CONSISTING OF A TIMER AND A SMALL TOY FISH LAUNCHED IN WATER; UNDERWATER TALKING TOYS; TOY FACE MASKS FOR SWIMMING; TOY FACE MASKS WITH LIGHTS FOR USE UNDERWATER; TOY SNORKELS; TOY SNORKELS WITH PERISCOPES; TOY DIVE BALLS, CONSISTING OF BALLS WITH TAILS FOR USE IN WATER; TOY FLOATING WATERPROOF RADIO; TOY GLIDERS FOR USE UNDERWATER; DIVE AND SEARCH WATER GAMES, CONSISTING OF TOY MAGNETIC FISH AND MAGNETIC DIVE GLOVES; WATER PROJECTING, SQUIRTING AND FLOATING TOYS; PUMP ACTION WATER BLASTERS (U.S. CLS. 22, 23, 38 AND 50).

SN 78-120,583. CETOVA, INC., JERSEY CITY, NJ. FILED 4-9-2002.

CETOVA

CLASS 9—ELECTRICAL AND SCIENTIFIC APPARATUS

FOR COMPUTER SOFTWARE, NAMELY FOR FINANCIAL ANALYSIS, REPORTING OF FINANCIAL INFORMATION, PRODUCTION REPORTING, ENTERPRISE REPORTING AND RESOURCE PLANNING, INVENTORY AND MANUFACTURING REPORTING. (U.S. CLS. 21, 23, 26, 36 AND 38).

CLASS 35—ADVERTISING AND BUSINESS

FOR BUSINESS CONSULTATION; PREPARING BUSINESS REPORTS; FINANCIAL STATEMENTS AND ANALYSIS FOR BUSINESSES; PROVIDING BUSINESS INFORMATION, NAMELY ENTERPRISE REPORTING, ENTERPRISE RESOURCE PLANNING, INVENTORY AND MANUFACTURING REPORTING (U.S. CLS. 100, 101 AND 102).

CLASS 36—INSURANCE AND FINANCIAL

FOR FINANCIAL INFORMATION PROCESSING; BUDGET ANALYSIS AND CONSULTATION; AND FINANCIAL REPORTING (U.S. CLS. 100, 101 AND 102).

CLASS 41—EDUCATION AND ENTERTAINMENT

FOR TRAINING ON THE USE, INSTALLATION, CONFIGURATION, AND IMPLEMENTATION OF COMPUTER SOFTWARE. (U.S. CLS. 100, 101 AND 107).

CLASS 42—SCIENTIFIC, COMPUTER AND LEGAL SERVICES

FOR CONSULTING SERVICES, NAMELY COMPUTER SOFTWARE CONSULTATIONS, INSTALLATION, CONFIGURATION, CUSTOMIZATION AND MAINTENANCE. (U.S. CLS. 100 AND 101).

SN 78-121,387. ROADMASTER (USA) CORP., EATONTOWN, NJ. FILED 4-12-2002.

HIGHWAYMAN

OWNER OF U.S. REG. NO. 1,758,042.

CLASS 9—ELECTRICAL AND SCIENTIFIC APPARATUS

FOR STEREO SPEAKERS, HEADPHONES, RECORD TURNTABLES, COMPACT DISC PLAYERS, STEREO AMPLIFIERS, CAR STEREOS, AUDIO MIXERS; RADIO TUNERS AND HEADPHONES (U.S. CLS. 21, 23, 26, 36 AND 38).

CLASS 11—ENVIRONMENTAL CONTROL APPARATUS

FOR NEON LIGHTS FOR VEHICLES; NEON LIGHT STICKS, NEON LIGHT KITS COMPRISING NEON LIGHTS AND MOUNTING BRACKETS (U.S. CLS. 13, 21, 23, 31 AND 34).

SN 78-121,441. MUNJI APS, 2200 COPENHAGEN N, DENMARK, FILED 4-12-2002.

PUNK ROYAL

PRIORITY CLAIMED UNDER SEC. 44(D) ON DENMARK APPLICATION NO. VA2003888, FILED 10-15-2001, REG. NO. VR20010439, DATED 10-30-2001, EXPIRES 10-30-2011.

CLASS 3—COSMETICS AND CLEANING PREPARATIONS

FOR SOAPS, PERFUME, ESSENTIAL OILS FOR PERSONAL USE; COSMETICS, HAIR LOTIONS; AND DENTIFRICES (U.S. CLS. 1, 4, 6, 50, 51 AND 52).

CLASS 24—FABRICS

FOR TEXTILES AND TEXTILES GOODS, NAMELY, FABRICS FOR TEXTILE USE, FABRICS FOR BOOTS AND SHOES, FABRICS OF IMITATION ANIMAL SKINS, TABLE CLOTHS, TABLE MATS, TABLE NAPKINS, BED LINEN, BED SHEETS, BED SPREADS, TEXTILE LABELS, CURTAINS, AND TOWELS (U.S. CLS. 42 AND 50).

CLASS 25—CLOTHING

FOR CLOTHING, NAMELY, BANANAS, BEACH CLOTHES, NAMELY, SWIM WEAR, SWIMSUITS, AND COVER UPS; BELTS, COATS, GLOVES, GOWNS, JACKETS, JERSEYS, JUMPERS, KNITWEAR, LEGGINGS, READY-MADE LININGS, OVERCOATS, PANTS, PULL-OVERS, PAJAMAS, SCARVES, SHAWLS, SKIRTS, SOCKS, STOCKINGS, SWEATERS, TROUSERS, UNDERWEAR; FOOTWEAR, NAMELY, SHOES, BOOTS AND SANDALS; AND HEADGEAR, NAMELY, HATS, CAPS AND HEADBANDS (U.S. CLS. 22 AND 39).

CLASS 35—ADVERTISING AND BUSINESS

FOR PROVISION OF BUSINESS CENTERS, NAMELY FULLY EQUIPPED WORKSPACES AND WORKSTATIONS EQUIPPED WITH DESKS, CHAIRS, SHELVES, FILING CABINETS, PERSONAL COMPUTERS, PERSONAL COMPUTER SCREENS, PRINTERS, TELEPHONES, FAX MACHINES, EQUIPMENT FOR INTERNET ACCESS, EQUIPMENT FOR VIDEO AND TELEPHONE CONFERENCING, PHOTOCOPYING MACHINES, AND STATIONERY SUITABLE FOR USE BY CORPORATIONS, COMPANIES, PARTNERSHIPS, ORGANIZATIONS, ASSOCIATIONS AND INDIVIDUALS, AND FULLY EQUIPPED MEETING ROOMS EQUIPPED WITH TABLES, CHAIRS, PERSONAL COMPUTERS, PERSONAL COMPUTER SCREENS, PRINTERS, TELEPHONES, FAX MACHINES, PHOTOCOPYING MACHINES, EQUIPMENT FOR INTERNET ACCESS, EQUIPMENT FOR VIDEO AND TELEPHONE CONFERENCING, PROJECTORS, SLIDE PROJECTORS, BOARDS, AND STATIONERY, AND FULLY EQUIPPED CONFERENCE ROOMS EQUIPPED WITH TABLES, CHAIRS, MICROPHONES, LOUDSPEAKERS, PROJECTORS, SLIDE PROJECTORS, BOARDS; PROVISION OF SUPPORT STAFF FOR BUSINESSMEN INCLUDING RECEPTIONIST SERVICES; REFERRAL SERVICES IN THE FIELDS OF COURIER AND PONY-EXPRESS, ACCOUNTANCY, ADVERTISING, DATA PROCESSING AND REPRODUCTION OF DOCUMENTS SERVICES, MARKETING RESEARCH, INSURANCE FOR WORK EQUIPMENT THAT ENABLES THE CONDUCT OF A BUSINESS AND INSURANCE UNDERWRITING, BUILDING INSURANCE AND INSURANCE UNDERWRITING INCLUDING FIRE INSURANCE, FLOOD INSURANCE, EARTHQUAKE INSURANCE, TERRORISM INSURANCE, AND INSURANCE FOR DAMAGES CAUSED TO BUILDINGS BY NEGLIGENCE REFERRALS, ACCIDENT INSURANCE AND INSURANCE UNDERWRITING, PROFESSIONAL NEGLIGENCE INSURANCE AND INSURANCE UNDERWRITING, HEALTH INSURANCE AND INSURANCE UNDERWRITING, FINANCIAL AND MONETARY INFORMATION PROVIDED BY ELECTRONIC MEANS, TEMPORARY HOUSING ACCOMMODATIONS, MEDICAL CARE, ATTORNEYS AND PHYSICIANS; ORGANIZING AND PROVIDING FACILITIES FOR CUSTOMERS PRODUCT OR SERVICE LAUNCHES; FRANCHISING SERVICES, NAMELY OFFERING TECHNICAL ASSISTANCE IN THE ESTABLISHMENT AND OPERATION OF INTERNATIONAL BUSINESS OFFICE RENTALS AND THE PROVISION OF FULLY EQUIPPED BUSINESS CENTERS, WORK STATIONS AND WORK SPACES; TELEPHONE, FAX, MAIL AND E-MAIL ANSWERING SERVICES; RE-DIRECTION OF MAIL NAMELY, PROVIDING A SERVICE WHEREBY MAIL RECEIVED AT ONE ADDRESS IS RE-SENT TO ANOTHER ADDRESS SELECTED BY THE CUSTOMER; ARRANGING AND CONDUCTING BUSINESS CONFERENCES; ORGANIZING MARKETING EVENTS IN THE FORM OF BUSINESS CONFERENCES, EDUCATIONAL AND TRAINING CONFERENCES, PRESENTATIONS, ART, PHOTOGRAPHY, AND CULTURE AND TRADE EXHIBITIONS; PROVIDING FACILITIES FOR MARKETING EVENTS IN THE FORM OF BUSINESS CONFERENCES; AND CONSULTANCY, INFORMATION AND ADVISORY SERVICES RELATING TO ALL THE AFORESAID SERVICES (U.S. CLS. 100, 101 AND 102).

SN 78-121.637. EOFFICE 2000 LIMITED, LONDON, UNITED KINGDOM, FILED 4-15-2002.

**CLASS 36—INSURANCE AND FINANCIAL**

FOR LEASING AND RENTAL OF OFFICE SPACE WITH FULLY EQUIPPED WORKSPACES AND WORKSTATIONS EQUIPPED WITH DESKS, CHAIRS, SHELVES, FILING CABINETS, PERSONAL COMPUTERS, PERSONAL COMPUTER SCREENS, PRINTERS, TELEPHONES, FAX MACHINES, APPARATUS FOR INTERNET ACCESS, APPARATUS FOR VIDEO AND TELEPHONE CONFERENCING, PHOTOCOPYING MACHINES, STATIONERY AND ANY OTHER EQUIPMENT THAT MAY BE REQUIRED FOR CONDUCTING A BUSINESS AND SUITABLE FOR USE BY CORPORATIONS, COMPANIES, PARTNERSHIPS, ORGANIZATIONS, ASSOCIATIONS, AND INDIVIDUALS, FULLY EQUIPPED MEETING ROOMS EQUIPPED WITH TABLES, CHAIRS, PERSONAL COMPUTERS, PERSONAL COMPUTER SCREENS, PRINTERS, TELEPHONES, FAX MACHINES, APPARATUS FOR INTERNET ACCESS, APPARATUS FOR VIDEO AND TELEPHONE CONFER-

OWNER OF UNITED KINGDOM REG. NO. 2260425, DATED 7-6-2001, EXPIRES 2-7-2011.

ENCING, PHOTOCOPYING MACHINES, PROJECTORS, SLIDE PROJECTORS, BOARDS, STATIONERY AND ANY OTHER EQUIPMENT THAT MAY BE REQUIRED FOR CONDUCTING A BUSINESS MEETING, AND FULLY EQUIPPED CONFERENCE ROOMS EQUIPPED WITH TABLES, CHAIRS, MICROPHONES, LOUDSPEAKERS, PROJECTORS, SLIDE PROJECTORS, BOARDS AND ANY OTHER EQUIPMENT THAT MAY BE REQUIRED FOR CONDUCTING A BUSINESS CONFERENCE; AND FINANCIAL AND MONETARY INFORMATION PROVIDED BY ELECTRONIC MEANS (U.S. CLS. 100, 101 AND 102).

SN 78-122,439. REAL ESTATE DUE DILIGENCE, INC., HAMILTON, MT. FILED 4-17-2002.

REDDFROG

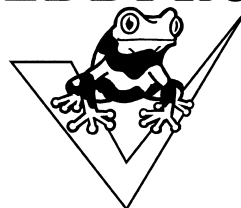

CLASS 38—COMMUNICATION

FOR PROVIDING TELECOMMUNICATION SERVICES, NAMELY PROVIDING TELECOMMUNICATIONS BY MEANS OF TELEPHONE, MOBILE PHONE, FAX, INTERNET, INTRANET, ELECTRONIC MAIL, VIDEO CONFERENCE EQUIPMENT, AND TELEPHONE CONFERENCE EQUIPMENT; PROVIDING TELECOMMUNICATION CONNECTIONS TO A GLOBAL COMPUTER NETWORK TO ENABLE THE CONDUCT OF A BUSINESS; INTEGRATED SERVICES DIGITAL NETWORK SERVICES; ELECTRONIC VOICE MESSAGING, NAMELY THE STORAGE AND SUBSEQUENT TRANSMISSION OF VOICE MESSAGES BY TELEPHONE; ELECTRONIC MAIL MESSAGING, NAMELY THE STORAGE AND SUBSEQUENT TRANSMISSION OF ELECTRONIC MAIL BY COMPUTER; RENTAL OF TELECOMMUNICATION EQUIPMENT, NAMELY TELEPHONES, FAX MACHINES, VIDEO CONFERENCE EQUIPMENT, TELEPHONE CONFERENCE EQUIPMENT, MOBILE PHONES, EQUIPMENT FOR ACCESS TO TELECOMMUNICATION VIA THE INTERNET OR BY MEANS OF ELECTRONIC MAIL; AND PROVIDING INFORMATION AND ADVICE IN THE FIELD OF TELECOMMUNICATIONS IN RELATION TO THE CONDUCT OF A BUSINESS; ELECTRONIC MAIL SERVICES, NAMELY, PROVIDING OF PERSONAL ELECTRONIC MAIL ADDRESSES (U.S. CLS. 100, 101 AND 104).

CLASS 41—EDUCATION AND ENTERTAINMENT

FOR ARRANGING AND CONDUCTING EDUCATIONAL CONFERENCES, TRAINING COURSES AND TRAINING ACTIVITIES ON BEHALF OF CUSTOMERS IN THE FIELD OF BUSINESS THAT IS REQUIRED BY THE CUSTOMERS; ARRANGING AND CONDUCTING SOCIAL ACTIVITIES IN THE FORM OF PARTIES, DANCES, BALLS, DINNERS, AND LUNCHESES; ARRANGING FOR TICKET RESERVATIONS FOR SHOWS AND OTHER ENTERTAINMENT EVENTS; ENTERTAINMENT SERVICES, NAMELY, ESCORTING BUSINESS CLIENTS TO PUBS, BARS, RESTAURANTS AND NIGHT CLUBS; PUBLICATION OF BOOKS, REPORTS, NEWSLETTERS, MAGAZINES, BROCHURES; AND PROVIDING INFORMATION AND ADVICE IN THE FIELD OF ENTERTAINMENT AND EDUCATION; PROVIDING FACILITIES FOR MARKETING EVENTS IN THE FORM OF EDUCATIONAL AND TRAINING CONFERENCES, PRESENTATIONS, ART, PHOTOGRAPHY, CULTURE AND TRADE EXHIBITIONS, SPORTING EVENTS, CONCERTS, BALLS, DINNERS, LUNCHESES, PARTIES (U.S. CLS. 100, 101 AND 107).

CLASS 42—SCIENTIFIC, COMPUTER AND LEGAL SERVICES

FOR PROVISION OF TEMPORARY BUSINESS CENTER ACCOMMODATION WITH FULLY EQUIPPED WORKSPACES, FULLY EQUIPPED WORKSTATIONS, FULLY EQUIPPED MEETING ROOMS AND FULLY EQUIPPED CONFERENCE ROOMS; LEGAL SERVICES; INTELLECTUAL PROPERTY LICENSING SERVICES; PROVIDING LEGAL CONSULTATION SERVICES (U.S. CLS. 100 AND 101).

CLASS 6—METAL GOODS

FOR METAL SIGN BOARDS AND METAL LABELS FOR ADVERTISING INFORMATION PERTAINING TO A STANDARDIZED SYSTEM OF INVESTIGATION AND DUE DILIGENCE PERTAINING TO ISSUES AND POTENTIAL ISSUES WITH REAL PROPERTY WHICH IMPACT ITS MARKETABILITY AND SALABILITY, PROVIDED TO REALTORS, REAL ESTATE LICENSEES, REAL ESTATE FRANCHISES, RELOCATION COMPANIES, SELLERS, BUYERS, OWNERS, LENDERS, ATTORNEYS, APPRAISERS, AND OTHER REPRESENTATIVES OF REAL PROPERTY IN ORDER TO AID IN THE SELLING, BUYING, EVALUATING, PRICING AND COUNSELING FOR THE SAME (U.S. CLS. 2, 12, 13, 14, 23, 25 AND 50).

CLASS 9—ELECTRICAL AND SCIENTIFIC APPARATUS

FOR COMPUTER SOFTWARE PROGRAMS AND PRE-RECORDED VIDEO AND AUDIO COMPACT DISCS, TAPES, AND DVD'S CONTAINING INFORMATION PERTAINING TO AND REGARDING THE FINANCIAL BENEFITS, RISK REDUCTION, REDUCED LIABILITY EXPOSURE, PROFESSIONAL BENEFITS, EDUCATIONAL BENEFITS, BUSINESS METHODOLOGY, DATA ORGANIZATION, MARKETING STRATEGIES, FRANCHISE BENEFITS AND APPLICATIONS, INDEXING METHODOLOGY, COMMUNICATIONS SYSTEMS, MARKETING SYSTEMS, PUBLIC SPEAKING OPPORTUNITIES AND COORDINATION, SEMINAR DEVELOPMENT, CAPITAL MANAGEMENT, CUSTOMER SERVICE SYSTEMS, COLLATERAL MATERIALS, COST TRACKING, WARRANTY REVIEW, ORDER TAKING, ACCOUNTING AND BILLING SYSTEMS, REORDER PROCESSING, PRICING AND BIDDING METHODOLOGY, COLLECTIONS, PACKAGING AND SHIPPING PROCESSES, INSURANCE REQUIREMENTS AND MANAGEMENT, LEAD DEVELOPMENT, DIRECT MAILING SYSTEMS, EMPLOYEE TRAINING, CONTRACTS, RECORD STORAGE, LEGAL SECURITY, GROWTH MANAGEMENT, AND PERMIT AND FEE REQUIREMENTS FOR USE IN REAL ESTATE RESEARCH, FEATURING A STANDARDIZED SYSTEM OF INVESTIGATION AND DUE DILIGENCE PERTAINING TO ISSUES AND POTENTIAL ISSUES WITH REAL PROPERTY WHICH IMPACT ITS MARKETABILITY AND SALABILITY, PROVIDED TO REALTORS, REAL ESTATE LICENSEES, REAL ESTATE FRANCHISES, RELOCATION COMPANIES, SELLERS, BUYERS; OWNERS, LENDERS, ATTORNEYS, APPRAISERS, AND OTHER REPRESENTATIVES OF REAL PROPERTY IN ORDER TO AID IN THE SELLING, BUYING, EVALUATING, PRICING, AND COUNSELING FOR THE SAME; AND COMPUTER SCREEN SAVER SOFTWARE FOR ADVERTISING THE FOREGOING (U.S. CLS. 21, 23, 26, 36 AND 38).

CLASS 16—PAPER GOODS AND PRINTED MATTER

FOR LOOSE LEAF NOTEBOOK BINDERS, NEWSLETTERS AND BOOKS CONTAINING INFORMATION PERTAINING TO AND REGARDING THE FINANCIAL BENEFITS, RISK REDUCTION, REDUCED LIABILITY EXPOSURE, PROFESSIONAL BENEFITS, EDUCATIONAL BENEFITS, BUSINESS METHODOLOGY, DATE ORGANIZATION, MARKETING STRATEGIES, FRANCHISE BENEFITS AND APPLICATIONS, INDEXING METHODOLOGY, COMMUNICATIONS SYSTEMS, SALES SYSTEMS, MARKETING SYSTEMS, PUBLIC SPEAKING OPPORTUNITIES AND COORDINATION, SEMINAR DEVELOPMENT, CAPITAL MANAGEMENT, CUSTOMER SERVICE SYSTEMS, COLLATERAL MATERIALS, COST TRACKING, WARRANTY REVIEW, ORDER TAKING, ACCOUNTING AND BILLING SYSTEMS, REORDER PROCESSING, PRICING AND BIDDING METHODOLOGY, COLLECTIONS, PACKAGING AND SHIPPING PROCESSES, INSURANCE REQUIREMENTS END MANAGEMENT, LEAD DEVELOPMENT, DIRECT MAILING SYSTEMS, EMPLOYEE TRAINING, CONTRACTS, RECORD STORAGE, LEGAL SECURITY, GROWTH MANAGEMENT, AND PERMIT AND FEE REQUIREMENTS, AND EDUCATIONAL PUBLICATIONS, NAMELY TRAINING AND INSTRUCTION MANUALS, IN THE FIELD OF STANDARDIZED SYSTEMS OF INVESTIGATION AND DUE DILIGENCE PERTAINING TO ISSUES AND POTENTIAL ISSUES WITH REAL PROPERTY WHICH IMPACT ITS MARKETABILITY AND SALABILITY, PROVIDED TO REALTORS, REAL ESTATE LICENSEES, REAL ESTATE FRANCHISES, RELOCATION COMPANIES, SELLERS, BUYERS, OWNERS, LENDERS, ATTORNEYS, APPRAISERS, AND OTHER REPRESENTATIVES OF REAL PROPERTY IN ORDER TO AID IN THE SELLING, BUYING, EVALUATING, PRICING, AND COUNSELING FOR THE SAME (U.S. CLS. 2, 5, 22, 23, 29, 37, 38 AND 50).

CLASS 20—FURNITURE AND ARTICLES NOT OTHERWISE CLASSIFIED

FOR PLASTIC, WOOD, AND HARDBOARD SIGN BOARDS AND PLASTIC, WOOD, AND HARDBOARD, LABELS FOR ADVERTISING INFORMATION PERTAINING TO A STANDARDIZED SYSTEM OF INVESTIGATION AND DUE DILIGENCE PERTAINING TO ISSUES AND POTENTIAL ISSUES WITH REAL PROPERTY WHICH IMPACT ITS MARKETABILITY AND SALABILITY, PROVIDED TO REALTORS, REAL ESTATE LICENSEES, REAL ESTATE FRANCHISES, RELOCATION COMPANIES, SELLERS, BUYERS, OWNERS, LENDERS, ATTORNEYS, APPRAISERS, AND OTHER REPRESENTATIVES OF REAL PROPERTY IN ORDER TO AID IN THE SELLING, BUYING, EVALUATING, AND COUNSELING FOR THE SAME (U.S. CLS. 2, 13, 22, 25, 32 AND 50).

CLASS 41—EDUCATION AND ENTERTAINMENT

FOR EDUCATIONAL SERVICES, NAMELY, CONDUCTING TRAINING IN THE FIELD OF REAL ESTATE AND DISTRIBUTING COURSE MATERIALS IN CONNECTION THEREWITH; EDUCATIONAL SERVICES, NAMELY CONDUCTING TRAINING IN THE FIELD OF STANDARDIZED SYSTEMS OF INVESTIGATION AND DUE DILIGENCE PERTAINING TO ISSUES AND POTENTIAL ISSUES WITH REAL PROPERTY WHICH IMPACT ITS MARKETABILITY AND SALABILITY, PROVIDED TO REALTORS, REAL ESTATE LICENSEES, REAL ESTATE FRANCHISES, RELOCATION COMPANIES, SELLERS, BUYERS, OWNERS, LENDERS, ATTORNEYS, APPRAISERS, AND OTHER REPRESENTATIVES OF REAL PROPERTY IN ORDER TO AID IN THE SELLING, BUYING, EVALUATING, PRICING, AND COUNSELING FOR THE SAME AND DISTRIBUTION OF COURSE MATERIALS IN CONNECTION THEREWITH (U.S. CLS. 100, 101 AND 107).

CLASS 42—SCIENTIFIC, COMPUTER AND LEGAL SERVICES

FOR REAL ESTATE RESEARCH SERVICES FEATURING A STANDARDIZED SYSTEM OF INVESTIGATION AND DUE DILIGENCE PERTAINING TO ISSUES AND POTENTIAL ISSUES WITH REAL PROPERTY WHICH IMPACT ITS MARKETABILITY AND SALABILITY, PROVIDED TO REALTORS, REAL ESTATE LICENSEES, SELLERS, BUYERS, OWNERS, LENDERS, ATTORNEYS, AND OTHER REPRESENTATIVES OF REAL PROPERTY IN ORDER TO AID IN THE SELLING, BUYING, EVALUATING, AND COUNSELING FOR THE SAME (U.S. CLS. 100 AND 101).

SN 78-122,807. AT&T CORP., NEW YORK, NY. FILED 4-19-2002.

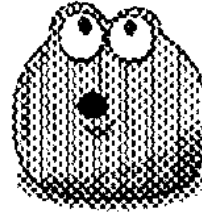

THE MARK CONSISTS OF A ROUND SHAPED FANCIFUL CHARACTER WITH TWO EYES, A MOUTH AND A RED BODY. THE COLOR RED IS CLAIMED AS A FEATURE OF THE MARK.

CLASS 38—COMMUNICATION

FOR TELECOMMUNICATIONS SERVICES, NAMELY THE ELECTRONIC TRANSMISSION OF VOICE, DATA, FACSIMILE AND INFORMATION (U.S. CLS. 100, 101 AND 104).

CLASS 41—EDUCATION AND ENTERTAINMENT

FOR ENTERTAINMENT SERVICES, NAMELY, PROVIDING ON-LINE COMPUTER GAMES (U.S. CLS. 100, 101 AND 107).

SN 78-123,753. LAWDEV, INC., SAN DIEGO, CA. FILED 4-24-2002.

LAWGISTICS**CLASS 37—CONSTRUCTION AND REPAIR**

FOR INSTALLATION OF COMPUTER HARDWARE (U.S. CLS. 100, 103 AND 106).
FIRST USE 2-1-2002; IN COMMERCE 2-1-2002.

CLASS 41—EDUCATION AND ENTERTAINMENT

FOR TRAINING SERVICES IN THE FIELD OF COMPUTER HARDWARE AND SOFTWARE (U.S. CLS. 100, 101 AND 107).
FIRST USE 2-1-2002; IN COMMERCE 2-1-2002.

CLASS 42—SCIENTIFIC, COMPUTER AND LEGAL SERVICES

FOR COMPUTER CONSULTATION; INSTALLATION AND DEVELOPMENT OF COMPUTER SOFTWARE; INTEGRATION OF COMPUTER SYSTEMS AND NETWORKS; TECHNICAL SUPPORT SERVICES, NAMELY, TROUBLESHOOTING OF COMPUTER HARDWARE AND SOFTWARE PROBLEMS (U.S. CLS. 100 AND 101).
FIRST USE 2-1-2002; IN COMMERCE 2-1-2002.

SN 78-125,712. TELUTION, INC., CHICAGO, IL. FILED 5-2-2002.

UNCONVENTIONAL THINKING. EXCEPTIONAL RESULTS.

CLASS 9—ELECTRICAL AND SCIENTIFIC APPARATUS

FOR COMPUTER SOFTWARE FOR USE IN PROVIDING CUSTOMER CARE, ORDER MANAGEMENT AND BILLING FOR COMPANIES IN THE FIELD OF TELECOMMUNICATIONS (U.S. CLS. 21, 23, 26, 36 AND 38).

CLASS 42—SCIENTIFIC, COMPUTER AND LEGAL SERVICES

FOR CONSULTING SERVICES IN THE FIELD OF DESIGN, SELECTION, IMPLEMENTATION AND USE OF COMPUTER SOFTWARE SYSTEMS FOR OTHERS (U.S. CLS. 100 AND 101).

SN 78-124,955. MIPS TECHNOLOGIES, INC., MOUNTAIN VIEW, CA. FILED 4-29-2002.

M4K

CLASS 9—ELECTRICAL AND SCIENTIFIC APPARATUS

FOR DOWNLOADABLE COMPUTER SOFTWARE AND DOWNLOADABLE COMPUTER CODE FOR USE IN, AND FOR USE IN THE DESIGN, DEVELOPMENT, DESCRIPTION AND TESTING OF, COMPUTING DEVICES, COMPUTER HARDWARE AND CODE; DOWNLOADABLE COMPUTER SOFTWARE AND DOWNLOADABLE COMPUTER CODE FOR DESCRIBING, DESIGNING, TESTING, MODELING, SIMULATING, COMPILING, DEBUGGING, DEVELOPING, VERIFYING, INTERFACING, AND CONSTRUCTING COMPUTING DEVICES, COMPONENT PARTS THEREFORE, COMPUTER HARDWARE AND CODE; COMPUTING AND ELECTRONIC DEVICES, NAMELY, PRINTED CIRCUIT BOARDS, DAUGHTER CARDS, DEVELOPMENT BOARDS, AND COMPONENT PARTS THEREFORE; SEMICONDUCTORS, SEMICONDUCTOR DEVICES, INTEGRATED CIRCUITS, CIRCUIT CHIPS, MICROPROCESSORS, AND MICROCONTROLLERS; SEMICONDUCTOR INTELLECTUAL PROPERTY (SIP) CORES, MICROPROCESSOR CORES AND MACRO CELLS; COMPUTER CODE PRODUCTS, NAMELY, DEVICE DRIVERS, SOFTWARE USED FOR HIGH PERFORMANCE MICROPROCESSOR CORES, OPERATING SYSTEM SOFTWARE AND APPLICATION SOFTWARE, NAMELY, COMPILERS, SIMULATORS AND ASSEMBLERS; AND DOWNLOADABLE DOCUMENTATION IN ELECTRONIC FORM, NAMELY, MANUALS, DATA SHEETS, GUIDES, BROCHURES AND LITERATURE SOLD AS A UNIT WITH ALL THE AFORESAID GOODS (U.S. CLS. 21, 23, 26, 36 AND 38).

CLASS 16—PAPER GOODS AND PRINTED MATTER

FOR BOOKLETS AND PAMPHLETS, ALL RELATING TO COMPUTER TECHNOLOGY, HARDWARE AND SOFTWARE (U.S. CLS. 2, 5, 22, 23, 29, 37, 38 AND 50).

CLASS 41—EDUCATION AND ENTERTAINMENT

FOR EDUCATIONAL SERVICES, NAMELY, CONDUCTING SEMINARS, CLASSES AND WORKSHOPS IN THE FIELD OF EMBEDDED COMPUTER SYSTEMS AND IN THE USE AND OPERATION OF COMPUTER TECHNOLOGY, INCLUDING CORES, CELLS, ARCHITECTURE, HARDWARE AND SOFTWARE (U.S. CLS. 100, 101 AND 107).

SN 78-127,009. CRANIUM INC., SEATTLE, WA. FILED 5-7-2002.

SOUNDSTAGE

CLASS 16—PAPER GOODS AND PRINTED MATTER

FOR TOYS, NAMELY, MODELING COMPOUND; MODELING COMPOUND SOLD AS A UNIT FOR PLAYING A BOARD GAME (U.S. CLS. 2, 5, 22, 23, 29, 37, 38 AND 50).

CLASS 28—TOYS AND SPORTING GOODS

FOR BOARD GAMES; EQUIPMENT SOLD AS A UNIT FOR PLAYING A BOARD GAME; QUESTION SETS FOR BOARD GAME; DOLLS; ACTION FIGURES; JIGSAW PUZZLES; MANIPULATIVE PUZZLES; THREE DIMENSIONAL PUZZLES; CARD GAMES; EQUIPMENT SOLD AS A UNIT FOR PLAYING CARD GAMES (U.S. CLS. 22, 23, 38 AND 50).

SN 78-127,208. CELLUS USA, INC., PARKER, CO. FILED 5-8-2002.

NO CLAIM IS MADE TO THE EXCLUSIVE RIGHT TO USE "MASP" AND "USA", APART FROM THE MARK AS SHOWN.

CLASS 9—ELECTRICAL AND SCIENTIFIC APPARATUS

FOR DOWNLOADABLE SOFTWARE THAT PROVIDES RING TONES, TEXT, GRAPHICS, LOGOS, ICONS, AND SCREEN SAVERS TO WIRELESS TELEPHONES (U.S. CLS. 21, 23, 26, 36 AND 38).

CLASS 38—COMMUNICATION

FOR TELECOMMUNICATION SERVICES, NAMELY, PROVIDING ELECTRONIC WIRELESS, TELEPHONE VOICE, AND DIGITAL ONE-WAY AND TWO-WAY MESSAGING SERVICES; PROVIDING WIRELESS HIGH SPEED ACCESS TO A GLOBAL COMPUTER INFORMATION NETWORK; ELECTRONIC, ELECTRIC, AND DIGITAL TRANSMISSION OF VOICE, DATA, IMAGES, SIGNALS, AND MESSAGES; STREAMING OF AUDIO AND VIDEO MATERIAL TO WIRELESS TELEPHONES; OUTCALL NOTIFICATION SERVICES; SUBSCRIPTION BASED ELECTRONIC MAIL SERVICES OVER WIRELESS NETWORKS; ELECTRONIC DELIVERY OF IMAGES AND PHOTOGRAPHS OVER A WIRELESS GLOBAL COMPUTER INFORMATION NETWORK; WIRELESS DIGITAL MESSAGING SERVICES; PROVIDING ON-LINE ELECTRONIC BULLETIN BOARDS AND CHAT ROOMS FOR THE TRANSMISSION OF MESSAGES AMONG COMPUTER USERS CONCERNING MOBILE CONTENT SERVICES; STREAMING OF AUDIO AND VIDEO MATERIAL ON THE INTERNET; DELIVERY OF MESSAGES BY ELECTRONIC TRANSMISSION (U.S. CLS. 100, 101 AND 104).

CLASS 42—SCIENTIFIC, COMPUTER AND LEGAL SERVICES

FOR APPLICATION SERVICE PROVIDER (ASP), NAMELY, HOSTING COMPUTER SOFTWARE APPLICATIONS OF OTHERS VIA WIRELESS NETWORKS; WIRELESS COMPUTER SOFTWARE DEVELOPMENT; COMPUTER CONSULTATION SERVICES; COMPUTER SERVICES, NAMELY, DESIGNING AND IMPLEMENTING WEBSITES FOR OTHERS; PROVIDING TECHNOLOGY INFORMATION IN THE FIELD OF SCIENTIFIC RESEARCH VIA WIRELESS NETWORKS (U.S. CLS. 100 AND 101).

SN 78-127,766. VIAS IMPORTS, LTD., NEW YORK, NY. FILED 5-10-2002.

WE IMPORT PASSION**CLASS 33—WINES AND SPIRITS**

FOR WINE (U.S. CLS. 47 AND 49).

CLASS 35—ADVERTISING AND BUSINESS

FOR DISTRIBUTORSHIP SERVICES FEATURING WINES (U.S. CLS. 100, 101 AND 102). FIRST USE 5-0-2001; IN COMMERCE 5-0-2001.

SN 78-129,139. OPA! SOUVLAKI FRANCHISE GROUP INC., CALGARY, ALBERTA, FILED 5-16-2002.

OPA! SOUVLAKI

NO CLAIM IS MADE TO THE EXCLUSIVE RIGHT TO USE "SOUVLAKI", APART FROM THE MARK AS SHOWN. THE ENGLISH TRANSLATION OF THE WORD "OPA" IN THE MARK IS "AN EXPRESSION OF GLEE".

CLASS 25—CLOTHING

FOR CLOTHING, NAMELY, T-SHIRTS, SWEAT-SHIRTS, PANTS, JACKETS, APRONS, CAPS, HATS (U.S. CLS. 22 AND 39).

CLASS 30—STAPLE FOODS

FOR FROZEN AND PACKAGED SOUVLAKI, PREPARED AND PACKAGED SOUVLAKI, FROZEN AND PACKAGED SPANAKOPITA, PREPARED AND PACKAGED SPANAKOPITA, FROZEN AND PACKAGED BAKLAVA, PREPARED AND PACKAGED BAKLAVA, FROZEN AND PACKAGED CALAMARI, PREPARED AND PACKAGED CALAMARI (U.S. CL. 46).

CLASS 42—SCIENTIFIC, COMPUTER AND LEGAL SERVICES

FOR RESTAURANT AND TAKE-OUT SERVICES; CARRYING ON THE BUSINESS OF ESTABLISHING FRANCHISE OPERATIONS (U.S. CLS. 100 AND 101).

SN 78-129,157. DUNSTAN, DONALD L., PORTLAND, OR. FILED 5-16-2002.

**CLASS 9—ELECTRICAL AND SCIENTIFIC APPARATUS**

FOR COMPUTER SOFTWARE FOR DEVELOPMENT TOOLS, NAMELY, COMPUTER PROGRAMS FOR COMPILING, INTERPRETING, ASSEMBLING, LINKING AND DEBUGGING SOURCE CODE; COMPUTER SOFTWARE DEVELOPMENT PLATFORMS, NAMELY AN INTEGRATED SET OF COMPUTER PROGRAMS FOR CONSTRUCTING, INTERPRETING AND DEBUGGING OTHER COMPUTER PROGRAMS (U.S. CLS. 21, 23, 26, 36 AND 38).

CLASS 29—MEATS AND PROCESSED FOODS

FOR FRUIT-BASED SNACK FOOD; SNACK MIX CONSISTING PRIMARILY OF PROCESSED FRUITS, PROCESSED NUTS AND/OR RAISINS; FOOD PACKAGE COMBINATIONS CONSISTING PRIMARILY OF CHEESE, MEAT AND/OR PROCESSED FRUIT (U.S. CL. 46).

SN 78-130,179. SPRINGBOARD CORPORATION, ONTARIO, CANADA, FILED 5-21-2002.

DECO**CLASS 41—EDUCATION AND ENTERTAINMENT**

FOR CASINOS (U.S. CLS. 100, 101 AND 107).

CLASS 43—HOTEL AND RESTAURANT SERVICES

FOR HOTELS, NOT INCLUDING RESTAURANT SERVICES (U.S. CLS. 100 AND 101).

SN 78-131,723. STATE BAR OF WISCONSIN, MADISON, WI. FILED 5-29-2002.

SN 78-133,105. BSN MEDICAL, INC., CHARLOTTE, NC. FILED 6-4-2002.

**WISCONSIN LAWYERS
EXPERT ADVISERS.
SERVING YOU.**

NO CLAIM IS MADE TO THE EXCLUSIVE RIGHT TO USE "WISCONSIN LAWYER EXPERT ADVISORS", APART FROM THE MARK AS SHOWN.

CLASS 35—ADVERTISING AND BUSINESS

FOR ASSOCIATION SERVICES, NAMELY PROMOTING THE INTEREST OF LAWYERS IN WISCONSIN AND PROMOTING THE RELATIONSHIP BETWEEN LAWYERS AND THEIR COMMUNITIES (U.S. CLS. 100, 101 AND 102).
FIRST USE 4-15-2002; IN COMMERCE 4-15-2002.

CLASS 41—EDUCATION AND ENTERTAINMENT

FOR EDUCATIONAL SERVICES AND PROGRAMS FOR LAWYERS, NAMELY PROVIDING CONTINUING LEGAL EDUCATION COURSES (U.S. CLS. 100, 101 AND 107).
FIRST USE 4-15-2002; IN COMMERCE 4-15-2002.

SN 78-132,459. WEISS, WENDY, NEW YORK, NY. FILED 5-31-2002.

**THE QUEEN OF COLD
CALLING**

NO CLAIM IS MADE TO THE EXCLUSIVE RIGHT TO USE "COLD CALLING", APART FROM THE MARK AS SHOWN.

CLASS 35—ADVERTISING AND BUSINESS

FOR BUSINESS MARKETING CONSULTATION SERVICES, NAMELY, PROVIDING ADVICE ON SALES AND PROMOTING THE GOODS AND SERVICES OF OTHERS (U.S. CLS. 100, 101 AND 102).
FIRST USE 8-15-2001; IN COMMERCE 8-15-2001.

CLASS 41—EDUCATION AND ENTERTAINMENT

FOR EDUCATIONAL SERVICES, NAMELY, PROVIDING LECTURES, WORKSHOPS AND SEMINARS IN THE FIELD OF SALES AND PROMOTING THE GOODS AND SERVICES OF OTHERS; PERSONAL COACHING SERVICES IN THE FIELD OF SALES AND MARKETING (U.S. CLS. 100, 101 AND 107).
FIRST USE 8-15-2001; IN COMMERCE 8-15-2001.

OPTIBAND

CLASS 5—PHARMACEUTICALS

FOR ADHESIVE BANDS AND TAPES FOR MEDICAL USE; MEDICAL PLASTERS; ADHESIVE BANDAGES; SURGICAL BANDAGES; WOUND DRESSINGS; GAUZE FOR DRESSINGS (U.S. CLS. 6, 18, 44, 46, 51 AND 52).

CLASS 10—MEDICAL APPARATUS

FOR ELASTIC, SUSPENSORY AND SUPPORT BANDAGES AND STOCKINGS; BANDAGES FOR JOINTS; SURGICAL SPLINTS; ORTHOPEDIC BRACES (U.S. CLS. 26, 39 AND 44).

SN 78-133,321. BKD, LLP, SPRINGFIELD, MO. FILED 6-5-2002.

BKD KEYNET

CLASS 35—ADVERTISING AND BUSINESS

FOR PROVIDING ON-LINE TAX PREPARATION, CONSULTATION AND ASSESSMENT, ACCOUNT AUDITING, TAX CONSULTING, ACCOUNTING OUTSOURCING BY MEANS OF A GLOBAL COMPUTER NETWORK (U.S. CLS. 100, 101 AND 102).

CLASS 36—INSURANCE AND FINANCIAL

FOR INVESTMENT ADVISORY AND CORPORATE FINANCE INFORMATION BY MEANS OF A GLOBAL COMPUTER NETWORK (U.S. CLS. 100, 101 AND 102).

SN 78-133,555. SONANCE ENTERTAINMENT GROUP LLC, AMBLER, PA. AND HENDERSON, MICHAEL, LAS VEGAS, NV. FILED 6-6-2002.

**CHILDREN ON THE
CORNER**

CLASS 9—ELECTRICAL AND SCIENTIFIC APPARATUS

FOR PRERECORDED SOUND AND AUDIOVISUAL RECORDINGS, NAMELY, CDS, DVDS, MINIDISCS AND VIDEOTAPES, FEATURING MUSIC AND MUSIC VIDEOS (U.S. CLS. 21, 23, 26, 36 AND 38).

CLASS 25—CLOTHING

FOR CLOTHING, NAMELY HATS, T-SHIRTS, SHIRTS, PANTS, SWEATSHIRTS, SWEATPANTS, BANDANAS, JACKETS, LEATHER JACKETS, PANTS, AND VESTS (U.S. CLS. 22 AND 39).

CLASS 41—EDUCATION AND ENTERTAINMENT

FOR ENTERTAINMENT SERVICES IN THE NATURE OF LIVE MUSICAL AND VOCAL PERFORMANCES BY A MUSICAL GROUP (U.S. CLS. 100, 101 AND 107).

SN 78-133,606. COMMERCIAL MORTGAGE SECURITIES ASSOCIATION, INC., NEW YORK, NY. FILED 6-6-2002.

CMBS 301

OWNER OF U.S. REG. NO. 2,471,199.
NO CLAIM IS MADE TO THE EXCLUSIVE RIGHT TO USE "CMBS", APART FROM THE MARK AS SHOWN.

CLASS 16—PAPER GOODS AND PRINTED MATTER

FOR FINANCIAL BOOKLETS CONTAINING READINGS, INFORMATIONAL AND EDUCATIONAL MATERIALS IN THE FIELD OF COMMERCIAL MORTGAGE-BACKED SECURITIES (U.S. CLS. 2, 5, 22, 23, 29, 37, 38 AND 50).

CLASS 41—EDUCATION AND ENTERTAINMENT

FOR EDUCATIONAL SERVICES, NAMELY CONDUCTING SEMINARS, CLASSES AND WORKSHOPS IN THE FIELD OF COMMERCIAL MORTGAGE-BACKED SECURITIES AND DISTRIBUTING COURSE MATERIALS IN CONNECTION THEREWITH (U.S. CLS. 100, 101 AND 107).

CLASS 25—CLOTHING

FOR CLOTHING, NAMELY SUITS, PANTSUITS, BLAZERS, VESTS, JUMPSUITS AND DRESSES; OUTERWEAR, NAMELY COATS, CAPES, PARKAS, WIND-PROOF JACKETS, SHELLS, JACKETS, STOLES, PONCHOS, FLEECE JACKETS, ANORAKS AND RAINCOATS; TOPS, NAMELY SHIRTS, BLOUSES, T-SHIRTS, PULL-OVERS, SWEATERS, SWEATSHIRTS, FLEECE TOPS, TURTLENECKS, HALTERS, BODYSUITS, TANK TOPS; BOTTOMS, NAMELY PANTS, OVERALLS, PEDAL PUSHERS, JODHPURS, SLACKS, JEANS, SHORTS, BERMUDAS, SWEATPANTS, CULOTTES, SKIRTS, TUNICS, JUMPERS AND WRAPAROUNDS; SLEEPWEAR, LOUNGEWEAR AND LINGERIE, NAMELY PAJAMAS, NIGHTGOWNS, NIGHT SHIRTS, CAFTANS, SMOKING JACKETS, BATHROBES, BATH WRAPS AND DRESSING GOWNS; HEADWEAR, NAMELY VISORS, CAPS, HATS, TOQUES, HEAD BANDS AND EARMUFFS; MITTENS, GLOVES AND MUFFS; ACCESSORIES, NAMELY TIES, SHAWLS, SCARVES AND BELTS; HOSIERY, NAMELY LEGGINGS, TIGHTS, LEOTARDS, SOCKS AND STOCKINGS; SPORTSWEAR, NAMELY TRACK SUITS, SWEATSUITS, SWEATSHIRTS, SWEATPANTS, JOGGING SUITS, WARMUP PANTS, WARMUP SHIRTS, WARMUP SUITS, ARMBANDS, CAPS, BASEBALL SHIRTS, BASEBALL STOCKINGS, BASEBALL UNIFORMS, BASEBALL CAPS, BASKETBALL SINGLETS, BASKETBALL JERSEYS, BASKETBALL SOCKS, BASKETBALL SHORTS, BASKETBALL PANTS, BASKETBALL SHIRTS, BOWLING SHIRTS, BOXING TRUNKS, CYCLING SHORTS, CYCLING TOPS, FOOTBALL SHIRTS, FOOTBALL PANTS, FOOTBALL JACKETS, GOLF PANTS, GOLF SHIRTS, GOLF VESTS, GOLF JACKETS, GOLF SOCKS, GOLF HATS, GOLF SHORTS, GOLF CAPS, GYM SHORTS, GYM SHIRTS, GYM PANTS, SNOWBOARD JACKETS, SNOWBOARD PANTS, SNOWSUITS, SKI SUITS, SKI JACKETS, SKI PANTS, TENNIS PANTS, TENNIS SHIRTS, TENNIS SHORTS, TENNIS JACKETS (U.S. CLS. 22 AND 39).

SN 78-135,536. HMA, INC., WEST DES MOINES, IA. FILED 6-13-2002.

CREATIVE RISK SOLUTIONS

NO CLAIM IS MADE TO THE EXCLUSIVE RIGHT TO USE "RISK SOLUTIONS", APART FROM THE MARK AS SHOWN.

CLASS 36—INSURANCE AND FINANCIAL

FOR INSURANCE CLAIMS ADMINISTRATION SERVICES IN THE FIELD OF AUTO, GENERAL LIABILITY, AND WORKERS COMPENSATION; AND RISK MANAGEMENT CONSULTING SERVICES IN THE FIELD OF AUTO, GENERAL LIABILITY, AND WORKERS COMPENSATION (U.S. CLS. 100, 101 AND 102).

CLASS 41—EDUCATION AND ENTERTAINMENT

FOR SAFETY TRAINING SERVICES IN THE FORM OF SEMINARS ON HOW TO REDUCE RISK COVERED BY INSURANCE IN THE FIELD OF AUTO, GENERAL LIABILITY, AND WORKERS COMPENSATION, AND THE DISTRIBUTION OF PRINTED MATERIALS IN CONNECTION THEREWITH; AND VIDEO TAPE PRODUCTION IN THE FIELD OF AUTO, GENERAL LIABILITY, AND WORKERS COMPENSATION (U.S. CLS. 100, 101 AND 107).

SN 78-134,833. CO.7 ENTERPRISES, INC., MONTREAL, QUEBEC, CANADA, FILED 6-11-2002.

CO.7

CLASS 14—JEWELRY

FOR JEWELRY, WATCHES, MEDALLIONS (U.S. CLS. 2, 27, 28 AND 50).

CLASS 18—LEATHER GOODS

FOR LUGGAGE, ALL-PURPOSE SPORTS BAGS, ATHLETIC BAGS, BEACH BAGS, CARRY-ON BAGS, DUFFEL BAGS, GARMENT BAGS FOR TRAVEL, GYM BAGS, OVERNIGHT BAGS, SCHOOL BAGS, SHOE BAGS FOR TRAVEL, SHOULDER BAGS, SUIT BAGS, TOTE BAGS, TRAVEL BAGS, BACKPACKS, FANNY PACKS, KNAPSACKS, RUCKSACKS, ATTACHE CASES, BRIEF-CASES (U.S. CLS. 1, 2, 3, 22 AND 41).

SN 78-135,725. BEAUTY HOLDING COMPANY, INC., HAMILTON, BERMUDA, FILED 6-14-2002.

FACE SECRETS

CLASS 18—LEATHER GOODS

FOR COSMETIC BAGS (U.S. CLS. 1, 2, 3, 22 AND 41).

CLASS 20—FURNITURE AND ARTICLES NOT OTHERWISE CLASSIFIED

FOR MIRRORS (U.S. CLS. 2, 13, 22, 25, 32 AND 50).

CLASS 21—HOUSEWARES AND GLASS

FOR BRUSHES, SPATULAS, WEDGES, ROUNDS, SQUARES, PUFFS AND SPONGES, ALL FOR COSMETIC USE (U.S. CLS. 2, 13, 23, 29, 30, 33, 40 AND 50).

SN 78-136,300. LAURENCE ALTSCHULER, M.D., P.C., OKLAHOMA CITY, OK. FILED 6-17-2002.

WHAT HAVE YOU GOT TO LOSE BUT THE PAIN?

CLASS 35—ADVERTISING AND BUSINESS

FOR RETAIL DRUG STORE SERVICES AND RETAIL PHARMACY SERVICES OFFERING PHARMACEUTICALS, MEDICINE AND PRODUCTS USED IN CONVENTIONAL AND ALTERNATIVE TREATMENT MODALITIES, NAMELY, HERBAL SUPPLEMENTS, NUTRITIONAL SUPPLEMENTS, VITAMINS, NUTRACEUTICALS, PHYTOCHEMICALS, SKIN LOTIONS, AND SKIN OINTMENTS (U.S. CLS. 100, 101 AND 102).
FIRST USE 5-3-1999; IN COMMERCE 5-3-1999.

CLASS 44—MEDICAL, BEAUTY AND AGRICULTURAL SERVICES

FOR MEDICAL SERVICES, NAMELY, TREATMENT IN CONVENTIONAL AND ALTERNATIVE MEDICAL PROTOCOLS AND A MEDICAL CLINIC OFFERING TREATMENT IN CONVENTIONAL AND ALTERNATIVE MEDICAL PROTOCOLS; PROVIDING MEDICAL INFORMATION IN THE FIELD OF HEALTH AND WELLNESS AND CONVENTIONAL AND ALTERNATIVE TREATMENT MODALITIES, AND OFFERING MEDICAL INFORMATION AND PHARMACEUTICAL ADVICE ABOUT PHARMACEUTICALS, MEDICINES AND PRODUCTS USED IN CONVENTIONAL AND ALTERNATIVE TREATMENT MODALITIES, NAMELY HERBAL SUPPLEMENTS, NUTRITIONAL SUPPLEMENTS, VITAMINS, NUTRACEUTICALS, AND PHYTOCHEMICALS (U.S. CLS. 100 AND 101).
FIRST USE 5-3-1999; IN COMMERCE 5-3-1999.

SN 78-136,655. BESTWAY USA, INC., JOHNSTON, RI. FILED 6-18-2002.

FLOW CLEAR

NO CLAIM IS MADE TO THE EXCLUSIVE RIGHT TO USE "FLOW", APART FROM THE MARK AS SHOWN.

CLASS 7—MACHINERY

FOR SWIMMING POOL PUMPS (U.S. CLS. 13, 19, 21, 23, 31, 34 AND 35).

CLASS 11—ENVIRONMENTAL CONTROL APPARATUS

FOR SWIMMING POOL FILTERS; FILTERS, HEATERS, AND PUMPS SOLD IN COMBINATION FOR USE IN SWIMMING POOLS (U.S. CLS. 13, 21, 23, 31 AND 34).

SN 78-138,138. THUNDERSTIK MERGER CORPORATION, PLYMOUTH, MN. BY MERGER THUNDERSTIK LODGE, INC., PLYMOUTH, MN. FILED 6-24-2002.

ROOSTER RIDGE

CLASS 41—EDUCATION AND ENTERTAINMENT

FOR PROVIDING FACILITIES FOR RECREATIONAL ACTIVITIES IN THE NATURE OF FISHING AND HUNTING (U.S. CLS. 100, 101 AND 107).

CLASS 43—HOTEL AND RESTAURANT SERVICES

FOR RESORT LODGING SERVICES (U.S. CLS. 100 AND 101).

SN 78-138,865. WALTRIP, DARRELL LEE, HARRISBURG, NC. FILED 6-26-2002.

BOOGITY! BOOGITY! BOOGITY!

CLASS 9—ELECTRICAL AND SCIENTIFIC APPARATUS

FOR SUNGLASSES, DECORATIVE MAGNETS, AND MOUSE PADS. (U.S. CLS. 21, 23, 26, 36 AND 38).

CLASS 14—JEWELRY

FOR JEWELRY, NAMELY, PINS, PENDANTS, CHAINS, NECKLACES, RINGS, AND EARRINGS. (U.S. CLS. 2, 27, 28 AND 50).

CLASS 16—PAPER GOODS AND PRINTED MATTER

FOR PRINTED MATTER, NAMELY, BROCHURES PERTAINING TO AUTO RACING, POSTERS, FLYERS, PROMO CARDS, POSTER PAPER DESIGNED FOR USE AS BILLBOARDS, CD COVERS, STICKERS, DECALS, CALENDARS AND TRADING CARDS (U.S. CLS. 2, 5, 22, 23, 29, 37, 38 AND 50).

CLASS 24—FABRICS

FOR TEXTILES, NAMELY, TOWELS, BED BLANKETS, PICNIC BLANKETS, BANNERS, PENNANTS, AND FLAGS (U.S. CLS. 42 AND 50).

CLASS 28—TOYS AND SPORTING GOODS

FOR TOYS AND SPORTING GOODS, NAMELY, MINIATURE CARS AND TRUCKS. (U.S. CLS. 22, 23, 38 AND 50).

SN 78-140,292. BOWMAN AND BROOKE LLP, MINNEAPOLIS, MN. FILED 7-1-2002.

ORDER OUT OF CHAOS**CLASS 35—ADVERTISING AND BUSINESS**

FOR BUSINESS MANAGEMENT SERVICES (U.S. CLS. 100, 101 AND 102).

SN 78-139,827. MINNTECH CORPORATION, MINNEAPOLIS, MN. FILED 6-28-2002.

ROSS**CLASS 42—SCIENTIFIC, COMPUTER AND LEGAL SERVICES**

FOR LEGAL SERVICES, NAMELY, CASE MANAGEMENT, CLAIMS RESOLUTION AND LITIGATION (U.S. CLS. 100 AND 101).

CLASS 35—ADVERTISING AND BUSINESS

FOR INVENTORY MANAGEMENT IN THE FIELD OF CHEMICALS AND OTHER COMMODITIES FOR DIALYSIS TREATMENT (U.S. CLS. 100, 101 AND 102).

SN 78-140,576. AMERICAN MOVIE CLASSICS COMPANY, JERICHO, NY. FILED 7-2-2002.

CLASS 37—CONSTRUCTION AND REPAIR

FOR REPAIR AND MAINTENANCE OF DIALYSIS MACHINES (U.S. CLS. 100, 103 AND 106).

MOVIE JACKPOT

NO CLAIM IS MADE TO THE EXCLUSIVE RIGHT TO USE "MOVIE", APART FROM THE MARK AS SHOWN.

CLASS 40—MATERIAL TREATMENT

FOR WATER TREATMENT FOR DIALYSIS (U.S. CLS. 100, 103 AND 106).

CLASS 41—EDUCATION AND ENTERTAINMENT

FOR TRAINING SERVICES IN THE FIELD OF DIALYSIS MACHINES (U.S. CLS. 100, 101 AND 107).

CLASS 9—ELECTRICAL AND SCIENTIFIC APPARATUS

FOR ELECTRONIC DATABASE IN THE FIELD OF MOTION PICTURES RECORDED ON COMPUTER MEDIA (U.S. CLS. 21, 23, 26, 36 AND 38).

CLASS 42—SCIENTIFIC, COMPUTER AND LEGAL SERVICES

FOR TESTING, ANALYSIS AND EVALUATION OF THE SERVICES OF OTHERS IN OPERATING AND MAINTAINING DIALYSIS MACHINES; REVIEWING STANDARDS AND PRACTICES OF OTHERS TO ASSURE COMPLIANCE WITH HEALTH QUALITY STANDARDS IN THE DELIVERY OF DIALYSIS SERVICES TO PATIENTS (U.S. CLS. 100 AND 101).

CLASS 41—EDUCATION AND ENTERTAINMENT

FOR ENTERTAINMENT SERVICES, NAMELY, PROVIDING AN ON-LINE COMPUTER DATABASE IN THE FIELD OF MOTION PICTURES (U.S. CLS. 100, 101 AND 107).

SN 78-140,289. BOWMAN AND BROOKE LLP, MINNEAPOLIS, MN. FILED 7-1-2002.

WAR AND PEACE**CLASS 35—ADVERTISING AND BUSINESS**

FOR BUSINESS MANAGEMENT SERVICES (U.S. CLS. 100, 101 AND 102).

SN 78-140,578. AMERICAN MOVIE CLASSICS COMPANY, JERICHO, NY. FILED 7-2-2002.

MOVIE MOOD RING

NO CLAIM IS MADE TO THE EXCLUSIVE RIGHT TO USE "MOVIE", APART FROM THE MARK AS SHOWN.

CLASS 42—SCIENTIFIC, COMPUTER AND LEGAL SERVICES

FOR LEGAL SERVICES, NAMELY, CASE MANAGEMENT, CLAIMS RESOLUTION AND LITIGATION (U.S. CLS. 100 AND 101).

CLASS 9—ELECTRICAL AND SCIENTIFIC APPARATUS

FOR ELECTRONIC DATABASE IN THE FIELD OF MOTION PICTURES RECORDED ON COMPUTER MEDIA (U.S. CLS. 21, 23, 26, 36 AND 38).

CLASS 41—EDUCATION AND ENTERTAINMENT

FOR ENTERTAINMENT SERVICES, NAMELY, PROVIDING AN ON-LINE COMPUTER DATABASE IN THE FIELD OF MOTION PICTURES (U.S. CLS. 100, 101 AND 107).

SN 78-140,632. CGS & ASSOCIATES, INC., CORAL SPRINGS, FL. FILED 7-2-2002.

SN 78-142,403. PART'COM MANAGEMENT, PARIS, FRANCE, FILED 7-9-2002.

ROOF-A-CIDE

CLASS 5—PHARMACEUTICALS

FOR ALGAECIDES AND BACTERICIDES FOR USE ON COMMERCIAL AND RESIDENTIAL ROOFS (U.S. CLS. 6, 18, 44, 46, 51 AND 52).

FIRST USE 10-1-1999; IN COMMERCE 10-1-1999.

CLASS 37—CONSTRUCTION AND REPAIR

FOR ROOF CLEANING SERVICES, NAMELY, PROVIDING ROOF TREATMENT SERVICES THAT KILL ALGAE AND BACTERIA ON RESIDENTIAL AND COMMERCIAL ROOFS (U.S. CLS. 100, 103 AND 106).

FIRST USE 10-1-1999; IN COMMERCE 10-1-1999.

SN 78-141,251. XANTERRA, INC., AURORA, CO. FILED 7-3-2002.



NO CLAIM IS MADE TO THE EXCLUSIVE RIGHT TO USE "PARKS" AND "RESORTS", APART FROM THE MARK AS SHOWN.

CLASS 35—ADVERTISING AND BUSINESS

FOR MANAGEMENT OF PARKS, HOTELS, LODGES, RESORTS, CONCESSIONS AND RESTAURANTS FOR OTHERS; RETAIL GIFT SHOPS; RETAIL SOUVENIR STORES; RETAIL CONVENIENCE STORES; RETAIL SPORTING GOODS STORES; AND PROVIDING CONCESSION STANDS FEATURING FOOD AND SOUVENIRS (U.S. CLS. 100, 101 AND 102).

FIRST USE 4-5-2002; IN COMMERCE 4-5-2002.

CLASS 41—EDUCATION AND ENTERTAINMENT

FOR RECREATIONAL PARK SERVICES; RECREATIONAL SERVICES IN THE NATURE OF GOLF, TENNIS, AND SPAS; PROVIDING FACILITIES FOR RECREATION ACTIVITIES; PROVIDING FITNESS AND EXERCISE FACILITIES (U.S. CLS. 100, 101 AND 107).

FIRST USE 4-5-2002; IN COMMERCE 4-5-2002.

CLASS 43—HOTEL AND RESTAURANT SERVICES

FOR HOTEL, RESORT LODGING AND RESTAURANT SERVICES; PROVIDING CONVENTION FACILITIES; PROVIDING CAMPGROUND FACILITIES (U.S. CLS. 100 AND 101).

FIRST USE 4-5-2002; IN COMMERCE 4-5-2002.

PART'COM

PRIORITY CLAIMED UNDER SEC. 44(D) ON FRANCE APPLICATION NO. 023142659, FILED 1-21-2002, REG. NO. 023142659, DATED 1-21-2002, EXPIRES 1-21-2012.

CLASS 35—ADVERTISING AND BUSINESS

FOR BUSINESS CONSULTATION, BUSINESS MANAGEMENT ASSISTANCE, BUSINESS CONSULTATION IN STRATEGY MATTERS; BUSINESS MANAGEMENT; BUSINESS DEVELOPMENT CONSULTING, PROFESSIONAL BUSINESS CONSULTING; BUSINESS EVALUATION OF FINANCIAL STATISTICS AND VALUE OF COMPANIES, BUSINESS INVESTIGATIONS, BUSINESS COST ASSESSMENTS, CONDUCTING MARKET STUDIES, ECONOMICAL FORECASTS (U.S. CLS. 100, 101 AND 102).

CLASS 36—INSURANCE AND FINANCIAL

FOR BANKING; FINANCIAL INQUIRIES, INVESTIGATIONS, FORECASTS AND ASSESSMENTS; MUTUAL FUNDS AND FUND INVESTMENTS; CAPITAL INVESTMENTS; VENTURE CAPITAL SERVICES; FINANCIAL INCUBATION SERVICES; COMPANY FINANCING SERVICES; FUND FORMATION AND INVESTMENTS, FORMING AND MANAGING FINANCIAL ACQUISITION PORTFOLIOS, FINANCIAL CONSULTING AND ASSESSMENTS NAMELY FOR MANAGING FINANCIAL ACQUISITIONS IN QUOTED OR UNQUOTED COMPANY CAPITALS (U.S. CLS. 100, 101 AND 102).

SN 78-142,611. NATIONAL SCRIP CENTER, INC., SANTA ROSA, CA. FILED 7-10-2002.

NSC FUND ACCELERATOR

NO CLAIM IS MADE TO THE EXCLUSIVE RIGHT TO USE "FUND", APART FROM THE MARK AS SHOWN.

CLASS 9—ELECTRICAL AND SCIENTIFIC APPARATUS

FOR MAGNETICALLY ENCODED CREDIT CARDS, DEBIT CARDS, STORED VALUE CARDS AND DISCOUNT CARDS TO BE USED BY CHARITABLE ORGANIZATIONS FOR FUNDRAISING (U.S. CLS. 21, 23, 26, 36 AND 38).

CLASS 36—INSURANCE AND FINANCIAL

FOR ISSUING STORED VALUE CARDS, CREDIT CARDS AND DEBIT CARDS TO CHARITABLE ORGANIZATIONS FOR FUNDRAISING (U.S. CLS. 100, 101 AND 102).

SN 78-144,217. MANPOWER INC., MILWAUKEE, WI. FILED 7-16-2002.

TALENTPORT

CLASS 35—ADVERTISING AND BUSINESS

FOR EMPLOYMENT AGENCY SERVICES; TEMPORARY EMPLOYMENT AGENCY SERVICES; JOB PLACEMENT SERVICES; CAREER DEVELOPMENT; EMPLOYMENT RECRUITMENT SERVICES; EMPLOYMENT COUNSELING AND RECRUITING; EMPLOYMENT HIRING, RECRUITING, PLACEMENT, STAFFING AND CAREER NETWORKING SERVICES; EMPLOYMENT OUTPLACEMENT SERVICES; PROVIDING AND MANAGING CONTRACT PERSONNEL RESOURCING PROGRAMS; ANALYZING AND CONSULTING ON PERSONNEL NEEDS; PROVIDING CONTRACT AND TEMPORARY CONTRACT PERSONNEL STAFFING SERVICES; ARRANGING FOR AND MANAGING THE PROVISION OF TEMPORARY CONTRACT PERSONNEL; PERSONNEL MANAGEMENT AND PERSONNEL RESOURCING CONSULTANCY SERVICES; PROVIDING INFORMATION AND CONSULTANCY SERVICES ON THE PROCUREMENT OF TEMPORARY AND CONTRACT PERSONNEL; COMPUTER ON-LINE ORDERING, AND PROVIDING COMPUTER ON-LINE REPORTS, BOTH VIA A GLOBAL INFORMATION NETWORK, IN THE FIELDS OF PERSONNEL PROCUREMENT AND PERSONNEL RESOURCING; HUMAN RESOURCES CONSULTING ON RECRUITING, TRAINING AND TESTING OF EMPLOYEES; TESTING TO DETERMINE EMPLOYMENT SKILLS; EMPLOYMENT COUNSELING FOR OTHERS; PROVIDING CAREER INFORMATION VIA A WEBSITE ON A GLOBAL INFORMATION NETWORK; PROVIDING INFORMATION ON JOBS VIA A WEBSITE ON A GLOBAL INFORMATION NETWORK; PROVIDING INFORMATION ON EMPLOYEE PAY AND BENEFITS IN CONNECTION WITH CONTRACT PERSONNEL STAFFING, ON-LINE VIA A GLOBAL INFORMATION NETWORK; PROVIDING AN ON-LINE COMPUTER DATABASE IN THE FIELDS OF JOBS AND CONTRACT PERSONNEL STAFFING (U.S. CLS. 100, 101 AND 102).

CLASS 41—EDUCATION AND ENTERTAINMENT

FOR PROVIDING TRAINING IN BUSINESS AND JOB SKILLS AND OFFICE TECHNOLOGY; PROVIDING ON-LINE COURSES OF STUDY IN THE FOLLOWING - INFORMATION TECHNOLOGY, SOFTWARE USE, JOB, OFFICE AND BUSINESS SKILLS - VIA A WEBSITE ON A GLOBAL INFORMATION NETWORK (U.S. CLS. 100, 101 AND 107).

SN 78-145,142. HOK GROUP, INC., ST. LOUIS, MO. FILED 7-18-2002.

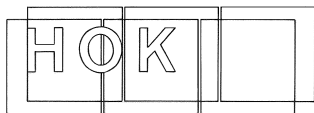

OWNER OF U.S. REG. NOS. 788,284, 2,499,886 AND 2,581,646.

CLASS 37—CONSTRUCTION AND REPAIR

FOR BUILDING CONSTRUCTION SERVICES (U.S. CLS. 100, 103 AND 106).
FIRST USE 1-15-2002; IN COMMERCE 1-15-2002.

CLASS 42—SCIENTIFIC, COMPUTER AND LEGAL SERVICES

FOR ARCHITECTURAL DESIGN AND INTERIOR DESIGN SERVICES (U.S. CLS. 100 AND 101).
FIRST USE 1-15-2002; IN COMMERCE 1-15-2002.

SN 78-146,304. NHOUSE, LLC, NEW YORK, NY. FILED 7-22-2002.

N HARLEM NY

NO CLAIM IS MADE TO THE EXCLUSIVE RIGHT TO USE "HARLEM NY", APART FROM THE MARK AS SHOWN.

CLASS 29—MEATS AND PROCESSED FOODS

FOR FOOD PRODUCTS, NAMELY, COOKING OILS, EDIBLE OILS, JAMS, JELLIES, FRUIT PRESERVES (U.S. CL. 46).

CLASS 30—STAPLE FOODS

FOR FOOD PRODUCTS, NAMELY, VINEGARS, SPICES, TABLE SYRUPS, PANCAKE SYRUPS, MAPLE SYRUPS, SALAD DRESSINGS, BAKERY GOODS, BREADS, BISCUIT MIXES, PANCAKE MIXES, WAFFLE MIXES (U.S. CL. 46).

SN 78-148,302. BEGONIA BREEDERS ASSOCIATION B.V., EV. AALSMEEER, NETHERLANDS, FILED 7-29-2002.

FRINZIES

CLASS 31—NATURAL AGRICULTURAL PRODUCTS

FOR HORTICULTURAL PRODUCTS, NAMELY PLANTS OF THE PLANT SPECIES BEGONIA; LIVE PLANTS AND FLOWERS AND PARTS THEREOF OF THE PLANT SPECIES BEGONIA; PLANT MATERIAL, NAMELY PLANT SEEDS, LEAVES, BUDS, CUTTINGS AND TISSUE CULTURE MATERIAL FOR THE PROPAGATION, MULTIPLICATION AND REPRODUCTION OF THE PLANT SPECIES BEGONIA (U.S. CLS. 1 AND 46).

CLASS 35—ADVERTISING AND BUSINESS

FOR PROMOTING THE INTERESTS OF HORTICULTURAL PRODUCTS, NAMELY PLANTS OF THE PLANT SPECIES BEGONIA, PLANT MATERIAL, NAMELY PLANT SEEDS, LEAVES, BUDS, CUTTINGS AND TISSUE CULTURE MATERIAL FOR THE PROPAGATION, MULTIPLICATION AND REPRODUCTION OF THE PLANT SPECIES BEGONIA; MEDIATION OF COMMERCIAL AFFAIRS IN THE FIELD OF HORTICULTURAL PRODUCTS, NAMELY PLANTS OF THE PLANT SPECIES BEGONIA, PLANT MATERIAL, NAMELY PLANT SEEDS, LEAVES, BUDS, CUTTINGS AND TISSUE CULTURE MATERIAL FOR THE PROPAGATION, MULTIPLICATION AND REPRODUCTION OF THE PLANT SPECIES BEGONIA (U.S. CLS. 100, 101 AND 102).

CLASS 44—MEDICAL, BEAUTY AND AGRICULTURAL SERVICES

FOR PROPAGATION OF FLOWERS AND PLANTS, THE AFORESAID SERVICES IN PARTICULAR CONCERNING THE SPECIES BEGONIA (U.S. CLS. 100 AND 101).

SN 78-149,120. SYNGENTA CROP PROTECTION, INC., GREENSBORO, NC. FILED 7-31-2002.

TOLERA

CLASS 1—CHEMICALS

FOR HERBICIDE-TOLERANT GENES FOR INTRODUCTION INTO AGRICULTURAL SEED TO PROVIDE RESISTANCE TO PLANTS GROWN THEREFROM (U.S. CLS. 1, 5, 6, 10, 26 AND 46).

CLASS 5—PHARMACEUTICALS

FOR HERBICIDES FOR DOMESTIC USE (U.S. CLS. 6, 18, 44, 46, 51 AND 52).

CLASS 31—NATURAL AGRICULTURAL PRODUCTS

FOR AGRICULTURAL SEED (U.S. CLS. 1 AND 46).

CLASS 9—ELECTRICAL AND SCIENTIFIC APPARATUS

FOR TRAILER WIRING, TRAILER ELECTRICAL CONNECTORS, ELECTRICAL CONTROLS FOR TRAILER BRAKES, 12 VOLT CONVERTERS, AND 12 VOLT CIRCUIT PROTECTORS (U.S. CLS. 21, 23, 26, 36 AND 38).

CLASS 12—VEHICLES

FOR VEHICLE TOWING EQUIPMENT, NAMELY, TRAILER HITCHES, GOOSE NECK HITCHES, FIFTH WHEEL HITCHES, STEP BUMPER HITCHES; TRAILER HITCH ACCESSORIES, NAMELY, HITCH BALLS, HITCH BALL COVERS, TRAILER RECEIVERS, TRAILER COUPLERS, SAFETY CHAINS, PULL PINS, CLIPS, SWAY CONTROLS, TRAILER LOCKS, TOW HOOKS, PINTLE HOOKS AND ADAPTERS (U.S. CLS. 19, 21, 23, 31, 35 AND 44).

SN 78-149,581. AGUILERA, CHRISTINA, BEVERLY HILLS, CA. FILED 7-31-2002.

XTINA

CLASS 9—ELECTRICAL AND SCIENTIFIC APPARATUS

FOR SERIES OF MUSICAL SOUND AND VIDEO RECORDINGS (U.S. CLS. 21, 23, 26, 36 AND 38).

CLASS 16—PAPER GOODS AND PRINTED MATTER

FOR POSTERS, STICKERS AND DECALS, PHOTOGRAPHS (U.S. CLS. 2, 5, 22, 23, 29, 37, 38 AND 50).

CLASS 25—CLOTHING

FOR CLOTHING—NAMELY, SHIRTS, JACKETS, PANTS, SKIRTS, SOCKS, AND SWEATERS; SHOES FOOTWEAR; HATS AND CAPS (U.S. CLS. 22 AND 39).

CLASS 41—EDUCATION AND ENTERTAINMENT

FOR ENTERTAINMENT SERVICES IN THE NATURE OF A LIVE MUSICAL PERFORMANCE; PRESENTATION OF A LIVE SHOW PERFORMANCE AND MUSICAL CONCERT; LIVE PERFORMANCES BY A MUSICAL GROUP (U.S. CLS. 100, 101 AND 107).

SN 78-151,051. ALTHEA TECHNOLOGIES, INC., SAN DIEGO, CA. FILED 8-5-2002.

eXpress Profiling

NO CLAIM IS MADE TO THE EXCLUSIVE RIGHT TO USE "PROFILING", APART FROM THE MARK AS SHOWN.

CLASS 9—ELECTRICAL AND SCIENTIFIC APPARATUS

FOR COMPUTER SOFTWARE FOR USE IN SCREENING, ANALYZING AND RESEARCHING DRUGS AND COMPOUNDS IN THE FIELDS OF GENES AND GENE RESEARCH (U.S. CLS. 21, 23, 26, 36 AND 38).

CLASS 42—SCIENTIFIC, COMPUTER AND LEGAL SERVICES

FOR CUSTOM SOFTWARE DESIGN IN THE FIELD OF GENES (U.S. CLS. 100 AND 101).

CLASS 44—MEDICAL, BEAUTY AND AGRICULTURAL SERVICES

FOR MEDICAL TESTING AND ANALYTICAL SERVICES IN THE FIELD OF GENES (U.S. CLS. 100 AND 101).

SN 78-149,875. REESE PRODUCTS, INC., GOSHEN, IN. FILED 8-1-2002.

REESE PROFESSIONAL SERIES

OWNER OF U.S. REG. NOS. 2,030,575, 2,668,912 AND OTHERS.

NO CLAIM IS MADE TO THE EXCLUSIVE RIGHT TO USE "SERIES", APART FROM THE MARK AS SHOWN.

SN 78-151,120. FREMANTLE MEDIA NORTH AMERICA, INC., SANTA MONICA, CA. FILED 8-5-2002.



CLASS 16—PAPER GOODS AND PRINTED MATTER

FOR POSTERS, CALENDARS, NOTEBOOKS, BINDERS, DAILY ORGANIZERS, MEMOPADS, STICKERS, COMIC BOOKS, PLAYING CARDS, WRITING PAPER, ENVELOPES, GREETING CARDS, PAPER COASTERS, PAPER MATS, NEWSPAPERS FOR GENERAL CIRCULATION, BOOKS AND MAGAZINES IN THE FIELD OF TALENT SHOWS, PHOTOGRAPHS, POSTCARDS, TRADING CARDS, CARDBOARD STAND-UP CUTOUTS FEATURING PHOTOGRAPHS OR ARTWORK, PREPAID PHONE DEBIT CARDS WITHOUT MAGNETIC CODING, TRADING CARD MILK BOTTLE CAPS, AND PERSONAL CHECKS (U.S. CLS. 2, 5, 22, 23, 29, 37, 38 AND 50).

CLASS 25—CLOTHING

FOR CLOTHING, NAMELY, RAINWEAR, T-SHIRTS, SWEAT SHIRTS, JERSEYS, SHORTS, SWEAT PANTS, JACKETS, HATS, CAPS, SCARVES, GLOVES, HOSIERY, NECKTIES, PAJAMAS, ROBES, NIGHT SHIRTS, NIGHT GOWNS, UNDERWEAR, HEAD BANDS, WRIST BANDS, SWIM SUITS, SKIRTS, SHIRTS, TANK TOPS, PANTS, COATS, SWEATERS, LEOTARDS, LEG WARMERS, STOCKINGS, SOCKS, PANTY HOSE, TIGHTS, BELTS; FOOTWEAR, NAMELY, SHOES, ATHLETIC SHOES, SLIPPERS, BOOTS, SANDALS; AND HEADWEAR, NAMELY, HATS AND CAPS (U.S. CLS. 22 AND 39).

CLASS 28—TOYS AND SPORTING GOODS

FOR TARGET GAMES, BOARD GAMES AND CARD GAMES, KITES, TOY ACTION FIGURES, DISC-TYPE TOSS TOYS, BOWS AND ARROWS, BALLS OF ALL KINDS, DOLLS, DOLL PLAYSETS, PLUSH TOYS, TOY VEHICLES, TOY CARDS, TOY TRUCKS, TOY BUCKET AND SHOVEL SETS, ROLLER SKATES, TOY MODEL HOBBYCRAFT KITS, TOY ROCKETS, TOY GUNS, TOY HOLSTERS, MUSICAL TOYS, JIGSAW PUZZLES, BADMINTON SETS, BUBBLE MAKING WANDS AND SOLUTION SETS, TOY FIGURINES, TOY BANKS, PUPPETS, TOY BALLOONS, YO-YOS, SKATEBOARDS, SCOOTERS, FACE MASKS, STAND ALONE VIDEO GAME MACHINES, LCD GAME MACHINES, HAND HELD UNIT FOR PLAYING ELECTRONIC GAMES, BUT SPECIFICALLY EXCLUDING DICE GAMES AND COMPUTER SOFTWARE GAMES (U.S. CLS. 22, 23, 38 AND 50).

SN 78-151,530. HAXTON, CHRISTOPHER W, LOLO, MT. FILED 8-6-2002.

FISH WHISPERER

NO CLAIM IS MADE TO THE EXCLUSIVE RIGHT TO USE "FISH", APART FROM THE MARK AS SHOWN.

CLASS 16—PAPER GOODS AND PRINTED MATTER

FOR BOOK MARKS; BOOKS IN THE FIELD OF FISHING; CALENDARS; STATIONARY; POST CARDS; CHECK BOOK COVERS; BOOK COVERS; PAPER GOODS AND PRINTED MATTER IN THE NATURE OF ART ETCHINGS, ART PICTURES, AND ART PRINTS; INSTRUCTION MANUALS IN THE FIELD OF FISHING (U.S. CLS. 2, 5, 22, 23, 29, 37, 38 AND 50).
FIRST USE 4-20-2002; IN COMMERCE 4-29-2002.

CLASS 18—LEATHER GOODS

FOR WALLETTS; WADING STAFFS; WALKING STICKS; CANES (U.S. CLS. 1, 2, 3, 22 AND 41).
FIRST USE 4-20-2002; IN COMMERCE 4-29-2002.

CLASS 25—CLOTHING

FOR BELTS; SHIRTS; CAPS; HATS; VESTS; JACKETS; NECK TIES; SCARVES; BANDANAS (U.S. CLS. 22 AND 39).
FIRST USE 4-20-2002; IN COMMERCE 4-29-2002.

SN 78-153,885. K-2 CORPORATION, VASHON, WA. FILED 8-13-2002.

T:NINE

CLASS 9—ELECTRICAL AND SCIENTIFIC APPARATUS

FOR SPORTS HELMET (U.S. CLS. 21, 23, 26, 36 AND 39).

CLASS 28—TOYS AND SPORTING GOODS

FOR SKIS, SKI POLES, AND SKI BINDINGS (U.S. CLS. 22, 23, 38 AND 50).

SN 78-153,887. K-2 CORPORATION, VASHON, WA. FILED 8-13-2002.

FATTY

CLASS 9—ELECTRICAL AND SCIENTIFIC APPARATUS

FOR SPORTS HELMET (U.S. CLS. 21, 23, 26, 36 AND 38).

CLASS 28—TOYS AND SPORTING GOODS

FOR SKIS, SKI POLES, AND SKI BINDINGS (U.S. CLS. 22, 23, 38 AND 50).

SN 78-155,711. ESPOSITO, JENNIFER, A., WESTMINSTER, CO. FILED 8-19-2002.

SN 78-156,574. REAL LIFE MARKETING, LLC, PORTLAND, OR. FILED 8-21-2002.

ESPO'S CUCINA DOLCE CAFE (ESPO'S SWEET KITCHEN CAFE)

NO CLAIM IS MADE TO THE EXCLUSIVE RIGHT TO USE "CUCINA DOLCE CAFE" AND "SWEET KITCHEN CAFE", APART FROM THE MARK AS SHOWN.

CLASS 30—STAPLE FOODS

FOR GELATO; ICE CREAM, SORBETTO, FLAVORED WATER ICE; SORBETTO (SORBET); FROZEN YOGURT; WAFFLES AND CONES FOR ICE CREAM AND GELATO; FROZEN CAKES, AND OTHER FROZEN CONFECTIONS, FLAVORING SYRUPS AND TOPPING SYRUPS; BAKERY AND CONFECTIONERY GOODS, NAMELY, COOKIES, MUFFINS, SCONES, BREADS, ROLLS, PASTRY, SWEETROLLS, TARTS, BROWNIES, CAKES, PIES AND OTHER BAKERY PRODUCTS; MIXES FOR BAKERY AND CONFECTIONERY GOODS; ESPRESSO, COFFEE, TEA AND CHAI BEVERAGES AS WELL AS NON-ALCOHOLIC DRINKS MADE WITH A ESPRESSO, COFFEE, TEA OR CHAI BASE; WHOLE BEAN AND GROUND COFFEE AND ESPRESSO AS WELL AS TEA LEAVES (U.S. CL. 46).

CLASS 35—ADVERTISING AND BUSINESS

FOR RETAIL STORE SERVICES FEATURING GELATO, ICE CREAM, SORBETTO (SORBET) AND FLAVORED WATER ICE; RETAIL BAKERY SHOPS; RESTAURANT FRANCHISING; RESTAURANT MANAGEMENT FOR OTHERS (U.S. CLS. 100, 101 AND 102).



SN 78-156,418. HOVNANIAN ENTERPRISES, INC., RED BANK, NJ. FILED 8-21-2002.

K. HOVNANIAN'S DISTINCTIVE PROPERTIES

OWNER OF U.S. REG. NOS. 1,519,167 AND 1,519,168.
NO CLAIM IS MADE TO THE EXCLUSIVE RIGHT TO USE "DISTINCTIVE PROPERTIES", APART FROM THE MARK AS SHOWN.

THE NAME "K. HOVNANIAN" IDENTIFIES A LIVING INDIVIDUAL WHOSE CONSENT IS OF RECORD.

CLASS 35—ADVERTISING AND BUSINESS

FOR REAL ESTATE ADVERTISING SERVICES; REAL ESTATE MARKETING SERVICES, NAMELY, PROVIDING ON-LINE AND HARD COPY MARKETING MATERIALS AND PRESENTATIONS FOR PROSPECTIVE CUSTOMERS, ON-LINE SERVICES FEATURING TOURS OF RESIDENTIAL AND COMMERCIAL REAL ESTATE, ALL AS PROVIDED ON THE GLOBAL COMPUTER NETWORK (U.S. CLS. 100, 101 AND 102).

CLASS 36—INSURANCE AND FINANCIAL

FOR REAL ESTATE SERVICES, NAMELY, REAL ESTATE BROKERAGE, MANAGEMENT, LEASING AND RENTAL OF RESIDENTIAL AND COMMERCIAL PROPERTIES (U.S. CLS. 100, 101 AND 102).

NO CLAIM IS MADE TO THE EXCLUSIVE RIGHT TO USE "CHRISTIAN MUSIC NETWORK", APART FROM THE MARK AS SHOWN.

THE STIPPLING IS FOR SHADING PURPOSES ONLY AND DOES NOT INDICATE COLOR.

CLASS 35—ADVERTISING AND BUSINESS

FOR MARKETING SERVICES, NAMELY, DISSEMINATING AND PROMOTING THE MUSIC OF OTHERS; DIRECT MARKETING ADVERTISING FOR OTHERS, FEATURING MUSIC, TOUR INFORMATION, REVIEWS OF MUSICAL PERFORMANCES AND RECORDINGS; CONSUMER AND MARKET RESEARCH SERVICES; PROMOTING THE SALE OF GOODS OF OTHERS THROUGH THE DISTRIBUTION OF AUDIO AND PRINTED MATERIAL AND PROMOTIONAL CONTESTS (U.S. CLS. 100, 101 AND 102).

FIRST USE 9-0-2001; IN COMMERCE 9-0-2001.

CLASS 41—EDUCATION AND ENTERTAINMENT

FOR PROVIDING PRERECORDED MUSIC, INFORMATION IN THE FIELD OF MUSIC, AND COMMENTARIES AND ARTICLES ABOUT MUSIC, ALL ON-LINE VIA A GLOBAL COMPUTER NETWORK (U.S. CLS. 100, 101 AND 107).

FIRST USE 9-0-2001; IN COMMERCE 9-0-2001.

SN 78-157,026. MCL CREATION FACTORY, LTD., KOW-
LOON, HONG KONG, FILED 8-22-2002.

SN 78-157,872. PPG INDUSTRIES OHIO, INC., CLEVELAND,
OH. FILED 8-26-2002.

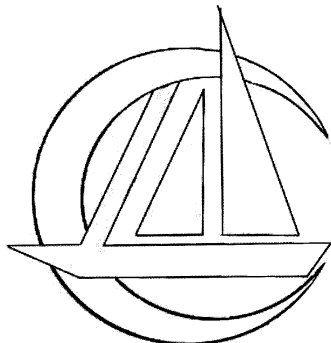

CLASS 18—LEATHER GOODS

FOR BACKPACKS, SCHOOL BAGS, TRAVEL BAGS,
HANDBAGS, AND PURSES (U.S. CLS. 1, 2, 3, 22 AND
41).

FIRST USE 7-1-2002; IN COMMERCE 7-1-2002.

CLASS 25—CLOTHING

FOR CLOTHES, NAMELY HATS, SHIRTS, T-SHIRTS,
SWEATERS, JACKETS, SHORTS, PANTS, AND SHOES
(U.S. CLS. 22 AND 39).

FIRST USE 7-1-2002; IN COMMERCE 7-1-2002.

SN 78-157,287. MBO BINDER & CO. OF AMERICA,
WESTHAMPTON, NJ. FILED 8-23-2002.

MBO

CLASS 7—MACHINERY

FOR PAPER FOLDING MACHINES; MACHINE PARTS
FOR USE WITH PAPER FOLDING MACHINES,
NAMELY, FOLD ROLLERS, PRE-SPLITTER SHAFTS,
HIGH-SPEED PAPER GUIDES, PAPER STACKERS, PA-
PER FEEDERS, ANTI-STATIC PLATES, MICROPROCES-
SOR CONTROLLED GATEFOLD PLATES, MOTORIZED
RETAINING PLATES, DOUBLE-STREAM DEVICES,
BELT DRIVE SYSTEMS, NOISE-DAMPENING HOODS;
PERFORATING, SCORING AND CUTTING DEVICES
FOR USE WITH PAPER FOLDING MACHINES; VA-
CUUM IN-FEED AND VACUUM ALIGN DEVICES
SYSTEMS FOR USE WITH PAPER FOLDING MA-
CHINES; COMPUTERIZED MAKE-READY DEVICES,
COMPRISED OF MOTORIZED BUCKLE FOLDING
PLATES FOR USE WITH FOLDING PAPER MACHINES
(U.S. CLS. 13, 19, 21, 23, 31, 34 AND 35).

FIRST USE 0-0-1970; IN COMMERCE 0-0-1970.

CLASS 9—ELECTRICAL AND SCIENTIFIC APPARATUS

FOR ELECTRONIC CONTROL AND USER INTER-
FACE UNITS FOR USE WITH PAPER FOLDING MA-
CHINES (U.S. CLS. 21, 23, 26, 36 AND 38).

FIRST USE 0-0-1970; IN COMMERCE 0-0-1970.



THE LINING IS A FEATURE OF THE MARK AND DOES
NOT INDICATE COLOR.

CLASS 1—CHEMICALS

FOR VEHICLE WINDSHIELD REPAIR SYSTEMS,
NAMELY - CHEMICAL RESINS AND EPOXIES (U.S.
CLS. 1, 5, 6, 10, 26 AND 46).

CLASS 3—COSMETICS AND CLEANING PRE- PARATIONS

FOR POLISHES (U.S. CLS. 1, 4, 6, 50, 51 AND 52).

CLASS 7—MACHINERY

FOR VACUUM PRESSURE PUMPS (U.S. CLS. 13, 19,
21, 23, 31, 34 AND 35).

CLASS 8—HAND TOOLS

FOR HAND TOOLS FOR VEHICLE WINDSHIELD
REPAIR, NAMELY REFRACTURING HAMMERS, RE-
FRACTURING NEEDLE PUNCHES, STEEL TIP PROBES,
SWIVEL MIRRORS, DRILLS, RESIN SYRINGES, BLOW
TORCHES AND RAZOR BLADES (U.S. CLS. 23, 28 AND
44).

CLASS 9—ELECTRICAL AND SCIENTIFIC APPARATUS

FOR INSTRUCTIONAL AND TEACHING MATERIALS
IN THE NATURE OF PRE-RECORDED AUDIO AND
VIDEO TAPES FEATURING INFORMATION IN THE
FIELD OF WINDSHIELD REPAIR AND UV LIGHTS
FOR WINDSHIELD REPAIR (U.S. CLS. 21, 23, 26, 36
AND 38).

CLASS 12—VEHICLES

FOR HOOD SHIELDS FOR USE IN PROTECTING
STRUCTURAL PARTS OF VEHICLES (U.S. CLS. 19, 21,
23, 31, 35 AND 44).

CLASS 16—PAPER GOODS AND PRINTED MATTER

FOR PRINTED INSTRUCTIONAL AND TEACHING
MATERIALS FOR WINDSHIELD REPAIR (U.S. CLS. 2, 5,
22, 23, 29, 37, 38 AND 50).

CLASS 21—HOUSEWARES AND GLASS

FOR BOTTLES FOR APPLYING ALCOHOL, SOLD
EMPTY (U.S. CLS. 2, 13, 23, 29, 30, 33, 40 AND 50).

SN 78-158,710. HANWHA L & C CORPORATION, SEOUL, REPUBLIC OF KOREA, FILED 8-28-2002.

HANEX

CLASS 11—ENVIRONMENTAL CONTROL APPARATUS

FOR BATH TUBS; SINKS; AND SINK BOWLS (U.S. CLS. 13, 21, 23, 31 AND 34).

CLASS 19—NON-METALLIC BUILDING MATERIALS

FOR ARTIFICIAL STONE; ARTIFICIAL MARBLE; DECORATIVE ARTIFICIAL STONES AS BUILDING MATERIALS; ARTIFICIAL STONE CONTAINING METHYL METHACRYLATE AND POLY METHYL METHACRYLATE AS STAPLE INGREDIENTS; UNFINISHED ARTIFICIAL STONE FOR USE ON COUNTERTOPS OF KITCHEN OR INSIDE WALLS; ARTIFICIAL STONE TO BE USED AS COUNTERTOPS OR WALL COVERING; PLASTIC TILES; AND TILES MADE FROM ARTIFICIAL STONE (U.S. CLS. 1, 12, 33 AND 50).

CLASS 21—HOUSEWARES AND GLASS

FOR HAND WASH BASINS (U.S. CLS. 2, 13, 23, 29, 30, 33, 40 AND 50).

SN 78-159,420. POLAN, NEAL, S., TORRANCE, CA. FILED 8-29-2002.

AFFORDABLE CLASSICS

NO CLAIM IS MADE TO THE EXCLUSIVE RIGHT TO USE "CLASSICS", APART FROM THE MARK AS SHOWN. SEC. 2(F).

CLASS 35—ADVERTISING AND BUSINESS

FOR AUTO DEALERSHIP FEATURING CLASSIC CARS (U.S. CLS. 100, 101 AND 102).
FIRST USE 0-0-1983; IN COMMERCE 0-0-1983.

CLASS 37—CONSTRUCTION AND REPAIR

FOR AUTOBODY BODY REPAIR, PAINTING, MAINTENANCE AND AUTOMOBILE UPHOLSTERY REPAIR (U.S. CLS. 100, 103 AND 106).
FIRST USE 0-0-1983; IN COMMERCE 0-0-1983.

SN 78-160,245. STANLEY G. ALEXANDER, INC., DBA ALEXANDER'S MOVING AND STORAGE, INC., TUSTIN, CA. FILED 9-3-2002.

ALEXANDER'S

CLASS 16—PAPER GOODS AND PRINTED MATTER

FOR PACKAGING MATERIALS, NAMELY, CARDBOARD BOXES AND PLASTIC BUBBLE WRAP (U.S. CLS. 2, 5, 22, 23, 29, 37, 38 AND 50).
FIRST USE 0-0-1953; IN COMMERCE 0-0-1953.

CLASS 35—ADVERTISING AND BUSINESS

FOR BUSINESS RELOCATION; BUSINESS SERVICES IN THE NATURE OF PROJECT MANAGEMENT FOR BUSINESS OF OFFICE RELOCATIONS; BUSINESS SERVICES, NAMELY, FACILITIES MANAGEMENT OF TECHNICAL OPERATIONS, TRANSPORTATION LOGISTIC SERVICES, NAMELY, ARRANGING THE TRANSPORTATION OF GOODS FOR OTHERS (U.S. CLS. 100, 101 AND 102).

FIRST USE 2-0-1998; IN COMMERCE 2-0-1998.

CLASS 36—INSURANCE AND FINANCIAL

FOR ASSISTING OTHER TO FIND HOUSING, NAMELY, APARTMENTS AND HOUSES FOR LEASE OR PURCHASE, PROVIDING INFORMATION TO OTHERS IN THE FIELD OF REAL ESTATE LISTINGS, MORTGAGE LENDING AND MORTGAGE BANKING (U.S. CLS. 100, 101 AND 102).

FIRST USE 0-0-1953; IN COMMERCE 0-0-1953.

CLASS 39—TRANSPORTATION AND STORAGE

FOR TRANSPORTATION SERVICES, NAMELY, DOMESTIC AND INTERNATIONAL TRANSPORTATION OF FREIGHT AND THE GOODS OF OTHERS BY TRUCK, TRAIN, SHIP, AND AIR; STORAGE OF THE GOODS OF OTHERS IN GENERAL; RENTAL AND LEASING OF MOVING TRUCKS AND VANS; WAREHOUSING SERVICES (U.S. CLS. 100 AND 105).

FIRST USE 0-0-1953; IN COMMERCE 0-0-1953.

SN 78-163,758. SODEXHO OPERATIONS, LLC, GAITHERSBURG, MD. FILED 9-13-2002.

PREFERENCE MADE SIMPLE

CLASS 35—ADVERTISING AND BUSINESS

FOR BUSINESS MARKETING CONSULTING SERVICES RENDERED TO RETIREMENT COMMUNITIES, FEATURING ANALYSES OF THE TASTES, PREFERENCES, AND SPENDING HABITS OF THE RESIDENTS OF SUCH COMMUNITIES (U.S. CLS. 100, 101 AND 102).

CLASS 36—INSURANCE AND FINANCIAL

FOR CHARGE CARD SERVICES RENDERED TO RESIDENTS OF RETIREMENT COMMUNITIES (U.S. CLS. 100, 101 AND 102).

CLASS 43—HOTEL AND RESTAURANT SERVICES

FOR CONTRACT FOOD SERVICES RENDERED TO RETIREMENT COMMUNITIES FEATURING CUSTOMIZED DINING PROGRAMS BASED ON ANALYSES OF THE TASTES, PREFERENCES, AND SPENDING HABITS OF THE RESIDENTS OF SUCH COMMUNITIES (U.S. CLS. 100 AND 101).

SN 78-163,820. CHEVRONTXACO CORPORATION, SAN FRANCISCO, CA. FILED 9-13-2002.

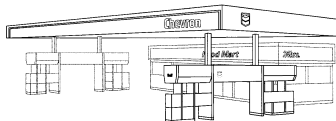

OWNER OF U.S. REG. NOS. 364,683, 1,611,549 AND 2,623,698.

NO CLAIM IS MADE TO THE EXCLUSIVE RIGHT TO USE "FOOD MART", "24 HR", OR THE REPRESENTATION OF THE FUNCTIONAL DESIGN FEATURES OF THE SERVICE STATION AND RETAIL CONVENIENCE STORE BUILDINGS, APART FROM THE MARK AS SHOWN.

THE MARK CONSISTS OF A SERVICE STATION FEATURING A CANOPY, ONE SIDE OF WHICH SHOWS THE WORD "CHEVRON" ON A BLUE BACKGROUND OUTLINED IN WHITE. THE COLOR BLUE IS A FEATURE OF THE MARK.

CLASS 35—ADVERTISING AND BUSINESS

FOR RETAIL CONVENIENCE STORE SERVICES (U.S. CLS. 100, 101 AND 102).
FIRST USE 3-18-1988; IN COMMERCE 3-18-1988.

CLASS 37—CONSTRUCTION AND REPAIR

FOR VEHICLE SERVICE STATION SERVICES AND AUTOMOBILE MAINTENANCE AND REPAIR SERVICES (U.S. CLS. 100, 103 AND 106).
FIRST USE 3-18-1988; IN COMMERCE 3-18-1988.

SN 78-164,053. INTERO REAL ESTATE SERVICES, INC., SAN JOSE, CA. FILED 9-13-2002.

INTERO REAL ESTATE SERVICES

NO CLAIM IS MADE TO THE EXCLUSIVE RIGHT TO USE "REAL ESTATE SERVICES", APART FROM THE MARK AS SHOWN.

THE ENGLISH TRANSLATION OF THE WORDING "INTERO" IS "ENTIRE".

CLASS 36—INSURANCE AND FINANCIAL

FOR FINANCIAL, REAL ESTATE, AND TITLE INSURANCE SERVICES, NAMELY, MORTGAGE LENDING, MORTGAGE BANKING AND ESCROW SERVICES (U.S. CLS. 100, 101 AND 102).
FIRST USE 9-1-2002; IN COMMERCE 9-1-2002.

CLASS 42—SCIENTIFIC, COMPUTER AND LEGAL SERVICES

FOR REAL ESTATE CLOSING SERVICES (U.S. CLS. 100 AND 101).
FIRST USE 9-1-2002; IN COMMERCE 9-1-2002.

SN 78-165,599. ANHING CORPORATION, LOS ANGELES, CA. FILED 9-18-2002.

CHAUDOC

OWNER OF U.S. REG. NO. 1,583,809.
THE ENGLISH TRANSLATION OF THE WORD "CHAUDOC" IN THE MARK IS "LITTLE BOAT" OR "LONELY".

CLASS 30—STAPLE FOODS

FOR COCONUT POWDER (U.S. CL. 46).
FIRST USE 3-0-1994; IN COMMERCE 3-0-1994.

CLASS 32—LIGHT BEVERAGES

FOR COCONUT JUICE (U.S. CLS. 45, 46 AND 48).
FIRST USE 2-0-1989; IN COMMERCE 2-0-1989.

SN 78-165,782. NEOPOST S.A., BAGNEUX, FRANCE, FILED 9-19-2002.



PRIORITY CLAIMED UNDER SEC. 44(D) ON FRANCE APPLICATION NO. 023154808, FILED 3-20-2002, REG. NO. 023154808, DATED 3-20-2002, EXPIRES 3-20-2012.

THE DRAWING IS LINED FOR THE COLOR BLUE.
THE MARK CONSISTS OF A STYLIZED FORM OF THE WORDS "MIX 'N GO" IN THE COLOR BLUE.

CLASS 7—MACHINERY

FOR ELECTRONIC APPARATUS FOR AUTOMATIC PROCESSING OF MAIL, NAMELY, MACHINES FOR ASSEMBLING, FOLDING, AND INSERTING LETTERS AND DOCUMENTS INTO ENVELOPES, MAIL SORTING AND SEALING MACHINES, MECHANICAL OFFICE MACHINES FOR PROCESSING MAIL, NAMELY, MACHINES FOR ASSEMBLING, FOLDING, INSERTING LETTERS AND DOCUMENTS INTO ENVELOPES; MECHANICAL ENVELOPE SEALING AND SORTING MACHINES; AND MECHANICAL FRANKING MACHINES (U.S. CLS. 13, 19, 21, 23, 31, 34 AND 35).

CLASS 9—ELECTRICAL AND SCIENTIFIC APPARATUS

FOR COMPUTER SOFTWARE FOR PROGRAMS FOR MAIL PROCESSING, NAMELY, SOFTWARE FOR MANAGING ASSEMBLY, FOLDING, INSERTING, SEALING AND SORTING FUNCTIONS OF MAIL PROCESSING MACHINES (U.S. CLS. 21, 23, 26, 36 AND 38).

SN 78-166,403. N.V. ORGANON, AB OSS, NETHERLANDS, FILED 9-20-2002.

FOCUS ON FERTILITY

NO CLAIM IS MADE TO THE EXCLUSIVE RIGHT TO USE "FERTILITY", APART FROM THE MARK AS SHOWN.

CLASS 16—PAPER GOODS AND PRINTED MATTER

FOR PUBLICATIONS, NAMELY, BROCHURES AND MAGAZINES IN THE FIELD OF FERTILITY; INFORMATION KITS ABOUT FERTILITY COMPRISING BOOKLETS AND BROCHURES (U.S. CLS. 2, 5, 22, 23, 29, 37, 38 AND 50).

CLASS 41—EDUCATION AND ENTERTAINMENT

FOR EDUCATIONAL SERVICES, NAMELY, CONDUCTING CLASSES, SEMINARS, CONFERENCES, AND WORKSHOPS IN THE FIELD OF FERTILITY (U.S. CLS. 100, 101 AND 107).

SN 78-167,467. FIRESTORM INVESTMENTS, INC., SPRING VALLEY, CA. FILED 9-24-2002.

X SPOT**CLASS 9—ELECTRICAL AND SCIENTIFIC APPARATUS**

FOR ADULT, SEXUALLY-ORIENTED MOTION PICTURE FILMS; ADULT, SEXUALLY-ORIENTED VIDEO RECORDINGS; PRE-RECORDED ADULT, SEXUALLY-ORIENTED VIDEOTAPES (U.S. CLS. 21, 23, 26, 36 AND 38).

CLASS 10—MEDICAL APPARATUS

FOR ADULT SEXUAL AIDS, NAMELY, DEVICES FOR AIDING IN COPULATION AND MASTURBATION, NAMELY, REPRODUCTIONS OF PARTS OF THE MALE AND FEMALE ANATOMY, NAMELY, PENISES, VAGINAS, AND OTHER BODY PROSTHESES, PUMPS, RINGS, CLAMPS, STIMULATORS, VIBRATORS, DILDOS, DONGS, BUTT PLUGS, VIBRATORS SLEEVES ON VIBRATORS SOLD TOGETHER WITH THE VIBRATORS, EXTENSION POLES SOLD TOGETHER WITH THE MASSAGING DEVICES, HARNESES, NIPPLE CLIPPERS, MASSAGE DEVICES, NAMELY, DEVICES FOR MASSAGING OR VIBRATING PORTIONS OF THE FACE AND BODY AND PACIFIERS FOR MASSAGING THE LIPS, AND SEX DOLLS; CONDOMS (U.S. CLS. 26, 39 AND 44).

CLASS 16—PAPER GOODS AND PRINTED MATTER

FOR ADULT, SEXUALLY-ORIENTED BOOKS; ADULT, SEXUALLY-ORIENTED MAGAZINES; ADULT, SEXUALLY-ORIENTED NEWSPAPERS (U.S. CLS. 2, 5, 22, 23, 29, 37, 38 AND 50).

CLASS 41—EDUCATION AND ENTERTAINMENT

FOR ADULT, SEXUALLY-ORIENTED MOTION PICTURE AND MOVIE THEATERS (U.S. CLS. 100, 101 AND 107).

SN 78-168,552. SAGE PORTFOLIO SYSTEMS, LLC, WATCHUNG, NJ. FILED 9-27-2002.

SAGE HILL TECHNOLOGIES

NO CLAIM IS MADE TO THE EXCLUSIVE RIGHT TO USE "TECHNOLOGIES", APART FROM THE MARK AS SHOWN.

CLASS 9—ELECTRICAL AND SCIENTIFIC APPARATUS

FOR COMPUTER SOFTWARE FOR USE IN INVESTMENT PORTFOLIO MANAGEMENT, COMPUTER SOFTWARE FOR USE IN CONSTRUCTION PROJECT ACCOUNTING (U.S. CLS. 21, 23, 26, 36 AND 38).

CLASS 42—SCIENTIFIC, COMPUTER AND LEGAL SERVICES

FOR COMPUTER SOFTWARE CONSULTING AND DEVELOPMENT (U.S. CLS. 100 AND 101).

SN 78-168,671. COMPASS GROUP USA, INC., CHARLOTTE, NC. FILED 9-27-2002.

MATRIX**CLASS 35—ADVERTISING AND BUSINESS**

FOR FOOD MANAGEMENT SERVICE FOR OTHERS; AND INSTITUTIONAL COMMISSARY SERVICES FEATURING SUNDRIES, SNACKS, BEVERAGES, HEALTH AND BEAUTY PRODUCTS, AND TOBACCO (U.S. CLS. 100, 101 AND 102).

CLASS 37—CONSTRUCTION AND REPAIR

FOR CONTRACT LAUNDRY SERVICES (U.S. CLS. 100, 103 AND 106).

CLASS 43—HOTEL AND RESTAURANT SERVICES

FOR CONTRACT FOOD, REFRESHMENT, AND BEVERAGE SERVICES; INSTITUTIONAL CAFETERIA COMMISSARY SERVICES FOR FOOD (U.S. CLS. 100 AND 101).

SN 78-171,784. PLANET DATA SOLUTIONS, INC., TARRYTOWN, NY. FILED 10-7-2002.

DATABILITY**CLASS 35—ADVERTISING AND BUSINESS**

FOR RECORDS MANAGEMENT SERVICES, NAMELY, DOCUMENT INDEXING FOR OTHERS; PROVIDING ON-LINE COMPUTER DATABASES IN THE FIELD OF RECORDS MANAGEMENT (U.S. CLS. 100, 101 AND 102).

CLASS 40—MATERIAL TREATMENT

FOR ELECTRONIC IMAGING, SCANNING, AND/OR DIGITIZING OF DOCUMENTS; DOCUMENT DATA TRANSFER AND CONVERSION SERVICES FROM ONE MEDIA TO ANOTHER (U.S. CLS. 100, 103 AND 106).

CLASS 42—SCIENTIFIC, COMPUTER AND LEGAL SERVICES

FOR DATA CONVERSION OF COMPUTER PROGRAM DATA OR INFORMATION (U.S. CLS. 100 AND 101).

SN 78-172,555. ECOLAB INC., ST. PAUL, MN. FILED 10-9-2002.

IT'S EASY TO BE AN X-PERT

CLASS 3—COSMETICS AND CLEANING PREPARATIONS

FOR LAUNDRY DETERGENTS, DESTAINERS AND SOFTENERS (U.S. CLS. 1, 4, 6, 50, 51 AND 52).

CLASS 9—ELECTRICAL AND SCIENTIFIC APPARATUS

FOR AUTOMATED DISPENSER FOR USE IN DISPENSING LAUNDRY DETERGENT, BLEACH, DESTAINERS AND SOFTENERS (U.S. CLS. 21, 23, 26, 36 AND 38).

SN 78-172,602. VULCAN SPORTS MEDIA, INC., SAINT LOUIS, MO. FILED 10-9-2002.

THE EXPERTS' CHOICE

CLASS 38—COMMUNICATION

FOR RADIO, TELEVISION AND INTERACTIVE TELEVISION BROADCASTING IN THE FIELD OF PROFESSIONAL AND AMATEUR SPORTS, AND SPORTS NEWS, SCORES AND STATISTICS (U.S. CLS. 100, 101 AND 104).

CLASS 41—EDUCATION AND ENTERTAINMENT

FOR PROVIDING A WEBSITE FEATURING INFORMATION ABOUT PROFESSIONAL AND AMATEUR SPORTS, AND SPORTS NEWS, SCORES AND STATISTICS; ENTERTAINMENT SERVICES IN THE NATURE OF PROVIDING RADIO, TELEVISION AND INTERACTIVE TELEVISION PROGRAMS IN THE FIELD OF PROFESSIONAL AND AMATEUR SPORTS, AND SPORTS NEWS, SCORES AND STATISTICS (U.S. CLS. 100, 101 AND 107).

SN 78-172,953. DELOITTE CONSULTING (US) L.P., NEW YORK, NY. FILED 10-10-2002.

STRIPPING THE BULL OUT OF BUSINESS

CLASS 9—ELECTRICAL AND SCIENTIFIC APPARATUS

FOR COMPUTER SOFTWARE AND DOWNABLE SOFTWARE FOR ANALYZING AND IMPROVING THE QUALITY OF ELECTRONIC DOCUMENTS AND COMPUTER PROGRAMS (U.S. CLS. 21, 23, 26, 36 AND 38).

CLASS 42—SCIENTIFIC, COMPUTER AND LEGAL SERVICES

FOR COMPUTER SERVICES, NAMELY DESIGNING SOFTWARE FOR ANALYZING AND IMPROVING THE QUALITY OF ELECTRONIC DOCUMENTS AND COMPUTER PROGRAMS; AND PROVIDING AN ON-LINE SITE TO ALLOW USERS TO DOWNLOAD SOFTWARE FROM THE INTERNET FOR ANALYZING AND IMPROVING THE QUALITY OF ELECTRONIC DOCUMENTS AND COMPUTER PROGRAMS (U.S. CLS. 100 AND 101).

SN 78-173,383. MILLIKEN & COMPANY, NEW YORK, NY. FILED 10-11-2002.

RETAIL REVOLUTION

NO CLAIM IS MADE TO THE EXCLUSIVE RIGHT TO USE "RETAIL", APART FROM THE MARK AS SHOWN.

CLASS 39—TRANSPORTATION AND STORAGE

FOR EXPRESS DELIVERY OF CARPET BY TRUCK (U.S. CLS. 100 AND 105).

CLASS 40—MATERIAL TREATMENT

FOR CUSTOM MANUFACTURE OF CARPET (U.S. CLS. 100, 103 AND 106).

SN 78-173,391. STAR DIAMOND GROUP, INC., NEW YORK, NY. FILED 10-11-2002.

"IN THE FIRE OF SPIRITUAL RESEARCH, THE PORTAL IS THUS DERIVED"

CLASS 9—ELECTRICAL AND SCIENTIFIC APPARATUS

FOR AUDIO CASSETTES AND AUDIO DISCS FEATURING INFORMATION IN THE FIELDS OF CONSCIOUSNESS, MEDITATION, METAPHYSICS, INTUITION, PARAPSYCHOLOGY, EXTRATERRESTRIALS, OUT-OF-BODY EXPERIENCES, CHANNELING AND RELATED SUBJECTS; AUDIO CASSETTES AND AUDIO DISCS IN THE NATURE OF RECORDED BOOKS; DOWNLOADABLE ELECTRONIC PUBLICATIONS IN THE NATURE OF ELECTRONIC BOOKS, ELECTRONIC MAGAZINES, ELECTRONIC NEWSLETTERS, ELECTRONIC PAMPHLETS, ELECTRONIC BROCHURES, ELECTRONIC BOOKLETS, ELECTRONIC REPORTS AND RECORDED AUDIO BOOKS, IN THE FIELDS OF CONSCIOUSNESS, MEDITATION, METAPHYSICS, INTUITION, PARAPSYCHOLOGY, EXTRATERRESTRIALS, OUT-OF-BODY EXPERIENCES, CHANNELING AND RELATED SUBJECTS; ELECTRONIC PUBLICATIONS SOLD IN THE FORM OF CD-ROMS, DVDS AND OTHER DIGITAL STORAGE MEDIA, IN THE NATURE OF BOOKS, MAGAZINES, NEWSLETTERS, PAMPHLETS, BROCHURES, BOOKLETS AND REPORTS, IN THE FIELDS OF CONSCIOUSNESS, MEDITATION, METAPHYSICS, INTUITION, PARAPSYCHOLOGY, EXTRATERRESTRIALS, OUT-OF-BODY EXPERIENCES, CHANNELING AND RELATED SUBJECTS (U.S. CLS. 21, 23, 26, 36 AND 38).

CLASS 16—PAPER GOODS AND PRINTED MATTER

FOR FICTION AND NON-FICTION BOOKS ON A VARIETY OF TOPICS; BOOKS, MAGAZINES, NEWSLETTERS, PAMPHLETS, BROCHURES, BOOKLETS AND PRINTED REPORTS, IN THE FIELDS OF CONSCIOUSNESS, MEDITATION, METAPHYSICS, INTUITION, PARAPSYCHOLOGY, EXTRATERRESTRIALS, OUT-OF-BODY EXPERIENCES, CHANNELING AND RELATED SUBJECTS (U.S. CLS. 2, 5, 22, 23, 29, 37, 38 AND 50).

SN 78-174,183. BELL SOUTH INTELLECTUAL PROPERTY CORPORATION, WILMINGTON, DE. FILED 10-14-2002.

MINUTE MANAGER

CLASS 36—INSURANCE AND FINANCIAL

FOR TELEPHONE CALLING CARD SERVICES (U.S. CLS. 100, 101 AND 102).

CLASS 38—COMMUNICATION

FOR LOCAL AND LONG DISTANCE TELEPHONE TRANSMISSION SERVICES (U.S. CLS. 100, 101 AND 104).

SN 78-175,160. EEMSO, INC., DALLAS, TX. FILED 10-16-2002.

E-STRIP

CLASS 5—PHARMACEUTICALS

FOR TRANSDERMAL PATCHES FOR USE IN THE TREATMENT OF ALLERGIC, CARDIO-VASCULAR, INFECTIOUS, NEUROLOGICAL, INFLAMMATORY, IMMUNOLOGICAL, METABOLIC, VIRAL, MICROBIAL, OSTEOPATHIC, DIETARY, RESPIRATORY, PSYCHIATRIC, HORMONAL, DENTAL, DERMAL, MUSCULAR AND EXCRETORY DISEASES AND CONDITIONS (U.S. CLS. 6, 18, 44, 46, 51 AND 52).

CLASS 10—MEDICAL APPARATUS

FOR TRANSDERMAL DRUG DELIVERY PATCHES SOLD WITHOUT MEDICATION (U.S. CLS. 26, 39 AND 44).

SN 78-175,584. OPEN HAND CHICAGO, INC., CHICAGO, IL. FILED 10-17-2002.

VITAL BRIDGES

CLASS 43—HOTEL AND RESTAURANT SERVICES

FOR CHARITABLE SERVICES, NAMELY, PROVIDING FOOD AND NUTRITIONAL PRODUCTS TO PEOPLE IMPACTED BY HIV AND AIDS (U.S. CLS. 100 AND 101).

CLASS 45—PERSONAL SERVICES

FOR CASE MANAGEMENT SERVICES, NAMELY, COORDINATION OF LEGAL, SOCIAL AND PSYCHOLOGICAL SERVICES FOR PEOPLE IMPACTED BY HIV AND AIDS (U.S. CLS. 100 AND 101).

SN 78-175,665. JACKSON, JOHN JAY, MINDEN, NV. FILED 10-17-2002.

VITAL MUSIC GROUP

NO CLAIM IS MADE TO THE EXCLUSIVE RIGHT TO USE "MUSIC GROUP", APART FROM THE MARK AS SHOWN.

CLASS 9—ELECTRICAL AND SCIENTIFIC APPARATUS

FOR PRE-RECORDED CD'S, AUDIOCASSETTES, DVD'S AND VIDEOCASSETTES ALL CONTAINING WORSHIP AND FAITH BASED MUSIC (U.S. CLS. 21, 23, 26, 36 AND 38).

CLASS 16—PAPER GOODS AND PRINTED MATTER

FOR SONG SHEETS AND MUSIC BOOKS ALL CONTAINING WORSHIP AND FAITH BASED MUSIC, BOOKLETS CONTAINING WORSHIP AND FAITH BASED MUSIC RESOURCES (U.S. CLS. 2, 5, 22, 23, 29, 37, 38 AND 50).

SN 78-176,503. SOLOMON, CHRISTINA, BEVERLY HILLS, CA. FILED 10-21-2002.

I LOVE MY MUMMY

CLASS 18—LEATHER GOODS

FOR UMBRELLAS, TOTE BAGS, AND BACKPACKS (U.S. CLS. 1, 2, 3, 22 AND 41).

CLASS 25—CLOTHING

FOR T-SHIRTS, SHIRTS, SWEATSHIRTS, HATS, INFANT WEAR, SOCKS, JACKETS, SCARVES, TIES, AND APRONS (U.S. CLS. 22 AND 39).

SN 78-176,829. HALLIBURTON ENERGY SERVICES, INC., CARROLLTON, TX. FILED 10-22-2002.

CRIMSON

CLASS 37—CONSTRUCTION AND REPAIR

FOR PROVIDING OIL AND GAS WELL SERVICES, NAMELY RECOMPLETION OF EXISTING WELLBORE GEOMETRIES, NAMELY, CONSTRUCTION AND INSTALLATION ACTIVITIES TO PREPARE THE WELL FOR PRODUCTION OF HYDROCARBONS; REMEDIAL COMPLETIONS ON CURRENTLY PRODUCING ZONES, NAMELY, CONSTRUCTION AND INSTALLATION SERVICES TO REPAIR PROBLEMS AND/OR TREAT CONDITIONS ARISING AFTER THE WELLBORE HAS BEEN CONSTRUCTED; COORDINATION AND ON-SITE SUPERVISION OF CONSTRUCTION AND INSTALLATION AT OIL AND GAS WELL SITES (U.S. CLS. 100, 103 AND 106).

CLASS 42—SCIENTIFIC, COMPUTER AND LEGAL SERVICES

FOR PROVIDING OIL AND GAS WELL SERVICES, NAMELY, OIL AND GAS WELL COMPLETION DESIGN SERVICES; OIL AND GAS WELL ENGINEERING SERVICES (U.S. CLS. 100 AND 101).

SN 78-177,546. CLUB FUEGO LLC, EDINBURG, TX. FILED 10-23-2002.

CLUB FUEGO

CLASS 6—METAL GOODS

FOR METAL KEY CHAINS (U.S. CLS. 2, 12, 13, 14, 23, 25 AND 50).

CLASS 8—HAND TOOLS

FOR NON-ELECTRIC CAN OPENERS (U.S. CLS. 23, 28 AND 44).

CLASS 9—ELECTRICAL AND SCIENTIFIC APPARATUS

FOR YARDSTICKS AND MOUSE PADS (U.S. CLS. 21, 23, 26, 36 AND 38).

CLASS 16—PAPER GOODS AND PRINTED MATTER

FOR POSTERS, POSTCARDS, GIFT CARDS, PENS, PENCILS, AND BUMPER STICKERS (U.S. CLS. 2, 5, 22, 23, 29, 37, 38 AND 50).

CLASS 20—FURNITURE AND ARTICLES NOT OTHERWISE CLASSIFIED

FOR NON-METAL KEY CHAINS (U.S. CLS. 2, 13, 22, 25, 32 AND 50).

CLASS 21—HOUSEWARES AND GLASS

FOR SHOT GLASSES, CUPS, FOAM DRINK HOLDERS, CHAMPAGNE GLASSES, CHAMPAGNE GOBLETS, AND BEER MUGS (U.S. CLS. 2, 13, 23, 29, 30, 33, 40 AND 50).

CLASS 25—CLOTHING

FOR T-SHIRTS, CAPS, BOXERS, JEAN JACKETS, LEATHER JACKETS, BANDANAS, AND APRONS (U.S. CLS. 22 AND 39).

CLASS 34—SMOKERS' ARTICLES

FOR METAL CIGARETTE LIGHTERS NOT OF PRECIOUS METAL (U.S. CLS. 2, 8, 9 AND 17).

SN 78-177,790. RODMAN, LAURA R., WASHINGTON, DC. AND JERARD, AIMEE L., FALLS CHURCH, VA. FILED 10-24-2002.

LEGACY DESIGN GROUP

NO CLAIM IS MADE TO THE EXCLUSIVE RIGHT TO USE "DESIGN GROUP", APART FROM THE MARK AS SHOWN.

CLASS 37—CONSTRUCTION AND REPAIR

FOR CONSTRUCTION MANAGEMENT SUPERVISION; KITCHEN AND BATH INSTALLATION AND RENOVATION; HOME RENOVATION; AND CONSULTATION RELATING TO THE AFOREMENTIONED FIELDS (U.S. CLS. 100, 103 AND 106).

CLASS 42—SCIENTIFIC, COMPUTER AND LEGAL SERVICES

FOR INTERIOR DESIGN; INTERIOR DESIGN CONSULTATION; INTERIOR DECORATING; INTERIOR DECORATING CONSULTATION (U.S. CLS. 100 AND 101).

SN 78-178,039. SENDTEC, INC., ST. PETERSBURG, FL. FILED 10-24-2002.

SENDTEC

CLASS 35—ADVERTISING AND BUSINESS

FOR DIRECT MARKETING ADVERTISING FOR OTHERS (U.S. CLS. 100, 101 AND 102). FIRST USE 2-15-2002; IN COMMERCE 2-15-2002.

CLASS 42—SCIENTIFIC, COMPUTER AND LEGAL SERVICES

FOR COMPUTER SOFTWARE DEVELOPMENT (U.S. CLS. 100 AND 101). FIRST USE 2-15-2002; IN COMMERCE 2-15-2002.

SN 78-178,132. WINNERCOMM, INC., TULSA, OK. FILED 10-24-2002.

WINNERCOMM

CLASS 38—COMMUNICATION

FOR TELEVISION BROADCASTING SERVICES (U.S. CLS. 100, 101 AND 104). FIRST USE 1-1-2000; IN COMMERCE 1-1-2000.

CLASS 41—EDUCATION AND ENTERTAINMENT

FOR TELEVISION PROGRAMMING SERVICES; AND COMMERCIAL TELEVISION PRODUCTION SERVICES (U.S. CLS. 100, 101 AND 107). FIRST USE 1-1-2000; IN COMMERCE 1-1-2000.

SN 78-178,904. MOLECULAR STAGING, INC., NEW HAVEN, CT. FILED 10-28-2002.

REPLIG

CLASS 1—CHEMICALS

FOR REAGENTS AND REAGENT KITS COMPRISED OF RANDOM HEXAMER PRIMERS, DNA POLYMERASE AND BUFFERS FOR DNA ANALYSIS FOR SCIENTIFIC AND MEDICAL RESEARCH USE (U.S. CLS. 1, 5, 6, 10, 26 AND 46).

CLASS 5—PHARMACEUTICALS

FOR DIAGNOSTIC REAGENTS AND REAGENT KITS COMPRISED OF RANDOM HEXAMER PRIMERS, DNA POLYMERASE, AND BUFFERS FOR DNA ANALYSIS FOR MEDICAL AND LABORATORY USE (U.S. CLS. 6, 18, 44, 46, 51 AND 52).

SN 78-178,987. BELDEN TECHNOLOGIES, INC., RICHMOND, IN. FILED 10-28-2002.

INSTALLED PERFORMANCE

CLASS 35—ADVERTISING AND BUSINESS

FOR MAIL ORDER CATALOG SERVICES FEATURING ELECTRICAL/ELECTRONIC AND FIBER OPTIC WIRES AND CABLES; ELECTRONIC RETAIL STORE SERVICES VIA TELEPHONE AND A GLOBAL COMPUTER NETWORK IN THE FIELD OF ELECTRICAL/ELECTRONIC AND FIBER OPTIC WIRES AND CABLES; PROVIDING CONSUMER PRODUCT INFORMATION SERVICES, NAMELY, PROVIDING SHOPPERS INFORMATION IN THE FIELD OF ELECTRICAL/ELECTRONIC AND FIBER OPTIC WIRES AND CABLES VIA TELEPHONE AND A GLOBAL COMPUTER NETWORK. (U.S. CLS. 100, 101 AND 102).

CLASS 42—SCIENTIFIC, COMPUTER AND LEGAL SERVICES

FOR PROVIDING TECHNICAL INFORMATION ON THE USE AND APPLICATION OF ELECTRICAL/ELECTRONIC AND FIBER OPTIC WIRES AND CABLES VIA TELEPHONE AND A GLOBAL COMPUTER NETWORK; PROVIDING ENGINEERING SERVICES IN THE FIELD OF ELECTRICAL/ELECTRONIC AND FIBER OPTIC WIRES AND CABLES. (U.S. CLS. 100 AND 101).

SN 78-179,001. BELDEN TECHNOLOGIES, INC., RICHMOND, IN. FILED 10-28-2002.

INSTALLABLE HEADROOM PERFORMANCE

CLASS 35—ADVERTISING AND BUSINESS

FOR MAIL ORDER CATALOG SERVICES FEATURING ELECTRICAL/ELECTRONIC AND FIBER OPTIC WIRES AND CABLES; ELECTRONIC RETAIL STORE SERVICES VIA TELEPHONE AND A GLOBAL COMPUTER NETWORK IN THE FIELD OF ELECTRICAL/ELECTRONIC AND FIBER OPTIC WIRES AND CABLES; PROVIDING CONSUMER PRODUCT INFORMATION SERVICES, NAMELY, PROVIDING SHOPPERS INFORMATION IN THE FIELD OF ELECTRICAL/ELECTRONIC AND FIBER OPTIC WIRES AND CABLES VIA TELEPHONE AND A GLOBAL COMPUTER NETWORK. (U.S. CLS. 100, 101 AND 102).

CLASS 42—SCIENTIFIC, COMPUTER AND LEGAL SERVICES

FOR PROVIDING TECHNICAL INFORMATION ON THE USE AND APPLICATION OF ELECTRICAL/ELECTRONIC AND FIBER OPTIC WIRES AND CABLES VIA TELEPHONE AND A GLOBAL COMPUTER NETWORK; PROVIDING ENGINEERING SERVICES IN THE FIELD OF ELECTRICAL/ELECTRONIC AND FIBER OPTIC WIRES AND CABLES. (U.S. CLS. 100 AND 101).

SN 78-179,282. ACCPAC INTERNATIONAL, INC., PLEASANTON, CA. FILED 10-28-2002.

SIMPLY WEBSTORE

NO CLAIM IS MADE TO THE EXCLUSIVE RIGHT TO USE "WEBSTORE", APART FROM THE MARK AS SHOWN.

CLASS 9—ELECTRICAL AND SCIENTIFIC APPARATUS

FOR COMPUTER SOFTWARE FOR USE IN THE FIELD OF PERSONAL AND BUSINESS FINANCE FOR ACCOUNTING FUNCTIONS, NAMELY GENERAL LEDGER, ACCOUNTS PAYABLE, ACCOUNTS RECEIVABLE, PAYROLL, BANK RECONCILIATION AND MANAGEMENT OF ACCOUNTING RECORDS; E-COMMERCE SOFTWARE TO ALLOW USERS TO PERFORM ELECTRONIC BUSINESS TRANSACTIONS AND REVIEW FINANCIAL INFORMATION VIA ELECTRONIC COMMUNICATION NETWORKS, NAMELY, THE GLOBAL COMPUTER NETWORK, AND USER MANUALS SOLD AS A UNIT THEREWITH. (U.S. CLS. 21, 23, 26, 36 AND 38).

CLASS 36—INSURANCE AND FINANCIAL

FOR COMPUTER SERVICES, NAMELY, PROVIDING FINANCIAL DATABASES OVER GLOBAL COMPUTER COMMUNICATIONS NETWORKS FEATURING FINANCIAL INFORMATION IN THE FIELD OF PERSONAL AND BUSINESS FINANCE AND E-COMMERCE (U.S. CLS. 100, 101 AND 102).

SN 78-179,585. CDX LABORATORIES, INC., SUFFERN, NY. FILED 10-29-2002.

PAPNET

CLASS 10—MEDICAL APPARATUS

FOR BRUSH BIOPSY TEST KIT CONTAINING SPECIMEN SAMPLING BRUSH INSTRUMENT, SPECIMEN SLIDE, SLIDE HOLDING CONTAINER, SPECIMEN FIXATIVE, MAILING PACKAGE, AND INSTRUCTIONS, PROVIDED AS A UNIT, AND MEDICAL DIAGNOSTIC APPARATUS FOR DETECTING PRECANCEROUS AND CANCEROUS LESIONS OF THE ORAL CAVITY, HYPHARYNX, PHARYNX, AND OTHER ORGANS (U.S. CLS. 26, 39 AND 44).

CLASS 44—MEDICAL, BEAUTY AND AGRICULTURAL SERVICES

FOR COMPUTER ASSISTED PATHOLOGY SERVICES, AND MEDICAL LABORATORY TESTING SERVICES, NAMELY, DETECTION OF AND SCREENING, EXAMINING AND ANALYZING SPECIMENS FOR PRECANCEROUS AND CANCEROUS LESIONS OF THE ORAL CAVITY, HYPHARYNX, PHARYNX, AND OTHER ORGANS (U.S. CLS. 100 AND 101).

SN 78-179,629. MANAGEMENT SIMULATIONS, INC., NORTHFIELD, IL. FILED 10-29-2002.

FOUNDATION

OWNER OF U.S. REG. NO. 2,593,024.

CLASS 41—EDUCATION AND ENTERTAINMENT

FOR EDUCATIONAL SERVICES, NAMELY, PROVIDING ON-LINE BUSINESS SIMULATION CLASSES, SEMINARS, CONFERENCES, AND WORKSHOPS IN THE FIELD OF BUSINESS MANAGEMENT TECHNIQUES SPECIFICALLY IN FINANCE, MARKETING, PRODUCTION, HUMAN RESOURCES, AND RESEARCH AND DEVELOPMENT, AND DISTRIBUTING COURSE MATERIALS IN CONNECTION THEREWITH (U.S. CLS. 100, 101 AND 107).

CLASS 42—SCIENTIFIC, COMPUTER AND LEGAL SERVICES

FOR PROVIDING TEMPORARY USE OF ON-LINE NON-DOWNLOADABLE SOFTWARE FOR EDUCATIONAL PURPOSES THAT ENABLES BUSINESS STUDENTS TO PERFORM SIMULATIONS OF BUSINESS MANAGEMENT TECHNIQUES SPECIFICALLY IN FINANCE, MARKETING, PRODUCTION, HUMAN RESOURCES, AND RESEARCH AND DEVELOPMENT; COMPUTER CONSULTATION IN THE USE OF COMPUTER SOFTWARE (U.S. CLS. 100 AND 101).

SN 78-179,677. GET CHARGED, PHILADELPHIA, PA. FILED 10-29-2002.

**CLASS 25—CLOTHING**

FOR HATS AND T-SHIRTS (U.S. CLS. 22 AND 39).

CLASS 41—EDUCATION AND ENTERTAINMENT

FOR EDUCATIONAL PROGRAMS, NAMELY WORKSHOPS AND EXHIBITS AND ONLINE INFORMATION SERVICES RELATING TO WORKSHOPS AND EXHIBITS TO ENCOURAGE ACTIVE PARTICIPATION IN SPORTS, FITNESS, PLAY AND COMMUNITY UNITY (U.S. CLS. 100, 101 AND 107).

SN 78-179,698. MEIJER, INC., GRAND RAPIDS, MI. FILED 10-29-2002.

**MEIJER COMPLETE.
COMPLETELY DIFFERENT.**

OWNER OF U.S. REG. NOS. 1,018,895, 2,705,363 AND OTHERS.

CLASS 35—ADVERTISING AND BUSINESS

FOR RETAIL STORE AND RETAIL DEPARTMENT STORE SERVICES FEATURING A WIDE VARIETY OF CONSUMER GOODS OF OTHERS, NAMELY, GROCERY, GENERAL CONSUMER MERCHANDISE, SOFT DRINKS AND BOTTLED WATERS, DAIRY PRODUCTS, LIQUOR, WINE, BAKERY, DELICATESSEN, MEAT, SEAFOOD, BULK FOODS, ELECTRONIC PRODUCTS AND ACCESSORIES, AUTOMOTIVE AND VEHICLE PARTS, AND ACCESSORIES, PETS AND PET SUPPLIES, FURNITURE, FOOTWEAR, CLOTHING, BABY CARE PRODUCTS, COSMETICS, LUGGAGE, HAND TOOLS, LAWN AND GARDEN ACCESSORIES, TOYS AND PLAYTHINGS, LIGHTING, GOLFING EQUIPMENT, SPORTING GOODS, SCHOOL SUPPLIES AND STATIONERY, SEASONAL AND HOLIDAY PRODUCTS, HARDWARE, HOME REPAIR SUPPLIES, GASOLINE, OIL, PLUMBING AND ELECTRICAL SUPPLIES, BOOKS AND MAGAZINES, MUSIC, SMALL APPLIANCES, OPTICAL GOODS, TOBACCO, JEWELRY, RETAIL PHARMACY SERVICES, ONLINE PRESCRIPTION REFILL SERVICES, ONLINE RETAIL STORE AND RETAIL DEPARTMENT STORE SERVICES FEATURING A WIDE VARIETY OF CONSUMER GOODS OF OTHERS (U.S. CLS. 100, 101 AND 102).

CLASS 40—MATERIAL TREATMENT

FOR RETAIL PHOTO FINISHING AND FILM PROCESSING SERVICES (U.S. CLS. 100, 103 AND 106).

CLASS 43—HOTEL AND RESTAURANT SERVICES

FOR RESTAURANT AND SNACK BAR SERVICES (U.S. CLS. 100 AND 101).

SN 78-180,087. DEALERS RESOURCES, INC., NORTHVILLE, MI. FILED 10-30-2002.

RESOURCE GUARD**CLASS 35—ADVERTISING AND BUSINESS**

FOR VEHICLE REGISTRATION SERVICES, NAMELY, ASSIGNMENT OF VEHICLE IDENTIFICATION NUMBERS TO DETER THEFT (U.S. CLS. 100, 101 AND 102).

CLASS 36—INSURANCE AND FINANCIAL

FOR MOTOR VEHICLE INSURANCE UNDERWRITING (U.S. CLS. 100, 101 AND 102).

SN 78-180,440. HEARTLANDER ENTERTAINMENT PROPERTIES, LLC, PIGEON FORGE, TN. FILED 10-31-2002.

**FIDDLERS' FEAST WILD
FRONTIER DINNER SHOW**

NO CLAIM IS MADE TO THE EXCLUSIVE RIGHT TO USE "DINNER SHOW", APART FROM THE MARK AS SHOWN.

CLASS 41—EDUCATION AND ENTERTAINMENT

FOR DINNER THEATER SERVICES (U.S. CLS. 100, 101 AND 107).

CLASS 43—HOTEL AND RESTAURANT SERVICES

FOR RESTAURANT SERVICES (U.S. CLS. 100 AND 101).

SN 78-183,523. BUXTON, CRAIG PAUL, POINT RICHMOND, CA. FILED 11-10-2002.

PURESENSE

SN 78-182,914. BUTTERFIELD & DAUGHTERS COMPUTERS LTD., VANCOUVER, BRITISH COLUMBIA, FILED 11-7-2002.

WEBPOST**CLASS 9—ELECTRICAL AND SCIENTIFIC APPARATUS**

FOR COMPUTER SOFTWARE FOR MANAGING, REDIRECTING, STORAGE AND MANIPULATION OF ELECTRONIC MAIL; COMPUTER SOFTWARE FOR THE CREATION AND DISSEMINATION OF DOCUMENTS, DATA, IMAGES, VIDEO OR AUDIO FOR AND TO MOBILE DEVICES; COMPUTER SOFTWARE FOR PROVIDING MULTI-USER ACCESS TO COMPUTER NETWORKS; AND COMPUTER SOFTWARE FOR USE IN CREATING AND DESIGNING WEB SITES (U.S. CLS. 21, 23, 26, 36 AND 38).

CLASS 42—SCIENTIFIC, COMPUTER AND LEGAL SERVICES

FOR COMPUTER SERVICES FOR THE MANAGEMENT OF DATA, IMAGES, AUDIO AND VIDEO CONTENT OF OTHERS; DEVELOPMENT OF SOFTWARE FOR OTHERS; HOSTING THE DATA, IMAGES, AUDIO AND VIDEO CONTENT OF OTHERS ON A GLOBAL COMPUTER NETWORK, INTERNAL NETWORKS, AND EXTRANETS; DESIGN, CONSTRUCTION, MAINTENANCE AND HOSTING OF WEB SITES FOR OTHERS; COMPUTER CONSULTATION, TECHNICAL SUPPORT, AND ADVICE REGARDING WEB SITE DESIGN, CONSTRUCTION, MAINTENANCE, OPTIMIZATION, AND REGARDING THE CREATION OF ONLINE COMMUNITIES, PERSONAL AND BUSINESS RELATED WEB SITES AND PAGES AND ELECTRONIC CATALOGS; PROVIDING TEMPORARY USE OF ON-LINE NON-DOWNLOADABLE SOFTWARE FOR CREATING ELECTRONIC CATALOGS, WEB SITES, ELECTRONIC STOREFRONTS AND DATABASE-RELATED APPLICATIONS ON GLOBAL AND INTERNAL COMMUNICATIONS NETWORKS (U.S. CLS. 100 AND 101).

CLASS 9—ELECTRICAL AND SCIENTIFIC APPARATUS

FOR SCIENTIFIC SENSOR AND COMMUNICATION INSTRUMENTS USED IN DETECTING, ANALYZING, INDICATING AND REPORTING ON THE LIKELIHOOD OF REAL AND POTENTIAL CONTAMINANTS INTRODUCED INTENTIONALLY OR UNINTENTIONALLY INTO NATURAL RESOURCES SUCH AS WATER, AIR AND SOIL. (U.S. CLS. 21, 23, 26, 36 AND 38).

CLASS 42—SCIENTIFIC, COMPUTER AND LEGAL SERVICES

FOR PROVIDING TEMPORARY USE OF ON-LINE NON-DOWNLOADABLE SOFTWARE USED TO COLLECT DATA AND INFORMATION FROM MULTIPLE DATA SOURCES, ANALYZE THIS DATA AND INFORMATION, PERFORM REPORTING, ALERTING AND COMMUNICATION FUNCTIONS ALL OF WHICH SUPPORT CONTINUOUS SURVEILLANCE OF ENVIRONMENTAL RESOURCES AND THE LIKELIHOOD OF REAL AND POTENTIAL CONTAMINANTS INTRODUCED INTENTIONALLY OR UNINTENTIONALLY; DATA AUTOMATION AND COLLECTION SERVICE, AND DATABASE DEVELOPMENT SERVICE, USING PROPRIETARY SCIENTIFIC SOFTWARE, TO EVALUATE, ANALYZE AND COLLECT SERVICE DATA AND INFORMATION FROM MULTIPLE DATA SOURCES, ANALYZE THIS DATA AND INFORMATION, PERFORM REPORTING, ALERTING AND COMMUNICATION FUNCTIONS ALL OF WHICH SUPPORT CONTINUOUS SURVEILLANCE OF ENVIRONMENTAL RESOURCES AND THE LIKELIHOOD OF REAL AND POTENTIAL CONTAMINANTS INTRODUCED INTENTIONALLY OR UNINTENTIONALLY (U.S. CLS. 100 AND 101).

SN 78-183,978. OFF MAIN FURNITURE, CORAL SPRINGS, FL. FILED 11-12-2002.

OFF MAIN

SN 78-183,159. OAK RUBBER COMPANY, THE, STOW, OH. FILED 11-8-2002.

OAKTEC

OWNER OF U.S. REG. NO. 2,400,522.

CLASS 9—ELECTRICAL AND SCIENTIFIC APPARATUS

FOR PROTECTIVE GLOVES FOR INDUSTRIAL USE (U.S. CLS. 21, 23, 26, 36 AND 38).

CLASS 10—MEDICAL APPARATUS

FOR GLOVES FOR MEDICAL USE (U.S. CLS. 26, 39 AND 44).

CLASS 20—FURNITURE AND ARTICLES NOT OTHERWISE CLASSIFIED

FOR FURNITURE (U.S. CLS. 2, 13, 22, 25, 32 AND 50). FIRST USE 3-9-2001; IN COMMERCE 3-9-2001.

CLASS 24—FABRICS

FOR UPHOLSTERY FABRIC (U.S. CLS. 42 AND 50). FIRST USE 3-9-2001; IN COMMERCE 3-9-2001.

CLASS 35—ADVERTISING AND BUSINESS

FOR RETAIL STORE SERVICES FEATURING FURNITURE, UPHOLSTERY FABRICS, RUGS AND HOME DECORATING ACCESSORIES (U.S. CLS. 100, 101 AND 102). FIRST USE 3-9-2001; IN COMMERCE 3-9-2001.

SN 78-184,012. LINSNER, JOSEPH, MICHAEL, CRANFORD, NJ. FILED 11-12-2002.

CRY FOR DAWN

CLASS 16—PAPER GOODS AND PRINTED MATTER

FOR COMIC BOOKS, BOOKS FEATURING STORIES IN ILLUSTRATED FORM, GRAPHIC NOVELS, POSTERS, ART PRINTS, LIMITED EDITION PRINTS, PORTFOLIO OF ILLUSTRATIONS (U.S. CLS. 2, 5, 22, 23, 29, 37, 38 AND 50).

FIRST USE 0-0-1989; IN COMMERCE 0-0-1989.

CLASS 25—CLOTHING

FOR T-SHIRTS (U.S. CLS. 22 AND 39).
FIRST USE 10-0-1990; IN COMMERCE 10-0-1990.

SN 78-184,231. BIOLITEC, INC., EAST LONGMEADOW, MA. FILED 11-12-2002.

ELVS

CLASS 10—MEDICAL APPARATUS

FOR OPTICAL AND LASER-POWERED SYSTEMS FOR USE IN MEDICAL AND SURGICAL VASCULAR TREATMENTS COMPRISING PRIMARILY A LASER SOURCE, A SENSING/CONTROL DEVICE AND OPTICS FOR VASCULAR TREATMENTS, AND PARTS AND ACCESSORIES THEREFOR; DIFFUSERS FOR MEDICAL AND SURGICAL USE; DIODE LASERS FOR USE IN MEDICAL AND SURGICAL INSTRUMENTS; OPTICAL FIBERS FOR USE IN MEDICAL AND SURGICAL INSTRUMENTS; LASERS, LIGHT SOURCES, LAMPS, LENSES, WAVE GUIDES, AND FIBER OPTIC PROBES, AND PARTS AND ACCESSORIES THEREFOR, ALL FOR MEDICAL USE (U.S. CLS. 26, 39 AND 44).

CLASS 35—ADVERTISING AND BUSINESS

FOR LICENSING OF PROCEDURES FOR MEDICAL AND SURGICAL VASCULAR TREATMENTS (U.S. CLS. 100, 101 AND 102).

SN 78-184,234. GP & ASSOCIATES, INC., DBA GILLEN POSTELL & ASSOCIATES, INC., SHORT HILLS, NJ. FILED 11-12-2002.

ANGELS OF THE ZODIAC

CLASS 14—JEWELRY

FOR JEWELRY (U.S. CLS. 2, 27, 28 AND 50).

CLASS 16—PAPER GOODS AND PRINTED MATTER

FOR PENS, PENCILS, WRITING JOURNALS, STAMPERS, GREETING CARDS AND NOTE CARDS (U.S. CLS. 2, 5, 22, 23, 29, 37, 38 AND 50).

CLASS 18—LEATHER GOODS

FOR HANDBAGS, COIN PURSES, TOTE BAGS (U.S. CLS. 1, 2, 3, 22 AND 41).

CLASS 20—FURNITURE AND ARTICLES NOT OTHERWISE CLASSIFIED

FOR DECORATIVE PILLOWS, PICTURE FRAMES AND PLASTIC FIGURINES (U.S. CLS. 2, 13, 22, 25, 32 AND 50).

CLASS 21—HOUSEWARES AND GLASS

FOR MUGS AND CERAMIC FIGURINES (U.S. CLS. 2, 13, 23, 29, 30, 33, 40 AND 50).

CLASS 28—TOYS AND SPORTING GOODS

FOR DOLLS, BOBBLE HEADS DOLLS AND WATER GLOBES (U.S. CLS. 22, 23, 38 AND 50).

SN 78-185,050. BOLLORE', COMMUNE D'ERGUE GABERIC, FRANCE, FILED 11-14-2002.



CLASS 8—HAND TOOLS

FOR POCKET KNIVES, SPORTS KNIVES, AND MULTI-TASK KNIVES (U.S. CLS. 23, 28 AND 44).

CLASS 25—CLOTHING

FOR CLOTHING, NAMELY, SHIRTS AND HATS (U.S. CLS. 22 AND 39).

SN 78-185,383. IDX INVESTMENT CORPORATION, SOUTH BURLINGTON, VT. FILED 11-15-2002.

FLOWPOINT

CLASS 9—ELECTRICAL AND SCIENTIFIC APPARATUS

FOR COMPUTER SOFTWARE FOR AUTOMATING THE ADMINISTRATIVE, FINANCIAL, BILLING, AND CLINICAL RECORDS OF HEALTHCARE ORGANIZATIONS, FOR ANALYZING THE ADMINISTRATIVE, FINANCIAL, BILLING, AND CLINICAL RECORDS OF HEALTHCARE ORGANIZATIONS, FOR HEALTHCARE REGULATORY COMPLIANCE, FOR CAPTURING, DISTRIBUTING, MANAGING AND VIEWING ELECTRONIC DOCUMENTS, AND FOR ELECTRONIC DATA INTERCHANGE (EDI) OF HEALTHCARE TRANSACTION INFORMATION, AND MANUALS THEREFOR SOLD TOGETHER AS A UNIT. (U.S. CLS. 21, 23, 26, 36 AND 38).

CLASS 35—ADVERTISING AND BUSINESS

FOR VALUE ADDED RESELLER SERVICES, NAMELY, DISTRIBUTORSHIP SERVICES IN THE FIELD OF COMPUTER HARDWARE (U.S. CLS. 100, 101 AND 102).

CLASS 38—COMMUNICATION

FOR ELECTRONIC DATA INTERCHANGE (EDI) SERVICES FOR HEALTHCARE TRANSACTION INFORMATION. (U.S. CLS. 100, 101 AND 104).

CLASS 41—EDUCATION AND ENTERTAINMENT

FOR COMPUTER EDUCATION TRAINING SERVICES IN THE FIELD OF SOFTWARE FOR AUTOMATING THE ADMINISTRATIVE, FINANCIAL, BILLING, AND CLINICAL RECORDS OF HEALTHCARE ORGANIZATIONS, FOR ANALYZING THE ADMINISTRATIVE, FINANCIAL, BILLING, AND CLINICAL RECORDS OF HEALTHCARE ORGANIZATIONS, FOR HEALTHCARE REGULATORY COMPLIANCE, FOR CAPTURING, DISTRIBUTING, MANAGING AND VIEWING ELECTRONIC DOCUMENTS, AND FOR ELECTRONIC DATA INTERCHANGE (EDI) OF HEALTHCARE TRANSACTION INFORMATION. (U.S. CLS. 100, 101 AND 107).

CLASS 42—SCIENTIFIC, COMPUTER AND LEGAL SERVICES

FOR INSTALLATION AND MAINTENANCE OF COMPUTER SOFTWARE FOR HEALTHCARE ORGANIZATIONS; DESIGNING COMPUTER SOFTWARE FOR HEALTHCARE ORGANIZATIONS; APPLICATION SERVICE PROVIDER (ASP) FEATURING COMPUTER SOFTWARE FOR AUTOMATING THE ADMINISTRATIVE, FINANCIAL, BILLING, AND CLINICAL RECORDS OF HEALTHCARE ORGANIZATIONS, FOR ANALYZING THE ADMINISTRATIVE, FINANCIAL, BILLING, AND CLINICAL RECORDS OF HEALTHCARE ORGANIZATIONS, FOR HEALTHCARE REGULATORY COMPLIANCE, FOR CAPTURING, DISTRIBUTING, MANAGING AND VIEWING ELECTRONIC DOCUMENTS, AND FOR ELECTRONIC DATA INTERCHANGE (EDI) OF HEALTHCARE TRANSACTION INFORMATION. (U.S. CLS. 100 AND 101).

SN 78-185,400. HEALTHTEX APPAREL CORP., WILMINGTON, DE. FILED 11-15-2002.

**B A B Y
HEALTHTEX**

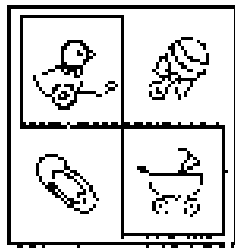

OWNER OF U.S. REG. NOS. 1,807,653 AND 2,612,422.
NO CLAIM IS MADE TO THE EXCLUSIVE RIGHT TO USE "BABY", APART FROM THE MARK AS SHOWN.
THE MARK CONSISTS OF THE WORDS "BABY HEALTHTEX" ACCOMPANIED BY THE DESIGN ELEMENT OF A SQUARE SUBDIVIDED INTO SMALLER SQUARES CONTAINING A PICTURE OF A TOY DUCK, A BABY RATTLE, A BABY PIN AND A BABY CARRIAGE.

CLASS 18—LEATHER GOODS

FOR DIAPER BAGS, TOTE BAGS, BABY BOTTLE BAGS (U.S. CLS. 1, 2, 3, 22 AND 41).

CLASS 24—FABRICS

FOR TOWELS, WASHCLOTHS, RECEIVING BLANKETS AND BED BLANKETS (U.S. CLS. 42 AND 50).

CLASS 25—CLOTHING

FOR AFTER BATH COVER UPS, CAPS (U.S. CLS. 22 AND 39).

CLASS 28—TOYS AND SPORTING GOODS

FOR TOYS, NAMELY, BABY RATTLES AND STUFFED TOY ANIMALS (U.S. CLS. 22, 23, 38 AND 50).

SN 78-185,554. TARGET BRANDS, INC., MINNEAPOLIS, MN. FILED 11-15-2002.

CLUB RED

CLASS 35—ADVERTISING AND BUSINESS

FOR ONLINE SERVICES FOR PROMOTING THE SALE AND USE OF CREDIT CARD ACCOUNTS THROUGH INCENTIVE PROGRAMS FOR RETAIL CONSUMERS; PROMOTING THE SALE OF GOODS AND SERVICES OF OTHERS THROUGH INCENTIVE PROGRAMS FOR RETAIL CONSUMERS; AND PROMOTING THE USE OF RETAIL DEPARTMENT STORE SERVICES THROUGH INCENTIVE PROGRAMS FOR RETAIL CONSUMERS. (U.S. CLS. 100, 101 AND 102).

CLASS 36—INSURANCE AND FINANCIAL

FOR ONLINE CREDIT CARD SERVICES (U.S. CLS. 100, 101 AND 102).

SN 78-185,556. BIOPHYSIX, INC., SAN DIEGO, CA. FILED 11-15-2002.

INFOMATRIX

CLASS 9—ELECTRICAL AND SCIENTIFIC APPARATUS

FOR ELECTRONIC DATABASE IN THE FIELD OF BIOCHEMICALS RECORDED ON COMPUTER MEDIA, COMPUTER SOFTWARE PROGRAM FOR ANALYZING BIOCHEMICAL CHARACTERISTICS (U.S. CLS. 21, 23, 26, 36 AND 38).

CLASS 42—SCIENTIFIC, COMPUTER AND LEGAL SERVICES

FOR PHARMACEUTICAL DRUG DEVELOPMENT SERVICES, CHEMICAL ANALYSIS AND CONSULTATION SERVICES, PRODUCT RESEARCH AND DEVELOPMENT FOR OTHERS, TECHNICAL CONSULTATION IN THE FIELD OF BIOCHEMISTRY, LICENSING OF INTELLECTUAL PROPERTY (U.S. CLS. 100 AND 101).

SN 78-185,563. BROADCOM CORPORATION, IRVINE, CA.
FILED 11-15-2002.



CLASS 9—ELECTRICAL AND SCIENTIFIC APPARATUS

FOR COMPUTER HARDWARE; INTEGRATED CIRCUITS; AND SOFTWARE FOR CONTROLLING AND USING INTEGRATED CIRCUITS (U.S. CLS. 21, 23, 26, 36 AND 38).

CLASS 42—SCIENTIFIC, COMPUTER AND LEGAL SERVICES

FOR DESIGN FOR OTHERS OF COMPUTERS, INTEGRATED CIRCUITS, COMMUNICATIONS HARDWARE AND SOFTWARE, AND NETWORKS (U.S. CLS. 100 AND 101).

SN 78-185,592. ENDAR CORPORATION, TEMECULA, CA.
FILED 11-15-2002.

FLIP YOUR LID

CLASS 4—LUBRICANTS AND FUELS

FOR CANDLES (U.S. CLS. 1, 6 AND 15).

CLASS 21—HOUSEWARES AND GLASS

FOR CANDLE HOLDERS WITH LID NOT OF PRECIOUS METAL; CANDLE HOLDERS WITH COASTER NOT OF PRECIOUS METAL (U.S. CLS. 2, 13, 23, 29, 30, 33, 40 AND 50).

SN 78-185,612. JACK KOBERNA RACING, TULIA, TX.
FILED 11-15-2002.

SURF MONSTER

CLASS 25—CLOTHING

FOR CLOTHING, NAMELY, SHIRTS, JERSEYS AND HATS. (U.S. CLS. 22 AND 39).

CLASS 28—TOYS AND SPORTING GOODS

FOR TOYS, NAMELY, TOY TRUCKS, TOY MODEL TRUCKS AND TOY DIECAST COLLECTIBLE TRUCKS. (U.S. CLS. 22, 23, 38 AND 50).

CLASS 41—EDUCATION AND ENTERTAINMENT

FOR ENTERTAINMENT SERVICES IN THE NATURE OF A MONSTER TRUCK AMUSEMENT RIDE; PARTICIPATING IN A MOTOR SPORTS EVENTS. (U.S. CLS. 100, 101 AND 107).

SN 78-185,643. JOHNSON DIVERSEY, INC., STURTEVANT, WI. FILED 11-15-2002.

J-METER

CLASS 3—COSMETICS AND CLEANING PREPARATIONS

FOR ALL PURPOSE CLEANING AND DEGREASING PREPARATIONS WITH OR WITHOUT DISINFECTING PROPERTIES (U.S. CLS. 1, 4, 6, 50, 51 AND 52).

CLASS 21—HOUSEWARES AND GLASS

FOR DISPENSERS FOR CLEANING AND DISINFECTING PREPARATIONS (U.S. CLS. 2, 13, 23, 29, 30, 33, 40 AND 50).

SN 78-186,417. MARUO CALCIUM COMPANY LIMITED, HYOGO, JAPAN, FILED 11-19-2002.

CALMATE

CLASS 1—CHEMICALS

FOR CHEMICALS, NAMELY, INORGANIC SALTS FOR USE IN THE PLASTIC INDUSTRY, FOR USE IN SCIENCE, PHOTOGRAPHY, AGRICULTURE, HORTICULTURE AND FORESTRY (U.S. CLS. 1, 5, 6, 10, 26 AND 46).

CLASS 5—PHARMACEUTICALS

FOR PHARMACEUTICAL PREPARATIONS, NAMELY, NUTRIENT SUPPLEMENTS, TONICS, NAMELY, MEDICAL TONICS FOR THE PREVENTION AND TREATMENT OF OSTEOPOROSIS, AND MEDICINAL ALTERNATIVES, NAMELY CALCIUM PREPARATIONS; FOOD FOR INFANTS (U.S. CLS. 6, 18, 44, 46, 51 AND 52).

SN 78-186,433. RAINY DAY PRODUCTIONS, LLC, CHICAGO, IL. FILED 11-19-2002.

WHAT HAPPENS WHEN

CLASS 9—ELECTRICAL AND SCIENTIFIC APPARATUS

FOR CHILDREN'S VIDEOTAPE SERIES THAT FOCUSES ON SPECIFIC SITUATIONS (U.S. CLS. 21, 23, 26, 36 AND 38).

CLASS 16—PAPER GOODS AND PRINTED MATTER

FOR CHILDREN'S BOOK SERIES THAT FOCUSES ON SPECIFIC SITUATIONS (U.S. CLS. 2, 5, 22, 23, 29, 37, 38 AND 50).

SN 78-188,343. LUCKY BRAND DUNGAREES, INC., VERNON, CA. FILED 11-24-2002.

SN 78-190,660. VISIONARY COMMUNICATIONS, INC., GILLETTE, WY. FILED 12-3-2002.

LUCKY BRAND

OWNER OF U.S. REG. NOS. 1,646,123, 2,330,052 AND OTHERS.

NO CLAIM IS MADE TO THE EXCLUSIVE RIGHT TO USE "BRAND", APART FROM THE MARK AS SHOWN.



CLASS 18—LEATHER GOODS

FOR PET APPAREL, NAMELY, SWEATERS, RAIN-COATS, HATS AND SHOES; DOG LEASHES, DOG AND CAT COLLARS AND CHARMS FOR ATTACHMENT THERETO (U.S. CLS. 1, 2, 3, 22 AND 41).

CLASS 20—FURNITURE AND ARTICLES NOT OTHERWISE CLASSIFIED

FOR WINDOWSHADES, INTERIOR WINDOW BLINDS; PILLOWS AND FURNITURE (U.S. CLS. 2, 13, 22, 25, 32 AND 50).

CLASS 21—HOUSEWARES AND GLASS

FOR VASES, SOAP DISPENSERS, DRINKING GLASSES, PITCHERS, BOWLS, DISHES; HOUSEHOLD ITEMS, NAMELY, SOAP DISHES, NAPKIN HOLDERS, SALT AND PEPPER SHAKERS AND SUGAR AND CREAMER SETS (U.S. CLS. 2, 13, 23, 29, 30, 33, 40 AND 50).

CLASS 24—FABRICS

FOR TOWELS, FACECLOTHS, SHOWER CURTAINS, PILLOWCASES, BEDSHEETS, BED BLANKETS, COMFORTERS, COMFORTER CASES, BEDSPREADS, PILLOW SHAMS, DUST RUFFLES, TABLECLOTHS NOT MADE OF PAPER, TEXTILE NAPKINS, TEXTILE POT HOLDERS AND TEXTILE OVEN MITTS, CURTAINS, DRAPERIES, TAPESTRY WALL HANGINGS OF TEXTILE (U.S. CLS. 42 AND 50).

CLASS 27—FLOOR COVERINGS

FOR RUGS, CARPETS, LINOLEUM FLOORING, WALLPAPER, FABRIC BATHMATS, AND TAPESTRY-STYLE WALL HANGINGS, NOT OF TEXTILE (U.S. CLS. 19, 20, 37, 42 AND 50).

SN 78-190,607. KAYSER-ROTH CORPORATION, GREENSBORO, NC. FILED 12-3-2002.

JUNE & DAISY

CLASS 14—JEWELRY

FOR JEWELRY (U.S. CLS. 2, 27, 28 AND 50).

CLASS 25—CLOTHING

FOR PANTIES, UNDERWEAR, SLEEPWEAR, LEGWEAR, SOCKS, PANTYHOSE, HOSIERY, TIGHTS AND LEGGINGS (U.S. CLS. 22 AND 39).

CLASS 26—FANCY GOODS

FOR BROOCHES AND HAIR ACCESSORIES, NAMELY, TWISTERS, CLAW CLIPS, AND SNAP CLIPS (U.S. CLS. 37, 39, 40, 42 AND 50).

CLASS 9—ELECTRICAL AND SCIENTIFIC APPARATUS

FOR INTERNET ACCESS SERVICES, NAMELY PROVIDING HIGH SPEED AND DIAL UP INTERNET ACCESS TO OTHERS; TELECOMMUNICATIONS SERVICES, NAMELY, ALLOWING AND PROVIDING FOR THE SECURE TRANSMISSION OF DATA, ELECTRONIC E-MAIL AND MESSAGING OVER THE INTERNET (U.S. CLS. 21, 23, 26, 36 AND 38).

FIRST USE 2-7-2002; IN COMMERCE 2-7-2002.

CLASS 42—SCIENTIFIC, COMPUTER AND LEGAL SERVICES

FOR HOSTING AND MAINTAINING WEBSITES FOR OTHERS (U.S. CLS. 100 AND 101).

FIRST USE 2-7-2002; IN COMMERCE 2-7-2002.

SN 78-191,508. ALIXPARTNERS, LLC, SOUTHFIELD, MI. FILED 12-5-2002.

ALIXPARTNERS

CLASS 35—ADVERTISING AND BUSINESS

FOR BUSINESS MANAGEMENT; BUSINESS AUDITING; BUSINESS ACQUISITION AND MERGER CONSULTATION; BUSINESS CONSULTATION; BUSINESS INFORMATION TECHNOLOGY MANAGEMENT, NAMELY, INFORMATION MANAGEMENT SERVICES IN THE FIELD OF TECHNOLOGY FOR BUSINESS; BUSINESS ORGANIZATIONAL CONSULTATION, INCLUDING RELATING TO BANKRUPTCY AND REORGANIZATION PROCEEDINGS; BUSINESS SUPERVISION; BUSINESS TURNAROUND CONSULTING SERVICES (U.S. CLS. 100, 101 AND 102).

FIRST USE 7-1-2002; IN COMMERCE 7-1-2002.

CLASS 36—INSURANCE AND FINANCIAL

FOR FINANCIAL ANALYSIS AND CONSULTATION; FINANCIAL RESEARCH; FINANCIAL FORECASTING; BUSINESS VALUATION SERVICES (U.S. CLS. 100, 101 AND 102).

FIRST USE 7-1-2002; IN COMMERCE 7-1-2002.

CLASS 42—SCIENTIFIC, COMPUTER AND LEGAL SERVICES

FOR LITIGATION CONSULTATION SERVICES; INTELLECTUAL PROPERTY CONSULTATION (U.S. CLS. 100 AND 101).

FIRST USE 7-1-2002; IN COMMERCE 7-1-2002.

SN 78-193,822. D. & J.F. CELLARS, INC., DUNDEE, OR. FILED 12-12-2002.

DPC

CLASS 21—HOUSEWARES AND GLASS

FOR BEVERAGE GLASSWARE (U.S. CLS. 2, 13, 23, 29, 30, 33, 40 AND 50).

CLASS 25—CLOTHING

FOR CLOTHING, NAMELY, HATS, JACKETS, T-SHIRTS, DENIM SHIRTS, POLO SHIRTS, SWEATSHIRTS AND APRONS (U.S. CLS. 22 AND 39).

CLASS 33—WINES AND SPIRITS

FOR WINE (U.S. CLS. 47 AND 49).

SN 78-210,326. GENOMIC HEALTH, INC., REDWOOD CITY, CA. FILED 2-3-2003.

ONCOTYPE

CLASS 5—PHARMACEUTICALS

FOR PROBES, PRIMERS, CHEMICALS, NAMELY, REAGENTS, AND INSTRUCTIONS SOLD AS A UNIT FOR CLINICAL DIAGNOSTICS IN THE FIELD OF CANCER DIAGNOSIS AND ANALYSIS (U.S. CLS. 6, 18, 44, 46, 51 AND 52).

CLASS 42—SCIENTIFIC, COMPUTER AND LEGAL SERVICES

FOR PROVIDING LABORATORY RESEARCH SERVICES IN THE FIELD OF GENE EXPRESSION, NAMELY, CANCER BIOLOGY (U.S. CLS. 100 AND 101).

CLASS 44—MEDICAL, BEAUTY AND AGRICULTURAL SERVICES

FOR PROVIDING MEDICAL DIAGNOSTIC SERVICES, TESTING, AND INFORMATION IN THE FIELD OF CANCER DIAGNOSIS (U.S. CLS. 100 AND 101).

SN 78-213,724. GUILLETTE & COS., AUSTIN, TX. FILED 2-12-2003.

HURON FOODS

NO CLAIM IS MADE TO THE EXCLUSIVE RIGHT TO USE "FOODS", APART FROM THE MARK AS SHOWN.

CLASS 5—PHARMACEUTICALS

FOR VITAMINS, VITAMIN SUPPLEMENTS, MINERAL SUPPLEMENTS, NUTRITIONAL SUPPLEMENTS, HERBAL SUPPLEMENTS, NUTRITIONAL DRINK MIX FOR USE AS A MEAL REPLACEMENT OR SUPPLEMENT, MEAL REPLACEMENT POWDERS, NUTRITIONAL FOOD BARS, DIETARY FOOD SUPPLEMENTS, BABY FOOD (U.S. CLS. 6, 18, 44, 46, 51 AND 52).

CLASS 29—MEATS AND PROCESSED FOODS

FOR EDIBLE OILS AND FATS, NAMELY, EDIBLE OIL IN LIQUID FORM, COOKING OIL SPRAY (U.S. CL. 46).

* * * * *

SECTION 2.— INTERNATIONAL CLASSIFICATION

The short titles associated below with the international class numbers are terms designed merely for quick identification and are not an official part of the international classification. The full names of international classes are given in section 6.1 of the trademark rules of practice.

The designation "U.S. Cl." appearing in this section refers to the U.S. class in effect prior to Sep. 1, 1973 rather than the international class which applies to applications filed on or after that date. For adoption of international classification see notice in the OFFICIAL GAZETTE of Jun. 26, 1973 (911 O.G. TM 210).

Application in one class

CLASS 1—CHEMICALS

SN 75-830,250. PPG INDUSTRIES OHIO, INC., CLEVELAND, OH. FILED 11-11-1999.

ACCU-TAB

OWNER OF U.S. REG. NO. 2,402,564.
FOR SOLID SANITIZING CHEMICALS, NAMELY CHLORINE TABLETS, FOR CHLORINATION AND SANITATION OF WATER FOR SWIMMING POOLS, POTABLE WATER, WASTE WATER AND INDUSTRIAL USE, CHARGED IN DISPENSING CONTAINERS (U.S. CLS. 1, 5, 6, 10, 26 AND 46).

CLASS 1—(Continued).

SN 76-218,580. ROO PRODUCTS, INC., WOODBURN, OR. FILED 3-5-2001.

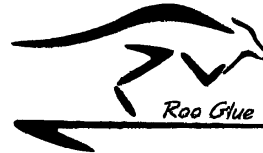

NO CLAIM IS MADE TO THE EXCLUSIVE RIGHT TO USE "GLUE", APART FROM THE MARK AS SHOWN.
FOR HOUSE MARK FOR WATER BASED ADHESIVES FOR USE IN FURNITURE, CABINETS, COUNTER TOPS, KITCHEN REMODELING, PLASTIC AND WOOD FIXTURES AND CRAFTS AND HOBBY INDUSTRIES (U.S. CLS. 1, 5, 6, 10, 26 AND 46).

SN 76-248,229. EARTHWORKS NATURAL ORGANIC PRODUCTS, MARTINS CREEK, PA. FILED 4-26-2001.

POTENT-SEA

FOR PLANT NUTRIENTS, NAMELY, BIOSTIMULANTS FOR HORTICULTURAL USE (U.S. CLS. 1, 5, 6, 10, 26 AND 46).
FIRST USE 4-0-1991; IN COMMERCE 4-0-1991.

75 Sentinel

SN 76-143,273. AEA TECHNOLOGY PLC, OXFORDSHIRE, OX11 0QJ, UNITED KINGDOM, FILED 10-10-2000.

PRIORITY CLAIMED UNDER SEC. 44(D) ON ERP N CMNTY TM OFC APPLICATION NO. 001691070, FILED 5-30-2000, REG. NO. 1691070, DATED 1-8-2001, EXPIRES 5-30-2010.

NO CLAIM IS MADE TO THE EXCLUSIVE RIGHT TO USE "75", APART FROM THE MARK AS SHOWN.

FOR RADIOACTIVE ISOTOPES FOR USE IN INDUSTRIAL RADIOGRAPHY (U.S. CLS. 1, 5, 6, 10, 26 AND 46).

SN 76-292,157. ART WILSON CO., CARSON CITY, NV. FILED 7-26-2001.

GROWEX

FOR AGRICULTURAL FERTILIZER (U.S. CLS. 1, 5, 6, 10, 26 AND 46).

CLASS 1—(Continued).

SN 76-293,048. DHARMACON RESEARCH, INC., LAFAYETTE, CO. FILED 7-31-2001.

SIACE-RNAI

FOR BIOTECHNOLOGY RELATED PRODUCTS, NAMELY, OLIGONUCLEOTIDES AND THE REAGENTS REQUIRED TO MAKE THE OLIGONUCLEOTIDES FOR SCIENTIFIC AND MEDICAL RESEARCH AND SCIENTIFIC AND MEDICAL RESEARCH APPLICATIONS, NAMELY, DRUG DISCOVERY, FUNCTIONAL GENOMICS, TARGET VALIDATION, THERAPEUTIC DEVELOPMENT, AND DIAGNOSTIC ASSAYS (U.S. CLS. 1, 5, 6, 10, 26 AND 46).

FIRST USE 7-11-2001; IN COMMERCE 7-11-2001.

SN 76-307,664. HENKEL KGAA, DUESSELDORF, FED REP GERMANY, FILED 8-30-2001.

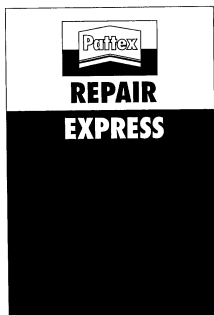

PRIORITY CLAIMED UNDER SEC. 44(D) ON FED REP GERMANY APPLICATION NO. 30114264.5/0, FILED 3-2-2001, REG. NO. 30114264, DATED 5-4-2001, EXPIRES 3-31-2011.

OWNER OF U.S. REG. NO. 2,399,302.

NO CLAIM IS MADE TO THE EXCLUSIVE RIGHT TO USE "REPAIR" AND "EXPRESS", APART FROM THE MARK AS SHOWN.

FOR ADHESIVES FOR USE IN HOME AND BUILDING CONSTRUCTION, RENOVATION, MAINTENANCE AND REPAIR (U.S. CLS. 1, 5, 6, 10, 26 AND 46).

CLASS 1—(Continued).

SN 76-307,666. HENKEL KGAA, DUESSELDORF, FED REP GERMANY, FILED 8-30-2001.



PRIORITY CLAIMED UNDER SEC. 44(D) ON FED REP GERMANY APPLICATION NO. 30114275.0/0, FILED 3-2-2001, REG. NO. 30114275, DATED 5-9-2001, EXPIRES 3-31-2011.

OWNER OF U.S. REG. NO. 2,399,302.

NO CLAIM IS MADE TO THE EXCLUSIVE RIGHT TO USE "REPAIR", APART FROM THE MARK AS SHOWN.

FOR ADHESIVES FOR USE IN HOME AND BUILDING CONSTRUCTION, RENOVATION, MAINTENANCE AND REPAIR (U.S. CLS. 1, 5, 6, 10, 26 AND 46).

SN 76-308,583. POLYGANICS B.V., 9713 GX GRONINGEN, NETHERLANDS, FILED 9-4-2001.

LACTHANE

FOR BIODEGRADABLE POLYMERIC CHEMICAL COMPOUNDS COMPRISED OF ESTERS, ETHERS, CARBONATES, PHOSPAZENES, AMIDES, TEREPHTHALATES, ANHYDRIDES, URETHANES, AND UREAS, FOR USE IN THE MANUFACTURE OF PHARMACEUTICALS, MEDICAL, SURGICAL AND VETERINARY DEVICES, COSMETICS, AND HYGIENIC PRODUCTS (U.S. CLS. 1, 5, 6, 10, 26 AND 46).

SN 76-345,598. DEPCO, INCORPORATED, HAUPPAUGE, NY. FILED 12-6-2001.

DEPCO INCORPORATED

NO CLAIM IS MADE TO THE EXCLUSIVE RIGHT TO USE "INCORPORATED", APART FROM THE MARK AS SHOWN.

FOR UNPROCESSED SILICONE POLYMERS, UNPROCESSED SILICONE PUTTY AND UNPROCESSED ELASTOMERS FOR USE IN A WIDE VARIETY OF FIELDS (U.S. CLS. 1, 5, 6, 10, 26 AND 46).

FIRST USE 6-0-1970; IN COMMERCE 6-0-1970.

CLASS 1—(Continued).

SN 76-350,551. QUEST SPECIALTY CHEMICAL COMPANY, SOUTH BEND, IN. FILED 12-14-2001.

QUEST SPECIALTY CHEMICAL COMPANY

NO CLAIM IS MADE TO THE EXCLUSIVE RIGHT TO USE "SPECIALTY CHEMICAL COMPANY", APART FROM THE MARK AS SHOWN.

FOR SPECIALTY CHEMICALS, NAMELY, ADHESIVES AND FILMS FOR BONDING; COATINGS AND FILMS FOR SURFACE PROTECTION; AND POLYMERS FOR USE IN THE FORMULATION OF ADHESIVES, FILMS AND COATINGS; EXCLUDING CHEMICALS FOR USE IN THE FOOD, BEVERAGE, FRAGRANCE, COSMETIC, PERSONAL CARE AND PHARMACOLOGICALLY ACTIVE INGREDIENTS FIELDS (U.S. CLS. 1, 5, 6, 10, 26 AND 46).

SN 76-355,407. DAIKIN INDUSTRIES, LTD., KITA-KU, OSAKA, JAPAN, FILED 1-7-2002.

OPTOFLON

OWNER OF JAPAN REG. NO. 2010526, DATED 12-18-1987, EXPIRES 12-18-2007.

FOR CHEMICAL POLYMERS FOR CLADDING MATERIALS OF OPTICAL FIBERS AND CHEMICAL MONOMER MATERIALS FOR MAKING CONTACT LENSES (U.S. CLS. 1, 5, 6, 10, 26 AND 46).

SN 76-360,156. GARICK CORPORATION, CLEVELAND, OH. FILED 1-17-2002.

FERTILGRO

FOR MANURE (U.S. CLS. 1, 5, 6, 10, 26 AND 46).

SN 76-376,237. QUIMICA FOLIAR, S.A. DE C.V., C.P. 53489, ESTADO DE MEXICO., MEXICO, FILED 3-1-2002.

FULVI-QF

FOR FERTILIZER, AND CHEMICALS FOR USE IN THE MANUFACTURE OF FERTILIZER, FOR AGRICULTURAL, HORTICULTURAL, AND FORESTRY USE (U.S. CLS. 1, 5, 6, 10, 26 AND 46).

CLASS 1—(Continued).

SN 76-376,620. CHICAGO GLUE MACHINE & SUPPLY CO., INC., BENSENVILLE, IL. FILED 2-27-2002.

Tacky Spots



FOR DOTS OF ADHESIVE MATERIAL DISPENSED ON STRIPS OF PAPER FOR CONSUMER, COMMERCIAL AND INDUSTRIAL USE (U.S. CLS. 1, 5, 6, 10, 26 AND 46).

FIRST USE 7-0-2000; IN COMMERCE 7-0-2000.

SN 76-396,380. OMS INVESTMENTS, INC., SANTA MONICA, CA. FILED 4-18-2002.

SMART SOLUTIONS

FOR FERTILIZERS FOR DOMESTIC USE, NAMELY, FERTILIZERS WITH WEED CONTROL, FERTILIZERS WITH INSECTICIDE, FERTILIZERS WITH CRABGRASS PREVENTER, FERTILIZER WITH FUNGUS CONTROL, FERTILIZER WITH MOSS CONTROL, FERTILIZER IN THE FORM OF SPIKES FOR HOUSE PLANTS, OUTDOOR PLANTS, TREES AND SHRUBBERY; PLANT FOODS AND FERTILIZERS IN THE FORM OF LIQUID, POWDER AND SOLID FORMS; CONTROLLED RELEASE FERTILIZERS; WATER-SOLUBLE FERTILIZER; POTTING SOIL, GROWING MEDIA FOR PLANTS, SOIL AMENDMENTS, HUMUS, COW MANURE, COMPOSTED COW MANURE, DEHYDRATED COW MANURE, DEHYDRATED MANURE, SOIL CONDITIONERS FOR AGRICULTURAL, DOMESTIC AND HORTICULTURAL USE, SOIL ADDITIVES, PEAT, GARDEN SOILS, PLANTING SOILS, LOAM, SOIL AMENDMENTS, WATER HOLDING ADDITIVES, CUSTOM BLENDED GROWING MEDIUM; HIGH MAGNESIUM FERTILIZER USED IN THE PRODUCTION OF GREENHOUSE AND NURSERY ORNAMENTAL PLANTS AND FOR PROFESSIONAL LANDSCAPE PLANTINGS; ORGANIC PEAT FOR USE AS A SOIL CONDITIONER; HORTICULTURAL CHARCOAL SOIL CONDITIONER, ALL FOR DOMESTIC USE (U.S. CLS. 1, 5, 6, 10, 26 AND 46).

SN 76-398,684. SURFMARK, L.L.C., CRYSTAL LAKE, IL. FILED 4-22-2002.

PIRANHA

FOR CHEMICAL, NAMELY, ANTIFOAM AND DEFOAMING AGENTS DESIGNED FOR PREVENTION OR SUPPRESSION OF FOAM FORMATION IN PESTICIDE SOLUTIONS IN SPRAY TANKS FOR USE IN CONNECTION WITH AGRICULTURAL, TURF AND ORNAMENTAL, AND INTEGRATED VEGETATION MANAGEMENT INDUSTRIES (U.S. CLS. 1, 5, 6, 10, 26 AND 46).

CLASS 1—(Continued).

SN 76-401,655. DEGUSSA AG, 40474 DUSSELDORF, FED REP GERMANY, FILED 4-29-2002.

Si 266

OWNER OF FED REP GERMANY REG. NO. 39636899, DATED 6-12-1997, EXPIRES 8-31-2006.

NO CLAIM IS MADE TO THE EXCLUSIVE RIGHT TO USE "SI", APART FROM THE MARK AS SHOWN.

FOR SILANES FOR USE IN THE MANUFACTURE OF RUBBER PRODUCTS IN THE RUBBER AND TIRE INDUSTRIES (U.S. CLS. 1, 5, 6, 10, 26 AND 46).

SN 76-401,657. DEGUSSA AG, 40474 DUSSELDORF, FED REP GERMANY, FILED 4-29-2002.

X 266-S

OWNER OF FED REP GERMANY REG. NO. 39636898, DATED 3-7-1997, EXPIRES 8-31-2006.

FOR SILANES FOR USE IN THE MANUFACTURE OF RUBBER PRODUCTS IN THE RUBBER AND TIRE INDUSTRIES (U.S. CLS. 1, 5, 6, 10, 26 AND 46).

SN 76-404,539. AKZO NOBEL CHEMICALS B.V., 3818 LE AMERSFOORT, NETHERLANDS, FILED 4-19-2002.



PRIORITY CLAIMED UNDER SEC. 44(D) ON BENELUX APPLICATION NO. 1001930, FILED 12-11-2001, REG. NO. 0700207, DATED 12-11-2001, EXPIRES 12-11-2011.

FOR FERTILIZER FOR AGRICULTURAL, HORTICULTURAL, HYDROPONIC AND DOMESTIC USE (U.S. CLS. 1, 5, 6, 10, 26 AND 46).

SN 76-417,983. REACTIVE SURFACES, LTD., AUSTIN, TX, FILED 6-5-2002.

REACTIVE SURFACES

FOR CHEMICAL ADDITIVES FOR USE IN DETOXIFYING ORGANOPHOSPHOROUS COMPOUNDS (U.S. CLS. 1, 5, 6, 10, 26 AND 46).

CLASS 1—(Continued).

SN 76-418,797. ACI WOOD PROTECTION, LLC, DELAWARE, OH. FILED 6-10-2002.

DICOIT

FOR CHEMICAL PRESERVATIVE FOR USE IN MANUFACTURE OF WOOD AND WOOD PRODUCTS (U.S. CLS. 1, 5, 6, 10, 26 AND 46).

SN 76-418,798. ACI WOOD PROTECTION, LLC, DELAWARE, OH. FILED 6-10-2002.

DECAYGUARD

FOR CHEMICAL PRESERVATIVE FOR USE IN THE MANUFACTURE OF WOOD AND WOOD PRODUCTS (U.S. CLS. 1, 5, 6, 10, 26 AND 46).

SN 76-425,476. DUPONT DOW ELASTOMERS LLC, WILMINGTON, DE. FILED 6-25-2002.

ENGAGE

FOR PLASTIC RESINS FOR USE IN THE MANUFACTURE OF A WIDE VARIETY OF PLASTIC ITEMS (U.S. CLS. 1, 5, 6, 10, 26 AND 46).

FIRST USE 2-10-1994; IN COMMERCE 2-10-1994.

SN 76-427,307. PRAXAIR TECHNOLOGY, INC., DANBURY, CT. FILED 7-3-2002.

MEDIPURE

FOR INDUSTRIAL AND SPECIALTY GASES, NAMELY NITROGEN, HELIUM, CARBON DIOXIDE, NITROUS OXIDE, OXYGEN AND VARIOUS MIXTURES OF ONE OR MORE OF THE ABOVE, FOR SCIENTIFIC RESEARCH, GENERAL INDUSTRIAL USED AND SPECIALTY USES IN THE NATURE OF STORAGE AND PRESERVATION OF MEDICINES, LABORATORY ANALYSIS, FREEZING AND PRESERVATION OF BIOLOGICAL SPECIMENS, AND STORAGE OF CELLS AND MOLECULES (U.S. CLS. 1, 5, 6, 10, 26 AND 46).

CLASS 1—(Continued).

SN 76-429,479. CP MEDIUS, LLC, YADKINVILLE, NC. FILED 7-9-2002.



FOR FERTILIZER FOR AGRICULTURAL AND DOMESTIC USE (U.S. CLS. 1, 5, 6, 10, 26 AND 46).

SN 76-429,987. PHOTON-X, INC., MALVERN, PA. FILED 7-8-2002.

NANOLYNX

FOR CHEMICAL COATINGS, NAMELY, NANO PARTICLE COATINGS USED FOR OPTICAL WAVE GUIDES (U.S. CLS. 1, 5, 6, 10, 26 AND 46).

SN 76-430,117. BUCKMAN LABORATORIES INTERNATIONAL, INC., MEMPHIS, TN. FILED 7-10-2002.

MEDALLION

FOR CHEMICALS USED IN PROCESSING WOOD PULP AND MANUFACTURING PAPER (U.S. CLS. 1, 5, 6, 10, 26 AND 46).

SN 76-436,467. FUJI HUNT PHOTOGRAPHIC CHEMICALS, INC., ALLENDALE, NJ. FILED 7-30-2002.

EMERALD

SEC. 2(F).
FOR FOUNTAIN SOLUTION FOR USE IN OFFSET LITHOGRAPHIC PRINTING (U.S. CLS. 1, 5, 6, 10, 26 AND 46).
FIRST USE 2-21-1986; IN COMMERCE 2-21-1986.

SN 76-456,345. REACTAMINE TECHNOLOGIES, INC., MADISON, WI. FILED 9-27-2002.

**REACTAMINE
TECHNOLOGIES**

NO CLAIM IS MADE TO THE EXCLUSIVE RIGHT TO USE "TECHNOLOGIES", APART FROM THE MARK AS SHOWN.

FOR CHEMICAL CHAIN EXTENDER FOR USE IN THE MANUFACTURE OF POLYUREA COATING (U.S. CLS. 1, 5, 6, 10, 26 AND 46).

CLASS 1—(Continued).

SN 76-457,643. MAKINO INC., MASON, OH. FILED 10-11-2002.



THE MARK CONSISTS OF THE GREEK LETTER "MU" AND THE LETTERS "S" AND "C".
FOR CHEMICAL PREPARATIONS, NAMELY, GRAPHITE PREPARATIONS FOR MACHINING OF METAL (U.S. CLS. 1, 5, 6, 10, 26 AND 46).
FIRST USE 11-1-1996; IN COMMERCE 11-1-1996.

SN 76-461,686. PALMER INTERNATIONAL, INC, SKIPPACK, PA. FILED 10-25-2002.

PALMER

OWNER OF U.S. REG. NO. 934,771.
SEC. 2(F).
FOR FRICTION PARTICLES AND SOUND DAMPENING COMPOUNDS USED IN BRAKES AND BRAKE SYSTEMS FOR CARS, TRUCKS, AND TRAINS LIQUID RESINS USED FOR ADDITIVES IN BRAKE LININGS (U.S. CLS. 1, 5, 6, 10, 26 AND 46).
FIRST USE 2-0-1959; IN COMMERCE 2-0-1959.

SN 76-464,781. FARACH, KARLA, MIAMI, FL. FILED 11-6-2002.

SUKAL

FOR ARTIFICIAL SWEETENER (U.S. CLS. 1, 5, 6, 10, 26 AND 46).

SN 76-472,927. POLYMERIC RESOURCES CORPORATION, WAYNE, NJ. FILED 11-25-2002.

NAXALLOY

FOR POLYCARBONATE RESIN ALLOYED WITH OTHER THERMOPLASTICS FOR USE IN THE MANUFACTURE OF MOLDED AND EXTRUDED PLASTIC PARTS (U.S. CLS. 1, 5, 6, 10, 26 AND 46).

FIRST USE 5-0-2000; IN COMMERCE 5-0-2000.

CLASS 1—(Continued).

SN 76-484,426. SOLOHILL ENGINEERING, INC., ANN ARBOR, MI. FILED 1-21-2003.

HILLEX

FOR MICROCARRIER BEADS FOR USE IN MANUFACTURING AND LABORATORY OR RESEARCH USE (U.S. CLS. 1, 5, 6, 10, 26 AND 46).

FIRST USE 1-1-1999; IN COMMERCE 1-1-1999.

SN 76-485,676. JUNGLE LABORATORIES CORPORATION, CIBOLO, TX. FILED 1-24-2003.



OWNER OF U.S. REG. NOS. 1,011,986, 2,582,147 AND OTHERS.

FOR WATER TREATING ADDITIVES FOR ORNAMENTAL FISH PONDS (U.S. CLS. 1, 5, 6, 10, 26 AND 46).
FIRST USE 11-0-2002; IN COMMERCE 11-0-2002.

SN 76-486,133. B. BROS. PACKAGING, INC., EAGAN, MN. FILED 1-27-2003.

SPLASH

OWNER OF U.S. REG. NOS. 1,682,586, 2,335,719 AND OTHERS.

FOR ANTIFREEZE; AND ANTIFREEZE AND COOLANT FOR USE IN AUTOMOTIVE SYSTEMS AND VEHICLE ENGINES (U.S. CLS. 1, 5, 6, 10, 26 AND 46).
FIRST USE 8-30-2002; IN COMMERCE 11-21-2002.

SN 76-486,134. B. BROS. PACKAGING, INC., EAGAN, MN. FILED 1-27-2003.



OWNER OF U.S. REG. NOS. 1,682,586, 2,335,719 AND OTHERS.

FOR ANTIFREEZE; AND ANTIFREEZE AND COOLANT FOR USE IN AUTOMOTIVE SYSTEMS AND VEHICLE ENGINES (U.S. CLS. 1, 5, 6, 10, 26 AND 46).
FIRST USE 8-30-2002; IN COMMERCE 11-21-2002.

CLASS 1—(Continued).

SN 78-125,750. FMC CORPORATION, PHILADELPHIA, PA. FILED 5-2-2002.

NOVAMATRIX

FOR ALGINATES AND ALGINATE PREPARATIONS USED IN THE PHARMACEUTICAL AND BIOMEDICAL INDUSTRIES FOR THICKENING, STABILIZING, GELLING AND FILM FORMING IN FOOD, PHARMACEUTICAL AND SPECIALTY APPLICATIONS (U.S. CLS. 1, 5, 6, 10, 26 AND 46).

SN 78-140,844. BROWN, MARSHALL L., NORCROSS, GA. AND LIGHT, THEODORE, NORCROSS, GA. FILED 7-2-2002.



NO CLAIM IS MADE TO THE EXCLUSIVE RIGHT TO USE "CHEMISTRIES", APART FROM THE MARK AS SHOWN.

THE STIPPLING IS FOR SHADING PURPOSES ONLY AND DOES NOT INDICATE COLOR.

FOR CHEMICAL ADDITIVES FOR USE IN THE MANUFACTURE OF MASONRY AND CONSTRUCTION MATERIALS (U.S. CLS. 1, 5, 6, 10, 26 AND 46).

SN 78-146,835. CRUMLEY, JONATHAN, CHATTANOOGA, TN. FILED 7-23-2002.



FOR POLYMER GRANULES FOR USE IN AGRICULTURE AND HORTICULTURE, THE PURPOSE OF SAID GRANULES BEING TO ABSORB AND THEN SLOWLY RELEASE WATER TO PLANT ROOTS (U.S. CLS. 1, 5, 6, 10, 26 AND 46).

FIRST USE 10-1-1985; IN COMMERCE 10-1-1985.

CLASS 1—(Continued).

SN 78-155,699. PROVEN WINNERS NORTH AMERICA, L.L.C., CAMPBELL, CA. FILED 8-19-2002.

PROVEN WINNERS PW

OWNER OF U.S. REG. NO. 2,207,362.
FOR PLANT FOOD, POTTING SOIL, FERTILIZERS FOR DOMESTIC USE, SOIL CONDITIONERS FOR DOMESTIC USE, SOIL ADDITIVES, MANURE (U.S. CLS. 1, 5, 6, 10, 26 AND 46).
FIRST USE 1-1-2003; IN COMMERCE 1-1-2003.

SN 78-178,054. SHERWIN-WILLIAMS COMPANY, THE, CLEVELAND, OH. FILED 10-24-2002.

MAKE IT ACID FREE!

FOR AEROSOL SPRAY COMPOSITION USED TO INCREASE THE PH OF PAPER (U.S. CLS. 1, 5, 6, 10, 26 AND 46).

SN 78-182,615. E. I. DU PONT DE NEMOURS AND COMPANY, WILMINGTON, DE. FILED 11-7-2002.

SPACERMAX

FOR UNPROCESSED SYNTHETIC RESIN USED IN THE MANUFACTURE OF CABLE FOR THE DATA COMMUNICATIONS INDUSTRY. (U.S. CLS. 1, 5, 6, 10, 26 AND 46).

SN 78-185,560. BIOPHYSIX, INC., SAN DIEGO, CA. FILED 11-15-2002.

MEMBREX

FOR BIOCHEMICALS, NAMELY, POLYMERS USED IN PHARMACEUTICAL, COSMETIC, SKIN CARE, AND HAIR CARE PRODUCTS MANUFACTURE (U.S. CLS. 1, 5, 6, 10, 26 AND 46).

SN 78-185,595. MARCHEM TECHNOLOGIES, LLC, PASO ROBLES, CA. FILED 11-15-2002.

MARCAMIDE

FOR CHEMICALS, NAMELY, ALKANOLAMIDES AND SURFACTANTS USED IN PERSONAL CARE PRODUCTS, INDUSTRIAL AND HOUSEHOLD CLEANERS, AND IN PETROLEUM PRODUCTION. (U.S. CLS. 1, 5, 6, 10, 26 AND 46).

CLASS 1—(Continued).

SN 78-185,832. INTERNATIONAL FLORA TECHNOLOGIES, LTD., GILBERT, AZ. FILED 11-16-2002.

AQUASOMES

FOR CHEMICAL ADDITIVES PREPARED FROM NATURAL PRODUCTS FOR USE IN THE MANUFACTURE OF COSMETIC AND PHARMACEUTICAL PRODUCTS (U.S. CLS. 1, 5, 6, 10, 26 AND 46).
FIRST USE 11-6-2002; IN COMMERCE 11-6-2002.

CLASS 2—PAINTS

SN 76-222,186. HR OPERATIONS, INC., LOGAN, UT. FILED 3-9-2001.

NHANCE

FOR WOOD SURFACE FINISHING AND REFINISHING COATINGS AND RESURFACING COATING, ALL THE AFOREMENTIONED FOR USE ON WOOD SURFACES, FURNITURE, FLOORS, CABINETS, DOORS, AND TRIM (U.S. CLS. 6, 11 AND 16).

SN 76-228,444. MICHELANGELO POMPEY PTY LIMITED, CASTLE HILL, NSW 2154, AUSTRALIA, FILED 3-21-2001.

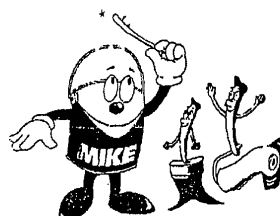

PRIORITY CLAIMED UNDER SEC. 44(D) ON AUSTRALIA APPLICATION NO. 863122, FILED 1-17-2001, REG. NO. 863122, DATED 1-17-2001, EXPIRES 1-17-2008.

THE MARK CONSISTS OF THE WORD MIKE AND A STYLIZED PAINT CAN, BRUSH AND PAINT ROLLER WITH HUMAN CHARACTERISTICS.

FOR INTERIOR AND EXTERIOR PAINTS (U.S. CLS. 6, 11 AND 16).

SN 76-387,958. DUNN-EDWARDS CORPORATION, LOS ANGELES, CA. FILED 3-28-2002.

EZ-PRIME

FOR PAINT PRIMER FOR EXTERIOR WOOD USE (U.S. CLS. 6, 11 AND 16).
FIRST USE 6-30-1977; IN COMMERCE 6-30-1977.

CLASS 2—(Continued).

SN 76-408,477. E. ALKO INC., CHATSWORTH, CA. FILED 5-15-2002.



NO CLAIM IS MADE TO THE EXCLUSIVE RIGHT TO USE "ORIGINAL AFTERMARKET MANUFACTURER", APART FROM THE MARK AS SHOWN.

FOR REMANUFACTURED TONER CARTRIDGES FOR LASER PRINTERS, COPIERS, INK JET PRINTERS AND FACSIMILE MACHINES, COPIER DRUM CARTRIDGES (U.S. CLS. 6, 11 AND 16).

FIRST USE 4-29-2002; IN COMMERCE 5-1-2002.

SN 76-417,759. MOTOR CITY FLOORING, L.L.C., DETROIT, MI. FILED 6-5-2002.

MUSCLEPRIME

FOR COATING FOR SEALING FLOORS (U.S. CLS. 6, 11 AND 16).

SN 76-421,944. ANTIQUE DRAPERY ROD COMPANY, DALLAS, TX. FILED 6-17-2002.

HEALTHY MILK PAINT

NO CLAIM IS MADE TO THE EXCLUSIVE RIGHT TO USE "MILK PAINT", APART FROM THE MARK AS SHOWN.

FOR INTERIOR AND EXTERIOR PAINT CONTAINING MILK (U.S. CLS. 6, 11 AND 16).

FIRST USE 5-22-2002; IN COMMERCE 5-30-2002.

SN 76-427,176. SNOW TREE ASSOCIATES, LLC, CAMBRIDGE SPRINGS, PA. FILED 7-3-2002.

SNOW TREE

FOR PROTECTIVE, WATERPROOF AND FIREPROOF COATINGS FOR USE IN AND BY THE HOME INDUSTRIAL, COMMERCIAL, AND RETAIL INDUSTRIES; AND PROTECTIVE, WATERPROOF, AND FIREPROOF COATINGS FOR USE ON AUTOMOTIVES, WOOD, METAL, LEATHER, RUBBER, VINYL, ARTWORK, NAMELY, COPPER, BRASS, BRONZE, AND GLASS, SLATE, TILE, STUCCO, PAPER, WICKER STONE, AND BRICK (U.S. CLS. 6, 11 AND 16).

CLASS 2—(Continued).

SN 76-435,040. AMERICAN POLYMERS INC., LAS VEGAS, NV. FILED 7-29-2002.

GAS-GUARD UHB TR-53

NO CLAIM IS MADE TO THE EXCLUSIVE RIGHT TO USE "UHB TR-53", APART FROM THE MARK AS SHOWN. FOR EPOXY COATING FOR USE ON CONCRETE INDUSTRIAL FLOORS (U.S. CLS. 6, 11 AND 16).

FIRST USE 4-2-1998; IN COMMERCE 4-2-1998.

SN 76-438,054. FUTURA COATINGS, INC., HAZELWOOD, MO. FILED 8-5-2002.

STYROTHANE

FOR AROMATIC AND ALIPHATIC POLYURETHANE COATING FOR USE IN THE FINISHING OF EXPANDED POLYSTYRENE AND ETHYL VINYL ACETATE PRODUCTS (U.S. CLS. 6, 11 AND 16).

FIRST USE 8-1-1987; IN COMMERCE 8-1-1987.

SN 76-449,934. LEX INTERNATIONAL, INC., PHOENIX, AZ. FILED 9-16-2002.



NO CLAIM IS MADE TO THE EXCLUSIVE RIGHT TO USE "ADVANCED PAINT SEALANT", APART FROM THE MARK AS SHOWN.

THE MARK CONSISTS OF THE WORD "LEX" CAPITALIZED IN BOLD LETTERS, UNDERScoreD BY THE WORDS "ADVANCED PAINT SEALANT PRODUCTS". A SWOOSH RUNS FROM THE LEFT SIDE AND OVER THE PRINTED WORDS. AN OVAL ENCIRCLES THE SWOOSH AND THE WORDS.

FOR PAINT PRESERVATIVE FOR AUTOMOBILES, AIRCRAFT AND BOATS IN THE NATURE OF A PAINT SEALANT (U.S. CLS. 6, 11 AND 16).

FIRST USE 12-18-2002; IN COMMERCE 12-18-2002.

SN 76-456,467. KOP-COAT, INC., PITTSBURGH, PA. FILED 10-7-2002.

BAZOOKA

FOR WOOD PRESERVATIVES FOR WOOD AND WOOD-BASED COMPOSITES FOR RESISTING DECAY, STAIN AND MOLD (U.S. CLS. 6, 11 AND 16).

CLASS 2—(Continued).

SN 76-463,233. C.P. PAINTS, INC., PALM BEACH GARDENS, FL. FILED 10-31-2002.

RAPID

FOR PAINT, PRIMERS, REDUCERS AND THINNERS FOR USE ON AUTOMOBILES (U.S. CLS. 6, 11 AND 16). FIRST USE 5-0-2002; IN COMMERCE 5-0-2002.

SN 78-185,705. PPG INDUSTRIES OHIO, INC., OHIO, OH. FILED 11-15-2002.

DURABED

FOR COATING COMPOSITIONS IN THE NATURE OF PAINT, NAMELY, PAINT FOR VEHICLES. (U.S. CLS. 6, 11 AND 16).

CLASS 3—COSMETICS AND CLEANING PREPARATIONS

SN 75-287,260. BEAUTE SANTE ENTREPRISE, B.S.E. S.A.R.L., F-35406 SAINT-MALO CEDEX, FRANCE, FILED 5-5-1997.

FLEUR'S

THE ENGLISH TRANSLATION OF "FLEURS" IS "FLOWERS".

FOR COSMETICS, NAMELY, SKIN CLEANSING PREPARATIONS, SKIN TONERS, SKIN PEELING MASKS, FACE CREAMS, BODY LOTIONS, BODY CREAMS, FACIAL MASKS, FACE MOISTURIZERS, BODY MOISTURIZERS, BATH OIL, AND PERFUME (U.S. CLS. 1, 4, 6, 50, 51 AND 52).

SN 75-400,049. COSMYL, INC., MEDLEY, FL. FILED 12-4-1997.

SPA THERAPIES

FOR BATH CARE PREPARATIONS, NAMELY AFTER BATH SPLASH, BATH AND BODY GEL, BATH OIL, BATH SALT, BODY LOTION, BODY SCRUB, BATH FOAM, SKIN CARE PREPARATIONS, NAMELY CLEANSING CREAM, MOISTURIZER, NON-MEDICATED SKIN GEL WITH ALOE VERA; FRAGRANCES, NAMELY PERFUMED SOAP; HAIR CARE PREPARATIONS NAMELY SHAMPOO AND CONDITIONER (U.S. CLS. 1, 4, 6, 50, 51 AND 52).

FIRST USE 8-1-1995; IN COMMERCE 8-1-1995.

CLASS 3—(Continued).

SN 75-894,013. LONGLOSTPERFUME.COM, INC., SAINT JAMES, NY. FILED 1-7-2000.

MOST PRECIOUS

FOR FRAGRANCE PRODUCTS, NAMELY, EAU DE TOILETTE (U.S. CLS. 1, 4, 6, 50, 51 AND 52). FIRST USE 9-0-1999; IN COMMERCE 9-0-1999.

SN 76-056,951. NOVABELLA, INC., POTTSVILLE, PA. FILED 5-26-2000.

MONSTER WASH

OWNER OF U.S. REG. NO. 2,396,424.
NO CLAIM IS MADE TO THE EXCLUSIVE RIGHT TO USE "WASH", APART FROM THE MARK AS SHOWN.
FOR SKIN CARE PRODUCTS, NAMELY MOISTURIZING CREAM, HAND SANITIZER AND BODY WASH; HAIR SHAMPOOS; AND SKIN SOAP (U.S. CLS. 1, 4, 6, 50, 51 AND 52).

SN 76-075,959. BOGARD, 75015 PARIS, FRANCE, FILED 6-23-2000.

The
TOOLS

PRIORITY CLAIMED UNDER SEC. 44(D) ON FRANCE APPLICATION NO. 99/831719, FILED 12-23-1999, REG. NO. 99/831719, DATED 12-23-1999, EXPIRES 12-23-2009.

FOR COSMETICS, NAMELY, EYE MAKE-UP, BLUSHES, MASCARAS, EYE SHADOWS, EYE GELS, EYE CREAMS, EYE PENCILS, EYE MAKE-UP REMOVERS, LIPSTICKS, BODY POWDERS, FACE POWDERS, MAKE-UP REMOVERS, COMPACTS CONTAINING MAKE-UP, TALCUM POWDERS, SKIN SOAPS, PERFUMES, BODY LOTIONS, HAIR LOTIONS, FACE LOTIONS, HAIR GELS, NAIL POLISHES, NAIL POLISH REMOVERS (U.S. CLS. 1, 4, 6, 50, 51 AND 52).

SN 76-109,827. MARY C MANNING LLC, NEW ROCHELLE, NY. FILED 8-16-2000.

SOMETHING BLUE

FOR PERFUMES, COLOGNE, EAU DE TOILETTES, BATH ADDITIVES NAMELY GELS, FOAMS, OILS AND NON-MEDICATED BATH SALTS, HAND AND BODY LOTIONS (U.S. CLS. 1, 4, 6, 50, 51 AND 52).

CLASS 3—(Continued).

SN 76-161,667. STEARNS PACKAGING CORPORATION, MADISON, WI. FILED 11-8-2000.

BRISK

FOR LAUNDRY DETERGENT (U.S. CLS. 1, 4, 6, 50, 51 AND 52).
FIRST USE 11-0-1974; IN COMMERCE 11-0-1974.

SN 76-211,117. CABOODLES COSMETICS, LLC, PIANO, IL. FILED 2-15-2001.

CHIX COSMETICS

NO CLAIM IS MADE TO THE EXCLUSIVE RIGHT TO USE "COSMETICS", APART FROM THE MARK AS SHOWN.
FOR COSMETICS (U.S. CLS. 1, 4, 6, 50, 51 AND 52).

SN 76-211,992. CONOPCO, INC., DBA LEVER BROTHERS COMPANY, NEW YORK, NY. FILED 2-16-2001.

RAIN PETALS

FOR BODY WASH, BODY MIST, FOAMING BATH GEL, BAR SOAP, BODY SPRAY AND BODY LOTION (U.S. CLS. 1, 4, 6, 50, 51 AND 52).

SN 76-244,649. REPUBLIC POWERED METALS, INC., MEDINA, OH. BY MERGER CONSOLIDATED COATINGS CORPORATION, DELTA, BRITISH COLUMBIA, CANADA, FILED 4-23-2001.

SWIRL

FOR CONCENTRATED CLEANER FOR USE ON EXTERIOR VINYL SIDING (U.S. CLS. 1, 4, 6, 50, 51 AND 52).

CLASS 3—(Continued).

SN 76-290,161. ART A FACE COSMETICS LIMITED, REMUERA, AUCKLAND, NEW ZEALAND, FILED 7-25-2001.

ART A FACE

PRIORITY CLAIMED UNDER SEC. 44(D) ON NEW ZEALAND APPLICATION NO. 636595, FILED 4-23-2001, REG. NO. 636595, DATED 10-25-2001, EXPIRES 4-23-2008.

FOR NON-MEDICATED SKIN CARE PREPARATIONS; BEAUTY CARE PRODUCTS, NAMELY, MUD MASKS, HYDRATING MASKS, BEAUTY MASKS, SKIN POLISHERS, FACIAL PEELS, FACE AND BODY LOTIONS AND CREAMS; ANTI-AGING FACE AND BODY LOTIONS AND CREAMS; ANTI-AGING EYE LOTIONS AND CREAMS; EYE LOTIONS AND CREAMS, SKIN MOISTURIZING LOTIONS AND CREAMS; NON-MEDICATED ANTI-AGING AND ANTI-OXIDANT FACE SERUMS; SKIN EXFOLIANTS AND FACE AND BODY SCRUBS; COSMETICS; BODY AND FACE SOAPS; PERFUME; ESSENTIALS OILS FOR PERSONAL USE; AND HAIR LOTIONS (U.S. CLS. 1, 4, 6, 50, 51 AND 52).

SN 76-295,525. SPENCER, ANGELINA MARIA, SAGAMORE HILLS, OH. FILED 8-6-2001.

E-SCENTUAL TOUCH

FOR BODY AND FACIAL SOAPS, PERFUMERY, BODY AND FACIAL LOTIONS, HERBAL FRAGRANCES FOR AROMATHERAPY (U.S. CLS. 1, 4, 6, 50, 51 AND 52).

SN 76-307,125. KONINKLIJKE SANDERS B.V., 2321 GL LEIDEN, NETHERLANDS, FILED 8-29-2001.

STARRY NIGHT

OWNER OF BENELUX REG. NO. 0683289, DATED 8-1-2001, EXPIRES 8-1-2011.

FOR SOAPS; PERFUMERY, NAMELY, PERFUMES, EAU DE TOILETTES; DEODORANTS FOR PERSONAL USE; HAIR LOTIONS; BODY LOTIONS; PRE- AND AFTER-SHAVE LOTIONS; BATH GELS; SHOWER GELS; SHAMPOOS; HAIR GELS (U.S. CLS. 1, 4, 6, 50, 51 AND 52).

SN 76-350,676. TEC SPECIALTY PRODUCTS, INC., SAINT PAUL, MN. FILED 12-19-2001.

EVERYDAY

FOR CLEANER FOR USE ON TILE AND STONE (U.S. CLS. 1, 4, 6, 50, 51 AND 52).

CLASS 3—(Continued).

SN 76-357,262. CELESTE INDUSTRIES CORP., EASTON, MD. FILED 1-10-2002.

SANI-SHINE

FOR DEGREASING PREPARATIONS NOT USED IN MANUFACTURING PROCESSES FOR USE IN THE AIRLINE, RAILROAD, SHIP, AND BUS INDUSTRIES; DEGREASING PREPARATIONS NOT USED IN MANUFACTURING PROCESSES FOR USE ON METAL, PLASTIC, VINYL, LEATHER, WOOD, LACQUERED, PAINTED, CONCRETE, UPHOLSTERED, CARPETED, AND GALLEY SURFACES; ALL-PURPOSE CLEANERS FOR USE OTHER THAN IN CONNECTION WITH THE TANNING INDUSTRY (U.S. CLS. 1, 4, 6, 50, 51 AND 52). FIRST USE 0-0-1996; IN COMMERCE 0-0-1996.

SN 76-376,473. L'OREAL, PARIS, FRANCE, FILED 2-28-2002.

VOLUM FITNESS

PRIORITY CLAIMED UNDER SEC. 44(D) ON FRANCE APPLICATION NO. 01/3.136.019, FILED 12-10-2001, REG. NO. 013136019, DATED 12-10-2001, EXPIRES 12-10-2011. OWNER OF U.S. REG. NO. 2,436,460.

THE ENGLISH TRANSLATION OF "VOLUM" IS "VOLUME".

FOR HAIR SHAMPOOS; GELS, SPRAYS, MOUSSES AND BALMS FOR HAIR STYLING AND HAIR CARE; HAIR LACQUERS; HAIR COLOURING AND HAIR DECOLORANT PREPARATIONS; PERMANENT WAVING AND CURLING PREPARATIONS; ESSENTIAL OILS FOR PERSONAL USE (U.S. CLS. 1, 4, 6, 50, 51 AND 52).

SN 76-378,691. BROUGHTON FARM SUPPLY, INC., BRIDPORT, VT. FILED 3-7-2002.



THE STIPPLING IS FOR SHADING PURPOSES ONLY FOR NON-MEDICATED HOOF BATH SOLUTION AND BATHING WATER CONDITIONER FOR THE CARE OF CATTLE (U.S. CLS. 1, 4, 6, 50, 51 AND 52). FIRST USE 12-7-2001; IN COMMERCE 12-7-2001.

SN 76-387,072. BRING IT UP, INC., WESTLAKE VILLAGE, CA. FILED 3-26-2002.

BRING IT UP

FOR ADHESIVES FOR COSMETIC USE, NAMELY FOR BROW, BREAST AND NECK LIFTS (U.S. CLS. 1, 4, 6, 50, 51 AND 52). FIRST USE 7-0-2001; IN COMMERCE 7-0-2001.

CLASS 3—(Continued).

SN 76-387,838. ANNAYAKE, 75008 PARIS, FRANCE, FILED 3-25-2002.



PRIORITY CLAIMED UNDER SEC. 44(D) ON FRANCE APPLICATION NO. 013123175, FILED 9-27-2001, REG. NO. 013123175, DATED 9-27-2001, EXPIRES 9-27-2011.

"ANNAYAKE" IS NOT THE NAME OF A LIVING INDIVIDUAL.

THE NON-LATIN CHARACTERS IN THE MARK TRANSLITERATE TO "NATSUMI" AND THIS TRANSLATES TO "BEAUTY OF SUMMER".

FOR PERFUMERY, NAMELY TOILET WATERS, PERFUMES, DEODORANTS FOR PERSONAL USE; COSMETICS, NAMELY BEAUTY CREAMS FOR THE FACE AND THE BODY, FRESH SKIN, FACIAL AND BODY LOTIONS FOR PERSONAL USE, MASCARAS, ESSENTIAL OILS FOR PERSONAL USE; SOAPS, PERFUMED SOAPS AND HAIR LOTIONS AND TOOTHPASTE (U.S. CLS. 1, 4, 6, 50, 51 AND 52).

SN 76-391,612. EB5 CORPORATION, PORTLAND, OR. FILED 4-4-2002.



THE MARK REPRESENTS THE LIKENESS OF A LIVING INDIVIDUAL WHOSE CONSENT IS OF RECORD.

FOR CREAMS AND LOTION FOR THE HAIR, SKIN, AND BODY (U.S. CLS. 1, 4, 6, 50, 51 AND 52). FIRST USE 6-0-1979; IN COMMERCE 6-0-1979.

CLASS 3—(Continued).

SN 76-392,651. CONCEPT II COSMETICS, INC., MIAMI, FL.
FILED 4-1-2002.



NO CLAIM IS MADE TO THE EXCLUSIVE RIGHT TO USE "BEBE", APART FROM THE MARK AS SHOWN.

THE ENGLISH TRANSLATION OF THE WORD "BEBE" IS "BABY".

FOR CLEANSING MILK, BABY WASH, BABY SHAMPOO, BABY OIL, BABY POWDER, BODY LOTION, SPLASH COLOGNE, AND NEUTRAL SOAP (U.S. CLS. 1, 4, 6, 50, 51 AND 52).

CLASS 3—(Continued).

SN 76-401,123. URBAN BOTANICA, INC., NEW YORK, NY.
FILED 5-1-2002.

URBAN BOTANICA

FOR BATH, BEAUTY, BODY, PERSONAL CARE AND SKINCARE PRODUCTS, NAMELY HAIR OILS, HAIR SHAMPOOS, HAIR CONDITIONERS, HAIR RINSES, HAIR SPRAYS, POMADES, BODY SPRITZES, BODY CREAMS, BODY BUTTERS, HAND CREAMS, BODY OILS, MASSAGE OILS, BATH GELS, BUBBLE BATH, SKIN TONERS, FACE AND BODY CLEANSERS, FACE AND BODY MASKS, FACIAL MOISTURIZERS, BODY MOISTURIZERS, FACIAL OILS, CUTICLE CREAMS, HAND CREAMS, BODY LOTIONS, FACIAL CREAMS, SKIN CREAMS, BODY BALMS, BODY WASHES, SOAPS; BODY OILS, HERBAL SALVES, AND BODY LOTIONS (U.S. CLS. 1, 4, 6, 50, 51 AND 52).

FIRST USE 3-25-2002; IN COMMERCE 4-17-2002.

SN 76-402,338. KOSE CORPORATION, TOKYO, JAPAN,
FILED 4-29-2002.

AGE RELEASE

FOR COSMETICS, PERFUMES, COSMETIC SOAPS FOR USE ON FACE AND HAIR LOTIONS (U.S. CLS. 1, 4, 6, 50, 51 AND 52).

SN 76-399,603. TECH ENTERPRISES INC., MADISON, WI.
FILED 4-22-2002.



NO CLAIM IS MADE TO THE EXCLUSIVE RIGHT TO USE "STAIN REMOVER", APART FROM THE MARK AS SHOWN.

FOR STAIN REMOVERS, CARPET CLEANERS AND HOUSEHOLD CLEANING PREPARATIONS (U.S. CLS. 1, 4, 6, 50, 51 AND 52).

FIRST USE 6-1-1985; IN COMMERCE 6-1-1985.

SN 76-402,971. GUM HAIR COMPANY LIMITED, ROMSEY,
HAMPSHIRE, UNITED KINGDOM, FILED 5-2-2002.

THE BIZ 4 FRIZZ

OWNER OF UNITED KINGDOM REG. NO. 2267613,
DATED 9-14-2001, EXPIRES 9-14-2008.

FOR HAIR CARE PREPARATIONS; HAIR LOTIONS; HAIR SHAMPOOS; HAIR CONDITIONERS; PRODUCTS FOR HAIR STYLING, HAIR HOLDING AND COLOURING, NAMELY, HAIR GELS, HAIR LIQUIDS, HAIR EMULSIONS, HAIR WAXES, HAIR PUTTIES, HAIR POMADES AND HAIR SPRAYS (U.S. CLS. 1, 4, 6, 50, 51 AND 52).

SN 76-403,778. SARATHI INTERNATIONAL INC., BANGALORE, INDIA, FILED 4-29-2002.

SARATHI

FOR INCENSE STICKS, DHOOP AND PERFUME (U.S. CLS. 1, 4, 6, 50, 51 AND 52).

CLASS 3—(Continued).

SN 76-403,779. SARATHI INTERNATIONAL INC., BANGALORE, INDIA, FILED 4-29-2002.

TULASI

FOR INCENSE STICKS, DHOOP AND PERFUME (U.S. CLS. 1, 4, 6, 50, 51 AND 52).

SN 76-403,959. SEXY HAIR CONCEPTS, LLC, CHATSWORTH, CA. FILED 5-3-2002.



FOR PERSONAL CARE PRODUCTS FOR WOMEN, NAMELY SKIN CLEANSING GELS AND LOTIONS (U.S. CLS. 1, 4, 6, 50, 51 AND 52).
FIRST USE 10-15-2000; IN COMMERCE 10-15-2000.

SN 76-409,776. TROPICAL FOREST COSMETICS, HOLLY HILL, FL. FILED 5-17-2002.

CELUTONE

FOR LIQUID GELS AND LOTIONS THAT HELP FIRM SKIN (U.S. CLS. 1, 4, 6, 50, 51 AND 52).
FIRST USE 5-7-2002; IN COMMERCE 5-7-2002.

SN 76-411,812. GRAPSEED OIL AUSTRALIA PTY LTD, TENERIFFE QUEENSLAND 4005, AUSTRALIA, FILED 5-23-2002.



DO YOUR BODY A FAVOR
GSO

THE DESIGN PORTION OF THE MARK IS COMPRISED OF A BISECTED GRAPE.
FOR SOAPS FOR PERSONAL USE, PERFUMERY, ESSENTIAL OILS FOR PERSONAL USE, COSMETICS AND HAIR LOTIONS (U.S. CLS. 1, 4, 6, 50, 51 AND 52).

CLASS 3—(Continued).

SN 76-411,813. GRAPSEED OIL AUSTRALIA PTY LTD, TENERIFFE QUEENSLAND 4005, AUSTRALIA, FILED 5-23-2002.



DO YOUR SKIN A FAVOR
GSO

THE DESIGN PORTION OF THE MARK IS COMPRISED OF A BISECTED GRAPE.
FOR SOAPS FOR PERSONAL USE, PERFUMERY, ESSENTIAL OILS FOR PERSONAL USE, COSMETICS AND HAIR LOTIONS (U.S. CLS. 1, 4, 6, 50, 51 AND 52).

SN 76-415,826. KAO KABUSHIKI KAISHA, TA KAO CORPORATION, CHUO-KU, TOKYO 103-8210, JAPAN, BY ASSIGNMENT JOHN FRIEDA PROFESSIONAL HAIR CARE, INC., WILTON, CT. FILED 6-4-2002.

SPUN GOLD

FOR HAIR SHAPING AND HIGHLIGHTING BALM (U.S. CLS. 1, 4, 6, 50, 51 AND 52).
FIRST USE 9-0-1998; IN COMMERCE 9-0-1998.

SN 76-417,379. LEMAX, SAN DIEGO, CA. FILED 6-3-2002.



THE MARK CONSISTS OF STYLIZED LETTERING; THE WORD "CARE" IS DISPLAYED ON BLOCKS.
FOR BABY SHAMPOO, BABY OIL, PETROLEUM JELLY FOR COSMETIC PURPOSES, BABY POWDER, BABY LOTION, HAND CREAM, BABY WIPES, BUBBLE BATH, HAIR STYLING GELS, SHOWER GEL SCENTED BODY SPRAY, AND ANTI-BACTERIAL SOAP (U.S. CLS. 1, 4, 6, 50, 51 AND 52).
FIRST USE 4-2-2002; IN COMMERCE 4-2-2002.

CLASS 3—(Continued).

SN 76-417,380. LEMAX, SAN DIEGO, CA. FILED 6-3-2002.



THE FOREIGN WORDING IN THE MARK TRANSLATES INTO ENGLISH AS "SATEN".

FOR HAIR CARE PRODUCTS, NAMELY, SHAMPOOS, CONDITIONERS, STYLING GELS, AND HAIR SPRAY; SCENTED BODY SPRAYS, SHOWER GEL, HAND CREAM, AND SKIN LOTION (U.S. CLS. 1, 4, 6, 50, 51 AND 52).

FIRST USE 4-2-2002; IN COMMERCE 4-2-2002.

SN 76-418,443. LUMACHEM, INC., WEST JORDAN, UT. FILED 6-7-2002.

QUICKWHITE

FOR DENTAL BLEACH (U.S. CLS. 1, 4, 6, 50, 51 AND 52).

FIRST USE 4-16-1997; IN COMMERCE 4-16-1997.

SN 76-421,772. ROE, KEITH A., TA ARISTOWAX PRODUCTS OF NORWICH, BURNSVILLE, NC. FILED 6-18-2002.

WOOD SILK

NO CLAIM IS MADE TO THE EXCLUSIVE RIGHT TO USE "WOOD", APART FROM THE MARK AS SHOWN. FOR FURNITURE POLISH (U.S. CLS. 1, 4, 6, 50, 51 AND 52).

SN 76-428,389. CASTER, 75008 PARIS, FRANCE, FILED 7-9-2002.

PHYTOBAUME

FOR HAIR CARE PREPARATIONS, NAMELY, BALM AND CREAM FOR DISENTANGLING AND BEAUTIFYING THE HAIR (U.S. CLS. 1, 4, 6, 50, 51 AND 52).

FIRST USE 9-0-1986; IN COMMERCE 12-0-1989.

CLASS 3—(Continued).

SN 76-428,390. CASTER, 75008 PARIS, FRANCE, FILED 7-9-2002.

PHYTOSESAME

FOR HAIR CARE PREPARATIONS, NAMELY, MASKS AND CREAMS TO PROTECT AND TO BEAUTIFY THE HAIR (U.S. CLS. 1, 4, 6, 50, 51 AND 52).

FIRST USE 5-0-1994; IN COMMERCE 12-0-1994.

SN 76-433,798. LANCOME PARFUMS ET BEAUTE & CIE, PARIS, FRANCE, FILED 7-24-2002.

DERMOTOX

PRIORITY CLAIMED UNDER SEC. 44(D) ON FRANCE APPLICATION NO. 02/3.146.952, FILED 2-11-2002, REG. NO. 023146952, DATED 2-11-2002, EXPIRES 2-11-2012.

FOR NON-MEDICATED SKIN CARE PREPARATIONS, NAMELY, COSMETICS (U.S. CLS. 1, 4, 6, 50, 51 AND 52).

SN 76-433,799. LABORATOIRE GARNIER & CIE, PARIS, FRANCE, FILED 7-24-2002.

MENBOOST

PRIORITY CLAIMED UNDER SEC. 44(D) ON FRANCE APPLICATION NO. 02/3.172.503, FILED 7-4-2002, REG. NO. 023172503, DATED 7-4-2002, EXPIRES 7-4-2012.

FOR PERFUME; TOILET SOAPS; TOILET WATER; BATH GELS AND SALTS; PERSONAL DEODORANTS; COSMETIC CREAMS, GELS, LOTIONS, MILKS AND POWDERS FOR THE BODY, FACE AND HANDS; SUN CARE CREAMS AND LOTIONS; SUN BLOCK AND SCREEN PREPARATIONS; MAKEUP; SHAMPOO; HAIR CONDITIONERS, GEL, MOUSSE AND SPRAY; HAIR COLOR; HAIR COLOR REMOVERS; HAIR PERMANENT CURL AND WAVE PREPARATIONS; AND ESSENTIAL OILS FOR PERSONAL USE (U.S. CLS. 1, 4, 6, 50, 51 AND 52).

SN 76-436,636. CABOODLES COSMETICS, LP, PLANO, IL. FILED 8-1-2002.



FOR COSMETICS (U.S. CLS. 1, 4, 6, 50, 51 AND 52).

CLASS 3—(Continued).

SN 76-443,157. LABORATOIRE GARNIER & CIE, PARIS, FRANCE, FILED 8-23-2002.

MENCOCOON

PRIORITY CLAIMED UNDER SEC. 44(D) ON FRANCE APPLICATION NO. 02/3.177.173, FILED 7-30-2002, REG. NO. 02/3.177.173, DATED 7-30-2002, EXPIRES 7-30-2012.

FOR PERFUME, TOILET WATER; GELS, SALTS FOR THE BATH AND THE SHOWER NOT FOR MEDICAL PURPOSE; TOILET SOAPS; BODY DEODORANTS; COSMETICS, NAMELY, CREAMS, MILKS, LOTIONS, GELS AND POWDERS FOR THE FACE, THE BODY AND THE HANDS; COSMETIC SUN CARE PREPARATIONS; MAKE-UP PREPARATIONS; SHAMPOOS; GELS, SPRAYS, MOUSSES AND BALMS FOR THE HAIR STYLING AND HAIR CARE; HAIR LACQUERS; HAIR COLOURING AND HAIR DECOLORANT PREPARATIONS; PERMANENT WAVING AND CURLING PREPARATIONS; ESSENTIAL OILS FOR PERSONAL USE (U.S. CLS. 1, 4, 6, 50, 51 AND 52).

SN 76-448,821. LANCOME PARFUMS ET BEAUTE & CIE, PARIS, FRANCE, FILED 9-12-2002.

INSTA-LIFT MASQUE

OWNER OF FRANCE REG. NO. 013128492, DATED 10-29-2001, EXPIRES 10-29-2011.

NO CLAIM IS MADE TO THE EXCLUSIVE RIGHT TO USE "MASQUE", APART FROM THE MARK AS SHOWN, FOR FACIAL MASK (U.S. CLS. 1, 4, 6, 50, 51 AND 52).

SN 76-453,960. UNITED STATES SOAP CORPORATION, LEESBURG, VA. FILED 9-30-2002.

KONA

FOR BAR SKIN SOAP, LIQUID SOAPS FOR HANDS, FACE, AND BODY; HAIR SHAMPOOS; HAIR CONDITIONER; BODY WASH; BATH FOAM; SHOWER GEL (U.S. CLS. 1, 4, 6, 50, 51 AND 52).

CLASS 3—(Continued).

SN 76-455,601. DJR HOLDINGS, LLC, NEW YORK, NY, FILED 10-1-2002.

DEF JAM WRESTLING

OWNER OF U.S. REG. NOS. 1,790,206, 2,361,626 AND OTHERS.

FOR FACIAL MAKEUP, CONCEALERS, BLUSHERS, FACIAL POWDERS, FOUNDATION MAKEUP, EYE MAKEUP, EYE PENCILS, EYEBROW PENCILS, MASCARA, FALSE EYELASHES, COSMETIC PENCILS, LIPSTICK, NON-MEDICATED LIP BALM, LIP GLOSS, LIP PENCILS, MAKEUP REMOVERS, MAKEUP APPLICATORS IN THE NATURE OF COTTON SWABS AND COTTON STICKS FOR COSMETIC PURPOSES, FACIAL CLEANSERS, TONERS, FACIAL EXFOLIANTS, FACIAL CREAMS, FACIAL LOTIONS AND NON-MEDICATED FACIAL TREATMENTS IN THE NATURE OF MASKS, CREAMS, POWDERS, SOAPS AND SCRUBS, NAIL CARE PREPARATIONS, NAIL POLISHES, NAIL POLISH REMOVERS, NAIL CREAMS, HAND CREAMS, BATH BEADS, BATH CRYSTALS, BATH FOAM, BATH GELS, BATH OILS, NON-MEDICATED BATH SALTS, BODY CLEANSERS, BODY FRAGRANCES FOR PERSONAL USE, BODY LOTIONS, BODY CONDITIONERS, BODY GELS, BODY POWDERS, BODY EXFOLIANTS, BODY CREAMS, SUNSCREEN PREPARATIONS, SUNTANNING PREPARATIONS, SELF-TANNING PREPARATIONS, AFTER-SUN LOTIONS, PERFUMES, COLOGNES, TOOTHPASTE, PERSONAL DEODORANT; HAIR CARE PRODUCTS, NAMELY, SHAMPOOS, CONDITIONERS, MOUSSE, GELS AND CREAMS; COSMETICS; SHAVING CREAMS; SHAVING GELS; SHAVING LOTIONS; SHAVING PREPARATIONS (U.S. CLS. 1, 4, 6, 50, 51 AND 52).

SN 76-455,626. DJR HOLDINGS, LLC, NEW YORK, NY, FILED 10-1-2002.

DEF JAM VENDETTA

OWNER OF U.S. REG. NOS. 1,790,206, 2,361,626 AND OTHERS.

FOR FACIAL MAKEUP, CONCEALERS, BLUSHERS, FACIAL POWDERS, FOUNDATION MAKEUP, EYE MAKEUP, EYE PENCILS, EYEBROW PENCILS, MASCARA, FALSE EYELASHES, COSMETIC PENCILS, LIPSTICK, NON-MEDICATED LIP BALM, LIP GLOSS, LIP PENCILS, MAKEUP REMOVERS, MAKEUP APPLICATORS IN THE NATURE OF COTTON SWABS AND COTTON STICKS FOR COSMETIC PURPOSES, FACIAL CLEANSERS, TONERS, FACIAL EXFOLIANTS, FACIAL CREAMS, FACIAL LOTIONS AND NON-MEDICATED FACIAL TREATMENTS IN THE NATURE OF MASKS, CREAMS, POWDERS, SOAPS AND SCRUBS, NAIL CARE PREPARATIONS, NAIL POLISHES, NAIL POLISH REMOVERS, NAIL CREAMS, HAND CREAMS, BATH BEADS, BATH CRYSTALS, BATH FOAM, BATH GELS, BATH OILS, NON-MEDICATED BATH SALTS, BODY CLEANSERS, BODY FRAGRANCES FOR PERSONAL USE, BODY LOTIONS, BODY CONDITIONERS, BODY GELS, BODY POWDERS, BODY EXFOLIANTS, BODY CREAMS, SUNSCREEN PREPARATIONS, SUNTANNING PREPARATIONS, SELF-TANNING PREPARATIONS, AFTER-SUN LOTIONS, PERFUMES, COLOGNES, TOOTHPASTE, PERSONAL DEODORANT; HAIR CARE PRODUCTS, NAMELY, SHAMPOOS, CONDITIONERS, MOUSSE, GELS AND CREAMS; COSMETICS; SHAVING CREAMS; SHAVING GELS; SHAVING LOTIONS; SHAVING PREPARATIONS (U.S. CLS. 1, 4, 6, 50, 51 AND 52).

CLASS 3—(Continued).

SN 76-456,994. RACHEL PERRY, INC., VAN NUYS, CA. FILED 10-7-2002.

AGE UNKNOWN

FOR SKIN CLEANSING LOTION, SELF HEATING SCRUB AND MASK FOR THE FACE, SKIN FIRING CREAM GEL SERUM, BODY CLEANSING WASH, GEL AND LOTION, BODY SCRUB, BODY FIRING GEL FOR THE SKIN (U.S. CLS. 1, 4, 6, 50, 51 AND 52).

SN 76-457,109. HANAHAH, BARBARA C., ARLINGTON HEIGHTS, IL. AND KORNECKI, LYNNE D., ARLINGTON HEIGHTS, IL. FILED 10-9-2002.

SOAP STUDS

FOR COSMETIC: TOILET PREPARATIONS AND TOILETRIES, NAMELY, COLOGNE, BODY SOAPS, BATH SALTS, FOOT POWDER, FOOT SPRAY, FOOT SOAK SOLUTIONS, HAND AND BODY LOTIONS AND MASSAGE OIL (U.S. CLS. 1, 4, 6, 50, 51 AND 52).

SN 76-457,110. HANAHAH, BARBARA C., ARLINGTON HEIGHTS, IL. AND KORNECKI, LYNNE D., ARLINGTON HEIGHTS, IL. FILED 10-9-2002.



NO CLAIM IS MADE TO THE EXCLUSIVE RIGHT TO USE "MEN'S TOILETRIES", APART FROM THE MARK AS SHOWN.

FOR COSMETICS; TOILET PREPARATIONS AND TOILETRIES, NAMELY, COLOGNE, BODY SOAPS, BATH SALTS, FOOT POWDER, FOOT SPRAY, FOOT SOAK SOLUTIONS, HAND AND BODY LOTIONS AND MASSAGE OIL (U.S. CLS. 1, 4, 6, 50, 51 AND 52).

SN 76-457,254. HERBACEUTICALS, INC., NAPA, CA. FILED 10-10-2002.

LIGAID

FOR NON-MEDICATED SKIN CARE PREPARATIONS, NAMELY, NON-MEDICATED RUBBING COMPOUNDS FOR THE RELIEF OF SORE MUSCLES AND JOINTS (U.S. CLS. 1, 4, 6, 50, 51 AND 52).

FIRST USE 5-1-2002; IN COMMERCE 5-1-2002.

CLASS 3—(Continued).

SN 76-464,874. PRESTONE PRODUCTS CORPORATION, DANBURY, CT. FILED 11-6-2002.



OWNER OF U.S. REG. NOS. 181,657, 2,465,619 AND OTHERS.

THE MARK CONSISTS OF A BLACK OVAL WITH A GRAY BORDER WITH THE WORDS "PRESTONE PROTECTION INSIDE & OUT" APPEARING INSIDE THE OVAL IN BLOCK WHITE LETTERING. BENEATH THE TERM "PRESTONE" IS A SPECTRUM COLOR BAR DESIGN IN WHICH COLOR, INCLUDING DARK BLUE, MEDIUM BLUE, PINK, RED, GOLD AND YELLOW, ARE ARRANGED IN GRADATIONS AND AN OVERLAPPING MANNER. THE COLOR BAR IS CLAIMED AS A FEATURE OF THE MARK.

FOR PREPARATIONS FOR CLEANING, WAXING AND POLISHING AUTOMOBILE BODIES AND SURFACES, INCLUDING BUT NOT LIMITED TO WHEELS, TIRES, GLASS, CARPET AND UPHOLSTERY (U.S. CLS. 1, 4, 6, 50, 51 AND 52).

SN 76-464,917. PALM BEACH TAN, INC., CARROLLTON, TX. FILED 11-6-2002.



OWNER OF U.S. REG. NOS. 2,377,171 AND 2,582,098. THE STIPPLING SHOWN IS A FEATURE OF THE MARK AND NOT INTENDED TO INDICATE COLOR.

FOR LOTIONS AND SKIN PRODUCTS, NAMELY, EXFOLIATING LOTIONS, SELF-TANNING LOTIONS, TAN ENHANCING MOISTURIZING LOTIONS, SUN-TANNING PREPARATIONS, SUN SCREEN AND SKIN MOISTURIZERS (U.S. CLS. 1, 4, 6, 50, 51 AND 52).

FIRST USE 1-0-2001; IN COMMERCE 1-0-2001.

SN 76-466,289. BIO-BOTANICA, INC., HAUPPAUGE, NY. FILED 11-4-2002.

PERIOSCRIPT

FOR DENTAL RINSES, NAMELY NON MEDICATED ORAL IRRIGATOR SOLUTIONS (U.S. CLS. 1, 4, 6, 50, 51 AND 52).

CLASS 3—(Continued).

SN 76-467,672. INTERNATIONAL LABORATORY TECHNOLOGY CORP., MIAMI, FL. FILED 11-7-2002.

PURE WASH

NO CLAIM IS MADE TO THE EXCLUSIVE RIGHT TO USE "WASH", APART FROM THE MARK AS SHOWN.
FOR ANTIBACTERIAL SOAP (U.S. CLS. 1, 4, 6, 50, 51 AND 52).

SN 76-468,014. JOHN PAUL MITCHELL SYSTEMS, SAUGUS, CA. FILED 11-12-2002.

SHAMPOO ONE

NO CLAIM IS MADE TO THE EXCLUSIVE RIGHT TO USE "SHAMPOO", APART FROM THE MARK AS SHOWN.
FOR HAIR CARE PREPARATIONS, NAMELY HAIR SHAMPOOS (U.S. CLS. 1, 4, 6, 50, 51 AND 52).
FIRST USE 2-1-1980; IN COMMERCE 2-1-1980.

SN 76-468,567. CHESEBROUGH-POND'S INC., WILMINGTON, DE. FILED 11-13-2002.

NUTRIUM

OWNER OF U.S. REG. NOS. 1,952,728, 2,341,890 AND 2,534,123.
FOR ANTI-PERSPIRANT AND DEODORANT (U.S. CLS. 1, 4, 6, 50, 51 AND 52).

SN 76-471,693. MADISON PARK GREETINGS, INC., SEATTLE, WA. FILED 11-25-2002.

SIMPLE STYLE

FOR SKIN SOAP, BODY AND SKIN LOTION AND BATH GEL (U.S. CLS. 1, 4, 6, 50, 51 AND 52).

SN 76-471,944. THE F.A.C.E. COMPANY, L.L.C., WILMINGTON, DE. FILED 11-26-2002.

PROLIFERA

FOR SKIN CREAMS (U.S. CLS. 1, 4, 6, 50, 51 AND 52).
FIRST USE 11-1-2002; IN COMMERCE 11-11-2002.

CLASS 3—(Continued).

SN 76-471,975. MADISON PARK GREETINGS, INC., SEATTLE, WA. FILED 11-25-2002.

LUSH LIFE

FOR SKIN SOAP, BODY AND SKIN LOTION AND BATH GEL (U.S. CLS. 1, 4, 6, 50, 51 AND 52).

SN 76-471,976. MADISON PARK GREETINGS, INC., SEATTLE, WA. FILED 11-25-2002.

PERFECTLY PAMPERED

FOR SKIN SOAP, BODY AND SKIN LOTION AND BATH GEL (U.S. CLS. 1, 4, 6, 50, 51 AND 52).

SN 76-471,977. MADISON PARK GREETINGS, INC., SEATTLE, WA. FILED 11-25-2002.

LU-DELUXE

FOR SKIN SOAP, BODY AND SKIN LOTION AND BATH GEL (U.S. CLS. 1, 4, 6, 50, 51 AND 52).

SN 76-471,978. MADISON PARK GREETINGS, INC., SEATTLE, WA. FILED 11-25-2002.

FABULOUS FUN

FOR SKIN SOAP, BODY AND SKIN LOTION AND BATH GEL (U.S. CLS. 1, 4, 6, 50, 51 AND 52).

SN 76-473,051. NEUTROGENA CORPORATION, LOS ANGELES, CA. FILED 12-6-2002.

T/GEL DAILY CONTROL

OWNER OF U.S. REG. NOS. 1,154,426 AND 1,780,985.
FOR SHAMPOO, CONDITIONERS AND STYLING GELS (U.S. CLS. 1, 4, 6, 50, 51 AND 52).

SN 76-477,362. PUREOLOGY RESEARCH, LLC, IRVINE, CA. FILED 12-23-2002.

SHINEMAX

FOR HAIR CARE AND HAIR STYLING PREPARATIONS (U.S. CLS. 1, 4, 6, 50, 51 AND 52).

CLASS 3—(Continued).

SN 76-480,150. DJR HOLDINGS, LLC, NEW YORK, NY.
FILED 12-26-2002.

DEF JAM

FOR FACIAL MAKEUP, CONCEALERS, BLUSHERS, FACIAL POWDERS, FOUNDATION MAKEUP, EYE MAKEUP, EYE PENCILS, EYEBROW PENCILS, MASCARA, FALSE EYELASHES, COSMETIC PENCILS, LIPSTICK, LIP GLOSS, LIP PENCILS, MAKEUP REMOVERS, MAKEUP APPLICATORS IN THE NATURE OF COTTON SWABS FOR COSMETIC PURPOSES, FACIAL CLEANSERS, TONERS, FACIAL EXFOLIANTS, FACIAL CREAMS, FACIAL LOTIONS AND NON-MEDICATED FACIAL TREATMENTS IN THE NATURE OF MASKS, CREAMS, POWDERS, SOAPS AND SCRUBS, NAIL CARE PREPARATIONS, NAIL POLISHES, NAIL POLISH REMOVERS, NAIL CREAMS, HAND CREAMS, BATH BEADS, BATH CRYSTALS, BATH FOAM, BATH GELS, BATH OILS, NON-MEDICATED BATH SALTS, SKIN CLEANSERS, BODY SCRUBS, BODY FRAGRANCES FOR PERSONAL USE, BODY LOTIONS, BODY CONDITIONERS, BODY GELS, BODY POWDERS, BODY EXFOLIANTS, BODY CREAMS, SUNSCREEN PREPARATIONS, SUNTANNING PREPARATIONS AND AFTER-SUN LOTIONS; SELF-TANNING PREPARATIONS, NAMELY, SELF TANNING MILK AND CREAM, ACCELERATED TANNING CREAM, SELF-TANNING LOTIONS, GELS AND SPRAYS; PERFUMES, COLOGNES, TOOTHPASTE AND PERSONAL DEODORANT; HAIR CARE PRODUCTS, NAMELY, SHAMPOOS, CONDITIONERS, MOUSSE, GELS, HAIR REMOVING CREAMS AND HAIR CARE CREAM PREPARATIONS; COSMETICS (U.S. CLS. 1, 4, 6, 50, 51 AND 52).

SN 78-049,598. WASSERMAN, STEVEN, M, BEVERLY HILLS, CA. FILED 2-21-2001.

CUM-KLEEN

FOR PERSONAL CLEANING MOIST TOWELETTE (U.S. CLS. 1, 4, 6, 50, 51 AND 52).
FIRST USE 2-1-2001; IN COMMERCE 2-1-2001.

CLASS 3—(Continued).

SN 78-073,918. TAKE CO., TOKYO, JAPAN, FILED 7-13-2001.

麗姿
Reishi

THE ENGLISH TRANSLATION OF THE WORD "REISHI" IN THE MARK IS "AN ELEGANT FIGURE". THE NON-LATIN CHARACTERS IN THE MARK TRANSLITERATE TO "REISHI" AND THIS MEANS "AN ELEGANT FIGURE" IN ENGLISH.

FOR LIPSTICK, MASCARA, ROUGE, BLUSHER, SUN MILK, SUN SCREEN LOTION, SUNSCREEN CREAM, SUN OIL, SUNTAN OIL, SKIN LOTION, EYE LINER, EYE SHADOW, MEDICATED SKIN CREAM, TOILET WATER, COLD CREAM, COSMETIC COMPACT CONTAINING POWDER, CLEANSING SKIN CREAM, FOUNDATION CREAM, FACE POWDER, SKIN WHITENING CREAM, SKIN WHITENING CREAM, HAND CREAM, PERFUME, HAIR CONDITIONER, HAIR CREAM, COSMETIC FACE POWDER, EYEBROW PENCIL, SKIN-CLEANSING CREAM, BATH SOAP, BEAUTY SOAP, SHAMPOO, CREAM SOAP, HAIR RINSE AND TOILET SOAP (U.S. CLS. 1, 4, 6, 50, 51 AND 52).

SN 78-090,701. ANDA, INC., DAVIE, FL. FILED 10-29-2001.

RESTOREX

FOR SKIN ABRASIVE PREPARATIONS, CLARIFIERS, CLEANSERS, CREAM, EMOLLIENTS, AND LOTION; COSMETICS, NAMELY CONCEALERS, FOUNDATIONS, LIPSTICK, MASCARA, AND TONERS (U.S. CLS. 1, 4, 6, 50, 51 AND 52).

SN 78-105,145. RECKITT BENCKISER N.V., HOOFDDORP, NETHERLANDS, FILED 1-28-2002.

JET-DRY

OWNER OF U.S. REG. NOS. 700,766 AND 1,984,490.
FOR DISHWASHER PRODUCTS, NAMELY, DETERGENT, RINSE/DRYING AGENT, ANTI-SPOTTING AGENT AND DISHWASHER CLEANER (U.S. CLS. 1, 4, 6, 50, 51 AND 52).
FIRST USE 10-1-1958; IN COMMERCE 3-1-2001.

CLASS 3—(Continued).

SN 78-116,697. COLGATE-PALMOLIVE COMPANY, NEW YORK, NY. FILED 3-21-2002.

COLGATE PURE WHITE

OWNER OF U.S. REG. NOS. 60,595, 427,475 AND OTHERS. NO CLAIM IS MADE TO THE EXCLUSIVE RIGHT TO USE "WHITE", APART FROM THE MARK AS SHOWN.

FOR ORAL CARE PRODUCTS, NAMELY, TOOTH-PASTE (U.S. CLS. 1, 4, 6, 50, 51 AND 52).

SN 78-123,162. VAN CAO, GARLAND, TX. FILED 4-22-2002.

PRO 2000

NO CLAIM IS MADE TO THE EXCLUSIVE RIGHT TO USE "PRO", APART FROM THE MARK AS SHOWN.

FOR CLASS 3— BEAUTY NAIL CARE PRODUCTS AND ACCESSORIES NAMELY; POLISHES, CREAMS, BUFFING LOTIONS, CLEANSING LOTIONS, ARTIFICIAL FINGERNAILS AND PRODUCTS USED IN APPLYING, SCULPTING, AND REMOVING ARTIFICIAL FINGERNAILS, NAMELY, NAIL TIPS, ACRYLIC LIQUID AND POWDER, PREPARATION PRIMER, ADHESIVE GLUE, APPLICATION GEL, GEL HARDENER, SILK WRAPS, LIQUID SEALER, LIQUID NAIL REMOVER, AND LIQUID FINISHING BLENDS, NAIL ENAMEL, NAIL POLISH, NAIL TOP AND BASE COATS, AND LIQUIDS APPLIED TO THE NAIL TO PREVENT NAIL CRACKING AND CHIPPING (U.S. CLS. 1, 4, 6, 50, 51 AND 52).
FIRST USE 1-2-1993; IN COMMERCE 1-2-1993.

SN 78-127,696. HYM INTERNATIONAL PTY LTD, COLLINGWOOD, VICTORIA 3066, AUSTRALIA, FILED 5-9-2002.

LALISSE

FOR COSMETIC PRODUCTS NAMELY CLEANSERS, MOISTURIZERS, TONERS, MASKS, SKIN SERUMS, SKIN MOISTURIZING TREATMENTS AND CONCEALERS, MAKE UP, FOUNDATION, EYE AND LIP COLOR, SKIN CREAMS, LOTIONS (U.S. CLS. 1, 4, 6, 50, 51 AND 52).

SN 78-131,821. BULLIE PRODUCTS, LLC, HOUSTON, TX. FILED 5-29-2002.

CATHARSIS

FOR COSMETICS (U.S. CLS. 1, 4, 6, 50, 51 AND 52).

CLASS 3—(Continued).

SN 78-132,513. RIVER WEST BRANDS LLC, CHICAGO, IL. FILED 5-31-2002.

GEE, YOUR HAIR SMELLS TERRIFIC

FOR HAIR CONDITIONER AND HAIR SHAMPOO (U.S. CLS. 1, 4, 6, 50, 51 AND 52).

SN 78-134,406. SUPRE, INC., DALLAS, TX. FILED 6-10-2002.

JING MEI

THE NAME IN THE MARK DOES NOT IDENTIFY A LIVING INDIVIDUAL.

THE ENGLISH TRANSLATION OF THE WORDING "JING MEI" IN THE MARK IS "ELEGANCE".

FOR SKIN CARE AND SKIN TREATMENT PREPARATIONS, NAMELY, CLEANSERS, CREAMS, MILKS, LOTIONS, GELS, OILS, MOISTURIZERS, NON-MEDICATED SERUMS, EXFOLIATING SCRUBS AND POWDERS FOR THE FACE, BODY, FEET AND HANDS; BATH AND SHOWER GELS, SALTS AND SCRUBS; SUN CARE PREPARATIONS; HAIR CARE PREPARATIONS (U.S. CLS. 1, 4, 6, 50, 51 AND 52).

SN 78-135,892. ALBERMARLE CORP., ATLANTA, GA. FILED 6-14-2002.

CROWNSOURCE

FOR SOAPS, NAMELY ANTIBACTERIAL SOAPS, LIQUID HAND SOAPS, AND SKIN CLEANSING LOTIONS; TOILET SEAT CLEANING PREPARATIONS; COSMETICS; COTTON FOR COSMETIC PURPOSES; COTTON SWABS FOR COSMETIC PURPOSES; PRE-MOISTENED COSMETIC TISSUES; MAKE-UP REMOVER PADS (U.S. CLS. 1, 4, 6, 50, 51 AND 52).

CLASS 3—(Continued).

SN 78-136,331. MOURGES, DENISE, EAST HAMPTON, NY. FILED 6-17-2002.

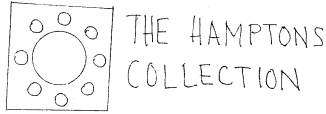

OWNER OF U.S. REG. NO. 2,580,002.
NO CLAIM IS MADE TO THE EXCLUSIVE RIGHT TO USE "COLLECTION", APART FROM THE MARK AS SHOWN.

SEC. 2(F).
FOR PERFUME; ESSENTIAL OILS FOR PERSONAL USE; COSMETICS, HAIR LOTIONS, HAIR SHAMPOOS, HARI DYES AND HAIR CONDITIONERS; TOOTH PASTE AND TOOTH WHITENERS; SOAPS; SUNTAN AND SUN BLOCK LOTIONS; FACIAL CLEANSERS, BODY CLEANSERS AND SKIN CLEANSERS, SCOURING POWDERS; FLOOR POLISHES AND FURNITURE POLISHES; GENERAL PURPOSE CLEANING, POLISHING, AND ABRASIVE LIQUIDS AND POWDERS; LAUNDRY SOAP, NAMELY LAUNDRY DETERGENT, LAUNDRY BLEACH AND FABRIC SOFTENERS (U.S. CLS. 1, 4, 6, 50, 51 AND 52).

SN 78-136,372. COLGATE-PALMOLIVE COMPANY, NEW YORK, NY. FILED 6-17-2002.

FRESH FLOW

FOR PERSONAL CARE PRODUCTS, NAMELY, DEODORANTS AND ANTIPERSPIRANTS (U.S. CLS. 1, 4, 6, 50, 51 AND 52).

SN 78-136,585. DIMEOLA & COMPANY, INC., BOCA RATON, FL. FILED 6-18-2002.

DIMEOLA

FOR PRE-SHAVE CONDITIONING CREAM AND AFTER-SHAVE EMOLLIENT (U.S. CLS. 1, 4, 6, 50, 51 AND 52).

FIRST USE 2-28-2003; IN COMMERCE 2-28-2003.

CLASS 3—(Continued).

SN 78-136,973. PHILOSOPHY, INC., PHOENIX, AZ. FILED 6-19-2002.

THE COLOR MAN

NO CLAIM IS MADE TO THE EXCLUSIVE RIGHT TO USE "COLOR", APART FROM THE MARK AS SHOWN.

FOR MAKE-UP KITS COMPRISED OF LIPSTICK, LIP GLOSS, LIP LINER, LIP BALM, BLUSH, FOUNDATION, EYE SHADOW, EYE LINER, MASCARA, CONCEALER, COSMETIC PENCILS, AND FACIAL POWDER; COSMETICS, NAMELY, LIPSTICK, LIP GLOSS, LIP LINER, LIP BALM, BLUSH, FOUNDATION, EYE SHADOW, EYE LINER, MASCARA, CONCEALER, COSMETIC PENCILS, AND FACIAL POWDER; FRAGRANCES, NAMELY, PERFUME, COLOGNE, AND AFTER-SHAVE; NON-MEDICATED SKIN CARE PRODUCTS, NAMELY, SOAP, SCRUBS, TONER, CONDITIONER, EXFOLIATORS, SKIN CLARIFIER, WRINKLE REMOVING SKIN CARE PREPARATIONS, AND MOISTURIZER; FACE AND BODY LOTION, CREAM, OIL, GEL AND SPRAY; SUN SCREEN PREPARATIONS, NAMELY, LOTION, CREAM, GEL, AND SPRAY; NON-MEDICATED FACE AND BODY SKIN LIGHTENER; HAIR CARE PRODUCTS, NAMELY, SHAMPOO, CONDITIONER, RINSE, GEL, MOUSSE, SPRAY AND TONIC; BATH CARE PRODUCTS, NAMELY, SOAP, SALTS, CRYSTALS, BEADS, GEL, OIL, POWDER, AND BUBBLE BATH; SCENTED HEAD-TO-TOE BODY WASH; NAIL CARE PREPARATIONS, NAMELY, CUTICLE CREAM, CUTICLE REMOVING PREPARATIONS, NAIL ENAMEL, NAIL POLISH, NAIL POLISH REMOVER, NAIL POLISH BASE COAT, NAIL POLISH TOP COAT, AND NAIL STRENGTHENERS; PERSONAL DEODORANT; MEN'S TOILETRIES, NAMELY, COLOGNE, AFTER SHAVE LOTION, SKIN CLEANSER, SKIN SCRUBS, SKIN TONER, SKIN CREAM, SHAVING GEL, SHAVING CREAM, TOILET WATER, PERSONAL DEODORANT, SHAMPOO, BODY LOTION, BODY TALC AND SKIN MOISTURIZER (U.S. CLS. 1, 4, 6, 50, 51 AND 52).

SN 78-137,117. ALBERMARLE CORP., ATLANTA, GA. FILED 6-19-2002.



FOR SOAPS; TOILET SEAT CLEANING PREPARATIONS; COSMETICS; MAKE-UP REMOVER PADS AND TISSUES, COTTON FOR COSMETIC PURPOSES; COTTON SWABS FOR COSMETIC PURPOSES; PRE-MOISTURIZED WIPES FOR COSMETIC USE, FINGER CLEANING IMPREGNATED TISSUES; PAPER PRODUCTS, NAMELY, DISPOSABLE WIPES IMPREGNATED WITH CLEANING PREPARATIONS OR TOILET PREPARATIONS FOR PERSONAL HYGIENE; PRE-MOISTENED COSMETIC WIPES (U.S. CLS. 1, 4, 6, 50, 51 AND 52).

CLASS 3—(Continued).

SN 78-137,177. ALBERMARLE CORP, ATLANTA, GA. FILED 6-19-2002.



NO CLAIM IS MADE TO THE EXCLUSIVE RIGHT TO USE "PRODUCTS", APART FROM THE MARK AS SHOWN. FOR SOAPS; NAMELY, ANTIBACTERIAL SOAPS, SKIN CLEANSING LOTION, AND LIQUID HANDS SOAPS; TOILET SEAT CLEANING PREPARATIONS; ALL PURPOSE CLEANING PREPARATIONS; COSMETICS; MAKE-UP REMOVER PADS AND TISSUES, COTTON FOR COSMETIC PURPOSES; COTTON SWABS FOR COSMETIC PURPOSES; PRE-MOISTENED AND NON-MOISTURIZED COSMETIC TOWELETTES, DISPOSABLE WIPES IMPREGNATED WITH CHEMICALS OR COMPOUNDS FOR FINGER CLEANING; DISPOSABLE WIPES IMPREGNATED WITH CHEMICALS OR COMPOUNDS, NAMELY, CLEANING PREPARATIONS AND TOILET PREPARATIONS (U.S. CLS. 1, 4, 6, 50, 51 AND 52).

SN 78-143,998. MERCK KGAA, DARMSTADT, FED REP GERMANY, FILED 7-15-2002.

SUNGLASSES FOR THE SKIN

PRIORITY CLAIMED UNDER SEC. 44(D) ON FED REP GERMANY APPLICATION NO. 30165594, FILED 11-30-2001, REG. NO. 30165594, DATED 4-1-2002, EXPIRES 11-30-2011.

FOR COSMETICS, NAMELY, GELS, CREAMS, OILS AND LOTIONS FOR THE FACE AND BODY; SUNTANNING PREPARATIONS (U.S. CLS. 1, 4, 6, 50, 51 AND 52).

SN 78-151,774. GADZOOKS, INC., CARROLLTON, TX. FILED 8-7-2002.

TAUNT

FOR COSMETICS, NAMELY, BODY GLITTER, FACE POWDER, EYE SHADOWS, LIPSTICKS (U.S. CLS. 1, 4, 6, 50, 51 AND 52).

FIRST USE 6-0-2002; IN COMMERCE 6-0-2002.

SN 78-154,420. L'OREAL USA CREATIVE, INC., NEW YORK, NY. FILED 8-15-2002.

FOREVER LIPCOLOR

NO CLAIM IS MADE TO THE EXCLUSIVE RIGHT TO USE "LIPCOLOR", APART FROM THE MARK AS SHOWN. FOR COSMETICS, NAMELY, LIPSTICK AND LIP GLOSS. (U.S. CLS. 1, 4, 6, 50, 51 AND 52).

CLASS 3—(Continued).

SN 78-156,214. THE PROCTER & GAMBLE COMPANY, CINCINNATI, OH. FILED 8-21-2002.

VELVET POWDER

NO CLAIM IS MADE TO THE EXCLUSIVE RIGHT TO USE "POWDER", APART FROM THE MARK AS SHOWN. FOR PERSONAL DEODORANTS/ANTI-PERSPIRANTS (U.S. CLS. 1, 4, 6, 50, 51 AND 52).

SN 78-157,673. CLEAN CONTROL CORPORATION, WARNER ROBINS, GA. FILED 8-26-2002.

CAR WASH CONTROL

NO CLAIM IS MADE TO THE EXCLUSIVE RIGHT TO USE "CAR WASH", APART FROM THE MARK AS SHOWN.

FOR CONCENTRATED FOAMING CLEANER DESIGNED FOR USE WITH A HAND HELD SCRUBBING BRUSH EQUIPMENT TO CUT THROUGH DIRT AND ROAD FILM (U.S. CLS. 1, 4, 6, 50, 51 AND 52).

SN 78-157,705. CLEAN CONTROL CORPORATION, WARNER ROBINS, GA. FILED 8-26-2002.

OVEN CONTROL

NO CLAIM IS MADE TO THE EXCLUSIVE RIGHT TO USE "OVEN", APART FROM THE MARK AS SHOWN.

FOR VERSATILE HIGHLY EFFICIENT, FAST ACTING OVEN CLEANER COMBINING A BALANCED BLEND OF GREASE AND CARBON REMOVERS, AND ALKALINE BUILDERS (U.S. CLS. 1, 4, 6, 50, 51 AND 52).

SN 78-162,234. IFY PACKAGING GROUP INC., UNION, NJ. FILED 9-9-2002.

JUDIAN

FOR LOTIONS, NAMELY, BABY LOTION, BATH LOTION, BODY MASK LOTION, HAND LOTION, HAIR LOTIONS, SHAVING LOTION, HAND CREAM, SKIN CLEANSING LOTION, SKIN LOTION, STYLING LOTIONS, SUN CARE LOTIONS, SUN TAN LOTION; SHOWER GEL; HAIR SHAMPOO; HAIR CONDITIONER; SKIN CONDITIONER; SCENTED BODY SPLASHES; HAIR MOISTURIZER, NAMELY, HAIR EMOLLIENT (U.S. CLS. 1, 4, 6, 50, 51 AND 52).

SN 78-162,927. OLINGHOUSE, JASON, D, ANKENY, IA. FILED 9-11-2002.

TATTOO SAVER

NO CLAIM IS MADE TO THE EXCLUSIVE RIGHT TO USE "TATTOO", APART FROM THE MARK AS SHOWN. FOR SUN BLOCK (U.S. CLS. 1, 4, 6, 50, 51 AND 52).

CLASS 3—(Continued).

SN 78-163,453. PHYSICIANS FORMULA COSMETICS, INC., AZUSA, CA. FILED 9-12-2002.

VIRTUAL FACE POWDER

OWNER OF U.S. REG. NOS. 2,526,119 AND 2,598,226. NO CLAIM IS MADE TO THE EXCLUSIVE RIGHT TO USE "FACE POWDER", APART FROM THE MARK AS SHOWN.

FOR COSMETICS (U.S. CLS. 1, 4, 6, 50, 51 AND 52).

SN 78-170,982. ECOLAB INC., ST. PAUL, MN. FILED 10-4-2002.

SOLID D-PRO

OWNER OF U.S. REG. NOS. 1,393,718, 2,491,511 AND OTHERS.

NO CLAIM IS MADE TO THE EXCLUSIVE RIGHT TO USE "SOLID", APART FROM THE MARK AS SHOWN.

FOR PRESOAKS AND DETARNISHERS FOR USE ON KITCHEN UTENSILS, SILVERWARE AND FLATWARE. (U.S. CLS. 1, 4, 6, 50, 51 AND 52).

SN 78-171,131. AMERICAN INTERNATIONAL INDUSTRIES, LOS ANGELES, CA. FILED 10-4-2002.

SKIN DRENCH

NO CLAIM IS MADE TO THE EXCLUSIVE RIGHT TO USE "SKIN", APART FROM THE MARK AS SHOWN.

FOR BODY LOTIONS, TANNING LOTIONS, TANNING OILS, TANNING GELS FOR FACE AND BODY; LOTIONS, SPRAYS AND GEL PREPARATIONS USED TO ACCELERATE TANNING; SUN SCREEN AND SUN BLOCK LOTIONS FOR FACE AND BODY; SUN SPOT LOTION; ALOE VERA GEL; FACIAL MOISTURIZERS; BODY AND FACIAL TONERS; FACIAL EXFOLIATING CREAM; LIP BALM; SHAVING CREAM; HAIR SHAMPOO; HAIR CONDITIONERS; BODY AND FACIAL CLEANSING GELS; DEODORANT; ANTIPERSPIRANTS; HAIR SPRAY; MOUTHWASH; SKIN SOAP; AND ESSENTIAL OILS FOR PERSONAL USE (U.S. CLS. 1, 4, 6, 50, 51 AND 52).

SN 78-171,449. KISS MY FACE, GARDINER, NY. FILED 10-6-2002.

SPORTS BAR

FOR AFTER SHAVE LOTIONS, BATH OILS, NON-MEDICATED BATH SALTS, BODY AND FACIAL LOTIONS, BAR SOAPS FOR HANDS, BODY AND FACE, BODY MOISTURIZERS, BODY SCRUBS, PERSONAL DEODORANTS, FACIAL CLEANSERS, FACIAL ASTRINGENTS FOR COSMETIC PURPOSES, FACIAL TONERS, FACIAL SCRUBS, FACIAL MASKS, FACIAL CREAMS, HAIR SHAMPOOS AND HAIR CONDITIONERS, HAIR STYLING GEL, HAND CREAMS, LIQUID SOAPS FOR FACE, HANDS AND BODY, SHOWER GELS AND FOAMING BATHS, AND SHAVING CREAMS (U.S. CLS. 1, 4, 6, 50, 51 AND 52).

CLASS 3—(Continued).

SN 78-174,617. KLEENZ-IT, L.P., HOUSTON, TX. FILED 10-15-2002.

KLEENZ-IT

FOR AUTOMOTIVE CLEANING PREPARATIONS (U.S. CLS. 1, 4, 6, 50, 51 AND 52).

SN 78-175,340. ECOLAB INC., ST. PAUL, MN. FILED 10-17-2002.

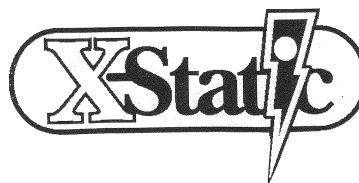

FOR ANTI-STATIC LAUNDRY BLOCK AND FABRIC SOFTENER. (U.S. CLS. 1, 4, 6, 50, 51 AND 52).

SN 78-175,353. ECOLAB INC., ST. PAUL, MN. FILED 10-17-2002.



FOR ANTI-STATIC LAUNDRY BLOCK AND FABRIC SOFTENER. (U.S. CLS. 1, 4, 6, 50, 51 AND 52).

SN 78-177,661. WANDER'S INC., KENT, WA. FILED 10-23-2002.

SOILS & OILS

FOR ALL PURPOSE CLEANER AND DEGREASER (U.S. CLS. 1, 4, 6, 50, 51 AND 52).

SN 78-178,449. ROBLEDO, JAIME BALLESTER, GUAYNABO, PUERTO RICO, FILED 10-25-2002.

ANIKELAO

THE ENGLISH TRANSLATION OF "ANIKELAO" IS "NICKEL-PLATED".

FOR AUTOMOTIVE CLEANING PREPARATIONS; ALL PURPOSE CLEANING PREPARATIONS (U.S. CLS. 1, 4, 6, 50, 51 AND 52).

CLASS 3—(Continued).

SN 78-180,705. SUPERIOR PRODUCTS CO., INC., SOUTH ROXANA, IL. FILED 10-31-2002.

COVER ALL

FOR DRESSING PREPARATION FOR AUTOMOBILE AND TRUCK TIRES (U.S. CLS. 1, 4, 6, 50, 51 AND 52).
FIRST USE 9-30-1994; IN COMMERCE 10-31-1994.

SN 78-184,189. COTY COSMETICS INC., NEW YORK, NY. FILED 11-12-2002.

WILD SPICE

FOR COLOGNE SPRAY, AFTERSHAVE, DEODORANT, BODY LOTION, SHOWER GEL, BODY SPRAY AND BODY POWDER (U.S. CLS. 1, 4, 6, 50, 51 AND 52).

SN 78-184,394. HUNTZINGER, THOMAS E., OCEANSIDE, CA. FILED 11-12-2002.

SMART WHITE

NO CLAIM IS MADE TO THE EXCLUSIVE RIGHT TO USE "WHITE", APART FROM THE MARK AS SHOWN.
FOR DENTAL BLEACHING GEL, NAMELY, COSMETIC TOOTH WHITENING AND BLEACHING PRODUCT, USED EITHER AT HOME BY AN INDIVIDUAL OR IN A DENTAL OFFICE BY A DENTIST ON A PATIENT AS A COSMETIC PROCEDURE TO ENHANCE THE APPEARANCE OF THE SMILE (U.S. CLS. 1, 4, 6, 50, 51 AND 52).
FIRST USE 11-18-1996; IN COMMERCE 11-18-1996.

SN 78-185,295. DIAL BRANDS, INC., SCOTTSDALE, AZ. FILED 11-14-2002.

DIAL BOTANICALS

OWNER OF U.S. REG. NOS. 549,768, 834,877 AND OTHERS.
FOR PERSONAL CARE PRODUCTS, NAMELY, BAR SOAP, BODY WASH, LIQUID HAND SOAP, BODY LOTION, DEODORANTS AND ANTI-PERSPIRANTS, BODY SCRUBS, WIPES FOR PERSONAL HYGIENE (U.S. CLS. 1, 4, 6, 50, 51 AND 52).

SN 78-185,349. MARAIS, MALCOLM, C. ROSWELL, GA. AND JONES, GLYN, E. ALPHARETTA, GA. FILED 11-14-2002.

SKINQUEST

FOR SKIN CARE PREPARATIONS, NAMELY, WRINKLE REMOVING SKIN CARE LOTION, CREAM, MOISTURIZER, EYE GEL, FACIAL MASK, SUNSCREEN, CLEANSER, TONER AND NIGHT CREAM (U.S. CLS. 1, 4, 6, 50, 51 AND 52).

CLASS 3—(Continued).

SN 78-185,359. GARCEAU, ARTHUR H., HOLLYWOOD, FL. FILED 11-15-2002.

MICRIN SMOKE-OUT

FOR MOUTHWASH (U.S. CLS. 1, 4, 6, 50, 51 AND 52).
FIRST USE 5-7-2002; IN COMMERCE 6-13-2002.

SN 78-185,583. HARRIS, MARK, H., GRAND JUNCTION, CO. FILED 11-15-2002.

POTTER POP

FOR GLITTERED SUNBLOCK SKIN LOTION THAT CRACKLES WHEN APPLIED TO THE SKIN (U.S. CLS. 1, 4, 6, 50, 51 AND 52).

SN 78-185,610. ADVENTUS PRODUCT MARKETING, LLC, ST. PAUL, MN. FILED 11-15-2002.

FORCEOUT

FOR GENERAL PURPOSE CLEANING, ODOR REMOVAL AND STAIN REMOVAL LIQUIDS AND POWDERS (U.S. CLS. 1, 4, 6, 50, 51 AND 52).
FIRST USE 12-3-2002; IN COMMERCE 12-4-2002.

SN 78-190,658. CLINIQUE LABORATORIES, INC., NEW YORK, NY. FILED 12-3-2002.

BEYOND BLUSHER

OWNER OF U.S. REG. NO. 1,717,018.
NO CLAIM IS MADE TO THE EXCLUSIVE RIGHT TO USE "BLUSHER", APART FROM THE MARK AS SHOWN.
FOR COSMETICS (U.S. CLS. 1, 4, 6, 50, 51 AND 52).

SN 78-193,539. L'OREAL USA CREATIVE, INC., NEW YORK, NY. FILED 12-11-2002.

GO WITH THE GLOW

FOR SKIN MOISTURIZERS (U.S. CLS. 1, 4, 6, 50, 51 AND 52).

SN 78-193,830. PRL USA HOLDINGS, INC., WILMINGTON, DE. FILED 12-12-2002.

DAYLIGHT

FOR EAU DE TOILETTE (U.S. CLS. 1, 4, 6, 50, 51 AND 52).

CLASS 3—(Continued).

SN 78-196,248. CHURCH & DWIGHT COMPANY, GREEN RIVER, WY. FILED 12-19-2002.

DRAMATICALLY WHITE

NO CLAIM IS MADE TO THE EXCLUSIVE RIGHT TO USE "WHITE", APART FROM THE MARK AS SHOWN. FOR PREPARATIONS FOR WHITENING TEETH. (U.S. CLS. 1, 4, 6, 50, 51 AND 52).

SN 78-196,258. CHURCH & DWIGHT COMPANY, GREEN RIVER, WY. FILED 12-19-2002.

WHITE EFFECTS

NO CLAIM IS MADE TO THE EXCLUSIVE RIGHT TO USE "WHITE", APART FROM THE MARK AS SHOWN. FOR PREPARATIONS FOR WHITENING TEETH. (U.S. CLS. 1, 4, 6, 50, 51 AND 52).

SN 78-203,188. PHYSICIANS FORMULA COSMETICS, INC., AZUSA, CA. FILED 1-14-2003.

BAKED BRONZER

NO CLAIM IS MADE TO THE EXCLUSIVE RIGHT TO USE "BRONZER", APART FROM THE MARK AS SHOWN. FOR COSMETICS (U.S. CLS. 1, 4, 6, 50, 51 AND 52).

CLASS 4—LUBRICANTS AND FUELS

SN 75-981,702. WHOLE FOODS MARKET IP, INC., AUSTIN, TX. BY ASSIGNMENT WHOLE FOODS MARKET SERVICES, INC., AUSTIN, TX. FILED 1-8-1999.



OWNER OF U.S. REG. NOS. 1,557,320 AND 1,961,586. FOR CHARCOAL BRIQUETTES (U.S. CLS. 1, 6 AND 15). FIRST USE 5-0-1997; IN COMMERCE 5-0-1997.

CLASS 4—(Continued).

SN 76-036,931. CASTROL LIMITED, SWINDON, WILTSHIRE SN3 1RE, UNITED KINGDOM, FILED 4-28-2000.

CDX

FOR LUBRICANTS FOR USE IN MARINE VESSELS (U.S. CLS. 1, 6 AND 15). FIRST USE 4-25-2000; IN COMMERCE 4-25-2000.

SN 76-337,026. NYCO SA, 75008 PARIS, FRANCE, FILED 11-13-2001.

NYCOLUBE

OWNER OF FRANCE REG. NO. 1223934, DATED 12-14-1972, RENEWED AS REG. NO. 2225238, DATED 7-22-2002, EXPIRES 7-22-2012.

OWNER OF U.S. REG. NOS. 1,123,079 AND 1,139,725. FOR LUBRICANTS OF ALL KINDS, NAMELY, ALL-PURPOSE LUBRICANTS, INDUSTRIAL LUBRICANTS, AIRCRAFT LUBRICANTS, AUTOMOTIVE LUBRICANTS, GRAPHITE LUBRICANTS, LUBRICANTS FOR INDUSTRIAL MACHINERY (U.S. CLS. 1, 6 AND 15). FIRST USE 12-1-1962; IN COMMERCE 1-8-1996.

SN 76-382,304. PRESSURE-LUBE, INC., MENOMONEE FALLS, WI. FILED 3-12-2002.

JAX DRY-GLIDE

FOR FOOD-GRADE SILICONE-BASED LUBRICANT FOR INDUSTRIAL USE IN THE FOOD PACKAGING INDUSTRY (U.S. CLS. 1, 6 AND 15). FIRST USE 6-1-1996; IN COMMERCE 6-1-1996.

SN 76-467,530. DEVON ENERGY CORPORATION, OKLAHOMA CITY, OK. FILED 11-18-2002.

FOR CRUDE OIL AND NATURAL GAS (U.S. CLS. 1, 6 AND 15). FIRST USE 4-0-1991; IN COMMERCE 4-0-1991.

CLASS 4—(Continued).

SN 76-468,281. MISTRAL LLC, SOLANA BEACH, CA. FILED 11-12-2002.

MISTRAL

THE ENGLISH TRANSLATION OF THE WORD "MISTRAL" IS A SPECIFIC WIND IN PROVENCE, FRANCE.
FOR CANDLES (U.S. CLS. 1, 6 AND 15).
FIRST USE 8-0-2001; IN COMMERCE 8-0-2001.

SN 76-474,472. BRIAR PATCH PRIMITIVES, INC., ST. JOSEPH, MN. FILED 12-6-2002.

LIBERTY STAR CANDLES

NO CLAIM IS MADE TO THE EXCLUSIVE RIGHT TO USE "CANDLES", APART FROM THE MARK AS SHOWN.
FOR SCENTED CONTAINER CANDLES (U.S. CLS. 1, 6 AND 15).
FIRST USE 1-1-1999; IN COMMERCE 1-1-1999.

SN 76-478,749. BIG BENDS, LLC, PLAINWELL, MI. FILED 12-24-2002.

NUT SAUCE

NO CLAIM IS MADE TO THE EXCLUSIVE RIGHT TO USE "NUT", APART FROM THE MARK AS SHOWN.
FOR LUBRICANT FOR APPLICATION TO THE STRINGS OF A MUSICAL INSTRUMENT (U.S. CLS. 1, 6 AND 15).
FIRST USE 4-15-2002; IN COMMERCE 4-15-2002.

SN 78-158,708. FUCHS LUBRITECH GMBH, WEILERBACH, SWITZERLAND, FILED 8-28-2002.

LUBRITECH

FOR LUBRICATING AGENTS FOR USE WITH— RAILROAD CARS; RAILROAD TRACKS; LOCOMOTIVES; CONSTRUCTION MACHINERY; CHEMICAL INDUSTRY EQUIPMENT; MINING EQUIPMENT; STEEL MANUFACTURING EQUIPMENT; ELECTRIC TOOLS, NAMELY SAWS, SANDERS, GRINDERS AND DRILLS; PNEUMATIC TOOLS, NAMELY STAPLERS, NAIL GUNS, WRENCHES AND DRILLS; ELECTRONIC EQUIPMENT, NAMELY CIRCUIT BOARDS, RADIOS, ALTERNATORS, RESISTORS, AND COMPUTER CHIPS; PLASTIC MANUFACTURING EQUIPMENT, NAMELY BLOW MOLDING MACHINES, INJECTION MOLDING MACHINES AND EXTRUSION MACHINES; FOOD PROCESSING EQUIPMENT; AGRICULTURAL EQUIPMENT; GLASS MANUFACTURING EQUIPMENT; TEXTILE MANUFACTURING EQUIPMENT; PHARMACEUTICAL PRODUCTION EQUIPMENT; MINERAL PROCESSING EQUIPMENT; CEMENT PROCESSING EQUIPMENT; POWER GENERATION EQUIPMENT; POWER DISTRIBUTION EQUIPMENT; STEEL MANUFACTURING EQUIPMENT; BEARINGS; AND CHAINS (U.S. CLS. 1, 6 AND 15).
FIRST USE 5-6-1996; IN COMMERCE 5-6-1996.

CLASS 4—(Continued).

SN 78-175,338. BRIAN KENDALL, LTD., COLUMBUS, OH. FILED 10-17-2002.

SMOKIN' TIRE

FOR CANDLES (U.S. CLS. 1, 6 AND 15).

CLASS 5—PHARMACEUTICALS

SN 75-448,015. AVENTIS PHARMA HOLDING GMBH, FED REP GERMANY, BY CHANGE OF NAME; BY CHANGE OF NAME HOECHST MARION ROUSSEL AG, FRANKFURT AM MAIN, FED REP GERMANY, FILED 3-11-1998.

NACALIN

OWNER OF FED REP GERMANY REG. NO. 39755050, DATED 1-7-1998, EXPIRES 11-30-2007.
FOR PHARMACEUTICAL PREPARATIONS, NAMELY, CARDIO-VASCULAR PREPARATIONS (U.S. CLS. 6, 18, 44, 46, 51 AND 52).

SN 75-494,472. FUEL QUALITY SERVICES, INC., FLOWERY BRANCH, GA. FILED 6-1-1998.

Micro-Gard

FOR BIOCIDES USED TO KILL OR PREVENT MICRO-ORGANISM, FUNGUS, BACTERIA, YEAST AND MOLD GROWTHS IN BUNKERS, OIL FIELDS, PIPELINES, OIL RESERVOIRS, INJECTION WATER, WATER HOLDING TANKS, DISPOSAL WELL WATER, DISTILLATE FUELS, NAMELY GASOLINE, CRUDE, JET FUEL, KEROSENE, AND DISTRIBUTION APPLICATIONS AND SUPPORTING SYSTEMS, NAMELY, RECIRCULATING WATER HANDLING SYSTEMS AND FLUIDS USED FOR DRILLING AND STIMULATION OF OIL WELLS (U.S. CLS. 6, 18, 44, 46, 51 AND 52).
FIRST USE 6-1-1996; IN COMMERCE 8-19-1996.

SN 75-756,158. MARKET ONE, INC., VALLEY HEAD, AL. FILED 7-22-1999.

ACTIVATE

FOR DIETARY SUPPLEMENTS, NAMELY NON-PRESCRIPTION NUTRITION SUPPLEMENTS (U.S. CLS. 6, 18, 44, 46, 51 AND 52).
FIRST USE 1-1-1998; IN COMMERCE 1-1-1998.

CLASS 5—(Continued).

SN 75-857,801. GRAMINEX L.L.C., SAGINAW, MI. BY ASSIGNMENT AB CERNELLE COMPANY, SWEDEN, FILED 11-26-1999.

CERVITAL

OWNER OF U.S. REG. NOS. 813,840, 915,388 AND OTHERS.
FOR NUTRITIONAL SUPPLEMENTS (U.S. CLS. 6, 18, 44, 46, 51 AND 52).
FIRST USE 0-0-1983; IN COMMERCE 0-0-1983.

SN 75-921,131. BRISTOL-MYERS SQUIBB COMPANY, NEW YORK, NY. FILED 2-16-2000.

**THERAGRAN HEART RIGHT
- AT THE HEART OF GOOD
HEALTH**

NO CLAIM IS MADE TO THE EXCLUSIVE RIGHT TO USE "HEART", APART FROM THE MARK AS SHOWN.
FOR VITAMIN PREPARATION (U.S. CLS. 6, 18, 44, 46, 51 AND 52).

SN 75-930,677. SANKYO COMPANY LIMITED, TOKYO, JAPAN, FILED 2-28-2000.

PANACOR

FOR PHARMACEUTICAL PREPARATIONS FOR THE TREATMENT OF CARDIOVASCULAR, CIRCULATORY, URINARY AND METABOLIC DISEASES (U.S. CLS. 6, 18, 44, 46, 51 AND 52).

SN 75-939,309. AVENTIS PHARMA S.A., 92160 ANTONY, FRANCE, FILED 3-9-2000.

GOLVAR

FOR PHARMACEUTICAL PREPARATIONS FOR THE TREATMENT OF CARDIOVASCULAR DISEASES (U.S. CLS. 6, 18, 44, 46, 51 AND 52).

CLASS 5—(Continued).

SN 76-001,494. ESSENTIA PHARMACEUTICALS, B.V., CHESTERFIELD, MO. FILED 3-16-2000.

ESSENTIA

FOR HOUSE MARK FOR A FULL LINE OF THE FOLLOWING GOODS – VITAMINS, MINERALS, HERBAL AND NUTRITIONAL SUPPLEMENTS; GELATIN AND NON-GELATIN COATED COMPOSITIONS SOLD AS AN INTEGRAL COMPONENT OF CAPSULES, CAPLETS, TABLETS AND ENCAPSULATED LIQUID AND POWDERED PHARMACEUTICALS, ALL FOR MEDICAL OR NUTRITIONAL USE; POWDERED MEAL REPLACEMENT DRINK MIXES; PHARMACEUTICALS FOR THE TREATMENT OF SUBLINGUAL CONDITIONS; TOPICAL ANALGESICS; TOPICAL ANESTHETICS; TOPICAL GELS FOR MEDICAL AND THERAPEUTIC USES TO TREAT SKIN CONDITIONS; SUPPOSITORIES FOR TREATMENT OF CONSTIPATION AND INFECTION; PHARMACEUTICALS INCLUDING SUBLINGUAL, ANALGESICS, NON-STEROIDAL ANTI-INFLAMMATORY DRUGS, COUGH/COLD PRODUCTS, LAXATIVES, AND DIGESTIVE AIDS; A PRODUCT MARK FOR THE FOLLOWING GOODS – VITAMINS, MINERALS, HERBAL AND NUTRITIONAL SUPPLEMENTS; GELATIN AND NON-GELATIN COATED COMPOSITIONS SOLD AS AN INTEGRAL COMPONENT OF CAPSULES, CAPLETS, TABLETS AND ENCAPSULATED LIQUID AND POWDERED PHARMACEUTICALS, ALL FOR MEDICAL OR NUTRITIONAL USE; POWDERED MEAL REPLACEMENT DRINK MIXES; PHARMACEUTICALS FOR THE TREATMENT OF SUBLINGUAL CONDITIONS; TOPICAL ANALGESICS; TOPICAL ANESTHETICS; TOPICAL GELS FOR MEDICAL AND THERAPEUTIC USES TO TREAT SKIN CONDITIONS; SUPPOSITORIES FOR TREATMENT OF CONSTIPATION AND INFECTION; NON-TOPICAL ANALGESICS; LAXATIVES; ANTI-INFLAMMATORIES; PHARMACEUTICAL PREPARATIONS FOR THE TREATMENT OF COUGHS AND COLDS, INDIGESTION AND CONSTIPATION (U.S. CLS. 6, 18, 44, 46, 51 AND 52).

SN 76-073,568. THE GOOD WITCH SCENTS, INC., WEST ISLIP, NY. FILED 6-19-2000.

WITCHSCENTS

FOR HOMEOPATHIC PREPARATIONS FOR USE IN THE TREATMENT OF ARTHRITIS, LIVER DETOXIFICATION, WEIGHT LOSS, AND FOR USE IN AROMATHERAPY (U.S. CLS. 6, 18, 44, 46, 51 AND 52).

SN 76-077,641. VI-JON LABORATORIES, INC., DBA VI-JON, INC., ST. LOUIS, MO. FILED 6-22-2000.

ICE MINT

NO CLAIM IS MADE TO THE EXCLUSIVE RIGHT TO USE "MINT", APART FROM THE MARK AS SHOWN.
FOR TARTAR CONTROL ANTISEPTIC MOUTHWASH AND DENTAL RINSE (U.S. CLS. 6, 18, 44, 46, 51 AND 52).
FIRST USE 2-4-2003; IN COMMERCE 2-4-2003.

CLASS 5—(Continued).

SN 76-131,124. JAGOTEC AG, CH-4132 MUTTENZ, SWITZERLAND, FILED 9-19-2000.

ORALEASE

FOR PHARMACEUTICAL PREPARATIONS FOR THE TREATMENT OF ORAL CAVITY PAIN (U.S. CLS. 6, 18, 44, 46, 51 AND 52).

SN 76-178,226. HEAL WITH NATURE, INC., MESA, AZ. FILED 12-11-2000.

HEAL WITH NATURE

NO CLAIM IS MADE TO THE EXCLUSIVE RIGHT TO USE "NATURE", APART FROM THE MARK AS SHOWN.

FOR NATUROPATHIC MEDICAL PRODUCTS, NAMELY, NUTRITIONAL SUPPLEMENTS, HOMEOPATHIC, VITAMINS, MINERALS AND HERBAL SUPPLEMENTS AND HERBAL TEAS FOR MEDICINAL PURPOSES (U.S. CLS. 6, 18, 44, 46, 51 AND 52).

FIRST USE 11-15-2000; IN COMMERCE 11-15-2000.

SN 76-188,672. TRANSDEMICS LTD., ASHDOD, ISRAEL, FILED 1-2-2001.

CAPSULIN

FOR ENCAPSULATED MEDICINE, NAMELY INSULIN, CONTAINED IN CAPSULE FORM FOR CONTROLLED AND PROLONGED RELEASE THROUGH THE SKIN OF A HUMAN (U.S. CLS. 6, 18, 44, 46, 51 AND 52).

CLASS 5—(Continued).

SN 76-192,417. LANZHOU FOCI PHARMACEUTICAL CO.LTD., LANZHOU, CHINA, FILED 1-9-2001.



THE MARK CONSISTS OF THE WORD "MINSHAN" IN CHINESE CHARACTERS AND AN ARBITRARY DEVICE.

FOR ANALGESICS USED FOR PHARMACEUTICAL PURPOSES; PURGATIVES; EVACUANTS FOR PHARMACEUTICAL PURPOSES; MEDICINES FOR CURING NEPHROPATHY, DYSPEPSIA, ANEMIA, INSOMNIA, EMMENIOPATHY, IMPOTENCE, EXPECTORANT, STERILITY, AND THE COMMON COLD; LAXATIVES; DIGESTIVES FOR PHARMACEUTICAL PURPOSES; LIQUORICES USED IN THE MANUFACTURE OF PHARMACEUTICALS; SYRUPS FOR USE IN CURING COLDS AND COUGHS; MEDICINAL HERBS; BABY FOODS; GERMICIDES (U.S. CLS. 6, 18, 44, 46, 51 AND 52).

SN 76-228,863. BETA PHARMA, INC., NEW HAVEN, CT. FILED 3-22-2001.

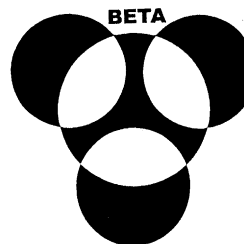

NO CLAIM IS MADE TO THE EXCLUSIVE RIGHT TO USE "BETA", APART FROM THE MARK AS SHOWN.

FOR SPECIALTY CHEMICALS FOR USE IN THE MANUFACTURE OF PHARMACEUTICALS (U.S. CLS. 6, 18, 44, 46, 51 AND 52).

FIRST USE 4-1-2001; IN COMMERCE 4-1-2001.

SN 76-237,623. ADEPTUS NUTRITION, INC., SAN DIEGO, CA. BY CHANGE OF NAME ADEPTUS ANIMAL NUTRITION, INC., SAN DIEGO, CA. FILED 4-6-2001.

GLEAM

FOR ANIMAL NUTRITIONAL SUPPLEMENTS (U.S. CLS. 6, 18, 44, 46, 51 AND 52).

CLASS 5—(Continued).

SN 76-238,413. EXTREME NUTRITIONALS, LLC, CHARLOTTE, NC. FILED 4-10-2001.

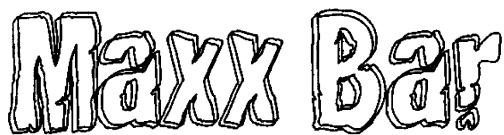

NO CLAIM IS MADE TO THE EXCLUSIVE RIGHT TO USE "BAR", APART FROM THE MARK AS SHOWN.
FOR NUTRITIONAL SUPPLEMENTS (U.S. CLS. 6, 18, 44, 46, 51 AND 52).

SN 76-287,680. WEIDER NUTRITION INTERNATIONAL, INC., SALT LAKE CITY, UT. FILED 7-19-2001.

FORCE +

OWNER OF U.S. REG. NOS. 1,946,248, 2,443,032 AND OTHERS.
FOR DIETARY SUPPLEMENTS (U.S. CLS. 6, 18, 44, 46, 51 AND 52).
FIRST USE 10-20-2000; IN COMMERCE 10-20-2000.

SN 76-301,513. CHUNG, YUN SOO, GARDENA, CA. FILED 8-20-2001.



**Progesterone
Cream**

NO CLAIM IS MADE TO THE EXCLUSIVE RIGHT TO USE "PROGESTERONE CREAM", APART FROM THE MARK AS SHOWN.

FOR PHARMACEUTICAL PREPARATIONS, NAMELY, CREAM CONSISTING OF NATURAL INGREDIENTS FOR THE TREATMENT OF MENOPAUSE AND PREMENSTRUAL SYNDROME (U.S. CLS. 6, 18, 44, 46, 51 AND 52).

FIRST USE 8-1-2001; IN COMMERCE 8-1-2001.

CLASS 5—(Continued).

SN 76-311,697. HOLLISTER-STIER LABORATORIES LLC, SPOKANE, WA. FILED 9-12-2001.

TWINJECT PD

NO CLAIM IS MADE TO THE EXCLUSIVE RIGHT TO USE "PD", APART FROM THE MARK AS SHOWN.

FOR AUTO-INJECTORS CONTAINING EPINEPHRINE FOR THE TREATMENT OF ANAPHYLACTIC REACTIONS AND SEVERE LIFE-THREATENING ASTHMA ATTACKS (U.S. CLS. 6, 18, 44, 46, 51 AND 52).

SN 76-312,700. NUTRACEUTICAL GUM CO., SAEGERTOWN, PA. FILED 9-14-2001.

SUPERBALL

FOR NUTRACEUTICAL GUM FOR USE AS NUTRITIONAL SUPPLEMENT (U.S. CLS. 6, 18, 44, 46, 51 AND 52).

FIRST USE 12-15-2001; IN COMMERCE 12-15-2001.

SN 76-318,830. BODY WELL DESIGN, LLC, SPOKANE, WA. FILED 9-27-2001.

NEURO COMPLETE RX

NO CLAIM IS MADE TO THE EXCLUSIVE RIGHT TO USE "COMPLETE", "RX", APART FROM THE MARK AS SHOWN.

FOR FOOD SUPPLEMENTS (U.S. CLS. 6, 18, 44, 46, 51 AND 52).

SN 76-341,009. KNOLL FARMACEUTICI S.P.A., 20053 MUGGIO (MILANO), ITALY, FILED 11-21-2001.

SAMYR

FOR PHARMACEUTICAL PREPARATIONS FOR THE TREATMENT OF DEPRESSION (U.S. CLS. 6, 18, 44, 46, 51 AND 52).

CLASS 5—(Continued).

SN 76-344,976. ALTA NATURAL HERBS & SUPPLEMENTS LTD., VANCOUVER, BRITISH COLUMBIA, CANADA, FILED 12-5-2001.

ALTA NATURAL

PRIORITY CLAIMED UNDER SEC. 44(D) ON CANADA APPLICATION NO. 1,109,287, FILED 7-11-2001.

NO CLAIM IS MADE TO THE EXCLUSIVE RIGHT TO USE "NATURAL", APART FROM THE MARK AS SHOWN.

FOR VITAMINS AND MINERAL SUPPLEMENTS; NUTRITIONAL AND HERBAL SUPPLEMENTS NAMELY ALOE VERA HERB POWDER, GRAPESEED EXTRACT, CURCUMIN, TURMERIC ROOT, APPLE CIDER VINEGAR POWDER, HUANG QI, BEE POLLEN, BEE PROPOLIS, BILBERRY EXTRACT AND POWDER, BLACK COHOSH EXTRACT AND POWDER, BLESSED THISTLE HERB POWDER, BONESET HERB POWDER, BORAGE OIL, BROMELAIN, BURDOCK ROOT POWDER, GINKGO BILBOA EXTRACT AND POWDER, HAWTHORNE EXTRACT, HAWTHORNE BERRY POWDER, CATS CLAW INNER BARK POWDER, CAYENNE, CHANCA PIEDRA, CHICKWEED HERB POWDER, CHITOSAN, GLUCOSAMINE, CHONDROITIN, BROMELAIN, GLUCOSAMINE SULFATE, CHONDROITIN SULFATE, GARCINIA CAMBOGIA EXTRACT, COENZYME Q10, ECHINACEA, GOLDENSEAL POWDER, ROSEHIP, COMFREY ROOT POWDER, CRANBERRY EXTRACT AND POWDER, DAMIANA LEAF HERB POWDER, DANDELION ROOT POWDER, BEETROOT POWDER AND EXTRACT, GRAPEFRUIT SEED, BLACK WALNUT, CLOVES, DANDELION ROOT, ARTICHOKE, BURDOCKROOT, PUMPKIN SEED, THYME, BARBERRY, PSYLLIUM HUSK POWDER, FLAXSEED, FENNEL SEEDS, UVA URSI POWDER, PEPPERMINT, SPEARMINT, DEVILS CLAW EXTRACT AND POWDER, DONG QUAI ROOT POWDER, EVENING PRIMROSE OIL, EYEBRIGHT POWDER, FENNEL SEED POWDER, FENUGREEK POWDER, FEVERFEW POWDER, FLAXSEED OIL, FO-TI ROOT POWDER, GARLIC POWDER, GINGER ROOT POWDER, GINSENG, SHARK CARTILAGE, GOTU KOLA POWDER, GRAVEL ROOT POWDER, GYMNEMA SYLVESTRE EXTRACT, HOPS POWDER, HORSETAIL POWDER, KAVA KAVA EXTRACT AND POWDER, KELP POWDER, KOLA NUT POWDER, LYSINE, TYROSINE, LECITHIN, LICORICE ROOT POWDER, LOBELIA INFLATA LEAF, LUTEIN, MACA, MARSHMALLOW ROOT POWDER, MILK THISTLE EXTRACT AND POWDER, METHYL-SULFONYLMETHANE, MULLEIN POWDER, MAGNESIUM CITRATE, MALIC ACID, MYRRH GUM POWDER, NETTLE POWDER, NOPAL POWDER, OLIVE LEAF EXTRACT, PAPAYA ENZYME, PSYLLIUM HUSK, PSYLLIUM HUSK POWDER, CALCIUM PYRUVATE, RASPBERRY RED POWDER, RED CLOVER POWDER, RHUBARB ROOT POWDER, ROYAL JELLY EXTRACT, SALMON OIL, SANGRE DE GRADO, SARSAPARILLA ROOT POWDER, SAW PALMETTO EXTRACT AND POWDER, SHARK LIVER OIL, SHEEP SORREL POWDER, SILICA EXTRACT, SILYMARIN MILKTHISTLE EXTRACT, SLIPPERY ELM BARK POWDER, SPIRULINA, SPIRULINA BLUE GREEN ALGAE, SQUALENE, ST JOHN'S WORT EXTRACT AND POWDER, STEVIA POWDER, SUMA, SEAL OIL, TRIBULUS TERRESTRIS POWDER AND EXTRACT, TURMERIC ROOT POWDER AND EXTRACT, UVA URSI EXTRACT, VALERIAN ROOT, BLACK WALNUT HULLS, WATERCRESS, MEXICAN WILD YAM, WHITE WILLOW BARK, WOOD BETONY, YELLOW DOCK, YUCCA ROOT AND YOHIMBE BARK (U.S. CLS. 6, 18, 44, 46, 51 AND 52).
FIRST USE 0-0-1997; IN COMMERCE 0-0-1997.

CLASS 5—(Continued).

SN 76-346,825. DICKEY CONSUMER PRODUCTS, INC., DBA DMD PHARMACEUTICALS, NOBLESVILLE, IN. FILED 12-7-2001.

EPHED 225

OWNER OF U.S. REG. NO. 2,158,647.
FOR DIETARY SUPPLEMENTS (U.S. CLS. 6, 18, 44, 46, 51 AND 52).

SN 76-363,469. DIATECT INTERNATIONAL CORPORATION, HEBER CITY, UT. FILED 1-11-2002.

DIATECT

FOR INSECTICIDES FOR AGRICULTURAL AND DOMESTIC USE (U.S. CLS. 6, 18, 44, 46, 51 AND 52).
FIRST USE 7-0-1990; IN COMMERCE 11-0-1990.

SN 76-366,118. SMITH, JOSEPH, BOCA RATON, FL. FILED 2-4-2002.

DOCTOR'S CORNER

FOR VITAMINS (U.S. CLS. 6, 18, 44, 46, 51 AND 52).
FIRST USE 1-1-1997; IN COMMERCE 6-1-2001.

SN 76-366,519. WAI YUEN TONG MEDICINE COMPANY LIMITED, KOWLOON, HONG KONG, FILED 2-5-2002.

WAI YUEN TONG

THE WORDING "WAI YUEN TONG" SERVES MERELY AS APPLICANT'S NAME, AND HAS NO MEANING.

FOR PHARMACEUTICAL PREPARATIONS, NAMELY CHINESE MEDICAL PREPARATIONS FOR USE IN THE TREATMENT OF BODY WEAKNESS THROUGH NOURISHING THE BLOOD, IMPROVING BLOOD CIRCULATION AND REVITALIZING ENERGY, REMOVING PHLEGM AND PROVIDING COLD RELIEF, REMOVING TOXIC SUBSTANCES AND DISSIPATING BODY HEAT, AND IMPROVING BODILY HEALTH UNDER PRINCIPLES OF CHINESE MEDICINE BY BALANCING THE "YIN" AND "YANG"; CHINESE HERBAL SUPPLEMENTS; AND CHINESE HERBAL TEAS FOR MEDICINAL PURPOSES (U.S. CLS. 6, 18, 44, 46, 51 AND 52).
FIRST USE 0-0-1992; IN COMMERCE 0-0-1992.

CLASS 5—(Continued).

SN 76-370,301. HERO NUTRITIONAL PRODUCTS, L.L.C., SAN CLEMENTE, CA. FILED 2-13-2002.

YUMMI BEARS

OWNER OF U.S. REG. NOS. 2,330,056 AND 2,553,108.
NO CLAIM IS MADE TO THE EXCLUSIVE RIGHT TO USE "BEARS", APART FROM THE MARK AS SHOWN.
FOR NUTRACEUTICALS AND FUNCTIONAL FOODS FOR USE AS NUTRITIONAL, VITAMIN, DIETARY, FOOD, MINERAL, AND HERBAL SUPPLEMENTS IN FOODS AND BEVERAGES (U.S. CLS. 6, 18, 44, 46, 51 AND 52).

CLASS 5—(Continued).

SN 76-391,939. PURE WORLD BOTANICALS, INC., SOUTH HACKENSACK, NJ. FILED 4-5-2002.

LEANLINE

FOR NATURAL BOTANICAL AND HERBAL INGREDIENTS SOLD FOR USE AS THE ACTIVE INGREDIENT OF DIETARY SUPPLEMENTS (U.S. CLS. 6, 18, 44, 46, 51 AND 52).

SN 76-372,919. SCENTCO, LLC, THOMASVILLE, GA. FILED 2-19-2002.

ANYWHERE AIR FRESHENER

NO CLAIM IS MADE TO THE EXCLUSIVE RIGHT TO USE "AIR FRESHENER", APART FROM THE MARK AS SHOWN.
FOR AIR FRESHENER FOR HOME, OFFICE AND AUTO (U.S. CLS. 6, 18, 44, 46, 51 AND 52).

SN 76-396,217. BLISTEX INC., OAK BROOK, IL. FILED 4-15-2002.

PRO TOUCH

FOR MEDICATED TOPICAL PREPARATIONS FOR HUMAN USE FOR LIP CARE, FOR LIP DRYNESS, AND MEDICATED SUN SCREEN PREPARATIONS FOR USE ON THE LIPS (U.S. CLS. 6, 18, 44, 46, 51 AND 52).

SN 76-380,745. WORLD NUTRITION, INC., PHOENIX, AZ. FILED 3-8-2002.

CalGuard

THE STIPLING IS FOR SHADING PURPOSES ONLY.
FOR NUTRITIONAL AND DIETARY SUPPLEMENTS (U.S. CLS. 6, 18, 44, 46, 51 AND 52).

SN 76-398,215. JOHNSON & JOHNSON, NEW BRUNSWICK, NJ. FILED 4-19-2002.

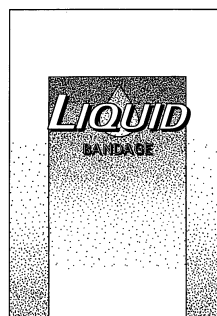

SN 76-383,266. JOHNSON & JOHNSON, NEW BRUNSWICK, NJ. FILED 3-18-2002.

OPTIUM DBM

NO CLAIM IS MADE TO THE EXCLUSIVE RIGHT TO USE "DBM", APART FROM THE MARK AS SHOWN.
FOR HUMAN TISSUE USED TO STIMULATE NEW BONE FORMATION IN SPINE, ORTHOPEDIC, AND TRAUMA SURGICAL APPLICATIONS (U.S. CLS. 6, 18, 44, 46, 51 AND 52).

NO CLAIM IS MADE TO THE EXCLUSIVE RIGHT TO USE "LIQUID BANDAGE", APART FROM THE MARK AS SHOWN.
THE STIPLING IS A FEATURE OF THE MARK AND DOES NOT INDICATE COLOR.
FOR WATERPROOF WOUND DRESSING (U.S. CLS. 6, 18, 44, 46, 51 AND 52).

CLASS 5—(Continued).

SN 76-398,794. SHEFRIN, DAVID K., WEST LINN, OR. FILED 4-19-2002.



FOR INGESTIBLE HERBAL SUPPLEMENTS AND HERBAL SUPPLEMENTS IN THE NATURE OF CREAMS FOR TOPICAL APPLICATIONS; HERBAL PRODUCTS FOR VAGINAL LUBRICATION IN THE FORM SUPPOSITORIES AND CREAMS (U.S. CLS. 6, 18, 44, 46, 51 AND 52).
FIRST USE 1-1-2002; IN COMMERCE 1-1-2002.

SN 76-400,512. LIFEBLOOD MEDICAL, INC., FREEHOLD, NJ. FILED 4-24-2002.

LIFOR

FOR SOLUTIONS FOR PERFUSING, PRESERVING AND STORING MAMMALIAN ORGANS FOR MEDICAL USE (U.S. CLS. 6, 18, 44, 46, 51 AND 52).

SN 76-401,393. N.V. ORGANON., 5349 AB OSS, NETHERLANDS, FILED 4-29-2002.

OBSTAGAN

PRIORITY CLAIMED UNDER SEC. 44(D) ON BENELUX APPLICATION NO. 1007822, FILED 3-22-2002, REG. NO. 0711490, DATED 3-22-2002, EXPIRES 3-22-2012.
FOR PHARMACEUTICAL PREPARATIONS FOR STIMULATION OF HUMAN FERTILITY (U.S. CLS. 6, 18, 44, 46, 51 AND 52).

SN 76-411,520. FREELIFE INTERNATIONAL LLC, MILFORD, CT. FILED 5-28-2002.

TRIM4LIFE ULTRA

OWNER OF U.S. REG. NOS. 2,079,689, 2,463,940 AND OTHERS.
FOR DIETARY SUPPLEMENTS AND NUTRITIONAL SUPPLEMENTS FOR USE IN WEIGHT MANAGEMENT (U.S. CLS. 6, 18, 44, 46, 51 AND 52).

CLASS 5—(Continued).

SN 76-414,438. ALLOSOURCE, CENTENNIAL, CO. FILED 5-28-2002.



THE MARK CONSISTS OF A STYLIZED REPRESENTATION OF A PERSON AND THE WORDING "ALLO SOURCE" AND DESIGN.
FOR LIVING BONE AND TISSUE FOR IMPLANTATION (U.S. CLS. 6, 18, 44, 46, 51 AND 52).
FIRST USE 3-0-2001; IN COMMERCE 3-0-2001.

SN 76-417,225. CERES FERTILITY, SAN DIEGO, CA. FILED 5-24-2002.

FERTILE ONE

FOR NUTRITIONAL SUPPLEMENTS (U.S. CLS. 6, 18, 44, 46, 51 AND 52).

SN 76-417,442. IRVITA PLANT PROTECTION N.V., CURACAO, NETHERLD ANTILLES, FILED 5-28-2002.

ACARISTOP

FOR PESTICIDES, INSECTICIDES AND ACARICIDES FOR AGRICULTURAL AND DOMESTIC USE (U.S. CLS. 6, 18, 44, 46, 51 AND 52).

SN 76-419,716. CEWAL, INC., LOS ANGELES, CA. FILED 6-12-2002.



NO CLAIM IS MADE TO THE EXCLUSIVE RIGHT TO USE "PAIN SPRAY", APART FROM THE MARK AS SHOWN.
FOR TOPICAL ANALGESIC (U.S. CLS. 6, 18, 44, 46, 51 AND 52).

CLASS 5—(Continued).

SN 76-420,065. ISAGENIX INTERNATIONAL, INC., PHOENIX, AZ. FILED 6-13-2002.

HAVE YOUR CAKE & EAT IT TOO

FOR NUTRITIONAL SUPPLEMENT IN THE FORM OF SNACK BARS FOR WEIGHT LOSS (U.S. CLS. 6, 18, 44, 46, 51 AND 52).



SN 76-420,769. THE NUTRACEUTICAL MEDICINE COMPANY INC., DUNCAN, BC, CANADA, FILED 6-13-2002.



PRIORITY CLAIMED UNDER SEC. 44(D) ON CANADA APPLICATION NO. 1125580, FILED 12-17-2001.
FOR DIETARY SUPPLEMENTS NAMELY, ANTI-CATABOLIC SUPPLEMENTS (U.S. CLS. 6, 18, 44, 46, 51 AND 52).
FIRST USE 10-0-2001; IN COMMERCE 10-0-2001.



SN 76-422,715. MAKHTESHIM CHEMICAL WORKS LTD., BEER SHEVA 84100, ISRAEL, FILED 6-17-2002.

PEDESTAL

FOR INSECTICIDES AND PESTICIDES FOR AGRICULTURAL AND DOMESTIC USE (U.S. CLS. 6, 18, 44, 46, 51 AND 52).

CLASS 5—(Continued).

SN 76-427,234. SELECT SUPPLEMENTS, INC., CARLSBAD, CA. FILED 7-3-2002.



FOR DIETARY SUPPLEMENTS SOLD IN BULK (U.S. CLS. 6, 18, 44, 46, 51 AND 52).



SN 76-427,412. ORANGE PEEL ENTERPRISES, INC., VERO BEACH, FL. FILED 7-3-2002.

PUT A LITTLE COLOR IN YOUR LIFE

FOR DIETARY SUPPLEMENTS (U.S. CLS. 6, 18, 44, 46, 51 AND 52).
FIRST USE 10-1-2001; IN COMMERCE 10-1-2001.



SN 76-427,743. INDEVEX HOLDINGS LTD., DUBLIN 2, IRELAND, FILED 6-18-2002.

INDEVEX

FOR NUTRITIONAL SUPPLEMENTS IN THE NATURE OF PROTEIN POWDER; CLUSTERED WATER TO BE CONSUMED FOR MEDICAL PURPOSES; NUTRITIONAL CONCENTRATE FOR USE AS A BEVERAGE ADDITIVE (U.S. CLS. 6, 18, 44, 46, 51 AND 52).

CLASS 5—(Continued).

SN 76-428,228. MERRICK'S, INC., MIDDLETON, WI. FILED 7-5-2002.

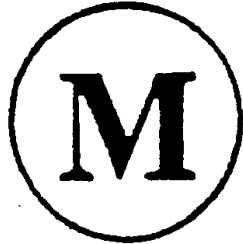

FOR MEDICATED ANIMAL FEEDS; MEDICATED ANIMAL FEED ADDITIVES; MEDICATED ANIMAL FEED SUPPLEMENTS FOR LIVESTOCK AND POULTRY; NUTRITIONAL SUPPLEMENTS FOR ANIMALS (U.S. CLS. 6, 18, 44, 46, 51 AND 52).
FIRST USE 9-0-1981; IN COMMERCE 9-0-1981.

SN 76-429,984. CRESCENTI, ERNESTO JOSE VICENTE, 1424 BUENOS AIRES, ARGENTINA, FILED 7-8-2002.

Crescenti



FOR PHARMACEUTICAL PREPARATIONS FOR INHIBITING OR PREVENTING THE GROWTH OR DEVELOPMENT OF MALIGNANT CELLS AND FOR STIMULATING THE IMMUNE SYSTEM (U.S. CLS. 6, 18, 44, 46, 51 AND 52).

SN 76-433,119. MERIAL, 69002 LYON, FRANCE, FILED 7-19-2002.

FRONTLINE PLUS

OWNER OF U.S. REG. NO. 2,049,456.
FOR INSECTICIDES AND ANTIPARASITIC AGENTS FOR VETERINARY USE (U.S. CLS. 6, 18, 44, 46, 51 AND 52).
FIRST USE 12-1-2000; IN COMMERCE 12-1-2000.

CLASS 5—(Continued).

SN 76-435,372. KEY ESSENTIALS, MILWAUKEE, WI. FILED 7-29-2002.

KEY ESSENTIALS

FOR FOOD SUPPLEMENTS; VITAMINS; MEDICATED LOTIONS FOR THE FACE AND BODY; AND MEDICATED REHYDRATING SKIN CREAMS (U.S. CLS. 6, 18, 44, 46, 51 AND 52).

SN 76-439,933. PIPEDREAM PRODUCTS, INC., CHATSWORTH, CA. FILED 8-12-2002.

MOIST

FOR GELS FOR USE AS PERSONAL LUBRICANTS (U.S. CLS. 6, 18, 44, 46, 51 AND 52).
FIRST USE 6-1-2000; IN COMMERCE 6-1-2000.

SN 76-441,789. OPTICS LABORATORY, INC., EL MONTE, CA. FILED 8-12-2002.

OCUFRESH

FOR MEDICATED EYE LOTIONS; OPHTHALMOLOGIC PREPARATIONS, NAMELY EYE LOTIONS; LUBRICANT EYE SOLUTIONS; AND REWETTING EYE SOLUTIONS (U.S. CLS. 6, 18, 44, 46, 51 AND 52).
FIRST USE 5-0-2002; IN COMMERCE 5-0-2002.

SN 76-443,200. E. JAANG CORPORATION, WU GU HSIANG, TAIWAN, FILED 8-23-2002.

ROBSON

THE DRAWING IS LINED FOR THE COLOR YELLOW.
FOR LIQUID AIR DEODORANTS; SOLID AIR DEODORANTS; AIR FRESHENERS (U.S. CLS. 6, 18, 44, 46, 51 AND 52).
FIRST USE 12-1-2001; IN COMMERCE 12-1-2001.

SN 76-453,767. BNG ENTERPRISES, INC., TEMPE, AZ. FILED 9-30-2002.

PROGRESIV

FOR ANTI-ACNE SKIN CARE SYSTEM COMPRISING TONER, LOTION, CLEANSER, MASK, FOUNDATION AND CONCEALER (U.S. CLS. 6, 18, 44, 46, 51 AND 52).

CLASS 5—(Continued).

SN 76-454,462. NOVOZYMES A/S, DK-2880 BAGSVAERD, DENMARK, FILED 9-25-2002.

NOVODOR

FOR PESTICIDES FOR AGRICULTURAL USE (U.S. CLS. 6, 18, 44, 46, 51 AND 52).
FIRST USE 2-0-1996; IN COMMERCE 2-0-1996.

SN 76-455,214. SOLVAY PHARMACEUTICALS B.V., WEESP, NETHERLANDS, FILED 9-30-2002.

PULZIUM

PRIORITY CLAIMED UNDER SEC. 44(D) ON BENELUX APPLICATION NO. 1014339, FILED 7-26-2002, REG. NO. 0713102, DATED 7-26-2002, EXPIRES 7-26-2012.

FOR PHARMACEUTICAL PREPARATIONS AND SUBSTANCES FOR THE TREATMENT OF CARDIO-VASCULAR DISEASES (U.S. CLS. 6, 18, 44, 46, 51 AND 52).

SN 76-455,215. SOLVAY PHARMACEUTICALS B.V., WEESP, NETHERLANDS, FILED 9-30-2002.

EQUASIS

PRIORITY CLAIMED UNDER SEC. 44(D) ON BENELUX APPLICATION NO. 1014336, FILED 7-26-2002, REG. NO. 0713101, DATED 7-26-2002, EXPIRES 7-26-2012.

FOR PHARMACEUTICAL PREPARATIONS AND SUBSTANCES FOR THE TREATMENT OF CARDIO-VASCULAR DISEASES (U.S. CLS. 6, 18, 44, 46, 51 AND 52).

SN 76-455,330. SOLVAY PHARMACEUTICALS B.V., WEESP, NETHERLANDS, FILED 9-30-2002.

FILIANCE

PRIORITY CLAIMED UNDER SEC. 44(D) ON BENELUX APPLICATION NO. 1014333, FILED 7-9-2002, REG. NO. 0713105, DATED 7-9-2002, EXPIRES 7-9-2012.

FOR PHARMACEUTICAL PREPARATIONS AND SUBSTANCES FOR THE TREATMENT OF CARDIO-VASCULAR DISEASES (U.S. CLS. 6, 18, 44, 46, 51 AND 52).

SN 76-455,331. SOLVAY PHARMACEUTICALS B.V., WEESP, NETHERLANDS, FILED 9-30-2002.

FILIANZE

PRIORITY CLAIMED UNDER SEC. 44(D) ON BENELUX APPLICATION NO. 1016577, FILED 8-20-2002, REG. NO. 0713104, DATED 8-20-2002, EXPIRES 8-20-2012.

FOR PHARMACEUTICAL PREPARATIONS AND SUBSTANCES FOR THE TREATMENT OF CARDIO-VASCULAR DISEASES (U.S. CLS. 6, 18, 44, 46, 51 AND 52).

CLASS 5—(Continued).

SN 76-458,207. COOPER CONCEPTS, INC., DALLAS, TX, FILED 10-15-2002.

**COOPER COMPLETE
ADVANCED OMEGA 3**

NO CLAIM IS MADE TO THE EXCLUSIVE RIGHT TO USE "COMPLETE" AND "OMEGA 3", APART FROM THE MARK AS SHOWN.

FOR NUTRITIONAL SUPPLEMENTS, NAMELY A CAPSULE OR TABLET CONTAINING HIGH POTENCY EPA/DHA OMEGA 3 FATTY ACIDS (U.S. CLS. 6, 18, 44, 46, 51 AND 52).

SN 76-458,521. LEONARDI, DAVID, LAS VEGAS, NV, FILED 10-16-2002.

CYCLE-BREAKER

FOR VITAMIN AND MINERAL SUPPLEMENTS; VITAMIN DROPS; NUTRITIONAL AND DIETARY SUPPLEMENTS; DIETARY FOOD SUPPLEMENTS; HERBAL SUPPLEMENTS; NATURAL FOOD SUPPLEMENTS; NUTRITIONALLY FORTIFIED POWDERS FOR DRINK MIXES (U.S. CLS. 6, 18, 44, 46, 51 AND 52).

SN 76-460,138. THERAVANCE, INC., SOUTH SAN FRANCISCO, CA, FILED 10-16-2002.

POLYCULE

FOR BI-FUNCTIONAL AND MULTIBINDING COMPOUNDS SOLD AS A COMPONENT OF PHARMACEUTICAL PREPARATIONS FOR THE TREATMENT OF HUMAN DISEASES OF THE RESPIRATORY, ENDOCRINE, CIRCULATORY, GASTROINTESTINAL, GENITOURINARY AND CENTRAL NERVOUS SYSTEM AND FOR THE TREATMENT OF CANCER, PAIN AND AS ANTI-INFECTIVES (U.S. CLS. 6, 18, 44, 46, 51 AND 52).

CLASS 5—(Continued).

SN 76-461,610. FIRST HORIZON PHARMACEUTICAL CORPORATION, ALPHARETTA, GA. FILED 10-23-2002.

FIRST HORIZON PHARMACEUTICAL

OWNER OF U.S. REG. NO. 2,000,679.
NO CLAIM IS MADE TO THE EXCLUSIVE RIGHT TO USE "PHARMACEUTICAL", APART FROM THE MARK AS SHOWN.

FOR PRESCRIPTION PHARMACEUTICAL PREPARATIONS FOR HUMANS, NAMELY, PAIN MEDICATIONS, CHELATING AGENTS, ANTIHISTAMINES, DECONGESTANTS, EARDROPS, EXPECTORANTS, LIQUID ANTITUSSIVES, SUSTAINED-RELEASE MEDICATIONS FOR TREATING HEART RHYTHM DISORDERS, SYNTHETIC ANTICHOLINERGICS, PREPARATIONS FOR TREATING CARDIOLOGY CONDITIONS, PREPARATIONS FOR TREATING GASTROENTEROLOGY CONDITIONS, PREPARATIONS FOR TREATING NEUROLOGY CONDITIONS, PREPARATIONS FOR TREATING URINARY TRACT INFECTIONS, AND PREPARATIONS FOR TREATING WOMEN'S HEALTH, NAMELY PRENATAL VITAMINS AND MENSTRUAL PAIN RELIEF MEDICATION (U.S. CLS. 6, 18, 44, 46, 51 AND 52).

FIRST USE 1-3-2001; IN COMMERCE 1-3-2001.

SN 76-462,295. TARO PHARMACEUTICALS U.S.A., INC., HAWTHORNE, NY. FILED 10-24-2002.

TAROPHARMA DERMATOLOGICS

OWNER OF U.S. REG. NOS. 2,003,997, 2,459,912 AND 2,548,653.

NO CLAIM IS MADE TO THE EXCLUSIVE RIGHT TO USE "DERMATOLOGICS", APART FROM THE MARK AS SHOWN.

FOR HOUSE MARK FOR A FULL LINE OF PHARMACEUTICAL PRODUCTS (U.S. CLS. 6, 18, 44, 46, 51 AND 52).

SN 76-467,186. KENPAL FARM PRODUCTS INC., CENTRALIA, ONTARIO, N0M 1K0, CANADA, FILED 11-8-2002.



THE STIPLING IN THE MARK ON THE DRAWING PAGE IS A FEATURE OF THE MARK AND NOT INTENDED TO INDICATE COLOR.

FOR MEDICATED ANIMAL FEED (U.S. CLS. 6, 18, 44, 46, 51 AND 52).

FIRST USE 8-20-2002; IN COMMERCE 8-20-2002.

CLASS 5—(Continued).

SN 76-471,671. ARCHER-DANIELS-MIDLAND COMPANY, DECATUR, IL. FILED 11-21-2002.

CULTURETECH

FOR ANIMAL FEED ADDITIVE IN THE NATURE OF YEAST DERIVED BYPRODUCTS FOR USE AS A NUTRITIONAL SUPPLEMENT, NAMELY, KILLED YEAST, LIVE YEAST AND PROBIOTICS (U.S. CLS. 6, 18, 44, 46, 51 AND 52).

SN 76-473,191. FERROSAN A/S, 2860 SOBORG, DENMARK, FILED 12-6-2002.

AFLURAX

OWNER OF DENMARK REG. NO. VR198908286, DATED 12-29-1989, EXPIRES 12-29-2009.

FOR GASTRO-INTESTINAL PREPARATION (U.S. CLS. 6, 18, 44, 46, 51 AND 52).

SN 76-476,956. SASSOVER, NATHAN, LOS ANGELES, CA. FILED 12-19-2002.

ALPHA PROGRAM

NO CLAIM IS MADE TO THE EXCLUSIVE RIGHT TO USE "PROGRAM", APART FROM THE MARK AS SHOWN.

FOR MEDICINAL PREPARATIONS IN THE FORM OF POWDERS, CAPSULES, TABLETS, SALVES, OINTMENTS, OILS, SOLUTIONS, AND DROPS ALL USED AS A NEURO-DEGENERATIVE INHIBITOR, NEURO-ENDOCRINE MODULATOR, AND NEURO-CEREBRAL METABOLISM ENHANCER FOR THE ELIMINATION OF ANXIETY AND HYPERACTIVITY, MITIGATION OF PANIC SYMPTOMOLOGY, REDUCTION OF FATIGUE, IMPROVEMENT OF SELF-CONFIDENCE AND SELF-ESTEEM, ELIMINATION OF THE NEED FOR ANTIDEPRESSANTS, COGNITIVE ENHANCEMENT, IMPROVEMENT OF AEROBIC ENDURANCE AND PERFORMANCE AND WEIGHT-TRAINING CAPACITY, IMPROVEMENT OF BLOOD CIRCULATION, REDUCTION OF BLOOD PRESSURE AND HYPERTENSION, IMPROVEMENT OF SEXUAL PERFORMANCE AND LIBIDO, REDUCTION OF HORMONAL IMBALANCE IN MENOPAUSAL AND POST-MENOPAUSAL WOMEN, IMPROVEMENT OF VISUAL AND AUDITORY ACUITY, IMPROVEMENT OF PHYSICAL AGILITY AND MUSCLE FLEXIBILITY, IMPROVEMENT OF SOCIAL INTERACTION SKILLS, PROMOTION OF RELAXATION RESPONSE AND MITIGATION OF CHRONIC SLEEP PATTERN DISORDERS SUCH AS INSOMNIA AND OTHER CHRONIC SLEEP DISORDERS, REDUCTION OF ARTHRITIC PAIN AND SWELLING, ENHANCEMENT OF IMMUNE SYSTEM FUNCTIONING, IMPROVEMENT OF THE METABOLISM, RELIEF FROM CONSTIPATION, IMPROVEMENT OF SKIN TONE, MITIGATION OF "JET LAG," AND REDUCTION IN CAFFEINE DEPENDENCE; AND THE TREATMENT OF A BROAD SPECTRUM OF CONDITIONS AND PATHOLOGIES, NAMELY, AGE-RELATED AND NEURO-DEGENERATIVE CONDITIONS AND PATHOLOGIES, NERVE DISEASES, GENERAL ANXIETY DISORDER, DEPRESSION, NEUROSIS, NEURASTHENIA, OBSSIVE-COMPULSIVE DISORDER, CHRONIC SLEEP DISORDER, CHRONIC FATIGUE SYNDROME, DIGESTIVE DISEASES, CHRONIC CONSTIPATION, HYPERTENSION, OSTEOARTHRITIS PAIN AND SWELLING, AND HUMAN SEXUAL DESIRE DISORDER (U.S. CLS. 6, 18, 44, 46, 51 AND 52).

FIRST USE 1-1-2002; IN COMMERCE 1-1-2002.

CLASS 5—(Continued).

SN 76-476,987. SASSOVER, NATHAN, LOS ANGELES, CA.
FILED 12-19-2002.

INTRATHERAPIES ALPHA PROGRAM

NO CLAIM IS MADE TO THE EXCLUSIVE RIGHT TO USE "PROGRAM", APART FROM THE MARK AS SHOWN.

FOR MEDICINAL PREPARATIONS IN THE FORM OF POWDERS, CAPSULES, TABLETS, SALVES, OINTMENTS, OILS, SOLUTIONS, AND DROPS ALL USED AS A NEURO-DEGENERATIVE INHIBITOR, NEURO-ENDOCRINE MODULATOR, AND NEURO-CEREBRAL METABOLISM ENHANCER FOR THE ELIMINATION OF ANXIETY AND HYPERACTIVITY, MITIGATION OF PANIC SYMPTOMOLOGY, REDUCTION OF FATIGUE, IMPROVEMENT OF SELF-CONFIDENCE AND SELF-ESTEEM, ELIMINATION OF THE NEED FOR ANTI-DEPRESSANTS, COGNITIVE ENHANCEMENT, IMPROVEMENT OF AEROBIC ENDURANCE AND PERFORMANCE AND WEIGHT-TRAINING CAPACITY, IMPROVEMENT OF BLOOD CIRCULATION, REDUCTION OF BLOOD PRESSURE AND HYPERTENSION, IMPROVEMENT OF SEXUAL PERFORMANCE AND LIBIDO, REDUCTION OF HORMONAL IMBALANCE IN MENOPAUSAL AND POST-MENOPAUSAL WOMEN, IMPROVEMENT OF VISUAL AND AUDITORY ACUITY, IMPROVEMENT OF PHYSICAL AGILITY AND MUSCLE FLEXIBILITY, IMPROVEMENT OF SOCIAL INTERACTION SKILLS, PROMOTION OF RELAXATION RESPONSE AND MITIGATION OF CHRONIC SLEEP PATTERN DISORDERS SUCH AS INSOMNIA AND OTHER CHRONIC SLEEP DISORDERS, REDUCTION OF ARTHRITIC PAIN AND SWELLING, ENHANCEMENT OF IMMUNE SYSTEM FUNCTIONING, IMPROVEMENT OF THE METABOLISM, RELIEF FROM CONSTIPATION, IMPROVEMENT OF SKIN TONE, MITIGATION OF "JET LAG," AND REDUCTION IN CAFFEINE DEPENDENCE; AND THE TREATMENT OF A BROAD SPECTRUM OF CONDITIONS AND PATHOLOGIES, NAMELY, AGE-RELATED AND NEURO-DEGENERATIVE CONDITIONS AND PATHOLOGIES, NERVE DISEASES, GENERAL ANXIETY DISORDER, DEPRESSION, NEUROSIS, NEURASTHENIA, OBSSIVE-COMPULSIVE DISORDER, CHRONIC SLEEP DISORDER, CHRONIC FATIGUE SYNDROME, DIGESTIVE DISEASES, CHRONIC CONSTIPATION, HYPERTENSION, OSTEOARTHRITIS PAIN AND SWELLING, AND HUMAN SEXUAL DESIRE DISORDER (U.S. CLS. 6, 18, 44, 46, 51 AND 52).

FIRST USE 1-1-2002; IN COMMERCE 1-1-2002.

SN 76-476,988. SASSOVER, NATHAN, LOS ANGELES, CA.
FILED 12-19-2002.

INTRATHERAPIES

FOR MEDICINAL PREPARATIONS IN THE FORM OF POWDERS, CAPSULES, TABLETS, SALVES, OINTMENTS, OILS, SOLUTIONS, AND DROPS ALL USED AS A NEURO-DEGENERATIVE INHIBITOR, NEURO-ENDOCRINE MODULATOR, AND NEURO-CEREBRAL METABOLISM ENHANCER FOR THE ELIMINATION OF ANXIETY AND HYPERACTIVITY, MITIGATION OF PANIC SYMPTOMOLOGY, REDUCTION OF FATIGUE, IMPROVEMENT OF SELF-CONFIDENCE AND SELF-ESTEEM, ELIMINATION OF THE NEED FOR ANTI-DEPRESSANTS, COGNITIVE ENHANCEMENT, IMPROVEMENT OF AEROBIC ENDURANCE AND PERFORMANCE AND WEIGHT-TRAINING CAPACITY, IMPROVEMENT OF BLOOD CIRCULATION, REDUCTION OF BLOOD PRESSURE AND HYPERTENSION, IMPROVEMENT OF SEXUAL PERFORMANCE AND LIBIDO, REDUCTION OF HORMONAL IMBALANCE IN MENOPAUSAL AND POST-MENOPAUSAL WOMEN, IMPROVEMENT OF VISUAL AND AUDITORY ACUITY,

CLASS 5—(Continued).

IMPROVEMENT OF PHYSICAL AGILITY AND MUSCLE FLEXIBILITY, IMPROVEMENT OF SOCIAL INTERACTION SKILLS, PROMOTION OF RELAXATION RESPONSE AND MITIGATION OF CHRONIC SLEEP PATTERN DISORDERS SUCH AS INSOMNIA AND OTHER CHRONIC SLEEP DISORDERS, REDUCTION OF ARTHRITIC PAIN AND SWELLING, ENHANCEMENT OF IMMUNE SYSTEM FUNCTIONING, IMPROVEMENT OF THE METABOLISM, RELIEF FROM CONSTIPATION, IMPROVEMENT OF SKIN TONE, MITIGATION OF "JET LAG," AND REDUCTION IN CAFFEINE DEPENDENCE; AND THE TREATMENT OF A BROAD SPECTRUM OF CONDITIONS AND PATHOLOGIES, NAMELY, AGE-RELATED AND NEURO-DEGENERATIVE CONDITIONS AND PATHOLOGIES, NERVE DISEASES, GENERAL ANXIETY DISORDER, DEPRESSION, NEUROSIS, NEURASTHENIA, OBSSIVE-COMPULSIVE DISORDER, CHRONIC SLEEP DISORDER, CHRONIC FATIGUE SYNDROME, DIGESTIVE DISEASES, CHRONIC CONSTIPATION, HYPERTENSION, OSTEOARTHRITIS PAIN AND SWELLING, AND HUMAN SEXUAL DESIRE DISORDER (U.S. CLS. 6, 18, 44, 46, 51 AND 52).

FIRST USE 1-1-2002; IN COMMERCE 1-1-2002.

SN 76-476,989. SASSOVER, NATHAN, LOS ANGELES, CA.
FILED 12-19-2002.

NURENEX

FOR MEDICINAL PREPARATIONS IN THE FORM OF POWDERS, CAPSULES, TABLETS, SALVES, OINTMENTS, OILS, SOLUTIONS, AND DROPS ALL USED AS A NEURO-DEGENERATIVE INHIBITOR, NEURO-ENDOCRINE MODULATOR, AND NEURO-CEREBRAL METABOLISM ENHANCER FOR THE ELIMINATION OF ANXIETY AND HYPERACTIVITY, MITIGATION OF PANIC SYMPTOMOLOGY, REDUCTION OF FATIGUE, IMPROVEMENT OF SELF-CONFIDENCE AND SELF-ESTEEM, ELIMINATION OF THE NEED FOR ANTI-DEPRESSANTS, COGNITIVE ENHANCEMENT INCLUDING IMPROVED CONCENTRATION, CLARITY, AND MENTAL FOCUS, IMPROVEMENT OF AEROBIC ENDURANCE AND PERFORMANCE AND WEIGHT-TRAINING CAPACITY, IMPROVEMENT OF BLOOD CIRCULATION, REDUCTION OF BLOOD PRESSURE AND HYPERTENSION, IMPROVEMENT OF SEXUAL PERFORMANCE AND LIBIDO, REDUCTION OF HORMONAL DISBALANCE IN MENOPAUSAL AND POST-MENOPAUSAL WOMEN, IMPROVEMENT OF VISUAL AND AUDITORY ACUITY, IMPROVEMENT OF PHYSICAL AGILITY AND MUSCLE FLEXIBILITY, IMPROVEMENT OF SOCIAL INTERACTION SKILLS, PROMOTION OF RELAXATION RESPONSE AND MITIGATION OF CHRONIC SLEEP PATTERN DISORDERS SUCH AS INSOMNIA AND OTHER CHRONIC SLEEP DISORDERS, REDUCTION OF ARTHRITIC PAIN AND SWELLING, ENHANCEMENT OF IMMUNE SYSTEM FUNCTIONING, IMPROVEMENT OF THE METABOLISM INCLUDING RELIEF FROM CONSTIPATION; IMPROVEMENT OF THE SKIN TONE; MITIGATION OF "JET LAG"; AND REDUCTION IN CAFFEINE DEPENDENCE, AND THE TREATMENT OF A BROAD SPECTRUM OF CONDITIONS AND PATHOLOGIES, INCLUDING CERTAIN PRE-EXISTING MEDICAL AS WELL AS AGE-RELATED AND NEURO-DEGENERATIVE CONDITIONS AND PATHOLOGIES INCLUDING NERVE DISEASES, GENERAL ANXIETY DISORDER, DEPRESSION, NEUROSIS, NEURASTHENIA, OBSSIVE-COMPULSIVE DISORDER, CHRONIC SLEEP DISORDER, CHRONIC FATIGUE SYNDROME, DIGESTIVE DISEASES, CHRONIC CONSTIPATION, HYPERTENSION, OSTEOARTHRITIS PAIN AND SWELLING, AND HUMAN SEXUAL DESIRE DISORDER (U.S. CLS. 6, 18, 44, 46, 51 AND 52).

FIRST USE 1-1-2002; IN COMMERCE 1-1-2002.

CLASS 5—(Continued).

SN 76-484,480. CRA INTERNATIONAL, CO., MIAMI, FL. FILED 1-22-2003.



NO CLAIM IS MADE TO THE EXCLUSIVE RIGHT TO USE "STOP SMOKING CREAM", APART FROM THE MARK AS SHOWN.

FOR TOPICALLY APPLIED CREAM USED TO DETER INDIVIDUALS FROM SMOKING FOR MEDICAL AND THERAPEUTIC USE (U.S. CLS. 6, 18, 44, 46, 51 AND 52).

SN 76-485,947. CIRCLE OF FRIENDS PRODUCTS, LLC, CHATSWORTH, CA. FILED 1-29-2003.

Little
Adventures

FOR ANTIBACTERIAL ALCOHOL SKIN SANITIZER GEL (U.S. CLS. 6, 18, 44, 46, 51 AND 52). FIRST USE 11-0-1999; IN COMMERCE 11-0-1999.

SN 76-486,174. EU YAN SANG INTERNATIONAL LTD., SINGAPORE, FILED 1-30-2003.

PSOVITE

FOR PHARMACEUTICAL PREPARATIONS FOR THE TREATMENT OF PSORIASIS (U.S. CLS. 6, 18, 44, 46, 51 AND 52).

SN 78-028,232. SMITHKLINE BEECHAM BIOLOGICALS MANUFACTURING S.A., RIXENSART, BELGIUM, FILED 9-29-2000.

MAGISTO

PRIORITY CLAIMED UNDER SEC. 44(D) ON UNITED KINGDOM APPLICATION NO. 2243691, FILED 8-26-2000, REG. NO. 696621, DATED 9-28-2000, EXPIRES 9-28-2040.

FOR VACCINES FOR HUMAN USE (U.S. CLS. 6, 18, 44, 46, 51 AND 52).

CLASS 5—(Continued).

SN 78-049,448. MAJEED, MUHAMMED, PISCATAWAY, NJ. FILED 2-21-2001.

NATURE'S LEAN MACHINE

FOR NATURAL EXTRACT FROM COLEUS FOSKOHLII FOR USE AS AN INGREDIENT IN DIETARY SUPPLEMENTS (U.S. CLS. 6, 18, 44, 46, 51 AND 52).

SN 78-055,742. PHARMACIA CORPORATION, PEAPACK, NJ. FILED 3-29-2001.

VESAR

FOR PHARMACEUTICAL PREPARATIONS USED IN THE TREATMENT OF CARDIOVASCULAR CONDITIONS (U.S. CLS. 6, 18, 44, 46, 51 AND 52).

SN 78-076,045. ARCHER, PHILIP R., THE COLONY, TX. FILED 7-27-2001.

BORDEAUX CARDIO

NO CLAIM IS MADE TO THE EXCLUSIVE RIGHT TO USE "CARDIO", APART FROM THE MARK AS SHOWN. FOR ALOE VERA BASED NUTRITIONAL SUPPLEMENTS (U.S. CLS. 6, 18, 44, 46, 51 AND 52).

SN 78-080,606. SYNGENTA PARTICIPATIONS AG, BASEL, SWITZERLAND, FILED 8-22-2001.

AXLE

FOR FUNGICIDE FOR AGRICULTURAL AND DOMESTIC USE. (U.S. CLS. 6, 18, 44, 46, 51 AND 52).

SN 78-085,069. 3M COMPANY, ST. PAUL, MN. BY MERGER, BY CHANGE OF NAME MINNESOTA MINING AND MANUFACTURING COMPANY, ST. PAUL, MN. FILED 9-22-2001.

SOLON

FOR PHARMACEUTICALS, NAMELY, IMMUNE RESPONSE MODIFIERS FOR USE IN TREATING OR PREVENTING INFECTIONS, VIRUSES, TUMORS, DISEASES, SURGICAL INCISIONS, CUTS, WOUNDS, WARTS AND DAMAGED SKIN. (U.S. CLS. 6, 18, 44, 46, 51 AND 52).

CLASS 5—(Continued).

SN 78-089,445. NOVARTIS AG, BASEL, SWITZERLAND, FILED 10-22-2001.

AGMIR

PRIORITY CLAIMED UNDER SEC. 44(D) ON SWITZERLAND APPLICATION NO. 10000/2001, FILED 10-16-2001, REG. NO. 490897, DATED 10-31-2001, EXPIRES 10-16-2011.

FOR PHARMACEUTICAL PREPARATIONS FOR THE TREATMENT OF DISORDERS OF THE CENTRAL NERVOUS SYSTEM, THE IMMUNE SYSTEM, THE CARDIO-VASCULAR SYSTEM, THE RESPIRATORY SYSTEM, THE MUSCULO-SKELETAL SYSTEM, FOR THE TREATMENT OF INFLAMMATORY DISORDERS, FOR THE TREATMENT OF SKIN DISORDERS, FOR THE TREATMENT OF CANCER, AND FOR THE TREATMENT OF EYE DISORDERS (U.S. CLS. 6, 18, 44, 46, 51 AND 52).

SN 78-089,457. NOVARTIS AG, BASEL, SWITZERLAND, FILED 10-22-2001.

CERGOLYA

PRIORITY CLAIMED UNDER SEC. 44(D) ON SWITZERLAND APPLICATION NO. 10003/2001, FILED 10-16-2001, REG. NO. 490900, DATED 10-31-2001, EXPIRES 10-16-2011.

FOR PHARMACEUTICAL PREPARATIONS FOR THE TREATMENT OF DISORDERS OF THE CENTRAL NERVOUS SYSTEM, THE IMMUNE SYSTEM, THE CARDIO-VASCULAR SYSTEM, THE RESPIRATORY SYSTEM, THE MUSCULO-SKELETAL SYSTEM, FOR THE TREATMENT OF INFLAMMATORY DISORDERS, FOR THE TREATMENT OF SKIN DISORDERS, FOR THE TREATMENT OF CANCER, AND FOR THE TREATMENT OF EYE DISORDERS (U.S. CLS. 6, 18, 44, 46, 51 AND 52).

SN 78-089,458. NOVARTIS AG, BASEL, SWITZERLAND, FILED 10-22-2001.

EXFORGE

PRIORITY CLAIMED UNDER SEC. 44(D) ON SWITZERLAND APPLICATION NO. 10001/2001, FILED 10-16-2001, REG. NO. 490898, DATED 10-31-2001, EXPIRES 10-16-2011.

FOR PHARMACEUTICAL PREPARATIONS FOR THE TREATMENT OF DISORDERS OF THE CENTRAL NERVOUS SYSTEM, THE IMMUNE SYSTEM, THE CARDIO-VASCULAR SYSTEM, THE RESPIRATORY SYSTEM, THE MUSCULO-SKELETAL SYSTEM, FOR THE TREATMENT OF INFLAMMATORY DISORDERS, FOR THE TREATMENT OF SKIN DISORDERS, FOR THE TREATMENT OF CANCER, AND FOR THE TREATMENT OF EYE DISORDERS (U.S. CLS. 6, 18, 44, 46, 51 AND 52).

CLASS 5—(Continued).

SN 78-093,253. ALTANAPHARMA AG, KONSTANZ, FED REP GERMANY, BY CHANGE OF NAME BYK GULDEN LOMBERG CHEMISCHE FABRIK GMBH, KONSTANZ, FED REP GERMANY, FILED 11-14-2001.

EZQUALT

FOR PHARMACEUTICAL PREPARATIONS FOR THE TREATMENT OF RESPIRATORY DISEASES AND CONDITIONS, PHARMACEUTICAL PREPARATIONS FOR THE TREATMENT OF GASTRO-INTESTINAL DISEASES AND CONDITIONS. (U.S. CLS. 6, 18, 44, 46, 51 AND 52).

SN 78-093,261. ALTANA PHARMA AG, KONSTANZ, FED REP GERMANY, BY CHANGE OF NAME BYK GULDEN LOMBERG CHEMISCHE FABRIK GMBH, KONSTANZ, FED REP GERMANY, FILED 11-14-2001.

QUOXEO

FOR PHARMACEUTICAL PREPARATIONS FOR THE TREATMENT OF RESPIRATORY DISEASES AND CONDITIONS, PHARMACEUTICAL PREPARATIONS FOR THE TREATMENT OF GASTRO-INTESTINAL DISEASES AND CONDITIONS (U.S. CLS. 6, 18, 44, 46, 51 AND 52).

SN 78-093,262. ALTANA PHARMA AG, KONSTANZ, FED REP GERMANY, BY CHANGE OF NAME BYK GULDEN LOMBERG CHEMISCHE FABRIK GMBH, KONSTANZ, FED REP GERMANY, FILED 11-14-2001.

TIPANZA

FOR PHARMACEUTICAL PREPARATIONS FOR THE TREATMENT OF RESPIRATORY DISEASES AND CONDITIONS, PHARMACEUTICAL PREPARATIONS FOR THE TREATMENT OF GASTRO-INTESTINAL DISEASES AND CONDITIONS (U.S. CLS. 6, 18, 44, 46, 51 AND 52).

SN 78-093,264. ALTANA PHARMA AG, KONSTANZ, FED REP GERMANY, BY CHANGE OF NAME BYK GULDEN LOMBERG CHEMISCHE FABRIK GMBH, KONSTANZ, FED REP GERMANY, FILED 11-14-2001.

XUOTMOS

FOR PHARMACEUTICAL PREPARATIONS FOR THE TREATMENT OF RESPIRATORY DISEASES AND CONDITIONS, PHARMACEUTICAL PREPARATIONS FOR THE TREATMENT OF GASTRO-INTESTINAL DISEASES AND CONDITIONS (U.S. CLS. 6, 18, 44, 46, 51 AND 52).

CLASS 5—(Continued).

SN 78-100,924. VITA CUBE SYSTEMS, INC., DENVER, CO.
FILED 1-4-2002.

VISUAL EYES

FOR DIETARY SUPPLEMENTS, NAMELY VITAMINS
AND HERBS FORMULATED TO PROMOTE VISION
HEALTH (U.S. CLS. 6, 18, 44, 46, 51 AND 52).
FIRST USE 7-2-2001; IN COMMERCE 9-21-2001.

SN 78-115,786. NOVARTIS AG, BASEL, SWITZERLAND,
FILED 3-19-2002.

LUCELBA

PRIORITY CLAIMED UNDER SEC. 44(D) ON SWITZER-
LAND APPLICATION NO. 2001/2002, FILED 3-6-2002, REG.
NO. 496523, DATED 3-26-2002, EXPIRES 3-6-2012.

FOR PHARMACEUTICAL PREPARATIONS FOR THE
TREATMENT OF DISORDERS OF THE CENTRAL
NERVOUS SYSTEM, THE IMMUNE SYSTEM, THE
CARDIO-VASCULAR SYSTEM, THE RESPIRATORY
SYSTEM, THE MUSCULO-SKELETAL SYSTEM, FOR
THE TREATMENT OF INFLAMMATORY DISORDERS,
FOR THE TREATMENT OF SKIN DISORDERS, FOR
THE TREATMENT OF CANCER, AND FOR THE
TREATMENT OF EYE DISORDERS (U.S. CLS. 6, 18, 44,
46, 51 AND 52).

SN 78-126,832. RANBAXY LABORATORIES LIMITED, NEW
DELHI, INDIA, FILED 5-7-2002.

PROXIL

FOR ANTIBIOTIC PHARMACEUTICAL AND MEDIC-
INAL PREPARATION FOR HUMAN USE (U.S. CLS. 6,
18, 44, 46, 51 AND 52).

SN 78-128,330. REMINGTON HEALTH PRODUCTS, L.L.C.,
FORT WORTH, TX. FILED 5-13-2002.



FOR VITAMINS, DIETARY SUPPLEMENTS, NUTRI-
TIONAL SUPPLEMENTS, AND MINERAL SUPPLE-
MENTS. (U.S. CLS. 6, 18, 44, 46, 51 AND 52).

CLASS 5—(Continued).

SN 78-131,940. YOUSO, TIMOTHY A, LAKE HAVASU CITY,
AZ. FILED 5-30-2002.

MIRACLE MOUTHWASH

NO CLAIM IS MADE TO THE EXCLUSIVE RIGHT TO
USE "MOUTHWASH", APART FROM THE MARK AS
SHOWN.

FOR MEDICATED MOUTHWASH (U.S. CLS. 6, 18, 44,
46, 51 AND 52).

SN 78-134,198. HISAMITSU PHARMACEUTICAL CO., INC.,
SAGA, JAPAN, FILED 6-8-2002.

SPOT THERAPY

PRIORITY CLAIMED UNDER SEC. 44(D) ON JAPAN
APPLICATION NO. 2002-44842, FILED 5-30-2002, REG. NO.
4638219, DATED 1-17-2003, EXPIRES 1-17-2013.

FOR ANTI-INFLAMMATORY AND ANALGESIC
AGENTS; PHARMACEUTICAL PREPARATIONS FOR
TREATMENT OF LUMBAGO, NAMELY MUSCULAR
AND FASCIAL LUMBAGO, SPONDYLOSIS DEFOR-
MANS DISCOPATHY, AND SPRAIN OF LUMBER
SPINE, OSTEOARTHRITIS, HUMEROSCAPULAR PERI-
ARTHRITIS, TENDINITIS, TENDO-VAGINITIS, PERI-
TENDINITIS, HUMERAL EPICONDYLITIS, TENNIS
ELBOW, MYALGIA AND POST-TRAUMATIC SWEL-
LING AND PAIN; OBLATES; GAUZE; MENSTRUAL
TAMPONS; MENSTRUAL NAPKINS; MENSTRUAL
PANTIES; COTTON FOR MEDICAL PURPOSE; MEDI-
CAL ADHESIVE PLASTERS; LIQUID BANDAGES (U.S.
CLS. 6, 18, 44, 46, 51 AND 52).

SN 78-135,072. N.V. ORGANON, 5349 OSS, NETHERLANDS,
FILED 6-12-2002.

GANIREST

PRIORITY CLAIMED UNDER SEC. 44(D) ON NETHER-
LANDS APPLICATION NO. 1007819, FILED 3-22-2002, REG.
NO. 709590, DATED 3-22-2002, EXPIRES 3-22-2012.

FOR MEDICINES AND PHARMACEUTICAL PRE-
PARATIONS FOR STIMULATION OF HUMAN FERTI-
LITY (U.S. CLS. 6, 18, 44, 46, 51 AND 52).

SN 78-135,587. EPITOPIX, LLC, WILLMAR, MN. FILED 6-13-
2002.

EPITOPIX

FOR VACCINES; VETERINARY VACCINES FOR DO-
MESTIC FOWL AND LIVESTOCK; BIOLOGICAL PRE-
PARATIONS FOR CONTROLLING BACTERIAL
DISEASES IN DOMESTIC FOWL AND LIVESTOCK
(U.S. CLS. 6, 18, 44, 46, 51 AND 52).

CLASS 5—(Continued).

SN 78-135,637. EPI TOPIX, LLC, WILLMAR, MN. FILED 6-13-2002.

SRP

FOR VACCINES; VETERINARY VACCINES FOR DOMESTIC FOWL AND LIVESTOCK; BIOLOGICAL PREPARATIONS FOR CONTROLLING BACTERIAL DISEASES IN DOMESTIC FOWL AND LIVESTOCK (U.S. CLS. 6, 18, 44, 46, 51 AND 52).

FIRST USE 2-7-2001; IN COMMERCE 2-7-2001.

SN 78-139,316. WONG, MIRIAM, MEI-YU, STAFFORD, TX. FILED 6-27-2002.

SPECTRAMEANS

FOR DIETARY AND NUTRITIONAL SUPPLEMENTS (U.S. CLS. 6, 18, 44, 46, 51 AND 52).

SN 78-139,504. AVENTIS PHARMA S.A., ANTONY, FRANCE, FILED 6-27-2002.

VELUXUS

PRIORITY CLAIMED UNDER SEC. 44(D) ON FRANCE APPLICATION NO. 023140531, FILED 1-8-2002, REG. NO. 023140531, DATED 1-8-2002, EXPIRES 1-8-2012.

FOR PHARMACEUTICAL PRODUCTS, NAMELY ANTI-DIABETIC PREPARATIONS (U.S. CLS. 6, 18, 44, 46, 51 AND 52).

SN 78-139,550. AVENTIS PHARMA S.A., BRIDGEWATER, NJ. FILED 6-27-2002.

SHORANT

PRIORITY CLAIMED UNDER SEC. 44(D) ON FRANCE APPLICATION NO. 023140530, FILED 1-8-2002, REG. NO. 023140530, DATED 1-8-2002, EXPIRES 1-8-2012.

FOR PHARMACEUTICAL PRODUCTS, NAMELY ANTI-DIABETIC PREPARATIONS (U.S. CLS. 6, 18, 44, 46, 51 AND 52).

SN 78-139,745. ULTRA BIOTECH LIMITED, DOUGLAS, ISLE OF MAN, FILED 6-28-2002.

CLYTINOL

FOR PHARMACEUTICAL PREPARATIONS AND SUBSTANCES FOR THE TREATMENT OF NASOPHARYNGEAL CANCER (U.S. CLS. 6, 18, 44, 46, 51 AND 52).

CLASS 5—(Continued).

SN 78-145,614. SYNGENTA PARTICIPATIONS AG, GREENSBORO, NC. FILED 7-19-2002.



FOR FUNGICIDES FOR USE IN AGRICULTURE, HORTICULTURE AND FORESTRY (U.S. CLS. 6, 18, 44, 46, 51 AND 52).

SN 78-152,441. LABORATOIRES GOEMAR, 35400 SAINT MALO, FRANCE, FILED 8-8-2002.

RHINOMIST

PRIORITY CLAIMED UNDER SEC. 44(D) ON FRANCE APPLICATION NO. 99773664, FILED 2-8-1999, REG. NO. 99773664, DATED 2-8-1999, EXPIRES 2-8-2009.

OWNER OF U.S. REG. NO. 2,072,543.
FOR NASAL SPRAY (U.S. CLS. 6, 18, 44, 46, 51 AND 52).

SN 78-153,339. ARMKEL, LLC, PRINCETON, NJ. FILED 8-12-2002.

NATURE'S RESPONSE

FOR PREPARATIONS FOR THE TREATMENT AND RELIEF OF VAGINAL DRYNESS AND EXTERNAL ITCHING, VAGINAL MOISTURIZERS, VAGINAL LUBRICANTS, AND WATER BASED PREPARATIONS OF VARIOUS VISCOSITIES FOR USE A PERSONAL LUBRICANTS (U.S. CLS. 6, 18, 44, 46, 51 AND 52).

SN 78-153,816. EASYTRIM, LLC, BOHEMIA, NY. FILED 8-13-2002.

HUNGERSTRESS

FOR NUTRITIONAL SUPPLEMENTS (U.S. CLS. 6, 18, 44, 46, 51 AND 52).

CLASS 5—(Continued).

SN 78-155,086. FUTURECEUTICALS, MOMENCE, IL. FILED 8-16-2002.



FruiteX.B

FOR DIETARY SUPPLEMENT (U.S. CLS. 6, 18, 44, 46, 51 AND 52).

SN 78-159,142. W. NEUDORFF GMBH KG, EMMERTHAL 1, FED REP GERMANY, FILED 8-29-2002.

PROMANAL

OWNER OF FED REP GERMANY REG. NO. 2901908, DATED 2-15-1995, EXPIRES 10-31-2004.

FOR PREPARATIONS FOR DESTROYING VERMIN; INSECTICIDES FOR AGRICULTURAL AND DOMESTIC USE (U.S. CLS. 6, 18, 44, 46, 51 AND 52).

SN 78-160,447. VITABIOTICS LTD, WEMBLEY, UNITED KINGDOM, FILED 9-4-2002.

JOINTACE

OWNER OF UNITED KINGDOM REG. NO. 2158285, DATED 8-28-1998, EXPIRES 2-14-2008.

FOR PHARMACEUTICAL PREPARATIONS, VITAMIN AND MINERAL PREPARATIONS, NUTRITIONAL AND HERBAL SUPPLEMENTS FOR USE IN THE TREATMENT OF AND PROTECTION OF JOINTS AND JOINT RELATED CONDITIONS; PHARMACEUTICAL PREPARATIONS, VITAMIN AND MINERAL PREPARATIONS, NUTRITIONAL AND HERBAL SUPPLEMENTS FOR USE IN THE TREATMENT OF AND PROTECTION OF JOINTS AND JOINT RELATED CONDITIONS (U.S. CLS. 6, 18, 44, 46, 51 AND 52).

SN 78-171,280. HELIX DIAGNOSTICS LLC, MADISON, WI. FILED 10-4-2002.

HELIX DIAGNOSTICS

NO CLAIM IS MADE TO THE EXCLUSIVE RIGHT TO USE "DIAGNOSTICS", APART FROM THE MARK AS SHOWN.

FOR DIAGNOSTIC PREPARATIONS FOR CLINICAL OR MEDICAL LABORATORY USE (U.S. CLS. 6, 18, 44, 46, 51 AND 52).

CLASS 5—(Continued).

SN 78-173,411. PHARMACIA & UPJOHN COMPANY, PEAPACK, NJ. FILED 10-11-2002.

XALACOMB

FOR PHARMACEUTICAL PREPARATIONS, NAMELY PREPARATIONS FOR THE TREATMENT OF INFECTIOUS DISEASES, CANCER, OPHTHALMOLOGIC CONDITIONS AND DISEASES, CENTRAL NERVOUS SYSTEMS DISEASES AND DISORDERS, PARKINSON'S DISEASE, CARDIOVASCULAR DISEASES AND CONDITIONS, MIGRAINES, PHARMACEUTICAL PREPARATIONS FOR THE TREATMENT AND SYMPTOMS OF DIABETES, GYNECOLOGICAL PREPARATIONS FOR THE TREATMENT OF BIRTH CONTROL, AND TREATMENT FOR TREATMENT OF ENDOMETRIOSIS, HORMONAL PREPARATIONS, NAMELY HORMONE REPLACEMENT THERAPY; PHARMACEUTICAL PREPARATIONS FOR UROLOGICAL USE, PHARMACEUTICAL PREPARATIONS FOR THE TREATMENT OF URINARY TRACT AND BLADDER INFECTIONS; ANALGESICS; ANTI-INFLAMMATORY PHARMACEUTICAL PREPARATIONS (U.S. CLS. 6, 18, 44, 46, 51 AND 52).

SN 78-176,322. LOWE, CHELSEA, BROOKLINE, MA. AND GIANATASIO, DAVID, BROOKLINE, MA. FILED 10-20-2002.

PERIOD PEACE

FOR SANITARY PRODUCT FOR OVERNIGHT USE, NAMELY, SANITARY PAD IN DISPOSABLE UNDERGARMENT (U.S. CLS. 6, 18, 44, 46, 51 AND 52).

SN 78-176,952. ATHLON PHARMACEUTICALS, INC., BIRMINGHAM, AL. FILED 10-22-2002.



BröveX

FOR PHARMACEUTICAL PREPARATION FOR THE TREATMENT OF ALLERGIES, SEASONAL AND PERENNIAL RHINORRHEA, ITCHY WATERY EYES, NOSE AND THROAT, AND HAY FEVER (U.S. CLS. 6, 18, 44, 46, 51 AND 52).

FIRST USE 6-1-2002; IN COMMERCE 6-1-2002.

CLASS 5—(Continued).

SN 78-179,790. THE ENRICH CORPORATION, OREM, UT. FILED 10-29-2002.

E-BURN

FOR MEDICATED HAIR LOTIONS; PHARMACEUTICAL, VETERINARY AND SANITARY SUBSTANCES, NAMELY, INFANTS' AND INVALIDS' FOODS, HERBAL TEAS FOR MEDICINAL PURPOSES, DIURETIC PREPARATIONS, WOUND DRESSINGS, BURN DRESSINGS, PREPARATIONS FOR TREATING COLDS, POLLEN FOR USE AS A DIETARY SUPPLEMENT, DIETARY SUPPLEMENTS, NUTRITIONAL SUPPLEMENTS, VITAMIN AND MINERAL SUPPLEMENTS; MATERIAL FOR BANDAGING, NAMELY, PLASTERS; MATERIAL FOR STOPPING TEETH, DENTAL WAX; ALL PURPOSE DISINFECTANTS (U.S. CLS. 6, 18, 44, 46, 51 AND 52).

SN 78-179,889. ARMKEL, LLC, PRINCETON, NJ. FILED 10-30-2002.

FIRST RESPONSE

FOR PREPARATIONS FOR USE IN THE TREATMENT AND RELIEF OF VAGINAL DRYNESS AND EXTERNAL ITCHING; VAGINAL MOISTURIZERS; AND WATER BASED PERSONAL LUBRICANTS (U.S. CLS. 6, 18, 44, 46, 51 AND 52).

SN 78-180,503. OPHEIM, JOAR A., WATSONVILLE, CA. FILED 10-31-2002.

VEGA OMEGA

NO CLAIM IS MADE TO THE EXCLUSIVE RIGHT TO USE "OMEGA", APART FROM THE MARK AS SHOWN, FOR DIETARY SUPPLEMENT (U.S. CLS. 6, 18, 44, 46, 51 AND 52).

SN 78-180,638. MANNA PRO CORPORATION, ST. LOUIS, MO. FILED 10-31-2002.

POWERHOUSE

FOR HORSE FEED SUPPLEMENT (U.S. CLS. 6, 18, 44, 46, 51 AND 52).

SN 78-184,490. RANBAXY LABORATORIES LIMITED, NEW DELHI, DELHI, INDIA, FILED 11-13-2002.

HISTACLEAR

FOR PHARMACEUTICAL PREPARATIONS, NAMELY, ANTIHISTAMINES AND DECONGESTANTS (U.S. CLS. 6, 18, 44, 46, 51 AND 52).

CLASS 5—(Continued).

SN 78-184,496. RANBAXY LABORATORIES LIMITED, NEW DELHI, DELHI, INDIA, FILED 11-13-2002.

ANHISTINE

FOR PHARMACEUTICAL PREPARATIONS, NAMELY, ANTIHISTAMINES AND DECONGESTANTS (U.S. CLS. 6, 18, 44, 46, 51 AND 52).

SN 78-184,770. RANBAXY LABORATORIES LIMITED, NEW DELHI, INDIA, FILED 11-13-2002.

PANIEXIN

FOR PHARMACEUTICAL AND MEDICINAL PREPARATIONS FOR HUMAN USE, NAMELY, ANTIBIOTICS. (U.S. CLS. 6, 18, 44, 46, 51 AND 52).

SN 78-185,714. SUPERGEN, INC., DUBLIN, CA. FILED 11-15-2002.

MITOZYTRIN

FOR PHARMACEUTICAL PREPARATIONS FOR USE IN THE TREATMENT OF MALIGNANCIES (U.S. CLS. 6, 18, 44, 46, 51 AND 52).

SN 78-185,715. S. C. JOHNSON & SON, INC., RACINE, WI. FILED 11-15-2002.

ON & ON

FOR AIR FRESHENERS. (U.S. CLS. 6, 18, 44, 46, 51 AND 52).

SN 78-186,029. TEVA PHARMACEUTICALS USA, INC., NORTH WALES, PA. FILED 11-18-2002.

GLYBURDIA

FOR PHARMACEUTICAL PREPARATIONS FOR THE TREATMENT OF DIABETES (U.S. CLS. 6, 18, 44, 46, 51 AND 52).

SN 78-186,415. DENTCO, INC., HUMACAO, PUERTO RICO, FILED 11-19-2002.

SUPER POLIGRIP POLISEAL

OWNER OF U.S. REG. NO. 444,018.
FOR DENTURE ADHESIVE (U.S. CLS. 6, 18, 44, 46, 51 AND 52).

CLASS 5—(Continued).

SN 78-186,429. TEVA PHARMACEUTICALS USA, INC., NORTH WALES, PA. FILED 11-19-2002.

BUPROLIFT SR

NO CLAIM IS MADE TO THE EXCLUSIVE RIGHT TO USE "SR", APART FROM THE MARK AS SHOWN.
FOR PHARMACEUTICAL PREPARATIONS FOR THE TREATMENT OF DEPRESSION (U.S. CLS. 6, 18, 44, 46, 51 AND 52).

SN 78-191,456. ASTRAZENECA AB, SODERTALJE, SWEDEN, FILED 12-5-2002.

NASOLVE

FOR PHARMACEUTICAL PREPARATIONS FOR THE TREATMENT OF DISEASES OF THE RESPIRATORY TRACT. (U.S. CLS. 6, 18, 44, 46, 51 AND 52).

SN 78-191,516. ALCON, INC., CH-6331 HUNENBERG, SWITZERLAND, FILED 12-5-2002.

**REMEMBER SYSTANE.
FORGET DRY EYE.**

FOR PHARMACEUTICAL PREPARATION FOR LUBRICATION OF THE EYES. (U.S. CLS. 6, 18, 44, 46, 51 AND 52).

SN 78-191,676. CLIPPER DISTRIBUTING COMPANY, LLC, ST. JOSEPH, MO. FILED 12-5-2002.



NO CLAIM IS MADE TO THE EXCLUSIVE RIGHT TO USE "DISTRIBUTING COMPANY", APART FROM THE MARK AS SHOWN.
FOR VETERINARY AND HUMAN PHARMACEUTICALS, NAMELY, ANTI-INFLAMMATORIES, ANTIMICROBIALS AND ANTIPARASITICS (U.S. CLS. 6, 18, 44, 46, 51 AND 52).

CLASS 6—METAL GOODS

SN 75-270,160. FEDERAL SCREW WORKS, DETROIT, MI. FILED 4-7-1997.

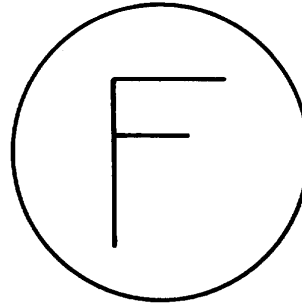

FOR FASTENERS, NAMELY, THREADED METAL FASTENERS; AND SPECIALTY COLD FORMED METAL PRODUCTS, NAMELY, BALL STUDS, BRAKE CALIPER PINS, WRIST PINS, SHAFTS, AND FLUID POWER COMPONENTS, NAMELY, PISTON PINS, HYDRAULIC VALVE SPOOLS, TERMINALS AND SLEEVES (U.S. CLS. 2, 12, 13, 14, 23, 25 AND 50).
FIRST USE 0-0-1917; IN COMMERCE 0-0-1917.

SN 76-040,550. VALVOSANITARIA BUGATTI S.P.A., CASTEGNATO (BRESCIA), ITALY, FILED 5-4-2000.



OWNER OF ITALY REG. NO. N774472, DATED 3-8-1999, EXPIRES 11-7-2006.
FOR MANUALLY OPERATED METAL VALVES, NAMELY, BRASS BALL VALVES AND VALVES FOR GAS AND WATER (U.S. CLS. 2, 12, 13, 14, 23, 25 AND 50).

SN 76-088,478. METPOST LIMITED, CARDIFF, CF3 8EX, UNITED KINGDOM, FILED 7-13-2000.

MET-GATE

OWNER OF UNITED KINGDOM REG. NO. 2218287, DATED 6-23-2000, EXPIRES 12-23-2009.
FOR METAL HARDWARE, NAMELY, BRACKETS SOLD AS A KIT FOR CONSTRUCTION OF A GATE (U.S. CLS. 2, 12, 13, 14, 23, 25 AND 50).

CLASS 6—(Continued).

SN 76-423,362. FEARS, LOWELL, HOUSTON, TX. FILED 6-20-2002.

SHUR-SHUT

FOR METAL GATES AND FENCES (U.S. CLS. 2, 12, 13, 14, 23, 25 AND 50).

SN 76-441,092. MURPHY, JOHN P., OCEAN CITY, MD. FILED 8-16-2002.



NO CLAIM IS MADE TO THE EXCLUSIVE RIGHT TO USE "COUPLINGS", APART FROM THE MARK AS SHOWN.

FOR METAL FITTINGS AND COUPLINGS FOR HOSES AND PIPES (U.S. CLS. 2, 12, 13, 14, 23, 25 AND 50).

FIRST USE 2-1-2002; IN COMMERCE 2-1-2002.

SN 76-450,731. INDUSTRIAL SALES CORPORATION, WESTPORT, CT. FILED 9-18-2002.

GRIP-TITE

FOR METAL WINDOW SUPPORT HARDWARE, NAMELY, METAL CABLES, SCREWS, TURNBUCKLES, EYE BRACKETS, NUTS, WASHERS, AND CLEATS (U.S. CLS. 2, 12, 13, 14, 23, 25 AND 50).

SN 76-461,758. U.S. GRANULES CORPORATION, PLYMOUTH, IN. FILED 10-25-2002.

U.S. GRANULES

NO CLAIM IS MADE TO THE EXCLUSIVE RIGHT TO USE "GRANULES", APART FROM THE MARK AS SHOWN. SEC. 2(F).

FOR ALUMINUM GRANULES SOLD IN A PROCESSED FORM FOR USE IN BLENDS OF THE MASTER ALLOYING INDUSTRY, FOR USE IN EXOTHERMIC REACTORS, FOR USE IN THE CHEMICAL INDUSTRY FOR THE PRODUCTION OF CATALYSTS AND AS A REACTANT, FOR USE IN THE EXPLOSIVES INDUSTRY, FOR USE IN THE EXOTHERMIC INDUSTRIES, FOR USE IN BLENDS OF ALUMINUM AND OTHER METALLIC GRANULES IN THE MASTER ALLOYING INDUSTRY, FOR USE IN THE STEEL AND FOUNDRY INDUSTRIES AS AN EXOTHERMIC FUEL FOR HOT TOPPING AND AS SLAG DEOXIDIZERS, REFRACTORY SLEEVES AND RISERS AND AS A FUEL USED IN THE PRODUCTION OF FERROMOLYBDENUM, FOR USE AS A FUEL IN EMULSION AND WATERGEL EXPLOSIVES, AND AS AN ADDITIVE USED IN THE COMBINATION OF FUEL OILS AND AMMONIUM NITRATE (U.S. CLS. 2, 12, 13, 14, 23, 25 AND 50).

FIRST USE 0-0-1986; IN COMMERCE 0-0-1986.

CLASS 6—(Continued).

SN 78-120,414. DAVID M. O'ROURKE, CENTRAL FALLS, RI. FILED 4-9-2002.

GORILLA GRIP POLE SECURITY SYSTEM

NO CLAIM IS MADE TO THE EXCLUSIVE RIGHT TO USE "GRIP POLE SECURITY SYSTEM", APART FROM THE MARK AS SHOWN.

FOR LOCKING DEVICES, NAMELY, METAL BRACKETS FOR ALUMINUM STAGING POLES AND A TAMPERPROOF METAL BRACKET THAT CAN BE BOLTED OR SCREWED TO A WALL OR OTHER SURFACE USED IN CONJUNCTION WITH A CHAIN OR PADLOCK TO SECURE EACH TO EACH OTHER OR TO SECURE INDIVIDUALLY WITH OTHER OBJECTS (U.S. CLS. 2, 12, 13, 14, 23, 25 AND 50).

SN 78-124,674. THOMPSON, TERESA L., WILBUR BY THE SEA, FL. FILED 4-28-2002.

HOT METAL MAMA

NO CLAIM IS MADE TO THE EXCLUSIVE RIGHT TO USE "METAL", APART FROM THE MARK AS SHOWN.

THE MARK CONSISTS OF THE WORDING "HOT METAL MAMA" OVER A DESIGN OF A WOMAN WEARING HIGH-HEELED SHOES, A DRESS AND A WELDING HOOD WITH THE REFLECTION OF FLAMES IN IT FROM THE BLOW TORCH SHE'S HOLDING.

FOR NON-PRECIOUS METAL SCULPTURES (U.S. CLS. 2, 12, 13, 14, 23, 25 AND 50).

FIRST USE 6-1-2001; IN COMMERCE 10-1-2001.

SN 78-140,799. HERWIN INC., RILLTON, PA. BY ASSIGNMENT HARRY E SMITH AND ASSOCIATES, INC., RILLTON, PA. FILED 7-2-2002.

DISPLAYGUARD

FOR METAL GUARD RAILS HAVING ELECTRONIC DISPLAYS MOUNTED THEREON (U.S. CLS. 2, 12, 13, 14, 23, 25 AND 50).

CLASS 6—(Continued).

SN 78-155,441. UNITRON PRODUCTS, INC., BRONX, NY. FILED 8-19-2002.

US STRUT

NO CLAIM IS MADE TO THE EXCLUSIVE RIGHT TO USE "STRUT", APART FROM THE MARK AS SHOWN.

SEC. 2(F).

FOR STRUCTURAL METAL SUPPORT, NAMELY, COLD ROLL FORMED CHANNELS HAVING A CONTINUOUS SLOT ON ONE SIDE AND SOLID OR PERFORATED ON THE BACK OF THE SECTION (U.S. CLS. 2, 12, 13, 14, 23, 25 AND 50).

FIRST USE 9-1-1982; IN COMMERCE 3-21-1990.

SN 78-157,661. AVIBANK MFG., INC., NORTH HOLLYWOOD, CA. FILED 8-26-2002.

INVISA-BOLT

FOR METAL FASTENERS, NAMELY, LOW-OBSERVABLE HEAD FASTENERS USED FOR ATTACHING TWO STRUCTURAL PANELS TOGETHER, FOR USE IN THE AEROSPACE INDUSTRY (U.S. CLS. 2, 12, 13, 14, 23, 25 AND 50).

SN 78-157,840. INTERLOCK STRUCTURES INTERNATIONAL, INC., MINNEAPOLIS, MN. FILED 8-26-2002.

STOWAWAY

FOR METAL TRUSSES FOR EXHIBIT BOOTHS (U.S. CLS. 2, 12, 13, 14, 23, 25 AND 50).

SN 78-164,125. STAR ASSOCIATES, SARASOTA, FL. FILED 9-13-2002.



FOR NAILS (U.S. CLS. 2, 12, 13, 14, 23, 25 AND 50).

CLASS 6—(Continued).

SN 78-166,070. CHOI, JOHN YOUNG, SEOUL, REPUBLIC OF KOREA, FILED 9-19-2002.

C & C

PRIORITY CLAIMED UNDER SEC. 44(D) ON REPUBLIC OF KOREA APPLICATION NO. 2002-0036047, FILED 8-7-2002, REG. NO. 2002-0036047, DATED 8-7-2002, EXPIRES 8-7-2012.

FOR MANUALLY OPERATED METAL VALVES; METAL PIPE COUPLINGS; METAL FLANGES; AND METAL HARDWARE, NAMELY SPRINGS (U.S. CLS. 2, 12, 13, 14, 23, 25 AND 50).

SN 78-176,383. INFOSIGHT CORPORATION, CHILLICOTHE, OH. FILED 10-21-2002.

KETTLETAG

FOR METAL IDENTIFICATION TAGS FOR PARTS SUBJECTED TO ZINC GALVANIZING (U.S. CLS. 2, 12, 13, 14, 23, 25 AND 50).

SN 78-178,078. AMERISTAR FENCE PRODUCTS, INC., TULSA, OK. FILED 10-24-2002.

AEGIS

FOR METAL FENCES AND GATES, AND PARTS THEREFOR (U.S. CLS. 2, 12, 13, 14, 23, 25 AND 50). FIRST USE 11-0-1992; IN COMMERCE 11-0-1992.

SN 78-178,828. MASTRO, RON J., HONOLULU, HI. FILED 10-27-2002.

ISOSTRAP

FOR PIPE STRAPS MADE PRIMARILY OF METAL WHICH ISOLATE PIPES FROM THE SURROUNDING STRUCTURES (U.S. CLS. 2, 12, 13, 14, 23, 25 AND 50).

SN 78-185,321. ESTERO BAY INVESTORS, INC., DBA DAVIS BOATS, PASO ROBLES, CA. FILED 11-14-2002.

BATTLE RAIL

NO CLAIM IS MADE TO THE EXCLUSIVE RIGHT TO USE "RAIL", APART FROM THE MARK AS SHOWN.

FOR MARINE ACCESSORIES, NAMELY, METAL BOW RAILS (U.S. CLS. 2, 12, 13, 14, 23, 25 AND 50).

CLASS 6—(Continued).

SN 78-975,056. LOCKHEED MARTIN CORPORATION, BETHESDA, MD. FILED 12-21-2001.

JOINT STRIKE FIGHTER

NO CLAIM IS MADE TO THE EXCLUSIVE RIGHT TO USE "STRIKE FIGHTER", APART FROM THE MARK AS SHOWN.

FOR METAL NAME PLATES (U.S. CLS. 2, 12, 13, 14, 23, 25 AND 50).

CLASS 7—MACHINERY

SN 76-018,135. TOLERANS INGOL, INC., WANAMASSA, NJ. FILED 4-5-2000.

TOLERANS

FOR STITCHERS FOR USE IN THE GRAPHICS INDUSTRY (U.S. CLS. 13, 19, 21, 23, 31, 34 AND 35). FIRST USE 0-0-1984; IN COMMERCE 0-0-1984.

SN 76-035,470. MONARCH INDUSTRIES LIMITED, WINNIPEG, MANITOBA, CANADA, FILED 4-26-2000.

WATER HORSE

NO CLAIM IS MADE TO THE EXCLUSIVE RIGHT TO USE "WATER", APART FROM THE MARK AS SHOWN.

FOR WATER PUMPS, NAMELY SUMP PUMPS, WELL PUMPS, SUCTION PUMPS, BILGE PUMPS, CENTRIFUGAL PUMPS, AND ROTARY PUMPS (U.S. CLS. 13, 19, 21, 23, 31, 34 AND 35).

FIRST USE 11-30-2002; IN COMMERCE 11-30-2002.

SN 76-037,593. LONG MANUFACTURING LTD., OAKVILLE, ONTARIO, CANADA, FILED 5-1-2000.



THE LINING SHOWN IN THE MARK IS MERELY TO INDICATE SHADING.

SEC. 2(F).
FOR AUTOMOTIVE TRANSMISSION AND ENGINE OIL COOLERS (U.S. CLS. 13, 19, 21, 23, 31, 34 AND 35). FIRST USE 6-0-1996; IN COMMERCE 6-0-1996.

CLASS 7—(Continued).

SN 76-123,696. FULMAC, LLC, HANCOCK, NH. FILED 9-7-2000.

REDBONE

FOR MECHANICAL PLOW ATTACHABLE TO AUTOMOBILES, TRUCKS OR OTHER MOVEABLE VEHICLES OR MACHINES AND STRUCTURAL AND REPLACEMENT PARTS THEREFOR, ALL SOLD AS A UNIT (U.S. CLS. 13, 19, 21, 23, 31, 34 AND 35).

SN 76-123,697. FULMAC, LLC, HANCOCK, NH. FILED 9-7-2000.



NO CLAIM IS MADE TO THE EXCLUSIVE RIGHT TO USE "SNOWPLOWS", APART FROM THE MARK AS SHOWN.

FOR MECHANICAL PLOW ATTACHABLE TO AUTOMOBILES, TRUCKS OR OTHER MOVEABLE VEHICLES OR MACHINES AND STRUCTURAL AND REPLACEMENT PARTS THEREFOR, ALL SOLD AS A UNIT (U.S. CLS. 13, 19, 21, 23, 31, 34 AND 35).

SN 76-178,103. TEKNEK ELECTRONICS LIMITED, RENFREWSHIRE PA4 9RT, UNITED KINGDOM, FILED 12-8-2000.

LASERTEK

FOR CLEANING MACHINES; CLEANING MACHINES FOR REMOVING IMPURITIES FROM THE SURFACE OF WORKPIECES AND CLEANING, FINISHING AND PROCESSING MACHINES FOR THE ELECTRONICS INDUSTRY, ELECTRICAL COMPONENTS INDUSTRY, PHOTOGRAPHIC INDUSTRY AND WEB TREATMENT INDUSTRY; PRINTING MACHINES; PARTS FOR ALL THE AFORESAID GOODS (U.S. CLS. 13, 19, 21, 23, 31, 34 AND 35).

SN 76-255,581. GRACO MINNESOTA INC., MINNEAPOLIS, MN. FILED 5-11-2001.

XTREME

FOR RECIPROCATING PISTON PUMPS FOR USE WITH PAINT AND COATINGS (U.S. CLS. 13, 19, 21, 23, 31, 34 AND 35).

CLASS 7—(Continued).

SN 76-271,906. MITSUBISHI ELECTRIC CORPORATION, CHIYODA-KU, TOKYO, JAPAN, FILED 6-15-2001.

ELENESSA

OWNER OF JAPAN REG. NO. 4585695, DATED 7-12-2002, EXPIRES 7-12-2012.
FOR ELEVATORS (U.S. CLS. 13, 19, 21, 23, 31, 34 AND 35).

SN 76-272,668. MARED INDUSTRIES, INCORPORATED, VAN NUYS, CA. FILED 6-19-2001.



OWNER OF U.S. REG. NO. 1,255,664.
NO CLAIM IS MADE TO THE EXCLUSIVE RIGHT TO USE "INDUSTRIAL TOOL", APART FROM THE MARK AS SHOWN.
SEC. 2(F).
FOR POWER SAW BLADES FOR USE ON CONCRETE, ASPHALT, MASONRY AND BRICK; DIAMOND TIP CUTTING BLADES FOR USE ON CONCRETE, ASPHALT, MASONRY AND BRICK; POWER DRILL BITS; POWER TOOLS, NAMELY, END MILLS; CARBIDE CUTTING TOOLS, NAMELY, END MILLS, INSERTS AND BLANKS; POWER-OPERATED ABRASIVE WHEELS AND POWER-OPERATED GRINDING WHEELS (U.S. CLS. 13, 19, 21, 23, 31, 34 AND 35).
FIRST USE 8-1-1979; IN COMMERCE 8-1-1979.

SN 76-275,291. STAB S.R.L., 44031 AMBROGIO, FERRARA, ITALY, FILED 6-21-2001.



PRIORITY CLAIMED UNDER SEC. 44(D) ON ERPNTY TM OFC APPLICATION NO. 2250645, FILED 6-11-2001, REG. NO. 2250645, DATED 10-24-2002, EXPIRES 6-11-2011.
NO CLAIM IS MADE TO THE EXCLUSIVE RIGHT TO USE "ITALY", APART FROM THE MARK AS SHOWN.
FOR ELECTRIC MOTORS FOR SATELLITE ANTENNAS (U.S. CLS. 13, 19, 21, 23, 31, 34 AND 35).

CLASS 7—(Continued).

SN 76-281,438. DUHN OIL TOOL, INC., BAKERSFIELD, CA. FILED 6-28-2001.

QUICKLOCK WELLHEAD SYSTEM

NO CLAIM IS MADE TO THE EXCLUSIVE RIGHT TO USE "WELLHEAD SYSTEM", APART FROM THE MARK AS SHOWN.
FOR WELLHEADS; DUAL WELLHEADS; ELECTRIC FEEDTHRU WELLHEADS; WELLHEAD EQUIPMENT, NAMELY CASING HEADS, CASING HANGERS, TUBING HEADS, TUBING HEAD SPOOLS, SECONDARY MECHANICAL SEALS, TUBING HANGERS, WELLHEAD TUBING HEAD ADAPTERS, WELLHEAD FLANGES, WELLHEAD CROSSES AND TEES, TREE CAPS, WELLHEAD AND CHRISTMAS TREE FLUID AND GAS FLOW VALVES, WELLHEAD AND CHRISTMAS TREE FLUID AND GAS FLOW CHOKES, TENSION SET PACKERS, RING SEAL PACKERS, AND ANY COMBINATION OF THE AFOREMENTIONED GOODS SOLD AS A UNIT (U.S. CLS. 13, 19, 21, 23, 31, 34 AND 35).

SN 76-320,838. TRANSPORTES CONTINUOS INTERIORES S.A., EL PAPIOL, SPAIN, FILED 10-4-2001.



FOR CONVEYORS, CONVEYOR BELTS, MACHINE COUPLINGS, AND MACHINE BELTS; ALL FOR USE IN THE FIELD OF VEHICLE PRODUCTION; MOTORS AND ENGINES, NOT FOR LAND VEHICLES; MACHINE TOOLS, NAMELY, LATHES, DRILLS, PLANERS, SHAPERS, BROACHERS, GRINDERS AND POLISHING MACHINES; VEHICLE ASSEMBLY LINES AND PARTS THEREOF, COMPOSED PRIMARILY OF DECKING AND CONTACTLESS POWER SUPPLY (CPS) MARRIAGE MACHINES FOR MOVING THE SKID VEHICLE WITH THE CAR PARTS INTO POSITION FOR ASSEMBLY (MARRIAGE) WITH OTHER CAR PARTS, ELECTRIFIED MONORAIL SYSTEM (EMS) MACHINES WITH PANTOGRAPHIC LIFTING HANGAR AND FREE MACHINES, SKILLET MACHINES, SKILLET MACHINES WITH LIFTING UNITS, VEHICLE AND MANMOVER BELT MAINTENANCE MACHINES FOR FINAL ASSEMBLY, FLAT TOP SLAT CONVEYOR MACHINES, FRICTION ROLLERS, INVERTED MONORAILS, LIFTS, ACCUMULATION CONVEYORS, PALLET CONVEYORS, PENDULUM CONVEYORS, POWER AND FREE CONVEYORS, SCRAP CONVEYORS, SKIDS, TURNABLES, SHUTTLES WITH POWER ROLL TABLES, POWER ROLL LIFT TABLES, SCISSOR LIFT TABLES, BI-CHAIN CONVEYORS, WAREHOUSING AND TRANSFER UNITS, AUTOMATED STORAGE AND RETRIEVAL MACHINES (U.S. CLS. 13, 19, 21, 23, 31, 34 AND 35).

CLASS 7—(Continued).

SN 76-342,391. CAE RANSOHOFF, INC., CINCINNATI, OH. FILED 11-21-2001.

SURE CLEAN

NO CLAIM IS MADE TO THE EXCLUSIVE RIGHT TO USE "CLEAN", APART FROM THE MARK AS SHOWN. FOR MACHINES FOR CLEANING INDUSTRIAL MACHINE PARTS (U.S. CLS. 13, 19, 21, 23, 31, 34 AND 35). FIRST USE 8-12-1991; IN COMMERCE 8-12-1991.

SN 76-382,232. SUNKIST GROWERS, INC., SHERMAN OAKS, CA. FILED 3-13-2002.

SUNKIST GROWERS

OWNER OF U.S. REG. NOS. 72,087, 1,772,513 AND OTHERS. FOR LAWN AND GARDEN STRING TRIMMER SPOOLS AND TILLING MACHINES; POWER LAWN AND GARDEN TOOLS, NAMELY CHIPPERS, SHREDDERS, CULTIVATORS, LAWN AND GARDEN EDGERS, AND GARDEN HOSE REELS (U.S. CLS. 13, 19, 21, 23, 31, 34 AND 35).

SN 76-388,404. JAGER, URS, CH-5702 NIEDERLENZ, SWITZERLAND, FILED 3-28-2002.



NO CLAIM IS MADE TO THE EXCLUSIVE RIGHT TO USE "SWISS QUALITY LEVEL" AND "FRESH SODA", APART FROM THE MARK AS SHOWN. FOR MACHINES AND PARTS THEREOF USED IN FILLING GAS INTO BEVERAGE BOTTLES AND CONTAINERS; MACHINES AND PARTS THEREOF USED IN THE PRODUCTION OF BEVERAGES (U.S. CLS. 13, 19, 21, 23, 31, 34 AND 35).

CLASS 7—(Continued).

SN 76-400,026. JRB COMPANY, INC., AKRON, OH. FILED 4-23-2002.

SMART-LOC

OWNER OF U.S. REG. NO. 1,794,689. FOR COUPLERS FOR OPERATIVELY AND PIVOTABLY CONNECTING EXCAVATION ATTACHMENTS TO BOTH AN ARM AND CONTROL LINK OF A POWERED EXCAVATOR APPARATUS FOR USE OF THE ATTACHMENT (U.S. CLS. 13, 19, 21, 23, 31, 34 AND 35). FIRST USE 6-0-2001; IN COMMERCE 6-0-2001.

SN 76-406,820. ASM INTERNATIONAL N.V., 3723 BC BILTHOVEN, NETHERLANDS, FILED 5-2-2002.

DRAGON

PRIORITY CLAIMED UNDER SEC. 44(D) ON BENELUX APPLICATION NO. 1001135, FILED 11-27-2001, REG. NO. 0702295, DATED 11-27-2001, EXPIRES 11-27-2011. FOR SEMICONDUCTOR WATER PROCESSING EQUIPMENT, NAMELY, THERMAL TREATMENT REACTORS; CHEMICAL VAPOR DEPOSITION REACTORS, ALSO OPERATING WITH ELECTRIC GAS-DISCHARGE; ELECTRONICALLY CONTROLLED SEMICONDUCTOR PROCESSING MACHINES FOR THE MANUFACTURE OF SEMICONDUCTORS AND FOR THE DEPOSITION OF THIN FILMS; REPLACEMENT PARTS FOR AFORESAID PRODUCTS (U.S. CLS. 13, 19, 21, 23, 31, 34 AND 35).

SN 76-409,321. GCA INDUSTRIES, SCOTTSDALE, AZ. FILED 5-20-2002.

TRUE BILLET

NO CLAIM IS MADE TO THE EXCLUSIVE RIGHT TO USE "BILLET", APART FROM THE MARK AS SHOWN. FOR LAND VEHICLE MECHANICAL ENGINE PARTS, NAMELY UNDERHOOD POLISHED ALUMINUM CAPS, COVERS, FENDER SUPPORTS, AND DIP STICKS (U.S. CLS. 13, 19, 21, 23, 31, 34 AND 35). FIRST USE 5-1-2002; IN COMMERCE 5-1-2002.

CLASS 7—(Continued).

SN 76-412,442. ZHEJIANG YINLUN MACHINERY CO., LTD., TIANTAI COUNTY, ZHEJIANG, CHINA, FILED 5-24-2002.

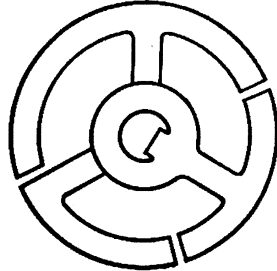

YINLUN

THE MARK "YINLUN" DOES NOT HAVE ANY MEANING IN THE RELEVANT TRADE OR INDUSTRY OR AS APPLIED TO THE GOODS; THE MARK FUNCTIONS AS A TRADEMARK TO IDENTIFY THE GOODS OF THE APPLICANT.

FOR OIL COOLERS FOR MACHINES (U.S. CLS. 13, 19, 21, 23, 31, 34 AND 35).
FIRST USE 9-30-1984; IN COMMERCE 9-1-1994.

SN 76-416,415. ZF LENKSYSTEME GMBH, D-73527 SCHWABISCH GMUEND, FED REP GERMANY, FILED 6-3-2002.

ZFLS-POWERSERV

FOR HYDRAULIC PUMPS FOR LAND VEHICLES, NAMELY, PUMPS FOR STEERING FLUIDS (U.S. CLS. 13, 19, 21, 23, 31, 34 AND 35).

SN 76-419,817. IWATA-MEDEA, INCORPORATED, PORTLAND, OR. FILED 6-12-2002.

REVOLUTION

FOR AIR BRUSHES FOR APPLYING PAINT; AIR-BRUSH KITS FOR USE WITH ART AND CRAFTS, CONSISTING OF AN AIR BRUSH, PAINT RESERVOIRS, AND INSTRUCTION MANUALS THEREFOR, ALL SOLD AS A UNIT (U.S. CLS. 13, 19, 21, 23, 31, 34 AND 35).
FIRST USE 11-27-2001; IN COMMERCE 11-27-2001.

SN 76-419,934. FMC TECHNOLOGIES, INC., CHICAGO, IL. FILED 6-13-2002.

TWINTEC

FOR MACHINES FOR FOOD CANNING AND MACHINES FOR FILLING AND CLOSING FOOD CANS (U.S. CLS. 13, 19, 21, 23, 31, 34 AND 35).

CLASS 7—(Continued).

SN 76-424,551. ARN, RUSS, VANCOUVER, WA. FILED 2-19-2002.

M/C

FOR HYDRAULIC JACK AND STANDS FOR MOTORCYCLES AND ALL TERRAIN VEHICLES (U.S. CLS. 13, 19, 21, 23, 31, 34 AND 35).
FIRST USE 9-0-2000; IN COMMERCE 9-0-2000.

SN 76-434,183. FMC TECHNOLOGIES, INC., CHICAGO, IL. FILED 7-25-2002.

ACCUMAVEYOR

FOR AUTOMATIC BUCKET AND TROUGH BELT-TYPE CONVEYOR AND STORAGE BELT FOR FEEDING NON-FREE FLOWING MATERIALS TO THE CONVEYOR (U.S. CLS. 13, 19, 21, 23, 31, 34 AND 35).
FIRST USE 6-29-1967; IN COMMERCE 6-29-1967.

SN 76-436,657. IWATA-MEDEA, INCORPORATED, PORTLAND, OR. FILED 8-1-2002.

EVOLUTION

FOR AIR BRUSHES FOR APPLYING PAINT; AIR-BRUSH KITS FOR USE WITH ART AND CRAFTS, CONSISTING OF AN AIR BRUSH, PAINT RESERVOIRS, AND INSTRUCTION MANUALS THEREFOR, ALL SOLD AS A UNIT (U.S. CLS. 13, 19, 21, 23, 31, 34 AND 35).

SN 76-437,374. SB MANUFACTURING INC., WICHITA, KS. FILED 8-5-2002.



NO CLAIM IS MADE TO THE EXCLUSIVE RIGHT TO USE "SUPERIOR BROOM", APART FROM THE MARK AS SHOWN.

LINING IN THE DRAWING IS A FEATURE OF THE MARK AND DOES NOT INDICATE COLOR.

FOR CONSTRUCTION EQUIPMENT VEHICLE, NAMELY SELF-PROPELLED STREET SWEEPERS (U.S. CLS. 13, 19, 21, 23, 31, 34 AND 35).

FIRST USE 8-1-2002; IN COMMERCE 8-1-2002.

CLASS 7—(Continued).

SN 76-437,744. PUMA INDUSTRIAL CO., LTD., CHANG-HWA, TAIWAN, FILED 8-2-2002.

**SCROLLEX**

FOR PNEUMATIC POWER TOOLS, NAMELY, AIR NAILERS, AIR STAPLERS, AIR SANDERS, AIR HAMMERS, AIR SCRAPERS, AIR RIVETING HAMMERS, AIR CHIPPING HAMMERS, AIR NEEDLE SCALERS, AIR RATCHET WRENCHES, AIR IMPACT WRENCHES, AIR SPRAY GUNS, LUBRICATORS, AIR POLISHERS, AIR DIE GRINDERS, AIR GRINDERS, AIR METAL SHEARS, AIR NIBBLERS, AIR SAWS, AIR DRILLS, AIR UNDERCOATING GUNS, AIR POWERED CAULKING GUNS, AIR POWERED GREASE GUNS, AIR SAND BLASTING GUNS, AIR TIRE BUFFERS, AIR HYDRAULIC RIVETERS, AIR SCREW DRIVERS, AIR BODY SAW/AIR CIRCULAR SAW, AIR CUT OFF TOOLS AND AIR HYDRAULIC PUNCH IN FLANGE TOOLS; ELECTRIC PUMPS; SUMP PUMPS; WATER PUMPS FOR USE IN MOTORS AND ENGINES; COMPRESSORS FOR REFRIGERATORS; ENGRAVING MACHINES; VALVES, BEING PART OF MACHINES; VALVES FOR PUMPS; FORGE BELLOWS; DRYING MACHINES; AIR FILTERS FOR MECHANICAL PURPOSES; AIR FILTERS FOR MOTORS AND ENGINES; OIL FILTERS FOR MOTORS AND ENGINES; FILTERS FOR WOODWORKING MACHINES AND METALWORKING MACHINES; PISTON RINGS; IGNITION PARTS FOR INTERNAL COMBUSTION ENGINES NAMELY, CONDENSERS; COMPRESSED AIR PUMPS; AIR COMPRESSORS; ENGINES NOT FOR LAND VEHICLES; CENTRIFUGAL PUMPS; CONNECTING RODS FOR MACHINES, MOTORS AND ENGINES; SPRAY GUNS FOR PAINTING; HYDRAULIC LIFT TABLES; PNEUMATIC HAMMERS; PNEUMATIC TRANSPORTERS; CENTRIFUGAL SEPARATORS; CYCLONE SEPARATORS; DUST SEPARATORS; OIL SEPARATORS; VIBRATORY SCREEN SEPARATORS; PISTONS FOR CYLINDERS; CARPET CLEANING MACHINES; DRY-CLEANING MACHINES; STEAM CLEANING MACHINES; MACHINES FOR CLEANING SURFACES USING HIGH PRESSURE WATER; PRESSURE WASHING MACHINES; CLOTHES WASHING MACHINES; DISH WASHING MACHINES; VEHICLE WASHING MACHINES; CRANK SHAFTS FOR MACHINES; REGULATORS, BEING PARTS OF MACHINES; PULLEYS, BEING PARTS OF MACHINES; VACUUM PUMPS; VEHICLE ENGINE PARTS, NAMELY, OIL TANK PLUGS AND CAPS; PUMP DIAPHRAGMS; CARTRIDGES FOR FILTERING MACHINES; AEROCONDENSERS; SPRAY PAINT SYSTEMS COMPRISED OF PUMPS, PUMP CONTROLLERS, NOZZLES, TUBING AND VALVES, AERATING PUMPS FOR AQUARIA; DIAPHRAGM PUMPS; PUMP DIAPHRAGMS FOR DIAPHRAGM PUMPS (U.S. CLS. 13, 19, 21, 23, 31, 34 AND 35).

CLASS 7—(Continued).

SN 76-447,072. ELB, INC., HOUSTON, TX. FILED 9-3-2002.

SPIN RAILS

NO CLAIM IS MADE TO THE EXCLUSIVE RIGHT TO USE "RAILS", APART FROM THE MARK AS SHOWN.
FOR METAL PIPE GRINDING RAILS FOR SKATEBOARDERS AND EXTREME SPORTS (U.S. CLS. 13, 19, 21, 23, 31, 34 AND 35).

SN 76-449,304. HAND TOOL DESIGN CORPORATION, WILMINGTON, DE. FILED 9-9-2002.

QUICK VAC

NO CLAIM IS MADE TO THE EXCLUSIVE RIGHT TO USE "VAC", APART FROM THE MARK AS SHOWN.
FOR PNEUMATICALLY POWERED FLUID EVACUATION SYSTEM COMPRISED OF FLUID COLLECTING SPHERE AND HOSES FOR REMOVAL OF FLUID FOR AUTOMOTIVE AND INDUSTRIAL APPLICATIONS (U.S. CLS. 13, 19, 21, 23, 31, 34 AND 35).
FIRST USE 2-1-2002; IN COMMERCE 2-1-2002.

SN 76-453,455. GENTRA SYSTEMS, INC., PLYMOUTH, MN. FILED 9-27-2002.

VERSAPURE

FOR AUTOMATED MACHINES FOR NUCLEIC ACID ISOLATION AND PURIFICATION (U.S. CLS. 13, 19, 21, 23, 31, 34 AND 35).

SN 76-463,977. AXIA INCORPORATED, STATESVILLE, NC. FILED 11-4-2002.

EMPRESS

FOR VARIABLE SPEED SEWING HEADS FOR HIGH PRODUCTION BAG CLOSING MACHINES (U.S. CLS. 13, 19, 21, 23, 31, 34 AND 35).
FIRST USE 1-0-1999; IN COMMERCE 1-0-1999.

SN 76-464,304. PBM GROUP, INC., LITITZ, PA. FILED 10-30-2002.

VORTINE

FOR POWER GARDEN IMPLEMENTS, NAMELY GARDEN TILLERS (U.S. CLS. 13, 19, 21, 23, 31, 34 AND 35).

CLASS 7—(Continued).

SN 76-464,333. MURRAY, INC., BRENTWOOD, TN. FILED 10-28-2002.

MURRAY

OWNER OF U.S. REG. NOS. 1,813,041, 2,299,857 AND OTHERS.
FOR SNOWBLOWERS, SNOWTHROWERS, AND COMPONENT PARTS THEREOF (U.S. CLS. 13, 19, 21, 23, 31, 34 AND 35).
FIRST USE 11-0-1994; IN COMMERCE 11-0-1994.

SN 76-465,158. TRAVAINI PUMPS U.S.A., INC., YORKTOWN, VA. FILED 11-1-2002.

COYOTE

FOR VACUUM PUMPS (U.S. CLS. 13, 19, 21, 23, 31, 34 AND 35).

SN 76-472,224. TEKMAX, INC., FRANKFORT, MI. FILED 12-5-2002.

TEKMAX

FOR POWER CORKSCREW (U.S. CLS. 13, 19, 21, 23, 31, 34 AND 35).
FIRST USE 11-0-2002; IN COMMERCE 11-0-2002.

SN 78-107,236. HESS MASCHINENFABRIK GMBH & CO. KG, BURBACH-WAHLBACH, FED REP GERMANY, FILED 2-6-2002.

TUMBLEMASTER

PRIORITY CLAIMED UNDER SEC. 44(D) ON FED REP GERMANY APPLICATION NO. 30202769.6, FILED 1-23-2002, REG. NO. 30202769, DATED 1-23-2002, EXPIRES 1-23-2012.
FOR MACHINES FOR MECHANICALLY ROUGHENING THE SURFACES AND EDGES OF NATURAL AND ARTIFICIAL STONES (U.S. CLS. 13, 19, 21, 23, 31, 34 AND 35).

CLASS 7—(Continued).

SN 78-133,132. STRASBAUGH, SAN LUIS OBISPO, CA. FILED 6-4-2002.



FOR GRINDING, POLISHING, AND LAPPING MACHINES FOR MANUFACTURING PHOTONICS, OPTICAL COMPONENTS AND TELECOMMUNICATION COMPONENTS, GRINDING, POLISHING, AND LAPPING MACHINES FOR THE PURPOSE OF GRINDING, POLISHING, AND LAPPING MATERIALS SUCH AS LENSES, FINE METAL, GLASS, PLASTIC, OR CERAMIC MATERIALS (U.S. CLS. 13, 19, 21, 23, 31, 34 AND 35).

SN 78-151,162. HICKS, KEN, H, MESA, AZ. FILED 8-6-2002.

TURBOFLUX

FOR BOUNDARY LAYER DISC TURBINE ENGINES FOR POWER GENERATION (U.S. CLS. 13, 19, 21, 23, 31, 34 AND 35).

SN 78-153,259. DANA CORPORATION, TOLEDO, OH. FILED 8-12-2002.

SUPERFLEX

FOR PISTON RINGS FOR USE IN INTERNAL COMBUSTION ENGINES (U.S. CLS. 13, 19, 21, 23, 31, 34 AND 35).

SN 78-153,542. LUAN, WILLIAM WEN BAI, CUPERTINO, CA. FILED 8-13-2002.



NO CLAIM IS MADE TO THE EXCLUSIVE RIGHT TO USE "SYSTEM", APART FROM THE MARK AS SHOWN.
FOR AUTOMOTIVE ENGINE BLOCKS; AUTOMOTIVE INTAKE MANIFOLDS; ENGINE RODS; INTERNAL COMBUSTION ENGINE PARTS NAMELY, PISTON AND PISTON RING; MACHINE PARTS, NAMELY, CYLINDERS; VEHICLE PARTS, NAMELY, CARBURETORS, ENGINE CASES, INTAKE MANIFOLDS, CAM COVERS, POWER VALVE FOR CARBURETORS, ENGINE CAM PROTECTORS (U.S. CLS. 13, 19, 21, 23, 31, 34 AND 35).

CLASS 7—(Continued).

SN 78-156,840. POLARIS POOL SYSTEMS, INC., VISTA, CA. FILED 8-22-2002.

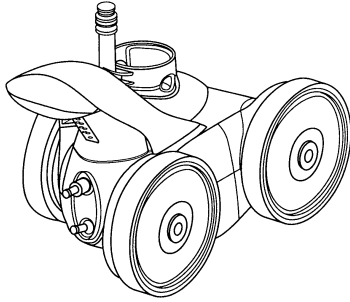

FOR MECHANICAL POOL CLEANING MACHINES (U.S. CLS. 13, 19, 21, 23, 31, 34 AND 35).

CLASS 7—(Continued).

SN 78-171,108. BRI-LIN, INCORPORATED, ROCHESTER, NH. FILED 10-4-2002.

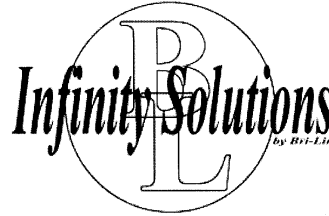

NO CLAIM IS MADE TO THE EXCLUSIVE RIGHT TO USE "SOLUTIONS", APART FROM THE MARK AS SHOWN.

FOR FOLDER AND SEALER MACHINE FOR ONE PIECE MAILER FORMS AND PAPER (U.S. CLS. 13, 19, 21, 23, 31, 34 AND 35).

FIRST USE 8-1-2002; IN COMMERCE 8-1-2002.

SN 78-169,374. IMPRESSION TECHNOLOGY PTY LIMITED, CROMER, NEW SOUTH WALES, AUSTRALIA, FILED 9-30-2002.



FOR PRINTING MACHINES, NAMELY, COMBINATION PAD AND SCREEN PRINTING MACHINES (U.S. CLS. 13, 19, 21, 23, 31, 34 AND 35).

SN 78-171,446. BOOMPARTS.COM INC., WAYNESBORO, PA. FILED 10-6-2002.



THE MARK CONSISTS OF "ROUSTABOUT" AND DESIGN.

FOR SWINGING BOOM MOBILE CRANES; FIXED BOOM MOBILE CRANES (U.S. CLS. 13, 19, 21, 23, 31, 34 AND 35).

SN 78-169,576. MILLIPORE CORPORATION, BEDFORD, MA. FILED 10-1-2002.

ACERTA

FOR FILLING MACHINES FEATURING PRE-STERILIZED COMPONENT BAGS, TUBING AND FILLING NEEDLES, FOR DISPENSING OF BULK FORMULATED LIQUID PHARMACEUTICAL, BIOPHARMACEUTICAL AND DIAGNOSTIC PRODUCTS (U.S. CLS. 13, 19, 21, 23, 31, 34 AND 35).

FIRST USE 4-1-2002; IN COMMERCE 4-1-2002.

SN 78-174,956. CLYDE BERGEMANN, INC., ATLANTA, GA. FILED 10-16-2002.

SMARTIMAGE

FOR MACHINE AND MACHINE TOOLS, NAMELY INFRARED IMAGING DEVICE THAT PROVIDES LOCALIZED INFORMATION REGARDING ASH ACCUMULATION ON HEAT TRANSFER SURFACES IN A BOILER (U.S. CLS. 13, 19, 21, 23, 31, 34 AND 35).

CLASS 7—(Continued).

SN 78-177,305. ALTEC INDUSTRIES, INC., BIRMINGHAM, AL. FILED 10-23-2002.

OPTI-VIEW

FOR OPERATOR SEAT FOR DIGGER DERRICKS, IN THE FIELDS OF ELECTRIC UTILITIES, TELECOMMUNICATIONS, CONSTRUCTION AND TREE CARE (U.S. CLS. 13, 19, 21, 23, 31, 34 AND 35).

SN 78-179,406. JACK SEWING MACHINE CO., LTD. OF ZHEJIANG, TAIZHOU CITY, ZHEJIANG PROVINCE, CHINA, FILED 10-29-2002.

JACK
杰 克

THE FOREIGN WORDING IN THE MARK TRANSLATES INTO ENGLISH AS "HERO; HEROIC". (THE CHARACTER ON THE LEFT); "GRAM; OVERCOME" (THE CHARACTER ON THE RIGHT); "THE NON-LATIN CHARACTER(S) IN THE MARK TRANSLITERATE INTO "JIE" (THE CHARACTER ON THE LEFT); "KE" (THE CHARACTER ON THE RIGHT), AND THIS MEANS AS INDICATED IN THE TRANSLATION SECTION OF THIS APPLICATION.

FOR SEWING MACHINES (U.S. CLS. 13, 19, 21, 23, 31, 34 AND 35).

FIRST USE 1-1-1999; IN COMMERCE 6-1-2002.

SN 78-180,563. TECUMSEH PRODUCTS COMPANY, TECUMSEH, MI. FILED 10-31-2002.

MASTERFLUX

FOR VARIABLE SPEED AIR CONDITIONING AND REFRIGERATION COMPRESSORS (U.S. CLS. 13, 19, 21, 23, 31, 34 AND 35).

FIRST USE 1-17-2002; IN COMMERCE 1-17-2002.

SN 78-185,174. SEARS, ROEBUCK AND CO., HOFFMAN ESTATES, IL. FILED 11-14-2002.

CLEAN-N-CARRY

FOR PRESSURE WASHERS. (U.S. CLS. 13, 19, 21, 23, 31, 34 AND 35).

CLASS 7—(Continued).

SN 78-186,427. SKYLIFT, INC., LORAIN, OH. FILED 11-19-2002.

MINI-ARBORIST

FOR POWER-OPERATED MAN LIFTS (U.S. CLS. 13, 19, 21, 23, 31, 34 AND 35).
FIRST USE 3-30-2002; IN COMMERCE 3-30-2002.

SN 78-191,628. NORTH AMERICAN DIAMOND TOOLS, INC., BREA, CA. FILED 12-5-2002.

NORAM

FOR POWER-OPERATED TOOLS, NAMELY DIAMOND TIPPED DRILLING, CUTTING AND GRINDING TOOLS, AND MACHINE PARTS FOR POWER-OPERATED TOOLS, NAMELY DIAMOND TIPPED SAW BLADES, DIAMOND CORE DRILL BITS, AND DIAMOND GRINDING WHEELS (U.S. CLS. 13, 19, 21, 23, 31, 34 AND 35).

CLASS 8—HAND TOOLS

SN 76-007,657. 1361382 ONTARIO INC., DBA CG TIPS, FRANKFORD, ONTARIO K0K 2C0, CANADA, FILED 3-23-2000.

CG TIPS

PRIORITY CLAIMED UNDER SEC. 44(D) ON CANADA APPLICATION NO. 1044138, FILED 1-27-2000, REG. NO. TMA553459, DATED 11-5-2001, EXPIRES 11-5-2016.

NO CLAIM IS MADE TO THE EXCLUSIVE RIGHT TO USE "TIPS", APART FROM THE MARK AS SHOWN.

FOR ATTACHMENTS AND ACCESSORIES FOR CAULKING GUNS AND CAULKING GUN ASSEMBLIES, NAMELY TIPS, NOZZLES, SPOUTS, ENDS, APPLICATORS, DISPENSERS, ADAPTORS, GUIDES, REINFORCING RINGS, BANDS AND ENDS, GENERALLY FOR USE IN FACILITATING THE MORE EFFICIENT APPLICATION OF CAULKING, SEALANT AND GLUE COMPOUNDS (U.S. CLS. 23, 28 AND 44).

SN 76-297,737. AMERICAN SAW & MFG. COMPANY, INC., EAST LONGMEADOW, MA. FILED 8-13-2001.

WOLVERINE

FOR BLADES FOR HACKSAWS (U.S. CLS. 23, 28 AND 44).

CLASS 8—(Continued).

SN 76-320,846. ASESORIA Y DESARROLLOS URREA, S.A. DE C.V., GUADALAJARA, JALISCO C.P. 44940, MEXICO, FILED 10-2-2001.



FOR HAND TOOLS, NAMELY, WRENCHES, TORQUE WRENCHES, HEX WRENCHES, SCREWDRIVERS, BITS FOR HAND DRILLS, HAMMERS, PLIERS, TINSNIPS AND CLAMPS (U.S. CLS. 23, 28 AND 44).

FIRST USE 10-1-1986; IN COMMERCE 10-1-1986.

SN 76-371,198. WATERFALL, INC., DETROIT, MI. FILED 2-15-2002.

WATERFALL

FOR HAND-OPERATED TOOL FOR USE IN PLUMBING REPAIRS, NAMELY, A FLEXIBLE GASKET ATTACHED TO A HOLLOW SHAFT OR TUBE FOR DIVERTING WATER IN PIPES (U.S. CLS. 23, 28 AND 44).

SN 76-406,000. GARBAGE GENIE CONCEPT 2000 LIMITED, DUBLIN 4, IRELAND, FILED 5-10-2002.

GARBAGE GENIE

NO CLAIM IS MADE TO THE EXCLUSIVE RIGHT TO USE "GARBAGE", APART FROM THE MARK AS SHOWN. FOR MANUALLY OPERATED RUBBISH COMPACTORS (U.S. CLS. 23, 28 AND 44).

SN 76-406,430. CAMILLUS CUTLERY CO., CAMILLUS, NY. FILED 5-13-2002.

ROUGH CUT

FOR HUNTING AND POCKET KNIVES (U.S. CLS. 23, 28 AND 44).

FIRST USE 10-5-1994; IN COMMERCE 10-5-1994.

SN 76-413,992. KONINKLIJKE PHILIPS ELECTRONICS N.V., EINDHOVEN, NETHERLANDS, FILED 5-24-2002.

MICRO +

PRIORITY CLAIMED UNDER SEC. 44(D) ON BENELUX APPLICATION NO. 1001095, FILED 11-27-2001, REG. NO. 0699238, DATED 11-27-2001, EXPIRES 11-27-2011.

FOR ELECTRIC SHAVERS, PARTS FOR ELECTRIC SHAVERS, NAMELY, CUTTING MEMBERS; ELECTRIC HAIR TRIMMERS, AND REPLACEMENT PARTS THEREFORE (U.S. CLS. 23, 28 AND 44).

CLASS 8—(Continued).

SN 76-414,089. OMS INVESTMENTS, INC., SANTA MONICA, CA. FILED 6-3-2002.

LEVINGTON

FOR HAND OPERATED LAWN AND GARDEN TOOLS, NAMELY, SHOVELS AND CUTTING TOOLS, NAMELY, PLANT SCISSORS, SHEARS, PRUNING SHEARS AND SAWS; MANUALLY-OPERATED FERTILIZER/SEED SPREADERS, HAND-HELD SPREADERS, HAND-PUMPED HOSE-END SPRAYERS WITH A SEPARATE CARTRIDGE FOR HOME AND GARDEN USE FOR THE APPLICATION OF FERTILIZERS, FUNGICIDES, PESTICIDES, WEED KILLERS AND OTHER CHEMICALS; HAND-OPERATED SPRAYERS AND FOGGERS FOR INSECTICIDES (U.S. CLS. 23, 28 AND 44).

SN 76-425,458. CONG TY TRACH NHIEM HUU HAN SAN XUAT CO KHI KEM NGHIA, AKA NGHIA NIPPERS PRODUCTION MECHANICAL ENGINEERING CO., LTD., HO CHI MINH CITY, VIETNAM, FILED 6-24-2002.

**SUPER NGHIA**

NO CLAIM IS MADE TO THE EXCLUSIVE RIGHT TO USE "SUPER", APART FROM THE MARK AS SHOWN.

THE LINED PARTS OF THE MARK ARE NOT INTENDED TO INDICATE COLOR. THE MARK CONSISTS IN PART OF THE WORDS SUPER NGHIA. THE WORD NGHIA IS A VIETNAMESE WORD WHICH HAS NO MEANING. THE DESIGN CONSISTS OF A STYLIZED TULIP; A STYLIZED WHITE FLYING BIRD ON A BLACK BACKGROUND.

FOR NAIL CLIPPERS, NAIL NIPPERS, NAIL FILES, HAIR-CUTTING SCISSORS, EYEBROW TWEEZERS AND HAND-OPERATED TOOLS FOR MAKING SYNTHETIC NAILS (U.S. CLS. 23, 28 AND 44).

FIRST USE 3-0-1997; IN COMMERCE 3-0-1997.

SN 76-437,754. RICHARDSON SHEFFIELD LTD., SHEFFIELD S3 8RW, GREAT BRITAIN, FILED 8-5-2002.

SO.EAT

FOR DOMESTIC KNIVES, FORKS AND SPOONS (U.S. CLS. 23, 28 AND 44).

CLASS 8—(Continued).

SN 76-440,389. GLAZE, INC., EDISON, NJ. FILED 8-8-2002.

CANOPOWER

FOR TOOL KIT WITH A BUILT-IN FLASHLIGHT CONSISTING OF MANUALLY OPERATED HAND TOOLS IN THE NATURE OF SCREWDRIVERS, SOCKET SETS, MEASURING TAPE AND DRIVER BITS (U.S. CLS. 23, 28 AND 44).

FIRST USE 8-18-2001; IN COMMERCE 8-18-2001.

SN 76-446,405. CASEMARK, INC., WILMINGTON, DE. FILED 9-3-2002.

CASE BROS.

OWNER OF U.S. REG. NOS. 541,284, 2,343,880 AND OTHERS.

FOR POCKET KNIVES, HUNTING KNIVES, AND FOLDING KNIVES (U.S. CLS. 23, 28 AND 44).

SN 76-447,669. EBERHARD, ANDREA R., WEEHAWKEN, NJ. FILED 9-3-2002.

The Ultimate Toddler Spoon

NO CLAIM IS MADE TO THE EXCLUSIVE RIGHT TO USE "TODDLER SPOON", APART FROM THE MARK AS SHOWN.

FOR SPOONS (U.S. CLS. 23, 28 AND 44).

SN 78-127,308. GERICH, HORST, MINDEN, NV. FILED 5-8-2002.

SMARTMIXER

FOR NON-COMPUTERIZED CARTRIDGES, WHEREBY PLURAL COMPONENTS, NAMELY SILICONES AND EPOXIES, ARE DISPENSED FOR USE IN CONSTRUCTION PROJECTS (U.S. CLS. 23, 28 AND 44).

SN 78-127,588. J & B TOOL COMPANY, LLC, PAWCATUCK, CT. FILED 5-9-2002.

RODDY

FOR HAND TOOLS, NAMELY, IRON-WORKING PLIERS AND REPLACEMENT BLADES FOR SUCH PLIERS (U.S. CLS. 23, 28 AND 44).

CLASS 8—(Continued).

SN 78-130,305. ANDREW, LEWIN, HARPENDEN, GREAT BRITAIN, FILED 5-21-2002.

The logo for ROOTWRENCH features a stylized, bold, black graphic of a wrench head on the left, followed by the word "ROOTWRENCH" in a large, bold, black, sans-serif font.

OWNER OF UNITED KINGDOM REG. NO. 2282636, DATED 10-9-2001, EXPIRES 10-9-2011.

NO CLAIM IS MADE TO THE EXCLUSIVE RIGHT TO USE "ROOTWRENCH", APART FROM THE MARK AS SHOWN.

FOR HAND TOOLS FOR GARDEN USE, NAMELY A WEEDING FORK (U.S. CLS. 23, 28 AND 44).

SN 78-166,346. WATERFALL, INC., DETROIT, MI. FILED 9-20-2002.

R1000

FOR HAND-OPERATED TOOL FOR USE IN PLUMBING REPAIRS, NAMELY, A FLEXIBLE GASKET ATTACHED TO A HOLLOW SHAFT OR TUBE FOR DIVERTING WATER IN PIPES (U.S. CLS. 23, 28 AND 44).

SN 78-191,128. LONGABERGER COMPANY, THE, NEWARK, OH. FILED 12-4-2002.

LONGABERGER

OWNER OF U.S. REG. NOS. 2,172,615, 2,349,619 AND OTHERS.

SEC. 2(F).

FOR FLATWARE (U.S. CLS. 23, 28 AND 44).

FIRST USE 9-1-2002; IN COMMERCE 9-1-2002.

CLASS 9—ELECTRICAL AND SCIENTIFIC APPARATUS

SN 74-260,632. DIRECTED AUDIO, INC., VISTA, CA. BY ASSIGNMENT ORION INDUSTRIES, INC., TEMPE, AZ. FILED 3-30-1992.



THE DRAWING IS LINED FOR THE COLOR(S) RED. FOR AUTOMOBILE AUDIO EQUIPMENT NAMELY AMPLIFIERS AND SPEAKERS (U.S. CLS. 21, 23, 26, 36 AND 38).

FIRST USE 1-1-1991; IN COMMERCE 1-1-1991.

CLASS 9—(Continued).

SN 75-192,710. ROSEN, DAVID B., DBA SOFTWARE INNOVATIONS, LEXINGTON, MA. FILED 11-4-1996.

LABTRAK

FOR COMPUTER SOFTWARE RECORDED ON DISKETTES FOR USE BY DENTAL PROFESSIONALS TO SUPERVISE THE PROGRESS AND FEES OF DENTAL LABORATORY TECHNICIANS PREPARING RESTORATIVE DENTITION (U.S. CLS. 21, 23, 26, 36 AND 38).
FIRST USE 8-7-1993; IN COMMERCE 8-7-1993.

SN 75-265,792. ALLEGRO SOFTWARE DEVELOPMENT CORPORATION, BOXBOROUGH, MA. FILED 3-28-1997.



FOR COMPUTER SOFTWARE USED TO FACILITATE ACCESS TO AND COMMUNICATION WITH, WITHIN, AND BETWEEN COMPUTER NETWORKS (U.S. CLS. 21, 23, 26, 36 AND 38).
FIRST USE 5-28-1996; IN COMMERCE 5-28-1996.

SN 75-507,302. THE WORKFLOW AUTOMATION CORPORATION, ONTARIO, CANADA, FILED 6-23-1998.

JFLOW

PRIORITY CLAIMED UNDER SEC. 44(D) ON CANADA APPLICATION NO. 865,187, FILED 12-23-1997, REG. NO. TMA574,130, DATED 1-21-2003, EXPIRES 1-21-2018.

FOR SOFTWARE TO MANAGE THE INTELLIGENT ROUTING OF INFORMATION (U.S. CLS. 21, 23, 26, 36 AND 38).
FIRST USE 2-20-1997; IN COMMERCE 2-20-1997.

SN 75-569,274. DATAMISSION PTY LIMITED, EASTWOOD NSW 2122, AUSTRALIA, FILED 10-13-1998.

WINCOMEXPLORER

FOR COMPUTER SOFTWARE FOR CONNECTING PERSONAL COMPUTERS TO A HOST COMPUTER FOR THE PURPOSE OF CONDUCTING A TERMINAL EMULATION SESSION (U.S. CLS. 21, 23, 26, 36 AND 38).

CLASS 9—(Continued).

SN 75-627,626. DOLBY LABORATORIES LICENSING CORPORATION, SAN FRANCISCO, CA. FILED 1-26-1999.

WE'VE GOT THE WHOLE WORLD LISTENING

FOR APPARATUS FOR USE IN CONNECTION WITH THE PROCESSING, RECORDING, REPRODUCTION, TRANSMISSION AND RECEPTION OF ELECTRONIC SIGNALS, NAMELY, CINEMA SOUND PROCESSORS FOR MOTION PICTURE SOUND TRACKS; MOTION PICTURE CINEMATOGRAPHIC FILMS FEATURING THE SPOKEN WORD, MUSIC, SOUND EFFECTS, ENTERTAINMENT AND GENERAL INFORMATION; MULTI-CHANNEL SOUND PROCESSORS; INTEGRATED CIRCUITS; AUDIO/VIDEO AMPLIFIERS AND RECEIVERS; TELEVISION RECEIVERS; VIDEO MONITORS; VIDEO TUNERS; AUDIO AND VIDEO RECORDERS; AUDIO AND VIDEO DISC PLAYERS; AUDIO AND VIDEO DISC DUBBING DECKS; PRE-RECORDED AUDIO DISCS, VIDEO DISCS, LASER DISCS, DVD VIDEO DISCS, AND DVD AUDIO DISCS, ALL FEATURING THE SPOKEN WORD, MUSIC, SOUND EFFECTS, ENTERTAINMENT AND GENERAL INFORMATION; DVD PLAYERS; CABLE TELEVISION RECEIVERS AND DECODERS; REMOTE CONTROL UNITS FOR THESE GOODS; COMPUTERS; COMPUTER PROGRAMS HAVING SOUND GENERATING CAPABILITIES, NAMELY, SOFTWARE USED TO DIGITALLY ENCODE AND DECODE MULTI-CHANNEL SOUND FOR PRE-RECORDED AUDIO DISCS, VIDEO DISCS, LASER DISCS, DVD DISCS, DVD VIDEO DISCS, AND DVD AUDIO DISCS; ELECTRONIC BROADCAST SIGNAL PROCESSORS; AND ELECTRONIC SATELLITE BROADCAST SIGNAL PROCESSORS (U.S. CLS. 21, 23, 26, 36 AND 38).
FIRST USE 1-0-1998; IN COMMERCE 1-0-1998.

SN 75-641,735. DATA GENERAL CORPORATION, WESTBORO, MA. FILED 2-16-1999.

SANALYZER

FOR COMPUTER SOFTWARE FOR MONITORING THE OPERATION AND STATUS OF COMPUTER HARDWARE CONNECTED TO A COMPUTER NETWORK AND CONTROLLING THE NETWORK TO IMPROVE NETWORK (U.S. CLS. 21, 23, 26, 36 AND 38).

SN 75-695,708. GATONERO, 33000 NIMES, FRANCE, BY ASSIGNMENT PICHON, OLIVIER FRANCIS, 88 QUEENSWAY, HONG KONG, FILED 4-30-1999.

THINGS

FOR COMPUTER SOFTWARE FOR USE IN ASSOCIATION WITH DATA FILES, DATABASES, AND APPLICATION SERVERS ON BOTH LOCAL AND GLOBAL COMPUTER INFORMATION NETWORKS WHICH ALLOWS SOFTWARE DEVELOPERS TO VIEW, MANIPULATE AND GRAPHICALLY DISPLAY SOFTWARE FUNCTIONALITY (U.S. CLS. 21, 23, 26, 36 AND 38).

CLASS 9—(Continued).

SN 75-699,298. MICRONIC B.V., 8211 AR LELYSTAD, NETHERLANDS, FILED 5-7-1999.

TRAXIS

PRIORITY CLAIMED UNDER SEC. 44(D) ON NETHERLANDS APPLICATION NO. 929844, FILED 1-4-1999, REG. NO. 929844, DATED 1-4-1999, EXPIRES 1-4-2009.

FOR OPTICAL READER FOR LABORATORY USE FOR TRACING, LOCATING AND SELECTING CODED TUBES HELD IN TUBE RACKS; COMPUTER SOFTWARE FOR USE IN THE AFORESAID OPTICAL READER; TEST TUBES AND TEST TUBE RACKS FOR USE WITH THE AFORESAID OPTICAL READER (U.S. CLS. 21, 23, 26, 36 AND 38).

SN 75-719,744. ORANGE PERSONAL COMMUNICATIONS SERVICES LIMITED, BRADLEY STOKE, BRISTOL, B512 4QJ, ENGLAND, FILED 6-2-1999.

ORANGE PHONE

PRIORITY CLAIMED UNDER SEC. 44(D) ON UNITED KINGDOM APPLICATION NO. 2195120, FILED 4-20-1999, REG. NO. 2195120, DATED 11-3-2000, EXPIRES 4-20-2009.

OWNER OF U.S. REG. NO. 2,344,619.
NO CLAIM IS MADE TO THE EXCLUSIVE RIGHT TO USE "PHONE", APART FROM THE MARK AS SHOWN.

FOR MOBILE TELEPHONES AND ACCESSORIES THEREFOR, NAMELY, BATTERIES, BATTERY CHARGERS, DESK TOP BATTERY CHARGING STANDS, DEVICES WHICH ALLOW USE OF A PHONE INSIDE OF AN AUTOMOBILE WITHOUT USE OF HANDS AND ADAPTORS WHICH ALLOW USE OF PHONES THROUGH AUTOMOBILE CIGARETTE LIGHTER SOCKETS; COIN-OPERATED PAY TELEPHONES AND CREDIT CARD OPERATED PAY TELEPHONES (U.S. CLS. 21, 23, 26, 36 AND 38).

SN 75-766,702. CRYSTAL VISION, LTD., SAWSTON, CAMBRIDGE CB2 4HN, ENGLAND, FILED 8-3-1999.

CRYSTAL VISION

FOR DIGITAL INTERFACE AND EFFECTS PRODUCTS, NAMELY, DIGITAL INTERFACE BOARDS DESIGNED FOR AUDIO AND VIDEO BROADCAST SERIAL DIGITAL COMPONENT INSTALLATIONS FOR USE IN THE BROADCAST TELEVISION INDUSTRY (U.S. CLS. 21, 23, 26, 36 AND 38).
FIRST USE 5-7-1996; IN COMMERCE 12-6-1996.

SN 75-780,748. SAMTACK COMPUTER INC., MARKHAM, ONTARIO, CANADA, FILED 8-20-1999.

D'MUSIC

PRIORITY CLAIMED UNDER SEC. 44(D) ON CANADA APPLICATION NO. 1022818, FILED 7-19-1999, REG. NO. TMA575984, DATED 2-19-2003, EXPIRES 2-19-2018.

FOR COMPUTER COMPONENTS NAMELY MP3 DIGITAL PLAYERS (U.S. CLS. 21, 23, 26, 36 AND 38).

CLASS 9—(Continued).

SN 75-840,056. INTEGRAL VISION, LAFAYETTE, CA. FILED 11-19-1999.

THE STANDARD IN PROJECT MANAGEMENT

NO CLAIM IS MADE TO THE EXCLUSIVE RIGHT TO USE "PROJECT MANAGEMENT", APART FROM THE MARK AS SHOWN.

FOR PROJECT MANAGEMENT COMPUTER SOFTWARE FOR USE IN DATABASE MANAGEMENT, ESTIMATING, DOCUMENT CONTROL, ENGINEERING CONTROL, PROCUREMENT CONTROL, PROJECT CONTROL, CONTRACT ADMINISTRATION, CONTRACT MONITORING, ACCOUNTING, HUMAN RESOURCES, AND MANAGEMENT INFORMATION FOR THE ENGINEERING, PROCUREMENT, AND CONSTRUCTION INDUSTRY, TO BE USED WITH SINGLE COMPUTERS, LOCAL COMPUTER NETWORKS AND A GLOBAL COMPUTER NETWORK; AND INSTRUCTIONAL MANUALS SOLD AS A UNIT THEREWITH (U.S. CLS. 21, 23, 26, 36 AND 38).

FIRST USE 2-0-1996; IN COMMERCE 2-0-1996.

SN 75-886,802. INTERSIL AMERICAS INC., IRVINE, CA. BY ASSIGNMENT INTERSIL CORPORATION, PALM BAY, FL. FILED 1-5-2000.



FOR RADIATION HARDENED SEMICONDUCTORS; RADIATION HARDENED INTEGRATED CIRCUITS, NAMELY, CIRCUITS CONTAINING TRANSISTORS OR OTHER SEMICONDUCTOR DEVICES USED IN CIRCUITS FOR COMPUTERS, WIRED AND WIRELESS COMMUNICATIONS, ELECTRONIC NETWORKS, DIGITAL AND ANALOG ELECTRONIC CIRCUITS, MICROPROCESSORS, MICROCONTROLLERS, DIGITAL SIGNAL PROCESSORS, PROGRAMMABLE LOGIC CIRCUITS, MEMORY CIRCUITS, POWER CONTROL CIRCUITS, AMPLIFIERS AND POWER CONVERTERS; ANALOG AND DIGITAL CONVERTERS; RADIATION HARDENED POWER SEMICONDUCTORS, NAMELY, MOSFETS, IGBTs, AND DISCRETE TRANSISTORS, THYRISTORS, RECTIFIERS, DIODES AND DIODE ARRAYS; RADIATION HARDENED ELECTRONIC CIRCUIT BOARDS AND ASSEMBLED ELECTRONIC MODULES CONTAINING SAID INTEGRATED CIRCUITS AND POWER TELECOMMUNICATION DEVICES; RADIATION HARDENED CIRCUIT BOARDS FOR TELEPHONES; WIRELESS COMMUNICATION, RADIO, TELEVISION AND TELEPHONE TRANSMISSION AND RECEPTION, DATA RECORDING AND STORAGE MEDIA; RADIATION HARDENED COMPUTER SOFTWARE, NAMELY, UTILITY PROGRAMS FOR

CLASS 9—(Continued).

USE WITH THE ABOVE GOODS, AND APPLICATION SOFTWARE FOR ENABLING TRANSMISSION, RECEPTION, RECORDING AND STORAGE OF DATA IN RADIATION HARDENED DATA RECORDING AND STORAGE MEDIA WHERE THE DATA IS TRANSMITTED OVER TELEPHONES, WIRELESS COMMUNICATION, RADIO, TELEVISION, AND TELEPHONE TRANSMISSION AND RECEPTION, DATA RECORDING, AND STORAGE MEDIA; COMPUTER SOFTWARE FOR USE IN THE MANUFACTURE OF RADIATION HARDENED SEMICONDUCTORS, NAMELY FOR PROCESS, CONTROL, YIELD ENHANCEMENT, AS WELL AS PROCESS AND CIRCUIT DESIGN; COMPUTER NETWORK MANAGEMENT UTILITIES SOFTWARE; ELECTRONIC COMPONENTS, NAMELY, HYBRID ELECTRONIC CIRCUITS, CIRCUIT BOARDS, INTEGRATED CIRCUIT PACKAGES, AND LEAD FRAMES USED IN MANUFACTURING RADIATION HARDENED SEMICONDUCTORS, AND USER MANUALS SOLD WITH THE ABOVE GOODS (U.S. CLS. 21, 23, 26, 36 AND 38).

SN 75-893,198. POWERTREND CORPORATION, SHILLINGTON, PA. FILED 1-10-2000.

TIGER

FOR BATTERIES FOR VEHICLES (U.S. CLS. 21, 23, 26, 36 AND 38).
FIRST USE 8-26-1999; IN COMMERCE 8-26-1999.

SN 75-922,182. VIDEOTEK, INC., POTTSTOWN, PA. FILED 2-17-2000.

SPYDERWEB

FOR COMPUTER SOFTWARE FOR THE OPERATION OF REMOTE CONTROL AND REMOTE ACCESS MONITORING EQUIPMENT (U.S. CLS. 21, 23, 26, 36 AND 38).

SN 75-923,396. CANON KABUSHIKI KAISHA, TOKYO, JAPAN, FILED 2-22-2000.

SMART FILE

NO CLAIM IS MADE TO THE EXCLUSIVE RIGHT TO USE "FILE", APART FROM THE MARK AS SHOWN.

FOR FILING SYSTEM, NAMELY, COPYING MACHINES, IMAGE DATA PROCESSING APPARATUS, INTERFACE BOARDS, MAGNETO OPTICAL DISK DRIVES AND COMPUTER SOFTWARE FOR MANAGING IMAGING FUNCTIONS (U.S. CLS. 21, 23, 26, 36 AND 38).

CLASS 9—(Continued).

SN 75-982,725. REVOLUTIONARY PRODUCTS, INC., LOS ANGELES, CA. FILED 3-12-2002.



The logo for 'Revo styler' features the word 'Revo' in a large, bold, black, sans-serif font. The letter 'o' in 'Revo' is stylized with a white dot in the center. Below 'Revo', the word 'styler' is written in a smaller, lowercase, black, sans-serif font.

NO CLAIM IS MADE TO THE EXCLUSIVE RIGHT TO USE "STYLER", APART FROM THE MARK AS SHOWN. FOR ELECTRICALLY DRIVEN ROTATING MECHANICAL HAIRBRUSH (U.S. CLS. 21, 23, 26, 36 AND 38).
FIRST USE 4-24-2002; IN COMMERCE 4-24-2002.

SN 76-014,064. AMERICAN BIOMETRIC COMPANY LIMITED, OTTAWA, ONTARIO, CANADA, FILED 3-31-2000.

IPAD

FOR CONTACT IMAGING DEVICE NAMELY CAPACITIVE BIOMETRIC SCANNERS AND OPTICAL BIOMETRIC SCANNERS FOR USE IN IMAGING OF PORTIONS OF A HUMAN BODY NAMELY FINGERPRINTS AND PALMS; PORTABLE BIOMETRIC IMAGING DEVICE NAMELY FINGERPRINT IMAGER AND PALM PRINT IMAGER WITH WIRELESS COMMUNICATION; CAPACITIVE FINGERPRINT SCANNER; OPTICAL FINGERPRINT SCANNER; CAPACITIVE FINGERPRINT SCANNER WITH WIRELESS COMMUNICATIONS INTERFACE; OPTICAL FINGERPRINT SCANNER WITH WIRELESS COMMUNICATION INTERFACE; CONTACT IMAGING DEVICE WITH PROCESSOR FOR IMAGING OF A PART OF A HUMAN BODY, PROCESSING THE IMAGE TO IDENTIFY A USER WITH THE IMAGES PORTION OF THE HUMAN BODY, AND A WIRELESS COMMUNICATION INTERFACE FOR PROVIDING AN ACCESS CODE NAMELY PASSWORD, AN ENCRYPTION KEY, OR A PIN TO A HOST SYSTEM (U.S. CLS. 21, 23, 26, 36 AND 38).

SN 76-019,884. ICC TELECOMMUNICATIONS PTY LTD, NEW SOUTH WALES 2000, AUSTRALIA, FILED 3-29-2000.

QUICKCOMM

FOR COMPUTER SOFTWARE FOR THE MONITORING AND MANAGING ACCOUNTS, COSTS, ORDERS, INVENTORY, AND BILLING INFORMATION IN CONNECTION WITH TELECOMMUNICATIONS AND OTHER UTILITY SERVICES (U.S. CLS. 21, 23, 26, 36 AND 38).

CLASS 9—(Continued).

SN 76-030,869. COLLOIDAL DYNAMICS PTY. LTD., EVELEIGH NEW SOUTH WALES 1430, AUSTRALIA, FILED 4-17-2000.

ZETAPROBE

PRIORITY CLAIMED UNDER SEC. 44(D) ON AUSTRALIA APPLICATION NO. 810565, FILED 10-15-1999, REG. NO. 810565, DATED 10-15-1999, EXPIRES 10-15-2009.

FOR APPARATUS AND COMPUTER SOFTWARE FOR MEASURING ZETA POTENTIAL OF COLLOIDAL PARTICLES IN THE FIELD OF COLLOID MEASUREMENT (U.S. CLS. 21, 23, 26, 36 AND 38).

SN 76-046,419. A.C.E. RECORDS, INC., HOUSTON, TX. FILED 5-12-2000.



NO CLAIM IS MADE TO THE EXCLUSIVE RIGHT TO USE "RECORDS", APART FROM THE MARK AS SHOWN. FOR AUDIO CASSETTES AND COMPACT DISCS IN THE FIELD OF MUSIC (U.S. CLS. 21, 23, 26, 36 AND 38). FIRST USE 5-0-1996; IN COMMERCE 5-0-1996.

SN 76-067,088. CELERITY, INC., NORCROSS, GA. FILED 6-8-2000.

CELERITYDOCS

FOR COMPUTER SOFTWARE FOR VOICE TRANSCRIPTION (U.S. CLS. 21, 23, 26, 36 AND 38).

CLASS 9—(Continued).

SN 76-070,449. BAE SYSTEMS PLC, FARNBOROUGH, HAMPSHIRE, GU14 6YU, GREAT BRITAIN, FILED 6-15-2000.

TERPROM EAGLE OWL

OWNER OF UNITED KINGDOM REG. NO. 2230067, DATED 9-29-2000, EXPIRES 4-19-2010.

OWNER OF U.S. REG. NO. 1,852,230.

FOR NAVIGATIONAL AVIONICS AND VEHICLE NAVIGATIONAL ELECTRONICS, NAMELY, COMPUTERS AND DATA PROCESSORS; COMPUTER PROGRAMS FOR USE IN EVALUATION, FILTERING AND MANIPULATION OF NAVIGATION AVIONICS DATA AND VEHICLE NAVIGATIONAL ELECTRONICS DATA; MAGNETIC STORAGE AND RECORDING DEVICES, NAMELY, PRERECORDED MAGNETIC TAPES AND DISCS, PROCESSORS WHEN PROGRAMMED, NAMELY, DATA PROCESSORS, SIGNAL PROCESSORS AND IMAGE PROCESSORS, AND ELECTRONIC DATABASES RECORDED ON COMPUTER MEDIA ALL PERTAINING TO NAVIGATIONAL AVIONICS AND VEHICLE NAVIGATIONAL ELECTRONICS; APPARATUS FOR STORING, DISPLAYING OR RECORDING MAPS IN DIGITAL FORM PERTAINING TO NAVIGATIONAL AVIONICS AND VEHICLE NAVIGATIONAL ELECTRONICS, NAMELY, PRERECORDED MAGNETIC TAPES AND DISCS; FORWARD LOOKING LASER SENSORS FOR TERRAIN OR OBSTACLE DETECTION, GROUND PROXIMITY WARNING SENSORS AND TERRAIN OR OBSTACLE AVOIDANCE SENSORS; AUTOMATIC STEERING APPARATUS FOR NAVIGATIONAL AVIONICS AND VEHICLE NAVIGATIONAL ELECTRONICS, NAMELY, AUTOPILOTS; AND PARTS AND FITTINGS FOR ALL THE AFORESAID GOODS (U.S. CLS. 21, 23, 26, 36 AND 38).

SN 76-076,893. XOPTIX, INC., WOODLAND HILLS, CA. FILED 6-22-2000.

XOPTIX

FOR SOLAR ENERGY FILMS AND DEVICES, NAMELY, APPARATUS FOR CONVERTING ELECTRONIC RADIATION TO ELECTRICAL ENERGY FEATURING PHOTOVOLTAIC FILMS OF CUSTOMIZABLE CONFIGURATIONS; AND OPTICAL FILTERS (U.S. CLS. 21, 23, 26, 36 AND 38).

SN 76-086,795. GRETAG IMAGING TRADING AG, 5430 WETTINGEN, SWITZERLAND, FILED 7-11-2000.

NETPRINTER

FOR APPARATUS FOR PHOTO FINISHING, NAMELY, FOR GENERATING PICTURES FROM DIGITAL SOURCES BY INKJET PRINTERS (U.S. CLS. 21, 23, 26, 36 AND 38).

CLASS 9—(Continued).

SN 76-103,884. COMPANHIA GRAFICA ASSESSORIA S/C LTDA., SANTANA DO PARNAIBA, SAO PAULO, BRAZIL, FILED 8-4-2000.



THE STIPPLING IS FOR SHADING PURPOSES ONLY AND IS NOT INTENDED TO INDICATE COLOR.

FOR SECURITY ALARM SYSTEMS, NAMELY, PERSONAL SECURITY ALARMS, ANTI-INTRUSION ALARMS AND BURGLAR ALARMS (U.S. CLS. 21, 23, 26, 36 AND 38).

SN 76-108,163. RADIOPATH, LLC, REDMOND, WA. FILED 8-14-2000.

TRUE READ

FOR UTILITY METER READING SYSTEM COMPRISING COMPUTER SOFTWARE AND AN ELECTRONIC MONITORING DEVICE FOR AUTOMATICALLY READING GAS, ELECTRIC AND WATER UTILITY METERS (U.S. CLS. 21, 23, 26, 36 AND 38).

FIRST USE 6-22-2000; IN COMMERCE 6-22-2000.

CLASS 9—(Continued).

SN 76-108,460. MbyN INC., SUNGNAM, KYUNGGI-DO, REPUBLIC OF KOREA, FILED 8-14-2000.



PRIORITY CLAIMED UNDER SEC. 44(D) ON REPUBLIC OF KOREA APPLICATION NO. 20000001414, FILED 3-24-2000, REG. NO. 0003771, DATED 9-24-2001, EXPIRES 9-24-2011.

FOR DOWNLOADABLE MUSICAL SOUND RECORDINGS VIA MUSIC VENDING MACHINES; BLANK MAGNETIC SOUND RECORDING STRIPS; PRERECORDED MAGNETIC SOUND RECORDING STRIPS CONTAINING MUSIC; ELECTRONIC AUTOMATIC DISTRIBUTION MACHINES, NAMELY, ELECTRONIC MUSIC JUKE BOXES AND ELECTRONIC VENDING MACHINES FOR PACKAGED GOODS; BLANK MAGNETIC COMPUTER TAPES; PRERECORDED MAGNETIC COMPUTER TAPES CONTAINING MUSIC; AUDIO RECORDERS; PRERECORDED AUDIO AND VIDEO TAPES FEATURING MUSIC; TELEVISION SATELLITE BROADCAST RECEIVERS; AUDIO AND VIDEO SIGNAL RECEIVERS; TELEVISION TRANSMITTERS; VIDEO RECORDERS; SATELLITE BROADCAST RECORDER; RECORDED COMPUTER OPERATING PROGRAMS; OPTICAL DISKS CONTAINING PROGRAMS FOR DATA MANAGEMENT, FILE MANAGEMENT AND OPERATING SYSTEMS; OPTICAL DISKS CONTAINING MUSIC AND VIDEO FILES; PORTABLE COMMUNICATION DEVICES NAMELY, VIDEO TELEPHONES SIGNAL REPEATER; COMPUTER HARDWARE USED TO ENHANCE DATA EXCHANGE OVER COMPUTER NETWORKS; COMPUTERS FOR USE IN VIDEO CONFERENCING; MICROPHONES; VIDEO CAMERAS; SEMICONDUCTORS; INTEGRATED CIRCUITS; VIDEO EDITING MACHINES; INVERTERS; ELECTRICAL TRANSFORMERS; AND RECTIFIERS (U.S. CLS. 21, 23, 26, 36 AND 38).

SN 76-124,216. GPT GLENDALE, INC., LAKELAND, FL. FILED 9-6-2000.

SPECTRASHIELD

FOR OPAQUE GOGGLES FOR USE BY PATIENTS TO PROTECT THE EYES DURING LASER AND NON-LASER MEDICAL OR COSMETIC TREATMENT OF THE FACE OR BODY (U.S. CLS. 21, 23, 26, 36 AND 38).
FIRST USE 9-25-1997; IN COMMERCE 9-25-1997.

SN 76-125,316. HIGH TOWER SOFTWARE, INC., IRVINE, CA. FILED 9-7-2000.

HIGHTOWER

FOR COMPUTER-OPERATING PROGRAMS FOR DATA MONITORING AND VISUALIZATION (U.S. CLS. 21, 23, 26, 36 AND 38).

FIRST USE 3-0-1997; IN COMMERCE 3-0-1997.

CLASS 9—(Continued).

SN 76-137,026. ENNOVATE NETWORKS, INC., BOXBOROUGH, MA. FILED 9-28-2000.

ENNOVATE ENSIGHT

FOR COMPUTER OPERATING SOFTWARE FOR CONTROLLING AND MANAGING NETWORKS, HIGH PERFORMANCE NETWORK ROUTERS AND DATA AND VOICE SWITCHING EQUIPMENT FOR USE BY GLOBAL DATA AND VOICE NETWORK SERVICE PROVIDERS AND TELECOMMUNICATIONS SERVICE PROVIDERS (U.S. CLS. 21, 23, 26, 36 AND 38).

SN 76-139,952. WORLD ENTERTAINMENT BROADCASTING CORPORATION, SCOTTSDALE, AZ. FILED 10-4-2000.

ARUSH ENTERTAINMENT

NO CLAIM IS MADE TO THE EXCLUSIVE RIGHT TO USE "ENTERTAINMENT", APART FROM THE MARK AS SHOWN.
FOR COMPUTER SOFTWARE, NAMELY, INTERACTIVE MULTIMEDIA COMPUTER GAME PROGRAMS (U.S. CLS. 21, 23, 26, 36 AND 38).

SN 76-143,864. WAVELINK CORPORATION, KIRKLAND, WA. FILED 10-9-2000.

WAVELINK STUDIO

OWNER OF U.S. REG. NO. 1,959,171.
FOR COMPUTER SOFTWARE FOR USE IN CREATING AND OPERATING WIRELESS NETWORKS (U.S. CLS. 21, 23, 26, 36 AND 38).

SN 76-143,869. WAVELINK CORPORATION, KIRKLAND, WA. FILED 10-9-2000.

WAVELINK TELNETCE

OWNER OF U.S. REG. NO. 1,959,171.
FOR COMPUTER SOFTWARE FOR USE IN CREATING AND OPERATING WIRELESS NETWORKS (U.S. CLS. 21, 23, 26, 36 AND 38).

CLASS 9—(Continued).

SN 76-144,126. NQL INC., SANTA ANA, CA. FILED 10-6-2000.

IQ

FOR COMPUTER SOFTWARE FOR USE IN THE CREATION, ACCESS, VIEWING, AND SEARCHING OF DOCUMENTS AND DATABASES CONTAINING AUDIO, VIDEO, AND TEXT INFORMATION THROUGH INTERNAL AND EXTERNAL NETWORKS; COMPUTER SOFTWARE FOR USE IN THE BROWSING, SCANNING, EXTRACTION, RETRIEVAL, AND ORGANIZATION OF DATA FROM INTERNAL AND EXTERNAL NETWORKS; COMPUTER SOFTWARE FOR USE IN SOFTWARE DEVELOPMENT (U.S. CLS. 21, 23, 26, 36 AND 38).

SN 76-159,376. CALL CENTER CONSULTING, INC., HURON, OH. FILED 11-6-2000.

MULTI-MESSENGER EXPRESS

FOR VOICE MESSAGING SYSTEM COMPRISING A PORTABLE LAPTOP COMPUTER WITH DOCKING STATION AND OPERATING SOFTWARE THEREFOR IN THE NATURE OF COMPACT DISCS AND FLOPPY DISCS FOR USE IN PLACING OUTGOING CALLS CONTAINING AN INFORMATIONAL MESSAGE, SUCH AS IN DISASTER RELIEF AND TELEMARKETING (U.S. CLS. 21, 23, 26, 36 AND 38).

SN 76-160,287. SOMA NETWORKS, INC., SAN FRANCISCO, CA. FILED 11-3-2000.

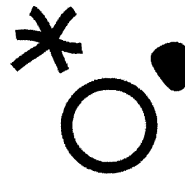

PRIORITY CLAIMED UNDER SEC. 44(D) ON CANADA APPLICATION NO. 1057975, FILED 5-5-2000.
FOR COMPUTER HARDWARE; TELEPHONY HARDWARE; COMPONENT PARTS AND FITTINGS FOR ALL THE AFORESAID; TELEPHONY SOFTWARE FOR USE IN TELEPHONE NETWORKS; COMPUTER SOFTWARE FOR USE IN DATA NETWORKS (U.S. CLS. 21, 23, 26, 36 AND 38).
FIRST USE 7-15-2002; IN COMMERCE 7-15-2002.

CLASS 9—(Continued).

SN 76-164,767. TELEFONICA, S.A., 28013 MADRID, SPAIN, FILED 11-14-2000.

TELEFONICA DATA USA

NO CLAIM IS MADE TO THE EXCLUSIVE RIGHT TO USE "DATA USA", APART FROM THE MARK AS SHOWN. THE ENGLISH TRANSLATION OF THE TERM "TELEFONICA" IS "TELEPHONIC".

SEC. 2(F) AS TO "TELEFONICA".
FOR TELEPHONY, TELEGRAPHY, TELEPHONIC EQUIPMENTS; EQUIPMENTS FOR THE TRANSMISSION AND RECEPTION OF MESSAGES, NAMELY, LAND TELEPHONES, MOBILE TELEPHONES, SWITCHBOARDS, ANSWERING MACHINES, RADIOTELEPHONES, FAX MACHINES, COMPUTERS FOR DATA PROCESSING, COMPUTER RECORDED PROGRAMS, COMPUTER DATA CARRIERS, RECORDED MULTIMEDIA SOFTWARE ON CD-ROM FOR TELECOMMUNICATION SERVICES, COMPUTER PERIPHERALS (U.S. CLS. 21, 23, 26, 36 AND 38).

SN 76-174,279. SIXTH DIMENSION, INC., FORT COLLINS, CO. FILED 12-1-2000.

6DINET

FOR COMPUTER SOFTWARE APPLICATIONS THAT ENABLE ENERGY PROVIDERS TO CONNECT WITH END USERS AND VICE-VERSA VIA A GLOBAL COMPUTER NETWORK (U.S. CLS. 21, 23, 26, 36 AND 38).

SN 76-184,231. VIRTUAL LOGISTIX, INC., SOUTHAMPTON, NY. FILED 12-21-2000.

VSP

FOR COMPUTER SOFTWARE PROGRAMS FOR USE ON STAND-ALONE, NETWORKED, AND COMPUTERS CONNECTED TO THE INTERNET FOR SEARCHING DATABASES, ORGANIZING DATABASE INFORMATION, CORRECTING DATABASE INFORMATION, AND MANAGING ENTERPRISE INFORMATION (U.S. CLS. 21, 23, 26, 36 AND 38).

SN 76-190,326. TOUCHTRAK SYSTEMS, INC., PORT HURON, MI. FILED 1-4-2001.

TOUCHTRAK

FOR COMPUTER PROGRAMS FOR COLLECTING AND REPORTING MAINTENANCE AND INSPECTION INFORMATION (U.S. CLS. 21, 23, 26, 36 AND 38).
FIRST USE 7-8-1992; IN COMMERCE 7-8-1992.

CLASS 9—(Continued).

SN 76-205,574. GEMINI INDUSTRIES, INC., CLIFTON, NJ. FILED 2-5-2001.

HANDS ON

FOR ACCESSORIES FOR PERSONAL DIGITAL ASSISTANT DEVICES, NAMELY, CONNECTING CABLES, SYNCING CABLES, CHARGING CABLES, STYLUSES AND CARRYING CASES FOR DEVICES (U.S. CLS. 21, 23, 26, 36 AND 38).

FIRST USE 11-9-2001; IN COMMERCE 11-9-2001.

SN 76-207,726. OON, YEONG KUANG, SCORESBY, VICTORIA 3179, AUSTRALIA, FILED 2-7-2001.

SCRIPTURIT

OWNER OF AUSTRALIA REG. NO. 846861, DATED 8-21-2000, EXPIRES 8-21-2010.

FOR COMPUTER SOFTWARE FOR KNOWLEDGE MANAGEMENT, NAMELY, SOFTWARE FOR ASSISTING WITH THE IDENTIFICATION, CAPTURE, AND USE OF INFORMATION RELATING TO THE PRINCIPLES AND TEXT FROM THE BIBLE (U.S. CLS. 21, 23, 26, 36 AND 38).

SN 76-208,058. TRIMUS LTD., HAIFA 31905, ISRAEL, FILED 2-9-2001.

DIMENSIONS BUILDER

NO CLAIM IS MADE TO THE EXCLUSIVE RIGHT TO USE "BUILDER", APART FROM THE MARK AS SHOWN. FOR SOFTWARE FOR CREATION OF MULTI-DIMENSIONAL WEBSITES (U.S. CLS. 21, 23, 26, 36 AND 38).

SN 76-218,413. NORTH AMERICAN CABLE COMPANY, INC., AURORA, IL. FILED 3-5-2001.

NORTH AMERICAN CABLE COMPANY, INC.

NO CLAIM IS MADE TO THE EXCLUSIVE RIGHT TO USE "CABLE COMPANY, INC.", APART FROM THE MARK AS SHOWN.

SEC. 2(F).
FOR COPPER AND FIBER OPTIC CABLE ASSEMBLIES AND HARNESSSES (U.S. CLS. 21, 23, 26, 36 AND 38).

FIRST USE 4-0-1994; IN COMMERCE 4-0-1994.

CLASS 9—(Continued).

SN 76-221,109. WAY2CALL COMMUNICATIONS LTD., TEL AVIV, ISRAEL, FILED 3-7-2001.

THE FIRST FOOT OF THE FIRST MILE

FOR DEVICES, NAMELY, TELEPHONE ADAPTORS THAT ENABLE THE CONNECTION OF PHONE TO IP (INTERNET PROTOCOLS) NETWORKS AND ALLOW FOR IP CALLS AND TRANSFER OF VOICE AND DATA VIA IP NETWORKS (U.S. CLS. 21, 23, 26, 36 AND 38).
FIRST USE 10-30-2000; IN COMMERCE 12-5-2000.

SN 76-231,650. SENECA NETWORKS, INC., ROCKVILLE, MD. FILED 3-29-2001.

SENECA NETWORKS

NO CLAIM IS MADE TO THE EXCLUSIVE RIGHT TO USE "NETWORKS", APART FROM THE MARK AS SHOWN.

FOR OPTICAL COMMUNICATION NETWORKS EQUIPMENT AND OPTICAL NETWORK ELEMENTS, NAMELY OPTICAL WAVEGUIDES, OPTICAL NODES, OPTICAL ADD-DROP MULTIPLEXERS, OPTICAL TRANSMITTERS, OPTICAL TRANSPONDERS, OPTICAL RECEIVERS, COMPUTER SOFTWARE FOR USE IN OPTICAL NETWORK MANAGEMENT, AND SWITCHES AND ROUTERS FOR AGGREGATING TRAFFIC ONTO OPTICAL WAVEGUIDES (U.S. CLS. 21, 23, 26, 36 AND 38).

SN 76-254,134. TETRADATA CORPORATION, GREENVILLE, SC. FILED 5-8-2001.



FOR COMPUTER SOFTWARE FOR COLLECTION, COMPILATION, STORAGE, REPORTING, AND PERFORMING STATISTICAL ANALYSIS OF TEST SCORES BY GENDER, ETHNICITY, AND ECONOMIC BACKGROUND AT THE STATE, CONSORTIUM, AND LOCAL SCHOOL DISTRICT LEVELS (U.S. CLS. 21, 23, 26, 36 AND 38).
FIRST USE 6-0-1999; IN COMMERCE 6-0-1999.

CLASS 9—(Continued).

SN 76-262,149. KINETICTIDE, INC., CUPERTINO, CA. BY CHANGE OF NAME EYEFROG.COM, INC., CUPERTINO, CA. FILED 5-24-2001.

NETWORKS IN MOTION

NO CLAIM IS MADE TO THE EXCLUSIVE RIGHT TO USE "NETWORKS", APART FROM THE MARK AS SHOWN.

FOR COMPUTER SOFTWARE THAT IS USED TO DISTRIBUTE SOFTWARE APPLICATIONS, MANAGE DATA, CONFIGURE A NETWORK OF COMPUTER SERVERS LOCALLY AND/OR GLOBALLY; COMPUTER SOFTWARE USED TO TRACK USE OF A COMPUTER NETWORK AND ITS CONTENT BY THOSE WITH ACCESS TO THAT COMPUTER NETWORK; AND COMPUTER SOFTWARE THAT IS USED TO CONFIGURE ROUTERS, SWITCHES AND OTHER NETWORK INTERFACE EQUIPMENT (U.S. CLS. 21, 23, 26, 36 AND 38).

SN 76-271,831. H.I.C. CO., LTD., TOKYO, 150-0011, JAPAN, FILED 6-15-2001.

EMOTIONAL ANIMATION

NO CLAIM IS MADE TO THE EXCLUSIVE RIGHT TO USE "ANIMATION", APART FROM THE MARK AS SHOWN.

FOR COMPUTER SOFTWARE FEATURING THREEDIMENSIONAL GRAPHICS FOR USE IN PLAYING GAMES AND DISPLAYING ANIMATED CARTOONS (U.S. CLS. 21, 23, 26, 36 AND 38).

SN 76-275,292. STAB S.R.L., 44031 AMBROGIO, FERRARA, ITALY, FILED 6-21-2001.



PRIORITY CLAIMED UNDER SEC. 44(D) ON ERPNCMNTY TM OFC APPLICATION NO. 2249506, FILED 6-11-2001. REG. NO. 2249506, DATED 8-6-2002, EXPIRES 6-11-2011.

FOR COMPUTER SOFTWARE EMBEDDED IN PERSONAL COMPUTER MEMORY CARDS AND SATELLITE RECEIVERS WHICH IS USED TO CONTROL THE OPERATION OF SATELLITE ANTENNA MOTORS (U.S. CLS. 21, 23, 26, 36 AND 38).

SN 76-275,321. SEVERN TRENT PLC, BIRMINGHAM, B26 3PU, ENGLAND, FILED 6-22-2001.

SEVERN TRENT SERVICES SMARTMETER

NO CLAIM IS MADE TO THE EXCLUSIVE RIGHT TO USE "SERVICES SMARTMETER", APART FROM THE MARK AS SHOWN.

FOR ELECTRONIC WATER METER (U.S. CLS. 21, 23, 26, 36 AND 38).

CLASS 9—(Continued).

SN 76-281,748. NEW ENERGY OPPORTUNITIES, INC., SUD-BURY, MA. FILED 7-10-2001.

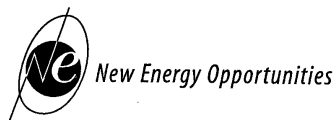

NO CLAIM IS MADE TO THE EXCLUSIVE RIGHT TO USE "ENERGY", APART FROM THE MARK AS SHOWN. FOR ENERGY CONSULTING SERVICES (U.S. CLS. 21, 23, 26, 36 AND 38). FIRST USE 10-31-2000; IN COMMERCE 10-31-2000.

SN 76-285,751. IATIA LIMITED, BOX HILL, VICTORIA 3128, AUSTRALIA, BY CHANGE OF NAME IATIA PTY LTD, BOX HILL, VICTORIA, AUSTRALIA, FILED 7-16-2001.

IATIA

PRIORITY CLAIMED UNDER SEC. 44(D) ON AUSTRALIA APPLICATION NO. 863485, FILED 1-19-2001, REG. NO. 863485, DATED 1-19-2001, EXPIRES 1-19-2011.

FOR MAGNIFYING SPECTACLES AND BINOCULARS; OPTICAL LOUPES; MICROSCOPES; IMAGING SYSTEM COMPRISED PRIMARILY OF A LENS, HARDWARE, AND ELECTRONIC IMAGE RECORDER FOR THE PRODUCTION OF PHOTOGRAPH AND ELECTRONIC IMAGES IN THE FIELDS OF SCIENTIFIC RESEARCH, INDUSTRIAL MANUFACTURING, AND DEFENSE SURVEILLANCE; IMAGING APPARATUS FOR THE PRODUCTION OF PHOTOGRAPHIC AND ELECTRONIC IMAGES OF BIOLOGICAL SAMPLES; COMPUTER SOFTWARE FOR STORING, RETRIEVING, DISPLAYING, MANIPULATING, TRANSMITTING, AND PRODUCING PHOTOGRAPHIC AND ELECTRONIC IMAGES IN THE FIELDS OF SCIENTIFIC RESEARCH, INDUSTRIAL MANUFACTURING, AND DEFENSE SURVEILLANCE; COMPUTER SOFTWARE FOR STORING, RETRIEVING, DISPLAYING, MANIPULATING, TRANSMITTING, AND PRODUCING PHOTOGRAPHIC AND ELECTRONIC IMAGES OF BIOLOGICAL SAMPLES; PHOTOGRAPHIC CAMERAS; SPOTTING SCOPES, NAMELY, DERMATOSCOPES AND INDIRECT OPHTHALMOSCOPES; COMBINED LOUPES AND INDIRECT OPHTHALMOSCOPES; LIGHT EMITTING DIODE LIGHT SOURCES FOR THE PREVIOUSLY MENTIONED PRODUCTS; LENS SYSTEMS COMPRISING GLASS LENS AND HOUSING FOR MICROSCOPES; LENS SYSTEMS COMPRISED PLASTIC LENS AND HOUSING FOR MICROSCOPES (U.S. CLS. 21, 23, 26, 36 AND 38).

CLASS 9—(Continued).

SN 76-288,159. GRACIDA EQUIPOS MAGNETICOS, S.A. DE C.V., MONTERREY, NUEVO LEON, MEXICO, FILED 7-20-2001.



THE MARK COMPRISES "GRACIDA" AND A HIGHLY STYLIZED OBLONG DESIGN FEATURING A HORIZONTAL STRIPE.

FOR MAGNETIC EQUIPMENT, NAMELY ELECTRO-MAGNETS, MAGNETIC SEPARATORS, MAGNETIC GRILLS, MAGNETIC DRUMS, MAGNETIC FILTERS, MAGNETIC CLAMPS, MAGNETIC PULLEYS, PERMANENT MAGNETS, MAGNETIC BARS, MAGNETIC LIFTS, AND MAGNETIC GRATES (U.S. CLS. 21, 23, 26, 36 AND 38).

FIRST USE 2-12-1998; IN COMMERCE 2-12-1998.

SN 76-295,621. AGILE SOFTWARE CORPORATION, SAN JOSE, CA. FILED 8-3-2001.

AGILE

OWNER OF U.S. REG. NO. 2,431,890.

FOR COMPUTER SOFTWARE; NAMELY PROGRAMS USED FOR (1) DATABASE AND BUSINESS MANAGEMENT APPLICATION PROCEDURES; (2) DOCUMENT MANAGEMENT FOR PRODUCT DATA, CAD DRAWINGS AND BILLS OF MATERIALS; (3) WORKFLOW MANAGEMENT FOR BUSINESS PROCESSES, ENGINEERING RELEASE CONTROL, ENGINEERING CHANGE MANAGEMENT, PARTS MANAGEMENT, AND NEW PRODUCT DEVELOPMENT PROCESSES; (4) COLLABORATIVE AND AUTOMATED MANAGEMENT OF PRODUCT INFORMATION; (5) ENABLING MOBILE USERS TO SECURELY ACCESS AND COLLABORATE ON PRODUCT CONTENT USING WIRELESS DEVICES, NAMELY PAGERS, CELLULAR PHONES, PERSONAL DIGITAL ASSISTANTS, AND COMPUTERS; (6) FACILITATING DIRECT INTERNET ACCESS AND ALLOWING USERS TO DEFINE, STORE, CHANGE AND MANAGE PRODUCT CONTENT INFORMATION; (7) ALLOWING ORIGINAL EQUIPMENT MANUFACTURERS TO PACKAGE AND DIRECTLY TRANSFER BUILD-AND-CHANGE PACKAGES; (8) ENABLING SUPPLY CHAIN PARTNERS BOTH TO CREATE AND VIEW PRODUCT CONTENT INFORMATION IN THE PRODUCT DEFINITION EXCHANGE FORMAT; (9) ALLOWING SUPPLY CHAIN PARTNERS TO SECURELY ACCESS ALL OF THE FUNCTIONALITY PROVIDED BY ELECTRONIC WEB HUBS UTILIZING STANDARD COMMUNICATION PROTOCOLS FOR THE GLOBAL INFORMATION COMPUTER NETWORK; (10) ALLOWING MANUFACTURERS TO SECURELY PROVIDE INTERNAL USERS AND SUPPLY CHAIN PARTNERS

CLASS 9—(Continued).

WITH ACCESS TO SOFTWARE CONTENT COMPILATION WITHOUT REQUIRING TRAINING, CONFIGURATION, INSTALLATION OR MAINTENANCE AT THE PARTNER SITE; (11) ALLOWING USERS TO SEND AND RECEIVE SUPPLY CHAIN INFORMATION IN A SECURE, PERSONALIZED MANNER OVER THE GLOBAL INFORMATION COMPUTER NETWORK, COMPRISING SOFTWARE PERFORMING COLLABORATION ON PRODUCT CONTENT, EXCHANGE AND MANAGEMENT OF PRODUCT BUILD-AND-CHANGE PACKAGES, AND SOURCE AND PROCUREMENT OF CUSTOM AND STANDARD COMPONENTS; (12) CONTENT MANAGEMENT IN A SOFTWARE DATABASE APPLICATION, USED TO MANAGE PRODUCT CONTENT CONFIGURATIONS, SUPPLY CHAIN CONTENT AND COMMUNICATION, AND THE ENGINEERING CHANGE ORDER PROCESS AND MANUFACTURING CHANGE ORDER PROCESS IN A COLLABORATIVE MANUFACTURING NETWORK; AND USERS' MANUALS SOLD THEREWITH AS A UNIT (U.S. CLS. 21, 23, 26, 36 AND 38).

FIRST USE 12-9-1997; IN COMMERCE 12-9-1997.

SN 76-300,426. MOTORNOSTIX (PROPRIETARY) LIMITED, CAPE TOWN, SOUTH AFRICA, FILED 8-16-2001.

MOTORNOSTIX

FOR ELECTRICAL AND ELECTRONIC APPARATUS COMPRISED OF SENSORS, COMPUTER HARDWARE AND OPERATING SOFTWARE FOR ACQUIRING AND ANALYZING DATA PERTAINING TO VARIABLE PARAMETERS SUCH AS TEMPERATURE, LIQUID LEVEL IN RESERVOIRS, VIBRATION, ELECTRICAL FLUX, TACHOMETRY, CURRENT SIGNATURES AND PROCESS VARIABLES, AND TRANSMITTING THE DATA ACQUIRED TO A REMOTE LOCATION FOR DIAGNOSTIC PURPOSES OR FOR PROCESS CONTROL OR FOR ESTABLISHING AN ALARM CONDITION OR FOR TWO OR MORE OF THESE PURPOSES (U.S. CLS. 21, 23, 26, 36 AND 38).

SN 76-302,934. LAMAS, JOSE LUIS GALLARDO, 08950 - ESPLUGUES DE LLOBREGAT BARCELONA, SPAIN, FILED 8-22-2001.

NESTDATA

PRIORITY CLAIMED UNDER SEC. 44(D) ON ERP N CMNTY TM OFC APPLICATION NO. 2231660, FILED 5-24-2001, REG. NO. 2231660, DATED 10-8-2002, EXPIRES 10-8-2012.

FOR COMPUTER PROGRAMS FOR THE ARRANGEMENT OF ENTERPRISE RESOURCE PLANNING (ERP) SOFTWARE (U.S. CLS. 21, 23, 26, 36 AND 38).

CLASS 9—(Continued).

SN 76-306,393. ARISTOCRAT TECHNOLOGIES AUSTRALIA PTY LTD., NEW SOUTH WALES, AUSTRALIA, FILED 8-29-2001.

HYPERLINK

OWNER OF AUSTRALIA REG. NO. 737018, DATED 6-17-1997, EXPIRES 6-17-2007.

FOR LINKED PROGRESSIVE GAMING MACHINES AND COMPONENTS THEREOF, NAMELY, GAMING MACHINES, CONTROLLERS, DISPLAYS, MACHINE INTERFACE CARDS, COMPUTER BOARDS, METERS, COMPUTER SOFTWARE AND FIRMWEAR AND ELECTRICAL WIRING AND CABLING (U.S. CLS. 21, 23, 26, 36 AND 38).

SN 76-307,720. BRUKER AXS, INC., MADISON, WI. FILED 8-31-2001.

PROTEUM R

NO CLAIM IS MADE TO THE EXCLUSIVE RIGHT TO USE "PROTEOME", APART FROM THE MARK AS SHOWN.

FOR SCIENTIFIC APPARATUS USED TO STUDY THE ATOMIC AND MOLECULAR STRUCTURES OF CRYSTALS IN LIFE SCIENCE CRYSTALLOGRAPHY TO DETERMINE WITH CERTAINTY THE ACTUAL ARRANGEMENT OF ATOMS WITHIN A CRYSTAL SPECIMEN WHICH APPARATUS INCLUDES DEDICATED COMPUTERS WITH ASSOCIATED HARDWARE AND SOFTWARE (U.S. CLS. 21, 23, 26, 36 AND 38).

SN 76-313,601. ARISTOCRAT TECHNOLOGIES AUSTRALIA PTY LTD, LANE COVE, NEW SOUTH WALES, AUSTRALIA, FILED 9-12-2001.

TIKI TORCH

OWNER OF AUSTRALIA REG. NO. 848187, DATED 8-29-2000, EXPIRES 8-29-2010.

FOR MACHINES FOR PLAYING GAMES OF CHANCE (U.S. CLS. 21, 23, 26, 36 AND 38).

SN 76-314,240. BRIGADE ELECTRONICS PLC, LONDON SE18 6BG, UNITED KINGDOM, FILED 9-18-2001.

bbs-tek

PRIORITY CLAIMED UNDER SEC. 44(D) ON ERP N CMNTY TM OFC APPLICATION NO. 2127595, FILED 3-13-2001, REG. NO. 002127595, DATED 4-7-2002, EXPIRES 3-13-2011.

FOR AUDIO WARNING DEVICES FOR VEHICLES, NAMELY, SIRENS, HORNS, AND BEEPERS FOR EMERGENCY VEHICLES AND REVERSING VEHICLES (U.S. CLS. 21, 23, 26, 36 AND 38).

CLASS 9—(Continued).

SN 76-314,757. MKS INC., WATERLOO, ON, CANADA, BY CHANGE OF NAME MORTICE KERN SYSTEMS INC., WATERLOO ONTARIO, CANADA, FILED 9-20-2001.

MKS INTEGRITY MANAGER

PRIORITY CLAIMED UNDER SEC. 44(D) ON CANADA APPLICATION NO. 1113065, FILED 8-15-2001.

NO CLAIM IS MADE TO THE EXCLUSIVE RIGHT TO USE "MANAGER", APART FROM THE MARK AS SHOWN.

FOR COMPUTER SOFTWARE, NAMELY, CHANGE MANAGEMENT SOFTWARE WHICH IS USED TO FACILITATE PROCESS CONTROL AND ENTERPRISE COLLABORATION OF SOFTWARE (U.S. CLS. 21, 23, 26, 36 AND 38).

FIRST USE 7-0-2001; IN COMMERCE 7-0-2001.

SN 76-316,301. HEIDELBERGER DRUCKMASCHINEN AKTIENGESELLSCHAFT, 69115 HEIDELBERG, FED REP GERMANY, FILED 9-24-2001.

METADIMENSION

PRIORITY CLAIMED UNDER SEC. 44(D) ON FED REP GERMANY APPLICATION NO. 30120481.0/0, FILED 3-28-2001, REG. NO. 30120481, DATED 5-7-2001, EXPIRES 3-31-2011.

FOR RASTER IMAGE PROCESSORS; DATA PROCESSING PROGRAMS FOR CONTROLLING PRINTING PRESSES, PLOTTERS AND RECORDERS (U.S. CLS. 21, 23, 26, 36 AND 38).

FIRST USE 7-16-2001; IN COMMERCE 7-16-2001.

SN 76-323,611. BOURN & KOCH, INC., ROCKFORD, IL. BY ASSIGNMENT; BY ASSIGNMENT FELLOWS CORPORATION, SPRINGFIELD, VT. FILED 10-10-2001.



OWNER OF U.S. REG. NO. 548,059. SEC. 2(F).

FOR GEAR MEASURING AND TESTING INSTRUMENTS, NAMELY, GEAR SHAPING EQUIPMENT AND TOOLS USED FOR MAKING GEARS (U.S. CLS. 21, 23, 26, 36 AND 38).

FIRST USE 6-1-1945; IN COMMERCE 6-1-1945.

SN 76-324,325. TELECT, INC., LIBERTY LAKE, WA. FILED 10-11-2001.

BLUE NICKEL

FOR TELECOMMUNICATIONS EQUIPMENT, NAMELY PATCH CORDS, PATCH PLUGS FOR INSERTION INTO BANTAM JACK ASSEMBLIES (U.S. CLS. 21, 23, 26, 36 AND 38).

FIRST USE 4-0-1991; IN COMMERCE 4-0-1991.

CLASS 9—(Continued).

SN 76-329,174. ELECTRONICS FOR IMAGING, INC., FOSTER CITY, CA. FILED 10-24-2001.

DOCSTREAM

FOR COMPUTER HARDWARE AND SOFTWARE CONSISTING OF DATA INTERFACE AND CONVERSION BOARDS FOR NETWORKING AND MANAGING, PROCESSING AND DELIVERING DATA AND SOFTWARE FOR IMAGE-PROCESSING AND DOCUMENT-SERVER APPLICATIONS FOR NETWORKING AND MANAGING, PROCESSING AND DELIVERING DATA USED IN CONNECTION WITH DIGITAL PRINTING (U.S. CLS. 21, 23, 26, 36 AND 38).

SN 76-333,126. DISCOVERY COMMUNICATIONS, INC., BETHESDA, MD. FILED 11-1-2001.

DOODLEZOO

FOR CHILDREN'S EDUCATIONAL SOFTWARE FEATURING INFORMATION RELATING TO HISTORY, SCIENCE, NATURE, AND CHILDREN'S ENTERTAINMENT GEARED TOWARDS CHILDREN, TEACHERS, STUDENTS AND PARENTS; PRE-RECORDED AUDIO, VIDEO DISK AND CD-ROM RECORDINGS FEATURING INFORMATION RELATED TO HISTORY, SCIENCE, NATURE, CHILDREN'S EDUCATION AND ENTERTAINMENT GEARED TOWARDS CHILDREN, TEACHERS, STUDENTS, AND PARENTS (U.S. CLS. 21, 23, 26, 36 AND 38).

SN 76-336,272. SECURE SYSTEMS LIMITED, WESTERN PERTH, AUSTRALIA, FILED 11-9-2001.

SILICON KEY VAULT

NO CLAIM IS MADE TO THE EXCLUSIVE RIGHT TO USE "SILICON", APART FROM THE MARK AS SHOWN.

FOR COMPUTER PERIPHERAL COMPRISING A CPU, COMPUTER MEMORY, COMPUTER OPERATING SYSTEM, AND ONBOARD MODIFIABLE SOFTWARE FOR SECURE OPERATION OF COMPUTER HARDWARE AND SECURE TRANSMISSION OF DATA (U.S. CLS. 21, 23, 26, 36 AND 38).

FIRST USE 2-21-2001; IN COMMERCE 2-21-2001.

SN 76-339,405. ACCU-SORT SYSTEMS, INC., HATFIELD, PA. FILED 11-16-2001.

FASTCOUNT

FOR PRODUCTION COUNTING AND REPORTING SYSTEMS COMPRISING SCANNERS, SENSORS, SCALES, PCS AND PRINTERS TO FACILITATE IDENTIFICATION, CONTROL, TRACKING, SORTING OR DISTRIBUTION OF CONVEYED ARTICLES (U.S. CLS. 21, 23, 26, 36 AND 38).

CLASS 9—(Continued).

SN 76-342,144. LEHMANN & MICHELS GMBH & CO. KG, D-22525 HAMBURG, FED REP GERMANY, FILED 11-28-2001.

CLASS 9—(Continued).

SN 76-345,403. USBNET, INC., SONGPA-KU, SEOUL, REPUBLIC OF KOREA, FILED 12-5-2001.

PREMET

FOR DIAGNOSTIC ANALYZING AND MEASURING EQUIPMENT FOR GAS AND DIESEL ENGINES, NAMELY, AN INTEGRATED UNIT WITH A PRESSURE SENSOR AND ASSOCIATED SOFTWARE TO PROVIDE DATA TO ENABLE ANALYSIS OF COMBUSTION AND PRESSURE IN ENGINE CYLINDERS (U.S. CLS. 21, 23, 26, 36 AND 38).

FIRST USE 4-26-1983; IN COMMERCE 1-0-1988.



SN 76-342,610. BRUKER DALTONIK GMBH, D-28359 BREMEN, FED REP GERMANY, FILED 11-28-2001.

PRIORITY CLAIMED UNDER SEC. 44(D) ON REPUBLIC OF KOREA APPLICATION NO. 2001-45441, FILED 10-17-2001.

FOR COMPUTERS; NOTEBOOK COMPUTERS; DISC DRIVES FOR COMPUTERS; DISC DRIVES FOR PORTABLE COMPUTERS; COMPUTER PRINTERS; COMPUTER MEMORIES AND COMPUTER WORK STATIONS COMPRISING COMPUTERS, AND COMPUTER MONITORS, KEYBOARDS AND PERIPHERALS (U.S. CLS. 21, 23, 26, 36 AND 38).

Proteineer

PRIORITY CLAIMED UNDER SEC. 44(D) ON ERP N CMNTY TM OFC APPLICATION NO. 002274496, FILED 6-26-2001, REG. NO. 002274496, DATED 7-11-2002, EXPIRES 6-26-2011.

FOR SPECTROMETERS; CONTROL, REGULATION AND DATA PROCESSING DEVICES FOR USE IN CONNECTION WITH SPECTROMETERS (U.S. CLS. 21, 23, 26, 36 AND 38).

SN 76-347,194. KONINKLIJKE PHILIPS ELECTRONICS N.V., EINDHOVEN, NETHERLANDS, FILED 12-10-2001.

LIVING TECHNOLOGY

SN 76-344,968. KABUSHIKI KAISHA TOSHIBA, DBA TOSHIBA CORPORATON, TOKYO, JAPAN, FILED 12-5-2001.

UTILITY VIEW

NO CLAIM IS MADE TO THE EXCLUSIVE RIGHT TO USE "UTILITY", APART FROM THE MARK AS SHOWN.

FOR COMPUTER SOFTWARE FOR REMOTE WATCHING OR REMOTE CONTROL OF PEOPLE, PLACES AND EVENTS (U.S. CLS. 21, 23, 26, 36 AND 38).

PRIORITY CLAIMED UNDER SEC. 44(D) ON BENELUX APPLICATION NO. 0992890, FILED 7-6-2001, REG. NO. 0692573, DATED 11-26-2001, EXPIRES 7-6-2011.

NO CLAIM IS MADE TO THE EXCLUSIVE RIGHT TO USE "TECHNOLOGY", APART FROM THE MARK AS SHOWN.

FOR INTEGRATED CIRCUITS, SEMICONDUCTORS AND COMPUTER CHIPS (U.S. CLS. 21, 23, 26, 36 AND 38).

CLASS 9—(Continued).

SN 76-347,425. BINAGRAPHICS, INC., ROCHESTER, MI. FILED 12-11-2001.

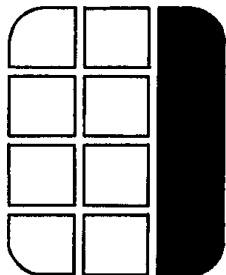

FOR HUMAN-COMPUTER INTERFACE DEVICES, NAMELY JOYSTICKS; COMPUTER SOFTWARE FOR INTERFACING BETWEEN THE HUMAN-COMPUTER INTERFACE DEVICES AND A COMPUTER, AND FOR USING THE HUMAN-COMPUTER INTERFACE DEVICES TO CONTROL DATA WITHIN THE COMPUTER ENVIRONMENT IN THE FIELD OF HUMAN-COMPUTER INTERACTION; CLOCKS; KEYPADS, NAMELY, NUMERIC ELECTRONIC KEYPADS; REVERSE KEYPADS, NAMELY KEYPADS HAVING KEYSWITCHES ARRANGED IN AN ARRAY FACING AWAY FROM THE KEYPAD OPERATOR; COMPUTER CONTROLLERS; COMPUTER MONITORS AND SCREENS; KEYPAD-ISOMORPHIC SYMBOLS, NAMELY SYMBOLS REPRESENTING PATTERNS WHICH MAY BE INPUTTED INTO A COMPUTER WITH A KEYPAD; KEYPAD MATRICIES, NAMELY AN ARRAY OF KEYSWITCHES THAT MAKE UP A KEYPAD; AND ELECTRIC PUSHBUTTON SWITCHES (U.S. CLS. 21, 23, 26, 36 AND 38).

SN 76-347,747. HIGH TOWER SOFTWARE, INC., ALISO VIEJO, CA. FILED 12-10-2001.

HIGHTOWER SOFTWARE

NO CLAIM IS MADE TO THE EXCLUSIVE RIGHT TO USE "SOFTWARE", APART FROM THE MARK AS SHOWN. FOR COMPUTER-OPERATING PROGRAMS FOR DATA MONITORING AND VISUALIZATION (U.S. CLS. 21, 23, 26, 36 AND 38).

FIRST USE 3-0-1997; IN COMMERCE 3-0-1997.

SN 76-366,890. MARK BRITTINGHAM ASSOCIATES, LLC, CALIFON, NJ. FILED 2-5-2002.

TRUE AGE

FOR COMPUTER SOFTWARE THAT PROVIDES A MEDICAL AND FITNESS ASSESSMENT QUESTIONNAIRE FOR USE IN THE FIELD OF FITNESS AND HEALTH CLUBS (U.S. CLS. 21, 23, 26, 36 AND 38).

FIRST USE 2-0-2001; IN COMMERCE 2-0-2001.

CLASS 9—(Continued).

SN 76-366,891. BRITTINGHAM SOFTWARE DESIGN, INC., CALIFON, NJ. FILED 2-5-2002.

MOTIVATION

FOR COMPUTER APPLICATION SOFTWARE FOR MAINTAINING EXERCISE AND FITNESS-ORIENTED ACTIVITY AND ATTENDANCE RECORDS FOR USE IN THE FIELD OF FITNESS CLUBS AND HEALTH CLUBS (U.S. CLS. 21, 23, 26, 36 AND 38).

FIRST USE 9-0-1996; IN COMMERCE 9-0-1996.

SN 76-367,045. KABUSHIKI KAISHA OPTOHUB, NAGANO-KEN, JAPAN, FILED 2-6-2002.

OPTOHUB

FOR OPTO-ELECTRONIC COMPONENTS AND DEVICES, NAMELY, OPTICAL FIBRES, ELECTRICAL CORDS FOR EXCLUSIVE USE IN OPTICAL FIBRES, CONNECTORS FOR OPTICAL FIBRES, CONNECTING PLUGS, CONNECTING JACKS, LASER DIODES (LD), MODULES OF LASER DIODES (LD MODULE), SEMICONDUCTOR LASERS, MODULES OF SEMI-CONDUCTOR LASERS, LIGHT EMITTING DIODES (LED), PHOTO-LED AND PHOTO-DIODE (PD) MODULES, AVALANCHE PHOTO DIODES, SILICON WAFERS, COMPOUND SEMICONDUCTOR WAFERS, THERMISTORS, CIRCULATORS, TRANSISTORS, OPTICAL MEMORY CARDS, MICROPROCESSORS, PRINTED CIRCUITS, PRINTED CIRCUITS BOARDS (PCB), CONNECTORS FOR PRINTED CIRCUITS BOARDS, MAGNETIC CORES, ELECTRIC CONDUCTORS, CONDUCTORS FOR OPTICAL FIBRES, ELECTRICAL WIRES AND CABLES, RESISTANCE WIRES, MICROLENSES, OPTICAL PACKAGES FOR INTEGRATED CIRCUITS, NAMELY, DUAL INLINE PACKAGES, BUTTERFLY PACKAGES, TRANSISTOR OUTLINE (TO) PACKAGES, AND DISCRETE PACKAGES, OPTICAL COUPLERS, OPTICAL PASSIVE COMPONENTS AND OPTICAL ACTIVE COMPONENTS, NAMELY, OPTICAL SWITCHES, WAVELENGTH DIVISION MULTIPLEXERS (WDM), AND DEMULTIPLEXERS, COMPUTER TERMINALS, ELECTRIC INJUNCTION BOXES, SWITCH-BOXES THAT INCLUDE ELECTRIC SWITCHES, ELECTRICAL BRANCH BOXES, ELECTRONIC CONTROL PANELS, COMMUTATORS, AND TRANSFORMERS, ELECTRICAL DISTRIBUTION BOXES, CAPACITORS, OSCILLATORS, MODULES OF OPTICAL TRANSCIEVERS, MODULES OF OPTICAL TRANSMITTERS, OPTICAL RECEIVERS, ATTENUATORS, ISOLATORS, OPTO-ISOLATORS, INTERFERENCE FILTERS, POWER METERS FOR OPTICAL FIBRES, OPTICAL DETECTORS, ENERGY MEASURING DEVICES, NAMELY, OPTICAL POWER METERS, SPECTRUM ANALYZERS, AMPLIFIERS, OPTICAL TIME DOMAINE REFLECTING (OTDR) METERS (U.S. CLS. 21, 23, 26, 36 AND 38).

SN 76-367,121. GO PHOTO, INC., CONGRESS, NY. FILED 2-5-2002.

HOT PIX

FOR STILL CAMERAS (U.S. CLS. 21, 23, 26, 36 AND 38).

CLASS 9—(Continued).

SN 76-369,921. FSV PAYMENT SYSTEMS LTD., HOUSTON, TX. BY ASSIGNMENT ATM BENEFITS AND SERVICES LLC, HOUSTON, TX. FILED 2-11-2002.

FLEXCARD

FOR DEBIT CARDS AND STORED VALUE CARDS (U.S. CLS. 21, 23, 26, 36 AND 38).
FIRST USE 5-1-2002; IN COMMERCE 5-1-2002.

SN 76-371,257. AGATE SOFTWARE, INC., DBA PAVILION SYSTEMS, LANSING, MI. FILED 2-14-2002.

QSOLVE

FOR COMPUTER SOFTWARE FOR USE BY ORGANIZATIONS IN MEETING QS9000 AND ISO-9000 QUALITY SPECIFICATIONS AND REQUIREMENTS BY TRACKING PROJECTS, MANAGING QUALITY DOCUMENTS, PROCEDURES AND AUDIT REPORTS, MANAGING NONCONFORMANCE IDENTIFICATION, ANALYSIS AND CORRECTIVE ACTIONS, PROJECT MANAGEMENT AND TASK TRACKING FOR PRODUCT DEVELOPMENT, AND KEEPING RECORDS (U.S. CLS. 21, 23, 26, 36 AND 38).
FIRST USE 2-7-1997; IN COMMERCE 2-7-1997.

SN 76-375,365. APPLIED OPTOELECTRONICS, INC., SUGAR LAND, TX. FILED 2-26-2002.

BRINGING THE WORLD TO LIGHT

FOR OPTOELECTRONIC DEVICES, NAMELY, LASERS, SEMICONDUCTOR LASERS, VERTICAL-CAVITY SURFACE-EMITTING LASERS, EDGE-EMITTING LASERS, DIODE LASERS, FABRY-PEROT LASERS, DISTRIBUTED FEEDBACK LASERS, AND QUANTUM CASCADE SEMICONDUCTOR LASERS, ALL FOR NON-MEDICAL USES; AND LIGHT EMITTING DIODES, COMPOUND SEMICONDUCTOR EPITAXIAL CRYSTALLINE WAFERS AND SILICON WAFER CHIPS (U.S. CLS. 21, 23, 26, 36 AND 38).

SN 76-375,718. ESSIENT PHOTONICS, INC., DALLAS, TX. FILED 2-25-2002.

ESSIENT

FOR OPTOELECTRONIC INTEGRATED CIRCUITS FOR THE COMMUNICATIONS MARKET (U.S. CLS. 21, 23, 26, 36 AND 38).
FIRST USE 1-16-2002; IN COMMERCE 1-16-2002.

CLASS 9—(Continued).

SN 76-376,677. NAN JIN RONG BAO XIANG BAO, LIMITED, GU ROU DISTRICT, NAN JIN SHI, CHINA, FILED 3-1-2002.

MAGICASE

FOR CD HOLDERS, CD VISOR DISPLAY CARD, CD PLAYER CASE, MULTI CD HOLDER, CD HOLDER DISPLAY BOX, CD CASE DISPLAY BOX, CELLULAR PHONE ORGANIZER AUTO VISOR, AND CAR ORGANIZER AUTO VISOR (U.S. CLS. 21, 23, 26, 36 AND 38).
FIRST USE 8-18-2000; IN COMMERCE 8-18-2000.

SN 76-376,909. ARISTOCRAT TECHNOLOGIES AUSTRALIA PTY LTD, LANE COVE, 2066, NSW, AUSTRALIA, FILED 2-28-2002.

JACKPOT KING

PRIORITY CLAIMED UNDER SEC. 44(D) ON AUSTRALIA APPLICATION NO. 001660715, FILED 8-29-2001, REG. NO. 887479, DATED 8-29-2001, EXPIRES 8-29-2011.
NO CLAIM IS MADE TO THE EXCLUSIVE RIGHT TO USE "JACKPOT", APART FROM THE MARK AS SHOWN.
FOR GAMING DEVICES, NAMELY, GAMING MACHINES AND ASSOCIATED SOFTWARE FOR USE THEREWITH (U.S. CLS. 21, 23, 26, 36 AND 38).

SN 76-377,902. FLS AUTOMATION A/S, DK-2500 VALBY, DENMARK, FILED 3-4-2002.

ECS/ProcessExpert

OWNER OF U.S. REG. NOS. 2,100,668, 2,164,946 AND OTHERS.
FOR ELECTRONIC DATA TREATMENT EQUIPMENT COMPRISING COMPUTER HARDWARE AND SOFTWARE FOR USE IN CONNECTION WITH PROCESS CONTROL AND AUTOMATION IN CEMENT PLANTS AND OTHER INDUSTRIES (U.S. CLS. 21, 23, 26, 36 AND 38).

SN 76-382,152. ONE WORLD MUSIC CORPORATION, SUMMERLAND, FL. FILED 3-12-2002.

CALYPSO KIDS

NO CLAIM IS MADE TO THE EXCLUSIVE RIGHT TO USE "CALYPSO", APART FROM THE MARK AS SHOWN.
FOR PRE-RECORDED MUSICAL SOUND RECORDINGS AND PRE-RECORDED MUSICAL VIDEO RECORDINGS, NAMELY, COMPACT DISCS AND DIGITAL VIDEO DISCS CONTAINING MUSIC, MUSICAL PERFORMANCES AND MUSIC VIDEOS (U.S. CLS. 21, 23, 26, 36 AND 38).

CLASS 9—(Continued).

SN 76-382,783. LPG SYSTEMS, 26000 VALENCE, FRANCE, FILED 3-13-2002.

RESULTS 6

PRIORITY CLAIMED UNDER SEC. 44(D) ON FRANCE APPLICATION NO. FR013120828, FILED 9-13-2001, REG. NO. 013120828, DATED 9-13-2001, EXPIRES 9-13-2011.

FOR PHOTOGRAPHIC DIAGNOSTIC EQUIPMENT FOR USE IN EVALUATING, MONITORING, MEASURING AND COMPARING SKIN CONDITIONS, SKIN VOLUME AND SKIN TRANSFORMATIONS, WHICH EQUIPMENT CONSISTS OF PHOTOGRAPHIC CAMERAS, REFLEX CAMERAS, DIGITAL CAMERAS, CAMERA FLASHES, PHOTOGRAPHIC PROJECTORS, PHOTOGRAPHIC BACKBOARDS WITH MECHANICAL AND ELECTRONIC MEASURING GUIDES (U.S. CLS. 21, 23, 26, 36 AND 38).

SN 76-390,640. HILTON TRADING CORPORATION, MIAMI, FL. FILED 4-2-2002.



NO CLAIM IS MADE TO THE EXCLUSIVE RIGHT TO USE "USA", APART FROM THE MARK AS SHOWN.

THE DESIGN CONSISTS OF CONCENTRIC BLADES EXTRUDED TO GIVE THE IMAGE 3D VOLUME APPEARANCE.

FOR AUTOMATED PAPER CURRENCY COUNTERS (U.S. CLS. 21, 23, 26, 36 AND 38).

FIRST USE 4-0-2000; IN COMMERCE 7-0-2000.

SN 76-391,500. SIMON & SCHUSTER, INC., NEW YORK, NY. FILED 4-4-2002.

PIMSLEUR INSTANT CONVERSATION

OWNER OF U.S. REG. NO. 2,597,735.

NO CLAIM IS MADE TO THE EXCLUSIVE RIGHT TO USE "INSTANT CONVERSATION", APART FROM THE MARK AS SHOWN.

THE NAME "PIMSLEUR" IDENTIFIES A LIVING INDIVIDUAL WHOSE CONSENT IS OF RECORD.

FOR PRERECORDED AUDIO TAPES AND CD-ROMS FOR TEACHING FOREIGN LANGUAGES (U.S. CLS. 21, 23, 26, 36 AND 38).

FIRST USE 4-1-2002; IN COMMERCE 4-1-2002.

CLASS 9—(Continued).

SN 76-392,018. F3, LLC, LOS ANGELES, CA. FILED 4-5-2002.

WEAVER BEAVER

FOR PRE-RECORDED AUDIO TAPES, AUDIO CASSETTES, AUDIO DISCS, VIDEO CASSETTES, VIDEOTAPES, VIDEO DISCS, COMPACT DISCS, DIGITAL AUDIO TAPES, DIGITAL VIDEO TAPES, DIGITAL VIDEO DISCS, DOWNLOADABLE VIDEO RECORDINGS, DOWNLOADABLE MUSICAL SOUND RECORDINGS, AND DOWNLOADABLE PUBLICATIONS IN THE NATURE OF BOOKS AND MAGAZINES, ALL FEATURING ANIMATED CHARACTERS, MUSIC, AND EDUCATIONAL AND ENTERTAINMENT CONTENT AND MATERIAL, NAMELY SONGS, COMEDY SKITS, PERFORMANCES, JOKES AND STORIES; MUSICAL SOUND RECORDINGS; CHILDREN'S EDUCATIONAL SOFTWARE; COMPUTER SCREEN SAVER SOFTWARE; CHILDREN'S EDUCATIONAL COMPUTER SOFTWARE; CHILDREN'S EDUCATIONAL COMPUTER PROGRAMS; CHILDREN'S EDUCATIONAL INTERACTIVE SOFTWARE PROGRAMS; DOWNLOADABLE CHILDREN'S EDUCATIONAL SOFTWARE USED FOR THE EDUCATING AND ENTERTAINING CHILDREN; COMPUTER GAME TAPES, COMPUTER GAME CARTRIDGES, COMPUTER GAME CASSETTES AND COMPUTER GAME SOFTWARE; MOUSE PADS; CALCULATORS; SUNGLASSES AND EYEGLASSES; AND SUNGLASS AND EYEGLASS CASES (U.S. CLS. 21, 23, 26, 36 AND 38).

SN 76-392,646. CELLULAR EXPORT INTERNATIONAL, INC., VAN NUYS, CA. FILED 4-8-2002.

HYDROFOAM

FOR CARRYING CASES DESIGNED FOR USE WITH CELLULAR TELEPHONES (U.S. CLS. 21, 23, 26, 36 AND 38).

FIRST USE 9-1-2001; IN COMMERCE 9-1-2001.

SN 76-393,290. ECTEL LTD., PETACH TIKVA 49517, ISRAEL, FILED 4-10-2002.

TMRS

PRIORITY CLAIMED UNDER SEC. 44(D) ON ISRAEL APPLICATION NO. 152849, FILED 10-21-2001, REG. NO. 152849, DATED 12-3-2002, EXPIRES 10-21-2008.

FOR TELECOMMUNICATION EQUIPMENT, NAMELY, COMPUTER SOFTWARE AND COMPUTER HARDWARE FOR PROVIDING OPERATION SUPPORT SYSTEM (OSS) FUNCTIONALITIES IN COMMUNICATION NETWORKS, WHICH FUNCTIONALITIES INCLUDE MONITORING, MEASURING, ANALYZING, SIGNAL CLASSIFICATION, REPORTING, TRAFFIC MANAGEMENT, NETWORK SURVEILLANCE, BILLING VERIFICATION, QUALITY MONITORING AND FRAUD DETECTION (U.S. CLS. 21, 23, 26, 36 AND 38).

CLASS 9—(Continued).

SN 76-393,542. KABUSHIKI KAISHA SEGA, DBA SEGA CORPORATION, TOKYO, JAPAN, FILED 4-10-2002.

MAGICAL FACE

PRIORITY CLAIMED UNDER SEC. 44(D) ON JAPAN APPLICATION NO. 2002-20513, FILED 3-15-2002, REG. NO. 4636948, DATED 1-17-2003, EXPIRES 1-17-2013.

NO CLAIM IS MADE TO THE EXCLUSIVE RIGHT TO USE "FACE", APART FROM THE MARK AS SHOWN.

FOR ANIMATION SOFTWARE; VIDEO GAME SOFTWARE; COMPUTER GAME PROGRAMS; COMPUTER GAME DISCS; VIDEO COMPUTER GAME PROGRAMS; HOME VIDEO COMPUTER GAME DISCS; GAME DISCS AND CIRCUIT BOARDS CONTAINING GAME PROGRAMS FOR USE WITH HAND HELD OR ARCADE VIDEO GAME MACHINES WITH BUILT-IN SCREENS (U.S. CLS. 21, 23, 26, 36 AND 38).

SN 76-394,591. CREATIVE TECHNOLOGY LTD., SINGAPORE 609921, SINGAPORE, FILED 4-11-2002.

NEWTON THEATER

NO CLAIM IS MADE TO THE EXCLUSIVE RIGHT TO USE "THEATER", APART FROM THE MARK AS SHOWN.

FOR COMPUTER HARDWARE; COMPUTER PERIPHERALS; ELECTRONIC AUDIO AND VIDEO COMPONENTS, NAMELY, AMPLIFIERS, RECEIVERS, TUNERS, SOUND MIXERS, DIAPHRAGMS, COUPLERS, AMPLIFYING TUBES, AMPLIFYING VALVES, EQUALIZERS, STEREO LOUDSPEAKERS, HEADPHONES, EARPHONES, CABINETS FOR LOUDSPEAKERS, CASSETTE TAPE PLAYERS/RECORDERS, AUDIO DECODERS, DIGITAL AUDIO PLAYERS/RECORDERS, DIGITAL VIDEO PLAYERS/RECORDERS, COMPACT DISC PLAYERS/RECORDERS AND RADIOS; CD ROMS, DVDS, VIDEO COMPACT DISCS, AND ACOUSTIC DISCS FEATURING RECORDED PERFORMANCES; COMPUTER SOFTWARE TO GENERATE, REPRODUCE, RECORD, CONTROL AND IMPROVE COMPUTER AND AUDIO EQUIPMENT SOUND QUALITY; COMPUTER SOFTWARE FOR THE ARRANGEMENT, SEQUENCING, STORAGE, REPRODUCTION, TRANSMISSION AND EDITING OF SOUND; COMPUTER SOFTWARE USED FOR AUDIO PLAYBACK AND FOR RECORDING, EFFECTING AND REPRODUCING SOUND (U.S. CLS. 21, 23, 26, 36 AND 38).

FIRST USE 1-0-2001; IN COMMERCE 1-0-2001.

SN 76-396,567. AUDIENCE, INC., LOS ALTOS, CA. BY CHANGE OF NAME APPLIED NEUROSYSTEMS CORPORATION, LOS ALTOS, CA. FILED 4-16-2002.

AUDIENCE

FOR COMPUTER SOFTWARE FOR USE IN ENABLING CONSUMER ELECTRONICS TO RECOGNIZE AND UNDERSTAND SOUND; INTEGRATED CIRCUITS FOR USE IN ENABLING CONSUMER ELECTRONICS TO RECOGNIZE AND UNDERSTAND SOUND; COMPUTER HARDWARE FOR USE IN ENABLING CONSUMER ELECTRONICS TO RECOGNIZE AND UNDERSTAND SOUND (U.S. CLS. 21, 23, 26, 36 AND 38).

CLASS 9—(Continued).

SN 76-397,372. GEMPSY FRANCE SA, 95200 SARCELLES, FRANCE, FILED 4-17-2002.

GEMPSY

FOR PRICE VERIFIERS AND KIOSKS, NAMELY, PRICE VERIFYING DEVICES WITH PERIPHERAL EXTENSIONS, CONSISTING OF SCREENS, PRINTERS, BAR CODE AND CLUB CARD READING CAPACITIES, USED FOR SCANNING BAR CODES ON PRODUCTS AND CLUB CARDS, AND SUBSEQUENT DISPLAYING OR PRINTING OF PRICE, RELATED PROMOTIONS, NAMELY SALES DISCOUNTS, AND CUSTOMER-RELATED INFORMATION (U.S. CLS. 21, 23, 26, 36 AND 38). FIRST USE 12-0-1992; IN COMMERCE 1-0-2002.

SN 76-397,930. BEN JANS ELECTRONICS NV/SA, ANTWERPEN, BELGIUM, FILED 4-19-2002.

LIFESTYLE IN DIGITAL

NO CLAIM IS MADE TO THE EXCLUSIVE RIGHT TO USE "DIGITAL", APART FROM THE MARK AS SHOWN.

FOR HYBRID COMPUTER NETWORKS, AUTOMATION SYSTEMS, COMPRISING SOFTWARE, ELECTRICAL LIFTS; SERVER SYSTEMS, COMPRISING ELECTRONIC STORAGE DEVICES, SUCH AS COMPUTER DISCS, ELECTRONIC COMMUNICATION AND DATA TRANSFER DEVICES; VIDEO SYSTEMS COMPRISING, MONITORS, TELEVISIONS, AND CAMERAS; AUDIO SYSTEMS, COMPRISING COMPACT DISC PLAYERS, RECEIVERS, DVD PLAYERS, RADIO TUNERS, TAPE PLAYERS, SPEAKERS, HEADPHONES; MULTIMEDIA SYSTEMS, COMPRISING VIDEO CONFERENCING SOFTWARE, MONITORS, CAMERAS, SPEAKERS, HEADPHONES, BLANK MULTIMEDIA CARDS, MULTIMEDIA DEVICES, NAMELY VIDEO RECORDERS, DVD PLAYERS, AUDIO AND VIDEO CASSETTE PLAYERS, AUDIO AND VIDEO MEDIA PLAYERS, CD PLAYERS, MP3 PLAYERS, RADIO FREQUENCY TUNERS, DIGITAL TUNERS, RADIO FREQUENCY RECEIVERS, DIGITAL RECEIVERS, VIDEO CABLES, AUDIO CABLES, AND DATA CABLES; DATA NETWORKING SYSTEMS, COMPRISING DATA COMMUNICATION DEVICES, TELECOMMUNICATIONS DEVICES, NAMELY MODEMS, RADIO FREQUENCY TUNERS, DIGITAL TUNERS, RADIO FREQUENCY RECEIVERS, DIGITAL RECEIVERS, MODEMS, BLUETOOTH RECEIVERS, INFRARED RECEIVERS; DATA MANAGEMENT SYSTEMS, COMPRISING COMPUTERS AND COMPUTER PERIPHERALS WHICH MAY INCLUDE MONITORS, TOUCH SCREENS, KEYBOARDS, PRINTERS, SCANNERS, MICE, TRACKBALLS, JOYSTICKS, GAMEPADS, CO-PROCESSORS, MODEMS, BLUETOOTH RECEIVERS, INFRARED RECEIVERS, HARD AND FLOPPY DISK DRIVES, CD-ROM RECORDABLE DEVICES, DVD RECORDABLE DEVICES, BLANK TAPE DRIVES, BLANK AUDIO CARDS, BLANK VIDEO CARDS, BLANK MULTIMEDIA CARDS, MAGNETIC CARD READERS, MAGNETIC CHIP READERS, MEMORY ADD-ONS, MEMORY BOARDS AND CHIPS, ELECTRICAL CABLES, DATA COMMUNICATION CABLES, ELECTRICAL CONNECTORS, DATA COMMUNICATION AND NETWORK CONNECTORS, DEVICE PLUG-SOCKETS, PATCH PANELS, CONNECTOR PANELS, POWER SUPPLIES, OPERATING SOFTWARE AND INSTRUCTION MANUALS; ELECTRONIC SECURITY SYSTEMS COMPRISING OPTICAL SCANNERS, RETINAL SCANNERS, FINGERPRINT SCANNERS, MOTION SENSORS, HEAT SENSORS, PRESSURE SENSORS, LIGHT SENSORS, PASSWORD ENABLED KEYPADS, MAGNETIC CARD READERS, MAGNETIC CHIP READERS, VIDEO SURVEILLANCE EQUIPMENT; DIGITAL HARDWARE COMPONENTS, NAMELY, COMPUTERS, COM-

CLASS 9—(Continued).

PUTER PERIPHERALS, MULTIMEDIA DEVICES, NAMELY VIDEO RECORDERS, DVD PLAYERS, AUDIO AND VIDEO CASSETTE PLAYERS, AUDIO AND VIDEO MEDIA PLAYERS, CD PLAYERS, MP3 PLAYERS, RADIO FREQUENCY TUNERS, DIGITAL TUNERS, RADIO FREQUENCY RECEIVERS, DIGITAL RECEIVERS, VIDEO CABLES, AUDIO CABLES, AND DATA CABLES; COMPUTER NETWORKING DEVICES, NAMELY, DIGITAL MODEMS, ANALOG MODEMS; FACSIMILE EQUIPMENT, MODEMS, BLUETOOTH RECEIVERS, INFRARED RECEIVERS; NETWORKING DEVICES, NAMELY DATA COMMUNICATION DEVICES, TELECOMMUNICATIONS DEVICES, NAMELY MODEMS, RADIO FREQUENCY TUNERS, DIGITAL TUNERS, RADIO FREQUENCY RECEIVERS, DIGITAL RECEIVERS, MODEMS, BLUETOOTH RECEIVERS, INFRARED RECEIVERS; DATA STORAGE DEVICES, NAMELY HARD AND FLOPPY DISK DRIVES, CD-ROM RECORDABLE DEVICES, DVD RECORDABLE DEVICES, BLANK TAPE DRIVES, BLANK AUDIO CARDS, BLANK VIDEO CARDS, BLANK MULTIMEDIA CARDS, MAGNETIC CARD READERS, MAGNETIC CHIP READERS, MEMORY ADD-ONS, MEMORY BOARDS AND CHIPS, AND DIGITAL SECURITY DEVICES, NAMELY SOFTWARE, OPTICAL SCANNERS, RETINAL SCANNERS, FINGERPRINT SCANNERS, MOTION SENSORS, HEAT SENSORS, PRESSURE SENSORS, LIGHT SENSORS, PASSWORD ENABLED KEYPADS, MAGNETIC CARD READERS, MAGNETIC CHIP READERS, VIDEO SURVEILLANCE EQUIPMENT, NAMELY OPTICAL SCANNERS, CAMERAS, DIGITAL CAMERAS, VIDEO CAMERAS; DIGITAL EQUIPMENT RACK SYSTEMS, COMPRISING COMPUTERS, COMPUTER PERIPHERALS, MULTIMEDIA COMPONENTS, NAMELY MONITORS, VIDEO DISPLAYS, SPEAKERS AND SPEAKER SYSTEMS, DIGITAL CAMERAS, DIGITAL VIDEO RECORDERS, DVD PLAYERS, AUDIO AND VIDEO CASSETTE PLAYERS, AUDIO AND VIDEO MEDIA PLAYERS, CD PLAYERS, MP3 PLAYERS, RADIO FREQUENCY TUNERS, DIGITAL TUNERS, RADIO FREQUENCY RECEIVERS, DIGITAL RECEIVERS, VIDEO CABLES, AUDIO CABLES, AND DATA CABLES, NETWORK COMPONENTS AND DIGITAL SECURITY COMPONENTS; COMPUTERS AND COMPUTER PERIPHERALS WHICH MAY INCLUDE MONITORS, TOUCH SCREENS, KEYBOARDS, PRINTERS, SCANNERS, MICE, TRACKBALLS, JOYSTICKS, GAMEPADS, CO-PROCESSORS, MODEMS, BLUETOOTH RECEIVERS, INFRARED RECEIVERS, HARD AND FLOPPY DISK DRIVES, CD-ROM RECORDABLE DEVICES, DVD RECORDABLE DEVICES, BLANK TAPE DRIVES, BLANK AUDIO CARDS, BLANK VIDEO CARDS, BLANK MULTIMEDIA CARDS, MAGNETIC CARD READERS, MAGNETIC CHIP READERS, MEMORY ADD-ONS, MEMORY BOARDS AND CHIPS, ELECTRICAL CABLES, DATA COMMUNICATION CABLES, ELECTRICAL CONNECTORS, DATA COMMUNICATION AND NETWORK CONNECTORS, DEVICE PLUG-SOCKETS, PATCH PANELS, CONNECTOR PANELS, POWER SUPPLIES, OPERATING SOFTWARE AND INSTRUCTION MANUALS; MULTIMEDIA DEVICES, NAMELY, MONITORS, VIDEO DISPLAYS, LOUDSPEAKERS, DIGITAL CAMERAS, DIGITAL VIDEO RECORDERS, MICROPHONES, DIGITAL AUDIO RECORDERS, INTEGRATED AUDIO/VISUAL SYSTEMS COMPRISING MULTIMEDIA DEVICES, NAMELY, MONITORS, VIDEO DISPLAYS, SPEAKERS AND SPEAKER SYSTEMS, DIGITAL CAMERAS, DIGITAL VIDEO RECORDERS, DVD PLAYERS, AUDIO AND VIDEO CASSETTE PLAYERS, AUDIO AND VIDEO MEDIA PLAYERS, CD PLAYERS, MP3 PLAYERS, RADIO FREQUENCY TUNERS, DIGITAL TUNERS, RADIO FREQUENCY RECEIVERS, DIGITAL RECEIVERS, VIDEO CABLES, AUDIO CABLES, AND DATA CABLES; COMPUTER NETWORKING DEVICES, NAMELY, DIGITAL MODEMS, ANALOG MODEMS, FACSIMILE EQUIPMENT, BLUETOOTH RECEIVERS, INFRARED RECEIVERS; FACSIMILE EQUIPMENT NAMELY FACSIMILE SOFTWARE, DIGITAL FACSIMILE MACHINES, ANALOG FACSIMILE MACHINES, FIRE WALLS; DIGITAL SECURITY DEVICES, NAMELY SOFTWARE, OPTICAL SCANNERS,

CLASS 9—(Continued).

RETINAL SCANNERS, FINGERPRINT SCANNERS, MOTION SENSORS, HEAT SENSORS, PRESSURE SENSORS, LIGHT SENSORS, PASSWORD ENABLED KEYPADS, MAGNETIC CARD READERS, MAGNETIC CHIP READERS, VIDEO SURVEILLANCE EQUIPMENT, NAMELY OPTICAL SCANNERS, CAMERAS, DIGITAL CAMERAS, VIDEO CAMERAS; DATA SURVEILLANCE EQUIPMENT, NAMELY, SOFTWARE, TELEPHONES, FACSIMILE MACHINES, VIDEO PHONES, RADIO FREQUENCY RECEIVER/TRANSMITTERS, DIGITAL MODEMS AND ANALOG MODEMS (U.S. CLS. 21, 23, 26, 36 AND 38).

SN 76-398,340. ELECTRONICS AND TELECOMMUNICATIONS RESEARCH INSTITUTE, YUSEONG-KU, DAEJEON, REPUBLIC OF KOREA. FILED 4-19-2002.

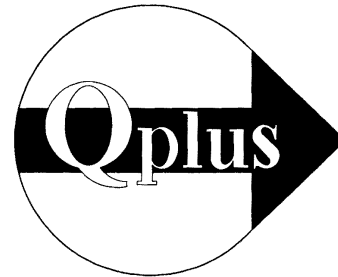

OWNER OF REPUBLIC OF KOREA REG. NO. 45-0001332, DATED 5-12-2000, EXPIRES 5-12-2010.

FOR COMPUTER PROGRAMS FOR OPERATING SYSTEMS, NAMELY, KERNEL PROGRAMS, LIBRARY PROGRAMS, UTILITY PROGRAMS AND GRAPHICAL APPLICATION PROGRAMS THEREIN; AND COMPUTER PROGRAMS FOR MANAGING COMMUNICATIONS AND DATA EXCHANGE BETWEEN INFORMATION APPLIANCES AND DESKTOP COMPUTERS (U.S. CLS. 21, 23, 26, 36 AND 38).

SN 76-398,548. GENE NETWORKS, INC., SAN JOSE, CA. FILED 4-22-2002.

GENECONNECT

FOR COMPUTER SOFTWARE- NAMELY-SOFTWARE MODULE WHICH PROVIDES DATA INTEGRATION AND COLLECTION FOR GENES (U.S. CLS. 21, 23, 26, 36 AND 38).

SN 76-398,842. ENHA GMBH, 66620 NONNWEILER, FED REP GERMANY, FILED 4-22-2002.

ROCKMAN

PRIORITY CLAIMED UNDER SEC. 44(D) ON ERPNCMNTY TM OFC APPLICATION NO. 002431518, FILED 10-30-2001, REG. NO. 2431518, DATED 11-26-2002, EXPIRES 11-26-2012.

FOR PROTECTIVE HELMETS; PROTECTIVE GLASSES; PROTECTIVE VISORS; HEARING PROTECTORS; AND RESPIRATORS OTHER THAN FOR ARTIFICIAL RESPIRATION (U.S. CLS. 21, 23, 26, 36 AND 38).

CLASS 9—(Continued).

SN 76-399,316. TOWER PRODUCTS INCORPORATED, SAUGERTIES, NY. FILED 4-24-2002.

FIRE OPTIC

NO CLAIM IS MADE TO THE EXCLUSIVE RIGHT TO USE "OPTIC", APART FROM THE MARK AS SHOWN.

FOR ELECTRONIC EQUIPMENT, NAMELY AUDIO AND VIDEO ROUTERS, SWITCHERS, AMPLIFIERS, CONVERTERS, MIXERS, CONNECTORS, AND ADAPTORS (U.S. CLS. 21, 23, 26, 36 AND 38).

SN 76-402,726. HELMUT FISCHER GMBH & CO. INSTITUT FUR ELEKTRONIK UND MESSTECHNIK, D-71069 SINDLINGEN, FED REP GERMANY, FILED 4-30-2002.

JEWELRING

FOR PLATENS FOR BETA-BACKSCATTER RADIATION MEASURING INSTRUMENTS, USED IN MEASURING THIN FILMS (U.S. CLS. 21, 23, 26, 36 AND 38). FIRST USE 6-0-1971; IN COMMERCE 6-0-1971.

SN 76-403,616. RED CHIP COMPANY LTD., TORTOLA, BR. VIRGIN ISLANDS, FILED 5-3-2002.

ULTRABASS

SEC. 2(F).
FOR ELECTRIC AUDIO EQUIPMENT, NAMELY, PSYCHOACOUSTIC SOUND PROCESSORS AND BASS COMBOS (U.S. CLS. 21, 23, 26, 36 AND 38). FIRST USE 8-25-1997; IN COMMERCE 12-16-1997.

CLASS 9—(Continued).

SN 76-404,841. NOLOGY ENGINEERING, INC., SAN MARCOS, CA. FILED 5-6-2002.

SPEED THRILLS

OWNER OF U.S. REG. NOS. 2,138,614 AND 2,349,670.
FOR MOTION PICTURE FILMS FEATURING ACTION, ADVENTURE AND/OR ANIMATION, AND MOTION PICTURE FILMS FOR BROADCAST ON TELEVISION FEATURING ACTION, ADVENTURE AND/OR ANIMATIONS; PRERECORDED AUDIO TAPES, AUDIO-VIDEO TAPES, AUDIO VIDEO CASSETTES, AUDIO VIDEO DISCS, AND DVD DISCS FEATURING ACTION, ADVENTURE, AND/OR ANIMATIONS; ELECTRONIC GAMES, NAMELY SOFTWARE GAMES RECORDED ON CD-ROM AND DVD DISCS FOR COMPUTERS; SOFTWARE GAMES RECORDED ON DISKETTES, CD-ROM, DVD DISCS, AND CARTRIDGES FOR CONSOLE AND INDIVIDUAL, PORTABLE GAMING SYSTEMS; AND COMPUTER SOFTWARE FOR ELECTRONIC GAMES THAT IS DOWNLOADABLE FROM A REMOTE COMPUTER SITE; EYEGLASSES, SUNGLASSES AND CASES THEREFORE; COMPUTER PROGRAMS, NAMELY, SOFTWARE LINKING DIGITIZED VIDEO AND AUDIO MEDIA TO A GLOBAL COMPUTER INFORMATION NETWORK AND INTERACTIVE SOFTWARE PROGRAMS LINKED TO A GLOBAL COMPUTER INFORMATION NETWORK; GAME EQUIPMENT SOLD AS A UNIT FOR PLAYING A PARLOR-TYPE COMPUTER GAME-VIDEO AND COMPUTER GAME PROGRAMS, AND VIDEO GAME CARTRIDGES (U.S. CLS. 21, 23, 26, 36 AND 38).

SN 76-405,233. SONY ELECTRONICS INC., PARK RIDGE, NJ. FILED 5-8-2002.

DYNABLACK

FOR TELEVISIONS AND PROJECTION TELEVISIONS (U.S. CLS. 21, 23, 26, 36 AND 38). FIRST USE 2-28-2002; IN COMMERCE 2-28-2002.

SN 76-405,630. CARMICHAEL HOLDINGS, LLC, STURGIS, MI. FILED 5-10-2002.

CATA

FOR COMPUTER SOFTWARE FOR PROVIDING ACCESS TO SECURE INTERACTIVE CONFERENCES AND MEETINGS THROUGH A GLOBAL COMPUTER NETWORK (U.S. CLS. 21, 23, 26, 36 AND 38). FIRST USE 1-26-2002; IN COMMERCE 1-26-2002.

CLASS 9—(Continued).

SN 76-405,983. VA, INC., ROCHESTER, NY. FILED 5-10-2002.

VINCENT ASSOCIATES

NO CLAIM IS MADE TO THE EXCLUSIVE RIGHT TO USE "ASSOCIATES", APART FROM THE MARK AS SHOWN.

FOR ELECTROMAGNETICALLY ACTUATED PHOTOGRAPHIC SHUTTERS, MICROSCOPE AND VIDEO MOUNTS FOR SHUTTERS, ELECTRONIC CONTROLS FOR SHUTTERS, ELECTRICAL CABLES FOR SHUTTERS (U.S. CLS. 21, 23, 26, 36 AND 38).

FIRST USE 0-0-1995; IN COMMERCE 0-0-1995.

SN 76-406,425. RAIDTRONICS, INC., CITY OF INDUSTRY, CA. FILED 5-13-2002.

RAIDMAX

FOR PERSONAL COMPUTERS, COMPUTER WORKSTATIONS, AND PERIPHERAL HARDWARE, NAMELY, COMPUTER CASES, STANDS, TERMINALS, KEYBOARDS, POWER SUPPLIES, CIRCUIT BOARDS, INTEGRATED CIRCUITS, CABLES, MOUSE, TRACKBALLS, TOUCHPADS, MONITORS, MODEMS AND MODEM CARDS, PCMCIA CARDS, MEMORIES, CONNECTOR BOARDS, JOYSTICKS, AND INTERFACE BOARDS (U.S. CLS. 21, 23, 26, 36 AND 38).

FIRST USE 9-15-2001; IN COMMERCE 10-1-2001.

SN 76-408,214. KDE INCORPORATION, KANGDONG-KU, SEOUL, REPUBLIC OF KOREA, FILED 5-15-2002.

KDE

THE MARK CONSISTS OF THE LETTERS "KDE" IN STYLIZED FORM.

FOR EQUIPMENT FOR USE IN MAGNETICALLY ENCODED RADIO FREQUENCY SMART CARD IDENTIFICATION SYSTEMS, KEYLESS ENTRY ACCESS SYSTEMS, AND ENCODED CREDIT AND DEBIT CARD SYSTEMS, NAMELY, MAGNETIC CODED CARD READERS, CARD READER TERMINALS, BARCODE CHECK READERS, BATTERY CHARGERS, RADIO FREQUENCY CARD VENDING MACHINES, DATA COLLECTORS AND RF-ID RADIO FREQUENCY IDENTIFICATION ACCESS TERMINALS (U.S. CLS. 21, 23, 26, 36 AND 38).

CLASS 9—(Continued).

SN 76-408,308. NEW AGE CONSULTANTS PTY LIMITED, RICHMOND, VIC, 3121, AUSTRALIA, FILED 5-13-2002.

MGA DUPLICA

PRIORITY CLAIMED UNDER SEC. 44(D) ON AUSTRALIA APPLICATION NO. 895002, FILED 11-14-2001, REG. NO. 895002, DATED 11-14-2001, EXPIRES 11-14-2011.

NO CLAIM IS MADE TO THE EXCLUSIVE RIGHT TO USE "MGA", APART FROM THE MARK AS SHOWN.

FOR SOFTWARE THAT DUPLICATES DATA FROM ONE OR MORE DATABASES INTO A TARGET DATABASE INCLUDING THE CAPACITY TO FILTER THIS DATA AND REPLICATE THE DATA AT DEFINED INTERVALS INCLUDING THE CREATION OF A BACK-UP DATABASE (U.S. CLS. 21, 23, 26, 36 AND 38).

SN 76-408,523. LAYER N NETWORKS, INC., TRAVIS COUNTY, AUSTIN, TX. FILED 5-14-2002.



NO CLAIM IS MADE TO THE EXCLUSIVE RIGHT TO USE "NETWORKS", APART FROM THE MARK AS SHOWN.

THE LINING IN THE MARK IS A FEATURE OF THE MARK AND IS NOT INTENDED TO INDICATE COLOR.

FOR SEMICONDUCTOR DEVICES, INTEGRATED CIRCUITS AND MASK WORKS FOR USE IN TELECOMMUNICATIONS AND NETWORKING APPLICATIONS; AND COMPUTER SOFTWARE FOR ACCESSING AND CONTROLLING SEMICONDUCTOR DEVICES, INTEGRATED CIRCUITS AND MASK WORKS USED IN TELECOMMUNICATIONS AND NETWORKING APPLICATIONS (U.S. CLS. 21, 23, 26, 36 AND 38).

SN 76-409,118. PHOTONIC SYSTEMS, INC., BURLINGTON, MA. FILED 5-16-2002.



NO CLAIM IS MADE TO THE EXCLUSIVE RIGHT TO USE "PHOTONIC SYSTEMS INC.", APART FROM THE MARK AS SHOWN.

FOR FIBER OPTIC EQUIPMENT FOR USE IN TELECOMMUNICATIONS, BROADCASTING AND RADAR APPLICATIONS, NAMELY LINKS FOR CONVEYING INFORMATION IN ELECTRONIC FORM OVER OPTICAL FIBERS, BIAS CONTROLLERS, NO-MOTION CONTROL MODULATORS, AND LASERS (U.S. CLS. 21, 23, 26, 36 AND 38).

CLASS 9—(Continued).

SN 76-409,244. MIXONIC, SAN FRANCISCO, CA. FILED 5-17-2002.

MIXONIC

FOR COMPUTER SOFTWARE USED TO UPLOAD, CREATE AND EDIT LABEL ARTWORK AND PRINTED PACKING ARTWORK FOR CDS, DVDS, OR OTHER MEDIA; COMPUTER SOFTWARE USED TO UPLOAD, STORE, AND MANAGE DATA, DIGITAL CONTENT, SOFTWARE, AUDIO BOOKS, MOVIES, PHOTOS, SOUND, IMAGES, GRAPHICS, AND OTHER MULTIMEDIA CONTENT THAT CAN BE CONVERTED INTO DIGITAL FORM; COMPUTER SOFTWARE USED TO PREVIEW, MANIPULATE, ADD, DELETE, AND EDIT DATA, DIGITAL CONTENT, AUDIO BOOKS, MOVIES, PHOTOS, SOUND, IMAGES, GRAPHICS, AND OTHER MULTIMEDIA CONTENT THAT CAN BE CONVERTED INTO DIGITAL FORM; COMPUTER SOFTWARE USED TO DUPLICATE AND REPRODUCE DATA, DIGITAL CONTENT, SOFTWARE, AUDIO BOOKS, MOVIES, PHOTOS, SOUND, IMAGES, GRAPHICS, AND OTHER MULTIMEDIA CONTENT THAT CAN BE CONVERTED INTO DIGITAL FORM; COMPUTER SOFTWARE TOOLS USED FOR DESIGNING AND PERSONALIZING WEB SITES; COMPUTER E-COMMERCE SOFTWARE TO ALLOW USERS TO PERFORM ELECTRONIC BUSINESS TRANSACTIONS VIA A GLOBAL COMPUTER NETWORK (U.S. CLS. 21, 23, 26, 36 AND 38).

SN 76-409,263. I-SPRINT INNOVATIONS PTE LTD, CHAI CHEE ROAD, SINGAPORE, FILED 5-16-2002.



NO CLAIM IS MADE TO THE EXCLUSIVE RIGHT TO USE "UNIVERSAL", APART FROM THE MARK AS SHOWN.

FOR COMPUTER APPLICATION SOFTWARE TO ALLOW USERS MULTIPLE ACCESS TO COMPUTER PROGRAMS, APPLICATIONS, OPERATIONS AND DATABASES, AND TO AUTHENTICATE ACCESS THERETO (U.S. CLS. 21, 23, 26, 36 AND 38).

SN 76-412,199. GEMSTONE SYSTEMS, INC., BEAVERTON, OR. FILED 5-22-2002.

GEMFIRE

FOR COMPUTER SOFTWARE, NAMELY, SOFTWARE TO ENABLE DATA SHARING ACROSS COMPUTER APPLICATIONS (U.S. CLS. 21, 23, 26, 36 AND 38).

CLASS 9—(Continued).

SN 76-412,521. NOLOGY ENGINEERING, INC., SAN MARCOS, CA. FILED 5-20-2002.

PDA DYNO

NO CLAIM IS MADE TO THE EXCLUSIVE RIGHT TO USE "PDA", APART FROM THE MARK AS SHOWN.

FOR COMPUTER SOFTWARE FOR USE IN TESTING, DISPLAYING, ANALYZING AND RECORDING AUTOMOTIVE ENGINE PERFORMANCE AND WIRE AND CABLE CONNECTORS AND ADAPTERS BETWEEN COMPUTERS AND TEST VEHICLES (U.S. CLS. 21, 23, 26, 36 AND 38).

SN 76-413,479. DRESSLER USA, INC., CAMPBELL, CA. FILED 5-22-2002.

SHOEBOX POWER SUPPLY

NO CLAIM IS MADE TO THE EXCLUSIVE RIGHT TO USE "POWER SUPPLY", APART FROM THE MARK AS SHOWN.

FOR SHOWBOX POWER SUPPLIES, NAMELY HIGHLIGHT RF POWER GENERATORS (U.S. CLS. 21, 23, 26, 36 AND 38).

SN 76-414,362. JOHNSON & JOHNSON, NEW BRUNSWICK, NJ. FILED 6-3-2002.

ENGEN

FOR CLINICAL LABORATORY APPARATUS, INSTRUMENTS AND CONVEYORS USED IN ASSOCIATION WITH BLOOD DIAGNOSTIC ANALYZERS, NAMELY, CENTRIFUGE, SORTER, DECAPPER, ALIQUOTTER, STORAGE AND RETRIEVAL MODULE, TRACK, MONITOR, PRINTER, RACKS AND COVERS, TRAYS, CARRIERS AND ROBOTIC ARM (U.S. CLS. 21, 23, 26, 36 AND 38).

SN 76-414,591. DAVID EDEN SHOE CORPORATION, WESTON, FL. FILED 5-31-2002.

DAVID EDEN

THE NAME IN THE MARK "DAVID EDEN" IDENTIFIES A LIVING INDIVIDUAL WHOSE CONSENT IS OF RECORD.

FOR SUN GLASSES (U.S. CLS. 21, 23, 26, 36 AND 38).

CLASS 9—(Continued).

SN 76-415,011. MOLEX INCORPORATED, LISLE, IL. FILED 5-30-2002.

TDP

FOR ELECTRICAL INTERCONNECTION COMPONENTS, NAMELY, ELECTRICAL CONNECTORS AND TRANSCEIVERS HAVING CONDUCTIVE TERMINALS THAT CARRY DIFFERENTIAL SIGNALS (U.S. CLS. 21, 23, 26, 36 AND 38).

SN 76-416,462. HALVORSON, GREGORY LYNN, MOUNT VERNON, WA. AND HALVORSON, MARLYS ELAINE, MOUNT VERNON, WA. FILED 5-31-2002.

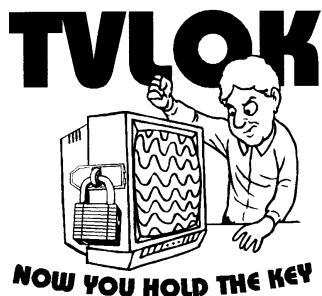

NO CLAIM IS MADE TO THE EXCLUSIVE RIGHT TO USE "TVLOK", APART FROM THE MARK AS SHOWN.

THE MARK IS DARK AND LIGHT BLUE.

THE MARK CONSISTS OF A KID POUNDING ON A TV, FOR ELECTRONIC DEVICE USED FOR DISABLING THE POWER ON TELEVISIONS (U.S. CLS. 21, 23, 26, 36 AND 38).

FIRST USE 4-15-2001; IN COMMERCE 4-15-2001.

SN 76-416,579. AIT INTERNATIONAL, INC., BROOKLYN, NY. FILED 5-23-2002.

PHONE STUFF

NO CLAIM IS MADE TO THE EXCLUSIVE RIGHT TO USE "PHONE", APART FROM THE MARK AS SHOWN.

FOR TELEPHONES, TELEPHONE EQUIPMENT, NAMELY, CALLER IDENTIFICATION BOXES, CORDLESS TELEPHONES, TELEPHONE HEADSETS, TELEPHONE AC-DC ADAPTERS, TELEPHONE BATTERIES, TELEPHONE COIL CORDS, TELEPHONE LINE CORDS, CORDLESS TELEPHONE BELT CLIPS, TELEPHONE HANDS-FREE KITS CONSISTING OF MICROPHONES, SPEAKERS AND CRADLES, SPEAKER TELEPHONES, AND ANTENNAS FOR CORDLESS TELEPHONES; CELLULAR TELEPHONE ACCESSORIES, NAMELY, CELLULAR TELEPHONE HEADSETS, CELLULAR TELEPHONE AC-DC ADAPTERS FOR CHARGING CELLULAR TELEPHONES, CELLULAR TELEPHONE BATTERIES, CELLULAR TELEPHONE CASES, CELLULAR TELEPHONE BELT CLIPS, CELLULAR TELEPHONE DESKTOP BATTERY CHARGERS, CELLULAR TELEPHONE TRAVEL BATTERY CHARGERS, CELLULAR TELEPHONE PLUG-IN CAR CHARGERS, AND CELLULAR TELEPHONE ANTENNAS (U.S. CLS. 21, 23, 26, 36 AND 38).

CLASS 9—(Continued).

SN 76-419,556. KATANAME, INC., SAN CARLOS, CA. FILED 6-11-2002.

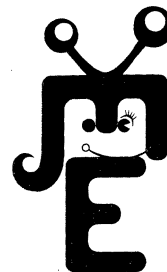

KATANAME

FOR COMPUTER GAME SOFTWARE; COMPUTER HARDWARE, NAMELY COMPUTER DEVICES CONNECTING TO A WIRELESS NETWORK; COMMUNICATIONS SOFTWARE FOR WIRELESS CONNECTING TO COMPUTER NETWORK USERS AND GLOBAL COMPUTER NETWORKS; COMPUTER SOFTWARE FOR WIRELESS ACCESS TO INFORMATION FROM THE INTERNET (U.S. CLS. 21, 23, 26, 36 AND 38).

SN 76-420,478. CEREBIS, L.P., DALLAS, TX. FILED 5-14-2002.



FOR COMPUTER SOFTWARE FOR COMMERCIAL REAL ESTATE PROPERTY MANAGEMENT FEATURING PORTFOLIO, ASSET AND TRANSACTION MANAGEMENT (U.S. CLS. 21, 23, 26, 36 AND 38).

FIRST USE 3-0-2001; IN COMMERCE 3-0-2001.

CLASS 9—(Continued).

SN 76-421,535. NIELSEN-KELLERMAN CO., INC., CHESTER, PA. FILED 6-14-2002.

KESTREL TRACKER

OWNER OF U.S. REG. NO. 2,116,023.
NO CLAIM IS MADE TO THE EXCLUSIVE RIGHT TO USE "TRACKER", APART FROM THE MARK AS SHOWN.
FOR PORTABLE WATERPROOF ELECTRONIC MEASURING AND TIMING INSTRUMENTS USED TO MONITOR ENVIRONMENTAL CONDITIONS NAMELY, WIND SPEED, TEMPERATURE, RELATIVE HUMIDITY, HEAT STRESS INDEX, DEW POINT AND ALTITUDE (U.S. CLS. 21, 23, 26, 36 AND 38).
FIRST USE 1-0-2001; IN COMMERCE 1-0-2001.

SN 76-421,659. KWITEK, BENJAMIN J., CANON CITY, CO. FILED 6-11-2002.

GELLYFISH

FOR ACCESSORIES FOR LAPTOPS, PERSONAL DIGITAL ASSISTANTS AND OTHER PORTABLE ELECTRONIC DEVICES, NAMELY, PADS FOR SUPPORTING A USER'S HAND WHILE OPERATING THE DEVICE (U.S. CLS. 21, 23, 26, 36 AND 38).

SN 76-424,949. SIEMENS AKTIENGESELLSCHAFT, MUNCHEN, FED REP GERMANY, FILED 6-18-2002.

CP 1512

PRIORITY CLAIMED UNDER SEC. 44(D) ON FED REP GERMANY APPLICATION NO. 30202938.9/0, FILED 1-22-2002, REG. NO. 30202938, DATED 2-18-2002, EXPIRES 1-31-2012.

FOR COMMUNICATION DEVICES FOR TRANSMISSION OF DATA IN INDUSTRIAL NETWORKS, NAMELY, COMPUTER INTERFACE CARDS, MICROPROCESSORS AND COMPUTER HARDWARE; COMMUNICATION DEVICES FOR USE IN INDUSTRIAL OPERATIONS FOR COMMUNICATION IN AND BETWEEN PROGRAMMABLE CONTROLLERS, PROGRAMMING DEVICES AND COMPUTERS; NAMELY, COMPUTER INTERFACE CARDS, MICROPROCESSORS AND COMPUTER HARDWARE (U.S. CLS. 21, 23, 26, 36 AND 38).

SN 76-425,767. FALCONSTOR SOFTWARE, INC., MELVILLE, NY. FILED 6-21-2002.

HOTZONE

FOR COMPUTER SOFTWARE FOR USE IN DATA STORAGE AND DATA MANAGEMENT (U.S. CLS. 21, 23, 26, 36 AND 38).

CLASS 9—(Continued).

SN 76-426,075. PAN COMMUNICATIONS, INC., MINATOKU, TOKYO 107, JAPAN, FILED 6-28-2002.

CELLCHATUBIQ

FOR CELLULAR TELEPHONE ACCESSORIES, NAMELY SPEAKER PHONE ADAPTERS (U.S. CLS. 21, 23, 26, 36 AND 38).

SN 76-426,076. PAN COMMUNICATIONS, INC., MINATOKU, TOKYO 107, JAPAN, FILED 6-28-2002.

CHATUBIQ

FOR CELLULAR TELEPHONE ACCESSORIES, NAMELY SPEAKER PHONE ADAPTERS (U.S. CLS. 21, 23, 26, 36 AND 38).

SN 76-426,119. HORNBY HOBBIES LIMITED, KENT CT9 4JX, UNITED KINGDOM, FILED 6-28-2002.

SCALEXTRIC

OWNER OF U.S. REG. NO. 727,200.
FOR ELECTRICAL CONTROLLERS WHICH DETERMINE THE SPEED OF TOY AUTOMOBILES (U.S. CLS. 21, 23, 26, 36 AND 38).
FIRST USE 1-0-1957; IN COMMERCE 9-4-1957.

SN 76-427,280. TREADWAYS CORPORATION, NORTH WALES, PA. FILED 7-3-2002.

TREADTECTOR

FOR ELECTRONIC DEVICE FOR CONTINUOUSLY MONITORING TIRE PRESSURE AND DISPLAYING A SIGNAL WHEN THE TIRE PRESSURE FALLS BELOW A PREDETERMINED LEVEL (U.S. CLS. 21, 23, 26, 36 AND 38).

SN 76-428,961. CORAL RIDGE MINISTRIES MEDIA, INC., FORT LAUDERDALE, FL. FILED 7-9-2002.

CORAL RIDGE MINISTRIES

SEC. 2(F).
FOR PRE-RECORDED AUDIO CASSETTES, PRE-RECORDED VIDEO CASSETTES, AND CD-ROMS, ALL FEATURING SERMONS, WORSHIP SERVICES, MUSIC, LECTURES, DOCUMENTARIES, AND SPOKEN WORDS IN THE FIELDS OF RELIGION, SPIRITUALITY, ETHICS, CULTURAL ISSUES, AND SOCIAL ISSUES; MOUSEPADS (U.S. CLS. 21, 23, 26, 36 AND 38).
FIRST USE 0-0-1978; IN COMMERCE 0-0-1978.

CLASS 9—(Continued).

SN 76-428,965. CORAL RIDGE MINISTRIES MEDIA, INC., FORT LAUDERDALE, FL. FILED 7-9-2002.



SEC. 2(F) AS TO "CORAL RIDGE MINISTRIES".
FOR PRE-RECORDED AUDIO CASSETTES, PRE-RECORDED VIDEO CASSETTES, AND CD-ROMS, ALL FEATURING SERMONS, WORSHIP SERVICES, MUSIC, LECTURES, DOCUMENTARIES, AND SPOKEN WORDS IN THE FIELDS OF RELIGION, SPIRITUALITY, ETHICS, CULTURAL ISSUES, AND SOCIAL ISSUES; MOUSEPADS (U.S. CLS. 21, 23, 26, 36 AND 38).
FIRST USE 0-0-1996; IN COMMERCE 0-0-1996.

SN 76-430,788. DOBBS STANFORD CORPORATION, DALLAS, TX. FILED 7-15-2002.

GRANDTEC USA

NO CLAIM IS MADE TO THE EXCLUSIVE RIGHT TO USE "USA", APART FROM THE MARK AS SHOWN.
FOR COMPUTER HARDWARE, NAMELY, PERIPHERALS; AND COMPUTER INTERFACING HARDWARE AND SOFTWARE FOR INTERFACING COMPUTERS TO PERIPHERAL DEVICES, AND FOR INTERFACING MULTIPLE PERIPHERAL DEVICES (U.S. CLS. 21, 23, 26, 36 AND 38).
FIRST USE 12-20-1999; IN COMMERCE 12-20-1999.

SN 76-433,118. ENECON CORPORATION, BETHPAGE, NY. FILED 7-19-2002.

FUEL BUDDY

NO CLAIM IS MADE TO THE EXCLUSIVE RIGHT TO USE "FUEL", APART FROM THE MARK AS SHOWN.
FOR MAGNETIC UNITS FOR ATTACHMENT TO FUEL LINES USED TO INCREASE FUEL ECONOMY AND REDUCE HARMFUL EMISSIONS IN COMBUSTION ENGINES (U.S. CLS. 21, 23, 26, 36 AND 38).

SN 76-433,998. SONY KABUSHIKI KAISHA, AKA SONY CORPORATION, TOKYO, JAPAN, FILED 7-23-2002.

COCOON

FOR TELEVISION RECEIVERS; LIQUID CRYSTAL DISPLAYS; PLASMA DISPLAY PANELS; VIDEO PROJECTORS; HARD DISC VIDEO RECORDERS; AUDIO TAPE PLAYERS AND RECORDERS; AUDIO DISC PLAYERS AND RECORDERS; VIDEO TAPE PLAYERS AND RECORDERS; VIDEO DISC PLAYERS AND RECORDERS; AUDIO RECEIVERS; AUDIO AMPLIFIERS; LOUSPEAKERS; TELEVISION TUNERS; RADIO TUNERS (U.S. CLS. 21, 23, 26, 36 AND 38).

CLASS 9—(Continued).

SN 76-434,067. SCIENTIFIC INSTRUMENT SERVICES, INC., RINGOES, NJ. FILED 7-25-2002.

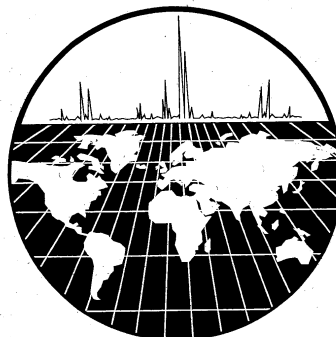

FOR SCIENTIFIC LABORATORY EQUIPMENT, NAMELY, SHORT PATH THERMAL DESORBER WITH ACCESSORIES; NAMELY, CONDITIONING OVEN, SAMPLING OVEN AND LIQUID SAMPLING APPARATUS, AND PARTS FOR MASS SPECTROMETERS; NAMELY, FILAMENTS, CONTINUOUS FLOW PROBES, FLANGES, THERMOCOUPLES AND HEATERS (U.S. CLS. 21, 23, 26, 36 AND 38).
FIRST USE 9-17-1990; IN COMMERCE 11-1-1990.

SN 76-441,573. ROSHAL, EUGENE, CHELYABINSK, RUSSIAN FEDERATIO, FILED 8-14-2002.

RAR

FOR COMPUTER SOFTWARE FOR DATA COMPRESSION, COMPUTER PROGRAMS FOR DATA COMPRESSION (U.S. CLS. 21, 23, 26, 36 AND 38).

SN 76-442,617. MIDWEST COMPUTER, INC., LOMBARD, IL. FILED 8-19-2002.

MEMORY BUG

NO CLAIM IS MADE TO THE EXCLUSIVE RIGHT TO USE "MEMORY", APART FROM THE MARK AS SHOWN.
FOR COMPUTER MEMORY AND DATA STORAGE DEVICES, NAMELY, SOLID STATE MEMORY AND HARD DISKS (U.S. CLS. 21, 23, 26, 36 AND 38).

CLASS 9—(Continued).

SN 76-443,027. INFORMAX, INC., BETHESDA, MD. FILED 8-22-2002.

LABSHARE

FOR COMPUTER SOFTWARE USED IN LIFE SCIENCE RESEARCH THAT PROVIDES A SECURE, SHARED ENVIRONMENT IN WHICH MULTIPLE SIMULTANEOUS USERS FROM ACROSS A SCIENTIFIC ORGANIZATION CAN STORE, ACCESS, MANAGE, SHARE, AND SEARCH DATA IN DATABASES, AND THAT PROVIDES SEARCH RESULTS THAT ARE GRAPHICALLY DISPLAYED AND CUSTOMIZABLE (U.S. CLS. 21, 23, 26, 36 AND 38).

CLASS 9—(Continued).

SN 76-446,958. SAMSUNG ELECTRONICS CO., LTD., KYUNGKI-DO, REPUBLIC OF KOREA, FILED 9-5-2002.

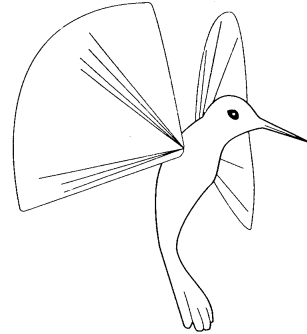

SN 76-443,245. MOLES, RON, DBA SHORTY ANTENNAS, FRESNO, CA. FILED 8-19-2002.



THE DESIGN CONSISTS OF A HUMMINGBIRD IN FLIGHT, WHEREIN THE BODY OF THE HUMMINGBIRD IS SUBSTANTIALLY YELLOW; THE HEAD, BEAK, BACK AND TAIL OF THE HUMMINGBIRD ARE ORANGE-RED; AND THE WINGS OF THE HUMMINGBIRD CONSIST OF A GRADATION OF COLORS, NAMELY YELLOW, ORANGE, RED, VIOLET, INDIGO, BLUE, GREEN, YELLOW AND ORANGE.

FOR MOBILE PHONES AND ACCESSORIES, NAMELY, BATTERIES; BATTERY CHARGERS; HEADPHONES, AND MOBILE PHONE CARRYING CASES FOR CONSUMERS (U.S. CLS. 21, 23, 26, 36 AND 38).

FOR AM/FM ANTENNAS FOR VEHICLES, INCLUDING CARS, TRUCKS, MOTORCYCLES AND WATERCRAFT (U.S. CLS. 21, 23, 26, 36 AND 38).

SN 76-447,635. PRIME COMMUNITY PUBLICATIONS, INC., MAPLE GROVE, MN. FILED 9-6-2002.

SN 76-445,988. ULTRATERA CORPORATION, HSIN CHU, TAIWAN, FILED 8-29-2002.

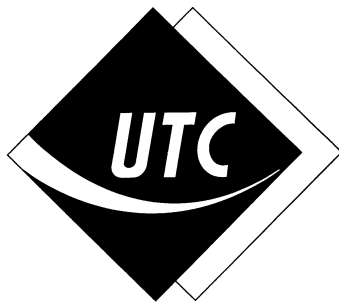

FOR WAFER; SEMICONDUCTOR MASK; SEMICONDUCTOR; INTEGRATED CIRCUITS; THE SOCKET FOR INTEGRATED CIRCUITS; LEAD FRAME FOR INTEGRATED CIRCUITS; AND VLSI AUTOMATIC TESTING UNIT (U.S. CLS. 21, 23, 26, 36 AND 38).

NO CLAIM IS MADE TO THE EXCLUSIVE RIGHT TO USE "GUIDE.COM", APART FROM THE MARK AS SHOWN.

FOR COMPUTER SOFTWARE FOR ADVERTISING AND MARKETING PURPOSES, NAMELY, PRERECORDED COMPUTER COMPACT DISCS FEATURING COMMUNITY RESOURCE GUIDES WHICH PROVIDE LISTINGS AND DESCRIPTIONS OF BUSINESSES AND THEIR PRODUCTS AND SERVICES AND COMMUNITY INFORMATION (U.S. CLS. 21, 23, 26, 36 AND 38).

FIRST USE 9-0-2001; IN COMMERCE 3-1-2002.

CLASS 9—(Continued).

SN 76-448,165. KING CYCLE HOLDING LTD., ROAD TOWN, TORTOLA, BR.VIRGIN ISLANDS, FILED 9-4-2002.

DIGIMASTER

OWNER OF U.S. REG. NO. 2,675,520.
FOR DIGITAL CAMERAS; CD BURNERS; BATTERIES; CAMERAS, TELEVISIONS; MOBILE PHONES; LIQUID CRYSTAL DISPLAY MONITORS; VIDEO GAME MACHINES FOR USE WITH TELEVISIONS; VIDEO GAME PLAYERS; AND ELECTRONIC MEMORY CARDS (U.S. CLS. 21, 23, 26, 36 AND 38).
FIRST USE 3-1-2002; IN COMMERCE 7-1-2002.

SN 76-451,822. ICSERV, INC., REXBURG, ID. FILED 9-23-2002.

EZ-NETTOOLS

FOR COMPUTER SOFTWARE FOR CREATING WEB PAGES, HOSTING WEB SITES AND WEB SITE PROMOTION; COMPUTER SOFTWARE FOR E-COMMERCE APPLICATIONS TO ALLOW USERS TO PERFORM ELECTRONIC BUSINESS TRANSACTIONS VIA A GLOBAL COMPUTER NETWORK (U.S. CLS. 21, 23, 26, 36 AND 38).

SN 76-451,834. QUANTUM TECHNOLOGIES, INC., HUNTSVILLE, AL. FILED 9-23-2002.

HEAR TECHNOLOGIES

NO CLAIM IS MADE TO THE EXCLUSIVE RIGHT TO USE "TECHNOLOGIES", APART FROM THE MARK AS SHOWN.

FOR PROFESSIONAL, HOME, AND MOBILE AUDIO, AND ELECTRONIC EQUIPMENT AND ACCESSORIES, NAMELY, ADAPTERS, AMBIENCE AND SURROUND SOUND PROCESSORS, AMPLIFIERS, ANTENNAS, BAND SEPARATORS, BRIDGEABLE AMPLIFIERS, ELECTRICAL AND OPTICAL CABLES, CARRYING CASES AND CARRYING BAGS, ELECTRICAL CONNECTORS, RADIOS INCORPORATING CLOCKS, COAXIAL AUDIO SPEAKERS, COMPUTERS, AUDIO SPEAKER CROSSOVERS, ELECTRIC POWER SUPPLY UNITS, FM UNIVERSAL MODULATORS, GRAPHIC EQUALIZERS, HEADPHONES, LOUDSPEAKERS, RACKS AND STANDS SPECIFICALLY DESIGNED TO SUPPORT OR TILT LOUDSPEAKERS AND PARTS THEREFORE, MICROPHONES, POWER INVERTERS, POWERED SUBWOOFERS, PRE-AMPLIFIERS, RADIO RECEIVERS, RADIO TRANSMITTERS, AUDIO AND VIDEO RECEIVERS, REMOTE CONTROLS, SIGNAL

CLASS 9—(Continued).

PROCESSORS, SPEAKER CABINETS, SPEAKER SELECTORS, ELECTRIC POWER STRIPS, SUBWOOFERS, VOLTAGE SURGE PROTECTORS, ELECTRICAL TRANSFORMERS, TRIAXIAL AUDIO SPEAKERS, TUNERS, GAME SWITCHES, TWEETERS, TERMINATORS AND SIGNAL REDUCERS, DUBBING APPARATUS, SIGNAL AMPLIFIERS, SIGNAL SPLITTERS, STEREO SOUND SIMULATORS, ELECTRICAL TRANSFORMERS AND NOISE FILTERS, ELECTRICAL AND OPTICAL SWITCHING UNITS, AND JUNCTION BOXES, VOLUME AND LEVEL CONTROLS, WIRELESS HEADPHONES, LOUDSPEAKERS, RECEIVERS, REMOTE CONTROLS AND TRANSMITTERS, ELECTRICAL AND OPTICAL WIRES, DYNAMIC SIGNAL PROCESSORS, DIGITAL SIGNAL PROCESSORS, ENCODING AND DECODING PROCESSORS, AUDIO MIXERS, ELECTRONIC CROSSOVERS, AUDIO DISTRIBUTION AMPLIFIERS, AUDIO SUMMING AMPLIFIERS, SIGNAL AND LEVEL TRANSFORMERS, ELECTRONIC PATCH BAYS AND ROUTERS, IN-EAR AUDIO HEAD SETS AND MOLDED ADAPTERS (U.S. CLS. 21, 23, 26, 36 AND 38).

SN 76-451,971. LINPO PRECISION LTD., TAIPEI, TAIWAN, FILED 9-23-2002.

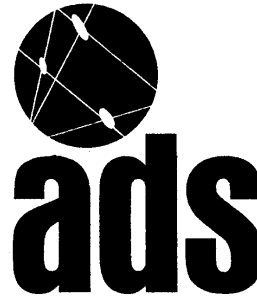

FOR INTEGRATED CIRCUIT CHIPS FOR USE IN MIXED SIGNAL IC, DIGITAL IC, SWITCHING CONTROLLER AND STEP DOWN SWITCHING REGULATOR FOR DC/AC CONVERTER APPLICATIONS (U.S. CLS. 21, 23, 26, 36 AND 38).

FIRST USE 9-1-2002; IN COMMERCE 9-1-2002.

SN 76-452,866. SERVICIOS CONDUMEX S.A. DE C.V., QUERETARO, QRO., MEXICO, FILED 9-20-2002.

TERMALITZAKON

FOR MAGNET WIRE FOR ELECTRONIC EQUIPMENT OF HIGH FREQUENCY, NAMELY, RADIOS, TELEVISIONS, SOUND AND COMMUNICATION EQUIPMENT (U.S. CLS. 21, 23, 26, 36 AND 38).

CLASS 9—(Continued).

SN 76-452,869. SERVICIOS CONDUMEX S.A. DE C.V., QUERETARO, QRO., MEXICO, FILED 9-20-2002.

SOLDALITZANEL

FOR MAGNET WIRE FOR ELECTRONIC EQUIPMENT OF HIGH FREQUENCY, NAMELY, RADIOS, TELEVISIONS, SOUND AND COMMUNICATION EQUIPMENT (U.S. CLS. 21, 23, 26, 36 AND 38).

SN 76-452,870. SERVICIOS CONDUMEX S.A. DE C.V., QUERETARO, QRO., MEXICO, FILED 9-20-2002.

SOLDALITZAKON

FOR MAGNET WIRE FOR ELECTRONIC EQUIPMENT OF HIGH FREQUENCY, NAMELY, RADIOS, TELEVISIONS, SOUND AND COMMUNICATION EQUIPMENT (U.S. CLS. 21, 23, 26, 36 AND 38).

SN 76-452,871. SERVICIOS CONDUMEX S.A. DE C.V., QUERETARO, QRO., MEXICO, FILED 9-20-2002.

SOLDALITZACON

FOR MAGNET WIRE FOR ELECTRONIC EQUIPMENT OF HIGH FREQUENCY, NAMELY, RADIOS, TELEVISIONS, SOUND AND COMMUNICATION EQUIPMENT (U.S. CLS. 21, 23, 26, 36 AND 38).

SN 76-452,963. SERVICIOS CONDUMEX S.A. DE C.V., QUERETARO, QRO, MEXICO, FILED 9-20-2002.

TERMALITZACON

FOR MAGNET WIRE FOR ELECTRONIC EQUIPMENT OF HIGH FREQUENCY, NAMELY, RADIOS, TELEVISIONS, SOUND AND COMMUNICATION EQUIPMENT (U.S. CLS. 21, 23, 26, 36 AND 38).

SN 76-452,964. SERVICIOS CONDUMEX S.A. DE C.V., QUERETARO, QRO, MEXICO, FILED 9-20-2002.

TERMALITZANEL

FOR MAGNET WIRE FOR ELECTRONIC EQUIPMENT OF HIGH FREQUENCY, NAMELY, RADIOS, TELEVISIONS, SOUND AND COMMUNICATION EQUIPMENT (U.S. CLS. 21, 23, 26, 36 AND 38).

CLASS 9—(Continued).

SN 76-453,532. COMMODITY GLOVE COMPANY, INC., WAYNE, PA. FILED 9-27-2002.

STEELGARD

FOR CUT-RESISTANT GLOVES FOR INDUSTRIAL USE (U.S. CLS. 21, 23, 26, 36 AND 38).

SN 76-455,807. SUSSMAN AUTOMATIC CORPORATION, LONG ISLAND CITY, NY. FILED 9-30-2002.

TEMPO/REMOTE

FOR ELECTRONIC TEMPERATURE AND TIME CONTROLS FOR STEAM BATH GENERATORS THAT MANUALLY OR AUTOMATICALLY SETS A DESIRED ELEVATED TEMPERATURE FOR STEAM GENERATION (U.S. CLS. 21, 23, 26, 36 AND 38).

SN 76-455,808. SUSSMAN AUTOMATIC CORPORATION, LONG ISLAND CITY, NY. FILED 9-30-2002.

TEMPO/PLUS

FOR ELECTRONIC TEMPERATURE AND TIME CONTROLS FOR STEAM BATH GENERATORS THAT MANUALLY OR AUTOMATICALLY SETS A DESIRED ELEVATED TEMPERATURE FOR STEAM GENERATION (U.S. CLS. 21, 23, 26, 36 AND 38).

SN 76-456,346. BNL EUROLENS, 01200 BELLEGARDE SUR VALSERINE, FRANCE, FILED 9-30-2002.

POLYGRADIENT

PRIORITY CLAIMED UNDER SEC. 44(D) ON FRANCE APPLICATION NO. 023158569, FILED 4-10-2002, REG. NO. 023158569, DATED 4-10-2002, EXPIRES 4-10-2012.

FOR OPTICAL GLASSES, SUNGLASSES (U.S. CLS. 21, 23, 26, 36 AND 38).

CLASS 9—(Continued).

SN 76-456,718. BFG TECHNOLOGIES, INC., LAKE BLUFF, IL. FILED 10-3-2002.

BFG TECHNOLOGIES

NO CLAIM IS MADE TO THE EXCLUSIVE RIGHT TO USE "TECHNOLOGIES", APART FROM THE MARK AS SHOWN.

FOR COMPUTER HARDWARE AND PERIPHERALS, NAMELY, VIDEO CIRCUIT BOARD CARDS, PRINTER CIRCUIT BOARD CARDS, CIRCUIT CARDS, INTEGRATED CIRCUIT CARDS AND SMART CARDS CONTAINING PROGRAMMING USED WITH TEXT, AUDIO, VIDEO, VOICE AND IMAGE DATA, GRAPHICS CARDS, ELECTRONIC CHIP CARDS, SOUND CARDS, VIDEO CARDS, PRINTED CIRCUIT BOARDS, ADD-IN CARDS FOR SOUND OR INTERFACE FUNCTIONS ON PRINTED CIRCUIT BOARDS, GRAPHIC CIRCUIT BOARDS, OPTICAL DRIVES, GAME PADS AND CARDS, VIDEO CIRCUIT BOARDS, MEMORY BOARDS AND INTERFACE BOARDS FOR MASS STORAGE (U.S. CLS. 21, 23, 26, 36 AND 38).

SN 76-457,060. U-WATCH RECORD, LLC, WHITE PLAINS, NY. BY ASSIGNMENT WHOLE OATS ENTERPRISES, WHITE PLAINS, NY. FILED 10-7-2002.

U-WATCH RECORDS

NO CLAIM IS MADE TO THE EXCLUSIVE RIGHT TO USE "RECORDS", APART FROM THE MARK AS SHOWN. FOR MUSICAL, AUDIO AND VIDEO RECORDINGS (U.S. CLS. 21, 23, 26, 36 AND 38).

FIRST USE 10-18-2002; IN COMMERCE 10-18-2002.

SN 76-458,556. LABSPHERE, INC., NORTH SUTTON, NH. FILED 10-16-2002.

OMNICALC

FOR COMPUTER SOFTWARE IN THE FIELD OF MEASURING AND ANALYZING THE OUTPUT OF LIGHT SOURCES, INCLUDING INCANDESCENT SOURCES, FLUORESCENT SOURCES, LASER SOURCES, AND LIGHT-EMITTING DIODES (LEDS) (U.S. CLS. 21, 23, 26, 36 AND 38).

SN 76-459,520. EBIT SANITA S.P.A., I-16153 GENOVA, ITALY, FILED 10-21-2002.

VISUSLAB

FOR IMAGE VISUALIZATION APPARATA FOR ULTRASOUND EXAMINATION MANAGEMENT (U.S. CLS. 21, 23, 26, 36 AND 38).

CLASS 9—(Continued).

SN 76-460,108. MARSALIS MUSIC LLC, CAMBRIDGE, MA. FILED 10-17-2002.

MARSALIS MUSIC

NO CLAIM IS MADE TO THE EXCLUSIVE RIGHT TO USE "MUSIC", APART FROM THE MARK AS SHOWN.

"MARSALIS" IDENTIFIES LIVING INDIVIDUALS WHOSE CONSENT IS OF RECORD.

FOR AUDIO AND/OR VIDEO RECORDINGS ON COMPACT DISCS, DVDS, CASSETTE TAPES, DIGITAL TAPES, VIDEOTAPES AND PHONOGRAPH RECORDS FEATURING MUSIC AND/OR SPOKEN WORD; DOWN-LOADABLE AUDIO AND VIDEO RECORDINGS FEATURING MUSIC AND/OR SPOKEN WORD (U.S. CLS. 21, 23, 26, 36 AND 38).

FIRST USE 8-13-2002; IN COMMERCE 8-13-2002.

SN 76-460,419. ARISTOCRAT TECHNOLOGIES AUSTRALIA PTY LIMITED, LANE COVE, NEW SOUTH WALES 2066, AUSTRALIA, FILED 10-22-2002.

ARISHINKO

FOR GAMING DEVICES, NAMELY, GAMING MACHINES AND ASSOCIATED SOFTWARE FOR USE THEREWITH (U.S. CLS. 21, 23, 26, 36 AND 38).

SN 76-460,558. ALPHA SYSTEMS LAB, INC., COSTA MESA, CA. FILED 10-18-2002.

**REMOTEWATCH
XPERIENCE**

OWNER OF U.S. REG. NO. 1,975,415.

FOR SECURITY AND SURVEILLANCE EQUIPMENT, NAMELY VIDEO CAMERAS, TRANSMITTERS, SENSORS, ELECTRIC SWITCHES AND COMPUTER HARDWARE (U.S. CLS. 21, 23, 26, 36 AND 38).

FIRST USE 12-0-2001; IN COMMERCE 12-0-2001.

SN 76-460,711. BARMAZEL, MARC, SANTA MONICA, CA. FILED 10-23-2002.

PROPERTY KEEPER

NO CLAIM IS MADE TO THE EXCLUSIVE RIGHT TO USE "PROPERTY", APART FROM THE MARK AS SHOWN.

FOR COMPUTER SOFTWARE FOR EVALUATING AND MANAGING REAL PROPERTY (U.S. CLS. 21, 23, 26, 36 AND 38).

CLASS 9—(Continued).

SN 76-460,912. ALLIED INNOVATIONS LLC, LAS VEGAS, NV. FILED 10-22-2002.

LENNOVATOR

FOR ELECTRIC POOL AND SPA CONTROLLERS (U.S. CLS. 21, 23, 26, 36 AND 38).

SN 76-465,188. TEXACO OVONIC BATTERY SYSTEMS LLC, TROY, MI. FILED 11-7-2002.

NIGUARD

FOR BATTERIES (U.S. CLS. 21, 23, 26, 36 AND 38).

SN 76-465,519. VISUAL ANALYTICS, INCORPORATED, POOLESVILLE, MD. FILED 10-30-2002.

DISAMBIGUATOR

FOR COMPUTER SOFTWARE FOR USE IN FINDING, ANALYZING AND REPORTING ON PATTERNS, TRENDS AND RELATIONSHIPS AMONG DATA; COMPUTER SOFTWARE THAT CORRECTS INCONSISTENCIES AND PROBLEMS WITH DATA, RETRIEVES DATA IN A DESIRED FORMAT AND SYNTAX, AND GENERATES REPORTS IN THE DESIRED FORMAT AND SYNTAX (U.S. CLS. 21, 23, 26, 36 AND 38).
FIRST USE 4-0-2001; IN COMMERCE 4-0-2001.

SN 76-466,315. PLAID BROTHERS SOFTWARE, INC., IRVINE, CA. FILED 11-13-2002.

WEBPLAID

FOR COMPUTER SOFTWARE USED FOR INVESTMENT PORTFOLIO MANAGEMENT (U.S. CLS. 21, 23, 26, 36 AND 38).

CLASS 9—(Continued).

SN 76-466,449. HASBRO, INC., PAWTUCKET, RI. FILED 11-13-2002.

RAZZAROO

FOR INTERACTIVE ENTERTAINMENT SOFTWARE, NAMELY, INTERACTIVE VIDEO GAME PROGRAMS, INTERACTIVE MULTIMEDIA COMPUTER GAME PROGRAMS, INTERACTIVE VIDEO GAMES OF VIRTUAL REALITY COMPRISED OF COMPUTER HARDWARE AND SOFTWARE; COMPUTER GAME SOFTWARE; COMPUTER AND VIDEO GAME APPARATUS, NAMELY, VIDEO GAME MACHINES FOR USE WITH TELEVISIONS; TELEPHONES; RADIO TELEPHONES; RADIOS; PRE-RECORDED AUDIO AND VIDEO TAPES FEATURING MUSIC; LASER DISCS, DVD DISCS, VIDEO DISCS, PHONOGRAPH RECORDS, COMPACT DISCS, AND CD-ROMS, ALL FEATURING GAMES, FILMS, AND MUSIC; ELECTRONIC CALCULATORS; BATTERIES; SUNGLASSES; CARRYING CASES FOR PORTABLE ELECTRONIC DEVICES; HEAD PHONES; AUDIO CASSETTE PLAYERS AND RECORDERS; CD PLAYERS; DVD PLAYERS; MOUSE PADS; GAMING MACHINES (U.S. CLS. 21, 23, 26, 36 AND 38).

SN 76-466,734. LOVE, DAVID ANTHONY, NEW YORK, NY. FILED 11-6-2002.

NO KID ' N RECORDS

NO CLAIM IS MADE TO THE EXCLUSIVE RIGHT TO USE "RECORDS", APART FROM THE MARK AS SHOWN.
FOR ELECTRICAL APPARATUS, NAMELY, PRE-RECORDED PHONOGRAPH RECORDS, COMPACT DISCS, AUDIO AND VIDEO CASSETTES, AND DVDS FEATURING MUSIC (U.S. CLS. 21, 23, 26, 36 AND 38).

SN 76-468,731. EDUCAUSE CORPORATION, BOULDER, CO. FILED 11-7-2002.

ECAR

FOR DOWNLOADABLE ELECTRONIC PUBLICATIONS IN THE NATURE OF REPORTS AND BULLETINS IN THE FIELDS OF INFORMATION RESOURCES AND TECHNOLOGY (U.S. CLS. 21, 23, 26, 36 AND 38).
FIRST USE 12-0-2001; IN COMMERCE 12-0-2001.

CLASS 9—(Continued).

SN 76-468,856. MITSUBISHI ELECTRIC CORPORATION, CHIYODA-KU, TOKYO, JAPAN, FILED 11-21-2002.

EZSocket

OWNER OF JAPAN REG. NO. 4431237, DATED 11-10-2000, EXPIRES 11-10-2010.

FOR COMPUTER PROGRAMS FOR USE IN THE DEVELOPMENT OF PROGRAMS RELATING TO FACTORY AUTOMATION AND FOR MONITORING AND CONTROLLING THE OPERATION OF FACTORY AUTOMATION APPARATUS (U.S. CLS. 21, 23, 26, 36 AND 38).

SN 76-469,486. ILC DOVER, INC., FREDERICA, DE. FILED 11-15-2002.

SCAPE

FOR (BASED ON USE IN COMMERCE) PROTECTIVE RESPIRATORS FOR USE IN CHEMICAL/BIOLOGICAL/RADIOLOGICAL PROTECTION, CHEMICAL PROTECTION, BIOLOGICAL PROTECTION AND RADIOLOGICAL PROTECTION (BASED ON INTENT TO USE) PROTECTIVE RESPIRATORS FOR USE IN SMOKE PROTECTION AND FIRE PROTECTION (U.S. CLS. 21, 23, 26, 36 AND 38).

FIRST USE 9-11-2002; IN COMMERCE 9-11-2002.

SN 76-469,789. HONDA ELECTRONICS CO., LTD., AICHKEN, JAPAN, FILED 11-26-2002.

HONDEX

OWNER OF JAPAN REG. NO. 4319536, DATED 10-1-1999, EXPIRES 10-1-2009.

FOR FISH SONAR, GPS PLOTTER FOR OCEAN NAVIGATION, ULTRASONIC DEPTH METER, ULTRASONIC DISTANCE MEASURING EQUIPMENT, ULTRASONIC WASHING EQUIPMENT, ULTRASONIC WELDER AND ULTRASONIC ATOMIZING EQUIPMENT (U.S. CLS. 21, 23, 26, 36 AND 38).

FIRST USE 10-0-1999; IN COMMERCE 10-0-1999.

SN 76-470,509. SONY ELECTRONICS INC., PARK RIDGE, NJ, FILED 11-14-2002.

PJNET!

FOR COMPUTER SOFTWARE FOR CONTROLLING MULTIPLE NETWORKED PROJECTORS, FOR REMOTE MONITORING OF NETWORKED PROJECTORS AND FOR PROGRAMMING TIME-BASED TASKS IN NETWORKED PROJECTORS (U.S. CLS. 21, 23, 26, 36 AND 38).

CLASS 9—(Continued).

SN 76-470,524. SKYWORLD INTERACTIVE, INC., STONEHAM, MA. FILED 11-14-2002.

SKYMESSANGER

FOR COMPUTER SOFTWARE, NAMELY SOFTWARE THAT PROVIDES CUSTOMIZABLE ALERT TOOLS THAT WILL ALLOW CONSTANT COMMUNICATIONS OF REAL-TIME INFORMATION FROM AN EXTRANET, INTRANET, OR WEBSITE TO DESKTOP COMPUTERS OF CUSTOMERS, CLIENTS AND EMPLOYEES (U.S. CLS. 21, 23, 26, 36 AND 38).

SN 76-470,771. TOPCODER, INC., GLASTONBURY, CT. FILED 11-29-2002.

POWERED BY [TOPCODER]

FOR COMPUTER SOFTWARE FOR OPERATION OF AND USE IN COMPUTER PROGRAMMING COMPETITIONS (U.S. CLS. 21, 23, 26, 36 AND 38).

FIRST USE 9-18-2002; IN COMMERCE 9-18-2002.

SN 76-470,911. ENEFCO INTERNATIONAL LTD., AUBURN, ME. FILED 11-25-2002.



FOR CLEANING CARDS FOR CLEANING THE CONCEALED MAGNETIC, PHOTO AND OPTICS SENSORS OF ATM MACHINES AND OTHER READER MECHANISMS, PRINT HEADS, ROLLERS AND FEED PATHS OF THERMAL PRINTERS AND ID PRINTERS; SWABS USED FOR CLEANING THE ACCESSIBLE MAGNETIC, PHOTO AND OPTICS SENSORS OF ATM MACHINES AND OTHER READER MECHANISMS, PRINT HEADS, ROLLERS AND FEED PATHS OF THERMAL PRINTERS AND ID PRINTERS (U.S. CLS. 21, 23, 26, 36 AND 38).

FIRST USE 11-1-2000; IN COMMERCE 1-15-2001.

SN 76-470,989. SYNPLICITY, INC., SUNNYVALE, CA. FILED 11-29-2002.

IDENTIFY

FOR COMPUTER SOFTWARE FOR ELECTRONIC CIRCUIT DESIGN (U.S. CLS. 21, 23, 26, 36 AND 38).

CLASS 9—(Continued).

SN 76-471,004. SOVEREIGN GRACE MINISTRIES, INC.,
GAITHERSBURG, MD. FILED 11-20-2002.

SOVEREIGN GRACE

OWNER OF U.S. REG. NO. 2,165,958.
FOR SERIES OF PRERECORDED AUDIO AND VIDEO CASSETTES, CDS, CD-ROMS, DVDS, MULTIMEDIA SOFTWARE, DOWNLOADABLE SOUND RECORDINGS, AND DOWNLOADABLE ELECTRONIC PUBLICATIONS IN THE NATURE OF BOOKS, MAGAZINES, ARTICLES, AND EDUCATIONAL MATERIALS, ALL IN THE FIELDS OF MUSIC, CHURCH DEVELOPMENT, LEADERSHIP, SPIRITUALITY, THEOLOGY, CHRISTIANITY, VALUES, ETHICS, CULTURE, AND SOCIAL ISSUES (U.S. CLS. 21, 23, 26, 36 AND 38).

SN 76-471,014. R2 TECHNOLOGY, INC., SUNNYVALE, CA.
FILED 11-20-2002.

PEERVIEW

FOR COMPUTER SOFTWARE USED TO MAGNIFY, HIGHLIGHT AND IDENTIFY REGIONS OF INTEREST IN RADIOLOGICAL IMAGES TO ASSIST RADIOLOGISTS IN THE DETECTION AND DIAGNOSIS OF CANCER AND OTHER ABNORMALITIES (U.S. CLS. 21, 23, 26, 36 AND 38).

SN 76-471,023. ID SOFTWARE, INC., MESQUITE, TX. FILED
11-18-2002.

**RETURN TO CASTLE
WOLFENSTEIN: OPERATION
RESURRECTION**

OWNER OF U.S. REG. NO. 1,895,186.
FOR COMPUTER SOFTWARE GAMES, COMPUTER SOFTWARE GAME PROGRAMS AND COMPUTER GAME CARTRIDGES OR CD-ROMS FOR VIDEO GAMES FOR ENTERTAINMENT USES WITH MANUALS SOLD AS A UNIT (U.S. CLS. 21, 23, 26, 36 AND 38).

SN 76-471,883. ID SOFTWARE, INC., MESQUITE, TX. FILED
11-15-2002.

**RETURN TO CASTLE
WOLFENSTEIN: TIDES OF
WAR**

OWNER OF U.S. REG. NO. 1,895,186.
FOR COMPUTER SOFTWARE GAMES, COMPUTER SOFTWARE GAME PROGRAMS AND COMPUTER GAME CARTRIDGES OR CD-ROMS FOR VIDEO GAMES FOR ENTERTAINMENT USES WITH MANUALS SOLD AS A UNIT (U.S. CLS. 21, 23, 26, 36 AND 38).

CLASS 9—(Continued).

SN 76-472,105. HIPAAT INC., SHELBOURNE, ONTARIO L0N
1S8, CANADA, FILED 12-5-2002.

HIPAAT

FOR COMPUTER SOFTWARE THAT MONITORS NETWORK TRAFFIC AND WORKS WITH USER AUTHORIZATION SOFTWARE AND HARDWARE TO ALLOW CONTROLLED ACCESS TO AND DISSEMINATION OF PATIENT HEALTH INFORMATION, RECOGNIZES AND IDENTIFIES VARIOUS PATIENT HEALTH INFORMATION ACCESS ACTIVITIES TO CREATE AUDIT EVENTS AND AN AUDIT REPOSITORY FOR STORAGE AND SEARCH EVALUATION, PROVIDES ENCRYPTION OF PATIENT HEALTH INFORMATION, VIRUS AND FIREWALL PROTECTION (U.S. CLS. 21, 23, 26, 36 AND 38).

SN 78-001,115. TALKSENDER.COM, WESTFORD, MA.
FILED 3-27-2000.

TALKCASTER

FOR COMPUTER COMMUNICATION SOFTWARE FOR SENDING AUDIO/VIDEO ELECTRONIC MAIL TO AND BETWEEN CONSUMERS AND BUSINESSES (U.S. CLS. 21, 23, 26, 36 AND 38).

SN 78-009,269. EZMEDPRIVACY, INC., PHOENIX, AZ.
FILED 5-22-2000.

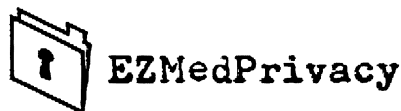

FOR COMPUTER SOFTWARE FOR MEDICAL RECORD PRIVACY LEGAL COMPLIANCE, NAMELY, SOFTWARE FOR COMPLIANCE TRAINING AND CERTIFICATION AND COMPILING AND MAINTAINING REGULATORY COMPLIANCE DATA CONCERNING APPROPRIATENESS OF MEDICAL RECORD DISCLOSURES (U.S. CLS. 21, 23, 26, 36 AND 38).

SN 78-010,610. LES ENTREPRISES DOVICO ENTERPRISES,
INC., MONCTON NEW BRUNSWICK, CANADA, FILED
5-31-2000.

TRACK-IT

FOR COMPUTER SOFTWARE TO MONITOR INVOICES, EXPENSES AND TIME SPENT ON PROJECTS AND ACTIVITIES USED FOR PROJECT MANAGEMENT AND TRACKING IN IT AND OTHER RELATED INDUSTRIES (U.S. CLS. 21, 23, 26, 36 AND 38).

FIRST USE 10-21-1996; IN COMMERCE 10-21-1996.

CLASS 9—(Continued).

SN 78-023,116. INSTRUMENT DISTRIBUTORS INTERNATIONAL, INC., GAITHERSBURG, MD. FILED 8-26-2000.

MoistureWave

FOR SCIENTIFIC INSTRUMENTS, NAMELY, A MOISTURE METER USED TO MEASURE MOISTURE IN FOODS AND PHARMACEUTICALS (U.S. CLS. 21, 23, 26, 36 AND 38).

SN 78-027,740. CONEXANT SYSTEMS, INC., NEWPORT BEACH, CA. FILED 9-26-2000.

ZIPWIRE

FOR SEMICONDUCTOR DEVICES AND SOFTWARE USED TO PROVIDE HIGH-SPEED DIGITAL SUBSCRIBER LOOP DSL FUNCTIONS FOR TELECOMMUNICATION EQUIPMENT MANUFACTURERS (U.S. CLS. 21, 23, 26, 36 AND 38).

SN 78-029,638. KARLSBERG, RONALD P., BEVERLY HILLS, CA. FILED 10-8-2000.

**NOTESMD NOTESMD.COM
NOTES.MD NOTESMD.NET
NOTESMD.ORG
NOTESMD.EDU**

FOR WEB-BASED/DELIVERED POINT-OF-CARE SOFTWARE ENABLING A PHYSICIAN TO GENERATE A COMPREHENSIVE MEDICAL CHART BASED ON A SPECIFIC ENCOUNTER WITH THE PATIENT; THE INFORMATION WHICH COMPRISES THE CHART IS DERIVED FROM THE COMBINATION OF A KNOWLEDGE TREE DATABASE AS WELL AS A DATABASE CONTAINING THE SPECIFIC PATIENT'S DEMOGRAPHIC INFORMATION THE SOFTWARE GENERATES UNIQUE GRAMMATICAL SENTENCES WHICH COMPRISE PARAGRAPHED SECTIONS UNDER PREDEFINED HEADERS/SUB HEADERS (U.S. CLS. 21, 23, 26, 36 AND 38).

FIRST USE 1-1-1998; IN COMMERCE 1-1-1998.

SN 78-036,359. PACIFIC DATAVISION, INC., SAN DIEGO, CA. FILED 11-22-2000.

DOCUBLASTER

FOR COMPUTER SOFTWARE FOR CREATING BUSINESS FORMS AND DOCUMENTS (U.S. CLS. 21, 23, 26, 36 AND 38).

FIRST USE 11-7-2000; IN COMMERCE 11-7-2000.

CLASS 9—(Continued).

SN 78-043,160. MONITORING TECHNOLOGY CORPORATION, FAIRFAX, VA. FILED 1-15-2001.

**20/20
HINDSIGHT**



FOR COMPUTER SYSTEMS COMPRISED OF VIDEO CAMERAS FOR GENERAL SURVEILLANCE, REAL TIME MONITORING, AND RECORDING OF AUTOMATED PRODUCTION LINES AND INDUSTRIAL MANUFACTURING PROCESSES (U.S. CLS. 21, 23, 26, 36 AND 38).

FIRST USE 4-10-2001; IN COMMERCE 4-10-2001.

SN 78-043,230. PINECONE IMAGING CORP, WEST LINN, OR. FILED 1-15-2001.

VEECHAT

FOR COMPUTER SOFTWARE USED FOR LINKING USERS INTO VIRTUAL COMMUNITIES AND CHAT ROOM SOFTWARE USED TO ENABLE A COMMUNITY OF CHAT ROOM USERS TO EXCHANGE MESSAGES AND INTERACT IN A VIRTUAL COMMUNITY; DIGITALLY ENCODED OBJECTS, NAMELY, COMPUTER ENCODED LABELS FOR IDENTIFYING USERS TO COMPLIANT COMPUTER DEVICES (U.S. CLS. 21, 23, 26, 36 AND 38).

SN 78-059,397. SUPERB RECORDS, LTD., LOS ANGELES, CA. FILED 4-19-2001.



NO CLAIM IS MADE TO THE EXCLUSIVE RIGHT TO USE "SUPERB RECORDS", APART FROM THE MARK AS SHOWN.

THE MARK CONTAINS A PICTORIAL REPRESENTATION OF A QUASAR.

FOR PHONOGRAPH RECORDS, PRERECORDED AUDIO TAPES, ENHANCED CDS, COMPACT DISCS, PRERECORDED VIDEO TAPES, PRERECORDED VIDEO CASSETTES, PRERECORDED AUDIO DIGITAL TAPES, DVDS AND LASER DISCS, ALL FEATURING MUSIC ENTERTAINMENT (U.S. CLS. 21, 23, 26, 36 AND 38).

FIRST USE 10-10-2001; IN COMMERCE 10-10-2001.

CLASS 9—(Continued).

SN 78-063,375. SCHNEIDER AUTOMATION, VALBONNE, FRANCE, FILED 5-14-2001.

TWIDO

PRIORITY CLAIMED UNDER SEC. 44(D) ON FRANCE APPLICATION NO. 003066354, FILED 11-15-2000, REG. NO. 003066354, DATED 11-15-2000, EXPIRES 11-15-2010.

FOR ELECTRICAL OR ELECTRONIC APPARATUS FOR THE REMOTE CONTROL OF INDUSTRIAL OPERATIONS; PROGRAMMABLE LOGIC CONTROLLERS; MODULES FOR PROGRAMMABLE LOGIC CONTROLLERS, NAMELY, INPUT OR OUTPUT MODULES, ANALOG MODULES, AND COUNTING AND POSITIONING MODULES; COMPUTER SOFTWARE FOR PROGRAMMABLE LOGIC CONTROLLERS AND MODULES FOR AUTOMATION OF INDUSTRIAL OPERATIONS (U.S. CLS. 21, 23, 26, 36 AND 38).

SN 78-067,983. DIAMOND DATA SYSTEMS, INC., RICHARDSON, TX. FILED 6-7-2001.

QUICKSTORE POINT-OF-SALE

NO CLAIM IS MADE TO THE EXCLUSIVE RIGHT TO USE "POINT-OF-SALE", APART FROM THE MARK AS SHOWN.

FOR COMPUTER SOFTWARE THAT PERFORMS INVENTORY CONTROL AND POINT OF SALE ACTIVITIES FOR USE IN RETAIL STORES SELLING MERCHANDISE (U.S. CLS. 21, 23, 26, 36 AND 38).
FIRST USE 6-0-1999; IN COMMERCE 5-31-2001.

SN 78-070,175. SAFETY VISION, L.P., HOUSTON, TX. FILED 6-20-2001.

SAFETYDX

FOR SOFTWARE FOR USE IN RECONFIGURING DIGITAL VIDEO RECORDERS (U.S. CLS. 21, 23, 26, 36 AND 38).

FIRST USE 3-31-2001; IN COMMERCE 3-31-2001.

SN 78-076,022. FINAPLEX, INC., SAN FRANCISCO, CA. FILED 7-27-2001.

FINAPLEX

FOR COMPUTER SOFTWARE USED FOR PERSONAL FINANCIAL MANAGEMENT (U.S. CLS. 21, 23, 26, 36 AND 38).

FIRST USE 9-1-2000; IN COMMERCE 2-19-2003.

CLASS 9—(Continued).

SN 78-083,315. FORD MODELS, INC., NEW YORK, NY. FILED 9-10-2001.

**FORD MODELS
SUPERMODEL OF THE
WORLD**

OWNER OF U.S. REG. NOS. 1,296,761 AND 2,481,166.

NO CLAIM IS MADE TO THE EXCLUSIVE RIGHT TO USE "MODELS SUPERMODEL OF THE WORLD", APART FROM THE MARK AS SHOWN.

FOR EYEGLASSES, SUNGLASSES, EYEGLASSES AND SUNGLASS FRAMES, EYEGLASS AND SUNGLASS CASES; VIDEO CASSETTES, VIDEO TAPES, AND MULTIMEDIA SOFTWARE RECORDED ON CD-ROM, ALL FEATURING BEHIND THE SCENES FOOTAGE OF MODELING COMPETITIONS (U.S. CLS. 21, 23, 26, 36 AND 38).

SN 78-083,916. ZINGALI LOUDSPEAKERS S.R.L., APRILIA (LT), ITALY, FILED 9-14-2001.

OMNIRAY ZINGALI

PRIORITY CLAIMED UNDER SEC. 44(D) ON ITALY APPLICATION NO. 001157, FILED 3-28-2001, REG. NO. 00852622, DATED 10-8-2001, EXPIRES 3-28-2011.

FOR ELECTRO-ACOUSTIC APPARATUS FOR TRANSMISSION AND REPRODUCTION OF SOUND, NAMELY ACTIVE AND PASSIVE LOUDSPEAKERS (U.S. CLS. 21, 23, 26, 36 AND 38).

SN 78-084,945. AZIMUTH, INC., MORGANTOWN, WV. FILED 9-21-2001.

TARGET MASTER

NO CLAIM IS MADE TO THE EXCLUSIVE RIGHT TO USE "TARGET", APART FROM THE MARK AS SHOWN.

FOR COMPUTER SOFTWARE FOR USE IN VISUALIZATION AND INFORMATION TRANSMISSION OF GEOSPATIAL ENVIRONMENTS AND PROCESSING IMAGERY INFORMATION, ALL IN THE FIELD OF IMAGERY ANALYSIS (U.S. CLS. 21, 23, 26, 36 AND 38).

FIRST USE 9-30-1998; IN COMMERCE 9-30-1998.

CLASS 9—(Continued).

SN 78-085,956. ANCIENT DRUM ENTERPRISES, LLC, SALINAS, CA. FILED 9-27-2001.



NO CLAIM IS MADE TO THE EXCLUSIVE RIGHT TO USE "MEDITATION SYSTEMS", APART FROM THE MARK AS SHOWN.

FOR SERIES OF COMPACT DISKS AND AUDIO CASSETTES FEATURING GUIDANCE FOR MEDITATION AND SUBLIMINAL PROGRAMS WITH MUSICAL BACKGROUNDS FOR THE PURPOSE OF RELAXATION, MEDITATION, AND SELF-HYPNOSIS (U.S. CLS. 21, 23, 26, 36 AND 38).

FIRST USE 3-1-2001; IN COMMERCE 9-1-2001.

SN 78-090,819. DURHAM GEO-ENTERPRISES, INC., STONE MOUNTAIN, GA. FILED 10-30-2001.



NO CLAIM IS MADE TO THE EXCLUSIVE RIGHT TO USE "SLOPE INDICATOR", APART FROM THE MARK AS SHOWN.

FOR GEOTECHNICAL INSTRUMENTS, NAMELY, INCLINOMETERS USED TO MEASURE TILT, DISPLACEMENT, PRESSURE, AND STRAIN IN SOIL, ROCK, CONCRETE AND STEEL STRUCTURES (U.S. CLS. 21, 23, 26, 36 AND 38).

FIRST USE 1-1-2001; IN COMMERCE 1-1-2001.

SN 78-097,259. ATLANTEK MICROSYSTEMS PTY. LTD., MAWSON LAKES, AUSTRALIA, FILED 12-7-2001.

PICPRODIGY

FOR COMPUTER HARDWARE; COMPUTER SOFTWARE FOR USE IN CONTROLLING AND OPERATING VIDEO IMAGING AND EDITING AND VIDEO SPECIAL EFFECTS (U.S. CLS. 21, 23, 26, 36 AND 38).

FIRST USE 7-31-2001; IN COMMERCE 7-31-2001.

CLASS 9—(Continued).

SN 78-097,778. JORDAN, PAUL, D, TEMPLE CITY, CA. FILED 12-11-2001.



FOR COMPUTER SOFTWARE FOR DESIGNING IMAGES, PLAYING IMAGES, AND VIDEO (U.S. CLS. 21, 23, 26, 36 AND 38).

FIRST USE 8-12-2001; IN COMMERCE 10-23-2001.

SN 78-097,876. TAYLOR, WILLIAM, ARTHUR, EVERGREEN, CO. FILED 12-12-2001.

TIME TRAVELER

FOR GAMING MACHINES; NAMELY, SLOT MACHINES WITH OR WITHOUT A VIDEO OUTPUT (U.S. CLS. 21, 23, 26, 36 AND 38).

SN 78-098,732. PER ANNUM, INC., NEW YORK, NY. FILED 12-17-2001.

THE PER ANNUM GREATER BOSTON CITY DIRECTORY

OWNER OF U.S. REG. NOS. 1,488,404, 2,560,122 AND OTHERS.

NO CLAIM IS MADE TO THE EXCLUSIVE RIGHT TO USE "GREATER BOSTON CITY DIRECTORY", APART FROM THE MARK AS SHOWN.

FOR COMPUTER SOFTWARE CONTAINING LISTINGS AND INFORMATION SPECIFICALLY RELATING TO THE GREATER BOSTON AREA (U.S. CLS. 21, 23, 26, 36 AND 38).

FIRST USE 4-0-1999; IN COMMERCE 4-0-1999.

CLASS 9—(Continued).

SN 78-098,965. PER ANNUM, INC., NEW YORK, NY. FILED 12-18-2001.

THE PER ANNUM METROPOLITAN CITY DIRECTORY

OWNER OF U.S. REG. NOS. 1,488,404, 2,560,122 AND OTHERS.

NO CLAIM IS MADE TO THE EXCLUSIVE RIGHT TO USE "METROPOLITAN CITY DIRECTORY", APART FROM THE MARK AS SHOWN.

FOR COMPUTER SOFTWARE CONTAINING LISTINGS AND INFORMATION RELATING TO MAJOR METROPOLITAN AREAS OF THE UNITED STATES (U.S. CLS. 21, 23, 26, 36 AND 38).

FIRST USE 4-0-1999; IN COMMERCE 4-0-1999.

SN 78-104,276. BAYDON SOLUTIONS LTD, DUBLIN, IRELAND, FILED 1-23-2002.

ASSISTWARE

FOR COMPUTER SOFTWARE FOR USE IN THE FIELD OF EMPLOYEE TRAINING, NAMELY COMPUTER PROGRAMS FOR THE CREATION OF INFORMATION RESOURCES THAT ASSIST OTHERS IN ANSWERING QUESTIONS AND FINDING INFORMATION ABOUT OTHER SOFTWARE AND COMPANY GUIDELINES, POLICIES, AND PROCEDURES (U.S. CLS. 21, 23, 26, 36 AND 38).

FIRST USE 12-19-1992; IN COMMERCE 12-19-1992.

SN 78-105,197. XPEDIATE CONSULTING, LLC, SAN RAFAEL, CA. FILED 1-28-2002.



NO CLAIM IS MADE TO THE EXCLUSIVE RIGHT TO USE "COMPLIANCE PORTAL", APART FROM THE MARK AS SHOWN.

FOR DOWNLOADABLE EDUCATIONAL COMPUTER SOFTWARE FOR WEB-BASED APPLICATIONS WHICH ENABLE HEALTHCARE ORGANIZATIONS, THROUGH MOCK SURVEYS AND SELF-ASSESSMENT ANALYSIS, TO BE IN COMPLIANCE WITH STATE, FEDERAL AND AGENCY REGULATIONS AND STANDARDS (U.S. CLS. 21, 23, 26, 36 AND 38).

FIRST USE 3-1-2001; IN COMMERCE 3-15-2001.

CLASS 9—(Continued).

SN 78-105,978. THERMAL WAVE IMAGING, INC., FERNDALE, MI. FILED 1-31-2002.

THERMOGRAPHIC SIGNAL RECONSTRUCTION

NO CLAIM IS MADE TO THE EXCLUSIVE RIGHT TO USE "THERMOGRAPHIC SIGNAL", APART FROM THE MARK AS SHOWN.

FOR COMPUTER SOFTWARE FOR COLLECTING, COMPILING, CONVERTING, MATHEMATICALLY MANIPULATING, SYNCHRONIZING AND ANALYZING INFRARED IMAGE DATA FOR INSPECTION, TESTING AND DIAGNOSIS; THERMAL IMAGING EQUIPMENT AND SYSTEMS FOR ACQUIRING, PROCESSING, CONVERTING, SYNCHRONIZING AND ANALYZING INFRARED IMAGE DATA OBTAINED IN SUBSURFACE NON-DESTRUCTIVE TESTING AND INSPECTION, COMPOSED PRIMARILY OF AN INFRARED CAMERA, HEAT SOURCE, COMPUTER AND SUPPLEMENTARY ELECTRONICS (U.S. CLS. 21, 23, 26, 36 AND 38).

SN 78-108,068. NORWOOD, NELSON BEDELL, AUSTIN, TX. FILED 2-11-2002.



NO CLAIM IS MADE TO THE EXCLUSIVE RIGHT TO USE "RECORDS", APART FROM THE MARK AS SHOWN.

THE FOREIGN WORDING IN THE MARK TRANSLATES INTO ENGLISH AS "GOOD LOOKING WOMAN".

FOR COMPACT DISCS FEATURING MUSIC (U.S. CLS. 21, 23, 26, 36 AND 38).

FIRST USE 12-1-2001; IN COMMERCE 12-1-2001.

SN 78-108,919. BEN-YEHUDA, NATHAN B., SAN DIEGO, CA. FILED 2-14-2002.

FLIGHTSUITE

FOR COMPUTER SOFTWARE FOR USE IN THE AVIATION INDUSTRY THAT IS USED TO ESTABLISH THE PROPER WEIGHT DISTRIBUTION ON AIRCRAFT (U.S. CLS. 21, 23, 26, 36 AND 38).

SN 78-110,046. ZYGOFLEX, INC., HIGHLAND VILLAGE, TX. FILED 2-20-2002.

ZYGOFLEX

FOR COMPUTER SOFTWARE AND HARDWARE FOR APPLICATION AND DATABASE INTEGRATION (U.S. CLS. 21, 23, 26, 36 AND 38).

CLASS 9—(Continued).

SN 78-110,047. ZYGOFLEX, INC., HIGHLAND VILLAGE, TX. FILED 2-20-2002.



FOR COMPUTER SOFTWARE AND HARDWARE FOR APPLICATION AND DATABASE INTEGRATION (U.S. CLS. 21, 23, 26, 36 AND 38).

SN 78-112,248. DELIVERY AGENT, LLC, SAN FRANCISCO, CA. FILED 3-4-2002.

SHOP THE SCENE

FOR COMPUTER SOFTWARE FOR E-COMMERCE FOR DATABASE MANAGEMENT (U.S. CLS. 21, 23, 26, 36 AND 38).

SN 78-114,556. NOBSCOT CORPORATION, KAILUA, HI. FILED 3-13-2002.

WEBEXIT

FOR COMPUTER SOFTWARE FOR HUMAN RESOURCE MANAGEMENT, NAMELY, MANAGING EMPLOYEE EXIT INTERVIEWS (U.S. CLS. 21, 23, 26, 36 AND 38).

FIRST USE 8-31-2000; IN COMMERCE 12-1-2000.

SN 78-114,666. TIME WARNER ENTERTAINMENT COMPANY, L.P., NEW YORK, NY. FILED 3-13-2002.

MUCHA LUCHA

THE ENGLISH TRANSLATION OF THE MARK IS "A LOT OF STRUGGLING."

FOR MOTION PICTURE FILMS FEATURING COMEDY, DRAMA, ACTION, ADVENTURE AND/OR ANIMATION, AND MOTION PICTURE FILMS FOR BROADCAST ON TELEVISION FEATURING COMEDY, DRAMA, ACTION, ADVENTURE AND/OR ANIMATION; PRERECORDED VINYL RECORDS, AUDIO TAPES, AUDIO-VIDEO TAPES, AUDIO VIDEO CASSETTES, AUDIO VIDEO DISCS, AND DIGITAL VERSATILE DISCS FEATURING MUSIC, COMEDY, DRAMA, ACTION, ADVENTURE, AND/OR ANIMATION; STEREO HEADPHONES; BATTERIES; CORDLESS TELEPHONES; HAND-HELD CALCULATORS; AUDIO CASSETTE AND CD PLAYERS; CD ROM GAMES; HAND-HELD KARAOKE PLAYERS, TELEPHONE AND/OR RADIO PAGERS; SHORT MOTION PICTURE FILM CASSETTES FEATURING COMEDY, DRAMA, ACTION,

CLASS 9—(Continued).

ADVENTURE AND/OR ANIMATION TO BE USED WITH HAND-HELD VIEWERS OR PROJECTORS; VIDEO CASSETTE RECORDERS AND PLAYERS, COMPACT DISC PLAYERS, DIGITAL AUDIO TAPE RECORDERS AND PLAYERS, ELECTRONIC DIARIES; RADIOS; MOUSE PADS; EYEGLASSES, SUNGLASSES AND CASES THEREFORE; PRERECORDED AUDIO TAPES AND BOOKLETS SOLD AS A UNIT FEATURING COMEDY, DRAMA, ACTION ADVENTURE, ANIMATION AND MUSIC INFORMATION; COMPUTER PROGRAMS, NAMELY, SOFTWARE LINKING DIGITIZED VIDEO AND AUDIO MEDIA TO A GLOBAL COMPUTER INFORMATION NETWORK; COMPUTER GAME PROGRAM, NAMELY, A PARLOR TYPE COMPUTER GAME PROGRAM; VIDEO AND COMPUTER GAME PROGRAMS; VIDEO GAME CARTRIDGES AND CASSETTES; CELLULAR TELEPHONE ACCESSORIES; ENCODED MAGNETIC CARDS, PHONE CARDS, CREDIT CARDS, CASH CARDS, DEBIT CARDS AND MAGNETIC KEY CARDS; AND DECORATIVE MAGNETS (U.S. CLS. 21, 23, 26, 36 AND 38).

SN 78-121,447. TOTAL DIRECT MARKETING, INC., INDIANAPOLIS, IN. FILED 4-12-2002.

EXTREME HARDWARE

NO CLAIM IS MADE TO THE EXCLUSIVE RIGHT TO USE "HARDWARE", APART FROM THE MARK AS SHOWN.

FOR PEDOMETERS, BICYCLE ODOMETERS; SAFETY PRODUCTS, NAMELY FLASHING SIGNALS AND AUDIBLE SIGNALS THAT CAN BE WORN OR CARRIED (U.S. CLS. 21, 23, 26, 36 AND 38).

SN 78-121,863. LIKE FATHER LIKE SON, RECORDS, INC. ATLANTA, GA. FILED 4-15-2002.

LIKE FATHER LIKE SON RECORDS

NO CLAIM IS MADE TO THE EXCLUSIVE RIGHT TO USE "RECORDS", APART FROM THE MARK AS SHOWN.

FOR MUSICAL SOUND RECORDINGS AND VIDEOS FEATURING MUSICAL ARTIST (U.S. CLS. 21, 23, 26, 36 AND 38).

SN 78-124,159. NOVARTIS AG, BASEL, SWITZERLAND, FILED 4-25-2002.

X-COLORS

PRIORITY CLAIMED UNDER SEC. 44(D) ON SWITZERLAND APPLICATION NO. 3489/2002, FILED 4-18-2002, REG. NO. 498372, DATED 4-25-2002, EXPIRES 4-18-2012.

FOR CONTACT LENSES (U.S. CLS. 21, 23, 26, 36 AND 38).

CLASS 9—(Continued).

SN 78-127,571. NOVARTIS AG, BASEL, SWITZERLAND, FILED 5-9-2002.

FOCAL ONE

PRIORITY CLAIMED UNDER SEC. 44(D) ON SWITZERLAND APPLICATION NO. 3987/2002, FILED 5-2-2002, REG. NO. 499271, DATED 5-21-2002, EXPIRES 5-2-2012.

FOR INTRAOCULAR LENSES (U.S. CLS. 21, 23, 26, 36 AND 38).

SN 78-127,862. COLIBERATE SYSTEMS, LLC, NEW YORK, NY. FILED 5-10-2002.

COLIBERATE

FOR COMPUTER SOFTWARE TO FACILITATE COLLABORATION AMONG USERS THROUGH THE SHARING OF DOCUMENTS AND DATA; CUSTOMER RELATIONSHIP MANAGEMENT SOFTWARE (U.S. CLS. 21, 23, 26, 36 AND 38).

SN 78-128,104. VIPA HEALTH SOLUTIONS, LLC, MIAMI, FL. FILED 5-13-2002.

SMARTEMR: PATIENT RECORDS, ANYWHERE ANYTIME

NO CLAIM IS MADE TO THE EXCLUSIVE RIGHT TO USE "SMARTEMR: PATIENT RECORDS", APART FROM THE MARK AS SHOWN.

FOR COMPUTER SOFTWARE FOR USE IN DATABASE MANAGEMENT USED BY PHYSICIANS AND OTHERS IN THE ACCESS OF MEDICAL INFORMATION (U.S. CLS. 21, 23, 26, 36 AND 38).

SN 78-128,109. PACKETSTORM COMMUNICATIONS, INC., EATONTOWN, NJ. FILED 5-13-2002.

HURRICANE

FOR TELECOMMUNICATIONS TEST EQUIPMENT, NAMELY, ELECTRONIC HARDWARE AND COMPUTER SOFTWARE, USED TO MEASURE AND ALTER THE SPEED AND ACCURACY OF INTERNET PROTOCOL DATA TRANSMISSION APPLICATIONS (U.S. CLS. 21, 23, 26, 36 AND 38).

CLASS 9—(Continued).

SN 78-128,111. TENDERLOIN TECHNOLOGIES, INC., SAN FRANCISCO, CA. FILED 5-13-2002.

BROWN BOTTLE RECORDS

NO CLAIM IS MADE TO THE EXCLUSIVE RIGHT TO USE "RECORDS", APART FROM THE MARK AS SHOWN.

FOR MUSICAL SOUND RECORDINGS; MUSICAL VIDEO RECORDINGS; ENHANCED SOUND AND/OR VIDEO RECORDINGS; INTERACTIVE SOUND AND/OR VIDEO RECORDINGS; DIGITAL MUSIC DOWNLOADABLE FROM THE INTERNET; COMPACT DISCS AND DVD'S FEATURING PRE-RECORDED MUSICAL PERFORMANCES (U.S. CLS. 21, 23, 26, 36 AND 38).

SN 78-128,367. AT HOME SCIENCE, INC., GLENWOOD SPRINGS, CO. FILED 5-13-2002.

AT HOME SCIENCE

FOR SCIENTIFIC EDUCATIONAL KITS COMPRISED OF INSTRUCTIONAL USER LAB MANUALS SOLD AS A UNIT THEREWITH, SAFETY GOGGLES, TEST TUBES, TEST TUBE BRUSHES, TEST TUBE STANDS, MICRO PIPETS, VIALS, AND PACKETS OF CHEMICALS, MAGNIFIERS, PH, LEAD, AND LITMUS TEST PAPERS, FILTER PAPERS, PETRI DISHES, BEAKERS, PLASTIC AND COPPER TUBING FOR USE WITH TEST TUBES, REACTION PLATES, MICROSCOPES, MULTIMETERS, SCALES, THERMOMETERS, TIMERS FOR EXPERIMENTS, PROTRACTORS, RULERS, GRADUATED CYLINDERS, AND COLLECTIONS OF THESE ITEMS INTENDED FOR USE IN A HOME AS WELL AS FORMAL LABORATORY, AND RELATED TO THE STUDY OF ALL FIELDS AND BRANCHES OF SCIENCE, NAMELY CHEMISTRY, BIOLOGY, PHYSICS, GEOLOGY, METEOROLOGY, AND ECOLOGY (U.S. CLS. 21, 23, 26, 36 AND 38).

SN 78-128,679. NEX1 TECHNOLOGIES CO. LTD., TAIPEI, TAIWAN, FILED 5-14-2002.

NEX1

FOR NETWORK CABLES, NETWORK CONNECTORS, LAN CABLE, LAN CONNECTORS, OPTICAL FIBER, PATCH CABLES, FIBER OPTICAL PATCH CABLES, PATCH PANELS, NETWORK JACKS, AND KEYTONE JACKS (U.S. CLS. 21, 23, 26, 36 AND 38).

FIRST USE 3-1-1999; IN COMMERCE 8-12-2000.

CLASS 9—(Continued).

SN 78-129,170. LOCKHEED MARTIN CORPORATION, BETHESDA, MD. FILED 5-16-2002.

METROGUARD

FOR NUCLEAR, BIOLOGICAL AND CHEMICAL DETECTION SYSTEM, NAMELY, AN AEROSOL SAMPLE COLLECTOR HAVING A RADIOLOGICAL SENSOR, ULTRAVIOLET BIOLOGICAL DETECTOR AND ACOUSTIC CHEMICAL SENSOR SUITE (U.S. CLS. 21, 23, 26, 36 AND 38).

SN 78-129,963. MASTERCARD INTERNATIONAL INCORPORATED, PURCHASE, NY. FILED 5-20-2002.

MASTERCARD PAYPASS

OWNER OF U.S. REG. NOS. 1,257,853 AND 2,212,783.
FOR COMPUTER HARDWARE AND SOFTWARE FOR USE IN ELECTRONIC BUSINESS TRANSACTIONS, NAMELY, COMPUTER E-COMMERCE SOFTWARE TO FACILITATE MICRO-PAYMENTS, NAMELY, PAYMENTS RANGING FROM A FEW CENTS TO SEVERAL DOLLARS, TO INTERNET RETAILERS, MERCHANTS AND CONTENT PROVIDERS; COMPUTER SOFTWARE THAT ALLOWS USERS TO ACCESS A DATABASE CONTAINING INFORMATION ON ACCOUNT BALANCES FOR THE PURPOSE OF FACILITATING ELECTRONIC COMMERCE; COMPUTER HARDWARE IN THE NATURE OF SMART CARDS CONTAINING AN INTEGRATED CIRCUIT CHIP FOR USE IN ELECTRONIC BUSINESS TRANSACTIONS AND PROXIMITY PAYMENT DEVICES KNOWN AS TRANSPONDERS FOR STORING ENCRYPTION KEYS AND ENCRYPTION SOFTWARE FOR CREATING DIGITAL CERTIFICATES AND DIGITAL SIGNATURES, COMPUTER SOFTWARE FOR SECURE DATA STORAGE AND RETRIEVAL AND TRANSMISSION OF CONFIDENTIAL CUSTOMER INFORMATION USED BY INDIVIDUALS, BANKING AND FINANCIAL INSTITUTIONS; MAGNETIC ENCODED CARDS AND SMART CARDS CONTAINING AN INTEGRATED CIRCUIT CHIP FOR USE IN ELECTRONIC BUSINESS TRANSACTIONS; MAGNETICALLY ENCODED CHARGE CARDS, BANK CARDS, CREDIT CARDS, DEBIT CARDS AND PAYMENT CARDS; CARD READERS FOR MAGNETICALLY ENCODED CARDS AND CARDS CONTAINING AN INTEGRATED CIRCUIT CHIP; COMPUTER SOFTWARE DESIGNED TO ENABLE MAGNETICALLY CODED CARDS AND SMART CARDS CONTAINING AN INTEGRATED CIRCUIT CHIP TO INTERACT WITH TERMINALS AND CARD READERS IN THE FINANCIAL SERVICES INDUSTRY; TELECOMMUNICATIONS EQUIPMENT, NAMELY ELECTRONIC POINT OF SALE TRANSACTION TERMINALS AND COMPUTER SOFTWARE FOR TRANSMITTING, DISPLAYING AND STORING TRANSACTION, IDENTIFICATION, AND FINANCIAL INFORMATION FOR USE IN THE FINANCIAL SERVICES, BANKING AND TELECOMMUNICATIONS INDUSTRIES; TELECOMMUNICATIONS EQUIPMENT, NAMELY, TRANSPONDERS; AND ELECTRONIC VERIFICATION APPARATUS, NAMELY COMPUTER HARDWARE AND SOFTWARE FOR AUTHENTICATING CHARGE CARDS, BANK CARDS, CREDIT CARDS, DEBIT CARDS AND PAYMENT CARDS (U.S. CLS. 21, 23, 26, 36 AND 38).

CLASS 9—(Continued).

SN 78-130,130. ELISIT SOLUTIONS, L.L.C., BLOOMFIELD, CT. FILED 5-21-2002.

ELISIT, THE MRI FOR BUSINESS

NO CLAIM IS MADE TO THE EXCLUSIVE RIGHT TO USE "FOR BUSINESS", APART FROM THE MARK AS SHOWN.

FOR GENERAL PURPOSE COMPUTER E-COMMERCE SOFTWARE FOR FINANCIAL PURPOSE, NAMELY, TO ALLOW USERS TO PERFORM ELECTRONIC BUSINESS TRANSACTIONS VIA A GLOBAL COMPUTER NETWORK (U.S. CLS. 21, 23, 26, 36 AND 38).

SN 78-132,380. GENERAL DYNAMICS DECISION SYSTEMS, INC., SCOTTSDALE, AZ. FILED 5-31-2002.

HOOK2

FOR COMBAT SEARCH AND RESCUE SYSTEM FOR USE WITH THE GLOBAL POSITIONING SYSTEM (GPS) CONSISTING OF COMPUTERS, COMPUTER SOFTWARE, RADIO TRANSMITTERS, RECEIVERS, TRANSCIEVERS, HANDHELD AND EMBEDDED INTERROGATORS, AND NETWORK INTERFACE DEVICES THAT PROVIDE ENCRYPTED TWO-WAY MESSAGING AND GPS DATA (U.S. CLS. 21, 23, 26, 36 AND 38).

SN 78-134,676. MESOSYSTEMS TECHNOLOGY, INC., KENNEWICK, WA. FILED 6-11-2002.

WATERSENTINEL

FOR SYSTEMS FOR COLLECTION, IDENTIFICATION, AND QUANTIFICATION OF BIOLOGICAL HAZARDS IN WATER, NAMELY WATER SAMPLERS AND BIOLOGICAL SAMPLE ANALYZERS (U.S. CLS. 21, 23, 26, 36 AND 38).

CLASS 9—(Continued).

SN 78-135,614. DIRECTED ELECTRONICS, INC., VISTA, CA.
FILED 6-13-2002.

HCCA

THE MARK CONSISTS OF "HCCA," AN ACRONYM COINED BY THE APPLICANT, WHICH MEANS "HIGH CURRENT COMPETITION AMPLIFIERS."

FOR AUDIO EQUIPMENT NAMELY - SPEAKERS, WOOFERS, TWEETERS, COMPONENT SPEAKERS, MID RANGE SPEAKERS, CROSSEOVERS, AMPLIFIERS, MONO AMPLIFIERS AND STEREO AMPLIFIER; AUDIO INSTALLATION ACCESSORIES NAMELY, ELECTRICAL SPEAKER WIRES, POWER DISTRIBUTION BLOCKS, IN LINE FUSE HOLDERS, ELECTRICAL GOLD-PLATED AGU FUSES, ELECTRICAL GOLD ANL FUSES, BATTERY CLAMPS AND ADAPTERS, POWER CAPACITORS, PREMIUM INSTALL AND POWER KITS COMPRISING ELECTRICAL POWER WIRE, ELECTRICAL AUTOMOTIVE TIME CURRENT (ATC) FUSE HOLDER WITH FUSE, ELECTRICAL GOLD-PLATED CRAMP-ON RING TERMINALS, PLASTIC SPLIT-LOOM TUBING FOR COVERING ELECTRICAL WIRE, ELECTRICAL PRIMARY WIRE, OXYGEN FREE COPPER (OFC) SPEAKER WIRE, ELECTRICAL GOLD-PLATED OFC RCA CABLE, ELECTRICAL POWER DISTRIBUTOR FUSE BLOCK AND ELECTRICAL POWER DISTRIBUTION BLOCK; ELECTRICAL GOLD RING TERMINALS, ELECTRICAL SPADE TERMINALS, ELECTRICAL GOLD RING TERMINALS USED FOR THE INSTALLATION OF AUDIO EQUIPMENT, AND ELECTRICAL AUDIO CABLES AND ADAPTERS. (U.S. CLS. 21, 23, 26, 36 AND 38).

SN 78-136,715. NOBILIS SOFTWARE, INC., BOSTON, MA.
FILED 6-18-2002.

**THE PROCESS OF DOING
BUSINESS**

FOR COMPUTER SOFTWARE FOR APPLICATION AND DATABASE INTEGRATION, NAMELY, FOR BUSINESS PROCESS MANAGEMENT AND WORKFLOW MANAGEMENT (U.S. CLS. 21, 23, 26, 36 AND 38).

SN 78-137,268. SONASHI ELECTRONICS LTD., HUNGHOM,
KOWLOON, HONG KONG, FILED 6-20-2002.

CD STATION

NO CLAIM IS MADE TO THE EXCLUSIVE RIGHT TO USE "CD", APART FROM THE MARK AS SHOWN.
FOR RADIO WITH INTEGRATED CD PLAYER (U.S. CLS. 21, 23, 26, 36 AND 38).

CLASS 9—(Continued).

SN 78-137,816. RADO UHREN AG (RADO WATCH CO. LTD.)
(MONTRES RADO S.A.), LENGNAU, SWITZERLAND,
FILED 6-21-2002.

RADO

PRIORITY CLAIMED UNDER SEC. 44(D) ON SWITZERLAND APPLICATION NO. 05125/2002, FILED 6-7-2002, REG. NO. 500677, DATED 6-7-2002, EXPIRES 6-7-2012.

OWNER OF U.S. REG. NOS. 788,733, 1,729,207 AND OTHERS.

FOR EYEGLASSES, SUNGLASSES, MAGNIFYING GLASSES; CASES, FRAMES, AND CHAINS FOR EYEGLASSES AND SUNGLASSES (U.S. CLS. 21, 23, 26, 36 AND 38).

SN 78-141,339. AXIOM MICRODEVICES, INC., ORANGE,
CA. FILED 7-3-2002.

AXIOM

NO CLAIM IS MADE TO THE EXCLUSIVE RIGHT TO USE "MICRODEVICES", APART FROM THE MARK AS SHOWN.

FOR SEMICONDUCTORS CHIPS FOR USE IN CELLULAR TELEPHONES AND WIRELESS COMMUNICATIONS DEVICES (U.S. CLS. 21, 23, 26, 36 AND 38).

SN 78-141,342. AXIOM MICRODEVICES, INC., ORANGE,
CA. FILED 7-3-2002.

AXIOM MICRODEVICES

NO CLAIM IS MADE TO THE EXCLUSIVE RIGHT TO USE "MICRODEVICES", APART FROM THE MARK AS SHOWN.

FOR SEMICONDUCTOR CHIPS FOR USE IN CELLULAR TELEPHONES AND WIRELESS COMMUNICATIONS DEVICES (U.S. CLS. 21, 23, 26, 36 AND 38).

SN 78-142,204. SKYWORKS SOLUTIONS, INC., IRVINE, CA.
FILED 7-9-2002.

**BREAKTHROUGH
SIMPLICITY**

FOR RADIO FREQUENCY AND BASEBAND WIRELESS COMMUNICATIONS EQUIPMENT, NAMELY, POWER AMPLIFIERS, ATTENUATORS, COUPLERS, AMPLIFIERS, POWER CONDITIONERS, BASE BAND PROCESSORS, TRANSMITTERS, RECEIVERS, TRANSCIEVERS, DOWN CONVERTERS, RADIOS, MODULATORS, DEMODULATORS, POWER UNITS, CABLES, HANDSETS, TUNERS, BASE STATIONS, MULTIPLEXERS, SIGNAL COMPRESSORS, SWITCHES, ROUTERS, CONVERTERS, MILLIMETER WAVE SEMICONDUCTOR CONTROLLERS, MILLIMETER WAVE SEMICONDUCTOR MIXERS, FILTERS, ANTENNAS, SEMICONDUCTOR DEVICES, CHIPSETS, HARDWARE, SEMICONDUCTOR WAFERS AND SOFTWARE FOR USE IN OPERATING WIRELESS COMMUNICATIONS EQUIPMENT (U.S. CLS. 21, 23, 26, 36 AND 38).

CLASS 9—(Continued).

SN 78-142,622. KING SHOW GAMES, LLC, MINNETONKA, MN. FILED 7-10-2002.

SUPER SALLY'S SHRIMP MANIA

FOR GAMBLING AND GAMING MACHINES; SLOT MACHINES; INTERACTIVE VIDEO GAMES OF VIRTUAL REALITY COMPRISED OF COMPUTER HARDWARE AND SOFTWARE; COMPUTER SOFTWARE FOR USE IN GAMBLING AND GAMING MACHINES; VIDEO DISPLAY SCREENS (U.S. CLS. 21, 23, 26, 36 AND 38).

SN 78-143,377. HAMPTON AUTOBEAT, LLC, BLOOMFIELD HILLS, MI. FILED 7-12-2002.

autobeat *daily*

NO CLAIM IS MADE TO THE EXCLUSIVE RIGHT TO USE "DAILY", APART FROM THE MARK AS SHOWN.

FOR DOWNLOADABLE ELECTRONIC PUBLICATIONS IN THE NATURE OF DAILY NEWSLETTERS RELATING TO THE AUTOMOTIVE INDUSTRY (U.S. CLS. 21, 23, 26, 36 AND 38).

FIRST USE 10-12-2000; IN COMMERCE 10-16-2000.

SN 78-144,315. SCH BUSINESS SOLUTIONS L.L.C., HOUSTON, TX. FILED 7-16-2002.

DECISINSIGHT

FOR COMPUTER SOFTWARE FOR APPLICATION AND DATABASE INTEGRATION (U.S. CLS. 21, 23, 26, 36 AND 38).

SN 78-144,574. PUBLIC BROADCASTING SERVICE, ALEXANDRIA, VA. FILED 7-17-2002.

BE MORE

FOR PRE-RECORDED VIDEOCASSETTES, VIDEO DISCS, DIGITAL VIDEO DISCS, CD-ROMS, AUDIO CASSETTES, AUDIO COMPACT DISCS, AND COMPUTER GAME PROGRAMS AND MULTIMEDIA SOFTWARE FEATURING A WIDE RANGE OF CULTURAL, EDUCATIONAL AND ENTERTAINMENT TOPICS AND FOR PLAYING GAMES AND ACTIVITIES. (U.S. CLS. 21, 23, 26, 36 AND 38).

CLASS 9—(Continued).

SN 78-147,765. BRIGHAM & ASSOCIATES, INC., PALM HARBOR, FL. FILED 7-26-2002.

NEW ATLAS PQ

FOR COMPUTER PROGRAMS FOR MONITORING THE QUALITY OF MEDICAL INSTRUMENTS, MEDICAL DEVICES AND PHARMACEUTICAL PRODUCTS (U.S. CLS. 21, 23, 26, 36 AND 38).

SN 78-148,828. PARROTT, JAMES R., TAMPA, FL. FILED 7-30-2002.

Flash Tax

NO CLAIM IS MADE TO THE EXCLUSIVE RIGHT TO USE "TAX", APART FROM THE MARK AS SHOWN.

NO STIPPLING OR SHADING IS INTENDED ON THE MARK. THE MARK IS MERELY THE WORDS "FLASH TAX" WITH A LIGHTNING BOLT BETWEEN THE TWO WORDS.

FOR COMPUTER SOFTWARE FOR ACCOUNTING PURPOSES (U.S. CLS. 21, 23, 26, 36 AND 38).

FIRST USE 4-24-2002; IN COMMERCE 5-12-2002.

SN 78-149,547. MACROSYSTEM US INC., BOULDER, CO. FILED 7-31-2002.

Casablanca PRESTIGE

OWNER OF U.S. REG. NOS. 2,352,235 AND 2,563,855.

FOR VIDEO EDITORS AND VIDEO RECORDERS FOR EDITING AND CREATING VIDEO TAPES, DIGITAL VERSATILE DISKS (DVDS), AND MULTIMEDIA PRESENTATIONS (U.S. CLS. 21, 23, 26, 36 AND 38).

SN 78-151,232. TOKENWORKS INC., WILMINGTON, DE. FILED 8-6-2002.

CARDDB

FOR MAGNETIC CODED CARDS READERS; ENCODED ELECTRONIC CHIP CARD AND SMARTCARD READERS AND SMARTCARD WRITERS CONTAINING PROGRAMMING NECESSARY TO INTERFACE CARDS AND ASSOCIATED READERS AND/OR WRITERS; COMPUTER SOFTWARE FOR USE IN OPERATING MAGNETIC CARD READERS, SMARTCARD READERS, MAGNETIC CODED CARD ENCODERS, AND SMARTCARD WRITERS (U.S. CLS. 21, 23, 26, 36 AND 38).

CLASS 9—(Continued).

SN 78-153,234. PIXOLOGY LIMITED, SURREY RESEARCH PARK, UNITED KINGDOM, FILED 8-12-2002.

PIXOLOGY IRISS

OWNER OF U.S. REG. NO. 2,676,026.
FOR COMPUTER SOFTWARE FOR USE DIGITAL PHOTOGRAPHY (U.S. CLS. 21, 23, 26, 36 AND 38).

SN 78-153,319. TARARI, INC., SAN DIEGO, CA. FILED 8-12-2002.



FOR SOFTWARE, FIRMWARE AND ELECTRONIC CIRCUITRY THAT PERFORMS THE FOLLOWING FUNCTIONS: XML CONTENT PROCESSING, SSL PROCESSING, RSA PUBLIC KEY PROCESSING, CONTENT ENCRYPTION/DECRYPTION PROCESSING, RANDOM NUMBER AND PSEUDO-RANDOM NUMBER GENERATION, ANTI-VIRUS PROCESSING, FIREWALL PROCESSING, INTRUSION DETECTION PROCESSING, LAYER 4/7 CONTENT PROCESSING, DATA ENCODING, DATA DECODING, DATA COMPRESSION, DATA DECOMPRESSION, TEXT PARSING PROCESSING, AND DATA PATTERN MATCHING PROCESSING THROUGH APPLICATION SPECIFIC CIRCUITRY, INCLUDING THE DEVELOPMENT OF BOARDS, AGENTS, AND SILICON IMPLEMENTATIONS OF THE AGENTS (U.S. CLS. 21, 23, 26, 36 AND 38).

SN 78-154,118. BARCHAS, SARAH, DBA HIGH HAVEN MUSIC, SONOITA, AZ. FILED 8-14-2002.



NO CLAIM IS MADE TO THE EXCLUSIVE RIGHT TO USE "MUSIC", APART FROM THE MARK AS SHOWN.
FOR PRE-RECORDED COMPACT DISCS AND AUDIO TAPES AND BOOKS SOLD AS A UNIT FEATURING MUSIC, AS WELL AS POETRY, STORYTELLING, LYRICS AND TEACHING MATERIALS IN THE FIELDS OF MULTI-CULTURAL AWARENESS AND LANGUAGE ARTS, INCORPORATING MUSICAL THEMES AND INSTRUMENTAL MUSIC (U.S. CLS. 21, 23, 26, 36 AND 38).
FIRST USE 6-22-1980; IN COMMERCE 6-22-1980.

CLASS 9—(Continued).

SN 78-154,140. ADVANCED DIGITAL CHIPS, INC., SEOUL, REPUBLIC OF KOREA, FILED 8-14-2002.



FOR MICROPROCESSORS, CENTRAL PROCESSOR UNITS, INTEGRATED CIRCUITS (U.S. CLS. 21, 23, 26, 36 AND 38).

SN 78-154,229. PEARSON MEDICAL TECHNOLOGIES, LLC, ALEXANDRIA, LA. FILED 8-14-2002.

M:PRINT

FOR COMPUTER SOFTWARE FOR PRINTING BAR CODE LABELS (U.S. CLS. 21, 23, 26, 36 AND 38).
FIRST USE 8-5-2002; IN COMMERCE 8-5-2002.

SN 78-154,249. MANAGEMENT SIMULATIONS, INC., NORTHFIELD, IL. FILED 8-14-2002.

FOUNDATION FOOTRACE

FOR COMPUTER INSTRUCTIONAL SOFTWARE IN THE FIELD OF BUSINESS EDUCATION (U.S. CLS. 21, 23, 26, 36 AND 38).

SN 78-154,890. ACCURATE TECHNOLOGY, INC, FLETCHER, NC. FILED 8-16-2002.

DIGI-SCALE

FOR LINEAR MEASURING SYSTEM, COMPRISED OF A SCALE, ENCODER AND LED OR LIQUID CRYSTAL DISPLAY (U.S. CLS. 21, 23, 26, 36 AND 38).

SN 78-156,691. PITTENGER, ROBERT, CINCINNATI, OH. FILED 8-22-2002.

COMPLIANCE NAVIGATOR

NO CLAIM IS MADE TO THE EXCLUSIVE RIGHT TO USE "COMPLIANCE", APART FROM THE MARK AS SHOWN.
FOR COMPUTER SOFTWARE FOR REGULATORY COMPLIANCE MANAGEMENT IN THE FIELDS OF MANUFACTURING, ENVIRONMENTAL AND SAFETY COMPLIANCE, FINANCE, INSURANCE AND FINANCIAL AUDITING (U.S. CLS. 21, 23, 26, 36 AND 38).
FIRST USE 8-21-2002; IN COMMERCE 8-21-2002.

CLASS 9—(Continued).

SN 78-157,837. TECHSONIC INDUSTRIES, INC., EUFAULA, AL. FILED 8-26-2002.

HUMMINBIRD SPYCAST

OWNER OF U.S. REG. NOS. 1,200,317, 1,509,336 AND OTHERS.

FOR MARINE ELECTRONIC APPARATUS, NAMELY, MARINE SONAR DEPTH FINDER AND FISH FINDER (U.S. CLS. 21, 23, 26, 36 AND 38).

SN 78-157,843. TECHSONIC INDUSTRIES, INC., EUFAULA, AL. FILED 8-26-2002.

SMARTCAST

FOR MARINE ELECTRONIC APPARATUS, NAMELY, MARINE SONAR DEPTH FINDER AND FISH FINDER (U.S. CLS. 21, 23, 26, 36 AND 38).

SN 78-158,157. WORDCRAFT INTERNATIONAL LTD., EG-GINTON, UNITED KINGDOM, FILED 8-27-2002.

THE NEWWWS

FOR COMPUTER SOFTWARE; COMPUTER SOFTWARE FOR MONITORING WEB SITES; COMPUTER SOFTWARE FOR PERIODICALLY CHECKING SELECTED WEB SITES AND REPORTING CHANGES IN CONTENT (U.S. CLS. 21, 23, 26, 36 AND 38).

SN 78-158,206. BANDAI CO., LTD., TOKYO, JAPAN, FILED 8-27-2002.

GASHAPON

OWNER OF JAPAN REG. NO. 4497939, DATED 8-10-2001, EXPIRES 8-10-2011.

FOR STAND ALONE COIN OPERATED VENDING MACHINE THAT RANDOMLY SELECTS A PRIZE; AUTOMATIC AND COIN OPERATED VENDING MACHINES, NAMELY MACHINES FOR DISPENSING TOYS ENCLOSED IN PLASTIC CAPSULES (U.S. CLS. 21, 23, 26, 36 AND 38).

CLASS 9—(Continued).

SN 78-158,525. DC COMICS, NEW YORK, NY. FILED 8-28-2002.

BATMAN: MYSTERY OF THE BATWOMAN

OWNER OF U.S. REG. NOS. 1,587,507, 1,652,640 AND 2,457,655.

FOR MOTION PICTURE FILMS FEATURING COMEDY, DRAMA, ACTION, ADVENTURE AND/OR ANIMATION, AND MOTION PICTURE FILMS FOR BROADCAST ON TELEVISION FEATURING COMEDY, DRAMA, ACTION, ADVENTURE AND/OR ANIMATION; PRERECORDED VINYL RECORDS, AUDIO TAPES, AUDIO-VIDEO TAPES, AUDIO VIDEO CASSETTES, AUDIO VIDEO DISCS, AND DIGITAL VERSATILE DISCS FEATURING MUSIC, COMEDY, DRAMA, ACTION, ADVENTURE, AND/OR ANIMATION; STEREO HEADPHONES; BATTERIES; CORDLESS TELEPHONES; HAND-HELD CALCULATORS; AUDIO CASSETTE AND CD PLAYERS; CD ROM COMPUTER GAME DISCS; HAND-HELD KARAOKE PLAYERS, TELEPHONE AND/OR RADIO PAGERS; SHORT MOTION PICTURE FILM CASSETTES FEATURING COMEDY, DRAMA, ACTION, ADVENTURE AND/OR ANIMATION TO BE USED WITH HAND-HELD VIEWERS OR PROJECTORS; VIDEO CASSETTE RECORDERS AND PLAYERS, COMPACT DISC PLAYERS, DIGITAL AUDIO TAPE RECORDERS AND PLAYERS, ELECTRONIC DIARIES; RADIOS; MOUSE PADS; EYEGLASSES, SUNGLASSES AND CASES THEREFORE; AUDIO TAPES AND BOOKLETS SOLD AS A UNIT FEATURING COMEDY, DRAMA, ACTION, ADVENTURE, ANIMATION AND MUSIC INFORMATION; COMPUTER PROGRAMS, NAMELY, SOFTWARE LINKING DIGITIZED VIDEO AND AUDIO MEDIA TO A GLOBAL COMPUTER INFORMATION NETWORK; GAME EQUIPMENT SOLD AS A UNIT FOR PLAYING A PARLOR-TYPE COMPUTER GAME; VIDEO AND COMPUTER GAME PROGRAMS; VIDEO GAME CARTRIDGES AND CASSETTES; CELLULAR TELEPHONE ACCESSORIES, NAMELY HANDS-FREE ACCESSORIES, CELLULAR TELEPHONE COVERS AND CELLULAR TELEPHONE FACE COVERS; ENCODED MAGNETIC CARDS, NAMELY, PHONE CARDS, CREDIT CARDS, CASH CARDS, DEBIT CARDS AND MAGNETIC KEY CARDS; AND DECORATIVE MAGNETS (U.S. CLS. 21, 23, 26, 36 AND 38).

SN 78-159,005. STOCKMAN, SHAWN, BEVERLY HILLS, CA. FILED 8-28-2002.

SOUL CHEMISTRY

NO CLAIM IS MADE TO THE EXCLUSIVE RIGHT TO USE "SOUL", APART FROM THE MARK AS SHOWN.

FOR A SERIES OF MUSICAL SOUND RECORDINGS (U.S. CLS. 21, 23, 26, 36 AND 38).

SN 78-159,680. CONTROL COMPONENTS, INC., RANCHO SANTA MARGARITA, CA. FILED 8-30-2002.

VALSIZ

FOR COMPUTER SOFTWARE FOR SELECTING AND EVALUATING THE SUITABILITY OF A VALVE IN AN INDUSTRIAL APPLICATION, AND CORRESPONDING SERVICE CONDITIONS (U.S. CLS. 21, 23, 26, 36 AND 38). FIRST USE 12-31-1985; IN COMMERCE 12-31-1985.

CLASS 9—(Continued).

SN 78-162,246. CYBERLINK CORP., HSIN TIEN CITY, TAIPEI HSIEN, TAIWAN, FILED 9-9-2002.



FOR COMPUTER SOFTWARE FOR AUDIO AND VIDEO PRODUCING, PLAYING AND RECORDING; OPTICAL DISCS AND MAGNETIC DISCS RECORDED WITH COMPUTER PROGRAMS FOR USE IN EDITING AUDIO AND VIDEO (U.S. CLS. 21, 23, 26, 36 AND 38).

SN 78-163,854. DYNISCO, LLC, FRANKLIN, MA. FILED 9-13-2002.

DYMAX

FOR PRESSURE MEASURING DEVICES, NAMELY, PRESSURE TRANSDUCERS FOR USE IN THE PLASTICS INDUSTRY (U.S. CLS. 21, 23, 26, 36 AND 38).

SN 78-163,981. INTERGGS, INC., DBA VERSADIAL SOLUTIONS, MISSION VIEJO, CA. FILED 9-13-2002.

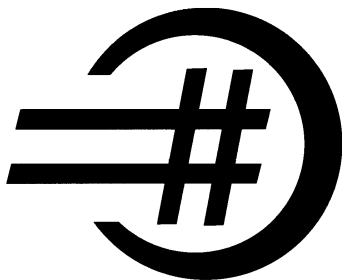

FOR COMPUTER SOFTWARE FOR TELEPHONE CALL LOGGING AND COMPUTER SOFTWARE FOR USE IN DIGITAL VOICE RECORDING (U.S. CLS. 21, 23, 26, 36 AND 38).
FIRST USE 2-14-2002; IN COMMERCE 2-14-2002.

SN 78-164,290. OPENSERVICE, INC., WESTBOROUGH, MA. FILED 9-16-2002.

PACKETWATCH

FOR COMPUTER SOFTWARE FOR MANAGING SERVERS, DEVICES AND APPLICATIONS ON A NETWORK, AND MONITORING NETWORK QUALITY; AND TECHNICAL AND INSTRUCTIONAL MANUALS SUPPLIED THEREWITH (U.S. CLS. 21, 23, 26, 36 AND 38).

CLASS 9—(Continued).

SN 78-165,992. DISCOVERY COMMUNICATIONS, INC., BETHESDA, MD. FILED 9-19-2002.

OPERATION JUNKYARD

FOR PRE-RECORDED AUDIO, VIDEO, COMPACT DISC, DVD AND CD-ROM RECORDINGS FEATURING AN ON-GOING TELEVISION PROGRAM IN THE FIELD OF SCIENCE AND TECHNOLOGY, AND COMPETITIONS RELATED THERETO; MOTION PICTURE FILMS RELATED TO AN ON-GOING TELEVISION PROGRAM IN THE FIELD OF SCIENCE AND TECHNOLOGY, AND COMPETITIONS RELATED THERETO; SUNGLASSES, CELLULAR PHONE FACEPLATES, COMPUTER ACCESSORIES, NAMELY, CD-ROM CASES AND MOUSE PADS, MAGNETS, ELECTRONIC PUBLICATIONS, NAMELY, TECHNOLOGY, AND COMPETITIONS RELATED THERETO, ELECTRIC SWITCH PLATES (U.S. CLS. 21, 23, 26, 36 AND 38).

SN 78-166,074. ANDERSON, WILLIAM J., OJAI, CA. FILED 9-19-2002.



FOR COMPUTER HARDWARE AND RELATED COMPUTER SOFTWARE FOR USE IN MONITORING RIG PERFORMANCE PARAMETERS, INCLUDING-HOOK LOAD, WEIGHT ON BIT, PENETRATION RATE, ROTARY RPM, ROTARY TORQUE, PIT VOLUME, RETURN FLOW AND RELATED PARAMETERS, DURING THE OIL, GAS AND GEOTHERMAL DRILLING PROCESS (U.S. CLS. 21, 23, 26, 36 AND 38).

SN 78-166,755. MICRO DISTRIBUTORS, INC., PEORIA, IL. FILED 9-23-2002.

THREE 7 TURBO

NO CLAIM IS MADE TO THE EXCLUSIVE RIGHT TO USE "TURBO", APART FROM THE MARK AS SHOWN.
FOR PRINTED COMPUTER CIRCUIT BOARDS FOR VIDEO GAMES (U.S. CLS. 21, 23, 26, 36 AND 38).

SN 78-167,118. MACHEREY, NAGEL & CO. HANDELSGESELLSCHAFT, DUEREN, FED REP GERMANY, FILED 9-24-2002.

PROTINO

FOR KITS AND SEPARATION SYSTEMS, NAMELY COLUMNS FOR THE PURIFICATION OF PROTEINS, IN PARTICULAR PROVIDED WITH DIFFERENT INTEGRATED FILTERS (U.S. CLS. 21, 23, 26, 36 AND 38).

CLASS 9—(Continued).

SN 78-168,426. ATRENTA INC., SAN JOSE, CA. FILED 9-26-2002.

ACTIVESPEC

FOR COMPUTER SOFTWARE TO IMPROVE SEMICONDUCTOR DESIGN (U.S. CLS. 21, 23, 26, 36 AND 38).

SN 78-168,695. MEDISERVE INFORMATION SYSTEMS, INC., TEMPE, AZ. FILED 9-27-2002.

MEDILINKS

FOR CLINICAL INFORMATION SYSTEMS SOFTWARE FOR USE BY HEALTHCARE ORGANIZATIONS TO ENTER AND MANAGE PHYSICIAN ORDERS, MANAGE CLINICAL DOCUMENTATION, PERFORM OUTCOME ANALYSIS AND REPORTING, PERFORM DECISION SUPPORT, PERFORM PATIENT CHARTING AND CAPTURE CHARGES FOR USE IN THE HEALTHCARE INDUSTRY (U.S. CLS. 21, 23, 26, 36 AND 38).
FIRST USE 7-1-1997; IN COMMERCE 7-1-1997.

SN 78-171,860. INTERNATIONAL FUND ADMINISTRATION, INC., NEW YORK, NY. FILED 10-7-2002.

PRAEEO

THE FOREIGN WORDING IN THE MARK TRANSLATES INTO ENGLISH AS "TO LEAD THE WAY".

FOR COMPUTER SOFTWARE FOR USE BY HEDGE FUND MANAGERS AND OTHER INVESTMENT MANAGERS TO SUPPORT ADMINISTRATIVE AND ACCOUNTING REQUIREMENTS, NAMELY CAPITAL AND SHARE BASED ACCOUNTING, FULLY INTEGRATED WEBSITES FOR CLIENTS, INVESTORS AND SERVICE PROVIDERS, INTEGRATED COMPLIANCE MODULES, CALCULATION AND REPORTING OF INVESTOR CAPITAL/SHARE VALUES, RECORDKEEPING AND REPORTING OF INVESTOR ACTIVITY, AND ELECTRONIC DOCUMENT STORAGE AND RETRIEVAL (U.S. CLS. 21, 23, 26, 36 AND 38).

SN 78-172,518. EXPOCHARGER INTERNATIONAL, INC., HOLLISTON, MA. FILED 10-9-2002.

EXPOCHARGER

FOR DOWNLOADABLE COMPUTER SOFTWARE APPLICATIONS FOR POSTING, EDITING AND MAINTAINING DATA FOR CONDUCTING ONLINE TRADESHOW EXHIBITIONS (U.S. CLS. 21, 23, 26, 36 AND 38).

FIRST USE 3-4-2002; IN COMMERCE 4-15-2002.

CLASS 9—(Continued).

SN 78-173,171. MOTOROLA, INC., SCHAUMBURG, IL. FILED 10-10-2002.

ALTIVEC

FOR COMPUTER OPERATING PROGRAMS; COMPUTER APPLICATION SOFTWARE, NAMELY, COMPUTER SOFTWARE FOR USE IN APPLICATIONS FOR MULTIMEDIA, GRAPHICS VIDEO, AUDIO AND NUMERICALLY INTENSIVE COMPUTATIONS; COMPUTER HARDWARE; INTEGRATED CIRCUITS; SEMICONDUCTOR PROCESSORS; COMPUTER HARDWARE AND SOFTWARE FOR DEVELOPMENT, TESTING PROGRAMMING AND PRODUCTION OF ALL OF THE FOREGOING. (U.S. CLS. 21, 23, 26, 36 AND 38).

SN 78-173,534. AK2 LLC, WHEATON, IL. FILED 10-11-2002.

AK²

THE MARK CONSISTS OF LETTERS AND NUMBER IN PLAIN BLOCK FORMAT AND NOT INTENDED OR CLAIMING ANY STYLIZED OR DESIGN FORMAT.

FOR MOTION PICTURE FILMS FEATURING ANIMATION; PRERECORDED VIDEO TAPES, CASSETTES, COMPACT DISCS, LASER DISCS, LASER DISCS, DVD-ROMS, CD-ROMS, ALL FEATURING CHILDREN'S ANIMATED MOTION PICTURE FILMS AND TELEVISION PROGRAMS; INTERACTIVE MULTIMEDIA VIDEO AND COMPUTER GAME SOFTWARE, PROGRAMS, CARTRIDGES, CASSETTES, DISCS, CD-ROMS, DVD DISCS, DVD-ROMS AND TAPES (U.S. CLS. 21, 23, 26, 36 AND 38).

CLASS 9—(Continued).

SN 78-175,331. MNEMONICS, INC., MOUNT LAUREL, NJ. FILED 10-17-2002.

NEEDLE IN A HAYSTACK

FOR MACHINE VISION SOFTWARE/HARDWARE THAT FINDS SMALL IMAGE DEFECTS IN LARGE IMAGE OBJECTS; SPECIFICALLY, IT IS USED FOR LOCALIZING OR FINDING SMALL OBJECTS, DEFECTS, OR ANOMALIES WITHIN A LARGER OBJECT OR FIELD OF VIEW; FOR USE IN A VARIETY OF INDUSTRIES AND APPLICATIONS INCLUDING BUT NOT LIMITED TO - DEFECT DETECTION IN SEMICONDUCTOR AND ELECTRONIC DEVICE MANUFACTURING, QUALITY CONTROL OF PRINTED DOCUMENTS, INSPECTION OF PHARMACEUTICAL MATERIALS, SATELLITE IMAGE COMPARISON, ANOMALY DETECTION IN RADIOGRAPHS AND TOMOGRAPHY SCANS, DEFECT DETECTION IN MANUFACTURED CONSUMER GOODS (U.S. CLS. 21, 23, 26, 36 AND 38).

SN 78-175,354. SCHNEIDER CORPORATION, THE, INDIANAPOLIS, IN. FILED 10-17-2002.

VERACITY

FOR COMPUTER SOFTWARE USED TO MAKE THREE-DIMENSIONAL EMBODIMENTS OF DESIGNS (U.S. CLS. 21, 23, 26, 36 AND 38).

SN 78-176,259. MAUCH, LARRY, A., LIVERMORE, CA. FILED 10-19-2002.

PLANNED PERFORMANCE

FOR LOGISTICAL PLANNING COMPUTER SOFTWARE FOR MANUFACTURING AND SUPPLY BASE MANAGEMENT (U.S. CLS. 21, 23, 26, 36 AND 38). FIRST USE 2-1-2002; IN COMMERCE 3-1-2002.

SN 78-176,292. CARRUTHERS, ELLIOT STEVEN, HUNTINGTON, NY. FILED 10-19-2002.

CHUZZLES

FOR COMPUTER GAME SOFTWARE FEATURING INTERACTIVE CHESS PUZZLES FOR ENTERTAINMENT PURPOSES. (U.S. CLS. 21, 23, 26, 36 AND 38).

CLASS 9—(Continued).

SN 78-176,512. THELONIOUS MUSIC CORP, NEW YORK, NY. FILED 10-21-2002.

THELONIOUS MONK

OWNER OF U.S. REG. NO. 2,327,760.
THE NAME SHOWN IN THE MARK DOES NOT IDENTIFY A PARTICULAR LIVING INDIVIDUAL.
FOR CDS, AUDIO CASSETTES, DVDS, VHS VIDEOTAPES, LP RECORDS, ALL CONTAINING PRE-RECORDED MUSIC (U.S. CLS. 21, 23, 26, 36 AND 38).
FIRST USE 3-1-1941; IN COMMERCE 0-0-1945.

SN 78-176,522. THELONIOUS MUSIC CORP, NEW YORK, NY. FILED 10-21-2002.

THELONIOUS RECORDS

OWNER OF U.S. REG. NO. 2,327,760.
NO CLAIM IS MADE TO THE EXCLUSIVE RIGHT TO USE "RECORDS", APART FROM THE MARK AS SHOWN.
THE LIKENESS (OR, "PORTRAIT") IN THE MARK DOES NOT IDENTIFY A LIVING INDIVIDUAL.
FOR CDS, AUDIO CASSETTES, DVDS, VHS VIDEOTAPES, LP RECORDS, ALL CONTAINING PRE-RECORDED MUSIC (U.S. CLS. 21, 23, 26, 36 AND 38).
FIRST USE 0-0-2001; IN COMMERCE 0-0-2001.

SN 78-177,063. TAXTIME USA, INC., BINGHAM FARMS, MI. FILED 10-22-2002.

MICHIGAN SALES TAX EXPRESS

NO CLAIM IS MADE TO THE EXCLUSIVE RIGHT TO USE "MICHIGAN SALES TAX", APART FROM THE MARK AS SHOWN.
FOR COMPUTER SOFTWARE FOR USE IN THE FIELD OF ACCOUNTING FOR COMPUTING AND ANALYZING STATE'S SALES TAX AND PREPARATION OF ASSOCIATED DOCUMENTS (U.S. CLS. 21, 23, 26, 36 AND 38).

SN 78-178,096. DIGITAL SCOUT, INC., COLUMBUS, OH. FILED 10-24-2002.

SCOUTWARE

OWNER OF U.S. REG. NOS. 32,925, 32,927 AND 1,978,277.
FOR COMPUTER SOFTWARE PROGRAMS FOR REPORTING, RECORDING, AND ANALYZING SPORTS DATA. (U.S. CLS. 21, 23, 26, 36 AND 38).

CLASS 9—(Continued).

SN 78-178,830. SOLARTECH INC, HARRISON TOWNSHIP, MI. FILED 10-27-2002.

SOLARMETER

SEC. 2(F).
FOR TEST AND MEASUREMENT LIGHT METERS, NAMELY ULTRAVIOLET RADIOMETERS (U.S. CLS. 21, 23, 26, 36 AND 38).
FIRST USE 12-18-1990; IN COMMERCE 8-21-1991.

SN 78-178,881. MURPHY INDUSTRIES, INC., TULSA, OK. FILED 10-28-2002.

GAGEMITTER

OWNER OF U.S. REG. NOS. 747,377 AND 1,308,708.
FOR MECHANICAL PRESSURE GAUGES WITH INTERNAL ELECTRONIC TRANSMITTER THAT PROVIDES AN ELECTRONIC OUTPUT CORRESPONDING TO PRESSURE (U.S. CLS. 21, 23, 26, 36 AND 38).

SN 78-178,908. LEXMARK INTERNATIONAL, INC., LEXINGTON, KY. FILED 10-28-2002.

PRINTCRYPTION

FOR LASER PRINTERS; PRINTED CIRCUIT BOARDS FOR USE IN CONNECTION WITH LASER PRINTERS; SOFTWARE FOR USE IN DATA ENCRYPTION AND DECRYPTION IN THE FIELD OF PRINTING (U.S. CLS. 21, 23, 26, 36 AND 38).

SN 78-178,944. NETWORK EXECUTIVE SOFTWARE, INC., MAPLE GROVE, MN. FILED 10-28-2002.

USER-ACCESS

FOR COMPUTER SOFTWARE THAT FACILITATES FILE TRANSFER (U.S. CLS. 21, 23, 26, 36 AND 38).
FIRST USE 12-1-1986; IN COMMERCE 12-1-1986.

SN 78-178,948. NETWORK EXECUTIVE SOFTWARE, INC., MAPLE GROVE, MN. FILED 10-28-2002.

HYPERCHANNEL

FOR COMPUTER SOFTWARE FOR PROVIDING HIGH-SPEED TRANSFER OF DIGITAL DATA BETWEEN COMPUTERS AND PERIPHERAL EQUIPMENT (U.S. CLS. 21, 23, 26, 36 AND 38).
FIRST USE 12-31-1976; IN COMMERCE 3-28-1980.

CLASS 9—(Continued).

SN 78-180,064. STAR 69 ENTERTAINMENT, LTD., NEW YORK, NY. FILED 10-30-2002.

LIVE @ ROXY

FOR PRE-RECORDED PHONOGRAPH RECORDS AND COMPACT DISCS FEATURING MUSIC (U.S. CLS. 21, 23, 26, 36 AND 38).

SN 78-180,068. STAR 69 ENTERTAINMENT, LTD., NEW YORK, NY. FILED 10-30-2002.

LIVE AT ROXY

FOR PRE-RECORDED PHONOGRAPH RECORDS AND COMPACT DISCS FEATURING MUSIC (U.S. CLS. 21, 23, 26, 36 AND 38).

SN 78-180,079. NYE LUBRICANTS, INC., FAIRHAVEN, MA. FILED 10-30-2002.

SMART GEL

NO CLAIM IS MADE TO THE EXCLUSIVE RIGHT TO USE "GEL", APART FROM THE MARK AS SHOWN.
FOR VISCOELASTIC OPTICAL COUPLANT FOR OPTOELECTRONIC DEVICES, NAMELY FIBER OPTIC CABLES (U.S. CLS. 21, 23, 26, 36 AND 38).

SN 78-180,420. THOMAS SWAN SCIENTIFIC EQUIPMENT LTD., CAMBRIDGE, UNITED KINGDOM, FILED 10-31-2002.

EPILAB

FOR CHEMICAL VAPOUR DEPOSITION REACTORS FOR MANUFACTURING SEMI- AND SUPER-CONDUCTORS (U.S. CLS. 21, 23, 26, 36 AND 38).

SN 78-180,553. SPRAYING SYSTEMS COMPANY, WHEATON, IL. FILED 10-31-2002.

SPRAYWARE

FOR SOFTWARE FOR DETERMINING OPTIMAL SPRAY NOZZLES AND ACCESSORY REQUIREMENTS FOR SPRAY APPLICATIONS AND ALLOWING SUBSEQUENT ORDERING OF THE SELECTED SPRAY NOZZLES AND ACCESSORIES OVER A GLOBAL COMPUTER NETWORK. (U.S. CLS. 21, 23, 26, 36 AND 38).

CLASS 9—(Continued).

SN 78-180,569. SPRAYING SYSTEMS COMPANY, WHEATON, IL. FILED 10-31-2002.

NOZZLEWARE

FOR SOFTWARE FOR DETERMINING OPTIMAL SPRAY NOZZLES AND ACCESSORY REQUIREMENTS FOR SPRAY APPLICATIONS AND ALLOWING SUBSEQUENT ORDERING OF THE SELECTED SPRAY NOZZLES AND ACCESSORIES OVER A GLOBAL COMPUTER NETWORK (U.S. CLS. 21, 23, 26, 36 AND 38).

SN 78-180,620. IOWA STUDENT LOAN LIQUIDITY CORPORATION, WEST DES MOINES, IA. FILED 10-31-2002.

ISBS

FOR WEB-BASED SOFTWARE THAT ALLOWS SCHOOLS TO TRANSMIT LOAN APPLICATION FILES TO ANY LOCATION. (U.S. CLS. 21, 23, 26, 36 AND 38).

SN 78-180,639. SPIELO MANUFACTURING INCORPORATED, MONCTON NEW BRUNSWICK, CANADA, FILED 10-31-2002.

CHOP SOOEY

FOR RECONFIGURABLE CASINO AND LOTTERY GAMING EQUIPMENT, NAMELY, SLOT MACHINES AND OPERATIONAL COMPUTER GAME SOFTWARE THEREFOR. (U.S. CLS. 21, 23, 26, 36 AND 38).

SN 78-180,674. LUMIDIGM, INC., ALBUQUERQUE, NM. FILED 10-31-2002.

LUMIDIGM

FOR SPECTRAL SENSORS (U.S. CLS. 21, 23, 26, 36 AND 38).

SN 78-180,677. LUMIDIGM, INC., ALBUQUERQUE, NM. FILED 10-31-2002.

LIGHTPRINT

FOR SPECTRAL SENSORS (U.S. CLS. 21, 23, 26, 36 AND 38).

CLASS 9—(Continued).

SN 78-182,053. TELEDEX LLC, SAN JOSE, CA. FILED 11-5-2002.

EXPRESSNET

FOR INTEGRATED HARDWARE COMPONENTS THAT PROVIDE HIGH-SPEED INTERNET ACCESS TO THE GUESTROOMS OF HOTELS, MOTELS AND OTHER SIMILAR LODGING PROPERTIES, NAMELY, NETWORK SWITCHES, CONCENTRATORS, SERVERS AND SIGNAL ADAPTORS (U.S. CLS. 21, 23, 26, 36 AND 38).

SN 78-182,527. ATOMIC OBJECT, GRAND RAPIDS, MI. FILED 11-6-2002.

ALIVE

FOR COMPUTER SOFTWARE FOR WEB SERVERS WHICH ALLOWS WEBSITE UPDATES TO BE DONE DIRECTLY FROM ANY WEB BROWSER ON ANY DEVICE ON THE GLOBAL COMPUTER NETWORK. (U.S. CLS. 21, 23, 26, 36 AND 38).

SN 78-182,959. AMERICAN ADVANCED POWER INC., FALL RIVER, MA. FILED 11-7-2002.

JUTX

FOR POWER SUPPLIES; POWER PROTECTION DEVICES, NAMELY, VOLTAGE SURGE PROTECTORS, UNDER-VOLTAGE PROTECTORS AND UNINTERRUPTIBLE POWER SUPPLIES FOR ELECTRONIC EQUIPMENT AND COMPUTERS; COMPUTER SOFTWARE PROGRAMS FOR USE WITH POWER PROTECTION DEVICES FOR MONITORING AND AUTOMATIC SHUTDOWN OF COMPUTER SYSTEMS; MOUNTING RACK ENCLOSURES SPECIALLY DESIGNED FOR STORING COMPUTER AND POWER PROTECTION EQUIPMENT AND ACCESSORIES; COMPUTER KEYBOARDS LASER POINTERS; COMPUTER MOUSE; COMPUTER HOUSINGS AND CASINGS; COMPUTER PROCESSORS; COMPUTER DISK DRIVES; VIDEO CASSETTE RECORDERS; LASER DISK PLAYERS; AUDIO SPEAKERS; ELECTRICAL SLOT GAME MACHINES; ELECTRICAL WIRES FOR COMPUTERS; LAMP VOLTAGE SURGE SUPPRESSORS; THERMOSTATS; VOLTAGE REGULATORS FOR VEHICLES; BATTERIES; RECHARGEABLE BATTERIES; COMPUTER LIGHT EMITTING DIODE DISPLAYS AND LIQUID CRYSTAL DISPLAYS (U.S. CLS. 21, 23, 26, 36 AND 38).

FIRST USE 11-0-1999; IN COMMERCE 11-0-1999.

SN 78-183,385. HARVEY, TIMOTHY, JOHN, TEMECULA, CA. FILED 11-8-2002.

USBEE LX

FOR ELECTRONIC POD THAT CONNECTS TO A COMPUTER OPERATING SYSTEM COMPATIBLE PC AND PROVIDES ELECTRONIC TEST EQUIPMENT FUNCTIONALITY (U.S. CLS. 21, 23, 26, 36 AND 38).

FIRST USE 5-1-2002; IN COMMERCE 5-1-2002.

CLASS 9—(Continued).

SN 78-183,668. ALDRICH, CLINTON, L, BROOKLYN, NY.
FILED 11-11-2002.

SWITCH WIZARD

NO CLAIM IS MADE TO THE EXCLUSIVE RIGHT TO USE "SWITCH", APART FROM THE MARK AS SHOWN.

FOR MEASURING AND TESTING DEVICES, NAMELY, TOOLS FOR TESTING AND CALIBRATING VACUUM AND PRESSURE CONTROL SWITCHES (U.S. CLS. 21, 23, 26, 36 AND 38).

SN 78-184,017. AZEOTECH, INC., ASHLAND, OR. FILED 11-12-2002.

AZEOTECH

FOR SOFTWARE FOR OBTAINING, ANALYZING, LOGGING, PROCESSING AND CONTROLLING INFORMATION FROM HARDWARE DEVICES (U.S. CLS. 21, 23, 26, 36 AND 38).

FIRST USE 4-29-2001; IN COMMERCE 12-14-2001.

SN 78-184,493. ABB WATER METERS INC., OCALA, FL.
FILED 11-13-2002.

INSIDER

FOR WATER METER WITH AN INTERNAL RF TRANSMITTER (U.S. CLS. 21, 23, 26, 36 AND 38).

FIRST USE 9-25-2000; IN COMMERCE 9-25-2000.

SN 78-184,502. ATICO INTERNATIONAL USA, INC., FORT LAUDERDALE, FL. FILED 11-13-2002.

STEPS FOR YOUR HEALTH

FOR DISTANCE MEASURING APPARATUS NAMELY PEDOMETERS; SAFETY EQUIPMENT, NAMELY PROTECTIVE REFLECTIVE VESTS AND HATS AND EMERGENCY HAZARD WARNING LIGHTS TO BE USED WHILE JOGGING OR WALKING IN THE DARK (U.S. CLS. 21, 23, 26, 36 AND 38).

SN 78-184,573. NUASIS CORPORATION, SAN JOSE, CA.
FILED 11-13-2002.

ONEQUEUE

FOR COMPUTER SOFTWARE FOR DISTRIBUTING, ROUTING AND MANAGING TELEPHONE CALLS, VOICEMAIL, EMAIL AND WEB COLLABORATION SESSIONS ACROSS NETWORKED CUSTOMER SERVICE CENTERS (U.S. CLS. 21, 23, 26, 36 AND 38).

CLASS 9—(Continued).

SN 78-184,575. NUASIS CORPORATION, SAN JOSE, CA.
FILED 11-13-2002.

SHUTTERS

FOR COMPUTER SOFTWARE FOR DISTRIBUTING, ROUTING AND MANAGING TELEPHONE CALLS, VOICEMAIL, EMAIL AND WEB COLLABORATION SESSIONS ACROSS NETWORKED CUSTOMER SERVICE CENTERS (U.S. CLS. 21, 23, 26, 36 AND 38).

SN 78-185,339. HORIZION MEDIA GROUP LLC, HARTFORD, CT. FILED 11-14-2002.

MY PLAY TOY

NO CLAIM IS MADE TO THE EXCLUSIVE RIGHT TO USE "TOY", APART FROM THE MARK AS SHOWN.

FOR PRE-RECORDED VIDEO TAPES AND COMPACT DISCS AND DVDS IN THE FIELD OF ADULT ENTERTAINMENT (U.S. CLS. 21, 23, 26, 36 AND 38).

SN 78-185,340. MSC.SOFTWARE CORPORATION, SANTA ANA, CA. FILED 11-14-2002.

MSC.ADAMS

OWNER OF U.S. REG. NOS. 1,324,419, 2,467,564 AND OTHERS.

FOR COMPUTER SOFTWARE FOR COMPLETE VIRTUAL PROTOTYPING AND REALISTICALLY SIMULATING BOTH VISUALLY AND MATHEMATICALLY THE FULL-MOTION BEHAVIOR OF COMPLEX MECHANICAL SYSTEM DESIGN (U.S. CLS. 21, 23, 26, 36 AND 38).

SN 78-185,572. MILLIPORE CORPORATION, BEDFORD, MA. FILED 11-15-2002.

MONTAGE

OWNER OF U.S. REG. NO. 2,613,534.

FOR KITS COMPRISED PRIMARILY OF A DEVICE HAVING ONE OR MORE SAMPLE WELLS, ONE OR MORE BOTTLES OF REAGENTS AND ONE OR MORE BOTTLES OF WASH SOLUTION FOR USE IN GENOMIC AND PROTEOMIC RESEARCH (U.S. CLS. 21, 23, 26, 36 AND 38).

SN 78-185,577. FULCRUM MICROSYSTEMS, INC., CALABASAS, CA. FILED 11-15-2002.

MAELSTROM

FOR ASYNCHRONOUS PROCESSORS SOLD AS COMPONENTS OF SEMI-CONDUCTORS (U.S. CLS. 21, 23, 26, 36 AND 38).

CLASS 9—(Continued).

SN 78-185,608. BOOZ ALLEN HAMILTON INC., MCLEAN, VA. FILED 11-15-2002.

ARM-IR

FOR COMPUTER SOFTWARE FOR SECURITY ANALYSIS AND RISK ASSESSMENT (U.S. CLS. 21, 23, 26, 36 AND 38).



SN 78-186,345. SMOOT, STEPHEN R., SAN FRANCISCO, CA. FILED 11-18-2002.

RELENTLESS SOFTWARE

NO CLAIM IS MADE TO THE EXCLUSIVE RIGHT TO USE "SOFTWARE", APART FROM THE MARK AS SHOWN. FOR DOWNLOADABLE COMPUTER SOFTWARE FOR VIDEO PROCESSING (U.S. CLS. 21, 23, 26, 36 AND 38).



SN 78-186,437. DIGITAL CHECK CORPORATION, NORTH-FIELD, IL. FILED 11-19-2002.

TSONE

FOR DIGITAL COUNTERTOP CHECK SCANNERS (U.S. CLS. 21, 23, 26, 36 AND 38).



SN 78-186,444. DIGITAL CHECK CORPORATION, NORTH-FIELD, IL. FILED 11-19-2002.

THE ONE

FOR DIGITAL COUNTERTOP CHECK SCANNERS (U.S. CLS. 21, 23, 26, 36 AND 38).



SN 78-190,619. THE LOUIS BERKMAN COMPANY, STUEBENVILLE, OH. FILED 12-3-2002.

MPX

FOR ELECTRONIC CONTROLS FOR SNOW PLOWS (U.S. CLS. 21, 23, 26, 36 AND 38).

CLASS 9—(Continued).

SN 78-190,813. INTUIT INC., MOUNTAIN VIEW, CA. FILED 12-3-2002.

QUICKBOOKS

OWNER OF U.S. REG. NO. 1,719,357 AND OTHERS. FOR COMPUTER SOFTWARE AND HARDWARE FOR USE IN TRANSACTION PROCESSING, ACCOUNTING, RECEIPT PRINTING, CUSTOMER RELATIONSHIP MANAGEMENT, INVENTORY MANAGEMENT AND OPERATIONS MANAGEMENT, ALL IN THE FIELD OF POINT OF SALE TRANSACTIONS AND RETAIL MANAGEMENT, AND USER MANUALS SOLD AS A UNIT THEREWITH; CASH DRAWERS; COMPUTER PRINTERS; POINT OF SALE PRINTERS AND TERMINALS; CREDIT CARD AND DEBIT CARD READERS AND SCANNERS; BAR CODE READERS AND SCANNERS; CREDIT CARD AND TRANSACTION PROCESSING TERMINALS AND COMPUTER HARDWARE (U.S. CLS. 21, 23, 26, 36 AND 38). FIRST USE 5-0-2002; IN COMMERCE 5-0-2002.



SN 78-191,434. ATMEL CORPORATION, SAN JOSE, CA. FILED 12-5-2002.

SECUREAVR

OWNER OF U.S. REG. NOS. 2,166,210, 2,180,449 AND 2,296,708. FOR SEMICONDUCTOR INTEGRATED CIRCUITS, NAMELY MICROCONTROLLER CHIPS HAVING CRYPTOGRAPHIC SECURITY FEATURES (U.S. CLS. 21, 23, 26, 36 AND 38).



SN 78-191,440. VIEWCAST.COM, INC., DBA VIEWCAST CORPORATION, DALLAS, TX. FILED 12-5-2002.

NIAGARA SCX

FOR COMPUTER SOFTWARE FOR MONITORING, CONTROLLING OR MANAGING VIDEO ENCODERS (U.S. CLS. 21, 23, 26, 36 AND 38). FIRST USE 4-8-2002; IN COMMERCE 4-8-2002.



SN 78-191,597. SSD CONTROL TECHNOLOGY INC., SOUTH BEND, IN. FILED 12-5-2002.

VINYLSUITE

FOR COMPUTER SOFTWARE FOR MACHINE CONTROL AND PROGRAMMING IN THE FIELD OF VINYL FENCING (U.S. CLS. 21, 23, 26, 36 AND 38).

CLASS 9—(Continued).

SN 78-193,797. NOXELL CORPORATION, HUNT VALLEY, MD. FILED 12-12-2002.

EASY BREEZY BEAUTIFUL

OWNER OF U.S. REG. NO. 2,168,540.
FOR CONTACT LENSES (U.S. CLS. 21, 23, 26, 36 AND 38).

SN 78-193,799. ISLAND AUTOMATED MEDICAL SERVICES, INC., ST. PETERSBURG, FL. FILED 12-12-2002.

EXCELLIS

FOR COMPUTER SOFTWARE FOR RECOGNIZING TYPED AND WRITTEN INFORMATION FROM SCANNED IMAGES OF DOCUMENTS AND WHICH AUTOMATICALLY IMPARTS THAT INFORMATION INTO THE DATABASE OF THE RECIPIENT SOFTWARE (U.S. CLS. 21, 23, 26, 36 AND 38).

FIRST USE 8-24-2001; IN COMMERCE 8-24-2001.

SN 78-193,800. NOXELL CORPORATION, HUNT VALLEY, MD. FILED 12-12-2002.

EASY BREEZY BEAUTIFUL COVERGIRL

OWNER OF U.S. REG. NOS. 404,783, 2,168,540 AND OTHERS.

FOR CONTACT LENSES (U.S. CLS. 21, 23, 26, 36 AND 38).

SN 78-213,719. WILSON GREATBATCH TECHNOLOGIES, INC., CLARENCE, NY. FILED 2-12-2003.

GX3

FOR BATTERIES. (U.S. CLS. 21, 23, 26, 36 AND 38).

SN 78-215,034. GEORGE, CHRISTOPHER, NEW KENSINGTON, PA. FILED 2-14-2003.

PHOTOSPACE

FOR COMPUTER SOFTWARE; NAMELY, COMPUTER PROGRAMS FOR VIEWING, VISUALIZING, RENDERING, NAVIGATING, INTERACTING, EXPERIENCING, MANAGING, ORGANIZING, COLLECTING, RECEIVING, TRANSMITTING, LOADING, STORING, SHARING, HOSTING, CREATING, EDITING, ENHANCING, ANNOTATING, MANIPULATING, AND PRINTING OF DIGITAL IMAGES. (U.S. CLS. 21, 23, 26, 36 AND 38).

CLASS 10—MEDICAL APPARATUS

SN 75-635,326. ATRIUM MEDICAL CORPORATION, HUDSON, NH. FILED 2-4-1999.

EXPRESS

FOR MEDICAL DEVICES NAMELY; THORACIC DRAINAGE COLLECTION DEVICES AND CLOSED WOUND DRAINAGE APPARATUS (U.S. CLS. 26, 39 AND 44).

SN 76-010,895. UNIVERSAL MEDICAL PRODUCTS, INC., LAURENCE HARBOR, NJ. FILED 3-28-2000.

BED SENTRY

NO CLAIM IS MADE TO THE EXCLUSIVE RIGHT TO USE "BED", APART FROM THE MARK AS SHOWN.

FOR PATIENT MONITORING DEVICE USED TO ALERT A CARE GIVER IF A PATIENT EXITS OR FALLS FROM HIS/HER BED (U.S. CLS. 26, 39 AND 44).
FIRST USE 7-0-1997; IN COMMERCE 7-0-1997.

SN 76-166,777. 1029894 ONTARIO INC., ST. LAURENT, QUEBEC, CANADA, FILED 11-16-2000.

RAMBLER

PRIORITY CLAIMED UNDER SEC. 44(D) ON CANADA APPLICATION NO. 1075227. FILED 9-15-2000, REG. NO. TMA567109, DATED 9-10-2002, EXPIRES 9-10-2017.
FOR INVALID WALKERS (U.S. CLS. 26, 39 AND 44).
FIRST USE 8-31-1995; IN COMMERCE 8-31-1995.

SN 76-184,628. ALLESEE ORTHODONTIC APPLIANCES, INC., STURTEVANT, WI. FILED 12-22-2000.

AOA

FOR ORTHODONTIC APPLIANCES (U.S. CLS. 26, 39 AND 44).
FIRST USE 0-0-1984; IN COMMERCE 0-0-1984.

CLASS 10—(Continued).

SN 76-238,058. MACROPORE, INC., SAN DIEGO, CA. FILED 4-9-2001.

MACROPORE FX

NO CLAIM IS MADE TO THE EXCLUSIVE RIGHT TO USE "MACROPORE", APART FROM THE MARK AS SHOWN.

FOR SURGICAL IMPLANTS, NAMELY, NON-LIVING TISSUE IMPLANTS FOR PLACEMENT INTO LIVING TISSUES; AND MEDICAL DEVICES, NAMELY, HOT WATER BATHS, SCREW DRIVERS, IMPLANT CUTTING AND SHAPING TOOLS, HEATING DEVICES, TACK SEATING DEVICES, TACK PUSHERS AND DRIVERS AND MICRODRILLS FOR IMPLANTING NON-LIVING TISSUE IMPLANTS INTO LIVING TISSUE (U.S. CLS. 26, 39 AND 44).

SN 76-252,412. AMEI TECHNOLOGIES INC., WILMINGTON, DE. FILED 5-3-2001.



OWNER OF U.S. REG. NO. 2,574,017. FOR ORTHOPEDIC AMBULATORY TRACTION DEVICES, NAMELY, INFLATABLE LUMBAR VESTS AND CERVICAL COLLARS (U.S. CLS. 26, 39 AND 44).

SN 76-254,787. VSM MEDTECH LTD., VANCOUVER, BC V6B 1N2, CANADA, FILED 5-8-2001.

MEDICAL ADVANCES THROUGH TECHNOLOGY

PRIORITY CLAIMED UNDER SEC. 44(D) ON CANADA APPLICATION NO. 1,090,180, FILED 1-23-2001, REG. NO. TMA572281, DATED 12-13-2002, EXPIRES 12-13-2017.

FOR MONITORS AND SENSORS THAT MEASURE, PROCESS AND TRANSMIT HUMAN VITAL SIGN INFORMATION, NAMELY, BLOOD PRESSURE, PULSE, BODY TEMPERATURE, RESPIRATION AND OXYGEN (U.S. CLS. 26, 39 AND 44).

CLASS 10—(Continued).

SN 76-311,799. SPINAL CONCEPTS, INC., AUSTIN, TX. FILED 9-12-2001.

SC-ACUFIX

FOR MEDICAL DEVICES UTILIZED BY SPINE SURGEONS, NAMELY, SPINAL BONE PLATES AND SPINAL BONE PLATE FASTENERS THAT ARE AND IMPLANTED IN HUMAN AND COUPLED TO HUMAN BONES FOR THE PURPOSE OF STABILIZING THE SPINE, AND SURGICAL INSTRUMENTS UTILIZED BY SPINE SURGEONS TO FACILITATE THE IMPLANTATION OF SUCH DEVICES (U.S. CLS. 26, 39 AND 44).

SN 76-383,231. VYGON, 95440 ECOUEN, FRANCE, FILED 3-12-2002.

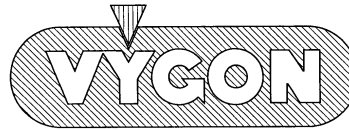

PRIORITY CLAIMED UNDER SEC. 44(D) ON FRANCE APPLICATION NO. 013121056, FILED 9-14-2001, REG. NO. 013121056, DATED 9-14-2001, EXPIRES 9-14-2011.

APPLICANT'S DRAWING IS LINED FOR COLORS GREEN, WHITE AND RED.

FOR SURGICAL, MEDICAL, DENTAL AND VETERINARY APPARATUS AND INSTRUMENTS IN THE NATURE OF SURGICAL DRAPES AND SCALPELS, MEDICAL SYRINGES, DENTAL BURRS AND BITE TRAYS; ARTIFICIAL LIMBS, EYES, AND TEETH, ORTHOPEDIC ARTICLES IN THE NATURE OF ORTHOPEDIC SUPPORTS, ORTHOPEDIC JOINT IMPLANTS, AND ORTHOPEDIC BRACES; SUTURE MATERIAL (U.S. CLS. 26, 39 AND 44).

FIRST USE 9-30-2000; IN COMMERCE 9-30-2000.

SN 76-385,096. BOOKER, STEPHEN W., SAVANNAH, GA. FILED 3-21-2002.



FOR BLOOD GLUCOSE MONITORING DEVICE TO MEASURE BLOOD GLUCOSE LEVELS (U.S. CLS. 26, 39 AND 44).

SN 76-389,015. MIRAE OPTICS CO., LTD., KYONGGI-DO, 430-016, REPUBLIC OF KOREA, FILED 4-1-2002.

CHAROPS

OWNER OF REPUBLIC OF KOREA REG. NO. 464442, DATED 1-15-2000, EXPIRES 2-3-2010.

FOR OPHTHALMOMETERS; OPHTHALMOSCOPES (U.S. CLS. 26, 39 AND 44).

CLASS 10—(Continued).

SN 76-405,088. JOHN, DAYMOND, NEW YORK, NY. FILED 5-6-2002.

ICON

FOR CONDOMS (U.S. CLS. 26, 39 AND 44).

SN 76-413,160. SHERWOOD SERVICES AG, SCHAFFHAUSEN, SWITZERLAND, FILED 5-29-2002.

LigaSure
vessel sealing system

OWNER OF U.S. REG. NO. 2,465,084.
NO CLAIM IS MADE TO THE EXCLUSIVE RIGHT TO USE "VESSEL SEALING SYSTEM", APART FROM THE MARK AS SHOWN.

FOR HOUSE MARK FOR SURGICAL DEVICES, NAMELY VESSEL SEALING SYSTEMS COMPRISED OF ELECTROSURGICAL GENERATORS, HAND PIECES, SEALERS AND ACCESSORIES THEREFOR (U.S. CLS. 26, 39 AND 44).

FIRST USE 6-0-2000; IN COMMERCE 6-0-2000.

SN 76-414,734. SIEMENS AKTIENGESELLSCHAFT, MÜNICH, FED REP GERMANY, FILED 5-31-2002.

Kion-i

PRIORITY CLAIMED UNDER SEC. 44(D) ON FED REP GERMANY APPLICATION NO. 30209165.3/1, FILED 2-21-2002, REG. NO. 30209165, DATED 3-19-2002, EXPIRES 2-29-2012.

OWNER OF U.S. REG. NO. 2,464,791.
FOR ANESTHESIA EQUIPMENT, NAMELY, ANESTHETIC DELIVERY APPARATUS, ANESTHETIC GAS DELIVERY APPARATUS, RESPIRATORS FOR ARTIFICIAL RESPIRATION, VENTILATION APPARATUS, RESPIRATORY MONITORING APPARATUS, APPARATUS FOR MONITORING GAS FLOW AND PATIENT MONITORING APPARATUS USED IN ANESTHESIA SYSTEMS, COMPUTER HARDWARE AND SOFTWARE FOR USE IN THE OPERATION OF ANESTHESIA SYSTEMS (U.S. CLS. 26, 39 AND 44).

CLASS 10—(Continued).

SN 76-419,775. OLYMPUS AMERICA INC., MELVILLE, NY. FILED 6-12-2002.

ENDO EXCELLENCE

FOR MEDICAL ENDOSCOPE PRODUCT LINE, NAMELY, ENDOSCOPES, LIGHT SOURCES FOR ENDOSCOPES, LAPAROSCOPES, BRONCHOSCOPES AND PARTS AND ACCESSORIES THEREFOR (U.S. CLS. 26, 39 AND 44).

SN 76-419,907. ORTHEON MEDICAL, WINTER PARK, FL. FILED 6-13-2002.

TENO FIX

FOR SURGICAL IMPLANT SYSTEMS COMPRISED OF STAINLESS STEEL SUTURES, STAINLESS STEEL ANCHORS, TAPERED NEEDLES, CRIMPING INSTRUMENTS, METAL SURGICAL STOP BEADS AND ANCHOR REMOVAL DEVICES (U.S. CLS. 26, 39 AND 44).

FIRST USE 10-1-2000; IN COMMERCE 10-1-2000.

SN 76-423,974. ASEPTICO, INC., WOODINVILLE, WA. FILED 6-19-2002.

ENDO ITR

FOR ELECTRONIC MOTOR SYSTEMS FOR USE IN THE PRACTICE OF MEDICINE AND PRIMARILY IN THE PRACTICE OF DENTISTRY, COMPRISED PRIMARILY OF A POWER UNIT, AN ELECTRONIC MOTOR, ELECTRICAL CONTROL CIRCUITS USED TO MODIFY THE OUTPUT OF THE MOTOR, AND CONTROL SWITCHES FOR ADJUSTING MOTOR OUTPUTS (U.S. CLS. 26, 39 AND 44).

FIRST USE 6-3-2002; IN COMMERCE 6-3-2002.

SN 76-429,076. SARCOS L.C., SALT LAKE CITY, UT. FILED 7-10-2002.

POLE VAULT

FOR MEDICAL EQUIPMENT, NAMELY, A MEDICATION CONTAINMENT DEVICE SOLD EMPTY FOR USE WITH A DRUG DISPENSING PUMP (U.S. CLS. 26, 39 AND 44).

SN 76-429,078. SARCOS L.C., SALT LAKE CITY, UT. FILED 7-10-2002.

VAULT

FOR MEDICAL EQUIPMENT, NAMELY, A MEDICATION CONTAINMENT DEVICE SOLD EMPTY FOR USE WITH A DRUG DISPENSING PUMP (U.S. CLS. 26, 39 AND 44).

CLASS 10—(Continued).

SN 76-429,734. KANEKA CORPORATION, KITA-KU, OSAKA, JAPAN, FILED 7-8-2002.

SELESORB

OWNER OF JAPAN REG. NO. 2490770, DATED 12-25-1992, EXPIRES 12-25-2012.
FOR MEDICAL APPARATUS, NAMELY, ABSORBERS FOR THE SELECTIVE ADSORPTION OF PLASMA COMPONENTS IN SURGICAL PROCEDURES (U.S. CLS. 26, 39 AND 44).

SN 76-431,033. VENTLAB CORPORATION, MOCKSVILLE, NC. FILED 7-12-2002.

VENTLAB

FOR RESUSCITATION BAGS, TRAUMA COLLARS, ENDOTRACHEAL TUBE HOLDERS, AEROSOL MEDICATION DELIVERY DEVICE WITHOUT MEDICATION, ANESTHESIA MASKS WITHOUT MEDICATION, INTUBATION DETECTION AND MONITORING DEVICES, HYPERINFLATION BAGS, AND NASAL CPAP (CONTINUOUS POSITIVE AIRWAY PRESSURE) MACHINES, MASKS, HEADGEAR, AND TUBING (U.S. CLS. 26, 39 AND 44).
FIRST USE 0-0-1990; IN COMMERCE 0-0-1990.

SN 76-432,693. EDWARDS LIFESCIENCES CORPORATION, IRVINE, CA. FILED 7-22-2002.

OPTIMAZE

FOR FIBER OPTIC LASER UNIT CONNECTED TO A DIFFUSER TIP FOR MEDICAL USE (U.S. CLS. 26, 39 AND 44).

SN 76-439,272. SOFRADIM PRODUCTION, 01600 TREVOUX, FRANCE, FILED 8-9-2002.



OWNER OF FRANCE REG. NO. 023162386, DATED 4-30-2002, EXPIRES 4-30-2012.
FOR MEDICAL FASTENERS USED, IN PARTICULAR, IN THE SURGICAL FIELD (U.S. CLS. 26, 39 AND 44).

CLASS 10—(Continued).

SN 76-439,719. KARL STORZ GMBH & CO. KG, D-78532 TUTTLINGEN, FED REP GERMANY, FILED 8-13-2002.

HYSTEROMATIC

FOR SURGICAL INSTRUMENTS; NAMELY, INSUFFLATORS (U.S. CLS. 26, 39 AND 44).

SN 76-440,976. HANGER ORTHOPEDIC GROUP, INC., BETHESDA, MD. FILED 8-16-2002.

ComfortFlex

FOR SOCKETS FOR LIMB PROSTHETIC DEVICES AND LIMB SOCKETS FOR PROSTHETIC DEVICES (U.S. CLS. 26, 39 AND 44).
FIRST USE 9-0-2000; IN COMMERCE 9-0-2000.

SN 76-450,864. SURGICAL SOLUTIONS LLC, VALENCIA, CA. FILED 6-6-2002.



FOR SURGICAL INSTRUMENTS, NAMELY, SUTURING DEVICES, ARTHROSCOPIC FLUID MANAGEMENT DEVICES AND FORCEPS (U.S. CLS. 26, 39 AND 44).

SN 76-452,169. CARE REHAB & ORTHOPAEDIC PRODUCTS, INC., MCLEAN, VA. FILED 9-18-2002.

CARE TENS

OWNER OF U.S. REG. NO. 2,064,460.
NO CLAIM IS MADE TO THE EXCLUSIVE RIGHT TO USE "TENS", APART FROM THE MARK AS SHOWN.
FOR PHYSICAL THERAPY EQUIPMENT, NAMELY, TRANSCUTANEOUS ELECTRICAL NERVE STIMULATION (U.S. CLS. 26, 39 AND 44).
FIRST USE 5-3-2002; IN COMMERCE 5-3-2002.

CLASS 10—(Continued).

SN 76-456,074. STARKEY LABORATORIES, INC., EDEN PRAIRIE, MN. FILED 10-4-2002.



NO CLAIM IS MADE TO THE EXCLUSIVE RIGHT TO USE "DIGITAL", APART FROM THE MARK AS SHOWN. THE LINING AND STIPPLING SHOWN IN THE DRAWING IS A FEATURE OF THE MARK AND IS NOT INTENDED TO INDICATE COLOR.

FOR HEARING AIDS AND RELATED USER'S MANUALS SOLD AS A UNIT (U.S. CLS. 26, 39 AND 44). FIRST USE 12-8-2001; IN COMMERCE 12-8-2001.

SN 76-463,157. HEATMAX, INC., DALTON, GA. FILED 10-25-2002.

COLDMAX

FOR CHEMICALLY-ACTIVATED BODY COOLING PACKS FOR MEDICAL PURPOSES (U.S. CLS. 26, 39 AND 44).

SN 76-473,898. RINGWALT, TOMMY, ENFIELD, CT. FILED 12-11-2002.

TOMMY GUN

FOR TATTOO MACHINE (U.S. CLS. 26, 39 AND 44). FIRST USE 7-1-1999; IN COMMERCE 7-1-1999.

SN 76-475,931. ASAHI MEDICAL CO., LTD., TOKYO, JAPAN, FILED 12-17-2002.

LeukoQuick

FOR FILTRATION APPARATUS FOR COLLECTING WHITE BLOOD CELLS CONTAINING HEMATOPOIETIC STEM CELLS FROM CORD BLOOD (U.S. CLS. 26, 39 AND 44).

CLASS 10—(Continued).

SN 76-484,221. VITALFLOR, INC., SATELLITE BEACH, FL. FILED 1-14-2003.

EZ-DX

OWNER OF U.S. REG. NO. 2,579,475. FOR MEDICAL DIAGNOSTIC DEVICES, NAMELY SELF-STAINING MICROSCOPE SLIDES AND CASSETTES (U.S. CLS. 26, 39 AND 44).

SN 76-485,246. CYMATICS INTERNATIONAL, INC., PORT JEFFERSON, NY. FILED 1-24-2003.

CYMATIQUE

FOR ACOUSTIC THERAPY DEVICES FOR TONING AND REJUVENATING THE SKIN AND FACIAL MUSCULATURE (U.S. CLS. 26, 39 AND 44).

SN 76-485,824. VMBC, LLC, ROSEVILLE, MN. FILED 1-29-2003.

VMBC

FOR MEDICAL APPARATUS, NAMELY, TISSUE LIGATION DEVICES (U.S. CLS. 26, 39 AND 44).

SN 78-066,123. MAJOR WIRE, INC., CHICAGO, IL. FILED 5-29-2001.

"MICHONSKI-BADGER STENT"

NO CLAIM IS MADE TO THE EXCLUSIVE RIGHT TO USE "STENT", APART FROM THE MARK AS SHOWN. FOR CORONARY ANGIOPLASTY DEVICE, NAMELY, MEDICAL STENT (U.S. CLS. 26, 39 AND 44).

SN 78-095,824. LEVINE, ANTHONY, H, WOODLAND HILLS, CA. FILED 11-29-2001.

I RUB MY DUCKIE

FOR ADULT SEX AIDS, NAMELY VIBRATORS AND MASSAGE DEVICES (U.S. CLS. 26, 39 AND 44).

CLASS 10—(Continued).

SN 78-099,498. HOYA CORPORATION, TOKYO, JAPAN, FILED 12-20-2001.

HOYA AF-1 (UV)

PRIORITY CLAIMED UNDER SEC. 44(D) ON JAPAN APPLICATION NO. 2001-110831, FILED 12-12-2001, REG. NO. 4620400, DATED 11-15-2002, EXPIRES 11-15-2012.

OWNER OF U.S. REG. NOS. 1,641,199, 2,399,073 AND OTHERS.

NO CLAIM IS MADE TO THE EXCLUSIVE RIGHT TO USE "UV", APART FROM THE MARK AS SHOWN.

THE FOREIGN WORDING IN THE MARK TRANSLATES INTO ENGLISH AS "MAINTAINING VALLEY".

FOR INTRAOCULAR LENSES FOR SURGICAL IMPLANTATION (U.S. CLS. 26, 39 AND 44).

SN 78-111,315. ALCON, INC., CH-6331 HUNENBERG, SWITZERLAND, FILED 2-27-2002.

UISEO

FOR OPHTHALMIC MEDICAL AND SURGICAL INSTRUMENTS, NAMELY SURGICAL DRAPES (U.S. CLS. 26, 39 AND 44).

SN 78-127,575. NOVARTIS AG, BASEL, SWITZERLAND, FILED 5-9-2002.

TRUFOLD

PRIORITY CLAIMED UNDER SEC. 44(D) ON SWITZERLAND APPLICATION NO. 3671/2002, FILED 4-24-2002, REG. NO. 498601, DATED 4-30-2002, EXPIRES 4-30-2022.

FOR INTRAOCULAR LENSES (U.S. CLS. 26, 39 AND 44).

SN 78-130,719. BIOSPHERE MEDICAL INC., ROCKLAND, MA. FILED 5-23-2002.

SEGWAY

FOR PERIPHERAL VASCULAR GUIDE WIRE TO TRACK CATHETERS (U.S. CLS. 26, 39 AND 44). FIRST USE 8-22-2002; IN COMMERCE 8-22-2002.

SN 78-133,907. TBS HOLDINGS, HOUSTON, TX. FILED 6-7-2002.

CARDIOSOFT

FOR MEDICAL EQUIPMENT, NAMELY, COMPUTER HARDWARE AND SOFTWARE, SOLD AS AN INTEGRAL COMPONENT THEREFORE, FOR USE IN INTERPRETING, STORING, PRESENTING, AND COMMUNICATING ECG DATA AND RELATED INFORMATION (U.S. CLS. 26, 39 AND 44).

CLASS 10—(Continued).

SN 78-146,572. SCIANAMBLO, MICHAEL J., SAN RAFAEL, CA. FILED 7-23-2002.

ENGINUITY WORKSAFE

FOR DENTAL EQUIPMENT, NAMELY, MANUAL AND POWER OPERATED ENDODONTIC TOOLS AND PARTS THEREFOR; ENDODONTIC IRRIGATION AND WASHING DEVICES AND PARTS THEREFOR; DENTAL SURGICAL IMPLANTS, NAMELY, NATURAL AND SYNTHETIC COMPOUNDS THAT ARE COMPATIBLE WITH LIVING TISSUE FOR DENTAL USE (U.S. CLS. 26, 39 AND 44).

SN 78-152,660. DERROYAL INDUSTRIES, INC., POWELL, TN. FILED 8-9-2002.

COMFO-EZE WALKER

NO CLAIM IS MADE TO THE EXCLUSIVE RIGHT TO USE "WALKER", APART FROM THE MARK AS SHOWN.

FOR WALKERS, NAMELY, LOWER EXTREMITY WALKING SPLINTS (U.S. CLS. 26, 39 AND 44).

FIRST USE 8-16-2002; IN COMMERCE 8-16-2002.

SN 78-155,971. WILLIAM COOK EUROPE APS, DK-4632 BIAEVERSKOV, DENMARK, FILED 8-20-2002.



High Performance
DETACH

PRIORITY CLAIMED UNDER SEC. 44(D) ON DENMARK APPLICATION NO. VA200201512, FILED 4-15-2002, REG. NO. VR200201480, DATED 4-25-2002, EXPIRES 4-25-2012.

OWNER OF U.S. REG. NO. 2,108,702.

NO CLAIM IS MADE TO THE EXCLUSIVE RIGHT TO USE "HIGH PERFORMANCE", APART FROM THE MARK AS SHOWN.

FOR SURGICAL, MEDICAL, DENTAL AND VETERINARY APPARATUS AND INSTRUMENTS FOR SURGICAL AND RADIOLOGICAL USE, NAMELY, GUIDEWIRES AND EMBOLIZATION COILS FOR THE FORMATION OF EMBOLI IN THE VASCULAR SYSTEM (U.S. CLS. 26, 39 AND 44).

SN 78-156,921. MOAB BRACING, INC., LAKE TAHOE, NV. FILED 8-22-2002.

MOAB

FOR ORTHOPEDIC DEVICES, NAMELY, BRACES, FOOTWEAR, SUPPORTS, SLINGS, IMMOBILIZERS, SPLINTS, AND PADS; AND CERVICAL COLLARS (U.S. CLS. 26, 39 AND 44).

FIRST USE 12-0-2002; IN COMMERCE 12-0-2002.

CLASS 10—(Continued).

SN 78-157,815. LITTLE RAPIDS CORPORATION, GREEN BAY, WI. FILED 8-26-2002.

FABRIWEAR

FOR DISPOSABLE EXAM VEST (U.S. CLS. 26, 39 AND 44).

SN 78-157,820. SAMSUNG AMERICA, INC., RIDGEFIELD PARK, NJ. FILED 8-26-2002.

ACCU-FAST

FOR THERMOMETERS FOR MEDICAL PURPOSES. (U.S. CLS. 26, 39 AND 44).

SN 78-160,214. HJ SOCK GROUP LTD., HINCKLEY, UNITED KINGDOM, FILED 9-3-2002.

FLYSAFE

FOR COMPRESSION HOSIERY, STOCKINGS AND SOCKS (U.S. CLS. 26, 39 AND 44).
FIRST USE 1-31-2002; IN COMMERCE 1-31-2002.

SN 78-164,425. MEDQUEST PRODUCTS, INC., SALT LAKE CITY, UT. FILED 9-16-2002.

HEARTQUEST

FOR MEDICAL DEVICES, NAMELY, BLOOD PUMPS FOR CARDIAC USE, PHYSIOLOGICAL SIMULATORS FOR MEDICAL APPLICATIONS; PULSATILE VENTRICULAR SIMULATORS, MOCK CIRCULATION SYSTEMS FOR SIMULATING BLOOD CIRCULATION COMPRISED OF INTERCONNECTING TUBING AND CHAMBERS, MINIMALLY INVASIVE CARDIOVASCULAR SIMULATORS, AND SURGICAL INSTRUMENTS, NAMELY, CARDIOVASCULAR STENTS, VASCULAR ACCESS DEVICES, ELECTRO SURGICAL ELECTRODES, BLOOD FLOW PROBES AND SCALPELS (U.S. CLS. 26, 39 AND 44).

CLASS 10—(Continued).

SN 78-172,361. VITALWEAR, INC., SAN FRANCISCO, CA. FILED 10-8-2002.

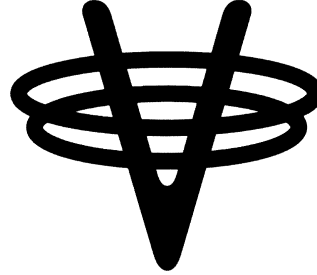

FOR THERAPEUTIC MEDICAL DEVICE IN THE NATURE OF A WATER RECIRCULATING THERMAL PACK SUPPLYING THERMAL AND COMPRESSION THERAPY (U.S. CLS. 26, 39 AND 44).

SN 78-179,000. MEDTRONIC XOMED, INC., MINNEAPOLIS, MN. FILED 10-28-2002.

NIM-SPINE

OWNER OF U.S. REG. NOS. 1,727,352 AND 2,396,350. FOR NERVE INTEGRITY MONITOR AND COMPONENT PARTS THEREFOR (U.S. CLS. 26, 39 AND 44).

SN 78-179,493. NUMED, INC., NICHOLVILLE, NY. FILED 10-29-2002.

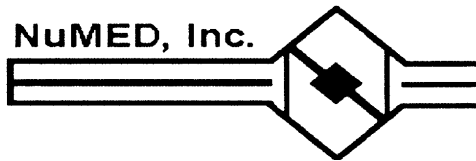

NO CLAIM IS MADE TO THE EXCLUSIVE RIGHT TO USE "INC.", APART FROM THE MARK AS SHOWN. FOR CARDIAC CATHETERS AND STENTS (U.S. CLS. 26, 39 AND 44).
FIRST USE 7-0-1984; IN COMMERCE 7-0-1984.

SN 78-182,513. VISIBELLE DERMA INSTITUTE, INC., BLOOMINGTON, MN. FILED 11-6-2002.

SPECTRACLEAR

FOR SKIN TREATMENT MACHINE, NAMELY A MACHINE FOR REMOVING A LAYER OF SKIN (U.S. CLS. 26, 39 AND 44).

CLASS 10—(Continued).

SN 78-182,522. VISIBELLE DERMA INSTITUTE, INC., BLOOMINGTON, MN. FILED 11-6-2002.

PHOTOCLEARANCE

FOR SKIN TREATMENT MACHINE, NAMELY A MACHINE FOR REMOVING A LAYER OF SKIN (U.S. CLS. 26, 39 AND 44).



SN 78-184,657. SCIMED LIFE SYSTEMS, INC., MAPLE GROVE, MN. FILED 11-13-2002.

PT²

FOR MEDICAL GUIDEWIRES (U.S. CLS. 26, 39 AND 44).



SN 78-184,926. SHERWOOD SERVICES AG, SCHAFFHAUSEN, SWITZERLAND, FILED 11-14-2002.

RENEWABLES

FOR CONTAINER FOR USED NEEDLES AND SYRINGES (U.S. CLS. 26, 39 AND 44).



SN 78-185,611. POCHATKO, DAVID J., WILLIAMSVILLE, NY. FILED 11-15-2002.

**DR. POCHATKO'S RIGIFLEX
POSTOPERATIVE SHOE**

NO CLAIM IS MADE TO THE EXCLUSIVE RIGHT TO USE "POSTOPERATIVE SHOE", APART FROM THE MARK AS SHOWN.

FOR SHOE THAT PROTECTS, SUPPORTS, AND ASSISTS IN THE REHABILITATION OF THE FOOT AFTER SURGERY, FRACTURE OR INJURY (U.S. CLS. 26, 39 AND 44).

CLASS 10—(Continued).

SN 78-185,648. COOK INCORPORATED, BLOOMINGTON, IN. FILED 11-15-2002.

PROCLAIM

FOR MEDICAL DEVICE, NAMELY, A DRUG-ELUTING CORONARY STENT (U.S. CLS. 26, 39 AND 44).



SN 78-191,241. MILLENNIUM MEDICAL TECHNOLOGIES, INC., SANTA FE, NM. FILED 12-4-2002.

HBS

FOR ORTHOPAEDIC ARTICLES AND MEDICAL DEVICES, NAMELY, CANNULATED BONE SCREWS (U.S. CLS. 26, 39 AND 44).
FIRST USE 9-15-2002; IN COMMERCE 9-15-2002.



SN 78-191,245. VISIBELLE DERMA INSTITUTE, INC., BLOOMINGTON, MN. FILED 12-4-2002.

SKINCLEAR

FOR LIGHT BASED HAIR REMOVAL MACHINE HAVING A BROAD BAND LIGHT SOURCE USABLE FOR MEDICAL PURPOSES. (U.S. CLS. 26, 39 AND 44).



CLASS 11—ENVIRONMENTAL CONTROL APPARATUS

SN 75-450,890. INTEGRA DYNAMICS INC., CALGARY, ALBERTA, CANADA, FILED 3-16-1998.

TAPMASTER

FOR MECHANICALLY ACTUATED FAUCET CONTROLLERS (U.S. CLS. 13, 21, 23, 31 AND 34).
FIRST USE 6-0-1994; IN COMMERCE 6-0-1994.



SN 75-775,738. HIGH END SYSTEMS, INC., AUSTIN, TX. FILED 8-10-1999.

LIGHTWAVE

FOR MICROPROCESSOR CONTROLLED ELECTRIC LIGHT FIXTURES (U.S. CLS. 13, 21, 23, 31 AND 34).
FIRST USE 1-1-1994; IN COMMERCE 1-1-1994.

CLASS 11—(Continued).

SN 76-073,949. FIESTA BARBEQUES LIMITED, BRAMPTON, ONTARIO, CANADA, FILED 6-21-2000.



PRIORITY CLAIMED UNDER SEC. 44(D) ON CANADA APPLICATION NO. 1041432, FILED 1-5-2000, REG. NO. TMA562732, DATED 5-28-2002, EXPIRES 5-28-2017.
OWNER OF U.S. REG. NOS. 1,768,556, 1,947,124 AND 2,101,962.

NO CLAIM IS MADE TO THE EXCLUSIVE RIGHT TO USE "LIFETIME CASTING", "TWO YEAR PARTS WARRANTY" AND "FIVE YEAR BURNER WARRANTY", APART FROM THE MARK AS SHOWN.

FOR BARBEQUE GRILLS AND REPLACEMENT PARTS THEREFOR (U.S. CLS. 13, 21, 23, 31 AND 34).

SN 76-074,100. FIESTA BARBEQUES LIMITED, BRAMPTON, ONTARIO L6T 5E1, CANADA, FILED 6-21-2000.

INFO FIESTA

PRIORITY CLAIMED UNDER SEC. 44(D) ON CANADA APPLICATION NO. 1040565, FILED 12-22-1999, REG. NO. TMA551815, DATED 10-1-2001, EXPIRES 10-1-2016.

OWNER OF U.S. REG. NOS. 1,768,556, 1,947,124 AND 2,101,962.

FOR BARBEQUE GRILLS AND REPLACEMENT PARTS THEREFOR (U.S. CLS. 13, 21, 23, 31 AND 34).

SN 76-243,267. ACCOR TECHNOLOGY, INC., BELLEVUE, WA. FILED 4-18-2001.

PUSHON

SEC. 2(F).
FOR PLUMBING FITTINGS AND PARTS, NAMELY, VALVES, TEST CAPS FOR PIPES, COUPLERS AND FLEXIBLE COUPLERS (U.S. CLS. 13, 21, 23, 31 AND 34).
FIRST USE 12-21-1988; IN COMMERCE 12-21-1988.

CLASS 11—(Continued).

SN 76-319,299. INAX CORPORATION, AICHI, JAPAN, FILED 10-1-2001.

LUSCENCE

FOR SHOWER TOILETS AND STRUCTURAL PARTS THEREFOR; TOILET SEATS; TOILET BOWLS; TOILET SEATS FOR HEATING, WASHING AND DRYING BODY PARTS; BIDETS AND REMOTE CONTROLS, SOLD TOGETHER AS A UNIT; WATER CLOSETS, AND REMOTE CONTROLS, SOLD TOGETHER AS A UNIT; TOILET TANKS AND STRUCTURAL PARTS THEREFOR; TOILET TANK ASSEMBLIES COMPRISED OF TOILET TANK BOWLS FOR FLUSHING TOILET TANKS; TOILETS AND REMOTE CONTROLS, SOLD TOGETHER AS A UNIT; TANKS, NAMELY, CISTERN TANKS; TANK BALLS; WATER FAUCETS; FIXED SPOUTS USED DIRECTLY IN BIDETS AND TOILETS; PLUMBING FIXTURES, NAMELY, SHOWER SPRAYERS FOR USE WITH TOILETS AND BIDETS; AND BIDET NOZZLES (U.S. CLS. 13, 21, 23, 31 AND 34).

SN 76-319,500. INAX CORPORATION, TOKONAME-SHI, AICHI, JAPAN, FILED 10-1-2001.

LUXURY LAVAGE

FOR SHOWER TOILETS AND STRUCTURAL PARTS THEREFOR; TOILET SEATS; TOILET BOWLS; TOILET SEATS FOR HEATING, WASHING AND DRYING BODY PARTS; BIDETS AND REMOTE CONTROLS, SOLD TOGETHER AS A UNIT; WATER CLOSETS, AND REMOTE CONTROLS, SOLD TOGETHER AS A UNIT; TOILET TANKS AND STRUCTURAL PARTS THEREFOR; TOILET TANK ASSEMBLIES COMPRISED OF TOILET TANK BOWLS FOR FLUSHING TOILET TANKS; TOILETS AND REMOTE CONTROLS, SOLD TOGETHER AS A UNIT; TANKS, NAMELY, CISTERN TANKS; TANK BALLS; WATER FAUCETS; FIXED SPOUTS USED DIRECTLY IN BIDETS AND TOILETS; PLUMBING FIXTURES, NAMELY, SHOWER SPRAYERS FOR USE WITH TOILETS AND BIDETS; AND BIDET NOZZLES (U.S. CLS. 13, 21, 23, 31 AND 34).

SN 76-342,292. YOSHIKAWA, KAZUhide, OSAKA, JAPAN, FILED 11-28-2001.

ARTLUNA

PRIORITY CLAIMED UNDER SEC. 44(D) ON JAPAN APPLICATION NO. 2001-063417, FILED 7-11-2001, REG. NO. 4589495, DATED 7-26-2002, EXPIRES 7-26-2012.

FOR LAMPS WITH STAINED-GLASS SHADES; STAINED-GLASS LAMP SHADES FOR LIGHTING APPARATUS, AND ELECTRIC LAMPS (U.S. CLS. 13, 21, 23, 31 AND 34).

SN 76-385,355. COMPUESTOS DOMINICANOS, S.A., SAN CRISTOBAL, DOMINICAN REP, FILED 3-21-2002.

TINACOM

FOR PLASTIC WATER STORAGE TANKS FOR DOMESTIC USE (U.S. CLS. 13, 21, 23, 31 AND 34).

CLASS 11—(Continued).

SN 76-390,137. BRUCK LIGHTING SYSTEMS, INC., COSTA MESA, CA. FILED 4-2-2002.

FLEX-LINE

FOR ELECTRIC LOW VOLTAGE TRACK LIGHTING SYSTEMS COMPRISING TRACKS, HANGERS, ADAPTERS, LIGHTING FIXTURES AND COMPONENTS FOR SAME (U.S. CLS. 13, 21, 23, 31 AND 34).

FIRST USE 10-0-1996; IN COMMERCE 11-0-1996.

SN 76-402,243. ZELCO INDUSTRIES, INC., MOUNT VERNON, NY. FILED 4-29-2002.

BUG LESS

FOR FLASHLIGHTS, BARBECUE LIGHTS AND LANTERNS WITH ELECTRONIC INSECT REPELLENT (U.S. CLS. 13, 21, 23, 31 AND 34).

SN 76-412,367. COMMON HERITAGE CORPORATION, HONOLULU, HI. FILED 5-20-2002.

SKY WATER

NO CLAIM IS MADE TO THE EXCLUSIVE RIGHT TO USE "WATER", APART FROM THE MARK AS SHOWN.

FOR WATER TREATMENT SYSTEM AND DESALINATION DEVICES, NAMELY A SYSTEM THAT USES COLD WATER TO CONDENSE MOISTURE FROM THE ATMOSPHERE THROUGH A HEAT EXCHANGER TO PRODUCE FRESH WATER (U.S. CLS. 13, 21, 23, 31 AND 34).

SN 76-416,265. SICHUAN CHANGHONG ELECTRONICS GROUP CORPORATION, MIANYANG, SICHUAN PROVINCE, CHINA, FILED 6-3-2002.

BOAO

THE TERM "BOAO" IS THE TRANSLITERATION OF TWO CHINESE CHARACTERS, THE ENGLISH TRANSLATION OF WHICH IS "ABUNDANT TRAVEL".

FOR LAMPS, ELECTRIC LIGHTING FIXTURES, ELECTRIC MAGNETIC OVENS, MICROWAVE OVENS FOR KITCHEN USE, REFRIGERATORS, AIR CONDITIONERS, AIR CONDITIONERS FOR VEHICLES, AIR PURIFIERS, KITCHEN RANGE VENTILATING HOODS, WATER PURIFICATION UNITS (U.S. CLS. 13, 21, 23, 31 AND 34).

FIRST USE 4-2-2002; IN COMMERCE 4-2-2002.

CLASS 11—(Continued).

SN 76-419,911. GOLD MEDAL PRODUCTS COMPANY, INC., CINCINNATI, OH. FILED 6-13-2002.

LOTTA VOLTS

FOR COTTON CANDY MAKING MACHINES, POP-CORN POPPING MACHINES (U.S. CLS. 13, 21, 23, 31 AND 34).

SN 76-426,136. PENTAIR POOL PRODUCTS, INC., MOORPARK, CA. FILED 6-28-2002.

PG2000

FOR FIBER OPTIC LIGHTING FIXTURES USED IN CONJUNCTION WITH ELECTRICAL ILLUMINATING (U.S. CLS. 13, 21, 23, 31 AND 34).

FIRST USE 11-30-2000; IN COMMERCE 11-30-2000.

SN 76-427,694. COMFITROL INDUSTRIES, INC., PHOENIX, AZ. FILED 7-2-2002.

ALTER-AIR

FOR HVAC EQUIPMENT, NAMELY, AIR CONDITIONERS, SWAMP COOLERS, AIR HANDLERS, AND HEAT EXCHANGERS (U.S. CLS. 13, 21, 23, 31 AND 34).

SN 76-430,545. SELECT BRANDS, INC., LENEXA, KS. FILED 7-15-2002.



FRUIT SAVER

NO CLAIM IS MADE TO THE EXCLUSIVE RIGHT TO USE "FRUIT SAVER", APART FROM THE MARK AS SHOWN.

THE MARK CONSISTS IN PART OF A STYLIZED DEPICTION OF A PEACH.

FOR ELECTRICAL APPLIANCE FOR PRESERVING AND CHILLING FRUIT (U.S. CLS. 13, 21, 23, 31 AND 34).

SN 76-431,788. WAHL CLIPPER CORPORATION, STERLING, IL. FILED 7-18-2002.

DIAL-A-FLOW

FOR ELECTRIC HAIR DRYERS (U.S. CLS. 13, 21, 23, 31 AND 34).

CLASS 11—(Continued).

SN 76-434,118. CATEYE CO., LTD., OSAKA-SHI, OSAKA, JAPAN, FILED 7-25-2002.

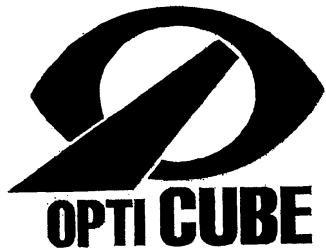

FOR LIGHTS FOR BICYCLES AND ELECTRIC LAMPS (U.S. CLS. 13, 21, 23, 31 AND 34).

SN 76-440,211. LEGION LIGHTING COMPANY, INC., BROOKLYN, NY. FILED 8-12-2002.

EXCELUME

FOR FLUORESCENT ELECTRIC LIGHT BULBS, ELECTRIC LIGHT BULBS, ELECTRIC DECORATIVE LIGHTS; ELECTRIC LIGHTING FIXTURES; LIGHT REFLECTORS (U.S. CLS. 13, 21, 23, 31 AND 34).
FIRST USE 7-15-2002; IN COMMERCE 7-15-2002.

SN 76-444,389. RAPIDFIRE, ALLENTOWN, PA. FILED 8-26-2002.

RAPIDFIRE

FOR GAS FURNACES FOR HEATING METALS (U.S. CLS. 13, 21, 23, 31 AND 34).
FIRST USE 4-12-1994; IN COMMERCE 3-31-1995.

SN 76-448,226. AMERICAN METER COMPANY, HORSHAM, PA. FILED 9-4-2002.

60 SERIES

NO CLAIM IS MADE TO THE EXCLUSIVE RIGHT TO USE "SERIES", APART FROM THE MARK AS SHOWN.
FOR PILOT REGULATOR FOR A GAS VALVE (U.S. CLS. 13, 21, 23, 31 AND 34).
FIRST USE 2-21-2002; IN COMMERCE 2-21-2002.

CLASS 11—(Continued).

SN 76-449,900. CLEANROOM SYSTEMS, INC., NORTH SYRACUSE, NY. FILED 9-16-2002.

ADVANCAIR

FOR ENVIRONMENTAL CONTROL EQUIPMENT, NAMELY AIR CONDITIONING AND FILTRATION UNITS WITH OR WITHOUT MAKE-UP AIR SYSTEM FOR PRESSURE CONTROL, AS WELL AS HUMIDITY CONTROL AND TEMPERATURE CONTROL (U.S. CLS. 13, 21, 23, 31 AND 34).
FIRST USE 9-0-1984; IN COMMERCE 9-0-1984.

SN 76-455,059. WAGNER, JAMES R., ANGOLA, IN. FILED 9-23-2002.

ETERNAL-LITE

FOR SOLAR POWERED LIGHTS FOR CEMETERY HEADSTONES AND CEMETERY MARKERS (U.S. CLS. 13, 21, 23, 31 AND 34).

SN 76-455,288. THERMOWINE, INC., RANCHO SANTA MARGARITA, CA. FILED 10-3-2002.

DOMO WINE

NO CLAIM IS MADE TO THE EXCLUSIVE RIGHT TO USE "WINE", APART FROM THE MARK AS SHOWN.

THE WORD "DOMO" IN THE MARK TRANSLATES INTO ENGLISH AS "DOME".

FOR REFRIGERATOR WITH DUAL TEMPERATURE ZONES (U.S. CLS. 13, 21, 23, 31 AND 34).

FIRST USE 9-15-2002; IN COMMERCE 9-15-2002.

SN 76-455,294. BASX SYSTEMS, LLC, FORT COLLINS, CO. FILED 10-3-2002.

CERAMX

FOR FILTRATION SYSTEMS USED FOR THE SEPARATION OF MATERIALS FROM CONTAMINATED LIQUIDS SUCH AS WASTEWATER, CLEANERS, PLATING BATHS, GALVANIZING CHEMICALS, COOLANTS AND ORGANIC SOLVENTS (U.S. CLS. 13, 21, 23, 31 AND 34).

SN 76-456,650. WATTS REGULATOR CO., NORTH AND-OVER, MA. FILED 10-8-2002.

TEMPEST

FOR ANTI-SCALD VALVES FOR SHOWERS, BATHS AND SINKS (U.S. CLS. 13, 21, 23, 31 AND 34).

CLASS 11—(Continued).

SN 76-463,962. STRONG INDUSTRIES INC., NORTHUMBERLAND, PA. FILED 9-19-2002.



THE MARK INCLUDES THE FOLLOWING COLORS. ALL OF THE LETTERS WITH THE EXCEPTION OF THE LETTER "O" ARE BLUE. A THIN WHITE BORDER SURROUNDS EACH OF THESE BLUE LETTERS AND A BLACK BORDER SURROUNDS THE WHITE BORDER. THE LETTER "O" CONSISTS OF A STYLIZED TURTLE HAVING A BROWN HEAD, LEGS AND FEET. THE TURTLE HAS A WHITE BODY WITH A GREEN CONCENTRIC RING AROUND ITS PERIMETER WITH A BLACK BORDER AROUND THE GREEN PERIMETER. THE TURTLE'S EYES ARE GREEN.

FOR POND INSTALLATION KIT CONSISTING OF SKIMMER, SKIMMER LID, WATERFALL UNIT, 45 MIL LINER, PUMP, PVC FLEX PIPE, UNDERWATER LIGHTING, FILTER MEDIA, SKIMMER BASKET, EXPANDING FOAM, LINER PATCH, BULK HEAD FITTINGS, BACTERIA FOR POND TREATMENT, PVC GLUE AND PRIMER, CHECK VALVE ASSEMBLY AND INSTRUCTION MANUAL ALL SOLD AS A UNIT (U.S. CLS. 13, 21, 23, 31 AND 34).

FIRST USE 8-14-2002; IN COMMERCE 8-14-2002.

SN 76-464,319. BRAMEC CORPORATION, NORTH SIOUX CITY, SD. FILED 10-30-2002.

CONE-HEAD

FOR STANDS AND BASES FOR AIR CONDITIONING UNITS, AIR HANDLING UNITS AND HEAT PUMPS (U.S. CLS. 13, 21, 23, 31 AND 34).

SN 76-464,320. BRAMEC CORPORATION, NORTH SIOUX CITY, SD. FILED 10-30-2002.

HEF-C-MENT

FOR STANDS AND BASES FOR AIR CONDITIONING UNITS, AIR HANDLING UNITS AND HEAT PUMPS (U.S. CLS. 13, 21, 23, 31 AND 34).

SN 76-464,459. FILTER SPECIALISTS INTERNATIONAL, INC., MICHIGAN CITY, IN. FILED 10-29-2002.

MAGSEP

FOR INDUSTRIAL FILTER FOR SEPARATING MAGNETIC PARTICLES FROM LIQUIDS (U.S. CLS. 13, 21, 23, 31 AND 34).

CLASS 11—(Continued).

SN 76-464,909. O.C. WHITE CO., THREE RIVERS, MA. FILED 11-6-2002.

PROLITE

FOR ELECTRIC FLUORESCENT LIGHTING FIXTURES (U.S. CLS. 13, 21, 23, 31 AND 34).
FIRST USE 12-31-1965; IN COMMERCE 12-0-1965.

SN 78-044,377. VORTEX PUMP LLC, OWINGS, MD. FILED 1-22-2001.



NO CLAIM IS MADE TO THE EXCLUSIVE RIGHT TO USE "PUMP AND "LLC", APART FROM THE MARK AS SHOWN.

FOR SEWAGE GRINDER PUMP FOR SEPTIC AND SEWAR SYSTEMS (U.S. CLS. 13, 21, 23, 31 AND 34).

SN 78-054,273. CO2 TECHNOLOGIES, INC., WEST DES MOINES, IA. FILED 3-21-2001.



THE DRAWING IS LINED TO INDICATE THE COLOR BLUE ON THE "CO" AND ORANGE ON THE "2".

FOR PERISHABLE PRESERVATION DEVICES, NAMELY, DEVICE IN THE NATURE OF A SELF-CONTAINED UNIT FEATURING A SHELL ENCLOSING AN ABSORBENT MATERIAL WITH HOLES TO ALLOW FOR EVAPORATION USED FOR INTRODUCING HUMIDITY INTO AN ATMOSPHERE (U.S. CLS. 13, 21, 23, 31 AND 34).

CLASS 11—(Continued).

SN 78-121,168. INDOOR PURIFICATION SYSTEMS, INC., LAYTON, UT. FILED 4-11-2002.



NO CLAIM IS MADE TO THE EXCLUSIVE RIGHT TO USE "AIR IONIZERS", APART FROM THE MARK AS SHOWN.

FOR AIR PURIFIER/IONIZER FOR REMOVING AIR IMPURITIES IN AN INHABITED ROOM AT HABITABLE ROOM TEMPERATURES (U.S. CLS. 13, 21, 23, 31 AND 34).

SN 78-121,339. KING OF FANS, INC., FT. LAUDERDALE, FL. FILED 4-12-2002.

GRANADA

FOR ENVIRONMENTAL CONTROL APPARATUS, NAMELY ELECTRIC CIRCULATING FANS FOR DOMESTIC AND COMMERCIAL USE; CEILING AND WALL SURFACE MOUNTED FANS, FIXTURES AND PARTS THEREFOR; PORTABLE FANS, FIXTURES AND PARTS THEREFOR; FREESTANDING FANS, FIXTURES AND PARTS THEREFOR; DESK FANS, FIXTURES AND PARTS THEREFOR; AND HIGH VELOCITY FLOOR FANS, FIXTURES AND PARTS THEREFOR (U.S. CLS. 13, 21, 23, 31 AND 34).

FIRST USE 8-0-1995; IN COMMERCE 8-0-1995.

SN 78-130,794. HUNTER FAN COMPANY, MEMPHIS, TN. FILED 5-23-2002.

MODERNE

THE ENGLISH TRANSLATION OF MARK IS "MODERN".
FOR PORTABLE ELECTRIC FANS (U.S. CLS. 13, 21, 23, 31 AND 34).

SN 78-179,687. BREWER, ROD, COCHRANE, ALBERTA, CANADA, FILED 10-29-2002.

IT'S A GUY THING

FOR TOILET SEAT CLIPS FOR LIFTING AND HOLDING TOILET LID AND SEAT IN UPRIGHT POSITION (U.S. CLS. 13, 21, 23, 31 AND 34).

CLASS 11—(Continued).

SN 78-180,485. L&L KILN MFG., INC., BOOTHWYN, PA. FILED 10-31-2002.

EASY-FIRE

FOR KILNS FOR CERAMICS AND POTTERY (U.S. CLS. 13, 21, 23, 31 AND 34).
FIRST USE 9-1-1997; IN COMMERCE 9-1-1997.

SN 78-180,682. W. D. CROFT CO., LTD., CORONA, CA. FILED 10-31-2002.

AVALON

FOR BARBECUES (U.S. CLS. 13, 21, 23, 31 AND 34).

SN 78-184,498. DAN'S FAN CITY, INC., OLDSMAR, FL. FILED 11-13-2002.

DIXIE BELLE

FOR CEILING FANS (U.S. CLS. 13, 21, 23, 31 AND 34).
FIRST USE 4-1-1980; IN COMMERCE 4-1-1980.

SN 78-186,123. THEORY3, INC., LAKE BUENA VISTA, FL. FILED 11-18-2002.

TIREFLYS REFLECTS

OWNER OF U.S. REG. NO. 2,502,223.
NO CLAIM IS MADE TO THE EXCLUSIVE RIGHT TO USE "REFLECTS", APART FROM THE MARK AS SHOWN.
FOR BICYCLE REFLECTORS (U.S. CLS. 13, 21, 23, 31 AND 34).

SN 78-190,589. AMERICAN STANDARD INTERNATIONAL INC., PISCATAWAY, NY. FILED 12-3-2002.

HATTERAS

FOR PLUMBING FITTINGS, NAMELY FAUCETS, FAUCET HANDLES, SHOWER HEADS, BATH SPOUTS, HAND SHOWERS, AND PARTS THEREOF. (U.S. CLS. 13, 21, 23, 31 AND 34).

CLASS 11—(Continued).

SN 78-195,812. WATKINS MANUFACTURING CORPORATION, VISTA, CA. FILED 12-18-2002.

JETSTREAM

OWNER OF U.S. REG. NO. 1,528,105.
FOR SPAS IN THE NATURE OF HEATED WHIRL-
POOLS (U.S. CLS. 13, 21, 23, 31 AND 34).
FIRST USE 7-1-1987; IN COMMERCE 7-1-1987.

CLASS 12—(Continued).

SN 76-289,246. BICICLETAS DE ALAVA, S.A., 01006 VITORIA (ALAVA), SPAIN, FILED 7-20-2001.

BH

OWNER OF SPAIN REG. NO. 1260392, DATED 11-21-1988,
EXPIRES 11-21-2008.
FOR BICYCLES AND PARTS THEREOF (U.S. CLS. 19,
21, 23, 31, 35 AND 44).

CLASS 12—VEHICLES

SN 75-438,206. SHINODA, KAREN D., NEW YORK, NY.
FILED 2-23-1998.

BOSS SHINODA

FOR AUTOMOTIVE DETAILING KIT, CONSISTING
OF SPOILERS AND DETAILING GRAPHICS (U.S. CLS.
19, 21, 23, 31, 35 AND 44).
FIRST USE 12-0-1994; IN COMMERCE 12-0-1994.

SN 75-582,957. GLOBAL AEROSPACE CORPORATION, AL-
TADENA, CA. FILED 11-4-1998.

STRATOSAIL

FOR AERODYNAMIC TRAJECTORY CONTROL
WING, FRAME, WINCH, AND TETHERS SOLD AS A
UNIT FOR CONTROLLING THE FLIGHT DIRECTION
OF LIGHTER-THAN-AIR SCIENTIFIC, RECREATIONAL
AND SPORT BALLOONS (U.S. CLS. 19, 21, 23, 31, 35 AND
44).
FIRST USE 2-9-2000; IN COMMERCE 3-20-2002.

SN 76-115,065. DELAWARE CAPITAL FORMATION, INC.,
WILMINGTON, DE. BY ASSIGNMENT KALYN/SIEBERT,
L.P., GATESVILLE, TX. FILED 8-23-2000.

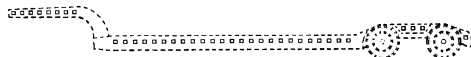

THE MARK CONSISTS OF A PATTERN OF SQUARE
HOLES WHICH ARE PLACED ALONG THE BEAMS OF
CARGO TRAILERS. THE NUMBER OF HOLES MAY VARY
DEPENDING ON THE LENGTH OF THE TRAILER. THE
DOTTED LINES SHOWN IN THE DRAWING OF THE
MARK ARE INTENDED TO SHOW THE POSITION OF
THE MARK ON THE GOODS AND ARE NOT A FEATURE
OF THE MARK.

SEC. 2(F).
FOR CARGO TRAILERS (U.S. CLS. 19, 21, 23, 31, 35
AND 44).
FIRST USE 0-0-1976; IN COMMERCE 0-0-1976.

SN 76-313,328. MAZDA MOTOR CORPORATION, HIROSHI-
MA, JAPAN, FILED 9-12-2001.



PRIORITY CLAIMED UNDER SEC. 44(D) ON JAPAN
APPLICATION NO. 2001-069844, FILED 8-1-2001, REG. NO.
4604596, DATED 9-13-2002, EXPIRES 9-13-2012.

OWNER OF U.S. REG. NOS. 706,561, 1,186,612 AND
OTHERS.

FOR AUTOMOBILES, STRUCTURAL PARTS THERE-
OF, TWO-WHEELED MOTOR VEHICLES, NAMELY,
MOTORCYCLES, AND BICYCLES, STRUCTURAL
PARTS THEREOF, BUT EXCLUDING LAMPS, SIGNALS,
AND SIMILAR LIGHTING EQUIPMENT FOR VEHI-
CLES, ENGINES FOR AUTOMOBILES, MOTORS AND
ENGINES FOR OTHER LAND VEHICLES, SUSPENSION
SYSTEMS FOR AUTOMOBILES, MOTORCYCLES, BI-
CYCLES, AND TRUCKS; SHOCK ABSORBERS AND
SPRINGS FOR LAND VEHICLES, DRIVE SHAFTS AND
AXLES FOR LAND VEHICLES, WHEEL BEARINGS
AND SHAFT COUPLINGS FOR LAND VEHICLES,
TRANSMISSIONS FOR LAND VEHICLES, BRAKES
FOR LAND VEHICLES, ANTI-THEFT ALARMS FOR
LAND VEHICLES (U.S. CLS. 19, 21, 23, 31, 35 AND 44).

SN 76-313,444. MAZDA MOTOR CORPORATION, AKI-GUN,
HIROSHIMA, JAPAN, FILED 9-12-2001.



PRIORITY CLAIMED UNDER SEC. 44(D) ON JAPAN
APPLICATION NO. 2001-069841, FILED 8-1-2001, REG. NO.
4604593, DATED 9-13-2002, EXPIRES 9-13-2012.

OWNER OF U.S. REG. NOS. 76,561, 1,186,612 AND
OTHERS.

FOR AUTOMOBILES, STRUCTURAL PARTS THERE-
OF, TWO-WHEELED MOTOR VEHICLES, NAMELY, MO-
TORCYCLES, AND BICYCLES, STRUCTURAL PARTS
THEREOF, BUT EXCLUDING LAMPS, SIGNALS, AND
SIMILAR LIGHTING EQUIPMENT FOR VEHICLES,
ENGINES FOR AUTOMOBILES, MOTORS AND EN-
GINES FOR OTHER LAND VEHICLES, SUSPENSION
SYSTEMS FOR AUTOMOBILES, MOTORCYCLES, BI-
CYCLES, AND TRUCKS, SHOCK ABSORBERS AND
SPRINGS FOR LAND VEHICLES, DRIVE SHAFTS AND
AXLES FOR LAND VEHICLES, WHEEL BEARINGS
AND SHAFT COUPLINGS FOR LAND VEHICLES,
TRANSMISSIONS FOR LAND VEHICLES, BRAKES
FOR LAND VEHICLES, ANTI-THEFT ALARMS FOR
LAND VEHICLES (U.S. CLS. 19, 21, 23, 31, 35 AND 44).

CLASS 12—(Continued).

SN 76-313,447. MAZDA MOTOR CORPORATION, AKI-GUN, HIROSHIMA, JAPAN, FILED 9-12-2001.

mazda 8

PRIORITY CLAIMED UNDER SEC. 44(D) ON JAPAN APPLICATION NO. 2001-069845, FILED 8-1-2001, REG. NO. 4604597, DATED 9-13-2002, EXPIRES 9-13-2012.

OWNER OF U.S. REG. NOS. 706,561, 1,186,612 AND OTHERS.

FOR AUTOMOBILES, STRUCTURAL PARTS THEREOF, TWO-WHEELED MOTOR VEHICLES, NAMELY, MOTORCYCLES, AND BICYCLES, STRUCTURAL PARTS THEREOF, BUT EXCLUDING LAMPS, SIGNALS, AND SIMILAR LIGHTING EQUIPMENT FOR VEHICLES, ENGINES FOR AUTOMOBILES, MOTORS AND ENGINES FOR OTHER LAND VEHICLES, SUSPENSION SYSTEMS FOR AUTOMOBILES, MOTORCYCLES, BICYCLES, AND TRUCKS, SHOCK ABSORBERS AND SPRINGS FOR LAND VEHICLES, DRIVE SHAFTS AND AXLES FOR LAND VEHICLES, WHEEL BEARINGS AND SHAFT COUPLINGS FOR LAND VEHICLES, TRANSMISSIONS FOR LAND VEHICLES, BRAKES FOR LAND VEHICLES, ANTI-THEFT ALARMS FOR LAND VEHICLES (U.S. CLS. 19, 21, 23, 31, 35 AND 44).

SN 76-320,482. BOHANNON, MICHAEL, WHISKEYTOWN, CA. FILED 10-3-2001.

MONKEY GRIP

NO CLAIM IS MADE TO THE EXCLUSIVE RIGHT TO USE "GRIP", APART FROM THE MARK AS SHOWN.

FOR HANDLE GRIPS FOR SPORTING EQUIPMENT—NAMELY BICYCLES (U.S. CLS. 19, 21, 23, 31, 35 AND 44).

SN 76-355,185. ATLANTIC WHOLESALERS INC., BROOKLYN, NY. FILED 1-4-2002.

DVS ROAD WHEELS

NO CLAIM IS MADE TO THE EXCLUSIVE RIGHT TO USE "ROAD WHEELS", APART FROM THE MARK AS SHOWN.

FOR VEHICLE WHEEL RIMS; VEHICLE WHEEL COVERS; HUB CAPS (U.S. CLS. 19, 21, 23, 31, 35 AND 44).
FIRST USE 11-22-2000; IN COMMERCE 11-22-2000.

SN 76-399,847. RECREATIONAL TECHNOLOGIES INCORPORATED (RTI), VANCOUVER, BRITISH COLUMBIA, CANADA, FILED 4-23-2002.

SYNCROS

FOR BICYCLE COMPONENTS AND ACCESSORIES, NAMELY, HANDLEBARS, HANDLEBAR STEMS, HANDLEBAR ENDS, BRAKE CABLE HANGERS, SEAT POSTS, BOTTOM BRACKETS, CRANK SETS, CRANK BOLTS, BRAKE PADS, TIRES, PEDALS, RIMS, CHAINS, SADDLES, BICYCLE PUMPS, BICYCLE BELLS AND BICYCLE FRAMES, BICYCLE TOOLS, NAMELY, AND TIRE PATCHES (U.S. CLS. 19, 21, 23, 31, 35 AND 44).

CLASS 12—(Continued).

SN 76-412,102. OFNER, ANTON GERALD, (W) A-1190 VIENNA, AUSTRIA, FILED 5-17-2002.

VARIOWING

PRIORITY CLAIMED UNDER SEC. 44(D) ON AUSTRIA APPLICATION NO. AM8032/2001, FILED 11-19-2001, REG. NO. 202600, DATED 3-12-2002, EXPIRES 3-12-2012.

FOR AIRCRAFT; STRUCTURAL PARTS OF AIRCRAFTS, NAMELY, AIRFOILS (U.S. CLS. 19, 21, 23, 31, 35 AND 44).

SN 76-414,851. BOMBARDIER INC., VALCOURT, CANADA, FILED 5-30-2002.

REV

FOR VEHICLES, NAMELY, SNOWMOBILES AND STRUCTURAL PARTS THEREFOR; AND SEMI-FITTED AND FITTED SNOWMOBILE COVERS (U.S. CLS. 19, 21, 23, 31, 35 AND 44).

FIRST USE 1-0-2002; IN COMMERCE 1-0-2002.

SN 76-414,854. BOMBARDIER INC., VALCOURT, QUEBEC, FILED 5-30-2002.

R.A.S.

FOR VEHICLES, NAMELY, SNOWMOBILES AND STRUCTURAL PARTS THEREFOR; AND SNOWMOBILE SUSPENSION SYSTEMS AND PARTS THEREOF (U.S. CLS. 19, 21, 23, 31, 35 AND 44).

FIRST USE 1-0-2002; IN COMMERCE 1-0-2002.

SN 76-435,400. DTR ASSOCIATES LIMITED PARTNERSHIP, MARLBOROUGH, MA. FILED 7-25-2002.

TRIPLEDEGE

SEC. 2(F).
FOR WINDSHIELD WIPERS FOR VEHICLES (U.S. CLS. 19, 21, 23, 31, 35 AND 44).
FIRST USE 1-3-1985; IN COMMERCE 1-3-1985.

SN 76-436,301. DAIMLERCHRYSLER AG, 70567 STUTTGART, FED REP GERMANY, FILED 7-31-2002.

RLX

PRIORITY CLAIMED UNDER SEC. 44(D) ON FED REP GERMANY APPLICATION NO. 30206907.012, FILED 2-11-2002, REG. NO. 30206907, DATED 4-15-2002, EXPIRES 2-29-2012.

FOR AUTOMOBILES AND STRUCTURAL PARTS THEREFOR (U.S. CLS. 19, 21, 23, 31, 35 AND 44).

CLASS 12—(Continued).

SN 76-442,966. NETWORK INDUSTRIES INC., CHULA VISTA, CA. FILED 8-19-2002.

QUALPRO

FOR MATERIAL HANDLING VEHICLES, NAMELY, FORKLIFTS, TELESCOPING MAST LIFTS, ARTICULATED ARM/SELF PROPELLED BOOMS, BOOM SUPPORT LIFTS, TRAILER MOUNTED LIFTS, PORTABLE PERSONNEL LIFTS AND STRUCTURAL PARTS FOR FORKLIFTS, STRUCTURAL PARTS FOR MATERIAL HANDLING VEHICLES, NAMELY, TIRES, WHEELS, AND WHEEL BEARINGS; HAND TRUCKS AND SCAMFOLDS ON ROLLERS (U.S. CLS. 19, 21, 23, 31, 35 AND 44).

SN 78-030,259. TECHNOLOGY SALES CORPORATION INC., CHARLOTTE, NC. FILED 10-12-2000.

RELIANT 1 BRAKE MONITOR

NO CLAIM IS MADE TO THE EXCLUSIVE RIGHT TO USE "BRAKE MONITOR", APART FROM THE MARK AS SHOWN.

FOR BRAKE ADJUSTER INDICATOR, NAMELY, AN ON-BOARD ELECTRONIC WARNING DEVICE FOR USE ON LARGE MULTI-AXLE TRUCKS AND BUSES EQUIPPED WITH AIR POWER BRAKES, COMPRISED OF ELECTRICAL SWITCHES AND ASSOCIATED MOUNTING BRACKETS, A STANDARD 12-VOLT VEHICULAR POWER SUPPLY CONNECTOR, A VISUAL DISPLAY MONITOR AND A WIRING HARNESS (U.S. CLS. 19, 21, 23, 31, 35 AND 44).

SN 78-089,274. DAIMLERCHRYSLER CORPORATION, AUBURN HILLS, MI. FILED 10-19-2001.

LIBERTY

FOR VEHICLES, NAMELY INFANT AND TODDLER STROLLERS (U.S. CLS. 19, 21, 23, 31, 35 AND 44). FIRST USE 1-27-2002; IN COMMERCE 1-27-2002.

SN 78-090,906. MAZDA MOTOR OF AMERICA, INC., IRVINE, CA. FILED 10-30-2001.

BODY OF A MINIVAN. SOUL OF A SPORTS CAR.

FOR AUTOMOBILES (U.S. CLS. 19, 21, 23, 31, 35 AND 44). FIRST USE 2-0-2002; IN COMMERCE 2-0-2002.

CLASS 12—(Continued).

SN 78-091,037. GENERAL MOTORS CORPORATION, DETROIT, MI. FILED 10-31-2001.

BASE CAMP

FOR MOTOR LAND VEHICLES, NAMELY, AUTOMOBILES, SPORT UTILITY VEHICLES, TRUCKS, VANS, ENGINES THEREFORE AND STRUCTURAL PARTS THEREOF (U.S. CLS. 19, 21, 23, 31, 35 AND 44).

SN 78-106,527. ROYCE UNION BICYCLE COMPANY, MIAMISBURG, OH. FILED 2-4-2002.

SAVOY

FOR BICYCLES AND STRUCTURAL PARTS THEREOF (U.S. CLS. 19, 21, 23, 31, 35 AND 44). FIRST USE 8-23-1956; IN COMMERCE 8-23-1956.

SN 78-124,650. ATV FOUR-PLAY, WADSWORTH, OH. FILED 4-28-2002.

ATV FOUR-PLAY

NO CLAIM IS MADE TO THE EXCLUSIVE RIGHT TO USE "ATV", APART FROM THE MARK AS SHOWN.

FOR ALL TERRAIN VEHICLE PERFORMANCE ENHANCEMENT SUSPENSION COMPONENTS, NAMELY, A- ARMS AND SWING ARMS (U.S. CLS. 19, 21, 23, 31, 35 AND 44).

SN 78-138,435. DAIMLERCHRYSLER CORPORATION, AUBURN HILLS, MI. FILED 6-25-2002.

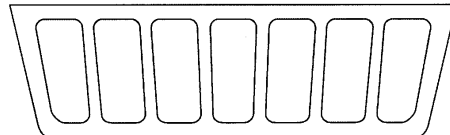

THE MARK CONSISTS OF THE THREE DIMENSIONAL CONFIGURATION OF THE FRONT GRILLE OF AN AUTOMOBILE, COMPRISING SEVEN VERTICAL SLOTS.

FOR MOTOR VEHICLES, NAMELY AUTOMOBILES AND SPORT UTILITY VEHICLES, AND STRUCTURAL PARTS THEREFOR (U.S. CLS. 19, 21, 23, 31, 35 AND 44). FIRST USE 8-11-1999; IN COMMERCE 8-11-1999.

CLASS 12—(Continued).

SN 78-149,753. AMERICAN RACING EQUIPMENT, INC., RANCHO DOMINGUEZ, CA. FILED 8-1-2002.

MOTTO RACING

NO CLAIM IS MADE TO THE EXCLUSIVE RIGHT TO USE "RACING", APART FROM THE MARK AS SHOWN.
FOR AUTOMOTIVE VEHICLE WHEELS AND COMPONENTS THEREOF (U.S. CLS. 19, 21, 23, 31, 35 AND 44).

SN 78-157,801. MIDWEST MOTORCYCLE SUPPLY DISTRIBUTORS CORP., ARNOLD, MO. FILED 8-26-2002.

BLACK CLOUD

FOR MOTORCYCLES AND STRUCTURAL PARTS THEREFOR (U.S. CLS. 19, 21, 23, 31, 35 AND 44).

SN 78-160,561. KUAN TONG INDUSTRIAL CO., LTD., TAINA, TAIWAN, FILED 9-4-2002.



FOR AUTOMOBILES AND STRUCTURAL PARTS THEREOF; MOTORCYCLES AND STRUCTURAL PARTS THEREOF; AND BICYCLES AND STRUCTURAL PARTS THEREOF (U.S. CLS. 19, 21, 23, 31, 35 AND 44).

SN 78-175,325. MJM YACHTS, LLC, CHARELSTON, SC. FILED 10-17-2002.

MJM

FOR RECREATIONAL BOATS (U.S. CLS. 19, 21, 23, 31, 35 AND 44).

SN 78-178,766. FREEDMAN, ROBERTA, PARKLAND, FL. FILED 10-26-2002.

LAUNDRE-Z

FOR LAUNDRY CARTS (U.S. CLS. 19, 21, 23, 31, 35 AND 44).

CLASS 12—(Continued).

SN 78-180,554. INDIANA MILLS & MANUFACTURING, INC., WESTFIELD, IN. FILED 10-31-2002.

ROLLTEK

FOR VEHICLE SAFETY SYSTEMS COMPRISED OF AIR BAGS, SEAT BELT PRETENSIONERS, AND SUSPENSION SEAT PULL DOWN DEVICES (U.S. CLS. 19, 21, 23, 31, 35 AND 44).

SN 78-183,615. GENERAL MOTORS CORPORATION, DETROIT, MI. FILED 11-11-2002.

CORRE POR TUS VENAS

THE ENGLISH TRANSLATION OF "CORRE POR TUS VENAS" IS "IT RUNS THROUGH YOUR VEINS".

FOR MOTOR LAND VEHICLES, NAMELY, AUTOMOBILES, SPORT UTILITY VEHICLES, TRUCKS, VANS, ENGINES THEREFOR AND STRUCTURAL PARTS THEREOF (U.S. CLS. 19, 21, 23, 31, 35 AND 44).

SN 78-183,953. WOOD MANUFACTURING COMPANY, INC., FLIPPIN, AR. FILED 11-12-2002.

CONTROL POST

FOR ORIGINAL EQUIPMENT AND AFTER-MARKET BOAT SEATS (U.S. CLS. 19, 21, 23, 31, 35 AND 44).

SN 78-184,581. SRI USA, INC., AMHERST, NY. FILED 11-13-2002.

SP 345

OWNER OF U.S. REG. NOS. 176,661 AND 1,214,772.
FOR TIRES (U.S. CLS. 19, 21, 23, 31, 35 AND 44).

SN 78-184,584. SRI USA, INC., AMHERST, NY. FILED 11-13-2002.

SP 383

OWNER OF U.S. REG. NOS. 176,661 AND 1,214,772.
FOR TIRES (U.S. CLS. 19, 21, 23, 31, 35 AND 44).

CLASS 12—(Continued).

SN 78-184,954. GULFSTREAM AEROSPACE CORPORATION, SAVANNAH, GA. FILED 11-14-2002.

G400

OWNER OF U.S. REG. NOS. 2,527,504, 2,552,560 AND OTHERS.
FOR AIRPLANES (U.S. CLS. 19, 21, 23, 31, 35 AND 44).

SN 78-184,960. GULFSTREAM AEROSPACE CORPORATION, SAVANNAH, GA. FILED 11-14-2002.

G500

OWNER OF U.S. REG. NOS. 2,527,504, 2,552,560 AND OTHERS.
FOR AIRPLANES (U.S. CLS. 19, 21, 23, 31, 35 AND 44).

SN 78-184,964. GULFSTREAM AEROSPACE CORPORATION, SAVANNAH, GA. FILED 11-14-2002.

G550

OWNER OF U.S. REG. NOS. 2,527,504, 2,552,560 AND OTHERS.
FOR AIRPLANES (U.S. CLS. 19, 21, 23, 31, 35 AND 44).

SN 78-185,946. A.E.R.O. AVIATION, INC., GRANITE CITY, IL. FILED 11-18-2002.

AVPRO

FOR AIRCRAFT ENGINE PARTS, NAMELY, BRAKE DISCS, BRAKE LININGS AND MECHANICAL PARTS THEREFOR (U.S. CLS. 19, 21, 23, 31, 35 AND 44).
FIRST USE 1-1-1994; IN COMMERCE 1-1-1994.

SN 78-191,298. NISSAN JIDOSHA KABUSHIKI KAISHA, TA NISSAN MOTOR CO., LTD., TOKYO, JAPAN, FILED 12-4-2002.

SKYVIEW

FOR MOTOR VEHICLE PARTS, NAMELY FIXED GLASS ROOF PANEL SYSTEMS (U.S. CLS. 19, 21, 23, 31, 35 AND 44).

CLASS 12—(Continued).

SN 78-191,539. SHIMANO INC., SAKAI, OSAKA, JAPAN, FILED 12-5-2002.

INTEGO

FOR BICYCLES, PARTS AND FITTINGS FOR BICYCLES, NAMELY, HUBS, INTERNAL GEAR HUBS, BICYCLE DYNAMO HUBS, HUB QUICK RELEASE LEVERS, GEAR RELEASE LEVERS, GEAR SHIFT LEVERS, FRONT DERAILLEURS, REAR DERAILLEURS, CHAIN GUIDES, FREEWHEELS, SPROCKETS, PULL-EYS, CHAINS, CHAIN DEFLECTORS, SHIFT CABLES, CRANKS, CRANK SETS, CHAIN WHEELS, PEDALS, TOE CLIPS, BRAKE LEVERS, FRONT BRAKES, REAR BRAKES, BRAKE CABLES, BRAKE SHOES, RIMS, WHEELS, SPOKES, SPOKE CLIPS, BOTTOM BRACKETS, SEAT PILLARS, SEAT PILLAR QUICK RELEASE, HEAD PARTS FOR FRAME-FORK ASSEMBLY, FRAMES, SUSPENSIONS, HANDLEBARS, HANDLE STEMS, GRIPS FOR HANDLEBARS, SADDLES, MUD GUARDS, KICK STANDS, CARRIERS, BELLS, HORNS, REARVIEW MIRRORS FOR BICYCLES, DERAILLEURS CONTROLLED BY COMPUTER, WHEEL BAGS FOR BICYCLES, ANTI-THEFT ALARMS FOR BICYCLES, ANTI-THEFT DEVICES FOR BICYCLES, DYNAMOS FOR BICYCLES, DIRECTION INDICATORS FOR BICYCLES (U.S. CLS. 19, 21, 23, 31, 35 AND 44).

SN 78-191,549. SHIMANO INC., SAKAI, OSAKA, JAPAN, FILED 12-5-2002.

SMOVER

FOR BICYCLES, PARTS AND FITTINGS FOR BICYCLES, NAMELY, HUBS, INTERNAL GEAR HUBS, BICYCLE DYNAMO HUBS, HUB QUICK RELEASE LEVERS, GEAR RELEASE LEVERS, GEAR SHIFT LEVERS, FRONT DERAILLEURS, REAR DERAILLEURS, CHAIN GUIDES, FREEWHEELS, SPROCKETS, PULL-EYS, CHAINS, CHAIN DEFLECTORS, SHIFT CABLES, CRANKS, CRANK SETS, CHAIN WHEELS, PEDALS, TOE CLIPS, BRAKE LEVERS, FRONT BRAKES, REAR BRAKES, BRAKE CABLES, BRAKE SHOES, RIMS, WHEELS, SPOKES, SPOKE CLIPS, BOTTOM BRACKETS, SEAT PILLARS, SEAT PILLAR QUICK RELEASE, HEAD PARTS FOR FRAME-FORK ASSEMBLY, FRAMES, SUSPENSIONS, HANDLEBARS, HANDLE STEMS, GRIPS FOR HANDLEBARS, SADDLES, MUD GUARDS, KICK STANDS, CARRIERS, BELLS, HORNS, REARVIEW MIRRORS FOR BICYCLES, DERAILLEURS CONTROLLED BY COMPUTER, WHEEL BAGS FOR BICYCLES, ANTI-THEFT ALARMS FOR BICYCLES, ANTI-THEFT DEVICES FOR BICYCLES, DYNAMOS FOR BICYCLES, DIRECTION INDICATORS FOR BICYCLES (U.S. CLS. 19, 21, 23, 31, 35 AND 44).

SN 78-193,725. AMES TRUE TEMPER PROPERTIES, INC., WILMINGTON, DE. FILED 12-12-2002.

EASY STORE

FOR WHEELBARROWS (U.S. CLS. 19, 21, 23, 31, 35 AND 44).

CLASS 12—(Continued).

SN 78-193,731. ROLF DIETRICH, TOLEDO, OH. FILED 12-12-2002.

ACCEL

FOR BICYCLE PARTS, NAMELY, BICYCLE WHEELS AND BICYCLE WHEEL RIMS (U.S. CLS. 19, 21, 23, 31, 35 AND 44).

SN 78-196,274. FORD MOTOR COMPANY, DEARBORN, MI. FILED 12-19-2002.

FACTION

FOR MOTOR VEHICLES, NAMELY, AUTOMOBILES, TRUCKS, VANS, SPORT UTILITY VEHICLES, MULTI-PURPOSE VEHICLES, AND THEIR STRUCTURAL PARTS AND ENGINES (U.S. CLS. 19, 21, 23, 31, 35 AND 44).

CLASS 13—FIREARMS

SN 76-181,402. AMERICAN PROMOTIONAL EVENTS, INC., FLORENCE, AL. FILED 12-18-2000.

DEPTH CHARGE

FOR FIREWORKS (U.S. CLS. 2 AND 9).
FIRST USE 5-15-2000; IN COMMERCE 5-15-2000.

CLASS 14—JEWELRY

SN 75-663,474. WORLDGEM BRANDS-GESTAO E INVESTIMENTOS LDA., FUNCHAL, MADEIRA, PORTUGAL, FILED 3-19-1999.

SANS PAREIL BY NIMEI

THE ENGLISH TRANSLATION OF "SANS PAREIL" IS "WITHOUT EQUAL".

FOR ARTICLES OF JEWELRY, NAMELY, RINGS, EARRINGS, NECKLACES, BRACELETS, BROOCHES AND PENDANTS; HOROLOGICAL INSTRUMENTS, NAMELY, WATCHES; TRINKETS OF PRECIOUS METALS, NAMELY, KEY CHAINS, KEY RINGS, AMULETS AND LAPEL PINS; WATCHES AND METAL KEY FOBS, TIE CLIPS, EAR CLIPS, MONEY CLIPS AND MEDALS, ALL MADE OF GOLD, SILVER AND/OR OTHER PRECIOUS METALS (U.S. CLS. 2, 27, 28 AND 50).

SN 75-743,188. MOVADO CORPORATION, WILMINGTON, DE. FILED 7-6-1999.

DANA

FOR WATCHES (U.S. CLS. 2, 27, 28 AND 50).

CLASS 14—(Continued).

SN 76-199,046. TXDC., L.P., IRVING, TX. BY ASSIGNMENT ZALE DELAWARE, INC., IRVING, TX. FILED 1-24-2001.

THE DIVA

FOR DIAMONDS AND DIAMOND JEWELRY (U.S. CLS. 2, 27, 28 AND 50).
FIRST USE 8-1-1999; IN COMMERCE 8-1-1999.

SN 76-274,915. ORCHID GEMS, SANTA MONICA, CA. FILED 6-22-2001.

ORCHID GEMS

NO CLAIM IS MADE TO THE EXCLUSIVE RIGHT TO USE "GEMS", APART FROM THE MARK AS SHOWN.

FOR JEWELRY AND JEWELRY ARTICLES MADE WITH OR WITHOUT PRECIOUS OR SEMI-PRECIOUS GEMSTONES; NAMELY BRACELETS, NECKLACES, EARRINGS, FINGER RINGS, CUFFLINKS, TIE TACKS (U.S. CLS. 2, 27, 28 AND 50).

SN 76-324,994. ASHWORTH, INC., CARLSBAD, CA. FILED 10-12-2001.

ASHWORTH

FOR JEWELRY AND WATCHES (U.S. CLS. 2, 27, 28 AND 50).
FIRST USE 11-0-2000; IN COMMERCE 11-0-2000.

SN 76-329,851. ABUNDANCE RESOURCE NETWORK, INC., ADDISON, TX. FILED 10-23-2001.



FOR JEWELRY (U.S. CLS. 2, 27, 28 AND 50).
FIRST USE 6-21-2001; IN COMMERCE 6-21-2001.

CLASS 14—(Continued).

SN 76-339,090. MCGAHEE, JOHN E., BROOKSVILLE, FL.
FILED 11-17-2001.

Purity Promise

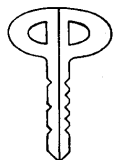

Key

NO CLAIM IS MADE TO THE EXCLUSIVE RIGHT TO USE "KEY", APART FROM THE MARK AS SHOWN. THE MARK CONSISTS IN PART OF BACK-TO-BACK LETTER "P'S" THAT FORM A KEY DESIGN. FOR JEWELRY (U.S. CLS. 2, 27, 28 AND 50).

SN 76-345,347. WALDMANN KG, D-75217 BIRKENFELD,
FED REP GERMANY, FILED 12-5-2001.

WALDMANN

SEC. 2(F).
FOR WRITING INSTRUMENTS; PENS; BALL PENS, FOUNTAIN PENS, ROLLER PENS, MULTICOLOR PENS; PENCILS; MULTICOLOR PENCILS, PROPELLING PENCILS; CRAYONS; DRAWING INSTRUMENTS; CASES, BOXES, HOLDERS AND CLIPS FOR WRITING AND DRAWING INSTRUMENTS (U.S. CLS. 2, 27, 28 AND 50). FIRST USE 0-0-1918; IN COMMERCE 1-0-1999.

SN 76-361,016. CYMA JAPAN CO., LTD., SAITAMA, JAPAN,
FILED 1-18-2002.

TRUSTY

OWNER OF JAPAN REG. NO. 2578400, DATED 9-30-1993,
EXPIRES 9-30-2003.
FOR HOROLOGICAL AND CHRONOMETRIC INSTRUMENTS, NAMELY, CLOCKS, WATCHES, CHRONOMETERS, AND REPLACEMENT PARTS AND FITTINGS THEREFOR (U.S. CLS. 2, 27, 28 AND 50).

SN 76-392,760. CHAUMET INTERNATIONAL S.A., 75001
PARIS, FRANCE, FILED 4-5-2002.

PLUMES

OWNER OF FRANCE REG. NO. 99812209, DATED 9-15-1999, EXPIRES 9-15-2009.
FOR WRIST-WATCHES, CHRONOMETERS, NECKLACES, BRACELETS, EARRINGS, PENDANTS, RINGS AND CUFF LINKS (U.S. CLS. 2, 27, 28 AND 50).

CLASS 14—(Continued).

SN 76-401,060. GLOBAL ARTISTS CO., LTD., TOKYO, 107-0052, JAPAN, FILED 4-26-2002.

NEW YORK DIARY

NO CLAIM IS MADE TO THE EXCLUSIVE RIGHT TO USE "NEW YORK", APART FROM THE MARK AS SHOWN. FOR PRECIOUS METALS ITEMS, NAMELY, COFFEE POTS, SUGAR BOWLS, TEAPOTS, NUT CRACKERS, NAPKIN HOLDERS AND RINGS, SERVING TRAYS, TOOTHPICK HOLDERS, BOXES IN THE NATURE OF DECORATIVE BOXES FOR NEEDLES AND JEWEL CASES, CANDLE SNUFFERS AND CANDLESTICKS, FLOWER VASES, BOWLS, TROPHIES, COMMEMORATIVE SHIELDS, INSIGNIAS AND BADGES, PERSONAL ORNAMENTS, IN THE NATURE OF HAT ORNAMENTS, BELT BUCKLES; PERSONAL ORNAMENTS, NAMELY, EARRINGS, CLIP EARRINGS, BONNET PINS, TIE CLIPS, TIE PINS, NECKLACES, BRACELETS, ANKLE BRACELETS, PENDANTS, BROOCHES, MEDALS, RINGS BEING JEWELRY, WEDDING BANDS, MEDALLIONS, CUFF LINKS, SEMI-WROUGHT PRECIOUS STONES AND THEIR IMITATIONS, UNWROUGHT PRECIOUS STONES; ARTICLES OF PRECIOUS METAL, NAMELY, CIGARETTE CASES, POWDER COMPACTS SOLD EMPTY AND SHOE ORNAMENTS; CLOCK AND WATCHES, WRIST WATCHES, TABLE CLOCKS, POCKET WATCHES, WALL CLOCKS, ALARM CLOCKS, PARTS AND ACCESSORIES OF WATCHES, NAMELY, WATCH CHAINS, WATCH CRYSTALS, WATCH BANDS AND WATCH STRAPS (U.S. CLS. 2, 27, 28 AND 50).

SN 76-407,688. KELLY, RONDA HAESSIG, CHICAGO, IL.
FILED 5-13-2002.

RK ORIGINALS

NO CLAIM IS MADE TO THE EXCLUSIVE RIGHT TO USE "ORIGINALS", APART FROM THE MARK AS SHOWN. FOR BEADED JEWELRY, NAMELY, NECKLACES, ANKLE BRACELETS, BRACELETS, NECKLACES CONVERTIBLE TO BELTS, BRACELETS CONVERTIBLE TO ANKLETS, BRACELETS CONVERTIBLE TO NECKLACES, PENDANTS (U.S. CLS. 2, 27, 28 AND 50). FIRST USE 1-1-2002; IN COMMERCE 1-1-2002.

SN 76-408,935. PIALLO HANDELS- UND VEREDELUNGS-GESELLSCHAFT M.B.H., A-1010 VIENNA, AUSTRIA,
FILED 5-16-2002.

DELACOUR

PRIORITY CLAIMED UNDER SEC. 44(D) ON AUSTRIA APPLICATION NO. AM8148/2001, FILED 11-23-2001, REG. NO. 203676, DATED 5-17-2002, EXPIRES 5-17-2010.
FOR JEWELRY, WATCHES AND CLOCKS (U.S. CLS. 2, 27, 28 AND 50).

CLASS 14—(Continued).

SN 76-415,987. SHAPIRO, LINDA S., LOS ANGELES, CA. FILED 6-5-2002.

COPPER GOES GLAMOROUS

FOR JEWELRY MADE IN WHOLE OR SUBSTANTIAL PART OF COPPER (U.S. CLS. 2, 27, 28 AND 50). FIRST USE 8-1-2001; IN COMMERCE 8-1-2001.

SN 76-439,109. GARRARD HOLDINGS LIMITED, LONDON W1S 4AS, UNITED KINGDOM, FILED 8-9-2002.

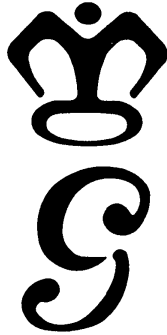

PRIORITY CLAIMED UNDER SEC. 44(D) ON UNITED KINGDOM APPLICATION NO. 2293013, FILED 2-16-2002, REG. NO. 2293013, DATED 2-16-2002, EXPIRES 2-16-2009. FOR SEMI-PRECIOUS GEMSTONES; PRECIOUS GEMSTONES; WATCHES, CLOCKS AND CHRONOGRAPHS FOR USE AS WATCHES, AND PARTS AND FITTINGS FOR ALL THE AFORESAID; JEWELRY AND IMITATION JEWELRY; STATUTES OF PRECIOUS METAL; CUFF-LINKS; TIE PINS AND DRESS STUDS (U.S. CLS. 2, 27, 28 AND 50).

SN 76-443,391. KATTAN, NAGIB HEZI, BEVERLY HILLS, CA. FILED 8-23-2002.



NO CLAIM IS MADE TO THE EXCLUSIVE RIGHT TO USE "BEVERLY HILLS" AND "DESIGNER COLLECTION", APART FROM THE MARK AS SHOWN. FOR JEWELRY, NAMELY RINGS, BRACELETS, NECKLACES, PENDANTS, SLIDERS, MADE WITH DIAMONDS AND PRECIOUS AND SEMI-PRECIOUS STONES (U.S. CLS. 2, 27, 28 AND 50).

CLASS 14—(Continued).

SN 76-444,949. SUNSTONE IMPORTS, INC., MORTON GROVE, IL. FILED 8-29-2002.

IN STEP

FOR JEWELRY (U.S. CLS. 2, 27, 28 AND 50).

SN 76-452,117. PEACE & LOVE JEWELRY BY NANCY DAVIS LLC, LOS ANGELES, CA. FILED 9-24-2002.

peace & love

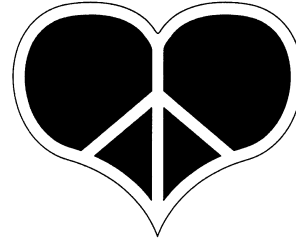

jewelry by nancy davis

NO CLAIM IS MADE TO THE EXCLUSIVE RIGHT TO USE "JEWELRY", APART FROM THE MARK AS SHOWN. "NANCY DAVIS" IS THE NAME OF A LIVING INDIVIDUAL WHOSE CONSENT IS OF RECORD. FOR JEWELRY AND WATCHES (U.S. CLS. 2, 27, 28 AND 50).

SN 76-460,815. ROMAN COMPANY, ST. LOUIS, MO. FILED 10-21-2002.

WILLOW HILLS

FOR STERLING SILVER JEWELRY (U.S. CLS. 2, 27, 28 AND 50).

SN 76-469,741. CARMEN L. COOK, DBA BEIJA INTERNATIONAL, PATASKALA, OH. FILED 11-25-2002.

BEIJA INTERNATIONAL

NO CLAIM IS MADE TO THE EXCLUSIVE RIGHT TO USE "INTERNATIONAL", APART FROM THE MARK AS SHOWN. THE ENGLISH TRANSLATION OF THE BRAZILIAN TERM "BEIJA" IN THE MARK MEANS "BEAUTIFUL". FOR LUXURY HAIR JEWELRY (U.S. CLS. 2, 27, 28 AND 50).

CLASS 14—(Continued).

SN 78-079,014. HUGHES, JENNIFER ANNE, TOLUCA LAKE, CA. FILED 8-13-2001.

LITTLE HULA GIRL

FOR JEWELRY, NAMELY, RINGS, TOE RINGS, NECKLACES, BRACELETS, ANKLETS, EARRINGS, BELLY CHAINS, PIN BEING JEWELRY, BROOCHES, TIARAS, CUFF-LINKS (U.S. CLS. 2, 27, 28 AND 50).
FIRST USE 11-5-2000; IN COMMERCE 11-21-2000.

SN 78-130,299. THORLAKSON, WENDY, VENICE, CA. FILED 5-21-2002.

JEAN JEWEL

FOR JEWELRY ACCESSORY, NAMELY, A SHORT DECORATIVE CHAIN WITH AN ORNAMENT OR CHARM ATTACHED TO IT TO BE WORN FROM THE BELT LOOP OF A PAIR OF PANTS OR OTHERWISE AS FASHION MIGHT DICTATE (U.S. CLS. 2, 27, 28 AND 50).

SN 78-130,766. JOSTENS, INC., MINNEAPOLIS, MN. FILED 5-23-2002.

LX

FOR JEWELRY, NAMELY BRACELETS AND NECKLACES (U.S. CLS. 2, 27, 28 AND 50).

SN 78-131,171. TEMPUS INTERNATIONAL CORPORATION, MIAMI, FL. FILED 5-24-2002.

COQUETTE

FOR FINE WATCHES SOLD EXCLUSIVELY THROUGH HIGH-END RETAIL STORES (U.S. CLS. 2, 27, 28 AND 50).
FIRST USE 8-1-2002; IN COMMERCE 8-1-2002.

SN 78-144,100. FRED JOAILLIER, PARIS, FRANCE, FILED 7-15-2002.

MOVE 1

FOR WATCHES, WATCH BANDS, WATCH CASES, WATCH MOVEMENTS, PARTS FOR WATCHES, WRIST WATCHES (U.S. CLS. 2, 27, 28 AND 50).
FIRST USE 6-15-2002; IN COMMERCE 6-15-2002.

CLASS 14—(Continued).

SN 78-151,355. LAURA MUNDER, INC., PALM BEACH, FL. FILED 8-6-2002.

LAURA M

THE NAME "LAURA M" IDENTIFIES A LIVING INDIVIDUAL WHOSE CONSENT IS OF RECORD.
FOR JEWELRY (U.S. CLS. 2, 27, 28 AND 50).

SN 78-151,668. BERTUCCI, MICHAEL, GURNEE, IL. FILED 8-7-2002.

HOW GOOD ARE YOU

FOR HOROLOGICAL AND CHRONOMETRIC INSTRUMENTS, NAMELY CLOCKS, WATCHES, TIMEPIECES AND CHRONOMETERS (U.S. CLS. 2, 27, 28 AND 50).

SN 78-155,601. FORTESCUE, JAMES M., WASHINGTON, NC. FILED 8-19-2002.

LIGHTHOUSE BELL

NO CLAIM IS MADE TO THE EXCLUSIVE RIGHT TO USE "BELL", APART FROM THE MARK AS SHOWN.
FOR JEWELRY (U.S. CLS. 2, 27, 28 AND 50).
FIRST USE 3-0-2001; IN COMMERCE 3-0-2001.

SN 78-166,167. SARA LEE D.E./NV, UTRECHT, NETHERLANDS, FILED 9-20-2002.

SENSEO

FOR COFFEE POTS, TEA POTS, COFFEE CANS AND TEA CANS ALL NON-ELECTRIC MADE OF PRECIOUS METALS, NON-ELECTRIC CAFETIERES, NAMELY, SMALL COFFEE AND TEA POTS MADE OF PRECIOUS METALS, COFFEE SETS AND TEA SETS MADE OF PRECIOUS METALS; COFFEE BOXES, TEA BOXES, COFFEE CANISTERS AND TEA CANISTERS MADE OF PRECIOUS METALS; SAUCERS, MADE OF PRECIOUS METALS; TEA EGGS, TEA STRAINERS MADE OF PRECIOUS METALS; CREAM SETS, CREAM CANS, SUGAR POTS AND TRAYS FOR DOMESTIC USE, ALL PRECIOUS METALS; HOLDERS FOR COFFEE GLASSES AND TEA GLASSES MADE OF PRECIOUS METALS (U.S. CLS. 2, 27, 28 AND 50).

SN 78-178,959. TERRA BY EK, INC., MIAMI, FL. FILED 10-28-2002.

TERRA BY EK

FOR JEWELRY, INCLUDING NECKLACES AND BRACELETS DETAILED WITH SEMI-PRECIOUS STONES, PENDANTS AND STERLING SILVER (U.S. CLS. 2, 27, 28 AND 50).

CLASS 14—(Continued).

SN 78-181,415. IMPORT SERVICES LIMITED, NEW YORK, NY. FILED 11-4-2002.

ISL

FOR JEWELRY, NAMELY, NECKLACES, EARRINGS, RINGS, BRACELETS, PENDANTS AND LOCKETS (U.S. CLS. 2, 27, 28 AND 50).

SN 78-185,416. QVC, INC., WEST CHESTER, PA. FILED 11-15-2002.

GOSSIP

FOR WATCHES (U.S. CLS. 2, 27, 28 AND 50).

SN 78-191,635. HOLZER Y CIA, S.A. DE C.V., COLONIA CHAPULTEPEC POLANCO, MEXICO, FILED 12-5-2002.

MOONMASTER

FOR HOROLOGICAL AND CHRONOMETRIC INSTRUMENTS, NAMELY WATCHES, CLOCKS AND THEIR PARTS. (U.S. CLS. 2, 27, 28 AND 50).

SN 78-193,417. LOCKHEED MARTIN CORPORATION, BETHESDA, MD. FILED 12-11-2002.

LOCKHEED MARTIN

OWNER OF U.S. REG. NOS. 2,022,037, 2,022,038 AND 2,627,156.
FOR JEWELRY, WATCHES (U.S. CLS. 2, 27, 28 AND 50).
FIRST USE 4-30-1996; IN COMMERCE 4-30-1996.

CLASS 15—MUSICAL INSTRUMENTS

SN 76-140,133. GUSTAV PIRAZZI & COMP. KG, D - 63069 OFFENBACH, FED REP GERMANY, FILED 10-3-2000.

evah pirazzi

PRIORITY CLAIMED UNDER SEC. 44(D) ON FED REP GERMANY APPLICATION NO. 30027678.8, FILED 4-10-2000, REG. NO. 30027678, DATED 8-1-2000, EXPIRES 4-30-2010.

THE NAME "EVAH PIRAZZI" DOES NOT IDENTIFY A LIVING INDIVIDUAL.

FOR STRINGS FOR MUSICAL INSTRUMENTS (U.S. CLS. 2, 21 AND 36).

FIRST USE 4-12-2000; IN COMMERCE 4-26-2000.

SN 76-456,471. ROLAND CORPORATION, KITA-KU, OSAKA, JAPAN, FILED 10-7-2002.

ACCU-PITCH

FOR MUSICAL INSTRUMENT TUNERS (U.S. CLS. 2, 21 AND 36).

SN 78-195,855. HOPKINS, PAUL A., SHELBYVILLE, TN. FILED 12-18-2002.

LOUZEE

FOR MUSICAL INSTRUMENTS, NAMELY, ACCORDIONS, ZITHERS, BANJOS, BASS VIOLINS, CELLOS, ACOUSTIC GUITARS, ELECTRIC GUITARS, ACOUSTIC/ELECTRIC GUITARS, ACOUSTIC BASSES, ELECTRIC BASSES, ACOUSTIC/ELECTRIC BASSES, LYRES, MANDOLINS, UKULELES, VIOLAS, AND VIOLINS; AND MUSICAL INSTRUMENT ACCESSORIES, NAMELY, INSTRUMENT CASES, INSTRUMENT BAGS, AND INSTRUMENT BOWS (U.S. CLS. 2, 21 AND 36).

CLASS 16—PAPER GOODS AND PRINTED MATTER

SN 75-618,023. CLW COMMUNICATIONS GROUP, INC., CHATTANOOGA, TN. FILED 1-11-1999.

NEW MILLENNIUM

FOR BIBLES, STUDY BIBLES AND OTHER BOOKS OF A RELIGIOUS NATURE (U.S. CLS. 2, 5, 22, 23, 29, 37, 38 AND 50).

CLASS 16—(Continued).

SN 76-037,883. BURNS, MARVIN LOUIS, NEW YORK, NY. FILED 5-1-2000.

THE OFFICIAL HIP HOP HALL OF FAME MAGAZINE - AND GROUP PUBLICATION

NO CLAIM IS MADE TO THE EXCLUSIVE RIGHT TO USE "THE OFFICIAL HIP HOP HALL OF FAME MAGAZINE" AND "PUBLICATION", APART FROM THE MARK AS SHOWN.

FOR MAGAZINE FEATURING MUSIC, EVENTS, FASHION AND OTHER HIP HOP RELATED MATTERS (U.S. CLS. 2, 5, 22, 23, 29, 37, 38 AND 50).

SN 76-059,825. CAPSTONE PRESS, INC., MANKATO, MN. FILED 5-31-2000.

PEBBLE BOOKS

NO CLAIM IS MADE TO THE EXCLUSIVE RIGHT TO USE "BOOKS", APART FROM THE MARK AS SHOWN.

FOR BOOKS FOR SCHOOL AGE CHILDREN (U.S. CLS. 2, 5, 22, 23, 29, 37, 38 AND 50).

FIRST USE 8-29-1997; IN COMMERCE 8-29-1997.

SN 76-083,045. POSEY PARK, LLC, CARROLLTON, TX. FILED 7-5-2000.

POSEY PARK

FOR PRINTED MATTER, NAMELY, POETRY BOOKS; ART BOOKS; PRINTED PAPER SHEETS CONTAINING POETRY; ART PRINTS; PAINTINGS; BABY BOOKS; WEDDING BOOKS; GIFT BOOKS; GREETING CARDS; CALENDARS (U.S. CLS. 2, 5, 22, 23, 29, 37, 38 AND 50).

FIRST USE 7-1-2002; IN COMMERCE 7-1-2002.

SN 76-083,217. PM COMPANY, CINCINNATI, OH. FILED 7-5-2000.

FLAGSHIP FABRIC

NO CLAIM IS MADE TO THE EXCLUSIVE RIGHT TO USE "FABRIC", APART FROM THE MARK AS SHOWN.

FOR WATER-RESISTANT PRINTING PAPER (U.S. CLS. 2, 5, 22, 23, 29, 37, 38 AND 50).

FIRST USE 2-15-1998; IN COMMERCE 2-15-1998.

CLASS 16—(Continued).

SN 76-127,439. GODFREY & KAHN, S.C., MILWAUKEE, WI. FILED 9-13-2000.

VANTAGE POINT

FOR NEWSLETTERS PUBLISHED BY A LAW FIRM TO ITS CLIENTS AND OTHER INTERESTED PARTIES ON LAW RELATED SUBJECTS (U.S. CLS. 2, 5, 22, 23, 29, 37, 38 AND 50).

SN 76-172,581. EK SUCCESS, LTD., CLIFTON, NJ. FILED 11-29-2000.

DIVA GIRL

FOR STATIONERY PRODUCTS, NAMELY, NOTE-PADS, NOTEBOOKS, PENS AND BOOK COVERS (U.S. CLS. 2, 5, 22, 23, 29, 37, 38 AND 50).

FIRST USE 12-23-1999; IN COMMERCE 12-23-1999.

SN 76-211,284. QST INDUSTRIES, INC., CHICAGO, IL. BY ASSIGNMENT JOHN SOLOMON, INC., SOMERVILLE, MA. FILED 2-16-2001.

HYDRO-STICK

FOR WATER ACTIVATED, SELF ADHESIVE TEAR-AWAY EMBROIDERY BACKING MADE FROM POLYESTER CELLULOSE AND RAYON WITH A STARCH POLYMER ADHESIVE (U.S. CLS. 2, 5, 22, 23, 29, 37, 38 AND 50).

FIRST USE 11-1-2000; IN COMMERCE 11-1-2000.

SN 76-211,781. WEISS & WINTER GMBH, D-19336 BAD WILSNACK, FED REP GERMANY, FILED 2-16-2001.

GESNER

PRIORITY CLAIMED UNDER SEC. 44(D) ON FED REP GERMANY APPLICATION NO. 30061235.4/1, FILED 8-16-2000, REG. NO. 30061235, DATED 2-7-2001, EXPIRES 8-31-2010.

FOR WRITING INSTRUMENTS, NAMELY, PEN HOLDERS, BALL-POINT PENS, FELT-TIP PENS, THIN PENS, MARKERS, COLORED PENCILS, WAX CRAYONS, POSTER PENS, SLATE PENCILS, PENCILS, CRAYONS, INDELIBLE PENCILS, AND PARTS THEREOF; PAPER AND PAPER PRODUCTS, NAMELY, ART AND DRAWING PAPER, PRINTING PAPER AND PRINTING BLOCKS; BOOKBINDING TAPE, GLUE FOR PAPER AND WRITING MATERIALS, PAINT BRUSHES, OFFICE ARTICLES, NAMELY, DESK PADS; DRAWING RULERS, STENCILS, WRITING INK, INK CONTAINERS FOR WRITING INK, DRAWING INSTRUMENTS, AND PAINTING SETS (U.S. CLS. 2, 5, 22, 23, 29, 37, 38 AND 50).

CLASS 16—(Continued).

SN 76-212,148. MOSSOP, CORNELISSEN CONSULTANTS INC., TORONTO, ONTARIO, CANADA, FILED 2-20-2001.

VALUESCARDS

FOR SEMINAR GUIDEBOOKS AND INSTRUCTIONAL MATERIALS FOR CAREER ASSESSMENT AND PLANNING, NAMELY, PRINTED FLASH CARDS AND INSTRUCTIONAL MANUALS USED IN CAREER ASSESSMENT AND PLANNING (U.S. CLS. 2, 5, 22, 23, 29, 37, 38 AND 50).

FIRST USE 4-23-1995; IN COMMERCE 6-5-1995.

SN 76-224,625. CORPORATE CREATIVE, INC., CHARLOTTE, NC. FILED 3-15-2001.

(A) ANYTHING BUT ORDINARY

FOR PRINTED MATERIALS, NAMELY, SERIES OF BOOKLETS PROVIDING BUSINESS ADVICE (U.S. CLS. 2, 5, 22, 23, 29, 37, 38 AND 50).

FIRST USE 1-15-2001; IN COMMERCE 1-15-2001.

SN 76-245,086. SPARKNOTES LLC, NEW YORK, NY. FILED 4-23-2001.

SPARKNOTES

OWNER OF U.S. REG. NO. 2,490,292.
FOR PUBLICATIONS, NAMELY, STUDY GUIDES IN THE FIELD OF LITERATURE (U.S. CLS. 2, 5, 22, 23, 29, 37, 38 AND 50).

CLASS 16—(Continued).

SN 76-250,621. COMMERCIAL PRESS (HONG KONG) CYBERBOOKS LIMITED, SHAU KEI WAN, HONG KONG, FILED 5-3-2001.



NO CLAIM IS MADE TO THE EXCLUSIVE RIGHT TO USE THE CHINESE CHARACTERS IN THE MARK WHICH TRANSLATE TO "COMMERCIAL WEB BOOKSHOP", APART FROM THE MARK AS SHOWN.

THE ENGLISH TRANSLATION OF "SHENG", MEANING "COMMERCE OR MERCHANT"; "WU", MEANING "MATTER, BUSINESS OR THINGS"; "WANG", MEANING "NET OR WEB"; "SHANG", MEANING "UPPER, ON TOP OR HIGHER"; "SHU", MEANING "BOOK"; "DIAN", MEANING "SHOP".

FOR SCHOOL TEXTBOOKS; BOOKS ON THE SUBJECT MATTERS OF LANGUAGE LEARNING, ARTS, RELIGION, SOCIAL SCIENCE, EDUCATION, PSYCHOLOGY, PHILOSOPHY, FINANCE, SCIENCE, ENGINEERING, INFORMATION TECHNOLOGY, SPORTS AND LIFESTYLE; NEWS AND FASHION MAGAZINES AND BROCHURES; DICTIONARIES AND REFERENCE BOOKS; MAPS AND CATALOGS FEATURING BOOKS, AND STATIONERY (U.S. CLS. 2, 5, 22, 23, 29, 37, 38 AND 50).

SN 76-252,047. BURK-BALLIER KIEHNLE DE PORTER, JOHANNA MARGARITA, COLONIA DEL VALLE 03100 MEXICO, MEXICO, FILED 5-4-2001.

COLORCITOS

OWNER OF MEXICO REG. NO. 620964, DATED 5-28-1997, EXPIRES 5-28-2007.

FOR PLASTICINE FOR HOBBY WORK AND MODELING; WATERCOLOR BOARDS; CRAYONS; ADHESIVES FOR HOUSEHOLD PURPOSES; ARTISTS' BRUSHES (U.S. CLS. 2, 5, 22, 23, 29, 37, 38 AND 50).

SN 76-256,258. LEE, JOON HEE, LOS ANGELES, CA. FILED 5-14-2001.

주간연예

THE FOREIGN CHARACTERS IN THE MARK TRANSLATE TO "JUKAN YEUN YEH" AND THIS MEANS "WEEKLY ENTERTAINMENT" IN ENGLISH.

SEC. 2(F).

FOR NEWSPAPERS PRINTED IN THE KOREAN LANGUAGE CONTAINING KOREAN NEWS, KOREAN CURRENT EVENTS AND KOREAN ADVERTISING (U.S. CLS. 2, 5, 22, 23, 29, 37, 38 AND 50).

FIRST USE 2-0-1990; IN COMMERCE 8-16-1992.

CLASS 16—(Continued).

SN 76-329,984. CURRICULUM ASSOCIATES, INC., NORTH BILLERICA, MA. FILED 10-23-2001.

QUICK-MATH

FOR PRINTED EDUCATIONAL MATERIALS FOR ASSISTING STUDENTS TO LEARN MATHEMATICS (U.S. CLS. 2, 5, 22, 23, 29, 37, 38 AND 50).
FIRST USE 8-21-2000; IN COMMERCE 8-21-2000.

SN 76-333,857. NEOPETS, INC., GLENDALE, CA. BY CHANGE OF NAME NEOPETS.COM, INC., GLENDALE, CA. FILED 11-6-2001.

NEOSCAPES

FOR PAPER GOODS AND PRINTED MATTER, SPECIFICALLY, TRADING CARDS, STATIONERY ITEMS, NAMELY, ENVELOPES, GREETING CARDS, ANNOUNCEMENT CARDS, NOTEBOOKS AND PADS, NOTE PAPER, NOTE CARDS, AND LABELS; STICKERS, STICKERS WITH FOAM BACKING, POSTERS, BOOKS AND PAMPHLETS FEATURING ANIMATED CHARACTERS (U.S. CLS. 2, 5, 22, 23, 29, 37, 38 AND 50).

SN 76-345,325. REED ELSEVIER INC., NEWTON, MA. FILED 12-6-2001.

THE WIRELESS AUTHORITY

FOR PERIODICAL PUBLICATIONS, NAMELY, MAGAZINES, DIRECTORIES, REFERENCE BOOKS, AND NEWSLETTERS ON A WIDE VARIETY OF TOPICS IN THE FIELD OF WIRELESS COMMUNICATIONS (U.S. CLS. 2, 5, 22, 23, 29, 37, 38 AND 50).
FIRST USE 12-3-2001; IN COMMERCE 12-3-2001.

CLASS 16—(Continued).

SN 76-348,023. DORIZAS, PETER, KILLARNEY HEIGHTS, AUSTRALIA, FILED 12-10-2001.

Fridge Pocket

PRIORITY CLAIMED UNDER SEC. 44(D) ON AUSTRALIA APPLICATION NO. 880751, FILED 6-29-2001, REG. NO. 880751, DATED 6-29-2001, EXPIRES 6-29-2011.

THE MARK CONSISTS OF IN PART THE WORDS "FRIDGE POCKET" ALONG WITH A STYLIZED "P" USED IN CONJUNCTION WITH A STYLIZED "D".

FOR CLEAR PLASTIC ENVELOPE WITH A BACKING FOR ATTACHING THE ENVELOPE TO SURFACES TO DISPLAY PRINTED MATERIALS (U.S. CLS. 2, 5, 22, 23, 29, 37, 38 AND 50).

SN 76-350,865. FOOD INGREDIENTS SPECIALITIES S.A., VILLARS-SUR-GLANE, SWITZERLAND, FILED 12-20-2001.

TECHNO-CULINARY NEWS

NO CLAIM IS MADE TO THE EXCLUSIVE RIGHT TO USE "NEWS", APART FROM THE MARK AS SHOWN.

FOR PERIODICAL PUBLICATIONS, NAMELY, MAGAZINES IN THE FIELD OF CULINARY ARTS AND FOOD DEVELOPMENT, SCIENCE AND TECHNOLOGY (U.S. CLS. 2, 5, 22, 23, 29, 37, 38 AND 50).

FIRST USE 4-0-1999; IN COMMERCE 4-0-1999.

SN 76-356,502. PEOPLES PUBLISHING GROUP, INC., THE, SADDLE BROOK, NJ. FILED 1-8-2002.

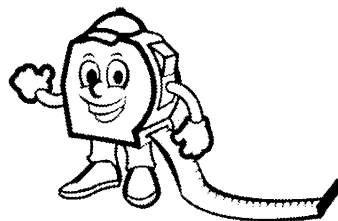

FOR TEXTBOOKS IN THE FIELDS OF ENGLISH, LANGUAGE ARTS, READING AND WRITING, MATHEMATICS, SCIENCE AND SOCIAL STUDIES (U.S. CLS. 2, 5, 22, 23, 29, 37, 38 AND 50).

FIRST USE 0-0-2000; IN COMMERCE 0-0-2000.

CLASS 16—(Continued).

SN 76-362,645. SONY KABUSHIKI KAISHA, TA SONY CORPORATION, TOKYO, JAPAN, FILED 1-24-2002.

QUALIA

FOR PRINTING PAPERS FOR VIDEO PRINTERS AND COMPUTER PRINTERS, PRINTED MATTER, NAMELY, MAGAZINES, BROCHURES AND PAMPHLETS REGARDING CONSUMER ELECTRONICS PRODUCTS, PENS, BALL POINT PENS, FOUNTAIN PENS, STATIONARY (U.S. CLS. 2, 5, 22, 23, 29, 37, 38 AND 50).

SN 76-373,191. BUBAR, DAVID N., DELMAR, NY. FILED 2-6-2002.

ELSMERE PRESS

OWNER OF U.S. REG. NOS. 2,204,006 AND 2,205,735. NO CLAIM IS MADE TO THE EXCLUSIVE RIGHT TO USE "PRESS", APART FROM THE MARK AS SHOWN. FOR PUBLICATIONS, NAMELY, BOOKS, PAMPHLETS, AND EDUCATIONAL MATERIAL ON SELF-HELP, SELF-IMPROVEMENT AND INSPIRATIONAL INFORMATION (U.S. CLS. 2, 5, 22, 23, 29, 37, 38 AND 50). FIRST USE 2-28-1999; IN COMMERCE 2-28-1999.

SN 76-380,200. FUSION PUBLISHING INC., WESTLAKE VILLAGE, CA. FILED 3-8-2002.

PLAY

FOR PRINTED PUBLICATIONS, NAMELY A PERIODIC ENTERTAINMENT MAGAZINE DIRECTED PRIMARILY TO VIDEO GAMES, MOVIES, MUSIC AND RELATED MERCHANDISE FOR ADOLESCENTS, YOUNG ADULTS AND ADULTS (U.S. CLS. 2, 5, 22, 23, 29, 37, 38 AND 50). FIRST USE 11-7-2001; IN COMMERCE 11-7-2001.

SN 76-384,099. ELECTROMED TECHNOLOGIES LLC, CHICAGO, IL. BY MERGER ELECTROMED TECHNOLOGIES, INC., CHICAGO, IL. FILED 3-19-2002.



THE LETTER "Q" APPEARS IN RED. THE MARK CONSISTS OF THE LETTERS "QT" AND A CIGARETTE DESIGN. FOR SMOKING CESSATION KIT COMPRISED OF AN INSTRUCTION BOOK AND SPECIALLY PROGRAMMED WATCH (U.S. CLS. 2, 5, 22, 23, 29, 37, 38 AND 50). FIRST USE 9-16-2002; IN COMMERCE 9-16-2002.

CLASS 16—(Continued).

SN 76-384,995. TATTOO MANUFACTURING, INC., TUCSON, AZ. FILED 3-20-2002.



FOR PRINTED MATERIALS, NAMELY, STICKERS, BROCHURES RECITING BODY ART PRODUCTS, AND REMOVEABLE TATTOOS (U.S. CLS. 2, 5, 22, 23, 29, 37, 38 AND 50).

SN 76-389,737. DISNEY ENTERPRISES, INC., BURBANK, CA. FILED 4-1-2002.



THE MARK CONSISTS OF THE WORDING "W.I.T.C.H." IN STYLIZED FORM WITH THE WORDING "WILL" "IRMA" "TARANEE" "CORNELIA" "HAY" "LIN" UNDERNEATH IN STYLIZED FORM.

FOR ADDRESS BOOKS, PHOTOGRAPH ALBUMS, APPLIQUES IN THE FORM OF DECALS, APPOINTMENT BOOKS, ARTS AND CRAFT PAINT KITS, AUTOGRAPH BOOKS, BABY BOOKS, PAPER PARTY BAGS, BALL-POINT PENS, BINDERS, BOOKENDS, BOOKMARKS, BOOKS FEATURING GAMES, STORIES, AND ACTIVITIES FOR CHILDREN AND TEENS, PAPER GIFT WRAP BOWS, PAPER CAKE DECORATIONS, CALENDARS, GIFT CARDS, GREETING CARDS, CARTOON STRIPS, PEN AND PENCIL CASES, DECORATIVE PAPER CENTERPIECES, CHALK, CHILDREN'S ACTIVITY BOOKS, MODELING CLAY, PAPER TABLE CLOTHS, COLORING BOOKS, COMIC STRIPS, COMIC BOOKS, PAPER PARTY DECORATIONS, DIARIES, GIFT WRAPPING PAPER, MAGAZINES FEATURING GAMES, STORIES, AND ACTIVITIES FOR CHILDREN AND TEENS, PAPER PARTY HATS, PAPER NAPKINS, PENS, PENCILS, STATIONERY, STICKERS, POSTERS, NOTEBOOKS, MEMO PADS, ERASERS, PENCIL SHARPENERS, STAPLERS, WRITING PAPER, ENVELOPES, PAPER WEIGHTS, PAPER COASTERS, PAPER MATS, NON-CALIBRATED RULERS, PHOTOGRAPHS, POSTCARDS, TRADING CARDS (U.S. CLS. 2, 5, 22, 23, 29, 37, 38 AND 50).

SN 76-389,954. PLANET SUR INTERNATIONAL, LTD., NEW YORK, NY. FILED 4-2-2002.

SUR MAGAZINE

NO CLAIM IS MADE TO THE EXCLUSIVE RIGHT TO USE "MAGAZINE", APART FROM THE MARK AS SHOWN. FOR MAGAZINES, PERIODICALS, NEWSLETTERS, AND BOOKS FEATURING INFORMATION RELATED TO ART, CULTURE, MEDIA, ENTERTAINMENT AND LIFESTYLE (U.S. CLS. 2, 5, 22, 23, 29, 37, 38 AND 50).

CLASS 16—(Continued).

SN 76-390,958. BUCKS FOR BABIES, L.L.C., MIDVALE, UT. FILED 4-3-2002.

BUCKS FOR BABY & U

FOR PRINTED MATERIALS, NAMELY MAGAZINES INCLUDING INFORMATIONAL ARTICLES AND PROMOTIONAL INCENTIVES PROVIDED BY OTHERS (U.S. CLS. 2, 5, 22, 23, 29, 37, 38 AND 50).

SN 76-391,931. GREENHOUSE, LLC, BROOMFIELD, CO. FILED 4-5-2002.

GREENHOUSE

FOR EDUCATIONAL PUBLICATIONS, NAMELY, TRAINING MANUALS AND MATERIALS IN THE FIELDS OF BUSINESS MARKETING, ADVERTISING SERVICES, AND CORPORATE BRAND IDENTITY FOR OTHERS (U.S. CLS. 2, 5, 22, 23, 29, 37, 38 AND 50).

SN 76-393,965. SCRIPTURA, INC., NEW ORLEANS, LA. FILED 4-11-2002.

ESSENTIAL PAPERS FOR ARTFUL LIVING

FOR STATIONERY, STATIONERY BOXES, STATIONERY FOLDERS, STATIONERY PAPER AND ENVELOPES, STATIONERY PORTFOLIOS, WRITING BRUSHES, WRITING INK, WRITING INSTRUMENTS, WRITING PADS, WRITING PAPER, WRITING TABLETS, PAPER CLIPS, PAPER CLIP HOLDERS, PAPER DISPLAY BOXES, PAPER EMBOSSERS, PAPER EXPANDING FILES, PAPER FILE JACKETS, PAPER FOR WRAPPING AND PACKAGING, PAPER GIFT WRAP RIBBONS AND BOWS, PAPER NOTE TABLETS, PAPER PARTY DECORATIONS, PAPER PARTY INVITATIONS, PAPER SHOPPING BAGS, PAPERWEIGHTS, WRITING JOURNALS AND PAPER CALENDARS AND PAPER AGENDA (U.S. CLS. 2, 5, 22, 23, 29, 37, 38 AND 50). FIRST USE 9-1-1995; IN COMMERCE 9-1-1995.

CLASS 16—(Continued).

SN 76-400,771. AMERICAN ACADEMY OF OPHTHALMOLOGY, INC., SAN FRANCISCO, CA. FILED 4-24-2002.



OWNER OF U.S. REG. NOS. 1,216,689, 1,561,652 AND OTHERS.

THE MARK IS COMPRISED IN PART BY THE LETTERS "AAO" STYLIZED.

SEC. 2(F) AS TO "AMERICAN ACADEMY OF OPHTHALMOLOGY" AND "THE EYE M.D. ASSOCIATION".

FOR PRINTED MATERIALS, NAMELY, PAMPHLETS, BROCHURES, MANUALS, AND JOURNALS IN THE FIELDS OF EYE CARE AND OPHTHALMOLOGY (U.S. CLS. 2, 5, 22, 23, 29, 37, 38 AND 50).

FIRST USE 1-1-1998; IN COMMERCE 1-1-1998.

SN 76-400,974. OLDCASTLE, INC., ATLANTA, GA. FILED 4-29-2002.

BELGARD RUGS

OWNER OF U.S. REG. NO. 2,186,972.

FOR PRINTED SALES AIDS, NAMELY, SHEETS IMPRINTED WITH IMAGES OF PAVING STONES AND OTHER SIMILAR BUILDING MATERIALS, FOR USE BY OTHERS IN THE SELLING OF PAVING STONES, RETAINING WALLS MADE OF STONE, AND SIMILAR BUILDING MATERIALS (U.S. CLS. 2, 5, 22, 23, 29, 37, 38 AND 50).

SN 76-402,074. HENKEL CONSUMER ADHESIVES, INC., AVON, OH. BY CHANGE OF NAME MANCO, INC., AVON, OH. FILED 5-1-2002.

WRAP-FIX

FOR ADHESIVE AND REPAIR TAPES FOR HOUSEHOLD AND DO-IT-YOURSELF PURPOSES (U.S. CLS. 2, 5, 22, 23, 29, 37, 38 AND 50).

SN 76-403,323. KIMBERLY-CLARK WORLDWIDE, INC., NEENAH, WI. BY ASSIGNMENT KIMBERLY-CLARK CORPORATION, NEENAH, WI. FILED 5-2-2002.



NO CLAIM IS MADE TO THE EXCLUSIVE RIGHT TO USE "PANTS", APART FROM THE MARK AS SHOWN.

FOR DISPOSABLE INCONTINENCE GARMENTS, NAMELY, DISPOSABLE YOUTH UNDERPANTS (U.S. CLS. 2, 5, 22, 23, 29, 37, 38 AND 50).

CLASS 16—(Continued).

SN 76-407,943. BLAINE BROOKE PHOTOGRAPHY, INC., LOUISVILLE, KY. FILED 5-14-2002.

JUSTICE ISN'T ALWAYS BLACK AND WHITE. SOMETIMES IT'S RED, WHITE, AND BLUE.

FOR PAPER GOODS AND PRINTED MATTER, NAMELY, ORIGINAL ART PRINTS, POSTERS, LIMITED EDITION ART PRINTS, PRINTED MATERIAL USED IN ARTWORK, NAMELY PRINTED PLANS, DRAWINGS, AND SKETCHES, WRITING TABLETS, NOTE CARDS, POSTCARDS, CROSSWORD PUZZLES, DISPLAY BOARDS FOR TRADE SHOWS, BOOKMARKS, DECALS, BUMPER STICKERS, PRINTED PAPER SIGNS, STATIONERY, BUSINESS CARDS, BROCHURES, ABOUT PATRIOTISM AND THE EVENTS OF SEPTEMBER 11, 2001 WITH REGARD TO TOURISM AND TRAVEL, LITHOGRAPHS, BROCHURES IN THE FIELD OF PUBLIC RELATIONS, PENCILS, PENS, ERASERS, STICKERS, TEMPLATES FOR DRAWINGS, PAMPHLETS IN THE FIELD OF PATRIOTISM AND TRAVEL WITH EMPHASIS ON NEW YORK CITY, MAGAZINES IN THE FIELD OF PATRIOTISM AND TRAVEL, COMIC BOOKS, NOTEBOOKS AND COLORING BOOKS (U.S. CLS. 2, 5, 22, 23, 29, 37, 38 AND 50).

SN 76-408,362. LEBHAR FRIEDMAN, INC., NEW YORK, NY. FILED 5-15-2002.

FOOD RETAILING TODAY

OWNER OF U.S. REG. NOS. 1,469,020 AND 2,580,735. NO CLAIM IS MADE TO THE EXCLUSIVE RIGHT TO USE "FOOD RETAILING", APART FROM THE MARK AS SHOWN.

FOR MAGAZINES IN THE FOOD DISTRIBUTION FIELD AT WHOLESALE AND RETAIL LEVELS (U.S. CLS. 2, 5, 22, 23, 29, 37, 38 AND 50).

FIRST USE 1-21-2002; IN COMMERCE 1-21-2002.

SN 76-411,570. DOHMEN CAPITAL HOLDINGS, INC., LOS ANGELES, CA. FILED 5-23-2002.

BERT DOHMEN'S SMARTE TRADER

OWNER OF U.S. REG. NOS. 1,888,423 AND 1,897,488. NO CLAIM IS MADE TO THE EXCLUSIVE RIGHT TO USE "TRADER", APART FROM THE MARK AS SHOWN.

THE NAME "BERT DOHMEN" IDENTIFIES A LIVING INDIVIDUAL WHOSE CONSENT IS OF RECORD.

FOR PROVIDING ON-LINE NEWSLETTERS FEATURING ANALYSES OF THE ECONOMY, INVESTMENT MARKETS, AND SPECIFIC STOCKS (U.S. CLS. 2, 5, 22, 23, 29, 37, 38 AND 50).

FIRST USE 4-19-2002; IN COMMERCE 4-19-2002.

CLASS 16—(Continued).

SN 76-416,592. DURST, FRED, NEW YORK, NY. FILED 5-30-2002.

HATORADE

FOR PRINTED AND RELATED MATTER, NAMELY, POSTERS, CALENDARS, TEMPORARY TATTOOS, STICKERS, NOTE CARDS, POSTCARDS, PICTURE POSTCARDS, GREETING CARDS, MUSICAL GREETING CARDS, PRINTED GREETING CARDS WITH ELECTRONIC INFORMATION STORED THEREIN, GIFT CARDS, OCCASION CARDS, SOCIAL NOTE CARDS, MOTIVATIONAL CARDS, CARDS BEARING UNIVERSAL GREETINGS, BLANK CARDS, BLANK NOTE CARDS, PLACE CARDS, BLANK AND PARTIALLY PRINTED CARDS, RECORD CARDS, SCORE CARDS, BUMPER STICKERS, TRADING CARDS, SCRAPBOOKS, STATIONERY, NOTE PADS, PAPER NOTE TABLETS, WRITING TABLETS, NOTEBOOKS, FOLDERS, FILE FOLDERS, STATIONERY FOLDERS, BOOKMARKS, PAPER PENNANTS, BINDERS, WRITING PAPER, ENVELOPES, APPOINTMENT BOOKS, ADDRESS BOOKS AND DESK PADS; PERSONAL ORGANIZERS, DESK TOP ORGANIZERS, ORGANIZERS FOR STATIONERY USE AND STATIONERY-TYPE PORTFOLIOS, PAPER FLAGS, MOUNTS FOR STAMPS, RUBBER STAMPS, RUBBER DOCUMENT STAMPS, STAMP ALBUMS, STAMP PAD INKS, STAMP PADS, SLEEVES FOR HOLDING AND PROTECTING STAMPS, PAPER BANNERS, HOLDERS FOR DESK ACCESSORIES, LETTER OPENERS, LETTER TRAYS, LETTER RACKS, PEN AND PENCIL CUPS, PENS, PENCILS, MARKERS, PEN AND PENCIL SETS, STICK MARKERS, ERASERS, DRAWING AND DRAFTING RULERS, PENCIL SHARPENERS, BOOK ENDS, BOOK COVERS, CHECKBOOK COVERS, BOOK HOLDERS, BOOK RESTS AND DECALS; PHOTOGRAPH AND COIN ALBUMS; BULLETIN BOARDS; PHOTOGRAPH MOUNTS; PHOTOGRAPHIC AND ART MOUNTS; PHOTOGRAPHIC PRINTS; PHOTOGRAPHS; LITHOGRAPHS; DECORATIVE PAPER CENTERPIECES; DECORATIVE PENCIL-TOP ORNAMENTS; PICTURE BOOKS; PAPER AND CARDBOARD PICTURE MOUNTS; PAPERWEIGHTS; PAPER CLIP HOLDERS; PAPER SIGN HOLDERS; PRINTED PAPER SIGNS (U.S. CLS. 2, 5, 22, 23, 29, 37, 38 AND 50).

SN 76-419,642. SPRINT PUBLISHING & ADVERTISING, INC., OVERLAND PARK, KS. FILED 6-10-2002.

THE BEST RED YELLOW PAGES

FOR TELEPHONE DIRECTORIES (U.S. CLS. 2, 5, 22, 23, 29, 37, 38 AND 50).

FIRST USE 1-0-1997; IN COMMERCE 1-0-1997.

SN 76-425,634. SORTER, FRANCES DENISE, NASHVILLE, TN. FILED 6-25-2002.

MUSIC SQUARE MAGAZINE

NO CLAIM IS MADE TO THE EXCLUSIVE RIGHT TO USE "MUSIC" AND "MAGAZINE", APART FROM THE MARK AS SHOWN.

FOR PRINTED MATTER; NAMELY, A PERIODICAL MAGAZINE RELATING TO MUSIC AND THE MUSIC INDUSTRY (U.S. CLS. 2, 5, 22, 23, 29, 37, 38 AND 50).

CLASS 16—(Continued).

SN 76-427,324. SCHLUSSEL, JOSEPH, NEW YORK, NY.
FILED 7-5-2002.



FOR NEWSLETTER FEATURING NEWS ITEMS RELATING TO DIAMONDS AND JEWELRY AND PRICES OF DIAMONDS (U.S. CLS. 2, 5, 22, 23, 29, 37, 38 AND 50).
FIRST USE 11-11-1969; IN COMMERCE 11-11-1969.

SN 76-428,606. MITCHELL, JANE A., TULSA, OK. FILED 7-9-2002.

BIBLE BLAST

NO CLAIM IS MADE TO THE EXCLUSIVE RIGHT TO USE "BIBLE", APART FROM THE MARK AS SHOWN.
FOR PRINTED COURSE MANUALS IN THE FIELD OF RELIGION (U.S. CLS. 2, 5, 22, 23, 29, 37, 38 AND 50).
FIRST USE 9-1-1991; IN COMMERCE 9-1-1993.

SN 76-429,153. ADRIAN, LAURELLE, SCOTTSDALE, AZ.
FILED 7-10-2002.

KITA... BECAUSE I MATTER!!

FOR CHILDREN'S BOOKS, COLORING BOOKS, POSTERS, STICKERS, PENCILS, NOTEBOOKS, BINDERS (U.S. CLS. 2, 5, 22, 23, 29, 37, 38 AND 50).
FIRST USE 1-1-2001; IN COMMERCE 1-1-2001.

SN 76-429,536. NORTH CAROLINA ASSOCIATION OF ELECTRIC COOPERATIVES, INC., RALEIGH, NC. FILED 7-11-2002.

CAROLINA COUNTRY

SEC. 2(F).
FOR MAGAZINES FEATURING INFORMATION RELATING TO RURAL ELECTRIC COOPERATIVES (U.S. CLS. 2, 5, 22, 23, 29, 37, 38 AND 50).
FIRST USE 8-1-1969; IN COMMERCE 8-1-1969.

CLASS 16—(Continued).

SN 76-433,331. PLANET CURVE, INC., LITHONIA, GA.
FILED 7-22-2002.

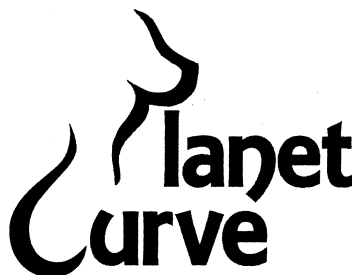

IMAGE CONSISTS OF "PLANET CURVE" WITH THE "P" REPRESENTED AS TOP OF FEMALE FORM, PINK IN COLOR, AND THE "C" AS BOTTOM OF FEMALE FORM, BLUE IN COLOR, REMAINING LETTERING IN SILVER.
FOR PHOTOGRAPHS AND MAGAZINES FEATURING ADULT PHOTOGRAPHY (U.S. CLS. 2, 5, 22, 23, 29, 37, 38 AND 50).
FIRST USE 5-1-2002; IN COMMERCE 5-1-2002.

SN 76-433,831. WIZARD PUBLICATIONS, INC., LIHU'E, HI.
FILED 7-22-2002.

HAWAII THE BIG ISLAND REVEALED THE ULTIMATE GUIDEBOOK

NO CLAIM IS MADE TO THE EXCLUSIVE RIGHT TO USE "GUIDEBOOK", APART FROM THE MARK AS SHOWN.
SEC. 2(F) AS TO "HAWAII THE BIG ISLAND" AND "ULTIMATE GUIDEBOOK".
FOR TRAVEL GUIDE BOOKS (U.S. CLS. 2, 5, 22, 23, 29, 37, 38 AND 50).
FIRST USE 12-0-1996; IN COMMERCE 12-0-1996.

SN 76-433,832. WIZARD PUBLICATIONS, INC., LIHU'E, HI.
FILED 7-22-2002.

MAUI REVEALED THE ULTIMATE GUIDEBOOK

NO CLAIM IS MADE TO THE EXCLUSIVE RIGHT TO USE "MAUI" OR "ULTIMATE GUIDEBOOK", APART FROM THE MARK AS SHOWN.
FOR TRAVEL GUIDE BOOKS (U.S. CLS. 2, 5, 22, 23, 29, 37, 38 AND 50).
FIRST USE 8-0-2000; IN COMMERCE 8-0-2000.

CLASS 16—(Continued).

SN 76-437,150. NORCOM INCORPORATED, NORCROSS, GA. FILED 8-2-2002.

PLEASANT HILL PRESS

NO CLAIM IS MADE TO THE EXCLUSIVE RIGHT TO USE "PRESS", APART FROM THE MARK AS SHOWN.
FOR BLANK WRITING JOURNALS (U.S. CLS. 2, 5, 22, 29, 37, 38 AND 50).

SN 76-438,733. SYSCO CORPORATION, HOUSTON, TX. FILED 8-8-2002.

THE SIGNPOST

FOR PRINTED NEWSLETTERS FEATURING ARTICLES AND INFORMATION RELATED TO THE FOOD INDUSTRY (U.S. CLS. 2, 5, 22, 23, 29, 37, 38 AND 50).
FIRST USE 5-1-2002; IN COMMERCE 5-1-2002.

SN 76-438,952. CUOMO, RIVERS, NEW YORK, NY. FILED 8-9-2002.

ENLIGHTENMENT TOUR

FOR PRINTED AND RELATED MATTER, NAMELY, POSTERS, CALENDARS, TEMPORARY TATTOOS, STICKERS, NOTE CARDS, POSTCARDS, PICTURE POSTCARDS, GREETING CARDS, MUSICAL GREETING CARDS, PRINTED GREETING CARDS WITH ELECTRONIC INFORMATION STORED THEREIN, GIFT CARDS, OCCASION CARDS, SOCIAL NOTE CARDS, MOTIVATIONAL CARDS, CARDS BEARING UNIVERSAL GREETINGS, BLANK CARDS, BLANK NOTE CARDS, PLACE CARDS, BLANK AND PARTIALLY PRINTED CARDS, RECORD CARDS, SCORE CARDS, PICTURE MOUNTS, BUMPER STICKERS, TRADING CARDS, SCRAPBOOKS, STATIONERY, NOTE PADS, PAPER NOTE TABLETS, WRITING TABLETS, NOTEBOOKS, FOLDERS, FILE FOLDERS, STATIONERY FOLDERS, BOOKMARKS, PAPER PENNANTS, BINDERS, WRITING PAPER, ENVELOPES, APPOINTMENT BOOKS, ADDRESS BOOKS AND DESK PADS; PERSONAL ORGANIZERS, DESK TOP ORGANIZERS, ORGANIZERS FOR STATIONERY USE AND STATIONERY-TYPE PORTFOLIOS, PAPER FLAGS, MOUNTS FOR STAMPS, RUBBER STAMPS, RUBBER DOCUMENT STAMPS, STAMP ALBUMS, STAMP PAD INKS, STAMP PADS, SLEEVES FOR HOLDING AND PROTECTING STAMPS, PAPER BANNERS, HOLDERS FOR DESK ACCESSORIES, LETTER OPENERS, LETTER TRAYS, LETTER RACKS, PEN AND PENCIL CUPS, PENS, PENCILS, MARKERS, PEN AND PENCIL SETS, STICK MARKERS, ERASERS, DRAWING AND DRAFTING RULERS, PENCIL SHARPENERS, BOOK ENDS, BOOK COVERS, CHECKBOOK COVERS, BOOK HOLDERS, BOOK RESTS AND DECALS; PHOTOGRAPH AND COIN ALBUMS; BULLETIN BOARDS; PHOTOGRAPH MOUNTS; PHOTOGRAPHIC AND ART MOUNTS; PHOTOGRAPHIC PRINTS; PHOTOGRAPHS; LITHOGRAPHS; DECORATIVE PAPER CENTERPIECES; DECORATIVE PENCIL-TOP ORNAMENTS; PICTURE BOOKS; PAPER AND CARDBOARD PICTURE MOUNTS; PAPERWEIGHTS; PAPER CLIP HOLDERS; PAPER SIGN HOLDERS; PRINTED PAPER SIGNS (U.S. CLS. 2, 5, 22, 23, 29, 37, 38 AND 50).

CLASS 16—(Continued).

SN 76-441,697. WHITESTONE ACQUISITION CORP., BLOOMINGTON, IN. FILED 8-20-2002.

EXCELSORB

FOR INCONTINENT BRIEFS AND LINERS (U.S. CLS. 2, 5, 22, 23, 29, 37, 38 AND 50).
FIRST USE 5-18-1989; IN COMMERCE 5-18-1989.

SN 76-443,684. AG SOURCE MAGAZINE, TULARE, CA. FILED 8-22-2002.

AG SOURCE MAGAZINE

NO CLAIM IS MADE TO THE EXCLUSIVE RIGHT TO USE "AG" AND "MAGAZINE", APART FROM THE MARK AS SHOWN.
FOR AGRICULTURAL MAGAZINE (U.S. CLS. 2, 5, 22, 23, 29, 37, 38 AND 50).
FIRST USE 10-0-1996; IN COMMERCE 10-0-1996.

SN 76-444,892. SIMPLYH, LLC, ORANJESTAD, ARUBA. FILED 8-26-2002.

WILD MEDICINE

NO CLAIM IS MADE TO THE EXCLUSIVE RIGHT TO USE "MEDICINE", APART FROM THE MARK AS SHOWN.
FOR SERIES OF BOOKS RELATING TO HEALTH, MEDICINE, SCIENCE, NUTRITION, NATURE AND METAPHYSICAL MATTERS (U.S. CLS. 2, 5, 22, 23, 29, 37, 38 AND 50).

SN 76-447,423. DECAL SPECIALTIES, INC., PAOLI, PA. FILED 9-6-2002.

EVERYDAY MEMORIES

FOR RUB ON TRANSFERS USED MAINLY FOR SCRAPBOOKING AND OTHER CRAFT ITEMS (U.S. CLS. 2, 5, 22, 23, 29, 37, 38 AND 50).
FIRST USE 4-17-2002; IN COMMERCE 4-17-2002.

SN 76-450,605. STORA ENSO NORTH AMERICA CORP., WISCONSIN RAPIDS, WI. FILED 8-28-2002.

MADE FOR YOUR MACHINE

FOR PRINTING PAPER FOR COMPUTER PRINTERS (U.S. CLS. 2, 5, 22, 23, 29, 37, 38 AND 50).

CLASS 16—(Continued).

SN 76-451,299. LIFETIME ENTERTAINMENT SERVICES, NEW YORK, NY. FILED 9-19-2002.

Lifetime

OWNER OF U.S. REG. NOS. 1,450,063 AND 2,266,954.
FOR MAGAZINES FEATURING INFORMATION AND ARTICLES ABOUT ISSUES OF INTEREST TO VIEWERS OF APPLICANT'S TELEVISION PROGRAMS, NAMELY CELEBRITIES, MUSIC, MOVIE AND BOOK REVIEWS, FASHION, ADVOCACY INITIATIVES TOWARDS ENDING VIOLENCE AGAINST WOMEN, BIOGRAPHIES OF EVERYDAY WOMEN, SHOPPING, COOKING, WEDDINGS, ASTROLOGY, INTERIOR DESIGN AND DECORATING, BEAUTY, RELATIONSHIPS, AND GARDENING (U.S. CLS. 2, 5, 22, 23, 29, 37, 38 AND 50).

SN 76-451,580. CC2 LLC, ST. LOUIS, MO. FILED 9-23-2002.



FOR ACTIVITY KITS COMPRISED OF PRINTED EDUCATIONAL MATERIAL, NAMELY, BOOKMARKS, NOTEPADS, NAME TAGS, CALENDARS, ASSIGNMENT BOOKS, PENCILS, PENS, ERASERS, RULES AND COMPASSES (U.S. CLS. 2, 5, 22, 23, 29, 37, 38 AND 50).

SN 76-451,925. NATIONAL HOUSEWARES MANUFACTURERS ASSOCIATION, ROSEMONT, IL. FILED 9-24-2002.



NO CLAIM IS MADE TO THE EXCLUSIVE RIGHT TO USE "HOUSEWARES", APART FROM THE MARK AS SHOWN.

FOR PUBLICATIONS, NAMELY, NEWSLETTERS FEATURING HOUSEWARES PRODUCT CATEGORY DATA COMPARING HOUSEHOLD PENETRATION AND ACTUAL PURCHASE INCIDENCE (U.S. CLS. 2, 5, 22, 23, 29, 37, 38 AND 50).
FIRST USE 4-1-2001; IN COMMERCE 4-1-2001.

CLASS 16—(Continued).

SN 76-452,254. BOYER INDUSTRIES CORPORATION, LAWRENCE, KS. FILED 9-23-2002.

PROSOCO OVERCOAT

OWNER OF U.S. REG. NOS. 1,513,260, 1,805,058 AND 2,609,036.

NO CLAIM IS MADE TO THE EXCLUSIVE RIGHT TO USE "OVERCOAT", APART FROM THE MARK AS SHOWN.
FOR TEMPORARY PROTECTIVE PAPER FILM FOR USE WITH PAINT AND COATING REMOVERS (U.S. CLS. 2, 5, 22, 23, 29, 37, 38 AND 50).

SN 76-454,659. LEWIN, THOMAS M., MINNEAPOLIS, MN. FILED 9-26-2002.

IDENTI-STRIPS

FOR PAPER IDENTIFICATION STRIP FOR AFFIXING TO BOOKS, MAGAZINES, ALBUMS, OR CONTAINERS OF CDS OR VIDEO CASSETTES (U.S. CLS. 2, 5, 22, 23, 29, 37, 38 AND 50).
FIRST USE 8-1-2002; IN COMMERCE 8-1-2002.

SN 76-455,407. THE MEAD CORPORATION, DAYTON, OH. FILED 9-26-2002.



OWNER OF U.S. REG. NOS. 1,447,409, 2,541,564 AND OTHERS.

FOR PERSONAL ORGANIZERS AND REFILLS FOR PERSONAL ORGANIZERS (U.S. CLS. 2, 5, 22, 23, 29, 37, 38 AND 50).
FIRST USE 11-12-2002; IN COMMERCE 11-12-2002.

SN 76-455,408. THE MEAD CORPORATION, DAYTON, OH. FILED 9-26-2002.

CAMBRIDGE HOME

OWNER OF U.S. REG. NOS. 1,447,409, 2,541,564 AND OTHERS.

FOR PERSONAL ORGANIZERS AND REFILLS FOR PERSONAL ORGANIZERS (U.S. CLS. 2, 5, 22, 23, 29, 37, 38 AND 50).
FIRST USE 11-12-2002; IN COMMERCE 11-12-2002.

CLASS 16—(Continued).

SN 76-455,563. KIMBERLY-CLARK WORLDWIDE, INC., NEENAH, WI. BY ASSIGNMENT KIMBERLY-CLARK CORPORATION, NEENAH, WI. FILED 10-3-2002.



NO CLAIM IS MADE TO THE EXCLUSIVE RIGHT TO USE "ALL AROUND STRETCH FOR IMPROVED FIT & COMFORT", APART FROM THE MARK AS SHOWN.

FOR DISPOSABLE DIAPERS (U.S. CLS. 2, 5, 22, 23, 29, 37, 38 AND 50).

SN 76-455,564. KIMBERLY-CLARK WORLDWIDE, INC., NEENAH, WI. BY ASSIGNMENT KIMBERLY-CLARK CORPORATION, NEENAH, WI. FILED 10-3-2002.



NO CLAIM IS MADE TO THE EXCLUSIVE RIGHT TO USE "STRETCH WAIST FOR IMPROVED FIT", APART FROM THE MARK AS SHOWN.

FOR DISPOSABLE DIAPERS (U.S. CLS. 2, 5, 22, 23, 29, 37, 38 AND 50).

SN 76-460,334. BUBB, PATRICIA, PHILADELPHIA, PA. FILED 10-17-2002.

WORDS LEFT UNSAID

FOR GREETING CARDS (U.S. CLS. 2, 5, 22, 23, 29, 37, 38 AND 50).

CLASS 16—(Continued).

SN 76-462,507. AMERICA ONLINE, INC., DULLES, VA. FILED 10-22-2002.

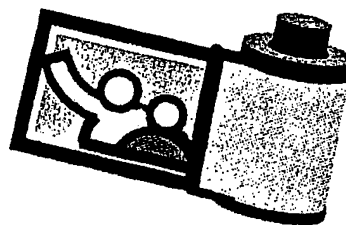

THE STIPPLING ON THE DRAWING IS FOR SHADING PURPOSES AND DOES NOT INDICATE COLOR.

FOR PUBLICATIONS AND PRINTED MATTER, NAMELY, MAGAZINES, BOOKS, PAMPHLETS, MANUALS, CATALOGUES, NEWSLETTERS, AND INSTRUCTIONAL AND TEACHING MATERIALS COVERING TOPICS OF GENERAL INTEREST IN THE FIELDS OF COMPUTERS AND ENTERTAINMENT; COLORING BOOKS, DECALS, POSTERS, POSTCARDS, AND CALENDARS (U.S. CLS. 2, 5, 22, 23, 29, 37, 38 AND 50).

FIRST USE 5-0-1998; IN COMMERCE 5-0-1998.

SN 76-463,854. AQUIL H. ROWE, BROCKTON, MA. FILED 11-4-2002.

UBIQUITOUS INK

FOR GREETING CARDS FEATURING POETRY AND POETRY BOOKS (U.S. CLS. 2, 5, 22, 23, 29, 37, 38 AND 50).

SN 76-464,879. CHECKS IN THE MAIL, INC., NEW BRAUNFELS, TX. FILED 10-31-2002.

CHECKS IN THE MAIL

OWNER OF U.S. REG. NO. 1,564,421.
FOR BANK CHECKS (U.S. CLS. 2, 5, 22, 23, 29, 37, 38 AND 50).

FIRST USE 9-10-1993; IN COMMERCE 9-10-1993.

SN 76-468,490. CALIFORNIA NEWSPAPERS PARTNERSHIP, DENVER, CO. FILED 11-20-2002.

SAN MATEO COUNTY TIMES

NO CLAIM IS MADE TO THE EXCLUSIVE RIGHT TO USE "SAN MATEO COUNTY", APART FROM THE MARK AS SHOWN.

FOR NEWSPAPERS FOR GENERAL CIRCULATION (U.S. CLS. 2, 5, 22, 23, 29, 37, 38 AND 50).

FIRST USE 3-0-1996; IN COMMERCE 3-0-1996.

CLASS 16—(Continued).

SN 76-468,724. EDUCAUSE CORPORATION, BOULDER, CO. FILED 11-7-2002.

ECAR

FOR PUBLICATIONS, NAMELY REPORTS AND BULLETINS IN THE FIELDS OF INFORMATION RESOURCES AND TECHNOLOGY (U.S. CLS. 2, 5, 22, 23, 29, 37, 38 AND 50).

FIRST USE 12-0-2001; IN COMMERCE 12-0-2001.

SN 76-469,591. MIRSKY-MACNAMARA, ARLENE C., DBA ABUSE PREVENTION SPECIALISTS, COVENTRY, CT. FILED 11-25-2002.



FOR PRINTED MATERIALS, NAMELY LECTURE AND SEMINAR MATERIALS, TRAINING MANUALS, AND MONTHLY NEWSLETTER DIRECTED TO ABUSE PROBLEMS ENCOUNTERED BY THE DISABLED, THE ELDERLY, AND OTHERS (U.S. CLS. 2, 5, 22, 23, 29, 37, 38 AND 50).

FIRST USE 9-12-1988; IN COMMERCE 9-12-1988.

SN 76-470,575. PHYSICIANS INSURANCE COMPANY OF WISCONSIN, MADISON, WI. FILED 11-27-2002.

TRENDWATCH

FOR NEWSLETTERS IN THE FIELD OF HEALTH CARE RISK MANAGEMENT (U.S. CLS. 2, 5, 22, 23, 29, 37, 38 AND 50).

FIRST USE 4-0-1996; IN COMMERCE 4-0-1996.

CLASS 16—(Continued).

SN 76-471,006. SOVEREIGN GRACE MINISTRIES, INC., GAITHERSBURG, MD. FILED 11-20-2002.

SOVEREIGN GRACE

OWNER OF U.S. REG. NO. 2,165,958.
FOR PUBLICATIONS AND PRINTED MATERIALS, NAMELY, MAGAZINES, BOOKS, BOOKLETS, PAMPHLETS, BROCHURES, BULLETINS, NEWSLETTERS, REPORTS, STUDY GUIDES, WORKBOOKS, CATALOGS, LEAFLETS, FLYERS, PRINTED TEACHING MATERIALS, TRACTS, AND SHEET MUSIC, ALL IN THE FIELDS OF MUSIC, CHURCH DEVELOPMENT, LEADERSHIP, SPIRITUALITY, THEOLOGY, CHRISTIANITY, VALUES, ETHICS, CULTURE, AND SOCIAL ISSUES; SONG BOOKS; STATIONERY; ADDRESS BOOKS; RELIGIOUS CIRCULAR LETTERS; POSTERS; GREETING CARDS; OCCASION CARDS; BLANK NOTE CARDS; POSTCARDS; CALENDARS; PRINTED MUSIC BOOKS (U.S. CLS. 2, 5, 22, 23, 29, 37, 38 AND 50).

SN 76-471,108. POLY-AMERICA, L.P., GRAND PRAIRIE, TX. FILED 11-25-2002.

TRITON

FOR TRASH BAGS (U.S. CLS. 2, 5, 22, 23, 29, 37, 38 AND 50).

SN 76-471,701. TOP COW PRODUCTIONS, INC., LOS ANGELES, CA. FILED 11-15-2002.

EVO

FOR PRINTED MATTER, NAMELY COMIC BOOKS, TRADING CARDS, MILK CAP TRADING CARDS, POSTERS, POSTCARDS AND PICTURE BOOKLETS IN ILLUSTRATED FORM (U.S. CLS. 2, 5, 22, 23, 29, 37, 38 AND 50).

SN 76-471,751. SMITH, ROBERT, NEW YORK, NY. FILED 11-6-2002.

W. C. FROGGY

FOR LINE OF BOOKS IN THE CHILDREN'S ILLUSTRATED GENRE TO BE PUBLISHED BY THE APPLICANT (U.S. CLS. 2, 5, 22, 23, 29, 37, 38 AND 50).

SN 76-472,167. STARLINE PUBLICATIONS, INC., POUGHKEEPSIE, NY. FILED 12-3-2002.

BROTHERS

FOR GENERAL INTEREST MAGAZINE FOR BLACK ADULT MEN (U.S. CLS. 2, 5, 22, 23, 29, 37, 38 AND 50).

CLASS 16—(Continued).

SN 76-473,540. MEAD CORPORATION, THE, DAYTON, OH. FILED 12-5-2002.

POLY PORTBOOK

OWNER OF U.S. REG. NOS. 1,501,340, 2,383,283 AND OTHERS.

NO CLAIM IS MADE TO THE EXCLUSIVE RIGHT TO USE "POLY", APART FROM THE MARK AS SHOWN.

FOR NOTEBOOKS (U.S. CLS. 2, 5, 22, 23, 29, 37, 38 AND 50).

FIRST USE 11-12-2002; IN COMMERCE 11-12-2002.

SN 76-474,038. MEAD CORPORATION, THE, DAYTON, OH. FILED 12-4-2002.

a world of
Fantasy

OWNER OF U.S. REG. NOS. 1,657,401 AND 2,187,653. FOR NOTEBOOKS, PENCIL POUCHES, BINDERS, STATIONERY-TYPE PORTFOLIOS (U.S. CLS. 2, 5, 22, 23, 29, 37, 38 AND 50).

FIRST USE 11-12-2002; IN COMMERCE 11-12-2002.

SN 76-474,039. MEAD CORPORATION, THE, DAYTON, OH. FILED 12-4-2002.

A WORLD OF FANTASY

OWNER OF U.S. REG. NOS. 1,657,401 AND 2,187,653. FOR NOTEBOOKS, PENCIL POUCHES, BINDERS, STATIONERY-TYPE PORTFOLIOS (U.S. CLS. 2, 5, 22, 23, 29, 37, 38 AND 50).

FIRST USE 11-12-2002; IN COMMERCE 11-12-2002.

SN 76-474,116. MEAD CORPORATION, THE, DAYTON, OH. FILED 12-5-2002.

**POLY
PORTBOOK**

OWNER OF U.S. REG. NOS. 1,501,340, 2,383,283 AND OTHERS.

NO CLAIM IS MADE TO THE EXCLUSIVE RIGHT TO USE "POLY", APART FROM THE MARK AS SHOWN.

FOR NOTEBOOKS (U.S. CLS. 2, 5, 22, 23, 29, 37, 38 AND 50).

FIRST USE 11-12-2002; IN COMMERCE 11-12-2002.

CLASS 16—(Continued).

SN 76-474,117. MEAD CORPORATION, THE, DAYTON, OH. FILED 12-5-2002.

Space Keeper

OWNER OF U.S. REG. NOS. 1,133,115, 2,536,441 AND OTHERS.

FOR BINDERS, ORGANIZERS AND DATE PLANNERS (U.S. CLS. 2, 5, 22, 23, 29, 37, 38 AND 50).

FIRST USE 11-12-2002; IN COMMERCE 11-12-2002.

SN 76-474,127. MEAD CORPORATION, THE, DAYTON, OH. FILED 12-5-2002.

SPACE KEEPER

OWNER OF U.S. REG. NOS. 1,133,115, 2,536,441 AND OTHERS.

FOR BINDERS, ORGANIZERS AND DATE PLANNERS (U.S. CLS. 2, 5, 22, 23, 29, 37, 38 AND 50).

FIRST USE 11-12-2002; IN COMMERCE 11-12-2002.

SN 76-474,225. PASTIS, STEPHAN, NEW YORK, NY. FILED 12-12-2002.

PEARLS BEFORE SWINE

FOR SYNDICATED COMIC STRIP (U.S. CLS. 2, 5, 22, 23, 29, 37, 38 AND 50).

FIRST USE 11-15-2000; IN COMMERCE 11-15-2000.

SN 76-474,231. WHITAKER BROTHERS BUSINESS MACHINES, INC., ROCKVILLE, MD. FILED 12-12-2002.

MICROSHRED

FOR OFFICE MACHINES, NAMELY, PAPER SHREDDERS (U.S. CLS. 2, 5, 22, 23, 29, 37, 38 AND 50).

SN 76-477,384. VITAMIN RETAILER MAGAZINE, INC., OJAI, CA. FILED 12-23-2002.

VITAMIN RETAILER

SEC. 2(F).

FOR MAGAZINE IN THE FIELDS OF THE VITAMIN, MINERALS, HERBS, SPORTS NUTRITION, HOMEOPATHY, AND DIETARY SUPPLEMENT INDUSTRIES (U.S. CLS. 2, 5, 22, 23, 29, 37, 38 AND 50).

FIRST USE 1-0-1994; IN COMMERCE 1-0-1994.

CLASS 16—(Continued).

SN 76-975,190. AT&T WIRELESS SERVICES, INC., REDMOND, WA. BY MERGER ALPHIE, INC., SEATTLE, WA. FILED 12-28-2001.

MMODE

FOR TELEPHONE CALLING CARDS, NOT MAGNETICALLY ENCODED (U.S. CLS. 2, 5, 22, 23, 29, 37, 38 AND 50).

SN 78-044,872. SHEEPCOMICS.COM INC., SEATTLE, WA. FILED 1-25-2001.

THE SHEEP COMICS AT SHEEPCOMICS.COM

NO CLAIM IS MADE TO THE EXCLUSIVE RIGHT TO USE "COMICS", APART FROM THE MARK AS SHOWN.

FOR CARTOON PRINTS, CARTOON STRIPS, CHRISTMAS CARDS, GREETING CARDS, PRINTED TEACHING MATERIALS IN THE FIELD OF RELIGION, TRIVIA CARDS, PRINTED LESSONS ON RELIGIOUS BIBLE SUBJECTS, STICKERS, CALENDARS (U.S. CLS. 2, 5, 22, 23, 29, 37, 38 AND 50).

SN 78-057,063. LISA FRANK, INC., TUCSON, AZ. FILED 4-5-2001.



FOR PRINTED MATERIALS FOR CHILDREN, NAMELY, PERSONAL ORGANIZERS, FOLDERS, AND TRADING CARDS. (U.S. CLS. 2, 5, 22, 23, 29, 37, 38 AND 50).

SN 78-060,737. TODAY'S CHILD, LLC, KINGSTON, PA. FILED 4-26-2001.

TODAY'S CHILD

FOR PARENTING PERIODICAL (U.S. CLS. 2, 5, 22, 23, 29, 37, 38 AND 50).

CLASS 16—(Continued).

SN 78-075,771. FLYNN, JOSEPH ROBERT, LARGO, FL. AND GRAY, COLLEEN ANN, LARGO, FL. FILED 7-26-2001.



NO CLAIM IS MADE TO THE EXCLUSIVE RIGHT TO USE "INC." AND "ENTERTAINMENT", APART FROM THE MARK AS SHOWN.

FOR MAGAZINES FEATURING LOCAL AND NATIONAL ENTERTAINMENT INFORMATION CONCERNING CLUBS, MUSIC, ART, AND FASHION (U.S. CLS. 2, 5, 22, 23, 29, 37, 38 AND 50).

FIRST USE 4-1-1999; IN COMMERCE 10-1-2000.

SN 78-093,426. OLSON, NICHOLAS L., HENDERSON, NV. FILED 11-15-2001.

HERITAGEBELL

FOR PRINTED AND BOUND BOOKS CONTAINING TRANSCRIBED COPIES OF HISTORICAL DOCUMENTS, SPECIFICALLY THE CHARTER DOCUMENTS OF THE UNITED STATES WHICH INCLUDE THE DECLARATION OF INDEPENDENCE, CONSTITUTION AND BILL OF RIGHTS (U.S. CLS. 2, 5, 22, 23, 29, 37, 38 AND 50).

SN 78-105,140. SMITH, EASTERN A., ATLANTA, GA. BY ASSIGNMENT SMITH, EASTERN A., ATLANTA, GA. FILED 1-28-2002.



HÖLLAR

FOR PRINTED MATERIALS, NAMELY, DECALS AND BUMPER STICKERS (U.S. CLS. 2, 5, 22, 23, 29, 37, 38 AND 50).

FIRST USE 1-6-2002; IN COMMERCE 1-6-2002.

CLASS 16—(Continued).

SN 78-108,865. KRAUSE PUBLICATIONS, INC., IOLA, WI. FILED 2-14-2002.



OWNER OF U.S. REG. NO. 1,325,179.

NO CLAIM IS MADE TO THE EXCLUSIVE RIGHT TO USE "COMICS BUYER'S GUIDE", APART FROM THE MARK AS SHOWN.

FOR NEWSPAPER ISSUED PERIODICALLY, FEATURING INFORMATION IN THE FIELD OF THE COMICS INDUSTRY (U.S. CLS. 2, 5, 22, 23, 29, 37, 38 AND 50).

FIRST USE 11-4-2001, 02/11/1983; IN COMMERCE 11-4-2001, 02/11/1983.

SN 78-120,146. MICROSOFT CORPORATION, REDMOND, WA. FILED 4-8-2002.

TORK

FOR PUBLICATIONS, NAMELY, STRATEGY GUIDE BOOKS, USER INSTRUCTION MANUALS, COMIC BOOKS, SERIES OF FICTION BOOKS, MAGAZINES AND NEWSLETTERS ALL IN THE FIELD OF COMPUTER GAMES, SCIENCE FICTION AND VIDEOGAMES; PENS, PENCILS, MARKERS, STATIONERY, STATIONERY-TYPE PORTFOLIOS, CLIPBOARDS, DESK SETS, PEN AND PENCIL HOLDERS, MOUNTED AND UNMOUNTED PHOTOGRAPHS, POSTER, MAGNETIC BOARDS, MEMO PADS, BINDERS, STAPLERS, PAPERWEIGHTS, PAPER COASTERS, CALENDARS, NOTEBOOKS, BOOK COVERS, STICKER BOOKS, GREETING CARDS AND NOTE CARDS (U.S. CLS. 2, 5, 22, 23, 29, 37, 38 AND 50).

CLASS 16—(Continued).

SN 78-124,796. WARNER BROS. ENTERTAINMENT INC., BURBANK, CA. BY ASSIGNMENT; BY ASSIGNMENT TIME WARNER ENTERTAINMENT COMPANY, L.P., NEW YORK, NY. FILED 4-29-2002.

SLAMBALL

FOR PRINTED MATTER AND PAPER GOODS—NAMELY, BOOKS FEATURING CHARACTERS FROM ANIMATED, ACTION ADVENTURE, COMEDY AND/OR DRAMA FEATURES, COMIC BOOKS, CHILDREN'S BOOKS, MAGAZINES FEATURING CHARACTERS FROM ANIMATED, ACTION ADVENTURE, COMEDY AND/OR DRAMA FEATURES, COLORING BOOKS, CHILDREN'S ACTIVITY BOOKS; STATIONERY, WRITING PAPER, ENVELOPES, NOTEBOOKS, DIARIES, NOTE CARDS, GREETING CARDS, TRADING CARDS; LITHOGRAPHS; PENS, PENCILS, CASES THEREFOR, ERASERS, CRAYONS, MARKERS, COLORED PENCILS, PAINTING SETS, CHALK AND CHALKBOARDS; DECALS, HEAT TRANSFERS; POSTERS; MOUNTED AND/OR UNMOUNTED PHOTOGRAPHS; BOOK COVERS, BOOK MARKS, CALENDARS, GIFT WRAPPING PAPER; PAPER PARTY FAVORS AND PAPER PARTY DECORATIONS—NAMELY, PAPER NAPKINS, PAPER DOILIES, PAPER PLACE MATS, CREPE PAPER, PAPER HATS, INVITATIONS, PAPER TABLE CLOTHS, PAPER CAKE DECORATIONS; PRINTED TRANSFERS FOR EMBROIDERY OR FABRIC APPLIQUES; PRINTED PATTERNS FOR COSTUMES, PAJAMAS, SWEATSHIRTS AND T-SHIRTS (U.S. CLS. 2, 5, 22, 23, 29, 37, 38 AND 50).

SN 78-125,322. COOPER, BRAD, LITTLETON, CO. FILED 5-1-2002.

GROUNDBREAKING SALES

NO CLAIM IS MADE TO THE EXCLUSIVE RIGHT TO USE "SALES", APART FROM THE MARK AS SHOWN.

FOR SERIES OF BOOKS ON THE SUBJECT OF SALES; PRINTED INSTRUCTIONAL, EDUCATIONAL AND TEACHING MATERIALS ON THE SUBJECT OF SALES, RELATIONSHIP BUILDING AND CLIENT CONNECTIONS (U.S. CLS. 2, 5, 22, 23, 29, 37, 38 AND 50).

SN 78-127,761. BUILD-A-BEAR WORKSHOP, INC., ST. LOUIS, MO. FILED 5-10-2002.

BUILD-A-BEAR FRIENDSHOP

OWNER OF U.S. REG. NOS. 2,428,666, 2,603,267 AND OTHERS.

FOR STATIONERY, ENVELOPES, WRITING TABLETS, CALENDARS, BOOKS, NAMELY SERIES OF FICTION BOOKS FOR CHILDREN AND ADULTS, AND SERIES OF NON-FICTION BOOKS ON INSPIRATIONAL TOPICS FOR CHILDREN AND ADULTS, ACTIVITY BOOKS, COLORING BOOKS, STICKERS, PENS, PENCILS, MARKERS AND CRAYONS (U.S. CLS. 2, 5, 22, 23, 29, 37, 38 AND 50).

CLASS 16—(Continued).

SN 78-131,005. EBSCO INDUSTRIES, INC., BIRMINGHAM, AL. FILED 5-24-2002.



OWNER OF U.S. REG. NO. 2,635,940.
NO CLAIM IS MADE TO THE EXCLUSIVE RIGHT TO USE "TEAM HUNTING", APART FROM THE MARK AS SHOWN.

THE MARK CONSISTS OF THE WORDING "KNIGHT & HALE ULTIMATE TEAM HUNTING" IN STYLIZED FORM. FOR MAGAZINE, NAMELY, A PUBLICATION PERTAINING TO OUTDOORSMEN (U.S. CLS. 2, 5, 22, 23, 29, 37, 38 AND 50).

FIRST USE 9-1-1997; IN COMMERCE 9-1-1997.

SN 78-131,856. NEVA, BETH A., FARGO, ND. FILED 5-29-2002.

AREA WEDDINGS

NO CLAIM IS MADE TO THE EXCLUSIVE RIGHT TO USE "WEDDINGS", APART FROM THE MARK AS SHOWN. FOR MAGAZINE FOR WEDDINGS AND WEDDING PREPARATION (U.S. CLS. 2, 5, 22, 23, 29, 37, 38 AND 50).

FIRST USE 6-30-2002; IN COMMERCE 6-30-2002.

SN 78-136,680. GENERAL BINDING CORPORATION, SKOKIE, IL. FILED 6-18-2002.

REGENCY

FOR PAPER COVER STOCK (U.S. CLS. 2, 5, 22, 23, 29, 37, 38 AND 50).
FIRST USE 2-1-2003; IN COMMERCE 2-1-2003.

CLASS 16—(Continued).

SN 78-148,899. JOHN M. LUND PHOTOGRAPHY, SAN FRANCISCO, CA. FILED 7-30-2002.



FOR GREETING CARDS, CALENDARS, POSTERS, PUZZLES, STICKERS, JOURNALS, NOTEBOOKS, BOOKS IN THE FIELD OF INSPIRATION, HUMOR AND ADVICE, STATIONERY, MOUNTED PHOTOGRAPHS, UNMOUNTED PHOTOGRAPHS, DIARIES, PHOTOGRAPHIC ALBUMS, RECORD BOOKS ABOUT PETS, BIRTHDAY BOOKS, ANNIVERSARY BOOKS, ADDRESS BOOKS, POSTCARDS, BOOKMARKS, PAPER LABELS AND GIFT TAGS, NOTE CARDS, NOTEBOOKS, PAPER AND CARDBOARD BOXES, GENERAL PURPOSE PLASTIC BAGS AND PAPER BAGS, DRAWING BOOKS AND CRAYONS, FOLDERS, BINDERS, WRAPPING PAPER, PENS, PENCILS, DRAWING RULERS, RUBBER ERASERS (U.S. CLS. 2, 5, 22, 23, 29, 37, 38 AND 50).

FIRST USE 3-5-2002; IN COMMERCE 7-30-2002.

SN 78-149,835. EPSTEIN, MERRIL JAY, LA JOLLA, CA. FILED 8-1-2002.

BRANDICAPPED

FOR BOOKS FEATURING INFORMATION ABOUT BRANDING AND MARKETING (U.S. CLS. 2, 5, 22, 23, 29, 37, 38 AND 50).

SN 78-156,131. LUDWIG, JOHN JOSEPH JR., CRESTVIEW, FL. FILED 8-20-2002.

AMERICAN FIREFIGHTER

FOR EMBROIDERY DESIGN PATTERNS IN THE NATURE OF A LOGO FOR SHIRTS (U.S. CLS. 2, 5, 22, 23, 29, 37, 38 AND 50).

SN 78-157,846. LIQUI-MARK CORP., WESTBURY, NY. FILED 8-26-2002.

DOUBLE UP

FOR MARKERS AND PENS (U.S. CLS. 2, 5, 22, 23, 29, 37, 38 AND 50).

CLASS 16—(Continued).

SN 78-167,010. MODERN MEDIA, LOS ANGELES, CA. FILED 9-23-2002.

I'M WITH STUPID

FOR CHILDREN'S BOOKS FEATURING CHARACTERS DESIGNATED AS STUPID (U.S. CLS. 2, 5, 22, 23, 29, 37, 38 AND 50).

SN 78-167,756. DEATON, JOHN H. SR., EATONTON, GA. FILED 9-25-2002.

FORGET-ME-KNOT

FOR CLIPBOARDS WITH ERASABLE WRITING SURFACE (U.S. CLS. 2, 5, 22, 23, 29, 37, 38 AND 50).

SN 78-172,522. CHARBENEAU, LEONARD LEE, TEMPLE, TX. FILED 10-9-2002.

CURLY FLEX

NO CLAIM IS MADE TO THE EXCLUSIVE RIGHT TO USE "FLEX", APART FROM THE MARK AS SHOWN.

FOR PAINT APPLICATOR ROLLER FRAMES (U.S. CLS. 2, 5, 22, 23, 29, 37, 38 AND 50).

SN 78-173,414. CHOICE MARKETING INC., ASTON, PA. FILED 10-11-2002.



NO CLAIM IS MADE TO THE EXCLUSIVE RIGHT TO USE "MARKETING SPORTSCARDS", APART FROM THE MARK AS SHOWN.

FOR CUSTOMIZED TRADING CARDS FOR ORGANIZATIONS AND INDIVIDUALS (U.S. CLS. 2, 5, 22, 23, 29, 37, 38 AND 50).

FIRST USE 10-1-2002; IN COMMERCE 10-1-2002.

SN 78-175,120. KEENE, CRAIG, KANSAS CITY, MO. FILED 10-16-2002.

COFFEE STAIN CARDS

NO CLAIM IS MADE TO THE EXCLUSIVE RIGHT TO USE "CARDS", APART FROM THE MARK AS SHOWN.

FOR PAPER GOODS, NAMELY, GREETING CARDS. (U.S. CLS. 2, 5, 22, 23, 29, 37, 38 AND 50).

FIRST USE 6-0-2001; IN COMMERCE 6-0-2001.

CLASS 16—(Continued).

SN 78-176,055. GEORGIA-PACIFIC CORPORATION, ATLANTA, GA. FILED 10-18-2002.

GEORGIA-PACIFIC SPARKLE

OWNER OF U.S. REG. NOS. 1,500,510, 1,585,652 AND 2,408,672.

FOR PAPER PRODUCTS IN THE NATURE OF COMMUNICATION PAPER AND BUSINESS PAPER, NAMELY, COMPUTER PAPER, PRINTING PAPER, COPY PAPER AND BOND PAPER (U.S. CLS. 2, 5, 22, 23, 29, 37, 38 AND 50).

SN 78-178,837. PROGRAM FIT, INCORPORATED, DUNCANNON, PA. FILED 10-27-2002.

FITGREETINGS

FOR GREETING CARDS, POSTCARDS, STATIONERY, AND ENVELOPES (U.S. CLS. 2, 5, 22, 23, 29, 37, 38 AND 50).

FIRST USE 12-1-2001; IN COMMERCE 12-1-2001.

SN 78-181,420. BOWRING, LARRY A., ARLINGTON, VA. FILED 11-4-2002.

STATIONMASTERS

FOR TRANSIT MAPS BASED ON STATION NEIGHBORHOODS (U.S. CLS. 2, 5, 22, 23, 29, 37, 38 AND 50).

FIRST USE 0-0-1987; IN COMMERCE 0-0-1987.

SN 78-183,461. SACRED HANDS STUDIO, INCORPORATED, DESTIN, FL. FILED 11-9-2002.

SACRED HANDS

FOR PRINTED MATERIALS HAVING A RELIGIOUS OR SPIRITUAL THEME, NAMELY, GREETING CARDS, ART PRINTS, POSTERS, BOOKMARKS, STATIONERY, BANNERS, NOTECARDS, JOURNALS AND ADDRESS BOOKS (U.S. CLS. 2, 5, 22, 23, 29, 37, 38 AND 50).

SN 78-183,977. SB PHARMCO PUERTO RICO, INC., CIDRA, PUERTO RICO, FILED 11-12-2002.

SOY MAS FUERTE QUE LA DIABETES

OWNER OF U.S. REG. NO. 2,462,690. THE ENGLISH TRANSLATION OF THIS MARK IS "I AM STRONGER THAN DIABETES"

FOR PRINTED EDUCATIONAL MATERIALS, NAMELY, PAMPHLETS AND BROCHURES RELATING TO THE TREATMENT AND PREVENTION OF DIABETES (U.S. CLS. 2, 5, 22, 23, 29, 37, 38 AND 50).

CLASS 16—(Continued).

SN 78-184,325. SEARS, ROEBUCK AND CO., HOFFMAN ESTATES, IL. FILED 11-12-2002.

PERSONAS DIFERENTES. TARJETAS DIFERENTES.

THE FOREIGN WORDING IN THE MARK TRANSLATES INTO ENGLISH AS "DIFFERENT PEOPLE. DIFFERENT CARDS."

FOR GIFT CARDS. (U.S. CLS. 2, 5, 22, 23, 29, 37, 38 AND 50).

SN 78-185,030. SMITH SAWYER, INGA, CHAPEL HILL, NC. FILED 11-14-2002.

THE LEADERSHIP LOFT

NO CLAIM IS MADE TO THE EXCLUSIVE RIGHT TO USE "LEADERSHIP", APART FROM THE MARK AS SHOWN.

FOR CURRICULA IN THE NATURE OF PRINTED MATERIALS USED FOR TEACHING LEADERSHIP CONCEPTS TO YOUTH, CHILDREN'S STORYBOOKS AND ACTIVITY BOOKS, AND CURRICULUM GUIDES FOR CAREGIVERS (U.S. CLS. 2, 5, 22, 23, 29, 37, 38 AND 50).

SN 78-185,299. POODLE SUIT PUBLISHING LLC, SCOTTSDALE, AZ. FILED 11-14-2002.

ANDRÉ

FOR CHILDREN'S BOOKS FEATURING A CARTOON POODLE CHARACTER (U.S. CLS. 2, 5, 22, 23, 29, 37, 38 AND 50).

SN 78-185,348. MAHARAJ, VISHNU, ROSEDALE, NY. AND MARAHAJ, ISHWAR, ROSEDALE, NY. FILED 11-14-2002.

MOGULS MAGAZINE

NO CLAIM IS MADE TO THE EXCLUSIVE RIGHT TO USE "MAGAZINE", APART FROM THE MARK AS SHOWN. FOR MAGAZINES DEVOTED TO LITERATURE, THE ARTS, POLITICS AND POPULAR CULTURE (U.S. CLS. 2, 5, 22, 23, 29, 37, 38 AND 50).

CLASS 16—(Continued).

SN 78-185,589. BUILD-A-BEAR WORKSHOP, INC., ST. LOUIS, MO. FILED 11-15-2002.

THE STUFF MEMORIES ARE MADE OF

FOR GREETING CARDS (U.S. CLS. 2, 5, 22, 23, 29, 37, 38 AND 50).

SN 78-185,726. CARUANA, VICKI G., COLORADO SPRINGS, CO. FILED 11-15-2002.

APPLES & CHALKDUST

FOR EDUCATIONAL BOOKS IN THE FIELD OF K-12 EDUCATIONAL CONSULTATION (U.S. CLS. 2, 5, 22, 23, 29, 37, 38 AND 50).

SN 78-186,087. JONES, JEFFREY A., WEST BARNSTABLE, MA. FILED 11-18-2002.

STACKED AND PACKED

FOR CALENDAR (U.S. CLS. 2, 5, 22, 23, 29, 37, 38 AND 50).
FIRST USE 12-31-1995; IN COMMERCE 12-31-1995.

SN 78-190,588. LEARNINGRX, INC., COLORADO SPRINGS, CO. FILED 12-3-2002.

READRX

FOR PRINTED INSTRUCTIONAL, EDUCATIONAL, AND TEACHING MATERIALS IN THE AREA OF READING AND SPELLING (U.S. CLS. 2, 5, 22, 23, 29, 37, 38 AND 50).
FIRST USE 11-25-2002; IN COMMERCE 11-25-2002.

SN 78-190,596. LEARNINGRX, INC., COLORADO SPRINGS, CO. FILED 12-3-2002.

PROCESSRX

FOR PRINTED INSTRUCTIONAL, EDUCATIONAL, AND TRAINING MATERIALS DESIGNED TO ENHANCE PROCESSING AND COGNITIVE SKILLS (U.S. CLS. 2, 5, 22, 23, 29, 37, 38 AND 50).
FIRST USE 11-25-2002; IN COMMERCE 11-25-2002.

CLASS 16—(Continued).

SN 78-190,599. LEARNINGRX, INC., COLORADO SPRINGS, CO. FILED 12-3-2002.

SPELLRX

FOR PRINTED INSTRUCTIONAL, EDUCATIONAL, AND TEACHING MATERIALS IN THE AREA OF SPELLING (U.S. CLS. 2, 5, 22, 23, 29, 37, 38 AND 50).
FIRST USE 11-25-2002; IN COMMERCE 11-25-2002.

SN 78-190,620. LEARNINGRX, INC., COLORADO SPRINGS, CO. FILED 12-3-2002.

THINKRX

FOR PRINTED INSTRUCTIONAL, EDUCATIONAL, AND TRAINING MATERIALS DESIGNED TO ENHANCE LOGIC, REASONING, AND THINKING SKILLS (U.S. CLS. 2, 5, 22, 23, 29, 37, 38 AND 50).
FIRST USE 11-25-2002; IN COMMERCE 11-25-2002.

SN 78-190,627. LEARNINGRX, INC., COLORADO SPRINGS, CO. FILED 12-3-2002.

ATTENDRX

FOR PRINTED INSTRUCTIONAL, EDUCATIONAL, AND TRAINING MATERIALS DESIGNED TO ENHANCE ATTENTION SKILLS (U.S. CLS. 2, 5, 22, 23, 29, 37, 38 AND 50).
FIRST USE 11-25-2002; IN COMMERCE 11-25-2002.

SN 78-190,636. LEARNINGRX, INC., COLORADO SPRINGS, CO. FILED 12-3-2002.

COMPREHENDRX

FOR PRINTED INSTRUCTIONAL, EDUCATIONAL, AND TRAINING MATERIALS DESIGNED TO ENHANCE COMPREHENSION SKILLS (U.S. CLS. 2, 5, 22, 23, 29, 37, 38 AND 50).
FIRST USE 11-25-2002; IN COMMERCE 11-25-2002.

SN 78-190,639. LEARNINGRX, INC., COLORADO SPRINGS, CO. FILED 12-3-2002.

WRITERX

FOR PRINTED INSTRUCTIONAL, EDUCATIONAL, AND TRAINING MATERIALS DESIGNED TO ENHANCE WRITING SKILLS (U.S. CLS. 2, 5, 22, 23, 29, 37, 38 AND 50).
FIRST USE 11-25-2002; IN COMMERCE 11-25-2002.

CLASS 16—(Continued).

SN 78-190,643. LEARNINGRX, INC., COLORADO SPRINGS, CO. FILED 12-3-2002.

STUDYRX

FOR PRINTED INSTRUCTIONAL, EDUCATIONAL, AND TRAINING MATERIALS DESIGNED TO ENHANCE STUDY SKILLS (U.S. CLS. 2, 5, 22, 23, 29, 37, 38 AND 50).
FIRST USE 11-25-2002; IN COMMERCE 11-25-2002.

SN 78-190,646. LEARNINGRX, INC., COLORADO SPRINGS, CO. FILED 12-3-2002.

BRAINRX

FOR PRINTED INSTRUCTIONAL, EDUCATIONAL, AND TRAINING MATERIALS DESIGNED TO ENHANCE PROCESSING AND COGNITIVE SKILLS (U.S. CLS. 2, 5, 22, 23, 29, 37, 38 AND 50).
FIRST USE 11-25-2002; IN COMMERCE 11-25-2002.

SN 78-190,648. LEARNINGRX, INC., COLORADO SPRINGS, CO. FILED 12-3-2002.

MEMORYRX

FOR PRINTED INSTRUCTIONAL, EDUCATIONAL, AND TRAINING MATERIALS DESIGNED TO ENHANCE MEMORY SKILLS (U.S. CLS. 2, 5, 22, 23, 29, 37, 38 AND 50).
FIRST USE 11-25-2002; IN COMMERCE 11-25-2002.

CLASS 17—RUBBER GOODS

SN 76-137,079. SEALED AIR CORPORATION (US), SADDLE BROOK, NJ. FILED 9-27-2000.

IMPACT

FOR PLASTIC FILMS FOR INDUSTRIAL OR COMMERCIAL PACKAGING USE (U.S. CLS. 1, 5, 12, 13, 35 AND 50).

SN 76-137,363. A. SCHULMAN, INC., AKRON, OH. FILED 9-28-2000.

INVISION

FOR DRY SOLID PLASTIC MATERIALS IN BULK POWDER, PELLET, GRANULE AND BEAD FORM FOR USE IN FURTHER PROCESSING BY THE PLASTICS MANUFACTURING INDUSTRY (U.S. CLS. 1, 5, 12, 13, 35 AND 50).
FIRST USE 3-6-2001; IN COMMERCE 3-6-2001.

CLASS 17—(Continued).

SN 76-204,642. COILHOSE PNEUMATICS, MCMINNVILLE, OR. FILED 2-5-2001.

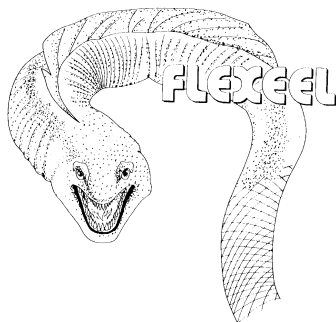

OWNER OF U.S. REG. NOS. 1,264,235 AND 2,097,112. THE LINING IS A FEATURE OF THE MARK AND DOES NOT INDICATE COLOR. FOR REINFORCED POLYURETHANE PLASTIC HOSE FOR PNEUMATIC AND FLUID APPLICATION (U.S. CLS. 1, 5, 12, 13, 35 AND 50). FIRST USE 11-1-1999; IN COMMERCE 11-1-1999.

SN 76-210,068. CEDARBERG INDUSTRIES, INC., EAGAN, MN. FILED 2-15-2001.

SNAP-LOC SYSTEMS

NO CLAIM IS MADE TO THE EXCLUSIVE RIGHT TO USE "SYSTEMS", APART FROM THE MARK AS SHOWN. SEC. 2(F). FOR INTERCONNECTABLE AND INTERCHANGEABLE COMPONENTS, NAMELY NOZZLES, ELBOWS, VALVES, REDUCERS, FITTINGS, MANIFOLDS, PIPE FITTINGS, BASES, SHIELDS, MAGNIFIERS AND CLIPS, ALL MADE OF PLASTIC, FOR USE AS AIR, LIQUID AND VACUUM HOSES, AND AS HOLDERS AND SUPPORTS FOR SUCH HOSES AND TOOLS FOR ASSEMBLY AND SEPARATION OF THE COMPONENTS, ALL ITEMS SOLD AS A UNIT (U.S. CLS. 1, 5, 12, 13, 35 AND 50). FIRST USE 9-13-1984; IN COMMERCE 9-13-1984.

SN 76-248,055. PLASTAG CORPORATION, ELK GROVE VILLAGE, IL. FILED 4-30-2001.

TUFFCARD

FOR PLASTIC MATERIAL FORMULATED WITH PVC IN PRE-CUT AND SHEET FORM USED TO MANUFACTURE DRIVER'S LICENSES, ACCESS CONTROL CARDS, CARDS FOR SEVERE-SERVICE AND EXTENDED LIFE APPLICATIONS, CREDIT CARDS, GOVERNMENT CARDS, IDENTIFICATION CARDS, MILITARY CARDS, SECURITY CARDS AND SMART CARDS (U.S. CLS. 1, 5, 12, 13, 35 AND 50). FIRST USE 2-22-2001; IN COMMERCE 2-22-2001.

CLASS 17—(Continued).

SN 76-300,320. TOYO BOSEKI KABUSHIKI KAISHA (TOYOBO CO., LTD.), KITA-KU, OSAKA, JAPAN, FILED 8-16-2001.

ECOSYAR

FOR PLASTIC FILM FOR INDUSTRIAL AND COMMERCIAL PACKING USE (U.S. CLS. 1, 5, 12, 13, 35 AND 50). FIRST USE 12-10-1999; IN COMMERCE 1-22-2001.

SN 76-314,737. PROTEUS, INC., BLOOMFIELD, NY. FILED 9-20-2001.

HELICORE

FOR PLASTIC TUBING FOR USE AS CORES TO FACILITATE ROLL WINDING OF VARIOUS GOODS, AND AS CONDUITS FOR DRAINAGE AND IRRIGATION (U.S. CLS. 1, 5, 12, 13, 35 AND 50). FIRST USE 1-22-1999; IN COMMERCE 1-22-1999.

SN 76-392,303. DEWITT COMPANY, SIKESTON, MO. FILED 4-8-2002.

SUDDEN SHADE

FOR NON-WOVEN POLYPROPYLENE COVERS FOR USE IN PROTECTING HORTICULTURAL PRODUCTS SUCH AS PLANTS (U.S. CLS. 1, 5, 12, 13, 35 AND 50). FIRST USE 12-0-1986; IN COMMERCE 12-0-1986.

SN 76-392,304. DEWITT COMPANY, SIKESTON, MO. FILED 4-8-2002.

PRO 5 WEED BARRIER

OWNER OF U.S. REG. NO. 1,571,994. NO CLAIM IS MADE TO THE EXCLUSIVE RIGHT TO USE "WEED BARRIER", APART FROM THE MARK AS SHOWN. FOR NON-WOVEN POLYPROPYLENE COVERS FOR USE IN PROTECTING HORTICULTURAL PRODUCTS SUCH AS PLANTS (U.S. CLS. 1, 5, 12, 13, 35 AND 50). FIRST USE 1-0-1986; IN COMMERCE 1-0-1986.

CLASS 17—(Continued).

SN 76-392,305. DEWITT COMPANY, SIKESTON, MO. FILED 4-8-2002.

PLANT GUARD

NO CLAIM IS MADE TO THE EXCLUSIVE RIGHT TO USE "GUARD", APART FROM THE MARK AS SHOWN. SEC. 2(F).

FOR NON-WOVEN POLYPROPYLENE COVERS FOR USE IN PROTECTING HORTICULTURAL PRODUCTS SUCH AS PLANTS (U.S. CLS. 1, 5, 12, 13, 35 AND 50). FIRST USE 2-0-1989; IN COMMERCE 2-0-1989.

SN 76-394,886. RBX INDUSTRIES, INC., ROANOKE, VA. FILED 4-12-2002.



OWNER OF U.S. REG. NO. 2,494,843.

NO CLAIM IS MADE TO THE EXCLUSIVE RIGHT TO USE "INDUSTRIES, INC.", APART FROM THE MARK AS SHOWN.

FOR RECONSTITUTED RUBBER COMPRISED OF SHREDDED SCRAP RUBBER IN THE FORM OF SHEETS, BLOCKS AND BARS FOR USE IN THE MANUFACTURE OF MATS, GASKETS AND PADS; PIPE INSULATION FOR USE WITH INDUSTRIAL AND RESIDENTIAL PIPES; CLOSED CELL FOAM LAMINATED TO VARIOUS FABRICS SUITABLE FOR USE IN THE MANUFACTURE BY OTHERS OF SPORTS MEDICINE/MEDICAL DEVICES, WET SUITS, DRY SUITS AND FISHING WADERS; ELASTOMERIC TUBULAR MATERIAL USED AS A CUSHIONED COVER ON HANDLES SUCH AS RAKE HANDLES, SHOVEL HANDLES, TROWEL HANDLES, KITCHEN UTENSIL HANDLES, BROOM HANDLES AND THE LIKE; CLOSED CELL INSULATION AND INSULATING TUBING USED IN REFRIGERATION AND AIR CONDITIONING SYSTEMS, AND IN CHILLED WATER TANKS AND WATER LINES; ELASTOMERIC TAPE HAVING INSULATING PROPERTIES; TUBULAR AND SHEET FORM THERMAL BUILDING INSULATION; MATERIAL FOR USE IN THE MANUFACTURE OF WET SUITS AND ATHLETIC PADDING, MADE OF CELLULAR RUBBER OR SYNTHETIC RUBBER, EXTRUDED OR FABRICATED IN SHEET FORM; SYNTHETIC RUBBER CORDING USED WITH CLOSED CELL RUBBER MATERIAL FOR USE IN BUILDING CONSTRUCTION AND MANUFACTURING; CELLULAR INSULATION MATERIALS, NAMELY, CUSHIONING, SOUND DEADENING, ANTI-VIBRATION, AND SHOCK-ABSORBING MATERIALS, ALL IN THE FORM OF BOARDS, SHEETS, TUBES AND MATS, AND MADE OF CELLULAR RUBBER OR SYNTHETIC RUBBER FOR GENERAL INDUSTRIAL USE; INSULATION, STRIPS, SEALING MATERIAL, GASKETING, CUSHIONING, SOUND-DEADENING MATERIAL, SHOCK PADDING, IN THE FORM OF BOARDS, SHEETS, TUBES AND MATS, MADE OF CELLULAR RUBBER OR SYNTHETIC RUBBER FOR USE IN BUILDING CONSTRUCTION AND MANUFACTURING; SEALING MATERIALS FOR BUILDING LAMP ASSEMBLIES, AUTOMOTIVE HEATER ASSEMBLIES, AIR CONDITIONING UNITS, REFRIGERATION UNITS AND ELECTRICAL APPLIANCES; FOAMED PLASTICS IN THE FORM OF BARS, BLOCKS, PELLETS, RODS, SHEETS, AND TUBES FOR USE IN MANUFACTURING (U.S. CLS. 1, 5, 12, 13, 35 AND 50).

CLASS 17—(Continued).

SN 76-406,312. APPLIED POLYMERICS, INC., MOUNT AIRY, NC. FILED 5-13-2002.

FIBRECRETE

FOR SYNTHETIC POLYMER MODIFIED RESIN COMPOUND FOR USE IN CEMENTITIOUS REPAIRS (U.S. CLS. 1, 5, 12, 13, 35 AND 50).

FIRST USE 5-11-2000; IN COMMERCE 5-12-2000.

SN 76-431,922. ENVIRONMENTAL SEALS LTD., KENT, UNITED KINGDOM, FILED 7-16-2002.



FOR WEATHER, DRAUGHT, ACOUSTIC, SMOKE AND FIRE SEALS; SLEEVES AND WRAPS ALL FOR FIREPROOFING OF PIPES AND CONDUITS (U.S. CLS. 1, 5, 12, 13, 35 AND 50).

FIRST USE 7-25-2002; IN COMMERCE 7-25-2002.

SN 76-431,923. ENVIRONMENTAL SEALS LTD., KENT, UNITED KINGDOM, FILED 7-16-2002.

321

FOR WEATHER, DRAUGHT, ACOUSTIC, SMOKE AND FIRE SEALS; SLEEVES AND WRAPS ALL FOR FIREPROOFING OF PIPES AND CONDUITS (U.S. CLS. 1, 5, 12, 13, 35 AND 50).

FIRST USE 7-25-2002; IN COMMERCE 7-25-2002.

SN 76-441,583. AUSON AB, SE-42147 VASTRA FROLUNDA, SWEDEN, FILED 8-14-2002.

NOXUDOL

FOR INSULATING AND SOUND DAMPENING COMPOUND, NAMELY, ELASTIC SOUND DAMPENING PASTE FOR USE ON METAL AND PLASTICS (U.S. CLS. 1, 5, 12, 13, 35 AND 50).

FIRST USE 5-1-1971; IN COMMERCE 9-10-1997.

CLASS 17—(Continued).

SN 76-448,483. N.V. BEKAERT S.A., ZWEVEGEM, BELGIUM,
FILED 9-11-2002.

HILITE

OWNER OF U.S. REG. NO. 2,590,161.
FOR PLASTIC FILMS, NAMELY SOLAR AND HEAT
RESISTANT WINDOW FILMS, INSULATING FILMS,
AND SCRATCH RESISTANT AND SAFETY FILMS
(U.S. CLS. 1, 5, 12, 13, 35 AND 50).
FIRST USE 3-30-1998; IN COMMERCE 3-30-1998.

SN 76-455,389. PROTECTO WRAP COMPANY, DENVER, CO.
FILED 10-3-2002.

**PROTECTO PREMIUM R-
BOARD**

OWNER OF U.S. REG. NOS. 981,491 AND 1,781,548.
NO CLAIM IS MADE TO THE EXCLUSIVE RIGHT TO
USE "PREMIUM R-BOARD", APART FROM THE MARK AS
SHOWN.
FOR INSULATION PANELS FOR ADHERENT APPLI-
CATION TO THE TOP OF BUILDING FOUNDATIONS
(U.S. CLS. 1, 5, 12, 13, 35 AND 50).

SN 76-463,707. KIWO HOLDINGS, INC., WILMINGTON, DE.
FILED 10-28-2002.

AMBERLITH

FOR MASKING FILM FOR USE IN PHOTOGRAPHY
AND GRAPHIC ARTS (U.S. CLS. 1, 5, 12, 13, 35 AND 50).
FIRST USE 12-3-1959; IN COMMERCE 12-3-1959.

SN 78-118,851. ITT AUTOMOTIVE, INC., AUBURN HILLS,
MI. FILED 4-2-2002.

HYDROLOCK

FOR NON-METAL SNAP-FIT COUPLINGS FOR RE-
SIDENTIAL AND COMMERCIAL TUBE, HOSE AND
PIPE PLUMBING APPLICATIONS (U.S. CLS. 1, 5, 12,
13, 35 AND 50).

CLASS 17—(Continued).

SN 78-129,888. GREGORY S. WHIPPO, LAKE ZURICH, IL.
FILED 5-20-2002.

REPELGRO

FOR SILVER METALLIC AND ALUMINUM PLATED,
ELECTROMAGNETIC WAVELENGTH REFLECTIVE
PLASTIC MULCH USED FOR INTEGRATED PEST
MANAGEMENT, ASSOCIATED VIRUS CONTROL,
AND TO INCREASE THE PAR (PHOTOSYNTHETIC
ACTIVE RADIATION) TO PLANT SYSTEMS BY MEANS
OF REFLECTION OF ELECTROMAGNETIC WAVE-
LENGTHS, UV (ULTRA VIOLET), IR (INFRARED),
AND PAR (PHOTOSYNTHETIC ACTIVE RADIATION)
(U.S. CLS. 1, 5, 12, 13, 35 AND 50).
FIRST USE 4-10-2002; IN COMMERCE 4-10-2002.

SN 78-163,309. HARA, JOE, LOS ANGELES, CA. FILED 9-12-
2002.



NO CLAIM IS MADE TO THE EXCLUSIVE RIGHT TO
USE "TAPE", APART FROM THE MARK AS SHOWN.
FOR POLYPROPYLENE TAPE FOR SEALING CAR-
TONS; PVC TAPE FOR SEALING CARTONS; SELF-
ADHESIVE PAPER MASKING TAPE (U.S. CLS. 1, 5, 12,
13, 35 AND 50).

SN 78-184,014. FREUDENBERG-NOK GENERAL PARTNER-
SHIP, PLYMOUTH, MI. FILED 11-12-2002.

BEVELIP

FOR NON-METAL PISTON SEALS. (U.S. CLS. 1, 5, 12,
13, 35 AND 50).

CLASS 18—LEATHER GOODS

CLASS 18—(Continued).

SN 76-132,791. AIRWALK INTERNATIONAL, LLC, GOLD-EN, CO. FILED 9-21-2000.

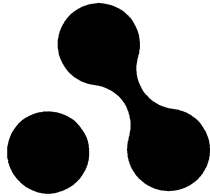

FOR ALL PURPOSE ATHLETIC BAGS, DUFFEL BAGS, BACKPACKS, TRAVELING BAGS, LUGGAGE, AND OTHER BAGS SOLD EMPTY, NAMELY, GYM BAGS (U.S. CLS. 1, 2, 3, 22 AND 41).
FIRST USE 8-0-2000; IN COMMERCE 8-0-2000.



SN 76-299,355. ORRICK, HERRINGTON & SUTCLIFFE LLP, SAN FRANCISCO, CA. FILED 8-13-2001.



FOR UMBRELLAS; CANVAS BRIEFCASES AND PERSONAL PRODUCTS BAGS DISTRIBUTED EMPTY (U.S. CLS. 1, 2, 3, 22 AND 41).
FIRST USE 1-0-2001; IN COMMERCE 1-0-2001.

CLASS 18—(Continued).

SN 76-330,998. CHATEAU INTERNATIONAL INC., NEW YORK, NY. FILED 10-29-2001.

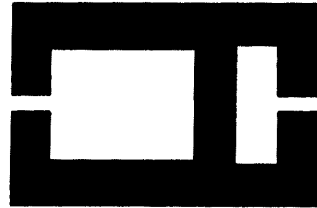

FOR LEATHER GOODS, NAMELY, LUGGAGE, HANDBAGS, POCKETBOOKS, SHOULDER BAGS, PURSES, WALLETS, BILLFOLDS, FRENCH PURSES, ATHLETIC BAGS, ATTACHE CASES, BRIEFCASE-TYPE PORTFOLIOS; BACKPACKS, RUCKSACKS AND HAVESACKS; WAIST PACKS AND FANNY PACKS; CARRYALLS, BUSINESS CARD CASES, CREDIT CARD CASES, KEY CASES, CHANGE PURSES, CLUTCH BAGS AND PURSES, UMBRELLAS, OVERNIGHT BAGS AND CASES, VANITY CASES SOLD EMPTY, COSMETIC CASES SOLD EMPTY; SUITCASES, CARRY-ON BAGS, CARRY-ON LUGGAGE, DUFFEL BAGS, SUIT BAGS, GARMENT BAGS, TRUNKS, AND TRAVEL BAGS FOR ENCLOSING COSMETICS, TOILETRIES, LOTIONS, TOOTH BRUSHES, AND TOOTHPASTE (U.S. CLS. 1, 2, 3, 22 AND 41).
FIRST USE 7-0-2001; IN COMMERCE 7-0-2001.



SN 76-389,128. VAGABOND SKOR VARBERG AB, 432 19 VARBERG, SWEDEN, FILED 4-1-2002.



OWNER OF SWEDEN REG. NO. 330682, DATED 3-26-1999, EXPIRES 3-26-2009.
FOR BAGS, NAMELY, ATTACHE CASES, SPORTSMAN'S HUNTING BAGS, BRIEFCASES, TEXTILE SHOPPING BAGS AND SCHOOL-BAGS; TRAVELING BAGS, SUITCASES; TRUNKS; UMBRELLAS, PARASOLS AND WALKING STICKS; SADDLERY (U.S. CLS. 1, 2, 3, 22 AND 41).

CLASS 18—(Continued).

SN 76-393,316. VOKAL CLOTHING COMPANY, LLC, FLORISSANT, MO. FILED 4-5-2002.

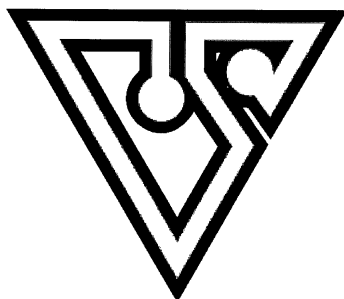

FOR ATTACHE CASES, BRIEFCASES, BRIEFCASE-TYPE PORTFOLIOS, HANDBAGS, SHOULDER BAGS, CLUTCHES, TOTE BAGS, DUFFEL BAGS, SCHOOL BAGS, GYM BAGS, BACKPACKS, SATCHELS, LUGGAGE, GARMENT BAGS FOR TRAVEL, CARRY-ON SUITCASES WITH AND WITHOUT WHEELS, TIE CASES, COSMETIC BAGS SOLD EMPTY, TOILETRY CASES SOLD EMPTY, COIN CASES, WAIST POUCHES, PURSES, WALLETS, CREDIT CARD CASES AND IDENTIFICATION TAGS FOR LUGGAGE (U.S. CLS. 1, 2, 3, 22 AND 41).

SN 76-401,061. GLOBAL ARTISTS CO., LTD., TOKYO, 107-0052, JAPAN, FILED 4-26-2002.

NEW YORK DIARY

NO CLAIM IS MADE TO THE EXCLUSIVE RIGHT TO USE "NEW YORK", APART FROM THE MARK AS SHOWN. FOR HANDBAG FRAMES, PURSE FRAMES, CLOTHING FOR DOMESTIC PETS, BAGS AND THE LIKE, NAMELY FOLDING BRIEFCASES, SHOULDER BAGS, GLADSTONE BAGS, BRIEFCASES, SUITCASES, CARRY-ON BAGS, TRUNKS, HANDBAGS, BOSTON BAGS, DRAWSTRING BACKPACKS, POUCHES, CARD CASES, NAMELY, BUSINESS CARD, CREDIT CARD CASES; LEATHER SHOPPING BAGS, PURSES, KEY CASES, WALLETS, VANITY CASES SOLD EMPTY, UMBRELLAS AND UMBRELLA FRAMES, TELESCOPIC UMBRELLAS, RAINPROOF PARASOLS, BEACH UMBRELLAS, PARASOLS, UMBRELLA COVERS, BAGS FOR UMBRELLAS, WALKING STICKS, SADDLERY CANES, METAL PARTS OF CANES AND WALKING STICKS, HANDLES OF CANES AND WALKING STICKS, LEATHER SOLD IN BULK, FUR SOLD IN BULK (U.S. CLS. 1, 2, 3, 22 AND 41).

CLASS 18—(Continued).

SN 76-407,893. TYR SPORT, INC., HUNTINGTON BEACH, CA. FILED 5-15-2002.

TYR MEETMAT

OWNER OF U.S. REG. NO. 1,458,467.
FOR TRAVELING BAGS; GYM BAGS; ATHLETIC BAGS; TOTE BAGS; BOOK BAGS; SCHOOL BAGS; SPORTS BAGS; DUFFEL BAGS; SHOULDER BAGS; LOCKER BAGS; BEACH BAGS; COIN PURSES; WALLETS; HANDBAGS AND PURSES; BAGS FOR CARRYING HAIR CARE IMPLEMENTS AND HAIR CARE PREPARATIONS, SOLD EMPTY; LUGGAGE; CARRY-ON BAGS; BRIEF CASES; TOILETRY CASES SOLD EMPTY; COSMETIC CASES SOLD EMPTY; FANNY PACKS (U.S. CLS. 1, 2, 3, 22 AND 41).

SN 76-412,351. FUNKY NOBLE PRODUCTIONS, INC., STATEN ISLAND, NY. FILED 5-29-2002.



FOR ALL-PURPOSE SPORTS AND ATHLETIC BAGS, FANNY PACKS, BACKPACKS, KNAPSACKS, SPORTS PACKS, WAIST PACKS, GYM BAGS, DUFFEL BAGS, TOTE BAGS, BOOK BAGS, HAND BAGS, PURSES, CLUTCH PURSES, CHANGE PURSES, SHOULDER BAGS, CARRY-ON BAGS, TRAVEL BAGS, GARMENT BAGS FOR TRAVEL, BEACH BAGS, SATCHELS, LUGGAGE, LUGGAGE TAGS, TRUNKS, SUITCASES, COSMETIC CASES SOLD EMPTY, TOILETRY CASES SOLD EMPTY, VANITY CASES SOLD EMPTY, COSMETIC BAGS SOLD EMPTY, TOOL BAGS SOLD EMPTY, ATTACHE CASES, BRIEF CASES, BRIEF-CASE TYPE PORTFOLIOS, MEN'S CLUTCHES, BUSINESS CASES, BUSINESS CARD CASES, CREDIT CARD CASES, CALLING CARD CASES, PASSPORT CASES, KEY CASES, COIN POUCHES, WALLETS, BILLFOLDS, UMBRELLAS AND PARASOLS (U.S. CLS. 1, 2, 3, 22 AND 41).

SN 76-428,962. CORAL RIDGE MINISTRIES MEDIA, INC., FORT LAUDERDALE, FL. FILED 7-9-2002.

CORAL RIDGE MINISTRIES

SEC. 2(F).
FOR TOTE BAGS (U.S. CLS. 1, 2, 3, 22 AND 41).
FIRST USE 9-30-1994; IN COMMERCE 9-30-1994.

CLASS 18—(Continued).

SN 78-097,482. TRAIL BLAZERS, INC., PORTLAND, OR.
FILED 12-10-2001.



OWNER OF U.S. REG. NOS. 1,892,082 AND 2,280,407.
SEC. 2(F) AS TO "PORTLAND".
FOR ATHLETIC BAGS, SHOE BAGS FOR TRAVEL,
OVERNIGHT BAGS, UMBRELLAS, BACKPACKS, BABY
BACKPACKS, DUFFEL BAGS, TOTE BAGS, LUGGAGE,
LUGGAGE TAGS, PATIO UMBRELLAS, VALISES, AT-
TACHE CASES, BILLFOLDS, WALLETS, BRIEFCASES,
CANES, BUSINESS CARD CASES, BOOK BAGS, ALL
PURPOSE SPORTS BAGS, GOLF UMBRELLAS, GYM
BAGS, PURSES, COIN PURSES, FANNY PACKS, WAIST
PACKS, COSMETIC CASES SOLD EMPTY, GARMENT
BAGS FOR TRAVEL, HANDBAGS, KEY CASES, KNAP-
SACKS, SUITCASES, TOILETRY CASES SOLD EMPTY,
TRUNKS FOR TRAVELING AND RUCKSACKS (U.S.
CLS. 1, 2, 3, 22 AND 41).

SN 78-103,133. INTERSHOE, INC., NEW YORK, CA. FILED 1-
16-2002.

VS

OWNER OF U.S. REG. NO. 2,041,978.
FOR HANDBAGS, WALLETS, PURSES, KEY CHAINS,
KEY CASES, BUSINESS CARD CASES, ATTACHE
CASES, BACKPACKS, LUGGAGE AND UMBRELLAS
(U.S. CLS. 1, 2, 3, 22 AND 41).

SN 78-157,838. VIACOM INTERNATIONAL INC., NEW
YORK, NY. FILED 8-26-2002.

RANDOM PLAY

OWNER OF U.S. REG. NO. 2,493,009.
FOR BAGS, NAMELY, KNAPSACKS, BACKPACKS,
TOTE BAGS, FANNY PACKS (U.S. CLS. 1, 2, 3, 22 AND
41).

CLASS 18—(Continued).

SN 78-157,849. PETITO, MICHAEL, OLD GREENWICH, CT.
FILED 8-26-2002.

PARK AVENUE POOCH

FOR ANIMAL CARRIERS, ANIMAL LEASHES, PET
CLOTHING (U.S. CLS. 1, 2, 3, 22 AND 41).

SN 78-171,821. L.C. LICENSING, INC., NEW YORK, NY.
FILED 10-7-2002.

APPLAUD

OWNER OF U.S. REG. NO. 2,009,135.
FOR HANDBAGS, WALLETS, CHANGE PURSES,
CLUTCH PURSES, BRIEF-CASE TYPE PORTFOLIOS,
COSMETIC AND TOILETRY CASES SOLD EMPTY,
KEY CASES, ATTACHE CASES AND UMBRELLAS
(U.S. CLS. 1, 2, 3, 22 AND 41).

SN 78-178,953. SAYTR, OMAHA, NE. FILED 10-28-2002.

TAMARA EVENING

FOR PURSES, HAND BAGS, EVENING BAGS (U.S.
CLS. 1, 2, 3, 22 AND 41).
FIRST USE 5-1-2002; IN COMMERCE 9-1-2002.

SN 78-193,696. SARA LEE GLOBAL FINANCE, L.L.C.,
WILMINGTON, DE. FILED 12-12-2002.

DOUBLE DRY

FOR ATHLETIC BAGS, FANNY PACK, TRAVEL
BAGS, BACKPACKS (U.S. CLS. 1, 2, 3, 22 AND 41).

**CLASS 19—NON-METALLIC BUILDING MA-
TERIALS**

SN 75-388,363. KARNDEAN INTERNATIONAL LIMITED,
WORCESTERSHIRE, ENGLAND, FILED 11-12-1997.

KARNDEAN DA VINCI

PRIORITY CLAIMED UNDER SEC. 44(D) ON UNITED
KINGDOM APPLICATION NO. 2135390, FILED 6-10-1997,
REG. NO. 2135390, DATED 4-24-1998, EXPIRES 6-10-2007.

"KARNDEAN DA VINCI" DOES NOT IDENTIFY A
LIVING INDIVIDUAL.

FOR NON-METALLIC FLOOR TILES; VINYL FLOOR
TILES PATTERNED TO REPLICATE WOOD FLOORING
AND GRANITE FLOOR TILES (U.S. CLS. 1, 12, 33 AND
50).

FIRST USE 9-0-1997; IN COMMERCE 9-0-1997.

CLASS 19—(Continued).

SN 76-147,009. THERMOPLAST INC., LAVAL, QUEBEC, CANADA, FILED 10-16-2000.

ALTITUDE

PRIORITY CLAIMED UNDER SEC. 44(D) ON CANADA APPLICATION NO. 1074767, FILED 9-13-2000, REG. NO. TMA564142, DATED 7-28-2002, EXPIRES 7-28-2017.

FOR NON-METAL PATIO DOORS (U.S. CLS. 1, 12, 33 AND 50).

FIRST USE 0-0-1995; IN COMMERCE 0-0-1995.

CLASS 19—(Continued).

SN 76-259,131. INTERNATIONAL PAPER COMPANY, STAMFORD, CT. FILED 5-16-2001.

DAVINCI

FOR NON-METALLIC BUILDING MATERIALS, NAMELY COMPOSITE WOOD AND PLASTIC MOLDED PRODUCTS, NAMELY BOARDS, BALUSTERS, RAILS, POSTS, PLANKS, RAILS, DECKING, FENCING, FOR USE IN THE CONSTRUCTION OF DECKS AND FENCES (U.S. CLS. 1, 12, 33 AND 50).

SN 76-186,745. EZIFIX FASTENING SYSTEMS AUSTRALIA PTY LTD, GEEBUNG, QUEENSLAND, 4034, AUSTRALIA, FILED 12-27-2000.



OWNER OF AUSTRALIA REG. NO. 675181, DATED 10-16-1995, EXPIRES 10-16-2005.

THE MARK CONSISTS OF A STYLIZATION OF THE TERMS "EZI FIX" WITH AN ARROW FORMING THE "I" IN THE TERM "FIX".

FOR NON-METAL FASTENERS, NAMELY FASTENING ANCHORS FOR CASTING INTO OR ON TO CONCRETE SLABS THAT FORM WALLS, FLOORS OR CEILINGS AND ALLOW SUPPORTS AND VARIOUS EQUIPMENT, INCLUDING ELECTRICAL WIRING, CABLE TRAYS, AIR CONDITIONING FIXTURES, LIGHTING, PLUMBING FIXTURES, SERVICE PIPES AND DUCTS AND OTHER LOADS, TO BE SUSPENDED FROM WALLS, FLOORS OR CEILINGS (U.S. CLS. 1, 12, 33 AND 50).

SN 76-263,081. INTERNATIONAL PAPER, STAMFORD, CT. FILED 5-24-2001.

DAVINCI CLASSIC FENCING

NO CLAIM IS MADE TO THE EXCLUSIVE RIGHT TO USE "FENCING", APART FROM THE MARK AS SHOWN. FOR NON-METALLIC BUILDING MATERIALS, NAMELY COMPOSITE WOOD AND PLASTIC MOLDED PRODUCTS, NAMELY BOARDS, BALUSTERS, RAILS, POSTS, PLANKS, RAILS, FENCING, FOR USE IN THE CONSTRUCTION OF FENCES (U.S. CLS. 1, 12, 33 AND 50).

SN 76-352,545. SAXINGER, EDUARD, 4040 STEYREGG, AUSTRIA, FILED 12-26-2001.



SN 76-195,116. EMCO BUILDING PRODUCTS LTD., LONDON, ONTARIO, N6A 5J9, CANADA, BY ASSIGNMENT EMCO LIMITED, LASALLE, QUEBEC H8R 1R9, CANADA, FILED 1-16-2001.

NIAGARA

PRIORITY CLAIMED UNDER SEC. 44(D) ON CANADA APPLICATION NO. 1088511, FILED 1-10-2001, REG. NO. TMA573829, DATED 1-16-2003, EXPIRES 1-16-2018.

FOR ROOFING SHINGLES (U.S. CLS. 1, 12, 33 AND 50).

PRIORITY CLAIMED UNDER SEC. 44(D) ON ERPNTY CMNTY TM OFC APPLICATION NO. 2139582, FILED 3-16-2001, REG. NO. 2139582, DATED 9-19-2002, EXPIRES 3-16-2011.

FOR MODULAR ROOMS TO BE USED AS SECURITY INFORMATION TECHNOLOGY-ROOMS WITH AIR CONDITIONED SYSTEM AND CENTRAL CONTROL (U.S. CLS. 1, 12, 33 AND 50).

CLASS 19—(Continued).

SN 76-390,940. CHEMCORE INDUSTRIES, INC., AUSTIN, TX. FILED 4-4-2002.

DOVAÉ

THE MARK IS PRESENTED WITHOUT ANY CLAIM AS TO SPECIAL FORM.

FOR SOLID SURFACE ACRYLIC OR ACRYLIC/POLYESTER COMPOSITE MATERIAL FOR USE IN THE MANUFACTURE OF COUNTERTOPS, VANITY TOPS, TABLES, SHOWERS, AND DESKS (U.S. CLS. 1, 12, 33 AND 50).

FIRST USE 9-1-2001; IN COMMERCE 9-1-2001.

SN 76-401,500. IRIS CERAMICA - SOCIETA' PER AZIONI, 41042 FIORANO MODENESE (MODENA), ITALY, FILED 4-29-2002.



**FABBRICA
MARMI E GRANITI**
TECHNOLOGICAL STONES

PRIORITY CLAIMED UNDER SEC. 44(D) ON ITALY APPLICATION NO. RE2002C00007, FILED 3-7-2002, REG. NO. 873013, DATED 7-29-2002, EXPIRES 3-7-2022.

OWNER OF U.S. REG. NOS. 1,005,000 AND 1,180,178.

NO CLAIM IS MADE TO THE EXCLUSIVE RIGHT TO USE "FABBRICA MARMI E GRANITI, CERAMICA" AND "TECHNOLOGICAL STONES", APART FROM THE MARK AS SHOWN.

THE ENGLISH TRANSLATION OF "FABBRICA MARMI E GRANITI" IS "FACTORY GRANITE AND MARBLE" AND THE ENGLISH TRANSLATION OF "CERAMICA" IS "CERAMIC".

FOR NON-METALLIC BUILDING MATERIALS FOR COVERING WALLS AND FLOORS, NAMELY STONES, MARBLE, GRANITE; CERAMIC TILES FOR FLOORING AND FACING (U.S. CLS. 1, 12, 33 AND 50).

SN 76-408,217. NORMAN, JEFF, MUKILTEO, WA. FILED 5-15-2002.

LIBERTY-RAIL

FOR REINFORCED COMPOSITE RAIL SYSTEMS COMPRISING NON-METAL PICKETS, RAILS, AND LOCKING BARS FOR SECURING THE PICKETS TO THE RAILS AND THE HARDWARE FOR MOUNTING THE RAILS TO A STRUCTURE, SOLD ASSEMBLED OR UNASSEMBLED AS A UNIT FOR RESIDENTIAL AND COMMERCIAL DECK RAILINGS (U.S. CLS. 1, 12, 33 AND 50).

CLASS 19—(Continued).

SN 76-417,405. GIN YOUNG ENTERPRISE CO., LTD., TAIPEI, TAIWAN, FILED 6-5-2002.

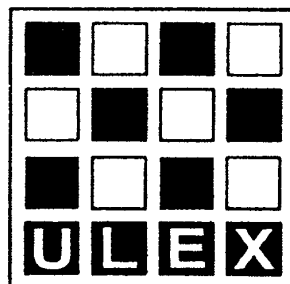

FOR FIREPROOF WALL BOARDS NOT OF METAL; CEILING PANEL BOARDS NOT OF METAL; FIRE-PROOF DOORS NOT OF METAL (U.S. CLS. 1, 12, 33 AND 50).

FIRST USE 2-2-2001; IN COMMERCE 2-2-2001.

SN 76-434,522. SKYLIGHTS UNLIMITED, HUNTINGTON BEACH, CA. FILED 7-26-2002.

SQUARE-FLEX

FOR HOLLOW, OPEN-ENDED TUBING WITH REFLECTIVE INTERIOR WALLS, ONE END OF WHICH IS LOCATED SO AS RECEIVE DAYLIGHT AND THE OTHER IS LOCATED AT A PLACE WHERE IT IS DESIRED TO INCREASE THE LIGHT LEVEL (U.S. CLS. 1, 12, 33 AND 50).

FIRST USE 9-0-1999; IN COMMERCE 9-0-1999.

SN 76-453,771. CRAFTMASTER MANUFACTURING, INC., CHICAGO, IL. FILED 9-30-2002.

CARMELLE

FOR NON-METAL MOLDED DOOR FACINGS (U.S. CLS. 1, 12, 33 AND 50).

FIRST USE 8-21-1991; IN COMMERCE 8-21-1991.

CLASS 19—(Continued).

SN 76-453,834. LOUISIANA-PACIFIC CORPORATION, PORTLAND, OR. FILED 9-30-2002.



OWNER OF U.S. REG. NOS. 2,149,270 AND 2,666,947.
NO CLAIM IS MADE TO THE EXCLUSIVE RIGHT TO USE "COMPOSITE DECKING", APART FROM THE MARK AS SHOWN.

FOR BUILDING MATERIALS, NAMELY, NON-METAL COMPOSITE DECKING AND RAILING (U.S. CLS. 1, 12, 33 AND 50).
FIRST USE 7-31-2002; IN COMMERCE 7-31-2002.

SN 76-463,571. LEWIS HYMAN, INC., CARSON, CA. FILED 11-1-2002.

SHADES FOR STYLE

NO CLAIM IS MADE TO THE EXCLUSIVE RIGHT TO USE "SHADES", APART FROM THE MARK AS SHOWN.
FOR NON-METAL EXTERIOR WINDOW BLINDS AND NON-METAL EXTERIOR WINDOW SHADES (U.S. CLS. 1, 12, 33 AND 50).

SN 76-464,016. BRIGHTSTONE, INC., HARBOR CITY, CA. FILED 11-4-2002.

ANFASTONE

FOR BUILDING MATERIALS, NAMELY NATURAL STONES (U.S. CLS. 1, 12, 33 AND 50).

SN 76-464,057. OLDCASTLE APG WEST, INC., DBA SUPER-LITE BLOCK, PHOENIX, AZ. FILED 11-4-2002.



I N T E G R A

OWNER OF U.S. REG. NO. 1,425,756.
FOR MASONRY BLOCK WALLS INCORPORATING MASONRY BLOCKS, POST TENSIONING CABLES AND FOAM INSULATION (U.S. CLS. 1, 12, 33 AND 50).

CLASS 19—(Continued).

SN 78-110,059. CARTER, RICKY S., PRAIRIEVILLE, LA. FILED 2-20-2002.

LAMCAR

FOR PLASTIC SAFETY APPARATUS, NAMELY, SAFETY BARRICADE FENCING USED IN CONSTRUCTION AREAS (U.S. CLS. 1, 12, 33 AND 50).
FIRST USE 11-13-2001; IN COMMERCE 2-11-2002.

SN 78-116,666. INTERPANE GLASS COMPANY, CLINTON, NC. FILED 3-21-2002.

POWERMISER

FOR FILMED GLASS SHEETS FOR ARCHITECTURAL USE (U.S. CLS. 1, 12, 33 AND 50).

SN 78-127,536. ASSOCIATED MATERIALS, INCORPORATED D/B/A ALSIDE, CUYAHOGA FALLS, OH. FILED 5-9-2002.

CHARTER OAK

FOR VINYL SIDING (U.S. CLS. 1, 12, 33 AND 50).
FIRST USE 7-31-1995; IN COMMERCE 7-31-1995.

SN 78-154,173. REYNOLDS CONSUMER PRODUCTS, INC., RICHMOND, VA. FILED 8-14-2002.

PARTNERING IDEAS INTO SOLUTIONS

FOR ROAD BASE AND GROUND SUPPORT PLASTIC WEBBING SHEETS FOR BUILDING ROADS AND PREVENTING EROSION (U.S. CLS. 1, 12, 33 AND 50).

SN 78-167,290. SUPERIOR PRODUCTS, INC., ELKRIDGE, MD. FILED 9-24-2002.

STUDIO CERAMICA

NO CLAIM IS MADE TO THE EXCLUSIVE RIGHT TO USE "CERAMICA", APART FROM THE MARK AS SHOWN.
THE WORD "CERAMICA" IS THE ITALIAN WORD FOR "CERAMICS".
FOR CERAMIC TILES; NATURAL STONE TILES; FLOOR PANELS; WALL TILES (U.S. CLS. 1, 12, 33 AND 50).
FIRST USE 9-16-2002; IN COMMERCE 9-16-2002.

CLASS 19—(Continued).

SN 78-170,317. MOOSE SPORT SURFACES, LTD., CHICAGO, IL. FILED 10-2-2002.

GAMECOURT

FOR RESILIENT POLYURETHANE FLOORING SYSTEM CONSISTING OF RUBBER BASE MAT ADHESIVE, POLYURETHANE COATING AND PAINT (U.S. CLS. 1, 12, 33 AND 50).

SN 78-171,635. MEDALLION HARDWOOD FLOORING, LTD., LINDEN, AL. FILED 10-7-2002.

BISCAYNE

FOR HARDWOOD FLOORS (U.S. CLS. 1, 12, 33 AND 50).

SN 78-181,133. ROSE. CHRIS P, PALOS VERDES ESTATES, CA. FILED 11-2-2002.

I LOVE YOU ROCKS

NO CLAIM IS MADE TO THE EXCLUSIVE RIGHT TO USE "ROCKS", APART FROM THE MARK AS SHOWN. FOR STONES (U.S. CLS. 1, 12, 33 AND 50).

SN 78-183,531. ANCHOR WALL SYSTEMS, INC., MINNETONKA, MN. FILED 11-10-2002.

SMARTSTONE

FOR MODULAR CONCRETE UNITS FOR USE IN LANDSCAPING APPLICATIONS, INCLUDING THE CONSTRUCTION OF RETAINING WALLS. (U.S. CLS. 1, 12, 33 AND 50).

SN 78-183,534. ANCHOR WALL SYSTEMS, INC., MINNETONKA, MN. FILED 11-10-2002.

CAMEO STONE

NO CLAIM IS MADE TO THE EXCLUSIVE RIGHT TO USE "STONE", APART FROM THE MARK AS SHOWN. FOR MODULAR CONCRETE UNITS FOR USE IN LANDSCAPING APPLICATIONS, INCLUDING THE CONSTRUCTION OF RETAINING WALLS. (U.S. CLS. 1, 12, 33 AND 50).

CLASS 19—(Continued).

SN 78-191,598. FORMICA CORPORATION, CINCINNATI, OH. FILED 12-5-2002.

LOCK & DROP

FOR BUILDING MATERIALS; NAMELY, PLASTIC LAMINATES IN SHEET FORM FOR USE IN BUILDING CONSTRUCTION (U.S. CLS. 1, 12, 33 AND 50).

CLASS 20—FURNITURE AND ARTICLES NOT OTHERWISE CLASSIFIED

SN 75-888,943. MEMORY COMPANY, INC., THE, PHENIX CITY, AL. FILED 1-7-2000.



OWNER OF U.S. REG. NO. 2,404,044. NO CLAIM IS MADE TO THE EXCLUSIVE RIGHT TO USE "COLLECTABLES", APART FROM THE MARK AS SHOWN.

SEC. 2(F) AS TO "COLLEGIATE COLLECTABLES". FOR RESIN SCULPTURES OF COLLEGE CAMPUS LANDMARKS AND MASCOTS (U.S. CLS. 2, 13, 22, 25, 32 AND 50).

SN 76-078,139. NIENKAMPER FURNITURE & ACCESSORIES INC., TORONTO, ONTARIO, CANADA, FILED 6-26-2000.

WAVELENGTH

PRIORITY CLAIMED UNDER SEC. 44(D) ON CANADA APPLICATION NO. 1063722, FILED 6-19-2000, REG. NO. TMA561,305, DATED 5-2-2002, EXPIRES 5-2-2017.

FOR CHAIRS, BENCHES AND SOFAS (U.S. CLS. 2, 13, 22, 25, 32 AND 50).

SN 76-125,955. SEALY TECHNOLOGY LLC, TRINITY, NC. FILED 9-11-2000.

COMFORT LIFE

OWNER OF U.S. REG. NO. 1,187,452. FOR MATTRESSES AND BOX SPRINGS (U.S. CLS. 2, 13, 22, 25, 32 AND 50). FIRST USE 5-30-1990; IN COMMERCE 5-30-1990.

CLASS 20—(Continued).

SN 76-310,495. CROWN CORK & SEAL TECHNOLOGIES CORPORATION, ALSIP, IL. FILED 9-6-2001.

BEVGUARD

FOR PLASTIC CLOSURES FOR BOTTLES AND OTHER CONTAINERS, FOR SALE TO AND USE BY BOTTLERS AND FOOD PROCESSORS (U.S. CLS. 2, 13, 22, 25, 32 AND 50).

FIRST USE 5-19-1994; IN COMMERCE 6-14-1994.

SN 76-310,497. CROWN CORK & SEAL TECHNOLOGIES CORPORATION, ALSIP, IL. FILED 9-6-2001.

BEVGUARD PLUS

FOR PLASTIC CLOSURES FOR BOTTLES AND OTHER CONTAINERS, FOR SALE TO AND USE BY BOTTLERS AND FOOD PROCESSORS (U.S. CLS. 2, 13, 22, 25, 32 AND 50).

SN 76-328,391. HOON IMPORT & EXPORT, INC., SAN DIEGO, CA. FILED 10-22-2001.

WISDOM

FOR MATTRESSES (U.S. CLS. 2, 13, 22, 25, 32 AND 50).

SN 76-329,453. NELSON, MICHAEL, SACRAMENTO, CA. FILED 10-24-2001.

PROUD AMERICAN ON BOARD

FOR PLAQUES (U.S. CLS. 2, 13, 22, 25, 32 AND 50).

SN 76-397,712. MERILLAT INDUSTRIES, LLC, ADRIAN, MI. FILED 4-17-2002.

PASSPORT

FOR CABINETS (U.S. CLS. 2, 13, 22, 25, 32 AND 50).

SN 76-399,743. HAWORTH, INC., HOLLAND, MI. FILED 4-24-2002.

TAKE YOUR SPACE WHERE YOUR MIND WANTS TO GO

FOR FURNITURE (U.S. CLS. 2, 13, 22, 25, 32 AND 50).

CLASS 20—(Continued).

SN 76-419,882. CARPENTER CO., RICHMOND, VA. FILED 6-4-2002.

PERFECT DOWN

OWNER OF U.S. REG. NO. 1,587,858.
NO CLAIM IS MADE TO THE EXCLUSIVE RIGHT TO USE "DOWN", APART FROM THE MARK AS SHOWN, FOR PILLOWS MADE IN PART OF DOWN (U.S. CLS. 2, 13, 22, 25, 32 AND 50).
FIRST USE 2-13-2002; IN COMMERCE 4-15-2002.

SN 76-420,920. CASCADE ENGINEERING, INC., GRAND RAPIDS, MI. FILED 6-14-2002.

CASCADE PRODUCTS

OWNER OF U.S. REG. NOS. 2,278,212, 2,526,576 AND OTHERS.
NO CLAIM IS MADE TO THE EXCLUSIVE RIGHT TO USE "PRODUCTS", APART FROM THE MARK AS SHOWN, FOR PLASTIC CONTAINERS FOR HOUSEHOLD WASTE AND RECYCLEABLES (U.S. CLS. 2, 13, 22, 25, 32 AND 50).

SN 76-430,045. CORPORATE IMAGE INTERNATIONAL, INC., ADDISON, IL. FILED 7-12-2002.

FABWALL

FOR ALUMINUM FRAME CLOTH COVERED WALL PARTITIONS (U.S. CLS. 2, 13, 22, 25, 32 AND 50).

SN 76-439,711. DUMPLET, ELSA, NEW YORK, NY. FILED 8-13-2002.



FOR MULTIPOSITIONAL HANGING DEVICE, NAMELY A NON-METAL SERIES OF HOOKS DESIGNED TO TEMPORARILY HANG A VARIETY OF DOMESTIC AND OFFICE OBJECTS (U.S. CLS. 2, 13, 22, 25, 32 AND 50).

CLASS 20—(Continued).

SN 76-447,744. PLEASANT COMPANY, MIDDLETON, WI. FILED 9-9-2002.



OWNER OF U.S. REG. NOS. 1,506,148, 2,491,317 AND OTHERS.

NO CLAIM IS MADE TO THE EXCLUSIVE RIGHT TO USE "COLLECTION", APART FROM THE MARK AS SHOWN.

FOR JEWELRY BOXES NOT OF METAL, PAPER PHOTO FRAMES, PICTURE FRAMES, POINT OF PURCHASE DISPLAYS (U.S. CLS. 2, 13, 22, 25, 32 AND 50).

FIRST USE 9-6-2002; IN COMMERCE 9-6-2002.

SN 76-450,673. TONEEMARA INDUSTRIES, INC., BROOKVILLE, IN. FILED 9-18-2002.



Hickory Classics

NO CLAIM IS MADE TO THE EXCLUSIVE RIGHT TO USE "HICKORY CLASSICS", APART FROM THE MARK AS SHOWN.

FOR CHAIRS AND KITS TO PRODUCE CHAIRS CONSISTING OF FRAME COMPONENTS AND BACK AND SEAT COMPONENTS (U.S. CLS. 2, 13, 22, 25, 32 AND 50).

SN 76-452,965. VITRA PATENTE AG, CH-4132 MUTTENZ, SWITZERLAND, FILED 9-20-2002.

JOYN

PRIORITY CLAIMED UNDER SEC. 44(D) ON SWITZERLAND APPLICATION NO. 01132/2002, FILED 4-5-2002, REG. NO. 497737, DATED 4-16-2002, EXPIRES 4-5-2012.

FOR OFFICE FURNITURE AND OFFICE FURNITURE SYSTEMS, NAMELY, CHAIRS, TABLES AND TABLE SYSTEMS COMPRISED OF ADJUSTABLE WORK SURFACES AND SHELVES (U.S. CLS. 2, 13, 22, 25, 32 AND 50).

CLASS 20—(Continued).

SN 76-465,343. FOLDCRAFT CO., KENYON, MN. FILED 11-5-2002.

BKR DESIGNS

NO CLAIM IS MADE TO THE EXCLUSIVE RIGHT TO USE "DESIGNS", APART FROM THE MARK AS SHOWN.

FOR UPHOLSTERED FURNITURE; FURNITURE NOT UPHOLSTERED, NAMELY, TABLES, CHAIRS, STOOLS, BENCHES, BOOTH STYLE SEATING, TABLETOPS, TABLE BASES, SEAT AND TABLE UNITS, FREE STANDING PARTITIONS, TABLE LEGS, CABINETS (U.S. CLS. 2, 13, 22, 25, 32 AND 50).

SN 76-470,515. DIAZ, VINCENT, HAVRE DE GRACE, MD. FILED 11-14-2002.

PAXPRO

FOR MATTRESSES, PILLOWS AND CUSHIONS (U.S. CLS. 2, 13, 22, 25, 32 AND 50).

SN 76-470,875. ELITE FURNITURE, INC., SAN JOSE, CA. FILED 11-29-2002.

THE FUSION OF FUNCTION AND COMFORT WITH STYLE

FOR FURNITURE, NAMELY COUCHES, CHAIRS, FUTONS AND MATTRESSES (U.S. CLS. 2, 13, 22, 25, 32 AND 50).

SN 76-470,876. ELITE FURNITURE, INC., SAN JOSE, CA. FILED 11-29-2002.

DESIGNED WITH YOU IN MIND

FOR FURNITURE, NAMELY COUCHES, CHAIRS, FUTONS AND MATTRESSES (U.S. CLS. 2, 13, 22, 25, 32 AND 50).

SN 78-106,694. GLASSPLAX, INC., RIVERSIDE, CA. FILED 2-4-2002.

SPERRIN

NO CLAIM IS MADE TO THE EXCLUSIVE RIGHT TO USE "CRYSTAL", APART FROM THE MARK AS SHOWN.

FOR AWARDS, NAMELY, PLAQUES MADE OF CRYSTAL; NON-METAL TROPHIES (U.S. CLS. 2, 13, 22, 25, 32 AND 50).

CLASS 20—(Continued).

SN 78-107,037. KE SALES INC, BOCA RATON, FL. FILED 2-5-2002.

FOLD 'N GO

FOR FOLDING PORTABLE TABLE FOR USE IN THE BUILDING CONSTRUCTION INDUSTRY, NAMELY, A PORTABLE CONSTRUCTION PLANNING TABLE (U.S. CLS. 2, 13, 22, 25, 32 AND 50).

SN 78-153,399. SWEZEY, RICHARD, SANTA MONICA, CA. FILED 8-12-2002.

POSTURE LOUNGER

NO CLAIM IS MADE TO THE EXCLUSIVE RIGHT TO USE "LOUNGER", APART FROM THE MARK AS SHOWN. FOR ERGONOMIC RECLINER-PILLOW FOR PROVIDING BACK, SHOULDER, NECK AND HEAD SUPPORT WHILE SITTING AND/OR LOUNGING ON BED, ON FLOOR, OR ELSEWHERE (U.S. CLS. 2, 13, 22, 25, 32 AND 50).

SN 78-162,975. CHUDINA, GEORGE J., DBA EAST RIVER OUTDOORS, NORTH TAZEWELL, VA. FILED 9-11-2002.

COZY-MAX

FOR SEATS DESIGNED FOR OUTDOOR ACTIVITIES SUCH AS HUNTING, FISHING, CAMPING AND RECREATIONAL SPORTING AND ENTERTAINMENT EVENTS (U.S. CLS. 2, 13, 22, 25, 32 AND 50).

SN 78-167,488. SMARTSEAL AS, SANDNES, NORWAY, FILED 9-24-2002.

MAGICAP

FOR PLASTIC CAP, DRINKING SPOUT AND DRINKING STRAW INTENDED FOR WATER, CARBONATED WATER, SOFT DRINKS, JUICE, MILK AND LIQUID FOOD CONTAINING A BUILT-IN MECHANISM FOR AUTOMATIC CONTROL OF FLUID FLOW (U.S. CLS. 2, 13, 22, 25, 32 AND 50).

CLASS 20—(Continued).

SN 78-169,596. DEAN JOHN HINGLEY MEDLAND, BUCKINGHAMSHIRE, UNITED KINGDOM, FILED 10-1-2002.

PLANTAGENET

FOR FURNITURE; FURNITURE FOR DOMESTIC PETS; BEDS FOR DOMESTIC PETS (U.S. CLS. 2, 13, 22, 25, 32 AND 50).

SN 78-169,847. BAMBOO-ABBOTT INC., EDISON, NJ. FILED 10-1-2002.

TROPICAL ISLE COLLECTION

NO CLAIM IS MADE TO THE EXCLUSIVE RIGHT TO USE "COLLECTION", APART FROM THE MARK AS SHOWN.

FOR WOVEN WOOD WINDOW SHADES (U.S. CLS. 2, 13, 22, 25, 32 AND 50).

SN 78-172,888. ILLINOIS TOOL WORKS INC., GLENVIEW, IL. FILED 10-10-2002.

SLIM-PACK

FOR PORTABLE CARRIERS FOR CONTAINERS IN THE NATURE OF PLASTIC PACKAGING FOR CONNECTING AND CARRYING CANS, BOTTLES, JARS AND CARTONS; PORTABLE PLASTIC RING CARRIERS FOR BOTTLES, CANS, JAR AND CARTONS (U.S. CLS. 2, 13, 22, 25, 32 AND 50).

FIRST USE 6-6-2002; IN COMMERCE 6-6-2002.

SN 78-176,487. WHITE, RANDOLPH L., PUNTA GORDA, FL. FILED 10-21-2002.

BABY SENSOR

NO CLAIM IS MADE TO THE EXCLUSIVE RIGHT TO USE "BABY", APART FROM THE MARK AS SHOWN.

FOR PILLOWS, MATTRESSES, CUSHIONS FOR INFANTS AND BABIES (U.S. CLS. 2, 13, 22, 25, 32 AND 50).

SN 78-177,781. JAMES, DAVID, F, TONBRIDGE, UNITED KINGDOM, FILED 10-24-2002.

JETREST

FOR PILLOWS, CUSHIONS AND MATTRESSES (U.S. CLS. 2, 13, 22, 25, 32 AND 50).

FIRST USE 1-30-1999; IN COMMERCE 11-1-2001.

CLASS 20—(Continued).

SN 78-178,051. MCCOLLUM, SHAWN B., BEDFORD, NH.
FILED 10-24-2002.

PROPADS

FOR SEATING AND SEATING PRODUCTS, NAMELY SEATING CUSHIONS FOR STADIUM CHAIRS AND BENCH SEATS (U.S. CLS. 2, 13, 22, 25, 32 AND 50).

SN 78-178,095. VARGAS, JOHN T, PALM HARBOR, FL.
FILED 10-24-2002.

SNACK SNAP

NO CLAIM IS MADE TO THE EXCLUSIVE RIGHT TO USE "SNACK", APART FROM THE MARK AS SHOWN.
FOR BAG CLOSING FASTENER, NAMELY A PLASTIC TONGUE AND GROOVE. (U.S. CLS. 2, 13, 22, 25, 32 AND 50).

SN 78-180,646. SHADE, REDI, COTATI, CA. FILED 10-31-2002.

EASY-LIFE

FOR WINDOW SHADES (U.S. CLS. 2, 13, 22, 25, 32 AND 50).

SN 78-183,326. BASIC COMFORT, INC., DENVER, CO.
FILED 11-8-2002.

NURSE EZ

NO CLAIM IS MADE TO THE EXCLUSIVE RIGHT TO USE "NURSE", APART FROM THE MARK AS SHOWN.
FOR NURSING SUPPORT PILLOWS (U.S. CLS. 2, 13, 22, 25, 32 AND 50).
FIRST USE 1-31-1999; IN COMMERCE 1-31-1999.

SN 78-185,213. WARVEL PRODUCTS, INC. - NORTH CAROLINA, LINWOOD, NC. FILED 11-14-2002.

PATRIOT

FOR OFFICE FURNITURE (U.S. CLS. 2, 13, 22, 25, 32 AND 50).

CLASS 20—(Continued).

SN 78-185,282. BASIC COMFORT, INC., DENVER, CO.
FILED 11-14-2002.

REST EZ

FOR SUPPORT PILLOWS FOR WOMEN (U.S. CLS. 2, 13, 22, 25, 32 AND 50).
FIRST USE 5-31-1999; IN COMMERCE 5-31-1999.

SN 78-186,050. NORTHPOLE LIMITED, KOWLOON, HONG KONG, FILED 11-18-2002.

BRING YOUR OWN BED

FOR AIRBEDS AND FOLDING BEDFRAMES (U.S. CLS. 2, 13, 22, 25, 32 AND 50).

SN 78-191,492. SIMPLE DESIGNS MANUFACTURING, INC., TUALATIN, OR. FILED 12-5-2002.

DREAMLOFT

FOR UPHOLSTERED FURNITURE AND SEAT CUSHIONS (U.S. CLS. 2, 13, 22, 25, 32 AND 50).

CLASS 21—HOUSEWARES AND GLASS

SN 74-342,954. KELLEY, MARIE G., LA JOLLA, CA. FILED 12-24-1992.

FOOD DUDES

FOR ALL PURPOSE, PORTABLE HOUSEHOLD CONTAINERS AND UTENSILS NOT MADE OF PRECIOUS METAL, NAMELY, MIXING SPOONS, BASTING AND SERVING SPOONS, SPATULAS, LADLES; HOUSEHOLD UTENSILS, NAMELY WHISKS, GRATERS, BASTERS, NON ELECTRIC LEMON AND JUICE SQUEEZERS, CONTAINERS FOR FOOD AND CONTAINERS FOR HOUSEHOLD AND KITCHEN USE NOT OF PRECIOUS METAL (U.S. CLS. 2, 13, 23, 29, 30, 33, 40 AND 50).

CLASS 21—(Continued).

SN 75-846,325. MILTON, DAVID, SCARBOROUGH, ONTARIO MIN 269, CANADA, FILED 11-11-1999.



PRIORITY CLAIMED UNDER SEC. 44(D) ON CANADA APPLICATION NO. 1,019,829, FILED 6-18-1999, REG. NO. TMA563648, DATED 6-18-2002, EXPIRES 6-18-2017.

NO CLAIM IS MADE TO THE EXCLUSIVE RIGHT TO USE "PAINTBOX", APART FROM THE MARK AS SHOWN.

FOR NON-METAL CONTAINER FOR STORAGE OF PAINT, PAINT BRUSHES, PAINT ROLLERS, AND PAINT TRAYS WHICH KEEPS THE ITEMS FRESH FOR CONTINUED USE DURING INTERIOR AND EXTERIOR PAINTING PROJECTS (U.S. CLS. 2, 13, 23, 29, 30, 33, 40 AND 50).

SN 76-306,653. CENTURY TOOL AND MANUFACTURING COMPANY, INC., CHERRY VALLEY, IL. FILED 8-30-2001.

BIRD BONANZA

NO CLAIM IS MADE TO THE EXCLUSIVE RIGHT TO USE "BIRD", APART FROM THE MARK AS SHOWN.

FOR SMALL ANIMAL FEEDERS (U.S. CLS. 2, 13, 23, 29, 30, 33, 40 AND 50).

SN 76-308,737. APPLITECH, LLC, CLEVELAND, OH. FILED 9-6-2001.

APPLITECH

FOR IMPREGNATED CLEANING AND POLISHING CLOTHS AND APPLICATORS FOR USE ON SHOES, CLOTHING AND SURFACES, NAMELY, CLEANING AND POLISHING MITTS, GLOVES AND APPLICATORS IMPREGNATED WITH CHEMICALS FOR APPLICATION TO SURFACES AND OPTIONALLY CONNECTED TO AN EXTENDABLE AND RETRACTABLE SLEEVE PROTECTING A PORTION OF THE USER'S ARM, SOLD TOGETHER AS A UNIT IN A RESALABLE PACKAGING CONTAINER FOR USE IN THE HOUSEHOLD, MEDICAL, PERSONAL CARE, VETERINARY, TRANSPORTATION VEHICLE AND INDUSTRIAL CLEANING FIELD (U.S. CLS. 2, 13, 23, 29, 30, 33, 40 AND 50).

CLASS 21—(Continued).

SN 76-332,681. BUBBLE HEAD, INC., PENSACOLA, FL. FILED 11-1-2001.

BUBBLE HEAD

NO CLAIM IS MADE TO THE EXCLUSIVE RIGHT TO USE "BUBBLE", APART FROM THE MARK AS SHOWN.

FOR WATER FAUCET PADDED PROTECTIVE COVERINGS WHICH ALSO SERVE AS DISPENSERS FOR LIQUID SOAP (U.S. CLS. 2, 13, 23, 29, 30, 33, 40 AND 50). FIRST USE 6-12-2000; IN COMMERCE 6-12-2000.

SN 76-339,861. ICE TUBES, INC., TALLMADGE, OH. FILED S.R. 11-20-2001; AM. P.R. 4-25-2003.

THE ICE TUBES TRAY

NO CLAIM IS MADE TO THE EXCLUSIVE RIGHT TO USE "TRAY", APART FROM THE MARK AS SHOWN.

FOR ICE TRAYS, NAMELY, ICE TUBE MOLDS (U.S. CLS. 2, 13, 23, 29, 30, 33, 40 AND 50).

FIRST USE 6-0-1998; IN COMMERCE 6-0-1998.

SN 76-419,118. ENCON SAFETY PRODUCTS, INC., HOUSTON, TX. FILED 6-10-2002.

FOG-FIXER

FOR PRE-MOISTENED TOWELLETES FOR USE IN PREVENTING FOG ON EYEWEAR (U.S. CLS. 2, 13, 23, 29, 30, 33, 40 AND 50).

FIRST USE 6-0-1988; IN COMMERCE 6-0-1988.

SN 76-431,274. MUG MASTER, INC., ROCHESTER, MN. FILED 7-3-2002.

THE POWER TO COOL, THE POWER TO WARM, THE POWER TO SATISFY

FOR BEVERAGEWARE, NAMELY, PLASTIC BEVERAGEWARE AND STAINLESS STEEL BEVERAGEWARE (U.S. CLS. 2, 13, 23, 29, 30, 33, 40 AND 50).

SN 76-451,076. CELESTIAL WINDS S. A., PANAMA CITY, PANAMA, FILED 9-13-2002.

DRINK HUGGIE

NO CLAIM IS MADE TO THE EXCLUSIVE RIGHT TO USE "DRINK", APART FROM THE MARK AS SHOWN.

FOR PLASTIC BOTTLES CARRIERS USED FOR CARRYING BOTTLED BEVERAGES (U.S. CLS. 2, 13, 23, 29, 30, 33, 40 AND 50).

CLASS 21—(Continued).

SN 76-451,457. SHIFTING FREQUENCIES, L.L.C., DALLAS, TX. FILED 9-16-2002.

MAGICAL MUG

NO CLAIM IS MADE TO THE EXCLUSIVE RIGHT TO USE "MUG", APART FROM THE MARK AS SHOWN.
FOR MUGS AND COASTERS (U.S. CLS. 2, 13, 23, 29, 30, 33, 40 AND 50).
FIRST USE 8-24-2001; IN COMMERCE 8-24-2001.

CLASS 21—(Continued).

SN 76-460,899. LIBBEY GLASS INC., TOLEDO, OH. FILED 10-18-2002.

OMEGA

FOR GLASS BEVERAGeware (U.S. CLS. 2, 13, 23, 29, 30, 33, 40 AND 50).

SN 76-453,947. Z STRATEGIES, INC., SAN DIEGO, CA. FILED 9-30-2002.



NO CLAIM IS MADE TO THE EXCLUSIVE RIGHT TO USE "COFFEE", APART FROM THE MARK AS SHOWN.
THE STIPPLING IS A FEATURE OF THE MARK AND DOES NOT INDICATE COLOR.
FOR COFFEE CUPS, COFFEE MUGS, THERMAL INSULATED CONTAINERS FOR BEVERAGES, INSULATED CUPS, THERMAL INSULATED BOTTLES, DRINKING GLASSES, DISHES, PLATES, BOWLS, BOTTLE OPENERS, PLASTIC JUGS FOR BEVERAGES, CONTAINERS FOR FOOD, PITCHERS, JARS FOR FOOD MADE FROM EARTHENWARE, GLASS, PORCELAIN OR PLASTIC, TRIVETS, CANISTER SETS, NON-ELECTRIC COFFEE POTS NOT OF PRECIOUS METAL, HAND OPERATED COFFEE GRINDERS AND COFFEE MILLS, NON-ELECTRIC COFFEE MAKERS, REUSABLE STAINLESS STEEL OR FABRIC COFFEE FILTERS FOR DOMESTIC ELECTRIC COFFEE MAKERS, COASTERS NOT MADE OUT OF PAPER OR TABLE LINEN (U.S. CLS. 2, 13, 23, 29, 30, 33, 40 AND 50).

SN 76-459,710. ANDE ROONEY INC., HIGHLAND, NY. FILED 10-16-2002.

COWBOY PETE'S

FOR BARBECUE COOKING UTENSILS, NAMELY, FORKS, SPATULAS, TONGS, SKEWERS, BRUSHES FOR BASTING, AND SEARING IRONS; METAL COOKING PANS, METAL TRAYS, NAPKIN HOLDERS, BEVERAGeware AND GLASS BEVERAGeware, TRIVETS, SPOON HOLDERS (U.S. CLS. 2, 13, 23, 29, 30, 33, 40 AND 50).
FIRST USE 10-1-1996; IN COMMERCE 4-1-2000.

SN 76-466,142. TABLETOPS UNLIMITED, INC., GARDENA, CA. FILED 11-12-2002.

VILLA GRANDE

THE ENGLISH TRANSLATION OF "VILLA GRANDE" IS "LARGE VILLA" OR "GREAT VILLA".
FOR DINNERWARE, NAMELY, DINNER PLATES, SOUP PLATES, SALAD PLATES, CEREAL BOWLS, MUGS, PASTA PLATES, DESSERT PLATES, SERVING PLATTERS, BOWLS, SERVING BOWLS, PITCHERS, TEA POTS NOT OF PRECIOUS METAL, CHAMPAGNE BUCKETS, CROCK POTS, BUTTER DISHES, CRUETS NOT OF PRECIOUS METAL, BREAD BOXES, SOUP TUREENS, GLASS RINSING TUBS, VASES, GINGER JARS, ROASTING PANS, CASSEROLE DISHES, DUTCH OVENS, TEA KETTLES, LASAGNA PANS, BUFFET SERVING DISHES, BUFFET PIE SERVERS, CHICKEN FRYING PANS, COLANDERS AND STOCK POTS (U.S. CLS. 2, 13, 23, 29, 30, 33, 40 AND 50).
FIRST USE 2-0-2002; IN COMMERCE 2-0-2002.

SN 76-466,143. TABLETOPS UNLIMITED, INC., GARDENA, CA. FILED 11-12-2002.

VINO

FOR DINNERWARE, NAMELY, DINNER PLATES, SOUP PLATES, SALAD PLATES, DESSERT PLATES, CEREAL BOWLS, MUGS, CHARGER PLATES, PASTA PLATES, SERVING PLATTERS, BOWLS, CHAMPAGNE BUCKETS, BUTTER DISHES, BREADBOXES, GLASS RINSING TUBS, VASES, GINGER JARS, ROASTING PANS, SUGAR BOWLS, CREAMER BOWLS, CASSEROLE DISHES, DUTCH OVENS, TEA KETTLES, MIXING BOWLS, BUFFET SERVING DISHES, BUFFET PIE SERVERS, CHICKEN FRYING PANS, STOCKPOTS, AND COLANDERS (U.S. CLS. 2, 13, 23, 29, 30, 33, 40 AND 50).
FIRST USE 4-0-2002; IN COMMERCE 4-0-2002.

CLASS 21—(Continued).

SN 76-466,144. TABLETOPS UNLIMITED, INC., GARDENA, CA. FILED 11-12-2002.

CARNIVAL

FOR DINNERWARE, NAMELY, DINNER PLATES, PASTA PLATES, SALAD PLATES, DESSERT PLATES, CEREAL BOWLS, MUGS, SERVING PLATTERS, PASTA SERVING BOWLS, PITCHERS, CANISTER SETS, PLACE SETTINGS CONSISTING OF PLATES AND BOWLS, SOAP DISPENSERS, SUGAR BOWLS AND CREAMERS, SALT AND PEPPER SHAKERS, COOKIE JARS, CHIPS AND DIP SERVING PLATTERS, BOWLS, RELISH DISHES, SOUP TUREENS, VASES, TEA POTS NOT OF PRECIOUS METAL, CAKE PLATES, TWO-TIERED SERVING DISHES, AND TEA SETS (U.S. CLS. 2, 13, 23, 29, 30, 33, 40 AND 50).

FIRST USE 8-0-1998; IN COMMERCE 8-0-1998.

SN 76-466,145. TABLETOPS UNLIMITED, INC., GARDENA, CA. FILED 11-12-2002.

CABERNET

FOR DINNERWARE, NAMELY, PASTA BOWLS, SOUP BOWLS, SALAD PLATES, CEREAL BOWLS, CUPS AND SAUCERS, MUGS, BOWLS, EDIBLE OIL DISPENSERS, PITCHERS, SALT AND PEPPER SHAKERS, SUGAR BOWLS AND CREAMERS, FLOWER POTS, COMPOTES, TRIVETS, SPOON RESTS, KITCHEN TOOL HOLDERS, DINNER PLATES, CASSEROLE DISHES, DUTCH OVENS, TEA KETTLES, LASAGNA PANS, ROASTING PANS, MIXING BOWLS, BUFFET SERVING DISHES, BUFFET PIE SERVERS, COLANDERS, AND STOCK POTS (U.S. CLS. 2, 13, 23, 29, 30, 33, 40 AND 50).

FIRST USE 4-0-2000; IN COMMERCE 4-0-2000.

SN 76-466,146. TABLETOPS UNLIMITED, INC., GARDENA, CA. FILED 11-12-2002.

ESPAÑA

THE ENGLISH TRANSLATION OF "ESPANA" IS "SPAIN".

FOR DINNERWARE, NAMELY, DINNER PLATES, PASTA PLATES, SALAD PLATES, DESSERT PLATES, CEREAL BOWLS, MUGS, SERVING PLATTERS, PASTA SERVING BOWLS, PITCHERS AND PLACE SETTINGS CONSISTING OF PLATES, MUGS AND BOWLS (U.S. CLS. 2, 13, 23, 29, 30, 33, 40 AND 50).

FIRST USE 8-0-1998; IN COMMERCE 8-0-1998.

CLASS 21—(Continued).

SN 76-470,558. SPACE NEEDLE CORPORATION, SEATTLE, WA. FILED 11-27-2002.



OWNER OF U.S. REG. NOS. 1,273,583, 1,287,108 AND OTHERS.

FOR MUGS, CUPS, PLATES, BEVERAGE GLASSWARE, CERAMIC STATUES AND STATUETTES (U.S. CLS. 2, 13, 23, 29, 30, 33, 40 AND 50).

FIRST USE 5-31-1962; IN COMMERCE 5-31-1962.

SN 76-473,274. RWD DISTRIBUTORS, INC., DBA RAVENSCROFT, NEW YORK, NY. FILED 11-26-2002.

AMPLIFIER

FOR WINE GLASSES (U.S. CLS. 2, 13, 23, 29, 30, 33, 40 AND 50).

FIRST USE 11-13-2002; IN COMMERCE 11-13-2002.

SN 76-473,552. THE EVERYDAY GARDENER, INC., JACKSON, MS. FILED 12-9-2002.

FLOWERS BY THE YARD

NO CLAIM IS MADE TO THE EXCLUSIVE RIGHT TO USE "FLOWERS", APART FROM THE MARK AS SHOWN. FOR HOLDERS FOR FLOWERS AND PLANTS (U.S. CLS. 2, 13, 23, 29, 30, 33, 40 AND 50).

FIRST USE 11-1-2000; IN COMMERCE 11-1-2000.

CLASS 21—(Continued).

SN 78-070,828. CHINA MIST TEA COMPANY, SCOTTSDALE, AZ. FILED 6-25-2001.

CHINA MIST

OWNER OF U.S. REG. NOS. 1,386,975, 2,044,376 AND OTHERS.

NO CLAIM IS MADE TO THE EXCLUSIVE RIGHT TO USE "CHINA", APART FROM THE MARK AS SHOWN.

FOR INSULATED TEA AND BEVERAGE CUPS, COFFEE CUPS, TEA CUPS AND MUGS, TEA KETTLES, TEA POTS NOT OF PRECIOUS METAL, BEVERAGE GLASSWARE, DINNERWARE DISHES, PLATES AND BOWLS, TRIVETS, STORAGE CANISTERS, TEA BALLS NOT OF PRECIOUS METAL, TEA INFUSORS NOT OF PRECIOUS METAL, TEA CADDIES, TEA SERVICES NOT OF PRECIOUS METAL, TEA SETS AND TEA STRAINERS (U.S. CLS. 2, 13, 23, 29, 30, 33, 40 AND 50).

SN 78-104,208. THOMAS, ROBERT G., EUGENE, OR. FILED 1-23-2002.

TEA SOCK

NO CLAIM IS MADE TO THE EXCLUSIVE RIGHT TO USE "TEA", APART FROM THE MARK AS SHOWN.

FOR 100% COTTON REUSEABLE TEA FILTER WITH WOODEN HANDLE AND STAINLESS STEEL WIRE RIM (U.S. CLS. 2, 13, 23, 29, 30, 33, 40 AND 50).

FIRST USE 12-20-1975; IN COMMERCE 4-20-1976.

SN 78-121,051. REYNOLDS METALS COMPANY, RICHMOND, VA. FILED 4-11-2002.

COMBO-PAK

FOR ALUMINUM FOIL CONTAINERS AND LIDS, SOLD AS A UNIT; AND PLASTIC CONTAINERS AND PLASTIC LIDS, SOLD AS A UNIT (U.S. CLS. 2, 13, 23, 29, 30, 33, 40 AND 50).

SN 78-146,647. GANTENBRINK, RUDOLF, MONACO, MONACO, FILED 7-23-2002.

VINOPUR

PRIORITY CLAIMED UNDER SEC. 44(D) ON FED REP GERMANY APPLICATION NO. 302046704, FILED 1-30-2002, REG. NO. 30204670, DATED 3-4-2002, EXPIRES 1-30-2012.

FOR FILTERS IN THE NATURE OF STRAINERS FOR HOUSEHOLD PURPOSES (U.S. CLS. 2, 13, 23, 29, 30, 33, 40 AND 50).

CLASS 21—(Continued).

SN 78-163,475. THERMOS L.L.C., SCHAUMBURG, IL. FILED 9-12-2002.

NIGHT HAWK

FOR THERMALLY INSULATED CONTAINERS FOR FOOD OR BEVERAGES (U.S. CLS. 2, 13, 23, 29, 30, 33, 40 AND 50).

SN 78-180,632. ZILBERMAN, GUY, ENGLEWOOD, NJ. FILED 10-31-2002.

FRAMEBASKET

FOR WASTEBASKET (U.S. CLS. 2, 13, 23, 29, 30, 33, 40 AND 50).

SN 78-181,999. BLOCK-MARTIN, LLC, LOS ANGELES, CA. FILED 11-5-2002.

PET'S PET

NO CLAIM IS MADE TO THE EXCLUSIVE RIGHT TO USE "PET'S", APART FROM THE MARK AS SHOWN.

FOR PET FEEDING DISHES (U.S. CLS. 2, 13, 23, 29, 30, 33, 40 AND 50).

SN 78-184,532. TV PRODUCTS USA, INC., NEW YORK, NY. FILED 11-13-2002.



FOR HEAT RESISTANT, WATERPROOF, CHEMICAL RESISTANT, FOOD-GRADE SILICONE GLOVES FOR HOUSEHOLD, KITCHEN AND LIGHT INDUSTRIAL USE. (U.S. CLS. 2, 13, 23, 29, 30, 33, 40 AND 50).

CLASS 22—CORDAGE AND FIBERS

CLASS 22—(Continued).

SN 76-373,675. KVAERNER OILFIELD PRODUCTS, INC., HOUSTON, TX. FILED 2-25-2002.

RATCH-A-STRAP

FOR ALL PURPOSE STRAPS (U.S. CLS. 1, 2, 7, 19, 22, 42 AND 50).
FIRST USE 6-1-1992; IN COMMERCE 6-1-1992.

SN 78-185,217. HIGH VOLTAGE GRAPHICS, INC., FT. COLLINS, CO. FILED 11-14-2002.

PLX

FOR POLYESTER FLOCK FIBER (U.S. CLS. 1, 2, 7, 19, 22, 42 AND 50).

CLASS 24—FABRICS

SN 76-022,423. NEW CREATIVE ENTERPRISES, INC., MILFORD, OH. FILED 4-10-2000.



THE LINING IS A FEATURE OF THE MARK AND DOES NOT INDICATE COLOR.
FOR HALLOWEEN-THEMED DECORATIVE NYLON FLAGS (U.S. CLS. 42 AND 50).

SN 76-043,902. YASHA FABRIC, INC., LOS ANGELES, CA. FILED 5-8-2000.

ZIRO-TEC

FOR FABRIC AND TEXTILE MATERIAL USED IN MANUFACTURE OF CLOTHING, COVERS, INSULATION, PADDING, AND FABRICATED PRODUCTS FOR PROTECTING AGAINST COLD (U.S. CLS. 42 AND 50).
FIRST USE 2-1-2000; IN COMMERCE 2-1-2000.

CLASS 24—(Continued).

SN 76-360,731. SHABBY CHIC, INC., LOS ANGELES, CA. FILED 1-22-2002.

TREASURES BY RACHEL ASHWELL

OWNER OF U.S. REG. NOS. 2,136,125, 2,315,476 AND 2,330,202.

THE NAME "RACHEL ASHWELL" IDENTIFIES A LIVING INDIVIDUAL WHOSE CONSENT IS OF RECORD.

FOR FABRICS, LINENS AND TEXTILES FOR THE FURTHER MANUFACTURE OF HOUSEWARES; FABRIC, LINEN AND TEXTILE PIECE GOODS FOR THE FURTHER MANUFACTURE OF HOUSEWARES; FABRICS, LINENS AND TEXTILES FOR BEDDING, BATHWARE, FURNITURE, HOME FURNISHINGS, HOUSEHOLD GOODS, WINDOW TREATMENTS AND CLOTHING; BED SPREADS; BED SHEETS; FITTED BED SHEETS; FLAT BED SHEETS; POPLIN AND T-SHIRT BED SHEETS; BED BLANKETS; RECEIVING BLANKETS; BED CANOPIES; DUVETS; DUVET COVERS; BED PADS; BEDDING LINEN; DUST RUFFLES; PILLOW CASES; PILLOW SHAMS; POTATOSACK PILLOW CASES; PILLOW CASES WITH RUFFLES; PILLOW SHAMS WITH RUFFLES; RUFFLED BEDSKIRTS; BEDSKIRTS; COMFORTERS; TOWELS; HOODED TOWELS; BATH LINENS; CLOTH BANNERS; FABRIC CURTAINS; DRAPERIES; DRAPERY PANELS; CLOTH DOILIES; CLOTH AND TEXTILE NAPKINS; DISH CLOTHS; WASH CLOTHS; CLOTH AND TEXTILE PLACEMATS; PUFFS FOR WINDOW TREATMENTS; FABRIC TABLE RUNNERS; SHROUDS; TABLE CLOTHS NOT OF PAPER; TEXTILE TAPESTRIES; FABRIC VALANCES; FABRIC CHAIR PADS; QUILTS; QUILTED SHAMS; SHOWER CURTAINS; TOWELS; BATHROOM TOWELS; HAND TOWELS; WASH TOWELS; KITCHEN TOWELS; POT HOLDERS; AND MATTRESS PADS (U.S. CLS. 42 AND 50).
FIRST USE 11-0-1999; IN COMMERCE 11-0-1999.

SN 76-361,717. CREATIONS EDITIONS D'ETOFFES D'AMEUBLEMENT, 75001 PARIS, FRANCE, FILED 1-23-2002.



NO CLAIM IS MADE TO THE EXCLUSIVE RIGHT TO USE "LE CRIN", APART FROM THE MARK AS SHOWN. THE ENGLISH TRANSLATION OF "LE CRIN" IS "HORSE HAIR".

FOR UPHOLSTERY FABRICS MADE IN PART OF HORSEHAIR (U.S. CLS. 42 AND 50).

CLASS 24—(Continued).

SN 76-394,145. TRIMBLE, LYNN, JUPITER, FL. FILED 4-11-2002.



THE MARK CONSISTS OF THE TERMS "BABY BE SAFE" IN BUILDING BLOCKS.

FOR BED SHEETS AND CRIB SHEETS FEATURING ATTACHED PILLOWCASES AND FOAM WEDGE PILLOWCASES (U.S. CLS. 42 AND 50).

FIRST USE 8-0-1999; IN COMMERCE 8-7-2000.

SN 76-403,510. COMPANHIA INDUSTRIAL CATAGUASES, CITY CATAGUASES, STATES MINAS GERAIS, BRAZIL, FILED 5-3-2002.



NO CLAIM IS MADE TO THE EXCLUSIVE RIGHT TO USE "COMPANHIA INDUSTRIAL CATAGUASES", APART FROM THE MARK AS SHOWN.

THE LINING SHOWN IN THE DRAWING IS A FEATURE OF THE MARK AND IS NOT INTENDED TO INDICATE COLOR.

THE FOREIGN WORDING IN THE MARK TRANSLATES INTO ENGLISH AS "INDUSTRIAL COMPANY".

FOR COTTON FABRIC (U.S. CLS. 42 AND 50).

SN 76-404,571. PERFORMANCE APPAREL CORP., SAN LUIS OBISPO, CA. FILED 5-7-2002.

BIO-SILVER

FOR NYLON FABRIC COMPOSED IN PART OF SILVER BASED ANTIMICROBIAL YARNS (U.S. CLS. 42 AND 50).

FIRST USE 12-0-2001; IN COMMERCE 12-0-2001.

SN 76-407,353. MARCUS, RICHARD S., NORTH MIAMI, FL. FILED 5-14-2002.

TEXSYNTHESIS

FOR BED BLANKETS FORMED FROM AN ARRAY OF FASHION FIBERS (U.S. CLS. 42 AND 50).

CLASS 24—(Continued).

SN 76-434,550. GLES BUSATTI DI SASSOLINI GIOVANNI & C. S.N.C., I-52031 ANGHIAIARI - AREZZO, ITALY, FILED 7-25-2002.



FOR BED LINENS, NAMELY, BED BLANKETS, BED SHEETS AND, BED SPREADS; HOUSEHOLD LINEN; TABLE LINEN, NAMELY, COASTERS, NAPKINS, PLACE MATS; UNFITTED FABRIC FURNITURE COVERS; HAND TOWELS OF TEXTILE MATERIAL; TAPETRIES OF TEXTILE MATERIAL; AND CHENILLE FABRIC (U.S. CLS. 42 AND 50).

FIRST USE 4-10-1976; IN COMMERCE 4-8-2001.

SN 76-456,957. BIANCA USA INC., NEW BRUNSWICK, NJ. FILED 10-7-2002.

BIANCA EXCLUSIVE

NO CLAIM IS MADE TO THE EXCLUSIVE RIGHT TO USE "EXCLUSIVE", APART FROM THE MARK AS SHOWN. FOR HOME TEXTILE PRODUCTS NAMELY- TOWELS, BED LINENS, TABLECLOTH, CURTAINS (U.S. CLS. 42 AND 50).

FIRST USE 1-1-2001; IN COMMERCE 5-31-2001.

SN 78-137,225. ALBERMARLE CORP., ATLANTA, GA. FILED 6-19-2002.



FOR NONWOVEN FABRIC SUBSTRATE FOR USE IN THE MANUFACTURE OF NAPKINS; TABLECOVERS; UNDERPADS; CLOTH WIPERS; DISPOSABLE LINENS; LINING FABRICS USED IN MANUFACTURE OF APPAREL AND FURNITURE AND TOWELS; HEALTH CARE AND HYGIENIC ITEMS, NAMELY, TOWELS, BED SHEETS, BED PADS; TOWELS MADE OF NATURAL SYNTHETIC FIBERS; KITCHEN TOWELS, TABLECLOTHS NOT OF PAPER, PLASTIC COASTERS, PLASTIC AND CLOTH COASTERS (U.S. CLS. 42 AND 50).

SN 78-185,301. BASIC COMFORT, INC., DENVER, CO. FILED 11-14-2002.

HANDY'S PLUS

FOR WATERPROOF BED PADS (U.S. CLS. 42 AND 50). FIRST USE 10-31-1994; IN COMMERCE 10-31-1994.

CLASS 24—(Continued).

SN 78-193,698. SARA LEE GLOBAL FINANCE, L.L.C., WILMINGTON, DE. FILED 12-12-2002.

DOUBLE DRY

FOR TOWELS FOR PERSONAL USE (U.S. CLS. 42 AND 50).

CLASS 25—CLOTHING

SN 75-258,602. J.A. BESNER & SONS (CANADA) LTD., MONTREAL, QUEBEC, CANADA, BY ASSIGNMENT LA STRADA FASHIONS, INC., WARMINSTER, PA. FILED 3-17-1997.

BRIOSO

THE SUBJECT MARK MAY BE TRANSLATED TO MEAN "BRISK".
FOR BOYS' WOVEN AND KNIT SHIRTS (U.S. CLS. 22 AND 39).
FIRST USE 8-0-1992; IN COMMERCE 8-0-1992.

SN 75-289,457. STONE INTERNATIONAL, LLC, TAYLORS, SC. BY ASSIGNMENT; BY ASSIGNMENT UMBRO INTERNATIONAL, INC., GREENVILLE, SC. FILED 5-9-1997.

ALMOST PERFECT

FOR IRREGULAR BOXER SHORTS (U.S. CLS. 22 AND 39).
FIRST USE 6-0-1999; IN COMMERCE 6-0-1999.

SN 75-434,428. ZEELANDER, INC., LOS ANGELES, CA. FILED 2-13-1998.



FOR CASUAL CLOTHING, NAMELY, CASUAL SHIRTS, CASUAL PANTS, JEANS, CASUAL SPORT COATS, CASUAL SWEATERS, SHORTS; CASUAL OUTERWEAR, NAMELY, ANORAKS, CASUAL JACKETS AND CASUAL COATS; AND CASUAL SPORTSWEAR, NAMELY, RUNNING SUITS, SWEAT SHIRTS AND SWEAT PANTS (U.S. CLS. 22 AND 39).
FIRST USE 0-0-1976; IN COMMERCE 0-0-1976.

CLASS 25—(Continued).

SN 75-452,068. EDGE ENTERPRISES, INC., BATON ROUGE, LA. FILED 3-18-1998.



NO CLAIM IS MADE TO THE EXCLUSIVE RIGHT TO USE "GEAR CLOTHING", APART FROM THE MARK AS SHOWN.
FOR CLOTHING, NAMELY, T-SHIRTS, SHIRTS, SWEATSHIRTS, JACKETS, SHORTS, VESTS, PANTS, SKIRTS, HATS AND CAPS (U.S. CLS. 22 AND 39).

SN 75-473,084. HARLEM HIGH INC., NEW YORK, NY. FILED 4-23-1998.

HARLEM HIGH

FOR T-SHIRTS, SWEATSHIRTS AND HEADWEAR (U.S. CLS. 22 AND 39).
FIRST USE 1-29-1997; IN COMMERCE 2-0-1997.

SN 75-650,819. BC&C APPAREL, INC., SANTA BARBARA, CA. BY ASSIGNMENT COTTON, JOEDY, SANTA BARBARA, CA. AND BYNUM, W. BLAINE, SANTA BARBARA, CA. FILED 2-26-1999.



FOR CLOTHING FOR MEN AND WOMEN, NAMELY HATS, CAPS, SHIRTS, TEE-SHIRTS, SWEATERS, SWEATSHIRTS, SWEAT PANTS, JEANS, SHORTS, JACKETS, UNDERWEAR, BOXER SHORTS, BRIEFS, AND LINGERIE (U.S. CLS. 22 AND 39).

SN 75-818,088. TULCHAN GROUP LIMITED, THE, CARNFORTH LANCASHIRE, ENGLAND, FILED 10-8-1999.

JUMPER

OWNER OF U.S. REG. NO. 1,821,410.
FOR CLOTHING, NAMELY, SWEATERS, T-SHIRTS, SWEATSHIRTS, BLOUSES, SHIRTS, SKIRTS, TROUSERS, JACKETS, SCARVES, NECKERCHIEFS, WRAPS, TIGHTS AND GLOVES; HEADWEAR; AND FOOTWEAR, NAMELY SOCKS (U.S. CLS. 22 AND 39).

CLASS 25—(Continued).

SN 75-823,436. KING PAR CORPORATION, FLUSHING, MI.
FILED 10-15-1999.

INTECH

FOR CLOTHING, NAMELY, GOLF HATS, GOLF RAIN
SUITS AND GOLF SWEATERS (U.S. CLS. 22 AND 39).
FIRST USE 12-1-1995; IN COMMERCE 12-1-1995.

SN 75-885,504. DECIPHER, INC., NORFOLK, VA. FILED 1-7-
2000.

**REAL BOYS. FOR REAL
GIRLS.**

FOR CLOTHING, NAMELY, SHIRTS, BLOUSES,
PANTS, SWEATERS, HATS, CAPS, EARMUFFS,
GLOVES, MITTENS, SCARVES, COATS, SWEATSHIRTS,
SOCKS, SHORTS, UNDERWEAR, SKIRTS, SKORTS,
SUITS, TIES, BATHING SUITS, NECKTIES, BOW TIES,
JACKETS, DRESSES, FOOTWEAR, BANDANNAS,
GOWNS, PAJAMAS, ROBES, LEGGINGS, LOUNGE-
WEAR, SKI WEAR, SHOES, VESTS, BEACHWEAR,
HOSIERY, VISORS (U.S. CLS. 22 AND 39).

SN 75-932,154. ELECTRIC VISUAL EVOLUTION, LLC, SAN
CLEMENTE, CA. FILED 3-2-2000.

ELECTRIC

FOR CLOTHING, HEADWEAR AND FOOTWEAR,
NAMELY, T-SHIRTS, PANTS, SHIRTS, JACKETS,
SWEATSHIRTS, SWEAT PANTS, JACKETS, HATS, CAPS,
SHOES, SOCKS AND COATS; SURFWEAR, NAMELY,
SURF TRUNKS; SKI CLOTHING, NAMELY, SKI PANTS,
SKI VESTS AND JACKETS (U.S. CLS. 22 AND 39).

SN 76-094,821. GIBSON, ANN SERGEANT, MILFORD, OH.
AND GIBSON, JEFFREY G., MILFORD, OH. FILED 7-21-
2000.



BARNWARE

FOR MENS', WOMEN'S AND CHILDREN'S CLOTH-
ING, NAMELY, CAPS, HATS, SHIRTS, SWEATERS,
JACKETS, PANTS, OVERALLS, SWEATSHIRTS, T-
SHIRTS AND VESTS (U.S. CLS. 22 AND 39).

CLASS 25—(Continued).

SN 76-170,451. THE SIMON PARTNERSHIP, GRAND
FORKS, BRITISH COLUMBIA, CANADA, FILED 11-24-
2000.



PRIORITY CLAIMED UNDER SEC. 44(D) ON CANADA
APPLICATION NO. 1,060,636, FILED 5-24-2000, REG. NO.
574,212, DATED 1-22-2003, EXPIRES 1-22-2018.

FOR T-SHIRTS, VESTS, JACKETS, SWEAT TOPS AND
SHIRTS, SWEAT PANTS, CARGO PANTS, SPORTS
SHORTS, CAPS (U.S. CLS. 22 AND 39).

SN 76-195,258. SIERRA PACIFIC APPAREL, LP., HOUSTON,
TX. FILED 1-18-2001.

SIERRA PACIFIC CLASSIC

OWNER OF U.S. REG. NO. 1,317,049.
NO CLAIM IS MADE TO THE EXCLUSIVE RIGHT TO
USE "CLASSIC", APART FROM THE MARK AS SHOWN.
FOR CLOTHING NAMELY, MEN'S AND WOMEN'S
DRESS SHIRTS (U.S. CLS. 22 AND 39).

SN 76-195,259. SIERRA PACIFIC APPAREL, LP., HOUSTON,
TX. FILED 1-18-2001.

**SIERRA PACIFIC
OUTDOORS**

OWNER OF U.S. REG. NO. 1,317,049.
NO CLAIM IS MADE TO THE EXCLUSIVE RIGHT TO
USE "OUTDOORS", APART FROM THE MARK AS SHOWN.
FOR CLOTHING NAMELY, MEN'S JACKETS, PULL-
OVERS, VESTS (U.S. CLS. 22 AND 39).

CLASS 25—(Continued).

SN 76-251,056. AMERICAN SPORTING GOODS CORPORATION, IRVINE, CA. FILED 5-7-2001.

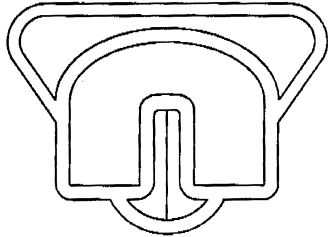

THE MARK CONSISTS OF THE STYLIZED LETTER "N" AND A TRIANGLE DESIGN.
FOR FOOTWEAR (U.S. CLS. 22 AND 39).
FIRST USE 12-1-1999; IN COMMERCE 12-1-1999.

SN 76-257,900. NEOPETS, INC., GLENDALE, CA. BY CHANGE OF NAME NEOPETS.COM, INC., GLENDALE, CA. FILED 5-11-2001.

NEOPETS

OWNER OF U.S. REG. NO. 2,423,197.
FOR CLOTHING, FOOTWEAR, HEADGEAR: NAMELY, SHIRTS, T-SHIRTS, SWEATSHIRTS, SWEATERS, BLOUSES, TANK TOPS, UNDERSHIRTS, JACKETS, COATS, DRESSES, SKIRTS, SHORTS, PANTS, JEANS, OVERALLS, SWEAT PANTS, UNDERWEAR, BOXERS, BRIEFS, PANTIES, SWIM WEAR, BATHING SUITS, NIGHTSHIRTS, ROBES, NIGHTGOWNS, PAJAMAS, TIGHTS, LEGGINGS, LEG WARMERS, NECKTIES, BOWTIES, ASCOTS, POCKET SQUARES, SCARVES, GLOVES, MITTENS, WRIST BANDS, BELTS, SASHES, SOCKS, SHOES, BOOTS, ATHLETIC SHOES, SLIPPERS, HATS, CAPS, HEAD BANDS, VISORS, HOODS, INFANTWEAR, BOOTIES, PLASTIC BABY BIBS, AND PLAY SUITS (U.S. CLS. 22 AND 39).
FIRST USE 1-24-2001; IN COMMERCE 1-24-2001.

SN 76-275,802. FOX RACING, INC., MORGAN HILL, CA. FILED 6-21-2001.

SHIFTMX

FOR CLOTHING, NAMELY, JACKETS, RAINCOATS, SWEATSHIRTS, JERSEYS, SHIRTS, BLOUSES, PANTS, TIGHTS, SHORTS, HATS, CAPS, SWEATBANDS, HEADBANDS, GLOVES, BELTS, SHOES, BOOTS, SOCKS, APRONS (U.S. CLS. 22 AND 39).

CLASS 25—(Continued).

SN 76-278,120. SHINJO, TSUYOSHI, NEW YORK, NY. FILED 6-28-2001.

SHINJO 5

FOR CLOTHING NAMELY, JERSEYS, T-SHIRTS, SWEATSHIRTS, SWEAT PANTS, WRIST BANDS, SPORT SHIRTS, JACKETS, PANTS, SHORTS, CAPS, HATS, HEADBANDS, SOCKS AND TANK TOPS (U.S. CLS. 22 AND 39).

SN 76-278,122. SHINJO, TSUYOSHI, NEW YORK, NY. FILED 6-28-2001.

SHINJO

FOR CLOTHING NAMELY, JERSEYS, T-SHIRTS, SWEATSHIRTS, SWEAT PANTS, WRIST BANDS, SPORT SHIRTS, JACKETS, PANTS, SHORTS, CAPS, HATS, HEADBANDS, SOCKS AND TANK TOPS (U.S. CLS. 22 AND 39).

SN 76-295,560. BENETTON GROUP S.P.A., TREVISO, ITALY, FILED 8-6-2001.



PRIORITY CLAIMED UNDER SEC. 44(D) ON ITALY APPLICATION NO. TV2001C00008, FILED 2-20-2001, REG. NO. 848691, DATED 7-24-2001, EXPIRES 2-20-2011.

FOR CLOTHING, NAMELY, SHIRTS, POLO SHIRTS, PULLOVERS, WAISTCOATS, TROUSERS, GAITERS, LEGGINGS, SUSPENDERS, BANDANAS, EAR FLAPS, SUN VISORS, JERKINS, MITTENS, TANK TOPS, CARDIGANS, JUMPERS, BATHING SUITS, BATH ROBES, NIGHTGOWNS, UNDERWEAR, PAJAMAS, PANTYHOSE, SLIPS, PETTICOATS, BODY SUITS, BRAS, CAMISOLES, CORSETS, JACKETS, WIND RESISTANT JACKETS, FOULARDS, HATS, CAPS, BERETS, PANTS, VESTS, TIES, SWEATERS, SHORTS, T-SHIRTS, BLOUSES, SKIRTS, SLACKS, DRESSES, JUMPSUITS, JEANS, BLAZERS, COATS, RAINCOATS, SOCKS, STOCKINGS, SCARVES, BELTS, GLOVES; SHOES, BOOTS, SLIPPERS, SANDALS (U.S. CLS. 22 AND 39).

CLASS 25—(Continued).

SN 76-312,298. PLAYTEX MARKETING CORPORATION, NEW YORK, NY. FILED 9-14-2001.

PLAYTEX BODY ZEN

OWNER OF U.S. REG. NOS. 372,367, 1,479,747 AND OTHERS.
FOR BRAS AND PANTIES (U.S. CLS. 22 AND 39).

SN 76-322,302. RAMORI, INC., HERNDON, VA. FILED 10-9-2001.



FOR MENS, AND WOMEN'S, AND CHILDREN CLOTHING, NAMELY, SHIRTS, HATS, SOCKS, UNDERWEAR, HEADWEAR, PANTS, JACKETS, JEANS, SHORTS, T-SHIRTS, BELTS, HOODED SWEATSHIRTS, FLEECES, VESTS (U.S. CLS. 22 AND 39).

SN 76-330,768. RUSSELL ASSET MANAGEMENT, INC., WILMINGTON, DE. FILED 10-29-2001.

RUSSELL ATHLETIC POWER

OWNER OF U.S. REG. NOS. 1,932,436, 2,591,125 AND OTHERS.

FOR SPORTSWEAR AND ACTIVEWEAR FOR MEN, WOMEN AND CHILDREN, NAMELY, WIND SUITS, TUNICS, PANTS, TOPS, T-SHIRTS, TANK-TOPS, SHIRTS, SHORTS, ATHLETIC UNIFORMS, POLO SHIRTS, SPORTS BRAS, ATHLETIC JERSEYS, PARKAS AND SOCKS, AND FLEECEWEAR, NAMELY, SWEAT-PANTS, SWEATSHIRTS, PULLOVER AND SHORTS, AND WOVENWEAR, NAMELY, JACKETS, SHIRTS, PANTS AND SHORTS (U.S. CLS. 22 AND 39).

CLASS 25—(Continued).

SN 76-335,864. NELSON, GUNNAR, CLEVELAND, OH. FILED 11-8-2001.

IT'S ALL ABOUT YOU

FOR ARTICLES OF CLOTHING, FOR MEN, WOMEN AND CHILDREN, NAMELY, PAJAMAS, NIGHT-SHIRTS, ROBES, JOGGING SUITS, SWEATSUITS, T-SHIRTS, SWEATSHIRTS, JERSEYS, TANK TOPS, COLLAR SHIRTS, BLOUSES, SHORTS, PANTS, JUMPERS, OVERALLS, ROMPERS, LEOTARDS, DRESSES, SKIRTS, SHORT SETS COMPRISED OF SHORTS AND TOPS, SWEATERS, JACKETS, COATS, RAINCOATS, SCARVES, BANDANNAS, UNDERWEAR, VESTS, CLOTH BIBS FOR INFANTS AND CHILDREN, TIES, BELTS AND SUSPENDERS, SOCKS, TIGHTS, LEGGINGS, HOSIERY, GLOVES, MITTENS, APRONS, SWIMSUITS, KNITTED HEADWEAR, HATS, CAPS AND VISORS; FOOTWEAR AND MASQUERADE COSTUMES (U.S. CLS. 22 AND 39).

SN 76-339,500. MACK, PAUL A., INKSTER, MI. FILED 11-19-2001.

FEDI

FOR APPAREL, NAMELY SHIRTS, PANTS, JACKETS, SWEAT SUITS AND HATS (U.S. CLS. 22 AND 39).
FIRST USE 3-30-2000; IN COMMERCE 3-30-2000.

SN 76-355,615. LARSEN, ARIC P., KANEHOE, HI. FILED 1-7-2002.

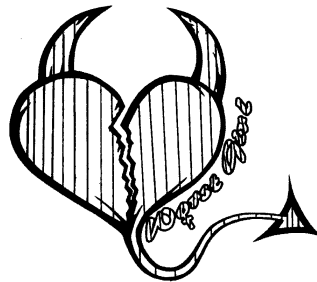

OWNER OF U.S. REG. NO. 2,394,927.

NO CLAIM IS MADE TO THE EXCLUSIVE RIGHT TO USE "GIRL", APART FROM THE MARK AS SHOWN.

THE MARK IS LINED FOR THE COLORS RED AND PINK. THE INSIDE OF THE HORNS, THE TAIL AND THE WORDS (WORST GIRL) ARE LINED FOR THE COLOR RED. THE INSIDE OF THE BROKEN HEART IS LINED FOR THE COLOR PINK.

FOR CLOTHING, NAMELY, SHIRTS, T-SHIRTS, SLEEVELESS T-SHIRTS, 3/4 SLEEVE SHIRTS, LONG SLEEVE SHIRTS, SWEAT SHIRTS, CASUAL SHIRTS, DRESS SHIRTS, POLO SHIRTS, TOPS, TANK TOPS, TUBE TOPS, HALTER TOPS, CAMISOLES, UNDERWEAR, PANTIES, THONGS, BRIEFS, BOXERS, SHORTS, JEAN SHORTS, CASUAL SHORTS, GYM SHORTS, SWEAT SHORTS, BIKINIS, THONG BIKINIS, PANTS, JEANS, CASUAL PANTS, RUNNING PANTS, SWEAT PANTS, DRESSES, SKIRTS, WRAPS, AND JACKETS; HEADWEAR, NAMELY, HATS, BASEBALL HATS, VISORS, BANDANAS, SKULL CAPS, AND BEANIES; AND FOOTWEAR, ALL FOR WOMEN (U.S. CLS. 22 AND 39).

FIRST USE 2-16-1998; IN COMMERCE 2-16-1998.

CLASS 25—(Continued).

SN 76-355,621. URGENT GEAR, INC., LOS ANGELES, CA. FILED 1-7-2002.

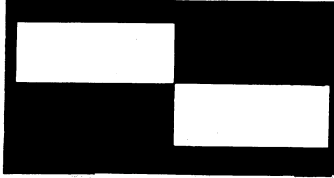

THE UPPER RIGHT AND LOWER LEFT QUADRANTS OF THE DESIGN ARE DARK NAVY BLUE. THE TOP AND BOTTOM WALLS OF THE DESIGN ARE ALSO DARK NAVY BLUE. THE UPPER LEFT AND LOWER RIGHT QUADRANTS OF THE DESIGN ARE WHITE. THE LEFT AND RIGHT WALLS OF THE DESIGN ARE RED.

FOR CLOTHING, NAMELY, TOPS, BOTTOMS, SHORTS, SHIRTS, AND PANTS (U.S. CLS. 22 AND 39). FIRST USE 3-0-1997; IN COMMERCE 3-0-1997.

SN 76-357,273. KVM INTERNATIONAL FASHIONS LTD., LOS ANGELES, CA. FILED 1-14-2002.

CHAUDRY

SEC. 2(F). FOR CLOTHING AND APPAREL FOR MEN, WOMEN AND CHILDREN, NAMELY JEANS, JACKETS, PANTS, T-SHIRTS, SWEATSHIRTS, ANORAKS, COATS, SHORTS, SOCKS, UNDERWEAR, HATS AND CAPS (U.S. CLS. 22 AND 39). FIRST USE 8-1-1999; IN COMMERCE 8-1-1999.

SN 76-373,043. NUNN RACING, LLC, INDIANAPOLIS, IN. FILED 2-20-2002.

MO NUNN RACING

FOR CLOTHING, NAMELY, SHIRTS, GOLF SHIRTS, T-SHIRTS, TANK TOPS, JACKETS, SWEATERS, SWEATSHIRTS, PANTS, SHORTS, PONCHOS, HATS, SUN VISORS, SHOES, AND BANDANAS (U.S. CLS. 22 AND 39).

SN 76-373,489. BOATRIGHT, DONALD J., JR., NASHVILLE, TN. FILED 2-25-2002.

BALLERS ONLY BO

FOR BANDANAS, BELTS, COATS, JACKETS, JEANS, SHIRTS, SOCKS, SUITS, SWEATERS, SWEATSHIRTS, T-SHIRTS (U.S. CLS. 22 AND 39).

CLASS 25—(Continued).

SN 76-381,015. GRABEBOOTIE, INC., ORLANDO, FL. FILED 3-12-2002.



FOR CLOTHING, NAMELY, SHIRTS, T-SHIRTS, SWEATSHIRTS, SINGLETS, TANK TOPS, COATS, JACKETS, SWEATERS, PULLOVERS, BELTS, SNEAKERS, BOOTS, SOCKS, UNDERGARMENTS, SHORTS, JEANS, CAPS, HATS AND VISORS (U.S. CLS. 22 AND 39). FIRST USE 3-1-2002; IN COMMERCE 3-1-2002.

SN 76-392,587. YOUNGONE NORTH AMERICAN LIAISON OFFICE, SEATTLE, WA. FILED 4-5-2002.

BROADPEAK

FOR JACKETS, VESTS PARKAS, PULLOVERS, ANORAKS, SHORTS, PANTS, SWEAT SUITS AND SKI BIBS (U.S. CLS. 22 AND 39).

SN 76-395,789. G. STAR APPAREL, INC., NEW YORK, NY. FILED 4-11-2002.

2B FREE

FOR CLOTHING, NAMELY SWEATERS, SWEATSHIRTS, JEANS, PANTS, SHORTS, T-SHIRTS, SHIRTS, TOPS, DRESSES, VESTS, JACKETS AND SKIRTS (U.S. CLS. 22 AND 39).

SN 76-404,207. JACK WHITE PRODUCTIONS USA INC, WOODLAND HILLS, CA. FILED 4-30-2002.

FIRSTLOVE

FOR T-SHIRTS AND HATS SOLD ONLY IN CONNECTION WITH A MUSICAL GROUP (U.S. CLS. 22 AND 39). FIRST USE 1-1-1997; IN COMMERCE 3-23-2000.

CLASS 25—(Continued).

SN 76-408,894. J.G. HOOK GROUP, LLC, NEW YORK, NY.
FILED 5-16-2002.

J.G. HOOK

THE NAME SHOWN IN THE TRADEMARK DOES NOT IDENTIFY A LIVING INDIVIDUAL.

FOR WOMEN'S SPORTSWEAR, NAMELY, CAREER AND CASUAL PANTS, SHORTS, BLAZERS, SKIRTS, SWEATERS, BLOUSES, KNIT TOPS AND SHIRTS; WOMEN'S DRESSES; WOMEN'S SUITS; WOMEN'S SWIMWEAR; WOMAN'S INTIMATES, NAMELY, BRAS, PANTIES, UNDERGARMENTS, LOUNGEWEAR AND SLEEPWEAR; WOMEN'S OUTERWEAR, NAMELY, WOOL COATS, LEATHER COATS, RAINWEAR AND JACKETS (U.S. CLS. 22 AND 39).

FIRST USE 1-0-1974; IN COMMERCE 7-0-1974.

SN 76-409,048. N.S.I. CORPORATION, NEW YORK, NY.
FILED 5-16-2002.

BABY BABE

FOR CLOTHING FOR TEENAGERS AND YOUNG WOMEN, NAMELY, T-SHIRTS, SWEATSHIRTS, SWEATPANTS, KNIT AND WOVEN SHIRTS, KNIT AND WOVEN PANTS, KNIT AND WOVEN SHORTS, JEANS, JACKETS, HATS, BELTS FOR CLOTHING AND SOCKS (U.S. CLS. 22 AND 39).

SN 76-412,426. WOLFORD AKTIENGESELLSCHAFT, A-6900
BREGENZ, AUSTRIA, FILED 5-24-2002.

INDIVIDUAL NATURE

PRIORITY CLAIMED UNDER SEC. 44(D) ON AUSTRIA APPLICATION NO. AM389/2002, FILED 1-22-2002, REG. NO. 203283, DATED 4-17-2002, EXPIRES 4-30-2012.

FOR ARTICLES OF CLOTHING, NAMELY, SHIRTS, TOPS, BODY SUITS, DRESSES, BRASSIERES, AND PANTIES (U.S. CLS. 22 AND 39).

SN 76-412,932. DANILO'R, INC., DBA POLECI, LOS ANGELES, CA. FILED 5-23-2002.

SYMMETRY

FOR CLOTHING, NAMELY, PANTS, TOPS, SKIRTS, SHIRTS, BLOUSES, DRESSES, JACKETS, COATS, SWEATERS, T-SHIRTS, TANK TOPS, AND CAMISOLES (U.S. CLS. 22 AND 39).

CLASS 25—(Continued).

SN 76-413,624. THURSDAY LLC, WHITEHOUSE STATION, NJ. FILED 5-29-2002.

THURSDAY

OWNER OF U.S. REG. NO. 2,482,453.
FOR CLOTHING, NAMELY, SHIRTS, T-SHIRTS, TANK TOPS, JERSEYS, JACKETS, AND SWEAT SHIRTS (U.S. CLS. 22 AND 39).

FIRST USE 12-1-1998; IN COMMERCE 12-1-1998.

SN 76-415,512. SAGINAW HOCKEY CLUB, LLC, SAGINAW, MI. FILED 6-5-2002.



THE DRAWING IS LINED FOR THE COLOR(S) RED AND BLUE.

FOR CLOTHING; NAMELY, SHIRTS, LONG-SLEEVED SHIRTS, THREE-QUARTER SLEEVED SHIRTS, T-SHIRTS, JERSEYS, SWEATERS, SWEATSHIRTS, JACKETS, PANTS, SWEATPANTS, WARM-UP SUITS, CHILDREN'S SWEATSHIRTS AND T-SHIRTS, WRISTBANDS, HEADBANDS, SHORTS, CAPS, SKI HATS, SCARVES, SOCKS, HATS, TANK TOPS, MITTENS, INFANT WEAR AND CLOTH BABY BIBS (U.S. CLS. 22 AND 39).

SN 76-417,353. DILLARD'S INC., LITTLE ROCK, AR. FILED 5-31-2002.

GLOVE FIT

FOR SHOES (U.S. CLS. 22 AND 39).
FIRST USE 10-0-2001; IN COMMERCE 10-0-2001.

CLASS 25—(Continued).

SN 76-418,061. LIPOSUR, S.L., 17220 SANT FELIU DE GUIXOLS (GIRONA), SPAIN, FILED 6-6-2002.



OWNER OF SPAIN REG. NO. 2414086, DATED 1-8-2002, EXPIRES 1-8-2012.

THE MARK CONSISTS OF A STYLIZED LETTER "Y" SUPERIMPOSED OVER THE LETTER "O" AND FOLLOWED BY THE LETTERS "KI".

FOR CLOTHING, NAMELY, SWEATERS, SHIRTS, BLOUSES, JACKETS, COATS, WIND RESISTANT JACKETS, TROUSERS, SKIRTS, DRESSES, SCARVES, GLOVES, STOCKINGS AND SOCKS; FOOTWEAR; AND HEADGEAR, NAMELY, CAPS AND HATS (U.S. CLS. 22 AND 39).

SN 76-419,650. BOOT ROYALTY COMPANY, L.P., FORT WORTH, TX. FILED 6-12-2002.

CHIP-A-TEX

FOR OUTSOLES FOR BOOTS (U.S. CLS. 22 AND 39).

SN 76-425,901. PLEASANT DREAMERS, INC., CENTERVILLE, OH. FILED 6-27-2002.

PLEASANT DREAMERS

FOR CLOTHING ARTICLES, NAMELY, PAJAMAS, SLEEPWEAR, LAYETTE SETS, ROBES, GOWNS, BED JACKETS, CHRISTENING GOWNS, BOXERS, BLOOMERS AND PANTS (U.S. CLS. 22 AND 39).

FIRST USE 4-0-2002; IN COMMERCE 4-0-2002.

SN 76-426,608. MENCANIN, STEVE, LAKE FOREST, CA. FILED 7-1-2002.

FATHEAD

FOR MEN'S AND WOMEN'S CLOTHING NAMELY, SHIRTS, SWEAT SHIRTS, T-SHIRTS, TANK TOPS, PANTS, SNOW PANTS, JACKETS, SPORT COATS, SHORTS, HATS AND BEANIES (U.S. CLS. 22 AND 39).

CLASS 25—(Continued).

SN 76-427,684. RICKETBALL, ELGIN, IL. FILED 7-1-2002.

RICKETBALL

FOR HEAD WEAR, DRESSES, SKIRTS, SUITS, SHIRTS, PANTS, SHOES, SWEATERS, LEATHER JACKETS, SOCKS, AND UNDERWEAR (U.S. CLS. 22 AND 39).

SN 76-431,354. SAN YUEH TEXTILE CO., LTD., CHANG HUA, TAIWAN, FILED 7-15-2002.

SOFIDRY

FOR DRESSES, BRASSIERES, SLEEPWEAR, BATH-ROBES, VESTS, COATS, SKIRTS, PANTS, BEACHWEAR, SWEATSHIRTS, GIRDLES, SWIMSUITS, CHILD GARMENTS, NAMELY SHIRTS, PANTS, OVERALLS, UNIFORMS, KNIT SHIRTS, T-SHIRTS, UNDERWEAR, UNDERWEAR (THERMAL), ATHLETIC UNIFORMS, JEANS AND SCARVES (U.S. CLS. 22 AND 39).

SN 76-432,973. ASHLEY NETTYE, INC., NEW YORK, NY. FILED 7-19-2002.



NO CLAIM IS MADE TO THE EXCLUSIVE RIGHT TO USE "COLLECTION", APART FROM THE MARK AS SHOWN.

FOR CLOTHING, NAMELY, SWIMWEAR, GLOVES, LINGERIE, HATS, BELTS, TIES, SCARVES, DRESSES, SWEATERS, SUITS, JEANS, TOPS, SHIRTS, SHORTS, AND SKORTS (U.S. CLS. 22 AND 39).

CLASS 25—(Continued).

SN 76-433,090. J H CALIFORNIA TRADING CO, LOS ANGELES, CA. FILED 7-22-2002.



FOR CLOTHING, NAMELY, SHIRTS, POLO SHIRTS, SWEATERS, JACKETS, PANTS, SHORTS, COATS, JOGGING SUITS, PAJAMAS, AND UNDERWEAR (U.S. CLS. 22 AND 39).

FIRST USE 1-1-2002; IN COMMERCE 1-1-2002.

CLASS 25—(Continued).

SN 76-436,551. KANG, CHIH-TSAO, ANAHEIM, CA. FILED 7-31-2002.



FOR BRAND NAME FOR SHIRTS, PANTS, SHOES (U.S. CLS. 22 AND 39).

SN 76-437,799. CALIFORNIA CONCEPTS, INC., GARDENA, CA. FILED 8-2-2002.

KAMA

FOR CLOTHING, NAMELY JACKETS, SWEATERS, VESTS, SWEAT SHIRTS, SWEAT PANTS, SHIRTS, BLOUSES, T-SHIRTS, PANTS, SHORTS, SKIRTS, SKORTS, DRESSES, SLEEPWEAR, SWIMWEAR, HATS AND SHOES (U.S. CLS. 22 AND 39).

SN 76-435,135. PADGETT, CLARENCE, JR., LAKEWOOD, CA. AND PADGETT, LAURA A., LAKEWOOD, CA. FILED 7-29-2002.

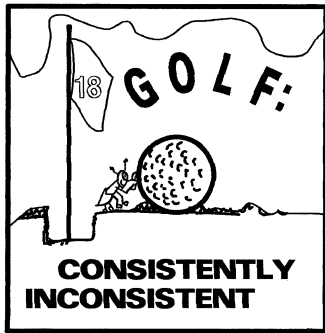

NO CLAIM IS MADE TO THE EXCLUSIVE RIGHT TO USE "GOLF", APART FROM THE MARK AS SHOWN.

FOR CAPS, VISORS, HATS, SHIRTS, HAT BANDS, T-SHIRTS, SWEAT SHIRTS, JACKETS, HEAD BANDS, JERSEYS, SWEAT BANDS, SWEAT SUITS, TANK TOPS, SUN VISORS, TIES, SPORT SHIRTS, SHORT SETS, TURTLENECK SWEATERS, VESTS, WRIST BANDS, UNIFORMS, MOCK TURTLENECK SWEATERS, SCARVES, PULLOVERS, SWEATERS, SLEEP SHIRTS, SASHES, RAINWEAR, V-NECK SWEATERS, ROBES, NECKWEAR, WIND SHIRTS, WRAPS, GYM SUITS, JUMPSUITS, DUSTERS (U.S. CLS. 22 AND 39).

SN 76-439,137. PHILADELPHIA 76ERS L.P., PHILADELPHIA, PA. FILED 8-9-2002.



OWNER OF U.S. REG. NOS. 849,181, 1,524,616 AND OTHERS.

THE STIPPLING IS FOR SHADING PURPOSES ONLY. SEC. 2(F) AS TO "PHILADELPHIA".

FOR CLOTHING, NAMELY HOSIERY, FOOTWEAR, BASKETBALL SHOES, BASKETBALL SNEAKERS, T-SHIRTS, SHIRTS, SWEATSHIRTS, SWEATPANTS, PANTS, TANK TOPS, JERSEYS, SHORTS, PAJAMAS, SPORT SHIRTS, RUGBY SHIRTS, SWEATERS, BELTS, TIES, NIGHTSHIRTS, HATS, WARM-UP SUITS, WARM-UP PANTS, WARM-UP TOPS, JACKETS, PARKAS, COATS, CLOTH BABY BIBS, HEAD BANDS, WRIST BANDS, APRONS, BOXER SHORTS, SLACKS, CAPS, EAR MUFFS, GLOVES, MITTENS, WOVEN AND KNIT SHIRTS (U.S. CLS. 22 AND 39).

CLASS 25—(Continued).

SN 76-441,185. MAGGY LONDON INTERNATIONAL, LTD., NEW YORK, NY. FILED 8-14-2002.

ANTHRACITE

FOR WOMEN'S APPAREL, NAMELY, PANTS, JACKETS, BLOUSES, DRESSES, SKIRTS, AND SHOES (U.S. CLS. 22 AND 39).

SN 76-441,513. CHOU, IOK HENG, TAIPA, MACAU, CHINA, FILED 8-19-2002.



"MENLOW" IN ITSELF MEAN "AVERAGE PEOPLE" IN CHINESE LANGUAGE.

FOR ATHLETIC SHOES, ATHLETIC UNIFORMS, BIKINIS, CAPS, COATS, GLOVES, HATS, JACKETS, JOGGING SUITS, OVERCOATS, SCARVES, SNEAKERS, SPORT SHIRTS, SWEAT SUITS, SWEATSOCKS, SWIMSUITS, TENNIS WEAR, T SHIRTS, WARM UP SUITS (U.S. CLS. 22 AND 39).

SN 76-443,670. THE TJX COMPANIES, INC., FRAMINGHAM, MA. FILED 8-26-2002.

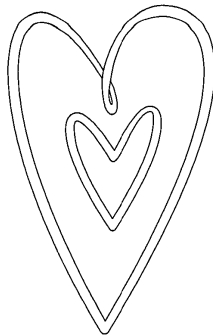

OWNER OF U.S. REG. NO. 2,676,861.
FOR CHILDREN'S CLOTHING, NAMELY, PANTS, SKIRTS, SWEATERS, TOPS, BLOUSES, SHIRTS, JACKETS, SOCKS, KNIT BOTTOMS, KNIT TOPS, AND VESTS (U.S. CLS. 22 AND 39).
FIRST USE 11-1-2001; IN COMMERCE 11-1-2001.

CLASS 25—(Continued).

SN 76-445,293. SAN SIMEON, INC., MANHATTAN BEACH, CA. FILED 8-29-2002.

SAMANTHA LOVE

THE NAME SHOWN IN THE MARK DOES NOT IDENTIFY ANY LIVING INDIVIDUAL.

FOR CLOTHING FOR WOMEN, AND CHILDREN, NAMELY, DRESSES, BLOUSES, TOPS, SKIRTS, PANTSUITS, SUITS, STOCKINGS, SHIRTS, JACKETS, SWEATERS, PANTS, FOOTWEAR, BELTS, T-SHIRTS, SOCKS, COORDINATED SHIRTS, JACKETS AND SLACKS, SWEAT SHIRTS, JERSEYS, SHORTS, JOGGING SUITS, SWEAT PANTS, HATS/CAPS, SCARVES, GLOVES, HOSIERY, NECKTIES, RAINWEAR, PAJAMAS, ROBES, AND NIGHT SHIRTS (U.S. CLS. 22 AND 39).

SN 76-446,183. CAPUCINE & CAPUCIN, INC., NEW YORK, NY. FILED 8-30-2002.

CAPUCINE & CAPUCIN

THE ENGLISH TRANSLATION OF THE WORDS "CAPUCINE" IN THE MARK IS "NASTURTIUM" AND "CAPUCIN" IS "CAPUCHIN".

FOR FOOTWEAR (U.S. CLS. 22 AND 39).
FIRST USE 6-0-2000; IN COMMERCE 8-0-2000.

SN 76-447,691. WIN WIN EXPORT/IMPORT, INC., S. EL MONTE, CA. FILED 9-6-2002.

SYBER

FOR ATHLETIC SHOES (U.S. CLS. 22 AND 39).
FIRST USE 3-1-2001; IN COMMERCE 3-1-2001.

CLASS 25—(Continued).

SN 76-447,692. CONAL INT'L TRADING CO., PASADENA, CA. FILED 9-6-2002.

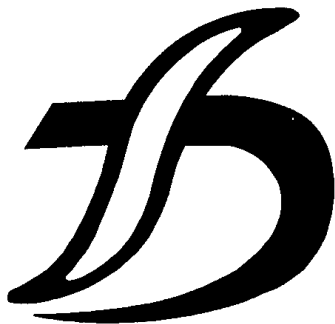

THE MARK CONSISTS OF AN IMAGE CONTAINING AN INVERTED "C" SHAPE INTERSECTED ON THE TOP BY A LINE THAT CURVES IN OPPOSITE DIRECTIONS AT THE TOP AND BOTTOM. THE TOP END OF THE "C" SHAPE MAINTAINS ITS WIDTH AND AT ITS END FORMS A DIAGONAL. THE BOTTOM END OF THE "C" SHAPE PROGRESSIVELY BECOMES THINNER UNTIL IT REACHES A POINTED END.

FOR SHOES (U.S. CLS. 22 AND 39).
FIRST USE 3-4-2002; IN COMMERCE 3-4-2002.

SN 76-450,412. SHARRON, LOWELL, SANTA MONICA, CA. FILED 9-13-2002.

SIX DEGREES

FOR APPAREL AND ACCESSORIES, NAMELY, PANTS, SHORTS, SKIRTS, T-SHIRTS, DRESSES, SPORT SHIRTS, BLOUSES, JACKETS, SWEATPANTS, SWEATSHIRTS, VESTS, SWEATERS, HATS, HEADBANDS AND SOCKS (U.S. CLS. 22 AND 39).

SN 76-451,102. BOB'S STORES CENTER, INC., MERIDEN, CT. FILED 9-16-2002.

BCC WORKWEAR

OWNER OF U.S. REG. NOS. 1,874,733 AND 1,938,457. NO CLAIM IS MADE TO THE EXCLUSIVE RIGHT TO USE "WORKWEAR", APART FROM THE MARK AS SHOWN.

FOR CLOTHING, NAMELY, TOPS AND BOTTOMS, OUTERWEAR, NAMELY, CAPS, JACKETS, AND PARKAS, AND FOOTWEAR (U.S. CLS. 22 AND 39).

CLASS 25—(Continued).

SN 76-451,842. CATFISH SOFTWARE, INC., SAN DIEGO, CA. FILED 9-23-2002.

CODERDOG

FOR CLOTHING, NAMELY, SHIRTS, T-SHIRTS, TANK TOPS, NIGHT SHIRTS, SWEATERS, SWEATSHIRTS, VESTS, JACKETS, COATS, TIES, BELTS FOR CLOTHING, PANTS, TROUSERS, SHORTS, BOXER SHORTS, SWEATPANTS, DRESSES, SKIRTS, SWIMWEAR, BOARD SHORTS, JOGGING SUITS, HOSIERY, SOCKS, BANDANAS, NECKERCHIEFS AND SCARVES, RAIN COATS, WIND-RESISTANT JACKETS, APRONS, BATH ROBES, CLOTH BABY BIBS, WET SUITS, GLOVES, MITTENS, HEADWEAR, NAMELY, HATS, CAPS, VISORS AND HEAD BANDS, AND FOOTWEAR, NAMELY ATHLETIC FOOTWEAR, CASUAL FOOTWEAR, BOOTS, SANDALS AND BEACH FOOTWEAR (U.S. CLS. 22 AND 39).

SN 76-456,308. FLORIDA GULF COAST UNIVERSITY BOARD OF TRUSTEES, FORT MYERS, FL. FILED 10-1-2002.



FOR MEN'S AND WOMEN'S CLOTHING, NAMELY, BALL CAPS, T-SHIRTS AND POLO SHIRTS (U.S. CLS. 22 AND 39).

FIRST USE 9-16-2002; IN COMMERCE 9-16-2002.

SN 76-456,328. ALFRED DUNNER, INC., NEW YORK, NY. FILED 9-27-2002.

ALFRED DUNNER

THE MARK DOES NOT IDENTIFY THE NAME OF A KNOWN LIVING INDIVIDUAL.

FOR WOMEN'S CLOTHING, NAMELY, SKIRTS, DRESSES, BLOUSES, T-SHIRTS, SWEATERS, JACKETS, BLAZERS, PANTS, SHORTS, VESTS AND COATS (U.S. CLS. 22 AND 39).

FIRST USE 0-0-1947; IN COMMERCE 0-0-1947.

CLASS 25—(Continued).

SN 76-457,834. PERLINS, MICHAEL A., CORONA, CA. AND BRACKETT, NICOLE D., CORONA, CA. AND SCOTT, MARY D., CORONA, CA. FILED 10-11-2002.

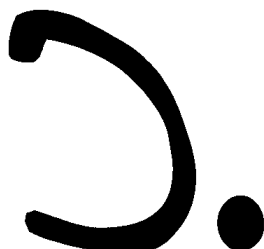

THE MARK CONSISTS OF A STYLIZED LETTER "C" TYPED BACKWARDS FOLLOWED BY A PERIOD.

FOR CLOTHING AND APPAREL FOR MEN, WOMEN, YOUNG ADULTS, CHILDREN AND INFANTS, NAMELY SHIRTS, EMBROIDERED SHIRTS, TEE SHIRTS, SHORTS, SPORT SHIRTS, SWEATSHIRTS, SWEATPANTS, LOUNGEWEAR, SLEEPWEAR, HATS (U.S. CLS. 22 AND 39).

SN 76-459,402. THE NOONAN GROUP, INC., LOS ANGELES, CA. FILED 10-15-2002.

NOM NAISSANCE ON MELROSE

THE ENGLISH TRANSLATION OF "NAISSANCE" IS "BIRTH".

FOR MATERNITY CLOTHING, NAMELY, PANTS, SKIRTS, DRESSES, BLOUSES, SHIRTS, SHORTS, JACKETS, T-SHIRTS, JEANS, BATHING SUITS, PAJAMAS, UNDERGARMENTS, AND INFANTWEAR (U.S. CLS. 22 AND 39).

FIRST USE 9-1-2002; IN COMMERCE 9-1-2002.

SN 76-459,673. HIRA COLLECTION INC., WALNUT, CA. FILED 10-21-2002.

HIRA

THE ENGLISH TRANSLATION OF THE INDIAN WORD "HIRA" IS "DIAMOND".

FOR EVENING GOWNS AND DRESSES; LEATHER COATS, JACKETS, PANTS, SKIRTS AND RIDING GLOVES; MEN'S SUITS AND TUXEDOS; CHILDREN'S CLOTHES, NAMELY, BOYS TUXEDOS, JACKETS AND SUITS, GIRLS EVENING, PROM, BRIDAL AND GRADUATION DRESSES AND GOWNS (U.S. CLS. 22 AND 39).

FIRST USE 10-13-1998; IN COMMERCE 10-13-1998.

CLASS 25—(Continued).

SN 76-459,866. MARLOW, NICK, DBA BETTY BELTS, BODEGA, CA. FILED 10-11-2002.

BETTY BELTS

NO CLAIM IS MADE TO THE EXCLUSIVE RIGHT TO USE "BELTS", APART FROM THE MARK AS SHOWN.

FOR BELTS (U.S. CLS. 22 AND 39).
FIRST USE 9-1-2002; IN COMMERCE 9-20-2002.

SN 76-460,186. DON JONATHAN CRAVATS, INC., ALPAR-ETTA, GA. FILED 10-22-2002.

Don Jonathan

THE NAME IN THE MARK DOES NOT IDENTIFY A LIVING INDIVIDUAL.

FOR CLOTHING, NAMELY, NECKWEAR, SCARVES, SOCKS, BOXER SHORTS, SHIRTS, GARMENT BELTS, SWEATERS, VESTS, PAJAMAS AND LINGERIE (U.S. CLS. 22 AND 39).

FIRST USE 6-23-1997; IN COMMERCE 6-23-1997.

SN 76-460,285. SYLVESTRE, WILTON S. JR., BROOKLYN, NY. FILED 10-15-2002.

L.E.A.G.U.E. ***EQUIPMENT*** F.S.P.O.

FOR CLOTHING, NAMELY, T-SHIRTS, LONG-SLEEVE T-SHIRTS, BASEBALL, FOOTBALL AND BASKETBALL JERSEYS, BASEBALL CAPS, SHORTS, SOCKS, SNEAKERS, HEADBANDS (U.S. CLS. 22 AND 39).

SN 76-460,447. INTERNATIONAL AID INC., SPRING LAKE, MI. FILED 10-22-2002.

INTERNATIONAL AID

OWNER OF U.S. REG. NO. 2,528,978.
FOR T-SHIRTS, SWEATSHIRTS, AND HATS (U.S. CLS. 22 AND 39).

FIRST USE 0-0-1995; IN COMMERCE 0-0-1995.

CLASS 25—(Continued).

SN 76-460,455. EYE CATCH, INC, MIAMI, FL. FILED 10-21-2002.

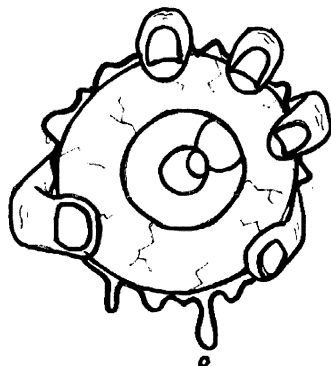

FOR PANTS, SHORTS, JACKETS, HATS, SHIRTS, SWEATERS, DRESSES, SKIRTS, TOPS, BELTS, LINGERIE AND UNDERWEAR (U.S. CLS. 22 AND 39).

SN 76-460,582. GRAJ + GUSTAVSEN, INC., NEW YORK, NY. FILED 10-16-2002.

AMALGAMATED SUPPLY CO.

OWNER OF U.S. REG. NOS. 1,886,158, 2,029,838 AND 2,292,978.

NO CLAIM IS MADE TO THE EXCLUSIVE RIGHT TO USE "SUPPLY CO.", APART FROM THE MARK AS SHOWN.

FOR MEN'S, WOMEN'S, AND CHILDREN'S WEARING APPAREL, NAMELY, SWEAT PANTS, SWEAT SHIRTS, FLEECE PANTS, JERSEY PANTS, BASEBALL CAPS, T-SHIRTS, PAJAMAS, UNION SUITS, UNDERWEAR, BOXER SHORTS, LONG UNDERWEAR, HATS, KNIT TOPS AND BOTTOMS, SLEEP SHIRTS AND SHORTS, TANK TOPS, THERMAL UNDERWEAR, OVERALLS, JUMPSUITS, WOVEN SHIRTS AND PANTS, SWEATERS, VESTS, SOCKS, SWIMSUITS, JACKETS, CAR COATS, PARKAS, SHOES, BOOTS, SLIPPERS, SCARVES, GLOVES, BELTS, SKIRTS, BLOUSES, DRESSES, SPORTS SHIRTS, AND POLO SHIRTS (U.S. CLS. 22 AND 39).

SN 76-460,924. GUMBERT, JERRY F., SIGEL, PA. FILED 10-18-2002.

GRIPTION

FOR FOOTWEAR (U.S. CLS. 22 AND 39).
FIRST USE 6-0-1999; IN COMMERCE 1-25-2002.

CLASS 25—(Continued).

SN 76-461,046. ANGIULI, FRANK, LOS ANGELES, CA. FILED 10-24-2002.

NATURAL HIGH

FOR CLOTHING, NAMELY, T-SHIRTS, LONG SLEEVE SHIRTS, SWEATSHIRTS, PANTS, SHORTS, AND SKIRTS (U.S. CLS. 22 AND 39).

FIRST USE 6-20-1998; IN COMMERCE 6-23-1998.

SN 76-473,851. NUCCI INTERNATIONAL CORP, NEW YORK, NY. FILED 12-11-2002.

VONDE

THE ENGLISH TRANSLATION OF "VONDE" IS "PAINFUL".

FOR CLOTHING, OUTERWARE AND UNDERWEAR NAMELY MEN'S AND CHILDREN'S SOCKS, PAJAMAS, SHORTS, SHIRTS, PANTS, SUITS, JACKETS, TIES, SWIMWARE, LADIES UNDERWEAR, BRAS, PAJAMAS, GOWNS, SKIRTS-AND DRESSES, NAMELY MEN'S AND WOMEN'S SHOES (U.S. CLS. 22 AND 39).

SN 76-473,874. NUCCI INTERNATIONAL CORP, NEW YORK, NY. FILED 12-11-2002.

MERKAZ

THE ENGLISH TRANSLATION OF "MERKAZ" IS "CENTER".

FOR CLOTHING, OUTERWARE AND UNDERWEAR NAMELY MEN'S AND CHILDREN'S SOCKS, PAJAMAS, SHORTS, SHIRTS, PANTS, SUITS, JACKETS, TIES, SWIMWARE, LADIES UNDERWEAR, BRAS, PAJAMAS, GOWNS, SKIRTS AND DRESSES, NAMELY MEN'S AND WOMEN'S SHOES (U.S. CLS. 22 AND 39).

SN 76-975,354. ASHLEY NETTYE, INC., NEW YORK, NY. FILED 7-19-2002.



NO CLAIM IS MADE TO THE EXCLUSIVE RIGHT TO USE "COLLECTION", APART FROM THE MARK AS SHOWN.

FOR PANTS, VESTS, SHIRTS, SKIRTS, AND BLAZERS (U.S. CLS. 22 AND 39).

FIRST USE 3-30-2002; IN COMMERCE 3-30-2002.

CLASS 25—(Continued).

SN 78-010,719. D.P. THAI TEES, INC., HONOLULU, HI. FILED 6-1-2000.

LOCAL SURF

NO CLAIM IS MADE TO THE EXCLUSIVE RIGHT TO USE "SURF", APART FROM THE MARK AS SHOWN.
FOR T-SHIRTS, SHIRTS, CAPS, SHORTS, PANTS, SWEAT SHIRTS, POLO SHIRTS, AND DRESSES (U.S. CLS. 22 AND 39).
FIRST USE 2-7-2003; IN COMMERCE 2-7-2003.

SN 78-010,823. SWENSON, JOY A, CARLIN, NV. FILED 6-1-2000.

MORE THAN MAINSTREET THUNDER IN THE HILLS

FOR CLOTHING, NAMELY, T-SHIRTS, HATS, BANDANAS, PANTS, GLOVES, BELTS, LINGERIE, SCARVES, SHOES, BOOTS, SHORTS, LEATHER COATS, LEATHER PANTS, LEATHER HATS, LEATHER VESTS, LEATHER GLOVES (U.S. CLS. 22 AND 39).

SN 78-014,494. THOMPSON, JR. GREEN T., WESTLAKE, LA. FILED 6-27-2000.

HONORARY CAJUN

FOR T-SHIRT (U.S. CLS. 22 AND 39).
FIRST USE 7-6-1999; IN COMMERCE 12-1-1999.

SN 78-034,115. LINCOLN, GARY, D., NEWPORT BEACH, CA. FILED 11-6-2000.

SCRIPTSHIRTS

FOR CLOTHING HAVING A SCRIPTURAL OR BIBLICAL THEME, NAMELY T-SHIRTS, SWEATSHIRTS, HATS, SOCKS, PANTS, DRESSES, AND FOOTWEAR (U.S. CLS. 22 AND 39).

SN 78-047,191. JONES, DAVID K., REDONDO BEACH, CA. FILED 2-8-2001.

FAT BASTARDS

FOR CLOTHING, NAMELY, SHIRTS, PANTS, SHORTS, SWEATSHIRTS; HEADWEAR; HATS; FOOTWEAR; SHOES (U.S. CLS. 22 AND 39).

CLASS 25—(Continued).

SN 78-051,918. DRIFT SURF, LLC, HONOLULU, HI. FILED 3-7-2001.



FOR SURFWEAR, NAMELY SURF TRUNKS AND BOARD SHORTS, AND SPORTSWEAR, NAMELY T-SHIRTS AND SHORTS (U.S. CLS. 22 AND 39).
FIRST USE 2-1-2001; IN COMMERCE 2-1-2001.

SN 78-065,905. SPORTS PHENOMS, INC., SAN FRANCISCO, CA. FILED S.R. 5-25-2001; AM. P.R. 4-29-2003.

PLAYGROUND LEGEND

FOR CLOTHING, NAMELY, SOCKS, ANKLETS, ATHLETIC FOOTWEAR, ATHLETIC SHOES, HEAD BANDS, SWEAT BANDS, WRIST BANDS, BATHING SUITS, BATHING TRUNKS, BATHROBES, BEACHWEAR, SHORTS, RAIN COATS, SPORT COATS, DUNGAREES, HATS, INFANT WEAR, WIND RESISTANT JACKETS, JEANS, JERSEYS, LEG WARMERS, LEGGINGS, OVERALLS, SWEAT PANTS, SHIRTS, SHORTS, JOGGING SUITS, SWEAT SUITS, WARM-UP SUITS, SWEATERS, SWIM WEAR, T-SHIRTS, TANK-TOPS, TENNIS WEAR, AND UNDERCLOTHES (U.S. CLS. 22 AND 39).

SN 78-071,377. RANGLES, DARLENE, MALIBU, CA. FILED 6-27-2001.

HULA GIRL

FOR CLOTHING, NAMELY, SHIRTS, SHORTS, PANTS, BEANIES, HATS, SOCKS, BATHING SUITS, TANK TOPS, TRUNKS, BELTS, SHOES, UNDERWEAR AND BRAS (U.S. CLS. 22 AND 39).

SN 78-086,661. SARA LEE CORPORATION, WINSTON-SALEM, NC. BY ASSIGNMENT SARAMAR, L.L.C., CHICAGO, IL. FILED 10-3-2001.

SMOOTH TONERS

OWNER OF U.S. REG. NOS. 1,773,668 AND 1,964,649.
FOR SHAPEWEAR, NAMELY, GIRDLES, THIGH SHAPERS, BODY SUITS, CONTROL BRIEFS, CONTROL SLIPS (U.S. CLS. 22 AND 39).
FIRST USE 3-15-2002; IN COMMERCE 3-15-2002.

CLASS 25—(Continued).

SN 78-097,489. TRAIL BLAZERS, INC., PORTLAND, OR. FILED 12-10-2001.



OWNER OF U.S. REG. NOS. 1,774,223, 1,892,082 AND OTHERS.

SEC. 2(F) AS TO "PORTLAND".

FOR CLOTHING, NAMELY HOSIERY, FOOTWEAR, BASKETBALL SHOES, BASKETBALL SNEAKERS, T-SHIRTS, SHIRTS, SWEATSHIRTS, SWEATPANTS, PANTS, TANK TOPS, JERSEYS, SHORTS, PAJAMAS, SPORT SHIRTS, RUGBY SHIRTS, SWEATERS, BELTS, TIES, NIGHTSHIRTS, HATS, WARM-UP SUITS, WARM-UP PANTS, WARM-UP TOPS, JACKETS, PARKAS, COATS, CLOTH BIBS, HEAD BANDS, WRIST BANDS, APRONS, BOXER SHORTS, SLACKS, CAPS, EAR MUFFS, GLOVES, MITTENS, WOVEN AND KNIT SHIRTS. (U.S. CLS. 22 AND 39).

SN 78-097,755. MYERS, RICHARD L., KING OF PRUSSIA, PA. FILED 12-11-2001.



FOR T-SHIRTS, HATS (U.S. CLS. 22 AND 39).

SN 78-105,143. BROWNE, ALAN J., VICTORVILLE, CA. AND BROWNE, DOREEN M., VICTORVILLE, CA. FILED 1-28-2002.

GOTTA PLAY!

FOR CLOTHING, NAMELY, HEADWEAR, T-SHIRTS, GOLF SHIRTS, SWEAT PANTS, AND BALL CAPS (U.S. CLS. 22 AND 39).

FIRST USE 3-5-1998; IN COMMERCE 1-30-2002.

CLASS 25—(Continued).

SN 78-106,108. JOANNA, BELL, WESTPORT, CT. FILED 1-31-2002.

CASED

FOR SHIRTS, BLOUSES, PANTS, SKIRTS, SHORTS, DRESSES, COATS, VESTS, JACKETS, SHOES, SOCKS, BEACHWEAR, BELTS, BOOTS, BRIEFS, BUSTIERS, CAPS, CLOGS, SCARFS, HATS, CAPS, BEANIES, JUMPSUITS, OVERALLS, APRONS, BODY SUITS, SHAWLS, GLOVES, INFANT WEAR, MITTENS, MUFFLERS, NECKWEAR, NIGHTGOWNS, PANTIES, PANTYHOSE, PARKAS, SKI WEAR, TUNICS, UNDERWEAR (U.S. CLS. 22 AND 39).

SN 78-111,358. WEAR ME APPAREL, NEW YORK, NY. FILED 2-27-2002.

SUGAR SWEET

FOR CLOTHING AND ACCESSORIES, NAMELY, BOTTOMS, PANTS, PANTSUITS, SWEATPANTS, SHORTS, SHORT SETS, SKIRTS, TOPS, DRESSES, SHIRTS, T-SHIRTS, SWEAT SHIRTS, SWEAT SUITS, BLOUSES, SWEATERS, JACKETS, JUMPERS, TIGHTS, SOCKS, BABY BOOTIES, COVERALLS, VESTS, CREEPER SETS, JUMPSUITS, ROMPERS, WINDSUITS, JACKET SETS AND COORDINATED TWO AND THREE PIECE PLAYSUITS, COATS, HATS, CAPS, BEACHWEAR, RAINWEAR, GLOVES, BANDANAS, HEADWEAR, UNDERCLOTHES, FOOTWEAR, INFANTWEAR, SLEEPWEAR (U.S. CLS. 22 AND 39).

FIRST USE 12-27-2001; IN COMMERCE 12-27-2001.

SN 78-113,166. COLOSSEUM ATHLETICS CORPORATION, GARDENA, CA. FILED 3-7-2002.

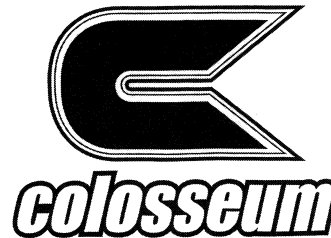

FOR CLOTHING, NAMELY MEN'S, INFANT'S, TODDLER'S, BOY'S, AND YOUTH'S HEADWEAR, HATS, CAPS, JERSEYS, T-SHIRTS, TANK TOPS, WOVEN SHIRTS, CARDIGANS, VESTS, JACKETS, COATS, PANTS, SWEATERS, SHIRTS, SWEATPANTS, SHORTS, SHOES, SOCKS, GLOVES, AND UNDERWEAR; AND WOMEN'S, INFANT'S, TODDLER'S, AND GIRL'S WEARING APPAREL, NAMELY T-SHIRTS, SWEATSHIRTS, JERSEYS, TANK TOPS, WOVEN SHIRTS, SWEATERS, CARDIGANS, VESTS, JACKETS, COATS, PANTS, SWEATPANTS, SHORTS, SKIRTS, DRESSES, BLOUSES, HATS, CAPS, HEADWEAR, GLOVES, COATS, SHOES, SOCKS, AND UNDERWEAR (U.S. CLS. 22 AND 39).

FIRST USE 12-1-1992; IN COMMERCE 12-1-1992.

CLASS 25—(Continued).

SN 78-113,184. TRICKLE,TODD, W, CHANDLER, AZ. FILED 3-7-2002.

SYVEN

FOR ICE AND ROLLER HOCKEY PANTS, ICE AND ROLLER HOCKEY JERSEYS, ICE AND ROLLER HOCKEY T-SHIRTS; PAINTBALL PANTS; PAINTBALL JERSEYS; PAINTBALL SHOES; PAINTBALL T-SHIRTS; LACROSSE PANTS; LACROSSE JERSEYS; AND LACROSSE SHOES (U.S. CLS. 22 AND 39).

SN 78-114,803. ORGUYO, INC., WESTWOOD, KS. FILED 3-14-2002.

ORGUYO

A SPANGLISH SPELLING OF THE WORD "LATINO PRIDE" IN SPANISH.

FOR MEN'S AND BOYS CLOTHING, NAMELY, JEANS, KHAKIS, URBAN HIP/HOP PANTS, SHORTS, POLO SHIRTS, SWEATERS, JACKETS, VESTS, LONG SLEEVE SHIRTS, SHORT SLEEVE SHIRTS, SHORT SLEEVE T-SHIRTS, LONG SLEEVE T-SHIRTS; SLEEVELESS/MUSCLE T-SHIRTS, HOODED JACKETS, SWEATSHIRTS, SWEATPANTS, PAJAMA BOTTOMS, SWIMWEAR, BOXERS, UNDERWEAR, ATHLETIC SOCKS, HATS, CAPS; WOMEN'S AND GIRLS CLOTHING, NAMELY, JEANS, STRETCH PANTS, URBAN HIP/HOP PANTS, SAILOR PANTS, SHORTS, DRESSES, SKIRTS, MINISKIRTS, SWEATERS, CAPES, JACKETS, VESTS, LONG SLEEVE SHIRTS, SHORT SLEEVE SHIRTS, NET SHIRTS, STRETCH CHAMIS, BLOUSES, LACE JERSEYS, MATTED JERSEYS, SHORT SLEEVE BELLY SHIRTS, HOODED JACKETS, SWEATSHIRTS, SWEATPANTS, BODY SUITS, PAJAMA BOTTOMS, SWIMWEAR, PANTIES, BRAS, CORSETS, BUSTIERS, ATHLETIC SOCKS, HATS, CAPS, BERETS; FOOTWEAR, NAMELY, SNEAKERS, SHOES, SANDALS; BABY CLOTHES, NAMELY, T-SHIRTS AND PAJAMAS, ACCESSORIES, NAMELY, GLOVES, SCARVES, AND BELTS (U.S. CLS. 22 AND 39).

SN 78-115,324. REQUIRED, INC., CARSON CITY, NV. FILED 3-15-2002.

REQUIRED CLOTHING

NO CLAIM IS MADE TO THE EXCLUSIVE RIGHT TO USE "CLOTHING", APART FROM THE MARK AS SHOWN.

FOR MEN'S, WOMEN'S AND CHILDREN'S CLOTHING, NAMELY, SWEATSHIRTS, SWEATPANTS, SWEATERS, SHIRTS, JEANS, JACKETS, COATS, SLACKS, SUITS, HATS, HEADBANDS, VISORS, CAPS, DRESSES, SHOES, SNEAKERS, BOOTS, WRISTBANDS, SOCKS, T-SHIRTS, BELTS, UNDERGARMENTS, NECKTIES, DRESS SHIRTS, COLLARED SHIRTS, RUGBY SHIRTS, TIES, KNIT SHIRTS, SHORTS, AND SANDALS. (U.S. CLS. 22 AND 39).

CLASS 25—(Continued).

SN 78-117,637. GARDNER, JAMES, L., JR., HANFORD, CA. FILED 3-26-2002.



NO CLAIM IS MADE TO THE EXCLUSIVE RIGHT TO USE "RACE", APART FROM THE MARK AS SHOWN.

FOR SHIRTS, HATS, PANTS, JACKETS, SWEATSHIRTS (U.S. CLS. 22 AND 39).

SN 78-121,142. S & D MENSWEAR, INC., BROOKLYN, NY. FILED 4-11-2002.

ASCENTIALS

FOR CLOTHING, NAMELY, SHIRTS, PANTS, SHORTS, JACKETS, SHOES, BOOTS, SANDALS, BELTS, UNDERWEAR, HEADWEAR, AND SCARVES. (U.S. CLS. 22 AND 39).

SN 78-126,144. SECRET BEACH CORP., HONOLULU, HI. FILED 5-3-2002.

SECRET BEACH

FOR CLOTHING, NAMELY, SWIMSUITS, SWIMWEAR, WET SUITS, BIKINIS, LINGERIE, BRAS, UNDERWEAR, FOOTWEAR, SHIRTS, SHORTS, PANTS, T-SHIRTS, TOPS, SKIRTS, DRESSES, SARONGS, SLIPPERS, CAPS, BEACHWEAR, BEACH-COVERUPS (U.S. CLS. 22 AND 39).

SN 78-127,487. KOPP, BRYAN, M, CINCINNATI, OH. FILED 5-9-2002.

OLD PAPPY'S MOTORWEAR

NO CLAIM IS MADE TO THE EXCLUSIVE RIGHT TO USE "MOTORWEAR", APART FROM THE MARK AS SHOWN.

FOR CLOTHING FOR MOTORCYCLE RIDERS, NAMELY, T-SHIRTS (U.S. CLS. 22 AND 39).

FIRST USE 3-10-2002; IN COMMERCE 5-9-2002.

CLASS 25—(Continued).

SN 78-129,937. MOTIWALA, FAWAD, NORTH SALT LAKE, UT. FILED 5-20-2002.

STYLO DNM ENGINEERING

NO CLAIM IS MADE TO THE EXCLUSIVE RIGHT TO USE "DNM", APART FROM THE MARK AS SHOWN.

FOR MEN'S, WOMEN'S AND CHILDREN'S CLOTHING, NAMELY T-SHIRTS, TANK TOPS, JACKETS, JERSEYS, SHORTS, PANTS, SWEATSHIRTS, SWEAT PANTS, HEAD WEAR, FOOTWEAR, SANDALS, SNEAKERS, BOOTS, SHOES, SOCKS, DRESSES, LEOTARDS, BELTS, UNDERGARMENTS (U.S. CLS. 22 AND 39).

SN 78-130,352. HARARI, DAVID R., NEW YORK, NY. FILED 5-21-2002.

STADUS

FOR MENS, LADIES AND CHILDRENS APPAREL, NAMELY, SHIRTS, PANTS, JEANS, OUTERWEAR, NAMELY, COATS, JACKETS, ACTIVEWEAR, NAMELY, JOGGING SUITS, SHORTS, DENIM AND LEATHER GARMENTS, NAMELY, PANTS, JACKETS, FOOTWEAR, FORMALWEAR, NAMELY, TUXEDOS, AND UNDER GARMENTS (U.S. CLS. 22 AND 39).

CLASS 25—(Continued).

SN 78-130,704. PACIFIC SUNWEAR OF CALIFORNIA, ANAHEIM, CA. FILED 5-23-2002.

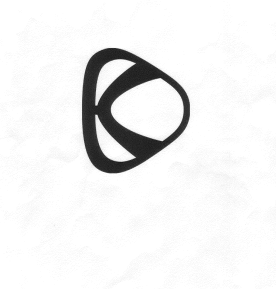

FOR MEN, WOMEN AND CHILDREN'S APPAREL, NAMELY, HATS, CAPS, VISORS, HOODS, BERETS, HEAD BANDS, SWEAT BANDS, EAR MUFFS, GLOVES, MITTENS, WRIST BANDS, SUSPENDERS, BELTS, SOCKS, STOCKINGS, PANTYHOSE, BODYSUITS, LEOTARDS, LEGGINGS, SWEAT SOCKS, THERMAL SOCKS, SHOES, SNEAKERS, GALOSHES, WADERS, BOOTS, SANDALS, SLIPPERS, KERCHIEFS, SCARVES, MUFFLERS, BANDANNAS, NECKERCHIEFS, VESTS, PAJAMAS, ROBES, KIMONOS, CAFTANS, SMOCKS, APRONS, BOXER SHORTS, BRIEFS, UNDERPANTS, CORSETS, CORSELETS, GIRDLES, BRASSIERES, BUSTIERS, CHEMISES, TEDDIES, CAMISOLES, SLIPS, NEGLIGENCES, PEIGNOIRS, SHIRTS, BLOUSES, KNIT TOPS, DRESSES, SKIRTS, JUMPSUITS, PANT SUITS, ROMPERS, SWIMMING TRUNKS, WET SUITS, THERMAL UNDERWEAR, UNDERSHIRTS, TUNICS, TANK TOPS, COTTON WOVEN SHIRTS, KNIT SHIRTS, POLO SHIRTS, T-SHIRTS, SWEAT SHIRTS, CREW NECK SWEATERS, V-NECK SWEATERS, TURTLENECK SWEATERS, CARDIGANS, SUITS, JOGGING SUITS, SHORTS, SWEAT SHORTS, JEANS, PANTS, SLACKS, TROUSERS, SWEAT PANTS, SKI SUITS, SKI PANTS, SKI BIBS, CAPES, SHAWLS, BLAZERS, WAISTCOATS, RAIN COATS, OVERCOATS, TOP COATS, SPORT COATS, PARKAS, BOLERO JACKETS, JACKETS, WIND RESISTANT JACKETS, OUTER JACKETS, LEATHER JACKETS, SKI JACKETS, FLANNEL JACKETS, WOOL JACKETS, POLYESTER WOVEN SHIRTS, RAYON WOVEN SHIRTS, WOOL WOVEN SHIRTS, LEATHER COATS, ELASTIC WAIST SHORTS, FIXED WAIST SHORTS, DENIM SHORTS, AND DENIM JACKETS (U.S. CLS. 22 AND 39).

FIRST USE 1-16-2002; IN COMMERCE 1-16-2002.

SN 78-140,542. SADITYJEANS, MODESTO, CA. FILED 7-2-2002.

FOR PRIVATE LABEL CLOTHING LINE, NAMELY, KNIT SHIRTS, PANTS, SHIRTS, DRESSES, SKIRTS; SHOES, JACKETS, LINGERIE, AND HATS, LEATHER COATS (U.S. CLS. 22 AND 39).

CLASS 25—(Continued).

SN 78-143,076. KABUSHIKI KAISHA BIG JOHN, TA BIG JOHN CORPORATION, KURASHIKI-CITY, JAPAN, FILED 7-11-2002.

GLHEART

FOR JEANS AND PANTS (U.S. CLS. 22 AND 39).
FIRST USE 10-18-1991; IN COMMERCE 10-18-1991.

CLASS 25—(Continued).

SN 78-149,459. CHARLOTTE HORNETS NBA LIMITED PARTNERSHIP, CHARLOTTE, NC. FILED 7-31-2002.



SN 78-143,855. ROWE, TRACY, M, SULLIVAN, IL. FILED 7-15-2002.

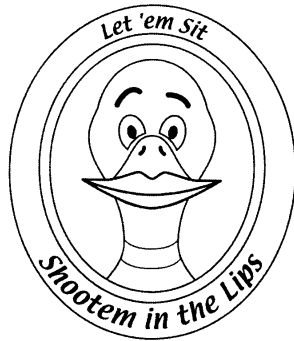

FOR CLOTHING, NAMELY, FOOTWEAR, HEADWEAR, SHIRTS, SOCKS, SHOES, HATS, PANTS, SHORTS, AND UNDERGARMENTS (U.S. CLS. 22 AND 39).

OWNER OF U.S. REG. NOS. 1,649,760, 1,658,538 AND OTHERS.

NO CLAIM IS MADE TO THE EXCLUSIVE RIGHT TO USE "NEW ORLEANS", APART FROM THE MARK AS SHOWN.

FOR CLOTHING, NAMELY HOSIERY, FOOTWEAR, BASKETBALL SHOES, BASKETBALL SNEAKERS, T-SHIRTS, SHIRTS, SWEATSHIRTS, SWEATPANTS, PANTS, TANK TOPS, JERSEYS, SHORTS, PAJAMAS, SPORT SHIRTS, RUGBY SHIRTS, SWEATERS, BELTS, TIES, NIGHTSHIRTS, HATS, WARM-UP SUITS, WARM-UP PANTS, WARM-UP TOPS, JACKETS, PARKAS, COATS, BABY CLOTH BIBS, HEAD BANDS, WRIST BANDS, APRONS, BOXER SHORTS, SLACKS, CAPS, EAR MUFFS, GLOVES, MITTENS, WOVEN AND KNIT SHIRTS (U.S. CLS. 22 AND 39).

SN 78-149,717. NEW ORLEANS HORNETS NBA LIMITED PARTNERSHIP, A N.C. LIMITED PARTNERSHIP, NEW ORLEANS, LA. BY CHANGE OF NAME CHARLOTTE HORNETS NBA LIMITED PARTNERSHIP, CHARLOTTE, NC. FILED 8-1-2002.



SN 78-148,278. ARMY OF ANGELS, INC., NEW YORK, NY. FILED 7-29-2002.

GSQUAD

FOR SHIRTS, PANTS, UNDERGARMENTS (U.S. CLS. 22 AND 39).

FOR CLOTHING, NAMELY HOSIERY, FOOTWEAR, BASKETBALL SHOES, BASKETBALL SNEAKERS, T-SHIRTS, SHIRTS, SWEATSHIRTS, SWEATPANTS, PANTS, TANK TOPS, JERSEYS, SHORTS, PAJAMAS, SPORT SHIRTS, RUGBY SHIRTS, SWEATERS, BELTS, TIES, NIGHTSHIRTS, HATS, WARM-UP SUITS, WARM-UP PANTS, WARM-UP TOPS, JACKETS, PARKAS, COATS, CLOTH BABY BIBS, HEAD BANDS, WRIST BANDS, APRONS, BOXER SHORTS, SLACKS, CAPS, EAR MUFFS, GLOVES, MITTENS, WOVEN AND KNIT SHIRTS (U.S. CLS. 22 AND 39).

CLASS 25—(Continued).

SN 78-150,164. R.G. BARRY (TEXAS) L.P., PICKERINGTON, OH. FILED 8-2-2002.

STEP OUT IN SOLID COMFORT

FOR SLIPPERS; SLIPPER PARTS, NAMELY CONTOURED FOOTBEDS AND CONTOURED FOOT INSERTS (U.S. CLS. 22 AND 39).

SN 78-151,973. BEACH CREATURES INC., MT. PLEASANT, SC. FILED 8-7-2002.

BEACH CREATURES

FOR T-SHIRTS (U.S. CLS. 22 AND 39).

SN 78-152,428. LEAPFROG ENTERPRISES, INC., EMERYVILLE, CA. FILED 8-8-2002.

LEAP GEAR

NO CLAIM IS MADE TO THE EXCLUSIVE RIGHT TO USE "GEAR", APART FROM THE MARK AS SHOWN.

FOR CLOTHING, NAMELY, SWEATERS, SHIRTS, JACKETS, BATHING SUITS, BEACHWEAR, UNDERWEAR, HALLOWEEN COSTUMES, DRESSES, HATS, CAPS, HOSIERY, INFANT WEAR, JACKETS, PAJAMAS, PANTS, SWEAT PANTS, SWEAT SHIRTS, SHOES, SHORTS, SLEEPERS, SOCKS, T-SHIRTS, TANK TOPS, TIGHTS, FLEECE PULLOVERS, BATHROBES, BOOTIES, BOXER SHORTS, CLOTH BABY BIBS, COATS, COVERALLS, DRESSES, FOOTWEAR, JUMPERS, NECKERCHIEFS, NECKTIES, VESTS, PANTS, POLO SHIRTS, PONCHOS, PULLOVERS, SCARVES, TURTLENECKS, SUN VISORS, AND WIND RESISTANT JACKETS (U.S. CLS. 22 AND 39).

SN 78-152,456. BRONX SUPPLY CORP., SAN FRANCISCO, CA. FILED 8-8-2002.



NO CLAIM IS MADE TO THE EXCLUSIVE RIGHT TO USE "BRONX SUPPLY CORP.", APART FROM THE MARK AS SHOWN.

FOR VINTAGE STYLE APPAREL, NAMELY HATS, CAPS, DRESSES, JACKETS, JEANS, JOGGING SUITS, WARM-UP SUITS, LOUNGE WEAR, NIGHTSHIRTS, SWEATERS, VESTS, HALTER TOPS, UNDERSHIRTS, T-SHIRTS, SWEATSHIRTS, SHORTS, GYM SHORTS, SWEAT SHORTS, TROUSERS, KHAKIS, AND WOVEN SHIRTS (U.S. CLS. 22 AND 39).

CLASS 25—(Continued).

SN 78-152,801. HATHAWAY, COURTNEY, DANEILLE, WOODLAND HILLS, CA. FILED 8-9-2002.

COURTNE'

FOR CLOTHING, NAMELY, BEACHWEAR, BRAS, UNDERWEAR, BODY SHAPERS, BUSTIERS, CAMISOLES, GARTER BELTS, HALTER TOPS, LINGERIE, LOUNGEWEAR, BOXER SHORTS, PAJAMAS, PANTIES, SARONGS, TANK TOPS, T-SHIRTS, SWIM WEAR, SWEAT SUITS, SHORTS, SLEEPWEAR, UNDERPANTS, SWEAT SHORTS, SWEAT PANTS, SWEAT SHIRTS, UNDER SHIRTS, TEDDIES, NEGLIGEES, NIGHT GOWNS, KNIT TOPS, FOUNDATION GARMENTS, BODY SUITS (U.S. CLS. 22 AND 39).

SN 78-154,745. PACIFIC SOUTHWEST TRADEMARK, LLC, GARDEN GROVE, CA. FILED 8-15-2002.

G.N.X.

FOR CLOTHING, NAMELY JACKETS, VESTS, SWEATERS, SHIRTS, PANTS, SHORTS, SWIMWEAR, SHOES AND HATS (U.S. CLS. 22 AND 39).

SN 78-161,575. TSI BRANDS, INC., WILMINGTON, DE. FILED 9-6-2002.

AUTHENTIC CHINO CASUALS

OWNER OF U.S. REG. NO. 2,026,209.
NO CLAIM IS MADE TO THE EXCLUSIVE RIGHT TO USE "CHINO CASUALS", APART FROM THE MARK AS SHOWN.

SEC. 2(F).
FOR SHIRTS, PANTS, SLACKS AND SHORTS (U.S. CLS. 22 AND 39).

FIRST USE 2-0-1995; IN COMMERCE 2-0-1995.

CLASS 25—(Continued).

SN 78-167,247. GAP (APPAREL) INC., SAN FRANCISCO, CA. FILED 9-24-2002.



OWNER OF U.S. REG. NOS. 944,941, 944,942 AND 1,055,151.

FOR CLOTHING, NAMELY, PANTS, SHORTS, SWEATPANTS, OVERALLS, SHIRTS, TEE-SHIRTS, SWEATSHIRTS, BLOUSES, SKIRTS, DRESSES, JACKETS, VESTS, COATS, RAINWEAR, SHOES, LINGERIE, SLEEPWEAR, LOUNGEWEAR, SWIMWEAR, GLOVES, SOCKS, HOSIERY, BELTS, SCARVES, HATS, TIES, SLIPPERS. (U.S. CLS. 22 AND 39).

SN 78-169,495. THINGS FOR LESS, OAKLAND, CA. FILED 9-30-2002.



THE ENGLISH TRANSLATION OF "GAZALI" IS "GAZELLE".
FOR ATHLETIC SHOES (U.S. CLS. 22 AND 39).

SN 78-170,344. FRANK VENAZIANO, NEWPORT BEACH, CA. FILED 10-2-2002.



FOR CLOTHING, NAMELY, T-SHIRTS, SHORTS, PANTS, FOOTWEAR AND SURF WEAR, SNOW WEAR, NAMELY, SNOW PANTS, SNOW SUITS, SNOWBOARD GLOVES (U.S. CLS. 22 AND 39).

CLASS 25—(Continued).

SN 78-172,018. FOOT LOCKER RETAIL, INC., NEW YORK, NY. FILED 10-8-2002.

OSAGA

OWNER OF U.S. REG. NO. 1,012,264.
FOR ATHLETIC WEAR - NAMELY, WARM-UP SUITS, JACKETS, T-SHIRTS, SHORTS (U.S. CLS. 22 AND 39).

SN 78-178,061. COSTUMEUSA, LLC, ENGLEWOOD, CO. FILED 10-24-2002.

BARBED WIRE AND ROSES

FOR CLOTHING, NAMELY WOMEN'S JACKETS, SKIRTS, PANTS, SHIRTS, VESTS AND DRESSES (U.S. CLS. 22 AND 39).

SN 78-178,840. TANASE, CHAZ, D. TRUMBULL, CT. FILED 10-27-2002.

R.GEAR CLOTHING COMPANY

NO CLAIM IS MADE TO THE EXCLUSIVE RIGHT TO USE "CLOTHING COMPANY", APART FROM THE MARK AS SHOWN.

FOR CLOTHING, NAMELY, SHIRTS, PANTS, HEADWEAR, FOOTWEAR, JACKETS, SWEATSHIRTS, SHORTS, SWEAT SUITS, HATS AND BEANIES (U.S. CLS. 22 AND 39).

SN 78-179,693. HEALTHTEX APPAREL CORP., WILMINGTON, DE. FILED 10-29-2002.



OWNER OF U.S. REG. NOS. 324,548, 502,089 AND 1,806,197.
FOR CLOTHING, NAMELY, SCARVES, MITTENS, GLOVES AND VESTS. (U.S. CLS. 22 AND 39).

SN 78-180,662. VIBRAM S.P.A., ALBIZZATE, ITALY, FILED 10-31-2002.

DURALOGICAL

FOR CLEATS AND SOLES FOR FOOTWEAR (U.S. CLS. 22 AND 39).

CLASS 25—(Continued).

SN 78-180,697. GEMPLER'S, INC., BELLEVIEW, WI. FILED 10-31-2002.

NO POLO SHIRT

NO CLAIM IS MADE TO THE EXCLUSIVE RIGHT TO USE "POLO SHIRT", APART FROM THE MARK AS SHOWN.

FOR CLOTHING, NAMELY SHIRTS (U.S. CLS. 22 AND 39).

SN 78-182,259. DUDLEY, JAMES W., BLUEFIELD, VA. FILED 11-6-2002.

TOPSUL

FOR SHIRTS, HATS, PANTS, COATS, SHORTS, AND BATHING SUITS (U.S. CLS. 22 AND 39).

SN 78-182,788. R.G. BARRY (TEXAS) L.P., PICKERINGTON, OH. FILED 11-7-2002.



FOR SLIPPERS; CLOTHING, NAMELY SLEEPWEAR AND LOUNGEWEAR (U.S. CLS. 22 AND 39). FIRST USE 10-10-2002; IN COMMERCE 10-10-2002.

SN 78-183,150. QVC, INC., WEST CHESTER, PA. FILED 11-8-2002.

GLOBAL ILLUSION

FOR WOMEN'S APPAREL, NAMELY SKIRTS, JACKETS, DRESSES, SHIRTS, PANTS, JEANS, LEGGINGS, SWEATERS, AND T-SHIRTS (U.S. CLS. 22 AND 39).

CLASS 25—(Continued).

SN 78-184,360. FARSHOUKH, SIRA, LOS ANGELES, CA. FILED 11-12-2002.

POLLI SAYS...

FOR CLOTHING, NAMELY DRESSES, SKIRTS, PANTS, SHIRTS, SHORTS, AND JEANS (U.S. CLS. 22 AND 39).

FIRST USE 2-1-2002; IN COMMERCE 2-1-2002.

SN 78-184,400. MEMBRAIN, LLC, BEVERLY HILLS, CA. FILED 11-13-2002.

NATIONAL EXTREME TOUR

FOR CLOTHING—NAMELY, SHIRTS, PANTS, BLOUSES, TOPS, SOCKS, CAPS, HATS, SHOES, UNDERGARMENTS AND DRESSES. (U.S. CLS. 22 AND 39).

SN 78-184,494. N & A FASHIONS INC., BROOKLYN, NY. FILED 11-13-2002.

OUNCE

FOR PANTS, SKIRTS, SHIRTS, SHORTS, UNDERWEAR, HATS, AND SWEATERS (U.S. CLS. 22 AND 39).

SN 78-185,037. SANDALZ, INC., OCEANSIDE, CA. FILED 11-14-2002.

PURE JUICE

FOR FOOTWEAR, NAMELY, ATHLETIC FOOTWEAR, CASUAL FOOTWEAR, SANDALS AND BEACH FOOTWEAR (U.S. CLS. 22 AND 39).

SN 78-185,185. VANITY FAIR, INC., WILMINGTON, DE. FILED 11-14-2002.

SECRET LUXURY

OWNER OF U.S. REG. NOS. 342,510 AND 1,997,385. FOR LINGERIE, SLEEPWEAR, AND HOSIERY (U.S. CLS. 22 AND 39).

SN 78-185,401. PEI LICENSING, INC., MIAMI, FL. FILED 11-15-2002.

WOOL-DYNAMICS

FOR CLOTHING, NAMELY PANTS, SLACKS AND TROUSERS. (U.S. CLS. 22 AND 39).

CLASS 25—(Continued).

SN 78-185,411. FOX RIVER MILLS, INC., OSAGE, IA. FILED 11-15-2002.



NO CLAIM IS MADE TO THE EXCLUSIVE RIGHT TO USE "AUTHENTIC OUTDOOR SOCKS", APART FROM THE MARK AS SHOWN. THE LINING IS A FEATURE OF THE MARK AND DOES NOT INDICATE COLOR.
 FOR SOCKS (U.S. CLS. 22 AND 39).
 FIRST USE 10-17-2002; IN COMMERCE 10-17-2002.

SN 78-185,861. AMERICA'S FAVORITE JEANS, INC., LOS ANGELES, CA. FILED 11-16-2002.

AVE.BLU

FOR CLOTHING, NAMELY, CHILDREN'S PANTS, CHILDREN'S SHIRTS, CHILDREN'S DRESSES, CHILDREN'S SKIRTS, CHILDREN'S JACKETS, CHILDREN'S COATS, CHILDREN'S JEANS, CHILDREN'S SWEATERS, CHILDREN'S HATS, CHILDREN'S CAPS, CHILDREN'S SHORT PANTS, CHILDREN'S SWEATERS, CHILDREN'S SWEATS (U.S. CLS. 22 AND 39).

SN 78-185,878. MCKENZIE, SHERRI, CUMBERLAND, MD. FILED 11-16-2002.

WONDER BUNS

FOR HOSIERY, LEGGINS, BIKER SHORTS, UNDERWEAR, GIRDLES, PANTIES, TIGHTS, STOCKINGS (U.S. CLS. 22 AND 39).

CLASS 25—(Continued).

SN 78-186,380. SERRALLES HOTEL, INC., PONCE, PUERTO RICO, FILED 11-19-2002.



FOR SPORTS CLOTHING, NAMELY, CAPS, SUN VISORS, TENNIS SHIRTS, TENNIS SHORTS, GOLF SHIRTS, GOLF SHORTS, POLO SHIRTS AND T-SHIRTS (U.S. CLS. 22 AND 39).
 FIRST USE 7-2-2002; IN COMMERCE 7-2-2002.

SN 78-191,249. CALLAWAY GOLF COMPANY, CARLSBAD, CA. FILED 12-4-2002.

XWT

FOR GOLF SHOES (U.S. CLS. 22 AND 39).

SN 78-191,300. TIKI TU, LONG BEACH, CA. FILED 12-4-2002.

TIKI TU

FOR SHIRTS, PANTS (U.S. CLS. 22 AND 39).

SN 78-191,310. MONTANA MAGIC, EVANSVILLE, IN. FILED 12-4-2002.

MONTANA MAGIC

FOR LEATHER JACKETS (U.S. CLS. 22 AND 39).

SN 78-191,495. ELETE, INC., DENVER, CO. FILED 12-5-2002.

IT' NOT FOR EVERYBODY

FOR CLOTHING, NAMELY SOCKS, PANTS, SHORTS, SHIRTS, JACKETS, WARM-UP SUITS, HEADWEAR AND FOOTWEAR (U.S. CLS. 22 AND 39).

CLASS 25—(Continued).

SN 78-193,699. SARA LEE GLOBAL FINANCE, L.L.C., WILMINGTON, DE. FILED 12-12-2002.

DOUBLE DRY

FOR SWEATSHIRTS, SWEATPANTS, T-SHIRTS, SHORTS, PANTS, TANK TOPS, JERSEYS, ATHLETIC UNIFORMS, BRAS, SPORTS BRAS, SPORTS SHIRTS, WARM-UP SUITS, EXERCISE SUITS, JACKETS, HEADBANDS, WRISTBANDS, GLOVES, SOCKS, UNDERWEAR, CAPS, HATS, SWIM CAPS, SWIMWEAR (U.S. CLS. 22 AND 39).

FIRST USE 1-10-2000; IN COMMERCE 1-10-2000.

SN 78-202,488. QVC, INC., WEST CHESTER, PA. FILED 1-13-2003.

DIALOGUE

OWNER OF U.S. REG. NO. 766,435.
FOR APPAREL, NAMELY SKIRTS, SWEATERS, CARDIGANS, VESTS, PANTS, TUNICS, SHIRTS AND SWEATER COATS (U.S. CLS. 22 AND 39).

SN 78-213,876. DOUBLEDRIIVE, LLC, FRANKLIN, TN. FILED 2-12-2003.

DOUBLEDRIIVE

FOR T-SHIRTS AND HATS (U.S. CLS. 22 AND 39).
FIRST USE 8-30-1998; IN COMMERCE 8-30-1998.

SN 78-975,073. PERFORMANCE MANAGEMENT INC., WASHINGTON, DC. FILED 7-26-2002.

NEGOTIATE THIS!

FOR CLOTHING, NAMELY, T-SHIRTS, SWEATSHIRTS, TANK TOPS, HATS AND BASEBALL CAPS (U.S. CLS. 22 AND 39).

CLASS 26—FANCY GOODS

SN 76-258,506. RAPFORD PTY. LTD., PEAKHURST, NSW 2210, AUSTRALIA, FILED 5-16-2001.

HALO

FOR HIGHLIGHTING FOIL MADE OF METAL; HIGHLIGHTING FOIL MADE OF METAL IN THE FORM OF DISCRETE STRIPS; HIGHLIGHTING FOIL MADE OF METAL IN THE FORM OF COILS (U.S. CLS. 37, 39, 40, 42 AND 50).

CLASS 26—(Continued).

SN 76-385,484. SILKIES, INC., VISTA, CA. FILED 3-18-2002.

SILKIES

SEC. 2(F).
FOR ARTIFICIAL FLORAL ARRANGEMENTS, PLANTS, AND TREES (U.S. CLS. 37, 39, 40, 42 AND 50).
FIRST USE 1-31-1981; IN COMMERCE 1-31-1981.

SN 76-429,805. ROSSOUW, DENISE, WEST HOLLYWOOD, CA. FILED 7-12-2002.



FOR HAIR ENHANCEMENT SYSTEM, CONSISTING OF HUMAN HAIR ATTACHED TO A MESH BASE, WITH FOUR ATTACHMENT CLIPS (U.S. CLS. 37, 39, 40, 42 AND 50).
FIRST USE 2-1-2002; IN COMMERCE 2-1-2002.

SN 78-071,739. QUINGDAO JIFA GROUP CO., LTD., MONTEREY PARK, CA. FILED 6-29-2001.

JIFA

"JIFA" HAS NO KNOWN TRANSLATION OR MEANING, BUT IS PHONETIC. "FA" MEANS "HAIR" IN CHINESE.
FOR HAIR ORNAMENTS AND WIGS (U.S. CLS. 37, 39, 40, 42 AND 50).

CLASS 26—(Continued).

SN 78-140,593. CHUMBLEY, JAMES F, EDMONDS, WA. FILED 7-2-2002.



NO CLAIM IS MADE TO THE EXCLUSIVE RIGHT TO USE "SEAMS", APART FROM THE MARK AS SHOWN.
 FOR HEAT-ACTIVATED FABRIC ADHESIVE TAPE FOR USE IN SEWING AND OTHER FABRIC FASTENING APPLICATIONS (U.S. CLS. 37, 39, 40, 42 AND 50).
 FIRST USE 11-1-2001; IN COMMERCE 11-1-2001.

SN 78-171,141. GOODY PRODUCTS, INC., PEACHTREE CITY, GA. FILED 10-4-2002.

JUST ADD WATER

FOR ELECTRIC DEVICES FOR CREATING HAIR STYLES, NAMELY NON-ELECTRIC HAIR CURLERS AND CLAMPS FOR STRAIGHTENING HAIR (U.S. CLS. 37, 39, 40, 42 AND 50).

SN 78-179,907. SC LICENSING, SOUTH EASTON, MA. FILED 10-30-2002.

ABBY

FOR WIGS (U.S. CLS. 37, 39, 40, 42 AND 50).
 FIRST USE 5-1-1999; IN COMMERCE 5-1-1999.

SN 78-179,945. SC LICENSING CORP, SOUTH EASTON, MA. FILED 10-30-2002.

BRUSSELS

FOR WIGS (U.S. CLS. 37, 39, 40, 42 AND 50).
 FIRST USE 1-1-1998; IN COMMERCE 1-1-1998.

CLASS 26—(Continued).

SN 78-179,948. SC LICENSING CORP, SOUTH EASTON, MA. FILED 10-30-2002.

COLLEEN

FOR WIGS (U.S. CLS. 37, 39, 40, 42 AND 50).
 FIRST USE 5-1-1999; IN COMMERCE 5-1-1999.

SN 78-179,961. SC LICENSING CORP, SOUTH EASTON, MA. FILED 10-30-2002.

GENTRY II

FOR WIGS (U.S. CLS. 37, 39, 40, 42 AND 50).
 FIRST USE 1-1-1993; IN COMMERCE 1-1-1993.

SN 78-180,659. SC LICENSING CORP, SOUTH EASTON, MA. FILED 10-31-2002.

ROSE

FOR WIGS (U.S. CLS. 37, 39, 40, 42 AND 50).
 FIRST USE 1-1-1984; IN COMMERCE 1-1-1984.

SN 78-191,534. BEAUTY HOLDING COMPANY, INC., HAMILTON, BERMUDA, FILED 12-5-2002.

METAGRIP

FOR HAIR STYLING ACCESSORIES, NAMELY, HAIR PINS AND CLIPS (U.S. CLS. 37, 39, 40, 42 AND 50).

CLASS 27—FLOOR COVERINGS

SN 75-839,414. BONAR FLOORS LIMITED, DERBYSHIRE, DES 3NT, ENGLAND, FILED 11-2-1999.

CORAL

PRIORITY CLAIMED UNDER SEC. 44(D) ON ERPNTY TM OFC APPLICATION NO. 1190537, FILED 5-27-1999, REG. NO. 1190537, DATED 10-8-2002, EXPIRES 5-27-2009.

FOR CARPETING, CARPET TILES, RUGS AND DOOR MATS, BATH RUGS AND FLOOR MATS (U.S. CLS. 19, 20, 37, 42 AND 50).

CLASS 27—(Continued).

SN 76-184,576. LUDLOW COMPOSITES CORPORATION, FREMONT, OH. FILED 12-21-2000.

YOGA-FLEX

FOR INDUSTRIAL ANTI-FATIGUE EXERCISE MATS (U.S. CLS. 19, 20, 37, 42 AND 50).
FIRST USE 8-0-1998; IN COMMERCE 8-0-1998.

SN 76-399,136. JOHNS MANVILLE AB, SE-250 07 HELSINGBORG, SWEDEN, FILED 4-23-2002.



PRIORITY CLAIMED UNDER SEC. 44(D) ON SWEDEN APPLICATION NO. 02-00808, FILED 2-5-2002, REG. NO. 356833, DATED 7-5-2002, EXPIRES 7-5-2012.
FOR GLASS FIBRE FABRICS FOR WALL AND CEILING COVERING (U.S. CLS. 19, 20, 37, 42 AND 50).
FIRST USE 5-0-1976; IN COMMERCE 5-0-1976.

SN 76-399,137. JOHNS MANVILLE AB, SE-250 07 HELSINGBORG, SWEDEN, FILED 4-23-2002.

TASSOGLAS

PRIORITY CLAIMED UNDER SEC. 44(D) ON SWEDEN APPLICATION NO. 02-00303, FILED 1-15-2002, REG. NO. 358258, DATED 11-13-2002, EXPIRES 11-13-2012.
FOR GLASS FIBRE FABRICS FOR WALL AND CEILING COVERING (U.S. CLS. 19, 20, 37, 42 AND 50).
FIRST USE 5-0-1976; IN COMMERCE 5-0-1976.

SN 76-407,085. JOY CARPETS, INC., FT. OGLETHORPE, GA. FILED 5-10-2002.

JOY TUFF

FOR CARPETS AND RUGS (U.S. CLS. 19, 20, 37, 42 AND 50).

CLASS 27—(Continued).

SN 76-412,639. SHAW INDUSTRIES GROUP, INC., DALTON, GA. BY CHANGE OF NAME SHAW INDUSTRIES, INC., DALTON, GA. FILED 5-22-2002.

THE HUMAN SPACE

FOR FLOORING PRODUCTS, NAMELY, CARPETS (U.S. CLS. 19, 20, 37, 42 AND 50).

SN 76-453,906. DOMCO TARKETT INC., FARNHAM, QUEBEC J2N 1J7, CANADA, FILED 9-30-2002.

PERMASTONE

FOR FLOOR COVERINGS, NAMELY, VINYL FLOOR COVERINGS IN THE FORM OF TILES, PLANKS AND SHEETS (U.S. CLS. 19, 20, 37, 42 AND 50).
FIRST USE 8-0-2002; IN COMMERCE 8-0-2002.

SN 78-153,433. MOHAWK CARPET CORPORATION, CALHOUN, GA. FILED 8-12-2002.

MOHAWK FOREVER FRESH

FOR CARPETS (U.S. CLS. 19, 20, 37, 42 AND 50).
FIRST USE 9-15-2002; IN COMMERCE 9-15-2002.

SN 78-175,131. INNOVATIONS IN WALLCOVERINGS, INC., NEW YORK, NY. FILED 10-16-2002.

GRRR!

FOR WALLCOVERING OF NONWOVEN MATERIALS (U.S. CLS. 19, 20, 37, 42 AND 50).

SN 78-193,771. SAP ACQUISITION COMPANY, LLC, BUFFALO GROVE, IL. FILED 12-12-2002.

TWISTER MAT

NO CLAIM IS MADE TO THE EXCLUSIVE RIGHT TO USE "MAT", APART FROM THE MARK AS SHOWN.
FOR DOOR MATS (U.S. CLS. 19, 20, 37, 42 AND 50).

CLASS 28—TOYS AND SPORTING GOODS

SN 75-558,554. HANWELL, JOHN, LONG BEACH, NY.
FILED 9-24-1998.

FLUFFY STUFFIES

FOR TOYS, NAMELY, CRAFT KITS COMPRISING
PLUSH MATERIALS, MARKERS AND OBJECTS TO BE
DECORATED (U.S. CLS. 22, 23, 38 AND 50).

SN 75-571,529. SOFTSPIKES, INC., ROCKVILLE, MD. FILED
10-16-1998.

BLACK WIDOW

OWNER OF U.S. REG. NOS. 2,476,087 AND 2,625,416.
FOR CLEATS FOR FOOTWEAR FOR SPORTS (U.S.
CLS. 22, 23, 38 AND 50).
FIRST USE 1-0-1999; IN COMMERCE 1-0-1999.

SN 75-664,923. JELLYCAT, LTD., LONDON, W14 OHH,
UNITED KINGDOM, FILED 3-22-1999.

JELLY KITTEN

FOR PLUSH TOYS, STUFFED TOY ANIMALS, DOLLS
AND PUPPETS (U.S. CLS. 22, 23, 38 AND 50).

SN 75-665,052. JELLYCAT, LTD., LONDON W14 OHH,
UNITED KINGDOM, FILED 3-22-1999.

JELLYCAT

FOR PLUSH TOYS, STUFFED TOY ANIMALS, DOLLS
AND PUPPETS (U.S. CLS. 22, 23, 38 AND 50).

CLASS 28—(Continued).

SN 75-741,550. ONEBLUEEYE PRODUCTIONS, LOS AN-
GELES, CA. FILED 6-30-1999.

ONEBLUEEYE

FOR TOYS AND SPORTING GOODS, NAMELY, PLAY
FIGURES AND ACCESSORIES THEREFOR, ACTION
FIGURES AND ACCESSORIES THEREFOR, PLUSH
TOYS, STUFFED TOYS, BOARD GAMES, CARD
GAMES, JIGSAW PUZZLES, MANIPULATIVE GAMES,
MARBLES, PADDLE BALL GAMES, YO-YO'S BAL-
LOONS, JUMP ROPES, KITES AND ACCESSORIES
THEREFOR, BUBBLE MAKING WANDS AND SOLU-
TION, MAGIC TRICK, BATH TOYS, PLAY SWIMMING
POOL, TOY VEHICLES AND ACCESSORIES THERE-
FOR, TOY BANKS, TOY BOXES, TOY GUNS, TOY
ARCHERY BOWS AND ARROWS, CHILDREN'S PLAY
COSMETICS, BABY RATTLES, BABY MULTIPLE AC-
TIVITY TOYS, TOY BASKETBALLS, FOOTBALLS, GOLF
BALLS, TENNIS BALLS, PLAYGROUND BALLS, SPORT
BALLS, SOCCER BALLS, VOLLEYBALL'S RUBBER AC-
TION BALLS, BASEBALL BATS, BASEBALL GLOVES,
FLYING DISKS, BODY BOARDS, BADMINTON SETS,
DART FLIGHTS, GOLF CLUB HEAD COVERS, ROLLER
SKATES, SKATEBOARDS, SWIM FLOATS FOR RE-
CREATIONAL USE, SNORKELS, FACE MASKS, PIN-
BALL-TYPE GAMES, CHRISTMAS TREE
DECORATIONS, EGG DECORATING KITS, HAND
HELD UNIT FOR PLAYING ELECTRONIC GAMES,
SWIM GOGGLES, SWIM MASKS, SWIM FINS, WINDUP
TOYS, AND IN-LINE SKATES (U.S. CLS. 22, 23, 38 AND
50).

SN 75-797,167. MIDWAY AMUSEMENT GAMES, LLC,
CHICAGO, IL. FILED 9-10-1999.

JET SET

FOR COIN-OPERATED ARCADE AND VIDEO GAMES
(U.S. CLS. 22, 23, 38 AND 50).

SN 75-819,235. ATKINSON, PATRICK J., BISMARCK, ND.
FILED 10-12-1999.

GOD'S CHILD

OWNER OF U.S. REG. NOS. 1,761,846 AND 2,225,312.
FOR PLAYTHINGS AND GAMES; NAMELY, BOARD
GAMES AND CARD GAMES (U.S. CLS. 22, 23, 38 AND
50).

SN 75-861,964. 1353088 ONTARIO INC., HAMILTON, ON-
TARIO, CANADA, FILED 12-1-1999.

AFTERBURNER

PRIORITY CLAIMED UNDER SEC. 44(D) ON CANADA
APPLICATION NO. 1017648, FILED 6-3-1999, REG. NO.
TMA571908, DATED 12-9-2002, EXPIRES 12-9-2017.

FOR EXERCISE EQUIPMENT, NAMELY A VARIABLE
WEIGHT LOAD SYSTEM USED IN STRENGTH TRAIN-
ING AND COMPRISED OF DUAL WATER TANKS,
AUTOMATIC SWITCHES AND A PUMP (U.S. CLS. 22,
23, 38 AND 50).

CLASS 28—(Continued).

SN 76-145,072. HIGH CEDAR ENTERPRISE CO., LTD.,
TAICHUNG HSIEN, TAIWAN, FILED 10-11-2000.

GRIP

THE WETTER THE BETTER

FOR GRIP TAPES FOR BASEBALL BATS, GOLF CLUBS, RACKETS, AND HOCKEY STICKS; ATHLETIC PROTECTIVE PADS FOR PROTECTING KNEE, WRIST, CHEST, SHOULDER, NECK, HAND, EAR, ELBOW, ARM, AND ANKLE; PROTECTIVE MASKS FOR USE IN FOOTBALL, BASEBALL, HOCKEY, AND SOFTBALL (U.S. CLS. 22, 23, 38 AND 50).

SN 76-244,961. KOLPIN OUTDOORS, INC., FOX LAKE, WI.
FILED 4-23-2001.

BOW BOOT

NO CLAIM IS MADE TO THE EXCLUSIVE RIGHT TO USE "BOW", APART FROM THE MARK AS SHOWN.
FOR HEAVY DUTY PLASTIC CASE FOR ARCHERY BOWS (U.S. CLS. 22, 23, 38 AND 50).

SN 76-259,631. MESCH, DIGGER, BROOKLYN, NY. FILED 5-18-2001.

PSYCHO PUMP

FOR TOY ACTION FIGURES, ROLE-PLAYING GAMES, TOY MODEL HOBBY CRAFT KITS; STAND-ALONE VIDEO OUTPUT GAME MACHINES; STAND-ALONE VIDEO GAME MACHINES; MULTI-MEDIA DIGITAL AND INTERACTIVE GAMES AND TOYS, NAMELY, ACTION FIGURES, ACTION VEHICLES, SPACE SHIPS AND PLUSH TOYS WHICH ARE DESIGNED TO RECEIVE UPDATED INFORMATION, SOME OF WHICH CAN BE DOWNLOADABLE FROM A GLOBAL COMPUTER NETWORK; BOARD GAMES (U.S. CLS. 22, 23, 38 AND 50).

CLASS 28—(Continued).

SN 76-261,862. BLEVINS, MARK, ALTA LOMA, CA. FILED 5-24-2001.

**BASKETBALL
SHOOTING
DISK**

NO CLAIM IS MADE TO THE EXCLUSIVE RIGHT TO USE "BASKETBALL", APART FROM THE MARK AS SHOWN.

FOR SPORTING GOODS, NAMELY BASKETBALL FREETHROW TRAINING DEVICES (U.S. CLS. 22, 23, 38 AND 50).

SN 76-317,684. MANLEY, VIOLET L., DENVER, CO. FILED 9-27-2001.

Scrummy

FOR WORD CARD GAME (U.S. CLS. 22, 23, 38 AND 50).

SN 76-322,344. BANOR ENTERPRISES, INC., BOURNE, MA.
FILED 10-10-2001.

**SECOND EFFORT
TECHNOLOGY**

NO CLAIM IS MADE TO THE EXCLUSIVE RIGHT TO USE "TECHNOLOGY", APART FROM THE MARK AS SHOWN.

FOR GOLF BALLS (U.S. CLS. 22, 23, 38 AND 50).
FIRST USE 9-1-2001; IN COMMERCE 9-1-2001.

SN 76-361,297. CORINTHIAN MARKETING PLC, BUCKINGHAMSHIRE HP12 4HX, UNITED KINGDOM, FILED 1-22-2002.

CORINTHIAN COMPACTS

PRIORITY CLAIMED UNDER SEC. 44(D) ON UNITED KINGDOM APPLICATION NO. 2288614, FILED 12-20-2001, REG. NO. 2288614, DATED 12-27-2002, EXPIRES 12-20-2011.
OWNER OF U.S. REG. NO. 2,143,294.

FOR TOYS, NAMELY, TOY FIGURES AND FIGURINES, TOY HUMAN CHARACTERS (U.S. CLS. 22, 23, 38 AND 50).

CLASS 28—(Continued).

SN 76-365,851. YOSHIDA SPORTS, INC., PORTLAND, OR.
FILED 2-1-2002.

MAP SYSTEM

NO CLAIM IS MADE TO THE EXCLUSIVE RIGHT TO
USE "SYSTEM", APART FROM THE MARK AS SHOWN.
FOR GOLF BAGS (U.S. CLS. 22, 23, 38 AND 50).

SN 76-369,365. BRAVO CORPORATION, CYPRESS, CA.
FILED 2-11-2002.

KRYPTO

OWNER OF U.S. REG. NO. 2,504,646.
FOR WHEELS FOR SKATEBOARDS, TOY SCOOTERS,
ROLLER SKATES AND IN-LINE SKATES (U.S. CLS. 22,
23, 38 AND 50).

SN 76-369,904. BRANDS WARENHANDELS GMBH, D-82049
PULLACH, FED REP GERMANY, FILED 2-12-2002.



OWNER OF FED REP GERMANY REG. NO. 39946694,
DATED 1-17-2000, EXPIRES 8-31-2009.

OWNER OF U.S. REG. NO. 2,587,210.
FOR SKI EQUIPMENT, NAMELY, SKIS, SKI BIND-
INGS AND SKI POLES; SKATEBOARDS, SURFBOARDS,
SNOWBOARDS AND PARTS THEREOF; ROLLER
SKATES; ICE SKATES; TENNIS BALL THROWING
MACHINES; TENNIS RACQUETS, CRICKET AND
BASEBALL BATS, GOLF CLUBS, HOCKEY STICKS;
CASES, BAGS AND CONTAINERS FOR THE TRANS-
PORT OF SPORTING GOODS, NAMELY, SKI BAGS,
SKATEBOARD BAGS, SURFBOARD BAGS, SNOW-
BOARD BAGS, ROLLER SKATE BAGS, ICE SKATE
BAGS, TENNIS RACKET BAGS, CRICKET BAT BAGS,
BASEBALL BAT BAGS, GOLF CLUB BAGS, HOCKEY
STICK BAGS, HANG GLIDER BAGS, PARAGLIDER
BAGS, KITE BAGS, BAGS FOR ICE SKATING BOOTS
AND BAGS FOR FOOTBALLS, BASEBALLS, SOCCER
BALLS, TENNIS BALLS, BASKETBALLS, VOLLEY
BALLS, BEACH BALLS, SQUASH BALLS, BOWLING
BALLS AND CRICKET BALLS; GOLF GLOVES; PLAY-
GROUND EQUIPMENT, NAMELY, SLIDES; SAIL-
BOARDS; HANG GLIDERS; PARAGLIDERS; KITES;
ICE SKATING BOOTS; WATER AND SURF SKIS AND
WATER SKI SOLE COVERS (U.S. CLS. 22, 23, 38 AND
50).

CLASS 28—(Continued).

SN 76-387,774. PLAYCORE WISCONSIN, INC., FT. PAYNE,
AL. FILED 3-26-2002.

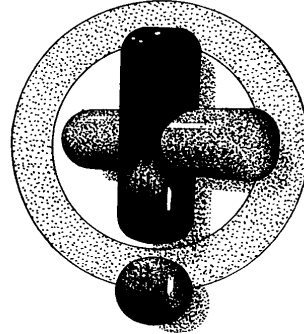

THE STIPPLING IS FOR SHADING PURPOSES.
FOR PLAYGROUND EQUIPMENT, NAMELY JUMP
PANEL, SLIDE, LADDER CRAWL TUBE, CLIMBING
POLE, STRETCH PANEL, STEERING WHEEL, ENCLO-
SURE, DIP STATION, DECKS, CRUNCH STATION,
BUBBLE PANEL, RUNG ENCLOSURE, STAIRS,
BRIDGE, TIC-TAC-TOE PANEL, SWINGS, ANIMAL
RIDERS, PARALLEL BARS, RINGS, PLAYGROUND
RAMP, PLAYGROUND PLATFORM, TUBE SLIDE,
CLIMBER, AND PLAYGROUND SUSPENSION BRIDGE
(U.S. CLS. 22, 23, 38 AND 50).

SN 76-388,351. VISTA PRESS VENTURES, LLC, DBA EA-
GLEMONT PRESS, BELLEVUE, WA. FILED 3-27-2002.

ADVENTURES OF RILEY

FOR BATH TOYS; SAND TOYS; BENDABLE TOYS;
COLLECTIBLE TOY FIGURES; BOARD GAMES; DOLLS
AND DOLL ACCESSORIES; STUFFED TOYS; PUPPETS;
JIGSAW PUZZLES; CASES FOR TOY ACTION FIGURES
AND PLAY ACCESSORIES (U.S. CLS. 22, 23, 38 AND 50).

SN 76-388,471. PARADIGM LEARNING, INC., TAMPA, FL.
FILED 3-28-2002.

ZODIAK

FOR EDUCATIONAL BOARD GAME IN THE FIELD
OF BUSINESS FINANCE AND STRATEGY USED IN
EMPLOYEE TRAINING (U.S. CLS. 22, 23, 38 AND 50).
FIRST USE 4-15-1994; IN COMMERCE 4-15-1994.

CLASS 28—(Continued).

SN 76-391,397. THINK OF IT!, INC., VENTURA, CA. FILED 4-4-2002.

THINK *OF-IT!

FOR TOYS AND GAMES, NAMELY DISC TOSS TOYS, MARBLES, RUBBER ACTION BALLS, EQUIPMENT SOLD AS A UNIT FOR PLAYING CHALK GAMES SUCH AS HOPSCOTCH, HOBBY CRAFT SETS FOR ORIGAMI, TOY HOOP SETS, FLYING DISCS, STUFFED TOY ANIMALS, MECHANICAL TOYS, AND MAGNETIC TOYS CONSISTING OF LETTERS, NUMBERS, SHAPES OR CHARACTERS (U.S. CLS. 22, 23, 38 AND 50).
FIRST USE 9-15-1997; IN COMMERCE 9-15-1997.

SN 76-392,172. SEOUL NASSAU (UK) LIMITECD, EAST GRINSTEAD, WEST SUSSEX RH19 1YH, UNITED KINGDOM, FILED 4-8-2002.



OWNER OF U.S. REG. NO. 2,637,588.

THE MARK CONSISTS, IN PART, OF A STYLIZED GOLF BALL REPRESENTING AN ENLARGED DOT ABOVE THE LETTER "I".

FOR SPORTING GOODS, NAMELY, GOLF BALLS; GOLF BALL MARKERS; GOLF BALL RETRIEVERS; GOLF TEES; GOLF GLOVES; GOLF BAGS; GOLF BAG TRAVEL COVERS; GOLF CADDY BAGS; GOLF TRAINING AIDS; GOLF PRACTICE NETS; AND ACCESSORIES, PARTS AND FITTINGS THEREFOR (U.S. CLS. 22, 23, 38 AND 50).

SN 76-396,083. ALIGNPRO, INC., LAKE OSWEGO, OR. FILED 4-16-2002.

ALIGNPRO

FOR GOLF BALL MARKING DEVICES (U.S. CLS. 22, 23, 38 AND 50).

CLASS 28—(Continued).

SN 76-400,007. GAY, JODIE, HAMPSTEAD, NC. AND GAY, TERRY, HAMPSTEAD, NC. FILED 4-25-2002.



THE WORDING IN THE MARK IS BLUE, THE FISH FACE IS YELLOW, THE FINS ARE BLUE, THE BODY OF THE FISH IS BLACK AND YELLOW, AND THE CANDY IN THE MOUTH IS RED.

FOR FISHING LURES (U.S. CLS. 22, 23, 38 AND 50).
FIRST USE 0-0-2001; IN COMMERCE 0-0-2001.

SN 76-401,863. PONY INTERNATIONAL, INC., BEVERLY HILLS, CA. FILED 4-30-2002.

CITY WINGS

FOR SPORTING GOODS AND EQUIPMENT, NAMELY, BASKETBALLS, BASEBALLS, FOOTBALLS, VOLLEYBALLS, SOCCER BALLS, RUGBY BALLS, TENNIS BALLS, TENNIS RACKETS, BASEBALL GLOVES AND MITTS, BASEBALL BATS, BOXING GLOVES AND BOXING BAGS, AND BASKETBALL HOOPS, NETS AND BACKBOARDS; SWIMMING EQUIPMENT AND GEAR, NAMELY, SWIM BOARDS FOR RECREATIONAL USE, SWIM FLOATS FOR RECREATIONAL USE, SWIM FINNS, AND SWIM MASKS; BICYCLING GLOVES; ICE HOCKEY EQUIPMENT AND GEAR, NAMELY, ICE HOCKEY STICKS, ICE HOCKEY PUCKS, ICE HOCKEY GLOVES, AND ICE HOCKEY GOALIE PADS; SKIS, SNOWBOARDS, SKATEBOARDS, ROLLER SKATES, IN-LINE SKATES, AND ICE SKATES (U.S. CLS. 22, 23, 38 AND 50).

SN 76-406,600. CECE & HEIDI LLC, BEVERLY HILLS, CA. FILED 5-15-2002.

THE SHABBAT BOX OF QUESTIONS

NO CLAIM IS MADE TO THE EXCLUSIVE RIGHT TO USE "BOX OF QUESTIONS", APART FROM THE MARK AS SHOWN.

FOR BOXED QUESTION AND ANSWER PARLOR GAME (U.S. CLS. 22, 23, 38 AND 50).

FIRST USE 2-13-2002; IN COMMERCE 2-13-2002.

CLASS 28—(Continued).

SN 76-409,276. MARIE, INC., PROVO, UT. FILED 5-20-2002.



THE MARK CONSISTS OF THE COLOR PINK FOR THE WORDS "ADORA BELLE" AND THE LIPS ARE ALSO IN THE COLOR PINK. THE REST OF THE MARK CONSISTS OF THE COLOR BLACK.
FOR DOLLS (U.S. CLS. 22, 23, 38 AND 50).
FIRST USE 8-1-1997; IN COMMERCE 8-1-1997.

SN 76-413,594. MAROX INTERNATIONAL, INC., EDISON, NJ. FILED 5-24-2002.

REACTOR

FOR PADDLE BALLS; PADDLES FOR USE IN PADDLE BALL GAMES AND PLATFORM TENNIS GAMES; PLATFORM TENNIS BALLS; EQUIPMENT FOR PLAYING PADDLE BALL GAMES AND PLATFORM TENNIS GAMES; AND HAND BALLS (U.S. CLS. 22, 23, 38 AND 50).

SN 76-418,139. FRANKLIN SPORTS, INC., STOUGHTON, MA. FILED 6-10-2002.

FAN FACE

FOR COSTUME MASKS WHICH INDICATE A PARTICULAR SPORTS TEAM (U.S. CLS. 22, 23, 38 AND 50).
FIRST USE 1-0-2001; IN COMMERCE 1-0-2001.

CLASS 28—(Continued).

SN 76-426,770. PACIFIC PAINTBALL SUPPLY, INC., SANTA ROSA, CA. FILED 7-1-2002.



FOR PAINTBALL GUNS, PAINTBALLS, PAINTBALL ACCESSORIES, NAMELY, AC HINGE FRAME, SWOOP GRIP, MODEL 98 SCREW KIT, AC VALVE TOOL, 7/8" ELBOW W/THUMB SCREWS, 140 RD POD, BARREL PLUG, 3 BARREL BAG, 5 BARREL BAG, FLEXIBLE SQUEEGEE, AC 45 FRAME NO GRIP, AC 45 FRAME W/ PANELS, STO 45 TRIGGER PLATE W/HOLE, AC 45 TRIGGER PLATE W/SLOT OLD STYLE, AC 45 TRIGGER PLATE W/SLOT NEW STYLE, AC 45 TRIGGER PLATE POLISHED, AC 45 SEAR PLATE, AC 45 S/S TRIGGER SPRING KIT, COMPRISED OF 3 TRIGGERS AND 2 SEARS FOR PAINTBALL, AC S/S TRIGGER RETURN SPRING MEDIUM S-530, AC S/S SEAR RETURN SPRING SOFT S-730, AC TRIGGER SHOE, AC PRO SERIES S/S COCKING ROD, AC TWISTED COCKING ROD, AC S/S PRO SERIES ROUND ACTUATING ROD AND COLLAR, AC S/S 1 PIECE PUMP ARM, MC S/S 1 PIECE PUMP ARM, AC ALUMINUM PUMP ARM, AC BALL DETENT, AC ALUMINUM BALL DETENT, AC 3-WAY HOSE KIT, AC 3-WAY HOSE BY THE FOOT, AC 3-WAY PLATED HOSE FITTING, AC BEAVERTAIL STANDARD, AC BEAVERTAIL 45, AC UNIVERSAL BEAVER TAIL, AC F/X BEAVER TAIL, MC VERTICAL ADAPTER, AC Y2K 1/4X28 S/S HAMMER KIT, CONSISTING OF VELOCITY SCREW, O-RING, MAIN SPRING, HAMMER, LUG, 2 NYLON SET SCREWS FOR PAINTBALL, AC 1/4X28 S/S HAMMER W/ LUG, AC S/S SCREW KIT CONSISTING OF 2 FRAMES, 4 GRIPS, 2 TIMING RODS, 1 VALVE PLUG FOR PAINTBALL, AC 3-WAY SHAFT W/ O RINGS, AC ALUMINUM 3-WAY W/SHAFT, AC PRO SERIES EXHAUST VALVE WITH STEM AND SEAL, AC S/S EXHAUST VALVE BODY/GUIDE, AC EXHAUST VALVE AND GUIDE COMPLETE, AC RHINO REGULATOR, S/S ROCK KNOB, ALUMINUM ROCK KNOB, AC 99' VENTURI BOLT, AC Y2K VENTURI BOLT, AC ALUMINUM 4 BALL PUSH PIN, AC S/S 4 BALL PUSH PIN, AC QUICK PULL PIN AND PLUNGER, AC 99' CUT COCKING BLOCK W/ WINDOWS, AC Y2K CUT COCKING BLOCK W/WINDOWS, AC 99' REVERSE P COCKING BLOCK, AC Y2K RAZOR COCKING BLOCK, AC 99' FULL SIZE GAS BLOCK, AC 00' MILLED GAS BLOCK W/ SET SCREWS, AC 00' FRONT PNEUMATIC PACKAGE W/SCREW, AC 99' FRONT PNEUMATIC PACKAGE W/CHAMBER, AC 99' FRONT PNEUMATIC PACKAGE W/CHAMBER, AC 99' S/S 4 PORT GAS BLOCK SCREW, AC Y2K S/S 4 PORT GAS BLOCK SCREW, AC 99' S/S 4 PORT POWER CHAMBER, AC S/S 4 PORT POWER CHAMBER POLISHED, AC Y2K S/S 4 PORT POWER CHAMBER, AC 99' STRAIGHT VERTICAL ASA ADAPTER, AC Y2K STRAIGHT VERTICAL ASA ADAPTER, AC 99' MILLED VERTICAL ASA ADAPTER, AC 00' MILLED VERTICAL ASA ADAPTER, AC 99' 15 DEGREE VERTICAL ASA ADAPTER, AC 00' 15 DEGREE VERTICAL ASA ADAPTER, AC 15 DEGREE VERTICAL ASA ADAPTER O RING, AC PARTS KIT, COMPRISED OF EXHAUST VALVE O-RINGS, C-CLIPS FOR PAINTBALL, AC S/S APPEARANCE PACKAGE, COMPRISED OF DETENT, SCREWS, 4 PORT GAS SCREW FOR PAINTBALL, AC BODY KITS CONSISTING OF GUN BODY, FEED PORT, ASA ADAPTER, COCKING BLOCK, GAS BLOCK, 45 FRAME, FOR PAINTBALL, 99' MILLED VERTICAL BODY RAW, COCKING ROD BUMPER, STO S/S VELOCITY ADJUSTING SCREW, 1/4X28 HAMMER LUG, S/S VALVE GUIDE RETAINING SCREW W/O RING, VALVE GUIDE TOOL W/ ARMS AND STOPPER, 45 FRAME COMPLETE, S/S THUMB ADJUSTER W/LOCK, DOUBLE FINGER TRIGGER, AM VERTICAL BOTTLE ADAPTER, DROP FORWARD FORE GRIP EXTENDER, FORE GRIP HANDLE, SHARK GILL SIGHT RAIL, LCD 45 FRAME W/TRIGGER, STAINLESS STEEL HAMMER, LCD 15 DEGREE VERTICAL BOTTLE ADAPTER, LCD FURY DIAMOND BOLT, FURY CHAMBER, LCD LOW RISE

CLASS 28—(Continued).

ADAPTER, LCD HIGH RISE ADAPTER, ALUMINUM BREECH KNOB, ADJUSTABLE LPR, ADJ SWEET SPOT TRIGGER, VENTURI BOLT, FIELD STRIP SCREW KIT, COMPRISING OF 7 SCREWS FOR PAINTBALL, VENOM S/S TURBO VALVE, SHARK GILL SIGHT RAIL, VERTICAL BOTTLE ADAPTER, LOW PRESSURE CHAMBER, COCKING SIDE PLATE COVER, NECK PROTECTOR, BALISTIC GUN BAG SMALL, BALISTIC GUN BAG LARGE, BALISTIC GUN POUCH, PADDED GUN BAG, BACK PACK, 90 DEGREE ALUMINUM SWIVEL ELBOW 1/8NPT, 90 DEGREE 1/8NPT, SLIDE CHECK, MICRO GAUGE 1200PSI, MICRO GAUGE 4500PSI, DROP FORWARD CRADLE, STUBBY DROP FORWARD, DROP FORWARD ECONO TANK ADAPTER, DROP FORWARD ON/OFF TANK ADAPTER, MICRO APOC DROP FORWARD CRADLE, RHINO DROP FORWARD W/WINDOWS, TEAR DROP FORWARD, COMPRESSED AIR CAP, MICRO TOURNEY LOCK DOWN, VALVE PROTECTOR, 45 GRIP PANEL SET, COMFORT GRIP PANEL, EXPANSION CHAMBER, GAS THROUGH GRIP, ANGLED BOTTOM LINE ADAPTER, ANGLED BOTTOM LINE ADAPTER, STRAIGHT BOTTOM LINE ADAPTER (U.S. CLS. 22, 23, 38 AND 50).
FIRST USE 2-1-2002; IN COMMERCE 3-1-2002.

SN 76-428,995. PHILCOX, SYDNEY, FAIRFAX, CA. AND PHILCOX, ELIZABETH, FAIRFAX, CA. FILED 7-9-2002.

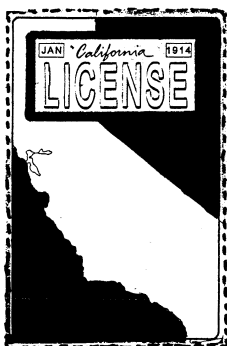

FOR PLAYING CARD GAME (U.S. CLS. 22, 23, 38 AND 50).
FIRST USE 6-1-2002; IN COMMERCE 6-1-2002.

SN 76-431,074. EDDIE BAUER, INC., REDMOND, WA. FILED 7-16-2002.



OWNER OF U.S. REG. NOS. 880,279, 880,280 AND OTHERS.
FOR CROQUET GAME PLAYING EQUIPMENT; BOCCE GAME PLAYING EQUIPMENT; VOLLEYBALL GAME PLAYING EQUIPMENT; BADMINTON GAME PLAYING EQUIPMENT; HORSESHOE GAME PLAYING EQUIPMENT (U.S. CLS. 22, 23, 38 AND 50).
FIRST USE 2-15-2002; IN COMMERCE 2-15-2002.

CLASS 28—(Continued).

SN 76-433,810. MAUI BOY DESIGNS, KIHEI, HI. FILED 7-23-2002.



FOR SPORTING GOODS, NAMELY SKATEBOARDS, SURFBOARDS, SAIL BOARDS, SKIM BOARDS, SCUBA FINS, SURF FINS, SURFBOARD FINS, SWIM FINS AND FLYING DISCS (U.S. CLS. 22, 23, 38 AND 50).

SN 76-436,352. LEJEUNE, FRANCIS E., JR., RIVER RIDGE, LA. FILED 7-29-2002.

AUTO SENSE

FOR GOLF EQUIPMENT, NAMELY GOLF CLUBS (U.S. CLS. 22, 23, 38 AND 50).

SN 76-442,181. PLEASANT COMPANY, MIDDLETON, WI. FILED 8-15-2002.

KEITRA

FOR DOLLS, DOLL CLOTHING, AND DOLL ACCESSORIES (U.S. CLS. 22, 23, 38 AND 50).

SN 76-443,520. MACHO PRODUCTS, INC., SEBASTIAN, FL. FILED 8-26-2002.

REDMAN

OWNER OF U.S. REG. NO. 1,733,284.
FOR PROTECTIVE EQUIPMENT FOR SELF-DEFENSE TRAINING, MARTIAL ARTS, SIMULATED COMBAT, NAMELY, MARTIAL ARTS HEAD GUARDS, CHEST PROTECTOR, SHOULDER PROTECTOR, ELBOW-FOREARM PROTECTOR, THIGH GUARD, KNEE-SHIN GUARD, THROAT GUARD, GROIN GUARD, REAR GUARD, AND CALF GUARD (U.S. CLS. 22, 23, 38 AND 50).
FIRST USE 8-22-1989; IN COMMERCE 8-22-1989.

CLASS 28—(Continued).

SN 76-449,467. ENTARA LIMITED, LONDON, UNITED KINGDOM, FILED 9-9-2002.

PIGGLEY WINKS

FOR DOLLS; PLUSH DOLLS; SOFT BRUSH TRICOT DOLLS; BATTERY-OPERATED AND ELECTRONIC-OPERATED DOLLS; SOUND-EMITTING DOLLS; WALKING DOLLS; ARTICULATED AND NON-ARTICULATED DOLLS; DOLLS WITH MOVING PARTS; DOLL CLOTHING; AND DOLL ACCESSORIES; PUPPETS; TOYS, NAMELY STUFFED TOY ANIMALS, TOY FIGURES, CLOTH AND PLUSH STUFFED TOYS AND PUZZLES, SOFT-SCULPTURE TOYS, BUILDING BLOCKS, PULL TOYS, BATTERY-OPERATED TALKING TOY PHONES, BENDABLE TOYS, TOY VEHICLES, MUSICAL TOYS; GAMES, NAMELY CARD GAMES, SKILL AND ACTION GAMES, DICE GAMES, WOODEN, JIGSAW, CUBE, PICTURE AND CARDBOARD PUZZLES, THREE-DIMENSIONAL PUZZLES, AND PUZZLES WITHIN FRAMES, ALL WITH OR WITHOUT ELECTRONIC FEATURES, DOMINOES, AND BOARD GAMES; BABY RATTLES; INFANTS RATTLES; TOY MOBILES; MECHANICAL TOYS; ELECTRONIC ACTION TOYS; TOY MODEL ACTION FIGURE KITS; INFLATABLE BATH AND POOL TOYS; PAIS; SHOVELS; ROLLER SKATES; RIDE-ON TOYS AND BATTERY-OPERATED RIDE-ON TOYS; TOY BANKS; TOY FLASHLIGHTS; TOY KITES; PLASTIC AND CHILDREN'S PORTABLE INFLATABLE SWIMMING POOLS; BUBBLE BLOWERS AND BUBBLE SOLUTION; CHRISTMAS TREE ORNAMENTS; AND COSTUME MASKS (U.S. CLS. 22, 23, 38 AND 50).

SN 76-449,778. LLOP, IVONNE DELAFLOR, ISLA DORADA CANCUN QUINTANA ROO, MEXICO, FILED 9-12-2002.



FOR GAMES AND PLAYTHINGS, NAMELY BACKGAMMON, BOARD GAMES, PLAYGROUND BALLS, DOLLS, DOMINOES, KITES, FACE MASKS, COSTUME MASKS, AND ROCKING HORSES (U.S. CLS. 22, 23, 38 AND 50).

SN 76-451,239. PIERNAS, ONDRE L., SAN DIEGO, CA, FILED 6-26-2002.

ANIMOS

FOR EDUCATIONAL CHILDREN'S PARLOR-GAME INCORPORATING CARDS OR CARD-LIKE TILES (U.S. CLS. 22, 23, 38 AND 50).
FIRST USE 6-2-2002; IN COMMERCE 6-2-2002.

CLASS 28—(Continued).

SN 76-452,520. LEARNING WRAP-UPS, INC., LAYTON, UT, FILED 9-25-2002.



OWNER OF U.S. REG. NO. 1,309,980.
NO CLAIM IS MADE TO THE EXCLUSIVE RIGHT TO USE "LEARNING" AND "SELF-CORRECTING", APART FROM THE MARK AS SHOWN.

THE MARK CONSISTS IN PART OF A DESIGN OF A HELIX.

FOR EDUCATIONAL APPARATUS; NAMELY, A QUESTION CARD GAME WITH SELF-CORRECTING FEATURE (U.S. CLS. 22, 23, 38 AND 50).

FIRST USE 3-15-2002; IN COMMERCE 3-15-2002.

SN 76-453,139. BLOCKBUSTER INC., DALLAS, TX, FILED 9-26-2002.

CARL & RAY

FOR TOYS, NAMELY PLUSH (U.S. CLS. 22, 23, 38 AND 50).

FIRST USE 8-13-2002; IN COMMERCE 8-13-2002.

SN 76-458,593. MEESE, INC., SADDLE BROOK, NJ, FILED 10-16-2002.

AQUA TOSS

NO CLAIM IS MADE TO THE EXCLUSIVE RIGHT TO USE "TOSS", APART FROM THE MARK AS SHOWN.

FOR FOOTBALL GAME TO BE USED IN SWIMMING POOLS (U.S. CLS. 22, 23, 38 AND 50).

FIRST USE 5-10-2002; IN COMMERCE 5-10-2002.

SN 76-459,613. SEAN DEVINE, INC., SIMPSONVILLE, SC, FILED 10-8-2002.

WATER WALKER

FOR PLAYING CARDS; CARD GAMES (U.S. CLS. 22, 23, 38 AND 50).

CLASS 28—(Continued).

SN 76-462,088. FUNRISE TOYS LTD., TSIMSHATSUI EAST, KOWLOON, HONG KONG, FILED 10-28-2002.

GAZILLION BUBBLES

NO CLAIM IS MADE TO THE EXCLUSIVE RIGHT TO USE "BUBBLES", APART FROM THE MARK AS SHOWN.
FOR TOYS, NAMELY BUBBLE FLUID, BUBBLE BLOWER TOYS AND ACCESSORIES THEREFOR (U.S. CLS. 22, 23, 38 AND 50).

SN 76-463,503. ROHAN-WEAVER, JOHN W., AOPKA, FL. FILED 10-28-2002.

Pure Swing

NO CLAIM IS MADE TO THE EXCLUSIVE RIGHT TO USE "SWING", APART FROM THE MARK AS SHOWN.
FOR GOLF CLUB SWING AID, NAMELY A PRECISION BENT METAL BAR SERVING AS A DYNAMIC GOLF CLUB SWING AID (U.S. CLS. 22, 23, 38 AND 50).
FIRST USE 10-10-2002; IN COMMERCE 10-10-2002.

SN 76-465,381. KATE SPADE LLC, NEW YORK, NY. FILED 11-7-2002.

KATE SPADE NEW YORK

OWNER OF U.S. REG. NOS. 2,446,491, 2,537,318 AND 2,613,247.

NO CLAIM IS MADE TO THE EXCLUSIVE RIGHT TO USE "NEW YORK", APART FROM THE MARK AS SHOWN.
THE NAME IN THE MARK IDENTIFIES A LIVING INDIVIDUAL WHOSE CONSENT IS OF RECORD.

FOR PORCELAIN DOLLS, DOLLS; PLAYSETS, NAMELY, DOLL FURNITURE, DOLL FURNITURE ACCESSORIES; DOLL CLOTHES AND DOLL ACCESSORIES; ACCESSORIES FOR DOLL CLOTHES, TOY FURNITURE, SPECIFICALLY BEDS, WARDROBES, CHIFFOROBES, VANITIES AND CHESTS; DOLL CASES (U.S. CLS. 22, 23, 38 AND 50).

SN 76-465,382. KATE SPADE LLC, NEW YORK, NY. FILED 11-7-2002.

KATE SPADE

OWNER OF U.S. REG. NOS. 2,064,708, 2,578,942 AND OTHERS.

THE NAME "KATE SPADE" IDENTIFIES A LIVING INDIVIDUAL WHOSE CONSENT IS OF RECORD.

FOR PORCELAIN DOLLS, DOLLS; PLAYSETS, NAMELY, DOLL FURNITURE, DOLL FURNITURE ACCESSORIES; DOLL CLOTHES AND DOLL ACCESSORIES; ACCESSORIES FOR DOLL CLOTHES, TOY FURNITURE, SPECIFICALLY BEDS, WARDROBES, CHIFFOROBES, VANITIES AND CHESTS; DOLL CASES (U.S. CLS. 22, 23, 38 AND 50).

CLASS 28—(Continued).

SN 76-467,203. FRANKLIN LEARNING SYSTEMS, INC., WESTPORT, CT. FILED 11-14-2002.



NO CLAIM IS MADE TO THE EXCLUSIVE RIGHT TO USE "FINANCIAL", APART FROM THE MARK AS SHOWN.
THE MARK IS LINED FOR THE COLOR RED.
FOR BOARD GAME (U.S. CLS. 22, 23, 38 AND 50).

SN 76-467,278. SUNSET GOLF, INC., LOUDONVILLE, OH. FILED 11-15-2002.

PUTTER POOL

FOR GAMES, NAMELY A GAME THAT COMBINES GOLF AND BILLIARDS (U.S. CLS. 22, 23, 38 AND 50).
FIRST USE 10-17-1990; IN COMMERCE 10-17-1990.

SN 76-467,477. RINGSIDE, INC., LENEXA, KS. FILED 11-15-2002.

ULTIMATE CLASSIC

OWNER OF U.S. REG. NO. 2,038,371.
FOR BOXING AND MARTIAL ARTS EQUIPMENT; NAMELY, BOXING GLOVES, PUNCH MITTS, GROIN AND ABDOMINAL PROTECTORS, HAND WRAPS, PUNCHING BAGS (U.S. CLS. 22, 23, 38 AND 50).
FIRST USE 5-1-2000; IN COMMERCE 5-1-2000.

SN 76-467,567. BOLO POLO, LLC, ST LOUIS, MO. FILED 11-18-2002.

BOLO POLO

NO CLAIM IS MADE TO THE EXCLUSIVE RIGHT TO USE "POLO", APART FROM THE MARK AS SHOWN.
FOR BALL TOSS GAME, NAMELY, BALLS TETHERED TOGETHER AND THE TARGET AT WHICH THEY ARE THROWN (U.S. CLS. 22, 23, 38 AND 50).

CLASS 28—(Continued).

SN 76-467,580. ROSKOPF GOLF L.L.C., PORTLAND, OR. FILED 11-15-2002.

ROSKOPF CUE STICK

FOR GOLF PUTTERS (U.S. CLS. 22, 23, 38 AND 50).

SN 76-471,905. WESTERN ARMS CO., LTD., TOKYO, JAPAN, FILED 12-3-2002.

HARD

FOR TOY GUNS (U.S. CLS. 22, 23, 38 AND 50).

SN 76-472,578. MILTON SALES, INC., MALDEN, WV. FILED 11-27-2002.

THIS LITTLE PIGGY...

FOR TICKETS FOR GAMES OF CHANCE, NAMELY, RAFFLE CARDS, LOTTERY CARDS, RAFFLE TICKETS, LOTTERY TICKETS, AND RAFFLE PULL TAB TICKETS (U.S. CLS. 22, 23, 38 AND 50).
FIRST USE 0-0-1999; IN COMMERCE 0-0-1999.

SN 76-473,482. ROAD CHAMPS, INC., MALIBU, CA. FILED 11-22-2002.

POWER CRAWLERS

FOR TOY VEHICLES (U.S. CLS. 22, 23, 38 AND 50).

SN 76-473,643. MANHATTAN GROUP, LLC, MINNEAPOLIS, MN. FILED 12-6-2002.

PUPPETTOS

OWNER OF U.S. REG. NO. 2,641,559.
FOR PUPPETS; HAND PUPPETS; MARIONETTE PUPPETS; TOY PUPPET THEATRES (U.S. CLS. 22, 23, 38 AND 50).

SN 76-473,943. THRILLTIME ENTERTAINMENT INTERNATIONAL, INC., BURNABY, BRITISH COLUMBIA, CANADA, FILED 12-10-2002.

SKYSPIDER

FOR AMUSEMENT RIDES (U.S. CLS. 22, 23, 38 AND 50).

CLASS 28—(Continued).

SN 76-477,371. NAMCO LTD., TOKYO, JAPAN, FILED 12-23-2002.

TEKKEN

OWNER OF U.S. REG. NOS. 2,079,670 AND 2,712,081.
FOR ACTION FIGURES, DOLLS AND TOY FIGURES (U.S. CLS. 22, 23, 38 AND 50).

SN 78-030,640. GAULDIN, MICHAEL G., ALEXANDRIA, VA. FILED 10-14-2000.



NO CLAIM IS MADE TO THE EXCLUSIVE RIGHT TO USE "DOG SOLDIERS", APART FROM THE MARK AS SHOWN.
THE PORTRAIT IN THE MARK DOES NOT IDENTIFY A LIVING INDIVIDUAL.
FOR 12 INCH ACTION FIGURES DEPICTING HISTORIC PLAINS INDIAN AND CAVALRY SOLDIERS (U.S. CLS. 22, 23, 38 AND 50).
FIRST USE 6-1-1999; IN COMMERCE 6-1-1999.

SN 78-037,393. MATTEL, INC., EL SEGUNDO, CA. FILED 12-1-2000.

ENFORCER

OWNER OF U.S. REG. NO. 1,863,283.
FOR TOY VEHICLES AND ACCESSORIES THEREFOR (U.S. CLS. 22, 23, 38 AND 50).

SN 78-041,577. MATTEL, INC., EL SEGUNDO, CA. FILED 1-3-2001.

PIECE OF CAKE

FOR DOLL CLOTHING AND DOLL ACCESSORIES (U.S. CLS. 22, 23, 38 AND 50).

CLASS 28—(Continued).

SN 78-045,771. MAKE YOUR MARK GOLF ACCESSORIES, INC., CAPE CORAL, FL. FILED 1-30-2001.

MARKER MAGIC

NO CLAIM IS MADE TO THE EXCLUSIVE RIGHT TO USE "MARKER", APART FROM THE MARK AS SHOWN. FOR GOLF BALL MARKERS (U.S. CLS. 22, 23, 38 AND 50).

FIRST USE 1-0-2001; IN COMMERCE 1-0-2001.

SN 78-055,324. MICROSOFT CORPORATION, REDMOND, WA. FILED 3-27-2001.

HALO

FOR TOYS, GAMES AND PLAYTHINGS, NAMELY, TOY ACTION FIGURES AND ACCESSORIES THEREFOR, MECHANICAL ACTION TOYS, BATTERY OPERATED ACTION TOYS, TOY VEHICLES, ACTION PLAY SETS SOLD AS A UNIT FOR MAKE-BELIEVE PLAY BATTLE OR ADVENTURE ACTIVITIES, TOY ENVIRONMENTS FOR USE WITH ACTION FIGURES, BENDABLE TOY FIGURINES, PUPPETS, BALLOONS, WATER SQUIRTING TOYS, INFLATABLE TOYS, TARGET GAMES, CHESS SETS, BOARD GAMES, CARD GAMES, JIGSAW PUZZLES, KITES, YO-YOS, TOY WEAPONS, TOY WATCHES, TOY CALCULATORS, ROLE PLAYING GAMES, TOY MODEL HOBBY CRAFT KITS, HAND HELD UNITS FOR PLAYING ELECTRONIC GAMES, COIN OPERATED ARCADE GAMES, PINBALL-TYPE GAMES, PINBALL MACHINES, TOY RUBBER BALLS, GOLF BALLS, GOLF BALL MARKERS, INFLATABLE SWIMMING POOLS FOR RECREATIONAL USE; ROLLER SKATES; IN-LINE SKATES; SKATEBOARDS; JUMP ROPES; FLYING DISCS; SNOW BOARDS; SNOW SLEDS FOR RECREATIONAL USE; SURF FINNS; SWIM FINNS; SURFBOARDS; SWIM BOARDS FOR RECREATIONAL USE AND CHRISTMAS TREE ORNAMENTS (U.S. CLS. 22, 23, 38 AND 50).

SN 78-060,830. TY INC., WESTMONT, IL. FILED 4-27-2001.

FANCY

FOR PLUSH TOYS (U.S. CLS. 22, 23, 38 AND 50).

SN 78-071,309. COUSIN CORPORATION OF AMERICA, LARGO, FL. FILED 6-27-2001.



FOR HOBBYCRAFT KITS COMPRISING BEADS (U.S. CLS. 22, 23, 38 AND 50).
FIRST USE 6-1-2001; IN COMMERCE 6-1-2001.

CLASS 28—(Continued).

SN 78-084,502. TARGET BRANDS, INC., MINNEAPOLIS, MN. FILED 9-19-2001.

BULLSEYE

FOR PLUSH TOYS (U.S. CLS. 22, 23, 38 AND 50).

SN 78-084,579. MATTEL, INC., EL SEGUNDO, CA. FILED 9-19-2001.

N-TEK ENFORCER

OWNER OF U.S. REG. NO. 1,863,283.
FOR TOYS, NAMELY, TOY ACTION FIGURE ACCESSORIES (U.S. CLS. 22, 23, 38 AND 50).

SN 78-118,551. PUTNAM, MARK, C, ALEXANDRIA, VA. FILED 3-30-2002.

HAZEL

FOR DOLLS; DOLL CLOTHING; DOLL SHOES; DOLL ACCESSORIES; DOLL HOUSES; DOLL CARTS AND WAGONS; CHILD-SIZE COOKING ACCESSORIES IN THE NATURE OF PLAYTHINGS, NAMELY DISHES, COOKING UTENSILS, AND COOKING APPLIANCES; DOLL COOKING ACCESSORIES, NAMELY, DOLL DISHES, DOLL COOKING UTENSILS, AND DOLL COOKING APPLIANCES (U.S. CLS. 22, 23, 38 AND 50).

SN 78-118,553. PUTNAM, MARK, C., ALEXANDRIA, VA. FILED 3-30-2002.

GUMDROP

FOR DOLLS; DOLL CLOTHING; DOLL SHOES; DOLL ACCESSORIES; DOLL HOUSES; DOLL CARTS AND WAGONS; CHILD-SIZE COOKING ACCESSORIES IN THE NATURE OF PLAYTHINGS, NAMELY DISHES, COOKING UTENSILS, AND COOKING APPLIANCES; DOLL COOKING ACCESSORIES, NAMELY, DOLL DISHES, DOLL COOKING UTENSILS, AND DOLL COOKING APPLIANCES (U.S. CLS. 22, 23, 38 AND 50).

CLASS 28—(Continued).

SN 78-124,288. DANTEX PRO LTD., HONG KONG, HONG KONG, FILED 4-26-2002.

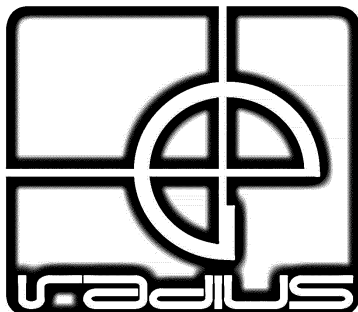

FOR ACTION TOYS, NAMELY, SKATEBOARDS AND IN-LINE SKATES. (U.S. CLS. 22, 23, 38 AND 50).

SN 78-124,883. COHEN, LAWRENCE M., DURANGO, CO. FILED 4-29-2002.

FLASH TARGET

NO CLAIM IS MADE TO THE EXCLUSIVE RIGHT TO USE "TARGET", APART FROM THE MARK AS SHOWN. SEC. 2(F).
 FOR FIREARM TARGET ACCESSORIES, NAMELY SIGNALING DEVICES TO INDICATE WHEN A TARGET HAS BEEN HIT BY A SHOT FROM A FIREARM (U.S. CLS. 22, 23, 38 AND 50).
 FIRST USE 3-1-1997; IN COMMERCE 3-1-1997.

SN 78-128,174. MATTEL, INC., EL SEGUNDO, CA. FILED 5-13-2002.

DANCE PARTY

FOR TOYS, GAMES AND PLAYTHINGS, NAMELY, DOLLS, DOLL CLOTHING AND DOLL ACCESSORIES (U.S. CLS. 22, 23, 38 AND 50).

SN 78-128,184. MATTEL, INC., EL SEGUNDO, CA. FILED 5-13-2002.

SWOOP COUPE

NO CLAIM IS MADE TO THE EXCLUSIVE RIGHT TO USE "COUPE", APART FROM THE MARK AS SHOWN.
 FOR TOYS, GAMES AND PLAYTHINGS, NAMELY, TOY VEHICLES AND ACCESSORIES THEREFOR (U.S. CLS. 22, 23, 38 AND 50).

CLASS 28—(Continued).

SN 78-128,224. MATTEL, INC., EL SEGUNDO, CA. FILED 5-13-2002.

PURPLE PASSION

OWNER OF U.S. REG. NOS. 1,687,198 AND 2,014,372.
 FOR TOYS, GAMES AND PLAYTHINGS, NAMELY, TOY VEHICLES AND ACCESSORIES THEREFOR (U.S. CLS. 22, 23, 38 AND 50).

SN 78-129,898. HD SPORTS LIMITED, SHEFFIELD, UNITED KINGDOM, FILED 5-20-2002.

WAVE BLADE

NO CLAIM IS MADE TO THE EXCLUSIVE RIGHT TO USE "BLADE", APART FROM THE MARK AS SHOWN.
 FOR ICE SKATES; ICE SKATE BLADES (U.S. CLS. 22, 23, 38 AND 50).

SN 78-130,589. CRANIUM INC., SEATTLE, WA. FILED 5-22-2002.

CONGA

FOR PARLOR GAMES; EQUIPMENT SOLD AS A UNIT FOR PLAYING A PARLOR GAME; EQUIPMENT SOLD AS A UNIT FOR PLAYING A CORPORATE TEAM BUILDING, LEADERSHIP, AND TRAINING GAME; JIGSAW PUZZLES; MANIPULATIVE PUZZLES; THREE DIMENSIONAL PUZZLES; CARD GAMES; EQUIPMENT SOLD AS A UNIT FOR PLAYING A CARD GAME (U.S. CLS. 22, 23, 38 AND 50).

SN 78-131,296. CLARK, HARVEY P., BOYLSTON, MA. FILED 5-27-2002.

KIC-TAC-TOE

FOR TARGETED KICKBALL GAME PLAYING EQUIPMENT FOR SOCCER TRAINING (U.S. CLS. 22, 23, 38 AND 50).

SN 78-135,012. MATTEL, INC., EL SEGUNDO, CA. FILED 6-12-2002.

SWAP & POP

FOR TOYS, GAMES AND PLAYTHINGS, NAMELY, DOLLS, TOY FIGURINES, AND ARTICLES OF CLOTHING FOR DOLLS AND TOY FIGURINES (U.S. CLS. 22, 23, 38 AND 50).

CLASS 28—(Continued).

SN 78-135,060. MATTEL, INC., EL SEGUNDO, CA. FILED 6-12-2002.

SINGING STAR

FOR TOYS, GAMES AND PLAYTHINGS, NAMELY, DOLLS, DOLL CLOTHING AND DOLL ACCESSORIES (U.S. CLS. 22, 23, 38 AND 50).

SN 78-135,086. MATTEL, INC., EL SEGUNDO, CA. FILED 6-12-2002.

VICTORIAN TEA

OWNER OF U.S. REG. NO. 2,602,835.
NO CLAIM IS MADE TO THE EXCLUSIVE RIGHT TO USE "VICTORIAN", APART FROM THE MARK AS SHOWN.
FOR TOYS, GAMES AND PLAYTHINGS, NAMELY, DOLLS (U.S. CLS. 22, 23, 38 AND 50).

SN 78-136,550. MACDONALD, CHRISTOPHER J., SAN CLEMENTE, CA. FILED 6-18-2002.

T-GOLF

FOR GOLF TRAINING DEVICE COMPRISED OF VARIED-HEIGHT GOLF TEES AND MODIFIED SHORTENED GOLF CLUB (U.S. CLS. 22, 23, 38 AND 50).

SN 78-141,377. COHEN, JUSTIN, HOWARD, ARLINGTON, VA. FILED 7-4-2002.

JUSTIN TIME PRODUCTIONS

NO CLAIM IS MADE TO THE EXCLUSIVE RIGHT TO USE "PRODUCTIONS", APART FROM THE MARK AS SHOWN.
FOR BOARD GAME (U.S. CLS. 22, 23, 38 AND 50).
FIRST USE 6-6-2002; IN COMMERCE 6-6-2002.

SN 78-155,032. FERREZ, MARCIO, HIALEAH, FL. FILED 8-16-2002.

Champion

FOR EXERCISING EQUIPMENT, NAMELY ROWING MACHINES (U.S. CLS. 22, 23, 38 AND 50).

CLASS 28—(Continued).

SN 78-156,149. RCR PASSTIME PRODUCTS, LLC, MOOR-PARK, CA. FILED 8-21-2002.

HOLE OUT! CARD GOLF

NO CLAIM IS MADE TO THE EXCLUSIVE RIGHT TO USE "CARD GOLF", APART FROM THE MARK AS SHOWN.
FOR CARD GAMES (U.S. CLS. 22, 23, 38 AND 50).

SN 78-157,603. CLAYPOOL, RALPH, W., PALM BEACH GARDENS, FL. FILED 8-25-2002.

DOGNIP

FOR SCENT ATTRACTANT USED IN OR ON DOG TOYS, DOG SNACKS, DOG CHEWS, DOG TREATS, DOG FOOD, DOG MEDICATION (U.S. CLS. 22, 23, 38 AND 50).

SN 78-157,828. VIACOM INTERNATIONAL INC., NEW YORK, NY. FILED 8-26-2002.

SPONGEBOB SQUAREPANTS

OWNER OF U.S. REG. NOS. 2,355,702, 2,565,488 AND OTHERS.
FOR BOARD GAMES AND ACTIVITY BALLS (U.S. CLS. 22, 23, 38 AND 50).
FIRST USE 3-1-2002; IN COMMERCE 3-1-2002.

SN 78-164,136. SCHLESINGER, DEBORAH, CHAPEL HILL, NC. FILED 9-13-2002.

USE YOUR TOOLS

FOR BOARD GAMES; EQUIPMENT SOLD AS A UNIT FOR PLAYING BOARD GAMES; PROMOTIONAL GAME MATERIALS; ROLE PLAYING GAME EQUIPMENT IN THE NATURE OF GAME BOOK MANUALS (U.S. CLS. 22, 23, 38 AND 50).

SN 78-168,953. LIN, TING-SHENG, TAIPEI, TAIWAN, FILED 9-28-2002.

ARMOTECH

FOR PAINTBALL GUNS (U.S. CLS. 22, 23, 38 AND 50).
FIRST USE 6-6-2002; IN COMMERCE 6-6-2002.

CLASS 28—(Continued).

SN 78-171,472. GARDNER, GARY ARLAN, SAN JOSE, CA. FILED 10-6-2002.

STUD SKATEBOARDS

NO CLAIM IS MADE TO THE EXCLUSIVE RIGHT TO USE SKATEBOARDS, APART FROM THE MARK AS SHOWN.

FOR SKATEBOARDS (U.S. CLS. 22, 23, 38 AND 50).

SN 78-172,513. PORTER ATHLETIC EQUIPMENT COMPANY, BROADVIEW, IL. FILED 10-9-2002.

POWR-LOK

OWNER OF U.S. REG. NOS. 1,922,206, 2,629,462 AND OTHERS.

FOR IN-LINE BRACING DEVICE SOLD AS A COMPONENT OF CEILING-SUSPENDED BASKETBALL BACKSTOPS FOR INDOOR USE (U.S. CLS. 22, 23, 38 AND 50).

SN 78-173,006. ZELLMER, WESTON, LANE, FOUNTAIN VALLEY, CA. FILED 10-10-2002.

COMBAT WING

NO CLAIM IS MADE TO THE EXCLUSIVE RIGHT TO USE "WING", APART FROM THE MARK AS SHOWN.

FOR REMOTE CONTROLLED MODEL AIRPLANE (U.S. CLS. 22, 23, 38 AND 50).

FIRST USE 5-23-1999; IN COMMERCE 5-23-1999.

SN 78-173,226. MOOSE MOUNTAIN TOYMAKERS LTD., KOWLOON, HONG KONG, FILED 10-10-2002.

GAME ROOM

FOR TOYS, NAMELY, STAND ALONE SPORTS ARCADE STYLE GAME MACHINES (U.S. CLS. 22, 23, 38 AND 50).

SN 78-175,846. INTEGRITY TOYS, INC., JERSEY CITY, NJ. FILED 10-18-2002.

FASHION ROYALTY

FOR DOLLS (U.S. CLS. 22, 23, 38 AND 50).
FIRST USE 2-1-2002; IN COMMERCE 9-1-2002.

CLASS 28—(Continued).

SN 78-175,986. WOLFSON, DIANE, TELLURIDE, CO. FILED 10-18-2002.

RIGAMAROLE

FOR GAMES, NAMELY, CARD GAMES, PARTY GAMES, PUZZLE GAMES, BOARD GAMES, PARLOR GAMES, AND EQUIPMENT SOLD AS A UNIT FOR PLAYING ALL SUCH GAMES (U.S. CLS. 22, 23, 38 AND 50).

SN 78-177,316. MASTERPIECES PUZZLE COMPANY INC., TUCSON, AZ. FILED 10-23-2002.

SPIN-O-NYMS

FOR TOYS AND GAMES, NAMELY, CARD GAMES, WORD GAMES, BOARD GAMES, SKILL AND ACTION GAMES AND BRAINTEASER GAMES (U.S. CLS. 22, 23, 38 AND 50).

SN 78-177,322. MASTERPIECES PUZZLE COMPANY INC., TUCSON, AZ. FILED 10-23-2002.

LEANING TOWER OF PIZZA

FOR TOYS AND GAMES, NAMELY, CARD GAMES, WORD GAMES, BOARD GAMES, SKILL AND ACTION GAMES AND BRAINTEASER GAMES (U.S. CLS. 22, 23, 38 AND 50).

SN 78-177,323. MASTERPIECES PUZZLE COMPANY INC., TUCSON, AZ. FILED 10-23-2002.

DUCKS IN A ROW

FOR TOYS AND GAMES, NAMELY, CARD GAMES, WORD GAMES, BOARD GAMES, SKILL AND ACTION GAMES AND BRAINTEASER GAMES (U.S. CLS. 22, 23, 38 AND 50).

SN 78-177,647. ROAD CHAMPS, INC, MALIBU, CA. FILED 10-23-2002.

READY TO WORK

FOR DIE CAST TOY VEHICLES (U.S. CLS. 22, 23, 38 AND 50).

CLASS 28—(Continued).

SN 78-177,689. RIDERWARE CO INC, TUCSON, AZ. FILED 10-23-2002.

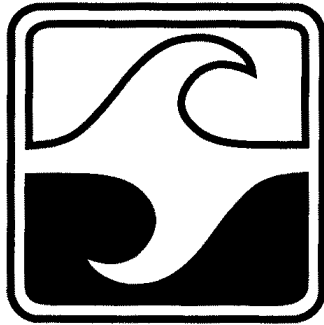

FOR SKATEBOARDS (U.S. CLS. 22, 23, 38 AND 50).
FIRST USE 9-10-2001; IN COMMERCE 9-22-2001.

SN 78-180,424. T-GOLF L.L.C., SAN CLEMENTE, CA. FILED 10-31-2002.

GET INTO THE SWING

FOR GOLF TRAINING DEVICE COMPRISED OF GOLF TEES AND GOLF CLUBS (U.S. CLS. 22, 23, 38 AND 50).

SN 78-180,640. RUOCCHIO, ALBERT C., RALEIGH, NC. FILED 10-31-2002.

HOOKER CHEMICAL

FOR ELECTRIC, MODEL TOY TRAINS AND ACCESSORIES, NAMELY: TRAIN SETS, TRAIN ENGINES, TRAIN CARS, TRAIN TRACK, DIE CAST VEHICLES, AND BUILDINGS (U.S. CLS. 22, 23, 38 AND 50).
FIRST USE 9-15-1987; IN COMMERCE 9-15-1987.

SN 78-182,582. HUFFY CORPORATION, MIAMISBURG, OH. FILED 11-7-2002.

LIMITED

FOR BASKETBALL BACKBOARDS, POLES, AND GOALS, AND PORTABLE BASKETBALL UNITS, CONTAINING A BASE, POLE, BACKBOARD AND GOAL (U.S. CLS. 22, 23, 38 AND 50).

CLASS 28—(Continued).

SN 78-183,606. INNOVATION EXPRESS, L.L.C., BRADENTON, FL. FILED 11-11-2002.

GERI-HAB

FOR EXERCISE, FITNESS AND REHABILITATION MACHINES AND EQUIPMENT FOR USE ON ARMS AND LEGS WHILE IN A SITTING OR LYING DOWN POSITION (U.S. CLS. 22, 23, 38 AND 50).

SN 78-183,671. HANNA-BARBERA PRODUCTIONS, INC., SHERMAN OAKS, CA. FILED 11-11-2002.

PENELOPE PITSTOP

FOR TOYS AND SPORTING GOODS, INCLUDING GAMES AND PLAYTHINGS—NAMELY, ACTION FIGURES AND ACCESSORIES THEREFOR; PLUSH TOYS; BALLOONS; BATHTUB TOYS; RIDE-ON TOYS; EQUIPMENT SOLD AS A UNIT FOR PLAYING CARD GAMES; TOY VEHICLES; DOLLS; FLYING DISCS; ELECTRONIC HAND-HELD GAME UNIT; GAME EQUIPMENT SOLD AS A UNIT FOR PLAYING A BOARD GAME, A CARD GAME, A MANIPULATIVE GAME, A PARLOR GAME AND AN ACTION TYPE TARGET GAME; STAND ALONE VIDEO OUTPUT GAME MACHINES; JIGSAW AND MANIPULATIVE PUZZLES; PAPER FACE MASKS; SKATEBOARDS; ICE SKATES; WATER SQUIRTING TOYS; BALLS—NAMELY, PLAYGROUND BALLS, SOCCER BALLS, BASEBALLS, BASKETBALLS; BASEBALL GLOVES; SWIMMING FLOATS FOR RECREATIONAL USE; KICKBOARD FLOTATION DEVICES FOR RECREATIONAL USE; SURFBOARDS; SWIM BOARDS FOR RECREATIONAL USE; SWIM FINS; TOY BAKEWARE AND TOY COOKWARE; TOY BANKS; TOY SNOW GLOBES; AND CHRISTMAS TREE ORNAMENTS (U.S. CLS. 22, 23, 38 AND 50).

SN 78-183,786. PLAYHARD INC., BOULDER, CO. FILED 11-11-2002.



THE LINING IS A FEATURE OF THE MARK.
FOR FLYING DISCS, ACTION SKILL GAMES, NAMELY FLYING DISC GAMES, FLYING DISC GAME ACCESSORIES, NAMELY ATHLETIC EQUIPMENT CONSISTING OF FIELD MARKERS AND TEAM MARKERS, EQUIPMENT FOR USE WITH FLYING DISCS, NAMELY FLYING DISC TARGETS, AND FLYING DISC CARRIERS (U.S. CLS. 22, 23, 38 AND 50).

CLASS 28—(Continued).

SN 78-183,869. PAINTBALL ONLINE, INC., TIGARD, OR.
FILED 11-11-2002.

CORE

FOR PAINTBALLS, PAINTBALL GUNS, AND PAINTBALL GUN ACCESSORIES, NAMELY, EXPANSION CHAMBER KITS, BOTTOM LINE KITS, BARRELS, BOLTS AND TRIGERS (U.S. CLS. 22, 23, 38 AND 50).

SN 78-184,390. WHAT KIDS WANT! INC., NORTHRIDGE, CA. FILED 11-12-2002.

MAGIC COOKIN' OVEN

NO CLAIM IS MADE TO THE EXCLUSIVE RIGHT TO USE "COOKING OVEN", APART FROM THE MARK AS SHOWN.

FOR TOYS, NAMELY TOY OVEN (U.S. CLS. 22, 23, 38 AND 50).

SN 78-184,413. MEARTHANE PRODUCTS CORPORATION, CRANSTON, RI. FILED 11-13-2002.

IT'LL STOP YOU COLD

FOR IN-LINE SKATES AND WHEELS FOR IN-LINE SKATES (U.S. CLS. 22, 23, 38 AND 50).

SN 78-184,946. HOFFMAN, EDWARD J., HONG KONG, HONG KONG, FILED 11-14-2002.

INSTANT GYM

NO CLAIM IS MADE TO THE EXCLUSIVE RIGHT TO USE "GYM", APART FROM THE MARK AS SHOWN.

FOR MANUALLY OPERATED EXERCISE EQUIPMENT (U.S. CLS. 22, 23, 38 AND 50).

SN 78-185,279. KIKKERLAND DESIGN, INC., NEW YORK, NY. AND DOMINGUES, FRANCISCO BICALHO, NEW YORK, NY. FILED 11-14-2002.

CRANKY

FOR WIND-UP TOY AND ACCESSORIES RELATED THERETO, SOLD AS A UNIT (U.S. CLS. 22, 23, 38 AND 50).

FIRST USE 4-1-2002; IN COMMERCE 4-1-2002.

CLASS 28—(Continued).

SN 78-185,302. KIKKERLAND DESIGNS, INC., NEW YORK, NY. FILED 11-14-2002.

CRITTER

FOR WIND-UP TOY AND ACCESSORIES RELATED THERETO, SOLD AS A UNIT (U.S. CLS. 22, 23, 38 AND 50).

FIRST USE 3-1-1997; IN COMMERCE 3-1-1997.

SN 78-185,309. KIKKERLAND DESIGNS, INC., NEW YORK, NY. FILED 11-14-2002.

KATITA

FOR WIND-UP TOY AND ACCESSORIES THERETO, SOLD AS A UNIT (U.S. CLS. 22, 23, 38 AND 50).

FIRST USE 7-1-1999; IN COMMERCE 7-1-1999.

SN 78-185,326. KIKKERLAND DESIGNS, INC., NEW YORK, NY. AND DONMIGUES, FRANCISCO BICALHO, NEW YORK, NY. FILED 11-14-2002.

SPARKLZ

FOR WIND-UP TOYS AND ACCESSORIES THERETO, SOLD AS A UNIT (U.S. CLS. 22, 23, 38 AND 50).

FIRST USE 4-1-2000; IN COMMERCE 4-1-2000.

SN 78-185,755. CREATE! PRESS, INC., CARLSBAD, CA. FILED 11-15-2002.

CREATE-A-STORY

FOR BOARD GAME (U.S. CLS. 22, 23, 38 AND 50).

FIRST USE 11-1-1999; IN COMMERCE 11-1-1999.

SN 78-186,047. BONNEAU, MICHAEL, D., SAN JOSE, CA. FILED 11-18-2002.

IVM

FOR GOLF PUTTERS (U.S. CLS. 22, 23, 38 AND 50).

SN 78-186,142. MAC GOLF INTERNATIONAL, INC., VALENCIA, CA. FILED 11-18-2002.

TURN IT UP

FOR GOLF CLUBS AND COMPONENT PARTS THEREOF, NAMELY, HEADS, SHAFTS AND GRIPS (U.S. CLS. 22, 23, 38 AND 50).

CLASS 28—(Continued).

SN 78-191,502. KIKKERLAND DESIGNS, INC., NEW YORK, NY. FILED 12-5-2002.

PITOMBA

FOR PULL-STRING TOYS AND ACCESSORIES THERE TO, SOLD AS A UNIT (U.S. CLS. 22, 23, 38 AND 50).

SN 78-193,732. COATTA, JAY,D., MINNETRISTA, MN. FILED 12-12-2002.

SPORTSBUDDIES

FOR DOLLS AND ACCESSORIES THEREFORE ACTION FIGURES AND ACCESSORIES THEREFORE (U.S. CLS. 22, 23, 38 AND 50).

SN 78-193,746. HUBBUB, INC., NORTHFIELD, IL. FILED 12-12-2002.

HUBBUB

FOR BOARD GAMES (U.S. CLS. 22, 23, 38 AND 50).

SN 78-196,254. FAT CAT, INC., WILLISTON, VT. FILED 12-19-2002.

MERRYTAILS

FOR PET TOYS (U.S. CLS. 22, 23, 38 AND 50).

CLASS 29—MEATS AND PROCESSED FOODS

SN 75-183,039. DAIRY CREST LIMITED, SURBITON, SURREY KT6 5Q1, ENGLAND, FILED 10-17-1996.



OWNER OF UNITED KINGDOM REG. NO. 1588355, DATED 10-12-1994, RENEWED AS REG. NO. 1588355, DATED 6-2-2000, EXPIRES 10-12-2011.

THE LINING ON THE DRAWING IS A FEATURE OF THE MARK AND IS NOT INTENDED TO INDICATE COLOR. FOR SANDWICH SPREADS; EDIBLE OILS AND EDIBLE FATS, NAMELY, SPREADS OBTAINED FROM VEGETABLE AND ANIMAL FATS (U.S. CL. 46).

CLASS 29—(Continued).

SN 76-073,982. SWEDISH MEATS, EK. FOR, JOHANNE-SHOV, SWEDEN, FILED 6-21-2000.

SQM

OWNER OF SWEDEN REG. NO. 344929, DATED 3-9-2001, EXPIRES 3-9-2011.

FOR FRESH AND FROZEN MEAT (U.S. CL. 46).

SN 76-172,357. WILLIAM POLL, INC., NEW YORK, NY. FILED 11-28-2000.

DIP INDULGENCE

NO CLAIM IS MADE TO THE EXCLUSIVE RIGHT TO USE "DIP", APART FROM THE MARK AS SHOWN.

FOR CREAMY GOURMET FOOD PRODUCTS, NAMELY, SNACK DIPS, DAIRY BASED DIPS AND FLAVORED DIPS CONTAINING CHEESE, ALL OF THE FOREGOING EXCLUDING SALSA AND OTHER SAUCES (U.S. CL. 46).

FIRST USE 6-0-1999; IN COMMERCE 6-0-1999.

SN 76-280,323. LIDL STIFTUNG & CO. KG, 74172 NECK-ARSULM, FED REP GERMANY, FILED 7-3-2001.

SIRIUS

OWNER OF FED REP GERMANY REG. NO. 39960673, DATED 11-4-1999, EXPIRES 9-30-2009.

FOR DRIED FRUITS; DRIED AND/OR ROASTED WHOLE OR GROUND NUT KERNELS (U.S. CL. 46).

CLASS 29—(Continued).

SN 76-282,331. MOULIN A HUILE ALZIARI, 06300 NICE, FRANCE, FILED 7-10-2001.

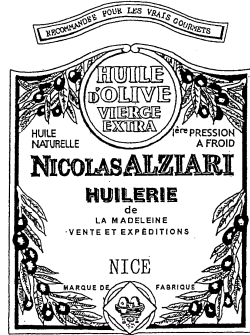

PRIORITY CLAIMED UNDER SEC. 44(D) ON FRANCE APPLICATION NO. 1647043, FILED 2-28-1991, REG. NO. 1647043, DATED 2-28-1991, EXPIRES 2-28-2001.

NO CLAIM IS MADE TO THE EXCLUSIVE RIGHT TO USE "RECOMMANDEE POUR LES VRAIS GOURMETS", "HUILE D'OLIVE", "VIERGE EXTRA", "HUILE NATURELLE", "LERE PRESSION A FROID", "HUILERIE DE LA MADELINE VENTE ET EXPEDITIONS", "NICE", AND "MARQUES DE FABRIQUE", APART FROM THE MARK AS SHOWN.

THE NAME SHOWN IN THE MARK DOES NOT IDENTIFY A LIVING INDIVIDUAL.

THE ENGLISH TRANSLATION OF "RECOMMANDEE POUR LES VRAIS GOURMETS" IS "RECOMMENDED FOR REAL GOURMETS". THE ENGLISH TRANSLATION OF "HUILE NATURELLE" IS "NATURAL OIL". THE ENGLISH TRANSLATION OF "JERE PRESSION A FROID" IS "FIRST COLD PRESSING". THE ENGLISH TRANSLATION OF "HUILERIE DE LA MADELEINE VENTE ET EXPEDITIONS" IS "OIL COMPANY OF LA MADELEINE SALE AND SHIPPING". THE ENGLISH TRANSLATION OF "MARQUE DE FABRIQUE" IS "TRADEMARK".

FOR OLIVE OIL (U.S. CL. 46).

SN 76-298,209. DEAN INTELLECTUAL PROPERTY SERVICES, L.P., DALLAS, TX. BY ASSIGNMENT; BY ASSIGNMENT; BY ASSIGNMENT SUIZA DAIRY GROUP, L.P., DALLAS, TX. FILED 8-9-2001.

YONSON

OWNER OF U.S. REG. NO. 780,775. FOR YOGURT (U.S. CL. 46). FIRST USE 4-26-1963; IN COMMERCE 4-26-1963.

SN 76-326,334. PUEBLO FOODS INTERNATIONAL, INC., NORTH MIAMI BEACH, FL. FILED 10-18-2001.

SABORFOODS

THE ENGLISH TRANSLATION OF "SABOR" IS "FLAVOR".

FOR MEATS, FISH, POULTRY, AND GAME; MEAT EXTRACTS, MILK, PRESERVED, DRIED, AND COOKED FRUITS AND VEGETABLES; AND EDIBLE OILS AND FATS (U.S. CL. 46).

CLASS 29—(Continued).

SN 76-354,324. TASTYFOOD INDUSTRIES (S) PTE LTD, JURONG TOWN, SINGAPORE, FILED 1-3-2002.



PRIORITY CLAIMED UNDER SEC. 44(D) ON SINGAPORE APPLICATION NO. T01/13666J, FILED 9-4-2001, REG. NO. T01/13666J, DATED 4-9-2001, EXPIRES 4-9-2011.

NO CLAIM IS MADE TO THE EXCLUSIVE RIGHT TO USE "JELLY", APART FROM THE MARK AS SHOWN.

FOR JELLY WITH FLAVORS OF FRUITS (U.S. CL. 46).

SN 76-381,128. OK FOODS, INC., FORT SMITH, AR. FILED 3-12-2002.



NO CLAIM IS MADE TO THE EXCLUSIVE RIGHT TO USE "FOOD" AND "QUALITY", APART FROM THE MARK AS SHOWN.

THE MARK CONSISTS OF THE WORD "FOODS", SUPERIMPOSED OVER THE WORD "OK", ON A CIRCLE, GUARDED ON EACH SIDE BY SOLDIERS, WITH A BANNER, WITH VERTICAL STIPPLING INDICATING THE COLOR RED, AND THE HORIZONTAL STIPPLING INDICATING THE COLOR BLUE.

FOR FRESH AND FROZEN CHICKEN AND CHICKEN PARTS AND PROCESSED CHICKEN (U.S. CL. 46).

FIRST USE 1-1-1958; IN COMMERCE 1-1-1958.

CLASS 29—(Continued).

SN 76-393,446. ABELE BERTOZZI S.P.A., 43100 PARMA, ITALY, FILED 4-8-2002.

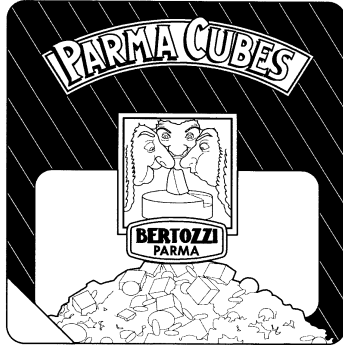

NO CLAIM IS MADE TO THE EXCLUSIVE RIGHT TO USE "CUBES" AND "PARMA", APART FROM THE MARK AS SHOWN.
 FOR CHEESE (U.S. CL. 46).
 FIRST USE 7-0-2001; IN COMMERCE 7-0-2001.

CLASS 29—(Continued).

SN 76-407,157. BERGIDUM, S.A.T., LEON, SPAIN, FILED 5-10-2002.



OWNER OF ERPN CMNTY TM OFC REG. NO. 1,425,636, DATED 2-26-2001, EXPIRES 12-15-2009.
 THE ENGLISH TRANSLATION OF THE ANCIENT DIALECT FROM NORTHERN SPAIN "LENDA DEL LAC" IN THE MARK IS "LAKE PATH".
 FOR PRESERVED, DRIED AND COOKED VEGETABLES, NAMELY, ROAST PEPPERS, CHESTNUTS, FIGS, PICKLES, LEEKS, PROCESSED VEGETABLES, CRYSTALLIZED FRUITS, FRUIT JELLIES, TOMATO PUREE, CHESTNUTS AND FIGS IN SYRUP (U.S. CL. 46).

SN 76-418,151. SCHWAN'S IP LLC, MARSHALL, MN. FILED 6-10-2002.

ASIAN TRADITION

SN 76-393,447. ABELE BERTOZZI S.P.A., 43100 PARMA, ITALY, FILED 4-8-2002.



NO CLAIM IS MADE TO THE EXCLUSIVE RIGHT TO USE "FLAKES" AND "PARMA", APART FROM THE MARK AS SHOWN.
 FOR CHEESE (U.S. CL. 46).
 FIRST USE 7-0-2001; IN COMMERCE 7-0-2001.

NO CLAIM IS MADE TO THE EXCLUSIVE RIGHT TO USE "ASIAN", APART FROM THE MARK AS SHOWN.
 FOR FROZEN ENTREES CONSISTING PRIMARILY OF MEAT, CHICKEN, PORK AND VEGETABLES (U.S. CL. 46).

SN 76-419,068. FROMARTHARIE, INC., WARREN, NJ. FILED 6-10-2002.

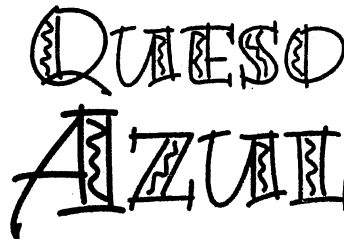

NO CLAIM IS MADE TO THE EXCLUSIVE RIGHT TO USE "QUESO AZUL", APART FROM THE MARK AS SHOWN.
 THE ENGLISH TRANSLATION OF "QUESO AZUL" IS "BLUE CHEESE".
 FOR CHEESE (U.S. CL. 46).

CLASS 29—(Continued).

SN 76-419,409. INCREDIBLY EDIBLE DELITES, INC., BROO-MALL, PA. FILED 6-11-2002.



OWNER OF U.S. REG. NO. 1,755,554.
 NO CLAIM IS MADE TO THE EXCLUSIVE RIGHT TO USE "EDIBLE DELITES, INC.", APART FROM THE MARK AS SHOWN.
 FOR FLORAL FRUIT AND VEGETABLE ARRANGEMENTS CONSISTING OF CUT OR SLICED FRUITS AND VEGETABLES (U.S. CL. 46).

SN 76-419,410. INCREDIBLY EDIBLE DELITES, INC., BROO-MALL, PA. FILED 6-11-2002.

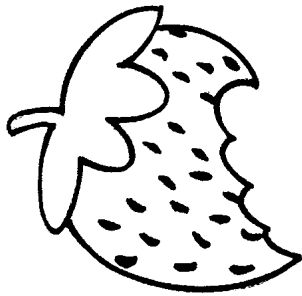

OWNER OF U.S. REG. NO. 1,755,554.
 FOR FLORAL FRUIT AND VEGETABLE ARRANGEMENTS CONSISTING OF CUT OR SLICED FRUITS AND VEGETABLES (U.S. CL. 46).
 FIRST USE 1-0-1996; IN COMMERCE 1-0-1996.

SN 76-423,282. SOCIETA PER AZIONI LUCCHESI OLII E VINI, 55100 LUCCA, ITALY, FILED 6-25-2002.

CALLISTO FRANCESCONI

OWNER OF U.S. REG. NO. 87,063.
 THE NAME "CALLISTO FRANCESCONI" DOES NOT IDENTIFY A LIVING INDIVIDUAL.
 FOR OLIVE OIL (U.S. CL. 46).
 FIRST USE 6-6-1907; IN COMMERCE 6-6-1907.

CLASS 29—(Continued).

SN 76-427,279. FREI, DANIEL, 9404 RORSCHACHERBERG, SWITZERLAND, FILED 12-18-2002.



*Black-Angus
 Gold • Beef*

NO CLAIM IS MADE TO THE EXCLUSIVE RIGHT TO USE "BLACK ANGUS" AND "BEEF", APART FROM THE MARK AS SHOWN.
 FOR MEAT, NAMELY, BEEF (U.S. CL. 46).
 FIRST USE 1-1-2000; IN COMMERCE 1-1-2000.

SN 76-441,076. PURESOURCE INC., GUELPH, ONTARIO, CANADA, FILED 8-16-2002.

OMEGALIFE

PRIORITY CLAIMED UNDER SEC. 44(D) ON CANADA APPLICATION NO. 1142990, FILED 6-6-2002.
 FOR MARGARINE (U.S. CL. 46).

SN 76-442,147. PURESOURCE INC., GUELPH ONTARIO, CANADA, FILED 8-16-2002.



PRIORITY CLAIMED UNDER SEC. 44(D) ON CANADA APPLICATION NO. 1142992, FILED 6-6-2002.
 NO CLAIM IS MADE TO THE EXCLUSIVE RIGHT TO USE "REAL BERRY", APART FROM THE MARK AS SHOWN.
 FOR APPLE-BASED DRIED FRUIT SNACK (U.S. CL. 46).

CLASS 29—(Continued).

SN 76-446,798. NATIONAL PROVISIONS, INC., MIAMI, FL. FILED 9-3-2002.



SEC. 2(F) AS TO "NATIONAL DELI".
FOR COOKED MEATS NAMELY, FRANKFURTERS, PASTRAMI, CORNED BEEF, PICKLED TONGUE, CORNED BRISKET OF BEEF, OVEN ROASTED BEEF, COOKED BEEF BRISKET AND COOKED BEEF TONGUE (U.S. CL. 46).
FIRST USE 1-1-1975; IN COMMERCE 1-1-1975.

SN 76-452,315. SWIFT BRANDS COMPANY, GREELEY, CO. FILED 9-23-2002.

FOUR STAR BEEF

NO CLAIM IS MADE TO THE EXCLUSIVE RIGHT TO USE "BEEF", APART FROM THE MARK AS SHOWN.
FOR BEEF AND BEEF CUTS (U.S. CL. 46).
FIRST USE 1-0-1982; IN COMMERCE 1-0-1982.

SN 76-475,420. CITRAPAC, INC., SEBRING, FL. FILED 11-29-2002.



FOR FRESH CUT CITRUS FRUITS AND PREPACKAGED PROCESSED CITRUS FRUITS (U.S. CL. 46).

CLASS 29—(Continued).

SN 78-024,732. BARTLETT, GREG, A, CORONA, CA. FILED 9-7-2000.

MOO CHEW

NO CLAIM IS MADE TO THE EXCLUSIVE RIGHT TO USE "CHEW", APART FROM THE MARK AS SHOWN.
FOR PREPARED AND PROCESSED BEEF JERKY PRODUCTS, COOKED, CURED, SMOKED, AND DRIED (U.S. CL. 46).
FIRST USE 0-0-1998; IN COMMERCE 5-5-1999.

SN 78-070,971. PILLER SAUSAGES & DELICATESSENS LTD., WATERLOO, ONTARIO, FILED 6-26-2001.

OPEN AND SERVE

PRIORITY CLAIMED UNDER SEC. 44(D) ON CANADA APPLICATION NO. 1090437, FILED 1-24-2001, REG. NO. 570,446, DATED 11-7-2002, EXPIRES 11-7-2017.
FOR INDIVIDUAL, DISCRETE SLICES OF PROCESSED COOKED AND CURED MEATS, NAMELY, TURKEY, BEEF AND PORK (U.S. CL. 46).

SN 78-108,130. SUN ORCHARD FRUIT COMPANY, INC., DBA SUN ORCHARD BRAND, BURT, NY. FILED 2-11-2002.



THE LINING IS A FEATURE OF THE MARK AND DOES NOT INDICATE COLOR.
FOR SLICED FRUIT OR VEGETABLES (U.S. CL. 46).
FIRST USE 10-28-2001; IN COMMERCE 10-28-2001.

SN 78-132,423. DEAN INTELLECTUAL PROPERTY SERVICES II, L.P., DALLAS, TX. BY ASSIGNMENT DTMC, INC., FRANKLIN PARK, IL. FILED 5-31-2002.

THE CHIP MAGNET

NO CLAIM IS MADE TO THE EXCLUSIVE RIGHT TO USE "CHIP", APART FROM THE MARK AS SHOWN.
FOR DAIRY-BASED DIPS (U.S. CL. 46).

CLASS 29—(Continued).

SN 78-138,367. ASSISTANCE FOOD AMERICA INC, MIAMI BEACH, FL. FILED 6-24-2002.

GOODAY

FOR FISH, FISH FILLETS AND TUNA FISH (U.S. CL. 46).
FIRST USE 1-0-2002; IN COMMERCE 1-0-2002.

SN 78-140,649. CONG TY CO PHAN SUA SAI GON, THANH PHO HO CHI MINH, VIETNAM, FILED 7-2-2002.

MERRY COW

FOR MILK AND DAIRY PRODUCTS, EXCLUDING ICE CREAM, ICE MILK AND FROZEN YOGURT (U.S. CL. 46).

SN 78-163,447. ZAXBY'S FRANCHISING, INC., ATHENS, GA. FILED 9-12-2002.

BUFFALO FINGERZ

NO CLAIM IS MADE TO THE EXCLUSIVE RIGHT TO USE "BUFFALO", APART FROM THE MARK AS SHOWN. FOR COOKED BREADED BONELESS WHITE MEAT STRIPS OF CHICKEN COATED WITH HOT SAUCE (U.S. CL. 46).

SN 78-179,330. SAEZ, JOSE, MIAMI, FL. FILED 10-29-2002.

EL CHAMO

THE ENGLISH TRANSLATION OF "EL CHAMO" IS "CHILD". FOR FRESH CURED AND COOKED SAUSAGE (U.S. CL. 46).

SN 78-180,494. MILTON ABELES, INC., MINEOLA, NY. FILED 10-31-2002.

CLUBHOUSE STEAK

NO CLAIM IS MADE TO THE EXCLUSIVE RIGHT TO USE "STEAK", APART FROM THE MARK AS SHOWN. FOR FOOD PRODUCTS, NAMELY BEEF STEAK (U.S. CL. 46).

CLASS 29—(Continued).

SN 78-183,335. LIPTON INVESTMENTS, INC., WILMINGTON, DE. FILED 11-8-2002.

I CAN'T BELIEVE IT'S NOT CHEESE

OWNER OF U.S. REG. NO. 1,257,722.
FOR CHEESE SUBSTITUTE (U.S. CL. 46).

SN 78-184,341. LIPTON INVESTMENTS, INC., WILMINGTON, DE. FILED 11-12-2002.

I CAN'T BELIEVE IT'S NOT SOUR CREAM!

OWNER OF U.S. REG. NO. 1,257,722.
FOR SOUR CREAM SUBSTITUTE (U.S. CL. 46).

SN 78-185,372. VALLE GRANDE LIMITADA, ISLA DE MAIPO, CHILE, FILED 11-15-2002.

OLAVE

PRIORITY CLAIMED UNDER SEC. 44(D) ON JAPAN APPLICATION NO. 2002-86407, FILED 10-11-2002. FOR OLIVE OIL (U.S. CL. 46).

SN 78-185,754. ORE-CAL CORPORATION, LOS ANGELES, CA. FILED 11-15-2002.

HARVEST OF THE SEA

OWNER OF U.S. REG. NOS. 1,222,779 AND 1,222,780. FOR SEAFOOD AND FISH (U.S. CL. 46).
FIRST USE 1-1-1963; IN COMMERCE 1-1-1963.

SN 78-185,758. ORE-CAL CORPORATION, LOS ANGELES, CA. FILED 11-15-2002.



OWNER OF U.S. REG. NOS. 1,222,779 AND 1,222,780. FOR SEAFOOD AND FISH (U.S. CL. 46).
FIRST USE 1-1-1963; IN COMMERCE 1-1-1963.

CLASS 29—(Continued).

SN 78-185,766. ORE-CAL CORPORATION, LOS ANGELES, CA. FILED 11-15-2002.

FISHERMAN'S OUTLET

OWNER OF U.S. REG. NOS. 1,334,542, 1,346,925 AND 1,519,293.
FOR SEAFOOD AND FISH (U.S. CL. 46).
FIRST USE 1-1-1963; IN COMMERCE 1-1-1963.

SN 78-186,411. GOLDSCHNEIDER, MICHAEL, BOULDER, CO. FILED 11-19-2002.

ROKKITS

FOR PROTEIN ENRICHED NUTRITION SNACK BAR FOR KIDS (U.S. CL. 46).

SN 78-191,302. TAN INDUSTRIES, INC., SAN FRANCISCO, CA. FILED 12-4-2002.

SOYLAMI

FOR SOY-BASED MEAT SUBSTITUTE (U.S. CL. 46).

SN 78-193,487. INTERNATIONAL MULTIFOODS CORPORATION, MINNETONKA, MN. FILED 12-11-2002.

HEARTY BAKED

NO CLAIM IS MADE TO THE EXCLUSIVE RIGHT TO USE "BAKED", APART FROM THE MARK AS SHOWN.
FOR DEHYDRATED INSTANT POTATOES (U.S. CL. 46).

SN 78-193,835. SIGNATURE FRUIT COMPANY LLC, MODESTO, CA. FILED 12-12-2002.

TASTE O' THE WEST

OWNER OF U.S. REG. NO. 163,556.
FOR CANNED FRUIT AND CANNED VEGETABLES (U.S. CL. 46).

FIRST USE 5-10-1921. THE MARK WAS FIRST USED ANYWHERE IN A DIFFERENT FORM OTHER THAN THAT SOUGHT TO BE REGISTERED ON 05/10/1921; IN COMMERCE 5-10-1921, THE MARK WAS FIRST USED IN COMMERCE IN A DIFFERENT FORM OTHER THAN THAT SOUGHT TO BE REGISTERED ON 05/10/1921.

CLASS 30—STAPLE FOODS

SN 75-492,373. BEN & JERRY'S HOMEMADE HOLDINGS, INC., BURLINGTON, VT. FILED 5-28-1998.

EXTREME SCREAM

FOR ICE CREAMS, FROZEN YOGURTS, SORBETS, FROZEN CONFECTIONS, AND FROZEN DESSERTS, NAMELY, ICE CREAM CAKES (U.S. CL. 46).

SN 76-085,291. CALVILLO, JESUS E., SAN ANTONIO, TX. FILED 7-10-2000.

EL MIRASOL

THE ENGLISH TRANSLATION OF THE SPANISH WORD "EL MIRASOL" IS "SUNFLOWER".
FOR SALSA (U.S. CL. 46).

SN 76-121,147. CHOCOLATES TURIN, S.A. DE C.V., MEXICO, MEXICO, FILED S.R. 9-1-2000; AM. P.R. 5-31-2002.



THE MARK CONSISTS OF THE COLOR RED IN THE TOP PORTION OF THE MARK, THE COLOR BROWN IN THE MAIN PORTION OF THE MARK, AND THE COLOR GOLD IN THE BORDERS AND OUTLINING OF THE MARK.

SEC. 2(F) AS TO "TURIN".
FOR CONFECTIONERY, NAMELY CHOCOLATES AND CANDIES (U.S. CL. 46).
FIRST USE 0-0-1987; IN COMMERCE 11-9-1993.

SN 76-202,904. SEATTLE'S BEST COFFEE LLC, SEATTLE, WA. FILED 1-31-2001.

X-TEA

FOR TEA (U.S. CL. 46).

CLASS 30—(Continued).

SN 76-222,983. COFFEE MASTERS, INC., SPRING GROVE, IL. FILED 3-12-2001.

BELLA CREMA

OWNER OF U.S. REG. NO. 1,921,293.
NO CLAIM IS MADE TO THE EXCLUSIVE RIGHT TO USE "CREMA", APART FROM THE MARK AS SHOWN.
THE WORD "BELLA" IS ITALIAN FOR "SWEETHEART".
THE ENGLISH TRANSLATION OF "CREMA" IS "CREAM".
FOR CAPPUCCINO AND CAPPUCCINO MIX (U.S. CL. 46).
FIRST USE 7-0-1994; IN COMMERCE 7-0-1994.

SN 76-232,812. LIDL STIFTUNG & CO. KG, 74172 NECK-ARSULM, FED REP GERMANY, FILED 3-29-2001.

ECORINO

OWNER OF UNITED KINGDOM REG. NO. 2131356, DATED 11-14-1997, EXPIRES 4-30-2007.
FOR CONFECTIONERY, NAMELY CANDY AND FROZEN CONFECTIONS; PASTRY PRODUCTS, NAMELY PASTRIES; ICE CREAM (U.S. CL. 46).

SN 76-276,692. NATURE'S PATH FOODS INC., DELTA, BRITISH COLUMBIA V4G 1E8, CANADA, FILED 6-20-2001.

OPTIMUM

PRIORITY CLAIMED UNDER SEC. 44(D) ON CANADA APPLICATION NO. 1,103,049, FILED 5-18-2001.
FOR WAFFLES (U.S. CL. 46).

SN 76-281,848. MARS, INCORPORATED, MCLEAN, VA. FILED 7-9-2001.

WHERE COOKIE MEETS CANDY

NO CLAIM IS MADE TO THE EXCLUSIVE RIGHT TO USE "COOKIE" AND "CANDY", APART FROM THE MARK AS SHOWN.
FOR COMBINATION CANDY AND COOKIE SNACK FOOD BARS (U.S. CL. 46).

CLASS 30—(Continued).

SN 76-292,577. MARS, INCORPORATED, MCLEAN, VA. FILED 7-31-2001.

CHOCOBA

FOR COCOA-BASED FOOD INGREDIENTS FOR USE IN SNACK CAKES, CUPCAKES, TREATS, TARTS, CHIPS, CEREAL, BAKING MIXES AND INGREDIENTS, ICE BARS, ENERGY BARS, PACKAGED MEALS, PACKAGED COMBINATION MEALS WITH OTHER FOOD AND DESSERT/SNACK ITEMS (U.S. CL. 46).

SN 76-303,100. MRS. SMITH'S BRANDS, INC., SUWANEE, GA. FILED 8-22-2001.

SOCCER GOALS

FOR BAKERY PRODUCTS, NAMELY SNACK CAKES (U.S. CL. 46).
FIRST USE 10-1-1998; IN COMMERCE 10-1-1998.

SN 76-326,333. PUEBLO FOODS INTERNATIONAL, INC., NORTH MIAMI BEACH, FL. FILED 10-18-2001.

VITA NUOVA

THE ENGLISH TRANSLATION OF "VITA NUOVA" IS "NEW LIFE".

FOR STAPLE GOODS, NAMELY, COFFEE, TEA, COCOA SUGAR, RICE, TAPIOCA, SAGO, ARTIFICIAL COFFEE; FLOUR AND PREPARATIONS MADE FROM CEREALS, NAMELY, BREAD AND PASTRY; CONFECTIONERY, NAMELY, BAKERY DESSERTS; FLAVORED ICES; HONEY, TREACLE; YEAST, BAKING-POWDER; SALT, MUSTARD; VINEGAR, MUSTARD, SAUCES USED AS CONDIMENTS; SPICES; ICE; AND PASTA (U.S. CL. 46).

SN 76-335,304. PRODUCTOS INDUSTRIALIZADOS DE SALTILLO, S. DE R.L. DE C.V., 25280 SALTILLO, COAHUILA, MEXICO, FILED 11-7-2001.



PRIORITY CLAIMED UNDER SEC. 44(D) ON MEXICO APPLICATION NO. 510,306, FILED 10-4-2001, REG. NO. 510306, DATED 5-10-2002, EXPIRES 10-4-2011.

THE LETTERS "W" AND "X" IN THE MARK ARE IN THE COLOR ORANGE; THE LETTER "I" AND THE HYPHEN OR ARROW SYMBOL ARE IN THE COLOR YELLOW; THE LETTER "L" IN THE COLOR GREEN; AND THE LETTER "D" IN THE COLOR RED. THE COLORS ARE FEATURES OF THE MARK.

FOR CANDY, CARAMELS, CHOCOLATE AND CHEWING GUM (U.S. CL. 46).

CLASS 30—(Continued).

SN 76-343,689. FLOWERS BAKERIES BRANDS, INC., WILMINGTON, DE. FILED 11-29-2001.

MARY JANE

OWNER OF U.S. REG. NOS. 796,488 AND 1,923,004. FOR BREAD (U.S. CL. 46). FIRST USE 2-0-1920; IN COMMERCE 2-0-1920.

SN 76-370,174. CONAGRA GROCERY PRODUCTS COMPANY, IRVINE, CA. FILED 2-11-2002.

KNOTT'S BERRY FARM

OWNER OF U.S. REG. NOS. 622,410, 1,537,507 AND OTHERS.

FOR FRUIT FLAVORED ICE CREAM TOPPINGS; FRUIT FLAVORED ICE CREAM SYRUP; FRUIT FLAVORED BASES FOR USE IN MAKING SLUSHES, SNOW CONES AND SHAKES; AND FRUIT FLAVORED ICE CREAM COATING (U.S. CL. 46).

SN 76-383,980. CENTRAL IMPULSORA, S.A. DE C.V., MEXICO 01210, D.F. MEXICO, FILED 3-19-2002.

CHOCO-VANILLA WAFERS

NO CLAIM IS MADE TO THE EXCLUSIVE RIGHT TO USE "WAFER", APART FROM THE MARK AS SHOWN. FOR COOKIES (U.S. CL. 46).

SN 76-388,688. LACO OVERSEAS, INC., MIAMI, FL. FILED 3-26-2002.



NO CLAIM IS MADE TO THE EXCLUSIVE RIGHT TO USE "FRUTTI", APART FROM THE MARK AS SHOWN. THE ENGLISH TRANSLATION OF THE WORD FRUTTI IN THE MARK IS FRUIT.

FOR CANDY, NAMELY, ASSORTED FRUIT FLAVORED MINIATURE GELATIN CUPS (U.S. CL. 46). FIRST USE 5-24-2001; IN COMMERCE 5-24-2001.

CLASS 30—(Continued).

SN 76-391,360. MOZZETTI, MARIO, ROME, ITALY, FILED 4-5-2002.



PRIORITY CLAIMED UNDER SEC. 44(D) ON ITALY APPLICATION NO. RM2002C00024, FILED 1-18-2002, REG. NO. 873003, DATED 7-24-2002, EXPIRES 1-18-2012.

THE ITALIAN WORDS "ALLA SCROFA" MEAN "TO THE SOW" AND "ROMA" MEANS "ROME".

FOR PASTA AND SAUCES, NAMELY, FETTUCCINE, DRIED FETTUCCINE, PRE-COOKED, NON-FROZEN AND SEMI-FRESH FETTUCCINE SEASON WITH SAUCE; FRESH FETTUCCINE; LASAGNA, MACARONI AND CHEESE, PASTA SALAD, MACARONI SALAD, SPAGHETTI, ZITI, MACARONI, GNOCCHI, SPAGHETTI AND MEATBALLS, ALIMENTARY PASTE; SAUCES WITH CHEESE, TOMATO SAUCES AND PESTO SAUCES (U.S. CL. 46).

SN 76-392,136. MARTINEZ, ISIDRO M., SAN ANTONIO, TX. FILED 4-8-2002.

TACONO

FOR CONE-SHAPED TACO SHELLS (U.S. CL. 46).

SN 76-398,071. MAHABAZAAR.COM, INC., GAITHERSBURG, MD. FILED 4-19-2002.



NO CLAIM IS MADE TO THE EXCLUSIVE RIGHT TO USE "QUALITY FOODS", APART FROM THE MARK AS SHOWN.

FOR EASTERN FOOD PRODUCTS, NAMELY, SPICES, SPICE MIXES, RICE, TEA, FLOUR, CHUTNEY, COFFEE, CHILI SAUCE, CHILI SEASONING, BISCUITS, BAKERY PRODUCTS, CEREAL BASED SNACK FOODS, FROZEN ENTREES CONSISTING PRIMARILY OF PASTA AND RICE, FROZEN CONFECTIONS, FROZEN MEALS CONSISTING PRIMARILY OF PASTA AND RICE, BREAD, BARBECUE SAUCE, CURRY, FLOUR BASED CHIPS, GRAVY, TAPIOCA, RICE CAKES (U.S. CL. 46).

FIRST USE 4-16-2002; IN COMMERCE 4-16-2002.

CLASS 30—(Continued).

SN 76-404,666. PROMOTION IN MOTION, INC., CLOSTER, NJ. FILED 5-8-2002.

SWISSKISS

FOR CHOCOLATE (U.S. CL. 46).

SN 76-411,548. SHUNFAR INTERNATIONAL, INC., ROWLAND HEIGHTS, CA. FILED 5-23-2002.

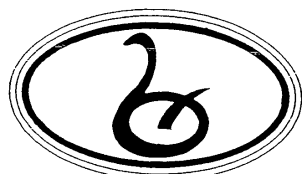

小天鹅

THE DESIGN IS COMPRISED OF A UNIQUE DESIGN OF A SWAN BEING DISPOSED WITHIN AN ECLIPSE DESIGN AND THE CHINESE CHARACTERS.

THE THREE CHINESE CHARACTER TRANSLITERATE AS "SHUA TIEN NGUR" WHICH TRANSLATE AS "BABY SWAN". THE MARK HAS NO OTHER MEANING OR SPECIFIC RELATIONSHIP TO THE GOODS.

FOR SOUP BASE FOR USE AS A HOT POT FLAVORING (U.S. CL. 46).

FIRST USE 2-0-2001; IN COMMERCE 2-0-2001.

SN 76-413,654. CANDELARIO, ERIBERTO, ZAPOPAN, JALISCO, MEXICO, FILED 5-22-2002.

JOVY PINGOOS

"PINGOO" IS A MEXICAN WAY TO SAY "MISCHIEVOUS"; "JOVY" IS A "NICKNAME".

FOR BITTERSWEET SOFT CANDY MADE OF CRYSTALLIZED SUGAR AND ARTIFICIAL FLAVORS (U.S. CL. 46).

CLASS 30—(Continued).

SN 76-413,877. SOUTH FLORIDA BAKERY, INC., MIAMI, FL. FILED 5-30-2002.



NO CLAIM IS MADE TO THE EXCLUSIVE RIGHT TO USE "GOURMET", APART FROM THE MARK AS SHOWN. THE FOREIGN WORDING IN THE MARK TRANSLATES INTO ENGLISH AS "FROM THE TROPICS".

FOR BREAD, PASTRY, PREPARATIONS MADE FROM FLOUR, NAMELY, CAKES, COOKIES AND BREAD; PREPARATIONS MADE FROM CEREALS AND BAKERY GOODS IN RAW, SEMI-BAKED OR FULLY BAKED STAGE; BAKERY GOODS AND PASTRIES, NAMELY, CUBAN BREAD, PUERTO RICAN BREAD, HISPANIC ROLLS, MEDIA NOCHE ROLLS, PAN DE GLORIA, MASA REAL, BREAD PUDDING, MALLORCA CORN BREAD, GUAVA PASTRIES, GUAVA AND CHEESE PASTRIES, CHEESE PASTRIES, COCONUT PASTIES, DULCE DEL LECHE PASTRIES, PINEAPPLE PASTRIES, MEAT FLAVOR AND SOY PROTEIN BASED PASTIES (U.S. CL. 46).

FIRST USE 4-15-1997; IN COMMERCE 4-15-1997.

SN 76-414,404. NUTRASWEET PROPERTY HOLDINGS, INC., CHICAGO, IL. FILED 5-30-2002.

OVERTIME

FOR CHEWING GUM AND CANDY BREATH MINTS (U.S. CL. 46).

SN 76-417,421. MARS, INCORPORATED, MCLEAN, VA. FILED 6-5-2002.

BEYOND CRUNCHY

NO CLAIM IS MADE TO THE EXCLUSIVE RIGHT TO USE "CRUNCHY", APART FROM THE MARK AS SHOWN. FOR CONFECTIONERY, NAMELY, CANDY (U.S. CL. 46).

SN 76-417,620. E.H. SOLUTION SEASONING INC, BRONX, NY. FILED 6-10-2002.

SOFRITO LA SOLUCION EH

NO CLAIM IS MADE TO THE EXCLUSIVE RIGHT TO USE "SOFRITO", APART FROM THE MARK AS SHOWN. THE ENGLISH TRANSLATION OF "SOFRITO LA SOLUCION EH" IS "SOFRITO THE SOLUTION EH".

FOR GENERAL FOOD SEASONING (U.S. CL. 46).

FIRST USE 12-0-2001; IN COMMERCE 12-0-2001.

CLASS 30—(Continued).

SN 76-423,116. AGRITECH S.P.A., 48100 SAN MICHELE (RA), ITALY, FILED 6-13-2002.



THE NAME IN THE MARK DOES NOT IDENTIFY A LIVING INDIVIDUAL. THE DEPICTION OF THE PERSON IN THE MARK IS MERELY FANCIFUL AND DOES NOT IDENTIFY A LIVING INDIVIDUAL.

FOR FROZEN BAKERY PRODUCTS, NAMELY, PIZZA, PIZZA DOUGH AND BREAD (U.S. CL. 46).

FIRST USE 2-5-2002; IN COMMERCE 2-5-2002.

CLASS 30—(Continued).

SN 76-441,712. RICH-SEAPAK CORPORATION, ST. SIMONS ISLAND, GA. FILED 8-20-2002.

TEXAS TOAST DIPPERS

NO CLAIM IS MADE TO THE EXCLUSIVE RIGHT TO USE "TEXAS TOAST", APART FROM THE MARK AS SHOWN.

FOR TOASTED BREAD STICK COATED WITH BUTTER AND GARLIC SAUCE OR TOPPED WITH CHEESE AND MARINARA OR GARLIC SAUCE (U.S. CL. 46).

SN 76-429,932. THE COCO TREE, INC., SPARTA, NJ. FILED 7-11-2002.

THE COCO TREE

NO CLAIM IS MADE TO THE EXCLUSIVE RIGHT TO USE "COCO", APART FROM THE MARK AS SHOWN.

FOR CANDY, NAMELY MILK CHOCOLATE, WHITE CHOCOLATE AND DARK CHOCOLATE WITH OR WITHOUT INCLUSIONS SUCH AS NUTS, FRUIT, MARZIPAN, CARAMELS AND OTHER FILLINGS; BAKED GOODS, BREADS, CAKE MIXES, CAKES, PASTRIES, CANDIES, CRYSTALLIZED FLOWERS, FLAVORING SYRUP, MALT EXTRACT FOR FOOD, MARSHMALLOW, MARZIPAN, PEANUT BUTTER CHIPS, ROLLED OATS, FROSTINGS, ALMOND PASTE, CHOCOLATE, CHOCOLATE CHIPS, COFFEE, COFFEE BEANS, ESPRESSO, SEASONING AND SPICES (U.S. CL. 46).

SN 76-453,946. Z STRATEGIES, INC., SAN DIEGO, CA. FILED 9-30-2002.



SN 76-438,345. ARGUS CAPITAL LLC, TIBURON, CA. FILED 8-7-2002.

APIS ONE

FOR HONEY (U.S. CL. 46).
FIRST USE 10-1-2001; IN COMMERCE 10-1-2001.

NO CLAIM IS MADE TO THE EXCLUSIVE RIGHT TO USE "FIJI COFFEE", APART FROM THE MARK AS SHOWN.

THE STIPPLING IS A FEATURE OF THE MARK AND DOES NOT INDICATE COLOR.

FOR GROUND AND WHOLE BEAN COFFEE; COCOA; HERBAL AND NON-HERBAL TEAS; COFFEE, TEA, COCOA AND ESPRESSO BASED BEVERAGES, AND BEVERAGES MADE WITH A BASE OF COFFEE AND/OR ESPRESSO, INSTANT COFFEE AND COFFEE SUBSTITUTES; READY-TO-DRINK COFFEE BEVERAGES; LIQUID AND POWDERED COFFEE, TEA, COCOA AND ESPRESSO BASED BEVERAGE MIXES; POWDERED FLAVORING ADDITIVES FOR NON-NUTRITIONAL PURPOSES; FLAVORING SYRUPS FOR BEVERAGES; BAKED GOODS, NAMELY, MUFFINS, SCONES, BISCUITS, COOKIES, PASTRIES AND BREADS AND READY-TO-MAKE MIXES OF THE SAME; ICE CREAM AND FROZEN CONFECTIONS; CHOCOLATE; CANDY AND CANDY CONFECTIONS AND READY-TO-EAT PROCESSED CEREALS (U.S. CL. 46).

CLASS 30—(Continued).

SN 76-457,075. RICHARD'S OF CHESTNUT HILL, INC., WEST BRIDGEWATER, MA. FILED 10-8-2002.



NO CLAIM IS MADE TO THE EXCLUSIVE RIGHT TO USE "GOURMET", APART FROM THE MARK AS SHOWN. THE LINING SHOWN IN THE DRAWING IS A FEATURE OF THE MARK.

THE NAME "RICHARD" IDENTIFIES A LIVING INDIVIDUAL WHOSE CONSENT IS OF RECORD.

FOR PACKAGED COFFEE, TEA, COCOA, CAPPUCCINO, CAFE LATTE AND CHAI MIX; COFFEE, TEA, COCOA, CAPPUCCINO, CAFE LATTE, HOT CHOCOLATE, AND CHAI MIX ALL SOLD IN PACKAGES UNDER PRIVATE LABEL; SNACK MIX, CONSISTING PRIMARILY OF TRAIL MIX, NUTS, CHOCOLATE COVERED NUTS, YOGURT COVERED RAISINS, CHOCOLATE COVERED COFFEE BEANS, AND PRETZELS, ALL SOLD IN PACKAGES UNDER PRIVATE LABEL (U.S. CL. 46).

FIRST USE 9-0-1990; IN COMMERCE 9-0-1990.

SN 76-458,550. KERRY GROUP SERVICES INTERNATIONAL, LTD., TRALEE, COUNTY KERRY, IRELAND, FILED 10-16-2002.

KERRYBIND

FOR BREADCRUMBS, NAMELY, A BREADCRUMB PRODUCT TO BE USED AS A FILLER AND/OR BINDER IN MEAT AND POULTRY PRODUCTS (U.S. CL. 46).

SN 76-459,105. INTERCORP EXCELLE INC., WESTON, ONTARIO, CANADA, FILED 10-9-2002.



PRIORITY CLAIMED UNDER SEC. 44(D) ON CANADA APPLICATION NO. 1149945, FILED 8-15-2002. OWNER OF U.S. REG. NO. 2,478,287.

NO CLAIM IS MADE TO THE EXCLUSIVE RIGHT TO USE "GOURMET", APART FROM THE MARK AS SHOWN. FOR FOOD AND FOOD PRODUCTS, NAMELY, DRESSINGS FOR SALADS, SALAD DRESSINGS, MEAT SAUCES AND MARINADES (U.S. CL. 46).

FIRST USE 0-0-1991; IN COMMERCE 0-0-1991.

CLASS 30—(Continued).

SN 76-464,786. JEL SHOOTERS, INC., ANTIOCH, CA. FILED 11-6-2002.



NO CLAIM IS MADE TO THE EXCLUSIVE RIGHT TO USE "JEL SHOOTERS", APART FROM THE MARK AS SHOWN.

FOR FLAVORED, SWEETENED GELATIN DESSERT MIX (U.S. CL. 46).

FIRST USE 3-25-2002; IN COMMERCE 3-25-2002.

SN 76-465,221. MOM'S KANDY KITCHEN, INC., REXBURG, ID. FILED 11-7-2002.

FLORENCE'S

THE NAME "FLORENCE'S" IDENTIFIES A LIVING INDIVIDUAL WHOSE CONSENT IS OF RECORD.

FOR CANDIES, CANDY BARS, CANDY CAKE DECORATIONS, CANDY COATED APPLES, CANDY COATED POPCORN, CANDY MINTS, CHOCOLATES, CHOCOLATE COVERED NUTS, CHOCOLATE TRUFFLES, CHOCOLATE-BASED READY-TO-EAT FOOD BARS (U.S. CL. 46).

FIRST USE 2-0-1981; IN COMMERCE 2-0-1981.

SN 76-465,617. THE FOREIGN CANDY COMPANY, INC., HULL, IA. FILED 11-8-2002.

RIP ROLLS

OWNER OF U.S. REG. NOS. 2,432,283 AND 2,549,652. NO CLAIM IS MADE TO THE EXCLUSIVE RIGHT TO USE "ROLLS", APART FROM THE MARK AS SHOWN. FOR CANDY (U.S. CL. 46).

FIRST USE 1-7-2003; IN COMMERCE 1-7-2003.

SN 76-466,257. HASBRO, INC., PAWTUCKET, RI. FILED 11-13-2002.

PINKIE PIE

FOR CANDY CAKE DECORATIONS, CHEWING GUM AND CANDY (U.S. CL. 46).

CLASS 30—(Continued).

SN 76-466,414. CHANDIRAMANI, LAKHI, PARAMUS, NJ. FILED 11-7-2002.

BINJAN FROM THE SACRED LAND

FOR RICE AND OTHER SIMILAR FOOD, NAMELY RICE CAKES, RICE SALAD AND RICE BASED SNACK FOOD AS GOODS (U.S. CL. 46).

SN 76-472,020. OUR FAMILY FARM, NEWPORT, KY. FILED 11-20-2002.



FOR BAKED SNACK GOODS, NAMELY COOKIES AND CRACKERS (U.S. CL. 46).
FIRST USE 10-3-2002; IN COMMERCE 10-3-2002.

SN 76-472,042. CAFFE D'AMORE, INC., MONROVIA, CA. FILED 11-25-2002.

IVY COTTAGE

FOR DRY MIXES FOR BAKERY PRODUCTS; MIXES FOR SCONES, CAKES, PANCAKES, WAFFLES, AND COOKIES (U.S. CL. 46).
FIRST USE 0-0-1989; IN COMMERCE 0-0-1989.

SN 76-472,890. TEXAS COFFEE COMPANY, INC., BEAUMONT, TX. FILED 12-9-2002.



OWNER OF U.S. REG. NO. 1,711,995.
FOR COFFEE AND TEA (U.S. CL. 46).
FIRST USE 0-0-1995; IN COMMERCE 0-0-1995.

CLASS 30—(Continued).

SN 76-473,865. DOC LEE'S PEPPER COMPANY, INC., GREENSBORO, NC. FILED 12-11-2002.

DOC LEE'S

FOR PEPPER RELISH (U.S. CL. 46).
FIRST USE 4-0-2001; IN COMMERCE 4-0-2001.

SN 76-474,210. PUFF-INS PASTRIES, INC., SUGAR LAND, TX. FILED 12-12-2002.

CINNA-PUFFS

FOR REFRIGERATED BAKERY PRODUCTS (U.S. CL. 46).

SN 76-474,316. AURORA SEASONINGS HOLDINGS LLC, JACKSON, WY. FILED 12-2-2002.

AURORA SEASONINGS

NO CLAIM IS MADE TO THE EXCLUSIVE RIGHT TO USE "SEASONINGS", APART FROM THE MARK AS SHOWN.

FOR SPICES, SEASONINGS, PROCESSED HERBS AND SAUCES (U.S. CL. 46).

SN 76-474,412. THE NATIONAL ARBOR DAY FOUNDATION, INC., LINCOLN, NE. FILED 12-12-2002.

ARBOR DAY

FOR COFFEE (U.S. CL. 46).
FIRST USE 12-21-2001; IN COMMERCE 12-21-2001.

SN 76-475,408. ALDI INC., BATAVIA, IL. FILED 11-8-2002.

BRIARGATE

OWNER OF U.S. REG. NOS. 2,011,591 AND 2,541,664.
FOR MUSTARD (U.S. CL. 46).

SN 76-475,496. CSM SUBHOLDINGS INC., WILMINGTON, DE. FILED 12-13-2002.

FRYBAKERS

FOR BATTERS AND DOUGHS FOR MAKING BAKERY PRODUCTS (U.S. CL. 46).

CLASS 30—(Continued).

SN 78-095,281. FLORA MANUFACTURING AND DISTRIBUTING LTD., BURNABY, BRITISH COLUMBIA, CANADA, FILED 11-27-2001.

COLD SNAP

FOR TEA (U.S. CL. 46).

SN 78-102,295. COFFEE TRADE SERVICES, INC., JERSEY CITY, NJ. FILED 1-11-2002.

BLACK TIE COFFEE

NO CLAIM IS MADE TO THE EXCLUSIVE RIGHT TO USE "COFFEE", APART FROM THE MARK AS SHOWN. FOR COFFEE BEANS (U.S. CL. 46). FIRST USE 10-28-1999; IN COMMERCE 10-28-1999.

SN 78-102,389. CURTIS, DANIEL RICHARD, ATLANTA, GA. FILED 1-13-2002.



NO CLAIM IS MADE TO THE EXCLUSIVE RIGHT TO USE "DESSERTS" AND "ZESTY LEMON MOUSSE", APART FROM THE MARK AS SHOWN. FOR DESSERTS, NAMELY, NO BAKE TIRAMISU AND MOUSSE (U.S. CL. 46).

SN 78-105,550. SHAW, STEPHAN, BALDWIN, NY. FILED 1-29-2002.

ENLIGHTENMINTS

FOR CANDY MINTS (U.S. CL. 46). FIRST USE 1-1-2000; IN COMMERCE 9-1-2000.

CLASS 30—(Continued).

SN 78-107,922. SARAMAR, L.L.C., CHICAGO, IL. FILED 2-11-2002.

MOCHA ALERT

NO CLAIM IS MADE TO THE EXCLUSIVE RIGHT TO USE "MOCHA", APART FROM THE MARK AS SHOWN. FOR COFFEE (U.S. CL. 46).

SN 78-129,466. CONOPCO, INC., DBA GOOD HUMOR-BREYERS ICE CREAM, GREEN BAY, WI. FILED 5-17-2002.

RASPA-PICA

THE MARK DERIVES FROM THE SPANISH WORD "RASPAR" WHICH MEANS "TO SHAVE" (AS IN ICE SHAVING) AND FROM THE SPANISH WORD "PICANTE", WHICH MEANS "SPICY". FOR FROZEN CONFECTIONS (U.S. CL. 46).

SN 78-135,873. TAPIOCA EXPRESS, INC., ALHAMBRA, CA. FILED 6-14-2002.

LATTEA

FOR TEA-BASED BEVERAGE CONTAINING MILK, WITH OR WITHOUT FLAVORED SYRUP OR FLAVORED POWDER (U.S. CL. 46). FIRST USE 6-1-2002; IN COMMERCE 6-1-2002.

SN 78-143,871. AMES, SANDRA, L., MORRISTOWN, VT. FILED 7-15-2002.

THE PICKLE FARM

NO CLAIM IS MADE TO THE EXCLUSIVE RIGHT TO USE "PICKLE", APART FROM THE MARK AS SHOWN. FOR BARBECUE SAUCE, CAPERS, CATSUP, CHOW CHOW, CHUTNEY, GRAVIES, HAM GLAZE, HONEY, HORSERADISH, HOT SAUCE, KETCHUP, MAPLE SYRUP, MARINADES, MAYONNAISE, MUSTARD, PAN-CAKES SYRUP, PICANTE SAUCE, PICKLE RELISH, PICKLED GINGER, RELISH, SALAD DRESSINGS, SALSA, SLOPPY JOE SAUCE, SOY SAUCE, SPAGHETTI SAUCE, TARTAR SAUCE, TERIYAKI SAUCE, TOMATO SAUCE, VINEGAR, WINE VINEGAR (U.S. CL. 46).

CLASS 30—(Continued).

SN 78-144,936. DAVIS, JANINE, LYNNE, DALLAS, TX. FILED 7-17-2002.



THE MARK CONSISTS OF THE WORD "DIVERSITEA" AND THE DESIGN OF A RED TEAPOT WITH A WHITE DIAGONAL STRIPE.
FOR TEA (U.S. CL. 46).
FIRST USE 2-1-2002; IN COMMERCE 5-7-2002.

SN 78-147,052. MAGILLY'S, TRAVERSE CITY, MI. FILED 7-24-2002.

MAGILLY'S

FOR CONFECTIONS, NAMELY BAKLAVA (U.S. CL. 46).

SN 78-154,177. BEN & JERRY'S HOMEMADE HOLDINGS, INC., BURLINGTON, VT. FILED 8-14-2002.

FUNDAMINTALLY MINT

NO CLAIM IS MADE TO THE EXCLUSIVE RIGHT TO USE "MINT", APART FROM THE MARK AS SHOWN.
FOR ICE CREAM, FROZEN YOGURT AND FROZEN CONFECTIONS (U.S. CL. 46).

SN 78-158,735. SCHWAN'S IP, LLC, MARSHALL, MN. FILED 8-28-2002.

BORDER ROLLS

NO CLAIM IS MADE TO THE EXCLUSIVE RIGHT TO USE "ROLLS", APART FROM THE MARK AS SHOWN.
FOR FOOD PRODUCTS, NAMELY APPETIZERS CONSISTING PRIMARILY OF VEGETABLES, BLACK BEANS AND/OR WHITE MEAT CHICKEN WRAPPED IN A CRISPY SHELL (U.S. CL. 46).

CLASS 30—(Continued).

SN 78-161,512. NEUHAUS, EN ABREGE N-M, SOCIETE ANONYME, VLEZENBEEK, BELGIUM, FILED 9-6-2002.

ASTRIO

OWNER OF BENELUX REG. NO. 071246, DATED 11-16-1971. EXPIRES 11-16-2007.
FOR PASTRIES, NAMELY, BISCUITS AND CAKE PASTE (U.S. CL. 46).

SN 78-163,522. THE COCA-COLA COMPANY, ATLANTA, GA. FILED 9-12-2002.

FLAVOR RAGE

NO CLAIM IS MADE TO THE EXCLUSIVE RIGHT TO USE "FLAVOR", APART FROM THE MARK AS SHOWN.
FOR FLAVORING SYRUPS TO BE ADDED TO SOFT DRINKS AND CARBONATED AND NONCARBONATED SEMI-FROZEN SOFT DRINKS (U.S. CL. 46).

SN 78-173,483. AURORA FOODS INC., ST. LOUIS, MO. FILED 10-11-2002.

POWER-UP PURPLE

NO CLAIM IS MADE TO THE EXCLUSIVE RIGHT TO USE "PURPLE", APART FROM THE MARK AS SHOWN.
FOR TABLE SYRUP (U.S. CL. 46).

SN 78-176,177. A HERD OF LAUGHTER ICE CREAM COMPANY, LLC, SPRINGFIELD, OR. FILED 10-18-2002.

CHERRYBOBERRY

FOR ICE CREAM AND FROZEN CONFECTIONS (U.S. CL. 46).

SN 78-176,186. A HERD OF LAUGHTER ICE CREAM COMPANY, LLC, SPRINGFIELD, OR. FILED 10-18-2002.

WHEN COOKIES CRUMBLE

FOR ICE CREAM AND FROZEN CONFECTIONS (U.S. CL. 46).

SN 78-176,422. KRAFT FOODS HOLDINGS, INC., NORTH-FIELD, IL. FILED 10-21-2002.

TONGUE CHANGERS

FOR COOKIES (U.S. CL. 46).

CLASS 30—(Continued).

SN 78-176,496. ZLS CORPORATION, APOPKA, FL. FILED 10-21-2002.

ROCKET FUEL COFFEE

NO CLAIM IS MADE TO THE EXCLUSIVE RIGHT TO USE "COFFEE", APART FROM THE MARK AS SHOWN. FOR COFFEE BEANS (U.S. CL. 46).



SN 78-177,608. FARE & FANCY, INC., AUBURNDALE, MA. FILED 10-23-2002.

FARE & FANCY

FOR CANDY AND CONFECTIONS, NAMELY, JELLY BEANS AND JELLY SHAPES (U.S. CL. 46).



SN 78-179,182. FOSTER POULTRY FARMS, DBA FOSTER FARMS, LIVINGSTON, CA. FILED 10-28-2002.

SUPREME BAKES

NO CLAIM IS MADE TO THE EXCLUSIVE RIGHT TO USE "SUPREME", APART FROM THE MARK AS SHOWN. FOR REFRIGERATED, FROZEN OR SHELF-STABLE MICROWAVEABLE OR READY-TO-HEAT ENTREES OF CHICKEN, MEAT, CHEESE AND/OR VEGETABLE FILLINGS WRAPPED IN BREAD OR DOUGH. (U.S. CL. 46).



SN 78-179,635. TRI STAR MARKETING, INC., URBANA, IL. FILED 10-29-2002.

RED BERET ROASTERS

NO CLAIM IS MADE TO THE EXCLUSIVE RIGHT TO USE "ROASTERS", APART FROM THE MARK AS SHOWN. FOR COFFEE (U.S. CL. 46). FIRST USE 4-30-2001; IN COMMERCE 4-30-2001.



SN 78-180,610. AMERICAN DAIRY QUEEN CORPORATION, EDINA, MN. FILED 10-31-2002.

STARKISS

OWNER OF U.S. REG. NO. 1,215,078. FOR FROZEN FLAVORED CONFECTIONS IN MOLDED FORM ON A STICK (U.S. CL. 46). FIRST USE 11-0-1974; IN COMMERCE 11-0-1974.

CLASS 30—(Continued).

SN 78-182,794. CLIF BAR INC., BERKELEY, CA. FILED 11-7-2002.

PEANUT TOFFEE BUZZ

NO CLAIM IS MADE TO THE EXCLUSIVE RIGHT TO USE "PEANUT TOFFEE", APART FROM THE MARK AS SHOWN. FOR GRAIN, SOY AND RICE-BASED READY TO EAT ENERGY FOOD BARS. (U.S. CL. 46).



SN 78-183,258. WRIGHT, FRANCIS JACK, LA QUINTA, CA. FILED 11-8-2002.

CRUSIN' CORN

NO CLAIM IS MADE TO THE EXCLUSIVE RIGHT TO USE "CORN", APART FROM THE MARK AS SHOWN. FOR CARAMEL POPCORN (U.S. CL. 46).



SN 78-183,451. ASIA-PACIFIC, LLC, ANCHORAGE, AK. FILED 11-9-2002.

BARISTINA

FOR SPECIALTY COFFEE BEVERAGE (U.S. CL. 46).



SN 78-183,568. WESTBRAE NATURAL FOODS, INC., COMP-TON, CA. FILED 11-11-2002.



OWNER OF U.S. REG. NOS. 2,368,762, 2,555,366 AND 2,677,645.

NO CLAIM IS MADE TO THE EXCLUSIVE RIGHT TO USE "NATURAL", APART FROM THE MARK AS SHOWN. FOR MUSTARDS, CATSUPS, SOY SAUCES, RICE CAKES, RICE WAFERS, COOKIES, PASTAS, COFFEES, TEAS, NON DAIRY RICE BASED FOOD BEVERAGES FOR USE AS A MILK SUBSTITUTE, NON DAIRY OAT BASED FOOD BEVERAGES FOR USE AS A MILK SUBSTITUTE, TOFU SAUCES AND PUDDINGS (U.S. CL. 46).

CLASS 30—(Continued).

SN 78-185,041. CANTWELL JAMES HUNTER, FT. LAUDERDALE, FL. FILED 11-14-2002.



NO CLAIM IS MADE TO THE EXCLUSIVE RIGHT TO USE "CANDIES", APART FROM THE MARK AS SHOWN. FOR CHOCOLATE COVERED ALMOND BUTTER CRUNCH CANDY (U.S. CL. 46).

SN 78-185,114. AUGUST STORCK KG, BERLIN, FED REP GERMANY, FILED 11-14-2002.

BRINGS ALL YOUR FAVORITES TOGETHER

OWNER OF U.S. REG. NO. 2,607,891.
FOR CANDY, CHOCOLATE, CHOCOLATE CANDIES
AND PASTRIES (U.S. CL. 46).

SN 78-185,284. THE ROB NELSON COMPANY, VANCOUVER, WA. FILED 11-14-2002.

FUN ONE

FOR BUBBLE GUM (U.S. CL. 46).

SN 78-185,338. KRAFT FOODS HOLDINGS, INC., NORTHFIELD, IL. FILED 11-14-2002.

OREO OozERS

OWNER OF U.S. REG. NOS. 93,009, 1,927,379 AND OTHERS.
FOR COOKIES (U.S. CL. 46).

CLASS 30—(Continued).

SN 78-185,457. ELDORADO COFFEE DISTRIBUTORS, LTD., MASPETH, NY. FILED 11-15-2002.

ELDORADO HAVANERO

FOR ESPRESSO GROUND COFFEE AND ESPRESSO COFFEE BEANS (U.S. CL. 46).

SN 78-185,819. KRAFT FOODS HOLDINGS, INC., NORTHFIELD, IL. FILED 11-16-2002.

UH-OH! OREO

OWNER OF U.S. REG. NOS. 93,009, 1,927,379 AND OTHERS.
FOR COOKIES (U.S. CL. 46).

SN 78-186,085. GROVES, GAIL L., BELLAIRE, OH. FILED 11-18-2002.

HOT DICE

FOR CONFECTIONERY, NAMELY, CANDY (U.S. CL. 46).

SN 78-191,699. ROSS, LAURA K., DBA THE TOFFEE HOUSE, WASHINGTON, PA. FILED 12-5-2002.

THE DANGEROUS STUFF

FOR CANDIES, NAMELY, TOFFEE AND CHOCOLATE CONFECTIONS (U.S. CL. 46).
FIRST USE 12-1-2001; IN COMMERCE 12-1-2001.

SN 78-195,829. GF CO., LTD., ANYANG-SI, KYUNGKI-DO, REPUBLIC OF KOREA, FILED 12-18-2002.

MORPH CANDY

NO CLAIM IS MADE TO THE EXCLUSIVE RIGHT TO USE "CANDY", APART FROM THE MARK AS SHOWN. FOR LOLLYPOPS, SUGAR, GUMDROPS, PUFFED RICE, ICE CREAM, CRYSTAL SUGAR, CANDY, FROZEN CONFECTIONS AND CRACKLING CANDY CONTAINING CARBONATE GAS TO MAKE OR CAUSE TO MAKE A SUCCESSION OF SHARP SNAPS (U.S. CL. 46).

CLASS 31—NATURAL AGRICULTURAL PRODUCTS

SN 75-665,889. HORA, ROLAND, BARTELBERGERWEG 1, FED REP GERMANY, FILED 3-22-1999.

DOGURT

FOR DOG FOOD CONTAINING YOGURT AND VITAMIN SUPPLEMENTS (U.S. CLS. 1 AND 46).
FIRST USE 1-25-2003; IN COMMERCE 1-25-2003.

SN 76-132,638. HARRINGTON-MCGILL, SISSY, EL CAJON, CA. FILED 9-22-2000.

CINNA-BONE

FOR DOG FOOD, NAMELY, NATURAL DOG TREATS AND BISCUITS (U.S. CLS. 1 AND 46).
FIRST USE 0-0-1990; IN COMMERCE 0-0-1990.

SN 76-140,758. WESTWAY TRADING CORPORATION, NEW ORLEANS, LA. FILED 10-4-2000.

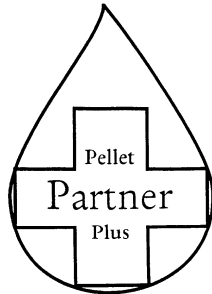

OWNER OF U.S. REG. NO. 1,796,479.
NO CLAIM IS MADE TO THE EXCLUSIVE RIGHT TO USE "PELLET" AND "PLUS", APART FROM THE MARK AS SHOWN.
THE MARK CONSISTS IN PART OF A CROSS DESIGN WITHIN A DROP DESIGN.
FOR NON-NUTRITIONAL FEED SUPPLEMENTS FOR LIVESTOCK (U.S. CLS. 1 AND 46).
FIRST USE 1-29-2001; IN COMMERCE 1-29-2001.

SN 76-231,988. KAL KAN FOODS, INC., VERNON, CA. FILED 3-29-2001.

ELITE

FOR FOOD FOR BIRDS (U.S. CLS. 1 AND 46).

CLASS 31—(Continued).

SN 76-254,287. MERTEC LLC, ADEL, IA. FILED 5-9-2001.



NO CLAIM IS MADE TO THE EXCLUSIVE RIGHT TO USE "BRAND", APART FROM THE MARK AS SHOWN.
FOR SEEDS, NAMELY CORN, SOYBEAN AND WHEAT SEEDS (U.S. CLS. 1 AND 46).
FIRST USE 6-1-1991; IN COMMERCE 6-1-1991.

SN 76-322,599. PETER RABBIT FARMS, INC., COACHELLA, CA. FILED 10-9-2001.

SWEET BABIES

NO CLAIM IS MADE TO THE EXCLUSIVE RIGHT TO USE "SWEET", APART FROM THE MARK AS SHOWN.
FOR FRESH VEGETABLES (U.S. CLS. 1 AND 46).

SN 76-355,642. S&M NUTEC, LLC, KANSAS CITY, MO. FILED 1-4-2002.

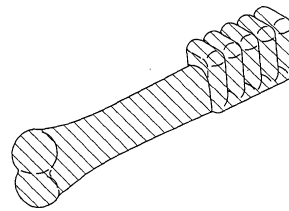

THE DRAWING IS LINED FOR THE COLOR GREEN, BUT COLOR IS NOT CLAIMED AS A FEATURE OF THE MARK.
THE MARK CONSISTS OF A CONFIGURATION OF A DOG BONE WITH THE SHAPE OF A HEAD OF A TOOTH BRUSH AT ONE END.
SEC. 2(F).
FOR PET SNACK FOOD (U.S. CLS. 1 AND 46).
FIRST USE 9-0-1996; IN COMMERCE 3-18-1998.

SN 76-387,840. BAILEY NURSERIES, INC., ST. PAUL, MN. FILED 3-25-2002.

SUGAR PLUM FAIRY

FOR LIVE PLANTS, NAMELY, LILAC BUSHES (U.S. CLS. 1 AND 46).

CLASS 31—(Continued).

SN 76-455,545. EARL CULLY HERITAGE TREES, INC., JACKSONVILLE, IL. FILED 9-30-2002.

DEBONAIR

FOR LIVE POND CYPRESS TREES (U.S. CLS. 1 AND 46).
FIRST USE 6-15-2002; IN COMMERCE 6-15-2002.

SN 76-456,592. RUTHERFORD GROUP, LA JOLLA, CA. FILED 10-8-2002.

TIETJEN VINEYARD

NO CLAIM IS MADE TO THE EXCLUSIVE RIGHT TO USE "VINEYARD", APART FROM THE MARK AS SHOWN. SEC. 2(F).
FOR FRESH WINE GRAPES (U.S. CLS. 1 AND 46).
FIRST USE 12-0-1986; IN COMMERCE 12-0-1986.

SN 76-463,603. RIVER RANCH FRESH FOODS, LLC, SALINAS, CA. FILED 11-4-2002.



THE LINING IS A FEATURE OF THE MARK AND IS NOT INTENDED TO INDICATE COLOR.
FOR FRESH VEGETABLES (U.S. CLS. 1 AND 46).
FIRST USE 9-30-1998; IN COMMERCE 9-30-1998.

SN 76-464,203. BLAIR, RICHARD L., LAKE ARROWHEAD, CA. FILED 11-5-2002.

**RICHARD L. BLAIR
VINEYARDS**

OWNER OF U.S. REG. NO. 2,335,698.
NO CLAIM IS MADE TO THE EXCLUSIVE RIGHT TO USE "VINEYARDS", APART FROM THE MARK AS SHOWN.
THE NAME "RICHARD L. BLAIR" IDENTIFIES A LIVING INDIVIDUAL WHOSE CONSENT IS OF RECORD.
FOR TABLE GRAPES (U.S. CLS. 1 AND 46).
FIRST USE 5-19-1999; IN COMMERCE 5-19-1999.

CLASS 31—(Continued).

SN 76-473,419. WADA FARMS POTATOES, INC., PINGREE, ID. FILED 12-4-2002.



FOR AGRICULTURAL PRODUCTS NOT INCLUDED IN OTHER CLASSES, NAMELY, RAW POTATOES (U.S. CLS. 1 AND 46).
FIRST USE 1-2-2002; IN COMMERCE 1-2-2002.

SN 76-473,839. TURF-SEED, INC., HUBBARD, OR. FILED 12-11-2002.

STADIUM

FOR GRASS SEED (U.S. CLS. 1 AND 46).

SN 78-129,465. LIDL STIFTUNG & CO. KG, NECKARSULM, FED REP GERMANY, FILED 5-17-2002.

BOLERO

OWNER OF IRELAND REG. NO. 219776, DATED 3-6-2002, EXPIRES 12-15-2010.
FOR FOODSTUFF FOR ANIMALS, NAMELY, PET FOOD, DOG BISCUITS (U.S. CLS. 1 AND 46).

SN 78-152,258. BOCCHI HOLDING B.V., BLEISWIJK, NETHERLANDS, FILED 8-8-2002.



THE MARK IS LINED FOR THE COLOR BLUE.
FOR FRESH FRUIT AND VEGETABLES (U.S. CLS. 1 AND 46).

CLASS 31—(Continued).

SN 78-153,829. PAN AMERICAN AGRICULTURE CORPORATION, OXNARD, CA. FILED 8-13-2002.



THE FOREIGN WORDING IN THE MARK TRANSLATES INTO ENGLISH AS "VEGETATION".
 SEC. 2(F) AS TO "SABZI".
 FOR FRESH VEGETABLES (U.S. CLS. 1 AND 46).
 FIRST USE 6-15-2002, THE MARK WAS FIRST USED ANYWHERE IN A DIFFERENT FORM OTHER THAN THAT SOUGHT TO BE REGISTERED ON 07/10/1997; IN COMMERCE 6-15-2002, THE MARK WAS FIRST USED IN COMMERCE IN A DIFFERENT FORM OTHER THAN THAT SOUGHT TO BE REGISTERED ON 07/10/1997.

SN 78-157,841. KAYTEE PRODUCTS INCORPORATED, CHILTON, WI. FILED 8-26-2002.

EXACT RX

OWNER OF U.S. REG. NO. 1,641,755.
 FOR PET AND ANIMAL FEED (U.S. CLS. 1 AND 46).

SN 78-165,610. ZOO MED LABORATORIES, INC., SAN LUIS OBISPO, CA. FILED 9-18-2002.

VITA-SAND

FOR CALCIUM AND VITAMIN SUBSTRATE FOR USE AS BEDDING FOR TERRARIUMS AND SMALL ANIMAL CAGES (U.S. CLS. 1 AND 46).

SN 78-176,456. LAWHON FARM SERVICES, INC., MCCRORY, AR. FILED 10-21-2002.



NO CLAIM IS MADE TO THE EXCLUSIVE RIGHT TO USE "COTTON GENETICS", APART FROM THE MARK AS SHOWN.
 FOR COTTON SEED (U.S. CLS. 1 AND 46).
 FIRST USE 1-15-2003; IN COMMERCE 1-15-2003.

CLASS 31—(Continued).

SN 78-177,695. HI-TEK RATIONS, INC, DUBLIN, GA. FILED 10-23-2002.

INTIMIDATOR

FOR DOG FOOD (U.S. CLS. 1 AND 46).
 FIRST USE 11-29-2002; IN COMMERCE 11-29-2002.

SN 78-179,532. VALLEYBROOK INTERNATIONAL VENTURES, INC., ABBOTSFORD, BRITISH COLUMBIA, CANADA, FILED 10-29-2002.



FOR LIVE PLANTS (U.S. CLS. 1 AND 46).
 FIRST USE 8-22-2002; IN COMMERCE 8-22-2002.

SN 78-180,498. MCCAULEY BROTHERS, INC., VERSAILLES, KY. FILED 10-31-2002.

TRIFORMANCE

FOR HORSE FEED (U.S. CLS. 1 AND 46).
 FIRST USE 1-22-1998; IN COMMERCE 1-22-1998.

SN 78-190,616. TURF MERCHANTS, INC., TANGENT, OR. FILED 12-3-2002.

GLR

FOR GRASS SEED (U.S. CLS. 1 AND 46).

SN 78-190,621. TURF MERCHANTS, INC., TANGENT, OR. FILED 12-3-2002.

DSR

FOR GRASS SEED (U.S. CLS. 1 AND 46).

CLASS 31—(Continued).

SN 78-193,544. IMS TRADING CORPORATION, NORTH BERGEN, NJ. FILED 12-11-2002.

DENTA FLOSS

FOR PET FOOD, NAMELY, ROLLED BEEF TENDON USED TO CLEAN TEETH IN PETS (U.S. CLS. 1 AND 46).

CLASS 32—LIGHT BEVERAGES

SN 75-838,717. INTERBREW, S.A., B-1000 BRUSSELS, BELGIUM, FILED 11-1-1999.



OWNER OF U.S. REG. NOS. 1,156,584, 1,176,441 AND 1,178,400.

NO CLAIM IS MADE TO THE EXCLUSIVE RIGHT TO USE "ANNO 1366, ARTOIS, LEUVEN, EXPOSITION, UNIVERSELLE INTERNATIONALE 1900, BELGES, EXPOSITION INTERNATIONALE BRUXELLES 1897, PREMIUM LAGER BEER" AND "BELGIUM'S ORIGINAL BEER", APART FROM THE MARK AS SHOWN.

THE DESIGN FEATURES IN THE MARK INCLUDED UNDER THE WORD "LEUVEN" ARE REPRESENTATIONS OF THREE MEDALS AWARDED TO APPLICANT. THE MEDAL ON THE LEFT INCLUDES A DESIGN OF A MAN, SITTING ON THE BACK OF A FLYING ANGEL, HOLDING A TORCH IN HIS LEFT HAND. THE WORDS EXPOSITION UNIVERSELLE INTERNATIONALE 1900 APPEAR AROUND THE DRAWING. THE MEDAL IN THE MIDDLE INCLUDES A PROFILE OF KING LEOPOLD II OF BELGIUM WITH THE WORDS LEOPOLD II ROIS DES BELGES PROTECTEUR DE L'EXPOSITION AROUND THE DESIGN. FINALLY, THE MEDAL IN THE RIGHT IS A DESIGN OF A WOMAN (INTENDED TO BE A MEMBER OF HIGH SOCIETY) STANDING BETWEEN A MAN (ON HER RIGHT) AND ANOTHER WOMAN (ON HER LEFT) WHO ARE SHAKING HANDS. THE CENTRAL CHARACTER HER HANDS ON THEIR SHOULDERS AS A SYMBOL OF AGREEMENT. THE WORDS EXPOSITION INTERNATIONALE BRUXELLES 1897 APPEAR AROUND THE DRAWING.

"STELLA" IS A LATIN AND ITALIAN WORD FOR "STAR". "ANNO" IS THE LATIN WORD FOR "YEAR". THE ENGLISH TRANSLATION OF "UNIVERSELLE INTERNATIONALE" IS "UNIVERSAL INTERNATIONAL" AND "ROIS DES BELGES PROTECTEUR DE L'EXPOSITION" IS "KINGS OF THE BELGIANS," PROTECTOR OF THE EXPOSITION."

FOR BEER (U.S. CLS. 45, 46 AND 48).
FIRST USE 4-26-1996; IN COMMERCE 4-26-1996.

CLASS 32—(Continued).

SN 76-174,463. GLOBAL BRANDS, INC., UPPER GRANDVIEW, NY. BY ASSIGNMENT ENERGY BRANDS, INC., WHITESTONE, NY. FILED 12-2-2000.

WATER +

OWNER OF U.S. REG. NO. 2,095,601.
NO CLAIM IS MADE TO THE EXCLUSIVE RIGHT TO USE "WATER", APART FROM THE MARK AS SHOWN.
FOR BEVERAGES, NAMELY BOTTLED DRINKING WATER AND NON-ALCOHOLIC SOFT DRINKS (U.S. CLS. 45, 46 AND 48).
FIRST USE 10-0-1999; IN COMMERCE 10-0-1999.

SN 76-322,068. PANTHER BREWING COMPANY, INC., NORWOOD, MA. FILED 10-5-2001.

SUBLIME BLUE ICE

NO CLAIM IS MADE TO THE EXCLUSIVE RIGHT TO USE "ICE", APART FROM THE MARK AS SHOWN.
FOR BEER AND MALT BEER (U.S. CLS. 45, 46 AND 48).

SN 76-322,183. PANTHER BREWING COMPANY, INC., NORWOOD, MA. FILED 10-5-2001.

SUBLIME BLUE

FOR BEER AND MALT BEER (U.S. CLS. 45, 46 AND 48).

SN 76-323,483. LE BLEU CORPORATION, ADVANCE, NC. FILED 10-11-2001.

LE BLEU FRUTE NON-CARBONATED

OWNER OF U.S. REG. NO. 1,698,481.
NO CLAIM IS MADE TO THE EXCLUSIVE RIGHT TO USE "FRUITY AND NON-CARBONATED", APART FROM THE MARK AS SHOWN.

THE STIPPLING IS FOR SHADING PURPOSES ONLY AND DOES NOT INDICATE COLOR.

THE TRANSLATION OF THE NON-ENGLISH WORDING "LE BLEU" IS FRENCH FOR "THE BLUE".

FOR FRUIT FLAVORED DRINKS (U.S. CLS. 45, 46 AND 48).

FIRST USE 2-0-2001; IN COMMERCE 2-0-2001.

CLASS 32—(Continued).

SN 76-337,241. VITAMONT (SOCIETE ANONYME), MON-FLANQUIN 47150, FRANCE, FILED 11-13-2001.



OWNER OF FRANCE REG. NO. 94541202, DATED 10-14-1994, EXPIRES 10-14-2004.

THE ENGLISH TRANSLATION OF "DELICE" IS "DELIGHT".

FOR FRUIT DRINKS AND FRUIT JUICES; SYRUPS AND CONCENTRATES FOR MAKING SOFT DRINKS AND FRUIT-BASED DRINKS (U.S. CLS. 45, 46 AND 48).

SN 76-381,401. SCHWEPPE'S INTERNATIONAL LIMITED, LONDON, W1X 6HT, UNITED KINGDOM, FILED 3-11-2002.

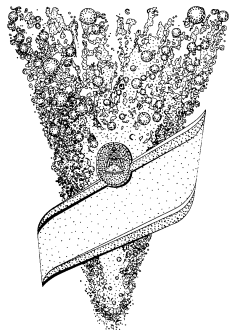

THE STIPPLING IN THE DRAWING IS FOR SHADING PURPOSES ONLY.

FOR NON-ALCOHOLIC DRINKS, NAMELY, FRUIT DRINKS AND SOFT DRINKS, AND PREPARATION FOR MAKING FRUIT DRINKS AND SOFT DRINKS; MINERAL AND AERATED WATERS; FRUIT JUICES; SYRUPS AND CONCENTRATES FOR MAKING NON-ALCOHOLIC BEVERAGES, NAMELY, FRUIT DRINKS AND SOFT DRINKS; GINGER ALE; LEMONADE (U.S. CLS. 45, 46 AND 48).

CLASS 32—(Continued).

SN 76-391,038. HEINEKEN IRELAND LIMITED, CORK, IRELAND, FILED 4-3-2002.

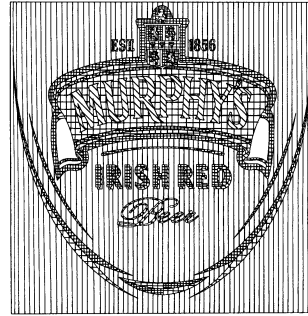

NO CLAIM IS MADE TO THE EXCLUSIVE RIGHT TO USE "EST. 1856" AND "IRISH RED BEER", APART FROM THE MARK AS SHOWN.

THE DRAWING IS LINED FOR THE COLORS RED, GREEN AND GOLD. THE AREA IN THE DRAWING NOT LINED FOR COLOR IS A SANDY SHADE.

THE MARK CONSISTS OF THE TERMS "MURPHY'S IRISH RED BEER, EST. 1856", TOGETHER WITH A CREST DESIGN COMPRISED OF FIVE LIONS, AND A BANNER AND PARTIAL OVAL DESIGN.

FOR BEER (U.S. CLS. 45, 46 AND 48).

SN 76-409,010. MARIGOLD COMMODITIES CORPORATION, SAN JUAN METRO MANILA, PHILIPPINES, FILED 5-16-2002.



Mama Sita's

THE STIPPLING SHOWN IN THE DRAWING IS A FEATURE OF THE MARK AND IS NOT INTENDED TO INDICATE COLOR.

THE NAME AND PORTRAIT IN THE MARK IDENTIFY TERESITA R. REYES WHOSE CONSENT IS OF RECORD. FOR FRUIT JUICES (U.S. CLS. 45, 46 AND 48).

CLASS 32—(Continued).

SN 76-410,731. MORINDA, INC., OREM, UT. FILED 5-22-2002.

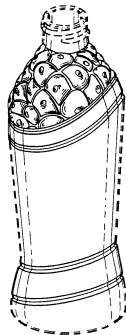

OWNER OF U.S. REG. NO. 2,586,236.
THE TRADEMARK COMPRISES THE SHAPE OF A THREE-DIMENSIONAL BOTTLE DESIGN WITH THE BASE OF THE NECK OF THE BOTTLE RESEMBLING THE FRUIT OF MORINDA CITRIFOLIA.
FOR SOFT DRINKS, FRUIT JUICES, VEGETABLE JUICES AND SPORTS DRINKS (U.S. CLS. 45, 46 AND 48).

SN 76-413,865. M. T. RAILCARS INC., STOCKTON, CA. FILED 5-28-2002.



NO CLAIM IS MADE TO THE EXCLUSIVE RIGHT TO USE "SODA" AND "OAXACA", "MEXICO", APART FROM THE MARK AS SHOWN.

THE MARK CONSISTS OF THE WORDS "XOLE SODA" WITH A DESIGN OF A SUN WITH A FACE.

FOR NON-ALCOHOLIC BEVERAGES, NAMELY, CARBONATED SOFT DRINKS AND FRUIT DRINKS; AND SYRUPS, CONCENTRATES AND OTHER PREPARATIONS FOR MAKING SOFT DRINKS AND FRUIT DRINKS (U.S. CLS. 45, 46 AND 48).

SN 76-431,212. KIUCHI BREWERY GOSHIKAISHA, NAKAMACHI NAKA-GUN IBARAKI, JAPAN, FILED 7-15-2002.

HITACHINO NEST

FOR BEERS (U.S. CLS. 45, 46 AND 48).
FIRST USE 6-30-1996; IN COMMERCE 9-17-2001.

CLASS 32—(Continued).

SN 76-457,853. FONTE SOLE HOLDING AG, 1211 GENEVA 17, SWITZERLAND, FILED 10-7-2002.

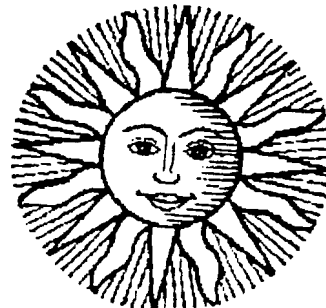

OWNER OF U.S. REG. NOS. 2,016,683 AND 2,269,262.
FOR CARBONATED AND NON-CARBONATED MINERAL AND SPRING WATER (U.S. CLS. 45, 46 AND 48).

FIRST USE 3-0-2000; IN COMMERCE 3-0-2000.

SN 76-457,992. EAT, INC., CHAPEL HILL, NC. FILED S.R. 10-11-2002; AM. P.R. 5-1-2003.

CAÑITA

THE ENGLISH TRANSLATION OF "CANITA" IS "SMALL REED", "HOLLOW PLANT STEM", "SHAFT", "LEG", "SHANK", "SHIN", "ROD", "GLASS", "STRAW".

FOR LIGHT, NON-CARBONATED, NATURAL BEVERAGES, NAMELY, FRUIT JUICES, FRUIT NECTARS, HIBISCUS FLAVORED SOFT DRINKS, TAMARIND FLAVORED SOFT DRINKS (U.S. CLS. 45, 46 AND 48).

FIRST USE 12-31-2000; IN COMMERCE 9-30-2002.

SN 76-459,306. JOHNSON, RANDALL DAVID, SKOKIE, IL. FILED 10-18-2002.



FOR DRINKING WATER, FLAVORED DRINKING WATER, SPORTS DRINKS, SOFT DRINKS AND CARBONATED AND NON-CARBONATED FRUIT DRINKS (U.S. CLS. 45, 46 AND 48).

CLASS 32—(Continued).

SN 76-473,775. WM. H. LEAHY ASSOCIATES, INC., NORTH-BROOK, IL. FILED 12-5-2002.

ORCHARD SPLASH

FOR FRUIT JUICES AND FRUIT JUICE CONCENTRATES (U.S. CLS. 45, 46 AND 48).
FIRST USE 10-15-2002; IN COMMERCE 10-15-2002.

SN 76-474,245. PHOENIX INTANGIBLES HOLDING COMPANY, GREENVILLE, DE. FILED 12-12-2002.

DR. AAHH

FOR SOFT DRINKS (U.S. CLS. 45, 46 AND 48).

SN 76-474,518. ZOE SPRINGS WATER, INC., EXCELSIOR, MN. FILED 12-10-2002.

ZOE SPRINGS WATER

NO CLAIM IS MADE TO THE EXCLUSIVE RIGHT TO USE "WATER", APART FROM THE MARK AS SHOWN.
FOR BOTTLED DRINKING WATER (U.S. CLS. 45, 46 AND 48).

SN 78-110,021. CAPITAL BREWERY CO., INC., MIDDLETON, WI. FILED 2-20-2002.

CAPITAL IMPORTS

OWNER OF U.S. REG. NO. 2,575,520.
NO CLAIM IS MADE TO THE EXCLUSIVE RIGHT TO USE "IMPORTS", APART FROM THE MARK AS SHOWN.
FOR BEER (U.S. CLS. 45, 46 AND 48).
FIRST USE 1-15-2002; IN COMMERCE 1-15-2002.

SN 78-152,026. AMAZON PRESERVATION PARTNERS, MANHATTAN BEACH, CA. FILED 8-7-2002.

ACAI - THE TASTE OF BRAZIL

NO CLAIM IS MADE TO THE EXCLUSIVE RIGHT TO USE "ACAI" AND "BRAZIL", APART FROM THE MARK AS SHOWN.
FOR FRUIT DRINKS, FRUIT JUICE, SPORTS DRINKS, FRUIT JUICE BEVERAGES ENHANCED WITH VITAMINS, MINERALS AND HERBS (U.S. CLS. 45, 46 AND 48).

CLASS 32—(Continued).

SN 78-154,224. TANK TOWN, DRIPPING SPRINGS, TX. FILED 8-14-2002.

A RAINBOW IN EVERY BOTTLE

FOR DRINKING WATER (U.S. CLS. 45, 46 AND 48).

SN 78-173,294. NO FEAR, INC., CARLSBAD, CA. FILED 10-10-2002.

NO FEAR

OWNER OF U.S. REG. NOS. 2,055,158, 2,095,492 AND OTHERS.
FOR SPORTS DRINKS, NAMELY, ENERGY DRINKS (U.S. CLS. 45, 46 AND 48).

SN 78-180,435. NALECZOWIANKA SP. Z O.O., 24-140 NALECZOW, POLAND, FILED 10-31-2002.

NALECZOWIANKA

THE MARK CONSISTS OF THE WORDING "NALECZOWIANKA" WITH DIACRITICAL MARKS. THE MARK IS PRESENTED WITHOUT ANY CLAIM AS TO SPECIAL FORM.
THE ENGLISH TRANSLATION OF "NALECZOWIANKA" IS "WOMAN FROM NALECZOW".
FOR CARBONATED AND NON-CARBONATED MINERAL WATER (U.S. CLS. 45, 46 AND 48).
FIRST USE 7-5-1993; IN COMMERCE 6-26-1995.

SN 78-180,647. JEL SERT CO., THE, WEST CHICAGO, IL. FILED 10-31-2002.

SUNSPASHERS

FOR POWDERED MIXES FOR MAKING SOFT DRINKS (U.S. CLS. 45, 46 AND 48).

SN 78-182,643. STOKELY-VAN CAMP, INC., CHICAGO, IL. FILED 11-7-2002.

MVP

FOR NON-CARBONATED FRUIT FLAVORED DRINKS (U.S. CLS. 45, 46 AND 48).

CLASS 32—(Continued).

SN 78-185,335. KRAFT FOODS HOLDINGS, INC., NORTH-FIELD, IL. FILED 11-14-2002.

LIFE SAVERS

OWNER OF U.S. REG. NOS. 93,080, 1,130,067 AND OTHERS.
FOR BEVERAGES; NAMELY, POWDERS, SYRUPS OR CONCENTRATES FOR MAKING SOFT DRINKS. (U.S. CLS. 45, 46 AND 48).

CLASS 33—(Continued).

SN 76-193,707. MEDRANO ESTATE S.A., MENDOZA, ARGENTINA, FILED 1-12-2001.

CASATERRA

THE ENGLISH TRANSLATION OF "CASATERRA" IS "HOUSE OF THE EARTH".
FOR WINE (U.S. CLS. 47 AND 49).
FIRST USE 1-1-2000; IN COMMERCE 1-1-2000.

SN 76-331,298. CHEVIOT BRIDGE PTY LTD, MELBOURNE, VICTORIA 3004, AUSTRALIA, FILED 10-29-2001.

CLASS 33—WINES AND SPIRITS

SN 75-696,146. FAIRMOUNT HOTELS & RESORTS (U.S.) INC., TORONTO, ONTARIO M5K 1B7, CANADA, BY ASSIGNMENT FAIRMOUNT HOTEL MANAGEMENT L.P., SAN FRANCISCO, CA. FILED 5-3-1999.

FAIRMONT

FOR WINES, SPIRITS, AND LIQUEURS (U.S. CLS. 47 AND 49).

SN 76-060,202. GERARDO CESARI S.P.A., 25027 QUINZANO (BRESCIA), ITALY, FILED 5-31-2000.



NO CLAIM IS MADE TO THE EXCLUSIVE RIGHT TO USE "PRODUCT OF ITALY", " PINOT GRIGIO DELLE VENEZIE INDICAZIONE GEOGRAFICA TIPICA WHITE WINE 1997", APART FROM THE MARK AS SHOWN.

THE ENGLISH TRANSLATION OF "DELLE VENEZIE INDICAZIONE GEOGRAFICA TIPICA" IS "TYPICAL GEOGRAPHICAL INDICATION OF DELLE VENEZIE", WHICH IS A REGION OF NORTH EAST ITALY (VENETO AND VENEZIA-GIULIA).

FOR WINES (U.S. CLS. 47 AND 49).



PRIORITY CLAIMED UNDER SEC. 44(D) ON AUSTRALIA APPLICATION NO. 890954, FILED 10-3-2001, REG. NO. 890954, DATED 10-3-2001, EXPIRES 10-3-2011.

NO CLAIM IS MADE TO THE EXCLUSIVE RIGHT TO USE "AUSTRALIAN WINES OF DISTINCTION", APART FROM THE MARK AS SHOWN.

FOR ALCOHOLIC BEVERAGES, NAMELY, AUSTRALIAN WINES (U.S. CLS. 47 AND 49).

SN 76-407,260. CALVET, 33300 BORDEAUX, FRANCE, FILED 5-9-2002.

XF

PRIORITY CLAIMED UNDER SEC. 44(D) ON FRANCE APPLICATION NO. 013132723, FILED 11-21-2001, REG. NO. 013132723, DATED 11-21-2001, EXPIRES 11-21-2011.

FOR ALCOHOLIC BEVERAGES, EXCLUDING BEERS, NAMELY, STILL WINES, SPARKLING WINES, DISTILLED LIQUOR, PREPARED ALCOHOLIC COCKTAILS, BRANDY, VODKA, WHISKY AND DISTILLED SPIRITS (U.S. CLS. 47 AND 49).

SN 76-408,088. WINERY EXCHANGE, INC., NOVATO, CA. FILED 5-14-2002.

ORTOLANO

THE ENGLISH TRANSLATION OF THE ITALIAN WORD "ORTOLANO" IS "KITCHEN GARDEN".
FOR WINE (U.S. CLS. 47 AND 49).

CLASS 33—(Continued).

SN 76-414,443. THE TALL BLOND INTERNATIONAL LTD.,
11415 TALLINN, ESTONIA, FILED 5-28-2002.

THE QUEEN OF VODKA

NO CLAIM IS MADE TO THE EXCLUSIVE RIGHT TO
USE "VODKA", APART FROM THE MARK AS SHOWN.
FOR VODKA (U.S. CLS. 47 AND 49).

SN 76-416,746. P.L.W.E., 33650 SAINT MORILLON, FRANCE,
FILED 6-5-2002.

BELLA ROSA

THE ENGLISH TRANSLATION OF "BELLA ROSA" IS
"NICE ROSE".
FOR WINE (U.S. CLS. 47 AND 49).

SN 76-419,047. A.V. IMPORTS, INC., COLUMBIA, MD.
FILED 6-10-2002.

KO

FOR WINES AND SPIRITS (U.S. CLS. 47 AND 49).

SN 76-419,048. A.V. IMPORTS, INC., COLUMBIA, MD.
FILED 6-10-2002.

RULE THE PARTY

FOR WINES AND SPIRITS (U.S. CLS. 47 AND 49).

SN 76-419,097. A.C.T.A. S.P.A., 36100 VICENZA, ITALY,
FILED 6-10-2002.

CASTELLO DEL POGGIO

OWNER OF ITALY REG. NO. 510583, DATED 6-13-1989,
RENEWED AS REG. NO. 801753, DATED 1-24-2000, EXPIRES
2-20-2007.

THE WORDS "CASTELLO DEL POGGIO" CAN BE
TRANSLATED AS "CASTLE OF THE KNOLL".
FOR WINES AND SPARKLING WINES (U.S. CLS. 47
AND 49).

CLASS 33—(Continued).

SN 76-419,432. WENTE BROS., LIVERMORE, CA. FILED 6-
11-2002.

DELLA CASA

THE TERM "DELLA CASA" IS BELIEVED TO MEAN "OF
THE HOUSE" IN ITALIAN.
SEC. 2(F).
FOR WINE (U.S. CLS. 47 AND 49).
FIRST USE 0-0-1987; IN COMMERCE 0-0-1987.

SN 76-422,587. BODEGAS CEPAS DE MENDOZA S.A.,
C1001AAD BUENOS AIRES, ARGENTINA, FILED 6-18-
2002.



CEPAS DE MENDOZA

NO CLAIM IS MADE TO THE EXCLUSIVE RIGHT TO
USE "CEPAS DE MENDOZA", APART FROM THE MARK
AS SHOWN.
THE FOREIGN WORDING IN THE MARK TRANSLATES
INTO ENGLISH AS "VINES OF MENDOZA".
FOR WINES (U.S. CLS. 47 AND 49).

SN 76-423,744. TERROIR IMPORTATION AND DISTRIBU-
TION (PROPRIETARY) LIMITED, SANDTON, GAU-
TENG, SOUTH AFRICA, FILED 6-20-2002.

MUJAJI

FOR WINE (U.S. CLS. 47 AND 49).

SN 76-424,369. SCHILLER, SCOTT J., BURR RIDGE, IL.
FILED 6-24-2002.



FOR LIQUEURS (U.S. CLS. 47 AND 49).

CLASS 33—(Continued).

SN 76-432,924. COGNAC GAUTIER S.A., 16140 AIGRE, FRANCE, FILED 7-22-2002.

LA CAPTIVE BY JEAN DANFLOU

OWNER OF U.S. REG. NO. 1,763,171.
THE ENGLISH TRANSLATION OF "LA CAPTIVE" IS "THE PRISONER".
FOR WINE, DISTILLED SPIRITS MADE FROM FRUITS, VEGETABLES, GRAINS; LIQUEURS AND CORDIALS (U.S. CLS. 47 AND 49).

SN 76-453,396. SCHILLER, SCOTT J., BURR RIDGE, IL. FILED 9-27-2002.

AUBURN

FOR ALCOHOLIC BEVERAGES, NAMELY LIQUEURS AND DISTILLED SPIRITS (U.S. CLS. 47 AND 49).

SN 76-454,132. KAGURA SHUZO USA, TORRANCE, CA. FILED 9-27-2002.

KUROUMA

THE FOREIGN WORDING IN THE MARK TRANSLATES INTO ENGLISH AS "DARK HORSE".
FOR JAPANESE DISTILLED SPIRITS OF BARLEY SOJU (U.S. CLS. 47 AND 49).

SN 76-467,032. COOPERATIVA AGRICOLA CONTROL PISQUERO DE ELQUI Y LIMARI LIMITADA, CHILE, FILED 11-5-2002.

TRES ERRES RRR

OWNER OF CHILE REG. NO. 564.280, DATED 3-20-2000, EXPIRES 3-20-2010.
THE ENGLISH TRANSLATION OF THE TERM "TRES ERRES" IS "THREE R'S".
FOR ALCOHOLIC BEVERAGES, NAMELY, PISCO (U.S. CLS. 47 AND 49).

SN 76-471,543. F. KORBEL & BROS., GUERNEVILLE, CA. FILED 11-18-2002.

THE LIFE YOU'VE ALWAYS DREAMED OF . . . AND THE WINE TO ENJOY IT.

FOR WINE (U.S. CLS. 47 AND 49).

CLASS 33—(Continued).

SN 76-472,827. NORD ESTATE WINES, LLC, NAPA, CA. FILED 12-6-2002.

PAGE NORD VINEYARD

NO CLAIM IS MADE TO THE EXCLUSIVE RIGHT TO USE "VINEYARD", APART FROM THE MARK AS SHOWN. THE NAME IN THE MARK DOES NOT IDENTIFY A LIVING INDIVIDUAL.
THE ENGLISH TRANSLATION OF THE WORD "NORD" IN THE MARK IS "NORTH".
FOR WINE (U.S. CLS. 47 AND 49).
FIRST USE 10-0-1999; IN COMMERCE 1-0-2000.

SN 76-472,830. DAVIDS PINOT VINEYARDS, INC., DBA SEA SMOKE CELLARS, LOMPOC, CA. FILED 12-6-2002.

GRATIS

FOR WINE (U.S. CLS. 47 AND 49).

SN 76-472,831. DAVIDS PINOT VINEYARDS, INC., DBA SEA SMOKE CELLARS, LOMPOC, CA. FILED 12-6-2002.

SOUTHING

FOR WINE (U.S. CLS. 47 AND 49).

SN 76-472,832. DAVIDS PINOT VINEYARDS, INC., DBA SEA SMOKE CELLARS, LOMPOC, CA. FILED 12-6-2002.

BOTELLA

FOR WINE (U.S. CLS. 47 AND 49).

SN 76-472,906. BRONCO WINE COMPANY, CERES, CA. FILED 12-9-2002.

CHARLES SHAW

THE NAME IN THE MARK DOES NOT IDENTIFY A LIVING INDIVIDUAL.
FOR WINE (U.S. CLS. 47 AND 49).
FIRST USE 0-0-1979; IN COMMERCE 0-0-1979.

CLASS 33—(Continued).

SN 76-474,563. VINICOLA DECORDI DEL BORGO IMPERIALE - CORTESOLE S.P.A. MOTTA BALUFFI (CREMONA), ITALY, FILED 12-11-2002.

EVANDER

FOR WINES AND SPARKLING WINES (U.S. CLS. 47 AND 49).

SN 76-474,565. VINICOLA DECORDI DEL BORGO IMPERIALE - CORTESOLE S.P.A. MOTTA BALUFFI (CREMONA), ITALY, FILED 12-11-2002.

BORGO IMPERIALE

THE ITALIAN MARK "BORGO IMPERIALE" IS TRANSLATED IN ENGLISH AS "IMPERIAL VILLAGE".
FOR WINES AND SPARKLING WINES (U.S. CLS. 47 AND 49).

SN 76-474,764. PRECEPT BRANDS LLC, BALDWINVILLE, NY. FILED 12-13-2002.

EL PASEO

THE ENGLISH TRANSLATION OF THE WORD "EL PASO" IN THE MARK IS "WALK" OR "PROMENADE".
FOR WINES (U.S. CLS. 47 AND 49).

SN 78-051,848. LADY BAY VINEYARD PTY LTD., WINGFIELD, SOUTH AUSTRALIA, AUSTRALIA, FILED 3-7-2001.

LADY BAY

OWNER OF AUSTRALIA REG. NO. 824726, DATED 2-24-2000, EXPIRES 2-24-2010.
FOR WINES (U.S. CLS. 47 AND 49).

SN 78-087,601. ARTHUR CRACK LIMITED, KENT, UNITED KINGDOM, FILED 10-9-2001.

CRACK ICE

PRIORITY CLAIMED UNDER SEC. 44(D) ON ERPN CMNTY TM OFC APPLICATION NO. 2174886, FILED 4-11-2001, REG. NO. 002174886, DATED 6-27-2002, EXPIRES 4-11-2011.

FOR POTEEN; ALCOHOLIC BEVERAGES CONTAINING POTEEN (U.S. CLS. 47 AND 49).

CLASS 33—(Continued).

SN 78-125,786. DIAGEO NORTH AMERICA, INC., STAMFORD, CT. FILED 5-2-2002.

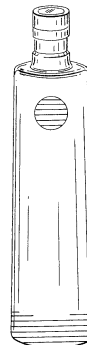

THE MARK CONSISTS OF A CONFIGURATION OF A ROUND BOTTLE, WHICH GRADUALLY BECOMES WIDER FROM THE TOP TO THE MIDDLE OF THE FRONT, TOP PART OF THE BOTTLE AND BLUE SHADING ALONG THE BOTTOM. THE HORIZONTAL LINES IN THE CIRCLE AND ALONG THE BOTTOM OF THE BOTTLE REPRESENT THE COLOR BLUE AND ARE NOT FEATURES OF THE MARK. THE VERTICAL LINES DRAWN INSIDE THE BOTTLE ARE NOT A FEATURE OF THE MARK BUT REPRESENT THREE-DIMENSIONAL PERSPECTIVE AND THE ROUNDNESS OF THE BOTTLE. THE DIAGONAL LINES INSIDE THE TOP OF THE BOTTLE CAP ALSO REPRESENT PERSPECTIVE AND ARE NOT FEATURES OF THE MARK.

FOR ALCOHOLIC BEVERAGES, NAMELY VODKA (U.S. CLS. 47 AND 49).

SN 78-130,375. RIVERINA WINES PTY LTD, GRIFFITH, NEW SOUTH WALES, AUSTRALIA, FILED 5-22-2002.

WARBURN

PRIORITY CLAIMED UNDER SEC. 44(D) ON AUSTRALIA APPLICATION NO. 912389, FILED 5-9-2002, REG. NO. 912389, DATED 5-9-2002, EXPIRES 5-9-2012.
FOR WINE (U.S. CLS. 47 AND 49).

SN 78-149,437. THE KAHLUA COMPANY, HEALDSBURG, CA. FILED 7-31-2002.

KUYA

FOR DISTILLED SPIRITS. (U.S. CLS. 47 AND 49).

SN 78-165,710. SCHRADER CELLARS, LLC, CALISTOGA, CA. FILED 9-19-2002.

VIEUX OS

THE WORDS "VIEUX OS" ARE FRENCH AND TRANSLATE LITERALLY AS "OLD BONES".
FOR WINES (U.S. CLS. 47 AND 49).

CLASS 33—(Continued).

SN 78-168,430. SOUTHCORP WINES PTY LIMITED, ARTARMON, NSW, AUSTRALIA, FILED 9-26-2002.

THOMAS HYLAND

OWNER OF U.S. REG. NO. 2,536,595.
THE MARK DOES NOT IDENTIFY A LIVING INDIVIDUAL.
FOR WINES (U.S. CLS. 47 AND 49).
FIRST USE 12-0-1999; IN COMMERCE 2-0-2002.

SN 78-173,362. MAPLE LEAF DISTILLERS INC., WINNIPEG, CANADA, FILED 10-11-2002.

TEQREMA

PRIORITY CLAIMED UNDER SEC. 44(D) ON CANADA APPLICATION NO. 1154736, FILED 10-8-2002.
FOR TEQUILA FRUIT FLAVORED CREAM LIQUEUR (U.S. CLS. 47 AND 49).

SN 78-180,491. UVAGUILERA, S.L., BURGOS, SPAIN, FILED 10-31-2002.

PALOMERO

FOR WINES (U.S. CLS. 47 AND 49).

SN 78-183,362. EARLY TIMES DISTILLERS COMPANY, LOUISVILLE, KY. FILED 11-8-2002.

EASY TOTE

FOR ALCOHOLIC BEVERAGES, NAMELY, DISTILLED SPIRITS (U.S. CLS. 47 AND 49).
FIRST USE 6-30-2001; IN COMMERCE 6-30-2001.

SN 78-185,048. CHIARELLA, PETER, NAPA, CA. FILED 11-14-2002.

CRANE FAMILY VINEYARDS

NO CLAIM IS MADE TO THE EXCLUSIVE RIGHT TO USE "FAMILY VINEYARDS", APART FROM THE MARK AS SHOWN.
FOR WINE (U.S. CLS. 47 AND 49).
FIRST USE 3-9-1999; IN COMMERCE 3-9-1999.

CLASS 33—(Continued).

SN 78-185,318. PIERCE, LEON W., STOCKTON, CA. FILED 11-14-2002.

LE CASK

NO CLAIM IS MADE TO THE EXCLUSIVE RIGHT TO USE "CASK", APART FROM THE MARK AS SHOWN.
FOR ALCOHOLIC BEVERAGES, NAMELY, WINES AND WINE COOLERS (U.S. CLS. 47 AND 49).

SN 78-185,748. JERRY GARCIA ESTATE LLC, SAN RAFAEL, CA. FILED 11-15-2002.

JERRY GARCIA

OWNER OF U.S. REG. NOS. 2,363,464, 2,645,963 AND OTHERS.
FOR WINE (U.S. CLS. 47 AND 49).

SN 78-186,134. DAUCOURT, JEAN-MARC, DALLAS, TX. FILED 11-18-2002.

ROYAL CREST

FOR COGNAC (U.S. CLS. 47 AND 49).

SN 78-191,292. ALLIED MANAGEMENT, INC., LIVINGSTON, NJ. FILED 12-4-2002.

SOLACE

FOR WINE (U.S. CLS. 47 AND 49).

SN 78-191,294. ALLIED MANAGEMENT, INC., LIVINGSTON, NJ. FILED 12-4-2002.

SCENARIO

FOR WINE (U.S. CLS. 47 AND 49).

SN 78-193,572. CAYUSE VINEYARDS, L.L.C., WALLA WALLA, WA. FILED 12-11-2002.

FLYING PIG

FOR WINE (U.S. CLS. 47 AND 49).
FIRST USE 7-1-2002; IN COMMERCE 7-1-2002.

CLASS 34—SMOKERS' ARTICLES

SN 76-239,201. NUEVA MATACAPAN TABACOS, S.A. DE C.V., TUXTLA, VERACRUZ, MEXICO, FILED 4-11-2001.

DON CAMILO CIGARS

NO CLAIM IS MADE TO THE EXCLUSIVE RIGHT TO USE "CIGARS", APART FROM THE MARK AS SHOWN. FOR TOBACCO PRODUCTS, NAMELY CIGARS (U.S. CLS. 2, 8, 9 AND 17).

SN 76-320,661. CARIBE IMPORTED CIGARS, INC., MIAMI, FL. FILED 10-3-2001.

EIROA SLR (SPECIAL LIMITED RESERVE)

NO CLAIM IS MADE TO THE EXCLUSIVE RIGHT TO USE "(SPECIAL LIMITED RESERVE)", APART FROM THE MARK AS SHOWN. FOR CIGARS (U.S. CLS. 2, 8, 9 AND 17).

SN 76-363,579. EAGLE MANUFACTURING COMPANY, WELLSBURG, WV. FILED 1-29-2002.

SAFESMOKER

FOR CIGARETTE ASH AND SPENT CIGARETTE RECEPTACLE (U.S. CLS. 2, 8, 9 AND 17). FIRST USE 4-8-2002; IN COMMERCE 4-8-2002.

SN 76-446,082. OETTINGER IMEX AG, 4002 BASEL, SWITZERLAND, FILED 8-28-2002.

3X3

FOR CIGARS (U.S. CLS. 2, 8, 9 AND 17).

SN 76-485,805. FREDKO MANAGEMENT N.V., CURACAO, NETHERLD ANTILLES, FILED 1-29-2003.

GATOR

FOR CIGARETTES (U.S. CLS. 2, 8, 9 AND 17).

CLASS 34—(Continued).

SN 78-157,851. DRL ENTERPRISES, INC., GLENVIEW, IL. FILED 8-26-2002.

1.5

OWNER OF U.S. REG. NOS. 1,328,866, 1,331,207 AND 1,481,006. SEC. 2(F). FOR CIGARETTE ROLLING PAPERS (U.S. CLS. 2, 8, 9 AND 17). FIRST USE 4-9-1976; IN COMMERCE 4-9-1976.

SN 78-162,933. ROYAL BLUNTS, INC., CORONA, CA. FILED 9-11-2002.

BLACK WOODS

FOR CIGARS, CIGARETTES, TOBACCO LEAVES FOR ROLLING CIGARETTES AND CIGARS AND CHEWING TOBACCO (U.S. CLS. 2, 8, 9 AND 17).

SN 78-184,015. LIBERTY BRANDS LLC, MELVILLE, NY. FILED 11-12-2002.

BREAKTIME

FOR CIGARETTES (U.S. CLS. 2, 8, 9 AND 17).

SN 78-185,230. ARANGOLD CORPORATION, NORTH-BROOK, IL. FILED 11-14-2002.

FINSBURY

FOR TOBACCO, SMOKELESS TOBACCO, CIGARS, SMOKING PIPES, AND SMOKING PIPE TOBACCO (U.S. CLS. 2, 8, 9 AND 17).

SN 78-185,234. ARANGOLD CORPORATION, NORTH-BROOK, IL. FILED 11-14-2002.

PEGASUS

FOR TOBACCO, SMOKELESS TOBACCO AND CIGARS. (U.S. CLS. 2, 8, 9 AND 17).

SN 78-190,600. H.A.T. CIGARETTE IMPORTS, INC., HORN LAKE, MS. FILED 12-3-2002.

DARK HORSE

FOR LOOSE TOBACCO (U.S. CLS. 2, 8, 9 AND 17).

CLASS 34—(Continued).

SN 78-190,608. H.A.T. CIGARETTE IMPORTS, INC., HORN LAKE, MS. FILED 12-3-2002.

BANKS

FOR CIGARETTES (U.S. CLS. 2, 8, 9 AND 17).

SN 78-190,615. H.A.T. CIGARETTE IMPORTS, INC., HORN LAKE, MS. FILED 12-3-2002.

MARKS

FOR CIGARETTES (U.S. CLS. 2, 8, 9 AND 17).

SERVICE MARKS

CLASS 35—ADVERTISING AND BUSINESS

SN 75-413,469. URBAN BRANDS, INC., SECAUCUS, NJ. BY CHANGE OF NAME ASHLEY STEWART GROUP LTD, THE, SECAUCUS, NJ. FILED 12-31-1997.

URBAN BRANDS

NO CLAIM IS MADE TO THE EXCLUSIVE RIGHT TO USE "BRANDS", APART FROM THE MARK AS SHOWN.
 FOR BUSINESS MANAGEMENT, CONSULTATION, PLANNING AND SUPERVISION SERVICES IN THE AREA OF RETAIL ESTABLISHMENTS (U.S. CLS. 100, 101 AND 102).
 FIRST USE 12-0-1998; IN COMMERCE 12-0-1998.

SN 75-625,785. PETERSON MANUFACTURING COMPANY, GRANDVIEW, MO. FILED 1-20-1999.



NO CLAIM IS MADE TO THE EXCLUSIVE RIGHT TO USE "CAT", APART FROM THE MARK AS SHOWN.
 FOR DISTRIBUTORSHIP SERVICES IN THE FIELD OF BOAT TRAILER LIGHTS (U.S. CLS. 100, 101 AND 102).
 FIRST USE 11-30-1998; IN COMMERCE 11-30-1998.

CLASS 35—(Continued).

SN 75-669,924. BRADEK CORPORATION, WASHINGTON, DC. FILED 3-29-1999.



FOR COMPUTERIZED ON-LINE RETAIL SERVICES FEATURING GENERAL MERCHANDISE, NAMELY, AUTOMOBILES, FURNITURE, BOOKS, MAGAZINES, JEWELRY, CLOTHING, PERSONAL COMPUTERS, COMPUTER SOFTWARE, PRERECORDED VIDEOS AND MOVIES IN DVD OR VHS FORMAT, ELECTRONICS, MUSIC, FLOWERS, GIFTS, OFFICE SUPPLIES, HOME SUPPLIES, GAMES, TOYS, PETS, FOOD, WINE, FRAGRANCES AND COSMETICS; PROMOTING THE GOODS AND SERVICES OF OTHERS BY PREPARING AND PLACING ADVERTISEMENTS ON ELECTRONIC WEB PAGES ACCESSED VIA A GLOBAL COMPUTER NETWORK; DISSEMINATION OF ADVERTISING FOR OTHERS VIA AN ON-LINE ELECTRONICS COMMUNICATION NETWORK; PROVIDING, BY MEANS OF A GLOBAL COMPUTER NETWORK, PRICING INFORMATION AND PRICE COMPARISON DATA ANALYSIS ABOUT THE ON-LINE GOODS AND SERVICES OF OTHERS; PROVIDING AN ON-LINE COMPUTER DATABASE FEATURING TRADE INFORMATION IN THE FIELD OF ON-LINE RETAILING IN GENERAL AND PROVIDING INFORMATION ABOUT THE SPECIFIC ON-LINE RETAIL SERVICES OF OTHERS IN PARTICULAR; PROVIDING ON-LINE BUSINESS DIRECTORIES FEATURING LISTINGS OF THE ON-LINE RETAIL SERVICES OF OTHERS; PROVIDING ON-LINE SHOPPERS' GUIDE INFORMATION SERVICES VIA THE INTERNET; AND COMPUTERIZED ON-LINE GIFT REGISTRY AND GIFT ORDERING SERVICES WHICH MATCH THE GIFT GIVER'S REQUIREMENTS WITH THE GIFT RECIPIENT'S WANTS AND NEEDS (U.S. CLS. 100, 101 AND 102).

SN 75-771,751. DANKA SERVICES INTERNATIONAL, ROCHESTER, NY. FILED 8-9-1999.



FOR DOCUMENT OUTSOURCING SERVICES (U.S. CLS. 100, 101 AND 102).

CLASS 35—(Continued).

SN 75-785,536. J. B. COMPUTER MANAGEMENT (JBCM), WOKINGHAM, BERKSHIRE, UNITED KINGDOM, FILED 9-23-1999.

CDC JBCM FLOW AUDIT

OWNER OF UNITED KINGDOM REG. NO. 2208827, DATED 9-8-1999, EXPIRES 9-8-2009.

NO CLAIM IS MADE TO THE EXCLUSIVE RIGHT TO USE "FLOW AUDIT", APART FROM THE MARK AS SHOWN.

FOR BUSINESS MANAGEMENT (U.S. CLS. 100, 101 AND 102).

SN 75-843,123. NOVONT ENTERPRISES INC., LOS ANGELES, CA. FILED 11-8-1999.

TIMETONE

FOR RETAIL STORE SERVICES FEATURING FOOD AND BEVERAGES, AUTO PARTS, AUTOMOBILES, CLOTHING, CHEMICAL PRODUCTS, ELECTRONICS, HOME APPLIANCES, AND MACHINES AND EQUIPMENT (U.S. CLS. 100, 101 AND 102).

SN 75-862,639. ARLINGTON SOFTWARE CORPORATION, MONTREAL, QUEBEC, CANADA, FILED 12-2-1999.



FOR MANAGEMENT CONSULTING SERVICES, NAMELY ALIGNING INFORMATION TECHNOLOGY PRODUCTS AND SERVICES WITH SPECIFIC BUSINESS REQUIREMENTS OF CLIENTS (U.S. CLS. 100, 101 AND 102).

FIRST USE 8-0-1999; IN COMMERCE 8-0-1999.

SN 75-891,974. Y&R PROPERTIES, SAN FRANCISCO, CA. BY ASSIGNMENT YOUNG & RUBICAM INC., NEW YORK, NY. FILED 1-11-2000.

BRAVO 2.1

FOR ADVERTISING AGENCY SERVICES; MARKET RESEARCH SERVICES; PUBLIC RELATIONS SERVICES; MARKETING SERVICES, NAMELY PROMOTING THE GOODS AND SERVICES OF OTHERS BY PREPARING AND PLACING ADVERTISEMENTS FOR DISSEMINATION THROUGH TELEVISION AND RADIO COMMERCIALS, DIRECT MAIL, PRINT PUBLICATIONS, BILLBOARDS, VIA A GLOBAL COMPUTER NETWORK AND OTHER MEDIA OUTLETS; BUSINESS CONSULTATION SERVICES IN THE FIELD OF PROMOTION AND MARKETING (U.S. CLS. 100, 101 AND 102).

CLASS 35—(Continued).

SN 75-899,310. BEAUTY HOLDING COMPANY, INC., HAMILTON HM12, BERMUDA, BY CHANGE OF NAME SALLY BEAUTY HOLDINGS, INC., HAMILTON HM 12, BERMUDA, FILED 1-19-2000.

VICTORY

FOR RETAIL STORE SERVICES IN THE FIELD OF BEAUTY SUPPLIES AND EQUIPMENT (U.S. CLS. 100, 101 AND 102).

FIRST USE 1-1-1979; IN COMMERCE 1-1-1979.

SN 75-912,158. DOLLERO FIGUEROA, ARMANDO ERNESTO, LERMA, EDO. DE MEXICO, MEXICO, AND DOLLERO FIGUEROA, CARLO, LERMA, EDO. DE MEXICO, MEXICO, FILED 2-7-2000.

SHASA

OWNER OF MEXICO REG. NO. 528,902, DATED 8-26-1996, EXPIRES 8-26-2006.

OWNER OF U.S. REG. NO. 2,226,033.

FOR RETAIL STORE SERVICES FEATURING CLOTHES, SHOES, PURSES, EARRINGS, NECKLACES, BRACELETS AND RINGS (U.S. CLS. 100, 101 AND 102).

SN 75-943,438. SITESTUFF.COM INC., AUSTIN, TX. FILED 3-3-2000.



NO CLAIM IS MADE TO THE EXCLUSIVE RIGHT TO USE "SITE", APART FROM THE MARK AS SHOWN.

THE MARK CONSISTS OF THE WORD "SITE" WITH THE "I" IN SITE REPRESENTED AS A BUILDING WITH AN ANTENNA, ALL OF WHICH APPEARS OVER THE WORD "STUFF.COM".

FOR ONLINE RETAIL STORE SERVICES FEATURING ELECTRICAL SUPPLIES, HOUSEHOLD OR ELECTRICAL APPLIANCES, BREAK ROOM SUPPLIES, FLOORING, FURNITURE AND ACCESSORIES, HARDWARE AND MAINTENANCE SUPPLIES, HEATING, VENTILATING AND AIR CONDITIONING PRODUCTS, JANITORIAL PRODUCTS, LAWN AND GARDEN PRODUCTS, LIGHTING, OFFICE PRODUCTS, PAINT AND SUNDRIES, PLUMBING PRODUCTS, HOUSEHOLD TOOLS, UNIFORMS AND APPAREL, AND WINDOW TREATMENT PRODUCTS USED IN THE MANAGEMENT, MAINTENANCE, REPAIR, AND OPERATION OF COMMERCIAL AND MULTI-FAMILY REAL ESTATE OPERATIONS (U.S. CLS. 100, 101 AND 102).

CLASS 35—(Continued).

SN 75-983,250. WEIMAR, ERIK, HIALEAH, FL. FILED 1-6-2000.

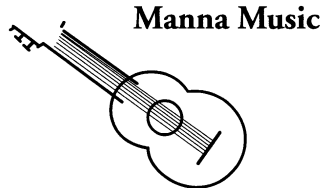

NO CLAIM IS MADE TO THE EXCLUSIVE RIGHT TO USE "MUSIC", APART FROM THE MARK AS SHOWN.

THE LINING IS A FEATURE OF THE MARK AND DOES NOT INDICATE COLOR. THE LINING INDICATES GUITAR STRINGS.

FOR PROMOTING THE CONCERTS OF OTHERS; AND PRODUCT MERCHANDISING (U.S. CLS. 100, 101 AND 102).

SN 76-001,634. ORDERMARKET, INC., LOS ANGELES, CA. FILED 3-16-2000.

ORDERMARKET

FOR COMPUTERIZED ON-LINE ORDERING, FULFILLMENT, AND DISTRIBUTORSHIP OF A WIDE VARIETY OF RETAIL AND WHOLESALE CONSUMER GOODS (U.S. CLS. 100, 101 AND 102).

SN 76-050,485. CII TECHNOLOGIES, INC., FAIRVIEW, NC. BY CHANGE OF NAME COMMUNICATIONS INSTRUMENTS, INC., FAIRVIEW, NC. FILED 5-17-2000.



FOR PROVIDING PRODUCT INFORMATION RELATING TO ELECTRICAL AND ELECTROMECHANICAL RELAYS, SWITCHES, SOLENOIDS AND CONTACTORS, AND ELECTRICAL FILTERS TO DISTRIBUTORS THROUGH A GLOBAL COMMUNICATION NETWORK (U.S. CLS. 100, 101 AND 102).

CLASS 35—(Continued).

SN 76-056,925. FLOWERS YOUR WAY (INTERNATIONAL & WORLDWIDE DELIVERY) ALL MAJOR CREDIT CARDS ACCEPTED CORPORATION, EDMONTON, ALBERTA, CANADA, FILED 5-26-2000.

FLOWERS YOUR WAY

PRIORITY CLAIMED UNDER SEC. 44(D) ON CANADA APPLICATION NO. 1054606, FILED 4-11-2000, REG. NO. 570325, DATED 11-6-2002, EXPIRES 11-6-2012.

NO CLAIM IS MADE TO THE EXCLUSIVE RIGHT TO USE "FLOWERS", APART FROM THE MARK AS SHOWN. FOR TELEPHONE AND COMPUTER ONLINE ORDERING SERVICE FEATURING FLOWERS, GOURMET BASKETS, FRUIT BASKETS, CHOCOLATES, CANDY, ALCOHOL, LINGERIE, JAMS AND OTHER CONDIMENTS, EXECUTIVE GIFTS, AND OTHER SPECIALTY ITEMS AND GIFTS (U.S. CLS. 100, 101 AND 102). FIRST USE 6-0-1999; IN COMMERCE 6-0-1999.

SN 76-056,926. FLOWERS YOUR WAY (INTERNATIONAL & WORLDWIDE DELIVERY) ALL MAJOR CREDIT CARDS ACCEPTED CORPORATION, EDMONTON, ALBERTA, CANADA, FILED 5-26-2000.

**LOVE LIKE YOU'VE NEVER
BEEN HURT DANCE LIKE
NOBODY'S WATCHING
WORK LIKE YOU OWN THE
COMPANY AND SEND
FLOWERS YOUR WAY**

PRIORITY CLAIMED UNDER SEC. 44(D) ON CANADA APPLICATION NO. 1054607, FILED 4-11-2000, REG. NO. TMA570125, DATED 11-1-2002, EXPIRES 11-1-2017.

FOR TELEPHONE AND COMPUTER ONLINE ORDERING SERVICE FEATURING FLOWERS, GOURMET BASKETS, FRUIT BASKETS, CHOCOLATES, CANDY, ALCOHOL, LINGERIE, JAMS AND OTHER CONDIMENTS, EXECUTIVE GIFTS, AND OTHER SPECIALTY ITEMS AND GIFTS (U.S. CLS. 100, 101 AND 102).

SN 76-066,800. GRAJ & GUSTAVSEN, INC., NEW YORK, NY. FILED 6-9-2000.

GGINVENT

FOR PROVIDING BUSINESS CONSULTING AND BUSINESS MARKETING CONSULTING REGARDING START-UP COMPANIES AND BUSINESS INCUBATION; MARKETING SERVICES NAMELY, COMPANY BRAND AND PRODUCT DEVELOPMENT SERVICES (U.S. CLS. 100, 101 AND 102).

FIRST USE 5-1-2000; IN COMMERCE 5-1-2000.

CLASS 35—(Continued).

SN 76-081,279. FREEI NETWORKS, INC., DBA FREEINTER-NET.COM, FEDERAL WAY, WA. FILED 6-30-2000.

INTROMERCIAL

FOR DISSEMINATION OF ADVERTISING FOR OTHERS VIA AN ON-LINE ELECTRONIC COMMUNICATIONS NETWORK; RENTAL OF ADVERTISING SPACE (U.S. CLS. 100, 101 AND 102).

SN 76-087,406. SPECCIA, MARK, WEST ISLIP, NY. FILED 7-13-2000.

METROCLICKS

FOR PROMOTING THE GOODS AND SERVICES OF OTHERS BY PREPARING AND PLACING ADVERTISEMENTS VIA THE INTERNET; AND ELECTRONIC RETAILING SERVICES FEATURING CONSUMER ELECTRONICS (U.S. CLS. 100, 101 AND 102).

SN 76-101,100. BRAINSTORM USA, LLC, ATLANTA, GA. FILED 8-2-2000.

BRAINSTORMUSA

FOR DIRECT MARKETING SERVICES RELATING TO EDUCATIONAL PRODUCTS AND EQUIPMENT, NAMELY SOFTWARE BUNDLES, COMPUTER HARDWARE, EDUCATION WEB SITE REFERRALS, SCHOLARSHIPS, TUTORING PROGRAMS AND PRESENTATIONS, MATERIALS FOR USE BY EDUCATORS AND PARENTS OF STUDENTS, ALL PROVIDED VIA ELECTRONIC COMMUNICATION MEDIA AND WEB SITES (U.S. CLS. 100, 101 AND 102).

FIRST USE 9-30-1997; IN COMMERCE 9-30-1997.

SN 76-143,768. GUITJENS, HENJO J.E.M., 1359 HA ALMERE, NETHERLANDS, AND VAN GINKEL, ERRIS P., 1359 HA ALMERE, NETHERLANDS, AND LEERSEN, JAQUES, 1359 HA ALMERE, NETHERLANDS, FILED 10-10-2000.

MOODFACTORY

OWNER OF BENELUX REG. NO. 0664596, DATED 4-17-2000, EXPIRES 4-17-2010.

FOR ADVERTISING AGENCY SERVICES, NAMELY, PLACING ADVERTISEMENTS AND PROMOTIONAL MATERIALS ON THE INTERNET FOR OTHERS; COMMERCIAL INFORMATION AGENCIES PROVIDING BUSINESS INFORMATION, E.G. MARKETING, DATA AND DEMOGRAPHIC DATA; COMPUTERIZED DATABASE MANAGEMENT (U.S. CLS. 100, 101 AND 102).

CLASS 35—(Continued).

SN 76-143,867. WAVELINK CORPORATION, KIRKLAND, WA. FILED 10-9-2000.

WAVELINK.COM

OWNER OF U.S. REG. NOS. 1,275,915, 1,275,916 AND 1,959,171.

FOR RETAIL STORE SERVICES FEATURING COMPUTER HARDWARE AND SOFTWARE FOR WIRELESS COMMUNICATIONS FOR USE OVER A GLOBAL COMPUTER NETWORK (U.S. CLS. 100, 101 AND 102).

SN 76-144,239. AHA!WORKS, INCORPORATED, DALLAS, TX. FILED 10-10-2000.

AHA!WORKS

FOR BUSINESS CONSULTATION, NAMELY, HELPING COMPANIES DEVELOP AND ACHIEVE CORPORATE VISION AND STRATEGIES (U.S. CLS. 100, 101 AND 102).

FIRST USE 7-1-1997; IN COMMERCE 7-1-1997.

SN 76-145,382. THE TRUSTEE OF NYT MANAGEMENT SERVICES, A MASSACHUSETTS BUSINESS TRUST, THE TRUSTEE COMPRISING NYT GROUP SERVICES LLC, A DELAWARE LIMITED LIABILITY COMPANY, TAMPA, FL. FILED 10-13-2000.

BostonWorks

FOR PROVIDING INFORMATION RELATING TO BUSINESS TRENDS AND CORPORATE AND EXECUTIVE PROFILES AND PROVIDING INFORMATION RELATING TO EMPLOYMENT COUNSELING, NAMELY, ADVICE ON JOB HUNTING AND RECRUITING, ALL VIA COMPUTER NETWORKS AND GLOBAL COMMUNICATIONS NETWORKS (U.S. CLS. 100, 101 AND 102).

FIRST USE 9-17-2000; IN COMMERCE 9-17-2000.

SN 76-179,313. NORDSTROM, INC., SEATTLE, WA. FILED 12-7-2000.

RISING STAR DESIGNERS

NO CLAIM IS MADE TO THE EXCLUSIVE RIGHT TO USE "DESIGNERS", APART FROM THE MARK AS SHOWN.

FOR RETAIL STORE SERVICES FEATURING WOMEN'S FASHION CLOTHING, WOMEN'S FASHION FOOTWEAR AND WOMEN'S FASHION ACCESSORIES, NAMELY HOSIERY, BELTS, HATS, GLOVES AND SCARVES (U.S. CLS. 100, 101 AND 102).

CLASS 35—(Continued).

SN 76-184,596. IQSOLUTIONS, INC., ROCKVILLE, MD.
FILED 12-21-2000.

IQ SOLUTIONS

NO CLAIM IS MADE TO THE EXCLUSIVE RIGHT TO USE "SOLUTIONS", APART FROM THE MARK AS SHOWN.

FOR BUSINESS CONSULTATION SERVICES IN THE FIELDS OF COMMUNICATION AND EDUCATION, PUBLIC RELATIONS, INFORMATION MANAGEMENT, INFORMATION CLEARING HOUSES AND "800" TYPE CALL CENTERS, BUSINESS ADMINISTRATION, PROJECT MANAGEMENT, CONFERENCE AND MEETING PLANNING, AND CONSULTATION SERVICES IN THE FIELD OF DEVELOPING PRINT, VIDEO, AND INTERACTIVE PRODUCTS, NAMELY, "HOW-TO" KITS, FACT SHEETS, MONOGRAPHS, ARTICLES, REPORTS, STANDARDS, GUIDELINES, MODEL PROGRAM DESCRIPTIONS, TRAINING MATERIALS, TRAINING AND PRESENTATION SOFTWARE, AND PUBLIC SERVICE ANNOUNCEMENTS (U.S. CLS. 100, 101 AND 102).

FIRST USE 8-1-1993; IN COMMERCE 8-1-1993.

SN 76-210,356. 2020ME HOLDINGS LIMITED, W1C 1BB
LONDON, UNITED KINGDOM, FILED 2-15-2001.

FREE TIME!

FOR ONLINE SERVICES TO FACILITATE THE CONDUCT OF BUSINESS BETWEEN PURCHASER AND SELLER, NAMELY, CUSTOMIZING CONSUMER PROFILES FOR THE EASY SELECTION OF PURCHASING OF ONLINE RETAIL PRODUCTS; ELECTRONIC RETAIL STORE SERVICES AND ONLINE ORDERING SERVICES VIA CUSTOMER PROFILING, FEATURING A WIDE VARIETY OF CONSUMER GOODS OF OTHERS; AND PROMOTING THE GOODS AND SERVICES OF OTHERS BY PROVIDING A LINK TO WEB SITES OF ELECTRONIC MERCHANTS (U.S. CLS. 100, 101 AND 102).

SN 76-210,451. WACKENHUT RESOURCES, PALM BEACH
GARDENS, FL. FILED 2-15-2001.



FOR OUTSOURCING SERVICES, NAMELY, PROFESSIONAL EMPLOYEE LEASING SERVICES (U.S. CLS. 100, 101 AND 102).

FIRST USE 11-15-2000; IN COMMERCE 11-16-2000.

CLASS 35—(Continued).

SN 76-211,979. MEDIA ARTS GROUP, INC., SAN JOSE, CA.
FILED 2-16-2001.



NO CLAIM IS MADE TO THE EXCLUSIVE RIGHT TO USE "MASTERS OF LIGHT GALLERY", APART FROM THE MARK AS SHOWN.

FOR ART GALLERIES (U.S. CLS. 100, 101 AND 102).

SN 76-211,980. MEDIA ARTS GROUP, INC., SAN JOSE, CA.
FILED 2-16-2001.



NO CLAIM IS MADE TO THE EXCLUSIVE RIGHT TO USE "MASTERS OF LIGHT GALLERIES", APART FROM THE MARK AS SHOWN.

FOR ART GALLERIES (U.S. CLS. 100, 101 AND 102).

SN 76-230,211. DRIVING MEDIA INC., CAMPBELL, CA.
FILED 3-23-2001.

DRIVING.COM

FOR COMPUTERIZED ONLINE ORDERING OF MOTOR VEHICLES SUCH AS VANS, CARS, TRUCKS, SPORTS UTILITY VEHICLES; PROVIDING AN ONLINE INTERACTIVE DATABASE IN THE FIELD OF MOTOR VEHICLES SALES, PRICES AND RATINGS OF MOTOR VEHICLES; PREPARING AND DISSEMINATING ADVERTISING AND ELECTRONIC BILLBOARDS ADVERTISING FOR OTHERS IN THE FIELD OF SALES, LEASING, PRICES AND RATINGS OF MOTOR VEHICLES; ONLINE MOTOR VEHICLES DEALERSHIPS; INDEPENDENT SALES REPRESENTATIVE SERVICES IN THE FIELD OF MOTOR VEHICLES SALES AND LEASING; PRICES AND RATINGS; PROVIDING SHOPPERS GUIDE INFORMATION IN THE FIELD OF MOTOR VEHICLES SALES, LEASING, PRICES AND RATINGS; ONLINE DIRECTORY SERVICES TO HELP LOCATE PEOPLE, PLACES, ORGANIZATION, PHONE NUMBERS, HOME PAGES AND ELECTRONIC MAIL ADDRESSES OF COMPANIES IN THE AUTOMOTIVE INDUSTRY (U.S. CLS. 100, 101 AND 102).

CLASS 35—(Continued).

SN 76-245,305. BAYERISCHE MOTOREN WERKE AKTIENGESELLSCHAFT, 80788 MUENCHEN, FED REP GERMANY, FILED 4-24-2001.

NEXT

FOR DEALERSHIP SERVICES IN THE FIELD OF AUTOMOBILES (U.S. CLS. 100, 101 AND 102).

SN 76-253,118. NEED2BUY.COM, INC., WESTLAKE VILLAGE, CA. FILED 5-8-2001.

NEED2BUY. POWERFULLY CONNECTED

FOR PROVIDING A WEBSITE OVER ELECTRONIC COMMUNICATION NETWORKS FOR BUSINESS PRODUCTS AND SERVICES FOR BUYERS AND SELLERS, NAMELY PROVIDING A VIRTUAL MARKETPLACE WHERE BUSINESSES CAN RESEARCH, BUY AND SELL PRODUCTS AND SERVICES, PUT THEIR NEEDS FOR PRODUCTS AND SERVICES OUT FOR BID, GET MATCHED WITH APPROPRIATE VENDORS, RECEIVE QUOTES FROM VENDORS, AND CAN ELECT TO COMPLETE SALES TRANSACTIONS EITHER ON-LINE OR OFF-LINE (U.S. CLS. 100, 101 AND 102).

SN 76-255,992. BIDZ.COM, INC., LOS ANGELES, CA. FILED 5-11-2001.



NO CLAIM IS MADE TO THE EXCLUSIVE RIGHT TO USE "BIDS", APART FROM THE MARK AS SHOWN.

FOR ARRANGING AND MEDIATING AUCTION SALES AND PURCHASES OVER THE GLOBAL COMPUTER NETWORK (U.S. CLS. 100, 101 AND 102).

FIRST USE 6-15-1999; IN COMMERCE 6-15-1999.

SN 76-278,278. METH COMMUNICATIONS GROUP LLC, PLYMOUTH MEETING, PA. FILED 7-2-2001.

VERBAL FLAGGING

FOR PUBLIC RELATIONS, BUSINESS MANAGEMENT, ADVERTISING AGENCIES AND CONSULTING SERVICES, IN THE FIELD OF ADVERTISING AND BUSINESS (U.S. CLS. 100, 101 AND 102).

FIRST USE 1-1-1998; IN COMMERCE 1-1-1998.

CLASS 35—(Continued).

SN 76-291,729. MILLENNIA CONSULTING, L.L.C., CHICAGO, IL. FILED 7-30-2001.

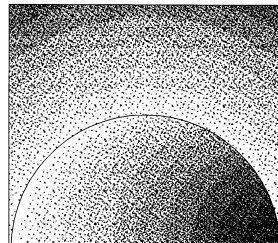
**MILLENNIA
CONSULTING**

NO CLAIM IS MADE TO THE EXCLUSIVE RIGHT TO USE "CONSULTING", APART FROM THE MARK AS SHOWN.

THE STIPPLING IS FOR SHADING PURPOSES ONLY AND DOES NOT INDICATE COLOR.

FOR BUSINESS PLANNING, CONSULTING, RESEARCH AND BUSINESS DEVELOPMENT SERVICES FOR NON-PROFIT GROUPS AND ORGANIZATIONS, CORPORATIONS AND GOVERNMENTAL ENTITIES (U.S. CLS. 100, 101 AND 102).

FIRST USE 7-0-1996; IN COMMERCE 7-0-1996.

SN 76-295,988. FISH MART, INC., WEST HAVEN, CT. FILED 8-8-2001.

FISH MART

SEC. 2(F).

FOR MAIL ORDER SERVICES FEATURING FISH, PETS, PLANTS, AND AQUATIC SUPPLIES, WHOLESALE DISTRIBUTORSHIPS FEATURING FISH, PETS, PLANTS, AND AQUATIC SUPPLIES; AND ON-LINE DISTRIBUTORSHIPS IN THE FIELD OF FISH, PETS, PLANTS, AND AQUATIC SUPPLIES FOR SALE EXCLUSIVELY TO RETAIL PET AND AQUARIUM STORES (U.S. CLS. 100, 101 AND 102).

FIRST USE 0-0-1974; IN COMMERCE 0-0-1974.

SN 76-308,437. HOME INTERIORS & GIFTS, INC., CARROLLTON, TX. FILED 8-31-2001.

VALUE PLUS

FOR RETAIL STORE SERVICES AND ON-LINE RETAIL STORE SERVICES ALL FEATURING HOME INTERIOR DECORATIONS AND DECORATIVE FURNITURE ACCENTS AND GIFTS SOLD ONLY THROUGH DIRECT SOLICITATION BY SALES AGENTS IN THE DIRECT SELLING FIELD; MAIL ORDER CATALOG SERVICES FEATURING HOME INTERIOR DECORATIONS, DECORATIVE FURNITURE ACCENTS AND GIFTS SOLD ONLY THROUGH DIRECT SOLICITATION BY SALES AGENTS IN THE DIRECT SELLING FIELD (U.S. CLS. 100, 101 AND 102).

FIRST USE 1-0-1998; IN COMMERCE 1-0-1998.

CLASS 35—(Continued).

SN 76-317,499. WAV, INC., WEST CHICAGO, IL. FILED 9-26-2001.

WAV

FOR WHOLESALE AND RETAIL DISTRIBUTORSHIP SERVICES IN THE FIELD OF WIRELESS AND SCANNING NETWORK GEAR (U.S. CLS. 100, 101 AND 102).
FIRST USE 6-1-1996; IN COMMERCE 6-1-1996.

SN 76-323,693. PRIVATE FORMULA CORPORATION, SOUTH MELBOURNE, VICTORIA 3205, AUSTRALIA, FILED 10-11-2001.

DR. LEWINN'S PRIVATE FORMULA

NO CLAIM IS MADE TO THE EXCLUSIVE RIGHT TO USE "PRIVATE FORMULA", APART FROM THE MARK AS SHOWN.

THE NAME "DR. LEWINN" DOES NOT IDENTIFY A PARTICULAR LIVING INDIVIDUAL.

FOR WHOLESALE AND RETAIL STORE SERVICES FEATURING SKIN CARE AND COSMETIC PRODUCTS FOR FACE AND BODY (U.S. CLS. 100, 101 AND 102).

SN 76-325,720. DISNEY ENTERPRISES, INC., BURBANK, CA. FILED 10-16-2001.



SEC. 2(F) AS TO "TOY OF THE YEAR AWARDS" AND AS TO "TOY".

FOR PROMOTING THE GOODS AND SERVICES OF OTHERS THROUGH CONDUCTING AN ANNUAL CONTEST WHERE CHILDREN PICK THEIR FAVORITE TOY; AND RETAIL STORE SERVICES FEATURING TOYS (U.S. CLS. 100, 101 AND 102).

FIRST USE 11-1-1998; IN COMMERCE 11-1-1998.

CLASS 35—(Continued).

SN 76-331,301. FIRST COAST ENERGY, L.L.P., JACKSONVILLE, FL. FILED 10-30-2001.



THE MARK CONSISTS OF THE WORD "DAILY'S" IN BRIGHT BLUE STYLIZED LETTERS DIRECTLY UNDER THE CAPITAL LETTER "D" IN BLOCK LETTER FORMAT. THE BACKGROUND COLOR OF THE LEFT PORTION OF THE "D" IS GOLD WITH A HALF SUN WITH BRIGHT YELLOW RAYS OVERLAPPING. THE CURVED PORTION OF THE "D" IS BRIGHT BLUE, HIGHLIGHTED WITH WHITE STARS AND WHITE DOTS.

FOR RETAIL STORE SERVICES FEATURING CONVENIENCE STORE ITEMS AND GASOLINE (U.S. CLS. 100, 101 AND 102).

SN 76-331,846. VALUEVISION INTERNATIONAL, INC., EDEN PRAIRIE, MN. FILED 10-31-2001.

HOME LIVING

NO CLAIM IS MADE TO THE EXCLUSIVE RIGHT TO USE "HOME", APART FROM THE MARK AS SHOWN.

FOR PROVIDING HOME SHOPPING SERVICES FEATURING GENERAL MERCHANDISE BY MEANS OF TELEVISION AND VIA A GLOBAL COMPUTER NETWORK (U.S. CLS. 100, 101 AND 102).

SN 76-342,701. RIVER CITY GROUP, LLC, THE, ST. CHARLES, MO. FILED 11-29-2001.

IGAMING EXCHANGE

NO CLAIM IS MADE TO THE EXCLUSIVE RIGHT TO USE "IGAMING", APART FROM THE MARK AS SHOWN.

FOR DISSEMINATION OF ADVERTISING MATTERS FOR OTHERS VIA AN ON-LINE ELECTRONIC COMMUNICATIONS NETWORK (U.S. CLS. 100, 101 AND 102).

FIRST USE 10-15-2001; IN COMMERCE 10-15-2001.

CLASS 35—(Continued).

SN 76-343,372. BRAVANTA, INC., SAN FRANCISCO, CA. FILED 11-29-2001.

RESULTS FIRST SUITE

FOR BUSINESS CONSULTATION SERVICES SPECIALIZING IN THE CUSTOM DESIGN OF BUSINESS PERFORMANCE SOLUTIONS FOR OTHERS, NAMELY, EMPLOYEE AND CUSTOMER INCENTIVE AND RECOGNITION PROGRAMS AND CUSTOMER LOYALTY PROGRAMS, PROVIDED VIA A GLOBAL COMPUTER NETWORK (U.S. CLS. 100, 101 AND 102).
FIRST USE 6-30-2001; IN COMMERCE 6-30-2001.

SN 76-355,297. GARRETT BUILDING MATERIALS, L.L.C., OKLA. CITY, OK. FILED 1-7-2002.



NO CLAIM IS MADE TO THE EXCLUSIVE RIGHT TO USE "INSULATING CONCRETE HOMES", APART FROM THE MARK AS SHOWN.

THE MARK CONSISTS OF THE WORDS "INSULATING CONCRETE HOMES" FORMING PART OF A STYLIZED HOUSE.

FOR DISTRIBUTORSHIPS IN THE FIELD OF INSULATING CONCRETE FORMS, DRAIN SYSTEMS, CONCRETE ROOF SYSTEMS, AND BASEMENT WATERPROOFING (U.S. CLS. 100, 101 AND 102).
FIRST USE 8-1-2001; IN COMMERCE 9-27-2001.

SN 76-362,973. COLEMAN, CHRISTINE Y., ATLANTA, GA. FILED 1-25-2002.

THE GREEN BANANA PAPERS

FOR BUSINESS MARKETING CONSULTING SERVICES (U.S. CLS. 100, 101 AND 102).
FIRST USE 8-1-1997; IN COMMERCE 8-1-1997.

SN 76-365,618. FEDEX CUSTOM CRITICAL, INC., AKRON, OH. FILED 2-4-2002.

AUTOTRANS EXPRESS

NO CLAIM IS MADE TO THE EXCLUSIVE RIGHT TO USE "EXPRESS", APART FROM THE MARK AS SHOWN.
FOR ARRANGING FOR THE PICK-UP, CARRIAGE AND DELIVERY OF TRUCKS, CARS, CAMPERS, MOTORCYCLES AND VANS VIA GROUND AND AIR CARRIERS (U.S. CLS. 100, 101 AND 102).

CLASS 35—(Continued).

SN 76-374,801. NATIONAL FEDERATION OF INDEPENDENT BUSINESS, NASHVILLE, TN. FILED 2-25-2002.

NFIB WELLPASS

OWNER OF U.S. REG. NOS. 2,243,986 AND 2,323,937.
FOR PROMOTING THE GOODS AND SERVICES OF OTHERS THROUGH THE DISTRIBUTION OF DISCOUNT CARDS IN THE FIELD OF HEALTH (U.S. CLS. 100, 101 AND 102).
FIRST USE 7-31-2000; IN COMMERCE 7-31-2000.

SN 76-379,393. WABLER, LINDA R., IRVINE, CA. FILED 3-6-2002.

THE WABLER MINIMUM EXPENSES NEEDED TECHNIQUE

NO CLAIM IS MADE TO THE EXCLUSIVE RIGHT TO USE "MINIMUM EXPENSES NEEDED TECHNIQUE", APART FROM THE MARK AS SHOWN.

FOR BUSINESS CONSULTING SERVICES (U.S. CLS. 100, 101 AND 102).

SN 76-383,841. HSB RELIABILITY TECHNOLOGIES LLC, KINGWOOD, TX. FILED 3-15-2002.

TOTAL PLANT RELIABILITY

OWNER OF U.S. REG. NOS. 1,747,570, 1,780,726 AND 2,394,418.

NO CLAIM IS MADE TO THE EXCLUSIVE RIGHT TO USE "TOTAL PLANT", APART FROM THE MARK AS SHOWN.

SEC. 2(F).
FOR BUSINESS CONSULTING SERVICES, NAMELY, ANALYZING EXISTING PERSONNEL PROCEDURES AND DEVELOPING IMPROVED PROCEDURES FOR OPTIMIZING INDUSTRIAL AND MANUFACTURING PLANT PRODUCTION INCLUDING ANALYSIS OF MANAGEMENT, PLANT OPERATIONS, MAINTENANCE AND PERSONNEL UTILIZATION (U.S. CLS. 100, 101 AND 102).
FIRST USE 1-1-1998; IN COMMERCE 1-1-1998.

SN 76-387,605. CHOICESTREAM, INC., CAMBRIDGE, MA. FILED 3-25-2002.

MYBESTBETS

FOR PROVIDING CONSUMER GOODS AND SERVICES INFORMATION CUSTOMIZED TO USER PREFERENCES BY MEANS OF A GLOBAL COMPUTER NETWORK (U.S. CLS. 100, 101 AND 102).
FIRST USE 9-15-2001; IN COMMERCE 9-15-2001.

CLASS 35—(Continued).

SN 76-389,159. YELLOW PAGES INTEGRATED MEDIA ASSOCIATION, BERKELEY HTS, NJ. FILED 3-28-2002.

YELLOW PAGES IMA

NO CLAIM IS MADE TO THE EXCLUSIVE RIGHT TO USE "YELLOW PAGES", APART FROM THE MARK AS SHOWN.

FOR ASSOCIATION SERVICES, NAMELY PROMOTING THE INTEREST OF YELLOW PAGES PUBLISHERS ON BEHALF OF ASSOCIATION MEMBERS (U.S. CLS. 100, 101 AND 102).

CLASS 35—(Continued).

SN 76-392,617. FINGER FURNITURE COMPANY, INC., HOUSTON, TX. FILED 4-9-2002.

FINGERS, YOUR COMPLETE INDOOR STORE

FOR RETAIL FURNITURE STORES (U.S. CLS. 100, 101 AND 102).

SN 76-389,497. WESTERN VIRGINIA FOUNDATION FOR THE ARTS AND SCIENCES, ROANOKE, VA. FILED 3-28-2002.

CENTER IN THE SQUARE

FOR ASSOCIATION SERVICES, NAMELY, PROMOTING THE INTERESTS OF THOSE CONCERNED WITH THE ARTS, SCIENCES, AND HUMANITIES, AND THE PRESERVATION OF THE HISTORY OF THE WESTERN VIRGINIA REGION (U.S. CLS. 100, 101 AND 102).

FIRST USE 0-0-1983; IN COMMERCE 0-0-1983.

SN 76-395,750. S.S. SARNA INC., MANHASSET, NY. FILED 4-15-2002.

SN 76-390,380. US ONCOLOGY, INC., HOUSTON, TX. FILED 4-3-2002.

ADVANCING CANCER CARE IN AMERICA

FOR BUSINESS MANAGEMENT SERVICES FOR GROUPS THAT PROVIDE MEDICAL SERVICES; PROMOTING PUBLIC AWARENESS OF AND PUBLIC POLICY RELATED TO CANCER AND RELATED PUBLIC HEALTH ISSUES (U.S. CLS. 100, 101 AND 102).

FIRST USE 4-29-2002; IN COMMERCE 4-29-2002.

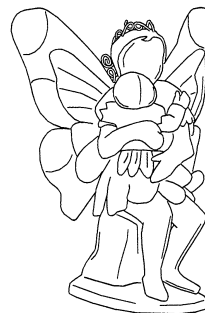

SN 76-391,850. REED, STANLEY FOSTER, DBA REED ASSOCIATES, CHARLESTON, SC. FILED 4-5-2002.

DIRECTORCENTRAL

FOR PROVIDING INFORMATION, ADVICE AND SCHOLARLY COMMENTARY REGARDING CORPORATE AFFAIRS, GOVERNANCE AND ETHICS BY MEANS OF A GLOBAL COMPUTER NETWORK (U.S. CLS. 100, 101 AND 102).

FOR WHOLESALE AND MAIL ORDER CATALOG SERVICES FEATURING GIFT AND NOVELTY ITEMS, FIGURINES OF ANIMALS, ANGELS, HOLIDAY FIGURES AND GNOMES, PLANTERS AND PLANT STAKES, CANDLE HOLDERS, BIRD BATHS, GARDEN FENCE, GLASS VOTIVES, WELCOME SIGNS, OIL LAMPS, TAPE DISPENSERS, CHIMES, PICTURE FRAMES, TEA LIGHTS, DIRECTION SIGNS, THERMOMETERS, VANITY MIRRORS, MUSICAL CAROUSELS, FLOWER VASES, DECORATIVE BEER STEINS, CUPS AND SAUCERS, TEAPOTS, AND ORNAMENTS (U.S. CLS. 100, 101 AND 102).

FIRST USE 1-8-2002; IN COMMERCE 1-8-2002.

CLASS 35—(Continued).

SN 76-396,252. WESSCO INTERNATIONAL, LOS ANGELES, CA. FILED 4-16-2002.

WE SOURCE THE WORLD FOR YOU

FOR RETAIL STORE SERVICES AND DISTRIBUTORSHIPS FEATURING TABLEWARE, NAMELY, PORCELAIN DINNERWARE, STAINLESS STEEL HOLLOWWARE, SERVING PIECES AND FLATWARE, HOT TOWELS, AMENITY KITS, LAVATORY AND CLUB AMENITIES, NAMELY, TOOTHBRUSHES, TOOTH-PASTE, MOUTHWASH, BREATH DROPS, SOAPS, SHAMPOOS, CONDITIONERS, HAND AND BODY LOTIONS, FACIAL CREAMS, SHAVE CREAMS, RAZORS AND HAIR BRUSHES, BABY KITS, NAMELY, BABY WASH, BABY LOTION AND BABY POWDER, PASSENGER COMFORT ITEMS, NAMELY, SLIPPERS, EYE SHADES, EARPLUGS AND SOCKS, GIFTS AND PROMOTIONAL ITEMS, NAMELY, PLAYING CARDS, LUGGAGE TAGS, KEY RINGS, AND DESK SETS, CHILDREN'S ITEMS, NAMELY, PLUSH, PLASTIC, FOAM AND INFLATABLE TOYS, WOODEN GAMES AND PUZZLES, BOARD GAMES, COLORING BOOKS WITH CRAYONS OR PENCILS, AND ACTIVITY SETS, ALL FOR THE AIRLINE, CRUISE, TRAVEL AND RETAIL INDUSTRIES (U.S. CLS. 100, 101 AND 102).

FIRST USE 4-1-1991; IN COMMERCE 4-1-1991.

SN 76-397,061. PALMETTO INSTITUTE, COLUMBIA, SC. FILED 4-17-2002.

PALMETTO INSTITUTE

NO CLAIM IS MADE TO THE EXCLUSIVE RIGHT TO USE "INSTITUTE", APART FROM THE MARK AS SHOWN. FOR RESEARCH SERVICES, NAMELY BUSINESS RESEARCH, ECONOMIC RESEARCH, SOCIAL RESEARCH, NAMELY RESEARCH DEALING WITH QUANTITATIVE SURVEY DATA, SOCIOECONOMIC RESEARCH, NAMELY PROVIDING INFORMATION FOR TARGET MARKETING PURPOSES AND MARKET RESEARCH (U.S. CLS. 100, 101 AND 102).

FIRST USE 2-20-2002; IN COMMERCE 2-20-2002.

SN 76-399,151. HAWN, MARK E., ATLANTA, GA. FILED 4-23-2002.

DOCUFORCE

FOR PROVIDING PHOTOCOPY AND DOCUMENT IMAGING SERVICES FOR OTHERS, AND BUSINESS SERVICES, NAMELY, MANAGEMENT OF PHOTOCOPY AND DOCUMENT IMAGING FACILITIES FOR OTHERS (U.S. CLS. 100, 101 AND 102).

CLASS 35—(Continued).

SN 76-399,266. HAMBY, ROSCOE J. JR., RANCHO MURIE-TA, CA. FILED 4-23-2002.



NO CLAIM IS MADE TO THE EXCLUSIVE RIGHT TO USE "GROUP PERSONNEL TESTING EXECUTIVE SEARCH MANAGEMENT DEVELOPMENT", APART FROM THE MARK AS SHOWN.

FOR TESTING TO DETERMINE EMPLOYMENT SKILLS AND DEVELOPMENT OF EMPLOYMENT TEST, ASSESSMENTS AND EVALUATIONS FOR OTHERS (U.S. CLS. 100, 101 AND 102).

FIRST USE 1-0-1989; IN COMMERCE 1-15-1989.

SN 76-399,330. HAMBY, ROSCOE J. JR., SLOUGHHOUSE, CA. FILED 4-22-2002.



NO CLAIM IS MADE TO THE EXCLUSIVE RIGHT TO USE "EMPLOYMENT NETWORK" AND "TEMPORARY AND PERMANENT STAFFING SOLUTIONS", APART FROM THE MARK AS SHOWN.

FOR TEMPORARY AND PERMANENT EMPLOYMENT HIRING, RECRUITING, PLACEMENT AND STAFFING SERVICES (U.S. CLS. 100, 101 AND 102).

FIRST USE 0-0-2001; IN COMMERCE 10-1-2001.

SN 76-401,529. VIRGINIA DATA PRODUCTS, INC., ROANOKE, VA. FILED 4-29-2002.

UPTIME4U.COM

FOR WHOLESALE AND MAIL ORDER SERVICES IN THE FIELD OF OFFICE, COMPUTER, NETWORK AND DATA CENTER SUPPLIES, FURNITURE AND ACCESSORIES (U.S. CLS. 100, 101 AND 102).

SN 76-403,197. AMC, INC., ATLANTA, GA. FILED 5-1-2002.

ATLANTA SPRING GIFT, ACCESSORIES & HOLIDAY MARKET

SEC. 2(F). FOR ARRANGING AND CONDUCTING TRADE SHOWS IN THE FIELD OF GIFTS AND HOME FURNISHINGS (U.S. CLS. 100, 101 AND 102).

FIRST USE 3-0-1996; IN COMMERCE 3-0-1996.

CLASS 35—(Continued).

SN 76-403,203. AMERICAN LOUDSPEAKER MANUFACTURERS ASSOCIATION, INC., PRINCETON JUNCTION, NJ. FILED 5-2-2002.

ALMA INTERNATIONAL

NO CLAIM IS MADE TO THE EXCLUSIVE RIGHT TO USE "INTERNATIONAL", APART FROM THE MARK AS SHOWN.

FOR ASSOCIATION SERVICES; NAMELY, ADVANCEMENT AND PROTECTION OF INTERESTS OF ALL LOUDSPEAKER MANUFACTURERS, LOUDSPEAKER COMPONENT MANUFACTURERS AND SERVICE PROVIDERS TO THE LOUDSPEAKER MANUFACTURING INDUSTRY, AND PROMOTION OF THE LOUDSPEAKER MANUFACTURING INDUSTRY (U.S. CLS. 100, 101 AND 102).

FIRST USE 8-6-2001; IN COMMERCE 12-20-2001.

SN 76-406,249. LANE BRYANT, INC., BENSALEM, PA. FILED 5-9-2002.

VENEZIA CLOTHING COMPANY

OWNER OF U.S. REG. NOS. 2,324,848, 2,725,568 AND OTHERS.

NO CLAIM IS MADE TO THE EXCLUSIVE RIGHT TO USE "CLOTHING COMPANY", APART FROM THE MARK AS SHOWN.

THE ENGLISH TRANSLATION OF "VENEZIA" IS "VENICE".

FOR RETAIL STORE SERVICES IN THE FIELD OF WOMEN'S APPAREL, NAMELY JACKETS, COATS, SWEATERS, SHIRTS, T-SHIRTS, TANK TOPS, JEANS, PANTS, DRESSES, SKIRTS, HATS, SCARVES, GLOVES, PAJAMAS, SOCKS, HOSIERY, VESTS, ROBES, BRAS, PANTIES, CONTROL UNDERGARMENTS, UNDERWEAR, CAMISOLES, SHORTS, SLIPS, BODY SUITS AND SLEEP SHIRTS (U.S. CLS. 100, 101 AND 102).

SN 76-407,124. SAVVIER, INC., TORRANCE, CA. FILED 5-13-2002.

SAVVIER DIRECT

NO CLAIM IS MADE TO THE EXCLUSIVE RIGHT TO USE "DIRECT", APART FROM THE MARK AS SHOWN.

FOR DIRECT RESPONSE RETAIL SERVICES BY MEANS OF INFOMERCIALS FEATURING A WIDE VARIETY OF CONSUMER GOODS, SUCH AS DIETARY SUPPLEMENTS AND REMEDIES, EXERCISE EQUIPMENT AND PROGRAMS AND HOUSEHOLD ITEMS (U.S. CLS. 100, 101 AND 102).

FIRST USE 8-1-2002; IN COMMERCE 1-15-2003.

CLASS 35—(Continued).

SN 76-407,293. FOODTOPIA, INC., NAPERVILLE, IL. FILED 5-3-2002.

FOODTOPIA

FOR RETAIL CONVENIENCE STORE (U.S. CLS. 100, 101 AND 102).

FIRST USE 10-1-2000; IN COMMERCE 10-1-2000.

SN 76-407,301. ADOPT-A-BEAR FACTORY, L.L.C., HOUMA, LA. FILED 5-13-2002.

ADOPT-A-PAL

FOR MAIL ORDER, RETAIL STORE, MAIL ORDER CATALOG SERVICES, WHOLESALE AND RETAIL DISTRIBUTORSHIP AND STORE SERVICES IN THE FIELD OF STUFFED TOY ANIMALS AND PLUSH TOY ANIMALS, DOLLS AND ACCESSORIES THEREFOR, INCLUDING SALES OVER THE INTERNET; PRODUCT DEMONSTRATIONS ON TOY MAKING (U.S. CLS. 100, 101 AND 102).

SN 76-407,302. ADOPT-A-BEAR FACTORY, L.L.C., HOUMA, LA. FILED 5-13-2002.

ADOPT-A-FRIEND

FOR MAIL ORDER, RETAIL STORE, MAIL ORDER CATALOG SERVICES, WHOLESALE AND RETAIL DISTRIBUTORSHIP AND STORE SERVICES IN THE FIELD OF STUFFED TOY ANIMALS AND PLUSH TOY ANIMALS, DOLLS AND ACCESSORIES THEREFOR, INCLUDING SALES OVER THE INTERNET; PRODUCT DEMONSTRATIONS ON TOY MAKING (U.S. CLS. 100, 101 AND 102).

SN 76-407,641. LIWET VENTURES, LLC, THOUSAND OAKS, CA. FILED 5-14-2002.

LIWET VENTURES

NO CLAIM IS MADE TO THE EXCLUSIVE RIGHT TO USE "VENTURES", APART FROM THE MARK AS SHOWN.

FOR BUSINESS DEVELOPMENT SERVICES IN THE NATURE OF BUSINESS PLANNING SERVICES AND PROVIDING START UP SUPPORT FOR BUSINESSES OF OTHERS; AND BUSINESS CONSULTING SERVICES (U.S. CLS. 100, 101 AND 102).

CLASS 35—(Continued).

SN 76-407,644. LIWET VENTURES, LLC, THOUSAND OAKS, CA. FILED 5-14-2002.

LIWET

FOR BUSINESS DEVELOPMENT SERVICES IN THE NATURE OF BUSINESS PLANNING SERVICES AND PROVIDING START UP SUPPORT FOR BUSINESSES OF OTHERS; AND BUSINESS CONSULTING SERVICES (U.S. CLS. 100, 101 AND 102).

SN 76-408,284. HORIZON AG, LLC, MEMPHIS, TN. FILED 5-13-2002.

ORYGEN

FOR PROVIDING AN ON-LINE COMPUTER DATABASE FEATURING INFORMATION ON TRACKING THE SALE AND DISTRIBUTION OF SEED TECHNOLOGY STEWARDSHIP AND THE SALE AND DISTRIBUTION OF AGRICULTURAL CHEMICALS USED IN THE TREATMENT AND PROCESSING OF SEED (U.S. CLS. 100, 101 AND 102).

FIRST USE 10-1-1999; IN COMMERCE 10-1-1999.

SN 76-408,300. HORIZON AG, LLC, MEMPHIS, TN. FILED 5-13-2002.

ORYGEN SEED MARKETING SYSTEM

NO CLAIM IS MADE TO THE EXCLUSIVE RIGHT TO USE "SEED MARKETING SYSTEM", APART FROM THE MARK AS SHOWN.

FOR PROVIDING AN ON-LINE COMPUTER DATABASE FEATURING INFORMATION ON TRACKING THE SALE AND DISTRIBUTION OF SEED TECHNOLOGY STEWARDSHIP AND THE SALE AND DISTRIBUTION OF AGRICULTURAL CHEMICALS USED IN THE TREATMENT AND PROCESSING OF SEED (U.S. CLS. 100, 101 AND 102).

CLASS 35—(Continued).

SN 76-408,311. MUTUAL SERVICE CORPORATION, WEST PALM BEACH, FL. FILED 5-13-2002.



THE MARK CONSISTS OF THE LETTERS "BBN" WITH AN ARBITRARY DESIGN.

FOR PROVIDING MARKETING ASSISTANCE AND BUSINESS BUILDING SUPPORT TO INVESTMENT PROFESSIONALS, NAMELY, PROVIDING INTERNET-BASED MARKETING INFORMATION AND RESOURCES TO ASSIST INVESTMENT PROFESSIONALS IN THE SALE AND PROVIDING OF INVESTMENTS AND INVESTMENT SERVICES (U.S. CLS. 100, 101 AND 102).

SN 76-412,501. ACTION CONCEPTS, INC., FORT WORTH, TX. FILED 5-28-2002.

FAST FORWARD
SKATE SHOP • SHOES • APPAREL

NO CLAIM IS MADE TO THE EXCLUSIVE RIGHT TO USE "SKATE SHOP", "SHOES", AND "APPAREL", APART FROM THE MARK AS SHOWN.

FOR RETAIL STORE SERVICES FEATURING MEN'S, WOMEN'S AND JUNIOR'S CLOTHING AND FOOTWEAR, JEWELRY, SUNGLASSES, SKATEBOARDS AND INLINE SKATES (U.S. CLS. 100, 101 AND 102).

FIRST USE 10-12-2000; IN COMMERCE 12-6-2000.

SN 76-412,911. LAVAGGI, STEVEN, SANTA CLARITA, CA. FILED 5-28-2002.

LAVAGGI ARTIST OF HOPE

FOR ON-LINE RETAIL STORE SERVICES, FEATURING JEWELRY, SCULPTURES, PRINTS, BOOKS, CARDS, DECALS, AND PINS (U.S. CLS. 100, 101 AND 102).

FIRST USE 12-1-2001; IN COMMERCE 12-1-2001.

SN 76-417,038. MCWILLIS MERCANTILE, INC., DBA FEAST-O-RAMA, FREDERICKSBURG, VA. FILED 6-4-2002.

FEAST-O-RAMA

FOR RETAIL STORE SERVICES FEATURING GOURMET FOODS (U.S. CLS. 100, 101 AND 102).

CLASS 35—(Continued).

SN 76-417,452. HUNTS OUTDOORS, LLC, HENDERSONVILLE, TN. FILED 6-11-2002.

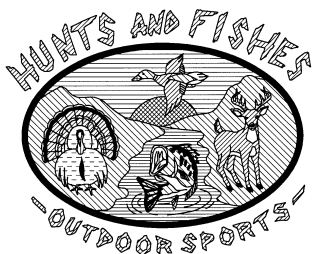

NO CLAIM IS MADE TO THE EXCLUSIVE RIGHT TO USE "HUNTS AND FISHES" AND "OUTDOOR SPORTS", APART FROM THE MARK AS SHOWN.

THE LINING ON THE DRAWING IS INTENDED TO INDICATE COLOR.

FOR ELECTRONIC CATALOG AND MAIL ORDER CATALOG SERVICES, MAIL ORDER SERVICES, AND ON-LINE RETAIL SERVICES IN THE FIELD OF HUNTING, FISHING, SHOOTING, CAMPING AND OUTDOOR RECREATIONAL EQUIPMENT, ACCESSORIES, GEAR, SUPPLIES, FOOTWEAR AND APPAREL (U.S. CLS. 100, 101 AND 102).

SN 76-419,377. STROUDS ACQUISITION CORPORATION, CITY OF INDUSTRY, CA. FILED 6-11-2002.

INSPIRING BEAUTIFUL HOMES

NO CLAIM IS MADE TO THE EXCLUSIVE RIGHT TO USE "BEAUTIFUL HOMES", APART FROM THE MARK AS SHOWN.

FOR RETAIL STORE SERVICES, NAMELY IN THE FIELDS OF HOME FURNISHINGS, HOME DECORATION, AND LINENS (U.S. CLS. 100, 101 AND 102).

FIRST USE 3-1-2002; IN COMMERCE 3-1-2002.

SN 76-420,442. ABN AMRO NORTH AMERICA, INC., CHICAGO, IL. FILED 6-11-2002.

EXECUTIVE RELOCATION

OWNER OF U.S. REG. NO. 2,199,038.

NO CLAIM IS MADE TO THE EXCLUSIVE RIGHT TO USE "RELOCATION", APART FROM THE MARK AS SHOWN.

SEC. 2(F).

FOR EMPLOYEE RELOCATION SERVICES (U.S. CLS. 100, 101 AND 102).

FIRST USE 4-30-1996; IN COMMERCE 4-30-1996.

CLASS 35—(Continued).

SN 76-420,725. TRANSZAP, INC., DENVER, CO. FILED 6-12-2002.

PETRO CONNECT

NO CLAIM IS MADE TO THE EXCLUSIVE RIGHT TO USE "PETRO", APART FROM THE MARK AS SHOWN.

FOR COMPUTER SERVICES, NAMELY, PROVIDING A WEB SITE AND DATABASE THAT AUTOMATES BUSINESS MANAGEMENT BY MONITORING, COMPILING AND DELIVERING BUSINESS, STATISTICAL AND ADMINISTRATION DATA, AND THAT AUTOMATES ACCOUNTING AND ELECTRIC INVOICING IN THE OIL AND GAS INDUSTRY (U.S. CLS. 100, 101 AND 102).

SN 76-421,834. ACCESS TECHNOLOGY SERVICES, INC., BOCA RATON, FL. FILED 6-17-2002.

IMAGEMAKER 360

OWNER OF U.S. REG. NO. 2,216,082.

NO CLAIM IS MADE TO THE EXCLUSIVE RIGHT TO USE "360", APART FROM THE MARK AS SHOWN.

FOR REAL ESTATE MARKETING SERVICES, NAMELY, ON-LINE SERVICES FEATURING TOURS OF RESIDENTIAL AND COMMERCIAL REAL ESTATE (U.S. CLS. 100, 101 AND 102).

FIRST USE 10-1-2000; IN COMMERCE 10-1-2000.

SN 76-424,407. COKEM INTERNATIONAL, LTD., PLYMOUTH, MN. FILED 6-24-2002.

COKEM INTERNATIONAL

NO CLAIM IS MADE TO THE EXCLUSIVE RIGHT TO USE "INTERNATIONAL", APART FROM THE MARK AS SHOWN.

FOR WHOLESALE AND RETAIL DISTRIBUTORSHIP SERVICES FEATURING VIDEO GAME PROGRAMS AND COMPUTER PROGRAMS (U.S. CLS. 100, 101 AND 102).

FIRST USE 2-1-2001; IN COMMERCE 2-1-2001.

SN 76-425,376. LULY, ANN BOOTH, STUDIO CITY, CA. FILED 6-24-2002.

HOITY TOITY

FOR RETAIL STORE SERVICES FEATURING JEWELRY, CLOTHING AND GIFTS (U.S. CLS. 100, 101 AND 102).

FIRST USE 11-0-1994; IN COMMERCE 11-0-1995.

CLASS 35—(Continued).

SN 76-426,243. ROYAL SCANDINAVIA A/S, 2000 FREDERIKSBERG, DENMARK, FILED 6-26-2002.



NO CLAIM IS MADE TO THE EXCLUSIVE RIGHT TO USE "SCANDINAVIAN INTERIOR CULTURE", APART FROM THE MARK AS SHOWN.

FOR EXPORT, IMPORT, WHOLESALE AND RETAIL STORE SERVICES FEATURING HOUSEHOLD FURNISHINGS, TABLEWARE, TEXTILES FOR CLOTHING, CLOTHING AND FOOTWEAR, UMBRELLAS, TRUNKS AND TRAVELING BAGS, SMOKER'S ARTICLES, ARTISTIC HANDICRAFT, TIME PIECES, EYEGLASSES, TOYS, MUSICAL INSTRUMENTS AND RECORDINGS, TOOLS FOR CARPENTRY AND GARDENING, SPORTS GOODS AND OFFICE SUPPLIES (U.S. CLS. 100, 101 AND 102).

SN 76-427,643. SECOND HARVEST FOOD BANK OF MIDDLE TENNESSEE, INC., NASHVILLE, TN. FILED 7-5-2002.

PROJECT PRESERVE

FOR DISTRIBUTORSHIP FEATURING THE DISTRIBUTION OF FOOD PRODUCTS TO INDIVIDUALS AND NOT-FOR-PROFIT SERVICE AGENCIES (U.S. CLS. 100, 101 AND 102).

FIRST USE 4-0-2000; IN COMMERCE 4-0-2000.

SN 76-429,121. MATTHEW CHOI ENTERPRISE, DBA - HOOKUP WIRELESS, CYPRESS, CA. FILED 7-9-2002.



NO CLAIM IS MADE TO THE EXCLUSIVE RIGHT TO USE "WIRELESS", APART FROM THE MARK AS SHOWN. FOR WHOLESALE AND RETAIL SERVICES FEATURING CELLULAR PHONES AND ACCESSORIES (U.S. CLS. 100, 101 AND 102).

FIRST USE 9-1-2000; IN COMMERCE 12-1-2000.

CLASS 35—(Continued).

SN 76-429,256. HOUGHTON MIFFLIN COMPANY, BOSTON, MA. FILED 7-10-2002.

PROMISSOR

FOR PROVIDING ON-LINE AND MAIL REGISTRATION SERVICES FOR PROFESSIONAL, OCCUPATIONAL AND VOCATIONAL TESTS; ISSUING AND TRACKING PROFESSIONAL CERTIFICATION AND LICENSES FOR OTHERS; PROMOTING THE GOODS AND SERVICES OF OTHERS, NAMELY, PROVIDING INFORMATION ABOUT EDUCATIONAL ASSESSMENT PROGRAMS AND PRODUCTS OF OTHERS (U.S. CLS. 100, 101 AND 102).

SN 76-430,396. WESTAFF SUPPORT, INC., WALNUT CREEK, CA. FILED 7-15-2002.

TALENT TRAK

NO CLAIM IS MADE TO THE EXCLUSIVE RIGHT TO USE "TALENT", APART FROM THE MARK AS SHOWN. FOR PERMANENT AND TEMPORARY PERSONNEL PLACEMENT SERVICES (U.S. CLS. 100, 101 AND 102). FIRST USE 6-1-2002; IN COMMERCE 6-1-2002.

SN 76-431,299. GOODIES FROM GOODMAN, INC., DALLAS, TX. FILED 7-15-2002.



OWNER OF U.S. REG. NO. 1,311,557. FOR RETAIL OUTLET AND RETAIL MAIL ORDER SERVICES IN THE FIELD OF FRUITS, VEGETABLES, CANDIES, NUTS, CHEESES, FLOWERS AND GOURMET SPECIALTIES (U.S. CLS. 100, 101 AND 102). FIRST USE 9-0-2001; IN COMMERCE 9-0-2001.

SN 76-433,202. SUPPLYMAN, INC., LOS ANGELES, CA. FILED 7-23-2002.



FOR PROVIDING AN ONLINE WEBSITE AND CATALOG FOR ORDERING SUPPLIES AND SERVICES USED IN THE PRODUCTION OF FILMS AND TELEVISION PROGRAMS (U.S. CLS. 100, 101 AND 102). FIRST USE 3-0-2002; IN COMMERCE 4-0-2002.

CLASS 35—(Continued).

SN 76-436,548. SPECIAL SERVICES GROUP, INC., ROSEMONT, IL. FILED 8-1-2002.

SSG LOGISTICS

NO CLAIM IS MADE TO THE EXCLUSIVE RIGHT TO USE "LOGISTICS", APART FROM THE MARK AS SHOWN. FOR TRANSPORTATION LOGISTICS SERVICES, NAMELY, ARRANGING THE TRANSPORTATION VIA COMMON CARRIER OF GOODS FOR OTHERS (U.S. CLS. 100, 101 AND 102).

SN 76-437,190. AMERICATAKEOUT INC., WOBURN, MA. FILED 8-2-2002.

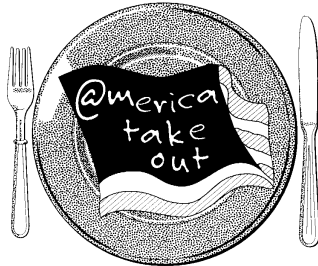

NO CLAIM IS MADE TO THE EXCLUSIVE RIGHT TO USE "TAKE OUT", APART FROM THE MARK AS SHOWN. THE STIPPLING SHOWN IN THE DRAWING IS USED MERELY TO INDICATE SHADING AND IS NOT A FEATURE OF THE MARK. THE DRAWING IS LINED FOR COLOR BUT COLOR IS NOT CLAIMED AS A FEATURE OF THE MARK.

FOR PROCESSING ORDERS FOR GOODS AND SERVICES ON BEHALF OF THIRD PARTIES (U.S. CLS. 100, 101 AND 102).

SN 76-437,922. BOB ROGERS & COMPANY, INC., BURBANK, CA. FILED 8-5-2002.

ATTRACTION DOCTOR

PRIORITY CLAIMED UNDER SEC. 44(D) ON UNITED KINGDOM APPLICATION NO. 2299329, FILED 4-30-2002.

FOR BUSINESS CONSULTING SERVICES; BUSINESS MANAGEMENT AND ORGANIZATION CONSULTANCY; NAMELY SUCH SERVICES FOR OPERATORS OF LOCATION BASED ENTERTAINMENT AND EDUCATION ATTRACTION VENUES, VISITOR CENTERS, CULTURAL CENTERS, MUSEUMS, ZOOS AND AQUARIUMS, BUSINESS CONSULTING SERVICES; BUSINESS MANAGEMENT AND ORGANIZATION CONSULTANCY; ORGANIZATION OF EXHIBITIONS AND TRADE FAIRS FOR COMMERCIAL OR ADVERTISING PURPOSES (U.S. CLS. 100, 101 AND 102).

CLASS 35—(Continued).

SN 76-438,399. STAFFMD, INC., HOMOSASSA, FL. FILED 8-7-2002.

PHYSICIANWORK.COM

FOR PROVIDING ON-LINE INFORMATION IN THE FIELD OF PHYSICIAN EMPLOYMENT, PHYSICIAN PLACEMENT AND PHYSICIAN RECRUITMENT; PROVIDING ON-LINE PHYSICIAN EMPLOYMENT, PHYSICIAN PLACEMENT AND PHYSICIAN RECRUITMENT SERVICES, NAMELY PROVIDING DATABASES OF PHYSICIAN JOB CANDIDATES AND PHYSICIAN JOB PROFILES VIA A GLOBAL COMPUTER NETWORK (U.S. CLS. 100, 101 AND 102).

FIRST USE 12-11-2000; IN COMMERCE 12-11-2000.

SN 76-440,476. CLEAR CHANNEL INTANGIBLES, INC., SAN ANTONIO, TX. FILED 8-14-2002.



NO CLAIM IS MADE TO THE EXCLUSIVE RIGHT TO USE "CAR SALE", APART FROM THE MARK AS SHOWN. FOR PROMOTING AND PRODUCING AUTOMOBILE SALES EXPOSITIONS FOR OTHERS (U.S. CLS. 100, 101 AND 102).

FIRST USE 10-3-2002; IN COMMERCE 10-3-2002.

SN 76-441,506. MIDWEST COMPUTER, INC., LOMBARD, IL. FILED 8-19-2002.

MIDWEST COMPUTER GROUP

NO CLAIM IS MADE TO THE EXCLUSIVE RIGHT TO USE "GROUP", APART FROM THE MARK AS SHOWN.

SEC. 2(F) AS TO "MIDWEST COMPUTER". FOR DISTRIBUTORSHIP SERVICES IN THE FIELD OF COMPUTERS AND RELATED PRODUCTS (U.S. CLS. 100, 101 AND 102).

FIRST USE 5-6-1998; IN COMMERCE 5-6-1998.

CLASS 35—(Continued).

SN 76-441,991. CURAGEN CORPORATION, BRANFORD, CT. FILED 8-15-2002.

CURAGEAR

FOR ONLINE RETAIL STORE SERVICES FEATURING CLOTHING AND PROMOTIONAL ITEMS, NAMELY, NOVELTY ITEMS (U.S. CLS. 100, 101 AND 102).

FIRST USE 7-29-2002; IN COMMERCE 7-29-2002.

CLASS 35—(Continued).

SN 76-443,183. STAFF QUEST, INC., WOODSTOCK, MD. FILED 8-23-2002.



SN 76-442,239. BURKETT, DOROTHY ANGELA, BALTIMORE, MD. FILED 8-21-2002.



APPLICANT, STAFF QUEST, INC., A MARYLAND CORPORATION, ENTERED INTO A SETTLEMENT AGREEMENT WITH STAFFQUEST, INC., A CALIFORNIA CORPORATION ("STAFFQUEST CALIFORNIA") WHEREBY THE PARTIES AGREED TO USE THE STAFFQUEST MARK CONCURRENTLY IN DIFFERENT GEOGRAPHIC AREAS. APPLICANT IS ENTITLED TO USE THE STAFFQUEST MARK IN THE STATES OF MARYLAND, VIRGINIA, PENNSYLVANIA AND THE DISTRICT OF COLUMBIA. STAFFQUEST CALIFORNIA THROUGH APPLICATION SERIAL NUMBER 75/375,804, IS ENTITLED TO USE THE STAFFQUEST MARK IN ALL OTHER STATES AND JURISDICTIONS.

NO CLAIM IS MADE TO THE EXCLUSIVE RIGHT TO USE "STAFF", APART FROM THE MARK AS SHOWN.

FOR TEMPORARY AND CONTRACT EMPLOYMENT PLACEMENT AND STAFFING SERVICES (U.S. CLS. 100, 101 AND 102).

FIRST USE 5-5-1997; IN COMMERCE 5-5-1997.

NO CLAIM IS MADE TO THE EXCLUSIVE RIGHT TO USE "COSMETIC'S", APART FROM THE MARK AS SHOWN.

THE STIPPLING IS FOR SHADING PURPOSES.

FOR RETAIL/WHOLESALE STORE SERVICES FEATURING COSMETICS (U.S. CLS. 100, 101 AND 102).

SN 76-443,918. SUN SAFETY ALLIANCE, INC., ALEXANDRIA, VA. FILED 8-21-2002.

SUN SAFETY ALLIANCE

SN 76-442,338. PIGGLY WIGGLY COMPANY, LEWISVILLE, TX. FILED 8-19-2002.



NO CLAIM IS MADE TO THE EXCLUSIVE RIGHT TO USE "SUN SAFETY", APART FROM THE MARK AS SHOWN.

FOR PROMOTING PUBLIC AWARENESS OF THE NEED FOR AND IMPORTANCE OF SUN CARE SAFETY, ESPECIALLY FOR CHILDREN, WITH THE GOAL OF HELPING TO PREVENT SKIN CANCER FROM SUN EXPOSURE AND TO ENCOURAGE MEMBERS OF THE PUBLIC TO TAKE ACTION TO PROTECT THEMSELVES AND THEIR FAMILIES, ESPECIALLY CHILDREN, FROM THE DANGERS OF THE SUN AND TO ENHANCE THE ABILITY OF HEALTHCARE PROVIDERS, INCLUDING COMMUNITY PHARMACISTS AND PHYSICIANS, TO PROMOTE THE MISSION OF ELIMINATING SKIN CANCER FROM SUN EXPOSURE (U.S. CLS. 100, 101 AND 102).

OWNER OF U.S. REG. NOS. 1,161,473, 1,564,852 AND OTHERS.

NO CLAIM IS MADE TO THE EXCLUSIVE RIGHT TO USE "FOODS", APART FROM THE MARK AS SHOWN.

FOR RETAIL SUPERMARKET SERVICES (U.S. CLS. 100, 101 AND 102).

FIRST USE 7-1-2001; IN COMMERCE 7-1-2001.

CLASS 35—(Continued).

SN 76-450,279. CITY OF SAN ANTONIO, SAN ANTONIO, TX. FILED 9-17-2002.



NO CLAIM IS MADE TO THE EXCLUSIVE RIGHT TO USE "FILM" AND "SAN ANTONIO", APART FROM THE MARK AS SHOWN.

FOR PROMOTING SERVICES, NAMELY, PROMOTING SAN ANTONIO AS A LOCATION FOR THE PRODUCTION OF MOTION PICTURES, TELEVISION FEATURES AND COMMERCIALS; CHAMBER OF COMMERCE SERVICES, NAMELY, PROMOTING SAN ANTONIO AS A LOCATION FOR PRODUCTION OF MOTION PICTURES, TELEVISION AND COMMERCIALS BY ACTING AS A LIAISON BETWEEN THE LOCAL GOVERNMENT AND COMMUNITY AND PRODUCTION (U.S. CLS. 100, 101 AND 102).
FIRST USE 10-0-1989; IN COMMERCE 10-0-1989.

CLASS 35—(Continued).

SN 76-453,315. SCREENING FOR MENTAL HEALTH, INC., WELLESLEY, MA. FILED 9-26-2002.



FOR MENTAL HEALTH SERVICES, NAMELY PROVIDING GOVERNMENTAL ENTITIES, HOSPITALS, AND COMMUNITY ORGANIZATIONS WITH SCREENING RESOURCES, EDUCATIONAL MATERIALS, AND OTHER RESOURCES TO PROMOTE AWARENESS, DETECTION, AND TREATMENT OF MENTAL HEALTH CONDITIONS; AND DISTRIBUTION OF WRITTEN MATERIALS IN CONNECTION THEREWITH (U.S. CLS. 100, 101 AND 102).
FIRST USE 1-18-2002; IN COMMERCE 1-21-2002.

SN 76-454,409. TOBLER'S FLOWERS, INCORPORATED, KANSAS CITY, MO. FILED 9-23-2002.

TOBLER'S

SEC. 2(F).
FOR RETAIL FLORIST SHOPS (U.S. CLS. 100, 101 AND 102).
FIRST USE 0-0-1967; IN COMMERCE 0-0-1967.

SN 76-454,603. NATIONAL SALES COMPANY, ST. LOUIS, MO. FILED 10-2-2002.



SN 76-451,935. MOOREHEAD, WANDA FAYE, ALTADENA, CA. FILED 9-24-2002.



NO CLAIM IS MADE TO THE EXCLUSIVE RIGHT TO USE "MUSIC CLEARANCES, LLC", APART FROM THE MARK AS SHOWN.
FOR COPYRIGHT MANAGEMENT (U.S. CLS. 100, 101 AND 102).

THE MARK CONSISTS OF THE STYLIZED LETTERS "NS" SURROUNDED BY THE LETTER "C".
FOR WHOLESALE DISTRIBUTORSHIP IN THE FIELD OF MECHANICAL, HEATING, PLUMBING AND REFRIGERATION PARTS AND SUPPLIES, NAMELY VALVES, FITTINGS, PUMPS, SEALS, CLAMPS, REGULATORS, FAUCETS, FASTENERS, GAS CONNECTORS, AND DRAIN PIPES (U.S. CLS. 100, 101 AND 102).
FIRST USE 0-0-1985; IN COMMERCE 0-0-1985.

CLASS 35—(Continued).

SN 76-454,805. DAISYSEED, INC., MORGANTOWN, WV.
FILED 10-2-2002.



NO CLAIM IS MADE TO THE EXCLUSIVE RIGHT TO USE "COMMUNICATIONS, INC.", APART FROM THE MARK AS SHOWN.

FOR BUSINESS MARKETING CONSULTING SERVICES; BUSINESS DEVELOPMENT SERVICES; PUBLIC RELATIONS (U.S. CLS. 100, 101 AND 102).
FIRST USE 1-0-2002; IN COMMERCE 1-0-2002.

SN 76-456,130. BODDICKER, PAUL, CHANHASSEN, MN.
FILED 10-1-2002.

YOUR LOCAL FOOD!

FOR ONLINE BUSINESS DIRECTORY SERVICES FEATURING RESTAURANTS BY LOCALITY; DIRECT MAIL ADVERTISING SERVICES FEATURING RESTAURANTS BY LOCALITY (U.S. CLS. 100, 101 AND 102).
FIRST USE 6-24-2002; IN COMMERCE 7-1-2002.

SN 76-456,211. SUGAREE BAKING CO., L.L.C., ST. LOUIS, MO. FILED 10-7-2002.

SUGAREE BAKING COMPANY

NO CLAIM IS MADE TO THE EXCLUSIVE RIGHT TO USE "BAKING COMPANY", APART FROM THE MARK AS SHOWN.

FOR SPECIAL ORDER RETAIL BAKERY SHOPS AND RETAIL BAKERY SHOPS BOTH FEATURING WEDDING CAKES AND BAKED GOODS IN GENERAL (U.S. CLS. 100, 101 AND 102).
FIRST USE 1-22-1996; IN COMMERCE 1-22-1996.

SN 76-456,523. MOTO XTREME, INC., BOCA RATON, FL.
FILED 10-8-2002.

MOTO XTREME

NO CLAIM IS MADE TO THE EXCLUSIVE RIGHT TO USE "MOTO", APART FROM THE MARK AS SHOWN.

FOR ONLINE RETAIL STORE SERVICES FEATURING CLOTHING, BOOKS, TOOLS AND ACCESSORIES FOR MOTORCYCLES, ATVS AND WATERCRAFT (U.S. CLS. 100, 101 AND 102).
FIRST USE 3-0-2002; IN COMMERCE 3-0-2002.

CLASS 35—(Continued).

SN 76-457,133. INDEX-D, LLC, BRIDGEPORT, CT. FILED 10-9-2002.

INDEX-D

FOR WHOLESALE STORES AND DISTRIBUTORSHIPS, AND RETAIL STORES, IN THE FIELD OF WINDOWS, DOORS AND OTHER ARCHITECTURAL PRODUCTS (U.S. CLS. 100, 101 AND 102).
FIRST USE 9-23-2002; IN COMMERCE 9-23-2002.

SN 76-457,234. WICKERSHAM JEWELERS, INC., BAKERSFIELD, CA. FILED 10-9-2002.

WICKERSHAM COMPANY

NO CLAIM IS MADE TO THE EXCLUSIVE RIGHT TO USE "COMPANY", APART FROM THE MARK AS SHOWN.
SEC. 2(F).

FOR RETAIL AND WHOLESALE STORES FEATURING JEWELRY (U.S. CLS. 100, 101 AND 102).
FIRST USE 6-1-1901; IN COMMERCE 12-8-1949.

SN 76-457,786. MORTGAGE BANKERS ASSOCIATION OF AMERICA, WASHINGTON, DC. FILED 10-11-2002.

MISMO

THE ENGLISH TRANSLATION OF "MISMO" IS "SAME".
FOR ASSOCIATION SERVICES, NAMELY PROMOTING THE INTERESTS OF THE MORTGAGE INDUSTRY BY DEVELOPING, PROMOTING AND MAINTAINING STANDARDS FOR ELECTRONIC COMMERCE IN THE REAL ESTATE FINANCE FIELD (U.S. CLS. 100, 101 AND 102).

FIRST USE 1-31-2000; IN COMMERCE 1-31-2000.

SN 76-458,291. RED SQUIRREL BRAND MARKETING, INC., HIGH POINT, NC. FILED 10-15-2002.

RED SQUIRREL BRAND MARKETING

NO CLAIM IS MADE TO THE EXCLUSIVE RIGHT TO USE "BRAND MARKETING", APART FROM THE MARK AS SHOWN.

FOR DIRECT MARKETING AND ADVERTISING SERVICES FOR OTHERS (U.S. CLS. 100, 101 AND 102).

CLASS 35—(Continued).

SN 76-460,221. UNITED WAY OF AMERICA, ALEXANDRIA, VA. FILED 10-11-2002.

WHAT MATTERS

FOR ASSOCIATION SERVICES, NAMELY PROMOTING THE INTERESTS OF MEMBER ORGANIZATIONS ENGAGED IN CHARITABLE FUND RAISING FOR HEALTH AND HUMAN SERVICES AGENCIES (U.S. CLS. 100, 101 AND 102).

SN 76-461,106. MERISTAR H&R OPERATING COMPANY, L.P., WASHINGTON, DC. FILED 10-24-2002.



FOR FOOD KIOSK SERVICES AT HOTELS AND RESORTS (U.S. CLS. 100, 101 AND 102).

SN 76-462,538. ADAMSHAND INC, DBA THE INTERVIEW EXCHANGE, SHREWSBURY, MA. FILED 10-29-2002.

THE INTERVIEW EXCHANGE

FOR RECRUITMENT AND JOB SEARCH (U.S. CLS. 100, 101 AND 102).
FIRST USE 8-2-2002; IN COMMERCE 9-0-2002.

SN 76-463,061. SERGAUTIS, WILLIAM, MIAMI BEACH, FL. FILED 10-30-2002.

AMERICANLATINA

FOR ADVERTISING SERVICES, NAMELY, PROMOTING THE CLOTHING, SHOES, AND FASHION ACCESSORIES OF OTHERS THROUGH ONLINE DIRECTORIES AND THE DISSEMINATION OF INFORMATION ABOUT FASHION AND ABOUT FASHION ACCESSORIES; AND ONLINE RETAIL ORDERING SERVICES FEATURING CLOTHING, SHOES, AND FASHION ACCESSORIES OF INTEREST TO WOMEN (U.S. CLS. 100, 101 AND 102).

CLASS 35—(Continued).

SN 76-464,064. WILLIAM M. BIRD AND COMPANY, INC., CHARLESTON, SC. FILED 11-4-2002.



FOR WHOLESALE DISTRIBUTORSHIP SERVICES FEATURING VINYL FLOORING, HARDWOOD FLOORING, CERAMIC FLOORING, CARPET AND TOOLS FOR THE INSTALLATION OF FLOORING MATERIALS; AND WHOLESALE ORDERING SERVICES IN THE FIELD OF VINYL FLOORING, HARDWOOD FLOORING, CERAMIC FLOORING, CARPET AND TOOLS FOR INSTALLATION OF FLOORING MATERIALS (U.S. CLS. 100, 101 AND 102).
FIRST USE 12-31-1936; IN COMMERCE 12-31-1936.

SN 76-465,672. SAVIN CORPORATION, STAMFORD, CT. FILED 11-12-2002.

SAVINNET

OWNER OF U.S. REG. NOS. 836,540, 2,559,245 AND OTHERS.
FOR COMPUTERIZED ON-LINE ORDERING SERVICES OF OFFICE MACHINERY PARTS AND SUPPLIES (U.S. CLS. 100, 101 AND 102).
FIRST USE 10-1-1998; IN COMMERCE 10-1-1998.

SN 76-466,436. CREDITBACK, INC., OREM, UT. FILED 11-13-2002.

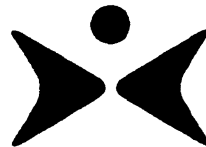

CreditBack

FOR PROMOTING THE SALE OF CREDIT CARD ACCOUNTS, THE SALE OF GOODS AND SERVICES OF OTHERS, AND MEMBERSHIP IN A CREDIT ASSOCIATION WHILE PROVIDING A PROPRIETARY CUSTOMER REWARDS AND LOYALTY PROGRAM PLATFORM THAT UTILIZES CUSTOMIZABLE MERCHANT REWARDS AND INCENTIVES, TARGETED AT ADVERTISING, CUSTOMER RELATIONSHIP MANAGEMENT, BUSINESS CONSULTING, AND COMPUTERIZED DATABASE MANAGEMENT AND REPORTING SERVICES, WHEREIN THE PLATFORM FACILITATES UNIVERSAL PROGRAM AVAILABILITY AMONG A PLURALITY OF MERCHANTS AND CUSTOMERS (U.S. CLS. 100, 101 AND 102).
FIRST USE 2-1-2002; IN COMMERCE 2-1-2002.

CLASS 35—(Continued).

SN 76-467,390. HOEG EXPORTACIONES, S.A., SPAIN, FILED 11-15-2002.



NO CLAIM IS MADE TO THE EXCLUSIVE RIGHT TO USE "FLOWERS", APART FROM THE MARK AS SHOWN.
 FOR RETAIL SHOPS FEATURING FLOWERS; FRANCHISING RETAIL OUTLETS, NAMELY OFFERING TECHNICAL ASSISTANCE IN THE ESTABLISHMENT AND/OR OPERATION OF FLOWER OUTLETS; RETAIL STORE SERVICES FOR FLOWERS; COMPUTERIZED ONLINE ORDERING SERVICES FEATURING FLOWERS (U.S. CLS. 100, 101 AND 102).

SN 76-467,692. AKALP, PHILIP, AGOURA HILLS, CA. FILED 11-6-2002.

**SIMPLY THE SMARTEST
 WAY TO INCORPORATE
 ONLINE**

FOR BUSINESS CONSULTATION; SECRETARIAL AND DOCUMENT FILING SERVICES FOR BUSINESS ENTITIES; BUSINESS RESEARCH SERVICES (U.S. CLS. 100, 101 AND 102).
 FIRST USE 9-12-2002; IN COMMERCE 9-12-2002.

SN 76-467,695. AKALP, PHILIP, AGOURA HILLS, CA. FILED 11-6-2002.

**CLICK. YOU'RE A LIMITED
 LIABILITY COMPANY**

FOR BUSINESS CONSULTATION; SECRETARIAL AND DOCUMENT FILING SERVICES FOR BUSINESS ENTITIES; BUSINESS RESEARCH SERVICES (U.S. CLS. 100, 101 AND 102).
 FIRST USE 9-12-2002; IN COMMERCE 9-12-2002.

SN 76-467,698. AKALP, PHILIP, AGOURA HILLS, CA. FILED 11-6-2002.

**CLICK. YOU'RE A
 CORPORATION**

FOR BUSINESS CONSULTATION; SECRETARIAL AND DOCUMENT FILING SERVICES FOR BUSINESS ENTITIES; BUSINESS RESEARCH SERVICES (U.S. CLS. 100, 101 AND 102).
 FIRST USE 9-12-2002; IN COMMERCE 9-12-2002.

CLASS 35—(Continued).

SN 76-468,473. RESULTS INBOUND SOLUTIONS, LLC, WEST PALM BEACH, FL. FILED 11-12-2002.

**RESULTS INBOUND
 SOLUTIONS**

NO CLAIM IS MADE TO THE EXCLUSIVE RIGHT TO USE "INBOUND SOLUTIONS", APART FROM THE MARK AS SHOWN.
 FOR INBOUND TELEMARKETING SERVICES (U.S. CLS. 100, 101 AND 102).

SN 76-468,586. EYE CARE COUNCIL, INC., TOPEKA, KS. FILED 11-7-2002.



FOR PROMOTING THE PRACTICE OF OPTOMETRY BY OTHERS THROUGH THE DISTRIBUTION OF PRINTED MATERIALS AND OTHER PROMOTION MEDIA (U.S. CLS. 100, 101 AND 102).
 FIRST USE 1-27-1992; IN COMMERCE 1-27-1992.

SN 76-468,684. SHORECLIFF COMMUNICATIONS, LLC, SAN JUAN CAPISTRANO, CA. FILED 11-20-2002.

TELCOTV

FOR ARRANGING AND CONDUCTING BUSINESS CONFERENCES; ARRANGING AND CONDUCTING TRADE SHOW EXHIBITIONS IN THE FIELD OF COMMUNICATIONS; TRADE SHOWS IN THE FIELD OF COMMUNICATIONS; PROVIDING TRADE INFORMATION ABOUT THE COMMUNICATIONS INDUSTRY (U.S. CLS. 100, 101 AND 102).
 FIRST USE 6-1-2002; IN COMMERCE 6-1-2002.

SN 76-468,855. NEW YORK CITY ICY COMPANY, NEW YORK, NY. FILED 11-21-2002.

NYC ICY

NO CLAIM IS MADE TO THE EXCLUSIVE RIGHT TO USE "NYC", APART FROM THE MARK AS SHOWN.
 FOR RETAIL STORE FEATURING ICE CREAM, FLAVORED WATER ICE AND ITALIAN ICE (U.S. CLS. 100, 101 AND 102).
 FIRST USE 4-0-2002; IN COMMERCE 5-0-2002.

CLASS 35—(Continued).

SN 76-470,028. EYGN LIMITED, NASSAU, BAHAMAS, FILED 11-25-2002.

Carve-Out Accelerator

THE MARK CONSISTS OF THE WORDS "CARVE", "OUT" AND "ACCELERATOR" WITH ONLY THE FIRST LETTER IN EACH WORD CAPITALIZED AND A HYPHEN BETWEEN "CARVE" AND "OUT".

FOR BUSINESS CONSULTATION SERVICES (U.S. CLS. 100, 101 AND 102).

FIRST USE 5-15-2002; IN COMMERCE 5-15-2002.

SN 76-471,005. SOVEREIGN GRACE MINISTRIES, INC., GAITHERSBURG, MD. FILED 11-20-2002.

SOVEREIGN GRACE

OWNER OF U.S. REG. NO. 2,165,958.
FOR OFFERING TECHNICAL ASSISTANCE IN THE ESTABLISHMENT AND OPERATION OF CHURCHES; ARRANGING AND CONDUCTING OF TRADE SHOW EXHIBITIONS IN THE FIELD OF RELIGIOUS BOOKS AND MUSIC; MAIL ORDER AND COMPUTERIZED ONLINE RETAIL SERVICES IN THE FIELD OF RELIGIOUS MUSIC, PUBLICATIONS, AND GOODS (U.S. CLS. 100, 101 AND 102).

SN 76-471,045. ECONOMY.COM, INC., WEST CHESTER, PA. FILED 11-25-2002.

MACRO WORKSTATION

NO CLAIM IS MADE TO THE EXCLUSIVE RIGHT TO USE "MACRO", APART FROM THE MARK AS SHOWN.

FOR ECONOMIC FORECASTING AND ANALYSIS SERVICES (U.S. CLS. 100, 101 AND 102).

SN 76-471,184. INTERNATIONAL WINDOW FILM ASSOCIATION, MARTINSVILLE, VA. FILED 11-29-2002.

INTERNATIONAL WINDOW FILM ASSOCIATION

OWNER OF U.S. REG. NO. 1,884,449.
NO CLAIM IS MADE TO THE EXCLUSIVE RIGHT TO USE ASSOCIATION, APART FROM THE MARK AS SHOWN.

SEC. 2(F).

FOR ASSOCIATION SERVICES; NAMELY, PROMOTING THE INTERESTS OF WINDOW FILM MANUFACTURERS, DISTRIBUTORS AND TINTERS (U.S. CLS. 100, 101 AND 102).

FIRST USE 8-8-1991; IN COMMERCE 8-8-1991.

CLASS 35—(Continued).

SN 76-471,392. E&H DISTRIBUTING CO., NORTH LAS VEGAS, NV. FILED 11-18-2002.

POINTS OF DISTINCTION

FOR CONDUCTING AN INCENTIVE AWARD PROGRAM TO PROMOTE THE DISTRIBUTORSHIP OF FOOD PRODUCTS, EQUIPMENT AND SUPPLIES TO THE FOODSERVICE INDUSTRY (U.S. CLS. 100, 101 AND 102).

SN 76-471,393. E&H DISTRIBUTING CO., NORTH LAS VEGAS, NV. FILED 11-18-2002.

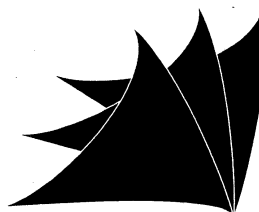
**POINTS OF DIFFERENCE**

FOR CONDUCTING AN INCENTIVE AWARD PROGRAM TO PROMOTE THE DISTRIBUTORSHIP OF FOOD PRODUCTS, EQUIPMENT AND SUPPLIES TO THE FOODSERVICE INDUSTRY (U.S. CLS. 100, 101 AND 102).

SN 76-471,394. E&H DISTRIBUTING CO., NORTH LAS VEGAS, NV. FILED 11-18-2002.

POINTS OF DIFFERENCE

FOR CONDUCTING AN INCENTIVE AWARD PROGRAM TO PROMOTE THE DISTRIBUTORSHIP OF FOOD PRODUCTS, EQUIPMENT AND SUPPLIES TO THE FOODSERVICE INDUSTRY (U.S. CLS. 100, 101 AND 102).

CLASS 35—(Continued).

SN 76-473,159. COSINE THREE MEDIA GROUP, LLC, LOS ANGELES, CA. FILED 12-9-2002.

COSINE ADVERTISING

NO CLAIM IS MADE TO THE EXCLUSIVE RIGHT TO USE "ADVERTISING", APART FROM THE MARK AS SHOWN.

FOR ADVERTISING AGENCY SERVICES; PUBLIC RELATIONS SERVICES; PUBLICITY AGENCY SERVICES; DIRECT MARKETING ADVERTISING SERVICES; BUSINESS MARKETING CONSULTING SERVICES; MARKET RESEARCH; MARKETING SERVICES, NAMELY PROMOTING THE GOODS AND SERVICES OF OTHERS BY CREATING AND IMPLEMENTING ADVERTISING AND PROMOTIONAL CAMPAIGNS; PREPARING AND PLACING ADVERTISEMENTS FOR DISSEMINATION THROUGH DIRECT MAIL, TELEVISION AND RADIO COMMERCIALS, PRINT PUBLICATIONS, BILLBOARDS, AND VIA A GLOBAL COMPUTER NETWORK; BUSINESS CONSULTATION SERVICES IN THE FIELD OF PRODUCT MARKETING AND PROMOTION, SALES PROMOTION SERVICES, NAMELY PROMOTING THE GOODS AND SERVICES OF OTHERS THROUGH THE DISTRIBUTION OF PRINTED AND AUDIO PROMOTIONAL MATERIALS AND BY RENDERING SALES PROMOTIONAL ADVICE; PROCUREMENT, NAMELY PURCHASING MEDIA TIME FOR OTHERS (U.S. CLS. 100, 101 AND 102).

SN 76-473,577. OBERWEIS DAIRY, INC., NORTH AURORA, IL. FILED 11-29-2002.

OBERWEIS DAIRY

OWNER OF U.S. REG. NOS. 2,325,294 AND 2,326,694. NO CLAIM IS MADE TO THE EXCLUSIVE RIGHT TO USE "DAIRY", APART FROM THE MARK AS SHOWN.

FOR RETAIL AND WHOLESALE STORE SERVICES FEATURING DAIRY PRODUCTS, BEVERAGES AND FOOD PRODUCTS; AND ONLINE RETAIL STORE SERVICES FEATURING DAIRY PRODUCTS, BEVERAGES, AND FOOD PRODUCTS (U.S. CLS. 100, 101 AND 102).

FIRST USE 0-0-1951; IN COMMERCE 0-0-1951.

SN 76-473,891. VELOCITY 3PL, INC., OBETZ, OH. FILED 12-11-2002.



FOR LOGISTICS MANAGEMENT IN THE FIELDS OF FREIGHT AND TRANSPORTATION (U.S. CLS. 100, 101 AND 102).

FIRST USE 11-16-2002; IN COMMERCE 11-16-2002.

CLASS 35—(Continued).

SN 76-473,956. VEXURE, INC, JACKSONVILLE, FL. FILED 12-11-2002.



FOR LOGISTICS MANAGEMENT IN THE FIELDS OF FREIGHT AND TRANSPORTATION (U.S. CLS. 100, 101 AND 102).

FIRST USE 11-16-2002; IN COMMERCE 11-16-2002.

SN 76-474,183. NACKEL, JEFFREY, DELRAY BEACH, FL. FILED 12-12-2002.



FOR SURVEY SERVICE TO OBTAIN CUSTOMER'S COMMENTS ON SERVICES PROVIDED BY SUPPLIERS (U.S. CLS. 100, 101 AND 102).

SN 76-474,236. NEW JERSEY EDUCATION ASSOCIATION, TRENTON, NJ. FILED 12-12-2002.



FOR ASSOCIATION SERVICES, NAMELY, PROMOTING THE INTERESTS OF THOSE IN THE EDUCATIONAL INDUSTRY, INCLUDING TEACHING STAFF AND EDUCATIONAL SUPPORT PROFESSIONALS; ARRANGING AND PROMOTING THE SALE OF DISCOUNTED GOODS AND SERVICES AND PROVIDING STATISTICAL INFORMATION FOR OTHERS, NAMELY, MEMBERS OF AN EDUCATION ASSOCIATION (U.S. CLS. 100, 101 AND 102).

FIRST USE 0-0-1947; IN COMMERCE 0-0-1947.

SN 76-475,154. FLAWLESS RECORDS INC., NEW YORK, NY. FILED 12-9-2002.

MOTION PACIFIC

FOR ON-LINE ORDERING SERVICES AND ON-LINE RETAIL STORE SERVICES FEATURING RECORDED MUSICAL PRODUCTS, FILM AND VIDEO PRODUCTS, EYEWEAR AND RELATED ACCESSORIES, BAGS, JEWELRY AND RELATED ITEMS, CLOTHING AND RELATED ACCESSORY ITEMS, AND POSTERS AND RELATED PRINTED MATERIALS (U.S. CLS. 100, 101 AND 102).

CLASS 35—(Continued).

SN 76-475,771. COGNITIO, LLC, CARMEL, IN. FILED 12-13-2002.



FOR MARKETING RESEARCH SERVICES (U.S. CLS. 100, 101 AND 102).
FIRST USE 11-6-2002; IN COMMERCE 11-18-2002.

SN 76-485,981. CIRCLE.COM, LLC, NEW YORK, NY. FILED 1-29-2003.

MOS MARKETING OPERATING SYSTEM

NO CLAIM IS MADE TO THE EXCLUSIVE RIGHT TO USE "MARKETING", APART FROM THE MARK AS SHOWN.

FOR BUSINESS MARKETING CONSULTING SERVICES; CORPORATE IDENTITY AND MARKETING CONSULTING SERVICES; PUBLIC RELATIONS SERVICES, AND ADVERTISING AGENCY SERVICES (U.S. CLS. 100, 101 AND 102).

SN 76-486,048. COBURN SUPPLY COMPANY, INC., BEAUMONT, TX. FILED 1-30-2003.

THE NAME WITH THE FLAME

FOR WHOLESALE DISTRIBUTORSHIP SERVICES IN THE AREAS OF PIPES, VALVES, AND FITTINGS, AND PLUMBING, HEATING, AIR CONDITIONING, ELECTRICAL, REFRIGERATION, AND MUNICIPAL UTILITY EQUIPMENT AND SUPPLIES (U.S. CLS. 100, 101 AND 102).

FIRST USE 1-0-2003; IN COMMERCE 1-0-2003.

SN 78-017,851. INNOVEX L.P., PARSIPPANY, NJ. BY ASSIGNMENT EPDOL, INC., RALEIGH, NC. FILED 7-21-2000.

MDUNITS

FOR PROMOTING THE WEBSITES, PRODUCTS, AND SERVICES OF OTHERS BY AWARDED PURCHASE POINTS TO CONSULTING PHYSICIANS IN EXCHANGE FOR PROVIDING ON-LINE EVALUATIONS OF THE PRODUCTS AND SERVICES OF OTHERS (U.S. CLS. 100, 101 AND 102).

FIRST USE 8-31-2001; IN COMMERCE 8-31-2001.

CLASS 35—(Continued).

SN 78-040,903. INTELLIWORKS, INC., IRVINE, CA. FILED 12-28-2000.



FOR BUSINESS MANAGEMENT, NAMELY PROVIDING COMPETITIVE STRATEGIES AND BUSINESS INTELLIGENCE TO BUSINESS OWNERS; BUSINESS MANAGEMENT CONSULTATION, NAMELY, STRATEGIC MANAGEMENT CONSULTING; AND BUSINESS DEVELOPMENT SERVICES, NAMELY, PROVIDING START-UP SUPPORT FOR BUSINESSES OF OTHERS (U.S. CLS. 100, 101 AND 102).
FIRST USE 9-0-1997; IN COMMERCE 10-0-1997.

SN 78-041,206. SZUTU, KEN, PALO ALTO, CA. FILED 12-31-2000.

Coupon@Tel

FOR ADVERTISING SERVICES, NAMELY PROVIDING AN ON-LINE DATABASE CONTAINING TELEPHONE NUMBERS AND INFORMATION RELATED TO AVAILABILITY AND LOCATION OF DISCOUNT COUPONS FOR BUSINESS GOODS AND SERVICES PROVIDED AT SUCH TELEPHONE NUMBERS; PROVIDING ON-LINE REGISTRATION OF SUCH INFORMATION BY SUBSCRIBERS AND PROVIDING SUCH ON-LINE INFORMATION TO THE GENERAL PUBLIC (U.S. CLS. 100, 101 AND 102).

SN 78-060,252. POLAND, LEILANI MAY, WINTER PARK, FL. FILED 4-25-2001.

The Resource Connection

NO CLAIM IS MADE TO THE EXCLUSIVE RIGHT TO USE "RESOURCE", APART FROM THE MARK AS SHOWN. FOR CONSULTING SERVICES, NAMELY, EMPLOYER AND EMPLOYEE ASSESSMENT, DEVELOPMENT, AND EVALUATION IN THE FIELDS OF SKILL DEVELOPMENT AND HUMAN PERFORMANCE (U.S. CLS. 100, 101 AND 102).

FIRST USE 1-1-1988; IN COMMERCE 1-1-1988.

CLASS 35—(Continued).

SN 78-061,203. IMAGINE GPS, INC., HENDERSON, NV. FILED 4-30-2001.

GPS CENTRAL

NO CLAIM IS MADE TO THE EXCLUSIVE RIGHT TO USE "GPS", APART FROM THE MARK AS SHOWN.
 FOR ONLINE AND TELEPHONE MAIL ORDER CATALOG AND RETAIL STORE SERVICES IN THE FIELD OF GLOBAL POSITIONING SYSTEM PRODUCTS, AND PROVIDING CONSUMER PRODUCT INFORMATION RELATING TO GLOBAL POSITIONING SYSTEM PRODUCTS (U.S. CLS. 100, 101 AND 102).
 FIRST USE 10-0-1999; IN COMMERCE 2-0-2000.

SN 78-062,988. HUDSON NEWS COMPANY, EAST RUTHERFORD, NJ. FILED 5-10-2001.

BOOK CORNER

NO CLAIM IS MADE TO THE EXCLUSIVE RIGHT TO USE "BOOK", APART FROM THE MARK AS SHOWN.
 FOR RETAIL BOOK STORE SERVICES (U.S. CLS. 100, 101 AND 102).
 FIRST USE 12-31-1982; IN COMMERCE 12-31-1982.

SN 78-063,397. MAHARISHI AYUR-VED PRODUCTS INTERNATIONAL, INC., COLORADO SPRINGS, CO. FILED 5-14-2001.

ANANDA

THE WORD "ANANDA" MEANS "BLISS" OR "HAPPINESS" IN SANSKRIT.
 FOR RETAIL OUTLETS FEATURING COSMETICS, PERSONAL SKIN CARE PRODUCTS, AND HERBAL SUPPLEMENTS (U.S. CLS. 100, 101 AND 102).

SN 78-090,411. RABINOVITZ, DAVID S, HARRISON, NY. FILED 10-26-2001.

TRADESEATS

FOR PROVIDING A WEBSITE VIA THE INTERNET TO FACILITATE THE TRADING AND EXCHANGING OF SPORTING AND CONCERT TICKETS AMONG FANS AROUND THE WORLD (U.S. CLS. 100, 101 AND 102).

CLASS 35—(Continued).

SN 78-094,709. LIVINGSTON INTERNATIONAL INC., TORONTO ONTARIO, CANADA, FILED 11-21-2001.



PRIORITY CLAIMED UNDER SEC. 44(D) ON CANADA APPLICATION NO. 1103924, FILED 5-23-2001.
 FOR IMPORTING AND EXPORTING CONSULTING SERVICES RELATING TO IMPORT-EXPORT REGULATIONS AND NAFTA REGULATIONS (U.S. CLS. 100, 101 AND 102).
 FIRST USE 3-1-2001; IN COMMERCE 5-21-2001.

SN 78-101,921. NATIONAL TOUR ASSOCIATION, INC., LEXINGTON, KY. FILED 1-10-2002.



NO CLAIM IS MADE TO THE EXCLUSIVE RIGHT TO USE "NORTH AMERICAN TOUR OPERATOR ASSOCIATION", APART FROM THE MARK AS SHOWN.
 FOR ASSOCIATION SERVICES, NAMELY PROMOTING THE INTERESTS OF THE GROUP TOUR AND TRAVEL INDUSTRY (U.S. CLS. 100, 101 AND 102).

SN 78-108,421. DIZPERSION CORPORATION, EVANSTON, IL. FILED 2-13-2002.

RUNNINGTEN

FOR DISSEMINATION OF ADVERTISING FOR OTHERS VIA THE INTERNET (U.S. CLS. 100, 101 AND 102).

CLASS 35—(Continued).

SN 78-109,561. BLACKETER, LOUANN, CANON CITY, CO. FILED 2-18-2002.



NO CLAIM IS MADE TO THE EXCLUSIVE RIGHT TO USE "ART" AND "GALLERY AND STUDIO". "P.O. BOX 612, CANON CITY, CO 81215-0612", APART FROM THE MARK AS SHOWN.

THE LINING IN THE DRAWING IS A FEATURE OF THE MARK AND NOT INTENDED TO INDICATE COLOR.

FOR ART GALLERIES (U.S. CLS. 100, 101 AND 102).
FIRST USE 2-2-2002; IN COMMERCE 2-2-2002.

SN 78-111,242. ACCESS VG, L.L.C., SALT LAKE CITY, UT. FILED 2-26-2002.

MOVIE ACCESS

NO CLAIM IS MADE TO THE EXCLUSIVE RIGHT TO USE "MOVIE", APART FROM THE MARK AS SHOWN.

FOR ADMINISTRATION OF A DISCOUNT PROGRAM FOR ENABLING PARTICIPANTS TO OBTAIN DISCOUNTS ON GOODS AND SERVICES THROUGH USE OF A DISCOUNT MEMBERSHIP CARD IN THE NATURE OF MOVIE INFORMATION, MOVIE TICKETS, VIDEO AND DVD RENTALS; DISCOUNT RETAIL STORE SERVICES IN THE FIELD OF MOVIE TICKETS, VIDEOS AND DVDS (U.S. CLS. 100, 101 AND 102).

SN 78-116,004. MASTERCARD INTERNATIONAL INCORPORATED, PURCHASE, NY. FILED 3-19-2002.

MASTERMILES

FOR ADVERTISING AGENCIES; BUSINESS MANAGEMENT; BUSINESS SUPERVISION; COMMERCIAL, INDUSTRIAL AND BUSINESS MANAGEMENT ASSISTANCE; BUSINESS APPRAISALS; ADVISORY SERVICES FOR BUSINESS MANAGEMENT; MARKET RESEARCH; MARKETING STUDIES; STATISTICAL INFORMATION FOR BUSINESS PURPOSES; ACCOUNTING SERVICES, NAMELY, PREPARATION OF STATEMENTS OF ACCOUNTS; BOOK-KEEPING; BUSINESS RESEARCH; PUBLIC RELATIONS; PUBLICATION OF PUBLICITY TEXTS; ISSUING OF PUBLICITY LEAFLETS; PROMOTING THE USE OF CREDIT AND DEBIT CARDS THROUGH INCENTIVE TRAVEL AWARD PROGRAMS (U.S. CLS. 100, 101 AND 102).

CLASS 35—(Continued).

SN 78-120,214. MID PENINSULA ACTION FOR TOMORROW, PALO ALTO, CA. FILED 4-8-2002.



NO CLAIM IS MADE TO THE EXCLUSIVE RIGHT TO USE "MID PENINSULA", APART FROM THE MARK AS SHOWN.

FOR POLITICAL ACTION COMMITTEE SERVICES, NAMELY, PROMOTING THE INTERESTS OF ENVIRONMENTALISTS IN THE FIELD OF POLITICS (U.S. CLS. 100, 101 AND 102).

FIRST USE 9-1-1997; IN COMMERCE 9-1-1997.

SN 78-120,919. BAKER, BILLY, PAUL, GLEN ROSE, TX. FILED 4-10-2002.

STORE FOR KNOWLEDGE

NO CLAIM IS MADE TO THE EXCLUSIVE RIGHT TO USE "STORE", APART FROM THE MARK AS SHOWN.

FOR RETAIL STORE SERVICES FEATURING NATURE GIFT ITEMS IN THE FIELDS OF SCIENCE, SPACE, WILDLIFE AND DINOSAURS (U.S. CLS. 100, 101 AND 102).

FIRST USE 1-1-2002; IN COMMERCE 1-1-2002.

SN 78-123,614. F & F FINE WINES INTERNATIONAL INC., RUTHERFORD, NJ. FILED 4-23-2002.

F&F FINE WINES INTERNATIONAL, INC.

NO CLAIM IS MADE TO THE EXCLUSIVE RIGHT TO USE "F & F FINE WINES INTERNATIONAL", APART FROM THE MARK AS SHOWN.

FOR IMPORT AGENCIES AND WHOLESALE DISTRIBUTORSHIPS IN THE FIELD OF WINE (U.S. CLS. 100, 101 AND 102).

FIRST USE 9-0-1991; IN COMMERCE 9-0-1991.

SN 78-124,110. BIERKRAFT INC, BROOKLYN, NY. FILED 4-25-2002.



FOR RETAIL GROCERY STORES FEATURING PHONE-IN ORDERS (U.S. CLS. 100, 101 AND 102).
FIRST USE 10-20-2001; IN COMMERCE 11-23-2001.

CLASS 35—(Continued).

SN 78-124,726. EASTERN STATES STUDENT EXCHANGE, INC., FAYETTE CITY, PA. FILED 4-29-2002.

RISE

FOR BUSINESS ORGANIZATIONAL CONSULTATION IN THE NATURE OF CLEARINGHOUSE SERVICES PERFORMED FOR OTHERS, IN THE AREA OF PUBLICITY, PUBLIC RELATIONS, SELECTION, COUNTRY ASSIGNMENT, TRAVEL PLANNING AND MONITORING OF FOREIGN EXCHANGE STUDENTS OF HIGH SCHOOL AGE, RECOMMENDED BY ROTARY CLUBS AND ROTARY DISTRICTS (U.S. CLS. 100, 101 AND 102).

SN 78-127,240. FORD MOTOR COMPANY, DEARBORN, MI. FILED 5-8-2002.



OWNER OF U.S. REG. NO. 2,520,707.
THE MARK CONSISTS OF THE WORDING "FORD OUTFITTERS" IN A RECTANGLE, WHICH IS SUPERIMPOSED OVER A DIAMOND CONTAINING STYLIZED MOUNTAINS AND A ROAD.

FOR PROMOTING THE GOODS AND SERVICES OF OTHERS THROUGH THE DISTRIBUTION OF PRINTED MATERIAL, AUDIO AND VIDEO TAPES, TELEVISION AND RADIO BROADCASTS AND PROMOTIONAL CONTESTS (U.S. CLS. 100, 101 AND 102).

SN 78-127,367. PRESERVING MEMORIES INC., GLEN BURNIE, MD. BY CHANGE OF NAME PRESERVING MEMORIES LLC, LINTHICUM, MD. FILED 5-8-2002.

PRESERVING MEMORIES

FOR RETAIL STORE SERVICES FEATURING PLAIN PAPER, THEMED PAPER, CARDSTOCK, SCISSORS, SHAPED PAPER PUNCHES, PAPER CUTTERS, PHOTO ADHESIVES, PAPER ADHESIVES, PHOTO SCRAPBOOKS, PHOTO SCRAPBOOK AND PROTECTORS, PHOTO SCRAPBOOK REFILL PAGES, STICKERS, PAPER DIE-CUTS, DIE-CUT STICKERS, ARCHIVAL SPRAY, PHOTO CLEANING CLOTHS, ALPHABET TEMPLATES, SHAPES TEMPLATES, SHAPE CUTTERS, EYELETS, STRING, EMBOSsing SETS, MARKERS, BUTTONS, BEADS, BRADS, WIRE, HAMMERS, TWEEZERS, THREAD NEEDLES, WIRE CUTTERS, PLIERS, HOLE PUNCHES, EYELET SETTER ALL FOR CREATING SCRAPBOOKS (U.S. CLS. 100, 101 AND 102).

CLASS 35—(Continued).

SN 78-129,862. HOMEDAD SERVICES INCORPORATED, LANCASTER, NY. FILED 5-20-2002.

HOMEDAD

FOR CONSULTING SERVICES FOR OWNER-OPERATED HOME BUSINESSES (U.S. CLS. 100, 101 AND 102). FIRST USE 8-14-1995; IN COMMERCE 2-15-1999.

SN 78-131,331. BILLY MARTIN'S WESTERN WEAR LA, INC., LOS ANGELES, CA. FILED 5-27-2002.



NO CLAIM IS MADE TO THE EXCLUSIVE RIGHT TO USE "USA", APART FROM THE MARK AS SHOWN.

THE STIPPLING IN THE MARK IS FOR SHADING PURPOSES ONLY AND DOES NOT INDICATE ANY COLOR.

THE NAME "BILLY MARTIN'S" SHOWN IN THE MARK DOES NOT IDENTIFY A PARTICULAR LIVING INDIVIDUAL.

THE MARK CONSISTS OF A SIX POINTED SHERIFF'S STAR/BADGE WITH THE WORDS "BILLY MARTIN'S USA" WRITTEN INSIDE THE BADGE.

FOR RETAIL BOUTIQUES FEATURING HIGH-END WESTERN LIFESTYLE APPAREL AND ACCESSORIES, JEWELRY, FURNITURE AND HOME DECOR ITEMS (U.S. CLS. 100, 101 AND 102).

FIRST USE 11-25-1978; IN COMMERCE 11-25-1978.

CLASS 35—(Continued).

SN 78-131,619. WATCHMARK CORPORATION, BELLEVUE, WA. FILED 5-28-2002.



FOR COMPILING STATISTICAL REPORTS FOR OTHERS FOR BUSINESS AND COMMERCIAL PURPOSES; COMPUTERIZED DATABASE MANAGEMENT; DATA PROCESSING SERVICES; LICENSING OF COMPUTER SOFTWARE; PREPARING BUSINESS REPORTS; PROVIDING STATISTICAL INFORMATION FOR BUSINESS AND COMMERCIAL PURPOSES (U.S. CLS. 100, 101 AND 102).

SN 78-131,735. MILANIAN, CYRUS, POMPANO BEACH, FL. FILED 5-29-2002.

THE TOWER OF LONDON EXPERIENCE

FOR BUSINESS DEVELOPMENT SERVICES, NAMELY, BUSINESS MANAGEMENT OF RESORT HOTELS, CASINOS, RESTAURANTS, SHOPPING MALLS, CONVENTION CENTERS, GAME MACHINES, THEME AMUSEMENT RIDES FOR OTHERS; PRODUCTS MERCHANDISING SERVICES (U.S. CLS. 100, 101 AND 102).

SN 78-135,956. PURPLE PHINO IMPORTS, INC., SCOTTSDALE, AZ. FILED 6-14-2002.

YEBO COLLECTION

NO CLAIM IS MADE TO THE EXCLUSIVE RIGHT TO USE "COLLECTION", APART FROM THE MARK AS SHOWN.

FOR WHOLESALE DISTRIBUTORSHIP FEATURING JEWELRY (U.S. CLS. 100, 101 AND 102).

SN 78-135,992. ALBERMARLE CORP., ATLANTA, GA. FILED 6-14-2002.

CROWNSOURCE

FOR BUSINESS SERVICES, NAMELY, CONSULTING SERVICES IN THE FIELD OF PAPER PRODUCTS (U.S. CLS. 100, 101 AND 102).

CLASS 35—(Continued).

SN 78-137,289. SYMMETRY CONSULTING, INC., DOWNTOWN, PA. FILED 6-20-2002.



NO CLAIM IS MADE TO THE EXCLUSIVE RIGHT TO USE "CONSULTING, INC.", APART FROM THE MARK AS SHOWN.

FOR BUSINESS MANAGEMENT, BUSINESS CONSULTING IN THE FIELD OF ORGANIZATION DEVELOPMENT AND PERFORMANCE DEVELOPMENT (U.S. CLS. 100, 101 AND 102).

FIRST USE 1-10-2000; IN COMMERCE 1-10-2000.

SN 78-139,270. THE SPORTSMAN'S GUIDE, INC., ST. PAUL, MN. FILED 6-27-2002.

GUIDE EXPRESS CHECKOUT

FOR COMPUTERIZED ON-LINE RETAIL SERVICES FEATURING FOOTWEAR, CLOTHING AND ACCESSORIES; HUNTING, FISHING, ARCHERY AND SHOOTING PRODUCTS AND ACCESSORIES; CAMPING AND OUTDOOR RECREATION PRODUCTS; OPTICS; EXTREME SPORTS PRODUCTS AND ACCESSORIES; GOVERNMENT SURPLUS PRODUCTS; DOMESTICS, NOVELTIES AND COLLECTIBLES; HARDWARE, TOOLS, KNIVES AND CUTLERY; BIKING, AUTOMOTIVE AND MARINE PRODUCTS AND ACCESSORIES; EXERCISE PRODUCTS; ELECTRONICS, AND OTHER CONSUMER PRODUCTS; FEATURING STREAMLINED BILLING AND ORDER FULFILLMENT SERVICES (U.S. CLS. 100, 101 AND 102).

SN 78-140,118. DENI, JOSEPH D. II, ENGLEWOOD, CO. FILED 6-29-2002.

SIMPLICITY ENERGY FARMS

NO CLAIM IS MADE TO THE EXCLUSIVE RIGHT TO USE "ENERGY FARM", APART FROM THE MARK AS SHOWN.

FOR BUSINESS CONSULTATION FOR ON-SITE ELECTRIC POWER FACILITIES (U.S. CLS. 100, 101 AND 102).

CLASS 35—(Continued).

SN 78-142,010. LAVA GROUP, INC., ATLANTA, GA. FILED 7-8-2002.

LAVA GROUP

NO CLAIM IS MADE TO THE EXCLUSIVE RIGHT TO USE "GROUP", APART FROM THE MARK AS SHOWN.

FOR BUSINESS MANAGEMENT, NAMELY, MANAGING THE INTELLECTUAL PROPERTY OF OTHERS; COPYRIGHT MANAGEMENT; LICENSING OF COMPUTER SOFTWARE, COMPUTER SYSTEMS, INDUSTRIAL EQUIPMENT, MUSICAL EQUIPMENT, MEDICAL EQUIPMENT, TELECOMMUNICATIONS EQUIPMENT, AUDIO AND VIDEO EQUIPMENT, AND EXERCISE EQUIPMENT; BUSINESS MANAGEMENT, NAMELY, MANAGEMENT OF LICENSING PROGRAMS FOR OTHERS (U.S. CLS. 100, 101 AND 102).

FIRST USE 7-1-2002; IN COMMERCE 7-1-2002.

CLASS 35—(Continued).

SN 78-148,736. SONS OF CONFEDERATE VETERANS, INC., COLUMBIA, TN. FILED 7-30-2002.

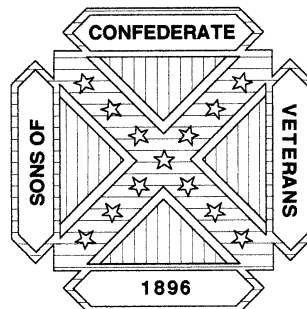

NO CLAIM IS MADE TO THE EXCLUSIVE RIGHT TO USE "SONS OF CONFEDERATE VETERANS" AND "1896", APART FROM THE MARK AS SHOWN.

THE DRAWING IS LINE FOR RED AND BLUE.

FOR ASSOCIATION SERVICES, NAMELY PROMOTING INTERESTS OF PERSONS WITH INTEREST IN HISTORY, AND PERSONS RELATED TO COMBATANTS IN THE AMERICAN CIVIL WAR (U.S. CLS. 100, 101 AND 102).

FIRST USE 0-0-1896; IN COMMERCE 0-0-1896.

SN 78-142,228. ABOUT, INC., NEW YORK, NY. FILED 7-9-2002.

DIRECTSPRINKS

OWNER OF U.S. REG. NOS. 2,539,485 AND 2,539,486.

FOR PROMOTING THE GOODS AND SERVICES OF OTHERS BY PREPARING AND CONTEXTUALLY PLACING TARGETED TEXT ADVERTISEMENTS IN ELECTRONIC NEWSLETTERS AND DIRECT EMAILS; DISSEMINATION OF ADVERTISING FOR OTHERS VIA AN ON-LINE ELECTRONIC COMMUNICATIONS NETWORK; ADVERTISING SERVICES, NAMELY PROVIDING ADVERTISING SPACE IN ELECTRONIC NEWSLETTERS AND DIRECT EMAIL (U.S. CLS. 100, 101 AND 102).

SN 78-150,136. SNOWSHOE MOUNTAIN, INC., SNOWSHOE, WV. FILED 8-2-2002.

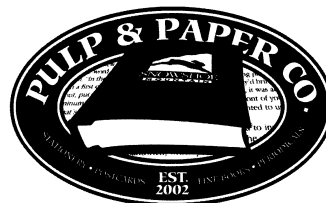

SN 78-144,495. DAVID KAPLAN MARKETING SERVICES, INCORPORATED, RIVERWOODS, IL. FILED 7-16-2002.

EAG

FOR BUSINESS MARKETING CONSULTING SERVICES IN THE FIELD OF SCHOOL FOOD SERVICE (U.S. CLS. 100, 101 AND 102).

NO CLAIM IS MADE TO THE EXCLUSIVE RIGHT TO USE "PAPER CO.", "STATIONERY", "POSTCARDS", "EST.2002", "FINE BOOKS", AND "PERIODICALS", APART FROM THE MARK AS SHOWN.

FOR RETAIL STORE SERVICES FEATURING A WIDE VARIETY OF CONSUMER GOODS OF OTHERS (U.S. CLS. 100, 101 AND 102).

CLASS 35—(Continued).

SN 78-150,912. LEADERSHIP DEVELOPMENT GROUP, INC., APEX, NC. FILED 8-5-2002.



**LEADERSHIP
DEVELOPMENT
GROUP, INC.**

NO CLAIM IS MADE TO THE EXCLUSIVE RIGHT TO USE "LEADERSHIP DEVELOPMENT GROUP, INC.", APART FROM THE MARK AS SHOWN.

THE MARK CONSISTS OF FIVE FOLDED, PAPER AIRPLANES ABOVE THE NAME "LEADERSHIP DEVELOPMENT GROUP, INC." THE AIRPLANES ARE: STARTING AT THE TOP LEFT TAN GOING CLOCKWISE PEA GREEN, BLUE, PURPLE, GREY, MAUVE.

FOR BUSINESS CONSULTATION SERVICES; BUSINESS PLANNING SERVICES; BUSINESS ORGANIZATIONAL SERVICES; BUSINESS MANAGEMENT SERVICES; PROVIDING STATISTICAL INFORMATION FOR BUSINESS PURPOSES; CONDUCTING OF BUSINESS RESEARCH AND SURVEYS; BUSINESS DEVELOPMENT SERVICES, NAMELY, PROVIDING START UP SUPPORT OF BUSINESS FOR OTHERS; FRANCHISING, NAMELY, OFFERING TECHNICAL ASSISTANCE IN THE ESTABLISHMENT AND OPERATION OF BUSINESS CONSULTATION COMPANIES; PROVIDING INFORMATION ABOUT ORGANIZATIONAL DEVELOPMENT AND STRATEGIC PLANNING IN BUSINESS BY PERSONAL FACILITATION AND VIA THE INTERNET (U.S. CLS. 100, 101 AND 102).

FIRST USE 4-10-2002; IN COMMERCE 4-10-2002.

SN 78-159,722. BURLINGTON COAT FACTORY WAREHOUSE CORPORATION, BURLINGTON, NJ. FILED 8-30-2002.

MJM DESIGNER SHOES

NO CLAIM IS MADE TO THE EXCLUSIVE RIGHT TO USE "DESIGNER SHOES", APART FROM THE MARK AS SHOWN.

FOR RETAIL SHOE STORE SERVICES (U.S. CLS. 100, 101 AND 102).

SN 78-160,043. LOGAN, KYLE TYRELL, DBA THE POCKET-BOOK PERSUADER, SCARSDALE, NY. FILED 9-2-2002.

**CONVINCING OTHERS TO
INVEST IN YOUR VISION**

FOR BUSINESS SERVICES, NAMELY BUSINESS PLAN WRITING, BUSINESS PLAN REVISIONS, BUSINESS PLAN RESEARCH, BUSINESS PLAN REVIEW, BUSINESS PLAN CONSULTING (U.S. CLS. 100, 101 AND 102).

CLASS 35—(Continued).

SN 78-163,483. L. L. BEAN, INC., FREEPORT, ME. FILED 9-12-2002.

TOUGHER THAN SCHOOL

NO CLAIM IS MADE TO THE EXCLUSIVE RIGHT TO USE "SCHOOL", APART FROM THE MARK AS SHOWN.

FOR MAIL ORDER SERVICES AND COMPUTERIZED ONLINE RETAIL SERVICES FEATURING BACKPACKS (U.S. CLS. 100, 101 AND 102).

FIRST USE 7-21-1992; IN COMMERCE 7-21-1992.

SN 78-164,277. HOUSE OF ROSE, LLC, MADISON, WI. FILED 9-16-2002.

PERFUME GARDENS

NO CLAIM IS MADE TO THE EXCLUSIVE RIGHT TO USE "PERFUME", APART FROM THE MARK AS SHOWN.

FOR ONLINE RETAIL ORDERING SERVICES AND RETAIL STORE SERVICES FEATURING PERFUMES, COLOGNES, FRAGRANCES, AND COSMETICS (U.S. CLS. 100, 101 AND 102).

SN 78-164,280. E.R. SQUIBB & SONS, L.L.C., PRINCETON, NJ. FILED 9-16-2002.

**CONVATEC OSTOMY
WELLNESS PROGRAM**

OWNER OF U.S. REG. NOS. 1,139,439, 1,392,909 AND OTHERS.

NO CLAIM IS MADE TO THE EXCLUSIVE RIGHT TO USE "OSTOMY WELLNESS PROGRAM", APART FROM THE MARK AS SHOWN.

FOR CUSTOMER SERVICE, NAMELY, THE PROVISION OF CUSTOMER INQUIRY AND INFORMATION SERVICES REGARDING PHARMACEUTICALS AND HEALTHCARE PRODUCTS AND SERVICES VIA TELEPHONE, ELECTRONIC MAIL, AND COMPUTER TERMINALS (U.S. CLS. 100, 101 AND 102).

SN 78-166,331. PCJ INC, SAINT HELENA, CA. FILED 9-20-2002.

JUSLYN VINEYARDS

NO CLAIM IS MADE TO THE EXCLUSIVE RIGHT TO USE "VINEYARDS", APART FROM THE MARK AS SHOWN.

FOR WINERY SERVICES, NAMELY WHOLESALE, ONLINE AND RETAIL STORE SERVICES FEATURING WINE (U.S. CLS. 100, 101 AND 102).

CLASS 35—(Continued).

SN 78-167,742. GARNISH LLC, NEW YORK, NY. FILED 9-25-2002.



FOR BUSINESS MARKETING CONSULTING SERVICES FOR THE ARTS, ENTERTAINMENT, MEDIA, NEW MEDIA, FASHION AND SPORTS INDUSTRIES (U.S. CLS. 100, 101 AND 102).

SN 78-167,754. GARNISH LLC, NEW YORK, NY. FILED 9-25-2002.

GARNISH

FOR BUSINESS MARKETING CONSULTING SERVICES FOR THE ARTS, ENTERTAINMENT, MEDIA, NEW MEDIA, FASHION AND SPORTS INDUSTRIES (U.S. CLS. 100, 101 AND 102).

SN 78-168,840. FRED MEYER STORES, INC., PORTLAND, OR. FILED 9-27-2002.

FRED MEYER REWARDS

OWNER OF U.S. REG. NOS. 927,931, 2,676,709 AND OTHERS.

NO CLAIM IS MADE TO THE EXCLUSIVE RIGHT TO USE "REWARDS", APART FROM THE MARK AS SHOWN. THE NAME "FRED MEYER" DOES NOT IDENTIFY A LIVING INDIVIDUAL.

FOR RETAIL STORE SERVICES IN THE FIELD OF GROCERIES AND GENERAL MERCHANDISE FEATURING A BONUS INCENTIVE PROGRAM FOR CUSTOMERS (U.S. CLS. 100, 101 AND 102).

SN 78-169,519. SPECTRAL WEB, INC., HOWARD BEACH, NY. FILED 9-30-2002.

SPECTRAL WEB

OWNER OF U.S. REG. NO. 2,540,615.

NO CLAIM IS MADE TO THE EXCLUSIVE RIGHT TO USE "WEB", APART FROM THE MARK AS SHOWN.

FOR PROVIDING INFORMATION IN THE FIELD OF BUSINESS IN THE NATURE OF BUSINESS WRITING, BUSINESS STRATEGIES, BUSINESS TAXONOMY, BUSINESS COMMUNICATIONS AND BUSINESS BRANDING VIA THE INTERNET, USING AN INTERCONNECTED AND INTERDEPENDENT NETWORK OF DOMAINS WITHIN THE WEB ("DOT WEB") INTERNET SUFFIX (GTLD) (U.S. CLS. 100, 101 AND 102).

FIRST USE 10-15-2000; IN COMMERCE 10-15-2000.

CLASS 35—(Continued).

SN 78-170,778. NATIONAL MOTORISTS ASSOCIATION, INC, WAUNAKEE, WI. FILED 10-3-2002.

NATIONAL MOTORISTS ASSOCIATION

NO CLAIM IS MADE TO THE EXCLUSIVE RIGHT TO USE "ASSOCIATION", APART FROM THE MARK AS SHOWN.

SEC. 2(F).

FOR ASSOCIATION SERVICES, NAMELY, PROMOTING THE INTERESTS OF MOTORISTS (U.S. CLS. 100, 101 AND 102).

FIRST USE 12-9-1990; IN COMMERCE 12-9-1990.

SN 78-172,128. M2L, INC., NEW YORK, NY. FILED 10-8-2002.

IT'S ABOUT GENUINE DESIGN

FOR WHOLESALE AND RETAIL STORE SERVICES IN THE FIELD OF FURNITURE, BEDDING, LAMPS AND HOME FURNISHINGS (U.S. CLS. 100, 101 AND 102).

FIRST USE 11-30-2000; IN COMMERCE 11-30-2000.

SN 78-172,838. NAVIGATOR ELECTRONICS, INC., FT. LAUDERDALE, FL. FILED 10-10-2002.

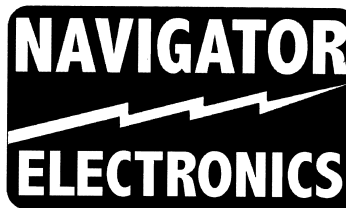

NO CLAIM IS MADE TO THE EXCLUSIVE RIGHT TO USE "ELECTRONICS", APART FROM THE MARK AS SHOWN.

THE MARK CONSISTS OF A RECTANGLE WITH LIGHTNING BOLT DIVIDING IT IN HALF WITH UPPER HALF GREEN AND LOWER HALF BLUE WITH "NAVIGATOR ELECTRONICS" AND LIGHTNING BOLT IN WHITE.

FOR WHOLESALE STORES FEATURING COMMUNICATION, NAVIGATION, AND ENTERTAINMENT EQUIPMENT FOR BOATS, PLEASURE YACHTS, AND COMMERCIAL VESSELS (U.S. CLS. 100, 101 AND 102).

FIRST USE 8-1-1998; IN COMMERCE 8-1-1998.

CLASS 35—(Continued).

SN 78-172,933. VANGUARDE MEDIA, INC., NEW YORK, NY. FILED 10-10-2002.

URBANIQ

OWNER OF U.S. REG. NOS. 2,587,641 AND 2,587,642.
FOR COMPUTER SERVICES, NAMELY PROVIDING AN INTERACTIVE WEB SITE FEATURING RESEARCH, ANALYSIS, REPORTS, CHARTS, DATA AND ONLINE NEWSLETTERS ON THE IMPACT AND USE OF TECHNOLOGY ON THE URBAN MARKET FOR USE BY URBAN ENTERTAINMENT PROFESSIONALS (U.S. CLS. 100, 101 AND 102).

SN 78-173,288. ST. JOHN KNITS, INC., IRVINE, CA. FILED 10-10-2002.



OWNER OF U.S. REG. NOS. 1,473,087, 1,686,972 AND OTHERS.
FOR RETAIL STORE SERVICES FEATURING APPAREL, SHOES AND CLOTHING ACCESSORIES (U.S. CLS. 100, 101 AND 102).
FIRST USE 4-30-1989; IN COMMERCE 4-30-1989.

SN 78-174,914. LTD COMMODITIES, INC., BANNOCKBURN, IL. FILED 10-16-2002.

LTD EMPLOYMENT SERVICES

OWNER OF U.S. REG. NOS. 2,315,411, 2,315,412 AND 2,409,188.

NO CLAIM IS MADE TO THE EXCLUSIVE RIGHT TO USE "EMPLOYMENT SERVICES", APART FROM THE MARK AS SHOWN.

FOR EMPLOYMENT SERVICES, NAMELY, HIRING, RECRUITING, PERSONNEL STAFFING AND EMPLOYMENT COUNSELING (U.S. CLS. 100, 101 AND 102).

CLASS 35—(Continued).

SN 78-174,922. OHIO TOBACCO USE PREVENTION & CONTROL FOUNDATION, COLUMBUS, OH. FILED 10-16-2002.

STAND

FOR PROMOTING PUBLIC AWARENESS OF THE NEED FOR TOBACCO USE PREVENTION AND CESSATION (U.S. CLS. 100, 101 AND 102).
FIRST USE 10-31-2000; IN COMMERCE 10-31-2000.

SN 78-175,066. XTREME TRAFFIC BUILDERS, INC., CHICAGO, IL. FILED 10-16-2002.

INVISADICE

FOR BUSINESS MARKETING AND DIRECT MAIL ADVERTISING, AND CONSULTING SERVICES IN THE FIELD OF BUSINESS MARKETING AND DIRECT MAIL ADVERTISING (U.S. CLS. 100, 101 AND 102).

SN 78-175,149. MURDICO, VINCENT A., ESCONDIDO, CA. FILED 10-16-2002.

STRATEGYHEAD

FOR BUSINESS MANAGEMENT AND CONSULTATION: BUSINESS MANAGEMENT PLANNING; BUSINESS MARKETING CONSULTING; BUSINESS MERGERS AND ACQUISITIONS CONSULTATION; BUSINESS RESEARCH; PERSONNEL MANAGEMENT AND COMPENSATION CONSULTATION; CONSULTATION SERVICES FOR THE EVALUATION AND MANAGEMENT OF EMPLOYEES; HUMAN RESOURCES CONSULTATION; PSYCHOLOGICAL TESTING FOR THE SELECTION OF PERSONNEL; CREATIVE CONSULTING, NAMELY, ENSURING CLIENTS HAVE A MESSAGE CONSISTENT WITH THEIR BUSINESS PLAN; ADVERTISING, NAMELY, CREATING CORPORATE LOGOS, CREATING CORPORATE AND BRAND IDENTITY, AND PRODUCTION AND DISTRIBUTION OF RADIO, TELEVISION AND INTERNET COMMERCIALS; PUBLIC RELATIONS (U.S. CLS. 100, 101 AND 102).
FIRST USE 9-3-2002; IN COMMERCE 9-19-2002.

SN 78-176,319. JENNINGS, ANNIE, BELLE MEAD, NJ. FILED 10-20-2002.

PAY FOR PLAY

FOR PUBLIC RELATION SERVICES; ADVERTISING SERVICES, NAMELY, DISSEMINATION OF ADVERTISING MATTER FOR OTHERS VIA THE INTERNET, RADIO, TELEVISION AND PRINT, AND PLACING ADVERTISEMENTS FOR OTHERS (U.S. CLS. 100, 101 AND 102).

CLASS 35—(Continued).

SN 78-176,362. ROBERT ABBOTT HOLDING, INC., FOSTER CITY, CA. FILED 10-20-2002.

TALENTCITY

OWNER OF U.S. REG. NO. 2,556,885.
FOR PROVIDING INFORMATION IN THE FIELD OF MODELING AND TALENT VIA A GLOBAL COMPUTER NETWORK; PROMOTING THE TALENT SERVICES OF OTHERS BY DISSEMINATING MATERIAL ON BEHALF OF ACTORS, ACTRESSES, MODELS AND MUSICIANS VIA A GLOBAL COMPUTER NETWORK; AND PROVIDING ADVERTISING FOR OTHERS VIA A GLOBAL COMPUTER NETWORK (U.S. CLS. 100, 101 AND 102).
FIRST USE 1-1-2000; IN COMMERCE 1-1-2000.

SN 78-176,415. THE SHERWIN-WILLIAMS COMPANY, CLEVELAND, OH. FILED 10-21-2002.

SHER-LINK

FOR ON-LINE RETAIL STORE SERVICES FEATURING PAINT AND COATING PRODUCTS (U.S. CLS. 100, 101 AND 102).
FIRST USE 1-31-2001; IN COMMERCE 1-31-2001.

SN 78-177,509. BIG Y FOODS, INC., SPRINGFIELD, MA. FILED 10-23-2002.

T&V

FOR RETAIL SHOPS FEATURING ALCOHOLIC BEVERAGES AND FOOD (U.S. CLS. 100, 101 AND 102).

SN 78-177,684. FOREST SERVICE EMPLOYEES FOR ENVIRONMENTAL ETHICS, INC., EUGENE, OR. FILED 10-23-2002.

REDDY SQUIRREL

FOR PROMOTING THE PUBLIC AWARENESS OF WILDFIRE PREPAREDNESS AND PROTECTION (U.S. CLS. 100, 101 AND 102).
FIRST USE 8-1-2002; IN COMMERCE 8-1-2002.

SN 78-178,158. WALTERS, JEFFREY, K, JEFFERSON CITY, MO. FILED 10-24-2002.

SOUND LOOKS SPEED

FOR CONTESTS AND INCENTIVE AWARD PROGRAMS TO PROMOTE THE SALE OF PRODUCTS AND SERVICES OF OTHERS (U.S. CLS. 100, 101 AND 102).

CLASS 35—(Continued).

SN 78-178,653. CONWAY, DAVID, ENCINITAS, CA. FILED 10-25-2002.



the Serenity Source

Your source for a healthier, stress-free life

FOR ON-LINE AND PHYSICAL RETAIL STORE SERVICES FEATURING STRESS-RELIEF PRODUCTS, NAMELY, HOMEOPATHIC REMEDIES, MEDICINAL HERBS, AROMA THERAPY, HEALTHY TEAS, BODY PRODUCTS, YOGA PRODUCTS, MUSIC AND VIDEOS (U.S. CLS. 100, 101 AND 102).
FIRST USE 8-1-2002; IN COMMERCE 9-25-2002.

SN 78-178,710. ACCESS MEDIAWORKS INC., DESOTO, TX. FILED 10-26-2002.

HIP HOP CRUISE, HIP HOP CRUISE SHIP

NO CLAIM IS MADE TO THE EXCLUSIVE RIGHT TO USE "HIP HOP", APART FROM THE MARK AS SHOWN.
FOR ADVERTISING AGENCY, NAMELY, PROMOTING THE PRODUCTS OF MUSIC RECORDING LABELS AND DISTRIBUTION COMPANIES THROUGH THE DISTRIBUTION OF PRINTED AND AUDIO PROMOTIONAL MATERIALS AND BY RENDERING SALES PROMOTION ADVICE (U.S. CLS. 100, 101 AND 102).

SN 78-178,745. DEX MEDIA, INC., ENGLEWOOD, CO. BY ASSIGNMENT QWEST COMMUNICATIONS INTERNATIONAL INC., DENVER, CO. FILED 10-26-2002.

DALLAS INSIDER

NO CLAIM IS MADE TO THE EXCLUSIVE RIGHT TO USE "DALLAS", APART FROM THE MARK AS SHOWN.
FOR PROVIDING ON-LINE TELEPHONE DIRECTORIES VIA A GLOBAL INFORMATION NETWORK; AND PROMOTING THE GOODS AND SERVICES OF OTHERS THROUGH THE DISTRIBUTION OF PRINTED AND ON-LINE ADVERTISING AND DIRECTORIES (U.S. CLS. 100, 101 AND 102).

SN 78-178,749. DEX MEDIA, INC., ENGLEWOOD, CO. BY ASSIGNMENT QWEST COMMUNICATIONS INTERNATIONAL INC., DENVER, CO. FILED 10-26-2002.

CHICAGO INSIDER

NO CLAIM IS MADE TO THE EXCLUSIVE RIGHT TO USE "CHICAGO", APART FROM THE MARK AS SHOWN.
FOR PROVIDING ON-LINE TELEPHONE DIRECTORIES VIA A GLOBAL INFORMATION NETWORK; AND PROMOTING THE GOODS AND SERVICES OF OTHERS THROUGH THE DISTRIBUTION OF PRINTED AND ON-LINE ADVERTISING AND DIRECTORIES (U.S. CLS. 100, 101 AND 102).

CLASS 35—(Continued).

SN 78-178,952. HANKINS, STEVEN, WICHITA, KS. FILED 10-28-2002.

MOTOR MODELS

NO CLAIM IS MADE TO THE EXCLUSIVE RIGHT TO USE "MODELS", APART FROM THE MARK AS SHOWN.

FOR MODELING AGENCY SERVICES FOR THE VEHICLE, AIRCRAFT, BOATING, AGRICULTURAL AND EQUIPMENT INDUSTRIES— NAMELY ARRANGING FOR AND PROVIDING MODELS TO BE USED BY DEALERS, PARTS SUPPLIERS AND ASSOCIATED BUSINESSES IN THE VEHICLE, AIRCRAFT, BOATING, AGRICULTURAL AND EQUIPMENT INDUSTRIES (U.S. CLS. 100, 101 AND 102).

FIRST USE 10-18-2002; IN COMMERCE 10-18-2002.

SN 78-178,984. THE CUSTOMER CONNECTION, INC., ESCONDIDO, CA. FILED 10-28-2002.

THE CUSTOMER CONNECTION

FOR MAILING PROMOTIONAL OFFERS FOR OTHERS IN THE FIELD OF CUSTOMER RELATIONSHIP MARKETING (U.S. CLS. 100, 101 AND 102).

FIRST USE 11-30-1997; IN COMMERCE 11-30-1997.

SN 78-179,208. CRITTER MINE, INC., STANSBURY PARK, UT. FILED 10-28-2002.

PICK 'EM STUFF 'EM LUV 'EM

FOR RETAIL STORE SERVICES IN THE FIELDS OF STUFFED TOY ANIMALS AND PLUSH TOY ANIMALS AND ACCESSORIES THEREFOR (U.S. CLS. 100, 101 AND 102).

SN 78-179,209. STRATEGIC COMMUNICATIONS GROUP, INC., SILVER SPRING, MD. FILED 10-28-2002.

NETWORK OF RELATIONSHIPS

FOR BUSINESS CONSULTATION SERVICES, BUSINESS NETWORKING, AND PUBLIC RELATIONS SERVICE (U.S. CLS. 100, 101 AND 102).

FIRST USE 9-7-2001; IN COMMERCE 9-7-2001.

CLASS 35—(Continued).

SN 78-179,529. THE OHIO MANUFACTURERS' ASSOCIATION, COLUMBUS, OH. FILED 10-29-2002.

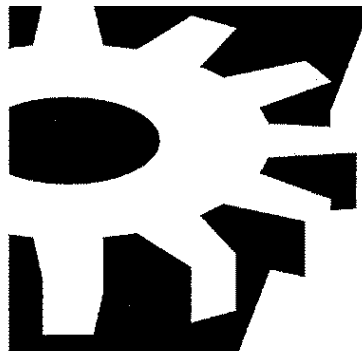

FOR ASSOCIATION SERVICES, NAMELY, REPRESENTING THE POLITICAL INTERESTS OF MANUFACTURERS AND PROMOTING THE INTERESTS OF THE MANUFACTURING INDUSTRY; DISTRIBUTING VARIOUS COMMUNICATIONS, PUBLICATIONS AND BROCHURES FOR MEMBERS AND SUPPORTERS; PROVIDING SERVICES TO MEMBERS AND SUPPORTERS (U.S. CLS. 100, 101 AND 102).

FIRST USE 4-14-1997; IN COMMERCE 8-1-1997.

SN 78-180,612. NATIONAL TAX REFUND CENTER, INC., ATLANTA, GA. FILED 10-31-2002.

NTRC

FOR ACCOUNTING AND TAX PREPARATION AND FILING SERVICES (U.S. CLS. 100, 101 AND 102).

FIRST USE 1-1-2002; IN COMMERCE 1-1-2002.

SN 78-180,669. SPHERION PACIFIC ENTERPRISES LLC, FT. LAUDERDALE, FL. FILED 10-31-2002.

HIRE SOURCE

FOR ONLINE AND TELEPHONE-BASED SERVICE FOR ASSESSMENT OF JOB CANDIDATES (U.S. CLS. 100, 101 AND 102).

SN 78-180,712. SPHERION PACIFIC ENTERPRISES LLC, FT. LAUDERDALE, FL. FILED 10-31-2002.

HIRE CALIBER

FOR ONLINE AND TELEPHONE-BASED SERVICE FOR BEHAVIORAL ASSESSMENT OF JOB CANDIDATES (U.S. CLS. 100, 101 AND 102).

CLASS 35—(Continued).

SN 78-181,199. LAWTV, INC., NEW YORK, NY. FILED 11-4-2002.

IT'S MANHATTAN-ING!

FOR ADVERTISING AND PROMOTING GOODS AND SERVICES OF OTHERS IN THE CITY OF NEW YORK THROUGH GENERAL ADVERTISING, NAMELY, DISSEMINATION OF PRINTED MATERIALS AND PROVIDING RADIO AND TELEVISION ADVERTISING; AND TOURIST-ORIENTED PROMOTIONAL ADVERTISING THROUGH THE DISSEMINATION OF ADVERTISING MATTER AND PREPARING AND PLACING ADVERTISEMENTS IN AN ELECTRONIC MAGAZINE ACCESSED THROUGH THE INTERNET (U.S. CLS. 100, 101 AND 102).

SN 78-181,870. JIM BALL INC., DESTIN, FL. FILED 11-5-2002.

ZBUZ

FOR RETAIL CLOTHING, SHOES, JEWELRY, ACCESSORY, GIFT, HOME ACCENT AND FURNITURE STORE SERVICES. (U.S. CLS. 100, 101 AND 102).

SN 78-182,555. STEVENS, THOMAS HAROLD, DBA T. H. STEVENS ASSOCIATES, MARBLE, NC. FILED 11-6-2002.

**OMNICOMPETENT
OPERATIONS**

FOR BUSINESS DEVELOPMENT SERVICES, NAMELY, PROVIDING START-UP SUPPORT FOR BUSINESSES OF OTHERS; BUSINESS PROCESS RE-ENGINEERING SERVICES; BUSINESS PLANNING; BUSINESS ORGANIZATIONAL CONSULTATION (U.S. CLS. 100, 101 AND 102).

FIRST USE 2-0-2002; IN COMMERCE 10-0-2002.

SN 78-183,723. DOLPHIN OUTDOOR POWER EQUIPMENT, INC., POMPANO BEACH, FL. FILED 11-11-2002.

GOT GRASS?

FOR ON-LINE RETAIL STORE SERVICES FEATURING GAS POWERED LAWN AND GARDEN EQUIPMENT (U.S. CLS. 100, 101 AND 102).

CLASS 35—(Continued).

SN 78-183,735. TEE TIME ENTERPRISES, INC., ATLANTA, GA. FILED 11-11-2002.

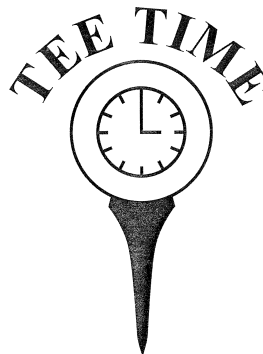

FOR ADVERTISING SERVICE PREPARING GOLF RELATED ADVERTISING SPECIALTY PRODUCTS FOR OTHERS (U.S. CLS. 100, 101 AND 102).
FIRST USE 6-15-1997; IN COMMERCE 9-1-1997.

SN 78-183,768. RECRUITMINDS, LLC, POINT PLEASANT, NJ. FILED 11-11-2002.

RECRUITMINDS

FOR EMPLOYMENT RECRUITING AND STAFFING SERVICES FOR BIO-PHARMACEUTICAL, BIOTECHNOLOGY, PHARMACEUTICAL AND HEALTHCARE INDUSTRIES (U.S. CLS. 100, 101 AND 102).
FIRST USE 11-1-2001; IN COMMERCE 11-1-2001.

SN 78-183,867. SECURE ASSET REPORTING SERVICES, INC., ANCHORAGE, AK. FILED 11-11-2002.

SARS SECURE TRAC

FOR TRACKING, LOCATING, AND MONITORING OF VEHICLES, MARITIME VESSELS, AIRCRAFT, ROLLING RAILROAD STOCK, CARGO CONTAINERS, AND LIQUIDS STORED IN BULK (U.S. CLS. 100, 101 AND 102).

SN 78-183,871. SECURE ASSET REPORTING SERVICES, INC., ANCHORAGE, AK. FILED 11-11-2002.

SARS TRACPOINT

FOR TRACKING, LOCATING, AND MONITORING OF VEHICLES, MARITIME VESSELS, AIRCRAFT, ROLLING RAILROAD STOCK, CARGO CONTAINERS, AND LIQUIDS STORED IN BULK (U.S. CLS. 100, 101 AND 102).

CLASS 35—(Continued).

SN 78-183,874. SECURE ASSET REPORTING SERVICES, INC., ANCHORAGE, AK. FILED 11-11-2002.

SARS DIRECTRAC

FOR TRACKING, LOCATING, AND MONITORING OF VEHICLES, MARITIME VESSELS, AIRCRAFT, ROLLING RAILROAD STOCK, CARGO CONTAINERS, AND LIQUIDS STORED IN BULK (U.S. CLS. 100, 101 AND 102).

SN 78-184,958. BRYLANE, L.P., INDIANAPOLIS, IN. FILED 11-14-2002.

KING SIZE OUTLET

OWNER OF U.S. REG. NOS. 931,531 AND 977,344.
NO CLAIM IS MADE TO THE EXCLUSIVE RIGHT TO USE "OUTLET", APART FROM THE MARK AS SHOWN.
FOR ON-LINE RETAIL CLOTHING STORE SERVICES (U.S. CLS. 100, 101 AND 102).

SN 78-185,247. HEB GROCERY COMPANY, LP, SAN ANTONIO, TX. FILED 11-14-2002.

Off the Hook, Ready to Cook!

FOR RETAIL FOOD STORE SERVICES FEATURING FISH AND SEAFOOD (U.S. CLS. 100, 101 AND 102).

SN 78-185,600. ANTONIO PUIG, S.A., BARCELONA, SPAIN, FILED 11-15-2002.

PASSION ATTITUDE

FOR RETAIL STORE SERVICES FOR PERFUMERY, COSMETICS AND PERSONAL CARE PRODUCTS. (U.S. CLS. 100, 101 AND 102).

CLASS 35—(Continued).

SN 78-185,822. TEXAS CLASSROOM TEACHERS ASSOCIATION, AUSTIN, TX. FILED 11-16-2002.



OWNER OF U.S. REG. NOS. 2,101,307, 2,179,932 AND 2,552,728.

FOR ASSOCIATION SERVICES, NAMELY PROMOTING THE ROLES OF TEACHERS AND OTHER INSTRUCTIONAL PROFESSIONALS IN PUBLIC EDUCATION (U.S. CLS. 100, 101 AND 102).
FIRST USE 0-0-1985; IN COMMERCE 0-0-1985.

SN 78-190,585. SEARS, ROEBUCK AND CO., HOFFMAN ESTATES, IL. FILED 12-3-2002.

SEARS

OWNER OF U.S. REG. NOS. 642,438, 2,621,139 AND OTHERS.

FOR RETAIL DEPARTMENT STORE SERVICES (U.S. CLS. 100, 101 AND 102).
FIRST USE 1-0-1894; IN COMMERCE 1-0-1894.

SN 78-191,309. LEWIS, MALCOLM D., PALO ALTO, CA. FILED 12-4-2002.

PREMIERGUIDE

FOR COMPUTER SERVICES, NAMELY PROVIDING INFORMATION ON LOCAL HOME AND BUSINESS SERVICES VIA A GLOBAL COMPUTER NETWORK (U.S. CLS. 100, 101 AND 102).

SN 78-191,340. SWANSON, ANTHONY, T., EDEN PRAIRIE, MN. FILED 12-5-2002.

NEWZILLA

FOR PROMOTING THE GOODS AND SERVICES OF OTHERS BY PROVIDING HYPERTEXT LINKS TO THE WEB SITES OF OTHERS (U.S. CLS. 100, 101 AND 102).

CLASS 35—(Continued).

SN 78-193,836. FASTCHANNEL NETWORK, INC., NEEDHAM, MA. FILED 12-12-2002.

CREATIVECHANNEL

FOR SERVICES PROVIDING BUSINESS INFORMATION AND ADVERTISING RESEARCH DATA, NAMELY, PROVIDING BUSINESS PROFILES, BIOGRAPHIES AND CREATIVE PORTFOLIOS FOR THE ADVERTISING AND BROADCASTING PRODUCTION INDUSTRIES BY MEANS OF COMPUTER NETWORK; PROVIDING BUSINESS CONSULTATION SERVICES REGARDING LOCATING TALENT FOR THE ADVERTISING AND BROADCASTING INDUSTRIES; PROVIDING ELECTRONIC AND HARD COPIES OF COMPETITIVE RADIO, TELEVISION, MAGAZINE AND NEWSPAPER ADVERTISING; PROVIDING FACILITIES FOR BUSINESS MEETINGS NAMELY AN ELECTRONIC FORUM FOR BUSINESSES TO TRANSACT BUSINESS IN THE ADVERTISING AND BROADCASTING INDUSTRIES (U.S. CLS. 100, 101 AND 102).

SN 78-195,871. VERIZON COMMUNICATIONS INC., NEW YORK, NY. FILED 12-18-2002.

LIVESOURCE

FOR TELEPHONE OPERATOR SERVICES (U.S. CLS. 100, 101 AND 102).

CLASS 36—INSURANCE AND FINANCIAL

SN 75-246,869. LOYAL AMERICAN LIFE INSURANCE COMPANY, CINCINNATI, OH. FILED 2-24-1997.



FOR LIFE, HEALTH AND DISABILITY INSURANCE UNDERWRITING SERVICES (U.S. CLS. 100, 101 AND 102).

CLASS 36—(Continued).

SN 75-392,512. ENTERPRISE OIL PLC, LONDON, WC2N 5EJ, ENGLAND, FILED 11-19-1997.



OWNER OF UNITED KINGDOM REG. NO. 1338180, DATED 3-11-1988, EXPIRES 3-11-2005.

NO CLAIM IS MADE TO THE EXCLUSIVE RIGHT TO USE "OIL", APART FROM THE MARK AS SHOWN.

FOR FINANCIAL SERVICE, NAMELY, FINANCIAL MANAGEMENT, FINANCIAL PLANNING AND FINANCIAL RESEARCH PROVIDED TO BUSINESSES IN THE OIL INDUSTRY (U.S. CLS. 100, 101 AND 102).

SN 75-534,331. SOUTHERN HIGHLANDS, L.L.C., SCOTTSDALE, AZ. FILED 8-11-1998.



THE MARK CONSISTS IN PART OF THE LETTERS "SH". FOR REAL ESTATE MANAGEMENT SERVICES FOR RESIDENTIAL COMMUNITIES AND GOLF COURSE FACILITIES (U.S. CLS. 100, 101 AND 102). FIRST USE 1-31-1999; IN COMMERCE 1-31-1999.

SN 75-615,857. SIGNAL, THE, WAYNE, PA. FILED 1-5-1999.

SUNSURE

FOR INSURANCE ADMINISTRATIVE, BROKERAGE AND CLAIMS PROCESSING SERVICES IN THE FIELD OF WIRELESS AND MOBILE COMMUNICATIONS EQUIPMENT (U.S. CLS. 100, 101 AND 102).

SN 75-623,985. LEGACY FINANCIAL GROUP, INC., OVERLAND PARK, KS. FILED 1-20-1999.

LEGACY FINANCIAL GROUP

NO CLAIM IS MADE TO THE EXCLUSIVE RIGHT TO USE "FINANCIAL GROUP", APART FROM THE MARK AS SHOWN.

FOR LIFE AND DISABILITY INSURANCE AGENCY SERVICES AND INVESTMENT AND FINANCIAL PLANNING SERVICES (U.S. CLS. 100, 101 AND 102).

CLASS 36—(Continued).

SN 75-751,877. FINANCIAL PASSPORT, INC., VIENNA, VA. BY CHANGE OF NAME PACE FINANCIAL NETWORK, VIENNA, VA. FILED 7-14-1999.

YOUR TICKET TO FINANCIAL SECURITY

NO CLAIM IS MADE TO THE EXCLUSIVE RIGHT TO USE "FINANCIAL SECURITY", APART FROM THE MARK AS SHOWN.

FOR FUNDS INVESTMENT; INSURANCE AGENCY IN THE FIELDS OF LIFE INSURANCE, ACCIDENT AND HEALTH INSURANCE, VARIABLE ANNUITIES AND LIFE INSURANCE CONTRACTS, AND PROPERTY AND CASUALTY INSURANCE; MORTGAGE LENDING (U.S. CLS. 100, 101 AND 102).

SN 75-845,531. MMC BANCORP, BOSTON, MA. FILED 12-2-1999.

EW@VEBANC

FOR BANKING SERVICES PROVIDED OVER A GLOBAL COMPUTER NETWORK. (U.S. CLS. 100, 101 AND 102).

SN 75-845,532. MMC BANCORP, BOSTON, MA. FILED 12-2-1999.

EW@VEBANC.COM

FOR BANKING SERVICES PROVIDED OVER A GLOBAL COMPUTER NETWORK. (U.S. CLS. 100, 101 AND 102).

SN 75-845,533. MMC BANCORP, BOSTON, MA. FILED 12-2-1999.

EW@VEBANC.NET

FOR BANKING SERVICES PROVIDED OVER A GLOBAL COMPUTER NETWORK. (U.S. CLS. 100, 101 AND 102).

SN 75-845,534. MMC BANCORP, BOSTON, MA. FILED 12-2-1999.

EW@VEBANC.ORG

FOR BANKING SERVICES PROVIDED OVER A GLOBAL COMPUTER NETWORK. (U.S. CLS. 100, 101 AND 102).

CLASS 36—(Continued).

SN 75-845,535. MMC BANCORP, BOSTON, MA. FILED 12-2-1999.

EW@VEBANK

FOR BANKING SERVICES PROVIDED OVER A GLOBAL COMPUTER NETWORK (U.S. CLS. 100, 101 AND 102).

SN 75-845,536. MMC BANCORP, BOSTON, MA. FILED 12-2-1999.

EW@VEBANK.COM

FOR BANKING SERVICES PROVIDED OVER A GLOBAL COMPUTER NETWORK (U.S. CLS. 100, 101 AND 102).

SN 75-845,538. MMC BANCORP, BOSTON, MA. FILED 12-2-1999.

EW@VEBANK.ORG

FOR BANKING SERVICES PROVIDED OVER A GLOBAL COMPUTER NETWORK (U.S. CLS. 100, 101 AND 102).

SN 75-845,581. MMC BANCORP, BOSTON, MA. FILED 12-2-1999.

EWAVEB@NC

FOR BANKING SERVICES PROVIDED OVER A GLOBAL COMPUTER NETWORK. (U.S. CLS. 100, 101 AND 102).

SN 75-845,583. MMC BANCORP, BOSTON, MA. FILED 12-2-1999.

EWAVEB@NC.COM

FOR BANKING SERVICES PROVIDED OVER A GLOBAL COMPUTER NETWORK. (U.S. CLS. 100, 101 AND 102).

CLASS 36—(Continued).

SN 75-845,585. MMC BANCORP, BOSTON, MA. FILED 12-2-1999.

EWAVEB@NC.ORG

FOR BANKING SERVICES PROVIDED OVER A GLOBAL COMPUTER NETWORK. (U.S. CLS. 100, 101 AND 102).

CLASS 36—(Continued).

SN 75-845,591. MMC BANCORP, BOSTON, MA. FILED 12-2-1999.

EWAVEB@NK.NET

FOR BANKING SERVICES PROVIDED OVER A GLOBAL COMPUTER NETWORK. (U.S. CLS. 100, 101 AND 102).

SN 75-845,586. MMC BANCORP, BOSTON, MA. FILED 12-2-1999.

EWAVEB@NC.NET

FOR BANKING SERVICES PROVIDED OVER A GLOBAL COMPUTER NETWORK. (U.S. CLS. 100, 101 AND 102).

SN 75-845,593. MMC BANCORP, BOSTON, MA. FILED 12-2-1999.

EW@VEB@NC

FOR BANKING SERVICES PROVIDED OVER A GLOBAL COMPUTER NETWORK (U.S. CLS. 100, 101 AND 102).

SN 75-845,587. MMC BANCORP, BOSTON, MA. FILED 12-2-1999.

EWAVEB@NK

FOR BANKING SERVICES PROVIDED OVER A GLOBAL COMPUTER NETWORK. (U.S. CLS. 100, 101 AND 102).

SN 75-845,594. MMC BANCORP, BOSTON, MA. FILED 12-2-1999.

EW@VEB@NC.COM

FOR BANKING SERVICES PROVIDED OVER A GLOBAL COMPUTER NETWORK. (U.S. CLS. 100, 101 AND 102).

SN 75-845,588. MMC BANCORP, BOSTON, MA. FILED 12-2-1999.

EWAVEB@NK.COM

FOR BANKING SERVICES PROVIDED OVER A GLOBAL COMPUTER NETWORK. (U.S. CLS. 100, 101 AND 102).

SN 75-845,595. MMC BANCORP, BOSTON, MA. FILED 12-2-1999.

EW@VEB@NC.ORG

FOR BANKING SERVICES PROVIDED OVER A GLOBAL COMPUTER NETWORK. (U.S. CLS. 100, 101 AND 102).

SN 75-845,589. MMC BANCORP, BOSTON, MA. FILED 12-2-1999.

EWAVEB@NK.ORG

FOR BANKING SERVICES PROVIDED OVER A GLOBAL COMPUTER NETWORK (U.S. CLS. 100, 101 AND 102).

SN 75-845,596. MMC BANCORP, BOSTON, MA. FILED 12-2-1999.

EW@VEB@NC.NET

FOR BANKING SERVICES PROVIDED OVER A GLOBAL COMPUTER NETWORK. (U.S. CLS. 100, 101 AND 102).

CLASS 36—(Continued).

SN 75-845,598. MMC BANCORP, BOSTON, MA. FILED 12-2-1999.

EW@VEB@NK

FOR BANKING SERVICES PROVIDED OVER A GLOBAL COMPUTER NETWORK. (U.S. CLS. 100, 101 AND 102).

SN 75-845,599. MMC BANCORP, BOSTON, MA. FILED 12-2-1999.

EW@VEB@NK.COM

FOR BANKING SERVICES PROVIDED OVER A GLOBAL COMPUTER NETWORK. (U.S. CLS. 100, 101 AND 102).

SN 76-013,898. LIFE INSURANCE MARKETING CO., INC., THE WELLINGTON, FL. BY ASSIGNMENT EXECUTIVE INSURANCE AGENCY, INC., BEACHWOOD, OH. FILED 3-30-2000.

ASSOCIATED CONSULTING SERVICES

NO CLAIM IS MADE TO THE EXCLUSIVE RIGHT TO USE "CONSULTING SERVICES", APART FROM THE MARK AS SHOWN.

SEC. 2(F).
FOR PROVIDING FEE-BASED FINANCIAL CONSULTATION TO FINANCIAL INSTITUTIONS (U.S. CLS. 100, 101 AND 102).

FIRST USE 0-0-1974; IN COMMERCE 0-0-1974.

SN 76-036,369. ING BANK OF CANADA, NORTH YORK, ONTARIO, M5J 2T7, CANADA, FILED 4-27-2000.

SAVE YOUR MONEY

OWNER OF CANADA REG. NO. TMA503986, DATED 11-12-1998, EXPIRES 11-12-2013.

NO CLAIM IS MADE TO THE EXCLUSIVE RIGHT TO USE "SAVE" AND "MONEY", APART FROM THE MARK AS SHOWN.

FOR BANKING; TRUST COMPANY SERVICES (U.S. CLS. 100, 101 AND 102).

CLASS 36—(Continued).

SN 76-039,799. MERRILL LYNCH & CO., INC., NEW YORK, NY. FILED 5-2-2000.

THE SMARTEST PLACE TO INVEST ONLINE

FOR INSURANCE BROKERAGE SERVICES; REAL ESTATE FINANCING SERVICES; REAL ESTATE INVESTMENT SERVICES; REAL ESTATE MANAGEMENT SERVICES; REAL ESTATE BROKERAGE SERVICES; SECURITY AND COMMODITY BROKERAGE AND DEALING SERVICES; MORTGAGE AND CONSUMER LENDING; UNDERWRITING SECURITIES; INVESTMENT BANKING; MORTGAGE BANKING; FINANCIAL MANAGEMENT SERVICES; AND FINANCIAL ADVISORY SERVICES (U.S. CLS. 100, 101 AND 102).
FIRST USE 3-26-2000; IN COMMERCE 3-26-2000.

SN 76-040,504. U.S. EDUCATION FINANCE MANAGEMENT CORPORATION, MIAMI, FL. FILED 5-4-2000.

E.U. PRESTAMOS DE CONSOLIDACION

NO CLAIM IS MADE TO THE EXCLUSIVE RIGHT TO USE "PRESTAMOS DE CONSOLIDACION", APART FROM THE MARK AS SHOWN.

THE ENGLISH TRANSLATION OF "PRESTAMOS DE CONSOLIDACION" IS "CONSOLIDATION LOANS".

FOR EDUCATION LOAN SERVICES; BROKERING EDUCATION LOANS (U.S. CLS. 100, 101 AND 102).

SN 76-205,527. PHOENIX HOME LIFE MUTUAL INSURANCE COMPANY, HARTFORD, CT. FILED 2-6-2001.

PHOENIX INCOME CHOICE

OWNER OF U.S. REG. NOS. 1,487,792, 2,399,281 AND OTHERS.

NO CLAIM IS MADE TO THE EXCLUSIVE RIGHT TO USE "INCOME", APART FROM THE MARK AS SHOWN.

FOR UNDERWRITING AN IMMEDIATE ANNUITY OFFERING BOTH FIXED AND VARIABLE PAYMENTS (U.S. CLS. 100, 101 AND 102).

FIRST USE 8-9-2001; IN COMMERCE 8-9-2001.

SN 76-261,211. FORTIS (NL) N.V., UTRECHT 3584 BA, NETHERLANDS, AND FORTIS (B), BRUSSELS, BELGIUM, BY ASSIGNMENT FORTIS, INC., NEW YORK, NY. FILED 5-22-2001.

FORTIS ADVANTAGE ONLINE SERVICES

NO CLAIM IS MADE TO THE EXCLUSIVE RIGHT TO USE "ONLINE SERVICES", APART FROM THE MARK AS SHOWN.

FOR INSURANCE SERVICES, NAMELY, UNDERWRITING NON-MEDICAL GROUP BENEFIT INSURANCE, PROVIDED VIA A GLOBAL COMPUTER NETWORK (U.S. CLS. 100, 101 AND 102).

CLASS 36—(Continued).

SN 76-268,434. RODEO REALTY, INC., NORTHRIDGE, CA. FILED 6-6-2001.



NO CLAIM IS MADE TO THE EXCLUSIVE RIGHT TO USE "REALTY INC. FINE ESTATES", APART FROM THE MARK AS SHOWN.
 FOR REAL ESTATE BROKERAGE SERVICES (U.S. CLS. 100, 101 AND 102).
 FIRST USE 2-23-2001; IN COMMERCE 2-23-2001.

SN 76-270,404. BLAIR CORPORATION, WARREN, PA. FILED 6-12-2001.

JLB SERVICE NATIONAL BANK

NO CLAIM IS MADE TO THE EXCLUSIVE RIGHT TO USE "SERVICE NATIONAL BANK", APART FROM THE MARK AS SHOWN.
 FOR FINANCING SERVICES (U.S. CLS. 100, 101 AND 102).

SN 76-275,089. ALZHEIMER SOCIETY OF WASHINGTON, BELLINGHAM, WA. FILED 6-19-2001.

"GO THE EXTRA MILE FOR ALZHEIMER'S"

FOR CHARITABLE FUND RAISING SERVICES IN THE FIELD OF ALZHEIMER'S AND OTHER DEMENTING ILLNESSES (U.S. CLS. 100, 101 AND 102).

CLASS 36—(Continued).

SN 76-304,372. FOX EMPIRE REAL ESTATE, INC., BRONX, NY. FILED 8-27-2001.



THE MARK CONSISTS, IN PART, OF A STYLIZED DESIGN OF A BUILDING.
 FOR REAL ESTATE AGENCIES; REAL ESTATE LISTINGS; REAL ESTATE BROKERAGE (U.S. CLS. 100, 101 AND 102).

SN 76-320,573. FEDERAL HOME LOAN MORTGAGE CORPORATION, MCLEAN, VA. FILED 10-4-2001.

LP CLASSIC

FOR FINANCIAL SERVICES IN THE FIELD OF MORTGAGE LOANS AND MORTGAGE-BACKED OR MORTGAGE-RELATED SECURITIES (U.S. CLS. 100, 101 AND 102).
 FIRST USE 3-0-2001; IN COMMERCE 3-0-2001.

SN 76-324,002. SANDY SPRING BANK, OLNEY, MD. FILED 10-11-2001.

SANDY SPRING BANK

OWNER OF U.S. REG. NO. 2,107,114.
 NO CLAIM IS MADE TO THE EXCLUSIVE RIGHT TO USE "BANK", APART FROM THE MARK AS SHOWN.
 SEC. 2(F) AS TO "SANDY SPRING".
 FOR FINANCIAL SERVICES, NAMELY, FINANCIAL INVESTMENT IN THE FIELDS OF SECURITIES, ESTATES, REAL ESTATE; FINANCIAL ANALYSIS; FINANCIAL PLANNING; STUDENT LOANS; MORTGAGE LENDING, INSURANCE SERVICES, NAMELY ADMINISTRATION AND SECURITIES; CREDIT AND DEBIT CARD SERVICES, FINANCIAL ASSET MANAGEMENT, AND BANKING SERVICES (U.S. CLS. 100, 101 AND 102).
 FIRST USE 9-21-2001; IN COMMERCE 9-21-2001.

CLASS 36—(Continued).

SN 76-324,006. SANDY SPRING BANK, OLNEY, MD. FILED 10-11-2001.



OWNER OF U.S. REG. NO. 2,107,114.
NO CLAIM IS MADE TO THE EXCLUSIVE RIGHT TO USE "BANK", APART FROM THE MARK AS SHOWN.
THE DRAWING IS LINED FOR THE COLOR GOLD.
SEC. 2(F) AS TO "SANDY SPRING".

FOR FINANCIAL SERVICES, NAMELY, FINANCIAL INVESTMENT IN THE FIELDS OF SECURITIES, ESTATES, REAL ESTATE; FINANCIAL ANALYSIS; FINANCIAL PLANNING; STUDENT LOANS; MORTGAGE LENDING, INSURANCE SERVICES, NAMELY ADMINISTRATION AND SECURITIES; CREDIT AND DEBIT CARD SERVICES, FINANCIAL ASSET MANAGEMENT, AND BANKING SERVICES (U.S. CLS. 100, 101 AND 102).

FIRST USE 9-21-2001; IN COMMERCE 9-21-2001.

CLASS 36—(Continued).

SN 76-342,403. HIGHBRIDGE CAPITAL MANAGEMENT, LLC, NEW YORK, NY. FILED 11-28-2001.



OWNER OF U.S. REG. NOS. 2,417,249, 2,417,250 AND 2,454,647.

NO CLAIM IS MADE TO THE EXCLUSIVE RIGHT TO USE "CAPITAL MANAGEMENT, LLC", APART FROM THE MARK AS SHOWN.

THE STRIPING IS A FEATURE OF THE MARK AND IS DISPLAYED IN THE COLOR GREEN. THE SOLID BLOCK IN THE MARK IS A FEATURE OF THE MARK AND IS DISPLAYED IN THE COLOR BLUE.

FOR FINANCIAL SERVICES, NAMELY, INVESTMENT ADVISORY SERVICES, INVESTMENT MANAGEMENT SERVICES AND ASSET MANAGEMENT SERVICES (U.S. CLS. 100, 101 AND 102).

SN 76-336,485. YALE UNIVERSITY, NEW HAVEN, CT. FILED 11-13-2001.

YALE SCHOOL OF MANAGEMENT STOCK MARKET CONFIDENCE INDEXES

OWNER OF U.S. REG. NOS. 1,391,543, 2,271,288 AND OTHERS.

NO CLAIM IS MADE TO THE EXCLUSIVE RIGHT TO USE "SCHOOL OF MANAGEMENT STOCK MARKET CONFIDENCE INDEXES", APART FROM THE MARK AS SHOWN.

FOR COMPUTER SERVICES, NAMELY PROVIDING OTHERS WITH INFORMATION ABOUT INVESTOR ATTITUDE AND PREFERENCES ONLINE VIA THE GLOBAL COMPUTER NETWORK (U.S. CLS. 100, 101 AND 102).

FIRST USE 11-7-2001; IN COMMERCE 11-7-2001.

SN 76-346,239. VANDEVCO LIMITED, VANCOUVER, WA. FILED 12-10-2001.



NO CLAIM IS MADE TO THE EXCLUSIVE RIGHT TO USE "VANCOUVERCENTER", APART FROM THE MARK AS SHOWN.

THE MARK CONSISTS OF THE WORD "VANCOUVERCENTER" WITH VARIOUS VERTICAL AND HORIZONTAL LINES CENTERED ABOVE THE WORD "VANCOUVERCENTER".

FOR LEASING OF REAL ESTATE AND REAL ESTATE MANAGEMENT (U.S. CLS. 100, 101 AND 102).

FIRST USE 9-22-1999; IN COMMERCE 9-22-1999.

SN 76-340,710. ENCORE CREDIT CORP., NEWPORT BEACH, CA. FILED 11-21-2001.

ENCORE CREDIT CORP.

NO CLAIM IS MADE TO THE EXCLUSIVE RIGHT TO USE "CREDIT CORP.", APART FROM THE MARK AS SHOWN.

FOR PURCHASING LOANS SECURED BY ONE TO FOUR FAMILY RESIDENCES; ORIGINATING LOANS SECURED BY ONE TO FOUR FAMILY RESIDENCES; SERVICING LOANS SECURED BY ONE TO FOUR FAMILY RESIDENCES; SELLING LOANS SECURED BY ONE TO FOUR FAMILY RESIDENCES THAT HAVE BEEN PURCHASED OR ORIGINATED BY APPLICANT (U.S. CLS. 100, 101 AND 102).

SN 76-346,552. PREMERA BLUE CROSS, SEATTLE, WA. FILED 12-7-2001.

STRATA

FOR ADMINISTRATION AND ORGANIZING OF PREPAID AND/OR PREFERRED PROVIDER HEALTH, MEDICAL, DENTAL, HOSPITAL, PHARMACEUTICAL, PRESCRIPTION DRUG PLANS AND RELATED HEALTHCARE PLANS AND NETWORKS (U.S. CLS. 100, 101 AND 102).

CLASS 36—(Continued).

SN 76-346,622. PREMERA BLUE CROSS, SEATTLE, WA. FILED 12-7-2001.

STRATA PLUS1

FOR ADMINISTRATION AND ORGANIZING OF PREPAID AND/OR PREFERRED PROVIDER HEALTH, MEDICAL, DENTAL, HOSPITAL, PHARMACEUTICAL, PRESCRIPTION DRUG PLANS AND RELATED HEALTHCARE PLANS AND NETWORKS (U.S. CLS. 100, 101 AND 102).

SN 76-352,802. CONSOLIDATED FINANCIAL CORPORATION, BINGHAM FARMS, MI. FILED 12-27-2001.

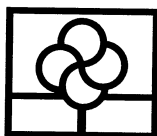

Consolidated Financial
Corporation

Better Choices. Better Planning. Better Future.

NO CLAIM IS MADE TO THE EXCLUSIVE RIGHT TO USE "CONSOLIDATED FINANCIAL CORPORATION", APART FROM THE MARK AS SHOWN.

FOR INVESTMENT OF FUNDS FOR OTHERS; INSURANCE CLAIMS PROCESSING; INSURANCE ADMINISTRATION IN THE FIELD OF THIRD PARTY ADMINISTRATION; INSURANCE AGENCIES IN THE FIELD OF LIFE INSURANCE, ANNUITIES, GROUP INSURANCE AND SUPPLEMENTAL INSURANCES; INSURANCE CLAIMS ADMINISTRATION; ESTATE PLANNING; AND FINANCIAL SERVICES IN THE NATURE OF INVESTMENT SECURITIES (U.S. CLS. 100, 101 AND 102).

FIRST USE 7-1-2001; IN COMMERCE 7-1-2001.

SN 76-354,545. K3T PARTNERS, LLC, NEW YORK, NY. FILED 12-27-2001.

STAR PARTNERS

NO CLAIM IS MADE TO THE EXCLUSIVE RIGHT TO USE "PARTNERS", APART FROM THE MARK AS SHOWN.

FOR INVESTMENT FUND SERVICES, NAMELY HEDGE FUNDS AND PRODUCTS STRUCTURED AROUND HEDGE FUNDS, WHICH ARE MARKETED EXCLUSIVELY TO ACCREDITED INVESTORS IN THE SPORTS, ARTS, MEDIA AND ENTERTAINMENT BUSINESSES (U.S. CLS. 100, 101 AND 102).

CLASS 36—(Continued).

SN 76-355,813. MAGNA ENTERTAINMENT CORP., AURORA, ONTARIO, CANADA, FILED 1-8-2002.

EXPRESSBET

PRIORITY CLAIMED UNDER SEC. 44(D) ON CANADA APPLICATION NO. 1124773, FILED 12-11-2001.

FOR PARIMUTUEL WAGERING SERVICES, NAMELY ON-LINE, INTERNET AND ELECTRONIC ADVANCE DEPOSIT AND PRE-PAID ACCOUNT WAGERING, TELEPHONE AND TELEVISION ADVANCE DEPOSIT AND PRE-PAID ACCOUNT WAGERING, OFF-TRACK AND ON-TRACK WAGERING, ALL OFFERED SOLELY THROUGH APPLICANT'S EXCLUSIVE NETWORK (U.S. CLS. 100, 101 AND 102).

SN 76-358,361. PRAESIDIUM, INC., ARLINGTON, TX. FILED 1-14-2002.

**TRI-GUARD SAFETY
TEMPLATES**

FOR RISK MANAGEMENT SERVICES, NAMELY, ASSESSING COMPLIANCE WITH RISK MANAGEMENT POLICIES AND PRACTICES DESIGNED TO REDUCE INSTITUTIONAL AND ORGANIZATIONAL ABUSE OF VULNERABLE PERSONS THROUGH THE USE OF PROPRIETARY GUIDELINES AND CHECKLISTS (U.S. CLS. 100, 101 AND 102).

FIRST USE 0-0-1992; IN COMMERCE 2-1-1992.

SN 76-360,187. RHONE GROUP LLC, NEW YORK, NY. FILED 1-17-2002.

RHÔNE GROUP LLC

NO CLAIM IS MADE TO THE EXCLUSIVE RIGHT TO USE "GROUP LLC", APART FROM THE MARK AS SHOWN.

FOR INVESTMENT ADVICE; FINANCIAL SERVICES IN THE NATURE OF INVESTMENT SECURITY; FINANCIAL SERVICES IN THE NATURE OF AN INVESTMENT, CAPITAL INVESTMENT CONSULTATION, FUND INVESTMENT CONSULTATION, INVESTMENT CONSULTATION, INVESTMENT MANAGEMENT, REAL ESTATE INVESTMENT (U.S. CLS. 100, 101 AND 102).

FIRST USE 2-8-1998; IN COMMERCE 2-8-1998.

CLASS 36—(Continued).

SN 76-361,060. HARTFORD LIFE INSURANCE COMPANY, SIMSBURY, CT. FILED 1-22-2002.

MERLIN EXPRESS

NO CLAIM IS MADE TO THE EXCLUSIVE RIGHT TO USE "EXPRESS", APART FROM THE MARK AS SHOWN.

FOR INSURANCE ACTUARIAL SERVICES PROVIDED ON-LINE TO ASSIST PRODUCERS IN THE SALE OF LIFE INSURANCE PRODUCTS BY PROVIDING PROJECTIONS WHICH SHOW HOW POLICIES WILL PERFORM OVER THE INSURED'S LIFETIME (U.S. CLS. 100, 101 AND 102).

SN 76-364,997. CONWAY COMPANY, LLC, CINCINNATI, OH. FILED 1-31-2002.

**ANALYSIS, SOLUTIONS,
RESULTS FOR THE NON-
PROFIT COMMUNITY**

NO CLAIM IS MADE TO THE EXCLUSIVE RIGHT TO USE "NON-PROFIT COMMUNITY", APART FROM THE MARK AS SHOWN.

FOR CONSULTING SERVICES IN THE FIELD OF CHARITABLE FUND RAISING FOR NON-PROFIT ORGANIZATIONS (U.S. CLS. 100, 101 AND 102).
FIRST USE 11-21-2001; IN COMMERCE 11-21-2001.

SN 76-368,929. INTERNATIONAL ASSOCIATION OF REGISTERED FINANCIAL CONSULTANTS, INC., MIDDLETOWN, OH. FILED 2-8-2002.

RFA

FOR FINANCIAL CONSULTING (U.S. CLS. 100, 101 AND 102).
FIRST USE 9-30-1998; IN COMMERCE 9-30-1998.

SN 76-370,277. WALKER MACRAE INC., MANCHESTER, NH. FILED 2-13-2002.

WALKER MACRAE

THE NAME " WALKER MACRAE" DOES NOT IDENTIFY A LIVING INDIVIDUAL.

FOR PROVIDING FINANCIAL MANAGEMENT SERVICES FOR TAX-QUALIFIED PLANS TO ENABLE FULL UTILIZATION OF INVESTMENT MANAGEMENT SUBSIDIES TO SUPPORT COMPREHENSIVE RETIREMENT PLAN ADMINISTRATION AND PARTICIPANT SERVICES (U.S. CLS. 100, 101 AND 102).
FIRST USE 4-1-1998; IN COMMERCE 10-31-2001.

CLASS 36—(Continued).

SN 76-372,347. PUBLIC DATA CORPORATION, NEW YORK, NY. FILED 2-19-2002.

**PUBLIC DATA
CORPORATION**

NO CLAIM IS MADE TO THE EXCLUSIVE RIGHT TO USE "DATA CORPORATION", APART FROM THE MARK AS SHOWN.

SEC. 2(F).
FOR PROVIDING AN ONLINE COMPUTER DATABASE IN THE FIELD OF REAL ESTATE, CONSISTING OF DEEDS, MORTGAGES, BANKRUPTCY RECORD LIENS, AND DOCUMENTS RELATING TO REAL ESTATE RECORDATIONS OR FILINGS (U.S. CLS. 100, 101 AND 102).
FIRST USE 1-1-1987; IN COMMERCE 1-1-1987.

SN 76-377,939. FMR CORP., BOSTON, MA. FILED 3-4-2002.

**FIDELITY PERSONAL
ADVISORY SERVICES**

OWNER OF U.S. REG. NOS. 1,543,851, 2,384,555 AND OTHERS.

NO CLAIM IS MADE TO THE EXCLUSIVE RIGHT TO USE "PERSONAL ADVISORY SERVICES", APART FROM THE MARK AS SHOWN.

FOR FINANCIAL SERVICES, NAMELY, INVESTMENT MANAGEMENT SERVICES, FUND INVESTMENT SERVICES AND SECURITIES INVESTMENT SERVICES (U.S. CLS. 100, 101 AND 102).

SN 76-379,958. TIERONE BANK, LINCOLN, NE. FILED 3-8-2002.

TIERONE CORPORATION

OWNER OF U.S. REG. NO. 2,159,825 AND OTHERS.
NO CLAIM IS MADE TO THE EXCLUSIVE RIGHT TO USE "CORPORATION", APART FROM THE MARK AS SHOWN.

FOR FINANCIAL SERVICES, NAMELY, FULL SERVICE CONSUMER AND COMMERCIAL BANKING SERVICES; INVESTMENT PRODUCT SERVICES, NAMELY PROVIDING MUTUAL FUND AND ANNUITY INVESTMENT SERVICES, STOCK AND BOND BROKERAGE SERVICES AND INVESTMENT CONSULTATION SERVICES; ELECTRONIC FUNDS TRANSFER PROVIDED THROUGH AUTOMATED TELLER MACHINES, DEBIT CARD AND CREDIT CARD SERVICES; CASH MANAGEMENT SERVICES; CONSUMER AND COMMERCIAL LEASING FINANCING; REAL ESTATE FINANCING FEATURING MORTGAGE LENDING, HOME EQUITY LOANS AND COMMERCIAL EQUITY FINANCING; CONSUMER, CONSTRUCTION AND CORPORATE/BUSINESS LOANS AND LINES OF CREDIT; MORTGAGE BANKING AND BROKERAGE SERVICES; AND INSURANCE AGENCY SERVICES IN THE FIELD OF TERM, LIFE AND LONG-TERM CARE (U.S. CLS. 100, 101 AND 102).
FIRST USE 10-2-2002; IN COMMERCE 10-2-2002.

CLASS 36—(Continued).

SN 76-382,552. BANK OF NEW YORK, THE, NEW YORK, NY. FILED 3-14-2002.

EMPOWERING OUR PARTNERS WORLDWIDE

NO CLAIM IS MADE TO THE EXCLUSIVE RIGHT TO USE "WORLDWIDE", APART FROM THE MARK AS SHOWN.

FOR SECURITIES PROCESSING SERVICES, NAMELY, ISSUING SECURITIES IN THE NATURE OF A TRADING INSTRUMENT REPRESENTING AN OWNERSHIP INTEREST IN A PORTFOLIO OF AMERICAN DEPOSITORY RECEIPTS, CUSTODY OF SECURITIES, CORPORATE TRUST SERVICES, NAMELY, TRUSTEE SERVICES, REGISTRAR SERVICES AND PAYING AGENT SERVICES FOR ASSET-BACKED SECURITIES, AUCTIONS, COLLATERALIZED DEBT OBLIGATIONS, CORPORATE FINANCING, DEFAULT ADMINISTRATION, DERIVATIVES, ESCROW, GLOBAL FINANCE, INSURANCE TRUSTS, MORTGAGE-BACKED SECURITIES, MUNICIPAL FINANCING AND STRUCTURED FINANCING, TRADE EXECUTION, CLEARANCE, SECURITIES TRANSACTION REPORTING, SECURITIES LENDING, INVESTMENT ACCOUNTING AND GLOBAL PAYMENTS; CORPORATE BANKING SERVICES, NAMELY, PROVIDING CREDIT AND LOANS, FOREIGN CURRENCY EXCHANGE, GLOBAL TRADE LETTERS OF CREDIT, AND RISK MANAGEMENT SERVICES (U.S. CLS. 100, 101 AND 102).

SN 76-383,897. E-VANTAGE INTERNATIONAL, INC., LEXINGTON, MA. FILED 3-19-2002.

E-VANTAGE INTERNATIONAL

NO CLAIM IS MADE TO THE EXCLUSIVE RIGHT TO USE "INTERNATIONAL", APART FROM THE MARK AS SHOWN.

FOR RISK MANAGEMENT SERVICES IN THE FIELD OF CURRENCY EXCHANGE (U.S. CLS. 100, 101 AND 102).

FIRST USE 2-1-1999; IN COMMERCE 2-1-1999.

SN 76-393,027. HANOVERTRADE.COM, INC., EDISON, NJ. FILED 4-8-2002.

THE CRA SOURCE

NO CLAIM IS MADE TO THE EXCLUSIVE RIGHT TO USE "CRA", APART FROM THE MARK AS SHOWN.

FOR FINANCIAL LOAN AND CONSULTING SERVICES (U.S. CLS. 100, 101 AND 102).

CLASS 36—(Continued).

SN 76-400,708. CALIFORNIA FEDERAL BANK, SAN FRANCISCO, CA. FILED 4-25-2002.

AUTOONE

FOR FINANCIAL SERVICES, NAMELY, LOAN PROCESSING, LOAN FINANCING AND LOAN SERVICING (U.S. CLS. 100, 101 AND 102).

FIRST USE 8-0-1997; IN COMMERCE 8-0-1997.

SN 76-400,767. HOPE CHEST FOR BREAST CANCER FOUNDATION, SHAKOPEE, MN. FILED 4-24-2002.

HOPE CHEST FOR BREAST CANCER

NO CLAIM IS MADE TO THE EXCLUSIVE RIGHT TO USE "BREAST CANCER", APART FROM THE MARK AS SHOWN.

FOR CHARITABLE FUNDRAISING SERVICES (U.S. CLS. 100, 101 AND 102).

SN 76-404,256. RELIANCE HOUSING FOUNDATION, INC., FT. LAUDERDALE, FL. FILED 5-7-2002.



NO CLAIM IS MADE TO THE EXCLUSIVE RIGHT TO USE "HOUSING FOUNDATION", APART FROM THE MARK AS SHOWN.

FOR HOUSING AGENCY SERVICES, NAMELY, LOCATING FIT, SAFE, AND AFFORDABLE HOUSING FOR LOW-INCOME PEOPLE, NAMELY, FAMILIES AND SPECIAL NEEDS POPULATIONS (U.S. CLS. 100, 101 AND 102).

FIRST USE 9-0-1997; IN COMMERCE 9-0-1997.

SN 76-404,677. RELIANCE HOUSING FOUNDATION, INC., FT. LAUDERDALE, FL. FILED 5-7-2002.

RELIANCE

FOR HOUSING AGENCY SERVICES, NAMELY LOCATING FIT, SAFE, AND AFFORDABLE HOUSING FOR LOW-INCOME PEOPLE, NAMELY, FAMILIES AND SPECIAL NEEDS POPULATIONS (U.S. CLS. 100, 101 AND 102).

FIRST USE 9-0-1997; IN COMMERCE 9-0-1997.

CLASS 36—(Continued).

SN 76-404,785. ABN AMRO NORTH AMERICA, INC., CHICAGO, IL. FILED 5-8-2002.



workplacedirect

THE STIPPLING IN THE DRAWING IS A FEATURE OF THE MARK AND IS NOT INTENDED TO INDICATE COLOR.

FOR GENERAL BANKING AND FINANCIAL SERVICES, NAMELY, TELEPHONE BANKING SERVICES, ONLINE BANKING SERVICES, CHECKING ACCOUNT SERVICES, BILL PAYMENT SERVICES, CONSUMER AND HOME LOAN SERVICES, AUTOMATED TELLER MACHINE SERVICES, AND PAYCHECK DEPOSIT SERVICES, PROVIDING INFORMATION REGARDING THE FOREGOING VIA THE INTERNET, AND PROVIDING FINANCIAL, INVESTMENT, TAX, AND MORTGAGE INFORMATION TO EMPLOYEES OF BUSINESSES (U.S. CLS. 100, 101 AND 102).

FIRST USE 7-1-1997; IN COMMERCE 7-1-1997.

SN 76-409,648. INTERSTATE BUSINESS MANAGEMENT, INC., DALLAS, TX. FILED 5-17-2002.



Thrifty Tax

NO CLAIM IS MADE TO THE EXCLUSIVE RIGHT TO USE "TAX", APART FROM THE MARK AS SHOWN.

THE LINING IS A FEATURE OF THE MARK AND DOES NOT INDICATE COLOR.

FOR TAX SERVICES, NAMELY, TAX PAYMENT PROCESSING AND TAX PAYMENT DEBITING (U.S. CLS. 100, 101 AND 102).

FIRST USE 3-31-1986; IN COMMERCE 3-31-1986.

CLASS 36—(Continued).

SN 76-411,925. FRIENDS OF BENJAMIN FRANKLIN HOUSE, US, THE, PHILADELPHIA, PA. FILED 5-17-2002.

THE FRIENDS OF BENJAMIN FRANKLIN HOUSE

NO CLAIM IS MADE TO THE EXCLUSIVE RIGHT TO USE "BENJAMIN FRANKLIN HOUSE", APART FROM THE MARK AS SHOWN.

FOR CHARITABLE FUNDRAISING SERVICES DEDICATED TO THE RESTORATION AND PRESERVATION OF HISTORICAL BUILDINGS AND LANDMARKS (U.S. CLS. 100, 101 AND 102).

FIRST USE 2-19-1997; IN COMMERCE 2-19-1997.

SN 76-418,088. CYBERCORP HOLDINGS, INC., AUSTIN, TX. FILED 6-7-2002.

CYBERX2

OWNER OF U.S. REG. NO. 2,354,706.

FOR BROKERAGE SERVICES AND INVESTMENT SERVICES PROVIDED ELECTRONICALLY AND VIA GLOBAL INFORMATION NETWORKS, NAMELY, ELECTRONIC TRADING IN SECURITIES, STOCKS AND OPTIONS; PROVIDING FINANCIAL AND INVESTMENT INFORMATION, FINANCIAL AND INVESTMENT NEWS, FINANCIAL AND INVESTMENT RESEARCH, FINANCIAL AND INVESTMENT DATABASES, ALL FOR USE BY INVESTORS IN THE TRADING AND ANALYSIS OF INVESTMENTS, FINANCES, AND FINANCIAL PLANNING, VIA A GLOBAL COMPUTER NETWORK (U.S. CLS. 100, 101 AND 102).

FIRST USE 6-30-2000; IN COMMERCE 6-30-2000.

SN 76-418,986. AMERICA'S PROMISE - THE ALLIANCE FOR YOUTH, INC., ALEXANDRIA, VA. FILED 6-7-2002.

STRIVE FOR FIVE

FOR CHARITABLE FUNDRAISING (U.S. CLS. 100, 101 AND 102).

SN 76-420,214. SECURITY BENEFIT LIFE INSURANCE COMPANY, TOPEKA, KS. FILED 6-11-2002.

SECURITY BENEFIT GROUP RETIREMENT PROGRAM

OWNER OF U.S. REG. NOS. 1,516,668, 2,527,301 AND OTHERS.

NO CLAIM IS MADE TO THE EXCLUSIVE RIGHT TO USE "GROUP RETIREMENT PROGRAM", APART FROM THE MARK AS SHOWN.

FOR FINANCIAL SERVICES, NAMELY, RETIREMENT PLANS, DEFERRED COMPENSATION PLANS, PROFIT SHARING PLANS AND PENSION PLANS; PROVISION OF INFORMATION REGARDING SUCH PLANS; AND ADMINISTRATION OF SUCH PLANS (U.S. CLS. 100, 101 AND 102).

CLASS 36—(Continued).

SN 76-420,545. DORGAN INVESTMENTS LIMITED, NASSAU, BAHAMAS, FILED 6-13-2002.



EXPENSE REDUCTION ANALYSTS

NO CLAIM IS MADE TO THE EXCLUSIVE RIGHT TO USE "EXPENSE REDUCTION ANALYSTS", APART FROM THE MARK AS SHOWN.

FOR FINANCIAL APPRAISAL AND CONSULTANCY SERVICES, NAMELY, CONDUCTING FINANCIAL RESEARCH, ANALYSIS AND VALUATION OF BUSINESS AND PROVIDING FINANCIAL CONSULTATION TO BUSINESSES REGARDING EXPENSE REDUCTION (U.S. CLS. 100, 101 AND 102).

FIRST USE 9-0-1991; IN COMMERCE 9-0-1991.

SN 76-421,990. SUNTRUST BANKS, INC., ORLANDO, FL. FILED 6-17-2002.

INVESTOR'S PREMIER

NO CLAIM IS MADE TO THE EXCLUSIVE RIGHT TO USE "INVESTOR'S", APART FROM THE MARK AS SHOWN.

FOR INVESTMENT CONSULTATION AND INVESTMENT MANAGEMENT, NAMELY, PROVIDING A SUB-ADVISORY WRAP FEE PROGRAM FOR SEPARATE INVESTMENT ACCOUNTS OFFERING DISCRETIONARY INVESTMENT CONSULTING SERVICES AND ACCESS TO INSTITUTIONAL QUALITY INVESTMENT MANAGERS (U.S. CLS. 100, 101 AND 102).

SN 76-426,287. BAYERISCHE HYPO- UND VEREINSBANK AG, D-80538 MUNICH, FED REP GERMANY, FILED 6-28-2002.

SPACE IS MONEY

OWNER OF FED REP GERMANY REG. NO. 30136294, DATED 9-20-2001, EXPIRES 6-30-2011.

NO CLAIM IS MADE TO THE EXCLUSIVE RIGHT TO USE "MONEY", APART FROM THE MARK AS SHOWN.

FOR BANKING SERVICES, FINANCING SERVICES, MONETARY EXCHANGE SERVICES, ELECTRONIC FUNDS TRANSFER SERVICES, STOCK BROKERAGE SERVICES, MORTGAGE BANKING AND LENDING SERVICES, REAL ESTATE BROKERAGE SERVICES (U.S. CLS. 100, 101 AND 102).

SN 76-429,430. AEGON ASSET MANAGEMENT SERVICES, INC., ST. PETERSBURG, FL. FILED 7-3-2002.

**WORLD FINANCIAL GROUP
ELITE CAPITAL BUILDER**

NO CLAIM IS MADE TO THE EXCLUSIVE RIGHT TO USE "FINANCIAL GROUP ELITE CAPITAL BUILDER", APART FROM THE MARK AS SHOWN.

FOR FINANCIAL CONSULTING AND FINANCIAL MANAGEMENT SERVICES (U.S. CLS. 100, 101 AND 102).

CLASS 36—(Continued).

SN 76-429,986. INDYMAC BANK, F.S.B., PASADENA, CA. FILED 7-8-2002.

LOCK & LOCATE

FOR BANKING; MORTGAGE LENDING; COMMERCIAL LENDING SERVICES; CONSUMER LENDING SERVICES; REAL ESTATE BROKERAGE; INSURANCE BROKERAGE IN THE FIELD OF REAL ESTATE TITLES; SECURITY BROKERAGE; SECURITIES TRADING FOR OTHERS; AND CREDIT CARD SERVICES (U.S. CLS. 100, 101 AND 102).

FIRST USE 6-27-2002; IN COMMERCE 6-27-2002.

SN 76-439,062. ONYX ACCEPTANCE CORPORATION, FOOTHILL RANCH, CA. FILED 8-8-2002.

ePartner Network

NO CLAIM IS MADE TO THE EXCLUSIVE RIGHT TO USE "NETWORK", APART FROM THE MARK AS SHOWN.

FOR PROVIDES AUTOMOBILE FINANCING SERVICES VIA A WEB SITE OR GLOBAL COMPUTER NETWORK FOR COMPANIES TO OFFER TO THEIR CUSTOMERS (U.S. CLS. 100, 101 AND 102).

FIRST USE 1-11-2002; IN COMMERCE 1-11-2002.

SN 76-439,064. ONYX ACCEPTANCE CORPORATION, FOOTHILL RANCH, CA. FILED 8-8-2002.

ePartner  Network

SUCCESS IN TEAMWORK

§§

NO CLAIM IS MADE TO THE EXCLUSIVE RIGHT TO USE "NETWORK", APART FROM THE MARK AS SHOWN.

FOR PROVIDES AUTOMOBILE FINANCING SERVICES VIA A WEB SITE OR GLOBAL COMPUTER NETWORK FOR COMPANIES TO OFFER TO THEIR CUSTOMERS (U.S. CLS. 100, 101 AND 102).

FIRST USE 1-11-2002; IN COMMERCE 1-11-2002.

SN 76-439,438. MATTERHORN FINANCIAL SERVICES, INC., TIMONIUM, MD. FILED 8-12-2002.

MATTERHORN

FOR INSURANCE UNDERWRITING SERVICES IN THE FIELD OF LENDERS SINGLE INTEREST INSURANCE, MORTGAGE IMPAIRMENT INSURANCE, GAP INSURANCE, PERFORMANCE BONDS AND OTHER INSURANCE RELATING TO LENDING AND LEASING ACTIVITIES; INSURANCE CLAIMS ADMINISTRATION SERVICES; INSURANCE CLAIMS PROCESSING SERVICES; AND INSURANCE AGENCY SERVICES (U.S. CLS. 100, 101 AND 102).

FIRST USE 6-0-2000; IN COMMERCE 6-0-2000.

CLASS 36—(Continued).

SN 76-439,440. MATTERHORN FINANCIAL SERVICES, INC., TIMONIUM, MD. FILED 8-12-2002.

MATTERHORN

FOR INSURANCE UNDERWRITING SERVICES IN THE FIELD OF LENDERS SINGLE INTEREST INSURANCE, MORTGAGE IMPAIRMENT INSURANCE, GAP INSURANCE, PERFORMANCE BONDS AND OTHER INSURANCE RELATING TO LENDING AND LEASING ACTIVITIES; INSURANCE CLAIMS ADMINISTRATION SERVICES; INSURANCE CLAIMS PROCESSING SERVICES; AND INSURANCE AGENCY SERVICES (U.S. CLS. 100, 101 AND 102).

FIRST USE 10-0-2000; IN COMMERCE 10-0-2000.

SN 76-439,476. VISTA HEALTH PLAN, INC., HOLLYWOOD, FL. FILED 8-12-2002.

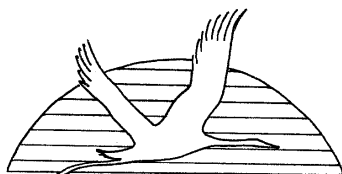

THE LINING ON THE DRAWING IS A FEATURE OF THE MARK AND IS NOT INTENDED TO INDICATE COLOR.

FOR INSURANCE UNDERWRITING AND ADMINISTRATION SERVICES IN THE FIELD OF HEALTH INSURANCE AND MANAGED HEALTH CARE PLANS (U.S. CLS. 100, 101 AND 102).

FIRST USE 7-1-2002; IN COMMERCE 7-1-2002.

SN 76-447,668. PASS FOOTBALL LEAGUE LLC, LOS ANGELES, CA. FILED 9-3-2002.

GOALS FOR YOUTH

NO CLAIM IS MADE TO THE EXCLUSIVE RIGHT TO USE "YOUTH", APART FROM THE MARK AS SHOWN.

FOR CHARITABLE FUND RAISING SERVICES FOR YOUNG PEOPLE (U.S. CLS. 100, 101 AND 102).

SN 76-451,582. MRB, INC., PHILADELPHIA, PA. FILED 9-23-2002.

METROREPORT

FOR INSURANCE SERVICES, NAMELY, PROVIDING A DATABASE TO THE FINANCIAL, CORPORATE, REAL ESTATE, AND LEGAL INDUSTRIES FEATURING SOFTWARE USING EXTENSIBLE MARKUP LANGUAGE (XML) FOR FACILITATING THE EXCHANGE OF INFORMATION IN THE NATURE OF REPORTS FOR CLAIMS AND SUBROGATION REPORTING (U.S. CLS. 100, 101 AND 102).

FIRST USE 9-30-1957; IN COMMERCE 9-30-1957.

CLASS 36—(Continued).

SN 76-455,774. TRACEY, ROBERT J., BROOKLYN, NY. FILED 9-30-2002.

BROOKLYN PROUD

NO CLAIM IS MADE TO THE EXCLUSIVE RIGHT TO USE "BROOKLYN", APART FROM THE MARK AS SHOWN.

FOR REAL ESTATE BROKERAGE SERVICES (U.S. CLS. 100, 101 AND 102).

FIRST USE 5-0-2001; IN COMMERCE 5-0-2001.

SN 76-456,290. THE MILLS LIMITED PARTNERSHIP, ARLINGTON, VA. FILED 10-2-2002.

CINCY MILLS

FOR SHOPPING CENTER SERVICES AND LEASING OF SHOPPING MALL SPACE (U.S. CLS. 100, 101 AND 102).

SN 76-457,944. PORTLAND-PACIFIC LLC, SANTA BARBARA, CA. FILED 10-3-2002.

PORTLAND-PACIFIC

FOR REAL ESTATE INVESTMENT AND PROPERTY MANAGEMENT (U.S. CLS. 100, 101 AND 102).

SN 76-459,381. MIDFIRST BANK, OKLAHOMA CITY, OK. FILED 10-15-2002.

SUPER VALUE TUESDAY

NO CLAIM IS MADE TO THE EXCLUSIVE RIGHT TO USE "TUESDAY", APART FROM THE MARK AS SHOWN.

FOR BANKING; LOAN FINANCING; SAVINGS AND LOAN SERVICES; HOME EQUITY LOANS; CHECKING ACCOUNT SERVICES; SAVINGS ACCOUNT SERVICES (U.S. CLS. 100, 101 AND 102).

FIRST USE 7-20-2002; IN COMMERCE 7-20-2002.

CLASS 36—(Continued).

SN 76-460,918. DLJ LONG TERM INVESTMENT CORPORATION, CHICAGO, IL. FILED 10-22-2002.



FOR BROKERAGE AND DEALER SERVICES IN SECURITIES, BONDS, MUTUAL FUNDS, OTHER INVESTMENT FUNDS, AND COMMODITIES; FINANCIAL ADVISORY AND CONSULTING SERVICES; FINANCIAL INVESTMENT AND MANAGEMENT SERVICES; FINANCIAL RESEARCH AND INFORMATION SERVICES (U.S. CLS. 100, 101 AND 102).
FIRST USE 5-0-2002; IN COMMERCE 5-0-2002.

SN 76-463,634. HNI RISK SERVICES, INC., NEW BERLIN, WI. FILED 11-1-2002.



NO CLAIM IS MADE TO THE EXCLUSIVE RIGHT TO USE "RISK SERVICES", APART FROM THE MARK AS SHOWN.
FOR INSURANCE BROKERAGE SERVICES; RISK MANAGEMENT SERVICES; RISK CONTROL CONSULTING (U.S. CLS. 100, 101 AND 102).
FIRST USE 9-1-2002; IN COMMERCE 9-1-2002.

CLASS 36—(Continued).

SN 76-467,897. SECOND NATIONAL BANK OF WARREN, WARREN, OH. FILED 11-18-2002.



NO CLAIM IS MADE TO THE EXCLUSIVE RIGHT TO USE "SECOND NATIONAL BANK", APART FROM THE MARK AS SHOWN.
FOR BANKING SERVICES (U.S. CLS. 100, 101 AND 102).
FIRST USE 10-1-1998; IN COMMERCE 10-1-1998.

SN 76-469,672. ROBERTS ENTERPRISES, INC., SILVER SPRINGS, FL. FILED 11-13-2002.

THE GOURMET COLLECTION BY ABUNDANT FUNDS

NO CLAIM IS MADE TO THE EXCLUSIVE RIGHT TO USE "THE GOURMET COLLECTION" AND "FUNDS", APART FROM THE MARK AS SHOWN.
FOR CHARITABLE FUND RAISING FOR SCHOOLS THROUGH THE USE OF CATALOGS FEATURING CHEESECAKES AND COOKIES (U.S. CLS. 100, 101 AND 102).
FIRST USE 1-0-2001; IN COMMERCE 1-0-2001.

SN 76-470,473. BURKE GROUP INC., HONEOYE FALLS, NY. FILED 11-27-2002.

WORKSITECOMMERCE

FOR BANKING SERVICES; INSURANCE SERVICES, NAMELY INSURANCE BROKERAGE, INSURANCE AGENCIES, INSURANCE ADMINISTRATION AND INSURANCE CONSULTATION, IN THE FIELDS OF LIFE, PROPERTY AND CASUALTY, ACCIDENT, HEALTH AND OTHER INSURANCE; CREDIT INSURANCE SERVICES; FINANCIAL SERVICES, NAMELY, FINANCIAL AND INVESTMENT CONSULTING, MANAGEMENT AND ADVISORY SERVICES; INVESTMENT AND SECURITIES BROKERAGE SERVICES; PROVIDING INFORMATION ON INVESTMENT AND SECURITIES PERFORMANCE; ANNUITIES SERVICES; CHARITABLE FUND RAISING SERVICES (U.S. CLS. 100, 101 AND 102).

CLASS 36—(Continued).

SN 76-471,257. NEW YORK STOCK EXCHANGE, INC., NEW YORK, NY. FILED 11-18-2002.

NYSE SPECIALIST PORTFOLIO

NO CLAIM IS MADE TO THE EXCLUSIVE RIGHT TO USE "SPECIALIST PORTFOLIO", APART FROM THE MARK AS SHOWN.

FOR CONDUCTING A SECURITIES EXCHANGE AND RELATED STOCK MARKET SERVICES, NAMELY, DISSEMINATING AND PROVIDING ACCESS TO FINANCIAL AND SECURITIES INFORMATION INCLUDING SECURITIES ORDER MANAGEMENT INFORMATION, VIA ELECTRONIC MEANS (U.S. CLS. 100, 101 AND 102).
FIRST USE 6-0-2000; IN COMMERCE 6-0-2000.

SN 76-471,498. THE AMERIDREAM CHARITY, INC., GAITHERSBURG, MD. FILED 11-29-2002.



OWNER OF U.S. REG. NOS. 2,578,724 AND 2,609,725.
NO CLAIM IS MADE TO THE EXCLUSIVE RIGHT TO USE "INCORPORATED", APART FROM THE MARK AS SHOWN.
FOR FINANCIAL ASSISTANCE IN THE FORM OF DOWNPAYMENT AND DEBT RELIEF GIFT FUNDS FOR LOW AND MODERATE INCOME HOMEBUYERS (U.S. CLS. 100, 101 AND 102).

SN 76-472,038. HORWITZ, LEWIS P., CENTURY CITY, CA. FILED 11-25-2002.

LHO

FOR FINANCIAL SERVICES, NAMELY, FINANCING MOTION PICTURES AND TELEVISION PRODUCTIONS (U.S. CLS. 100, 101 AND 102).
FIRST USE 8-0-1980; IN COMMERCE 8-0-1980.

SN 76-472,560. UBS AG, CH-8001, ZURICH, SWITZERLAND, FILED 12-4-2002.

SPIRITS

FOR STOCK BROKERAGE, MONEY MANAGEMENT, INVESTMENT ADVISORY SERVICES AND ASSET AND STOCK PORTFOLIO MANAGEMENT (U.S. CLS. 100, 101 AND 102).
FIRST USE 11-22-2002; IN COMMERCE 11-22-2002.

CLASS 36—(Continued).

SN 76-474,058. BANK OF AMERICA CORPORATION, CHARLOTTE, NC. FILED 12-12-2002.



FOR BANKING AND RELATED FINANCIAL SERVICES (U.S. CLS. 100, 101 AND 102).

SN 76-477,444. UPIB, INC., HAMILTON, BERMUDA, FILED 12-20-2002.

ONE UP

FOR BANKING SERVICES (U.S. CLS. 100, 101 AND 102).
FIRST USE 10-4-1990; IN COMMERCE 10-4-1990.

SN 76-482,525. CAMBRIDGE ASSOCIATES LLC, BOSTON, MA. FILED 1-15-2003.

CAMBRIDGE CAPITAL ADVISORY SERVICE

OWNER OF U.S. REG. NOS. 1,448,853, 2,239,702 AND OTHERS.

NO CLAIM IS MADE TO THE EXCLUSIVE RIGHT TO USE "CAPITAL ADVISORY SERVICE", APART FROM THE MARK AS SHOWN.

SEC. 2(F) AS TO "CAMBRIDGE".
FOR INVESTMENT AND FINANCIAL CONSULTING AND ADVISORY SERVICES FOR OTHERS; INVESTMENT AND FINANCIAL PLANNING; INVESTMENT AND FINANCIAL MANAGEMENT; INVESTMENT AND FINANCIAL PERFORMANCE ANALYSIS; RESEARCH AND ANALYSIS IN THE INVESTMENT AND FINANCIAL FIELDS; PROVIDING INVESTMENT AND FINANCIAL INFORMATION TO OTHERS BY ELECTRONIC AND NON-ELECTRONIC MEANS (U.S. CLS. 100, 101 AND 102).
FIRST USE 5-0-2000; IN COMMERCE 5-0-2000.

CLASS 36—(Continued).

SN 78-036,000. BULLWINKEL, DOUGLAS K., WALNUT CREEK, CA. FILED 11-19-2000.



NO CLAIM IS MADE TO THE EXCLUSIVE RIGHT TO USE "COP LOANS.COM", APART FROM THE MARK AS SHOWN.

THE BADGE TO THE FAR LEFT IS FILLED IN A SOLID GOLD/DEEP YELLOW COLOR AND IS OUTLINED IN BLACK. THE SOLID PORTION OF THE LETTERING "COPLOANS.COM" IS COLORED A DARK ROYAL BLUE, SURROUNDED BY A SOLID WHITE BORDER AND OUTLINED IN BLACK.

FOR MORTGAGE BROKERAGE FOR HOME MORTGAGE SERVICES (U.S. CLS. 100, 101 AND 102).

SN 78-045,923. PORTOGO, INC., MINNEAPOLIS, MN. FILED 1-31-2001.

INSURITI

FOR INSURANCE AGENCY SERVICES IN THE FIELD OF INTERNET TRANSMISSION LIABILITY; INSURANCE UNDERWRITING IN THE FIELD OF INTERNET TRANSMISSION LIABILITY (U.S. CLS. 100, 101 AND 102).

SN 78-085,371. WOOD, ANDREW H., WALTON, NY. AND WOOD, PAUL F., WALTON, NY. FILED 9-25-2001.

LAZARUS TRUSTS

NO CLAIM IS MADE TO THE EXCLUSIVE RIGHT TO USE "TRUSTS", APART FROM THE MARK AS SHOWN.

FOR BANKING SERVICES; INVESTMENT AND TRUST COMPANY SERVICES; CREATION AND MANAGEMENT OF TRUSTS; BROKERAGE, ADMINISTRATION AND UNDERWRITING OF ANNUITIES AND ALL TYPES OF INSURANCE; BROKERAGE OF SECURITIES AND COMMODITIES; FINANCIAL CONSULTATION SERVICES IN THE FIELD OF INVESTMENT ADVICE AND ESTATE PLANNING (U.S. CLS. 100, 101 AND 102).

CLASS 36—(Continued).

SN 78-100,688. ABN AMRO BANK N.V., AMSTERDAM, NETHERLANDS, FILED 1-3-2002.

VAN GOGH

PRIORITY CLAIMED UNDER SEC. 44(D) ON BENELUX APPLICATION NO. 993173, FILED 7-10-2001, REG. NO. 0696295, DATED 7-10-2001, EXPIRES 7-10-2011.

FOR BANKING SERVICES; INVESTMENT BANKING SERVICES; MERCHANT BANKING SERVICES; FINANCIAL SERVICES, NAMELY, MONEY LENDING AND INVESTMENT FUND TRANSFER AND TRANSACTION SERVICES; SERVICES OF COMMISSION AGENTS, NAMELY, INVESTMENT ADVICE; STOCK BROKERAGE SERVICES; INSURANCE SERVICES, NAMELY, LIFE INSURANCE UNDERWRITING; INSURANCE UNDERWRITING SERVICES FOR ALL TYPES OF INSURANCE; ACTUARIAL SERVICES; INTERMEDIARY SERVICES WITH REGARD TO INSURANCE, NAMELY, CLAIMS ADJUSTMENT IN THE FIELD OF INSURANCE; SERVICES OF COMMISSION AGENTS AND INSURANCE BROKERS, NAMELY, BROKERAGE IN THE FIELD OF INSURANCE; ADMINISTRATION OF EMPLOYEE PENSION PLANS; FINANCIAL ANALYSIS AND CONSULTATION IN THE FIELD OF PENSION PLANS; INVESTMENT MANAGEMENT; INVESTMENT CONSULTATION; FINANCIAL MANAGEMENT; PROVIDING TEMPORARY LOANS; BROKERAGE IN THE FIELD OF STOCKS, BONDS AND COMMODITY FUTURES; RENDERING OF SERVICES WITH REGARD TO SUBSCRIPTION TO SHARES, NAMELY, FORMATION, BROKERAGE AND MANAGEMENT OF LIMITED PARTNERSHIPS; FINANCIAL VALUATION OF PERSONAL PROPERTY AND REAL ESTATE; FIDUCIARY REPRESENTATIVES; ADMINISTRATION OF SAVINGS ACCOUNTS; REAL ESTATE TRUSTEE SERVICES; CHARITABLE FUND RAISING; SAFE DEPOSIT BOX SERVICES; FINANCIAL EXCHANGE SERVICES IN THE FIELD OF FOREIGN EXCHANGE TRANSACTIONS AND FOREIGN EXCHANGE ARBITRAGE AND TRADING IN FORWARD EXCHANGE RATES; DISCOUNT BROKERAGE SERVICES; BILL CONSOLIDATION SERVICES; FINANCIAL GUARANTEE AND SURETY SERVICES; AGENCIES IN THE FIELD OF BONDS AND OTHER SECURITIES; CREDIT AGENCIES; FINANCIAL SERVICES, NAMELY, INVESTMENT FUND TRANSFER AND TRANSACTION SERVICES; COMMODITY TRADING FOR OTHERS; DEBT RECOVERY AND COLLECTION AGENCIES; MORTGAGE LENDING SERVICES; FINANCIAL ANALYSIS AND CONSULTATION IN THE FIELD OF FUND FLOW MANAGEMENT; COMMODITIES EXCHANGE SERVICES; CAPITAL INVESTMENT CONSULTATION; CREDIT CONSULTATION; FINANCIAL ANALYSIS AND CONSULTATION; FUND INVESTMENT CONSULTATION; INSURANCE CONSULTATION; AND INVESTMENT CONSULTATION; ALL SERVICES PROVIDED DIRECTLY AS WELL AS VIA THE INTERNET, EXTERNAL COMPUTER NETWORKS AND BY OTHER ELECTRONIC MEANS (U.S. CLS. 100, 101 AND 102).

SN 78-114,565. LINCOLN NATIONAL LIFE INSURANCE COMPANY, THE, FORT WAYNE, IN. FILED 3-13-2002.

ABE

OWNER OF U.S. REG. NO. 1,748,839.

FOR ANNUITY UNDERWRITING SERVICES FEATURING AN ANNUITY THAT ENABLES ACCOUNT HOLDERS TO MAINTAIN EXISTING DEATH BENEFIT COVERAGE FROM A PREVIOUS ANNUITY CONTRACT (U.S. CLS. 100, 101 AND 102).

FIRST USE 1-14-2002; IN COMMERCE 1-14-2002.

CLASS 36—(Continued).

SN 78-116,436. INTERMART CORP., THOUSAND OAKS, CA. FILED 3-21-2002.

SMARTCARDWALLET

FOR FINANCIAL SERVICES; NAMELY, PROVIDING CREDIT CARDS, DEBIT CARDS, CHARGE CARDS, STORED VALUE CARDS, SMART CARDS, TRAVELERS CARDS, CASH DISBURSEMENTS, AND TRANSACTION AUTHORIZATION AND SETTLEMENT SERVICES (U.S. CLS. 100, 101 AND 102).

SN 78-122,637. LANGVA, MARC D., WAYZATA, MN. FILED 4-18-2002.

FREEDOM ADVISOR

NO CLAIM IS MADE TO THE EXCLUSIVE RIGHT TO USE "ADVISOR", APART FROM THE MARK AS SHOWN. FOR FINANCIAL SERVICES NAMELY FINANCIAL PLANNING/ADVICE (U.S. CLS. 100, 101 AND 102). FIRST USE 7-1-2000; IN COMMERCE 7-1-2000.

SN 78-129,155. BANDON DUNES, L.P., CHICAGO, IL. FILED 5-16-2002.

BANDON DUNES REALTY

OWNER OF U.S. REG. NO. 2,329,835. NO CLAIM IS MADE TO THE EXCLUSIVE RIGHT TO USE "REALTY", APART FROM THE MARK AS SHOWN. FOR REAL STATE SERVICES, NAMELY, REAL ESTATE LISTING, BROKERAGE, INVESTMENT, CONSULTING AND MANAGEMENT (U.S. CLS. 100, 101 AND 102).

SN 78-134,114. FEDERAL NATIONAL MORTGAGE ASSOCIATION, DBA FANNIE MAE, WASHINGTON, DC. FILED 6-7-2002.

HOMEMANAGER

FOR MORTGAGE LOAN SERVICES (U.S. CLS. 100, 101 AND 102).

CLASS 36—(Continued).

SN 78-138,327. SINCLAIR OIL CORPORATION, SALT LAKE CITY, UT. FILED 6-24-2002.

SINCLAIR HEALTH SERVICES

NO CLAIM IS MADE TO THE EXCLUSIVE RIGHT TO USE "HEALTH SERVICES", APART FROM THE MARK AS SHOWN.

SEC. 2(F). FOR ADMINISTRATION OF PRE-PAID HEALTH CARE PLANS AND PREFERRED PROVIDER HEALTH CARE PLANS (U.S. CLS. 100, 101 AND 102). FIRST USE 6-0-1997; IN COMMERCE 6-0-1997.

SN 78-139,417. UNITEDNATIONAL MORTGAGE CORPORATION, BERNARDSVILLE, NJ. FILED 6-27-2002.

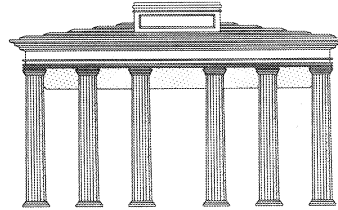

THE LINING AND STIPPLING ARE FEATURES OF THE MARK AND DO NOT INDICATE COLOR. FOR HOME EQUITY LOANS AND MORTGAGE LENDING SERVICES (U.S. CLS. 100, 101 AND 102).

SN 78-140,738. KEYCORP, CLEVELAND, OH. FILED 7-2-2002.

KEY EQUIPMENT FINANCE

OWNER OF U.S. REG. NOS. 149,527, 2,566,844 AND OTHERS.

NO CLAIM IS MADE TO THE EXCLUSIVE RIGHT TO USE "EQUIPMENT FINANCE", APART FROM THE MARK AS SHOWN.

FOR EQUIPMENT FINANCE, INCLUDING LEASE FINANCING, OF COMMERCIAL EQUIPMENT FOR BUSINESSES (U.S. CLS. 100, 101 AND 102). FIRST USE 5-1-2001; IN COMMERCE 5-1-2001.

SN 78-143,331. TEQUILA CUERVO LA ROJENA, S.A. DE C.V., ZAPOPAN JALISCO, CODIGO 45070, MEXICO, FILED 7-12-2002.

GRAN CENTENARIO PAINT THE PARTY

THE ENGLISH TRANSLATION OF "GRAN CENTENARIO" IS "GRAND CENTURY". FOR CHARITABLE FUND RAISING SERVICES (U.S. CLS. 100, 101 AND 102).

CLASS 36—(Continued).

SN 78-145,155. GOLDMAN, SACHS & CO., NEW YORK, NY.
FILED 7-18-2002.

GS \$ INVESTOP

OWNER OF U.S. REG. NOS. 2,394,892, 2,437,565 AND
2,532,433.

FOR FINANCIAL INFORMATION SERVICES,
NAMELY, CALCULATION, PROVISION, AND UPDAT-
ING OF THE BENEFIT OF OTHERS OF A FINANCIAL
CREDIT INDEX (U.S. CLS. 100, 101 AND 102).

SN 78-145,678. INTERNATIONAL REALTORS, INC., LOUIS-
VILLE, KY. FILED 7-19-2002.



NO CLAIM IS MADE TO THE EXCLUSIVE RIGHT TO
USE "INTERNATIONAL REALTORS, INC.", APART FROM
THE MARK AS SHOWN.

THE MARK CONSISTS OF THE DESIGN OF A GLOBE
WITH THE CONTINENTS PICTURED IN THE COLOR
GOLD. COLOR IS CLAIMED AS PART OF THE MARK.

FOR REAL ESTATE AGENCIES, NAMELY BUYING
AND SELLING HOMES AND COMMERCIAL PROPER-
TIES FOR OTHERS (U.S. CLS. 100, 101 AND 102).

FIRST USE 1-1-2001; IN COMMERCE 1-1-2001.

SN 78-149,679. FERRAZZA, MICHAEL J., WEXFORD, PA.
FILED 8-1-2002.

MORTGAGE911

FOR MORTGAGE BROKERAGE, MORTGAGE LEND-
ING AND LOAN FINANCING SERVICES, NAMELY,
ASSISTING CONSUMERS WITH IMPAIRED CREDIT
OR NON-CONFORMING LENDING SITUATIONS OBTAIN
MORTGAGE FINANCING (U.S. CLS. 100, 101 AND
102).

FIRST USE 7-0-2002; IN COMMERCE 7-0-2002.

SN 78-157,790. MEYER RESIDENTIAL LLC, HOUSTON, TX.
FILED 8-26-2002.

CROSSING PLACE

FOR REALTY SERVICES, NAMELY, LEASING AND
MANAGEMENT OF APARTMENT PROPERTIES; AND
REAL ESTATE BROKERAGE SERVICES IN THE FIELD
OF APARTMENT PROPERTIES (U.S. CLS. 100, 101 AND
102).

FIRST USE 10-30-2001; IN COMMERCE 10-30-2001.

CLASS 36—(Continued).

SN 78-164,820. LEHMAN BROTHERS INC., NEW YORK, NY.
FILED 9-17-2002.

SMARTCONNECT

OWNER OF U.S. REG. NO. 2,475,362.
FOR ON-LINE BROKERAGE SERVICES FOR TRAD-
ING FUTURES (U.S. CLS. 100, 101 AND 102).
FIRST USE 8-21-2002; IN COMMERCE 8-21-2002.

SN 78-165,954. FIRST TENNESSEE NATIONAL CORPORA-
TION, MEMPHIS, TN. FILED 9-19-2002.

FTN

OWNER OF U.S. REG. NO. 2,388,036.
FOR HOUSE MARK FOR A FULL LINE OF FINAN-
CIAL SERVICES, NAMELY, MORTGAGE SERVICES,
SECURITIES BROKERAGE SERVICES, INVESTMENT
BANKING SERVICES, FINANCIAL SERVICES,
NAMELY INVESTMENT BANKING, FINANCIAL PORT-
FOLIO MANAGEMENT AND CONSULTATION, PRO-
VIDING FINANCIAL RESEARCH REGARDING
EQUITY REPORTS AND STRUCTURED FINANCE
AND INSURANCE SERVICES EXCEPT FOR ANNUITY
UNDERWRITING SERVICES (U.S. CLS. 100, 101 AND
102).

SN 78-172,089. XCU CAPITAL CORPORATION, INC.,
CARLSBAD, CA. FILED 10-8-2002.

XCU MANAGED PROGRAM

OWNER OF U.S. REG. NO. 1,983,865.
NO CLAIM IS MADE TO THE EXCLUSIVE RIGHT TO
USE "MANAGED PROGRAM", APART FROM THE MARK
AS SHOWN.

FOR INVESTMENT BROKERAGE SERVICES FOR
CREDIT UNION MEMBERS (U.S. CLS. 100, 101 AND
102).

FIRST USE 9-0-2002; IN COMMERCE 9-0-2002.

SN 78-172,503. FRANKLIN, JOYCE, LARKSPUR, CA. FILED
10-9-2002.

ENJOY LIFE. PLAN WISELY.

FOR FINANCIAL PLANNING, FINANCIAL LIFE
PLANNING, INVESTMENT ADVISORY SERVICES, IN-
VESTMENT MANAGEMENT AND FINANCIAL PLAN-
NING AND MANAGEMENT, NAMELY WEALTH
PLANNING AND WEALTH MANAGEMENT (U.S. CLS.
100, 101 AND 102).

FIRST USE 10-7-2002; IN COMMERCE 10-7-2002.

CLASS 36—(Continued).

SN 78-173,249. LE'S INTERCONTINENTAL MONEY TRANSFER, INC., WESTMINSTER, CA. FILED 10-10-2002.

LE'S INTERCONTINENTAL MONEY TRANSFER, INC. LE
GỎI-TIÊN LE

NO CLAIM IS MADE TO THE EXCLUSIVE RIGHT TO USE "INTERCONTINENTAL MONEY TRANSFER, INC." AND "GOI-TIEN LE", APART FROM THE MARK AS SHOWN.

THE FOREIGN WORDING IN THE MARK TRANSLATES INTO ENGLISH AS "GOI TIEN" MEANS "SEND MONEY" AND "LE" MEANS "QUICK".

FOR MONEY TRANSFER SERVICES; ELECTRONIC FUND TRANSFERS; ELECTRONIC PROCESSING AND TRANSMISSION OF MONETARY PAYMENT AND FUND TRANSFERS (U.S. CLS. 100, 101 AND 102).
FIRST USE 10-15-1999; IN COMMERCE 10-15-1999.

SN 78-173,384. MAINE REAL ESTATE INFORMATION SYSTEM, INC., SOUTH PORTLAND, ME. FILED 10-11-2002.

MLS-LT

FOR PROVIDING REAL ESTATE INFORMATION BY MEANS OF A TELEPHONE-ACCESSIBLE VOICE-ACTIVATED DATABASE (U.S. CLS. 100, 101 AND 102).

SN 78-175,351. GENOA SAVINGS AND LOAN COMPANY, THE, GENOA, OH. FILED 10-17-2002.

**WE SEE NEIGHBORS
WHERE OTHERS SEE
NUMBERS**

FOR BANKING SERVICES (U.S. CLS. 100, 101 AND 102).
FIRST USE 11-1-1999; IN COMMERCE 11-1-1999.

SN 78-176,392. POPULAR, INC., SAN JUAN, PUERTO RICO, FILED 10-21-2002.

**CENTRO HIPOTECARIO
POPULAR**

OWNER OF U.S. REG. NOS. 1,610,074, 2,467,524 AND OTHERS.

NO CLAIM IS MADE TO THE EXCLUSIVE RIGHT TO USE "CENTRO HIPOTECARIO", APART FROM THE MARK AS SHOWN.

THE FOREIGN WORDING IN THE MARK TRANSLATES INTO ENGLISH AS "POPULAR MORTGAGE CENTER".

FOR FINANCIAL SERVICES, NAMELY MORTGAGE BROKERAGE AND MORTGAGE LENDING SERVICES. (U.S. CLS. 100, 101 AND 102).

CLASS 36—(Continued).

SN 78-177,937. ZPOINT ADVISORS LP, PURCHASE, NY. FILED 10-24-2002.

ZPOINT MASTER FUND

NO CLAIM IS MADE TO THE EXCLUSIVE RIGHT TO USE "MASTER FUND", APART FROM THE MARK AS SHOWN.

FOR FINANCIAL SERVICES; NAMELY, INVESTMENT ADVISORY SERVICES; INVESTMENT MANAGEMENT SERVICES; AND ASSET MANAGEMENT SERVICES (U.S. CLS. 100, 101 AND 102).

SN 78-178,069. PITNEY BOWES INC., STAMFORD, CT. FILED 10-24-2002.

EASYPERMITPOSTAGE

FOR FINANCIAL SERVICES, NAMELY, MONEY LENDING FOR PAYMENT OF POSTAGE; AND ELECTRONIC PAYMENT SERVICES FOR PROCESSING ELECTRONIC FUNDS TRANSFERS FOR PAYMENT OF PERMIT MAIL, BULK MAIL AND POSTAGE. (U.S. CLS. 100, 101 AND 102).

SN 78-178,584. CITICORP, NEW YORK, NY. FILED 10-25-2002.

RETIREMENT REIMAGINED

NO CLAIM IS MADE TO THE EXCLUSIVE RIGHT TO USE "RETIREMENT", APART FROM THE MARK AS SHOWN.

FOR FINANCIAL SERVICES, NAMELY FUNDS INVESTMENT, INVESTMENT ADVICE; FINANCIAL MANAGEMENT AND FINANCIAL ADVICE; AND FINANCIAL RETIREMENT PLANNING SERVICES (U.S. CLS. 100, 101 AND 102).

SN 78-178,945. HARTFORD FIRE INSURANCE COMPANY, HARTFORD, CT. FILED 10-28-2002.

**THE HARTFORD PLAN FOR
LIFE SERIES**

OWNER OF U.S. REG. NOS. 1,155,051, 2,262,935 AND OTHERS.

NO CLAIM IS MADE TO THE EXCLUSIVE RIGHT TO USE "PLAN FOR LIFE SERIES", APART FROM THE MARK AS SHOWN.

SEC. 2(F) AS TO "THE HARTFORD".
FOR ANNUITY UNDERWRITING SERVICES, RETIREMENT PLANNING AND ADMINISTRATIVE SERVICES, AND MUTUAL FUND SERVICES (U.S. CLS. 100, 101 AND 102).

CLASS 36—(Continued).

SN 78-178,949. HARTFORD FIRE INSURANCE COMPANY, HARTFORD, CT. FILED 10-28-2002.

**CLASSIC HARTFORD
LEADERS OUTLOOK**

OWNER OF U.S. REG. NOS. 1,155,051, 2,432,862 AND OTHERS.
SEC. 2(F) AS TO "HARTFORD".
FOR VARIABLE ANNUITY UNDERWRITING INSURANCE SERVICES (U.S. CLS. 100, 101 AND 102).
FIRST USE 9-19-2002; IN COMMERCE 9-19-2002.

SN 78-181,465. GODWIN W. ESHESIMUA, MIRAMAR, FL. FILED 11-4-2002.

XO CASH ACCESS

NO CLAIM IS MADE TO THE EXCLUSIVE RIGHT TO USE "CASH ACCESS", APART FROM THE MARK AS SHOWN.
FOR DEBIT CARD SERVICES FOR HEALTHCARE CONSUMERS (U.S. CLS. 100, 101 AND 102).

SN 78-182,068. OXFORD FINANCE CORPORATION, ALEXANDRIA, VA. FILED 11-5-2002.

**TODAY'S CAPITAL FOR
TOMORROW'S CURES**

FOR FINANCING SERVICES (U.S. CLS. 100, 101 AND 102).
FIRST USE 10-3-1999; IN COMMERCE 10-3-1999.

SN 78-183,763. LAND/WATER/SKY, L.L.C., BANDERA, TX. FILED 11-11-2002.



THE DRAWING IS LINED FOR THE COLOR(S) RED, BLUE AND GREEN BUT COLOR IS NOT A FEATURE OF THE MARK.
FOR LAND ACQUISITION, NAMELY, REAL ESTATE BROKERAGE SERVICES (U.S. CLS. 100, 101 AND 102).
FIRST USE 2-0-2002; IN COMMERCE 2-0-2002.

CLASS 36—(Continued).

SN 78-185,397. FUNDSQUEST INC, HUNTINGDON VALLEY, PA. FILED 11-15-2002.

TREASURE BUILDER

FOR CHARITABLE FUND RAISING SERVICES FOR NON-PROFIT ORGANIZATIONS. (U.S. CLS. 100, 101 AND 102).

SN 78-185,565. QUANTIA CAPITAL MANAGEMENT GP, LLC, PRINCETON, NJ. FILED 11-15-2002.

QUANTIA

FOR FINANCIAL SERVICES, NAMELY FINANCIAL FUNDS MANAGEMENT. (U.S. CLS. 100, 101 AND 102).

SN 78-185,827. WHOSHOME, INC., MADISON, WI. FILED 11-16-2002.

WHOSHOME

FOR REAL ESTATE SERVICES, NAMELY, BROKERAGE AND LISTING SERVICES (U.S. CLS. 100, 101 AND 102).
FIRST USE 8-16-2002; IN COMMERCE 8-16-2002.

SN 78-185,833. WHOSHOME, INC., MADISON, WI. FILED 11-16-2002.

REAL ESTATE. REAL VALUE.

FOR REAL ESTATE SERVICES, NAMELY, BROKERAGE AND LISTING SERVICES (U.S. CLS. 100, 101 AND 102).
FIRST USE 8-16-2002; IN COMMERCE 8-16-2002.

SN 78-186,038. AMERICAN CARD SERVICES, INC., ORINDA, CA. FILED 11-18-2002.

**PROSPER FROM OUR
EXPERIENCE**

FOR DEBIT CARD SERVICES (U.S. CLS. 100, 101 AND 102).

CLASS 36—(Continued).

SN 78-186,084. DRIVERSHIELD CORP., RONKONKOMA, NY. FILED 11-18-2002.

ACCESSITY

FOR INSURANCE CLAIMS MANAGEMENT SERVICES (U.S. CLS. 100, 101 AND 102).

SN 78-186,469. FMR CORP., BOSTON, MA. FILED 11-19-2002.



FOR ADMINISTRATION OF EMPLOYEE BENEFIT PLANS; ADMINISTRATION OF EMPLOYEE PENSION PLANS; ADMINISTRATION OF EMPLOYEE HEALTH CARE AND EMPLOYEE WELFARE BENEFIT PLANS; INVESTMENT OF FUNDS FOR OTHERS (U.S. CLS. 100, 101 AND 102).

SN 78-190,595. FIRST NATIONAL OF NEBRASKA, INC., OMAHA, NE. FILED 12-3-2002.



OWNER OF U.S. REG. NO. 1,270,238.
NO CLAIM IS MADE TO THE EXCLUSIVE RIGHT TO USE "FIRST NATIONAL BANK USA", APART FROM THE MARK AS SHOWN.
FOR BANKING SERVICES (U.S. CLS. 100, 101 AND 102).

SN 78-190,606. MARRIOTT INTERNATIONAL, INC., BETHESDA, MD. FILED 12-3-2002.

MARRIOTT VACATIONS

OWNER OF U.S. REG. NOS. 899,900, 2,451,587 AND OTHERS.
NO CLAIM IS MADE TO THE EXCLUSIVE RIGHT TO USE "VACATIONS", APART FROM THE MARK AS SHOWN.
FOR REAL ESTATE SERVICES, NAMELY, FINANCING, MANAGEMENT, BROKERAGE AND LEASING OF TIMESHARE PROPERTIES; TICKET BROKERING SERVICES (U.S. CLS. 100, 101 AND 102).

CLASS 36—(Continued).

SN 78-191,711. SUN LIFE ASSURANCE COMPANY OF CANADA, TORONTO, ONTARIO, CANADA, FILED 12-5-2002.

SLF

FOR INSURANCE AND FINANCIAL SERVICES, NAMELY, FINANCIAL INVESTMENT IN THE FIELD OF SECURITIES AND REAL ESTATE; FINANCIAL MANAGEMENT SERVICES; UNDERWRITING, ISSUING, AND ADMINISTRATION OF ANNUITIES AND LIFE, HEALTH, AND DISABILITY INSURANCE; MUTUAL FUND INVESTMENT SERVICES; UNDERWRITING AND ADMINISTRATION OF RETIREMENT PLANS AND PENSION PLANS; INVESTMENT CONSULTING SERVICES; AND REAL ESTATE CONSULTING SERVICES (U.S. CLS. 100, 101 AND 102).

SN 78-196,255. COMPTON II, MITCHELL, THOMAS, BONITA, CA. FILED 12-19-2002.

REFIGUY.COM

FOR REAL ESTATE MORTGAGE LOAN BROKERAGE SERVICES (U.S. CLS. 100, 101 AND 102).

CLASS 37—CONSTRUCTION AND REPAIR

SN 76-144,191. RISI, JOSEPH S., SANTA BARBARA, CA. FILED 10-11-2000.

AMERICAN WEST HOMES

NO CLAIM IS MADE TO THE EXCLUSIVE RIGHT TO USE "HOMES", APART FROM THE MARK AS SHOWN.
FOR RESIDENTIAL CONSTRUCTION (U.S. CLS. 100, 103 AND 106).
FIRST USE 5-1-1994; IN COMMERCE 5-1-1994.

SN 76-160,281. SOMA NETWORKS, INC., TORONTO, ONTARIO M5V 1R2, CANADA, FILED 11-3-2000.

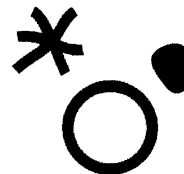

PRIORITY CLAIMED UNDER SEC. 44(D) ON CANADA APPLICATION NO. 1057975, FILED 5-5-2000.
FOR INSTALLATION AND MAINTENANCE OF COMPUTER HARDWARE, TELEPHONY HARDWARE, COMPONENT PARTS AND FITTINGS FOR ALL THE AFORESAID, TELEPHONY SOFTWARE FOR USE IN TELEPHONE NETWORKS, AND COMPUTER SOFTWARE FOR USE IN DATA NETWORKS (U.S. CLS. 100, 103 AND 106).
FIRST USE 10-31-2001; IN COMMERCE 10-31-2001.

CLASS 37—(Continued).

SN 76-209,466. RESTRUCTION CORPORATION, SEDALIA, CO. FILED 2-14-2001.

RESTRUCTION

FOR -CONSTRUCTION SERVICES SPECIALIZING IN THE STRUCTURAL REPAIR, REHABILITATION AND RESTORATION OF PARKING GARAGES, BUILDINGS AND BUILDING FACADES, HISTORICAL BUILDINGS, BRIDGES, PAVEMENT, WATER AND WASTE WATER FACILITIES, DAMS, TUNNELS, OTHER STRUCTURES AND RELATED CONSULTING SERVICES (U.S. CLS. 100, 103 AND 106).

FIRST USE 4-29-1975; IN COMMERCE 4-29-1975.

SN 76-303,811. GREAT GULF HOMES AMERICAN CORP., DALLAS, TX. FILED 8-23-2001.

RIVERSTONE HOMES

NO CLAIM IS MADE TO THE EXCLUSIVE RIGHT TO USE "HOMES", APART FROM THE MARK AS SHOWN.
FOR RESIDENTIAL HOME CONSTRUCTION (U.S. CLS. 100, 103 AND 106).

SN 76-347,033. HARRIS RESEARCH, INC., LOGAN, UT. FILED 12-10-2001.

CLASS 37—(Continued).

SN 76-347,296. HARRIS RESEARCH, INC., LOGAN, UT. FILED 12-10-2001.

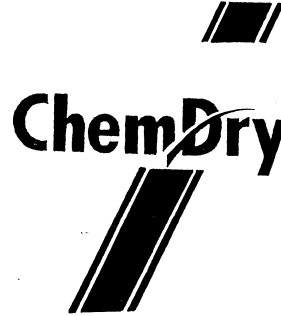

OWNER OF U.S. REG. NOS. 1,119,887 AND 1,357,192.
IN THE MARK, THE LETTERS "CHEM" ARE A SHADE OF GREEN, THE LETTERS "DRY" ARE A SHADE OF BLUE, AND THE TAPERED BAND, INTERSECTING THE LETTER "D" IN "DRY", IS A SHADE OF PURPLE. WITH RESPECT TO THE THREE PARALLEL STRIPES, RUNNING DIAGONALLY ABOVE AND BELOW THE WORD "CHEM-DRY", THE MIDDLE DIAGONAL STRIPE, WHICH IS THE WIDEST OF THE THREE DIAGONAL STRIPES, IS A SHADE OF BLUE; THE THINNER DIAGONAL STRIPE, ON ONE SIDE OF THE MIDDLE DIAGONAL STRIPE, RUNNING GENERALLY THROUGH THE LETTERS "DRY", IS A SHADE OF PURPLE; AND THE THINNER DIAGONAL STRIPE, ON THE OTHER SIDE OF THE MIDDLE DIAGONAL STRIPE, IS A SHADE OF GREEN.
FOR CARPET CLEANING, UPHOLSTERY CLEANING AND DRAPERY CLEANING; CARPET CLEANING FEATURING FRAGRANCE, UPHOLSTERY CLEANING FEATURING FRAGRANCE, AND DRAPERY CLEANING FEATURING FRAGRANCE (U.S. CLS. 100, 103 AND 106).
FIRST USE 12-0-1997; IN COMMERCE 12-0-1997.

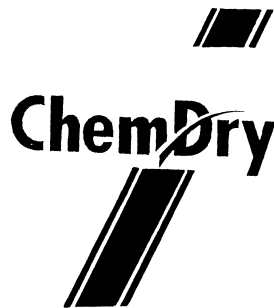

SN 76-423,341. BIELINSKI BROS. BUILDERS, INC., WAUKE-SHA, WI. FILED 6-19-2002.

REDI-HOMES

OWNER OF U.S. REG. NOS. 1,119,887 AND 1,357,192.
FOR CARPET CLEANING, UPHOLSTERY CLEANING AND DRAPERY CLEANING; CARPET CLEANING FEATURING FRAGRANCE, UPHOLSTERY CLEANING FEATURING FRAGRANCE, AND DRAPERY CLEANING FEATURING FRAGRANCE (U.S. CLS. 100, 103 AND 106).
FIRST USE 12-0-1997; IN COMMERCE 12-0-1997.

SEC. 2(F).
FOR HOME CONSTRUCTION SERVICES (U.S. CLS. 100, 103 AND 106).
FIRST USE 11-0-1991; IN COMMERCE 11-0-1991.

CLASS 37—(Continued).

SN 76-430,060. CORE TECHNICAL SERVICES LTD., ABERDEEN, SCOTLAND, FILED 7-12-2002.

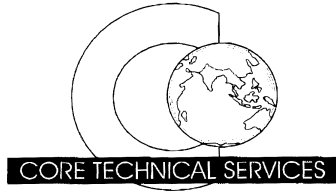

NO CLAIM IS MADE TO THE EXCLUSIVE RIGHT TO USE "TECHNICAL SERVICES", APART FROM THE MARK AS SHOWN.

FOR MARINE MAINTENANCE, REPAIR AND CONSTRUCTION SERVICES (U.S. CLS. 100, 103 AND 106).
FIRST USE 12-1-1996; IN COMMERCE 11-1-1997.

SN 76-430,061. CORE TECHNICAL SERVICES LTD., ABERDEEN, SCOTLAND, FILED 7-12-2002.

CORE TECHNICAL SERVICES

NO CLAIM IS MADE TO THE EXCLUSIVE RIGHT TO USE "TECHNICAL SERVICES", APART FROM THE MARK AS SHOWN.

FOR MARINE MAINTENANCE, REPAIR AND CONSTRUCTION SERVICES (U.S. CLS. 100, 103 AND 106).
FIRST USE 1-7-1986; IN COMMERCE 11-1-1997.

SN 76-442,023. CARSMETICS, INC., CLEARWATER, FL. FILED 8-21-2002.



OWNER OF U.S. REG. NO. 1,777,415.
NO CLAIM IS MADE TO THE EXCLUSIVE RIGHT TO USE "MINOR ACCIDENT EXPERTS", APART FROM THE MARK AS SHOWN.

FOR AUTOMOTIVE REPAIR SERVICES (U.S. CLS. 100, 103 AND 106).
FIRST USE 7-27-2001; IN COMMERCE 7-27-2001.

CLASS 37—(Continued).

SN 76-449,198. LONGMAR, INC., WALDORF, MD. FILED 9-12-2002.

DRYCLEAN CENTRAL

NO CLAIM IS MADE TO THE EXCLUSIVE RIGHT TO USE "DRY CLEAN", APART FROM THE MARK AS SHOWN.

FOR DRY CLEANING SERVICES; LAUNDRY SERVICES FOR CLOTHING (U.S. CLS. 100, 103 AND 106).

SN 76-453,106. SHADESCAPES USA, INC., PAONIA, CO. FILED 9-26-2002.

SHADESCAPES USA

NO CLAIM IS MADE TO THE EXCLUSIVE RIGHT TO USE "USA", APART FROM THE MARK AS SHOWN.

FOR TECHNICAL CONSULTING SERVICES IN THE FIELD OF SELECTION, ARRANGEMENT, AND INSTALLATION OF SHADE STRUCTURES FOR RESIDENTIAL AND COMMERCIAL LOCATIONS (U.S. CLS. 100, 103 AND 106).

SN 76-454,103. DRACOOOL OF LYKENS, INC., LYKENS, PA. FILED 10-1-2002.

DRACOOOL OF LYKENS

FOR INSTALLATION, CLEANING, RESTORATION, MAINTENANCE AND REPAIR OF HEAT EXCHANGERS, INCLUDING PARTS (U.S. CLS. 100, 103 AND 106).
FIRST USE 0-0-1956; IN COMMERCE 0-0-1956.

SN 76-459,334. W.O. HARPER PLUMBING CO., AUSTIN, TX. FILED 10-18-2002.



NO CLAIM IS MADE TO THE EXCLUSIVE RIGHT TO USE "PLUMBING" AND "410 WEST 18TH ST." AND "476-2657" AND "SINCE 1921", APART FROM THE MARK AS SHOWN.

FOR PLUMBING AND GAS LINE REPAIR SERVICES, NAMELY UNSTOPPING, REPAIRING, AND REPLACING DRAINS, INDOOR PLUMBING PIPES AND SEWER PIPES, AND REPAIRING AND REPLACING INDOOR SYSTEMS FOR DELIVERY OF NATURAL GAS (U.S. CLS. 100, 103 AND 106).
FIRST USE 12-31-1963; IN COMMERCE 12-31-1963.

CLASS 37—(Continued).

SN 76-462,999. BOSSELMAN INC., GRAND ISLAND, NE. FILED 10-30-2002.

BOSS TRUCK SHOP

NO CLAIM IS MADE TO THE EXCLUSIVE RIGHT TO USE "TRUCK SHOP", APART FROM THE MARK AS SHOWN.

FOR SERVICE AND REPAIR OF SEMI-TRUCK, SEMI-TRAILER, AND OTHER MOTOR VEHICALS (U.S. CLS. 100, 103 AND 106).

FIRST USE 1-1-2002; IN COMMERCE 1-1-2002.

SN 76-470,346. ANTHONY HOME IMPROVEMENTS, INC., ELKINS PARK, PA. FILED 11-22-2002.

BUILT ON TRUST

FOR REPAIR OF BUILDINGS; CUSTOM BUILDING RENOVATION; HOME REMODELING, REPAIR AND RESTORATION SERVICES (U.S. CLS. 100, 103 AND 106).

FIRST USE 2-1-2000; IN COMMERCE 2-1-2000.

SN 76-477,628. CCMKS, L.L.C., HILLSBORO, KS. FILED 12-20-2002.



car wash

NO CLAIM IS MADE TO THE EXCLUSIVE RIGHT TO USE "CAR WASH", APART FROM THE MARK AS SHOWN. FOR CAR WASH SERVICES (U.S. CLS. 100, 103 AND 106).

FIRST USE 11-1-2002; IN COMMERCE 11-1-2002.

SN 76-975,358. RICHARDSON ELECTRONICS, LTD., LA-FOX, IL. FILED 2-19-2002.

GLOBAL REACH WITH LOCAL SERVICE

FOR SERVICES OF INSTALLATION, REPAIR AND MAINTENANCE OF COMMERCIAL AND RESIDENTIAL SECURITY SYSTEMS CONSISTING OF CLOSED CIRCUIT TELEVISION BURGLAR AND FIRE ALARMS AND ACCESS CONTROL SYSTEMS (U.S. CLS. 100, 103 AND 106).

FIRST USE 12-1-2001; IN COMMERCE 12-1-2001.

CLASS 37—(Continued).

SN 78-103,269. DOMINION HOMES, INC., DUBLIN, OH. FILED 1-17-2002.

A NEW STANDARD IN HOMEBUILDING

FOR RESIDENTIAL BUILDING CONSTRUCTION SERVICES (U.S. CLS. 100, 103 AND 106).

SN 78-149,657. PADRO, FRANCISCO, LAURENCE HARBOR, NJ. FILED 8-1-2002.

ANGLE UP BRUSH

FOR HOUSE PAINTING (U.S. CLS. 100, 103 AND 106).

SN 78-174,845. HALLIBURTON ENERGY SERVICES, INC., CARROLLTON, TX. FILED 10-16-2002.

SUPER-SAT

FOR OIL AND GAS WELL DRILLING USING RISERLESS DRILLING FLUIDS (U.S. CLS. 100, 103 AND 106).

SN 78-183,949. FAITH TECHNOLOGIES, INC., APPLETON, WI. FILED 11-12-2002.

SKC ELECTRIC

NO CLAIM IS MADE TO THE EXCLUSIVE RIGHT TO USE "ELECTRIC", APART FROM THE MARK AS SHOWN. FOR ELECTRICAL CONTRACTING SERVICES (U.S. CLS. 100, 103 AND 106).

SN 78-185,356. FLETCHER, JAMES E., GREENEVILLE, TN. FILED 11-14-2002.

FLETCHER PIANO SERVICE

NO CLAIM IS MADE TO THE EXCLUSIVE RIGHT TO USE "PIANO SERVICE", APART FROM THE MARK AS SHOWN.

FOR PIANO SERVICES, NAMELY, TUNING, REPAIRING, REBUILDING AND REFURBISHING (U.S. CLS. 100, 103 AND 106).

FIRST USE 6-1-1964; IN COMMERCE 6-1-1964.

CLASS 37—(Continued).

SN 78-191,138. JERALD DEVELOPMENT GROUP, INC.,
THE WALL, NJ. FILED 12-4-2002.



THE MARK CONSISTS OF A GOLD DECORATIVE "N" IN
A SHADED OVAL, WITH A PURPLE LAUREL AT THE
BASE AND DECORATIVE TEXT "NOBILITY CREST"
BELOW THE DESIGN.

FOR LAND DEVELOPMENT SERVICES, NAMELY
PLANNING AND LAYING OUT OF RESIDENTIAL
COMMUNITIES (U.S. CLS. 100, 103 AND 106).

FIRST USE 8-1-2002; IN COMMERCE 8-25-2002.

SN 78-193,538. JET SUPPORT SERVICES, INC., CHICAGO,
IL. FILED 12-11-2002.



OWNER OF U.S. REG. NOS. 2,013,978 AND 2,156,006.
FOR REPAIR AND MAINTENANCE OF AIRCRAFT
(U.S. CLS. 100, 103 AND 106).
FIRST USE 10-1-1999; IN COMMERCE 10-1-1999.

CLASS 38—COMMUNICATION

SN 75-629,012. Z-TEL TECHNOLOGIES, INC., TAMPA, FL.
FILED 1-28-1999.

Z-NET

FOR TELECOMMUNICATION SERVICES, NAMELY,
PROVIDING LOCAL AND LONG DISTANCE TELE-
PHONE SERVICES; PROVIDING ELECTRONIC VOICE,
VOICE MAIL, FACSIMILE AND DATA TRANSMISSION,
AND ELECTRONIC MAIL; PROVIDING TELEPHONE
ROUTING SERVICES NAMELY ACTIVATING CALL
FORWARDING FROM TELEPHONE TO TELEPHONE;
PROVIDING COMMUNICATION CONNECTIONS FOR
THE TRANSMISSION OF VOICE, ELECTRONIC MAIL
AND DATA BY LINKING USERS VIA FACSIMILES
AND TELEPHONES AND A GLOBAL COMPUTER NET-
WORK; PROVIDING ELECTRONIC DATA INTER-
CHANGE SERVICES (U.S. CLS. 100, 101 AND 104).

SN 75-642,708. VIRTUALINC CORPORATION, RICHARD-
SON, TX. FILED 2-18-1999.

GUESTLINC

FOR COMMUNICATION SERVICES, NAMELY, VI-
DEO CONFERENCING SERVICES (U.S. CLS. 100, 101
AND 104).

SN 75-847,257. NETVOICE TECHNOLOGIES, INC., DALLAS,
TX. FILED 11-12-1999.

PACKET RUNNER

NO CLAIM IS MADE TO THE EXCLUSIVE RIGHT TO
USE "PACKET", APART FROM THE MARK AS SHOWN.

FOR TELECOMMUNICATIONS SERVICES OVER THE
GLOBAL COMPUTER INFORMATION NETWORK,
NAMELY, PROVIDING TELECOMMUNICATIONS CON-
NECTIONS TO A GLOBAL COMPUTER NETWORK
AND PERSONAL COMMUNICATIONS SERVICES (U.S.
CLS. 100, 101 AND 104).

CLASS 38—(Continued).

SN 76-034,393. NETWORK INTELLIGENCE, INC., SAN ANTONIO, TX. FILED 4-24-2000.

SIMPLE BUSINESS

NO CLAIM IS MADE TO THE EXCLUSIVE RIGHT TO USE "BUSINESS", APART FROM THE MARK AS SHOWN.

FOR COMPUTER SERVICES, NAMELY, PROVIDING MULTIPLE USER ACCESS TO THE GLOBAL COMPUTER INFORMATION NETWORK; TELECOMMUNICATIONS SERVICES, NAMELY, THE ELECTRONIC TRANSMISSION OF VOICE, FACSIMILE, DATA, VIDEO AND INFORMATION; PROVIDING TELECOMMUNICATIONS CONNECTIONS TO GLOBAL COMPUTER NETWORKS; PROVIDING TELECOMMUNICATIONS CONNECTIONS TO ONLINE INFORMATION SERVICES; PROVIDING INTEGRATED COMMUNICATIONS SERVICES TO OTHERS IN THE NATURE OF LONG DISTANCE, LOCAL TELEPHONE, INTERNET, VIDEO CONFERENCING AND WIRELESS TELECOMMUNICATIONS FOR THE TRANSMISSION OF VOICE, AUDIO, VIDEO, DATA, TEXT, FACSIMILE AND INFORMATION (U.S. CLS. 100, 101 AND 104).

SN 76-149,628. ASTROVISION INTERNATIONAL, INC., BETHESDA, MD. FILED 10-18-2000.

AVII

FOR VIEWER-CUSTOMIZABLE BROADCASTING OF NEWS, WEATHER OR OTHER PROGRAMMING ORIGINATING BY SATELLITE (U.S. CLS. 100, 101 AND 104).

SN 76-327,507. GROOVE NATION, INC., ATLANTA, GA. FILED 10-19-2001.

GROOVENATION

FOR INTERNET RADIO, NAMELY, STREAMING OF AUDIO AND VIDEO MATERIAL OVER THE INTERNET; AUDIO AND VIDEO WEB BROADCASTING (U.S. CLS. 100, 101 AND 104).

FIRST USE 6-1-1994; IN COMMERCE 4-1-1996.

SN 76-363,616. PASS & SEYMOUR/LEGRAND, SYRACUSE, NY. FILED 1-28-2002.

ACTIVATE

FOR TELECOMMUNICATION AND DATA CONNECTOR ASSEMBLIES (U.S. CLS. 100, 101 AND 104).

FIRST USE 4-30-2001; IN COMMERCE 4-30-2001.

CLASS 38—(Continued).

SN 76-377,263. HUMAX CO., LTD., YONGIN CITY KVUNG-GI-DO 449-080, REPUBLIC OF KOREA, FILED 3-1-2002.

HUMAX

IT IS TO BE NOTED THAT THE COLOR OF THE LETTERING IN THE MARK IS BLUE.

FOR CABLE TELEVISION BROADCASTING SERVICES, INTERNET BROADCASTING SERVICES, TELEVISION BROADCASTING SERVICES; TELECOMMUNICATION SERVICES, NAMELY, PROVIDING FIBER OPTIC NETWORK SERVICES; TELECOMMUNICATION SERVICES, NAMELY, LOCAL AND LONG DISTANCE TRANSMISSION OF DATA BY MEANS OF TELEPHONE, TELEGRAPHIC, CABLE AND/OR SATELLITE TRANSMISSIONS; TELECOMMUNICATION SERVICES, NAMELY, LOCAL AND LONG DISTANCE TRANSMISSION OF VOICE, DATA, GRAPHICS BY MEANS OF SATELLITE TRANSMISSIONS AND/OR CELLULAR TELEPHONE; WIRELESS FACSIMILE MAIL SERVICES, WIRELESS PBX SERVICES, AND WIRELESS VOICE MAIL SERVICES; TELECOMMUNICATION EQUIPMENT RENTAL SERVICES, TELEGRAM COMMUNICATION SERVICES, AND VIDEO CONFERENCE SERVICES (U.S. CLS. 100, 101 AND 104).

SN 76-387,639. IDT CORPORATION, NEWARK, NJ. FILED 3-27-2002.

ENTERPRISE INNOVATIONS

FOR TELECOMMUNICATIONS SERVICES, NAMELY DOMESTIC, INTERNATIONAL, AND LONG DISTANCE TELEPHONE SERVICES, AND DOMESTIC, INTERNATIONAL AND LONG DISTANCE CALL BACK SERVICES; AND INTERNET PROVIDER SERVICES, NAMELY, PROVIDING MULTIPLE-USER AND DEDICATED ACCESS TO THE INTERNET; COMMUNICATION SERVICES IN THE NATURE OF CONTENT AND MEDIA DISTRIBUTION SERVICES IN THE NATURE OF PROVIDING STREAMING VIDEO, DATA AND OTHER CONTENT OVER THE INTERNET UTILIZING INTERCONNECTED COMPUTER, CABLE, SATELLITE AND BROADCAST SYSTEM AND FIXED WIRELESS SYSTEMS; PROVIDING ENHANCED INTERNET TELEPHONY SERVICES (VOIP) (U.S. CLS. 100, 101 AND 104).

SN 76-405,152. WESTERN PACIFIC TELECOMMUNICATIONS, CARSON, CA. FILED 5-9-2002.

WINGSPAN

FOR COMMUNICATION SERVICES EQUIPMENT, NAMELY CABLE CLOSURES, AND CABLE CLOSURES FOR SPLICING CABLES (U.S. CLS. 100, 101 AND 104).

FIRST USE 7-31-1997; IN COMMERCE 7-31-1997.

CLASS 38—(Continued).

SN 76-412,206. ENEGREN COMPUTER SERVICE, INC., WICHITA, KS. FILED 5-20-2002.

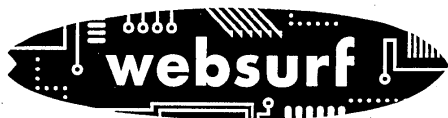

NO CLAIM IS MADE TO THE EXCLUSIVE RIGHT TO USE "WEBSURF", APART FROM THE MARK AS SHOWN.

FOR PROVIDING MULTIPLE-USER ACCESS TO A GLOBAL COMPUTER INFORMATION NETWORK FOR THE TRANSFER AND DISSEMINATION OF A WIDE RANGE OF INFORMATION (U.S. CLS. 100, 101 AND 104).

FIRST USE 7-31-1996; IN COMMERCE 7-31-1996.

SN 76-417,974. WILINK U.S. HOLDINGS INC., RICHMOND, VA. FILED 6-5-2002.



NO CLAIM IS MADE TO THE EXCLUSIVE RIGHT TO USE "IR", APART FROM THE MARK AS SHOWN.

FOR TELECOMMUNICATIONS NAMELY, ELECTRONIC TRANSMISSION OF DATA AND DOCUMENTS FEATURING INVESTOR RELATIONS EVENTS AND INFORMATION VIA A GLOBAL COMPUTER NETWORK, THE INTERNET, WIRELESS DEVICES, AND TELEPHONE DIRECTED TO BUSINESSES; ELECTRONIC TRANSMISSION OF INVESTMENT INFORMATION, BUSINESS AND FUND REPORTS AND PROSPECTUSES VIA A GLOBAL COMPUTER NETWORK, THE INTERNET AND WIRELESS DEVICES DIRECTED TO BUSINESSES; STREAMING OF VIDEO AND AUDIO CONTENT VIA A GLOBAL COMPUTER NETWORK, THE INTERNET, TELEPHONE AND WIRELESS DEVICES; INTERNET, TELEPHONE AND WIRELESS MESSAGE SERVICE, NAMELY, THE RECORDING AND SUBSEQUENT TRANSMISSION OF VOICE, TEXT AND PICTORIAL MESSAGES BY TELEPHONE AND ELECTRONIC, ELECTRIC AND DIGITAL TRANSMISSION OF MESSAGES DIRECTED TO BUSINESSES (U.S. CLS. 100, 101 AND 104).

CLASS 38—(Continued).

SN 76-419,470. CBeyond COMMUNICATIONS, LLC, ATLANTA, GA. FILED 6-11-2002.

BEYONDVOICE II

FOR TELECOMMUNICATION SERVICES, NAMELY THE ELECTRONIC TRANSMISSION OF VOICE, DATA, VIDEO, FACSIMILE AND INFORMATION; LOCAL, LONG DISTANCE, TOLL-FREE AND INTERNATIONAL VOICE, DATA, AND FACSIMILE TELEPHONE SERVICES; PROVIDING MULTIPLE USER DIAL-UP AND DEDICATED ACCESS TO INTERNAL COMPUTER NETWORKS AND GLOBAL COMPUTER NETWORKS; ELECTRONIC VOICE MESSAGING TRANSMISSION OF VOICE MESSAGES BY TELEPHONE; VIDEO CONFERENCING TRANSMISSION; ELECTRONIC MAIL SERVICES AND HIGH SPEED INTERNET ACCESS (U.S. CLS. 100, 101 AND 104).

FIRST USE 10-1-2000; IN COMMERCE 10-1-2000.

SN 76-419,471. CBeyond COMMUNICATIONS, LLC, ATLANTA, GA. FILED 6-11-2002.

BEYONDVOICE I

FOR TELECOMMUNICATION SERVICES, NAMELY THE ELECTRONIC TRANSMISSION OF VOICE, DATA, VIDEO, FACSIMILE AND INFORMATION; LOCAL, LONG DISTANCE, TOLL-FREE AND INTERNATIONAL VOICE, DATA, AND FACSIMILE TELEPHONE SERVICES; PROVIDING MULTIPLE USER DIAL-UP AND DEDICATED ACCESS TO INTERNAL COMPUTER NETWORKS AND GLOBAL COMPUTER NETWORKS; ELECTRONIC VOICE MESSAGING TRANSMISSION OF VOICE MESSAGES BY TELEPHONE; VIDEO CONFERENCING TRANSMISSION; ELECTRONIC MAIL SERVICES AND HIGH SPEED INTERNET ACCESS (U.S. CLS. 100, 101 AND 104).

FIRST USE 10-1-2000; IN COMMERCE 10-1-2000.

SN 76-421,201. WALSH MEDIA INC, OAK BROOK, IL. FILED 6-12-2002.

WALSH MEDIA, INC.

NO CLAIM IS MADE TO THE EXCLUSIVE RIGHT TO USE "MEDIA, INC.", APART FROM THE MARK AS SHOWN.

SEC. 2(F).

FOR ELECTRONIC VOICE MESSAGING, NAMELY THE RECORDING AND SUBSEQUENT TRANSMISSION OF VOICE MESSAGES BY TELEPHONE FOR BUSINESS COMMUNICATION (U.S. CLS. 100, 101 AND 104).

FIRST USE 9-1-1989; IN COMMERCE 9-1-1989.

CLASS 38—(Continued).

SN 76-426,356. INNOVATIVE ANSWERS, INC., LAKE, MI. FILED 7-1-2002.

AIM-HIGH

FOR PROVIDING ELECTRONIC DELIVERY OF IMAGES AND PHOTOGRAPHS VIA A GLOBAL COMPUTER NETWORK; ELECTRONIC MAIL SERVICES; PROVIDING ON-LINE CHAT ROOMS AND BULLETIN BOARDS FOR TRANSMISSION OF MESSAGES AMONG COMPUTER USERS AND CONCERNING THEIR ORGANIZATION'S MEMBERSHIP, MEETING AND OTHER CLUB RELATED INFORMATION (U.S. CLS. 100, 101 AND 104).
FIRST USE 6-24-2002; IN COMMERCE 6-24-2002.

SN 76-448,154. INPHONIC, INC., WASHINGTON, DC. FILED 9-4-2002.

LIBERTY WIRELESS

NO CLAIM IS MADE TO THE EXCLUSIVE RIGHT TO USE "WIRELESS", APART FROM THE MARK AS SHOWN.
FOR TELECOMMUNICATIONS RESELLER SERVICES, NAMELY, PROVIDING CELLULAR TELECOMMUNICATIONS SERVICES (U.S. CLS. 100, 101 AND 104).

SN 76-451,576. STREEM COMMUNICATIONS, LLC, LOVES PARK, IL. FILED 9-23-2002.

STREEM CENTER

NO CLAIM IS MADE TO THE EXCLUSIVE RIGHT TO USE "CENTER", APART FROM THE MARK AS SHOWN.
FOR DESKTOP FACSIMILE TRANSMISSION AND RETRIEVAL SERVICES; ELECTRONIC STORE-AND-FORWARD MESSAGING; WIRELESS DIGITAL MESSAGING SERVICES (U.S. CLS. 100, 101 AND 104).
FIRST USE 6-1-2002; IN COMMERCE 6-1-2002.

SN 76-451,577. STREEM COMMUNICATIONS, LLC, LOVES PARK, IL. FILED 9-23-2002.

STREEM

FOR DESKTOP FACSIMILE TRANSMISSION AND RETRIEVAL SERVICES; ELECTRONIC STORE-AND-FORWARD MESSAGING; WIRELESS DIGITAL MESSAGING SERVICES (U.S. CLS. 100, 101 AND 104).
FIRST USE 6-1-2002; IN COMMERCE 6-1-2002.

CLASS 38—(Continued).

SN 76-451,633. STREEM COMMUNICATIONS, LLC, LOVES PARK, IL. FILED 9-23-2002.



FOR DESKTOP FACSIMILE TRANSMISSION AND RETRIEVAL SERVICES; ELECTRONIC STORE-AND-FORWARD MESSAGING; WIRELESS DIGITAL MESSAGING SERVICES (U.S. CLS. 100, 101 AND 104).
FIRST USE 6-1-2002; IN COMMERCE 6-1-2002.

SN 76-468,665. BET INTERACTIVE, L.L.C., WASHINGTON, DC. FILED 11-8-2002.

HOLLA GRAM

FOR PROVIDING ONLINE ELECTRONIC MESSAGING AND DATA TRANSMISSION SERVICES, INCLUDING INTERACTIVE BULLETIN BOARDS, MESSAGING SERVICES, ELECTRONIC MAIL SERVICES, AND CUSTOMIZED ELECTRONIC MAIL SERVICES FEATURING INTERACTIVE VIDEOS (U.S. CLS. 100, 101 AND 104).
FIRST USE 9-18-2002; IN COMMERCE 9-18-2002.

SN 76-469,416. ROCKEFELLER GROUP, INC., NEW YORK, NY. FILED 11-13-2002.

YOUR PROVEN PARTNER IN COMMUNICATIONS SOLUTIONS

FOR INTEGRATED COMMUNICATIONS SERVICES, NAMELY, ELECTRONIC TRANSMISSION OF VOICE AND DATA VIA WIRELESS COMMUNICATIONS NETWORKS, WIRED BUILDING COMMUNICATIONS INFRASTRUCTURE AND THE INTERNET (U.S. CLS. 100, 101 AND 104).
FIRST USE 5-1-2002; IN COMMERCE 5-1-2002.

SN 76-473,049. 900EMAIL, ARVADA, CO. FILED 12-6-2002.

900EMAIL

FOR ELECTRONIC MAIL SERVICES (U.S. CLS. 100, 101 AND 104).
FIRST USE 12-14-2000; IN COMMERCE 12-14-2000.

CLASS 38—(Continued).

SN 76-473,442. OUTDOOR LIFE NETWORK, L.L.C., STAMFORD, CT. FILED 11-20-2002.

OUT YOU GO

FOR CABLE AND SATELLITE TELEVISION BROADCASTING (U.S. CLS. 100, 101 AND 104).

SN 76-478,252. NBA PROPERTIES, INC., NEW YORK, NY. FILED 12-23-2002.

NBA INSIDE TICKET

OWNER OF U.S. REG. NOS. 1,525,782, 2,118,226 AND OTHERS.

FOR WEBCASTING SERVICES IN THE NATURE OF BROADCASTING BASKETBALL GAMES, BASKETBALL EVENTS, BASKETBALL PROGRAMS, PLAYER INTERVIEWS AND PRESS CONFERENCES IN THE FIELD OF BASKETBALL OVER THE INTERNET, SUBSCRIPTION AUDIO AND VIDEO BROADCASTS IN THE FIELD OF BASKETBALL OVER THE INTERNET, AUDIO BROADCASTING OVER THE INTERNET; VIDEO BROADCASTING OVER THE INTERNET; BROADCASTS OF ONGOING RADIO PROGRAMS OVER THE INTERNET, BROADCASTING HIGHLIGHTS OF TELEVISION, CABLE TELEVISION AND RADIO PROGRAMS IN THE FIELD OF BASKETBALL OVER THE INTERNET (U.S. CLS. 100, 101 AND 104).

FIRST USE 11-7-2002; IN COMMERCE 11-7-2002.

SN 78-017,914. INTERPACKET NETWORKS, INC., SANTA MONICA, CA. BY CHANGE OF NAME INTERPACKET NETWORKS, INC., SANTA MONICA, CA. FILED 7-21-2000.

ESPRESSO LITE

OWNER OF U.S. REG. NOS. 2,287,919 AND 2,289,101. FOR COMPUTERIZED COMMUNICATION SERVICES, NAMELY, PROVIDING FOR THE TRANSMISSION AND RECEPTION OF ELECTRONIC MAIL, NEWS, VIDEO, VOICE, FACSIMILE AND OTHER DATA AND INFORMATION OVER GLOBAL COMPUTER COMMUNICATIONS NETWORKS; TRANSMISSION, BROADCASTING AND RECEPTION OF ELECTRONIC MAIL, NEWS, VIDEO, VOICE, FACSIMILE AND OTHER DATA AND INFORMATION BY SATELLITE (U.S. CLS. 100, 101 AND 104).

CLASS 38—(Continued).

SN 78-108,288. RESTAURANTMANAGER.COM, INC., MCALLEN, TX. FILED 2-12-2002.



NO CLAIM IS MADE TO THE EXCLUSIVE RIGHT TO USE "RESTAURANTMANAGER.COM", APART FROM THE MARK AS SHOWN.

THE LETTER "R" IS IN RED COLOR.

FOR PROVIDING ON-LINE ELECTRONIC BULLETIN BOARDS FOR TRANSMITTING MESSAGES, INDUSTRY NEWS, JOB POSITIONS AND RESUMES AMONG COMPUTER USERS IN THE FIELD OF RESTAURANT MANAGEMENT; AND ELECTRONIC MAIL SERVICES (U.S. CLS. 100, 101 AND 104).

SN 78-127,521. MORAN, MIKE, BASEL, SWITZERLAND, FILED 5-9-2002.

EVERYTHING IS SOMETHING TO SOMEONE SOMEWHERE

FOR ELECTRONIC TRANSMISSION OF DATA, INFORMATION, IMAGES AND SOUND VIA GLOBAL COMPUTER NETWORKS (U.S. CLS. 100, 101 AND 104).

SN 78-131,025. DUENSING, ROBERT, DBA BEST REGARDS, LENEXA, KS. AND DUENSING, CHERRIE, DBA BEST REGARDS, LENEXA, KS. FILED 5-24-2002.

STORKPICS

FOR ELECTRONIC DELIVERY OF IMAGES AND PHOTOGRAPHS VIA A GLOBAL COMPUTER NETWORK (U.S. CLS. 100, 101 AND 104).

FIRST USE 5-20-2002; IN COMMERCE 5-20-2002.

SN 78-132,762. COMLINK WIRELESS, INC., CAROL STREAM, IL. FILED 6-3-2002.

COMLINK WIRELESS

NO CLAIM IS MADE TO THE EXCLUSIVE RIGHT TO USE "WIRELESS", APART FROM THE MARK AS SHOWN.

FOR WIRELESS COMMUNICATIONS SERVICES, FEATURING TWO-WAY RADIO COMMUNICATION (U.S. CLS. 100, 101 AND 104).

FIRST USE 9-10-2001; IN COMMERCE 3-1-2002.

CLASS 38—(Continued).

SN 78-132,769. COMLINK WIRELESS, INC., CAROL STREAM, IL. FILED 6-3-2002.



NO CLAIM IS MADE TO THE EXCLUSIVE RIGHT TO USE "WIRELESS" AND "DISPATCH AND DATA SOLUTIONS", APART FROM THE MARK AS SHOWN. FOR WIRELESS COMMUNICATIONS SERVICES, FEATURING TWO-WAY RADIO COMMUNICATION (U.S. CLS. 100, 101 AND 104). FIRST USE 9-10-2001; IN COMMERCE 3-1-2002.

CLASS 38—(Continued).

SN 78-165,753. AT&T CORP., NEW YORK, NY. FILED 9-19-2002.

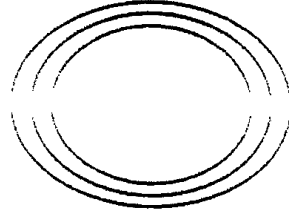

THE MARK CONSISTS OF THE FANCIFUL DEPICTION OF THREE INCOMPLETE OVOID FIGURES. FOR TELECOMMUNICATIONS SERVICES, NAMELY INTERNET ACCESS SERVICES. (U.S. CLS. 100, 101 AND 104).

SN 78-132,945. JAHSMAN, WILLIAM E., SALT LAKE CITY, UT. FILED 6-3-2002.



NO CLAIM IS MADE TO THE EXCLUSIVE RIGHT TO USE "GIGAPOP", APART FROM THE MARK AS SHOWN. FOR PROVIDING A HIGH SPEED REGIONAL INTERNET PROTOCOL-BASED ACCESS TO AREA NETWORKS AND A GLOBAL COMPUTER INFORMATION NETWORK (U.S. CLS. 100, 101 AND 104). FIRST USE 4-16-2001; IN COMMERCE 8-1-2001.

SN 78-176,289. DELOR, THOMAS, CLEARWATER, FL. FILED 10-19-2002.

1 - 8 0 0 - A S - S E E N - O N - T V

FOR TELECOMMUNICATIONS SERVICE, NAMELY, ROUTING CALLS TO THIRD-PARTIES SELLING THE PRODUCT OR PRODUCTS REQUESTED BY THE CALLER (U.S. CLS. 100, 101 AND 104). FIRST USE 4-29-1999; IN COMMERCE 4-29-1999.

SN 78-165,750. AT&T CORP., NEW YORK, NY. FILED 9-19-2002.

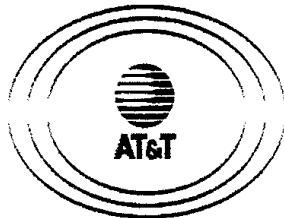

THE MARK CONSISTS OF THE "AT&T" & GLOBE DESIGN LOGO WITHIN THE FANCIFUL DEPICTION OF THREE INCOMPLETE OVOID FIGURES. FOR TELECOMMUNICATIONS SERVICES, NAMELY INTERNET ACCESS SERVICES (U.S. CLS. 100, 101 AND 104).

SN 78-180,495. FMR CORP., BOSTON, MA. FILED 10-31-2002.

GO COACH!

FOR WIRELESS ELECTRONIC TRANSMISSION OF MESSAGES AND DATA WHEREBY CUSTOMERS OF A GROUND TRANSPORTATION PROVIDER MAY TRANSMIT AND RECEIVE INFORMATION PERTAINING TO THEIR RESERVATIONS AND TRANSPORTATION REQUIREMENTS (U.S. CLS. 100, 101 AND 104). FIRST USE 9-1-2001; IN COMMERCE 9-1-2001.

SN 78-185,701. HORNUNG, STEPHEN, J., ALEXANDRIA, VA. FILED 11-15-2002.

1-888-JUSTSAY

FOR TELECOMMUNICATIONS SERVICES, NAMELY, PROVIDING VOICE-ACTIVATED COMMUNICATIONS THROUGH LANDLINE AND WIRELESS COMMUNICATIONS DEVICES (U.S. CLS. 100, 101 AND 104).

CLASS 38—(Continued).

SN 78-187,548. HORNUNG, STEPHEN, J., ALEXANDRIA, VA. FILED 11-21-2002.

1-800-JUSTSAY

FOR TELECOMMUNICATIONS SERVICES, NAMELY, PROVIDING VOICE-ACTIVATED COMMUNICATIONS THROUGH LANDLINE AND WIRELESS COMMUNICATIONS DEVICES. (U.S. CLS. 100, 101 AND 104).

SN 78-193,530. MARTELLO, JEANNETTE, SOUTH PASADENA, CA. FILED 12-11-2002.

SKIN DEEP

FOR CABLE TELEVISION BROADCASTING, CABLE TELEVISION TRANSMISSION, PAY-PER-VIEW TELEVISION TRANSMISSION SERVICES, SUBSCRIPTION TELEVISION BROADCASTING, TELEVISION BROADCASTING, TELEVISION TRANSMISSION SERVICES (U.S. CLS. 100, 101 AND 104).

SN 78-195,859. VERIZON AVENUE CORP, LAKE FOREST, IL. FILED 12-18-2002.

ONEPOINT

OWNER OF U.S. REG. NOS. 2,232,774, 2,237,409 AND 2,239,425.

FOR TELEPHONE TELECOMMUNICATION SERVICES, NAMELY VOICE MESSAGING SERVICES (U.S. CLS. 100, 101 AND 104).

SN 78-195,874. VERIZON COMMUNICATIONS INC., NEW YORK, NY. FILED 12-18-2002.

MAKE PROGRESS EVERY DAY

FOR TELEPHONE COMMUNICATION SERVICES, NAMELY, THE TRANSMISSION OF VOICE, VIDEO AND DATA; PROVIDING MULTIPLE-USER ACCESS TO A GLOBAL COMMUNICATIONS NETWORK (U.S. CLS. 100, 101 AND 104).

SN 78-196,432. SPRINT COMMUNICATIONS COMPANY L.P., OVERLAND PARK, KS. FILED 12-19-2002.

SPRINT COMPLETE SENSE

OWNER OF U.S. REG. NOS. 1,104,943, 1,603,860 AND OTHERS.

FOR TELECOMMUNICATIONS SERVICES, NAMELY, LOCAL AND LONG DISTANCE TELEPHONE SERVICES (U.S. CLS. 100, 101 AND 104).

CLASS 38—(Continued).

SN 78-214,718. WAVEDIVISION HOLDINGS, LLC, KIRKLAND, WA. FILED 2-13-2003.

WAVE

FOR CABLE TELEVISION TRANSMISSION SERVICES (U.S. CLS. 100, 101 AND 104).

CLASS 39—TRANSPORTATION AND STORAGE

SN 75-684,391. CELEBRITY CRUISES INC., MIAMI, FL. FILED 4-15-1999.

MILLENNIUM

FOR CRUISE SHIP SERVICES (U.S. CLS. 100 AND 105).

SN 75-856,179. CLASSICAL CRUISES, INC., NEW YORK, NY. FILED 11-23-1999.

CLASSICAL CRUISES

NO CLAIM IS MADE TO THE EXCLUSIVE RIGHT TO USE "CRUISES", APART FROM THE MARK AS SHOWN.

FOR ARRANGING TRAVEL TOURS, SIGHTSEEING TOURS AND CRUISES; CONDUCTING SIGHTSEEING TOURS FOR OTHERS FEATURING ON-SITE LECTURE PROGRAMS ABOUT THE AREAS BEING VISITED (U.S. CLS. 100 AND 105).

FIRST USE 2-0-1989; IN COMMERCE 2-0-1989.

SN 76-330,027. EDISON PROPERTIES, LLC, NEWARK, NJ. BY ASSIGNMENT EDISON PARKING CORPORATION, NEWARK, NJ. FILED 10-26-2001.



OWNER OF U.S. REG. NOS. 2,331,604, 2,416,829 AND OTHERS.

NO CLAIM IS MADE TO THE EXCLUSIVE RIGHT TO USE "PAYFAST" AND "PARK FAST", APART FROM THE MARK AS SHOWN.

FOR PRE-PAID SELF-SERVICE AND VALET PARKING PLANS PROVIDED IN CONNECTION WITH A DEBIT CARD (U.S. CLS. 100 AND 105).

FIRST USE 5-5-1999; IN COMMERCE 5-5-1999.

CLASS 39—(Continued).

SN 76-337,854. WASHINGTON EXPRESS LLC, BELTSVILLE, MD. BY ASSIGNMENT WASHINGTON EXPRESS SERVICES, INC., BELTSVILLE, MD. FILED 11-14-2001.



OWNER OF U.S. REG. NO. 1,880,085.
SEC. 2(F) "WASHINGTON EXPRESS".
FOR COURIER SERVICES (U.S. CLS. 100 AND 105).

SN 76-366,462. SMALL PAWS RESCUE, INC., TULSA, OK.
FILED 2-5-2002.

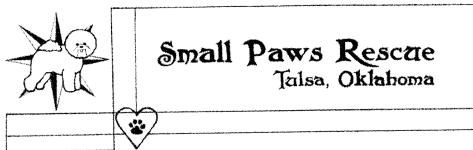

NO CLAIM IS MADE TO THE EXCLUSIVE RIGHT TO USE "RESCUE" AND "TULSA, OKLAHOMA", APART FROM THE MARK AS SHOWN.
FOR NON-PROFIT CANINE RESCUE SERVICES, DIRECTED TO BICHON AND NON-PUREBRED BICHON MIX CANINES (U.S. CLS. 100 AND 105).
FIRST USE 10-12-1998; IN COMMERCE 10-12-1998.

SN 76-384,500. HACKBARTH DELIVERY SERVICE, MOBILE, AL. FILED 3-19-2002.

THE K.Y.S.O. COMPANY

NO CLAIM IS MADE TO THE EXCLUSIVE RIGHT TO USE "COMPANY", APART FROM THE MARK AS SHOWN.
FOR MAIL AND PARCEL PICK-UP AND DELIVERY SERVICE (U.S. CLS. 100 AND 105).

SN 76-387,637. GRAPE TECHNOLOGY GROUP, INC., BETHLEHEM, PA. FILED 3-27-2002.

DRIVE GUIDE

NO CLAIM IS MADE TO THE EXCLUSIVE RIGHT TO USE "GUIDE", APART FROM THE MARK AS SHOWN.
FOR INFORMATION SERVICES, NAMELY, PROVIDING TRAVEL DIRECTIONS TO MOBILE PHONE USERS (U.S. CLS. 100 AND 105).

CLASS 39—(Continued).

SN 76-413,158. WELLS FARGO HOME MORTGAGE, INC., DES MOINES, IA. FILED 5-29-2002.

**HOME MOVE
MANAGEMENT & MORE**

NO CLAIM IS MADE TO THE EXCLUSIVE RIGHT TO USE "HOME MOVE MANAGEMENT", APART FROM THE MARK AS SHOWN.
FOR RESIDENTIAL MOVING SERVICES (U.S. CLS. 100 AND 105).

SN 76-421,462. STORAGE LOFT LLC, HOFFMAN ESTATES, IL. FILED 6-14-2002.

LIFE STORAGE

NO CLAIM IS MADE TO THE EXCLUSIVE RIGHT TO USE "STORAGE", APART FROM THE MARK AS SHOWN.
FOR STORAGE OF HOUSEHOLD, BUSINESS, RECREATIONAL AND PERSONAL GOODS (U.S. CLS. 100 AND 105).

SN 76-446,778. ARREDONDO & COMPANY, LLC, STAMFORD, CT. FILED 9-3-2002.



FOR SUPPLYING STORAGE SERVICES, NAMELY WAREHOUSE AND GENERAL STORAGE; PROVIDING STORAGE FACILITIES AND STORAGE SERVICES FOR OTHERS, NAMELY WAREHOUSE STORAGE FACILITIES, INCLUDING CLIMATE CONTROLLED AND NON CLIMATE CONTROLLED SPACES, LOCKER STORAGE SERVICES, AND THE STORAGE OF CONTAINERS FOR THE STORAGE OF GOODS; PROVIDING SELF-STORAGE FACILITIES, NAMELY THE RENTAL OF UNITS IN A BUILDING FOR THE STORAGE OF GOODS OF OTHERS; RENTAL OF MOVING EQUIPMENT AND VEHICLES, NAMELY DOLLIES AND MOVING CARTS, TRAILERS, TRAILER HITCHES AND TOW DOLLIES, MOVING VANS AND TRUCKS FOR MOVING GOODS, AND FURNITURE PADS; TRANSPORTATION OF OTHERS GOODS BY TRUCK; STORAGE OF RECORDS, FURNITURE AND VARIOUS OTHER GOODS OF OTHERS (U.S. CLS. 100 AND 105).
FIRST USE 12-15-1997; IN COMMERCE 12-15-1997.

CLASS 39—(Continued).

SN 76-457,379. AIR PACIFIC LIMITED, NADI, FIJI, FILED 10-4-2002.

YOUR ISLAND IN THE SKY

OWNER OF U.S. REG. NO. 1,214,348.
FOR AIR TRANSPORTATION SERVICES, NAMELY PROVIDING AIRLINE RESERVATION AND TICKETING SERVICES VIA COMPUTERS AND THE INTERNET, TELEPHONE RESERVATIONS SERVICES; GATE HANDLING AND AIRCRAFT BOARDING SERVICES, PRIORITY SEATING SERVICES FOR AIRLINE PASSENGERS; PROVIDING AIR TRANSPORTATION AND TRAVEL RELATED INFORMATION (U.S. CLS. 100 AND 105).
FIRST USE 4-1-1971; IN COMMERCE 8-1-1971.

SN 76-460,713. WCI COMMUNITIES, INC., BONITA SPRINGS, FL. FILED 10-23-2002.

LET GO. CATCH LIFE.

FOR MARINA SERVICES, NAMELY, DOCKAGE SERVICES, LONG-TERM AND SHORT TERM BOAT STORAGE, FUELING AND LAUNCH SERVICES (U.S. CLS. 100 AND 105).

SN 76-465,128. UNITED FEDERAL CARRIERS, INC., CARSON CITY, NV. FILED 11-7-2002.

WINEGRAM

FOR MESSAGE AND WINE DELIVERY IN RESPONSE TO TELEPHONE OR OTHER ELECTRONIC ORDER (U.S. CLS. 100 AND 105).

SN 76-467,411. UNITED PARCEL SERVICE OF AMERICA, INC., ATLANTA, GA. FILED 11-15-2002.

UPS ON-CALL PICKUP

OWNER OF U.S. REG. NO. 2,116,450.
NO CLAIM IS MADE TO THE EXCLUSIVE RIGHT TO USE "PICKUP", APART FROM THE MARK AS SHOWN.
FOR TRANSPORTATION AND DELIVERY OF PERSONAL PROPERTY BY AIR, RAIL, BOAT, AND MOTOR VEHICLE (U.S. CLS. 100 AND 105).

SN 76-468,511. HAWAIIAN AIRLINES, INC., HONOLULU, HI. FILED 11-8-2002.

HAWAII STARTS HERE

NO CLAIM IS MADE TO THE EXCLUSIVE RIGHT TO USE "HAWAII", APART FROM THE MARK AS SHOWN.
FOR AIR TRANSPORTATION SERVICES (U.S. CLS. 100 AND 105).

CLASS 39—(Continued).

SN 76-471,858. SOUTHEAST STORAGE & DEVELOPMENT COMPANY, LLC, BLUFFTON, SC. FILED 11-15-2002.



NO CLAIM IS MADE TO THE EXCLUSIVE RIGHT TO USE "CELLARS" AND "WINE STORAGE", APART FROM THE MARK AS SHOWN.

LINING IS A FEATURE OF THE MARK AND NOT MEANT TO INDICATE COLOR.
FOR RENTAL OF STORAGE SPACE (U.S. CLS. 100 AND 105).

FIRST USE 0-0-1999; IN COMMERCE 0-0-1999.

SN 76-473,893. STONIER TRANSPORTATION GROUP, INC., JACKSONVILLE, FL. FILED 12-11-2002.



FOR FREIGHT TRANSPORTATION BY TRUCK (U.S. CLS. 100 AND 105).

FIRST USE 1-1-1998; IN COMMERCE 1-1-1998.

SN 78-103,307. TRAVEL INCORPORATED, DULUTH, GA. FILED 1-17-2002.



NO CLAIM IS MADE TO THE EXCLUSIVE RIGHT TO USE "EITINERARY", APART FROM THE MARK AS SHOWN.

FOR TRAVEL AGENCY SERVICES, NAMELY, PROVIDING TRAVEL ITINERARIES AND INVOICES VIA A GLOBAL COMPUTER NETWORK; TRAVEL INFORMATION SERVICES VIA A GLOBAL COMPUTER NETWORK (U.S. CLS. 100 AND 105).

FIRST USE 12-5-2001; IN COMMERCE 12-5-2001.

CLASS 39—(Continued).

SN 78-122,431. AMERICAN VALET & LIMOUSINE, INCORPORATED, PHOENIX, AZ. FILED 4-17-2002.

AMERICAN VALET

OWNER OF U.S. REG. NO. 2,193,331.
 NO CLAIM IS MADE TO THE EXCLUSIVE RIGHT TO USE "VALET", APART FROM THE MARK AS SHOWN. SEC. 2(F).
 FOR VALET PARKING (U.S. CLS. 100 AND 105).
 FIRST USE 1-1-1994; IN COMMERCE 4-27-1999.

CLASS 39—(Continued).

SN 78-175,693. SKYBRATIONS, LLC, MERRIMACK, NH. FILED 10-17-2002.



NO CLAIM IS MADE TO THE EXCLUSIVE RIGHT TO USE "LUGGAGE SHIPPERS", APART FROM THE MARK AS SHOWN.
 FOR FREIGHT FORWARDING SERVICES (U.S. CLS. 100 AND 105).
 FIRST USE 7-15-2002; IN COMMERCE 7-15-2002.

SN 78-141,008. LILLEY, JOHN K., LINDEN, VA. AND LILLEY, ANGELA C., LINDEN, VA. FILED 7-3-2002.

LIL HAULER

NO CLAIM IS MADE TO THE EXCLUSIVE RIGHT TO USE "HAULER", APART FROM THE MARK AS SHOWN.
 FOR TRUCK HAULING SERVICES (U.S. CLS. 100 AND 105).
 FIRST USE 3-15-1999; IN COMMERCE 5-12-1999.

SN 78-178,942. HARTFORD FIRE INSURANCE COMPANY, HARTFORD, CT. FILED 10-28-2002.

THE HARTFORD VAULT

SN 78-159,712. SIEMER & HAND TRAVEL, INC., SAN FRANCISCO, CA. FILED 8-30-2002.

JOURNEYS OF DISCOVERY

FOR ARRANGING TRAVEL TOURS (U.S. CLS. 100 AND 105).
 FIRST USE 9-0-2000; IN COMMERCE 9-0-2000.

OWNER OF U.S. REG. NOS. 1,155,051, 2,487,011 AND OTHERS.
 NO CLAIM IS MADE TO THE EXCLUSIVE RIGHT TO USE "VAULT", APART FROM THE MARK AS SHOWN. SEC. 2(F) AS TO "THE HARTFORD".
 FOR COMPUTER SERVICES, NAMELY, PROVIDING ELECTRONIC STORAGE VAULT FOR SENSITIVE DATA WITH AUTOMATIC AUTHENTICATED RELEASE AND TRANSMITTAL OF DATA TO THIRD PARTIES VIA A GLOBAL COMPUTER NETWORK. (U.S. CLS. 100 AND 105).

SN 78-161,721. TRAVEL HARMONY, HERNDON, VA. FILED 9-7-2002.



NO CLAIM IS MADE TO THE EXCLUSIVE RIGHT TO USE "TRAVEL", APART FROM THE MARK AS SHOWN.
 FOR TRAVEL AGENCY SERVICES, NAMELY ARRANGING BUSINESS AND VACATION TRANSPORTATION FOR INDIVIDUALS, HONEYMOONERS, AND GROUPS (U.S. CLS. 100 AND 105).
 FIRST USE 3-12-2002; IN COMMERCE 7-22-2002.

SN 78-184,124. ATLANTIC TAMBONE, INC., LYNNFIELD, MA. FILED 11-12-2002.

STORAGE UNLIMITED

NO CLAIM IS MADE TO THE EXCLUSIVE RIGHT TO USE "STORAGE", APART FROM THE MARK AS SHOWN.
 FOR GENERAL WAREHOUSE STORAGE SERVICES (U.S. CLS. 100 AND 105).

CLASS 40—MATERIAL TREATMENT

SN 75-926,828. STERLING AUTOMATION, INC., MAPLE PLAIN, MN. FILED 2-23-2000.



NO CLAIM IS MADE TO THE EXCLUSIVE RIGHT TO USE "AUTOMATION INC.", APART FROM THE MARK AS SHOWN.

FOR CUSTOM MANUFACTURE OF ELECTRICAL CONTROL SYSTEMS AND PANELS (U.S. CLS. 100, 103 AND 106).

FIRST USE 11-1-1995; IN COMMERCE 11-1-1995.

SN 76-409,916. HERITAGE PRESERVATION CORPORATION, SPARTANBURG, SC. FILED 5-20-2002.

M-PACT

FOR PRINTING SERVICES (U.S. CLS. 100, 103 AND 106).

FIRST USE 4-12-2002; IN COMMERCE 4-12-2002.

SN 76-417,458. JAH INNOVATIONS INC., FAYETTEVILLE, GA. FILED 6-13-2002.



NO CLAIM IS MADE TO THE EXCLUSIVE RIGHT TO USE "PLASTICS", APART FROM THE MARK AS SHOWN.

THE LINING IS A FEATURE OF THE MARK AND DOES NOT INDICATE COLOR.

FOR CUSTOM MANUFACTURE OF MEAL AND SERVING TRAYS OF PRECIOUS METALS, MEAL AND SERVING TRAYS NOT OF PRECIOUS METALS, AND TABLEWARE, NAMELY, PLASTIC KNIVES, FORKS, AND SPOONS; MANUFACTURE OF MEAL AND SERVING TRAYS OF PRECIOUS METALS, MEAL AND SERVING TRAYS NOT OF PRECIOUS METALS, AND TABLEWARE, NAMELY PLASTIC KNIVES, FORMS, AND SPOONS TO THE ORDER AND SPECIFICATION OF OTHERS (U.S. CLS. 100, 103 AND 106).

CLASS 40—(Continued).

SN 76-435,162. SHAN DONG LUNENG HOLDINGS GROUP CO., SHANDONG, CHINA, FILED 7-29-2002.



THE CHINESE CHARACTERS IN THE MARK TRANSLITERATE TO "LU NENG", WHICH HAS NO ENGLISH TRANSLATION.

FOR PHOTOGRAPHIC PRINTING; WASTE TREATMENT; AIR PURIFICATION; WATER TREATMENT; PRODUCTION OF ENERGY; PROVIDING INFORMATION IN RELATION TO MATERIAL TREATMENT; METAL TREATMENT; APPLYING FINISHES TO TEXTILES; WOODWORKING; PAPER FINISHING; WINDOW TINTING TREATMENT, BEING SURFACE COATING; POTTERY FIRING; FOOD AND DRINK PRESERVATION; SLAUGHTERING OF ANIMALS; DRESSMAKING (U.S. CLS. 100, 103 AND 106).

SN 76-440,247. K&R INSTRUMENTS, INC., ORLANDO, FL. FILED 8-8-2002.

AUTO-AD-VENTURES

FOR CUSTOM MANUFACTURE OF AUTO ACCESSORY PROMOTIONAL ITEMS FOR OTHERS, NAMELY, KEY CHAINS, SUN SHADES, VISOR ORGANIZERS, TIRE GAUGES, COMPASSES, AND DASHBOARD NOTE PADS (U.S. CLS. 100, 103 AND 106).

SN 76-445,538. SONY ELECTRONICS INC., PARK RIDGE, NJ. FILED 8-28-2002.



NO CLAIM IS MADE TO THE EXCLUSIVE RIGHT TO USE "VIDEO 2PC", APART FROM THE MARK AS SHOWN.

FOR VIDEO CONVERSION SERVICE; NAMELY, CONVERSION OF VIDEO RECORDINGS TO COMPACT DISCS (U.S. CLS. 100, 103 AND 106).

CLASS 40—(Continued).

SN 76-445,540. SONY ELECTRONICS INC., PARK RIDGE, NJ. FILED 8-28-2002.

VIDEO2PIX

NO CLAIM IS MADE TO THE EXCLUSIVE RIGHT TO USE "VIDEO 2 PIX", APART FROM THE MARK AS SHOWN.

FOR VIDEO CONVERSION SERVICE; NAMELY, CONVERSION OF STILL IMAGES ON VIDEO RECORDINGS TO COMPACT DISCS (U.S. CLS. 100, 103 AND 106).

CLASS 40—(Continued).

SN 76-472,112. ECKERD CORPORATION, LARGO, FL. FILED 12-5-2002.

SMILE AFTER SMILE

FOR PHOTO FINISHING SERVICES FEATURING A BONUS PROGRAM FOR CUSTOMER'S FREQUENT USAGE OF PHOTO FINISHING SERVICES (U.S. CLS. 100, 103 AND 106).

FIRST USE 10-20-2002; IN COMMERCE 10-20-2002.

SN 76-454,342. TARGET SHEET METAL, INC., GAITHERSBURG, MD. FILED 10-1-2002.

TARGET SHEET METAL, INC.

NO CLAIM IS MADE TO THE EXCLUSIVE RIGHT TO USE "TARGET" AND "SHEET METAL INC", APART FROM THE MARK AS SHOWN.

FOR FABRICATION AND INSTALLATION OF CONSTRUCTION ELEMENTS MADE OUT OF SHEET METAL, NAMELY, DUCTWORK (U.S. CLS. 100, 103 AND 106).

FIRST USE 7-1-1996; IN COMMERCE 1-1-1997.

SN 78-033,524. TEITELBAUM, MICHAEL L., NEW YORK, NY. FILED 11-2-2000.



THE LEFT SIDE OF THE OVAL CONTAINING THE LETTER "R" IS RED. THE RIGHT SIDE OF THE OVAL CONTAINING THE LETTERS "PAC" BEGINS WITH THE COLOR BLUE TO THE LEFT, AND GRADUATES TO A BLUEISH-WHITE COLOR TO THE RIGHT.

FOR CUSTOM MANUFACTURE OF LABELS AND HANG TAGS (U.S. CLS. 100, 103 AND 106).

FIRST USE 10-19-2000; IN COMMERCE 10-19-2000.

SN 76-462,269. INTUIT INC., MOUNTAIN VIEW, CA. FILED 10-29-2002.

INTUIT

OWNER OF U.S. REG. NOS. 1,840,504, 1,944,876 AND OTHERS.

FOR PRINTING SERVICES; OFFSET PRINTING SERVICES; STATIONERY PRINTING SERVICES; CUSTOMIZED PRINTING OF COMPANY NAMES AND LOGOS FOR PROMOTIONAL AND ADVERTISING PURPOSES ON THE GOODS OF OTHERS (U.S. CLS. 100, 103 AND 106).

FIRST USE 2-0-1984; IN COMMERCE 2-0-1984.

SN 78-128,116. TENDERLOIN TECHNOLOGIES, INC., SAN FRANCISCO, CA. FILED 5-13-2002.

BROWN BOTTLE RECORDS

NO CLAIM IS MADE TO THE EXCLUSIVE RIGHT TO USE "RECORDS", APART FROM THE MARK AS SHOWN.

FOR DUPLICATION OF SOUND AND/OR VIDEO RECORDINGS (U.S. CLS. 100, 103 AND 106).

SN 76-469,123. MDI PRODUCTS, LLC, SEBASTIAN, FL. FILED 11-21-2002.

MDI PRODUCTS

NO CLAIM IS MADE TO THE EXCLUSIVE RIGHT TO USE "PRODUCTS", APART FROM THE MARK AS SHOWN.

FOR PARTS MOLDING, NAMELY, PLASTIC INJECTION MOLDING OF PARTS (U.S. CLS. 100, 103 AND 106).

FIRST USE 10-6-2001; IN COMMERCE 11-30-2001.

SN 78-136,352. SCHIMELFENIG, JAY D., WAHPETON, ND. FILED 6-17-2002.

LOUD INK

NO CLAIM IS MADE TO THE EXCLUSIVE RIGHT TO USE "INK", APART FROM THE MARK AS SHOWN.

FOR SILK SCREEN PRINTING (U.S. CLS. 100, 103 AND 106).

FIRST USE 6-25-1999; IN COMMERCE 6-25-1999.

CLASS 40—(Continued).

SN 78-149,780. ZOU, TAIGUI, BETHEL PARK, PA. FILED 8-1-2002.



NO CLAIM IS MADE TO THE EXCLUSIVE RIGHT TO USE "TECHNOLOGY", APART FROM THE MARK AS SHOWN.

FOR CUSTOMER MANUFACTURE OF ALUMINUM AND MAGNESIUM EXTRUSION GOODS (U.S. CLS. 100, 103 AND 106).

SN 78-154,931. DST OUTPUT, INC., KANSAS CITY, MO. FILED 8-16-2002.

RAPID COMPLIANCE

FOR COMMERCIAL PRINTING AND ELECTRONIC PRINTING (U.S. CLS. 100, 103 AND 106).

SN 78-175,392. TAYLOR CORPORATION, NORTH MANKATO, MN. FILED 10-17-2002.

BY REQUEST

FOR PRINTING SERVICES, NAMELY, BLANK AND CUSTOM PRINTING OF WEDDING INVITATIONS, SOCIAL STATIONERY AND WEDDING ACCESSORIES; CUSTOM ENGRAVING ON WEDDING RELATED ITEMS (U.S. CLS. 100, 103 AND 106).

FIRST USE 1-18-2003; IN COMMERCE 1-18-2003.

SN 78-176,350. VERIDIUM CORPORATION, PATERSON, NJ. FILED 10-20-2002.

VERIDIUM

FOR HAZARDOUS WASTE MANAGEMENT; RECYCLING (U.S. CLS. 100, 103 AND 106).

CLASS 40—(Continued).

SN 78-183,314. BRINK'S NETWORK, INC., WILMINGTON, DE. FILED 11-8-2002.

BRINK'S DOCUMENT DESTRUCTION

OWNER OF U.S. REG. NOS. 529,622, 2,585,259 AND OTHERS.

NO CLAIM IS MADE TO THE EXCLUSIVE RIGHT TO USE "DOCUMENT DESTRUCTION", APART FROM THE MARK AS SHOWN.

FOR DOCUMENT DESTRUCTION SERVICES (U.S. CLS. 100, 103 AND 106).

SN 78-185,291. IMMERSION GRAPHICS CORPORATION, COLUMBUS, GA. FILED 11-14-2002.

FINAL FINISH

FOR DIP TRANSFER PRINTING ON PRODUCT SURFACES (U.S. CLS. 100, 103 AND 106).

FIRST USE 1-1-1996; IN COMMERCE 1-1-1996.

CLASS 41—EDUCATION AND ENTERTAINMENT

SN 75-446,864. PARAMOUNT PICTURES CORPORATION, LOS ANGELES, CA. FILED 3-9-1998.

WILD THINGS

FOR ENTERTAINMENT SERVICES IN THE NATURE OF A REALITY BASED ANIMAL ADVENTURE TELEVISION SERIES (U.S. CLS. 100, 101 AND 107).

FIRST USE 9-21-1997; IN COMMERCE 9-21-1997.

SN 75-608,072. CALDWELL, TIMOTHY L., FLINT, MI. FILED 12-18-1998.

CHOSEN

FOR ENTERTAINMENT, NAMELY, LIVE PERFORMANCES BY A SINGING GROUP (U.S. CLS. 100, 101 AND 107).

CLASS 41—(Continued).

SN 75-676,118. VULCAN INC., SEATTLE, WA. BY CHANGE OF NAME VULCAN NORTHWEST INC., BELLEVUE, WA. FILED 4-6-1999.

VULCAN NORTHWEST

NO CLAIM IS MADE TO THE EXCLUSIVE RIGHT TO USE "NORTHWEST", APART FROM THE MARK AS SHOWN.

FOR EDUCATIONAL AND ENTERTAINMENT SERVICES, NAMELY, PROVIDING FACILITIES FOR LIVE PERFORMANCES BY MUSICAL GROUPS, AUDIO AND/OR VIDEO PRODUCTION AND RECORDING, RECORD PRODUCTION, AND FILM PRODUCTION, PROVIDING FACILITIES FOR RESEARCH AND INSTRUCTION IN THE FIELDS OF ART, SCIENCE AND MEDICINE, PROVIDING CLASSES, COURSES, SEMINARS, WORKSHOPS, CONFERENCES AND LECTURES AT THE UNDERGRADUATE, GRADUATE, POST-GRADUATE, ADULT EDUCATION AND PROFESSIONAL LEVELS IN A WIDE VARIETY OF FIELDS, ON-LINE EDUCATIONAL SERVICES, NAMELY, PROVIDING COURSES OF INSTRUCTION AND INTERACTIVE COURSES OF INSTRUCTION AT THE GRADE SCHOOL, HIGH SCHOOL, COLLEGE, GRADUATE AND VOCATIONAL SCHOOL LEVELS IN A VARIETY OF ACADEMIC SUBJECTS, ON-LINE EDUCATIONAL TESTING, NAMELY PREPARING, ADMINISTERING AND SCORING EDUCATIONAL TESTS, AND ASSESSMENT AND COUNSELING SERVICES BASED ON THE TEST RESULTS, AND PROVIDING SERVICES RENDERED IN CONNECTION WITH THE OPERATION OF A MUSIC MUSEUM; PRODUCTION AND DISTRIBUTION OF TELEVISION PROGRAMMING; PRODUCTION AND DISTRIBUTION OF AUDIO AND AUDIOVISUAL PROGRAMMING, MOTION PICTURES, FILMS, VIDEO TAPE RECORDING, AND MULTIMEDIA INTERACTIVE PROGRAMMING SERVICES IN THE FIELD OF RADIO, TELEVISION, CABLE TELEVISION, AND ONLINE; MOTION PICTURE STUDIO SERVICES, NAMELY DISTRIBUTION AND PRODUCTION OF MOTION PICTURES, LIGHTING PRODUCTION SERVICES, POST PRODUCTION SERVICES, AND PROVISION OF SOUND STAGES AND PROPS; CABLE TELEVISION PROGRAMMING; PRODUCTION AND DISTRIBUTION OF RADIO PROGRAMMING; SPORTS AND ENTERTAINMENT INFORMATION PROVIDED BY ELECTRONIC MEANS; MUSEUM SERVICES; MUSEUM EXHIBITION SERVICES; GALLERY EXHIBITION SERVICES; COMMUNITY SERVICES RELATED TO EDUCATION AND ENTERTAINMENT, NAMELY, ORGANIZING COMMUNITY FESTIVALS FEATURING A VARIETY OF ACTIVITIES, NAMELY SPORTING EVENTS, CONCERTS, CINEMA, PERFORMING ARTS EVENTS AND THE LIKE, AND EXHIBITIONS RELATING TO MUSIC, ART, SCIENCE, TECHNOLOGY AND TELECOMMUNICATIONS, MEDICINE AND HEALTH, AND FINANCE AND INVESTMENT; CONDUCTING CLASSES, SEMINARS, WORKSHOPS, LECTURES AND EDUCATIONAL COMMUNITY OUTREACH PROGRAMS IN THE NATURE OF WORKSHOPS AND CLASSES, ALL RELATED TO MUSIC, ART, SCIENCE, TECHNOLOGY AND TELECOMMUNICATIONS, MEDICINE AND HEALTH, FINANCE AND INVESTMENT, AND EDUCATION AND ENTERTAINMENT, AND PROVIDING ASSISTANCE TO COMMUNITY GROUPS, ALL RELATING TO EDUCATION, ENVIRONMENTAL PROTECTION, YOUTH SERVICES, SOCIAL SERVICES, AID TO THE DISABLED AND DISADVANTAGED, AND ANIMAL WELFARE; PUBLICATION OF MAGAZINES AND NEWSLETTERS RELATING TO EDUCATIONAL AND ENTERTAINMENT SERVICES; AND PROVIDING FACILITIES FOR CONCERTS, CINEMA AND PERFORMING ARTS EVENTS, AND EXHIBITIONS RELATING TO MUSIC, ART, SCIENCE, TECHNOLOGY AND TELECOMMUNICATIONS, MEDICINE AND HEALTH, AND FINANCE AND INVESTMENT; PROVIDING AN ON-LINE ELEC-

CLASS 41—(Continued).

TRONIC DATABASE IN THE FIELDS OF MUSIC, EDUCATION AND ENTERTAINMENT, AND AUDIO AND VIDEO PRODUCTION AND RECORDING, RECORD PRODUCTION, AND FILM PRODUCTION ON A GLOBAL COMPUTER NETWORK, WIDE-AREA NETWORK, AND LOCAL-AREA NETWORK; AND PROVIDING INFORMATION IN THE FIELDS OF MUSIC, EDUCATION AND ENTERTAINMENT, AND AUDIO AND VIDEO PRODUCTION AND RECORDING, RECORD PRODUCTION, AND FILM PRODUCTION VIA WEBSITES ON GLOBAL COMPUTER NETWORKS (U.S. CLS. 100, 101 AND 107).

SN 75-705,535. FORT HAYS STATE UNIVERSITY, HAYS, KS. FILED 6-10-1999.

**STERNBERG MUSEUM OF
NATURAL HISTORY**

NO CLAIM IS MADE TO THE EXCLUSIVE RIGHT TO USE "MUSEUM OF NATURAL HISTORY", APART FROM THE MARK AS SHOWN.

SEC. 2(F).

FOR THEATRICAL BOOKING IN THE FIELD OF NATURAL HISTORY AND RELATED FIELDS, INCLUDING, BUT NOT LIMITED TO BIOLOGY, GEOLOGY AND PALEONTOLOGY; MOTION PICTURE THEATERS; EDUCATIONAL AND ENTERTAINMENT SERVICES, NAMELY, PROVIDING SPEAKERS IN THE FIELD OF NATURAL HISTORY AND RELATED FIELDS, INCLUDING, BUT NOT LIMITED TO, BIOLOGY, GEOLOGY AND PALEONTOLOGY; AND ENTERTAINMENT SERVICES, NAMELY, PRODUCING PLAYS IN THE FIELD OF NATURAL HISTORY AND RELATED FIELDS, INCLUDING, BUT NOT LIMITED TO, BIOLOGY, GEOLOGY AND PALEONTOLOGY; ANIMAL EXHIBITIONS; ARRANGING AND CONDUCTING EDUCATIONAL CONFERENCES; AUDIO RECORDING AND PRODUCTIONS; AWARDS AND/OR EDUCATIONAL SERVICES, NAMELY, PROVIDING SERVICES TO GROUPS OR INDIVIDUALS INTERESTED IN NATURAL HISTORY AND RELATED SCIENTIFIC AND EDUCATIONAL EXPERIENCES, TO DEMONSTRATE EXCELLENCE IN THE FIELD OF NATURAL HISTORY AND RELATED FIELDS, INCLUDING, BUT NOT LIMITED TO BIOLOGY, GEOLOGY AND PALEONTOLOGY; PUBLICATION OF BOOKS; SCHEDULING OF CABLE TELEVISION PROGRAMMING; PRODUCTION OF CABLE TELEVISION PROGRAMS; CABLE TELEVISION PROGRAMMING OR SCHEDULING IN THE FIELD OF NATURAL HISTORY AND RELATED FIELDS, INCLUDING, BUT NOT LIMITED TO BIOLOGY, GEOLOGY AND PALEONTOLOGY; CABLE TELEVISION PROGRAMMING AND SCHEDULING IN THE FIELD OF NATURAL HISTORY AND RELATED FIELDS, INCLUDING, BUT NOT LIMITED TO BIOLOGY, GEOLOGY AND PALEONTOLOGY; RENTAL OF CINEMA PROJECTION APPARATUS AND ACCESSORIES; CINEMA STUDIOS; CINEMA THEATERS; PRODUCTION OF CLOSED CAPTIONING TELEVISION PROGRAMS; COMMUNITY FESTIVALS FEATURING A VARIETY OF ACTIVITIES, NAMELY, SPORTING EVENTS, ART EXHIBITIONS, FLEA MARKETS, ETHNIC DANCES AND THE LIKE IN THE FIELD OF NATURAL HISTORY AND RELATED FIELDS, INCLUDING, BUT NOT LIMITED TO BIOLOGY, GEOLOGY AND PALEONTOLOGY; COMPETITIONS IN THE FIELD OF NATURAL HISTORY AND RELATED FIELDS, INCLUDING, BUT NOT LIMITED TO BIOLOGY, GEOLOGY AND PALEONTOLOGY; ENTERTAINMENT IN THE NATURE OF COMPUTER EDUCATION TRAINING SERVICES, ARRANGING AND CONDUCTING EDUCATION CONFERENCES AND/OR CORRESPONDENCE COURSES AND EDUCATION IN THE FIELD OF NATURAL HISTORY AND RELATED FIELDS, INCLUDING, BUT NOT LIMITED TO BIOLOGY, GEOLOGY AND PALEONTOLOGY; EDUCATIONAL DEMONSTRATIONS; DEVELOPING EDUCATIONAL MANUALS FOR OTHERS IN THE FIELD OF NATURAL HISTORY AND RELATED

CLASS 41—(Continued).

FIELDS, INCLUDING, BUT NOT LIMITED TO BIOLOGY, GEOLOGY AND PALEONTOLOGY; DEVELOPMENT AND DISSEMINATION OF EDUCATIONAL MATERIALS OF OTHERS IN THE FIELD OF, INCLUDING, BUT NOT LIMITED TO BIOLOGY, GEOLOGY AND PALEONTOLOGY; VIDEO EDITING, EDUCATION AND ENTERTAINMENT SERVICES, NAMELY, PROVIDING MOTIVATIONAL AND EDUCATIONAL SPEAKERS, INCLUDING, BUT NOT LIMITED TO BIOLOGY, GEOLOGY AND PALEONTOLOGY; ARRANGING AND CONDUCTING EDUCATIONAL CONFERENCES, EDUCATIONAL DEMONSTRATIONS AND/OR EDUCATIONAL MATERIALS OF OTHERS IN THE FIELD OF NATURAL HISTORY AND RELATED FIELDS, INCLUDING, BUT NOT LIMITED TO BIOLOGY, GEOLOGY AND PALEONTOLOGY; DEVELOPMENT AND DISSEMINATION OF RESEARCH AND TEACHING IN THE FIELD OF NATURAL HISTORY AND RELATED FIELDS, INCLUDING, BUT NOT LIMITED TO BIOLOGY, GEOLOGY AND PALEONTOLOGY; EDUCATIONAL RESEARCH AND/OR EDUCATIONAL SERVICES, NAMELY, PROVIDING COURSES OF INSTRUCTION AT THE PRIMARY, SECONDARY, COLLEGE LEVEL, INCLUDING EDUCATIONAL PROGRAMS IN THE FIELD OF NATURAL HISTORY AND RELATED FIELDS, INCLUDING, BUT NOT LIMITED TO BIOLOGY, GEOLOGY AND PALEONTOLOGY; EDUCATIONAL SERVICES, NAMELY, PROVIDING INCENTIVES TO ALL AGE GROUPS INTERESTED IN NATURAL HISTORY AND THE RELATED FIELDS, INCLUDING, BUT NOT LIMITED TO BIOLOGY, GEOLOGY AND PALEONTOLOGY ORGANIZATIONS, ETC; TO DEMONSTRATE EXCELLENCE IN THE FIELD OF NATURAL HISTORY, AND CONDUCTING SEMINARS, FIELD WORK, CLASSES, SEMINARS, CONFERENCES, WORKSHOPS IN THE FIELD OF NATURAL HISTORY AND RELATED FIELDS, INCLUDING, BUT NOT LIMITED TO BIOLOGY, GEOLOGY AND PALEONTOLOGY; EDUCATIONAL TESTING IN THE FIELD OF NATURAL HISTORY AND RELATED FIELDS, INCLUDING, BUT NOT LIMITED TO BIOLOGY, GEOLOGY AND PALEONTOLOGY; CONDUCTING EDUCATIONAL AND/OR ENTERTAINMENT EXHIBITIONS IN THE NATURE OF NATURAL HISTORY AND RELATED FIELDS, INCLUDING, BUT NOT LIMITED TO BIOLOGY, GEOLOGY AND PALEONTOLOGY; MOTION PICTURE THEATERS; EDUCATIONAL AND ENTERTAINMENT SERVICES, NAMELY, PROVIDING SPEAKERS IN THE FIELD OF NATURAL HISTORY AND RELATED FIELDS, INCLUDING, BUT NOT LIMITED TO, BIOLOGY, GEOLOGY AND PALEONTOLOGY; ENTERTAINMENT IN THE NATURE OF PRERECORDED MESSAGE OR TEXT IN THE FIELD OF NATURAL HISTORY AND RELATED FIELDS, INCLUDING, BUT NOT LIMITED TO BIOLOGY, GEOLOGY AND PALEONTOLOGY MESSAGES BY TELEPHONE; ENTERTAINMENT SERVICES, NAMELY, PERSONAL APPEARANCES BY SCIENTISTS, EXPERTS OR OTHER RELATED CELEBRITIES IN THE FIELD OF NATURAL HISTORY AND RELATED FIELDS, INCLUDING, BUT NOT LIMITED TO BIOLOGY, GEOLOGY AND PALEONTOLOGY; ENTERTAINMENT SERVICES, NAMELY, PROVIDING AN ON-LINE COMPUTER GAME IN THE FIELD OF NATURAL HISTORY AND RELATED FIELDS, INCLUDING, BUT NOT LIMITED TO BIOLOGY, GEOLOGY AND PALEONTOLOGY; ENTERTAINMENT IN THE FIELD OF NATURAL HISTORY AND RELATED FIELDS, INCLUDING, BUT NOT LIMITED TO BIOLOGY, GEOLOGY AND PALEONTOLOGY SHOWS DISTRIBUTED OVER TELEVISION, SATELLITE, AND INTERNET; ORGANIZING EXHIBITIONS FOR THE FIELD OF NATURAL HISTORY AND RELATED FIELDS, INCLUDING, BUT NOT LIMITED TO BIOLOGY, GEOLOGY AND PALEONTOLOGY; EXHIBITIONS IN THE NATURE OF DINOSAUR OR FOSSIL DISPLAYS, BIOLOGICAL AND RELATED DISPLAYS, CULTURAL DISPLAYS RELATED TO THE FIELD OF NATURAL HISTORY AND RELATED FIELDS, INCLUDING, BUT NOT LIMITED TO BIOLOGY, GEOLOGY AND PALEONTOLOGY; PROVIDING FACILITIES FOR TOURNAMENTS, EXHIBITIONS, CONFERENCES IN THE FIELD OF NATURAL HISTORY AND RELATED FIELDS, INCLUDING, BUT NOT LIMITED TO BIOLOGY, GEOLOGY AND PALEONTOLOGY;

CLASS 41—(Continued).

TOLOGY; INCENTIVES TO PEOPLE, ORGANIZATIONS, ETC TO DEMONSTRATE EXCELLENCE IN THE FIELD OF NATURAL HISTORY AND RELATED FIELDS, INCLUDING, BUT NOT LIMITED TO BIOLOGY, GEOLOGY AND PALEONTOLOGY THROUGH THE ISSUE; INSTRUCTION IN THE FIELD OF NATURAL HISTORY AND RELATED FIELDS, INCLUDING, BUT NOT LIMITED TO BIOLOGY, GEOLOGY AND PALEONTOLOGY, ENTERTAINMENT IN THE NATURE OF LASER SHOWS, LIBRARIES, LIGHT SHOWS IN THE FIELD OF NATURAL HISTORY AND RELATED FIELDS, INCLUDING, BUT NOT LIMITED TO BIOLOGY, GEOLOGY AND PALEONTOLOGY; ENTERTAINMENT IN THE NATURE OF PRE-RECORDED MESSAGES BY TELEPHONE IN THE FIELD OF NATURAL HISTORY AND RELATED FIELDS, INCLUDING, BUT NOT LIMITED TO BIOLOGY, GEOLOGY AND PALEONTOLOGY; MULTIMEDIA ENTERTAINMENT SOFTWARE PRODUCTION SERVICES IN THE FIELD OF NATURAL HISTORY AND RELATED FIELDS, INCLUDING, BUT NOT LIMITED TO BIOLOGY, GEOLOGY AND PALEONTOLOGY; MUSIC COMPOSITION AND TRANSCRIPTION FOR OTHERS, LIVE MUSIC CONCERTS, AND TELEVISION NEWS SHOWS IN THE FIELD OF NATURAL HISTORY AND RELATED FIELDS, INCLUDING, BUT NOT LIMITED TO BIOLOGY, GEOLOGY AND PALEONTOLOGY; ORGANIZING COMMUNITY FESTIVALS FEATURING A VARIETY OF ACTIVITIES, NAMELY ART EXHIBITIONS, DINOSAUR OR FOSSIL DISPLAYS, BIOLOGICAL AND RELATED DISPLAYS, CULTURAL DISPLAYS, ORGANIZING EXHIBITIONS IN THE FIELD OF NATURAL HISTORY AND RELATED FIELDS, INCLUDING, BUT NOT LIMITED TO BIOLOGY, GEOLOGY AND PALEONTOLOGY, CONDUCTION OF WORKSHOPS AND SEMINARS ON PERSONAL AWARENESS IN THE FIELD OF NATURAL HISTORY AND RELATED FIELDS, INCLUDING, BUT NOT LIMITED TO BIOLOGY, GEOLOGY AND PALEONTOLOGY; AUDIO RECORDING PRODUCTION, MOTION PICTURE PRODUCTION FILM, PRODUCTION OF TELEVISION SHOWS, PLAYS, CABLE TELEVISION PROGRAMS, PROGRAMMING SCHEDULING IN THE FIELD OF NATURAL HISTORY AND RELATED FIELDS, INCLUDING, BUT NOT LIMITED TO BIOLOGY, GEOLOGY AND PALEONTOLOGY; RADIO PROGRAMMING AND SCHEDULING IN THE FIELD OF NATURAL HISTORY AND RELATED FIELDS, INCLUDING, BUT NOT LIMITED TO BIOLOGY, GEOLOGY AND PALEONTOLOGY; PROGRAMMING AND SCHEDULING OF PROGRAMS ON A GLOBAL COMPUTER NETWORK, PROGRAMMING TO CABLE TELEVISION SYSTEMS, PRODUCTION OF CABLE TELEVISION, AND OTHER RELATED PROGRAMS IN THE FIELD OF NATURAL HISTORY AND RELATED FIELDS, INCLUDING, BUT NOT LIMITED TO BIOLOGY, GEOLOGY AND PALEONTOLOGY; PROVIDING COURSES OF INSTRUCTION IN THE FIELD OF NATURAL HISTORY AND RELATED FIELDS, INCLUDING, BUT NOT LIMITED TO BIOLOGY, GEOLOGY AND PALEONTOLOGY AT A VARIETY OF LEVELS, INCLUDING, BUT NOT LIMITED TO INSTRUCTION IN KINDERGARTEN THROUGH TWELFTH GRADE METHODS OR ACTIVITIES, COLLEGIATE AND POST GRADUATE COURSES; PROVIDING FACILITIES FOR EVENTS RELATED TO THE FIELD OF NATURAL HISTORY AND RELATED FIELDS, INCLUDING, BUT NOT LIMITED TO BIOLOGY, GEOLOGY AND PALEONTOLOGY; PUBLICATION OF ITEMS RELATED TO THE FIELD OF NATURAL HISTORY AND RELATED FIELDS, INCLUDING, BUT NOT LIMITED TO BIOLOGY, GEOLOGY AND PALEONTOLOGY, EG BOOKS, MAGAZINES, TREATISES, MANUALS; PRODUCTION OF RADIO AND TELEVISION PROGRAMS AND SCHEDULING OF RADIO PROGRAMMING AND DISTRIBUTION OF RADIO PROGRAMS FOR OTHERS, IN THE FIELD OF NEWS IN THE FIELD OF NATURAL HISTORY AND RELATED FIELDS, INCLUDING, BUT NOT LIMITED TO BIOLOGY, GEOLOGY AND PALEONTOLOGY; PROVIDING FACILITIES FOR RECREATIONAL CAMPS AND RECREATIONAL SERVICES IN THE NATURE OF NATURAL HISTORY AND RELATED FIELDS EXPERIENCES, INCLUDING, BUT NOT LIMITED TO BIOLOGY, GEOLOGY AND PALEONTOLOGY; EDUCATIONAL RESEARCH, RESERVATIONS FOR SHOWS AND OTHER ENTERTAINMENT EVENTS; WORKSHOPS AND SEMINARS ABOUT RELATED EDUCATIONAL EXPERIENCES IN THE FIELD OF NATURAL HISTORY AND RELATED FIELDS, INCLUDING, BUT NOT LIMITED TO BIOLOGY, GEOLOGY AND PALEONTOLOGY;

CLASS 41—(Continued).

AL HISTORY AND RELATED FIELDS, INCLUDING, BUT NOT LIMITED TO BIOLOGY, GEOLOGY AND PALEONTOLOGY; LIVE PERFORMANCES BY SINGERS, GROUPS OF SCIENTISTS, RESEARCHERS, FIELD WORK, EXPERIENCE OR EDUCATIONAL PROGRAMS, PLAYS AND RELATED EXPERIENCES IN THE FIELD OF NATURAL HISTORY AND RELATED FIELDS, INCLUDING, BUT NOT LIMITED TO BIOLOGY, GEOLOGY AND PALEONTOLOGY; PREPARATION OF, BUT NOT LIMITED TO, SPECIMENS, REPLICAS AND CASTS OR MOLDINGS, SPECIAL EFFECTS ANIMATION SERVICES FOR FILM AND VIDEO, TELEVISION SYNDICATION PROGRAMS IN THE FIELD OF NATURAL HISTORY AND RELATED FIELDS, INCLUDING, BUT NOT LIMITED TO BIOLOGY, GEOLOGY AND PALEONTOLOGY; TEACHING IN THE FIELD OF NATURAL HISTORY AND RELATED FIELDS, INCLUDING, BUT NOT LIMITED TO BIOLOGY, GEOLOGY AND PALEONTOLOGY; ENTERTAINMENT IN THE NATURE OF PRERECORDED ADVERTISEMENTS AND/OR MESSAGES RELATED TO NATURAL HISTORY AND/OR THE PROGRAMS AND EDUCATIONAL EXPERIENCES RELATED THERETO; TELEVISION SCHEDULING OR PROGRAMMING BOTH TO ADVERTISE PROGRAMS AND TO PROVIDE SPECIFIC EDUCATION IN THE FIELD OF NATURAL HISTORY AND RELATED FIELDS, INCLUDING, BUT NOT LIMITED TO BIOLOGY, GEOLOGY AND PALEONTOLOGY; EDUCATIONAL TESTING IN THE FIELD OF NATURAL HISTORY AND RELATED FIELDS, INCLUDING, BUT NOT LIMITED TO BIOLOGY, GEOLOGY AND PALEONTOLOGY; ARRANGING FOR TICKET RESERVATIONS FOR SHOWS AND OTHER ENTERTAINMENT EVENTS, COMPUTER EDUCATION TRAINING, TRAINING IN THE USE AND OPERATION OF COMPUTERS, DATA PROCESSORS AND OTHER TECHNOLOGY RELATED TO EDUCATIONAL EXPERIENCES IN THE FIELD OF NATURAL HISTORY AND RELATED FIELDS, INCLUDING, BUT NOT LIMITED TO BIOLOGY, GEOLOGY AND PALEONTOLOGY; VOCATIONAL EDUCATION IN THE FIELD OF NATURAL HISTORY AND RELATED FIELDS, INCLUDING, BUT NOT LIMITED TO BIOLOGY, GEOLOGY AND PALEONTOLOGY; WORKSHOPS AND SEMINARS IN THE FIELD OF NATURAL HISTORY AND RELATED FIELDS, INCLUDING, BUT NOT LIMITED TO BIOLOGY, GEOLOGY AND PALEONTOLOGY (U.S. CLS. 100, 101 AND 107).

FIRST USE 4-2-1991, THE MARK WAS FIRST USED ANYWHERE IN A DIFFERENT FORM OTHER THAN THAT SOUGHT TO BE REGISTERED ON 09/17/1969; IN COMMERCE 4-2-1991, THE MARK WAS FIRST USED IN COMMERCE IN A DIFFERENT FORM OTHER THAN THAT SOUGHT TO BE REGISTERED ON 09/17/1969.

SN 75-827,349. FITNESS INNOVATIONS INCORPORATED, PITTSBURGH, PA. FILED 10-20-1999.

**FITNESS INNOVATIONS BY
JEFF RILEY**

NO CLAIM IS MADE TO THE EXCLUSIVE RIGHT TO USE "FITNESS", APART FROM THE MARK AS SHOWN. FOR PERSONAL PHYSICAL FITNESS TRAINING (U.S. CLS. 100, 101 AND 107).
FIRST USE 4-3-1997; IN COMMERCE 5-3-1997.

CLASS 41—(Continued).

SN 75-978,136. PRECISION DYNAMICS, INC., PHOENIX, AZ. FILED 11-21-1997.

PRECISION DYNAMICS

FOR EDUCATIONAL SERVICES FOR THE AUTOMOTIVE INDUSTRY, NAMELY, PROVIDING SALES AND PRODUCT TRAINING AND DRIVING INSTRUCTION (U.S. CLS. 100, 101 AND 107).
FIRST USE 4-30-1993; IN COMMERCE 4-30-1993.

SN 75-982,949. WHITNEY EDUCATION GROUP, INC., CAPE CORAL, FL. FILED 10-13-1999.

WIN!

FOR EDUCATIONAL SERVICES, NAMELY CLASSES, WORKSHOPS AND CONFERENCES REGARDING PROPERTY MANAGEMENT, WHOLESALE BUYING, FORECLOSURES, LEASE AND PURCHASE OPTIONS, AND ASSET PROTECTION, IN THE FIELD OF REAL ESTATE (U.S. CLS. 100, 101 AND 107).
FIRST USE 11-12-1992; IN COMMERCE 11-12-1992.

SN 76-002,570. XM SATELLITE RADIO INC., WASHINGTON, DC. BY ASSIGNMENT XM SATELLITE RADIO HOLDINGS, INC., WASHINGTON, DC. FILED 3-17-2000.

XM CAFE

FOR ENTERTAINMENT SERVICES, NAMELY, PROVIDING AUDIO PROGRAMS FEATURING MUSIC, SPORTS, TALK, NEWS AND DATA VIA SATELLITE AND VIA A GLOBAL COMMUNICATION NETWORK (U.S. CLS. 100, 101 AND 107).

SN 76-049,823. VALENTINE MEDIA, INC., NEW YORK, NY. FILED 5-16-2000.

APOCALYPSTICK

FOR ENTERTAINMENT SERVICES IN THE NATURE OF ONLINE VIDEO GAME PROGRAMS PROVIDED OVER THE GLOBAL COMPUTER NETWORK (U.S. CLS. 100, 101 AND 107).

CLASS 41—(Continued).

SN 76-097,050. EPISCOPAL HOME FOR CHILDREN, ST. LOUIS, MO. FILED 7-26-2000.

AAH2LEARN

FOR EDUCATIONAL SERVICES, NAMELY ORGANIZING AND CONDUCTING LECTURES, WORKSHOPS, SEMINARS, CLASSES, INDIVIDUAL INSTRUCTION, AND OTHER PROGRAMS IN THE FIELDS OF PSYCHOLOGY, SPIRITUAL AWARENESS, SELF-IMPROVEMENT, PERSONAL DEVELOPMENT, RELIGIOUS TEACHINGS, AND RELATED INSPIRATIONAL SUBJECTS, AND DISTRIBUTING COURSE MATERIAL, LITERATURE, AND PUBLICATIONS IN CONNECTION THEREWITH (U.S. CLS. 100, 101 AND 107).

SN 76-106,744. INTELLIMET, INC., SCOTTSDALE, AZ. FILED 8-8-2000.

INTELLIMETRO

FOR EDUCATIONAL SERVICES, NAMELY, CONDUCTING CLASSES, SEMINARS, CONFERENCES, LECTURES, CLINICS, AND WORKSHOPS, IN THE FIELD OF PREPARING, CONDUCTING, COMPILING DATA FROM, EVALUATING, AND PREPARING REPORTS FROM BUSINESS SYSTEMS ASSESSMENTS AND BUSINESS PROCEDURE ASSESSMENTS, AND IN THE FIELD OF THE CERTIFICATION OF BUSINESS SYSTEMS AND BUSINESS PROCEDURES FOR COMPLIANCE WITH INDUSTRY BUSINESS AND/OR QUALITY STANDARDS (U.S. CLS. 100, 101 AND 107).

SN 76-173,504. PROFILE NETWORK INC., DBA SPORTS PROFILES, SKOKIE, IL. FILED 11-30-2000.

SPORTS FANS CHOICE AWARDS

NO CLAIM IS MADE TO THE EXCLUSIVE RIGHT TO USE "SPORTS FANS" AND "AWARDS", APART FROM THE MARK AS SHOWN.

FOR PRODUCTION OF TELEVISION PROGRAMS WHERE INDIVIDUAL ATHLETES ARE PUBLICLY RECOGNIZED AND MAY RECEIVE TROPHIES OR GIFTS IN HONOR OF OUTSTANDING ATHLETIC ACCOMPLISHMENTS OR PERFORMANCES (U.S. CLS. 100, 101 AND 107).

FIRST USE 12-0-1996; IN COMMERCE 12-0-1996.

CLASS 41—(Continued).

SN 76-183,086. STAR CITY PTY LIMITED, PYRMONT, NEW SOUTH WALES 2009, AUSTRALIA, FILED 12-19-2000.



FOR CASINOS; PROVIDING CASINO FACILITIES; GAMING SERVICES, NAMELY, GAMES OF CHANCE; ENTERTAINMENT IN THE NATURE OF GAMING; ENTERTAINMENT, NAMELY, LIVE MUSICAL PERFORMANCES; CABARET PERFORMANCES, THEATRICAL PRODUCTIONS, AND COMEDY PRODUCTIONS; PROVIDING FACILITIES FOR RECREATIONAL ACTIVITIES; LOTTERY SERVICES (U.S. CLS. 100, 101 AND 107).

SN 76-183,670. KABUSHIKI KAISHA SEGA, DBA SEGA CORPORATION, TOKYO 144-0043, JAPAN, FILED 12-20-2000.



PRIORITY CLAIMED UNDER SEC. 44(D) ON JAPAN APPLICATION NO. 2000-113323, FILED 10-18-2000, REG. NO. 4530944, DATED 12-21-2001, EXPIRES 12-21-2011.

FOR PROVIDING RECREATION FACILITIES, AMUSEMENTS ARCADES, AND AMUSEMENT PARK; ENTERTAINMENT IN THE NATURE OF AN AMUSEMENT PARK RIDE (U.S. CLS. 100, 101 AND 107).

SN 76-217,253. GREICO FINANCIAL TRAINING INSTITUTE, INC., NEW YORK, NY. FILED S.R. 2-28-2001; AM. P.R. 3-10-2003.

GREICO ON LINE

OWNER OF U.S. REG. NOS. 2,390,956, 2,390,957 AND 2,483,045.

NO CLAIM IS MADE TO THE EXCLUSIVE RIGHT TO USE "ON LINE", APART FROM THE MARK AS SHOWN. SEC. 2(F).

FOR LICENSING TRAINING IN THE FIELD OF FINANCIAL SECURITIES; PERSONNEL TRAINING IN THE FIELDS OF FINANCIAL INSURANCE, SECURITIES, BANKING AND BROKERAGE SERVICES; EDUCATIONAL SERVICES NAMELY CONDUCTING CONTINUING EDUCATION CLASSES IN THE FIELD OF FINANCIAL SECURITIES (U.S. CLS. 100, 101 AND 107).

CLASS 41—(Continued).

SN 76-217,708. ENGENDERHEALTH, NEW YORK, NY. BY CHANGE OF NAME AVSC INTERNATIONAL, NEW YORK, NY. FILED 3-1-2001.



NO CLAIM IS MADE TO THE EXCLUSIVE RIGHT TO USE "HEALTH", APART FROM THE MARK AS SHOWN. FOR EDUCATIONAL SERVICES, NAMELY, CONDUCTING AND ARRANGING SEMINARS, CONFERENCES, WORKSHOPS AND ON-LINE SEMINARS IN THE FIELD OF HEALTH CARE (U.S. CLS. 100, 101 AND 107).

SN 76-236,288. NORTH-40.COM LLC, DENVER, CO. FILED 4-6-2001.



THE MARK CONSISTS OF A ROAD SIGN WITH THE WORD "NORTH" ABOVE THE NUMERAL "40". FOR ENTERTAINMENT SERVICES NAMELY LIVE PERFORMANCES BY A MUSICAL GROUP; ENTERTAINMENT SERVICES NAMELY THE PRODUCTION AND DISTRIBUTION FOR OTHERS OF RECORDS FEATURING MUSICAL RECORDINGS (U.S. CLS. 100, 101 AND 107). FIRST USE 6-1-2000; IN COMMERCE 6-1-2000.

SN 76-246,750. SONGSEARCH, LLC, REDLANDS, CA. FILED 4-24-2001.

SONGSEARCH

SEC. 2(F). FOR ENTERTAINMENT SERVICES, NAMELY, PROVIDING AN ON-LINE DATABASE FOR SEARCHING AND OBTAINING DATA ABOUT SONG TITLES (U.S. CLS. 100, 101 AND 107). FIRST USE 10-1-1995; IN COMMERCE 10-1-1995.

CLASS 41—(Continued).

SN 76-250,424. BIRD3, LAGUNA BEACH, CA. FILED 5-1-2001.



FOR ENTERTAINMENT SERVICES IN THE NATURE OF LIVE MUSICAL PERFORMANCES (U.S. CLS. 100, 101 AND 107). FIRST USE 3-15-2001; IN COMMERCE 3-15-2001.

SN 76-257,987. MPOWERED IDEAS, INC., REDONDO BEACH, CA. FILED 5-17-2001.

TOTALLY COMMITTED

FOR ENTERTAINMENT SERVICES, NAMELY, LIVE MUSICAL PERFORMANCES; AUDIO RECORDING AND PRODUCTION; VIDEOTAPE PRODUCTION; AND ENTERTAINMENT IN THE NATURE OF AN ON-GOING TELEVISION PROGRAM IN THE FIELD OF MUSIC (U.S. CLS. 100, 101 AND 107).

SN 76-285,934. HARDKORE CHAMPIONSHIP WRESTLING, INC., SUNRISE, FL. FILED 7-9-2001.

**HARDKORE
CHAMPIONSHIP
WRESTLING, INC.**

NO CLAIM IS MADE TO THE EXCLUSIVE RIGHT TO USE "CHAMPIONSHIP WRESTLING, INC.", APART FROM THE MARK AS SHOWN. FOR ENTERTAINMENT SERVICES, NAMELY, ARRANGING AND CONDUCTING LIVE PROFESSIONAL WRESTLING EVENTS (U.S. CLS. 100, 101 AND 107). FIRST USE 10-31-1999; IN COMMERCE 10-31-1999.

CLASS 41—(Continued).

SN 76-286,940. TUFTS UNIVERSITY, MEDFORD, MA.
FILED 7-18-2001.

THE FLETCHER SCHOOL

NO CLAIM IS MADE TO THE EXCLUSIVE RIGHT TO USE "SCHOOL", APART FROM THE MARK AS SHOWN. THE TERM "FLETCHER" IN THE MARK DOES NOT IDENTIFY A LIVING INDIVIDUAL.

SEC. 2(F).

FOR EDUCATIONAL SERVICES, NAMELY, CONDUCTING COURSES AND INSTRUCTION, NAMELY CLASSES, SEMINARS AND WORKSHOPS AT THE GRADUATE AND POST-GRADUATE LEVELS IN THE FIELDS OF INTERNATIONAL LAW, INTERNATIONAL RELATIONS, INTERNATIONAL BUSINESS, AND DIPLOMACY LEADING TO ACADEMIC DEGREES AND CONDUCTING COURSES, NAMELY CLASSES, SEMINARS AND WORKSHOPS FOR PROFESSIONALS PRACTICING IN THE SAME FIELDS (U.S. CLS. 100, 101 AND 107).

FIRST USE 0-0-1933; IN COMMERCE 0-0-1933.

SN 76-287,472. TUFTS UNIVERSITY, MEDFORD, MA.
FILED 7-18-2001.

**THE FLETCHER SCHOOL OF
LAW AND DIPLOMACY**

NO CLAIM IS MADE TO THE EXCLUSIVE RIGHT TO USE "SCHOOL OF LAW AND DIPLOMACY", APART FROM THE MARK AS SHOWN.

THE TERM "FLETCHER" IN THE MARK DOES NOT IDENTIFY A LIVING INDIVIDUAL.

SEC. 2(F).

FOR EDUCATIONAL SERVICES, NAMELY, CONDUCTING COURSES AND INSTRUCTION, NAMELY CLASSES, SEMINARS AND WORKSHOPS AT THE GRADUATE AND POST-GRADUATE LEVELS IN THE FIELDS OF INTERNATIONAL LAW, INTERNATIONAL RELATIONS, INTERNATIONAL BUSINESS, AND DIPLOMACY LEADING TO ACADEMIC DEGREES AND CONDUCTING COURSES, NAMELY CLASSES, SEMINARS AND WORKSHOPS FOR PROFESSIONALS PRACTICING IN THE SAME FIELDS (U.S. CLS. 100, 101 AND 107).

FIRST USE 0-0-1933; IN COMMERCE 0-0-1933.

CLASS 41—(Continued).

SN 76-316,802. DORADO C.I.G.S. S.P.A., 43040 VARANO
DE'MELEGARI (PARMA), ITALY, FILED 9-25-2001.

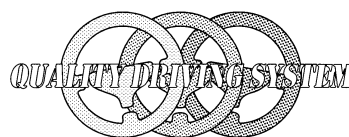

PRIORITY CLAIMED UNDER SEC. 44(D) ON ERPN CMNTY TM OFC APPLICATION NO. 2345247, FILED 8-14-2001, REG. NO. 2345248, DATED 10-14-2002, EXPIRES 10-14-2011.

NO CLAIM IS MADE TO THE EXCLUSIVE RIGHT TO USE "QUALITY DRIVING SYSTEM", APART FROM THE MARK AS SHOWN.

THE WORD PORTION OF THE MARK IS IN RED AND THE DESIGN PORTION OF THE MARK IS IN DIFFERENT SHADES OF GRAY AS SHOWN IN EXHIBIT A SUBMITTED HEREWITH.

FOR EDUCATIONAL SERVICES, NAMELY, CONDUCTING COURSES, CLASSES, SEMINARS, CONFERENCES AND WORKSHOPS IN THE FIELD OF SAFE AND SPORTING DRIVING, AND THE DISTRIBUTION OF COURSE MATERIALS IN CONNECTION THEREWITH; AND ENTERTAINMENT SERVICES, NAMELY, ORGANIZING SPORTING AND CULTURAL EVENTS (U.S. CLS. 100, 101 AND 107).

SN 76-329,626. MISSION CITY PRESS, INC., SAN ANTONIO,
TX. FILED 10-24-2001.

A LIFE OF FAITH

OWNER OF U.S. REG. NO. 2,478,126.

FOR EDUCATIONAL SERVICES, NAMELY, CONDUCTING ON-LINE INTERACTIVE BIBLE CLASSES FOR CHILDREN TO PROMOTE CHRISTIANITY AND SPIRITUAL GROWN, AND DISTRIBUTION OF COURSE MATERIAL IN CONNECTION THEREWITH; CHRISTIAN RELIGIOUS INSTRUCTION SERVICES (U.S. CLS. 100, 101 AND 107).

FIRST USE 7-15-1999; IN COMMERCE 7-15-1999.

CLASS 41—(Continued).

SN 76-335,602. INTENTIONAL LEADERSHIP, INC., BOULDER, CO. FILED 11-7-2001.

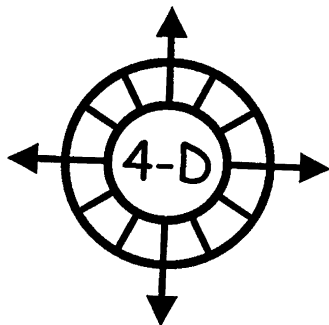

FOR EDUCATIONAL SERVICES, NAMELY, CONDUCTING TRAINING CLASSES, SEMINARS, WORKSHOPS, AND EDUCATIONAL RETREATS TO FACILITATE THE IMPLEMENTATION AND USE OF EDUCATIONAL ASSESSMENT AND MEASUREMENT TOOLS IN THE FIELDS OF HUMAN RESOURCES, COMMUNICATIONS SKILLS, PERSONAL GROWTH, LEADERSHIP AND BUSINESS, AND TIME AND RELATIONSHIP MANAGEMENT (U.S. CLS. 100, 101 AND 107).

SN 76-345,110. STARZ ENCORE GROUP LLC, ENGLEWOOD, CO. FILED 12-5-2001.



OWNER OF U.S. REG. NOS. 2,050,515, 2,651,265 AND OTHERS.

NO CLAIM IS MADE TO THE EXCLUSIVE RIGHT TO USE "BLACK", APART FROM THE MARK AS SHOWN.

SEC. 2(F) AS TO "STARZ!".

FOR ENTERTAINMENT SERVICES, NAMELY, PROGRAMMING AND PRODUCTION OF TELEVISION PROGRAMS, AND PROGRAMMING, PRODUCTION, AND DISTRIBUTION OF MOTION PICTURES, ALL FOR CABLE AND SATELLITE TELEVISION BROADCASTING (U.S. CLS. 100, 101 AND 107).

FIRST USE 3-9-2001; IN COMMERCE 3-9-2001.

CLASS 41—(Continued).

SN 76-349,651. OXFORD LEARNING CENTRES, INC., LONDON, ONTARIO, CANADA, FILED 12-18-2001.

BEYOND TUTORING

PRIORITY CLAIMED UNDER SEC. 44(D) ON CANADA APPLICATION NO. 1122494, FILED 11-15-2001.

NO CLAIM IS MADE TO THE EXCLUSIVE RIGHT TO USE "TUTORING", APART FROM THE MARK AS SHOWN.

FOR EDUCATION SERVICES, NAMELY, SUPPLEMENTAL AND/OR REMEDIAL EDUCATION SERVICES, NAMELY, PERSONAL COACHING IN THE FIELD OF COGNITIVE SKILLS TO FACILITATE ACADEMIC GROWTH THROUGH INTERACTIVE COACHING; PROVIDING TUTORING OF STUDENTS ON ALL SUBJECTS TO ENHANCE AND DEVELOP ACADEMIC SKILLS; CONDUCTING COURSES OF INSTRUCTION AND LEARNING ENHANCEMENT THROUGH THE DEVELOPMENT OF CRITICAL THINKING, PROBLEM SOLVING AND GENERALIZATION COGNITIVE SKILLS (U.S. CLS. 100, 101 AND 107).

FIRST USE 2-29-2000; IN COMMERCE 2-29-2000.

SN 76-352,324. ESSERE CORPORATION, PITTSBURGH, PA. FILED 12-26-2001.

JUST BE YOU

FOR CONDUCTING WORKSHOPS AND SEMINARS IN PERSONAL AWARENESS (U.S. CLS. 100, 101 AND 107).

SN 76-352,634. EAGLE REGISTRATIONS INC., DAYTON, OH. FILED 12-21-2001.

AFFORDABLE ISO

FOR EDUCATION AND TRAINING, NAMELY, CLASSES, SEMINARS, LECTURES IN THE FIELD OF BUSINESS COMPLIANCE WITH INTERNATIONAL STANDARDS (U.S. CLS. 100, 101 AND 107).

FIRST USE 5-0-2001; IN COMMERCE 5-0-2001.

SN 76-354,493. DEMETRIOS, EAMES, SANTA MONICA, CA. FILED 1-2-2002.

PARALLEL CALIFORNIA

NO CLAIM IS MADE TO THE EXCLUSIVE RIGHT TO USE "CALIFORNIA", APART FROM THE MARK AS SHOWN.

FOR ENTERTAINMENT SERVICES, NAMELY, PROVIDING A WEB SITE FEATURING FICTIONAL NEWSLETTERS AND STORIES (U.S. CLS. 100, 101 AND 107).

FIRST USE 12-12-2001; IN COMMERCE 12-12-2001.

CLASS 41—(Continued).

SN 76-360,904. LITTLE BONANZA, INC., RENO, NV. FILED 1-22-2002.

BONANZA CASINO

NO CLAIM IS MADE TO THE EXCLUSIVE RIGHT TO USE "CASINO", APART FROM THE MARK AS SHOWN.
FOR GAMING SERVICES, NAMELY, CASINOS (U.S. CLS. 100, 101 AND 107).
FIRST USE 2-0-1978; IN COMMERCE 2-0-1978.

SN 76-373,046. NUNN RACING LLC, INDIANAPOLIS, IN. FILED 2-20-2002.

MO NUNN RACING

NO CLAIM IS MADE TO THE EXCLUSIVE RIGHT TO USE "RACING", APART FROM THE MARK AS SHOWN.
FOR ENTERTAINMENT SERVICES, NAMELY PARTICIPATION IN PROFESSIONAL AUTOMOBILE RACING EVENTS AGAINST OTHER RACING TEAM PARTICIPANTS (U.S. CLS. 100, 101 AND 107).
FIRST USE 3-26-2000; IN COMMERCE 3-26-2000.

SN 76-373,698. ANDERSON, KENT G., BISMARCK, ND. FILED 2-20-2002.

FUTURE

FOR EDUCATIONAL SERVICES, NAMELY, PROVIDING COURSES IN THE FIELD OF BUSINESS, HEALTH, ECONOMICS, HISTORY, SCIENCE, HEALTH, TRANSPORTATION, OUTER SPACE, NEW PRODUCT AND NEW INDUSTRIES DEVELOPMENT, MARKETING, GOVERNMENT, AND THE COOKING FOR MIDDLE SCHOOLS, HIGH SCHOOLS, COLLEGES, AND UNIVERSITIES (U.S. CLS. 100, 101 AND 107).

SN 76-375,242. CORTIS, ROBERT, WHITMORE LAKE, MI. FILED 2-26-2002.

AMERICA SALUTES

NO CLAIM IS MADE TO THE EXCLUSIVE RIGHT TO USE "AMERICA", APART FROM THE MARK AS SHOWN.
FOR ENTERTAINMENT SERVICES, NAMELY, PRODUCTION OF TELEVISION SHOWS FEATURING MUSICAL, COMEDY, VARIETY, AWARD PRESENTATION AND PATRIOTIC CONTENT; ENTERTAINMENT SERVICES, NAMELY, PROGRAMMING AND SCHEDULING OF TELEVISION SHOWS (U.S. CLS. 100, 101 AND 107).

CLASS 41—(Continued).

SN 76-382,383. ROCKY MOUNTAIN NATIONAL RENDEZVOUS, LAKEWOOD, CO. FILED 3-14-2002.

ROCKY MOUNTAIN NATIONAL RENDEZVOUS

NO CLAIM IS MADE TO THE EXCLUSIVE RIGHT TO USE "RENDEZVOUS", APART FROM THE MARK AS SHOWN.

SEC. 2(F).
FOR RECREATIONAL SERVICES IN THE NATURE OF LIVING HISTORY ENCAMPMENT AND MUZZLE LOADER SHOOTING CONTEST (U.S. CLS. 100, 101 AND 107).

FIRST USE 6-30-1996; IN COMMERCE 8-1-1996.

SN 76-383,011. UNIVERSAL CITY STUDIOS, INC., UNIVERSAL CITY, CA. FILED 3-18-2002.

UNIVERSAL STUDIOS HOLLYWOOD SPECIAL EFFECTS STAGES

OWNER OF U.S. REG. NOS. 1,519,252 AND 2,523,034.
NO CLAIM IS MADE TO THE EXCLUSIVE RIGHT TO USE "HOLLYWOOD SPECIAL EFFECTS STAGES", APART FROM THE MARK AS SHOWN.
FOR AMUSEMENT PARK SERVICES (U.S. CLS. 100, 101 AND 107).

SN 76-387,768. HIMALAYAN INTERNATIONAL INSTITUTE OF YOGA SCIENCE AND PHILOSOPHY OF THE USA, HONESDALE, PA. FILED 3-26-2002.

DYNAMICS OF MEDITATION

SEC. 2(F).
FOR EDUCATIONAL PROGRAMS AND SEMINARS IN THE FIELD OF MEDITATION, BREATHING PRACTICES, STRESS REDUCTION, CONCENTRATION EXERCISES AND MIND AND BODY HEALTH (U.S. CLS. 100, 101 AND 107).
FIRST USE 0-0-1978; IN COMMERCE 0-0-1978.

SN 76-392,032. NATIONAL EMERGENCY NUMBER ASSOCIATION, INC., COLUMBUS, OH. FILED 4-6-2002.

I MADE THE RIGHT CALL

FOR EDUCATIONAL SERVICES IN THE NATURE OF PROVIDING RECOGNITION, AWARDS AND INCENTIVES TO CHILDREN WHO HAVE MADE LIFE OR PROPERTY-SAVING CALLS USING THE 9-1-1 EMERGENCY TELEPHONE NUMBER SYSTEM. TO HELP EDUCATE THE PUBLIC ABOUT THE IMPORTANCE OF LEARNING ABOUT THE SYSTEM AND ITS PROPER USE (U.S. CLS. 100, 101 AND 107).

FIRST USE 2-5-2002; IN COMMERCE 2-5-2002.

CLASS 41—(Continued).

SN 76-396,755. GLOBAL INFORMATION LICENSING CORPORATION, CLAYMONT, DE. FILED 4-17-2002.

CE LIVE

NO CLAIM IS MADE TO THE EXCLUSIVE RIGHT TO USE "CE", APART FROM THE MARK AS SHOWN.

FOR PROVIDING CONTINUING MEDICAL EDUCATION COURSES, NAMELY, CONDUCTING CLINICAL AND NON-CLINICAL PROGRAMS IN A CLASSROOM SETTING (U.S. CLS. 100, 101 AND 107).

SN 76-398,279. CRICKET PRODUCTIONS, INC., MIAMI, FL. FILED 4-22-2002.



THE LINING IS A FEATURE OF THE MARK AND DOES NOT INDICATE COLOR.

THE MARK CONSISTS OF CRICKET DESIGN WHEREIN THE BODY IS DEPICTED IN LIGHT GREEN AND THE BREASTPLATE IS ALTERNATING RED AND LIGHT GREEN FROM TOP TO BOTTOM.

FOR PRODUCTION OF AUDIO CASSETTES FEATURING EDUCATIONAL STORIES FOR CHILDREN; AND PUBLICATION OF CHILDREN'S EDUCATIONAL BOOKS (U.S. CLS. 100, 101 AND 107).

FIRST USE 10-1-1999; IN COMMERCE 10-1-1999.

SN 76-398,571. SHERIDAN BROADCASTING CORPORATION, PITTSBURGH, PA. FILED 4-22-2002.

SONI D'S OLD SKOOL MEGA MIX

THE NAME IN THE MARK IDENTIFIES A LIVING INDIVIDUAL WHOSE CONSENT IS OF RECORD.

FOR ENTERTAINMENT SERVICES, NAMELY, AN ON-GOING RADIO PROGRAM FEATURING MUSIC (U.S. CLS. 100, 101 AND 107).

FIRST USE 3-17-2001; IN COMMERCE 3-17-2001.

CLASS 41—(Continued).

SN 76-399,715. MPOWERED IDEAS MEDIA, REDONDO BEACH, CA. FILED 4-23-2002.



FOR ENTERTAINMENT SERVICES, NAMELY, LIVE MUSICAL PERFORMANCES; AUDIO AND VIDEOTAPE RECORDING AND PRODUCTION SERVICES FOR OTHERS; PRODUCTION OF TELEVISION PROGRAMS (U.S. CLS. 100, 101 AND 107).

SN 76-400,370. I.P. INTERNATIONAL, INC., SEVEN MILE BEACH, CAYMAN ISLANDS, FILED 4-25-2002.

FUN TV

NO CLAIM IS MADE TO THE EXCLUSIVE RIGHT TO USE "TV", APART FROM THE MARK AS SHOWN.

FOR ENTERTAINMENT SERVICES, NAMELY, PROVIDING INFORMATION ONLINE FEATURING LOCAL AND REGIONAL RECREATIONAL ACTIVITIES; AN ONGOING TELEVISION PROGRAM IN THE NATURE OF LOCAL AND REGIONAL RECREATIONAL ACTIVITIES (U.S. CLS. 100, 101 AND 107).

SN 76-401,034. SMOKE ON THE WATER CHILI COOK OFF, CHARLESTON, WV. FILED 4-26-2002.

SMOKE ON THE WATER CHILI COOK OFF

NO CLAIM IS MADE TO THE EXCLUSIVE RIGHT TO USE "CHILI COOK OFF", APART FROM THE MARK AS SHOWN.

FOR ENTERTAINMENT SERVICES, NAMELY, ORGANIZING, ARRANGING AND CONDUCTING COOKING COMPETITIONS (U.S. CLS. 100, 101 AND 107).

FIRST USE 6-1-1999; IN COMMERCE 6-1-1999.

SN 76-401,372. JUKO-KAI INTERNATIONAL, INC., RICHARDSON, TX. FILED 4-26-2002.

TAI-KI

THE WORD "TAI" MEANS "BODY" IN JAPANESE. THE WORK "KI" MEANS "INTERNAL ENERGY" IN JAPANESE. SEC. 2(F).

FOR EDUCATIONAL SERVICES, NAMELY TRAINING IN A JAPANESE-BASED FORM OF EXERCISE (U.S. CLS. 100, 101 AND 107).

FIRST USE 0-0-1961; IN COMMERCE 0-0-1961.

CLASS 41—(Continued).

SN 76-402,011. HOLT TEXAS LTD, DBA HOLT COMPANY OF TEXAS, SAN ANTONIO, TX. FILED 5-1-2002.

PROTECH!

FOR EDUCATIONAL SERVICES, NAMELY PROVIDING TECHNICAL TRAINING DEALING WITH HEAVY EQUIPMENT, DIESEL ENGINES, GAS ENGINES, OTHER LARGE MACHINERY, AND ASSOCIATED WRITTEN MATERIALS (U.S. CLS. 100, 101 AND 107).
FIRST USE 11-1-1996; IN COMMERCE 11-1-1996.

SN 76-404,535. CHOU FAMILY FOUNDATION, RALEIGH, NC. FILED 5-2-2002.

L² Foundation

NO CLAIM IS MADE TO THE EXCLUSIVE RIGHT TO USE "FOUNDATION", APART FROM THE MARK AS SHOWN.

FOR EDUCATIONAL SERVICES, NAMELY, CONDUCTING CONFERENCES, SEMINARS, FORUMS, AND WORKSHOPS AND PROVIDING CONSULTATION IN THE FIELDS OF LEADERSHIP DEVELOPMENT, PHILANTHROPY, ENTREPRENEURSHIP, CHARITABLE, RELIGIOUS, AND SOCIAL SERVICES BY AND AMONG ASIAN AMERICANS, AND ORGANIZATIONAL DEVELOPMENT, FUNDRAISING, AND STRATEGIC PLANNING FOR NON-PROFIT ORGANIZATIONS, EDUCATIONAL RESEARCH, NAMELY, SPONSORING AND CONDUCTING RESEARCH RELATING TO LEADERSHIP DEVELOPMENT, PHILANTHROPY, ENTREPRENEURSHIP, AND CHARITABLE, RELIGIOUS, AND SOCIAL SERVICES BY AND AMONG ASIAN AMERICANS; COMPUTER SERVICES, NAMELY, PROVIDING ONLINE NEWSLETTERS, BROCHURES, AND INFORMATIONAL REPORTS IN THE FIELDS OF LEADERSHIP DEVELOPMENT, PHILANTHROPY, ENTREPRENEURSHIP, AND CHARITABLE, RELIGIOUS, AND SOCIAL SERVICES BY AND AMONG ASIAN AMERICANS VIA A GLOBAL COMMUNICATION NETWORK (U.S. CLS. 100, 101 AND 107).
FIRST USE 4-1-2001; IN COMMERCE 4-1-2001.

CLASS 41—(Continued).

SN 76-405,587. EFFECTIVENESS ENHANCEMENT, INC., LOUISVILLE, KY. FILED 4-30-2002.

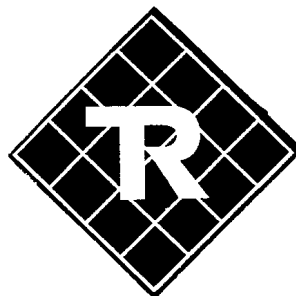

FOR EDUCATIONAL SERVICES, NAMELY, PRESENTING WORKSHOPS ON PSYCHOLOGICAL TESTING (U.S. CLS. 100, 101 AND 107).
FIRST USE 12-22-1995; IN COMMERCE 12-22-1995.

SN 76-405,588. EFFECTIVENESS ENHANCEMENT, INC., LOUISVILLE, KY. FILED 4-30-2002.

EXPLORING YOU

FOR EDUCATIONAL SERVICES, NAMELY, PRESENTING WORKSHOPS ON PSYCHOLOGICAL TESTING (U.S. CLS. 100, 101 AND 107).
FIRST USE 10-9-2001; IN COMMERCE 1-2-2002.

SN 76-405,737. NEW FRONTIER MEDIA, INC., BOULDER, CO. FILED 5-10-2002.

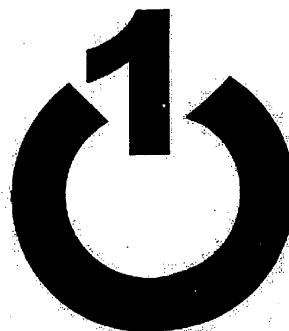

FOR ENTERTAINMENT SERVICES IN THE NATURE OF MUSIC PROGRAMMING DISTRIBUTED VIA TELEVISION AND GLOBAL COMPUTER COMMUNICATION NETWORKS (U.S. CLS. 100, 101 AND 107).

CLASS 41—(Continued).

SN 76-405,745. NEW FRONTIER MEDIA, INC., BOULDER, CO. FILED 5-10-2002.

MODE ONE

FOR ENTERTAINMENT SERVICES IN THE NATURE OF MUSIC PROGRAMMING DISTRIBUTED VIA TELEVISION AND GLOBAL COMPUTER COMMUNICATION NETWORKS (U.S. CLS. 100, 101 AND 107).

SN 76-405,863. BRUCE MAST & ASSOCIATES, INC., EXETER, NH. FILED 5-3-2002.

**LEADERSHIP
ON THE LINE**

*A Core Service of Bruce Mast & Associates, Inc.
Professionals in Leadership and Organizational Development*

NO CLAIM IS MADE TO THE EXCLUSIVE RIGHT TO USE "ASSOCIATES, INC." AND "PROFESSIONALS IN LEADERSHIP AND ORGANIZATIONAL DEVELOPMENT", APART FROM THE MARK AS SHOWN.

FOR EDUCATIONAL SERVICES, NAMELY, PROVIDING SEMINARS AND COURSES OF INSTRUCTION TO BUSINESSES AND OTHER ORGANIZATIONS ON LEADERSHIP SKILLS AND ORGANIZATIONAL DEVELOPMENT (U.S. CLS. 100, 101 AND 107).

FIRST USE 9-25-2001; IN COMMERCE 9-25-2001.

SN 76-407,478. FAMILY VALUES TOUR LLC, BEVERLY HILLS, CA. FILED 5-14-2002.

FAMILY VALUES

OWNER OF U.S. REG. NO. 2,300,918.
FOR ENTERTAINMENT SERVICES, NAMELY, TOURING MUSIC FESTIVALS (U.S. CLS. 100, 101 AND 107).
FIRST USE 8-0-1998; IN COMMERCE 8-0-1998.

SN 76-409,215. REAL FAMILIES, INC., WEXFORD, PA. FILED 5-16-2002.

REALITY TALKS

NO CLAIM IS MADE TO THE EXCLUSIVE RIGHT TO USE "REALITY", APART FROM THE MARK AS SHOWN.

FOR ENTERTAINMENT IN THE NATURE OF AN ONGOING TELEVISION TALK SHOW IN THE FIELD OF FAMILY RELATIONSHIPS AND DYNAMICS (U.S. CLS. 100, 101 AND 107).

CLASS 41—(Continued).

SN 76-410,283. TENNESSEE PRODUCTION CENTER, SEYMOUR, TN. FILED 5-20-2002.

**BIG MAMA
ENTERTAINMENT**

NO CLAIM IS MADE TO THE EXCLUSIVE RIGHT TO USE "ENTERTAINMENT", APART FROM THE MARK AS SHOWN.

FOR AUDIO RECORDING AND PRODUCTION; PRODUCTION OF VIDEO TAPES, VIDEO CASSETTES AND VIDEO DISCS; AND PRODUCTION OF TELEVISION PROGRAMS (U.S. CLS. 100, 101 AND 107).

SN 76-411,963. THE ARIZONA SPORTS FOUNDATION, TEMPE, AZ. FILED 5-23-2002.

**COLLEGE FOOTBALL'S
BIGGEST PARTY**

SEC. 2(F).
FOR ENTERTAINMENT SERVICES, NAMELY ORGANIZING COMMUNITY FESTIVALS FEATURING A VARIETY OF ACTIVITIES INCLUDING PARADES, SPORTING EVENTS, AND MUSICAL PERFORMANCES (U.S. CLS. 100, 101 AND 107).

FIRST USE 1-0-1996; IN COMMERCE 1-0-1996.

SN 76-412,187. BABCOCK, JOSEPH T., FRANKLIN, TN. FILED 5-22-2002.

THE COUNTRY CHORALE

OWNER OF U.S. REG. NO. 1,977,443.
NO CLAIM IS MADE TO THE EXCLUSIVE RIGHT TO USE "CHORALE", APART FROM THE MARK AS SHOWN.
SEC. 2(F).

FOR ENTERTAINMENT SERVICES, NAMELY, LIVE PERFORMANCES BY A MUSICAL PERFORMING GROUP (U.S. CLS. 100, 101 AND 107).

FIRST USE 10-8-1989; IN COMMERCE 11-17-1994.

SN 76-412,400. M'CLOUD, CALLOWAY GRETCHEN MARI, NELLYSFORD, VA. FILED 5-24-2002.

HORSCERY

FOR EDUCATIONAL SERVICES, NAMELY, PROVIDING INSTRUCTION IN HORSE TRAINING, AND HORSEBACK RIDING (U.S. CLS. 100, 101 AND 107).

FIRST USE 12-0-2001; IN COMMERCE 12-0-2001.

CLASS 41—(Continued).

SN 76-413,218. ARKANSAS COMMUNITY FOUNDATION, INC., LITTLE ROCK, AR. FILED 5-28-2002.



YOUTH ADVISORY COUNCIL
An Arkansas Community Foundation Initiative

NO CLAIM IS MADE TO THE EXCLUSIVE RIGHT TO USE "YOUTH ADVISORY COUNCIL" AND "AN ARKANSAS COMMUNITY FOUNDATION INITIATIVE", APART FROM THE MARK AS SHOWN.

FOR EDUCATION SERVICES, NAMELY, PROVIDING TRAINING CLASSES IN THE FIELD OF PHILANTHROPY, VOLUNTEERISM, SERVANT LEADERSHIP, FUNDRAISING AND GRANT-MAKING (U.S. CLS. 100, 101 AND 107).

FIRST USE 3-1-2002; IN COMMERCE 3-1-2002.

SN 76-415,672. MATTEL, INC., EL SEGUNDO, CA. FILED 5-31-2002.



NO CLAIM IS MADE TO THE EXCLUSIVE RIGHT TO USE "SYSTEM", APART FROM THE MARK AS SHOWN.

FOR EDUCATION AND ENTERTAINMENT SERVICES, NAMELY, AN ONLINE COMPUTER SERVICE COMPRISED OF ACTIVITIES, PROJECTS AND GAMES IN CONNECTION WITH CHILDREN'S TOYS (U.S. CLS. 100, 101 AND 107).

CLASS 41—(Continued).

SN 76-416,331. PALOMAR COMMUNITY COLLEGE DISTRICT, SAN MARCOS, CA. FILED 6-3-2002.



NO CLAIM IS MADE TO THE EXCLUSIVE RIGHT TO USE "COLLEGE", APART FROM THE MARK AS SHOWN, FOR EDUCATIONAL SERVICES, NAMELY ARRANGING AND CONDUCTING CLASSES, WORKSHOPS, SEMINARS AND CONFERENCES AT THE COLLEGE AND PROFESSIONAL LEVEL; PROVIDING COURSES OF INSTRUCTION AND DEGREE PROGRAMS AT THE COLLEGE AND PROFESSIONAL LEVEL; DISTRIBUTION OF COURSE MATERIALS IN CONNECTION THEREWITH, AND PROVIDING INFORMATION IN THE FIELD OF EDUCATION VIA A GLOBAL COMPUTER NETWORK (U.S. CLS. 100, 101 AND 107).

SN 76-416,333. PALOMAR COMMUNITY COLLEGE DISTRICT, SAN MARCOS, CA. FILED 6-3-2002.



NO CLAIM IS MADE TO THE EXCLUSIVE RIGHT TO USE "COLLEGE" AND "LEARNING", APART FROM THE MARK AS SHOWN.

FOR EDUCATIONAL SERVICES, NAMELY ARRANGING AND CONDUCTING CLASSES, WORKSHOPS, SEMINARS AND CONFERENCES AT THE COLLEGE AND PROFESSIONAL LEVEL; PROVIDING COURSES OF INSTRUCTION AND DEGREE PROGRAMS AT THE COLLEGE AND PROFESSIONAL LEVEL; DISTRIBUTION OF COURSE MATERIALS IN CONNECTION THEREWITH, AND PROVIDING INFORMATION IN THE FIELD OF EDUCATION VIA A GLOBAL COMPUTER NETWORK (U.S. CLS. 100, 101 AND 107).

SN 76-416,334. PALOMAR COMMUNITY COLLEGE DISTRICT, SAN MARCOS, CA. FILED 6-3-2002.

PALOMAR COLLEGE

NO CLAIM IS MADE TO THE EXCLUSIVE RIGHT TO USE "COLLEGE", APART FROM THE MARK AS SHOWN.

FOR EDUCATIONAL SERVICES, NAMELY ARRANGING AND CONDUCTING CLASSES, WORKSHOPS, SEMINARS AND CONFERENCES AT THE COLLEGE AND PROFESSIONAL LEVEL; PROVIDING COURSES OF INSTRUCTION AND DEGREE PROGRAMS AT THE COLLEGE AND PROFESSIONAL LEVEL; DISTRIBUTION OF COURSE MATERIALS IN CONNECTION THEREWITH, AND PROVIDING INFORMATION IN THE FIELD OF EDUCATION VIA A GLOBAL COMPUTER NETWORK (U.S. CLS. 100, 101 AND 107).

FIRST USE 3-12-1958; IN COMMERCE 3-12-1958.

CLASS 41—(Continued).

SN 76-418,412. YOGA JOURNAL LLC, BERKELEY, CA. FILED 6-7-2002.

YOGA CRUISE

NO CLAIM IS MADE TO THE EXCLUSIVE RIGHT TO USE "YOGA", APART FROM THE MARK AS SHOWN. FOR EDUCATIONAL SERVICES, NAMELY, COURSES AND SEMINARS RELATING TO YOGA, HEALTH AND CONSCIOUSNESS (U.S. CLS. 100, 101 AND 107).

CLASS 41—(Continued).

SN 76-424,625. YAHOO! INC., SUNNYVALE, CA. FILED 6-21-2002.

TOKI TOKI BOOM

FOR ENTERTAINMENT SERVICES, NAMELY, PROVIDING AN ONLINE COMPUTER GAME (U.S. CLS. 100, 101 AND 107). FIRST USE 7-15-2002; IN COMMERCE 7-15-2002.

SN 76-420,063. SPANISH BROADCASTING SYSTEM, INC., COCONUT GROVE, FL. FILED 6-13-2002.

HISPANOS UNIDOS

NO CLAIM IS MADE TO THE EXCLUSIVE RIGHT TO USE "HISPANOS", APART FROM THE MARK AS SHOWN. THE ENGLISH TRANSLATION OF HISPANOS UNIDOS IS UNITED HISPANICS.

FOR ENTERTAINMENT, NAMELY, LIVE MUSIC CONCERTS (U.S. CLS. 100, 101 AND 107). FIRST USE 12-9-2001; IN COMMERCE 12-9-2001.

SN 76-425,687. COMAREX, S.A. DE C.V., LAS LOMAS, C.P. 11700, MEXICO, FILED 6-26-2002.

SN 76-420,103. DREAM EVENTS, INC., SHARPSBURG, MD. FILED 5-16-2002.

DREAM EVENTS, INC.

NO CLAIM IS MADE TO THE EXCLUSIVE RIGHT TO USE "EVENTS, INC.", APART FROM THE MARK AS SHOWN.

FOR EVENT PLANNING FOR SPECIALIZED WEEK-END RETREATS, WEDDINGS AND CORPORATE EVENTS (U.S. CLS. 100, 101 AND 107). FIRST USE 12-0-1999; IN COMMERCE 12-0-1999.

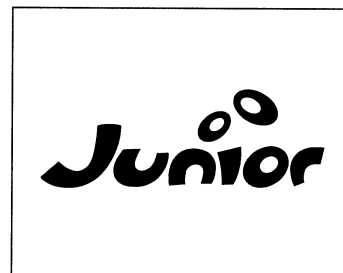

SN 76-422,908. STEBBEN, GREGG, MONTEREY, CA. FILED 6-19-2002.



NO CLAIM IS MADE TO THE EXCLUSIVE RIGHT TO USE "MEDIA", APART FROM THE MARK AS SHOWN.

FOR PUBLICATION OF PUBLICITY TEXTS FOR RETAIL AND BUSINESS-TO-BUSINESS DISTRIBUTION (U.S. CLS. 100, 101 AND 107). FIRST USE 3-10-2002; IN COMMERCE 3-16-2002.

MULTICOLOR DRAWING OF STYLIZED WORD "JUNIOR". THE COLOR OF THE LETTERS OF THE STYLIZED WORD ARE AS FOLLOWS: "J" IN RED, "U" IN GREEN, "N" IN PURPLE, "I" IN ORANGE, "O" IN PINK AND "R" IN BLUE. THE WORD, "JUNIOR", IS DISPLAYED WITH A YELLOW BACKGROUND. TWO BLUE CIRCLES ARE ABOVE THE WORD, ONE IS PLACED ON TOP OF THE LETTER "I" AND THE OTHER CIRCLE IS SLIGHTLY INCLINED BETWEEN THE LETTERS "I" AND "O".

FOR DISTRIBUTION AND PRODUCTION OF MEDIA PROGRAMS, NAMELY, CHILDREN ANIMATED AND NON-ANIMATED TELEVISION PROGRAMS, FILMS, MOTION PICTURES, VIDEOS, AND MULTIMEDIA PRESENTATIONS VIA SATELLITE, CABLE, OPTICAL, BROAD BAND, NARROW BAND, WIRE, FIBER, SCRAMBLED BROADCAST FOR TAPING, MASTER ANTENNA, LOW POWER TELEVISION, CLOSED CIRCUIT TELEVISION, HIGH DEFINITION TELEVISION, TAPES, CASSETTES, DISCS AND OTHER TELECOMMUNICATION MEDIUMS FOR RESIDENTIAL AND COMMERCIAL USAGE (U.S. CLS. 100, 101 AND 107).

CLASS 41—(Continued).

SN 76-425,697. COMAREX, S.A. DE C.V., LAS LOMAS, C.P. 11700, MEXICO, FILED 6-26-2002.



NO CLAIM IS MADE TO THE EXCLUSIVE RIGHT TO USE "SUPERCINEMA", APART FROM THE MARK AS SHOWN.

FOR DISTRIBUTION AND PRODUCTION OF MEDIA PROGRAMS, NAMELY, FILMS, MOTION PICTURES, VIDEOS, MULTIMEDIA PRESENTATIONS, AND TELEVISION PROGRAMS, VIA SATELLITE, CABLE, OPTICAL, BROAD BAND, NARROW BAND, WIRE, FIBER, SCRAMBLED BROADCAST FOR TAPING, MASTER ANTENNA, LOW POWER TELEVISION, CLOSED CIRCUIT TELEVISION, HIGH DEFINITION TELEVISION, TAPES, CASSETTES AND DISCS FOR COMMERCIAL AND RESIDENTIAL USAGE (U.S. CLS. 100, 101 AND 107).

SN 76-426,769. CLARK, WILLIAM, JACKSONVILLE, FL. FILED 7-1-2002.



NO CLAIM IS MADE TO THE EXCLUSIVE RIGHT TO USE "KARATE FOR KIDS", APART FROM THE MARK AS SHOWN.

FOR MARTIAL ARTS AND LIFE SKILLS TRAINING FOR CHILDREN, (U.S. CLS. 100, 101 AND 107).
FIRST USE 10-1-1986; IN COMMERCE 10-1-1986.

SN 76-430,805. COTTONWOOD CHRISTIAN CENTER, INC., LOS ALAMITOS, CA. FILED 7-15-2002.

ANSWERS WITH BAYLESS CONLEY

THE NAME BAYLESS CONLEY IDENTIFIES A LIVING INDIVIDUAL WHOSE CONSENT IS OF RECORD.

FOR EDUCATION IN THE FIELD OF RELIGIOUS MINISTERING RENDERED THROUGH BROADCAST MEDIA, NAMELY, TELEVISION, RADIO, THE INTERNET AND PRINT MEDIA AND DISTRIBUTING WRITTEN MATERIAL IN CONNECTION THEREWITH (U.S. CLS. 100, 101 AND 107).

CLASS 41—(Continued).

SN 76-432,440. HAMPTON GOLF, INC., JACKSONVILLE, FL. FILED 7-17-2002.

FAMILYTEES

FOR GOLF COURSES, GOLF CLUB SERVICES, GOLF LESSONS AND INSTRUCTIONAL CLINICS AND PROVIDING INFORMATION VIA THE INTERNET IN THE FIELD OF GOLF COURSES, GOLF CLUB SERVICES AND GOLF INSTRUCTION (U.S. CLS. 100, 101 AND 107).

SN 76-432,441. HAMPTON GOLF, INC., JACKSONVILLE, FL. FILED 7-17-2002.

FAMILYTEE.COM

FOR GOLF COURSES, GOLF CLUB SERVICES, GOLF LESSONS AND INSTRUCTIONAL CLINICS AND PROVIDING INFORMATION VIA THE INTERNET IN THE FIELD OF GOLF COURSES, GOLF CLUB SERVICES AND GOLF INSTRUCTION (U.S. CLS. 100, 101 AND 107).

SN 76-434,487. NYX ENTERTAINMENT INC., ROCKVILLE, MD. FILED 7-24-2002.

NEW YORK EXPERIENCE ENTERTAINMENT

NO CLAIM IS MADE TO THE EXCLUSIVE RIGHT TO USE "NEW YORK" OR "ENTERTAINMENT", APART FROM THE MARK AS SHOWN.

FOR DISC JOCKEY SERVICES, NAMELY, PROVIDING SOUND EQUIPMENT, MUSIC AND MASTER OF CEREMONY SERVICES, DANCERS AND LIGHTING FOR PARTIES AND SPECIAL EVENTS (U.S. CLS. 100, 101 AND 107).

FIRST USE 4-0-1988; IN COMMERCE 4-0-1988.

SN 76-434,864. HEALTH CHOICE NETWORK, INC., MIAMI, FL. FILED 7-26-2002.

HEALTHY BODY HEALTHY SOUL

FOR EDUCATIONAL SERVICES NAMELY, SPONSORING SEMINARS AND WORKSHOPS AND PROVIDING EDUCATIONAL INSTRUCTION IN THE HEALTH CARE FIELD DEALING WITH SMOKING AVOIDANCE AND CESSATION, DRUG AND ALCOHOL ABUSE AND DISEASE PREVENTION AND WELLNESS (U.S. CLS. 100, 101 AND 107).

CLASS 41—(Continued).

SN 76-435,433. SACRAMENTO KINGS LIMITED PARTNERSHIP, L.P., SACRAMENTO, CA. FILED 7-29-2002.

SLAMSON

FOR ENTERTAINMENT SERVICES IN THE NATURE OF PERSONAL APPEARANCES BY A COSTUMED MASCOT AT BASKETBALL GAMES AND EXHIBITIONS, CLINICS, PROMOTIONS, AND OTHER BASKETBALL-RELATED EVENTS, SPECIAL EVENTS AND PARTIES; FAN CLUB SERVICES; ENTERTAINMENT AND EDUCATIONAL SERVICES IN THE NATURE OF ONGOING TELEVISION AND RADIO PROGRAMS IN THE FIELD OF BASKETBALL AND RENDERING LIVE BASKETBALL GAMES AND BASKETBALL EXHIBITIONS AND BASKETBALL EVENTS; CONDUCTING AND ARRANGING BASKETBALL CLINICS AND COACHES CLINICS AND BASKETBALL EVENTS; ENTERTAINMENT SERVICES, NAMELY PROVIDING A WEBSITE FEATURING THE FOLLOWING— BASKETBALL NEWS, INFORMATION, STATISTICS, TRIVIA, TELEVISION HIGHLIGHTS, VIDEO RECORDINGS, INTERACTIVE VIDEO HIGHLIGHT SELECTIONS, RADIO PROGRAMS, RADIO HIGHLIGHTS, AND AUDIO RECORDINGS IN THE FIELD OF BASKETBALL, ON-LINE COMPUTER GAMES, VIDEO GAMES, INTERACTIVE VIDEO GAMES, ACTION SKILL GAMES, ARCADE GAMES, ADULTS' AND CHILDREN'S PARTY GAMES, BOARD GAMES, AND TRIVIA GAMES (U.S. CLS. 100, 101 AND 107).

FIRST USE 9-0-1994; IN COMMERCE 9-0-1994.

SN 76-436,624. XTREME ZOLAR, INC., PARAMOUNT, CA. FILED 8-1-2002.

ZOLAR

OWNER OF U.S. REG. NO. 2,370,300.
FOR ENTERTAINMENT IN THE NATURE OF ON GOING TELEVISION PROGRAMS IN THE FIELD OF CHILDREN'S ENTERTAINMENT; ENTERTAINMENT IN THE NATURE OF LIVE THEATRICAL SHOWS AND APPEARANCES BY LIVE CHARACTERS; ENTERTAINMENT SERVICES, NAMELY PROVIDING A WEBSITE FEATURING ENTERTAINMENT IN THE NATURE OF THEATRICAL PERFORMANCES IN MOTION PICTURES; PRODUCTION AND DISTRIBUTION OF MOTION PICTURES (U.S. CLS. 100, 101 AND 107).

CLASS 41—(Continued).

SN 76-437,015. ASIS INTERNATIONAL, INC., ALEXANDRIA, VA. FILED 8-1-2002.



OWNER OF U.S. REG. NO. 1,438,384.
NO CLAIM IS MADE TO THE EXCLUSIVE RIGHT TO USE "PHYSICAL SECURITY PROFESSIONAL, BOARD CERTIFIED" AND "INTERNATIONAL", APART FROM THE MARK AS SHOWN.

FOR CONDUCTING EDUCATIONAL COURSES IN THE FIELD OF SECURITY AND PROTECTION OF PEOPLE, PROPERTY AND IDEAS AND PREPARING, ADMINISTERING AND SCORING OF STANDARDIZED TESTS IN THE FIELD OF SECURITY AND PROTECTION OF PEOPLE, PROPERTY AND IDEAS (U.S. CLS. 100, 101 AND 107).

SN 76-437,220. TUPAC AMARU SHAKUR FOUNDATION, WEST HOLLYWOOD, CA. FILED 8-5-2002.

TUPAC AMARU SHAKUR FOUNDATION

NO CLAIM IS MADE TO THE EXCLUSIVE RIGHT TO USE "FOUNDATION", APART FROM THE MARK AS SHOWN.

THE MARK "TUPAC AMARU SHAKUR" DOES NOT IDENTIFY A LIVING INDIVIDUAL.

FOR CONDUCTING EDUCATION CLASSES AND SUMMER CAMPS IN THE FIELD OF PERFORMING ARTS, CREATIVE WRITING, POETRY AND SPOKEN WORDS; MUSEUM SERVICES NAMELY ORGANIZING EDUCATION EXHIBITIONS IN THE FIELD OF PERFORMING AND CREATIVE ARTS (U.S. CLS. 100, 101 AND 107).

FIRST USE 5-21-2000; IN COMMERCE 5-21-2000.

SN 76-438,948. ADVANCE MAGAZINE PUBLISHERS INC., NEW YORK, NY. FILED 8-5-2002.

CONDE NAST BRIDAL INFOBANK

NO CLAIM IS MADE TO THE EXCLUSIVE RIGHT TO USE "BRIDAL INFOBANK", APART FROM THE MARK AS SHOWN.

THE NAME "CONDE NAST" DOES NOT IDENTIFY A LIVING INDIVIDUAL.

FOR COMPUTER SERVICES, NAMELY, PROVIDING A COMPUTER DATABASE IN THE FIELD OF WEDDING PLANNING CONSULTATION FOR BRIDES AND GROOMS, NAMELY, ADVICE FOR INVITATIONS, RECEPTIONS, CATERING, FASHION, ENTERTAINMENT AND HONEYMOONS (U.S. CLS. 100, 101 AND 107).

CLASS 41—(Continued).

SN 76-439,997. HORLER, KRISTEN M., MILL VALLEY, CA. FILED 8-9-2002.

BABY BOOT CAMP

FOR GROUP FITNESS CLASSES FOR PRE-NATAL WOMEN, AND NEW MOTHERS AND THEIR BABIES (U.S. CLS. 100, 101 AND 107).
FIRST USE 1-7-2002; IN COMMERCE 1-7-2002.

SN 76-443,485. MORELLO, THOMAS, LOS ANGELES, CA. AND COMMERFORD, TIMOTHY, LOS ANGELES, CA. AND WILK, BRAD, LOS ANGELES, CA. AND CORNELL, CHRIS, LOS ANGELES, CA. FILED 8-26-2002.

AUDIOSLAVE

FOR ENTERTAINMENT, NAMELY, LIVE PERFORMANCES BY A MUSICAL GROUP (U.S. CLS. 100, 101 AND 107).

SN 76-444,001. KRONKOSKY CHARITABLE FOUNDATION, SAN ANTONIO, TX. FILED 8-27-2002.

PRECIOUS MINDS, NEW CONNECTIONS

FOR EDUCATIONAL SERVICES IN THE NATURE OF SEMINARS, WORKSHOPS, AND CLASSES PERTAINING TO EARLY CHILDHOOD DEVELOPMENT AND PARENTING (U.S. CLS. 100, 101 AND 107).
FIRST USE 6-0-1999; IN COMMERCE 6-0-1999.

SN 76-447,047. OAK HAVEN, LLC, CLARKESVILLE, GA. FILED 9-5-2002.

OAK HAVEN

FOR EDUCATION AND TRAINING IN THE FIELDS OF RELIGION, SPIRITUALITY AND WELLNESS; AND CONSULTING SERVICES IN THE FIELDS OF RELIGIOUS, SPIRITUALITY AND WELLNESS TRAINING/EDUCATION (U.S. CLS. 100, 101 AND 107).

CLASS 41—(Continued).

SN 76-448,748. DRUG FREE PENNSYLVANIA, INC., HARRISBURG, PA. FILED 9-12-2002.



NO CLAIM IS MADE TO THE EXCLUSIVE RIGHT TO USE "DRUG FREE PENNSYLVANIA", APART FROM THE MARK AS SHOWN.

FOR EDUCATION TO CHILDREN AND ADULTS ON AWARENESS OF USING ILLEGAL DRUGS AND MISUSING ALCOHOL, IN PARTICULAR, SUPERVISORY SEMINARS ON DRUG-FREE WORKPLACES, DRUG TESTING, EMPLOYEE ASSISTANCE PROGRAMS AND POLICY DRAFTING ALONG WITH SKILLS-BASED PARENTAL SEMINARS AT WORKPLACES AND SCHOOLS REGARDING COMMUNICATING WITH CHILDREN (U.S. CLS. 100, 101 AND 107).

FIRST USE 10-0-2001; IN COMMERCE 10-0-2001.

SN 76-450,243. ETHAN INTERACTIVE, INC., COLUMBUS, OH. FILED 9-17-2002.

OUTIE

FOR PROVIDING RECOGNITION BY MEANS OF AWARDS FOR BUSINESSES AND INDIVIDUALS WHO HAVE MADE SIGNIFICANT CONTRIBUTIONS TO THE GAY COMMUNITY (U.S. CLS. 100, 101 AND 107).

FIRST USE 2-0-1997; IN COMMERCE 2-0-1997.

SN 76-450,769. FOCUS ENTERTAINMENT PRODUCTIONS, INC., STAMFORD, CT. FILED 9-18-2002.

THE \$100,000 TELEPHONE CALL

NO CLAIM IS MADE TO THE EXCLUSIVE RIGHT TO USE "\$100,000", APART FROM THE MARK AS SHOWN.

FOR ENTERTAINMENT SERVICES, IN THE NATURE OF A TELEVISION GAME SHOW (U.S. CLS. 100, 101 AND 107).

CLASS 41—(Continued).

SN 76-452,474. BOB JONES UNIVERSITY, INC., GREENVILLE, SC. FILED 9-25-2002.



NO CLAIM IS MADE TO THE EXCLUSIVE RIGHT TO USE "INSTITUTE OF BIBLICAL EDUCATION", APART FROM THE MARK AS SHOWN.

THE MARK CONSISTS OF A RISING OR SETTING SUN OVER A BIBLE, WITH THE LETTERS "IBE" AND THE WORDS "INSTITUTE OF BIBLICAL EDUCATION" UNDER THE DESIGN.

FOR RELIGIOUS INSTRUCTION SERVICES, NAMELY, CONDUCTING COURSES IN BIBLICAL STUDY (U.S. CLS. 100, 101 AND 107).

FIRST USE 10-0-1994; IN COMMERCE 10-0-1994.

SN 76-453,281. MENDELL, KEVIN, CARMEL, IN. FILED 9-20-2002.



FOR ENTERTAINMENT SERVICES, NAMELY, CONDUCTING THEME PARTIES AT VARIOUS LOCATIONS OF THE CLIENT'S CHOOSING (U.S. CLS. 100, 101 AND 107).

FIRST USE 2-24-2002; IN COMMERCE 2-24-2002.

SN 76-455,664. HARRISON, JOHNNIE M., EDGEWATER, NJ. FILED 10-3-2002.

NABFEME SHERO

OWNER OF U.S. REG. NO. 2,423,109.

NO CLAIM IS MADE TO THE EXCLUSIVE RIGHT TO USE "SHERO", APART FROM THE MARK AS SHOWN.

FOR AWARDS PROGRAM FOR THE PRESENTATION OF AWARDS TO WOMEN HEROES IN RECOGNITION OF THEIR ACHIEVEMENTS AND QUALITIES (U.S. CLS. 100, 101 AND 107).

FIRST USE 11-19-1999; IN COMMERCE 11-19-1999.

CLASS 41—(Continued).

SN 76-455,748. GILMAN, SARRI L., LANGLEY, WA. FILED 10-4-2002.

FROM COPS TO KIDS

FOR TRAINING FOR POLICE OFFICERS CONCERNING THE PERSPECTIVE OF CHILDREN IN VARIOUS SITUATIONS WHERE POLICE BECOME INVOLVED (U.S. CLS. 100, 101 AND 107).

SN 76-455,750. LOREN STAPLIN, KULPSVILLE, PA. FILED 9-30-2002.

DRIVINGHEALTH

FOR PROVIDING COURSES OF INSTRUCTION TO TRAIN THE ELDERLY ON SAFE DRIVING PRACTICES AND PROVIDING SKILLS ASSESSMENTS IN CONNECTION THEREWITH (U.S. CLS. 100, 101 AND 107).

SN 76-455,806. TRUSTEES OF THE HAMLINE UNIVERSITY OF MINNESOTA, ST. PAUL, MN. FILED 9-30-2002.

CHANGING WHAT IT MEANS TO BE A LAWYER

FOR PROVIDING COURSES OF INSTRUCTION AT THE UNDERGRADUATE AND GRADUATE LEVELS IN THE FIELD OF LAW; PROVIDING CONTINUING LEGAL EDUCATION COURSES (U.S. CLS. 100, 101 AND 107).

SN 76-457,176. VELASQUEZ, TANIA D., CAPE CORAL, FL. FILED 10-9-2002.

LADYBUG

FOR ENTERTAINMENT IN THE NATURE OF LIVE CULTURAL MUSICAL PERFORMANCES (U.S. CLS. 100, 101 AND 107).

FIRST USE 1-1-1997; IN COMMERCE 1-1-1997.

SN 76-457,189. WELLS, SUSAN W., CHICAGO, IL. FILED 10-9-2002.

A DRUG WAR CAROL

NO CLAIM IS MADE TO THE EXCLUSIVE RIGHT TO USE "DRUG WAR", APART FROM THE MARK AS SHOWN.

FOR EDUCATIONAL SERVICES, NAMELY, CONDUCTING CLASSES, SEMINARS, CONFERENCES, AND WORKSHOPS ON THE TOPIC OF THE US WAR ON DRUGS AND DISTRIBUTING COURSE MATERIALS IN CONNECTION THEREWITH (U.S. CLS. 100, 101 AND 107).

CLASS 41—(Continued).

SN 76-457,198. WNYC RADIO, NEW YORK, NY. FILED 10-9-2002.

THE NO SHOW

NO CLAIM IS MADE TO THE EXCLUSIVE RIGHT TO USE "SHOW", APART FROM THE MARK AS SHOWN.

FOR ENTERTAINMENT SERVICES IN THE NATURE OF AN ON-GOING RADIO PROGRAM FEATURING COMMENTARY, INTERVIEWS, COMEDY, SATIRE AND MUSIC (U.S. CLS. 100, 101 AND 107).

FIRST USE 9-7-2002; IN COMMERCE 9-7-2002.

SN 76-457,725. MURRAY, RAYMOND, DORCHESTER, MA. AND WEBBE, MILTON, DORCHESTER, MA. FILED 10-11-2002.

**THE P.H.E.W. - PROPHETS
HOLDING ETERNAL
WISDOM**

FOR ENTERTAINMENT, NAMELY LIVE CONCERTS MUSIC PRODUCTION AND COMPOSITION (U.S. CLS. 100, 101 AND 107).

SN 76-458,768. JOE VERDE GROUP, SAN JUAN CAPISTRANO, CA. FILED 10-17-2002.

JOE VERDE GROUP

NO CLAIM IS MADE TO THE EXCLUSIVE RIGHT TO USE "GROUP", APART FROM THE MARK AS SHOWN.

THE NAME "JOE VERDE" IDENTIFIES A LIVING INDIVIDUAL WHOSE CONSENT IS OF RECORD.

FOR EDUCATIONAL AND TRAINING SERVICES; NAMELY CONDUCTING SALES AND MANAGEMENT TRAINING SEMINARS AND CLASSES FOR THE AUTOMOTIVE, BOAT AND RECREATIONAL VEHICLE SALES INDUSTRIES (U.S. CLS. 100, 101 AND 107).

FIRST USE 10-0-2000; IN COMMERCE 10-0-2000.

SN 76-459,354. SCIPPAGROUP, TIBURON, CA. FILED 10-15-2002.

**STELLA CUCINA (STAR
KITCHEN)**

NO CLAIM IS MADE TO THE EXCLUSIVE RIGHT TO USE "CUCINA" AND "KITCHEN", APART FROM THE MARK AS SHOWN.

FOR ENTERTAINMENT SERVICES, NAMELY, TELEVISION SHOW PRODUCTION (U.S. CLS. 100, 101 AND 107).

CLASS 41—(Continued).

SN 76-460,079. INFORMATION MANAGEMENT NETWORK, INC., NEW YORK, NY. FILED 10-15-2002.

IMN

FOR EDUCATIONAL SERVICES, NAMELY, CONDUCTING CONFERENCES IN THE FIELD OF FINANCE, TECHNOLOGY AND SECURITY AND DISTRIBUTING COURSE MATERIALS IN CONNECTION THEREWITH (U.S. CLS. 100, 101 AND 107).

FIRST USE 1-0-1994; IN COMMERCE 1-0-1994.

SN 76-460,710. WCI COMMUNITIES, INC., BONITA SPRINGS, FL. FILED 10-23-2002.

LET GO. CATCH LIFE.

FOR COUNTRY CLUB SERVICES AND GOLF CLUB SERVICES, NAMELY, OPERATION OF COUNTRY CLUBS AND GOLF COURSES, PROVIDING RECREATIONAL AND ENTERTAINMENT SERVICES AND FACILITIES THEREFOR, NAMELY, GOLF COURSES, TENNIS COURT FACILITIES, FITNESS FACILITIES, AND SWIMMING POOLS, AND PROVIDING INSTRUCTION IN GOLF (U.S. CLS. 100, 101 AND 107).

SN 76-461,476. BLOCKBUSTER INC., DALLAS, TX. FILED 10-24-2002.

MOVIE FREEDOM PASS

NO CLAIM IS MADE TO THE EXCLUSIVE RIGHT TO USE "MOVIE" OR "PASS", APART FROM THE MARK AS SHOWN.

FOR RENTAL AND COMPUTERIZED ON-LINE RENTAL SERVICES OF PRE-RECORDED VIDEOS, MOVIES, COMPUTERIZED VIDEO GAMES, FILMS, MOTION PICTURES, VIDEO CASSETTES, VIDEO DISCS, LASER DISCS, VIDEO AND AUDIO COMPACT DISCS, DIGITAL VERSATILE DISCS, AND DVDS (U.S. CLS. 100, 101 AND 107).

FIRST USE 10-15-2002; IN COMMERCE 10-15-2002.

SN 76-461,477. BLOCKBUSTER INC., DALLAS, TX. FILED 10-24-2002.

DVD FREEDOM PASS

NO CLAIM IS MADE TO THE EXCLUSIVE RIGHT TO USE "DVD" OR "PASS", APART FROM THE MARK AS SHOWN.

FOR RENTAL AND COMPUTERIZED ON-LINE RENTAL SERVICES OF PRE-RECORDED VIDEOS, MOVIES, COMPUTERIZED VIDEO GAMES, FILMS, MOTION PICTURES, VIDEO CASSETTES, VIDEO DISCS, LASER DISCS, VIDEO AND AUDIO COMPACT DISCS, DIGITAL VERSATILE DISCS, AND DVDS (U.S. CLS. 100, 101 AND 107).

FIRST USE 5-21-2002; IN COMMERCE 5-21-2002.

CLASS 41—(Continued).

SN 76-461,478. BLOCKBUSTER INC., DALLAS, TX. FILED 10-24-2002.

GAMES FREEDOM PASS

NO CLAIM IS MADE TO THE EXCLUSIVE RIGHT TO USE "GAMES" OR "PASS", APART FROM THE MARK AS SHOWN.

FOR RENTAL AND COMPUTERIZED ON-LINE RENTAL SERVICES OF PRE-RECORDED VIDEOS, MOVIES, COMPUTERIZED VIDEO GAMES, FILMS, MOTION PICTURES, VIDEO CASSETTES, VIDEO DISCS, LASER DISCS, VIDEO AND AUDIO COMPACT DISCS, DIGITAL VERSATILE DISCS, AND DVDS (U.S. CLS. 100, 101 AND 107).

FIRST USE 5-21-2002; IN COMMERCE 5-21-2002.

SN 76-462,162. ALEXIS O. DECLET & JAMES J. BLAKENEY PARTNERSHIP, THE, BROOKLYN, NY. FILED 10-28-2002.

BROOKHILL

FOR ENTERTAINMENT SERVICES IN THE NATURE OF ONGOING TELEVISION PROGRAMS IN THE FIELD OF ANIMATED CARTOONS (U.S. CLS. 100, 101 AND 107).

SN 76-463,309. MONEA, PAUL M., CANTON, OH. FILED 10-31-2002.

WORLD SERIES OF RAP

NO CLAIM IS MADE TO THE EXCLUSIVE RIGHT TO USE "RAP", APART FROM THE MARK AS SHOWN.

FOR ENTERTAINMENT SERVICES IN THE NATURE OF A TELEVISION SERIES FEATURING MUSIC AND GAME SHOWS (U.S. CLS. 100, 101 AND 107).

SN 76-464,486. HAIGOOD, RAYMOND A., AUGUSTA, GA. FILED 10-29-2002.

DOUBLE EDGE RECORDS

NO CLAIM IS MADE TO THE EXCLUSIVE RIGHT TO USE "RECORDS", APART FROM THE MARK AS SHOWN.

FOR RECORDING OF LYRICAL AND MUSICAL CONTENT ON VINYL RECORDS, COMPACT DISCS, VIDEOS, MP3S, AND CASSETTES (U.S. CLS. 100, 101 AND 107).

CLASS 41—(Continued).

SN 76-468,294. SWEET FANCY MOSES, INC., MORRO BAY, CA. FILED 11-12-2002.

WHERE WIT LIVES

FOR COMPUTER SERVICES, NAMELY PROVIDING AN ON-LINE MAGAZINE AND WEB-SITE FEATURING LITERARY WORKS VIA A GLOBAL COMPUTER NETWORK (U.S. CLS. 100, 101 AND 107).

FIRST USE 2-0-2001; IN COMMERCE 2-0-2001.

SN 76-468,818. CORNERSTONE PROMOTION, INC., NEW YORK, NY. FILED 11-18-2002.

THE FADER LABEL

NO CLAIM IS MADE TO THE EXCLUSIVE RIGHT TO USE "LABEL", APART FROM THE MARK AS SHOWN.

FOR RECORD PRODUCTION; RECORD MASTER PRODUCTION; MUSIC PRODUCTION; AUDIO RECORDING AND PRODUCTION; VIDEOTAPE PRODUCTION; MOTION PICTURE SONG PRODUCTION; PRODUCTION OF VIDEO DISCS FOR OTHERS; RECORDING STUDIOS; ENTERTAINMENT SERVICES, NAMELY, PRODUCING AND DISTRIBUTING MUSICAL AUDIO AND VIDEO RECORDINGS; MUSIC COMPOSITION AND TRANSCRIPTION FOR OTHERS; SONG WRITING SERVICES; MUSIC PUBLISHING SERVICES; ENTERTAINMENT IN THE NATURE OF A LIVE MUSICAL PERFORMER; ENTERTAINMENT IN THE NATURE OF A LIVE MUSICAL GROUP; ENTERTAINMENT IN THE NATURE OF LIVE PERFORMANCES BY A MUSICAL ARTIST AND MUSICAL GROUP; ENTERTAINMENT IN THE NATURE OF VISUAL AND AUDIO PERFORMANCES BY A MUSICAL ARTIST AND MUSICAL GROUP; ENTERTAINMENT, NAMELY, LIVE MUSIC CONCERTS; ENTERTAINMENT, NAMELY, PERSONAL APPEARANCES BY A MUSICIAN; ENTERTAINMENT SERVICES, NAMELY, PROVIDING A WEB SITE FEATURING MUSICAL PERFORMANCES, MUSICAL VIDEOS, RELATED FILM CLIPS, PHOTOGRAPHS, AND OTHER MULTIMEDIA MATERIALS; ENTERTAINMENT SERVICES, NAMELY, PROVIDING PRERECORDED MUSIC, INFORMATION IN THE FIELD OF MUSIC, COMMENTARY AND ARTICLES ABOUT MUSIC, ALL ONLINE VIA A GLOBAL COMPUTER NETWORK; TELEVISION AND RADIO PRODUCTION; TELEVISION SHOW PRODUCTION; RADIO ENTERTAINMENT PRODUCTION; ENTERTAINMENT IN THE NATURE OF ON-GOING TELEVISION AND RADIO PROGRAMS FEATURING MUSICAL PERFORMANCES (U.S. CLS. 100, 101 AND 107).

SN 76-470,773. TOPCODER, INC., GLASTONBURY, CT. FILED 11-29-2002.

POWERED BY [TOPCODER]

FOR ENTERTAINMENT IN THE NATURE OF COMPETITIONS IN THE FIELD OF COMPUTER PROGRAMMING (U.S. CLS. 100, 101 AND 107).

FIRST USE 9-18-2002; IN COMMERCE 9-18-2002.

CLASS 41—(Continued).

SN 76-470,811. ANNIE'S ENTERPRISES, INC., NORTH CALAIS, VT. FILED 11-27-2002.

SALADS FOR SCHOOLS

FOR EDUCATIONAL SERVICES, NAMELY CONDUCTING PROGRAMS IN THE FIELD OF NUTRITION (U.S. CLS. 100, 101 AND 107).

SN 76-471,560. BURROUGHS AND CHAPIN COMPANY, INC., MYRTLE BEACH, SC. FILED 11-19-2002.

MYRTLEWOOD GOLF CLUB

NO CLAIM IS MADE TO THE EXCLUSIVE RIGHT TO USE "GOLF CLUB", APART FROM THE MARK AS SHOWN.

FOR ENTERTAINMENT SERVICES, NAMELY, COUNTRY CLUB SERVICES (U.S. CLS. 100, 101 AND 107).
FIRST USE 1-0-1994; IN COMMERCE 1-0-1994.

SN 76-472,797. UNIVERSAL CITY STUDIOS LLLP, UNIVERSAL CITY, CA. FILED 12-9-2002.

ESCAPE FROM THE MUMMY'S TOMB

OWNER OF U.S. REG. NO. 2,547,477.
FOR AMUSEMENT PARK SERVICES (U.S. CLS. 100, 101 AND 107).

SN 76-473,160. COSINE THREE MEDIA GROUP, LLC, LOS ANGELES, CA. FILED 12-9-2002.

COSINE ENTERTAINMENT

NO CLAIM IS MADE TO THE EXCLUSIVE RIGHT TO USE "ENTERTAINMENT", APART FROM THE MARK AS SHOWN.

FOR PRODUCTION AND DISTRIBUTION OF MOVIES, TELEVISION MOVIES, TELEVISION PROGRAMS, RADIO, AND CABLE TELEVISION PROGRAMMING SERVICES; ENTERTAINMENT SERVICES, NAMELY, PROVIDING TELEVISION, RADIO PROGRAMS, AND MOTION PICTURE FILMS VIA A GLOBAL COMPUTER NETWORK; MUSIC ENTERTAINMENT PRODUCTION SERVICES; ENTERTAINMENT SERVICES, NAMELY, PROVIDING A WEB SITE FEATURING MUSICAL PERFORMANCES, MUSICAL VIDEOS, RELATED FILM CLIPS, PHOTOGRAPHS, AND OTHER MULTIMEDIA MATERIALS; ENTERTAINMENT SERVICES, NAMELY, PROVIDING PRERECORDED MUSIC, INFORMATION IN THE FIELD OF TELEVISION, RADIO, MOTION PICTURE FILMS, AND MUSIC, AND COMMENTARY AND ARTICLES ABOUT THE ENTERTAINMENT INDUSTRY VIA A GLOBAL COMPUTER NETWORK (U.S. CLS. 100, 101 AND 107).

CLASS 41—(Continued).

SN 76-473,268. MAGNA ENTERTAINMENT CORP., AURORA, ONTARIO L4G 7K1, CANADA, FILED 12-4-2002.

MICHIGAN DOWNS

NO CLAIM IS MADE TO THE EXCLUSIVE RIGHT TO USE "MICHIGAN", APART FROM THE MARK AS SHOWN.

FOR ENTERTAINMENT SERVICES, NAMELY, ORGANIZING AND CONDUCTING HORSE RACES, BROADCASTING OF HORSE RACES AND ORGANIZING AND CONDUCTING PRE AND POST HORSE RACE PARADES, ORGANIZING AND CONDUCTING WINNERS' CIRCLE EVENTS (U.S. CLS. 100, 101 AND 107).

SN 76-474,059. MAACO ENTERPRISES, INC., KING OF PRUSSIA, PA. FILED 12-12-2002.



FOR TRAINING SERVICES IN THE FIELD OF VEHICLE PAINTING, REFINISHING AND REPAIR SERVICES (U.S. CLS. 100, 101 AND 107).

FIRST USE 3-0-1995; IN COMMERCE 3-0-1995.

SN 76-474,172. 1492 HOSPITALITY GROUP, INC., HOCKESSIN, DE. FILED 12-10-2002.

MOUNTAIN BRANCH

FOR GOLF COURSE AND GOLF CLUB SERVICES (U.S. CLS. 100, 101 AND 107).

FIRST USE 12-1-1999; IN COMMERCE 12-1-1999.

CLASS 41—(Continued).

SN 76-485,967. CENTEX BUSINESS CONSULTANTS, L.C., AUSTIN, TX. FILED 1-29-2003.

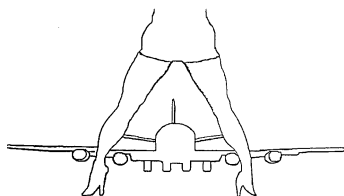

FOR CABARET SERVICES (U.S. CLS. 100, 101 AND 107).
FIRST USE 12-1-2002; IN COMMERCE 12-1-2002.

SN 78-041,256. SPEAKEASY FILMS, INC., MILWAUKEE, WI. FILED 1-1-2001.

SPEAKEASY FILMS

NO CLAIM IS MADE TO THE EXCLUSIVE RIGHT TO USE "FILMS", APART FROM THE MARK AS SHOWN.
FOR MOTION PICTURE FILM PRODUCTION AND VIDEOTAPE PRODUCTION (U.S. CLS. 100, 101 AND 107).
FIRST USE 1-1-1997; IN COMMERCE 6-1-1997.

SN 78-066,955. WINK BACK, SAN FRANCISCO, CA. FILED 6-1-2001.

THE GO GAME

NO CLAIM IS MADE TO THE EXCLUSIVE RIGHT TO USE "GAME", APART FROM THE MARK AS SHOWN.
FOR NON-DOWNLOADABLE WIRELESS ENABLED SCAVENGER HUNT GAME TO BE PLAYED ON CELL PHONES AND PDA'S AND OTHER WIRELESS DEVICES AND VIEWED ON ASSOCIATED WEBSITES AND ON TELEVISION (U.S. CLS. 100, 101 AND 107).

SN 78-069,991. TAKAHASHI, KANA, V, SAN FRANCISCO, CA. FILED 6-19-2001.

LOOSE ID

FOR MOTION PICTURE FILM PRODUCTION (U.S. CLS. 100, 101 AND 107).

CLASS 41—(Continued).

SN 78-074,288. WARREN MILLER ENTERTAINMENT, INC., NEW YORK, NY. BY ASSIGNMENT INTERNATIONAL ENTERTAINMENT GROUP, INC., BOULDER, CO. FILED 7-17-2001.

WARREN MILLER'S GLOBAL ADVENTURE

OWNER OF U.S. REG. NOS. 2,087,095, 2,096,710 AND 2,192,419.

NO CLAIM IS MADE TO THE EXCLUSIVE RIGHT TO USE "GLOBAL ADVENTURE", APART FROM THE MARK AS SHOWN.

THE NAME "WARREN MILLER" IDENTIFIES A LIVING INDIVIDUAL WHOSE CONSENT IS OF RECORD.
FOR ENTERTAINMENT SERVICES IN THE NATURE OF TELEVISION BROADCAST PROGRAMS FEATURING ANIMALS, TRAVEL AND SPORTS (U.S. CLS. 100, 101 AND 107).

FIRST USE 1-15-1999; IN COMMERCE 1-15-1999.

SN 78-083,701. CORPORACION EMCETA S.A., CARACAS, VENEZUELA, FILED 9-13-2001.



PRIORITY CLAIMED UNDER SEC. 44(D) ON VENEZUELA APPLICATION NO. 15007, FILED 8-20-2001, REG. NO. N-42,600, DATED 11-19-2001, EXPIRES 11-19-2011.

THE WORDS "BAILO" AND "TERAPIA" MAY BE TRANSLATED TO ENGLISH INDIVIDUALLY AS "DANCE" AND "THERAPY".

FOR DANCE INSTRUCTION FOR ENTERTAINMENT PURPOSES (U.S. CLS. 100, 101 AND 107).

SN 78-087,641. DELICIOUS KARMA LLC, PALO ALTO, CA. FILED 10-10-2001.

DELICIOUS KARMA

FOR SPECIAL EVENT PLANNING (U.S. CLS. 100, 101 AND 107).
FIRST USE 1-1-2000; IN COMMERCE 1-1-2000.

CLASS 41—(Continued).

SN 78-092,205. PHILIP PELUSI PHYTO LINK 4.0, INC., PITTSBURGH, PA. FILED 11-7-2001.

FAST TRACK LEADERSHIP

NO CLAIM IS MADE TO THE EXCLUSIVE RIGHT TO USE "LEADERSHIP", APART FROM THE MARK AS SHOWN.

FOR EDUCATIONAL SERVICES, NAMELY, CONDUCTING WORKSHOPS AND CONFERENCES IN THE FIELDS OF DEVELOPING PRESENTATION SKILLS AND LEADERSHIP SKILLS FOR OWNERS, MANAGERS AND SERVICE PROVIDING PROFESSIONALS OF BEAUTY SALONS, FIGURE SALONS, HAIRDRESSING SALONS, SKIN CARE SALONS, TANNING SALONS, AND HEALTH SPAS (U.S. CLS. 100, 101 AND 107).

SN 78-101,739. GRECCO, MICHAEL, SANTA MONICA, CA. FILED 1-9-2002.

**MICHAEL GRECCO
PHOTOGRAPHY**

NO CLAIM IS MADE TO THE EXCLUSIVE RIGHT TO USE "PHOTOGRAPHY", APART FROM THE MARK AS SHOWN.

FOR PHOTOGRAPHY SERVICES, NAMELY, PORTRAITURE, PUBLICITY PHOTOS AND COMMERCIAL AND EDITORIAL PHOTOS (U.S. CLS. 100, 101 AND 107).
FIRST USE 1-1-1998; IN COMMERCE 1-1-1998.

SN 78-106,062. ANDERSON, MEGORY, SAN FRANCISCO, CA. FILED 1-31-2002.

SACRED DYING

NO CLAIM IS MADE TO THE EXCLUSIVE RIGHT TO USE "DYING", APART FROM THE MARK AS SHOWN.

FOR CLASSES, SEMINARS AND WORKSHOPS ON THE TOPIC OF MULTI-RELIGIOUS AND MULTI-CULTURAL TRADITIONS OF DEATH (U.S. CLS. 100, 101 AND 107).
FIRST USE 8-8-1996; IN COMMERCE 8-8-1996.

CLASS 41—(Continued).

SN 78-109,141. COTTAGE GROVE GOLF DEVELOPMENT COMPANY, LLC, MARSHALL, WI. FILED 2-15-2002.



NO CLAIM IS MADE TO THE EXCLUSIVE RIGHT TO USE "GOLF COURSE", APART FROM THE MARK AS SHOWN.

FOR GOLF COURSES; GOLF CLUB SERVICES FEATURING A CLUBHOUSE, LOCKER ROOM, PUBLIC LOBBY AREAS AND PRIVATE MEETING ROOMS; PROVIDING GOLF INSTRUCTION SERVICES; CONDUCTING GOLF TOURNAMENTS AND EXHIBITIONS (U.S. CLS. 100, 101 AND 107).

SN 78-116,411. INNER EXPANSION WORKSHOPS, INC., IRVINE, CA. FILED 3-20-2002.



NO CLAIM IS MADE TO THE EXCLUSIVE RIGHT TO USE "WORKSHOPS", APART FROM THE MARK AS SHOWN.

FOR EDUCATIONAL SERVICES, NAMELY, CONDUCTING CLASSES, SEMINARS, CONFERENCES, WORKSHOPS IN FIELD OF PERSONAL DEVELOPMENT AND TRAINING AND DISTRIBUTING COURSE MATERIALS SUCH AS WORKBOOKS, VIDEOS, ETC (U.S. CLS. 100, 101 AND 107).
FIRST USE 11-8-2000; IN COMMERCE 11-8-2000.

SN 78-117,008. LAZY RIVER PRODUCTIONS, INC., FAIRVIEW, UT. FILED 3-22-2002.

STADIUM OF FIRE

NO CLAIM IS MADE TO THE EXCLUSIVE RIGHT TO USE "STADIUM", APART FROM THE MARK AS SHOWN.

FOR ENTERTAINMENT SERVICES, NAMELY ORGANIZING LIVE ENTERTAINMENT IN THE NATURE OF LIVE MUSIC, DANCE, THEATER, MULTI MEDIA PRESENTATIONS, THEATRICAL PRESENTATIONS, FIREWORK DISPLAYS, PYROTECHNIC DISPLAYS, SPECIAL EFFECTS, BAND PERFORMANCES, SINGING PERFORMANCE, AND VARIETY ACT PERFORMANCES (U.S. CLS. 100, 101 AND 107).
FIRST USE 6-0-1987; IN COMMERCE 6-0-1987.

CLASS 41—(Continued).

SN 78-120,117. ANYTIME FITNESS, INC., WEST ST. PAUL, MN. FILED 4-8-2002.

ANYTIME FITNESS

NO CLAIM IS MADE TO THE EXCLUSIVE RIGHT TO USE "FITNESS", APART FROM THE MARK AS SHOWN.
FOR HEALTH AND FITNESS CLUB SERVICES (U.S. CLS. 100, 101 AND 107).

SN 78-120,149. MICROSOFT CORPORATION, REDMOND, WA. FILED 4-8-2002.

TORK

FOR PROVIDING ON-LINE MAGAZINE AND A COMPUTERIZED DATABASE, BOTH FEATURING INFORMATION IN THE FIELD OF COMPUTER GAMES, SCIENCE FICTION AND GAMES; PROVIDING INFORMATION ON-LINE RELATING TO COMPUTER GAMES AND COMPUTER ENHANCEMENTS FOR GAMES; ENTERTAINMENT SERVICES, NAMELY, PROVIDING AN ON-LINE COMPUTER GAME; PRODUCTION AND DISTRIBUTION OF MOTION PICTURES AND TELEVISION PROGRAMS; AND ENTERTAINMENT IN THE NATURE OF ON-GOING TELEVISION PROGRAMS IN THE FIELD OF COMPUTER GAMES, SCIENCE FICTION AND GAMES (U.S. CLS. 100, 101 AND 107).

SN 78-120,515. KISIC, BLAS A., WOODLAND HILLS, CA. FILED 4-9-2002.



NO CLAIM IS MADE TO THE EXCLUSIVE RIGHT TO USE "COMMUNICATIONS", APART FROM THE MARK AS SHOWN.

THE FOREIGN WORDING IN THE MARK TRANSLATES INTO ENGLISH AS "JOKE".

FOR FOREIGN LANGUAGE TRANSLATION AND INTERPRETATION SERVICES (U.S. CLS. 100, 101 AND 107).

FIRST USE 2-1-1995; IN COMMERCE 2-1-1995.

SN 78-121,044. GREFENSTETTE, CARL M., DBA WORLD-WIDE FILMWORKS, PITTSBURGH, PA. FILED 4-11-2002.

NIGHT OF THE SINGING DEAD

FOR ENTERTAINMENT SERVICES IN THE NATURE OF A LIVE, MUSICAL COMEDY, THEATRICAL PRODUCTION IN WHICH PARTICIPANTS PORTRAY DECEASED CELEBRITY PERSONALITIES (U.S. CLS. 100, 101 AND 107).

FIRST USE 10-31-1986; IN COMMERCE 10-31-1986.

CLASS 41—(Continued).

SN 78-126,149. BOLDT, GREGORY B., BELLEUVE, WA. FILED 5-3-2002.

Teams Win

FOR EDUCATIONAL TRAINING SERVICES, NAMELY, PROVIDING TRAINING CLASSES FOR SMALL TO MEDIUM SIZE GROUPS IN THE FIELDS OF ORGANIZATIONAL DEVELOPMENT, GROUP PERFORMANCE MANAGEMENT AND MEASUREMENT, LEADERSHIP SKILLS, GROUP NEGOTIATION, GROUP FACILITATION, CONFLICT INTERVENTION, AND VERBAL AND WRITTEN COMMUNICATIONS SUCH THAT INDIVIDUALS LEARN HOW TO START, EXPAND, AND OTHERWISE IMPROVE ALL TYPES OF ORGANIZATIONS INCLUDING NON-PROFIT GROUPS SUCH AS CHURCHES, SCHOOLS, AND HOSPITALS AS WELL AS COMMUNITY ORGANIZATIONS SUCH AS GOVERNMENT, POLITICAL GROUPS, REGIONAL OR NATIONAL ASSOCIATIONS, MULTI-COMPANY ALLIANCES, SPORTS GROUPS, AND THE LIKE; PROVIDING EDUCATIONAL SPEAKER SERVICES TO LARGE GROUPS THAT ARE DELIVERED AT GROUP FORUMS SUCH AS CHURCHES, AND REGIONAL OR NATIONAL CONFERENCES AND CONVENTIONS IN THE FIELDS OF ORGANIZATIONAL DEVELOPMENT, GROUP PERFORMANCE MANAGEMENT AND MEASUREMENT, LEADERSHIP SKILLS, GROUP NEGOTIATION, GROUP FACILITATION, CONFLICT INTERVENTION, AND VERBAL AND WRITTEN COMMUNICATIONS SUCH THAT INDIVIDUALS LEARN HOW TO START, EXPAND, AND OTHERWISE IMPROVE ALL TYPES OF ORGANIZATIONS INCLUDING NON-PROFIT GROUPS SUCH AS CHURCHES, SCHOOLS, AND HOSPITALS AS WELL AS COMMUNITY ORGANIZATIONS SUCH AS GOVERNMENT, POLITICAL GROUPS, REGIONAL OR NATIONAL ASSOCIATIONS, MULTI-COMPANY ALLIANCES, SPORTS GROUPS, AND THE LIKE (U.S. CLS. 100, 101 AND 107).

SN 78-128,119. TENDERLOIN TECHNOLOGIES, INC., SAN FRANCISCO, CA. FILED 5-13-2002.

BROWN BOTTLE RECORDS

NO CLAIM IS MADE TO THE EXCLUSIVE RIGHT TO USE "RECORDS", APART FROM THE MARK AS SHOWN.

FOR PRODUCTION OF AUDIO AND VIDEO RECORDINGS; RECORDING STUDIO SERVICES (U.S. CLS. 100, 101 AND 107).

CLASS 41—(Continued).

SN 78-128,463. GAMBRO, INC., LAKEWOOD, CO. FILED 5-14-2002.



FOR EDUCATIONAL SERVICES, NAMELY, CONDUCTING SEMINARS AND INDIVIDUAL EDUCATION IN THE FIELD OF RENAL DISEASE AND DISTRIBUTION OF EDUCATIONAL MATERIALS IN CONNECTION THEREWITH; EDUCATIONAL SERVICES FOR RENAL DISEASE PATIENTS, NAMELY, INDIVIDUAL EDUCATION IN THE FIELD OF DIAGNOSIS, TREATMENT, HEALTH, NUTRITION, AND DISEASE MANAGEMENT (U.S. CLS. 100, 101 AND 107).

SN 78-129,284. WALKER, JULIET E.K., CHICAGO, IL. FILED 5-16-2002.

HISTORIC TOWN OF NEW PHILADELPHIA

NO CLAIM IS MADE TO THE EXCLUSIVE RIGHT TO USE "NEW PHILADELPHIA", APART FROM THE MARK AS SHOWN.

SEC. 2(F).
FOR EDUCATIONAL DEMONSTRATIONS IN THE NATURE OF CONDUCTING EXHIBITS AND LIVE PROGRAMS ABOUT HISTORY OF AND ARCHEOLOGICAL FINDINGS AT NEW PHILADELPHIA, IN PIKE COUNTY, ILLINOIS; GUIDED TOURS OF AN HISTORICAL SITE; PRESENTING MUSICAL CONCERTS, RECITALS AND FESTIVALS, THEATRICAL PRODUCTIONS AND MOTION PICTURES; EDUCATIONAL SERVICES, NAMELY CONDUCTING SEMINARS AND CLASSES IN THE FIELDS OF EARLY AMERICAN HISTORY, CRAFTS AND GARDENS; THE TOWN OF NEW PHILADELPHIA FOUNDED BY "FREE FRANK MCWORTER A SLAVE WHO BOUGHT HIS FREEDOM" (U.S. CLS. 100, 101 AND 107).

FIRST USE 7-19-1975; IN COMMERCE 7-19-1975.

SN 78-131,855. 3RD STOREE MUSIC, LLC., LOS ANGELES, CA. FILED 5-29-2002.

3RD STOREE

FOR ENTERTAINMENT SERVICES, NAMELY, SONG-WRITING, PRODUCTION OF AUDIO AND VISUAL RECORDINGS, AND LIVE PERFORMANCES BY A MUSICAL GROUP (U.S. CLS. 100, 101 AND 107).

FIRST USE 5-1-1992; IN COMMERCE 5-1-1992.

CLASS 41—(Continued).

SN 78-132,932. KENILWORTH SYSTEMS CORPORATION, MINEOLA, NY. FILED 6-3-2002.

PLAY ALONG WITH NEVADA, LIVE

NO CLAIM IS MADE TO THE EXCLUSIVE RIGHT TO USE "LIVE", APART FROM THE MARK AS SHOWN.

FOR SERVICES IN PROVIDING PLAYING OF CASINO GAMES FROM LOCATIONS REMOTE FROM A CASINO (U.S. CLS. 100, 101 AND 107).

SN 78-132,993. SAVATTERI PRODUCTIONS, INC., LONG BEACH, NY. FILED 6-4-2002.

IGNITE THE SOURCE

FOR EDUCATIONAL AND ENTERTAINMENT SERVICES, NAMELY, PROVIDING MOTIVATIONAL AND EDUCATIONAL SPEAKERS (U.S. CLS. 100, 101 AND 107).

SN 78-134,857. WAVBANK, INC., SEATTLE, WA. FILED 6-11-2002.

WAVBANK

FOR PUBLICATION, AND DISTRIBUTION FOR OTHERS, OF RESEARCH REPORTS PROVIDING COMPARATIVE ANALYSIS AND IDENTIFICATION OF MOLECULAR SIGNALS AND SUBSTANCES; PUBLICATION, AND DISTRIBUTION FOR OTHERS, OF SCIENTIFIC AND MEDICAL RESEARCH REPORTS (U.S. CLS. 100, 101 AND 107).

SN 78-136,327. HEISS, FRANK, NEW YORK, NY. FILED 6-17-2002.

HICK STEP

FOR ENTERTAINMENT SERVICES, NAMELY, LIVE PERFORMANCES BY A MUSICAL BAND, ENTERTAINMENT SERVICES, NAMELY, PERSONAL APPEARANCES BY A MUSICAL BAND, MUSIC PRODUCTION SERVICES, ENTERTAINMENT NAMELY, PRODUCTION OF LIVE MUSICAL SHOWS, VIDEOTAPE PRODUCTION (U.S. CLS. 100, 101 AND 107).

SN 78-136,353. MULTI-STATE LOTTERY ASSOCIATION, WEST DES MOINES, IA. FILED 6-17-2002.

ILA

FOR LOTTERY SERVICES AND ADMINISTRATION OF LOTTERIES FOR OTHERS (U.S. CLS. 100, 101 AND 107).

CLASS 41—(Continued).

SN 78-136,618. BENTI, PATRICK P., REVERE, MA. AND WILSON, MARY, HENDERSON, NV. FILED 6-18-2002.

NTM

FOR PROVIDING RECOGNITION AND INCENTIVES BY WAY OF AWARDS TO DEMONSTRATE EXCELLENCE IN THE FIELD OF MUSIC, ENTERTAINMENT, AND RECORDING ARTS AND SCIENCES (U.S. CLS. 100, 101 AND 107).

SN 78-137,689. TROMMER, ROSEMERRY WAHTOLA, PLACERVILLE, CO. FILED 6-21-2002.

WORD WOMAN

FOR ENTERTAINMENT SERVICES IN THE NATURE OF LIVE POETRY PERFORMANCES; AND EDUCATIONAL SERVICES, NAMELY CONDUCTING WORKSHOPS AND DELIVERING INSPIRATIONAL KEYNOTE SPEECHES IN THE AREA OF PERSONAL DEVELOPMENT (U.S. CLS. 100, 101 AND 107).

SN 78-138,930. HONER, JODI, NYC, NY. FILED 6-26-2002.

TURF-SURFERS – SURFIN.TV

FOR TELEVISION SHOW PRODUCTION; ENTERTAINMENT IN THE NATURE OF A TELEVISION SERIES FEATURING INTERVIEWS WITH INDIVIDUALS IN THE AREA OF CURRENT EVENTS; ENTERTAINMENT, NAMELY A CONTINUING COMEDY, VARIETY SHOW BROADCAST OVER TELEVISION, CABLE, AND SATELLITE TELEVISION, AND VIA A GLOBAL COMPUTER NETWORK (U.S. CLS. 100, 101 AND 107).

SN 78-141,010. LIVINGSTON CAPITAL, L.L.C., METAIRIE, LA. FILED 7-3-2002.

CITIVUE.COM

FOR PHOTOGRAPHY SERVICES, NAMELY, OFFERING PROOF VIEWING OVER A GLOBAL COMPUTER NETWORK (U.S. CLS. 100, 101 AND 107).

CLASS 41—(Continued).

SN 78-141,025. SILVERWINGS PRODUCTIONS, INCORPORATED, DES MOINES, IA. FILED 7-3-2002.



NO CLAIM IS MADE TO THE EXCLUSIVE RIGHT TO USE "TELEVISION SHOW", APART FROM THE MARK AS SHOWN.

FOR SERVICES, NAMELY, ON-GOING TELEVISION PROGRAMS PROVIDING REAL ESTATE AND HOMES FOR SALE INFORMATION (U.S. CLS. 100, 101 AND 107). FIRST USE 5-20-2002; IN COMMERCE 6-17-2002.

SN 78-143,560. BAYLOR UNIVERSITY, WACO, TX. FILED 7-12-2002.

BUILDING A NATION OF READERS, ARTISTS AND DREAMERS

FOR EDUCATIONAL SERVICES, NAMELY, CONDUCTING SEMINARS, CLASSES, CONFERENCES AND WORKSHOPS IN THE FIELD OF LITERATURE, MUSIC, ART, ATHLETICS, PERFORMANCE AND ENTERTAINMENT, DISTRIBUTING COURSE MATERIAL THEREWITH; EDUCATIONAL SERVICES NAMELY, PROVIDING MOTIVATIONAL AND EDUCATIONAL SPEAKERS; ENTERTAINMENT SERVICES, NAMELY, PERSONAL APPEARANCES AND PERFORMANCES BY SPORTS CELEBRITIES, ARTISTS, AUTHORS, MUSICIANS, DANCERS, ACTORS AND ENTERTAINERS TO PROMOTE LITERACY AND ARTS AWARENESS AMONG CHILDREN (U.S. CLS. 100, 101 AND 107). FIRST USE 8-31-2000; IN COMMERCE 8-31-2000.

SN 78-145,113. DANCE PERSPECTIVES FOUNDATION, INC., NEW YORK CITY, NY. FILED 7-18-2002.

JOSE ROLLINS DE LA TORRE BUENO PRIZE IN DANCE LITERATURE

NO CLAIM IS MADE TO THE EXCLUSIVE RIGHT TO USE "PRIZE IN DANCE LITERATURE", APART FROM THE MARK AS SHOWN.

THE NAME(S), PORTRAIT(S), AND/OR SIGNATURE(S) SHOWN IN THE MARK DOES NOT IDENTIFY A PARTICULAR LIVING INDIVIDUAL.

FOR EDUCATIONAL SERVICES - NAMELY, PROVIDING INCENTIVES TO AUTHORS AND PUBLISHERS TO DEMONSTRATE EXCELLENCE IN THE FIELD OF DANCE LITERATURE THROUGH THE ISSUANCE OF AWARDS (U.S. CLS. 100, 101 AND 107).

CLASS 41—(Continued).

SN 78-145,205. SUMMERHAWK, KENDALL, TUCSON, AZ. FILED 7-18-2002.

BE YOURSELF MARKETING

NO CLAIM IS MADE TO THE EXCLUSIVE RIGHT TO USE "MARKETING", APART FROM THE MARK AS SHOWN.

FOR EDUCATIONAL SERVICES, NAMELY, CONDUCTING SEMINARS, CONFERENCES, CLASSES, WORKSHOPS, PERSONAL COACHING SESSIONS, GROUP COACHING SESSIONS, AND TELE-CLASS SESSIONS IN THE FIELD OF BUSINESS MARKETING, BUSINESS SALES TECHNIQUES, TECHNIQUES TO IMPROVE ORAL AND WRITTEN COMMUNICATION SKILLS AND TECHNIQUES FOR MORE EFFECTIVE MARKETING OF SERVICES IN A WAY THAT IS EFFECTIVE AND NATURAL FOR BUSINESSES AND SALESPERSONS TO DO; CUSTOM WRITING SERVICES (U.S. CLS. 100, 101 AND 107).

FIRST USE 3-1-2001; IN COMMERCE 3-1-2001.

SN 78-145,955. CARPENTER, JACQUE J/JEAN, CLEVELAND, MO. FILED 7-20-2002.

Tai Chi  Dim Sa

NO CLAIM IS MADE TO THE EXCLUSIVE RIGHT TO USE "TAI CHI", APART FROM THE MARK AS SHOWN.

THE NON-LATIN CHARACTER IN THE MARK TRANSLITERATE TO "DIM SA" AND THIS HAS NO MEANING OTHER THAN TRADEMARK SIGNIFICANCE.

FOR PERSONAL TRAINING SERVICES, NAMELY, PROVIDING STRENGTH AND BALANCE TRAINING USING FREE FLOWING EXERCISE MOTIONS FOR PATIENTS SUFFERING FROM MULTIPLE SCLEROSIS, STROKE AND CHRONIC PAIN CONDITIONS (U.S. CLS. 100, 101 AND 107).

SN 78-149,961. TESTOUT CORPORATION, PLEASANT GROVE, UT. FILED 8-1-2002.

TESTOUT CHALLENGE

OWNER OF U.S. REG. NO. 2,369,741.

NO CLAIM IS MADE TO THE EXCLUSIVE RIGHT TO USE "CHALLENGE", APART FROM THE MARK AS SHOWN.

FOR EDUCATIONAL SERVICES, NAMELY, PROVIDING TRAINING IN SOFTWARE CERTIFICATION PROFICIENCY; ENTERTAINMENT IN THE NATURE OF A COMPETITION IN THE FIELD OF SOFTWARE CERTIFICATION PROFICIENCY (U.S. CLS. 100, 101 AND 107).

FIRST USE 7-1-2000; IN COMMERCE 7-1-2000.

CLASS 41—(Continued).

SN 78-151,912. HORTUS, LTD, LITTLE ROCK, AR. FILED 8-7-2002.

**P. ALLEN SMITH'S
WONDERFUL WORLD OF
GARDENS**

THE NAME "P. ALLEN SMITH" IDENTIFIES A LIVING INDIVIDUAL WHOSE CONSENT IS OF RECORD.

FOR EDUCATIONAL AND ENTERTAINMENT SERVICES IN THE FORM OF TELEVISION PROGRAMS OR VIDEOS ON THE SUBJECT OF GARDENING AND HORTICULTURE (U.S. CLS. 100, 101 AND 107).

SN 78-152,057. SURFMET, INC., SAN JOSE, CA. FILED 8-7-2002.

THE WAVE MEDIA

OWNER OF U.S. REG. NO. 2,675,615.

NO CLAIM IS MADE TO THE EXCLUSIVE RIGHT TO USE "MEDIA", APART FROM THE MARK AS SHOWN.

FOR ON-LINE AND HARD COPY PUBLICATION OF NEWSPAPERS AND MAGAZINES FEATURING RESOURCE AND REFERENCE INFORMATION RELATING TO LOCAL AND REGIONAL NEWS, ENTERTAINMENT, CULTURAL EVENTS, AND CURRENT EVENTS (U.S. CLS. 100, 101 AND 107).

SN 78-154,440. ELS EDUCATIONAL SERVICES, INC., PRINCETON, NJ. FILED 8-15-2002.



FOR EDUCATIONAL SERVICES, NAMELY PROVIDING ENGLISH LANGUAGE INSTRUCTION IN A MANNER THAT ALSO EXPOSES STUDENTS TO AMERICAN CULTURAL EXPERIENCES FOR THE PURPOSE OF UTILIZING THEIR ENGLISH LANGUAGE SKILLS (U.S. CLS. 100, 101 AND 107).

SN 78-154,599. CREATIVE WEB STUDIO L.L.C., MIAMI BEACH, FL. FILED 8-15-2002.

FUNKSHION

FOR ENTERTAINMENT IN THE NATURE OF FASHION SHOWS (U.S. CLS. 100, 101 AND 107).

CLASS 41—(Continued).

SN 78-155,663. G4 MEDIA, LLC, LOS ANGELES, CA. FILED 8-19-2002.

BLISTER

FOR ENTERTAINMENT SERVICES IN THE NATURE OF A NEWS, TALK SHOW, TRAVEL, INTERVIEW, LIVE-ACTION, REALITY, COMEDY AND/OR ANIMATED TELEVISION PROGRAM IN THE FIELD OF GAMES INCLUDING VIDEO, COMPUTER, ONLINE AND WIRELESS GAMES (U.S. CLS. 100, 101 AND 107).
FIRST USE 5-1-2002; IN COMMERCE 5-1-2002.

SN 78-155,665. G4 MEDIA, LLC, LOS ANGELES, CA. FILED 8-19-2002.

CHEAT!

FOR ENTERTAINMENT SERVICES IN THE NATURE OF A NEWS, TALK SHOW, TRAVEL, INTERVIEW, LIVE-ACTION, REALITY, COMEDY AND/OR ANIMATED TELEVISION PROGRAM IN THE FIELD OF GAMES INCLUDING VIDEO, COMPUTER, ONLINE AND WIRELESS GAMES (U.S. CLS. 100, 101 AND 107).
FIRST USE 5-1-2002; IN COMMERCE 5-1-2002.

SN 78-155,667. G4 MEDIA, LLC, LOS ANGELES, CA. FILED 8-19-2002.

CINEMATECH

FOR ENTERTAINMENT SERVICES IN THE NATURE OF A NEWS, TALK SHOW, TRAVEL, INTERVIEW, LIVE-ACTION, REALITY, COMEDY AND/OR ANIMATED TELEVISION PROGRAM IN THE FIELD OF GAMES INCLUDING VIDEO, COMPUTER, ONLINE AND WIRELESS GAMES (U.S. CLS. 100, 101 AND 107).
FIRST USE 5-1-2002; IN COMMERCE 5-1-2002.

SN 78-155,680. G4 MEDIA, LLC, LOS ANGELES, CA. FILED 8-19-2002.

SWEAT

FOR ENTERTAINMENT SERVICES IN THE NATURE OF A NEWS, TALK SHOW, TRAVEL, INTERVIEW, LIVE-ACTION, REALITY, COMEDY AND/OR ANIMATED TELEVISION PROGRAM IN THE FIELD OF GAMES INCLUDING VIDEO, COMPUTER, ONLINE AND WIRELESS GAMES (U.S. CLS. 100, 101 AND 107).
FIRST USE 5-1-2002; IN COMMERCE 5-1-2002.

CLASS 41—(Continued).

SN 78-161,846. KYRIAZIS, CYNTHIA, AMBLER, PA. FILED 9-9-2002.

CLEAR YOUR DESK... CLEAR YOUR MIND... ORGANIZE IT

FOR TRAINING SERVICES IN THE FIELD OF BUSINESS, NAMELY TRAINING OFFICE WORKERS IN THE MOST EFFICIENT USE OF PAPER, TIME, OFFICE SPACE AND ELECTRONIC FILE MANAGEMENT (U.S. CLS. 100, 101 AND 107).
FIRST USE 7-1-1997; IN COMMERCE 7-1-1997.

SN 78-162,930. COOLEY, ROBERT WILLIAM, NEW YORK, NY. FILED 9-11-2002.

EYEKON

FOR PHOTOGRAPHY SERVICES (U.S. CLS. 100, 101 AND 107).
FIRST USE 7-24-1997; IN COMMERCE 7-24-1997.

SN 78-163,367. ROSSMAN, THOMAS, CLOVERDALE, IN. FILED 9-12-2002.



FOR ENTERTAINMENT AND EDUCATION SERVICES, NAMELY, LIVE DEMONSTRATIONS, EXHIBITIONS, AND TUTORIALS IN THE FIELD OF BILLIARDS (U.S. CLS. 100, 101 AND 107).
FIRST USE 10-1-1989; IN COMMERCE 10-1-1989.

CLASS 41—(Continued).

SN 78-164,197. GUERRERO, PAUL, REDONDO BEACH, CA. AND ENSBURY, DOUG, REDONDO BEACH, CA. AND JODOIN, MARK, REDONDO BEACH, CA. AND LAWLER, LINDSAY, REDONDO BEACH, CA. FILED 9-14-2002.

CIATTIC

FOR ENTERTAINMENT IN THE NATURE OF LIVE PERFORMANCES BY A MUSICAL BAND (U.S. CLS. 100, 101 AND 107).

SN 78-167,296. LASH, STEVE, DBA CERT.AINTY PUBLISHING, POTOMAC, MD. FILED 9-24-2002.

CERT.AINTY PUBLISHING

NO CLAIM IS MADE TO THE EXCLUSIVE RIGHT TO USE "PUBLISHING", APART FROM THE MARK AS SHOWN.

FOR ELECTRONIC PUBLISHING SERVICES, NAMELY, PUBLICATION OF TEXT AND GRAPHIC WORKS ON-LINE FEATURING NEWS OF LEGAL AFFAIRS; PUBLICATION OF E-MAIL REPORTS FEATURING NEWS OF LEGAL AFFAIRS; NEWS REPORTING SERVICES IN THE FIELD OF LEGAL AFFAIRS (U.S. CLS. 100, 101 AND 107).

SN 78-174,566. CANO, LARRY R., NEWPORT BEACH, CA. FILED 10-15-2002.

RALLY BRUIN

FOR ENTERTAINMENT SERVICES, NAMELY, PRODUCTION AND AUDIO RECORDING OF RADIO, TELEVISION, VIDEO, SATELLITE AND CABLE PROGRAMS; ENTERTAINMENT SERVICES, NAMELY, PRODUCTION AND AUDIO AND VIDEO RECORDING OF LIVE PERFORMANCES, SHOWS, EVENTS, CONCERTS, MUSICAL, DRAMA AND COMEDY THEATRE PRODUCTIONS; ORGANIZING EVENTS IN THE FIELD OF SPORTS ACTIVITIES, NAMELY, PROFESSIONAL, COLLEGE, HIGH SCHOOL AND AMATEUR FOOTBALL, SOCCER, BASEBALL, CRICKET, BASKETBALL, TENNIS, VOLLEYBALL, RUGBY, BADMINTON, HURLING, GYMNASTICS, SKIING, SWIMMING, BOATING, DIVING, ICE SKATING, LUGE, RUNNING, BIATHLON, TRIATHLON AND DECATHLON COMPETITIONS, GAMES, MEETS AND TOURNAMENTS; PRODUCTION AND AUDIO RECORDING OF RADIO AND TELEVISION PROGRAMS AND PUBLIC EVENTS, NAMELY, MUSICAL RECITALS, DEBATES, PUBLIC AND PRIVATE GATHERINGS, CULTURAL ACTIVITIES AND EVENTS, CONFERENCES, MEETINGS, RALLIES AND DISPLAYS; RENTAL OF CINEMA FILMS, VIDEO RECORDINGS, AUDIO RECORDINGS AND CD-ROMS IN THE FIELD OF ENTERTAINMENT; RENTAL AND LEASING OF APPARATUS AND INSTRUMENTS, NAMELY, CINEMA, FILM AND MOVIE PROJECTOR AND ACCESSORIES AND TAPE RECORDING EQUIPMENT; PUBLICATION OF BOOKS, MANUALS, MAGAZINES AND TEXT BOOKS; PRODUCTION AND DISTRIBUTION OF MOTION PICTURES; VIDEOTAPE PRODUCTION; AUDIO AND MULTIMEDIA RECORDING AND PRODUCTION (U.S. CLS. 100, 101 AND 107).

CLASS 41—(Continued).

SN 78-175,150. ARIZONA SCIENCE CENTER, PHOENIX, AZ. FILED 10-16-2002.



THE MARK CONSISTS OF A DESIGN SHOWING A SOLAR SYSTEM, TWO STYLIZED FLOWERS, A CIRCUIT BOARD AND A HAND.

FOR MUSEUM SERVICES (U.S. CLS. 100, 101 AND 107).

FIRST USE 11-18-1994; IN COMMERCE 12-1-1994.

SN 78-175,253. QUAKER FACILITIES FOUNDATION, INC., THE, MIDLOTHIAN, VA. FILED 10-16-2002.

FRIENDLY EXCURSIONS

NO CLAIM IS MADE TO THE EXCLUSIVE RIGHT TO USE "EXCURSIONS", APART FROM THE MARK AS SHOWN.

FOR EDUCATIONAL SERVICES, NAMELY, CONDUCTING SEMINARS AND WORKSHOPS IN THE FIELDS OF CREATING UNDERSTANDING AMONG PEOPLE AND BROADENING PERSONAL HORIZONS VIA DAY TRIPS TO LOCAL SIGHTSEEING LOCATIONS AND POINTS OF INTEREST (U.S. CLS. 100, 101 AND 107).

SN 78-176,814. DUGAN, CHRIS, PLEASANT HILL, CA. FILED 10-22-2002.

THE EFFECTION

FOR ENTERTAINMENT IN THE NATURE OF LIVE VISUAL AND AUDIO PERFORMANCES, NAMELY, MUSICAL BAND, ROCK GROUP, GYMNASTIC, DANCE, AND BALLET PERFORMANCES (U.S. CLS. 100, 101 AND 107).

CLASS 41—(Continued).

SN 78-180,423. MEGAMALLS,INC., ST CLOUD, FL. FILED 10-31-2002.

4BINGOBINGO.COM

NO CLAIM IS MADE TO THE EXCLUSIVE RIGHT TO USE "BINGO", APART FROM THE MARK AS SHOWN.

FOR ENTERTAINMENT SERVICES PROVIDING ON-LINE BINGO STYLE GAMING ACCESSED BY WORLD-WIDE COMPUTER NETWORK (U.S. CLS. 100, 101 AND 107).

SN 78-180,430. SAFE AMERICA FOUNDATION, INC., MAR-
IETTA, GA. FILED 10-31-2002.

WORLDSAFE

FOR EDUCATION SERVICES, NAMELY, CONDUCT-
ING CLASSES, WORKSHOPS AND SEMINARS ON
SAFETY ISSUES RELATING TO CYBER SAFETY ON
GLOBAL COMPUTER NETWORKS, FOOD SAFETY IN
THIRD WORLD COUNTRIES, TRAVEL SAFETY FOR
EXECUTIVES AND PERSONAL TRAVEL TIPS, AND
THE DISTRIBUTION OF COURSE MATERIALS IN
CONNECTION THEREWITH (U.S. CLS. 100, 101 AND
107).

FIRST USE 7-1-2000; IN COMMERCE 11-1-2000.

SN 78-180,648. BIX PIX ENTERTAINMENT, INC., CHICAGO,
IL. FILED 10-31-2002.

BIX PIX

FOR ENTERTAINMENT PRODUCTION SERVICES,
NAMELY CLAY ANIMATION SERVICES (U.S. CLS.
100, 101 AND 107).

FIRST USE 3-1-1997; IN COMMERCE 3-1-1997.

SN 78-183,444. AUTO DETAILING SOLUTIONS, GILBERT,
AZ. FILED 11-9-2002.

**AUTO DETAILING
SOLUTIONS**

NO CLAIM IS MADE TO THE EXCLUSIVE RIGHT TO
USE "AUTO DETAILING", APART FROM THE MARK AS
SHOWN.

FOR TRAINING SERVICES IN THE FIELD OF AUTO-
MOTIVE DETAILING AND RECONDITIONING SPECI-
FICALLY, TEACHING INDIVIDUALS AND
BUSINESSES HOW TO PROFESSIONALLY CLEAN
AND POLISH AUTOMOBILES (U.S. CLS. 100, 101 AND
107).

FIRST USE 9-27-2002; IN COMMERCE 9-27-2002.

CLASS 41—(Continued).

SN 78-184,141. SOUCY, MARC L., DORCHESTER, MA.
FILED 11-12-2002.



NO CLAIM IS MADE TO THE EXCLUSIVE RIGHT TO
USE "MUSIC PRODUCTIONS", APART FROM THE MARK
AS SHOWN.

FOR ORIGINAL MUSICAL RECORDING AND DEMO
RECORD PRODUCTION (U.S. CLS. 100, 101 AND 107).

SN 78-184,322. GALPER, ARI, SANTA MONICA, CA. FILED
11-12-2002.

REVERSE SELLING

OWNER OF U.S. REG. NO. 2,704,418.
NO CLAIM IS MADE TO THE EXCLUSIVE RIGHT TO
USE "SELLING", APART FROM THE MARK AS SHOWN.

FOR EDUCATIONAL SERVICES, NAMELY CON-
DUCTING CLASSES, SEMINARS, WORKSHOPS, TELE-
CONFERENCES AND INDIVIDUAL AND GROUP
COACHING IN THE FIELDS OF SALES IMPROVEMENT
AND COMMUNICATION SKILLS, MOTIVATION, SELF-
IMPROVEMENT AND BUSINESS EDUCATION AND
DISTRIBUTING INSTRUCTIONAL MATERIALS IN
CONNECTION THEREWITH (U.S. CLS. 100, 101 AND
107).

FIRST USE 1-1-2002; IN COMMERCE 1-1-2002.

SN 78-184,474. VIACOM INTERNATIONAL INC., NEW
YORK, NY. FILED 11-13-2002.

THE GOODS

OWNER OF U.S. REG. NOS. 1,975,470 AND 2,004,796.
FOR ENTERTAINMENT SERVICES IN THE NATURE
OF ONGOING OR PERIODIC TELEVISION SHOWS
WHICH ARE USED TO SELL MERCHANDISE OF
OTHERS (U.S. CLS. 100, 101 AND 107).

SN 78-185,596. LARRY HARMON PICTURES CORPORA-
TION, HOLLYWOOD, CA. FILED 11-15-2002.

BOZOWORLD

OWNER OF U.S. REG. NOS. 1,570,320, 2,120,654 AND
2,390,533.

FOR AMUSEMENT CENTERS; AMUSEMENT AR-
CADES; ENTERTAINMENT SERVICES, NAMELY, LIVE
PERFORMANCES FEATURING ELECTRONICALLY
ANIMATED CHARACTERS, LIVE PERFORMANCES
BY CLOWN CHARACTERS, AND BIRTHDAY PARTIES;
AMUSEMENT CENTERS FEATURING COIN OR TO-
KEN-OPERATED GAMES WITH ELECTRONICALLY
ANIMATED CHARACTERS (U.S. CLS. 100, 101 AND 107).

CLASS 41—(Continued).

SN 78-185,663. HANDS ON SCIENCE OUTREACH, SILVER SPRING, MD. FILED 11-15-2002.



NO CLAIM IS MADE TO THE EXCLUSIVE RIGHT TO USE "MATH", APART FROM THE MARK AS SHOWN.

FOR EDUCATIONAL SERVICES, NAMELY CONDUCTING CLASSES AND WORKSHOPS FOR CHILDREN AND CONDUCTING CLASSES FOR TEACHERS DEALING WITH PROGRAM TRAINING IN THE FIELD OF MATHEMATICS USING THE SPECIFIC MATERIALS THE HANDS ON SCIENCE OUTREACH PROGRAM HAS DEVELOPED (U.S. CLS. 100, 101 AND 107).

SN 78-185,745. STILL, LOS ANGELES, CA. FILED 11-15-2002.



FOR YOGA INSTRUCTION (U.S. CLS. 100, 101 AND 107).

SN 78-186,116. DISNEY ENTERPRISES, INC., BURBANK, CA. FILED 11-18-2002.

DISCOVERYLAND

FOR AMUSEMENT PARK SERVICES. (U.S. CLS. 100, 101 AND 107).

CLASS 41—(Continued).

SN 78-186,409. EARTHWORM PRODUCTIONS, LLC, STONE MOUNTAIN, GA. FILED 11-19-2002.

EARTHWORM PRODUCTIONS

NO CLAIM IS MADE TO THE EXCLUSIVE RIGHT TO USE "PRODUCTIONS", APART FROM THE MARK AS SHOWN.

FOR MUSIC AND VIDEO RECORDING PRODUCTION SERVICES; AND LIVE MUSIC PRODUCTION SERVICES (U.S. CLS. 100, 101 AND 107).

FIRST USE 4-4-1998; IN COMMERCE 1-12-2000.

SN 78-190,601. LIFE FOCUS, INC., LIBERTY LAKE, WA. FILED 12-3-2002.

SUCCESS TRACKING

FOR EDUCATIONAL SERVICES, NAMELY, CONDUCTING CLASSES AND WORK SHOPS IN THE FIELD OF WEIGHT LOSS AND DISTRIBUTING COURSE MATERIALS AND WORKSHEETS THEREWITH. (U.S. CLS. 100, 101 AND 107).

SN 78-191,227. PRAINITO, SAM, ST. LOUIS, MO. FILED 12-4-2002.

ARCH RIVALS

FOR ON-GOING TELEVISION PROGRAM CONSTITUTING A QUIZ/GAME SHOW ON THE SUBJECT OF ST LOUIS, MISSOURI; ENTERTAINMENT IN THE NATURE OF QUIZ COMPETITIONS REGARDING SAME (U.S. CLS. 100, 101 AND 107).

SN 78-191,314. FREMANTLEMEDIA OPERATIONS B.V., SUMATRALAAN 45, NETHERLANDS, FILED 12-4-2002.

POWER OF THE SPIRITS

FOR ENTERTAINMENT SERVICES IN THE NATURE OF A CONTINUING TELEVISION REALITY PROGRAM (U.S. CLS. 100, 101 AND 107).

SN 78-193,529. NORTH-CENTRAL CHRISTIAN BROADCASTING, DULUTH, MN. FILED 12-11-2002.

THE REFUGE

FOR ENTERTAINMENT SERVICES, NAMELY, RADIO PROGRAMMING (U.S. CLS. 100, 101 AND 107).

CLASS 41—(Continued).

SN 78-193,624. 24 HOUR FITNESS USA, INC., SAN RAMON, CA. FILED 12-11-2002.

STEPXTRA

FOR PHYSICAL FITNESS INSTRUCTION; EDUCATIONAL SERVICES, NAMELY, CONDUCTING PROGRAMS IN THE FIELD OF FITNESS AND HEALTH AND DISTRIBUTING COURSE MATERIALS IN CONNECTION THEREWITH (U.S. CLS. 100, 101 AND 107).
FIRST USE 2-5-2000; IN COMMERCE 2-5-2000.

SN 78-203,182. PIKE, DAILEY D., VAN NUYS, CA. FILED 1-14-2003.

**I WISH THESE WERE
BRAINS**

FOR ENTERTAINMENT SERVICES IN THE NATURE OF LIVE-ACTION, COMEDY, DRAMA AND/OR ANIMATED ON-GOING TELEVISION PROGRAMS; PRODUCTION OF LIVE-ACTION, COMEDY, DRAMA AND/OR ANIMATED TELEVISION PROGRAMS; ENTERTAINMENT SERVICES IN THE NATURE OF LIVE-ACTION, COMEDY, DRAMA AND/OR ANIMATED MOTION PICTURE THEATRICAL FILMS; PRODUCTION OF LIVE-ACTION, COMEDY, DRAMA AND/OR ANIMATED MOTION PICTURE THEATRICAL FILMS; LIVE THEATRICAL STAGE PERFORMANCES; AND PROVIDING AN ON-LINE COMPUTER DATABASE IN THE FIELD OF ENTERTAINMENT AND EDUCATIONAL INFORMATION VIA A GLOBAL COMPUTER NETWORK (U.S. CLS. 100, 101 AND 107).

**CLASS 42—SCIENTIFIC, COMPUTER AND
LEGAL SERVICES**

SN 74-324,771. A PC COMPUTER RENTAL CO., INC., CHARLESTOWN, MA. FILED 10-23-1992.



Fox Computer Rentals

NO CLAIM IS MADE TO THE EXCLUSIVE RIGHT TO USE "COMPUTER RENTALS", APART FROM THE MARK AS SHOWN.

THE LINING IS A FEATURE OF THE MARK AND DOES NOT INDICATE COLOR.

FOR LEASING AND RENTAL OF COMPUTERS, COMPUTER HARDWARE, AND ACCESSORIES RELATED THERETO (U.S. CLS. 100 AND 101).

FIRST USE 1-1-1992; IN COMMERCE 1-1-1992.

CLASS 42—(Continued).

SN 75-257,497. JOE WOODSTOCK, INC., KINGSTON, NY. FILED 3-14-1997.

JOE WOODSTOCK

NO CLAIM IS MADE TO THE EXCLUSIVE RIGHT TO USE "WOODSTOCK", APART FROM THE MARK AS SHOWN.

THE NAME "JOE WOODSTOCK" IS A FICTIONAL NAME AND NOT THE NAME OF A LIVING INDIVIDUAL.

FOR RESTAURANT SERVICES (U.S. CLS. 100 AND 101).

SN 75-348,326. CVS VANGUARD, INC., SCARSDALE, NY. BY CHANGE OF NAME FROM CVS H.C., INC., SCARSDALE, NY. FILED 8-28-1997.

CVS HEALTH CONNECTION

OWNER OF U.S. REG. NOS. 919,941, 1,419,485 AND 2,048,916.

NO CLAIM IS MADE TO THE EXCLUSIVE RIGHT TO USE "HEALTH", APART FROM THE MARK AS SHOWN.

FOR HEALTH CARE SERVICES, NAMELY DISEASE PREVENTION SERVICES, DISEASE MANAGEMENT SERVICES, AND HEALTH CARE CASE MANAGEMENT SERVICES; ALL RENDERED FROM LOCATIONS IN RETAIL DRUG STORES (U.S. CLS. 100 AND 101).

SN 75-413,247. MORNINGSIDE MINISTRIES, SAN ANTONIO, TX. FILED 1-2-1998.

MORNINGSIDE MINISTRIES

SUBJECT TO CONCURRENT USE PROCEEDING WITH REGISTRATION NO. 2,220,034 AND APPLICATION SER. NO. 76/043417. APPLICANT CLAIMS THE RIGHT TO EXCLUSIVE USE OF THE MARK FOR THE AREA COMPRISING THE STATE OF TEXAS.

NO CLAIM IS MADE TO THE EXCLUSIVE RIGHT TO USE "MINISTRIES", APART FROM THE MARK AS SHOWN.

FOR RETIREMENT AND REST HOMES, HEALTH CARE, HOME HEALTH CARE SERVICES, PROVIDING ASSISTED LIVING FACILITIES, CONSULTATION AND COUNSELING IN THE FIELDS OF NUTRITION, HEALTH AND RETIREMENT MINISTERIAL SERVICES, NURSING CARE, MEDICAL SERVICES, PHYSIOLOGICAL CONSULTATION, AND TESTING (U.S. CLS. 100 AND 101).

FIRST USE 12-0-1959; IN COMMERCE 12-0-1959.

CLASS 42—(Continued).

SN 75-567,849. EXTRACARE HEALTH SERVICES, MATAWAN, NJ. FILED 10-13-1998.

EXTRACARE HEALTH SERVICES

NO CLAIM IS MADE TO THE EXCLUSIVE RIGHT TO USE "HEALTH SERVICES", APART FROM THE MARK AS SHOWN.

FOR HEALTH CARE SERVICES, NAMELY, TREATMENT AND COUNSELING FOR BOTH SUBSTANCE ABUSE AND MENTAL HEALTH PROBLEMS (U.S. CLS. 100 AND 101).

FIRST USE 9-0-1991; IN COMMERCE 9-0-1991.

SN 75-601,501. TACKBARY, MARY, RIVERWOODS, IL. FILED 12-8-1998.

GLIMMER OF HOPE

FOR HEALTH INFORMATION SERVICES PROVIDED VIA THE INTERNET AND ELECTRONIC MAIL (U.S. CLS. 100 AND 101).

SN 75-662,417. PLANETALL.COM, INC., SEATTLE, WA. BY ASSIGNMENT AMAZON.COM, INC, SEATTLE, WA. FILED 3-17-1999.

PLANETALL

OWNER OF U.S. REG. NO. 2,125,411.
FOR PROVIDING AN INTERACTIVE DATABASE FEATURING AUTOMATICALLY UPDATING ADDRESS BOOK, PERSONAL PLANNER, DATE REMINDER, TRAVEL PLANNER AND ALUMNI AND PROFESSIONAL GROUP LINKS ALL VIA A GLOBAL COMPUTER NETWORK; PROVIDING TEMPORARY USE OF ON-LINE NON-DOWNLOADABLE SOFTWARE FOR EVENT SCHEDULING AND FOR MANAGING AND EDITING ADDRESS BOOKS, EVENT CALENDARS, AND OTHER PERSONAL AND PROFESSIONAL CONTACT INFORMATION (U.S. CLS. 100 AND 101).

SN 75-683,086. TITAN CORPORATION, THE, SAN DIEGO, CA. FILED 4-15-1999.

TITAN

OWNER OF U.S. REG. NOS. 1,316,135, 1,316,136 AND OTHERS.

FOR CONSULTATION SERVICES IN THE FIELDS OF AERONAUTICAL AND ASTRONAUTICAL ENGINEERING, COMPUTER SCIENCE, AND PHYSICS (U.S. CLS. 100 AND 101).

CLASS 42—(Continued).

SN 75-683,479. TITAN CORPORATION, THE, SAN DIEGO, CA. FILED 4-15-1999.

TITAN LINKABIT

OWNER OF U.S. REG. NOS. 1,316,135, 1,819,712 AND OTHERS.

FOR CONSULTATION SERVICES IN THE FIELDS OF AERONAUTICAL AND ASTRONAUTICAL ENGINEERING, COMPUTER SCIENCE, AND PHYSICS (U.S. CLS. 100 AND 101).

SN 75-687,334. MR. GREEK RESTAURANTS INC., TORONTO, ONTARIO, CANADA, FILED 4-20-1999.

MR. GREEK EXPRESS

PRIORITY CLAIMED UNDER SEC. 44(D) ON CANADA APPLICATION NO. 1006440, FILED 2-25-1999, REG. NO. TMA570015, DATED 10-31-2002, EXPIRES 10-31-2017.

NO CLAIM IS MADE TO THE EXCLUSIVE RIGHT TO USE "GREEK EXPRESS", APART FROM THE MARK AS SHOWN.

FOR RESTAURANT SERVICES AND TAKE-OUT FOOD SERVICES (U.S. CLS. 100 AND 101).

SN 75-694,823. BIOKEY, L.L.C., WAUWATOSA, WI. FILED 4-30-1999.

BIOKEY

FOR PRODUCT DEVELOPMENT, CONSULTATION AND ENGINEERING SERVICES IN THE FIELD OF BIOTECHNOLOGY (U.S. CLS. 100 AND 101).

FIRST USE 9-11-1997; IN COMMERCE 10-7-1997.

SN 75-700,372. NEXX ONLINE INC., TORONTO, ONTARIO, CANADA, FILED 6-2-1999.

NEXX

FOR HOSTING THE WEB SITES OF OTHERS ON A COMPUTER SERVER FOR A GLOBAL COMPUTER NETWORK; AND DESIGNING AND IMPLEMENTING WEB SITES FOR OTHERS WITH ELECTRONIC COMMERCE CAPABILITIES (U.S. CLS. 100 AND 101).

FIRST USE 3-20-1996; IN COMMERCE 12-1-1996.

CLASS 42—(Continued).

SN 75-725,496. AUSTIN QUANTUM SYSTEMS, INC., AUSTIN, TX. FILED 7-7-1999.



NO CLAIM IS MADE TO THE EXCLUSIVE RIGHT TO USE "ABOOKMARK.COM", APART FROM THE MARK AS SHOWN.

FOR CUSTOM IMPRINTING OF BOOKMARKS WITH DECORATIVE OR CUSTOM DESIGNS (U.S. CLS. 100 AND 101).

FIRST USE 3-1-1999; IN COMMERCE 3-15-1999.

SN 75-764,520. ALANTE, LLC, LOS ANGELES, CA. FILED 7-30-1999.



NO CLAIM IS MADE TO THE EXCLUSIVE RIGHT TO USE "SUSHI BAR", APART FROM THE MARK AS SHOWN. THE ENGLISH TRANSLATION OF "TENGU" IS "LONG NOSED GOBLIN".

FOR ON-PREMISES SUSHI AND JAPANESE RESTAURANT SERVICES; EXCLUDING THE SALE OF BEEF JERKY, SEAFOOD JERKY, FROZEN OR PACKAGED ORIENTAL ENTREES CONSISTING PRIMARILY OF MEAT, FISH, POULTRY OR VEGETABLE, PROCESSED NUTS, AND CHOCOLATES (U.S. CLS. 100 AND 101).

SN 75-839,707. KOFSKY, JOEL J., PHILADELPHIA, PA. FILED 11-4-1999.

ISITACASE.COM

FOR LEGAL SERVICES AND CONSULTING SERVICES IN THE FIELD OF LEGAL ANALYSIS (U.S. CLS. 100 AND 101).

CLASS 42—(Continued).

SN 75-878,482. SOCIETE DELPHES INC., MONTREAL, QUEBEC H2Y 2G1, CANADA, FILED 12-22-1999.

DIOGENE TECHNOLOGY

NO CLAIM IS MADE TO THE EXCLUSIVE RIGHT TO USE "TECHNOLOGY", APART FROM THE MARK AS SHOWN.

FOR COMPUTER SOFTWARE DESIGN AND DEVELOPMENT SERVICES FOR OTHERS, NAMELY DEVELOPMENT OF COMPUTER SOFTWARE AND INTERACTIVE MULTIMEDIA PRODUCTS AND COMPUTER SOFTWARE PROGRAMMING FOR OTHERS DEALING WITH ARTIFICIAL INTELLIGENCE, NATURAL LANGUAGE AND INFORMATION MANAGEMENT SYSTEMS (U.S. CLS. 100 AND 101).

FIRST USE 3-0-1998; IN COMMERCE 11-5-1999.

SN 75-884,757. PRACTICAL SOLUTIONS, INC., COLLEGE PARK, GA. FILED 1-3-2000.



FOR COMPUTER SERVICES, NAMELY, CREATING AND MAINTAINING WEB SITES FOR OTHERS, DESIGNING AND AUTHORIZING COMPUTER PROGRAMS FOR OTHERS, AND REGISTRATION OF DOMAIN NAMES FOR IDENTIFICATION OF USERS ON A GLOBAL COMPUTER NETWORK (U.S. CLS. 100 AND 101).

FIRST USE 7-1-1999; IN COMMERCE 7-1-1999.

SN 75-885,526. GOOD DOG! INC., HUNTINGTON WOODS, MI. FILED 1-7-2000.

GOOD DOG

OWNER OF U.S. REG. NO. 1,741,244.

NO CLAIM IS MADE TO THE EXCLUSIVE RIGHT TO USE "DOG", APART FROM THE MARK AS SHOWN.

FOR COMPUTER SERVICES, NAMELY INFORMATION AND ADVISORY SERVICES PROVIDED ON-LINE BY MEANS OF A GLOBAL COMPUTER NETWORK IN THE FIELD OF PETS, PET CARE, AND PRODUCT TESTING OF PET PRODUCTS AND PET FOOD (U.S. CLS. 100 AND 101).

FIRST USE 5-10-1988; IN COMMERCE 5-14-1988.

SN 75-905,459. GRANDROUND CONSULTING, DAVIS, CA. FILED 1-25-2000.

GRANDROUND

FOR COMPUTER PROGRAMMING SERVICES, NAMELY CREATING AND DESIGNING WEB SITES FOR OTHERS (U.S. CLS. 100 AND 101).

CLASS 42—(Continued).

SN 75-917,312. ANTON AIRFOOD, INC., WASHINGTON, DC.
FILED 2-15-2000.

RAPIDO'S FRESH FOOD FAST

OWNER OF U.S. REG. NO. 2,377,851.
NO CLAIM IS MADE TO THE EXCLUSIVE RIGHT TO
USE "FRESH FOOD FAST", APART FROM THE MARK AS
SHOWN.

THE ENGLISH TRANSLATION OF THE SPANISH WORD
"RAPIDO" IN THE MARK IS "RAPID".

FOR RESTAURANT SERVICES (U.S. CLS. 100 AND
101).

SN 75-936,262. LYON ADVERTISING, INC., AUSTIN, TX.
FILED 3-6-2000.

IBUTLER

FOR PERSONAL SERVICES FOR OTHERS, NAMELY,
IN-HOME OR OFFICE CONCIERGE SERVICES FOR
OTHERS COMPRISING MAKING REQUESTED PERSONAL
ARRANGEMENTS AND RESERVATIONS AND
PROVIDING CUSTOMER-SPECIFIC INFORMATION TO
MEET INDIVIDUAL NEEDS; PERSONAL SHOPPING
FOR OTHERS; PLANNING AND PREPARATION OF
MEALS; PET GROOMING, FEEDING AND WALKING
SERVICES FOR OTHERS, ALL OF WHICH SERVICES
ARE ACCESSED VIA COMPUTERIZED ONLINE SYSTEM
(U.S. CLS. 100 AND 101).

SN 75-938,042. TASMANIA RESOURCE, INC., NEWARK,
DE. FILED 3-8-2000.

WEB SESSION

NO CLAIM IS MADE TO THE EXCLUSIVE RIGHT TO
USE "WEB", APART FROM THE MARK AS SHOWN.

FOR PROVIDING TEMPORARY USE OF ON-LINE,
NON-DOWNLOADABLE SOFTWARE USED TO MANAGE
EDUCATIONAL PROGRAMS AND BUSINESS
MEETINGS OF OTHERS CONDUCTED OVER A GLOBAL
COMPUTER NETWORK (U.S. CLS. 100 AND 101).

SN 75-950,346. TIME4 MEDIA, INC., NEW YORK, NY. BY
CHANGE OF NAME TIMES MIRROR MAGAZINES, INC.,
NEW YORK, NY. FILED 2-29-2000.

GOLF MAGAZINE PICTURE COLLECTION

OWNER OF U.S. REG. NOS. 1,521,775, 2,272,491 AND
OTHERS.

NO CLAIM IS MADE TO THE EXCLUSIVE RIGHT TO
USE "PICTURE COLLECTION", APART FROM THE MARK
AS SHOWN.

SEC. 2(F) AS TO "GOLF".

FOR PHOTOGRAPH CLIPPING SERVICES, NAMELY,
PROVIDING A COLLECTION OF GOLF PHOTOGRAPHS
TO OTHERS (U.S. CLS. 100 AND 101).

FIRST USE 3-0-1999; IN COMMERCE 3-0-1999.

CLASS 42—(Continued).

SN 75-983,216. CENTERPOINT ENERGY, INC., HOUSTON,
TX. FILED 6-27-2001.



NO CLAIM IS MADE TO THE EXCLUSIVE RIGHT TO
USE "ENERGY", APART FROM THE MARK AS SHOWN.

FOR SPACE CONDITIONING SERVICES, NAMELY,
ENGINEERING THE EFFECTIVE USE OF ENERGY IN
A FINITE SPACE TO CONTROL OR MANIPULATE AIR
TEMPERATURE, HUMIDITY, AND RELATED VARIANTS
AND TO PROVIDE HEATING AND COOLING
SERVICES FOR FINITE SPACES (U.S. CLS. 100 AND
101).

SN 76-016,958. GOFREIGHT.COM, INC., FLOWER MOUND,
TX. FILED 4-3-2000.

GOFREIGHT.COM

FOR INFORMATION TECHNOLOGY SERVICES AND
ELECTRONIC COMMERCE, NAMELY PROVIDING A
SUBSCRIPTION ONLINE COMPUTER DATABASE AND
APPLICATION-BASED, INFORMATION TECHNOLOGY
SERVICE USING PUSH TECHNOLOGY TO INDICATE
AVAILABILITY AND FACILITATE DELIVERY OF
GOODS AND SERVICES POSTED BY AND PURCHASED
BY SUBSCRIBERS, INCLUDING PLACEMENT, TRACKING,
MONITORING AND REPORTING ON STATUS OF
SUBSCRIBER POSTINGS AND TRANSACTIONS; COMPUTER
SOFTWARE DEVELOPMENT (U.S. CLS. 100
AND 101).

SN 76-034,373. NETWORK INTELLIGENCE, INC., SAN
ANTONIO, TX. FILED 4-24-2000.

SIMPLE BUSINESS

NO CLAIM IS MADE TO THE EXCLUSIVE RIGHT TO
USE "BUSINESS", APART FROM THE MARK AS SHOWN.

FOR HOSTING WEB SITES OF OTHERS ON A
COMPUTER SERVER FOR A GLOBAL COMPUTER
NETWORK; DESIGNING AND IMPLEMENTING WEB
SITES FOR OTHERS (U.S. CLS. 100 AND 101).

SN 76-085,285. CALVILLO, JESUS E., SAN ANTONIO, TX.
FILED 7-10-2000.

EL MIRASOL

THE ENGLISH TRANSLATION OF THE SPANISH WORD
"EL MIRASOL" IS "SUNFLOWER".

FOR RESTAURANT SERVICES (U.S. CLS. 100 AND
101).

FIRST USE 3-31-1998; IN COMMERCE 3-31-1998.

CLASS 42—(Continued).

SN 76-098,989. ARRAY BIOPHARMA INC., BOULDER, CO. FILED 7-28-2000.

**ARRAY BIOPHARMA THE
DISCOVERY RESEARCH
COMPANY**

OWNER OF U.S. REG. NO. 2,547,706.
NO CLAIM IS MADE TO THE EXCLUSIVE RIGHT TO USE "THE DISCOVERY RESEARCH COMPANY", APART FROM THE MARK AS SHOWN.
FOR CHEMICAL AND PHARMACEUTICAL RESEARCH AND DEVELOPMENT FOR OTHERS; LABORATORY RESEARCH IN THE FIELD OF ANALYTICAL AND MEDICAL CHEMISTRY (U.S. CLS. 100 AND 101).
FIRST USE 12-31-1999; IN COMMERCE 12-31-1999.

SN 76-104,057. HERZIG EYE INSTITUTE INC., TORONTO, ONTARIO, CANADA, FILED 8-7-2000.

**CORPORATE CLEAR
ADVANTAGE PROGRAM**

PRIORITY CLAIMED UNDER SEC. 44(D) ON CANADA APPLICATION NO. 1045839, FILED 2-9-2000, REG. NO. TMA575900, DATED 2-19-2003, EXPIRES 2-19-2018.
NO CLAIM IS MADE TO THE EXCLUSIVE RIGHT TO USE "CORPORATE" AND "PROGRAM", APART FROM THE MARK AS SHOWN.
FOR REFRACTIVE AND CATARACT SURGERY (U.S. CLS. 100 AND 101).

SN 76-109,121. RAPTORBYTES INC., CAMROSE ALBERTA, CANADA, FILED 8-14-2000.

RAPTORBYTES

PRIORITY CLAIMED UNDER SEC. 44(D) ON CANADA APPLICATION NO. 1,047,123, FILED 2-17-2000, REG. NO. 572079, DATED 12-11-2002, EXPIRES 12-11-2017.
FOR COMPUTER CONSULTING SERVICES, NAMELY WEBSITE DESIGN AND COMPUTER NETWORK SUPPORT FOR OTHERS (U.S. CLS. 100 AND 101).

CLASS 42—(Continued).

SN 76-129,230. WORKSPEED, INC., NEW YORK, NY. FILED 9-14-2000.

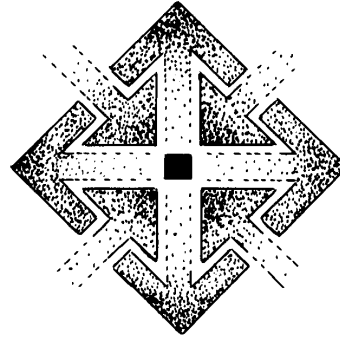

FOR PROVIDING AN INTERACTIVE COMPUTER WEB-SITE FOR LESSEES, PROPERTY OWNERS, PROPERTY MANAGERS, GOOD AND SERVICE PROVIDERS, AND TENANTS WHICH PROVIDES TEMPORARY USE OF ON-LINE NON-DOWNLOADABLE BUSINESS SOFTWARE MANAGING AND FULFILLING REQUEST MADE BY LESSES AND TENANTS TO PROPERTY OWNERS AND PROPERTY MANAGERS FOR REPAIR AND MAINTENANCE OF BUILDINGS AND FOR ORGANIZING BUSINESS OPERATIONS (U.S. CLS. 100 AND 101).
FIRST USE 8-22-2000; IN COMMERCE 8-22-2000.

SN 76-142,684. NORZYME, INC., NORTHBROOK, IL. FILED 10-4-2000.

**NORZYME, INC.
INNOVATIONS IN
BIOTECHNOLOGY**

NO CLAIM IS MADE TO THE EXCLUSIVE RIGHT TO USE "INC." AND "BIOTECHNOLOGY", APART FROM THE MARK AS SHOWN.
FOR SCIENTIFIC RESEARCH IN THE FIELD OF BIOLOGICALLY ACTIVE MOLECULES, BIOLOGICAL PREPARATIONS AND REAGENTS (U.S. CLS. 100 AND 101).

SN 76-146,976. AMERICAN EXPRESS COMPANY, NEW YORK, NY. FILED 10-16-2000.

**CORPORATE PLATINUM
EVENTURES**

NO CLAIM IS MADE TO THE EXCLUSIVE RIGHT TO USE "CORPORATE" AND "EVENTURES", APART FROM THE MARK AS SHOWN.
FOR MONTHLY ELECTRONIC NEWSLETTER PROMOTING BENEFITS AND OFFERS TO SMALL BUSINESS CARD MEMBERS (U.S. CLS. 100 AND 101).

CLASS 42—(Continued).

SN 76-160,284. SOMA NETWORKS, INC., SAN FRANCISCO, CA. FILED 11-3-2000.

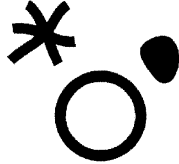

PRIORITY CLAIMED UNDER SEC. 44(D) ON CANADA APPLICATION NO. 1057975, FILED 5-5-2000.

FOR DESIGN AND ENGINEERING OF COMPUTER HARDWARE, TELEPHONY HARDWARE, COMPONENT PARTS AND FITTINGS FOR ALL THE AFORESAID, TELEPHONY SOFTWARE FOR USE IN TELEPHONE NETWORKS, AND COMPUTER SOFTWARE FOR USE IN DATA NETWORKS (U.S. CLS. 100 AND 101).

FIRST USE 10-31-2001; IN COMMERCE 10-31-2001.

SN 76-165,636. NIX, DAVID D., IRVING, TX. FILED 11-15-2000.

THE SMILE SPA

FOR GENERAL AND COSMETIC DENTISTRY (U.S. CLS. 100 AND 101).

FIRST USE 9-4-2000; IN COMMERCE 9-4-2000.

SN 76-173,044. GLOBAL VILLAGE BACKPACKERS INC., TORONTO, ONTARIO, CANADA, FILED 11-29-2000.



PRIORITY CLAIMED UNDER SEC. 44(D) ON CANADA APPLICATION NO. 1078265, FILED 10-11-2000, REG. NO. TMA574,983, DATED 2-4-2003, EXPIRES 2-4-2018.

FOR BACKPACKER HOSTELS SERVICES; TRAVEL SERVICES, NAMELY MAKING RESERVATIONS AND BOOKINGS FOR TEMPORARY LODGINGS; BAR AND PUB SERVICES (U.S. CLS. 100 AND 101).

CLASS 42—(Continued).

SN 76-179,705. REIS, MARY ELLEN, PEACHAM, VT. FILED 12-4-2000.

PACKNOLOGY

FOR PACKAGING DESIGN AND PACKAGING CONSULTATION SERVICES FOR OTHERS (U.S. CLS. 100 AND 101).

FIRST USE 11-15-2000; IN COMMERCE 11-15-2000.

SN 76-210,540. INSURING THE CHILDREN OF SOUTHERN OHIO, CINCINNATI, OH. FILED 2-14-2001.

INSURING THE
CHILDREN

NO CLAIM IS MADE TO THE EXCLUSIVE RIGHT TO USE "CHILDREN", APART FROM THE MARK AS SHOWN. FOR PROMOTING PUBLIC AWARENESS OF THE NEED FOR PREVENTION OF CHILD ABUSE AND NEGLECT (U.S. CLS. 100 AND 101).

FIRST USE 1-0-1995; IN COMMERCE 6-0-1996.

SN 76-217,707. ENGENDERHEALTH, NEW YORK, NY. BY CHANGE OF NAME AVSC INTERNATIONAL, NEW YORK, NY. FILED 3-1-2001.

**ENGENDERHEALTH**

Improving Women's Health Worldwide

NO CLAIM IS MADE TO THE EXCLUSIVE RIGHT TO USE "HEALTH", APART FROM THE MARK AS SHOWN.

FOR HEALTH CARE SERVICES; MEDICAL CONSULTATION IN THE FIELDS OF WOMEN REPRODUCTIVE HEALTH, FAMILY PLANNING AND COMMUNITY HEALTH (U.S. CLS. 100 AND 101).

SN 76-227,616. PRICEWATERHOUSECOOPERS LLP, NEW YORK, NY. FILED 3-19-2001.

B2B ALERT

NO CLAIM IS MADE TO THE EXCLUSIVE RIGHT TO USE "B2B", APART FROM THE MARK AS SHOWN.

FOR CONSULTING SERVICES IN THE FIELD OF INSURANCE REGULATORY MATTERS (U.S. CLS. 100 AND 101).

CLASS 42—(Continued).

SN 76-236,064. WNBA ENTERPRISES, LLC, SECAUCUS, NJ. FILED 4-5-2001.



NO CLAIM IS MADE TO THE EXCLUSIVE RIGHT TO USE "PHOENIX", APART FROM THE MARK AS SHOWN.
FOR COMPUTER SERVICES, NAMELY, PROVIDING ON-LINE MAGAZINES, ON-LINE NEWSLETTERS, ON-LINE COLORING BOOKS IN THE NATURE OF DRAWINGS AND PICTURES, AND ON-LINE CATALOGS, ALL IN THE FIELD OF BASKETBALL; CONDUCTING PUBLIC OPINION POLL SURVEYS FOR NON-BUSINESS, NON-MARKETING PURPOSES IN THE FIELD OF BASKETBALL OVER THE INTERNET; COMPUTER SERVICES, NAMELY, PROVIDING DATABASES FEATURING GENERAL AND LOCAL NEWS AND INFORMATION OF INTEREST TO SPECIFIC GEOGRAPHIC AREAS; PROVIDING TEMPORARY USE OF ON-LINE NON-DOWNLOADABLE SOFTWARE FEATURING THE FOLLOWING CONTENT— TELEVISION HIGHLIGHTS, VIDEO RECORDINGS, VIDEO STREAM RECORDINGS, INTERACTIVE VIDEO HIGHLIGHT SELECTIONS, RADIO PROGRAMS, RADIO HIGHLIGHTS AND AUDIO RECORDINGS IN THE FIELD OF BASKETBALL. INFORMATION, STATISTICAL INFORMATION, TRIVIA, DATABASE OF INFORMATION, DATABASE OF STATISTICAL INFORMATION, DATABASE OF TRIVIA, POLLING INFORMATION, AND INTERACTIVE POLLING IN THE FIELD OF BASKETBALL (U.S. CLS. 100 AND 101).
FIRST USE 5-0-1997; IN COMMERCE 5-0-1997.

CLASS 42—(Continued).

SN 76-243,365. NATIONAL RESTAURANT ASSOCIATION, WASHINGTON, DC. FILED 4-19-2001.



OWNER OF U.S. REG. NOS. 1,240,672, 1,243,949 AND 1,530,292.
NO CLAIM IS MADE TO THE EXCLUSIVE RIGHT TO USE "NETWORK" AND "GRASSROOTS", APART FROM THE MARK AS SHOWN.
SEC. 2(F) AS TO "NATIONAL RESTAURANT ASSOCIATION".
FOR PROVIDING AN ONLINE DATABASE IN THE FIELD OF HOSPITALITY; POLITICAL ACTION COMMITTEE SERVICES, NAMELY PROMOTING THE INTERESTS OF RESTAURATEURS IN THE FIELD OF POLITICS, NAMELY PROVIDING A NETWORK OF POLITICAL CONTACTS, LEGISLATIVE ACTIVITIES, POLITICAL RESPONSES AND INITIATIVES, AND GET-OUT-THE-VOTE CAMPAIGNS, USING TELEPHONE, MAIL AND A GLOBAL COMPUTER NETWORK (U.S. CLS. 100 AND 101).
FIRST USE 3-1-2001; IN COMMERCE 3-1-2001.

SN 76-254,070. HUMPHRIES, WILLIAM C., FORT WAYNE, IN. FILED 5-8-2001.

EDDIE MERLOT'S

THE NAME "EDDIE MERLOT" IN THE MARK DOES NOT IDENTIFY A LIVING INDIVIDUAL.
FOR RESTAURANT SERVICES (U.S. CLS. 100 AND 101).
FIRST USE 10-18-2001; IN COMMERCE 10-18-2001.

SN 76-258,600. HUMPHRIES, WILLIAM C., FORT WAYNE, IN. FILED 5-17-2001.



THE STIPPLING IS FOR SHADING PURPOSES ONLY AND DOES NOT INDICATE ANY COLOR.
THE NAME "EDDIE MERLOT" IN THE MARK DOES NOT IDENTIFY A LIVING INDIVIDUAL.
FOR RESTAURANT SERVICES (U.S. CLS. 100 AND 101).
FIRST USE 10-18-2001; IN COMMERCE 10-18-2001.

CLASS 42—(Continued).

SN 76-277,729. KABUSHIKI KAISHA HITACHI SEISAKUSHO, DBA HITACHI, LTD., TOKYO 101-8010, JAPAN, FILED 6-28-2001.

SuperH
RISC engine

PRIORITY CLAIMED UNDER SEC. 44(D) ON JAPAN APPLICATION NO. 2001-23802, FILED 3-15-2001, REG. NO. 4575815, DATED 6-7-2002, EXPIRES 6-7-2012.

OWNER OF U.S. REG. NOS. 2,012,287, 2,016,317 AND 2,312,369.

NO CLAIM IS MADE TO THE EXCLUSIVE RIGHT TO USE "RISC ENGINE", APART FROM THE MARK AS SHOWN.

FOR DESIGNING FOR OTHERS IN THE FIELDS OF ELECTRONICS, MANUFACTURING, SIGNALING, MEASURING, BIOLOGY, CHEMISTRY, ENGINEERING, OPTICS, CONSUMER ELECTRONICS, AND COMPUTERS; COMPUTER PROGRAMMING FOR OTHERS AND MAINTENANCE OF COMPUTER SOFTWARE; CONDUCTING RESEARCH, DESIGNING AND TESTING OF ELECTRICAL AND ELECTRONIC PRODUCTS FOR OTHERS; CONDUCTING RESEARCH, DESIGNING AND TESTING OF NEW PRODUCTS FOR OTHERS; AGENCIES FOR INDUSTRIAL PROPERTY CONSULTATION; EXPERT WITNESS SERVICES IN THE FIELDS OF COMPUTERS, SEMICONDUCTORS, ELECTRONICS DESIGN AND TESTING; LEGAL AND LITIGATION SUPPORT SERVICES; INTELLECTUAL PROPERTY LICENSING AGENCIES; RESEARCH AND EVALUATION OF SEMICONDUCTORS; RENTAL AND LEASING OF MEASURING APPARATUS AND INSTRUMENTS, NAMELY, BALANCES AND SCALES, THERMOMETERS NOT FOR MEDICAL PURPOSES, GAS METERS, WATER METERS, SPEED METERS, PRESSURE METERS, PHOTO METERS, LUMINOFLUX METERS, HYGROMETERS, CALORIMETERS, FLOW METERS, LEVEL GAUGES, GRAVIMETERS, VISCOMETERS, CLINOMETERS, SURFACE ROUGHNESS TESTERS, FLATNESS TESTING MACHINES, STRAIGHTNESS TESTING MACHINES; RENTAL AND LEASING OF COMPUTERS, COMPUTER COMPONENTS, NAMELY, CENTRAL PROCESSING UNITS, PROGRAMMED-DATA-CARRYING ELECTRONICS CIRCUITS, MAGNETIC DISKS AND TAPES, AND COMPUTER PERIPHERALS; RESEARCH, DEVELOPING AND DESIGNING OF SEMICONDUCTORS AND DEVICES, INTEGRATED CIRCUITS AND ELECTRONIC CIRCUITS; ADVICE, CONSULTATION AND PROVIDING INFORMATION IN THE FIELD OF RESEARCHING, DEVELOPING AND DESIGNING OF SEMICONDUCTORS AND SEMICONDUCTOR DEVICES, INTEGRATED CIRCUITS AND ELECTRONIC CIRCUITS FOR OTHERS; ADVICE, CONSULTATION AND PROVIDING INFORMATION IN THE FIELD OF DEVELOPING, DESIGNING, PROGRAMMING, AND MAINTENANCE OF COMPUTER SOFTWARE; TECHNICAL WRITING FOR OTHERS; PROVIDING INFORMATION IN THE FIELD OF RESEARCH, DEVELOPING AND DESIGNING OF SEMICONDUCTOR AND DEVICES, INTEGRATED CIRCUITS AND ELECTRONIC CIRCUITS BY MEANS OF A GLOBAL COMPUTER NETWORK; PROVIDING TEMPORARY USE OF ON-LINE, NON-DOWNLOADABLE SOFTWARE FOR USE IN DATABASE MANAGEMENT, FOR USE AS A SPREADSHEET, FOR USE AS A WORD PROCESSOR, FOR USE IN THE FIELD OF SEMICONDUCTOR PRODUCTION, FOR USE IN ELECTRONIC CIRCUIT DESIGN (U.S. CLS. 100 AND 101).

CLASS 42—(Continued).

SN 76-279,476. KUILIMA RESORT COMPANY, NEW YORK, NY. FILED 6-30-2001.



TURTLE BAY RESORT

NO CLAIM IS MADE TO THE EXCLUSIVE RIGHT TO USE "TURTLE BAY RESORT", APART FROM THE MARK AS SHOWN.

FOR HOTEL SERVICES (U.S. CLS. 100 AND 101).

SN 76-280,211. TRACIE MARTYN, INC., NEW YORK, NY. FILED 6-26-2001.

**RESCULPTING BODY
TREATMENT BY TRACIE
MARTYN**

OWNER OF U.S. REG. NO. 2,427,409.

NO CLAIM IS MADE TO THE EXCLUSIVE RIGHT TO USE "BODY TREATMENT", APART FROM THE MARK AS SHOWN.

"TRACIE MARTYN" IDENTIFIES A LIVING INDIVIDUAL WHOSE CONSENT IS OF RECORD.

SEC. 2(F) AS TO "RESCULPTING".

FOR SKIN CARE SERVICES, NAMELY, PROVIDING SKIN AND BODY CARE TREATMENT AND MASSAGE (U.S. CLS. 100 AND 101).

FIRST USE 0-0-1995; IN COMMERCE 9-0-1996.

SN 76-280,428. NOWCASTING INTERNATIONAL LIMITED, COUNTY CLAIRE, IRELAND, FILED 7-5-2001.

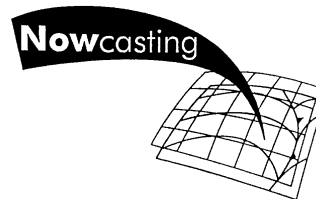

PRIORITY CLAIMED UNDER SEC. 44(D) ON ERP CMNTY TM OFC APPLICATION NO. 002254902, FILED 6-11-2001, REG. NO. 2254902, DATED 7-15-2002, EXPIRES 6-11-2011.

FOR SERVICES IN CONNECTION WITH THE PROVISION OF WEATHER FORECASTS, SEA CONDITION FORECASTS AND AERONAUTICAL FORECASTS; PROVISION OF DATA IN CONNECTION WITH WEATHER, SEA AND AIR CONDITIONS (U.S. CLS. 100 AND 101).

CLASS 42—(Continued).

SN 76-288,534. PAICE CORPORATION, SILVER SPRING, MD. FILED 7-20-2001.

PAICE

FOR DESIGNING, ENGINEERING AND LICENSING FOR OTHERS OF MOTOR VEHICLE MOTORS, DRIVE TRAIN SYSTEMS, AND COMPONENTS (U.S. CLS. 100 AND 101).
FIRST USE 9-13-1994; IN COMMERCE 9-13-1994.

SN 76-309,815. WORLD WATERPARK ASSOCIATION, OVERLAND PARK, KS. FILED 9-6-2001.

WORLD WATERPARK ASSOCIATION

NO CLAIM IS MADE TO THE EXCLUSIVE RIGHT TO USE "ASSOCIATION", APART FROM THE MARK AS SHOWN.

SEC. 2(F).
FOR ASSOCIATION SERVICES, NAMELY, PROMOTING THE INTERESTS OF PRIVATE AND PUBLIC WATER LEISURE FACILITY OWNERS, MANAGERS, SUPPLIERS AND DEVELOPERS (U.S. CLS. 100 AND 101).
FIRST USE 10-0-1984; IN COMMERCE 10-0-1984.

SN 76-323,301. HO, HELEN K., BETHESDA, MD. FILED 10-11-2001.



THE WORD "CHINALAWONE" IS RED. THE OVAL BORDER IS BLUE. THE SPACE BETWEEN THE OVAL BORDER AND THE WORD "CHINALAWONE" IS LIGHT BLUE.

FOR LEGAL SERVICES AND DOCUMENT TRANSLATION FOR INTERNATIONAL MATTERS RELATING TO CHINA (U.S. CLS. 100 AND 101).
FIRST USE 11-26-2001; IN COMMERCE 11-26-2001.

SN 76-331,115. CONVENAS, INC., BOHEMIA, NY. FILED 10-29-2001.

CONVENAS

FOR ENGINEERING SERVICES (U.S. CLS. 100 AND 101).

CLASS 42—(Continued).

SN 76-331,227. COASTAL PROPERTIES I, L.L.C., REHOBOTH BEACH, DE. FILED 10-29-2001.

THE BELLMOOR

FOR HOTEL SERVICES (U.S. CLS. 100 AND 101).
FIRST USE 8-1-2001; IN COMMERCE 8-1-2001.

SN 76-332,195. UMD TECHNOLOGY, INC., VANCOUVER, WA. FILED 10-30-2001.

UMD TECHNOLOGY

NO CLAIM IS MADE TO THE EXCLUSIVE RIGHT TO USE "TECHNOLOGY", APART FROM THE MARK AS SHOWN.

FOR DESIGN AND PRODUCT DEVELOPMENT SERVICES FOR OTHERS, NAMELY, DESIGN, PRODUCT DEVELOPMENT IN THE FIELDS OF ELECTRONICS, OPTICS AND MEDICAL DEVICES (U.S. CLS. 100 AND 101).

SN 76-333,614. IF AMERICA WOULD ONLY FOCUS, INC., SAN DIEGO, CA. FILED 11-2-2001.

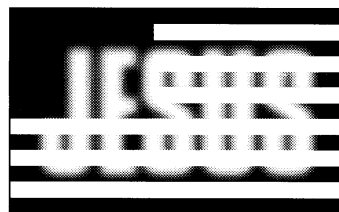

If America would only focus.

THE STIPPLING IN THE DRAWING, IS A FEATURE OF THE MARK AND IS NOT INTENDED TO INDICATE COLOR.

FOR CHARITABLE SERVICES, NAMELY PROVIDING NOT FOR PROFIT FAITH BASED COMMUNITY SERVICES, NAMELY, FOOD, CLOTHING, AND/OR MEDICINE (U.S. CLS. 100 AND 101).
FIRST USE 9-30-2001; IN COMMERCE 9-30-2001.

SN 76-333,635. SEARS, BARRY D., MARBLEHEAD, MA. FILED 11-1-2001.

ZONE KITCHEN

NO CLAIM IS MADE TO THE EXCLUSIVE RIGHT TO USE "KITCHEN", APART FROM THE MARK AS SHOWN.
FOR CATERING SERVICES (U.S. CLS. 100 AND 101).

CLASS 42—(Continued).

SN 76-347,605. ICHI SHOGUN RESTAURANT, SPOKANE, WA. FILED 12-11-2001.



THE MARK CONSISTS OF A REPRESENTATION OF A SAMURAI-LIKE JAPANESE WARRIOR AND THE STYLIZED WORD "SHOGUN".
FOR RESTAURANT SERVICES (U.S. CLS. 100 AND 101).

SN 76-349,437. ROBERT LEROY LEIBOWITZ, M.D., LOS ANGELES, CA. FILED 12-14-2001.

FINASTERIDE MAINTENANCE

NO CLAIM IS MADE TO THE EXCLUSIVE RIGHT TO USE "FINASTERIDE", APART FROM THE MARK AS SHOWN.
SEC. 2(F).
FOR MEDICAL SERVICES, NAMELY, PROVIDING MEDICAL INFORMATION AND TREATMENT STRATEGIES USING SPECIFIC PHARMACEUTICAL PREPARATIONS FOR THE TREATMENT AND MANAGEMENT OF ALL STAGES OF PROSTATE CANCER (U.S. CLS. 100 AND 101).
FIRST USE 4-18-1994; IN COMMERCE 4-18-1994.

SN 76-349,438. ROBERT LEROY LEIBOWITZ, M.D., LOS ANGELES, CA. FILED 12-14-2001.

TRIPLE HORMONE BLOCKADE

NO CLAIM IS MADE TO THE EXCLUSIVE RIGHT TO USE "HORMONE BLOCKADE", APART FROM THE MARK AS SHOWN.
SEC. 2(F).
FOR MEDICAL SERVICES, NAMELY, PROVIDING MEDICAL INFORMATION AND TREATMENT STRATEGIES USING SPECIFIC PHARMACEUTICAL PREPARATIONS FOR THE TREATMENT AND MANAGEMENT OF ALL STAGES OF PROSTATE CANCER (U.S. CLS. 100 AND 101).
FIRST USE 4-18-1994; IN COMMERCE 4-18-1994.

CLASS 42—(Continued).

SN 76-349,439. ROBERT LEROY LEIBOWITZ, M.D., LOS ANGELES, CA. FILED 12-14-2001.

TRIPLE ANDROGEN BLOCKADE

NO CLAIM IS MADE TO THE EXCLUSIVE RIGHT TO USE "ANDROGEN BLOCKADE", APART FROM THE MARK AS SHOWN.
SEC. 2(F).
FOR MEDICAL SERVICES, NAMELY, PROVIDING MEDICAL INFORMATION AND TREATMENT STRATEGIES USING SPECIFIC PHARMACEUTICAL PREPARATIONS FOR THE TREATMENT AND MANAGEMENT OF ALL STAGES OF PROSTATE CANCER (U.S. CLS. 100 AND 101).
FIRST USE 4-18-1994; IN COMMERCE 4-18-1994.

SN 76-352,507. CHEBA HUT FRANCHISING, INC., MESA, AZ. BY ASSIGNMENT NICE DREAMS, INC. TEMPE, AZ. FILED 12-26-2001.



FOR RESTAURANT SERVICES FEATURING TOASTED SUBMARINE SANDWICHES (U.S. CLS. 100 AND 101).
FIRST USE 8-23-2000; IN COMMERCE 9-30-1998.

SN 76-353,480. COUNCIL ON CERTIFICATION OF HEALTH, ENVIRONMENTAL AND SAFETY TECHNOLOGISTS, SAVOY, IL. FILED 12-31-2001.



NO CLAIM IS MADE TO THE EXCLUSIVE RIGHT TO USE "CONSTRUCTION", APART FROM THE MARK AS SHOWN.
FOR TESTING, ANALYSIS AND EVALUATION OF THE SERVICES OF SUPERVISORS AND/OR MANAGERS IN THE CONSTRUCTION INDUSTRY FOR PURPOSES OF CERTIFICATION OF HEALTH AND SAFETY STANDARDS IN THE WORKPLACE (U.S. CLS. 100 AND 101).
FIRST USE 1-0-2001; IN COMMERCE 1-0-2001.

CLASS 42—(Continued).

SN 76-353,484. LILLY'S OF SAN FRANCISCO, INC., INDIAN WELLS, CA. FILED 12-31-2001.



A Bob Tajar Enterprise

NO CLAIM IS MADE TO THE EXCLUSIVE RIGHT TO USE "SAN FRANCISCO" AND "THE PRIME STEAKHOUSE", APART FROM THE MARK AS SHOWN, FOR RESTAURANTS (U.S. CLS. 100 AND 101).

SN 76-372,124. DOCUCORP INTERNATIONAL, INC., DALLAS, TX. FILED 2-19-2002.

DOCUFLEX

OWNER OF U.S. REG. NO. 1,363,108.
FOR PROVIDING TEMPORARY USE OF ON-LINE NON-DOWNLOADABLE COMPUTER SOFTWARE FOR DOCUMENT AUTOMATION, ELECTRONIC PRESENTMENT OF INFORMATION, AND E-COMMERCE SOLUTIONS, NAMELY FOR DOCUMENT CREATION, PRODUCTION, CONVERSION, RECORDING, INDEXING, ARCHIVING, PRINTING, DISPLAYING, PUBLISHING, TRANSMISSION, ENCRYPTION, MANAGEMENT, TYPOGRAPHY, AND DISTRIBUTION, ALL FOR HIGH VOLUME DOCUMENTS FOR BUSINESS USE, VIA A GLOBAL COMPUTER INFORMATION NETWORK; PROVIDING DOCUMENT AUTOMATION, ELECTRONIC PRESENTMENT OF INFORMATION, AND ENTERPRISE INFORMATION AND E-COMMERCE SOLUTIONS, NAMELY DOCUMENT CREATION, PRODUCTION, CONVERSION, RECORDING, INDEXING, ARCHIVING, PRINTING, DISPLAYING, PUBLISHING, TRANSMISSION, ENCRYPTION, MANAGEMENT, TYPOGRAPHY, AND DISTRIBUTION SERVICES, ALL FOR HIGH VOLUME DOCUMENTS FOR BUSINESS USE (U.S. CLS. 100 AND 101).

FIRST USE 9-1-2001; IN COMMERCE 9-1-2001.

SN 76-375,189. CREATIVE PRESENTATION RESOURCES LLC, SAN FRANCISCO, CA. FILED 2-26-2002.

CREATIVE PRESENTATION RESOURCES

NO CLAIM IS MADE TO THE EXCLUSIVE RIGHT TO USE "PRESENTATION", APART FROM THE MARK AS SHOWN.

FOR COMPUTER SERVICES, NAMELY, DESIGNING NETWORK WEB PAGES FOR OTHERS; GRAPHIC ART DESIGN (U.S. CLS. 100 AND 101).

FIRST USE 8-0-1999; IN COMMERCE 9-0-1999.

CLASS 42—(Continued).

SN 76-379,193. IT SOLUTIONS CONSULTING, INC., JENKINTOWN, PA. FILED 3-8-2002.



FOR PROVIDING TEMPORARY USE ON-LINE NON-DOWNLOADABLE SOFTWARE FOR THE WRITING OF INDIVIDUAL EDUCATION PROGRAMS (IEPS) BY SPECIAL EDUCATION TEACHERS, ADMINISTRATORS, AND THERAPISTS IN THE FIELD OF EDUCATION (U.S. CLS. 100 AND 101).

FIRST USE 2-11-2002; IN COMMERCE 2-11-2002.

SN 76-379,852. UNIVERSAL ELECTRONICS INC., CYPRESS, CA. FILED 3-7-2002.



FOR PROVIDING AN INTERACTIVE WEBSITE OF INFORMATION PERTAINING TO HAND-HELD COMPUTERS, REMOTE CONTROL UNITS AND OTHER WIRELESS DEVICES; PROVIDING DATA FOR SETTING UP, UPGRADING AND CUSTOMIZING HAND-HELD COMPUTERS, REMOTE CONTROL UNITS AND PERSONAL DIGITAL ASSISTANTS; AND SOFTWARE DEVELOPMENT, INSTALLATION AND MAINTENANCE SERVICES IN THE FIELD OF HAND HELD COMPUTERS AND REMOTE CONTROL UNITS (U.S. CLS. 100 AND 101).

SN 76-382,773. NEWROADS, INC., GREENWICH, CT. FILED 3-14-2002.

REALCRM

FOR COMPUTER CONSULTATION SERVICES, NAMELY, PROVIDING COMPUTER CONSULTATION SERVICES TO FACILITATE CUSTOMER RELATIONSHIP MANAGEMENT, ELECTRONIC COMMERCE AND TO CREATE INTERFACES BETWEEN THE COMPUTER SYSTEMS OF OTHERS AND OUTSOURCED COMPUTER SOLUTIONS (U.S. CLS. 100 AND 101).

CLASS 42—(Continued).

SN 76-391,816. JKG GROUP, INC., NEW YORK, NY. FILED 4-3-2002.

LOJX

FOR APPLICATION SERVICE PROVIDER FEATURING SOFTWARE THAT PERMITS CUSTOMERS TO DESIGN BUSINESS STATIONERY PRODUCTS, FACILITATE ORDERING OF BUSINESS STATIONARY PRODUCTS, MANAGE INVENTORY OF BUSINESS STATIONERY PRODUCTS AND STORE DESIGNS FOR BUSINESS STATIONERY PRODUCTS (U.S. CLS. 100 AND 101).

FIRST USE 8-25-2000; IN COMMERCE 8-25-2000.

CLASS 42—(Continued).

SN 76-395,390. REGIONAL TITLE AGENCY, LLC, MOUNT LAUREL, NJ. FILED 4-15-2002.



REGIONAL TITLE

SN 76-391,920. SPIRENT PLC, CRAWLEY WEST SUSSEX, RH10 2QL, UNITED KINGDOM, FILED 4-5-2002.

**ANALYZE ASSURE
ACCELERATE**

FOR TESTING, ANALYSIS, INSTALLATION AND MAINTENANCE OF NETWORKING AND COMMUNICATIONS COMPUTER SOFTWARE FOR OTHERS; DEVELOPMENT OF COMPUTER SOFTWARE AND HARDWARE FOR OTHERS FOR USE IN CONNECTION WITH NETWORKING AND COMMUNICATIONS EQUIPMENT AND SERVICES; DESIGN VERIFICATION AND QUALITY ASSURANCE SERVICES FOR OTHERS FOR USE IN CONNECTION WITH NETWORKING AND COMMUNICATIONS EQUIPMENT AND SERVICES (U.S. CLS. 100 AND 101).

NO CLAIM IS MADE TO THE EXCLUSIVE RIGHT TO USE "REGIONAL TITLE", APART FROM THE MARK AS SHOWN.

FOR REAL ESTATE CLOSING SERVICES; REAL ESTATE RESEARCH SERVICES; REAL ESTATE SETTLEMENT SERVICES AND TITLE SEARCHES (U.S. CLS. 100 AND 101).

SN 76-393,100. POINT & CLICK SOFTWARE, INC., DELAWARE, OH. FILED 3-4-2002.



**POINT & CLICK
SOFTWARE INC.**

OWNER OF U.S. REG. NOS. 1,885,694 AND 1,941,108.
NO CLAIM IS MADE TO THE EXCLUSIVE RIGHT TO USE "SOFTWARE INC.", APART FROM THE MARK AS SHOWN.

THE DESIGN PORTION OF THE MARK CONSISTS OF A STYLIZED HAND WITH THUMB AND INDEX FINGER OUTSTRETCHED AND LOWER THREE FINGERS RETRACTED.

SEC. 2(F) AS TO "POINT & CLICK SOFTWARE".
FOR COMPUTER SERVICES, NAMELY, DESIGNING, DEVELOPING, IMPLEMENTING AND MAINTAINING WEB SITES FOR OTHERS (U.S. CLS. 100 AND 101).
FIRST USE 9-1-1994; IN COMMERCE 9-1-1994.

SN 76-407,155. HODGSON RUSS LLP, BUFFALO, NY. FILED 5-10-2002.



OWNER OF U.S. REG. NO. 2,316,945.
NO CLAIM IS MADE TO THE EXCLUSIVE RIGHT TO USE "ATTORNEYS" AND "LLP", APART FROM THE MARK AS SHOWN.

FOR LEGAL SERVICES (U.S. CLS. 100 AND 101).
FIRST USE 3-28-2001; IN COMMERCE 4-4-2001.

CLASS 42—(Continued).

SN 76-408,301. THOMAS PUBLISHING COMPANY, NEW YORK, NY. FILED 5-13-2002.



FOR COMPUTER CONSULTATION SERVICES IN THE NATURE OF DESIGNING AND IMPLEMENTING OF COMPUTER SOLUTIONS TO HELP COMPANIES MORE EFFICIENTLY MANAGE AND PUBLISH INFORMATION, DATA PROCESSING SERVICES, STORAGE OF ELECTRONIC MEDIA, NAMELY, IMAGES, TEXT AND AUDIO DATA FOR PUBLISHERS AND BUSINESS-TO-BUSINESS MANUFACTURERS, AND ELECTRONIC DESKTOP PUBLISHING FOR PUBLISHERS AND BUSINESS-TO-BUSINESS MANUFACTURERS, PUBLISHING SERVICES, NAMELY PUBLISHING SEARCHABLE ELECTRONIC CATALOGS FOR PUBLISHERS AND BUSINESS-TO-BUSINESS MANUFACTURERS (U.S. CLS. 100 AND 101).
FIRST USE 5-15-2000; IN COMMERCE 5-15-2000.

SN 76-409,103. PHOTONIC SYSTEMS, INC., BURLINGTON, MA. FILED 5-16-2002.



NO CLAIM IS MADE TO THE EXCLUSIVE RIGHT TO USE "PHOTONIC SYSTEMS INC.", APART FROM THE MARK AS SHOWN.
FOR CONSULTING SERVICES IN THE FIELD OF DESIGN, SELECTION, IMPLEMENTATION AND USE OF FIBER OPTIC EQUIPMENT FOR USE IN TELECOMMUNICATION, BROADCASTING, AND RADAR APPLICATIONS, NAMELY LINKS FOR CONVEYING INFORMATION IN ELECTRONIC FORM OVER OPTICAL FIBERS, BIAS CONTROLLERS, NO-MOTION CONTROL MODULATORS, AND LASERS (U.S. CLS. 100 AND 101).

SN 76-409,368. THIRD PERSON, INC., MILWAUKEE, WI. FILED 5-20-2002.

EXPERIENCE MAPPING

FOR COMPUTER SERVICES, NAMELY DESIGNING, DEVELOPING AND IMPLEMENTING WEB SITES FOR OTHERS (U.S. CLS. 100 AND 101).
FIRST USE 3-0-2001; IN COMMERCE 3-0-2001.

CLASS 42—(Continued).

SN 76-415,251. MERGE 2 MEDIA LLC, GRAND JUNCTION, CO. FILED 6-5-2002.



FOR GRAPHIC ART DESIGN (U.S. CLS. 100 AND 101).
FIRST USE 7-1-2002; IN COMMERCE 7-1-2002.

SN 76-415,501. FLY TECHNOLOGY, L.P., AUSTIN, TX. FILED 6-5-2002.

FLYCARD

FOR COMPUTER SERVICES, NAMELY, DESIGN AND HOSTING OF WEBSITES FOR OTHERS; HOSTING AUDIO AND VIDEO CONTENT, NAMELY, DATA, IMAGES, AUDIO AND VIDEO CONTENT OF OTHERS ON A GLOBAL COMPUTER NETWORK, INTERNAL NETWORKS, AND EXTRANETS; COMPUTER CONSULTATION AND ADVICE REGARDING WEBSITE DESIGN AND OPTIMIZATION, AND REGARDING THE CREATION OF ONLINE COMMUNITIES AND PERSONAL PORTALS; DOMAIN NAME REGISTRATION SERVICES FOR IDENTIFICATION OF USERS ON A GLOBAL COMPUTER NETWORK; PROVIDING TEMPORARY USE OF ONLINE NON-DOWNLOADABLE SOFTWARE FOR USE BY OTHERS TO DESIGN AND BUILD WEBSITES THAT FEATURE INSTANT MESSAGING, MESSAGE BOARDS, VIDEO E-MAIL, AND WEB CAMS, AND THAT ENABLE ELECTRONIC COMMERCE TRANSACTIONS, CHAT, INSTANT MESSAGING, VIRTUAL STORAGE SPACE, VIRTUAL FILE MANAGEMENT, AND E-MAIL RELATED SERVICES; TECHNICAL SUPPORT SERVICES, NAMELY, TROUBLESHOOTING OF COMPUTER HARDWARE AND SOFTWARE PROBLEMS; TECHNICAL SUPPORT, NAMELY, PROVIDING BACK-UP COMPUTER PROGRAMS AND FACILITIES; MAINTENANCE OF COMPUTER SOFTWARE (U.S. CLS. 100 AND 101).

CLASS 42—(Continued).

SN 76-415,504. FLY TECHNOLOGY, L.P., AUSTIN, TX.
FILED 6-5-2002.

THE WORLD'S PERSONAL WEBSITE COMPANY

FOR COMPUTER SERVICES, NAMELY, DESIGN AND HOSTING OF WEBSITES FOR OTHERS; HOSTING AUDIO AND VIDEO CONTENT, NAMELY, DATA, IMAGES, AUDIO AND VIDEO CONTENT OF OTHER ON A GLOBAL COMPUTER NETWORK, INTERNAL NETWORKS, AND EXTRANETS; COMPUTER CONSULTATION AND ADVICE REGARDING WEBSITE DESIGN AND OPTIMIZATION, AND REGARDING THE CREATION OF ONLINE COMMUNITIES AND PERSONAL PORTALS; DOMAIN NAME REGISTRATION SERVICES FOR IDENTIFICATION OF USERS ON A GLOBAL COMPUTER NETWORK; PROVIDING TEMPORARY USE OF ONLINE NON-DOWNLOADABLE SOFTWARE FOR USE BY OTHERS TO DESIGN AND BUILD WEBSITES THAT FEATURE INSTANT MESSAGING, MESSAGE BOARDS, VIDEO E-MAIL, AND WEB CAMS, AND THAT ENABLE ELECTRONIC COMMERCE TRANSACTIONS, CHAT, INSTANT MESSAGING, VIRTUAL STORAGE SPACE, VIRTUAL FILE MANAGEMENT, AND E-MAIL RELATED SERVICES; TECHNICAL SUPPORT SERVICES, NAMELY, TROUBLESHOOTING OF COMPUTER HARDWARE AND SOFTWARE PROBLEMS; TECHNICAL SUPPORT NAMELY PROVIDING BACKUP COMPUTER PROGRAMS AND FACILITIES; MAINTENANCE OF COMPUTER SOFTWARE (U.S. CLS. 100 AND 101).

SN 76-418,476. TRACTMANAGER, LLC, SADDLE BROOK, NJ. FILED 6-6-2002.

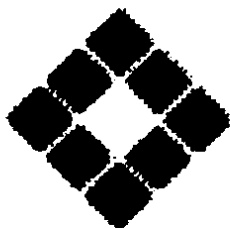

OWNER OF U.S. REG. NOS. 2,577,389, 2,603,589 AND 2,606,595.

FOR PROVIDING TEMPORARY USE OF ON-LINE NON-DOWNLOADABLE SOFTWARE FOR MANAGEMENT AND ADMINISTRATION OF DOCUMENT AND CONTRACT DATABASES (U.S. CLS. 100 AND 101).

FIRST USE 2-0-2000; IN COMMERCE 2-0-2000.

CLASS 42—(Continued).

SN 76-418,477. TRACTMANAGER, LLC, SADDLE BROOK, NJ. FILED 6-6-2002.

TRACTMANAGER

OWNER OF U.S. REG. NOS. 2,577,388 AND 2,606,595.
FOR PROVIDING TEMPORARY USE OF ON-LINE NON-DOWNLOADABLE SOFTWARE FOR MANAGEMENT AND ADMINISTRATION OF DOCUMENT AND CONTRACT DATABASES (U.S. CLS. 100 AND 101).
FIRST USE 9-10-1998; IN COMMERCE 9-10-1998.

SN 76-423,644. OMG AMERICAS, INC., CLEVELAND, OH.
FILED 6-24-2002.

F³E

FOR CONSULTATION IN THE FIELD OF PRODUCT DEVELOPMENT (U.S. CLS. 100 AND 101).

SN 76-423,799. RWK DESIGN, INC., FRANKFORT, IL.
FILED 6-21-2002.

RWK DESIGN

NO CLAIM IS MADE TO THE EXCLUSIVE RIGHT TO USE "DESIGN", APART FROM THE MARK AS SHOWN.

FOR COMPUTER SOFTWARE CONSULTATION; COMPUTER NETWORK DESIGN FOR OTHERS; COMPUTER SERVICES, NAMELY, DESIGNING AND IMPLEMENTING WEB SITES FOR OTHERS; HOSTING THE WEB SITES OF OTHERS ON A COMPUTER SERVER FOR A GLOBAL COMPUTER NETWORK; COMPUTER-AIDED DRAFTING OF DRAWINGS FOR PATENT AND TRADEMARK APPLICATIONS (U.S. CLS. 100 AND 101).

FIRST USE 1-1-1998; IN COMMERCE 1-1-1998.

CLASS 42—(Continued).

SN 76-424,345. HARD HAT INDUSTRY SOLUTIONS, INC., IRVINE, CA. FILED 6-24-2002.

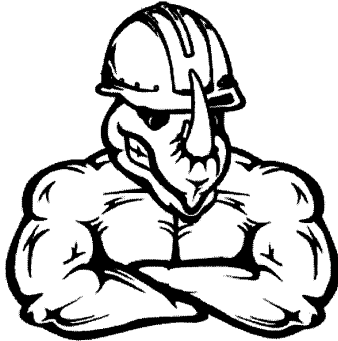

FOR PROVIDING TEMPORARY USE OF ON-LINE NON-DOWNLOADABLE SOFTWARE FOR USE IN DATABASE MANAGEMENT IN THE FIELD OF CONSTRUCTION (U.S. CLS. 100 AND 101).

SN 76-424,428. HARD HAT INDUSTRY SOLUTIONS, INC., IRVINE, CA. FILED 6-24-2002.

HARD HAT INDUSTRY SOLUTIONS

NO CLAIM IS MADE TO THE EXCLUSIVE RIGHT TO USE "INDUSTRY SOLUTIONS", APART FROM THE MARK AS SHOWN.

FOR PROVIDING TEMPORARY USE OF ON-LINE NON-DOWNLOADABLE SOFTWARE FOR USE IN DATABASE MANAGEMENT IN THE FIELD OF CONSTRUCTION (U.S. CLS. 100 AND 101).

SN 76-426,327. CHAMPION SOLUTIONS GROUP, INC., BOCA RATON, FL. FILED 6-28-2002.

CLUSTERCARE

FOR COMPUTER SYSTEMS ANALYSIS SERVICES, NAMELY QUANTITATIVE AND QUALITATIVE ANALYSIS OF FACTORS RELATING TO THE USE AND OPTIMIZATION OF COMPUTERS WITH HIGH AVAILABILITY SOFTWARE, WHICH ENABLES THEM TO PROVIDE FAIL-OVER, LOAD-BALANCING, AND MUTUAL TAKE-OVER CAPABILITIES (U.S. CLS. 100 AND 101).

FIRST USE 3-1-2002; IN COMMERCE 4-15-2002.

CLASS 42—(Continued).

SN 76-434,734. UNICENTRIC, INC., PITTSBURGH, PA. FILED 7-26-2002.

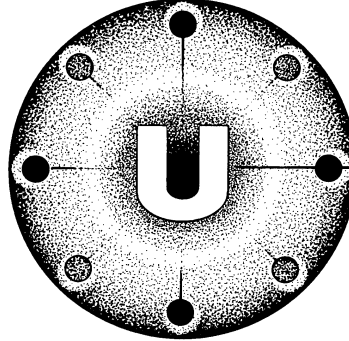

FOR APPLICATION SERVICE PROVIDER FOR NON-PROFIT, SOCIAL SERVICE AND HEALTHCARE ORGANIZATIONS FEATURING SOFTWARE IN THE FIELD OF CUSTOMER/CLIENT RELATIONSHIP MANAGEMENT, OFFICE MANAGEMENT, TIME MANAGEMENT, SOCIAL SERVICE MANAGEMENT, COMMUNICATION MANAGEMENT, EDUCATIONAL MANAGEMENT, WEBSITE MANAGEMENT, FUNDRAISING MANAGEMENT, AND GRANT WRITING MANAGEMENT SERVICES AND INFORMATION TECHNOLOGY CONSULTING AND DEVELOPMENT SERVICES FOR NON-PROFIT, SOCIAL SERVICE, AND HEALTHCARE ORGANIZATIONS (U.S. CLS. 100 AND 101).

FIRST USE 3-1-2002; IN COMMERCE 3-1-2002.

SN 76-438,518. ENTRAC TECHNOLOGIES INC., RICHMOND HILL, ONTARIO, CANADA, FILED 8-7-2002.

ENTRAC

FOR DESIGN AND DEVELOPMENT OF COMPUTER HARDWARE AND COMPUTER SOFTWARE FOR THE AUTOMATED MONITORING, CONTROL, BILLING, AND COLLECTION OF DATA AND REVENUE FOR COPIERS, COMPUTERS, FACSIMILE MACHINES, PRINTERS, OFFICE EQUIPMENT, AND ELECTRONIC DEVICES (U.S. CLS. 100 AND 101).

FIRST USE 12-0-2000; IN COMMERCE 12-0-2000.

SN 76-439,732. SIGNATURE RESEARCH, INC., CALUMET, MI. FILED 8-13-2002.

SIGNATURE RESEARCH

NO CLAIM IS MADE TO THE EXCLUSIVE RIGHT TO USE "RESEARCH", APART FROM THE MARK AS SHOWN. FOR PROVIDING ENGINEERING AND TECHNICAL CONSULTATION AND RESEARCH IN THE FIELD OF NATIONAL DEFENSE (U.S. CLS. 100 AND 101).

FIRST USE 0-0-1992; IN COMMERCE 0-0-1992.

CLASS 42—(Continued).

SN 76-440,996. FAUGHT DESIGN, LLC, ATLANTA, GA. FILED 8-16-2002.

JUMPSTART CREATIVE

NO CLAIM IS MADE TO THE EXCLUSIVE RIGHT TO USE "CREATIVE", APART FROM THE MARK AS SHOWN. FOR COMMERCIAL ART DESIGN AND GRAPHIC DESIGN SERVICES FOR OTHERS; WEBSITE DESIGN SERVICES FOR OTHERS (U.S. CLS. 100 AND 101).

SN 76-444,277. AMICUS LAW GROUP, PC, SEATTLE, WA. FILED 8-28-2002.

AMICUS LAW GROUP, PC

NO CLAIM IS MADE TO THE EXCLUSIVE RIGHT TO USE "LAW GROUP, PC", APART FROM THE MARK AS SHOWN.

THE ENGLISH TRANSLATION OF THE WORD "AMICUS" IN THE MARK IS "FRIEND".

FOR LEGAL SERVICES AND ADVICE (U.S. CLS. 100 AND 101).

FIRST USE 10-1-2001; IN COMMERCE 10-1-2001.

SN 76-448,814. WAVE SYSTEMS CORP., LEE, MA. FILED 9-12-2002.

SMARTSAFE

FOR PROVIDING TEMPORARY USE OF NON-DOWNLOADABLE COMPUTER SOFTWARE FOR ELECTRONIC SIGNATURE VERIFICATION, ELECTRONIC DOCUMENT TRANSMISSION AND MANAGEMENT, AND STORAGE OF ELECTRONIC DOCUMENTS, FILES, AND RECORDS, VIA COMPUTER NETWORKS (U.S. CLS. 100 AND 101).

FIRST USE 12-0-2000; IN COMMERCE 12-0-2000.

SN 76-451,181. ALIBABA.COM CORPORATION, GRAND CAYMAN, CAYMAN ISLANDS, FILED 9-19-2002.



THE MARK CONSISTS IN PART OF A STYLIZED LETTER "A".

FOR COMPUTER SERVICES, NAMELY, SOFTWARE DESIGN AND DEVELOPMENT FOR OTHERS; DESIGNING, IMPLEMENTING, MAINTAINING AND HOSTING WEB SITES FOR OTHERS; PROVIDING TEMPORARY USE OF ONLINE NON-DOWNLOADABLE SOFTWARE THAT PROVIDES AN ELECTRONIC CALENDAR, ADDRESS BOOK AND NOTES FEATURE, WHICH IS ACCESSIBLE VIA LOCAL AND GLOBAL COMPUTER NETWORKS (U.S. CLS. 100 AND 101).

CLASS 42—(Continued).

SN 76-457,777. BAETIS ENVIRONMENTAL SERVICES INC., CHICAGO, IL. FILED 10-11-2002.

BAETIS

FOR ENVIRONMENTAL CONSULTING SERVICES, FOR BOTH THE PUBLIC AND PRIVATE SECTORS, NAMELY PROVIDING FIELD SURVEYS, MONITORING, ANALYSIS AND RECOMMENDATIONS AS TO WATER QUALITY; ENVIRONMENTAL CONSULTATION SERVICES UTILIZING ECOLOGICAL SIMULATION MODELS TO PREDICT POLLUTION TRANSPORT FROM AIR AND LAND TO WATER; PREPARING ENVIRONMENTAL IMPACT STATEMENTS IN COMPLIANCE WITH THE NATIONAL ENVIRONMENTAL POLICY ACT OF 1969 AND REVIEWING STANDARDS AND PRACTICES TO ASSURE COMPLIANCE WITH FEDERAL, STATE AND LOCAL ENVIRONMENTAL LAWS (U.S. CLS. 100 AND 101).

SN 76-458,552. CRAWFORD SOFTWARE CONSULTING, INC., CHESTER, NH. FILED 10-16-2002.

CSCI

FOR CONSULTING SOFTWARE CONSULTING SERVICES FOR CUSTOMER DESIGNED SOLUTIONS; COMPUTER SOFTWARE CONSULTING SERVICES FOR OTHERS FOR MANUFACTURING, NAMELY SELECTION, DESIGN, IMPLEMENTATION, ENHANCEMENT, INTEGRATION AND PROGRAMMING; BUSINESS SOFTWARE SERVICES, NAMELY COMPUTER SYSTEMS INTEGRATION; COMPUTER PROJECT MANAGEMENT AND COMPUTER PROGRAMMING FOR OTHERS; COMPUTER NETWORK INTEGRATION, NAMELY, INSTALLATION, MAINTENANCE AND UPGRADING OF COMPUTER SOFTWARE SYSTEMS; COMPUTER NETWORK DESIGN FOR OTHERS; TECHNICAL COMPUTER CONSULTING SERVICES IN THE FIELD OF COMPUTER PROGRAMMING AND NETWORK INTEGRATION; COMPUTER SOFTWARE AND HARDWARE DESIGN AND DEVELOPMENT SERVICES FOR OTHERS; SOFTWARE PROGRAMMING FOR OTHERS; WEB-ENABLING SERVICES FOR EXISTING DATABASE SYSTEMS (U.S. CLS. 100 AND 101).

FIRST USE 6-3-2002; IN COMMERCE 6-3-2002.

SN 76-460,236. SUN CHEMICAL CORPORATION, FORT LEE, NJ. FILED 10-16-2002.

SUNCHEMICALINK.COM

OWNER OF U.S. REG. NO. 1,582,128.

FOR PROVIDING LINKS TO WEB SITES OF OTHERS FEATURING GRAPHIC ARTS; PROVIDING TECHNICAL INFORMATION IN THE FIELD OF GRAPHIC ARTS VIA THE INTERNET (U.S. CLS. 100 AND 101).

FIRST USE 4-25-2002; IN COMMERCE 4-25-2002.

CLASS 42—(Continued).

SN 76-463,616. ATTENSITY CORPORATION, SALT LAKE CITY, UT. FILED 11-4-2002.

ATTENSITY

FOR PROVIDING TEMPORARY USE OF ON-LINE NON-DOWNLOADABLE SOFTWARE THAT IS USED TO EXTRACT, ORGANIZE, AND ANALYZE DATA FOUND WITHIN FREE-FORM TEXT RECORDS (U.S. CLS. 100 AND 101).

SN 76-465,424. DYNAMIC GRAPHICS, INC., PEORIA, IL. FILED 11-7-2002.

LIQUID LIBRARY

FOR STOCK PHOTOGRAPHY SERVICES, NAMELY LICENSING REPRODUCTION RIGHTS TO PHOTOGRAPHS AND ARTWORK FOR USE IN THE FIELDS OF ENTERTAINMENT, EDUCATION, ELECTRONIC AND PRINT PUBLISHING, GRAPHIC DESIGN, ADVERTISING AND INTERACTIVE MULTI-MEDIA (U.S. CLS. 100 AND 101).

SN 76-469,648. UNIVERSITY OF CENTRAL FLORIDA, ORLANDO, FL. FILED 11-25-2002.

TECHRANGERS

FOR COMPUTER SERVICES, NAMELY, DESIGNING, CREATING AND IMPLEMENTING WEBSITES FOR OTHERS ON A GLOBAL COMPUTER NETWORK; COMPUTER CONSULTING SERVICES, NAMELY, PROVIDING TECHNICAL CUSTOMER SERVICE SUPPORT FOR COMPUTER SOFTWARE AND GLOBAL COMPUTER NETWORK USERS, NAMELY, TROUBLESHOOTING OF COMPUTER SOFTWARE PROBLEMS BY TELEPHONE AND ON-LINE VIA THE GLOBAL COMPUTER NETWORKS; COMPUTER CONSULTING SERVICES IN CONNECTION WITH ELECTRONIC COMMERCE (U.S. CLS. 100 AND 101).

FIRST USE 10-0-1996; IN COMMERCE 10-0-1996.

SN 76-470,645. ESOTERIX, INC., AUSTIN, TX. FILED 11-29-2002.

ENTRIX

FOR PROVIDING TEMPORARY ACCESS TO NON-DOWNLOADABLE COMPUTER SOFTWARE FOR THE PURPOSES OF EXCHANGING PATIENT MEDICAL INFORMATION AND LABORATORY TEST RESULTS (U.S. CLS. 100 AND 101).

FIRST USE 7-26-2002; IN COMMERCE 7-26-2002.

CLASS 42—(Continued).

SN 76-472,197. ELECTRONIC LABEL TECHNOLOGY, INC., BROKEN ARROW, OK. FILED 12-3-2002.

ELTSIGNS.COM

OWNER OF U.S. REG. NO. 2,199,659.

FOR PROVIDING TEMPORARY USE OF NON-DOWNLOADABLE SOFTWARE FOR CREATING AND PRINTING COLOR AND MONOCHROMATIC SIGNS, LABELS AND SHELF TALKERS BY SUBSCRIPTION (U.S. CLS. 100 AND 101).

FIRST USE 11-0-2001; IN COMMERCE 1-0-2002.

SN 76-472,248. REGLERA, LLC, DENVER, CO. FILED 12-5-2002.

REGLERA

"REGLERA" IS A DERIVATIVE OF THE SWEDISH WORD MEANING "TO REGULATE".

FOR RESEARCH AND TESTING SERVICES FOR OTHERS REGARDING REGULATORY COMPLIANCE IN THE DEVELOPMENT OF MEDICAL DEVICES; CONSULTING SERVICES IN THE FIELD OF REGULATORY AFFAIRS, MANUFACTURING COMPLIANCE AND VALIDATION AND MARKET INTRODUCTION AS RELATED TO MEDICAL DEVICES; CONSULTATION SERVICES IN THE FIELD OF COMPLIANCE EVALUATION TO INSURE VALIDITY AND ACCURACY OF REGULATORY SUBMISSIONS TO THE FDA BY MEDICAL DEVICE COMPANIES; PROVIDING REGULATORY INFORMATION AND IMPLEMENTATION SERVICES RELATING TO THE DEVELOPMENT AND VALIDATION OF MEDICAL DEVICES (U.S. CLS. 100 AND 101).

FIRST USE 7-1-2002; IN COMMERCE 7-1-2002.

SN 76-473,041. BABCOCK GENETICS, INC., ROCHESTER, MN. FILED 11-25-2002.



FOR CONSULTING SERVICES IN THE FIELD OF SWINE GENETICS (U.S. CLS. 100 AND 101).

FIRST USE 1-15-2001; IN COMMERCE 1-15-2001.

CLASS 42—(Continued).

SN 76-475,757. IRUN CORP., VAUGHAN, ONTARIO, CANADA, FILED 12-16-2002.

IRUN

FOR COMPUTER SERVICES, NAMELY, DESIGNING AND IMPLEMENTING CUSTOMIZED WEB SITES FOR SMALL AND MEDIUM SIZED BUSINESSES, ENTREPRENEURS AND CHARITIES THROUGHOUT NORTH AMERICA VIA THE INTERNET; PROVIDING SEARCH ENGINES FOR OBTAINING DATA ON A GLOBAL COMPUTER NETWORK; REGISTRATION OF DOMAIN NAMES FOR IDENTIFICATION OF USERS ON A GLOBAL COMPUTER NETWORK; COMPUTER CONSULTATION SERVICES (U.S. CLS. 100 AND 101).

SN 78-019,346. COKER, BRYAN W, LOS GATOS, CA. FILED 8-2-2000.

NETIZE

FOR COMPUTER SERVICES, NAMELY CREATING INDEXES OF INFORMATION, SITES AND OTHER RESOURCES AVAILABLE ON COMPUTER NETWORKS; PROVIDING SEARCH ENGINES FOR OBTAINING DATA ON A GLOBAL COMPUTER NETWORK; PROVIDING DATABASES FEATURING GENERAL AND LOCAL NEWS, AND INFORMATION OF INTEREST TO SPECIFIC GEOGRAPHIC AREAS (U.S. CLS. 100 AND 101).

SN 78-031,987. LEGAL LINK NETWORK, A PROFESSIONAL CORPORATION, DALLAS, TX. FILED 10-23-2000.

IS YOUR BUSINESS E-LEGAL?

FOR LEGAL SERVICES (U.S. CLS. 100 AND 101).

SN 78-031,989. LEGAL LINK NETWORK, A PROFESSIONAL CORPORATION, DALLAS, TX. FILED 10-23-2000.

BE E-LEGAL

FOR LEGAL SERVICES (U.S. CLS. 100 AND 101).

CLASS 42—(Continued).

SN 78-043,954. BRAVEPOINT, NORCROSS, GA. FILED 1-19-2001.

BRAVEPOINT

THE DRAWING IS LINED FOR THE COLOR BLUE.
FOR (BASED ON INTENT TO USE) COMPUTER CONSULTING IN THE FIELD OF E-BUSINESS APPLICATIONS WHICH INCLUDES CONSIDERATION OF A CLIENT'S PROCESSES, PEOPLE, AND SUPPLY CHAINS AND TECHNOLOGIES, AND ON-GOING TECHNICAL SUPPORT SERVICES, NAMELY, TROUBLESHOOTING OF COMPUTER HARDWARE AND SOFTWARE PROBLEMS VIA TELEPHONE, E-MAIL OR IN-PERSON SERVICES AND CONSULTATION RELATING THERE TO (U.S. CLS. 100 AND 101).

SN 78-090,393. MOSS ROSCHER & ASSOCIATES, INC, WOODINVILLE, WA. FILED 10-26-2001.

iSelect
Personal Session Planner

NO CLAIM IS MADE TO THE EXCLUSIVE RIGHT TO USE "PERSONAL SESSION PLANNER", APART FROM THE MARK AS SHOWN.

FOR PROVIDING TEMPORARY USE OF ONLINE NON-DOWNLOADABLE SOFTWARE FOR USE BY ATTENDEES OF CONFERENCES, WORKSHOPS, AND OTHER GROUP EVENTS TO CREATE CUSTOM SCHEDULES, ITINERARIES, AND NOTES REGARDING CONFERENCE SESSIONS AND TO PROVIDE AN OVERVIEW OF ALL SESSIONS AND EVENTS RELATED TO A PARTICULAR CONFERENCE (U.S. CLS. 100 AND 101).

SN 78-091,637. ENSO DESIGN, SEATTLE, WA. FILED 11-5-2001.

ENSO DESIGN

NO CLAIM IS MADE TO THE EXCLUSIVE RIGHT TO USE "DESIGN", APART FROM THE MARK AS SHOWN.

THE ENGLISH TRANSLATION OF "ENSO" IS "CIRCLE".
FOR GRAPHIC ART DESIGN SERVICES (U.S. CLS. 100 AND 101).

FIRST USE 2-21-2000; IN COMMERCE 3-1-2000.

CLASS 42—(Continued).

SN 78-100,675. INFOPACK CONSULTING, INC., GARDEN CITY, NY. FILED 1-3-2002.



NO CLAIM IS MADE TO THE EXCLUSIVE RIGHT TO USE "CONSULTING, INC.", APART FROM THE MARK AS SHOWN.

THE MARK IS LINED FOR THE COLOR RED. FOR TECHNICAL CONSULTATION AND RESEARCH IN THE FIELD OF IMMIGRATION LAW (U.S. CLS. 100 AND 101).

FIRST USE 9-19-2001; IN COMMERCE 10-21-2001.

SN 78-111,005. CAMION TECHNOLOGIES, LLC, SHAWNEE, KS. FILED 2-26-2002.

CAMION TECHNOLOGIES

NO CLAIM IS MADE TO THE EXCLUSIVE RIGHT TO USE "TECHNOLOGIES", APART FROM THE MARK AS SHOWN.

FOR COMPUTER SOFTWARE CONSULTING SERVICES IN THE FIELD OF DESIGN AND CUSTOMIZATION OF COMPUTER SOFTWARE, WEBSITE DESIGN, SYSTEMS INTEGRATION AND MAINTENANCE OF COMPUTER SOFTWARE FOR OTHERS (U.S. CLS. 100 AND 101).

FIRST USE 10-1-2001; IN COMMERCE 10-1-2001.

SN 78-112,490. TOTAL RECOGNITION SYSTEMS, LLC, NIWOT, CO. BY ASSIGNMENT PARASCRIPT, LLC, NIWOT, CO. FILED 3-4-2002.

FORM DEFINITION STUDIO

NO CLAIM IS MADE TO THE EXCLUSIVE RIGHT TO USE "FORM DEFINITION", APART FROM THE MARK AS SHOWN.

FOR DATA INPUT SERVICES, NAMELY DATA AUTOMATION AND COLLECTION SERVICES USING PROPRIETARY CHARACTER AND HANDWRITING RECOGNITION SOFTWARE TO INPUT, COLLECT, EVALUATE AND ANALYZE DATA; APPLICATION SERVICE PROVIDER SERVICES FEATURING CHARACTER AND HANDWRITING RECOGNITION SOFTWARE IN THE FIELD OF STRUCTURED FORMS PROCESSING (U.S. CLS. 100 AND 101).

CLASS 42—(Continued).

SN 78-127,296. TEKSOUTH CORPORATION, GARDEN-DALE, AL. FILED 5-8-2002.

TEKSOUTH IQ

FOR COMPUTER DATA WAREHOUSING PROVIDING DATA INTEGRATION ACCESS AND ANALYSIS AS AN APPLICATION SERVICE PROVIDER (U.S. CLS. 100 AND 101).

SN 78-127,586. DUPONT PHOTOMASKS, INC., ROUND ROCK, TX. FILED 5-9-2002.



FOR PROVIDING USE OF ONLINE NON-DOWNLOADABLE SOFTWARE FOR DETERMINING CUSTOMER, PURCHASE AND ACCOUNT INFORMATION FOR PHOTOMASKS, AND FOR DETERMINING THE PROGRESSION OF AN ORDER FOR PHOTOMASKS THROUGH THE MANUFACTURING PROCESS (U.S. CLS. 100 AND 101).

FIRST USE 3-24-2001; IN COMMERCE 4-24-2001.

SN 78-134,473. RIBOZYME PHARMACEUTICALS, INC., BOULDER, CO. FILED 6-10-2002.

AMENDAGEN

FOR MEDICINAL AND BIOLOGICAL PRODUCT RESEARCH, DEVELOPMENT AND TESTING (U.S. CLS. 100 AND 101).

SN 78-140,730. NEURION PHARMACEUTICALS, INC., LOS ANGELES, CA. FILED 7-2-2002.

RECEPTOPHORE

FOR CONDUCTING AND ANALYZING STUDIES REGARDING DRUG INTERACTIONS FOR THE PHARMACEUTICAL INDUSTRY (U.S. CLS. 100 AND 101).

CLASS 42—(Continued).

SN 78-146,479. HALTER, FAITH L., ARLINGTON, VA. FILED 7-23-2002.

ARTFUL ORGANIZING AND DESIGN

NO CLAIM IS MADE TO THE EXCLUSIVE RIGHT TO USE "ORGANIZING AND DESIGN", APART FROM THE MARK AS SHOWN.

FOR DESIGN FOR OTHERS IN THE FIELD OF PROFESSIONAL ORGANIZING AND INTERIOR DECORATING SERVICES FOR HOME AND OFFICE, INCLUDING BUT NOT LIMITED TO MAKING MORE EFFICIENT AND ATTRACTIVE USE OF SPACE, REDUCING CLUTTER, AND CLARIFYING/ENHANCING PERSONAL DESIGN STYLE AND PREFERENCES (U.S. CLS. 100 AND 101).

SN 78-147,312. HEXIMER COMMUNICATIONS, INC., ALISO VIEJO, CA. FILED 7-25-2002.

"NETWORK SECURITY IS OUR BUSINESS, BUILDING IT IS OUR PASSION"

FOR COMPUTER SERVICES, NAMELY, COMPUTER NETWORK DESIGN (U.S. CLS. 100 AND 101). FIRST USE 8-11-1999; IN COMMERCE 6-1-2002.

SN 78-153,599. ONCALL TECHSOLUTIONS, INC., STEWARTSVILLE, NJ. FILED 8-13-2002.

ONCALL TECHSOLUTIONS INC. SMALL OFFICE HOME OFFICE (SOHO) TECHNOLOGY INTEGRATION SPECIALISTS

NO CLAIM IS MADE TO THE EXCLUSIVE RIGHT TO USE "ON CALL, INC. SMALL OFFICE HOME OFFICE (SOHO) TECHNOLOGY INTEGRATION SPECIALISTS", APART FROM THE MARK AS SHOWN.

FOR COMPUTER, SOFTWARE AND NETWORKING TECHNOLOGY INTEGRATION (U.S. CLS. 100 AND 101).

SN 78-157,662. EBSCO CASIAS, INC., IPSWICH, MA. FILED 8-26-2002.

LINKSOURCE

FOR ONLINE SERVICES, NAMELY, SEARCH AND RETRIEVAL SERVICES FACILITATING THE LOCATION OF, ACCESS TO, RETRIEVAL, AND VIEWING OF JOURNAL ARTICLES AND OTHER ONLINE INFORMATION (U.S. CLS. 100 AND 101).

CLASS 42—(Continued).

SN 78-157,713. TYPE A MULTIMEDIA NETWORK, CHICAGO, IL. FILED 8-26-2002.

TYPE A

FOR DESIGN AND DEVELOPMENT OF CUSTOM WEBSITES AND OTHER SOFTWARE (U.S. CLS. 100 AND 101).

FIRST USE 11-25-1998; IN COMMERCE 1-1-1999.

SN 78-157,824. IDENTITYMINE, INCORPORATED, TACOMA, WA. FILED 8-26-2002.



identity mine

FOR COMPUTER CONSULTATION, NAMELY, CUSTOM COMPUTER SOFTWARE ASSESSMENT, DEVELOPMENT, DESIGN, CONFIGURATION AND PROGRAMMING SERVICES FOR OTHERS; INSTALLATION OF COMPUTER SOFTWARE; COMPUTER SERVICES, NAMELY, DESIGNING AND IMPLEMENTING WEB SITES FOR OTHERS; COMPUTER SOFTWARE AND NETWORK SOFTWARE CONSULTATION; MODIFICATION AND ADAPTATION OF EXISTING SOFTWARE PRODUCTS FOR SPECIFIC APPLICATIONS; TESTING OF NEW SOFTWARE PRODUCTS FOR OTHERS; TECHNICAL SOFTWARE WRITING FOR OTHERS; AND, MAINTENANCE OF COMPUTER SOFTWARE (U.S. CLS. 100 AND 101).

FIRST USE 1-1-2001; IN COMMERCE 3-1-2001.

SN 78-162,921. DIGITAL DEFENSE INCORPORATED, SAN ANTONIO, TX. FILED 9-11-2002.

DIGITAL DEFENSE

OWNER OF U.S. REG. NO. 2,495,723.

NO CLAIM IS MADE TO THE EXCLUSIVE RIGHT TO USE "DIGITAL", APART FROM THE MARK AS SHOWN.

FOR COMPUTER SERVICES, NAMELY, COMPUTER SYSTEMS ANALYSIS AND COMPUTER CONSULTATION SERVICES (U.S. CLS. 100 AND 101).

FIRST USE 1-0-2000; IN COMMERCE 1-0-2000.

SN 78-163,879. SUITESPEED, INC., LOUISVILLE, CO. FILED 9-13-2002.

SUITESPOT

FOR SOFTWARE ENGINEERING SERVICES AND COMPUTER HARDWARE CONFIGURATION SERVICES TO ENABLE CLIENT HOTELS, CONVENTION CENTERS, PUBLIC MEETING CENTERS, TRANSPORTATION CENTERS, APARTMENT BUILDINGS, OFFICE BUILDINGS AND THE LIKE, TO OFFER HIGH-SPEED, WIRELESS INTERNET ACCESS TO GUESTS, VISITORS AND OCCUPANTS (U.S. CLS. 100 AND 101).

FIRST USE 8-13-2002; IN COMMERCE 8-13-2002.

CLASS 42—(Continued).

SN 78-163,938. EASTMAN CHEMICAL COMPANY, KINGSPORT, TN. FILED 9-13-2002.

DIGITAL OYSTER

NO CLAIM IS MADE TO THE EXCLUSIVE RIGHT TO USE "DIGITAL", APART FROM THE MARK AS SHOWN.

FOR PROVIDING ONLINE INFORMATION IN THE FIELD OF COMPUTER SERVICES, NAMELY, INFORMATION REGARDING THE DESIGN, SELECTION, IMPLEMENTATION AND USE OF COMPUTER HARDWARE AND SOFTWARE SYSTEMS IN BUSINESS OPERATIONS, NAMELY, DATA STORAGE RECOVERY AND CONTINUITY APPLICATIONS, WEBSITE MANAGEMENT, SUPPLY CHAIN MONITORING AND INVENTORY CONTROL, AND BUSINESS MANAGEMENT APPLICATIONS DEVELOPMENT AND HOSTING (U.S. CLS. 100 AND 101).

SN 78-166,111. LUBETRAK.COM, LLC., EVANSTON, WY. FILED 9-19-2002.

LUBETRAK

FOR ONLINE SERVICES IN THE AREA OF LUBRICATION ANALYSIS, NAMELY, PROVIDING AN ON-LINE VIRTUAL LAB OFFERING INTERNET DRIVEN COLLABORATION, KNOWLEDGE-BASE TRAINING, CONSULTATION, PROACTIVE MAINTENANCE SOLUTIONS, E-LUBRICATION, RECOMMENDATIONS, TRENDING, GRAPHING AND MANAGEMENT REPORTING IN THE FIELDS OF FLUID TECHNOLOGY, BUSINESS, AND RELATED INDUSTRIES (U.S. CLS. 100 AND 101).

FIRST USE 9-23-2000; IN COMMERCE 9-23-2000.

SN 78-168,432. INTERFACE PEOPLE, LLC, CARROLLTON, TX. FILED 9-26-2002.

IPEOPLE

FOR COMPUTER PROGRAMMING FOR OTHERS (U.S. CLS. 100 AND 101).

FIRST USE 3-1-2002; IN COMMERCE 3-1-2002.

SN 78-168,518. PROVIDERLAW CORPORATION, KEMPTON, PA. FILED 9-27-2002.

DENIALTRAC

FOR WEB-BASED SOFTWARE, NAMELY, PROVIDING TEMPORARY USE OF ONLINE NON-DOWNLOADABLE SOFTWARE THAT ALLOWS FOR TRACKING AND RESOLUTION OF DENIALS OF COVERAGE BY MEDICAL INSURANCE CARRIERS AND OTHER THIRD PARTY PROVIDERS (U.S. CLS. 100 AND 101).

CLASS 42—(Continued).

SN 78-171,968. MOORE, MICHAEL, AURORA, CO. FILED 10-8-2002.

MOORECREATIVE

FOR TRADITIONAL AND COMPUTER-BASED GRAPHIC ART DESIGN SERVICES, NAMELY, ILLUSTRATION, LETTERING, LOGO DESIGN, CORPORATE IDENTITY DESIGN, PRODUCT PACKAGING DESIGN, SIGNAGE DESIGN, RETAIL ENVIRONMENT DESIGN AND OTHER COMMERCIAL ENVIRONMENT DESIGN, TRADE SHOW BOOTH DESIGN, POINT-OF-PURCHASE DISPLAY DESIGN, AND CREATION OF COMMERCIALY PRINTED MATERIALS IN THE FORM OF DISPLAYS, PROMOTIONAL AIDS, AND SIGNS FOR OTHERS; COMPUTER SERVICES, NAMELY, DESIGNING, IMPLEMENTING, AND MAINTAINING WEB SITES, AND COMPUTER GRAPHICAL USER INTERFACE SOFTWARE DESIGN FOR OTHERS FEATURING INTERACTIVE MEDIA, NAMELY, SOUND AND ANIMATION ON INTERACTIVE MULTIMEDIA CD-ROMS AND GLOBAL COMPUTER NETWORKS (U.S. CLS. 100 AND 101).

FIRST USE 11-1-1991; IN COMMERCE 10-19-1992.

SN 78-173,182. NOLLMAN, JORDAN, CAMBRIDGE, MA. FILED 10-10-2002.



NO CLAIM IS MADE TO THE EXCLUSIVE RIGHT TO USE "STUDIOS", APART FROM THE MARK AS SHOWN.

FOR INDUSTRIAL DESIGN SERVICES; PRODUCT DEVELOPMENT SERVICES (U.S. CLS. 100 AND 101).

FIRST USE 7-31-2001; IN COMMERCE 7-31-2001.

SN 78-175,141. PARSONS ADVANCED HOLDINGS, INC., SCOTTSDALE, AZ. FILED 10-16-2002.

MAD DOG

FOR REGISTRATION AND MONITORING OF DOMAIN NAMES FOR OTHERS FOR IDENTIFICATION OF USERS ON A GLOBAL COMPUTER NETWORK; HOSTING THE WEB SITES OF OTHERS ON A COMPUTER SERVER FOR A GLOBAL COMPUTER NETWORK (U.S. CLS. 100 AND 101).

SN 78-176,900. GOLDKIND, TINA, HOLBROOK, NY. FILED 10-22-2002.

SWIRL DESIGN

NO CLAIM IS MADE TO THE EXCLUSIVE RIGHT TO USE "DESIGN", APART FROM THE MARK AS SHOWN.

FOR PRODUCT DEVELOPMENT, PRODUCT DEVELOPMENT CONSULTATION, PRODUCT RESEARCH AND DEVELOPMENT, AND PACKAGING DESIGN FOR OTHERS (U.S. CLS. 100 AND 101).

CLASS 42—(Continued).

SN 78-178,924. HALLIBURTON ENERGY SERVICES, INC., CARROLLTON, TX. FILED 10-28-2002.

WIDEN THE MUD WEIGHT WINDOW!

FOR ANALYSIS AND TESTING FOR OIL WORKINGS REGARDING THE PREVENTION OF LOST CIRCULATION CONTROL, REDUCING TROUBLE TIME, AND IMPROVING PRODUCTION ECONOMICS (U.S. CLS. 100 AND 101).

SN 78-179,216. DOYLE, MICHAEL, J, MONROE, NY. FILED 10-28-2002.

EXODIA WEB DESIGNS

NO CLAIM IS MADE TO THE EXCLUSIVE RIGHT TO USE "WEB DESIGNS", APART FROM THE MARK AS SHOWN.

FOR COMPUTER SERVICES, NAMELY, DESIGNING, CREATING, MAINTAINING, WEB SITES FOR OTHERS (U.S. CLS. 100 AND 101).

SN 78-179,690. SHEPPARD MULLIN RICHTER & HAMPTON LLP, COSTA MESA, CA. FILED 10-29-2002.

CRADLE TO LIQUIDITY

FOR LEGAL SERVICES (U.S. CLS. 100 AND 101).
FIRST USE 10-28-2002; IN COMMERCE 10-28-2002.

SN 78-179,875. KUMAR, VIKRAM SHEEL, BOSTON, MA. FILED 10-30-2002.



FOR DATA AUTOMATION AND COLLECTION SERVICE USING PROPRIETARY SOFTWARE TO EVALUATE, ANALYZE AND COLLECT MEDICAL DATA (U.S. CLS. 100 AND 101).

CLASS 42—(Continued).

SN 78-181,149. DMITRI, DON, BROOKLYN, NY. FILED 11-2-2002.



"FOTKI" IS A SLANG RUSSIAN WORD WHICH MEANS "PHOTO".

SEC. 2(F).
FOR COMPUTER SERVICES, NAMELY PROVIDING A WEB PAGE USED TO CREATE PERSONALIZED WEBSITES FEATURING ONLINE PHOTOS OF OTHERS (U.S. CLS. 100 AND 101).

FIRST USE 1-1-1998; IN COMMERCE 1-1-1998.

SN 78-182,726. RAMBUS INC., LOS ALTOS, CA. FILED 11-7-2002.

RDRAM

FOR LICENSING OF INTELLECTUAL PROPERTY AND TECHNOLOGY (U.S. CLS. 100 AND 101).
FIRST USE 8-0-1993; IN COMMERCE 8-0-1993.

SN 78-183,528. MABBUTT, DAVID L., SAN FRANCISCO, CA. FILED 11-10-2002.



NO CLAIM IS MADE TO THE EXCLUSIVE RIGHT TO USE "SPORTS", APART FROM THE MARK AS SHOWN.

FOR CUSTOM DESIGN OF NEW PRODUCTS FOR OTHERS FEATURING SPORTS OR SPORTING THEMES (U.S. CLS. 100 AND 101).

SN 78-185,549. BIOPHYSIX, INC., SAN DIEGO, CA. FILED 11-15-2002.

SPIRON

FOR PHARMACEUTICAL DRUG DEVELOPMENT SERVICES, CHEMICAL ANALYSIS AND CONSULTATION SERVICES, PRODUCT RESEARCH AND DEVELOPMENT FOR OTHERS, TECHNICAL CONSULTATION IN THE FIELD OF BIOCHEMISTRY, LICENSING OF INTELLECTUAL PROPERTY (U.S. CLS. 100 AND 101).

CLASS 42—(Continued).

SN 78-193,710. WOODARD, EMHARDT, NAUGHTON, MORTARTY & MCNETT LLP, INDIANAPOLIS, IN. FILED 12-12-2002.

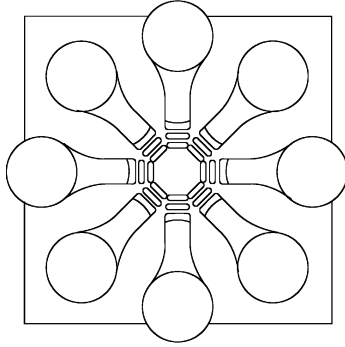

FOR LEGAL SERVICES (U.S. CLS. 100 AND 101).
FIRST USE 11-7-2001; IN COMMERCE 11-7-2001.

CLASS 43—(Continued).

SN 76-366,966. AMERICAN FOOD AND GUEST SERVICES, INC., BETHESDA, MD. FILED 2-6-2002.



NO CLAIM IS MADE TO THE EXCLUSIVE RIGHT TO USE "CAFE EXPRESS", "CAFE" AND "DELI", APART FROM THE MARK AS SHOWN.
THE LINING IS A FEATURE OF THE MARK AND DOES NOT INDICATE COLOR.
FOR RESTAURANT SERVICES (U.S. CLS. 100 AND 101).
FIRST USE 11-0-2000; IN COMMERCE 11-0-2000.

SN 78-195,818. PATERRA, INC., VILLANOVA, PA. FILED 12-18-2002.

PROTYS

FOR PROVIDING ON-LINE COMPUTER DATABASE OF JAPANESE PATENTS IN ENGLISH. (U.S. CLS. 100 AND 101).

SN 76-367,785. WILD MARKS, INC., LAS VEGAS, NV. FILED 2-5-2002.

WE SELL FOOD THAT REMEMBERS ITS ROOTS

FOR DELICATESSEN, RESTAURANT AND CAFE SERVICES (U.S. CLS. 100 AND 101).

CLASS 43—HOTEL AND RESTAURANT SERVICES

SN 76-362,473. MSH SOUTH INC., WILMINGTON, DE. FILED 1-25-2002.

COCOA SUITES

NO CLAIM IS MADE TO THE EXCLUSIVE RIGHT TO USE "SUITES", APART FROM THE MARK AS SHOWN.
FOR HOTELS; PROVIDING CONVENTION FACILITIES (U.S. CLS. 100 AND 101).
FIRST USE 5-0-1981; IN COMMERCE 5-0-1981.

SN 76-380,850. METROPOLITAN TRANSPORTATION AUTHORITY, NEW YORK, NY. FILED 3-12-2002.

GRAND CENTRAL DINING CONCOURSE

OWNER OF U.S. REG. NOS. 2,417,277, 2,567,988 AND OTHERS.
NO CLAIM IS MADE TO THE EXCLUSIVE RIGHT TO USE "DINING CONCOURSE", APART FROM THE MARK AS SHOWN.
FOR FOOD PAVILION STYLE RESTAURANT AND CARRY OUT RESTAURANT SERVICES FEATURING VARIOUS TYPES OF FOOD NAMELY INDIAN, ASIAN, CARIBBEAN, ITALIAN, GERMAN, CAJUN, MEXICAN AND AMERICAN CUISINE AS WELL AS DELICATESSEN, SEAFOOD, BAKERY, SOUPS, SALADS, ICE CREAM, YOGURT AND OTHER DAIRY ITEMS (U.S. CLS. 100 AND 101).
FIRST USE 0-0-1998; IN COMMERCE 0-0-1998.

CLASS 43—(Continued).

SN 76-380,851. METROPOLITAN TRANSPORTATION AUTHORITY, NEW YORK, NY. FILED 3-12-2002.

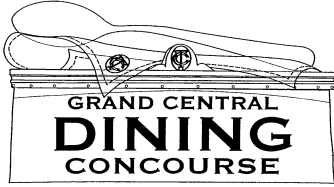

OWNER OF U.S. REG. NOS. 2,415,521, 2,417,278 AND OTHERS.

NO CLAIM IS MADE TO THE EXCLUSIVE RIGHT TO USE "DINING CONCOURSE", APART FROM THE MARK AS SHOWN.

THE LINING IN THE DRAWING OF THE MARK IS A FEATURE OF THE MARK AND DOES NOT INDICATE COLOR.

THE MARK CONSISTS OF THE WORDS "GRAND CENTRAL DINING CONCOURSE". THE LETTERS "GCT" SHOWN IN STYLIZED MONOGRAM FORM AND A SERVING PLATTER ON WHICH LAY A SPOON AND ROLLED LINEN NAPKIN.

FOR FOOD PAVILION STYLE RESTAURANT AND CARRY OUT RESTAURANT SERVICES FEATURING VARIOUS TYPES OF FOOD NAMELY INDIAN, ASIAN, CARIBBEAN, ITALIAN, GERMAN, CAJUN, MEXICAN AND AMERICAN CUISINE AS WELL AS DELICATESSEN, SEAFOOD, BAKERY, SOUPS, SALADS, ICE CREAM, YOGURT AND OTHER DAIRY ITEMS (U.S. CLS. 100 AND 101).

FIRST USE 0-0-1998; IN COMMERCE 0-0-1998.

SN 76-386,854. PERSONAL SHELTER PROJECT, INC., LITTLETON, CO. FILED 3-22-2002.

PERSONAL SHELTER PROJECT

OWNER OF U.S. REG. NO. 1,900,247.
SEC. 2(F).

FOR CHARITABLE SERVICES, NAMELY DEVELOPING A WORLD-WIDE COMMUNITY ACTION NETWORK WHICH DISSEMINATES INFORMATION AND PROVIDES RELIEF IN THE NATURE OF DISTRIBUTING SHELTERS FOR POOR, DISTRESSED, SUFFERING AND UNDERPRIVILEGED PERSONS ON A LOCAL AND GLOBAL SCALE (U.S. CLS. 100 AND 101).

FIRST USE 12-31-1991; IN COMMERCE 1-31-1992.

SN 76-398,809. HASHIMOTO'S, LLC, DENVER, CO. FILED 4-22-2002.

OWNER OF U.S. REG. NO. 2,103,530.
THE ENGLISH TRANSLATION OF "JAPON" IS "JAPAN".
FOR PROVIDING CATERING SERVICES OF JAPANESE AND FUSION ORIENTAL FOODS AND BEVERAGES (U.S. CLS. 100 AND 101).

FIRST USE 10-7-2000; IN COMMERCE 10-7-2000.

CLASS 43—(Continued).

SN 76-420,094. TROPICAL SMOOTHIE FRANCHISE DEVELOPMENT CORPORATION, SHALIMAR, FL. FILED 6-13-2002.



OWNER OF U.S. REG. NOS. 2,016,952 AND 2,103,370.

NO CLAIM IS MADE TO THE EXCLUSIVE RIGHT TO USE "SMOOTHIE" AND "CAFE", APART FROM THE MARK AS SHOWN.

FOR FAST FOOD JUICE BAR SERVICES (U.S. CLS. 100 AND 101).

FIRST USE 10-1-1999; IN COMMERCE 10-1-1999.

SN 76-427,792. SEDLAZEK, SCOTT F., EAST BRUNSWICK, NJ. FILED 6-27-2002.

FEED THE WORLD-ONE DAY AT A TIME

FOR CHARITABLE SERVICES, NAMELY, PROVIDING FOOD AND TEMPORARY HOUSING ACCOMMODATIONS TO NEEDY PERSONS (U.S. CLS. 100 AND 101).

SN 76-430,025. KABUSHIKI KAISHA FOUR SEEDS, MINATO-KU, TOKYO, JAPAN, FILED 7-10-2002.

TORAFUKU

THE ENGLISH TRANSLATION OF THE WORD "TORAFUKU" IN THE MARK IS "BIG HAPPINESS".

FOR RESTAURANT SERVICES (U.S. CLS. 100 AND 101).

SN 76-447,022. QUILLEN, GREGORY, NAPLES, FL. FILED 9-5-2002.

WON HUNG LO

FOR RESTAURANT SERVICES (U.S. CLS. 100 AND 101).

CLASS 43—(Continued).

SN 76-450,442. ROBERTS, SERGIO, DEL. MIGUEL HIDALGO, MEXICO, FILED 9-17-2002.

AQUI LOS JUGOS

THE ENGLISH TRANSLATION OF THE MARK WORD "AQUI LOS JUGO" IS "HERE ARE THE JUICES".
FOR RESTAURANT SERVICES, NAMELY, JUICE BARS PROVIDING A VARIETY OF JUICES AND COMBINATIONS OF JUICES (U.S. CLS. 100 AND 101).

SN 76-453,956. WESTMINSTER MANAGEMENT, LLC, FLORHAM PARK, NJ. FILED 9-30-2002.

THE MORE HOTELS

NO CLAIM IS MADE TO THE EXCLUSIVE RIGHT TO USE "HOTELS", APART FROM THE MARK AS SHOWN.
FOR HOTEL AND RESTAURANT SERVICES (U.S. CLS. 100 AND 101).

SN 76-454,363. EDISON HOLDING CORP., LAS VEGAS, NV. FILED 10-1-2002.

**PRIME HOTEL AND
CONFERENCE CENTER**

FOR HOTEL SERVICES (U.S. CLS. 100 AND 101).

SN 76-454,366. EDISON HOLDING CORP., LAS VEGAS, NV. FILED 10-1-2002.

**PRIME Suites**

FOR HOTEL SERVICES (U.S. CLS. 100 AND 101).

SN 76-459,201. SOTERA'S, INC., LAS VEGAS, NV. FILED 10-11-2002.

SONIO'S CAFE ROTISSERIE

NO CLAIM IS MADE TO THE EXCLUSIVE RIGHT TO USE "CAFE ROTISSERIE", APART FROM THE MARK AS SHOWN.

THE NAME(S), PORTRAIT(S), AND/OR SIGNATURE(S) SHOWN IN THE MARK DOES NOT IDENTIFY A PARTICULAR LIVING INDIVIDUAL.

FOR RESTAURANT SERVICES (U.S. CLS. 100 AND 101).
FIRST USE 10-1-1998; IN COMMERCE 10-1-1998.

CLASS 43—(Continued).

SN 76-460,380. SEGALL, E.M., PEMBROKE PINES, FL. FILED 10-22-2002.

FOR RESTAURANT SERVICES (U.S. CLS. 100 AND 101).
FIRST USE 10-15-2002; IN COMMERCE 10-15-2002.

SN 76-463,365. IL PANINO CAFFE, INC., BULVERDE, TX. FILED 10-31-2002.

IL PANINO CAFFE'

NO CLAIM IS MADE TO THE EXCLUSIVE RIGHT TO USE "COFFEE", APART FROM THE MARK AS SHOWN.

THE ENGLISH TRANSLATION OF "IL PANINO CAFFE" IS "THE SANDWICH COFFEE".

FOR RESTAURANT SERVICES FEATURING ITALIAN SANDWICHES RECIPES, APPETIZERS, SALADS, COFFEE BEVERAGES, PASTRIES, ICE CREAM, WINE AND BEER AND ITALIAN COFFEE (U.S. CLS. 100 AND 101).

SN 76-464,689. HAMPTON BLUE, INC., EAST MORICHES, NY. FILED 11-6-2002.

SYMPOSIUM WINE LOUNGE

NO CLAIM IS MADE TO THE EXCLUSIVE RIGHT TO USE "WINE LOUNGE", APART FROM THE MARK AS SHOWN.

FOR RESTAURANT AND BAR SERVICES (U.S. CLS. 100 AND 101).

SN 76-470,934. TALARIS RESEARCH INSTITUTE, SEATTLE, WA. FILED 11-26-2002.

**CENTER FOR MIND, BRAIN
AND LEARNING**

FOR DAY CARE SERVICES (U.S. CLS. 100 AND 101).

CLASS 43—(Continued).

SN 76-473,721. BOHRER, DALE L., SR., SHARPSBURG, MD.
FILED 12-5-2002.

SALAD BUFFET PLUS

NO CLAIM IS MADE TO THE EXCLUSIVE RIGHT TO USE "SALAD BUFFET", APART FROM THE MARK AS SHOWN.

FOR BUFFET RESTAURANT FOCUSING ON HEALTHY FOODS, INCLUDING A LARGE SALAD BAR, AND OTHER SOUPS, SANDWICHES AND HOT DISHES (U.S. CLS. 100 AND 101).

SN 76-474,315. ERICKSON RETIREMENT COMMUNITIES, LLC, BALTIMORE, MD. FILED 12-2-2002.

FOX RUN VILLAGE

NO CLAIM IS MADE TO THE EXCLUSIVE RIGHT TO USE "VILLAGE", APART FROM THE MARK AS SHOWN.

FOR LIFE CARE RETIREMENT HOME SERVICES (U.S. CLS. 100 AND 101).

SN 76-475,646. OHSHO ENTERPRISES, INC., HONOLULU, HI. FILED 12-16-2002.

餃子の王将

OWNER OF U.S. REG. NOS. 2,181,272 AND 2,184,775.
THE NON-LATIN CHARACTERS IN THE MARK TRANSLITERATE TO "GYOZA NO OHSHO", WHICH MEANS "OHSHO'S GYOZA". IN ENGLISH, THE JAPANESE WORD "OHSHO" MEANS "KING".
FOR RESTAURANT SERVICES (U.S. CLS. 100 AND 101).

SN 76-484,281. CAFE ENTERPRISES, INC., TAYLORS, SC.
FILED 1-22-2003.

FATZ

OWNER OF U.S. REG. NO. 2,362,158.
FOR RESTAURANT SERVICES (U.S. CLS. 100 AND 101).
FIRST USE 11-2-1988; IN COMMERCE 11-2-1988.

CLASS 43—(Continued).

SN 76-484,283. CAFE ENTERPRISES, INC., TAYLORS, SC.
FILED 1-22-2003.

FATZ CAFE

OWNER OF U.S. REG. NO. 2,362,158.
NO CLAIM IS MADE TO THE EXCLUSIVE RIGHT TO USE "CAFE", APART FROM THE MARK AS SHOWN.
FOR RESTAURANT SERVICES (U.S. CLS. 100 AND 101).

FIRST USE 11-2-1988; IN COMMERCE 11-2-1988.

SN 76-485,576. CANNERY CASINO RESORTS, LLC, LAS VEGAS, NV. FILED 1-28-2003.

CANNERY ROW

FOR RESTAURANT SERVICES; BAR SERVICES; FOOD PREPARATION SERVICES (U.S. CLS. 100 AND 101).

FIRST USE 1-3-2003; IN COMMERCE 1-3-2003.

SN 76-485,577. CANNERY CASINO RESORTS, LLC, LAS VEGAS, NV. FILED 1-28-2003.

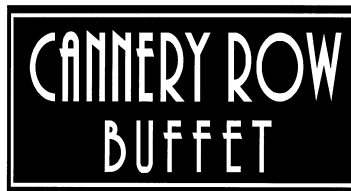

NO CLAIM IS MADE TO THE EXCLUSIVE RIGHT TO USE "BUFFET", APART FROM THE MARK AS SHOWN.
FOR RESTAURANT SERVICES; BAR SERVICES; FOOD PREPARATION SERVICES (U.S. CLS. 100 AND 101).

FIRST USE 1-3-2003; IN COMMERCE 1-3-2003.

SN 78-119,673. LA SALSA, INC., SANTA BARBARA, CA.
FILED 4-4-2002.



OWNER OF U.S. REG. NOS. 1,257,963, 2,484,633 AND OTHERS.

NO CLAIM IS MADE TO THE EXCLUSIVE RIGHT TO USE "CANTINA", APART FROM THE MARK AS SHOWN.
THE ENGLISH TRANSLATION OF THE WORD "LA SALSA" IN THE MARK IS "THE SAUCE".

FOR RESTAURANT SERVICES (U.S. CLS. 100 AND 101).

CLASS 43—(Continued).

SN 78-130,139. EVENTSTYLE, INC., NEW YORK, NY. FILED 5-21-2002.

EVENTSTYLE

OWNER OF U.S. REG. NO. 2,563,816.
FOR CORPORATE, PRIVATE, AND PUBLIC CATERING (U.S. CLS. 100 AND 101).
FIRST USE 0-0-1999; IN COMMERCE 3-0-2000.

SN 78-141,516. RAIN DELAY HOLDINGS, INC., AUSTIN, TX. FILED 7-5-2002.



THE MARK CONSISTS OF A BLUE RAINDROP SITUATED DIAGONALLY WITHIN A GREEN DIAMOND SHAPE.

FOR PROVIDING TEMPORARY ACCOMMODATIONS WITH FOOD AND DRINK, NAMELY, BED AND BREAKFAST SERVICES AND LODGE SERVICES (U.S. CLS. 100 AND 101).

SN 78-153,285. THE INTERNATIONALLY FAMOUS FRY-WORLD, TALLAHASSEE, FL. FILED 8-12-2002.

DUNCAN'S

FOR RESTAURANT AND COCKTAIL LOUNGE SERVICES (U.S. CLS. 100 AND 101).

SN 78-161,919. DAMW BUSINESS, LLC, SUGAR HILL, GA. FILED 9-9-2002.

MY POTS IN YOUR KITCHEN!

FOR RESTAURANT SERVICES, CATERING SERVICES, AND PERSONAL CHEF SERVICES, NAMELY, FOOD PREPARATION AT CUSTOMER'S HOUSES (U.S. CLS. 100 AND 101).

CLASS 43—(Continued).

SN 78-163,843. EKWALL, MICHAEL ANDREW, PALO ALTO, CA. FILED 9-13-2002.



OWNER OF U.S. REG. NO. 2,203,898.
NO CLAIM IS MADE TO THE EXCLUSIVE RIGHT TO USE "LA BODEGUITA", APART FROM THE MARK AS SHOWN.

THE ENGLISH TRANSLATION OF "LA BODEGUITA DEL MEDIO" IS "THE LITTLE RESTAURANT IN THE MIDDLE".

FOR RESTAURANT SERVICES FEATURING FOOD, DRINK AND TOBACCO (U.S. CLS. 100 AND 101).

FIRST USE 5-30-1997; IN COMMERCE 6-30-1997.

SN 78-175,127. FRITZINGER, MATTHEW, CHICAGO, IL. FILED 10-16-2002.

STATE STREET SANDWICHES & SALADS

NO CLAIM IS MADE TO THE EXCLUSIVE RIGHT TO USE "SANDWICHES & SALADS", APART FROM THE MARK AS SHOWN.

FOR RESTAURANT SERVICES (U.S. CLS. 100 AND 101).

SN 78-178,602. METRO POLLO CORP., CARROLLTON, TX. FILED 10-25-2002.

MEXICAN GRILL AND CHICKEN FOR ALL

NO CLAIM IS MADE TO THE EXCLUSIVE RIGHT TO USE "MEXICAN GRILL AND CHICKEN", APART FROM THE MARK AS SHOWN.

FOR RESTAURANT SERVICES (U.S. CLS. 100 AND 101).

SN 78-178,807. KUPERMAN, MARK, ITHACA, NY. AND DELLAMANO, ANTHONY, ITHACA, NY. FILED 10-27-2002.

JOHNNY APPLESTIX

THE NAME "JOHNNY APPLESTIX" DOES NOT IDENTIFY A LIVING INDIVIDUAL.

FOR FAST FOOD RESTAURANT CHAIN (U.S. CLS. 100 AND 101).

CLASS 43—(Continued).

SN 78-184,337. CONTINENTAL PACIFIC HOTELS, NOVATO, CA. FILED 11-12-2002.

RICKEY'S

FOR RESTAURANT AND HOTEL SERVICES (U.S. CLS. 100 AND 101).

SN 78-193,558. HAUSBRANDT TRIESTE 1892 SPA, NERVESA DELLA BATTAGLIA (TREVISO), ITALY, FILED 12-11-2002.

HAUSBRANDT

OWNER OF U.S. REG. NO. 2,472,725.
FOR CAFETERIAS, CAFES, SNACK-BARS, RESTAURANTS, SELF-SERVICE RESTAURANTS, PUBS, HOTELS, MAKING HOTEL AND MOTEL RESERVATIONS FOR OTHERS, MOTELS, CATERING, COCKTAIL LOUNGE SERVICES, COFFEE SHOPS, CANTEEN SERVICES (U.S. CLS. 100 AND 101).

CLASS 44—MEDICAL, BEAUTY AND AGRICULTURAL SERVICES

SN 76-378,550. CARITA, 75008 PARIS, FRANCE, FILED 3-4-2002.

CARITA

OWNER OF FRANCE REG. NO. 1210812, DATED 8-2-1982, EXPIRES 8-2-2012.
OWNER OF U.S. REG. NOS. 684,182, 2,240,042 AND 2,337,084.

THE ENGLISH TRANSLATION OF "CARITA" IS "CHARITY", "LOVE", "BENEVOLENCE", "ALMS", "COMPASSION" OR "PITY".

FOR HAIRDRESSING SALONS; BEAUTY SALONS; HAIRDRESSING SERVICES (U.S. CLS. 100 AND 101).

SN 76-385,431. NOVO NORDISK A/S, DK-2880 BAGSVAERD, DENMARK, FILED 3-19-2002.

ANSWER Program

NO CLAIM IS MADE TO THE EXCLUSIVE RIGHT TO USE "PROGRAM", APART FROM THE MARK AS SHOWN.
FOR DATABASE REGISTRY SERVICES, NAMELY, PROVIDING AN ON-LINE COMPUTER DATABASE REGISTRY IN THE FIELD OF GROWTH HORMONES (U.S. CLS. 100 AND 101).

CLASS 44—(Continued).

SN 76-390,581. PISCIOTTANO, MAURICE, MCMURRAY, PA. FILED 4-1-2002.

PRO-SCREENER

FOR MEDICAL AND CHIROPRACTIC SERVICES, NAMELY DEVELOPMENT OF MEDICAL AND CHIROPRACTIC DIAGNOSES AND TREATMENT TECHNOLOGIES FOR OTHERS (U.S. CLS. 100 AND 101).
FIRST USE 1-29-2002; IN COMMERCE 1-29-2002.

SN 76-391,184. HOME HEALTHCARE LABORATORY OF AMERICA, INC., FRANKLIN, TN. FILED 4-3-2002.

WEBHHLA

FOR INFORMATION SERVICES, NAMELY, PROVIDING MEDICAL TEST RESULTS AND LABORATORY INFORMATION BY COMPUTER VIA A SECURE INTERNET NETWORK (U.S. CLS. 100 AND 101).
FIRST USE 8-0-2000; IN COMMERCE 8-0-2000.

SN 76-411,107. COUNTRY GREEN LAWN & LANDSCAPE MAINTENANCE, INC., ROCHESTER, MN. FILED 5-23-2002.

**COUNTRY
GREEN**
Lawncare & Landscape Maintenance

NO CLAIM IS MADE TO THE EXCLUSIVE RIGHT TO USE "LAWNCARE & LANDSCAPE MAINTENANCE", APART FROM THE MARK AS SHOWN.
FOR LAWN CARE (U.S. CLS. 100 AND 101).

SN 76-413,677. ERGOSCIENCE, INC., BIRMINGHAM, AL. FILED 5-29-2002.

ERGOSCIENCE

FOR MEDICAL TESTING AND EVALUATION TO DETERMINE AN INDIVIDUAL'S CAPABILITIES FOR PERFORMING PHYSICAL WORK; PHYSICAL AND OCCUPATIONAL THERAPY (U.S. CLS. 100 AND 101).
FIRST USE 5-1-1992; IN COMMERCE 5-1-1992.

CLASS 44—(Continued).

SN 76-415,971. MANOR CARE, INC., TOLEDO, OH. FILED 6-6-2002.

SINCERUS CARE

NO CLAIM IS MADE TO THE EXCLUSIVE RIGHT TO USE "CARE", APART FROM THE MARK AS SHOWN.
FOR HOSPICE AND HEALTH CARE REHABILITATION SERVICES (U.S. CLS. 100 AND 101).

SN 76-431,181. GOBAR, GLENNA M., SAN FRANCISCO, CA. FILED 7-16-2002.

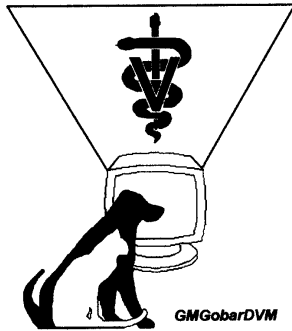

NO CLAIM IS MADE TO THE EXCLUSIVE RIGHT TO USE VETERINARY CADUCEUS SYMBOL AND THE LETTERING "DVM", APART FROM THE MARK AS SHOWN.
THE NAME IN THE MARK IDENTIFIES A LIVING INDIVIDUAL WHOSE CONSENT IS OF RECORD.
FOR CONSULTING SERVICES IN THE VETERINARY AND MEDICAL INFORMATICS FIELDS IN ORDER TO ASSIST OTHERS TO BRING TOGETHER CLINICAL MEDICINE, RESEARCH, AND INFORMATION TECHNOLOGY ENVIRONMENTS (U.S. CLS. 100 AND 101).
FIRST USE 1-1-1997; IN COMMERCE 1-1-2001.

SN 76-444,249. NORTH COUNTRY ORTHOPAEDIC GROUP, P.C., WATERTOWN, NY. FILED 8-26-2002.

NORTH COUNTRY ORTHOPAEDIC GROUP, P.C.

NO CLAIM IS MADE TO THE EXCLUSIVE RIGHT TO USE "ORTHOPAEDIC GROUP, P.C.", APART FROM THE MARK AS SHOWN.
FOR MEDICAL SERVICES, NAMELY THE TREATMENT OF DISEASE AND INJURY OF THE MUSCULOSKELETAL SYSTEM; SPORTS MEDICINE SERVICES; PEDIATRIC ORTHOPAEDIC SERVICES, NAMELY, TREATMENT OF JOINT INJURIES AND DISORDERS, ARTHRITIS, CARPAL SYNDROME; MEDICAL EVALUATION SERVICES, NAMELY, CLINICAL ASSESSMENT PROGRAM FOR PATIENTS RECEIVING MEDICAL REHABILITATION SERVICES FOR PURPOSES OF GUIDING TREATMENT AND ASSESSING PROGRAM EFFECTIVENESS (U.S. CLS. 100 AND 101).

CLASS 44—(Continued).

SN 76-446,277. CENTENE CORPORATION, ST. LOUIS, MO. FILED 9-3-2002.

BUCKEYE COMMUNITY HEALTH PLAN

NO CLAIM IS MADE TO THE EXCLUSIVE RIGHT TO USE "COMMUNITY HEALTH PLAN", APART FROM THE MARK AS SHOWN.
FOR MANAGED HEALTHCARE (U.S. CLS. 100 AND 101).

SN 76-452,317. MANSUETO, ROBERT F., CORONADO, CA. FILED 9-23-2002.

DICOA

FOR DENTAL IMPLANT SERVICES (U.S. CLS. 100 AND 101).
FIRST USE 8-25-2002; IN COMMERCE 8-25-2002.

SN 76-452,703. ROGERS, WILLIAM E., CENTERVILLE, OH. FILED 9-25-2002.

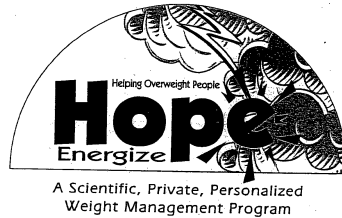

NO CLAIM IS MADE TO THE EXCLUSIVE RIGHT TO USE "A SCIENTIFIC, PRIVATE, PERSONALIZED WEIGHT MANAGEMENT PROGRAM", APART FROM THE MARK AS SHOWN.
FOR WEIGHT REDUCTION DIET PLANNING AND SUPERVISION (U.S. CLS. 100 AND 101).

SN 76-471,588. HANSEN'S TREE, LAWN & LANDSCAPING SERVICES, INC., ST. PETERS, MO. FILED 12-2-2002.

OUR WORK IS TREEMENDOUS

FOR GARDENING, LANDSCAPE SERVICES AND TREE REMOVAL LANDSCAPE SERVICES (U.S. CLS. 100 AND 101).
FIRST USE 1-0-1989; IN COMMERCE 1-0-1989.

CLASS 44—(Continued).

SN 76-480,228. CORAM, INC., DENVER, CO. FILED 1-3-2003.

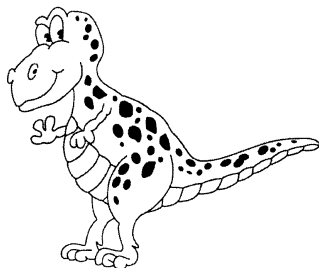

FOR MEDICAL SERVICES, NAMELY INFUSION SERVICES PROVIDED AT HOME AND IN CLINICS; NURSING SERVICES; PROVIDING MEDICAL INFORMATION CONCERNING HEMOPHILIA (U.S. CLS. 100 AND 101).

SN 78-072,040. AMERICHoice CORPORATION, VIENNA, VA. BY ASSIGNMENT AMERICHoice HEALTH SERVICES, INC., VIENNA, VA. FILED 7-2-2001.

AmeriChoice
PERSONAL CARE MODEL

OWNER OF U.S. REG. NOS. 2,361,941, 2,387,411 AND OTHERS.

NO CLAIM IS MADE TO THE EXCLUSIVE RIGHT TO USE "PERSONAL CARE MODEL", APART FROM THE MARK AS SHOWN.

FOR PROVIDING COUNSELING AND INFORMATION TO INDIVIDUALS IN THE FIELD OF HEALTH AND HEALTH CARE (U.S. CLS. 100 AND 101).

FIRST USE 11-0-1998; IN COMMERCE 11-0-1998.

CLASS 44—(Continued).

SN 78-125,641. SMITHKLINE BEECHAM CORPORATION, PHILADELPHIA, PA. FILED 5-2-2002.



THE MARK CONSISTS OF THE WORD "PEDIARIX" ON A YELLOW OBLONG, WITH A PURPLE "P", A DARK BLUE "E", A LIGHT BLUE "D", A RED "I", A GREEN "A", AND THE LETTERS "R", "I" AND "X" IN WHITE, WITH A FIVE-POINTED STAR SHAPE OVER THE LETTERS "RIX". THE POINTS OF THE STAR SHAPE ARE PURPLE, DARK BLUE, LIGHT BLUE, RED AND GREEN. THE LETTERS ARE SHADED TO GIVE A 3-DIMENSIONAL LOOK.

FOR PROVIDING HEALTH INFORMATION VIA THE INTERNET, NAMELY, PROVIDING INFORMATION CONCERNING PEDIATRIC VACCINES (U.S. CLS. 100 AND 101).

SN 78-130,796. SMITHKLINE BEECHAM CORPORATION, PHILADELPHIA, PA. FILED 5-23-2002.

COMMITMENT TO ACCESS

NO CLAIM IS MADE TO THE EXCLUSIVE RIGHT TO USE "ACCESS", APART FROM THE MARK AS SHOWN.

FOR CHARITABLE SERVICES, NAMELY PROVIDING INDIGENT PATIENTS WITH PRESCRIPTION DRUGS TOGETHER WITH INFORMATION ABOUT PHARMACEUTICAL ACCESS AND REIMBURSEMENT PROGRAMS (U.S. CLS. 100 AND 101).

SN 78-130,967. SMITHKLINE BEECHAM CORPORATION, PHILADELPHIA, PA. FILED 5-24-2002.

CLEAR THINKING

creative | learning to | educate others on | advances in | respiratory management

NO CLAIM IS MADE TO THE EXCLUSIVE RIGHT TO USE "LEARNING TO EDUCATE OTHERS ON ADVANCES IN RESPIRATORY MANAGEMENT", APART FROM THE MARK AS SHOWN.

FOR PROVIDING INFORMATION IN THE FIELD OF RESPIRATORY INFECTION AND TREATMENTS THEREFORE, DIRECTED TO MEDICAL PROFESSIONALS VIA THE INTERNET (U.S. CLS. 100 AND 101).

SN 78-139,309. MOTIONWISE, LLC, BIRMINGHAM, MI. FILED 6-27-2002.

MOTIONWISE

FOR MESSAGE (U.S. CLS. 100 AND 101).
FIRST USE 10-1-1992; IN COMMERCE 9-1-2000.

CLASS 44—(Continued).

SN 78-142,437. VINTECH MANAGEMENT SERVICES, LLC, HARWINTON, CT. FILED 7-9-2002.



THE MARK CONTAINS THE COLORS RED AND BLUE, WITH RED IN THE LEFT SEMI-CIRCULAR DESIGN, INCLUDING THE DECORATIVE EDGES OF THE SEMI-CIRCULAR DESIGN, AND THE BLUE IN THE RIGHT SEMI-STAR DESIGN.
FOR EMERGENCY MEDICAL SERVICES (U.S. CLS. 100 AND 101).

SN 78-171,588. ESTASI SALON AND SPA, CAVE CREEK, AZ. FILED 10-7-2002.

ESTASI SALON AND SPA

NO CLAIM IS MADE TO THE EXCLUSIVE RIGHT TO USE "SALON AND SPA", APART FROM THE MARK AS SHOWN.
THE ENGLISH TRANSLATION OF THE WORD "ESTASI" IN THE MARK IS "BLISS".
FOR SALON AND SPA SERVICES, NAMELY HAIR STYLING, FACIALS, MASSAGE, PEDICURES, MANICURES, TANNING AND BODY TREATMENTS (U.S. CLS. 100 AND 101).

SN 78-176,316. PETRO, PAUL, E, MARINA, CA. AND PETRO, DEBRA, MARINA, CA. FILED 10-20-2002.



FOR HAIR STYLING AND TANNING SALONS (U.S. CLS. 100 AND 101).

CLASS 44—(Continued).

SN 78-178,445. MEDICAL TECHNOLOGIES UNLIMITED INC., FT. LAUDERDALE, FL. FILED 10-25-2002.

E²FA

FOR MEDICAL SERVICES, NAMELY ENHANCED ELECTRODIAGNOSTIC TESTING THE PURPOSE FOR WHICH IS ELECTRODIAGNOSTIC TESTING FOR SOFT TISSUE INJURIES (U.S. CLS. 100 AND 101).

SN 78-180,220. BOVIGEN, LLC, NEW ORLEANS, LA. FILED 10-30-2002.

GENETIC PROGENY DIFFERENCE

NO CLAIM IS MADE TO THE EXCLUSIVE RIGHT TO USE "GENETIC PROGENY", APART FROM THE MARK AS SHOWN.
FOR ANIMAL HUSBANDRY (U.S. CLS. 100 AND 101).

SN 78-183,087. AMERICAN CANCER SOCIETY, INC., ATLANTA, GA. FILED 11-8-2002.

GET YOUR SCREEN TEST

FOR PROVIDING HEALTH INFORMATION ABOUT EARLY DETECTION AND PREVENTION OF CANCER (U.S. CLS. 100 AND 101).
FIRST USE 5-21-2002; IN COMMERCE 7-23-2002.

SN 78-184,931. PCH HOLDINGS, LLC, MT. PLEASANT, SC. FILED 11-14-2002.

SLENDERIFIC

FOR COUNSELING IN THE FIELD OF WEIGHT LOSS, NUTRITION AND WELLNESS (U.S. CLS. 100 AND 101).

CLASS 44—(Continued).

SN 78-185,792. WOGHIREN, EFE, LOS ANGELES, CA. FILED 11-15-2002.

KUNNDA MEN'S HUT INTERNATIONAL SALON FOR MEN

NO CLAIM IS MADE TO THE EXCLUSIVE RIGHT TO USE "MEN'S" AND "INTERNATIONAL SALON FOR MEN", APART FROM THE MARK AS SHOWN.

FOR BEAUTY CARE FOR MEN, NAMELY BEAUTY SALONS, MANICURING, HAIR CUTTING AND STYLING, AND SHAVING SERVICES, ALL FOR MEN (U.S. CLS. 100 AND 101).

SN 78-190,665. CEDAR HILL LANDSCAPING, SOMERSET, NJ. FILED 12-3-2002.

MULCHAPPLIER

FOR LANDSCAPING SERVICES (U.S. CLS. 100 AND 101).
FIRST USE 10-4-1996; IN COMMERCE 10-4-1996.

SN 78-191,568. MEDTRONIC SOFAMOR DANEK, INC., MEMPHIS, TN. FILED 12-5-2002.



NO CLAIM IS MADE TO THE EXCLUSIVE RIGHT TO USE "SPINAL DEFORMITY EDUCATION GROUP", APART FROM THE MARK AS SHOWN.

FOR PROVIDING MEDICAL INFORMATION IN THE FIELD OF CERVICAL SPINE SURGERY TO CERVICAL SPINE MEDICAL PROFESSIONALS (U.S. CLS. 100 AND 101).

CLASS 45—PERSONAL SERVICES

SN 76-424,367. CLICKDATE, INC., OREM, UT. FILED 6-21-2002.

CLICKDATE

FOR HOUSE MARK FOR PROVIDING SERVICES OF ON-LINE DATING, ON-LINE MATCHMAKING, ON-LINE PERSONALS, ON-LINE HANGOUT, AN ON-LINE SOCIAL ENVIRONMENT, MATCHMAKING, PERSONALS ADVERTISEMENTS, SOCIAL ENVIRONMENTS, AND A MEETING PLACE FOR MEETING OTHER SINGLES (U.S. CLS. 100 AND 101).

FIRST USE 1-1-2002; IN COMMERCE 1-1-2002.

SN 76-428,950. CORAL RIDGE MINISTRIES MEDIA, INC., FORT LAUDERDALE, FL. FILED 7-9-2002.

CORAL RIDGE MINISTRIES

SEC. 2(F).

FOR PROVIDING INFORMATION VIA A GLOBAL COMPUTER NETWORK IN THE FIELDS OF RELIGION, SPIRITUALITY, ETHICS, CULTURAL ISSUES, AND SOCIAL ISSUES (U.S. CLS. 100 AND 101).

FIRST USE 0-0-2001; IN COMMERCE 0-0-2001.

SN 76-429,758. LATIS NETWORKS, INC., SUPERIOR, CO. FILED 7-9-2002.

STILLSECURE

FOR COMPUTER MONITORING SERVICES, NAMELY, MONITORING OF COMPUTER NETWORK SYSTEMS FOR SECURITY PURPOSES (U.S. CLS. 100 AND 101).

FIRST USE 1-24-2002; IN COMMERCE 2-15-2002.

SN 76-435,404. SMITH, LISA, FAR ROCKAWAY, NY. FILED 7-29-2002.

SUGGESTIONS IN A BASKET

FOR PREPARATION OF CUSTOMIZED GIFT BASKETS WITH SELECTED ITEMS REGARDING A PARTICULAR OCCASION OR THEME, NAMELY, GOURMET FOODS, CHOCOLATES, TEA, COFFEE, CHEESES, CRACKERS, POPCORN, COOKIES, BOTTLED BEVERAGES-EXCEPT BEER, GIFTS, PICTURE FRAMES, SILK FLOWERS, STRAW, STATIONERY, PEN AND PENCILS, CANDLES, SPA PRODUCTS, AROMA THERAPY, NAME PLATES, PAPERWEIGHTS, GOLF BALLS, TEES, RIBBONS, ARTIFICIAL FLOWERS, BAGS UMBRELLAS, GLASSES OR PORCELAIN FIGURINES, STUFFED ANIMALS, SATIN FABRICS, LOTIONS, SOAPS, BUSINESS GIFTS (U.S. CLS. 100 AND 101).

CLASS 45—(Continued).

SN 76-450,290. PIC USA, INC., FRANKLIN, KY. FILED 9-17-2002.

VERISPEC

FOR IDENTITY PRESERVATION SERVICES FOR USE WITH LIVE ANIMALS, CARCASSES, OR PIECES OF MEAT, NAMELY PROVIDING INFORMATION LINKING THE LIVE ANIMALS, CARCASSES, OR PIECES OF MEAT BACK TO THE PRODUCTION SYSTEM, INDIVIDUAL LOCATIONS ON WHICH THE ANIMAL WAS REARED, OR THE GENETIC SOURCE ASSOCIATED WITH THE ORIGIN OF THE ANIMAL (U.S. CLS. 100 AND 101).

FIRST USE 4-5-2001; IN COMMERCE 5-1-2001.

SN 76-453,988. CIA SECURITY SERVICES INC., HADDON HEIGHTS, NJ. FILED 9-30-2002.

XPRESSGUARD

FOR SECURITY GUARD SERVICES, NAMELY, PROVIDING SECURITY GUARDS AT ANY LOCATION IN THE UNITED STATES AND CANADA IN FOUR HOURS OR LESS (U.S. CLS. 100 AND 101).

FIRST USE 8-30-2002; IN COMMERCE 8-30-2002.

SN 76-456,422. S.T.A.N.D.U.P., INC., KANSAS CITY, MO. FILED 10-7-2002.

S.T.A.N.D.U.P.

FOR CASE MANAGEMENT SERVICES, NAMELY, COORDINATION OF LEGAL, SOCIAL AND PSYCHOLOGICAL SERVICES FOR DOMESTICALLY ABUSED WOMEN AND CHILDREN (U.S. CLS. 100 AND 101).

FIRST USE 11-2-2002; IN COMMERCE 11-2-2002.

SN 76-462,512. FIRST DATA CORPORATION, GREENWOOD VILLAGE, CO. FILED 10-22-2002.



The logo for 'aSuretee' features the word 'aSuretee' in a stylized, lowercase font. The 'a' is lowercase and the 'Suretee' is in a slightly larger, bold font. A thick, black, curved underline sweeps under the letters 'Suretee'.

OWNER OF U.S. REG. NO. 2,692,464.
FOR PROVIDING USER AUTHENTICATION SERVICES IN E-COMMERCE AND ELECTRONIC TRANSACTIONS, NAMELY, IMPLEMENTING CHIP-BASED DIGITAL SIGNATURES THAT CAN BE USED FOR AUTHENTICATION AND VERIFICATION PURPOSES IN ANY TYPE OF TRANSACTION WITHIN AN ACCOUNT-BASED BUSINESS PROCESS OR APPLICATION (U.S. CLS. 100 AND 101).

FIRST USE 6-1-2002; IN COMMERCE 6-1-2002.

CLASS 45—(Continued).

SN 76-465,606. LAUREN'S LIGHT, TENAFLY, NJ. FILED 10-30-2002.

LAUREN'S LIGHT

FOR CASE MANAGEMENT SERVICES, NAMELY, COORDINATION OF LEGAL, SOCIAL, ADMINISTRATIVE, AND PSYCHOLOGICAL SERVICES FOR PEOPLE WITH CANCER AND OTHER SERIOUS ILLNESSES AND THEIR FAMILIES (U.S. CLS. 100 AND 101).

SN 76-470,541. MATCHOMATIC.COM, LLC, FORT LAUDERDALE, FL. FILED 11-29-2002.

MATCHOMATIC

FOR COMPUTER SERVICES, PROVIDING ON-LINE DATING SERVICES BY MEANS OF A COMPUTER NETWORK (U.S. CLS. 100 AND 101).

SN 78-116,704. HARVEST ROCK CHURCH OF HOLLYWOOD, LA CRESCENTA, CA. FILED 3-21-2002.

**THE GATHERING PLACE
CHRISTIAN FELLOWSHIP
OF HOLLYWOOD**

NO CLAIM IS MADE TO THE EXCLUSIVE RIGHT TO USE "CHRISTIAN FELLOWSHIP OF HOLLYWOOD", APART FROM THE MARK AS SHOWN.

FOR RELIGIOUS SERVICES, NAMELY OPERATING PLACES OF ASSEMBLY FOR PRAYER AND WORSHIP; MINISTERIAL SERVICES; NAMELY, PROVIDING RELIGIOUS WORSHIP SERVICES AND CONDUCTING CHURCH SPONSORED RELIGIOUS PROGRAMS (U.S. CLS. 100 AND 101).

SN 78-172,023. CREATIVE PET PRODUCTS, INC., SPRING VALLEY, WI. FILED 10-8-2002.

ROAM TO HOME

FOR 24-HOUR NATIONAL LOST PET IDENTIFICATION AND NOTIFICATION PROGRAM USING TOLL FREE TELEPHONE NUMBER (U.S. CLS. 100 AND 101).
FIRST USE 6-13-2002; IN COMMERCE 6-13-2002.

SN 78-172,512. CHURCH, WALTER E., BOISE, ID. FILED 10-9-2002.

AMERICA BLESS GOD

NO CLAIM IS MADE TO THE EXCLUSIVE RIGHT TO USE "AMERICA", APART FROM THE MARK AS SHOWN.
FOR PERSONAL RELIGIOUS SERVICES, NAMELY MINISTERIAL SERVICES (U.S. CLS. 100 AND 101).

CLASS 45—(Continued).

SN 78-178,778. WHITE BUFFALO VENTURES, LLC., AUSTIN, TX. FILED 10-26-2002.

LANDMARK SINGLES

NO CLAIM IS MADE TO THE EXCLUSIVE RIGHT TO USE "SINGLES", APART FROM THE MARK AS SHOWN.
FOR ON-LINE DATING SERVICES TARGETED TO GRADUATES OF PERSONAL DEVELOPMENT COURSES (U.S. CLS. 100 AND 101).

* * * * *

SECTION 4.—PRIOR UNITED STATES CLASSIFICATION

APPLICATION IN ONE CLASS

COLLECTIVE MEMBERSHIP MARKS

SN 76-409,749. TECHGUARD SECURITY, L.L.C., CHESTERFIELD, MO. FILED 5-20-2002.

CLASS 200—COLLECTIVE MEMBERSHIP
SN 76-409,573. THE NATIONAL EXCHANGE CLUB, TOLEDO, OH. FILED 5-16-2002.



NO CLAIM IS MADE TO THE EXCLUSIVE RIGHT TO USE "BUSINESS", APART FROM THE MARK AS SHOWN. THE LINING IS A FEATURE OF THE MARK AND DOES NOT INDICATE COLOR.

DESIGN OF A SMALL GROUP OF STANDING PERSONS IN SILHOUETTE SUPERIMPOSED OVER A CIRCULAR DESIGN WITH HORIZONTAL LINING AND DARK SHADING

FOR INDICATE MEMBERSHIP IN A NON-PROFIT SERVICE ORGANIZATION OF BUSINESS LEADERS AND BUSINESS OWNERS .

FIRST USE 12-11-1996; IN COMMERCE 12-11-1996.

OWNER OF U.S. REG. NO. 2,489,316.
NO CLAIM IS MADE TO THE EXCLUSIVE RIGHT TO USE "CERTIFIED SECURITY", APART FROM THE MARK AS SHOWN.

THIS CERTIFICATION MARK, AS USED BY AUTHORIZED ENTITIES, CERTIFIES THAT THE GOODS MEET APPLICANT'S ESTABLISHED STANDARDS FOR, WITHOUT LIMITATION, SECURITY, PRIVACY, CONFIDENTIALITY, TRANSACTION INTEGRITY AND/OR SYSTEM AVAILABILITY.

FOR COMPUTER HARDWARE AND SOFTWARE, INCLUDING INFORMATION SITES AND DATA ACCESSIBLE FROM GLOBAL AND OTHER COMPUTER NETWORKS.

SN 78-127,440. VERMONT ORGANIC FARMERS, LLC, RICHMOND, VT. FILED 5-9-2002.

SN 76-409,574. THE NATIONAL EXCHANGE CLUB, TOLEDO, OH. FILED 5-16-2002.

BUSINESS MASTERS

NO CLAIM IS MADE TO THE EXCLUSIVE RIGHT TO USE "BUSINESS", APART FROM THE MARK AS SHOWN.

FOR INDICATE MEMBERSHIP IN A NON-PROFIT SERVICE ORGANIZATION OF BUSINESS LEADERS AND BUSINESS OWNERS.

FIRST USE 12-11-1996; IN COMMERCE 12-11-1996.



NO CLAIM IS MADE TO THE EXCLUSIVE RIGHT TO USE "ORGANIC FARMERS", "CERTIFIED ORGANIC", AND "P.O. BOX 697", "RICHMOND, VT 05477", AND "434-4122", APART FROM THE MARK AS SHOWN.

CERTIFICATION MARKS

CLASS A—GOODS

THE CERTIFICATION MARK, AS USED BY PERSONS AUTHORIZED BY THE APPLICANT, CERTIFIES THAT THE PRODUCTS TO WHICH THE CERTIFICATION MARK IS AFFIXED HAVE BEEN GROWN OR PRODUCED ORGANICALLY IN VERMONT.
FOR ORGANIC AGRICULTURAL PRODUCTS.
FIRST USE 1-1-1990; IN COMMERCE 1-1-1990.

SN 76-430,059. NATIONAL AUTOMOTIVE RADIATOR SERVICE ASSOCIATION, PENNSBURG, PA. FILED 7-12-2002.

CLASS B—SERVICES

SN 76-412,368. THE COMPUTING TECHNOLOGY INDUSTRY ASSOCIATION, INC., OAKBROOK TERRACE, IL. FILED 5-14-2002.

A +

OWNER OF U.S. REG. NO. 1,994,504.
THE MARK, AS USED BY PERSONS AUTHORIZED BY THE CERTIFIER, CERTIFIES THAT THE PERSONS PERFORMING THE SERVICES HAVE DEMONSTRATED A PRESCRIBED LEVEL OF COMPETENCY BY PASSING AN EXAMINATION TEST DEVELOPED BY THE CERTIFIER AND ADMINISTERED BY AN INDEPENDENT TESTING COMPANY ON BEHALF OF THE CERTIFIER
FOR CONFIGURING, INSTALLING, DIAGNOSING, REPAIRING, UPGRADING AND MAINTAINING MICROCOMPUTERS AND ASSOCIATED COMPUTER HARDWARE AND SOFTWARE PRODUCTS.
FIRST USE 6-0-1993; IN COMMERCE 6-0-1993.

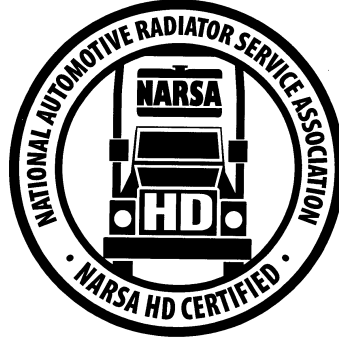

OWNER OF U.S. REG. NOS. 2,254,973 AND 2,260,474.
NO CLAIM IS MADE TO THE EXCLUSIVE RIGHT TO USE "ASSOCIATION", "HD", OR "HD CERTIFIED", APART FROM THE MARK AS SHOWN.
THE MARK, AS INTENDED TO BE USED BY AUTHORIZED PERSONS, IS INTENDED TO CERTIFY THAT SAID AUTHORIZED PERSONS MEET CERTAIN QUALIFICATIONS, STANDARDS, CONDITIONS, OR TESTS OF COMPETENCY, SKILL, AND KNOWLEDGE, AS THE CASE MAY BE.
SEC. 2(F) "NATIONAL AUTOMOTIVE RADIATOR SERVICE ASSOCIATION".
FOR RADIATOR AND COOLING SYSTEM REPAIR AND MAINTENANCE SERVICES.

* * * * *

TRADEMARK REGISTRATIONS ISSUED

PRINCIPAL REGISTER

SECTION 1.— INTERNATIONAL CLASSIFICATION

The short titles associated below with the international class numbers are terms designed merely for quick identification and are not an official part of the international classification. The full names of international classes are given in section 6.1 of the trademark rules of practice.

The designation "U.S. Cl." appearing in this section refers to the U.S. class in effect prior to Sep. 1, 1973 rather than the international class which applies to applications filed on or after that date. For adoption of international classification see notice in the OFFICIAL GAZETTE of Jun. 26, 1973 (911 O.G. TM 210).

CLASS 1—CHEMICALS

- 2,728,462. **ABITIBI CONSOLIDATED AND DESIGN**. ABITIBI-CONSOLIDATED INC., MULTIPLE CLASS, (INT. CLS. 1, 16 AND 19), (U.S. CLS. 1, 2, 5, 6, 10, 12, 22, 23, 26, 29, 33, 37, 38, 46 AND 50). SN 75-481,760. PUB. 4-1-2003. FILED 5-8-1998.
- 2,728,472. **SEPBOX**. ANALYTICON AG BIOTECHNOLOGIE . PHARMAZIE, MULTIPLE CLASS, (INT. CLS. 1, 5 AND 9), (U.S. CLS. 1, 5, 6, 10, 18, 21, 23, 26, 36, 38, 44, 46, 51 AND 52). SN 75-602,767. PUB. 4-1-2003. FILED 12-8-1998.
- 2,728,483. **THE REAL THING AND DESIGN**. ECOAG INITIATIVES INC., MULTIPLE CLASS, (INT. CLS. 1 AND 31), (U.S. CLS. 1, 5, 6, 10, 26 AND 46). SN 75-687,407. PUB. 9-17-2002. FILED 4-20-1999.
- 2,728,507. **CORUS**. CORUS UK LIMITED, BY CHANGE OF NAME BRITISH STEEL LIMITED, MULTIPLE CLASS, (INT. CLS. 1, 6, 7, 9, 11, 16, 19, 39 AND 40), (U.S. CLS. 1, 2, 5, 6, 10, 12, 13, 14, 19, 21, 22, 23, 25, 26, 29, 31, 33, 34, 35, 36, 37, 38, 46, 50, 100, 103, 105 AND 106). SN 75-902,731. PUB. 4-1-2003. FILED 1-28-2000.
- 2,728,556. **DIOSOURCE**. DIOSYNTH B.V., (U.S. CLS. 1, 5, 6, 10, 26 AND 46). SN 76-117,461. PUB. 4-16-2002. FILED 8-24-2000.
- 2,728,580. **AMPERGY**. H.C. STARCK GMBH & CO. KG, MULTIPLE CLASS, (INT. CLS. 1, 6 AND 9), (U.S. CLS. 1, 2, 5, 6, 10, 12, 13, 14, 21, 23, 25, 26, 36, 38, 46 AND 50). SN 76-169,190. PUB. 4-16-2002. FILED 11-21-2000.
- 2,728,725. **SEITZSCHENK**. SEITZSCHENK FILTERSYSTEMS GMBH, MULTIPLE CLASS, (INT. CLS. 1, 7, 11 AND 17), (U.S. CLS. 1, 5, 6, 10, 12, 13, 19, 21, 23, 26, 31, 34, 35, 46 AND 50). SN 76-359,050. PUB. 4-1-2003. FILED 1-15-2002.
- 2,728,764. **MERLIN**. QBIGENE, INC., MULTIPLE CLASS, (INT. CLS. 1 AND 5), (U.S. CLS. 1, 5, 6, 10, 18, 26, 44, 46, 51 AND 52). SN 76-376,433. PUB. 4-1-2003. FILED 2-25-2002.
- 2,728,951. **PUREOX**. CHESAPEAKE SPECIALTY PRODUCTS, INC., (U.S. CLS. 1, 5, 6, 10, 26 AND 46). SN 76-434,407. PUB. 4-1-2003. FILED 7-24-2002.
- 2,729,109. **EQUITY**. NATURIZE BIOSCIENCES, INC., (U.S. CLS. 1, 5, 6, 10, 26 AND 46). SN 76-455,028. PUB. 4-1-2003. FILED 9-27-2002.
- 2,729,247. **GATOR GRO**. HOWARD FERTILIZER COMPANY, (U.S. CLS. 1, 5, 6, 10, 26 AND 46). SN 78-146,323. PUB. 4-1-2003. FILED 7-22-2002.
- 2,729,248. **GATOR GOLD**. HOWARD FERTILIZER COMPANY, (U.S. CLS. 1, 5, 6, 10, 26 AND 46). SN 78-146,325. PUB. 4-1-2003. FILED 7-22-2002.

CLASS 2—PAINTS

- 2,728,554. **SICPAPROTECT**. SICPA HOLDING S.A., MULTIPLE CLASS, (INT. CLS. 2, 9, 16, 38, 39 AND 42), (U.S. CLS. 2, 5, 6, 11, 16, 21, 22, 23, 26, 29, 36, 37, 38, 50, 100, 101, 104 AND 105). SN 76-111,775. PUB. 4-1-2003. FILED 8-17-2000.
- 2,728,555. **SICPAMARK**. SICPA HOLDING S.A., MULTIPLE CLASS, (INT. CLS. 2, 9, 16, 38, 39 AND 42), (U.S. CLS. 2, 5, 6, 11, 16, 21, 22, 23, 26, 29, 36, 37, 38, 50, 100, 101, 104 AND 105).

- SN 76-111,781. PUB. 4-1-2003. FILED 8-17-2000.
- 2,728,724. **LUSID**. LUSID TECHNOLOGIES, INC., (U.S. CLS. 6, 11 AND 16). SN 76-358,983. PUB. 4-1-2003. FILED 1-2-2002.
- 2,729,091. **MADISON CHEMICAL INDUSTRIES INC.**, MADISON CHEMICAL INDUSTRIES INC., (U.S. CLS. 6, 11 AND 16). SN 76-452,072. PUB. 4-1-2003. FILED 9-19-2002.
- 2,729,228. **FURNITURE FIXER**. WOODCARE COMPANY, (U.S. CLS. 6, 11 AND 16). SN 78-141,509. PUB. 4-1-2003. FILED 7-5-2002.
- 2,729,252. **ALUMINIZED BLOXIDE**. ILLINOIS TOOL WORKS INC., (U.S. CLS. 6, 11 AND 16). SN 78-146,760. PUB. 4-1-2003. FILED 7-23-2002.
- 2,729,296. **MASTER CHOICE**. FRAZEE INDUSTRIES, INC., (U.S. CLS. 6, 11 AND 16). SN 78-155,191. PUB. 4-1-2003. FILED 8-16-2002.

CLASS 3—COSMETICS AND CLEANING PREPARATIONS

- 2,728,457. **PHYTESCENS**. VERNIN, JACQUES, MULTIPLE CLASS, (INT. CLS. 3 AND 5), (U.S. CLS. 1, 4, 6, 18, 44, 46, 50, 51 AND 52). SN 75-314,144. PUB. 8-20-2002. FILED 6-24-1997.
- 2,728,492. **PURE MOMENT ALFRED SUNG**. MIMRAN GROUP INC., MULTIPLE CLASS, (INT. CLS. 3, 4 AND 5), (U.S. CLS. 1, 4, 6, 15, 18, 44, 46, 50, 51 AND 52). SN 75-836,037. PUB. 6-11-2002. FILED 10-29-1999.
- 2,728,493. **TEATRO ALLA SCALA AND DESIGN**. FONDAZIONE TEATRO ALLA SCALA DI MILANO, MULTIPLE CLASS, (INT. CLS. 3, 6, 8, 9, 11, 14, 15, 16, 18, 20, 21, 24, 25, 26, 28, 30, 32, 33, 34, 35, 36, 38, 39, 41 AND 42), (U.S. CLS. 1, 2, 3, 4, 5, 6, 8, 9, 12, 13, 14, 17, 21, 22, 23, 25, 26, 27, 28, 29, 30, 31, 32, 33, 34, 36, 37, 38, 39, 40, 41, 42, 44, 45, 46, 47, 48, 49, 50, 51, 52, 100, 101, 102, 104, 105 AND 107). SN 75-843,730. PUB. 9-17-2002. FILED 11-9-1999.
- 2,728,596. **VINLIFE**. TARAC AUSTRALIA PTY LTD, MULTIPLE CLASS, (INT. CLS. 3, 5, 29, 30 AND 32), (U.S. CLS. 1, 4, 6, 18, 44, 45, 46, 48, 50, 51 AND 52). SN 76-210,286. PUB. 6-11-2002. FILED 2-14-2001.
- 2,728,631. **COLOR SAVE LIPSTICK SEALER**. ELAN INTERNATIONAL LTD., (U.S. CLS. 1, 4, 6, 50, 51 AND 52). SN 76-266,133. PUB. 4-1-2003. FILED 6-5-2001.
- 2,728,655. **37(DEGREES) AND DESIGN**. TAMMES, BARBARA, MULTIPLE CLASS, (INT. CLS. 3, 30 AND 32), (U.S. CLS. 1, 4, 6, 45, 46, 48, 50, 51 AND 52). SN 76-296,925. PUB. 4-1-2003. FILED 8-7-2001.
- 2,728,663. **MISCELLANEOUS DESIGN**. PACO RABANNE PARFUMS, (U.S. CLS. 1, 4, 6, 50, 51 AND 52). SN 76-310,024. PUB. 4-1-2003. FILED 9-7-2001.
- 2,728,665. **HERBORIST AND DESIGN**. SHANGHAI JAHWA UNITED CO., LTD, (U.S. CLS. 1, 4, 6, 50, 51 AND 52). SN 76-312,028. PUB. 4-1-2003. FILED 9-17-2001.
- 2,728,714. **D FRIZZ AND DESIGN**. GRESHAM COSMETICS PTY LTD, (U.S. CLS. 1, 4, 6, 50, 51 AND 52). SN 76-355,494. PUB. 4-1-2003. FILED 1-7-2002.
- 2,728,717. **KLAPP**. GERHARD KLAPP COSMETICS E.K., (U.S. CLS. 1, 4, 6, 50, 51 AND 52). SN 76-356,475. PUB. 4-1-2003. FILED 1-8-2002.

2,728,726. **BUGATTI**. BUGATTI, CHARLES, AND BUGATTI, STEPHANIE, (U.S. CLS. 1, 4, 6, 50, 51 AND 52). SN 76-359,418. PUB. 4-1-2003. FILED 1-16-2002.

2,728,733. **POTIONS & POSSIBILITIES**. FOSTER, JULIE ELIZABETH, (U.S. CLS. 1, 4, 6, 50, 51 AND 52). SN 76-362,697. PUB. 4-1-2003. FILED 1-24-2002.

2,728,745. **GLISTEN**. AMERICAN CREW, INC., (U.S. CLS. 1, 4, 6, 50, 51 AND 52). SN 76-369,357. PUB. 4-1-2003. FILED 2-11-2002.

2,728,775. **JAX AND DESIGN**. JEROME ALEXANDER GLOBAL, INC., (U.S. CLS. 1, 4, 6, 50, 51 AND 52). SN 76-379,394. PUB. 4-1-2003. FILED 3-6-2002.

2,728,777. **NIVEA VISAGE PERFECT CONTOUR**. BEIERS-DORF AKTIENGESELLSCHAFT, (U.S. CLS. 1, 4, 6, 50, 51 AND 52). SN 76-380,010. PUB. 4-1-2003. FILED 3-8-2002.

2,728,796. **VITABOLIC CLARIFIER**. LANCOME PARFUMS ET BEAUTE & CIE, (U.S. CLS. 1, 4, 6, 50, 51 AND 52). SN 76-384,979. PUB. 4-1-2003. FILED 3-20-2002.

2,728,815. **MANDARINE**. VOTIVO, LTD., (U.S. CLS. 1, 4, 6, 50, 51 AND 52). SN 76-394,470. PUB. 4-1-2003. FILED 4-11-2002.

2,728,831. **IMPACTIVE**. LANCOME PARFUMS ET BEAUTE & CIE, (U.S. CLS. 1, 4, 6, 50, 51 AND 52). SN 76-402,198. PUB. 4-1-2003. FILED 5-1-2002.

2,728,867. **GREAT COLOR STARTS WITH GREAT HAIR**. LABORATOIRE GARNIER & CIE, (U.S. CLS. 1, 4, 6, 50, 51 AND 52). SN 76-411,407. PUB. 4-1-2003. FILED 5-28-2002.

2,728,895. **PROFESSIONAL AEROSOLS IN A BETTER PACKAGE**. CHASE PRODUCTS COMPANY, MULTIPLE CLASS, (INT. CLS. 3, 4 AND 5), (U.S. CLS. 1, 4, 6, 15, 18, 44, 46, 50, 51 AND 52). SN 76-421,449. PUB. 4-1-2003. FILED 6-14-2002.

2,728,928. **MISCELLANEOUS DESIGN**. KESS INDUSTRIAL PRODUCTS, INC., (U.S. CLS. 1, 4, 6, 50, 51 AND 52). SN 76-428,998. PUB. 4-1-2003. FILED 7-9-2002.

2,728,935. **HANS OOM PAH PAH (STYLIZED)**. CIRCLE OF FRIENDS, LLC, (U.S. CLS. 1, 4, 6, 50, 51 AND 52). SN 76-430,512. PUB. 4-1-2003. FILED 7-15-2002.

2,728,995. **ADVANAGE THE WONDER CLEANER**. AUSTIN DIVERSIFIED PRODUCTS, INC., (U.S. CLS. 1, 4, 6, 50, 51 AND 52). SN 76-441,803. PUB. 4-1-2003. FILED 8-13-2002.

2,729,056. **CREST (STYLIZED)**. PROCTER & GAMBLE COMPANY, THE, (U.S. CLS. 1, 4, 6, 50, 51 AND 52). SN 76-447,221. PUB. 4-1-2003. FILED 9-6-2002.

2,729,057. **CREST AND DESIGN**. THE PROCTER & GAMBLE COMPANY, MULTIPLE CLASS, (INT. CLS. 3 AND 21), (U.S. CLS. 1, 2, 4, 6, 13, 23, 29, 30, 33, 40, 50, 51 AND 52). SN 76-447,222. PUB. 4-1-2003. FILED 9-6-2002.

2,729,186. **STRUCTURANCE**. BEAUTE CREATEURS (SOCIETE ANONYME), (U.S. CLS. 1, 4, 6, 50, 51 AND 52). SN 78-119,798. PUB. 4-1-2003. FILED 4-5-2002.

2,729,206. **JEAN-CLAUDE JITROIS**. COSTE, JEAN-CLAUDE CHRISTIAN, (U.S. CLS. 1, 4, 6, 50, 51 AND 52). SN 78-131,848. PUB. 4-1-2003. FILED 5-29-2002.

2,729,250. **AUDLEY'S**. INTER-CONTINENTAL HOTELS CORPORATION, (U.S. CLS. 1, 4, 6, 50, 51 AND 52). SN 78-146,612. PUB. 4-1-2003. FILED 7-23-2002.

2,729,269. **A AND DESIGN**. AESTHETICA SKIN CARE CORPORATION, MULTIPLE CLASS, (INT. CLS. 3 AND 5), (U.S. CLS. 1, 4, 6, 18, 44, 46, 50, 51 AND 52). SN 78-151,843. PUB. 4-1-2003. FILED 8-7-2002.

2,729,277. **COOL SHOWER**. CHURCH & DWIGHT COMPANY, (U.S. CLS. 1, 4, 6, 50, 51 AND 52). SN 78-152,269. PUB. 4-1-2003. FILED 8-8-2002.

2,729,280. **MORE POWER FOR LESS MONEY**. AIKEN CHEMICAL COMPANY, INC., (U.S. CLS. 1, 4, 6, 50, 51 AND 52). SN 78-152,310. PUB. 4-1-2003. FILED 8-8-2002.

2,729,320. **SCENTABLES**. CELEBRATION HALLOWEEN, INC., (U.S. CLS. 1, 4, 6, 50, 51 AND 52). SN 78-158,313. PUB. 4-1-2003. FILED 8-27-2002.

2,729,330. **360 (DEGREES) (STYLIZED)**. PEI LICENSING, INC., (U.S. CLS. 1, 4, 6, 50, 51 AND 52). SN 78-158,883. PUB. 4-1-2003. FILED 8-28-2002.

CLASS 4—LUBRICANTS AND FUELS

2,728,492 (*See Class 3 for this trademark*).

2,728,609. **LINDA HART'S ANGEL GIFT BASKETS**. TRIPLETT, LINDA J., (U.S. CLS. 1, 6 AND 15). SN 76-234,273. PUB. 4-1-2003. FILED 4-3-2001.

2,728,816. **CEDAR & SAGE**. VOTIVO, LTD., (U.S. CLS. 1, 6 AND 15). SN 76-394,570. PUB. 4-1-2003. FILED 4-11-2002.

2,728,895 (*See Class 3 for this trademark*).

CLASS 5—PHARMACEUTICALS

2,728,457 (*See Class 3 for this trademark*).

2,728,464. **AZ A L K A Z O N E AND DESIGN**. BETTER HEALTHLAB, INC., MULTIPLE CLASS, (INT. CLS. 5, 11 AND 32), (U.S. CLS. 6, 13, 18, 21, 23, 31, 34, 44, 45, 46, 48, 51 AND 52). SN 75-527,096. PUB. 7-24-2001. FILED 7-27-1998.

2,728,470. **SYMBIO AND DESIGN**. DEGUSSA-HULS AKTIENGESELLSCHAFT, BY MERGER DEGUSSA AKTIENGESELLSCHAFT, (U.S. CLS. 6, 18, 44, 46, 51 AND 52). SN 75-588,342. PUB. 11-16-1999. FILED 11-13-1998.

2,728,472 (*See Class 1 for this trademark*).

2,728,475. **ACOUVIST**. SCHERING AKTIENGESELLSCHAFT, (U.S. CLS. 6, 18, 44, 46, 51 AND 52). SN 75-628,312. PUB. 12-12-2000. FILED 1-26-1999.

2,728,482. **SONAVIST**. SCHERING AKTIENGESELLSCHAFT, (U.S. CLS. 6, 18, 44, 46, 51 AND 52). SN 75-673,477. PUB. 5-22-2001. FILED 4-1-1999.

2,728,488. **SURE TRIM**. MILEXIMUM NATURAL PRODUCTS, INC., (U.S. CLS. 6, 18, 44, 46, 51 AND 52). SN 75-792,544. PUB. 7-16-2002. FILED 9-3-1999.

2,728,492 (*See Class 3 for this trademark*).

2,728,505. **XAPRILIA**. SANOFI - SYNTHELABO, (U.S. CLS. 6, 18, 44, 46, 51 AND 52). SN 75-872,310. PUB. 4-17-2001. FILED 12-15-1999.

2,728,528. **THE TRAVEL DOCTOR TMVC TRAVELER'S MEDICAL & VACCINATION CENTRE ... FOR A SAFE AND HEALTHY JOURNEY AND DESIGN**. TRAVELLER'S MEDICAL AND VACCINATION CENTRE PTY LTD, MULTIPLE CLASS, (INT. CLS. 5, 9, 16 AND 42), (U.S. CLS. 2, 5, 6, 18, 21, 22, 23, 26, 29, 36, 37, 38, 44, 46, 50, 51, 52, 100 AND 101). SN 76-025,780. PUB. 7-9-2002. FILED 4-13-2000.

2,728,557. **ALLIANCE PHARMACEUTICAL CORP.**. ALLIANCE PHARMACEUTICAL CORP., (U.S. CLS. 6, 18, 44, 46, 51 AND 52). SN 76-120,670. PUB. 4-1-2003. FILED 8-31-2000.

2,728,581. **SUREFRESH**. FEMPRO INC., (U.S. CLS. 6, 18, 44, 46, 51 AND 52). SN 76-170,666. PUB. 7-9-2002. FILED 11-27-2000.

2,728,596 (*See Class 3 for this trademark*).

2,728,601. **ALLIANCE PHARMACEUTICAL CORP. AND DESIGN**. ALLIANCE PHARMACEUTICAL CORP., (U.S. CLS. 6, 18, 44, 46, 51 AND 52). SN 76-220,113. PUB. 4-1-2003. FILED 3-6-2001.

2,728,634. **SYSTEM JO (STYLIZED)**. UNITED CONSORTIUM, (U.S. CLS. 6, 18, 44, 46, 51 AND 52). SN 76-273,660. PUB. 4-1-2003. FILED 6-19-2001.

2,728,728. **WATSON WOMEN'S HEALTH AND DESIGN**. WATSON PHARMACEUTICALS, INC., (U.S. CLS. 6, 18, 44, 46, 51 AND 52). SN 76-359,852. PUB. 4-1-2003. FILED 1-18-2002.

2,728,764 (*See Class 1 for this trademark*).

2,728,895 (*See Class 3 for this trademark*).

2,728,936. **JENNIFER'S DIET**. THE 75' ENTERPRISES, INC., (U.S. CLS. 6, 18, 44, 46, 51 AND 52). SN 76-430,826. PUB. 4-1-2003. FILED 7-15-2002.

2,729,092. **A AND DESIGN**. AMERILAB TECHNOLOGIES, INC., (U.S. CLS. 6, 18, 44, 46, 51 AND 52). SN 76-452,126. PUB. 4-1-2003. FILED 9-24-2002.

2,729,094. **AMERILAB AND DESIGN**. AMERILAB TECHNOLOGIES, INC., (U.S. CLS. 6, 18, 44, 46, 51 AND 52). SN 76-452,365. PUB. 4-1-2003. FILED 9-24-2002.

2,729,098. **MEDTRIM**. MEREY, DAISY, (U.S. CLS. 6, 18, 44, 46, 51 AND 52). SN 76-453,275. PUB. 4-1-2003. FILED 9-20-2002.

2,729,099. **OPTIMIZER**. Y-TEX CORPORATION, (U.S. CLS. 6, 18, 44, 46, 51 AND 52). SN 76-453,339. PUB. 4-1-2003. FILED 9-27-2002.

2,729,100. **1ST STEP FOR ENERGY**. HIGH PERFORMANCE

FITNESS, INC., (U.S. CLS. 6, 18, 44, 46, 51 AND 52). SN 76-453,468. PUB. 4-1-2003. FILED 9-27-2002.

2,729,101. **OMEGARIN**. IDEAL HEALTH, INC., (U.S. CLS. 6, 18, 44, 46, 51 AND 52). SN 76-453,773. PUB. 4-1-2003. FILED 9-30-2002.

2,729,102. **FITSHAKE**. IDEAL HEALTH, INC., (U.S. CLS. 6, 18, 44, 46, 51 AND 52). SN 76-453,780. PUB. 4-1-2003. FILED 9-30-2002.

2,729,105. **POWER ADAPT**. NATURA, LLC, (U.S. CLS. 6, 18, 44, 46, 51 AND 52). SN 76-454,210. PUB. 4-1-2003. FILED 9-26-2002.

2,729,106. **VITAL ADAPT**. NATURA, LLC, (U.S. CLS. 6, 18, 44, 46, 51 AND 52). SN 76-454,211. PUB. 4-1-2003. FILED 9-26-2002.

2,729,107. **VIGEN (STYLIZED)**. KIM, KEVIN SAN, (U.S. CLS. 6, 18, 44, 46, 51 AND 52). SN 76-454,236. PUB. 4-1-2003. FILED 10-1-2002.

2,729,111. **MAGNA-BON**. THE NEW MAGNA-BON CORP., INC., (U.S. CLS. 6, 18, 44, 46, 51 AND 52). SN 76-455,461. PUB. 4-1-2003. FILED 9-30-2002.

2,729,112. **CORTISTOP**. AROMATIC RESEARCH & TECHNOLOGY, LC., DBA YOUNG LIVING ESSENTIAL OILS, (U.S. CLS. 6, 18, 44, 46, 51 AND 52). SN 76-455,467. PUB. 4-1-2003. FILED 9-30-2002.

2,729,125. **KIRKLAND SIGNATURE**. COSTCO WHOLESALE CORPORATION, (U.S. CLS. 6, 18, 44, 46, 51 AND 52). SN 76-478,207. PUB. 4-1-2003. FILED 12-23-2002.

2,729,216. **NICOTAN**. JOANNOU, CHRISTOS E., (U.S. CLS. 6, 18, 44, 46, 51 AND 52). SN 78-136,014. PUB. 4-1-2003. FILED 6-14-2002.

2,729,217. **MEFILM**. MOLNLYCKE HEALTH CARE AB, (U.S. CLS. 6, 18, 44, 46, 51 AND 52). SN 78-136,104. PUB. 4-1-2003. FILED 6-16-2002.

2,729,232. **TROP T**. ROCHE DIAGNOSTICS CORPORATION, (U.S. CLS. 6, 18, 44, 46, 51 AND 52). SN 78-143,094. PUB. 4-1-2003. FILED 7-11-2002.

2,729,259. **PHARMVIEW**. PHARMCHEM, INC., (U.S. CLS. 6, 18, 44, 46, 51 AND 52). SN 78-148,757. PUB. 4-1-2003. FILED 7-30-2002.

2,729,261. **BLOUSOME GOLD**. ALWAYS B.B. INT'L, INC., (U.S. CLS. 6, 18, 44, 46, 51 AND 52). SN 78-148,992. PUB. 4-1-2003. FILED 7-30-2002.

2,729,266. **PHYSIOWHEY**. NATURESMART, LLC, (U.S. CLS. 6, 18, 44, 46, 51 AND 52). SN 78-151,805. PUB. 4-1-2003. FILED 8-7-2002.

2,729,268. **DEFENDER FX**. NATURESMART, LLC, (U.S. CLS. 6, 18, 44, 46, 51 AND 52). SN 78-151,841. PUB. 4-1-2003. FILED 8-7-2002.

2,729,269 (See Class 3 for this trademark).

2,729,284. **U.S. VET**. G.C. HANFORD MANUFACTURING COMPANY, (U.S. CLS. 6, 18, 44, 46, 51 AND 52). SN 78-153,562. PUB. 4-1-2003. FILED 8-13-2002.

2,729,312. **CREATED BY NATURE...CAPTURED BY GLADE**. S. C. JOHNSON & SON, INC., (U.S. CLS. 6, 18, 44, 46, 51 AND 52). SN 78-156,704. PUB. 4-1-2003. FILED 8-22-2002.

2,729,322. **FIBERWISE**. MELALEUCA, INC., (U.S. CLS. 6, 18, 44, 46, 51 AND 52). SN 78-158,393. PUB. 4-1-2003. FILED 8-27-2002.

CLASS 6—METAL GOODS

2,728,493 (See Class 3 for this trademark).

2,728,507 (See Class 1 for this trademark).

2,728,523. **COMPONENTA**. COMPONENTA OYJ, MULTIPLE CLASS, (INT. CLS. 6, 7, 12 AND 40), (U.S. CLS. 2, 12, 13, 14, 19, 21, 23, 25, 31, 34, 35, 44, 50, 100, 103 AND 106). SN 76-017,461. PUB. 10-22-2002. FILED 4-4-2000.

2,728,530. **MISCELLANEOUS DESIGN**. TERMI-MESH AUSTRALIA PTY LTD., MULTIPLE CLASS, (INT. CLS. 6 AND 37), (U.S. CLS. 2, 12, 13, 14, 23, 25, 50, 100, 103 AND 106). SN 76-031,349. PUB. 4-1-2003. FILED 4-21-2000.

2,728,531. **MISCELLANEOUS DESIGN**. TERMI-MESH AUSTRALIA PTY LTD., MULTIPLE CLASS, (INT. CLS. 6 AND 37), (U.S. CLS. 2, 12, 13, 14, 23, 25, 50, 100, 103 AND 106). SN 76-032,073. PUB. 4-1-2003. FILED 4-21-2000.

2,728,567. **WILLIAM YEOWARD**. YEOWARD, WILLIAM

BERNARD, MULTIPLE CLASS, (INT. CLS. 6, 11, 14, 20, 21, 24 AND 27), (U.S. CLS. 2, 12, 13, 14, 19, 20, 21, 22, 23, 25, 27, 28, 29, 30, 31, 32, 33, 34, 37, 40, 42 AND 50). SN 76-141,248. PUB. 4-1-2003. FILED 10-5-2000.

2,728,580 (See Class 1 for this trademark).

2,728,622. **I-LOCK (STYLIZED)**. EASTERN COMPANY, THE, (U.S. CLS. 2, 12, 13, 14, 23, 25 AND 50). SN 76-256,116. PUB. 4-1-2003. FILED 5-11-2001.

2,728,763. **KOBE**. WEATHERFORD/LAMB, INC., MULTIPLE CLASS, (INT. CLS. 6, 7 AND 9), (U.S. CLS. 2, 12, 13, 14, 19, 21, 23, 25, 26, 31, 34, 35, 36, 38 AND 50). SN 76-376,141. PUB. 4-1-2003. FILED 2-22-2002.

2,728,797. **MAIL CUSTODIAN**. HILL, RICHARD D., DBA DANCING BEAR IRON WORKS, (U.S. CLS. 2, 12, 13, 14, 23, 25 AND 50). SN 76-385,228. PUB. 3-11-2003. FILED 3-21-2002.

2,728,884. **FB-W**. THYSSENKRUPP STAHL AG, (U.S. CLS. 2, 12, 13, 14, 23, 25 AND 50). SN 76-418,311. PUB. 1-21-2003. FILED 5-28-2002.

2,728,933. **PREMIUM PRO-STEEL**. MENARD, INC., (U.S. CLS. 2, 12, 13, 14, 23, 25 AND 50). SN 76-430,272. PUB. 4-1-2003. FILED 7-12-2002.

2,728,956. **EQUI-SNAP**. COASTAL PET PRODUCTS, INC., (U.S. CLS. 2, 12, 13, 14, 23, 25 AND 50). SN 76-435,111. PUB. 4-1-2003. FILED 7-29-2002.

2,728,990. **DRIFTWOOD**. GENTEK BUILDING PRODUCTS, INC., (U.S. CLS. 2, 12, 13, 14, 23, 25 AND 50). SN 76-441,508. PUB. 4-1-2003. FILED 8-19-2002.

2,729,189. **SIX PAC TRUNK**. STAF MANUFACTURING, INC., (U.S. CLS. 2, 12, 13, 14, 23, 25 AND 50). SN 78-120,328. PUB. 4-1-2003. FILED 4-3-2002.

CLASS 7—MACHINERY

2,728,467. **LIFE-POWER**. POSCH, LEOPOLD, DBA POSCH INNOVATIVER MASCHINENBAU U. HANDEL, MULTIPLE CLASS, (INT. CLS. 7, 29, 30, 31, 32 AND 33), (U.S. CLS. 1, 13, 19, 21, 23, 31, 34, 35, 45, 46, 47, 48 AND 49). SN 75-577,634. PUB. 4-1-2003. FILED 10-24-1998.

2,728,471. **PETFORM**. KRAUSS-MAFFEI KUNSTSTOFFTECHNIK GMBH, BY ASSIGNMENT KRAUSS-MAFFEI AG, (U.S. CLS. 13, 19, 21, 23, 31, 34 AND 35). SN 75-590,937. PUB. 1-11-2000. FILED 11-18-1998.

2,728,507 (See Class 1 for this trademark).

2,728,523 (See Class 6 for this trademark).

2,728,541. **WOODSON**. WOODSON INCORPORATED, (U.S. CLS. 13, 19, 21, 23, 31, 34 AND 35). SN 76-082,757. PUB. 4-1-2003. FILED 7-3-2000.

2,728,568. **SIGNAPACK**. HEIDELBERGER DRUCKMASCHINEN AKTIENGESELLSCHAFT, MULTIPLE CLASS, (INT. CLS. 7 AND 9), (U.S. CLS. 13, 19, 21, 23, 26, 31, 34, 35, 36 AND 38). SN 76-141,779. PUB. 4-30-2002. FILED 10-5-2000.

2,728,611. **CHEMRAZ**. GREENE TWEED OF DELAWARE, INC., MULTIPLE CLASS, (INT. CLS. 7 AND 17), (U.S. CLS. 1, 5, 12, 13, 19, 21, 23, 31, 34, 35 AND 50). SN 76-236,016. PUB. 4-1-2003. FILED 4-6-2001.

2,728,646. **CHANGES FOR THE BETTER**. MITSUBISHI ELECTRIC CORPORATION, MULTIPLE CLASS, (INT. CLS. 7, 9, 11, 12, 37, 38, 41 AND 42), (U.S. CLS. 13, 19, 21, 23, 26, 31, 34, 35, 36, 38, 44, 100, 101, 103, 104, 106 AND 107). SN 76-286,714. PUB. 4-1-2003. FILED 7-17-2001.

2,728,654. **MAX**. SCHRODER MASCHINENBAU KG, (U.S. CLS. 13, 19, 21, 23, 31, 34 AND 35). SN 76-296,765. PUB. 4-1-2003. FILED 8-8-2001.

2,728,678. **RICH AND DESIGN**. HOKUSHIN SEIKI CO., LTD., (U.S. CLS. 13, 19, 21, 23, 31, 34 AND 35). SN 76-320,358. PUB. 4-1-2003. FILED 10-3-2001.

2,728,704. **RICHTER**. ITT RICHTER CHEMIE-TECHNIK GMBH, MULTIPLE CLASS, (INT. CLS. 7, 9 AND 11), (U.S. CLS. 13, 19, 21, 23, 26, 31, 34, 35, 36 AND 38). SN 76-348,007. PUB. 4-1-2003. FILED 12-13-2001.

2,728,725 (See Class 1 for this trademark).

2,728,763 (See Class 6 for this trademark).

2,728,768. **AMERICAN COUPLINGS**. DIXON VALVE & COUPLING COMPANY, (U.S. CLS. 13, 19, 21, 23, 31, 34 AND 35). SN 76-377,454. PUB. 4-1-2003. FILED 3-4-2002.

2,728,773. **BERENDSEN FLUID POWER AND DESIGN**. BE-

- RENDSEN FLUID POWER, INC., MULTIPLE CLASS, (INT. CLS. 7, 9, 11 AND 17), (U.S. CLS. 1, 5, 12, 13, 19, 21, 23, 26, 31, 34, 35, 36, 38 AND 50). SN 76-378,848. PUB. 4-1-2003. FILED 3-5-2002.
- 2,728,819. **HYDRA MAX**. DOCK PRODUCTS CANADA INC., (U.S. CLS. 13, 19, 21, 23, 31, 34 AND 35). SN 76-395,511. PUB. 4-1-2003. FILED 4-12-2002.
- 2,728,879. **UNITED STATES SAW WE ARE WOODWORKERS AND DESIGN**. OLDHAM SAW CO., INC., (U.S. CLS. 13, 19, 21, 23, 31, 34 AND 35). SN 76-417,087. PUB. 4-1-2003. FILED 6-5-2002.
- 2,728,919. **MISCELLANEOUS DESIGN**. SERVO MAGNETICS INCORPORATED, MULTIPLE CLASS, (INT. CLS. 7 AND 9), (U.S. CLS. 13, 19, 21, 23, 26, 31, 34, 35, 36 AND 38). SN 76-427,079. PUB. 4-1-2003. FILED 7-2-2002.
- 2,728,981. **MFORCE**. MAKITA U.S.A., INC., (U.S. CLS. 13, 19, 21, 23, 31, 34 AND 35). SN 76-439,432. PUB. 4-1-2003. FILED 8-12-2002.
- 2,729,012. **ARMOR-PLATED UNIBROACH**. CS UNITEC, INC., (U.S. CLS. 13, 19, 21, 23, 31, 34 AND 35). SN 76-443,050. PUB. 4-1-2003. FILED 8-23-2002.
- 2,729,014. **CHLORKING**. CHLORKING, INC., (U.S. CLS. 13, 19, 21, 23, 31, 34 AND 35). SN 76-443,137. PUB. 4-1-2003. FILED 8-23-2002.
- 2,729,126. **AD**. WINDMOLLER & HOLSCHER KG, (U.S. CLS. 13, 19, 21, 23, 31, 34 AND 35). SN 76-975,138. PUB. 4-1-2003. FILED 2-25-2002.
- 2,729,136. **BAZAN AND DESIGN**. EMPRESA NACIONAL BAZAN DE CONSTRUCCIONES NAVALES MILITARES, S.A., MULTIPLE CLASS, (INT. CLS. 7 AND 11), (U.S. CLS. 13, 19, 21, 23, 31, 34 AND 35). SN 78-040,774. PUB. 4-1-2003. FILED 12-27-2000.
- 2,729,142. **GOURMET CHAMP "IDEAS THAT COOK"**. CHAMP INDUSTRIES, INC., (U.S. CLS. 13, 19, 21, 23, 31, 34 AND 35). SN 78-061,908. PUB. 4-1-2003. FILED 5-3-2001.
- 2,729,143. **TOSOK (STYLIZED)**. NIDEC TOSOK CORPORATION, MULTIPLE CLASS, (INT. CLS. 7 AND 9), (U.S. CLS. 13, 19, 21, 23, 26, 31, 34, 35, 36 AND 38). SN 78-063,672. PUB. 4-1-2003. FILED 5-15-2001.
- 2,729,167. **CONCEPT SQ**. JOHNSON PUMP (UK) LIMITED, (U.S. CLS. 13, 19, 21, 23, 31, 34 AND 35). SN 78-109,519. PUB. 4-1-2003. FILED 2-18-2002.
- 2,729,176. **FERRIS**. FERRIS INDUSTRIES, INC., (U.S. CLS. 13, 19, 21, 23, 31, 34 AND 35). SN 78-115,651. PUB. 4-1-2003. FILED 3-18-2002.
- 2,729,207. **PLASTIGATOR AND DESIGN**. GLYCON CORP., (U.S. CLS. 13, 19, 21, 23, 31, 34 AND 35). SN 78-132,104. PUB. 4-1-2003. FILED 5-30-2002.
- 2,729,299. **R AND DESIGN**. REPUBLIC WELDING CO., DBA REPUBLIC MACHINE, (U.S. CLS. 13, 19, 21, 23, 31, 34 AND 35). SN 78-155,262. PUB. 4-1-2003. FILED 8-18-2002.
- 2,729,342. **ELITE**. SEARS, ROEBUCK AND CO., (U.S. CLS. 13, 19, 21, 23, 31, 34 AND 35). SN 78-160,445. PUB. 4-1-2003. FILED 9-4-2002.
- 2,729,354. **METER**. METER S.P.A., (U.S. CLS. 13, 19, 21, 23, 31, 34 AND 35). SN 78-165,063. PUB. 4-1-2003. FILED 9-17-2002.

CLASS 8—HAND TOOLS

- 2,728,493 (*See Class 3 for this trademark*).
- 2,728,902. **SPECKGRABBER**. KINETRONICS CORPORATION, (U.S. CLS. 23, 28 AND 44). SN 76-423,795. PUB. 4-1-2003. FILED 6-24-2002.
- 2,729,013. **CASE**. CASEMARK, INC., (U.S. CLS. 23, 28 AND 44). SN 76-443,066. PUB. 4-1-2003. FILED 8-21-2002.
- 2,729,022. **X PRESS (STYLIZED)**. BADGE-A-MINIT, LTD., (U.S. CLS. 23, 28 AND 44). SN 76-443,856. PUB. 4-1-2003. FILED 8-26-2002.
- 2,729,026. **POCKET RATCHET AND DESIGN**. ALLTRADE TOOLS LLC, (U.S. CLS. 23, 28 AND 44). SN 76-443,925. PUB. 4-1-2003. FILED 8-27-2002.
- 2,729,287. **GLOCK**. GLOCK, INC., (U.S. CLS. 23, 28 AND 44). SN 78-154,710. PUB. 4-1-2003. FILED 8-15-2002.

CLASS 9—ELECTRICAL AND SCIENTIFIC APPARATUS

- 2,728,454. **QUICKSEARCH**. QUICKLAW INC., BY CHANGE OF NAME QL SYSTEMS LIMITED, MULTIPLE CLASS, (INT. CLS. 9, 35 AND 42), (U.S. CLS. 21, 23, 26, 36, 38, 100, 101 AND 102). SN 74-718,075. PUB. 4-1-2003. FILED 8-21-1995.
- 2,728,459. **POP'N'PLAY**. PIRON, DAVID, MULTIPLE CLASS, (INT. CLS. 9, 16 AND 28), (U.S. CLS. 2, 5, 21, 22, 23, 26, 29, 36, 37, 38 AND 50). SN 75-404,654. PUB. 10-3-2000. FILED 12-12-1997.
- 2,728,460. **BUGVILLE**. GIZMO GYPSIES, (U.S. CLS. 21, 23, 26, 36 AND 38). SN 75-477,702. PUB. 4-1-2003. FILED 5-1-1998.
- 2,728,468. **VTC (STYLIZED)**. VIRTUAL TECHNOLOGY CORPORATION, (U.S. CLS. 21, 23, 26, 36 AND 38). SN 75-579,786. PUB. 4-1-2003. FILED 10-30-1998.
- 2,728,472 (*See Class 1 for this trademark*).
- 2,728,473. **ECPARTNER**. MULTIACTIVE TECHNOLOGIES INC., MULTIPLE CLASS, (INT. CLS. 9 AND 42), (U.S. CLS. 21, 23, 26, 36, 38, 100 AND 101). SN 75-608,626. PUB. 5-21-2002. FILED 12-18-1998.
- 2,728,477. **UNITED PAN - EUROPE COMMUNICATIONS N.V.U P C AND DESIGN**. UNITED PAN-EUROPE COMMUNICATIONS N.V., MULTIPLE CLASS, (INT. CLS. 9, 38, 41 AND 42), (U.S. CLS. 21, 23, 26, 36, 38, 100, 101, 104 AND 107). SN 75-651,176. PUB. 4-30-2002. FILED 2-26-1999.
- 2,728,489. **IPC**. 3D MICROCOMPUTERS WHOLESALE & DISTRIBUTION (CANADA) INC., (U.S. CLS. 21, 23, 26, 36 AND 38). SN 75-815,638. PUB. 4-1-2003. FILED 10-6-1999.
- 2,728,490. **NOOFFICE**. NOOFFICE INVEST AS, MULTIPLE CLASS, (INT. CLS. 9, 20, 25, 28, 35 AND 42), (U.S. CLS. 2, 13, 21, 22, 23, 25, 26, 32, 36, 38, 39, 50, 100, 101 AND 102). SN 75-823,506. PUB. 9-17-2002. FILED 10-15-1999.
- 2,728,493 (*See Class 3 for this trademark*).
- 2,728,498. **TCA AND DESIGN**. ITG SOFTWARE, INC., BY ASSIGNMENT ITG INC., (U.S. CLS. 21, 23, 26, 36 AND 38). SN 75-859,982. PUB. 4-1-2003. FILED 11-30-1999.
- 2,728,500. **CLOSED JOINT STOCK COMPANY MOSCOW INTERBANK CURRENCY EXCHANGE AND DESIGN**. MOSCOW INTERBANK CURRENCY EXCHANGE, MULTIPLE CLASS, (INT. CLS. 9, 14, 16, 35, 36 AND 42), (U.S. CLS. 2, 5, 21, 22, 23, 26, 27, 28, 29, 36, 37, 38, 50, 100, 101 AND 102). SN 75-869,377. PUB. 4-30-2002. FILED 12-10-1999.
- 2,728,501. **WWW.MICEX.COM AND DESIGN**. MOSCOW INTERBANK CURRENCY EXCHANGE, MULTIPLE CLASS, (INT. CLS. 9, 14, 16, 35, 36 AND 42), (U.S. CLS. 2, 5, 21, 22, 23, 26, 27, 28, 29, 36, 37, 38, 50, 100, 101 AND 102). SN 75-869,378. PUB. 4-30-2002. FILED 12-10-1999.
- 2,728,502. **MICEX AND DESIGN**. MOSCOW INTERBANK CURRENCY EXCHANGE, MULTIPLE CLASS, (INT. CLS. 9, 14, 16, 35, 36 AND 42), (U.S. CLS. 2, 5, 21, 22, 23, 26, 27, 28, 29, 36, 37, 38, 50, 100, 101 AND 102). SN 75-869,546. PUB. 4-30-2002. FILED 12-10-1999.
- 2,728,503. **MMVB.RU AND DESIGN**. MOSCOW INTERBANK CURRENCY EXCHANGE, MULTIPLE CLASS, (INT. CLS. 9, 14, 16, 35, 36 AND 42), (U.S. CLS. 2, 5, 21, 22, 23, 26, 27, 28, 29, 36, 37, 38, 50, 100, 101 AND 102). SN 75-869,547. PUB. 4-30-2002. FILED 12-10-1999.
- 2,728,506. **BUGZEYE**. DOMINIK RECHNER, DBA BUG'Z EYE PRODUCTIONS, MULTIPLE CLASS, (INT. CLS. 9 AND 16), (U.S. CLS. 2, 5, 21, 22, 23, 26, 29, 36, 37, 38 AND 50). SN 75-875,312. PUB. 4-1-2003. FILED 12-29-1999.
- 2,728,507 (*See Class 1 for this trademark*).
- 2,728,509. **SCHOOLLINK AND DESIGN**. SCHOOL LINK, INC., MULTIPLE CLASS, (INT. CLS. 9, 38 AND 41), (U.S. CLS. 21, 23, 26, 36, 38, 100, 101, 104 AND 107). SN 75-910,222. PUB. 4-1-2003. FILED 1-27-2000.
- 2,728,514. **DATA GLIDER**. C.E.C. INDUSTRIAL CONSULTANTS INC., (U.S. CLS. 21, 23, 26, 36 AND 38). SN 75-945,196. PUB. 4-1-2003. FILED 2-24-2000.
- 2,728,518. **MAXML**. BANKERS SYSTEMS, INC., (U.S. CLS. 21, 23, 26, 36 AND 38). SN 75-983,025. PUB. 4-1-2003. FILED 12-1-1999.
- 2,728,519. **R.C. OLMSTEAD**. R.C. OLMSTEAD, INC., MULTIPLE CLASS, (INT. CLS. 9, 35 AND 42), (U.S. CLS. 21, 23, 26, 36, 38, 100, 101 AND 102). SN 76-007,149. PUB. 3-11-2003. FILED 3-22-2000.
- 2,728,520. **TRACKOS AND DESIGN**. NETNEARU CORP.,

- (U.S. CLS. 21, 23, 26, 36 AND 38). SN 76-008,518. PUB. 4-1-2003. FILED 3-23-2000.
- 2,728,521. **TRACKOS**. NETNEARU CORP., (U.S. CLS. 21, 23, 26, 36 AND 38). SN 76-008,519. PUB. 4-1-2003. FILED 3-23-2000.
- 2,728,524. **FIELDTRANS**. ALSTOM, (U.S. CLS. 21, 23, 26, 36 AND 38). SN 76-018,425. PUB. 4-30-2002. FILED 4-5-2000.
- 2,728,525. **FIELDROP**. ALSTOM, (U.S. CLS. 21, 23, 26, 36 AND 38). SN 76-018,426. PUB. 4-30-2002. FILED 4-5-2000.
- 2,728,528 (*See Class 5 for this trademark*).
- 2,728,532. **ALPINE**. EXTREME NETWORKS, INC., (U.S. CLS. 21, 23, 26, 36 AND 38). SN 76-041,456. PUB. 1-2-2001. FILED 5-5-2000.
- 2,728,533. **CGS**. SEMICONDUCTOR ENERGY LABORATORY CO., LTD., MULTIPLE CLASS, (INT. CLS. 9, 10, 11, 12 AND 28), (U.S. CLS. 13, 19, 21, 22, 23, 26, 31, 34, 35, 36, 38, 39, 44 AND 50). SN 76-061,446. PUB. 9-24-2002. FILED 5-23-2000.
- 2,728,534. **VENTURA EDUCATIONAL SYSTEMS**. VENTURA, FRED, AND VENTURA, MARNE, (U.S. CLS. 21, 23, 26, 36 AND 38). SN 76-062,861. PUB. 4-1-2003. FILED 6-6-2000.
- 2,728,540. **NYSE E-BROKER (STYLIZED)**. NEW YORK STOCK EXCHANGE, INC, (U.S. CLS. 21, 23, 26, 36 AND 38). SN 76-079,397. PUB. 4-1-2003. FILED 6-28-2000.
- 2,728,550. **BIG DADDY RECORDS**. ZHERKA, SELIM, MULTIPLE CLASS, (INT. CLS. 9, 35 AND 41), (U.S. CLS. 21, 23, 26, 36, 38, 100, 101, 102 AND 107). SN 76-103,279. PUB. 4-1-2003. FILED 8-4-2000.
- 2,728,551. **EYESITE**. MOTION MEDIA TECHNOLOGY LIMITED, MULTIPLE CLASS, (INT. CLS. 9, 38 AND 42), (U.S. CLS. 21, 23, 26, 36, 38, 100, 101 AND 104). SN 76-105,419. PUB. 7-2-2002. FILED 8-8-2000.
- 2,728,553. **IIS**. INTEGRATED INFORMATION SYSTEMS, INC., (U.S. CLS. 21, 23, 26, 36 AND 38). SN 76-110,716. PUB. 4-1-2003. FILED 8-16-2000.
- 2,728,554 (*See Class 2 for this trademark*).
- 2,728,555 (*See Class 2 for this trademark*).
- 2,728,559. **MISCELLANEOUS DESIGN**. BNP PARIBAS, MULTIPLE CLASS, (INT. CLS. 9, 35, 36 AND 38), (U.S. CLS. 21, 23, 26, 36, 38, 100, 101, 102 AND 104). SN 76-131,796. PUB. 8-20-2002. FILED 9-19-2000.
- 2,728,560. **ZEROKNOWLEDGE (STYLIZED)**. ZERO-KNOWLEDGE SYSTEMS, INC., MULTIPLE CLASS, (INT. CLS. 9 AND 42), (U.S. CLS. 21, 23, 26, 36, 38, 100 AND 101). SN 76-132,222. PUB. 4-1-2003. FILED 9-20-2000.
- 2,728,568 (*See Class 7 for this trademark*).
- 2,728,569. **SURFWATCH AND DESIGN**. SURFCONTROL PLC, (U.S. CLS. 21, 23, 26, 36 AND 38). SN 76-149,609. PUB. 4-1-2003. FILED 10-19-2000.
- 2,728,571. **NOVATRACK (STYLIZED)**. NOVA MEASURING INSTRUMENTS LTD., (U.S. CLS. 21, 23, 26, 36 AND 38). SN 76-153,398. PUB. 9-17-2002. FILED 10-24-2000.
- 2,728,577. **THE STUDY GROUP BAR EXAM ESSAY TRAINER COURSE GET THE ESSAY TRAINER EDGE AND DESIGN**. REVIEW SERVICES, INC., MULTIPLE CLASS, (INT. CLS. 9, 16 AND 41), (U.S. CLS. 2, 5, 21, 22, 23, 26, 29, 36, 37, 38, 50, 100, 101 AND 107). SN 76-166,055. PUB. 4-1-2003. FILED 11-14-2000.
- 2,728,578. **PELAGO AND DESIGN**. PELAGO NETWORKS, INC., BY CHANGE OF NAME BEACON NETWORKS, INC., (U.S. CLS. 21, 23, 26, 36 AND 38). SN 76-166,084. PUB. 4-1-2003. FILED 11-15-2000.
- 2,728,580 (*See Class 1 for this trademark*).
- 2,728,587. **GENEREX**. LG INFORMATION & COMMUNICATIONS, LTD., (U.S. CLS. 21, 23, 26, 36 AND 38). SN 76-187,329. PUB. 4-1-2003. FILED 12-28-2000.
- 2,728,589. **WIZZEN (STYLIZED)**. BIFFS, INC., (U.S. CLS. 21, 23, 26, 36 AND 38). SN 76-191,041. PUB. 4-1-2003. FILED 12-27-2000.
- 2,728,590. **TEX-FLEX**. TEXLOC HOLDINGS, INC., MULTIPLE CLASS, (INT. CLS. 9 AND 17), (U.S. CLS. 1, 5, 12, 13, 21, 23, 26, 35, 36, 38 AND 50). SN 76-192,886. PUB. 8-20-2002. FILED 1-11-2001.
- 2,728,591. **KEY PROGRAM**. NEW REVENUE SOLUTIONS, LLC, MULTIPLE CLASS, (INT. CLS. 9, 16 AND 35), (U.S. CLS. 2, 5, 21, 22, 23, 26, 29, 36, 37, 38, 50, 100, 101 AND 102). SN 76-192,975. PUB. 4-1-2003. FILED 1-12-2001.
- 2,728,592. **PETER GABRIEL**. GABRIEL, PETER, MULTIPLE CLASS, (INT. CLS. 9, 25 AND 41), (U.S. CLS. 21, 22, 23, 26, 36, 38, 39, 100, 101 AND 107). SN 76-196,885. PUB. 4-1-2003. FILED 1-18-2001.
- 2,728,603. **MBF AND DESIGN**. M.B. FOSTER ASSOCIATES LIMITED, MULTIPLE CLASS, (INT. CLS. 9, 16 AND 42), (U.S. CLS. 2, 5, 21, 22, 23, 26, 29, 36, 37, 38, 50, 100 AND 101). SN 76-228,151. PUB. 4-1-2003. FILED 3-20-2001.
- 2,728,605. **REQUESTSENSE**. PTS PIC, MULTIPLE CLASS, (INT. CLS. 9, 35 AND 42), (U.S. CLS. 21, 23, 26, 36, 38, 100, 101 AND 102). SN 76-229,657. PUB. 4-1-2003. FILED 3-23-2001.
- 2,728,606. **SALESENSE**. PTS PLC, MULTIPLE CLASS, (INT. CLS. 9, 35 AND 42), (U.S. CLS. 21, 23, 26, 36, 38, 100, 101 AND 102). SN 76-229,659. PUB. 4-1-2003. FILED 3-23-2001.
- 2,728,610. **RAINBOW DISPLAYS AND DESIGN**. RAINBOW DISPLAYS, INC., (U.S. CLS. 21, 23, 26, 36 AND 38). SN 76-234,708. PUB. 4-1-2003. FILED 4-4-2001.
- 2,728,616. **XPERTBRIDGE AND DESIGN**. F.M. SYSTEMS LIMITED, MULTIPLE CLASS, (INT. CLS. 9, 16, 35 AND 42), (U.S. CLS. 2, 5, 21, 22, 23, 26, 29, 36, 37, 38, 50, 100, 101 AND 102). SN 76-247,656. PUB. 4-1-2003. FILED 4-27-2001.
- 2,728,617. **PROFLUX**. MOXTEK, INC., (U.S. CLS. 21, 23, 26, 36 AND 38). SN 76-248,211. PUB. 4-1-2003. FILED 4-27-2001.
- 2,728,618. **RICHARD CLAYDERMAN**. DELPHINE PRODUCTIONS, MULTIPLE CLASS, (INT. CLS. 9, 28, 35, 38, 41 AND 42), (U.S. CLS. 21, 22, 23, 26, 36, 38, 50, 100, 101, 102, 104 AND 107). SN 76-248,747. PUB. 4-1-2003. FILED 4-30-2001.
- 2,728,623. **MISCELLANEOUS DESIGN**. NEAT GROUP, INC., MULTIPLE CLASS, (INT. CLS. 9 AND 42), (U.S. CLS. 21, 23, 26, 36, 38, 100 AND 101). SN 76-256,702. PUB. 4-1-2003. FILED 5-14-2001.
- 2,728,624. **AMENAZA**. AMENAZA TECHNOLOGIES LIMITED, MULTIPLE CLASS, (INT. CLS. 9, 16, 35, 41 AND 42), (U.S. CLS. 2, 5, 21, 22, 23, 26, 29, 36, 37, 38, 50, 100, 101, 102 AND 107). SN 76-257,121. PUB. 4-1-2003. FILED 5-16-2001.
- 2,728,627. **RADIOMETRICS**. RADIOMETRICS CORPORATION, (U.S. CLS. 21, 23, 26, 36 AND 38). SN 76-259,824. PUB. 4-1-2003. FILED 5-21-2001.
- 2,728,629. **MISCELLANEOUS DESIGN**. HUMANEYES TECHNOLOGIES, LTD., (U.S. CLS. 21, 23, 26, 36 AND 38). SN 76-261,362. PUB. 4-1-2003. FILED 5-18-2001.
- 2,728,635. **NIGHT HAWK**. SILENT WITNESS ENTERPRISES LTD., (U.S. CLS. 21, 23, 26, 36 AND 38). SN 76-273,896. PUB. 4-1-2003. FILED 6-20-2001.
- 2,728,637. **BLUE TOP**. JOHNSON CONTROLS BATTERY GROUP, INC., (U.S. CLS. 21, 23, 26, 36 AND 38). SN 76-275,228. PUB. 4-1-2003. FILED 6-21-2001.
- 2,728,643. **SPEC POWER**. SPECTRUM CONTROL, INC., (U.S. CLS. 21, 23, 26, 36 AND 38). SN 76-280,681. PUB. 4-1-2003. FILED 7-6-2001.
- 2,728,644. **UP MY WEB**. INTEGRAL MEDIA, MULTIPLE CLASS, (INT. CLS. 9, 35, 38, 39 AND 41), (U.S. CLS. 21, 23, 26, 36, 38, 100, 101, 102, 104, 105 AND 107). SN 76-283,076. PUB. 4-1-2003. FILED 7-10-2001.
- 2,728,645. **PPM PLUS**. PPM INFORMATION SOLUTIONS, INC., (U.S. CLS. 21, 23, 26, 36 AND 38). SN 76-285,398. PUB. 6-25-2002. FILED 7-17-2001.
- 2,728,646 (*See Class 7 for this trademark*).
- 2,728,656. **MINI35**. GABEL, BENJAMIN, AND STEINMEYER, KATHARINA, AND KASTNER, LARS, AND GEKTIDIS, MARCOS, (U.S. CLS. 21, 23, 26, 36 AND 38). SN 76-300,783. PUB. 4-1-2003. FILED 8-15-2001.
- 2,728,658. **GEOVISTA**. GEOSPAN CORPORATION, MULTIPLE CLASS, (INT. CLS. 9, 35 AND 40), (U.S. CLS. 21, 23, 26, 36, 38, 100, 101, 102, 103 AND 106). SN 76-303,556. PUB. 4-1-2003. FILED 8-23-2001.
- 2,728,685. **SOLAR MAX (STYLIZED)**. THE MUSEUM OF SCIENCE AND INDUSTRY, MULTIPLE CLASS, (INT. CLS. 9, 21, 25 AND 41), (U.S. CLS. 2, 13, 21, 22, 23, 26, 29, 30, 33, 36, 38, 39, 40, 50, 100, 101 AND 107). SN 76-324,725. PUB. 4-1-2003. FILED 10-12-2001.
- 2,728,691. **FLUOARC**. CARL-ZEISS-STIFTUNG, DBA CARL ZEISS, (U.S. CLS. 21, 23, 26, 36 AND 38). SN 76-335,235. PUB. 4-1-2003. FILED 11-7-2001.
- 2,728,693. **N AND DESIGN**. NORLUX CORP., (U.S. CLS. 21, 23, 26, 36 AND 38). SN 76-338,683. PUB. 4-1-2003. FILED 11-15-2001.
- 2,728,700. **YELLOW TOP**. JOHNSON CONTROLS BATTERY

- GROUP, INC., (U.S. CLS. 21, 23, 26, 36 AND 38). SN 76-346,859. PUB. 4-1-2003. FILED 12-10-2001.
- 2,728,701. **MISCELLANEOUS DESIGN.** JOHNSON CONTROLS BATTERY GROUP, INC., (U.S. CLS. 21, 23, 26, 36 AND 38). SN 76-346,860. PUB. 4-1-2003. FILED 12-10-2001.
- 2,728,702. **MISCELLANEOUS DESIGN.** JOHNSON CONTROLS BATTERY GROUP, INC., (U.S. CLS. 21, 23, 26, 36 AND 38). SN 76-346,868. PUB. 4-1-2003. FILED 12-10-2001.
- 2,728,703. **RED TOP.** JOHNSON CONTROLS BATTERY GROUP, INC., (U.S. CLS. 21, 23, 26, 36 AND 38). SN 76-347,318. PUB. 4-1-2003. FILED 12-10-2001.
- 2,728,704 (*See Class 7 for this trademark*).
- 2,728,708. **A NEW WAY TO NAVIGATE CHANGING REALITIES.** FINANCIAL EDUCATION, INC., (U.S. CLS. 21, 23, 26, 36 AND 38). SN 76-350,873. PUB. 4-1-2003. FILED 12-20-2001.
- 2,728,715. **SCULLY WHISTLER.** SCULLY SIGNAL COMPANY, (U.S. CLS. 21, 23, 26, 36 AND 38). SN 76-356,009. PUB. 4-1-2003. FILED 1-7-2002.
- 2,728,718. **CONDOR.** KINEMETRICS, INC., (U.S. CLS. 21, 23, 26, 36 AND 38). SN 76-356,644. PUB. 4-1-2003. FILED 1-9-2002.
- 2,728,721. **STUDIOMOUSE.** ACCO WORLD CORPORATION, (U.S. CLS. 21, 23, 26, 36 AND 38). SN 76-357,732. PUB. 7-9-2002. FILED 1-10-2002.
- 2,728,729. **MONSTER POWER.** MONSTER CABLE PRODUCTS, INC., (U.S. CLS. 21, 23, 26, 36 AND 38). SN 76-360,257. PUB. 4-1-2003. FILED 1-16-2002.
- 2,728,734. **PRINTQUICK.COM.** HIJK, (U.S. CLS. 21, 23, 26, 36 AND 38). SN 76-362,954. PUB. 4-1-2003. FILED 1-28-2002.
- 2,728,738. **MISCELLANEOUS DESIGN.** INTERNATIONAL ELECTRONICS, INC., (U.S. CLS. 21, 23, 26, 36 AND 38). SN 76-365,241. PUB. 4-1-2003. FILED 1-30-2002.
- 2,728,743. **SECRET BEACH.** ROTH, ERIC M., (U.S. CLS. 21, 23, 26, 36 AND 38). SN 76-368,978. PUB. 4-1-2003. FILED 2-8-2002.
- 2,728,744. **FONTEXPLORER.** HEIDELBERGER DRUCKMASCHINEN AKTIENGESELLSCHAFT, (U.S. CLS. 21, 23, 26, 36 AND 38). SN 76-369,351. PUB. 4-1-2003. FILED 2-8-2002.
- 2,728,746. **TUNSTALL.** TUNSTALL TELECOM LIMITED, (U.S. CLS. 21, 23, 26, 36 AND 38). SN 76-369,686. PUB. 4-1-2003. FILED 2-11-2002.
- 2,728,752. **TRUSURROUND XT.** SRS LABS, INC., (U.S. CLS. 21, 23, 26, 36 AND 38). SN 76-373,106. PUB. 4-1-2003. FILED 2-20-2002.
- 2,728,754. **U-SCAN SELF-CHECKOUT.** OPTIMAL ROBOTICS CORP., (U.S. CLS. 21, 23, 26, 36 AND 38). SN 76-373,712. PUB. 4-1-2003. FILED 2-21-2002.
- 2,728,758. **TONY HAWK'S BOOM BOOM HUCKJAM.** HAWK, ANTHONY, (U.S. CLS. 21, 23, 26, 36 AND 38). SN 76-374,664. PUB. 4-1-2003. FILED 2-21-2002.
- 2,728,762. **IXCORE.** IXIA, (U.S. CLS. 21, 23, 26, 36 AND 38). SN 76-375,894. PUB. 4-1-2003. FILED 2-27-2002.
- 2,728,763 (*See Class 6 for this trademark*).
- 2,728,765. **MEGATHEATER.** CREATIVE TECHNOLOGY LTD., (U.S. CLS. 21, 23, 26, 36 AND 38). SN 76-376,476. PUB. 4-1-2003. FILED 2-25-2002.
- 2,728,766. **RFB&D LEARNING THROUGH LISTENING AND DESIGN.** RECORDING FOR THE BLIND & DYSLEXIC INCORPORATED, (U.S. CLS. 21, 23, 26, 36 AND 38). SN 76-376,589. PUB. 4-1-2003. FILED 3-1-2002.
- 2,728,773 (*See Class 7 for this trademark*).
- 2,728,789. **SOLARBAN.** MONTANA PACIFIC, INC., (U.S. CLS. 21, 23, 26, 36 AND 38). SN 76-383,251. PUB. 4-1-2003. FILED 3-18-2002.
- 2,728,798. **TOWER ESSENTIALS.** MTS, INCORPORATED, MULTIPLE CLASS, (INT. CLS. 9 AND 16), (U.S. CLS. 2, 5, 21, 22, 23, 26, 29, 36, 37, 38 AND 50). SN 76-385,371. PUB. 4-1-2003. FILED 3-21-2002.
- 2,728,803. **MARVAIR.** AIRXCEL, INC., MULTIPLE CLASS, (INT. CLS. 9 AND 11), (U.S. CLS. 13, 21, 23, 26, 31, 34, 36 AND 38). SN 76-388,942. PUB. 4-1-2003. FILED 3-28-2002.
- 2,728,817. **MARK SMART.** ADAPTIVE INDUSTRIES, INC., (U.S. CLS. 21, 23, 26, 36 AND 38). SN 76-395,046. PUB. 4-1-2003. FILED 4-11-2002.
- 2,728,818. **NOFRIENDS.** NOFRIENDS, MULTIPLE CLASS, (INT. CLS. 9 AND 25), (U.S. CLS. 21, 22, 23, 26, 36, 38 AND 39). SN 76-395,374. PUB. 4-1-2003. FILED 4-15-2002.
- 2,728,824. **JETCO.** AUTO-SPARES CANADA INC., MULTIPLE CLASS, (INT. CLS. 9 AND 11), (U.S. CLS. 13, 21, 23, 26, 31, 34, 36 AND 38). SN 76-398,521. PUB. 4-1-2003. FILED 4-22-2002.
- 2,728,842. **FAMILY MESS.** HOUSE OF THE LORD, THE, (U.S. CLS. 21, 23, 26, 36 AND 38). SN 76-405,562. PUB. 4-1-2003. FILED 5-13-2002.
- 2,728,849. **V AND DESIGN.** SLOTZNICK, BENJAMIN, MULTIPLE CLASS, (INT. CLS. 9 AND 38), (U.S. CLS. 21, 23, 26, 36, 38, 100, 101 AND 104). SN 76-407,790. PUB. 4-1-2003. FILED 5-14-2002.
- 2,728,850. **LSI.** LOCKMASTERS, INC., MULTIPLE CLASS, (INT. CLS. 9 AND 41), (U.S. CLS. 21, 23, 26, 36, 38, 100, 101 AND 107). SN 76-407,840. PUB. 4-1-2003. FILED 5-14-2002.
- 2,728,861. **UM AND DESIGN.** UNIMEASURE, INC., (U.S. CLS. 21, 23, 26, 36 AND 38). SN 76-410,176. PUB. 4-1-2003. FILED 5-16-2002.
- 2,728,862. **UNIMEASURE UM AND DESIGN.** UNIMEASURE, INC., (U.S. CLS. 21, 23, 26, 36 AND 38). SN 76-410,177. PUB. 4-1-2003. FILED 5-16-2002.
- 2,728,871. **OPERA ON THE ROCKS.** GROSJEAN, DIAHNE, (U.S. CLS. 21, 23, 26, 36 AND 38). SN 76-414,380. PUB. 4-1-2003. FILED 5-29-2002.
- 2,728,889. **UTILITYCENTER.** UTILITY AUTOMATION INTEGRATORS, INC., (U.S. CLS. 21, 23, 26, 36 AND 38). SN 76-419,826. PUB. 4-1-2003. FILED 6-12-2002.
- 2,728,893. **ARC GUARD.** NATIONAL SAFETY APPAREL, INC., (U.S. CLS. 21, 23, 26, 36 AND 38). SN 76-421,169. PUB. 4-1-2003. FILED 6-12-2002.
- 2,728,899. **MARIMELJ ENTERTAINMENT GROUP AND DESIGN.** MARIMELJ ENTERTAINMENT GROUP, LLC, MULTIPLE CLASS, (INT. CLS. 9 AND 41), (U.S. CLS. 21, 23, 26, 36, 38, 100, 101 AND 107). SN 76-422,997. PUB. 4-1-2003. FILED 6-14-2002.
- 2,728,905. **DISTRIBUTIVE DATADRILL.** DISTRIBUTIVE SOFTWARE, INC., (U.S. CLS. 21, 23, 26, 36 AND 38). SN 76-424,229. PUB. 4-1-2003. FILED 6-24-2002.
- 2,728,912. **THE FLATLANDERS.** THE FLATLANDERS UNLIMITED, LTD., MULTIPLE CLASS, (INT. CLS. 9 AND 41), (U.S. CLS. 21, 23, 26, 36, 38, 100, 101 AND 107). SN 76-426,163. PUB. 4-1-2003. FILED 6-28-2002.
- 2,728,919 (*See Class 7 for this trademark*).
- 2,728,925. **THE ROCK.** POINT BLANK BODY ARMOR, INC., (U.S. CLS. 21, 23, 26, 36 AND 38). SN 76-428,777. PUB. 4-1-2003. FILED 7-1-2002.
- 2,728,931. **INFOTRIEVER.** INFOTRIEVER, INC., (U.S. CLS. 21, 23, 26, 36 AND 38). SN 76-429,444. PUB. 4-1-2003. FILED 7-1-2002.
- 2,728,964. **UNIVERSAL SYSTEM DESIGNS AND DESIGN.** UNIVERSAL SYSTEM DESIGNS, (U.S. CLS. 21, 23, 26, 36 AND 38). SN 76-436,650. PUB. 4-1-2003. FILED 8-1-2002.
- 2,728,967. **TERRAIN BUILDER.** ELECTRONIC CHARTS COMPANY, INC., (U.S. CLS. 21, 23, 26, 36 AND 38). SN 76-437,577. PUB. 4-1-2003. FILED 8-5-2002.
- 2,728,975. **CSG AND DESIGN.** CSG SYSTEMS, INC., MULTIPLE CLASS, (INT. CLS. 9, 35 AND 42), (U.S. CLS. 21, 23, 26, 36, 38, 100, 101 AND 102). SN 76-439,115. PUB. 4-1-2003. FILED 8-9-2002.
- 2,728,976. **CSG.** CSG SYSTEMS, INC., MULTIPLE CLASS, (INT. CLS. 9, 35 AND 42), (U.S. CLS. 21, 23, 26, 36, 38, 100, 101 AND 102). SN 76-439,116. PUB. 4-1-2003. FILED 8-9-2002.
- 2,728,978. **MAKFORCE.** MAKITA U.S.A., INC., (U.S. CLS. 21, 23, 26, 36 AND 38). SN 76-439,231. PUB. 4-1-2003. FILED 8-12-2002.
- 2,728,983. **PLAY WITH THE PROS AS KIDS!** INFOGRAMS, INC., (U.S. CLS. 21, 23, 26, 36 AND 38). SN 76-439,514. PUB. 4-1-2003. FILED 8-8-2002.
- 2,729,031. **TWISTY GIRL.** DUALSTAR ENTERTAINMENT GROUP, LLC, (U.S. CLS. 21, 23, 26, 36 AND 38). SN 76-444,490. PUB. 4-1-2003. FILED 8-26-2002.
- 2,729,032. **N-DEX FREE.** TILLOTSON CORPORATION, AKA BEST MANUFACTURING CO., MULTIPLE CLASS, (INT. CLS. 9 AND 10), (U.S. CLS. 21, 23, 26, 36, 38, 39 AND 44). SN 76-444,546. PUB. 4-1-2003. FILED 8-28-2002.
- 2,729,033. **MAGNETIC GOSPEL BY S&S.** MILANOWSKI, WARREN, (U.S. CLS. 21, 23, 26, 36 AND 38). SN 76-444,632. PUB. 4-1-2003. FILED 8-26-2002.

- 2,729,034. **BILSTEIN B19**. KRUPP BILSTEIN GMBH, MULTIPLE CLASS, (INT. CLS. 9 AND 12), (U.S. CLS. 19, 21, 23, 26, 31, 35, 36, 38 AND 44). SN 76-444,908. PUB. 4-1-2003. FILED 8-19-2002.
- 2,729,040. **PEDESTRIA**. MARKANNA STUDIOS, INC., DBA MVB FONTS, (U.S. CLS. 21, 23, 26, 36 AND 38). SN 76-446,159. PUB. 4-1-2003. FILED 9-4-2002.
- 2,729,041. **FANTABULAR**. MARKANNA STUDIOS, INC., DBA MVB FONTS, (U.S. CLS. 21, 23, 26, 36 AND 38). SN 76-446,160. PUB. 4-1-2003. FILED 9-4-2002.
- 2,729,042. **SIRENNE**. MARKANNA STUDIOS, INC., DBA MVB FONTS, (U.S. CLS. 21, 23, 26, 36 AND 38). SN 76-446,162. PUB. 4-1-2003. FILED 9-4-2002.
- 2,729,043. **SHOT DOT**. UNITED STATES MARKETING CORPORATION, (U.S. CLS. 21, 23, 26, 36 AND 38). SN 76-446,270. PUB. 4-1-2003. FILED 9-3-2002.
- 2,729,046. **NETWORKING PEOPLE WITH INFORMATION**. P2P LINK LLC, MULTIPLE CLASS, (INT. CLS. 9, 35 AND 36), (U.S. CLS. 21, 23, 26, 36, 38, 100, 101 AND 102). SN 76-446,564. PUB. 4-1-2003. FILED 9-3-2002.
- 2,729,049. **COMPLIANCEEASE AND DESIGN**. LOGICEASE SOLUTIONS, INC., (U.S. CLS. 21, 23, 26, 36 AND 38). SN 76-446,660. PUB. 4-1-2003. FILED 9-3-2002.
- 2,729,050. **PDADISCOVERY**. TRUST DIGITAL, LLC, (U.S. CLS. 21, 23, 26, 36 AND 38). SN 76-446,664. PUB. 4-1-2003. FILED 9-3-2002.
- 2,729,066. **DUOVERB**. LINE 6, INC., (U.S. CLS. 21, 23, 26, 36 AND 38). SN 76-448,206. PUB. 4-1-2003. FILED 9-4-2002.
- 2,729,073. **AMERICAN GIRL**. PLEASANT COMPANY, (U.S. CLS. 21, 23, 26, 36 AND 38). SN 76-448,767. PUB. 4-1-2003. FILED 9-12-2002.
- 2,729,078. **BRACING**. GOLDSTEIN, JERRY, DBA "BRACING INTERNATIONAL", (U.S. CLS. 21, 23, 26, 36 AND 38). SN 76-449,771. PUB. 4-1-2003. FILED 9-3-2002.
- 2,729,081. **SCREENARENA**. TIGGON CORPORATION, (U.S. CLS. 21, 23, 26, 36 AND 38). SN 76-449,924. PUB. 4-1-2003. FILED 9-16-2002.
- 2,729,082. **EVERY NATION PRODUCTIONS**. MORNING STAR INTERNATIONAL, INC., MULTIPLE CLASS, (INT. CLS. 9, 16 AND 35), (U.S. CLS. 2, 5, 21, 22, 23, 26, 29, 36, 37, 38, 50, 100, 101 AND 102). SN 76-449,961. PUB. 4-1-2003. FILED 9-16-2002.
- 2,729,083. **ACCESS DENIED!**. WHITEHALL DALLAS CORPORATION, (U.S. CLS. 21, 23, 26, 36 AND 38). SN 76-450,141. PUB. 4-1-2003. FILED 9-16-2002.
- 2,729,084. **DISCSTAQ**. PACIFIC DIGITAL CORPORATION, (U.S. CLS. 21, 23, 26, 36 AND 38). SN 76-450,162. PUB. 4-1-2003. FILED 9-16-2002.
- 2,729,085. **AMTRAK**. NATIONAL RAILROAD PASSENGER CORPORATION, (U.S. CLS. 21, 23, 26, 36 AND 38). SN 76-450,543. PUB. 4-1-2003. FILED 9-12-2002.
- 2,729,089. **FUSIONPOINT**. FUSIONPOINT TECHNOLOGIES CORP., (U.S. CLS. 21, 23, 26, 36 AND 38). SN 76-451,865. PUB. 4-1-2003. FILED 9-23-2002.
- 2,729,119. **INTUIT**. INTUIT INC., (U.S. CLS. 21, 23, 26, 36 AND 38). SN 76-462,271. PUB. 4-1-2003. FILED 10-29-2002.
- 2,729,129. **EASYMOTION**. LUO, JIAN, DBA EASYMOTION.-COM, MULTIPLE CLASS, (INT. CLS. 9 AND 42), (U.S. CLS. 21, 23, 26, 36, 38, 100 AND 101). SN 78-016,184. PUB. 3-11-2003. FILED 7-11-2000.
- 2,729,132. **NEWCHANGE**. NEWCHANGE LTD., MULTIPLE CLASS, (INT. CLS. 9, 16, 35 AND 42), (U.S. CLS. 2, 5, 21, 22, 23, 26, 29, 36, 37, 38, 50, 100, 101 AND 102). SN 78-022,881. PUB. 9-17-2002. FILED 8-24-2000.
- 2,729,135. **DOULOS**. DOULOS LIMITED, MULTIPLE CLASS, (INT. CLS. 9, 16, 41 AND 42), (U.S. CLS. 2, 5, 21, 22, 23, 26, 29, 36, 37, 38, 50, 100, 101 AND 107). SN 78-039,924. PUB. 4-1-2003. FILED 12-19-2000.
- 2,729,137. **VOXBOX**. MANLEY LABORATORIES INCORPORATED, (U.S. CLS. 21, 23, 26, 36 AND 38). SN 78-040,789. PUB. 4-1-2003. FILED 12-27-2000.
- 2,729,143 (See Class 7 for this trademark).
- 2,729,146. **TRICRYPTION ENGINE AND DESIGN**. ERUCES, INC., (U.S. CLS. 21, 23, 26, 36 AND 38). SN 78-079,610. PUB. 4-1-2003. FILED 8-16-2001.
- 2,729,148. **QUICKPRO (STYLIZED)**. INFOPOWER CORPORATION, (U.S. CLS. 21, 23, 26, 36 AND 38). SN 78-084,446. PUB. 4-1-2003. FILED 9-18-2001.
- 2,729,151. **BASSBIN TWINS**. HOUSER, PETE J, (U.S. CLS. 21, 23, 26, 36 AND 38). SN 78-095,387. PUB. 4-1-2003. FILED 11-28-2001.
- 2,729,156. **DESASIM**. DECISION SUPPORT ASSOCIATES, INC., (U.S. CLS. 21, 23, 26, 36 AND 38). SN 78-101,077. PUB. 4-1-2003. FILED 1-5-2002.
- 2,729,158. **AQUARIUSNET**. TERARECON, INC., (U.S. CLS. 21, 23, 26, 36 AND 38). SN 78-102,296. PUB. 4-1-2003. FILED 1-11-2002.
- 2,729,171. **MANAGE EVERYTHING BUT THE WEATHER**. SITE-SPECIFIC TECHNOLOGY DEVELOPMENT GROUP, INC., (U.S. CLS. 21, 23, 26, 36 AND 38). SN 78-112,770. PUB. 4-1-2003. FILED 3-5-2002.
- 2,729,178. **MIND BALANCE**. TROPUS INSTITUTE, INC., (U.S. CLS. 21, 23, 26, 36 AND 38). SN 78-117,206. PUB. 4-1-2003. FILED 3-25-2002.
- 2,729,194. **BANDLINK CD INTELLIGENCE AND DESIGN**. JAVAKITTY MEDIA, INC., (U.S. CLS. 21, 23, 26, 36 AND 38). SN 78-123,641. PUB. 4-1-2003. FILED 4-23-2002.
- 2,729,199. **ECLINICALWORKS**. COCOWEB.COM, LLC, (U.S. CLS. 21, 23, 26, 36 AND 38). SN 78-127,558. PUB. 4-1-2003. FILED 5-9-2002.
- 2,729,209. **SOURCEGATOR**. XCITEC GMBH, (U.S. CLS. 21, 23, 26, 36 AND 38). SN 78-133,546. PUB. 4-1-2003. FILED 6-6-2002.
- 2,729,212. **INVENSYS**. INVENSYS PLC, (U.S. CLS. 21, 23, 26, 36 AND 38). SN 78-135,021. PUB. 4-1-2003. FILED 6-12-2002.
- 2,729,226. **WINROUTE**. KERIO TECHNOLOGIES INC., (U.S. CLS. 21, 23, 26, 36 AND 38). SN 78-140,046. PUB. 4-1-2003. FILED 6-28-2002.
- 2,729,234. **CASHPUMP AND DESIGN**. MERCHANT ATM PARTNERS, MULTIPLE CLASS, (INT. CLS. 9 AND 36), (U.S. CLS. 21, 23, 26, 36, 38, 100, 101 AND 102). SN 78-143,329. PUB. 4-1-2003. FILED 7-12-2002.
- 2,729,244. **ENLIGHT (STYLIZED)**. ENLIGHT CORPORATION, (U.S. CLS. 21, 23, 26, 36 AND 38). SN 78-145,945. PUB. 4-1-2003. FILED 7-20-2002.
- 2,729,253. **SERVOCAM**. AMT MACHINE SYSTEMS LTD., (U.S. CLS. 21, 23, 26, 36 AND 38). SN 78-146,908. PUB. 4-1-2003. FILED 7-24-2002.
- 2,729,255. **MUVO**. CREATIVE TECHNOLOGY LTD., (U.S. CLS. 21, 23, 26, 36 AND 38). SN 78-146,946. PUB. 4-1-2003. FILED 7-24-2002.
- 2,729,262. **XMLSP**. COMPUTER TECHNOLOGY INC., (U.S. CLS. 21, 23, 26, 36 AND 38). SN 78-149,035. PUB. 4-1-2003. FILED 7-30-2002.
- 2,729,270. **LITELOCK**. NUVISIONS INTERNATIONAL, INC., (U.S. CLS. 21, 23, 26, 36 AND 38). SN 78-151,904. PUB. 4-1-2003. FILED 8-7-2002.
- 2,729,274. **TRANSITFOLIO**. RISK LABORATORIES, (U.S. CLS. 21, 23, 26, 36 AND 38). SN 78-152,091. PUB. 4-1-2003. FILED 8-7-2002.
- 2,729,288. **SHARK BAIT**. FORMATION TECHNOLOGIES, (U.S. CLS. 21, 23, 26, 36 AND 38). SN 78-154,729. PUB. 4-1-2003. FILED 8-15-2002.
- 2,729,300. **SIDEWINDER**. INNOVATIVE SOLUTIONS AND TECHNOLOGIES, LLC, (U.S. CLS. 21, 23, 26, 36 AND 38). SN 78-155,280. PUB. 4-1-2003. FILED 8-18-2002.
- 2,729,316. **THUNDER AND DESIGN**. APACHE TECHNOLOGIES, INC., (U.S. CLS. 21, 23, 26, 36 AND 38). SN 78-157,135. PUB. 4-1-2003. FILED 8-23-2002.
- 2,729,319. **GIST**. GIST COMMUNICATIONS, INC., (U.S. CLS. 21, 23, 26, 36 AND 38). SN 78-158,295. PUB. 4-1-2003. FILED 8-27-2002.
- 2,729,332. **XCOMPRESS**. POST POINT SOFTWARE, INC., (U.S. CLS. 21, 23, 26, 36 AND 38). SN 78-158,941. PUB. 4-1-2003. FILED 8-28-2002.
- 2,729,336. **RAINCONNECT**. RAINFINITY, (U.S. CLS. 21, 23, 26, 36 AND 38). SN 78-159,432. PUB. 4-1-2003. FILED 8-29-2002.
- 2,729,337. **PRO WARRINGTON**. NORCROSS SAFETY PRODUCTS, L.L.C., (U.S. CLS. 21, 23, 26, 36 AND 38). SN 78-159,512. PUB. 4-1-2003. FILED 8-30-2002.
- 2,729,357. **DELTAHITE**. EMINENCE SPEAKER LLC, (U.S. CLS. 21, 23, 26, 36 AND 38). SN 78-165,961. PUB. 4-1-2003. FILED 9-19-2002.
- 2,729,359. **INTUIT**. INTUIT INC., (U.S. CLS. 21, 23, 26, 36 AND 38). SN 78-178,237. PUB. 4-1-2003. FILED 10-24-2002.

CLASS 10—MEDICAL APPARATUS

- 2,728,533 (*See Class 9 for this trademark*).
 2,728,600. **MISIS**. CO.DON AKTIENGESELLSCHAFT, MULTIPLE CLASS, (INT. CLS. 10, 40 AND 42), (U.S. CLS. 26, 39, 44, 100, 101, 103 AND 106). SN 76-215,938. PUB. 4-1-2003. FILED 2-26-2001.
 2,728,748. **PACE**. SIEMENS AKTIENGESELLSCHAFT, (U.S. CLS. 26, 39 AND 44). SN 76-371,216. PUB. 9-17-2002. FILED 2-14-2002.
 2,728,749. **VERSATOOL**. M-PACT WORLDWIDE L.L.C., (U.S. CLS. 26, 39 AND 44). SN 76-371,263. PUB. 4-1-2003. FILED 2-19-2002.
 2,728,847. **MONOMID BLUE**. CP MEDICAL, (U.S. CLS. 26, 39 AND 44). SN 76-406,682. PUB. 4-1-2003. FILED 5-10-2002.
 2,729,032 (*See Class 9 for this trademark*).
 2,729,087. **MISCELLANEOUS DESIGN**. TOMY INCORPORATED, (U.S. CLS. 26, 39 AND 44). SN 76-451,384. PUB. 4-1-2003. FILED 9-20-2002.
 2,729,093. **PROTECTING THOSE WHO SERVE AND PROTECT US**. DIGITCARE CORPORATION, (U.S. CLS. 26, 39 AND 44). SN 76-452,300. PUB. 4-1-2003. FILED 9-23-2002.
 2,729,113. **MISCELLANEOUS DESIGN**. STARKEY LABORATORIES, INC., (U.S. CLS. 26, 39 AND 44). SN 76-455,850. PUB. 4-1-2003. FILED 10-4-2002.
 2,729,114. **ACCOLADE**. STARKEY LABORATORIES, INC., (U.S. CLS. 26, 39 AND 44). SN 76-455,851. PUB. 4-1-2003. FILED 10-4-2002.
 2,729,116. **SOUNDSTREAM AND DESIGN**. STARKEY LABORATORIES, INC., (U.S. CLS. 26, 39 AND 44). SN 76-455,855. PUB. 4-1-2003. FILED 10-4-2002.
 2,729,117. **SOUNDSTREAM**. STARKEY LABORATORIES, INC., (U.S. CLS. 26, 39 AND 44). SN 76-455,856. PUB. 4-1-2003. FILED 10-4-2002.
 2,729,190. **SATINEDGE**. ALCON UNIVERSAL LTD., (U.S. CLS. 26, 39 AND 44). SN 78-122,248. PUB. 4-1-2003. FILED 4-17-2002.
 2,729,275. **TNR**. COMBY, MULTIPLE CLASS, (INT. CLS. 10 AND 16), (U.S. CLS. 2, 5, 22, 23, 26, 29, 37, 38, 39, 44 AND 50). SN 78-152,097. PUB. 4-1-2003. FILED 8-7-2002.
 2,729,292. **FLEX-NECK**. JANIN GROUP, INC., (U.S. CLS. 26, 39 AND 44). SN 78-154,991. PUB. 4-1-2003. FILED 8-16-2002.
 2,729,308. **UNISON**. SPINAL CONCEPTS, INC., (U.S. CLS. 26, 39 AND 44). SN 78-156,428. PUB. 4-1-2003. FILED 8-21-2002.

CLASS 11—ENVIRONMENTAL CONTROL APPARATUS

- 2,728,464 (*See Class 5 for this trademark*).
 2,728,493 (*See Class 3 for this trademark*).
 2,728,507 (*See Class 1 for this trademark*).
 2,728,533 (*See Class 9 for this trademark*).
 2,728,567 (*See Class 6 for this trademark*).
 2,728,612. **JOHNCO**. JOHN MANUFACTURING LTD., (U.S. CLS. 13, 21, 23, 31 AND 34). SN 76-242,512. PUB. 4-1-2003. FILED 4-19-2001.
 2,728,646 (*See Class 7 for this trademark*).
 2,728,657. **ELECTRA**. LUMISOURCE, INC., (U.S. CLS. 13, 21, 23, 31 AND 34). SN 76-303,029. PUB. 4-1-2003. FILED 8-17-2001.
 2,728,704 (*See Class 7 for this trademark*).
 2,728,707. **VINIDOR**. LIEBHERR-HOLDING GMBH, (U.S. CLS. 13, 21, 23, 31 AND 34). SN 76-349,654. PUB. 4-1-2003. FILED 12-19-2001.
 2,728,725 (*See Class 1 for this trademark*).
 2,728,727. **SEITZSCHENK-SUPRADISC**. SEITZSCHENK FILTERSYSTEMS GMBH, (U.S. CLS. 13, 21, 23, 31 AND 34). SN 76-359,723. PUB. 4-1-2003. FILED 1-17-2002.
 2,728,755. **ADESSO AND DESIGN**. ADESSO INC., MULTIPLE CLASS, (INT. CLS. 11 AND 20), (U.S. CLS. 2, 13, 21, 22, 23, 25, 31, 32, 34 AND 50). SN 76-373,732. PUB. 4-1-2003. FILED 2-20-2002.
 2,728,773 (*See Class 7 for this trademark*).
 2,728,793. **PEERLESS**. PEERLESS HEATER COMPANY, INC., (U.S. CLS. 13, 21, 23, 31 AND 34). SN 76-384,412. PUB. 4-1-2003. FILED 3-18-2002.

- 2,728,794. **SURE SEAL**. SURE-SEAL, LLC, (U.S. CLS. 13, 21, 23, 31 AND 34). SN 76-384,474. PUB. 4-1-2003. FILED 3-19-2002.
 2,728,803 (*See Class 9 for this trademark*).
 2,728,824 (*See Class 9 for this trademark*).
 2,728,830. **SLAMMER**. ALPINE STORMWATER MANAGEMENT COMPANY, (U.S. CLS. 13, 21, 23, 31 AND 34). SN 76-401,893. PUB. 4-1-2003. FILED 4-30-2002.
 2,728,836. **KABOLA**. KABOLA HEATING SYSTEMS MACHINEFABRIEK GEBS. POST BV, (U.S. CLS. 13, 21, 23, 31 AND 34). SN 76-403,570. PUB. 4-1-2003. FILED 5-3-2002.
 2,728,966. **SPA KING**. AIR SUPPLY INTERNATIONAL PTY LTD, (U.S. CLS. 13, 21, 23, 31 AND 34). SN 76-437,345. PUB. 4-1-2003. FILED 8-5-2002.
 2,729,136 (*See Class 7 for this trademark*).
 2,729,168. **M MERIT ORIGINALS AND DESIGN**. GLENWOOD DESIGNS, (U.S. CLS. 13, 21, 23, 31 AND 34). SN 78-109,701. PUB. 4-1-2003. FILED 2-19-2002.
 2,729,173. **LUNAR ACCENTS (STYLIZED)**. MELVILLE, JOSHUA K., (U.S. CLS. 13, 21, 23, 31 AND 34). SN 78-114,224. PUB. 4-1-2003. FILED 3-12-2002.
 2,729,233. **ROOF OVER VENT-A-RIDGE**. ALCOA INC., (U.S. CLS. 13, 21, 23, 31 AND 34). SN 78-143,302. PUB. 4-1-2003. FILED 7-12-2002.
 2,729,348. **THE WELLESLEY**. HUNTER FAN COMPANY, (U.S. CLS. 13, 21, 23, 31 AND 34). SN 78-163,579. PUB. 4-1-2003. FILED 9-12-2002.
 2,729,355. **CUISINART**. CONAIRCIP, INC., (U.S. CLS. 13, 21, 23, 31 AND 34). SN 78-165,715. PUB. 4-1-2003. FILED 9-19-2002.

CLASS 12—VEHICLES

- 2,728,523 (*See Class 6 for this trademark*).
 2,728,533 (*See Class 9 for this trademark*).
 2,728,574. **SKAMPER LITE**. THOR TECH, INC., (U.S. CLS. 19, 21, 23, 31, 35 AND 44). SN 76-157,859. PUB. 7-9-2002. FILED 11-1-2000.
 2,728,595. **STILO**. FIAT AUTO S.P.A., (U.S. CLS. 19, 21, 23, 31, 35 AND 44). SN 76-209,276. PUB. 4-1-2003. FILED 2-13-2001.
 2,728,646 (*See Class 7 for this trademark*).
 2,728,736. **S 63**. DAIMLERCHRYSLER AG, MULTIPLE CLASS, (INT. CLS. 12, 28 AND 37), (U.S. CLS. 19, 21, 22, 23, 31, 35, 38, 44, 50, 100, 103 AND 106). SN 76-364,011. PUB. 4-1-2003. FILED 1-25-2002.
 2,728,877. **X-SERIES**. VOLVO PENTA OF THE AMERICAS, INC., (U.S. CLS. 19, 21, 23, 31, 35 AND 44). SN 76-416,355. PUB. 4-1-2003. FILED 6-3-2002.
 2,728,910. **CONTAINMOBILE**. L&P PROPERTY MANAGEMENT COMPANY, (U.S. CLS. 19, 21, 23, 31, 35 AND 44). SN 76-424,493. PUB. 4-1-2003. FILED 6-24-2002.
 2,728,955. **GYMBOREE**. GYM-MARK, INC., MULTIPLE CLASS, (INT. CLS. 12, 21, 22 AND 26), (U.S. CLS. 1, 2, 7, 13, 19, 21, 22, 23, 29, 30, 31, 33, 35, 37, 39, 40, 42, 44 AND 50). SN 76-435,091. PUB. 4-1-2003. FILED 7-24-2002.
 2,728,989. **FOAMAIR**. FLA ORTHOPEDICS, INC., (U.S. CLS. 19, 21, 23, 31, 35 AND 44). SN 76-441,359. PUB. 4-1-2003. FILED 8-19-2002.
 2,728,991. **NORTHCOAST**. C & C FIBERGLASS COMPONENTS, INC., (U.S. CLS. 19, 21, 23, 31, 35 AND 44). SN 76-441,537. PUB. 4-1-2003. FILED 8-19-2002.
 2,728,999. **STARHAULER**. STARCRAFT CORPORATION, (U.S. CLS. 19, 21, 23, 31, 35 AND 44). SN 76-442,248. PUB. 4-1-2003. FILED 8-21-2002.
 2,729,034 (*See Class 9 for this trademark*).
 2,729,141. **Q BABY AND DESIGN**. SUN TOME TRADING CORP., (U.S. CLS. 19, 21, 23, 31, 35 AND 44). SN 78-059,420. PUB. 4-1-2003. FILED 4-20-2001.
 2,729,179. **MICRO AND DESIGN**. HUFFY CORPORATION, (U.S. CLS. 19, 21, 23, 31, 35 AND 44). SN 78-117,461. PUB. 4-1-2003. FILED 3-26-2002.
 2,729,278. **SNIPER**. PACIFIC CYCLE, LLC, (U.S. CLS. 19, 21, 23, 31, 35 AND 44). SN 78-152,279. PUB. 4-1-2003. FILED 8-8-2002.
 2,729,279. **JOYRIDER**. PACIFIC CYCLE, LLC, (U.S. CLS. 19, 21, 23, 31, 35 AND 44). SN 78-152,281. PUB. 4-1-2003. FILED

- 8-8-2002.
 2,729,281. **3 FASTECH AND DESIGN**. PORTER, INC., (U.S. CLS. 19, 21, 23, 31, 35 AND 44). SN 78-153,444. PUB. 4-1-2003. FILED 8-12-2002.
 2,729,291. **KING RANCH**. KING RANCH, INC., (U.S. CLS. 19, 21, 23, 31, 35 AND 44). SN 78-154,980. PUB. 4-1-2003. FILED 8-16-2002.
 2,729,351. **WEATHERLOCK**. AUTO GLASS COMPONENTS, INC., (U.S. CLS. 19, 21, 23, 31, 35 AND 44). SN 78-164,533. PUB. 4-1-2003. FILED 9-16-2002.

CLASS 14—JEWELRY

- 2,728,493 (*See Class 3 for this trademark*).
 2,728,500 (*See Class 9 for this trademark*).
 2,728,501 (*See Class 9 for this trademark*).
 2,728,502 (*See Class 9 for this trademark*).
 2,728,503 (*See Class 9 for this trademark*).
 2,728,567 (*See Class 6 for this trademark*).
 2,728,594. **OTAZU**. CORREA, LUIS RODRIGO, TA OTAZU, (U.S. CLS. 2, 27, 28 AND 50). SN 76-203,182. PUB. 4-1-2003. FILED 1-30-2001.
 2,728,626. **MISCELLANEOUS DESIGN**. DESIGNS BY THE SEA, INC., (U.S. CLS. 2, 27, 28 AND 50). SN 76-259,249. PUB. 4-1-2003. FILED 5-21-2001.
 2,728,636. **CLEARLY SUPERIOR KRISTALL THE DIAMONDS OF RUSSIA AND DESIGN**. KRISTALL JEWELER, INC., BY ASSIGNMENT GEMDIAM CORP., (U.S. CLS. 2, 27, 28 AND 50). SN 76-275,014. PUB. 4-1-2003. FILED 6-22-2001.
 2,728,853. **EMBRACEABLES EMBRACE YOUR PROMISE AND DESIGN**. SANDBERG & SIKORSKI DIAMOND CORP., (U.S. CLS. 2, 27, 28 AND 50). SN 76-409,106. PUB. 4-1-2003. FILED 5-16-2002.
 2,728,916. **STUDIO 311**. ABERLE, KATHERINE J., (U.S. CLS. 2, 27, 28 AND 50). SN 76-426,886. PUB. 4-1-2003. FILED 6-27-2002.

CLASS 15—MUSICAL INSTRUMENTS

- 2,728,493 (*See Class 3 for this trademark*).
 2,729,010. **WERIL AND DESIGN**. WERIL INSTRUMENTOS MUSICAIS LTDA., (U.S. CLS. 2, 21 AND 36). SN 76-443,036. PUB. 4-1-2003. FILED 8-22-2002.
 2,729,011. **WERIL TOQUE COM EMOCAO AND DESIGN**. WERIL INSTRUMENTOS MUSICAIS LTDA., (U.S. CLS. 2, 21 AND 36). SN 76-443,037. PUB. 4-1-2003. FILED 8-22-2002.
 2,729,028. **SUMMER OF LOVE**. EVETS CORPORATION, (U.S. CLS. 2, 21 AND 36). SN 76-444,022. PUB. 4-1-2003. FILED 8-27-2002.
 2,729,349. **TWANG**. MAROTTA, FRED, DBA THE REPAIR ZONE, (U.S. CLS. 2, 21 AND 36). SN 78-164,129. PUB. 4-1-2003. FILED 9-13-2002.

CLASS 16—PAPER GOODS AND PRINTED MATTER

- 2,728,459 (*See Class 9 for this trademark*).
 2,728,461. **REWARDS RESULTS KNOWLEDGE**. LOYALTY MANAGEMENT GROUP CANADA INC., MULTIPLE CLASS, (INT. CLS. 16, 25, 35, 39 AND 42), (U.S. CLS. 2, 5, 22, 23, 29, 37, 38, 39, 50, 100, 101, 102 AND 105). SN 75-478,137. PUB. 4-1-2003. FILED 4-30-1998.
 2,728,462 (*See Class 1 for this trademark*).
 2,728,463. **LAURENT-PERRIER**. LAURENT-PERRIER, BY CHANGE OF NAME VVE LAURENT-PERRIER & CO., MULTIPLE CLASS, (INT. CLS. 16, 38 AND 42), (U.S. CLS. 2, 5, 22, 23, 29, 37, 38, 39, 50, 100, 101 AND 104). SN 75-499,842. PUB. 6-11-2002. FILED 6-10-1998.
 2,728,466. **WORLDSAVERS**. YOUNG, ALEX L, DBA NARS (NATIONAL ACADEMIC RESEARCH SERVICES) DBA

- WORLDSAVERS**, MULTIPLE CLASS, (INT. CLS. 16 AND 35), (U.S. CLS. 2, 5, 22, 23, 29, 37, 38, 50, 100, 101 AND 102). SN 75-577,497. PUB. 4-1-2003. FILED 10-26-1998.
 2,728,469. **WALL STREET INSTITUTE AND DESIGN**. WALL STREET INSTITUTE KFT, MULTIPLE CLASS, (INT. CLS. 16 AND 41), (U.S. CLS. 2, 5, 22, 23, 29, 37, 38, 50, 100, 101 AND 107). SN 75-583,301. PUB. 8-31-1999. FILED 11-5-1998.
 2,728,493 (*See Class 3 for this trademark*).
 2,728,499. **K/P CORPORATION**. K/P CORPORATION, MULTIPLE CLASS, (INT. CLS. 16, 25, 35 AND 42), (U.S. CLS. 2, 5, 22, 23, 29, 37, 38, 39, 50, 100, 101 AND 102). SN 75-862,568. PUB. 4-1-2003. FILED 12-2-1999.
 2,728,500 (*See Class 9 for this trademark*).
 2,728,501 (*See Class 9 for this trademark*).
 2,728,502 (*See Class 9 for this trademark*).
 2,728,503 (*See Class 9 for this trademark*).
 2,728,506 (*See Class 9 for this trademark*).
 2,728,507 (*See Class 1 for this trademark*).
 2,728,510. **DREAMS COME TRUE**. TAMBORINE ENTERTAINMENT AMERICA, INC., BY ASSIGNMENT MS ARTIST PRODUCTS, INC., MULTIPLE CLASS, (INT. CLS. 16 AND 41), (U.S. CLS. 2, 5, 22, 23, 29, 37, 38, 50, 100, 101 AND 107). SN 75-923,574. PUB. 4-1-2003. FILED 2-22-2000.
 2,728,516. **BRADY CAMPAIGN TO PREVENT GUN VIOLENCE**. BRADY CAMPAIGN TO PREVENT GUN VIOLENCE, BY CHANGE OF NAME HANDGUN CONTROL, INC., MULTIPLE CLASS, (INT. CLS. 16, 18, 21, 25, 26, 36 AND 42), (U.S. CLS. 1, 2, 3, 5, 13, 22, 23, 29, 30, 33, 37, 38, 39, 40, 41, 42, 50, 100, 101 AND 102). SN 75-982,390. PUB. 4-1-2003. FILED 4-25-2001.
 2,728,528 (*See Class 5 for this trademark*).
 2,728,547. **READY SET SELL**. WONG, SHARON M., DBA READY SET SELL, MULTIPLE CLASS, (INT. CLS. 16 AND 42), (U.S. CLS. 2, 5, 22, 23, 29, 37, 38, 50, 100 AND 101). SN 76-096,044. PUB. 4-1-2003. FILED 7-25-2000.
 2,728,554 (*See Class 2 for this trademark*).
 2,728,555 (*See Class 2 for this trademark*).
 2,728,573. **YADA YADA YADA!**. OBLIO TELECOM, INC., (U.S. CLS. 2, 5, 22, 23, 29, 37, 38 AND 50). SN 76-155,249. PUB. 4-1-2003. FILED 10-30-2000.
 2,728,577 (*See Class 9 for this trademark*).
 2,728,588. **COMMUNITY VOICES: HEALTHCARE FOR THE UNDERSERVED**. W.K. KELLOGG FOUNDATION, MULTIPLE CLASS, (INT. CLS. 16, 36, 41 AND 42), (U.S. CLS. 2, 5, 22, 23, 29, 37, 38, 50, 100, 101, 102 AND 107). SN 76-190,163. PUB. 4-1-2003. FILED 1-5-2001.
 2,728,591 (*See Class 9 for this trademark*).
 2,728,597. **ADOPT A GRANNY**. HELP THE AGED, MULTIPLE CLASS, (INT. CLS. 16 AND 36), (U.S. CLS. 2, 5, 22, 23, 29, 37, 38, 50, 100, 101 AND 102). SN 76-212,368. PUB. 4-1-2003. FILED 2-20-2001.
 2,728,603 (*See Class 9 for this trademark*).
 2,728,616 (*See Class 9 for this trademark*).
 2,728,619. **NAILPRO (STYLIZED)**. CREATIVE AGE PUBLICATIONS, INC., (U.S. CLS. 2, 5, 22, 23, 29, 37, 38 AND 50). SN 76-249,316. PUB. 4-1-2003. FILED S.R. 5-1-2001; AM. P.R. 1-8-2003.
 2,728,621. **ELECTRO COATED ABRASIVE DOLPHINS PACO AND DESIGN**. PACO CORPORATION, (U.S. CLS. 2, 5, 22, 23, 29, 37, 38 AND 50). SN 76-251,741. PUB. 4-1-2003. FILED 5-4-2001.
 2,728,624 (*See Class 9 for this trademark*).
 2,728,662. **FRONT ROW**. MASSACHUSETTS FINANCIAL SERVICES COMPANY, (U.S. CLS. 2, 5, 22, 23, 29, 37, 38 AND 50). SN 76-309,176. PUB. 4-1-2003. FILED 9-5-2001.
 2,728,670. **SMART INVENTIONS**. SMART INVENTIONS, INC., MULTIPLE CLASS, (INT. CLS. 16, 21, 24 AND 35), (U.S. CLS. 2, 5, 13, 22, 23, 29, 30, 33, 37, 38, 40, 42, 50, 100, 101 AND 102). SN 76-316,860. PUB. 4-1-2003. FILED 9-24-2001.
 2,728,684. **PROTAB**. HOLMBERG COMPANY, INC., (U.S. CLS. 2, 5, 22, 23, 29, 37, 38 AND 50). SN 76-324,094. PUB. 4-1-2003. FILED 10-9-2001.
 2,728,690. **CORRECTIONAL FOODSERVICE AND DESIGN**. INTERNATIONAL PUBLISHING CO. OF AMERICA, INC., (U.S. CLS. 2, 5, 22, 23, 29, 37, 38 AND 50). SN 76-333,814. PUB. 4-1-2003. FILED 11-6-2001.
 2,728,699. **MISCELLANEOUS DESIGN**. AF2 ENTERPRISES

- LLC, (U.S. CLS. 2, 5, 22, 23, 29, 37, 38 AND 50). SN 76-346,660. PUB. 4-1-2003. FILED 12-10-2001.
- 2,728,705. **WILLY WYP'S. JOHN MCLURE PTY LTD., TA IFX W.A.**, (U.S. CLS. 2, 5, 22, 23, 29, 37, 38 AND 50). SN 76-348,775. PUB. 4-1-2003. FILED 12-13-2001.
- 2,728,740. **ANNALS OF INTERNAL MEDICINE. AMERICAN COLLEGE OF PHYSICIANS -AMERICAN SOCIETY OF INTERNAL MEDICINE**, (U.S. CLS. 2, 5, 22, 23, 29, 37, 38 AND 50). SN 76-366,392. PUB. 4-1-2003. FILED 2-4-2002.
- 2,728,767. **FLAVIA. FLAVIA'S LEGACY, LLC**, (U.S. CLS. 2, 5, 22, 23, 29, 37, 38 AND 50). SN 76-377,272. PUB. 4-1-2003. FILED 3-1-2002.
- 2,728,786. **DAZZLEPAK. BLUE RIDGE PAPER PRODUCTS, INC.**, (U.S. CLS. 2, 5, 22, 23, 29, 37, 38 AND 50). SN 76-381,500. PUB. 4-1-2003. FILED 3-12-2002.
- 2,728,798 (*See Class 9 for this trademark*).
- 2,728,807. **LA MONARCA TARJETA TELEFONICA. WEST VISTA COMMUNICATIONS INC.**, (U.S. CLS. 2, 5, 22, 23, 29, 37, 38 AND 50). SN 76-390,735. PUB. 4-1-2003. FILED 4-1-2002.
- 2,728,814. **THE ACADEMY OF ELECTRICAL CONTRACTING. NATIONAL ELECTRICAL CONTRACTORS ASSOCIATION, MULTIPLE CLASS, (INT. CL. 16 AND U.S. CL. 200)**, (U.S. CLS. 2, 5, 22, 23, 29, 37, 38 AND 50). SN 76-393,858. PUB. 4-1-2003. FILED 4-11-2002.
- 2,728,860. **FOLDED EMOTION AND DESIGN. GRAHAM, GIA A.**, (U.S. CLS. 2, 5, 22, 23, 29, 37, 38 AND 50). SN 76-410,150. PUB. 4-1-2003. FILED 5-21-2002.
- 2,728,865. **THANK GOODNESS FOR KLEENEX TISSUE. KIMBERLY-CLARK CORPORATION**, (U.S. CLS. 2, 5, 22, 23, 29, 37, 38 AND 50). SN 76-411,238. PUB. 4-1-2003. FILED 5-20-2002.
- 2,728,870. **TANGO TWIRL. TANGO TWIRL CO.**, (U.S. CLS. 2, 5, 22, 23, 29, 37, 38 AND 50). SN 76-414,078. PUB. 4-1-2003. FILED 6-3-2002.
- 2,728,876. **OPS. KEENE SANITARY SUPPLY, INC.**, (U.S. CLS. 2, 5, 22, 23, 29, 37, 38 AND 50). SN 76-416,310. PUB. 4-1-2003. FILED 6-3-2002.
- 2,728,880. **DETAILS. FAIRCHILD PUBLICATIONS INC.**, (U.S. CLS. 2, 5, 22, 23, 29, 37, 38 AND 50). SN 76-417,248. PUB. 4-1-2003. FILED 4-24-2002.
- 2,728,894. **MDC ADVISOR. IMDISI, INC.**, (U.S. CLS. 2, 5, 22, 23, 29, 37, 38 AND 50). SN 76-421,433. PUB. 4-1-2003. FILED 6-14-2002.
- 2,728,903. **SOFT TAILS AND DESIGN. ABS LICENSE, S.A. DE C.V.**, (U.S. CLS. 2, 5, 22, 23, 29, 37, 38 AND 50). SN 76-423,797. PUB. 3-4-2003. FILED 6-21-2002.
- 2,728,924. **SCHOLASTIC ADMINISTR@TOR SOLUTIONS FOR TODAY'S ED-TECH LEADERS (STYLIZED), SCHOLASTIC INC.**, (U.S. CLS. 2, 5, 22, 23, 29, 37, 38 AND 50). SN 76-428,649. PUB. 4-1-2003. FILED 7-2-2002.
- 2,728,958. **ALLOYGIRL. ALLOY, INC.**, (U.S. CLS. 2, 5, 22, 23, 29, 37, 38 AND 50). SN 76-435,390. PUB. 4-1-2003. FILED 7-29-2002.
- 2,728,959. **RAYSTONE RECORDS. RAYSTONE PRODUCTIONS, INC.**, (U.S. CLS. 2, 5, 22, 23, 29, 37, 38 AND 50). SN 76-435,511. PUB. 4-1-2003. FILED 7-29-2002.
- 2,728,962. **COLLEGE 4 YOU. CFAS, L.L.C.**, (U.S. CLS. 2, 5, 22, 23, 29, 37, 38 AND 50). SN 76-435,813. PUB. 4-1-2003. FILED 7-30-2002.
- 2,728,973. **ALA EDITIONS. AMERICAN LIBRARY ASSOCIATION**, (U.S. CLS. 2, 5, 22, 23, 29, 37, 38 AND 50). SN 76-439,001. PUB. 4-1-2003. FILED 8-9-2002.
- 2,728,994. **H HINKLEY AFTERHOURS DESIGN ILLUMINATE ENJOY AND DESIGN. HINKLEY LIGHTING INCORPORATED**, (U.S. CLS. 2, 5, 22, 23, 29, 37, 38 AND 50). SN 76-441,706. PUB. 4-1-2003. FILED 8-20-2002.
- 2,728,998. **BITTY BEAR'S BUNCH. PLEASANT COMPANY, MULTIPLE CLASS, (INT. CLS. 16 AND 28)**, (U.S. CLS. 2, 5, 22, 23, 29, 37, 38 AND 50). SN 76-442,180. PUB. 4-1-2003. FILED 8-15-2002.
- 2,729,017. **YEAR-IN-A-FRAME. THE MEAD CORPORATION**, (U.S. CLS. 2, 5, 22, 23, 29, 37, 38 AND 50). SN 76-443,445. PUB. 4-1-2003. FILED 8-23-2002.
- 2,729,035. **SAN DIEGO HOME/GARDEN. MCKINNON ENTERPRISES**, (U.S. CLS. 2, 5, 22, 23, 29, 37, 38 AND 50). SN 76-445,040. PUB. 4-1-2003. FILED 8-29-2002.
- 2,729,038. **INSTANT INFUSION. NAVIDI, NOOSHIN**, (U.S. CLS. 2, 5, 22, 23, 29, 37, 38 AND 50). SN 76-445,722. PUB. 4-1-2003. FILED 8-30-2002.
- 2,729,051. **COMMAND. 3M COMPANY, MULTIPLE CLASS, (INT. CLS. 16 AND 26)**, (U.S. CLS. 2, 5, 22, 23, 29, 37, 38, 39, 40, 42 AND 50). SN 76-446,709. PUB. 4-1-2003. FILED 9-4-2002.
- 2,729,082 (*See Class 9 for this trademark*).
- 2,729,122. **INTUIT. INTUIT INC.**, (U.S. CLS. 2, 5, 22, 23, 29, 37, 38 AND 50). SN 76-464,192. PUB. 4-1-2003. FILED 11-4-2002.
- 2,729,128. **EWORLD. INTERNATIONAL DATA GROUP, INC., MULTIPLE CLASS, (INT. CLS. 16 AND 42)**, (U.S. CLS. 2, 5, 22, 23, 29, 37, 38, 50, 100 AND 101). SN 78-005,333. PUB. 4-1-2003. FILED 4-24-2000.
- 2,729,130. **COMPUTERWORLD ROI. INTERNATIONAL DATA GROUP, INC.**, (U.S. CLS. 2, 5, 22, 23, 29, 37, 38 AND 50). SN 78-019,303. PUB. 4-1-2003. FILED 8-2-2000.
- 2,729,132 (*See Class 9 for this trademark*).
- 2,729,135 (*See Class 9 for this trademark*).
- 2,729,139. **MASS MUTINY AND DESIGN. MASSACHUSETTS MUTINY, MULTIPLE CLASS, (INT. CLS. 16 AND 25)**, (U.S. CLS. 2, 5, 22, 23, 29, 37, 38, 39 AND 50). SN 78-057,079. PUB. 1-21-2003. FILED 4-5-2001.
- 2,729,149. **POLICETECH (STYLIZED). BLAKELY, TIMOTHY D.**, (U.S. CLS. 2, 5, 22, 23, 29, 37, 38 AND 50). SN 78-090,292. PUB. 4-1-2003. FILED 10-26-2001.
- 2,729,165. **DIBELS. DYNAMIC MEASUREMENT GROUP, INC.**, (U.S. CLS. 2, 5, 22, 23, 29, 37, 38 AND 50). SN 78-108,626. PUB. 4-1-2003. FILED 2-13-2002.
- 2,729,182. **ALLEY CAT ALLIES. ALLEY CAT ALLIES, MULTIPLE CLASS, (INT. CLS. 16, 35, 41 AND 44)**, (U.S. CLS. 2, 5, 22, 23, 29, 37, 38, 50, 100, 101, 102 AND 107). SN 78-118,389. PUB. 4-1-2003. FILED 3-29-2002.
- 2,729,185. **DEFENSIVE EATING. BELLRINGER SUPPLY CORPORATION**, (U.S. CLS. 2, 5, 22, 23, 29, 37, 38 AND 50). SN 78-119,232. PUB. 4-1-2003. FILED 4-3-2002.
- 2,729,246. **CHEVRONTEXACO. CHEVRONTEXACO CORPORATION**, (U.S. CLS. 2, 5, 22, 23, 29, 37, 38 AND 50). SN 78-146,317. PUB. 4-1-2003. FILED 7-23-2002.
- 2,729,251. **HINT OF TINT ON THE EDGE. DISCOUNT OPTICS, INC.**, (U.S. CLS. 2, 5, 22, 23, 29, 37, 38 AND 50). SN 78-146,759. PUB. 4-1-2003. FILED 7-23-2002.
- 2,729,265. **DEADLINE. MARVEL CHARACTERS, INC.**, (U.S. CLS. 2, 5, 22, 23, 29, 37, 38 AND 50). SN 78-151,782. PUB. 4-1-2003. FILED 8-7-2002.
- 2,729,267. **MISCELLANEOUS DESIGN. CLEARSNAP, INC.**, (U.S. CLS. 2, 5, 22, 23, 29, 37, 38 AND 50). SN 78-151,812. PUB. 4-1-2003. FILED 8-7-2002.
- 2,729,272. **S.W.A.X] AND DESIGN. STOLTZ, DENA K., DBA APEX INNOVATIONS**, (U.S. CLS. 2, 5, 22, 23, 29, 37, 38 AND 50). SN 78-151,958. PUB. 4-1-2003. FILED 8-7-2002.
- 2,729,275 (*See Class 10 for this trademark*).
- 2,729,304. **FELITTLE PEOPLE. KHOJA, FELICIA, S.**, (U.S. CLS. 2, 5, 22, 23, 29, 37, 38 AND 50). SN 78-155,750. PUB. 4-1-2003. FILED 8-20-2002.
- 2,729,309. **THE ICE STAND UP STAPLER AND DESIGN. HUNT HOLDINGS, INC.**, (U.S. CLS. 2, 5, 22, 23, 29, 37, 38 AND 50). SN 78-156,437. PUB. 4-1-2003. FILED 8-21-2002.
- 2,729,326. **KFC KIDS LAPTOP PACK. KFC CORPORATION, MULTIPLE CLASS, (INT. CLS. 16, 29 AND 43)**, (U.S. CLS. 2, 5, 22, 23, 29, 37, 38, 46, 50, 100 AND 101). SN 78-158,593. PUB. 4-1-2003. FILED 8-28-2002.
- 2,729,333. **DYNASTY. VOYAGE TELECOM, INC.**, (U.S. CLS. 2, 5, 22, 23, 29, 37, 38 AND 50). SN 78-159,250. PUB. 4-1-2003. FILED 8-29-2002.
- 2,729,340. **DISCOVERY COVE. SEA WORLD, INC.**, (U.S. CLS. 2, 5, 22, 23, 29, 37, 38 AND 50). SN 78-160,382. PUB. 4-1-2003. FILED 9-4-2002.
- 2,729,341. **TOP BOSS. CLEARSNAP, INC.**, (U.S. CLS. 2, 5, 22, 23, 29, 37, 38 AND 50). SN 78-160,433. PUB. 4-1-2003. FILED 9-4-2002.
- 2,729,350. **DELTA PLANNER. ALPERT, PAUL S.**, (U.S. CLS. 2, 5, 22, 23, 29, 37, 38 AND 50). SN 78-164,146. PUB. 4-1-2003. FILED 9-14-2002.

CLASS 17—RUBBER GOODS

- 2,728,590 (*See Class 9 for this trademark.*)
 2,728,611 (*See Class 7 for this trademark.*)
 2,728,680. **NOVICON INDUSTRIES AND DESIGN.** MEDFAB CORPORATION, (U.S. CLS. 1, 5, 12, 13, 35 AND 50). SN 76-322,062. PUB. 4-1-2003. FILED 10-9-2001.
 2,728,725 (*See Class 1 for this trademark.*)
 2,728,735. **ORTHTEK.** GREENE, TWEED OF DELAWARE, INC., (U.S. CLS. 1, 5, 12, 13, 35 AND 50). SN 76-363,021. PUB. 4-1-2003. FILED 1-25-2002.
 2,728,761. **RUBBER COVERED ROLLS THAT LOVE TO RUN.** VALLEY ROLLER COMPANY, INC., (U.S. CLS. 1, 5, 12, 13, 35 AND 50). SN 76-375,762. PUB. 4-1-2003. FILED 2-27-2002.
 2,728,773 (*See Class 7 for this trademark.*)
 2,728,779. **CRYOFLEX.** SENIOR INVESTMENTS AG, (U.S. CLS. 1, 5, 12, 13, 35 AND 50). SN 76-380,579. PUB. 4-1-2003. FILED 3-11-2002.
 2,728,820. **XL-90.** DOCK PRODUCTS CANADA INC., (U.S. CLS. 1, 5, 12, 13, 35 AND 50). SN 76-395,512. PUB. 4-1-2003. FILED 4-12-2002.

CLASS 18—LEATHER GOODS

- 2,728,478. **FLEX RIDER AND DESIGN.** INTEC CORPORATION, MULTIPLE CLASS, (INT. CLS. 18, 25 AND 28), (U.S. CLS. 1, 2, 3, 22, 23, 38, 39, 41 AND 50). SN 75-652,313. PUB. 4-1-2003. FILED 3-2-1999.
 2,728,493 (*See Class 3 for this trademark.*)
 2,728,516 (*See Class 16 for this trademark.*)
 2,728,923. **THE IVY LEAGUE.** COUNCIL OF IVY GROUP PRESIDENTS, (U.S. CLS. 1, 2, 3, 22 AND 41). SN 76-428,478. PUB. 4-1-2003. FILED 7-8-2002.
 2,728,963. **DOGGIE BOW TIES AND DESIGN.** MCGUIRE, LYNNE CAMILLE, (U.S. CLS. 1, 2, 3, 22 AND 41). SN 76-436,192. PUB. 4-1-2003. FILED 7-31-2002.
 2,729,181. **HORSE TRAX.** MATTEC CORPORATION, (U.S. CLS. 1, 2, 3, 22 AND 41). SN 78-117,919. PUB. 4-1-2003. FILED 3-27-2002.

CLASS 19—NON-METALLIC BUILDING MATERIALS

- 2,728,462 (*See Class 1 for this trademark.*)
 2,728,481. **JOBSITE MOBILE OFFICES AND DESIGN.** JOBSITE TRAILER CORPORATION, (U.S. CLS. 1, 12, 33 AND 50). SN 75-661,896. PUB. 4-1-2003. FILED 3-15-1999.
 2,728,507 (*See Class 1 for this trademark.*)
 2,728,671. **CLAYMARK NEW ZEALAND SAWMILLERS & TIMBER REMANUFACTURERS AND DESIGN.** CLAYTON HOLDINGS LIMITED, (U.S. CLS. 1, 12, 33 AND 50). SN 76-319,026. PUB. 4-1-2003. FILED 9-27-2001.
 2,728,672. **MISCELLANEOUS DESIGN.** CLAYTON HOLDINGS LIMITED, (U.S. CLS. 1, 12, 33 AND 50). SN 76-319,100. PUB. 4-1-2003. FILED 9-27-2001.
 2,728,673. **CLAYMARK.** CLAYTON HOLDINGS LIMITED, (U.S. CLS. 1, 12, 33 AND 50). SN 76-319,102. PUB. 4-1-2003. FILED 9-27-2001.
 2,728,674. **CLAYMARK NEW ZEALAND SUSTAINABLY MANAGED TREE FARMED PINE AND DESIGN.** CLAYTON HOLDINGS LIMITED, (U.S. CLS. 1, 12, 33 AND 50). SN 76-319,103. PUB. 4-1-2003. FILED 9-27-2001.
 2,728,675. **CLAYMARK NEW ZEALAND AND DESIGN.** CLAYTON HOLDINGS LIMITED, (U.S. CLS. 1, 12, 33 AND 50). SN 76-319,104. PUB. 4-1-2003. FILED 9-27-2001.
 2,728,676. **CLAYMARK AND DESIGN.** CLAYTON HOLDINGS LIMITED, (U.S. CLS. 1, 12, 33 AND 50). SN 76-319,105. PUB. 4-1-2003. FILED 9-27-2001.
 2,728,977. **DURALOCK.** CERTAINTED CORP., (U.S. CLS. 1, 12, 33 AND 50). SN 76-439,212. PUB. 4-1-2003. FILED 8-12-2002.
 2,729,002. **BARNHOME.** DOSKOCIL MANUFACTURING COMPANY, INC., (U.S. CLS. 1, 12, 33 AND 50). SN 76-442,510. PUB. 4-1-2003. FILED 8-22-2002.

- 2,729,018. **LEGEND.** ROCKWOOD RETAINING WALLS INC., (U.S. CLS. 1, 12, 33 AND 50). SN 76-443,512. PUB. 4-1-2003. FILED 8-26-2002.
 2,729,154. **MILESTONE EX.** VARIFORM, INC., (U.S. CLS. 1, 12, 33 AND 50). SN 78-097,532. PUB. 4-1-2003. FILED 12-10-2001.
 2,729,213. **TERRA HARDWOODS.** SMYERS, DANIEL J, (U.S. CLS. 1, 12, 33 AND 50). SN 78-135,144. PUB. 4-1-2003. FILED 6-12-2002.

CLASS 20—FURNITURE AND ARTICLES NOT OTHERWISE CLASSIFIED

- 2,728,490 (*See Class 9 for this trademark.*)
 2,728,493 (*See Class 3 for this trademark.*)
 2,728,494. **CENTA-STAR.** NORD FEDER GMBH & CO. KG WOHNTEXTILIEN, MULTIPLE CLASS, (INT. CLS. 20 AND 24), (U.S. CLS. 2, 13, 22, 25, 32, 42 AND 50). SN 75-851,741. PUB. 9-17-2002. FILED 11-17-1999.
 2,728,567 (*See Class 6 for this trademark.*)
 2,728,647. **NETWORK CENTER.** STUDIO RTA, INC., (U.S. CLS. 2, 13, 22, 25, 32 AND 50). SN 76-287,811. PUB. 4-1-2003. FILED 7-19-2001.
 2,728,651. **LUXURY SUPPORT.** INNOMAX CORPORATION, (U.S. CLS. 2, 13, 22, 25, 32 AND 50). SN 76-295,148. PUB. 4-1-2003. FILED 8-7-2001.
 2,728,750. **PUZZLE.** LTL WHOLESALE, INC., DBA LTL HOME PRODUCTS, INC., (U.S. CLS. 2, 13, 22, 25, 32 AND 50). SN 76-371,707. PUB. 4-1-2003. FILED 2-15-2002.
 2,728,755 (*See Class 11 for this trademark.*)
 2,728,781. **VICTORY COLLECTIBLES.** VICTORY COLLECTIBLES, LTD., (U.S. CLS. 2, 13, 22, 25, 32 AND 50). SN 76-380,807. PUB. 4-1-2003. FILED 3-11-2002.
 2,728,888. **FLATPAK.** L&P PROPERTY MANAGEMENT COMPANY, (U.S. CLS. 2, 13, 22, 25, 32 AND 50). SN 76-419,524. PUB. 4-1-2003. FILED 6-11-2002.
 2,728,906. **LOKK - LATCH PRO.** D & D GROUP PTY LTD, (U.S. CLS. 2, 13, 22, 25, 32 AND 50). SN 76-424,258. PUB. 4-1-2003. FILED 6-24-2002.
 2,728,921. **PLANT HUGGERS.** E&B GIFTWARE, LLC, (U.S. CLS. 2, 13, 22, 25, 32 AND 50). SN 76-427,648. PUB. 4-1-2003. FILED 7-5-2002.
 2,729,019. **ENCHANTING TREASURES.** INTERNATIONAL WHOLESALE SERVICE, INC., MULTIPLE CLASS, (INT. CLS. 20 AND 21), (U.S. CLS. 2, 13, 22, 23, 25, 29, 30, 32, 33, 40 AND 50). SN 76-443,536. PUB. 4-1-2003. FILED 8-26-2002.
 2,729,068. **HYPNOS.** JAMISON BEDDING, INC., (U.S. CLS. 2, 13, 22, 25, 32 AND 50). SN 76-448,290. PUB. 4-1-2003. FILED 9-10-2002.
 2,729,077. **BUDDIES.** DDS, CO., (U.S. CLS. 2, 13, 22, 25, 32 AND 50). SN 76-449,639. PUB. 4-1-2003. FILED 9-16-2002.
 2,729,086. **AMTRAK.** NATIONAL RAILROAD PASSENGER CORPORATION, (U.S. CLS. 2, 13, 22, 25, 32 AND 50). SN 76-450,549. PUB. 4-1-2003. FILED 9-12-2002.
 2,729,159. **SIGNATURE SIGNS & AD SPECIALTIES AND DESIGN.** HOLLAND, DAVID, (U.S. CLS. 2, 13, 22, 25, 32 AND 50). SN 78-103,296. PUB. 4-1-2003. FILED 1-17-2002.
 2,729,227. **CARDINAL DESIGNS AND DESIGN.** COLORAMICS, LLC, (U.S. CLS. 2, 13, 22, 25, 32 AND 50). SN 78-140,452. PUB. 4-1-2003. FILED 7-1-2002.
 2,729,263. **TITANIUM.** COLUMBIA SPORTSWEAR NORTH AMERICA, INC., (U.S. CLS. 2, 13, 22, 25, 32 AND 50). SN 78-149,182. PUB. 4-1-2003. FILED 7-31-2002.
 2,729,276. **NEPTUNE DREAM.** DYNASTY CONSOLIDATED INDUSTRIES, INC., (U.S. CLS. 2, 13, 22, 25, 32 AND 50). SN 78-152,144. PUB. 4-1-2003. FILED 8-8-2002.
 2,729,289. **SLEEP SYNCHRONIZATION SYSTEM.** DYNASTY CONSOLIDATED INDUSTRIES, INC., (U.S. CLS. 2, 13, 22, 25, 32 AND 50). SN 78-154,921. PUB. 4-1-2003. FILED 8-16-2002.
 2,729,313. **FLAVIA.** FLAVIA'S LEGACY, LLC, (U.S. CLS. 2, 13, 22, 25, 32 AND 50). SN 78-156,923. PUB. 4-1-2003. FILED 8-22-2002.
 2,729,315. **HIGHNESS PRIDE.** DYNASTY CONSOLIDATED INDUSTRIES, INC., (U.S. CLS. 2, 13, 22, 25, 32 AND 50). SN 78-157,124. PUB. 4-1-2003. FILED 8-23-2002.

2,729,317. **POSTURE PLEASURE**. DYNASTY CONSOLIDATED INDUSTRIES, INC., (U.S. CLS. 2, 13, 22, 25, 32 AND 50). SN 78-157,875. PUB. 4-1-2003. FILED 8-26-2002.

2,728,709. **MISCELLANEOUS DESIGN**. BURBERRY LIMITED, (U.S. CLS. 42 AND 50). SN 76-351,946. PUB. 4-1-2003. FILED 12-21-2001.

CLASS 21—HOUSEWARES AND GLASS

2,728,458. **COFFEE EXPRESS**. COFFEE EXPRESS CO., MULTIPLE CLASS, (INT. CLS. 21, 25 AND 30), (U.S. CLS. 2, 13, 22, 23, 29, 30, 33, 39, 40, 46 AND 50). SN 75-346,501. PUB. 4-1-2003. FILED 8-25-1997.
 2,728,493 (*See Class 3 for this trademark*).
 2,728,497. **ROCKET MOP-IT**. HURRELL, LEONA, (U.S. CLS. 2, 13, 23, 29, 30, 33, 40 AND 50). SN 75-851,999. PUB. 4-1-2003. FILED 11-12-1999.
 2,728,516 (*See Class 16 for this trademark*).
 2,728,544. **GREENBRIER BASKET COMPANY AND DESIGN**. GREENBRIER BASKET COMPANY, LLC, (U.S. CLS. 2, 13, 23, 29, 30, 33, 40 AND 50). SN 76-086,521. PUB. 4-1-2003. FILED 7-12-2000.
 2,728,567 (*See Class 6 for this trademark*).
 2,728,670 (*See Class 16 for this trademark*).
 2,728,685 (*See Class 9 for this trademark*).
 2,728,839. **ZOO PALS AND DESIGN**. PACTIV CORPORATION, (U.S. CLS. 2, 13, 23, 29, 30, 33, 40 AND 50). SN 76-404,788. PUB. 4-1-2003. FILED 5-8-2002.
 2,728,937. **EZCAN (STYLIZED)**. DIE-TECH INDUSTRIES, INC., (U.S. CLS. 2, 13, 23, 29, 30, 33, 40 AND 50). SN 76-431,120. PUB. 4-1-2003. FILED 7-16-2002.
 2,728,938. **EASYCAN (STYLIZED)**. DIE-TECH INDUSTRIES, INC., (U.S. CLS. 2, 13, 23, 29, 30, 33, 40 AND 50). SN 76-431,121. PUB. 4-1-2003. FILED 7-16-2002.
 2,728,955 (*See Class 12 for this trademark*).
 2,729,019 (*See Class 20 for this trademark*).
 2,729,057 (*See Class 3 for this trademark*).
 2,729,196. **WESSEN (STYLIZED)**. WESSEN INDUSTRIES LIMITED, (U.S. CLS. 2, 13, 23, 29, 30, 33, 40 AND 50). SN 78-125,978. PUB. 4-1-2003. FILED 5-3-2002.
 2,729,221. **TL AND DESIGN**. THANG LONG METAL WARES COMPANY, (U.S. CLS. 2, 13, 23, 29, 30, 33, 40 AND 50). SN 78-138,014. PUB. 4-1-2003. FILED 6-24-2002.
 2,729,231. **BACKSTROKER AND DESIGN**. VOUGHT, ELIZABETH, C., (U.S. CLS. 2, 13, 23, 29, 30, 33, 40 AND 50). SN 78-142,316. PUB. 4-1-2003. FILED 7-9-2002.
 2,729,256. **LIBERTY LIDS**. HOOVER-HAWLEY ASSOCIATES, INC., (U.S. CLS. 2, 13, 23, 29, 30, 33, 40 AND 50). SN 78-147,956. PUB. 4-1-2003. FILED 7-26-2002.
 2,729,343. **ECO-AIR**. SERVICE IDEAS, INC., (U.S. CLS. 2, 13, 23, 29, 30, 33, 40 AND 50). SN 78-160,581. PUB. 4-1-2003. FILED 9-4-2002.

CLASS 22—CORDAGE AND FIBERS

2,728,955 (*See Class 12 for this trademark*).
 2,729,161. **PERFECT POOL BOTTOM**. GLADON COMPANY, INC., (U.S. CLS. 1, 2, 7, 19, 22, 42 AND 50). SN 78-106,040. PUB. 4-1-2003. FILED 1-31-2002.
 2,729,180. **WING**. T.I. & ASSOCIATES, (U.S. CLS. 1, 2, 7, 19, 22, 42 AND 50). SN 78-117,729. PUB. 4-1-2003. FILED 3-27-2002.

CLASS 24—FABRICS

2,728,493 (*See Class 3 for this trademark*).
 2,728,494 (*See Class 20 for this trademark*).
 2,728,495. **CENTA-STAR**. NORD FEDER GMBH & CO. KG WOHNTEXTILIEN, (U.S. CLS. 42 AND 50). SN 75-851,742. PUB. 9-17-2002. FILED 11-17-1999.
 2,728,529. **RITZ PARIS RITZ HOTEL PARIS AND DESIGN**. RITZ HOTEL, LIMITED, THE, (U.S. CLS. 42 AND 50). SN 76-030,529. PUB. 4-16-2002. FILED 4-20-2000.
 2,728,567 (*See Class 6 for this trademark*).
 2,728,670 (*See Class 16 for this trademark*).

CLASS 25—CLOTHING

2,728,452. **PIZZA MAKER AND DESIGN**. SYSCO CORPORATION, MULTIPLE CLASS, (INT. CLS. 25, 29, 30 AND 35), (U.S. CLS. 22, 39, 46, 100, 101 AND 102). SN 74-373,002. PUB. 4-1-2003. FILED 3-29-1993.
 2,728,455. **RUNNING ROOM**. YASU CORPORATION, DBA THE RUNNING ROOM, MULTIPLE CLASS, (INT. CLS. 25 AND 35), (U.S. CLS. 22, 39, 100, 101 AND 102). SN 75-084,425. PUB. 4-1-2003. FILED 4-5-1996.
 2,728,458 (*See Class 21 for this trademark*).
 2,728,461 (*See Class 16 for this trademark*).
 2,728,478 (*See Class 18 for this trademark*).
 2,728,490 (*See Class 9 for this trademark*).
 2,728,493 (*See Class 3 for this trademark*).
 2,728,499 (*See Class 16 for this trademark*).
 2,728,516 (*See Class 16 for this trademark*).
 2,728,539. **TRAIL WEST**. YOUNG LIFE, (U.S. CLS. 22 AND 39). SN 76-075,238. PUB. 4-1-2003. FILED 5-17-2000.
 2,728,592 (*See Class 9 for this trademark*).
 2,728,661. **COSMIC WONDER**. YUGEN KAISHA COSMIC WONDER, (U.S. CLS. 22 AND 39). SN 76-308,245. PUB. 4-1-2003. FILED 9-4-2001.
 2,728,685 (*See Class 9 for this trademark*).
 2,728,730. **NEVSUM**. NEVER SUMMER INDUSTRIES, INC., MULTIPLE CLASS, (INT. CLS. 25 AND 28), (U.S. CLS. 22, 23, 38, 39 AND 50). SN 76-361,156. PUB. 4-1-2003. FILED 1-23-2002.
 2,728,769. **THE ROCK NORTH CAROLINA SPEEDWAY AND DESIGN**. NORTH CAROLINA SPEEDWAY, INC., (U.S. CLS. 22 AND 39). SN 76-378,016. PUB. 4-1-2003. FILED 3-4-2002.
 2,728,818 (*See Class 9 for this trademark*).
 2,728,858. **BLUNT WRAP**. BLUNT WRAP U.S.A., INC., (U.S. CLS. 22 AND 39). SN 76-409,636. PUB. 4-1-2003. FILED 5-17-2002.
 2,728,874. **AMOR & PSYCHE**. ROTEX TEXTILHANDEL UND PRODUKTIONSGESELLSCHAFT MBH, (U.S. CLS. 22 AND 39). SN 76-415,146. PUB. 4-1-2003. FILED 5-31-2002.
 2,729,000. **MISCELLANEOUS DESIGN**. BAKER, BRUCE W., (U.S. CLS. 22 AND 39). SN 76-442,324. PUB. 4-1-2003. FILED 8-21-2002.
 2,729,023. **SUNDAY'S BEST OPTIONS FROM MATT TOTILLO**. SOUTHPAW TRADING LTD., (U.S. CLS. 22 AND 39). SN 76-443,869. PUB. 4-1-2003. FILED 8-26-2002.
 2,729,024. **OPTIONS OVER EASY FROM MATT TOTILLO**. SOUTHPAW TRADING LTD., (U.S. CLS. 22 AND 39). SN 76-443,870. PUB. 4-1-2003. FILED 8-26-2002.
 2,729,118. **INTUIT**. INTUIT INC., (U.S. CLS. 22 AND 39). SN 76-462,270. PUB. 4-1-2003. FILED 10-29-2002.
 2,729,127. **HAVE I GOT NEWS FOR YOU**. HAT TRICK PRODUCTIONS LTD., (U.S. CLS. 22 AND 39). SN 76-975,497. PUB. 5-21-2002. FILED 6-22-2000.
 2,729,139 (*See Class 16 for this trademark*).
 2,729,164. **AMERICAN 5 (STYLIZED)**. U.S. DYNAMIC INDUSTRY GROUP, INC., MULTIPLE CLASS, (INT. CLS. 25 AND 28), (U.S. CLS. 22, 23, 38, 39 AND 50). SN 78-108,116. PUB. 4-1-2003. FILED 2-11-2002.
 2,729,187. **THE VINEYARD CREW (TVC) DO THE CREW DON'T GET DOGGED AND DESIGN**. WHITE, BLAINE, A'MMON, (U.S. CLS. 22 AND 39). SN 78-120,048. PUB. 4-1-2003. FILED 4-7-2002.
 2,729,192. **STACKS AND DESIGN**. LEON, MICHAEL C, (U.S. CLS. 22 AND 39). SN 78-122,448. PUB. 4-1-2003. FILED 4-17-2002.
 2,729,260. **ELEPHANT TRUNKS BY TOMMY BAHAMA AND DESIGN**. VIEWPOINT INTERNATIONAL, INC., (U.S. CLS. 22 AND 39). SN 78-148,931. PUB. 4-1-2003. FILED 7-30-2002.
 2,729,314. **MISCELLANEOUS DESIGN**. FERRARA PAN CANDY CO., INC., (U.S. CLS. 22 AND 39). SN 78-157,119. PUB. 4-1-2003. FILED 8-23-2002.
 2,729,321. **HOOPS UNLIMITED**. SCULLY, GLENN, AND

SCULLY, LOUISE, (U.S. CLS. 22 AND 39), SN 78-158,371. PUB. 4-1-2003. FILED 8-27-2002.
 2,729,329. **MISCELLANEOUS DESIGN**. YAKIRA, L.L.C., (U.S. CLS. 22 AND 39), SN 78-158,878. PUB. 4-1-2003. FILED 8-28-2002.
 2,729,345. **SPORTS AIR**. SPORTSAIR, INC., (U.S. CLS. 22 AND 39), SN 78-162,252. PUB. 4-1-2003. FILED 9-10-2002.

CLASS 26—FANCY GOODS

2,728,493 (*See Class 3 for this trademark*).
 2,728,516 (*See Class 16 for this trademark*).
 2,728,955 (*See Class 12 for this trademark*).
 2,729,051 (*See Class 16 for this trademark*).

CLASS 27—FLOOR COVERINGS

2,728,567 (*See Class 6 for this trademark*).
 2,728,954. **STICK N STEP**. CHOATE, NICK, (U.S. CLS. 19, 20, 37, 42 AND 50), SN 76-434,950. PUB. 4-1-2003. FILED 7-26-2002.

CLASS 28—TOYS AND SPORTING GOODS

2,728,459 (*See Class 9 for this trademark*).
 2,728,478 (*See Class 18 for this trademark*).
 2,728,490 (*See Class 9 for this trademark*).
 2,728,493 (*See Class 3 for this trademark*).
 2,728,515. **TROJANS**. UNIVERSITY OF SOUTHERN CALIFORNIA, (U.S. CLS. 22, 23, 38 AND 50), SN 75-982,255. PUB. 4-1-2003. FILED 7-19-2001.
 2,728,533 (*See Class 9 for this trademark*).
 2,728,586. **SHOCCARD**. BLACKWRAP SPORTS, INC, MULTIPLE CLASS, (INT. CLS. 28 AND 37), (U.S. CLS. 22, 23, 38, 50, 100, 103 AND 106), SN 76-187,053. PUB. 4-1-2003. FILED 12-26-2000.
 2,728,602. **SALMING DARE TO BE DIFFERENT AND DESIGN**. SALMING, BORJE, (U.S. CLS. 22, 23, 38 AND 50), SN 76-227,917. PUB. 4-1-2003. FILED 3-21-2001.
 2,728,618 (*See Class 9 for this trademark*).
 2,728,730 (*See Class 25 for this trademark*).
 2,728,736 (*See Class 12 for this trademark*).
 2,728,741. **POLAR SLED AND DESIGN**. THIELEN MARKETING, INC, (U.S. CLS. 22, 23, 38 AND 50), SN 76-366,742. PUB. 4-1-2003. FILED 2-5-2002.
 2,728,846. **WILDLIFE INNOVATIONS, INC. AND DESIGN**. WILDLIFE INNOVATIONS, INC., (U.S. CLS. 22, 23, 38 AND 50), SN 76-406,368. PUB. 4-1-2003. FILED 5-13-2002.
 2,728,907. **ELEIKO**. ELEIKO SPORT AB, (U.S. CLS. 22, 23, 38 AND 50), SN 76-424,278. PUB. 4-1-2003. FILED 6-21-2002.
 2,728,932. **DR. FEEL**. FEEL GOLF CO., INC., (U.S. CLS. 22, 23, 38 AND 50), SN 76-430,107. PUB. 4-1-2003. FILED 7-10-2002.
 2,728,965. **GORILLABOT**. HASBRO, INC., (U.S. CLS. 22, 23, 38 AND 50), SN 76-436,988. PUB. 4-1-2003. FILED 8-2-2002.
 2,728,968. **MELLOW YELLOW**. BANG GOLF INC., (U.S. CLS. 22, 23, 38 AND 50), SN 76-438,061. PUB. 4-1-2003. FILED 8-5-2002.
 2,728,987. **DOGTOWN (STYLIZED)**. MUIR, MICHAEL, (U.S. CLS. 22, 23, 38 AND 50), SN 76-441,279. PUB. 4-1-2003. FILED 8-19-2002.
 2,728,998 (*See Class 16 for this trademark*).
 2,729,005. **MCKENZIE HD**. MCKENZIE SPORTS PRODUCTS INC., (U.S. CLS. 22, 23, 38 AND 50), SN 76-442,751. PUB. 4-1-2003. FILED 8-22-2002.
 2,729,055. **SNAPPHONICS**. PEARSON EDUCATION, INC, (U.S. CLS. 22, 23, 38 AND 50), SN 76-447,161. PUB. 4-1-2003. FILED 9-4-2002.
 2,729,058. **GOLD PREFERRED**. RAWLINGS SPORTING GOODS COMPANY, INC., (U.S. CLS. 22, 23, 38 AND 50), SN 76-447,224. PUB. 4-1-2003. FILED 9-6-2002.
 2,729,063. **HOT SCOT**. TOMMY ARMOUR GOLF COM-

PANY, (U.S. CLS. 22, 23, 38 AND 50), SN 76-447,950. PUB. 4-1-2003. FILED 9-9-2002.
 2,729,152. **JUNGLE SWORD**. BVS ENTERTAINMENT, INC., (U.S. CLS. 22, 23, 38 AND 50), SN 78-097,122. PUB. 4-1-2003. FILED 12-6-2001.
 2,729,164 (*See Class 25 for this trademark*).
 2,729,302. **SOFTBOOT**. K-2 CORPORATION, (U.S. CLS. 22, 23, 38 AND 50), SN 78-155,410. PUB. 4-1-2003. FILED 8-19-2002.
 2,729,328. **DUNLOP**. DNA (HOUSEMARKS) LIMITED, (U.S. CLS. 22, 23, 38 AND 50), SN 78-158,873. PUB. 4-1-2003. FILED 8-28-2002.
 2,729,356. **FUEL**. RAWLINGS SPORTING GOODS COMPANY, INC., (U.S. CLS. 22, 23, 38 AND 50), SN 78-165,769. PUB. 4-1-2003. FILED 9-19-2002.

CLASS 29—MEATS AND PROCESSED FOODS

2,728,452 (*See Class 25 for this trademark*).
 2,728,467 (*See Class 7 for this trademark*).
 2,728,480. **MORTA D'OU ZEFFIRINO AND DESIGN**. ZEFFIRINO S.N.C. DI BELLONI ZEFFIRINO & C., MULTIPLE CLASS, (INT. CLS. 29, 30, 31, 32, 33 AND 42), (U.S. CLS. 1, 45, 46, 47, 48, 49, 100 AND 101), SN 75-660,155. PUB. 4-30-2002. FILED 3-15-1999.
 2,728,484. **EPP AND DESIGN**. FROMALP AG, MULTIPLE CLASS, (INT. CLS. 29, 30 AND 31), (U.S. CLS. 1 AND 46), SN 75-689,194. PUB. 8-7-2001. FILED 4-23-1999.
 2,728,535. **SHILOH FARMS GEN. 49:10 AND DESIGN**. SHILOH TRUST, AN ARKANSAS TRUST, THE TRUSTEE COMPRISING JAMES JANOSCH, A U.S. CITIZEN, THE MULTIPLE CLASS, (INT. CLS. 29 AND 30), (U.S. CL. 46), SN 76-065,179. PUB. 4-1-2003. FILED 6-6-2000.
 2,728,572. **NATU SPORT**. SEITENBACHER GMBH & CO., NATURKOST, MULTIPLE CLASS, (INT. CLS. 29 AND 30), (U.S. CL. 46), SN 76-154,056. PUB. 4-16-2002. FILED 10-25-2000.
 2,728,596 (*See Class 3 for this trademark*).
 2,728,598. **CT CASPIAN TRADITION AND DESIGN**. CASPIAN TRADITION S.A., (U.S. CL. 46), SN 76-212,461. PUB. 5-7-2002. FILED 2-20-2001.
 2,728,607. **FRENCH DAYS**. DUTY FREE ASSOCIATES - D F A, MULTIPLE CLASS, (INT. CLS. 29, 30, 32, 33, 34 AND 42), (U.S. CLS. 2, 8, 9, 17, 45, 46, 47, 48, 49, 100 AND 101), SN 76-231,561. PUB. 4-1-2003. FILED 3-27-2001.
 2,728,659. **CHOCOLATTL**. PEETERS PRODUKTEN B.V., (U.S. CL. 46), SN 76-307,053. PUB. 4-1-2003. FILED 8-28-2001.
 2,728,698. **COUNTRY SELECT CATFISH AND DESIGN**. CONFISH, INC., (U.S. CL. 46), SN 76-342,940. PUB. 4-1-2003. FILED 11-29-2001.
 2,728,776. **LIYUAN AND DESIGN**. LIYUAN FOODS CO., LTD., (U.S. CL. 46), SN 76-379,761. PUB. 4-1-2003. FILED 3-7-2002.
 2,728,799. **CIRIO AND DESIGN**. CIRIO DEL MONTE ITALIA S.P.A., (U.S. CL. 46), SN 76-385,435. PUB. 4-1-2003. FILED 3-19-2002.
 2,728,809. **M2G**. SANDMAR MARKETING, (U.S. CL. 46), SN 76-391,846. PUB. 4-1-2003. FILED 4-5-2002.
 2,728,810. **MOO-2-GO**. SANDMAR MARKETING, (U.S. CL. 46), SN 76-391,926. PUB. 4-1-2003. FILED 4-5-2002.
 2,728,821. **TOP CHICK**. ALBERTVILLE QUALITY FOODS, INC., (U.S. CL. 46), SN 76-395,780. PUB. 4-1-2003. FILED 4-10-2002.
 2,729,047. **AGROFRUCT**. POLISH FOLKLORE IMPORT CO., INC., (U.S. CL. 46), SN 76-446,584. PUB. 4-1-2003. FILED 9-3-2002.
 2,729,079. **ROYAL BLACKWOOD**. INDUSTRIAL LINK, INC., (U.S. CL. 46), SN 76-449,824. PUB. 4-1-2003. FILED 9-12-2002.
 2,729,123. **TODAY'S FLAVORS MADE SIMPLE**. HORMEL FOODS, LLC, MULTIPLE CLASS, (INT. CLS. 29 AND 30), (U.S. CL. 46), SN 76-466,796. PUB. 4-1-2003. FILED 11-5-2002.
 2,729,134. **REVILLA AND DESIGN**. NAVIDUL, S.A., (U.S. CL. 46), SN 78-037,290. PUB. 4-1-2003. FILED 11-30-2000.
 2,729,238. **TRAIL'S BEST AND DESIGN**. SARA LEE CORPORATION, (U.S. CL. 46), SN 78-144,351. PUB. 4-1-2003. FILED 7-16-2002.
 2,729,326 (*See Class 16 for this trademark*).

2,729,347. **AGREE OR IT'S FREE**. PINNACLE FOODS BRANDS CORPORATION, (U.S. CL. 46). SN 78-162,571. PUB. 4-1-2003. FILED 9-10-2002.

CLASS 30—STAPLE FOODS

2,728,452 (*See Class 25 for this trademark*).
 2,728,458 (*See Class 21 for this trademark*).
 2,728,465. **CM CAFE MOTO VAPOR KG/CM AND DESIGN**. CAFE MOTO, (U.S. CL. 46). SN 75-536,344. PUB. 4-1-2003. FILED 8-14-1998.
 2,728,467 (*See Class 7 for this trademark*).
 2,728,474. **VIDALIA'S BEST CONTAINS NO FAT AND DESIGN**. MANNING FARMS, INC., BY ASSIGNMENT LARRY K. WALDEN AND KAREN B. WALDEN PARTNERSHIP, THE, DBA VIDALIA'S BEST, (U.S. CL. 46). SN 75-622,202. PUB. 4-1-2003. FILED 1-19-1999.
 2,728,480 (*See Class 29 for this trademark*).
 2,728,484 (*See Class 29 for this trademark*).
 2,728,487. **BIMBO BAKERIES USA AND DESIGN**. CENTRAL IMPULSORA, S.A. DE C.V., BY ASSIGNMENT MRS BAIRD'S BAKERIES BUSINESS TRUST, MULTIPLE CLASS, (INT. CLS. 30 AND 40), (U.S. CLS. 46, 100, 103 AND 106). SN 75-791,484. PUB. 4-1-2003. FILED 9-1-1999.
 2,728,491. **MISCELLANEOUS DESIGN**. MORINAGA & CO., LTD., MULTIPLE CLASS, (INT. CLS. 30 AND 32), (U.S. CLS. 45, 46 AND 48). SN 75-827,428. PUB. 6-11-2002. FILED 10-20-1999.
 2,728,493 (*See Class 3 for this trademark*).
 2,728,512. **BEAVER CHIPS**. SHOWMART MANGEMENT LTD., (U.S. CL. 46). SN 75-941,577. PUB. 4-1-2003. FILED 3-10-2000.
 2,728,535 (*See Class 29 for this trademark*).
 2,728,545. **ELSA (STYLIZED)**. MONARI FEDERZONI S.P.A., (U.S. CL. 46). SN 76-093,277. PUB. 4-1-2003. FILED 7-21-2000.
 2,728,561. **ICHIBAN DELIGHT**. AZUMA FOODS INTERNATIONAL INC. U.S.A., (U.S. CL. 46). SN 76-132,403. PUB. 4-1-2003. FILED 9-21-2000.
 2,728,563. **MISCELLANEOUS DESIGN**. DIPPIN' DOTS, INC., (U.S. CL. 46). SN 76-137,546. PUB. 4-1-2003. FILED 9-28-2000.
 2,728,572 (*See Class 29 for this trademark*).
 2,728,596 (*See Class 3 for this trademark*).
 2,728,607 (*See Class 29 for this trademark*).
 2,728,649. **WESTBURY**. NATIONAL BULK FOOD DISTRIBUTORS, INC., (U.S. CL. 46). SN 76-291,507. PUB. 4-1-2003. FILED 7-27-2001.
 2,728,655 (*See Class 3 for this trademark*).
 2,728,706. **LIPTON COLD BREW AND DESIGN**. LIPTON INVESTMENTS, INC., (U.S. CL. 46). SN 76-349,577. PUB. 4-1-2003. FILED 12-18-2001.
 2,728,713. **SASSY CRUNCH**. PECORARO, SHARON A., (U.S. CL. 46). SN 76-354,656. PUB. 4-1-2003. FILED 12-27-2001.
 2,728,732. **STORZ**. CHR. STORZ GMBH & CO. KG, (U.S. CL. 46). SN 76-362,077. PUB. 4-1-2003. FILED 1-22-2002.
 2,728,770. **CAFE IGUACU (STYLIZED)**. CIA. IGUACU DE CAFE SOLUVEL, (U.S. CL. 46). SN 76-378,025. PUB. 4-1-2003. FILED 3-6-2002.
 2,728,844. **UNWRAP A SMILE**. MCKEE FOODS KINGMAN, INC., BY ASSIGNMENT MCKEE FOODS CORPORATION, (U.S. CL. 46). SN 76-405,592. PUB. 4-1-2003. FILED 4-30-2002.
 2,728,872. **LOLLIPOP PAINT SHOP CANDY POWDER AND DESIGN**. IMPACT CONFECTIONS, INC., (U.S. CL. 46). SN 76-415,031. PUB. 4-1-2003. FILED 5-30-2002.
 2,728,896. **GOOD STUFF**. BIMBO BAKERIES USA, INC., (U.S. CL. 46). SN 76-421,963. PUB. 4-1-2003. FILED 6-17-2002.
 2,728,929. **MISCELLANEOUS DESIGN**. HELLAS BAKERY AND PITA, INC., (U.S. CL. 46). SN 76-429,440. PUB. 4-1-2003. FILED 7-1-2002.
 2,728,940. **ROCKIN' SOURS**. LINDLEY, JERRY ALAN, (U.S. CL. 46). SN 76-431,674. PUB. 4-1-2003. FILED 7-18-2002.
 2,728,941. **SYSCO INTERNATIONAL**. SYSCO CORPORATION, (U.S. CL. 46). SN 76-431,753. PUB. 4-1-2003. FILED 7-17-2002.
 2,728,949. **R AND DESIGN**. REQUEST FOODS, INC., (U.S. CL. 46). SN 76-434,018. PUB. 4-1-2003. FILED 7-23-2002.
 2,729,059. **AZTEC**. MARIBEL'S SWEETS, INC., (U.S. CL. 46).

SN 76-447,393. PUB. 4-1-2003. FILED 9-6-2002.
 2,729,065. **BEST OF THE WEST**. WYCKOFF, PETER J., (U.S. CL. 46). SN 76-448,178. PUB. 4-1-2003. FILED 9-9-2002.
 2,729,075. **P. NUTTY**. HERSHEY CREAMERY COMPANY, (U.S. CL. 46). SN 76-449,562. PUB. 4-1-2003. FILED 9-13-2002.
 2,729,076. **CHU JIANG**. GIANT UNION COMPANY, INC., (U.S. CL. 46). SN 76-449,568. PUB. 4-1-2003. FILED 9-13-2002.
 2,729,123 (*See Class 29 for this trademark*).
 2,729,145. **THE CAKE BOX**. CAKE BOX INC, (U.S. CL. 46). SN 78-073,483. PUB. 4-1-2003. FILED 7-11-2001.
 2,729,150. **YIAYIA'S AND DESIGN**. GG&T CORPORATION, (U.S. CL. 46). SN 78-090,481. PUB. 4-1-2003. FILED 10-27-2001.
 2,729,236. **SPHINX SPELT**. WILD MARKS, INC., (U.S. CL. 46). SN 78-143,859. PUB. 4-1-2003. FILED 7-15-2002.
 2,729,258. **TERRA E SOLE**. P.M. SALES, LLC, (U.S. CL. 46). SN 78-148,186. PUB. 4-1-2003. FILED 7-28-2002.

CLASS 31—NATURAL AGRICULTURAL PRODUCTS

2,728,467 (*See Class 7 for this trademark*).
 2,728,480 (*See Class 29 for this trademark*).
 2,728,483 (*See Class 1 for this trademark*).
 2,728,484 (*See Class 29 for this trademark*).
 2,728,780. **HOLEX FLOWER AND DESIGN**. ZUREL GROUP B.V., (U.S. CLS. 1 AND 46). SN 76-380,706. PUB. 4-1-2003. FILED 3-8-2002.
 2,728,783. **LACTO-SACC**. ALLTECH, INC., (U.S. CLS. 1 AND 46). SN 76-381,237. PUB. 4-1-2003. FILED 3-12-2002.
 2,728,868. **WHITE CHARMING**. DE RUITER'S NIEUWE ROZEN B.V., (U.S. CLS. 1 AND 46). SN 76-412,484. PUB. 4-1-2003. FILED 5-24-2002.
 2,729,048. **ONE BITE AND YOU'LL SMILE**. KAPRIELIAN BROS. PACKING CO., (U.S. CLS. 1 AND 46). SN 76-446,639. PUB. 4-1-2003. FILED 9-3-2002.
 2,729,054. **MISCELLANEOUS DESIGN**. CUMA PRODUCTS, L.L.C., (U.S. CLS. 1 AND 46). SN 76-446,926. PUB. 4-1-2003. FILED 9-5-2002.
 2,729,069. **R & M. R & M REFRIGERATED, INC.**, (U.S. CLS. 1 AND 46). SN 76-448,293. PUB. 4-1-2003. FILED 9-10-2002.
 2,729,133. **UNIGEN**. UNITED GENETICS SEEDS CO., (U.S. CLS. 1 AND 46). SN 78-026,265. PUB. 4-1-2003. FILED 9-17-2000.

CLASS 32—LIGHT BEVERAGES

2,728,464 (*See Class 5 for this trademark*).
 2,728,467 (*See Class 7 for this trademark*).
 2,728,480 (*See Class 29 for this trademark*).
 2,728,491 (*See Class 30 for this trademark*).
 2,728,493 (*See Class 3 for this trademark*).
 2,728,596 (*See Class 3 for this trademark*).
 2,728,607 (*See Class 29 for this trademark*).
 2,728,655 (*See Class 3 for this trademark*).
 2,728,835. **MAYIM TOVIM AND DESIGN**. ERLICH & FRIED, (U.S. CLS. 45, 46 AND 48). SN 76-402,867. PUB. 4-1-2003. FILED 4-30-2002.

CLASS 33—WINES AND SPIRITS

2,728,467 (*See Class 7 for this trademark*).
 2,728,480 (*See Class 29 for this trademark*).
 2,728,493 (*See Class 3 for this trademark*).
 2,728,549. **HAWTHORNE MOUNTAIN VINEYARDS**. HAWTHORNE MOUNTAIN VINEYARDS LTD., BY CHANGE OF NAME HAWTHORNE MOUNTAIN VINEYARDS (2000) LTD., (U.S. CLS. 47 AND 49). SN 76-103,231. PUB. 4-1-2003. FILED 8-4-2000.
 2,728,583. **LO ARCAAYA**. SOCIEDAD AGRICOLA LO ARCAAYA LTDA., (U.S. CLS. 47 AND 49). SN 76-173,985. PUB.

6-11-2002. FILED 12-4-2000.
 2,728,607 (*See Class 29 for this trademark*).
 2,728,625. **COLERAINE**. TE MATA ESTATE WINERY LIMITED, (U.S. CLS. 47 AND 49). SN 76-257,576. PUB. 1-7-2003. FILED 4-30-2001.
 2,728,679. **J. SANDERS AND DESIGN**. WOODRUFF PROPERTIES, LTD., (U.S. CLS. 47 AND 49). SN 76-320,919. PUB. 4-1-2003. FILED 10-3-2001.
 2,728,813. **AMISFIELD**. LAKE HAYES VINEYARD LIMITED, (U.S. CLS. 47 AND 49). SN 76-393,780. PUB. 4-1-2003. FILED 4-11-2002.
 2,729,200. **CONVENTO VIEJO**. J. BOUCHON Y COMPANIA LIMITADA, (U.S. CLS. 47 AND 49). SN 78-127,881. PUB. 4-1-2003. FILED 5-10-2002.
 2,729,201. **BUSHMAN'S GULLY**. RIVERINA WINES PTY LTD, (U.S. CLS. 47 AND 49). SN 78-130,377. PUB. 4-1-2003. FILED 5-22-2002.

CLASS 34—SMOKERS' ARTICLES

2,728,493 (*See Class 3 for this trademark*).
 2,728,607 (*See Class 29 for this trademark*).
 2,729,095. **PRIDE PASSION PERDOMO**. NICK'S CIGAR COMPANY, DBA TABACALERA PERDOMO S.A., (U.S. CLS. 2, 8, 9 AND 17). SN 76-453,122. PUB. 4-1-2003. FILED 9-26-2002.

SERVICE MARKS

CLASS 35—ADVERTISING AND BUSINESS

2,728,452 (*See Class 25 for this trademark*).
 2,728,454 (*See Class 9 for this trademark*).
 2,728,455 (*See Class 25 for this trademark*).
 2,728,461 (*See Class 16 for this trademark*).
 2,728,466 (*See Class 16 for this trademark*).
 2,728,490 (*See Class 9 for this trademark*).
 2,728,493 (*See Class 3 for this trademark*).
 2,728,499 (*See Class 16 for this trademark*).
 2,728,500 (*See Class 9 for this trademark*).
 2,728,501 (*See Class 9 for this trademark*).
 2,728,502 (*See Class 9 for this trademark*).
 2,728,503 (*See Class 9 for this trademark*).
 2,728,511. **TRIBECA FILM CENTER**. TRIBECA FILM CENTER, INC., MULTIPLE CLASS, (INT. CLS. 35 AND 36), (U.S. CLS. 100, 101 AND 102). SN 75-924,774. PUB. 4-1-2003. FILED 2-22-2000.
 2,728,517. **ABBY AND ME**. STOKES, ABIGAIL, MULTIPLE CLASS, (INT. CLS. 35 AND 41), (U.S. CLS. 100, 101, 102 AND 107). SN 75-982,558. PUB. 4-1-2003. FILED 11-14-2000.
 2,728,519 (*See Class 9 for this trademark*).
 2,728,522. **ENSIL**. 1081002 ONTARIO LIMITED, MULTIPLE CLASS, (INT. CLS. 35, 37, 40 AND 42), (U.S. CLS. 100, 101, 102, 103 AND 106). SN 76-013,825. PUB. 1-8-2002. FILED 3-30-2000.
 2,728,536. **COMPANYDNA**. COMPANYDNA INC., BY CHANGE OF NAME IRECOGNIZE INC., MULTIPLE CLASS, (INT. CLS. 35 AND 42), (U.S. CLS. 100, 101 AND 102). SN 76-071,423. PUB. 4-1-2003. FILED 6-15-2000.
 2,728,537. **IM MUNO GENE TICS AND DESIGN**. CENTRE NATIONAL DE LA RECHERCHE SCIENTIFIQUE, MULTIPLE CLASS, (INT. CLS. 35, 38 AND 39), (U.S. CLS. 100, 101, 102, 104 AND 105). SN 76-071,477. PUB. 7-9-2002. FILED 6-16-2000.
 2,728,543. **ISPROCKET**. ISPROCKET, INC., (U.S. CLS. 100, 101 AND 102). SN 76-084,054. PUB. 4-1-2003. FILED 7-6-2000.
 2,728,546. **ABEL VALENZUELA EL REY DE LA TACHUELA AND DESIGN**. ALVAREZ, ALICIA, MULTIPLE CLASS, (INT. CLS. 35, 37 AND 42), (U.S. CLS. 100, 101, 102, 103 AND 106). SN 76-095,998. PUB. 4-1-2003. FILED 7-25-2000.
 2,728,550 (*See Class 9 for this trademark*).
 2,728,559 (*See Class 9 for this trademark*).

2,728,562. **S.I. NETWORK**. S.I. SYSTEMS LTD., (U.S. CLS. 100, 101 AND 102). SN 76-134,537. PUB. 4-1-2003. FILED 9-25-2000.
 2,728,566. **THE POWER OF PARTNERSHIP**. LINKSHARE CORPORATION, (U.S. CLS. 100, 101 AND 102). SN 76-140,647. PUB. 4-1-2003. FILED 10-4-2000.
 2,728,570. **R AND DESIGN**. RETEK, INC., MULTIPLE CLASS, (INT. CLS. 35, 38 AND 42), (U.S. CLS. 100, 101, 102 AND 104). SN 76-153,156. PUB. 4-1-2003. FILED 10-13-2000.
 2,728,576. **ERT.NET**. ENVIRONMENTAL RESOURCES TRUST, INC., (U.S. CLS. 100, 101 AND 102). SN 76-163,261. PUB. 4-1-2003. FILED 11-10-2000.
 2,728,582. **AWARDED PRODUCT OF THE YEAR AND DESIGN**. CHRISTIAN LE BRET, (U.S. CLS. 100, 101 AND 102). SN 76-172,072. PUB. 6-25-2002. FILED 11-28-2000.
 2,728,591 (*See Class 9 for this trademark*).
 2,728,605 (*See Class 9 for this trademark*).
 2,728,606 (*See Class 9 for this trademark*).
 2,728,613. **NSI NURSING SOLUTIONS, INC.**. NSI NURSING SOLUTIONS, INC., (U.S. CLS. 100, 101 AND 102). SN 76-242,828. PUB. 4-1-2003. FILED 4-18-2001.
 2,728,614. **M AND DESIGN**. MARSHALL SOLUTIONS, INC., (U.S. CLS. 100, 101 AND 102). SN 76-243,686. PUB. 4-1-2003. FILED 4-20-2001.
 2,728,615. **FLOORUNIVERSE**. FLOORUNIVERSE, INC., BY ASSIGNMENT SURFACEEXCHANGE, INC., DBA FLOORUNIVERSE, INC., (U.S. CLS. 100, 101 AND 102). SN 76-247,572. PUB. 4-1-2003. FILED 4-27-2001.
 2,728,616 (*See Class 9 for this trademark*).
 2,728,618 (*See Class 9 for this trademark*).
 2,728,624 (*See Class 9 for this trademark*).
 2,728,630. **VOYAGEUR EAST**. MOMO PANACHE LIMITED PARTNERSHIP, (U.S. CLS. 100, 101 AND 102). SN 76-264,868. PUB. 4-1-2003. FILED 6-1-2001.
 2,728,640. **ERGONAUTS**. ERGONAUTS: PERFORMANCE TECHNOLOGISTS LLC, (U.S. CLS. 100, 101 AND 102). SN 76-276,872. PUB. 4-1-2003. FILED 6-27-2001.
 2,728,641. **AIR**. AMERICAN INSTITUTES FOR RESEARCH IN THE BEHAVIORAL SCIENCES, (U.S. CLS. 100, 101 AND 102). SN 76-279,740. PUB. 4-1-2003. FILED 7-5-2001.
 2,728,644 (*See Class 9 for this trademark*).
 2,728,648. **ECNEXT KNOWLEDGE CENTER**. ECNEXT, INC., (U.S. CLS. 100, 101 AND 102). SN 76-289,126. PUB. 4-1-2003. FILED 7-24-2001.
 2,728,658 (*See Class 9 for this trademark*).
 2,728,660. **MINADO AND DESIGN**. MINADO CO., INC., (U.S. CLS. 100, 101 AND 102). SN 76-308,161. PUB. 4-1-2003. FILED 8-31-2001.
 2,728,668. **VIEWER'S FORUM AND DESIGN**. TGC, INC., MULTIPLE CLASS, (INT. CLS. 35 AND 41), (U.S. CLS. 100, 101, 102 AND 107). SN 76-316,763. PUB. 4-1-2003. FILED 9-24-2001.
 2,728,669. **LA CANASTA FURNISHINGS AND DESIGN**. LA CANASTA FURNISHINGS, INC., (U.S. CLS. 100, 101 AND 102). SN 76-316,837. PUB. 4-1-2003. FILED 9-24-2001.
 2,728,670 (*See Class 16 for this trademark*).
 2,728,677. **CRISISTRAK AND DESIGN**. BARKLEY EVERGREEN & PARTNERS, INC., (U.S. CLS. 100, 101 AND 102). SN 76-319,149. PUB. 4-1-2003. FILED 9-28-2001.
 2,728,692. **COMMUTER CHOICE AMERICA'S WAY TO WORK AND DESIGN**. U.S. ENVIRONMENTAL PROTECTION AGENCY, AND U.S. DEPARTMENT OF TRANSPORTATION, MULTIPLE CLASS, (INT. CLS. 35 AND 41), (U.S. CLS. 100, 101, 102 AND 107). SN 76-335,325. PUB. 4-1-2003. FILED 3-9-2001.
 2,728,694. **A RETIRED COLLECTION**. A RETIRED COLLECTION, LLC, (U.S. CLS. 100, 101 AND 102). SN 76-339,965. PUB. 4-1-2003. FILED 11-19-2001.
 2,728,695. **HIGH COTTON DIRECT MARKETING AND DESIGN**. HIGH COTTON DIRECT MARKETING, INC., (U.S. CLS. 100, 101 AND 102). SN 76-340,262. PUB. 4-1-2003. FILED 11-20-2001.
 2,728,696. **ZIPPO**. ZIPP MARK, INC., (U.S. CLS. 100, 101 AND 102). SN 76-340,828. PUB. 4-1-2003. FILED 11-21-2001.
 2,728,712. **USA FIGURE SKATING TEAM AND DESIGN**. UNITED STATES FIGURE SKATING ASSOCIATION, THE, MULTIPLE CLASS, (INT. CLS. 35 AND 41 AND U.S. CL. 200), (U.S. CLS. 100, 101, 102 AND 107). SN 76-

- 353,150. PUB. 4-1-2003. FILED 12-22-2001.
- 2,728,719. **YOU WOULD EVEN SAY IT GLOWS.** ST. NICHOLAS MUSIC INC., (U.S. CLS. 100, 101 AND 102). SN 76-357,702. PUB. 4-1-2003. FILED 1-11-2002.
- 2,728,720. **WON'T YOU GUIDE MY SLEIGH TONIGHT?.** ST. NICHOLAS MUSIC INC., (U.S. CLS. 100, 101 AND 102). SN 76-357,704. PUB. 4-1-2003. FILED 1-11-2002.
- 2,728,737. **MISCELLANEOUS DESIGN.** VALLEY OIL COMPANY, LLC, (U.S. CLS. 100, 101 AND 102). SN 76-365,190. PUB. 4-1-2003. FILED 1-30-2002.
- 2,728,747. **MERCHANT ACCESS.** ACCESS VG, L.L.C., (U.S. CLS. 100, 101 AND 102). SN 76-370,269. PUB. 4-1-2003. FILED 2-12-2002.
- 2,728,751. **STUDENTPROSPECTOR (STYLIZED).** EDUCATIONAL DIRECTORIES UNLIMITED, INC., (U.S. CLS. 100, 101 AND 102). SN 76-371,976. PUB. 4-1-2003. FILED 2-19-2002.
- 2,728,771. **ELARASYS.** ELARASYS, INC., (U.S. CLS. 100, 101 AND 102). SN 76-378,812. PUB. 4-1-2003. FILED 3-7-2002.
- 2,728,782. **WINE SENSE AND DESIGN.** WINE SENSE PARK AVENUE, INC., (U.S. CLS. 100, 101 AND 102). SN 76-380,944. PUB. 4-1-2003. FILED 3-12-2002.
- 2,728,784. **MISCELLANEOUS DESIGN.** ENPRIA, INC., MULTIPLE CLASS, (INT. CLS. 35 AND 42), (U.S. CLS. 100, 101 AND 102). SN 76-381,406. PUB. 4-1-2003. FILED 3-11-2002.
- 2,728,792. **ASF INTERNATIONAL.** AMERICAN SERVICE FINANCE, INC., DBA ASF INTERNATIONAL, INC., MULTIPLE CLASS, (INT. CLS. 35 AND 36), (U.S. CLS. 100, 101 AND 102). SN 76-384,275. PUB. 4-1-2003. FILED 3-19-2002.
- 2,728,795. **MEDBOUND BILLING SOLUTIONS, INC..** MEDBOUND BILLING SOLUTIONS, INC., (U.S. CLS. 100, 101 AND 102). SN 76-384,570. PUB. 4-1-2003. FILED 3-20-2002.
- 2,728,804. **FIRSTENERGY SOLUTIONS.** FIRSTENERGY CORP., MULTIPLE CLASS, (INT. CLS. 35, 36, 37, 38, 39 AND 42), (U.S. CLS. 100, 101, 102, 103, 104, 105 AND 106). SN 76-389,169. PUB. 4-1-2003. FILED 3-28-2002.
- 2,728,825. **THE STORE FOR LOVERS!.** AMBIANCE, INC., (U.S. CLS. 100, 101 AND 102). SN 76-398,741. PUB. 4-1-2003. FILED 4-22-2002.
- 2,728,826. **THE GREAT LOVERS CLUB.** AMBIANCE, INC., (U.S. CLS. 100, 101 AND 102). SN 76-398,743. PUB. 4-1-2003. FILED 4-22-2002.
- 2,728,827. **THE GREAT LOVERS CLUB AND DESIGN.** AMBIANCE, INC., (U.S. CLS. 100, 101 AND 102). SN 76-399,160. PUB. 4-1-2003. FILED 4-23-2002.
- 2,728,840. **AUTO ADDICTIONS.** VAN SCYOC'S AUTO ADDICTION INC., (U.S. CLS. 100, 101 AND 102). SN 76-405,533. PUB. 4-1-2003. FILED 5-10-2002.
- 2,728,845. **HERITAGE EXPOSITION SERVICES.** HERITAGE EXPOSITION SERVICES, INC., MULTIPLE CLASS, (INT. CLS. 35, 39 AND 43), (U.S. CLS. 100, 101, 102 AND 105). SN 76-405,907. PUB. 4-1-2003. FILED 5-3-2002.
- 2,728,854. **FOR THE JOURNEY THAT IS LIFE.** WELLSPAN HEALTH, MULTIPLE CLASS, (INT. CLS. 35, 42, 44 AND 45), (U.S. CLS. 100, 101 AND 102). SN 76-409,124. PUB. 4-1-2003. FILED 5-16-2002.
- 2,728,859. **U AND DESIGN.** UMBRA INC., (U.S. CLS. 100, 101 AND 102). SN 76-409,852. PUB. 4-1-2003. FILED 5-20-2002.
- 2,728,869. **TOTAL OWNERSHIP EXPERIENCE.** NISSAN NORTH AMERICA, INC., (U.S. CLS. 100, 101 AND 102). SN 76-412,651. PUB. 4-1-2003. FILED 5-28-2002.
- 2,728,873. **THE ADARE GROUP AND DESIGN.** HOUSE, DEBORAH A., MULTIPLE CLASS, (INT. CLS. 35 AND 36), (U.S. CLS. 100, 101 AND 102). SN 76-415,097. PUB. 4-1-2003. FILED 6-6-2002.
- 2,728,886. **MYSTIQUE SHOPPER AND DESIGN.** MYSTIQUE SHOPPER, (U.S. CLS. 100, 101 AND 102). SN 76-418,627. PUB. 4-1-2003. FILED 6-7-2002.
- 2,728,890. **NURSES CARE FOR AMERICA AND DESIGN.** AMERICAN NURSES ASSOCIATION, INC., (U.S. CLS. 100, 101 AND 102). SN 76-419,833. PUB. 4-1-2003. FILED 6-12-2002.
- 2,728,898. **MISCELLANEOUS DESIGN.** URRRA CO., INC., (U.S. CLS. 100, 101 AND 102). SN 76-422,946. PUB. 4-1-2003. FILED 6-19-2002.
- 2,728,901. **NFO WORLDGROUP.** NFO WORLDWIDE, INC., (U.S. CLS. 100, 101 AND 102). SN 76-423,481. PUB. 4-1-2003. FILED 6-18-2002.
- 2,728,909. **H-E-BUDDY.** HEB GROCERY COMPANY, LP, (U.S. CLS. 100, 101 AND 102). SN 76-424,489. PUB. 4-1-2003. FILED 6-24-2002.
- 2,728,915. **AFFORDABLE SUPPLEMENTS AND DESIGN.** AFFORDABLE SUPPLEMENTS, INC., (U.S. CLS. 100, 101 AND 102). SN 76-426,799. PUB. 4-1-2003. FILED 7-1-2002.
- 2,728,917. **M METROPOLITAN NEWS CLIPS SERVICE INC. AND DESIGN.** METROPOLITAN NEWSCLIPS SERVICE, INC., (U.S. CLS. 100, 101 AND 102). SN 76-426,896. PUB. 4-1-2003. FILED 6-28-2002.
- 2,728,920. **TOWNFINDER.** SCHNEIDER, DAVID L., (U.S. CLS. 100, 101 AND 102). SN 76-427,347. PUB. 4-1-2003. FILED 7-5-2002.
- 2,728,926. **CON-WAY GUARANTEED! (STYLIZED).** CNF INC., MULTIPLE CLASS, (INT. CLS. 35 AND 39), (U.S. CLS. 100, 101, 102 AND 105). SN 76-428,881. PUB. 4-1-2003. FILED 7-2-2002.
- 2,728,930. **MISCELLANEOUS DESIGN.** HELLAS BAKERY AND PITA, INC., (U.S. CLS. 100, 101 AND 102). SN 76-429,441. PUB. 4-1-2003. FILED 7-1-2002.
- 2,728,944. **POSTONCE.** GLOBAL TECHNOLOGY ASSOCIATES, (U.S. CLS. 100, 101 AND 102). SN 76-432,797. PUB. 4-1-2003. FILED 7-22-2002.
- 2,728,948. **MISCELLANEOUS DESIGN.** INTERNATIONAL WOMEN'S FORUM, (U.S. CLS. 100, 101 AND 102). SN 76-433,418. PUB. 4-1-2003. FILED 7-16-2002.
- 2,728,952. **GCBAA AND DESIGN.** GOLF COURSE BUILDERS ASSOCIATION OF AMERICA, INC., (U.S. CLS. 100, 101 AND 102). SN 76-434,594. PUB. 4-1-2003. FILED 7-26-2002.
- 2,728,975 (*See Class 9 for this trademark*).
- 2,728,976 (*See Class 9 for this trademark*).
- 2,728,979. **ORGANICS ON THE GO AND DESIGN.** EAGLE FLIGHT ENTERPRISE, INC., (U.S. CLS. 100, 101 AND 102). SN 76-439,360. PUB. 4-1-2003. FILED 8-12-2002.
- 2,728,984. **TERESPONDO.COM AND DESIGN.** TERESPONDO.COM, INC., (U.S. CLS. 100, 101 AND 102). SN 76-439,737. PUB. 4-1-2003. FILED 8-13-2002.
- 2,728,988. **BH BETTER HEALTH (STYLIZED).** BH FITNESS AND RECREATION, INC., (U.S. CLS. 100, 101 AND 102). SN 76-441,326. PUB. 4-1-2003. FILED 8-19-2002.
- 2,728,997. **MANTENGA A LOS NINOS VIVOS MANEJE 25 (STYLIZED).** EVERSON, THOMAS J., (U.S. CLS. 100, 101 AND 102). SN 76-442,177. PUB. 4-1-2003. FILED 8-15-2002.
- 2,729,007. **ENCOURAGE MARKETING.** ENCOURAGE MARKETING, LLC, (U.S. CLS. 100, 101 AND 102). SN 76-442,890. PUB. 4-1-2003. FILED 8-22-2002.
- 2,729,008. **TECHNOLOGY ENHANCED MARKETING.** ENCOURAGE MARKETING, LLC, (U.S. CLS. 100, 101 AND 102). SN 76-442,892. PUB. 4-1-2003. FILED 8-22-2002.
- 2,729,009. **MISCELLANEOUS DESIGN.** GENESYS CONSULTING SERVICES, INC., (U.S. CLS. 100, 101 AND 102). SN 76-442,943. PUB. 4-1-2003. FILED 8-22-2002.
- 2,729,030. **M2S2.** HAGEMEYER NORTH AMERICA, INC., (U.S. CLS. 100, 101 AND 102). SN 76-444,455. PUB. 4-1-2003. FILED 8-28-2002.
- 2,729,044. **NTS (STYLIZED).** NATIONAL TECHNICAL SYSTEMS, INC., (U.S. CLS. 100, 101 AND 102). SN 76-446,472. PUB. 4-1-2003. FILED 9-3-2002.
- 2,729,046 (*See Class 9 for this trademark*).
- 2,729,053. **THE RIGHT TALENT RIGHT NOW.** OXFORD GLOBAL RESOURCES, INC., (U.S. CLS. 100, 101 AND 102). SN 76-446,912. PUB. 4-1-2003. FILED 9-5-2002.
- 2,729,061. **BIRDS OF A FEATHER.** BIRDS OF A FEATHER, INT'L., (U.S. CLS. 100, 101 AND 102). SN 76-447,445. PUB. 4-1-2003. FILED 9-5-2002.
- 2,729,082 (*See Class 9 for this trademark*).
- 2,729,096. **INSURANCE IN TOUCH WITH YOUR WORLD.** CNA FINANCIAL CORPORATION, MULTIPLE CLASS, (INT. CLS. 35 AND 36), (U.S. CLS. 100, 101 AND 102). SN 76-453,141. PUB. 4-1-2003. FILED 9-26-2002.
- 2,729,097. **REESO.** REESO TILES, INC., (U.S. CLS. 100, 101 AND 102). SN 76-453,200. PUB. 4-1-2003. FILED 9-26-2002.
- 2,729,115. **A GREAT FEELING WHEN YOU SHOP.** COUNT ON ME, L.L.C., (U.S. CLS. 100, 101 AND 102). SN 76-455,854. PUB. 4-1-2003. FILED 10-4-2002.
- 2,729,121. **INTUIT.** INTUIT INC., (U.S. CLS. 100, 101 AND 102). SN 76-464,189. PUB. 4-1-2003. FILED 11-4-2002.

- 2,729,132 (*See Class 9 for this trademark*).
 2,729,140. **SUPER BOUNCE**. SUPER BOUNCE, INC., (U.S. CLS. 100, 101 AND 102). SN 78-058,138. PUB. 4-1-2003. FILED 4-12-2001.
 2,729,160. **PRO-MED PRODUCTS**. PRO-MED PRODUCTS, INC., (U.S. CLS. 100, 101 AND 102). SN 78-105,260. PUB. 4-1-2003. FILED 1-28-2002.
 2,729,162. **ACA AMERICAN CONTRACTORS ALLIANCE (STYLIZED)**. AMERICAN CONTRACTORS ALLIANCE, INC., (U.S. CLS. 100, 101 AND 102). SN 78-106,773. PUB. 4-1-2003. FILED 2-4-2002.
 2,729,163. **BLOOMING PRAIRIE**. BLOOMING PRAIRIE CO-OPERATIVE WAREHOUSE, MULTIPLE CLASS, (INT. CLS. 35 AND 41), (U.S. CLS. 100, 101, 102 AND 107). SN 78-107,435. PUB. 4-1-2003. FILED 2-7-2002.
 2,729,169. **GP GREAT PLAINS NATURAL GAS CO. AND DESIGN**. MDU RESOURCES GROUP, INC., MULTIPLE CLASS, (INT. CLS. 35, 37 AND 39), (U.S. CLS. 100, 101, 102, 103, 105 AND 106). SN 78-110,070. PUB. 4-1-2003. FILED 2-20-2002.
 2,729,177. **ARCHIVE BUILDERS**. GILHEANY, STEPHEN, J., (U.S. CLS. 100, 101 AND 102). SN 78-116,437. PUB. 4-1-2003. FILED 3-21-2002.
 2,729,182 (*See Class 16 for this trademark*).
 2,729,191. **BILLINGEDGE SOLUTIONS AND DESIGN**. COMPUTER AND COMMUNICATION TECHNOLOGIES INC., (U.S. CLS. 100, 101 AND 102). SN 78-122,301. PUB. 11-5-2002. FILED 4-17-2002.
 2,729,193. **DUALREACH**. DUALREACH, MULTIPLE CLASS, (INT. CLS. 35, 41 AND 45), (U.S. CLS. 100, 101, 102 AND 107). SN 78-123,120. PUB. 4-1-2003. FILED 4-22-2002.
 2,729,197. **SIGNED EDITIONS AND DESIGN**. WEINS, JANINE J., (U.S. CLS. 100, 101 AND 102). SN 78-126,100. PUB. 4-1-2003. FILED 5-3-2002.
 2,729,202. **SINCE 1967 HAVERHILLS (STYLIZED)**. HARRIS, PAUL ROBERT, (U.S. CLS. 100, 101 AND 102). SN 78-130,802. PUB. 4-1-2003. FILED 5-23-2002.
 2,729,218. **IHELPHYOU**. IHELPHYOU, INC., (U.S. CLS. 100, 101 AND 102). SN 78-136,107. PUB. 4-1-2003. FILED 6-16-2002.
 2,729,220. **THE ASSOCIATION OF BONE AND JOINT SURGEONS 1947 AND DESIGN**. THE ASSOCIATION OF BONE AND JOINT SURGEONS, MULTIPLE CLASS, (INT. CLS. 35 AND 41), (U.S. CLS. 100, 101, 102 AND 107). SN 78-137,821. PUB. 4-1-2003. FILED 6-21-2002.
 2,729,224. **AMACAI**. AMACAI INFORMATION CORPORATION, (U.S. CLS. 100, 101 AND 102). SN 78-139,562. PUB. 4-1-2003. FILED 6-27-2002.
 2,729,242. **BENEFIT FROM OUR EXPERIENCE**. BENELOGIC, LLC, MULTIPLE CLASS, (INT. CLS. 35 AND 36), (U.S. CLS. 100, 101 AND 102). SN 78-145,369. PUB. 4-1-2003. FILED 7-18-2002.
 2,729,243. **LFA SOLUTIONSLINC**. LINCOLN FINANCIAL ADVISORS CORPORATION, (U.S. CLS. 100, 101 AND 102). SN 78-145,824. PUB. 4-1-2003. FILED 7-19-2002.
 2,729,245. **COMPONENT HEALTH WATCH (CHW)**. ISUPPLI CORP., (U.S. CLS. 100, 101 AND 102). SN 78-146,165. PUB. 4-1-2003. FILED 7-22-2002.
 2,729,282. **TETCO**. TETCO, INC., MULTIPLE CLASS, (INT. CLS. 35 AND 37), (U.S. CLS. 100, 101, 102, 103 AND 106). SN 78-153,446. PUB. 4-1-2003. FILED 8-12-2002.
 2,729,293. **CREATED ELEGANCE**. LANNYTE COMPANY, INC., (U.S. CLS. 100, 101 AND 102). SN 78-155,057. PUB. 4-1-2003. FILED 8-16-2002.
 2,729,294. **WE AND DESIGN**. WEISMAN ENTERPRISES, INC., (U.S. CLS. 100, 101 AND 102). SN 78-155,112. PUB. 4-1-2003. FILED 8-16-2002.
 2,729,301. **ERGOBAY**. ERGOBAY, LLC, (U.S. CLS. 100, 101 AND 102). SN 78-155,321. PUB. 4-1-2003. FILED 8-19-2002.
 2,729,318. **CAPTAINS OF INDUSTRY**. FRED & TED ENTERTAINMENT, INC., (U.S. CLS. 100, 101 AND 102). SN 78-158,066. PUB. 4-1-2003. FILED 8-27-2002.
 2,729,325. **CYBERSTRIKE**. NEW MEDIA STRATEGIES, INC., (U.S. CLS. 100, 101 AND 102). SN 78-158,583. PUB. 4-1-2003. FILED 8-28-2002.
 2,729,334. **TURNING HEALTHCARE DATA INTO INTELLIGENCE**. AMERICAN HEALTH DATA INSTITUTE, INC., (U.S. CLS. 100, 101 AND 102). SN 78-159,293. PUB. 4-1-2003. FILED 8-29-2002.
 2,729,344. **YOUR PROFIT IS OUR PRIORITY**. ADP, INC., (U.S. CLS. 100, 101 AND 102). SN 78-160,707. PUB. 4-1-2003. FILED 9-4-2002.
-
- CLASS 36—INSURANCE AND FINANCIAL**
- 2,728,456. **SIERRAWEST BANK**. SIERRA TAHOE BANCORP, (U.S. CLS. 100, 101 AND 102). SN 75-085,313. PUB. 4-1-2003. FILED 4-8-1996.
 2,728,486. **SUPERIOR ACCESS**. SUPERIOR ACCESS INSURANCE SERVICES, INC., (U.S. CLS. 100, 101 AND 102). SN 75-745,484. PUB. 4-1-2003. FILED 8-3-1999.
 2,728,493 (*See Class 3 for this trademark*).
 2,728,500 (*See Class 9 for this trademark*).
 2,728,501 (*See Class 9 for this trademark*).
 2,728,502 (*See Class 9 for this trademark*).
 2,728,503 (*See Class 9 for this trademark*).
 2,728,511 (*See Class 35 for this trademark*).
 2,728,516 (*See Class 16 for this trademark*).
 2,728,526. **UNIVERSITY PROPERTIES**. YALE UNIVERSITY, MULTIPLE CLASS, (INT. CLS. 36 AND 37), (U.S. CLS. 100, 101, 102, 103 AND 106). SN 76-020,820. PUB. 4-1-2003. FILED 4-7-2000.
 2,728,559 (*See Class 9 for this trademark*).
 2,728,585. **WORKING CAPITAL FOR GROWING BUSINESS**. PRAIRIE BUSINESS CREDIT, INC., (U.S. CLS. 100, 101 AND 102). SN 76-177,679. PUB. 4-1-2003. FILED 12-7-2000.
 2,728,588 (*See Class 16 for this trademark*).
 2,728,597 (*See Class 16 for this trademark*).
 2,728,633. **TELETELLER**. FIRST FEDERAL LINCOLN BANK, (U.S. CLS. 100, 101 AND 102). SN 76-268,149. PUB. 4-1-2003. FILED 6-7-2001.
 2,728,639. **POWER PLUS**. MUNDER FUNDS, INC., THE, (U.S. CLS. 100, 101 AND 102). SN 76-276,427. PUB. 4-1-2003. FILED 6-22-2001.
 2,728,642. **ORBIMED**. ORBIMED ADVISORS LLC, (U.S. CLS. 100, 101 AND 102). SN 76-280,240. PUB. 11-6-2001. FILED 7-3-2001.
 2,728,652. **HALSTEAD THE PROPERTY COMPANY (STYLIZED)**. HALSTEAD HOLDINGS, LLC, (U.S. CLS. 100, 101 AND 102). SN 76-296,050. PUB. 4-1-2003. FILED 8-6-2001.
 2,728,682. **TWIN PORTS SPIRIT**. METRIS DIRECT, INC., (U.S. CLS. 100, 101 AND 102). SN 76-322,839. PUB. 4-1-2003. FILED 10-9-2001.
 2,728,688. **AMERICAN AIRLINES FEDERAL CREDIT UNION**. AMERICAN AIRLINES, INC., (U.S. CLS. 100, 101 AND 102). SN 76-330,466. PUB. 4-1-2003. FILED 10-26-2001.
 2,728,710. **POLITZER & HANEY**. POLITZER & HANEY, INC., (U.S. CLS. 100, 101 AND 102). SN 76-352,368. PUB. 4-1-2003. FILED 12-26-2001.
 2,728,723. **IBOXX**. IBOXX LIMITED, (U.S. CLS. 100, 101 AND 102). SN 76-358,949. PUB. 4-1-2003. FILED 1-16-2002.
 2,728,731. **BAY GULF CREDIT UNION AND DESIGN**. BAY GULF CREDIT UNION, (U.S. CLS. 100, 101 AND 102). SN 76-361,360. PUB. 4-1-2003. FILED 1-23-2002.
 2,728,742. **MISCELLANEOUS DESIGN**. ISOLATED DATA SYSTEMS, L.L.C., (U.S. CLS. 100, 101 AND 102). SN 76-367,269. PUB. 4-1-2003. FILED 2-4-2002.
 2,728,757. **TEL RURAL AMERICA**. AHEP FOUNDERS, LLC, (U.S. CLS. 100, 101 AND 102). SN 76-373,972. PUB. 4-1-2003. FILED 2-25-2002.
 2,728,778. **CB CONWAY BANK**. CONWAY BANK, N.A., (U.S. CLS. 100, 101 AND 102). SN 76-380,432. PUB. 4-1-2003. FILED 3-11-2002.
 2,728,788. **THINK BIGGER**. TRANSAMERICA OCCIDENTAL LIFE INSURANCE COMPANY, (U.S. CLS. 100, 101 AND 102). SN 76-383,207. PUB. 4-1-2003. FILED 3-12-2002.
 2,728,792 (*See Class 35 for this trademark*).
 2,728,800. **MM AND DESIGN**. MELLON EQUITY ASSOCIATES, LLP, (U.S. CLS. 100, 101 AND 102). SN 76-385,444. PUB. 4-1-2003. FILED 3-19-2002.
 2,728,804 (*See Class 35 for this trademark*).
 2,728,833. **SCHOOL NUTRITION SERVICES AND DESIGN**. AMERICAN DIETETIC ASSOCIATION, MULTIPLE CLASS, (INT. CLS. 36 AND 41), (U.S. CLS. 100, 101, 102 AND 107). SN 76-402,219. PUB. 4-1-2003. FILED 4-29-2002.

- 2,728,838. **TURBO FORWARD SALE**. DEUTSCHE BANK SECURITIES, INC., (U.S. CLS. 100, 101 AND 102). SN 76-404,337. PUB. 4-1-2003. FILED 5-7-2002.
- 2,728,855. **SILVERPLUME**. AMS SERVICES, INC., (U.S. CLS. 100, 101 AND 102). SN 76-409,291. PUB. 4-1-2003. FILED 5-17-2002.
- 2,728,857. **SILVER PLUME AND DESIGN**. AMS SERVICES, INC., (U.S. CLS. 100, 101 AND 102). SN 76-409,468. PUB. 4-1-2003. FILED 5-17-2002.
- 2,728,873 (*See Class 35 for this trademark*).
- 2,728,875. **HIRST RE AND DESIGN**. HIRST INVESTMENT MANAGEMENT INC., (U.S. CLS. 100, 101 AND 102). SN 76-416,068. PUB. 4-1-2003. FILED 6-6-2002.
- 2,728,878. **HOUSE OF GIVING**. HOUSE OF GIVING, (U.S. CLS. 100, 101 AND 102). SN 76-416,394. PUB. 4-1-2003. FILED 6-3-2002.
- 2,728,897. **S AND DESIGN**. DOUGLAS SHAW & ASSOCIATES, (U.S. CLS. 100, 101 AND 102). SN 76-422,661. PUB. 4-1-2003. FILED 6-19-2002.
- 2,728,942. **FLEET FLEXPLUS**. FLEETBOSTON FINANCIAL CORPORATION, (U.S. CLS. 100, 101 AND 102). SN 76-432,132. PUB. 4-1-2003. FILED 7-18-2002.
- 2,728,980. **PLEA PROFESSIONAL LAW ENFORCEMENT ASSOCIATION AND DESIGN**. PROFESSIONAL LAW ENFORCEMENT ASSOCIATION, INC., (U.S. CLS. 100, 101 AND 102). SN 76-439,361. PUB. 4-1-2003. FILED 8-12-2002.
- 2,728,996. **FUNDVEST (STYLIZED)**. DLJ LONG TERM INVESTMENT CORPORATION, (U.S. CLS. 100, 101 AND 102). SN 76-442,174. PUB. 4-1-2003. FILED 8-16-2002.
- 2,729,001. **GENE GARCIA NO ONE APPROVES MORE**. GARCIA, GINES J., (U.S. CLS. 100, 101 AND 102). SN 76-442,414. PUB. 4-1-2003. FILED 8-22-2002.
- 2,729,004. **FUNDVEST FOCUS (STYLIZED)**. DLJ LONG TERM INVESTMENT CORPORATION, (U.S. CLS. 100, 101 AND 102). SN 76-442,592. PUB. 4-1-2003. FILED 8-16-2002.
- 2,729,020. **911GUARDIAN.COM**. ENFORCE-IT!, LLC, (U.S. CLS. 100, 101 AND 102). SN 76-443,662. PUB. 4-1-2003. FILED 8-26-2002.
- 2,729,027. **MAKING FLOOD SIMPLE**. THE SEIBELS BRUCE GROUP, INC., (U.S. CLS. 100, 101 AND 102). SN 76-443,926. PUB. 4-1-2003. FILED 8-27-2002.
- 2,729,029. **X AND DESIGN**. UNITED LIFE AGENCY SERVICES, L.L.C., (U.S. CLS. 100, 101 AND 102). SN 76-444,127. PUB. 4-1-2003. FILED 8-22-2002.
- 2,729,039. **LINT ROLLER PARTY**. BEST FRIENDS ANIMAL SANCTUARY, (U.S. CLS. 100, 101 AND 102). SN 76-445,732. PUB. 4-1-2003. FILED 8-29-2002.
- 2,729,046 (*See Class 9 for this trademark*).
- 2,729,052. **FCR**. FINANCIAL COUNSELING RESOURCES, LLC, (U.S. CLS. 100, 101 AND 102). SN 76-446,897. PUB. 4-1-2003. FILED 9-3-2002.
- 2,729,096 (*See Class 35 for this trademark*).
- 2,729,120. **FAMILIES OF FREEDOM**. CITIZENS' SCHOLARSHIP FOUNDATION OF AMERICA, INC., (U.S. CLS. 100, 101 AND 102). SN 76-462,627. PUB. 4-1-2003. FILED 10-30-2002.
- 2,729,124. **FAMILIES OF FREEDOM 2 BUILDING FUTURES THROUGH EDUCATION AND DESIGN**. CITIZENS' SCHOLARSHIP FOUNDATION OF AMERICA, INC., (U.S. CLS. 100, 101 AND 102). SN 76-469,015. PUB. 4-1-2003. FILED 11-21-2002.
- 2,729,144. **E-LMO FAST TRACK**. GE MORTGAGE HOLDINGS, LLC, (U.S. CLS. 100, 101 AND 102). SN 78-072,170. PUB. 4-1-2003. FILED 7-3-2001.
- 2,729,153. **THE WEST CORPORATION CORPORATION DE L'OUEST (STYLIZED)**. NCHAKO, LENA P., AND NCHAKO, COLIN N., (U.S. CLS. 100, 101 AND 102). SN 78-097,289. PUB. 4-1-2003. FILED 12-7-2001.
- 2,729,170. **FXTRADZ.COM YOUR FOREX SOLUTION (STYLIZED)**. GLOBAL TRADZ, INC., (U.S. CLS. 100, 101 AND 102). SN 78-110,347. PUB. 4-1-2003. FILED 2-22-2002.
- 2,729,172. **RATECLIMBER**. F.N.B. CORPORATION, (U.S. CLS. 100, 101 AND 102). SN 78-112,781. PUB. 4-1-2003. FILED 3-5-2002.
- 2,729,222. **MORTGAGE MAKERS AND DESIGN**. TENNESSEE VALLEY FEDERAL CREDIT UNION, (U.S. CLS. 100, 101 AND 102). SN 78-139,006. PUB. 4-1-2003. FILED 6-26-2002.
- 2,729,225. **CURRENCY CONNECTION AND DESIGN**. REPUBLIC BANK & TRUST COMPANY, (U.S. CLS. 100, 101 AND 102). SN 78-139,748. PUB. 4-1-2003. FILED 6-28-2002.
- 2,729,234 (*See Class 9 for this trademark*).
- 2,729,235. **CASH CARE III**. MCC NATIONAL BROKERAGE, INC., (U.S. CLS. 100, 101 AND 102). SN 78-143,799. PUB. 4-1-2003. FILED 7-15-2002.
- 2,729,241. **NEWFIRST NATIONAL BANK AND DESIGN**. NEWFIRST NATIONAL BANK, (U.S. CLS. 100, 101 AND 102). SN 78-145,150. PUB. 4-1-2003. FILED 7-18-2002.
- 2,729,242 (*See Class 35 for this trademark*).
- 2,729,257. **HEALTHY FOCUS**. BLUECROSS BLUESHIELD OF TENNESSEE, (U.S. CLS. 100, 101 AND 102). SN 78-147,959. PUB. 4-1-2003. FILED 7-26-2002.
- 2,729,271. **PAYWIRE**. DBWIRED, INC., (U.S. CLS. 100, 101 AND 102). SN 78-151,908. PUB. 4-1-2003. FILED 8-7-2002.
- 2,729,290. **BETTER THAN A BANK**. MUNA FEDERAL CREDIT UNION, (U.S. CLS. 100, 101 AND 102). SN 78-154,943. PUB. 4-1-2003. FILED 8-16-2002.
- 2,729,297. **SPEED, SIMPLICITY, SERVICE**. BEECH FINANCIAL SERVICES, LLC, (U.S. CLS. 100, 101 AND 102). SN 78-155,215. PUB. 4-1-2003. FILED 8-17-2002.
- 2,729,307. **OUR PROMISE IS PERSONAL**. CANADA LIFE ASSURANCE COMPANY, THE, (U.S. CLS. 100, 101 AND 102). SN 78-156,185. PUB. 4-1-2003. FILED 8-21-2002.
- 2,729,311. **FIFTEEN GROUP**. FIFTEEN GROUP, LLC, (U.S. CLS. 100, 101 AND 102). SN 78-156,701. PUB. 4-1-2003. FILED 8-22-2002.
- 2,729,327. **SCOTTRADER**. SCOTTRADER, INC., (U.S. CLS. 100, 101 AND 102). SN 78-158,751. PUB. 4-1-2003. FILED 8-28-2002.
- 2,729,339. **FX CONNECT**. STATE STREET CORPORATION, (U.S. CLS. 100, 101 AND 102). SN 78-159,702. PUB. 4-1-2003. FILED 8-30-2002.
- 2,729,360. **INTUIT**. INTUIT INC., (U.S. CLS. 100, 101 AND 102). SN 78-180,304. PUB. 4-1-2003. FILED 10-30-2002.

CLASS 37—CONSTRUCTION AND REPAIR

- 2,728,522 (*See Class 35 for this trademark*).
- 2,728,526 (*See Class 36 for this trademark*).
- 2,728,530 (*See Class 6 for this trademark*).
- 2,728,531 (*See Class 6 for this trademark*).
- 2,728,546 (*See Class 35 for this trademark*).
- 2,728,552. **BOBVILA.COM**. B.V.T.V., INC., MULTIPLE CLASS, (INT. CLS. 37 AND 42), (U.S. CLS. 100, 101, 103 AND 106). SN 76-110,342. PUB. 4-1-2003. FILED 8-17-2000.
- 2,728,564. **Z STRIPE FACTORY PAINTED PIN STRIPES AND DESIGN**. Z-STRIPE, INC., (U.S. CLS. 100, 103 AND 106). SN 76-138,136. PUB. 12-3-2002. FILED 10-2-2000.
- 2,728,586 (*See Class 28 for this trademark*).
- 2,728,646 (*See Class 7 for this trademark*).
- 2,728,736 (*See Class 12 for this trademark*).
- 2,728,791. **VAC-A-TEE**. LMK ENTERPRISES, INC., (U.S. CLS. 100, 103 AND 106). SN 76-384,089. PUB. 4-1-2003. FILED 3-7-2002.
- 2,728,804 (*See Class 35 for this trademark*).
- 2,728,885. **MORGAN CITY RENTALS AND DESIGN**. T & J ENTERPRISES, L.L.C., (U.S. CLS. 100, 103 AND 106). SN 76-418,607. PUB. 4-1-2003. FILED 6-7-2002.
- 2,728,892. **CANNON ASSOCIATES**. CANNON ASSOCIATES, MULTIPLE CLASS, (INT. CLS. 37 AND 42), (U.S. CLS. 100, 101, 103 AND 106). SN 76-420,905. PUB. 4-1-2003. FILED 6-14-2002.
- 2,728,922. **SERVICETEAM EXPERIENCE**. ATKINSON, PATRICK J., (U.S. CLS. 100, 103 AND 106). SN 76-428,231. PUB. 4-1-2003. FILED 7-5-2002.
- 2,729,016. **STOP THAT BREAKDOWN**. ECP INCORPORATED, (U.S. CLS. 100, 103 AND 106). SN 76-443,420. PUB. 4-1-2003. FILED 8-26-2002.
- 2,729,021. **DRYSPACE**. DRYSPACE, INC., (U.S. CLS. 100, 103 AND 106). SN 76-443,676. PUB. 4-1-2003. FILED 8-23-2002.
- 2,729,037. **DECO ASPHALT INNOVATION IN ASPHALT PAVING AND DESIGN**. MIRSEPASSI, SADEGH, (U.S. CLS. 100, 103 AND 106). SN 76-445,216. PUB. 4-1-2003. FILED 6-28-2002.

- 2,729,062. **BIG WEST CORPORATION**. BIG WEST CORPORATION, (U.S. CLS. 100, 103 AND 106). SN 76-447,565. PUB. 4-1-2003. FILED 9-6-2002.
- 2,729,088. **AMX**. AMX MANAGEMENT, INC., (U.S. CLS. 100, 103 AND 106). SN 76-451,807. PUB. 4-1-2003. FILED 9-23-2002.
- 2,729,104. **CHURCH BROTHERS**. CHURCH BROTHERS COLLISION REPAIR, LLC, (U.S. CLS. 100, 103 AND 106). SN 76-454,070. PUB. 4-1-2003. FILED 9-30-2002.
- 2,729,169 (*See Class 35 for this trademark*).
- 2,729,174. **HAVE YOUR NEW DREAM HOME AT YOUR OLD ADDRESS**. WEISS, ARVIN STANLEY, (U.S. CLS. 100, 103 AND 106). SN 78-114,616. PUB. 4-1-2003. FILED 3-13-2002.
- 2,729,208. **PRECISION DRILLING AND DESIGN**. PRECISION DRILLING CORPORATION, MULTIPLE CLASS, (INT. CLS. 37, 40 AND 42), (U.S. CLS. 100, 101, 103 AND 106). SN 78-132,116. PUB. 4-1-2003. FILED 5-30-2002.
- 2,729,210. **SPRAYMAX**. SPRAYMAX, INC., (U.S. CLS. 100, 103 AND 106). SN 78-134,424. PUB. 4-1-2003. FILED 6-10-2002.
- 2,729,211. **ITC (STYLIZED)**. INTEGRATED INFORMATION TECHNOLOGY CORPORATION, MULTIPLE CLASS, (INT. CLS. 37 AND 42), (U.S. CLS. 100, 101, 103 AND 106). SN 78-134,700. PUB. 4-1-2003. FILED 6-11-2002.
- 2,729,215. **SHOP FROM HOME WE BRING THE SHOWROOM TO YOU**. WATROUS, LES, P., (U.S. CLS. 100, 103 AND 106). SN 78-135,654. PUB. 4-1-2003. FILED 6-13-2002.
- 2,729,282 (*See Class 35 for this trademark*).

CLASS 38—COMMUNICATION

- 2,728,463 (*See Class 16 for this trademark*).
- 2,728,477 (*See Class 9 for this trademark*).
- 2,728,493 (*See Class 3 for this trademark*).
- 2,728,509 (*See Class 9 for this trademark*).
- 2,728,537 (*See Class 35 for this trademark*).
- 2,728,548. **WHERE THE INTERNET LIVES**. INTERXION HOLDING N.V., (U.S. CLS. 100, 101 AND 104). SN 76-101,229. PUB. 7-9-2002. FILED 8-2-2000.
- 2,728,551 (*See Class 9 for this trademark*).
- 2,728,554 (*See Class 2 for this trademark*).
- 2,728,555 (*See Class 2 for this trademark*).
- 2,728,559 (*See Class 9 for this trademark*).
- 2,728,570 (*See Class 35 for this trademark*).
- 2,728,618 (*See Class 9 for this trademark*).
- 2,728,628. **HYPERPHONE**. NETCALL TELECOM, INCORPORATED, MULTIPLE CLASS, (INT. CLS. 38 AND 42), (U.S. CLS. 100, 101 AND 104). SN 76-261,349. PUB. 4-1-2003. FILED 5-22-2001.
- 2,728,632. **Q INTELLIGENT MEETINGS AND DESIGN**. INTELLIGENT MEETINGS CORP., (U.S. CLS. 100, 101 AND 104). SN 76-266,805. PUB. 4-1-2003. FILED 6-5-2001.
- 2,728,644 (*See Class 9 for this trademark*).
- 2,728,646 (*See Class 7 for this trademark*).
- 2,728,681. **ATVCL.NET**. ALLEN'S TV CABLE SERVICE, INC., MULTIPLE CLASS, (INT. CLS. 38 AND 42), (U.S. CLS. 100, 101 AND 104). SN 76-322,719. PUB. 4-1-2003. FILED 10-9-2001.
- 2,728,716. **OPB AND DESIGN**. OREGON PUBLIC BROADCASTING, MULTIPLE CLASS, (INT. CLS. 38 AND 41), (U.S. CLS. 100, 101, 104 AND 107). SN 76-356,271. PUB. 4-1-2003. FILED 1-9-2002.
- 2,728,759. **MISCELLANEOUS DESIGN**. PLANET CASH, LLC, (U.S. CLS. 100, 101 AND 104). SN 76-375,229. PUB. 4-1-2003. FILED 2-26-2002.
- 2,728,804 (*See Class 35 for this trademark*).
- 2,728,806. **WORSHIP AND DESIGN**. CHRISTIAN NETWORK, INC., THE, (U.S. CLS. 100, 101 AND 104). SN 76-389,920. PUB. 4-1-2003. FILED 3-29-2002.
- 2,728,849 (*See Class 9 for this trademark*).
- 2,728,927. **ENDLESS MINUTES**. CORR WIRELESS COMMUNICATIONS, LLC, (U.S. CLS. 100, 101 AND 104). SN 76-428,996. PUB. 4-1-2003. FILED 7-9-2002.
- 2,728,939. **SMARTCOMS**. SMARTCOMS, INC., (U.S. CLS. 100, 101 AND 104). SN 76-431,449. PUB. 4-1-2003. FILED 7-17-2002.
- 2,728,986. **GLOBAL NOMADS GROUP**. GLOBAL NOMADS

- GROUP, (U.S. CLS. 100, 101 AND 104). SN 76-441,270. PUB. 4-1-2003. FILED 8-19-2002.
- 2,729,015. **LA CONSENTIDA**. ENTRAVISION COMMUNICATIONS CORPORATION, (U.S. CLS. 100, 101 AND 104). SN 76-443,389. PUB. 4-1-2003. FILED 8-23-2002.
- 2,729,045. **AIRNEX COMMUNICATIONS AND DESIGN**. AIRNEX COMMUNICATIONS, INC., (U.S. CLS. 100, 101 AND 104). SN 76-446,522. PUB. 4-1-2003. FILED 9-3-2002.
- 2,729,157. **RADIO ON DEMAND IA-CONNECTIONS IA-C NETWORK (STYLIZED)**. JONES, GEORGIA A., MULTIPLE CLASS, (INT. CLS. 38 AND 41), (U.S. CLS. 100, 101, 104 AND 107). SN 78-101,284. PUB. 4-1-2003. FILED 1-7-2002.
- 2,729,214. **DYNAMIC BROADBAND**. WEBUNWIRED, LLC, (U.S. CLS. 100, 101 AND 104). SN 78-135,231. PUB. 4-1-2003. FILED 6-12-2002.
- 2,729,285. **LIGHTBOUND**. HRS INTERNET, LLC, DBA LIGHTBOUND, MULTIPLE CLASS, (INT. CLS. 38 AND 42), (U.S. CLS. 100, 101 AND 104). SN 78-154,430. PUB. 4-1-2003. FILED 8-15-2002.

CLASS 39—TRANSPORTATION AND STORAGE

- 2,728,461 (*See Class 16 for this trademark*).
- 2,728,476. **MISCELLANEOUS DESIGN**. JOHANN BIRKART INT. SPEDITION GMB & CO. KG, (U.S. CLS. 100 AND 105). SN 75-648,014. PUB. 1-14-2003. FILED 2-23-1999.
- 2,728,493 (*See Class 3 for this trademark*).
- 2,728,507 (*See Class 1 for this trademark*).
- 2,728,527. **PARADISE ISLAND VACATIONS**. KERZNER INTERNATIONAL NORTH AMERICA, INC., BY CHANGE OF NAME SUN INTERNATIONAL NORTH AMERICA, INC., MULTIPLE CLASS, (INT. CLS. 39, 41 AND 42), (U.S. CLS. 100, 101, 105 AND 107). SN 76-021,932. PUB. 4-1-2003. FILED 4-7-2000.
- 2,728,537 (*See Class 35 for this trademark*).
- 2,728,554 (*See Class 2 for this trademark*).
- 2,728,555 (*See Class 2 for this trademark*).
- 2,728,644 (*See Class 9 for this trademark*).
- 2,728,804 (*See Class 35 for this trademark*).
- 2,728,834. **SUNKIST**. SUNKIST GROWERS, INC., (U.S. CLS. 100 AND 105). SN 76-402,250. PUB. 4-1-2003. FILED 4-30-2002.
- 2,728,845 (*See Class 35 for this trademark*).
- 2,728,926 (*See Class 35 for this trademark*).
- 2,728,960. **TIDEWATER**. TIDEWATER INC., (U.S. CLS. 100 AND 105). SN 76-435,698. PUB. 4-1-2003. FILED 7-30-2002.
- 2,728,961. **T AND DESIGN**. TIDEWATER INC., (U.S. CLS. 100 AND 105). SN 76-435,699. PUB. 4-1-2003. FILED 7-30-2002.
- 2,729,067. **ALLIED RENT A CAR**. AMS HOLDINGS, INC., (U.S. CLS. 100 AND 105). SN 76-448,253. PUB. 4-1-2003. FILED 9-10-2002.
- 2,729,147. **GAS ADVANTAGE HOME AND DESIGN**. PIEDMONT NATURAL GAS COMPANY, INC., (U.S. CLS. 100 AND 105). SN 78-083,892. PUB. 4-1-2003. FILED 9-14-2001.
- 2,729,169 (*See Class 35 for this trademark*).
- 2,729,240. **FLIGHTGRATITUDE**. JETBLUE AIRWAYS CORPORATION, (U.S. CLS. 100 AND 105). SN 78-144,995. PUB. 4-1-2003. FILED 7-17-2002.
- 2,729,305. **TRANS-TRADE**. TRANS-TRADE, INC., (U.S. CLS. 100 AND 105). SN 78-155,778. PUB. 4-1-2003. FILED 8-20-2002.
- 2,729,358. **INTUIT**. INTUIT INC., (U.S. CLS. 100 AND 105). SN 78-177,257. PUB. 4-1-2003. FILED 10-22-2002.

CLASS 40—MATERIAL TREATMENT

- 2,728,487 (*See Class 30 for this trademark*).
- 2,728,507 (*See Class 1 for this trademark*).
- 2,728,522 (*See Class 35 for this trademark*).
- 2,728,523 (*See Class 6 for this trademark*).
- 2,728,558. **THE REEL THING**. THE REEL THING, INC., (U.S. CLS. 100, 103 AND 106). SN 76-129,490. PUB. 4-1-2003.

FILED 9-15-2000.
 2,728,600 (*See Class 10 for this trademark.*)
 2,728,658 (*See Class 9 for this trademark.*)
 2,728,689. **ANAMAX**. ANAMAX CORPORATION, (U.S. CLS. 100, 103 AND 106). SN 76-331,645. PUB. 4-1-2003. FILED 10-29-2001.
 2,728,756. **IPSCO MAKING TUBULARS BETTER AND DESIGN**. IPSCO INC., (U.S. CLS. 100, 103 AND 106). SN 76-373,865. PUB. 4-1-2003. FILED 2-21-2002.
 2,728,772. **ASPEN ENVIRONMENTAL, LTD. AND DESIGN**. ASPEN ENVIRONMENTAL, LTD., (U.S. CLS. 100, 103 AND 106). SN 76-378,828. PUB. 4-1-2003. FILED 3-6-2002.
 2,728,900. **SPEEDWISE**. SPEEDWISE, LLC, (U.S. CLS. 100, 103 AND 106). SN 76-423,073. PUB. 4-1-2003. FILED 6-20-2002.
 2,729,208 (*See Class 37 for this trademark.*)

CLASS 41—EDUCATION AND ENTERTAINMENT

2,728,469 (*See Class 16 for this trademark.*)
 2,728,477 (*See Class 9 for this trademark.*)
 2,728,485. **MUCHCOMBATZONE**. CHUM LIMITED, (U.S. CLS. 100, 101 AND 107). SN 75-714,612. PUB. 4-1-2003. FILED 5-27-1999.
 2,728,493 (*See Class 3 for this trademark.*)
 2,728,504. **IIS INTEGRATED INFORMATION SYSTEMS AND DESIGN**. INTEGRATED INFORMATION SYSTEMS, INC., (U.S. CLS. 100, 101 AND 107). SN 75-871,201. PUB. 4-1-2003. FILED 12-13-1999.
 2,728,509. **ADVANCED BRAIN TECHNOLOGIES**. ADVANCED BRAIN TECHNOLOGIES, LLC, (U.S. CLS. 100, 101 AND 107). SN 75-902,842. PUB. 4-1-2003. FILED 1-25-2000.
 2,728,509 (*See Class 9 for this trademark.*)
 2,728,510 (*See Class 16 for this trademark.*)
 2,728,517 (*See Class 35 for this trademark.*)
 2,728,527 (*See Class 39 for this trademark.*)
 2,728,538. **JACKIE ROBINSON PARK OF FAME INC. AND DESIGN**. JACKIE ROBINSON PARK OF FAME, INC., (U.S. CLS. 100, 101 AND 107). SN 76-074,709. PUB. 4-1-2003. FILED 6-21-2000.
 2,728,550 (*See Class 9 for this trademark.*)
 2,728,575. **LEGALWIZ**. BRONCHICK, WILLIAM, MULTIPLE CLASS, (INT. CLS. 41 AND 42), (U.S. CLS. 100, 101 AND 107). SN 76-158,666. PUB. 4-1-2003. FILED 11-2-2000.
 2,728,577 (*See Class 39 for this trademark.*)
 2,728,579. **FREFLEXRX.COM**. FREFLEXRX, LLC., (U.S. CLS. 100, 101 AND 107). SN 76-166,498. PUB. 4-1-2003. FILED 11-17-2000.
 2,728,588 (*See Class 16 for this trademark.*)
 2,728,592 (*See Class 9 for this trademark.*)
 2,728,593. **HUMAN UTILITIES-WHOLE ARMOUR AND DESIGN**. ROGERS, EDGAR LYNN, (U.S. CLS. 100, 101 AND 107). SN 76-201,657. PUB. 4-1-2003. FILED 1-29-2001.
 2,728,599. **NM STATE**. NEW MEXICO STATE UNIVERSITY BOARD OF REGENTS, (U.S. CLS. 100, 101 AND 107). SN 76-215,548. PUB. 4-1-2003. FILED 2-23-2001.
 2,728,608. **METHOD CENTER**. BURTON CORPORATION, THE, (U.S. CLS. 100, 101 AND 107). SN 76-234,095. PUB. 4-1-2003. FILED 4-2-2001.
 2,728,618 (*See Class 9 for this trademark.*)
 2,728,620. **BASSO PROFONDO AND DESIGN**. MORTON, MARK ALISON, (U.S. CLS. 100, 101 AND 107). SN 76-250,176. PUB. 4-1-2003. FILED 4-30-2001.
 2,728,624 (*See Class 9 for this trademark.*)
 2,728,644 (*See Class 9 for this trademark.*)
 2,728,646 (*See Class 7 for this trademark.*)
 2,728,664. **NOQUEMANON AND DESIGN**. SUPERIORLAND SKI CLUB, (U.S. CLS. 100, 101 AND 107). SN 76-311,931. PUB. 4-1-2003. FILED 9-14-2001.
 2,728,666. **SPIN**. SPINUSA, INC., (U.S. CLS. 100, 101 AND 107). SN 76-314,418. PUB. 4-1-2003. FILED 9-19-2001.
 2,728,667. **SPIN VIDEO HOME TRAINING**. SPINUSA, INC., (U.S. CLS. 100, 101 AND 107). SN 76-314,422. PUB. 4-1-2003. FILED 9-19-2001.
 2,728,668 (*See Class 35 for this trademark.*)

2,728,685 (*See Class 9 for this trademark.*)
 2,728,687. **NOTHING BUT THE GOOD STUFF**. UNIVERSAL STUDIOS, INC., (U.S. CLS. 100, 101 AND 107). SN 76-326,978. PUB. 12-3-2002. FILED 10-19-2001.
 2,728,692 (*See Class 35 for this trademark.*)
 2,728,712 (*See Class 35 for this trademark.*)
 2,728,716 (*See Class 38 for this trademark.*)
 2,728,739. **MI CASA AND DESIGN**. MI CASA ES SU CASA, INC., MULTIPLE CLASS, (INT. CLS. 41 AND 43), (U.S. CLS. 100, 101 AND 107). SN 76-365,843. PUB. 4-1-2003. FILED 2-1-2002.
 2,728,760. **PACES**. SOCIETY OF MEXICAN AMERICAN ENGINEERS AND SCIENTISTS, THE, (U.S. CLS. 100, 101 AND 107). SN 76-375,340. PUB. 4-1-2003. FILED 2-25-2002.
 2,728,785. **SILVER DOCS**. DISCOVERY COMMUNICATIONS, INC., (U.S. CLS. 100, 101 AND 107). SN 76-381,463. PUB. 4-1-2003. FILED 3-12-2002.
 2,728,801. **CHAP**. COMMUNITY HEALTH ACCESS PROJECT, INC., MULTIPLE CLASS, (INT. CLS. 41 AND 44), (U.S. CLS. 100, 101 AND 107). SN 76-387,700. PUB. 4-1-2003. FILED 3-25-2002.
 2,728,808. **COMPED SOLUTIONS**. ROCKHURST UNIVERSITY CONTINUING EDUCATION CENTER, INC., DBA COMP ED SOLUTIONS, (U.S. CLS. 100, 101 AND 107). SN 76-391,231. PUB. 4-1-2003. FILED 4-3-2002.
 2,728,811. **TESTS4 POLICE.COM AND DESIGN**. 4MOST ENTERPRISES, LLC, (U.S. CLS. 100, 101 AND 107). SN 76-391,991. PUB. 4-1-2003. FILED 4-4-2002.
 2,728,823. **NU-OPP INC. AND DESIGN**. MCDONALD, RUSHION, (U.S. CLS. 100, 101 AND 107). SN 76-397,400. PUB. 4-1-2003. FILED 4-17-2002.
 2,728,828. **ALLIGATOR BROTHERS**. SWARTZ, HENRY LEE, (U.S. CLS. 100, 101 AND 107). SN 76-399,556. PUB. 4-1-2003. FILED 4-24-2002.
 2,728,832. **HUNGER AND ENVIRONMENTAL NUTRITION AND DESIGN**. AMERICAN DIETETIC ASSOCIATION, (U.S. CLS. 100, 101 AND 107). SN 76-402,218. PUB. 4-1-2003. FILED 4-29-2002.
 2,728,833 (*See Class 36 for this trademark.*)
 2,728,841. **FAMILY MESS**. HOUSE OF THE LORD, THE, (U.S. CLS. 100, 101 AND 107). SN 76-405,561. PUB. 4-1-2003. FILED 5-13-2002.
 2,728,850 (*See Class 9 for this trademark.*)
 2,728,851. **JACK'S CLUB**. HORSESHOE GAMING HOLDING CORP., (U.S. CLS. 100, 101 AND 107). SN 76-408,748. PUB. 4-1-2003. FILED 5-15-2002.
 2,728,852. **BVU AND DESIGN**. BUENA VISTA UNIVERSITY, (U.S. CLS. 100, 101 AND 107). SN 76-408,758. PUB. 4-1-2003. FILED 5-16-2002.
 2,728,856. **THE CORRAL**. THE CORRAL, (U.S. CLS. 100, 101 AND 107). SN 76-409,339. PUB. 4-1-2003. FILED 5-17-2002.
 2,728,864. **BUBL**. BOARD OF COOPERATIVE EDUCATIONAL SERVICES, FIRST SUPERVISORY DISTRICT OF MONROE COUNTY, NEW YORK (MONROE #1 BOCES), (U.S. CLS. 100, 101 AND 107). SN 76-410,662. PUB. 4-1-2003. FILED 5-22-2002.
 2,728,883. **WORKSTRATEGIES**. SELECTMARK, INC., MULTIPLE CLASS, (INT. CLS. 41 AND 44), (U.S. CLS. 100, 101 AND 107). SN 76-418,049. PUB. 4-1-2003. FILED 6-7-2002.
 2,728,887. **MEINEKE UNIVERSITY AND DESIGN**. MEINEKE DISCOUNT MUFFLER SHOPS, INC., (U.S. CLS. 100, 101 AND 107). SN 76-419,512. PUB. 4-1-2003. FILED 6-11-2002.
 2,728,891. **BLS AND DESIGN**. LASER INSTITUTE OF AMERICA, INC., (U.S. CLS. 100, 101 AND 107). SN 76-420,060. PUB. 4-1-2003. FILED 6-13-2002.
 2,728,899 (*See Class 9 for this trademark.*)
 2,728,908. **MARKET YOUR MAGIC**. MARJORIE BRODY, (U.S. CLS. 100, 101 AND 107). SN 76-424,387. PUB. 4-1-2003. FILED 6-12-2002.
 2,728,911. **PRO ROCK AUDIO AND DESIGN**. LEUSCHNER, DAVID, (U.S. CLS. 100, 101 AND 107). SN 76-425,902. PUB. 4-1-2003. FILED 6-27-2002.
 2,728,912 (*See Class 9 for this trademark.*)
 2,728,934. **HERITAGE QUARTET AND DESIGN**. HERITAGE QUARTET, (U.S. CLS. 100, 101 AND 107). SN 76-430,402. PUB. 4-1-2003. FILED 7-15-2002.
 2,728,945. **WORKING WITH GRACE**. LOWE, SANDRA MICHELLE, (U.S. CLS. 100, 101 AND 107). SN 76-432,811. PUB.

- 4-1-2003. FILED 7-22-2002.
- 2,728,947. **TRIBUTE BOOK**. MODERN MEMOIRS, (U.S. CLS. 100, 101 AND 107). SN 76-433,218. PUB. 4-1-2003. FILED 7-23-2002.
- 2,728,950. **SAN DIEGO RV RESORT AND DESIGN**. PAYDAR PROPERTIES, INC., (U.S. CLS. 100, 101 AND 107). SN 76-434,133. PUB. 4-1-2003. FILED 7-25-2002.
- 2,728,957. **EOTD**. ECCMA ELECTRONIC COMMERCE CODE MANAGEMENT ASSOCIATION, (U.S. CLS. 100, 101 AND 107). SN 76-435,223. PUB. 4-1-2003. FILED 7-29-2002.
- 2,728,974. **THE PROGRAM EXCHANGE**. SAATCHI & SAATCHI NORTH AMERICA, INC., (U.S. CLS. 100, 101 AND 107). SN 76-439,100. PUB. 4-1-2003. FILED 8-9-2002.
- 2,728,982. **LOUD MOUTH**. WILSON, TRACEY B., (U.S. CLS. 100, 101 AND 107). SN 76-439,479. PUB. 4-1-2003. FILED 8-12-2002.
- 2,728,985. **SERVES YOU RIGHT**. VALENTINO, STEPHEN, (U.S. CLS. 100, 101 AND 107). SN 76-439,868. PUB. 4-1-2003. FILED 8-12-2002.
- 2,728,992. **POWER OF PAUSE**. GUILMARTIN, NANCE, (U.S. CLS. 100, 101 AND 107). SN 76-441,571. PUB. 4-1-2003. FILED 8-14-2002.
- 2,728,993. **THE MUSEUM IN THE STREETS**. THE MUSEUM IN THE STREETS, LLC, (U.S. CLS. 100, 101 AND 107). SN 76-441,587. PUB. 4-1-2003. FILED 8-15-2002.
- 2,729,006. **EYES ADRIFT**. EYES ADRIFT, LLC, (U.S. CLS. 100, 101 AND 107). SN 76-442,809. PUB. 4-1-2003. FILED 8-21-2002.
- 2,729,025. **HAL JACKSON'S TALENTED TEENS INTERNATIONAL**. JACKSON, HAL, (U.S. CLS. 100, 101 AND 107). SN 76-443,910. PUB. 4-1-2003. FILED 8-21-2002.
- 2,729,064. **ETERNAL AND DESIGN**. ETERNAL PRODUCTIONS, INC., DBA ETERNAL ENTERTAINMENT, (U.S. CLS. 100, 101 AND 107). SN 76-447,962. PUB. 4-1-2003. FILED 9-9-2002.
- 2,729,070. **HUMANERGY ORGANIZATIONAL SUCCESS THROUGH THE POWER OF PEOPLE. AND DESIGN**. HUMANERGY, INC., (U.S. CLS. 100, 101 AND 107). SN 76-448,375. PUB. 4-1-2003. FILED 9-10-2002.
- 2,729,071. **HUMANERGY (STYLIZED)**. HUMANERGY, INC., (U.S. CLS. 100, 101 AND 107). SN 76-448,420. PUB. 4-1-2003. FILED 9-10-2002.
- 2,729,072. **OCTUBAFEST**. HARVEY PHILLIPS FOUNDATION, INC., (U.S. CLS. 100, 101 AND 107). SN 76-448,444. PUB. 4-1-2003. FILED 9-11-2002.
- 2,729,074. **ENERGYM MUSIC**. HALL, LARRY R., (U.S. CLS. 100, 101 AND 107). SN 76-448,845. PUB. 4-1-2003. FILED 9-12-2002.
- 2,729,080. **A PERFECT DAY DJ**. A PERFECT DAY DJ, LLC, (U.S. CLS. 100, 101 AND 107). SN 76-449,848. PUB. 4-1-2003. FILED 9-16-2002.
- 2,729,090. **READ READING EXCELLENCE AND DISCOVERY FOUNDATION AND DESIGN**. READING EXCELLENT AND DISCOVERY FOUNDATION, INC., (U.S. CLS. 100, 101 AND 107). SN 76-451,887. PUB. 4-1-2003. FILED 9-23-2002.
- 2,729,108. **PICTURES IN THE PARK**. CONAGRA GROCERY PRODUCTS COMPANY, (U.S. CLS. 100, 101 AND 107). SN 76-454,304. PUB. 4-1-2003. FILED 10-1-2002.
- 2,729,110. **MISCELLANEOUS DESIGN**. CLARE, PAMELA, (U.S. CLS. 100, 101 AND 107). SN 76-455,075. PUB. 4-1-2003. FILED 9-27-2002.
- 2,729,135 (*See Class 9 for this trademark*).
- 2,729,138. **JIMIMAX**. MCFARLAND, JAMES NORMAN, (U.S. CLS. 100, 101 AND 107). SN 78-047,189. PUB. 4-1-2003. FILED 2-8-2001.
- 2,729,157 (*See Class 38 for this trademark*).
- 2,729,163 (*See Class 35 for this trademark*).
- 2,729,166. **YOURNOVEL.COM**. YOURNOVEL.COM, INC., (U.S. CLS. 100, 101 AND 107). SN 78-109,174. PUB. 4-1-2003. FILED 2-15-2002.
- 2,729,175. **N.O.K.**. CARR, ADAM, AND CARR, BRIAN, AND CARR, ERIC, (U.S. CLS. 100, 101 AND 107). SN 78-114,974. PUB. 4-1-2003. FILED 3-14-2002.
- 2,729,182 (*See Class 16 for this trademark*).
- 2,729,183. **SPRINGFIELD SIRENS**. FERRARA, JOSEPH, (U.S. CLS. 100, 101 AND 107). SN 78-118,401. PUB. 4-1-2003. FILED 3-29-2002.
- 2,729,184. **EXTRAORDINARY EVERYDAY PEOPLE**. ALETA ENTERPRISES, INC. DBA VISIONS UNLIMITED, (U.S. CLS. 100, 101 AND 107). SN 78-118,522. PUB. 4-1-2003. FILED 3-30-2002.
- 2,729,188. **LIBERTY UNIVERSITY KNOWLEDGE A FLAME FOUNDED 1971 WWW.LIBERTY.EDU AND DESIGN**. LIBERTY UNIVERSITY, (U.S. CLS. 100, 101 AND 107). SN 78-120,286. PUB. 4-1-2003. FILED 4-8-2002.
- 2,729,193 (*See Class 35 for this trademark*).
- 2,729,220 (*See Class 35 for this trademark*).
- 2,729,230. **UNTAMED RECORDS**. UNTAMED RECORDS, LLC, (U.S. CLS. 100, 101 AND 107). SN 78-142,036. PUB. 4-1-2003. FILED 7-8-2002.
- 2,729,239. **ADRENALINATV**. CINEASTRAL PRODUCTIONS, INC., (U.S. CLS. 100, 101 AND 107). SN 78-144,465. PUB. 4-1-2003. FILED 7-16-2002.
- 2,729,283. **TO THE POINT**. THE BAILEY GROUP, INC., (U.S. CLS. 100, 101 AND 107). SN 78-153,480. PUB. 4-1-2003. FILED 8-12-2002.
- 2,729,286. **FYI**. BONUS.COM INC., (U.S. CLS. 100, 101 AND 107). SN 78-154,682. PUB. 4-1-2003. FILED 8-15-2002.
- 2,729,298. **DARK HOLLER**. SCHROEDER, PAUL WINSTON, (U.S. CLS. 100, 101 AND 107). SN 78-155,232. PUB. 4-1-2003. FILED 8-17-2002.
- 2,729,303. **MASQUE**. CHIRICO, DUANE, (U.S. CLS. 100, 101 AND 107). SN 78-155,450. PUB. 4-1-2003. FILED 8-19-2002.
- 2,729,323. **MEDINA (MIDDLE EASTERN DANCE IN NORTH AMERICA)**. HOWARD, JOY, A., (U.S. CLS. 100, 101 AND 107). SN 78-158,411. PUB. 4-1-2003. FILED 8-27-2002.
- 2,729,338. **THE VIRTUAL LEADER**. HEITER, STEFANIE, JULIANE, (U.S. CLS. 100, 101 AND 107). SN 78-159,531. PUB. 4-1-2003. FILED 8-30-2002.
- 2,729,346. **VISUALOGIX**. VALDOVINOS, JESUS, (U.S. CLS. 100, 101 AND 107). SN 78-162,259. PUB. 4-1-2003. FILED 9-10-2002.

CLASS 42—SCIENTIFIC, COMPUTER AND LEGAL SERVICES

- 2,728,453. **FRISCO'S**. STATHOULIS, JOANNE, DBA FRISCO'S CAR HOP DRIVE-IN, (U.S. CL. 100). SN 74-430,173. PUB. 8-9-1994. FILED 8-30-1993.
- 2,728,454 (*See Class 9 for this trademark*).
- 2,728,461 (*See Class 16 for this trademark*).
- 2,728,463 (*See Class 16 for this trademark*).
- 2,728,473 (*See Class 9 for this trademark*).
- 2,728,477 (*See Class 9 for this trademark*).
- 2,728,480 (*See Class 29 for this trademark*).
- 2,728,490 (*See Class 9 for this trademark*).
- 2,728,493 (*See Class 3 for this trademark*).
- 2,728,496. **DESIGNBYFEEL**. DOUGHERTY, MICHAEL, (U.S. CLS. 100 AND 101). SN 75-851,993. PUB. 4-1-2003. FILED 11-17-1999.
- 2,728,499 (*See Class 16 for this trademark*).
- 2,728,500 (*See Class 9 for this trademark*).
- 2,728,501 (*See Class 9 for this trademark*).
- 2,728,502 (*See Class 9 for this trademark*).
- 2,728,503 (*See Class 9 for this trademark*).
- 2,728,513. **LET ME BE YOUR ECSTASY - GOD**. GODSPEAKS, INC., (U.S. CLS. 100 AND 101). SN 75-943,316. PUB. 1-14-2003. FILED 3-15-2000.
- 2,728,516 (*See Class 16 for this trademark*).
- 2,728,519 (*See Class 9 for this trademark*).
- 2,728,522 (*See Class 35 for this trademark*).
- 2,728,527 (*See Class 39 for this trademark*).
- 2,728,528 (*See Class 5 for this trademark*).
- 2,728,536 (*See Class 35 for this trademark*).
- 2,728,546 (*See Class 35 for this trademark*).
- 2,728,547 (*See Class 16 for this trademark*).
- 2,728,551 (*See Class 9 for this trademark*).
- 2,728,552 (*See Class 37 for this trademark*).
- 2,728,554 (*See Class 2 for this trademark*).
- 2,728,555 (*See Class 2 for this trademark*).
- 2,728,560 (*See Class 9 for this trademark*).
- 2,728,565. **ALERT IPO AND DESIGN**. JUPITERMEDIA CORPORATION, BY CHANGE OF NAME; BY CHANGE OF

- NAME INTERNET.COM CORPORATION, (U.S. CLS. 100 AND 101). SN 76-139,080. PUB. 4-1-2003. FILED 10-2-2000.
- 2,728,570 (*See Class 35 for this trademark.*).
- 2,728,575 (*See Class 41 for this trademark.*).
- 2,728,584. **DELPHI**. DELPHI CONSULTING GROUP, INC., (U.S. CLS. 100 AND 101). SN 76-174,398. PUB. 7-30-2002. FILED 12-1-2000.
- 2,728,588 (*See Class 16 for this trademark.*).
- 2,728,600 (*See Class 10 for this trademark.*).
- 2,728,603 (*See Class 9 for this trademark.*).
- 2,728,604. **CODEDOGS**. 1443412 ONTARIO INC., (U.S. CLS. 100 AND 101). SN 76-228,804. PUB. 4-1-2003. FILED 3-26-2001.
- 2,728,605 (*See Class 9 for this trademark.*).
- 2,728,606 (*See Class 9 for this trademark.*).
- 2,728,607 (*See Class 29 for this trademark.*).
- 2,728,616 (*See Class 9 for this trademark.*).
- 2,728,618 (*See Class 9 for this trademark.*).
- 2,728,623 (*See Class 9 for this trademark.*).
- 2,728,624 (*See Class 9 for this trademark.*).
- 2,728,628 (*See Class 38 for this trademark.*).
- 2,728,638. **NEURO-REFLEX THERAPY INSTITUTE, INC. AND DESIGN**. NEURO-REFLEX THERAPY INSTITUTE, INC., (U.S. CLS. 100 AND 101). SN 76-275,274. PUB. 4-1-2003. FILED 6-19-2001.
- 2,728,646 (*See Class 7 for this trademark.*).
- 2,728,650. **RIGINSIGHT**. HALLIBURTON ENERGY SERVICES, INC., BY ASSIGNMENT ONEOFFSHORE, INC., (U.S. CLS. 100 AND 101). SN 76-291,998. PUB. 4-1-2003. FILED 7-29-2001.
- 2,728,653. **GS AND DESIGN**. GRAPHIC SURGERY, LLC, (U.S. CLS. 100 AND 101). SN 76-296,205. PUB. 4-1-2003. FILED 7-27-2001.
- 2,728,681 (*See Class 38 for this trademark.*).
- 2,728,683. **KIT & KABOODLE PET CARE SERVICE**. KIT & KABOODLE PET CARE SERVICE, LLC, (U.S. CLS. 100 AND 101). SN 76-323,501. PUB. 10-15-2002. FILED 10-11-2001.
- 2,728,686. **LAKELAND REGIONAL CANCER CENTER ADVANCING THE CURE. COMMITTED TO CARE AND DESIGN**. LAKELAND REGIONAL HEALTH SYSTEMS, INC., (U.S. CLS. 100 AND 101). SN 76-325,134. PUB. 4-1-2003. FILED 10-15-2001.
- 2,728,697. **ONEFACTORYTEAM!**. ADBRAINTAGE, S.A., (U.S. CLS. 100 AND 101). SN 76-342,546. PUB. 4-1-2003. FILED 11-29-2001.
- 2,728,753. **GST GEOSPATIAL TECH AND DESIGN**. GEOSPATIAL TECHNOLOGIES, INC., (U.S. CLS. 100 AND 101). SN 76-373,278. PUB. 4-1-2003. FILED 2-22-2002.
- 2,728,774. **BLUE FOX SOLUTIONS AND DESIGN**. BLUE FOX SOLUTIONS, INC., (U.S. CLS. 100 AND 101). SN 76-379,138. PUB. 4-1-2003. FILED 3-6-2002.
- 2,728,784 (*See Class 35 for this trademark.*).
- 2,728,787. **BLACK LIQUOR CLUB B & W AND DESIGN**. BABCOCK & WILCOX COMPANY, THE, (U.S. CLS. 100 AND 101). SN 76-382,991. PUB. 4-1-2003. FILED 3-18-2002.
- 2,728,790. **BLACK LIQUOR CLUB**. BABCOCK & WILCOX COMPANY, THE, (U.S. CLS. 100 AND 101). SN 76-383,313. PUB. 4-1-2003. FILED 3-15-2002.
- 2,728,804 (*See Class 35 for this trademark.*).
- 2,728,822. **GEKL TECHNOLOGIES**. GEKL TECHNOLOGIES, INC., (U.S. CLS. 100 AND 101). SN 76-397,396. PUB. 4-1-2003. FILED 4-18-2002.
- 2,728,837. **THE ESSENCE OF HOME**. GABBERTS INC., (U.S. CLS. 100 AND 101). SN 76-404,147. PUB. 4-1-2003. FILED 5-6-2002.
- 2,728,854 (*See Class 35 for this trademark.*).
- 2,728,863. **TEXTICKET**. SCAN, INC., (U.S. CLS. 100 AND 101). SN 76-410,631. PUB. 4-1-2003. FILED 5-22-2002.
- 2,728,882. **MEDICINELODGE**. MEDICINELODGE, INC., (U.S. CLS. 100 AND 101). SN 76-418,026. PUB. 4-1-2003. FILED 6-7-2002.
- 2,728,892 (*See Class 37 for this trademark.*).
- 2,728,969. **PREGUNTE POR MARGARITA**. TROLMAN, GLASER & LICHTMAN, P.C., (U.S. CLS. 100 AND 101). SN 76-438,485. PUB. 4-1-2003. FILED 8-7-2002.
- 2,728,970. **PEI SAVANT, INC.**, (U.S. CLS. 100 AND 101). SN 76-438,495. PUB. 4-1-2003. FILED 8-5-2002.
- 2,728,971. **SEI SAVANT, INC.**, (U.S. CLS. 100 AND 101). SN 76-438,496. PUB. 4-1-2003. FILED 8-5-2002.
- 2,728,975 (*See Class 9 for this trademark.*).
- 2,728,976 (*See Class 9 for this trademark.*).
- 2,729,060. **MISCELLANEOUS DESIGN**. MOBULAR TECHNOLOGIES, INC., (U.S. CLS. 100 AND 101). SN 76-447,397. PUB. 4-1-2003. FILED 9-6-2002.
- 2,729,128 (*See Class 16 for this trademark.*).
- 2,729,129 (*See Class 9 for this trademark.*).
- 2,729,131. **SNEAKERS SPORTS GRILLE**. PRATT, GREGORY JOHN, DBA SNEAKERS SPORTS GRILLE, (U.S. CLS. 100 AND 101). SN 78-021,156. PUB. 4-1-2003. FILED 8-14-2000.
- 2,729,132 (*See Class 9 for this trademark.*).
- 2,729,135 (*See Class 9 for this trademark.*).
- 2,729,155. **SMARTWAVE AND DESIGN**. STURIALE, NITA, (U.S. CLS. 100 AND 101). SN 78-097,653. PUB. 4-1-2003. FILED 12-11-2001.
- 2,729,195. **SKINNYPIGEON AND DESIGN**. SKINNY PIGEON, INC., (U.S. CLS. 100 AND 101). SN 78-125,681. PUB. 4-1-2003. FILED 5-2-2002.
- 2,729,205. **ADVANETRIX (STYLIZED)**. ADVANETRIX, INC., (U.S. CLS. 100 AND 101). SN 78-130,890. PUB. 4-1-2003. FILED 5-23-2002.
- 2,729,208 (*See Class 37 for this trademark.*).
- 2,729,211 (*See Class 37 for this trademark.*).
- 2,729,237. **MISCELLANEOUS DESIGN**. MAROTTA, PAUL DAVID, (U.S. CLS. 100 AND 101). SN 78-144,093. PUB. 4-1-2003. FILED 7-15-2002.
- 2,729,249. **ALLMYWARRANTIES.COM (STYLIZED)**. GIRO, INC., (U.S. CLS. 100 AND 101). SN 78-146,543. PUB. 4-1-2003. FILED 7-23-2002.
- 2,729,264. **RAPTECON**. BURGESS-CASSLER, ANTHONY, (U.S. CLS. 100 AND 101). SN 78-150,818. PUB. 4-1-2003. FILED 8-5-2002.
- 2,729,285 (*See Class 38 for this trademark.*).
- 2,729,295. **EXALITY**. BARRERE, WILLIAM, G., (U.S. CLS. 100 AND 101). SN 78-155,161. PUB. 4-1-2003. FILED 8-16-2002.
- 2,729,310. **DEVELOPMENTENGINE**. FORT HILL COMPANY, (U.S. CLS. 100 AND 101). SN 78-156,479. PUB. 4-1-2003. FILED 8-21-2002.
- 2,729,324. **GENESIS**. GENESIS LLP, (U.S. CLS. 100 AND 101). SN 78-158,510. PUB. 4-1-2003. FILED 8-28-2002.
- 2,729,331. **CADOPENER**. CADOPENER.COM, LLC, (U.S. CLS. 100 AND 101). SN 78-158,898. PUB. 4-1-2003. FILED 8-28-2002.

CLASS 43—HOTEL AND RESTAURANT SERVICES

- 2,728,711. **PIROPOS**. PIROPOS, L.L.C., (U.S. CLS. 100 AND 101). SN 76-352,407. PUB. 8-20-2002. FILED 12-26-2001.
- 2,728,722. **THE PHOENICIAN**. SHERATON CORPORATION, THE, (U.S. CLS. 100 AND 101). SN 76-358,860. PUB. 4-1-2003. FILED 1-15-2002.
- 2,728,739 (*See Class 41 for this trademark.*).
- 2,728,829. **KEATON'S BARBECUE**. KEATON'S BARBECUE, INC., (U.S. CLS. 100 AND 101). SN 76-400,593. PUB. 4-1-2003. FILED 4-26-2002.
- 2,728,845 (*See Class 35 for this trademark.*).
- 2,728,866. **BIG WING WONG RESTAURANT INC AND DESIGN**. BIG WING WONG RESTAURANT, INC., (U.S. CLS. 100 AND 101). SN 76-411,287. PUB. 4-1-2003. FILED 5-30-2002.
- 2,728,881. **MILLER'S ALE HOUSE AND DESIGN**. ALE HOUSE MANAGEMENT, INC., (U.S. CLS. 100 AND 101). SN 76-417,497. PUB. 4-1-2003. FILED 6-3-2002.
- 2,728,913. **WINE FOR ALL**. TISHERMAN, WILLIAM R., (U.S. CLS. 100 AND 101). SN 76-426,612. PUB. 4-1-2003. FILED 7-1-2002.
- 2,728,914. **PAIRING WINE AND FUN SINCE THE 20TH CENTURY**. TISHERMAN, WILLIAM R., (U.S. CLS. 100 AND 101). SN 76-426,613. PUB. 4-1-2003. FILED 7-1-2002.
- 2,728,943. **UNCLE REMUS**. UNCLE REMUS RESTAURANT, INC., (U.S. CLS. 100 AND 101). SN 76-432,203. PUB. 4-1-2003. FILED 7-19-2002.
- 2,728,946. **BEMBOS BEMBOS BURGER GRILL AND DESIGN**.

LORIMAR S.A.C., (U.S. CLS. 100 AND 101). SN 76-433,182. PUB. 4-1-2003. FILED 7-19-2002.
 2,728,953. **THAIPHOON**. TUPP, INC., DBA THAIPHOON RESTAURANT, (U.S. CLS. 100 AND 101). SN 76-434,611. PUB. 4-1-2003. FILED 7-25-2002.
 2,728,972. **LEGAL SEA FOODS ESTABLISHED 1950 RESTAURANT OYSTER BAR IF IT ISN'T FRESH, IT ISN'T LEGAL AND DESIGN**. LEGAL SEA FOODS, INC., (U.S. CLS. 100 AND 101). SN 76-438,867. PUB. 4-1-2003. FILED 8-9-2002.
 2,729,103. **IMPECCABLE TASTES**. IMPECCABLE TASTES FINE CATERING, INC., (U.S. CLS. 100 AND 101). SN 76-453,781. PUB. 4-1-2003. FILED 9-30-2002.
 2,729,223. **CHOCTAW NATION HOSPITALITY HOUSE**. CHOCTAW NATION OF OKLAHOMA, (U.S. CLS. 100 AND 101). SN 78-139,268. PUB. 4-1-2003. FILED 6-27-2002.
 2,729,254. **RIDE-THRU**. PIZZA RANCH, INC., (U.S. CLS. 100 AND 101). SN 78-146,924. PUB. 4-1-2003. FILED 7-24-2002.
 2,729,273. **FIRE HUT**. PORJAI ENTERPRISES, INC., (U.S. CLS. 100 AND 101). SN 78-151,974. PUB. 4-1-2003. FILED 8-7-2002.
 2,729,326 (*See Class 16 for this trademark*).
 2,729,352. **LOLITA'S TACO SHOP**. LOLITA'S RESTAURANTS, INC., DBA LOLITA'S TACO SHOP, (U.S. CLS. 100 AND 101). SN 78-164,634. PUB. 4-1-2003. FILED 9-16-2002.
 2,729,353. **PATIENCE IS THE ESSENCE OF FINE MEXICAN FOOD**. LOLITA'S RESTAURANTS, INC., DBA LOLITA'S TACO SHOP, (U.S. CLS. 100 AND 101). SN 78-164,640. PUB. 4-1-2003. FILED 9-16-2002.

SN 78-159,426. PUB. 4-1-2003. FILED 8-29-2002.

CLASS 45—PERSONAL SERVICES

2,728,805. **LIFEMATES THE RELATIONSHIP PEOPLE**. LIFE-GROWTH CORPORATION, (U.S. CLS. 100 AND 101). SN 76-389,486. PUB. 4-1-2003. FILED 4-2-2002.
 2,728,843. **FAMILY MESS**. HOUSE OF THE LORD, THE, (U.S. CLS. 100 AND 101). SN 76-405,566. PUB. 4-1-2003. FILED 5-13-2002.
 2,728,854 (*See Class 35 for this trademark*).
 2,729,193 (*See Class 35 for this trademark*).
 2,729,219. **MISCELLANEOUS DESIGN**. ABUNDANT LIFE CHRISTIAN CENTRE, INC., (U.S. CLS. 100 AND 101). SN 78-136,374. PUB. 4-1-2003. FILED 6-17-2002.

* * * * *

CLASS 44—MEDICAL, BEAUTY AND AGRICULTURAL SERVICES

2,728,801 (*See Class 41 for this trademark*).
 2,728,802. **CROP DOCTOR**. ROCKWOOL INTERNATIONAL A/S, (U.S. CLS. 100 AND 101). SN 76-388,045. PUB. 4-1-2003. FILED 3-25-2002.
 2,728,812. **PFIZER FOR LIVING AND DESIGN**. PFIZER INC., (U.S. CLS. 100 AND 101). SN 76-392,386. PUB. 4-1-2003. FILED 4-5-2002.
 2,728,848. **SARASOTA MEMORIAL HEALTH CARE SYSTEM AND DESIGN**. SARASOTA COUNTY PUBLIC HOSPITAL BOARD, (U.S. CLS. 100 AND 101). SN 76-407,656. PUB. 4-1-2003. FILED 5-14-2002.
 2,728,854 (*See Class 35 for this trademark*).
 2,728,883 (*See Class 41 for this trademark*).
 2,728,904. **H E BUDDY AND DESIGN**. HEB GROCERY COMPANY, LP, (U.S. CLS. 100 AND 101). SN 76-423,918. PUB. 4-1-2003. FILED 6-24-2002.
 2,728,918. **LASEAWAY**. MEDICAL LASER TECHNOLOGIES, INC., (U.S. CLS. 100 AND 101). SN 76-426,930. PUB. 4-1-2003. FILED 6-27-2002.
 2,729,003. **QUALITY OF LIFE PRESERVER**. UNIVERSAL HEALTH SERVICES, INC., (U.S. CLS. 100 AND 101). SN 76-442,552. PUB. 4-1-2003. FILED 8-22-2002.
 2,729,036. **THERMALIFT**. ESPARZA, JAVIER RUIZ, (U.S. CLS. 100 AND 101). SN 76-445,157. PUB. 4-1-2003. FILED 8-29-2002.
 2,729,182 (*See Class 16 for this trademark*).
 2,729,198. **C WORK R (STYLIZED)**. CENTER FOR WORK REHABILITATION, INC., (U.S. CLS. 100 AND 101). SN 78-126,675. PUB. 4-1-2003. FILED 5-6-2002.
 2,729,203. **THE SALLY BALIN MEDICAL CENTER**. LONGEVITY RESEARCH, INC., (U.S. CLS. 100 AND 101). SN 78-130,817. PUB. 4-1-2003. FILED 5-23-2002.
 2,729,204. **SBMC**. LONGEVITY RESEARCH, INC., (U.S. CLS. 100 AND 101). SN 78-130,821. PUB. 4-1-2003. FILED 5-23-2002.
 2,729,229. **I AM TATTOOS.COM AND DESIGN**. EYE DESIGN TATTOO STUDIOS, INC., DBA I AM TATTOOS.COM, (U.S. CLS. 100 AND 101). SN 78-141,590. PUB. 4-1-2003. FILED 7-5-2002.
 2,729,306. **MISCELLANEOUS DESIGN**. GOLFOLOGIST, LLC, THE, (U.S. CLS. 100 AND 101). SN 78-155,904. PUB. 4-1-2003. FILED 8-20-2002.
 2,729,335. **WIRED.MD**. WIRED.MD, (U.S. CLS. 100 AND 101).

SECTION 2.—PRIOR UNITED STATES CLASSIFICATION

COLLECTIVE MEMBERSHIP MARKS

CLASS 200—COLLECTIVE MEMBERSHIP

2,728,712 (*See Class 35 for this trademark.*)

2,728,814 (*See Class 16 for this trademark.*)

CERTIFICATION MARKS

CLASS B—SERVICES

2,728,479. **CERTIFIED SPECIALIST OHIO STATE BAR ASSOCIATION OHIO STATE BAR ASSOCIATION AND DESIGN.** OHIO STATE BAR ASSOCIATION, SN 75-658,128.

PUB. 1-7-2003. FILED 3-11-1999.

* * * * *

TRADEMARK REGISTRATIONS ISSUED UNDER SECTION 1(d)

The following marks have registered on the Principal Register pursuant to the intent-to-use provisions of Section 1(d) of the Trademark Act of 1946, as amended.

SECTION 1.— INTERNATIONAL CLASSIFICATION

The short titles associated below with the international class numbers are terms designed merely for quick identification and are not an official part of the international classification. The full names of international classes are given in section 6.1 of the trademark rules of practice.

The designation "U.S. Cl." appearing in this section refers to the U.S. class in effect prior to Sep. 1, 1973 rather than the international class which applies to applications filed on or after that date. For adoption of international classification see notice in the OFFICIAL GAZETTE of Jun. 26, 1973 (911 O.G. TM 210).

Application in more than one class

2,729,361. TELLURIDE CLOTHING COMPANY, INC., NEWTON, MA, BY ASSIGNMENT; BY ASSIGNMENT CAMBRIDGE DRY GOODS COMPANY, INC., NEWTON, MA. SN 74-412,926. PUB. 10-4-1994, FILED 7-14-1993.

APPLICATION NO. 2,004,176, FILED 12-28-1995, REG. NO. 2,004,176, DATED 5-24-1996, EXPIRES 12-28-2005.

THE NAME SHOWN IN THE MARK DOES NOT IDENTIFY A PARTICULAR LIVING INDIVIDUAL.

TELLURIDE CLOTHING COMPANY

NO CLAIM IS MADE TO THE EXCLUSIVE RIGHT TO USE "CLOTHING COMPANY", APART FROM THE MARK AS SHOWN.

CLASS 18—LEATHER GOODS

FOR TOTE BAGS (U.S. CLS. 1, 2, 3, 22 AND 41).
FIRST USE 1-0-1995; IN COMMERCE 1-0-1995.

CLASS 25—CLOTHING

FOR MEN'S, WOMEN'S AND CHILDREN'S SPORTSWEAR AND ACCESSORIES, NAMELY SWEATERS, SHIRTS, TOPS, PANTS, SHORTS, SKIRTS, KNIT TOPS, JERSEYS, HATS, SCARVES, LEGWARMERS, JACKETS, T-SHIRTS, DRESSES, JUMPERS, BELTS, SOCKS AND BLOUSES (U.S. CLS. 22 AND 39).
FIRST USE 0-0-1993; IN COMMERCE 0-0-1993.

CLASS 3—COSMETICS AND CLEANING PREPARATIONS

FOR (BASED ON 44(E)) BLEACHING PREPARATIONS FOR LAUNDRY USE; ALL PURPOSE CLEANING, POLISHING, SCOURING AND ABRASIVE PREPARATIONS; SKIN SOAP; (BASED ON USE IN COMMERCE AND ON 44(E)) PERFUMES; (BASED ON 44(E)) ESSENTIAL OILS FOR PERSONAL USE; COSMETICS, NAMELY, LIPSTICK, MASCARA, EYELINER, AND EYE SHADOW; HAIR LOTIONS; AND DENTIFRICES (U.S. CLS. 1, 4, 6, 50, 51 AND 52).
FIRST USE 10-3-2002; IN COMMERCE 10-3-2002.

CLASS 25—CLOTHING

FOR (BASED ON 44(E)) OUTERWEAR, NAMELY, JACKETS, COATS, STUFF JACKETS, HUNTING JACKETS, TRENCH COATS, LIGHT OVERCOATS, RAIN-CAPIES, RAIN-COATS, RAGLAN; COATS, SUITS, WAISTCOATS, TROUSERS, JACKETS, SHIRTS, SHORTS, JERSEYS, CARDIGANS, PULLOVERS, T-SHIRTS, TRACK SUITS, SLACKS, SWIM WEAR, VESTS, UNDERPANTS, PYJAMAS, SCARVES, TIES, CRAVATS, SOCKS, SLIPPERS, GLOVES, HEAD SWEATBANDS, BELTS FOR WEAR (U.S. CLS. 22 AND 39).

2,729,362. GRUPO MASSIMO DUTTI, S.A., 15142 ARTEIXO (LA CORUNA), SPAIN. SN 75-126,825. PUB. 7-13-1999, FILED 6-28-1996.

MASSIMO
MASSIMO DUTTI

2,729,379. TOUR TOGETHER, INC., ASPEN, CO. SN 75-436,081. PUB. 11-30-1999, FILED 2-18-1998.

TOUR TOGETHER

PRIORITY CLAIMED UNDER SEC. 44(D) ON SPAIN APPLICATION NO. 2,004,175, FILED 12-28-1995, REG. NO. 2,004,175, DATED 5-27-1996, EXPIRES 12-28-2005.
PRIORITY CLAIMED UNDER SEC. 44(D) ON SPAIN

NO CLAIM IS MADE TO THE EXCLUSIVE RIGHT TO USE "TOUR", APART FROM THE MARK AS SHOWN.

CLASS 35—ADVERTISING AND BUSINESS

FOR PROMOTING AND MARKETING OF MUSICAL RECORDINGS, LIVE MUSICAL PERFORMANCES, MUSIC FESTIVALS, AND TOURS OF MUSICAL GROUPS FOR OTHERS; PROMOTING THE TOURS OF OTHERS THROUGH THE DEVELOPMENT OF ADVERTISEMENT AND PROMOTIONAL CAMPAIGNS FOR MUSICAL RECORDINGS, MUSIC PERFORMERS AND GROUPS, CONCERT TOURS AND MUSIC FESTIVAL TOURS OF OTHERS; PLACING AND DISSEMINATING ADVERTISING AND PROMOTIONAL MATERIALS FOR MUSIC PERFORMERS AND GROUPS, CONCERT TOURS AND MUSIC FESTIVAL TOURS OF OTHERS; TALENT AGENCY SERVICES IN THE NATURE OF AGENCY REPRESENTATION FOR THE PURPOSE OF OBTAINING CORPORATE SPONSORSHIPS, ENDORSEMENTS AND PROMOTIONAL DEALS FOR MUSICAL RECORDINGS, MUSIC PERFORMERS AND GROUPS, CONCERT TOURS AND MUSIC FESTIVAL TOURS OF OTHERS; PUBLIC RELATIONS SERVICES (U.S. CLS. 100, 101 AND 102).

FIRST USE 1-0-1996; IN COMMERCE 2-0-1996.

CLASS 41—EDUCATION AND ENTERTAINMENT

FOR ENTERTAINMENT SERVICES, NAMELY, ARRANGING AND CONDUCTING MUSIC INDUSTRY CONVENTIONS AND ARRANGING MUSICAL ENTERTAINMENT TOURS (U.S. CLS. 100, 101 AND 107).

FIRST USE 1-0-1996; IN COMMERCE 2-0-1996.

2,729,382. TELUTION, INC., CHICAGO, IL. SN 75-464,555.
PUB. 3-26-2002, FILED 4-8-1998.

COMMUNICATION EXCHANGE

NO CLAIM IS MADE TO THE EXCLUSIVE RIGHT TO USE "COMMUNICATION", APART FROM THE MARK AS SHOWN.

CLASS 9—ELECTRICAL AND SCIENTIFIC APPARATUS

FOR COMPUTER SOFTWARE FOR USE IN PROVIDING CUSTOMER CARE, ORDER MANAGEMENT AND BILLING IN THE FIELD OF TELECOMMUNICATIONS (U.S. CLS. 21, 23, 26, 36 AND 38).

FIRST USE 6-24-1998; IN COMMERCE 6-24-1998.

CLASS 42—SCIENTIFIC, COMPUTER AND LEGAL SERVICES

FOR DESIGN, IMPLEMENTATION, AND OPERATION OF COMPUTER SOFTWARE FOR OTHERS IN THE FIELDS OF TELECOMMUNICATIONS AND GLOBAL COMPUTER NETWORKS, AND CONSULTATION SERVICES IN THE FIELDS OF TELECOMMUNICATIONS AND GLOBAL COMPUTER NETWORKS (U.S. CLS. 100 AND 101).

FIRST USE 6-24-1998; IN COMMERCE 6-24-1998.

2,729,384. COLORYTE INC., NORCROSS, GA. SN 75-474,052.
PUB. 2-22-2000, FILED 4-24-1998.

COLORYTE

CLASS 9—ELECTRICAL AND SCIENTIFIC APPARATUS

FOR OPTICAL APPARATUS AND INSTRUMENTS, NAMELY OPTICAL FILTERS, EYEGLASS LENSES, CONTAINERS FOR EYEGLASSES, EYEGLASS CASES, AND COMPUTER SOFTWARE FOR COLOR VISION DIAGNOSTICS TO TEST, DETECT, MEASURE, AND CORRECT COLOR VISION IN THE OPHTHALMOLOGY FIELD (U.S. CLS. 21, 23, 26, 36 AND 38).

FIRST USE 4-0-2001; IN COMMERCE 4-0-2001.

CLASS 10—MEDICAL APPARATUS

FOR DIAGNOSTIC APPARATUS FOR MEDICAL PURPOSES, NAMELY, OPHTHALMOSCOPES, OPHTHALMOMETERS AND INSTRUMENTS FOR DETECTING, DIAGNOSING, AND MEASURING COLOR VISION DEFECTS (U.S. CLS. 26, 39 AND 44).

FIRST USE 4-0-2001; IN COMMERCE 4-0-2001.

CLASS 16—PAPER GOODS AND PRINTED MATTER

FOR PRINTED MATERIALS, NAMELY, PLATES AND TABLES CONSISTING OF ILLUSTRATIONS FOR HANDBOOKS AND MANUALS IN THE FIELD OF OPHTHALMOLOGY; DIAGRAMS CONTAINING INFORMATION IN THE FIELD OF OPHTHALMOLOGY; AND MANUALS AND HANDBOOKS IN THE FIELD OF INSTRUCTION OF OPHTHALMOLOGY (U.S. CLS. 2, 5, 22, 23, 29, 37, 38 AND 50).

FIRST USE 7-0-2001; IN COMMERCE 7-0-2001.

CLASS 40—MATERIAL TREATMENT

FOR MANUFACTURE OF COLOR VISION CORRECTIVE FILMS, EYEGLASS LENSES AND EYEGLASSES TO ORDER AND/OR SPECIFICATION OF OTHERS (U.S. CLS. 100, 103 AND 106).

FIRST USE 4-0-2001; IN COMMERCE 4-0-2001.

CLASS 42—SCIENTIFIC, COMPUTER AND LEGAL SERVICES

FOR MEDICAL SERVICES IN OPHTHALMOLOGY, NAMELY, COLOR VISION DETECTION, MEASUREMENT AND CORRECTION; OPTICIANS' SERVICES; CONSULTATION IN THE FIELD OF COLOR VISION DETECTION, MEASUREMENT AND CORRECTION AND CORRECTIVE EQUIPMENT, NAMELY, FILMS, EYEGLASSES, EYEGLASS LENSES, COMPUTER SOFTWARE DESIGN FOR OTHERS IN THE FIELD OF COLOR VISION RESEARCH, TESTING, DETECTION, MEASUREMENT AND CORRECTION (U.S. CLS. 100 AND 101).

FIRST USE 4-0-2001; IN COMMERCE 4-0-2001.

2,729,387. CONSECO, INC., CARMEL, IN. SN 75-482,601.
PUB. 4-18-2000, FILED 5-11-1998.

CONSECO

OWNER OF U.S. REG. NO. 2,020,988.

CLASS 35—ADVERTISING AND BUSINESS

FOR CONCESSION STANDS FEATURING FOOD AND SOUVENIRS (U.S. CLS. 100, 101 AND 102).
FIRST USE 1-0-1999; IN COMMERCE 10-15-1999.

CLASS 38—COMMUNICATION

FOR BROADCASTING TELEVISION, RADIO, CABLE TELEVISION, CABLE RADIO, SUBSCRIPTION TELEVISION, VIDEO, AUDIO PROGRAMS OF FIELDHOUSE EVENTS; BROADCASTING PROGRAMS OF FIELDHOUSE EVENTS VIA A GLOBAL COMPUTER NETWORK (U.S. CLS. 100, 101 AND 104).
FIRST USE 1-0-1999; IN COMMERCE 10-15-1999.

CLASS 39—TRANSPORTATION AND STORAGE

FOR FIELDHOUSE PARKING LOT SERVICES (U.S. CLS. 100 AND 105).
FIRST USE 1-0-1999; IN COMMERCE 10-15-1999.

CLASS 41—EDUCATION AND ENTERTAINMENT

FOR ENTERTAINMENT SERVICES, NAMELY, PROVIDING AND LEASING FIELDHOUSE FACILITIES FOR SPORTING EVENTS, EXHIBITIONS, CONCERTS, SHOWS, TOURS, MEETINGS, SEMINARS, AND CONVENTIONS; FOR ENTERTAINMENT, POLITICAL, CHARITABLE, RELIGIOUS SOCIAL OR COMMERCIAL OR OTHER PRIVATE OR PUBLIC EVENTS OR GATHERINGS; AND FOR OTHER SERVICES THAT CAN BE PROVIDED IN OR ACTIVITIES THAT CAN BE HELD IN SUCH AN ENTERTAINMENT FACILITY; OPERATING FIELDHOUSE PARKING, CONCESSION, SECURITY, CATERING, FOOD SERVICE AND OTHER SERVICES; PROVIDING RADIO, TELEVISION, INTER OR OTHER MEDIUM BROADCAST FACILITIES IN CONNECTION WITH FIELDHOUSE EVENTS; LICENSING AND OPERATING FIELDHOUSE SUITES FOR EVENT-VIEWING PURPOSES; PROMOTIONAL AND ADVERTISING SERVICES RELATING TO THE FOREGOING; AND MANAGEMENT SERVICES, EVENT PLANNING, EVENT COORDINATION, RESERVATION AND TICKETING SERVICES (U.S. CLS. 100, 101 AND 107).
FIRST USE 1-0-1999; IN COMMERCE 10-15-1999.

CLASS 42—SCIENTIFIC, COMPUTER AND LEGAL SERVICES

FOR SECURITY GUARD SERVICES; CATERING AND FOOD SERVICES; PROVIDING CONVENTION FACILITIES AND BANQUET AND SOCIAL FUNCTION FACILITIES FOR SPECIAL OCCASIONS (U.S. CLS. 100 AND 101).
FIRST USE 1-0-1999; IN COMMERCE 10-15-1999.

CLASS 11—ENVIRONMENTAL CONTROL APPARATUS

FOR ULTRA VIOLET, VISIBLE, AND/OR INFRARED LAMPS FOR CURING EPOXIES OR GLUES; LIGHTS FOR IRRADIATION APPARATUS, UTILIZING ULTRA VIOLET, VISIBLE, AND/OR INFRARED LIGHT RAYS; RESIN HARDENING LIGHTS UTILIZING ULTRA VIOLET, VISIBLE, AND/OR INFRARED LIGHT RAYS; LIGHT SYSTEMS COMPOSED OF LIGHTS, ELECTRICAL POWER SUPPLIES, AND FIBER OPTIC BUNDLES TO DELIVER LIGHT TO WORKPIECES (U.S. CLS. 13, 21, 23, 31 AND 34).
FIRST USE 11-10-2000; IN COMMERCE 11-10-2000.

2,729,408. CARTER, GARTH, MINERSVILLE, UT. SN 75-546,830. PUB. 4-11-2000, FILED 9-2-1998.

HUNTIN' FOOL

NO CLAIM IS MADE TO THE EXCLUSIVE RIGHT TO USE "HUNTING", APART FROM THE MARK AS SHOWN.

CLASS 16—PAPER GOODS AND PRINTED MATTER

FOR NEWSLETTERS IN THE FIELD OF HUNTING (U.S. CLS. 2, 5, 22, 23, 29, 37, 38 AND 50).
FIRST USE 12-1-1995; IN COMMERCE 12-1-1995.

CLASS 25—CLOTHING

FOR CLOTHING; NAMELY, SHIRTS, SHORTS, PANTS, HATS AND COATS (U.S. CLS. 22 AND 39).
FIRST USE 12-1-1995; IN COMMERCE 12-1-1995.

2,729,410. PARADIGM GENETICS, INC., RESEARCH TRIANGLE PARK, NC. SN 75-555,270. PUB. 10-12-1999, FILED 9-18-1998.

PARADIGM GENETICS

NO CLAIM IS MADE TO THE EXCLUSIVE RIGHT TO USE "GENETICS", APART FROM THE MARK AS SHOWN.

CLASS 1—CHEMICALS

FOR GENES FOR USE IN THE MANUFACTURE OF AGRICULTURAL SEED, ASSAYS FOR SCREENING CHEMICALS FOR AGRICULTURAL USE (U.S. CLS. 1, 5, 6, 10, 26 AND 46).
FIRST USE 9-1-1997; IN COMMERCE 9-1-1997.

CLASS 42—SCIENTIFIC, COMPUTER AND LEGAL SERVICES

FOR RESEARCH AND DEVELOPMENT SERVICES IN AGRICULTURAL GENETICS (U.S. CLS. 100 AND 101).
FIRST USE 9-1-1997; IN COMMERCE 9-1-1997.

2,729,403. HAMAMASTU CORPORATION, BRIDGEWATER, NJ. SN 75-527,996. PUB. 3-21-2000, FILED 7-28-1998.

LIGHTNINGCURE

CLASS 7—MACHINERY

FOR PLASTIC WORKING MACHINES AND PARTS THEREFOR; MACHINES FOR MANUFACTURING SEMICONDUCTOR ELEMENTS AND/OR INTEGRATED CIRCUITS (U.S. CLS. 13, 19, 21, 23, 31, 34 AND 35).
FIRST USE 11-10-2000; IN COMMERCE 11-10-2000.

2,729,420. GRAHAM V. LEDGERWOOD, COSTA MESA, CA.
SN 75-577,937. PUB. 3-26-2002, FILED 10-26-1998.

MYSTIC WORLD FELLOWSHIP

NO CLAIM IS MADE TO THE EXCLUSIVE RIGHT TO USE "MYSTIC" OR "FELLOWSHIP", APART FROM THE MARK AS SHOWN.

CLASS 9—ELECTRICAL AND SCIENTIFIC APPARATUS

FOR PRE-RECORDED AUDIO, VIDEO TAPES, DOWNLOADABLE AUDIO AND VIDEO RECORDINGS PERTAINING TO MYSTICISM AND METAPHYSICS; AND DOWNLOADABLE ELECTRONIC PUBLICATIONS IN THE NATURE OF NEWSLETTERS IN THE FIELD OF MYSTICISM AND METAPHYSICS (U.S. CLS. 21, 23, 26, 36 AND 38).

FIRST USE 10-21-1998; IN COMMERCE 12-16-2002.

CLASS 16—PAPER GOODS AND PRINTED MATTER

FOR NEWSLETTERS AND BOOKS PERTAINING TO MYSTICISM AND METAPHYSICS (U.S. CLS. 2, 5, 22, 23, 29, 37, 38 AND 50).

FIRST USE 10-21-1998; IN COMMERCE 12-16-2002.

CLASS 41—EDUCATION AND ENTERTAINMENT

FOR ENTERTAINMENT IN THE NATURE OF ONGOING TELEVISION AND RADIO PROGRAMS IN THE FIELD OF MYSTICISM AND METAPHYSICS; ENTERTAINMENT SERVICES, NAMELY, PROVIDING TELEVISION AND RADIO PROGRAMS IN THE FIELD OF MYSTICISM AND METAPHYSICS VIA A GLOBAL COMPUTER NETWORK; AND EDUCATION IN THE FIELD OF MYSTICISM AND METAPHYSICS RENDERED THROUGH CORRESPONDENCE COURSES (U.S. CLS. 100, 101 AND 107).

FIRST USE 10-21-1998; IN COMMERCE 12-16-2002.

CLASS 42—SCIENTIFIC, COMPUTER AND LEGAL SERVICES

FOR COMPUTER SERVICES, NAMELY, PROVIDING ON-LINE NEWSLETTERS IN THE FIELD OF MYSTICISM AND METAPHYSICS (U.S. CLS. 100 AND 101).

FIRST USE 10-21-1998; IN COMMERCE 12-1-2002.

2,729,427. ITT MANUFACTURING ENTERPRISES, INC., WILMINGTON, DE. SN 75-604,606. PUB. 6-12-2001, FILED 12-14-1998.



ITT Industries
Engineered for life

OWNER OF U.S. REG. NOS. 1,299,968 AND 1,751,561.

NO CLAIM IS MADE TO THE EXCLUSIVE RIGHT TO USE "ENGINEERED" AND "INDUSTRIES", APART FROM THE MARK AS SHOWN.

THE DESIGN FEATURE OF THE MARK IS LINED FOR THE COLOR YELLOW.

THE DESIGN FEATURE OF THE MARK CONSISTS OF

SEVERAL DIFFERENT SHAPED BLOCKS INTERLOCKING OR OVERLAPPING TO FORM A DISTINCTIVE ENGINEERED BLOCKS DESIGN.

CLASS 37—CONSTRUCTION AND REPAIR

FOR SERVICING OF TRANSPORTATION PRODUCTS AND EQUIPMENT, FLUID HANDLING CONTROL AND TRANSFER PRODUCTS AND EQUIPMENT, MILITARY AND DEFENSE PRODUCTS AND EQUIPMENT, AND ELECTRICAL AND ELECTRONIC PRODUCTS AND EQUIPMENT (U.S. CLS. 100, 103 AND 106).

FIRST USE 9-30-1998; IN COMMERCE 9-30-1998.

CLASS 42—SCIENTIFIC, COMPUTER AND LEGAL SERVICES

FOR DESIGN OF TRANSPORTATION PRODUCTS AND EQUIPMENT, FLUID HANDLING CONTROL AND TRANSFER PRODUCTS AND EQUIPMENT, MILITARY AND DEFENSE PRODUCTS AND EQUIPMENT, AND ELECTRICAL AND ELECTRONIC PRODUCTS AND EQUIPMENT (U.S. CLS. 100 AND 101).

FIRST USE 9-30-1998; IN COMMERCE 9-30-1998.

2,729,428. ESPA INTERNATIONAL (UK) LIMITED, FARNHAM, SURREY, UNITED KINGDOM. SN 75-607,570. PUB. 5-21-2002, FILED 12-17-1998.

ESPA

CLASS 3—COSMETICS AND CLEANING PREPARATIONS

FOR NON-MEDICATED TOILET PREPARATIONS, NAMELY, SKIN CARE CREAMS, LOTIONS, OILS, GELS, MOISTURIZERS, TONERS FOR HANDS, FEET, EYES, BODY AND LEGS, BATH AND BODY OILS, SOAP SCRUB, BATH AND BODY SKIN SCRUB, BODY GELS, FACIAL AND BODY MASKS AND EXFOLIATORS, FOAM BATH, HAIR PRODUCTS, NAMELY, CONDITIONERS, SHAMPOOS, HAIR GELS AND DEODORANTS; ESSENTIAL OILS FOR PERSONAL USE; HAIR AND NAIL CARE PREPARATIONS; AND SKIN SOAPS (U.S. CLS. 1, 4, 6, 50, 51 AND 52).

FIRST USE 9-0-1993; IN COMMERCE 10-0-2000.

CLASS 24—FABRICS

FOR TOWELS, BED AND TABLE LINEN (U.S. CLS. 42 AND 50).

FIRST USE 9-0-1993; IN COMMERCE 10-0-2000.

CLASS 35—ADVERTISING AND BUSINESS

FOR BUSINESS MANAGEMENT OF HEALTH SPAS, HEALTH HYDROS, HEALTH FARMS, HEALTH CLUBS, LEISURE CLUBS AND RESORT HOTELS (U.S. CLS. 100, 101 AND 102).

FIRST USE 9-0-1993; IN COMMERCE 4-0-1995.

CLASS 41—EDUCATION AND ENTERTAINMENT

FOR HEALTH CLUBS (U.S. CLS. 100, 101 AND 107).
FIRST USE 9-0-1993; IN COMMERCE 4-0-1995.

CLASS 42—SCIENTIFIC, COMPUTER AND LEGAL SERVICES

FOR ARCHITECTURAL DESIGN OF HEALTH SPAS, HEALTH CLUBS AND RESORT HOTELS; HEALTH SPAS, AND RESORT HOTELS (U.S. CLS. 100 AND 101).
FIRST USE 9-0-1993; IN COMMERCE 4-0-1995.

2,729,429. BALANCE DESIGNS, INC., MANCHESTER CENTER, VT. SN 75-609,198. PUB. 5-30-2000, FILED 12-21-1998.

VEW-DO

OWNER OF U.S. REG. NO. 1,930,896.

CLASS 25—CLOTHING

FOR CLOTHING, NAMELY, HATS, SHIRTS, SWEAT-SHIRTS (U.S. CLS. 22 AND 39).
FIRST USE 2-1-1992; IN COMMERCE 2-1-1992.

CLASS 28—TOYS AND SPORTING GOODS

FOR SPORTING GOODS, NAMELY, EXERCISE BALANCE BOARDS (U.S. CLS. 22, 23, 38 AND 50).
FIRST USE 2-1-1992; IN COMMERCE 2-1-1992.

2,729,430. LAMPBLASTER, INC., HIALEAH, FL. SN 75-611,847. PUB. 11-9-1999, FILED 12-24-1998.

LAMP BLASTER DIRECT

NO CLAIM IS MADE TO THE EXCLUSIVE RIGHT TO USE "LAMP", APART FROM THE MARK AS SHOWN.

CLASS 35—ADVERTISING AND BUSINESS

FOR COMPUTERIZED ON-LINE ORDERING AND RETAIL SERVICES IN THE FIELD OF LAMPS, LIGHT-BULBS, LAMPSHADES, LAMP CORDS, LIGHTS, LIGHTING FIXTURES, LIGHTING TUBES, AND LIGHTING UNITS (U.S. CLS. 100, 101 AND 102).
FIRST USE 7-1-2002; IN COMMERCE 7-1-2002.

CLASS 42—SCIENTIFIC, COMPUTER AND LEGAL SERVICES

FOR COMPUTER SERVICES, NAMELY PROVIDING INFORMATION ONLINE AND OVER A GLOBAL COMPUTER NETWORK IN THE FIELD OF LAMPS AND LIGHTING (U.S. CLS. 100 AND 101).
FIRST USE 7-1-2002; IN COMMERCE 7-1-2002.

2,729,442. BUFFETT, JIMMY, KEY WEST, FL. SN 75-651,815.
PUB. 9-28-1999, FILED 3-2-1999.

MARGARITAVILLE**CLASS 18—LEATHER GOODS**

FOR BAGS, NAMELY TRAVEL BAGS, TOTE BAGS AND BEACH BAGS (U.S. CLS. 1, 2, 3, 22 AND 41).
FIRST USE 10-0-1991; IN COMMERCE 10-0-1991.

CLASS 20—FURNITURE AND ARTICLES NOT OTHERWISE CLASSIFIED

FOR CHAIRS, NAMELY BEACH CHAIRS AND DECK CHAIRS (U.S. CLS. 2, 13, 22, 25, 32 AND 50).
FIRST USE 3-0-2000; IN COMMERCE 3-0-2000.

CLASS 21—HOUSEWARES AND GLASS

FOR PORTABLE FOOD AND DRINK COOLERS; BOTTLES, SOLD EMPTY, NAMELY, WATER BOTTLES AND SQUEEZE BOTTLES; AND FOAM DRINK HOLDERS (U.S. CLS. 2, 13, 23, 29, 30, 33, 40 AND 50).
FIRST USE 2-0-1985; IN COMMERCE 2-0-1985.

CLASS 24—FABRICS

FOR TOWELS AND BEACH TOWELS (U.S. CLS. 42 AND 50).
FIRST USE 2-0-1985; IN COMMERCE 2-0-1985.

CLASS 25—CLOTHING

FOR CLOTHING, NAMELY CAPS, VISORS, HATS, BEACH COVER-UPS, T-SHIRTS, TANK TOPS, BOXER SHORTS, WIND RESISTANT JACKETS (U.S. CLS. 22 AND 39).
FIRST USE 1-0-1985; IN COMMERCE 1-0-1985.

CLASS 28—TOYS AND SPORTING GOODS

FOR SPORTS EQUIPMENT AND SPORTING GOODS, NAMELY, VOLLEYBALLS, BEACH BALLS, AND FLYING DISKS (U.S. CLS. 22, 23, 38 AND 50).
FIRST USE 4-0-1995; IN COMMERCE 4-0-1995.

2,729,452. PARAGRAPH DEVELOPMENT CORPORATION, ATLANTA, GA. SN 75-674,505. PUB. 8-22-2000, FILED 4-5-1999.

ACTIVE PARAGRAPH**CLASS 9—ELECTRICAL AND SCIENTIFIC APPARATUS**

FOR SOFTWARE AND COMPUTER PROGRAMS USED FOR GENERATING AND MANAGING ELECTRONIC DOCUMENTS, NAMELY, WORD PROCESSING SOFTWARE AND DATABASE MANAGEMENT SOFTWARE; COMPUTER SOFTWARE FOR USE IN TRANSFERRING ELECTRONIC DOCUMENTS VIA LOCAL AND GLOBAL COMPUTER NETWORKS; COMPUTER SOFTWARE DEVELOPMENT TOOLS (U.S. CLS. 21, 23, 26, 36 AND 38).
FIRST USE 6-1-1999; IN COMMERCE 6-1-1999.

CLASS 42—SCIENTIFIC, COMPUTER AND LEGAL SERVICES

FOR COMPUTER SOFTWARE DESIGN IN THE FIELD OF BUSINESS APPLICATIONS FOR OTHERS (U.S. CLS. 100 AND 101).

FIRST USE 6-1-1999; IN COMMERCE 6-1-1999.

2,729,471. THOMBAS COMPANY, LLC, THE, ALPHARETTA, GA. SN 75-717,505. PUB. 8-22-2000, FILED 6-1-1999.

MOULDINGDIRECT**CLASS 19—NON-METALLIC BUILDING MATERIALS**

FOR ARCHITECTURAL MOULDINGS MADE OF WOOD (U.S. CLS. 1, 12, 33 AND 50).

FIRST USE 1-9-2002; IN COMMERCE 1-9-2002.

CLASS 20—FURNITURE AND ARTICLES NOT OTHERWISE CLASSIFIED

FOR PICTURE FRAME MOULDING (U.S. CLS. 2, 13, 22, 25, 32 AND 50).

FIRST USE 2-12-2002; IN COMMERCE 2-12-2002.

2,729,460. STAR CUTTER COMPANY, FARMINGTON HILLS, MI. SN 75-692,162. PUB. 10-3-2000, FILED 4-27-1999.

STARFORCE

OWNER OF U.S. REG. NOS. 872,520 AND 2,031,515.

CLASS 2—PAINTS

FOR FINISHING TYPE COATINGS FOR USE ON INDUSTRIAL TOOLING, NAMELY, CUTTING TOOLS, MEDICAL TOOLS FORMING TOOLS AND DIES (U.S. CLS. 6, 11 AND 16).

FIRST USE 0-0-1998; IN COMMERCE 0-0-1998.

2,729,474. SHELL OIL COMPANY, HOUSTON, TX. SN 75-724,217. PUB. 6-11-2002, FILED 6-8-1999.

KALIDO

PRIORITY CLAIMED UNDER SEC. 44(D) ON UNITED KINGDOM APPLICATION NO. 2184273, FILED 12-11-1998.

CLASS 7—MACHINERY

FOR PARTS FOR POWER-OPERATED INDUSTRIAL TOOLS, NAMELY, SAWS, DRILLS AND CUTTERS, WHICH PARTS ARE MOUNTED ON SPINDLES OF INDUSTRIAL, POWER MACHINERY (U.S. CLS. 13, 19, 21, 23, 31, 34 AND 35).

FIRST USE 0-0-1998; IN COMMERCE 0-0-1998.

CLASS 9—ELECTRICAL AND SCIENTIFIC APPARATUS

FOR COMPUTER PROGRAMS, NAMELY, COMPUTER DATABASE MANAGEMENT PROGRAMS FOR USE IN INFORMATION MANAGEMENT SYSTEMS (U.S. CLS. 21, 23, 26, 36 AND 38).

FIRST USE 6-8-1999; IN COMMERCE 6-8-1999.

CLASS 10—MEDICAL APPARATUS

FOR MEDICAL TOOLS, NAMELY SAWS, DRILLS AND BROACHES (U.S. CLS. 26, 39 AND 44).

FIRST USE 0-0-1998; IN COMMERCE 0-0-1998.

CLASS 42—SCIENTIFIC, COMPUTER AND LEGAL SERVICES

FOR COMPUTER CONSULTATION SERVICES FOR THE FIELD OF COMPUTER BASED INFORMATION SYSTEMS (U.S. CLS. 100 AND 101).

FIRST USE 6-8-1999; IN COMMERCE 6-8-1999.

2,729,465. ABBOTT LABORATORIES, ABBOTT PARK, IL. SN 75-708,103. PUB. 10-10-2000, FILED 5-18-1999.

SOFTACT**CLASS 5—PHARMACEUTICALS**

FOR MEDICAL DIAGNOSTIC REAGENTS FOR ANALYSIS OF GLUCOSE LEVELS (U.S. CLS. 6, 18, 44, 46, 51 AND 52).

FIRST USE 4-2-2001; IN COMMERCE 4-2-2001.

2,729,475. DECIPHER INC., NORFOLK, VA. SN 75-725,168. PUB. 4-24-2001, FILED 7-2-1999.

THE ART OF GREAT GAMES

OWNER OF U.S. REG. NO. 1,985,618.

CLASS 10—MEDICAL APPARATUS

FOR MEDICAL DIAGNOSTIC INSTRUMENTS FOR ANALYSIS OF GLUCOSE LEVELS (U.S. CLS. 26, 39 AND 44).

FIRST USE 4-2-2001; IN COMMERCE 4-2-2001.

CLASS 16—PAPER GOODS AND PRINTED MATTER

FOR BOOKS FEATURING ROLE PLAYING GAMES, ENCYCLOPEDIAS FOR GAMES, AND STRATEGY GUIDES FOR GAMES (U.S. CLS. 2, 5, 22, 23, 29, 37, 38 AND 50).

FIRST USE 4-0-2002; IN COMMERCE 4-0-2002.

CLASS 28—TOYS AND SPORTING GOODS

FOR PLAY FIGURES, SCRATCH OFF GAMES IN THE NATURE OF CARDS, ROLE PLAYING GAME EQUIPMENT IN THE NATURE OF GAME BOOK GUIDE MANUALS AND SOURCE BOOKS, AND MINIATURE GAMES COMPRISED OF MINIATURE FIGURINES (U.S. CLS. 22, 23, 38 AND 50).

FIRST USE 4-0-2000; IN COMMERCE 4-0-2000.

2,729,480. BUYLINKONLINE.COM CORPORATION, SANTA FE SPRINGS, CA. SN 75-731,683. PUB. 8-8-2000, FILED 6-18-1999.

BUYLINKONLINE.COM**CLASS 9—ELECTRICAL AND SCIENTIFIC APPARATUS**

FOR ELECTRONIC COMPONENTS AND COMPUTER COMPONENTS FOR INDUSTRIAL USE, NAMELY, LCD'S, SINGLE BOARD COMPUTERS, INVERTERS AND SOLENOIDS (U.S. CLS. 21, 23, 26, 36 AND 38).

FIRST USE 8-3-1999; IN COMMERCE 11-8-1999.

CLASS 35—ADVERTISING AND BUSINESS

FOR COMPUTERIZED ON-LINE RETAIL SERVICES IN THE FIELD OF ELECTRONIC COMPONENTS AND COMPUTER PRODUCTS (U.S. CLS. 100, 101 AND 102).

FIRST USE 8-3-1999; IN COMMERCE 11-8-1999.

2,729,483. VISTEON CORPORATION, DEARBORN, MI, BY ASSIGNMENT FORD MOTOR COMPANY, DEARBORN, MI. SN 75-737,692. PUB. 12-26-2000, FILED 6-25-1999.

AUTONEURAL SYSTEMS

NO CLAIM IS MADE TO THE EXCLUSIVE RIGHT TO USE "SYSTEMS", APART FROM THE MARK AS SHOWN.

CLASS 40—MATERIAL TREATMENT

FOR CUSTOM MANUFACTURE OF AUTOMOTIVE ELECTRONIC EQUIPMENT, MULTIMEDIA SYSTEMS, AND CLIMATE CONTROL SYSTEMS (U.S. CLS. 100, 103 AND 106).

FIRST USE 3-4-2001; IN COMMERCE 3-4-2001.

CLASS 42—SCIENTIFIC, COMPUTER AND LEGAL SERVICES

FOR TESTING AND DESIGN FOR OTHERS IN THE FIELDS OF MOTOR VEHICLES, AUTOMOTIVE ELECTRONIC EQUIPMENT, COMPUTER SOFTWARE, MULTIMEDIA SYSTEMS, AND CLIMATE CONTROL SYSTEMS; ENGINEERING AND TECHNICAL CONSULTATION IN THE FIELDS OF MOTOR VEHICLES, AUTOMOTIVE ELECTRONIC EQUIPMENT, MULTIMEDIA SYSTEMS, COMPUTER SOFTWARE AND CLIMATE CONTROL SYSTEMS (U.S. CLS. 100 AND 101).

FIRST USE 3-4-2001; IN COMMERCE 3-4-2001.

2,729,490. SENSTAR-STELLAR CORPORATION, KANATA ONTARIO, CANADA. SN 75-750,864. PUB. 7-16-2002, FILED 7-14-1999.



PRIORITY CLAIMED UNDER SEC. 44(D) ON CANADA APPLICATION NO. 1,002,090, FILED 1-15-1999, REG. NO. TMA533873, DATED 9-29-2000, EXPIRES 9-29-2015.

CLASS 9—ELECTRICAL AND SCIENTIFIC APPARATUS

FOR INTRUSION DETECTORS, NAMELY BURIED OR AERIAL CABLE SENSORS, MICROPHONIC CABLE DISTURBANCE SENSORS, FENCE MOUNTED DETECTION SENSORS, ELECTROSTATIC FIELD DISTURBANCE SENSORS, VIDEO MOTION SENSORS, MICROWAVE SENSORS, NETWORKING AND DISPLAY/CONTROL DEVICES; PARTS FOR INTRUSION DETECTION SYSTEMS, NAMELY SENSOR CABLES, CONNECTORS, TRANSPONDERS, TRANSDUCERS, TRANSCIEVERS, MULTIPLEX ALARM MONITORS AND PROCECESSORS, KEYPADS, KEYBOARDS, DISPLAY MONITORS, VIDEO DISPLAY TERMINALS, SIGNAL PROCESSORS, CENTRAL PROCESSING UNITS, CONTROL SWITCHES, POWER SUPPLIES, LIGHTNING ARRESTORS, WEATHER STATION SENSORS, ENCRYPTION SYSTEMS, INFRARED ILLUMINATORS, DISPLAY PANELS (U.S. CLS. 21, 23, 26, 36 AND 38).

FIRST USE 7-0-1997; IN COMMERCE 7-0-1997.

CLASS 42—SCIENTIFIC, COMPUTER AND LEGAL SERVICES

FOR DESIGN OF INTRUSION DETECTION SYSTEMS (U.S. CLS. 100 AND 101).

FIRST USE 7-0-1997; IN COMMERCE 7-0-1997.

2,729,493. BONT FOOTWEAR PTY LTD, NEW SOUTH WALES 2194, AUSTRALIA, BY ASSIGNMENT BONT SKATES PTY LTD, NEW SOUTH WALES 2194, AUSTRALIA. SN 75-756,474. PUB. 4-23-2002, FILED 7-21-1999.



THE ENGLISH TRANSLATION OF THE WORD "BONT" IS "COLORFUL".

CLASS 25—CLOTHING

FOR CLOTHING, NAMELY, T-SHIRTS, SINGLETs, TRACK SUIT PANTS, CASUAL PANTS, PROTECTIVE SPORTS PANTS FOR SKATING, TRACK SUITS, JACKETS, RACING SUITS FOR ROLLER, IN-LINE AND ICE SKATING, SHORTS, SOCKS, JUMPERS, JERSEYS, SHIRTS, SNOW SKI CLOTHING, NAMELY, SKI BIBS, SKI PANTS AND SKI MASKS, DRESSES, TOPS AND BOTTOMS, KIDS WEAR, NAMELY, SHORTS, TOPS AND BOTTOMS, SWIM WEAR, HEADWEAR, NAMELY, HEADBANDS, AND FOOTWEAR, NAMELY, RUNNING SHOES, SANDALS, THONGS, BOOTS AND SHOES, ALL OF THE FOREGOING FOR USE IN CONNECTION WITH SKATING AND SKIING (U.S. CLS. 22 AND 39).

FIRST USE 8-21-1999; IN COMMERCE 8-21-1999.

CLASS 28—TOYS AND SPORTING GOODS

FOR ROLLER SKATES, NAMELY, QUAD SKATES, IN-LINE SKATES, ICE SKATES AND PARTS THEREFOR, NAMELY, BLADES, FRAMES, WHEELS AND BEARINGS; SKATING BOOTS AND PARTS THEREFOR; PROTECTIVE PADDING FOR SKATING, NAMELY, SHIN AND KNEE GUARDS AND PADS AND NECK GUARDS (U.S. CLS. 22, 23, 38 AND 50).

FIRST USE 8-21-1999; IN COMMERCE 8-21-1999.

2,729,502. CARDSOFT INTERNATIONAL PTY LIMITED, MANLY NSW 2095, AUSTRALIA. SN 75-778,262. PUB. 6-18-2002, FILED 8-17-1999.

CARDSOFT**CLASS 9—ELECTRICAL AND SCIENTIFIC APPARATUS**

FOR COMPUTER SOFTWARE AND SOFTWARE APPLICATIONS FOR USE IN FACILITATING AND ENHANCING THE PROCESSING AND FUNCTIONALITY OF ELECTRONIC COMMERCE, LOYALTY, GAMES, GRAPHICS AND MOBILE COMMERCE APPLICATIONS, SOFTWARE INTEROPERABILITY, AND THE OPERATION OF HANDHELD ELECTRONIC DEVICES AND SMART CARDS; COMPUTER SOFTWARE FOR USE INCAPACITATING AND ENHANCING COMMUNICATION DATA TRANSMISSION, THE INTERACTION AND INTERFACING CAPABILITY WITH AND BETWEEN VIRTUAL AND ACTUAL ELECTRONIC DEVICES, NAMELY, SERVER-BASED AND PC-BASED HARDWARE, HANDHELD COMPUTER UNITS, EMBEDDED SYSTEMS AND SMART CARDS; COMPUTER SOFTWARE AND SOFTWARE APPLICATION ENHANCING AND IMPROVING THE OPERATING EFFICIENCY, AVAILABILITY AND CAPABILITY OF VIRTUAL AND ACTUAL ELECTRONIC DEVICES, NAMELY, SERVER-BASED AND PC-BASED HARDWARE, HANDHELD COMPUTER UNITS, EMBEDDED SYSTEMS AND SMART CARDS; COMPUTER OPERATING SOFTWARE; INSTRUCTION MANUAL FOR USE WITH COMPUTER SOFTWARE, AND SOLD AS A UNIT (U.S. CLS. 21, 23, 26, 36 AND 38).

FIRST USE 5-1-2002; IN COMMERCE 8-22-2002.

CLASS 42—SCIENTIFIC, COMPUTER AND LEGAL SERVICES

FOR COMPUTER PROGRAMMING FOR OTHERS; COMPUTER SOFTWARE DESIGN FOR OTHERS; MAINTENANCE AND UPDATING OF COMPUTER SOFTWARE; CONSULTANCY IN THE FIELD OF COMPUTER SOFTWARE AND SOFTWARE APPLICATIONS; LICENSING OF INTELLECTUAL PROPERTY, NAMELY, COMPUTER SOFTWARE (U.S. CLS. 100 AND 101).

FIRST USE 1-1-2001; IN COMMERCE 1-1-2001.

2,729,508. LIBERTY FUND, INC., INDIANAPOLIS, IN. SN 75-786,948. PUB. 11-28-2000, FILED 8-27-1999.

AMAGI BOOKS

NO CLAIM IS MADE TO THE EXCLUSIVE RIGHT TO USE "BOOKS", APART FROM THE MARK AS SHOWN.

THE ENGLISH TRANSLATION OF THE WORD "AMAGI" IS "FREEDOM".

CLASS 16—PAPER GOODS AND PRINTED MATTER

FOR SERIES OF NON-FICTION BOOKS FOCUSING ON THE SUBJECTS OF LIBERTY AND RESPONSIBILITY, FEATURING CONTENT IN THE AREAS OF HISTORY, ECONOMIC THEORY, POLITICAL THEORY, PHILOSOPHY, BIOGRAPHY, AND LITERARY CRITICISM (U.S. CLS. 2, 5, 22, 23, 29, 37, 38 AND 50).

FIRST USE 5-22-2002; IN COMMERCE 5-22-2002.

CLASS 41—EDUCATION AND ENTERTAINMENT

FOR PUBLICATION OF BOOKS (U.S. CLS. 100, 101 AND 107).

FIRST USE 5-22-2002; IN COMMERCE 5-22-2002.

2,729,522. CHICAGO CODING SYSTEMS, INC., ST. CHARLES, IL. SN 75-808,292. PUB. 5-7-2002, FILED 9-24-1999.



SEC. 2(F) AS TO "CHICAGO CODING SYSTEMS".

CLASS 9—ELECTRICAL AND SCIENTIFIC APPARATUS

FOR BAR CODING EQUIPMENT, NAMELY, BAR CODE PRINTING SYSTEMS COMPRISING PRINTERS, BAR CODE APPLICATOR MACHINES AND SOFTWARE THEREFOR; AND LABEL PRINTING SYSTEMS COMPRISING THERMAL AND INK JET PRINTERS, LABEL APPLICATOR MACHINES AND SOFTWARE THEREFOR (U.S. CLS. 21, 23, 26, 36 AND 38).

FIRST USE 10-0-1999; IN COMMERCE 10-0-1999.

CLASS 16—PAPER GOODS AND PRINTED MATTER

FOR LABELING EQUIPMENT, NAMELY, DISPENSERS; AND STENCILING EQUIPMENT, NAMELY, STENCILING INK AND MARKING PRODUCTS IN THE NATURE OF ROLLERS, BRUSHES, MARKING PENS, AND STENCIL MACHINES (U.S. CLS. 2, 5, 22, 23, 29, 37, 38 AND 50).

FIRST USE 10-0-1999; IN COMMERCE 10-0-1999.

2,729,527. CIGNA INTELLECTUAL PROPERTY, INC., WILMINGTON, DE, BY ASSIGNMENT CIGNA CORPORATION, PHILADELPHIA, PA. SN 75-813,748. PUB. 5-2-2000, FILED 10-4-1999.

EXPERIENCE. OUR DIFFERENCE.**CLASS 9—ELECTRICAL AND SCIENTIFIC APPARATUS**

FOR COMPUTER PROGRAMS FOR USE IN PROCESSING WORKERS' COMP. DISABILITY, AND HEALTH CARE CLAIMS (U.S. CLS. 21, 23, 26, 36 AND 38).

FIRST USE 9-1-1999; IN COMMERCE 9-1-1999.

CLASS 35—ADVERTISING AND BUSINESS

FOR COST MANAGEMENT OF DISABILITY BENEFIT PLANS AND HEALTH PLANS FOR OTHERS (U.S. CLS. 100, 101 AND 102).

FIRST USE 9-1-1999; IN COMMERCE 9-1-1999.

CLASS 42—SCIENTIFIC, COMPUTER AND LEGAL SERVICES

FOR HEALTH INFORMATION SERVICES, HEALTH CARE SERVICES (U.S. CLS. 100 AND 101).

FIRST USE 9-1-1999; IN COMMERCE 9-1-1999.

2,729,539. AMERICAN FIBERS AND YARNS COMPANY, CHAPEL HILL, NC. SN 75-837,735. PUB. 5-14-2002, FILED 11-2-1999.

American
FIBERS AND YARNS COMPANY

NO CLAIM IS MADE TO THE EXCLUSIVE RIGHT TO USE "AMERICAN FIBERS AND YARNS COMPANY", APART FROM THE MARK AS SHOWN.

THE LINING IS A FEATURE OF THE MARK AND IS NOT INTENDED TO INDICATE COLOR.

CLASS 23—YARNS AND THREADS

FOR SYNTHETIC YARNS FOR USE IN UPHOLSTERY, APPAREL, AND AUTOMOTIVE FABRICS (U.S. CL. 43).

FIRST USE 11-0-1999; IN COMMERCE 11-0-1999.

CLASS 40—MATERIAL TREATMENT

FOR CUSTOM MANUFACTURE OF SYNTHETIC FIBERS AND YARNS FOR USE IN UPHOLSTERY, APPAREL, AND AUTOMOTIVE FABRICS (U.S. CLS. 100, 103 AND 106).

FIRST USE 11-0-1999; IN COMMERCE 11-0-1999.

2,729,549. FRANKLIN HEALTH, INC., UPPER SADDLE RIVER, NJ. SN 75-848,946. PUB. 9-19-2000, FILED 11-15-1999.

UAI

CLASS 35—ADVERTISING AND BUSINESS

FOR DATA PROCESSING AND COMPUTERIZED DATABASE MANAGEMENT IN THE FIELD OF HEALTH CARE (U.S. CLS. 100, 101 AND 102).

FIRST USE 0-0-1999; IN COMMERCE 0-0-2000.

CLASS 42—SCIENTIFIC, COMPUTER AND LEGAL SERVICES

FOR CONSULTING SERVICES IN THE FIELD OF HEALTH CARE MANAGEMENT; PROVIDING HEALTH CARE INFORMATION BY TELEPHONE AND ELECTRONIC MEANS; PREPARING INTERDISCIPLINARY HEALTH CARE TREATMENT PLANS FOR USE IN THE CARE AND MANAGEMENT OF PATIENTS; MAINTENANCE AND MANAGEMENT OF MEDICAL RECORDS; PROVIDING INTERACTIVE HEALTH CARE INFORMATION SERVICES ON A GLOBAL ELECTRONIC COMPUTER NETWORK FOR THE GENERAL PUBLIC AND SUBSCRIBERS; PROVIDING OUTCOMES MEASUREMENT INCLUDING MONITORING, QUANTIFYING AND ASSESSING THE PROGRESS OF PATIENT CARE FOR USE IN HEALTH CARE MANAGEMENT; HEALTH CARE MANAGEMENT AND CONSULTATION IN THE FIELD OF HEALTH CARE (U.S. CLS. 100 AND 101).

FIRST USE 0-0-1999; IN COMMERCE 0-0-2000.

2,729,553. ZEON CORPORATION, CHIYODA-KU, TOKYO, JAPAN, BY CHANGE OF NAME NIPPON ZEON CO., LTD., CHIYODA-KU, TOKYO, JAPAN. SN 75-854,394. PUB. 11-13-2001, FILED 11-22-1999.

ZEON

OWNER OF U.S. REG. NO. 2,036,390.

CLASS 1—CHEMICALS

FOR CHEMICALS, NAMELY, INORGANIC ACIDS, ALKALIES, INORGANIC SALTS, OXIDES, SULPHIDES, AROMATICS, ALIPHATICS, ORGANIC HALOGENIDES, ALCOHOLS, PHENOLS, ETHERS, ALDEHYDES AND KETONES, ORGANIC ACIDS AND THEIR SALTS, ESTERS, NITROGEN COMPOUNDS, HETEROCYCLIC COMPOUNDS, CARBOHYDRATES, PROTEINS AND ENZYMES, ORGANOPHOSPHOROUS COMPOUNDS AND ORGANOARSENIS COMPOUNDS, ORGANOMETALLIC COMPOUNDS, SURFACE-ACTIVE AGENTS (SURFACTANTS), AND CHEMICAL AGENTS FOR INDUSTRIAL USE; ADHESIVES, NAMELY, GUM ARABIC MUCILAGE, PLASTIC ADHESIVES AND LATEX ADHESIVES; UNPROCESSED ARTIFICIAL RESINS, NAMELY, CONDENSATIONAL PLASTICS AND POLYMERIZATION PLASTICS (U.S. CLS. 1, 5, 6, 10, 26 AND 46).

FIRST USE 4-30-2000; IN COMMERCE 4-30-2000.

CLASS 3—COSMETICS AND CLEANING PREPARATIONS

FOR SYNTHETIC AROMATICS, NAMELY, SYNTHETIC PERFUMERY SUCH AS GERANIOL, ARTIFICIAL MUSK, VANILLIN AND HELIOTROPIN, BLENDS OF SUCH AROMATICS, AND FOOD FLAVORINGS COMPRISING ESSENTIAL OILS (U.S. CLS. 1, 4, 6, 50, 51 AND 52).

FIRST USE 4-30-1997; IN COMMERCE 4-30-1997.

CLASS 17—RUBBER GOODS

FOR ADHESIVE MATERIALS, NAMELY, ADHESIVE TAPE FOR INDUSTRIAL AND COMMERCIAL USE; SYNTHETIC RUBBER FOR GENERAL INDUSTRIAL USE, NAMELY, ACRYLIC RUBBER, SILICONE RUBBER, STYRENE-BUTADIENE RUBBER, NITRYLE RUBBER, BUTYL RUBBER AND FLUORORUBBER; ELECTRIC INSULATING MATERIALS MADE FROM PLASTICS OR SYNTHETIC RUBBER; SEMI-PROCESSED PLASTICS IN THE FORMS OF PANELS, SHEETS, FILMS, PIPES, BELTS AND RODS (U.S. CLS. 1, 5, 12, 13, 35 AND 50).

FIRST USE 4-30-2002; IN COMMERCE 4-30-2002.

CLASS 30—STAPLE FOODS

FOR AROMATIC FOOD ADDITIVES FOR NON-NUTRITIONAL PURPOSES (U.S. CL. 46).
FIRST USE 4-30-1997; IN COMMERCE 4-30-1997.

2,729,557. SLEEPMED, INCORPORATED, BOSTON, MA. SN 75-859,658. PUB. 3-12-2002, FILED 11-30-1999.

SLEEPMED**CLASS 10—MEDICAL APPARATUS**

FOR THERAPEUTIC DEVICES FOR NEUROLOGICAL DISORDERS, NAMELY, AIR MATTRESSES FOR MEDICAL PURPOSES AND MEDICAL ELECTRODES (U.S. CLS. 26, 39 AND 44).
FIRST USE 12-1-2000; IN COMMERCE 12-1-2000.

CLASS 42—SCIENTIFIC, COMPUTER AND LEGAL SERVICES

FOR MEDICAL DIAGNOSTIC RESEARCH SERVICES FOR SLEEP AND OTHER NEUROLOGICAL DISORDERS (U.S. CLS. 100 AND 101).
FIRST USE 12-1-2000; IN COMMERCE 12-1-2000.

2,729,562. POSS, WALTER, SAN FRANCISCO, CA. SN 75-865,848. PUB. 5-15-2001, FILED 12-6-1999.

NOHELPDESK.COM**CLASS 16—PAPER GOODS AND PRINTED MATTER**

FOR PRINTED MATTER; NAMELY, GREETING CARDS, POSTERS AND COMIC STRIPS (U.S. CLS. 2, 5, 22, 23, 29, 37, 38 AND 50).
FIRST USE 11-15-2002; IN COMMERCE 11-15-2002.

CLASS 25—CLOTHING

FOR CLOTHING; NAMELY, SHIRTS AND HATS (U.S. CLS. 22 AND 39).
FIRST USE 11-15-2002; IN COMMERCE 11-15-2002.

2,729,582. ESPEED, INC., NEW YORK, NY. SN 75-891,879. PUB. 10-23-2001, FILED 1-7-2000.



The logo for eSpeed features the word "eSpeed" in a stylized, italicized font. The letter "e" is lowercase and has a horizontal line through its middle. The "S" is uppercase and has a horizontal line through its middle. The "P" is uppercase and has a horizontal line through its middle. The "E" is uppercase and has a horizontal line through its middle. The "D" is uppercase and has a horizontal line through its middle.

THE LINES SHOWN IN THE DRAWING ARE A FEATURE OF THE MARK AND ARE NOT INTENDED TO INDICATE COLOR.

CLASS 9—ELECTRICAL AND SCIENTIFIC APPARATUS

FOR COMPUTER SOFTWARE THAT ENABLES TRADING IN FINANCIAL INSTRUMENTS, PROVIDES TRADE EXECUTION AND TRADE CONFIRMATION CAPABILITIES, AND PROVIDES ACCESS TO FINANCIAL INFORMATION AND FINANCIAL MARKET INFORMATION, REAL TIME AND OTHERWISE (U.S. CLS. 21, 23, 26, 36 AND 38).
FIRST USE 4-1-2000; IN COMMERCE 4-1-2000.

CLASS 38—COMMUNICATION

FOR TELECOMMUNICATION SERVICES, NAMELY, ELECTRONIC TRANSMISSION OF DATA VIA COMPUTER TERMINALS (U.S. CLS. 100, 101 AND 104).
FIRST USE 4-1-2000; IN COMMERCE 4-1-2000.

2,729,584. TRUSTEES OF THE WAI LAN YOGA TRUST, PORT HUENEME, CA. SN 75-892,385. PUB. 5-15-2001, FILED 1-7-2000.

WAI LANA YOGA

OWNER OF U.S. REG. NO. 2,315,533.
NO CLAIM IS MADE TO THE EXCLUSIVE RIGHT TO USE "YOGA", APART FROM THE MARK AS SHOWN.

CLASS 25—CLOTHING

FOR MEN'S, WOMEN'S AND CHILDREN'S CLOTHING, NAMELY, BLOUSES, JACKETS, JUMP SUITS, COATS, PANTS, PULLOVERS, SCARVES, SHIRTS, SWEAT SHIRTS, SWEAT PANTS, SWEAT JACKETS, T-SHIRTS, TOPS AND BOTTOMS (U.S. CLS. 22 AND 39).
FIRST USE 12-0-2001; IN COMMERCE 12-0-2001.

CLASS 41—EDUCATION AND ENTERTAINMENT

FOR EDUCATIONAL AND ENTERTAINMENT SERVICES, NAMELY, PRODUCTION OF RADIO PROGRAMS, TELEVISION PROGRAMS AND WEBCAST PROGRAMS; DISTRIBUTION OF RADIO PROGRAMS, TELEVISION PROGRAMS AND WEBCAST PROGRAMS FOR OTHERS; PROVIDING TELEVISION AND RADIO PROGRAMS IN THE FIELDS OF MUSIC, EXERCISE, FITNESS, HEALTH, NUTRITION, RELAXATION, HEALTHY LIVING, LIFESTYLES, NATURAL LIVING, DIET, NATURAL HEALING, AROMATHERAPY; EDUCATION SERVICES, NAMELY, CONDUCTING CLASSES IN THE FIELDS OF MUSIC, EXERCISE, FITNESS, HEALTH, NUTRITION, RELAXATION, HEALTHY LIVING, LIFESTYLES, NATURAL LIVING, DIET, NATURAL HEALING (U.S. CLS. 100, 101 AND 107).
FIRST USE 6-0-1998; IN COMMERCE 6-0-1998.

2,729,586. LIEBERMANN, RAANAN, NORTH HAVEN, CT.
SN 75-896,038. PUB. 6-25-2002, FILED 1-13-2000.

SIGNTL

CLASS 9—ELECTRICAL AND SCIENTIFIC APPARATUS

FOR COMPUTERS, LAPTOP COMPUTERS, HAND-HELD COMPUTERS, AND SOFTWARE FOR COMPUTERS FOR ALLOWING DEAF PEOPLE AND HEARING IMPAIRED PEOPLE TO READ BOOKS IN SIGN LANGUAGE; COMPUTERS, LAPTOP COMPUTERS, HAND-HELD COMPUTERS, AND SOFTWARE FOR ENABLING DEAF AND HEARING IMPAIRED PEOPLE TO VIEW ORAL PRESENTATIONS AND ORAL COMMUNICATIONS IN SIGN LANGUAGE (U.S. CLS. 21, 23, 26, 36 AND 38).

FIRST USE 1-25-2001; IN COMMERCE 2-7-2001.

CLASS 38—COMMUNICATION

FOR PROVIDING COMMUNICATION SERVICES FOR INDIVIDUALS WHO ARE DEAF, HARD OF HEARING, AND/OR SPEECH IMPAIRED, NAMELY PROVIDING SIGN LANGUAGE, DELIVERY AND/OR INTERPRETATIONS OF TEXT AND BOOKS VIA TELECOMMUNICATION PHONE LINES, VIA THE INTERNET, AND VIA WIRELESS TRANSMISSIONS (U.S. CLS. 100, 101 AND 104).

FIRST USE 1-25-2001; IN COMMERCE 2-7-2001.

CLASS 41—EDUCATION AND ENTERTAINMENT

FOR SIGN LANGUAGE INTERPRETING SERVICES (U.S. CLS. 100, 101 AND 107).

FIRST USE 1-25-2001; IN COMMERCE 2-7-2001.

2,729,589. DOCUCORP INTERNATIONAL, INC., DALLAS, TX. SN 75-902,399. PUB. 6-4-2002, FILED 1-26-2000.

THE FORM SPOT

NO CLAIM IS MADE TO THE EXCLUSIVE RIGHT TO USE "FORM", APART FROM THE MARK AS SHOWN.

CLASS 38—COMMUNICATION

FOR ELECTRONIC TRANSMISSION OF DATA, DOCUMENTS, BUSINESS FORMS AND INSURANCE FORMS (U.S. CLS. 100, 101 AND 104).

FIRST USE 2-1-2000; IN COMMERCE 2-1-2000.

CLASS 39—TRANSPORTATION AND STORAGE

FOR ELECTRONIC STORAGE AND ARCHIVAL OF DATA, DOCUMENTS, BUSINESS FORMS AND INSURANCE FORMS FOR OTHERS (U.S. CLS. 100 AND 105).

FIRST USE 2-1-2000; IN COMMERCE 2-1-2000.

CLASS 41—EDUCATION AND ENTERTAINMENT

FOR ELECTRONIC PUBLISHING SERVICES, NAMELY, PUBLICATION OF DATA, DOCUMENTS, BUSINESS FORMS AND INSURANCE FORMS FOR OTHERS VIA A GLOBAL COMPUTER NETWORK (U.S. CLS. 100, 101 AND 107).

FIRST USE 2-1-2000; IN COMMERCE 2-1-2000.

CLASS 42—SCIENTIFIC, COMPUTER AND LEGAL SERVICES

FOR COMPUTER SERVICES, NAMELY, A WEBSITE FEATURING BUSINESS FORMS AND INSURANCE FORMS; DOCUMENT CREATION, CONVERSION, MANAGEMENT, RECORDING, INDEXING, ARCHIVING, DATA ENCRYPTION, DISTRIBUTION AND TYPOGRAPHY VIA A GLOBAL COMPUTER NETWORK (U.S. CLS. 100 AND 101).

FIRST USE 2-1-2000; IN COMMERCE 2-1-2000.

2,729,595. HWA YUAN FOODS CO., LTD., WU CHI CHEN, TAICHUNG HSIEN, TAIWAN. SN 75-906,398. PUB. 5-14-2002, FILED 1-31-2000.

SOUR BABY

NO CLAIM IS MADE TO THE EXCLUSIVE RIGHT TO USE "SOUR", APART FROM THE MARK AS SHOWN.

CLASS 29—MEATS AND PROCESSED FOODS

FOR POTATO CHIPS (U.S. CL. 46).

FIRST USE 12-1-2002; IN COMMERCE 12-1-2002.

CLASS 30—STAPLE FOODS

FOR RICE COOKIES, COOKIES, BISCUITS, EGG ROLLS, CREAM BISCUITS, PUDDINGS, PUDDING POWDERS, CANDIES, PEPPERMINT SWEETS, NAMELY PEPPERMINT FLAVORED CHOCOLATES (U.S. CL. 46).

FIRST USE 12-1-2002; IN COMMERCE 12-1-2002.

2,729,601. INVITROGEN CORPORATION, CARLSBAD, CA.
SN 75-912,326. PUB. 6-4-2002, FILED 1-10-2000.



OWNER OF U.S. REG. NO. 1,730,474.

CLASS 1—CHEMICALS

FOR FULL LINE OF KITS FOR THE EXPRESSION, AMPLIFICATION, PURIFICATION AND ANALYSIS OF BIOLOGICAL SAMPLES, SAID KITS CONSISTING PRIMARILY OF ONE OR MORE OF THE FOLLOWING: PROTEINS, NUCLEIC ACIDS, HORMONES, PURIFICATION SUPPORTS, RESINS, CELLS, GELS, PROBES, BUFFERS, STAINS AND ASSOCIATED REAGENTS AND DEVICES FOR CARRYING OUT SAID PURPOSES (U.S. CLS. 1, 5, 6, 10, 26 AND 46).

FIRST USE 0-0-1987; IN COMMERCE 0-0-1987.

CLASS 9—ELECTRICAL AND SCIENTIFIC APPARATUS

FOR FULL LINE OF EQUIPMENT AND APPARATUS FOR PROTEIN AND NUCLEIC ACID ELECTROPHORESIS (U.S. CLS. 21, 23, 26, 36 AND 38).

FIRST USE 10-1-2001; IN COMMERCE 10-1-2001.

CLASS 42—SCIENTIFIC, COMPUTER AND LEGAL SERVICES

FOR LABORATORY RESEARCH SERVICES IN THE FIELD OF MOLECULAR BIOLOGY, NAMELY NUCLEIC ACID SYNTHESIS AND ANALYSIS, GENE IDENTIFICATION, GENE CLONING, GENE EXPRESSION, GENE MAPPING, ELECTROPHORESIS, PROTEIN PURIFICATION AND ANALYSIS, AND PROTEIN INTERACTION DETECTION (U.S. CLS. 100 AND 101).

FIRST USE 0-0-1987; IN COMMERCE 0-0-1987.

2,729,603. RUNTIME REVOLUTION, EDINBURGH, UNITED KINGDOM. SN 75-915,236. PUB. 8-28-2001, FILED 2-1-2000.

REVOLUTION**CLASS 9—ELECTRICAL AND SCIENTIFIC APPARATUS**

FOR COMPUTER SOFTWARE COMPRISING A PROGRAMMING LANGUAGE AND USER INTERFACE FOR CREATING CROSS PLATFORM COMPUTER APPLICATIONS RECORDED ON COMPACT DISCS, MAGNETIC MEDIA, AND AVAILABLE FOR DOWNLOADING VIA THE INTERNET (U.S. CLS. 21, 23, 26, 36 AND 38).

FIRST USE 10-29-1999; IN COMMERCE 6-29-2001.

CLASS 16—PAPER GOODS AND PRINTED MATTER

FOR PRINTED COMPUTER MANUALS AND BROCHURES FEATURING INFORMATION ABOUT SOFTWARE FOR CREATING CROSS PLATFORM COMPUTER APPLICATIONS (U.S. CLS. 2, 5, 22, 23, 29, 37, 38 AND 50).

FIRST USE 10-29-1999; IN COMMERCE 6-29-2001.

2,729,613. AGING EXCELLENCE, INC., PORTLAND, ME. SN 75-921,053. PUB. 12-18-2001, FILED 2-16-2000.

AGING EXCELLENCE**CLASS 39—TRANSPORTATION AND STORAGE**

FOR PROVIDING SUPPORT SERVICES FOR SENIOR CITIZENS TO ASSIST INDIVIDUALS TO REMAIN ACTIVE AND INDEPENDENT, NAMELY, ARRANGING TRAVEL SERVICES (U.S. CLS. 100 AND 105).

FIRST USE 5-25-1999; IN COMMERCE 1-28-2003.

CLASS 42—SCIENTIFIC, COMPUTER AND LEGAL SERVICES

FOR SENIOR DAY CARE AND COMPANIONSHIP, AND PERSONAL SHOPPING SERVICES (U.S. CLS. 100 AND 101).

FIRST USE 5-25-1999; IN COMMERCE 1-28-2003.

2,729,622. GOODMARK USA INC., BOCA RATON, FL, BY CHANGE OF NAME PARTY SUCCESS INC., BOCA RATON, FL. SN 75-932,546. PUB. 3-27-2001, FILED 3-2-2000.

SANTA'S CHRISTMAS SHOP

NO CLAIM IS MADE TO THE EXCLUSIVE RIGHT TO USE "CHRISTMAS SHOP", APART FROM THE MARK AS SHOWN.

CLASS 2—PAINTS

FOR PAINTS, NAMELY, LACQUER SPRAYS FOR DECORATIVE PURPOSES (U.S. CLS. 6, 11 AND 16).

FIRST USE 8-20-2002; IN COMMERCE 8-20-2002.

CLASS 3—COSMETICS AND CLEANING PREPARATIONS

FOR ROOM FRAGRANCES (U.S. CLS. 1, 4, 6, 50, 51 AND 52).

FIRST USE 8-20-2002; IN COMMERCE 8-20-2002.

CLASS 28—TOYS AND SPORTING GOODS

FOR CHRISTMAS DECORATIONS AND TRIMMINGS, EXCEPT CONFECTIONARY OR ILLUMINATION ARTICLES, NAMELY, HOME DECORATIONS, TREE ORNAMENTS, TINSELS, GARLANDS, ICICLES, AND IMITATION SNOW PRODUCTS, NAMELY, SNOW SPRAYS IN A VARIETY OF COLORS AND ICE CRYSTAL SPRAYS (U.S. CLS. 22, 23, 38 AND 50).

FIRST USE 8-20-2002; IN COMMERCE 8-20-2002.

2,729,625. SKIDATA AG, A-5083 GARTENAU, AUSTRIA. SN 75-934,665. PUB. 5-14-2002, FILED 3-3-2000.

SKIDATA

OWNER OF AUSTRIA REG. NO. 124643, DATED 3-31-1989, EXPIRES 3-31-2009.

CLASS 6—METAL GOODS

FOR [BASED ON 44(E)] METAL GUARD RAILS (U.S. CLS. 2, 12, 13, 14, 23, 25 AND 50).

CLASS 9—ELECTRICAL AND SCIENTIFIC APPARATUS

FOR [BASED ON 44(E)] APPARATUS AND INSTRUMENTS FOR ACCESS CONTROL, NAMELY, AUTOMATIC TURNSTILES, AUTOMATIC TRAFFIC BARRIERS FOR CAR PARKS, COMPUTERS, ANTENNAS, MAGNETIC AND CONTACTLESS DATA CARRIERS, NAMELY, BLANK MAGNETIC AND CONTACTLESS CHIP CARDS, MAGNETIC AND CONTACTLESS RECORDERS AND READERS FOR RECORDING ON MAGNET AND CONTACTLESS DATA CARRIERS AND READING THE RECORDED MAGNETIC AND CONTACTLESS DATA CARRIERS; CASH REGISTERS (U.S. CLS. 21, 23, 26, 36 AND 38).

FIRST USE 0-0-1978; IN COMMERCE 0-0-1989.

CLASS 14—JEWELRY

FOR [BASED ON 44(E)] WATCHES (U.S. CLS. 2, 27, 28 AND 50).

CLASS 16—PAPER GOODS AND PRINTED MATTER

FOR [BASED ON 44(E)] BLANK AND PRINTED TICKETS; PAPER IDENTIFICATION CARDS (U.S. CLS. 2, 5, 22, 23, 29, 37, 38 AND 50).

FIRST USE 0-0-1978; IN COMMERCE 0-0-1989.

CLASS 20—FURNITURE AND ARTICLES NOT OTHERWISE CLASSIFIED

FOR PLASTIC SUSPENDABLE DEVICES FOR TICKETS, NAMELY CORD RECEPTIONALS PROVIDED WITH RESTORING SPRINGS FOR KEEPING VERIFICATION CARDS (U.S. CLS. 2, 13, 22, 25, 32 AND 50).

FIRST USE 0-0-1978; IN COMMERCE 0-0-1989.

2,729,627. AQUILA MERCHANT SERVICES, INC., KANSAS CITY, MO. BY CHANGE OF NAME UTILICORP HOLDINGS INC., KANSAS CITY, MO. SN 75-937,888. PUB. 12-25-2001, FILED 3-7-2000.

GUARANTEEDPEAKING**CLASS 36—INSURANCE AND FINANCIAL**

FOR WEATHER RISK MANAGEMENT SERVICES, NAMELY, PROVIDING A MEANS BY WHICH DISTRIBUTION COMPANIES CAN MANAGE WINTERTIME WEATHER AND GAS COMMODITY PRICE RISK THROUGH AN ENERGY DERIVATIVE CALL OPTION WHERE THE VALUE OF THE OPTION IS DEPENDENT UPON THE NEXT DAY'S WEATHER FORECAST (U.S. CLS. 100, 101 AND 102).

FIRST USE 2-1-2000; IN COMMERCE 2-1-2000.

CLASS 39—TRANSPORTATION AND STORAGE

FOR ENERGY SERVICES, NAMELY, PROVIDING A FIXED AMOUNT OF ENERGY AT A PRE-DETERMINED FIXED-UNIT PRICE TO DISTRIBUTION COMPANIES BASED UPON THE NEXT DAY'S WEATHER FORECAST IN CONNECTION WITH AN ENERGY DERIVATIVE PURCHASING OPTION (U.S. CLS. 100 AND 105).

FIRST USE 2-1-2000; IN COMMERCE 2-1-2000.

2,729,629. TMW MARKETING COMPANY, INC., FREMONT, CA. SN 75-938,701. PUB. 6-11-2002, FILED 3-8-2000.

MENSWEARHOUSE.COM

OWNER OF U.S. REG. NOS. 1,521,918, 2,021,562, AND OTHERS.

CLASS 35—ADVERTISING AND BUSINESS

FOR COMPUTER ON-LINE RETAIL SERVICES IN THE FIELD OF MEN'S CLOTHING, SPORTSWEAR, RELATED ACCESSORIES AND GIFT CERTIFICATES FOR PAPER DELIVERY; PROVIDING INFORMATION ABOUT CORPORATE AND BUSINESS PRINCIPLES OF THE APPLICANT'S CORPORATE PARENT, AND NEWSLETTERS OF GENERAL INTEREST; PROVIDING AN ON-LINE SEARCHABLE DATABASE GUIDE FOR LOCATING, ORGANIZING AND PRESENTING MEN'S CLOTHING AND RETAIL STORES (U.S. CLS. 100, 101 AND 102).

FIRST USE 7-0-1996; IN COMMERCE 7-23-2001.

CLASS 38—COMMUNICATION

FOR PROVIDING ON-LINE ELECTRONIC BULLETIN BOARDS FOR TRANSMISSION OF MESSAGES AMONG COMPUTER USERS CONCERNING MEN'S CLOTHING AND ACCESSORIES (U.S. CLS. 100, 101 AND 104).

FIRST USE 7-0-1996; IN COMMERCE 7-23-2001.

CLASS 42—SCIENTIFIC, COMPUTER AND LEGAL SERVICES

FOR PROVIDING AN ON-LINE COMPUTER DATABASE IN THE NATURE OF AN INTERACTIVE DIRECTORY FEATURING INFORMATION ABOUT MEN'S CLOTHING AND ACCESSORIES (U.S. CLS. 100 AND 101).

FIRST USE 7-0-1996; IN COMMERCE 7-23-2001.

2,729,645. MARINER INTERNATIONAL TRAVEL, INC., CLEARWATER, FL. SN 75-982,945. PUB. 12-4-2001, FILED 8-10-2001.

NAUTIC BLUE**CLASS 12—VEHICLES**

FOR POWER BOATS (U.S. CLS. 19, 21, 23, 31, 35 AND 44).

FIRST USE 9-11-2001; IN COMMERCE 9-11-2001.

CLASS 35—ADVERTISING AND BUSINESS

FOR BUSINESS MANAGEMENT OF POWERBOATS FOR OTHERS (U.S. CLS. 100, 101 AND 102).

FIRST USE 9-11-2001; IN COMMERCE 9-11-2001.

CLASS 37—CONSTRUCTION AND REPAIR

FOR MAINTENANCE, REPAIR, SERVICING AND CLEANING OF YACHTS (U.S. CLS. 100, 103 AND 106).

FIRST USE 9-11-2001; IN COMMERCE 9-11-2001.

CLASS 39—TRANSPORTATION AND STORAGE

FOR POWER BOAT CHARTERS (U.S. CLS. 100 AND 105).

FIRST USE 9-11-2001; IN COMMERCE 9-11-2001.

2,729,652. ARMSTRONG, LANCE, AUSTIN, TX. SN 75-983,199. PUB. 12-25-2001, FILED 10-6-1999.

LANCE ARMSTRONG

"LANCE ARMSTRONG" IDENTIFIES A LIVING INDIVIDUAL WHOSE CONSENT IS OF RECORD.

CLASS 14—JEWELRY

FOR JEWELRY, NAMELY, WATCHES (U.S. CLS. 2, 27, 28 AND 50).

FIRST USE 7-0-2000; IN COMMERCE 7-0-2000.

CLASS 25—CLOTHING

FOR FOOTWEAR, HEAD BANDS, SCARVES, CLOTHING CAPS, CLOTHING BELTS, PANTS, SHORTS, T-SHIRTS, WARM UP SHIRTS, SHIRTS, SWEATERS, SOCKS, WRIST BANDS, GOLF SHIRTS, SWEATSHIRTS, SWEAT PANTS, GLOVES, JUMP SUITS, TIGHTS, LEOTARDS, CLOTHING TOPS, UNITARDS, VEST AND BICYCLE SHOES AND BICYCLE SOCKS (U.S. CLS. 22 AND 39).

FIRST USE 9-0-2002; IN COMMERCE 9-0-2002.

CLASS 30—STAPLE FOODS

FOR STAPLE FOODS, NAMELY, BREAKFAST CEREALS, CEREAL BASED SNACK FOOD, READY TO EAT CEREAL DERIVED FOOD BARS, PROCESSED CEREALS AND CEREAL BASED SNACK FOOD (U.S. CL. 46).

FIRST USE 8-0-1999; IN COMMERCE 8-0-1999.

2,729,653. GYROTONIC SALES CORPORATION, NEW YORK, NY. SN 75-983,210. PUB. 1-30-2001, FILED 2-15-2000.



GYROTONIC

CLASS 28—TOYS AND SPORTING GOODS

FOR EXERCISE EQUIPMENT, NAMELY, MANUALLY OPERATED EXERCISE EQUIPMENT WITH CIRCULARITY OF FUNCTION IN MULTIPLE PLANES, EXERCISE MACHINES, EXERCISE TABLES AND BENCHES, EXERCISE WEIGHTS, PULLEYS AND BARS (U.S. CLS. 22, 23, 38 AND 50).

FIRST USE 7-0-1989; IN COMMERCE 7-0-1989.

CLASS 41—EDUCATION AND ENTERTAINMENT

FOR EXERCISE SERVICES, NAMELY, PHYSICAL FITNESS INSTRUCTION AND PHYSICAL EDUCATION SERVICES (U.S. CLS. 100, 101 AND 107).

FIRST USE 8-0-1992; IN COMMERCE 8-0-1992.

2,729,657. PLANET PROPAGANDA, INC., MADISON, WI, BY CHANGE OF NAME PLANET DESIGN COMPANY, MADISON, WI. SN 76-001,009. PUB. 7-9-2002, FILED 3-15-2000.

PLANET PROPAGANDA

NO CLAIM IS MADE TO THE EXCLUSIVE RIGHT TO USE "PROPAGANDA", APART FROM THE MARK AS SHOWN.

CLASS 35—ADVERTISING AND BUSINESS

FOR ADVERTISING AGENCY SERVICES, NAMELY PROMOTING THE SERVICES OF OTHERS THROUGH TELEVISION, RADIO, NEWSPAPER, MAGAZINE, DIRECT-MAIL, BROCHURES, OUTDOOR BILLBOARDS AND INTERNET WEBSITES; BUSINESS MARKETING CONSULTING SERVICES; PUBLIC RELATIONS CONSULTATION; CREATING TRADEMARKS AND SERVICE MARKS FOR OTHERS, NAMELY BUSINESS AND PRODUCT NAMING (U.S. CLS. 100, 101 AND 102).

FIRST USE 10-1-2002; IN COMMERCE 10-1-2002.

CLASS 41—EDUCATION AND ENTERTAINMENT

FOR SCRIPT WRITING SERVICES; TELEVISION PRODUCTION AND AUDIO PRODUCTION SERVICES, NAMELY FILM AND VIDEO TITLE DESIGN, SOUND AND AUDIO DESIGN (U.S. CLS. 100, 101 AND 107).

FIRST USE 10-1-2002; IN COMMERCE 10-1-2002.

CLASS 42—SCIENTIFIC, COMPUTER AND LEGAL SERVICES

FOR GRAPHIC ART DESIGN, NAMELY COMMERCIAL ART DESIGN, GRAPHIC ART DESIGN FOR USE IN BROADCAST TELEVISION STUDIOS AND MOTION PICTURE FILMS; PACKAGING DESIGN FOR OTHERS; CUSTOM WRITING SERVICES; WEBSITE DESIGN AND DEVELOPMENT, NAMELY DESIGNING AND IMPLEMENTING WEBSITES FOR OTHERS; COMPUTER SITE DESIGN, NAMELY DESIGNING ENTERTAINING WEBSITES FOR OTHERS; COMPUTER SOFTWARE DESIGN FOR OTHERS, NAMELY DESIGNING USER INTERFACES FOR COMPUTER SOFTWARE (U.S. CLS. 100 AND 101).

FIRST USE 10-1-2002; IN COMMERCE 10-1-2002.

2,729,660. H. BRINKHAUS GMBH & CO. KG, D-48231 WARENDORF, FED REP GERMANY. SN 76-002,468. PUB. 7-2-2002, FILED 3-17-2000.

LORD INLETT

CLASS 20—FURNITURE AND ARTICLES NOT OTHERWISE CLASSIFIED

FOR BEDDING, NAMELY, MATTRESSES, NECK ROLLS, NECK PILLOWS; PILLOWS; AND SLEEPING BAGS FILLED WITH FEATHERS, DOWN, NATURAL FIBERS, SYNTHETIC FIBERS, AND/OR FOAMED MATERIAL IN FLAKE-LIKE SHAPES OR ROD-LIKE SHAPES, AS WELL AS COMBINATIONS OF THE ABOVE-MENTIONED STUFFING MATERIALS (U.S. CLS. 2, 13, 22, 25, 32 AND 50).

FIRST USE 0-0-2000; IN COMMERCE 0-0-2001.

CLASS 22—CORDAGE AND FIBERS

FOR UPHOLSTERY AND STUFFING MATERIALS, NAMELY, DOWN FEATHERS, FLEECE WOOL AND RAW SILK (U.S. CLS. 1, 2, 7, 19, 22, 42 AND 50).

FIRST USE 0-0-2000; IN COMMERCE 0-0-2001.

CLASS 24—FABRICS

FOR MATTRESS COVERS; MATTRESS PADS; WOOL BED BLANKETS; WOVEN WOOL FABRICS; WOVEN CASHMERE FABRICS; WOVEN CAMEL WOOL FABRICS; WOVEN SILK FABRICS; FLEECES MADE OF WOOL, SILK, CASHMERE AND/OR POLYESTER; BED LINENS, NAMELY, FINISHED COMFORTERS, SHEETS, PILLOWS COVERS, COMFORTER COVERS, AND THROWS; AND BEDDING, NAMELY, COMFORTERS AND PADS (U.S. CLS. 42 AND 50).

FIRST USE 0-0-2000; IN COMMERCE 0-0-2001.

2,729,663. ORCHID BIOSCIENCES, INC., PRINCETON, NJ.
SN 76-004,477. PUB. 4-30-2002, FILED 3-20-2000.

ORCHID

CLASS 1—CHEMICALS

FOR CHEMICALS FOR USE IN GENETIC RESEARCH; ASSAYS AND REAGENTS FOR USE IN GENETIC RESEARCH; AND REAGENT KITS COMPRISING REAGENTS FOR GENETIC RESEARCH AND INSTRUCTIONS FOR USE THEREWITH (U.S. CLS. 1, 5, 6, 10, 26 AND 46).

FIRST USE 12-15-1999; IN COMMERCE 12-15-1999.

CLASS 9—ELECTRICAL AND SCIENTIFIC APPARATUS

FOR COMPUTER HARDWARE FOR GENETIC RESEARCH; COMPUTER SOFTWARE FOR GENETIC DIVERSITY ANALYSIS IN THE FIELD OF GENETIC RESEARCH AND TESTING, LABORATORY INSTRUMENTS AND APPARATUS NAMELY, REACTION PLATES AND DETECTION PLATES AND THE LIKE (U.S. CLS. 21, 23, 26, 36 AND 38).

FIRST USE 12-15-1999; IN COMMERCE 12-15-1999.

CLASS 42—SCIENTIFIC, COMPUTER AND LEGAL SERVICES

FOR RESEARCH, TESTING AND SCREENING SERVICES IN THE FIELDS OF BIOLOGY, GENETICS AND THERAPEUTICS (U.S. CLS. 100 AND 101).

FIRST USE 12-15-1999; IN COMMERCE 12-15-1999.

2,729,680. DOMINION RESOURCES, INC., RICHMOND, VA.
SN 76-021,892. PUB. 6-11-2002, FILED 4-7-2000.

DOMINION HOPE

OWNER OF U.S. REG. NOS. 1,551,318, 2,156,058, AND OTHERS.

CLASS 35—ADVERTISING AND BUSINESS

FOR MANAGEMENT ASSISTANCE SERVICES IN THE AREA OF ENERGY NEEDS OF INDUSTRY; BUSINESS CONSULTATION IN THE FIELD OF EFFICIENT ENERGY USE (U.S. CLS. 100, 101 AND 102).

FIRST USE 7-0-2000; IN COMMERCE 7-0-2000.

CLASS 36—INSURANCE AND FINANCIAL

FOR BROKERAGE OF NATURAL GAS (U.S. CLS. 100, 101 AND 102).

FIRST USE 7-0-2000; IN COMMERCE 7-0-2000.

CLASS 37—CONSTRUCTION AND REPAIR

FOR INSTALLATION, CONSTRUCTION, MAINTENANCE AND REPAIR OF TRANSMISSION FACILITIES, ENERGY EQUIPMENT, AND ENERGY SYSTEMS (U.S. CLS. 100, 103 AND 106).

FIRST USE 7-0-2000; IN COMMERCE 7-0-2000.

CLASS 39—TRANSPORTATION AND STORAGE

FOR PUBLIC UTILITY SERVICES, NAMELY, THE TRANSMISSION AND DISTRIBUTION OF NATURAL GAS (U.S. CLS. 100 AND 105).

FIRST USE 7-0-2000; IN COMMERCE 7-0-2000.

2,729,683. SAE SILVER ARROW ESTABLISHMENT, 9490 VADUZ, LIECHTENSTEIN. SN 76-025,324. PUB. 1-22-2002, FILED 4-13-2000.

SPIKED SILVER

CLASS 25—CLOTHING

FOR T-SHIRTS AND JACKETS (U.S. CLS. 22 AND 39).
FIRST USE 11-0-2000; IN COMMERCE 11-0-2000.

CLASS 32—LIGHT BEVERAGES

FOR NON-ALCOHOLIC BEVERAGES, CRANBERRY JUICE, SOFT DRINKS, NAMELY, CARBONATED CRANBERRY FLAVOURED SOFT DRINKS, NON-ALCOHOLIC BEVERAGES WITH CAFFEINE, TAURINE, GUARANA AND YERBA MATE (U.S. CLS. 45, 46 AND 48).

FIRST USE 11-0-2000; IN COMMERCE 11-0-2000.

2,729,687. AMERSHAM BIOSCIENCES AB, UPPSALA, SWEDEN, BY CHANGE OF NAME AMERSHAM PHARMACIA BIOTECH AB, SE-751 84 UPPSALA, SWEDEN.
SN 76-027,935. PUB. 8-7-2001, FILED 4-18-2000.

TRICORN

CLASS 1—CHEMICALS

FOR CHEMICAL REAGENTS FOR RESEARCH AND SCIENTIFIC USE; CHEMICAL REAGENTS THAT FACILITATE THE SEPARATION OF MIXTURES OF ORGANIC AND BIOLOGICAL MATERIALS; AND CHROMATOGRAPHY CHEMICALS (U.S. CLS. 1, 5, 6, 10, 26 AND 46).

FIRST USE 11-20-2002; IN COMMERCE 11-20-2002.

CLASS 9—ELECTRICAL AND SCIENTIFIC APPARATUS

FOR SCIENTIFIC APPARATUS AND INSTRUMENTS, NAMELY, LABORATORY AND RESEARCH EQUIPMENT CONSISTING OF A PACK COLUMN OF CHEMICAL SOLIDS THAT FUNCTION TO FACILITATE THE SEPARATION OF MIXTURES OR ORGANIC OR BIOLOGICAL MATERIALS BASED UPON THEIR DIFFERING MOLECULAR WEIGHTS OR STRUCTURES (U.S. CLS. 21, 23, 26, 36 AND 38).

FIRST USE 11-20-2002; IN COMMERCE 11-20-2002.

2,729,688. AMERISURE MUTAL INSURANCE COMPANY, FARMINGTON HILLS, MI, BY CHANGE OF NAME MICHIGAN MUTUAL INSURANCE COMPANY, DBA AMERISURE COMPANIES, FARMINGTON HILLS, MI. SN 76-028,427. PUB. 4-16-2002, FILED 4-18-2000.



CLASS 35—ADVERTISING AND BUSINESS

FOR ADMINISTERING INCENTIVE REWARD PROGRAMS FOR INSURANCE UNDERWRITING AGENCIES AND AGENTS/BROKERS TO PROMOTE PERFORMANCE IN THE AREAS OF SALES, PROFITABILITY, PRODUCTION AND RETENTION OF ACCOUNTS IN THE INSURANCE INDUSTRY (U.S. CLS. 100, 101 AND 102).

FIRST USE 3-0-2000; IN COMMERCE 3-0-2000.

CLASS 36—INSURANCE AND FINANCIAL

FOR INSURANCE UNDERWRITING SERVICES IN THE FIELD OF PROPERTY AND CASUALTY RENDERED THROUGH AGENT/BROKERS (U.S. CLS. 100, 101 AND 102).

FIRST USE 3-0-2000; IN COMMERCE 3-0-2000.

2,729,689. SIX FLAGS THEME PARKS, INC., ARLINGTON, TX. SN 76-030,062. PUB. 12-25-2001, FILED 4-19-2000.

CANDY STORM

NO CLAIM IS MADE TO THE EXCLUSIVE RIGHT TO USE "CANDY", APART FROM THE MARK AS SHOWN.

CLASS 30—STAPLE FOODS

FOR CANDY AND CONFECTIONERY PRODUCTS, NAMELY, COOKIES, CAKES, PIES (U.S. CL. 46).

FIRST USE 6-21-2000; IN COMMERCE 6-21-2000.

CLASS 35—ADVERTISING AND BUSINESS

FOR RETAIL CANDY AND CONFECTIONERY STORE SERVICES (U.S. CLS. 100, 101 AND 102).

FIRST USE 6-21-2000; IN COMMERCE 6-21-2000.

2,729,709. AURIA CORPORATION, EDEN PRAIRIE, MN. SN 76-051,961. PUB. 4-9-2002, FILED 5-19-2000.

AURIA

CLASS 35—ADVERTISING AND BUSINESS

FOR BUSINESS MANAGEMENT CONSULTATION IN THE FIELD OF WORKPLACE TRAINING AND EDUCATION ASSESSMENT (U.S. CLS. 100, 101 AND 102).

FIRST USE 4-0-2000; IN COMMERCE 4-0-2000.

CLASS 41—EDUCATION AND ENTERTAINMENT

FOR EDUCATIONAL SERVICES, NAMELY, PROVIDING WORKPLACE TRAINING COURSES VIA AN ELECTRONIC COMPUTER COMMUNICATIONS NETWORK TO IMPROVE COMPETENCY, COMPLIANCE AND PERFORMANCE (U.S. CLS. 100, 101 AND 107).

FIRST USE 4-0-2000; IN COMMERCE 4-0-2000.

2,729,710. CERRO TORRE CO., LTD, SEOUL, REPUBLIC OF KOREA. AND SIM, BON SOO, SEOUL, REPUBLIC OF KOREA. SN 76-054,564. PUB. 11-13-2001, FILED 5-22-2000.



OWNER OF U.S. REG. NO. 2,029,160. THE ENGLISH TRANSLATION OF "CERRO TORRE" IS "CASTLE MOUNTAIN".

CLASS 18—LEATHER GOODS

FOR LUMBAR BARS; TRAVEL BAGS; BACKPACKS; AND CARRYING BAG FOR BACK PACKS (U.S. CLS. 1, 2, 3, 22 AND 41).

FIRST USE 1-13-1998; IN COMMERCE 2-2-2002.

CLASS 25—CLOTHING

FOR FOOTWEAR, SWEATERS, DRESS SHIRTS, HATS, CAPS, AND CLOTHING, NAMELY, SPORTS SHIRTS, ALOHA SHIRTS, SPORT SHIRTS, UNIFORMS FOR SPORTS, VESTS, CARDIGANS, PULLOVERS, T-SHIRTS, POLO SHIRTS, TRACK SUITS, SWEAT SHIRTS, SWEAT PANTS, GLOVES FOR CLOTHING, EAR MUFFS FOR CLOTHING, SCARVES, STOCKINGS FOR SPORTS, SOCKS, AND GLOVES (U.S. CLS. 22 AND 39).

FIRST USE 1-13-1998; IN COMMERCE 5-30-2002.

CLASS 28—TOYS AND SPORTING GOODS

FOR SNOWBOARD BAGS; SPORTING GOODS, NAMELY, CLIMBERS' HARNESSES; MOUNTAINEERING EQUIPMENT, NAMELY, CARABINERS AND CRAMPONS; CLIMBING ROPES FOR ICE, MOUNTAIN AND/OR ROCK CLIMBING (U.S. CLS. 22, 23, 38 AND 50).

FIRST USE 1-13-1998; IN COMMERCE 1-29-2002.

2,729,713. GLOBAL EXECUTIVE TRAVEL SELECTIONS, INC., NEW YORK, NY. SN 76-057,679. PUB. 4-9-2002, FILED 5-26-2000.

GLOBAL EXECUTIVE

CLASS 39—TRANSPORTATION AND STORAGE

FOR TRAVEL SERVICES, NAMELY, MAKING TRANSPORTATION ARRANGEMENTS BY OFFERING BUSINESS CLASS AIR TICKETS AT DISCOUNTED PRICES AND VOUCHERS FOR CAR RENTALS, LIMOUSINE TRANSFERS AND AIRLINE TICKETS (U.S. CLS. 100 AND 105).

FIRST USE 12-31-2000; IN COMMERCE 12-31-2000.

CLASS 42—SCIENTIFIC, COMPUTER AND LEGAL SERVICES

FOR TRAVEL SERVICES, NAMELY, MAKING ARRANGEMENTS FOR LODGING BY PROVIDING VOUCHERS FOR LODGING AT HOTELS (U.S. CLS. 100 AND 101).

FIRST USE 12-31-2000; IN COMMERCE 12-31-2000.

2,729,738. ROTH, DAVID C., DALLAS, TX. AND ROTH, BARBARA J., DALLAS, TX. SN 76-076,875. PUB. 12-11-2001, FILED 6-22-2000.

PATH PRAY AND THINGS HAPPEN**CLASS 16—PAPER GOODS AND PRINTED MATTER**

FOR BOOK COVERS, BOOK MARKS, CALENDARS, PENS, PENCILS, PEN AND PENCIL CASES AND PAPER BAGS (U.S. CLS. 2, 5, 22, 23, 29, 37, 38 AND 50).

FIRST USE 3-3-2003; IN COMMERCE 3-4-2003.

CLASS 25—CLOTHING

FOR CLOTHING, NAMELY, T-SHIRTS, SHORTS, SWIM WEAR, JACKETS, PANTS, CAPS, BELTS AND SWEATSHIRTS (U.S. CLS. 22 AND 39).

FIRST USE 3-3-2003; IN COMMERCE 3-4-2003.

2,729,739. TEALUXE, INC., FRANKLIN, MA. SN 76-077,667. PUB. 4-30-2002, FILED 6-26-2000.

TEA FOR ALL**CLASS 21—HOUSEWARES AND GLASS**

FOR HOUSEWARES, NAMELY, TEA POTS NOT OF PRECIOUS METAL, BEVERAGE GLASSWARE, TEA CANISTERS, INSULATED BEVERAGE CUPS, TEA CUPS, AND MUGS; NON-ELECTRIC APPLIANCES, NAMELY, KETTLES MADE OF METAL, STAINLESS STEEL AND/OR CERAMIC (U.S. CLS. 2, 13, 23, 29, 30, 33, 40 AND 50).

FIRST USE 9-11-1998; IN COMMERCE 9-11-1998.

CLASS 30—STAPLE FOODS

FOR TEA AND TEA-BASED BEVERAGES FOR CONSUMPTION ON OR OFF THE PREMISES (U.S. CL. 46).

FIRST USE 9-11-1998; IN COMMERCE 9-11-1998.

2,729,746. NANOPHASE TECHNOLOGIES CORPORATION, BURR RIDGE, IL. SN 76-083,091. PUB. 1-1-2002, FILED 7-5-2000.

NANOCLAD

OWNER OF U.S. REG. NOS. 1,978,349, 1,979,671, AND OTHERS.

CLASS 1—CHEMICALS

FOR CERAMIC PARTICLES CAPABLE OF BEING FORMED INTO PRODUCTS (U.S. CLS. 1, 5, 6, 10, 26 AND 46).

FIRST USE 9-28-2000; IN COMMERCE 9-28-2000.

CLASS 6—METAL GOODS

FOR METALS AND METAL OXIDE PARTICLES CAPABLE OF BEING FORMED INTO FINISHED PRODUCTS (U.S. CLS. 2, 12, 13, 14, 23, 25 AND 50).

FIRST USE 9-28-2000; IN COMMERCE 9-28-2000.

2,729,751. VENTANA MEDICAL SYSTEMS, INC., TUCSON, AZ. SN 76-085,150. PUB. 7-2-2002, FILED 7-7-2000.

PATHWAY**CLASS 1—CHEMICALS**

FOR DIAGNOSTIC TEST KITS COMPRISED OF REAGENTS AND IMMUNODIAGNOSTICS FOR SCIENTIFIC AND/OR RESEARCH USE (U.S. CLS. 1, 5, 6, 10, 26 AND 46).

FIRST USE 12-7-2000; IN COMMERCE 12-7-2000.

CLASS 5—PHARMACEUTICALS

FOR DIAGNOSTIC TEST KITS COMPRISED OF REAGENTS AND IMMUNODIAGNOSTICS FOR MEDICAL AND/OR CLINICAL LABORATORY USE (U.S. CLS. 6, 18, 44, 46, 51 AND 52).

FIRST USE 12-7-2000; IN COMMERCE 12-7-2000.

2,729,752. IQNAVIGATOR, INC., DENVER, CO. SN 76-085,367. PUB. 4-23-2002, FILED 7-7-2000.

CHARTING NEW COURSES FOR WORKFORCE MANAGEMENT**CLASS 9—ELECTRICAL AND SCIENTIFIC APPARATUS**

FOR COMPUTER SOFTWARE FOR USE BY EMPLOYERS TO AID IN THE MANAGEMENT AND THE ADMINISTRATION OF THE PROCUREMENT PROCESS FOR TEMPORARY AND PERMANENT LABOR IN THE INFORMATION TECHNOLOGY INDUSTRY AND OTHER INTELLECTUAL CAPITAL INDUSTRIES (U.S. CLS. 21, 23, 26, 36 AND 38).

FIRST USE 5-0-2000; IN COMMERCE 5-0-2000.

CLASS 42—SCIENTIFIC, COMPUTER AND LEGAL SERVICES

FOR PROVIDING TEMPORARY USE OF ON-LINE NON-DOWNLOADABLE SOFTWARE FOR USE BY EMPLOYERS TO AID IN THE MANAGEMENT AND THE ADMINISTRATION OF THE PROCUREMENT PROCESS FOR TEMPORARY AND PERMANENT LABOR IN THE INFORMATION TECHNOLOGY INDUSTRY AND OTHER INTELLECTUAL CAPITAL INDUSTRIES (U.S. CLS. 100 AND 101).

FIRST USE 5-0-2000; IN COMMERCE 5-0-2000.

2,729,756. AFFINITY INTERNET, INC., EL SEGUNDO, CA. SN 76-087,819. PUB. 5-14-2002, FILED 7-11-2000.

affinity

CLASS 35—ADVERTISING AND BUSINESS

FOR BUSINESS CONSULTING SERVICES; PROCUREMENT SERVICES, NAMELY PURCHASING COMPUTER SOFTWARE, LONG DISTANCE TELEPHONE SERVICES, BILL PAYING SERVICES, INVENTORY MANAGEMENT SERVICES, AND INTERNET CONNECTIVITY SERVICES FOR OTHERS; RETAIL STORE SERVICES IN THE FIELD OF OFFICE SUPPLIES, COMPUTER SOFTWARE, AND BUSINESS PRODUCTS; OPERATING OF BUSINESSES FOR OTHERS, NAMELY OPERATING OF ON-LINE RETAIL STORES IN A WIDE VARIETY OF FIELDS (U.S. CLS. 100, 101 AND 102).

FIRST USE 1-1-1997; IN COMMERCE 1-1-1997.

CLASS 38—COMMUNICATION

FOR ELECTRONIC MAIL SERVICES (U.S. CLS. 100, 101 AND 104).

FIRST USE 1-1-1997; IN COMMERCE 1-1-1997.

CLASS 42—SCIENTIFIC, COMPUTER AND LEGAL SERVICES

FOR COMPUTER SERVICES, NAMELY, APPLICATION SERVICE PROVIDER SERVICES IN THE NATURE OF HOSTING THE SOFTWARE APPLICATIONS OF OTHERS OVER THE INTERNET; WEB HOSTING SERVICES; DOMAIN NAME REGISTRATION SERVICES (U.S. CLS. 100 AND 101).

FIRST USE 1-1-1997; IN COMMERCE 1-1-1997.

2,729,760. AVALON PHOTONICS, LTD., SWITZERLAND. SN 76-093,185. PUB. 5-7-2002, FILED 7-21-2000.

AVALON PHOTONICS

NO CLAIM IS MADE TO THE EXCLUSIVE RIGHT TO USE "PHOTONICS", APART FROM THE MARK AS SHOWN.

CLASS 9—ELECTRICAL AND SCIENTIFIC APPARATUS

FOR DATA COMMUNICATIONS PRODUCTS, NAMELY, VERTICAL CAVITY SURFACE EMITTING LASER DIODE (VCSEL); LIGHT EMITTING DIODE (LED); SINGLE MODE AND MULTI-MODE INTEGRATED CIRCUIT CHIPS FOR DATA COMMUNICATIONS, TELECOMMUNICATION, AND ATOMIC CLOCK APPLICATIONS; HIGH SPEED VCSEL CHIPS AND PRINTED CIRCUIT ARRAYS FOR FLIP CHIP INTEGRATION WITH DRIVER INTEGRATED CIRCUITS; INTEGRATED VCSEL CHIPS AND LED DRIVER ARRAYS; PIN LIGHT EMITTING DIODES; TRANSCIEVERS; AND FIBER OPTIC AMPLIFIERS (U.S. CLS. 21, 23, 26, 36 AND 38).

FIRST USE 8-18-2000; IN COMMERCE 8-18-2000.

CLASS 14—JEWELRY

FOR ATOMIC CLOCKS AND PARTS THEREOF (U.S. CLS. 2, 27, 28 AND 50).

FIRST USE 10-2-2001; IN COMMERCE 10-2-2001.

CLASS 42—SCIENTIFIC, COMPUTER AND LEGAL SERVICES

FOR DESIGN FOR OTHERS OF CUSTOM VCSEL LIGHT EMITTING DIODE ARRAYS AND PRINTED WAFERS (U.S. CLS. 100 AND 101).

FIRST USE 10-18-2000; IN COMMERCE 10-18-2000.

2,729,764. RAWLINGS SPORTING GOODS COMPANY, INC., ST. LOUIS, MO. SN 76-094,653. PUB. 8-6-2002, FILED 7-24-2000.

**PRO
DRI**

CLASS 24—FABRICS

FOR FABRIC, NAMELY, MOISTURE WICKING POLYESTER MICROFIBER FABRIC FOR USE IN UNDERSHIRTS, T-SHIRTS, UNDERWEAR, JERSEYS AND PANTS FOR BASEBALL AND SOFTBALL, JERSEYS AND PANTS FOR FOOTBALL, JERSEYS AND SHORTS FOR BASKETBALL, WARM-UP TOPS, WARM-UP PANTS, WARM-UP JACKETS, PULLOVERS, MOCK TURTLENECKS, AND VESTS, EXCLUDING CLOTHING FOR GOLF AND SOCKS OF ANY TYPE (U.S. CLS. 42 AND 50).

FIRST USE 5-0-2000; IN COMMERCE 5-0-2000.

CLASS 25—CLOTHING

FOR CLOTHING, NAMELY, UNDERSHIRTS, T-SHIRTS, UNDERWEAR, JERSEYS AND PANTS FOR BASEBALL AND SOFTBALL, JERSEYS AND PANTS FOR FOOTBALL, JERSEYS AND SHORTS FOR BASKETBALL, WARM-UP TOPS, WARM-UP PANTS, WARM-UP JACKETS, PULLOVERS, MOCK TURTLENECKS, AND VESTS, EXCLUDING CLOTHING FOR GOLF AND SOCKS OF ANY TYPE (U.S. CLS. 22 AND 39).

FIRST USE 5-0-2000; IN COMMERCE 5-0-2000.

2,729,765. TVTAXI.COM, INC., FT. LAUDERDALE, FL. SN 76-094,960. PUB. 7-2-2002, FILED 7-24-2000.

MATRIXPLAYER

CLASS 9—ELECTRICAL AND SCIENTIFIC APPARATUS

FOR COMPUTER SOFTWARE THAT ALLOWS CONTENT PROVIDERS TO CREATE, AND USERS TO VIEW, MULTIMEDIA PRESENTATIONS TRANSMITTED OVER A GLOBAL COMPUTER NETWORK, NAMELY, SOFTWARE FOR FACILITATING THE CREATING, MANAGEMENT, AND/OR TRANSFER OF STREAMED AND VIDEO DATA COMPRISING GRAPHIC DISPLAYS, SOUNDS, MUSIC, AND IMAGES, AND ASSOCIATED INSTRUCTIONAL MANUALS SOLD THEREWITH (U.S. CLS. 21, 23, 26, 36 AND 38).

FIRST USE 2-28-2000; IN COMMERCE 2-28-2000.

CLASS 42—SCIENTIFIC, COMPUTER AND LEGAL SERVICES

FOR COMPUTER SERVICES, NAMELY PROVIDING WEB APPLICATIONS AND WEB PAGE COMPONENTS WHICH ALLOW CONTENT PROVIDERS TO CREATE, AND USERS TO VIEW, MULTIMEDIA PRESENTATIONS TRANSMITTED OVER A GLOBAL COMPUTER NETWORK OR OTHER NETWORK, AND PROVIDING SERVERS FOR TRANSMISSION OF THE MULTIMEDIA PRESENTATIONS (U.S. CLS. 100 AND 101).

FIRST USE 2-28-2000; IN COMMERCE 2-28-2000.

2,729,770. SOCIAL ENTERPRISE, INC., SAN RAFAEL, CA.
SN 76-097,125. PUB. 6-18-2002, FILED 7-25-2000.

KINDMARK**CLASS 9—ELECTRICAL AND SCIENTIFIC APPARATUS**

FOR COMPUTER SOFTWARE FOR SIMPLIFYING THE MANAGEMENT OF WORKPLACE CHARITABLE DONATION PROGRAMS WITH A WEB BASED APPLICATION, FOR MANAGING AND TRACKING DATA, PRESENTING INFORMATION ON CHARITABLE GIVING OPTIONS, AND GENERATING REPORTS (U.S. CLS. 21, 23, 26, 36 AND 38).

FIRST USE 11-0-2000; IN COMMERCE 11-0-2000.

CLASS 36—INSURANCE AND FINANCIAL

FOR CONSULTING SERVICES IN THE FIELD OF WORKPLACE CHARITABLE DONATION PROGRAMS AND COMMUNITY FUNDRAISING, AND PROVIDING INFORMATION RELATED THERETO (U.S. CLS. 100, 101 AND 102).

FIRST USE 11-0-2000; IN COMMERCE 11-0-2000.

2,729,786. EAST COAST CONSULTING GROUP LLC,
PHILADELPHIA, PA. SN 76-108,848. PUB. 7-2-2002,
FILED 8-14-2000.

EAST COAST CONSULTING GROUP

NO CLAIM IS MADE TO THE EXCLUSIVE RIGHT TO USE "CONSULTING GROUP", APART FROM THE MARK AS SHOWN.

CLASS 35—ADVERTISING AND BUSINESS

FOR BUSINESS CONSULTING SERVICES; BUSINESS MARKETING AND MARKET RESEARCH AND ANALYSIS SERVICES; BUSINESS PLANNING SERVICES (U.S. CLS. 100, 101 AND 102).

FIRST USE 3-30-2000; IN COMMERCE 3-30-2000.

CLASS 41—EDUCATION AND ENTERTAINMENT

FOR EDUCATIONAL SERVICES, NAMELY, CONDUCTING SEMINARS AND WORKSHOPS IN THE FIELDS OF BUSINESS ANALYSIS AND MARKET ANALYSIS (U.S. CLS. 100, 101 AND 107).

FIRST USE 3-30-2000; IN COMMERCE 3-30-2000.

2,729,793. NSF INTERNATIONAL, INC., ANN ARBOR, MI.
SN 76-114,787. PUB. 5-7-2002, FILED 8-23-2000.

WHITE BOOK

NO CLAIM IS MADE TO THE EXCLUSIVE RIGHT TO USE "BOOK" WITH RESPECT TO THE RECITED GOODS FALLING WITHIN CLASS 16, APART FROM THE MARK AS SHOWN.

CLASS 16—PAPER GOODS AND PRINTED MATTER

FOR DIRECTORY OF PROPRIETARY SUBSTANCES USED IN FOOD PREPARATION AND NON-FOOD COMPOUNDS USED IN SLAUGHTERING AND PROCESSING PLANTS ALONG WITH MANUFACTURERS' NAMES AND ADDRESSES (U.S. CLS. 2, 5, 22, 23, 29, 37, 38 AND 50).

FIRST USE 1-0-2000; IN COMMERCE 1-0-2000.

CLASS 35—ADVERTISING AND BUSINESS

FOR COMPUTER SERVICES, NAMELY, PROVIDING AN ON-LINE DIRECTORY OF PROPRIETARY SUBSTANCES USED IN FOOD PREPARATION AND NON-FOOD COMPOUNDS USED IN SLAUGHTERING AND PROCESSING PLANTS ALONG WITH MANUFACTURERS' NAMES AND ADDRESSES (U.S. CLS. 100, 101 AND 102).

FIRST USE 1-0-2000; IN COMMERCE 1-0-2000.

2,729,795. SKATEBOARD WORLD INDUSTRIES, INC., EL SEGUNDO, CA. SN 76-115,442. PUB. 7-16-2002, FILED 8-22-2000.

ENJOICO**CLASS 25—CLOTHING**

FOR CLOTHING, NAMELY, T-SHIRTS, SWEAT-SHIRTS, JACKETS, PANTS, SHORTS, AND HATS (U.S. CLS. 22 AND 39).

FIRST USE 9-0-2000; IN COMMERCE 9-0-2000.

CLASS 28—TOYS AND SPORTING GOODS

FOR SKATEBOARDS, SKATEBOARD WHEELS SOLD BOTH SEPARATELY AND AS A UNIT, HARDWARE AND PARTS THEREFOR, NAMELY, BEARINGS, MOUNTING HARDWARE, DECKS, GRIP TAPE, AND RISER PADS (U.S. CLS. 22, 23, 38 AND 50).

FIRST USE 9-0-2000; IN COMMERCE 9-0-2000.

2,729,799. ALBERTSON'S, INC., BOISE, ID. SN 76-117,830. PUB. 6-4-2002, FILED 8-23-2000.

IDENTITY

CLASS 3—COSMETICS AND CLEANING PREPARATIONS

FOR BATH, BEAUTY AND PERSONAL CARE PRODUCTS, NAMELY, NON-MEDICATED SKIN CARE PREPARATIONS, NAMELY, LOTIONS FOR MOISTURIZING THE BODY; BODY SHIMMER, BATH PRODUCTS, NAMELY, BATH GEL, BODY MIST, BODY LOTIONS; HAIR CARE PREPARATIONS, NAMELY SHAMPOOS, CONDITIONERS, SPRAYS AND GELS (U.S. CLS. 1, 4, 50, 51 AND 52).

FIRST USE 12-0-2000; IN COMMERCE 12-0-2000.

CLASS 4—LUBRICANTS AND FUELS

FOR SCENTED CANDLES (U.S. CLS. 1, 6 AND 15).
FIRST USE 12-0-2000; IN COMMERCE 12-0-2000.

2,729,800. AMERICAN BANKERS INSURANCE ASSOCIATION, WASHINGTON, DC. SN 76-118,158. PUB. 3-26-2002, FILED 8-25-2000.

ABIA AMERICAN BANKERS INSURANCE ASSOCIATION

NO CLAIM IS MADE TO THE EXCLUSIVE RIGHT TO USE "AMERICAN BANKERS INSURANCE ASSOCIATION", APART FROM THE MARK AS SHOWN.

CLASS 35—ADVERTISING AND BUSINESS

FOR PROMOTING THE SERVICES OF BANKING INSURANCE COMPANIES THROUGH THE DISTRIBUTION OF PRINTED AND AUDIO PROMOTIONAL MATERIALS AND BY RENDERING SALES PROMOTION ADVICE (U.S. CLS. 100, 101 AND 102).

FIRST USE 4-1-2001; IN COMMERCE 4-1-2001.

CLASS 42—SCIENTIFIC, COMPUTER AND LEGAL SERVICES

FOR ASSOCIATION SERVICES, NAMELY, PROMOTING THE INTERESTS OF BANK HOLDING COMPANY EMPLOYEES AND FINANCIAL SERVICE HOLDING COMPANY EMPLOYEES ENGAGED IN THE INSURANCE PROFESSION (U.S. CLS. 100 AND 101).

FIRST USE 4-1-2001; IN COMMERCE 4-1-2001.

2,729,801. SALVAGI, RAGHUNANDAN S., NEW HAVEN, CT. SN 76-118,383. PUB. 7-23-2002, FILED 8-26-2000.

SPLAR

CLASS 35—ADVERTISING AND BUSINESS

FOR PROVIDING INFORMATION ON THE AVAILABILITY OF US GOODS NEEDED BY DEVELOPING COUNTRIES, PROVIDING BUSINESS MANAGEMENT AND ENTREPRENEURSHIP INFORMATION OVER A GLOBAL COMPUTER NETWORK (U.S. CLS. 100, 101 AND 102).

FIRST USE 6-30-2001; IN COMMERCE 6-30-2001.

CLASS 42—SCIENTIFIC, COMPUTER AND LEGAL SERVICES

FOR PROVIDING THE FOLLOWING INFORMATION OVER A GLOBAL COMPUTER NETWORK—INFORMATION PERTAINING TO HEALTH, MEDICINE, CARE OF PHYSICALLY IMPAIRED PERSONS, CARE OF ORPHANED CHILDREN, CARE OF ELDERLY PERSONS, CARE OF TERMINALLY ILL PATIENTS, MEDITATION, AND TECHNOLOGY (U.S. CLS. 100 AND 101).

FIRST USE 6-30-2001; IN COMMERCE 6-30-2001.

2,729,806. HEALTH NET OF CALIFORNIA, INC., WOODLAND HILLS, CA. BY ASSIGNMENT; HEALTH NET, WOODLAND HILLS, CA. SN 76-121,046. PUB. 9-3-2002, FILED 9-1-2000.

CLASS 35—ADVERTISING AND BUSINESS

FOR COMPUTERIZED ONLINE RETAIL SERVICES FEATURING HEALTH PLANS AND HEALTH CARE PRODUCTS AND SERVICES; HEALTH CARE UTILIZATION, REVIEW AND COST CONTAINMENT SERVICES; MEDICAL COST MANAGEMENT FOR THE HEALTH BENEFIT PLANS OF OTHERS; MEDICAL BILLING INFORMATION RETRIEVAL SERVICES; LITIGATION MANAGEMENT SERVICES (U.S. CLS. 100, 101 AND 102).

FIRST USE 11-0-2000; IN COMMERCE 11-0-2000.

CLASS 36—INSURANCE AND FINANCIAL

FOR HEALTH, MEDICAL AND HOSPITALIZATION INSURANCE SERVICES, NAMELY INSURANCE CONSULTATION IN THE FIELD OF EMPLOYEE HEALTH PROGRAMS INCLUDING ACTING AS A LIAISON BETWEEN HEALTH CARE PROVIDERS AND INSURANCE COMPANIES AND OTHERS RESPONSIBLE FOR PAYMENT OF HEALTH CARE SERVICES, AND ARRANGING AND NEGOTIATING AGREED-UPON RATES FOR MEDICAL SERVICES TO SUBSCRIBERS' EMPLOYEES; INSURANCE UNDERWRITING IN THE FIELD OF HEALTH CARE, MEDICAL, AND HOSPITALIZATION; ORGANIZING PRE-PAID HEALTH PLANS; UNDERWRITING OF HEALTH CARE INDEMNITY INSURANCE PLANS; ADMINISTRATION AND ORGANIZATION OF PRE-PAID HEALTH CARE PLANS TO ELIGIBLE MEDICARE BENEFICIARIES; HEALTH CARE INSURANCE CLAIMS PROCESSING; ADMINISTRATION AND UNDERWRITING OF EMPLOYEE HEALTH CARE PLANS AND EMPLOYEE BENEFIT PLANS; ADMINISTRATION OF WORKERS' COMPENSATION CLAIMS AND BENEFITS; HEALTH CARE BENEFITS ADMINISTRATION; PROVIDING INFORMATION IN THE FIELD OF HEALTH INSURANCE VIA A GLOBAL COMPUTER NETWORK (U.S. CLS. 100, 101 AND 102).

FIRST USE 11-0-2000; IN COMMERCE 11-0-2000.

CLASS 41—EDUCATION AND ENTERTAINMENT

FOR EDUCATIONAL SERVICES, NAMELY, PROVIDING CLASSES, SEMINARS, CONFERENCES, AND WORKSHOPS IN THE FIELD OF RETURN-TO-WORK/VOCATIONAL REHABILITATION PROGRAMS, AND SAFETY AND ACCIDENT PREVENTION PROGRAMS; DEVELOPMENT AND DISSEMINATION OF EDUCATIONAL MATERIALS IN THE FIELDS OF NUTRITION, SAFETY, HEALTH AND FITNESS FOR CHILDREN (U.S. CLS. 100, 101 AND 107).

FIRST USE 11-0-2000; IN COMMERCE 11-0-2000.

CLASS 42—SCIENTIFIC, COMPUTER AND LEGAL SERVICES

FOR HEALTH CARE SERVICES IN THE NATURE OF HEALTH MAINTENANCE ORGANIZATIONS AND PREFERRED PROVIDER ORGANIZATIONS; MEDICAL SERVICES, NAMELY, DEVELOPING EMPLOYEE ASSISTANCE PROGRAMS FOR PERSONAL PROBLEM ASSESSMENT, WELLNESS PROMOTION, AND REFERRAL SERVICES AND CONSULTING RELATED THERETO; MANAGED CHIROPRACTIC CARE SERVICES; PREFERRED PROVIDER ORGANIZATION SERVICES, NAMELY PROVIDING PEER REVIEW, UTILIZATION REVIEW, AND BENEFICIARY SERVICES PROGRAMS TO PHYSICIANS AND HOSPITALS; COMPUTER SERVICES, NAMELY, PROVIDING ON-LINE MAGAZINES AND NEWSLETTERS IN THE FIELDS OF HEALTH CARE, HEALTH CARE INSURANCE, AND LIFESTYLE, AND PROVIDING INFORMATION IN THE FIELDS OF HEALTH CARE AND RELATED PRODUCTS, AND HEALTH CARE FOR CONSUMERS, HEALTH CARE VENDORS, AND HEALTH CARE COMPANIES VIA A GLOBAL COMPUTER NETWORK; FRAUD DETECTION SERVICES, NAMELY REVIEW OF HEALTH CARE SERVICES FOR DETECTION OF FRAUD BY HEALTH CARE PROVIDERS OR CONSUMERS; HEALTH CARE SERVICES IN THE NATURE OF HEALTH CARE MANAGEMENT ORGANIZATION (U.S. CLS. 100 AND 101).

FIRST USE 11-0-2000; IN COMMERCE 11-0-2000.

2,729,809. GERSTL, KAREN, MANALAPAN, NJ. SN 76-124,680. PUB. 7-2-2002, FILED 9-9-2000.



NO CLAIM IS MADE TO THE EXCLUSIVE RIGHT TO USE "STRATEGIES", APART FROM THE MARK AS SHOWN.

CLASS 35—ADVERTISING AND BUSINESS

FOR BUSINESS MANAGEMENT CONSULTING SERVICES, NAMELY, ANALYSIS OF BUSINESS PROCESS EFFICIENCY, PRODUCTIVITY AND QUALITY; IMPLEMENTATION OF DESIGNED BUSINESS PROCESSES FOR OTHERS (U.S. CLS. 100, 101 AND 102).

FIRST USE 10-25-2000; IN COMMERCE 10-25-2000.

CLASS 42—SCIENTIFIC, COMPUTER AND LEGAL SERVICES

FOR COMPUTER SOFTWARE DESIGN FOR OTHERS, NAMELY, CUSTOMIZED, COMPANY SPECIFIC, SYSTEM DESIGN FOR USE IN SUPPORTING WORK PROCESSES; DESIGN OF BUSINESS WORK PROCESSES FOR OTHERS (U.S. CLS. 100 AND 101).

FIRST USE 10-25-2000; IN COMMERCE 10-25-2000.

2,729,817. FIRST CHOICE POWER, INC., FORT WORTH, TX. SN 76-130,243. PUB. 4-23-2002, FILED 9-18-2000.

FIRST CHOICE POWER**CLASS 35—ADVERTISING AND BUSINESS**

FOR ORDERING SERVICES IN THE FIELD OF ENERGY RELATED COMMODITIES; AUDITING ENERGY RATES FOR OTHERS (U.S. CLS. 100, 101 AND 102).

FIRST USE 5-0-2001; IN COMMERCE 5-0-2001.

CLASS 39—TRANSPORTATION AND STORAGE

FOR PUBLIC UTILITY SERVICES (U.S. CLS. 100 AND 105).

FIRST USE 5-0-2001; IN COMMERCE 5-0-2001.

CLASS 42—SCIENTIFIC, COMPUTER AND LEGAL SERVICES

FOR CONSULTING SERVICES IN THE FIELDS OF ENERGY UTILIZATION AND CONSERVATION (U.S. CLS. 100 AND 101).

FIRST USE 5-0-2001; IN COMMERCE 5-0-2001.

2,729,830. TEXAS NEW MEXICO POWER COMPANY, FORT WORTH, TX. SN 76-139,722. PUB. 4-2-2002, FILED 10-3-2000.

TNPE.COM**CLASS 36—INSURANCE AND FINANCIAL**

FOR FINANCIAL SERVICES, NAMELY, PROVIDING ONLINE BILL PAYMENT AND ACCOUNT MANAGEMENT FOR UTILITY CONSUMERS (U.S. CLS. 100, 101 AND 102).

FIRST USE 5-29-2002; IN COMMERCE 5-29-2002.

CLASS 39—TRANSPORTATION AND STORAGE

FOR PUBLIC UTILITY SERVICES IN THE NATURE OF ELECTRICITY DISTRIBUTION, ELECTRICITY TRANSMISSION, AND ENERGY AUDITS (U.S. CLS. 100 AND 105).

FIRST USE 5-29-2002; IN COMMERCE 5-29-2002.

CLASS 42—SCIENTIFIC, COMPUTER AND LEGAL SERVICES

FOR COMPUTER SERVICES, NAMELY, PROVIDING A WEBSITE FEATURING UTILITY AND ENERGY CONSERVATION INFORMATION (U.S. CLS. 100 AND 101).

FIRST USE 5-29-2002; IN COMMERCE 5-29-2002.

2,729,832. TRINITY VILLAGE HOMELESS REDEVELOPMENT CENTER, RANCHO CUCAMONGA, CA. SN 76-141,922. PUB. 3-19-2002, FILED 10-6-2000.



NO CLAIM IS MADE TO THE EXCLUSIVE RIGHT TO USE "HOMELESS REDEVELOPMENT CENTER", APART FROM THE MARK AS SHOWN.

CLASS 41—EDUCATION AND ENTERTAINMENT

FOR EDUCATIONAL AND TRAINING SERVICES TO UNEMPLOYED HOMELESS AND THE UNDEREMPLOYED HOMELESS FOR ENTRY BACK INTO THE MAIN STREAM OF LIFE, NAMELY CONDUCTING CLASSES AND SEMINARS IN MONEY MANAGEMENT, BUDGETING, SAVINGS, COOKING AND NUTRITIONAL CLASSES, LIBRARY USAGE, ANGER MANAGEMENT, BEHAVIOR MODIFICATION, SELF-ESTEEM, SEARCHING FOR JOBS AND JOB INTERVIEW TECHNIQUES (U.S. CLS. 100, 101 AND 107).

FIRST USE 6-26-1999; IN COMMERCE 3-26-1999.

CLASS 42—SCIENTIFIC, COMPUTER AND LEGAL SERVICES

FOR PROVIDING TEMPORARY HOUSING ACCOMMODATIONS; FOOD PREPARATION; MEDICAL SERVICES; TEMPORARY HOUSING FOR UP TO ONE YEAR (U.S. CLS. 100 AND 101).

FIRST USE 3-26-1999; IN COMMERCE 3-26-1999.

2,729,836. JOHNSON, RAYMOND O., MORROW, GA. SN 76-145,728. PUB. 5-7-2002, FILED 10-13-2000.



NO CLAIM IS MADE TO THE EXCLUSIVE RIGHT TO USE "BARBECUE", APART FROM THE MARK AS SHOWN.

THE MARK CONSISTS OF THE WORDS "RAY J'S BARBECUE" NEXT TO A GRAPHICAL REPRESENTATION OF A CARTOON PIG WEARING A CHEF'S UNIFORM AND A HAT WITH A SCARF USING A SPOON AS A CANE.

CLASS 30—STAPLE FOODS

FOR BARBECUE SAUCES (U.S. CL. 46).

FIRST USE 11-3-2000; IN COMMERCE 11-3-2000.

CLASS 42—SCIENTIFIC, COMPUTER AND LEGAL SERVICES

FOR RESTAURANT SERVICES; CARRY OUT RESTAURANTS; RESTAURANTS FEATURING HOME DELIVERY (U.S. CLS. 100 AND 101).

FIRST USE 11-3-2000; IN COMMERCE 11-3-2000.

2,729,845. SENIORNET, SAN FRANCISCO, CA. SN 76-148,690. PUB. 7-30-2002, FILED 10-16-2000.



OWNER OF U.S. REG. NOS. 1,770,492 AND 2,450,451.

CLASS 38—COMMUNICATION

FOR TELECOMMUNICATIONS SERVICES IN THE NATURE OF ON-LINE ELECTRONIC MAIL DISCUSSION GROUPS, MESSAGE BOARDS AND CHAT ROOMS ON THE INTERNET FOR TRANSMISSION OF MESSAGES AMONG COMPUTER USERS ALL IN THE FIELDS OF HEALTH, SOCIAL CONCERNS, THE ARTS, LEISURE, HOBBIES, EDUCATION, AND PERSONAL FINANCE MANAGEMENT (U.S. CLS. 100, 101 AND 104).

FIRST USE 9-30-2001; IN COMMERCE 9-30-2001.

CLASS 41—EDUCATION AND ENTERTAINMENT

FOR PROVIDING TRAINING IN THE USE AND OPERATION OF COMPUTERS AND COMPUTER DEVICES FOR USE ON THE INTERNET; AND COMPUTER SERVICES, NAMELY, PROVIDING ON-LINE DATABASES FEATURING INFORMATION REGARDING THE ARTS, LEISURE, AND EDUCATION FOR SENIOR CITIZENS (U.S. CLS. 100, 101 AND 107).

FIRST USE 9-30-2001; IN COMMERCE 9-30-2001.

CLASS 42—SCIENTIFIC, COMPUTER AND LEGAL SERVICES

FOR COMPUTER SERVICES, NAMELY, PROVIDING ON-LINE DATABASES FEATURING INFORMATION REGARDING HEALTH AND SOCIAL CONCERNS FOR SENIOR CITIZENS (U.S. CLS. 100 AND 101).

FIRST USE 9-30-2001; IN COMMERCE 9-30-2001.

2,729,856. AQUEDUCT, INC., ALISO VIEJO, CA, BY CHANGE OF NAME BUYNOW INC., ALISO VIEJO, CA. SN 76-153,342. PUB. 6-25-2002, FILED 10-24-2000.



CLASS 35—ADVERTISING AND BUSINESS

FOR MANAGING THE ON-LINE RETAIL STORES OF THIRD PARTY MANUFACTURERS AND DISTRIBUTORS (U.S. CLS. 100, 101 AND 102).

FIRST USE 10-31-2000; IN COMMERCE 10-31-2000.

CLASS 42—SCIENTIFIC, COMPUTER AND LEGAL SERVICES

FOR HOSTING THE ONLINE RETAIL STORE WEBSITES OF THIRD PARTY MANUFACTURERS AND DISTRIBUTORS AND COMPUTER SERVICES, NAMELY, CREATING AND MAINTAINING THE ONLINE RETAIL STORE WEBSITES OF THIRD PARTY MANUFACTURERS AND DISTRIBUTORS (U.S. CLS. 100 AND 101).

FIRST USE 10-31-2000; IN COMMERCE 10-31-2000.

2,729,861. HAIGHTS CROSS COMMUNICATIONS, INC., WHITE PLAINS, NY. SN 76-156,131. PUB. 5-21-2002, FILED 10-27-2000.

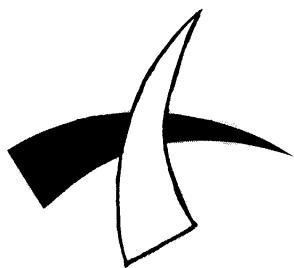
**CLASS 9—ELECTRICAL AND SCIENTIFIC APPARATUS**

FOR HOUSE MARK FOR A FULL LINE OF ELECTRONIC PUBLICATIONS IN THE FIELD OF EDUCATIONAL AND PROFESSIONAL PUBLISHING, NAMELY, LAW, MEDICINE THAT IS DOWNLOADABLE AND RECORDED ON CD-ROMS (U.S. CLS. 21, 23, 26, 36 AND 38).

FIRST USE 3-0-2002; IN COMMERCE 3-0-2002.

CLASS 16—PAPER GOODS AND PRINTED MATTER

FOR HOUSE MARK FOR A FULL LINE OF BOOKS, BOOKLETS AND NEWSLETTERS FEATURING MEDICAL, INFORMATION TECHNOLOGY, LEGAL AND EDUCATIONAL INFORMATION (U.S. CLS. 2, 5, 22, 23, 29, 37, 38 AND 50).

FIRST USE 1-0-2000; IN COMMERCE 1-0-2000.

2,729,862. BUCHANAN INGERSOLL PROFESSIONAL CORPORATION, PITTSBURGH, PA. SN 76-156,763. PUB. 9-17-2002, FILED 10-31-2000.

**CLASS 36—INSURANCE AND FINANCIAL**

FOR TITLE INSURANCE BROKERAGE SERVICES (U.S. CLS. 100, 101 AND 102).

FIRST USE 1-31-2001; IN COMMERCE 1-31-2001.

CLASS 42—SCIENTIFIC, COMPUTER AND LEGAL SERVICES

FOR REAL ESTATE CLOSING SERVICES (U.S. CLS. 100 AND 101).

FIRST USE 1-31-2001; IN COMMERCE 1-31-2001.

2,729,866. INTUIT INC., MOUNTAIN VIEW, CA. SN 76-159,316. PUB. 12-18-2001, FILED 11-3-2000.

INTUIT QUICKBASE**CLASS 35—ADVERTISING AND BUSINESS**

FOR PROVIDING DATA MANAGEMENT SERVICES; ENABLING DATA MANAGEMENT, NAMELY, PROVIDING INFORMATION AND CONSULTING IN THE FIELD OF DATA MANAGEMENT; AND DATA SHARING SERVICES (U.S. CLS. 100, 101 AND 102).

FIRST USE 12-11-2000; IN COMMERCE 12-11-2000.

CLASS 42—SCIENTIFIC, COMPUTER AND LEGAL SERVICES

FOR ENABLING DATA MANAGEMENT, NAMELY, PROVIDING TEMPORARY USE OF NON-DOWNLOADABLE SOFTWARE DEVELOPMENT TOOLS AND TEMPLATES FOR DATA MANAGEMENT; ENABLING DATA SHARING, NAMELY PROVIDING TEMPORARY USE OF NON-DOWNLOADABLE SOFTWARE FOR USE IN SHARING DATA WITH OTHERS; DATA HOSTING SERVICES; ENABLING DATA HOSTING SERVICES, NAMELY, HOSTING SOFTWARE PROGRAMS FOR USE IN MANAGING, ORGANIZING, AND SHARING DATA ON A COMPUTER SERVER ON A GLOBAL COMPUTER NETWORK AND ON INTERNAL COMPUTER NETWORKS; ENABLING DATA MANAGEMENT, NAMELY, TECHNICAL SUPPORT SERVICES, NAMELY, TROUBLE SHOOTING COMPUTER DATABASE PROBLEMS BY TELEPHONE AND VIA A GLOBAL COMPUTER INFORMATION NETWORK (U.S. CLS. 100 AND 101).

FIRST USE 12-11-2000; IN COMMERCE 12-11-2000.

2,729,870. 3DNA CORP., TORONTO, ONTARIO, ONTARIO. SN 76-160,474. PUB. 5-14-2002, FILED 11-3-2000.

3DNA**CLASS 9—ELECTRICAL AND SCIENTIFIC APPARATUS**

FOR COMPUTER SOFTWARE FOR THE PROCEDURAL CREATION, GENERATION AND VIEWING OF THREE DIMENSIONAL COMPUTER GRAPHICS AND PRINTED INSTRUCTIONAL MANUALS SOLD AS A UNIT THEREFOR (U.S. CLS. 21, 23, 26, 36 AND 38).

FIRST USE 10-0-2000; IN COMMERCE 10-0-2000.

CLASS 42—SCIENTIFIC, COMPUTER AND LEGAL SERVICES

FOR TECHNICAL SUPPORT, NAMELY, TROUBLESHOOTING OF PROBLEMS OF COMPUTER SOFTWARE FOR THE PROCEDURAL CREATION, GENERATION AND VIEWING OF THREE DIMENSIONAL COMPUTER GRAPHICS VIA TELEPHONE, E-MAIL AND IN PERSON (U.S. CLS. 100 AND 101).

FIRST USE 10-0-2000; IN COMMERCE 10-0-2000.

2,729,872. VOLPE AND KOENIG, P.C., PHILADELPHIA, PA.
SN 76-161,877. PUB. 6-11-2002, FILED 11-8-2000.

BRINGING LAW TO YOUR IDEAS

CLASS 41—EDUCATION AND ENTERTAINMENT

FOR EDUCATIONAL SERVICES, NAMELY, CONDUCTING SEMINARS, CLASSES, CONFERENCES AND WORKSHOPS IN THE FIELD OF INTELLECTUAL PROPERTY LAW (U.S. CLS. 100, 101 AND 107).
FIRST USE 10-1-2000; IN COMMERCE 2-13-2003.

CLASS 42—SCIENTIFIC, COMPUTER AND LEGAL SERVICES

FOR LEGAL SERVICES IN THE FIELD OF INTELLECTUAL PROPERTY LAW (U.S. CLS. 100 AND 101).
FIRST USE 10-1-2000; IN COMMERCE 10-1-2000.

2,729,876. DEIO CORPORATION, FINLAND. SN 76-163,904.
PUB. 5-14-2002, FILED 11-13-2000.

CARING FOR INFORMATION

CLASS 9—ELECTRICAL AND SCIENTIFIC APPARATUS

FOR COMPUTER SOFTWARE FOR THE MANAGEMENT OF HEALTH CARE RELATED INFORMATION, NAMELY, FOR THE CREATION OF DEPARTMENT SPECIFIC CARE STANDARDS AND PROTOCOLS, FOR THE AUTOMATIC DATA CAPTURE FROM MEDICAL DEVICES, FOR THE MANUAL ASSESSMENT, PLANNING AND DOCUMENTATION OF CARE, FOR STORING AND DISTRIBUTING PATIENT DATA WITHIN A NETWORK AND FOR TRANSFERRING THE PATIENT DATA BETWEEN NETWORKS; COMPUTER SOFTWARE FOR THE MANAGEMENT OF INFORMATION FROM AN OPERATING THEATER AND CRITICAL CARE ENVIRONMENT, NAMELY, FOR THE CREATION OF DEPARTMENT SPECIFIC CARE STANDARDS AND PROTOCOLS, FOR THE AUTOMATIC DATA CAPTURE FROM MEDICAL DEVICES, FOR THE MANUAL ASSESSMENT, PLANNING AND DOCUMENTATION OF CARE, FOR STORING AND DISTRIBUTING PATIENT DATA WITHIN A NETWORK AND FOR THE TRANSFERRING OF PATIENT DATA BETWEEN NETWORKS; COMPUTER SOFTWARE FOR STORING AND TRANSFERRING HEALTH CARE RELATED INFORMATION; DATABASE MANAGEMENT SOFTWARE IN THE FIELD OF HEALTH CARE (U.S. CLS. 21, 23, 26, 36 AND 38).
FIRST USE 8-21-2001; IN COMMERCE 8-21-2001.

CLASS 37—CONSTRUCTION AND REPAIR

FOR INSTALLATION AND MAINTENANCE OF COMPUTERIZED INFORMATION SYSTEMS (U.S. CLS. 100, 103 AND 106).
FIRST USE 8-21-2001; IN COMMERCE 8-21-2001.

CLASS 39—TRANSPORTATION AND STORAGE

FOR ELECTRONIC STORING FOR OTHERS OF HEALTH CARE RELATED INFORMATION (U.S. CLS. 100 AND 105).
FIRST USE 8-21-2001; IN COMMERCE 8-21-2001.

CLASS 41—EDUCATION AND ENTERTAINMENT

FOR TRAINING IN THE FIELD OF COMPUTERIZED INFORMATION SYSTEMS (U.S. CLS. 100, 101 AND 107).
FIRST USE 8-21-2001; IN COMMERCE 8-21-2001.

CLASS 42—SCIENTIFIC, COMPUTER AND LEGAL SERVICES

FOR COMPUTER SOFTWARE DESIGN FOR OTHERS; COMPLETE SOFTWARE SERVICES, NAMELY, THE INSTALLATION AND MAINTENANCE OF COMPUTER SOFTWARE FOR HEALTH CARE PROVIDERS; COMPUTERIZED STORING AND TRANSFERRING HEALTH CARE RELATED INFORMATION; COMPUTER CONSULTATION FOR COMPUTERIZED INFORMATION SYSTEMS (U.S. CLS. 100 AND 101).
FIRST USE 8-21-2001; IN COMMERCE 8-21-2001.

2,729,883. PIQUANTE INTERNATIONAL LIMITED, TORTOLA, BR. VIRGIN ISLANDS. SN 76-167,183. PUB. 6-18-2002, FILED 11-17-2000.

PEPPADEW

CLASS 29—MEATS AND PROCESSED FOODS

FOR PRESERVED, DRIED AND COOKED FRUITS AND VEGETABLES; CONCENTRATE FRUIT PULPS; JAMS; JELLIES; PICCALILLI; PICKLES; SOUP; SPREADS, NAMELY, FRUIT-BASED SPREADS, CHEESE SPREADS, VEGETABLE-BASED SPREADS, GARLIC-BASED SPREADS, MEAT-BASED SPREADS; VEGETABLE, MEAT AND FRUIT PASTES; FRUIT AND VEGETABLE PATE, DIPS (U.S. CL. 46).
FIRST USE 0-0-1995; IN COMMERCE 0-0-2001.

CLASS 30—STAPLE FOODS

FOR SAUCES; RELISHES; KETCHUPS; CHUTNEYS, BEAN PASTE, ALMOND PASTE, ALIMENTARY PASTE (U.S. CL. 46).
FIRST USE 0-0-1995; IN COMMERCE 0-0-2001.

2,729,884. RESEARCH INVESTMENT NETWORK, INC., IRVINE, CA, BY CHANGE OF NAME; RICOS INTERNATIONAL, INC., IRVINE, CA. SN 76-167,867. PUB. 8-27-2002, FILED 11-20-2000.

RIN

CLASS 35—ADVERTISING AND BUSINESS

FOR ACQUISITION AND MANAGEMENT OF INTELLECTUAL PROPERTY PORTFOLIOS FOR OTHERS (U.S. CLS. 100, 101 AND 102).
FIRST USE 10-1-2001; IN COMMERCE 10-1-2001.

CLASS 36—INSURANCE AND FINANCIAL

FOR INVESTMENT FOR OTHERS IN THE FIELD OF INTELLECTUAL PROPERTY (U.S. CLS. 100, 101 AND 102).
FIRST USE 10-1-2001; IN COMMERCE 10-1-2001.

CLASS 42—SCIENTIFIC, COMPUTER AND LEGAL SERVICES

FOR LICENSING OF INTELLECTUAL PROPERTY; INTELLECTUAL PROPERTY, PATENT AGENCY, AND INDUSTRIAL PROPERTY CONSULTATION (U.S. CLS. 100 AND 101).

FIRST USE 10-1-2001; IN COMMERCE 10-1-2001.

2,729,893. LEINER HEALTH SERVICES CORP., CARSON, CA. SN 76-174,798. PUB. 4-30-2002, FILED 11-29-2000.

VITAMIN CABINET

NO CLAIM IS MADE TO THE EXCLUSIVE RIGHT TO USE "VITAMIN", APART FROM THE MARK AS SHOWN.

CLASS 35—ADVERTISING AND BUSINESS

FOR RETAIL STORE SERVICES VIA A GLOBAL COMPUTER NETWORK AND FEATURING VITAMINS AND DIETARY FOOD SUPPLEMENTS (U.S. CLS. 100, 101 AND 102).

FIRST USE 12-0-2001; IN COMMERCE 12-0-2001.

CLASS 42—SCIENTIFIC, COMPUTER AND LEGAL SERVICES

FOR PROVIDING AN ON-LINE COMPUTER DATABASE IN THE FIELD OF NUTRITION COUNSELING (U.S. CLS. 100 AND 101).

FIRST USE 12-0-2001; IN COMMERCE 12-0-2001.

2,729,908. SOUTHERN SALES & MARKETING GROUP, INC., ATLANTA, GA. SN 76-181,679. PUB. 7-2-2002, FILED 12-15-2000.

E-Z TILT

NO CLAIM IS MADE TO THE EXCLUSIVE RIGHT TO USE "TILT", APART FROM THE MARK AS SHOWN.

CLASS 18—LEATHER GOODS

FOR UMBRELLAS (U.S. CLS. 1, 2, 3, 22 AND 41).

FIRST USE 12-0-2000; IN COMMERCE 12-0-2000.

CLASS 22—CORDAGE AND FIBERS

FOR AWNINGS (U.S. CLS. 1, 2, 7, 19, 22, 42 AND 50).

FIRST USE 12-0-2000; IN COMMERCE 12-0-2000.

2,729,911. BRIGHTPOINT, INC., INDIANAPOLIS, IN. SN 76-185,967. PUB. 5-7-2002, FILED 12-22-2000.

BRIGHTPOINT ONLINE

OWNER OF U.S. REG. NOS. 2,170,782 AND 2,353,363.

NO CLAIM IS MADE TO THE EXCLUSIVE RIGHT TO USE "ONLINE", APART FROM THE MARK AS SHOWN.

CLASS 35—ADVERTISING AND BUSINESS

FOR DISTRIBUTORSHIPS IN THE FIELD OF WIRELESS COMMUNICATION EQUIPMENT, NAMELY, DISTRIBUTORSHIPS FOR WIRELESS TELEPHONES AND WIRELESS TELEPHONE BATTERY CHARGERS, BATTERY ELIMINATORS, REPLACEMENT BATTERIES, WATTAGE BOOSTERS, HANDS FREE HEADSETS AND KITS, HOLDERS AND CRADLES, CARRYING CASES AND BAGS, EARPHONES, MICROPHONES, CIGAR-ETTE LIGHTER ADAPTERS, ANTENNAE, HANG-UP CUPS, HANDSET EXTENSION CABLES, POWER CABLES AND DATA CABLES; MAIL ORDER CATALOG SERVICES FEATURING WIRELESS COMMUNICATION EQUIPMENT AND ACCESSORIES THEREFOR; COMPUTERIZED ON-LINE ORDERING AND PRODUCT ORDER FULFILLMENT SERVICES IN THE FIELD OF WIRELESS COMMUNICATION EQUIPMENT AND ACCESSORIES THEREFOR; INVENTORY MANAGEMENT OF WIRELESS COMMUNICATION EQUIPMENT AND ACCESSORIES THEREFOR FOR OTHERS; PACKAGING WIRELESS COMMUNICATION EQUIPMENT AND ACCESSORIES THEREFOR TO THE ORDER AND SPECIFICATION OF OTHERS; ACCOUNTS RECEIVABLE MANAGEMENT SERVICES IN THE FIELD OF WIRELESS COMMUNICATION EQUIPMENT AND ACCESSORIES THEREFOR (U.S. CLS. 100, 101 AND 102).

FIRST USE 5-8-2001; IN COMMERCE 5-8-2001.

CLASS 36—INSURANCE AND FINANCIAL

FOR FINANCIAL SERVICES RELATING TO WIRELESS COMMUNICATION EQUIPMENT AND ACCESSORIES THEREFOR, NAMELY, CREDIT AND DEBT RECOVERY COLLECTION SERVICES, AND CREDIT RISK MANAGEMENT SERVICES (U.S. CLS. 100, 101 AND 102).

FIRST USE 5-8-2001; IN COMMERCE 5-8-2001.

CLASS 37—CONSTRUCTION AND REPAIR

FOR REPAIR AND REFURBISHING OF WIRELESS COMMUNICATION EQUIPMENT AND ACCESSORIES THEREFOR (U.S. CLS. 100, 103 AND 106).

FIRST USE 5-8-2001; IN COMMERCE 5-8-2001.

CLASS 39—TRANSPORTATION AND STORAGE

FOR INVENTORY STORAGE SERVICES, NAMELY, STORAGE OF WIRELESS COMMUNICATION EQUIPMENT AND ACCESSORIES THEREFOR FOR OTHERS (U.S. CLS. 100 AND 105).

FIRST USE 5-8-2001; IN COMMERCE 5-8-2001.

CLASS 42—SCIENTIFIC, COMPUTER AND LEGAL SERVICES

FOR PACKAGING DESIGN FOR WIRELESS COMMUNICATION EQUIPMENT AND ACCESSORIES THEREFOR TO THE ORDER AND SPECIFICATION OF OTHERS (U.S. CLS. 100 AND 101).

FIRST USE 5-8-2001; IN COMMERCE 5-8-2001.

2,729,924. ATTENZA.COM, INC., DALLAS, TX. SN 76-191,442. PUB. 12-11-2001, FILED 1-8-2001.



ATTENZA

THE MARK CONSISTS, IN PART OF, A STYLIZED "A".

CLASS 9—ELECTRICAL AND SCIENTIFIC APPARATUS

FOR COMPUTER SOFTWARE FOR USE IN CREATION, DESIGN, DEVELOPMENT, GENERATION, TRANSMISSION AND OPERATION OF HOST SITES AND COMPUTER SOFTWARE FOR USE IN MULTIMEDIA PRODUCTION AND DISTRIBUTION VIA A GLOBAL COMPUTER NETWORK, NAMELY, FOR USE IN THE INTEGRATION OF TEXT, AUDIO, AND GRAPHICS (U.S. CLS. 21, 23, 26, 36 AND 38).

FIRST USE 1-0-2001; IN COMMERCE 1-0-2001.

CLASS 42—SCIENTIFIC, COMPUTER AND LEGAL SERVICES

FOR COMPUTER SERVICES, NAMELY, PROVIDING ONLINE TECHNICAL SUPPORT SERVICES, NAMELY, TROUBLESHOOTING OF COMPUTER HARDWARE AND SOFTWARE PROBLEMS, AND PROVIDING TEMPORARY USE OF NONDOWNLOADABLE ELECTRONIC TUTORIALS FOR TROUBLESHOOTING THE SAME, ALL PROVIDED VIA A GLOBAL COMPUTER NETWORK (U.S. CLS. 100 AND 101).

FIRST USE 1-0-2001; IN COMMERCE 1-0-2001.

2,729,930. FAMIGLIA INTERNATIONAL, INC., NEW YORK, NY. SN 76-192,819. PUB. 7-2-2002, FILED 1-9-2001.



THE WORDING "FAMIGLIA" MEANS "FAMILY" IN ITALIAN.

CLASS 29—MEATS AND PROCESSED FOODS

FOR FINE FOODS, NAMELY, CHEESES, MEATS AND OILS (U.S. CL. 46).

FIRST USE 10-0-1998; IN COMMERCE 10-0-1998.

CLASS 30—STAPLE FOODS

FOR FINE FOODS, NAMELY, PESTOS AND SAUCES (U.S. CL. 46).

FIRST USE 10-0-1998; IN COMMERCE 10-0-1998.

CLASS 42—SCIENTIFIC, COMPUTER AND LEGAL SERVICES

FOR RESTAURANT SERVICES (U.S. CLS. 100 AND 101).

FIRST USE 10-0-1998; IN COMMERCE 10-0-1998.

2,729,937. ANSCHUTZ MANCHESTER HOCKEY, LLC, LOS ANGELES, CA. SN 76-198,771. PUB. 11-27-2001, FILED 1-24-2001.

MANCHESTER MONARCHS

OWNER OF U.S. REG. NO. 1,860,058.

NO CLAIM IS MADE TO THE EXCLUSIVE RIGHT TO USE "MANCHESTER", APART FROM THE MARK AS

SHOWN.

CLASS 21—HOUSEWARES AND GLASS

FOR BEVERAGE GLASSWARE; DRINKING GLASSES; SHOT GLASSES; WATER BOTTLES SOLD EMPTY; CUPS; AND MUGS (U.S. CLS. 2, 13, 23, 29, 30, 33, 40 AND 50).

FIRST USE 4-1-2001; IN COMMERCE 4-1-2001.

CLASS 25—CLOTHING

FOR CLOTHING, NAMELY, SHIRTS, JERSEYS, SWEATERS, SWEATSHIRTS, JACKETS, VESTS, T-SHIRTS, GOLF SHIRTS, POLO SHIRTS, WIND SHIRTS, WRISTBANDS, SWEATBANDS, SHORTS, CAPS, HATS, SOCKS, NIGHTSHIRTS, BOXER SHORTS AND CLOTH BIBS (U.S. CLS. 22 AND 39).

FIRST USE 4-1-2001; IN COMMERCE 4-1-2001.

CLASS 28—TOYS AND SPORTING GOODS

FOR HOCKEY STICKS; MINI HOCKEY STICKS; HOCKEY PUCKS; AND TOYS, NAMELY TOY ICE RESURFACING MACHINES (U.S. CLS. 22, 23, 38 AND 50).

FIRST USE 4-1-2001; IN COMMERCE 4-1-2001.

CLASS 41—EDUCATION AND ENTERTAINMENT

FOR ENTERTAINMENT SERVICES, NAMELY, PROFESSIONAL ICE HOCKEY GAMES AND EXHIBITIONS (U.S. CLS. 100, 101 AND 107).

FIRST USE 4-1-2001; IN COMMERCE 4-1-2001.

2,729,939. LORD, BISSELL & BROOK, CHICAGO, IL. SN 76-199,965. PUB. 6-11-2002, FILED 1-25-2001.

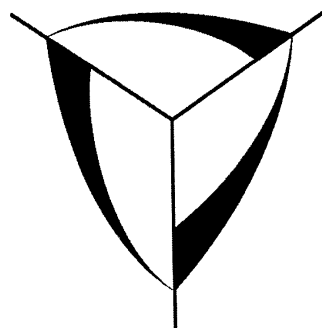

THE MARK CONSISTS OF A SHIELD DESIGN RESEMBLING A LETTER "Y" WITH ARCED LINES CONNECTING EACH SEGMENT.

CLASS 16—PAPER GOODS AND PRINTED MATTER

FOR PRINTED PUBLICATIONS, NAMELY, NEWSLETTERS, BROCHURES AND PAMPHLETS IN THE FIELD OF LAW (U.S. CLS. 2, 5, 22, 23, 29, 37, 38 AND 50).

FIRST USE 6-1-2001; IN COMMERCE 6-1-2001.

CLASS 41—EDUCATION AND ENTERTAINMENT

FOR CONDUCTING SEMINARS, WORKSHOPS AND TRAINING COURSES IN THE FIELD OF LAW (U.S. CLS. 100, 101 AND 107).
FIRST USE 6-1-2001; IN COMMERCE 6-1-2001.

CLASS 42—SCIENTIFIC, COMPUTER AND LEGAL SERVICES

FOR LEGAL SERVICES; PROVIDING INFORMATION IN THE FIELD OF LAW BY MEANS OF A GLOBAL COMPUTER NETWORK (U.S. CLS. 100 AND 101).
FIRST USE 6-1-2001; IN COMMERCE 6-1-2001.

2,729,940. FLORISTS' TRANSWORLD DELIVERY, INC., DOWNERS GROVE, IL. SN 76-200,104. PUB. 10-8-2002, FILED 1-26-2001.

FOL**CLASS 38—COMMUNICATION**

FOR ELECTRONIC MAIL SERVICES (U.S. CLS. 100, 101 AND 104).
FIRST USE 10-0-1999; IN COMMERCE 10-0-1999.

CLASS 42—SCIENTIFIC, COMPUTER AND LEGAL SERVICES

FOR COMPUTER SERVICES, NAMELY, WEBSITE DEVELOPMENT FOR OTHERS, WEBSITE DESIGN AND REGISTRATION OF DOMAIN NAMES FOR IDENTIFICATION OF USERS ON A GLOBAL COMPUTER NETWORK; HOSTING THE WEB SITES OF OTHERS ON A COMPUTER SERVER FOR A GLOBAL COMPUTER NETWORK (U.S. CLS. 100 AND 101).
FIRST USE 10-1-1999; IN COMMERCE 10-1-1999.

2,729,943. SOCIAL ENTERPRISES, INC., SAN RAFAEL, CA. SN 76-201,178. PUB. 4-30-2002, FILED 1-29-2001.

KM**CLASS 9—ELECTRICAL AND SCIENTIFIC APPARATUS**

FOR COMPUTER SOFTWARE FOR SIMPLIFYING THE MANAGEMENT OF WORKPLACE CHARITABLE DONATION PROGRAMS WITH A WEB BASED APPLICATION, FOR MANAGING AND TRACKING DATA, PRESENTING INFORMATION ON CHARITABLE GIVING OPTIONS, AND GENERATING REPORTS (U.S. CLS. 21, 23, 26, 36 AND 38).
FIRST USE 11-0-2000; IN COMMERCE 11-0-2000.

CLASS 36—INSURANCE AND FINANCIAL

FOR CONSULTING SERVICES IN THE FIELD OF WORKPLACE CHARITABLE DONATION PROGRAMS AND COMMUNITY FUNDRAISING, AND PROVIDING INFORMATION RELATED THERETO; ADMINISTRATION OF EMPLOYEE BENEFIT PLANS AND PENSION PLANS; AND INSURANCE BROKERAGE IN THE FIELD OF HEALTH AND LIFE INSURANCE (U.S. CLS. 100, 101 AND 102).
FIRST USE 11-0-2000; IN COMMERCE 11-0-2000.

2,729,957. UNCLE BEN'S, INC., VERNON, CA. SN 76-205,322. PUB. 5-14-2002, FILED 2-6-2001.

UNCLE BEN'S BREAKFAST BOWL

OWNER OF U.S. REG. NOS. 437,176, 903,134, AND OTHERS.

NO CLAIM IS MADE TO THE EXCLUSIVE RIGHT TO USE "BREAKFAST", APART FROM THE MARK AS SHOWN.

CLASS 29—MEATS AND PROCESSED FOODS

FOR PREPARED FOODS CONSISTING PRIMARILY OF EGGS, MEAT, VEGETABLES, FRUIT, CHEESE AND SAUCE (U.S. CL. 46).
FIRST USE 1-0-2002; IN COMMERCE 1-0-2002.

CLASS 30—STAPLE FOODS

FOR PREPARED FOODS CONSISTING PRIMARILY OF CEREAL AND/OR RICE, WITH EGGS, MEAT, VEGETABLES, FRUIT, SAUCE AND/OR CHEESE (U.S. CL. 46).
FIRST USE 1-0-2002; IN COMMERCE 1-0-2002.

2,729,959. HOMESTORE.COM, INC., WESTLAKE VILLAGE, CA. SN 76-206,936. PUB. 1-15-2002, FILED 2-6-2001.

**homestore.com****CLASS 35—ADVERTISING AND BUSINESS**

FOR ADVERTISING SERVICES, NAMELY, PREPARING ADVERTISEMENTS FOR OTHERS, PLACING ADVERTISEMENTS FOR OTHERS, DISPLAYING ADVERTISEMENTS FOR OTHERS, AND DISSEMINATION OF ADVERTISING FOR OTHERS VIA A GLOBAL COMPUTER NETWORK; PROVIDING INFORMATION IN THE FIELD OF BUSINESS, PERSONNEL, EMPLOYEE AND PERSONAL RELOCATION SERVICES BY MEANS OF A GLOBAL COMPUTER NETWORK (U.S. CLS. 100, 101 AND 102).
FIRST USE 6-4-1999; IN COMMERCE 6-4-1999.

CLASS 36—INSURANCE AND FINANCIAL

FOR PROVIDING REAL ESTATE SERVICES BY MEANS OF A GLOBAL COMPUTER NETWORK, NAMELY, REAL ESTATE AGENCY, REAL ESTATE APPRAISAL AND VALUATION, REAL ESTATE LISTING, AND REAL ESTATE REFERRALS; PROVIDING MORTGAGE FINANCING INFORMATION AND INFORMATION ABOUT LENDERS, INSURANCE, HOME REMODEL FINANCING, PURCHASE OF NEW HOMES, AND RENTALS BY MEANS OF A GLOBAL COMPUTER NETWORK; PROVIDING REAL ESTATE INFORMATION BY MEANS OF A GLOBAL COMPUTER NETWORK; AND PROVIDING ECONOMIC INFORMATION RELATED TO REAL ESTATE PURCHASES (U.S. CLS. 100, 101 AND 102).
FIRST USE 6-4-1999; IN COMMERCE 6-4-1999.

CLASS 37—CONSTRUCTION AND REPAIR

FOR PROVIDING INFORMATION IN THE FIELD OF HOUSE MODELS, FLOOR PLANS, DEVELOPMENT OF NEW HOMES, BUILDING RENOVATION, HOME REMODELING, HOME BUILDERS, SUBDIVISIONS, AND HOUSING DEVELOPMENTS BY MEANS OF A GLOBAL COMPUTER NETWORK (U.S. CLS. 100, 103 AND 106).

FIRST USE 6-4-1999; IN COMMERCE 6-4-1999.

CLASS 39—TRANSPORTATION AND STORAGE

FOR PROVIDING INFORMATION IN THE FIELD OF MOVING SERVICES BY MEANS OF A GLOBAL COMPUTER NETWORK (U.S. CLS. 100 AND 105).

FIRST USE 6-4-1999; IN COMMERCE 6-4-1999.

CLASS 42—SCIENTIFIC, COMPUTER AND LEGAL SERVICES

FOR PROVIDING INFORMATION IN THE FIELDS OF HOME DECORATION, HOME TECHNOLOGY, MAPS PHOTOGRAPHS, SCHOOL INFORMATION AND OTHER COMMUNITY AND DEMOGRAPHIC DATA BY MEANS OF A GLOBAL COMPUTER (U.S. CLS. 100 AND 101).

FIRST USE 6-4-1999; IN COMMERCE 6-4-1999.

2,729,960. NOVEMBAL, 92592 LEVALLOIS PERRET, FRANCE. SN 76-207,410. PUB. 5-28-2002, FILED 2-9-2001.

ALASKA**CLASS 17—RUBBER GOODS**

FOR MATERIALS FOR PACKAGING, PREPACKAGING, PACKING, OVERPACKING, CLOSURE OF OBJECTS AND FOR ATTACHMENT OF OBJECTS, NAMELY PACKING CUSHIONING AND STUFFING MATERIALS OF RUBBER OR PLASTICS; PADDING MATERIALS OF RUBBER OR PLASTICS FOR LIQUID TIGHT PURPOSES IN PACKAGING AND PACKING; STUFFING OF RUBBER OR PLASTICS; LIQUID PROOF PACKAGING, NAMELY JOINT PACKINGS FOR CLOSING PARTS OF CONTAINERS, BOTTLES, JARS, BOXES, SMALL BOTTLES, TINS, RUBBER CONTAINERS, TIN STOPPERS, AND LIQUID TIGHT RINGS OF RUBBER OR VULCANIZED FIBER FOR CLOSING PARTS OF CONTAINERS, BOTTLES, JARS, BOXES, SMALL BOTTLES, TINS AND WASHERS OF RUBBER OR VULCANIZED FIBER (U.S. CLS. 1, 5, 12, 13, 35 AND 50).

FIRST USE 10-18-1994; IN COMMERCE 10-18-1994.

CLASS 20—FURNITURE AND ARTICLES NOT OTHERWISE CLASSIFIED

FOR PLUGS FOR RECEPTACLES, FOR FOOD PRODUCTS, DRINKS, COSMETICS, PHARMACEUTICAL, PARAPHARMACEUTICAL AND PHYTHOLOGICAL PRODUCTS AND FOR MAINTENANCE PRODUCTS, NAMELY, CORKS, NON-METALLIC CAPS, PLASTIC CAPS FOR BOTTLES, JARS, BOXES, CONTAINERS, SMALL BOTTLES, TINS, NON-METALLIC BOTTLE CAPS, NON-METALLIC BOTTLE CLOSURES, NON-METAL CLOSURES FOR CONTAINERS, NON-METAL CLOSING DEVICES FOR NON-METALLIC RECIPIENTS, CAPS, COVERS, LIDS, TOPS, PLUGS AND NON-METALLIC CLICK-IN CAPS, IN CORK, SUBSIDIARY CORKS AND PLASTIC FOR BOTTLES, JARS, BOXES, CONTAINERS, SMALL BOTTLES, TINS, NON-METAL CLOSURES FOR CONTAINERS, BOXES THAT MAY BE PULLED AWAY OR PULLED OFF, CRIMPED CLOSING DEVICES NAMELY DEVICES GATHERED WITHOUT SOLDERING, NONMETALLIC CLIP-END CLOSING DEVICES NAMELY FIXED PARTS AND STOPPERS WHICH FIT INTO EACH OTHER, NON-METAL CLIPPED CLOSING DEVICES, NAMELY STOPPERS WHICH FIT INTO THE CONTAINER NECK (BOTTLES, JARS, BOXES,

SMALL BOTTLES, TINS), DEPRESSION DEVICES, NAMELY DEPRESSION DEVICES IN PLASTIC WITH A MOBILE PART TO PUSH TO OPEN BOTTLES, JARS, BOXES, CONTAINERS, SMALL BOTTLES, TINS, SLIDING, LEVER OPERATED AND CHILDPROOF OR TAMPER-PROOF DEVICES NAMELY DEVICES IN PLASTIC WITH HARD OPENINGS FOR TOXIC PRODUCTS; SPRING, MANUAL, SCREW-IN, PUSH-IN, SLIDE CLOSING DEVICES WITH CAPS, CLOSING BINDERS, CORK OR SUBSIDIARY CAPS, RING CAPS, PAIR-OFF TABS, FIXED OR MOBILE ORIFICES WITH CLASPS, WITH APPLICATORS, CAPS; PUMPS IN PLASTIC NAMELY SYSTEMS TO RAISE LIQUID BY SUCKING UP OR BY REVERSING BACK, VALVES IN PLASTIC NAMELY SYSTEMS TO CONTROL LIQUID MOVEMENT, CAPTIVE VALVE CLOSING DEVICES AND OVERCAPS IN PLASTIC NAMELY PLASTIC STOPPERS AND THIN STOPPERS CATCHING THE OPENING OF BOTTLES, JARS, BOXES, CONTAINERS, SMALL BOTTLES, TINS, SCALED PLUGS IN PLASTIC NAMELY OVERCAP TO PUT ON ANOTHER STOPPER, CLOSING PARTS, PLUGGING AND PLASTIC CAPPING PARTS FOR RECEPTACLES, FOR FOOD PRODUCTS, DRINKS, COSMETICS, PHARMACEUTICALS, PARAPHARMACEUTICALS, PHYTOPATHOLOGICAL PRODUCTS AND FOR MAINTENANCE PRODUCTS, NAMELY RUBBER PLUGS, PLASTIC CAPS, PLASTIC BOTTLE CAPS, PLASTIC BOTTLE CLOSURES, PLASTIC CONTAINER CLOSURES AND CLOSURES FOR PLASTIC RECIPIENTS, NAMELY BOTTLES, JARS, BOXES, SMALL BOTTLES, TINS (U.S. CLS. 2, 13, 22, 25, 32 AND 50).

FIRST USE 10-18-1994; IN COMMERCE 10-18-1994.

2,729,962. BREAKTHROUGHS ABROAD, INC., ESTES PARK, CO. SN 76-207,532. PUB. 4-30-2002, FILED 2-12-2001.

BREAKTHROUGHS ABROAD

NO CLAIM IS MADE TO THE EXCLUSIVE RIGHT TO USE "ABROAD", APART FROM THE MARK AS SHOWN.

CLASS 41—EDUCATION AND ENTERTAINMENT

FOR EDUCATIONAL SERVICES, NAMELY, PROVIDING EDUCATIONAL TRAINING FOR OTHERS IN THE FIELDS OF DOMESTIC AND INTERNATIONAL COMMUNITY SERVICE, LANGUAGES, CULTURAL ISSUES AND CULTURAL AWARENESS, AND DISTRIBUTING EDUCATIONAL OR TRAINING MATERIALS IN CONNECTION THEREWITH (U.S. CLS. 100, 101 AND 107).

FIRST USE 9-30-2000; IN COMMERCE 1-31-2001.

CLASS 42—SCIENTIFIC, COMPUTER AND LEGAL SERVICES

FOR SPONSORING, DEVELOPING AND CARRYING OUT YOUTH AND ADULT EXCHANGE PROGRAMS PROVIDING COMMUNITY SERVICE AND CULTURAL LEARNING EXPERIENCES FOR OTHERS IN FOREIGN AND DOMESTIC SETTINGS; PROVIDING TEMPORARY HOUSING ACCOMMODATIONS FOR VOLUNTEERS; AND ORGANIZING AND CONDUCTING VOLUNTEER PROGRAMS FOR DOMESTIC AND INTERNATIONAL COMMUNITY SERVICE (U.S. CLS. 100 AND 101).

FIRST USE 9-30-2000; IN COMMERCE 1-31-2001.

2,729,963. MCKINLEY, KEVIN, EAU CLAIRE, WI. SN 76-207,861. PUB. 11-27-2001, FILED 2-9-2001.

MAKE YOUR KID A MILLIONAIRE

CLASS 9—ELECTRICAL AND SCIENTIFIC APPARATUS

FOR PRE-RECORDED AUDIOTAPES FEATURING FINANCE, INVESTMENT, ESTATE PLANNING AND EDUCATION STRATEGIES AND TECHNIQUES; PRE-RECORDED VIDEOTAPES FEATURING FINANCE, INVESTMENT, ESTATE PLANNING AND EDUCATION STRATEGIES AND TECHNIQUES; PRE-RECORDED CD-ROMS FEATURING FINANCE, INVESTMENT, ESTATE PLANNING AND EDUCATION STRATEGIES AND TECHNIQUES (U.S. CLS. 21, 23, 26, 36 AND 38).
FIRST USE 10-30-2001; IN COMMERCE 10-30-2001.

CLASS 16—PAPER GOODS AND PRINTED MATTER

FOR BOOKS, NEWSLETTERS, ARTICLES, PAMPHLETS AND MANUALS IN THE FIELD OF FINANCE, INVESTMENTS, ESTATE PLANNING AND EDUCATION (U.S. CLS. 2, 5, 22, 23, 29, 37, 38 AND 50).
FIRST USE 9-18-2001; IN COMMERCE 9-18-2001.

CLASS 41—EDUCATION AND ENTERTAINMENT

FOR EDUCATIONAL SERVICES; NAMELY, PROVIDING SEMINARS, CLASSES AND WORKSHOPS IN THE FIELD OF FINANCE, INVESTMENT, ESTATE PLANNING AND EDUCATION STRATEGIES AND TECHNIQUES FOR THE INDICATED GOODS/SERVICES (U.S. CLS. 100, 101 AND 107).
FIRST USE 11-30-2001; IN COMMERCE 11-30-2001.

2,729,970. MINNESOTA SAFETY COUNCIL, INC., ST. PAUL, MN. SN 76-211,721. PUB. 11-27-2001, FILED 2-16-2001.

SAFE-A-ROONI

CLASS 16—PAPER GOODS AND PRINTED MATTER

FOR PRINTED MATERIALS, NAMELY BROCHURES, BOOKLETS, BOOKS AND POSTERS FEATURING INFORMATION ON CHILDREN'S SAFETY (U.S. CLS. 2, 5, 22, 23, 29, 37, 38 AND 50).
FIRST USE 8-0-2000; IN COMMERCE 8-0-2000.

CLASS 41—EDUCATION AND ENTERTAINMENT

FOR ENTERTAINMENT SERVICES, NAMELY, PROVIDING COMPUTER GAMES ABOUT CHILDREN'S SAFETY VIA A GLOBAL COMMUNICATIONS NETWORK (U.S. CLS. 100, 101 AND 107).
FIRST USE 5-0-2001; IN COMMERCE 5-0-2001.

CLASS 42—SCIENTIFIC, COMPUTER AND LEGAL SERVICES

FOR PROVIDING INFORMATION ABOUT CHILDREN'S SAFETY VIA TELEPHONE, FACSIMILE, AND VIA A GLOBAL COMMUNICATIONS NETWORK (U.S. CLS. 100 AND 101).
FIRST USE 8-0-2000; IN COMMERCE 8-0-2000.

2,729,980. HEALTHWISE, INCORPORATED, BOISE, ID. SN 76-216,039. PUB. 11-27-2001, FILED 2-22-2001.

PRESCRIPTION-STRENGTH INFORMATION

NO CLAIM IS MADE TO THE EXCLUSIVE RIGHT TO USE "INFORMATION", APART FROM THE MARK AS SHOWN.

CLASS 9—ELECTRICAL AND SCIENTIFIC APPARATUS

FOR PRERECORDED AUDIOTAPES, VIDEOTAPES, COMPUTER SOFTWARE, AND MULTIMEDIA PROGRAMS IN THE FIELDS OF HEALTH EDUCATION, HEALTH PROMOTION, DISEASE MANAGEMENT AND HEALTH CARE (U.S. CLS. 21, 23, 26, 36 AND 38).
FIRST USE 3-19-2001; IN COMMERCE 3-19-2001.

CLASS 42—SCIENTIFIC, COMPUTER AND LEGAL SERVICES

FOR MEDICAL AND HEALTH CARE INFORMATION IN THE FIELDS OF HEALTH EDUCATION, HEALTH PROMOTION, DISEASE MANAGEMENT AND HEALTH CARE VIA A GLOBAL COMPUTER NETWORK PROVIDED ON-LINE FROM A COMPUTER DATABASE OR FROM THE INTERNET (U.S. CLS. 100 AND 101).
FIRST USE 10-18-2000; IN COMMERCE 10-18-2000.

2,729,965. GENTEX CORPORATION, ZEELAND, MI. SN 76-210,539. PUB. 9-4-2001, FILED 2-14-2001.

BCW

CLASS 9—ELECTRICAL AND SCIENTIFIC APPARATUS

FOR LIGHT EMITTING DIODES (U.S. CLS. 21, 23, 26, 36 AND 38).
FIRST USE 11-25-2002; IN COMMERCE 11-26-2002.

CLASS 11—ENVIRONMENTAL CONTROL APPARATUS

FOR LIGHTS FOR VEHICLES (U.S. CLS. 13, 21, 23, 31 AND 34).
FIRST USE 11-25-2002; IN COMMERCE 11-26-2002.

2,729,986. YALE UNIVERSITY, NEW HAVEN, CT. SN 76-219,237. PUB. 9-24-2002, FILED 3-2-2001.

YALE ENTREPRENEURIAL SOCIETY

OWNER OF U.S. REG. NOS. 1,391,543, 2,271,288, AND OTHERS.

NO CLAIM IS MADE TO THE EXCLUSIVE RIGHT TO USE "ENTREPRENEURIAL SOCIETY", APART FROM THE MARK AS SHOWN.

CLASS 41—EDUCATION AND ENTERTAINMENT

FOR EDUCATIONAL SERVICES, NAMELY, PROVIDING SEMINARS AND COURSES OF INSTRUCTION ON ENTREPRENEURIAL OPPORTUNITIES; EDUCATIONAL AND ENTERTAINMENT SERVICES NAMELY PROVIDING SPEAKERS ON TOPICS CONCERNING ENTREPRENEURIAL ACTIVITIES; ARRANGING AND CONDUCTING COMPETITIONS FOR PRIZES IN THE FIELD OF ENTREPRENEURIAL ACTIVITIES FOR THE BEST BUSINESS PLANS (U.S. CLS. 100, 101 AND 107).

FIRST USE 0-0-1999; IN COMMERCE 0-0-1999.

CLASS 42—SCIENTIFIC, COMPUTER AND LEGAL SERVICES

FOR ASSOCIATION SERVICES, NAMELY, PROMOTING THE INTERESTS OF FOR PROFIT AND NOT-FOR-PROFIT ENTREPRENEURS; PROMOTING MENTORING AND NETWORKING ACTIVITIES AMONG ENTREPRENEURS (U.S. CLS. 100 AND 101).

FIRST USE 0-0-1999; IN COMMERCE 0-0-1999.

2,729,993. MORGAN STANLEY, NEW YORK, NY, BY CHANGE OF NAME MORGAN STANLEY DEAN WITTER & CO., NEW YORK, NY. SN 76-219,718. PUB. 9-3-2002, FILED 3-5-2001.



The logo for Morgan Stanley, featuring the word "Morgan" in a serif font and "Stanley" in a bold sans-serif font, with a small stylized symbol above the 'n' in Stanley.

THE NAME "MORGAN STANLEY" DOES NOT IDENTIFY A LIVING INDIVIDUAL.

CLASS 9—ELECTRICAL AND SCIENTIFIC APPARATUS

FOR COMPUTER SOFTWARE FOR USE IN INVESTMENT BANKING, INVESTMENT MANAGEMENT, INVESTMENT RESEARCH AND ANALYSIS, INVESTMENT ADVICE, FINANCIAL INFORMATION SERVICES, FINANCIAL PROJECTIONS, COMPILATION OF MARKET INDICES, PAYMENT SYSTEMS, ACCOUNTING SYSTEMS, CREDIT CARD SYSTEMS, ONLINE BANKING, FINANCIAL PLANNING, AND THE TRADING OF SECURITIES, CURRENCIES, OPTIONS, FOREIGN EXCHANGE, FUTURES, FUNDS AND COMMODITIES; CREDIT CARD PROCESSING SYSTEMS, NAMELY, CREDIT CARD TERMINALS, PRINTERS FOR CREDIT CARD TERMINALS, AND PERSONAL IDENTIFICATION NUMBER KEYPADS; SMART CARDS FOR STORING FINANCIAL AND PERSONAL INFORMATION (U.S. CLS. 21, 23, 26, 36 AND 38).

FIRST USE 6-30-2002; IN COMMERCE 6-30-2002.

CLASS 16—PAPER GOODS AND PRINTED MATTER

FOR INVESTMENT RESEARCH REPORTS; MAGAZINES AND NEWSLETTERS CONTAINING FINANCIAL AND BUSINESS INFORMATION; SECURITIES OFFERING DOCUMENTS, NAMELY, PROSPECTUSES; PRINTED MARKET INDICES; PRINTED TRAINING MATERIALS IN THE FIELD OF FINANCIAL SERVICES; PRINTED DOCUMENTATION FOR COMPUTER SOFTWARE IN THE FIELD OF FINANCIAL SERVICES; FINANCIAL REPORTS RELATING TO MERGER, ACQUISITION, RESTRUCTURING, AND OTHER CORPORATE FINANCE ACTIVITIES (U.S. CLS. 2, 5, 22, 23, 29, 37, 38 AND 50).

FIRST USE 6-30-2002; IN COMMERCE 6-30-2002.

CLASS 35—ADVERTISING AND BUSINESS

FOR TAX ADVISORY SERVICES; FINANCIAL ACCOUNTING SERVICES (U.S. CLS. 100, 101 AND 102).

FIRST USE 6-30-2002; IN COMMERCE 6-30-2002.

CLASS 36—INSURANCE AND FINANCIAL

FOR INVESTMENT BANKING SERVICES; FINANCIAL SERVICES IN THE NATURE OF UNDERWRITING, DISTRIBUTION AND TRADING OF SECURITIES FOR OTHERS; SECURITIES BROKERAGE SERVICES; INVESTMENT RESEARCH SERVICES; INVESTMENT MANAGEMENT AND ADVICE; FINANCIAL SERVICES IN THE NATURE OF TRADING FUTURES, CURRENCIES, OPTIONS, FOREIGN EXCHANGE, AND COMMODITIES FOR OTHERS; FINANCIAL CLEARING HOUSE; ESTATE PLANNING SERVICES; TRUSTEE SERVICES; ADMINISTRATION OF EMPLOYEE PENSION PLANS; MUTUAL FUND BROKERAGE, DISTRIBUTION AND INVESTMENT; DERIVATIVE SECURITIES INVESTMENT; RISK MANAGEMENT SERVICES; INSURANCE BROKERAGE; INSURANCE ADMINISTRATION IN THE FIELDS OF HOME, VEHICLE, LIFE, ACCIDENT, AND PERSONAL LIABILITY INSURANCE; FINANCIAL PLANNING SERVICES; BANKING SERVICES; CREDIT CARD SERVICES; DEBIT CARD SERVICES; CHECK CARD SERVICES; ADMINISTRATION OF CREDIT CARD INSURANCE, DEBIT CARD INSURANCE, AND CHECK CARD INSURANCE; PROVIDING FINANCIAL NEWS AND INFORMATION VIA A GLOBAL COMMUNICATIONS NETWORK; PROVIDING FINANCIAL SERVICES VIA A GLOBAL COMMUNICATIONS NETWORK, FINANCIAL SERVICES IN THE NATURE OF MERGER, ACQUISITION, AND RESTRUCTURING (U.S. CLS. 100, 101 AND 102).

FIRST USE 6-30-2002; IN COMMERCE 6-30-2002.

2,729,995. TOMOTHERAPY INCORPORATED, MADISON, WI. SN 76-219,829. PUB. 6-18-2002, FILED 3-5-2001.

TOMOTHERAPY HI ART

NO CLAIM IS MADE TO THE EXCLUSIVE RIGHT TO USE "ART", APART FROM THE MARK AS SHOWN.

CLASS 9—ELECTRICAL AND SCIENTIFIC APPARATUS

FOR SOFTWARE TO SUPPORT THE PLANNING, DELIVERY AND ANALYSIS OF INTENSITY-MODULATED RADIATION THERAPY TO CANCER PATIENTS (U.S. CLS. 21, 23, 26, 36 AND 38).

FIRST USE 4-1-2002; IN COMMERCE 12-6-2002.

CLASS 10—MEDICAL APPARATUS

FOR MEDICAL APPARATUS TO DELIVER INTENSITY-MODULATED RADIATION THERAPY FOR CANCER TREATMENT (U.S. CLS. 26, 39 AND 44).

FIRST USE 4-1-2002; IN COMMERCE 12-6-2002.

2,729,997. NORTHLICH, INC., CINCINNATI, OH. SN 76-220,007. PUB. 6-4-2002, FILED 3-5-2001.

INVENTUREWORKS

CLASS 41—EDUCATION AND ENTERTAINMENT

FOR EDUCATIONAL SERVICES, NAMELY CONDUCTING COURSES OF INSTRUCTION AT THE COLLEGE LEVEL IN THE FIELDS OF NEW PRODUCT RESEARCH, DESIGN AND DEVELOPMENT; BRAND DEVELOPMENT; BUSINESS MARKETING AND ADVERTISING STRATEGIES; CONSUMER BEHAVIOR RESEARCH; TRADE CHANNEL RESEARCH; PREPARING ADVERTISING FOR OTHERS; RETAIL STORE AND RETAIL STORE ENVIRONMENT DESIGN; PRODUCT PACKAGING DESIGN; BUSINESS DEVELOPMENT PLANS; AND BUSINESS MARKETING CONSULTATION (U.S. CLS. 100, 101 AND 107).

FIRST USE 1-0-2001; IN COMMERCE 1-0-2001.

CLASS 42—SCIENTIFIC, COMPUTER AND LEGAL SERVICES

FOR RESEARCH AND DEVELOPMENT OF NEW PRODUCTS FOR OTHERS; DESIGN AND TESTING OF NEW PRODUCTS FOR OTHERS (U.S. CLS. 100 AND 101).

FIRST USE 1-0-2001; IN COMMERCE 1-0-2001.

2,730,002. JAYS FOODS, L.L.C., CHICAGO, IL. SN 76-222,460. PUB. 7-16-2002, FILED 3-9-2001.

JAYS ZESTIDOS

OWNER OF U.S. REG. NOS. 711,947 AND 711,948.

CLASS 29—MEATS AND PROCESSED FOODS

FOR CHEESE DIP (U.S. CL. 46).
FIRST USE 6-5-2001; IN COMMERCE 6-5-2001.

CLASS 30—STAPLE FOODS

FOR TORTILLA CHIPS, CORN CHIPS AND SALSA (U.S. CL. 46).
FIRST USE 8-1-2002; IN COMMERCE 8-1-2002.

2,730,021. IPSUM NETWORKS, INC., NEWTON, PA. SN 76-233,933. PUB. 9-10-2002, FILED 3-30-2001.

IPSUM NETWORKS

NO CLAIM IS MADE TO THE EXCLUSIVE RIGHT TO USE "NETWORKS", APART FROM THE MARK AS SHOWN.

CLASS 9—ELECTRICAL AND SCIENTIFIC APPARATUS

FOR COMPUTER HARDWARE AND SOFTWARE FOR USE IN PROVIDING SECURITY, DIAGNOSTIC CONTROL AND MONITORING OF DATA; AND COMPUTER HARDWARE AND SOFTWARE FOR USE IN PROVIDING SECURITY, DIAGNOSTIC CONTROL, MAINTENANCE, REPAIR AND MONITORING OF THIRD PARTY COMPUTER SYSTEMS AND INFORMATION NETWORKS (U.S. CLS. 21, 23, 26, 36 AND 38).

FIRST USE 4-29-2002; IN COMMERCE 1-27-2003.

CLASS 37—CONSTRUCTION AND REPAIR

FOR COMPUTER HARDWARE INSTALLATION, REPAIR AND MAINTENANCE SERVICES (U.S. CLS. 100, 103 AND 106).

FIRST USE 4-29-2002; IN COMMERCE 1-27-2003.

CLASS 42—SCIENTIFIC, COMPUTER AND LEGAL SERVICES

FOR COMPUTER SERVICES, NAMELY, COMPUTER PROGRAMMING FOR OTHERS, DESIGNING, INSTALLING, UPDATING, AND MAINTAINING COMPUTER SOFTWARE FOR OTHERS, TECHNICAL CONSULTATION AND RESEARCH IN THE FIELD OF COMPUTER SOFTWARE DEVELOPMENT, VIA GLOBAL COMPUTER NETWORK (U.S. CLS. 100 AND 101).

FIRST USE 4-29-2002; IN COMMERCE 1-27-2003.

2,730,027. ROBICON CORPORATION, NEW KENSINGTON, PA. SN 76-235,932. PUB. 7-2-2002, FILED 4-5-2001.



The logo for AS/Robicon features the text "AS/Robicon" in a bold, sans-serif font. A thick, black, curved line arches over the text, starting from the left and ending on the right, resembling a stylized 'A' or a protective shield.

OWNER OF U.S. REG. NOS. 1,653,375, 2,119,704, AND 2,204,849.

CLASS 7—MACHINERY

FOR INDUCTION AND DIRECT CURRENT MOTORS, SYNCHRONOUS MOTORS AND ELECTRICAL GENERATORS FOR POWERING OF INDUSTRIAL MACHINERY (U.S. CLS. 13, 19, 21, 23, 31, 34 AND 35).
FIRST USE 9-0-2002; IN COMMERCE 9-0-2002.

CLASS 9—ELECTRICAL AND SCIENTIFIC APPARATUS

FOR LOW VOLTAGE AND MEDIUM VOLTAGE VARIABLE FREQUENCY DRIVES FOR THE CONTROL OF INDUCTION AND SYNCHRONOUS MOTORS; DIRECT CURRENT DRIVES FOR THE CONTROL OF DC MOTORS; ELECTRICAL POWER SUPPLIES AND ELECTRICAL POWER CONTROL SYSTEMS COMPRISED OF ELECTRICAL TRANSFORMERS, POWER SEMICONDUCTORS, DC AND AC POWER CONVERTERS, AND CONTROL CIRCUITRY FOR THE CONTROL OF STATIC INDUSTRIAL PROCESS APPLICATIONS; APPLICATION SOFTWARE FOR THE CONTROL OF VARIABLE FREQUENCY AND DIRECT CURRENT DRIVES IN INDUSTRIAL APPLICATIONS (U.S. CLS. 21, 23, 26, 36 AND 38).

FIRST USE 2-0-2002; IN COMMERCE 2-0-2002.

CLASS 37—CONSTRUCTION AND REPAIR

FOR INSTALLATION AND REPAIR OF LOW VOLTAGE AND MEDIUM VOLTAGE VARIABLE FREQUENCY DRIVES, DIRECT CURRENT DRIVES, INDUCTION AND DIRECT CURRENT MOTORS AND GENERATORS FOR POWERING OF INDUSTRIAL MACHINERY, ELECTRICAL POWER SUPPLIES AND POWER CONTROL SYSTEMS FOR THE CONTROL OF STATIC INDUSTRIAL PROCESS APPLICATION (U.S. CLS. 100, 103 AND 106).

FIRST USE 1-0-2002; IN COMMERCE 1-0-2002.

CLASS 42—SCIENTIFIC, COMPUTER AND LEGAL SERVICES

FOR INSTALLATION AND REPAIR OF APPLICATION SOFTWARE FOR THE CONTROL OF VARIABLE FREQUENCY AND DIRECT CURRENT DRIVES IN INDUSTRIAL APPLICATIONS (U.S. CLS. 100 AND 101).

FIRST USE 9-0-2002; IN COMMERCE 9-0-2002.

2,730,051. AMERISERV FINANCIAL, INC., JOHNSON, PA, BY CHANGE OF NAME USBANCORP, INC., JOHNSTOWN, PA. SN 76-243,747. PUB. 10-9-2001, FILED 4-19-2001.

AMERISERV ASSOCIATES

NO CLAIM IS MADE TO THE EXCLUSIVE RIGHT TO USE "ASSOCIATES", APART FROM THE MARK AS SHOWN.

CLASS 35—ADVERTISING AND BUSINESS

FOR ASSET AND LIABILITY MANAGEMENT SERVICES AND CONSULTING (U.S. CLS. 100, 101 AND 102).

FIRST USE 5-7-2001; IN COMMERCE 5-7-2001.

CLASS 36—INSURANCE AND FINANCIAL

FOR PORTFOLIO AND INVESTMENT CONSULTING SERVICES (U.S. CLS. 100, 101 AND 102).

FIRST USE 5-7-2001; IN COMMERCE 5-7-2001.

2,730,036. BARNES & NOBLE, INC., NEW YORK, NY. SN 76-238,934. PUB. 4-23-2002, FILED 4-5-2001.

PUNCTUATE!**CLASS 9—ELECTRICAL AND SCIENTIFIC APPARATUS**

FOR CD AND DVD HOLDERS, MOUSE PADS AND MAGNETS (U.S. CLS. 21, 23, 26, 36 AND 38).

FIRST USE 9-1-2000; IN COMMERCE 9-1-2000.

CLASS 14—JEWELRY

FOR WATCHES, CLOCKS AND COMBINATION CLOCKS AND CALCULATORS (U.S. CLS. 2, 27, 28 AND 50).

FIRST USE 9-1-2000; IN COMMERCE 9-1-2000.

CLASS 16—PAPER GOODS AND PRINTED MATTER

FOR PAPER WEIGHTS, PUSH PINS, ADDRESS BOOKS, STATIONERY, LAP DESKS, PORTABLE WRITING TABLES, PAPER GIFT BAGS, CORK BOARDS, BOOK ENDS AND BOOK HOLDERS, DOCUMENT HOLDERS AND PHOTOGRAPH ALBUMS; SUEDE AND LEATHER CHECK BOOK, BUSINESS CARD, ADDRESS BOOK AND CREDIT CARD CASES AND COVERS (U.S. CLS. 2, 5, 22, 23, 29, 37, 38 AND 50).

FIRST USE 9-1-2000; IN COMMERCE 9-1-2000.

CLASS 18—LEATHER GOODS

FOR BOOK BAGS AND SCHOOL BOOK BAGS (U.S. CLS. 1, 2, 3, 22 AND 41).

FIRST USE 9-1-2000; IN COMMERCE 9-1-2000.

CLASS 21—HOUSEWARES AND GLASS

FOR STORAGE BOXES MADE OF SILK (U.S. CLS. 2, 13, 23, 29, 30, 33, 40 AND 50).

FIRST USE 9-1-2000; IN COMMERCE 9-1-2000.

2,730,054. SPORTS EXPRESS, L.L.C., HOUSTON, TX. SN 76-244,023. PUB. 6-25-2002, FILED 4-20-2001.

SPORTS EXPRESS

NO CLAIM IS MADE TO THE EXCLUSIVE RIGHT TO USE "EXPRESS", APART FROM THE MARK AS SHOWN.

CLASS 35—ADVERTISING AND BUSINESS

FOR COMPUTERIZED TRACKING AND TRACING OF FREIGHT, LUGGAGE AND CARGO IN TRANSIT FOR TRAVELERS; PROVIDING COST ESTIMATES AND AVAILABILITY FOR THE PICK UP, TRANSPORTATION AND DELIVERY OF LUGGAGE AND CARGO FROM ONE PLACE TO ANOTHER FOR TRAVELERS AND THE TRACING AND TRACKING THEREOF OFFERED ON A GLOBAL COMPUTER NETWORK (U.S. CLS. 100, 101 AND 102).

FIRST USE 2-18-2002; IN COMMERCE 2-18-2002.

CLASS 39—TRANSPORTATION AND STORAGE

FOR ARRANGING FOR THE PICK UP, TRANSPORTATION AND DELIVERY OF LUGGAGE AND CARGO FROM ONE PLACE TO ANOTHER FOR TRAVELERS; ARRANGING FOR THE PICK UP, TRANSPORTATION AND DELIVERY OF LUGGAGE AND CARGO FROM ONE PLACE TO ANOTHER FOR TRAVELERS OFFERED ON A GLOBAL COMPUTER NETWORK (U.S. CLS. 100 AND 105).

FIRST USE 2-18-2002; IN COMMERCE 2-18-2002.

2,730,064. NEWCOMB OIL CO. LLC, BARDSTOWN, KY. SN 76-248,357. PUB. 8-27-2002, FILED 4-30-2001.

2,730,069. VANMOOR, ARTHUR, BOCA RATON, FL. SN 76-252,979. PUB. 7-2-2002, FILED 5-7-2001.

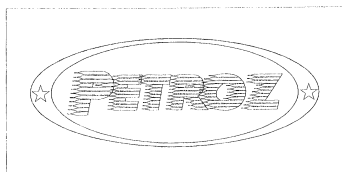

THE LINING SHOWN IN THE DRAWING IS A FEATURE OF THE MARK AND IS NOT INTENDED TO INDICATE COLOR.

THE WORD "PETROZ" IS IN RED STYLIZED LETTERS, WITHIN AN ELONGATED YELLOW OVAL; THE OVAL IS OUTLINED IN RED, WITH A YELLOW STAR WITHIN THE RED OUTLINE AT EACH END OF THE OVAL; THE OVAL AND OUTLINE ARE WITHIN A BLUE RECTANGLE.

CLASS 4—LUBRICANTS AND FUELS

FOR GASOLINE (U.S. CLS. 1, 6 AND 15).
FIRST USE 3-27-2001; IN COMMERCE 3-27-2001.

CLASS 35—ADVERTISING AND BUSINESS

FOR GASOLINE SERVICE STATIONS, NAMELY, RETAIL GASOLINE SUPPLY SERVICES (U.S. CLS. 100, 101 AND 102).

FIRST USE 3-27-2001; IN COMMERCE 3-27-2001.

2,730,068. @STAKE, INC., CAMBRIDGE, MA. SN 76-252,873. PUB. 6-18-2002, FILED 5-7-2001.

SMARTRISK

CLASS 35—ADVERTISING AND BUSINESS

FOR BUSINESS CONSULTING SERVICES, NAMELY, PROVIDING INFORMATION AND NETWORK SECURITY CONSULTING SERVICES, INCLUDING SYSTEMS EVALUATION AND SYSTEMS AUDITING SERVICES (U.S. CLS. 100, 101 AND 102).

FIRST USE 9-1-2001; IN COMMERCE 9-1-2001.

CLASS 42—SCIENTIFIC, COMPUTER AND LEGAL SERVICES

FOR SYSTEMS PLANNING AND DESIGN SERVICES, SYSTEMS ARCHITECTURE SERVICES, SYSTEMS INTEGRATION SERVICES, AND SYSTEMS TESTING; MAINTENANCE OF COMPUTER SYSTEMS; COMPUTER SYSTEM INTRUSION DETECTION AND MONITORING SERVICES (U.S. CLS. 100 AND 101).

FIRST USE 9-1-2001; IN COMMERCE 9-1-2001.

IFO

CLASS 12—VEHICLES

FOR VEHICLES, NAMELY, AIRPLANES, HELICOPTERS, GLIDERS, MOTORIZED BLIMPS, ZEPPELINS, AND VEHICULAR AIR OR GAS BALLOONS; AND PARACHUTES (U.S. CLS. 19, 21, 23, 31, 35 AND 44).

FIRST USE 12-1-2002; IN COMMERCE 12-1-2002.

CLASS 28—TOYS AND SPORTING GOODS

FOR HANG GLIDERS; HANG GLIDERS POWERED BY A MOTORIZED BACKPACK; AND PARAGLIDERS (U.S. CLS. 22, 23, 38 AND 50).

FIRST USE 12-1-2002; IN COMMERCE 12-1-2002.

2,730,086. XPAYS, INC., SAN FRANCISCO, CA. SN 76-259,651. PUB. 9-11-2001, FILED 5-21-2001.

XTHREADZ

CLASS 9—ELECTRICAL AND SCIENTIFIC APPARATUS

FOR DJ SLIPMATS (U.S. CLS. 21, 23, 26, 36 AND 38).
FIRST USE 10-21-2002; IN COMMERCE 10-21-2002.

CLASS 18—LEATHER GOODS

FOR SHOULDER BAGS, GYM BAGS AND ALL PURPOSE SPORTS BAGS (U.S. CLS. 1, 2, 3, 22 AND 41).
FIRST USE 10-21-2002; IN COMMERCE 10-21-2002.

CLASS 28—TOYS AND SPORTING GOODS

FOR SKATEBOARDS AND FOOTBALL TABLES (U.S. CLS. 22, 23, 38 AND 50).

FIRST USE 10-21-2002; IN COMMERCE 10-21-2002.

CLASS 35—ADVERTISING AND BUSINESS

FOR PROMOTING THE GOODS AND SERVICES OF OTHERS BY PREPARING AND PLACING ADVERTISEMENTS VIA THE GLOBAL COMPUTER NETWORK (U.S. CLS. 100, 101 AND 102).

FIRST USE 10-21-2002; IN COMMERCE 10-21-2002.

2,730,101. VISIBLE WORLD, INC., NEW YORK, NY. SN 76-262,593. PUB. 7-9-2002, FILED 5-25-2001.

INTELLISPOT

CLASS 35—ADVERTISING AND BUSINESS

FOR ADVERTISING SERVICES, NAMELY, DIRECT MEDIA ADVERTISING AND PROMOTING THE GOODS AND SERVICES OF OTHERS WITH CUSTOMIZED VIDEO VIA ADDRESSABLE VIDEO DELIVERY NETWORKS, NAMELY, CABLE SYSTEMS, SATELLITE BROADCASTS, STREAMING VIDEO AND INTERNET; AND ASSEMBLING AUDIO-VISUAL ADVERTISING DISPLAYS (U.S. CLS. 100, 101 AND 102).

FIRST USE 2-1-2001; IN COMMERCE 2-1-2001.

CLASS 38—COMMUNICATION

FOR TELECOMMUNICATIONS SERVICES, NAMELY, DELIVERING AUDIO-VISUAL ADVERTISING DISPLAYS VIA ADDRESSABLE VIDEO NETWORKS, NAMELY, CABLE SYSTEMS, SATELLITE BROADCASTS, STREAMING VIDEO AND INTERNET (U.S. CLS. 100, 101 AND 104).

FIRST USE 2-1-2001; IN COMMERCE 2-1-2001.

CLASS 40—MATERIAL TREATMENT

FOR CUSTOMIZING AUDIO-VISUAL ADVERTISING DISPLAYS (U.S. CLS. 100, 103 AND 106).

FIRST USE 2-1-2001; IN COMMERCE 2-1-2001.

2,730,158. JOB CONNECTION, INC., THE, EL PASO, TX. SN 76-279,814. PUB. 4-9-2002, FILED 7-5-2001.

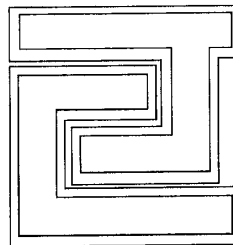

THE MARK CONSISTS OF BLOCKED INTERTWINED LETTERS "J" AND "C" IN PANTONE BLUE 072U WITH A METALLIC SILVER OUTLINE. ADDITIONALLY, THE COLORS WILL BE SHADED TO CREATE A RAISED THREE DIMENSIONAL EFFECT.

2,730,148. JAMES INDUSTRIES, INC., HOLLIDAYSBURG, PA. SN 76-277,608. PUB. 8-20-2002, FILED 6-27-2001.

SLINKY SCIENCE

OWNER OF U.S. REG. NOS. 427,951, 2,265,735, AND OTHERS.

NO CLAIM IS MADE TO THE EXCLUSIVE RIGHT TO USE "SCIENCE", APART FROM THE MARK AS SHOWN.

CLASS 9—ELECTRICAL AND SCIENTIFIC APPARATUS

FOR EDUCATIONAL SCIENCE KITS COMPOSED OF INGREDIENTS AND INSTRUMENTS FOR CONDUCTING EXPERIMENTS AND CONSTRUCTING A SCIENTIFIC ITEM FOR OBSERVING AND TESTING BASIC SCIENTIFIC PRINCIPLES NAMELY, MAGNIFYING GLASSES, MAGNETS, MEASURING SPOONS, THERMOMETERS, DIODES, CAPACITORS, ELECTRODES, INTEGRATED CIRCUITS, CIRCUIT BOARDS, AND PRINTED INSTRUCTION BOOKS FEATURING EXPERIMENTS SOLD AS A UNIT (U.S. CLS. 21, 23, 26, 36 AND 38).

FIRST USE 4-26-2001; IN COMMERCE 4-26-2001.

CLASS 16—PAPER GOODS AND PRINTED MATTER

FOR PRINTED EDUCATIONAL AND TEACHING MATERIALS, NAMELY PRE-PACKAGED SCIENCE KITS COMPOSED PRIMARILY OF PRINTED INSTRUCTION BOOKLETS FOR CONDUCTING EXPERIMENTS AND CONSTRUCTING SCIENTIFIC ITEMS FOR OBSERVING AND TESTING BASIC SCIENTIFIC PRINCIPLES; FINGERPRINT KITS; ACTIVITY BOOKS (U.S. CLS. 2, 5, 22, 23, 29, 37, 38 AND 50).

FIRST USE 4-26-2001; IN COMMERCE 4-26-2001.

CLASS 28—TOYS AND SPORTING GOODS

FOR EDUCATIONAL TOY SCIENCE KITS FOR USE BY CHILDREN, NAMELY, TOY CHEMISTRY SETS, TOY PHYSICS SETS, TOY ASTRONOMY SETS, TOY EARTH SCIENCE SETS AND TOY GEOLOGY SETS; PUZZLES (U.S. CLS. 22, 23, 38 AND 50).

FIRST USE 4-26-2001; IN COMMERCE 4-26-2001.

CLASS 35—ADVERTISING AND BUSINESS

FOR EMPLOYMENT HIRING, RECRUITING, PLACEMENT AND STAFFING; EMPLOYMENT OUTPLACEMENT SERVICES; AND EMPLOYMENT VERIFICATION SERVICES (U.S. CLS. 100, 101 AND 102).

FIRST USE 8-1-2000; IN COMMERCE 8-1-2000.

CLASS 42—SCIENTIFIC, COMPUTER AND LEGAL SERVICES

FOR PRE-EMPLOYMENT BACKGROUND INVESTIGATION SERVICES; AND PRIVATE INVESTIGATION SERVICES (U.S. CLS. 100 AND 101).

FIRST USE 8-1-2000; IN COMMERCE 8-1-2000.

2,730,168. CERTIPORT, INC., AMERICAN FORK, UT, BY CHANGE OF NAME NIVO INTERNATIONAL CORPORATION, AMERICAN FORK, UT. SN 76-283,587. PUB. 7-23-2002, FILED 7-9-2001.

**CLASS 41—EDUCATION AND ENTERTAINMENT**

FOR EDUCATIONAL SERVICES, NAMELY, CONDUCTING TRAINING CLASSES IN THE FIELD OF COMPUTER SOFTWARE AND HARDWARE (U.S. CLS. 100, 101 AND 107).

FIRST USE 1-9-2002; IN COMMERCE 1-9-2002.

CLASS 42—SCIENTIFIC, COMPUTER AND LEGAL SERVICES

FOR TESTING AND EVALUATION OF COMPUTER OPERATORS (U.S. CLS. 100 AND 101).
FIRST USE 1-9-2002; IN COMMERCE 1-9-2002.

2,730,170. SOUND PRESS LLC, THE, CINCINNATI, OH. SN 76-283,820. PUB. 5-14-2002, FILED 7-10-2001.

WORSHIP@WORK**CLASS 9—ELECTRICAL AND SCIENTIFIC APPARATUS**

FOR PRE-RECORDED AUDIO CDS, CD-ROMS, DVDS, DIGITAL AUDIO TAPES, VIDEO CASSETTES, PHONOGRAPH RECORDS AND SOUND RECORDINGS FEATURING RELIGIOUS MUSIC (U.S. CLS. 21, 23, 26, 36 AND 38).
FIRST USE 9-27-2001; IN COMMERCE 9-27-2001.

CLASS 41—EDUCATION AND ENTERTAINMENT

FOR EDUCATIONAL SERVICES; NAMELY, CONDUCTING CONFERENCES, SEMINARS AND CLASSES FOCUSED ON MUSIC, WORSHIP TO GOD, AND INSTRUCTION OF GOD'S PRINCIPLES (U.S. CLS. 100, 101 AND 107).
FIRST USE 9-27-2001; IN COMMERCE 5-8-2002.

2,730,178. HORIBA, LTD., KYOTO, JAPAN. SN 76-287,088. PUB. 7-23-2002, FILED 7-18-2001.

EXPLORE THE FUTURE**CLASS 9—ELECTRICAL AND SCIENTIFIC APPARATUS**

FOR ANALYTICAL INSTRUMENTS FOR OPTICAL SYSTEMS, NAMELY, IMAGING SPECTROMETERS, CHARGED COUPLE DEVICE DETECTORS, SINGLE CHANNEL DETECTORS, COMPACT MONOCHROMATORS, AND DOUBLE MONOCHROMATORS; ANALYTICAL INSTRUMENTS FOR THIN FILM CHARACTERIZATION, NAMELY, SPECTROSCOPIC ELLIPSOMETERS, END-POINT DETECTORS, CLUSTER TOOL PROCESS CONTROLLERS, OPTICAL EMISSION SPECTROMETERS, LASER AND WHITE LIGHT INTERFEROMETRY APPARATUS; LANGMUIR PROBES FOR PLASMA DIAGNOSTICS; RAMAN SPECTROSCOPY INSTRUMENTS FOR USE IN LABORATORY RESEARCH; RAMAN SPECTROSCOMETERS FOR USE IN IDENTIFYING LAB SAMPLES, PROCESS STREAM MONITORING, MONITORING PEROXIDE LEVELS, MONITORING CERAMIC MATERIALS, MONITORING THERMAL DECOMPOSITION, DETERMINING QUALITY OF ISOMERS, QUALITY OF CELLULOSE FIBERS, QUALITY OF THE MANUFACTURING PROCESS OF PHARMACEUTICALS, AND FOR VERIFICATION OF GEMS; RAMAN SPECTROMETERS FOR USE IN ONLINE ANALYSIS AND PROCESS MONITORING; SPECTROFLUOROMETERS FOR USE IN MEASURING MOLECULAR FLUORESCENCE IN ANY LIGHT MEASUREMENT IN THE ULTRAVIOLET THROUGH INFRARED SPECTRUM, NAMELY, FLUORESCENCE SPECTROPHOTOMETER; FREQUENCY DOMAIN LIFETIME SPECTROPHOTOMETER FOR PERFORMING PICOSECOND ANISOTROPY AND MEASURING PICOSECOND LIFETIMES; SPECTROMETERS FOR MEASURING TOTAL SPECTRAL CHARACTERIZATION; A DEVICE USED TO PERFORM FIBER-OPTIC MEASUREMENTS, NAMELY, FIBER-OPTIC SPECTRO-

FLUOROMETER; ORIGINAL EQUIPMENT MANUFACTURER DIFFRACTION GRATINGS AND ASSEMBLIES, NAMELY, DIFFRACTION GRATINGS, ORIGINAL EQUIPMENT MONOCHROMATORS, ORIGINAL EQUIPMENT MANUFACTURER SPECTROGRAPHS, AND WAVELENGTH DIVISION MULTIPLEXERS; LABORATORY EQUIPMENT, NAMELY, POLARIMETERS; RADIATION SURVEY METER; PYROELECTRIC INFRARED DETECTORS; NON-CONTACT INFRARED THERMOMETER; CHEMICAL CONCENTRATION MONITOR; OIL CONTENT ANALYZER; ANALYTICAL AND MEASURING APPARATUS AND INSTRUMENTS FOR GENERAL PURPOSES, NAMELY, PH METERS, CONDUCTIVITY METERS, SALT METERS, ION METERS, OXYGEN METERS, SALINITY CHECKERS, PH ELECTRODES, ION SELECTIVE ELECTRODES, NON-CONTACT INFRARED THERMOMETERS; APPARATUS AND INSTRUMENTS FOR PROCESS CONTROL AND ENERGY, NAMELY, PROCESS PH/OXIDATION-REDUCTION POTENTIAL ANALYZERS, PH SENSOR ASSEMBLIES, PH ANALYZERS, CONDUCTIVITY MONITORS, DISSOLVED OXYGEN MONITORS, TURBIDITY MONITORS, SILICA MONITORS, SILICA ANALYZERS, DISSOLVED OXYGEN ANALYZERS, TRACE SODIUM ION MONITORS, HYDRAZINE MONITORS, PHOSPHATE ANALYZERS, PROCESS GAS ANALYZERS, THERMAL CONDUCTIVITY GAS OR HYDROGEN ANALYZERS, MAGNETOPNEUMATIC OXYGEN ANALYZERS, PARAMAGNETIC OXYGEN ANALYZERS, BURNER EMISSION ANALYZERS, INFRARED GAS ANALYZERS; ELECTRONIC AND INFORMATION APPARATUS AND INSTRUMENTS FOR ELECTRONICS, NEW MATERIAL AND SEMICONDUCTOR INDUSTRIES, NAMELY, ENERGY DISPERSIVE XRAY ANALYZERS, X-RAY FLUORESCENCE ANALYZERS, CARBON ANALYZERS, CARBON/SULFUR ANALYZERS OXYGEN/NITROGEN/HYDROGEN ANALYZERS, PARTICLE SIZE DISTRIBUTION ANALYZERS, GAS PYCNOMETERS, RETICLE/MASK PARTICLE DETECTION SYSTEMS COMPRISING LASER SCATTERING AND PATTERN DISCRIMINATION AND MAPPING ON CATHODE RAY TUBES, WAFER FLATNESS ANALYZERS, LIQUID PARTICLE COUNTER, ULTRA-PURE WATER MONITORS, TRACE GAS MONITORS, SEMICONDUCTOR IMPURITY ANALYZERS, MASS FLOW CONTROLLERS, VAPORIZED LIQUID SOURCE CONTROL SYSTEMS COMPRISING MASS FLOW CONTROLLERS FOR DELIVERY OF VAPOR PRESSURE LIQUID, OPTICAL CRYSTALS, SCINTILLATION CRYSTALS, X-RAY DETECTORS, PYROELECTRIC INFRARED DETECTORS, THERMOPILE DETECTORS, INTELLIGENT TACHOMETERS; APPARATUS AND INSTRUMENTS FOR FOOD INDUSTRY, AGRICULTURE, FORESTRY AND FISHERIES, NAMELY, SALINITY METERS, CALCIUM HARDNESS METERS, DISSOLVED OXYGEN CHECKERS, PLANT PHOTOSYNTHESIS ANALYZERS; LIVING ENVIRONMENT AND POLLUTION MONITORING AND ANALYZING APPARATUS AND INSTRUMENTS, NAMELY, MONITORS TO MEASURE GAS AND DUST; APPARATUS AND INSTRUMENTS FOR VEHICLE ENGINES, NAMELY, AUTOMOTIVE EMISSION ANALYSIS SYSTEMS COMPRISING FLOW CONTROLLER AND ANALYZERS, VOLUME SAMPLERS, AUTOMOTIVE EMISSION ANALYZERS, INFRARED GAS ANALYZERS, AIR-FUEL RATIO ANALYZERS, VEHICLE EMISSION TEST SYSTEMS COMPRISING COMPUTER HARDWARE AND SOFTWARE PROCESSING EMISSIONS DATA, EMISSION TEST PROCESSORS, ENGINE PERFORMANCE TEST SYSTEMS COMPRISING ANALYZERS FOR DATA COLLECTION AND PROCESSING, DIRECT CURRENT CHASSIS DYNAMOMETERS, SEALED HOUSING FOR EVAPORATIVE DETERMINATION, GAS PURIFIERS AND GAS DIVIDERS; ANALYZERS CONSISTING OF COMPUTERS AND COMPUTER PROGRAMS FOR USE IN BLOOD ANALYSIS FOR DIAGNOSTIC PURPOSES; ELECTRONIC BLOOD ANALYZERS; ELECTRONIC BLOOD SAMPLE ANALYZERS; MEASURING APPARATUS AND INSTRUMENTS USED IN CONJUNCTION WITH COLORS, GLOSS AND SURFACE CHARACTERISTICS, NAMELY, REFLECTOMETERS AND PARTS THERE-

FOR; WATERPROOF, ELECTRONIC SENSING SYSTEM COMPRISING SENSORS, ELECTRONIC HARDWARE, INSIGNAL CONDITIONING SOFTWARE FOR MEASUREMENT IN ON-LINE TRANSMISSION OF WATER QUALITY PARAMETERS, INCLUDING TEMPERATURE, DESOLVED OXYGEN, PH LEVEL AND SPECIFIC CONDUCTANCE, OXIDATION REDUCTION POTENTIAL, AMMONIUM ION, DEPTH AND TURBIDITY; INDUSTRIAL EQUIPMENT, NAMELY, AN EMISSION CONTROL UNIT USED TO PURIFY VOLATILE ORGANIC COMPOUNDS AND HAZARDOUS AIR POLLUTANTS LATENT GASES (U.S. CLS. 21, 23, 26, 36 AND 38).
FIRST USE 3-4-2001; IN COMMERCE 3-4-2001.

CLASS 10—MEDICAL APPARATUS

FOR MEDICAL ANALYSIS APPARATUS AND INSTRUMENTS, NAMELY, BLOOD SAMPLE ANALYZERS, BLOOD SAMPLE HOLDERS, BLOOD SAMPLE HANDLERS, BLOOD SAMPLE NEEDLES, SYRINGES, SYRINGE NEEDLES; HEMATINETERS; BLOOD TESTING APPARATUS; DIAGNOSTIC APPARATUS FOR MEDICAL PURPOSES, NAMELY, BLOOD CELL COUNTERS (U.S. CLS. 26, 39 AND 44).
FIRST USE 3-4-2001; IN COMMERCE 3-4-2001.

CLASS 37—CONSTRUCTION AND REPAIR

FOR REPAIR AND MAINTENANCE SERVICES FOR ANALYTICAL AND MEASURING APPARATUS AND INSTRUMENTS FOR GENERAL PURPOSES, NAMELY, PH METERS, CONDUCTIVITY METERS, SALT METERS, ION METERS, OXYGEN METERS, SALINITY CHECKERS, PH ELECTRODES, ION SELECTIVE ELECTRODES, NONCONTACT INFRARED THERMOMETERS; APPARATUS AND INSTRUMENTS FOR PROCESS CONTROL AND ENERGY, NAMELY, PROCESS PH/OXIDATION-REDUCTION POTENTIAL ANALYZERS, PH SENSOR ASSEMBLIES, PH ANALYZERS, CONDUCTIVITY MONITORS, DISSOLVED OXYGEN MONITORS, TURBIDITY MONITORS, SILICA MONITORS, SILICA ANALYZERS, DISSOLVED OXYGEN ANALYZERS, TRACE SODIUM ION MONITORS, HYDRAZINE MONITORS, PHOSPHATE ANALYZERS, PROCESS GAS ANALYZERS, THERMAL CONDUCTIVITY GAS OR HYDROGEN ANALYZERS, MAGNETOPNEUMATIC OXYGEN ANALYZERS, PARAMAGNETIC OXYGEN ANALYZERS, BURNER EMISSION ANALYZERS, INFRARED GAS ANALYZERS; ELECTRONIC AND INFORMATION APPARATUS AND INSTRUMENTS FOR ELECTRONICS, NEW MATERIAL AND SEMICONDUCTOR INDUSTRIES, NAMELY, ENERGY DISPERSIVE X-RAY ANALYZERS, X-RAY FLUORESCENCE ANALYZERS, CARBON ANALYZERS, CARBON/SULFUR ANALYZERS OXYGEN/NITROGEN/HYDROGEN ANALYZERS, PARTICLE SIZE DISTRIBUTION ANALYZERS, GAS PYCNOMETERS, RETICLE/MASK PARTICLE DETECTION SYSTEMS, WAFER FLATNESS ANALYZERS, LIQUID PARTICLE COUNTER, ULTRA-PURE WATER MONITORS, TRACE GAS MONITORS, SEMICONDUCTOR IMPURITY ANALYZERS, MASS FLOW CONTROLLERS, VAPORIZED LIQUID SOURCE CONTROL SYSTEMS, OPTICAL CRYSTALS, SCINTILLATION CRYSTALS, X-RAY DETECTORS, PYROELECTRIC INFRARED DETECTORS, THERMOPILE DETECTORS, INTELLIGENT TACHOMETERS; APPARATUS AND INSTRUMENTS FOR FOOD INDUSTRY, AGRICULTURE, FORESTRY AND FISHERIES, NAMELY, SALINITY METERS, CALCIUM HARDNESS METERS, DISSOLVED OXYGEN CHECKERS, PLANT PHOTOSYNTHESIS ANALYZERS; LIVING ENVIRONMENT AND POLLUTION MONITORING AND ANALYZING APPARATUS AND INSTRUMENTS; APPARATUS AND INSTRUMENTS FOR VEHICLE ENGINES, NAMELY, AUTOMOTIVE EMISSION ANALYSIS SYSTEMS, VOLUME SAMPLERS, AUTOMOTIVE EMISSION ANALYZERS, INFRARED GAS ANALYZERS, AIRFUEL RATIO ANALYZERS, VEHICLE EMISSION TEST SYSTEMS, EMISSION TEST PROCESSORS, ENGINE PERFORMANCE TEST SYSTEMS, DIRECT CURRENT CHASSIS DYNAMO-METERS, SEALED HOUSING FOR EVAPORATIVE DETERMINATION, GAS PURIFIERS AND GAS DIVIDERS; ANALYTICAL INSTRUMENTS FOR OPTICAL SYSTEMS, NAMELY, IMAGING SPECTROMETERS, CHARGED COUPLE DEVICE DETECTORS, SINGLE CHANNEL DETECTORS, COMPACT MONOCHROMATORS, AND DOUBLE MONOCHROMA-

TORS; ANALYTICAL INSTRUMENTS FOR THIN FILM CHARACTERIZATION, NAMELY, SPECTROSCOPIC ELIPSOMETERS, END-POINT DETECTORS, CLUSTER TOOL PROCESS CONTROLLERS, OPTICAL EMISSION SPECTROMETERS, LASER AND WHITE LIGHT INTERFEROMETRY APPARATUS; LANGMUIR PROBES FOR PLASMA DIAGNOSTICS; RAMAN SPECTROSCOPY INSTRUMENTS FOR USE IN LABORATORY RESEARCH; RAMAN SPECTROSCOMETERS FOR USE IN IDENTIFYING LAB SAMPLES, PROCESS STREAM MONITORING, MONITORING PEROXIDE LEVELS, MONITORING CERAMIC MATERIALS, MONITORING THERMAL DECOMPOSITION, DETERMINING QUALITY OF ISOMERS, QUALITY OF CELLULOSE FIBERS, QUALITY OF THE MANUFACTURING PROCESS OF PHARMACEUTICALS, AND FOR VERIFICATION OF GEMS; RAMAN SPECTROMETERS FOR USE IN ON-LINE ANALYSIS AND PROCESS MONITORING; SPECTROFLUOROMETERS FOR USE IN MEASURING MOLECULAR FLUORESCENCE IN ANY LIGHT MEASUREMENT IN THE ULTRAVIOLET THROUGH INFRARED SPECTRUM, NAMELY, FLUORESCENCE SPECTROPHOTOMETER; FREQUENCY DOMAIN LIFETIME SPECTROPHOTOMETER FOR PERFORMING PICOSECOND ANISOTROPY AND MEASURING PICOSECOND LIFETIMES; SPECTROMETERS FOR MEASURING TOTAL SPECIAL CHARACTERIZATION; A DEVICE USED TO PERFORM FIBER-OPTIC MEASUREMENTS, NAMELY, FIBER-OPTIC SPECTROFLUOROMETER; ORIGINAL EQUIPMENT MANUFACTURER DIFFRACTION GRATINGS AND ASSEMBLIES, NAMELY, DIFFRACTION GRATINGS, ORIGINAL EQUIPMENT MANUFACTURER MONOCHROMATORS, ORIGINAL EQUIPMENT MANUFACTURER SPECTROGRAPHS, AND WAVELENGTH DIVISION MULTIPLEXERS; LABORATORY EQUIPMENT, NAMELY, POLARIMETERS; RADIATION SURVEY METER; PYROELECTRIC INFRARED DETECTORS; NON-CONTACT INFRARED THERMOMETER; CHEMICAL CONCENTRATION MONITOR; OIL CONTENT ANALYZER; ANALYZERS CONSISTING OF COMPUTERS AND COMPUTER PROGRAMS FOR USE IN BLOOD ANALYSIS FOR DIAGNOSTIC PURPOSES; ELECTRIC BLOOD ANALYZERS; ELECTRIC BLOOD SAMPLE ANALYZERS, MEDICAL APPARATUS AND INSTRUMENTS, NAMELY, BLOOD SAMPLE HANDLERS, BLOOD SAMPLE NEEDLES, SYRINGES, SYRINGE NEEDLES; HEMATINETERS; BLOOD TESTING APPARATUS; DIAGNOSTIC APPARATUS FOR MEDICAL PURPOSES, NAMELY, BLOOD CELL COUNTERS (U.S. CLS. 100, 103 AND 106).

FIRST USE 3-4-2001; IN COMMERCE 3-4-2001.

2,730,179. RALPH A. HILLER, COMPANY, EXPORT, PA. SN 76-287,283. PUB. 6-18-2002, FILED 7-18-2001.

INTELLIGENCE IN MOTION

CLASS 35—ADVERTISING AND BUSINESS

FOR WHOLESALE DISTRIBUTORSHIPS FEATURING FLUID POWER EQUIPMENT (U.S. CLS. 100, 101 AND 102).

FIRST USE 7-18-2002; IN COMMERCE 7-18-2002.

CLASS 37—CONSTRUCTION AND REPAIR

FOR MAINTENANCE AND REPAIR OF FLUID POWER EQUIPMENT (U.S. CLS. 100, 103 AND 106).

FIRST USE 7-18-2002; IN COMMERCE 7-18-2002.

CLASS 40—MATERIAL TREATMENT

FOR CUSTOM MANUFACTURE OF HYDRAULIC AND PNEUMATIC SYSTEMS (U.S. CLS. 100, 103 AND 106).

FIRST USE 7-18-2002; IN COMMERCE 7-18-2002.

CLASS 42—SCIENTIFIC, COMPUTER AND LEGAL SERVICES

FOR ENGINEERING AND DESIGN IN THE FIELD OF HYDRAULIC AND PNEUMATIC SYSTEMS (U.S. CLS. 100 AND 101).

FIRST USE 7-18-2002; IN COMMERCE 7-18-2002.

2,730,180. CATHOLIC TELECOM, LLC, ATLANTA, GA. SN 76-287,303. PUB. 6-18-2002, FILED 7-18-2001.

CATHOLIC LONG DISTANCE

NO CLAIM IS MADE TO THE EXCLUSIVE RIGHT TO USE "LONG DISTANCE", APART FROM THE MARK AS SHOWN.

CLASS 38—COMMUNICATION

FOR TELECOMMUNICATION SERVICES, NAMELY, LONG DISTANCE TRANSMISSION OF VOICE, DATA, GRAPHICS BY MEANS OF TELEPHONE, TELEGRAPHIC, CABLE, AND SATELLITE TRANSMISSIONS; TELECOMMUNICATION RESELLER SERVICES, NAMELY, PROVIDING LONG DISTANCE TELECOMMUNICATION SERVICES (U.S. CLS. 100, 101 AND 104).

FIRST USE 6-10-2002; IN COMMERCE 6-10-2002.

CLASS 42—SCIENTIFIC, COMPUTER AND LEGAL SERVICES

FOR RESIDENTIAL AND COMMERCIAL TELECOMMUNICATIONS CONSULTATION IN THE FIELD OF VOICE, DATA, INTERNET, AND OTHER TELECOMMUNICATIONS RELATED SERVICES (U.S. CLS. 100 AND 101).

FIRST USE 6-10-2002; IN COMMERCE 6-10-2002.

2,730,185. GAELCO, S.A., BARCELONA, SPAIN. SN 76-289,181. PUB. 8-6-2002, FILED 7-24-2001.



NO CLAIM IS MADE TO THE EXCLUSIVE RIGHT TO USE "ATV", APART FROM THE MARK AS SHOWN.

CLASS 9—ELECTRICAL AND SCIENTIFIC APPARATUS

FOR SLOT MACHINES AND COMPUTER PROGRAMS FOR ELECTRONIC GAMES (U.S. CLS. 21, 23, 26, 36 AND 38).

FIRST USE 3-0-2002; IN COMMERCE 3-0-2002.

CLASS 28—TOYS AND SPORTING GOODS

FOR COIN-OPERATED GAMES AND ENTERTAINMENT MACHINES, NAMELY, STAND-ALONE VIDEO GAME MACHINES AND HAND-HELD VIDEO GAMES (U.S. CLS. 22, 23, 38 AND 50).

FIRST USE 3-0-2002; IN COMMERCE 3-0-2002.

2,730,195. CFI MANUFACTURING, INC., SARASOTA, FL. SN 76-293,096. PUB. 6-11-2002, FILED 7-31-2001.

CARTER CG GRANDLE

OWNER OF U.S. REG. NOS. 2,345,494 AND 2,355,162. THE NAME "CARTER GRANDLE" DOES NOT IDENTIFY A LIVING INDIVIDUAL.

CLASS 18—LEATHER GOODS

FOR PATIO UMBRELLAS AND MARKET UMBRELLAS (U.S. CLS. 1, 2, 3, 22 AND 41).

FIRST USE 9-0-2002; IN COMMERCE 9-0-2002.

CLASS 20—FURNITURE AND ARTICLES NOT OTHERWISE CLASSIFIED

FOR OUTDOOR FURNITURE, LAWN FURNITURE, PATIO FURNITURE, CASUAL FURNITURE, UMBRELLA STANDS AND CUSHIONS (U.S. CLS. 2, 13, 22, 25, 32 AND 50).

FIRST USE 9-0-2001; IN COMMERCE 9-0-2001.

2,730,206. NATIONAL MARINE ELECTRONICS ASSOCIATION, INC., NEW BERN, NC. SN 76-294,908. PUB. 3-19-2002, FILED 8-3-2001.

**CLASS 9—ELECTRICAL AND SCIENTIFIC APPARATUS**

FOR COMPUTER SOFTWARE FOR USE IN IMPLEMENTING INDUSTRY STANDARDS FOR THE MARINE ELECTRONICS INDUSTRY (U.S. CLS. 21, 23, 26, 36 AND 38).

FIRST USE 9-0-2001; IN COMMERCE 9-0-2001.

CLASS 16—PAPER GOODS AND PRINTED MATTER

FOR PRINTED MATTER, NAMELY, PUBLICATIONS, MANUALS, AND INSTRUCTIONAL MATERIALS RELATING TO INDUSTRY STANDARDS FOR THE MARINE ELECTRONICS INDUSTRY (U.S. CLS. 2, 5, 22, 23, 29, 37, 38 AND 50).

FIRST USE 9-0-2001; IN COMMERCE 9-0-2001.

CLASS 42—SCIENTIFIC, COMPUTER AND LEGAL SERVICES

FOR ASSOCIATION SERVICES, NAMELY, CREATING, MAINTAINING, DISSEMINATING AND ADMINISTERING INDUSTRY STANDARDS FOR THE MARINE ELECTRONICS INDUSTRY, AND PROMOTING THE INTERESTS OF THE MARINE ELECTRONICS INDUSTRY (U.S. CLS. 100 AND 101).

FIRST USE 9-0-2001; IN COMMERCE 9-0-2001.

2,730,212. LIBERMAN BROADCASTING, INC., BURBANK, CA. SN 76-296,971. PUB. 7-16-2002, FILED 8-6-2001.

LA RANCHERA

THE ENGLISH TRANSLATION OF "LA RANCHERA" IS "THE COUNTRY ONE".

CLASS 38—COMMUNICATION

FOR RADIO BROADCASTING SERVICES (U.S. CLS. 100, 101 AND 104).
FIRST USE 2-22-1999; IN COMMERCE 2-22-1999.

CLASS 41—EDUCATION AND ENTERTAINMENT

FOR PRODUCTION OF RADIO PROGRAMS; ENTERTAINMENT SERVICES IN THE NATURE OF ON-GOING RADIO PROGRAMS FEATURING MUSIC, NEWS, TALK SHOWS, LISTENER CALL-INS, TRAFFIC REPORTS AND EVENTS (U.S. CLS. 100, 101 AND 107).
FIRST USE 2-22-1999; IN COMMERCE 2-22-1999.

2,730,238. DESA INTERNATIONAL INC., BOWLING GREEN, KY. SN 76-304,587. PUB. 5-7-2002, FILED 8-24-2001.



DESA
INTERNATIONAL

OWNER OF U.S. REG. NOS. 2,095,386 AND 2,097,910.

CLASS 7—MACHINERY

FOR POWER OPERATED TOOLS, NAMELY, CHAIN SAWS AND PARTS THEREFOR, POWDER ACTUATED TOOLS, NAMELY FASTENER DRIVING TOOLS COMPRISING LOAD AND PINS, AND STUD DRIVERS SOLD AS A UNIT, STAPLE GUNS, NAIL GUNS, AND RIVETERS (U.S. CLS. 13, 19, 21, 23, 31, 34 AND 35).
FIRST USE 7-25-2001; IN COMMERCE 7-25-2001.

CLASS 8—HAND TOOLS

FOR HAND TOOLS, NAMELY MANUAL GLUE GUNS, MANUAL STAPLE GUNS, MANUAL NAIL GUNS AND MANUAL HAMMER TACKERS (U.S. CLS. 23, 28 AND 44).
FIRST USE 7-25-2001; IN COMMERCE 7-25-2001.

CLASS 9—ELECTRICAL AND SCIENTIFIC APPARATUS

FOR ELECTRONIC MOTION SENSITIVE SWITCHES, ELECTRIC SWITCHES, ELECTRIC DOOR BELLS, MOTION SENSING OCCUPANCY SENSORS, WIRELESS SWITCH DEVICES AND DOOR CHIMES (U.S. CLS. 21, 23, 26, 36 AND 38).
FIRST USE 7-25-2001; IN COMMERCE 7-25-2001.

CLASS 11—ENVIRONMENTAL CONTROL APPARATUS

FOR ELECTRIC LIGHTING FIXTURES, MOTION SENSING SECURITY LIGHTS, MOTION SENSING DECORATE COACH LIGHTS, PACE HEATERS, NAMELY, FLUID FIRED, FIXED AND MOBILE SPACE HEATERS FOR DOMESTIC AND INDUSTRIAL USE (U.S. CLS. 13, 21, 23, 31 AND 34).

FIRST USE 7-25-2001; IN COMMERCE 7-25-2001.

2,730,252. EMERACHEM LLC, KNOXVILLE, TN. SN 76-307,586. PUB. 3-5-2002, FILED 8-31-2001.

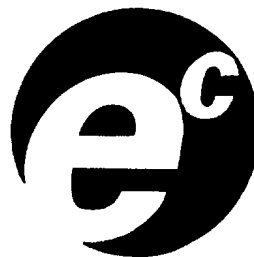

THE MARK CONSISTS OF THE LETTERS "EC", AND THE DESIGN AS SHOWN IN THE DRAWING.

CLASS 1—CHEMICALS

FOR CATALYTIC SYSTEM COMPRISING CHEMICAL COMPOUNDS USED FOR THE REDUCTION AND REMOVAL OF NITROGEN OXIDES, CARBON MONOXIDE, AND VOLATILE ORGANIC COMPOUNDS, SULFUR AND PARTICULATE MATTER EMITTED FROM COMBUSTION SOURCES AS A RESULT OF BURNING FOSSIL FUELS (U.S. CLS. 1, 5, 6, 10, 26 AND 46).
FIRST USE 9-30-2001; IN COMMERCE 9-30-2001.

CLASS 7—MACHINERY

FOR MACHINES USED FOR THE REDUCTION AND REMOVAL OF NITROGEN OXIDES, CARBON MONOXIDE, AND VOLATILE ORGANIC COMPOUNDS, SULFUR AND PARTICULATE MATTER EMITTED FROM COMBUSTION SOURCES AS A RESULT OF BURNING FOSSIL FUELS (U.S. CLS. 13, 19, 21, 23, 31, 34 AND 35).
FIRST USE 9-30-2001; IN COMMERCE 9-30-2001.

CLASS 40—MATERIAL TREATMENT

FOR SERVICES FOR OTHER FOR THE REDUCTION AND REMOVAL OF NITROGEN OXIDES, CARBON MONOXIDE, AND VOLATILE ORGANIC COMPOUNDS, SULFUR AND PARTICULATE MATTER EMITTED FROM COMBUSTION SOURCES AS A RESULT OF BURNING FOSSIL FUELS (U.S. CLS. 100, 103 AND 106).
FIRST USE 9-30-2001; IN COMMERCE 9-30-2001.

2,730,260. TAIWAN PET COMB ENTERPRISES CO., LTD., CHANG-HUA, HSIEN, TAIWAN. SN 76-309,874. PUB. 7-23-2002, FILED 9-6-2001.

HELLO PET

NO CLAIM IS MADE TO THE EXCLUSIVE RIGHT TO USE "PET", APART FROM THE MARK AS SHOWN.

CLASS 8—HAND TOOLS

FOR MAT SPLITTERS, NAIL CLIPPERS, NAIL TRIMMERS AND CLAW SCISSORS, ALL FOR ANIMAL USE (U.S. CLS. 23, 28 AND 44).
FIRST USE 9-10-2002; IN COMMERCE 9-10-2002.

CLASS 21—HOUSEWARES AND GLASS

FOR COMBS AND CURRYCOMBS, ALL FOR ANIMAL USE (U.S. CLS. 2, 13, 23, 29, 30, 33, 40 AND 50).
FIRST USE 9-10-2002; IN COMMERCE 9-10-2002.

2,730,271. IRON AGE CORPORATION, PITTSBURGH, PA.
SN 76-314,396. PUB. 4-30-2002, FILED 9-19-2001.



CLASS 25—CLOTHING

FOR FOOTWEAR (U.S. CLS. 22 AND 39).
FIRST USE 2-8-2002; IN COMMERCE 2-8-2002.

CLASS 35—ADVERTISING AND BUSINESS

FOR DISTRIBUTORSHIP IN THE FIELD OF FOOTWEAR (U.S. CLS. 100, 101 AND 102).
FIRST USE 2-8-2002; IN COMMERCE 2-8-2002.

2,730,278. WASHINGTON APPLE COMMISSION, WENATCHEE, WA, BY CHANGE OF NAME WASHINGTON STATE APPLE ADVERTISING COMMISSION, AKA WASHINGTON APPLE COMMISSION, WENATCHEE, WA. SN 76-317,527. PUB. 5-14-2002, FILED 9-25-2001.



OWNER OF U.S. REG. NOS. 730,583, 1,528,514, AND OTHERS.
NO CLAIM IS MADE TO THE EXCLUSIVE RIGHT TO

USE "WASHINGTON", APART FROM THE MARK AS SHOWN.

THE RAINBOW SPECTRUM OF THE APPLE IS CLAIMED AS A FEATURE OF THE MARK.

THE DESIGN MARK IS IN COLOR, AND CONSISTS OF AN APPLE COLORED AS A RAINBOW SPECTRUM FROM LEFT TO RIGHT AND THE STYLIZED WORD WASHINGTON IN BLUE BISECTING THE APPLE.

CLASS 31—NATURAL AGRICULTURAL PRODUCTS

FOR UNPROCESSED APPLES (U.S. CLS. 1 AND 46).
FIRST USE 10-1-2001; IN COMMERCE 10-1-2001.

CLASS 35—ADVERTISING AND BUSINESS

FOR ADVERTISING COMMISSION SERVICES, NAMELY, PROMOTING THE INTERESTS OF THOSE GROWING, PROCESSING, PACKING AND SHIPPING APPLES IN THE STATE OF WASHINGTON (U.S. CLS. 100, 101 AND 102).
FIRST USE 8-1-2001; IN COMMERCE 8-1-2001.

2,730,284. STRATIFY, INC., MOUNTAIN VIEW, CA, BY CHANGE OF NAME PURPLEYOGI, INC., MOUNTAIN VIEW, CA. SN 76-319,357. PUB. 5-21-2002, FILED 9-28-2001.

DISCOVER MORE

CLASS 9—ELECTRICAL AND SCIENTIFIC APPARATUS

FOR SOFTWARE FOR COLLECTING, LINKING, ORGANIZING AND PRIORITIZING DATA FROM MULTIPLE SOURCES INTO A HIERARCHICAL DISPLAY; CONTENT AND DATA MANAGEMENT SOFTWARE; SOFTWARE FOR ENHANCING CUSTOMER RELATIONSHIP MANAGEMENT SOFTWARE, SALES FORCE AUTOMATION SOFTWARE, CORPORATE PORTALS, SEARCH ENGINES AND NEW AGGREGATION SERVICES (U.S. CLS. 21, 23, 26, 36 AND 38).
FIRST USE 10-0-2001; IN COMMERCE 10-0-2001.

CLASS 42—SCIENTIFIC, COMPUTER AND LEGAL SERVICES

FOR CUSTOMER SUPPORT SERVICES, NAMELY, SOFTWARE INSTALLATION, INTEGRATION, MAINTENANCE, UPGRADING AND TROUBLESHOOTING (U.S. CLS. 100 AND 101).
FIRST USE 10-0-2001; IN COMMERCE 10-0-2001.

2,730,302. RESEARCH INVESTMENT NETWORK, INC., IRVINE, CA. SN 76-322,001. PUB. 8-27-2002, FILED 11-20-2000.



CLASS 35—ADVERTISING AND BUSINESS

FOR ACQUISITION AND MANAGEMENT OF INTELLECTUAL PROPERTY PORTFOLIOS FOR OTHERS (U.S. CLS. 100, 101 AND 102).

FIRST USE 10-1-2001; IN COMMERCE 10-1-2001.

CLASS 36—INSURANCE AND FINANCIAL

FOR INVESTMENT FOR OTHERS IN THE FIELD OF INTELLECTUAL PROPERTY (U.S. CLS. 100, 101 AND 102).

FIRST USE 10-1-2001; IN COMMERCE 10-1-2001.

CLASS 42—SCIENTIFIC, COMPUTER AND LEGAL SERVICES

FOR LICENSING OF INTELLECTUAL PROPERTY; INTELLECTUAL PROPERTY, PATENT AGENCY, AND INDUSTRIAL PROPERTY CONSULTATION (U.S. CLS. 100 AND 101).

FIRST USE 10-1-2001; IN COMMERCE 10-1-2001.

2,730,314. GOLDMAR ENTERPRISES, INC., ORLANDO, FL, BY ASSIGNMENT MARGO UNLIMITED, INC., NEW PORT RICHEY, FL. SN 76-325,402. PUB. 9-17-2002, FILED 10-15-2001.



NO CLAIM IS MADE TO THE EXCLUSIVE RIGHT TO USE "CHOCOLATIERS", APART FROM THE MARK AS SHOWN.

CLASS 30—STAPLE FOODS

FOR CANDY (U.S. CL. 46).

FIRST USE 8-24-2002; IN COMMERCE 8-24-2002.

CLASS 35—ADVERTISING AND BUSINESS

FOR RETAIL SERVICES FEATURING CANDY (U.S. CLS. 100, 101 AND 102).

FIRST USE 8-24-2002; IN COMMERCE 8-24-2002.

2,730,332. SUNEX INTERNATIONAL, INC., GREENVILLE, SC. SN 76-329,971. PUB. 6-25-2002, FILED 10-25-2001.

MIGHTY MICROBE

CLASS 3—COSMETICS AND CLEANING PREPARATIONS

FOR BIODEGRADABLE CLEANING FLUID TO CLEAN DIRTY PARTS OF AUTOMOBILES, TRUCKS AND MACHINERY EQUIPMENT (U.S. CLS. 1, 4, 6, 50, 51 AND 52).

FIRST USE 3-4-2002; IN COMMERCE 3-4-2002.

CLASS 7—MACHINERY

FOR MACHINES THAT USE A BIODEGRADABLE CLEANING FLUID FOR CLEANING DIRTY PARTS OF AUTOMOBILES, TRUCKS AND MACHINERY EQUIPMENT (U.S. CLS. 13, 19, 21, 23, 31, 34 AND 35).

FIRST USE 3-4-2002; IN COMMERCE 3-4-2002.

2,730,335. U.S. ARCHITECTURAL AND TRANSPORTATION BARRIERS COMPLIANCE BOARD, WASHINGTON, DC. SN 76-330,622. PUB. 7-30-2002, FILED 10-26-2001.



CLASS 41—EDUCATION AND ENTERTAINMENT

FOR PROVIDING TRAINING IN THE NATURE OF SEMINARS, CLASSES AND WORKSHOPS RELATING TO DISABILITY ACCESSIBILITY GUIDELINES AND STANDARDS FOR BUILDINGS, TRANSIT VEHICLES, TELECOMMUNICATIONS EQUIPMENT AND STANDARDS FOR ELECTRONIC AND INFORMATION TECHNOLOGY (U.S. CLS. 100, 101 AND 107).

FIRST USE 4-0-2002; IN COMMERCE 4-0-2002.

CLASS 42—SCIENTIFIC, COMPUTER AND LEGAL SERVICES

FOR PROMULGATING AND MAINTAINING DISABILITY ACCESSIBILITY GUIDELINES FOR BUILDINGS, TRANSIT VEHICLES, TELECOMMUNICATIONS EQUIPMENT AND STANDARDS FOR ELECTRONIC AND INFORMATION TECHNOLOGY; AND OFFERING TECHNICAL CONSULTATION RELATING DISABILITY ACCESSIBILITY GUIDELINES AND STANDARDS FOR BUILDINGS, TRANSIT VEHICLES, TELECOMMUNICATIONS EQUIPMENT AND STANDARDS FOR ELECTRONIC AND INFORMATION TECHNOLOGY (U.S. CLS. 100 AND 101).

FIRST USE 4-0-2002; IN COMMERCE 4-0-2002.

2,730,339. NITEO PARTNERS, INC., NEW YORK, NY. SN 76-331,665. PUB. 5-14-2002, FILED 10-25-2001.

NITEO PARTNERS

NO CLAIM IS MADE TO THE EXCLUSIVE RIGHT TO USE "PARTNERS", APART FROM THE MARK AS SHOWN. THE ENGLISH TRANSLATION OF "NITEO" IS "TO SHINE, GLITTER, OR BE BRIGHT".

CLASS 35—ADVERTISING AND BUSINESS

FOR BUSINESS CONSULTING IN THE FIELDS OF MEDIA, MARKETING, BUSINESS MANAGEMENT AND BRAND MANAGEMENT (U.S. CLS. 100, 101 AND 102). FIRST USE 9-1-2001; IN COMMERCE 9-1-2001.

CLASS 42—SCIENTIFIC, COMPUTER AND LEGAL SERVICES

FOR CONSULTING IN THE FIELD OF COMPUTER TECHNOLOGY AND COMPUTER SYSTEMS INTEGRATION, CUSTOM COMPUTER SOFTWARE DESIGN AND DEVELOPMENT SERVICES FOR OTHERS (U.S. CLS. 100 AND 101). FIRST USE 9-1-2001; IN COMMERCE 9-1-2001.

2,730,344. NLP IP COMPANY, WILMINGTON, DE. SN 76-333,987. PUB. 7-9-2002, FILED 11-5-2001.

IN-HOUSE TEXAS

NO CLAIM IS MADE TO THE EXCLUSIVE RIGHT TO USE "TEXAS", APART FROM THE MARK AS SHOWN.

CLASS 16—PAPER GOODS AND PRINTED MATTER

FOR PUBLICATIONS, NAMELY, NEWSPAPERS AND MAGAZINES PERTAINING TO THE LEGAL FIELD (U.S. CLS. 2, 5, 22, 23, 29, 37, 38 AND 50). FIRST USE 0-0-1998; IN COMMERCE 1-0-2002.

CLASS 42—SCIENTIFIC, COMPUTER AND LEGAL SERVICES

FOR ONLINE PUBLICATIONS, NAMELY, NEWSPAPERS AND MAGAZINES PERTAINING TO THE LEGAL FIELD (U.S. CLS. 100 AND 101). FIRST USE 0-0-1989; IN COMMERCE 1-0-2002.

2,730,346. SHEESLEY, JOHN M., SAN ANTONIO, TX. SN 76-334,158. PUB. 7-2-2002, FILED 11-5-2001.

REDIFUEL

CLASS 37—CONSTRUCTION AND REPAIR

FOR AUTOMOBILE SERVICE STATION SERVICES (U.S. CLS. 100, 103 AND 106). FIRST USE 9-1-2002; IN COMMERCE 9-1-2002.

CLASS 39—TRANSPORTATION AND STORAGE

FOR DELIVERY OF PETROLEUM PRODUCTS BY TRUCK TO OTHERS (U.S. CLS. 100 AND 105). FIRST USE 9-1-2002; IN COMMERCE 9-1-2002.

2,730,355. RODAN & FIELDS, LLC, OAKLAND, CA. SN 76-336,813. PUB. 9-17-2002, FILED 11-13-2001.

MULTI-MED THERAPY

NO CLAIM IS MADE TO THE EXCLUSIVE RIGHT TO USE "THERAPY", APART FROM THE MARK AS SHOWN.

CLASS 3—COSMETICS AND CLEANING PREPARATIONS

FOR NON-MEDICATED SKIN CARE PRODUCTS, NAMELY, SKIN CONCEALERS, SKIN CONDITIONERS, SKIN CREAM, SKIN LOTIONS, SKIN MOISTURIZERS, SKIN FACIAL MOUSSE, PATCHES CONTAINING SUN SCREEN AND SUN BLOCK FOR USE ON THE SKIN, SKIN ABRASIVE PREPARATIONS, SKIN CLARIFIERS, SKIN CLEANSERS, SKIN CLEANING CREAM, SKIN CLEANSING LOTION, SKIN EMOLLIENTS, SKIN GELS FOR ACCELERATING, ENHANCING OR EXTENDING TANS, SKIN LIGHTENERS SKIN MASKS, SKIN MOISTURIZER MASKS, SKIN SOAP, SKIN TEXTURIZERS, SKIN TONERS, SKIN WHITENING CREAMS AND WRINKLE REMOVING SKIN CARE PREPARATIONS (U.S. CLS. 1, 4, 6, 50, 51 AND 52). FIRST USE 5-15-2002; IN COMMERCE 5-15-2002.

CLASS 5—PHARMACEUTICALS

FOR MEDICATED SKIN CARE PREPARATIONS (U.S. CLS. 6, 18, 44, 46, 51 AND 52). FIRST USE 5-15-2002; IN COMMERCE 5-15-2002.

2,730,373. TEAMMATES FOR KIDS FOUNDATION, LITTLETON, CO. SN 76-340,880. PUB. 7-9-2002, FILED 11-20-2001.

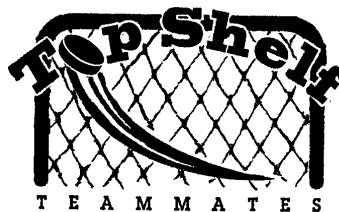

CLASS 25—CLOTHING

FOR ATHLETIC FOOTWEAR, ATHLETIC SHOES, ATHLETIC UNIFORMS, BABUSHKAS, SWEAT BANDS, WRIST BANDS, BELTS, BOOTS, CAPS, OVERALLS, COVER UPS, FOOTWEAR, GLOVES, GOLF SHIRTS, GOLF SHOES, GYM SHORTS, GYM SUITS, HATS, HEAD WEAR, JACKETS, JEANS, JERSEYS, JOGGING SUITS, SHIRTS, LEATHER COATS, PANTS, PULL-OVERS, SHOES, SHORTS, SOCKS, SPORT COATS, SPORT SHIRTS, SWEAT SUITS, WARM-UP SUITS, SWEAT PANTS, SWEAT SHIRTS, SWEAT SHORTS, SWEATERS, T-SHIRTS, BOW TIES, TIES, TURTLE-NECKS, VESTS, VISORS, SUN VISORS, BASEBALL CAPS (U.S. CLS. 22 AND 39). FIRST USE 6-18-2001; IN COMMERCE 6-18-2001.

CLASS 36—INSURANCE AND FINANCIAL

FOR CHARITABLE FUND RAISING, ELEEMOSYNARY SERVICES IN THE FIELD OF MONETARY DONATIONS, MEMORIAL FUND RAISING, PHILANTHROPIC SERVICES CONCERNING MONETARY DONATIONS, FINANCIAL SPONSORSHIP OF SPORTS AND MUSIC EVENTS (U.S. CLS. 100, 101 AND 102).

FIRST USE 7-10-2001; IN COMMERCE 7-10-2001.

2,730,402. CRYPTOMETRICS, INC., CRESTWOOD, NY. SN 76-345,622. PUB. 7-2-2002, FILED 12-5-2001.

CRYPTOMETRICS**CLASS 9—ELECTRICAL AND SCIENTIFIC APPARATUS**

FOR COMPUTER HARDWARE AND SOFTWARE FOR IDENTITY VERIFICATION OF SENDERS, RECIPIENTS, SIGNATURE AND CONTENT OF ELECTRONICALLY TRANSMITTED MESSAGES, DOCUMENTS AND OTHER INFORMATION FOR USE IN GOVERNMENTAL, COMMERCIAL, FINANCIAL, MEDICAL, AND CONSUMER FIELDS (U.S. CLS. 21, 23, 26, 36 AND 38).

FIRST USE 1-6-2003; IN COMMERCE 1-6-2003.

CLASS 36—INSURANCE AND FINANCIAL

FOR FINANCIAL INFORMATION PROVIDED BY ELECTRONIC MEANS (U.S. CLS. 100, 101 AND 102).

FIRST USE 1-0-2002; IN COMMERCE 1-0-2002.

CLASS 38—COMMUNICATION

FOR ELECTRONIC MAIL SERVICES, NAMELY, PROVIDING RETURN RECEIPTS, CERTIFICATIONS, VERIFICATIONS AND REGISTRATIONS OF TRANSFERS OF INFORMATION ELECTRONICALLY PRIMARILY BY MEANS OF ELECTRONIC MAIL MESSAGES; TRANSMISSION OF ELECTRONIC GREETING CARDS, INVITATIONS, MAILERS, LETTERS AND STATIONARY ON A GLOBAL COMPUTER NETWORK (U.S. CLS. 100, 101 AND 104).

FIRST USE 1-0-2002; IN COMMERCE 1-0-2002.

2,730,376. TEAMMATES FOR KIDS FOUNDATION, LITTLETON, CO. SN 76-341,077. PUB. 4-30-2002, FILED 11-21-2001.

T7K**CLASS 25—CLOTHING**

FOR ATHLETIC FOOTWEAR, ATHLETIC SHOES, ATHLETIC UNIFORMS, BABUSHKAS, SWEAT BANDS, WRIST BANDS, BELTS, BOOTS, CAPS, OVERALLS, COVER UPS, FOOTWEAR, GLOVES, GOLF SHIRTS, GOLF SHOES, GYM SHORTS, GYM SUITS, HATS, HEAD WEAR, JACKETS, JEANS, JERSEYS, JOGGING SUITS, SHIRTS, LEATHER COATS, PANTS, PULL-OVERS, SHOES, SHORTS, SOCKS, SPORT COATS, SPORT SHIRTS, SWEAT SUITS, WARM-UP SUITS, SWEAT PANTS, SWEAT SHIRTS, SWEAT SHORTS, SWEATERS, T-SHIRTS, BOW TIES, TIES, TURTLE NECKS, VESTS, VISORS, SUN VISORS, BASEBALL CAPS (U.S. CLS. 22 AND 39).

FIRST USE 7-10-2001; IN COMMERCE 7-10-2001.

CLASS 36—INSURANCE AND FINANCIAL

FOR CHARITABLE FUND RAISING, ELEEMOSYNARY SERVICES IN THE FIELD OF MONETARY DONATIONS, MEMORIAL FUND RAISING, PHILANTHROPIC SERVICES CONCERNING MONETARY DONATIONS, FINANCIAL SPONSORSHIP OF SPORTS AND MUSIC EVENTS (U.S. CLS. 100, 101 AND 102).

FIRST USE 7-10-2001; IN COMMERCE 7-10-2001.

2,730,404. FAUCET-QUEENS INC., THE, VERNON HILLS, IL. SN 76-345,769. PUB. 6-25-2002, FILED 12-4-2001.

DOLLAR STRETCHERS**CLASS 6—METAL GOODS**

FOR METAL HOUSEHOLD HARDWARE, NAMELY, D-RING KEY HOLDERS, METAL LUGGAGE LOCKS AND LUGGAGE TAGS, SOLD AS A UNIT; METAL FASTENER KITS COMPRISED OF BRAIDED METAL WIRE, PICTURE HANGERS, NAILS, NUTS, SCREWS AND BOLTS; BICYCLE CABLE LOCKS (U.S. CLS. 2, 12, 13, 14, 23, 25 AND 50).

FIRST USE 12-0-2002; IN COMMERCE 12-0-2002.

2,730,393. HEALTH NET, INC., WOODLAND HILLS, CA. SN 76-344,420. PUB. 7-2-2002, FILED 12-3-2001.

QUITTING MATTERS**CLASS 16—PAPER GOODS AND PRINTED MATTER**

FOR NEWSLETTERS RELATED TO HELPING PEOPLE CEASE ADDICTIONS (U.S. CLS. 2, 5, 22, 23, 29, 37, 38 AND 50).

FIRST USE 12-0-2001; IN COMMERCE 12-0-2001.

CLASS 8—HAND TOOLS

FOR HAND TOOLS, NAMELY, CLAMPS AND VICES, MINI-CLAMPS, HOBBY KNIVES; MINI TOOL SETS CONSISTING OF MINIATURE SCREW DRIVERS, PLIERS AND HOBBY KNIVES, MULTI-FUNCTION KNIVES, MICRO-SPRING CLAMPS, PISTOL GRIP SCREWDRIVERS, 8-1 LIGHTED SCREWDRIVERS, MULTI-PIECE T-BAR TOOL, MALLETS; SCISSORS (U.S. CLS. 23, 28 AND 44).

FIRST USE 12-0-2002; IN COMMERCE 12-0-2002.

CLASS 41—EDUCATION AND ENTERTAINMENT

FOR EDUCATIONAL SERVICES, NAMELY PROGRAMS AIMED AT HELPING PEOPLE CEASE ADDICTIONS (U.S. CLS. 100, 101 AND 107).

FIRST USE 11-12-2002; IN COMMERCE 11-12-2002.

CLASS 9—ELECTRICAL AND SCIENTIFIC APPARATUS

FOR ELECTRICAL 3-PRONG TO 2-PRONG ADAPTOR PLUGS, TAPE MEASURES, COMPACT DISC HOLDERS (U.S. CLS. 21, 23, 26, 36 AND 38).

FIRST USE 12-0-2002; IN COMMERCE 12-0-2002.

CLASS 22—CORDAGE AND FIBERS

FOR STRETCH CORDS AND CABLE TIES (U.S. CLS. 1, 2, 7, 19, 22, 42 AND 50).
FIRST USE 12-0-2002; IN COMMERCE 12-0-2002.

2,730,414. ARENA FOOTBALL LEAGUE, LLC, CHICAGO, IL. SN 76-347,790. PUB. 6-18-2002, FILED 12-12-2001.

GEORGIA FORCE

NO CLAIM IS MADE TO THE EXCLUSIVE RIGHT TO USE "GEORGIA", APART FROM THE MARK AS SHOWN.

CLASS 16—PAPER GOODS AND PRINTED MATTER

FOR GENERAL MERCHANDISE CATALOGS, BUMPER STICKERS, WRITING PADS AND PENS, PENCILS, TRADING CARDS, POSTERS, PAPER PENNANTS, POST CARDS, CALENDARS, PAPER STICKERS, APPLIQUES IN THE FORM OF DECALS, PRINTED EVENT ADMISSION TICKETS, GREETING CARDS, STATISTICAL BOOKS, NEWSLETTERS AND PAMPHLETS IN THE FIELD OF FOOTBALL FOR DISTRIBUTION TO TELEVISION AND RADIO MEDIA (U.S. CLS. 2, 5, 22, 23, 29, 37, 38 AND 50).
FIRST USE 1-26-2002; IN COMMERCE 1-26-2002.

CLASS 25—CLOTHING

FOR MEN'S, WOMEN'S AND CHILDREN'S CLOTHING, NAMELY, PLAYER UNIFORMS CONSISTING OF FOOTWEAR, JERSEY TOPS AND PANTS, CHEERLEADER UNIFORMS, REPLICA UNIFORM SHIRTS, COACHES' CAPS, WOOL HATS, PAINTERS' CAPS, BASEBALL CAPS, VISORS, HEADBANDS, BELTS, T-SHIRTS, TANK TOPS, GOLF SHIRTS, SWEATERS, SWEATSHIRTS, LEATHER JACKETS, NECKTIES, COATS, SHORTS, SWEATPANTS, PANTS, SOCKS AND UNDERWEAR (U.S. CLS. 22 AND 39).
FIRST USE 1-26-2002; IN COMMERCE 1-26-2002.

CLASS 41—EDUCATION AND ENTERTAINMENT

FOR ENTERTAINMENT SERVICES, NAMELY ORGANIZING AND PRESENTING FOOTBALL GAMES BEFORE LIVE AUDIENCES AND ON TELEVISION, RADIO, FOR GLOBAL COMPUTER NETWORK DISPLAY AND OTHER MEDIA (U.S. CLS. 100, 101 AND 107).
FIRST USE 1-26-2002; IN COMMERCE 1-26-2002.

2,730,430. PRESNELL ASSOCIATES, INC., LOUISVILLE, KY. SN 76-351,366. PUB. 9-10-2002, FILED 12-21-2001.

QK4**CLASS 37—CONSTRUCTION AND REPAIR**

FOR CONSTRUCTION MANAGEMENT AND SUPERVISION; AND CONSTRUCTION PLANNING (U.S. CLS. 100, 103 AND 106).
FIRST USE 2-2-2002; IN COMMERCE 2-2-2002.

CLASS 42—SCIENTIFIC, COMPUTER AND LEGAL SERVICES

FOR ENGINEERING; TECHNICAL CONSULTATION IN THE FIELD OF ENGINEERING; ARCHITECTURAL DESIGN; INTERIOR DECORATION CONSULTATION; AND LANDSCAPE GARDENING DESIGN FOR OTHERS (U.S. CLS. 100 AND 101).
FIRST USE 2-0-2002; IN COMMERCE 2-0-2002.

2,730,440. DSI TOYS, INC., HOUSTON, TX. SN 76-352,771. PUB. 6-25-2002, FILED 12-27-2001.

TWIST-N-TWIRL BRAIDER

NO CLAIM IS MADE TO THE EXCLUSIVE RIGHT TO USE "BRAIDER", APART FROM THE MARK AS SHOWN.

CLASS 8—HAND TOOLS

FOR HAND-HELD MECHANICAL HAIR BRAIDING DEVICE (U.S. CLS. 23, 28 AND 44).
FIRST USE 6-1-2002; IN COMMERCE 6-18-2002.

CLASS 28—TOYS AND SPORTING GOODS

FOR TOYS, NAMELY, BRAIDING DEVICE FOR A DOLL'S HAIR (U.S. CLS. 22, 23, 38 AND 50).
FIRST USE 6-1-2002; IN COMMERCE 6-18-2002.

2,730,480. BECTON, DICKINSON AND COMPANY, FRANKLIN LAKES, NJ. SN 76-364,113. PUB. 9-17-2002, FILED 1-25-2002.



OWNER OF U.S. REG. NOS. 442,281, 712,691, AND OTHERS.

CLASS 5—PHARMACEUTICALS

FOR CONTROL SOLUTIONS FOR CALIBRATING AND TESTING MEDICAL EQUIPMENT (U.S. CLS. 6, 18, 44, 46, 51 AND 52).
FIRST USE 2-4-2003; IN COMMERCE 2-4-2003.

CLASS 9—ELECTRICAL AND SCIENTIFIC APPARATUS

FOR COMPUTER SOFTWARE FOR USE IN CONNECTION WITH A BLOOD GLUCOSE METER (U.S. CLS. 21, 23, 26, 36 AND 38).
FIRST USE 2-4-2003; IN COMMERCE 2-4-2003.

CLASS 10—MEDICAL APPARATUS

FOR BLOOD GLUCOSE METERS, TEST STRIPS, LANCET DEVICES (U.S. CLS. 26, 39 AND 44).
FIRST USE 2-4-2003; IN COMMERCE 2-4-2003.

2,730,489. KOTA CORPORATION, THE, MEDFIELD, MA.
SN 76-367,533. PUB. 7-2-2002, FILED 2-7-2002.



CLASS 25—CLOTHING

FOR HOCKEY CLOTHING, NAMELY HOCKEY SHIRTS, HOCKEY SWEATSHIRTS, HOCKEY CAPS AND HOCKEY PANTS (U.S. CLS. 22 AND 39).
FIRST USE 12-0-2002; IN COMMERCE 12-0-2002.

CLASS 28—TOYS AND SPORTING GOODS

FOR HOCKEY EQUIPMENT, NAMELY HOCKEY STICKS, HOCKEY SHOULDER PADS, HOCKEY SHIN PADS, HOCKEY EQUIPMENT BAGS, HOCKEY SKATES, AND HOCKEY GLOVES (U.S. CLS. 22, 23, 38 AND 50).
FIRST USE 10-0-2002; IN COMMERCE 10-0-2002.

2,730,490. THOTWAVE TECHNOLOGIES, LLC, CARY, NC.
SN 76-368,096. PUB. 11-5-2002, FILED 2-8-2002.

THINKING DATA

NO CLAIM IS MADE TO THE EXCLUSIVE RIGHT TO USE "DATA", APART FROM THE MARK AS SHOWN.

CLASS 35—ADVERTISING AND BUSINESS

FOR DATA PROCESSING SERVICES IN THE FIELDS OF DATA COLLECTION, DATA MANAGEMENT, DATA ANALYSIS, WORKFLOW AUTOMATION, DOCUMENT MANAGEMENT, RESEARCH PROJECT MANAGEMENT, NAMELY, QUALITATIVE AND QUANTITATIVE EVALUATION OF RESEARCH DATA AS PART OF THE DATA PROCESSING SERVICES, AND STATISTICAL REPORT GENERATION (U.S. CLS. 100, 101 AND 102).
FIRST USE 11-0-2002; IN COMMERCE 11-0-2002.

CLASS 42—SCIENTIFIC, COMPUTER AND LEGAL SERVICES

FOR DATA WAREHOUSING SERVICES (U.S. CLS. 100 AND 101).
FIRST USE 11-0-2002; IN COMMERCE 11-0-2002.

2,730,531. NAMCO HOMETEK INC., SAN JOSE, CA. SN 76-975,220. PUB. 3-19-2002, FILED 2-23-2001.

DEAD TO RIGHTS

CLASS 9—ELECTRICAL AND SCIENTIFIC APPARATUS

FOR VIDEO GAMES, NAMELY, VIDEO GAME CARTRIDGES AND VIDEO GAME DISCS (U.S. CLS. 21, 23, 26, 36 AND 38).
FIRST USE 8-20-2002; IN COMMERCE 8-20-2002.

CLASS 16—PAPER GOODS AND PRINTED MATTER

FOR BOOKS FEATURING ACTION AND ADVENTURE STORIES; AND COMIC BOOKS (U.S. CLS. 2, 5, 22, 23, 29, 37, 38 AND 50).
FIRST USE 8-20-2002; IN COMMERCE 8-20-2002.

2,730,534. SAWYER, WILLIAM P., CINCINNATI, OH. SN 76-975,291. PUB. 4-23-2002, FILED 10-22-2001.

HANNAH THE HAND

OWNER OF U.S. REG. NOS. 2,424,639, 2,424,674, AND 2,521,040.

CLASS 3—COSMETICS AND CLEANING PREPARATIONS

FOR ANTI-BACTERIAL SOAP, LIQUID SKIN SOAP, AND BAR SKIN SOAP (U.S. CLS. 1, 4, 6, 50, 51 AND 52).
FIRST USE 12-28-2002; IN COMMERCE 12-28-2002.

CLASS 5—PHARMACEUTICALS

FOR PRE-MOISTENED ANTISEPTIC TOWELETTES (U.S. CLS. 6, 18, 44, 46, 51 AND 52).
FIRST USE 12-28-2002; IN COMMERCE 12-28-2002.

CLASS 16—PAPER GOODS AND PRINTED MATTER

FOR PAPER TOWELS AND FACIAL TISSUES; COMIC BOOKS AND COLORING BOOKS AND PRINTED EDUCATIONAL TEACHING MATERIAL ON THE SUBJECT OF THE IMPORTANCE OF PROPER HAND WASHING TECHNIQUES TO PREVENT TRANSMISSION OF COMMUNICABLE DISEASE (U.S. CLS. 2, 5, 22, 23, 29, 37, 38 AND 50).
FIRST USE 12-28-2002; IN COMMERCE 12-28-2002.

2,730,535. SAWYER, WILLIAM P., CINCINNATI, OH. SN 76-975,292. PUB. 4-23-2002, FILED 10-22-2001.

HANDY THE HAND

OWNER OF U.S. REG. NOS. 2,424,639, 2,424,674, AND 2,521,040.

CLASS 3—COSMETICS AND CLEANING PREPARATIONS

FOR ANTI-BACTERIAL SOAP, LIQUID SKIN SOAP, AND BAR SKIN SOAP (U.S. CLS. 1, 4, 6, 50, 51 AND 52).
FIRST USE 12-28-2002; IN COMMERCE 12-28-2002.

CLASS 5—PHARMACEUTICALS

FOR PRE-MOISTENED ANTISEPTIC TOWELETTES (U.S. CLS. 6, 18, 44, 46, 51 AND 52).
FIRST USE 12-28-2002; IN COMMERCE 12-28-2002.

CLASS 16—PAPER GOODS AND PRINTED MATTER

FOR PAPER TOWELS AND FACIAL TISSUES; COMIC BOOKS AND COLORING BOOKS AND PRINTED EDUCATIONAL TEACHING MATERIAL ON THE SUBJECT OF THE IMPORTANCE OF PROPER HAND WASHING TECHNIQUES TO PREVENT TRANSMISSION OF COMMUNICABLE DISEASE (U.S. CLS. 2, 5, 22, 23, 29, 37, 38 AND 50).

FIRST USE 12-28-2002; IN COMMERCE 12-28-2002.

2,730,537. HEALTHSOUTH, BIRMINGHAM, AL. SN 76-975,339. PUB. 5-14-2002, FILED 5-23-2001.

HEART COLLEGE

NO CLAIM IS MADE TO THE EXCLUSIVE RIGHT TO USE "COLLEGE", APART FROM THE MARK AS SHOWN.

CLASS 16—PAPER GOODS AND PRINTED MATTER

FOR PRINT MATERIAL AND EDUCATIONAL TEXTS, NAMELY, NEWSLETTERS, MAGAZINES, PAMPHLETS AND BROCHURES PRESENTING INFORMATION IN THE FIELD OF HEART RISK ASSESSMENT, EVALUATION AND REMEDIATION (U.S. CLS. 2, 5, 22, 23, 29, 37, 38 AND 50).

FIRST USE 5-23-2001; IN COMMERCE 5-23-2001.

CLASS 25—CLOTHING

FOR MEN'S, WOMEN'S AND CHILDREN'S APPAREL, NAMELY, SHIRTS, T-SHIRTS, SWEAT SHIRTS, BLOUSES, PANTS, JACKETS AND POLO SHIRTS (U.S. CLS. 22 AND 39).

FIRST USE 5-23-2001; IN COMMERCE 5-23-2001.

CLASS 41—EDUCATION AND ENTERTAINMENT

FOR EDUCATIONAL SERVICES, NAMELY, CONDUCTING CLASSES, CONFERENCES, SEMINARS, AND WORKSHOPS IN THE FIELD OF HEART RISK ASSESSMENT, EVALUATION AND REMEDIATION AND DISTRIBUTION OF COURSE MATERIALS IN CONNECTION THEREWITH (U.S. CLS. 100, 101 AND 107).

FIRST USE 5-23-2001; IN COMMERCE 5-23-2001.

CLASS 42—SCIENTIFIC, COMPUTER AND LEGAL SERVICES

FOR CONSULTING SERVICES IN THE FIELD OF HEART RISK ASSESSMENT, EVALUATION AND REMEDIATION (U.S. CLS. 100 AND 101).

FIRST USE 5-23-2001; IN COMMERCE 5-23-2001.

2,730,538. ATICO INTERNATIONAL USA INC., FORT LAUDERDALE, FL. SN 76-975,368. PUB. 3-5-2002, FILED 7-9-2001.

ACCENT ON SPRING**CLASS 11—ENVIRONMENTAL CONTROL APPARATUS**

FOR LAMPS (U.S. CLS. 13, 21, 23, 31 AND 34).
FIRST USE 10-15-2001; IN COMMERCE 12-29-2001.

CLASS 20—FURNITURE AND ARTICLES NOT OTHERWISE CLASSIFIED

FOR PICTURE FRAMES, SHADOWBOXES, WOODEN CHESTS, WOODEN LETTERHOLDERS AND PLANTERS (U.S. CLS. 2, 13, 22, 25, 32 AND 50).

FIRST USE 1-15-2001; IN COMMERCE 12-29-2001.

CLASS 21—HOUSEWARES AND GLASS

FOR CERAMIC VASES, CANDLE HOLDERS NOT OF PRECIOUS METAL, WIND CHIMES, BEVERAGE GLASSWARE, CERAMIC MUGS, PLATES, CUPS, BOWLS, TRIVETS (U.S. CLS. 2, 13, 23, 29, 30, 33, 40 AND 50).

FIRST USE 10-15-2001; IN COMMERCE 12-30-2001.

CLASS 26—FANCY GOODS

FOR ARTIFICIAL FLOWERS (U.S. CLS. 37, 39, 40, 42 AND 50).

FIRST USE 10-19-2001; IN COMMERCE 12-21-2001.

2,730,541. TAHARI, ELIE, NEW YORK, NY. SN 76-975,413. PUB. 5-21-2002, FILED 5-8-2000.

ELIE TAHARI

OWNER OF U.S. REG. NOS. 1,489,405, 1,979,893, AND OTHERS.

THE NAME "ELIE TAHARI" IDENTIFIES A LIVING INDIVIDUAL WHOSE CONSENT IS OF RECORD.

CLASS 14—JEWELRY

FOR JEWELRY, CLOCKS AND WATCHES (U.S. CLS. 2, 27, 28 AND 50).

FIRST USE 7-0-2001; IN COMMERCE 7-0-2001.

CLASS 18—LEATHER GOODS

FOR LEATHER GOODS NAMELY, HANDBAGS, KEY CASES, WALLETS, TOTE BAGS, COSMETIC BAGS SOLD EMPTY, BACKPACKS, FANNY PACKS, DIARY AND ADDRESS BOOK COVERS, AND LUGGAGE; AND UMBRELLAS (U.S. CLS. 1, 2, 3, 22 AND 41).

FIRST USE 7-0-2001; IN COMMERCE 7-0-0201.

CLASS 25—CLOTHING

FOR BELTS (U.S. CLS. 22 AND 39).

FIRST USE 7-0-2001; IN COMMERCE 7-0-2001.

CLASS 35—ADVERTISING AND BUSINESS

FOR RETAIL STORE SERVICES IN THE FIELDS OF APPAREL, FOOTWEAR, COSMETICS, LOTIONS AND PERFUMES, BAGS AND LUGGAGE AND WATCHES AND JEWELRY (U.S. CLS. 100, 101 AND 102).

FIRST USE 7-0-2001; IN COMMERCE 7-0-2001.

2,730,549. GETTYS GROUP INC., THE, CHICAGO, IL. SN 78-002,125. PUB. 4-23-2002, FILED 4-1-2000.

2,730,583. BRAINSVILLE.COM, BERKELEY, CA. SN 78-038,330. PUB. 5-14-2002, FILED 12-7-2000.

FTS

CLASS 37—CONSTRUCTION AND REPAIR

FOR TURN-KEY RENOVATION IN THE FIELD OF HOTELS (U.S. CLS. 100, 103 AND 106).
FIRST USE 12-1-2000; IN COMMERCE 12-1-2000.

CLASS 42—SCIENTIFIC, COMPUTER AND LEGAL SERVICES

FOR ARCHITECTURAL DESIGN OF HOTEL ROOMS AND HOTEL INTERIORS FOR OTHERS, INTERIOR DESIGN OF HOTEL ROOMS AND HOTEL INTERIORS FOR OTHERS (U.S. CLS. 100 AND 101).
FIRST USE 12-1-2000; IN COMMERCE 12-1-2000.

2,730,554. TILDENWOODS CORPORATION, PURCELLVILLE, VA. SN 78-010,053. PUB. 7-23-2002, FILED 5-25-2000.

CENTRIFUGE

CLASS 9—ELECTRICAL AND SCIENTIFIC APPARATUS

FOR COMPUTER SOFTWARE FOR GRAPHICALLY DISPLAYING RELATIONSHIPS AMONG DATA IN DATABASES (U.S. CLS. 21, 23, 26, 36 AND 38).
FIRST USE 9-29-2002; IN COMMERCE 9-29-2002.

CLASS 42—SCIENTIFIC, COMPUTER AND LEGAL SERVICES

FOR COMPUTER SERVICES, NAMELY, USING SOFTWARE FOR OTHERS TO GRAPHICALLY DISPLAY RELATIONSHIPS AMONG DATA IN DATABASES (U.S. CLS. 100 AND 101).
FIRST USE 9-29-2002; IN COMMERCE 9-29-2002.

2,730,574. FLEXCON COMPANY, INC., SPENCER, MA. SN 78-032,239. PUB. 8-13-2002, FILED 10-25-2000.

THINFLEX

CLASS 16—PAPER GOODS AND PRINTED MATTER

FOR ADHESIVE-BACKED PLASTIC FILMS SOLD IN SHEET AND ROLL FORM FOR USE WITH PRINTERS AS A MEDIUM UPON WHICH INFORMATION AND GRAPHIC IMAGES CAN BE PRINTED (U.S. CLS. 2, 5, 22, 23, 29, 37, 38 AND 50).
FIRST USE 4-3-2001; IN COMMERCE 4-3-2001.

CLASS 17—RUBBER GOODS

FOR ADHESIVE-BACKED PLASTIC FILMS FOR USE IN THE MANUFACTURE OF LABELS AND DECALS (U.S. CLS. 1, 5, 12, 13, 35 AND 50).
FIRST USE 4-3-2001; IN COMMERCE 4-3-2001.

BRAINSVILLE

CLASS 9—ELECTRICAL AND SCIENTIFIC APPARATUS

FOR MULTIMEDIA COMPUTER SOFTWARE FOR EDUCATION, NAMELY, EDUCATIONAL SOFTWARE FEATURING INSTRUCTION ON COMPUTER PROGRAMMING, VIDEO AND DIGITAL IMAGING TECHNIQUES, SELF IMPROVEMENT, USE OF MEDICAL EQUIPMENT AND TECHNIQUES FOR PERFORMING MEDICAL PROCEDURES, GRAPHIC ART DESIGN, COMPUTER WEB SITE DESIGN, ARCHITECTURAL DESIGN, HOME IMPROVEMENT, SALES AND MARKETING STRATEGIES, THE OPERATION OF COMPUTER HARDWARE, HEALTHCARE EDUCATION, FINANCIAL INVESTMENT STRATEGIES (U.S. CLS. 21, 23, 26, 36 AND 38).
FIRST USE 9-11-2000; IN COMMERCE 9-11-2000.

CLASS 41—EDUCATION AND ENTERTAINMENT

FOR MULTIMEDIA ENTERTAINMENT SOFTWARE PRODUCTION SERVICES (U.S. CLS. 100, 101 AND 107).
FIRST USE 7-1-2000; IN COMMERCE 7-1-2000.

CLASS 42—SCIENTIFIC, COMPUTER AND LEGAL SERVICES

FOR DATA CONVERSION OF AUDIO, VIDEO, AND MULTIMEDIA CONTENT INTO FORMATS DOWNLOADABLE VIA THE GLOBAL COMPUTER NETWORK (U.S. CLS. 100 AND 101).
FIRST USE 7-1-2000; IN COMMERCE 7-1-2000.

2,730,588. MOEN INCORPORATED, NORTH OLMSTED, OH. SN 78-039,353. PUB. 10-23-2001, FILED 12-14-2000.

BOUTIQUE

OWNER OF U.S. REG. NO. 905,365.

CLASS 6—METAL GOODS

FOR METAL ROBE HOOKS (U.S. CLS. 2, 12, 13, 14, 23, 25 AND 50).
FIRST USE 6-0-2001; IN COMMERCE 6-0-2001.

CLASS 21—HOUSEWARES AND GLASS

FOR BATH ACCESSORIES, NAMELY, TOWEL BARS, TOWEL RINGS, ROBE HOOKS, TOOTHBRUSH HOLDERS, TOILET TISSUE HOLDERS, SOAP DISHES AND CUP HOLDERS (U.S. CLS. 2, 13, 23, 29, 30, 33, 40 AND 50).
FIRST USE 6-0-2001; IN COMMERCE 6-0-2001.

2,730,589. MOEN INCORPORATED, NORTH OLMSTED, OH. SN 78-039,363. PUB. 4-30-2002, FILED 12-14-2000.

CALAIS

CLASS 6—METAL GOODS

FOR METAL ROBE HOOKS (U.S. CLS. 2, 12, 13, 14, 23, 25 AND 50).
FIRST USE 1-0-2001; IN COMMERCE 1-0-2001.

CLASS 21—HOUSEWARES AND GLASS

FOR BATH ACCESSORIES, NAMELY, TOWEL BARS, TOWEL RINGS, TOOTHBRUSH HOLDERS, TOILET TISSUE HOLDERS, SOAP DISHES AND CUP HOLDERS (U.S. CLS. 2, 13, 23, 29, 30, 33, 40 AND 50).
FIRST USE 1-0-2001; IN COMMERCE 1-0-2001.

2,730,616. INTERNET TRUCKSTOP LLC, NEW PLYMOUTH, ID. SN 78-051,608. PUB. 6-4-2002, FILED 3-6-2001.

PINTAC

CLASS 39—TRANSPORTATION AND STORAGE

FOR CONSULTING SERVICES IN THE FIELD OF MAXIMIZING TRUCK LOAD EFFICIENCY AND EVALUATION OF LOAD EFFICACY AVAILABLE ONLINE (U.S. CLS. 100 AND 105).
FIRST USE 4-6-2001; IN COMMERCE 4-6-2001.

CLASS 42—SCIENTIFIC, COMPUTER AND LEGAL SERVICES

FOR APPLICATION SERVICE PROVIDER (ASP) FEATURING SOFTWARE USED TO GRAPHICALLY COMPARE FREIGHT AND AVAILABLE CAPACITY IN ORDER TO MAXIMIZE TRUCK LOAD EFFICIENCY AND EVALUATE LOAD EFFICACY (U.S. CLS. 100 AND 101).
FIRST USE 4-6-2001; IN COMMERCE 4-6-2001.

2,730,622. ECOMMERCE LICENSING GROUP LLC, NESHANIC STATION, NJ. SN 78-053,202. PUB. 7-2-2002, FILED 3-14-2001.



THE MARK CONSISTS OF A STYLIZED GLOBE SURROUNDED BY A RING, HALF OF WHICH CONSISTS OF ALTERNATING LIGHT AND DARK BAND WITH CON-

TRASTING RECTANGULAR CUTOUTS, WHILE THE OTHER HALF CONSISTS OF A BAND THAT FADES FROM LIGHT TO DARK.

CLASS 35—ADVERTISING AND BUSINESS

FOR ON-LINE RETAIL STORE SERVICES IN THE FIELDS OF INDUSTRIAL, OFFICE, HOME, AND PERSONAL SECURITY (U.S. CLS. 100, 101 AND 102).
FIRST USE 1-1-2002; IN COMMERCE 1-1-2002.

CLASS 42—SCIENTIFIC, COMPUTER AND LEGAL SERVICES

FOR PROVIDING INFORMATION IN THE FIELDS OF INDUSTRIAL, OFFICE, HOME AND PERSONAL SECURITY (U.S. CLS. 100 AND 101).
FIRST USE 1-1-2002; IN COMMERCE 1-1-2002.

2,730,632. SALU, INC., PORTLAND, OR. SN 78-056,528. PUB. 4-30-2002, FILED 4-3-2001.

MEDICAL SPECIALTY HUB

NO CLAIM IS MADE TO THE EXCLUSIVE RIGHT TO USE "MEDICAL SPECIALTY", APART FROM THE MARK AS SHOWN.

CLASS 35—ADVERTISING AND BUSINESS

FOR CORPORATE WEBSITE ADVERTISING AND MARKETING, NAMELY, OFFERING AN ONLINE FORUM FOR BUSINESS PARTNERSHIPS IN THE AREA OF MEDICINE FOR BUYERS AND SELLERS AND POTENTIAL BUSINESS PARTNERS TO TRADE, EXCHANGE INFORMATION ABOUT THEIR PRODUCTS OR SERVICES, AND TO FACILITATE THE IDENTIFICATION OF BUSINESS PARTNERS, PHYSICIANS, AND EQUIPMENT AND SERVICES, IN THE AREA OF MEDICINE, MEDICAL GOODS/SERVICES INCLUDING PROFESSIONAL AND PATIENT SOLUTIONS; ORGANIZING TRADE SHOWS IN THE MEDICAL FIELD INCLUDING PREPARATION OF TRADE SHOW BOOTHS, CORPORATE GIVEAWAYS, PROMOTIONAL BROCHURES, CORPORATE STATIONERY AND POSTERS (U.S. CLS. 100, 101 AND 102).
FIRST USE 4-3-2001; IN COMMERCE 4-3-2001.

CLASS 42—SCIENTIFIC, COMPUTER AND LEGAL SERVICES

FOR CORPORATE WEBSITE DESIGN; CORPORATE WEBSITE CONSULTATION; DEVELOPMENT OF WEBSITES FOR PHYSICIANS SPECIALISTS, AND PROVIDING PHYSICIAN SPECIALISTS ONLINE, NON-DOWNLOADABLE SOFTWARE DEVELOPMENT TOOLS TO ESTABLISH AND MAINTAIN A PRACTICE WEBSITE INCLUDING THE DESIGN OF E-MAIL AND MEDICAL MESSAGING FEATURES; DEVELOPING CORPORATE WEBSITES AND COMPUTER CONSULTATION IN THE NATURE OF OFFERING TECHNICAL ASSISTANCE RELATING TO THE DEVELOPMENT OF CORPORATE WEBSITES THAT ALLOW ACCESS TO GOODS AND SERVICES OF BUSINESS PARTNERS VIA THE INTERNET; HOSTING CORPORATE WEBSITES (U.S. CLS. 100 AND 101).
FIRST USE 4-3-2001; IN COMMERCE 4-3-2001.

2,730,642. NOON IMPORT-EXPORT SALES, INC., DANVILLE, CA. SN 78-061,449. PUB. 6-4-2002, FILED 5-1-2001.

BARF

CLASS 5—PHARMACEUTICALS

FOR PET NUTRITIONAL SUPPLEMENTS (U.S. CLS. 6, 18, 44, 46, 51 AND 52).
FIRST USE 3-1-2002; IN COMMERCE 3-1-2002.

CLASS 31—NATURAL AGRICULTURAL PRODUCTS

FOR PET FOOD (U.S. CLS. 1 AND 46).
FIRST USE 3-1-2002; IN COMMERCE 3-1-2002.

2,730,643. NOON IMPORT-EXPORT SALES, INC., DANVILLE, CA. SN 78-061,451. PUB. 6-4-2002, FILED 5-1-2001.

BARF WORLD

CLASS 5—PHARMACEUTICALS

FOR PET NUTRITIONAL SUPPLEMENTS (U.S. CLS. 6, 18, 44, 46, 51 AND 52).
FIRST USE 3-1-2002; IN COMMERCE 3-1-2002.

CLASS 31—NATURAL AGRICULTURAL PRODUCTS

FOR PET FOOD (U.S. CLS. 1 AND 46).
FIRST USE 3-1-2002; IN COMMERCE 3-1-2002.

2,730,650. SURF2THIS, INC., WAUKESHA, WI, BY MERGER WALLACEBRENT CORPORATION, WAUKESHA, WI. SN 78-063,663. PUB. 1-8-2002, FILED 5-15-2001.

SURF2THIS

CLASS 9—ELECTRICAL AND SCIENTIFIC APPARATUS

FOR COMPUTER SOFTWARE, NAMELY, SOFTWARE USED FOR BROWSING A GLOBAL COMMUNICATIONS NETWORK (U.S. CLS. 21, 23, 26, 36 AND 38).
FIRST USE 3-1-2002; IN COMMERCE 9-1-2002.

CLASS 41—EDUCATION AND ENTERTAINMENT

FOR TRAINING IN THE USE OF COMPUTER SOFTWARE (U.S. CLS. 100, 101 AND 107).
FIRST USE 3-1-2002; IN COMMERCE 9-1-2002.

CLASS 42—SCIENTIFIC, COMPUTER AND LEGAL SERVICES

FOR COMPUTER SOFTWARE CONSULTATION (U.S. CLS. 100 AND 101).
FIRST USE 3-1-2002; IN COMMERCE 9-1-2002.

2,730,666. WHITE KNIGHT FLUID HANDLING, INCORPORATED, HEMLOCK, MI. SN 78-070,222. PUB. 7-2-2002, FILED 6-20-2001.

WHITE KNIGHT PRINTING & PUBLISHING

NO CLAIM IS MADE TO THE EXCLUSIVE RIGHT TO USE "PRINTING & PUBLISHING", APART FROM THE MARK AS SHOWN.

CLASS 16—PAPER GOODS AND PRINTED MATTER

FOR PRINTED MATTER AND PUBLICATIONS, NAMELY, BOOKS, MAGAZINES, ARTICLES, NEWSLETTERS AND JOURNALS ON A VARIETY OF TOPICS; GREETING CARDS; POSTCARDS, CARTOONS, CALENDARS (U.S. CLS. 2, 5, 22, 23, 29, 37, 38 AND 50).
FIRST USE 11-22-2002; IN COMMERCE 11-22-2002.

CLASS 41—EDUCATION AND ENTERTAINMENT

FOR PUBLISHING SERVICES, NAMELY, PUBLICATION OF BOOKS, MAGAZINES, ARTICLES, NEWSLETTERS, JOURNALS, GREETING CARDS, POSTCARDS, CARTOONS AND CALENDARS FOR OTHERS (U.S. CLS. 100, 101 AND 107).
FIRST USE 11-22-2002; IN COMMERCE 11-22-2002.

2,730,667. LIGHTNING2, LLC, SOUTH BURLINGTON, VT. SN 78-070,419. PUB. 7-2-2002, FILED 6-21-2001.

COMPRESSURE COMFORT

NO CLAIM IS MADE TO THE EXCLUSIVE RIGHT TO USE "COMFORT", APART FROM THE MARK AS SHOWN.

CLASS 10—MEDICAL APPARATUS

FOR BRAS, CAMISOLES, GIRDLES, CORSETS, TORSO BINDERS, CHEST-BANDS, ARM-BANDS, LEG-BANDS AND STOCKINGS FOR THERAPEUTIC USE IN TREATMENT OF PRIMARY AND SECONDARY EDEMA AND LYMPHEDEMA (U.S. CLS. 26, 39 AND 44).
FIRST USE 8-28-2002; IN COMMERCE 8-28-2002.

CLASS 25—CLOTHING

FOR FOUNDATION GARMENTS, NAMELY, BRAS, CAMISOLES, GIRDLES AND CORSETS; STOCKINGS (U.S. CLS. 22 AND 39).
FIRST USE 8-28-2002; IN COMMERCE 8-28-2002.

2,730,677. SCIENDA, LLC, ORANGEBURG, CA. SN 78-072,989. PUB. 7-2-2002, FILED 7-9-2001.

CHANGING THE WAY THE WORLD IS BUILT.

CLASS 37—CONSTRUCTION AND REPAIR

FOR BUILDING CONSTRUCTION SERVICES (U.S. CLS. 100, 103 AND 106).
FIRST USE 6-4-2001; IN COMMERCE 8-8-2001.

CLASS 41—EDUCATION AND ENTERTAINMENT

FOR TRAINING SERVICES IN THE FIELD OF ARCHITECTURAL DESIGN, STRUCTURAL ANALYSIS, SYSTEMS INTEGRATION, MECHANICAL DESIGN, STRUCTURE ASSEMBLY, PLANT OPERATIONS, TROUBLE SHOOTING, MARKETING, SALES MANAGEMENT, BUSINESS DEVELOPMENT, QUALITY MANAGEMENT AND CERTIFICATIONS (U.S. CLS. 100, 101 AND 107).
FIRST USE 6-4-2001; IN COMMERCE 8-8-2001.

2,730,678. WALTERS, TENNYSON O., ENGLEWOOD CLIFFS, NJ. SN 78-073,178. PUB. 4-16-2002, FILED 7-10-2001.

PLANT THE SEED**CLASS 9—ELECTRICAL AND SCIENTIFIC APPARATUS**

FOR RECORDS, CASSETTES, TAPES, COMPACT DISCS, AUDIO AND VIDEO TAPES, DIGITAL VIDEO DISCS, CD-ROMS FEATURING SOUND RECORDINGS, BIBLE READINGS, COMEDY, POETRY, DRAMATIC WORKS, DANCE (U.S. CLS. 21, 23, 26, 36 AND 38).
FIRST USE 8-11-1997; IN COMMERCE 7-10-2001.

CLASS 16—PAPER GOODS AND PRINTED MATTER

FOR BOOKS WITH RELIGIOUS SUBJECT MATTER; PUBLICATIONS, NAMELY MAGAZINES AND BROCHURES BOTH WITH RELIGIOUS SUBJECT MATTER (U.S. CLS. 2, 5, 22, 23, 29, 37, 38 AND 50).
FIRST USE 8-11-1997; IN COMMERCE 7-10-2001.

CLASS 41—EDUCATION AND ENTERTAINMENT

FOR ENTERTAINMENT NAMELY, LIVE PERFORMANCES BY A MUSICAL BAND (U.S. CLS. 100, 101 AND 107).
FIRST USE 8-11-1997; IN COMMERCE 7-10-2001.

2,730,680. ADEZA BIOMEDICAL CORPORATION, SUNNYVALE, CA. SN 78-074,195. PUB. 10-22-2002, FILED 7-16-2001.



The logo for Tliq features the letters 'T', 'L', and 'i' in a bold, sans-serif font. The 'i' has a dot. To the right of the 'i' is a stylized lowercase 'q' that is partially enclosed by a circular shape, resembling a drop or a stylized letter 'q'.

CLASS 9—ELECTRICAL AND SCIENTIFIC APPARATUS

FOR DIAGNOSTIC APPARATUS COMPRISED OF A DETECTING ANALYZER CAPABLE OF RAPID DIAGNOSIS AND DETECTION OF ANALYTES FOR LABORATORY AND SCIENTIFIC PURPOSES (U.S. CLS. 21, 23, 26, 36 AND 38).
FIRST USE 5-16-2001; IN COMMERCE 5-16-2001.

CLASS 10—MEDICAL APPARATUS

FOR MEDICAL DIAGNOSTIC APPARATUS COMPRISED OF A DETECTING ANALYZER CAPABLE OF RAPID DIAGNOSIS AND DETECTION OF ANALYTES FOR USE TO SHOW EVIDENCE OF DISEASES; VETERINARY DIAGNOSTIC APPARATUS COMPRISED OF A DETECTING ANALYZER CAPABLE OF RAPID DIAGNOSIS AND DETECTION OF ANALYTES FOR USE TO SHOW EVIDENCE OF DISEASE, BUT NOT FOR THE PURPOSE OF TRYPSIN-LIKE IMMUNOREACTIVITY TESTING (U.S. CLS. 26, 39 AND 44).
FIRST USE 5-16-2001; IN COMMERCE 5-16-2001.

2,730,682. ZINGY, INC., NEW YORK, NY. SN 78-074,718. PUB. 6-4-2002, FILED 7-19-2001.

ZINGY**CLASS 38—COMMUNICATION**

FOR ELECTRONIC TRANSMISSION OF MESSAGES AND DATA, NAMELY, TEXT MESSAGES, IMAGE MESSAGES, POSTCARDS AND GROUP MESSAGES, TO MOBILE COMMUNICATIONS DEVICES; PROVIDING ON-LINE CHAT ROOMS FOR TRANSMISSION OF MESSAGES OF GENERAL INTEREST AMONG USERS OF MOBILE COMMUNICATION DEVICES; TELECOMMUNICATION SERVICES, NAMELY, PROVIDING CUSTOMIZED RING TONES AND VOICE RECORDINGS TO MOBILE COMMUNICATIONS DEVICES (U.S. CLS. 100, 101 AND 104).
FIRST USE 9-5-2001; IN COMMERCE 9-5-2001.

CLASS 41—EDUCATION AND ENTERTAINMENT

FOR ENTERTAINMENT SERVICES, NAMELY, PROVIDING SINGLE PLAYER, MULTI-PLAYER AND KNOWLEDGE TEST COMPUTER GAMES TO USERS OF MOBILE COMMUNICATIONS DEVICES (U.S. CLS. 100, 101 AND 107).
FIRST USE 9-5-2001; IN COMMERCE 9-5-2001.

2,730,709. DELKOR SYSTEMS, INC., MINNEAPOLIS, MN. SN 78-082,571. PUB. 3-5-2002, FILED 9-5-2001.

DELKOR TRAY-PAK

NO CLAIM IS MADE TO THE EXCLUSIVE RIGHT TO USE "TRAY PACK", APART FROM THE MARK AS SHOWN.

CLASS 7—MACHINERY

FOR PACKAGING MACHINERY, NAMELY, AUTOMATIC SEALING WRAP MACHINE FOR PERISHABLE AND NONPERISHABLE GOODS (U.S. CLS. 13, 19, 21, 23, 31, 34 AND 35).
FIRST USE 6-10-2001; IN COMMERCE 6-15-2001.

CLASS 16—PAPER GOODS AND PRINTED MATTER

FOR CARDBOARD USED IN PACKAGING (U.S. CLS. 2, 5, 22, 23, 29, 37, 38 AND 50).
FIRST USE 6-10-2001; IN COMMERCE 6-15-2001.

2,730,712. SHIRWIN KNOWLEDGE & LEARNING SYSTEMS, INC., EDMONTON, ALBERTA, CANADA. SN 78-083,389. PUB. 7-2-2002, FILED 9-10-2001.

SHIRWIN

CLASS 9—ELECTRICAL AND SCIENTIFIC APPARATUS

FOR EDUCATIONAL COMPUTER SOFTWARE PROGRAMS FEATURING INFORMATION AND TEST MATERIALS FOR USE IN TEACHING AND ENHANCING PROFESSIONAL DEVELOPMENT, EDUCATION AND CERTIFICATION OF EMPLOYEES (U.S. CLS. 21, 23, 26, 36 AND 38).

FIRST USE 12-15-2001; IN COMMERCE 12-15-2001.

CLASS 42—SCIENTIFIC, COMPUTER AND LEGAL SERVICES

FOR COMPUTER SOFTWARE DESIGN FOR OTHERS AND COMPUTER PROGRAMMING FOR OTHERS (U.S. CLS. 100 AND 101).

FIRST USE 10-9-2000; IN COMMERCE 10-9-2000.

2,730,714. ALBION LABORATORIES, INC., CLEARFIELD, UT. SN 78-084,371. PUB. 10-1-2002, FILED 9-18-2001.

ALBION ADVANCED NUTRITION

OWNER OF U.S. REG. NOS. 1,485,934, 1,973,213, AND 2,401,864.

NO CLAIM IS MADE TO THE EXCLUSIVE RIGHT TO USE "NUTRITION", APART FROM THE MARK AS SHOWN.

CLASS 1—CHEMICALS

FOR PLANT FOOD, NAMELY MINERAL NUTRITIONAL SUPPLEMENTS FOR PLANTS (U.S. CLS. 1, 5, 6, 10, 26 AND 46).

FIRST USE 9-0-2001; IN COMMERCE 1-0-2002.

CLASS 5—PHARMACEUTICALS

FOR NUTRITIONAL SUPPLEMENTS FOR ANIMALS AND HUMANS (U.S. CLS. 6, 18, 44, 46, 51 AND 52).

FIRST USE 9-0-2001; IN COMMERCE 9-0-2001.

CLASS 40—MATERIAL TREATMENT

FOR CONTRACT MANUFACTURING (U.S. CLS. 100, 103 AND 106).

FIRST USE 9-0-2001; IN COMMERCE 9-0-2001.

2,730,728. WALLING, JIM, CALGARY, ALBERTA. SN 78-087,400. PUB. 5-7-2002, FILED 10-8-2001.

SPIRAL OF LIFE

CLASS 20—FURNITURE AND ARTICLES NOT OTHERWISE CLASSIFIED

FOR HOLIDAY ORNAMENTS MADE FROM BONE IVORY, PLASTER, PLASTIC, WAX OR WOOD (U.S. CLS. 2, 13, 22, 25, 32 AND 50).

FIRST USE 2-9-1999; IN COMMERCE 2-9-1999.

CLASS 21—HOUSEWARES AND GLASS

FOR HOLIDAY ORNAMENTS MADE FROM CHINA, CRYSTAL, GLASS, PORCELAIN AND TERRACOTTA (U.S. CLS. 2, 13, 23, 29, 30, 33, 40 AND 50).

FIRST USE 2-9-1999; IN COMMERCE 2-9-1999.

2,730,732. WALTERS, CHARLES R., WASHINGTON, DC. SN 78-087,820. PUB. 7-30-2002, FILED 10-10-2001.

MIND MONEY CONNECTION

NO CLAIM IS MADE TO THE EXCLUSIVE RIGHT TO USE "MONEY", APART FROM THE MARK AS SHOWN.

CLASS 36—INSURANCE AND FINANCIAL

FOR FINANCIAL AND INVESTMENT CONSULTING, INVESTMENT MANAGEMENT AND BROKERAGE (U.S. CLS. 100, 101 AND 102).

FIRST USE 4-27-1993; IN COMMERCE 7-10-1994.

CLASS 41—EDUCATION AND ENTERTAINMENT

FOR WORKSHOPS, LECTURES, AND SEMINARS IN THE FIELD OF FINANCIAL AND INVESTMENT CONSULTING AND INVESTMENT MANAGEMENT AND BROKERAGE (U.S. CLS. 100, 101 AND 107).

FIRST USE 4-27-1993; IN COMMERCE 7-10-1994.

2,730,733. INTEGRITY MEDIA, INC., MOBILE, AL, BY CHANGE OF NAME INTEGRITY INCORPORATED, MOBILE, AL. SN 78-088,628. PUB. 7-2-2002, FILED 10-16-2001.

INTEGRITY GOSPEL

OWNER OF U.S. REG. NOS. 1,169,015, 2,525,124, AND OTHERS.

NO CLAIM IS MADE TO THE EXCLUSIVE RIGHT TO USE "GOSPEL", APART FROM THE MARK AS SHOWN.

CLASS 9—ELECTRICAL AND SCIENTIFIC APPARATUS

FOR PRERECORDED AUDIO AND AUDIO-VIDEO CASSETTE TAPES, COMPACT DISCS, CD-ROMS AND COMPUTER SOFTWARE, ALL FEATURING MUSICAL, DRAMATIC, RELIGIOUS, EDUCATIONAL, CHILDREN'S, FAMILY OR ANIMATED ENTERTAINMENT (U.S. CLS. 21, 23, 26, 36 AND 38).

FIRST USE 7-16-2002; IN COMMERCE 7-16-2002.

CLASS 16—PAPER GOODS AND PRINTED MATTER

FOR BOOKS, BOOKLETS, MAGAZINES, NEWSLETTERS, AND WORKBOOKS, ALL FEATURING MUSICAL, DRAMATIC, RELIGIOUS, EDUCATIONAL, CHILDREN'S OR FAMILY ENTERTAINMENT; SHEET MUSIC AND SONG BOOKS (U.S. CLS. 2, 5, 22, 23, 29, 37, 38 AND 50).

FIRST USE 1-10-2003; IN COMMERCE 1-10-2003.

2,730,750. KIDSPEACE CORPORATION, BETHLEHEM, PA. SN 78-093,330. PUB. 6-18-2002, FILED 11-14-2001.

KIDSPEACE INSTITUTE

OWNER OF U.S. REG. NOS. 1,917,070, 2,352,234, AND OTHERS.

NO CLAIM IS MADE TO THE EXCLUSIVE RIGHT TO USE "INSTITUTE", APART FROM THE MARK AS SHOWN.

CLASS 41—EDUCATION AND ENTERTAINMENT

FOR EDUCATIONAL SERVICES, NAMELY, CONDUCTING CLASSES, SEMINARS, CONFERENCES AND WORKSHOPS IN THE FIELDS OF BEHAVIORAL AND MENTAL HEALTH CARE AND LEADERSHIP AND DISTRIBUTING COURSE MATERIALS THEREWITH (U.S. CLS. 100, 101 AND 107).

FIRST USE 12-1-2001; IN COMMERCE 2-1-2002.

CLASS 42—SCIENTIFIC, COMPUTER AND LEGAL SERVICES

FOR BEHAVIORAL AND MENTAL HEALTH CARE RESEARCH (U.S. CLS. 100 AND 101).

FIRST USE 12-1-2001; IN COMMERCE 6-1-2002.

2,730,752. APOGEE HOLDINGS, INC., HOUSTON, TX. SN 78-095,166. PUB. 8-6-2002, FILED 11-27-2001.



NO CLAIM IS MADE TO THE EXCLUSIVE RIGHT TO USE HOLDINGS, INC., APART FROM THE MARK AS SHOWN.

THE STIPPLING IS A FEATURE OF THE MARK.

CLASS 35—ADVERTISING AND BUSINESS

FOR BUSINESS MANAGEMENT AND CONSULTATION IN THE FIELD OF EMPLOYEE BENEFITS; HEALTH CARE UTILIZATION AND REVIEW SERVICES; EMPLOYEE HEALTH AND WELFARE PLAN DESIGN AND BROKERAGE (U.S. CLS. 100, 101 AND 102).

FIRST USE 11-20-2000; IN COMMERCE 4-2-2002.

CLASS 36—INSURANCE AND FINANCIAL

FOR ADMINISTRATION OF EMPLOYEE BENEFIT PLANS, NAMELY, ADMINISTRATION OF EXECUTIVE NON-QUALIFIED BENEFIT PLANS; ADMINISTRATION OF EMPLOYEE WELFARE BENEFIT PLANS; ADMINISTRATION OF PRE-PAID HEALTH CARE PLANS; INSURANCE CONSULTATION; INSURANCE BROKERAGE; ESTATE PLANNING; FINANCIAL CONSULTATION, NAMELY, COMPENSATION AND FINANCIAL RETIREMENT PLAN CONSULTATION; FINANCIAL PLANNING; SECURITY BROKERAGE; FINANCIAL INVESTMENT IN THE FIELD OF SECURITIES (U.S. CLS. 100, 101 AND 102).

FIRST USE 11-20-2000; IN COMMERCE 4-2-2002.

2,730,805. TMI, INC., HOUSTON, TX. SN 78-105,559. PUB. 10-1-2002, FILED 1-29-2002.

CRIGHTON RIDGE**CLASS 36—INSURANCE AND FINANCIAL**

FOR REAL ESTATE BROKERAGE (U.S. CLS. 100, 101 AND 102).

FIRST USE 9-1-1998; IN COMMERCE 3-1-1999.

CLASS 37—CONSTRUCTION AND REPAIR

FOR RESIDENTIAL BUILDING CONSTRUCTION, AND REAL ESTATE DEVELOPMENT, NAMELY, DEVELOPING RESIDENTIAL HOUSING COMMUNITIES (U.S. CLS. 100, 103 AND 106).

FIRST USE 9-1-1998; IN COMMERCE 3-1-1999.

2,730,806. TMI, INC., HOUSTON, TX. SN 78-105,571. PUB. 10-8-2002, FILED 1-29-2002.

**CLASS 36—INSURANCE AND FINANCIAL**

FOR REAL ESTATE BROKERAGE (U.S. CLS. 100, 101 AND 102).

FIRST USE 9-1-1998; IN COMMERCE 3-1-1999.

CLASS 37—CONSTRUCTION AND REPAIR

FOR RESIDENTIAL BUILDING CONSTRUCTION, AND REAL ESTATE DEVELOPMENT, NAMELY, DEVELOPING RESIDENTIAL HOUSING COMMUNITIES (U.S. CLS. 100, 103 AND 106).
FIRST USE 9-1-1998; IN COMMERCE 3-1-1999.

2,730,834. HEALTHTEX APPAREL CORP., WILMINGTON, DE. SN 78-118,703. PUB. 10-8-2002, FILED 4-1-2002.

KID MATCH

2,730,812. DEMANDTEC, INC., SAN CARLOS, CA. SN 78-108,611. PUB. 8-6-2002, FILED 2-13-2002.

DEMAND BETTER

NO CLAIM IS MADE TO THE EXCLUSIVE RIGHT TO USE "KID", APART FROM THE MARK AS SHOWN.

CLASS 9—ELECTRICAL AND SCIENTIFIC APPARATUS

CLASS 35—ADVERTISING AND BUSINESS

FOR BUSINESS MANAGEMENT CONSULTING SERVICES IN THE AREAS OF STATISTICAL ANALYSIS OF BUSINESS DATA AND PRICING AND PROMOTION (U.S. CLS. 100, 101 AND 102).
FIRST USE 11-8-2001; IN COMMERCE 11-8-2001.

FOR SUNGLASSES (U.S. CLS. 21, 23, 26, 36 AND 38).
FIRST USE 1-24-2003; IN COMMERCE 1-24-2003.

CLASS 25—CLOTHING

CLASS 42—SCIENTIFIC, COMPUTER AND LEGAL SERVICES

FOR COMPUTER SOFTWARE PROGRAMMING SERVICES IN THE AREA OF STATISTICAL ANALYSIS OF BUSINESS DATA AND PRICING AND PROMOTION (U.S. CLS. 100 AND 101).
FIRST USE 11-8-2001; IN COMMERCE 11-8-2001.

FOR LEATHER BELTS AND SUSPENDERS; BEACH COVER-UPS, CLOTH BIBS, BOOTIES, BRIEFS, CASUAL PANTS, COATS, COVERALLS, CREEPERS, T-SHIRTS, DRESSES, FOOTWEAR, HEADBANDS, HOSIERY, JACKETS, JEANS, JUMPERS, LAYETTES, NIGHTGOWNS, NIGHTSHIRTS, OVERALLS, PAJAMAS, PANTIES, ROBES, ROMPERS, SHIRTS, SHORTALLS, SHORTS, SKIRTS, SLEEPERS, SOCKS, SWEATSUITS, SWEATERS, SWIMSUITS, VESTS, WIND-RESISTANT JACKETS (U.S. CLS. 22 AND 39).
FIRST USE 1-24-2003; IN COMMERCE 1-24-2003.

* * * * *

SECTION 2.— INTERNATIONAL CLASSIFICATION

The short titles associated below with the international class numbers are terms designed merely for quick identification and are not an official part of the international classification. The full names of international classes are given in section 6.1 of the trademark rules of practice.

The designation "U.S. Cl." appearing in this section refers to the U.S. class in effect prior to Sep. 1, 1973 rather than the international class which applies to applications filed on or after that date. For adoption of international classification see notice in the OFFICIAL GAZETTE of Jun. 26, 1973 (911 O.G. TM 210).

Application in one class

CLASS 1—CHEMICALS

2,729,398. NANOGRAM CORPORATION, FREMONT, CA. SN 75-507,689. PUB. 12-7-1999, FILED 6-22-1998.

NGM

FOR CHEMICAL POWDERS, NAMELY SUBMICRON METAL POWDERS, SUBMICRON POWDERS OF METAL COMPOSITIONS AND SUBMICRON POWDERS OF SILICON COMPOSITIONS FOR USE IN THE MANUFACTURE OF ABRASIVE COMPOSITIONS, BATTERIES, BATTERY ELECTRODES, CAPACITORS, CATALYSTS, ELECTRONIC COMPONENTS, FLAT PANEL DISPLAYS, ULTRAVIOLET ABSORBING MATERIALS, ELECTROMAGNETIC SHIELDING, AND SOLAR CELLS; LIQUID DISPERSIONS OF SUBMICRON CHEMICAL POWDERS, NAMELY AQUEOUS DISPERSIONS AND DISPERSIONS IN ORGANIC SOLVENTS FOR USE IN THE MANUFACTURE OF ABRASIVE COMPOSITIONS, BATTERIES, BATTERY ELECTRODES, CAPACITORS, CATALYSTS, ELECTRONIC COMPONENTS, FLAT PANEL DISPLAYS, ULTRAVIOLET ABSORBING MATERIALS, ELECTROMAGNETIC SHIELDING, AND SOLAR CELLS; CHEMICALS FOR USE IN THE MANUFACTURE OF ABRASIVE COMPOSITIONS, BATTERIES, BATTERY ELECTRODES, CAPACITORS, CATALYSTS, ELECTRONIC COMPONENTS, FLAT PANEL DISPLAYS, ULTRAVIOLET ABSORBING MATERIALS, ELECTROMAGNETIC SHIELDING, AND SOLAR CELLS (U.S. CLS. 1, 5, 6, 10, 26 AND 46).
FIRST USE 2-26-2003; IN COMMERCE 2-26-2003.

2,729,405. KERRY GROUP PLC, TRALEE, COUNTY KERRY, IRELAND. SN 75-529,953. PUB. 1-4-2000, FILED 8-3-1998.



OWNER OF U.S. REG. NO. 1,881,731.
THE MARK IS LINED FOR THE COLORS BLUE AND GOLD.
FOR EMULSIFIERS FOR USE IN THE MANUFACTURE OF FOODS (U.S. CLS. 1, 5, 6, 10, 26 AND 46).
FIRST USE 11-21-1997; IN COMMERCE 11-21-1997.

CLASS 1—(Continued).

2,729,425. JACKSON, LAWRENCE H., WADDELL, AZ. SN 75-601,004. PUB. 8-1-2000, FILED 12-7-1998.

CHAMPION GREEN

NO CLAIM IS MADE TO THE EXCLUSIVE RIGHT TO USE "GREEN", APART FROM THE MARK AS SHOWN.
FOR FERTILIZER AND SOIL CONDITIONERS FOR AGRICULTURAL AND DOMESTIC USE (U.S. CLS. 1, 5, 6, 10, 26 AND 46).
FIRST USE 9-27-2000; IN COMMERCE 9-27-2000.

2,729,526. APPLI-TEC, INC., HAVERHILL, MA. SN 75-812,507. PUB. 6-25-2002, FILED 10-1-1999.

CRYO-PAC

FOR PRE-MIXED, FROZEN AND PREPACKAGED ADHESIVES, NAMELY EPOXIES, POLYURETHANES, SILICONES AND POLYSULFIDES FOR USE IN THE MANUFACTURE OF ELECTRONIC AND MECHANICAL PRODUCTS IN A VARIETY OF APPLICATIONS, NAMELY, THE ELECTRONIC, AERO AND SPACE FLIGHT, MEDICAL EQUIPMENT, DEFENSE, COMPUTER HARDWARE, TELECOMMUNICATIONS AND JEWELRY INDUSTRIES; PRE-MIXED, FROZEN AND PREPACKAGED EPOXY GLUE FOR GENERAL BONDING AND REPAIR PURPOSES; PREMIXED, FROZEN AND PREPACKAGED POTTING AND STAKING COMPOUNDS, NAMELY, EPOXIES, POLYURETHANES, SILICONES AND POLYSULFIDES, FOR USE IN THE MANUFACTURE OF ELECTRONIC AND MECHANICAL PRODUCTS IN A VARIETY OF APPLICATIONS, NAMELY, THE ELECTRONIC, AERO AND SPACE FLIGHT, MEDICAL EQUIPMENT, DEFENSE, COMPUTER HARDWARE TELECOMMUNICATIONS AND JEWELRY INDUSTRIES; AND UNPROCESSED ARTIFICIAL AND SYNTHETIC RESINS FOR USE IN EPOXIES, POLYURETHANES, SILICONES AND POLYSULFIDES TO COVER AND SEAL ELECTRONIC AND MECHANICAL PARTS IN A VARIETY OF APPLICATIONS IN THE ELECTRONIC, AERO AND SPACE FLIGHT, MEDICAL EQUIPMENT, DEFENSE, COMPUTER HARDWARE, TELECOMMUNICATIONS AND JEWELRY INDUSTRIES (U.S. CLS. 1, 5, 6, 10, 26 AND 46).
FIRST USE 10-1-1999; IN COMMERCE 10-1-1999.

CLASS 1—(Continued).

2,729,531. INDUSTRIA CHIMICA GENERAL SNC, 41100 MODENA, ITALY. SN 75-821,050. PUB. 12-18-2001, FILED 10-12-1999.

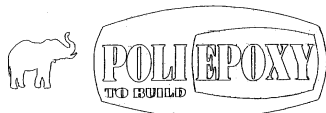

NO CLAIM IS MADE TO THE EXCLUSIVE RIGHT TO USE "EPOXY" AND "TO BUILD", APART FROM THE MARK AS SHOWN.

THE DRAWING IS LINED FOR THE COLOR(S) RED AND GREY.

THE WORDING IN THE MARK IS IN THE COLOR WHITE, THE DESIGN OF THE ELEPHANT AND THE BACKGROUND OF THE LARGE OVAL SURROUNDING THE WORDING ARE IN THE COLOR BLACK, AND THE SMALLER OVAL SURROUNDING THE WORD EPOXY IS IN THE COLOR RED.

FOR INDUSTRIAL ADHESIVE USED IN THE PERMANENT GLUING OF MATERIALS, NAMELY, MARBLE, GRANITE, STONES, CONCRETE, IRON, FOR USE IN BUILDING INDUSTRY AND LANDSCAPING INDUSTRY AND EXCLUDING COATING AND ADHESIVE ON THE FINISHED PRODUCTS (U.S. CLS. 1, 5, 6, 10, 26 AND 46).

FIRST USE 8-0-2000; IN COMMERCE 8-0-2000.

2,729,624. AXT, INC., FREMONT, CA, BY CHANGE OF NAME AMERICAN XTAL TECHNOLOGY, INC., FREMONT, CA. SN 75-934,179. PUB. 5-15-2001, FILED 3-2-2000.



THE STIPPLING IN THE DRAWING IS A FEATURE OF THE MARK AND DOES NOT INDICATE COLOR.

FOR COMPOUND SEMICONDUCTOR MATERIALS AND SUBSTRATES, NAMELY, GALLIUM ARSENIDE, INDIUM PHOSPHIDE, GERMANIUM, GALLIUM PHOSPHIDE, GALLIUM NITRIDE AND SILICON CARBIDE FOR USE IN THE TELECOMMUNICATIONS INDUSTRY, FIBER OPTIC TELECOMMUNICATIONS INDUSTRY, HIGH-SPEED NETWORKING INDUSTRY, DISPLAY AND LIGHTING INDUSTRY, SEMICONDUCTOR MATERIALS AND DEVICES INDUSTRY, LIGHT EMITTING DIODE INDUSTRY, ELECTRO- AND OPTOELECTRONIC DEVICE INDUSTRY, SATELLITE COMMUNICATIONS SYSTEMS INDUSTRY, COMMUNICATIONS SEMICONDUCTOR INDUSTRY, WIRELESS DEVICES INDUSTRY, LASER INDUSTRY, CONSUMER ELECTRONICS INDUSTRY, RADAR INDUSTRY AND DIRECT BROADCAST TELEVISION SYSTEMS INDUSTRY (U.S. CLS. 1, 5, 6, 10, 26 AND 46).

FIRST USE 6-0-2000; IN COMMERCE 6-0-2000.

CLASS 1—(Continued).

2,729,631. CLARIANT GMBH, 65926 FRANKFURT, FED REP GERMANY. SN 75-939,782. PUB. 12-26-2000, FILED 3-9-2000.

LOCRON

FOR CHEMICAL PRODUCTS FOR INDUSTRIAL AND SCIENTIFIC PURPOSES, NAMELY, ALUMINUM HYDROXYCHLORIDE (U.S. CLS. 1, 5, 6, 10, 26 AND 46).
FIRST USE 11-30-1997; IN COMMERCE 11-30-1997.

2,729,681. POWER SERVICE PRODUCTS, INC., WEATHERFORD, TX. SN 76-021,979. PUB. 3-26-2002, FILED 4-7-2000.



THE LINING IN THE DRAWING IS A FEATURE OF THE MARK AND DOES NOT INDICATE ANY PARTICULAR COLOR.

FOR CHEMICAL ADDITIVES FOR USE IN COMBINATION WITH ENGINE FUELS (U.S. CLS. 1, 5, 6, 10, 26 AND 46).

FIRST USE 2-0-2000; IN COMMERCE 2-0-2000.

2,729,777. SFR CORPORATION, BUTTE, MT. SN 76-101,567. PUB. 11-13-2001, FILED 8-2-2000.

PROTECTA

FOR CHEMICAL LUBRICATING OIL ADDITIVES (U.S. CLS. 1, 5, 6, 10, 26 AND 46).

FIRST USE 11-27-2002; IN COMMERCE 1-8-2003.

2,729,781. BASF AKTIENGESELLSCHAFT, FED REP GERMANY. SN 76-104,880. PUB. 12-4-2001, FILED 8-7-2000.

F 500

NO CLAIM IS MADE TO THE EXCLUSIVE RIGHT TO USE "500", APART FROM THE MARK AS SHOWN.

FOR CHEMICALS, NAMELY FUNGICIDAL ACTIVE INGREDIENTS FOR USE IN THE FORMULATION OF FUNGICIDES IN THE AGRICULTURAL, HORTICULTURAL AND FORESTRY INDUSTRIES (U.S. CLS. 1, 5, 6, 10, 26 AND 46).

FIRST USE 1-6-2003; IN COMMERCE 1-6-2003.

CLASS 1—(Continued).

2,729,792. RAPP POLYMERE GMBH, D-72072 TUBINGEN, FED REP GERMANY. SN 76-113,985. PUB. 7-9-2002, FILED 8-21-2000.

HYPOGEL

FOR INDUSTRIAL CHEMICALS, NAMELY CHEMICAL PREPARATIONS FOR SCIENTIFIC PURPOSES AND FOR ANALYSES IN LABORATORIES; SYNTHETIC RESINS FOR CHROMATOGRAPHY, ION EXCHANGE AND SCAVENGING (U.S. CLS. 1, 5, 6, 10, 26 AND 46).
FIRST USE 12-31-1999; IN COMMERCE 12-31-1999.

2,729,873. ROHM AMERICA LLC, PISCATAWAY, NJ. SN 76-162,587. PUB. 1-8-2002, FILED 11-9-2000.

LEADING THE WAY

FOR SYNTHETIC RESINS FOR USE IN THE MANUFACTURE OF ROAD MARKING PAINTS (U.S. CLS. 1, 5, 6, 10, 26 AND 46).
FIRST USE 3-1-2003; IN COMMERCE 3-1-2003.

2,729,972. BORAL INDUSTRIES INC., ROSWELL, GA. SN 76-212,067. PUB. 3-26-2002, FILED 2-16-2001.

BORAL SPC

OWNER OF U.S. REG. NOS. 1,586,785 AND 1,587,851. FOR CONCRETE ADMIXTURES (U.S. CLS. 1, 5, 6, 10, 26 AND 46).
FIRST USE 4-10-2001; IN COMMERCE 4-10-2001.

2,729,992. COGNIS CORPORATION, CINCINNATI, OH. SN 76-219,666. PUB. 6-25-2002, FILED 3-5-2001.

WATERPOXY

FOR SYNTHETIC RESINS FOR USE IN THE MANUFACTURE OF COATINGS AND PAINTS (U.S. CLS. 1, 5, 6, 10, 26 AND 46).
FIRST USE 4-30-1995; IN COMMERCE 12-31-1998.

CLASS 1—(Continued).

2,730,000. CAL INDIA FOODS INTERNATIONAL, DBA SPECIALTY ENZYMES AND BIOCHEMICALS CO., CHINO, CA. SN 76-220,764. PUB. 5-7-2002, FILED 3-6-2001.

SEB

FOR ENZYME PREPARATIONS USED IN THE MANUFACTURE OF INDUSTRIAL AND RESIDENTIAL DETERGENTS, AUTOMATIC DISHWASHER CLEANING AGENTS, PERSONAL CARE PRODUCTS, SHAMPOOS, SOAPS, EXFOLIANTS, PROBIOTIC PREPARATIONS FOR NUTRITIONAL HEALTH FOR HUMANS AND ANIMALS, NUTRITIONAL SUPPLEMENTS, BEVERAGES, JUICES, PHARMACEUTICALS, HEALTH FOOD, INDUSTRIAL ALCOHOL, ANIMAL, FISH, AND POULTRY FEEDS, AND NATURAL EXTRACTS; ENZYME PREPARATIONS FOR INDUSTRIAL AND COMMERCIAL PROCESSING, BREWING AND DISTILLING, TEXTILE PROCESSING, GARMENT AND DENIM WASHING PROCESS, LEATHER PROCESSING, BAKING, FLOUR MILLING, FOOD PROCESSING, AND PAPER PULP PROCESSING (U.S. CLS. 1, 5, 6, 10, 26 AND 46).
FIRST USE 5-3-2002; IN COMMERCE 5-3-2002.

2,730,074. W. R. GRACE & CO.-CONN., COLUMBIA, MD. SN 76-254,533. PUB. 12-25-2001, FILED 5-10-2001.

POLARIS

FOR CHEMICALS FOR USE IN INDUSTRY, NAMELY, FLUID CRACKING CATALYSTS AND ADDITIVES USED IN THE PETROLEUM AND REFINING INDUSTRIES (U.S. CLS. 1, 5, 6, 10, 26 AND 46).
FIRST USE 10-10-2000; IN COMMERCE 10-10-2000.

2,730,076. E.I. DU PONT DE NEMOURS AND COMPANY, WILMINGTON, DE. SN 76-255,280. PUB. 12-25-2001, FILED 5-10-2001.

TRASYS

FOR SYNTHETIC RESINS FOR USE IN THE MANUFACTURE OF MOLD RELEASE COATINGS AND ANTI-STICK LUBRICATING COATINGS FOR GENERAL INDUSTRIAL USE (U.S. CLS. 1, 5, 6, 10, 26 AND 46).
FIRST USE 6-21-2002; IN COMMERCE 6-21-2002.

2,730,130. RHODIA, 92512 BOULOGNE BILLANCOURT CEDEX, FRANCE. SN 76-272,001. PUB. 10-23-2001, FILED 6-15-2001.

RHODIASOLV

FOR CHEMICALS FOR USE IN INDUSTRY, IN PARTICULAR IN THE ELECTRONIC, FINE ORGANIC, AND HOME CARE INDUSTRIES SOLVENTS FOR USE IN THESE INDUSTRIES (U.S. CLS. 1, 5, 6, 10, 26 AND 46).
FIRST USE 12-0-1998; IN COMMERCE 12-0-1998.

CLASS 1—(Continued).

2,730,133. XENCOR, INC., MONROVIA, CA. SN 76-272,231. PUB. 10-2-2001, FILED 6-15-2001.

PDA

FOR BIOTECHNOLOGICAL PRODUCTS, BEING PULP AND PAPER PROCESSING ENZYMES, NAMELY XYLANASE FOR BLEACH BOOSTING, PITCH REDUCTION LIPASES, CELLULASES FOR BLEACH BOOSTING; DETERGENT ENZYMES, NAMELY, DETERGENT PROTEASES, DETERGENT CELLULASES, DETERGENT LIPASES; WASTE REMEDIATION ENZYMES, NAMELY, DEHALOGENASE ENZYMES; BIOMASS PROCESSING ENZYMES, NAMELY, CELLULASES, AMYLASES, AND GLUCOAMYLASES (U.S. CLS. 1, 5, 6, 10, 26 AND 46). FIRST USE 10-22-2002; IN COMMERCE 10-22-2002.

2,730,203. ADVANTIS TECHNOLOGIES, INC., ALPHARETTA, GA. SN 76-294,199. PUB. 11-27-2001, FILED 8-1-2001.

RESERVE & RENEW

FOR WATER CONDITIONING CHEMICAL COMPOUNDS FOR THE SANITIZATION AND TREATMENT OF WATER IN SPAS, HOT TUBS AND THERAPEUTIC BATHS (U.S. CLS. 1, 5, 6, 10, 26 AND 46). FIRST USE 7-1-2001; IN COMMERCE 7-1-2001.

2,730,218. SCHENECTADY INTERNATIONAL, INC., SCHENECTADY, NY. SN 76-298,652. PUB. 5-7-2002, FILED 8-14-2001.

ISOSOLVE

OWNER OF U.S. REG. NOS. 636,315, 1,557,466, AND OTHERS. FOR WIRE ENAMEL SOLVENTS (U.S. CLS. 1, 5, 6, 10, 26 AND 46). FIRST USE 9-25-2001; IN COMMERCE 9-25-2001.

2,730,246. SUMMIT SEED, INC., MANTENO, IL. SN 76-306,716. PUB. 5-14-2002, FILED 8-29-2001.

HYDRO TURBONET

NO CLAIM IS MADE TO THE EXCLUSIVE RIGHT TO USE "HYDRO", APART FROM THE MARK AS SHOWN. FOR CHEMICAL ADDITIVE FOR INCORPORATION INTO HYDRO-SEEDING MULCH (U.S. CLS. 1, 5, 6, 10, 26 AND 46). FIRST USE 5-13-2002; IN COMMERCE 5-13-2002.

CLASS 1—(Continued).

2,730,371. ABSORBAKLEEN, L.L.C., MINSTER, OH. SN 76-340,266. PUB. 4-30-2002, FILED 11-20-2001.

RHYOFIL

FOR VOLCANIC ASH FOR USE IN AN INDUSTRIAL MINERAL FUNCTIONAL FILLER OR EXTENDER, AND AS A FILTER AID (U.S. CLS. 1, 5, 6, 10, 26 AND 46). FIRST USE 8-0-2001; IN COMMERCE 1-0-2002.

2,730,410. CHEMI S.P.A., CINISELLO BALSAMO (MILAN), ITALY. SN 76-347,195. PUB. 5-14-2002, FILED 12-10-2001.

SERINAID

FOR CHEMICALS, NAMELY PHOSPHATIDYLSERINES USED IN THE PHARMACEUTICAL, COSMETIC AND FOOD INDUSTRIES (U.S. CLS. 1, 5, 6, 10, 26 AND 46). FIRST USE 3-9-2001; IN COMMERCE 3-9-2001.

2,730,500. PRESERVATION TECHNOLOGIES, L.P., CRANBERRY TOWNSHIP, PA. SN 76-372,075. PUB. 9-10-2002, FILED 2-19-2002.

PAPER BRIGHT

NO CLAIM IS MADE TO THE EXCLUSIVE RIGHT TO USE "PAPER", APART FROM THE MARK AS SHOWN. FOR CHEMICALS FOR ABSORBING ULTRAVIOLET LIGHT TO RETARD THE YELLOWING OF PAPER (U.S. CLS. 1, 5, 6, 10, 26 AND 46). FIRST USE 2-20-2002; IN COMMERCE 2-20-2002.

2,730,519. NOVEON IP HOLDINGS CORP., CLEVELAND, OH. SN 76-383,538. PUB. 9-17-2002, FILED 3-13-2002.

NOVEMER

FOR WATER-SOLUBLE AND WATER-SWELLABLE SYNTHETIC POLYMERIC MATERIALS FOR USE AS THICKENING, SUSPENDING, OR EMTULSIFYING AGENTS (U.S. CLS. 1, 5, 6, 10, 26 AND 46). FIRST USE 10-11-2002; IN COMMERCE 10-11-2002.

2,730,520. AQUARIA, INC., MOORPARK, CA. SN 76-384,480. PUB. 10-8-2002, FILED 3-19-2002.

BIO-SPIRA

FOR BACTERIA AND PREPARATIONS CONTAINING BACTERIA FOR USE IN WATER TREATMENT (U.S. CLS. 1, 5, 6, 10, 26 AND 46). FIRST USE 6-0-2002; IN COMMERCE 10-0-2002.

CLASS 1—(Continued).

2,730,526. SHIPLEY COMPANY, LLC, MARLBOROUGH, MA. SN 76-391,491. PUB. 10-15-2002, FILED 4-4-2002.

TELEPOSIT

FOR CHEMICAL CATALYSTS FOR METAL DEPOSITION, INCLUDING PHOTOREACTIVE CATALYSTS SUITABLE FOR ELECTROLESS AND ELECTROLYTIC DEPOSITION (U.S. CLS. 1, 5, 6, 10, 26 AND 46).
FIRST USE 10-15-2002; IN COMMERCE 10-15-2002.

2,730,578. POLYMER ENGINEERING CORPORATION, OXNARD, CA. SN 78-037,428. PUB. 8-14-2001, FILED 12-1-2000.

FLEXURE

FOR URETHANE-BASED ELECTRONIC COMPONENT ENCAPSULANTS (U.S. CLS. 1, 5, 6, 10, 26 AND 46).
FIRST USE 11-11-2002; IN COMMERCE 11-11-2002.

2,730,655. BEN & JERRY'S HOMEMADE HOLDINGS, INC., BURLINGTON, VT. SN 78-065,023. PUB. 12-18-2001, FILED 5-22-2001.

TERRA FUELA

THE ENGLISH TRANSLATION OF THE WORD "TERRA" IN THE MARK IS "EARTH".
FOR COMPOST (U.S. CLS. 1, 5, 6, 10, 26 AND 46).
FIRST USE 8-28-2001; IN COMMERCE 8-28-2001.

2,730,675. BIOSUN SYSTEMS CORPORATION, MAPLE GROVE, MN. SN 78-072,920. PUB. 7-2-2002, FILED 7-9-2001.

BIOSUN

FOR COMPOSITIONS OF BACTERIA, ENZYMES AND BLENDS THEREOF FOR CONTROLLING ODORS AND REDUCING SOLIDS FOR USE IN THE AGRICULTURAL AND WASTE TREATMENT INDUSTRIES (U.S. CLS. 1, 5, 6, 10, 26 AND 46).
FIRST USE 8-8-1996; IN COMMERCE 8-8-1996.

2,730,715. GEO SPECIALTY CHEMICALS, INC., CLEVELAND, OH. SN 78-084,473. PUB. 4-2-2002, FILED 9-19-2001.

LIQUA-CUP

FOR LIQUID PEROXIDE CATALYST FOR USE IN THE MANUFACTURE OF POLYMERS (U.S. CLS. 1, 5, 6, 10, 26 AND 46).
FIRST USE 3-1-2003; IN COMMERCE 3-1-2003.

CLASS 1—(Continued).

2,730,719. INDOPCO, INC., DBA NATIONAL STARCH & CHEMICAL COMPANY, BRIDGEWATER, NJ. SN 78-085,598. PUB. 7-9-2002, FILED 9-26-2001.

VERSAFLEX

OWNER OF U.S. REG. NO. 2,091,733.
FOR CARBOXYLATE AND SULFONATE COPOLYMERS USED TO CONTROL DEPOSITS FOUND IN WATER TREATMENT SYSTEMS (U.S. CLS. 1, 5, 6, 10, 26 AND 46).
FIRST USE 4-2-2002; IN COMMERCE 4-2-2002.

2,730,759. BAYER POLYMERS LLC, PITTSBURGH, PA, BY ASSIGNMENT BAYER CORPORATION, PITTSBURGH, PA. SN 78-096,293. PUB. 6-4-2002, FILED 12-3-2001.

CREKAT

FOR CHEMICAL ADDITIVES FOR USE IN THE MANUFACTURE OF POWDER COATINGS FOR THE AUTOMOTIVE AND INDUSTRIAL FINISHING INDUSTRIES (U.S. CLS. 1, 5, 6, 10, 26 AND 46).
FIRST USE 9-21-2001; IN COMMERCE 9-21-2001.

CLASS 2—PAINTS

2,729,903. TRIPLE E B.V., 3572 AX UTRECHT, NETHERLANDS. SN 76-179,245. PUB. 6-25-2002, FILED 12-12-2000.

THERMOGUARD

OWNER OF BENELUX REG. NO. 0967149, DATED 6-16-2000, EXPIRES 6-16-2010.
FOR RUST PRESERVATIVES IN THE NATURE OF A COATING USED ON HEAT EXCHANGERS (U.S. CLS. 6, 11 AND 16).
FIRST USE 4-1-2000; IN COMMERCE 2-16-2001.

2,730,188. STO CORP., ATLANTA, GA. SN 76-290,449. PUB. 8-20-2002, FILED 7-26-2001.

DECORTEX

FOR PROTECTIVE COATINGS IN THE NATURE OF PAINTS, WATER SEALANTS AND BARRIERS (U.S. CLS. 6, 11 AND 16).
FIRST USE 3-1-2002; IN COMMERCE 3-1-2002.

CLASS 2—(Continued).

2,730,228. SCHOOL SPECIALTY, INC., APPLETON, WI. SN 76-302,139. PUB. 11-13-2001, FILED 8-20-2001.

ULTRA PLUS

FOR PAINTS FOR USE IN CLASSROOMS INCLUDING TEMPERA PAINTS (U.S. CLS. 6, 11 AND 16).
FIRST USE 8-25-2001; IN COMMERCE 8-25-2001.

2,730,243. SHEPHERD COLOR COMPANY, THE, CINCINNATI, OH. SN 76-306,084. PUB. 3-5-2002, FILED 8-28-2001.

ARCTIC

FOR INORGANIC COLORED PIGMENTS USED IN PAINT, PLASTICS, CEMENT AND GLASS (U.S. CLS. 6, 11 AND 16).
FIRST USE 10-22-2001; IN COMMERCE 10-22-2001.

2,730,275. ACE HARDWARE CORPORATION, OAK BROOK, IL. SN 76-315,706. PUB. 2-12-2002, FILED 9-17-2001.

COLOR YOUR LIFE

FOR INDOOR AND OUTDOOR PAINT, COATINGS AND VARNISHES (U.S. CLS. 6, 11 AND 16).
FIRST USE 8-0-2001; IN COMMERCE 8-0-2001.

2,730,441. DYNACRAFT INDUSTRIES INC., TA BACK TO NATURE PRODUCTS CO., ENGLISHTOWN, NJ. SN 76-353,189. PUB. 7-16-2002, FILED 12-28-2001.



THE STIPPLING IS FOR SHADING PURPOSES.
FOR LEATHER COLORING KIT CONSISTING OF A PAINT, A WASH AND A PREPARATION (U.S. CLS. 6, 11 AND 16).
FIRST USE 3-18-2002; IN COMMERCE 3-18-2002.

CLASS 2—(Continued).

2,730,467. GRUPO SAYER, S.A. DE C.V., APASEO EL ALTO, QUERETARO 38511, MEXICO. SN 76-361,365. PUB. 9-3-2002, FILED 1-22-2002.

GPS COATINGS

NO CLAIM IS MADE TO THE EXCLUSIVE RIGHT TO USE "COATINGS", APART FROM THE MARK AS SHOWN.
FOR INDUSTRIAL AND ARCHITECTURAL COATINGS, NAMELY STAINS, PAINTS AND VARNISHES (U.S. CLS. 6, 11 AND 16).
FIRST USE 1-29-2002; IN COMMERCE 1-29-2002.

2,730,487. INDUSTRIAS MARCA, S.A., 08907 L' HOPITALET DE LLOBREGAT, SPAIN. SN 76-367,429. PUB. 7-9-2002, FILED 2-6-2002.

IBERIA

FOR CLOTHING DYE (U.S. CLS. 6, 11 AND 16).
FIRST USE 4-0-2002; IN COMMERCE 4-0-2002.

2,730,618. VALSPAR CORPORATION, THE, MINNEAPOLIS, MN. SN 78-051,727. PUB. 10-2-2001, FILED 3-7-2001.

DURASPAR

FOR INDUSTRIAL COATING IN THE NATURE OF PAINT (U.S. CLS. 6, 11 AND 16).
FIRST USE 10-1-2001; IN COMMERCE 10-1-2001.

2,730,718. SHERWIN-WILLIAMS COMPANY, THE, CLEVELAND, OH. SN 78-084,851. PUB. 9-10-2002, FILED 9-21-2001.

FAST-CLAD

FOR PROTECTIVE AND DECORATIVE COATINGS USED IN THE NATURE OF PAINT (U.S. CLS. 6, 11 AND 16).
FIRST USE 1-24-2003; IN COMMERCE 1-24-2003.

2,730,829. CAI INC, GEORGETOWN, MA. SN 78-117,178. PUB. 11-5-2002, FILED 3-25-2002.

HERCUBOND SURFACE

NO CLAIM IS MADE TO THE EXCLUSIVE RIGHT TO USE "SURFACE", APART FROM THE MARK AS SHOWN.
FOR PRINTERS' INK (U.S. CLS. 6, 11 AND 16).
FIRST USE 4-12-2002; IN COMMERCE 4-12-2002.

CLASS 2—(Continued).

2,730,830. CAI INC, GEORGETOWN, MA. SN 78-117,188. PUB. 10-8-2002, FILED 3-25-2002.

HERCUFLEX

FOR PRINTERS' INK (U.S. CLS. 6, 11 AND 16).
FIRST USE 4-8-2002; IN COMMERCE 4-8-2002.

2,730,833. CAI INC, GEORGETOWN, MA. SN 78-117,779. PUB. 10-29-2002, FILED 3-27-2002.

AQUA-UB

FOR PRINTERS' INK (U.S. CLS. 6, 11 AND 16).
FIRST USE 12-3-2001; IN COMMERCE 12-3-2001.

CLASS 3—COSMETICS AND CLEANING PREPARATIONS

2,729,409. STELLA GUAPA, INC., BEVERLY HILLS, CA. SN 75-546,904. PUB. 9-28-1999, FILED 9-2-1998.

MOVIE STAR MAKEUP

NO CLAIM IS MADE TO THE EXCLUSIVE RIGHT TO USE "MAKEUP", APART FROM THE MARK AS SHOWN.
FOR BLUSHER (U.S. CLS. 1, 4, 6, 50, 51 AND 52).
FIRST USE 12-17-2002; IN COMMERCE 12-17-2002.

2,729,411. HERBA LAB INC., VANCOUVER, BRITISH COLUMBIA, CANADA. SN 75-555,888. PUB. 5-21-2002, FILED 9-21-1998.

HERBACORT

PRIORITY CLAIMED UNDER SEC. 44(D) ON CANADA APPLICATION NO. 890404, FILED 9-16-1998, REG. NO. 543983, DATED 4-20-2001, EXPIRES 4-20-2016.

FOR NON-MEDICATED HERBAL SKIN CARE PRODUCT, NAMELY, AN OINTMENT FOR RELIEF FROM ECZEMA, DERMATITIS, ACNE, PSORIASIS, ITCHING, INSECT BITES, MINOR CUTS, MINOR BURNS, ACHES AND MUSCLE SORENESS (U.S. CLS. 1, 4, 6, 50, 51 AND 52).
FIRST USE 10-9-1998; IN COMMERCE 12-10-2000.

CLASS 3—(Continued).

2,729,457. STEVENSON, RICHARD L., NEWPORT BEACH, CA. SN 75-686,298. PUB. 11-30-1999, FILED 4-19-1999.

MAKAHA

THE ENGLISH TRANSLATION OF THE HAWAIIAN WORD "MAKAHA" IS "A MEETING PLACE."
FOR SUNTAN PREPARATIONS, NAMELY, SUN BLOCKS AND SUNSCREENS (U.S. CLS. 1, 4, 6, 50, 51 AND 52).
FIRST USE 2-20-2003; IN COMMERCE 2-20-2003.

2,729,458. PARFUMS GIVENCHY, 92300 LEVALLOIS PERRET, FRANCE. SN 75-686,700. PUB. 5-16-2000, FILED 4-20-1999.

MIROIR

THE ENGLISH TRANSLATION OF THE WORD "MIRROIR" IN THE MARK IS "MIRROR".

FOR TOILET SOAPS, PERFUMES, EAUX DE COLOGNE, TOILET WATER, ESSENTIAL OILS FOR PERSONAL USE, FACIAL MILKS, SKIN LOTIONS, SKIN CREAMS, BODY EMULSIONS, FACIAL EMULSIONS, GELS FOR FACE AND BODY, COLORED SKIN CREAMS, ROUGE, FACIAL POWDERS, MAKEUP REMOVING LOTIONS, MAKEUP REMOVING MILKS, MAKEUP REMOVING CREAMS, MAKEUP REMOVING GELS, BODY CREAMS, NON-MEDICATED BATH GELS, NON-MEDICATED BATH OILS, NON-MEDICATED BATH SALTS, TALCUM POWDER, PERFUMED BODY POWDER, PERFUMED BATH POWDER, DEODORANTS FOR PERSONAL USE, NON-MEDICATED HAIR PREPARATIONS, NAMELY, HAIR SPRAY, HAIR GEL, HAIR CREAMS, HAIR BALMS, HAIR FOAMS, HAIR SHAMPOOS (U.S. CLS. 1, 4, 6, 50, 51 AND 52).
FIRST USE 0-0-1999; IN COMMERCE 0-0-1999.

2,729,459. FIELDPOINT BV, 1017 PP AMSTERDAM, NETHERLANDS. SN 75-688,370. PUB. 7-16-2002, FILED 4-22-1999.

LA DANZA

THE ENGLISH TRANSLATION OF "LA DANZA" IS "INTRIGUE".

FOR PERFUMES; ESSENTIAL OILS FOR PERSONAL USE; COSMETICS, NAMELY, MASCARA, FOUNDATION, CONCEALER, FACIAL POWDER, LIPSTICK, LIP PENCILS, LIP GLOSS, EYELINER, EYE SHADOW, BLUSH, NAIL POLISH, MAKE-UP REMOVER; DENTRIFICES (U.S. CLS. 1, 4, 6, 50, 51 AND 52).
FIRST USE 3-18-1999; IN COMMERCE 2-7-2002.

2,729,486. GINS, CATHY, NEW YORK, NY. SN 75-746,390. PUB. 2-22-2000, FILED 7-1-1999.

BENEFISCENTS

FOR PERFUMES, SKIN SOAPS, ESSENTIAL OILS FOR PERSONAL USE, COSMETICS, NAMELY, MAKEUP AND BATH GELS; BODY AND HAIR LOTIONS; ROOM FRAGRANCES (U.S. CLS. 1, 4, 6, 50, 51 AND 52).
FIRST USE 2-1-2003; IN COMMERCE 2-1-2003.

CLASS 3—(Continued).

2,729,495. OXIS HEALTH PRODUCTS, INC., PORTLAND, OR. SN 75-766,422. PUB. 6-5-2001, FILED 8-2-1999.

L-ERGO

FOR DERMAL PROTECTANTS, NAMELY, SKIN LOTIONS (U.S. CLS. 1, 4, 6, 50, 51 AND 52);
FIRST USE 8-27-2002; IN COMMERCE 8-27-2002.

2,729,520. CONOPCO, INC., DBA HELENE CURTIS, CHICAGO, IL. SN 75-804,462. PUB. 5-16-2000, FILED 9-21-1999.

FRUIT ENERGY

NO CLAIM IS MADE TO THE EXCLUSIVE RIGHT TO USE "FRUIT", APART FROM THE MARK AS SHOWN.
FOR HAIR CARE PRODUCTS, NAMELY, SHAMPOO AND CONDITIONER (U.S. CLS. 1, 4, 6, 50, 51 AND 52).
FIRST USE 2-3-2003; IN COMMERCE 2-3-2003.

2,729,523. PARFUMS CHRISTIAN DIOR, S.A., 75008 PARIS, FRANCE. SN 75-809,243. PUB. 7-2-2002, FILED 9-27-1999.

PHENOMEN-A

FOR EYE CREAM, NIGHT CREAM, SKIN CREAM, FACIAL LOTIONS AND SKIN MOISTURIZER (U.S. CLS. 1, 4, 6, 50, 51 AND 52).
FIRST USE 9-0-1999; IN COMMERCE 9-0-1999.

2,729,563. GUTHY-RENKER CORPORATION, PALM DESERT, CA. SN 75-866,698. PUB. 8-15-2000, FILED 12-7-1999.

SHEER COVER

NO CLAIM IS MADE TO THE EXCLUSIVE RIGHT TO USE "COVER", APART FROM THE MARK AS SHOWN.
FOR FULL LINE OF COSMETICS, NAMELY, FOUNDATION, EYE MAKEUP, EYE MAKEUP REMOVER, EYE PENCILS, EYE SHADOW, EYEBROW PENCILS, EYELINERS, EYE CREAM, FACE POWDER, ROUGE, BLUSH, MASCARA, LIPSTICK, LIPSTICK PENCILS AND LIP GLOSS (U.S. CLS. 1, 4, 6, 50, 51 AND 52).
FIRST USE 1-10-2003; IN COMMERCE 1-10-2003.

CLASS 3—(Continued).

2,729,618. JAQUA GIRLS, INC., SANTA BARBARA, CA. SN 75-928,566. PUB. 6-11-2002, FILED 2-29-2000.

TOP TO TOE

FOR BEAUTY PRODUCTS, NAMELY BODY, HAND AND FOOT LOTIONS; EYE SOOTHERS, NAMELY EYE CREAMS, GELS AND TREATED EYE PADS; SCENTED BODY SPRAYS; AROMATHERAPY SPRAYS; NAIL POLISHES; NAIL HARDENERS; CUTICLE SOFTENERS; SACHETS AND POTPOURRIS; FACIAL SCRUBS; FACIAL MASKS; SKIN TONERS; AND KITS CONTAINING COMBINATIONS OF THE ABOVE ALL SOLD AS A UNIT (U.S. CLS. 1, 4, 6, 50, 51 AND 52).
FIRST USE 5-2-2000; IN COMMERCE 5-2-2000.

2,729,632. DESERT SCENTS LLC, ALBUQUERQUE, NM. SN 75-940,547. PUB. 8-13-2002, FILED 2-22-2000.

TURQUOISE & SILVER

FOR TOILETRIES, NAMELY PERFUME AND COLOGNE (U.S. CLS. 1, 4, 6, 50, 51 AND 52).
FIRST USE 8-1-1998; IN COMMERCE 11-30-2000.

2,729,648. MALANGA, KEVIN, WEST ORANGE, NJ. SN 75-983,164. PUB. 6-13-2000, FILED 4-9-1999.

INDOCHINE

THE ENGLISH TRANSLATION OF "INDOCHINE" IS "INDOCHINA".
FOR PERFUMES (U.S. CLS. 1, 4, 6, 50, 51 AND 52).
FIRST USE 11-11-2002; IN COMMERCE 11-11-2002.

2,729,650. NEUTROGENA CORPORATION, LOS ANGELES, CA. SN 75-983,176. PUB. 4-25-2000, FILED 5-17-1999.

MICRO-MIST

FOR HAIR CARE PREPARATIONS (U.S. CLS. 1, 4, 6, 50, 51 AND 52).
FIRST USE 9-15-2002; IN COMMERCE 9-15-2002.

CLASS 3—(Continued).

2,729,662. B STORM, INC., AMHERST, OH. SN 76-004,008.
PUB. 12-11-2001, FILED 3-17-2000.



NO CLAIM IS MADE TO THE EXCLUSIVE RIGHT TO USE "INC.", APART FROM THE MARK AS SHOWN.

THE STIPPLING SHOWN IN THE DRAWING IS INTENDED TO BE A FEATURE OF THE MARK AND NOT TO INDICATE COLOR.

THE MARK CONSISTS OF THE TERM "BRAINSTORM INC." AND THE STYLIZED DESIGN OF A HURRICANE.

FOR AUTOMOTIVE CLEANING PREPARATIONS; AUTOMOBILE CLEANERS (U.S. CLS. 1, 4, 6, 50, 51 AND 52).

FIRST USE 12-5-1999; IN COMMERCE 12-5-1999.

2,729,685. KOSE CORPORATION, CHUO-KU, TOKYO, JAPAN. SN 76-026,725. PUB. 8-21-2001, FILED 4-11-2000.

INTUICE

THE MARK IS FANCIFUL IN NATURE.

FOR SKIN CARE, NAMELY, SKIN LOTION, EXFOLIATIVE CREAM, CLEANSING OIL, CLEANING LOTION, CLEANSING CREAM, CLEANSING GEL, WASHING CREAM, MOISTURIZER, EYE TREATMENT LOTION, FACIAL MASK; MAKE UP, NAMELY, MAKE UP LOTION, MAKE UP CREAM, MAKE UP BASE, POWDER FOUNDATION, LIQUID FOUNDATION AND FACE POWDER; BODY LOTION; HAIR LOTION; SUNSCREEN; PERFUME; COSMETIC FACE SOAPS AND COSMETIC SKIN SOAPS (U.S. CLS. 1, 4, 6, 50, 51 AND 52).

FIRST USE 8-0-1998; IN COMMERCE 12-0-2000.

2,729,704. PAULA DORF COSMETICS, INC., NEW YORK, NY. SN 76-045,568. PUB. 1-30-2001, FILED 5-11-2000.

ZITA

FOR PERFUME (U.S. CLS. 1, 4, 6, 50, 51 AND 52).
FIRST USE 1-24-2003; IN COMMERCE 1-24-2003.

2,729,824. PROVIDE, PROVIDE L.L.C., NEW YORK, NY. SN 76-135,779. PUB. 5-1-2001, FILED 9-26-2000.

HUGS TO GO

FOR MAKEUP, LIQUID AND SOLID SKIN SOAPS, BATH GEL, SKIN MOISTURIZER, AND PERFUME (U.S. CLS. 1, 4, 6, 50, 51 AND 52).

FIRST USE 10-1-2002; IN COMMERCE 10-1-2002.

CLASS 3—(Continued).

2,729,825. PROVIDE, PROVIDE L.L.C., NEW YORK, NY. SN 76-135,780. PUB. 5-1-2001, FILED 9-26-2000.

I AM MAD

FOR MAKEUP, LIQUID AND SOLID SKIN SOAPS, BATH GEL, SKIN MOISTURIZER, AND PERFUME (U.S. CLS. 1, 4, 6, 50, 51 AND 52).

FIRST USE 10-1-2002; IN COMMERCE 10-1-2002.

2,729,837. UNICOMPANY S.R.L., ROME, ITALY. SN 76-146,133. PUB. 6-25-2002, FILED 10-13-2000.



FOR HAIR CARE PRODUCTS, NAMELY, HAIR CLEANING PREPARATIONS, HAIR CONDITIONERS, HAIR SHAMPOO, HAIR GEL, HAIR REMOVING CREAMS, HAIR RINSES, HAIR SPRAYS, HAIR STRAIGHTENING PREPARATIONS, HAIR STYLING PREPARATIONS, HAIR WAIVING LOTIONS, HYDROGEN PEROXIDE FOR USE ON THE HAIR (U.S. CLS. 1, 4, 6, 50, 51 AND 52).

FIRST USE 7-1-2000; IN COMMERCE 11-1-2001.

2,729,885. TISHCON CORP., WESTBURY, NY. SN 76-168,028.
PUB. 6-11-2002, FILED 11-20-2000.

DERMAQGEL

FOR SKIN CARE PRODUCTS, NAMELY, BODY LOTIONS, SKIN MOISTURIZERS, SUN SCREENS, WRINKLE TREATMENT CREAMS, FACIAL MAKE-UP AND CONCEAL CREAMS (U.S. CLS. 1, 4, 6, 50, 51 AND 52).

FIRST USE 12-13-2002; IN COMMERCE 12-13-2002.

2,729,921. FINANZ ST. HONORE B.V., 1017 CG AMSTERDAM, NETHERLANDS. SN 76-190,582. PUB. 8-13-2002, FILED 1-5-2001.

GENTRY

FOR FRAGRANCES, NAMELY PERFUME, COLOGNE AND AFTER SHAVE; ANTIPERSPIRANTS AND DEODORANTS; AND BODY LOTION (U.S. CLS. 1, 4, 6, 50, 51 AND 52).

FIRST USE 3-17-2003; IN COMMERCE 3-17-2003.

CLASS 3—(Continued).

2,729,971. GOLDMARK, FRANCES, NEW HOPE, PA. SN 76-211,799. PUB. 8-14-2001, FILED 2-20-2001.

EAU MY

FOR PERFUMES, COLOGNES, COSMETICS AND BODY LOTIONS (U.S. CLS. 1, 4, 6, 50, 51 AND 52). FIRST USE 8-7-2001; IN COMMERCE 8-7-2001.

2,730,040. L'OREAL, PARIS, FRANCE. SN 76-241,458. PUB. 9-18-2001, FILED 4-16-2001.

NUTRI-BUILD

FOR HAIR MOUSSE (U.S. CLS. 1, 4, 6, 50, 51 AND 52). FIRST USE 1-31-2003; IN COMMERCE 1-31-2003.

2,730,143. LADY BURD EXCLUSIVE COSMETICS, INC., FARMINGDALE, NY. SN 76-275,387. PUB. 10-1-2002, FILED 6-21-2001.

NATURE'S DERMATOLOGY

NO CLAIM IS MADE TO THE EXCLUSIVE RIGHT TO USE "DERMATOLOGY", APART FROM THE MARK AS SHOWN.

FOR COSMETICS AND NON-MEDICATED SKIN CARE PREPARATIONS (U.S. CLS. 1, 4, 6, 50, 51 AND 52). FIRST USE 12-31-2002; IN COMMERCE 12-31-2002.

2,730,147. GW INTERNATIONAL INC., CARLSBAD, CA. SN 76-276,775. PUB. 6-25-2002, FILED 6-26-2001.

NOLITA

FOR HAIR CARE PRODUCTS, NAMELY, HAIR SHAMPOO, HAIR CONDITIONER, HAIR STYLING AIDS, NAMELY, STYLING GEL, HAIRSPRAY, FIRM HOLD CLAY, LIQUID GEL, AND HAIR WAX (U.S. CLS. 1, 4, 6, 50, 51 AND 52). FIRST USE 10-1-2001; IN COMMERCE 1-2-2002.

2,730,151. L.C. LICENSING, INC., NEW YORK, NY. SN 76-277,974. PUB. 2-26-2002, FILED 6-28-2001.

COME DANCE WITH ME

FOR PERFUMES, COLOGNES, BODY CREAMS, BODY LOTIONS, TALCUM POWDER, BATH SOAP, TOILET SOAP, BATH GEL, SHOWER GEL AND BODY SCRUB (U.S. CLS. 1, 4, 6, 50, 51 AND 52). FIRST USE 7-24-2001; IN COMMERCE 7-24-2001.

CLASS 3—(Continued).

2,730,160. T.W. ENTERPRISES, LTD., ST. CLOUD, MN, BY ASSIGNMENT; BY ASSIGNMENT; BY ASSIGNMENT COLIANT CORPORATION, MINNETONKA, MN. SN 76-280,970. PUB. 7-23-2002, FILED 7-5-2001.

CHILLY PEPPER

OWNER OF U.S. REG. NO. 2,466,518. FOR SUN TAN LOTIONS (U.S. CLS. 1, 4, 6, 50, 51 AND 52). FIRST USE 10-1-2001; IN COMMERCE 10-1-2001.

2,730,204. REINOL-JANEK CHEMICALS (PTY) LTD., GAUTENG, SOUTH AFRICA. SN 76-294,783. PUB. 11-13-2001, FILED 8-3-2001.

REINOL

FOR HAND CLEANING PREPARATIONS; TOILET SOAPS; SKIN PROTECTION CREAMS; SKIN CARE CREAMS; BODY LOTIONS (U.S. CLS. 1, 4, 6, 50, 51 AND 52). FIRST USE 11-0-1982; IN COMMERCE 3-4-2002.

2,730,221. STRATEGIC BRANDS INTERNATIONAL LLC, WESTPORT, CT. SN 76-298,937. PUB. 7-2-2002, FILED 8-9-2001.

UNDEFEATED

FOR MEN'S COLOGNE, BODY SPRAY, BATH AND SHOWER GEL, HAIR STYLING GEL, AND DEODORANT (U.S. CLS. 1, 4, 6, 50, 51 AND 52). FIRST USE 12-31-2002; IN COMMERCE 12-31-2002.

2,730,233. AMEGNIZIN, LOUIS, 77700 BAILLY ROMAINVILLIERS, FRANCE. SN 76-303,665. PUB. 10-29-2002, FILED 8-23-2001.

DH7

FOR SKIN SOAPS; ESSENTIAL OILS FOR PERSONAL USE, COSMETICS (U.S. CLS. 1, 4, 6, 50, 51 AND 52). FIRST USE 8-12-2001; IN COMMERCE 10-24-2001.

CLASS 3—(Continued).

2,730,241. MEDIQUE COSMETICS INC., ALBERTA T2P 1B2, CANADA. SN 76-304,954. PUB. 1-8-2002, FILED 8-27-2001.



FOR TOPICAL SKIN CARE PRODUCTS FOR COSMETIC PURPOSES, NAMELY FACIAL MASKS, SKIN CREAMS (U.S. CLS. 1, 4, 6, 50, 51 AND 52).
FIRST USE 10-31-1996; IN COMMERCE 2-14-2001.

2,730,261. CYTHEREA CORP., LONDON, ONTARIO, CANADA. SN 76-309,994. PUB. 6-25-2002, FILED 9-7-2001.

CYTHEREA

PRIORITY CLAIMED UNDER SEC. 44(D) ON CANADA APPLICATION NO. 1108305, FILED 6-29-2001.

FOR SKIN CARE PRODUCTS, NAMELY CLEANSING PREPARATIONS, LIQUID FOAM BATH, SHOWER GEL, MOISTURIZING CREAMS AND LOTIONS, SUNTAN CREAMS, OILS AND LOTIONS, MASSAGE LOTIONS, SHAVING CREAMS, HAND CREAMS AND LOTIONS, SKIN TONERS, NAIL POLISH, NAIL POLISH REMOVERS, NAIL STRENGTHENERS, NAIL POLISH THINERS, NAIL POLISH SOLVENTS, NAIL POLISH BASE COATS, NAIL POLISH PROTECTIVE COATS, NAIL POLISH DRYERS, CREAM CUTICLE REMOVERS, BAR AND LIQUID SOAPS; HAIR CARE PRODUCTS, NAMELY SHAMPOO, CONDITIONER, RINSE PREPARATIONS, STYLING GEL, HAIR SPRAY; COSMETICS NAMELY BLUSHES, PRESSED ROUGES, POWDERED ROUGES, LIQUID ROUGES, MASCARAS, EYELINERS, EYE SHADOW, EYE SHADOW PENCILS, COLOUR SHADOWS FOR THE EYE, SHADOW POWDERS, BROW PENCILS, LIP LINER, LIPSTICKS, LIP GLOSS, NON-MEDICATED LIP BALMS, COSMETIC AND LIP COLOUR PALETTES, UNDEREYE CONCEALERS, FOUNDATIONS, FACE POWDERS, FOUNDATION CREAMS, FOUNDATION OINTMENTS, FOUNDATION LOTIONS, LIQUID MAKE-UP, HIGH-LIGHTERS FOR THE FACE, HIGHLIGHTER DUST FOR THE FACE AND BODY, GLITTER GEL FOR THE FACE AND BODY, EYEBROW SETS COMPOSED OF EYE BROW PENCILS, COLOUR CREAMS FOR THE FACE AND BODY; PRE-MOISTENED MAKE-UP REMOVER PADS; PERFUMERY NAMELY PERFUMES, COLOGNES (U.S. CLS. 1, 4, 6, 50, 51 AND 52).
FIRST USE 6-27-2001; IN COMMERCE 11-11-2002.

CLASS 3—(Continued).

2,730,297. JOHNSON & JOHNSON, NEW BRUNSWICK, NJ. SN 76-321,186. PUB. 8-6-2002, FILED 10-5-2001.

SUPER SUDZER

FOR BAR SOAP FOR SKIN AND BODY WASH (U.S. CLS. 1, 4, 6, 50, 51 AND 52).
FIRST USE 2-10-2002; IN COMMERCE 2-10-2002.

2,730,298. LEONARD PARFUMS, 75008 PARIS, FRANCE. SN 76-321,278. PUB. 6-18-2002, FILED 10-3-2001.

LEONARA

FOR PERFUME AND TOILET WATER (U.S. CLS. 1, 4, 6, 50, 51 AND 52).
FIRST USE 12-0-2001; IN COMMERCE 12-19-2001.

2,730,303. I.C.O.N. LINE, INC., WOODLAND HILLS, CA. SN 76-322,294. PUB. 6-25-2002, FILED 10-9-2001.

DONE

FOR HAIR CARE PRODUCTS, NAMELY, LEAVE-IN REPAIR, MOISTURIZER INFUSER, STRENGTHENING PROTEIN AND NON-MEDICATED SCALP TREATMENT PREPARATIONS (U.S. CLS. 1, 4, 6, 50, 51 AND 52).
FIRST USE 4-1-2002; IN COMMERCE 4-1-2002.

2,730,326. PERMATEX, INC., HARTFORD, CT. SN 76-327,961. PUB. 5-14-2002, FILED 10-22-2001.

BRUSH-UP

FOR HAND CLEANERS (U.S. CLS. 1, 4, 6, 50, 51 AND 52).
FIRST USE 10-22-2001; IN COMMERCE 10-22-2001.

2,730,374. L'OREAL USA CREATIVE, INC., NEW YORK, NY. SN 76-340,940. PUB. 7-9-2002, FILED 11-21-2001.

SWITCHTRIX

OWNER OF U.S. REG. NOS. 1,737,909, 2,226,310, AND OTHERS.
FOR HAIR STYLING PREPARATION (U.S. CLS. 1, 4, 6, 50, 51 AND 52).
FIRST USE 2-1-2003; IN COMMERCE 2-1-2003.

CLASS 3—(Continued).

2,730,423. SCHERING-PLOUGH HEALTHCARE PRODUCTS, INC., MEMPHIS, TN. SN 76-350,305. PUB. 7-16-2002, FILED 12-19-2001.

COPPERTONE SPECTRA 3

OWNER OF U.S. REG. NOS. 567,828, 1,529,228, AND OTHERS.
FOR SUNSCREEN PREPARATIONS (U.S. CLS. 1, 4, 6, 50, 51 AND 52).
FIRST USE 11-13-2002; IN COMMERCE 11-13-2002.

2,730,451. S. C. JOHNSON & SON, INC., RACINE, WI. SN 76-355,713. PUB. 7-23-2002, FILED 1-4-2002.

REFRESHING RAIN

FOR TOILET BOWL CLEANER (U.S. CLS. 1, 4, 6, 50, 51 AND 52).
FIRST USE 8-8-2002; IN COMMERCE 8-8-2002.

2,730,455. SHISEIDO COMPANY, LTD., TOKYO, JAPAN. SN 76-356,674. PUB. 9-17-2002, FILED 1-8-2002.

ENERGEX LOTION

NO CLAIM IS MADE TO THE EXCLUSIVE RIGHT TO USE "LOTION", APART FROM THE MARK AS SHOWN.
FOR SKIN SOAPS, DEODORANT SOAPS; PERFUMERIES, NAMELY, PERFUME, COLOGNE; COSMETICS, NAMELY, LIPSTICK, BLUSH, ROUGE, MAKEUP; HAIR CARE PRODUCTS, NAMELY, SHAMPOO, CONDITIONER, HAIR GEL; SKIN CARE AND BODY CARE PREPARATIONS, NAMELY, SKIN CREAM, SKIN LOTION, SKIN CLEANSERS, BODY MASKS, BODY SCRUBS, BODY OILS AND BODY POWDER (U.S. CLS. 1, 4, 6, 50, 51 AND 52).
FIRST USE 6-30-2002; IN COMMERCE 6-30-2002.

2,730,456. JAFRA COSMETICS INTERNATIONAL, INC., WESTLAKE VILLAGE, CA. SN 76-356,781. PUB. 7-16-2002, FILED 1-9-2002.

I BREATHE, I LOVE, I LIVE, I DREAM

FOR FRAGRANCES; NAMELY, PERFUMES (U.S. CLS. 1, 4, 6, 50, 51 AND 52).
FIRST USE 5-1-2002; IN COMMERCE 5-1-2002.

CLASS 3—(Continued).

2,730,507. TRACIE MARTYN INTERNATIONAL, LLC, NEW YORK, NY. SN 76-374,405. PUB. 9-10-2002, FILED 2-25-2002.

DREAM CLEAN

FOR SKIN CARE PRODUCTS, NAMELY SKIN CLEANSING PREPARATIONS; PERSONAL HYGIENE PRODUCTS, NAMELY TOTAL BODY CLEANING PREPARATION, BODY WASH AND BODY SCRUB (U.S. CLS. 1, 4, 6, 50, 51 AND 52).
FIRST USE 12-0-2002; IN COMMERCE 12-0-2002.

2,730,518. COLORLAB COSMETICS, INC., ROCKFORD, IL. SN 76-382,578. PUB. 10-22-2002, FILED 3-18-2002.

PEOPLE POLISH

FOR KITS FOR MAKING FLAVORED AND SCENTED BODY AND HAIR GEL COMPRISING GEL AGENTS, GLITTER, FRAGRANCE, COLORING AGENTS, MIXING EQUIPMENT, STORAGE CONTAINERS AND ROLLERBALLS (U.S. CLS. 1, 4, 6, 50, 51 AND 52).
FIRST USE 9-3-2002; IN COMMERCE 9-3-2002.

2,730,523. L'OREAL USA CREATIVE, INC., NEW YORK, NY. SN 76-388,858. PUB. 11-5-2002, FILED 3-29-2002.

ROUGH PASTE

NO CLAIM IS MADE TO THE EXCLUSIVE RIGHT TO USE "PASTE", APART FROM THE MARK AS SHOWN.
FOR HAIR STYLING GEL (U.S. CLS. 1, 4, 6, 50, 51 AND 52).
FIRST USE 10-0-2000; IN COMMERCE 10-0-2002.

2,730,532. MINNETONKA BRANDS, INC., EDEN PRAIRIE, MN. SN 76-975,237. PUB. 4-23-2002, FILED 1-31-2001.

WATTLES

FOR BUBBLE BATH, FOAM BATH, SKIN CLEANSING LIQUID (U.S. CLS. 1, 4, 6, 50, 51 AND 52).
FIRST USE 4-0-2001; IN COMMERCE 4-0-2001.

2,730,540. GRANT LLOYD BERRY, INC., ARMONK, NY. SN 76-975,397. PUB. 5-29-2001, FILED 9-11-2000.

PENCIL FACTORY

NO CLAIM IS MADE TO THE EXCLUSIVE RIGHT TO USE "PENCIL", APART FROM THE MARK AS SHOWN.
FOR COSMETICS, NAMELY, EYELINER AND LIPLINER PENCILS (U.S. CLS. 1, 4, 6, 50, 51 AND 52).
FIRST USE 8-13-2002; IN COMMERCE 8-13-2002.

CLASS 3—(Continued).

2,730,544. LAILA, INC., LOS ANGELES, CA. SN 76-975,427.
PUB. 10-22-2002, FILED 11-28-2000.

GEIR THE POWER OF NORWAY

OWNER OF U.S. REG. NO. 2,328,211.
NO CLAIM IS MADE TO THE EXCLUSIVE RIGHT TO
USE "NORWAY", APART FROM THE MARK AS SHOWN.
FOR PERFUMES (U.S. CLS. 1, 4, 6, 50, 51 AND 52).
FIRST USE 8-22-2001; IN COMMERCE 8-22-2001.

2,730,619. COSMETIC TECHNOLOGIES CORPORATION,
MIAMI, FL. SN 78-052,308. PUB. 7-2-2002, FILED 3-9-2001.



NO CLAIM IS MADE TO THE EXCLUSIVE RIGHT TO
USE "BOTANICAL STYLER", APART FROM THE MARK
AS SHOWN.

FOR HAIR SHAMPOOS, HAIR CONDITIONERS, HAIR
GELS, HAND AND BODY LOTIONS, HAND CREAMS,
FACIAL CREAMS, BODY CREAMS, BABY LOTIONS,
AND BABY SHAMPOOS (U.S. CLS. 1, 4, 6, 50, 51 AND 52).
FIRST USE 1-15-2003; IN COMMERCE 1-15-2003.

2,730,624. PAYER ISRAEL GLASS LTD., MA'ALE EFRAIYM,
ISRAEL. SN 78-054,391. PUB. 8-6-2002, FILED 3-22-2001.

SELAH

FOR PERFUMES, FRAGRANCES, NAMELY EAU DE
PARFUM, EAU DE COLOGNE, ROOM FRAGRANCE,
SCENTED FACIAL, HAND AND BODY CREAMS AND
LOTIONS, BABY CREAMS AND LOTIONS (U.S. CLS. 1,
4, 6, 50, 51 AND 52).
FIRST USE 9-1-2002; IN COMMERCE 9-1-2002.

2,730,707. NOXELL CORPORATION, HUNT VALLEY, MD.
SN 78-082,101. PUB. 3-26-2002, FILED 8-31-2001.

STRETCH & SEPARATE

OWNER OF U.S. REG. NOS. 1,608,750, 1,662,896, AND
2,309,364.
FOR COSMETICS, NAMELY, MASCARA (U.S. CLS. 1,
4, 6, 50, 51 AND 52).
FIRST USE 1-31-2003; IN COMMERCE 1-31-2003.

CLASS 3—(Continued).

2,730,711. BROWN, AGATHA, ORANJESTAD, ARUBA. SN
78-082,862. PUB. 1-15-2002, FILED 9-6-2001.

CONQUEST

FOR WOMEN'S AND MEN'S FRAGRANCE PRO-
DUCTS, NAMELY - PERFUME, COLOGNE, TOILET
WATER, SCENTED BODY LOTION AND SCENTED
BATH GEL, AFTER SHAVE COLOGNE AND LOTION
(U.S. CLS. 1, 4, 6, 50, 51 AND 52).
FIRST USE 2-21-2003; IN COMMERCE 2-21-2003.

2,730,721. GUINOT, PARIS, FRANCE. SN 78-085,672. PUB. 3-
12-2002, FILED 9-26-2001.

MASTERING THE ART OF MAKE-UP

FOR SKIN AND FACE MOISTURIZING, CONDITION-
ING, FIRING, SMOOTHING AND TONING CREAMS
AND LOTIONS, EYE CREAMS AND LOTIONS, NECK
CREAMS AND LOTIONS, WRINKLE SMOOTHING
CREAMS AND LOTIONS, SKIN LIGHTENING PRE-
PARATIONS, FACE AND BODY POWDER, SUNSC-
REENS, SUN BLOCKS, LIP LINER, LIPSTICK, LIP
GLOSS, BLUSHER, EYE SHADOW, EYELINER, ROUGE,
MASCARA, MAKEUP, NAIL ENAMEL, CUTICLE
CREAM, NAIL STRENGTHENING PREPARATIONS,
NAIL HARDENING PREPARATIONS, AND NONMEDI-
CATED PREPARATIONS TO PROTECT THE SKIN
FROM THE EFFECTS OF WIND, SUN AND ENVIRON-
MENTAL POLLUTION (U.S. CLS. 1, 4, 6, 50, 51 AND 52).
FIRST USE 7-0-2002; IN COMMERCE 8-0-2002.

2,730,743. ECOLAB INC., ST. PAUL, MN. SN 78-091,510. PUB.
7-2-2002, FILED 11-2-2001.

SOLID SHOT

NO CLAIM IS MADE TO THE EXCLUSIVE RIGHT TO
USE "SOLID", APART FROM THE MARK AS SHOWN.

FOR CLEANING PREPARATIONS; NAMELY FLOOR
CLEANERS, GLASS CLEANERS, ALL-PURPOSE CLEA-
NERS, PRESOAKS FOR DISHES, SILVERWARE AND
POTS AND PANS, DETERGENTS FOR POTS AND PANS
AND WAREWASHING DETERGENTS (U.S. CLS. 1, 4, 6,
50, 51 AND 52).
FIRST USE 7-18-2002; IN COMMERCE 7-18-2002.

CLASS 3—(Continued).

2,730,745. MURPHY-PHOENIX COMPANY, THE, NEW YORK, NY, BY ASSIGNMENT COLGATE-PALMOLIVE COMPANY, NEW YORK, NY. SN 78-092,516. PUB. 10-15-2002, FILED 11-9-2001.

MURPHY SOFT WIPE

OWNER OF U.S. REG. NOS. 2,232,201, 2,244,651, AND OTHERS.

NO CLAIM IS MADE TO THE EXCLUSIVE RIGHT TO USE "SOFT WIPE", APART FROM THE MARK AS SHOWN. FOR DISPOSABLE WIPES IMPREGNATED WITH CHEMICALS OR COMPOUNDS FOR HOUSEHOLD USE (U.S. CLS. 1, 4, 6, 50, 51 AND 52).

FIRST USE 6-0-2002; IN COMMERCE 6-0-2002.

2,730,746. R RIEVELEY & ASSOCIATES, BLAINE, WA. SN 78-092,640. PUB. 5-21-2002, FILED 11-9-2001.

LARISSE

FOR SKIN CARE PRODUCTS, NAMELY, ANTI-AGING CREAMS, ASTRINGENTS FOR COSMETIC PURPOSES, BEAUTY MASKS, SKIN CLEANSING LOTION, COLD CREAM, SKIN CONDITIONER OR MOISTURIZER, EYE CREAM, NIGHT CREAM, VANISHING CREAM, FACIAL CLEANSERS, FACIAL CREAMS, FACIAL EMULSIONS, FACIAL MASKS, FACIAL SCRUBS; BODY CARE PRODUCTS, NAMELY, BODY CREAMS AND LOTIONS, BODY EMULSIONS, BODY MASKS, BODY OIL, BODY POWDER, BODY SCRUBS, PERSONAL DEODORANT, HAND CREAM, CREAMS FOR CELLULITE REDUCTION, DEPILATORY CREAMS, HAIR REMOVING CREAM, PEDICURE CREAM, FOOT CREAMS, MASSAGE LOTION, FOOT LOTION; BATH PRODUCTS, NAMELY, SOAP SOLID AND LIQUID, BATH BEADS, BATH CRYSTALS, BATH FOAM, BATH GEL, BATH OIL, BUBBLE BATH, EFFERVESCENT BATH SOLIDS, BATH PEARLS, BATH POWDER, BATH SALTS, BODY WASHES, SHOWER GEL, NON-MEDICATED BODY SOAKS; COSMETICS, NAMELY, CONCEALERS NAMELY FOR THE SKIN, FACE AND BODY, BLUSH, BLUSHER, EYE GELS, EYE PENCILS, EYE MAKE-UP REMOVER, LIP GLOSS, LIPSTICK, LIP LINERS, LIP SEALERS, EAU DE PERFUME, COLOGNE, EAU DE TOILETTE, ESSENTIAL OILS FOR PERSONAL USE, ESSENTIAL OILS FOR USE IN THE MANUFACTURE OF SCENTED PRODUCTS, POTPOURRI; HAIR CARE PRODUCTS, NAMELY, HAIR CARE PREPARATIONS, HAIR CLEANING PREPARATIONS, HAIR COLORS, HAIR CONDITIONERS, HAIR LOTIONS, HAIR MOUSSE, HAIR RINSES, HAIR STYLING PREPARATIONS; PRE-SUN PRODUCTS, NAMELY, SUN BLOCK, SUN SCREEN, SUN CREAMS, SUN TAN LOTION, SUN TAN GEL, SUN TAN OIL, AFTER-SUN LOTIONS, AND SELF-TANNING LOTIONS (U.S. CLS. 1, 4, 6, 50, 51 AND 52).

FIRST USE 7-15-2002; IN COMMERCE 11-14-2002.

2,730,760. PROCTER & GAMBLE COMPANY, THE, CINCINNATI, OH. SN 78-096,303. PUB. 7-9-2002, FILED 12-3-2001.

CITRUS SPORT

NO CLAIM IS MADE TO THE EXCLUSIVE RIGHT TO USE "CITRUS", APART FROM THE MARK AS SHOWN.

FOR BAR SOAP FOR USE ON FACE, HAND AND BODY; FRAGRANCE SOLD AS A COMPONENT OF BAR SOAP (U.S. CLS. 1, 4, 6, 50, 51 AND 52).

FIRST USE 2-28-2002; IN COMMERCE 2-28-2002.

CLASS 3—(Continued).

2,730,761. PT. BEA SARI JELITA, SEMARANG, INDONESIA. SN 78-096,500. PUB. 8-13-2002, FILED 12-4-2001.

BEA

FOR ANTI-BACTERIAL SOAP, DEODORANT SOAP, DETERGENT SOAP, MEDICATED SOAP, SKIN SOAP, TOILET SOAP, LAUNDRY DETERGENT, AND TOOTH PASTE (U.S. CLS. 1, 4, 6, 50, 51 AND 52).

FIRST USE 12-31-1993; IN COMMERCE 12-31-1995.

2,730,781. JOICO LABORATORIES, INC., CITY OF INDUSTRY, CA. SN 78-100,619. PUB. 7-2-2002, FILED 1-2-2002.

SPIKER ERASER

FOR NON-MEDICATED HAIR CARE PREPARATIONS (U.S. CLS. 1, 4, 6, 50, 51 AND 52).

FIRST USE 8-15-2002; IN COMMERCE 8-15-2002.

2,730,787. AVON PRODUCTS, INC., NEW YORK, NY. SN 78-101,728. PUB. 6-11-2002, FILED 1-9-2002.

PASSION DANCE

FOR FRAGRANCE PRODUCTS, NAMELY, EAU DE TOILETTE (U.S. CLS. 1, 4, 6, 50, 51 AND 52).

FIRST USE 12-19-2002; IN COMMERCE 12-19-2002.

2,730,795. REVLO CONSUMER PRODUCTS CORPORATION, NEW YORK, NY. SN 78-103,455. PUB. 8-13-2002, FILED 1-18-2002.

BRIGHT EYES

NO CLAIM IS MADE TO THE EXCLUSIVE RIGHT TO USE "EYES", APART FROM THE MARK AS SHOWN.

FOR MAKEUP (U.S. CLS. 1, 4, 6, 50, 51 AND 52).

FIRST USE 12-12-2002; IN COMMERCE 12-12-2002.

2,730,813. REVLO CONSUMER PRODUCTS CORPORATION, NEW YORK, NY. SN 78-108,819. PUB. 7-23-2002, FILED 2-14-2002.

ALWAYS-ON

FOR COSMETICS AND MAKEUP (U.S. CLS. 1, 4, 6, 50, 51 AND 52).

FIRST USE 1-31-2003; IN COMMERCE 1-31-2003.

CLASS 3—(Continued).

2,730,836. NU SKIN INTERNATIONAL, INC., PROVO, UT.
SN 78-119,404. PUB. 10-15-2002, FILED 4-3-2002.

PERENNIAL

FOR COSMETICS, NAMELY SKIN MOISTURIZER,
BATH LOTION, SKIN CLEANSING LOTION AND SKIN
LOTION (U.S. CLS. 1, 4, 6, 50, 51 AND 52).
FIRST USE 9-15-2002; IN COMMERCE 9-15-2002.

CLASS 4—LUBRICANTS AND FUELS

2,729,436. TRIPLE PLAY TECHNOLOGIES, L.L.C., BATON
ROUGE, LA. SN 75-639,678. PUB. 12-28-1999, FILED 2-9-
1999.

TP-3

FOR ALL PURPOSE LUBRICANTS (U.S. CLS. 1, 6 AND
15).
FIRST USE 3-10-2003; IN COMMERCE 3-10-2003.

2,729,505. SPRAGUE ENERGY CORPORATION, PORTS-
MOUTH, NH. SN 75-784,013. PUB. 5-2-2000, FILED 8-25-
1999.

ROAD FORCE

FOR DIESEL FUELS (U.S. CLS. 1, 6 AND 15).
FIRST USE 3-1-2002; IN COMMERCE 3-1-2002.

2,729,511. FLINT HILLS RESOURCES, LP, WICHITA, KS, BY
CHANGE OF NAME KOCH PETROLEUM GROUP, L.P.,
WICHITA, KS. SN 75-788,906. PUB. 5-23-2000, FILED 8-31-
1999.



THE DRAWING IS LINED FOR THE COLOR BLUE.
FOR FUEL FOR MOTOR VEHICLES, NAMELY, GA-
SOLINE (U.S. CLS. 1, 6 AND 15).
FIRST USE 9-22-1999; IN COMMERCE 9-22-1999.

CLASS 4—(Continued).

2,730,014. DTE SMITH BRANCH, LLC, ANN ARBOR, MI. SN
76-226,304. PUB. 9-11-2001, FILED 3-16-2001.

PINNTEX

FOR BULK SYNTHETIC FUEL, NAMELY, COAL
COMBINED WITH A LATEX BINDER (U.S. CLS. 1, 6
AND 15).
FIRST USE 3-20-2001; IN COMMERCE 3-20-2001.

2,730,245. MIRACLE CANDLE COMPANY, LAREDO, TX. SN
76-306,574. PUB. 7-2-2002, FILED 8-29-2001.

SCENTCRAFT

FOR CANDLES (U.S. CLS. 1, 6 AND 15).
FIRST USE 3-0-2002; IN COMMERCE 3-0-2002.

2,730,401. AMERICAN AGIP CO., INC., CABOT, PA. SN 76-
345,464. PUB. 6-11-2002, FILED 12-4-2001.

EXTRA LIFE

FOR MOTOR OILS, LUBRICANTS AND TRANSMIS-
SION FLUIDS (U.S. CLS. 1, 6 AND 15).
FIRST USE 3-11-2002; IN COMMERCE 3-11-2002.

2,730,774. CITGO PETROLEUM CORPORATION, TULSA,
OK. SN 78-098,899. PUB. 7-9-2002, FILED 12-18-2001.

**FOR YOUR LIFE IN THE
FAST LANE**

FOR GENERAL PURPOSE LUBRICATING OILS AND
GREASES (U.S. CLS. 1, 6 AND 15).
FIRST USE 12-0-2001; IN COMMERCE 12-0-2001.

CLASS 5—PHARMACEUTICALS

2,729,399. ESPERION THERAPEUTICS, INC., ANN ARBOR,
MI. SN 75-514,463. PUB. 6-1-1999, FILED 7-7-1998.

ESPERION

FOR PHARMACEUTICAL PREPARATIONS FOR THE
TREATMENT OF METABOLIC DISEASE (U.S. CLS. 6, 18,
44, 46, 51 AND 52).
FIRST USE 6-24-1998; IN COMMERCE 7-17-2002.

CLASS 5—(Continued).

2,729,432. MGI PHARMA, INC., MINNETONKA, MN. SN 75-619,611. PUB. 11-9-1999, FILED 1-12-1999.

ROVONC

FOR PHARMACEUTICAL PREPARATION FOR THE TREATMENT OF CANCER (U.S. CLS. 6, 18, 44, 46, 51 AND 52).

FIRST USE 1-21-2003; IN COMMERCE 1-21-2003.

2,729,437. WINSTON LABORATORIES, INC., VERNON HILLS, IL. SN 75-641,155. PUB. 12-28-1999, FILED 2-16-1999.

CIVANEX

FOR PHARMACEUTICAL PREPARATION FOR HUMAN USE FOR THE TREATMENT OF ARTHRITIS PAIN, NEURALGIAS, AND PSORIASIS (U.S. CLS. 6, 18, 44, 46, 51 AND 52).

FIRST USE 1-22-2003; IN COMMERCE 1-22-2003.

2,729,444. VIRBAC S.A., 06511 CARROS CEDEX, FRANCE. SN 75-659,874. PUB. 11-30-1999, FILED 3-17-1999.

EQUELL

FOR VETERINARY PRODUCTS, NAMELY, AN ORAL PARASITICIDE FOR HORSES (U.S. CLS. 6, 18, 44, 46, 51 AND 52).

FIRST USE 10-0-2002; IN COMMERCE 12-0-2002.

2,729,476. THOMAS H. CROOK, III, PH.D., OXFORD, MD, BY ASSIGNMENT PSYCHOLOGIX, INC., SCOTTSDALE, AZ. SN 75-729,648. PUB. 12-28-1999, FILED 6-15-1999.

BRAIN CRUNCHES

FOR DIETARY AND NUTRITIONAL SUPPLEMENTS (U.S. CLS. 6, 18, 44, 46, 51 AND 52).

FIRST USE 0-0-1995; IN COMMERCE 0-0-1995.

2,729,484. BEST PROCESS, INC., ROGERS, AR. SN 75-741,874. PUB. 4-17-2001, FILED 6-23-1999.

ALKA DOG

NO CLAIM IS MADE TO THE EXCLUSIVE RIGHT TO USE "DOG", APART FROM THE MARK AS SHOWN.

FOR DIETARY SUPPLEMENTS AND VITAMINS FOR DOGS (U.S. CLS. 6, 18, 44, 46, 51 AND 52).

FIRST USE 10-0-2000; IN COMMERCE 10-0-2000.

CLASS 5—(Continued).

2,729,521. TWIN LABORATORIES INC., HAUPPAUGE, NY. SN 75-806,238. PUB. 8-1-2000, FILED 9-23-1999.

FUEL PLEX

FOR DIETARY SUPPLEMENTS (U.S. CLS. 6, 18, 44, 46, 51 AND 52).

FIRST USE 3-0-1999; IN COMMERCE 3-0-1999.

2,729,664. PFIZER INC., NEW YORK, NY. SN 76-006,645. PUB. 6-5-2001, FILED 3-22-2000.

A180

FOR ANTI-BACTERIAL FOR LIVESTOCK FOR TREATMENT OF RESPIRATORY, ENTERIC AND SOFT TISSUE INFECTIONS (U.S. CLS. 6, 18, 44, 46, 51 AND 52).

FIRST USE 10-7-2002; IN COMMERCE 10-7-2002.

2,729,698. ASSOCIATION FOR AMERICAN HEALTH SPECIALISTS, MEXICO, MO. SN 76-038,858. PUB. 5-15-2001, FILED 5-1-2000.

NUTRAGENOMIC

FOR DIETARY SUPPLEMENTS, NUTRITIONAL SUPPLEMENTS, VITAMIN AND MINERAL SUPPLEMENTS, HERBAL SUPPLEMENTS (U.S. CLS. 6, 18, 44, 46, 51 AND 52).

FIRST USE 9-14-2001; IN COMMERCE 9-14-2001.

2,729,759. BASF AKTIENGESELLSCHAFT, LUDWIGSHAFEN AM RHEIN, FED REP GERMANY. SN 76-091,595. PUB. 7-17-2001, FILED 7-6-2000.

F 500

NO CLAIM IS MADE TO THE EXCLUSIVE RIGHT TO USE "500", APART FROM THE MARK AS SHOWN.

FOR HERBICIDES, FUNGICIDES, INSECTICIDES AND PESTICIDES FOR AGRICULTURAL USE (U.S. CLS. 6, 18, 44, 46, 51 AND 52).

FIRST USE 1-6-2003; IN COMMERCE 1-6-2003.

2,729,778. WORLD BLACK BELT, INC., TARZANA, CA. SN 76-101,670. PUB. 5-22-2001, FILED 8-2-2000.

WORLD BLACK BELT

FOR NUTRITIONAL AND DIETARY SUPPLEMENTS, VITAMIN PREPARATIONS, NUTRIENTS AND TONICS, MINERAL PREPARATIONS, ENERGY REPLACEMENT PREPARATIONS ALL BEING NUTRITIONAL SUPPLEMENTS FOR USE BY ATHLETES (U.S. CLS. 6, 18, 44, 46, 51 AND 52).

FIRST USE 2-0-2001; IN COMMERCE 2-0-2001.

CLASS 5—(Continued).

2,729,798. DIAL BRANDS, INC., SCOTTSDALE, AZ. SN 76-117,367. PUB. 8-20-2002, FILED 8-28-2000.

ACTIV-FOAM

FOR ANTIBACTERIAL, ANTI-MICROBIAL FOAMING HAND WASH (U.S. CLS. 6, 18, 44, 46, 51 AND 52).
FIRST USE 1-29-2001; IN COMMERCE 1-29-2001.

2,729,851. NULAB, INC., CLEARWATER, FL. SN 76-149,971. PUB. 7-17-2001, FILED 10-20-2000.

SUPER-CAL

FOR NUTRITIONAL INGREDIENTS, NAMELY, A PROPRIETARY BLEND OF CALCIUM ASCORBATE, CALCIUM CITRATE AND CALCIUM ASPERTATE, SOLD AS AN INTEGRAL COMPONENT OF DIETARY SUPPLEMENTS (U.S. CLS. 6, 18, 44, 46, 51 AND 52).
FIRST USE 10-9-2002; IN COMMERCE 10-9-2002.

2,729,886. FIRST HORIZON PHARMACEUTICAL CORPORATION, ROSWELL, GA. SN 76-169,376. PUB. 7-9-2002, FILED 11-21-2000.

PRENATE GT

OWNER OF U.S. REG. NOS. 1,252,683 AND 2,131,143. FOR MULTIVITAMIN AND MULTIMINERAL NUTRITIONAL SUPPLEMENTS (U.S. CLS. 6, 18, 44, 46, 51 AND 52).
FIRST USE 8-0-2001; IN COMMERCE 8-0-2001.

2,729,901. G.O. INTERNATIONAL, INC., TEANECK, NJ. SN 76-178,835. PUB. 11-20-2001, FILED 12-11-2000.

ALCO-HALT

FOR FOOD SUPPLEMENTS (U.S. CLS. 6, 18, 44, 46, 51 AND 52).
FIRST USE 3-0-2001; IN COMMERCE 3-0-2001.

2,729,920. EPHORLIFE, LLC, SALT LAKE CITY, UT. SN 76-189,791. PUB. 8-28-2001, FILED 1-4-2001.

CARDIOFORM

FOR DIETARY AND NUTRITIONAL SUPPLEMENTS (U.S. CLS. 6, 18, 44, 46, 51 AND 52).
FIRST USE 11-15-2000; IN COMMERCE 11-15-2000.

CLASS 5—(Continued).

2,729,934. PEGASUS LABORATORIES, INC, PENSACOLA, FL. SN 76-197,275. PUB. 9-24-2002, FILED 1-22-2001.

COLLASATE

FOR ANIMAL WOUND CARE PRODUCTS, NAMELY, A HEALING GEL, POST-OPERATIVE AND TRAUMA MANAGEMENT DRESSING (U.S. CLS. 6, 18, 44, 46, 51 AND 52).
FIRST USE 8-10-2001; IN COMMERCE 8-10-2001.

2,730,003. PLUM CREEK PHARMACEUTICALS, INC., AMARILLO, TX. SN 76-223,174. PUB. 4-30-2002, FILED 3-12-2001.

NAP

FOR PHARMACEUTICAL PREPARATIONS FOR THE TREATMENT OF ACUTE AND CHRONIC PAIN (U.S. CLS. 6, 18, 44, 46, 51 AND 52).
FIRST USE 10-18-2002; IN COMMERCE 10-18-2002.

2,730,015. VITA CUBE SYSTEMS, INC., DENVER, CO. SN 76-228,960. PUB. 12-11-2001, FILED 3-15-2001.

**SIMPLE INNOVATIVE
COMPLETE NUTRITION**

FOR NUTRITIONAL SUPPLEMENTS, NAMELY SOLID, LIQUID AND POWERED DIETARY SUPPLEMENTS; DIETARY SUPPLEMENT NUTRITIONAL BARS CONTAINING PROTEINS, CARBOHYDRATES, VITAMINS AND MINERALS (U.S. CLS. 6, 18, 44, 46, 51 AND 52).
FIRST USE 2-1-2001; IN COMMERCE 1-15-2002.

2,730,085. VICAM, L.P., WATERTOWN, MA. SN 76-259,416. PUB. 5-28-2002, FILED 5-21-2001.

VICAM

FOR VETERINARY PREPARATIONS, IN THE FORM OF A SEX-SELECTION KIT, CONSISTING OF ANTIBODIES, REAGENTS, BUFFERS, AND RACKS FOR THE PURPOSES OF SEPARATING SPERM INTO TWO POPULATIONS, X CHROMOSOME-BEARING AND Y CHROMOSOME-BEARING SPERM, INCLUDING BOVINE AND PORCINE, WHICH SEPARATION RESULTS IN THE MANUFACTURE OF STRAWS, KITS, OR OTHER PROTOCOLS FOR APPLICATION IN THE AREA OF ARTIFICIAL INSEMINATION OF LIVESTOCK (U.S. CLS. 6, 18, 44, 46, 51 AND 52).
FIRST USE 1-29-2003; IN COMMERCE 1-29-2003.

CLASS 5—(Continued).

2,730,094. MERCK & CO., INC., WHITEHOUSE STATION, NJ. SN 76-260,938. PUB. 6-18-2002, FILED 5-23-2001.



FOR PHARMACEUTICAL ANTI-BIOTIC AND ANTI-INFECTIVE PREPARATIONS (U.S. CLS. 6, 18, 44, 46, 51 AND 52).

FIRST USE 11-12-2002; IN COMMERCE 11-12-2002.

2,730,118. TEVA PHARMACEUTICALS USA, INC., NORTH WALES, PA. SN 76-268,515. PUB. 7-23-2002, FILED 6-7-2001.



NO CLAIM IS MADE TO THE EXCLUSIVE RIGHT TO USE "NEUROSCIENCE", APART FROM THE MARK AS SHOWN.

THE ENGLISH TRANSLATION OF THE WORD "TEVA" IN THE MARK IS "NATURE".

FOR PHARMACEUTICAL PREPARATIONS FOR THE TREATMENT OF CENTRAL NERVOUS SYSTEM DISORDERS (U.S. CLS. 6, 18, 44, 46, 51 AND 52).

FIRST USE 7-0-2001; IN COMMERCE 7-0-2001.

2,730,119. TEVA PHARMACEUTICALS USA, INC., NORTH WALES, PA. SN 76-268,516. PUB. 7-23-2002, FILED 6-7-2001.

TEVA NEUROSCIENCE

NO CLAIM IS MADE TO THE EXCLUSIVE RIGHT TO USE "NEUROSCIENCE", APART FROM THE MARK AS SHOWN.

THE ENGLISH TRANSLATION OF "TEVA" IS "NATURE".

FOR PHARMACEUTICAL PREPARATIONS FOR THE TREATMENT OF CENTRAL NERVOUS SYSTEM DISORDERS (U.S. CLS. 6, 18, 44, 46, 51 AND 52).

FIRST USE 7-0-2001; IN COMMERCE 7-0-2001.

CLASS 5—(Continued).

2,730,126. ASHLAND INC., COVINGTON, KY. SN 76-270,502. PUB. 7-2-2002, FILED 6-12-2001.

EAGLE ONE

OWNER OF U.S. REG. NOS. 1,466,117, 1,981,471, AND OTHERS.

FOR AIR FRESHENERS FOR AUTOMOBILES (U.S. CLS. 6, 18, 44, 46, 51 AND 52).

FIRST USE 2-1-1998; IN COMMERCE 2-1-1998.

2,730,132. XENCOR, INC., MONROVIA, CA. SN 76-272,229. PUB. 10-2-2001, FILED 6-15-2001.

PDA

FOR PHARMACEUTICAL PREPARATIONS FOR HORMONE REPLACEMENT THERAPIES, NAMELY CANCER GENE THERAPY, DIABETES THERAPY, T-CELL THERAPY, BLOOD GROWTH FACTORS, NEURAL GROWTH FACTOR THERAPY, ANTI-COAGULANT THERAPY, BIOLOGICAL RESPONSE MODIFIER THERAPY, ANTI-CANCER ANTIBODY THERAPY, ANTI-VIRAL THERAPY, ANTI-MICROBIAL THERAPY; DRUG SCREENING REAGENTS, NAMELY CYTOKINE RECEPTOR ASSAY REAGENTS; AND HIGH THROUGHPUT ASSAYS (U.S. CLS. 6, 18, 44, 46, 51 AND 52).

FIRST USE 10-23-2002; IN COMMERCE 10-23-2002.

2,730,140. BARR LABORATORIES, INC., POMONA, NY. SN 76-274,761. PUB. 10-9-2001, FILED 6-20-2001.

CAMILA

FOR PHARMACEUTICAL PREPARATIONS, NAMELY, ORAL CONTRACEPTIVES (U.S. CLS. 6, 18, 44, 46, 51 AND 52).

FIRST USE 10-30-2002; IN COMMERCE 10-30-2002.

2,730,166. VIRBAC CORPORTION, FORT WORTH, TX, BY ASSIGNMENT BLUE RIDGE PHARMACEUTICALS, INC., GREENSBORO, NC. SN 76-282,970. PUB. 10-30-2001, FILED 7-3-2001.

IVERHART PLUS

FOR HEART WORM PREVENTATIVE FOR SMALL ANIMALS (U.S. CLS. 6, 18, 44, 46, 51 AND 52).

FIRST USE 7-24-2001; IN COMMERCE 7-24-2001.

CLASS 5—(Continued).

2,730,219. METAGENICS, INC., SAN CLEMENTE, CA. SN 76-298,745. PUB. 11-13-2001, FILED 8-7-2001.

CELAPRO

FOR DIETARY SUPPLEMENTS (U.S. CLS. 6, 18, 44, 46, 51 AND 52).
FIRST USE 7-8-2002; IN COMMERCE 7-8-2002.

2,730,220. OCUSOFT, INC., RICHMOND, TX. SN 76-298,788. PUB. 5-28-2002, FILED 8-13-2001.

STYMIE

FOR PHARMACEUTICAL EYE PRODUCTS, NAMELY, LUBRICANTS, DROPS, OINTMENTS, GELS, AND SOLUTIONS FOR USE IN THE TREATMENT OF DRY EYES AND MEDICATED PRE-MOISTENED WIPES (U.S. CLS. 6, 18, 44, 46, 51 AND 52).
FIRST USE 9-1-2001; IN COMMERCE 9-1-2001.

2,730,226. NBTY, INC., BOHEMIA, NY. SN 76-301,748. PUB. 12-18-2001, FILED 8-21-2001.

LEAN SUCCESS

FOR NUTRITIONAL SUPPLEMENTS (U.S. CLS. 6, 18, 44, 46, 51 AND 52).
FIRST USE 10-12-2001; IN COMMERCE 10-12-2001.

2,730,235. GARVEY PROCESSING, INC., ST. CHARLES, IL. SN 76-304,340. PUB. 6-25-2002, FILED 8-23-2001.

COTTON SPROUT PLUS

NO CLAIM IS MADE TO THE EXCLUSIVE RIGHT TO USE "COTTON SPROUT", APART FROM THE MARK AS SHOWN.
FOR ANIMAL FEED ADDITIVES FOR USE AS NUTRITIONAL SUPPLEMENTS (U.S. CLS. 6, 18, 44, 46, 51 AND 52).
FIRST USE 8-3-2001; IN COMMERCE 8-3-2001.

2,730,290. YEAGER, LISA, MISSOULA, MT. SN 76-319,521. PUB. 10-1-2002, FILED 10-1-2001.

MENOVITE

FOR DIETARY SUPPLEMENT FOR MENOPAUSE (U.S. CLS. 6, 18, 44, 46, 51 AND 52).
FIRST USE 1-1-2002; IN COMMERCE 1-1-2002.

CLASS 5—(Continued).

2,730,306. 4LIFE RESEARCH, L.C., SANDY, UT. SN 76-322,894. PUB. 10-8-2002, FILED 10-9-2001.

FLEX 4LIFE

FOR DIETARY SUPPLEMENTS; VITAMIN, MINERAL AND HERBAL SUPPLEMENTS (U.S. CLS. 6, 18, 44, 46, 51 AND 52).
FIRST USE 3-0-2002; IN COMMERCE 3-0-2002.

2,730,337. STANDARD PROCESS INC., PALMYRA, WI. SN 76-331,419. PUB. 6-18-2002, FILED 10-30-2001.

GASTRO-FIBER

OWNER OF U.S. REG. NO. 2,332,945.
FOR DIETARY SUPPLEMENTS (U.S. CLS. 6, 18, 44, 46, 51 AND 52).
FIRST USE 1-0-2002; IN COMMERCE 1-0-2002.

2,730,427. HOPE CHEMICAL SUPPLEMENTS, L.L.C., LAKE BLUFF, IL. SN 76-350,819. PUB. 5-14-2002, FILED 12-13-2001.

CARN-AWARE

FOR VITAMINS, NUTRITIONAL AND DIETARY SUPPLEMENTS (U.S. CLS. 6, 18, 44, 46, 51 AND 52).
FIRST USE 1-29-2002; IN COMMERCE 1-29-2002.

2,730,429. 4LIFE RESEARCH, L.C., SANDY, UT. SN 76-351,237. PUB. 9-17-2002, FILED 12-14-2001.

FIBER 4LIFE

OWNER OF U.S. REG. NOS. 2,475,300 AND 2,486,970.
NO CLAIM IS MADE TO THE EXCLUSIVE RIGHT TO USE FIBER, APART FROM THE MARK AS SHOWN.
FOR DIETARY AND NUTRITIONAL DRINK (U.S. CLS. 6, 18, 44, 46, 51 AND 52).
FIRST USE 2-15-2002; IN COMMERCE 2-15-2002.

2,730,432. BIOENHANCE TECHNOLOGIES, INC., SALISBURY, MD. SN 76-351,791. PUB. 7-9-2002, FILED 12-21-2001.

VISIONARY SUPPLEMENTS

NO CLAIM IS MADE TO THE EXCLUSIVE RIGHT TO USE "SUPPLEMENTS", APART FROM THE MARK AS SHOWN.
FOR NUTRITIONAL AND DIETARY SUPPLEMENTS (U.S. CLS. 6, 18, 44, 46, 51 AND 52).
FIRST USE 11-13-2002; IN COMMERCE 11-13-2002.

CLASS 5—(Continued).

2,730,448. DEL PHARMACEUTICALS, INC., UNIONDALE, NY. SN 76-355,004. PUB. 6-18-2002, FILED 1-7-2002.

GENTLE NATURALS

FOR MEDICATED ECZEMA CREAM, MEDICATED ECZEMA BATH WASH, MEDICATED CRADLE CAP TREATMENT, SOOTHING VAPOR CREAM AND GEL PACK FOR EARACHES (U.S. CLS. 6, 18, 44, 46, 51 AND 52).

FIRST USE 4-1-2002; IN COMMERCE 4-1-2002.

2,730,449. VITANUTRA, INC., YOUNGSTOWN, OH. SN 76-355,292. PUB. 10-8-2002, FILED 1-7-2002.

FIBRO X

FOR NUTRITIONAL SUPPLEMENTS AND DIETARY SUPPLEMENTS (NUTRACEUTICALS) (U.S. CLS. 6, 18, 44, 46, 51 AND 52).

FIRST USE 1-1-2002; IN COMMERCE 1-1-2002.

2,730,473. HUGHES NEW YORK INCORPORATED, ATLANTA, GA. SN 76-362,006. PUB. 7-9-2002, FILED 1-23-2002.

AMORIST

FOR PERSONAL LUBRICANTS FOR USE DURING SEXUAL INTERCOURSE AND OTHER SEXUAL ACTIVITIES (U.S. CLS. 6, 18, 44, 46, 51 AND 52).

FIRST USE 7-9-2002; IN COMMERCE 7-9-2002.

2,730,483. RENAISSANCE HERBS, INC., CHATSWORTH, CA. SN 76-365,169. PUB. 7-30-2002, FILED 2-1-2002.



FOR DIETARY, NUTRITIONAL, HERBAL AND FOOD SUPPLEMENTS, AND DIETARY SUPPLEMENTS CONSISTING OF HERBAL EXTRACTS AND ENZYMES (U.S. CLS. 6, 18, 44, 46, 51 AND 52).

FIRST USE 5-15-2002; IN COMMERCE 6-9-2002.

CLASS 5—(Continued).

2,730,536. CUMBERLAND SWAN HOLDINGS, INC., SMYRNA, TN. SN 76-975,325. PUB. 4-16-2002, FILED 5-10-2000.



OWNER OF U.S. REG. NOS. 438,253, 2,299,149, AND OTHERS.

FOR ALCOHOL SKIN ANTISEPTIC; AMMONIA SPIRIT AS A RESPIRATORY STIMULANT; ANALGESICS; ANTACIDS; ANTI-DIARRHEAL MEDICATION; ANTI-HISTAMINES; ANTI-ITCH LOTION; ANTI-PLAQUE DENTAL RINSE; ANTISEPTIC MOUTHWASH; ANTISEPTIC SKIN CREAMS AND LOTIONS; ANTISEPTICS; ANTI-TUSSIVES; BENZOIN TINCTURE FOR MEDICAL USE; CAFFEINE MEDICATION FOR USE IN RELIEVING DROWSINESS; CALAMINE LOTION; CAMPHOR PREPARATIONS FOR USE AS AN ANALGESIC; CHILDREN'S COUGH ELIXIR; CITRATE OF MAGNESIUM FOR USE AS A LAXATIVE; COD LIVER OIL; MEDICINAL PREPARATIONS FOR USE IN TREATING COUGHS AND COLDS; DANDRUFF SHAMPOO; DIETARY SUPPLEMENTS; DIGESTIVE AIDS FOR USE AS DIETARY SUPPLEMENT; EPSOM SALT; ETHYL RUBBING ALCOHOL; GENTIAN VIOLET FOR USE AS A BACTERICIDE AND FUNGICIDE; GLYCERIN SUPPOSITORIES; HEMORRHOIDAL CREAM; HYDROGEN PEROXIDE FOR MEDICAL USE; INFANT'S SIMETHICONE DROPS FOR USE IN THE TREATMENT OF EAR INFECTIONS; IPECAC SYRUP; LAXATIVE PREPARATIONS; MEDICATED BODY POWDER; MEDICINAL SOFT SOAP; ASPIRIN SINUS MEDICATION; PAIN RELIEVER AND SLEEP AID PREPARATIONS; SODIUM BICARBONATE FOR MEDICINAL USE AS A DIGESTIVE AID; SORE THROAT TREATMENT SPRAY; STOOL SOFTENER; PHARMACEUTICAL PREPARATIONS FOR USE IN REDUCING STRESS IN THE FORM OF LIQUIDS AND TABLETS; IRON TABLETS FOR USE AS A DIETARY SUPPLEMENT; SUPPOSITORIES; TRIACTING EXPECTORANT; TRIPLE ANTIBIOTIC OINTMENT, VAGINAL OINTMENTS IN THE NATURE OF ANTI-FUNGALS AND VAGINAL SUPPOSITORIES; AND WITCH HAZEL ASTRINGENT (U.S. CLS. 6, 18, 44, 46, 51 AND 52).

FIRST USE 3-27-2002; IN COMMERCE 5-27-2002.

2,730,560. VAST RESOURCES, INC., SAN FERNANDO, CA. SN 78-019,151. PUB. 6-12-2001, FILED 8-1-2000.

SCREAMING ORGASM

FOR PERSONAL LUBRICANTS (U.S. CLS. 6, 18, 44, 46, 51 AND 52).

FIRST USE 1-0-2003; IN COMMERCE 1-0-2003.

CLASS 5—(Continued).

2,730,566. GUSTAFSON, L.L.C., PLANO, TX. SN 78-027,018.
PUB. 8-20-2002, FILED 9-21-2000.

TITAN

FOR CHEMICALS USED AS SEED-APPLIED FUNGICIDES FOR AGRICULTURAL USE (U.S. CLS. 6, 18, 44, 46, 51 AND 52).
FIRST USE 1-0-2003; IN COMMERCE 1-0-2003.

CLASS 5—(Continued).

2,730,703. SMITHKLINE BEECHAM BIOLOGICALS S.A., RIXENSART, BELGIUM. SN 78-080,467. PUB. 12-11-2001, FILED 8-22-2001.

PEDIARIX

FOR VACCINES FOR HUMAN USE (U.S. CLS. 6, 18, 44, 46, 51 AND 52).
FIRST USE 1-9-2003; IN COMMERCE 1-9-2003.

2,730,671. WYETH, MADISON, NJ, BY CHANGE OF NAME AMERICAN HOME PRODUCTS CORPORATION, MADISON, NJ. SN 78-071,651. PUB. 2-26-2002, FILED 6-29-2001.

Restor-A-Flex

OWNER OF U.S. REG. NOS. 501,389, 1,321,727, AND OTHERS.
FOR VETERINARY NUTRITIONAL DIETARY SUPPLEMENT (U.S. CLS. 6, 18, 44, 46, 51 AND 52).
FIRST USE 10-30-2001; IN COMMERCE 10-30-2001.

2,730,690. DIAL BRANDS, INC., SCOTTSDALE, AZ. SN 78-076,590. PUB. 8-20-2002, FILED 7-31-2001.

MISTY MORNING

OWNER OF U.S. REG. NO. 1,419,714.
FOR AIR FRESHENERS AND ROOM DEODORIZERS, FOR HOUSEHOLD USE (U.S. CLS. 6, 18, 44, 46, 51 AND 52).
FIRST USE 7-25-2002; IN COMMERCE 7-25-2002.

2,730,691. DIAL BRANDS, INC., SCOTTSDALE, AZ. SN 78-076,591. PUB. 8-20-2002, FILED 7-31-2001.

TROPICAL BERRIES

FOR AIR FRESHENERS AND ROOM DEODORIZERS (U.S. CLS. 6, 18, 44, 46, 51 AND 52).
FIRST USE 8-8-2002; IN COMMERCE 8-8-2002.

2,730,753. X M INTERNATIONAL, L.L.C., SALT LAKE CITY, UT. SN 78-095,286. PUB. 8-6-2002, FILED 11-27-2001.

NITROVARIN

FOR DIETARY SUPPLEMENTS, MAINLY USED FOR SPORTS PERFORMANCE AND WEIGHT CONTROL (U.S. CLS. 6, 18, 44, 46, 51 AND 52).
FIRST USE 12-19-2001; IN COMMERCE 12-19-2001.

2,730,779. WALCO INTERNATIONAL, INC., GRAPEVINE, TX. SN 78-100,182. PUB. 7-2-2002, FILED 12-28-2001.

TETNI-VAX

FOR VETERINARY OVINE VACCINE (U.S. CLS. 6, 18, 44, 46, 51 AND 52).
FIRST USE 1-8-2003; IN COMMERCE 1-8-2003.

2,730,785. VITA CUBE SYSTEMS, INC., DENVER, CO. SN 78-101,033. PUB. 7-9-2002, FILED 1-4-2002.

GC ELITE

FOR DIETARY SUPPLEMENTS, NAMELY AMINO ACIDS FORMULATED FOR MUSCLE ENERGY (U.S. CLS. 6, 18, 44, 46, 51 AND 52).
FIRST USE 5-8-2001; IN COMMERCE 7-12-2001.

2,730,810. FARNAM COMPANIES, INC., PHOENIX, AZ. SN 78-108,209. PUB. 9-3-2002, FILED 2-12-2002.

IVERCARE

FOR ANTIPARASITIC PREPARATION FOR ANIMALS; NAMELY, HORSES (U.S. CLS. 6, 18, 44, 46, 51 AND 52).
FIRST USE 4-1-2002; IN COMMERCE 4-1-2002.

CLASS 5—(Continued).

2,730,811. FARNAM COMPANIES, INC., PHOENIX, AZ. SN 78-108,212. PUB. 9-3-2002, FILED 2-12-2002.

ROTATION

FOR ANTIPARASITIC PREPARATION FOR ANIMALS; NAMELY, HORSES (U.S. CLS. 6, 18, 44, 46, 51 AND 52).

FIRST USE 4-1-2002; IN COMMERCE 4-1-2002.

2,730,826. BAYER CORPORATION, PITTSBURGH, PA. SN 78-114,843. PUB. 9-24-2002, FILED 3-14-2002.

ASCENSIA ELITE

FOR DIAGNOSTIC REAGENTS AND ASSAYS FOR THE ANALYSIS OF BODY FLUIDS (U.S. CLS. 6, 18, 44, 46, 51 AND 52).

FIRST USE 6-15-2002; IN COMMERCE 6-15-2002.

2,730,832. PROCTER & GAMBLE COMPANY, THE, CINCINNATI, OH. SN 78-117,422. PUB. 10-8-2002, FILED 3-26-2002.

CLEANWEAVE

FOR TOPSHEET FOR CATAMENIAL PRODUCTS, NAMELY, SANITARY NAPKINS, AND PANTY LINERS (U.S. CLS. 6, 18, 44, 46, 51 AND 52).

FIRST USE 9-17-2002; IN COMMERCE 9-17-2002.

CLASS 6—METAL GOODS

2,729,507. LAKE ERIE SCREW CORPORATION, LAKEWOOD, OH. SN 75-784,331. PUB. 3-28-2000, FILED 8-26-1999.

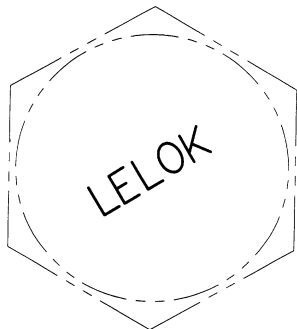

THE MATTER SHOWN BY THE DOTTED LINES IS NOT PART OF THE MARK AND IT SERVES ONLY TO SHOW THE POSITION OF THE MARK IN RELATION TO THE GOODS.

FOR METAL THREADED FASTENERS (U.S. CLS. 2, 12, 13, 14, 23, 25 AND 50).
FIRST USE 12-11-2002; IN COMMERCE 12-11-2002.

CLASS 6—(Continued).

2,729,676. DAVIS, SHAWN, MCKEES ROCKS, PA. SN 76-018,548. PUB. 4-30-2002, FILED 4-5-2000.

PRIME STEEL BUILDINGS

NO CLAIM IS MADE TO THE EXCLUSIVE RIGHT TO USE "STEEL BUILDINGS", APART FROM THE MARK AS SHOWN.

FOR PREFABRICATED STEEL BUILDINGS AND COMPONENTS THEREFOR, NAMELY FRAMES, SHEETING, GIRTS AND PURLINS ALL MADE OF METAL (U.S. CLS. 2, 12, 13, 14, 23, 25 AND 50).

FIRST USE 8-30-1998; IN COMMERCE 8-30-1998.

2,729,771. ABBOTT-INTERFAST CORPORATION, WHEELING, IL. SN 76-099,757. PUB. 10-30-2001, FILED 7-31-2000.

THE SCREW THAT WORKS LIKE A TOOL

FOR METAL FASTENERS, NAMELY, SCREWS (U.S. CLS. 2, 12, 13, 14, 23, 25 AND 50).

FIRST USE 3-1-1999; IN COMMERCE 3-15-1999.

2,730,007. BECKER, DUANE WM., WATKINS, MN. SN 76-224,473. PUB. 3-19-2002, FILED 3-14-2001.



OWNER OF U.S. REG. NO. 1,936,059.
THE LINING SHOWN IN THE DRAWING IS FOR SHADING PURPOSES AND DOES NOT INDICATE COLOR.
FOR ROLLED, PRESS-BRAKED, AND/OR CAST METAL BUILDING STUDS AND RUNNERS (U.S. CLS. 2, 12, 13, 14, 23, 25 AND 50).
FIRST USE 3-22-2001; IN COMMERCE 3-22-2001.

2,730,108. CYCLO MANUFACTURING COMPANY, DENVER, CO. SN 76-265,758. PUB. 6-4-2002, FILED 5-31-2001.

KEY TROL

FOR METAL LOCK BOXES (U.S. CLS. 2, 12, 13, 14, 23, 25 AND 50).
FIRST USE 12-3-2001; IN COMMERCE 12-3-2001.

CLASS 6—(Continued).

2,730,125. LORIN INDUSTRIES, INC., MUSKEGON, MI. SN 76-270,501. PUB. 1-8-2002, FILED 6-12-2001.

ADHERE

FOR ANODIZED ALUMINUM IN SHEET OR COIL FORM (U.S. CLS. 2, 12, 13, 14, 23, 25 AND 50).
FIRST USE 4-2-2002; IN COMMERCE 4-2-2002.

2,730,142. OLSZEWSKI, DONALD J., PENFIELD, PA. AND OLSZEWSKI, RITA V., PENFIELD, PA. SN 76-274,922. PUB. 6-18-2002, FILED 6-22-2001.

KEY MOMENTS

FOR MESSAGE BEARING METAL PLATES (U.S. CLS. 2, 12, 13, 14, 23, 25 AND 50).
FIRST USE 3-7-2003; IN COMMERCE 3-7-2003.

2,730,157. MICASA TRADING CORPORATION, DBA IMPEX SYSTEMS GROUP, INC., MIAMI, FL. SN 76-279,732. PUB. 4-30-2002, FILED 7-2-2001.

SHIELD

FOR METAL WALL HANGERS (U.S. CLS. 2, 12, 13, 14, 23, 25 AND 50).
FIRST USE 5-20-2002; IN COMMERCE 5-20-2002.

2,730,187. GAGLIANO, RICHARD J., GIG HARBOR, WA. SN 76-289,698. PUB. 6-25-2002, FILED 7-24-2001.

L.I.F.T.

FOR PREFABRICATED ASSEMBLIES OF METAL COMPONENTS DESIGNED TO BE INTEGRATED WITH OR ATTACHED TO PIN PILES IN THE CONSTRUCTION OF MINIMIZED-SITE-DISTURBANCES FOUNDATIONS FOR BUILDINGS AND OTHER STRUCTURES (U.S. CLS. 2, 12, 13, 14, 23, 25 AND 50).
FIRST USE 1-1-2003; IN COMMERCE 1-1-2003.

2,730,269. BUCKSHOT, INC., WILMINGTON, NC. SN 76-314,086. PUB. 6-18-2002, FILED 9-17-2001.

SWIFTLOC

FOR HUNTING TREE STAND LOCKS MADE OF METAL (U.S. CLS. 2, 12, 13, 14, 23, 25 AND 50).
FIRST USE 1-31-2002; IN COMMERCE 1-31-2002.

CLASS 6—(Continued).

2,730,345. NEUMANN, JERRY B., NEW BERN, NC. SN 76-334,007. PUB. 5-28-2002, FILED 11-5-2001.

HARDWAREVILLE

FOR SMALL ITEMS OF DECORATIVE METAL HARDWARE, NAMELY, HINGES, KNOBS, PULLS, HANDLES AND LOCKS (U.S. CLS. 2, 12, 13, 14, 23, 25 AND 50).
FIRST USE 12-10-2001; IN COMMERCE 12-10-2001.

2,730,602. DOCK HEIGHT ADJUSTMENT, INC., HOLLAND, MI. SN 78-044,291. PUB. 1-15-2002, FILED 1-22-2001.

DOCKADJUST

FOR ADJUSTABLE STEEL MARINE DOCK SUPPORT BRACKETS (U.S. CLS. 2, 12, 13, 14, 23, 25 AND 50).
FIRST USE 1-1-2001; IN COMMERCE 4-1-2001.

2,730,610. DANA CORPORATION, TOLEDO, OH. SN 78-048,753. PUB. 12-11-2001, FILED 2-16-2001.

VICTO-STACK

FOR METAL GASKETS (U.S. CLS. 2, 12, 13, 14, 23, 25 AND 50).
FIRST USE 1-1-2003; IN COMMERCE 1-1-2003.

CLASS 7—MACHINERY

2,729,446. BOARD MACHINING COMPANY, RALEIGH, NC. SN 75-662,144. PUB. 4-18-2000, FILED 3-17-1999.

STRAITOPLANE

FOR WOOD WORKING MACHINERY, NAMELY PLANERS (U.S. CLS. 13, 19, 21, 23, 31, 34 AND 35).
FIRST USE 1-0-2003; IN COMMERCE 1-0-2003.

2,729,456. HOT RODS MOTORCYCLE & AUTO PARTS CORPORATION, URBANDALE, IA. SN 75-680,073. PUB. 11-30-1999, FILED 4-30-1999.

HOT CAMS

NO CLAIM IS MADE TO THE EXCLUSIVE RIGHT TO USE "CAMS", APART FROM THE MARK AS SHOWN.

FOR CAMSHAFTS FOR INTERNAL COMBUSTION ENGINES - MOTORCYCLE, ATV, SNOWMOBILE, WATERCRAFT AND AUTOMOBILE (U.S. CLS. 13, 19, 21, 23, 31, 34 AND 35).
FIRST USE 3-5-2002; IN COMMERCE 3-5-2002.

CLASS 7—(Continued).

2,729,469. REESE ENGINEERING LIMITED, PALMERSTON NORTH, NEW ZEALAND. SN 75-712,694. PUB. 4-16-2002, FILED 5-24-1999.

Heli-Wrapper

FOR AGRICULTURAL MACHINERY, NAMELY, ANIMAL FEED BALE MACHINES, AND COMPONENT PARTS AND FITTINGS THEREFOR (U.S. CLS. 13, 19, 21, 23, 31, 34 AND 35).

FIRST USE 2-0-1999; IN COMMERCE 2-0-1999.

2,729,639. TOTES ISOTONER CORPORATION, CINCINNATI, OH. SN 75-981,992. PUB. 8-27-2002, FILED 5-29-2001.

IMAGES BY TOTES

FOR VACUUM CLEANER (U.S. CLS. 13, 19, 21, 23, 31, 34 AND 35).

FIRST USE 6-30-1998; IN COMMERCE 6-30-1998.

2,729,726. HUGHES SUPPLY IP, INC., WILMINGTON, DE, BY ASSIGNMENT HUGHES SUPPLY MANAGEMENT SERVICES, INC., ORLANDO, FL. SN 76-070,681. PUB. 3-6-2001, FILED 6-15-2000.

TERMINATOR

FOR GARBAGE DISPOSALS (U.S. CLS. 13, 19, 21, 23, 31, 34 AND 35).

FIRST USE 9-0-2000; IN COMMERCE 9-0-2000.

CLASS 7—(Continued).

2,729,766. DEERE & COMPANY, MOLINE, IL. SN 76-095,359. PUB. 8-13-2002, FILED 7-19-2000.



FOR AGRICULTURAL MACHINES, NAMELY, PLOWS, CULTIVATORS, HARROWS, REAPERS, GRAIN HARVESTERS, HAY RAKES, STACKERS, UNLOADERS, FORKS, POWER CORN, COTTON, POTATO, SEED PLANTERS, POWER BROADCAST SEEDERS, GRAIN DRILLS, POTATO DIGGERS, MANURE SPREADERS, FERTILIZER DISTRIBUTORS, SPRAYING MACHINES, STALK CUTTERS, SURFACE GRADERS, CORN HARVESTERS AND HUSKERS, CORN SHELLERS, FEED GRINDERS, ENSILAGE CUTTERS, FEED CUTTERS, LAWN MOWERS AND REEL MOWER VEHICLES, CLOD CRUSHERS, SOIL PULVERIZERS, LAND ROLLERS, SPRAYING AND FARM PUMPS, COMBINES; EARTH-MOVING MACHINES, NAMELY, LOGGING, LAND-SHAPING AND LAND-CLEARING MACHINES, LOADERS, SKID STEER LOADERS, LOADER BACKHOES, BULLDOZERS, EXCAVATORS, SCRAPERS; WOOD SAWING MACHINES; HIGH PRESSURE SPRAY-TYPE WASHING MACHINE FOR SPRAYING WATER, DETERGENTS AND OTHER LIQUIDS; SNOW BLOWERS AND SNOW THROWERS; CHAIN SAWS; POSTHOLE DIGGERS; AND GASOLINE AND DIESEL INTERNAL COMBUSTION ENGINES FOR THE AFOREMENTIONED MACHINES (U.S. CLS. 13, 19, 21, 23, 31, 34 AND 35).

FIRST USE 11-1-2000; IN COMMERCE 11-1-2000.

2,729,822. SCHUNK GMBH & CO. KG., D-74348 LAUFFEN/NECKAR, FED REP GERMANY. SN 76-135,303. PUB. 4-30-2002, FILED 9-26-2000.

THW

FOR MACHINES FOR METALWORKING, WOODWORKING, AND PLASTICS PROCESSING INDUSTRIES, NAMELY, CLAMPING CHUCKS, MANDRELS, CLAMPING CHUCKS OF METAL FOR WORK PIECES, GRIPPING CHUCKS, ELECTRICALLY, HYDRAULICALLY OR PNEUMATICALLY DRIVEN TRANSLATING, SWIVELING AND LIFTING CHUCKS, ROTATING CHUCKS, METAL CLAMPING DRILL CHUCKS FOR POWER DRILLS, POWERED EXPANSION CHUCKS, POWERED SHRINKAGE CHUCKS, BACK STAY FOR LATHES, CLAMPING CYLINDERS FOR POWER CLAMPING CHUCKS, POWERED EXTENSION CHUCKS, AND PARTS THEREOF (U.S. CLS. 13, 19, 21, 23, 31, 34 AND 35).

FIRST USE 12-17-1999; IN COMMERCE 12-17-1999.

CLASS 7—(Continued).

2,729,823. SCHUNK GMBH & CO. KG., D-74348 LAUFFEN/
NECKAR, FED REP GERMANY. SN 76-135,307. PUB. 4-30-
2002, FILED 9-26-2000.

THL

FOR MACHINES FOR METALWORKING, WOOD-
WORKING, AND PLASTICS PROCESSING INDUS-
TRIES, NAMELY, CLAMPING CHUCKS, MANDRELS,
CLAMPING CHUCKS OF METAL FOR WORK PIECES,
GRIPPING CHUCKS, ELECTRICALLY, HYDRAULI-
CALLY OR PNEUMATICALLY DRIVEN TRANSLAT-
ING, SWIVELING AND LIFTING CHUCKS, ROTATING
CHUCKS, METAL CLAMPING DRILL CHUCKS FOR
POWER DRILLS, POWERED EXPANSION CHUCKS,
POWERED SHRINKAGE CHUCKS, BACK STAY FOR
LATHES, CLAMPING CYLINDERS FOR POWER
CLAMPING CHUCKS, POWERED EXTENSION
CHUCKS, AND PARTS THEREOF (U.S. CLS. 13, 19, 21,
23, 31, 34 AND 35).

FIRST USE 3-5-2002; IN COMMERCE 3-5-2002.

2,729,909. ESAB GROUP, INC., FLORENCE, SC. SN 76-
182,877. PUB. 9-3-2002, FILED 12-19-2000.

POWERCUT

FOR PLASMA ARC CUTTING MACHINE (U.S. CLS.
13, 19, 21, 23, 31, 34 AND 35).

FIRST USE 6-8-2001; IN COMMERCE 6-8-2001.

2,729,974. ENZ (U.S.A.), INC., SOUTH ELGIN, IL. SN 76-
213,025. PUB. 5-28-2002, FILED 2-21-2001.

JETMAX

FOR NOZZLE INSERTS MADE OF METAL AND
CERAMICS FOR HYDRAULIC CLEANING WHICH
ARE PARTS OF POWER OPERATED SPRAYERS (U.S.
CLS. 13, 19, 21, 23, 31, 34 AND 35).

FIRST USE 4-0-2002; IN COMMERCE 4-0-2002.

2,730,022. LAIN, JAMES D., PADUCAH, KY. SN 76-234,081.
PUB. 6-18-2002, FILED 4-2-2001.

GLOW & GO

FOR NEON SPARK PLUG WIRES, USED IN RELA-
TION TO MOTORCYCLES AND HOT-RODS (U.S. CLS.
13, 19, 21, 23, 31, 34 AND 35).

FIRST USE 6-18-2001; IN COMMERCE 6-18-2001.

CLASS 7—(Continued).

2,730,032. DAIDO METAL CO., LTD., KITA-KU, NAGOYA,
JAPAN. SN 76-238,096. PUB. 6-18-2002, FILED 4-10-2001.

JOOM

FOR MACHINERY FOR USE IN METAL WORKING
AND PLASTIC WORKING, NAMELY, MACHINERY
WHICH DELIVERS DROPLETS OF OIL AND WATER
TO PERMIT SEMI-DRY AND DRY MACHINING OF
METAL AND PLASTIC PARTS; AND PARTS THEREFOR
(U.S. CLS. 13, 19, 21, 23, 31, 34 AND 35).

FIRST USE 4-2-2001; IN COMMERCE 3-29-2002.

2,730,095. HOWELL, RICHARD L., JR., YORBA LINDA, CA.
SN 76-261,204. PUB. 5-28-2002, FILED 5-22-2001.

HODRIL

OWNER OF U.S. REG. NO. 1,989,983.
FOR EARTH MOVING ATTACHMENTS FOR USE
WITH TRUCKS, TRACTORS, AGRICULTURAL, AND
CONSTRUCTION VEHICLES, AND WITH SKIDS FOR
USE IN EXCAVATING AND MOVING SOIL (U.S. CLS.
13, 19, 21, 23, 31, 34 AND 35).

FIRST USE 7-25-2001; IN COMMERCE 7-26-2001.

2,730,134. OMS INVESTMENTS, INC., WILMINGTON, DE.
SN 76-272,795. PUB. 5-28-2002, FILED 6-18-2001.

EDGE GUARD

FOR MECHANICAL SPREADERS (U.S. CLS. 13, 19, 21,
23, 31, 34 AND 35).

FIRST USE 1-31-2001; IN COMMERCE 1-31-2001.

2,730,154. RENNCO INC., HOMER, MI. SN 76-278,816. PUB.
10-23-2001, FILED 6-29-2001.

VOYAGER

FOR MACHINE FOR FORMING AND SEALING
PLASTIC FILM PACKAGES (U.S. CLS. 13, 19, 21, 23, 31,
34 AND 35).

FIRST USE 2-14-2003; IN COMMERCE 2-14-2003.

CLASS 7—(Continued).

2,730,201. BRIGGS & STRATTON CORPORATION, WAUWATOSA, WI. SN 76-294,180. PUB. 5-21-2002, FILED 8-1-2001.

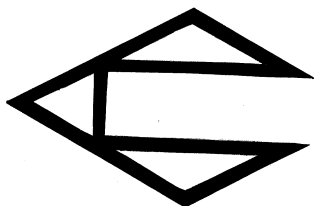

THE MARK CONSISTS OF THREE TRIANGLES. FOR INTERNAL COMBUSTION ENGINES NOT FOR LAND VEHICLES; ENGINE DRIVEN GENERATORS, MULTI-PURPOSE HIGH PRESSURE WASHERS, ELECTRIC GENERATORS; INTERNAL COMBUSTION ENGINES FOR LAND VEHICLES (U.S. CLS. 13, 19, 21, 23, 31, 34 AND 35).

FIRST USE 6-1-2001; IN COMMERCE 6-1-2001.

2,730,300. NEUENHAUSER MASCHINENBAU GMBH & CO. KG, 49828 NEUENHAUS, FED REP GERMANY. SN 76-321,772. PUB. 4-30-2002, FILED 10-5-2001.

TWISTER

FOR SOIL PREPARATION DEVICES, MACHINES AND SOIL PREPARATION SYSTEMS NAMELY, SCREENING AND SCREEN-CRUSHING MACHINES, SOIL SEPARATING AND SOIL CONDITIONING MACHINES, CONVEYERS, BUCKET SEPARATORS, SCREEN WALLED BUCKETS, BUCKETS FOR BACKHOES AND BACKHOE LOADERS, EARTH MOVING MACHINES, STATIONARY AND FIXED SCREENS FOR SOIL PREPARATION, CRUSHING MILLS, CRUSHERS AND CRUSHING DEVICES, COMMINATION MACHINES AND REPLACEMENT PARTS THEREFOR (U.S. CLS. 13, 19, 21, 23, 31, 34 AND 35).

FIRST USE 12-31-1997; IN COMMERCE 1-1-2000.

2,730,320. R & D MANUFACTURING INC., ELK GROVE, CA. SN 76-326,981. PUB. 5-14-2002, FILED 10-19-2001.

**THE MOTOR
MAINTENANCE PEOPLE**

NO CLAIM IS MADE TO THE EXCLUSIVE RIGHT TO USE "MOTOR MAINTENANCE", APART FROM THE MARK AS SHOWN.

FOR EJECTOR PUMPS FOR TRANSFERRING OIL AND WATER BASED FLUIDS FOR USE IN MOTORS AND ENGINES (U.S. CLS. 13, 19, 21, 23, 31, 34 AND 35).

FIRST USE 12-26-2001; IN COMMERCE 12-26-2001.

CLASS 7—(Continued).

2,730,486. CENTEK INDUSTRIES, INC., THOMASVILLE, GA. SN 76-366,284. PUB. 7-2-2002, FILED 2-1-2002.

CENTUBULAR

FOR MARINE MUFFLERS (U.S. CLS. 13, 19, 21, 23, 31, 34 AND 35).

FIRST USE 2-0-2002; IN COMMERCE 2-0-2002.

2,730,572. ELECTROLUX HOME PRODUCTS, INC., CLEVELAND, DE, BY MERGER, BY CHANGE OF NAME WCI OUTDOOR PRODUCTS, INC., CLEVELAND, OH. SN 78-030,267. PUB. 5-14-2002, FILED 10-12-2000.



NO CLAIM IS MADE TO THE EXCLUSIVE RIGHT TO USE "CENTER EXIT", APART FROM THE MARK AS SHOWN.

FOR CUTTING HEADS FOR POWER OPERATED LAWN AND GARDEN TRIMMERS (U.S. CLS. 13, 19, 21, 23, 31, 34 AND 35).

FIRST USE 1-31-2001; IN COMMERCE 1-31-2001.

2,730,596. HP INTELLECTUAL CORP., WILMINGTON, DE. SN 78-042,790. PUB. 7-2-2002, FILED 1-11-2001.

SLIMLINE

FOR ELECTRIC CAN OPENERS FOR DOMESTIC USE (U.S. CLS. 13, 19, 21, 23, 31, 34 AND 35).

FIRST USE 5-31-2001; IN COMMERCE 5-31-2001.

2,730,674. WHITE KNIGHT FLUID HANDLING, INCORPORATED, HEMLOCK, MI. SN 78-072,768. PUB. 7-2-2002, FILED 7-7-2001.

FACILITATOR

FOR FLUID PUMPS FOR USE IN ULTRA-CLEAN AND STERILE ENVIRONMENTS, NAMELY, RECIPROCATING PUMPS, PNEUMATIC PUMPS, HYDRAULIC PUMPS, AND POSITIVE DISPLACEMENT PUMPS; PUMP CONTROL VALVES; PUMP ACTUATION AND CONTROL VALVES; AND STRUCTURAL COMPONENTS PARTS THEREFORE (U.S. CLS. 13, 19, 21, 23, 31, 34 AND 35).

FIRST USE 9-28-2001; IN COMMERCE 9-28-2001.

CLASS 7—(Continued).

2,730,687. CONAIR CIP, INC., STAMFORD, CT, BY ASSIGNMENT CONAIR CORPORATION, STAMFORD, CT. SN 78-076,362. PUB. 12-11-2001, FILED 7-30-2001.

PREP 7

FOR ELECTRIC AND BATTERY OPERATED KITCHEN APPLIANCES, NAMELY, FOOD PROCESSORS (U.S. CLS. 13, 19, 21, 23, 31, 34 AND 35).
FIRST USE 9-1-2001; IN COMMERCE 9-1-2001.

2,730,720. GENERAL ELECTRIC COMPANY, SCHENECTADY, NY. SN 78-085,608. PUB. 7-2-2002, FILED 9-26-2001.

TRICLEAN

FOR DISHWASHING MACHINES AND PARTS THEREOF, FOR DOMESTIC USE (U.S. CLS. 13, 19, 21, 23, 31, 34 AND 35).
FIRST USE 7-0-1999; IN COMMERCE 9-0-1999.

2,730,767. SALTON, INC., LAKE FOREST, IL. SN 78-097,286. PUB. 7-2-2002, FILED 12-7-2001.

THE LEMONADER

FOR ELECTRIC JUICERS (U.S. CLS. 13, 19, 21, 23, 31, 34 AND 35).
FIRST USE 2-28-2002; IN COMMERCE 2-28-2002.

2,730,816. GOODYEAR TIRE & RUBBER COMPANY, THE, AKRON, OH. SN 78-109,494. PUB. 7-23-2002, FILED 2-18-2002.

ACCULINEAR

FOR POWER TRANSMISSION BELTS FOR USE ON MACHINERY (U.S. CLS. 13, 19, 21, 23, 31, 34 AND 35).
FIRST USE 10-22-2001; IN COMMERCE 10-22-2001.

2,730,846. EMERSON ELECTRIC CO., ST. LOUIS, MO. SN 78-131,545. PUB. 11-19-2002, FILED 5-28-2002.

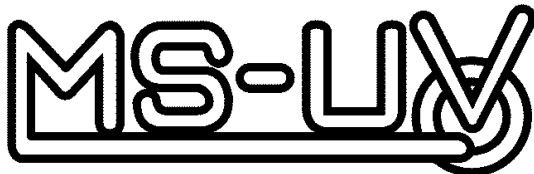

FOR PORTABLE STAND FOR BENCH TOP POWER TOOLS (U.S. CLS. 13, 19, 21, 23, 31, 34 AND 35).
FIRST USE 9-3-2002; IN COMMERCE 9-3-2002.

CLASS 8—HAND TOOLS

2,729,415. CTECH AG, CH-7001 CHUR, SWITZERLAND. SN 75-568,577. PUB. 11-2-1999, FILED 10-13-1998.

YOUR POCKET OFFICE

FOR A MULTIFUNCTIONAL HAND TOOL CONSISTING OF A KNIFE, AND/OR A CUTTER KNIFE, AND/OR SCISSORS, AND/OR A PAPER KNIFE, AND/OR A HOLE PUNCH, AND/OR A STAPLER, AND/OR PLIERS, AND/OR A RULER, AND/OR PINCERS, AND/OR A STAPLE REMOVER, AND/OR A MAGNIFIER, AND/OR A SCREW DRIVER, AND A CASE ADAPTED FOR ALL OF THE AFOREMENTIONED (U.S. CLS. 23, 28 AND 44).
FIRST USE 12-20-2002; IN COMMERCE 12-20-2002.

2,729,804. MERCER TOOL CORP., NEW YORK, NY. SN 76-118,910. PUB. 6-25-2002, FILED 8-29-2000.

GEMINI

FOR CUTLERY, NAMELY METAL KNIVES (U.S. CLS. 23, 28 AND 44).
FIRST USE 11-0-2000; IN COMMERCE 11-0-2000.

2,729,919. TEST RITE PRODUCTS CORPORATION, BUENA PARK, CA. SN 76-189,239. PUB. 5-14-2002, FILED 1-2-2001.

SMART GEAR

NO CLAIM IS MADE TO THE EXCLUSIVE RIGHT TO USE "GEAR", APART FROM THE MARK AS SHOWN.
FOR HAND TOOLS, NAMELY, CLAMPS, DRILLS, FILES, SAWS, SOCKETS, VISES, NUTDRIVERS, SOCKET WRENCHES, SOCKET SET, WRENCHES, SCISSORS, UTILITY KNIVES, SCREWDRIVERS, HAMMERS, PLIERS, NIPPERS, VISES, CLAMPS, WIRE CRIMPING TOOLS, WIRE STRIPPERS, WIRE CUTTERS, SCRAPERS; HAND JACKS (U.S. CLS. 23, 28 AND 44).
FIRST USE 3-26-2001; IN COMMERCE 3-26-2001.

2,730,084. AREL, RICHARD, ST-LEONARD D'ASTON, QUEBEC, CANADA. SN 76-259,247. PUB. 3-26-2002, FILED 5-21-2001.

MAXALL

FOR HARDWARE HAND TOOLS, NAMELY, BEVELS, COMBINATION SQUARES, HAMMERS, SCREWDRIVERS, SAWS, SPORT KNIVES, AND GRIPS FOR HAND TOOLS (U.S. CLS. 23, 28 AND 44).
FIRST USE 7-1-2001; IN COMMERCE 7-1-2001.

CLASS 8—(Continued).

2,730,327. INNOVATION FACTORY, INC., HAVERTOWN, PA. SN 76-328,398. PUB. 4-16-2002, FILED 10-22-2001.

SNOWMOVER

FOR HAND TOOLS, NAMELY TOOLS FOR REMOVING SNOW FROM VEHICLES (U.S. CLS. 23, 28 AND 44). FIRST USE 12-0-2001; IN COMMERCE 12-0-2001.

CLASS 9—ELECTRICAL AND SCIENTIFIC APPARATUS

2,729,367. LADDER CO., LTD., DBA LADDER PUBLISHING CO., LTD. AND DBA LADDER MULTIMEDIA CO. LTD., TAIPEI, TAIWAN. SN 75-267,499. PUB. 1-27-1998, FILED 4-1-1997.



NO CLAIM IS MADE TO THE EXCLUSIVE RIGHT TO USE "LEARNING", APART FROM THE MARK AS SHOWN. FOR COMPACT DISCS FEATURING EDUCATIONAL MATERIALS AND LANGUAGE COURSES (U.S. CLS. 21, 23, 26, 36 AND 38). FIRST USE 7-1-1996; IN COMMERCE 12-20-2002.

2,729,370. LIFESPAN BIOSCIENCES, INC., SEATTLE, WA. SN 75-331,264. PUB. 10-19-1999, FILED 7-28-1997.

LIFESPAN BIOSCIENCES

NO CLAIM IS MADE TO THE EXCLUSIVE RIGHT TO USE "BIOSCIENCES", APART FROM THE MARK AS SHOWN.

FOR PRERECORDED CD-ROMS, INSTRUCTIONAL MANUALS AND REPORTS PROVIDED AS A UNIT CONTAINING A DATABASE OF SCIENTIFIC DATA RESULTS AND INFORMATION PRODUCED FROM CUSTOM MOLECULAR BIOLOGY AND PATHOLOGY AND GENE DISCOVERY SERVICES PROVIDED FOR OTHERS (U.S. CLS. 21, 23, 26, 36 AND 38). FIRST USE 9-0-1998; IN COMMERCE 9-0-1998.

CLASS 9—(Continued).

2,729,377. NATIONAL VALEDICTORIAN SOCIETY, LOUVIERS, CO. SN 75-429,256. PUB. 10-19-1999, FILED 2-5-1998.

TOP STUDENT TECHNIQUES

NO CLAIM IS MADE TO THE EXCLUSIVE RIGHT TO USE "STUDENT TECHNIQUES", APART FROM THE MARK AS SHOWN.

FOR PRE-RECORDED AUDIOTAPES FEATURING INFORMATION ON THE DEVELOPMENT OF STUDY AND ACADEMIC SKILLS (U.S. CLS. 21, 23, 26, 36 AND 38).

FIRST USE 11-29-2002; IN COMMERCE 11-29-2002.

2,729,392. MONDEX INTERNATIONAL LIMITED, LONDON EC4M 5SQ, ENGLAND. SN 75-495,076. PUB. 10-19-1999, FILED 6-2-1998.

READIMONDEX

OWNER OF U.S. REG. NOS. 2,141,641 AND 2,183,178. FOR COMPUTER SOFTWARE USED FOR THE MANAGEMENT OF ELECTRONIC VALUE REPRESENTING CURRENCY OR OTHER MEDIUM OF EXCHANGE, AND FOR ELECTRONIC BUSINESS TRANSACTIONS, INCLUDING ON-LINE BANKING TRANSACTIONS; COMPUTER ELECTRONIC COMMERCE SOFTWARE TO ALLOW USERS TO PERFORM ELECTRONIC BUSINESS TRANSACTIONS VIA A GLOBAL COMPUTER NETWORK (U.S. CLS. 21, 23, 26, 36 AND 38). FIRST USE 5-14-1999; IN COMMERCE 5-14-1999.

2,729,406. UBI SOFT, INC., SAN FRANCISCO, CA. SN 75-531,900. PUB. 6-15-1999, FILED 8-6-1998.

RAYMAN 2 THE GREAT ESCAPE

FOR ELECTRONIC GAMES, NAMELY SOFTWARE ON DISKS, CD-ROMS, CARTRIDGES, AND DVDS FOR COMPUTERS AND CONSOLE GAMING SYSTEMS (U.S. CLS. 21, 23, 26, 36 AND 38). FIRST USE 11-1-1998; IN COMMERCE 11-1-1998.

2,729,414. COODER, RY, BEVERLY HILLS, CA. SN 75-563,212. PUB. 8-22-2000, FILED 10-1-1998.

PERRO VERDE

THE ENGLISH TRANSLATION OF "PERRO VERDE" IS "GREEN DOG".

FOR MUSICAL SOUND AND VIDEO RECORDINGS; AUDIO-VISUAL RECORDINGS FEATURING MUSIC (U.S. CLS. 21, 23, 26, 36 AND 38).

FIRST USE 1-28-2003; IN COMMERCE 1-28-2003.

CLASS 9—(Continued).

2,729,417. LINEAR MEASUREMENT INSTRUMENTS CORPORATION, BYRON, MI. SN 75-570,734. PUB. 9-3-2002, FILED 10-15-1998.

LMI

FOR SYSTEMS COMPRISING GAGES THAT CHECK DIMENSIONAL MEASUREMENTS USED FOR QUALITY CONTROL, ELECTRONIC INTERFACE ACCESSORIES, NAMELY, DIMENSIONAL MEASUREMENT DATA TRANSFER DEVICES FOR ANALOG AND DIGITAL DIMENSIONAL GAGING, MULTIPLEXERS, NAMELY, DEVICES USED TO CONNECT MULTIPLE GAGES FOR THE DISPLAY AND THE TRANSFER OF DIMENSIONAL MEASUREMENT DATA TO OTHER DEVICES, COMPUTERS, COMPUTER MONITORS, COMPUTER SOFTWARE TO SETUP AND STORE GAGE CALIBRATION INFORMATION AND DISPLAY THE DATA FROM THE DIMENSIONAL GAGES NUMERICALLY AND GRAPHICALLY AND TO PASS THE DATA ALONG IN A CUSTOMER SPECIFIC FILE FORMAT (U.S. CLS. 21, 23, 26, 36 AND 38).

FIRST USE 6-30-1993; IN COMMERCE 6-30-1993.

2,729,424. CYPTRON, INC., ATLANTA, GA. SN 75-598,921. PUB. 1-4-2000, FILED 12-2-1998.

FREEWORLD

FOR PRE-RECORDED AUDIO CASSETTES, COMPACT DISCS, VINYL RECORDS, ALL FEATURING MUSICAL SOUND RECORDINGS (U.S. CLS. 21, 23, 26, 36 AND 38).

FIRST USE 11-18-1997; IN COMMERCE 11-18-1997.

2,729,481. VERISITY DESIGN, INC., MOUNTAIN VIEW, CA. SN 75-733,780. PUB. 4-25-2000, FILED 6-22-1999.

INVISIBLE SPECMAN

FOR COMPUTER SOFTWARE FOR USE IN PERFORMING QUALITY CONTROL CHECKS IN THE DESIGN OF SEMICONDUCTORS (U.S. CLS. 21, 23, 26, 36 AND 38).

FIRST USE 9-21-1998; IN COMMERCE 8-31-1999.

2,729,485. TELEMEDIC SYSTEMS, INC., REDMOND, WA. SN 75-744,530. PUB. 2-29-2000, FILED 7-7-1999.

VITALSOFT

FOR COMPUTER SOFTWARE USED FOR MONITORING PATIENTS' VITAL SIGNS AND FOR MANAGING MEDICAL DATA (U.S. CLS. 21, 23, 26, 36 AND 38).

FIRST USE 6-30-1999; IN COMMERCE 6-30-1999.

CLASS 9—(Continued).

2,729,489. MAJOR LEAGUE BASEBALL PROPERTIES, INC., NEW YORK, NY. SN 75-749,594. PUB. 11-7-2000, FILED 7-13-1999.

HOME RUN DERBY

OWNER OF U.S. REG. NO. 2,086,742.

SEC. 2(F).

FOR COMPUTER GAME PROGRAMS; VIDEO GAME SOFTWARE; CARTRIDGES FOR VIDEO GAMES (U.S. CLS. 21, 23, 26, 36 AND 38).

FIRST USE 5-0-1987; IN COMMERCE 5-0-1987.

2,729,492. AI SIGNAL RESEARCH, INC., HUNTSVILLE, AL. SN 75-755,736. PUB. 9-11-2001, FILED 7-20-1999.

PC-SIGNAL

FOR COMPUTER SOFTWARE THAT ANALYZES ELECTRONIC SIGNALS BY ANALYZING VIBRATION AND STRAIN AND BY ANALYZING ACOUSTIC WAVES (U.S. CLS. 21, 23, 26, 36 AND 38).

FIRST USE 6-29-2001; IN COMMERCE 11-7-2002.

2,729,494. DETECTOR ELECTRONICS CORPORATION, MINNEAPOLIS, MN. SN 75-761,494. PUB. 9-4-2001, FILED 7-27-1999.

Protect·ir

FOR OPTICAL FLAME DETECTOR USING INFRARED SENSORS FOR DETECTION OF LIGHT, FOR COMMERCIAL USE BY HEAVY INDUSTRIES, UTILITIES AND THE MILITARY (U.S. CLS. 21, 23, 26, 36 AND 38).

FIRST USE 11-0-1999; IN COMMERCE 11-0-1999.

2,729,498. FITEL USA CORPORATION, NORCOSS, GA, BY ASSIGNMENT SPECTRAN SPECIALTY OPTICS COMPANY, AVON, CT. SN 75-768,840. PUB. 2-15-2000, FILED 8-4-1999.

GYROSIL

FOR SINGLE-MODE OPTICAL FIBER FOR GYROSCOPES (U.S. CLS. 21, 23, 26, 36 AND 38).

FIRST USE 10-20-1997; IN COMMERCE 10-20-1997.

CLASS 9—(Continued).

2,729,504. CLEVO CO., SAN-CHUNG CITY, TAIPEI COUNTY, TAIWAN. SN 75-783,725. PUB. 1-1-2002, FILED 8-26-1999.



FOR COMPUTER HARDWARE, NAMELY, LIGHT PENS WHICH ARE INPUT DEVICES; BLANK FLOPPY DISCS FOR COMPUTERS; PRE-RECORDED CD-ROMS FEATURING MUSIC AND COMPUTER SOFTWARE FOR USE IN OPERATING LIGHT PENS WHICH ARE COMPUTER INPUT DEVICES; MAGNETIC CODED CARD READERS; COMPUTER DISC DRIVES; COMPUTER MEMORIES; MEMORY CARDS FOR STORAGE; BAR CODE READERS; READ-ONLY MEMORY CHIPS ALSO KNOWN AS ROM CHIPS; COMPUTER AIDED DESIGN SOFTWARE FOR CREATING, EDITING AND PRINTING ARCHITECTURAL DRAWINGS AND ENGINEERING DRAWINGS; COMPUTER SOFTWARE FOR CREATING OTHER COMPUTER SOFTWARE; COMPUTER PRINTER BUFFERS; DATA PROCESSORS; PRE-RECORDED DISCS AND MAGNETIC COMPUTER TAPE CONTAINING COMPUTER PROGRAMS IN THE FIELD OF LIGHT PENS WHICH ARE INPUT DEVICES, AND COMPUTER AIDED DESIGN FOR CREATING, EDITING AND PRINTING ARCHITECTURAL DRAWINGS AND ENGINEERING DRAWINGS; COMPUTER TOUCH SCREENS; PRERECORDED VIDEO CASSETTES FEATURING TELEVISION PROGRAMS; MAGNETIC CODED IDENTIFICATION CARDS; MICROCOMPUTERS; UNINTERRUPTED ELECTRICAL POWER SUPPLIES; ELECTRIC TIMERS; TELEVISION SETS; COMPUTER SOFTWARE FOR TRANSLATING INFORMATION FROM ONE LANGUAGE INTO ANOTHER LANGUAGE; ANTI-GLARE SCREENS; VIDEO GAME MACHINES FOR USE WITH TELEVISIONS; VIDEO GAME JOYSTICKS FOR USE WITH TELEVISION GAMES; PLASTIC SEPARATOR CASES FOR SEPARATING STORAGE BATTERIES; ELECTRONIC VEHICLE WHEEL ALIGNMENT MACHINES; LASER DISC RECORD ALBUMS FEATURING MUSIC; COMPUTER DISPLAY MONITORS; OPTICAL SIGNAL TRANSMITTER/RECEIVERS; MICROWAVE TRANSMITTER/RECEIVERS; AUDIO TRANSMITTER/RECEIVERS; TELECOMMUNICATIONS SIGNAL TRANSFORMERS; STEREO WATTAGE AMPLIFIERS; ELECTRICAL DIGITAL TO ANALOG TRANSFORMERS; ELECTRICAL ANALOG TO DIGITAL TRANSFORMERS; COMPUTER SOFTWARE FOR TRANSLATING ENGLISH CHARACTERS INTO CHINESE CHARACTERS; SILICON WAFERS; HIGH VOLTAGE TRANSFORMERS; LOW VOLTAGE TRANSFORMERS; LCD COMPUTER MONITORS; COMPUTER KEYBOARDS; AUDIO SPEAKERS; AUDIO TAPE RECORDERS; AUDIO MIXERS; ELECTRIC IRONS; AND PAPER COPIERS (U.S. CLS. 21, 23, 26, 36 AND 38).
FIRST USE 7-17-2002; IN COMMERCE 7-17-2002.

2,729,510. MEDICAL MANAGER RESEARCH & DEVELOPMENT, INC., ALACHUA, FL. SN 75-788,676. PUB. 4-11-2000, FILED 8-31-1999.

OMNIDOC

FOR COMPUTER SOFTWARE PROGRAMS FOR PROCESSING AND MANAGING MEDICAL RECORDS (U.S. CLS. 21, 23, 26, 36 AND 38).
FIRST USE 8-31-1999; IN COMMERCE 8-31-1999.

CLASS 9—(Continued).

2,729,518. SIGNATURE EYEWEAR, INC., INGLEWOOD, CA. SN 75-802,892. PUB. 5-2-2000, FILED 9-17-1999.

OPEN ROAD

FOR EYEGLASSES, SUNGLASSES, GOGGLES, AND FRAMES, CASES, AND STRAPS THEREFOR (U.S. CLS. 21, 23, 26, 36 AND 38).
FIRST USE 1-1-2000; IN COMMERCE 1-1-2000.

2,729,524. MICROSOFT CORPORATION, REDMOND, WA. SN 75-811,226. PUB. 3-27-2001, FILED 9-28-1999.

WINDOWS POWERED

OWNER OF U.S. REG. NOS. 1,444,633, 1,955,219, AND OTHERS.
SEC. 2(F) AS TO "WINDOWS".
FOR COMPUTERS, COMPUTER PERIPHERALS, HAND HELD COMPUTERS; SET-TOP BOXES FOR TELEVISION, CELLULAR PHONES; BLANK SMART CARDS; SMART CARDS, NAMELY A FULL LINE OF ENCODED ELECTRONIC CHIP CARDS CONTAINING PROGRAMMING FOR VARIOUS BUSINESS AND TECHNICAL FUNCTIONS; COMPUTER SERVERS; OPERATING SYSTEM PROGRAMS THEREFOR AND ; COMPUTER GAMES SOFTWARE (U.S. CLS. 21, 23, 26, 36 AND 38).
FIRST USE 8-0-2000; IN COMMERCE 8-0-2000.

2,729,525. ELEKTROTEK INC., HOLLYWOOD, FL. SN 75-811,852. PUB. 7-4-2000, FILED 9-30-1999.

BASS MEKANIK

OWNER OF U.S. REG. NO. 2,313,488.
FOR AMPLIFIERS, SPEAKERS (U.S. CLS. 21, 23, 26, 36 AND 38).
FIRST USE 1-0-2002; IN COMMERCE 1-0-2002.

2,729,533. KINKO'S VENTURES, INC., VENTURA, CA. SN 75-823,300. PUB. 4-17-2001, FILED 10-14-1999.

KFP

FOR COMPUTER SOFTWARE FOR PREPARATION AND TRANSMISSION OF DIGITAL FILES FOR PRINTING (U.S. CLS. 21, 23, 26, 36 AND 38).
FIRST USE 9-30-1999; IN COMMERCE 9-30-1999.

CLASS 9—(Continued).

2,729,534. TECSEC, INCORPORATED, VIENNA, VA. SN 75-827,147. PUB. 5-21-2002, FILED 10-19-1999.

CKM ENABLED

OWNER OF U.S. REG. NO. 2,272,655.
 FOR COMPUTER PROGRAMS FOR USE IN ENCRYPTING DATA AND CONTROLLING ACCESS TO DATA AND PROGRAMS; COMPUTER SOFTWARE FOR USE IN ENCRYPTING DATA AND CONTROLLING ACCESS TO DATA AND PROGRAMS; AND COMPUTER UTILITY PROGRAMS (U.S. CLS. 21, 23, 26, 36 AND 38).
 FIRST USE 2-10-2003; IN COMMERCE 2-10-2003.

2,729,537. SPICE ENTERTAINMENT, INC., CHICAGO, IL. SN 75-832,225. PUB. 6-25-2002, FILED 10-26-1999.

SPICE

OWNER OF U.S. REG. NOS. 1,690,906, 2,091,263, AND OTHERS.
 FOR VIDEO CASSETTES AND DISCS FEATURING ADULT ENTERTAINMENT (U.S. CLS. 21, 23, 26, 36 AND 38).
 FIRST USE 6-15-1999; IN COMMERCE 6-15-1999.

2,729,544. OCWEN FINANCIAL CORPORATION, WEST PALM BEACH, FL. SN 75-843,761. PUB. 11-14-2000, FILED 11-9-1999.

REALSYNERGY

FOR COMPUTER SOFTWARE USED FOR THE MANAGEMENT AND ADMINISTRATION OF MORTGAGE LOANS AND INCOME-PRODUCING PROPERTY IN THE FIELD OF COMMERCIAL REAL-ESTATE, FINANCE, AND INVESTMENT (U.S. CLS. 21, 23, 26, 36 AND 38).
 FIRST USE 6-0-2000; IN COMMERCE 7-0-2000.

2,729,545. ACCEL8 TECHNOLOGY CORPORATION, DENVER, CO. SN 75-844,029. PUB. 12-12-2000, FILED 11-9-1999.

OPEN EVALUS

NO CLAIM IS MADE TO THE EXCLUSIVE RIGHT TO USE "EVALUATE", APART FROM THE MARK AS SHOWN.
 FOR COMPUTER SOFTWARE USED IN THE EVALUATION OF COMPUTER CODE FOR SOFTWARE MIGRATION, WEB-ENABLEMENT AND MODERNIZATION (U.S. CLS. 21, 23, 26, 36 AND 38).
 FIRST USE 10-21-1999; IN COMMERCE 10-21-1999.

CLASS 9—(Continued).

2,729,547. CERTEK SOFTWARE DESIGNS, INC., PLAINFIELD, NJ. SN 75-845,241. PUB. 3-26-2002, FILED 11-30-1999.



NO CLAIM IS MADE TO THE EXCLUSIVE RIGHT TO USE "SOFTWARE DESIGNS, INC.", APART FROM THE MARK AS SHOWN.

THE LINING IN THE DRAWING IS A FEATURE OF THE PRESENT MARK AND IS NOT INTENDED TO INDICATE COLOR.

FOR COMPUTERS AND POINT OF SALE SOFTWARE, CREDIT CARD PROCESSING SOFTWARE AND SOFTWARE FOR CREATING ONLINE VIRTUAL STOREFRONTS ALL IN THE FIELDS OF BUSINESS, GOVERNMENT, EDUCATION, SCIENCE AND PERSONAL COMPUTING (U.S. CLS. 21, 23, 26, 36 AND 38).
 FIRST USE 11-30-1999; IN COMMERCE 11-30-1999.

2,729,550. STD MANUFACTURING, LTD., KWAI CHUNG, N.T. HONG KONG. SN 75-851,090. PUB. 4-17-2001, FILED 11-18-1999.

GOPAD

FOR VIDEO AND COMPUTER GAME ACCESSORIES, NAMELY CONTROLLERS AND JOYSTICKS (U.S. CLS. 21, 23, 26, 36 AND 38).
 FIRST USE 9-20-1999; IN COMMERCE 9-20-1999.

2,729,551. INNOTEK, INC., GARRETT, IN. SN 75-852,152. PUB. 7-2-2002, FILED 11-18-1999.

GUN DOG

NO CLAIM IS MADE TO THE EXCLUSIVE RIGHT TO USE "DOG", APART FROM THE MARK AS SHOWN.

FOR ELECTRICAL ANIMAL BEHAVIOR TRAINING AND CONTROL SYSTEMS, NAMELY REMOTE TRAINING SYSTEMS CONSISTING OF ELECTRICAL RADIO FREQUENCY TRANSMITTERS AND REMOTE CONTROLLED ELECTRICAL RECEIVER ANIMAL COLLARS; ELECTRICAL BARKING CONTROL ANIMAL COLLARS; ELECTRONIC PET CONTAINMENT SYSTEMS CONSISTING OF ELECTRICAL TRANSMITTERS AND ELECTRICAL RECEIVER ANIMAL COLLARS; AND ELECTRICAL ANIMAL TRACKING AND LOCATING SYSTEMS CONSISTING OF ELECTRICAL RECEIVERS AND ELECTRICAL ANIMAL TRANSMITTER COLLARS (U.S. CLS. 21, 23, 26, 36 AND 38).
 FIRST USE 3-0-1996; IN COMMERCE 3-0-1996.

CLASS 9—(Continued).

2,729,566. NATAN, MICHAEL J., MOUNTAIN VIEW, CA. SN 75-871,560. PUB. 5-15-2001, FILED 12-14-1999.

NANOBARCODES

FOR ENCODED NANOPARTICULATE IDENTIFICATION TAGS (U.S. CLS. 21, 23, 26, 36 AND 38).
FIRST USE 12-27-2002; IN COMMERCE 12-27-2002.

2,729,567. PLUA POWER, INC., LATHAM, NY, BY MERGER PLUG POWER, INC., LATHAM, NY. SN 75-873,987. PUB. 5-14-2002, FILED 12-18-1999.



OWNER OF U.S. REG. NO. 2,362,565.
FOR FUEL CELL SYSTEMS, NAMELY, FUEL CELL STACKS, FUEL PROCESSORS, FUEL REFORMERS, POWER CONTROLLERS, POWER INVERTERS, POWER CONDITIONERS, AND ENERGY STORAGE DEVICES, NAMELY, BATTERIES (U.S. CLS. 21, 23, 26, 36 AND 38).
FIRST USE 8-21-2001; IN COMMERCE 8-21-2001.

2,729,568. PLUG POWER, INC., LATHAM, NY. SN 75-873,989. PUB. 5-14-2002, FILED 12-18-1999.



OWNER OF U.S. REG. NO. 2,362,565.
NO CLAIM IS MADE TO THE EXCLUSIVE RIGHT TO USE "FUEL CELL SYSTEMS", APART FROM THE MARK AS SHOWN.
FOR FUEL CELL SYSTEMS, NAMELY, FUEL CELL STACKS, FUEL PROCESSORS, FUEL REFORMERS, POWER CONTROLLERS, POWER INVERTERS, POWER CONDITIONERS, AND ENERGY STORAGE DEVICES, NAMELY, BATTERIES (U.S. CLS. 21, 23, 26, 36 AND 38).
FIRST USE 8-21-2001; IN COMMERCE 8-21-2001.

2,729,576. YATRA CORPORATION, MINNEAPOLIS, MN. SN 75-885,257. PUB. 7-9-2002, FILED 1-7-2000.

COGNIZER

FOR COMPUTER SOFTWARE FOR TRAVEL COST OPTIMIZATION, USING AN INTERNET WEB SITE FOR COMMUNICATION WITH CONSUMERS (U.S. CLS. 21, 23, 26, 36 AND 38).
FIRST USE 8-15-2002; IN COMMERCE 8-15-2002.

CLASS 9—(Continued).

2,729,578. CONGRUENCY INC., ROCHELLE PARK, NJ. SN 75-886,724. PUB. 6-4-2002, FILED 1-4-2000.

I.PICASSO

FOR VOICE AND DATA COMMUNICATIONS DEVICES, NAMELY, USER TERMINALS, TELEPHONES, COMPUTERS, SERVERS, COMPUTER HUBS, SWITCHES AND ROUTERS WHICH PROVIDE VOICE, DATA, FACSIMILE, ELECTRONIC MAIL AND FINANCIAL TRANSACTION COMMUNICATIONS THROUGH THE GLOBAL COMMUNICATION NETWORK (U.S. CLS. 21, 23, 26, 36 AND 38).
FIRST USE 3-0-2000; IN COMMERCE 3-0-2000.

2,729,587. WARRIOR SOLUTIONS, INC., BOULDER, CO. SN 75-900,193. PUB. 1-9-2001, FILED 1-17-2000.



FOR COMPUTERS; COMPUTER SOFTWARE FOR USE IN DATABASE MANAGEMENT FOR MILITARY PURPOSES (U.S. CLS. 21, 23, 26, 36 AND 38).
FIRST USE 11-17-1999; IN COMMERCE 3-1-2001.

2,729,593. DYNAMIC TECHNOLOGIES, INC., DBA OCEAN SYSTEMS, BURTONSVILLE, MD. SN 75-905,106. PUB. 9-11-2001, FILED 1-21-2000.



FOR COMPUTER WORKSTATION CONSISTING OF VIDEO INPUT AND OUTPUT HARDWARE AND SOFTWARE FOR THE PURPOSES OF WORKING WITH VIDEO EVIDENCE AND MANAGING EVIDENCE OF VARIOUS TYPES AND FORMS (U.S. CLS. 21, 23, 26, 36 AND 38).
FIRST USE 10-1-1999; IN COMMERCE 10-1-1999.

CLASS 9—(Continued).

2,729,594. VOXWARE, INC., PRINCETON, NJ. SN 75-905,728. PUB. 5-28-2002, FILED 1-29-2000.

VOICELOGISTICS

FOR INTERACTIVE MULTIMEDIA COMPUTER PROGRAM FOR AUDIO BASED APPLICATIONS AND ASSOCIATED COMPUTER WORK STATIONS AND PERIPHERALS (U.S. CLS. 21, 23, 26, 36 AND 38).
FIRST USE 6-1-2000; IN COMMERCE 6-1-2000.

2,729,599. TRANSGENOMIC, INC., SAN JOSE, CA. SN 75-909,962. PUB. 3-26-2002, FILED 2-4-2000.

RNASEP

OWNER OF U.S. REG. NO. 1,985,679.
FOR CHROMATOGRAPHY INSTRUMENTS AND SEPARATION COLUMNS USED IN RNA SEPARATION AND PURIFICATION (U.S. CLS. 21, 23, 26, 36 AND 38).
FIRST USE 9-29-2001; IN COMMERCE 9-29-2001.

2,729,605. ONEPATH NETWORKS, INC., PRINCETON, NJ, BY ASSIGNMENT FOXCUM, INC., PRINCETON, NJ. SN 75-915,989. PUB. 11-20-2001, FILED 2-10-2000.

iPATH

FOR COMMUNICATIONS EQUIPMENT, NAMELY TRANSMITTER AND RECEIVER UNITS USED BY SERVICE PROVIDERS FOR DELIVERY OF BROADBAND VIDEO, VOICE AND DATA COMMUNICATIONS VIA A SINGLE FIBER-OPTIC LINE AND A COAXIAL CABLE TO SUBSCRIBERS IN MULTIPLE-DWELLING AND SINGLE FAMILY RESIDENCES (U.S. CLS. 21, 23, 26, 36 AND 38).
FIRST USE 0-0-2001; IN COMMERCE 0-0-2001.

2,729,606. KONINKLIJKE PHILIPS ELECTRONICS N.V., EINDHOVEN, NETHERLANDS. SN 75-916,110. PUB. 5-28-2002, FILED 2-11-2000.

RUSH

FOR MP3 PLAYERS (U.S. CLS. 21, 23, 26, 36 AND 38).
FIRST USE 6-0-2000; IN COMMERCE 6-0-2000.

CLASS 9—(Continued).

2,729,611. ANTARCTICA SYSTEMS INC., VANCOUVER B.C. CANADA. SN 75-918,165. PUB. 11-27-2001, FILED 2-14-2000.

ANTARCTICA

FOR COMPUTER SOFTWARE FOR INTERPRETING, ORGANIZING, CLASSIFYING, AND PRESENTING DATA IN THE FORM OF TWO-DIMENSIONAL AND THREE-DIMENSIONAL MAPS AND GRAPHICS (U.S. CLS. 21, 23, 26, 36 AND 38).
FIRST USE 11-30-2000; IN COMMERCE 11-30-2000.

2,729,620. ET INDUSTRIES INC., TORONTO, ONTARIO, CANADA. SN 75-929,950. PUB. 4-2-2002, FILED 2-25-2000.

MONITOR WING

NO CLAIM IS MADE TO THE EXCLUSIVE RIGHT TO USE "MONITOR", APART FROM THE MARK AS SHOWN.
FOR COMPUTER MONITOR ACCESSORIES, NAMELY, BULLETIN BOARDS AND DRY ERASE BOARDS FOR ATTACHING TO COMPUTER MONITORS (U.S. CLS. 21, 23, 26, 36 AND 38).
FIRST USE 3-0-2000; IN COMMERCE 3-0-2000.

2,729,628. CONFLUENCE TECHNOLOGIES, INC., PITTSBURGH, PA. SN 75-938,014. PUB. 6-5-2001, FILED 3-8-2000.

DEMAND PERFORMANCE

FOR MUTUAL FUND AND BENEFIT PLAN PORTFOLIO MANAGEMENT SOFTWARE FOR USE BY PROFESSIONAL INVESTMENT AND BENEFIT PLAN MANAGERS AND INDIVIDUALS (U.S. CLS. 21, 23, 26, 36 AND 38).
FIRST USE 3-24-2000; IN COMMERCE 4-10-2000.

2,729,630. FEKETE ASSOCIATES INC., CALGARY, AB T2P 0M2, CANADA. SN 75-939,536. PUB. 7-17-2001, FILED 3-8-2000.

F.A.S.T. MBA

OWNER OF U.S. REG. NOS. 1,987,145, 2,303,928, AND OTHERS.

FOR COMPUTER SOFTWARE NAMELY- PETROLEUM INDUSTRY COMPUTER SOFTWARE FOR USE IN OIL, GAS AND WATER RESERVOIRS, USED TO MANIPULATE PRODUCTION AND PRESSURE DATA, TO CALCULATE OIL, GAS AND WATER VOLUMES IN SINGLE POOLS, GEO-PRESSURED AND COMMUNICATING RESERVOIRS AND TO DISPLAY THE ANALYSIS AND RESULTS IN VARIOUS FORMS (U.S. CLS. 21, 23, 26, 36 AND 38).
FIRST USE 3-0-2000; IN COMMERCE 3-0-2000.

CLASS 9—(Continued).

2,729,633. MASTERCARD INTERNATIONAL INCORPORATED, PURCHASE, NY. SN 75-941,281. PUB. 10-30-2001, FILED 3-10-2000.

MASTERCARD M/CHIP

OWNER OF U.S. REG. NOS. 1,292,519, 2,212,783, AND OTHERS.

FOR COMPUTER SOFTWARE COMPRISING A DIGITAL OR ELECTRONIC WALLET FOR STORAGE OF VALUE IN A CENTRALIZED DATABASE TO FACILITATE ECOMMERCE; COMPUTER HARDWARE IN THE NATURE OF ENCRYPTION KEYS AND ENCRYPTION SOFTWARE FOR CREATING DIGITAL CERTIFICATES AND DIGITAL SIGNATURES, COMPUTER SOFTWARE FOR SECURE DATA STORAGE AND RETRIEVAL AND TRANSMISSION OF CONFIDENTIAL CUSTOMER INFORMATION USED BY INDIVIDUALS, BANKING AND FINANCIAL INSTITUTIONS; COMPUTER SOFTWARE DESIGNED TO ENABLE SMART CARDS TO INTERACT WITH TERMINALS AND READERS; COMPUTER SOFTWARE FOR TRANSMITTING, DISPLAYING AND STORING TRANSACTION, IDENTIFICATION, AND FINANCIAL INFORMATION FOR USE IN THE FINANCIAL SERVICES, BANKING AND TELECOMMUNICATIONS INDUSTRIES; AND ELECTRONIC VERIFICATION APPARATUS, NAMELY, COMPUTER HARDWARE AND SOFTWARE FOR VERIFYING AUTHENTICATION OF CHARGE CARDS, CREDIT CARDS, DEBIT CARDS AND PAYMENT CARDS (U.S. CLS. 21, 23, 26, 36 AND 38).

FIRST USE 12-0-2000; IN COMMERCE 12-0-2000.

2,729,640. TOTES ISOTONER CORPORATION, CINCINNATI, OH. SN 75-981,993. PUB. 8-27-2002, FILED 5-29-2001.

IMAGES BY TOTES

FOR BATTERY POWERED LIGHTS, NAMELY, EMERGENCY LIGHTS; HARDWARE, NAMELY, COMPUTER VACUUM; MEASURING TAPE; MULTIPLE SOCKET LIGHTER SOCKET PLUG; TIRE PRESSURE GAUGE (U.S. CLS. 21, 23, 26, 36 AND 38).

FIRST USE 6-30-2000; IN COMMERCE 6-30-2000.

2,729,646. BOTHHAND ENTERPRISE INC., TAINAN, TAIWAN. SN 75-983,142. PUB. 3-7-2000, FILED 10-22-1998.

LAN-MATE

FOR ELECTRIC PLUG, TERMINAL (U.S. CLS. 21, 23, 26, 36 AND 38).

FIRST USE 12-1-1999; IN COMMERCE 12-1-1999.

CLASS 9—(Continued).

2,729,651. ARC SECOND, INC., STERLING, VA. SN 75-983,181. PUB. 5-29-2001, FILED 6-16-1999.

3D INTELLIGENCE

NO CLAIM IS MADE TO THE EXCLUSIVE RIGHT TO USE "3D", APART FROM THE MARK AS SHOWN.

FOR COMPUTER SOFTWARE FOR USE IN DATA SENSING AND ANALYSIS IN SCIENTIFIC, NAUTICAL, SURVEYING, ELECTRONIC, AND ROBOTICS APPLICATIONS; COMPUTER HARDWARE, COMPUTER PERIPHERALS; EQUIPMENT AND ACCESSORIES FOR USE IN MEASUREMENT OF SPATIAL POSITIONING INFORMATION AND SPATIAL LOCATIONS FOR SPATIAL POSITIONING SYSTEMS; NAMELY, LIGHT TRANSMITTERS; LIGHT SENSORS; SIGNAL RECEIVERS; PORTABLE POSITION SENSORS FOR SENSING SIGNALS; CALCULATING ELECTRONIC CIRCUITS, DISPLAY SCREENS FOR DISPLAYING RESULTS OF THE CALCULATING ELECTRONIC CIRCUITS; AUTOMATION ELECTRONIC CIRCUITS FOR CONTROLLING EQUIPMENT USING THE RESULTS OF THE CALCULATING CIRCUITS; AND PARTS THEREFOR; LABORATORY ROBOTICS (U.S. CLS. 21, 23, 26, 36 AND 38).

FIRST USE 7-14-2001; IN COMMERCE 7-14-2001.

2,729,697. TRANSNATIONAL NEWS COMPANY, INC., UNION, WV. SN 76-038,806. PUB. 9-11-2001, FILED 4-23-2000.

COMPUTER BOY

NO CLAIM IS MADE TO THE EXCLUSIVE RIGHT TO USE "COMPUTER", APART FROM THE MARK AS SHOWN.

FOR PRE-RECORDED COMPACT DISCS AND AUDIO TAPES FEATURING CHILDREN'S ENTERTAINMENT PROGRAMS (U.S. CLS. 21, 23, 26, 36 AND 38).

FIRST USE 3-19-1997; IN COMMERCE 11-10-2002.

2,729,700. PCI TECHNOLOGIES INC., AJAX, ONTARIO, L1S 6W6, CANADA. SN 76-040,520. PUB. 11-13-2001, FILED 5-3-2000.

MAXAMP

FOR HEADEND AMPLIFIERS FOR RADIO FREQUENCY SIGNAL AMPLIFICATION OR ISOLATION IN BROADBAND NETWORKS (U.S. CLS. 21, 23, 26, 36 AND 38).

FIRST USE 1-6-2000; IN COMMERCE 1-6-2000.

2,729,711. ICONVERSE.COM, INC., SUDBURY, MA. SN 76-055,065. PUB. 10-30-2001, FILED 5-23-2000.

ICONVERSE

FOR COMPUTER HARDWARE AND SOFTWARE FOR FACILITATING THE TRANSFER OF WEB SITES ONTO WIRELESS OR PORTABLE DEVICES (U.S. CLS. 21, 23, 26, 36 AND 38).

FIRST USE 9-18-2000; IN COMMERCE 3-29-2001.

CLASS 9—(Continued).

2,729,716. EROOMSYSTEM TECHNOLOGIES, INC., LAS VEGAS, NV. SN 76-066,060. PUB. 7-24-2001, FILED 6-7-2000.



NO CLAIM IS MADE TO THE EXCLUSIVE RIGHT TO USE "E ROOM SYSTEM TECHNOLOGIES", APART FROM THE MARK AS SHOWN.

FOR COMPUTERS, AND DEDICATED UTILITY SOFTWARE THEREFOR, FOR COLLECTING INFORMATION FROM AND DISTRIBUTING INFORMATION TO COMPUTER PERIPHERALS FOR USE IN HOTELS, HEALTH CARE FACILITIES, TIME SHARE PROPERTIES AND CRUISE SHIPS (U.S. CLS. 21, 23, 26, 36 AND 38).

FIRST USE 11-0-2000; IN COMMERCE 11-0-2000.

2,729,729. HYPERFORMIX, INC., FORMERLY SCIENTIFIC & ENGINEERING SOFTWARE, INC., AUSTIN, TX. SN 76-071,866. PUB. 6-18-2002, FILED 6-16-2000.

MAKING EBUSINESS PERFORM

FOR COMPUTER SOFTWARE, NAMELY SOFTWARE FOR USE IN THE MODELING AND OPTIMIZING SYSTEMS COMPRISED OF PROCESSORS, MEMORY STORAGE, DATA TRANSMISSION CIRCUITS AND DISPLAYS AND FOR COMMUNICATION OVER COMPUTER NETWORKS (U.S. CLS. 21, 23, 26, 36 AND 38).

FIRST USE 6-30-2000; IN COMMERCE 6-30-2000.

2,729,731. THERMO LABSYSTEMS OY, HELSINKI, FINLAND, BY CHANGE OF NAME LABSYSTEMS OY (2), FIN-00881, HELSINKI, FINLAND. SN 76-073,653. PUB. 12-18-2001, FILED 6-20-2000.

FINNTIP BIOCON

OWNER OF U.S. REG. NOS. 1,029,936 AND 1,029,937.

FOR LABORATORY INSTRUMENTS, NAMELY, PIPETTES, PIPETTES WITH ADJUSTABLE VOLUME, MULTIPLE PIPETTES, MULTIPLE PIPETTES WITH ADJUSTABLE VOLUME, PIPETTE TIPS, EXCHANGEABLE PIPETTE TIPS, PIPETTES AND PIPETTE TIPS FOR HANDLING OF LIQUID, DISPOSABLE PIPETTE TIPS, PIPETTE TIPS PROVIDED WITH SCALE, PIPETTE STANDS, TEST TUBE ELEMENTS AND CUVETTE ELEMENTS, LIDS AND STANDS THEREOF, PHOTOMETERS, SPECTROPHOTOMETERS, AND ANALYZERS (U.S. CLS. 21, 23, 26, 36 AND 38).

FIRST USE 10-11-2001; IN COMMERCE 10-11-2001.

CLASS 9—(Continued).

2,729,732. POMAIR TRADING INC., ROAD TOWN, TORTOLA, BR. VIRGIN ISLANDS. SN 76-074,717. PUB. 6-5-2001, FILED 6-21-2000.

TECHNOMARINE

OWNER OF U.S. REG. NO. 2,363,580.

FOR SUNGLASSES, DIVING HELMETS, DIVING GLOVES, DIVING SUITS, REGULATORS FOR USE IN SCUBA DIVING (U.S. CLS. 21, 23, 26, 36 AND 38).

FIRST USE 1-1-2003; IN COMMERCE 1-1-2003.

2,729,735. WILLIAMSON & ASSOCIATES, INC., SEATTLE, WA. SN 76-076,092. PUB. 5-21-2002, FILED 6-22-2000.

C-BASS

FOR UNDERWATER ALUMINUM SLED PULLED ALONG THE SEAFLOOR CONTAINING MULTIPLEXED CHANNEL, MICROPROCESSORS, ELECTRODE ARRAY, ACOUSTIC PROFILER, AND A MINIATURE CONE PENETROMETER FOR USE IN SURVEYING AND ASSESSING BURIAL SITES OF TRANSOCEANIC SUBMARINE TELECOM CABLES (U.S. CLS. 21, 23, 26, 36 AND 38).

FIRST USE 1-0-1997; IN COMMERCE 1-0-1997.

2,729,737. LINNET GEOMATIC INTERNATIONAL INC., WINNIPEG, MANITOBA R3C 3T1, CANADA. SN 76-076,850. PUB. 4-3-2001, FILED 6-26-2000.

EXTEND THE ENTERPRISE

FOR COMPUTER SOFTWARE IN THE FIELDS OF AGRICULTURE MANAGEMENT; FORESTRY CONSERVATION AND MANAGEMENT; AND SOIL AND WATER CONSERVATION AND MANAGEMENT (U.S. CLS. 21, 23, 26, 36 AND 38).

FIRST USE 11-1-2002; IN COMMERCE 11-1-2002.

2,729,740. TRILOG GROUP, S.A.R.L., BEIRUT, LEBANON. SN 76-078,409. PUB. 5-8-2001, FILED 6-26-2000.

BIZDAP

FOR COMPUTER SOFTWARE, NAMELY, WORK FLOW MANAGEMENT SOFTWARE FOR BUSINESS PROCESS AUTOMATION (U.S. CLS. 21, 23, 26, 36 AND 38).

FIRST USE 5-0-2000; IN COMMERCE 9-0-2000.

CLASS 9—(Continued).

2,729,744. OUTPOST TRADING AG, 4123 ALISEHWIL, SWITZERLAND. SN 76-081,188. PUB. 9-18-2001, FILED 6-30-2000.

BIGSTAR

OWNER OF U.S. REG. NOS. 1,752,666 AND 2,096,563. FOR EYEWEAR, NAMELY, EYEGLASSES AND SUNGLASSES; AND EYEWEAR ACCESSORIES, NAMELY, CASES FOR SUNGLASSES AND EYEGLASSES (U.S. CLS. 21, 23, 26, 36 AND 38).

FIRST USE 12-0-2001; IN COMMERCE 4-0-2002.

2,729,745. FCI AMERICAS TECHNOLOGY, INC., RENO, NV. SN 76-081,227. PUB. 5-8-2001, FILED 6-30-2000.

GIG-ARRAY

OWNER OF U.S. REG. NOS. 2,186,572 AND 2,354,176. FOR ELECTRICAL CONNECTORS (U.S. CLS. 21, 23, 26, 36 AND 38).

FIRST USE 4-1-2002; IN COMMERCE 4-1-2002.

2,729,782. UBS AG, CH 8001, SWITZERLAND. SN 76-104,988. PUB. 3-5-2002, FILED 8-8-2000.

EVALUATE 360

NO CLAIM IS MADE TO THE EXCLUSIVE RIGHT TO USE "EVALUATE", APART FROM THE MARK AS SHOWN. FOR COMPUTER SOFTWARE APPLICATION THAT AUTOMATES THE PROCESS OF CONDUCTING PERFORMANCE EVALUATIONS OF PEOPLE (IE, EMPLOYEES OR STUDENTS), PRODUCTS AND SERVICES (U.S. CLS. 21, 23, 26, 36 AND 38).

FIRST USE 12-0-2000; IN COMMERCE 12-0-2000.

2,729,789. EDUCATIONAL INSIGHTS, INC., CARSON, CA. SN 76-112,311. PUB. 7-2-2002, FILED 8-17-2000.

EGGSPERT

FOR ELECTRONIC DEVICES, NAMELY, ELECTRONIC BOOKS, ELECTRONIC BOARD PROGRAMS, ELECTRONIC PADS AND ELECTRONIC TOUCH PADS, ELECTRONIC KEYPADS, ELECTRONIC TOUCH SCREENS, CONTAINING A PLURALITY OF TRIGGER MECHANISMS THAT DETERMINE THE FIRST PERSON TO DEPRESS A TRIGGER MECHANISM (U.S. CLS. 21, 23, 26, 36 AND 38).

FIRST USE 1-0-2002; IN COMMERCE 2-16-2002.

CLASS 9—(Continued).

2,729,808. MELLANOX TECHNOLOGIES, INC., SANTA CLARA, CA. SN 76-124,299. PUB. 3-19-2002, FILED 9-6-2000.

INFINIBRIDGE

FOR COMPUTER HARDWARE AND PERIPHERALS; SEMICONDUCTORS; SOFTWARE DRIVERS; HOST CHANNEL ADAPTERS; TARGET CHANNEL ADAPTERS; SWITCHES; ROUTERS; AND SOFTWARE FOR SERVER TO SERVER COMMUNICATIONS, TRANSMITTING DATA ACROSS A CONNECTION BETWEEN COMPUTERS, AND ENABLING A COMPUTER TO ACCESS DATA FROM A STORAGE DEVICE, ALL FOR THE SERVER, COMMUNICATION AND DATA STORAGE MARKETS (U.S. CLS. 21, 23, 26, 36 AND 38).

FIRST USE 1-0-2001; IN COMMERCE 1-0-2001.

2,729,812. SILICON MOTION, INC., SAN JOSE, CA. SN 76-125,858. PUB. 6-4-2002, FILED 9-12-2000.

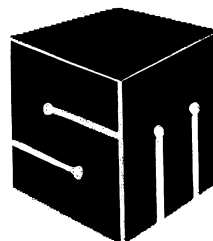

FOR COMPUTER CHIPS USED TO CREATE GRAPHICS; COMPUTER CHIPS USED FOR DIGITAL VOICE RECORDING, NOISE CANCELLATION, WIRELESS COMMUNICATION AND MP3S; COMPUTER CHIPS FOR INTERNET APPLIANCES, HANDHELD DEVICES, PERSONAL DIGITAL ASSISTANTS, GRAPHICS, NOTEBOOK COMPUTERS, COMMUNICATIONS, VOICE, MP3, BROADBAND AND BASEBAND COMMUNICATION PRODUCTS, SMARTPHONES, POINT-OF-SALE SYSTEMS AND IN-CAR COMPUTER SYSTEMS (U.S. CLS. 21, 23, 26, 36 AND 38).

FIRST USE 1-0-1999; IN COMMERCE 2-0-2000.

2,729,815. ADC TELECOMMUNICATIONS, INC., MINNETONKA, MN. SN 76-128,222. PUB. 5-7-2002, FILED 9-14-2000.

DIGIVANCE

FOR ANTENNAS AND TELECOMMUNICATIONS EQUIPMENT, NAMELY AMPLIFIERS, REPEATERS AND DIGITIZERS AND OPTICAL TRANSCEIVERS USED TO DIGITALLY TRANSPORT RADIO FREQUENCY (RF) SIGNALS IN ORDER TO FACILITATE WIRELESS COMMUNICATIONS (U.S. CLS. 21, 23, 26, 36 AND 38).

FIRST USE 9-0-2000; IN COMMERCE 9-0-2000.

CLASS 9—(Continued).

2,729,827. J.W. SINGER & SONS LTD., SOMERSET BA11 4RW, ENGLAND. SN 76-137,307. PUB. 4-30-2002, FILED 9-28-2000.

CLASS 9—(Continued).

2,729,842. UBS AG, CH 8001, SWITZERLAND. SN 76-148,199. PUB. 7-3-2001, FILED 10-17-2000.



FOR NON-FERROUS ALLOY SPRINKLER FRAMES FOR THE FIRE PROTECTION INDUSTRY (U.S. CLS. 21, 23, 26, 36 AND 38).
FIRST USE 12-0-1990; IN COMMERCE 12-0-1990.



FOR COMPUTER SOFTWARE APPLICATION THAT AUTOMATES THE PROCESS OF CONDUCTING PERFORMANCE EVALUATIONS OF PEOPLE, PRODUCTS AND SERVICES (U.S. CLS. 21, 23, 26, 36 AND 38).
FIRST USE 12-0-2000; IN COMMERCE 12-0-2000.

2,729,840. G.T. DISTRIBUTORS, INC., ROSSVILLE, GA. SN 76-147,886. PUB. 6-25-2002, FILED 10-16-2000.

BLUE SHIELD

FOR PROTECTIVE CLOTHING, NAMELY, BALLISTIC VESTS, FOR USE IN LAW ENFORCEMENT (U.S. CLS. 21, 23, 26, 36 AND 38).
FIRST USE 11-20-2000; IN COMMERCE 11-20-2000.

2,729,843. UBS AG, CH 8001, SWITZERLAND. SN 76-148,219. PUB. 7-3-2001, FILED 10-17-2000.

2,729,841. STRUCTURAL DESKTOP INCORPORATED, VAN BUREN, AR, BY ASSIGNMENT BURROUGH-BRASUELL CORP., VAN BUREN, AR. SN 76-147,919. PUB. 7-9-2002, FILED 10-13-2000.



STRUCTURAL DESKTOP

NO CLAIM IS MADE TO THE EXCLUSIVE RIGHT TO USE "DESKTOP", APART FROM THE MARK AS SHOWN.
FOR COMPUTER SOFTWARE FOR CONVERSION OF DATA CREATED BY ANALYSIS PROGRAMS INTO A CUSTOM COMPUTER MODEL, WITH ADDITION TO AND EDITING OF THE MODEL, WITH THE END GOAL OF AUTOMATIC DRAFTING FILES TO BE EXTRACTED FROM SAID MODEL IN THE FIELD OF STRUCTURAL ENGINEERING THROUGH COMPUTER ASSISTED DRAFTING (U.S. CLS. 21, 23, 26, 36 AND 38).
FIRST USE 1-26-2001; IN COMMERCE 5-9-2001.

THE DESIGN OF THE MARK CONSISTS OF A LOWER-CASE "E" IN BOLD BLACK ENCIRCLED BY A GRAY ARROW POINTING DOWN TO THE NUMBER "360," WHICH IS SLIGHTLY BELOW AND TO THE RIGHT OF THE "E" AND IS IN THE COLOR BLACK.
FOR COMPUTER SOFTWARE APPLICATION THAT AUTOMATES THE PROCESS OF CONDUCTING PERFORMANCE EVALUATIONS OF PEOPLE, PRODUCTS AND SERVICES (U.S. CLS. 21, 23, 26, 36 AND 38).
FIRST USE 12-0-2000; IN COMMERCE 12-0-2000.

CLASS 9—(Continued).

2,729,846. ELEKTA AB (PUBL), SE - 103 93 STOCKHOLM, SWEDEN. SN 76-148,754. PUB. 4-2-2002, FILED 10-17-2000.

AtlasSpace

FOR RECORDED COMPUTER SOFTWARE FOR USE IN PLANNING SURGICAL PROCEDURES IN MEDICAL AND SURGICAL SCIENCES (U.S. CLS. 21, 23, 26, 36 AND 38).

FIRST USE 3-0-2002; IN COMMERCE 3-0-2002.

2,729,852. WAPCOM INC., 42504 NETANYA, ISRAEL. SN 76-150,409. PUB. 1-15-2002, FILED 10-19-2000.

MOVIOUS

FOR SOFTWARE FOR THE MANAGEMENT OF DATA SERVICES FOR NETWORK OPERATORS (U.S. CLS. 21, 23, 26, 36 AND 38).

FIRST USE 1-0-2001; IN COMMERCE 1-0-2001.

2,729,855. VITALECT, INC., MOUNTAIN VIEW, CA. SN 76-152,444. PUB. 6-18-2002, FILED 10-19-2000.

VITALECT

FOR EDUCATIONAL SOFTWARE FEATURING INSTRUCTION IN THE FIELDS OF BUSINESS, TECHNOLOGY, FINANCIAL SERVICES, AND HEALTHCARE (U.S. CLS. 21, 23, 26, 36 AND 38).

FIRST USE 8-0-2000; IN COMMERCE 8-0-2000.

2,729,857. SALES DIRECTOR, LLC, HOUSTON, TX. SN 76-155,167. PUB. 5-7-2002, FILED 10-27-2000.

SALESDIRECTOR.COM

FOR DOWNLOADABLE SOFTWARE FOR GENERATING SALES MANAGEMENT REPORTS (U.S. CLS. 21, 23, 26, 36 AND 38).

FIRST USE 5-0-2000; IN COMMERCE 6-0-2002.

CLASS 9—(Continued).

2,729,867. CUTTING EDGE SOFTWARE, INC., DALLAS, TX. SN 76-159,464. PUB. 5-14-2002, FILED 11-3-2000.

POWERFUL SOFTWARE MADE SIMPLE

FOR COMPUTER SOFTWARE FOR PERSONAL DIGITAL ASSISTANTS; NAMELY SOFTWARE FOR PERFORMING WORD PROCESSING, SPREADSHEET, CHARTING, DATABASE AND E-MAIL FUNCTIONS (U.S. CLS. 21, 23, 26, 36 AND 38).

FIRST USE 11-9-2000; IN COMMERCE 11-9-2000.

2,729,869. STANLEY ELECTRIC CO., LTD., MEGURO-KU, TOKYO, JAPAN. SN 76-159,855. PUB. 9-10-2002, FILED 11-6-2000.

i R A V B I T

FOR ELECTRIC WIRES AND CABLES; OPTICAL LENSES, FILTERS, REFLECTORS AND PRISMS FOR ELECTRIC COMMUNICATION MACHINE AND APPARATUS; PORTABLE COMMUNICATION APPARATUS, NAMELY TELEPHONES, MOBILE TELEPHONES AND WALKIE TALKIES; VEHICULAR COMMUNICATION APPARATUS, NAMELY LOCAL AREA NETWORK COMMUNICATION SYSTEM FOR COMPUTERS FOR USE ON VEHICLES, CONSISTING OF TELEPHONES, SPEAKERS, ANTENNAS, CONNECTORS AND COMPUTER PERIPHERALS; BEACON APPARATUS, NAMELY LIGHT BEACONS AND ANTENNA FOR A VEHICLE INFORMATION AND COMMUNICATION SYSTEM; ANTENNA CONNECTORS; ELECTRICAL PICKUPS; AND SEMICONDUCTOR ELEMENTS (U.S. CLS. 21, 23, 26, 36 AND 38).

FIRST USE 1-15-2003; IN COMMERCE 1-15-2003.

CLASS 9—(Continued).

2,729,874. MATSUSHITA ELECTRIC INDUSTRIAL CO., LTD., OSAKA-FU, JAPAN. SN 76-162,896. PUB. 11-12-2002, FILED 11-9-2000.

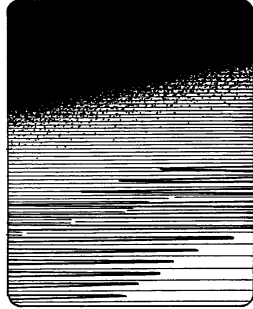

THE STIPPLING IS FOR SHADING PURPOSES.
 THE MARK CONSISTS OF ROYAL BLUE AND BLACK STRIPES WITH THE ROYAL BLUE STRIPES MORE PROMINENT IN THE BOTTOM PORTION OF THE DRAWING AND THE BLACK STRIPES BECOMING MORE PROMINENT UNTIL THE TOP PORTION OF THE DRAWING BECOMES COMPLETELY BLACK.
 FOR MEMORY CARDS (U.S. CLS. 21, 23, 26, 36 AND 38).
 FIRST USE 6-30-2000; IN COMMERCE 11-20-2000.

2,729,878. ZEBRA IMAGING, INC., PFLUGERVILLE, TX. SN 76-164,826. PUB. 6-11-2002, FILED 11-13-2000.

ZEBRA IMAGING

NO CLAIM IS MADE TO THE EXCLUSIVE RIGHT TO USE "IMAGING", APART FROM THE MARK AS SHOWN.
 FOR HOLOGRAPHIC OPTICAL ELEMENTS, NAMELY, LENSES, MIRRORS, DIFFUSION SCREENS, GRATINGS, FILTERS, DEFLECTORS AND OTHER COMPLEX OPTICAL ELEMENTS; ELECTRONIC RECORDERS FOR PRODUCING HOLOGRAMS (U.S. CLS. 21, 23, 26, 36 AND 38).
 FIRST USE 2-15-2000; IN COMMERCE 3-21-2000.

CLASS 9—(Continued).

2,729,887. WRQ, INC., SEATTLE, WA. SN 76-170,082. PUB. 3-5-2002, FILED 11-22-2000.

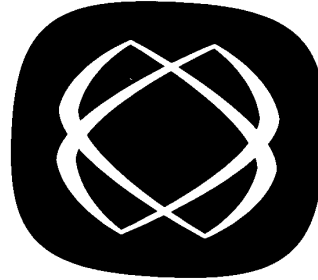

THE MARK CONSISTS OF TWO STYLIZED, INTER-TWINED RECTANGULAR SHAPES ON DIAGONAL PLANES, WITH A SHADED BACKGROUND.
 FOR COMPUTER SOFTWARE AND INSTRUCTION MANUALS SOLD AS A UNIT TO CONNECT AND CREATE SECURE CHANNELS OF COMMUNICATION BETWEEN REMOTE, MOBILE AND WORK STATION COMPUTERS IN THE FIELDS OF CELLULAR COMMUNICATIONS, INTERCOMPUTER COMMUNICATIONS AND COMMUNICATIONS WITHIN AND BETWEEN COMPUTER NETWORKS; COMPUTER SOFTWARE FOR TERMINAL EMULATION, COMPUTER PROGRAMMING, FILE TRANSFER, GLOBAL NETWORK ACCESS, PRINTING COMPUTER FILES TO PAPER OR DIGITAL FILES; COMPUTER SOFTWARE FOR TRACKING, ANALYZING AND SUMMARIZING BUSINESS PRODUCTIVITY; COMPUTER SOFTWARE FOR CROSS-PLATFORM PROGRAMMING, PASSWORD INTEGRATION, AUTHENTICATION AND ACCESS SECURITY; COMPUTER SOFTWARE FOR INTEGRATING ENTERPRISE SOFTWARE APPLICATIONS AND DATABASES; COMPUTER SOFTWARE AND DEVELOPMENT TOOLS FOR ORGANIZING, EXTRACTING AND ACCESSING DATA FROM MAIN-FRAME COMPUTERS; COMPUTER SOFTWARE FOR CONNECTING, MANAGING, SECURING AND OPTIMIZING WIRELESS AND WIRELINE COMMUNICATIONS BETWEEN COMPUTERS AND COMPUTER NETWORKS (U.S. CLS. 21, 23, 26, 36 AND 38).
 FIRST USE 1-11-2001; IN COMMERCE 1-11-2001.

2,729,890. CELLOMICS, INC., PITTSBURGH, PA. SN 76-173,374. PUB. 8-14-2001, FILED 11-30-2000.

CELLSPACE

FOR COMPUTER SOFTWARE FOR USE IN DATABASE MANAGEMENT IN THE FIELD OF BIOCHEMICAL AND MOLECULAR SCIENCE (U.S. CLS. 21, 23, 26, 36 AND 38).
 FIRST USE 9-30-2002; IN COMMERCE 9-30-2002.

CLASS 9—(Continued).

2,729,894. CREATIVE SCIENCE SYSTEMS, INC., CAMPBELL, CA. SN 76-174,955. PUB. 8-14-2001, FILED 11-28-2000.



FOR COMPUTER SOFTWARE FOR USE IN INTEGRATING COMPUTER SYSTEMS AND NETWORKS (U.S. CLS. 21, 23, 26, 36 AND 38).
FIRST USE 9-28-2000; IN COMMERCE 11-8-2000.

2,729,897. HORIBA LTD., MINAMI-KU, KYOTO, JAPAN. SN 76-177,133. PUB. 7-16-2002, FILED 12-7-2000.

ECDM

FOR CHASSIS DYNAMOMETER (U.S. CLS. 21, 23, 26, 36 AND 38).
FIRST USE 8-0-2001; IN COMMERCE 8-0-2001.

2,729,898. FRETWELL-DOWNING INFORMATICS LIMITED, SHEFFIELD, UNITED KINGDOM. SN 76-177,191. PUB. 6-18-2002, FILED 12-8-2000.

ZPORTAL

FOR COMPUTER SOFTWARE FOR USE IN DATABASE MANAGEMENT; COMPUTER PROGRAMS FOR USE IN DATABASE MANAGEMENT; COMPUTER SOFTWARE FOR USE IN MAKING INFORMATION AVAILABLE AND SEARCHABLE ON THE INTERNET; DATA PROCESSING EQUIPMENT AND COMPUTERS; AND COMPUTER PERIPHERAL DEVICES (U.S. CLS. 21, 23, 26, 36 AND 38).
FIRST USE 1-8-2003; IN COMMERCE 1-8-2003.

2,729,902. DOBLE ENGINEERING COMPANY, WATERTOWN, MA. SN 76-179,078. PUB. 5-28-2002, FILED 12-11-2000.

IDD

FOR ELECTRICAL POWER SUBSTATION MONITOR COMPRISED OF SENSORS THAT MEASURE ELECTRICAL AND PHYSICAL SIGNALS, COMPUTER HARDWARE, AND COMPUTER SOFTWARE, ALL FOR THE PURPOSE OF MONITORING SUBSTATION APPARATUS CONSISTING OF ONE OR MORE OF A TRANSFORMER, CIRCUIT BREAKER, CIRCUIT SWITCHER AND STATION BATTERY TO DETERMINE ITS CONDITION, SOLD DIRECTLY TO POWER DISTRIBUTION FACILITIES (U.S. CLS. 21, 23, 26, 36 AND 38).
FIRST USE 8-23-2001; IN COMMERCE 8-23-2001.

CLASS 9—(Continued).

2,729,912. PIONEER KABUSHIKI KAISHA, DBA PIONEER CORPORATION, TOKYO 153-8654, JAPAN. SN 76-186,414. PUB. 7-9-2002, FILED 12-27-2000.

VCCS

FOR LOUDSPEAKERS AND SPEAKER SYSTEMS, NAMELY, SUBWOOFERS, WOOFERS, SPEAKER CONES AND PARTS SOLD TOGETHER AS A UNIT (U.S. CLS. 21, 23, 26, 36 AND 38).
FIRST USE 12-0-2000; IN COMMERCE 12-0-2000.

2,729,928. AXIOM SYSTEMS LTD., BERKSHIRE RG41 5HU, ENGLAND. SN 76-192,704. PUB. 5-7-2002, FILED 1-11-2001.

AXIOSS

FOR COMPUTER SOFTWARE FOR OPERATING SYSTEMS SUPPORT; COMPUTER FOR EXECUTING, TRACING, AND AUTOMATING ORDERS; AND COMPUTER SOFTWARE FOR MANAGING INVENTORIES (U.S. CLS. 21, 23, 26, 36 AND 38).
FIRST USE 4-6-2001; IN COMMERCE 6-4-2002.

2,729,941. MAPP PRODUCTIONS, INC., MOUNT DORA, FL. SN 76-200,275. PUB. 4-16-2002, FILED 1-26-2001.

UNIVERSIDAD DEL BEBÉ INTELIGENTE

NO CLAIM IS MADE TO THE EXCLUSIVE RIGHT TO USE "BEBE", APART FROM THE MARK AS SHOWN.
THE ENGLISH TRANSLATION OF "UNIVERSIDAD DEL BEBÉ INTELIGENTE" IS "INTELLIGENT BABY UNIVERSITY".
FOR MUSICAL VIDEO RECORDINGS FEATURING EDUCATIONAL ENTERTAINMENT FOR BABIES AND YOUNG CHILDREN (U.S. CLS. 21, 23, 26, 36 AND 38).
FIRST USE 9-24-2001; IN COMMERCE 9-24-2001.

2,729,942. HEROIX CORPORATION, NEWTON, MA. SN 76-200,511. PUB. 9-10-2002, FILED 1-26-2001.

HEROIX EQ

OWNER OF U.S. REG. NO. 2,021,254.
FOR COMPUTER PROGRAMS FOR USE BY BUSINESSES FOR MANAGING THEIR DATABASES AND COMPUTER NETWORKS, FOR MANAGING THE ALLOCATION OF THEIR APPLICATIONS SOFTWARE WITHIN THE BUSINESS, FOR MANAGING THEIR ENTERPRISE COMPUTER INFRASTRUCTURE, AND FOR MANAGING THEIR WEB SITES (U.S. CLS. 21, 23, 26, 36 AND 38).
FIRST USE 4-30-2001; IN COMMERCE 7-31-2001.

CLASS 9—(Continued).

2,729,945. SILKE VOGELMANN-SINE, PH.D., INC., HONOLULU, HI. SN 76-201,876. PUB. 4-9-2002, FILED 1-25-2001.

DR. SILKE

FOR PRE-RECORDED COMPACT DISCS FEATURING INFORMATION IN THE FIELD OF SELF-HELP AND SPIRITUAL GROWTH (U.S. CLS. 21, 23, 26, 36 AND 38). FIRST USE 12-1-2002; IN COMMERCE 12-1-2002.

CLASS 9—(Continued).

2,729,952. SOUNDTUBE ENTERTAINMENT, INC., PARK CITY, UT. SN 76-204,145. PUB. 9-10-2002, FILED 2-2-2001.

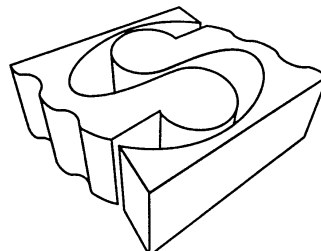

FOR AUDIO EQUIPMENT FOR REPRODUCING SOUND, NAMELY STEREO SPEAKERS, HOME THEATER SPEAKERS, WEATHER-RESISTANT OUTDOOR SPEAKERS, AUDIO SPEAKERS FOR COMMERCIAL INSTALLATIONS, AND LISTENING STATION SPEAKERS (U.S. CLS. 21, 23, 26, 36 AND 38). FIRST USE 2-28-2000; IN COMMERCE 5-31-2000.

2,729,947. CHICAGO STOCK EXCHANGE, INCORPORATED, CHICAGO, IL. SN 76-202,469. PUB. 3-5-2002, FILED 1-30-2001.

BROKERPLEX

FOR COMPUTER SOFTWARE FOR USE BY SECURITIES BROKERS AND DEALERS FOR ROUTING ORDERS FOR THE PURCHASE AND SALE OF SECURITIES (U.S. CLS. 21, 23, 26, 36 AND 38). FIRST USE 1-25-2001; IN COMMERCE 1-25-2001.

2,729,956. SPANWORKS, INC., SAN RAMON, CA. SN 76-205,250. PUB. 7-2-2002, FILED 2-6-2001.

RENDEZVOUS

FOR COMPUTER SOFTWARE PROGRAMS AND MANUALS SOLD AS A UNIT FOR THE MANAGEMENT OF A PROXIMATE AREA NETWORK, TO BE MARKETED ONLY IN DIRECT SALES CHANNELS (U.S. CLS. 21, 23, 26, 36 AND 38). FIRST USE 2-28-2003; IN COMMERCE 2-28-2003.

2,729,949. GAS GRABBER INC., CHAPEL HILL, NC. SN 76-203,498. PUB. 7-2-2002, FILED 2-2-2001.



NO CLAIM IS MADE TO THE EXCLUSIVE RIGHT TO USE "GAS", APART FROM THE MARK AS SHOWN. FOR DEVICE FOR USE IN HOLDING GAS PUMP HANDLE IN A OPEN POSITION TO ENABLE FUEL PUMPING (U.S. CLS. 21, 23, 26, 36 AND 38). FIRST USE 1-1-2002; IN COMMERCE 10-1-2002.

2,729,958. SAFE USA, INC., CANNON FALLS, MN. SN 76-205,840. PUB. 9-17-2002, FILED 1-5-2001.

**StrengthPro
Software**

NO CLAIM IS MADE TO THE EXCLUSIVE RIGHT TO USE "SOFTWARE", APART FROM THE MARK AS SHOWN. FOR SOFTWARE FOR USE IN STRENGTH TRAINING, NAMELY, TO CREATE A SPREADSHEET THAT ALLOW USERS TO PLOT TYPE OF EXERCISE AND NUMBER OF REPETITIONS PERFORMED (U.S. CLS. 21, 23, 26, 36 AND 38). FIRST USE 1-5-2001; IN COMMERCE 1-5-2001.

CLASS 9—(Continued).

2,729,964. NVIDIA CORPORATION, SANTA CLARA, CA. SN 76-209,711. PUB. 6-25-2002, FILED 2-14-2001.

NVIDIA G²FORCE 2Go

FOR COMPUTER HARDWARE, NAMELY GRAPHICS PROCESSING UNITS (U.S. CLS. 21, 23, 26, 36 AND 38). FIRST USE 6-0-2001; IN COMMERCE 6-0-2001.

2,729,968. MULTIMEDIA CATALOG SYSTEMS, BATON ROUGE, LA. SN 76-210,774. PUB. 5-14-2002, FILED 2-2-2001.

VIRDALLION

FOR COMPUTER MULTIMEDIA SOFTWARE FOR USE IN THE ENTERTAINMENT FIELD FOR USE AT MARDI GRAS FESTIVALS (U.S. CLS. 21, 23, 26, 36 AND 38).

FIRST USE 2-1-2001; IN COMMERCE 1-21-2002.

2,729,969. STEELTORCH SOFTWARE, INC., NASHUA, NH. SN 76-211,626. PUB. 11-27-2001, FILED 2-16-2001.

SteelTorch 

FOR COMPUTER SOFTWARE FOR MONITORING AND TRACKING WEB SERVER USAGE AND ACTIVITY (U.S. CLS. 21, 23, 26, 36 AND 38).

FIRST USE 12-8-2000; IN COMMERCE 2-0-2001.

2,729,982. GEORGIANO, JOSEPH, HICKSVILLE, NY. AND MATH, IRWIN, GREENVALE, NY. SN 76-217,058. PUB. 7-9-2002, FILED 2-22-2001.

LITEWAY

FOR RACKING ESPECIALLY ADAPTED FOR HOLDING ELECTRICAL COMPONENTS (U.S. CLS. 21, 23, 26, 36 AND 38).

FIRST USE 10-31-2002; IN COMMERCE 10-31-2002.

2,729,998. BLACKBOARD INC., WASHINGTON, DC. SN 76-220,069. PUB. 5-21-2002, FILED 3-5-2001.

BLACKBOARD**CLASS 9—(Continued).**

OWNER OF U.S. REG. NOS. 1,263,461, 2,315,293, AND 2,469,112.

FOR HARDWARE AND COMPUTER SOFTWARE IN THE FIELD OF ELECTRONIC ACCESS FOR CONTROLLING ADMITTANCE TO FACILITIES AND AUTHORIZING ACCESS TO PRODUCTS AND SERVICES; HARDWARE AND COMPUTER SOFTWARE IN THE FIELD OF DEBIT CARD CONTROL SYSTEMS FOR PROCESSING ELECTRONIC TRANSACTIONS, NAMELY DEBIT CARD AUTHORIZATION AND TRANSACTION SETTLEMENT (U.S. CLS. 21, 23, 26, 36 AND 38).

FIRST USE 3-15-2001; IN COMMERCE 3-15-2001.

2,730,006. POST GLOVER RESISTORS, INC., ERLANGER, KY. SN 76-224,001. PUB. 4-30-2002, FILED 3-13-2001.

PULSERPLUS

FOR ELECTRICAL INDUSTRIAL INSTRUMENT, NAMELY, A HIGH RESISTANCE GROUNDING UNIT FOR USE IN FINDING GROUND FAULTS BY WAY OF A PULSING FAULT CURRENT (U.S. CLS. 21, 23, 26, 36 AND 38).

FIRST USE 2-28-2001; IN COMMERCE 2-28-2001.

2,730,020. MEASUREMENT SPECIALTIES, INC., FAIRFIELD, NJ. SN 76-233,637. PUB. 1-29-2002, FILED 3-30-2001.

CLEAR VIEW

FOR SCALES (U.S. CLS. 21, 23, 26, 36 AND 38). FIRST USE 8-31-2001; IN COMMERCE 8-31-2001.

2,730,025. WORLD WIDE PACKETS, INC., VERADALE, WA. SN 76-235,339. PUB. 5-7-2002, FILED 3-28-2001.

ETHERNET TO THE SUBSCRIBER

FOR FIBER OPTIC CABLE (U.S. CLS. 21, 23, 26, 36 AND 38). FIRST USE 1-0-2001; IN COMMERCE 1-0-2001.

CLASS 9—(Continued).

2,730,028. SURVIVOR PRODUCTIONS, LLC, LOS ANGELES, CA. SN 76-236,625. PUB. 7-16-2002, FILED 4-6-2001.



THE LINING REPRESENTS LIGHT CAST FROM THE TORCH AND IS A FEATURE OF THE MARK AND IS NOT INTENDED TO INDICATE COLOR.

THE MARK CONSISTS, IN PART, OF AN OVAL AS A CARRIER CONTAINING A STYLIZED DRAWING OF A SILHOUETTE OF A FIGURE HOLDING A TORCH, WITH LINES REPRESENTING LIGHT CAST FROM THE FLAMING TORCH.

FOR CURRENCY AND CREDIT OPERATED SLOT MACHINES AND GAMING DEVICES, NAMELY GAMING MACHINES FOR USE IN GAMING ESTABLISHMENTS (U.S. CLS. 21, 23, 26, 36 AND 38).

FIRST USE 6-1-2002; IN COMMERCE 6-1-2002.

2,730,029. COMROAD AG, MUNCHEN, FED REP GERMANY. SN 76-236,842. PUB. 9-18-2001, FILED 4-6-2001.

SNAP@DRIVE

OWNER OF FED REP GERMANY REG. NO. 30049862, DATED 11-14-2000, EXPIRES 7-21-2010.

FOR INTERFACE ADAPTERS AND CRADLES USED TO HOUSE PERSONAL DIGITAL ASSISTANTS, AND USER MANUALS SOLD AS A UNIT THEREWITH (U.S. CLS. 21, 23, 26, 36 AND 38).

FIRST USE 7-14-2000; IN COMMERCE 7-14-2000.

2,730,033. HASBRO, INC., PAWTUCKET, RI. SN 76-238,203. PUB. 12-25-2001, FILED 4-11-2001.

DANCE-BOT

FOR AUDIO PLAYBACK DEVICE; NAMELY, A MINIATURE BOOM BOX WITH LEGS (U.S. CLS. 21, 23, 26, 36 AND 38).

FIRST USE 10-8-2001; IN COMMERCE 10-8-2001.

CLASS 9—(Continued).

2,730,049. TIME DOMAIN CORPORATION, HUNTSVILLE, AL. SN 76-243,603. PUB. 6-25-2002, FILED 4-19-2001.

PULSON 200

OWNER OF U.S. REG. NO. 2,373,081.

FOR INTEGRATED CHIPS, AND ENABLING SOFTWARE USED FOR THE GENERATION, TRANSMISSION, RECEPTION, AND PROCESSING OF ULTRA WIDE FREQUENCY BAND EMISSIONS, AND USER DOCUMENTATION THEREFOR SOLD TOGETHER AS A UNIT (U.S. CLS. 21, 23, 26, 36 AND 38).

FIRST USE 11-0-2001; IN COMMERCE 11-0-2002.

2,730,059. ZEPTOSENS AG, CH-4108 WITERSWIL, SWITZERLAND. SN 76-246,945. PUB. 4-23-2002, FILED 4-26-2001.

ZEPTOREADER

FOR LABORATORY EQUIPMENT AND APPARATUS, NAMELY, BIOANALYTICAL APPLIANCES COMPRISING FLUIDIC INSTRUMENTS FOR SEPARATION AND MASS SPECTROMETRIC TECHNOLOGIES; SENSITIZED BIOCHIPS AND BIOREACTIVE SURFACES, CHEMICAL AND BIOCHEMICAL SENSORS, BIOCHIPS CONTAINING NUCLEIC ACID, PROTEIN AND RECEPTOR MICROARRAYS, AND MICRO FLUIDIC CELL OR BIOCHIP CARTRIDGES IN NUCLEIC ACID AND PROTEOMIC RESEARCH; LABORATORY APPARATUS AND INSTRUMENTS, COMPRISING FLUIDIC INSTRUMENTS AND OPTICAL EXCITERS AND DETECTORS, FOR THE PRODUCTION AND QUALITY CONTROL OF SENSITIZED BIOCHIPS AND BIOREACTIVE SURFACES CONTAINING CHEMICAL AND BIOCHEMICAL SENSORS, NUCLEIC ACID, PROTEIN AND RECEPTOR MICROARRAYS; SPECTROMETERS AND OPTICAL SCANNERS; OPTICAL EXCITERS AND DETECTORS FOR BIOCHIPS; PHOTODIODES AND PHOTODIODE ARRAYS; PHOTOMULTIPLIERS; PHOTOGRAPHIC CAMERAS; VIDEO CAMERAS; CHARGE-COUPLED DEVICE (CCD) CAMERAS, NAMELY, CAMERAS EMPLOYING A LIGHT-SENSITIVE SILICON CHIP FOR THE DETECTION AND COLLECTION OF OPTICAL SIGNALS FROM BIOCHIPS; IMAGING SYSTEMS COMPRISING CAMERAS, COMPUTERS AND EXPOSURE CONTROLS FOR USE WITH PHOTODIODE ARRAYS; PHOTOMULTIPLIERS, PHOTOGRAPHIC CAMERAS, VIDEO AND CCD CAMERAS FOR THE DETECTION AND COLLECTION OF OPTICAL SIGNALS FROM BIOCHIPS; MANUALLY OPERATED AND AUTOMATED SAMPLE PREPARATION, ASSAY AND HYBRIDIZATION STATIONS FOR THE CONDITIONING, PROBE INTRODUCTION AND AUTOMATION OF WASH AND ASSAY CYCLES FOR THE PROBE BINDING TO MICROARRAYS IN NUCLEIC ACID AND PROTEOMIC RESEARCH; COMPUTER SOFTWARE CONTAINING ALGORITHMS FOR IDENTIFYING, FILTERING, QUANTIFYING AND ANALYZING DATA FROM BIOCHIP IMAGES AND CONTROLLING AND AUTOMATING THE PRODUCTION, IDENTIFICATION, ASSAYING, IMAGING AND ANALYSIS OF BIOCHIPS;

CLASS 9—(Continued).

COMPUTER SOFTWARE FOR STUDY DESIGN, NAMELY DESIGN OF EXPERIMENTAL CONDITIONS, BIOCHIP DESIGN, NAMELY CHOICE OF RECOGNITION ELEMENTS AND THEIR GEOMETRICAL DEPOSITION ON A BIOCHIP, ASSAY DESIGN, NAMELY DESIGN OF ASSAY ARCHITECTURE AND CONDITIONS, AND DATA ANALYSIS FROM BIOCHIP IMAGES; COMPUTER SOFTWARE FOR THE GENERATION OF DATABASES AND LIBRARIES, INPUT OF BIOCHIP DATA INTO DATABASES AND LIBRARIES, AND INTERFACING WITH EXTERNAL DATABASES AND LIBRARIES FOR THE CORRELATION OF ANALYTICAL DATA WITH RESULTS FROM BIOLOGICAL OR PHARMACOLOGICAL STUDIES; COMPUTER MONITORS, PRINTERS AND KEYPADS FOR THE DISPLAY OF BIOCHIP IMAGES; COMPUTER HARD DRIVES, DISK DRIVES AND CD ROM DRIVES FOR THE STORAGE OF ANALYTICAL BIOCHIP DATA INTO DATABASES AND LIBRARIES FOR CORRELATION WITH RESULTS FROM BIOLOGICAL OR PHARMACOLOGICAL STUDIES (U.S. CLS. 21, 23, 26, 36 AND 38).
FIRST USE 12-30-2002; IN COMMERCE 12-30-2002.

2,730,066. INNOMEDIA PTE LTD., SINGAPORE 117684, SINGAPORE. SN 76-251,521. PUB. 6-11-2002, FILED 5-4-2001.

BUDDYTALK

FOR COMPUTER SOFTWARE AND HARDWARE FOR REAL TIME COMMUNICATIONS OVER GLOBAL COMPUTER AND TELEPHONE COMMUNICATIONS NETWORKS (U.S. CLS. 21, 23, 26, 36 AND 38).
FIRST USE 8-27-2001; IN COMMERCE 3-8-2002.

2,730,073. TERREL H. BELL AND ASSOCIATES, EDUCATIONAL CONSULTANTS, SALT LAKE CITY, UT. SN 76-254,391. PUB. 6-4-2002, FILED 5-4-2001.

NATIONAL ACADEMIC LEAGUE

NO CLAIM IS MADE TO THE EXCLUSIVE RIGHT TO USE "ACADEMIC", APART FROM THE MARK AS SHOWN. FOR VIDEO RECORDINGS ON THE TOPICS OF ACADEMIC STUDY SKILLS, THINKING SKILLS, COMPLEX PROBLEM SOLVING, SETTING AND REACHING GOALS, CONDUCTING SCHOLASTIC COMPETITIONS, PRESENTATION SKILLS, WINNING AND LOSING GRACEFULLY AND TEAMWORK; AUDIO RECORDINGS ON THE TOPICS OF ACADEMIC STUDY SKILLS, THINKING SKILLS, COMPLEX PROBLEM SOLVING, SETTING AND REACHING GOALS, CONDUCTING SCHOLASTIC COMPETITIONS, PRESENTATION SKILLS, WINNING AND LOSING GRACEFULLY AND TEAMWORK; ELECTRONIC DATABASE IN THE FIELD OF ACADEMIC QUESTIONS FOR USE IN SCHOLASTIC COMPETITIONS RECORDED ON COMPUTER MEDIA (U.S. CLS. 21, 23, 26, 36 AND 38).
FIRST USE 9-0-1995; IN COMMERCE 9-0-1995.

CLASS 9—(Continued).

2,730,112. SAMSUNG ELECTRO-MECHANICS CO., LTD., SUWON-SI, KYUNGKI-DO, REPUBLIC OF KOREA. SN 76-267,025. PUB. 5-28-2002, FILED 6-6-2001.

SEMPass

FOR PRINTED CIRCUIT BOARDS, PRINTED CIRCUITS, INTEGRATED CIRCUITS, SEMI-CONDUCTORS, LIGHT EMITTING DIODES, TRANSISTORS, SILICON WAFERS AND THERMISTORS (U.S. CLS. 21, 23, 26, 36 AND 38).
FIRST USE 1-0-2002; IN COMMERCE 1-0-2002.

2,730,129. KABUSHIKI KAISHA SQUARE, TA SQUARE CO., LTD., TOKYO, JAPAN. SN 76-271,489. PUB. 7-16-2002, FILED 6-13-2001.

FINAL FANTASY

OWNER OF U.S. REG. NO. 2,204,583 AND OTHERS. FOR COMPUTER GAME SOFTWARE; VIDEO GAME SOFTWARE; SOUND RECORDINGS IN THE FORM OF OPTICAL DISCS, MAGNETIC DISCS AND/OR MEMORY CARDS FEATURING MUSIC AND ENTERTAINMENT; AUDIO VISUAL RECORDINGS IN THE FORM OF OPTICAL DISCS, MAGNETIC DISCS AND/OR MEMORY CARDS FEATURING MUSIC AND ENTERTAINMENT; PRE-RECORDED AUDIO CASSETTES FEATURING MUSIC; PRE-RECORDED COMPACT DISCS FEATURING MUSIC; PRE-RECORDED DIGITAL VIDEO DISCS FEATURING MUSIC AND ANIMATION; PRE-RECORDED VIDEO CASSETTES FEATURING MUSIC, ACTION AND ADVENTURE STORIES AND/OR ANIMATED CARTOON STORIES; PRE-RECORDED COMPACT DISCS FEATURING ACTION AND ADVENTURE STORIES AND/OR ANIMATED CARTOON STORIES; PRE-RECORDED DIGITAL VIDEO DISCS FEATURING MUSIC, ACTION AND ADVENTURE STORIES AND/OR ANIMATED CARTOON STORIES; MOTION PICTURE FILMS FEATURING MUSIC, ACTION AND ADVENTURE STORIES AND/OR ANIMATED CARTOON STORIES; MULTIMEDIA SOFTWARE RECORDED ON CD-ROMS FEATURING ANIMATION AND/OR COMPUTER GRAPHICS; MAGNETS; EYEGASSES; MOUSE PADS; STRAPS FOR CELLULAR PHONES; TRANSCEIVERS (U.S. CLS. 21, 23, 26, 36 AND 38).
FIRST USE 12-0-1987; IN COMMERCE 6-0-1990.

2,730,137. BENEFIT RESOURCES INC., ROCHESTER, NY. SN 76-273,757. PUB. 7-9-2002, FILED 6-19-2001.

ETRAC

FOR PRE-TAX MAGNETICALLY ENCODED DEBIT CARDS FOR MASS TRANSIT AND PUBLIC TRANSPORTATION SERVICES (U.S. CLS. 21, 23, 26, 36 AND 38).
FIRST USE 7-1-2001; IN COMMERCE 7-1-2001.

CLASS 9—(Continued).

2,730,141. ARTISAN ENTERTAINMENT INC., SANTA MONICA, CA. SN 76-274,872. PUB. 5-21-2002, FILED 6-21-2001.

YOGA FUSION

NO CLAIM IS MADE TO THE EXCLUSIVE RIGHT TO USE "YOGA", APART FROM THE MARK AS SHOWN. FOR PRE-RECORDED VIDEO CASSETTES AND DVDS IN THE FIELD OF EXERCISE AND FITNESS (U.S. CLS. 21, 23, 26, 36 AND 38).
FIRST USE 8-21-2001; IN COMMERCE 8-21-2001.



2,730,144. HUMMINGBIRD LTD., NORTH YORK, ONTARIO M2H 2W1, CANADA. SN 76-276,170. PUB. 8-13-2002, FILED 6-25-2001.

ME-CLIP

FOR COMPUTER SOFTWARE THE ENABLES COMPUTER HARDWARE AND SOFTWARE TO SEND, RECEIVE OR EXCHANGE INFORMATION WITH WIRELESS OR WIRED DEVICES, OR ALLOWS APPLICATION INTEGRATION (U.S. CLS. 21, 23, 26, 36 AND 38).
FIRST USE 6-0-2002; IN COMMERCE 6-0-2002.



2,730,150. SCALFANI, CHARLES J., LAGUNA NIGUEL, CA. SN 76-277,889. PUB. 1-22-2002, FILED 6-25-2001.

FIGHTCLOUD

FOR PRE-RECORDED COMPACT DISCS FEATURING MUSIC (U.S. CLS. 21, 23, 26, 36 AND 38).
FIRST USE 9-1-2001; IN COMMERCE 9-1-2001.

CLASS 9—(Continued).

2,730,153. ICP ELECTRONICS INC., SHI-CHI CITY, TAIPEI HSIEN, TAIWAN. SN 76-278,412. PUB. 7-2-2002, FILED 6-29-2001.



FOR COMPUTER DISK DRIVER; NETWORK ATTACHED STORAGE DEVICES, NAMELY, INTELLIGENT STORAGE SYSTEMS, CAPABLE OF NETWORK COMMUNICATION, COMPRISING PROCESSORS, MEMORIES, OPERATING SOFTWARE, DATA STORAGE UNITS FOR STORING DATA AND SOFTWARE FOR MANAGING AND CONTROLLING DATA (U.S. CLS. 21, 23, 26, 36 AND 38).
FIRST USE 8-1-2001; IN COMMERCE 5-7-2002.



2,730,173. ASTUTE NETWORKS, INC., SAN DIEGO, CA. SN 76-285,128. PUB. 6-18-2002, FILED 7-13-2001.

ASTUTE NETWORKS

NO CLAIM IS MADE TO THE EXCLUSIVE RIGHT TO USE "NETWORKS", APART FROM THE MARK AS SHOWN. FOR COMPUTER HARDWARE, NAMELY, SEMICONDUCTORS AND SEMICONDUCTOR DEVICES; PRINTED CIRCUIT BOARDS, INTEGRATED CIRCUITS AND MICROPROCESSORS (U.S. CLS. 21, 23, 26, 36 AND 38).
FIRST USE 11-22-2002; IN COMMERCE 11-22-2002.

CLASS 9—(Continued).

2,730,176. PLAY LIKE THE PROS, LLC, EDGEWOOD, KY.
SN 76-286,641. PUB. 7-9-2002, FILED 7-17-2001.

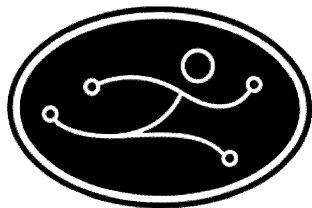

THE MARK CONSISTS OF IN PART OF A RUNNING STICK FIGURE INSIDE AN OVAL.

FOR PRE-RECORDED INSTRUCTIONAL MATERIALS, NAMELY, VIDEO TAPES, VIDEO CASSETTES, CD-ROMS, DVDS, AUDIO TAPES, AUDIO CASSETTES, ON-LINE STREAMING VIDEO AND ACCOMPANYING MANUALS, FOR USE IN THE FIELD OF SPORTS (U.S. CLS. 21, 23, 26, 36 AND 38).

FIRST USE 1-1-2002; IN COMMERCE 1-1-2002.

2,730,211. BROOKTROUT, INC., NEEDHAM, MA. SN 76-296,341. PUB. 5-21-2002, FILED 8-7-2001.

REALBLOCS

FOR MODULAR COMPUTER HARDWARE SYSTEMS COMPRISED OF COMPUTER HARDWARE AND SOFTWARE FOR BUILDING COMPUTER TELEPHONY APPLICATIONS (U.S. CLS. 21, 23, 26, 36 AND 38).

FIRST USE 2-0-2001; IN COMMERCE 10-0-2002.

2,730,214. OMNITI, INC., LAUREL, MD. SN 76-297,146. PUB. 5-28-2002, FILED 8-9-2001.

**POSTAL ENGINE**

NO CLAIM IS MADE TO THE EXCLUSIVE RIGHT TO USE "POSTAL ENGINE", APART FROM THE MARK AS SHOWN.

FOR COMPUTER SOFTWARE, NAMELY SOFTWARE THAT PROVIDES FACILITIES FOR CONSUMER DEMOGRAPHICS COLLECTION, THE DELIVERY OF ELECTRONIC MESSAGES TO TARGETED CONSUMERS BASED ON THE DEMOGRAPHIC INFORMATION, AND STATISTICAL DATA FORMULATED BY RESPONSES TO DEMOGRAPHIC TARGETING (U.S. CLS. 21, 23, 26, 36 AND 38).

FIRST USE 9-1-2002; IN COMMERCE 9-1-2002.

CLASS 9—(Continued).

2,730,216. HUNTER ENGINEERING COMPANY, BRIDGETON, MO. SN 76-297,514. PUB. 8-27-2002, FILED 8-10-2001.

ALIGNGUIDE

FOR WHEEL ALIGNMENT SOFTWARE, NAMELY A COMPUTER PROGRAM FOR TRAINING PERSONNEL IN THE USE OF WHEEL ALIGNMENT SYSTEMS (U.S. CLS. 21, 23, 26, 36 AND 38).

FIRST USE 1-1-2002; IN COMMERCE 1-1-2002.

2,730,225. MIRADOR SYSTEMS INC., DURHAM, NC. SN 76-300,264. PUB. 5-21-2002, FILED 8-16-2001.

**MIRADOR CONCEPT
MANAGER**

NO CLAIM IS MADE TO THE EXCLUSIVE RIGHT TO USE "CONCEPT MANAGER", APART FROM THE MARK AS SHOWN.

FOR COMPUTER SOFTWARE FOR EXTRACTING CONCEPTS FROM DOCUMENTS, NAMELY PROGRAMS FOR SEARCHING KEY TERMS OF DOCUMENTS AND FOR SUMMARIZING AND ORGANIZING THE CONTENT OF SUCH DOCUMENTS (U.S. CLS. 21, 23, 26, 36 AND 38).

FIRST USE 7-24-2001; IN COMMERCE 9-17-2001.

2,730,230. ENERGY AND PROPULSION SYSTEMS, ASBESTOS (QUEBEC), CANADA. SN 76-303,317. PUB. 1-1-2002, FILED 8-22-2001.

SMART-E

FOR ENERGY MANAGEMENT SYSTEM NAMELY, AN ELECTRIC MOTOR, GENERATOR, ELECTRONIC CIRCUITRY AND CONTROL PANEL, SOLD AS A KIT, FOR MONITORING AND CONTROLLING THE PROVIDING OF PROPULSION ENERGY PROPORTIONAL TO USER DEMANDS, AND FOR CHARGING A BATTERY (U.S. CLS. 21, 23, 26, 36 AND 38).

FIRST USE 2-0-2002; IN COMMERCE 2-0-2002.

CLASS 9—(Continued).

2,730,242. CELLOMICS, INC., PITTSBURGH, PA. SN 76-305,801. PUB. 4-23-2002, FILED 8-28-2001.

KINETICSCAN

FOR COMPUTERIZED CELL SCREENING SYSTEM, NAMELY LIGHT MICROSCOPE OPTICS, OPTICAL DETECTORS, WAVELENGTH SELECTION DEVICES NAMELY, FILTER WHEELS AND SLIDERS, LIGHT MODULATORS, NAMELY, SHUTTERS AND DIAPHRAGMS, MICROSCOPE OBJECTIVES, MOTORIZED MOUNTS, OPTICAL IMAGING DETECTORS, NAMELY, CCD CAMERAS, ENVIRONMENTAL CONTROL CHAMBERS, AND AUTOMATED PIPETTERS; COMPUTER HARDWARE, NAMELY, SCANNING HARDWARE, AND CONTROLLERS FOR DRIVING OPTICAL AND MECHANICAL COMPONENTS OF THE CELL SCREENING SYSTEM; COMPUTER SOFTWARE FOR USE IN CONDUCTING CELL-BASED ANALYSIS BY OPTICAL METHODS (U.S. CLS. 21, 23, 26, 36 AND 38).
FIRST USE 6-30-2002; IN COMMERCE 6-30-2002.

2,730,244. KINETICS INDUSTRIES INC., TRENTON, NJ. SN 76-306,449. PUB. 8-6-2002, FILED 8-30-2001.

KINETSYNC

FOR SOLID STATE COMBINATION CONTROLLER AND MONITOR UNIT FOR MONITORING AND CONTROLLING THE FIELD EXCITATION DURING STARTING OF SYNCHRONOUS ELECTRICAL MOTORS AND THEN MONITORING AND CONTROLLING THE FIELD EXCITATION AND OPERATING POWER FACTOR OF THESE MOTORS WHILE RUNNING (U.S. CLS. 21, 23, 26, 36 AND 38).
FIRST USE 5-4-2001; IN COMMERCE 5-4-2001.

2,730,250. EXAMEN, INC., SACRAMENTO, CA. SN 76-307,485. PUB. 6-18-2002, FILED 8-29-2001.

LEGALCHECK

FOR COMPUTER SOFTWARE FOR AUTOMATED BILL REVIEW (U.S. CLS. 21, 23, 26, 36 AND 38).
FIRST USE 2-15-2002; IN COMMERCE 2-15-2002.

2,730,268. AXON INSTRUMENTS, INC., UNION CITY, CA. SN 76-314,002. PUB. 6-18-2002, FILED 9-10-2001.

IMAGEXPRESS

FOR FLOURESCENT SCANNER FOR USE BY PHARMACEUTICAL AND RESEARCH LABORATORIES IN THE SCANNING OF MULTIWELL PLATES (U.S. CLS. 21, 23, 26, 36 AND 38).
FIRST USE 1-24-2003; IN COMMERCE 1-24-2003.

CLASS 9—(Continued).

2,730,292. NIPPON DENKI KABUSHIKI KAISHA, DBA NEC CORPORATION, TOKYO, JAPAN. SN 76-320,042. PUB. 7-2-2002, FILED 10-1-2001.

NB/P

FOR ELECTRICAL COMPONENTS, NAMELY, CAPACITORS (U.S. CLS. 21, 23, 26, 36 AND 38).
FIRST USE 11-0-2001; IN COMMERCE 11-0-2001.

2,730,293. INGATE SYSTEMS AB, 117 27 STOCKHOLM, SWEDEN. SN 76-320,129. PUB. 3-19-2002, FILED 10-2-2001.



FOR COMPUTER HARDWARE AND SOFTWARE FOR SESSION INITIAL PROTOCOL AND FIREWALLS (U.S. CLS. 21, 23, 26, 36 AND 38).
FIRST USE 2-16-2002; IN COMMERCE 5-3-2002.

2,730,294. DIGITAL IMPACT, INC., SAN MATEO, CA. SN 76-320,268. PUB. 3-12-2002, FILED 10-1-2001.

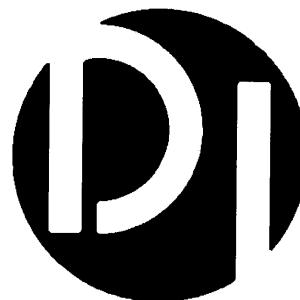

FOR COMPUTER SOFTWARE FOR USE IN CREATING, IMPLEMENTING AND AUDITING MARKETING AND ADVERTISING PROGRAMS CONDUCTED VIA E-MAIL (U.S. CLS. 21, 23, 26, 36 AND 38).
FIRST USE 9-0-2001; IN COMMERCE 11-13-2001.

CLASS 9—(Continued).

2,730,299. PANTONE, INC., CARLSTADT, NJ. SN 76-321,741. PUB. 6-4-2002, FILED 10-5-2001.

COLOR CUE

NO CLAIM IS MADE TO THE EXCLUSIVE RIGHT TO USE "COLOR", APART FROM THE MARK AS SHOWN.

FOR HANDHELD ELECTRONIC DEVICE USED TO INTERPRET AND IDENTIFY SPECIFIC COLORS, FOR USE IN IDENTIFYING COLORS OF PAINTS, FABRICS, FURNITURE, APPAREL AND THE LIKE (U.S. CLS. 21, 23, 26, 36 AND 38).

FIRST USE 12-0-2001; IN COMMERCE 12-0-2001.

2,730,313. HAIDAR, ANWAR, ARLINGTON, VA. AND HAIDAR, BASSEL, ARLINGTON, VA. AND HAIDAR, HOUSSAM, ARLINGTON, VA. SN 76-324,673. PUB. 3-19-2002, FILED 10-11-2001.

SERVING YOUR DATA YOUR WAY

FOR COMPUTER SOFTWARE PROGRAM AND INSTRUCTION MANUALS SOLD AS A UNIT TO ACCESS MULTIPLE COMPUTER SOFTWARE PROGRAMS AND DATA BASES VIA THE WEB (U.S. CLS. 21, 23, 26, 36 AND 38).

FIRST USE 6-15-2001; IN COMMERCE 6-15-2001.

2,730,343. VBS, INC., SIOUX CENTER, IA. SN 76-333,130. PUB. 5-21-2002, FILED 11-1-2001.

DYNA TABLE

NO CLAIM IS MADE TO THE EXCLUSIVE RIGHT TO USE "TABLE", APART FROM THE MARK AS SHOWN.

FOR COMPUTER CONTROLLED PLASMA TORCH CUTTING TABLES (U.S. CLS. 21, 23, 26, 36 AND 38).

FIRST USE 1-29-2003; IN COMMERCE 1-29-2003.

2,730,347. WHITE, RICKY D., CLAYTON, CA. SN 76-334,171. PUB. 5-28-2002, FILED 11-5-2001.

COMCADDY

FOR CONTAINER FOR HOLDING AND TRANSPORTING CELL PHONES (U.S. CLS. 21, 23, 26, 36 AND 38).

FIRST USE 2-13-2003; IN COMMERCE 2-13-2003.

CLASS 9—(Continued).

2,730,352. WAVESMITH NETWORKS, INC., ACTON, MA. SN 76-336,376. PUB. 7-2-2002, FILED 11-12-2001.

WAVECORE

FOR COMPUTER OPERATING SYSTEMS FOR MULTISERVICE SWITCHES (U.S. CLS. 21, 23, 26, 36 AND 38). FIRST USE 5-25-2001; IN COMMERCE 5-25-2001.

2,730,377. COMPUTER SCIENCES CORPORATION, EL SEGUNDO, CA. SN 76-341,232. PUB. 9-17-2002, FILED 11-21-2001.

NBACCELERATOR

FOR COMPUTER PROGRAM FOR USE FOR LIFE AND ANNUITY INSURANCE ADMINISTRATION (U.S. CLS. 21, 23, 26, 36 AND 38).

FIRST USE 1-1-2002; IN COMMERCE 1-1-2002.

2,730,378. JEOL LTD., AKISHIMA, TOKYO 196-8558, JAPAN. SN 76-341,278. PUB. 4-30-2002, FILED 11-21-2001.

ACCUTOF

FOR MASS SPECTROMETERS (U.S. CLS. 21, 23, 26, 36 AND 38).

FIRST USE 3-17-2002; IN COMMERCE 3-17-2002.

2,730,389. WAVE7 OPTICS, INC., ALPHARETTA, GA. SN 76-343,590. PUB. 5-14-2002, FILED 11-30-2001.

BEYOND BROADBAND

FOR TELECOMMUNICATIONS AND DATA NETWORKING EQUIPMENT, NAMELY, OPTICAL NETWORK HARDWARE AND SOFTWARE USED FOR FIBER OPTIC TRANSMISSION TO RESIDENCES OR BUSINESSES (U.S. CLS. 21, 23, 26, 36 AND 38).

FIRST USE 6-30-2002; IN COMMERCE 6-30-2002.

2,730,390. WAVE7 OPTICS, INC., ALPHARETTA, GA. SN 76-343,592. PUB. 5-14-2002, FILED 11-30-2001.

LMM

FOR TELECOMMUNICATIONS AND DATA NETWORKING EQUIPMENT, NAMELY, OPTICAL NETWORK HARDWARE AND SOFTWARE USED FOR FIBER OPTIC TRANSMISSION TO RESIDENCES OR BUSINESSES (U.S. CLS. 21, 23, 26, 36 AND 38).

FIRST USE 8-20-2002; IN COMMERCE 8-20-2002.

CLASS 9—(Continued).

2,730,392. WORKBOX, INC., SAN FRANCISCO, CA. SN 76-343,957. PUB. 6-4-2002, FILED 11-30-2001.

CUT

FOR DOWNLOADABLE SOFTWARE THAT ALLOWS USERS TO UPDATE WEBSITE CONTENT THROUGH WEB BROWSER AND EMAIL SOFTWARE (U.S. CLS. 21, 23, 26, 36 AND 38).

FIRST USE 10-1-2001; IN COMMERCE 10-1-2001.

2,730,399. RULESTREAM CORPORATION, MAYFIELD HEIGHTS, OH, BY CHANGE OF NAME NAVION SOFTWARE CORP., MAYFIELD HEIGHTS, OH. SN 76-345,348. PUB. 6-11-2002, FILED 12-5-2001.

CPR²

FOR COMPUTER SOFTWARE FOR USE IN EVALUATING, ANALYZING, CAPTURING, AND MANAGING INFORMATION AND DATA RELATING TO ENGINEERING KNOWLEDGE REQUIRED TO AUTOMATE PORTIONS OF AN ENGINEERING DESIGN PROCESS, OF A TECHNICAL SALES PROCESS, OR OF A TECHNICAL PURCHASING PROCESS (U.S. CLS. 21, 23, 26, 36 AND 38).

FIRST USE 9-11-2000; IN COMMERCE 9-11-2000.

2,730,409. SYNCFUSION, INC., CARY, NC. SN 76-347,166. PUB. 6-4-2002, FILED 12-10-2001.

SYNCFUSION

FOR COMPUTER SOFTWARE DEVELOPMENT TOOLS (U.S. CLS. 21, 23, 26, 36 AND 38).

FIRST USE 4-1-2002; IN COMMERCE 4-4-2002.

2,730,420. CONCEPT ENGINEERING GMBH, 79111 FREIBURG, FED REP GERMANY. SN 76-349,441. PUB. 6-18-2002, FILED 12-14-2001.

SPICEVISION

FOR COMPUTER SOFTWARE, NAMELY SOFTWARE FOR GENERATING AND DISPLAYING SCHEMATIC REPRESENTATIONS OF ELECTRONIC CIRCUITS (U.S. CLS. 21, 23, 26, 36 AND 38).

FIRST USE 5-6-2002; IN COMMERCE 12-1-2002.

CLASS 9—(Continued).

2,730,442. CREATIVE TECHNOLOGY LTD., SINGAPORE 609921, SINGAPORE. SN 76-353,332. PUB. 7-9-2002, FILED 12-27-2001.

PRODIKEYS

FOR COMPUTER HARDWARE; COMPUTER SOFTWARE TO GENERATE, REPRODUCE, RECORD, CONTROL AND IMPROVE COMPUTER AND AUDIO EQUIPMENT SOUND QUALITY, COMPUTER SOFTWARE FOR THE ARRANGEMENT, SEQUENCING, STORAGE, REPRODUCTION, TRANSMISSION AND EDITING OF SOUND, COMPUTER SOFTWARE AND PROGRAMS CONTAINING DATA OF SOUND OR IMAGES, COMPUTER SOFTWARE USED FOR KARAOKE, FOR AUDIO PLAYBACK AND FOR RECORDING, EFFECTING AND REPRODUCING OF AUDIO SOUNDS, AND COMPUTER SOFTWARE TO ALLOW USERS TO PLAY MUSICAL INSTRUMENTS AND FOR THE DEMONSTRATION, PROMOTION AND EDUCATION OF MUSICAL INSTRUMENTS; ELECTRONIC AUDIO COMPONENTS, NAMELY, SOUND SYSTEMS AND STEREO LOUDSPEAKERS (U.S. CLS. 21, 23, 26, 36 AND 38).

FIRST USE 5-0-2002; IN COMMERCE 10-15-2002.

2,730,447. TELEGY NETWORKS INC., GERMANTOWN, MD. SN 76-354,939. PUB. 6-25-2002, FILED 1-4-2002.

TELOGY SOFTWARE

OWNER OF U.S. REG. NOS. 1,654,531 AND 1,917,162.
NO CLAIM IS MADE TO THE EXCLUSIVE RIGHT TO USE "SOFTWARE", APART FROM THE MARK AS SHOWN.
FOR SOFTWARE AND COMPONENT PARTS THEREOF FOR USE IN THE TRANSMISSION OF VOICE, FAX AND DATA IN COMPUTERS, TELEPHONES, FAX MACHINES, ROUTERS AND OTHER TELECOMMUNICATIONS EQUIPMENT (U.S. CLS. 21, 23, 26, 36 AND 38).
FIRST USE 2-28-2001; IN COMMERCE 2-28-2001.

2,730,462. SHARP IMAGE GAMING, INC., CHATSWORTH, CA. SN 76-359,208. PUB. 7-23-2002, FILED 1-16-2002.

TRAILER CASH

NO CLAIM IS MADE TO THE EXCLUSIVE RIGHT TO USE "CASH", APART FROM THE MARK AS SHOWN.

FOR GAMING EQUIPMENT, NAMELY, SLOT MACHINES, WITH OR WITHOUT VIDEO OUTPUT (U.S. CLS. 21, 23, 26, 36 AND 38).

FIRST USE 1-29-2002; IN COMMERCE 3-28-2002.

2,730,465. FOSSIL, INC., RICHARDSON, TX. SN 76-360,665. PUB. 9-10-2002, FILED 1-21-2002.

ELEMENTS

FOR SUNGLASSES (U.S. CLS. 21, 23, 26, 36 AND 38).
FIRST USE 12-0-2001; IN COMMERCE 12-0-2001.

CLASS 9—(Continued).

2,730,468. FORINSTANCE.COM LLC, DBA QUOVIX, INDIANAPOLIS, IN. SN 76-361,447. PUB. 9-17-2002, FILED 1-22-2002.

RABBLEROUSER

FOR COMPUTER SOFTWARE FOR USE IN CONNECTION WITH E-MAIL AND CHAT ROOM COMMUNICATIONS AND FOR BUSINESS SCHEDULING AND TRACKING (U.S. CLS. 21, 23, 26, 36 AND 38).
FIRST USE 2-15-2002; IN COMMERCE 2-15-2002.

2,730,470. INTELLIDEN, INC., COLORADO SPRINGS, CO. SN 76-361,520. PUB. 8-13-2002, FILED 1-22-2002.

INTELLIDEN R30

FOR COMPUTER SOFTWARE AND HARDWARE FOR MANAGING COMPUTER NETWORK INFRASTRUCTURE (U.S. CLS. 21, 23, 26, 36 AND 38).
FIRST USE 1-22-2002; IN COMMERCE 6-0-2002.

2,730,471. INTELLIDEN, INC., COLORADO SPRINGS, CO. SN 76-361,624. PUB. 8-13-2002, FILED 1-22-2002.

INTELLIDEN R10

FOR COMPUTER SOFTWARE AND HARDWARE FOR MANAGING COMPUTER NETWORK INFRASTRUCTURE (U.S. CLS. 21, 23, 26, 36 AND 38).
FIRST USE 1-22-2002; IN COMMERCE 6-0-2002.

2,730,475. GENLYTE THOMAS GROUP LLC, LEWISVILLE, KY. SN 76-362,822. PUB. 7-9-2002, FILED 1-25-2002.

OASIS

FOR ELECTRONIC CONTROLLERS FOR RESIDENTIAL, COMMERCIAL AND THEATRICAL LIGHTING INSTALLATIONS (U.S. CLS. 21, 23, 26, 36 AND 38).
FIRST USE 3-1-2003; IN COMMERCE 3-1-2003.

2,730,488. JASC SOFTWARE, INC., EDEN PRAIRIE, MN. SN 76-367,492. PUB. 9-10-2002, FILED 2-6-2002.

AFTER SHOT

FOR COMPUTER PROGRAMS FOR CREATING, EDITING, REPRODUCING AND MANIPULATING PHOTOGRAPHS, AND MANUALS FOR USE THEREWITH, SOLD AS A UNIT (U.S. CLS. 21, 23, 26, 36 AND 38).
FIRST USE 2-25-2002; IN COMMERCE 2-25-2002.

CLASS 9—(Continued).

2,730,502. TIME INC., NEW YORK, NY. SN 76-372,922. PUB. 10-29-2002, FILED 2-21-2002.

PEOPLE EN ESPAÑOL

OWNER OF U.S. REG. NO. 2,182,518.
NO CLAIM IS MADE TO THE EXCLUSIVE RIGHT TO USE "EN ESPANOL", APART FROM THE MARK AS SHOWN.

THE WORDING IN THE MARK "EN ESPANOL" TRANSLATES TO "IN SPANISH".

FOR PRERECORDED AUDIO TAPES AND COMPACT DISCS FEATURING MUSIC (U.S. CLS. 21, 23, 26, 36 AND 38).

FIRST USE 4-2-2002; IN COMMERCE 4-2-2002.

2,730,506. COIN ACCEPTORS, INC., ST. LOUIS, MO. SN 76-374,384. PUB. 9-17-2002, FILED 2-22-2002.



OWNER OF U.S. REG. NO. 2,433,880.
FOR COIN CHANGERS (U.S. CLS. 21, 23, 26, 36 AND 38).

FIRST USE 10-17-2002; IN COMMERCE 10-17-2002.

2,730,511. PREVALENT DEVICES LLC, NISKAYUNA, NY. SN 76-374,877. PUB. 9-17-2002, FILED 2-25-2002.

PHRAZE-IT

FOR COMPUTER SOFTWARE FOR THE ENTRY OF DATA AND INFORMATION INTO SMALL-SCREEN DEVICES NAMELY PERSONAL DIGITAL ASSISTANTS (PDAS), MOBILE PHONES, WEB APPLIANCES, PAGERS, DIGITAL REMOTE CONTROLS, WEB TABLETS, TABLET PCS, WEB PADS AND DETACHABLE KEYBOARDS (U.S. CLS. 21, 23, 26, 36 AND 38).
FIRST USE 4-25-2002; IN COMMERCE 4-25-2002.

CLASS 9—(Continued).

2,730,539. SCHAWK, INC., DES PLAINES, IL. SN 76-975,396. PUB. 1-30-2001, FILED 3-24-2000.

CLASS 9—(Continued).

2,730,567. O2 MICRO INTERNATIONAL LIMITED, GRAND CAYMAN, CAYMAN ISLANDS, BY ASSIGNMENT O2MICRO, INC., SANTA CLARA, CA. SN 78-027,933. PUB. 10-1-2002, FILED 9-27-2000.

PARTS-PRODUCTION AND RESOURCE TRACKING SYSTEM

NO CLAIM IS MADE TO THE EXCLUSIVE RIGHT TO USE "RESOURCE TRACKING SYSTEM", APART FROM THE MARK AS SHOWN.

FOR COMPUTER SOFTWARE FOR TRACKING AND ARCHIVING DIGITAL IMAGES THROUGHOUT THE PRE-PRESS AND PRINTING PROCESS AND FOR MANUALS DISTRIBUTED AS A UNIT (U.S. CLS. 21, 23, 26, 36 AND 38).

FIRST USE 6-23-2001; IN COMMERCE 6-23-2001.



2,730,553. OPUS HEALTHCARE SOLUTIONS, INC., AUSTIN, TX. SN 78-009,631. PUB. 5-22-2001, FILED 5-24-2000.

OPUSOM

FOR ORDER MANAGEMENT COMPUTER SOFTWARE FOR USE BY HEALTHCARE FACILITIES TO TRACK ALL HOSPITAL SERVICES THAT MAY BE DOWNLOADED FROM THE INTERNET (U.S. CLS. 21, 23, 26, 36 AND 38).

FIRST USE 9-19-2002; IN COMMERCE 9-19-2002.



2,730,564. AVERY DENNISON CORPORATION, PASADENA, CA. SN 78-025,403. PUB. 8-27-2002, FILED 9-11-2000.

INFOCHAIN EXPRESS

NO CLAIM IS MADE TO THE EXCLUSIVE RIGHT TO USE "EXPRESS", APART FROM THE MARK AS SHOWN.

FOR COMPUTER PERIPHERALS, NAMELY, PRINTERS AND SCANNERS; COMPUTER SOFTWARE FOR USE IN AUTOMATING BUSINESS TRANSACTIONS, TRACKING MATERIALS, AND CONTROLLING INVENTORY (U.S. CLS. 21, 23, 26, 36 AND 38).

FIRST USE 1-0-2002; IN COMMERCE 1-0-2002.

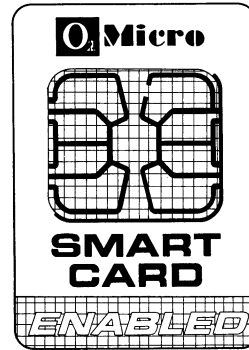

NO CLAIM IS MADE TO THE EXCLUSIVE RIGHT TO USE "SMART CARD ENABLED", APART FROM THE MARK AS SHOWN.

THE MARK CONSISTS OF A DRAWING IN WHITE BACKGROUND WITH THE WORD "O2MICRO" IN THE TOP IN BLACK AND THE SUBSCRIPT "2" IN RED, AND BELOW THE WORD "O2MICRO" IS AN ILLUSTRATION OF A ROUNDED SQUARE IN GOLD WITHIN WHICH THERE ARE CONNECTING LINES IN BLACK, FORMING EIGHT CONNECTING FIGURES WITH AN OPENING IN ONE SIDE OF EACH FIGURE, WITH ALL THE CONNECTING FIGURES FORMING A CONNECTOR, AND IN THE MIDDLE, IS AN OCTAGONAL SHAPE WITH AN OPENING AT THE TOP AND BOTTOM SIDES, BELOW THE GOLD ROUNDED SQUARE IS THE WORD "SMART" IN BLACK, BELOW THE WORD "SMART" IS THE WORD "CARD" IN BLACK, BELOW THE WORD "CARD" IS A GOLD BACKGROUND WITH THE WORD "ENABLED" IN WHITE. THE DRAWING INCLUDES THE COLORS BLACK, GOLD, WHITE AND RED, AND APPLICANT CLAIMS THESE COLORS AS INHERENT FEATURES OF THE MARK.

FOR INTEGRATED CIRCUITS FOR CONTROLLING THE OPERATION OF SMART CARD READERS AND THE OPERATION OF CARDBUS CONTROLLERS (U.S. CLS. 21, 23, 26, 36 AND 38).

FIRST USE 9-1-2002; IN COMMERCE 9-1-2002.

CLASS 9—(Continued).

2,730,575. CURL CORPORATION, CAMBRIDGE, MA. SN 78-032,772. PUB. 2-19-2002, FILED 10-27-2000.

SURGE

FOR COMPUTER SOFTWARE FOR EXECUTING COMPUTER PROGRAMS, NAMELY, COMPILERS, RUN-TIME SOFTWARE, MULTIMEDIA SOFTWARE ENGINES, GRAPHICAL USER INTERFACES, AND INSTRUCTION MANUALS DISTRIBUTED THEREWITH; SOFTWARE LIBRARY COMPRISED OF SOFTWARE FOR USE IN MANAGING AND EXECUTING PROGRAMS RUN ON WEB BROWSERS AND INSTRUCTION MANUALS DISTRIBUTED THEREWITH; COMPUTER SOFTWARE FOR THE DESIGN, VIEWING AND PLAYBACK OF MULTIMEDIA CONTENT, ANIMATIONS, IMAGES, AUDIO AND GRAPHICS AND INSTRUCTION MANUALS DISTRIBUTED THEREWITH; COMPUTER SOFTWARE FOR WEB SITE DESIGN; COMPUTER SOFTWARE FOR ENHANCEMENT OF WEB BROWSERS BY MEANS OF PLUG-IN SOFTWARE COMPONENTS FOR EXECUTION OF SOFTWARE FROM WEB SITES; COMPUTER SOFTWARE FOR ENHANCEMENT OF WEB BROWSERS BY MEANS OF SOFTWARE WRITTEN TO BE EXECUTED ON WEB BROWSERS (U.S. CLS. 21, 23, 26, 36 AND 38).

FIRST USE 10-2-2001; IN COMMERCE 10-2-2001.

2,730,580. SYMTRON TECHNOLOGY, INC., TAIPEI, TAIWAN. SN 78-038,101. PUB. 4-30-2002, FILED 12-6-2000.

FACEON SCREENSAVER

NO CLAIM IS MADE TO THE EXCLUSIVE RIGHT TO USE "SCREENSAVER", APART FROM THE MARK AS SHOWN.

FOR COMPUTER SCREEN SAVER SOFTWARE UTILIZING FACE RECOGNITION (U.S. CLS. 21, 23, 26, 36 AND 38).

FIRST USE 3-4-2001; IN COMMERCE 3-4-2001.

2,730,581. SYMTRON TECHNOLOGY, INC., TAIPEI, TAIWAN. SN 78-038,105. PUB. 4-30-2002, FILED 12-6-2000.

FACEON

FOR COMPUTER SOFTWARE RECOGNIZING HUMAN FACES FOR ACCESS TO, PROCESS OF AND CONTROL OF COMPUTER, DATA AND NETWORKS (U.S. CLS. 21, 23, 26, 36 AND 38).

FIRST USE 3-4-2001; IN COMMERCE 3-4-2001.

CLASS 9—(Continued).

2,730,582. SYMTRON TECHNOLOGY, INC., TAIPEI, TAIWAN. SN 78-038,107. PUB. 5-14-2002, FILED 12-6-2000.

FACEON PC SUITE

NO CLAIM IS MADE TO THE EXCLUSIVE RIGHT TO USE "PC SUITE", APART FROM THE MARK AS SHOWN.

FOR COMPUTER SOFTWARE USED TO DEVELOP COMPUTER APPLICATIONS UTILIZING FACE RECOGNITION FOR COMPUTER, FILES, DATABASE AND NETWORK ACCESS CONTROL (U.S. CLS. 21, 23, 26, 36 AND 38).

FIRST USE 3-4-2001; IN COMMERCE 3-4-2001.

2,730,593. CD GARDEN INC., STEVENSON, WA. SN 78-040,864. PUB. 5-21-2002, FILED 12-28-2000.

CD GARDEN

NO CLAIM IS MADE TO THE EXCLUSIVE RIGHT TO USE "CD", APART FROM THE MARK AS SHOWN. FOR CHILDREN'S EDUCATIONAL SOFTWARE (U.S. CLS. 21, 23, 26, 36 AND 38).

FIRST USE 6-30-1997; IN COMMERCE 6-30-1997.

2,730,594. KABUSHIKI KAISHA TOYOTA CHUO KEN-KYUSHO, AICHI, JAPAN. SN 78-041,065. PUB. 5-7-2002, FILED 12-29-2000.

THUMS

FOR COMPUTER PROGRAMS AND COMPUTER SOFTWARE FOR MECHANICAL ANALYSIS OF THE HUMAN BODY (U.S. CLS. 21, 23, 26, 36 AND 38).

FIRST USE 10-1-2002; IN COMMERCE 10-1-2002.

2,730,595. FITEL USA CORPORATION, NORCORSS, GA. BY ASSIGNMENT LUCENT TECHNOLOGIES INC., MURRAY HILL, NJ. SN 78-042,103. PUB. 8-14-2001, FILED 1-8-2001.

ULTRAWAVE

FOR TELECOMMUNICATIONS PRODUCTS, NAMELY, OPTICAL FIBER (U.S. CLS. 21, 23, 26, 36 AND 38).

FIRST USE 3-20-2001; IN COMMERCE 3-20-2001.

CLASS 9—(Continued).

2,730,597. AETHER SYSTEMS, INC., OWINGS MILLS, MD.
SN 78-043,401. PUB. 6-25-2002, FILED 1-16-2001.

AERLEAD

FOR COMPUTER SOFTWARE FOR USE IN DISTRIBUTING, ACCOUNTING FOR, TRACKING AND MANAGING SALES LEAD INFORMATION (U.S. CLS. 21, 23, 26, 36 AND 38).

FIRST USE 9-30-2001; IN COMMERCE 9-30-2001.

2,730,607. SYMTRON TECHNOLOGY, INC., TAIPEI, TAIWAN. SN 78-046,324. PUB. 4-23-2002, FILED 2-2-2001.

we Know you by your Face

FOR COMPUTER SOFTWARE, NAMELY, SOFTWARE FOR UTILIZING FACE RECOGNITION TECHNIQUE BY CAPTURING AND RECOGNIZING HUMAN FACES IN INTERNET, PERSONAL COMPUTER, SURVEILLANCE AND MOBILE PHONE ENVIRONMENTS, FOR LIMITING ACCESS AND PROTECTING DATA (U.S. CLS. 21, 23, 26, 36 AND 38).

FIRST USE 3-4-2001; IN COMMERCE 3-4-2001.

2,730,609. KEYSTROKE TECHNOLOGY SOLUTIONS, INC., SEATTLE, WA. SN 78-047,653. PUB. 6-18-2002, FILED 2-9-2001.

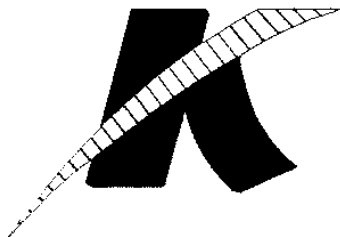

THE LINING IN THE DRAWING IS FOR SHADING PURPOSE ONLY.

THE MARK CONSISTS OF A STYLIZED LETTER "K".
FOR COMPUTER SOFTWARE FOR USE IN ORIGINATING MORTGAGES AND LOANS, AND HELPING LENDERS AND BROKERS ORIGINATE LOANS AND MAKE LOAN ELIGIBILITY AND PRICING DECISIONS IN THE FIELD OF FINANCIAL SERVICES (U.S. CLS. 21, 23, 26, 36 AND 38).

FIRST USE 3-0-2001; IN COMMERCE 3-0-2001.

CLASS 9—(Continued).

2,730,627. FOUNDATIONIP, LLC, MINNEAPOLIS, MN, BY ASSIGNMENT PORTFOLIO, INC., MINNEAPOLIS, MN. SN 78-054,953. PUB. 6-4-2002, FILED 3-26-2001.

FOUNDATIONIP

FOR COMPUTER SOFTWARE FOR TRACKING RENEWAL DATES AND ORGANIZING DATA ASSOCIATED WITH PATENT AND TRADEMARK PROSECUTION FOR USE BY INTELLECTUAL PROPERTY PRACTITIONERS (U.S. CLS. 21, 23, 26, 36 AND 38).

FIRST USE 5-1-2002; IN COMMERCE 5-1-2002.

2,730,636. TECHNOLOGY NETWORKS, INC., CARSON CITY, NV. SN 78-059,032. PUB. 10-8-2002, FILED 4-18-2001.

LABGEAR

FOR COMPUTER OPERATING PROGRAM FOR USE IN FACILITATING COMMUNICATION BETWEEN INTERNET BROWSERS AND TRAINING EQUIPMENT CONSISTING OF ROUTERS, SWITCHES, SERVERS, AND OTHER COMPUTING DEVICES UTILIZING TCP/IP PROTOCOL (U.S. CLS. 21, 23, 26, 36 AND 38).

FIRST USE 3-1-2001; IN COMMERCE 5-1-2001.

2,730,638. CHAPIN, HOWARD DAY, EDMONDS, WA. SN 78-059,374. PUB. 4-30-2002, FILED 4-19-2001.

AWARETEC

FOR COMPUTER PROGRAMS TO IMPROVE OPERATIONAL EFFECTIVENESS AND COMMUNICATION WITH REMOTE DEVICES, NAMELY, MOTION, TEMPERATURE, IMAGE, SMOKE, ALARM, ACCESS, BIOMETRIC, NETWORK, IDENTIFICATION CARD, SENSORS, READERS, AND INPUT DEVICES; AND ACQUISITION AND COMPARISON OF REAL-TIME VERSUS STORED INFORMATION, NAMELY, REAL-TIME BIOMETRIC COLLECTED DATA COMPARED WITH INFORMATION ON A SMART CARD AND CENTRAL DATABASE. REAL-TIME VIDEO ACQUISITION COMPARED TO EXISTING VIDEO IMAGE PROFILES AND RULES, AND REAL-TIME COLLECTION OF ENVIRONMENTAL DATA WITH STORED INFORMATION AND OPERATIONAL RULES; FOR USE IN THE FIELDS OF SECURITY, ACCESS CONTROL, COMPUTER NETWORKS, MONITORING AND TELEMETRY (U.S. CLS. 21, 23, 26, 36 AND 38).

FIRST USE 12-4-2002; IN COMMERCE 12-4-2002.

2,730,656. HYPER CORPORATION, PLEASANTON, CA. SN 78-065,114. PUB. 10-8-2002, FILED 5-22-2001.

BLUEVISION

FOR COMPUTER SOFTWARE TO BE USED FOR TESTING WIRELESS COMMUNICATIONS PROTOCOLS AND APPLICATIONS (U.S. CLS. 21, 23, 26, 36 AND 38).

FIRST USE 12-31-2001; IN COMMERCE 2-28-2002.

CLASS 9—(Continued).

2,730,659. SWAN SPEAKER SYSTEM INC., MONTEREY PARK, CA. SN 78-066,703. PUB. 8-27-2002, FILED 5-31-2001.

XSPEAKER

FOR ELECTRONIC SPEAKER PARTS AND LOUD-SPEAKER SYSTEMS, NAMELY, LOUDSPEAKERS, AUDIO SPEAKERS, SUBWOOFERS, AUDIO MIXERS, AND ACOUSTIC POWER AMPLIFIERS (U.S. CLS. 21, 23, 26, 36 AND 38).

FIRST USE 6-17-2002; IN COMMERCE 6-17-2002.

2,730,672. ASCENT TECHNOLOGY, INC., CAMBRIDGE, MA. SN 78-071,928. PUB. 12-4-2001, FILED 7-2-2001.

SMARTAIRLINE

FOR COMPUTER SOFTWARE FOR AIR TRANSPORTATION RESOURCE MANAGEMENT AND USER MANUALS SOLD AS A UNIT THEREWITH (U.S. CLS. 21, 23, 26, 36 AND 38).

FIRST USE 8-1-2001; IN COMMERCE 1-15-2002.

2,730,673. CYGNUS ENTERTAINMENT, INC., ORLANDO, FL. SN 78-072,642. PUB. 1-1-2002, FILED 7-6-2001.

CEIRIS

FOR COMPUTER SOFTWARE NAMELY SOFTWARE FOR MANAGING ELECTRONIC TICKET SALES AND ONLINE AND OFFLINE RESERVATIONS FOR TRANSPORTATION AND ENTERTAINMENT AND LEISURE-RELATED EVENTS AND VENUES (U.S. CLS. 21, 23, 26, 36 AND 38).

FIRST USE 1-8-2002; IN COMMERCE 1-8-2002.

2,730,681. INNOVATIVE SAFETY TECHNOLOGIES, INC., PORTLAND, OR, BY MERGER INNOVATIVE SAFETY TECHNOLOGIES, LLC, WEST LINN, OR. SN 78-074,205. PUB. 5-14-2002, FILED 7-16-2001.

NO TUG SAFETY PLATE

NO CLAIM IS MADE TO THE EXCLUSIVE RIGHT TO USE "SAFETY PLATE", APART FROM THE MARK AS SHOWN.

FOR ELECTRICAL OUTLET SAFETY PLATES DESIGNED TO PREVENT ELECTRICAL SHOCK TO PERSONS BY BOTH COVERING THE OUTLETS WHEN NOT IN USE AND ALSO TO LOCK THE POWER CORD INTO PLACE WHEN IN USE (U.S. CLS. 21, 23, 26, 36 AND 38).

FIRST USE 1-0-2002; IN COMMERCE 1-0-2002.

CLASS 9—(Continued).

2,730,685. CROSSLAYER NETWORKS, INC, FREMONT, CA. SN 78-075,724. PUB. 8-6-2002, FILED 7-25-2001.

SILICONQOS

NO CLAIM IS MADE TO THE EXCLUSIVE RIGHT TO USE "SILICON", APART FROM THE MARK AS SHOWN.

FOR SEMICONDUCTOR (U.S. CLS. 21, 23, 26, 36 AND 38).

FIRST USE 2-1-2002; IN COMMERCE 6-1-2002.

2,730,694. ADTECH SOLUTIONS, LLC, ALPHARETTA, GA. SN 78-077,275. PUB. 7-2-2002, FILED 8-3-2001.

SACK-IT TECHNOLOGY

NO CLAIM IS MADE TO THE EXCLUSIVE RIGHT TO USE "TECHNOLOGY", APART FROM THE MARK AS SHOWN.

FOR SOFTWARE AND MANUALS SOLD THEREWITH AS A UNIT IN THE FIELD OF DATA STORAGE, MANAGEMENT AND RETRIEVAL (U.S. CLS. 21, 23, 26, 36 AND 38).

FIRST USE 3-0-2002; IN COMMERCE 3-0-2002.

2,730,702. MOTIC INSTRUMENTS INC., RICHMOND, B.C., CANADA. SN 78-079,861. PUB. 7-9-2002, FILED 8-17-2001.

MOTIC

FOR MICROSCOPES; SPECTROPHOTOMETERS; COMPUTER SOFTWARE FOR IMAGE PROCESSING; REMOTE MICROSCOPE CONTROLLERS FOR REMOTELY FOCUSING A MICROSCOPE AND MOVING THE STAGE OF A MICROSCOPE; DIGITAL CAMERAS; AND ADAPTERS FOR ADAPTING A CAMERA TO A MICROSCOPE (U.S. CLS. 21, 23, 26, 36 AND 38).

FIRST USE 1-31-2001; IN COMMERCE 1-31-2001.

2,730,723. JCM AMERICAN CORPORATION, LAS VEGAS, NV. SN 78-086,044. PUB. 7-16-2002, FILED 9-28-2001.

ICB

FOR ELECTRONIC SAFE FOR USE WITH GAMING, AMUSEMENT AND VENDING DEVICES; COMPUTER SOFTWARE FOR USE IN COUNTING CURRENCY AND COUPONS AND MAINTAINING INVENTORY INFORMATION RELATING TO SUCH CURRENCY AND COUPONS DEPOSITED INTO GAMING, AMUSEMENT AND VENDING MACHINES (U.S. CLS. 21, 23, 26, 36 AND 38).

FIRST USE 8-20-2001; IN COMMERCE 12-5-2002.

CLASS 9—(Continued).

2,730,725. MINOLTA KABUSHIKI KAISHA (MINOLTA CO., LTD.), OSAKA-SHI, JAPAN. SN 78-086,605. PUB. 6-25-2002, FILED 10-2-2001.



NO CLAIM IS MADE TO THE EXCLUSIVE RIGHT TO USE "TECHNOLOGY", APART FROM THE MARK AS SHOWN.

THE STIPPLING IS A FEATURE OF THE MARK. THE STIPPLING IS FOR SHADING PURPOSES ONLY.

THE MARK CONSISTS OF THE WORDING "PRISMLASER TECHNOLOGY" AND A DESIGN OF OVERLAPPING TRIANGLES IN DIFFERENT SHADES.

FOR ELECTRO PHOTOGRAPHIC PRINTERS, COPYING MACHINES, FACSIMILE MACHINES, SCANNERS AND MULTIFUNCTIONAL PRODUCTS, NAMELY MACHINES WHICH OFFER COPYING, PRINTING, FAXING AND SCANNING FUNCTIONS; AND COMPUTER SOFTWARE FOR ALL THE AFOREMENTIONED MACHINES (U.S. CLS. 21, 23, 26, 36 AND 38).

FIRST USE 11-11-2001; IN COMMERCE 11-11-2001.

2,730,730. WALDE, INC., ARLINGTON, VA. SN 78-087,589. PUB. 6-11-2002, FILED 10-9-2001.

FILMSTAR

FOR PHOTOGRAPHIC EQUIPMENT CONSISTING OF OPTICAL SCANNERS, COMPUTER HARDWARE AND SOFTWARE SOLD AS A UNIT FOR PHOTOGRAPHIC AND DIGITAL IMAGING USERS, ENABLING THEM TO DIGITALLY SCAN NEGATIVES AND POSITIVES OF CONSUMER, PROFESSIONAL AND MOVIE FILM FORMATS FROM 8MM TO 70MM FOR THE CREATION OF OUTPUT PRODUCTS SUCH AS DIGITAL FILES, PRINTS, COMPACT DISCS, DIGITAL VIDEO DISCS, INTERNET UPLOADS, AND FLOPPY DISKS (U.S. CLS. 21, 23, 26, 36 AND 38).

FIRST USE 9-14-2001; IN COMMERCE 6-27-2002.

CLASS 9—(Continued).

2,730,731. BIOWARE CORP., EDMONTON, ALBERTA, CANADA. SN 78-087,744. PUB. 7-23-2002, FILED 10-10-2001.

BIOWARE AURORA ENGINE

PRIORITY CLAIMED UNDER SEC. 44(D) ON CANADA APPLICATION NO. 1115872, FILED 9-18-2001.

OWNER OF U.S. REG. NOS. 2,115,937, 2,454,474, AND 2,460,807.

NO CLAIM IS MADE TO THE EXCLUSIVE RIGHT TO USE "ENGINE", APART FROM THE MARK AS SHOWN.

FOR SOFTWARE USED TO CREATE FULL MULTIMEDIA ELECTRONIC VIDEO GAMES AND COMPUTER ANIMATION, AND RELATED MANUALS (U.S. CLS. 21, 23, 26, 36 AND 38).

FIRST USE 6-0-2002; IN COMMERCE 6-0-2002.

2,730,755. CHANDRASEKHAR, MEERA, COLUMBIA, MO. SN 78-095,729. PUB. 9-24-2002, FILED 11-29-2001.

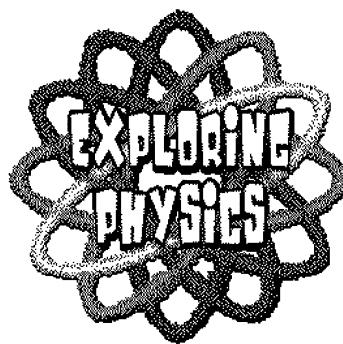

NO CLAIM IS MADE TO THE EXCLUSIVE RIGHT TO USE "PHYSICS", APART FROM THE MARK AS SHOWN.

THE STIPPLING IS FOR SHADING PURPOSES ONLY AND IS NOT A FEATURE OF THE MARK.

FOR EDUCATIONAL SOFTWARE FEATURING INSTRUCTION IN THE FIELD OF PHYSICS (U.S. CLS. 21, 23, 26, 36 AND 38).

FIRST USE 10-1-2000; IN COMMERCE 3-3-2001.

CLASS 9—(Continued).

2,730,758. CURL CORPORATION, CAMBRIDGE, MA. SN 78-096,081. PUB. 7-9-2002, FILED 11-30-2001.



FOR COMPUTER SOFTWARE FOR EXECUTING OTHER COMPUTER PROGRAMS, COMPILERS, RUN-TIME SOFTWARE, MULTIMEDIA SOFTWARE ENGINES, GRAPHICAL USER INTERFACES, AND INSTRUCTION MANUALS DISTRIBUTED THEREWITH; SOFTWARE LIBRARIES COMPRISED OF SOFTWARE FOR USE IN MANAGING AND EXECUTING PROGRAMS RUN ON WEB BROWSERS, AND INSTRUCTION MANUALS DISTRIBUTED THEREWITH; COMPUTER SOFTWARE FOR THE DESIGN, VIEWING AND PLAYBACK OF MULTIMEDIA CONTENT, ANIMATIONS, IMAGES, AUDIO AND GRAPHICS AND INSTRUCTION MANUALS DISTRIBUTED THEREWITH; COMPUTER SOFTWARE FOR WEB SITE DESIGN; COMPUTER SOFTWARE FOR ENHANCEMENT OF WEB BROWSERS (U.S. CLS. 21, 23, 26, 36 AND 38).
FIRST USE 10-2-2001; IN COMMERCE 10-2-2001.

2,730,764. XSRECORDS, INC., NASHVILLE, TN. SN 78-096,909. PUB. 6-11-2002, FILED 12-6-2001.

XSRECORDS

FOR PRE-RECORDED COMPACT DISCS FEATURING MUSIC; DOWNLOADABLE MUSICAL SOUND RECORDINGS (U.S. CLS. 21, 23, 26, 36 AND 38).
FIRST USE 7-9-2002; IN COMMERCE 7-9-2002.

2,730,772. MERCURY COMPUTER SYSTEMS, INC., CHELMSFORD, MA. SN 78-098,740. PUB. 9-24-2002, FILED 12-17-2001.

RACE SERIES

NO CLAIM IS MADE TO THE EXCLUSIVE RIGHT TO USE SERIES, APART FROM THE MARK AS SHOWN.
FOR DIGITAL DATA PROCESSING EQUIPMENT, NAMELY, NETWORK SWITCHES; MULTICOMPUTERS; SYSTEM BOARDS; INPUT/OUTPUT MODULES; INTERCONNECT MODULES; AND COMPUTER SOFTWARE FOR THE OPERATION OF DIGITAL DATA PROCESSING EQUIPMENT; AND INSTRUCTIONAL BOOKS AND MANUALS SOLD AS A UNIT THEREWITH (U.S. CLS. 21, 23, 26, 36 AND 38).
FIRST USE 2-17-1998; IN COMMERCE 2-17-1998.

CLASS 9—(Continued).

2,730,773. MERCURY COMPUTER SYSTEMS, INC., CHELMSFORD, MA. SN 78-098,741. PUB. 9-24-2002, FILED 12-17-2001.



NO CLAIM IS MADE TO THE EXCLUSIVE RIGHT TO USE SERIES, APART FROM THE MARK AS SHOWN.

FOR DIGITAL DATA PROCESSING EQUIPMENT, NAMELY, NETWORK SWITCHES; MULTICOMPUTERS; SYSTEM BOARDS; INPUT/OUTPUT MODULES; INTERCONNECT MODULES; AND COMPUTER SOFTWARE FOR THE OPERATION OF DIGITAL DATA PROCESSING EQUIPMENT; AND INSTRUCTIONAL BOOKS AND MANUALS SOLD AS A UNIT THEREWITH (U.S. CLS. 21, 23, 26, 36 AND 38).

FIRST USE 2-17-1998; IN COMMERCE 2-17-1998.

2,730,776. NORTHERN SAFETY CO., INC., FRANKFORT, NY. SN 78-100,080. PUB. 6-25-2002, FILED 12-27-2001.

TRI-STAR

FOR EYEWEAR, NAMELY, SAFETY GLASSES (U.S. CLS. 21, 23, 26, 36 AND 38).
FIRST USE 1-14-2002; IN COMMERCE 1-17-2002.

2,730,780. SPEEDLINE TECHNOLOGIES, INC., FRANKLIN, MA. SN 78-100,542. PUB. 8-27-2002, FILED 1-2-2002.

TORRID ZONE

FOR ELECTRONIC COMPONENT ASSEMBLY APPARATUS, NAMELY, A CLEANING AND DRYING APPARATUS USED IN CONNECTION WITH THE PRODUCTION OF PRINTED CIRCUIT BOARDS AND THE ASSEMBLY OF ELECTRONIC CIRCUIT COMPONENTS (U.S. CLS. 21, 23, 26, 36 AND 38).
FIRST USE 1-1-2003; IN COMMERCE 1-1-2003.

2,730,782. AT&T CORP., NEW YORK, NY. SN 78-100,769. PUB. 7-9-2002, FILED 1-3-2002.

PENNIES RULE!

FOR PREPAID TELECOMMUNICATIONS CALLING CARDS, MAGNETICALLY ENCODED (U.S. CLS. 21, 23, 26, 36 AND 38).
FIRST USE 3-1-2002; IN COMMERCE 3-1-2002.

CLASS 9—(Continued).

2,730,793. APPLIED SYSTEMS INTELLIGENCE, INC., ROSWELL, GA. SN 78-103,056. PUB. 9-24-2002, FILED 1-16-2002.

WEBPIPE

FOR COMPUTER SOFTWARE, NAMELY, COMPUTER SOFTWARE FOR THE PURPOSE OF INTERFACING AND EXCHANGING DATA WITH OTHER SOFTWARE APPLICATIONS THAT ARE HOSTED ON THE INTERNET (U.S. CLS. 21, 23, 26, 36 AND 38).
FIRST USE 1-16-2002; IN COMMERCE 1-16-2002.

2,730,804. OPTIMUM POWER CONVERSION, INC., IRVINE, CA. SN 78-105,309. PUB. 10-15-2002, FILED 1-28-2002.

TESLA CONVERTER

OWNER OF U.S. REG. NO. 1,876,395.
FOR SWITCHED-MODE POWER CONVERTERS NAMELY, SWITCHING POWER SUPPLIES (U.S. CLS. 21, 23, 26, 36 AND 38).
FIRST USE 7-1-2002; IN COMMERCE 11-1-2002.

2,730,807. HARMAN INTERNATIONAL INDUSTRIES, INCORPORATED, NORTHRIDGE, CA. SN 78-106,172. PUB. 7-30-2002, FILED 2-1-2002.

LARES

FOR AUDIO SYSTEMS FOR THE AUGMENTATION AND ENHANCEMENT OF NATURAL ACOUSTICS THROUGH ELECTRONIC MANIPULATION OF SOUND USING DIGITAL SIGNAL PROCESSING EQUIPMENT, NAMELY EQUALIZERS, MICROPHONES, LOUDSPEAKERS AND AMPLIFIERS (U.S. CLS. 21, 23, 26, 36 AND 38).
FIRST USE 2-19-1991; IN COMMERCE 2-19-1991.

2,730,821. MAYSTEEL LLC, MEMONONEE FALLS, WI. SN 78-111,435. PUB. 8-27-2002, FILED 2-27-2002.

ULTRAVAC

FOR SWITCHES AND SWITCH GEARS USED IN TRANSMISSION AND DISTRIBUTION OF ELECTRICAL POWER, NAMELY CAPACITOR SWITCHES, VACUUM SWITCHES (U.S. CLS. 21, 23, 26, 36 AND 38).
FIRST USE 5-17-2002; IN COMMERCE 5-17-2002.

CLASS 9—(Continued).

2,730,842. IPENDENCE, INC, DRAPER, UT. SN 78-124,379. PUB. 10-29-2002, FILED 4-26-2002.

QUICKMILE

FOR COMPUTER SOFTWARE FOR TRACKING AUTOMOBILE MILEAGE AND MAINTENANCE (U.S. CLS. 21, 23, 26, 36 AND 38).
FIRST USE 4-1-2002; IN COMMERCE 4-15-2002.

2,730,845. MILLIPORE CORPORATION, BEDFORD, MA. SN 78-127,424. PUB. 11-5-2002, FILED 5-9-2002.

PYROGRADE

FOR MULTIPLE WELL PLATES FOR USE IN THE SAMPLE PREPARATION AND PURIFICATION OF DNA SAMPLES (U.S. CLS. 21, 23, 26, 36 AND 38).
FIRST USE 7-10-2002; IN COMMERCE 7-10-2002.

2,730,847. MICROSOFT CORPORATION, REDMOND, WA. SN 78-975,045. PUB. 4-30-2002, FILED 9-8-2000.



FOR VIDEO GAME PLAYER MACHINES FOR USE WITH TELEVISIONS AND COMPUTERS, AND OPERATING SYSTEM SOFTWARE PROGRAMS AND COMPUTER UTILITY PROGRAMS FOR USE THEREWITH; ELECTRONIC DEVICES, NAMELY, COMPUTER HARDWARE FOR ACCESSING GLOBAL COMPUTER AND COMMUNICATION NETWORKS; AND OPERATING SYSTEM SOFTWARE PROGRAMS AND COMPUTER AND COMMUNICATION NETWORKS, AND OPERATING SYSTEM SOFTWARE PROGRAMS AND COMPUTER UTILITY PROGRAMS FOR USE THEREWITH; COMPUTER HARDWARE AND PERIPHERALS; COMPUTER GAME CONTROLLERS; COMPUTER GAME PADS AND CONTROLLERS; COMPUTER SOFTWARE FOR PLAYING VIDEO GAMES AND COMPUTER GAMES AND FOR ACCESSING AND BROWSING GLOBAL COMPUTER AND COMMUNICATION NETWORKS; COMPUTER SOFTWARE FOR COMPRESSING AND DECOMPRESSING DATA AND VIDEO IMAGES, WORD TEXT EDITING; COMPUTER GAME PROGRAMS AND COMPUTER VIDEO GAME PROGRAMS DOWNLOADABLE FROM GLOBAL COMPUTER NETWORKS AND GLOBAL COMMUNICATIONS NETWORKS; AND USER MANUALS FOR ALL THE AFOREMENTIONED SOFTWARE AND DEVICES SOLD AS A UNIT THEREWITH (U.S. CLS. 21, 23, 26, 36 AND 38).
FIRST USE 11-21-2001; IN COMMERCE 11-21-2001.

CLASS 10—MEDICAL APPARATUS

CLASS 10—(Continued).

2,729,376. NOVOSTE CORPORATION, NORCROSS, GA. SN 75-426,167. PUB. 1-4-2000, FILED 1-30-1998.

BETA-RAIL

FOR RADIOLOGICAL APPARATUS FOR MEDICAL PURPOSES, NAMELY RADIATION THERAPY CATHETER DELIVERY DEVICES; COMPONENT PARTS THEREOF, NAMELY, TRANSFER OR LOADING DEVICES, DELIVERY CATHETERS, RADIOACTIVE SOURCES, MARKER SEEDS, CONNECTORS, RECEPTACLES, STERILE SHEATHS, AND PUMPS, SYRINGES OR OTHER DEVICES USED TO CREATE MOTIVE FORCE; AND ACCESSORIES THEREFOR, NAMELY GUIDE WIRES, GUIDE CATHETERS, NON-RADIOACTIVE SOURCES (DUMMY OR PASSIVE SOURCES), PASSIVE-RUN DEVICES (DUMMY TRANSFER DEVICES), RADIOACTIVE SOURCE RECOVERY EQUIPMENT, BAIL-OUT CONTAINERS, BIOHAZARD CONTAINERS, RADIOACTIVITY SHIELDS, RADIATION SAFE CONTAINERS, STORAGE CONTAINERS WITH RADIOACTIVITY SHIELDING, TRANSPORT CASES, TUBING, CANNULAS, CONNECTORS, ADAPTERS, EXTENSIONS, STERILE SHEATHS, STERILE DRAPES, COVERS, PROTECTORS, TIMERS, AND LIGHTING DEVICES (U.S. CLS. 26, 39 AND 44).

FIRST USE 3-26-2003; IN COMMERCE 3-26-2003.

2,729,431. JOHNSON & JOHNSON, NEW BRUNSWICK, NJ. SN 75-612,666. PUB. 4-24-2001, FILED 12-28-1998.

BACTISEAL

FOR MEDICAL SURGICAL DEVICE IN THE NATURE OF A SHUNT IMPREGNATED WITH ANTISEPTICS AND ANTIBIOTICS USED TO TREAT HYDROCEPHALIC AND INTRACRANIAL PRESSURE CONDITIONS (U.S. CLS. 26, 39 AND 44).

FIRST USE 6-10-2002; IN COMMERCE 6-10-2002.

2,729,467. HOMEDICS, INC., KEEGO HARBOR, MI. SN 75-711,635. PUB. 12-14-1999, FILED 5-21-1999.

AEROSSAGE

FOR MASSAGERS (U.S. CLS. 26, 39 AND 44).
FIRST USE 3-1-2003; IN COMMERCE 3-1-2003.

2,729,499. LINE ART, INC., NEW YORK, NY. SN 75-769,483. PUB. 6-25-2002, FILED 8-6-1999.

CONDOMINTS

FOR CONDOMS SOLD AS A PACKAGE UNIT CONTAINING CANDY (U.S. CLS. 26, 39 AND 44).
FIRST USE 3-13-2003; IN COMMERCE 3-13-2003.

CLASS 10—(Continued).

2,729,513. MICHEL, JEANINE, OAKLAND, NJ. SN 75-794,255. PUB. 5-2-2000, FILED 7-30-1999.



FOR COMBINATION POSITIONING/MOBILITY DEVICE USED AS A THERAPEUTIC AID TO ASSIST IN THE DEVELOPMENT OF THE CHILD IN AN EARLY INTERVENTION PROGRAM (U.S. CLS. 26, 39 AND 44).
FIRST USE 11-30-1999; IN COMMERCE 11-30-1999.

2,729,535. THERAPEUTIC INNOVATIONS, L.L.C., FT. MITCHELL, KY. SN 75-828,580. PUB. 6-5-2001, FILED 10-21-1999.

SIMPLY-FIT

FOR ELECTRICAL MUSCLE STIMULATOR (U.S. CLS. 26, 39 AND 44).
FIRST USE 2-0-2001; IN COMMERCE 2-0-2001.

2,729,585. CONMED CORPORATION, UTICA, NY. SN 75-894,733. PUB. 7-9-2002, FILED 1-12-2000.

BIG YANK

FOR MEDICAL DEVICES NAMELY SUCTION APPARATUS USED FOR SURGERY (U.S. CLS. 26, 39 AND 44).
FIRST USE 2-0-2002; IN COMMERCE 2-0-2002.

2,729,621. SINGER, RICHARD FRANCIS, JR., DERWOOD, MD. SN 75-931,947. PUB. 11-28-2000, FILED 2-29-2000.

TUNNEL TECH

FOR ORTHOPEDIC ARTICLES, NAMELY SPLINTS, BRACES, SUPPORTS, PILLOWS AND CUSHIONS (U.S. CLS. 26, 39 AND 44).
FIRST USE 3-28-2002; IN COMMERCE 3-28-2002.

CLASS 10—(Continued).

2,729,626. FOOT LEVELERS, INC., ROANOKE, VA. SN 75-935,753. PUB. 7-2-2002, FILED 3-3-2000.

MONTANA

FOR ORTHOPEDIC SHOES FOR CORRECTING FOOT PROBLEMS AND POSTURE PROBLEMS, SOLD ONLY TO PRESCRIBING PHYSICIANS OR OTHER PRACTITIONERS (U.S. CLS. 26, 39 AND 44).
FIRST USE 4-17-2000; IN COMMERCE 4-17-2000.

2,729,892. J.C.E.C. COMPANY, INC., KENDALL PARK, NJ. SN 76-173,875. PUB. 5-21-2002, FILED 12-1-2000.



DILAPAN-S

THE MARK COMPRISES A HYPHENATED PRINTED WORD ACCOMPANIED BY A TULIP-SHAPED DESIGN ENCASED IN A CIRCLE.
FOR CERVICAL DILATORS (U.S. CLS. 26, 39 AND 44).
FIRST USE 12-16-2002; IN COMMERCE 1-3-2003.

2,729,994. TOMOTHERAPY INCORPORATED, MADISON, WI. SN 76-219,827. PUB. 6-18-2002, FILED 3-5-2001.



NO CLAIM IS MADE TO THE EXCLUSIVE RIGHT TO USE "THERAPY", APART FROM THE MARK AS SHOWN.
FOR MEDICAL APPARATUS TO DELIVER INTENSITY-MODULATED RADIATION THERAPY FOR CANCER TREATMENT (U.S. CLS. 26, 39 AND 44).
FIRST USE 11-7-2000; IN COMMERCE 2-22-2002.

CLASS 10—(Continued).

2,730,010. INNERCOOL THERAPIES, INC., SAN DIEGO, CA. SN 76-225,298. PUB. 6-11-2002, FILED 3-15-2001.

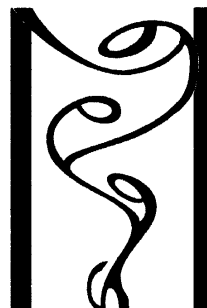

THE VISUAL DEPICTION OF A TYPE OF TURBULENT FLOW, NAMELY, A KARMEN VORTEX STREET, EMANATING FROM A SINGLE LOCATION.
FOR MEDICAL DEVICE, NAMELY, THERAPEUTIC DEVICE FOR CHANGING THE TEMPERATURE OF BLOOD (U.S. CLS. 26, 39 AND 44).
FIRST USE 3-1-2001; IN COMMERCE 7-18-2002.

2,730,080. ZOT NEDERLAND B.V., 1096 AR AMSTERDAM, NETHERLANDS. SN 76-257,841. PUB. 7-2-2002, FILED 5-15-2001.

TEX-EL SYSTEM

NO CLAIM IS MADE TO THE EXCLUSIVE RIGHT TO USE "SYSTEM", APART FROM THE MARK AS SHOWN.
FOR ELECTRO-MEDICAL APPARATUS FOR THERAPEUTIC TREATMENT OF THE HUMAN BODY, NAMELY BODY TREATMENT APPARATUS COMPRISING ELECTRODES APPLIED ON LIGAMENT SUPPORTS, ATHLETIC SUPPORTS, ANKLE SUPPORTS, KNEE SUPPORTS, ELBOW SUPPORTS, WRIST SUPPORTS AND ON UNDERWEAR ARTICLES, NAMELY ELECTRO-STIMULATION PANTS, DRAWERS, BRASIERES, T-SHIRTS, SOCKS, STOCKINGS, BANDS, BRACES, AND SUSPENDERS (U.S. CLS. 26, 39 AND 44).
FIRST USE 10-18-2001; IN COMMERCE 10-18-2001.

2,730,146. DALE MEDICAL PRODUCTS, INC., PLAINVILLE, MA. SN 76-276,555. PUB. 8-20-2002, FILED 6-26-2001.

TAKE HOLD OF PATIENT CARE

FOR MEDICAL DEVICES, NAMELY, MEDICAL TUBE HOLDERS (U.S. CLS. 26, 39 AND 44).
FIRST USE 9-0-2001; IN COMMERCE 9-0-2001.

CLASS 10—(Continued).

2,730,208. ZEVEK, INC., SALT LAKE CITY, UT. SN 76-295,075. PUB. 4-2-2002, FILED 8-3-2001.

TECHNOLOGY TRANSFORMING LIFE

FOR MEDICAL EQUIPMENT, NAMELY, MEDICAL FLUID SENSORS, ENTERAL FEEDING PUMPS, MEDICAL LASERS, BUBBLE DETECTION SENSORS, PRESSURE SENSORS, OCCLUSION DETECTORS, MEDICAL FLUID DELIVERY PUMPS, INFUSION SETS, CATHETERS, AND SURGICAL INSTRUMENTS, NAMELY, ULTRASONIC SURGICAL HANDPIECES (U.S. CLS. 26, 39 AND 44).
FIRST USE 3-18-2003; IN COMMERCE 3-18-2003.

2,730,366. PARADIGM-TREX, LLC, SAN DIEGO, CA. SN 76-338,669. PUB. 6-4-2002, FILED 11-15-2001.

DERMACHILLER

FOR SURGICAL AND MEDICAL INSTRUMENTS, NAMELY, INSTRUMENTS FOR COOLING THE SKIN (U.S. CLS. 26, 39 AND 44).
FIRST USE 11-21-2001; IN COMMERCE 11-21-2001.

2,730,394. SWEDE-O, INC., NORTH BRANCH, MN. SN 76-344,537. PUB. 7-16-2002, FILED 12-3-2001.

TARSAL LOK

FOR ANKLE BRACES (U.S. CLS. 26, 39 AND 44).
FIRST USE 3-28-2002; IN COMMERCE 3-28-2002.

2,730,405. SURGICAL SOLUTIONS LLC, VALENCIA, CA. SN 76-346,042. PUB. 10-8-2002, FILED 12-7-2001.



NO CLAIM IS MADE TO THE EXCLUSIVE RIGHT TO USE "SURGICAL", APART FROM THE MARK AS SHOWN.
FOR SURGICAL INSTRUMENTS, NAMELY SUTURING DEVICES, ARTHROSCOPIC FLUID MANAGEMENT DEVICES AND FORCEPS (U.S. CLS. 26, 39 AND 44).
FIRST USE 1-0-2003; IN COMMERCE 3-0-2002.

CLASS 10—(Continued).

2,730,412. COLOPLAST CORP., MARIETTA, GA. SN 76-347,516. PUB. 5-14-2002, FILED 12-12-2001.

TRESIA

FOR EXTERNAL BREAST PROSTHESES- (U.S. CLS. 26, 39 AND 44).
FIRST USE 1-6-2003; IN COMMERCE 1-6-2003.

2,730,453. LINVATEC CORPORATION, LARGO, FL. SN 76-355,943. PUB. 6-18-2002, FILED 1-7-2002.

PRIMECUT

FOR SURGICAL SAW BLADES, NAMELY OSCILLATING, RECIPROCATING AND SAGITTAL SAW BLADES FOR USE WITH POWERED SURGICAL HAND PIECES TO RESECT BONE (U.S. CLS. 26, 39 AND 44).
FIRST USE 11-29-2002; IN COMMERCE 11-29-2002.

2,730,562. HARDY, C.T., SAFTEY HARBOR, FL. SN 78-022,630. PUB. 7-2-2002, FILED 8-23-2000.

BIOCEPS

FOR ENDO-THERAPEUTICS MEDICAL INSTRUMENTS, NAMELY, ENDOSCOPIC BIOPSY FORCEPS, SNARES, AND GRASPERS (U.S. CLS. 26, 39 AND 44).
FIRST USE 6-25-1997; IN COMMERCE 6-25-1997.

2,730,598. MEDTRONIC, INC., MINNEAPOLIS, MN. SN 78-043,466. PUB. 8-28-2001, FILED 1-17-2001.

AUTOLOG

FOR TRANSFUSION SETS (U.S. CLS. 26, 39 AND 44).
FIRST USE 12-31-2000; IN COMMERCE 12-31-2000.

2,730,625. JOHNSON & JOHNSON, NEW BRUNSWICK, NJ. SN 78-054,536. PUB. 7-16-2002, FILED 3-22-2001.

ULTRACLEAR

FOR LANCING DEVICES AND CAPS FOR USE BY DIABETICS FOR LANCING (U.S. CLS. 26, 39 AND 44).
FIRST USE 1-15-2001; IN COMMERCE 1-15-2001.

CLASS 10—(Continued).

2,730,626. JOHNSON & JOHNSON, NEW BRUNSWICK, NJ. SN 78-054,540. PUB. 7-16-2002, FILED 3-22-2001.

ULTRASMART

FOR BLOOD GLUCOSE MONITORING DEVICE FOR CHECKING BLOOD GLUCOSE LEVELS (U.S. CLS. 26, 39 AND 44).

FIRST USE 2-13-2003; IN COMMERCE 2-13-2003.

2,730,722. JANUS DEVELOPMENT GROUP, INC., GREENVILLE, NC. SN 78-085,933. PUB. 8-6-2002, FILED 9-27-2001.

SpeechEasy

FOR SPEECH THERAPY DEVICE; NAMELY, APPARATUS TO AMELIORATE STUTTERING USING RECEIVER, AUDITORY DELAY AND/OR FREQUENCY SHIFT CIRCUIT, AND TRANSMITTER; SPEECH THERAPY DEVICE, NAMELY, APPARATUS TO AMELIORATE STUTTERING CONFIGURED FOR POSITIONING IN OR ADJACENT TO THE EAR (U.S. CLS. 26, 39 AND 44).

FIRST USE 9-30-2001; IN COMMERCE 11-30-2001.

2,730,729. MEDTRONIC INC., MINNEAPOLIS, MN. SN 78-087,474. PUB. 3-19-2002, FILED 10-9-2001.

TRILLIUM

FOR HOLLOW FIBER BLOOD OXYGENATOR COATED WITH BIOPASSIVE SURFACE COATING (U.S. CLS. 26, 39 AND 44).

FIRST USE 4-30-2002; IN COMMERCE 4-30-2002.

2,730,736. JUST FOR MOMS, RESEDA, CA. SN 78-089,534. PUB. 7-2-2002, FILED 10-22-2001.



NO CLAIM IS MADE TO THE EXCLUSIVE RIGHT TO USE "JUST FOR MOMS", APART FROM THE MARK AS SHOWN.

FOR PREGNANCY DISCOMFORT RELIEF PRODUCTS AND MASSAGE AND ACUPRESSURE PRODUCTS, NAMELY, PILLOWS FOR MEDICAL USE (U.S. CLS. 26, 39 AND 44).

FIRST USE 12-1-2002; IN COMMERCE 12-1-2002.

CLASS 10—(Continued).

2,730,788. AMS RESEARCH CORPORATION, MINNETONKA, MN, BY ASSIGNMENT AMERICAN MEDICAL SYSTEMS, INC., MINNETONKA, MN. SN 78-102,075. PUB. 8-20-2002, FILED 1-10-2002.

INTEMESH

FOR MEDICAL PRODUCTS, NAMELY, IMPLANTABLE SYNTHETIC RECONSTRUCTIVE MATERIAL FOR USE IN SOFT TISSUE SUPPORT AND RECONSTRUCTIVE SURGERY (U.S. CLS. 26, 39 AND 44).

FIRST USE 8-15-2002; IN COMMERCE 8-15-2002.

2,730,814. MICRODENTAL LABORATORIES, DUBLIN, CA. SN 78-109,188. PUB. 9-24-2002, FILED 2-15-2002.

MICROFIT

FOR PRESSURE INJECTED CUSTOM DENTURE PLATE (U.S. CLS. 26, 39 AND 44).

FIRST USE 5-1-2002; IN COMMERCE 5-1-2002.

2,730,822. EVERYTHING FOR LOVE, INC., PINE MOUNTAIN, CA. SN 78-112,083. PUB. 9-24-2002, FILED 3-1-2002.

SQWIGGLER

FOR MASSAGE APPARATUS, ELECTRIC AND NON-ELECTRIC (U.S. CLS. 26, 39 AND 44).

FIRST USE 2-15-2003; IN COMMERCE 2-15-2003.

2,730,827. BAYER CORPORATION, PITTSBURGH, PA. SN 78-114,845. PUB. 9-24-2002, FILED 3-14-2002.

ASCENSIA ELITE

FOR MEDICAL DIAGNOSTIC INSTRUMENTS FOR THE ANALYSIS OF BODY FLUIDS; LANCING DEVICES (U.S. CLS. 26, 39 AND 44).

FIRST USE 6-15-2002; IN COMMERCE 6-15-2002.

CLASS 11—ENVIRONMENTAL CONTROL APPARATUS

2,729,364. FRENCH, JOHN R., SAN DIEGO, CA. SN 75-196,819. PUB. 11-25-1997, FILED 11-12-1996.

CALIFORNIA CAMPFIRE

NO CLAIM IS MADE TO THE EXCLUSIVE RIGHT TO USE "CALIFORNIA", APART FROM THE MARK AS SHOWN.

FOR PORTABLE STRUCTURES IN WHICH AN OUTDOOR FIRE CAN BE BUILT (U.S. CLS. 13, 21, 23, 31 AND 34).

FIRST USE 11-11-2002; IN COMMERCE 11-11-2002.

CLASS 11—(Continued).

2,729,388. TETRA LAVAL HOLDINGS & FINANCE S.A., CH-1009 PULLY, SWITZERLAND. SN 75-482,619. PUB. 12-14-1999, FILED 5-11-1998.

HOYER COMET

PRIORITY CLAIMED UNDER SEC. 44(D) ON SWITZERLAND APPLICATION NO. VA05714, FILED 11-17-1997.

FOR PASTEURIZING; UNITS, FREEZERS, AND FREEZERS FOR ICE CREAM (U.S. CLS. 13, 21, 23, 31 AND 34).

FIRST USE 11-0-1997; IN COMMERCE 7-0-1998.

2,729,596. MARTHA STEWART LIVING OMNIMEDIA, INC., NEW YORK, NY. SN 75-907,594. PUB. 6-25-2002, FILED 2-1-2000.

**MARTHA STEWART
EVERYDAY**

THE NAME "MARTHA STEWART" IDENTIFIES A LIVING INDIVIDUAL WHOSE CONSENT IS OF RECORD.

FOR INDOOR LIGHTING, NAMELY, ELECTRICALLY OPERATED LAMPS AND LIGHTING FIXTURES (U.S. CLS. 13, 21, 23, 31 AND 34).

FIRST USE 7-23-2001; IN COMMERCE 7-23-2001.

2,729,641. TOTES ISOTONER CORPORATION, CINCINNATI, OH. SN 75-981,994. PUB. 8-27-2002, FILED 5-29-2001.

IMAGES BY TOTES

FOR BATTERY POWERED LIGHTS, NAMELY, FLASHLIGHT, LAMP AND SPOTLIGHT (U.S. CLS. 13, 21, 23, 31 AND 34).

FIRST USE 6-30-1998; IN COMMERCE 6-30-1998.

2,729,654. WU, TAMMIE P., NEW YORK, NY. SN 75-983,217. PUB. 10-5-1999, FILED 11-25-1998.

MASTERWERKE

FOR HOUSEHOLD APPLIANCES, NAMELY ELECTRIC TOASTERS, TOASTER OVENS, STEAM TOASTER OVENS, ROASTERS, BROILERS, ROTISSERIES, AND PARTS THEREFOR (U.S. CLS. 13, 21, 23, 31 AND 34).

FIRST USE 5-30-2002; IN COMMERCE 5-30-2002.

CLASS 11—(Continued).

2,729,665. SUNPENTOWN INTERNATIONAL INC., CITY OF INDUSTRY, CA. SN 76-007,244. PUB. 2-20-2001, FILED 3-22-2000.



THE ENGLISH TRANSLATION OF "TAKASIMA" IS "HIGH ISLAND".

FOR HOUSEHOLD AIR CLEANERS, AIR PURIFYING UNITS FOR DOMESTIC USE, ELECTRIC FANS, HUMIDIFIERS, ELECTRIC FANS, ELECTRIC GRIDDLES, ELECTRIC HEATERS, ELECTRIC HOT PLATES, ELECTRIC KETTLES, AIR CONDITIONERS, ELECTRIC LAMPS, LAMP SHADES, OVENS FOR DOMESTIC COOKING, ELECTRIC PRESSURE COOKERS, ELECTRIC RICE COOKERS, ELECTRIC STOVES, ELECTRIC TOASTERS, KEROSENE HEATERS, WATER DISPENSERS FOR DOMESTIC USE AND ELECTRIC SLOW COOKERS (U.S. CLS. 13, 21, 23, 31 AND 34).

FIRST USE 1-6-2003; IN COMMERCE 1-6-2003.

2,729,741. COMBINED TALENTS, INC., HARLAN, IN. SN 76-079,629. PUB. 3-20-2001, FILED 6-28-2000.

EVERMORE

FOR ELECTRIC CANDLES (U.S. CLS. 13, 21, 23, 31 AND 34).

FIRST USE 6-3-2000; IN COMMERCE 8-8-2000.

CLASS 11—(Continued).

2,729,818. TRUCK-LITE CO., INC, FALCONER, NY. SN 76-130,352. PUB. 7-30-2002, FILED 9-16-2000.

35

OWNER OF U.S. REG. NO. 2,185,931.
 FOR LIGHT EMITTING DIODES LIGHTING PRODUCTS FOR VEHICLES, NAMELY, HEADLIGHTS, TAILLIGHTS, MARKER LIGHTS, CLEARANCE LIGHTS, IDENTIFICATION LIGHTS, STOP LIGHTS, TURN LIGHTS, LIGHTING KITS, LICENSE PLATE LIGHTS, BACK-UP LIGHTS, INTERIOR AND UTILITY LIGHTS, SNOW PLOW LIGHTS, FOG AND DRIVING LIGHTS, WARNING AND EMERGENCY LIGHTS, DAYTIME RUNNING LIGHT SYSTEMS, AND FLASHING LIGHTS; INCANDESCENT LIGHTING PRODUCTS FOR VEHICLES, NAMELY, HEADLIGHTS, TAILLIGHTS, MARKER LIGHTS, CLEARANCE LIGHTS, IDENTIFICATION LIGHTS, STOP LIGHTS, TURN LIGHTS, LIGHTING KITS, LICENSE PLATE LIGHTS, BACK-UP LIGHTS, INTERIOR AND UTILITY LIGHTS, SNOW PLOW LIGHTS, FOG AND DRIVING LIGHTS, WARNING AND EMERGENCY LIGHTS, DAYTIME RUNNING LIGHT SYSTEMS, AND FLASHING LIGHTS (U.S. CLS. 13, 21, 23, 31 AND 34).
 FIRST USE 9-30-2002; IN COMMERCE 9-30-2002.

2,729,819. TRUCK-LITE CO., INC., FALCONER, NY. SN 76-130,437. PUB. 7-30-2002, FILED 9-16-2000.

15

OWNER OF U.S. REG. NO. 2,185,931.
 FOR LIGHT EMITTING DIODES LIGHTING PRODUCTS FOR VEHICLES, NAMELY, HEADLIGHTS, TAIL LIGHTS, MARKER LIGHTS, CLEARANCE LIGHTS, IDENTIFICATION LIGHTS, STOP LIGHTS, TURN LIGHTS, LIGHTING KITS COMPRISED OF LAMPS, GROMMETS, PLUGS, FLANGES, LICENSE PLATE LIGHTS, BACK-UP LIGHTS, INTERIOR AND UTILITY LIGHTS, SNOW PLOW LIGHTS, FOG AND DRIVING LIGHTS, DAYTIME RUNNING LIGHTS, AND FLASHING LIGHTS; INCANDESCENT LIGHTING PRODUCTS FOR VEHICLES, NAMELY, HEADLIGHTS, TAIL LIGHTS, MARKER LIGHTS, CLEARANCE LIGHTS, IDENTIFICATION LIGHTS, STOP LIGHTS, TURN LIGHTS, LIGHTING KITS COMPRISED OF LAMPS, GROMMETS, PLUGS, FLANGES, LICENSE PLATE LIGHTS, BACK-UP LIGHTS, INTERIOR AND UTILITY LIGHTS, SNOW PLOW LIGHTS, FOG AND DRIVING LIGHTS, DAYTIME RUNNING LIGHTS, AND FLASHING LIGHTS (U.S. CLS. 13, 21, 23, 31 AND 34).
 FIRST USE 9-17-2002; IN COMMERCE 9-17-2002.

CLASS 11—(Continued).

2,729,820. TRUCK-LITE CO., INC., FALCONER, NY. SN 76-130,441. PUB. 7-30-2002, FILED 9-16-2000.

21

OWNER OF U.S. REG. NO. 2,185,931.
 FOR LIGHT EMITTING DIODES LIGHTING PRODUCTS FOR VEHICLES, NAMELY, HEADLIGHTS, TAIL LIGHTS, MARKER LIGHTS, CLEARANCE LIGHTS, IDENTIFICATION LIGHTS, STOP LIGHTS, TURN LIGHTS, LIGHTING KITS COMPRISED OF LAMPS, FLANGES, ADAPTER PLUGS, AND GROMMETS, LICENSE PLATE LIGHTS, BACK-UP LIGHTS, INTERIOR AND UTILITY LIGHTS, SNOW PLOW LIGHTS, FOG AND DRIVING LIGHTS, DAYTIME RUNNING LIGHTS, AND FLASHING LIGHTS; INCANDESCENT LIGHTING PRODUCTS FOR VEHICLES, NAMELY, HEADLIGHTS, TAIL LIGHTS, MARKER LIGHTS, CLEARANCE LIGHTS, IDENTIFICATION LIGHTS, STOP LIGHTS, TURN LIGHTS, LIGHTING KITS COMPRISED OF FLANGES, LAMPS, GROMMETS AND ADAPTER PLUGS, LICENSE PLATS LIGHTS, BACK-UP LIGHTS, INTERIOR AND UTILITY LIGHTS, SNOW PLOW LIGHTS, FOG AND DRIVING LIGHTS, DAYTIME RUNNING LIGHTS, AND FLASHING LIGHTS (U.S. CLS. 13, 21, 23, 31 AND 34).
 FIRST USE 9-17-2002; IN COMMERCE 9-17-2002.

2,729,821. TRUCK-LITE CO., FALCONER, NY. SN 76-130,446. PUB. 8-6-2002, FILED 9-16-2000.

12

OWNER OF U.S. REG. NO. 2,185,931.
 FOR LIGHT EMITTING DIODES LIGHTING PRODUCTS FOR VEHICLES, NAMELY, HEADLIGHTS, TAIL LIGHTS, MARKER LIGHTS, CLEARANCE LIGHTS, IDENTIFICATION LIGHTS, STOP LIGHTS, TURN LIGHTS, LIGHTING KITS COMPRISED OF FLANGES, LAMPS, ADAPTER PLUGS AND GROMMETS, LICENSE PLATE LIGHTS, BACK-UP LIGHTS, INTERIOR AND UTILITY LIGHTS, SNOW PLOW LIGHTS, FOG AND DRIVING LIGHTS, DAYTIME RUNNING LIGHTS, AND FLASHING LIGHTS; INCANDESCENT LIGHTING PRODUCTS FOR VEHICLES, NAMELY, HEADLIGHTS, TAIL LIGHTS, MARKER LIGHTS, CLEARANCE LIGHTS, IDENTIFICATION LIGHTS, STOP LIGHTS, TURN LIGHTS, LIGHTING KITS COMPRISED OF FLANGES, LAMPS, ADAPTER PLUGS AND GROMMETS, LICENSE PLATE LIGHTS, BACK-UP LIGHTS, INTERIOR AND UTILITY LIGHTS, SNOW PLOW LIGHTS, FOG AND DRIVING LIGHTS, DAYTIME RUNNING LIGHTS, AND FLASHING LIGHTS (U.S. CLS. 13, 21, 23, 31 AND 34).
 FIRST USE 9-17-2002; IN COMMERCE 9-17-2002.

CLASS 11—(Continued).

2,729,923. SAMSUNG ELECTRONICS CO., LTD., KYUNGKI-DO, REPUBLIC OF KOREA. SN 76-190,695. PUB. 7-9-2002, FILED 1-8-2001.



NO CLAIM IS MADE TO THE EXCLUSIVE RIGHT TO USE "DIGITAL VARIABLE MULTI", APART FROM THE MARK AS SHOWN.

FOR AIR CONDITIONERS FOR USE IN BUILDINGS AND RESIDENCES (U.S. CLS. 13, 21, 23, 31 AND 34). FIRST USE 2-0-2001; IN COMMERCE 2-0-2001.

2,729,932. HUNTER FAN COMPANY, MEMPHIS, TN. SN 76-193,540. PUB. 5-21-2002, FILED 1-15-2001.

THE CASCADE

OWNER OF U.S. REG. NO. 1,541,443. FOR OUTDOOR PATIO FAN MOUNTS FOR CEILING FANS (U.S. CLS. 13, 21, 23, 31 AND 34). FIRST USE 4-4-2001; IN COMMERCE 4-4-2001.

2,730,018. PHILIPS ELECTRONICS NORTH AMERICA CORPORATION, NEW YORK, NY. SN 76-231,703. PUB. 1-8-2002, FILED 3-27-2001.

DURAMAX

FOR ELECTRIC LIGHT BULBS (U.S. CLS. 13, 21, 23, 31 AND 34). FIRST USE 6-10-2002; IN COMMERCE 6-23-2002.

2,730,042. EVEREADY BATTERY COMPANY, INC., ST. LOUIS, MO. SN 76-242,018. PUB. 5-28-2002, FILED 4-17-2001.

COMFORT GRIP

FOR FLASHLIGHTS (U.S. CLS. 13, 21, 23, 31 AND 34). FIRST USE 12-4-2001; IN COMMERCE 12-4-2001.

CLASS 11—(Continued).

2,730,103. WATER PIK, INC., NEWPORT BEACH, CA. SN 76-263,762. PUB. 12-11-2001, FILED 5-29-2001.

WATERPIK

OWNER OF U.S. REG. NOS. 923,514, 1,967,141, AND OTHERS. FOR PERSONAL CARE FOOT SPAS AND BATH SPAS (U.S. CLS. 13, 21, 23, 31 AND 34). FIRST USE 1-11-2002; IN COMMERCE 1-11-2002.

2,730,175. BEEVINWOOD, INC., WEST MANCHESTER, OH. SN 76-285,944. PUB. 11-6-2001, FILED 7-9-2001.

KOMFORT-MODE

FOR PORTABLE TOILET COMMODO (U.S. CLS. 13, 21, 23, 31 AND 34). FIRST USE 10-28-2002; IN COMMERCE 12-10-2002.

2,730,255. CORDELIA LIGHTING, INC., RANCHO DOMINGUEZ, CA. SN 76-308,133. PUB. 4-16-2002, FILED 8-31-2001.

ALTAIR FANCOMPANY

NO CLAIM IS MADE TO THE EXCLUSIVE RIGHT TO USE "FAN COMPANY", APART FROM THE MARK AS SHOWN. FOR CEILING FANS, CEILING FAN ACCESSORIES, NAMELY LIGHT KITS (U.S. CLS. 13, 21, 23, 31 AND 34). FIRST USE 10-2-2001; IN COMMERCE 10-2-2001.

2,730,265. MARLEY COOLING TECHNOLOGIES, INC., OVERLAND PARK, KS, BY ASSIGNMENT MARLEY COOLING TOWER COMPANY, THE, OVERLAND PARK, KS. SN 76-312,915. PUB. 8-27-2002, FILED 9-17-2001.

PRIMUS

THE ENGLISH TRANSLATION OF THE LATIN WORD "PRIMUS" IS "FIRST". FOR WATER COOLING TOWERS (U.S. CLS. 13, 21, 23, 31 AND 34). FIRST USE 2-21-2002; IN COMMERCE 2-21-2002.

2,730,329. SMITH & LOVELESS, INC., LENEXA, KS. SN 76-328,788. PUB. 7-2-2002, FILED 10-23-2001.

PROTRONIX

FOR WASTEWATER TREATMENT EQUIPMENT, NAMELY, WETWELL MOUNTED PUMP STATIONS (U.S. CLS. 13, 21, 23, 31 AND 34). FIRST USE 1-11-2002; IN COMMERCE 1-11-2002.

CLASS 11—(Continued).

2,730,437. WATKINS MANUFACTURING CORPORATION, VISTA, CA. SN 76-352,182. PUB. 6-11-2002, FILED 12-21-2001.

EURO-PULSE

FOR HYDROJETS SOLD AS A COMPONENT OF SPAS IN THE NATURE OF HEATED WHIRLPOOLS (U.S. CLS. 13, 21, 23, 31 AND 34).
FIRST USE 2-8-2001; IN COMMERCE 2-8-2001.

2,730,438. WATKINS MANUFACTURING CORPORATION, VISTA, CA. SN 76-352,592. PUB. 5-28-2002, FILED 12-21-2001.

Q CHAMBER

FOR EQUIPMENT COMPARTMENT SOLD AS A COMPONENT OF SPAS IN THE NATURE OF HEATED WHIRLPOOLS (U.S. CLS. 13, 21, 23, 31 AND 34).
FIRST USE 8-17-2001; IN COMMERCE 8-17-2001.

2,730,439. WATKINS MANUFACTURING CORPORATION, VISTA, CA. SN 76-352,638. PUB. 5-28-2002, FILED 12-21-2001.

SOLE SOOTHERS

FOR HYDROJETS SOLD AS A COMPONENT OF SPAS IN THE NATURE OF HEATED WHIRLPOOLS (U.S. CLS. 13, 21, 23, 31 AND 34).
FIRST USE 3-8-2001; IN COMMERCE 3-8-2001.

2,730,474. H & H INDUSTRIES, INC., ELMWOOD, IL. SN 76-362,055. PUB. 9-17-2002, FILED 1-22-2002.

TASK-MASTER

FOR INCANDESCENT LIGHT BULBS FOR USE IN TRAFFIC SIGNALS (U.S. CLS. 13, 21, 23, 31 AND 34).
FIRST USE 2-6-2001; IN COMMERCE 2-6-2001.

2,730,504. AQUA GLASS CORPORATION, ADAMSVILLE, TN. SN 76-373,695. PUB. 6-25-2002, FILED 2-20-2002.

TITAN

FOR BASE FOR TUB AND SHOWER SURROUNDS (U.S. CLS. 13, 21, 23, 31 AND 34).
FIRST USE 10-29-2002; IN COMMERCE 10-29-2002.

CLASS 11—(Continued).

2,730,517. CHERNE INDUSTRIES INCORPORATED, MINNEAPOLIS, MN. SN 76-381,318. PUB. 9-24-2002, FILED 3-13-2002.

I-SERIES

FOR PLUMBING SUPPLIES, NAMELY, PNEUMATIC PIPELINE PLUGS (U.S. CLS. 13, 21, 23, 31 AND 34).
FIRST USE 3-11-2002; IN COMMERCE 3-11-2002.

2,730,530. HALOGEN LIGHTING PRODUCTS CORPORATION, KANEVILLE, IL. SN 76-409,571. PUB. 11-19-2002, FILED 5-16-2002.



OWNER OF U.S. REG. NOS. 2,162,561, 2,458,562, AND OTHERS.

THE MARK IS NOT LINED FOR COLOR. STIPPLING INDICATES SHADING.

FOR ELECTRIC LIGHTING FIXTURES (U.S. CLS. 13, 21, 23, 31 AND 34).
FIRST USE 9-1-2002; IN COMMERCE 9-1-2002.

2,730,565. SELUX CORPORATION, HIGHLAND, NY. SN 78-026,576. PUB. 9-4-2001, FILED 9-19-2000.

ARC

FOR ELECTRIC LIGHTING FIXTURE; NAMELY, AN EXTERIOR, POLE MOUNTED, LIGHT FIXTURE (U.S. CLS. 13, 21, 23, 31 AND 34).
FIRST USE 5-23-2000; IN COMMERCE 1-7-2002.

2,730,576. MILLIPORE CORPORATION, BILLERICA, MA. SN 78-035,357. PUB. 8-13-2002, FILED 11-15-2000.

SYNERGY

FOR WATER PURIFICATION UNITS AND PARTS THEREFOR (U.S. CLS. 13, 21, 23, 31 AND 34).
FIRST USE 4-25-2001; IN COMMERCE 4-25-2001.

CLASS 11—(Continued).

2,730,614. HP INTELLECTUAL CORP., WILMINGTON, CT. SN 78-050,376. PUB. 12-11-2001, FILED 2-27-2001.

THERMAL SELECT

NO CLAIM IS MADE TO THE EXCLUSIVE RIGHT TO USE "THERMAL", APART FROM THE MARK AS SHOWN. FOR ELECTRIC COFFEEMAKERS FOR DOMESTIC USE (U.S. CLS. 13, 21, 23, 31 AND 34). FIRST USE 4-30-2000; IN COMMERCE 4-30-2000.

2,730,639. SNYDER, PAUL E., MIAMI, FL. SN 78-059,440. PUB. 9-24-2002, FILED 4-20-2001.

Truly
FRAMELESS

NO CLAIM IS MADE TO THE EXCLUSIVE RIGHT TO USE "FRAMELESS", APART FROM THE MARK AS SHOWN. FOR CUSTOM SHOWER ENCLOSURES (U.S. CLS. 13, 21, 23, 31 AND 34). FIRST USE 1-1-1995; IN COMMERCE 1-1-2000.

CLASS 12—VEHICLES

2,729,375. MITSUBISHI MOTORS NORTH AMERICA, INC., CYPRESS, CA, BY CHANGE OF NAME MITSUBISHI MOTOR SALES OF AMERICA, INC., CYPRESS, CA. SN 75-408,539. PUB. 3-6-2001, FILED 12-19-1997.

OUTLANDER

FOR AUTOMOBILES AND STRUCTURAL PARTS THEREOF (U.S. CLS. 19, 21, 23, 31, 35 AND 44). FIRST USE 10-9-2002; IN COMMERCE 10-9-2002.

CLASS 12—(Continued).

2,729,396. GENMAR INDUSTRIES, INC., MINNEAPOLIS, MN. SN 75-506,182. PUB. 1-22-2002, FILED 6-24-1998.



NO CLAIM IS MADE TO THE EXCLUSIVE RIGHT TO USE "INTEGRATED" AND "STRAKE", APART FROM THE MARK AS SHOWN. FOR BOATS (U.S. CLS. 19, 21, 23, 31, 35 AND 44). FIRST USE 7-18-1997; IN COMMERCE 7-18-1997.

2,729,438. RODMAN, LINDA, LONG BEACH, CA. SN 75-641,491. PUB. 11-23-1999, FILED 2-18-1999.

DUB

FOR LAND VEHICLE PARTS, NAMELY WHEELS (U.S. CLS. 19, 21, 23, 31, 35 AND 44). FIRST USE 1-29-2003; IN COMMERCE 1-29-2003.

2,729,441. AMERICAN AXLE & MANUFACTURING, INC., DETROIT, MI. SN 75-650,445. PUB. 12-7-1999, FILED 2-22-1999.

RADIAX

FOR AUTOMOBILE PARTS, NAMELY, A PIVOT JOINT USED IN CONNECTION WITH IDLER ARM ASSEMBLIES (U.S. CLS. 19, 21, 23, 31, 35 AND 44). FIRST USE 5-0-2002; IN COMMERCE 5-0-2002.

2,729,530. BRAKE SENTRY, LLC, ASHEVILLE, NC, BY ASSIGNMENT FLEET MAINTENANCE TECHNOLOGIES, INC., PANAMA CITY, FL. SN 75-820,237. PUB. 8-8-2000, FILED 11-1-1999.

BRAKE SENTRY

NO CLAIM IS MADE TO THE EXCLUSIVE RIGHT TO USE "BRAKE", APART FROM THE MARK AS SHOWN. FOR BRAKE HARDWARE FOR VEHICLES (U.S. CLS. 19, 21, 23, 31, 35 AND 44). FIRST USE 7-1-2000; IN COMMERCE 8-20-2000.

CLASS 12—(Continued).

2,729,548. EMLER, DON, RANCHO DOMINGUEZ, CA. SN 75-846,423. PUB. 10-31-2000, FILED 11-2-1999.

GNARLY

FOR MOTORCYCLE EXHAUST PIPES (U.S. CLS. 19, 21, 23, 31, 35 AND 44).
FIRST USE 1-10-1999; IN COMMERCE 3-1-1999.

2,729,591. NANAIMO SHIPYARD LTD., NANAIMO, BRITISH COLUMBIA V9S 4C9, CANADA, BY ASSIGNMENT ALLSOP, JON, BRITISH COLUMBIA V9F 9J8, CANADA. SN 75-903,318. PUB. 1-16-2001, FILED 1-25-2000.

OCEANHAVEN

FOR BOATS (U.S. CLS. 19, 21, 23, 31, 35 AND 44).
FIRST USE 11-13-2002; IN COMMERCE 11-13-2002.

2,729,763. DEERE & COMPANY, MOLINE, IL. SN 76-094,557. PUB. 7-23-2002, FILED 7-19-2000.



FOR WAGONS, WHEEL AND CRAWLER TRACTORS AND ENGINES AND PARTS THEREFOR, MOTORIZED UTILITY CARTS FOR USE IN MATERIAL TRANSPORT, AND GASOLINE AND DIESEL INTERNAL COMBUSTION ENGINES FOR THE AFOREMENTIONED VEHICLES, AND DUMP TRUCKS AND TRACTORS (U.S. CLS. 19, 21, 23, 31, 35 AND 44).
FIRST USE 11-1-2000; IN COMMERCE 11-1-2000.

CLASS 12—(Continued).

2,729,913. E-TON DYNAMICS TECHNOLOGY INDUSTRY CO., LTD., TAINAN, TAIWAN. SN 76-187,635. PUB. 7-16-2002, FILED 12-28-2000.

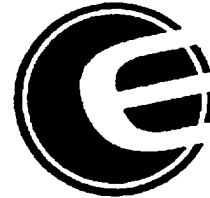

FOR ELECTRIC VEHICLES FOR THE PHYSICALLY HANDICAPPED PATIENTS, NAMELY, WHEEL CHAIRS; MOTORIZED GOLF CARTS; ELECTRIC BIKES (U.S. CLS. 19, 21, 23, 31, 35 AND 44).
FIRST USE 7-13-2001; IN COMMERCE 7-13-2001.

2,729,929. YAMAHA HATSUDOKI KABUSHIKI KAISHA, SHIZUOKA-KEN, JAPAN. SN 76-192,797. PUB. 9-18-2001, FILED 1-10-2001.

X-REAS

FOR SHOCK ABSORBERS FOR VEHICLES (U.S. CLS. 19, 21, 23, 31, 35 AND 44).
FIRST USE 11-0-2002; IN COMMERCE 11-0-2002.

2,730,026. HANKOOK TIRE CO., LTD., SEOUL, 135-723, REPUBLIC OF KOREA. SN 76-235,584. PUB. 10-9-2001, FILED 4-3-2001.

PATHBREAKER

FOR TIRES, INNER TUBES FOR VEHICLE TIRES (U.S. CLS. 19, 21, 23, 31, 35 AND 44).
FIRST USE 10-7-2002; IN COMMERCE 11-8-2002.

CLASS 12—(Continued).

2,730,045. MITSUBISHI MOTORS NORTH AMERICA, INC., CYPRESS, CA, BY CHANGE OF NAME MITSUBISHI MOTOR SALES OF AMERICA, INC., CYPRESS, CA. SN 76-242,559. PUB. 6-11-2002, FILED 4-18-2001.



NO CLAIM IS MADE TO THE EXCLUSIVE RIGHT TO USE "4WD", APART FROM THE MARK AS SHOWN.
FOR MOTOR VEHICLES, NAMELY, AUTOMOBILES, SPORT UTILITY VEHICLES AND STRUCTURAL PARTS THEREOF (U.S. CLS. 19, 21, 23, 31, 35 AND 44).
FIRST USE 9-5-2001; IN COMMERCE 9-5-2001.

2,730,065. JAYCO, INC., MIDDLEBURY, IN. SN 76-250,347. PUB. 5-28-2002, FILED 5-2-2001.

GRANITE RIDGE

FOR RECREATION VEHICLES, NAMELY, MOTOR HOMES (U.S. CLS. 19, 21, 23, 31, 35 AND 44).
FIRST USE 6-30-2001; IN COMMERCE 7-1-2001.

2,730,072. AMERICAN SPORTS DESIGN COMPANY, SPRINGBORO, OH. SN 76-254,009. PUB. 9-10-2002, FILED 5-8-2001.

THUNDERBOLT

FOR BICYCLES AND STRUCTURAL PARTS THEREOF (U.S. CLS. 19, 21, 23, 31, 35 AND 44).
FIRST USE 9-30-2002; IN COMMERCE 9-30-2002.

2,730,161. WARWICK MILLS, INC., NEW IPSWICH, NH. SN 76-281,491. PUB. 5-14-2002, FILED 7-5-2001.



OWNER OF U.S. REG. NO. 2,126,913.
THE STIPPLING IS A FEATURE OF THE MARK AND DOES NOT INDICATE COLOR.
FOR BICYCLE TIRES; TIRE LINERS FOR BICYCLES AND INNER TUBES FOR BICYCLE TIRES (U.S. CLS. 19, 21, 23, 31, 35 AND 44).
FIRST USE 8-29-1996; IN COMMERCE 8-29-1996.

CLASS 12—(Continued).

2,730,248. SUZUKI MOTOR CORPORATION, SHIZUOKA-PREF. 432-8611, JAPAN. SN 76-307,131. PUB. 9-24-2002, FILED 8-29-2001.

V-STROM

PRIORITY CLAIMED UNDER SEC. 44(D) ON JAPAN APPLICATION NO. 2001-19094, FILED 3-5-2001.
FOR VEHICLES FOR LOCOMOTION BY LAND NAMELY MOTORCYCLES AND STRUCTURAL AND REPLACEMENT PARTS THEREOF (U.S. CLS. 19, 21, 23, 31, 35 AND 44).
FIRST USE 2-1-2002; IN COMMERCE 2-1-2002.

2,730,254. DEFLECTA-SHIELD ACCESSORIES, INC., HOWE, IN, BY CHANGE OF NAME DELTA III, INC., HOWE, IN. SN 76-308,012. PUB. 3-19-2002, FILED 8-31-2001.

TAIL-LOADER

FOR CARGO CARRIERS FOR VEHICLES (U.S. CLS. 19, 21, 23, 31, 35 AND 44).
FIRST USE 10-27-2001; IN COMMERCE 6-1-2002.

2,730,418. WINGATE, MATTHEW J., DURHAM, NH. SN 76-349,293. PUB. 7-2-2002, FILED 12-18-2001.

R2R

FOR VEHICLE ROOF RACKS AND ATTACHMENTS THEREOF, NAMELY, CARGO CARRIERS, SKI CARRIERS, SAILBOARD CARRIERS, KAYAK CARRIERS, SURFBOARD CARRIERS, SNOWBOARD CARRIERS, AND BICYCLE CARRIERS; VEHICLE REAR-MOUNTED CARRIERS FOR VEHICLES, CARGO CARRIERS, SKI CARRIERS, SAILBOARD CARRIERS, KAYAK CARRIERS, SURFBOARD CARRIERS, SNOWBOARD CARRIERS, AND BICYCLE CARRIERS; VEHICLE SEAT COVERS AND HATCHBACK AND CARGO BED COVERS (U.S. CLS. 19, 21, 23, 31, 35 AND 44).
FIRST USE 10-5-2002; IN COMMERCE 10-5-2002.

2,730,505. KOOL STOP INTERNATIONAL, INC., LAKE OSWEGO, OR. SN 76-374,043. PUB. 6-25-2002, FILED 2-25-2002.

KOOL-FOLD

FOR JOGGING STROLLERS (U.S. CLS. 19, 21, 23, 31, 35 AND 44).
FIRST USE 7-0-2002; IN COMMERCE 7-0-2002.

CLASS 12—(Continued).

2,730,510. SRAM CORPORATION, CHICAGO, IL, BY ASSIGNMENT ROCKSHOX, INC., COLORADO SPRINGS, CO. SN 76-374,771. PUB. 8-6-2002, FILED 2-25-2002.

CLASS 12—(Continued).

2,730,662. SSANG YONG MOTOR COMPANY, KYUNGGI-DO, REPUBLIC OF KOREA. SN 78-068,111. PUB. 5-14-2002, FILED 6-8-2001.

PILOT

FOR BICYCLE PARTS, NAMELY, BICYCLE SHOCK ABSORBERS, BICYCLE SUSPENSIONS AND BICYCLE FORKS (U.S. CLS. 19, 21, 23, 31, 35 AND 44).
FIRST USE 1-15-2002; IN COMMERCE 1-15-2002.



2,730,529. EVENFLO COMPANY, INC., VANDALIA, OH. SN 76-404,167. PUB. 10-29-2002, FILED 5-7-2002.

OWNER OF U.S. REG. NO. 2,129,868.
NO CLAIM IS MADE TO THE EXCLUSIVE RIGHT TO USE "MOTOR", APART FROM THE MARK AS SHOWN.
THE STIPLING IN THE DRAWING IS FOR SHADING PURPOSES ONLY AND DOES NOT INDICATE COLOR.
THE ENGLISH TRANSLATION OF THE WORD "SSANGYONG" IN THE MARK IS "TWIN DRAGONS".

FOR SPORTS UTILITY VEHICLES, MULTI-PURPOSE VEHICLES, PASSENGER CARS, VANS, PICK-UP TRUCKS, BUSES, TRACTOR TRAILERS, DUMP TRUCKS, RACING CARS, VEHICLE WHEELS, AND FORK LIFT TRUCKS AND MOTORCYCLES (U.S. CLS. 19, 21, 23, 31, 35 AND 44).
FIRST USE 2-7-2002; IN COMMERCE 2-7-2002.

CHASE

FOR CHILD CAR SEATS (U.S. CLS. 19, 21, 23, 31, 35 AND 44).
FIRST USE 11-0-2002; IN COMMERCE 11-0-2002.

2,730,689. ELECTRO CHEMICAL FINISHING CO., WYOMING, MI. SN 78-076,553. PUB. 12-25-2001, FILED 7-31-2001.

GRENADA

2,730,605. DAIMLERCHRYSLER CORPORATION, AUBURN HILLS, MI. SN 78-046,019. PUB. 11-6-2001, FILED 2-1-2001.

FOR VEHICLE PARTS, NAMELY, BADGES AND LICENSE PLATE FRAMES (U.S. CLS. 19, 21, 23, 31, 35 AND 44).
FIRST USE 7-27-2000; IN COMMERCE 7-27-2000.

DREAM CRUISER

2,730,735. DAIMLERCHRYSLER CORPORATION, AUBURN HILLS, MI. SN 78-089,272. PUB. 3-26-2002, FILED 10-19-2001.

OWNER OF U.S. REG. NO. 2,371,607.
FOR MOTOR VEHICLES, NAMELY, AUTOMOBILES AND STRUCTURAL PARTS THEREOF (U.S. CLS. 19, 21, 23, 31, 35 AND 44).
FIRST USE 1-14-2001; IN COMMERCE 1-14-2001.

WAGONEER

FOR VEHICLES, NAMELY INFANT AND TODDLER STROLLERS (U.S. CLS. 19, 21, 23, 31, 35 AND 44).
FIRST USE 1-13-2002; IN COMMERCE 1-13-2002.

CLASS 12—(Continued).

2,730,784. DAIMLERCHRYSLER CORPORATION, AUBURN HILLS, MI. SN 78-100,874. PUB. 7-16-2002, FILED 1-4-2002.

TRU-LOK

FOR AUTOMOTIVE TRANSMISSION AND DIFFERENTIAL PARTS SOLD AS COMPONENTS OF PASSENGER AUTOMOBILES AND TRUCKS (U.S. CLS. 19, 21, 23, 31, 35 AND 44).

FIRST USE 8-15-2002; IN COMMERCE 8-15-2002.

2,730,801. DAIMLERCHRYSLER CORPORATION, AUBURN HILLS, MI. SN 78-104,622. PUB. 9-3-2002, FILED 1-24-2002.

GTC

FOR MOTOR VEHICLES, NAMELY, PASSENGER AUTOMOBILES, AND STRUCTURAL PARTS AND ENGINES THEREFOR (U.S. CLS. 19, 21, 23, 31, 35 AND 44).

FIRST USE 1-0-2002; IN COMMERCE 1-0-2002.

CLASS 13—FIREARMS

2,729,573. HUNTER PACIFIC LIMITED, TORTOLA, BR. VIRGIN ISLANDS. SN 75-878,059. PUB. 9-12-2000, FILED 12-23-1999.

JUMPING FLASH

FOR FIREWORKS (U.S. CLS. 2 AND 9).

FIRST USE 3-19-2001; IN COMMERCE 3-19-2001.

2,730,092. LOCKHEED MARTIN CORPORATION, BETHESDA, MD. SN 76-260,454. PUB. 1-1-2002, FILED 5-23-2001.

PAC-3

FOR GUIDED MISSILES (U.S. CLS. 2 AND 9).

FIRST USE 9-30-2001; IN COMMERCE 9-30-2001.

2,730,192. SLURRY EXPLOSIVE CORPORATION, OKLAHOMA CITY, OK. SN 76-291,486. PUB. 3-26-2002, FILED 7-30-2001.

PERIMEX

FOR EXPLOSIVE PRODUCTS, NAMELY, WATERGEL EXPLOSIVES (U.S. CLS. 2 AND 9).

FIRST USE 1-15-2003; IN COMMERCE 1-15-2003.

CLASS 14—JEWELRY**CLASS 14—(Continued).**

2,729,390. SMITH, MICHAEL A., COLUMBUS, OH. SN 75-490,684. PUB. 11-23-1999, FILED 5-26-1998.

MORAL COMPASS

FOR JEWELRY (U.S. CLS. 2, 27, 28 AND 50).

FIRST USE 2-12-2003; IN COMMERCE 2-12-2003.

2,729,541. PROGRESS WATCH AG., 2503 BIEL, SWITZERLAND. SN 75-840,768. PUB. 3-5-2002, FILED 11-5-1999.

PROGRESS WATCH

PRIORITY CLAIMED UNDER SEC. 44(D) ON SWITZERLAND APPLICATION NO. 0403011999, FILED 5-7-1999, REG. NO. 473055, DATED 5-15-2000, EXPIRES 5-7-2009.

NO CLAIM IS MADE TO THE EXCLUSIVE RIGHT TO USE "WATCH", APART FROM THE MARK AS SHOWN.

FOR MOVEMENTS FOR WATCHES AND CLOCKS AND PARTS THEREOF (U.S. CLS. 2, 27, 28 AND 50).

FIRST USE 7-31-2000; IN COMMERCE 9-19-2001.

2,729,796. OROAMERICA, INC., BURBANK, CA. SN 76-115,936. PUB. 7-16-2002, FILED 8-25-2000.

TIVOLI

FOR JEWELRY (U.S. CLS. 2, 27, 28 AND 50).

FIRST USE 2-21-2001; IN COMMERCE 2-21-2001.

2,729,865. DIAMCO, LLC, SHORT HILLS, NJ. SN 76-159,090. PUB. 8-14-2001, FILED 11-3-2000.

DIAMCO

FOR DIAMONDS (U.S. CLS. 2, 27, 28 AND 50).

FIRST USE 9-0-2000; IN COMMERCE 9-0-2000.

2,730,046. ERWIN PEARL, INC., NEW YORK, NY. SN 76-243,055. PUB. 12-4-2001, FILED 4-19-2001.

FOREVER PRECIOUS

OWNER OF U.S. REG. NOS. 1,847,329 AND 1,922,884.

NO CLAIM IS MADE TO THE EXCLUSIVE RIGHT TO USE "PRECIOUS", APART FROM THE MARK AS SHOWN.

FOR JEWELRY (U.S. CLS. 2, 27, 28 AND 50).

FIRST USE 10-22-2002; IN COMMERCE 10-22-2002.

CLASS 14—(Continued).

2,730,417. ANDEL JEWELRY, LLC, LONG ISLAND CITY, NY. SN 76-349,203. PUB. 5-28-2002, FILED 12-17-2001.

TODAY AND FOREVER

FOR JEWELRY (U.S. CLS. 2, 27, 28 AND 50).
FIRST USE 10-22-2001; IN COMMERCE 10-22-2001.

2,730,482. DESIGNWORKS JEWELRY GROUP LTD., LONG ISLAND CITY, NY, BY CHANGE OF NAME ORIGINAL DESIGNS INC., LONG ISLAND CITY, NY. SN 76-364,961. PUB. 7-2-2002, FILED 1-30-2002.

CARESSA

FOR FINE GOLD, PLATINUM AND DIAMOND JEWELRY, NAMELY EARRINGS, RINGS, BRACELETS, NECKLACES AND PENDANTS (U.S. CLS. 2, 27, 28 AND 50).
FIRST USE 2-1-2002; IN COMMERCE 2-1-2002.

2,730,521. DIAMINTANGIBLES INTERNATIONAL, LTD., NASSAU, BAHAMAS. SN 76-386,349. PUB. 10-8-2002, FILED 3-25-2002.

ELIXIR OF LIGHT

FOR DIAMONDS AND FINE JEWELRY (U.S. CLS. 2, 27, 28 AND 50).
FIRST USE 3-10-2003; IN COMMERCE 3-10-2003.

CLASS 15—MUSICAL INSTRUMENTS

2,729,389. GUITRON CORPORATION, THE, VERDUN, PROVINCE OF QUEBEC, H3E 1T6, CANADA. SN 75-488,600. PUB. 11-9-1999, FILED 5-20-1998.

GUITRON

FOR ELECTRONIC MUSICAL INSTRUMENTS; MUSIC SYNTHESIZERS (U.S. CLS. 2, 21 AND 36).
FIRST USE 2-24-2000; IN COMMERCE 1-16-2003.

2,729,600. CASIO KEISANKI KABUSHIKI KAISHA, DBA CASIO COMPUTER CO., LTD., SHIBUYA-KU, TOKYO, JAPAN. SN 75-911,622. PUB. 4-24-2001, FILED 2-7-2000.

ZPI SOUND SOURCE

NO CLAIM IS MADE TO THE EXCLUSIVE RIGHT TO USE "SOUND SOURCE", APART FROM THE MARK AS SHOWN.
FOR ELECTRONIC MUSICAL KEYBOARDS (U.S. CLS. 2, 21 AND 36).
FIRST USE 3-0-2000; IN COMMERCE 3-0-2000.

CLASS 15—(Continued).

2,729,602. WILFER, HANS-PETER, D-08258 MARKNEUKIRCHEN, FED REP GERMANY. SN 75-913,184. PUB. 3-19-2002, FILED 2-7-2000.

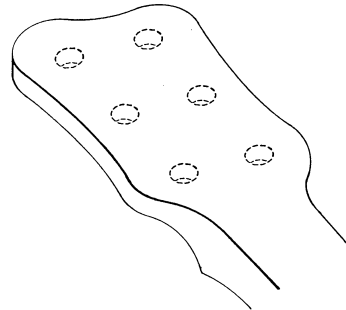

THE MARK CONSISTS OF A CONFIGURATION OF A 6-STRING GUITAR HEAD PLATE.
SEC. 2(F).

FOR GUITARS AND BASS GUITARS, NAMELY, ELECTRIC GUITARS, ELECTRIC BASS GUITARS AND ACOUSTIC GUITARS (U.S. CLS. 2, 21 AND 36).
FIRST USE 11-30-1989; IN COMMERCE 2-28-1990.

2,729,725. KAWAI AMERICA CORPORATION, COMPTON, CA. SN 76-070,042. PUB. 10-16-2001, FILED 6-13-2000.

WINDSOR

FOR PIANOS (U.S. CLS. 2, 21 AND 36).
FIRST USE 12-27-2002; IN COMMERCE 12-27-2002.

2,730,370. OTTO JOS. KLIER MUSIKINSTRUMENTE GMBH, D-91088 BUBENREUTH, FED REP GERMANY. SN 76-339,895. PUB. 7-2-2002, FILED 11-19-2001.

Otto Jos. Klier

THE MARK DOES NOT IDENTIFY A LIVING INDIVIDUAL.
FOR MUSICAL INSTRUMENTS, NAMELY VIOLINS, VIOLAS, CELLOS (U.S. CLS. 2, 21 AND 36).
FIRST USE 12-31-1970; IN COMMERCE 12-31-1970.

CLASS 15—(Continued).

2,730,443. CREATIVE TECHNOLOGY LTD., SINGAPORE 609921, SINGAPORE. SN 76-353,333. PUB. 10-1-2002, FILED 12-27-2001.

CLASS 16—(Continued).

2,729,378. BROWN, LINDSEY M., MARIETTA, GA. AND BROWN, JUDITH W., MARIETTA, GA. SN 75-434,147. PUB. 8-24-1999, FILED 2-13-1998.

PRODIKEYS

FOR MUSICAL INSTRUMENTS; GUITAR STRAPS; GUITAR STRINGS; MUSICAL INSTRUMENT STANDS; SHEET MUSIC STANDS; VALVES FOR MUSICAL INSTRUMENTS; CASES FOR MUSICAL INSTRUMENTS (U.S. CLS. 2, 21 AND 36).

FIRST USE 5-0-2002; IN COMMERCE 10-15-2002.

2,730,485. AVEDIS ZILDJIAN CO., NORWELL, MA. SN 76-365,910. PUB. 6-18-2002, FILED 1-30-2002.

ZXT

FOR MUSICAL PERCUSSION INSTRUMENTS NAMELY, CYMBALS (U.S. CLS. 2, 21 AND 36).
FIRST USE 7-19-2002; IN COMMERCE 7-19-2002.

CLASS 16—PAPER GOODS AND PRINTED MATTER

2,729,363. FINANCIAL TIMES LIMITED, THE, LONDON SE1 9HL, ENGLAND. SN 75-143,436. PUB. 6-12-2001, FILED 8-1-1996.

MASTERING

PRIORITY CLAIMED UNDER SEC. 44(D) ON UNITED KINGDOM APPLICATION NO. 2102810, FILED 6-14-1996.
FOR PRINTED PUBLICATIONS, NAMELY, NEWSPAPERS, MAGAZINES, AND A SERIES OF NON-FICTION BOOKS REGARDING BUSINESS AND FINANCIAL MATTERS; PRINTED INSTRUCTIONAL, EDUCATIONAL, AND TEACHING MATERIALS IN THE FIELDS OF BUSINESS, FINANCE, ECONOMICS AND MARKETING (U.S. CLS. 2, 5, 22, 23, 29, 37, 38 AND 50).
FIRST USE 8-0-1995; IN COMMERCE 5-12-1997.



NO CLAIM IS MADE TO THE EXCLUSIVE RIGHT TO USE "CLUB OF AMERICA", APART FROM THE MARK AS SHOWN.

FOR PRINTED MATERIALS PRINTED WITH THE INDICIA OF A SOCIAL CLUB ALL SPECIFICALLY RELATING TO THE SUBJECT SOCIAL CLUB, NAMELY, STATIONERY, BOOKMARKS, BOOK COVERS, CHILDREN'S BOOKS, PHOTO ALBUMS, PAPER MATS FOR ART WORK, PAPER BANNERS, PAMPHLETS AND NEWSLETTERS RELATING TO THE OPERATION OF THE SUBJECT SOCIAL CLUB, CALENDARS AND MEMBERSHIP KITS CONSISTING PRIMARILY OF PRINTED PAPER MATERIALS, NAMELY, MEMBERSHIP CERTIFICATES, MEMBERSHIP CARDS, NAME BADGES, SIGNS, BANNERS, RULES AND BYLAWS AS WELL AS CHILDREN'S BOOKS (U.S. CLS. 2, 5, 22, 23, 29, 37, 38 AND 50).

FIRST USE 10-28-2002; IN COMMERCE 10-28-2002.

CLASS 16—(Continued).

2,729,380. X PRIZE FOUNDATION, INC., ROCKVILLE, MD.
SN 75-440,645. PUB. 5-4-1999, FILED 2-25-1998.

THE NEW RACE TO SPACE

OWNER OF U.S. REG. NO. 2,362,855.
FOR PRINTED MATTER AND PUBLICATIONS, NAMELY, PAPERBACK AND HARDCOVER BOOKS FEATURING NON-FICTION ABOUT SCIENCE, TRAVEL, HISTORY AND MATH AND FICTION, CHILDREN'S BOOKS, COLORING BOOKS, CHILDREN'S ACTIVITY BOOKS, CROSS WORD PUZZLES, REFERENCE BOOKS FEATURING SCIENCE, TRAVEL, HISTORY AND MATH, EDUCATIONAL BOOKS FEATURING SCIENCE, TRAVEL, HISTORY AND MATH, COMIC BOOKS, CHILDREN'S MAGAZINES, NEWSLETTERS FEATURING ENTERTAINMENT FOR CHILDREN AND EDUCATIONAL TOPICS FOR CHILDREN; PAPER AND PAPER ARTICLES IN THE NATURE OF MEMORABILIA, NAMELY, PRINTED ART REPRODUCTIONS, COMMEMORATIVE COLLAGES, LITHOGRAPHS, GRAPHIC ART REPRODUCTIONS; AUTOGRAPHED AND UN-AUTOGRAPHED MEMORABILIA IN THE NATURE OF UNMOUNTED PHOTOGRAPHS, POSTERS, BOOK COVERS, TRADING CARDS, PLAYING CARDS, COLLECTORS' SCRAPBOOKS FOR PHOTOGRAPHS AND MEMORABILIA, PHOTOGRAPH ALBUMS, STATIONERY FOR SOCIAL AND COMMERCIAL USE, GREETING CARDS, CHRISTMAS CARDS BOXED AND UNBOXED, PAPER GIFT BOXES, GIFT WRAPPING PAPER AND GIFT TRIM IN THE NATURE OF PAPER RIBBONS AND PAPER BOWS; PAPER PARTY DECORATIONS, NAMELY, PAPER WALL DECORATIONS; STICKERS; TABLE PLACEMENTS, NAMELY, PAPER NAPKINS; TOILET PAPER AND FACIAL TISSUES; WRITING PAPER; ENVELOPES; BOXED BLANK NOTE CARDS; NOTE PADS; BINDERS; LOOSE-LEAF BINDERS FOR ORGANIZING; CLIP BOARDS; AND INDEX DIVIDERS (U.S. CLS. 2, 5, 22, 23, 29, 37, 38 AND 50).

FIRST USE 1-22-1998; IN COMMERCE 1-22-1998.

2,729,391. URBAN TELEVISION NETWORK, INC., MARINA DEL RAY, CA. SN 75-491,340. PUB. 4-27-1999, FILED 5-27-1998.

UTN

FOR PRINTED TELEVISION PROGRAM GUIDES (U.S. CLS. 2, 5, 22, 23, 29, 37, 38 AND 50).
FIRST USE 9-5-1998; IN COMMERCE 9-5-1998.

CLASS 16—(Continued).

2,729,512. MORESA, S.A. DE C.V., MEXICO, D.F., MEXICO.
SN 75-789,554. PUB. 4-30-2002, FILED 9-1-1999.



OWNER OF MEXICO REG. NO. 327259, DATED 7-22-1987, RENEWED AS REG. NO. 327259, DATED 7-26-1995, EXPIRES 7-26-2005.

FOR PRINTING AND PUBLICATIONS FOR OTHERS, NAMELY, GENERAL FEATURE MAGAZINES, BROCHURES ABOUT ENGINE COMPONENTS, INSTRUCTION SHEETS ON ENGINE COMPONENTS, AND PICTURES (U.S. CLS. 2, 5, 22, 23, 29, 37, 38 AND 50).

FIRST USE 10-0-1949; IN COMMERCE 1-0-1989.

2,729,514. ASSOCIATION OF AUTOMOTIVE AFTERMARKET DISTRIBUTORS, MEMPHIS, TN. SN 75-795,651. PUB. 10-1-2002, FILED 9-8-1999.

COLLISION PRO

FOR NEWSLETTERS AND BROCHURES ON THE SUBJECT OF AUTOMOTIVE REPAIR PARTS AND SERVICES, MASKING PAPER, MIXING BOARDS, PAINT PADDLES, SPRAY SOCKS, AND PAINT SPREADERS (U.S. CLS. 2, 5, 22, 23, 29, 37, 38 AND 50).

FIRST USE 4-0-2000; IN COMMERCE 4-0-2000.

2,729,517. CHARLES SCHWAB & CO., INC., SAN FRANCISCO, CA. SN 75-802,794. PUB. 9-4-2001, FILED 9-17-1999.

WEBSHOP

FOR PRINTED MATERIALS, NAMELY, PRINTED INSTRUCTIONAL AND TEACHING MATERIALS, WORKSHEETS, AND WORKBOOKS IN THE FIELDS OF INVESTMENT, FINANCE, FINANCIAL PLANNING, PORTFOLIO MANAGEMENT, RETIREMENT PLANNING, MONEY MANAGEMENT, INVESTMENT STRATEGY, AND ASSET ALLOCATION (U.S. CLS. 2, 5, 22, 23, 29, 37, 38 AND 50).

FIRST USE 8-12-1999; IN COMMERCE 8-12-1999.

CLASS 16—(Continued).

2,729,528. BLANEY, MICHAEL JOHN, SANTA MONICA, CA.
SN 75-814,165. PUB. 8-1-2000, FILED 10-4-1999.

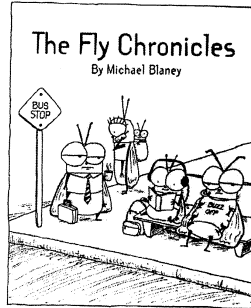

NO CLAIM IS MADE TO THE EXCLUSIVE RIGHT TO USE "CHRONICLES", APART FROM THE MARK AS SHOWN.
FOR COMIC STRIP (U.S. CLS. 2, 5, 22, 23, 29, 37, 38 AND 50).
FIRST USE 10-31-2000; IN COMMERCE 1-15-2003.

2,729,542. GOLDMAN, JANET, NEW YORK, NY. SN 75-841,260. PUB. 6-27-2000, FILED 11-4-1999.

INSIDE JANET'S JEWELRY BOX

FOR NEWSLETTER FEATURING ADVICE IN THE FIELD OF FASHION STYLE AND FASHION ACCESSORIES (U.S. CLS. 2, 5, 22, 23, 29, 37, 38 AND 50).
FIRST USE 3-19-2003; IN COMMERCE 3-19-2003.

2,729,559. FRANKLIN, ELIZABETH, SAN FRANCISCO, CA.
SN 75-862,381. PUB. 4-24-2001, FILED 11-30-1999.

CLARA FYER

"CLARA FYER" DOES NOT IDENTIFY A LIVING INDIVIDUAL.
FOR BOOKS, NAMELY BOOKS FEATURING INSPIRATIONAL MESSAGES (U.S. CLS. 2, 5, 22, 23, 29, 37, 38 AND 50).
FIRST USE 10-11-2002; IN COMMERCE 10-11-2002.

2,729,561. UNIQUE MEDIA, INCORPORATED, TORONTO, ONTARIO, CANADA. SN 75-863,983. PUB. 5-22-2001, FILED 11-12-1999.

UNIQUE COLLECTION

OWNER OF U.S. REG. NOS. 2,230,196, 2,410,572, AND OTHERS.

CLASS 16—(Continued).

NO CLAIM IS MADE TO THE EXCLUSIVE RIGHT TO USE "COLLECTION", APART FROM THE MARK AS SHOWN.
FOR MAPS, POSTERS AND POSTCARDS (U.S. CLS. 2, 5, 22, 23, 29, 37, 38 AND 50).
FIRST USE 12-4-2002; IN COMMERCE 12-4-2002.

2,729,583. ALTARATIONS, LLC, FAYETTEVILLE, NC. SN 75-891,903. PUB. 8-28-2001, FILED 1-7-2000.



THE MARK CONSISTS IN PART OF THE STYLIZED LETTER "A", "SURROUNDED BY A STYLIZED HEART DESIGN.

FOR CALENDARS, POSTERS, STATIONERY, WRITING PAPER, ENVELOPES, GIFT CARDS, NOTE PADS, NOTE PAPER, MEMORANDA PADS, MEMORANDA BOOKS, BOOK MARKS, DIARIES, STICKERS, POSTCARDS, WRAPPING PAPER, GREETING CARDS, TISSUE PAPER, BUMPER STICKERS, PAPER PENNANTS, LINING PAPER, DECALS, DAILY PLANNERS, DESK TOP PLANNERS, BLOTTERS, LABELS, PRINTED AWARDS AND PRINTED LABELS NOT OF TEXTILE (U.S. CLS. 2, 5, 22, 23, 29, 37, 38 AND 50).

FIRST USE 12-5-2002; IN COMMERCE 12-5-2002.

2,729,607. BELLSOUTH INTELLECTUAL PROPERTY CORPORATION, WILMINGTON, DE. SN 75-916,347. PUB. 9-3-2002, FILED 2-11-2000.

THE ORIGINAL SEARCH ENGINE

NO CLAIM IS MADE TO THE EXCLUSIVE RIGHT TO USE "ORIGINAL", APART FROM THE MARK AS SHOWN.
FOR CLASSIFIED DIRECTORIES (U.S. CLS. 2, 5, 22, 23, 29, 37, 38 AND 50).
FIRST USE 10-25-2000; IN COMMERCE 10-25-2000.

CLASS 16—(Continued).

2,729,634. MISSOURI EMPLOYERS MUTUAL INSURANCE, COLUMBIA, MO. SN 75-943,544. PUB. 11-27-2001, FILED 3-14-2000.

CLASS 16—(Continued).

2,729,649. EBAY INC., SAN JOSE, CA. SN 75-983,172. PUB. 10-24-2000, FILED 12-23-1998.

TAKING CARE OF FOLKS

FOR PRINTED BROCHURES, INFORMATIONAL FLIERS AND INFORMATIONAL LEAFLETS FEATURING INFORMATION IN THE AREA OF CLAIMS, CLAIMS ADMINISTRATION, CLAIMS MANAGEMENT, DISABILITY MANAGEMENT, LOSS PREVENTION, AND SAFETY AND UNDERWRITING IN THE FIELD OF INSURANCE; PRINTED INSTRUCTIONAL, EDUCATIONAL AND TEACHING MATERIALS FEATURING INFORMATION IN THE AREA OF CLAIMS, CLAIMS ADMINISTRATION, CLAIMS MANAGEMENT, DISABILITY MANAGEMENT, LOSS PREVENTION, AND SAFETY AND UNDERWRITING IN THE FIELD OF INSURANCE (U.S. CLS. 2, 5, 22, 23, 29, 37, 38 AND 50).
FIRST USE 6-3-2002; IN COMMERCE 6-3-2002.



OWNER OF U.S. REG. NO. 2,218,732.
FOR PUBLICATIONS, NAMELY, A SERIES OF NON-FICTION BOOKS, CONCERNING HOBBIES, COLLECTIBLES, AUCTIONS, AND A WIDE VARIETY OF PRODUCTS RELATING TO ANTIQUES, ART, LITERATURE, CULTURE, TECHNOLOGY, TRAVEL, SPORTS, ENTERTAINMENT, HOME FURNISHINGS, GARDEN ITEMS, MUSICAL INSTRUMENTS, MOTOR VEHICLES, TOYS AND GAMES, FASHION, JEWELRY, ELECTRONICS, PHOTOGRAPHY, HOLIDAY RELATED ITEMS, FILM AND VIDEO; PAPER AND STATIONERY ITEMS, NAMELY, MEMO PADS, PAPER POSTCARDS, BUMPER STICKERS, CALENDARS, DECORATIVE STICKERS AND DECALS (U.S. CLS. 2, 5, 22, 23, 29, 37, 38 AND 50).
FIRST USE 11-0-1999; IN COMMERCE 11-0-1999.

2,729,661. EIDOS INTERACTIVE LIMITED, WIMBLEDON, LONDON, SW19 3RU, UNITED KINGDOM. SN 76-002,727. PUB. 9-24-2002, FILED 3-17-2000.

HITMAN: CODENAME 47

2,729,635. GRUBER, STEVEN A., DBA DYFLAM, PALM BAY, FL. SN 75-945,353. PUB. 11-21-2000, FILED 2-24-2000.

FOR STATIONERY, BOOKS, IN THE FIELD OF INTERACTIVE ELECTRONIC ADVENTURE SPY/SUSPENSE GAMES IN A SERIES; INSTRUCTION MANUALS RELATED TO INTERACTIVE ELECTRONIC ADVENTURE SPY/SUSPENSE GAMES IN A SERIES; PERIODICAL PUBLICATIONS, NAMELY, A MAGAZINE AND BROCHURES RELATED TO ADVENTURE SPY/SUSPENSE GAMES IN A SERIES; POSTERS RELATED TO ADVENTURE SPY/SUSPENSE GAMES IN A SERIES (U.S. CLS. 2, 5, 22, 23, 29, 37, 38 AND 50).
FIRST USE 12-0-2000; IN COMMERCE 12-0-2000.

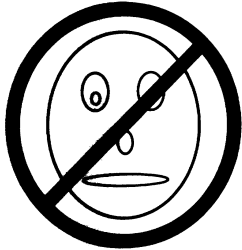

2,729,678. INDEX NEWSPAPERS LLC, SEATTLE, WA, BY ASSIGNMENT LOADED-FOR-BEAR PUBLISHING CO., SEATTLE, WA. SN 76-019,457. PUB. 1-2-2001, FILED 4-6-2000.

THE PORTLAND MERCURY

FOR DECALS, BUMPERSTICKERS (U.S. CLS. 2, 5, 22, 23, 29, 37, 38 AND 50).
FIRST USE 5-10-2000; IN COMMERCE 5-10-2000.

NO CLAIM IS MADE TO THE EXCLUSIVE RIGHT TO USE "THE PORTLAND", APART FROM THE MARK AS SHOWN.
FOR NEWSPAPERS FOR GENERAL CIRCULATION (U.S. CLS. 2, 5, 22, 23, 29, 37, 38 AND 50).
FIRST USE 7-18-2002; IN COMMERCE 7-18-2002.

CLASS 16—(Continued).

2,729,686. WORLD TEAM TENNIS, INC., CHICAGO, IL. SN 76-027,800. PUB. 6-11-2002, FILED 4-17-2000.

SUPER TIEBREAKER

FOR PRINTED MATERIAL, NAMELY, A MAGAZINE PROMOTING TENNIS (U.S. CLS. 2, 5, 22, 23, 29, 37, 38 AND 50).

FIRST USE 7-0-1981; IN COMMERCE 7-0-1981.

2,729,690. JACK DANIEL'S PROPERTIES, INC., SAN RAFAEL, CA. SN 76-034,949. PUB. 5-1-2001, FILED 4-25-2000.



OWNER OF U.S. REG. NOS. 394,017, 1,290,702, AND OTHERS.

NO CLAIM IS MADE TO THE EXCLUSIVE RIGHT TO USE "BRAND", APART FROM THE MARK AS SHOWN.

THE NAME "JACK DANIEL'S" IN THE MARK IS NOT THE NAME OF A LIVING INDIVIDUAL.

FOR PAPER AND PAPER ARTICLES; NAMELY, POSTERS, POSTCARDS, NOTEPADS, PLAYING CARDS, PAPER NAPKINS, WRITING AND NOTE PAPER, STATIONERY, PAPER COASTERS, MOUNTED AND UNMOUNTED PHOTOGRAPHS, TABLECLOTHS MADE OF PAPER, PAPER PLACE MATS, BANNERS MADE OF PAPER, BULLETIN AND NOTICE BOARDS, CORKBOARDS, CALENDARS, PENS AND PENCILS AND CASES THEREFOR, PICTURES, POSTCARDS, MAGAZINE AND PERIODICALS FOR GENERAL INTEREST (U.S. CLS. 2, 5, 22, 23, 29, 37, 38 AND 50).

FIRST USE 10-15-2002; IN COMMERCE 10-15-2002.

CLASS 16—(Continued).

2,729,753. READING JANE'S WAY INC., LAGUNA NIGUEL, CA. SN 76-085,767. PUB. 5-14-2002, FILED 7-10-2000.



NO CLAIM IS MADE TO THE EXCLUSIVE RIGHT TO USE "READING", APART FROM THE MARK AS SHOWN. THE NAME "JANE'S" DOES NOT IDENTIFY A LIVING INDIVIDUAL.

FOR PRINTED EDUCATIONAL TEACHING MATERIALS, NAMELY, READING KITS COMPRISED OF ACTIVITIES AND LESSON PLANS DESIGNED TO TEACH BEGINNING READING TO KINDERGARTEN-AGE CHILDREN (U.S. CLS. 2, 5, 22, 23, 29, 37, 38 AND 50).

FIRST USE 7-10-2000; IN COMMERCE 7-10-2000.

2,729,802. BARNARD INVESTMENTS, LLC, PASADENA, CA. SN 76-118,419. PUB. 11-27-2001, FILED 8-29-2000.

STORBOX

FOR PACKAGING MATERIALS AND PACKING SUPPLIES, NAMELY, PACKING PAPER; TISSUE PAPER FOR PACKING; PLASTIC BUBBLE PACKS FOR PACKING; PAPER POUCHES WITH FOAM PADDING FOR PACKING (U.S. CLS. 2, 5, 22, 23, 29, 37, 38 AND 50).

FIRST USE 7-31-2001; IN COMMERCE 7-31-2001.

2,729,927. SAPPI GRATKORN GMBH, A-8101 GRATKORN, AUSTRIA. SN 76-192,658. PUB. 6-4-2002, FILED 1-10-2001.

MAGNO

FOR PRINTING PAPER FOR USE IN MAGAZINES, REVIEWS, BOOKS, PROSPECTUS, BROCHURES, CALENDARS, POSTERS, GRAPHIC REPRODUCTIONS, PHOTOGRAPHS (U.S. CLS. 2, 5, 22, 23, 29, 37, 38 AND 50).

FIRST USE 1-0-1998; IN COMMERCE 1-0-1998.

2,729,933. TRAVEL GUIDE, INC., CHARLOTTESVILLE, VA. SN 76-196,201. PUB. 4-30-2002, FILED 1-18-2001.

THE ODYSSEY REPORT

NO CLAIM IS MADE TO THE EXCLUSIVE RIGHT TO USE "REPORT", APART FROM THE MARK AS SHOWN.

FOR NEWSLETTERS RELATING TO LUXURY GOLFING AND SPORTING VACATION DESTINATIONS (U.S. CLS. 2, 5, 22, 23, 29, 37, 38 AND 50).

FIRST USE 10-15-2001; IN COMMERCE 10-15-2001.

CLASS 16—(Continued).

2,729,950. CHOI, JAE K., CERRITOS, CA. SN 76-203,538. PUB. 6-25-2002, FILED 2-1-2001.

JANGSUMAUL

FOR NEWSLETTERS, MONTHLY MAGAZINES, AND PERIODIC PUBLICATIONS, ALL PROVIDING HEALTH RELATED INFORMATION INCLUDING INFORMATION ON NATURAL AND ORGANIC FOODS AND HEALTHY LIFESTYLES; CATALOGS FEATURING PRODUCTS RELATED TO HEALTH, NATURAL AND ORGANIC FOODS, AND HEALTHY LIFESTYLES (U.S. CLS. 2, 5, 22, 23, 29, 37, 38 AND 50).
FIRST USE 3-1-2002; IN COMMERCE 3-1-2002.

CLASS 16—(Continued).

2,729,976. COLE & ASHCROFT, INC., HOUSTON, TX. SN 76-215,234. PUB. 10-8-2002, FILED 2-23-2001.



FOR CARDBOARD BOXES AND CONTAINERS; CORRUGATED BOXES AND CONTAINERS (U.S. CLS. 2, 5, 22, 23, 29, 37, 38 AND 50).
FIRST USE 7-31-2001; IN COMMERCE 7-31-2001.

2,729,955. LOS ANGELES RINGBINDER COMPANY, NEWBURY PARK, CA. SN 76-204,899. PUB. 6-18-2002, FILED 2-5-2001.

VALUE VIEW

FOR THREE RING BINDERS (U.S. CLS. 2, 5, 22, 23, 29, 37, 38 AND 50).
FIRST USE 2-28-2001; IN COMMERCE 2-28-2001.

2,730,009. HARTLE MEDIA, LLC, SAN FRANCISCO, CA. SN 76-225,218. PUB. 7-2-2002, FILED 3-15-2001.

7 X 7

FOR PERIODICAL PUBLICATIONS REGARDING TOPICS OF GENERAL INTEREST IN THE SAN FRANCISCO, CALIFORNIA AREA (U.S. CLS. 2, 5, 22, 23, 29, 37, 38 AND 50).
FIRST USE 9-1-2001; IN COMMERCE 9-1-2001.

2,729,967. TOUCHSTONE APPLIED SCIENCE ASSOCIATES, INC., BREWSTER, NY. SN 76-210,583. PUB. 12-11-2001, FILED 2-15-2001.



NO CLAIM IS MADE TO THE EXCLUSIVE RIGHT TO USE "TEST OF ENGLISH LANGUAGE PROFICIENCY", APART FROM THE MARK AS SHOWN.

THE DRAWING IS NOT LINED FOR COLOR.
FOR PRINTED ASSESSMENT MATERIALS CONSISTING OF A SERIES OF TESTS FOCUSING ON ENGLISH-LANGUAGE SPEAKING, LISTENING, READING AND WRITING ABILITIES OF STUDENTS FOR WHOM ENGLISH IS A SECOND OR OTHER LANGUAGE FOR PLACEMENT, MEASURING ACHIEVEMENT AND EVALUATION IN ENGLISH LANGUAGE PROFICIENCY IN GRADES KINDERGARTEN THROUGH GRADE 12 (U.S. CLS. 2, 5, 22, 23, 29, 37, 38 AND 50).
FIRST USE 7-31-2001; IN COMMERCE 7-31-2001.

2,730,057. JACOB RITTER GMBH, D-64395 BRENSBACH, FED REP GERMANY. SN 76-246,496. PUB. 1-15-2002, FILED 4-24-2001.



NO CLAIM IS MADE TO THE EXCLUSIVE RIGHT TO USE "PEN CORPORATION", APART FROM THE MARK AS SHOWN.

THE MARK CONSISTS IN PART OF THE STYLIZED LETTER "R".
FOR WRITING PENS (U.S. CLS. 2, 5, 22, 23, 29, 37, 38 AND 50).
FIRST USE 1-1-2003; IN COMMERCE 1-1-2003.

CLASS 16—(Continued).

2,730,058. TAIWAN HOPAX CHEMICALS MFG. CO., LTD., KAOHSIUNG, TAIWAN. SN 76-246,850. PUB. 6-25-2002, FILED 4-26-2001.

CLEARNOTE

FOR MEMO PADS, WRITING PAPER PADS, NOTE-PAPERS; NOTE PADS; BOOKMARKERS; INDEX CARDS; SELF-ADHESIVE NOTES; TAPES FOR STATIONERY AND HOUSEHOLD PURPOSES; LABELS, NOT OF TEXTILE; TABS; SELF-ADHESIVE LABELS; BULLETIN BOARDS OF CARDBOARD; REPOSITIONABLE SELF-STICK MEMO BOARDS (U.S. CLS. 2, 5, 22, 23, 29, 37, 38 AND 50).

FIRST USE 12-21-2001; IN COMMERCE 12-21-2001.

2,730,088. COFFEY INVESTMENTS, L.L.C., HOUSE SPRINGS, MO. SN 76-259,818. PUB. 5-14-2002, FILED 5-18-2001.

SNUGGLE-TIME CREATIONS

FOR PERSONALIZED BOOKS, OCCASION CARDS, PAPER BANNERS, CALENDARS, STATIONERY (U.S. CLS. 2, 5, 22, 23, 29, 37, 38 AND 50).

FIRST USE 1-1-2002; IN COMMERCE 1-1-2002.

2,730,105. APPLETON PAPERS INC., APPLETON, WI. SN 76-264,905. PUB. 10-22-2002, FILED 5-31-2001.

APPLETON

OWNER OF U.S. REG. NOS. 1,197,835 AND 2,084,804.
FOR UNCOATED PAPER; COATED PAPER NAMELY, INDUSTRIAL COATED PAPER, PRINTING AND WRITING PAPER, PRINTING AND RECORDING PAPER FOR USE WITH THERMAL PRINTING AND RECORDING DEVICES, COATED FLUORESCENT PAPER, PRESSURE SENSITIVE PAPER, FACSIMILE PAPER, SECURITY PAPER, BATTERY LINER PAPER, BLANK PAPER TAGS AND LABELS (U.S. CLS. 2, 5, 22, 23, 29, 37, 38 AND 50).

FIRST USE 2-3-2003; IN COMMERCE 2-3-2003.

2,730,116. MULTNOMAH PUBLISHERS, INC., SISTERS, OR. SN 76-268,351. PUB. 8-27-2002, FILED 6-6-2001.

LISTS TO LIVE BY

NO CLAIM IS MADE TO THE EXCLUSIVE RIGHT TO USE "LISTS", APART FROM THE MARK AS SHOWN.

FOR SERIES OF FICTION BOOKS AND NON-FICTION BOOKS ON THE TOPICS OF INSPIRATION, ADVICE, AND INSIGHT INTO LOVE, FAITH, FRIENDSHIP, HEALTH, SUCCESS, WORK, HOME, AND FAMILY LIFE (U.S. CLS. 2, 5, 22, 23, 29, 37, 38 AND 50).

FIRST USE 7-7-1999; IN COMMERCE 7-7-1999.

CLASS 16—(Continued).

2,730,117. MULTNOMAH PUBLISHERS, INC., SISTERS, OR. SN 76-268,352. PUB. 5-14-2002, FILED 6-6-2001.

MULTNOMAH GIFTS

OWNER OF U.S. REG. NOS. 1,869,520 AND 2,244,506.
NO CLAIM IS MADE TO THE EXCLUSIVE RIGHT TO USE "GIFTS", APART FROM THE MARK AS SHOWN.

SEC. 2(F) AS TO "MULTNOMAH".

FOR SERIES OF FICTION AND NONFICTION BOOKS ABOUT FRIENDSHIP, RELATIONSHIPS, FAMILY LIFE, INSPIRATION, HOLIDAYS AND SPECIAL OCCASIONS; STATIONERY WRITING PAPER AND ENVELOPES; DESK SETS; DESK ACCESSORY HOLDERS; POSTERS; PAPER NOT PADS; PAPER MEMO PADS; PENS; PENCILS; GIFT CARDS; GREETING CARDS; OCCASION CARDS; WRITING JOURNALS; ADDRESS BOOKS; PHOTOGRAPH ALBUMS; CARDBOARD BOXES; STICKERS; BOOKMARKS; AND CALENDARS (U.S. CLS. 2, 5, 22, 23, 29, 37, 38 AND 50).

FIRST USE 12-27-2001; IN COMMERCE 12-27-2001.

2,730,237. MERIT PAPER CORPORATION, FARMINGDALE, NY. SN 76-304,432. PUB. 2-5-2002, FILED 8-16-2001.

CHIC-KIT

FOR PLASTIC BAGS FOR CARRYING TAKEOUT FOOD (U.S. CLS. 2, 5, 22, 23, 29, 37, 38 AND 50).

FIRST USE 5-1-2002; IN COMMERCE 5-1-2002.

2,730,266. MITSUBISHI ENPITSU KABUSHIKI KAISHA, SHINAGAWA-KU, TOYKO, JAPAN. SN 76-313,369. PUB. 4-30-2002, FILED 9-14-2001.

uni-ball signo Rainbow

OWNER OF U.S. REG. NOS. 1,474,933, 2,371,661, AND OTHERS.

FOR ROLLER PEN (U.S. CLS. 2, 5, 22, 23, 29, 37, 38 AND 50).

FIRST USE 9-3-2001; IN COMMERCE 1-1-2002.

2,730,274. GRACE MCNAMARA, INC., ST. PAUL, MN. SN 76-315,202. PUB. 7-2-2002, FILED 9-19-2001.

LOOP

FOR MAGAZINES DIRECTED TO THE INTERIOR DESIGN INDUSTRY (U.S. CLS. 2, 5, 22, 23, 29, 37, 38 AND 50).

FIRST USE 3-28-2002; IN COMMERCE 3-28-2002.

CLASS 16—(Continued).

2,730,304. ST. CROIX COLLECTIBLES, INC., HUDSON, WI. SN 76-322,546. PUB. 5-14-2002, FILED 10-9-2001.

G G U M

FOR TRADING CARDS WITH MEMORABILIA, NAMELY, PIECES OF SPORTS EQUIPMENT, CLOTHING, AND OTHER PERSONAL ITEMS OR PROFESSIONAL EQUIPMENT OR PARTS OF THE FOREGOING OWNED OR USED BY FAMOUS INDIVIDUALS OR IN WELL-KNOWN EVENTS SOLD AS A UNIT (U.S. CLS. 2, 5, 22, 23, 29, 37, 38 AND 50).
FIRST USE 10-19-2001; IN COMMERCE 10-19-2001.

2,730,321. MEAD CORPORATION, THE, DAYTON, OH. SN 76-327,158. PUB. 4-16-2002, FILED 10-18-2001.

THE NEXT GENERATION OF ORGANIZATION

OWNER OF U.S. REG. NOS. 968,182 AND 1,776,701.
FOR PADFOLIOS, BINDERS, BUSINESS CARD HOLDERS, DATE PLANNERS AND DOCUMENT HOLDERS (U.S. CLS. 2, 5, 22, 23, 29, 37, 38 AND 50).
FIRST USE 11-12-2002; IN COMMERCE 11-12-2002.

2,730,358. PACIFICHEALTH LABORATORIES, INC., WOODBRIDGE, NJ. SN 76-337,391. PUB. 5-14-2002, FILED 11-13-2001.

POWERING MUSCLES

FOR EDUCATIONAL PUBLICATIONS, NAMELY, PRINTED EDUCATIONAL AND TEACHING MATERIALS FOR TEACHING ATHLETES, COACHES, AND TRAINERS ABOUT NUTRITION (U.S. CLS. 2, 5, 22, 23, 29, 37, 38 AND 50).
FIRST USE 11-30-2001; IN COMMERCE 11-30-2001.

2,730,372. BINNEY & SMITH INC., EASTON, PA. SN 76-340,799. PUB. 7-9-2002, FILED 11-23-2001.

INKTANK

FOR HIGHLIGHTERS, MARKERS, AND PENS (U.S. CLS. 2, 5, 22, 23, 29, 37, 38 AND 50).
FIRST USE 1-31-2002; IN COMMERCE 1-31-2002.

CLASS 16—(Continued).

2,730,375. LEOPARD COMMUNICATIONS, BOULDER, CO. SN 76-340,960. PUB. 6-25-2002, FILED 11-21-2001.

MARKETING. COMMUNICATIONS. IN THAT ORDER.

FOR BOOKLETS, NEWSLETTERS, PAMPHLETS, BROCHURES, MONOGRAPHS, BOOKS AND REPORTS IN THE FIELD OF MARKETING COMMUNICATIONS AND MARKETING STRATEGIES (U.S. CLS. 2, 5, 22, 23, 29, 37, 38 AND 50).
FIRST USE 10-4-2001; IN COMMERCE 12-22-2001.

2,730,382. ASSOCIATED HYGIENIC PRODUCTS, LLC, DULUTH, GA. SN 76-341,882. PUB. 6-18-2002, FILED 11-26-2001.

THE SMART MOM DIAPER

NO CLAIM IS MADE TO THE EXCLUSIVE RIGHT TO USE "DIAPER", APART FROM THE MARK AS SHOWN.
FOR DISPOSABLE DIAPERS AND DISPOSABLE TRAINING PANTS (U.S. CLS. 2, 5, 22, 23, 29, 37, 38 AND 50).
FIRST USE 2-1-2001; IN COMMERCE 3-6-2003.

2,730,384. SMEAD MANUFACTURING COMPANY, HASTINGS, MN. SN 76-342,241. PUB. 6-11-2002, FILED 11-27-2001.

EZFOLD

FOR BLANK LABELS FOR FILE FOLDERS (U.S. CLS. 2, 5, 22, 23, 29, 37, 38 AND 50).
FIRST USE 7-1-2002; IN COMMERCE 7-2-2002.

2,730,388. DALLMANN-JONES, ANTHONY S., FOND DU LAC, WI. SN 76-343,420. PUB. 6-18-2002, FILED 12-3-2001.

DR. ZEST

FOR SERIES OF BOOKS IN THE FIELD OF PERSONAL GROWTH AND SELF-HELP (U.S. CLS. 2, 5, 22, 23, 29, 37, 38 AND 50).
FIRST USE 6-5-2002; IN COMMERCE 9-15-2002.

CLASS 16—(Continued).

2,730,494. WINDS OF FIRE DANCE MINISTRY, INC., BELLVILLE, OH. SN 76-369,596. PUB. 9-10-2002, FILED 2-11-2002.



NO CLAIM IS MADE TO THE EXCLUSIVE RIGHT TO USE "GARMENTS", APART FROM THE MARK AS SHOWN.

FOR PATTERNS USED FOR MAKING DANCE GARMENTS (U.S. CLS. 2, 5, 22, 23, 29, 37, 38 AND 50).
FIRST USE 11-0-2002; IN COMMERCE 11-0-2002.

2,730,496. CACIOLI, LISA, NORTH HAVEN, CT. SN 76-370,493. PUB. 8-6-2002, FILED 2-13-2002.

TAEKID-DO

FOR PRINTED MATTER, NAMELY BOOKS, BROCHURES AND INSTRUCTIONAL MANUALS, ALL RELATING TO THE FIELD OF MARTIAL ARTS AND SELF ESTEEM (U.S. CLS. 2, 5, 22, 23, 29, 37, 38 AND 50).
FIRST USE 3-1-2003; IN COMMERCE 3-1-2003.

2,730,513. RANDOLPH, STEVEN J., NORTHRIDGE, CA. SN 76-378,694. PUB. 7-2-2002, FILED 3-7-2002.

OFF THE PORCH

FOR PRINTED NOVELTY CARDS (U.S. CLS. 2, 5, 22, 23, 29, 37, 38 AND 50).
FIRST USE 1-15-2003; IN COMMERCE 1-15-2003.

2,730,522. NOBLEWORKS, INC., HOBOKEN, NJ. SN 76-386,749. PUB. 10-29-2002, FILED 3-25-2002.

LOST THE PLOT

FOR GREETING CARDS AND CALENDARS (U.S. CLS. 2, 5, 22, 23, 29, 37, 38 AND 50).
FIRST USE 9-30-2000; IN COMMERCE 9-30-2000.

2,730,543. HEALTH NET, INC., WOODLAND HILLS, CA. SN 76-975,422. PUB. 7-2-2002, FILED 11-19-2001.

NUTRITION ON THE GO**CLASS 16—(Continued).**

NO CLAIM IS MADE TO THE EXCLUSIVE RIGHT TO USE "NUTRITION", APART FROM THE MARK AS SHOWN.

FOR PRINTED MATERIALS, NAMELY, STATIONERY FOLDERS, STATIONERY, BROCHURES AND PAMPHLETS, ALL CONCERNING NUTRITION AND HEALTH; MAGAZINES AND NEWSLETTERS IN THE FIELD OF NUTRITION AND HEALTH (U.S. CLS. 2, 5, 22, 23, 29, 37, 38 AND 50).

FIRST USE 12-31-1998; IN COMMERCE 12-31-1998.

2,730,555. KOVALIC, ROBERT J., MADISON, WI. SN 78-010,337. PUB. 3-26-2002, FILED 5-29-2000.

DORK TOWER

FOR CARTOON STRIPS AND PRINTS (U.S. CLS. 2, 5, 22, 23, 29, 37, 38 AND 50).
FIRST USE 8-1-1996; IN COMMERCE 8-1-1996.

2,730,563. ABBOTT LABORATORIES, ABBOTT PARK, IL. SN 78-023,238. PUB. 6-26-2001, FILED 8-28-2000.

ACCU-POINT

FOR PRINTED CHARTS, NAMELY ACETATE SHEET FOR GRAPHING A CHILD'S GROWTH RATE (U.S. CLS. 2, 5, 22, 23, 29, 37, 38 AND 50).
FIRST USE 2-0-2002; IN COMMERCE 2-0-2002.

2,730,603. ARKOPHARMA S.A., CARROS, FRANCE. SN 78-045,145. PUB. 6-25-2002, FILED 1-26-2001.

NUTRITION EDGE

NO CLAIM IS MADE TO THE EXCLUSIVE RIGHT TO USE "NUTRITION", APART FROM THE MARK AS SHOWN.

FOR MAGAZINE DEVOTED TO NUTRITION AND THE USE OF DIETARY SUPPLEMENTS (U.S. CLS. 2, 5, 22, 23, 29, 37, 38 AND 50).
FIRST USE 9-30-2001; IN COMMERCE 9-30-2001.

2,730,606. FORWARD STEP THE LEARNING COALITION, LOS ANGELES, CA. SN 78-046,062. PUB. 5-28-2002, FILED 2-1-2001.

COMPASS - LEARN TO NAVIGATE YOUR LIFE

FOR PRINTED INSTRUCTIONAL, EDUCATIONAL, AND TEACHING MATERIALS IN THE FIELD OF CHARACTER DEVELOPMENT AND LIFE SKILLS TRAINING PROGRAMS FOR TEENAGERS, FOR YOUNG ADULTS, AND FOR ADULTS WHO ARE IN CRISIS PROGRAMS, ALL FOR USE WITH EDUCATIONAL VIDEO TAPES (U.S. CLS. 2, 5, 22, 23, 29, 37, 38 AND 50).

FIRST USE 2-6-2001; IN COMMERCE 5-20-2002.

CLASS 16—(Continued).

2,730,637. LISA FRANK, INC., TUCSON, AZ. SN 78-059,074.
PUB. 7-2-2002, FILED 4-18-2001.

RUCKUS

FOR PRINTED MATERIALS FOR CHILDREN, NAMELY, STICKERS, STICKER ALBUMS AND BOOKS, NOTEBOOKS, FOLDERS, BINDERS, ORGANIZERS FOR STATIONERY AND PERSONAL ORGANIZERS, STATIONERY-TYPE PORTFOLIOS, WRITING PADS, MEMO PADS, PENS, PENCILS, AND STATIONERY, ALL REPRESENTING A ST BERNARD DOG (U.S. CLS. 2, 5, 22, 23, 29, 37, 38 AND 50).

FIRST USE 6-8-2001; IN COMMERCE 6-8-2001.

2,730,652. YOON, RICHARD, G., NEWARK, DE. SN 78-064,151. PUB. 7-9-2002, FILED 5-17-2001.

ACALETE

FOR MAGAZINE FEATURING INFORMATION IN THE FIELD OF EDUCATIONAL AND ACADEMIC INTEREST TO ELEVATE THE IMAGE OF ACADEMICS BY HIGHLIGHTING OUTSTANDING INDIVIDUALS WHO HAVE ACHIEVED SUCCESS AT MANY LEVELS, ONE OF WHICH MUST BE ACADEMIC, BY PORTRAYING MULTI-TALENTED INDIVIDUALS AS ROLE MODELS (U.S. CLS. 2, 5, 22, 23, 29, 37, 38 AND 50).

FIRST USE 12-1-2000; IN COMMERCE 12-1-2001.

2,730,708. COREAD CORPORATION, REDONDO BEACH, CA. SN 78-082,391. PUB. 7-16-2002, FILED 9-4-2001.

PICTURE A WORLD OF UNDERSTANDING

FOR LANGUAGE TRANSLATION PRODUCTS IN THE NATURE OF PRINTED SHEETS FEATURING DUAL DIALS USED TO FACILITATE DIRECT COMMUNICATION (U.S. CLS. 2, 5, 22, 23, 29, 37, 38 AND 50).

FIRST USE 9-1-2002; IN COMMERCE 1-21-2003.

2,730,819. CHAPMAN, DIANE YVONNE, DBA WORDS TO YOUR ADVANTAGE, ALISO VIEJO, CA. SN 78-110,406. PUB. 9-3-2002, FILED 2-22-2002.

QUOTEPOURRI

FOR PRINTED PRODUCTS, NAMELY LISTS FEATURING QUOTATION COLLECTIONS OR INDIVIDUAL QUOTATIONS CHOSEN BY SUBJECT MATTER (U.S. CLS. 2, 5, 22, 23, 29, 37, 38 AND 50).

FIRST USE 12-1-2001; IN COMMERCE 3-1-2002.

CLASS 16—(Continued).

2,730,825. GREENBAUM, DAVID, J., NEW YORK, NY. SN 78-113,217. PUB. 10-15-2002, FILED 3-7-2002.

LET'S GO KOSHER

FOR KOSHER DISCOUNT GUIDES, COUPON BOOKS AND CARDS OFFERING SAVINGS TO CONSUMERS FROM KOSHER MERCHANTS (U.S. CLS. 2, 5, 22, 23, 29, 37, 38 AND 50).

FIRST USE 11-15-2001; IN COMMERCE 2-19-2002.

2,730,838. 3CRAZYLADIES, PALMDALE, CA. SN 78-122,487. PUB. 11-5-2002, FILED 4-18-2002.

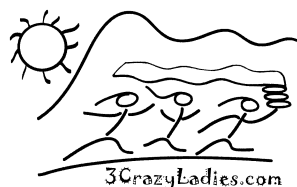

THE MARK CONSISTS OF THREE FEMALE STICK FIGURES WITH THE FIRST FIGURE CARRYING THREE BOLTS OF CLOTH. THE TOP BOLT OF CLOTH IS BLOWING BACK. THERE ARE MOUNTAINS AND A SUN IN THE BACKGROUND.

FOR PATTERNS FOR MAKING QUILTS;PREPACKAGED SAMPLE KITS COMPRISING QUILTING PATTERNS;PRINTED PAPER PATTERNS FOR FOUNDATION PIECING OF QUILTS;BOOKLETS, INSTRUCTION SHEETS AND BROCHURES ON QUILT MAKING (U.S. CLS. 2, 5, 22, 23, 29, 37, 38 AND 50).

FIRST USE 5-1-2002; IN COMMERCE 5-4-2002.

CLASS 17—RUBBER GOODS

2,729,487. COLDER PRODUCTS COMPANY, ST. PAUL, MN. SN 75-746,965. PUB. 5-2-2000, FILED 7-9-1999.

DRUMQUIK

FOR PLASTIC QUICK DISCONNECT COUPLING FOR CONTAINERS FOR DISPENSING CHEMICALS (U.S. CLS. 1, 5, 12, 13, 35 AND 50).

FIRST USE 10-24-2002; IN COMMERCE 10-24-2002.

2,729,488. OAK-MITSUI INC., CAMDEN, SC. SN 75-747,890. PUB. 12-28-1999, FILED 7-12-1999.

FARADIGM

FOR MULTILAYER LAMINATES CONSISTING OF MATERIALS IMPARTING INTERNAL CAPACITANCE FOR USE IN MANUFACTURING CIRCUIT BOARDS (U.S. CLS. 1, 5, 12, 13, 35 AND 50).

FIRST USE 3-20-2003; IN COMMERCE 3-20-2003.

CLASS 17—(Continued).

2,730,107. HUNTER DOUGLAS INC., UPPER SADDLE RIVER, NJ. SN 76-265,757. PUB. 11-5-2002, FILED 5-31-2001.

Techstyle
ACOUSTICAL CEILINGS BY **HunterDouglas**

NO CLAIM IS MADE TO THE EXCLUSIVE RIGHT TO USE "ACOUSTICAL CEILINGS", APART FROM THE MARK AS SHOWN.

FOR ACOUSTICAL CEILING AND WALL PANELS (U.S. CLS. 1, 5, 12, 13, 35 AND 50).

FIRST USE 6-24-2002; IN COMMERCE 6-24-2002.

2,730,186. TEXAS ENCORE MATERIALS, INC., KANSAS CITY, MO. SN 76-289,250. PUB. 8-20-2002, FILED 7-23-2001.

ATR

FOR RUBBER MATERIAL MADE FROM USED TIRE RUBBER AND OTHER COMPONENTS AND USED AS A RAW MATERIAL IN THE MANUFACTURE OF PLASTIC AND RUBBER GOODS, INCLUDING COATINGS AND ASPHALT BINDER MATERIAL (U.S. CLS. 1, 5, 12, 13, 35 AND 50).

FIRST USE 11-21-2001; IN COMMERCE 11-21-2001.

2,730,315. IMPERIAL PIPE CORPORATION, TORONTO, ONTARIO, CANADA. SN 76-325,876. PUB. 5-14-2002, FILED 10-12-2001.

RADIANTPLUS

FOR BUILDING MATERIALS, NAMELY, PIPES AND FITTINGS THEREFOR MADE PRIMARILY OF CROSS-LINKED POLYETHYLENE (U.S. CLS. 1, 5, 12, 13, 35 AND 50).

FIRST USE 12-1-2002; IN COMMERCE 12-1-2002.

2,730,770. FOAMEX L.P., LINWOOD, PA. SN 78-098,226. PUB. 7-2-2002, FILED 12-13-2001.

RESILITEX

FOR FOAMS FOR USE IN MAKING PILLOWS AND FURNITURE CUSHIONS (U.S. CLS. 1, 5, 12, 13, 35 AND 50).

FIRST USE 5-24-2002; IN COMMERCE 5-24-2002.

CLASS 17—(Continued).

2,730,828. GENERAL BINDING CORPORATION, SKOKIE, IL. SN 78-116,721. PUB. 11-5-2002, FILED 3-21-2002.

EASYSEAL

FOR PLASTIC FILM FOR USE IN LAMINATING PAPER (U.S. CLS. 1, 5, 12, 13, 35 AND 50).

FIRST USE 12-31-2002; IN COMMERCE 12-31-2002.

2,730,839. BAYER POLYMERS LLC, PITTSBURGH, PA, BY ASSIGNMENT BAYER CORPORATION, PITTSBURGH, PA. SN 78-122,497. PUB. 11-5-2002, FILED 4-18-2002.

LEDA

FOR PLASTIC RESINS IN BARS, BLOCKS, PELLETS, RODS, SHEETS AND TUBES, ALL FOR FURTHER MANUFACTURE (U.S. CLS. 1, 5, 12, 13, 35 AND 50).

FIRST USE 9-4-2002; IN COMMERCE 9-4-2002.

2,730,840. BAYER POLYMERS LLC, PITTSBURGH, PA, BY ASSIGNMENT BAYER CORPORATION, PITTSBURGH, PA. SN 78-122,504. PUB. 11-5-2002, FILED 4-18-2002.

IMAGIO

FOR PLASTIC RESINS IN BARS, BLOCKS, PELLETS, RODS, SHEETS AND TUBES, ALL FOR FURTHER MANUFACTURE (U.S. CLS. 1, 5, 12, 13, 35 AND 50).

FIRST USE 9-4-2002; IN COMMERCE 9-4-2002.

CLASS 18—LEATHER GOODS

2,729,707. LADYLIKE, CALABASAS, CA. SN 76-049,390. PUB. 3-19-2002, FILED 5-10-2000.

LADYLIKE

FOR CASES SOLD EMPTY, NAMELY, TOILETRY AND VANITY CASES FOR SANITARY PRODUCTS AND OTHER PERSONAL ITEMS; ZIPPERED POUCHES FOR SANITARY PRODUCTS AND OTHER PERSONAL ITEMS; HOLDERS, NAMELY, PURSES FOR HOLDING SANITARY PRODUCTS AND OTHER PERSONAL ITEMS (U.S. CLS. 1, 2, 3, 22 AND 41).

FIRST USE 4-17-2001; IN COMMERCE 4-17-2001.

2,730,044. ALCO INDUSTRIES, INC., DBA STYLETTE, OAKDALE, PA. SN 76-242,259. PUB. 12-25-2001, FILED 4-17-2001.

AERO-SHUTTLE

FOR PET CARRIERS (U.S. CLS. 1, 2, 3, 22 AND 41).

FIRST USE 2-26-2003; IN COMMERCE 2-26-2003.

CLASS 18—(Continued).

2,730,196. PARK, HYUN, LOS ANGELES, CA. SN 76-293,204. PUB. 12-25-2001, FILED 8-1-2001.

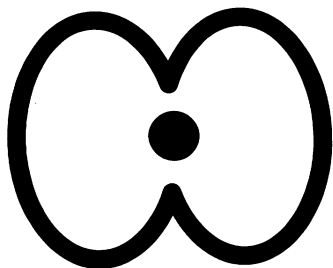

FOR BAGS NAMELY, HANDBAGS, PURSES, WALLETS, AND TOTE BAGS (U.S. CLS. 1, 2, 3, 22 AND 41). FIRST USE 9-1-2001; IN COMMERCE 9-1-2001.

2,730,533. TROSMAN, INC., NEW YORK, NY. SN 76-975,287. PUB. 11-27-2001, FILED 12-11-2000.

NOT RATIONAL

FOR HANDBAGS AND WALLETS (U.S. CLS. 1, 2, 3, 22 AND 41). FIRST USE 12-15-2000; IN COMMERCE 12-15-2000.

2,730,612. CHRISTIE, BRIAN, FAIRFAX, VA. SN 78-049,849. PUB. 1-15-2002, FILED 2-23-2001.

**IF IT'S NOT A MANNBAG,
IT'S A PURSE**

FOR ATHLETIC ALL PURPOSE BAGS (U.S. CLS. 1, 2, 3, 22 AND 41). FIRST USE 5-15-2001; IN COMMERCE 5-15-2001.

CLASS 18—(Continued).

2,730,786. NATURAL WORLD DEVELOPMENT LIMITED, KOWLOON, HONG KONG, HONG KONG. SN 78-101,186. PUB. 9-24-2002, FILED 1-7-2002.



THE MARK CONSISTS OF TWO CURVE LINES FORMING THE LETTER "N" IN FRONT OF THE WORD "ATWOOD" WITH A CURVE LINE ABOVE THE STYLIZED WORD "NATWOOD".

FOR HANDBAGS, SHOULDER BAGS, ALL PURPOSE SPORT BAGS, BACKPACKS, WALLETS, KEY CASES, BRIEFCASES, ATTACHE CASES, TRAVELLING TRUNKS, LUGGAGE, GARMENT BAGS FOR TRAVELLING, UMBRELLAS (U.S. CLS. 1, 2, 3, 22 AND 41). FIRST USE 1-4-2002; IN COMMERCE 1-12-2003.

CLASS 19—NON-METALLIC BUILDING MATERIALS

2,729,412. GRAYSTONE BLOCK COMPANY, INC., MODESTO, CA. SN 75-556,394. PUB. 3-28-2000, FILED 9-18-1998.

SOLAR STONE

FOR CONCRETE MASONRY UNITS (U.S. CLS. 1, 12, 33 AND 50). FIRST USE 0-0-1989; IN COMMERCE 3-0-1996.

2,729,447. INDUSTRIAS AUXILIARES FAUS, S.L., 46700 GANDIA, SPAIN. SN 75-662,689. PUB. 6-20-2000, FILED 3-18-1999.

FAUS DECOR

OWNER OF U.S. REG. NO. 2,260,079. NO CLAIM IS MADE TO THE EXCLUSIVE RIGHT TO USE "DECOR", APART FROM THE MARK AS SHOWN. FOR WALL PANELS AND MOLDING NOT OF METAL (U.S. CLS. 1, 12, 33 AND 50). FIRST USE 2-5-2003; IN COMMERCE 2-5-2003.

2,729,454. INDIAN INDUSTRIES, INC., EVANSVILLE, IN. SN 75-676,881. PUB. 1-4-2000, FILED 4-7-1999.

DURO SLATE

NO CLAIM IS MADE TO THE EXCLUSIVE RIGHT TO USE "SLATE", APART FROM THE MARK AS SHOWN. FOR FIBERBOARD USED IN THE CONSTRUCTION OF POOL TABLES (U.S. CLS. 1, 12, 33 AND 50). FIRST USE 3-31-1997; IN COMMERCE 6-30-1997.

CLASS 19—(Continued).

2,729,669. ASPHALT MATERIALS, INC., INDIANAPOLIS, IN. SN 76-010,347. PUB. 11-13-2001, FILED 3-27-2000.

GREEN 
ASPHALT

NO CLAIM IS MADE TO THE EXCLUSIVE RIGHT TO USE "GREEN ASPHALT", APART FROM THE MARK AS SHOWN.

FOR ASPHALT (U.S. CLS. 1, 12, 33 AND 50).
FIRST USE 1-27-2003; IN COMMERCE 1-27-2003.

2,729,674. STREULI SALES, INC., COLFAX, NC. SN 76-013,592. PUB. 1-8-2002, FILED 3-30-2000.

**MADERA GRANDE EIGHT
FOOT ANDEAN DOORS**

NO CLAIM IS MADE TO THE EXCLUSIVE RIGHT TO USE "MADERA" AND "EIGHT FOOT ANDEAN DOORS", APART FROM THE MARK AS SHOWN.

THE ENGLISH TRANSLATION OF THE WORD "MADERA GRANDE" IN THE MARK IS "LARGE WOOD OR BIG WOOD".

FOR DOORS, SIDELITES, AND TRANSOMS MADE OF WOOD AND GLASS (U.S. CLS. 1, 12, 33 AND 50).
FIRST USE 11-0-1999; IN COMMERCE 11-0-1999.

2,729,750. UNION PLANTERS BANK, NATIONAL ASSOCIATION, DECATUR, AL, BY ASSIGNMENT E S ROBBINS CORPORATION, MUSCLE SHOALS, AL. SN 76-084,335. PUB. 4-30-2002, FILED 7-6-2000.

POLYPLUS

FOR NON-METAL FENCING MATERIAL, NAMELY-WIRE REINFORCED POLYMER FENCING (U.S. CLS. 1, 12, 33 AND 50).

FIRST USE 7-0-2000; IN COMMERCE 7-0-2000.

2,729,860. CHRISTY REFRACTORIES COMPANY, L.L.C., ST. LOUIS, MO. SN 76-156,023. PUB. 11-5-2002, FILED 10-30-2000.

SEAL-CAST

FOR REFRACTORY AND INDUSTRIAL CERAMIC PRODUCTS, NAMELY, REFRACTORY SHAPES, CASTABLES, REFRACTORY FILTERS, CATALYST SUPPORTS, CRUCIBLES, REFRACTORY CLAYS, DRY CERAMIC MIX REFRACTORY TILES AND REFRACTORY BRICKS (U.S. CLS. 1, 12, 33 AND 50).

FIRST USE 12-31-1999; IN COMMERCE 12-31-1999.

CLASS 19—(Continued).

2,729,918. CUSTOM BUILDING PRODUCTS, SEAL BEACH, CA. SN 76-188,403. PUB. 2-12-2002, FILED 1-2-2001.

RHINO BOARD

NO CLAIM IS MADE TO THE EXCLUSIVE RIGHT TO USE "BOARD", APART FROM THE MARK AS SHOWN.

FOR BACKERBOARDS AND FLOORING UNDERLAYMENT FOR USE IN INSTALLING CERAMIC TILE, NATURAL STONE AND RESILIENT FLOORING, AND OTHER TILE, NATURAL STONE AND RESILIENT FLOOR INSTALLATION PRODUCTS (U.S. CLS. 1, 12, 33 AND 50).

FIRST USE 7-2-2001; IN COMMERCE 7-2-2001.

2,729,938. SPIDER COURT, INC., WINDSOR, ONTARIO, CANADA. SN 76-199,522. PUB. 4-16-2002, FILED 1-25-2001.

SPIDER

FOR PLASTIC FLOORING COMPRISED OF PLASTIC FLOORING TILES (U.S. CLS. 1, 12, 33 AND 50).

FIRST USE 1-0-2001; IN COMMERCE 1-0-2001.

2,730,070. SPC RESOURCES, INC., WILMINGTON, DE. SN 76-253,587. PUB. 9-4-2001, FILED 5-8-2001.

DURAGLAS

FOR FIBER TUBES FOR USE AS FORMS IN CONCRETE CONSTRUCTION AND HAVING AN INSIDE COATING RESULTING IN A SMOOTH SURFACE (U.S. CLS. 1, 12, 33 AND 50).

FIRST USE 1-1-2000; IN COMMERCE 1-1-2000.

2,730,121. WASHINGTON HARDWOODS, INC., SEATTLE, WA. SN 76-268,915. PUB. 12-11-2001, FILED 6-8-2001.

DURASTRAIGHT

FOR HARDWOOD WINDOW AND DOOR FRAMES FOR INTERIOR WINDOWS AND DOORS (U.S. CLS. 1, 12, 33 AND 50).

FIRST USE 6-1-2002; IN COMMERCE 6-1-2002.

CLASS 19—(Continued).

2,730,182. MODERN CONCRETE, OTTSVILLE, PA. SN 76-287,783. PUB. 5-28-2002, FILED 7-20-2001.



NO CLAIM IS MADE TO THE EXCLUSIVE RIGHT TO USE "RESTROOM RESOURCE", APART FROM THE MARK AS SHOWN.

FOR PRECAST CONCRETE RESTROOMS (U.S. CLS. 1, 12, 33 AND 50).
FIRST USE 7-1-2002; IN COMMERCE 7-27-2002.

2,730,194. ASHMORE LIMITED, NEW BRUNSWICK, CANADA. SN 76-292,864. PUB. 5-14-2002, FILED 7-31-2001.



PRIORITY CLAIMED UNDER SEC. 44(D) ON CANADA APPLICATION NO. 1,099,399., FILED 4-12-2001.

THE STIPPLING SHOWN IN THE DRAWING IS MEANT TO INDICATE SHADING.

FOR WOODEN OUTDOOR STORAGE BUILDINGS (U.S. CLS. 1, 12, 33 AND 50).
FIRST USE 6-10-2002; IN COMMERCE 8-14-2002.

2,730,276. ASERRADEROS ARAUCO S.A., LAS CONDES, SANTIAGO, CHILE. SN 76-315,896. PUB. 5-14-2002, FILED 9-21-2001.

CLASSICBOARD

FOR NON-METAL BUILDING MATERIALS FOR EXTERIOR USE, NAMELY, WOOD SIDING, TRIM AND FREEBOARDS (U.S. CLS. 1, 12, 33 AND 50).

FIRST USE 8-0-2001; IN COMMERCE 9-0-2001.

2,730,333. TNEMEC COMPANY INC., KANSAS CITY, MO. SN 76-330,229. PUB. 7-2-2002, FILED 10-29-2001.

CHEMBLOC H2S

FOR EPOXY MORTAR FOR APPLICATION TO CONCRETE (U.S. CLS. 1, 12, 33 AND 50).
FIRST USE 2-0-2002; IN COMMERCE 2-0-2002.

CLASS 19—(Continued).

2,730,350. HOMER TLC, INC., CLAYMONT, DE. SN 76-334,786. PUB. 6-4-2002, FILED 11-5-2001.

TRAFFICMASTER

OWNER OF U.S. REG. NO. 2,321,766.
FOR LAMINATED WOOD FLOORS, HARDWOOD FLOORS, CERAMIC TILE, VINYL TILE (U.S. CLS. 1, 12, 33 AND 50).

FIRST USE 5-0-2000; IN COMMERCE 5-0-2000.

2,730,379. RIDGLASS MANUFACTURING COMPANY, INC., FRESNO, CA. SN 76-341,366. PUB. 6-25-2002, FILED 11-23-2001.

KWIK RIDGE

NO CLAIM IS MADE TO THE EXCLUSIVE RIGHT TO USE "RIDGE", APART FROM THE MARK AS SHOWN.

FOR BUILDING MATERIALS, NAMELY NON-METAL ROOFING (U.S. CLS. 1, 12, 33 AND 50).

FIRST USE 8-28-2001; IN COMMERCE 8-28-2001.

2,730,528. EXTERIOR SYSTEMS, INC., MACEDONIA, OH. SN 76-396,884. PUB. 10-22-2002, FILED 4-18-2002.

WHISPER GLASS

NO CLAIM IS MADE TO THE EXCLUSIVE RIGHT TO USE "GLASS", APART FROM THE MARK AS SHOWN.

FOR GLASS FOR WINDOWS (U.S. CLS. 1, 12, 33 AND 50).

FIRST USE 10-1-2002; IN COMMERCE 10-1-2002.

2,730,584. CRANE PLASTICS SIDING LLC, COLUMBUS, OH. SN 78-038,347. PUB. 4-9-2002, FILED 12-8-2000.

WINDBRACER

FOR VINYL BEAD RUN ALONG TOP OF NAILING HEM SOLD AS A COMPONENT FEATURE OF VINYL SIDING USEFUL FOR THE ENHANCEMENT OF WIND LOAD PERFORMANCE (U.S. CLS. 1, 12, 33 AND 50).

FIRST USE 1-31-2001; IN COMMERCE 1-31-2001.

2,730,797. AMCRAFT BUILDING PRODUCTS CO., INC., BELOIT, WI. SN 78-103,901. PUB. 10-8-2002, FILED 1-21-2002.

RIVER CANYON

FOR VINYL SIDING (U.S. CLS. 1, 12, 33 AND 50).
FIRST USE 1-31-2002; IN COMMERCE 1-31-2002.

CLASS 19—(Continued).

2,730,843. CONSTRUCTION PRODUCTS, INC. OF TENNESSEE, JACKSON, TN. SN 78-124,754. PUB. 11-19-2002, FILED 4-29-2002.

STRESS-DOCK

FOR FLOATING PRE-STRESSED CONCRETE WHARVES (U.S. CLS. 1, 12, 33 AND 50).
FIRST USE 7-25-2002; IN COMMERCE 7-25-2002.

CLASS 20—FURNITURE AND ARTICLES NOT OTHERWISE CLASSIFIED

2,729,404. DAIMLER CHRYSLER CORPORATION, AUBURN HILLS, MI, BY CHANGE OF NAME CHRYSLER CORPORATION, AUBURN HILLS, MI. SN 75-529,123. PUB. 8-3-1999, FILED 7-31-1998.

JEEP

OWNER OF U.S. REG. NO. 1,841,351.
FOR SLEEPING BAGS AND BEDS ALL FOR USE WHEN CAMPING (U.S. CLS. 2, 13, 22, 25, 32 AND 50).
FIRST USE 8-1-2002; IN COMMERCE 8-1-2002.

2,729,443. ZARRELLA, CARMINE, STATEN ISLAND, NY. SN 75-655,862. PUB. 7-18-2000, FILED 3-8-1999.

PALM PILLOW

NO CLAIM IS MADE TO THE EXCLUSIVE RIGHT TO USE "PILLOW", APART FROM THE MARK AS SHOWN.
FOR CHILDREN'S HAND-SIZE DECORATIVE PILLOWS (U.S. CLS. 2, 13, 22, 25, 32 AND 50).
FIRST USE 10-22-2002; IN COMMERCE 10-22-2002.

2,729,560. VERTIFLEX INCORPORATED, NORTHBROOK, IL. SN 75-863,930. PUB. 1-9-2001, FILED 12-3-1999.

QUICK WERX

FOR OFFICE FURNITURE, DESKS, TABLES, COMPUTER WORKSTATIONS COMPRISING COMPUTER TABLES, KEYBOARD DRAWERS, PENCIL DRAWERS, WORK TABLES, CORNER TABLES, HUTCHES, PRINTER STANDS, PRINTER SHELVES, STORAGE SHELVES, AND MOBILE FILE PEDESTALS, FILING CABINETS, METAL FILING CABINETS, METAL SHELVES, MODULAR OFFICE STORAGE SHELVES, COMMERCIAL COMPUTER WORKSTATIONS COMPRISED OF ROOM DIVIDERS, COMMERCIAL CONTAINERS, AND MOVEABLE OFFICE PARTITIONS, AND MAGAZINE RACKS (U.S. CLS. 2, 13, 22, 25, 32 AND 50).
FIRST USE 1-0-2001; IN COMMERCE 1-0-2001.

CLASS 20—(Continued).

2,729,717. MENASHA CORPORATION, NEENAH, WI, BY CHANGE OF NAME; BY ASSIGNMENT COOKSON PLASTIC MOLDING CORP., LATHAM, NY. SN 76-066,209. PUB. 1-16-2001, FILED 6-8-2000.

AGRI-PAL

FOR PALLETS OF PLASTIC CONSTRUCTION (U.S. CLS. 2, 13, 22, 25, 32 AND 50).
FIRST USE 4-30-1999; IN COMMERCE 4-30-1999.

2,729,767. DECK AMERICA, INC., WOODBRIDGE, VA. SN 76-095,435. PUB. 9-24-2002, FILED 7-25-2000.

RHINO P.A.C.K.

FOR PRE-ENGINEERED FOUNDATION SUPPORT KITS COMPRISED OF NON-METAL FOOTERS, POSTS, POST SUPPORTS, AND CANTILEVER POST SUPPORTS FOR RECREATIONAL AND COMMERCIAL WOODEN DECKS AND AUXILIARY STRUCTURES, NAMELY BENCHES, WINDOWS, SUNPORCH TYPE STRUCTURES AND SUNROOMS AND NOT COMPRISED OF WORK TABLES, WORK BENCHES, INDUSTRIAL SHELVING, OR STORAGE RACKS (U.S. CLS. 2, 13, 22, 25, 32 AND 50).
FIRST USE 10-31-2000; IN COMMERCE 10-31-2000.

2,729,813. FOREST GROUP NEDERLAND B.V., 7418 EK DEVENTER, NETHERLANDS. SN 76-127,611. PUB. 6-18-2002, FILED 9-12-2000.



PRIORITY CLAIMED UNDER SEC. 44(D) ON BENELUX APPLICATION NO. 0959705, FILED 3-14-2000, REG. NO. 0668618. DATED 3-14-2000, EXPIRES 3-14-2010.

FOR CURTAIN RAILS, CURTAIN RODS, FASTENING MATERIALS FOR CURTAIN RAILS AND CURTAIN RODS, NAMELY, WALL SUPPORTS, SIDE WALL SUPPORTS, CEILING BRACKETS, EXTENSION BRACKETS, BRACKETS AND SUPPORTS WITH SNAP-IN FASTENINGS, CONNECTING BRIDGES; NON-METAL CURTAIN HOOKS, CURTAIN RINGS, CURTAIN ROLLERS, AND CURTAIN GLIDERS, END STOPS FOR CURTAIN RAILS AND CURTAIN RODS; CORDS AND CHAINS FOR OPENING AND CLOSING CURTAINS; WINDOW BLINDS (U.S. CLS. 2, 13, 22, 25, 32 AND 50).
FIRST USE 3-1-2000; IN COMMERCE 3-1-2000.

CLASS 20—(Continued).

2,729,871. EXPAND INTERNATIONAL AB, STOCKHOLM, SWEDEN. SN 76-161,404. PUB. 12-18-2001, FILED 11-8-2000.

EXPAND BANNERSTAND

NO CLAIM IS MADE TO THE EXCLUSIVE RIGHT TO USE "BANNER STAND", APART FROM THE MARK AS SHOWN.

FOR FURNITURE FOR DECORATIVE AND DISPLAY PURPOSES, NAMELY, PORTABLE SEMI-PERMANENT STRUCTURES; COLLAPSIBLE AND RAISABLE SUPPORTING STRUCTURES, NAMELY, FRAMED STANDS, PORTABLE ROLLER SCREENS FOR DISPLAY OF POSTERS, PICTURES AND MESSAGES; AND STRUCTURAL AND MECHANICAL PARTS FOR ALL OF THE AFORESAID (U.S. CLS. 2, 13, 22, 25, 32 AND 50).
FIRST USE 6-0-2001; IN COMMERCE 6-0-2001.

2,729,879. CHOO CHOO IMPORTS, PORTLAND, OR. SN 76-164,865. PUB. 6-4-2002, FILED 11-13-2000.

KIKI WOOD

NO CLAIM IS MADE TO THE EXCLUSIVE RIGHT TO USE "WOOD", APART FROM THE MARK AS SHOWN.

FOR DECORATIVE PIECES OF BOGWOOD FOR USE IN AQUARIUMS, TERRARIUMS, AND/OR AS MINIATURE LANDSCAPING (U.S. CLS. 2, 13, 22, 25, 32 AND 50).
FIRST USE 4-12-2001; IN COMMERCE 12-18-2001.

2,730,019. CONTAINER TECHNOLOGY, INC., SANTA BARBARA, CA. SN 76-233,303. PUB. 9-24-2002, FILED 3-30-2001.

ISOPURE

FOR 1-TO-330 GALLON HIGH DENSITY POLYETHYLENE (HDPE) NON-METAL LIQUID CONTAINERS FOR USE IN THE ELECTRONIC CHEMICAL INDUSTRY (U.S. CLS. 2, 13, 22, 25, 32 AND 50).
FIRST USE 7-15-2000; IN COMMERCE 7-15-2000.

2,730,159. THE BOYDS COLLECTION, LTD., MCSHERRYSTOWN, PA. SN 76-279,887. PUB. 8-6-2002, FILED 6-27-2001.

LIL WINGS

FOR FIGURINES PRIMARILY MADE OF RESIN (U.S. CLS. 2, 13, 22, 25, 32 AND 50).
FIRST USE 1-31-2003; IN COMMERCE 1-31-2003.

CLASS 20—(Continued).

2,730,200. AUTOTECHNIK, INC., LOUISVILLE, KY. SN 76-294,087. PUB. 3-19-2002, FILED 8-1-2001.

**CRYSTAL
GUARD**

FOR FURNITURE AND ARTICLES NOT OTHERWISE CLASSIFIED, NAMELY, PROTECTIVE TRANSPARENT AND TINTED FILMS AND LAMINATES APPLIED TO GLASS OR PLASTIC LENS, AND TO OTHER TYPES OF GLASS OR PLASTIC TRANSPARENT PANELS AND SHEETS (U.S. CLS. 2, 13, 22, 25, 32 AND 50).
FIRST USE 6-1-2002; IN COMMERCE 6-1-2002.

2,730,202. RA BRANDS, L.L.C., MADISON, NC. SN 76-294,186. PUB. 7-16-2002, FILED 8-1-2001.

STREN

OWNER OF U.S. REG. NOS. 678,371, 2,042,660, AND 2,185,143.

FOR FISH FEEDERS (U.S. CLS. 2, 13, 22, 25, 32 AND 50).
FIRST USE 3-0-2002; IN COMMERCE 3-0-2002.

2,730,281. OGLE, GEORGE B. II, CAPISTRANO BEACH, CA. SN 76-318,009. PUB. 6-25-2002, FILED 9-25-2001.

ANGEL ASHES

FOR FUNERARY URNS (U.S. CLS. 2, 13, 22, 25, 32 AND 50).
FIRST USE 11-21-2002; IN COMMERCE 11-21-2002.

2,730,391. DRAPER DBS, PERKASIE, PA. SN 76-343,932. PUB. 6-4-2002, FILED 11-30-2001.

UNFRAME

FOR FURNITURE AND CABINETRY (U.S. CLS. 2, 13, 22, 25, 32 AND 50).
FIRST USE 2-1-2000; IN COMMERCE 2-1-2000.

2,730,461. COMRIE, FREDERICK G., DEL MAR, CA. AND COMRIE, JOHN G., DEL MAR, CA. SN 76-357,796. PUB. 8-13-2002, FILED 1-10-2002.

HE WON'T LET YOU DOWN

FOR BED FRAMES (U.S. CLS. 2, 13, 22, 25, 32 AND 50).
FIRST USE 3-15-2002; IN COMMERCE 3-15-2002.

CLASS 20—(Continued).

2,730,472. SPACESAVER CORPORATION, FORT ATKINSON, WI. SN 76-361,733. PUB. 9-3-2002, FILED 1-23-2002.

STORAGE OPTIMIZED

NO CLAIM IS MADE TO THE EXCLUSIVE RIGHT TO USE "STORAGE", APART FROM THE MARK AS SHOWN.

FOR FURNITURE, NAMELY, FILE CABINETS, STORAGE CABINETS AND SHELVING UNITS; MOBILE FILE, STORAGE AND SHELVING UNITS, AND PARTS AND ACCESSORIES THEREFORE, NAMELY, SHELVES, CARRIAGES, POWER UNITS AND CONTROL UNITS FOR SAME; MOBILE STORAGE AND FILING SYSTEMS COMPRISED OF A PLURALITY OF MOBILE TRACK-GUIDED STORAGE CARRIAGES WHICH ARE MOVABLE TOGETHER AND APART TO OPEN-UP AND CLOSE ACCESS AISLES BETWEEN THE STORAGE CARRIAGES AND PARTS AND ACCESSORIES THEREFORE, NAMELY, HANGING FILE BARS, SHELVES, ANTI-TIP DEVICES, CARD HOLDERS, DIVIDERS, SERVICE TOOLS, INSTALLATION TOOLS, DRAWERS, DRAWER BRACKETS, HANGING FOLDER FRAMES, DRAWER LOCKS, TRIM STRIPS, BACK PANELS; COMPONENTS FOR ASSEMBLING DRAWERS, NAMELY, DRAWER FRONTS, DRAWER BACKS, DRAWER SIDES; KICK PLATES, LABEL HOLDERS, SLIDING SHELVES AND FILE DIVIDERS; COMPONENTS FOR ASSEMBLING FILE DIVIDERS, NAMELY, SLIDE BRACKETS, CROSS BRACKETS, SLOTTED OR PLAIN CENTER STOP BRACKETS; BIN DIVIDERS; COMPONENTS FOR ASSEMBLING BINS, NAMELY, BIN FRONTS, BIN BACKS AND CARD HOLDERS; COMPUTER REEL HANGERS; REEL RACKS; MOBILE STORAGE CARRIAGES EQUIPPED WITH SHELVES OR OTHER STORAGE DEVICES; SAFETY AND SECURITY SYSTEMS COMPRISING INFRA-RED OPTICAL SENSORS USED ON A PLURALITY OF SPACED-APART MOVEABLE CARRIAGES TO DETECT AN OBJECT OR A PERSON IN THE OPEN AISLE OF THE SHELVING SYSTEM; ELECTRONIC CONTROL FOR MOBILE STORAGE UNITS (U.S. CLS. 2, 13, 22, 25, 32 AND 50).

FIRST USE 2-6-2003; IN COMMERCE 2-6-2003.

2,730,498. NAUTICA APPAREL, INC., NEW YORK, NY. SN 76-371,330. PUB. 10-8-2002, FILED 2-16-2002.

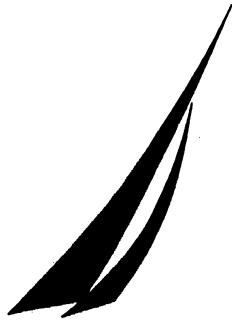

FOR BED PILLOWS AND PILLOWS (U.S. CLS. 2, 13, 22, 25, 32 AND 50).
FIRST USE 6-0-2001; IN COMMERCE 6-0-2001.

CLASS 20—(Continued).

2,730,604. SOUTHEAST CASKET DISTRIBUTORS AND FUNERAL SUPPLIES, INC., MACON, GA. SN 78-046,006. PUB. 6-18-2002, FILED 2-1-2001.

COLLEGIATE MEMORIALS

NO CLAIM IS MADE TO THE EXCLUSIVE RIGHT TO USE "MEMORIALS", APART FROM THE MARK AS SHOWN.

FOR CASKETS AND FUNERARY URNS (U.S. CLS. 2, 13, 22, 25, 32 AND 50).

FIRST USE 11-27-2002; IN COMMERCE 11-27-2002.

2,730,635. HUNG HSIANG BEDDING CO., LTD., TAOYUAN HSIEN, TAIWAN. SN 78-057,953. PUB. 6-4-2002, FILED 4-11-2001.

MONLIS
夢莉絲

THE TERM "MONLIS" IS THE TRANSLITERATION OF THE THREE CHINESE CHARACTERS USED IN THE MARK THAT DOES NOT HAVE SPECIFIC ENGLISH TRANSLATION.

FOR BED, SPRING BED, MATTRESS, BED FRAMES AND FURNITURE (U.S. CLS. 2, 13, 22, 25, 32 AND 50).

FIRST USE 6-1-1988; IN COMMERCE 1-1-2003.

2,730,704. KILEY, BARBARA WEBER, YORBA LINDA, CA. SN 78-081,044. PUB. 2-12-2002, FILED 8-24-2001.

REMEMBER ME

FOR FUNERARY URN FOR A PET'S ASHES INCORPORATED INTO MEMORIAL BOOK (U.S. CLS. 2, 13, 22, 25, 32 AND 50).

FIRST USE 2-24-2003; IN COMMERCE 2-25-2003.

CLASS 21—HOUSEWARES AND GLASS

CLASS 21—(Continued).

2,729,397. CIT GROUP/BUSINESS CREDIT, INC., THE, NEW YORK, NY, BY ASSIGNMENT CONTINENTAL SPRAYERS INTERNATIONAL, INC., ST. PETERS, MO. SN 75-507,258. PUB. 7-13-1999, FILED 6-23-1998.

LUXOR

FOR HAND OPERATED LOTION PUMPS SOLD EMPTY FOR DISPENSING LOTION (U.S. CLS. 2, 13, 23, 29, 30, 33, 40 AND 50).
FIRST USE 8-1-1999; IN COMMERCE 8-27-2002.

2,729,419. S. C. JOHNSON HOME STORAGE, INC., RACINE, WI. SN 75-574,184. PUB. 11-23-1999, FILED 10-20-1998.

ZIPLOC. ALL YOU EVER WANTED IN A CONTAINER

FOR PLASTIC CONTAINERS FOR FOOD STORAGE AND HOUSEHOLD USE (U.S. CLS. 2, 13, 23, 29, 30, 33, 40 AND 50).
FIRST USE 1-14-2002; IN COMMERCE 1-14-2002.

2,729,435. FARNAM COMPANIES, INC., PHOENIX, AZ. SN 75-635,544. PUB. 7-23-2002, FILED 2-5-1999.

CAPTIVATOR

FOR INSECT TRAPS AND/OR INSECT TRAPS HAVING A CHEMICAL ATTRACTANT, THE PURPOSE OF WHICH IS TO ATTRACT AND/OR KILL INSECTS (U.S. CLS. 2, 13, 23, 29, 30, 33, 40 AND 50).
FIRST USE 3-0-1999; IN COMMERCE 3-0-1999.

2,729,464. MCG MARKETING CONSULTANTS GROUP, INC., NEW YORK, NY. SN 75-703,965. PUB. 6-5-2001, FILED 5-12-1999.

DEGAS

FOR VASES, DECORATIVE BOXES, PLATES AND DECORATIVE PLATES, ALL OF THE FOREGOING MADE OF PORCELAIN (U.S. CLS. 2, 13, 23, 29, 30, 33, 40 AND 50).
FIRST USE 5-0-2002; IN COMMERCE 5-0-2002.

2,729,863. GARRETSON, JOHN E., PARADISE VALLEY, AZ. SN 76-158,075. PUB. 1-1-2002, FILED 11-3-2000.

BUGGY BEAMER

FOR INSECT TRAP (U.S. CLS. 2, 13, 23, 29, 30, 33, 40 AND 50).
FIRST USE 12-5-2002; IN COMMERCE 12-5-2002.

CLASS 21—(Continued).

2,729,954. WORLDWIDE INTEGRATED RESOURCES, INC., COMMERCE, CA. SN 76-204,769. PUB. 10-9-2001, FILED 2-1-2001.



FOR SPONGES AND SPONGE REFILLS FOR ROLLER MOPS (U.S. CLS. 2, 13, 23, 29, 30, 33, 40 AND 50).
FIRST USE 12-9-2002; IN COMMERCE 12-9-2002.

2,729,977. VITA CRAFT CORPORATION, SHAWNEE, KS. SN 76-215,412. PUB. 6-11-2002, FILED 2-26-2001.

MAGIC SEAL

NO CLAIM IS MADE TO THE EXCLUSIVE RIGHT TO USE "SEAL", APART FROM THE MARK AS SHOWN.
FOR NON-ELECTRIC COOKWARE, NAMELY, COOKING PANS AND FRY PANS (U.S. CLS. 2, 13, 23, 29, 30, 33, 40 AND 50).
FIRST USE 9-0-2000; IN COMMERCE 9-0-2000.

2,730,011. FLO-PAC CORPORATION, MINNEAPOLIS, MN. SN 76-225,434. PUB. 6-11-2002, FILED 3-15-2001.

DUO-PAN

OWNER OF U.S. REG. NOS. 1,959,727 AND 1,967,050.
FOR DIRT AND DUST RECEPTACLES FOR HOUSEHOLD, JANITORIAL AND INDUSTRIAL USE, NAMELY, DUST PANS (U.S. CLS. 2, 13, 23, 29, 30, 33, 40 AND 50).
FIRST USE 2-1-2001; IN COMMERCE 3-30-2001.

CLASS 21—(Continued).

2,730,083. PICNIC TIME, INC., MOORPARK, CA. SN 76-258,873. PUB. 6-25-2002, FILED 5-18-2001.



NO CLAIM IS MADE TO THE EXCLUSIVE RIGHT TO USE "PICNIC", APART FROM THE MARK AS SHOWN.

FOR FITTED PICNIC BASKETS IN THE NATURE OF BACKPACKS CONTAINING TABLE CLOTHS, UTENSILS AND NAPKINS, AND SOLD AS A UNIT (U.S. CLS. 2, 13, 23, 29, 30, 33, 40 AND 50).

FIRST USE 6-20-2001; IN COMMERCE 6-20-2001.

CLASS 22—(Continued).

2,730,552. KID SAFE POOL NETS, INC., FORT LAUDERDALE, FL. SN 78-008,882. PUB. 8-21-2001, FILED 5-19-2000.



NO CLAIM IS MADE TO THE EXCLUSIVE RIGHT TO USE "KID" AND "POOL NETS" APART FROM THE MARK AS SHOWN., APART FROM THE MARK AS SHOWN.

FOR NETTING USED TO PREVENT CHILDREN FROM FALLING INTO A SWIMMING POOL (U.S. CLS. 1, 2, 7, 19, 22, 42 AND 50).

FIRST USE 5-1-2000; IN COMMERCE 9-1-2000.

2,730,356. KIMBERLY-CLARK WORLDWIDE, INC., NEENAH, WI, BY ASSIGNMENT KIMBERLY-CLARK CORPORATION, NEENAH, WI. SN 76-336,945. PUB. 6-18-2002, FILED 11-13-2001.

KIMFRESH

FOR ANTIMICROBIAL AGENT OR SOLUTIONS INCLUDED AS AN INTEGRATED INGREDIENT OF NON-WOVEN FABRIC WIPES FOR INSTITUTIONAL USE (U.S. CLS. 2, 13, 23, 29, 30, 33, 40 AND 50).

FIRST USE 5-24-2002; IN COMMERCE 5-24-2002.

2,730,613. CNA HOLDINGS, INC., SUMMIT, NJ. SN 78-050,000. PUB. 12-11-2001, FILED 2-23-2001.



OWNER OF U.S. REG. NOS. 1,340,809 AND 1,748,571. THE MARK CONSISTS OF THE STYLIZED LETTERS "P", "B" AND "I", WITH A FLAME DESIGN OVER THE "I".

FOR POLYBENZIMIDAZOLE FIBER FOR VARIOUS END USE APPLICATIONS (U.S. CLS. 1, 2, 7, 19, 22, 42 AND 50).

FIRST USE 9-2-1992; IN COMMERCE 9-2-1992.

CLASS 22—CORDAGE AND FIBERS

2,729,642. TOTES ISOTONER CORPORATION, CINCINNATI, OH. SN 75-981,999. PUB. 8-27-2002, FILED 5-29-2001.

IMAGES BY TOTES

FOR AUTOMOTIVE ACCESSORIES, NAMELY, ADJUSTABLE LENGTH TRUNK STRAP (U.S. CLS. 1, 2, 7, 19, 22, 42 AND 50).

FIRST USE 5-31-1996; IN COMMERCE 5-31-1996.

CLASS 23—YARNS AND THREADS

2,729,712. MANIFATTURA LANE GAETANO MARZOTTO & FIGLI S.P.A., 36078 VALDAGNO (VICENZA), ITALY. SN 76-055,967. PUB. 7-9-2002, FILED 5-19-2000.

AMICO

"AMICO" CAN BE TRANSLATED INTO ENGLISH AS "FRIEND".

FOR YARNS, THREADS, FOR TEXTILE (U.S. CL. 43). FIRST USE 6-0-1996; IN COMMERCE 6-0-1996.

2,730,128. BEDFORD INDUSTRIES, INC., WORTHINGTON, MN. SN 76-271,188. PUB. 2-19-2002, FILED 6-13-2001.

POLY-STRAP

FOR BUNDLING STRAPS (U.S. CLS. 1, 2, 7, 19, 22, 42 AND 50).

FIRST USE 2-21-2003; IN COMMERCE 2-21-2003.

CLASS 24—FABRICS

CLASS 24—(Continued).

2,729,381. STILTENDE GENIUS S.R.L., I-44012 BONDENO (FE), ITALY. SN 75-451,699. PUB. 7-2-2002, FILED 3-17-1998.



FOR NETTING AND CURTAINS FOR USE IN PREVENTING MOSQUITOES AND INSECTS FROM ENTERING A SPECIFIED AREA (U.S. CLS. 42 AND 50).
FIRST USE 10-1-1998; IN COMMERCE 10-1-1998.

2,729,643. INTEX CORPORATION, GREENSBORO, NC. SN 75-982,212. PUB. 7-9-2002, FILED 9-24-1999.

XHALE

FOR POLYESTER KNIT FABRIC HAVING MOISTURE WICKING PROPERTIES FOR USE IN UNIFORM SHIRTS AND CAMOUFLAGE PRINTED SHIRTS (U.S. CLS. 42 AND 50).
FIRST USE 10-18-2002; IN COMMERCE 10-18-2002.

2,729,906. RITE-HITE HOLDING CORPORATION, MILWAUKEE, WI. SN 76-181,411. PUB. 7-2-2002, FILED 12-18-2000.

DURATHON

FOR INDUSTRIAL FABRIC, NAMELY, VINYL WITH TRI-POLYMER COATING, FOR USE IN CONNECTION WITH PROTECTING SIDE PADS OF LOADING DOCK SEALS AND SHELTERS (U.S. CLS. 42 AND 50).
FIRST USE 6-1-2001; IN COMMERCE 6-1-2001.

2,729,985. CHF INDUSTRIES, INC., NEW YORK, NY, BY ASSIGNMENT; BY CHANGE OF NAME CHF INDUSTRIES, INC., NEW YORK, NY. SN 76-219,147. PUB. 5-7-2002, FILED 3-2-2001.

IT'S ALL IN THE BAG

FOR BEDDING TEXTILES, NAMELY, SHEETS, PILLOW CASES, PILLOW SHAMS, BEDSPREADS, COMFORTERS, QUILTS, DUVETS AND DUST RUFFLES (U.S. CLS. 42 AND 50).
FIRST USE 6-0-2002; IN COMMERCE 6-0-2002.

CLASS 24—(Continued).

2,730,387. BI PROPERTIES I INC., GREENSBORO, NC. SN 76-343,001. PUB. 4-30-2002, FILED 11-29-2001.

ISOTHERM

OWNER OF U.S. REG. NO. 724,543.
FOR FABRICS FOR USE IN THE MANUFACTURE OF CLOTHING (U.S. CLS. 42 AND 50).
FIRST USE 8-8-2002; IN COMMERCE 8-8-2002.

2,730,406. PEKING HANDICRAFT, INC., SOUTH SAN FRANCISCO, CA. SN 76-346,132. PUB. 5-28-2002, FILED 12-6-2001.

SIMPLE SOLUTIONS

FOR QUILTS (U.S. CLS. 42 AND 50).
FIRST USE 3-8-2002; IN COMMERCE 3-8-2002.

2,730,499. NAUTICA APPAREL, INC., NEW YORK, NY. SN 76-371,331. PUB. 10-8-2002, FILED 2-16-2002.

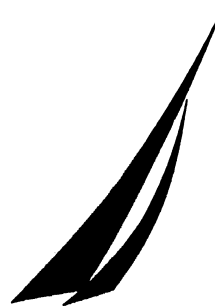

FOR MATTRESS PADS, BED VESTS, DUVETS, DUVET COVERS, PILLOW CASES, AND PILLOW PROTECTORS (U.S. CLS. 42 AND 50).
FIRST USE 6-0-2001; IN COMMERCE 6-0-2001.

2,730,820. WESTPORT CORPORATION, PINE BROOK, NJ. SN 78-111,124. PUB. 10-29-2002, FILED 2-26-2002.

CANVEX

FOR TEXTILE FABRICS USED FOR THE MANUFACTURE OF CLOTHING, PRIMARILY CONSISTING OF NYLON AND POLYESTER (U.S. CLS. 42 AND 50).
FIRST USE 4-1-2002; IN COMMERCE 8-25-2002.

CLASS 25—CLOTHING

CLASS 25—(Continued).

2,729,385. CHANDLER, HERMAN L., JR., DBA UNIFIED DELEGATION OF INTELLIGENT GENTLEMEN, ROSELLE, NJ. AND MAYES, DENNIS, DBA UNIFIED DELEGATION OF INTELLIGENT GENTLEMEN, ROSELLE, NJ. AND ROBINSON, CHRISTOPHER O., DBA UNIFIED DELEGATION OF INTELLIGENT GENTLEMEN, ROSELLE, NJ. AND SEGARS, TOMMIE, DBA UNIFIED DELEGATION OF INTELLIGENT GENTLEMEN, ROSELLE, NJ. AND TATE, LARRY, DBA UNIFIED DELEGATION OF INTELLIGENT GENTLEMEN, ROSELLE, NJ. SN 75-479,300. PUB. 12-21-1999, FILED 5-4-1998.

UDIG

FOR CLOTHING, NAMELY SNEAKERS, SOCKS, SHORTS, T-SHIRTS, GOLF SHIRTS, SWEAT SHIRTS, BASEBALL CAPS, JERSEYS, JOGGING SUITS, JACKETS, COATS, GLOVES, VISORS, JEANS, SKIRTS, WIND RESISTANT JACKET, SWEATBANDS, BATHING TRUNKS, AND BATHING SUITS (U.S. CLS. 22 AND 39). FIRST USE 2-0-2003; IN COMMERCE 2-0-2003.

2,729,402. SPEIRS, GREGORY, BRONXVILLE, NY. SN 75-523,613. PUB. 10-8-2002, FILED 7-22-1998.



FOR T-SHIRTS, BASEBALL CAPS, BOXER SHORTS, NECKTIES, BASEBALL JACKETS, BOXER SHORTS, TANK TOPS, SNEAKERS, DENIM SHIRTS, DRESS SHIRTS, GOLF SHIRTS, GLOVES, FLEECE PULLOVER JACKETS, SWEATERS, WARM-UP SUITS, SHORTS, SOCKS, HEADBANDS, SWEATSHIRTS, HATS, BERETS, SCARVES, POLO SHIRTS, FLEECE HATS AND CAPS (U.S. CLS. 22 AND 39).

FIRST USE 3-7-1996; IN COMMERCE 10-20-1998.

2,729,479. SARA LEE CORPORATION, WINSTON-SALEM, NC. SN 75-731,172. PUB. 1-4-2000, FILED 6-17-1999.

COMFORTSOFT

OWNER OF U.S. REG. NOS. 1,815,011 AND 1,833,894. FOR T-SHIRTS, FLEECE TOPS AND BOTTOMS, SHORTS, TANK TOPS, SPORTSHIRTS (U.S. CLS. 22 AND 39).

FIRST USE 2-28-2002; IN COMMERCE 2-28-2002.

CLASS 25—(Continued).

2,729,612. GYROTONIC SALES CORPORATION, NEW YORK, NY. SN 75-919,006. PUB. 1-30-2001, FILED 2-15-2000.



FOR T-SHIRTS, SWEATSHIRTS, SWEATPANTS, SHORTS, GOLF SHIRTS AND CAPS (U.S. CLS. 22 AND 39).

FIRST USE 10-0-2000; IN COMMERCE 10-0-2000.

2,729,647. V SECRET CATALOGUE, INC., WILMINGTON, DE. SN 75-983,159. PUB. 1-8-2002, FILED 10-4-1999.

DESIRE

FOR CLOTHING, NAMELY, BRAS AND PANTIES (U.S. CLS. 22 AND 39).

FIRST USE 11-0-1999; IN COMMERCE 11-0-1999.

2,729,655. L.C. LICENSING, INC., NEW YORK, NY. SN 75-983,230. PUB. 9-11-2001, FILED 5-22-1998.

OWNER OF U.S. REG. NOS. 2,027,829, 2,160,698, AND 2,171,423.

FOR MEN'S AND WOMEN'S CLOTHING, NAMELY, SHIRTS, BLOUSES, SWEATSHIRTS, CARDIGANS, VESTS, SWEATERS AND T-SHIRTS (U.S. CLS. 22 AND 39).

FIRST USE 10-1-2002; IN COMMERCE 10-1-2002.

2,729,666. SEARS, ROEBUCK AND CO., HOFFMAN ESTATES, IL. SN 76-008,200. PUB. 4-30-2002, FILED 3-23-2000.

METAPHOR

FOR FOOTWEAR (U.S. CLS. 22 AND 39). FIRST USE 11-1-2000; IN COMMERCE 11-1-2000.

CLASS 25—(Continued).

2,729,733. BBC INTERNATIONAL LTD., BOCA RATON, FL. SN 76-075,081. PUB. 2-19-2002, FILED 6-22-2000.

CYBER NET

OWNER OF U.S. REG. NO. 2,239,594.
FOR FOOTWEAR (U.S. CLS. 22 AND 39).
FIRST USE 10-0-2000; IN COMMERCE 10-0-2000.

2,729,783. ROCKPORT COMPANY, LLC, THE, CANTON, MA. SN 76-106,116. PUB. 4-30-2002, FILED 8-10-2000.

**ROCKPORT**

OWNER OF U.S. REG. NOS. 1,075,072, 1,263,015, AND 1,706,924.

FOR FOOTWEAR; HEADWEAR; AND CLOTHING, NAMELY, SHIRTS, T-SHIRTS, SWEATERS, VESTS, SWEATSHIRTS, PANTS, SHORTS, SWEATPANTS, JACKETS, COATS, SOCKS, HATS, CAPS, VISORS, HEADBANDS, SWEATBANDS, WRISTBANDS, GLOVES AND SCARVES (U.S. CLS. 22 AND 39).

FIRST USE 4-30-2001; IN COMMERCE 4-30-2001.

2,729,791. STEELE, CODY, SOLANA BEACH, CA. SN 76-112,348. PUB. 5-22-2001, FILED 8-21-2000.

CODE RED

FOR CLOTHING, NAMELY, T-SHIRTS, SHIRTS (U.S. CLS. 22 AND 39).
FIRST USE 11-12-2001; IN COMMERCE 1-13-2003.

2,729,814. JDR APPAREL GROUP, LLC, NEW YORK, NY. SN 76-128,081. PUB. 7-30-2002, FILED 9-14-2000.

JON JAC

THE NAME "JON JAC" DOES NOT IDENTIFY A LIVING INDIVIDUAL.

FOR CLOTHING, NAMELY, BLOUSES, BOTTOMS, CARDIGANS, DRESSES, DUSTERS, GYM SHORTS, GYM SUITS, JACKETS, JERSEYS, JOGGING SUITS, KNIT SHIRTS, LEGGINGS, OVERALLS, PAJAMAS, PANTIES, PANTS, PANTSUITS, PEDAL PUSHERS, POLO SHIRTS, PONCHOS, PULLOVERS, QUILTED VESTS, SHIRTS, SHORTS, SKIRTS, SPORT SHIRTS, SWEAT PANTS, SWEAT SHIRTS, SWEAT SHORTS, SWEAT SUITS, SWEATERS, WARMUP SUITS (U.S. CLS. 22 AND 39).

FIRST USE 11-30-2000; IN COMMERCE 11-30-2000.

CLASS 25—(Continued).

2,729,816. WONDER-FORM INC., ST. LEONARD, QUEBEC, CANADA. SN 76-128,799. PUB. 4-30-2002, FILED 9-15-2000.

MILLE FIORE

OWNER OF CANADA REG. NO. TMA524823, DATED 3-14-2000, EXPIRES 3-14-2015.

THE ENGLISH TRANSLATION OF THE WORDS "MILLE FIORE" IN THE MARK IS "THOUSAND FLOWERS".

FOR INTIMATE APPAREL, NAMELY, BRAS, PANTIES, THONG UNDERWEAR, GARTER BELTS, BUSTIERS, MERRY WIDOWS, CAMISOLES, SLIPS (U.S. CLS. 22 AND 39).

FIRST USE 10-24-2002; IN COMMERCE 10-24-2002.

2,729,850. BASTEL, VICTORIA (DOLPHINA), SANTA MONICA, CA. SN 76-149,563. PUB. 4-9-2002, FILED 10-18-2000.

**DOLPHINA'S
GODDESSWEAR**

FOR PANTS, HATS, CAPS, FOOTWEAR, SPORTSWEAR, SOCKS, BELTS, SHIRTS, JACKETS, OUTERWEAR, WORKOUTWEAR, COSTUMES AND ACCESSORIES (U.S. CLS. 22 AND 39).

FIRST USE 6-0-2000; IN COMMERCE 6-0-2000.

2,729,900. FLAT OUT SPORTS, LLC, ANN ARBOR, MI. SN 76-178,171. PUB. 2-19-2002, FILED 12-11-2000.

FLAT OUT

FOR APPAREL, NAMELY, T-SHIRTS, JACKETS, PARKA, PULL-OVERS, CAPS, HATS, SHIRTS, PANTS, SHORTS, SHOES, SWEATSUITS, SWEATBANDS, SOCKS, TEAM ATHLETIC UNIFORMS (U.S. CLS. 22 AND 39).

FIRST USE 12-11-2000; IN COMMERCE 6-1-2001.

2,729,905. INNOVA INC., DAVENPORT, IA. SN 76-180,551. PUB. 9-24-2002, FILED 12-13-2000.

ULTREX COOKWARE

OWNER OF U.S. REG. NOS. 2,277,412, 2,384,191, AND OTHERS.

NO CLAIM IS MADE TO THE EXCLUSIVE RIGHT TO USE "COOKWARE", APART FROM THE MARK AS SHOWN.

FOR DOMESTIC KITCHEN APRONS (U.S. CLS. 22 AND 39).

FIRST USE 6-30-2001; IN COMMERCE 6-30-2001.

CLASS 25—(Continued).

2,730,063. TURNER NETWORK TELEVISION LP, LLLP, ATLANTA, GA. SN 76-247,804. PUB. 1-29-2002, FILED 4-27-2001.

WE KNOW DRAMA

FOR CLOTHING FOR MEN, WOMEN AND CHILDREN, NAMELY, SHIRTS, T-SHIRTS, SWEATSHIRTS, JOGGING SUITS, HATS, CAPS AND SUN-VISORS (U.S. CLS. 22 AND 39).

FIRST USE 6-8-2001; IN COMMERCE 6-8-2001.

2,730,078. PRINTMARK INDUSTRIES, INC., HAZLETON, PA. SN 76-256,705. PUB. 7-30-2002, FILED 5-14-2001.

TERRYLASTIC

FOR HEAD BANDS AND WRIST BANDS (U.S. CLS. 22 AND 39).

FIRST USE 11-0-2001; IN COMMERCE 12-0-2001.

2,730,090. PURPLE PIN DESIGNS LIMITED, KWUN TONG, HONG KONG. SN 76-260,157. PUB. 11-27-2001, FILED 5-22-2001.

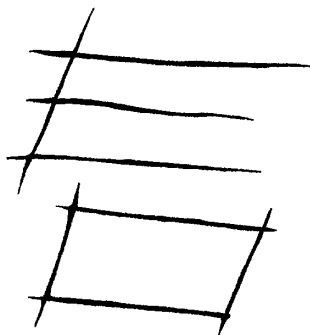

FOR CLOTHING, NAMELY, JEANS, TROUSERS, SHORT PANTS, SHIRTS, POLO SHIRTS, WOVEN SHIRTS, KNIT SHIRTS, SWEATSHIRTS, FLEECE TOPS, SKIRTS, RAINCOATS, CARDIGANS, JACKETS, WAIST-COATS, BLOUSES, SOCKS, GLOVES, NECKTIES, SCARVES, HATS, BATHING SUITS; FOOTWEAR AND HEADWEAR (U.S. CLS. 22 AND 39).

FIRST USE 7-0-2000; IN COMMERCE 12-31-2002.

CLASS 25—(Continued).

2,730,097. PIVOTAL CENTURY PLAZA HOTEL, LLC, PHOENIX, AZ. SN 76-261,740. PUB. 5-7-2002, FILED 5-23-2001.

SPA MYSTIQUE

NO CLAIM IS MADE TO THE EXCLUSIVE RIGHT TO USE "SPA", APART FROM THE MARK AS SHOWN.

FOR T-SHIRTS, SHORTS, BATHROBES, BASEBALL HATS, JACKETS, JOGGING SUITS, SWEAT PANTS, SWEAT SHIRTS, SOCKS AND SANDALS (U.S. CLS. 22 AND 39).

FIRST USE 4-15-2001; IN COMMERCE 5-15-2001.

2,730,149. BALLINGER GOLD, INC., NEW YORK, NY, BY CHANGE OF NAME BIMOTEUR, INC., NEW YORK, NY. SN 76-277,649. PUB. 3-26-2002, FILED 6-28-2001.

MARY LUCILLE

THE NAME "MARY LUCILLE" DOES NOT IDENTIFY A LIVING INDIVIDUAL.

FOR WOMEN'S SPORTSWEAR, NAMELY, KNIT AND WOVEN TOPS AND BOTTOMS, SWEATERS, BLOUSES, SLACKS, SKIRTS, DRESSES; WOMEN'S OUTERWEAR, NAMELY, COATS, AND JACKETS (U.S. CLS. 22 AND 39).

FIRST USE 10-26-2001; IN COMMERCE 10-26-2001.

2,730,171. CREATIVE APPAREL CONCEPTS, INC., MINNEAPOLIS, MN. SN 76-284,717. PUB. 7-2-2002, FILED 7-10-2001.

STARFLY

FOR INTIMATE APPAREL, NAMELY, NIGHTSHIRTS, PAJAMAS, UNDERWEAR, SOCKS, ROBES, SLIPPERS, BOXER SHORTS, NIGHTCAPS, FLEECE LOUNGERS, BRAS (U.S. CLS. 22 AND 39).

FIRST USE 9-1-2002; IN COMMERCE 9-1-2002.

2,730,172. CREATIVE APPAREL CONCEPTS, INC., MINNEAPOLIS, MN. SN 76-284,718. PUB. 4-16-2002, FILED 7-10-2001.

GLOW IN THE DARK SLEEPWEAR

NO CLAIM IS MADE TO THE EXCLUSIVE RIGHT TO USE "SLEEPWEAR", APART FROM THE MARK AS SHOWN.

FOR INTIMATE APPAREL, NAMELY, NIGHTSHIRTS, PAJAMAS, UNDERWEAR, SOCKS, ROBES, SLIPPERS, BOXER SHORTS, NIGHTCAPS, FLEECE LOUNGERS, BRAS (U.S. CLS. 22 AND 39).

FIRST USE 9-1-2002; IN COMMERCE 9-1-2002.

CLASS 25—(Continued).

2,730,240. GARRETT, LAMONT, CHICAGO, IL. SN 76-304,914. PUB. 1-1-2002, FILED 8-28-2001.



FOR CLOTHING; NAMELY T-SHIRTS, SHORTS, SWEATERS, SWEATSHIRTS, SWEATPANTS, VESTS, JACKETS, JERSEYS, COMPRESSION SHORTS, WRISTBANDS, GLOVES, HEADWEAR; NAMELY BASEBALL CAPS, HATS, BANDANAS, VISORS, HEADBANDS, SKULLCAPS, HELMETS, AND FOOTWEAR; NAMELY ATHLETIC SHOES, SOCKS, BEACH/SHOWER SHOES, RECOVERY SHOES, SANDALS (U.S. CLS. 22 AND 39).
FIRST USE 2-6-2003; IN COMMERCE 2-20-2003.

2,730,253. CINQ, LTD., NEW YORK, NY. SN 76-307,836. PUB. 9-24-2002, FILED 9-4-2001.

NICOLE G

THE MARK COMPRISES THE NAME OF A LIVING INDIVIDUAL.

FOR WOMEN'S SPORTSWEAR NAMELY, JACKETS, PANTS, SKIRTS, BLOUSES, DRESSES, SHIRTS AND KNIT TOPS (U.S. CLS. 22 AND 39).
FIRST USE 1-30-2002; IN COMMERCE 1-30-2002.

2,730,264. MACK AND MOORE, INC., MINNEAPOLIS, MN. SN 76-312,679. PUB. 7-9-2002, FILED 9-13-2001.

NIGHT IRENE

FOR CLOTHING AND SLEEPWEAR FOR GIRLS, NAMELY, PAJAMAS, NIGHTGOWNS, NIGHTSHIRTS, LOUNGE PANTS, ROBES, SHIRTS, SHORTS, TANK TOPS, DRESSES AND SLIP DRESSES (U.S. CLS. 22 AND 39).

FIRST USE 3-0-2002; IN COMMERCE 3-0-2002.

CLASS 25—(Continued).

2,730,305. WELLS LAMONT CORPORATION, NILES, IL. SN 76-322,788. PUB. 5-21-2002, FILED 10-9-2001.



OWNER OF U.S. REG. NOS. 539,574, 556,154, AND OTHERS.

NO CLAIM IS MADE TO THE EXCLUSIVE RIGHT TO USE "LEATHER PALM GLOVES", APART FROM THE MARK AS SHOWN.

THE LINING IN THE DRAWING IS FOR SHADING PURPOSES ONLY AND DOES NOT INDICATE COLOR.

FOR GLOVES (U.S. CLS. 22 AND 39).

FIRST USE 1-1-1999; IN COMMERCE 1-1-1999.

2,730,308. FRAZIER CLOTHING CO., INC., NEW YORK, NY. SN 76-323,117. PUB. 5-7-2002, FILED 10-10-2001.

OLIVIA PAIGE

THE NAME "OLIVIA PAIGE" DOES NOT IDENTIFY A LIVING INDIVIDUAL.

FOR CLOTHING, NAMELY, TANK TOPS, CAMISOLES, TEE SHIRTS, JACKETS, SWEATERS, CARDIGANS, SPORTS BRAS, DRESSES, BODY SUITS, PANTS, SHORTS, SKIRTS, LEGGINGS, STIRRUP PANTS (U.S. CLS. 22 AND 39).

FIRST USE 3-1-2002; IN COMMERCE 3-1-2002.

2,730,311. NATIONAL BASEBALL HALL OF FAME AND MUSEUM, INC., COOPERSTOWN, NY. SN 76-323,742. PUB. 7-2-2002, FILED 10-10-2001.

BASEBALL AS AMERICA

OWNER OF U.S. REG. NO. 2,191,138.
FOR T-SHIRTS, JERSEYS, GOLF SHIRTS, SWEAT SHIRTS, CAPS, JACKETS, SCARVES AND NECKTIES (U.S. CLS. 22 AND 39).

FIRST USE 11-8-2001; IN COMMERCE 3-12-2002.

2,730,324. E.H.L. IMPORTS CORP., BROOKLYN, NY. SN 76-327,818. PUB. 5-14-2002, FILED 10-13-2001.

ONCE & AGAIN

FOR CLOTHING, NAMELY SHIRTS, T-SHIRTS, SWEATSHIRTS, PANTS, SHORTS, COATS, JACKETS, HATS, CAPS, AND SHOES (U.S. CLS. 22 AND 39).

FIRST USE 11-0-2002; IN COMMERCE 11-0-2002.

CLASS 25—(Continued).

2,730,365. STANTON, ALBERT C. JR., ANNAPOLIS, MD. SN 76-338,613. PUB. 6-4-2002, FILED 11-16-2001.

GOD'S WORD SHALL ALWAYS RULE

FOR APPAREL FOR MEN, WOMEN, AND CHILDREN, NAMELY, SHIRTS, T-SHIRTS, SWEATSHIRTS, SWEATSUITS, SHORTS, HATS, AND JACKETS (U.S. CLS. 22 AND 39).

FIRST USE 0-0-1995; IN COMMERCE 0-0-1995.

2,730,435. YOUR CONNECTION, INC., LOS ANGELES, CA. SN 76-352,089. PUB. 9-24-2002, FILED 12-24-2001.

It's a beautiful thing!



FOR T-SHIRTS AND SWEATSHIRTS (U.S. CLS. 22 AND 39).

FIRST USE 5-23-2000; IN COMMERCE 7-21-2000.

2,730,450. INTER-BRIGHT INC., CITY OF INDUSTRY, CA. SN 76-355,329. PUB. 9-24-2002, FILED 1-4-2002.

JOLIE VICKI

THE MARK IN THIS APPLICATION DOES NOT IDENTIFY ANY REAL PERSON, BUT IS A CONTRACTION OF THE FICTITIOUS NAME "JOLIE VICTORIA"

THE TRANSLATION OF THE WORD "JOLIE" IS "PRETTY".

FOR FOOTWEAR, NAMELY SHOES (U.S. CLS. 22 AND 39).

FIRST USE 12-31-1990; IN COMMERCE 12-31-1990.

2,730,463. L.C. LICENSING, INC., NEW YORK, NY. SN 76-359,682. PUB. 8-20-2002, FILED 1-14-2002.

CRAZY FOR WRAPS

FOR SHAWLS, CAPES AND SCARVES (U.S. CLS. 22 AND 39).

FIRST USE 6-0-2001; IN COMMERCE 6-0-2001.

CLASS 25—(Continued).

2,730,542. KABUSHIKI KAISHA SONY COMPUTER ENTERTAINMENT, TA SONY COMPUTER ENTERTAINMENT INC., MINATO-KU, TOKYO, JAPAN. SN 76-975,417. PUB. 7-16-2002, FILED 12-11-2001.

PlayStation

FOR CLOTHING, NAMELY, T-SHIRTS, SHIRTS, SWEATERS, PARKAS, OUTER COATS, PANTS, ATHLETIC SUITS, SHORTS, HATS, HOODS, SHOES AND BOOTS (U.S. CLS. 22 AND 39).

FIRST USE 12-0-2001; IN COMMERCE 12-0-2001.

2,730,561. BLUEBERRY BLVD., LLC, AMITYVILLE, NY. SN 78-020,296. PUB. 3-26-2002, FILED 8-9-2000.

BLUEBERI BOULEVARD

FOR CHILDREN'S CLOTHING, NAMELY DRESSES, TOPS, BLOUSES, PANTS, AND SETS COMPRISED OF COMBINATIONS OF THE FOREGOING (U.S. CLS. 22 AND 39).

FIRST USE 5-0-2000; IN COMMERCE 5-0-2000.

2,730,568. CANADELLE LIMITED PARTNERSHIP, MONTREAL, QUEBEC, CANADA. SN 78-028,092. PUB. 7-3-2001, FILED 9-28-2000.

THE WONDER OF STRETCH

NO CLAIM IS MADE TO THE EXCLUSIVE RIGHT TO USE "STRETCH", APART FROM THE MARK AS SHOWN. FOR BRAS AND PANTIES (U.S. CLS. 22 AND 39).

FIRST USE 4-15-2001; IN COMMERCE 4-15-2001.

CLASS 25—(Continued).

2,730,590. SUMMERS-ARMSTRONG, SHONDRA, LAS VEGAS, NV. SN 78-039,767. PUB. 6-25-2002, FILED 12-19-2000.

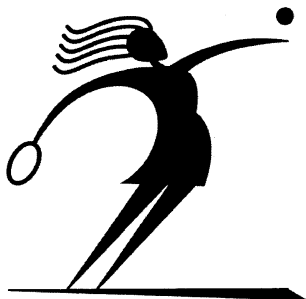

FOR TENNIS CLOTHING, NAMELY, TENNIS TOPS, TENNIS SHIRTS, TENNIS SKIRTS, T-SHIRTS, JACKETS, TENNIS PANTIES AND TENNIS DRESSES (U.S. CLS. 22 AND 39).

FIRST USE 8-1-2001; IN COMMERCE 6-1-2002.

2,730,601. SLOAN, LINDA, LITTLETON, CO. BY ASSIGNMENT BRUEMMER, MARGARET, LITTLETON, CO. AND SLOAN, LINDA, LITTLETON, CO. SN 78-044,137. PUB. 3-12-2002, FILED 1-20-2001.

BITCHWHERE

FOR CLOTHING, NAMELY, SHIRTS, JACKETS, SHORTS, PANTS, UNDERWEAR AND HEADWEAR (U.S. CLS. 22 AND 39).

FIRST USE 7-13-2001; IN COMMERCE 7-13-2001.

2,730,617. SARA LEE CORPORATION, WINSTON-SALEM, NC. SN 78-051,721. PUB. 7-2-2002, FILED 3-7-2001.

BODY ENHANCERS

FOR HOSIERY, PANTYHOSE, TIGHTS AND SOCKS (U.S. CLS. 22 AND 39).

FIRST USE 5-25-2002; IN COMMERCE 5-25-2002.

CLASS 25—(Continued).

2,730,621. CLUB COULOIR ACTIONWEAR INC., VANCOUVER, B.C., CANADA. SN 78-052,987. PUB. 7-2-2002, FILED 3-14-2001.

ROTOR SPORTS

PRIORITY CLAIMED UNDER SEC. 44(D) ON CANADA APPLICATION NO. 1076913, FILED 9-29-2000.

NO CLAIM IS MADE TO THE EXCLUSIVE RIGHT TO USE "SPORTS", APART FROM THE MARK AS SHOWN.

FOR MEN'S, WOMEN'S, AND CHILDREN'S ACTIVE SPORTS CLOTHING, NAMELY, JACKETS, BIB PANTS, PANTS, WOVEN AND KNITS TOPS, SWEATERS, T-SHIRTS, HATS, SHORTS, GLOVES, SWEATSHIRTS, SWEATPANTS, SOCKS, AND SHOES (U.S. CLS. 22 AND 39).

FIRST USE 11-1-2001; IN COMMERCE 11-1-2001.

2,730,660. RAINBOW INVESTMENT GROUP, DBA AUSTIN RAGE, HOUSTON, TX. SN 78-067,382. PUB. 7-9-2002, FILED 6-5-2001.



NO CLAIM IS MADE TO THE EXCLUSIVE RIGHT TO USE AUSTIN, APART FROM THE MARK AS SHOWN.

FOR CLOTHING, NAMELY MEN'S, WOMEN'S AND CHILDREN'S SHIRTS, SHORTS, PANTS, WARM-UP SUITS, JERSEYS, SWEATERS, JACKETS, CAPS, VISORS, SOCKS AND BANDANNAS (U.S. CLS. 22 AND 39).

FIRST USE 1-1-2001; IN COMMERCE 8-27-2001.

2,730,661. SARAMAR, L.L.C., CHICAGO, IL. SN 78-068,052. PUB. 1-1-2002, FILED 6-8-2001.

LIFT 1 2 3

FOR BRAS AND PANTIES (U.S. CLS. 22 AND 39).

FIRST USE 12-31-2001; IN COMMERCE 12-31-2001.

2,730,726. ROCKY SHOES & BOOTS, INC., NELSONVILLE, OH. SN 78-086,747. PUB. 10-8-2002, FILED 10-3-2001.

SAWBLADE

FOR FOOTWEAR (U.S. CLS. 22 AND 39).

FIRST USE 2-28-2002; IN COMMERCE 2-28-2002.

CLASS 25—(Continued).

2,730,749. VIBRAM S.P.A., ALBIZZATE VARESE, ITALY. SN 78-093,089. PUB. 5-7-2002, FILED 11-13-2001.



FOR SOLES FOR FOOTWEAR, NOT MADE TO ORDER (U.S. CLS. 22 AND 39).
FIRST USE 4-0-2002; IN COMMERCE 4-0-2002.

2,730,775. DABBIERO, FRANK A., BERTHOUD, CO. SN 78-099,800. PUB. 7-2-2002, FILED 12-22-2001.

SE HABLA BASKETBALL

NO CLAIM IS MADE TO THE EXCLUSIVE RIGHT TO USE "BASKETBALL", APART FROM THE MARK AS SHOWN.

THE FOREIGN WORDING IN THE MARK TRANSLATES INTO ENGLISH AS "IS SPOKEN".

FOR CLOTHING, NAMELY, T-SHIRTS, KNIT SHIRTS, SHIRTS, SWEATSHIRTS, SHORTS, CAPS, HATS, JACKETS (U.S. CLS. 22 AND 39).

FIRST USE 10-3-2001; IN COMMERCE 11-15-2002.

2,730,790. QUICK CHICK RACING, LLC., BROOMFIELD, CO. SN 78-102,365. PUB. 9-3-2002, FILED 1-12-2002.

QUARTER MILE GIRL

NO CLAIM IS MADE TO THE EXCLUSIVE RIGHT TO USE "GIRL", APART FROM THE MARK AS SHOWN.

FOR WOMEN'S AND CHILDREN'S WEARING APPAREL, NAMELY, HATS, CAPS, BEANIES, T-SHIRTS, LONG T-SHIRTS, TURTLE NECKS, SWEATSHIRTS, SWEATPANTS, JACKETS, AND SOCKS (U.S. CLS. 22 AND 39).

FIRST USE 1-12-2002; IN COMMERCE 1-12-2002.

2,730,815. GROUNDED INC., SEATTLE, WA. SN 78-109,328. PUB. 7-23-2002, FILED 2-17-2002.

GROUND SPEAK

FOR SHIRTS, VESTS, SWEATSHIRTS, SWEATERS, SWEATPANTS, SHORTS, JACKETS, CAPS, BATHROBES, NIGHT SHIRTS, SUSPENDERS, COATS, SWEATERS, SWEATBANDS, SCARVES, GLOVES, MITTENS, SOCKS, TIES, VISORS, WRIST BANDS AND PAJAMAS (U.S. CLS. 22 AND 39).

FIRST USE 10-0-2000; IN COMMERCE 4-2-2003.

CLASS 25—(Continued).

2,730,823. QUINTERO, JAYNE, FOX POINT, WI. SN 78-112,397. PUB. 9-10-2002, FILED 3-4-2002.

SMOXROX

FOR ART SMOCKS (U.S. CLS. 22 AND 39).
FIRST USE 8-0-2002; IN COMMERCE 8-0-2002.

2,730,837. JOCKEY INTERNATIONAL, INC., KENOSHA, WI. SN 78-121,309. PUB. 10-22-2002, FILED 4-12-2002.

SMOOTH CONTOURS

NO CLAIM IS MADE TO THE EXCLUSIVE RIGHT TO USE "CONTOURS", APART FROM THE MARK AS SHOWN. FOR UNDERWEAR TOPS AND BOTTOMS FOR WOMEN (U.S. CLS. 22 AND 39).

FIRST USE 1-31-2003; IN COMMERCE 1-31-2003.

2,730,844. XPAYS, INC., SAN FRANCISCO, CA. SN 78-127,353. PUB. 11-19-2002, FILED 5-8-2002.



THE LIKENESS IN THE MARK DOES NOT IDENTIFY A LIVING INDIVIDUAL.

FOR CLOTHING, NAMELY, T-SHIRTS, LONG SLEEVE T-SHIRTS, BABY TEES, BASEBALL CAPS, SWEATSHIRTS, SWEATPANTS, UNDERWEAR, SWEATERS, JACKETS, SKIRTS AND PANTS (U.S. CLS. 22 AND 39).

FIRST USE 1-1-2002; IN COMMERCE 6-1-2002.

CLASS 26—FANCY GOODS

2,729,509. AVENUE, INC., THE, WILMINGTON, DE. SN 75-787,019. PUB. 7-16-2002, FILED 8-27-1999.

AVENUE

OWNER OF U.S. REG. NOS. 2,144,949, 2,251,168, AND OTHERS.

FOR HAIRPINS, HAIR CLASPS, HAIR BANDS, BOBBY PINS, ORNAMENTAL HAIR DECORATIONS, FABRIC HAIR ELASTICS (U.S. CLS. 37, 39, 40, 42 AND 50).

FIRST USE 11-0-2002; IN COMMERCE 11-0-2002.

CLASS 26—(Continued).

2,729,701. HALLMARK LICENSING, INC., KANSAS CITY, MO. SN 76-044,674. PUB. 12-25-2001, FILED 5-10-2000.

RAINBOW BRITE

OWNER OF U.S. REG. NOS. 2,296,346, 2,302,403, AND OTHERS.
FOR CLOTH PATCHES FOR CLOTHING (U.S. CLS. 37, 39, 40, 42 AND 50).
FIRST USE 10-31-2002; IN COMMERCE 10-31-2002.

2,730,431. SHALOM INTERNATIONAL CORPORATION, CARTERETTE, NJ. SN 76-351,488. PUB. 6-4-2002, FILED 12-13-2001.

A LITTLE JAZZ

FOR HAIR ACCESSORIES, NAMELY BARRETTES, PONYTAIL HOLDERS, BOWS, ORNAMENTAL HAIR COMBS, HAIR CLIPS, HAIR BANDS AND HEAD BANDS (U.S. CLS. 37, 39, 40, 42 AND 50).
FIRST USE 1-1-2001; IN COMMERCE 1-1-2001.

CLASS 27—FLOOR COVERINGS

2,729,936. ACURVA, LLC, LAYTON, UT. SN 76-198,246. PUB. 11-6-2001, FILED 1-22-2001.

SOLE SENSE

NO CLAIM IS MADE TO THE EXCLUSIVE RIGHT TO USE "SOLE", APART FROM THE MARK AS SHOWN.
FOR PLASTIC MATS IN THE NATURE OF BATH MATS WITH SCRUBBING BRISTLES ON ONE-SIDE FOR USE ON FEET (U.S. CLS. 19, 20, 37, 42 AND 50).
FIRST USE 3-1-2002; IN COMMERCE 3-1-2002.

2,730,024. BI PROPERTIES I INC., GREENSBORO, NC. SN 76-234,774. PUB. 8-14-2001, FILED 4-3-2001.

NEOFLOOR

FOR FLOORCOVERINGS, NAMELY CARPET, CARPET TILES AND RUGS (U.S. CLS. 19, 20, 37, 42 AND 50).
FIRST USE 8-10-2001; IN COMMERCE 8-10-2001.

CLASS 27—(Continued).

2,730,318. BI PROPERTIES I INC., GREENSBORO, NC. SN 76-326,621. PUB. 3-26-2002, FILED 10-17-2001.



OWNER OF U.S. REG. NOS. 694,624, 1,769,370, AND OTHERS.

THE DESIGN CONSISTS OF A SHADED TRIANGLE WITH A STYLIZED "6" IN ITS CENTER.
FOR TEXTILE FLOOR COVERINGS, NAMELY, CARPET (U.S. CLS. 19, 20, 37, 42 AND 50).
FIRST USE 11-12-1999; IN COMMERCE 11-12-1999.

2,730,508. YORK WALLCOVERINGS, INC., YORK, PA. SN 76-374,536. PUB. 6-25-2002, FILED 2-22-2002.

SHIP SHAPE

FOR WALLPAPER (U.S. CLS. 19, 20, 37, 42 AND 50).
FIRST USE 2-20-2002; IN COMMERCE 4-10-2002.

2,730,798. MOHAWK BRANDS, INC., WILMINGTON, DE. SN 78-104,103. PUB. 7-30-2002, FILED 1-22-2002.

BECAUSE SPILLS HAPPEN

FOR CARPET CUSHION (U.S. CLS. 19, 20, 37, 42 AND 50).
FIRST USE 6-12-2002; IN COMMERCE 6-12-2002.

2,730,799. MOHAWK BRANDS, INC., WILMINGTON, DE. SN 78-104,107. PUB. 8-13-2002, FILED 1-22-2002.

WET LOCK

NO CLAIM IS MADE TO THE EXCLUSIVE RIGHT TO USE "WET", APART FROM THE MARK AS SHOWN.
FOR CARPET CUSHION (U.S. CLS. 19, 20, 37, 42 AND 50).
FIRST USE 6-12-2002; IN COMMERCE 6-12-2002.

CLASS 28—TOYS AND SPORTING GOODS

CLASS 28—(Continued).

2,729,365. SILICH, CHERYL ANN, INDIANAPOLIS, IN. SN 75-245,040. PUB. 10-5-1999, FILED 2-21-1997.

ADVENTURES IN OZ WITH CHERYL

FOR COSTUME MASKS, PAPER FACE MASKS, PARTY FAVORS IN THE NATURE OF SMALL TOYS; THREE-DIMENSIONAL PUZZLES, EXERCISE AND GYMNASIAC BANNERS AND MATS, EXERCISE MATS (U.S. CLS. 22, 23, 38 AND 50).

FIRST USE 10-1-1998; IN COMMERCE 10-1-2002.

2,729,421. KABUSHIKI KAISHA PERSON'S, DBA PERSON'S CO., LTD., TOKYO, JAPAN. SN 75-578,885. PUB. 6-20-2000, FILED 10-28-1998.

PERSON'S

FOR TENNIS BALLS, TENNIS RACKETS, TENNIS RACKET CASES, TENNIS NETS, CADDY BAGS FOR GOLF, GOLF CLUBS, GREEN MARKERS FOR GOLF BALLS, GOLF TEES, GOLF GLOVES, GOLF BALLS, GOLF TRAINING MATS, SKIS, SKI EDGES, SKI POLES, BOARDS FOR WIND SURFING, SURF BOARDS, SNOW BOARDS (U.S. CLS. 22, 23, 38 AND 50).

FIRST USE 6-3-2002; IN COMMERCE 6-30-2002.

2,729,426. INTUNE CORPORATION, VENTURA, CA. SN 75-602,380. PUB. 4-25-2000, FILED 12-9-1998.

TURN IT UP

FOR CHRISTMAS TREE ORNAMENTS (U.S. CLS. 22, 23, 38 AND 50).

FIRST USE 12-9-1998; IN COMMERCE 12-20-2002.

2,729,439. KULICK, LORIE, CROWN POINT, IN. SN 75-646,545. PUB. 11-2-1999, FILED 2-23-1999.

MATCH MANIA

FOR BOARD GAMES (U.S. CLS. 22, 23, 38 AND 50).
FIRST USE 4-0-2000; IN COMMERCE 4-0-2000.

CLASS 28—(Continued).

2,729,448. BUILD-A-BEAR WORKSHOP, INC., ST. LOUIS, MO, BY MERGER BUILD-A-BEAR WORKSHOP, L.L.C., ST. LOUIS, MO. SN 75-664,633. PUB. 4-4-2000, FILED 3-17-1999.

TRAVELING TEDDY

OWNER OF U.S. REG. NO. 2,669,191.

NO CLAIM IS MADE TO THE EXCLUSIVE RIGHT TO USE "TEDDY", APART FROM THE MARK AS SHOWN.

FOR ACCESSORIES FOR STUFFED AND PLUSH TOY ANIMALS, NAMELY, CARRIERS FOR STUFFED AND PLUSH TOY ANIMALS AND TOY BACKPACKS (U.S. CLS. 22, 23, 38 AND 50).

FIRST USE 6-8-2001; IN COMMERCE 6-8-2001.

2,729,450. BRYAN, BRUCE, BEVERLY HILLS, CA. SN 75-671,910. PUB. 1-4-2000, FILED 3-30-1999.

NANOFLUOR

FOR TOYS, GAMES, AND PLAYTHINGS, NAMELY, MECHANICAL ACTION TOYS; WIND-UP TOYS; ELECTRICAL ACTION TOYS; TOY VEHICLES; RIDE-ON TOYS; MUSICAL TOYS; TOY ACTION FIGURES; TOY WATER SQUIRTING GUNS; BUBBLE MAKING TOYS AND SOLUTION SETS; TOY WEAPONS; COSTUME MASKS; TARGET SHOOTING SETS COMPRISING TOYS GUNS, DARTS, AND TARGET; EDUCATIONAL SCIENTIFIC KITS COMPRISED PRIMARILY OF TOY MICROSCOPES, BEAKERS, TEST TUBES, AND SLIDES FOR TEACHING CHILDREN SCIENCE; DOLLS AND DOLL ACCESSORIES; MOBILES FOR CHILDREN; TOY BUILDING BLOCKS; STUFFED TOYS; YOYOS; PLASTIC TOY HOOPS; JUMP ROPES; JIGSAW AND MANIPULATIVE PUZZLES; ILLUMINATED TOYS, NAMELY, ILLUMINATED KICK BAGS, ILLUMINATED BOARD GAMES AND CARD GAMES; TOY HOBBY AND CRAFT KITS COMPRISING MOLDS AND MOLDING COMPOUND FOR MAKING TOY FIGURES; TOY NOVELTY ITEMS, NAMELY, TOY EGGS, TOY GLOWING POWDER AND TOY CIGARETTES; BATH TOYS; SWIM BOARDS FOR RECREATIONAL USE; FLOATS FOR RECREATIONAL USE; BODY BOARDS; SURFBOARDS; SURFBOARD WAX, AND WATER SKIS (U.S. CLS. 22, 23, 38 AND 50).

FIRST USE 4-3-2002; IN COMMERCE 4-3-2002.

2,729,455. BOEING MANAGEMENT COMPANY, SEAL BEACH, CA, BY ASSIGNMENT BOEING COMPANY, THE, SEATTLE, WA. SN 75-679,912. PUB. 2-6-2001, FILED 4-9-1999.

F-15 STRIKE EAGLE

OWNER OF U.S. REG. NO. 2,212,331.
FOR TOY AND MODEL AIRPLANES (U.S. CLS. 22, 23, 38 AND 50).
FIRST USE 4-22-2002; IN COMMERCE 4-22-2002.

CLASS 28—(Continued).

2,729,532. JACKSON, BRUCE E., NOVELTY, OH. SN 75-821,732. PUB. 5-23-2000, FILED 10-13-1999.

THE STRATEGY OF THE ANCIENTS, FOR THE RULERS OF THE FUTURE

FOR BOARD GAME (U.S. CLS. 22, 23, 38 AND 50).
FIRST USE 11-1-2001; IN COMMERCE 11-1-2001.

2,729,572. BUILD-A-BEAR WORKSHOP, INC., ST. LOUIS, MO, BY MERGER BUILD-A-BEAR WORKSHOP, L.L.C., ST. LOUIS, MO. SN 75-876,452. PUB. 7-2-2002, FILED 12-20-1999.

JELLI BEARS

NO CLAIM IS MADE TO THE EXCLUSIVE RIGHT TO USE "BEARS", APART FROM THE MARK AS SHOWN.

FOR CLOTHING AND ACCESSORIES FOR STUFFED AND PLUSH TOY ANIMALS; DOLL ACCESSORIES (U.S. CLS. 22, 23, 38 AND 50).

FIRST USE 2-1-2000; IN COMMERCE 2-1-2000.

2,729,598. CHOU, ALEC, TAINAN CITY, TAIWAN. SN 75-909,489. PUB. 6-4-2002, FILED 2-4-2000.

NAIAD

FOR SWIMMING GOGGLES, SNORKELS, FACE MASKS FOR DIVING (U.S. CLS. 22, 23, 38 AND 50).
FIRST USE 10-5-2001; IN COMMERCE 3-15-2002.

2,729,616. TRENDMASTERS, INC., ST. LOUIS, MO. SN 75-924,342. PUB. 10-31-2000, FILED 2-24-2000.

STARCASTLE & STARDANCERS

OWNER OF U.S. REG. NOS. 2,005,292, 2,200,649, AND OTHERS.

FOR MINIATURIZED DOLLS AND ACCESSORIES THEREFOR, DOLLS AND ACCESSORIES THEREFOR, TOY JEWELRY, TOY JEWELRY BOXES, ACTION FIGURES AND ACCESSORIES THEREFOR, MECHANICAL ACTION FIGURES AND ACCESSORIES THEREFOR, CASES FOR PLAY ACCESSORIES, PLAYSET BUILDINGS AND ACCESSORIES THEREFOR; PLUSH TOYS, ANIMATED PLUSH TOYS, MECHANICAL PLUSH TOYS, POCKET PLAYSETS, TOY TEA SETS, TOY ANIMAL FIGURES, FASHION DOLLS, CLOTHING FOR FASHION DOLLS, FASHION DOLL ACCESSORIES, CASES FOR FASHION DOLLS AND ACCESSORIES, FASHION DOLL MECHANICAL VEHICLES, COLLECTIBLE FASHION DOLLS, COLLECTIBLE DOLL DISPLAY STANDS, CHILDREN'S DRESS UP SETS, CHILDREN'S PLAY COSMETICS (U.S. CLS. 22, 23, 38 AND 50).

FIRST USE 2-24-2000; IN COMMERCE 9-29-2001.

CLASS 28—(Continued).

2,729,677. POSSIBLE DREAMS, LTD., FOXBORO, MA. SN 76-018,798. PUB. 8-28-2001, FILED 4-6-2000.

KINDERGUARD

FOR CHRISTMAS TREE ORNAMENTS (U.S. CLS. 22, 23, 38 AND 50).
FIRST USE 1-14-2002; IN COMMERCE 1-17-2002.

2,729,693. WILD PLANET TOYS, INC., SAN FRANCISCO, CA. SN 76-037,235. PUB. 5-14-2002, FILED 4-28-2000.

WHERE FUN COMES FROM

FOR GAMES AND PLAYTHINGS, NAMELY, ACTION FIGURES AND ACCESSORIES THEREFOR, ELECTRONIC ACTION TOYS, STUFFED ANIMALS, AERODYNAMIC DISKS USED FOR PLAYING CATCHING GAMES, TOY MUSICAL INSTRUMENTS, PLAYGROUND BALLS, TOY CONSTRUCTION BLOCKS, BOARD GAMES, TOY SCIENCE KITS INCLUDING CHILDREN'S SCIENCE ACTIVITY SETS CONSISTING OF EQUIPMENT FOR PERFORMING EXPERIMENTS RELATING TO SPECIFIC ASPECTS OF THE CHEMICAL SCIENCES AND AN INSTRUCTIONAL MANUAL RELATED THERETO, CHEMISTRY SETS THAT INCLUDE CHEMICAL SUPPLIES AND INSTRUCTIONS, EDUCATIONAL TOYS KITS COMPRISING ALL OF THE FOLLOWING - TOY CONSTRUCTION BUILDING ELEMENTS, ON-BOARD ELECTRONIC CONTROL, MOTORS, AND SENSORS, ALL FOR BUILDING ELECTRONIC MOTORIZED TOYS, INCLUDING ROBOTS, SENSORS AND SPY GADGETS, DOLLS AND DOLL ACCESSORIES, KITES, COSTUME MASKS, TOY MOBILES, MODEL AIRPLANES, TOY THERMOMETERS, RUBBER ACTION BALLS, OBSERVATION TOYS, NAMELY, TELESCOPES, MICROSCOPES, PERISCOPES, BINOCULARS, AND COMBINATION TOY TELESCOPES/MICROSCOPES, CONSTRUCTION/PUZZLE TOYS WITH SCULPTURED PIECES, WATER TOYS, NAMELY SQUIRTING AND FLOATING TOYS AND TOY BAROMETERS; TOY EXPLORER SETS WHICH CONTAIN MAGNIFYING GLASSES AND PLASTIC TOYS USED FOR NARRATIVE VIEWING; TOY LISTENING DEVICES CONSISTING OF AN AMPLIFIER AND HEADPHONES FOR LISTENING TO BIRDS, INSECTS AND OTHER NATURAL SOUNDS; TOY GLOVES WITH SMALL PLASTIC ITEMS ATTACHED USED FOR PLAYING MAKE BELIEVE GAMES; TOY COMMUNICATION DEVICES CONSISTING OF SMALL WIRELESS TWO-WAY RADIOS; TOY BUG COLLECTING KITS CONSISTING OF PARAPHERNALIA FOR COLLECTING INSECTS; TOY FLASHLIGHTS, TOY PLANETARIUMS, TOY CANTEENS, TOY BATTERY BELT, TOY MICROPHONE/LOUDSPEAKER, TOY CONSTRUCTION SETS, TOY FLYING DEVICES, NAMELY, A DISK TO TOSS IN PLAYING A GAME WHERE OTHER DISKS ARE FLIPPED AND COLLECTED; TOY WATCHES AND TOY LANTERNS; HOBBY CRAFT SETS FOR USE BY CHILDREN TO MAKE JEWELRY AND TILE ART AND PLASTIC SHRINK-ART OBJECTS, GLOW-IN-THE-DARK TOYS, TOY KALEIDOSCOPES, TOY CARRY-ALL BELTS, NON-METALLIC TOY KNIVES WITH TOY TOOLS, TOY CANTEENS AND TOY FLASHLIGHTS (U.S. CLS. 22, 23, 38 AND 50).

FIRST USE 2-0-2000; IN COMMERCE 2-0-2000.

CLASS 28—(Continued).

2,729,719. HOLUB, CRAIG S., LIVELY, ONTARIO, CANADA. SN 76-066,327. PUB. 7-23-2002, FILED 6-8-2000.



PRIORITY CLAIMED UNDER SEC. 44(D) ON CANADA APPLICATION NO. 1,045,709, FILED 2-8-2000, REG. NO. TMA553706, DATED 11-13-2001, EXPIRES 11-13-2016.

FOR GOLF BALL MARK REPAIR TOOLS, GOLF BALL MARKERS, GOLF PUTTER COVERS, AND PORTABLE GOLF BALL WASHERS (U.S. CLS. 22, 23, 38 AND 50).

FIRST USE 11-20-2000; IN COMMERCE 11-20-2000.

2,729,730. WING ENTERPRISES, INC., SPRINGVILLE, UT. SN 76-073,152. PUB. 10-15-2002, FILED 6-19-2000.

PEEKS

FOR WINTER SPORTS EQUIPMENT, NAMELY, SNOW SHOES AND ACCESSORIES, NAMELY, SNOW SHOE BINDINGS AND PORTABLE SNOW SHOE CARRIERS (U.S. CLS. 22, 23, 38 AND 50).

FIRST USE 8-31-1998; IN COMMERCE 8-31-1998.

2,729,787. A&E TELEVISION NETWORKS, NEW YORK, NY. SN 76-108,968. PUB. 6-11-2002, FILED 8-14-2000.

BIOGRAPHY

OWNER OF U.S. REG. NOS. 2,186,382, 2,291,613, AND 2,403,285.

SEC. 2(F).

FOR BOARD GAMES (U.S. CLS. 22, 23, 38 AND 50).

FIRST USE 8-31-2000; IN COMMERCE 8-31-2000.

2,729,849. INGE-GLAS GMBH & CO. KG, 96465 NEUSTADT B. COBURG, FED REP GERMANY. SN 76-149,534. PUB. 2-19-2002, FILED 10-18-2000.

INGE'S CHRISTMAS HEIRLOOMS

NO CLAIM IS MADE TO THE EXCLUSIVE RIGHT TO USE "CHRISTMAS HEIRLOOMS", APART FROM THE MARK AS SHOWN.

FOR CHRISTMAS TREE DECORATIONS AND ORNAMENTS, EXCLUDING CONFECTIONERY OR ILLUMINATION ARTICLES (U.S. CLS. 22, 23, 38 AND 50).

FIRST USE 3-1-2001; IN COMMERCE 3-1-2001.

CLASS 28—(Continued).

2,729,910. STORELLI, JOHN, FORT LAUDERDALE, FL. SN 76-185,785. PUB. 9-11-2001, FILED 12-26-2000.

HOVER-LURE KING OF BASS

FOR FISHING EQUIPMENT, NAMELY; LURES, FLOATS, LURE-FLOAT COMBINATIONS, AND FISH ATTRACTANTS, NAMELY, ARTIFICIAL FLIES, ARTIFICIAL INSECTS, ARTIFICIAL INSECT LARVAE, AND ARTIFICIAL WORMS (U.S. CLS. 22, 23, 38 AND 50).

FIRST USE 1-0-2002; IN COMMERCE 1-0-2002.

2,729,922. PERETZ, HOWARD G., WATCHUNG, NJ. SN 76-190,669. PUB. 6-4-2002, FILED 1-8-2001.

SHOUT!

FOR TOYS, NAMELY, DOLLS (U.S. CLS. 22, 23, 38 AND 50).

FIRST USE 4-0-2002; IN COMMERCE 4-0-2002.

2,729,944. ESTES-COX CORP., PENROSE, CO, BY ASSIGNMENT CENTURI CORPORATION, PENROSE, CO. SN 76-201,871. PUB. 12-4-2001, FILED 1-30-2001.

HI-FLIER

OWNER OF U.S. REG. NOS. 1,150,462 AND 1,209,888. FOR AERIAL TOYS, NAMELY, GLIDERS, MODEL ROCKETS, AND AIRPLANES (U.S. CLS. 22, 23, 38 AND 50).

FIRST USE 12-10-2002; IN COMMERCE 12-10-2002.

2,730,001. JASMAN, INC., ITASCA, IL. SN 76-221,986. PUB. 5-14-2002, FILED 3-9-2001.

CHOPPER PATROL

NO CLAIM IS MADE TO THE EXCLUSIVE RIGHT TO USE "CHOPPER", APART FROM THE MARK AS SHOWN.

FOR TOYS AND GAMES, NAMELY, TOY VEHICLES AND TOY AIRCRAFT AND RELATED ACCESSORIES IN THE NATURE OF PLAY MATS, TOY BUILDINGS AND REMOTE CONTROLS SOLD AS A UNIT THEREWITH (U.S. CLS. 22, 23, 38 AND 50).

FIRST USE 5-4-2001; IN COMMERCE 5-4-2001.

2,730,016. FUNTRONICS, INC., LOUISVILLE, KY. SN 76-230,591. PUB. 2-19-2002, FILED 3-26-2001.

PRIZE VAULT

NO CLAIM IS MADE TO THE EXCLUSIVE RIGHT TO USE "PRIZE", APART FROM THE MARK AS SHOWN.

FOR ARCADE GAME MACHINES (U.S. CLS. 22, 23, 38 AND 50).

FIRST USE 3-0-2001; IN COMMERCE 3-0-2001.

CLASS 28—(Continued).

2,730,114. KWIECIENSKI, RICHARD, HOMOSASSA, FL. SN 76-267,145. PUB. 9-10-2002, FILED 6-4-2001.

GOLF-D'LITE

FOR LIGHTWEIGHT GOLF CLUB CARRYING FRAME (U.S. CLS. 22, 23, 38 AND 50).
FIRST USE 6-1-2001; IN COMMERCE 7-21-2001.

2,730,135. ADIDAS INTERNATIONAL B.V., 1006 BB AMSTERDAM, NETHERLANDS. SN 76-272,886. PUB. 2-19-2002, FILED 6-13-2001.

FEVERNOVA

FOR GYMNASIAC AND SPORTING ARTICLES, NAMELY, SPORT BALLS, SOCCER BALLS, SHIN GUARDS AND SOCCER GLOVES (U.S. CLS. 22, 23, 38 AND 50).
FIRST USE 12-31-2001; IN COMMERCE 12-31-2001.

2,730,169. DC COMICS, NEW YORK, NY. SN 76-283,607. PUB. 6-25-2002, FILED 7-10-2001.

POCKET SUPER HEROES

NO CLAIM IS MADE TO THE EXCLUSIVE RIGHT TO USE "SUPER HEROES", APART FROM THE MARK AS SHOWN.

FOR TOYS AND SPORTING GOODS, NAMELY GAMES AND PLAYTHINGS—NAMELY, ACTION FIGURES AND ACCESSORIES THEREFOR; PLUSH TOYS; DOLLS; HAND-HELD UNIT FOR PLAYING ELECTRONIC GAMES (U.S. CLS. 22, 23, 38 AND 50).
FIRST USE 7-31-2002; IN COMMERCE 7-31-2002.

2,730,190. GOLFER'S FOOTPRINT, INC., THE, MERIDIAN, ID. SN 76-291,445. PUB. 7-2-2002, FILED 7-26-2001.



NO CLAIM IS MADE TO THE EXCLUSIVE RIGHT TO USE "GOLFER'S", APART FROM THE MARK AS SHOWN.

FOR SPORTING GOODS, NAMELY, A TRAINING AID IN THE FORM OF A GOLF PRACTICE MAT THAT TEACHES GOLFERS HOW TO SET UP AND EXECUTE A PROPER SWING (U.S. CLS. 22, 23, 38 AND 50).
FIRST USE 1-20-2001; IN COMMERCE 1-28-2002.

CLASS 28—(Continued).

2,730,191. HACKADAY, ROBERT, LONG BEACH, CA. SN 76-291,475. PUB. 11-27-2001, FILED 7-30-2001.

UBN2it

FOR BOXING AND MARTIAL ARTS TRAINING TARGETS (U.S. CLS. 22, 23, 38 AND 50).
FIRST USE 1-2-2003; IN COMMERCE 1-2-2003.

2,730,199. MISGUIDED GAMES, INC., HUDSON, OH. SN 76-293,930. PUB. 9-10-2002, FILED 8-3-2001.



FOR ROLE PLAYING GAME (U.S. CLS. 22, 23, 38 AND 50).
FIRST USE 1-15-2001; IN COMMERCE 7-1-2002.

2,730,209. K-2 CORPORATION, VASHON, WA. SN 76-295,353. PUB. 11-27-2001, FILED 8-6-2001.

SLIP-FIT

FOR IN-LINE SKATES (U.S. CLS. 22, 23, 38 AND 50).
FIRST USE 10-0-2001; IN COMMERCE 10-0-2001.

2,730,217. DUNLOP SLAZENGER GROUP AMERICAS INC., GREENVILLE, SC. SN 76-297,682. PUB. 6-25-2002, FILED 8-13-2001.

NOODLE

FOR GOLF EQUIPMENT, NAMELY, GOLF BALLS (U.S. CLS. 22, 23, 38 AND 50).
FIRST USE 8-31-2001; IN COMMERCE 8-31-2001.

CLASS 28—(Continued).

2,730,222. RIP LLC, IDAHO FALLS, ID, BY ASSIGNMENT VINCENT, JAMES D., BLACKFOOT, ID. AND VINCENT, CECILY C. PEARSON, BLACKFOOT, ID. SN 76-299,265. PUB. 2-19-2002, FILED 8-14-2001.



OWNER OF U.S. REG. NOS. 1,918,134, 2,162,204, AND OTHERS.

THE ENGLISH TRANSLATION OF "RIO" IS "RIVER". FOR TIPPETS, FISHING LINES (U.S. CLS. 22, 23, 38 AND 50).

FIRST USE 9-15-2001; IN COMMERCE 10-1-2001.

2,730,231. FITNESS QUEST INC., CANTON, OH. SN 76-303,486. PUB. 4-30-2002, FILED 8-23-2001.

GAZELLE EDGE

FOR MANUALLY OPERATED EXERCISE EQUIPMENT (U.S. CLS. 22, 23, 38 AND 50).

FIRST USE 10-22-2001; IN COMMERCE 10-22-2001.

2,730,232. FITNESS QUEST INC., CANTON, OH. SN 76-303,487. PUB. 4-30-2002, FILED 8-23-2001.

GAZELLE WALKABOUT

FOR MANUALLY OPERATED EXERCISE EQUIPMENT (U.S. CLS. 22, 23, 38 AND 50).

FIRST USE 11-8-2001; IN COMMERCE 11-8-2001.

2,730,310. KINGMAN INTERNATIONAL CORPORATION, BALDWIN PARK, CA. SN 76-323,605. PUB. 3-19-2002, FILED 10-9-2001.

AGGRESSOR

FOR PAINTBALL GUNS, AND ACCESSORIES THEREFOR IN THE NATURE OF BARRELS, GRIP FRAMES, FRAME COVERS, GRIPS, EXPANSION, CHAMBERS, SIGHT RAILS, TRIGGER ASSEMBLIES, BARREL PLUGS, AND TURBULENCE BOLTS (U.S. CLS. 22, 23, 38 AND 50).

FIRST USE 11-21-2001; IN COMMERCE 2-6-2002.

CLASS 28—(Continued).

2,730,359. SELLNER MANUFACTURING CO., INC., FARIBAULT, MN. SN 76-337,570. PUB. 5-14-2002, FILED 11-12-2001.

JALOPY JUNCTION

FOR AMUSEMENT RIDES OF THE TYPE USED IN CARNIVALS, AMUSEMENT PARKS AND SIMILAR RECREATIONAL SETTINGS (U.S. CLS. 22, 23, 38 AND 50).

FIRST USE 2-1-2002; IN COMMERCE 2-11-2002.

2,730,362. INTEGRITY TOYS, INC., JERSEY CITY, NJ. SN 76-337,869. PUB. 7-9-2002, FILED 11-14-2001.

ADELE

FOR DOLLS (U.S. CLS. 22, 23, 38 AND 50).

FIRST USE 1-23-2003; IN COMMERCE 1-23-2003.

2,730,380. FITNESS EQUIPMENT SERVICES, L.L.C., SALT LAKE CITY, UT. SN 76-341,655. PUB. 5-28-2002, FILED 11-26-2001.

SOLE

FOR EXERCISE EQUIPMENT, NAMELY, TREADMILLS, STAIR STEPPING MACHINES, STATIONARY EXERCISE BICYCLES, ROWING MACHINES, WEIGHTLIFTING MACHINES AND WEIGHTS (U.S. CLS. 22, 23, 38 AND 50).

FIRST USE 10-1-2001; IN COMMERCE 10-1-2001.

2,730,395. MIZUNO USA, INC., NORCROSS, GA. SN 76-344,571. PUB. 6-25-2002, FILED 12-3-2001.

MIZUNO TECHFIRE FURY

OWNER OF U.S. REG. NOS. 2,440,267 AND 2,539,669. FOR SOFTBALL BATS (U.S. CLS. 22, 23, 38 AND 50).

FIRST USE 7-1-2002; IN COMMERCE 7-2-2002.

CLASS 28—(Continued).

2,730,397. TOEI ANIMATION CO., INC., TOKYO, 162, JAPAN. SN 76-345,081. PUB. 6-25-2002, FILED 12-6-2001.

PUAR

FOR GAMES, PLAYTHINGS AND SPORTING GOODS, NAMELY, COLLECTIBLE TOY FIGURES AND ACTION FIGURES AND ACTION FIGURE ACCESSORIES, TALKING TOY FIGURES, ELECTRONIC OR MECHANICAL TOY BATONS, TOY MILK CAPS, WIND-UP-TOYS, PLUSH TOYS, TOY VEHICLES, DOLLS AND ROLL-PLAYING GAME EQUIPMENT IN THE NAME OF MALE ACTION TOYS AND MODELS, ACTIVITY SETS AND PLAYSET ENVIRONMENTS COMPRISED OF MINI FIGURES/SCENE DISPLAYS, TOY FIGURES, SPIN-TOP TOYS; ELECTRONIC TOYS, NAMELY COIN-OPERATED VIDEO GAMES; HAND HELD UNIT FOR PLAYING VIDEO GAMES; STAND ALONE VIDEO GAME MACHINES; STAND ALONE VIDEO OUTPUT GAME MACHINES (U.S. CLS. 22, 23, 38 AND 50).
FIRST USE 10-0-2002; IN COMMERCE 10-0-2002.

2,730,398. FAT CAT, INC., WILLISTON, VT. SN 76-345,101. PUB. 6-11-2002, FILED 12-5-2001.

SNUGGLE BUG

FOR PET TOYS (U.S. CLS. 22, 23, 38 AND 50).
FIRST USE 4-9-2002; IN COMMERCE 4-9-2002.

2,730,426. BENETTON SPORTSYSTEM USA, INC., BORDENTOWN, NJ. SN 76-350,629. PUB. 6-18-2002, FILED 12-20-2001.

AIR +

FOR TENNIS, SQUASH AND RACQUETBALL RACQUETS (U.S. CLS. 22, 23, 38 AND 50).
FIRST USE 2-0-2002; IN COMMERCE 2-0-2002.

2,730,452. SCHUMACKER & COMPANY, SUNRISE, FL. SN 76-355,886. PUB. 7-23-2002, FILED 1-8-2002.

FREEDOM STORM

FOR BOWLING BALL (U.S. CLS. 22, 23, 38 AND 50).
FIRST USE 10-1-2001; IN COMMERCE 1-28-2002.

2,730,454. MILESTONE GOLF ENTERPRISES, JESSUP, MD. SN 76-356,635. PUB. 9-3-2002, FILED 1-9-2002.

HTI

FOR GOLF CLUBS (U.S. CLS. 22, 23, 38 AND 50).
FIRST USE 3-1-2002; IN COMMERCE 3-1-2002.

CLASS 28—(Continued).

2,730,459. FOTOBALL USA, INC., SAN DIEGO, CA. SN 76-357,569. PUB. 8-6-2002, FILED 1-9-2002.

LIL' BOBBER

FOR DOLLS (U.S. CLS. 22, 23, 38 AND 50).
FIRST USE 10-29-2002; IN COMMERCE 10-29-2002.

2,730,495. SHOUT! TOYS, LLC, WATCHUNG, NJ. SN 76-370,402. PUB. 9-17-2002, FILED 2-14-2002.

BEAUTIFUL DREAMER

FOR DOLLS (U.S. CLS. 22, 23, 38 AND 50).
FIRST USE 6-0-2002; IN COMMERCE 6-0-2002.

2,730,503. TEK-NEK TOYS INTERNATIONAL, INC., MOKEANA, IL. SN 76-373,067. PUB. 9-3-2002, FILED 2-19-2002.

DINO PUPPETS

NO CLAIM IS MADE TO THE EXCLUSIVE RIGHT TO USE "PUPPETS", APART FROM THE MARK AS SHOWN. FOR HAND PUPPETS WITH ELECTRONIC COMPONENTS (U.S. CLS. 22, 23, 38 AND 50).
FIRST USE 7-9-2002; IN COMMERCE 7-9-2002.

2,730,586. MATTEL, INC., EL SEGUNDO, CA. SN 78-038,886. PUB. 8-14-2001, FILED 12-12-2000.

ORKO

FOR TOY ACTION FIGURES AND ACCESSORIES THEREFOR (U.S. CLS. 22, 23, 38 AND 50).
FIRST USE 12-6-2000; IN COMMERCE 12-6-2000.

2,730,608. HOROWITZ, SUSAN, NEW YORK, NY. SN 78-047,253. PUB. 6-18-2002, FILED 2-8-2001.

MY TEDDYFRIEND

FOR SOFT SCULPTURE TOYS, TEDDY BEARS, TALKING TOYS, CHILDREN'S MULTIPLE ACTIVITY TOYS, SQUEEZE TOYS, BABY MULTIPLE ACTIVITY TOYS, BATH TOYS, CRIB TOYS, FANTASY CHARACTER TOYS, INFANT TOYS, PARTY FAVORS IN THE NATURE OF SMALL TOYS, PLUSH TOYS, TOYS DESIGNED TO BE ATTACHED TO STROLLERS, HIGH CHAIRS, BABY RATTLES, CHRISTMAS TREE DECORATIONS, JIGSAW PUZZLES, MANIPULATIVE PUZZLES, ADULTS' AND CHILDREN'S PARTY GAMES, CARD GAMES, BOARD GAMES, MOBILES FOR CHILDREN, CRIB MOBILES, TOY BUILDING BLOCKS, MUSIC BOX TOYS, MECHANICAL ACTION TOYS (U.S. CLS. 22, 23, 38 AND 50).
FIRST USE 3-7-2003; IN COMMERCE 3-7-2003.

CLASS 28—(Continued).

2,730,623. SHIPSHAPES, LLC, ANNAPOLIS, MD. SN 78-054,184. PUB. 5-28-2002, FILED 3-21-2001.

ShipShapes

FOR TOY WOOD MODEL SHIPS; AND TOY MODEL HOBBY CRAFT KITS FOR MAKING WOODEN SHIPS, AND PRINTED INSTRUCTIONAL, INFORMATIONAL AND DECORATIVE MATERIALS, SOLD TOGETHER AS A UNIT (U.S. CLS. 22, 23, 38 AND 50).

FIRST USE 3-22-2001; IN COMMERCE 3-22-2001.

2,730,644. MATTEL, INC., EL SEGUNDO, CA. SN 78-061,646. PUB. 6-18-2002, FILED 5-2-2001.

GARDEN BLOOM LOCKET

NO CLAIM IS MADE TO THE EXCLUSIVE RIGHT TO USE "LOCKET", APART FROM THE MARK AS SHOWN.

FOR TOYS, GAMES AND PLAYTHINGS, NAMELY, MINIATURE DOLLS, MINIATURE DOLL ACCESSORIES AND MINIATURE DOLL PLAYSETS, SOLD TOGETHER AS UNIT, THAT WHEN CLOSED, MAY BE WORN BY CHILDREN AS JEWELRY (U.S. CLS. 22, 23, 38 AND 50).

FIRST USE 9-29-2001; IN COMMERCE 9-29-2001.

2,730,653. TY INC., OAK BROOK, IL. SN 78-064,244. PUB. 7-16-2002, FILED 5-17-2001.

**THE BEANIE BOPPERS
COLLECTION**

OWNER OF U.S. REG. NOS. 2,049,196, 2,080,995, AND OTHERS.

NO CLAIM IS MADE TO THE EXCLUSIVE RIGHT TO USE "COLLECTION", APART FROM THE MARK AS SHOWN.

FOR PLUSH TOYS; DOLLS; DOLL ACCESSORIES (U.S. CLS. 22, 23, 38 AND 50).

FIRST USE 7-3-2001; IN COMMERCE 7-3-2001.

2,730,663. GEOFFREY, INC., PARAMUS, NJ. SN 78-068,396. PUB. 7-9-2002, FILED 6-11-2001.

FLEAS ON FLETCHER

FOR EQUIPMENT SOLD AS A UNIT FOR PLAYING A BATTERY-OPERATED TYPE PARLOR GAME (U.S. CLS. 22, 23, 38 AND 50).

FIRST USE 9-16-2001; IN COMMERCE 9-16-2001.

CLASS 28—(Continued).

2,730,679. MATTEL, INC., EL SEGUNDO, CA. SN 78-073,542. PUB. 7-23-2002, FILED 7-12-2001.

TOW & TUNE

FOR TOYS, GAMES AND PLAYTHINGS, NAMELY, TOY VEHICLE PLAYSETS AND ACCESSORIES THEREFOR (U.S. CLS. 22, 23, 38 AND 50).

FIRST USE 8-0-2000; IN COMMERCE 8-0-2000.

2,730,706. ART ASYLUM, INC, THE, BROOKLYN, NY. SN 78-081,432. PUB. 6-4-2002, FILED 8-28-2001.

ASYLUM ULTIMATE

FOR COLLECTIBLE PLASTIC FIGURES, DOLLS, DOLL ACCESSORIES AND ACTION FIGURES (U.S. CLS. 22, 23, 38 AND 50).

FIRST USE 11-1-2002; IN COMMERCE 11-1-2002.

2,730,713. TRASK, RAIFIORD G III, WRIGHTSVILLE BEACH, NC. SN 78-084,191. PUB. 11-5-2002, FILED 9-17-2001.

LUMINA

THE ENGLISH TRANSLATION OF THE WORD "LUMINA" IN THE MARK IS "LIGHT".

FOR FISHING RODS AND REELS (U.S. CLS. 22, 23, 38 AND 50).

FIRST USE 1-31-2002; IN COMMERCE 1-31-2002.

2,730,737. SASSY PRODUCT DEVELOPMENT AND MARKETING, INC., LAFAYETTE, CA. SN 78-089,861. PUB. 3-19-2002, FILED 10-24-2001.

GEYSER GUYS

FOR WATER SQUIRTING TOYS (U.S. CLS. 22, 23, 38 AND 50).

FIRST USE 7-28-2002; IN COMMERCE 7-28-2002.

CLASS 28—(Continued).

2,730,744. WHITE, JAMES E., PLEASANT HILL, CA. AND KOZEL, LINDA, PLEASANT HILL, CA. SN 78-091,585. PUB. 5-7-2002, FILED 11-3-2001.



FOR SOFT SCULPTURE PLUSH TOYS (U.S. CLS. 22, 23, 38 AND 50).
FIRST USE 12-1-2001; IN COMMERCE 3-21-2002.

2,730,748. CALLAWAY GOLF COMPANY, CARLSBAD, CA. SN 78-093,084. PUB. 7-16-2002, FILED 11-13-2001.



NO CLAIM IS MADE TO THE EXCLUSIVE RIGHT TO USE "BLUE", APART FROM THE MARK AS SHOWN.
FOR GOLF BALLS AND GOLF BAGS (U.S. CLS. 22, 23, 38 AND 50).
FIRST USE 9-24-2001; IN COMMERCE 9-24-2001.

CLASS 28—(Continued).

2,730,766. GOOD UNITED CO., TAIPEI, TAIWAN. SN 78-097,093. PUB. 7-23-2002, FILED 12-6-2001.

TOTAL SLIDE

NO CLAIM IS MADE TO THE EXCLUSIVE RIGHT TO USE "SLIDE", APART FROM THE MARK AS SHOWN.

FOR MANUALLY-OPERATED EXERCISE EQUIPMENT, STATIONARY EXERCISE BICYCLES, EXERCISE MACHINES, EXERCISE BENCHES, GYMNASIIC APPARATUS, EXERCISING EQUIPMENT, NAMELY, ABDOMINAL BOARDS, ROWING MACHINES, WEIGHT LIFTING MACHINES, PULLEYS, STAIR-STEPPING MACHINES, MANUALLY OPERATED JOGGING MACHINES, POWERED TREADMILLS FOR RUNNING, AND CHEST EXPANDERS (U.S. CLS. 22, 23, 38 AND 50).
FIRST USE 4-12-2002; IN COMMERCE 4-12-2002.

2,730,768. MY FAVORITE COMPANY, INC., VENICE, CA. SN 78-097,424. PUB. 7-23-2002, FILED 12-10-2001.

HAPPY HAUNTERS

NO CLAIM IS MADE TO THE EXCLUSIVE RIGHT TO USE "HAPPY", APART FROM THE MARK AS SHOWN.

FOR GAMES AND TOYS, NAMELY, PLUSH TOYS, ACTION FIGURES, BOARD GAMES AND CARD GAMES (U.S. CLS. 22, 23, 38 AND 50).
FIRST USE 9-1-2002; IN COMMERCE 9-1-2002.

2,730,783. CONFOTI, SUNNYVALE, CA. SN 78-100,786. PUB. 10-1-2002, FILED 1-3-2002.

CONFOTI

FOR CONFETTI THAT HAS PHOTOGRAPHIC IMAGERY ON ITS SURFACE (U.S. CLS. 22, 23, 38 AND 50).
FIRST USE 12-20-2001; IN COMMERCE 2-10-2002.

2,730,794. JAS. D. EASTON, INC., VAN NUYS, CA. SN 78-103,156. PUB. 7-30-2002, FILED 1-16-2002.

BLASTING CAP

FOR SPORTING GOODS; NAMELY, BASEBALL BATS (U.S. CLS. 22, 23, 38 AND 50).
FIRST USE 5-1-2002; IN COMMERCE 5-1-2002.

CLASS 28—(Continued).

2,730,802. NATIONAL ENTERTAINMENT COLLECTIBLES ASSOCIATION INC, KENILWORTH, NJ. SN 78-105,098. PUB. 9-17-2002, FILED 1-27-2002.



NO CLAIM IS MADE TO THE EXCLUSIVE RIGHT TO USE "TOYS", APART FROM THE MARK AS SHOWN. FOR PVC TOYS, NAMELY, ACTION FIGURES AND POSEABLE DOLLS (U.S. CLS. 22, 23, 38 AND 50). FIRST USE 3-1-2002; IN COMMERCE 7-1-2002.

2,730,841. NEW LINE PRODUCTIONS, INC., NEW YORK, NY. SN 78-122,987. PUB. 11-5-2002, FILED 4-19-2002.

MINI ME

OWNER OF U.S. REG. NOS. 2,418,334 AND 2,471,639. FOR TOYS AND SPORTING GOODS, INCLUDING GAMES AND PLAYTHINGS - NAMELY, ACTION FIGURES AND ACCESSORIES THEREFOR; PLUSH TOYS; BALLOONS; BATHTUB TOYS; RIDE-ON TOYS; EQUIPMENT SOLD AS A UNIT FOR PLAYING CARD GAMES; TOY VEHICLES; DOLLS; FLYING DISCS; ELECTRONIC HAND-HELD GAME UNIT; GAME EQUIPMENT SOLD AS A UNIT FOR PLAYING A BOARD GAME, A CARD GAME, A MANIPULATIVE GAME, A PARLOR GAME AND AN ACTION TYPE TARGET GAME; STAND ALONE VIDEO OUTPUT GAME MACHINES; JIGSAW AND MANIPULATIVE PUZZLES; PAPER FACE MASKS; SKATEBOARDS; ICE SKATES; WATER SQUIRTING TOYS; BALLS - NAMELY, PLAYGROUND BALLS, SOCCER BALLS, BASEBALLS, BASKETBALLS; BASEBALL GLOVES; SWIMMING FLOATS FOR RECREATIONAL USE; KICKBOARD FLOTATION DEVICES FOR RECREATIONAL USE; SURFBOARDS; SWIM BOARDS FOR RECREATIONAL USE; SWIM FINS; TOY BAKEWARE AND TOY COOKWARE; TOY BANKS; TOY SNOW GLOBES; AND CHRISTMAS TREE ORNAMENTS (U.S. CLS. 22, 23, 38 AND 50). FIRST USE 6-11-1999; IN COMMERCE 6-11-1999.

CLASS 29—MEATS AND PROCESSED FOODS**CLASS 29—(Continued).**

2,729,422. PUBLIX SUPER MARKETS, INC, LAKELAND, FL. SN 75-592,227. PUB. 12-21-1999, FILED 11-19-1998.

PUBLIX GREENWISE MARKET

NO CLAIM IS MADE TO THE EXCLUSIVE RIGHT TO USE "MARKET", APART FROM THE MARK AS SHOWN.

FOR FOOD PRODUCTS, NAMELY, EGGS, CHEESES, MILK, FLAVORED MILK, CHOCOLATE MILK, SOUR CREAM, COTTAGE CHEESE, FRESH AND PROCESSED SEAFOOD AND SHELLFISH, REFRIGERATED YOGURT, POTATO CHIPS, PROCESSED NUTS, EDIBLE PROCESSED SEEDS, DRIED FRUITS, JAMS, JELLIES, DRIED BEANS, PEANUT BUTTER, COOKING OIL, FRESH AND PROCESSED MEAT AND POULTRY, AND TOMATO PASTE (U.S. CL. 46).

FIRST USE 3-14-2001; IN COMMERCE 3-14-2001.

2,729,423. PUBLIX SUPER MARKETS, INC., LAKELAND, FL. SN 75-592,640. PUB. 12-14-1999, FILED 11-19-1998.

GREENWISE

FOR FOOD PRODUCTS, NAMELY, EGGS, CHEESES, MILK, FLAVORED MILK, CHOCOLATE MILK, SOUR CREAM, COTTAGE CHEESE, FRESH AND PROCESSED SEAFOOD AND SHELLFISH, REFRIGERATED YOGURT, POTATO CHIPS, PROCESSED NUTS, EDIBLE PROCESSED SEEDS, DRIED FRUITS, JAMS, JELLIES, DRIED BEANS, PEANUT BUTTER, COOKING OIL, FRESH AND PROCESSED MEAT AND POULTRY, AND TOMATO PASTE (U.S. CL. 46).

FIRST USE 3-14-2001; IN COMMERCE 3-14-2001.

2,729,501. FERRARO FOODS, INC., SOUTH PLAINFIELD, NJ. SN 75-776,961. PUB. 3-7-2000, FILED 8-16-1999.

DOMENICO VITALE

THE NAME "DOMENICO VITALE" DOES NOT IDENTIFY A LIVING INDIVIDUAL.

FOR CANNED TOMATOES, TOMATO PASTE, TOMATO PUREE, CANNED CHICK PEAS, AND CANNED KIDNEY BEANS (U.S. CL. 46).

FIRST USE 9-23-1999; IN COMMERCE 9-23-1999.

2,729,554. VANCE'S FOODS, INC., SOLDOTNA, AK. SN 75-855,634. PUB. 9-5-2000, FILED 11-22-1999.

VANCE'S FOODS, INC.

NO CLAIM IS MADE TO THE EXCLUSIVE RIGHT TO USE "FOODS, INC.", APART FROM THE MARK AS SHOWN.

FOR DAIRY BASED FOOD BEVERAGE; POTATO BASED, SOY BASED, AND WHEY BASED FOOD BEVERAGE USED AS A MILK SUBSTITUTE (U.S. CL. 46).

FIRST USE 1-1-2001; IN COMMERCE 1-1-2001.

CLASS 29—(Continued).

2,729,644. MARTEK BIOSCIENCES BOULDER CORPORATION, BOULDER, CO. BY MERGER; BY CHANGE OF NAME OMEGATECH INC., BOULDER, CO. SN 75-982,744. PUB. 1-11-2000, FILED 7-28-1998.

BABIES NEED THEIR DHA LONG BEFORE THEIR ABC'S

NO CLAIM IS MADE TO THE EXCLUSIVE RIGHT TO USE "DHA", APART FROM THE MARK AS SHOWN. FOR EGGS (U.S. CL. 46).
FIRST USE 3-0-1998; IN COMMERCE 3-0-1998.

2,729,656. GOOD HEALTH NATURAL FOODS, INC., NORTHPORT, NY. SN 76-000,984. PUB. 9-17-2002, FILED 3-15-2000.

BISTRO CHIPS

NO CLAIM IS MADE TO THE EXCLUSIVE RIGHT TO USE "CHIPS", APART FROM THE MARK AS SHOWN. FOR COOKING OILS; VEGETABLE-BASED SNACK FOODS; POTATO CHIPS AND POTATO CRISPS (U.S. CL. 46).
FIRST USE 8-31-2001; IN COMMERCE 8-31-2001.

2,729,762. OLEIFICI COLAVITA S.P.A., 00040 POMEZIA (ROMA), ITALY. SN 76-093,675. PUB. 1-8-2002, FILED 7-21-2000.

MOLIVO

FOR OILS AND FATS FOR EDIBLE USE, EITHER OF ANIMAL OR VEGETABLE ORIGIN, NAMELY OLIVE OIL AND SEEDS OIL, MARGARINE, BUTTER, LARD, PRESERVED FRUIT AND VEGETABLES, ALIMENTARY PRESERVES AND ALIMENTARY PRODUCTS PRESERVED IN OIL AND VINEGAR, NAMELY MEAT, FISH AND VEGETABLES PRESERVED IN OIL AND VINEGAR (U.S. CL. 46).
FIRST USE 4-22-2002; IN COMMERCE 4-22-2002.

2,729,828. PIZZERIA UNO CORPORATION, WILMINGTON, DE. SN 76-138,114. PUB. 12-18-2001, FILED 9-29-2000.

BUFFALO BONES

NO CLAIM IS MADE TO THE EXCLUSIVE RIGHT TO USE "BUFFALO", APART FROM THE MARK AS SHOWN. FOR PREPARED ENTREES CONSISTING PRIMARILY OF PORK, FOR CONSUMPTION ON OR OFF THE PREMISES (U.S. CL. 46).
FIRST USE 11-26-2002; IN COMMERCE 11-26-2002.

CLASS 29—(Continued).

2,729,899. FERNANDO'S FOODS CORPORATION, LA PALMA, CA. SN 76-178,111. PUB. 1-29-2002, FILED 12-11-2000.

ANDALE GOURMET

NO CLAIM IS MADE TO THE EXCLUSIVE RIGHT TO USE "GOURMET", APART FROM THE MARK AS SHOWN. THE ENGLISH TRANSLATION OF "ANDALE GOURMET" IS "HURRY UP GOURMET". FOR SHREDDED BEEF, PORK AND CHICKEN; BEEF STRIPS, CHICKEN STRIPS (U.S. CL. 46).
FIRST USE 12-0-2000; IN COMMERCE 12-0-2000.

2,729,931. FAIRMONT SNACKS GROUP, INC., INDEPENDENCE, OH. SN 76-193,321. PUB. 5-28-2002, FILED 1-12-2001.

PETERSON'S NATURE'S PLEASURES

FOR SNACK MIX CONSISTING PRIMARILY OF ROASTED NUTS, DRIED FRUITS OR COMBINATIONS THEREOF; AND SNACK MIX CONSISTING PRIMARILY OF ROASTED NUTS, DRIED FRUITS OR COMBINATIONS THEREOF, AND ALSO CONTAINING SPICES, SESAME STICKS, TOASTED CORN KERNELS, CANDY, EDIBLE SEEDS OR COMBINATIONS THEREOF (U.S. CL. 46).
FIRST USE 5-11-2001; IN COMMERCE 8-13-2001.

2,729,973. LINDEN OAKS CORPORATION, WILMINGTON, DE. SN 76-212,409. PUB. 5-21-2002, FILED 2-20-2001.

THANK YOU

OWNER OF U.S. REG. NOS. 38,465 AND 1,188,837. FOR FRUIT TOPPINGS AND FILLINGS, CANNED AND FROZEN VEGETABLES, CHILI WITH BEANS, CHILI, BEEF STEW, CHICKEN STEW, SOUP, ENTREES CONSISTING PRIMARILY OF POULTRY AND/OR MEAT, NAMELY: CHICKEN NOODLE DINNER, CHICKEN DINNER WITH VEGETABLES, NOODLE BEEF STROGANOFF, CHEESEBURGER MACARONI, SEASONED HERB NOODLES AND BEEF, CHILI MACARONI; SAUERKRAUT, AND MARINADES (U.S. CL. 46).
FIRST USE 9-0-1993; IN COMMERCE 9-0-1993.

2,730,047. DTMC, INC., FRANKLIN PARK, IL. SN 76-243,317. PUB. 4-9-2002, FILED 4-19-2001.

CHUG SHAKE

OWNER OF U.S. REG. NOS. 2,187,950, 2,306,388, AND OTHERS. NO CLAIM IS MADE TO THE EXCLUSIVE RIGHT TO USE "SHAKE", APART FROM THE MARK AS SHOWN. FOR DAIRY PRODUCTS EXCLUDING ICE CREAM, ICE MILK AND FROZEN YOGURT (U.S. CL. 46).
FIRST USE 9-0-2001; IN COMMERCE 9-0-2001.

CLASS 29—(Continued).

2,730,120. GFI HOLDINGS, INC., SAN JOSE, CA. SN 76-268,576. PUB. 2-12-2002, FILED 6-8-2001.

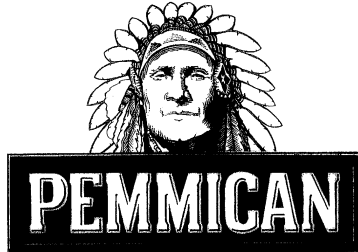

OWNER OF U.S. REG. NOS. 1,408,717, 2,407,232, AND OTHERS.

NO CLAIM IS MADE TO THE EXCLUSIVE RIGHT TO USE "PEMMICAN", APART FROM THE MARK AS SHOWN. THE LINING AND STIPPLING ARE FEATURES OF THE MARK AND DO NOT INDICATE COLOR.

THE DEPICTION OF THE NATIVE AMERICAN IN THE MARK DOES NOT IDENTIFY A LIVING INDIVIDUAL.

THE TRADEMARK CONSISTS OF THE HEAD AND NECK OF A NATIVE AMERICAN WITH A HEADDRESS AND ORNAMENTATION ATOP A RECTANGULAR BOX CONTAINING THE WORD "PEMMICAN" IN UPPER CASE BLOCK LETTERS.

FOR SMOKED MEAT SNACKS, NAMELY, BEEFJERKY AND MEAT STICKS (U.S. CL. 46).

FIRST USE 7-0-2002; IN COMMERCE 7-0-2002.

2,730,163. COST PLUS MARKETING SERVICES, INC., OAKLAND, CA. SN 76-282,537. PUB. 1-8-2002, FILED 7-9-2001.

ASIAN PASSAGE

NO CLAIM IS MADE TO THE EXCLUSIVE RIGHT TO USE "ASIAN", APART FROM THE MARK AS SHOWN.

FOR GROUND, SHELLED, ROASTED AND PROCESSED NUTS, PROCESSED ANCHOVIES, ANCHOVY PASTE, PROCESSED FRUITS AND VEGETABLES, ASPIC, BANANA CHIPS, DRIED BEANS, PEAS AND LENTILS, PROCESSED BEANS; DAIRY-BASED, SOY-BASED, WHEY-BASED AND VEGETABLE-BASED FOOD BEVERAGES; BOUILLON, SOUP BROTH, NUT BUTTER, FRUIT-BASED FILLINGS FOR CAKES AND PIES, CAVIAR, CHEESE, CHEESE AND CRACKER COMBINATIONS, CHEESE FONDUE, CHEESE FOOD, CHEESE SPREADS, CHEESE SUBSTITUTES, MARSCHINO CHERRIES, CHILE CON QUESO, CHILI WITH OR WITHOUT BEANS, FRUIT CHIPS, POTATO CHIPS, YUCCA CHIPS; MEAT, FISH, OR VEGETABLE BASED CHOW MEIN; CHOWDER, CLAM JUICE, COOKING OIL, CRYSTALLIZED FRUIT, DAIRY BASED DIPS, PROCESSED DATES, DIPS INCLUDING SNACK FOOD BUT NOT INCLUDING SALSA AND OTHER SAUCES USED AS DIPS, EDIBLE FATS, EDIBLE OIL, EGG NOG MIXES, ESCARGOT, MEAT EXTRACTS, FOIE GRAS; BOTTLED, CANNED AND DRIED FRUITS AND VEGETABLES; FRUITS PRESERVED IN ALCOHOL, UNFLAVORED AND UNSWEETENED GELATINS, GHERKINS, GUAVA PASTE, JAMS, JELLIES, JERKY, LARD, LEMON

CLASS 29—(Continued).

CURD, PROCESSED LEMONS, LIVER PASTE, MARMALADE, MINCEMEAT, NUT TOPPING, SALAD OIL, VEGETABLE OIL, OLIVE OIL, FLAVORED OILS, PROCESSED OLIVES, ONION RINGS, TOMATO PASTE, VEGETABLE PASTE, PATE, PICCALILLI, PICKLED FRUITS AND VEGETABLES, PROCESSED PIMIENTOS, PORK RINDS, POTATO CRISPS, INSTANT POTATOES, VEGETABLE PROTEIN BITS HAVING A BACON FLAVOR, PROCESSED PUMPKIN SEEDS, TOMATO PUREE, QUENELLES, RAISINS, FRUIT SALADS, SARDINES, SAUERKRAUT, PROCESSED EDIBLE SEAWEED, PROCESSED EDIBLE SEEDS, SHELLFISH, FRUIT-BASED SNACK FOOD, SNACK MIX CONSISTING PRIMARILY OF PROCESSED FRUITS, PROCESSED NUTS AND/OR RAISINS, SNAILS, SOUP MIXES, SOUPS, CANNED AND DRIED SOYBEANS, TAHINI, CANNED, COOKED OR OTHERWISE PROCESSED TOMATOES, PRESERVED TRUFFLES, TUNAFISH, VEGETABLE BASED SPREADS, VEGETABLE OILS FOR COOKING, VEGETABLE-BASED FOOD BEVERAGES, PICKLED VEGETABLES (U.S. CL. 46).

FIRST USE 4-15-2002; IN COMMERCE 4-15-2002.

2,730,223. GRASCO, S.A., BOGOTA, COLOMBIA. SN 76-299,650. PUB. 2-26-2002, FILED 8-13-2001.

LA FINA

THE ENGLISH TRANSLATION OF "LA FINA" IS "THE FINE ONE".

FOR MARGARINE (U.S. CL. 46).

FIRST USE 2-0-1960; IN COMMERCE 12-0-2000.

2,730,330. RIGONI USA, INC., OXFORD, CT. SN 76-329,604. PUB. 5-14-2002, FILED 10-25-2001.



THE ENGLISH TRANSLATION OF "FIORDIFRUTTA" IS "FRUIT FROM THE FLOWER".

FOR JAMS, JELLIES, PRESERVES, MARMALADE, FRUIT-BASED SPREADS (U.S. CL. 46).

FIRST USE 9-0-2002; IN COMMERCE 9-0-2002.

CLASS 29—(Continued).

2,730,407. BUFFETT, JIMMY, KEY WEST, FL. SN 76-346,265. PUB. 6-25-2002, FILED 12-6-2001.

MARGARITAVILLE SHRIMP

OWNER OF U.S. REG. NOS. 1,641,613, 2,284,131, AND OTHERS.

NO CLAIM IS MADE TO THE EXCLUSIVE RIGHT TO USE "SHRIMP", APART FROM THE MARK AS SHOWN. FOR PRE-PACKAGED, SHRIMP FOR HUMAN CONSUMPTION (U.S. CL. 46).

FIRST USE 2-0-2003; IN COMMERCE 2-0-2003.

2,730,415. KENTUCKY BISON CO., GOSHEN, KY. SN 76-348,031. PUB. 6-11-2002, FILED 12-12-2001.

LEWIS & CLARK BUFFALO JERKY

NO CLAIM IS MADE TO THE EXCLUSIVE RIGHT TO USE "BUFFALO JERKY", APART FROM THE MARK AS SHOWN.

FOR BUFFALO JERKY (U.S. CL. 46). FIRST USE 2-27-2003; IN COMMERCE 2-27-2003.

2,730,458. JFC, INC., ST. CLOUD, MN. SN 76-357,248. PUB. 10-15-2002, FILED 1-8-2002.

WING 'UMS

NO CLAIM IS MADE TO THE EXCLUSIVE RIGHT TO USE "WING", APART FROM THE MARK AS SHOWN.

FOR PREPARED APPETIZERS CONSISTING OF POULTRY AND POULTRY PARTS (U.S. CL. 46). FIRST USE 5-0-2002; IN COMMERCE 8-0-2002.

2,730,491. BUFFALO GUYS, LLC, THE, ELK MOUNTAIN, WY, BY CHANGE OF NAME GREAT PLAINS BISON CO. LLC, ELK MOUNTAIN, WY. SN 76-369,251. PUB. 8-27-2002, FILED 2-12-2002.

NATURE'S PRAIRIE

FOR BUFFALO MEAT AND PROCESSED FOODS CONSISTING PRIMARILY OF BUFFALO MEAT, NAMELY, GROUND BUFFALO MEAT PATTIES, GROUND BUFFALO MEAT BULK, BUFFALO MEAT STEAKS, BUFFALO MEAT ROASTS, BUFFALO MEAT JERKY, BUFFALO MEAT MEATLOAF, BUFFALO MEAT HOT DOGS, BUFFALO MEAT SAUSAGE, BUFFALO MEAT CHILI, BUFFALO MEAT SOUP, AND BUFFALO MEAT STEW (U.S. CL. 46).

FIRST USE 1-0-2003; IN COMMERCE 1-0-2003.

CLASS 29—(Continued).

2,730,620. PETERSON, BRAD, EL CAJON, CA. AND CINCOTTA, JOHN, SANTEE, CA. SN 78-052,615. PUB. 5-28-2002, FILED 3-12-2001.

FIREHOUSE FARE

NO CLAIM IS MADE TO THE EXCLUSIVE RIGHT TO USE "FARE", APART FROM THE MARK AS SHOWN. FOR FROZEN CHILI (U.S. CL. 46). FIRST USE 5-1-2002; IN COMMERCE 4-1-2003.

2,730,701. HARBOR BRANCH OCEANOGRAPHIC INSTITUTION, INC., FORT PIERCE, FL. SN 78-079,850. PUB. 1-15-2002, FILED 8-17-2001.

OCEANSWEET

FOR AQUACULTURE PRODUCTS, NAMELY SHRIMP AND CLAMS (U.S. CL. 46). FIRST USE 9-10-2001; IN COMMERCE 10-10-2001.

2,730,751. BOCA FOODS COMPANY, MADISON, WI. SN 78-094,509. PUB. 6-4-2002, FILED 11-21-2001.

THE TASTE WILL CHANGE YOU

FOR VEGETABLE OR SOY BASED MEAT ALTERNATIVES (U.S. CL. 46). FIRST USE 10-1-2002; IN COMMERCE 10-1-2002.

2,730,769. COST PLUS MARKETING SERVICES, INC., OAKLAND, CA. SN 78-097,986. PUB. 7-9-2002, FILED 12-12-2001.

SOIREE

FOR GROUND, SHELLED, ROASTED AND PROCESSED NUTS, PROCESSED ANCHOVIES, ANCHOVY PASTE, PROCESSED FRUITS AND VEGETABLES, ASPIC, BANANA CHIPS, DRIED BEANS, PEAS AND LENTILS, PROCESSED BEANS; DAIRY-BASED, SOY-BASED, WHEY-BASED AND VEGETABLE-BASED FOOD BEVERAGES; BOUILLON, SOUP BROTH, NUT BUTTER, FRUIT-BASED FILLINGS FOR CAKES AND PIES, CAVIAR, CHEESE, CHEESE AND CRACKER COMBINATIONS, CHEESE FONDUE, CHEESE FOOD, CHEESE SPREADS, CHEESE SUBSTITUTES, MARSCHINO CHERRIES, CHILE CON QUESO, CHILI WITH OR WITHOUT BEANS, FRUIT CHIPS, POTATO CHIPS, YUCCA CHIPS; MEAT, FISH, OR VEGETABLE BASED CHOW MEIN; CHOWDER, CLAM JUICE, COOKING OIL, CRYSTALLIZED FRUIT, DAIRY BASED DIPS, PROCESSED DATES, DIPS INCLUDING SNACK FOOD BUT NOT INCLUDING SALSA AND OTHER SAUCES USED AS DIPS, SALAD DRESSING, EDIBLE FATS, EDIBLE OIL, EGG NOG MIXES, ESCARGOT, MEAT EXTRACTS, FOIE GRAS; BOTTLED, CANNED AND DRIED FRUITS AND VEGETABLES; FRUITS PRESERVED IN ALCOHOL, UNFLAVORED AND UNSWEETENED GELATINS, GHERKINS, GUAVA PASTE, JAMS,

CLASS 29—(Continued).

JELLIES, JERKY, LARD, LEMON CURD, PROCESSED LEMONS, LIVER PASTE, MARMALADE, MINCEMEAT, NUT TOPPING, SALAD OIL, VEGETABLE OIL, OLIVE OIL, FLAVORED OILS, PROCESSED OLIVES, ONION RINGS, TOMATO PASTE, VEGETABLE PASTE, PATE, PICCALILLI, PICKLED FRUITS AND VEGETABLES, PIMIENTOS, PORK RINDS, POTATO CRISPS, INSTANT POTATOES, VEGETABLE PROTEIN BITS HAVING A BACON FLAVOR, PROCESSED PUMPKIN SEEDS, TOMATO PUREE, QUENELLES, RAISINS, FRUIT SALADS, SARDINES, SAUERKRAUT, PROCESSED EDIBLE SEA-WEED, PROCESSED EDIBLE SEEDS, SHELLFISH, FRUIT-BASED SNACK FOOD, SNACK MIX CONSISTING PRIMARILY OF PROCESSED FRUITS, PROCESSED NUTS AND/OR RAISINS, SNAILS, SOUP MIXES, SOUPS, CANNED AND DRIED SOYBEANS, TAHINI, CANNED, COOKED OR OTHERWISE PROCESSED TOMATOES, PRESERVED TRUFFLES, TUNAFISH, VEGETABLE BASED SPREADS, VEGETABLE OILS FOR COOKING, VEGETABLE-BASED FOOD BEVERAGES, PICKLED VEGETABLES (U.S. CL. 46).

FIRST USE 5-15-2002; IN COMMERCE 5-15-2002.

2,730,796. DOMINO'S PIZZA PMC, INC., ANN ARBOR, MI. SN 78-103,579. PUB. 9-24-2002, FILED 1-18-2002.

BUFFALO CHICKEN KICKERS

NO CLAIM IS MADE TO THE EXCLUSIVE RIGHT TO USE "BUFFALO CHICKEN", APART FROM THE MARK AS SHOWN.

FOR CHICKEN, NAMELY SPICY BONELESS CHICKEN STRIPS (U.S. CL. 46).

FIRST USE 10-15-2002; IN COMMERCE 10-15-2002.

CLASS 30—STAPLE FOODS

2,729,366. BHEND, MARC Y.J., LYNNWOOD, WA. SN 75-263,336. PUB. 9-1-1998, FILED 3-24-1997.

KOKA MOKA

FOR FOOD, NAMELY, BAGELS, BAKERY GOODS, BAKERY PRODUCTS, CAKES, CANDY, CHOCOLATE, COOKIES, ICE CREAM, ICE CREAM CONES, MUFFINS, PASTRIES, AND PIES (U.S. CL. 46).

FIRST USE 11-10-2001; IN COMMERCE 11-10-2001.

2,729,413. ASAHI FOODS CO., LTD., KUMIYAMA-CHO, KUSE-GUN, KYOTO, JAPAN. SN 75-558,710. PUB. 11-23-1999, FILED 9-23-1998.

CUPUACU

FOR , CHOCOLATE CANDIES (U.S. CL. 46).
FIRST USE 11-18-2001; IN COMMERCE 11-18-2001.

CLASS 30—(Continued).

2,729,496. WOLPA, MARK, BERKELEY, CA. SN 75-767,050. PUB. 2-15-2000, FILED 8-3-1999.

TOE-JAM

OWNER OF U.S. REG. NOS. 2,205,885, 2,285,491, AND OTHERS.

FOR CANDY AND COOKIES IN THE SHAPE OF A FOOT (U.S. CL. 46).

FIRST USE 2-10-2003; IN COMMERCE 2-10-2003.

2,729,497. WOLPA, MARK, BERKELEY, CA. SN 75-767,075. PUB. 3-14-2000, FILED 8-3-1999.

BEAR FEET

OWNER OF U.S. REG. NOS. 1,664,296, 2,174,856, AND OTHERS.

FOR CANDY AND COOKIES IN THE SHAPE OF A BEAR AND A FOOT (U.S. CL. 46).

FIRST USE 2-10-2003; IN COMMERCE 2-10-2003.

2,729,506. BERNATELLO'S PIZZA, INC., MAPLE LAKE, MN, BY ASSIGNMENT DADCO DIVERSIFIED, INC., EAU CLAIRE, WI. SN 75-784,078. PUB. 5-16-2000, FILED 8-25-1999.

FRESH RISE

OWNER OF U.S. REG. NOS. 1,982,155 AND 1,987,239.
NO CLAIM IS MADE TO THE EXCLUSIVE RIGHT TO USE "FRESH", APART FROM THE MARK AS SHOWN.
FOR FOODS, NAMELY, PIZZAS, DOUGHS, BREADS, BISCUITS, PIZZA CRUSTS, ROLLS AND BAGELS (U.S. CL. 46).

FIRST USE 1-0-1997; IN COMMERCE 1-0-1997.

2,729,515. FERRARA PAN CANDY CO., INC., FOREST PARK, IL. SN 75-798,705. PUB. 4-4-2000, FILED 9-15-1999.

ATOMIC SOUR BALL

OWNER OF U.S. REG. NOS. 614,947, 1,316,009, AND OTHERS.

NO CLAIM IS MADE TO THE EXCLUSIVE RIGHT TO USE "SOUR BALL", APART FROM THE MARK AS SHOWN.
FOR CANDY (U.S. CL. 46).

FIRST USE 12-20-2002; IN COMMERCE 12-20-2002.

CLASS 30—(Continued).

2,729,540. KETTLE FOODS, INC., SALEM, OR, BY ASSIGNMENT SOKOLOFF, MARTIN, NEW YORK, NY. SN 75-840,370. PUB. 5-15-2001, FILED 11-24-1999.

KETTLE SWEET

NO CLAIM IS MADE TO THE EXCLUSIVE RIGHT TO USE "SWEET", APART FROM THE MARK AS SHOWN. FOR PACKAGED CARAMEL POPCORN, CARAMEL KAMUT, AND CARAMEL SPELT (U.S. CL. 46). FIRST USE 12-0-1999; IN COMMERCE 2-0-2000.

2,729,617. DREYER'S GRAND ICE CREAM, INC., OAKLAND, CA. SN 75-927,912. PUB. 9-17-2002, FILED 2-25-2000.

S'MORES & MORE

NO CLAIM IS MADE TO THE EXCLUSIVE RIGHT TO USE "S'MORES", APART FROM THE MARK AS SHOWN. FOR DAIRY BASED FROZEN CONFECTIONS (U.S. CL. 46). FIRST USE 2-0-2000; IN COMMERCE 2-0-2000.

2,729,692. SEATTLE'S BEST COFFEE LLC, SEATTLE, WA. SN 76-037,035. PUB. 6-11-2002, FILED 4-28-2000.

TWILIGHT

FOR COFFEE (U.S. CL. 46). FIRST USE 4-30-2000; IN COMMERCE 4-30-2000.

2,729,748. BULLDOG SAUCE KABUSHIKI KAISHA, TA BULL-DOG SAUCE CO., LTD., CHUO-KU, TOKYO, JAPAN. SN 76-083,817. PUB. 6-25-2002, FILED 7-6-2000.

GOMATON

FOR SAUCE FOR BARBECUES (U.S. CL. 46). FIRST USE 4-0-2000; IN COMMERCE 5-0-2000.

CLASS 30—(Continued).

2,729,797. BARNIE'S COFFEE & TEA COMPANY, INC., ORLANDO, FL. SN 76-116,389. PUB. 5-22-2001, FILED 8-24-2000.



THE MARK CONSISTS OF THE DESIGN OF A CUP WITH STEAM RISING FROM THE CUP. FOR COFFEE, TEA, AND GIFT PACKS OF COFFEE AND TEA (U.S. CL. 46). FIRST USE 8-31-1999; IN COMMERCE 8-31-1999.

2,729,838. METABOLIFE INTERNATIONAL, INC., SAN DIEGO, CA. SN 76-147,048. PUB. 6-11-2002, FILED 10-16-2000.

METABOLIFE

FOR GRAIN BASED SNACK BARS (U.S. CL. 46). FIRST USE 11-21-2000; IN COMMERCE 11-21-2000.

2,729,907. DE WAFELBAKKERS, INC., NORTH LITTLE ROCK, AR. SN 76-181,622. PUB. 11-13-2001, FILED 12-15-2000.

A PLUS

FOR PANCAKES, WAFFLES AND FRENCH TOAST (U.S. CL. 46). FIRST USE 3-0-2001; IN COMMERCE 3-0-2001.

2,729,953. PETERSEN, PAUL, NEW YORK, NY. SN 76-204,538. PUB. 5-14-2002, FILED 2-5-2001.

PABLO DIABLO'S

THE NAME IN THE MARK DOES NOT IDENTIFY A LIVING INDIVIDUAL. FOR SAUCES, HOT SAUCES, SALSA, SEASONINGS, SALAD DRESSINGS, FOOD FLAVORINGS, FOOD ADDITIVES FOR NON-NUTRITIONAL PURPOSES FOR USE AS FLAVORING, INGREDIENT OR FILLER, SOUTH-TEXAS AND MEXICAN STYLE FOODS, NAMELY BURRITOS, FAJITAS, NACHOS, TACOS, TAMALES AND TORTILLAS (U.S. CL. 46). FIRST USE 9-30-1997; IN COMMERCE 10-11-2001.

CLASS 30—(Continued).

2,729,966. COST PLUS MARKETING SERVICES, INC., OAKLAND, CA. SN 76-210,553. PUB. 8-6-2002, FILED 2-12-2001.



OWNER OF U.S. REG. NOS. 1,977,800, 2,326,779, AND 2,422,735.

THE LINING SHOWN IN THE DRAWING IS A FEATURE OF THE MARK AND NOT INTENDED TO INDICATE COLOR.

THE ENGLISH TRANSLATION OF "MARCHÉ DU MONDE" IS "WORLD MARKET".

FOR DESSERT SAUCES AND SPREADS, NAMELY, HAZELNUT CHOCOLATE SAUCES AND SPREADS (U.S. CL. 46).

FIRST USE 6-20-2001; IN COMMERCE 6-20-2001.

CLASS 30—(Continued).

2,730,131. VICORP RESTAURANTS, INC., DENVER, CO. SN 76-272,175. PUB. 6-11-2002, FILED 6-15-2001.

MAGNIFICENT!

FOR MENU ITEMS, NAMELY, HAM, CHICKEN, TURKEY, BREAKFAST AND MEAT LOAF SANDWICHES (U.S. CL. 46).

FIRST USE 9-1-2001; IN COMMERCE 9-1-2001.

2,729,981. NOODLES BY LEONARDO, INC., DEVILS LAKE, ND. SN 76-216,487. PUB. 5-14-2002, FILED 2-27-2001.

SIMPLY MAC

FOR PREPARED ENTREES CONSISTING PRIMARILY OF PASTA, PASTA SALAD (U.S. CL. 46).

FIRST USE 9-13-2001; IN COMMERCE 9-13-2001.

2,730,139. MARTEK, LLC, PERU, IN. SN 76-274,446. PUB. 5-14-2002, FILED 6-20-2001.

Modern
Foods

2,730,122. WINCORP INTERNATIONAL, INC., MEDLEY, FL. SN 76-269,366. PUB. 6-18-2002, FILED 6-11-2001.



NO CLAIM IS MADE TO THE EXCLUSIVE RIGHT TO USE "CHEESE", APART FROM THE MARK AS SHOWN.

FOR SHELF STABLE, FOOD PACKAGE COMBINATIONS CONSISTING PRIMARILY OF PASTA, AND ALSO INCLUDING PROCESSED CHEESE (U.S. CL. 46).

FIRST USE 7-0-2001; IN COMMERCE 7-0-2001.

NO CLAIM IS MADE TO THE EXCLUSIVE RIGHT TO USE "FOODS", APART FROM THE MARK AS SHOWN.

FOR FLOUR-BASED FOOD PRODUCTS, NAMELY, FROZEN BISCUITS; FROZEN FLOUR-BASED GRAVIES; DRY POWDER BISCUITS MIXES; DRY SEASONING MIXES FOR MEATS TO BE APPLIED PRIOR TO COOKING (U.S. CL. 46).

FIRST USE 6-20-2001; IN COMMERCE 6-20-2001.

CLASS 30—(Continued).

2,730,162. COST PLUS MARKETING SERVICES, INC., OAKLAND, CA. SN 76-282,536. PUB. 1-1-2002, FILED 7-9-2001.

ASIAN PASSAGE

NO CLAIM IS MADE TO THE EXCLUSIVE RIGHT TO USE "ASIAN", APART FROM THE MARK AS SHOWN.

FOR VINEGAR, FLAVORED VINEGARS, PASTA, BISCOTTI, BREAD STICKS, SPICES AND HERBS IN ALL FORMS, PIZZA CRUST AND DOUGH, SAUCES, FLAVORING SYRUP, BARBECUE SAUCE, HOT SAUCE, MARINADE, SALSA, CORN CHIPS, CANDY, COCOA, CHOCOLATE, FLAVORED COCOA MIXES, COFFEE AND TEA, COFFEE SUBSTITUTES, BAKERY GOODS AND PRODUCTS, GRAIN BASED FOOD BEVERAGES, PROCESSED CEREALS, PROCESSED GRAINS, BREAD MIXES, CAKE AND PIE MIXES, CUSTARD BASED FILLINGS FOR PIES AND CAKES; EDIBLE CAKE DECORATIONS; CONDIMENTS, NAMELY, MUSTARD, KETCHUP AND RELISH; CAPERS, CANDY, CARAMEL POPCORN, CHEESE SAUCE, CHOCOLATE CHIPS, CORN CHIPS, DRIED CHILI PEPPERS, CHUTNEY, CHOW CHOW, COOKIES, CRACKERS, EXTRACTS USED AS FLAVORING, FLAVORING SYRUPS, FLOUR, READY TO EAT CEREAL DERIVED FOOD BARS, FROSTINGS AND FROSTING MIXES, GRAVIES AND GRAVY MIXES, CHEWING GUM, HONEY, MAYONNAISE, NOODLES, CHOCOLATE COVERED NUTS, OATMEAL, PICKLE RELISH, PANCAKE MIXES, PROCESSED POPCORN, PRETZELS, PUDDINGS AND PUDDING MIXES, RICE, RICE BASED FOOD BEVERAGES, NATURAL SWEETENERS, AND YEAST (U.S. CL. 46).

FIRST USE 5-6-2002; IN COMMERCE 5-6-2002.

2,730,183. SAVE-A-LOT FOOD STORES, INC., EARTH CITY, MO. SN 76-288,536. PUB. 9-17-2002, FILED 7-20-2001.

RICE TOWN

NO CLAIM IS MADE TO THE EXCLUSIVE RIGHT TO USE "RICE", APART FROM THE MARK AS SHOWN.

FOR RICE (U.S. CL. 46).
FIRST USE 10-4-2002; IN COMMERCE 10-4-2002.

2,730,259. GUMBALL GOURMET, LLC, IDAHO FALLS, ID. SN 76-309,320. PUB. 4-30-2002, FILED 9-5-2001.

GUMBALL GOURMET

NO CLAIM IS MADE TO THE EXCLUSIVE RIGHT TO USE "GUMBALL", APART FROM THE MARK AS SHOWN.

FOR GUM BALLS; BUBBLE GUM; CHEWING GUM (U.S. CL. 46).
FIRST USE 10-1-2001; IN COMMERCE 10-1-2001.

CLASS 30—(Continued).

2,730,272. ULKER GIDA SANAYI VE TICARET A.S., 34015 TOPKAPI ISTANBUL, TURKEY. SN 76-315,072. PUB. 5-21-2002, FILED 9-20-2001.

METOO

FOR CHOCOLATES, CHOCOLATE-BASED CANDIES, BISCUITS (U.S. CL. 46).

FIRST USE 5-16-2002; IN COMMERCE 5-16-2002.

2,730,349. ROCKMAN CO., COMMERCE, CA. SN 76-334,711. PUB. 8-6-2002, FILED 11-6-2001.



NO CLAIM IS MADE TO THE EXCLUSIVE RIGHT TO USE THE PICTORIAL REPRESENTATION OF THE RICE GRAIN, APART FROM THE MARK AS SHOWN.

THE STIPLING IS A FEATURE OF THE MARK, AND NOT INTENDED TO INDICATE COLOR.

THE MARK CONSISTS OF THE WORDS "RICECHOICE", WITH THE DISTINCTIVE LOGO OF A RICE GRAIN.

FOR STAPLE FOODS, NAMELY, RICE, RICE NOODLES, RICE STICK, RICE VERMICELLI, SPAGHETTI, MACARONI AND NOODLES (U.S. CL. 46).

FIRST USE 8-26-2002; IN COMMERCE 8-26-2002.

2,730,479. WHETSTONE CANDY COMPANY, INC., ST. AUGUSTINE, FL. SN 76-363,785. PUB. 7-23-2002, FILED 1-28-2002.

NITWITZ

FOR CANDY AND BUBBLE GUM (U.S. CL. 46).
FIRST USE 2-11-2002; IN COMMERCE 2-11-2002.

2,730,559. SARAMAR, L.L.C., CHICAGO, IL. SN 78-016,218. PUB. 5-22-2001, FILED 7-11-2000.

WHERE PIE COMES FROM

NO CLAIM IS MADE TO THE EXCLUSIVE RIGHT TO USE "PIE", APART FROM THE MARK AS SHOWN.

FOR PIES, PIE SHELLS, QUICHES, COBBLERS AND DUMPLINGS (U.S. CL. 46).
FIRST USE 5-31-2002; IN COMMERCE 5-31-2002.

CLASS 30—(Continued).

2,730,600. SHERYL'S CHOCOLATE CREATIONS, INC., HICKSVILLE, NY. SN 78-044,132. PUB. 10-15-2002, FILED 1-20-2001.

CRACK-UPS

FOR CHOCOLATE COVERED GRAHAM CRACKERS (U.S. CL. 46).
FIRST USE 9-1-1999; IN COMMERCE 1-1-2000.

2,730,611. DEAN INTELLECTUAL PROPERTY SERVICES, L.P., DALLAS, TX, BY ASSIGNMENT; BY ASSIGNMENT; BY ASSIGNMENT SUIZA DAIRY GROUP, L.P., DALLAS, TX. SN 78-049,109. PUB. 7-2-2002, FILED 2-19-2001.

SPARKLERS

FOR FROZEN CONFECTIONS (U.S. CL. 46).
FIRST USE 2-0-2001; IN COMMERCE 2-0-2001.

2,730,630. REPUBLIC OF TEA, INC., THE, NOVATO, CA. SN 78-055,779. PUB. 7-2-2002, FILED 3-29-2001.

ZEN DREAM TEA

NO CLAIM IS MADE TO THE EXCLUSIVE RIGHT TO USE "TEA", APART FROM THE MARK AS SHOWN.
FOR TEA (U.S. CL. 46).
FIRST USE 4-1-2001; IN COMMERCE 4-1-2001.

2,730,683. GLOBETRENDS, INC., CATHAM, NJ. SN 78-075,368. PUB. 12-4-2001, FILED 7-24-2001.

VAUXHALL GARDENS

FOR TEAS (U.S. CL. 46).
FIRST USE 7-1-2001; IN COMMERCE 8-16-2001.

2,730,688. TROJAN FOOD STUFF CO., LTD., TAIPEI, TAIWAN. SN 78-076,370. PUB. 7-9-2002, FILED 7-30-2001.



NO CLAIM IS MADE TO THE EXCLUSIVE RIGHT TO USE "MOCHA", APART FROM THE MARK AS SHOWN.
FOR COFFEE FLAVORED ICES AND ICED COFFEE (U.S. CL. 46).
FIRST USE 8-3-2001; IN COMMERCE 8-3-2001.

CLASS 30—(Continued).

2,730,697. BEN & JERRY'S HOMEMADE HOLDINGS, INC., BURLINGTON, VT. SN 78-078,456. PUB. 1-1-2002, FILED 8-9-2001.

PEANUT BUTTER ME UP

NO CLAIM IS MADE TO THE EXCLUSIVE RIGHT TO USE "PEANUT BUTTER", APART FROM THE MARK AS SHOWN.

FOR ICE CREAM, FROZEN YOGURT AND SORBET (U.S. CL. 46).
FIRST USE 2-28-2002; IN COMMERCE 2-28-2002.

2,730,817. LANCE MFG. LLC, CHARLOTTE, NC. SN 78-109,600. PUB. 10-29-2002, FILED 2-19-2002.



NO CLAIM IS MADE TO THE EXCLUSIVE RIGHT TO USE "CHEESE" AND "CHEESE FLAVOR", APART FROM THE MARK AS SHOWN.

THE STIPPLING IS FOR SHADING PURPOSES ONLY.
FOR SNACK FOODS, NAMELY CHEESE FLAVORED PUFFED CORN SNACKS (U.S. CL. 46).
FIRST USE 2-18-2002; IN COMMERCE 2-18-2002.

CLASS 31—NATURAL AGRICULTURAL PRODUCTS

2,729,400. GAYLE MARTZ, INC., NEW YORK, NY. SN 75-520,597. PUB. 11-9-1999, FILED 7-17-1998.



OWNER OF U.S. REG. NOS. 1,649,499 AND 2,044,070.
NO CLAIM IS MADE TO THE EXCLUSIVE RIGHT TO USE "TRAVEL TREATS", APART FROM THE MARK AS SHOWN.

THE LINING IN THE DRAWING IS A FEATURE OF THE MARK AND DOES NOT INDICATE COLOR.

FOR PET FOOD; PET TREATS, NAMELY, EDIBLE DOG AND CAT TREATS; EDIBLE RAW HIDE CHEWS AND BONES (U.S. CLS. 1 AND 46).

FIRST USE 6-16-2000; IN COMMERCE 6-16-2000.

CLASS 31—(Continued).

2,729,588. XENOGEN CORPORATION, ALAMEDA, CA. SN 75-902,180. PUB. 11-27-2001, FILED 1-27-2000.

LPTA

FOR LIVE TRANSGENIC ANIMALS (U.S. CLS. 1 AND 46).
FIRST USE 12-11-2002; IN COMMERCE 11-12-2002.

2,729,659. JONATHAN SPROUTS, INC., EAST FREETOWN, MA. SN 76-002,395. PUB. 1-2-2001, FILED 3-16-2000.

NORMAL FLORA

NO CLAIM IS MADE TO THE EXCLUSIVE RIGHT TO USE "FLORA", APART FROM THE MARK AS SHOWN.
FOR FRESH VEGETABLE SPROUTS; SEEDS FOR GROWING FRESH VEGETABLE SPROUTS FOR HUMAN CONSUMPTION (U.S. CLS. 1 AND 46).
FIRST USE 3-26-2003; IN COMMERCE 3-26-2003.

2,729,847. SOUTH MILL MUSHROOM SALES, INC., KENNETT SQUARE, PA. SN 76-148,985. PUB. 11-13-2001, FILED 10-18-2000.

MAKE IT WITH MUSHROOMS

FOR FRESH MUSHROOMS (U.S. CLS. 1 AND 46).
FIRST USE 1-24-2002; IN COMMERCE 1-24-2002.

2,729,875. BALD MOUNTAIN FARMS, INC., MCALESTER, OK. SN 76-162,984. PUB. 6-18-2002, FILED 11-9-2000.



NO CLAIM IS MADE TO THE EXCLUSIVE RIGHT TO USE "FARMS, INC.", APART FROM THE MARK AS SHOWN.
FOR FRESH FRUITS AND VEGETABLES (U.S. CLS. 1 AND 46).
FIRST USE 6-0-2001; IN COMMERCE 6-0-2001.

CLASS 31—(Continued).

2,730,050. CEBECO INTERNATIONAL SEEDS, INC., HALSEY, OR. SN 76-243,706. PUB. 6-11-2002, FILED 4-18-2001.

MARINE

FOR GRASS SEED (U.S. CLS. 1 AND 46).
FIRST USE 8-0-2001; IN COMMERCE 8-0-2001.

2,730,167. PET SPICE, INC., FITCHBURG, MA. SN 76-283,519. PUB. 12-11-2001, FILED 7-11-2001.

CHEF CLAWDE

FOR FLAVOR ENHANCER FOR CAT FOOD (U.S. CLS. 1 AND 46).
FIRST USE 10-1-2002; IN COMMERCE 10-1-2002.

2,730,197. OMS INVESTMENTS, INC., WILMINGTON, DE. SN 76-293,274. PUB. 9-17-2002, FILED 7-31-2001.

NATURE SCAPES

FOR MULCH (U.S. CLS. 1 AND 46).
FIRST USE 1-2-2002; IN COMMERCE 1-2-2002.

2,730,273. MARKER 29 PRODUCE, INC., ONANCOCK, VA. SN 76-315,114. PUB. 2-19-2002, FILED 9-20-2001.

WE'RE SWEET

FOR FRESH CARROTS (U.S. CLS. 1 AND 46).
FIRST USE 12-0-2001; IN COMMERCE 12-0-2001.

2,730,282. LONG & SCOTT FARMS, INC., MOUNT DORA, FL. SN 76-318,594. PUB. 10-1-2002, FILED 10-1-2001.

SCOTT'S ZELLWOOD SWEET CORN

NO CLAIM IS MADE TO THE EXCLUSIVE RIGHT TO USE "ZELLWOOD SWEET CORN", APART FROM THE MARK AS SHOWN.
FOR FRESH CORN (U.S. CLS. 1 AND 46).
FIRST USE 10-1-2002; IN COMMERCE 10-1-2002.

CLASS 31—(Continued).

2,730,419. FARM SERVICE COOPERATIVE, HARLAN, IA.
SN 76-349,351. PUB. 9-17-2002, FILED 12-17-2001.

FOALS FIRST

FOR MILK REPLACEMENT FOR LIVESTOCK (U.S.
CLS. 1 AND 46).
FIRST USE 12-0-2001; IN COMMERCE 2-0-2002.

2,730,457. BRAND X INC., THAYER, MO. SN 76-357,111. PUB.
7-23-2002, FILED 1-10-2002.

BRAND X

NO CLAIM IS MADE TO THE EXCLUSIVE RIGHT TO
USE "BRAND", APART FROM THE MARK AS SHOWN.
FOR LIVESTOCK, POULTRY AND DOMESTIC ANI-
MAL FEEDS (U.S. CLS. 1 AND 46).
FIRST USE 12-9-2002; IN COMMERCE 12-9-2002.

2,730,615. NESTLE PURINA PETCARE COMPANY, ST.
LOUIS, MO, BY CHANGE OF NAME RALSTON PURINA
COMPANY, ST. LOUIS, MO. SN 78-051,570. PUB. 12-4-2001,
FILED 3-6-2001.

**HEALTHFUL. FLAVORFUL.
BENEFUL.**

NO CLAIM IS MADE TO THE EXCLUSIVE RIGHT TO
USE "HEALTHFUL" OR "FLAVORFUL", APART FROM THE
MARK AS SHOWN.
FOR PET FOOD (U.S. CLS. 1 AND 46).
FIRST USE 7-15-2001; IN COMMERCE 7-15-2001.

2,730,645. DELECTA FRUIT CC, WESTERN CAPE, SOUTH
AFRICA. SN 78-061,885. PUB. 6-11-2002, FILED 5-3-2001.

DELECTA

FOR FRESH FRUIT (U.S. CLS. 1 AND 46).
FIRST USE 2-0-1999; IN COMMERCE 1-0-2003.

2,730,705. EZGREEN ASSOCIATES, LLC, KINGSPORT, TN.
SN 78-081,386. PUB. 6-4-2002, FILED 8-28-2001.

EZTURF

FOR SEEDED LAWN PANEL, NAMELY, A CELLU-
LOSE SUBSTRATE COMPRISING SEED AND FERTILI-
ZER (U.S. CLS. 1 AND 46).
FIRST USE 6-11-2001; IN COMMERCE 6-11-2001.

CLASS 31—(Continued).

2,730,777. BLUE SEAL FEEDS, INC., LONDONDERRY, NH.
SN 78-100,086. PUB. 7-2-2002, FILED 12-27-2001.

BIRDER'S SECRET

FOR WILD BIRD FEED (U.S. CLS. 1 AND 46).
FIRST USE 3-15-2002; IN COMMERCE 3-15-2002.

2,730,778. BLUE SEAL FEEDS, INC., LONDONDERRY, NH.
SN 78-100,091. PUB. 7-9-2002, FILED 12-27-2001.

SHOW HUTCH DELUXE

NO CLAIM IS MADE TO THE EXCLUSIVE RIGHT TO
USE "DELUXE", APART FROM THE MARK AS SHOWN.
FOR RABBIT FEEDS (U.S. CLS. 1 AND 46).
FIRST USE 3-15-2002; IN COMMERCE 3-15-2002.

CLASS 32—LIGHT BEVERAGES

2,729,466. YAKIMA CHIEF RANCHES, INC., SUNNYSIDE,
WA. SN 75-709,270. PUB. 7-2-2002, FILED 5-19-1999.

WARRIOR

FOR PROCESSED HOPS, NAMELY, DRIED HOP
CONES, PELLETIZED HOPS AND HOP EXTRACTS
FOR MAKING BEER (U.S. CLS. 45, 46 AND 48).
FIRST USE 9-27-1999; IN COMMERCE 9-27-1999.

2,729,478. PANTHER BREWING COMPANY, WESTWOOD,
MA. SN 75-730,854. PUB. 5-1-2001, FILED 6-16-1999.

SUBLIME

FOR BEER AND MALT BEER (U.S. CLS. 45, 46 AND
48).
FIRST USE 11-0-1999; IN COMMERCE 11-0-1999.

2,729,552. KALIL BOTTLING CO., TUCSON, AZ. SN 75-
852,866. PUB. 7-4-2000, FILED 11-17-1999.

KINO

OWNER OF U.S. REG. NO. 2,014,291.
FOR BOTTLED AND CANNED DRINKING WATER,
INCLUDING CARBONATED AND NONCARBONATED
WATER (U.S. CLS. 45, 46 AND 48).
FIRST USE 3-18-2003; IN COMMERCE 3-18-2003.

CLASS 32—(Continued).

2,729,706. CHESAPEAKE BAY BREWING COMPANY, LA PLATA, MD. SN 76-049,353. PUB. 12-18-2001, FILED 5-16-2000.

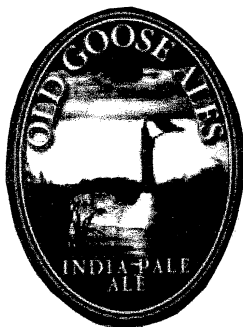

NO CLAIM IS MADE TO THE EXCLUSIVE RIGHT TO USE "ALES" AND "INDIA PALE ALE", APART FROM THE MARK AS SHOWN.

FOR BEER AND ALE (U.S. CLS. 45, 46 AND 48).
FIRST USE 11-4-2001; IN COMMERCE 11-4-2001.

2,729,833. ANADOLU EFES TECHNICAL AND MANAGEMENT CONSULTANCY N.V., CURACAO, NETHERLD ANTILLES. SN 76-143,001. PUB. 6-4-2002, FILED 10-6-2000.

STARY MELNIK

THE ENGLISH TRANSLATION OF "STARY MELNIK" IS "AN OLD MILLER MAN".

FOR NON-ALCOHOLIC BEVERAGES, NAMELY, SOFT DRINKS, NON-ALCOHOLIC APERITIFS, FRUIT JUICE BEVERAGES, FRUIT EXTRACTS FOR MAKING NON-ALCOHOLIC BEVERAGES, GRAPE MUST, LITHIA WATER, SELTZER WATER, SODA WATER, TABLE WATERS, AERATED WATER; CONCENTRATES, SYRUPS OR POWDERS AND PASTILLES USED IN THE PREPARATION OF SOFT DRINKS, AERATED WATER, MINERAL WATER AND EFFERVESCING SOFT DRINKS; MINERAL WATER; ISOTONIC DRINKS, GINGER ALE, GINGER BEER, NON-ALCOHOLIC COCKTAILS; ESSENCES NOT IN THE NATURE OF ESSENTIAL OILS FOR THE MANUFACTURE OF LIQUEURS, SOFT DRINKS AND MINERAL WATERS; LEMONADES, SYRUPS FOR MAKING LEMONADE; VEGETABLE JUICES, ORGEAT, BEER WORT, BEER, MALT BEER, SARSAPARILLA, VEGETABLE JUICES, FRUIT JUICES, FRUIT NECTARS, TOMATO JUICE, MALT WORT, MUST, EXTRACTS OF HOPS FOR MAKING BEER (U.S. CLS. 45, 46 AND 48).

FIRST USE 1-1-2000; IN COMMERCE 9-29-2002.

CLASS 32—(Continued).

2,729,882. ANADOLU EFES TECHNICAL AND MANAGEMENT CONSULTANCY N.V., CURACAO, NETHERLD ANTILLES. SN 76-167,011. PUB. 6-4-2002, FILED 11-17-2000.



THE CYRILLIC CHARACTERS IN THE MARK TRANSLITERATE TO STARY MELNIK, WHICH MEANS "AN OLD MILLERMAN" IN ENGLISH.

FOR NON-ALCOHOLIC BEVERAGES, NAMELY, SOFT DRINKS, NON-ALCOHOLIC APERITIFS, FRUIT JUICE BEVERAGES, FRUIT EXTRACTS FOR MAKING NON-ALCOHOLIC BEVERAGES, GRAPE MUST, LITHIA WATER, SELTZER WATER, SODA WATER, TABLE WATERS, AERATED WATER; CONCENTRATES, SYRUPS OR POWDERS AND PASTILLES USED IN THE PREPARATION OF SOFT DRINKS, AERATED WATER, MINERAL WATER AND EFFERVESCING SOFT DRINKS; MINERAL WATER; ISOTONIC DRINKS, GINGER ALE, GINGER BEER, NON-ALCOHOLIC COCKTAILS; ESSENCES NOT IN THE NATURE OF ESSENTIAL OILS FOR THE MANUFACTURE OF LIQUEURS, SOFT DRINKS AND MINERAL WATERS; LEMONADES, SYRUPS FOR MAKING LEMONADE; VEGETABLE JUICES, ORGEAT, BEER WORT, BEER, MALT BEER, SARSAPARILLA, VEGETABLE JUICES, FRUIT JUICES, FRUIT NECTARS, TOMATO JUICE, MALT WORT, MUST, EXTRACTS OF HOPS FOR MAKING BEER (U.S. CLS. 45, 46 AND 48).

FIRST USE 1-1-2000; IN COMMERCE 9-29-2002.

2,730,353. BIENES RAICES METROPOLITANOS, S.A. DE C.V., MEXICO CITY, MEXICO. SN 76-336,407. PUB. 7-23-2002, FILED 11-9-2001.

GARCI CRESPO

THE NAME "GARCI CRESPO" DOES NOT IDENTIFY A LIVING INDIVIDUAL.

FOR SOFT DRINKS AND CARBONATED DRINKING WATER (U.S. CLS. 45, 46 AND 48).

FIRST USE 1-1-1928; IN COMMERCE 4-1-2002.

CLASS 32—(Continued).

2,730,476. COCA-COLA COMPANY, THE, ATLANTA, GA. SN 76-363,081. PUB. 7-30-2002, FILED 1-25-2002.

RAIZE

FOR BEVERAGES, NAMELY DRINKING WATERS, FLAVORED WATERS, MINERAL AND AERATED WATERS; AND OTHER NON-ALCOHOLIC BEVERAGES, NAMELY, SOFT DRINKS, ENERGY DRINKS AND ISOTONIC DRINKS; FRUIT DRINKS AND JUICES; SYRUPS, CONCENTRATES AND POWDERS FOR MAKING BEVERAGES, NAMELY MINERAL AND AERATED WATERS, SOFT DRINKS, ENERGY DRINKS, ISOTONIC DRINKS, FRUIT DRINKS AND JUICES (U.S. CLS. 45, 46 AND 48).

FIRST USE 12-16-2002; IN COMMERCE 12-16-2002.

2,730,524. PANTRY, INC., THE, SANFORD, NC. SN 76-389,324. PUB. 10-8-2002, FILED 3-28-2002.

CELESTE

FOR NATURAL SPRING WATER (U.S. CLS. 45, 46 AND 48).

FIRST USE 6-6-2002; IN COMMERCE 6-6-2002.

2,730,716. TROPICANA PRODUCTS, INC., BRADENTON, FL. SN 78-084,734. PUB. 9-10-2002, FILED 9-20-2001.

ORANGE STRAWBERRY BANANA BURST

OWNER OF U.S. REG. NO. 2,200,612.
NO CLAIM IS MADE TO THE EXCLUSIVE RIGHT TO USE "ORANGE STRAWBERRY BANANA", APART FROM THE MARK AS SHOWN.

FOR FRUIT JUICE AND FRUIT JUICE DRINKS (U.S. CLS. 45, 46 AND 48).

FIRST USE 3-1-2002; IN COMMERCE 3-1-2002.

2,730,734. ROKEACH FOOD CORPORATION, NEWARK, NJ. SN 78-089,024. PUB. 10-22-2002, FILED 10-18-2001.

PRI-HAKEREM

"PRI" IS THE HEBREW WORD FOR "FRUIT" AND "KEREM" IS THE HEBREW WORD FOR "VINEYARD".

FOR GRAPE JUICE (U.S. CLS. 45, 46 AND 48).

FIRST USE 1-25-2003; IN COMMERCE 1-25-2003.

2,730,738. CAPRI SUN, INC., SAN MATEO, CA. SN 78-090,386. PUB. 7-2-2002, FILED 10-26-2001.

ISLAND REFRESHERS**CLASS 32—(Continued).**

NO CLAIM IS MADE TO THE EXCLUSIVE RIGHT TO USE "REFRESHERS", APART FROM THE MARK AS SHOWN.

FOR BEVERAGES, NAMELY, SOFT DRINKS, FRUIT DRINKS, POWDERS, SYRUPS OR CONCENTRATES FOR USE IN MAKING SOFT DRINKS (U.S. CLS. 45, 46 AND 48).

FIRST USE 2-3-2003; IN COMMERCE 2-3-2003.

2,730,757. MICHAEL, MIELOCK J., PLAINFIELD, IL. SN 78-096,073. PUB. 7-9-2002, FILED 11-30-2001.

"DRINK IT FOR LIFE"

FOR BOTTLED DRINKING WATER (U.S. CLS. 45, 46 AND 48).

FIRST USE 1-1-2002; IN COMMERCE 1-1-2002.

2,730,835. PEPSICO, INC., PURCHASE, NY. SN 78-119,140. PUB. 10-22-2002, FILED 4-3-2002.

MOVIMIENTO PEPSI

THE FOREIGN WORDING IN THE MARK TRANSLATE INTO ENGLISH AS "MOVEMENT".

FOR SOFT DRINKS (U.S. CLS. 45, 46 AND 48).

FIRST USE 6-0-2002; IN COMMERCE 6-0-2002.

CLASS 33—WINES AND SPIRITS

2,729,393. CORBY DISTILLERIES LIMITED, MONTREAL, QUEBEC H3A 3L6, CANADA. SN 75-498,869. PUB. 8-6-2002, FILED 6-9-1998.

THE CANADIAN
WHISKY
GUILD

Hand-Crafted Quality

PRIORITY CLAIMED UNDER SEC. 44(D) ON CANADA APPLICATION NO. 864033, FILED 12-15-1997, REG. NO. TMA544542, DATED 5-4-2001, EXPIRES 5-4-2016.

NO CLAIM IS MADE TO THE EXCLUSIVE RIGHT TO USE "THE CANADIAN WHISKY GUILD", "HAND-CRAFTED", AND "QUALITY", APART FROM THE MARK AS SHOWN.

FOR CANADIAN WHISKY (U.S. CLS. 47 AND 49).

FIRST USE 3-31-2000; IN COMMERCE 3-31-2000.

CLASS 33—(Continued).

2,729,658. TAKARA SHUZO, CO., LTD., FUSHIMI-KU, KYOTO, JAPAN. SN 76-001,841. PUB. 9-17-2002, FILED 3-16-2000.

タカラ

OWNER OF U.S. REG. NOS. 336,147, 1,017,722, AND OTHERS.

THE JAPANESE CHARACTERS IN THE MARK TRANSLITERATE TO "TAKARA" WHICH MEANS "TREASURE" IN ENGLISH.

FOR SAKE; WINE; SHOCHU, NAMELY, JAPANESE DISTILLED SPIRITS; LIQUEURS; PREPARED ALCOHOLIC COCKTAILS; AND MIRIN, NAMELY, JAPANESE COOKING LIQUOR (U.S. CLS. 47 AND 49).

FIRST USE 4-1-2000; IN COMMERCE 4-1-2000.

2,729,668. STOLLER WHOLESALE WINES & SPIRITS, INC., FRANKLIN PARK, IL. SN 76-009,985. PUB. 1-9-2001, FILED 3-25-2000.

CANADIAN STAG

NO CLAIM IS MADE TO THE EXCLUSIVE RIGHT TO USE "CANADIAN", APART FROM THE MARK AS SHOWN, FOR CANADIAN BLENDED WHISKEY (U.S. CLS. 47 AND 49).

FIRST USE 10-23-2002; IN COMMERCE 10-23-2002.

2,729,670. SICHUAN CHENGDU QUANXING GROUP CO., LTD., SICHUAN PROVIDENCE, PEOPLES REPUBLIC OF, CHINA. SN 76-010,361. PUB. 11-13-2001, FILED 3-27-2000.

水井坊
SHUIJINGFANG

THE THREE CHINESE CHARACTERS IN THE MARK IS SHUIJINGFANG. THE FIRST CHINESE CHARACTER, WHICH TRANSLITERATES TO SHUI, MEANS WATER; THE SECOND CHINESE CHARACTER, WHICH TRANSLITERATES TO JING, MEANS WELL WHILE THE THIRD CHINESE CHARACTER, WHICH TRANSLITERATES TO FANG, MEANS WORKSHOP. HOWEVER, THE COMBINATION OF THE THREE CHINESE CHARACTERS HAS NO DICTIONARY MEANING IN ENGLISH.

FOR ARRAK, DISTILLED LIQUOR, DISTILLED SPIRITS, BRANDY SPIRITS, POTABLE SPIRITS, EXTRACTS OF SPIRITOUS LIQUORS, WINES, ALCOHOLIC FRUIT EXTRACTS, RICE WINES, APERITIFS WITH A DISTILLED ALCOHOLIC LIQUOR BASE, BRANDY, SAKE, LIQUEURS (U.S. CLS. 47 AND 49).

FIRST USE 5-0-2000; IN COMMERCE 5-0-2000.

CLASS 33—(Continued).

2,729,810. CHEVIOT BRIDGE PTY LTD, MELBOURNE, VICTORIA 3004, AUSTRALIA. SN 76-125,386. PUB. 6-25-2002, FILED 9-8-2000.



THE LINING AND STIPLING ARE FEATURES OF THE MARK AND ARE NOT INTENDED TO INDICATE COLOR. FOR ALCOHOLIC BEVERAGES, NAMELY, WINES (U.S. CLS. 47 AND 49).

FIRST USE 3-0-2000; IN COMMERCE 11-0-2001.

2,729,844. APPLEBEE'S INTERNATIONAL, INC., OVERLAND PARK, KS. SN 76-148,302. PUB. 11-20-2001, FILED 10-17-2000.

MUCHO CRANRITA

THE ENGLISH TRANSLATION OF "MUCHO" IS "MUCH".

FOR ALCOHOLIC COCKTAILS SERVED ON THE PREMISES (U.S. CLS. 47 AND 49).

FIRST USE 11-11-2001; IN COMMERCE 11-11-2001.

2,729,881. SUTTER HOME WINERY, DBA TRINCHERO FAMILY ESTATES, ST. HELENA, CA. SN 76-166,298. PUB. 7-16-2002, FILED 11-14-2000.

TRINCHERO FAMILY ESTATES

OWNER OF U.S. REG. NO. 2,235,191. NO CLAIM IS MADE TO THE EXCLUSIVE RIGHT TO USE "FAMILY ESTATES", APART FROM THE MARK AS SHOWN.

FOR WINE (U.S. CLS. 47 AND 49).

FIRST USE 4-0-2000; IN COMMERCE 4-0-2000.

2,729,948. JOSE CANEPA Y CIA. LTDA., CERRILLOS SANTIAGO, CHILE. SN 76-202,587. PUB. 4-16-2002, FILED 1-31-2001.

MONTENUEVO

THE ENGLISH TRANSLATION OF "MONTENUEVO" IS "NEW HILL".

FOR WINE (U.S. CLS. 47 AND 49).

FIRST USE 6-0-1993; IN COMMERCE 1-0-2001.

CLASS 33—(Continued).

2,729,983. LOURENSFORD LEASING (PTY) LTD, SOMERSET-WEST, 7130, SOUTH AFRICA. SN 76-217,288. PUB. 2-26-2002, FILED 2-28-2001.

LOURENSFORD

FOR ALCOHOLIC BEVERAGES, NAMELY WINES, DISTILLED SPIRITS AND LIQUEURS (U.S. CLS. 47 AND 49).
FIRST USE 8-0-2002; IN COMMERCE 10-0-2002.

2,730,060. CAVAS DEL CONDE S.A., BUENOS AIRES, ARGENTINA. SN 76-247,781. PUB. 2-19-2002, FILED 4-30-2001.

PIEDRA DEL MOLINO

THE ENGLISH TRANSLATION OF "PIEDRA DEL MOLINO" IS "THE MILL STONE".
FOR WINES (U.S. CLS. 47 AND 49).
FIRST USE 5-0-1991; IN COMMERCE 5-21-2001.

2,730,061. CAVAS DEL CONDE S.A., BUENOS AIRES, ARGENTINA. SN 76-247,782. PUB. 2-26-2002, FILED 4-30-2001.

DON GAUCHO

THE ENGLISH TRANSLATION OF "DON GAUCHO" IS "SIR OR MR. COWBOY".
FOR WINES (U.S. CLS. 47 AND 49).
FIRST USE 9-4-2000; IN COMMERCE 5-21-2001.

2,730,067. NATUREL, LLC, ONTARIO, CA. SN 76-252,783. PUB. 7-2-2002, FILED 4-27-2001.

INFINIDAD

THE ENGLISH TRANSLATION OF "INFINIDAD" IS "INFINITY".
FOR MESCAL - DISTILLED SPIRITS - TEQUILA, NAMELY, TEQUILA LIQUEUR AND SPECIALLY TEQUILA - LIQUEUR, NAMELY AGUARDIENTE (U.S. CLS. 47 AND 49).
FIRST USE 4-27-2001; IN COMMERCE 4-27-2001.

2,730,164. R. H. KEENAN COMPANY, ST. HELENA, CA. SN 76-282,694. PUB. 10-30-2001, FILED 7-9-2001.

MERNET

FOR WINE (U.S. CLS. 47 AND 49).
FIRST USE 8-22-2002; IN COMMERCE 8-22-2002.

CLASS 33—(Continued).

2,730,309. MORENO SOCIEDAD ANONIMA, 14006 CORDOBA, SPAIN. SN 76-323,287. PUB. 10-22-2002, FILED 10-10-2001.

MUSA

OWNER OF U.S. REG. NOS. 518,117 AND 2,471,277.
THE ENGLISH TRANSLATION OF "MUSA" IS "MUSE".
FOR COOKING WINES (U.S. CLS. 47 AND 49).
FIRST USE 12-30-1941; IN COMMERCE 11-25-2002.

2,730,351. WILLAKENZIE ESTATE, INC., YAMHILL, OR. SN 76-335,784. PUB. 3-26-2002, FILED 11-8-2001.

EMERY

FOR WINE (U.S. CLS. 47 AND 49).
FIRST USE 5-1-2002; IN COMMERCE 5-1-2002.

2,730,515. BERINGER BLASS WINE ESTATES COMPANY, NAPA, CA. SN 76-380,528. PUB. 9-17-2002, FILED 3-11-2002.

WHITE HILLS VINEYARD

NO CLAIM IS MADE TO THE EXCLUSIVE RIGHT TO USE "VINEYARD", APART FROM THE MARK AS SHOWN.
FOR WINE (U.S. CLS. 47 AND 49).
FIRST USE 7-1-2002; IN COMMERCE 7-1-2002.

2,730,516. BERINGER BLASS WINE ESTATES COMPANY, NAPA, CA. SN 76-380,529. PUB. 9-24-2002, FILED 3-11-2002.

HEIRLOOM

FOR WINE (U.S. CLS. 47 AND 49).
FIRST USE 6-21-2002; IN COMMERCE 6-28-2002.

2,730,724. MONTECASTELLI SELECTIONS LTD., NEW YORK, NY. SN 78-086,406. PUB. 7-2-2002, FILED 10-11-2001.

IL LIBRETTO

"IL LIBRETTO" IN THE ITALIAN LANGUAGE, TRANSLATES IN ENGLISH TO "THE BOOKLET".
FOR WINE (U.S. CLS. 47 AND 49).
FIRST USE 3-5-2003; IN COMMERCE 3-5-2003.

CLASS 34—SMOKERS' ARTICLES

CLASS 34—(Continued).

2,729,451. JAPAN TOBACCO INC., TOKYO, JAPAN. SN 75-672,604. PUB. 3-28-2000, FILED 4-1-1999.

VIRIBUS UNITIS

FOR CIGARETTES (U.S. CLS. 2, 8, 9 AND 17).
FIRST USE 7-0-2002; IN COMMERCE 7-0-2002.

2,729,747. BULGARTABAC HOLDING AD, 1000 SOFIA, BULGARIA. SN 76-083,741. PUB. 7-30-2002, FILED 7-6-2000.

WELCOME

FOR LEAF TOBACCO, PROCESSED AND MANUFACTURED TOBACCO; TOBACCO PRODUCTS, NAMELY, CHEWING TOBACCO, CIGARETTES, FILTERS FOR CIGARETTES, CIGARETTE PAPER; SMOKING ACCESSORIES, NAMELY, CIGARETTE LIGHTERS NOT OF PRECIOUS METAL, MATCHES, PIPES, CIGARETTE BOXES NOT OF PRECIOUS METAL, ASHTRAYS NOT OF PRECIOUS METAL, CIGARETTE HOLDERS NOT OF PRECIOUS METAL, TOBACCO JARS NOT OF PRECIOUS METAL AND TOBACCO POUCHES (U.S. CLS. 2, 8, 9 AND 17).
FIRST USE 1-31-1984; IN COMMERCE 1-31-1984.

2,729,891. BULGARTABAC HOLDING AD AND NIKOLAI SIMEONOV MALINOV PARTNERSHIP, THE, 1000 SOFIA, BULGARIA. SN 76-173,642. PUB. 6-19-2001, FILED 11-30-2000.



FOR CIGARETTES, TOBACCO, CIGARETTE PAPER, FILTERS, CIGARETTE TIPS, MATCHES, ASHTRAYS, CIGARETTE HOLDERS, CASES AND LIGHTERS NOT OF PRECIOUS METAL (U.S. CLS. 2, 8, 9 AND 17).
FIRST USE 0-0-1995; IN COMMERCE 0-0-1995.

CLASS 34—(Continued).

2,730,207. EVE HOLDINGS INC., WILMINGTON, DE. SN 76-295,052. PUB. 5-7-2002, FILED 8-3-2001.

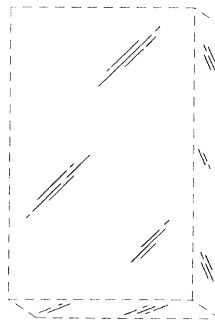

THE MARK CONSISTS OF HOLOGRAPHIC PAPER THAT REFLECTS A SPECTRUM OF COLOR IN A PATTERN OF OBLIQUE, PARALLEL LINES. THE DOTTED LINES AND LINING SHOWN IN THE DRAWING FORM NO PART OF THE MARK, AND ARE FOR SHADING OR OTHER ILLUSTRATIVE PURPOSES ONLY.

FOR CIGARETTES (U.S. CLS. 2, 8, 9 AND 17).
FIRST USE 3-27-2001; IN COMMERCE 3-27-2001.

SERVICE MARKS**CLASS 35—ADVERTISING AND BUSINESS**

2,729,372. AGE WAVE, L.L.C., EMERYVILLE, CA. SN 75-389,156. PUB. 3-2-1999, FILED 11-12-1997.

AGE WAVE

OWNER OF U.S. REG. NOS. 1,458,786, 1,677,941, AND 2,104,257.

FOR TELEMARKETING; PREPARING ADVERTISEMENTS AND TARGET MARKETING MATERIALS FOR OTHERS; BUSINESS CONSULTING SERVICES, NAMELY, ASSISTING BUSINESSES TO IMPLEMENT MARKETING STRATEGIES TARGETED TO CERTAIN SEGMENTS OF THE POPULATION, TO ATTRACT PURCHASERS OF THEIR SERVICES FROM CERTAIN SEGMENTS OF THE POPULATION, AND TO RETAIN THE LOYALTY AND SATISFACTION OF CUSTOMERS FROM THOSE SEGMENTS OF THE POPULATION; AND OUTSOURCING SERVICES, NAMELY, PROVIDING CONSULTANTS IN THE FIELD OF HEALTH CARE, DIRECT MAIL SOLICITATION, DIRECT RESPONSE MARKETING, AND TELEPHONE CALL CENTER PERSONNEL (U.S. CLS. 100, 101 AND 102).
FIRST USE 0-0-1986; IN COMMERCE 0-0-1986.

CLASS 35—(Continued).

2,729,373. FELDMAN, IRA, POTOMAC, MD. SN 75-390,633. PUB. 10-26-1999, FILED 11-17-1997.

C.E.O. CHIEF ENVIRONMENTAL OFFICER

NO CLAIM IS MADE TO THE EXCLUSIVE RIGHT TO USE "CHIEF ENVIRONMENTAL OFFICER", APART FROM THE MARK AS SHOWN.

FOR MANAGEMENT CONSULTING IN THE FIELD OF ENVIRONMENTAL STRATEGY, NAMELY, IMPLEMENTING OUTSOURCED CORPORATE STRATEGIC ENVIRONMENTAL PROGRAMS (U.S. CLS. 100, 101 AND 102).

FIRST USE 6-0-2001; IN COMMERCE 6-0-2001.

2,729,468. JARMAC GROUP, INC., THE, SOUTH EASTON, MA. SN 75-712,602. PUB. 12-14-1999, FILED 5-24-1999.

CUSTOMWORKS

FOR DISTRIBUTORSHIPS FEATURING ELECTRONICS, NAMELY, STEREOs, VIDEOS, TELEPHONES AND HOME AUTOMATION PRODUCTS (U.S. CLS. 100, 101 AND 102).

FIRST USE 5-25-1999; IN COMMERCE 5-25-1999.

2,729,477. RETAIL SERVICES, INC., DALLAS, TX. SN 75-730,096. PUB. 5-14-2002, FILED 7-9-1999.

PATRONS

FOR PROMOTING THE GOODS AND SERVICES OF OTHERS THROUGH THE ADMINISTRATION OF AN INCENTIVE AWARD PROGRAM WHEREBY CONSUMERS EARN POINTS BY THE PURCHASE OF GOODS AND SERVICES FROM DIFFERENT PARTICIPATING MERCHANTS AND SERVICE ESTABLISHMENTS WHERE THE POINTS ARE EXCHANGED FOR MONEY, MERCHANDISE OR SERVICES AND COLLECTIVELY APPLIED TO A CAUSE OR ORGANIZATION SELECTED BY THE PARTICIPATING CONSUMER (U.S. CLS. 100, 101 AND 102).

FIRST USE 9-0-2001; IN COMMERCE 9-0-2001.

2,729,500. TIME WARNER INC., NEW YORK, NY. SN 75-774,677. PUB. 6-19-2001, FILED 8-13-1999.

TIME-LIFE

OWNER OF U.S. REG. NOS. 803,930, 2,287,792, AND OTHERS.

FOR ON-LINE RETAIL SERVICES FEATURING AUDIO AND VIDEO RECORDINGS AND FICTION AND NON-FICTION BOOKS, OFFERED VIA GLOBAL COMPUTER NETWORK (U.S. CLS. 100, 101 AND 102).

FIRST USE 6-15-1997; IN COMMERCE 6-15-1997.

CLASS 35—(Continued).

2,729,503. SUPPLEE, JOHN, DBA THE SUPPLEE GROUP, STERLING, VA. SN 75-783,216. PUB. 6-19-2001, FILED 8-24-1999.

ART

FOR HUMAN RESOURCES CONSULTING SERVICES FOR OTHERS RELATIVE TO RECRUITING, RETENTION AND EMPLOYEE TURNOVER (U.S. CLS. 100, 101 AND 102).

FIRST USE 8-1-1999; IN COMMERCE 8-1-1999.

2,729,556. TERRY'S TIRE TOWN, INC., ALLIANCE, OH. SN 75-858,353. PUB. 10-23-2001, FILED 11-26-1999.

"ON THE RIM, ON THE CAR, NO HIDDEN CHARGES"

NO CLAIM IS MADE TO THE EXCLUSIVE RIGHT TO USE "NO HIDDEN CHARGES", APART FROM THE MARK AS SHOWN.

FOR RETAIL STORE SERVICES FEATURING AUTOMOTIVE PARTS, NAMELY, TIRES AND WHEELS (U.S. CLS. 100, 101 AND 102).

FIRST USE 4-1-2002; IN COMMERCE 4-1-2002.

2,729,565. SOUTHERN STATES COOPERATIVE, INCORPORATED, RICHMOND, VA. SN 75-871,334. PUB. 1-16-2001, FILED 12-14-1999.

FARMERFIRST

FOR PROVIDING PURCHASE INCENTIVES TO CUSTOMERS BY OFFERING DISCOUNTS ON MERCHANDISE AND SERVICES OF OTHERS (U.S. CLS. 100, 101 AND 102).

FIRST USE 3-28-2003; IN COMMERCE 3-28-2003.

2,729,570. GARDENS ALIVE, INC., LAWRENCEBURG, IN, BY CHANGE OF NAME MYSEASONS.COM, INC., PEORIA, IL. SN 75-875,789. PUB. 6-19-2001, FILED 12-20-1999.

MYSEASONS

FOR MAIL ORDER CATALOG AND ONLINE RETAIL STORE SERVICES FEATURING GENERAL MERCHANDISE IN THE FIELD OF HOME, KITCHEN AND BATH, GARDEN, YARD, GIFTS AND SEASONAL CELEBRATION SUPPLIES (U.S. CLS. 100, 101 AND 102).

FIRST USE 1-4-2002; IN COMMERCE 1-4-2002.

CLASS 35—(Continued).

2,729,571. ADVERTISING.COM, INC., BALTIMORE, MD, BY CHANGE OF NAME; TEKNOSURF.COM, INC., BALTIMORE, MD. SN 75-876,105. PUB. 1-1-2002, FILED 12-20-1999.



THE MARK CONSISTS OF A FANCIFUL REPRESENTATION OF AN "A" INCORPORATING A PROJECTILE HITTING A TARGET.

FOR COMPUTER SERVICES, NAMELY, PROVIDING AN INTERACTIVE ON-LINE COMPUTER DATABASE IN THE FIELD OF CONSUMER DEMOGRAPHICS AND BEHAVIORAL INFORMATION FOR BUSINESS PURPOSES AND PROVIDING REPORTING SERVICES VIA AN ON-LINE GLOBAL COMPUTER INFORMATION NETWORK RELATING TO COMPUTER NETWORK USE AND USERS FOR BUSINESS PURPOSES (U.S. CLS. 100, 101 AND 102).

FIRST USE 1-17-2000; IN COMMERCE 1-17-2000.

2,729,574. D. J. ARDORE, INC., BOONTON TOWNSHIP, NJ. SN 75-882,695. PUB. 4-23-2002, FILED 12-28-1999.

ARDORE

THE WORD "ARDORE" IS AN ITALIAN WORD THAT TRANSLATES INTO ENGLISH AS "ARDOR" OR "PASSION".

FOR PROVIDING AN ON-LINE DIRECTORY SERVICE VIA A GLOBAL COMPUTER NETWORK IN THE FIELDS OF RESTAURANTS AND HOTELS (U.S. CLS. 100, 101 AND 102).

FIRST USE 3-31-2000; IN COMMERCE 3-31-2000.

2,729,577. ABRAMS LITTLE-GILL LOBERFELD TISHMAN & WITTY PC, BOSTON, MA. SN 75-886,432. PUB. 7-30-2002, FILED 1-4-2000.

PROFIT FROM OUR EXPERIENCE

FOR ACCOUNTING SERVICES (U.S. CLS. 100, 101 AND 102).

FIRST USE 10-0-2000; IN COMMERCE 10-0-2000.

2,729,581. COMMUNICATION SOCIETY LLC, CARY, IL. SN 75-890,971. PUB. 10-10-2000, FILED 1-6-2000.

COMMUNICATION SOCIETY

FOR CONSULTATION SERVICES IN THE FIELD OF MARKETING FOR OTHERS (U.S. CLS. 100, 101 AND 102).

FIRST USE 1-5-2000; IN COMMERCE 6-5-2000.

CLASS 35—(Continued).

2,729,590. TLC CANDLE CORP., MAYFIELD, KY. SN 75-903,031. PUB. 12-19-2000, FILED 1-26-2000.

TLC CANDLE

NO CLAIM IS MADE TO THE EXCLUSIVE RIGHT TO USE "CANDLE", APART FROM THE MARK AS SHOWN.

FOR MAIL-ORDER SERVICES, ON-LINE RETAIL STORE SERVICES AND WHOLESALE DISTRIBUTORSHIPS FEATURING CANDLES, CANDLE HOLDERS, CANDLE SNUFFERS, CANDLE RINGS, CANDLE WAXES, VOTIVE CANDLES, PILLAR CANDLES, JAR CANDLES, AROMATHERAPY CANDLES, NATURAL PLANT AND ESSENTIAL OIL BASED CANDLES, CANDLES IN GLASS CONTAINERS, CANDLES IN METAL TINS, AND SCENTED WAX PRODUCTS (U.S. CLS. 100, 101 AND 102).

FIRST USE 10-1-2002; IN COMMERCE 10-1-2002.

2,729,623. HITCHCOCK CHAIR CO., LTD., THE, NEW HARTFORD, CT, BY ASSIGNMENT HITCHCOCK HOLDING CO., NEW HARTFORD, CT. SN 75-933,852. PUB. 11-27-2001, FILED 3-3-2000.

THE HITCHCOCK STORE

OWNER OF U.S. REG. NOS. 633,628, 676,977, AND 1,208,426.

NO CLAIM IS MADE TO THE EXCLUSIVE RIGHT TO USE "STORE", APART FROM THE MARK AS SHOWN.

SEC. 2(F) AS TO "HITCHCOCK".
FOR RETAIL FURNITURE STORES (U.S. CLS. 100, 101 AND 102).

FIRST USE 6-13-1992; IN COMMERCE 6-13-1992.

2,729,691. RIVERWOOD INTERNATIONAL CORPORATION, ATLANTA, GA. SN 76-035,364. PUB. 7-2-2002, FILED 4-26-2000.

RADAR II

FOR EFFICIENCY EXPERT SERVICES, NAMELY, PROVIDING AN AUTOMATED PRODUCTION EQUIPMENT PERFORMANCE EFFICIENCY REPORTING SERVICE WITH USER DEFINED INTERACTIVE PERFORMANCE DATA SEARCH AND DISPLAY FUNCTIONALITY (U.S. CLS. 100, 101 AND 102).

FIRST USE 4-0-2000; IN COMMERCE 6-0-2002.

CLASS 35—(Continued).

2,729,699. NEWSOM DESIGNS, LLC, DALLAS, TX. SN 76-039,744. PUB. 6-18-2002, FILED 5-2-2000.

WISTERIA

FOR RETAIL STORE SERVICES, MAIL ORDER CATALOGUE SERVICES, AND RETAIL STORE SERVICES VIA A GLOBAL COMPUTER NETWORK, ALL FEATURING LAWN AND GARDEN FURNISHINGS, AND ACCESSORIES; AND HOME FURNISHINGS AND ACCESSORIES, NAMELY, WALL HANGINGS, POTS, FLOWER HOLDERS AND PLANTERS, BASKETS, VASES, URNS, BARBECUE AND FIREPLACE EQUIPMENT, BEDS AND PILLOWS FOR PETS, DOOR MATS, DECORATIVE STOOLS AND BENCHES, CANDLESTICKS AND CANDLE HOLDERS, FIGURINES, MIRRORS, AND BIRDHOUSES (U.S. CLS. 100, 101 AND 102).
FIRST USE 6-1-2000; IN COMMERCE 9-1-2000.

2,729,718. HERMAN MILLER, INC., ZEELAND, MI. SN 76-066,243. PUB. 6-25-2002, FILED 6-7-2000.

HERMAN MILLER OPTIONS

OWNER OF U.S. REG. NOS. 733,770, 1,494,492, AND OTHERS.

THE NAME "HERMAN MILLER" IN THE MARK DOES NOT IDENTIFY A PARTICULAR LIVING INDIVIDUAL.

FOR FURNITURE STORE SERVICES, BUSINESS CONSULTATION AND BUSINESS PLANNING (U.S. CLS. 100, 101 AND 102).

FIRST USE 8-1-2000; IN COMMERCE 8-1-2000.

2,729,721. OMX, INC., LAS VEGAS, NV. SN 76-068,425. PUB. 7-9-2002, FILED 6-13-2000.

WHERE SMART BUSINESS IS GOING

FOR ADVERTISING SERVICES, NAMELY PROMOTING THE SERVICES OF OTHERS THROUGH THE DISSEMINATION OF ADVERTISING MATTER ON A GLOBAL COMPUTER NETWORK, THE DISTRIBUTION OF PRINTED AND AUDIO PROMOTIONAL MATERIAL AND PROMOTIONAL DISPLAYS; PROVIDING INFORMATION ON ADVERTISING, MARKETING, HUMAN RESOURCES, AND ELECTRONIC COMMERCE SERVICES; PROVIDING INFORMATION ON OFFICE SUPPORT SERVICES, NAMELY, ADMINISTRATIVE, CLERICAL, AND SECRETARIAL SERVICES (U.S. CLS. 100, 101 AND 102).

FIRST USE 5-1-2001; IN COMMERCE 5-1-2001.

CLASS 35—(Continued).

2,729,722. OMX, INC., LAS VEGAS, NV. SN 76-068,433. PUB. 8-20-2002, FILED 6-13-2000.

OFFICEMAX.COM WHERE SMART BUSINESS IS GOING

OWNER OF U.S. REG. NOS. 1,511,330, 2,114,795, AND OTHERS.

FOR ADVERTISING SERVICES, NAMELY PROMOTING THE SERVICES OF OTHERS THROUGH THE DISSEMINATION OF ADVERTISING MATTER ON A GLOBAL COMPUTER NETWORK, THE DISTRIBUTION OF PRINTED AND AUDIO PROMOTIONAL MATERIAL AND PROMOTIONAL DISPLAYS; PROVIDING INFORMATION ON ADVERTISING, MARKETING, HUMAN RESOURCES, AND ELECTRONIC COMMERCE SERVICES; PROVIDING INFORMATION ON OFFICE SUPPORT SERVICES, NAMELY, ADMINISTRATIVE, CLERICAL, AND SECRETARIAL SERVICES (U.S. CLS. 100, 101 AND 102).

FIRST USE 5-1-2001; IN COMMERCE 5-1-2001.

2,729,723. OMX, INC., LAS VEGAS, NV. SN 76-068,434. PUB. 3-19-2002, FILED 6-13-2000.

OfficeMax.com
Where Smart Business Is Going

OWNER OF U.S. REG. NOS. 1,511,330, 2,114,795, AND OTHERS.

FOR ADVERTISING SERVICES, NAMELY, PROMOTING THE SERVICES OF OTHERS THROUGH A GLOBAL COMPUTER INFORMATION NETWORKS, THE DISTRIBUTION OF PRINTED AND AUDIO PROMOTIONAL MATERIALS, AND PROMOTIONAL DISPLAYS, AND PROVIDING INFORMATION ABOUT THE SALE OF SERVICES OF OTHERS, NAMELY, ADMINISTRATIVE, TRAVEL, ADVERTISING, MARKETING, COMMUNICATIONS, COMPUTER, FINANCIAL, INSURANCE, HUMAN RESOURCES AND ELECTRONIC COMMERCE SERVICES, OF OTHERS (U.S. CLS. 100, 101 AND 102).

FIRST USE 5-1-2001; IN COMMERCE 5-1-2001.

2,729,727. VITAL PROCESSING SERVICES, LLC, TEMPE, AZ. SN 76-070,855. PUB. 12-11-2001, FILED 6-14-2000.

VITAL MERCHANT SERVICES

OWNER OF U.S. REG. NOS. 2,180,528 AND 2,243,535.

NO CLAIM IS MADE TO THE EXCLUSIVE RIGHT TO USE "MERCHANT SERVICES", APART FROM THE MARK AS SHOWN.

FOR ON-LINE RETAIL AND WHOLESALE SERVICES IN THE FIELD OF ELECTRONIC PAYMENT AUTHORIZATION TERMINALS (U.S. CLS. 100, 101 AND 102).

FIRST USE 9-17-2002; IN COMMERCE 9-17-2002.

CLASS 35—(Continued).

2,729,758. FINEST THINGS ONLINE LLC, NEW YORK, NY. SN 76-088,862. PUB. 7-10-2001, FILED 7-13-2000.

TOPPEST

FOR PROVIDING AN ON-LINE BUYERS GUIDE FEATURING RETAIL NEWS, RETAIL INFORMATION, AND OTHER TOPICS OF GENERAL INTEREST TO CONSUMERS OF LUXURY GOODS AND SERVICES; COMPUTERIZED ON-LINE RETAIL SERVICES IN THE FIELD OF LUXURY GENERAL MERCHANDISE; PROMOTING THE GOODS AND SERVICES OF OTHERS BY PREPARING AND PLACING ADVERTISEMENTS IN AN ELECTRONIC DIRECTORY ACCESSED THROUGH A GLOBAL COMPUTER NETWORK (U.S. CLS. 100, 101 AND 102).

FIRST USE 1-1-2003; IN COMMERCE 1-1-2003.

2,729,773. BUSINESS PROCESS OUTSOURCING LTD., PORT LOUIS, MAURITIUS, BY ASSIGNMENT BPO SERVICES INC., NEW YORK, NY. SN 76-100,778. PUB. 9-11-2001, FILED 8-1-2000.

itAccounts

FOR ON-LINE WEB-BASED ACCOUNTING SERVICES AND COMPUTERIZED DATABASE MANAGEMENT (U.S. CLS. 100, 101 AND 102).

FIRST USE 1-1-2001; IN COMMERCE 1-1-2001.

2,729,805. 1ST SOURCE BANK, SOUTH BEND, IN. SN 76-119,622. PUB. 5-14-2002, FILED 8-22-2000.

1ST VEHICLE SOURCE

NO CLAIM IS MADE TO THE EXCLUSIVE RIGHT TO USE "VEHICLE SOURCE", APART FROM THE MARK AS SHOWN.

FOR PROCUREMENT, NAMELY, PURCHASING AUTOS, CARS AND TRUCKS FOR OTHERS (U.S. CLS. 100, 101 AND 102).

FIRST USE 9-1-2000; IN COMMERCE 9-1-2000.

2,729,834. KAYON CORPORATION, CHARLESTON, SC. SN 76-143,306. PUB. 6-25-2002, FILED 10-10-2000.

WHITEWASH

FOR RETAIL STORE SERVICES IN THE FIELD OF CLOTHING, HOUSEWARES, BEDDING, BATH ACCESSORIES, GIFTS AND CANDLES (U.S. CLS. 100, 101 AND 102).

FIRST USE 10-0-1998; IN COMMERCE 10-0-1998.

CLASS 35—(Continued).

2,729,853. SPORTS AUTHORITY MICHIGAN, INC., THE, FORT LAUDERDALE, FL. SN 76-150,757. PUB. 8-7-2001, FILED 10-20-2000.

COME OUT AND PLAY

FOR RETAIL OUTLETS FEATURING CLOTHING, FOOTWEAR, OUTERWEAR AND HEADGEAR; DISSEMINATION OF ADVERTISING FOR OTHERS VIA THE INTERNET, NEWSPAPERS, MAGAZINES, AND RADIO AND TELEVISION BROADCASTS (U.S. CLS. 100, 101 AND 102).

FIRST USE 9-30-2001; IN COMMERCE 9-30-2001.

2,729,854. IMAGESURE LLC, CHICAGO, IL. SN 76-150,867. PUB. 6-11-2002, FILED 10-20-2000.

IMAGESURE

FOR PROMOTING THE GOODS AND SERVICES OF OTHERS BY PROVIDING A WEB SITE FEATURING DATABASES OF DOWNLOADABLE ADVERTISING TEMPLATES THAT MAY BE SEARCHED AND CUSTOMIZED IN USER-DEFINED WAYS (U.S. CLS. 100, 101 AND 102).

FIRST USE 12-0-2000; IN COMMERCE 12-0-2000.

2,729,858. HEALTH VIEW EYE CARE CENTERS, S.C., MEDFORD, WI. SN 76-155,542. PUB. 7-10-2001, FILED 10-27-2000.

LENSFITTERS.COM

FOR ONLINE RETAIL STORE SERVICES FEATURING CONTACT LENSES, EYEGLASSES, SUNGLASSES AND ACCESSORIES THEREFOR; AN INCENTIVE PROGRAM WHEREBY DOCTORS PROVIDE CONTACT LENSES, PRESCRIPTION EYEGLASSES, SUNGLASSES, AND ACCESSORIES THEREFOR TO THEIR PATIENTS VIA AN ONLINE ORDER FULFILLMENT SERVICE (U.S. CLS. 100, 101 AND 102).

FIRST USE 8-15-2002; IN COMMERCE 8-15-2002.

CLASS 35—(Continued).

2,729,859. HEALTH VIEW EYE CARE CENTERS, S.C., MEDFORD, WI. SN 76-155,543. PUB. 1-15-2002, FILED 10-27-2000.

ADELPHOI PATIENT RETENTION SYSTEMS

NO CLAIM IS MADE TO THE EXCLUSIVE RIGHT TO USE "PATIENT" AND "SYSTEMS", APART FROM THE MARK AS SHOWN.

FOR RETAIL STORE SERVICES FEATURING CONTACT LENSES, EYEGLASSES, SUNGLASSES AND ACCESSORIES THEREFOR; CONSULTING SERVICES IN THE FIELD OF SALES OF MEDICAL SUPPLIES, CONTACT LENSES, EYEGLASSES, SUNGLASSES AND ACCESSORIES THEREFOR; AN INCENTIVE PROGRAM WHEREBY DOCTORS PROVIDE CONTACT LENSES, PRESCRIPTION EYEGLASSES, SUNGLASSES, AND ACCESSORIES THEREFOR TO THEIR PATIENTS VIA AN ONLINE ORDER FULFILLMENT SERVICE (U.S. CLS. 100, 101 AND 102).

FIRST USE 8-15-2002; IN COMMERCE 8-15-2002.

2,729,889. ELLIAS, DAANISH, MUMBAI, INDIA. SN 76-171,844. PUB. 3-19-2002, FILED 11-28-2000.

WORLD OF STEEL

NO CLAIM IS MADE TO THE EXCLUSIVE RIGHT TO USE "STEEL", APART FROM THE MARK AS SHOWN.

FOR COMPUTERIZED ON-LINE TRADING SERVICES, NAMELY, PROVIDING AN ELECTRONIC MARKET PLACE FOR MATCHING BUYERS AND SELLERS OF SEMI-FINISHED STEEL, FINISHED STEEL, STEEL SCRAPS AND RAW MATERIALS VIA A GLOBAL COMPUTER NETWORK; BUSINESS MANAGEMENT AND CONSULTATION IN THE AREA OF LOGISTIC DISTRIBUTION, PACKAGING, TRACKING AND TRANSPORTATION OF SEMI-FINISHED STEEL, FINISHED STEEL, STEEL SCRAPS AND RAW MATERIALS (U.S. CLS. 100, 101 AND 102).

FIRST USE 4-1-2000; IN COMMERCE 4-1-2000.

2,729,896. MINDCREST, INC., CHICAGO, IL. SN 76-176,732. PUB. 6-11-2002, FILED 12-6-2000.

MINDCREST

FOR BUSINESS MANAGEMENT CONSULTATION, NAMELY, THE ORGANIZATION, COMPILATION AND DISSEMINATION OF KNOWLEDGE BASED COMPUTER INFORMATION SYSTEMS, RESEARCH AND DRAFTING SUPPORT SERVICES (U.S. CLS. 100, 101 AND 102).

FIRST USE 9-25-2001; IN COMMERCE 9-25-2001.

CLASS 35—(Continued).

2,729,916. FORMAN MILLS, INC., PENNSAUKEN, NJ. SN 76-187,895. PUB. 7-30-2002, FILED 12-21-2000.



OWNER OF U.S. REG. NO. 1,823,412.
FOR RETAIL STORE SERVICES FEATURING MEN'S, WOMEN'S, AND CHILDREN'S CLOTHING (U.S. CLS. 100, 101 AND 102).

FIRST USE 2-7-2003; IN COMMERCE 2-7-2003.

2,729,935. SOLA INTERNATIONAL INC., SUNNYVALE, CA. SN 76-197,348. PUB. 9-24-2002, FILED 1-18-2001.

YOUR EYES

NO CLAIM IS MADE TO THE EXCLUSIVE RIGHT TO USE "EYES", APART FROM THE MARK AS SHOWN.

FOR RETAIL SERVICES FEATURING OPHTHALMIC LENSES AND EYEWEAR; ADVERTISING SERVICES, NAMELY PROVIDING POINT OF SALE AND PROMOTIONAL DISPLAYS OF OPHTHALMIC LENSES AND EYEWEAR FOR OTHERS (U.S. CLS. 100, 101 AND 102).

FIRST USE 7-2-2001; IN COMMERCE 7-2-2001.

2,729,946. PARALLEL CONSULTANTS, INC., RYDAL, PA. SN 76-202,392. PUB. 10-9-2001, FILED 1-29-2001.

PARALLEL CEO

NO CLAIM IS MADE TO THE EXCLUSIVE RIGHT TO USE "CEO", APART FROM THE MARK AS SHOWN.

FOR CONSULTING SERVICES IN THE FIELD OF ELECTRONIC BUSINESS (U.S. CLS. 100, 101 AND 102).

FIRST USE 10-0-2001; IN COMMERCE 10-0-2001.

CLASS 35—(Continued).

2,729,979. ANDERSON, DAVE E., SHAWNEE MISSION, MO.
SN 76-216,020. PUB. 7-16-2002, FILED 2-26-2001.

MANAGEMENT VISION IN 3D

NO CLAIM IS MADE TO THE EXCLUSIVE RIGHT TO USE "MANAGEMENT", APART FROM THE MARK AS SHOWN.

FOR BUSINESS MANAGEMENT AND CONSULTATION SERVICES (U.S. CLS. 100, 101 AND 102).
FIRST USE 6-1-2002; IN COMMERCE 6-1-2002.

2,729,984. WATERBOR BURN AND CANCER FOUNDATION, THE, NEW YORK, NY. SN 76-219,099. PUB. 6-11-2002, FILED 3-2-2001.



NO CLAIM IS MADE TO THE EXCLUSIVE RIGHT TO USE "BURN AND CANCER FOUNDATION", APART FROM THE MARK AS SHOWN.

THE STIPPLING IS A FEATURE OF THE MARK AND DOES NOT INDICATE COLOR.

THE MARK CONSISTS IN PART OF A DESIGN OF A BIRD.

FOR CONDUCTING AUCTIONS VIA A GLOBAL COMPUTER NETWORK FOR CHARITABLE FUND RAISING; DISSEMINATION OF ADVERTISING FOR OTHERS ON A GLOBAL COMPUTER NETWORK VIA ONLINE (U.S. CLS. 100, 101 AND 102).
FIRST USE 6-0-2001; IN COMMERCE 6-0-2001.

CLASS 35—(Continued).

2,730,012. CABOULI, PAULINE, CHAPPAQUA, NY. SN 76-225,597. PUB. 12-25-2001, FILED 3-14-2001.

THE REMEMBERING GARDEN

NO CLAIM IS MADE TO THE EXCLUSIVE RIGHT TO USE "GARDEN", APART FROM THE MARK AS SHOWN.

FOR RETAIL STORE SERVICES AND MAIL ORDER CATALOG SERVICES BOTH FEATURING THE FOLLOWING GOODS - VEGETABLE PLANTS AND SEEDS; HERB PLANTS AND SEEDS; LIVE FRUIT TREES AND VINES; FRUIT SHRUBS; LIVE NUT TREES; ORNAMENTAL FRUIT AND FLOWERING TREES; BERRY BUSHES; GARLIC BULBS, SHALLOT BULBS AND ONION BULBS; POTATO TUBERS; FLOWER BULBS; FLOWER SEEDS; ANNUAL AND PERENNIAL FLOWER PLANTS AND SHRUBS; FLOWERS; GRASSES; LAWN MOWERS; MULCHERS; TREE-TRAINING STAKES AND KITS; FERTILIZERS AND PLANT BOOSTERS; PLASTIC MULCH; FRUIT PICKERS; BASKETS; PROTECTIVE PLASTIC AND NETTING FOR PLANTS; ANIMAL AND BUG REPELLENTS; DECORATIVE GARDEN STATUES AND LAWN DECORATIONS; DECORATIVE GARDEN PLAQUES, STONES AND TILES; SUNDIALS; REFLECTIVE GARDEN GLOBES; WATER GARDEN KITS; FLAGS; FLAGPOLES; DECK AND WINDOW BOXES; VASES; BIRD FEEDERS; BIRD BATHS; BIRD SEED; SCARECROWS; BUTTERFLY HOUSES; BEE HOUSES; FLOWER-BASED PERFUMES AND COLOGNES; ESSENTIAL SCENTED OILS; FLOWER, VEGETABLE AND HERBAL SOAPS; BATH SALTS AND BUBBLE BATHS; ROOM FRAGRANCES; HAND AND BODY CREAMS; POTPOURRI; POTPOURRI AND SACHET KITS; PLANT DRYING AND PRESSING KITS; EGG DYEING KITS; PUMPKIN-CARVING KITS; BOTANICAL-THEME AND HISTORICAL-THEME DINNERWARE; TABLEWARE; TABLECLOTHS AND NAPKINS; CURTAINS; FABRICS AND UPHOLSTERY; BLANKETS AND THROWS; AREA RUGS; PILLOWS; WALLPAPER AND WALLPAPER TRIM; STENCILS; PAINTS; PAINT BRUSHES AND PAINT KITS; CRAFT ITEMS; MAGNETS; STORAGE BOXES AND CONTAINERS; PICNIC WARE; GARDEN TABLES; GARDEN BENCHES AND CHAIRS; LANTERNS; OUTDOOR LIGHTS; TRELLISES; GAZEBOS; FENCES; WATERING CANS; GARDEN HOSES AND IRRIGATION SUPPLIES; COMPOSTING PRODUCTS; GARDENING IMPLEMENTS, NAMELY TROWELS, WEEDERS, FORKS, LOPPERS, SCISSORS, PRUNERS, HEDGE TRIMMERS, SEEDERS AND SHOVELS; WHEELBARROWS; FRESH FLOWER PRESERVATIVE POWDERS; PLANT FOOD; GARDENING BOOKS; COOKBOOKS; COOKING IMPLEMENTS, NAMELY KNIVES, SPATULAS, SPOONS, TONGS; BARBECUE IMPLEMENTS; APRONS; ICE CREAM AND GELATI MAKERS; JUICERS; POTS AND PANS; KITCHEN TOWELS, OVEN MITTS; GIFT CARDS, GREETING CARDS AND HOLIDAY CARDS; GIFT WRAPPING PAPER; GIFT PACKAGES AND GIFT BASKETS; CALENDARS; DATE BOOKS; PLANTING PLANNERS; JOURNALS; ART PENCILS AND ART PAPER; POSTCARDS; POSTERS; ADDRESS BOOKS; ORGANIZERS; PICTURE FRAMES; FRAMED PRINTS; STATIONERY; DECORATIVE STICKERS; SEWING, KNITTING AND CROCHET SUPPLIES; BUTTONS; NEEDLEPOINT PATTERNS AND EMBROIDERY KITS; QUILTING SUPPLIES; CLOCKS; CUPBOARDS; RIBBONS; GARDENING HATS; GARDENING T-SHIRTS; GARDENING PANTS; GARDENING SHOES; GARDENING GLOVES; OLIVE OIL; SALT; JAMS; JELLIES; PRESERVES; SAUCES; TEAS; TEAPOTS; COASTERS; COFFEE; COFFEE URNS; COOKIE CUTTERS; BAKING MIXES; SYRUPS; HONEY; COOKIES; CANDY; MUFFIN MIXES; BREAD MIXES AND BREAD MAKERS; VINEGAR; SALAD DRESSINGS; BUTTERS; CANDLES; CANDLE HOLDERS; PET HOUSES; PET BASKETS; PET BEDS; DECORATIVE SHELVES; COSTUME JEWELRY; PERSONALIZED GIFT BASKETS AND GIFT BOXES (U.S. CLS. 100, 101 AND 102).
FIRST USE 5-10-2002; IN COMMERCE 1-1-2003.

CLASS 35—(Continued).

2,730,017. IAMINDEPENDENT.COM, INC., TENAFLY, NJ. SN 76-231,431. PUB. 7-9-2002, FILED 3-27-2001.

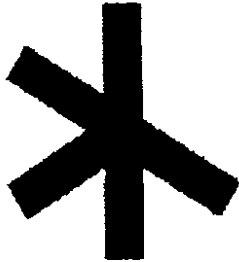

FOR EMPLOYMENT SERVICES, NAMELY EMPLOYMENT RECRUITMENT, STAFFING AND PLACEMENT SERVICES; PROVIDING MARKETING ASSISTANCE AND BUSINESS MANAGEMENT SERVICES TO BUSINESSES AND INDEPENDENT CONTRACTORS, NAMELY, BILLING, ACCOUNTING AND ADMINISTRATIVE SERVICES; HUMAN RESOURCE MANAGEMENT SERVICES; BUSINESS MARKETING CONSULTING SERVICES AND SALES SUPPORTS SERVICES, NAMELY, INVOICING, PAYROLL, TAX DISBURSEMENTS AND REPORTING, EXPENSE TRACKING AND REIMBURSEMENT, COLLECTIONS, INSURANCE AND RETIREMENT PLAN ADMINISTRATION AND CONTRACT REVIEW; TAX CONSULTATION AND PREPARATION SERVICES; PAYROLL PREPARATION SERVICES; AND ARRANGING FOR THE RENTAL OF OFFICE EQUIPMENT, VIA A GLOBAL COMPUTER NETWORK (U.S. CLS. 100, 101 AND 102).
FIRST USE 2-1-2001; IN COMMERCE 4-2-2001.

2,730,030. EL TERRIFICO, LLC, MEMPHIS, TN. SN 76-237,020. PUB. 5-7-2002, FILED 4-6-2001.



NO CLAIM IS MADE TO THE EXCLUSIVE RIGHT TO USE "TAMALES CO." OR "QUALITY COOKING SINCE 1960", APART FROM THE MARK AS SHOWN.

FOR MAIL ORDER CATALOG SERVICES, TELEPHONE SHOP-AT-HOME SERVICES AND COMPUTERIZED ON-LINE RETAIL STORE SERVICES ALL FEATURING PREPARED FOODS, CONDIMENTS AND CLOTHING (U.S. CLS. 100, 101 AND 102).
FIRST USE 10-31-2001; IN COMMERCE 10-31-2001.

CLASS 35—(Continued).

2,730,034. MEDIMEDIA USA, INC., TETERBORO, NJ, BY ASSIGNMENT QUADRANT HEALTHCOM INC., CHATHAM, NJ. SN 76-238,234. PUB. 6-4-2002, FILED 4-10-2001.

TRIGENESIS MANAGEMENT SYSTEMS

NO CLAIM IS MADE TO THE EXCLUSIVE RIGHT TO USE "MANAGEMENT SYSTEMS", APART FROM THE MARK AS SHOWN.
FOR BUSINESS PLANNING (U.S. CLS. 100, 101 AND 102).

FIRST USE 4-0-2001; IN COMMERCE 4-0-2001.

2,730,035. PUBLICIS USA HOLDINGS, INC., DALLAS, TX. SN 76-238,882. PUB. 7-9-2002, FILED 4-11-2001.

PUBLICIS DIALOG HOLISTIC COMMUNICATIONS

OWNER OF U.S. REG. NO. 2,284,867.
NO CLAIM IS MADE TO THE EXCLUSIVE RIGHT TO USE "HOLISTIC COMMUNICATIONS", APART FROM THE MARK AS SHOWN.

FOR ADVERTISING AGENCY SERVICES; BUSINESS CONSULTATION; DOCUMENT REPRODUCTION; PUBLIC RELATIONS SERVICES; BUSINESS MANAGEMENT CONSULTATION FOR INDUSTRIAL OR COMMERCIAL ENTERPRISES; MARKET RESEARCH (U.S. CLS. 100, 101 AND 102).

FIRST USE 11-30-2001; IN COMMERCE 11-30-2001.

2,730,037. QVC, INC., WEST CHESTER, PA. SN 76-238,969. PUB. 5-14-2002, FILED 4-11-2001.

CELEBRATE YOUR SUMMER STYLE

FOR PROVIDING HOME SHOPPING SERVICES IN THE FIELD OF GENERAL MERCHANDISE THROUGH THE USE OF TELEVISION, TELEPHONE AND THE INTERNET (U.S. CLS. 100, 101 AND 102).

FIRST USE 5-12-2001; IN COMMERCE 5-12-2001.

CLASS 35—(Continued).

2,730,077. BAKER & TAYLOR, INC., CHARLOTTE, NC. SN 76-256,488. PUB. 6-25-2002, FILED 5-14-2001.

INFORMATA

THE TERM "INFORMATA" MAY BE TRANSLATED FROM ITALIAN TO MEAN "SHE IS INFORMED".

FOR COMPUTERIZED ONLINE RETAIL AND DISTRIBUTION SERVICES IN THE FIELD OF ENTERTAINMENT PRODUCTS, NAMELY, BOOKS, CDS, VIDEOS, AUDIO, DVD AND RELATED GOODS; COMPUTERIZED ONLINE RETAIL SERVICES IN THE FIELD OF LIBRARIES AND LIBRARY RELATED PRODUCTS; BUSINESS MANAGEMENT, NAMELY, MANAGEMENT OF DIGITAL DISTRIBUTION RIGHTS FOR ELECTRONIC BOOKS; LICENSING OF DATA AND APPLICATIONS IN THE FIELD OF LIBRARY MANAGEMENT AND RETAILING OF ENTERTAINMENT PRODUCTS (U.S. CLS. 100, 101 AND 102).

FIRST USE 7-1-2000; IN COMMERCE 7-8-2000.

2,730,079. KINGSDOWN, INC., MEBANE, NC. SN 76-257,631. PUB. 1-1-2002, FILED 5-15-2001.



OWNER OF U.S. REG. NO. 520,839 AND OTHERS. FOR RETAIL STORE SERVICES FEATURING BEDDING (U.S. CLS. 100, 101 AND 102).

FIRST USE 6-15-2002; IN COMMERCE 6-15-2002.

2,730,081. STODDARD, PAMELA NOLIE, PLACERVILLE, CA. SN 76-258,132. PUB. 7-2-2002, FILED 5-17-2001.



FOR STUFFED TOY HORSES (U.S. CLS. 100, 101 AND 102).

FIRST USE 3-3-2003; IN COMMERCE 3-3-2003.

CLASS 35—(Continued).

2,730,089. CURIOUS GRAPE CORPORATION, THE, FALLS CHURCH, VA. SN 76-259,890. PUB. 6-18-2002, FILED 5-22-2001.

BRINGING WINE BACK DOWN TO EARTH

FOR RETAIL STORE SERVICES, ONLINE RETAIL SERVICES, TELEPHONE SHOP-AT-HOME SERVICES, AND MAIL ORDER SERVICES, ALL FEATURING WINE (U.S. CLS. 100, 101 AND 102).

FIRST USE 8-15-2001; IN COMMERCE 8-15-2001.

2,730,104. BREAKTHROUGH COMMUNICATIONS, INC., NORTHBROOK, IL. SN 76-264,566. PUB. 12-18-2001, FILED 5-31-2001.

OVERTURE

FOR PERSONNEL MANAGEMENT CONSULTATION (U.S. CLS. 100, 101 AND 102).

FIRST USE 5-14-1996; IN COMMERCE 5-14-1996.

2,730,110. CLEANPIX, INC., CALGARY, ALBERTA, CANADA. BY ASSIGNMENT VIGNEAULT, NELSON, CALGARY, ALBERTA. T2G 3M3, CANADA. SN 76-266,815. PUB. 5-21-2002, FILED 6-4-2001.



PRIORITY CLAIMED UNDER SEC. 44(D) ON CANADA APPLICATION NO. 1085892, FILED 12-11-2000.

THE MARK CONSISTS IN PART OF A STYLIZED HUMAN FACE.

FOR PROVIDING AN ONLINE INTERACTIVE COMPUTER DATABASE FOR OTHERS IN THE FIELD OF CORPORATE DIGITAL BRANDING ASSETS, NAMELY, LOGOS, ADVERTISEMENTS, PRODUCT PICTURES, VIDEO AND SOUND CLIPS (U.S. CLS. 100, 101 AND 102).

FIRST USE 5-0-2002; IN COMMERCE 5-0-2002.

2,730,115. CIRCOL.NET, INC., CARMEL, IN. SN 76-267,357. PUB. 10-16-2001, FILED 6-5-2001.

CIRCOL.NET

FOR PROVIDING CONSTRUCTION JOB INFORMATION TO POTENTIAL BIDDERS OVER A GLOBAL COMPUTER INFORMATION NETWORK (U.S. CLS. 100, 101 AND 102).

FIRST USE 8-6-2002; IN COMMERCE 8-6-2002.

CLASS 35—(Continued).

2,730,127. LOFIELD CORP., CORNELIA, GA. SN 76-270,514.
PUB. 5-14-2002, FILED 6-12-2001.

WHISTLE EXPRESS

FOR RETAIL STORE SERVICES FEATURING CON-
VENIENCE STORE ITEMS AND GASOLINE (U.S. CLS.
100, 101 AND 102).
FIRST USE 8-1-2001; IN COMMERCE 8-1-2001.

2,730,136. CIBER, INC., GREENWOOD VILLAGE, CO. SN 76-
273,330. PUB. 8-6-2002, FILED 6-19-2001.

CIBERJOBS

FOR PROVIDING INFORMATION IN THE FIELD OF
JOB PLACEMENT, EMPLOYMENT AND CAREER
PLANNING VIA A GLOBAL COMPUTER NETWORK
(U.S. CLS. 100, 101 AND 102).
FIRST USE 2-6-2003; IN COMMERCE 2-6-2003.

2,730,156. SOUTHERN BUSINESS COMMUNICATIONS,
INC., NORCROSS, GA. SN 76-279,487. PUB. 6-18-2002,
FILED 7-2-2001.

AV DEPOT

OWNER OF U.S. REG. NO. 1,647,781.
NO CLAIM IS MADE TO THE EXCLUSIVE RIGHT TO
USE "AV", APART FROM THE MARK AS SHOWN.

FOR RETAIL MAIL ORDER CATALOGUE AND
SHOWROOM SERVICES IN THE FIELD OF BUSINESS
AND PRESENTATION GRAPHICS EQUIPMENT AND
PRODUCTS; ON-LINE RETAIL STORE SERVICES FEAT-
URING BUSINESS AND PRESENTATION GRAPHICS
EQUIPMENT AND PRODUCTS (U.S. CLS. 100, 101 AND
102).

FIRST USE 3-31-1990; IN COMMERCE 3-31-1990.

2,730,174. 4LIFE RESEARCH, L.C., SANDY, UT. SN 76-
285,187. PUB. 10-8-2002, FILED 7-16-2001.

GLOBAL 4LIFE

OWNER OF U.S. REG. NO. 2,475,300.
FOR BUSINESS SERVICES, NAMELY PROVIDING
DISTRIBUTORSHIPS AND MULTI-LEVEL MARKETING
BUSINESS SERVICES FEATURING DIETARY SUPPLE-
MENTS, VITAMINS, MINERAL SUPPLEMENTS AND
HERBAL SUPPLEMENTS (U.S. CLS. 100, 101 AND 102).
FIRST USE 7-31-2001; IN COMMERCE 7-31-2001.

CLASS 35—(Continued).

2,730,181. FOXMARK MEDIA, LLC, CHATTANOOGA, TN.
SN 76-287,686. PUB. 6-25-2002, FILED 7-19-2001.

MALLBRANDS

FOR ADVERTISING AGENCIES AND BUSINESS
MARKETING CONSULTING SERVICES (U.S. CLS. 100,
101 AND 102).
FIRST USE 5-1-2002; IN COMMERCE 5-1-2002.

2,730,198. WYNDHAM IP CORPORATION, WILMINGTON,
DE. SN 76-293,499. PUB. 4-30-2002, FILED 7-31-2001.

WYNDLEADS 

FOR BUSINESS MARKETING SERVICES, NAMELY
PROPERTY TO PROPERTY CROSS-MARKETING PRO-
GRAM FOR PROMOTION OF HOTEL SERVICES (U.S.
CLS. 100, 101 AND 102).

FIRST USE 11-2-2000; IN COMMERCE 12-10-2000.

2,730,205. KOHL'S ILLINOIS, INC., AURORA, IL. SN 76-
294,797. PUB. 5-21-2002, FILED 8-6-2001.

MÁS COMO A TI TE GUSTA

OWNER OF U.S. REG. NO. 2,095,246.
THE ENGLISH TRANSLATION OF THE MARK IS
"MORE OF THE WAY YOU LIKE IT".
FOR RETAIL DEPARTMENT STORE SERVICES (U.S.
CLS. 100, 101 AND 102).
FIRST USE 7-29-2001; IN COMMERCE 7-29-2001.

CLASS 35—(Continued).

2,730,213. YAMHILL'S SOUTHERN EXPOSURE, LTD., NEW-BERG, OR. SN 76-297,118. PUB. 5-28-2002, FILED 8-7-2001.

**NATALIE'S
E S T A T E
W I N E R Y**



NO CLAIM IS MADE TO THE EXCLUSIVE RIGHT TO USE "ESTATE WINERY", APART FROM THE MARK AS SHOWN.

THE MARK CONSISTS, IN PART, OF THE WORDS, "NATALIE'S ESTATE WINERY", THE DESIGN OF A HUMMINGBIRD, AND DESIGN.

FOR WINERY SERVICES, NAMELY, RETAIL STORE SERVICES FEATURING WINES; RETAIL STORES FEATURING WINES (U.S. CLS. 100, 101 AND 102).

FIRST USE 11-22-2001; IN COMMERCE 11-22-2001.

CLASS 35—(Continued).

2,730,279. TELECOMMUTING ADVANTAGE GROUP, INC., SAN FRANCISCO, CA. SN 76-317,958. PUB. 4-16-2002, FILED 9-28-2001.

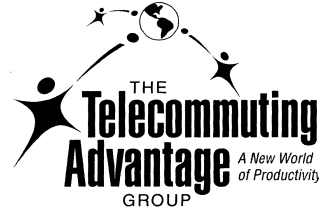

NO CLAIM IS MADE TO THE EXCLUSIVE RIGHT TO USE "TELECOMMUTING" AND "GROUP", APART FROM THE MARK AS SHOWN.

THE MARK CONSISTS, OF THE WORDS "THE TELECOMMUTING ADVANTAGE GROUP A NEW WORLD OF PRODUCTIVITY" BELOW A DESIGN SHOWING THREE STYLIZED HUMANS THROWING BALLS TOWARD THE PLANET EARTH.

FOR BUSINESS MANAGEMENT CONSULTATION; BUSINESS CONSULTING IN THE FIELD OF TELECOMMUTING (U.S. CLS. 100, 101 AND 102).

FIRST USE 11-11-2002; IN COMMERCE 11-11-2002.

2,730,285. WOLVERINE WORLD WIDE, INC., ROCKFORD, MI. SN 76-319,430. PUB. 10-8-2002, FILED 9-28-2001.

TRACK 'N TRAIL

OWNER OF U.S. REG. NOS. 1,158,597, 2,316,110, AND OTHERS.

FOR RETAIL SHOE STORE SERVICES (U.S. CLS. 100, 101 AND 102).

FIRST USE 7-26-2002; IN COMMERCE 7-26-2002.

2,730,215. AERO DESIGN AND MANUFACTURING COMPANY, INC., DULUTH, MN. SN 76-297,401. PUB. 2-19-2002, FILED 8-9-2001.

RIDE THERE.

FOR MAIL ORDER CATALOG SERVICES FEATURING CLOTHING AND ACCESSORIES FOR MOTORCYCLE RIDERS (U.S. CLS. 100, 101 AND 102).

FIRST USE 12-0-2002; IN COMMERCE 12-0-2002.

2,730,296. HARDHAT TECHNOLOGIES, INC., WILMINGTON, NC. SN 76-320,713. PUB. 3-19-2002, FILED 10-2-2001.



FOR ADVERTISING AGENCIES, PREPARING ADVERTISEMENTS FOR OTHERS, AND ADVERTISING FOR OTHERS IN THE NATURE OF DISPLAYING ADVERTISEMENTS (U.S. CLS. 100, 101 AND 102).

FIRST USE 7-15-2002; IN COMMERCE 7-15-2002.

CLASS 35—(Continued).

2,730,307. BEDDING EXPERTS, INC., CAROL STREAM, IL. SN 76-323,009. PUB. 6-25-2002, FILED 10-5-2001.

BEDDING EXPERTS

OWNER OF U.S. REG. NO. 1,613,341.
NO CLAIM IS MADE TO THE EXCLUSIVE RIGHT TO USE "BEDDING", APART FROM THE MARK AS SHOWN. SEC. 2(F).
FOR RETAIL FURNITURE STORE SERVICES (U.S. CLS. 100, 101 AND 102).
FIRST USE 0-0-1983; IN COMMERCE 0-0-1983.

2,730,319. GLASS, LISA, WASHINGTON, DC. SN 76-326,742. PUB. 4-30-2002, FILED 10-18-2001.

TIRED FEET

FOR RETAIL STORES AND WHOLESALE DISTRIBUTORSHIP SERVICES IN THE FIELD OF SHOES (U.S. CLS. 100, 101 AND 102).
FIRST USE 8-1-2002; IN COMMERCE 8-1-2002.

2,730,331. AMERICAN HEALTHWAYS, INC., NASHVILLE, TN. SN 76-329,741. PUB. 5-28-2002, FILED 10-25-2001.

TRUST CHANNELS

FOR HEALTH CARE MANAGEMENT SERVICES, NAMELY, COORDINATING A PATIENT'S HEALTH CARE IN ORDER TO ACHIEVE A MORE SUCCESSFUL HEALTH OUTCOME (U.S. CLS. 100, 101 AND 102).
FIRST USE 6-6-2001; IN COMMERCE 6-6-2001.

2,730,357. STARLITE MEDIA LLC, NEW YORK, NY. SN 76-337,293. PUB. 7-2-2002, FILED 11-13-2001.

NECESSITY MEDIA

NO CLAIM IS MADE TO THE EXCLUSIVE RIGHT TO USE "MEDIA", APART FROM THE MARK AS SHOWN.
FOR ADVERTISING SERVICES, NAMELY, ARRANGING FOR AND PROVIDING THE ADVERTISING OF THE GOODS AND SERVICES FOR OTHERS (U.S. CLS. 100, 101 AND 102).
FIRST USE 4-30-2002; IN COMMERCE 4-30-2002.

CLASS 35—(Continued).

2,730,368. SAFEWAY INC., PLEASANTON, CA. SN 76-339,533. PUB. 7-16-2002, FILED 11-20-2001.



NO CLAIM IS MADE TO THE EXCLUSIVE RIGHT TO USE ".COM", APART FROM THE MARK AS SHOWN.
FOR RETAIL GROCERY SERVICES AND RETAIL PHARMACY SERVICES (U.S. CLS. 100, 101 AND 102).
FIRST USE 10-15-2001; IN COMMERCE 10-15-2001.

2,730,408. RESULTE UNIVERSAL LLC, DALLAS, TX, BY CHANGE OF NAME RESULTE UNIVERSAL, LLC, DALLAS, TX. SN 76-346,537. PUB. 5-21-2002, FILED 12-8-2001.

RESULTE UNIVERSAL

FOR EMPLOYEE STAFFING AND PERSONNEL RECRUITING SERVICES (U.S. CLS. 100, 101 AND 102).
FIRST USE 10-0-2001; IN COMMERCE 10-0-2001.

2,730,433. AUCTIONWORKS.COM, INC., ATLANTA, GA. SN 76-351,883. PUB. 6-18-2002, FILED 12-20-2001.

MERCHANT STREAM

NO CLAIM IS MADE TO THE EXCLUSIVE RIGHT TO USE "MERCHANT", APART FROM THE MARK AS SHOWN.

FOR ON-LINE AUCTION MANAGEMENT AND FACILITATION SERVICES CONDUCTED VIA A GLOBAL COMPUTER NETWORK (U.S. CLS. 100, 101 AND 102).
FIRST USE 2-10-2003; IN COMMERCE 2-10-2003.

2,730,444. FURNITURE GOLDMINE OF VIRGINIA, INC., FALLS CHURCH, VA. SN 76-354,034. PUB. 7-2-2002, FILED 12-28-2001.

**WHERE PRICES DROP
UNTIL YOU SHOP!**

FOR RETAIL FURNITURE STORES (U.S. CLS. 100, 101 AND 102).
FIRST USE 8-1-2001; IN COMMERCE 8-1-2001.

CLASS 35—(Continued).

2,730,445. INTERNET VENTURES LLC, FARMINGTON HILLS, MI. SN 76-354,226. PUB. 6-18-2002, FILED 1-2-2002.

MRBLAZER

FOR RETAIL CLOTHING STORE SERVICES VIA AN ON-LINE ELECTRONIC COMMUNICATIONS NETWORK (U.S. CLS. 100, 101 AND 102).
FIRST USE 1-12-2002; IN COMMERCE 1-12-2002.

2,730,460. 3 RIVERS CONNECT, PITTSBURGH, PA. SN 76-357,716. PUB. 9-10-2002, FILED 1-11-2002.

EVALUATION STATION

FOR PROVIDING AN ON-LINE COMPUTER DATABASE OF BUSINESS INFORMATION RELATING TO THE PERFORMANCE OF HEALTH AND HUMAN SERVICES PROGRAMS AS WELL AS ANALYSIS AND REPORTS RELATING THERETO (U.S. CLS. 100, 101 AND 102).

FIRST USE 1-8-2002; IN COMMERCE 1-8-2002.

2,730,466. BRANDSIDE CORPORATION, SAN MATEO, CA. SN 76-360,846. PUB. 7-9-2002, FILED 1-18-2002.

BRANDSIDE

FOR ADVERTISING SERVICES, NAMELY, CREATING CORPORATE AND BRAND IDENTITY FOR OTHERS; CREATING TRADEMARKS FOR OTHERS (U.S. CLS. 100, 101 AND 102).

FIRST USE 5-0-2002; IN COMMERCE 5-0-2002.

2,730,481. CHRISTIAN, JANICE, WEST CHESTER, PA. SN 76-364,819. PUB. 7-2-2002, FILED 1-31-2002.



FOR MAIL ORDER CATALOG SERVICES, NETWORK MARKETING DISTRIBUTORSHIP SERVICES BY INDEPENDENT SALES REPRESENTATIVES, ALL IN FIELDS OF BEAUTY CARE, PERSONAL CARE PRODUCTS, TOILETRIES, COSMETICS, CLOTHING, VITAMINS AND NUTRITIONAL SUPPLEMENTS, GIFT ITEMS, CANDLES, PRE-RECORDED AUDIO, VIDEO CASSETTES AND COMPACT DISCS, BOOKS, JOURNALS, AND PRINTED MATTER (U.S. CLS. 100, 101 AND 102).
FIRST USE 11-1-2001; IN COMMERCE 11-1-2001.

CLASS 35—(Continued).

2,730,493. HRD PRESS, INC., AMHERST, MA. SN 76-369,576. PUB. 7-23-2002, FILED 2-12-2002.

FIRSTVIEW

FOR TESTING SERVICES, NAMELY TEST ADMINISTRATION AND EVALUATION, AND BEHAVIOR, PERSONALITY AND ABILITIES TESTING FOR EMPLOYMENT PURPOSES (U.S. CLS. 100, 101 AND 102).
FIRST USE 1-1-2002; IN COMMERCE 1-1-2002.

2,730,501. PETREN ENTERPRISES, ALEXANDRIA, VA. SN 76-372,247. PUB. 9-24-2002, FILED 2-20-2002.

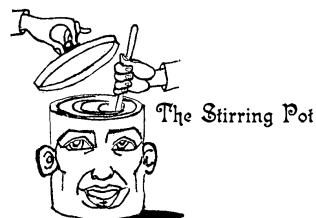

FOR ON-LINE RETAIL STORE SERVICES FEATURING GENERAL MERCHANDISE; PROMOTING THE GOODS AND SERVICES OF OTHERS BY MEANS OF OPERATING AN ON-LINE SHOPPING MALL WITH LINKS TO THE RETAIL WEB SITES OF OTHERS (U.S. CLS. 100, 101 AND 102).

FIRST USE 3-27-2002; IN COMMERCE 11-25-2002.

2,730,514. MANNING, SELVAGE & LEE, INC., NEW YORK, NY. SN 76-379,641. PUB. 9-10-2002, FILED 3-7-2002.

CHANGE MINDS

FOR PUBLIC RELATIONS SERVICES; MARKET RESEARCH SERVICES; AND CONDUCTING PUBLIC ATTITUDE SURVEYS AND STUDIES (U.S. CLS. 100, 101 AND 102).

FIRST USE 6-0-2002; IN COMMERCE 6-0-2002.

2,730,551. HEBLY, ADRIAAN, HILVERSUM, NETHERLANDS. SN 78-006,375. PUB. 1-1-2002, FILED 5-1-2000.

HUMORHOUSE

FOR RETAIL STORE AND ON-LINE RETAIL STORE SERVICES FEATURING PRODUCTS AROUND HUMOR, NAMELY BOOKS, VIDEO/AUDIO CASSETTES/CD'S, MAGAZINES, PARTY AND THEMATIC AND EVENTS ARTICLES, HUMORISTS GIFT ARTICLES, TOYS, JOKES, CARTOONS, GAMES, CARDS, POSTERS, PAINTINGS, PARTY THEME CLOTHING, CARICATURES, TAILOR-MADE HUMORISTIC SPEECHES (U.S. CLS. 100, 101 AND 102).

FIRST USE 1-1-2002; IN COMMERCE 9-1-2002.

CLASS 35—(Continued).

2,730,556. COLLEGIATE LICENSING COMPANY, THE, ATLANTA, GA. SN 78-011,006. PUB. 9-3-2002, FILED 6-2-2000.

THE COLLEGIATE EXCHANGE

NO CLAIM IS MADE TO THE EXCLUSIVE RIGHT TO USE "COLLEGIATE", APART FROM THE MARK AS SHOWN.

FOR PROMOTING BUSINESS TO BUSINESS COMMERCE, NAMELY, ONLINE ORDERING AND DISTRIBUTORSHIP SERVICES FEATURING LICENSING PRODUCTS IN THE FIELDS OF CLOTHING, JEWELRY, HOUSEWARES, FURNITURE, OFFICE PRODUCTIONS, GIFTS, AND NOVELTIES, PAPER AND PRINTING AND PUBLISHING ITEMS, SPORTING GOODS, TOYS, ELECTRONICS, CONSUMABLES, HEALTH AND BEAUTY ITEMS, INFANT ITEMS AND FOOTWEAR, PROVIDED VIA A GLOBAL COMPUTER NETWORK (U.S. CLS. 100, 101 AND 102).

FIRST USE 7-17-2000; IN COMMERCE 7-17-2000.

2,730,557. MAGNET COMMUNICATIONS LLC, NEW YORK, NY, BY CHANGE OF NAME CREAMER DICKSON BASFORD, LLC, NEW YORK, NY. SN 78-013,095. PUB. 10-9-2001, FILED 6-16-2000.

MAGNET COMMUNICATIONS

NO CLAIM IS MADE TO THE EXCLUSIVE RIGHT TO USE "COMMUNICATIONS", APART FROM THE MARK AS SHOWN.

FOR PUBLIC RELATIONS; PUBLIC RELATIONS SERVICES IN THE FIELD OF INVENTOR RELATIONS; BUSINESS RESEARCH; PROVIDING FACILITIES FOR BUSINESS MEETINGS (U.S. CLS. 100, 101 AND 102).

FIRST USE 7-15-2000; IN COMMERCE 7-15-2000.

2,730,569. FRIEDMAN, HARVEY, BEVERLY HILLS, CA. SN 78-029,978. PUB. 7-23-2002, FILED 10-10-2000.

2C ADVERTISING AND BUSINESS

NO CLAIM IS MADE TO THE EXCLUSIVE RIGHT TO USE "ADVERTISING AND BUSINESS", APART FROM THE MARK AS SHOWN.

FOR PROVIDING INFORMATION IN THE FIELD OF ADVERTISING FOR USE BY ADVERTISING AGENCIES, AND IN THE FIELD OF BUSINESS MANAGEMENT, VIA WEBSITES ON THE INTERNET (U.S. CLS. 100, 101 AND 102).

FIRST USE 10-15-2000; IN COMMERCE 10-15-2000.

CLASS 35—(Continued).

2,730,585. SOCIAL SOLUTIONS, INC., HALF MOON BAY, CA. SN 78-038,454. PUB. 8-28-2001, FILED 12-8-2000.

SOCIAL GENOME

FOR BUSINESS RESEARCH FEATURING ANALYSIS OF WORK-ORIENTED BUSINESS PRACTICES FROM AN ANTHROPOLOGICAL AND SOCIAL SCIENCE PERSPECTIVE (U.S. CLS. 100, 101 AND 102).

FIRST USE 5-11-2002; IN COMMERCE 5-11-2002.

2,730,591. A.J. PRINDLE & CO., LLC, NOVI, MI, BY ASSIGNMENT FORD MOTOR COMPANY, DEARBORN, MI. SN 78-039,927. PUB. 6-4-2002, FILED 12-19-2000.

AJ PRINDLE & CO.

NO CLAIM IS MADE TO THE EXCLUSIVE RIGHT TO USE "CO.", APART FROM THE MARK AS SHOWN.

THE NAME SHOWN IN THE MARK "AJ PRINDLE", DOES NOT IDENTIFY A LIVING INDIVIDUAL.

FOR MAIL ORDER AND COMPUTERIZED ONLINE RETAIL SERVICES IN THE FIELD OF GENERAL MERCHANDISE (U.S. CLS. 100, 101 AND 102).

FIRST USE 12-5-2000; IN COMMERCE 3-31-2001.

2,730,592. IMDB, INC., SEATTLE, WA. SN 78-040,289. PUB. 6-25-2002, FILED 12-21-2000.

IMDB

FOR PROVIDING AN ON-LINE COMMERCIAL INFORMATION DIRECTORY; DISSEMINATION OF ADVERTISING FOR OTHERS VIA AN ON-LINE ELECTRONIC COMMUNICATIONS NETWORK; PROVIDING A SEARCHABLE ON-LINE ADVERTISING GUIDE FEATURING THE GOODS AND SERVICES OF OTHERS; COMPUTERIZED DATABASE MANAGEMENT SERVICES; ON-LINE ORDERING SERVICES FEATURING MOVIES, MOTION PICTURES, DOCUMENTARIES, FILMS, TELEVISION PROGRAMS, GRAPHICS, ANIMATION AND MULTIMEDIA PRESENTATIONS, VIDEOS AND DVDS, AND OTHER AUDIOVISUAL WORKS (U.S. CLS. 100, 101 AND 102).

FIRST USE 9-1-1998; IN COMMERCE 9-1-1998.

CLASS 35—(Continued).

2,730,640. K. KYSER COMPANY, FARMERS BRANCH, TX. SN 78-060,130. PUB. 12-25-2001, FILED 4-24-2001.



NO CLAIM IS MADE TO THE EXCLUSIVE RIGHT TO USE "COMPANY", APART FROM THE MARK AS SHOWN. FOR WHOLESALE DISTRIBUTORSHIP FEATURING STAINLESS STEEL AND TEFLON TUBING AND COMPONENTS (U.S. CLS. 100, 101 AND 102). FIRST USE 10-1-2001; IN COMMERCE 10-1-2001.

2,730,641. SIX COUNTINENTS HOTELS, INC., ATLANTA, GA, BY CHANGE OF NAME BASS HOTELS & RESORTS, INC., ATLANTA, GA. SN 78-060,835. PUB. 6-4-2002, FILED 4-27-2001.



NO CLAIM IS MADE TO THE EXCLUSIVE RIGHT TO USE "1-800 MEETING", APART FROM THE MARK AS SHOWN. FOR ARRANGING AND PROVIDING FACILITIES FOR BUSINESS MEETINGS (U.S. CLS. 100, 101 AND 102). FIRST USE 5-1-2001; IN COMMERCE 5-2-2001.

2,730,648. OEM OF CONNECTICUT, INC., EAST HARTFORD, CT. SN 78-062,057. PUB. 5-28-2002, FILED 5-4-2001.

OEM AMERICA

NO CLAIM IS MADE TO THE EXCLUSIVE RIGHT TO USE "AMERICA", APART FROM THE MARK AS SHOWN. FOR SERVING AS A HUMAN RESOURCES DEPARTMENT FOR OTHERS; PROVIDING PERSONNEL RECORDS MANAGEMENT; COST MANAGEMENT FOR THE HEALTH BENEFIT PLANS OF OTHERS; ADMINISTRATION OF BUSINESS PAYROLL FOR OTHERS; TAX PREPARATION; EMPLOYEE LEASING (U.S. CLS. 100, 101 AND 102). FIRST USE 1-3-1989; IN COMMERCE 2-1-1989.

CLASS 35—(Continued).

2,730,649. MARSHALL GOLDSMITH INCORPORATED, RANCHO SANTA FE, CA. SN 78-063,161. PUB. 9-25-2001, FILED 5-11-2001.

A4SL

FOR BUSINESS MANAGEMENT CONSULTING SERVICES (U.S. CLS. 100, 101 AND 102). FIRST USE 3-20-2001; IN COMMERCE 4-15-2001.

2,730,654. DESIGN DESIGN, INC., GRAND RAPIDS, MI. SN 78-064,298. PUB. 10-23-2001, FILED 5-18-2001.

SOLUTIONS

FOR AUTOMATED GREETING CARD RESTOCKING SERVICES RENDERED EXCLUSIVELY FOR GREETING CARD RETAILERS (U.S. CLS. 100, 101 AND 102). FIRST USE 5-31-2001; IN COMMERCE 5-31-2001.

2,730,664. INTERPUBLIC GROUP OF COMPANIES, INC., THE, NEW YORK, NY. SN 78-069,519. PUB. 3-12-2002, FILED 6-16-2001.

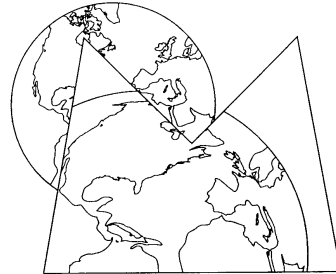

FOR ADVERTISING AGENCY SERVICES AND BUSINESS MARKETING SERVICES (U.S. CLS. 100, 101 AND 102). FIRST USE 7-1-2001; IN COMMERCE 7-1-2001.

2,730,676. PAYLESS SHOESOURCE WORLDWIDE, INC., TOPEKA, KS. SN 78-072,980. PUB. 11-13-2001, FILED 7-9-2001.

SHOEFINDER

FOR RETAIL SHOE STORE SERVICES (U.S. CLS. 100, 101 AND 102). FIRST USE 8-6-2001; IN COMMERCE 8-6-2001.

CLASS 35—(Continued).

2,730,693. LOS ANGELES TIMES COMMUNICATIONS LLC, LOS ANGELES, CA. SN 78-077,214. PUB. 1-15-2002, FILED 8-2-2001.

IN PRINT. ONLINE. YOUR FUTURE IS HERE

FOR DISSEMINATION OF CLASSIFIED ADVERTISING MATTER FOR OTHERS VIA PRINT AND THE INTERNET (U.S. CLS. 100, 101 AND 102).
FIRST USE 9-0-2001; IN COMMERCE 9-0-2001.

2,730,696. ASSOCIATION FOR CHALLENGE COURSE TECHNOLOGY, INC., MARTIN, MI. SN 78-078,294. PUB. 7-2-2002, FILED 8-8-2001.



NO CLAIM IS MADE TO THE EXCLUSIVE RIGHT TO USE "ASSOCIATION FOR CHALLENGE COURSE TECHNOLOGY", APART FROM THE MARK AS SHOWN.

FOR ASSOCIATION SERVICES, NAMELY, PROMOTING THE INTERESTS OF CHALLENGE COURSE PROFESSIONALS; ESTABLISHING STANDARDS FOR THE INSTALLATION, INSPECTION, OPERATION, AND ETHICAL PRACTICES OF CHALLENGE COURSES; AND PROMOTING THE USE OF CHALLENGE COURSES (U.S. CLS. 100, 101 AND 102).

FIRST USE 9-0-1994; IN COMMERCE 10-3-1994.

2,730,698. PETCO ANIMAL SUPPLIES, INC., SAN DIEGO, CA. SN 78-078,920. PUB. 5-14-2002, FILED 8-13-2001.

SUPERMARKETS ARE FOR PEOPLE. PETCO IS FOR PETS.

OWNER OF U.S. REG. NOS. 1,695,073 AND 2,172,931.
FOR RETAIL STORE AND ON-LINE RETAIL STORE SERVICES IN THE FIELD OF PET SUPPLIES; ON-LINE BUSINESS DIRECTORIES FEATURING INFORMATION IN THE FIELD OF PET SERVICES AND PET SUPPLIES (U.S. CLS. 100, 101 AND 102).

FIRST USE 9-5-2001; IN COMMERCE 9-5-2001.

CLASS 35—(Continued).

2,730,700. LCJ ENTERPRISES LLC, ST. LOUIS, MO. SN 78-079,801. PUB. 10-15-2002, FILED 8-17-2001.



NO CLAIM IS MADE TO THE EXCLUSIVE RIGHT TO USE "TOTAL CUSTOMER SERVICE", APART FROM THE MARK AS SHOWN.

FOR BUSINESS CONSULTING SERVICES IN THE FIELD OF CUSTOMER SERVICES (U.S. CLS. 100, 101 AND 102).

FIRST USE 11-13-2002; IN COMMERCE 11-13-2002.

2,730,742. GETTAGRIPPE RESOURCE SYSTEMS, INC., RICHFIELD, MN, BY ASSIGNMENT INDEPENDENT DIVERSIFIED REAL ESTATE SERVICES, INC., RICHFIELD, MN. SN 78-091,252. PUB. 10-29-2002, FILED 11-1-2001.

ONELEVELLIVING

OWNER OF U.S. REG. NO. 2,465,493.

FOR ON-LINE MARKETPLACE SERVICES FOR HOME BUYERS, SELLERS, CONTRACTORS AND SUPPLIERS FEATURING REAL ESTATE GOODS AND SERVICES (U.S. CLS. 100, 101 AND 102).

FIRST USE 8-6-2002; IN COMMERCE 8-6-2002.

2,730,754. PERRY, SCOTT E., LOS ANGELES, CA. SN 78-095,514. PUB. 10-22-2002, FILED 11-28-2001.

SPERRY MEDIA

NO CLAIM IS MADE TO THE EXCLUSIVE RIGHT TO USE "MEDIA", APART FROM THE MARK AS SHOWN.

FOR ADVERTISING AGENCY SERVICES, NAMELY, PROMOTING THE PRODUCTS AND SERVICES OF RECORDING LABELS AND PERFORMING MUSICAL GROUPS THROUGH THE DISTRIBUTION OF AUDIO AND AUDIOVISUAL PROMOTIONAL MATERIALS AND BY RENDERING PROMOTIONAL ADVICE (U.S. CLS. 100, 101 AND 102).

FIRST USE 1-1-2002; IN COMMERCE 1-1-2002.

2,730,756. B-CHIC, INC., NEW YORK, NY. SN 78-096,050. PUB. 6-25-2002, FILED 11-30-2001.

B-CHIC

FOR ON-LINE RETAIL STORE SERVICES FEATURING ARTWORK AND HOME FURNISHINGS (U.S. CLS. 100, 101 AND 102).

FIRST USE 12-16-2001; IN COMMERCE 12-16-2001.

CLASS 35—(Continued).

2,730,765. GOEDE, ROGER A, ZEBULON, NC. SN 78-096,973.
PUB. 8-6-2002, FILED 12-6-2001.

HOTNIGHTS.BIZ

FOR COMPUTERIZED ON-LINE RETAIL SERVICES IN THE FIELD OF GIFT BASKETS CONSISTING OF FOOD AND DRINK ITEMS, PERSONAL CARE PRODUCTS INCLUDING BODY OILS AND AROMA THERAPY ITEMS, NOVELTIES THAT MAY BE INCLUDED IN THE GIFT BASKETS SUCH AS FIGURINES, MOVIES, AUDIO TAPES OR THE INDIVIDUAL ITEMS THAT WOULD BE CONTAINED IN THE BASKETS (U.S. CLS. 100, 101 AND 102).

FIRST USE 11-1-2001; IN COMMERCE 11-1-2001.

2,730,789. ELECTRICAL FASTENERS CO., INC., BRIDGEVIEW, IL. SN 78-102,181. PUB. 8-6-2002, FILED 1-11-2002.



FOR RETAIL STORE AND ON-LINE RETAIL STORE SERVICES FEATURING HARDWARE, BUILDING TOOLS, BUILDING MATERIALS AND CONSTRUCTION SUPPLIES (U.S. CLS. 100, 101 AND 102).

FIRST USE 1-1-1990; IN COMMERCE 1-1-1990.

2,730,824. IDEASPHERE, INC., WAYLAND, MA. SN 78-113,213. PUB. 9-24-2002, FILED 3-7-2002.

IDEASPHERE

FOR BUSINESS MANAGEMENT AND CONSULTING SERVICES; ARRANGING AND CONDUCTING BUSINESS CONFERENCES; BUSINESS DEVELOPMENT SERVICES, NAMELY, PROVIDING MANAGEMENT SUPPORT FOR BUSINESSES OF OTHERS; PERSONNEL MANAGEMENT CONSULTING (U.S. CLS. 100, 101 AND 102).

FIRST USE 11-0-2001; IN COMMERCE 11-0-2001.

CLASS 35—(Continued).

2,730,831. KOMAR, RAYMOND A, PORT CHARLOTTE, FL. SN 78-117,402. PUB. 10-22-2002, FILED 3-26-2002.

PSEA.COM

FOR CAREER PLACEMENT; EMPLOYMENT HIRING, RECRUITING, PLACEMENT, STAFFING AND CAREER NETWORKING SERVICES, AND RESUME PREPARATION FOR PUBLIC SAFETY PROFESSIONALS (U.S. CLS. 100, 101 AND 102).

FIRST USE 2-15-2002; IN COMMERCE 2-15-2002.

CLASS 36—INSURANCE AND FINANCIAL

2,729,369. ALVORD, JOEL B., BOSTON, MA. SN 75-289,160.
PUB. 11-9-1999, FILED 5-9-1997.

SHAWMUT EQUITY PARTNERS

NO CLAIM IS MADE TO THE EXCLUSIVE RIGHT TO USE "EQUITY PARTNERS", APART FROM THE MARK AS SHOWN.

FOR OPERATION AND MANAGEMENT OF PRIVATE EQUITY AND VENTURE CAPITAL FUNDS; PRIVATE EQUITY AND VENTURE CAPITAL INVESTMENT SERVICES (U.S. CLS. 100, 101 AND 102).

FIRST USE 4-0-1997; IN COMMERCE 4-0-1997.

2,729,416. CARDREADY INTERNATIONAL, INC., CULVER CITY, CA. SN 75-569,543. PUB. 10-26-1999, FILED 10-12-1998.

CREDITREADY

FOR GLOBAL COMPUTER NETWORK CREDIT AND DEBIT CARD TRANSACTION PROCESSING SERVICES (U.S. CLS. 100, 101 AND 102).

FIRST USE 1-21-2003; IN COMMERCE 1-21-2003.

2,729,434. COMPASS BANCSHARES, INC., BIRMINGHAM, AL. SN 75-634,561. PUB. 12-7-1999, FILED 2-4-1999.

BUSINESSWORKS

FOR FINANCIAL SERVICES, NAMELY, ADVISING CLIENTS ON THE SELECTION OF BANKING SERVICES; AND, BANKING SERVICES (U.S. CLS. 100, 101 AND 102).

FIRST USE 2-27-2003; IN COMMERCE 2-27-2003.

CLASS 36—(Continued).

2,729,463. SIRIOS CAPITAL MANAGEMENT, L.P., BOSTON, MA. SN 75-701,958. PUB. 10-24-2000, FILED 5-10-1999.

SIRIOS

FOR FINANCIAL SERVICES; NAMELY, INVESTMENT ADVISORY SERVICES; INVESTMENT MANAGEMENT SERVICES; AND ASSET MANAGEMENT SERVICES, ALL IN THE NATURE OF MANAGING AND INVESTING THE FUNDS OF OTHERS IN PRIVATE EQUITY AND HIGH NET WORTH INVESTMENT VEHICLES, HEDGE FUNDS, STOCKS AND MUTUAL FUNDS (U.S. CLS. 100, 101 AND 102).

FIRST USE 6-0-1999; IN COMMERCE 6-0-1999.

2,729,472. CITIZENS FINANCIAL GROUP, INC., PROVIDENCE, RI. SN 75-718,936. PUB. 5-30-2000, FILED 6-3-1999.

CITIZENS TRADE

NO CLAIM IS MADE TO THE EXCLUSIVE RIGHT TO USE "TRADE", APART FROM THE MARK AS SHOWN.

FOR BANKING (U.S. CLS. 100, 101 AND 102).
FIRST USE 4-2-2002; IN COMMERCE 4-2-2002.

2,729,482. TRANSAMERICA REAL ESTATE TAX SERVICE, INC., DALLAS, TX, BY ASSIGNMENT TRANSAMERICA CORPORATION, SAN FRANCISCO, CA. SN 75-736,654. PUB. 12-19-2000, FILED 6-24-1999.

POWERLINES

FOR PROVIDING AN ON-LINE DATABASE FEATURING INFORMATION IN THE FIELD OF REAL ESTATE (U.S. CLS. 100, 101 AND 102).

FIRST USE 1-0-2000; IN COMMERCE 1-0-2000.

2,729,519. MILLS LIMITED PARTNERSHIP, THE, ARLINGTON, VA, BY ASSIGNMENT OPRY MILLS LIMITED PARTNERSHIP, ARLINGTON, VA. SN 75-803,053. PUB. 11-27-2001, FILED 9-17-1999.



FOR SHOPPING CENTER SERVICES AND LEASING OF SHOPPING MALL SPACE (U.S. CLS. 100, 101 AND 102).

FIRST USE 5-11-2000; IN COMMERCE 5-11-2000.

CLASS 36—(Continued).

2,729,564. BUFFTREE BUILDING COMPANY, INC., NEW BEDFORD, MA. SN 75-869,051. PUB. 8-1-2000, FILED 12-10-1999.

THE BUFFTREE FOUNDATION

NO CLAIM IS MADE TO THE EXCLUSIVE RIGHT TO USE "FOUNDATION", APART FROM THE MARK AS SHOWN.

FOR CHARITABLE FUND RAISING SERVICES (U.S. CLS. 100, 101 AND 102).

FIRST USE 2-9-2002; IN COMMERCE 2-9-2002.

2,729,569. ARAG INSURANCE COMPANY, DES MOINES, IA. SN 75-875,272. PUB. 6-5-2001, FILED 12-29-1999.

LIFECYCLES

FOR ADMINISTERING PRE-PAID LEGAL INSURANCE PROGRAMS AND INSURANCE BROKERAGE SERVICES (U.S. CLS. 100, 101 AND 102).

FIRST USE 6-22-2001; IN COMMERCE 6-22-2001.

2,729,579. RFV HOLDINGS LTD., TORTOLA, BR. VIRGIN ISLANDS. SN 75-886,840. PUB. 5-8-2001, FILED 1-4-2000.



FOR FINANCIAL SERVICES, NAMELY, CURRENCY TRADING FOR OTHERS, ELECTRONIC COMMODITY TRADING FOR OTHERS, SECURITIES TRADING SERVICES VIA THE GLOBAL COMPUTER INFORMATION NETWORK, FINANCIAL INFORMATION IN THE NATURE OF RATES OF EXCHANGE OF CURRENCY (U.S. CLS. 100, 101 AND 102).

FIRST USE 3-0-2000; IN COMMERCE 3-0-2000.

CLASS 36—(Continued).

2,729,609. GENERAL RE CORPORATION, STAMFORD, CT. SN 75-917,145. PUB. 7-16-2002, FILED 2-11-2000.

DoubleCAT

FOR REINSURANCE UNDERWRITING SERVICES FEATURING CATASTROPHE LOSS COVERAGE COUPLED WITH ALL-LINES AGGREGATE EXCESS LOSS COVERAGE (U.S. CLS. 100, 101 AND 102). FIRST USE 12-18-2001; IN COMMERCE 12-18-2001.

2,729,614. EQUITY TITLE & CLOSING SERVICES, INC., EAST PROVIDENCE, RI. SN 75-922,982. PUB. 6-12-2001, FILED 2-22-2000.

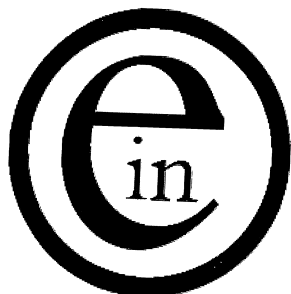

FOR RESIDENTIAL REAL ESTATE TRANSACTION SERVICES, NAMELY, MORTGAGE BROKERAGE AND TITLE APPRAISAL SERVICES (U.S. CLS. 100, 101 AND 102). FIRST USE 1-1-2003; IN COMMERCE 1-1-2003.

2,729,667. PLMCO ADVISORS LP, STAMFORD, CT. SN 76-009,596. PUB. 10-30-2001, FILED 3-27-2000.

FISH

FOR FINANCIAL INVESTMENT SERVICES IN THE FIELD OF MUTUAL FUNDS (U.S. CLS. 100, 101 AND 102). FIRST USE 6-0-2000; IN COMMERCE 6-0-2000.

2,729,684. SPENGMANN, BRIAN F., ST. LOUIS, MO. SN 76-025,686. PUB. 6-18-2002, FILED 4-14-2000.

CREWE CAPITAL MANAGEMENT

CLASS 36—(Continued).

NO CLAIM IS MADE TO THE EXCLUSIVE RIGHT TO USE "CAPITAL MANAGEMENT", APART FROM THE MARK AS SHOWN.

FOR FINANCIAL MANAGEMENT, FINANCIAL ANALYSIS AND CONSULTATION AND FINANCIAL INVESTMENT IN THE FIELD OF SECURITIES (U.S. CLS. 100, 101 AND 102).

FIRST USE 1-5-2003; IN COMMERCE 1-5-2003.

2,729,708. RETIREMENT SYSTEM GROUP INC., NEW YORK, NY. SN 76-050,041. PUB. 5-14-2002, FILED 5-17-2000.

RETIREMENT EQUITY ACCUMULATION PLAN (REAP)

NO CLAIM IS MADE TO THE EXCLUSIVE RIGHT TO USE "RETIREMENT EQUITY ACCUMULATION PLAN", APART FROM THE MARK AS SHOWN.

FOR PENSION BENEFIT PLAN CONSULTATION SERVICES (U.S. CLS. 100, 101 AND 102).

FIRST USE 7-17-2000; IN COMMERCE 7-17-2000.

2,729,728. FALLBROOK NATIONAL BANK, FALLBROOK, CA. SN 76-071,725. PUB. 7-23-2002, FILED 6-16-2000.

COMMUNITY NATIONAL BANK



NO CLAIM IS MADE TO THE EXCLUSIVE RIGHT TO USE "NATIONAL BANK", APART FROM THE MARK AS SHOWN.

FOR BANKING SERVICES (U.S. CLS. 100, 101 AND 102).

FIRST USE 10-1-2000; IN COMMERCE 10-1-2000.

2,729,755. MT. MCKINLEY MANAGERS, L.L.C., LIBERTY CORNER, NJ. SN 76-087,785. PUB. 3-26-2002, FILED 7-10-2000.

MT. MCKINLEY

FOR INSURANCE ADMINISTRATION, AGENCY SERVICES, BROKERAGE AND UNDERWRITING IN THE FIELDS OF PROPERTY INSURANCE, CASUALTY INSURANCE, SURETY INSURANCE, HEALTH INSURANCE AND MARINE INSURANCE (U.S. CLS. 100, 101 AND 102).

FIRST USE 3-29-2000; IN COMMERCE 3-29-2000.

CLASS 36—(Continued).

2,729,774. FINSAGE INC., ROUND ROCK, TX, BY CHANGE OF NAME FINSAGE.COM INC., ROUND ROCK, TX. SN 76-101,455. PUB. 9-4-2001, FILED 8-1-2000.

FINSAGE

FOR PROVIDING FINANCIAL SERVICES IN THE NATURE OF INVESTMENT MANAGEMENT AND FINANCIAL ANALYSIS AND CONSULTATION ON THE WORLD WIDE WEB (U.S. CLS. 100, 101 AND 102).
FIRST USE 8-0-2002; IN COMMERCE 8-0-2002.

2,729,775. FINSAGE INC., ROUND ROCK, TX, BY CHANGE OF NAME FINSAGE.COM INC., ROUND ROCK, TX. SN 76-101,457. PUB. 9-4-2001, FILED 8-1-2000.

FINSAGE.COM

FOR PROVIDING FINANCIAL SERVICES IN THE NATURE OF INVESTMENT MANAGEMENT AND FINANCIAL ANALYSIS AND CONSULTATION ON THE WORLD WIDE WEB (U.S. CLS. 100, 101 AND 102).
FIRST USE 8-0-2002; IN COMMERCE 8-0-2002.

2,729,776. FINSAGE INC., ROUND ROCK, TX, BY CHANGE OF NAME FINSAGE.COM INC., ROUND ROCK, TX. SN 76-101,458. PUB. 3-19-2002, FILED 8-1-2000.

**WHERE KNOWLEDGE IS
YOUR ROI - RETURN ON
INFORMATION**

FOR PROVIDING FINANCIAL SERVICES IN THE NATURE OF INVESTMENT MANAGEMENT, AND FINANCIAL ANALYSIS AND CONSULTATION ON THE WORLD WIDE WEB (U.S. CLS. 100, 101 AND 102).
FIRST USE 8-0-2002; IN COMMERCE 8-0-2002.

2,729,780. GOLDENTREE ASSET MANAGEMENT LP, NEW YORK, NY. SN 76-103,048. PUB. 5-15-2001, FILED 8-3-2000.

GTAM

FOR FINANCIAL SERVICES, NAMELY, INVESTMENT ADVISORY SERVICES, INVESTMENT MANAGEMENT SERVICES AND ASSET MANAGEMENT SERVICES (U.S. CLS. 100, 101 AND 102).
FIRST USE 3-0-2000; IN COMMERCE 3-0-2000.

CLASS 36—(Continued).

2,729,829. SECURITY STATE SAVINGS BANK, LAS VEGAS, NV. SN 76-139,405. PUB. 6-18-2002, FILED 10-2-2000.



NO CLAIM IS MADE TO THE EXCLUSIVE RIGHT TO USE "STATE SAVINGS BANK", APART FROM THE MARK AS SHOWN.

FOR BANKING SERVICES; INVESTMENT ADVICE AND INVESTMENT CONSULTATION SERVICES; MONEY MARKET ACCOUNT SERVICES (U.S. CLS. 100, 101 AND 102).
FIRST USE 12-10-2000; IN COMMERCE 12-20-2000.

2,729,864. JACKSON NATIONAL LIFE INSURANCE COMPANY, LANSING, MI. SN 76-158,816. PUB. 10-16-2001, FILED 11-3-2000.

JFB

FOR BANKING SERVICES (U.S. CLS. 100, 101 AND 102).
FIRST USE 5-5-1999; IN COMMERCE 5-5-1999.

2,729,888. CIRCUIT CITY STORES WEST COAST, INC., WALNUT, CA. SN 76-171,240. PUB. 6-25-2002, FILED 11-27-2000.

FNANB ONLINE

OWNER OF U.S. REG. NOS. 1,986,528, 2,007,398, AND 2,192,263.

NO CLAIM IS MADE TO THE EXCLUSIVE RIGHT TO USE "ONLINE", APART FROM THE MARK AS SHOWN.

FOR BANKING SERVICES FOR BANK CUSTOMERS OFFERED VIA A GLOBAL COMPUTER NETWORK (U.S. CLS. 100, 101 AND 102).

FIRST USE 2-1-2001; IN COMMERCE 2-1-2001.

2,729,914. COLUMBUS CIRCLE INVESTORS, STAMFORD, CT. SN 76-187,808. PUB. 7-2-2002, FILED 12-28-2000.

CCI CAPITAL PARTNERS

NO CLAIM IS MADE TO THE EXCLUSIVE RIGHT TO USE "CAPITAL PARTNERS", APART FROM THE MARK AS SHOWN.

FOR FINANCIAL SERVICES, NAMELY, INVESTMENT MANAGEMENT SERVICES, INVESTMENT ADVISORY AND CONSULTATION SERVICES, ASSET MANAGEMENT SERVICES, AND FUND MANAGEMENT SERVICES (U.S. CLS. 100, 101 AND 102).

FIRST USE 11-0-2000; IN COMMERCE 11-0-2000.

CLASS 36—(Continued).

2,729,915. COLUMBUS CIRCLE INVESTORS, STAMFORD, CT. SN 76-187,850. PUB. 7-2-2002, FILED 12-28-2000.

CCI INTERNATIONAL PARTNERS

NO CLAIM IS MADE TO THE EXCLUSIVE RIGHT TO USE "INTERNATIONAL PARTNERS", APART FROM THE MARK AS SHOWN.

FOR FINANCIAL SERVICES, NAMELY, INVESTMENT MANAGEMENT SERVICES, INVESTMENT ADVISORY AND CONSULTATION SERVICES, ASSET MANAGEMENT SERVICES, AND FUND MANAGEMENT SERVICES (U.S. CLS. 100, 101 AND 102).
FIRST USE 11-0-2000; IN COMMERCE 11-0-2000.



2,729,917. COLUMBUS CIRCLE INVESTORS, STAMFORD, CT. SN 76-188,038. PUB. 7-2-2002, FILED 12-28-2000.

CCI HEALTHCARE PARTNERS

NO CLAIM IS MADE TO THE EXCLUSIVE RIGHT TO USE "HEALTHCARE PARTNERS", APART FROM THE MARK AS SHOWN.

FOR FINANCIAL SERVICES, NAMELY, INVESTMENT MANAGEMENT SERVICES, INVESTMENT ADVISORY AND CONSULTATION SERVICES, ASSET MANAGEMENT SERVICES, AND FUND MANAGEMENT SERVICES (U.S. CLS. 100, 101 AND 102).
FIRST USE 11-0-2000; IN COMMERCE 11-0-2000.



2,729,925. SPECIALTY FINANCIAL, RENO, NV. SN 76-191,624. PUB. 6-11-2002, FILED 1-8-2001.

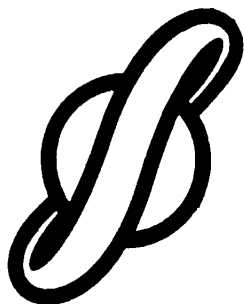

THE MARK CONSISTS OF A CIRCLE WITH A RING AROUND IT.
FOR FINANCIAL SERVICES, NAMELY, REAL ESTATE LOANS (U.S. CLS. 100, 101 AND 102).
FIRST USE 1-31-2001; IN COMMERCE 1-31-2001.

CLASS 36—(Continued).

2,729,975. RESERVE MANAGEMENT CORPORATION, NEW YORK, NY. SN 76-214,877. PUB. 9-10-2002, FILED 2-22-2001.

RESERVE ECHECKING

NO CLAIM IS MADE TO THE EXCLUSIVE RIGHT TO USE "ECHECKING", APART FROM THE MARK AS SHOWN.

FOR FINANCIAL SERVICES, NAMELY ONLINE CHECKING ACCOUNT FOR CUSTOMERS WHO MAINTAIN MONEY FUND ACCOUNT OR INSURED DEPOSIT ACCOUNT (U.S. CLS. 100, 101 AND 102).
FIRST USE 7-27-2001; IN COMMERCE 7-27-2001.



2,729,988. NATIONAL BROADCASTING COMPANY, INC., NEW YORK, NY. SN 76-219,271. PUB. 6-4-2002, FILED 3-2-2001.

SHOPNBC.COM

OWNER OF U.S. REG. NOS. 510,630, 1,057,966, AND OTHERS.

FOR CREDIT CARD SERVICES (U.S. CLS. 100, 101 AND 102).
FIRST USE 10-15-2001; IN COMMERCE 10-15-2001.



2,729,990. NATIONAL BROADCASTING COMPANY, INC., NEW YORK, NY. SN 76-219,274. PUB. 6-11-2002, FILED 3-2-2001.

SHOPNBC

OWNER OF U.S. REG. NOS. 510,630, 1,057,966, AND OTHERS.

FOR CREDIT CARD SERVICES (U.S. CLS. 100, 101 AND 102).
FIRST USE 10-15-2001; IN COMMERCE 10-15-2001.



2,730,004. HARRIS TRUST AND SAVINGS BANK, CHICAGO, IL. SN 76-223,297. PUB. 6-18-2002, FILED 3-12-2001.

HARRIS BANKING CARD

OWNER OF U.S. REG. NOS. 1,008,229, 2,473,688, AND OTHERS.

NO CLAIM IS MADE TO THE EXCLUSIVE RIGHT TO USE "BANKING CARD", APART FROM THE MARK AS SHOWN.

SEC. 2(F).
FOR BANKING SERVICES, PARTICULARLY BANKING CARD SERVICES ALLOWING POINT-OF-PURCHASE DEBITS DIRECTLY FROM A DEMAND DEPOSIT ACCOUNT (U.S. CLS. 100, 101 AND 102).
FIRST USE 11-30-1997; IN COMMERCE 11-30-1997.

CLASS 36—(Continued).

2,730,023. NORTHEAST EQUITY MANAGEMENT, LLC, PORT WASHINGTON, NY. SN 76-234,368. PUB. 1-15-2002, FILED 4-2-2001.



NO CLAIM IS MADE TO THE EXCLUSIVE RIGHT TO USE "EQUITY MANAGEMENT", APART FROM THE MARK AS SHOWN.

FOR LEASING OF REAL PROPERTY (U.S. CLS. 100, 101 AND 102).

FIRST USE 2-0-2001; IN COMMERCE 2-0-2001.

2,730,031. KEYCORP, CLEVELAND, OH. SN 76-237,275. PUB. 6-18-2002, FILED 4-4-2001.

SECOLINK SETTLEMENT SERVICES

NO CLAIM IS MADE TO THE EXCLUSIVE RIGHT TO USE "SETTLEMENT SERVICES", APART FROM THE MARK AS SHOWN.

FOR FINANCIAL SERVICES, NAMELY, CONSUMER AND COMMERCIAL PROPERTY APPRAISAL AND TITLE INSURANCE SERVICES, EVALUATION OF FLOOD CONDITIONS FOR INSURANCE PURPOSES AND LOAN CLOSING SERVICES (U.S. CLS. 100, 101 AND 102).

FIRST USE 1-6-2003; IN COMMERCE 1-6-2003.

2,730,039. ENERBANK USA, SALT LAKE CITY, UT, BY ASSIGNMENT CMS CAPITAL CORP., DEARBORN, MI. SN 76-240,767. PUB. 3-19-2002, FILED 4-16-2001.

EnerBank

FOR BANKING SERVICES, NAMELY CONSUMER LENDING SERVICES COMPOSED OF CLOSED-END, UNSECURED TERM FINANCING FOR ENERGY-RELATED HOME IMPROVEMENTS MARKETED THROUGH VARIOUS LOAN PROGRAM SPONSORS, INCLUDING UTILITIES, MANUFACTURERS, DISTRIBUTORS AND RETAILERS OF ENERGY-RELATED HOME PRODUCTS AND SERVICES (U.S. CLS. 100, 101 AND 102).

FIRST USE 6-1-2002; IN COMMERCE 6-1-2002.

CLASS 36—(Continued).

2,730,075. NASDAQ STOCK MARKET, INC., THE, WASHINGTON, DC. SN 76-254,852. PUB. 4-2-2002, FILED 5-9-2001.

NASDAQ POSTDATA

OWNER OF U.S. REG. NOS. 922,973, 1,259,277, AND OTHERS.

NO CLAIM IS MADE TO THE EXCLUSIVE RIGHT TO USE "POSTDATA", APART FROM THE MARK AS SHOWN. FOR COMPUTER SERVICES, NAMELY PROVIDING INFORMATION IN THE FIELD OF SECURITIES TRADING AND SECURITIES MARKETS VIA A GLOBAL COMPUTER NETWORK AND SECURE COMPUTER NETWORKS (U.S. CLS. 100, 101 AND 102).

FIRST USE 3-0-2002; IN COMMERCE 3-0-2002.

2,730,087. REAL PROPERTY SOLUTIONS GROUP, JACKSONVILLE, FL, BY CHANGE OF NAME INTERIOR STRATEGIES, INC., DBA REAL PROPERTY SOLUTIONS, JACKSONVILLE, FL. SN 76-259,778. PUB. 7-2-2002, FILED 5-21-2001.

MAKING PLACE AND SPACE WORK PROFITABLY FOR BUSINESS

FOR REAL ESTATE CONSULTING SERVICES (U.S. CLS. 100, 101 AND 102).

FIRST USE 9-1-2001; IN COMMERCE 9-1-2001.

2,730,098. MURPHY, GERALD B., INDIANOLA, IA. SN 76-261,891. PUB. 6-25-2002, FILED 5-24-2001.

UNITED AG RESOURCES

NO CLAIM IS MADE TO THE EXCLUSIVE RIGHT TO USE AG RESOURCES, APART FROM THE MARK AS SHOWN.

FOR CONSULTATION SERVICES TO FARMERS AND AGRICULTURAL LENDING INSTITUTIONS IN THE FIELD OF AGRICULTURAL LENDING AND CROP INSURANCE, NAMELY IN THE DEVELOPMENT OF PLANS THAT ENHANCE THE CHANCES OF LOAN REPAYMENT THROUGH A SYSTEMATIC FARM COMMODITY SALES PLAN SUPPORTED BY AN APPROPRIATE LEVEL OF CROP INSURANCE (U.S. CLS. 100, 101 AND 102).

FIRST USE 6-0-2002; IN COMMERCE 6-0-2002.

CLASS 36—(Continued).

2,730,099. MURPHY, GERALD B., INDIANOLA, IA. SN 76-261,892. PUB. 6-18-2002, FILED 5-24-2001.

RESOURCES THAT YIELD SUCCESS

FOR CONSULTATION SERVICES TO FARMERS AND AGRICULTURAL LENDING INSTITUTIONS IN THE FIELD OF AGRICULTURAL LENDING AND CROP INSURANCE (U.S. CLS. 100, 101 AND 102).
FIRST USE 6-0-2002; IN COMMERCE 6-0-2002.

2,730,102. MORGAN STANLEY, NEW YORK, NY. SN 76-263,113. PUB. 9-17-2002, FILED 5-25-2001.

SPARQS

FOR FINANCIAL SERVICES IN THE NATURE OF AN INVESTMENT SECURITY (U.S. CLS. 100, 101 AND 102).
FIRST USE 6-11-2002; IN COMMERCE 6-11-2002.

2,730,106. SEARS, ROEBUCK AND CO., HOFFMAN ESTATES, IL. SN 76-265,439. PUB. 1-15-2002, FILED 6-1-2001.

SEARS PARTNERSHIP ADVANTAGE

OWNER OF U.S. REG. NOS. 2,090,665, 2,323,952, AND OTHERS.
FOR CREDIT CARD SERVICES (U.S. CLS. 100, 101 AND 102).
FIRST USE 1-1-2001; IN COMMERCE 1-1-2001.

2,730,145. SPECTRUM FINANCIAL SOLUTIONS, LLC., RED BANK, NY. SN 76-276,354. PUB. 7-2-2002, FILED 6-25-2001.

FLUTE

FOR FINANCIAL SERVICES IN THE FIELD OF CHARITABLE GIFT PLANNING, NAMELY, CREATING UNITRUSTS USING LIFE INSURANCE AND MUNICIPAL BONDS (U.S. CLS. 100, 101 AND 102).
FIRST USE 12-28-2001; IN COMMERCE 12-28-2001.

2,730,152. UBS PAINWEBBER INC., WEHAWKEN, NJ. SN 76-277,999. PUB. 6-25-2002, FILED 6-28-2001.

CEFS

FOR FINANCIAL INFORMATION CONCERNING STOCK BENEFIT PLANS, STOCKS, STOCK OPTIONS; STOCK BROKERAGE SERVICES; AND ADMINISTRATION OF STOCK PLANS (U.S. CLS. 100, 101 AND 102).
FIRST USE 1-1-2001; IN COMMERCE 1-1-2001.

CLASS 36—(Continued).

2,730,155. SUPPORTKIDS, INC., AUSTIN, TX. SN 76-279,440. PUB. 6-25-2002, FILED 7-2-2001.

supportkids
THE CHILD SUPPORT EXPERTS

OWNER OF U.S. REG. NOS. 2,038,750, 4,496,194, AND OTHERS.

NO CLAIM IS MADE TO THE EXCLUSIVE RIGHT TO USE "THE CHILD SUPPORT EXPERTS", APART FROM THE MARK AS SHOWN.

FOR CHILD SUPPORT RECOVERY AND COLLECTION SERVICES TO ASSIST CUSTODIAL PARENTS IN RECOVERING CHILD SUPPORT (U.S. CLS. 100, 101 AND 102).

FIRST USE 7-2-2001; IN COMMERCE 7-2-2001.

2,730,177. STEIN ROE INVESTMENT COUNSEL LLC, CHICAGO, IL. SN 76-286,947. PUB. 12-18-2001, FILED 7-18-2001.

MANAGING COMPLEXITY

FOR INVESTMENT COUNSELING; INVESTMENT MANAGEMENT; INVESTMENT ADVISORY SERVICES; FINANCIAL PLANNING (U.S. CLS. 100, 101 AND 102).
FIRST USE 6-2-2002; IN COMMERCE 6-2-2002.

2,730,258. COLONIAL LIFE & ACCIDENTAL INSURANCE COMPANY, COLUMBIA, SC. SN 76-309,199. PUB. 7-2-2002, FILED 9-5-2001.

COLONIAL SUPPLEMENTAL INSURANCE

NO CLAIM IS MADE TO THE EXCLUSIVE RIGHT TO USE "SUPPLEMENTAL INSURANCE", APART FROM THE MARK AS SHOWN.

FOR INSURANCE UNDERWRITING IN THE FIELD OF LIFE AND ACCIDENT AND HEALTH (U.S. CLS. 100, 101 AND 102).

FIRST USE 1-29-2002, THE MARK WAS FIRST USED ANYWHERE IN A DIFFERENT FORM OTHER THAN THAT SOUGHT TO BE REGISTERED ON 09/00/1939; IN COMMERCE 1-29-2002, THE MARK WAS FIRST USED IN COMMERCE IN A DIFFERENT FORM OTHER THAN THAT SOUGHT TO BE REGISTERED ON 01/01/1945.

CLASS 36—(Continued).

2,730,286. TRITIUM TECHNOLOGY INC., UNIONDALE, NY. SN 76-319,487. PUB. 7-2-2002, FILED 9-29-2001.

FUSIONCOLLECTIONS

FOR CONSULTING SERVICES RELATING TO DEBT COLLECTION, DEBT CONSOLIDATION, DEBT MANAGEMENT, CREDIT RISK ASSESSMENT, FORECLOSURES AND FORFEITURES (U.S. CLS. 100, 101 AND 102).

FIRST USE 9-10-2002; IN COMMERCE 9-10-2002.

2,730,287. TRITIUM TECHNOLOGY INC., UNIONDALE, NY. SN 76-319,488. PUB. 7-9-2002, FILED 9-29-2001.

THE NEW SCIENCE OF COLLECTIONS

NO CLAIM IS MADE TO THE EXCLUSIVE RIGHT TO USE "COLLECTIONS", APART FROM THE MARK AS SHOWN.

FOR CONSULTING SERVICES RELATING TO DEBT COLLECTION, DEBT CONSOLIDATION, DEBT MANAGEMENT, CREDIT RISK ASSESSMENT, FORECLOSURES AND FORFEITURES (U.S. CLS. 100, 101 AND 102).

FIRST USE 9-10-2002; IN COMMERCE 9-10-2002.

2,730,288. TRITIUM TECHNOLOGY INC., UNIONDALE, NY. SN 76-319,490. PUB. 7-2-2002, FILED 9-29-2001.

INSTASKIP

FOR CONSULTING SERVICES RELATING TO DEBT COLLECTION, DEBT CONSOLIDATION, DEBT MANAGEMENT, CREDIT RISK ASSESSMENT, FORECLOSURES AND FORFEITURES (U.S. CLS. 100, 101 AND 102).

FIRST USE 9-10-2002; IN COMMERCE 9-10-2002.

2,730,289. TRITIUM TECHNOLOGY INC., UNIONDALE, NY. SN 76-319,492. PUB. 7-2-2002, FILED 9-29-2001.

FUSIONSTS

FOR CONSULTING SERVICES RELATING TO DEBT COLLECTION, DEBT CONSOLIDATION, DEBT MANAGEMENT, CREDIT RISK ASSESSMENT, FORECLOSURES AND FORFEITURES (U.S. CLS. 100, 101 AND 102).

FIRST USE 9-10-2002; IN COMMERCE 9-10-2002.

CLASS 36—(Continued).

2,730,316. JACKSON NATIONAL LIVE INSURANCE COMPANY, LANSING, MI. SN 76-325,981. PUB. 9-17-2002, FILED 10-16-2001.

INCOME ESCALATOR

NO CLAIM IS MADE TO THE EXCLUSIVE RIGHT TO USE "INCOME", APART FROM THE MARK AS SHOWN.

FOR FINANCIAL SERVICES, NAMELY, ANNUITY UNDERWRITING SERVICES (U.S. CLS. 100, 101 AND 102).

FIRST USE 9-1-2001; IN COMMERCE 9-1-2001.

2,730,317. JONES, DUNN & COMPANY, MACEDONIA, OH. SN 76-326,555. PUB. 6-25-2002, FILED 10-17-2001.

ADVANTIUM

FOR POST-AUDIT ACCOUNTING SERVICES (U.S. CLS. 100, 101 AND 102).

FIRST USE 11-13-2001; IN COMMERCE 11-13-2001.

2,730,323. HARTFORD FIRE INSURANCE COMPANY, HARTFORD, CT. SN 76-327,548. PUB. 9-3-2002, FILED 10-22-2001.

ALWAYS THINKING AHEAD

FOR INSURANCE UNDERWRITING FOR ALL TYPES OF INSURANCE, INSURANCE ADMINISTRATION SERVICES, INVESTMENT MANAGEMENT SERVICES, MUTUAL FUND MANAGEMENT SERVICES, FINANCIAL ADVISORY SERVICES (U.S. CLS. 100, 101 AND 102).

FIRST USE 6-1-2002; IN COMMERCE 6-1-2002.

2,730,325. PARAGON FEDERAL CREDIT UNION, WASHINGTON TOWNSHIP, NJ. SN 76-327,875. PUB. 8-6-2002, FILED 10-22-2001.



NO CLAIM IS MADE TO THE EXCLUSIVE RIGHT TO USE "FINANCIAL ACCESS SERVICE TELLER", APART FROM THE MARK AS SHOWN.

FOR CREDIT UNION SERVICES (U.S. CLS. 100, 101 AND 102).

FIRST USE 4-1-2002; IN COMMERCE 4-1-2002.

CLASS 36—(Continued).

2,730,334. COBRA COMPLIANCE SYSTEMS, INC., COLD-WATER, MI. SN 76-330,436. PUB. 6-18-2002, FILED 10-26-2001.

COBRA ENTERPRISE

NO CLAIM IS MADE TO THE EXCLUSIVE RIGHT TO USE "COBRA", APART FROM THE MARK AS SHOWN.
FOR MANAGEMENT SERVICES; NAMELY, ADMINISTRATION OF EMPLOYEE HEALTH CARE INSURANCE BENEFITS (U.S. CLS. 100, 101 AND 102).
FIRST USE 1-1-2001; IN COMMERCE 1-1-2001.



2,730,360. PAYOUT, LLC, WASHINGTON, DC. SN 76-337,694. PUB. 4-16-2002, FILED 11-15-2001.

PayOut

FOR TRANSFER OF ELECTRONIC FUNDS IN CREDIT AND DEBIT TRANSACTIONS (U.S. CLS. 100, 101 AND 102).
FIRST USE 12-1-2002; IN COMMERCE 12-1-2002.



2,730,363. STATE STREET RESEARCH & MANAGEMENT COMPANY, BOSTON, MA. SN 76-338,537. PUB. 5-28-2002, FILED 11-15-2001.

QUANDAMENTAL

FOR INVESTMENT MANAGEMENT SERVICES (U.S. CLS. 100, 101 AND 102).
FIRST USE 9-0-2001; IN COMMERCE 9-0-2001.



2,730,367. PLEXIENT, LLC, NEW YORK, NY. SN 76-338,690. PUB. 4-16-2002, FILED 11-14-2001.

PLEXIENT

FOR FINANCIAL SERVICES, NAMELY, VENTURE CAPITAL SERVICES; VENTURE FUND FORMATION, INVESTMENT AND MANAGEMENT (U.S. CLS. 100, 101 AND 102).
FIRST USE 6-15-2001; IN COMMERCE 6-15-2001.

CLASS 36—(Continued).

2,730,403. ILLINOIS MUTUAL LIFE INSURANCE CO., PEORIA, IL. SN 76-345,758. PUB. 8-6-2002, FILED 12-4-2001.

SELECT ADVANTAGE ANNUITY

NO CLAIM IS MADE TO THE EXCLUSIVE RIGHT TO USE "ANNUITY", APART FROM THE MARK AS SHOWN.
FOR LIFE INSURANCE UNDERWRITING SERVICES (U.S. CLS. 100, 101 AND 102).
FIRST USE 3-15-2001; IN COMMERCE 3-15-2001.

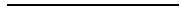

2,730,477. MOUNTAIN GREENERY, L.L.C., OKLAHOMA CITY, OK. SN 76-363,505. PUB. 6-11-2002, FILED 1-28-2002.

MOUNTAIN GREENERY

FOR LEASING AND MANAGEMENT OF COMMERCIAL REAL ESTATE (U.S. CLS. 100, 101 AND 102).
FIRST USE 12-1-2002; IN COMMERCE 12-1-2002.

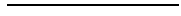

2,730,512. FOUNDATION ONE INSURANCE SERVICES, LTD., FRISCO, TX. SN 76-375,535. PUB. 9-24-2002, FILED 2-26-2002.

FOUNDATION ONE SECURE CHOICE

OWNER OF U.S. REG. NO. 2,394,221.
NO CLAIM IS MADE TO THE EXCLUSIVE RIGHT TO USE "FOUNDATION", APART FROM THE MARK AS SHOWN.
FOR ORGANIZING HEALTH INSURANCE PROGRAMS AND HEALTH BENEFIT PROGRAMS FOR OTHERS (U.S. CLS. 100, 101 AND 102).
FIRST USE 3-11-2002; IN COMMERCE 3-19-2002.



2,730,550. DIRTBANC, LLC, WEBSTER GROVES, MO. SN 78-006,063. PUB. 5-8-2001, FILED 4-28-2000.

DIRTBANC

FOR BROKERAGE SERVICES FOR DIRT, EARTH, AND/OR SOIL (U.S. CLS. 100, 101 AND 102).
FIRST USE 2-1-2001; IN COMMERCE 2-1-2001.

CLASS 36—(Continued).

2,730,579. GUARD FINANCIAL GROUP, INC., WILKES-BARRE, PA. SN 78-037,713. PUB. 9-10-2002, FILED 12-4-2000.

GUARD FINANCIAL GROUP

OWNER OF U.S. REG. NO. 1,641,207.

NO CLAIM IS MADE TO THE EXCLUSIVE RIGHT TO USE "FINANCIAL GROUP", APART FROM THE MARK AS SHOWN.

FOR BANKING SERVICES; INVESTMENT ADVICE AND FUNDS INVESTMENT SERVICES; FINANCIAL INVESTMENT IN THE FIELDS OF SECURITIES AND REAL ESTATE; FINANCIAL SERVICES, NAMELY, FINANCIAL MANAGEMENT AND PLANNING, FINANCIAL ANALYSIS AND CONSULTATION; INSURANCE SERVICES, NAMELY, INSURANCE UNDERWRITING IN THE FIELDS OF LIFE, HEALTH, REAL ESTATE, PERSONAL PROPERTY, ACCIDENT, FIRE, WORKER'S COMPENSATION AND TRAVEL; INSURANCE ADMINISTRATION; INSURANCE AGENCIES (U.S. CLS. 100, 101 AND 102).

FIRST USE 2-0-2001; IN COMMERCE 2-0-2001.

2,730,651. GENERAL MOTORS ACCEPTANCE CORPORATION, DETROIT, MI. SN 78-064,065. PUB. 7-2-2002, FILED 5-17-2001.

LENSCAPE

FOR MORTGAGE LENDING SERVICES (U.S. CLS. 100, 101 AND 102).

FIRST USE 3-1-2001; IN COMMERCE 3-1-2001.

2,730,665. CUNDY, INC., FORT LAUDERDALE, FL. SN 78-069,709. PUB. 5-28-2002, FILED 6-18-2001.

ΦUNDY QUOTE

OWNER OF U.S. REG. NO. 2,401,275.

NO CLAIM IS MADE TO THE EXCLUSIVE RIGHT TO USE "QUOTE", APART FROM THE MARK AS SHOWN.

FOR INSURANCE UNDERWRITING SERVICES, NAMELY PROVIDING RATE INFORMATION TO POTENTIAL CUSTOMERS WHO REQUEST RATE INFORMATION THROUGH AN INTERNET SITE FOR LIFE INSURANCE UNDERWRITING SERVICES, HEALTH INSURANCE UNDERWRITING SERVICES, DISABILITY INSURANCE UNDERWRITING SERVICES, AND ANNUITY UNDERWRITING SERVICES (U.S. CLS. 100, 101 AND 102).

FIRST USE 7-0-2001; IN COMMERCE 7-0-2001.

CLASS 36—(Continued).

2,730,684. CHICKASAW BANC HOLDING COMPANY, YUKON, OK. SN 78-075,709. PUB. 1-29-2002, FILED 7-25-2001.

BANK2 TWICE THE BANK

FOR BANKING SERVICES, NAMELY, INSTALLMENT, COMMERCIAL AND REAL ESTATE LOANS; MORTGAGE LOAN SERVICES; AUTOMATIC TELLER MACHINE SERVICES; DEBIT CARD SERVICES; CREDIT CARD SERVICES; ELECTRONIC FUND TRANSFERS, PROVIDING BANKING SERVICES VIA INTERACTIVE BANKING INTERNET SITE; TRUST SERVICES, NAMELY PERSONAL AND CORPORATE INVESTMENT AND ASSET MANAGEMENT SERVICES; INSURANCE SERVICES, NAMELY COMMERCIAL AND CONSUMER UNDERWRITING SERVICES IN PROPERTY AND CASUALTY, LIFE INSURANCE, HEALTH INSURANCE AND ANNUITIES; CASH MANAGEMENT SERVICES; AND BROKERAGE SERVICES, NAMELY INVESTMENT BROKERAGE, INSURANCE BROKERAGE, AND MORTGAGE BROKERAGE SERVICES (U.S. CLS. 100, 101 AND 102).

FIRST USE 12-6-2001; IN COMMERCE 12-6-2001.

2,730,692. AT&T CORP., NEW YORK, NY. SN 78-076,914. PUB. 1-8-2002, FILED 8-1-2001.

AT&T PREPAID WEB CENTS

OWNER OF U.S. REG. NOS. 1,293,305, 1,298,084, AND OTHERS.

NO CLAIM IS MADE TO THE EXCLUSIVE RIGHT TO USE "PREPAID WEB", APART FROM THE MARK AS SHOWN.

FOR PREPAID TELECOMMUNICATIONS CALLING CARD AND DEBIT CARD SERVICES (U.S. CLS. 100, 101 AND 102).

FIRST USE 4-1-2003; IN COMMERCE 4-1-2003.

2,730,699. JSC FEDERAL CREDIT UNION, HOUSTON, TX. SN 78-079,560. PUB. 11-5-2002, FILED 8-16-2001.

JSC
Federal Credit Union

NO CLAIM IS MADE TO THE EXCLUSIVE RIGHT TO USE "FEDERAL CREDIT UNION", APART FROM THE MARK AS SHOWN.

FOR CREDIT UNIONS SERVICES (U.S. CLS. 100, 101 AND 102).

FIRST USE 8-1-2001; IN COMMERCE 8-1-2001.

CLASS 36—(Continued).

2,730,727. MORSE, GREG, ARLINGTON, TX. SN 78-086,859.
PUB. 9-17-2002, FILED 10-4-2001.

WORTHINGTON NATIONAL BANK

NO CLAIM IS MADE TO THE EXCLUSIVE RIGHT TO USE "NATIONAL BANK", APART FROM THE MARK AS SHOWN.

FOR BANKING SERVICES (U.S. CLS. 100, 101 AND 102).

FIRST USE 11-21-2002; IN COMMERCE 11-21-2002.

2,730,747. AETNA INC., BLUE BELL, PA. SN 78-092,884. PUB.
7-2-2002, FILED 11-13-2001.

AETNA PRIMARY CARE

OWNER OF U.S. REG. NOS. 822,577, 2,167,068, AND OTHERS.

NO CLAIM IS MADE TO THE EXCLUSIVE RIGHT TO USE "PRIMARY CARE", APART FROM THE MARK AS SHOWN.

FOR UNDERWRITING AND ADMINISTERING HEALTH CARE BENEFIT PLANS (U.S. CLS. 100, 101 AND 102).

FIRST USE 6-30-2002; IN COMMERCE 6-30-2002.

2,730,791. NORTH SHORE BANK, FSB, BROOKFIELD, WI.
SN 78-102,458. PUB. 10-22-2002, FILED 1-14-2002.

NORTH OF EXPECTED

FOR BANKING SERVICES (U.S. CLS. 100, 101 AND 102).

FIRST USE 1-22-2002; IN COMMERCE 1-22-2002.

2,730,809. CAPITAL ONE FINANCIAL CORPORATION,
GLEN ALLEN, VA. SN 78-106,970. PUB. 7-23-2002, FILED
2-5-2002.

RAINY DAY

FOR FINANCIAL SERVICES, NAMELY PROVIDING LOANS, DEBT SUSPENSION AND DEBT CANCELLATION SERVICES, AND PERMANENT OR TEMPORARY CREDIT LIMIT INCREASES TO INDIVIDUALS WITH UNEXPECTED FLUCTUATIONS IN INCOME (U.S. CLS. 100, 101 AND 102).

FIRST USE 2-3-2003; IN COMMERCE 2-3-2003.

CLASS 37—CONSTRUCTION AND REPAIR

CLASS 37—(Continued).

2,729,473. 24/7 EASY CLEAN, INC., ASHEBORO, NC. SN 75-
723,436. PUB. 10-2-2001, FILED 6-7-1999.

EASY CLEAN

NO CLAIM IS MADE TO THE EXCLUSIVE RIGHT TO USE "CLEAN", APART FROM THE MARK AS SHOWN.

FOR COIN-OPERATED, SELF-SERVICE CLOTH LAUNDRY SERVICES (U.S. CLS. 100, 103 AND 106).

FIRST USE 8-14-2000; IN COMMERCE 8-14-2000.

2,729,636. INTERNATIONAL TRUCK INTELLECTUAL
PROPERTY COMPANY, LLC, WARRENVILLE, IL. SN
75-960,836. PUB. 8-20-2002, FILED 3-17-2000.

ISIS

FOR PROVIDING INFORMATION RELATING TO VEHICLE AND ENGINE REPAIR AND MAINTENANCE THROUGH A GLOBAL COMMUNICATIONS NETWORK (U.S. CLS. 100, 103 AND 106).

FIRST USE 1-31-1999; IN COMMERCE 1-31-1999.

2,729,695. RENDEZVOUS COLORADO, LLC, DENVER, CO,
BY CHANGE OF NAME MARYVALE VILLAGE LLC,
DENVER, CO. SN 76-037,915. PUB. 12-10-2002, FILED 4-28-
2000.

RENDEZVOUS

FOR REAL ESTATE DEVELOPMENT; LAND DEVELOPMENT SERVICES, NAMELY, PLANNING AND LAYING OUT OF RESIDENTIAL AND/OR COMMERCIAL COMMUNITIES; LEASING OF REAL PROPERTY; RESIDENTIAL AND COMMERCIAL BUILDING CONSTRUCTION (U.S. CLS. 100, 103 AND 106).

FIRST USE 10-18-2000; IN COMMERCE 10-18-2000.

2,729,702. MADIKATE, INC., DBA EASTERN ARIZONA
GLASS AND E.A GLASS, THATCHER, AZ. SN 76-044,768.
PUB. 11-27-2001, FILED 5-9-2000.

E.A. GLASS

NO CLAIM IS MADE TO THE EXCLUSIVE RIGHT TO USE "GLASS", APART FROM THE MARK AS SHOWN.

FOR VEHICLE GLASS REPAIR AND REPLACEMENT; RESIDENTIAL GLASS REPLACEMENT; AND COMMERCIAL GLASS REPLACEMENT (U.S. CLS. 100, 103 AND 106).

FIRST USE 7-0-2001; IN COMMERCE 7-0-2001.

CLASS 37—(Continued).

2,729,724. AIRE SERV HEATING & AIR CONDITIONING, INC., WACO, TX. SN 76-069,677. PUB. 3-26-2002, FILED 6-13-2000.

WE TREAT YOUR HOME LIKE IT'S OUR OWN

FOR INSTALLATION, MAINTENANCE AND REPAIR OF HEATING AND AIR CONDITIONING EQUIPMENT (U.S. CLS. 100, 103 AND 106).
FIRST USE 4-0-2000; IN COMMERCE 4-0-2000.

2,729,996. EVERDRY MARKETING & MANAGEMENT, INC., MACEDONIA, OH. SN 76-219,864. PUB. 10-9-2001, FILED 3-5-2001.

EVERFLOOR

FOR CONCRETE FLOOR RESURFACING SERVICES (U.S. CLS. 100, 103 AND 106).
FIRST USE 12-10-2002; IN COMMERCE 12-10-2002.

2,730,270. XACTWARE, INC., OREM, UT. SN 76-314,275. PUB. 2-26-2002, FILED 9-19-2001.

HOMESITEPRO

FOR PROVIDING ONLINE COMPUTER DATABASE IN THE FIELD OF BUILDING PLANS, BUILDING CONTENTS, BUILDING OWNER INFORMATION, MODELS, WARRANTIES AND POLICIES (U.S. CLS. 100, 103 AND 106).
FIRST USE 3-0-2002; IN COMMERCE 3-0-2002.

2,730,411. CASCADE ENGINEERING, INC., GRAND RAPIDS, MI. SN 76-347,391. PUB. 7-30-2002, FILED 12-11-2001.

INVISIBLE WASTE SERVICES

NO CLAIM IS MADE TO THE EXCLUSIVE RIGHT TO USE "WASTE SERVICES", APART FROM THE MARK AS SHOWN.
FOR TRASH COLLECTION SERVICES (U.S. CLS. 100, 103 AND 106).
FIRST USE 10-31-2001; IN COMMERCE 10-31-2001.

CLASS 37—(Continued).

2,730,421. VENVEST, INC., ST. LOUIS, MO. SN 76-349,686. PUB. 7-9-2002, FILED 12-17-2001.

MY PLUMBER WILL SMELL GOOD, SHOW UP ON TIME OR I'LL PAY YOU

FOR REPAIR, MAINTENANCE AND INSTALLATION SERVICES IN THE FIELD OF PLUMBING (U.S. CLS. 100, 103 AND 106).
FIRST USE 12-0-2001; IN COMMERCE 12-0-2001.

2,730,428. CARMOTIVE, LLC, SACRAMENTO, CA, BY ASSIGNMENT WICKLAND OIL COMPANY, SACRAMENTO, CA. SN 76-351,225. PUB. 6-11-2002, FILED 12-18-2001.

CARMOTIVE

FOR VEHICLE PREVENTIVE MAINTENANCE SERVICES (U.S. CLS. 100, 103 AND 106).
FIRST USE 1-1-2002; IN COMMERCE 9-20-2002.

2,730,464. HIDEAWAYS, LLC, SURPRISE, AZ. SN 76-360,146. PUB. 10-1-2002, FILED 1-22-2002.



HideAways LLC

NO CLAIM IS MADE TO THE EXCLUSIVE RIGHT TO USE "LLC", APART FROM THE MARK AS SHOWN.
THE MARK CONSISTS OF THE WORD "HIDEAWAYS LLC" WITH THREE CONNECTING SNOW-CAPPED MOUNTAIN PEAKS ABOVE IT ALL IN DARK GREEN ON WHITE BACKGROUND.
FOR REAL ESTATE DEVELOPMENT (U.S. CLS. 100, 103 AND 106).
FIRST USE 3-1-2002; IN COMMERCE 3-1-2002.

CLASS 37—(Continued).

2,730,469. CASCADE ENGINEERING, INC., GRAND RAPIDS, MI. SN 76-361,457. PUB. 8-6-2002, FILED 1-18-2002.



NO CLAIM IS MADE TO THE EXCLUSIVE RIGHT TO USE "WASTE SERVICES", APART FROM THE MARK AS SHOWN.
FOR TRASH COLLECTION SERVICES (U.S. CLS. 100, 103 AND 106).
FIRST USE 10-31-2001; IN COMMERCE 10-31-2001.

2,730,558. ROBERT G. SNYDER CONTRACTORS, INC., RALEIGH, NC. SN 78-013,337. PUB. 7-24-2001, FILED 6-19-2000.

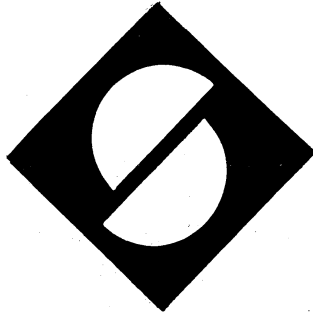

THE MARK CONSISTS OF A BLACK DIAMOND WITH A STYLIZED LETTER "S".
FOR COMMERCIAL CONSTRUCTION REAL ESTATE DEVELOPMENT (U.S. CLS. 100, 103 AND 106).
FIRST USE 2-25-1987; IN COMMERCE 2-25-1987.

2,730,803. TMI, INC., HOUSTON, TX. SN 78-105,261. PUB. 9-3-2002, FILED 1-28-2002.

TRENDMAKER

FOR BUILDING CONSTRUCTION (U.S. CLS. 100, 103 AND 106).
FIRST USE 12-31-1972; IN COMMERCE 9-30-1997.

CLASS 38—COMMUNICATION

CLASS 38—(Continued).

2,729,394. S SQUARED L.L.C., CHICAGO, IL. SN 75-503,814. PUB. 9-24-2002, FILED 6-17-1998.

RANGER

FOR DEVELOPING AND PROVIDING ROAMING SERVICES FOR THE WIRELESS TELECOMMUNICATIONS INDUSTRY (U.S. CLS. 100, 101 AND 104).
FIRST USE 7-1-1998; IN COMMERCE 7-1-1998.

2,729,418. WILCOX, GEORGE L., MINNEAPOLIS, MN. SN 75-570,771. PUB. 5-23-2000, FILED 10-15-1998.

STREET.COM

FOR TELECOMMUNICATIONS SERVICES, NAMELY, ELECTRONIC TRANSMISSION OF DATA FOR OTHERS (U.S. CLS. 100, 101 AND 104).
FIRST USE 10-0-1998; IN COMMERCE 10-0-1998.

2,729,546. E*TRADE GROUP, INC., MENLO PARK, CA. SN 75-844,326. PUB. 9-19-2000, FILED 11-9-1999.

E*TRADE FINANCIAL

OWNER OF U.S. REG. NOS. 1,854,863, 2,220,629, AND OTHERS.
NO CLAIM IS MADE TO THE EXCLUSIVE RIGHT TO USE "FINANCIAL SERVICES", APART FROM THE MARK AS SHOWN.
FOR PROVIDING MULTIPLE-USER ACCESS TO A GLOBAL COMPUTER INFORMATION NETWORK; TELECOMMUNICATIONS GATEWAY SERVICES, NAMELY PROVIDING AN ONLINE LINK TO NEWS, FINANCIAL INFORMATION, BUSINESS INFORMATION, CURRENT EVENTS AND REFERENCE MATERIALS (U.S. CLS. 100, 101 AND 104).
FIRST USE 2-0-2002; IN COMMERCE 2-0-2002.

2,729,673. COX COMMUNICATIONS, INC., ATLANTA, GA. SN 76-012,797. PUB. 8-14-2001, FILED 3-29-2000.

CONTROL PLUS PACKAGE

NO CLAIM IS MADE TO THE EXCLUSIVE RIGHT TO USE "CONTROL" AND "PACKAGE", APART FROM THE MARK AS SHOWN.
FOR CELLULAR TELEPHONE SERVICES, TELEPHONE COMMUNICATION SERVICES, LOCAL AND LONG DISTANCE PHONE SERVICES AND PAGING SERVICES (U.S. CLS. 100, 101 AND 104).
FIRST USE 4-0-2000; IN COMMERCE 4-0-2000.

CLASS 38—(Continued).

2,729,675. SORENSON MEDIA, INC., SALT LAKE CITY, UT. SN 76-016,542. PUB. 9-24-2002, FILED 4-3-2000.

SORENSON MEDIA

OWNER OF U.S. REG. NO. 2,235,065.
NO CLAIM IS MADE TO THE EXCLUSIVE RIGHT TO USE "MEDIA", APART FROM THE MARK AS SHOWN.

SEC. 2(F).
FOR BROADCASTING AUDIO AND VIDEO PROGRAMS VIA A GLOBAL COMPUTER NETWORK (U.S. CLS. 100, 101 AND 104).

FIRST USE 4-3-2000; IN COMMERCE 4-3-2000.

2,729,714. SCHOEFFLER, DANIEL A., HUNTINGTON, NY. SN 76-063,451. PUB. 7-9-2002, FILED 6-1-2000.

THRUMAIL

FOR COMMUNICATIONS FORWARDING SERVICES, NAMELY PROVIDING A SERVICE TO WHICH ELECTRONIC MAIL (E-MAIL), VOICEMAIL, TELEPHONE CALLS, INSTANT MESSAGES, AND PAGING MESSAGES CAN BE SENT FOR FORWARDING TO RECIPIENTS (U.S. CLS. 100, 101 AND 104).

FIRST USE 1-1-2003; IN COMMERCE 1-1-2003.

2,729,769. ENVOYWORLDWIDE, INC., BEDFORD, MA, BY CHANGE OF NAME MESSAGEBLASTER.COM, INC, BILLERICA, MA. SN 76-095,937. PUB. 8-14-2001, FILED 7-25-2000.

ENVOYWORLDWIDE

FOR COMMUNICATIONS SERVICES, NAMELY, ELECTRONIC TRANSMISSION OF INFORMATION AND DATA VIA A GLOBAL COMPUTER NETWORK; VOICE MAIL SERVICES; FACSIMILE SERVICES; PAGING SERVICES; INSTANT MESSAGING SERVICES; AND ELECTRONIC MAIL SERVICES (U.S. CLS. 100, 101 AND 104).

FIRST USE 8-31-2000; IN COMMERCE 8-31-2000.

2,729,835. DIGITAL LATIN AMERICA, LLC, BOCA RATON, FL. SN 76-145,648. PUB. 6-11-2002, FILED 10-12-2000.

DLA

FOR COMMUNICATION SERVICES, NAMELY, VIDEO AND DATA TRANSMISSION SERVICES VIA SATELLITE (U.S. CLS. 100, 101 AND 104).

FIRST USE 6-2-2002; IN COMMERCE 6-2-2002.

CLASS 38—(Continued).

2,730,013. LIVETV, LLC, IRVINE, CA. SN 76-225,912. PUB. 8-14-2001, FILED 3-16-2001.

AIRRADIO

FOR SATELLITE TRANSMISSION OF TELEVISION, RADIO AND AUDIO PROGRAMS FOR THE AIRLINE INDUSTRY (U.S. CLS. 100, 101 AND 104).

FIRST USE 6-0-2001; IN COMMERCE 6-0-2001.

2,730,111. TRANSTEL COMMUNICATIONS, INC., SALT LAKE CITY, UT. SN 76-267,005. PUB. 6-18-2002, FILED 6-5-2001.

NINEFOLD

FOR TELECOMMUNICATION SERVICES, NAMELY, LONG DISTANCE TELEPHONE SERVICES (U.S. CLS. 100, 101 AND 104).

FIRST USE 6-0-2001; IN COMMERCE 6-0-2001.

2,730,189. TZU CHI TELEVISION, TAIPEI, CHINA. SN 76-290,556. PUB. 5-28-2002, FILED 7-27-2001.

大愛電視

NO CLAIM IS MADE TO THE EXCLUSIVE RIGHT TO USE THE THIRD AND FOURTH CHARACTERS, READING FROM LEFT TO RIGHT, WHICH TRANSLITERATE AS "TELEVISION", APART FROM THE MARK AS SHOWN.

THE NON-LATIN CHARACTERS IN THE MARK TRANSLITERATE TO "DA-AI TELEVISION" AND THIS MEANS "GREAT LOVE TELEVISION" IN ENGLISH.

FOR CABLE TELEVISION, SUBSCRIPTION TELEVISION, TELEVISION, AND VIDEO BROADCASTING (U.S. CLS. 100, 101 AND 104).

FIRST USE 8-31-1999; IN COMMERCE 8-31-1999.

CLASS 38—(Continued).

2,730,341. DIRECTV, INC., EL SEGUNDO, CA. SN 76-332,869. PUB. 7-9-2002, FILED 10-31-2001.



OWNER OF U.S. REG. NO. 1,994,233.
NO CLAIM IS MADE TO THE EXCLUSIVE RIGHT TO USE "PAY PER VIEW", APART FROM THE MARK AS SHOWN.

FOR PAY-PER-VIEW SATELLITE TELEVISION TRANSMISSION SERVICES (U.S. CLS. 100, 101 AND 104).
FIRST USE 11-1-2001; IN COMMERCE 11-1-2001.

2,730,396. HUGHES ELECTRONICS CORPORATION, EL SEGUNDO, CA. SN 76-344,671. PUB. 7-30-2002, FILED 12-5-2001.



OWNER OF U.S. REG. NO. 2,493,120.
FOR TELECOMMUNICATIONS SERVICES, NAMELY THE TRANSMISSION OF VOICE, VIDEO, DATA, INFORMATION AND DOCUMENTS VIA SATELLITE, TELEPHONE AND COMPUTER; TELECOMMUNICATIONS GATEWAY SERVICES; PROVIDING TELECOMMUNICATIONS CONNECTIONS TO A GLOBAL COMPUTER NETWORK; BROADCASTING PROGRAMS VIA A GLOBAL COMPUTER NETWORK; ELECTRONIC TRANSMISSION OF MESSAGES AND DATA; VIDEO BROADCASTING AND VIDEO MESSAGING SERVICES; TELEPHONE VOICE MESSAGING SERVICES; AUDIO BROADCASTING; PROVIDING MULTIPLE-USER ACCESS TO A GLOBAL COMPUTER INFORMATION NETWORK AND INTERACTIVE SATELLITE COMMUNICATION SERVICES (U.S. CLS. 100, 101 AND 104).

FIRST USE 9-0-2001; IN COMMERCE 9-0-2001.

CLASS 39—TRANSPORTATION AND STORAGE**CLASS 39—(Continued).**

2,729,705. HOTEL SOFTWARE SYSTEMS, LTD., PORTLAND, OR. SN 76-048,619. PUB. 12-11-2001, FILED 5-11-2000.

ZOOMINN

FOR PROVIDING ONLINE TRAVEL AND TOURISM INFORMATION AND PROVIDING ACCESS TO WEBSITES OF OTHERS FEATURING TRAVEL AND TOURISM INFORMATION VIA A GLOBAL COMPUTER NETWORK (U.S. CLS. 100 AND 105).

FIRST USE 11-30-2001; IN COMMERCE 11-30-2001.

2,729,926. AMERICAN EXPRESS COMPANY, NEW YORK, NY. SN 76-192,555. PUB. 6-11-2002, FILED 1-11-2001.

REZTALK

FOR TRAVEL AGENCY SERVICES, NAMELY, PROVIDING AIRLINE FLIGHT INFORMATION, RESERVATION AND BOOKING SERVICES VIA A TOUCH-TONE AND VOICE RECOGNITION TELEPHONE SYSTEM (U.S. CLS. 100 AND 105).

FIRST USE 12-31-1999; IN COMMERCE 12-31-1999.

2,730,008. CRESCOMM, INC., MIAMI, FL. SN 76-224,605. PUB. 6-25-2002, FILED 3-14-2001.

CRESCOMM CRUISES

NO CLAIM IS MADE TO THE EXCLUSIVE RIGHT TO USE CRUISES, APART FROM THE MARK AS SHOWN.

FOR TRAVEL SERVICES, NAMELY, ARRANGING OF CRUISES VIA THE INTERNET (U.S. CLS. 100 AND 105).

FIRST USE 1-8-2001; IN COMMERCE 3-7-2001.

2,730,291. SPENCE TRANSPORTATION, INC., MARLBOROUGH, MA. SN 76-319,656. PUB. 6-18-2002, FILED 10-1-2001.

ZEBRA SHUTTLE

NO CLAIM IS MADE TO THE EXCLUSIVE RIGHT TO USE "SHUTTLE", APART FROM THE MARK AS SHOWN.

FOR TRANSPORTATION OF PASSENGERS BY CARS AND VANS (U.S. CLS. 100 AND 105).

FIRST USE 10-1-2001; IN COMMERCE 10-1-2001.

CLASS 39—(Continued).

2,730,328. GREIN, JERI, DBA JBG IMAGEMAKER, DES PLAINES, IL. SN 76-328,506. PUB. 4-30-2002, FILED 10-22-2001.

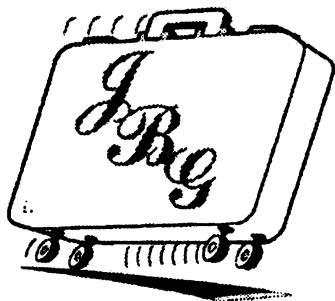

THE MARK CONSISTS, IN PART, OF THE LETTERS "JBG".
FOR PROVIDING TRAVEL INFORMATION SERVICES (U.S. CLS. 100 AND 105).
FIRST USE 8-0-2001; IN COMMERCE 12-0-2001.

2,730,570. FRIEDMAN, HARVEY, BEVERLY HILLS, CA. SN 78-029,997. PUB. 7-23-2002, FILED 10-10-2000.

2C TRANSPORTATION AND STORAGE

NO CLAIM IS MADE TO THE EXCLUSIVE RIGHT TO USE "TRANSPORTATION AND STORAGE", APART FROM THE MARK AS SHOWN.
FOR PROVIDING INFORMATION REGARDING FREIGHT TRANSPORTATION AND STORAGE (U.S. CLS. 100 AND 105).
FIRST USE 10-15-2000; IN COMMERCE 10-15-2000.

2,730,763. NOVARTIS AG, BASEL, SWITZERLAND. SN 78-096,732. PUB. 7-9-2002, FILED 12-5-2001.

NUTRITION
TO YOUR DOOR

FOR DELIVERY OF GROCERIES, NUTRITIONAL SUPPLEMENTS, VITAMINS, AND SUNDRIES TO HOMES, ASSISTED CARE FACILITIES, AND NURSING HOMES (U.S. CLS. 100 AND 105).
FIRST USE 10-1-2001; IN COMMERCE 10-1-2001.

CLASS 40—MATERIAL TREATMENT**CLASS 40—(Continued).**

2,729,433. UNITED STATES FILTER CORPORATION, PALM DESERT, CA. SN 75-631,657. PUB. 12-28-1999, FILED 2-2-1999.

TAKING CARE OF THE WORLD'S WATER...AND YOURS

OWNER OF U.S. REG. NO. 2,162,741.
FOR WATER TREATMENT SERVICES (U.S. CLS. 100, 103 AND 106).
FIRST USE 1-0-1999; IN COMMERCE 1-0-1999.

2,729,536. TURNSTYLE RECORDS, GARDENA, CA. SN 75-830,523. PUB. 5-1-2001, FILED 11-12-1999.

TURNSTYLE RECORDS

NO CLAIM IS MADE TO THE EXCLUSIVE RIGHT TO USE "RECORDS", APART FROM THE MARK AS SHOWN.
FOR AUDIO RECORD/LACQUER MASTERING AND DUBPLATES FOR MUSIC REPLICATION (U.S. CLS. 100, 103 AND 106).
FIRST USE 11-15-1995; IN COMMERCE 1-16-1999.

2,729,696. VIRIV CORP., BROOKFIELD, WI. SN 76-038,428. PUB. 9-17-2002, FILED 5-2-2000.

RSCFV

FOR CUSTOM MANUFACTURING OF RECOMBINANT, SINGLE-CHAIN, PHAGE-DISPLAYED, SOLUBLE, MONOCLONAL, VARIABLE AND ANTIBODY FRAGMENTS TO THE ORDER AND SPECIFICATION OF OTHERS (U.S. CLS. 100, 103 AND 106).
FIRST USE 3-12-2000; IN COMMERCE 3-12-2000.

2,729,754. HASCO I.A. LIMITED, EARTH CITY, MO. SN 76-087,111. PUB. 3-12-2002, FILED 7-12-2000.

WEBNURSERY

OWNER OF U.S. REG. NOS. 2,369,918 AND 2,396,821.
FOR PHOTOFINISHING SERVICES; ELECTRONIC IMAGING, SCANNING, DIGITIZING, ALTERATION, AND/OR RETOUCHING OF PHOTOGRAPHIC IMAGES; PHOTOGRAPHIC COMPUTER IMAGING (U.S. CLS. 100, 103 AND 106).
FIRST USE 6-0-2002; IN COMMERCE 6-0-2002.

CLASS 40—(Continued).

2,729,768. DFB PHARMACEUTICALS, INC., SAN ANTONIO, TX. BY CHANGE OF NAME DFB HOLDING, INC., SAN ANTONIO, TX. SN 76-095,671. PUB. 6-12-2001, FILED 7-11-2000.

DFB PHARMACEUTICALS

NO CLAIM IS MADE TO THE EXCLUSIVE RIGHT TO USE "PHARMACEUTICALS", APART FROM THE MARK AS SHOWN.

FOR CUSTOM MANUFACTURING OF ETHICAL PHARMACEUTICALS, OVER-THE-COUNTER DRUGS AND COSMETICS (U.S. CLS. 100, 103 AND 106).

FIRST USE 5-1-2001; IN COMMERCE 2-12-2003.

2,729,904. CONFLUENT PHOTONICS CORPORATION, ANDOVER, MA. SN 76-179,556. PUB. 6-4-2002, FILED 12-13-2000.

CONFLUENT PHOTONICS

NO CLAIM IS MADE TO THE EXCLUSIVE RIGHT TO USE "PHOTONICS", APART FROM THE MARK AS SHOWN.

FOR MANUFACTURE FOR OTHERS OF COMPONENTS FOR USE IN OPTICAL NETWORKS, NAMELY, FIBER OPTIC COMPONENTS, MULTIPLEXORS, DEMULTIPLEXORS, SWITCHES AND OTHER DEVICES USED TO MANIPULATE THE MOVEMENT OF LIGHT TRANSMITTED VIA FIBER OPTIC NETWORKS (U.S. CLS. 100, 103 AND 106).

FIRST USE 3-17-2001; IN COMMERCE 3-17-2001.

2,730,038. VICTOR INNOVATEX INC., VILLE DE ST-GEORGES, QUEBEC G6A 1K1, CANADA. SN 76-239,781. PUB. 4-23-2002, FILED 4-12-2001.

ECO INTELLIGENCE INITIATIVES

FOR MANUFACTURING ENVIRONMENTAL-FRIENDLY FABRIC FOR OFFICE FURNITURE MANUFACTURERS FOLLOWING A PROGRAM AIMED TOWARDS SUSTAINING AND SAFEGUARDING THE ENVIRONMENT; AND CONSULTING SERVICES FOR OFFICE FURNITURE MANUFACTURERS WISHING TO WORK WITH SUPPLIERS AND CONSULTANTS WHO ALSO WORK TO SUSTAIN AND PROTECT THE ENVIRONMENT (U.S. CLS. 100, 103 AND 106).

FIRST USE 1-1-2001; IN COMMERCE 1-1-2001.

2,730,052. MICHAELS STORES, INC., IRVING, TX, BY MERGER 5931 BUSINESS TRUST, A DELAWARE BUSINESS TRUST, THE SOLE TRUSTEE BEING PNC BANK, WILMINGTON, DE. SN 76-243,913. PUB. 6-18-2002, FILED 4-6-2001.

MICHAELS MANUFACTURING GROUP**CLASS 40—(Continued).**

OWNER OF U.S. REG. NOS. 1,222,952, 2,232,360, AND OTHERS.

NO CLAIM IS MADE TO THE EXCLUSIVE RIGHT TO USE "MANUFACTURING GROUP", APART FROM THE MARK AS SHOWN.

FOR FRAMING WORKS OF ART FOR OTHERS; ASSEMBLY OF PRE-FRAMED ART FOR OTHERS; MANUFACTURING SERVICES TO THE ORDER AND SPECIFICATION OF OTHERS OF PICTURE FRAMES, PICTURE FRAME MOLDING, ART PRINTS, UNFINISHED WOOD PRODUCTS, SILK AND DRIED TREES AND FLOWERS (U.S. CLS. 100, 103 AND 106).

FIRST USE 7-0-2001; IN COMMERCE 7-0-2001.

2,730,056. FMC CORPORATION, PHILADELPHIA, PA. SN 76-244,240. PUB. 5-14-2002, FILED 4-20-2001.

NO LIMIT

FOR CUSTOM FORMULATION AND MANUFACTURING OF LITHIUM CHEMICALS AND FORMULATIONS THEREOF FOR OTHERS (U.S. CLS. 100, 103 AND 106).

FIRST USE 12-31-2000; IN COMMERCE 12-31-2000.

2,730,100. SNACKS TO YOU, INC., HANOVER, PA. SN 76-261,961. PUB. 8-6-2002, FILED 5-25-2001.

HERITAGE CARD N^o CANDLE

NO CLAIM IS MADE TO THE EXCLUSIVE RIGHT TO USE "CARD AND CANDLE", APART FROM THE MARK AS SHOWN.

FOR CUSTOM MANUFACTURE OF CANDLES AND CANDLE LABELS (U.S. CLS. 100, 103 AND 106).

FIRST USE 6-0-2001; IN COMMERCE 6-0-2001.

2,730,571. FRIEDMAN, HARVEY, BEVERLY HILLS, CA. SN 78-029,998. PUB. 7-23-2002, FILED 10-10-2000.

2C TREATMENT OF MATERIALS

NO CLAIM IS MADE TO THE EXCLUSIVE RIGHT TO USE "TREATMENT OF MATERIALS", APART FROM THE MARK AS SHOWN.

FOR PROVIDING INFORMATION REGARDING THE TREATMENT OF MATERIALS (U.S. CLS. 100, 103 AND 106).

FIRST USE 10-15-2000; IN COMMERCE 10-15-2000.

CLASS 41—EDUCATION AND ENTERTAINMENT

CLASS 41—(Continued).

2,729,368. MICHAELSON, PAUL R., LAS VEGAS, NV. SN 75-286,865. PUB. 12-14-1999, FILED 5-5-1997.

LEGACY SERIES

OWNER OF U.S. REG. NO. 2,130,918.
NO CLAIM IS MADE TO THE EXCLUSIVE RIGHT TO USE "SERIES", APART FROM THE MARK AS SHOWN.
FOR EDUCATIONAL SERVICES, NAMELY, CONDUCTING BUSINESS-ORIENTED WORKSHOPS AND SEMINARS IN THE SECURITIES, ESTATE PLANNING AND CORPORATE FIELDS (U.S. CLS. 100, 101 AND 107).
FIRST USE 8-28-2002; IN COMMERCE 8-28-2002.

2,729,371. LETZER, SALLY, CALABASA, CA. SN 75-342,383. PUB. 4-27-1999, FILED 8-18-1997.

L.Q.

FOR EDUCATIONAL AND ENTERTAINMENT SERVICE, NAMELY, PRODUCTION OF LIVE THEATRICAL PERFORMANCES; PRODUCTION OF RADIO AND TELEVISION PROGRAMS; AUDIO RECORDING AND PRODUCTION, DIGITAL VIDEO DISC AND VIDEO PRODUCTION, CONDUCTING CLASSES, TRAINING AND SEMINARS, PROVIDING EDUCATIONAL AND ENTERTAINMENT INFORMATION THROUGH THE USE OF A GLOBAL COMPUTER INFORMATION NETWORK ALL ON THE SUBJECT OF ASSISTING PEOPLE TO RECOGNIZE THAT EVERY THOUGHT AND FEELING WE HAVE, WHICH IS MANIFEST IN OUR ACTIONS, IS FOR THE SOLE PURPOSE OF RECEIVING LOVE AND SUPPORT THAT WILL MAXIMIZE THEIR PERSONAL RESOURCE CAPACITY, ACHIEVING A QUALITY EXPERIENCE OF LIFE THAT MEANS YOU'VE LIVED WELL (U.S. CLS. 100, 101 AND 107).
FIRST USE 8-30-1997; IN COMMERCE 3-7-2002.

2,729,374. NATIONAL PEDICULOSIS ASSOCIATION, INC., NEEDHAM, MA. SN 75-405,068. PUB. 4-13-1999, FILED 12-15-1997.

LICEMEISTER

FOR EDUCATIONAL SERVICES, NAMELY, CONDUCTING CLASSES DEALING WITH THE SCREENING, DETECTION AND REMOVAL OF LICE AND NITS (U.S. CLS. 100, 101 AND 107).
FIRST USE 5-0-2002; IN COMMERCE 5-0-2002.

2,729,386. BANKSIA PRODUCTIONS PTY LIMITED, GREENWICH, NEW SOUTH WALES, AUSTRALIA. SN 75-480,119. PUB. 11-28-2000, FILED 5-6-1998.

HUMPHREY B. BEAR

PRIORITY CLAIMED UNDER SEC. 44(D) ON AUSTRALIA APPLICATION NO. B320904, FILED 7-31-1997, REG. NO. B320904, DATED 7-31-1997, EXPIRES 8-10-1999.
PRIORITY CLAIMED UNDER SEC. 44(D) ON AUSTRALIA APPLICATION NO. B320902, FILED 7-31-1997, REG. NO. B320902, DATED 7-31-1997, EXPIRES 8-10-1999.

CLASS 41—(Continued).

PRIORITY CLAIMED UNDER SEC. 44(D) ON AUSTRALIA APPLICATION NO. B138408, FILED 7-31-1997, REG. NO. B138408, DATED 7-31-1997, EXPIRES 5-19-2009.

PRIORITY CLAIMED UNDER SEC. 44(D) ON AUSTRALIA APPLICATION NO. B261625, FILED 7-22-1997, REG. NO. B261625, DATED 8-7-1997, EXPIRES 9-4-2007.

PRIORITY CLAIMED UNDER SEC. 44(D) ON AUSTRALIA APPLICATION NO. 757016, FILED 3-11-1998, REG. NO. 757016, DATED 3-11-1998, EXPIRES 3-11-2008.

OWNER OF AUSTRALIA REG. NO. B261626, DATED 7-31-1997, EXPIRES 9-4-2007.

HUMPHREY B. BEAR DOES NOT IDENTIFY A LIVING INDIVIDUAL

FOR EDUCATION AND ENTERTAINMENT SERVICES, NAMELY, AUDIO AND VISUAL RECORDING AND PRODUCTION; PRODUCTION OF TELEVISION PROGRAMS FOR OTHERS; AND DEVELOPMENT AND DISSEMINATION OF CHILDREN'S EDUCATIONAL MATERIALS OF OTHERS IN THE FIELDS OF MATH, SCIENCE, HISTORY, READING, GRAMMAR, GEOGRAPHY AND MUSIC (U.S. CLS. 100, 101 AND 107).
FIRST USE 1-0-1970; IN COMMERCE 1-0-1998.

2,729,395. MENTICE, GOTHENBURG, SWEDEN. SN 75-506,093. PUB. 1-4-2000, FILED 6-22-1998.

PROCEDICUS

FOR EDUCATIONAL SERVICES, NAMELY, CONDUCTING CLASSES, SEMINARS AND CONFERENCES IN THE FIELD OF MEDICINE USING VIRTUAL REALITY TO SIMULATE SURGICAL PROCEDURES (U.S. CLS. 100, 101 AND 107).
FIRST USE 3-0-1999; IN COMMERCE 3-0-2000.

2,729,401. BALLARD, NORMAN, NEW YORK, NY. SN 75-522,863. PUB. 1-11-2000, FILED 7-16-1998.

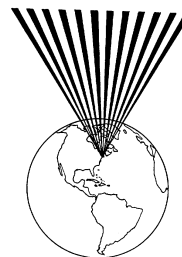

THE LINING IS A FEATURE OF THE MARK AND DOES NOT INDICATE COLOR.

FOR ENTERTAINMENT SERVICES, NAMELY, PROMOTING, ORGANIZING, ARRANGING, PRODUCING AND CONDUCTING EXHIBITIONS, FESTIVALS, SHOWS, CELEBRATIONS FOR ENTERTAINMENT PURPOSES FOR PRIVATE, PUBLIC, CIVIC AND GOVERNMENT FUNCTIONS, MONUMENT SALUTES, RALLIES AND CELEBRATIONS; ENTERTAINMENT IN THE NATURE OF VISUAL DISPLAYS FOR THE AFORESAID PURPOSES; ENTERTAINMENT IN THE NATURE OF LIGHT AND LASER SHOWS (U.S. CLS. 100, 101 AND 107).

FIRST USE 1-1-2002; IN COMMERCE 1-1-2002.

CLASS 41—(Continued).

2,729,407. BRIGHT BEGINNINGS, DENVER, CO. SN 75-536,438. PUB. 12-14-1999, FILED 8-14-1998.

PARENT FRIENDLY

FOR DEVELOPMENT AND DISSEMINATION OF EDUCATIONAL MATERIALS FOR OTHERS IN THE FIELD OF CHILD CARE AND EMPLOYMENT OF PARENTS (U.S. CLS. 100, 101 AND 107).

FIRST USE 3-7-2003; IN COMMERCE 3-7-2003.

2,729,445. CORWIN, ANN, LAGUNA NIGUEL, CA. SN 75-660,720. PUB. 7-24-2001, FILED 3-15-1999.

TODDLER TALK

FOR EDUCATIONAL SERVICES, NAMELY, CONDUCTING INTERACTIVE SEMINARS, WORKSHOPS AND SUPPORT GROUPS FOR PARENTS AND THE CHILDREN RELATING TO ACADEMIC AND SOCIAL SKILL DEVELOPMENT, LITERACY, PARENTING, HEALTH AND SAFETY ISSUES, AND MUSIC INSTRUCTION (U.S. CLS. 100, 101 AND 107).

FIRST USE 6-1-1996; IN COMMERCE 6-5-1996.

2,729,449. CASHFLOW TECHNOLOGIES, INC., PARADISE VALLEY, AZ. SN 75-666,453. PUB. 12-18-2001, FILED 3-23-1999.

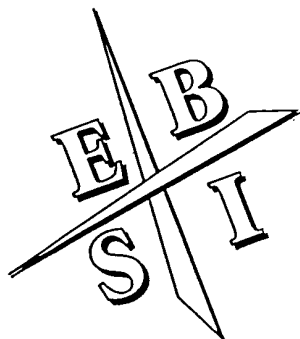

FOR EDUCATIONAL SERVICES, NAMELY, CONDUCTING CLASSES, SEMINARS, CONFERENCES, WORKSHOPS IN THE FIELD OF FINANCIAL EDUCATION (U.S. CLS. 100, 101 AND 107).

FIRST USE 12-0-1997; IN COMMERCE 12-0-1997.

2,729,453. INDIANAPOLIS MOTOR SPEEDWAY CORPORATION, INDIANAPOLIS, IN. SN 75-676,486. PUB. 6-26-2001, FILED 4-6-1999.

INDY CAR

OWNER OF U.S. REG. NOS. 1,021,234, 2,193,560, AND

CLASS 41—(Continued).

OTHERS.

NO CLAIM IS MADE TO THE EXCLUSIVE RIGHT TO USE "CAR", APART FROM THE MARK AS SHOWN.

SEC. 2(F) AS TO "INDY".

FOR PROVIDING ENTERTAINMENT SERVICES IN THE FORM OF AUTOMOBILE RACES (U.S. CLS. 100, 101 AND 107).

FIRST USE 1-2-2003; IN COMMERCE 1-2-2003.

2,729,461. UNITED STATES POSTAL SERVICE, WASHINGTON, DC. SN 75-694,221. PUB. 1-18-2000, FILED 4-27-1999.

**AGENTS OF IMPACT.
AGENTS OF CHANGE.**

FOR EDUCATIONAL SERVICES, NAMELY, OFFERING COURSES OF INSTRUCTION IN THE FIELD OF INSPECTION (U.S. CLS. 100, 101 AND 107).

FIRST USE 10-0-1999; IN COMMERCE 10-0-1999.

2,729,470. TALK TEENS, INC., CORAL GABLES, FL. SN 75-714,679. PUB. 12-21-1999, FILED 5-27-1999.

OUTLOUD

FOR ENTERTAINMENT SERVICES IN THE NATURE OF ONGOING VARIETY AND NEWS PROGRAMS DISTRIBUTED OVER TELEVISION, SATELLITE, AUDIO, RADIO, VIDEO AND THE GLOBAL COMPUTER NETWORK ON ISSUES RELATING TO TEENAGERS (U.S. CLS. 100, 101 AND 107).

FIRST USE 3-13-2003; IN COMMERCE 3-13-2003.

2,729,516. VIACOM INTERNATIONAL INC., NEW YORK, NY. SN 75-800,595. PUB. 12-12-2000, FILED 10-12-1999.

FIGURE IT OUT WILD STYLE

OWNER OF U.S. REG. NO. 2,164,595.
FOR ENTERTAINMENT SERVICES IN THE NATURE OF AN ONGOING TELEVISION GAME SHOW (U.S. CLS. 100, 101 AND 107).

FIRST USE 11-1-1999; IN COMMERCE 11-1-1999.

CLASS 41—(Continued).

2,729,615. LUCASFILM LTD., NICASIO, CA. SN 75-923,910. PUB. 11-28-2000, FILED 2-18-2000.

SKYWALKER

FOR ENTERTAINMENT SERVICES PROVIDED OVER A GLOBAL COMPUTER NETWORK IN THE NATURE OF MOTION PICTURES AND SOUND EFFECTS; PROVIDING INFORMATION REGARDING SOUND EDITING OF A MOTION PICTURE, TELEVISION PROGRAMS, TELEVISION COMMERCIALS AND MUSICAL RECORDINGS OVER A GLOBAL COMPUTER NETWORK; PROVIDING SPECIAL EFFECTS FOR TELEVISION, MOTION PICTURES (U.S. CLS. 100, 101 AND 107).

FIRST USE 3-24-2001; IN COMMERCE 3-24-2001.

2,729,694. MCCAULEY, JACK B., WARREN, MI. SN 76-037,887. PUB. 6-25-2002, FILED 5-1-2000.

DRY DOCK BAND

NO CLAIM IS MADE TO THE EXCLUSIVE RIGHT TO USE "BAND", APART FROM THE MARK AS SHOWN. FOR ENTERTAINMENT SERVICES, NAMELY A LIVE PERFORMING BAND (U.S. CLS. 100, 101 AND 107).

FIRST USE 3-11-2003; IN COMMERCE 3-11-2003.

2,729,703. WILD BRAIN, INC., SAN FRANCISCO, CA. SN 76-045,192. PUB. 2-27-2001, FILED 5-10-2000.

POOCHINI

FOR ENTERTAINMENT SERVICES, NAMELY A CONTINUING ANIMATED CARTOON PROGRAM DISTRIBUTED OVER TELEVISION, SATELLITE, AUDIO AND VIDEO MEDIA (U.S. CLS. 100, 101 AND 107).

FIRST USE 9-0-1999; IN COMMERCE 10-1-2002.

2,729,720. JAROCH, MICHAEL E., LITTLETON, CO. SN 76-068,382. PUB. 6-11-2002, FILED 6-12-2000.

ABCDREAM.COM

FOR EDUCATIONAL SERVICES, NAMELY, CONDUCTING INTERACTIVE CREATIVE WRITING AND READING PROGRAMS AND CREATIVE THINKING PROGRAMS FOR CHILDREN, PARENTS, AND TEACHERS VIA THE INTERNET; ENTERTAINMENT SERVICES, NAMELY, PROVIDING LIVE HIGH-TECH DIGITAL STORY-TELLING PROGRAMS VIA TELEVISION AND THE INTERNET (U.S. CLS. 100, 101 AND 107).

FIRST USE 2-3-2003; IN COMMERCE 2-3-2003.

CLASS 41—(Continued).

2,729,736. STARLIGHT RUNNER ENTERTAINMENT, INC., NEW YORK, NY. SN 76-076,668. PUB. 7-2-2002, FILED 6-23-2000.

STARLIGHT RUNNER ENTERTAINMENT

NO CLAIM IS MADE TO THE EXCLUSIVE RIGHT TO USE "ENTERTAINMENT", APART FROM THE MARK AS SHOWN.

FOR ENTERTAINMENT SERVICES, NAMELY, THE PRODUCTION OF MOTION PICTURE FILMS AND INTERACTIVE TELEVISION PROGRAMS; AND PROVIDING AN ONLINE INTERACTIVE COMPUTER GAME (U.S. CLS. 100, 101 AND 107).

FIRST USE 6-10-2002; IN COMMERCE 6-10-2002.

2,729,743. A&E TELEVISION NETWORKS, NEW YORK, NY. SN 76-080,847. PUB. 7-2-2002, FILED 6-29-2000.

HISTORY VIEWPOINT

NO CLAIM IS MADE TO THE EXCLUSIVE RIGHT TO USE "HISTORY", APART FROM THE MARK AS SHOWN.

FOR ENTERTAINMENT SERVICES, NAMELY, ONGOING SERIES OF CABLE TELEVISION PROGRAMS FEATURING HISTORY, HISTORICAL SUBJECTS AND INDIVIDUALS, HISTORICAL SETTINGS AND HISTORICAL DRAMAS (U.S. CLS. 100, 101 AND 107).

FIRST USE 9-30-2000; IN COMMERCE 9-30-2000.

2,729,772. FIESTA PALMS LLC, NORTH LAS VEGAS, NV. SN 76-100,494. PUB. 6-11-2002, FILED 8-1-2000.



A MALOOF CASINO RESORT

NO CLAIM IS MADE TO THE EXCLUSIVE RIGHT TO USE "CASINO RESORT", APART FROM THE MARK AS SHOWN.

FOR CASINO SERVICES; PROVIDING FACILITIES FOR NON-GAMING VIDEO ARCADE GAMES; PROVIDING AMUSEMENT CENTERS AND ARCADES; ENTERTAINMENT SERVICES, NAMELY PROVIDING ON-LINE CASINO STYLE GAMING SERVICES ACCESSED VIA GLOBAL COMPUTER NETWORK; PROVIDING CASINO, GAMING AND ENTERTAINMENT INFORMATION SERVICES BY MEANS OF WEB SITES AND GLOBAL COMPUTER NETWORKS; ENTERTAINMENT SERVICES IN THE NATURE OF ARRANGING, CONDUCTING, AND PROVIDING FACILITIES FOR CONCERTS AND LIVE PERFORMANCES; AND ENTERTAINMENT SERVICES, NAMELY LIVE PERFORMANCES FEATURING LIVE AND PRERECORDED MUSIC AND VIDEO, SINGERS, MUSIC GROUPS, DANCERS, MAGICIANS, ACTORS, ACROBATS AND COMEDIANS (U.S. CLS. 100, 101 AND 107).

FIRST USE 11-15-2001; IN COMMERCE 11-15-2001.

CLASS 41—(Continued).

2,729,788. OUTDOOR LIFE NETWORK, L.L.C., STAMFORD, CT. SN 76-109,323. PUB. 7-24-2001, FILED 8-15-2000.

PEOPLE FOR THE PLANET

FOR ENTERTAINMENT SERVICES, NAMELY AN ONGOING RADIO PROGRAM RELATING TO THE ENVIRONMENT (U.S. CLS. 100, 101 AND 107).
FIRST USE 2-14-2002; IN COMMERCE 2-14-2002.

2,729,803. BLACKHAM, ROSE, DENVER, CO. SN 76-118,703. PUB. 7-2-2002, FILED 8-29-2000.

**THE POWER OF THE NOT-
I'S**

FOR EDUCATIONAL SERVICES, NAMELY, CONDUCTING SEMINARS, INSTRUCTIONAL CLASSES AND PRESENTATIONS IN THE FIELD OF PERSONAL GROWTH AND FULFILLMENT, AND THE DISTRIBUTION OF COURSE MATERIALS IN CONNECTION THEREWITH (U.S. CLS. 100, 101 AND 107).
FIRST USE 12-1-1972; IN COMMERCE 12-1-1972.

2,729,880. ST. JOE COMPANY, THE, JACKSONVILLE, FL. SN 76-166,168. PUB. 4-16-2002, FILED 11-16-2000.



THE MARK CONSISTS IN PART OF A DEPICTION OF A PORTION OF A GOLF COURSE.
FOR PROVIDING FACILITIES FOR RECREATIONAL ACTIVITIES (U.S. CLS. 100, 101 AND 107).
FIRST USE 12-1-2001; IN COMMERCE 12-1-2001.

2,729,978. RUSSO, ANDREW P. LO, SANTA BARBARA, CA. SN 76-215,482. PUB. 5-28-2002, FILED 2-22-2001.

COOKING CABARET

NO CLAIM IS MADE TO THE EXCLUSIVE RIGHT TO USE "COOKING", APART FROM THE MARK AS SHOWN.
FOR EDUCATIONAL SERVICES, NAMELY, CONDUCTING DEMONSTRATIONS IN THE FIELD OF PROFESSIONAL COOKING AND FOOD PREPARATION; AND, ENTERTAINMENT SERVICES, NAMELY, PERSONAL APPEARANCES AT LIVE ENTERTAINMENT EVENTS, FUND RAISING EVENTS AND ON TELEVISION PROGRAMS BY A CELEBRITY COOKING PROFESSIONAL (U.S. CLS. 100, 101 AND 107).
FIRST USE 2-15-2003; IN COMMERCE 2-15-2003.

CLASS 41—(Continued).

2,729,987. NATIONAL BROADCASTING COMPANY, INC., NEW YORK, NY. SN 76-219,270. PUB. 6-11-2002, FILED 3-2-2001.

SHOPNBC.COM

OWNER OF U.S. REG. NOS. 510,360, 1,057,966, AND OTHERS.

FOR ENTERTAINMENT SERVICES, NAMELY, PRODUCTION OF TELEVISION SHOWS FOR TELEVISION, CABLE AND SATELLITE TELEVISION, AND THE INTERNET; AND TELEVISION PROGRAMMING (U.S. CLS. 100, 101 AND 107).
FIRST USE 6-22-2001; IN COMMERCE 6-22-2001.

2,729,989. NATIONAL BROADCASTING COMPANY, INC., NEW YORK, NY. SN 76-219,273. PUB. 6-4-2002, FILED 3-2-2001.

SHOPNBC

OWNER OF U.S. REG. NOS. 510,630, 1,057,966, AND OTHERS.

FOR ENTERTAINMENT SERVICES, NAMELY, PRODUCTION OF TELEVISION SHOWS FOR TELEVISION, CABLE AND SATELLITE TELEVISION, AND THE INTERNET; AND TELEVISION PROGRAMMING (U.S. CLS. 100, 101 AND 107).
FIRST USE 6-22-2001; IN COMMERCE 6-22-2001.

2,730,041. GREAT WALLENDAS, INC., THE, SARASOTA, FL. SN 76-241,852. PUB. 5-14-2002, FILED 4-18-2001.

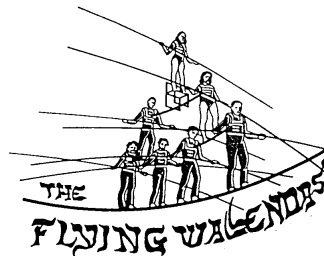

OWNER OF U.S. REG. NO. 1,643,047.
THE MARK CONSISTS OF A STYLIZED DEPICTION OF A SEVEN PERSON PYRAMID HIGH WIRE CIRCUS PERFORMANCE WITH LETTERING BELOW THE PICTURE "THE FLYING WALLENDAS"
FOR ENTERTAINMENT SERVICES IN THE NATURE OF CIRCUS PERFORMANCE (U.S. CLS. 100, 101 AND 107).
FIRST USE 4-1-1997; IN COMMERCE 12-16-2002.

CLASS 41—(Continued).

2,730,048. OBERTHUR GAMING TECHNOLOGIES CORP., SAN ANTONIO, TX. SN 76-243,345. PUB. 6-25-2002, FILED 4-20-2001.

ULTIMATE CASH CIRCUIT

NO CLAIM IS MADE TO THE EXCLUSIVE RIGHT TO USE "CASH", APART FROM THE MARK AS SHOWN.

FOR LOTTERY SERVICES (U.S. CLS. 100, 101 AND 107).

FIRST USE 3-22-2001; IN COMMERCE 3-22-2001.

2,730,055. CHAUNCEY, THOMAS, SAN FRANCISCO, CA. SN 76-244,165. PUB. 3-26-2002, FILED 4-20-2001.

PARTISAN ARTS

NO CLAIM IS MADE TO THE EXCLUSIVE RIGHT TO USE "ARTS", APART FROM THE MARK AS SHOWN.

FOR BOOKING SERVICES FOR MUSICAL ARTISTS (U.S. CLS. 100, 101 AND 107).

FIRST USE 1-0-2001; IN COMMERCE 1-0-2001.

2,730,071. NASHVILLE HOCKEY CLUB LIMITED PARTNERSHIP, NASHVILLE, TN. SN 76-253,744. PUB. 6-25-2002, FILED 5-8-2001.



OWNER OF U.S. REG. NOS. 2,364,958 AND 2,419,490. NO CLAIM IS MADE TO THE EXCLUSIVE RIGHT TO USE "NASHVILLE", APART FROM THE MARK AS SHOWN.

FOR ENTERTAINMENT SERVICES IN THE NATURE OF PROFESSIONAL ICE HOCKEY EXHIBITIONS (U.S. CLS. 100, 101 AND 107).

FIRST USE 11-26-2002; IN COMMERCE 11-27-2002.

2,730,109. UNIVERSITY OF WASHINGTON, SEATTLE, WA. SN 76-265,803. PUB. 5-28-2002, FILED 5-31-2001.



NO CLAIM IS MADE TO THE EXCLUSIVE RIGHT TO

CLASS 41—(Continued).

USE "INFORMATION SCHOOL", APART FROM THE MARK AS SHOWN.

THE MARK CONSISTS IN PART OF A STYLIZED LETTER "I".

FOR EDUCATION IN THE FIELDS OF LIBRARY AND INFORMATION SCIENCE; PROVIDING COURSES OF INSTRUCTION AT THE UNIVERSITY, COLLEGE, AND POSTGRADUATE LEVELS AND DISTRIBUTING COURSE MATERIALS IN CONNECTION THEREWITH; AND EDUCATIONAL RESEARCH (U.S. CLS. 100, 101 AND 107).

FIRST USE 8-0-2000; IN COMMERCE 8-0-2000.

2,730,113. CLARION MARKETING GROUP, INC., LENEXA, KS. SN 76-267,077. PUB. 6-18-2002, FILED 6-5-2001.

ENCOURAGEMENT TO GO

FOR EDUCATIONAL SERVICES, NAMELY, PROVIDING SEMINARS AND PROGRAMS AND GIVING SPEECHES TO MOTIVATE INDIVIDUALS AND ORGANIZATIONS TO IMPROVE THEMSELVES, TO BE MORE ACTIVE, AND TO ACHIEVE MORE (U.S. CLS. 100, 101 AND 107).

FIRST USE 1-31-2002; IN COMMERCE 1-31-2002.

2,730,224. MCGRAW-HILL COMPANIES, INC., THE, NEW YORK, NY. SN 76-299,828. PUB. 6-4-2002, FILED 8-15-2001.

I-KNOW

FOR STANDARDIZED EDUCATIONAL TESTING AND SCORING SERVICES DELIVERED ONLINE VIA SECURE WEB CONNECTIONS (U.S. CLS. 100, 101 AND 107).

FIRST USE 6-15-2002; IN COMMERCE 9-1-2002.

CLASS 41—(Continued).

2,730,229. NAMCO CYBERTAINMENT INC., BENSONVILLE, IL. SN 76-302,342. PUB. 3-12-2002, FILED 8-21-2001.

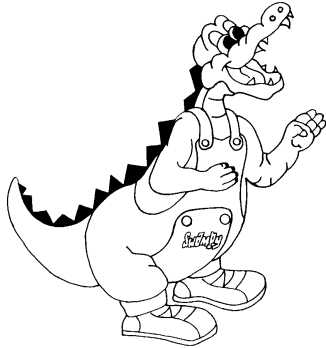

THE LINING IN THE DRAWING IS A FEATURE OF THE MARK AND DOES NOT INDICATE COLOR. THE DESIGN CONSISTS OF AN ALLIGATOR WEARING OVERALLS AND SHOES WITH THE WORD "SWAMPY" WRITTEN ACROSS THE FRONT OF THE ALLIGATOR'S OVERALLS. FOR FAMILY AMUSEMENT CENTER SERVICES (U.S. CLS. 100, 101 AND 107). FIRST USE 4-9-2002; IN COMMERCE 4-9-2002.

2,730,234. BLACK ENTERTAINMENT TELEVISION, INC., WASHINGTON, DC. SN 76-304,329. PUB. 1-22-2002, FILED 8-23-2001.

THE WAY WE DO IT

FOR ENTERTAINMENT SERVICES IN THE NATURE OF AN ON-GOING TELEVISION VARIETY SHOW FEATURING INTERVIEWS, MUSICAL PERFORMANCES, DRAMATIC PERFORMANCES, COMEDIC ROUTINES AND HOME VIDEOS (U.S. CLS. 100, 101 AND 107). FIRST USE 9-20-2001; IN COMMERCE 9-20-2001.

2,730,236. AWADA, YEHIA, LAS VEGAS, NV. SN 76-304,371. PUB. 5-14-2002, FILED 8-27-2001.



NO CLAIM IS MADE TO THE EXCLUSIVE RIGHT TO USE "3 5 7 POKER", APART FROM THE MARK AS SHOWN. FOR CASINO SERVICES FEATURING THE CARD GAME 3-5-7 POKER (U.S. CLS. 100, 101 AND 107). FIRST USE 8-20-2002; IN COMMERCE 8-20-2002.

CLASS 41—(Continued).

2,730,263. BALLY TOTAL FITNESS HOLDING CORPORATION, CHICAGO, IL. SN 76-312,336. PUB. 5-28-2002, FILED 9-10-2001.

REAL PEOPLE. REAL RESULTS.

FOR HEALTH CLUB SERVICES (U.S. CLS. 100, 101 AND 107). FIRST USE 10-0-2001; IN COMMERCE 10-0-2001.

2,730,277. DULAC, SERGE, KISSIMMEE, FL. SN 76-317,210. PUB. 6-18-2002, FILED 9-26-2001.

THE EX-CHANGING OF THE GUARDS

FOR ENTERTAINMENT SERVICES IN THE NATURE OF A LIVE SHOW OF IMPROVISATION TO BE PERFORMED IN FRONT OF AN AUDIENCE (U.S. CLS. 100, 101 AND 107). FIRST USE 6-26-2001; IN COMMERCE 6-26-2001.

2,730,280. TELECOMMUTING ADVANTAGE GROUP, INC., SAN FRANCISCO, CA. SN 76-317,983. PUB. 4-23-2002, FILED 9-28-2001.

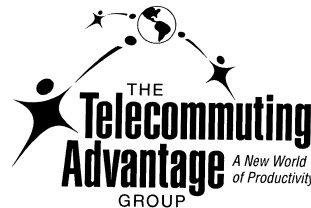

NO CLAIM IS MADE TO THE EXCLUSIVE RIGHT TO USE "TELECOMMUTING" AND "GROUP", APART FROM THE MARK AS SHOWN. THE MARK CONSISTS OF THE WORDS "THE TELECOMMUTING ADVANTAGE GROUP A NEW WORLD OF PRODUCTIVITY" BELOW A DESIGN SHOWING THREE STYLIZED HUMANS THROWING BALLS TOWARD THE PLANET EARTH. FOR EDUCATIONAL SERVICES AND TRAINING, NAMELY, CONDUCTING SEMINARS IN THE FIELDS OF COMPUTERS, TELECOMMUTING, AND BUSINESS MANAGEMENT, AND DISTRIBUTING COURSE MATERIALS IN CONNECTION THEREWITH (U.S. CLS. 100, 101 AND 107). FIRST USE 11-11-2002; IN COMMERCE 11-11-2002.

CLASS 41—(Continued).

2,730,283. GRAHAM, SCOTT, DBA FAIRGREEN GOLF, SAN ANTONIO, TX. SN 76-318,881. PUB. 5-7-2002, FILED 9-28-2001.

FAIRGREEN GOLF

NO CLAIM IS MADE TO THE EXCLUSIVE RIGHT TO USE "GOLF", APART FROM THE MARK AS SHOWN.

FOR ENTERTAINMENT IN THE NATURE OF GOLF GAMES; EDUCATIONAL SERVICES, NAMELY, CONDUCTING PROGRAMS IN THE FIELD OF ALTERNATIVE GOLF COURSE DESIGN, USAGE OF GOLF COURSES, AND GOLF GAMES (U.S. CLS. 100, 101 AND 107).

FIRST USE 6-30-2001; IN COMMERCE 6-30-2001.

2,730,295. HEALTH & FITNESS PUBLISHING, INC., HOUSTON, TX. SN 76-320,628. PUB. 8-27-2002, FILED 10-3-2001.

THE WINNING CIRCLE

NO CLAIM IS MADE TO THE EXCLUSIVE RIGHT TO USE "WINNING", APART FROM THE MARK AS SHOWN.

FOR ARRANGING AWARD CEREMONIES AND PARTIES FOR WINNERS OF FOOT RACES AND OTHER TRACK AND FIELD EVENTS (U.S. CLS. 100, 101 AND 107).

FIRST USE 7-1-2002; IN COMMERCE 7-1-2002.

2,730,312. NATIONAL BASEBALL HALL OF FAME AND MUSEUM, INC., COOPERSTOWN, NY. SN 76-323,970. PUB. 7-2-2002, FILED 10-10-2001.

BASEBALL AS AMERICA

OWNER OF U.S. REG. NO. 2,191,138. FOR CONDUCTING EDUCATIONAL EXHIBITIONS FEATURING BASEBALL ARTIFACTS (U.S. CLS. 100, 101 AND 107).

FIRST USE 11-8-2001; IN COMMERCE 3-12-2002.

2,730,336. FIRST PRESBYTERIAN SCHOOL, ARCADIA, CA. SN 76-331,197. PUB. 7-30-2002, FILED 10-29-2001.

**CLASS 41—(Continued).**

NO CLAIM IS MADE TO THE EXCLUSIVE RIGHT TO USE "FIRST PRESBYTERIAN SCHOOL" OR "U.S.A. 1995", APART FROM THE MARK AS SHOWN.

FOR EDUCATION SERVICES, NAMELY, PROVIDING COURSES OF INSTRUCTION AT THE HIGH SCHOOL LEVEL, GRADES 9-12 (U.S. CLS. 100, 101 AND 107).

FIRST USE 4-1-1995; IN COMMERCE 4-1-1995.

2,730,354. PARAMOUNT PARKS INC., CHARLOTTE, NC. SN 76-336,458. PUB. 4-16-2002, FILED 11-9-2001.

THERE'S NO BETTER TIME

FOR AMUSEMENT PARK SERVICES (U.S. CLS. 100, 101 AND 107).

FIRST USE 3-23-2002; IN COMMERCE 3-23-2002.

2,730,361. ONE TO ONE FITNESS, INC., MCLEAN, VA. SN 76-337,839. PUB. 5-28-2002, FILED 11-15-2001.

ACTIVE DUTY, FITNESS FOR WOMEN

NO CLAIM IS MADE TO THE EXCLUSIVE RIGHT TO USE "FITNESS FOR WOMEN", APART FROM THE MARK AS SHOWN.

FOR EXERCISE PROGRAMS AND CLASSES (U.S. CLS. 100, 101 AND 107).

FIRST USE 3-0-2002; IN COMMERCE 3-0-2002.

2,730,364. COLUMBIA PICTURES TELEVISION, INC., CULVER CITY, CA. SN 76-338,548. PUB. 6-4-2002, FILED 11-15-2001.

RUSSIAN ROULETTE

FOR ENTERTAINMENT SERVICES IN THE NATURE OF A TELEVISION GAME SHOW (U.S. CLS. 100, 101 AND 107).

FIRST USE 6-3-2002; IN COMMERCE 6-3-2002.

CLASS 41—(Continued).

2,730,383. COLLIER, LANCE, CLEVELAND, OH. SN 76-342,089. PUB. 9-3-2002, FILED 11-27-2001.

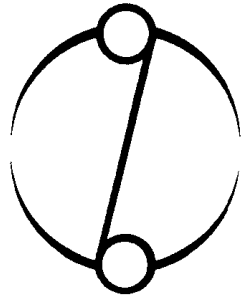

FOR ENTERTAINMENT SERVICES, NAMELY, LIVE MUSICAL PERFORMANCES THROUGH PERSONAL APPEARANCES; LIVE PERFORMANCES BY A MUSICAL GROUP ON TELEVISION AND RADIO; PERSONAL APPEARANCES BY A MUSICAL GROUP ON TELEVISION AND RADIO; PROVIDING INFORMATION ABOUT TOUR DATES AND PERFORMANCE SCHEDULE BY A MUSICAL GROUP VIA THE INTERNET; PROVIDING BIOGRAPHICAL INFORMATION ABOUT A MUSICAL GROUP; AND PROVIDING NON-DOWNLOADABLE MUSICAL RECORDING VIA THE INTERNET (U.S. CLS. 100, 101 AND 107).
FIRST USE 8-3-2002; IN COMMERCE 8-3-2002.

2,730,416. OFFLINE HOLDINGS CORPORATION, NEW YORK, NY. SN 76-348,341. PUB. 6-18-2002, FILED 12-11-2001.

CHRONICLE

FOR ENTERTAINMENT SERVICES NAMELY, TELEVISION PROGRAMMING IN THE FIELD OF DOCUMENTARIES (U.S. CLS. 100, 101 AND 107).
FIRST USE 6-0-2002; IN COMMERCE 6-0-2002.

2,730,424. WESTERFIELD, DIVINA K., CARMEL, IN. SN 76-350,315. PUB. 11-5-2002, FILED 12-19-2001.

TELE-CLINICS

FOR EDUCATIONAL SERVICES, NAMELY, CONDUCTING CLASSES, FORUMS, SEMINARS, GROUPS, INSTRUCTIONAL SESSIONS, AND WORKSHOPS ALL IN THE FIELD OF BUSINESS AND PERSONAL DEVELOPMENT VIA THE TELEPHONE OR THE INTERNET (U.S. CLS. 100, 101 AND 107).
FIRST USE 5-12-1999; IN COMMERCE 5-12-1999.

CLASS 41—(Continued).

2,730,425. DORIS DILLON CENTER, THE, NEW YORK, NY. SN 76-350,402. PUB. 7-23-2002, FILED 12-20-2001.

TEACHERWORKS

FOR DISTANCE LEARNING EDUCATIONAL SERVICES, NAMELY, PROVIDING COURSES OF INSTRUCTION AT THE COLLEGE AND GRADUATE LEVEL VIA TELEPHONE, INTERACTIVE TELEVISION, AND THE INTERNET AND DISTRIBUTION OF COURSE MATERIALS IN CONNECTION THEREWITH (U.S. CLS. 100, 101 AND 107).
FIRST USE 8-29-2002; IN COMMERCE 8-29-2002.

2,730,478. ELEMENT K ONLINE LLC, ROCHESTER, NY. SN 76-363,697. PUB. 7-30-2002, FILED 1-28-2002.

E-LEARNING WITH A HUMAN TOUCH

FOR EDUCATIONAL SERVICES, NAMELY, PROVIDING TRAINING THROUGH THE INTERNET AND INTRANETS, IN THE FIELDS OF INFORMATION TECHNOLOGY, BUSINESS MANAGEMENT SKILLS, AND WORKPLACE SAFETY (U.S. CLS. 100, 101 AND 107).
FIRST USE 7-0-2001; IN COMMERCE 7-0-2001.

2,730,484. ARENA FOOTBALL LEAGUE LLC, CHICAGO, IL. SN 76-365,559. PUB. 6-25-2002, FILED 2-4-2002.



NO CLAIM IS MADE TO THE EXCLUSIVE RIGHT TO USE "GEORGIA", APART FROM THE MARK AS SHOWN. THE MARK CONSISTS, IN PART, OF A FANCIFUL SWORD.
FOR ENTERTAINMENT SERVICES, NAMELY ORGANIZING AND PRESENTING FOOTBALL GAMES BEFORE LIVE AUDIENCES AND ON TELEVISION, RADIO, FOR GLOBAL COMPUTER NETWORK DISPLAY AND OTHER MEDIA (U.S. CLS. 100, 101 AND 107).
FIRST USE 1-26-2002; IN COMMERCE 1-26-2002.

CLASS 41—(Continued).

2,730,492. MOBILE MAMMAL PRODUCTIONS, INC., ATLANTA, GA. SN 76-369,303. PUB. 7-23-2002, FILED 2-12-2002.

ADVENTURE RACING DIARIES

NO CLAIM IS MADE TO THE EXCLUSIVE RIGHT TO USE "ADVENTURE RACING", APART FROM THE MARK AS SHOWN.

FOR ENTERTAINMENT IN THE NATURE OF ONGOING TELEVISION PROGRAMS IN THE FIELD OF ADVENTURE RACING, IN WHICH TEAMS COMPETE IN MULTI-DISCIPLINED ATHLETIC AND ENDURANCE COMPETITIONS AND NAVIGATE THROUGH A DESIGNATED COURSE (U.S. CLS. 100, 101 AND 107).
FIRST USE 2-1-2002; IN COMMERCE 3-15-2002.

2,730,497. CACIOLI, LISA, NORTH HAVEN, CT. SN 76-370,494. PUB. 7-30-2002, FILED 2-13-2002.

TAEKID-DO

FOR EDUCATIONAL SERVICES, NAMELY CONDUCTING INSTRUCTION, TRAINING, CLINICS, CLASSES, SEMINARS AND WORKSHOPS IN THE FIELD OF MARTIAL ARTS AND SELF ESTEEM (U.S. CLS. 100, 101 AND 107).
FIRST USE 3-1-2003; IN COMMERCE 3-1-2003.

2,730,525. MARYLAND PUBLIC BROADCASTING COMMISSION, OWINGS MILLS, MD. SN 76-390,671. PUB. 10-22-2002, FILED 4-1-2002.

PLASTIC FORK DIARIES

NO CLAIM IS MADE TO THE EXCLUSIVE RIGHT TO USE "FORK", APART FROM THE MARK AS SHOWN.

FOR EDUCATIONAL AND ENTERTAINMENT SERVICES, NAMELY, PROVIDING A WEB SITE OFFERING CONTENT TO FAMILIARIZE CHILDREN WITH FOOD INGREDIENTS, EATING HABITS AND COOKING TECHNIQUES, PROMOTING HEALTHY EATING AND INCREASING AWARENESS OF ETHNIC CULINARY TRADITIONS (U.S. CLS. 100, 101 AND 107).
FIRST USE 3-20-2003; IN COMMERCE 3-20-2003.

CLASS 41—(Continued).

2,730,599. MICROSOFT CORPORATION, REDMOND, WA. SN 78-043,748. PUB. 7-9-2002, FILED 1-18-2001.

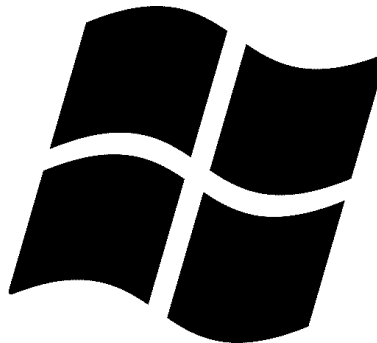

OWNER OF U.S. REG. NOS. 1,815,350, 1,816,354, AND OTHERS.

THE MARK CONSISTS OF A FLAG DESIGN. COLOR IS NOT CLAIMED AS PART OF THE MARK.

FOR EDUCATIONAL SERVICES, NAMELY, PROVIDING ON-LINE COMPUTER SOFTWARE USER TRAINING VIA A GLOBAL COMPUTER NETWORK; CONDUCTING CLASSES AND SEMINARS IN THE FIELD OF COMPUTERS AND COMPUTER PROGRAMS; AND PROVIDING ENTERTAINMENT INFORMATION VIA THE INTERNET IN THE FIELDS OF ENTERTAINMENT, MOVIES, SPORTS AND MUSIC (U.S. CLS. 100, 101 AND 107).

FIRST USE 7-2-2001; IN COMMERCE 7-2-2001.

2,730,628. NATIONAL INDEPENDENT AUTOMOBILE DEALERS ASSOCIATION, ARLINGTON, TX. SN 78-054,957. PUB. 7-2-2002, FILED 3-26-2001.



OWNER OF U.S. REG. NO. 2,204,930.

NO CLAIM IS MADE TO THE EXCLUSIVE RIGHT TO USE "CERTIFIED MASTER DEALER" AND "NATIONAL INDEPENDENT AUTOMOBILE DEALERS ASSOCIATION", APART FROM THE MARK AS SHOWN.

THE LINING IN THE DRAWING IS A FEATURE OF THE MARK AND DOES NOT INDICATE COLOR.

FOR EDUCATIONAL SERVICES IN THE NATURE OF A PROGRAM LEADING TO AN EDUCATIONAL DESIGNATION, NAMELY, CONDUCTING CLASSES, SEMINARS, CONFERENCES AND WORKSHOPS IN THE AUTOMOTIVE FIELD RELATED TO THE OPERATION OF USED MOTOR VEHICLE DEALERSHIPS (U.S. CLS. 100, 101 AND 107).

FIRST USE 6-10-2001; IN COMMERCE 6-10-2001.

CLASS 41—(Continued).

2,730,633. MEDTRONIC INC., MINNEAPOLIS, MN. SN 78-057,657. PUB. 7-9-2002, FILED 4-10-2001.

FRIDAYS WITH THE EXPERTS

FOR EDUCATIONAL SERVICES, NAMELY, CONDUCTING WORKSHOPS FOR MEDICAL PROFESSIONALS IN BEATING HEART TECHNIQUES (U.S. CLS. 100, 101 AND 107).

FIRST USE 12-1-2001; IN COMMERCE 12-1-2001.

2,730,634. MEDTRONIC, INC., MINNEAPOLIS, MN. SN 78-057,662. PUB. 7-9-2002, FILED 4-10-2001.

OCTOPUS SELECT

NO CLAIM IS MADE TO THE EXCLUSIVE RIGHT TO USE "OCTOPUS", APART FROM THE MARK AS SHOWN. FOR EDUCATIONAL SERVICES, NAMELY, CONDUCTING WORKSHOPS FOR MEDICAL PROFESSIONALS IN THE USE OF OCTOPUS BEATING HEART PRODUCT (U.S. CLS. 100, 101 AND 107).

FIRST USE 12-1-2001; IN COMMERCE 12-1-2001.

2,730,658. SILVER DOLLAR CITY, INC., BRANSON, MO. SN 78-066,578. PUB. 7-16-2002, FILED 5-31-2001.

CROSSROADS

FOR ENTERTAINMENT SERVICES, NAMELY PROVIDING AMUSEMENT PARK FACILITIES; PROVIDING PLAYGROUND FACILITIES FOR OTHERS; EDUCATIONAL SERVICES, NAMELY, CONDUCTING CLASSES IN THE FIELD OF CRAFTS; AND ENTERTAINMENT IN THE NATURE OF FILM AND IN-HOUSE SPECIAL EFFECTS DESIGN (U.S. CLS. 100, 101 AND 107).

FIRST USE 11-5-2001; IN COMMERCE 11-5-2001.

2,730,669. FORD MODELS, INC., NEW YORK, NY. SN 78-071,339. PUB. 6-11-2002, FILED 6-27-2001.

FORD MODELS SUPERMODEL OF THE WORLD

OWNER OF U.S. REG. NOS. 1,296,761 AND 2,481,166.

NO CLAIM IS MADE TO THE EXCLUSIVE RIGHT TO USE "MODELS SUPERMODEL OF THE WORLD", APART FROM THE MARK AS SHOWN.

FOR ENTERTAINMENT SERVICES, NAMELY CONDUCTING AND PROMOTING BEAUTY PAGEANTS AND COMPETITIONS (U.S. CLS. 100, 101 AND 107).

FIRST USE 12-0-2002; IN COMMERCE 12-0-2002.

CLASS 41—(Continued).

2,730,670. MICHAELS, KEVIN S., HICKSVILLE, NY. SN 78-071,433. PUB. 6-11-2002, FILED 6-28-2001.

CURSE

FOR ENTERTAINMENT NAMELY, LIVE PERFORMANCES BY A MUSICAL BAND (U.S. CLS. 100, 101 AND 107).

FIRST USE 7-16-2001; IN COMMERCE 7-16-2001.

2,730,686. BASSIN' AMERICA INC., DBA BASSIN' USA, PORT JEFFERSON STATION, NY. SN 78-075,848. PUB. 10-1-2002, FILED 7-26-2001.



NO CLAIM IS MADE TO THE EXCLUSIVE RIGHT TO USE "BASSIN'", "WWW.BASSINUSA.COM", "USA", APART FROM THE MARK AS SHOWN.

THE MARK CONSISTS IN PART OF THE WORDS "BASSIN' WWW.BASSINUSA.COM USA"; A FISHERMAN IS HOLDING A BENT FISHING ROD WITH A LURE ATTACHED AT THE END OF THE LINE, IN FRONT OF THE WORDING. A HUGE LARGEMOUTH BASS IS ABOUT TO ENGULF THE LURE ABOVE THE WORDING. A PARTIAL GLOBE SHOWING CONTINENTS LIES WITHIN THE "U" OF "USA" AND A CIRCULAR CARRIER LIES BEHIND THE ENTIRE MARK.

FOR PROVIDING INFORMATION OVER THE INTERNET IN THE FIELD OF BASS FISHING FOR FISHERMEN AROUND THE WORLD, INCLUDING INFORMATION SPECIFIC TO LARGEMOUTH, SMALL MOUTH, SPOTTED, STRIPED AND HYBRID BASS, TOURNAMENT BASS FISHING, FISHING TACKLE AND EQUIPMENT, GUIDE SERVICES AND FISHING DESTINATIONS (U.S. CLS. 100, 101 AND 107).

FIRST USE 10-20-1999; IN COMMERCE 11-22-1999.

CLASS 41—(Continued).

2,730,695. UNIVERSAL TV DISTRIBUTION HOLDINGS LLC, UNIVERSAL CITY, CA, BY CHANGE OF NAME STUDIOS USA TELEVISION DISTRIBUTION LLC, WEST HOLLYWOOD, CA. SN 78-078,242. PUB. 6-18-2002, FILED 8-8-2001.

LAW & ORDER: CRIMINAL INTENT

NO CLAIM IS MADE TO THE EXCLUSIVE RIGHT TO USE "CRIMINAL INTENT", APART FROM THE MARK AS SHOWN.

FOR ENTERTAINMENT SERVICES, NAMELY AN ONGOING DRAMATIC TELEVISION SERIES (U.S. CLS. 100, 101 AND 107).

FIRST USE 9-30-2001; IN COMMERCE 9-30-2001.

2,730,739. SCHUSTER, JAN, POMPANO BEACH, FL. SN 78-090,628. PUB. 4-9-2002, FILED 10-29-2001.

EUROVERBA

FOR LANGUAGE TRANSLATION SERVICES (U.S. CLS. 100, 101 AND 107).

FIRST USE 4-10-2000; IN COMMERCE 9-1-2000.

2,730,762. STATE OF MIND MUZIC, ATLANTA, GA. SN 78-096,546. PUB. 10-29-2002, FILED 12-4-2001.

PRETTY TONI

THE NAME "TONI" DOES NOT IDENTIFY A LIVING INDIVIDUAL.

FOR ENTERTAINMENT SERVICES IN THE NATURE OF A LIVE MUSICAL GROUP (U.S. CLS. 100, 101 AND 107).

FIRST USE 4-1-2002; IN COMMERCE 9-1-2002.

2,730,771. PIKE, DAILEY D., VAN NUYS, CA. SN 78-098,585. PUB. 10-15-2002, FILED 12-16-2001.

GIGOLETTE

FOR ENTERTAINMENT SERVICES IN THE NATURE OF LIVE-ACTION, COMEDY, DRAMA AND/OR ANIMATED MOTION PICTURE THEATRICAL FILMS; PRODUCTION OF LIVE-ACTION, COMEDY, DRAMA AND/OR ANIMATED MOTION PICTURE THEATRICAL FILMS; ENTERTAINMENT SERVICES IN THE NATURE OF LIVE-ACTION, COMEDY, DRAMA AND/OR ANIMATED ON-GOING TELEVISION PROGRAMS; PRODUCTION OF LIVE-ACTION, COMEDY, DRAMA AND/OR ANIMATED ON-GOING TELEVISION PROGRAMS; ENTERTAINMENT SERVICES IN THE NATURE OF EXHIBITION OF LIVE MUSICAL AND THEATRICAL PERFORMANCES; PRODUCTION OF LIVE MUSICAL AND THEATRICAL PERFORMANCES (U.S. CLS. 100, 101 AND 107).

FIRST USE 12-1-2001; IN COMMERCE 12-1-2001.

CLASS 42—SCIENTIFIC, COMPUTER AND LEGAL SERVICES

2,729,383. FOR PET'S SAKE, INC., SEATTLE, WA. SN 75-465,947. PUB. 6-22-1999, FILED 4-10-1998.



NO CLAIM IS MADE TO THE EXCLUSIVE RIGHT TO USE "PET CENTER", APART FROM THE MARK AS SHOWN.

FOR PROVIDING FULL SERVICE ANIMAL GROOMING FACILITIES AND SELF-SERVICE ANIMAL GROOMING FACILITIES; ESPRESSO BAR SERVICES (U.S. CLS. 100 AND 101).

FIRST USE 7-16-1996; IN COMMERCE 7-18-1998.

2,729,440. KAUTZ, WILLIAM R., GENEVA, IL. SN 75-649,674. PUB. 12-14-1999, FILED 3-1-1999.

TAG ART

FOR PRODUCT DESIGN FOR OTHERS (U.S. CLS. 100 AND 101).

FIRST USE 2-21-2003; IN COMMERCE 2-21-2003.

2,729,462. CEREP SA, 75007 PARIS, FRANCE. SN 75-700,363. PUB. 12-11-2001, FILED 6-2-1999.

CEREP BIOPRINT

FOR PROVIDING ACCESS TO OTHERS TO PHARMACOLOGICAL AND PHARMACEUTICAL TESTING DATA, PREDICTIVE ANALYSIS MODELS AND ANALYSIS OF DATA (U.S. CLS. 100 AND 101).

FIRST USE 7-21-1999; IN COMMERCE 7-21-1999.

2,729,491. SELA2, INC., MAHWAH, NJ, BY ASSIGNMENT SKILA, INC., MAHWAH, NJ. SN 75-752,405. PUB. 9-18-2001, FILED 7-16-1999.

INTELLIGRATION

FOR COMPUTER SERVICES, NAMELY, DEVELOPING AND MAINTAINING DATABASES AND PROVIDING SEARCH CAPABILITY IN THE DATABASES BY THIRD PARTIES (U.S. CLS. 100 AND 101).

FIRST USE 6-29-1999; IN COMMERCE 6-29-1999.

CLASS 42—(Continued).

2,729,529. VERIFICATION TECHNOLOGIES, INC., CENTER-BROOK, CT. SN 75-818,269. PUB. 2-20-2001, FILED 10-8-1999.

GLOBAL FINGERPRINT VERIFICATION

NO CLAIM IS MADE TO THE EXCLUSIVE RIGHT TO USE "GLOBAL" AND "VERIFICATION", APART FROM THE MARK AS SHOWN.

FOR PRODUCT INGREDIENT AUTHENTICATION SERVICES FOR THE FOOD AND BEVERAGE INDUSTRY (U.S. CLS. 100 AND 101).

FIRST USE 5-0-2001; IN COMMERCE 5-0-2001.

2,729,538. KENDLE INTERNATIONAL, INC., CINCINNATI, OH. SN 75-833,499. PUB. 8-1-2000, FILED 10-27-1999.

TRIALWEB

FOR COMPUTERIZED RESEARCH AND INFORMATION SERVICES, NAMELY PROVIDING CLINICAL TRIAL DATA VIA THE WORLD WIDE WEB (U.S. CLS. 100 AND 101).

FIRST USE 3-1-2002; IN COMMERCE 3-1-2002.

2,729,543. CENTRIC MEDIA, INC., BERKELEY, CA. SN 75-842,153. PUB. 2-27-2001, FILED 11-5-1999.

BOOMERANGIT.COM

FOR COMPUTER SERVICES, NAMELY, TRACKING AND RECOVERY OF LOST AND STOLEN GOODS, PROVIDED OVER A GLOBAL COMPUTER NETWORK (U.S. CLS. 100 AND 101).

FIRST USE 6-1-2002; IN COMMERCE 6-1-2002.

2,729,555. XFI CORPORATION, BETHESDA, MD. SN 75-855,795. PUB. 6-12-2001, FILED 11-22-1999.

DECISION TIME

FOR PROVIDING TEMPORARY USE OF ON-LINE NON-DOWNLOADABLE DECISION GUIDE SOFTWARE AND COMPUTER PROGRAMS, NAMELY AUTOMATED OR INTERACTIVE MARKETING OR SALES APPLICATIONS WHICH GUIDE CONSUMERS' PURCHASING DECISIONS, AND FOR COMMUNICATIONS OVER A GLOBAL COMPUTER NETWORK (U.S. CLS. 100 AND 101).

FIRST USE 9-2-2002; IN COMMERCE 9-2-2002.

CLASS 42—(Continued).

2,729,558. TRANSFORM PHARMACEUTICALS, INC., CAMBRIDGE, MA. SN 75-859,997. PUB. 5-15-2001, FILED 11-30-1999.

FAST

FOR RESEARCH AND DEVELOPMENT OF CUSTOM-MADE CHEMICAL COMPOSITIONS ARRANGED IN A PREDETERMINED-PATTERN IN STORAGE COMPARTMENTS FOR USE IN SCREENING OF PROPERTIES TO DETERMINE OPTIMAL COMPOUNDS (U.S. CLS. 100 AND 101).

FIRST USE 2-14-2000; IN COMMERCE 2-14-2000.

2,729,575. SOCIETE DE PARTICIPATIONS ET D'INVESTISSEMENTS DE MOTELS, 75755 PARIS CEDEX 15, FRANCE. SN 75-883,708. PUB. 12-19-2000, FILED 12-30-1999.

NOUS ALLONS LAISSER LA LUMIERE ALLUMÉE POUR VOUS

OWNER OF U.S. REG. NO. 2,018,769.
THE ENGLISH TRANSLATION OF "NOUS ALLONS LAISSER LA LUMIERE ALLUMÉE POUR VOUS" IS "WE'LL LEAVE THE LIGHT ON FOR YOU".

FOR MOTEL SERVICES (U.S. CLS. 100 AND 101).

FIRST USE 3-9-2003; IN COMMERCE 3-9-2003.

2,729,580. HOUSTON INTERWEB DESIGN, INC., HOUSTON, TX. SN 75-890,368. PUB. 6-4-2002, FILED 1-9-2000.

POLITICALNET.COM

FOR POLITICAL WEB SITE SERVICES, NAMELY PROVIDING WEBSITE HOSTING; PROVIDING ON-LINE SEARCHABLE POLITICAL DATABASE, SEARCH AND RETRIEVAL SERVICES IN THE NATURE OF POLITICAL AND PUBLIC RECORDS, INCLUDING LINKS TO STATE AND FEDERAL COURT DATABASES, AND OTHER POLITICAL INFORMATION SITES; PROVIDING ONLINE NEWS AND EDITORIALS ON TOPICS OF GENERAL POLITICAL INTEREST ONLINE VIA A WEBSITE ON A GLOBAL COMPUTER NETWORK; AND PROVIDING POLITICAL INFORMATION INCLUDING NEWS AND EDITORIAL ON TOPICS OF GENERAL POLITICAL INTEREST ONLINE, VIA A GLOBAL COMPUTER NETWORK (U.S. CLS. 100 AND 101).

FIRST USE 9-0-1998; IN COMMERCE 9-0-1998.

2,729,592. CLICKNSETTLE.COM, INC., GREAT NECK, NY, BY CHANGE OF NAME NAM CORPORATION, GREAT NECK, NY. SN 75-903,683. PUB. 10-24-2000, FILED 1-26-2000.

MYADR

NO CLAIM IS MADE TO THE EXCLUSIVE RIGHT TO USE "ADR", APART FROM THE MARK AS SHOWN.

FOR ALTERNATIVE DISPUTE RESOLUTION SERVICES (U.S. CLS. 100 AND 101).

FIRST USE 9-3-2002; IN COMMERCE 10-0-2002.

CLASS 42—(Continued).

2,729,597. CHOICE ONE COMMUNICATIONS, INC., ROCHESTER, NY. SN 75-908,597. PUB. 11-13-2001, FILED 2-2-2000.

CHOICEONEONLINE

FOR DESIGNING, DEVELOPING, AND MAINTAINING WEB SITES FOR OTHERS; HOSTING THE WEB SITES OF OTHERS ON A COMPUTER SERVER FOR A GLOBAL COMPUTER NETWORK (U.S. CLS. 100 AND 101).

FIRST USE 10-1-2000; IN COMMERCE 10-1-2000.

2,729,604. BIGGUS, GLEN, GLEN ELLYN, IL. SN 75-915,466. PUB. 10-8-2002, FILED 2-2-2000.

TROPES

FOR PROVIDING INFORMATION AT THE SPECIFIC REQUEST OF END-USERS BY MEANS OF TELEPHONE OR GLOBAL COMPUTER NETWORKS; COMPUTER DESIGN, HOSTING THE WEB SITES OF OTHERS THE GLOBAL COMPUTER NETWORK, COMPUTER CONSULTING AND TECHNICAL SUPPORT AND COMPUTER ASSISTANCE SERVICES (U.S. CLS. 100 AND 101).

FIRST USE 10-16-1999; IN COMMERCE 1-1-2000.

2,729,608. BRYAN CAVE LLP, ST. LOUIS, MO. SN 75-916,636. PUB. 10-3-2000, FILED 2-11-2000.

ECAVE

FOR ONLINE COMPUTER WEBSITE SERVICES VIA GLOBAL AND INTERNAL COMPUTER NETWORKS, NAMELY, PROVIDING INFORMATION IN THE FIELDS OF LAW, LAWYERS, LAWYERING, LEGAL NEWS, LEGAL RESEARCH, LEGAL RESOURCES, AND LEGAL SERVICES (U.S. CLS. 100 AND 101).

FIRST USE 8-31-2000; IN COMMERCE 8-31-2000.

CLASS 42—(Continued).

2,729,610. ANTARCTICA SYSTEMS INC., VANCOUVER B.C. CANADA. SN 75-917,393. PUB. 11-27-2001, FILED 2-14-2000.

ANTARCTICA

FOR COMPUTER SERVICES FOR OTHERS, NAMELY, THE INSTALLATION OF COMPUTER SOFTWARE FOR INTERPRETING, ORGANIZING, CLASSIFYING, AND PRESENTING DATA IN THE FORM OF TWO-DIMENSIONAL AND THREE-DIMENSIONAL MAPS AND GRAPHICS; COMPUTER SERVICES FOR OTHERS, NAMELY, THE FORMATTING AND UPLOADING OF DATA AND CUSTOMIZATION OF COMPUTER SOFTWARE FOR INTERPRETING, ORGANIZING, CLASSIFYING, AND PRESENTING DATA IN THE FORM OF TWO-DIMENSIONAL AND THREE-DIMENSIONAL MAPS AND GRAPHICS; COMPUTER SERVICES FOR OTHERS, NAMELY, THE UPDATING AND REFORMATTING OF NEW DATA FOR USE IN ASSOCIATION WITH COMPUTER SOFTWARE FOR INTERPRETING, ORGANIZING, CLASSIFYING, AND PRESENTING DATA IN THE FORM OF TWO-DIMENSIONAL AND THREE-DIMENSIONAL MAPS AND GRAPHICS; COMPUTER SERVICES FOR OTHERS, NAMELY, THE MAINTENANCE OF COMPUTER SOFTWARE FOR INTERPRETING, ORGANIZING, CLASSIFYING, AND PRESENTING DATA IN THE FORM OF TWO-DIMENSIONAL AND THREE-DIMENSIONAL MAPS AND GRAPHICS (U.S. CLS. 100 AND 101).

FIRST USE 11-30-2000; IN COMMERCE 11-30-2000.

2,729,619. VILLA PORTOFINO I, LLC, PALM DESERT, CA. SN 75-928,818. PUB. 6-4-2002, FILED 2-22-2000.

**Villa Portofino**

THE MARK CONSISTS OF A DISTINCTIVE GOLD SHIELD WITH THE GOLD INITIALS "VP" WITH THE WORDS "VILLA PORTOFINO" DISPLAYED UNDERNEATH.

THE ENGLISH TRANSLATION OF "VILLA PORTOFINO" IS "FINE PORT HOUSE".

FOR PROVIDING LUXURIOUS HOUSING ACCOMMODATIONS FOR SENIORS (U.S. CLS. 100 AND 101). FIRST USE 1-0-2000; IN COMMERCE 1-0-2000.

2,729,637. VENETIAN CASINO RESORT, LLC, LAS VEGAS, NV, BY ASSIGNMENT LAS VEGAS SANDS, INC., LAS VEGAS, NV. SN 75-979,976. PUB. 7-22-1997, FILED 3-7-1996.

PALAZZO

FOR HOTEL SERVICES, NAMELY, PROVIDING FACILITIES FOR CONVENTIONS, CONFERENCES, BANQUETS, SOCIAL FUNCTIONS, FUND RAISING, AND SPECIAL EVENTS; AND PROVIDING HOTEL LODGING SERVICES (U.S. CLS. 100 AND 101).

FIRST USE 5-4-1999; IN COMMERCE 5-4-1999.

CLASS 42—(Continued).

2,729,638. RELIANT ENERGY, INCORPORATED, HOUSTON, TX. SN 75-981,391. PUB. 1-15-2002, FILED 1-17-2001.

RELIANT STADIUM

NO CLAIM IS MADE TO THE EXCLUSIVE RIGHT TO USE "STADIUM", APART FROM THE MARK AS SHOWN. FOR RESTAURANT AND BAR SERVICES; PROVIDING GENERAL PURPOSE FACILITIES FOR EXHIBITIONS (U.S. CLS. 100 AND 101).

FIRST USE 8-0-2002; IN COMMERCE 8-0-2002.

CLASS 42—(Continued).

2,729,679. FLYTLIE, KNUT, DK-7100 VEJLE, DENMARK. SN 76-019,927. PUB. 12-11-2001, FILED 4-7-2000.

VITAMINDOCTOR

FOR MEDICAL SERVICES; BEAUTY SALONS; NUTRITION COUNSELING; SCIENTIFIC RESEARCH; PRODUCT RESEARCH; COMPUTER PROGRAMMING FOR OTHERS (U.S. CLS. 100 AND 101).

FIRST USE 1-30-2003; IN COMMERCE 1-30-2003.

2,729,671. CENTRIC MEDIA, INC., BERKELEY, CA. SN 76-012,056. PUB. 1-8-2002, FILED 3-28-2000.



FOR REGISTRATION SERVICES, NAMELY ASSIGNMENT OF IDENTIFICATION NUMBERS TO ENHANCE RECOVERY OF LOST OR STOLEN PROPERTY, AND DISSEMINATION OF INFORMATION RELATING TO LOST OR STOLEN PROPERTY VIA A GLOBAL COMMUNICATIONS NETWORK (U.S. CLS. 100 AND 101).

FIRST USE 6-1-2002; IN COMMERCE 6-1-2002.

2,729,682. TERRACE SECURITY COMPANY, HOUSTON, TX. SN 76-024,684. PUB. 3-12-2002, FILED 4-13-2000.

SECURITY AMBASSADOR

NO CLAIM IS MADE TO THE EXCLUSIVE RIGHT TO USE "SECURITY", APART FROM THE MARK AS SHOWN. FOR SECURITY GUARD SERVICES (U.S. CLS. 100 AND 101).

FIRST USE 4-0-1997; IN COMMERCE 4-0-1997.

2,729,715. AMERICAN SIMMENTAL ASSOCIATION, BOZEMAN, MT. SN 76-063,580. PUB. 3-5-2002, FILED 6-5-2000.

MB-ICE

FOR SCIENTIFIC RESEARCH, NAMELY, ANALYZING AND PRESENTING CUSTOMIZED LIVESTOCK PERFORMANCE DATA FROM AN EVALUATION SYSTEM COMPRISED OF A PROPRIETARY DATABASE IN THE FIELD OF AGRICULTURAL GENETICS (U.S. CLS. 100 AND 101).

FIRST USE 1-1-1997; IN COMMERCE 1-1-1997.

2,729,672. FRESH CHOICE, INC., MORGAN HILL, CA. SN 76-012,179. PUB. 4-9-2002, FILED 3-28-2000.



OWNER OF U.S. REG. NOS. 1,684,046, 2,383,575, AND OTHERS.

NO CLAIM IS MADE TO THE EXCLUSIVE RIGHT TO USE "EXPRESS", APART FROM THE MARK AS SHOWN. FOR RESTAURANT SERVICES (U.S. CLS. 100 AND 101).

FIRST USE 6-0-1999; IN COMMERCE 6-0-1999.

2,729,734. COPYRIGHT CLEARANCE CENTER, INC., DANVERS, MA. SN 76-076,067. PUB. 7-9-2002, FILED 6-22-2000.

RIGHTSLINK

FOR LICENSING SERVICES FOR THE INTELLECTUAL PROPERTY OF OTHERS (U.S. CLS. 100 AND 101).

FIRST USE 5-1-2000; IN COMMERCE 5-1-2000.

CLASS 42—(Continued).

2,729,742. SKOLAR INC., PALO ALTO, CA, BY CHANGE OF NAME E-SKOLAR, INC., PALO ALTO, CA. SN 76-080,577. PUB. 9-17-2002, FILED 6-30-2000.



THE NAME "STANFORD SKOLAR M.D." DOES NOT IDENTIFY A LIVING INDIVIDUAL.
FOR PROVIDING INFORMATION IN THE FIELD OF MEDICINE BY MEANS OF A GLOBAL COMPUTER NETWORK (U.S. CLS. 100 AND 101).
FIRST USE 6-0-2001; IN COMMERCE 6-0-2001.

2,729,749. MERITAGE TECHNOLOGIES, INC., COLUMBUS, OH. SN 76-084,065. PUB. 7-16-2002, FILED 7-6-2000.

MERITAGE TECHNOLOGIES

NO CLAIM IS MADE TO THE EXCLUSIVE RIGHT TO USE "TECHNOLOGIES", APART FROM THE MARK AS SHOWN.

FOR COMPUTERS SERVICES, NAMELY, THE DESIGN, DEVELOPMENT AND IMPLEMENTATION FOR OTHERS OF CUSTOM SOFTWARE PRODUCTS FOR USE WITH LOCAL AND GLOBAL COMPUTER NETWORKS; THE DESIGN, DEVELOPMENT AND IMPLEMENTATION OF CUSTOM SOFTWARE PRODUCTS FOR INTERNAL MANAGEMENT, COMMUNICATIONS AND E-COMMERCE; LEASING OF COMPUTER SOFTWARE; HOSTING OF WEB SITES FOR OTHERS ON A COMPUTER SERVER FOR A GLOBAL COMPUTER NETWORK; COMPUTER SYSTEMS DESIGN AND COMPUTER NETWORK DESIGN; INTEGRATION OF COMPUTER SOFTWARE, COMPUTER SYSTEMS AND COMPUTER NETWORKS; AND DESIGNING AND IMPLEMENTING WEB SITES FOR OTHERS; CONSULTING SERVICES IN THE FIELD OF COMPUTERS AND COMPUTER NETWORKS; COMPUTER SOFTWARE UPDATING AND MAINTENANCE; AND PROVIDING TECHNICAL CONSULTING AND RELATED PROBLEM-SOLVING SERVICES IN THE FIELD OF COMPUTER NETWORKS, PROVIDING INFORMATION IN THE FIELD OF COMPUTER NETWORKS, AND OPTIMIZATION OF COMPUTER NETWORK SYSTEMS (U.S. CLS. 100 AND 101).

FIRST USE 12-6-2002; IN COMMERCE 12-6-2002.

2,729,757. THEORIS, INC., CARMEL, IN, BY CHANGE OF NAME SOFTWARE SYNERGY, INC., FISHERS, IN. SN 76-088,682. PUB. 7-30-2002, FILED 7-13-2000.

THEORIS

FOR PROVIDING COMPUTER CONSULTATION, COMPUTER SYSTEMS ANALYSIS, COMPUTER PROGRAMMING, AND COMPUTER SOFTWARE DESIGN SERVICES FOR OTHERS; AND PROVIDING WEB SITE DESIGN SERVICES FOR OTHERS, NAMELY, DESIGNING, CREATING, AND MAINTAINING WEB SITES; AND DESIGNING AND IMPLEMENTING WEB PAGES (U.S. CLS. 100 AND 101).

FIRST USE 8-1-2000; IN COMMERCE 8-1-2000.

CLASS 42—(Continued).

2,729,761. DFB PHARMACEUTICALS, INC., SAN ANTONIO, TX, BY CHANGE OF NAME DFB HOLDING, INC., SAN ANTONIO, TX. SN 76-093,297. PUB. 6-12-2001, FILED 7-11-2000.

DFB PHARMACEUTICALS

NO CLAIM IS MADE TO THE EXCLUSIVE RIGHT TO USE "PHARMACEUTICALS", APART FROM THE MARK AS SHOWN.

FOR PRODUCT RESEARCH AND DEVELOPMENT IN THE FIELD ETHICAL PHARMACEUTICALS, OVER-THE-COUNTER DRUGS AND COSMETICS (U.S. CLS. 100 AND 101).

FIRST USE 5-1-2001; IN COMMERCE 2-12-2003.

2,729,779. YOUR COMPANY COLLECTION, INC., DAYTON, OH. SN 76-102,110. PUB. 4-23-2002, FILED 8-2-2000.

YOUR COMPANY COLLECTION

FOR CUSTOM IMPRINTING SERVICES IN THE FIELDS OF BUSINESS SUPPLIES, PROMOTIONAL MERCHANDISE, ADVERTISING MATTER, CORPORATE CLOTHING AND EMPLOYEE RECOGNITION AND SERVICE AWARDS (U.S. CLS. 100 AND 101).

FIRST USE 1-0-2001; IN COMMERCE 1-0-2001.

2,729,784. SUPPORTSOFT, INC., REDWOOD CITY, CA, BY CHANGE OF NAME; SERVICE911.COM, INC., DALLAS, TX. SN 76-106,741. PUB. 5-14-2002, FILED 8-8-2000.

SUPPORTSOFT

FOR COMPUTER SERVICES, NAMELY, PROVIDING ON-LINE TECHNICAL SUPPORT SERVICES, NAMELY, TROUBLESHOOTING OF COMPUTER HARDWARE AND SOFTWARE PROBLEMS, AND PROVIDING TEMPORARY USE OF NON-DOWNLOADABLE ELECTRONIC TUTORIALS FOR TROUBLESHOOTING THE SAME, ALL PROVIDED VIA A GLOBAL COMPUTER NETWORK (U.S. CLS. 100 AND 101).

FIRST USE 3-28-2002; IN COMMERCE 3-28-2002.

CLASS 42—(Continued).

2,729,785. XDIMENSIONAL TECHNOLOGIES, INC., BREA, CA. SN 76-106,750. PUB. 4-23-2002, FILED 8-8-2000.



FOR COMPUTER SOFTWARE DESIGN FOR OTHERS; CONSULTING SERVICES IN THE FIELDS OF COMPUTER HARDWARE, SOFTWARE, AUTOMATIONS, SYSTEM INTEGRATION, ANALYSIS OF WORKFLOW PROCEDURES, AND PLANNING, IMPLEMENTATION, AND MANAGEMENT OF AUTOMATION; LEASING OF SOFTWARE OVER A GLOBAL COMPUTER NETWORK; COMPUTER HARDWARE AND SOFTWARE DESIGN; INSTALLATION, MAINTENANCE AND REPAIR OF COMPUTER SOFTWARE SYSTEMS; SET-UP OF INTEGRATED E-MAIL SYSTEMS AS WELL AS TECHNICAL SUPPORT OF INTEGRATED E-MAIL SYSTEMS VIA TELEPHONE POSTINGS ON GLOBAL COMPUTER NETWORKS, AND IN PERSON; TECHNICAL SUPPORT OF INTERNET INFORMATION SERVERS VIA TELEPHONE, E-MAIL, POSTINGS ON GLOBAL COMPUTER NETWORKS, AND IN PERSON; TECHNICAL SUPPORT OF ACCESS TO INTRANET AND INTRANET NETWORKS VIA TELEPHONE, E-MAIL, AND IN PERSON; INSTALLATION OF THIRD PARTY SOFTWARE AS WELL AS TECHNICAL SUPPORT, NAMELY, TROUBLESHOOTING OF THIRD PARTY SOFTWARE PROBLEMS VIA TELEPHONE, E-MAIL, POSTINGS ON GLOBAL COMPUTER NETWORKS, AND IN PERSON (U.S. CLS. 100 AND 101).

FIRST USE 6-0-2000; IN COMMERCE 6-0-2000.

2,729,790. SIDNEY L. EISENBAUM, M.D., PROF. L.L.C., AURORA, CO. SN 76-112,344. PUB. 1-15-2002, FILED 8-18-2000.

ADVANCED IMAGES IN COSMETIC SURGERY

NO CLAIM IS MADE TO THE EXCLUSIVE RIGHT TO USE "COSMETIC SURGERY", APART FROM THE MARK AS SHOWN.

FOR COSMETIC SURGERY SERVICES (U.S. CLS. 100 AND 101).

FIRST USE 10-0-2000; IN COMMERCE 10-0-2000.

2,729,794. UP THE CREEK RESTAURANTS, INC., DULUTH, GA. SN 76-114,882. PUB. 8-21-2001, FILED 8-22-2000.

UP THE CREEK

FOR RESTAURANT SERVICES (U.S. CLS. 100 AND 101).

FIRST USE 2-16-1999; IN COMMERCE 12-18-2000.

CLASS 42—(Continued).

2,729,807. MYLEGALPROBLEM, INC., PITTSBURGH, PA. SN 76-122,435. PUB. 1-8-2002, FILED 9-1-2000.

WHERE AMERICA FINDS A LAWYER

FOR LEGAL INFORMATION AND SERVICES (U.S. CLS. 100 AND 101).

FIRST USE 2-0-2001; IN COMMERCE 2-0-2001.

2,729,811. PELAGO NETWORKS, INC., MARLBOROUGH, MA, BY CHANGE OF NAME BEACON NETWORKS, INC., MARLBOROUGH, MA. SN 76-125,575. PUB. 8-6-2002, FILED 9-11-2000.

PELAGO

THE ENGLISH TRANSLATION OF "PELAGO" IS "SEA". FOR COMPUTER NETWORK ENGINEERING, DEVELOPMENT AND DESIGN FOR OTHERS IN THE FIELD OF TELECOMMUNICATIONS EQUIPMENT, VOICE DATA AND VIDEO APPLICATIONS; TECHNICAL CONSULTATION IN THE FIELDS OF PLANNING, DEPLOYMENT, INTEGRATION AND MAINTENANCE OF TELECOMMUNICATIONS EQUIPMENT; INSTALLATION OF TELECOMMUNICATIONS COMPUTER SOFTWARE (U.S. CLS. 100 AND 101).

FIRST USE 9-3-2001; IN COMMERCE 9-3-2001.

2,729,826. XDIMENSIONAL TECHNOLOGIES, INC., BREA, CA. SN 76-135,806. PUB. 4-23-2002, FILED 9-25-2000.

XDTI

FOR COMPUTER SOFTWARE DESIGN FOR OTHERS; CONSULTING SERVICES IN THE FIELDS OF COMPUTER HARDWARE, SOFTWARE, AUTOMATIONS, SYSTEM INTEGRATION, ANALYSIS OF WORKFLOW PROCEDURES, AND PLANNING IMPLEMENTATION, AND MANAGEMENT OF AUTOMATION; LEASING OF SOFTWARE OVER A GLOBAL COMPUTER NETWORK; COMPUTER HARDWARE AND SOFTWARE DESIGN; INSTALLATION, MAINTENANCE AND REPAIR OF COMPUTER SOFTWARE SYSTEMS; SET-UP OF INTEGRATED E-MAIL SYSTEMS AS WELL AS TECHNICAL SUPPORT OF INTEGRATED E-MAIL SYSTEMS VIA TELEPHONE, POSTINGS ON GLOBAL COMPUTER NETWORKS, AND IN PERSON; TECHNICAL SUPPORT OF INTERNET INFORMATION SERVERS VIA TELEPHONE, E-MAIL, POSTINGS ON GLOBAL COMPUTER NETWORKS, AND IN PERSON; TECHNICAL SUPPORT OF ACCESS TO INTRANET AND INTERNET NETWORKS VIA TELEPHONE, E-MAIL, AND IN PERSON; INSTALLATION OF THIRD PARTY SOFTWARE AS WELL AS TECHNICAL SUPPORT, NAMELY, TROUBLESHOOTING OF THIRD PARTY SOFTWARE PROBLEMS VIA TELEPHONE E-MAIL, POSTINGS ON GLOBAL COMPUTER NETWORKS, AND IN PERSON (U.S. CLS. 100 AND 101).

FIRST USE 10-0-2001; IN COMMERCE 10-0-2001.

CLASS 42—(Continued).

2,729,831. TRIS PHARMA, INC., WEST WINDSOR, NJ. SN 76-141,240. PUB. 4-16-2002, FILED 10-5-2000.

TRIS PHARMA

FOR SCIENTIFIC RESEARCH AND DEVELOPMENT FOR PHARMACEUTICALS, NEUTRACEUTICALS, DRUG DELIVERY PRODUCTS AND BIOMEDICAL PRODUCTS AND RAW MATERIALS AND COMPONENTS USED IN PHARMACEUTICALS; LICENSING OF INTELLECTUAL PROPERTY; TESTING FOR OTHERS OF PHARMACEUTICALS, NEUTRACEUTICALS, DRUG DELIVERY PRODUCTS AND BIOMEDICAL PRODUCTS (U.S. CLS. 100 AND 101).

FIRST USE 9-0-2000; IN COMMERCE 3-15-2001.

2,729,839. CMP MEDIA LLC, MANHASSET, NY. SN 76-147,449. PUB. 6-18-2002, FILED 10-16-2000.

CROSS TRAINING FOR WEB TEAMS

NO CLAIM IS MADE TO THE EXCLUSIVE RIGHT TO USE "WEB", APART FROM THE MARK AS SHOWN.

FOR PROVIDING INFORMATION ABOUT THE HIGH TECHNOLOGY INDUSTRY VIA A GLOBAL COMPUTER NETWORK (U.S. CLS. 100 AND 101).

FIRST USE 8-0-1999; IN COMMERCE 8-0-1999.

2,729,848. ATHOC, INC., SAN FRANCISCO, CA. SN 76-149,223. PUB. 5-7-2002, FILED 10-18-2000.



FOR COMPUTER SERVICES, NAMELY CREATING INDEXES OF INFORMATION, SITES AND OTHER RESOURCES AVAILABLE ON COMPUTER NETWORKS, PROVIDING CUSTOMIZED ONLINE WEB PAGES FEATURING USER-DEFINED INFORMATION, WHICH INCLUDES SEARCH ENGINES AND ONLINE WEB LINKS TO OTHER WEB SITES, PROVIDING INFORMATION AT THE SPECIFIC REQUEST OF END-USERS BY MEANS OF GLOBAL COMPUTER NETWORKS, INCLUDING PROPRIETARY SITES, AND ALLOWING OTHERS TO IDENTIFY, GRAPHICALLY VIEW, COMMUNICATE AND INTERACT WITH MULTIPLE OTHER USERS CONNECTED TO THE SAME ON-LINE SITES OR TO LINKED ON-LINE SITES, TO COMBINE TEXT, GRAPHICS, AUDIO, VIDEO AND DATABASE INFORMATION IN INTERACTION WITH OTHER USERS, AND WITH THE ON-LINE SITE IN ORDER TO RETRIEVE COMMERCIAL SERVICES AND CONTENT OVER A GLOBAL COMPUTER NETWORK (U.S. CLS. 100 AND 101).

FIRST USE 1-27-2000; IN COMMERCE 1-27-2000.

CLASS 42—(Continued).

2,729,868. SISTERS OF ST. FRANCIS OF SYLVANIA, OHIO, SYLVANIA, OH. SN 76-159,534. PUB. 6-25-2002, FILED 11-3-2000.

SYLVANIA FRANCISCANS: MAKING A DIFFERENCE

SEC. 2(F) AS TO "SYLVANIA FRANCISCANS".

FOR MINISTERIAL SERVICES PROVIDED IN SCHOOLS, HOSPITALS, HEALTH CARE FACILITIES, HOUSING FOR THE ELDERLY, SOCIAL INSTITUTIONS AND PROTECTIVE HOUSING FOR THE ABUSED, NEEDY AND POOR, PRISONS, AND CENTERS FOR ART AND PERFORMING ARTS (U.S. CLS. 100 AND 101).

FIRST USE 2-28-2001; IN COMMERCE 2-28-2001.

2,729,877. EURAND INTERNATIONAL S.P.A., 20100 MILANO, ITALY. SN 76-163,967. PUB. 11-13-2001, FILED 11-13-2000.

DIFFUTAB

FOR DESIGN AND DEVELOPMENT OF PHARMACEUTICAL FORMULATIONS (U.S. CLS. 100 AND 101).

FIRST USE 0-0-1985; IN COMMERCE 0-0-1985.

2,729,895. C/HCA, INC., NASHVILLE, TN. SN 76-176,676. PUB. 8-21-2001, FILED 12-6-2000.

MOUNTAINSTARHEALTH.COM

FOR HEALTH CARE AND MEDICAL SERVICES; NAMELY, PROVIDING MEDICAL AND HEALTH INFORMATION; COUNSELING IN THE FIELD OF HEALTH; MEDICAL CLINICS AND LABORATORIES; MEDICAL RESEARCH (U.S. CLS. 100 AND 101).

FIRST USE 2-1-2001; IN COMMERCE 2-1-2001.

2,729,951. SUNSHINE DAYCARE CENTER, TEMPLE HILLS, MD. SN 76-203,618. PUB. 9-10-2002, FILED 2-2-2001.



SUNSHINE DAYCARE CENTER

NO CLAIM IS MADE TO THE EXCLUSIVE RIGHT TO USE "DAYCARE CENTER", APART FROM THE MARK AS SHOWN.

FOR EARLY CHILD CARE AND DEVELOPMENT SERVICES (U.S. CLS. 100 AND 101).

FIRST USE 1-1-2002; IN COMMERCE 1-1-2002.

CLASS 42—(Continued).

2,729,961. SECURITY ASSOCIATES INTERNATIONAL, INC., ARLINGTON HEIGHTS, IL. SN 76-207,425. PUB. 12-11-2001, FILED 2-9-2001.

STREETS SAFE

FOR SECURITY ALARM MONITORING SERVICES FEATURING A PERSONAL GLOBAL POSITIONING ALARM SYSTEM (U.S. CLS. 100 AND 101).
FIRST USE 3-31-2001; IN COMMERCE 3-31-2001.

2,729,991. BEAUTY BAZAR, INC., PALO ALTO, CA. SN 76-219,508. PUB. 12-4-2001, FILED 2-28-2001.



NO CLAIM IS MADE TO THE EXCLUSIVE RIGHT TO USE "EST 1976", APART FROM THE MARK AS SHOWN.
FOR BEAUTY SALON AND HEALTH SPA SERVICES (U.S. CLS. 100 AND 101).
FIRST USE 11-0-2001; IN COMMERCE 11-0-2001.

CLASS 42—(Continued).

2,729,999. CHOICE HOTELS INTERNATIONAL, INC., SILVER SPRING, MD. SN 76-220,461. PUB. 7-23-2002, FILED 3-7-2001.



OWNER OF U.S. REG. NOS. 1,183,294, 2,414,198, AND OTHERS.
NO CLAIM IS MADE TO THE EXCLUSIVE RIGHT TO USE "INN", APART FROM THE MARK AS SHOWN.
FOR HOTEL AND MOTEL SERVICES (U.S. CLS. 100 AND 101).
FIRST USE 5-31-2001; IN COMMERCE 5-31-2001.

2,730,005. CENTOCOR, INC., MALVERN, PA. SN 76-223,797. PUB. 4-9-2002, FILED 3-14-2001.

REMICARE

FOR PROVIDING INFORMATION REGARDING MEDICAL ISSUES OVER THE INTERNET (U.S. CLS. 100 AND 101).
FIRST USE 12-17-2001; IN COMMERCE 12-17-2001.

2,730,043. TOPIC RADIO, INC., RESEARCH TRIANGLE PARK, NC. SN 76-242,047. PUB. 7-23-2002, FILED 4-17-2001.

TOPIC RADIO

NO CLAIM IS MADE TO THE EXCLUSIVE RIGHT TO USE "TOPIC", APART FROM THE MARK AS SHOWN.
FOR CUSTOMIZED INFORMATION ACCESS SERVICES, NAMELY, PROVIDING NON-DOWNLOADABLE SOFTWARE INTERFACING BY COMPUTER, TELEPHONE, PERSONAL DIGITAL ASSISTANT OR OTHER ELECTRONIC DEVICE FOR END USER CREATION, NAVIGATION, AND MODIFICATION OF UNIQUE PER-USER MULTIMEDIA CONTENT IN A MULTI-USER ENVIRONMENT (U.S. CLS. 100 AND 101).
FIRST USE 5-31-2001; IN COMMERCE 5-31-2001.

CLASS 42—(Continued).

2,730,053. VENNETTI, RALPH S., BENSENVILLE, IL. SN 76-243,957. PUB. 6-25-2002, FILED 4-20-2001.

VERTEGRATE

FOR CREATION AND PRODUCTION OF ORIGINAL ARTWORK FOR OTHERS FOR USE IN PACKAGE DESIGN, PRINT AND BROADCAST ADVERTISING, INTERNET SITE DEVELOPMENT AND TRADE SHOW GRAPHICS (U.S. CLS. 100 AND 101).

FIRST USE 8-3-2001; IN COMMERCE 8-3-2001.

2,730,062. BIG BOB GIBSON BAR-B-Q, INC., DECATUR, AL. SN 76-247,787. PUB. 7-2-2002, FILED 4-30-2001.

BOB GIBSON BAR-B-Q

NO CLAIM IS MADE TO THE EXCLUSIVE RIGHT TO USE "BAR-B-Q", APART FROM THE MARK AS SHOWN. THE NAME "BOB GIBSON" DOES NOT IDENTIFY A LIVING INDIVIDUAL.

FOR RESTAURANT SERVICES (U.S. CLS. 100 AND 101).

FIRST USE 2-15-2003; IN COMMERCE 2-15-2003.

2,730,082. FINEST THINGS ONLINE LLC, SOMERS, NY. SN 76-258,693. PUB. 12-11-2001, FILED 5-17-2001.



THE MARK IS COMPRISED OF A TOP HAT ADJACENT TO THE TERM "TOPPEST.COM".

FOR COMPUTER SERVICES, NAMELY, PROVIDING AN ON-LINE MAGAZINE FEATURING RETAIL NEWS, RETAIL INFORMATION, AND OTHER TOPICS OF GENERAL INTEREST TO CONSUMERS OF LUXURY GOODS AND SERVICES; HOSTING THE WEBSITES OF OTHERS ON A COMPUTER SERVER FOR A GLOBAL COMPUTER NETWORK (U.S. CLS. 100 AND 101).

FIRST USE 1-1-2003; IN COMMERCE 1-1-2003.

2,730,091. ZSERVE CORPORATION, SPRINGVILLE, UT. SN 76-260,394. PUB. 10-16-2001, FILED 5-21-2001.

DATEMATE

FOR SOCIAL INTRODUCTION SERVICES PROVIDED VIA A GLOBAL COMPUTER NETWORK (U.S. CLS. 100 AND 101).

FIRST USE 12-17-2002; IN COMMERCE 12-17-2002.

CLASS 42—(Continued).

2,730,093. AFFIBODY TECHNOLOGY AB, 113 47 STOCKHOLM, SWEDEN. SN 76-260,614. PUB. 6-11-2002, FILED 5-22-2001.

PREST

FOR RESEARCH AND TESTING IN THE FIELD OF BIOTECHNICS AND DIAGNOSTICS (U.S. CLS. 100 AND 101).

FIRST USE 4-1-2001; IN COMMERCE 4-1-2001.

2,730,096. SHONHOLTZ, SIGMUND R., DBA SECOND TIME AROUND WATCH CO., WEST HOLLYWOOD, CA. SN 76-261,600. PUB. 11-13-2001, FILED 5-23-2001.

RETRACTOMETER

FOR PROVIDING A WEB SITE ON A GLOBAL COMPUTER NETWORK FEATURING INFORMATION IN THE FIELD OF SIZING WATCH BANDS (U.S. CLS. 100 AND 101).

FIRST USE 2-3-2003; IN COMMERCE 2-3-2003.

2,730,123. HOFFMANN-LA ROCHE INC., NUTLEY, NJ, BY MERGER HLR TECHNOLOGY CORPORATION, NUTLEY, NJ. SN 76-269,834. PUB. 7-16-2002, FILED 6-11-2001.

PSORIA-SENSE

FOR PROVIDING INFORMATION ON THE SUBJECT OF PSORIASIS AND TREATMENT OPTION VIA THE INTERNET (U.S. CLS. 100 AND 101).

FIRST USE 7-31-2001; IN COMMERCE 7-31-2001.

2,730,124. RAYTHEON COMPANY, LEXINGTON, MA. SN 76-270,341. PUB. 7-9-2002, FILED 6-12-2001.

REACT ONLINE

NO CLAIM IS MADE TO THE EXCLUSIVE RIGHT TO USE "ONLINE", APART FROM THE MARK AS SHOWN.

FOR PROVIDING ON-LINE ANALYSIS AND REPORTING SERVICES RELATING TO MATERIAL AND COMPONENT TESTING (U.S. CLS. 100 AND 101).

FIRST USE 12-10-2001; IN COMMERCE 12-10-2001.

2,730,165. HORIZON HEALTH CORPORATION, LEWISVILLE, TX. SN 76-282,968. PUB. 11-13-2001, FILED 7-3-2001.

THE BRONTOSAURUS TRACK

FOR PROVIDING MEDICAL AND PHYSICAL REHABILITATION SERVICES (U.S. CLS. 100 AND 101).

FIRST USE 8-0-2002; IN COMMERCE 8-0-2002.

CLASS 42—(Continued).

2,730,184. GEORGE P. JOHNSON COMPANY, AUBURN HILLS, MI. SN 76-289,012. PUB. 5-14-2002, FILED 7-20-2001.

EVENTLOGIC

FOR EVENT PLANNING CONSULTATION (U.S. CLS. 100 AND 101).
FIRST USE 6-30-2001; IN COMMERCE 6-30-2001.

2,730,193. AYALA, J. LUIS, NASHVILLE, TN. SN 76-291,612. PUB. 6-25-2002, FILED 7-26-2001.

PALMAS VERDES

THE ENGLISH TRANSLATION OF "PALMAS VERDES" IS "GREEN PALMS".
FOR RESTAURANT SERVICES (U.S. CLS. 100 AND 101).
FIRST USE 2-17-2003; IN COMMERCE 2-17-2003.

2,730,227. LEVANTUR, S.A., 30008 MURCIA, SPAIN. SN 76-301,754. PUB. 7-2-2002, FILED 8-20-2001.



BAHIA PRINCIPE
CLUBS & RESORTS

OWNER OF SPAIN REG. NO. 2149141, DATED 8-20-1998, EXPIRES 3-10-2008.

NO CLAIM IS MADE TO THE EXCLUSIVE RIGHT TO USE "CLUBS & RESORTS", APART FROM THE MARK AS SHOWN.

THE ENGLISH TRANSLATION OF THE WORD "BAHIA PRINCIPE" IN THE MARK IS "PRINCE BAY".

FOR ACCOMMODATION SERVICES, NAMELY, HOTELS (U.S. CLS. 100 AND 101).

FIRST USE 10-3-1998; IN COMMERCE 1-5-1999.

CLASS 42—(Continued).

2,730,239. H-D MICHIGAN, INC., ANN ARBOR, MI. SN 76-304,740. PUB. 6-25-2002, FILED 8-24-2001.



NO CLAIM IS MADE TO THE EXCLUSIVE RIGHT TO USE "MOTORCYCLES, 1903 OR 2003", APART FROM THE MARK AS SHOWN.

FOR RESTAURANT AND BAR SERVICES; TEMPORARY ACCOMMODATIONS RESERVATIONS, RENTAL OF TEMPORARY ACCOMMODATIONS (U.S. CLS. 100 AND 101).

FIRST USE 7-20-2002; IN COMMERCE 7-20-2002.

2,730,247. SOUTH CITY MANAGEMENT GROUP II, LLC, ATLANTA, GA. SN 76-306,740. PUB. 6-11-2002, FILED 8-29-2001.

FIFTH GROUP

NO CLAIM IS MADE TO THE EXCLUSIVE RIGHT TO USE "GROUP", APART FROM THE MARK AS SHOWN.
FOR RESTAURANT AND CATERING SERVICES (U.S. CLS. 100 AND 101).

FIRST USE 10-15-2001; IN COMMERCE 10-15-2001.

2,730,249. EXAMEN, INC., SACRAMENTO, CA. SN 76-307,484. PUB. 7-23-2002, FILED 8-29-2001.

LEGALCHECK

FOR SUPPORT SERVICES FOR SOFTWARE PERFORMING AUTOMATED BILL REVIEW, NAMELY, QUALITY ASSURANCE SERVICES FOR REVIEW OF SOFTWARE OUTPUT AND TECHNICAL SUPPORT SERVICES FOR SOFTWARE (U.S. CLS. 100 AND 101).

FIRST USE 2-15-2002; IN COMMERCE 2-15-2002.

2,730,251. ZION, GARY RANDALL, BETHESDA, MD. SN 76-307,525. PUB. 6-18-2002, FILED 8-31-2001.

COHERENT CONCEPTS

FOR COMPUTER SERVICES, NAMELY, CREATING, DESIGNING, IMPLEMENTING AND MAINTAINING WEB SITES FOR OTHERS; HOSTING THE WEB SITES OF OTHERS ON A COMPUTER SERVER FOR A GLOBAL COMPUTER NETWORK (U.S. CLS. 100 AND 101).

FIRST USE 2-19-2003; IN COMMERCE 2-19-2003.

CLASS 42—(Continued).

2,730,256. ELECTRONIC IMAGING SYSTEMS OF AMERICA, INC., ROLLING MEADOWS, IL. SN 76-308,404. PUB. 7-2-2002, FILED 9-4-2001.

AD/STAT

FOR PROVIDING ELECTRONIC VERIFICATION OF TEAR SHEETS, NAMELY, PROVIDING ADVERTISERS WITH ELECTRONIC COPIES AND PRINTED COPIES OF THEIR ADVERTISEMENTS AND MATCHING PUBLISHING STATEMENTS THAT APPEARED ON A PAGE OF A PUBLICATION (U.S. CLS. 100 AND 101).

FIRST USE 10-31-2001; IN COMMERCE 10-31-2001.

2,730,257. ELECTRONIC IMAGING SYSTEMS OF AMERICA, INC., ROLLING MEADOWS, IL. SN 76-308,406. PUB. 7-2-2002, FILED 9-4-2001.

**THE ORIGINAL
ELECTRONIC TEARSHEET
SOLUTION**

NO CLAIM IS MADE TO THE EXCLUSIVE RIGHT TO USE "THE ORIGINAL ELECTRONIC TEARSHEET", APART FROM THE MARK AS SHOWN.

FOR PROVIDING ELECTRONIC VERIFICATION OF TEAR SHEETS, NAMELY, PROVIDING ADVERTISERS WITH ELECTRONIC COPIES AND PRINTED COPIES OF THEIR ADVERTISEMENTS AND MATCHING PUBLISHING STATEMENTS THAT APPEARED ON A PAGE OF A PUBLICATION (U.S. CLS. 100 AND 101).

FIRST USE 10-31-2001; IN COMMERCE 10-31-2001.

2,730,262. GROCHOCINSKI, GROCHOCINSKI & LLOYD, LTD., ORLAND PARK, IL. SN 76-312,322. PUB. 7-16-2002, FILED 9-17-2001.



FOR LEGAL SERVICES (U.S. CLS. 100 AND 101).
FIRST USE 2-17-2002; IN COMMERCE 2-17-2002.

CLASS 42—(Continued).

2,730,267. HALLIBURTON ENERGY SERVICES, INC., CARROLLTON, TX. SN 76-313,455. PUB. 1-29-2002, FILED 9-18-2001.

WELLIFE

FOR OIL AND GAS WELL SERVICES, NAMELY, PROVIDING CONSULTING AND DESIGN ANALYSIS FOR CEMENTING OPERATIONS (U.S. CLS. 100 AND 101).

FIRST USE 11-30-2001; IN COMMERCE 11-30-2001.

2,730,301. MOTHERS AGAINST DRUNK DRIVING, IRVING, TX. SN 76-321,997. PUB. 6-11-2002, FILED 10-8-2001.



OWNER OF U.S. REG. NOS. 1,537,000, 1,675,509, AND OTHERS.

NO CLAIM IS MADE TO THE EXCLUSIVE RIGHT TO USE "ACTIVISM, VICTIM SERVICES" AND "EDUCATION", APART FROM THE MARK AS SHOWN.

FOR ASSOCIATION SERVICES, NAMELY PROMOTING THE INTERESTS OF PERSONS OPPOSED TO DRUNK DRIVING AND SUPPORTING VICTIMS OF DRUNK DRIVING (U.S. CLS. 100 AND 101).

FIRST USE 6-3-2002; IN COMMERCE 7-1-2002.

2,730,322. DASHA RESTAURANT GROUP, LLC, NEW YORK, NY. SN 76-327,164. PUB. 5-21-2002, FILED 10-18-2001.

TOUGH CLUB

NO CLAIM IS MADE TO THE EXCLUSIVE RIGHT TO USE "CLUB", APART FROM THE MARK AS SHOWN.

FOR RESTAURANT SERVICES (U.S. CLS. 100 AND 101).

FIRST USE 9-24-2002; IN COMMERCE 9-24-2002.

2,730,338. UROLOGY SPECIALISTS, P.C., DBA CONNECTICUT CENTER FOR CONTINENCE, WATERBURY, CT. SN 76-331,522. PUB. 7-30-2002, FILED 10-29-2001.

**LET'S MAKE
MASSACHUSETTS A DRY
STATE**

OWNER OF U.S. REG. NOS. 2,358,466 AND 2,528,197.
FOR MEDICAL SERVICES (U.S. CLS. 100 AND 101).
FIRST USE 2-14-2003; IN COMMERCE 2-14-2003.

CLASS 42—(Continued).

2,730,340. ACCUSESS ENVIRONMENTAL, INC., BATON ROUGE, LA. SN 76-332,384. PUB. 5-14-2002, FILED 10-31-2001.

ENVIROSCORE

FOR ENVIRONMENTAL AUDITING SERVICES, NAMELY CONSULTING SERVICES OFFERED TO ANALYZE THE ENVIRONMENTAL RISKS AND LIABILITIES ASSOCIATED WITH FINANCIAL TRANSACTIONS AND EXTENSIONS OF CREDIT (U.S. CLS. 100 AND 101).

FIRST USE 5-1-2002; IN COMMERCE 5-1-2002.



2,730,348. DOUGLAS MATHESON & CO., INC., SAN LUIS OBISPO, CA. SN 76-334,335. PUB. 7-2-2002, FILED 11-6-2001.



NO CLAIM IS MADE TO THE EXCLUSIVE RIGHT TO USE "DOG", APART FROM THE MARK AS SHOWN. FOR RESTAURANT SERVICES (U.S. CLS. 100 AND 101).

FIRST USE 12-8-2002; IN COMMERCE 12-8-2002.



2,730,369. EMPRESA NACIONAL DE TELECOMUNICACIONES S.A., SANTIAGO, CHILE. SN 76-339,740. PUB. 6-4-2002, FILED 11-19-2001.

ZULMA

FOR PSYCHIC CONSULTATION AND HOROSCOPE READING SERVICES (U.S. CLS. 100 AND 101).

FIRST USE 1-8-2002; IN COMMERCE 1-8-2002.

CLASS 42—(Continued).

2,730,381. LITTLE SIX, INC., PRIOR LAKE, MN. SN 76-341,662. PUB. 5-7-2002, FILED 11-26-2001.

MYSTIC CELEBRITY PALACE

OWNER OF U.S. REG. NOS. 1,783,495, 2,487,315, AND OTHERS.

NO CLAIM IS MADE TO THE EXCLUSIVE RIGHT TO USE "CELEBRITY PALACE", APART FROM THE MARK AS SHOWN.

FOR ARENA SERVICES NAMELY PROVIDING FACILITIES FOR SPORTING, MUSICAL, THEATRICAL, DANCING, COMEDY, AND CELEBRITY, CONCERTS, PERFORMANCES, AND EVENTS; PROVIDING FACILITIES FOR MEETINGS, RECEPTIONS, SEMINARS, BANQUETS, CONVENTIONS, CONFERENCES, TRADE SHOWS, AND EXHIBITIONS (U.S. CLS. 100 AND 101).

FIRST USE 2-0-2001; IN COMMERCE 2-0-2001.



2,730,385. INSIGHTFUL CORPORATION, SEATTLE, WA. SN 76-342,600. PUB. 10-1-2002, FILED 11-28-2001.

INFACIT

FOR COMPUTER SOFTWARE DEVELOPMENT SERVICES (U.S. CLS. 100 AND 101).

FIRST USE 10-15-2001; IN COMMERCE 10-15-2001.



2,730,386. INSIGHTFUL CORPORATION, SEATTLE, WA. SN 76-342,624. PUB. 10-8-2002, FILED 11-28-2001.



FOR COMPUTER SOFTWARE DEVELOPMENT SERVICES (U.S. CLS. 100 AND 101).

FIRST USE 10-15-2001; IN COMMERCE 10-15-2001.

CLASS 42—(Continued).

2,730,400. SOUTH CITY MANAGEMENT GROUP II, LLC, ATLANTA, GA. SN 76-345,363. PUB. 6-25-2002, FILED 12-5-2001.



NO CLAIM IS MADE TO THE EXCLUSIVE RIGHT TO USE "GROUP RESTAURANTS", APART FROM THE MARK AS SHOWN.

FOR RESTAURANT AND CATERING SERVICES (U.S. CLS. 100 AND 101).

FIRST USE 10-15-2001; IN COMMERCE 10-15-2001.

2,730,413. NEO GEN SCREENING, INC., BRIDGEVILLE, PA. SN 76-347,636. PUB. 7-30-2002, FILED 12-11-2001.

NGS MOLECULAR

NO CLAIM IS MADE TO THE EXCLUSIVE RIGHT TO USE "MOLECULAR", APART FROM THE MARK AS SHOWN.

FOR ANALYTICAL SERVICES, NAMELY PROVIDING MOLECULAR SCREENING ASSAYS FOR HUMAN NEWBORNS (U.S. CLS. 100 AND 101).

FIRST USE 1-16-2003; IN COMMERCE 1-16-2003.

2,730,422. AGRICULTURAL GAS COMPANY, THE, HUDSON, WI. SN 76-349,742. PUB. 5-28-2002, FILED 12-18-2001.

THERMOGATION

FOR TECHNICAL CONSULTATION RELATING TO GROWING PLANTS AT OPTIMAL TEMPERATURE; AND GROWING PLANTS AT OPTIMAL TEMPERATURE (U.S. CLS. 100 AND 101).

FIRST USE 3-0-2002; IN COMMERCE 3-0-2002.

CLASS 42—(Continued).

2,730,434. SENIOR PSYCHOLOGY SERVICES, INC., SAN DIEGO, CA. SN 76-351,986. PUB. 6-25-2002, FILED 12-21-2001.

VERICARE

FOR MENTAL CARE HEALTH FACILITIES AND MENTAL HEALTH MEDICAL SERVICES AND NURSING HOME SERVICES AND CONVALESCENT SERVICES (U.S. CLS. 100 AND 101).

FIRST USE 3-15-2002; IN COMMERCE 3-15-2002.

2,730,436. DANIELE, PETER J., ALLENWOOD, NJ. SN 76-352,099. PUB. 8-20-2002, FILED 12-26-2001.

THE INSPECTION GUYS

NO CLAIM IS MADE TO THE EXCLUSIVE RIGHT TO USE "INSPECTION", APART FROM THE MARK AS SHOWN.

FOR REAL ESTATE INSPECTION SERVICES AND HOME INSPECTION SERVICES (U.S. CLS. 100 AND 101).

FIRST USE 1-30-2002; IN COMMERCE 1-30-2002.

2,730,446. LYLE ANDERSON COMPANY, INC., THE, SCOTTSDALE, AZ. SN 76-354,694. PUB. 5-28-2002, FILED 1-3-2002.



FOR RESTAURANT AND CATERING SERVICES, BAR AND LOUNGE SERVICES (U.S. CLS. 100 AND 101).

FIRST USE 12-31-2000; IN COMMERCE 12-31-2000.

2,730,527. FAHLGREN, STEVEN M., ORLANDO, FL. SN 76-391,639. PUB. 10-15-2002, FILED 4-4-2002.

FOR THE CONSUMER

FOR ATTORNEY SERVICES (U.S. CLS. 100 AND 101).

FIRST USE 12-14-2001; IN COMMERCE 4-15-2002.

CLASS 42—(Continued).

2,730,545. COMPUCOM SYSTEMS, INC., DALLAS, TX. SN 76-975,429. PUB. 7-9-2002, FILED 12-5-2000.

CONVERGEMOBILE

FOR COMPUTER CONSULTING SERVICES, COMPUTER SOFTWARE INSTALLATION AND MAINTENANCE, AND LEASING SERVICES IN THE FIELD OF COMPUTERS AND COMPUTER-RELATED EQUIPMENT (U.S. CLS. 100 AND 101).
FIRST USE 10-0-2000; IN COMMERCE 10-0-2000.

2,730,546. SILVER LAW INC., FT. LAUDERDALE, FL. SN 78-000,125. PUB. 10-15-2002, FILED 3-20-2000.

COOLLAWYER.COM

FOR LEGAL SERVICES, NAMELY PROVIDE INFORMATION AND LEGAL FORMS IN THE FIELD OF INTELLECTUAL PROPERTY VIA A GLOBAL COMPUTER NETWORK (U.S. CLS. 100 AND 101).
FIRST USE 4-15-2000; IN COMMERCE 4-15-2000.

2,730,547. LOVING WORKS CORPORATION, SILVER SPRING, MD. SN 78-000,201. PUB. 8-28-2001, FILED 3-21-2000.

LWINET

FOR HOSTING OF INTRANET, EXTRANET AND INTERNET SITES AND THIS DESIGN, DEVELOPMENT AND IMPLEMENTATION OF SOFTWARE APPLICATIONS ENABLING DOCUMENT AND INFORMATION EXCHANGE, FILE MAINTENANCE, ELECTRONIC MAIL AND SECURITY WITH SUCH SITES; DESIGNING, IMPLEMENTING AND MAINTAINING OF INTRANET, EXTRANET AND INTERNET SITES AND PAGES FOR OTHERS AND CONSULTING PROVIDED IN RELATION THERETO (U.S. CLS. 100 AND 101).
FIRST USE 12-23-1999; IN COMMERCE 1-1-2000.

2,730,548. SILVER LAW INC., FT. LAUDERDALE, FL. SN 78-000,288. PUB. 10-22-2002, FILED 3-21-2000.

COOLLAWYER

FOR LEGAL SERVICES (U.S. CLS. 100 AND 101).
FIRST USE 5-1-2000; IN COMMERCE 5-1-2000.

CLASS 42—(Continued).

2,730,573. JACKSON, MARY Y., WASHINGTON, DC. SN 78-031,074. PUB. 7-3-2001, FILED 10-17-2000.

**THE SHORTERIMAGE
ORIGINATORS OF THE NEW
PETITE 5'2" AND UNDER WE
ARE GOING TO CHANGE
YOUR LIFE!**

FOR PROVIDING FASHION INFORMATION FOR PETITE PERSONS 5'2" AND UNDER (U.S. CLS. 100 AND 101).
FIRST USE 1-17-2002; IN COMMERCE 2-8-2002.

2,730,577. BAKER HUGHES INCORPORATED, HOUSTON, TX. SN 78-035,422. PUB. 6-4-2002, FILED 11-15-2000.

GYROTRAK

FOR PROVIDING MEASUREMENT-WHILE-DRILLING GYROCOMPASS ORIENTATION AND STEERING IN ORDER TO AID IN THE PROCESS OF OIL WELL DRILLING AND DIRECTIONAL TRACKING FOR OTHERS (U.S. CLS. 100 AND 101).
FIRST USE 12-1-1999; IN COMMERCE 12-1-1999.

2,730,587. FOUNDSTONE, INC., IRVINE, CA. SN 78-039,038. PUB. 5-14-2002, FILED 12-12-2000.

FOUNDSECURE

FOR COMPUTER CONSULTING SERVICES IN THE FIELDS OF COMPUTER NETWORK SECURITY, DETECTION OF COMPUTER TAMPERING, EVALUATION, ASSESSMENT AND REPORTING OF COMPUTER NETWORK SECURITY SYSTEMS; DEVELOPMENT AND IMPLEMENTATION OF COMPUTER NETWORK SECURITY SYSTEMS AND POLICIES; CUSTOM DESIGN OF COMPUTER NETWORK SECURITY SYSTEMS AND COMPUTER NETWORKS FOR OTHERS; COMPUTER NETWORK SECURITY INVESTIGATIONS (U.S. CLS. 100 AND 101).
FIRST USE 1-0-2002; IN COMMERCE 1-0-2002.

2,730,629. STARS RESTAURANTS CORP., OKLAHOMA CITY, OK. SN 78-055,063. PUB. 1-8-2002, FILED 3-26-2001.

**GREG'S FOUR STAR DRIVE-
IN**

NO CLAIM IS MADE TO THE EXCLUSIVE RIGHT TO USE "DRIVE-IN", APART FROM THE MARK AS SHOWN. FOR RESTAURANT SERVICES, SPECIFICALLY FAST FOOD DRIVE-IN SERVICES (U.S. CLS. 100 AND 101).
FIRST USE 10-22-2002; IN COMMERCE 10-22-2002.

CLASS 42—(Continued).

2,730,631. DATAHIVE, LLC, MANCHESTER, NH. SN 78-055,990. PUB. 5-28-2002, FILED 3-30-2001.

iRegister

FOR RESERVATION SERVICES FOR OTHERS, NAMELY, CONDUCTING ON-LINE RESERVATIONS TO ATTENDEES AT INTERNAL AND EXTERNAL EVENTS SUCH AS TRADE SHOWS AND SEMINARS; PROVIDING AN ON-LINE DATABASE FEATURING INFORMATION REGARDING ATTENDEES' RESERVATIONS (U.S. CLS. 100 AND 101).

FIRST USE 12-0-2000; IN COMMERCE 12-0-2000.

2,730,646. PRISMA ENTERTAINMENT LLC, WEST LOS ANGELES, CA. SN 78-061,910. PUB. 7-23-2002, FILED 5-3-2001.

PLAN B

FOR RESTAURANT SERVICES (U.S. CLS. 100 AND 101).

FIRST USE 6-1-2001; IN COMMERCE 10-1-2001.

2,730,647. QUALCOMM INCORPORATED, SAN DIEGO, CA. SN 78-061,912. PUB. 6-4-2002, FILED 5-3-2001.

BREW

FOR CONSULTATION, EVALUATION AND RESEARCH IN THE FIELDS OF SOFTWARE DEVELOPMENT AND THE USE OF SOFTWARE APPLICATIONS AND DATA, AND HOSTING COMPUTER SOFTWARE APPLICATIONS AND DATA FOR OTHERS (U.S. CLS. 100 AND 101).

FIRST USE 2-1-2001; IN COMMERCE 2-1-2001.

CLASS 42—(Continued).

2,730,657. HERNANDEZ, ROLANDO, MIAMI, FL. SN 78-066,093. PUB. 6-18-2002, FILED 5-29-2001.

WRITE THE RULES OF EBUSINESS

FOR COMPUTER CONSULTATION IN THE FIELD OF ANALYSIS, DESIGN, DEVELOPMENT, AND IMPLEMENTATION OF BUSINESS RULES, NAMELY, BUSINESS POLICIES AND PROCEDURES THAT ARE ENCODED IN COMPUTER SOFTWARE, COMPUTER DATABASES, COMPUTER SOFTWARE APPLICATION PROGRAMS, AND GRAPHICAL USER INTERFACE SOFTWARE FOR USE IN GLOBAL COMPUTER INFORMATION NETWORKS, ELECTRONIC BUSINESS SERVICES, AND ELECTRONIC GOVERNMENT SERVICES (U.S. CLS. 100 AND 101).

FIRST USE 5-16-2001; IN COMMERCE 6-14-2001.

2,730,668. WELLS, TIMOTHY, DERWOOD, MD. SN 78-071,140. PUB. 9-10-2002, FILED 6-26-2001.

qualityhub 

FOR CONSULTING SERVICES IN THE BIOMEDICAL FIELD (U.S. CLS. 100 AND 101).

FIRST USE 9-15-2000; IN COMMERCE 12-1-2000.

2,730,710. INGERSOLL-RAND COMPANY, WOODCLIFF LAKE, NJ. SN 78-082,608. PUB. 6-4-2002, FILED 9-5-2001.

INTELLIGUARD

FOR PROVIDING REMOTE MONITORING SERVICES OF ENTIRE COMPRESSED AIR SYSTEMS COMPRISED OF COMPRESSORS, DRYERS, COOLING TOWERS AND FILTERS (U.S. CLS. 100 AND 101).

FIRST USE 3-16-2001; IN COMMERCE 10-31-2001.

CLASS 42—(Continued).

2,730,717. QUESTA ENGINEERING CORPORATION, GOLDEN, CO. SN 78-084,789. PUB. 9-17-2002, FILED 9-20-2001.



FOR PETROLEUM ENGINEERING CONSULTING (U.S. CLS. 100 AND 101).
FIRST USE 1-0-1993; IN COMMERCE 1-0-1993.

2,730,740. JAMES, STACY MARIE, DUBLIN, OH. SN 78-090,654. PUB. 8-20-2002, FILED 10-29-2001.

WALKING VICTORIOUS

FOR CONSULTATION IN THE FIELD OF RELIGION, INSPIRATIONAL AND MOTIVATIONAL SPEAKING AND WRITING ON THE TOPIC OF RELIGION (U.S. CLS. 100 AND 101).
FIRST USE 6-1-1995; IN COMMERCE 6-1-1996.

2,730,741. GENE JOHNSON, INC., SAINT AUGUSTINE, FL. SN 78-090,771. PUB. 4-16-2002, FILED 10-30-2001.

HIVBASE

FOR DATA AUTOMATION AND COLLECTION SERVICE USING PROPRIETARY SOFTWARE TO EVALUATE, ANALYZE AND COLLECT SERVICE DATA (U.S. CLS. 100 AND 101).
FIRST USE 6-1-2002; IN COMMERCE 9-1-2002.

2,730,792. MURIGENICS, INC., HERCULES, CA. SN 78-102,708. PUB. 8-6-2002, FILED 1-15-2002.

MURIGENICS

FOR BIOTECHNOLOGY RESEARCH AND DEVELOPMENT (U.S. CLS. 100 AND 101).
FIRST USE 6-30-2001; IN COMMERCE 7-30-2001.

CLASS 42—(Continued).

2,730,800. CENTAPH INC., BOLTON, MA. SN 78-104,600. PUB. 8-6-2002, FILED 1-24-2002.

CENTAPH

FOR COMPUTER DISASTER PREVENTION AND PLANNING; COMPUTER DATA BACKUP AND RECOVERY (U.S. CLS. 100 AND 101).
FIRST USE 2-23-2002; IN COMMERCE 2-23-2002.

2,730,818. DEALER MARKETING SERVICES, INC., ROCK ISLAND, IL. SN 78-109,604. PUB. 10-15-2002, FILED 2-19-2002.

PROMAX ONLINE

OWNER OF U.S. REG. NO. 2,564,462.
NO CLAIM IS MADE TO THE EXCLUSIVE RIGHT TO USE "ONLINE", APART FROM THE MARK AS SHOWN.
FOR PROVIDING TEMPORARY USE OF ON-LINE NON DOWNLOADABLE SOFTWARE FOR USE BY RETAIL AUTOMOBILE DEALERS IN PERFORMING A MULTIPLICITY OF FUNCTIONS, NAMELY, DATABASE MANAGEMENT OF AUTOMOBILE INVENTORIES, SCHEDULING AND MANAGEMENT OF SALES CONTACTS BETWEEN SALES PERSONS AND POTENTIAL CUSTOMERS; CALCULATION AND COMPARISON OF FINANCING OPTIONS FOR NEW AND USED AUTOMOBILES; OBTAINING CREDIT BUREAU REPORTS CONCERNING PROSPECTIVE AUTOMOBILE PURCHASERS; COMPLETION AND PRINTING OF SALES CONTRACTS FOR RETAIL AUTOMOBILE SALES; AND, GENERATION OF REPORTS CONCERNING AUTOMOBILE SALES TRANSACTIONS, VIA A GLOBAL COMPUTER NETWORK (U.S. CLS. 100 AND 101).
FIRST USE 8-5-2002; IN COMMERCE 8-5-2002.

CLASS 43—HOTEL AND RESTAURANT SERVICES

2,730,210. DAMW SERVICES LLC, SUGAR HILL, GA. SN 76-295,537. PUB. 9-17-2002, FILED 8-6-2001.

MY POTS IN YOUR KITCHEN!

FOR FOOD PREPARATION SERVICES AT CUSTOMERS' HOMES (U.S. CLS. 100 AND 101).
FIRST USE 8-3-2001; IN COMMERCE 8-3-2001.

CLASS 44—MEDICAL, BEAUTY AND AGRICULTURAL SERVICES

CLASS 44—(Continued).

2,730,342. SCHMOOZE-N-POOCH A LA CART, INC., CINCINNATI, OH. SN 76-333,051. PUB. 6-18-2002, FILED 11-1-2001.

**SCHMOOZE-N-POOCH A LA
CART**

FOR ANIMAL GROOMING (U.S. CLS. 100 AND 101).
FIRST USE 10-31-2001; IN COMMERCE 10-31-2001.

CLASS 44—(Continued).

2,730,509. ACTS RETIREMENT-LIFE COMMUNITIES, INC., WEST POINT, PA. SN 76-374,563. PUB. 9-17-2002, FILED 2-21-2002.

WILLOWBROOKE COURT

FOR NURSING SERVICES, NAMELY OPERATING SKILLED NURSING FACILITIES AND PROVIDING SKILLED NURSING CARE (U.S. CLS. 100 AND 101).
FIRST USE 12-0-2001; IN COMMERCE 12-0-2001.

2,730,808. CENTERRE HEALTHCARE CORPORATION, ST. LOUIS, MO. SN 78-106,653. PUB. 7-23-2002, FILED 2-4-2002.

CENTERRE

FOR HEALTH CARE SERVICES, NAMELY INPATIENT REHABILITATION SERVICES (U.S. CLS. 100 AND 101).
FIRST USE 1-31-2003; IN COMMERCE 1-31-2003.

* * * * *

PRIOR UNITED STATES CLASSIFICATION

APPLICATION IN ONE CLASS

COLLECTIVE MEMBERSHIP MARKS

2,730,138. NATIONAL ASSOCIATION OF TAX PROFESSIONALS, APPLETON, WI. SN 76-274,350. PUB. 8-20-2002, FILED 6-19-2001.



OWNER OF U.S. REG. NOS. 1,226,254, 1,227,081, AND 1,645,183.
FOR INDICATING MEMBERSHIP IN AN ORGANIZATION FOR PROFESSIONAL TAX PRACTITIONERS (U.S. CL. 200).
FIRST USE 6-0-2001; IN COMMERCE 6-0-2001.

CLASS 200—COLLECTIVE MEMBERSHIP

* * * * *

SUPPLEMENTAL REGISTER

These registrations are not subject to opposition.

SECTION 1.— INTERNATIONAL CLASSIFICATION

The short titles associated below with the international class numbers are terms designed merely for quick identification and are not an official part of the international classification. The full names of international classes are given in section 6.1 of the trademark rules of practice.

The designation "U.S. Cl." appearing in this section refers to the U.S. class in effect prior to Sep. 1, 1973 rather than the international class which applies to applications filed on or after that date. For adoption of international classification see notice in the OFFICIAL GAZETTE of Jun. 26, 1973 (911 O.G. TM 210).

Application in more than one class

2,730,865. HEAD ACQUISITION, L.P., CHICAGO, IL, BY MERGER URBAN SHOPPING CENTERS, INC., CHICAGO, IL. SN 76-107,751. FILED P.R. 8-10-2000; AM. S.R. 1-31-2001.

2,730,873. HISPANIC RADIO NETWORK, LLC., WASHINGTON, DC. SN 76-186,774. FILED P.R. 12-22-2000; AM. S.R. 12-26-2001.

GALLERIA AT ROSEVILLE

NO CLAIM IS MADE TO THE EXCLUSIVE RIGHT TO USE "GALLERIA", APART FROM THE MARK AS SHOWN.

CLASS 35—ADVERTISING AND BUSINESS

FOR SHOPPERS' GUIDE INFORMATION SERVICES (U.S. CLS. 100, 101 AND 102).
FIRST USE 9-2-1998; IN COMMERCE 9-2-1998.

CLASS 36—INSURANCE AND FINANCIAL

FOR LEASING AND MANAGEMENT OF SHOPPING MALL SPACE; AND SHOPPING CENTER SERVICES (U.S. CLS. 100, 101 AND 102).
FIRST USE 9-2-1998; IN COMMERCE 9-2-1998.

2,730,866. CYLEX, INC., COLUMBIA, MD. SN 76-118,071.
FILED P.R. 8-28-2000; AM. S.R. 8-22-2002.

IN VITRO CMI

CLASS 1—CHEMICALS

FOR TEST KITS COMPRISED OF BIOLOGICAL AND CHEMICAL REAGENTS; AND RELATED ASSAYS BOTH FOR SCIENTIFIC AND MEDICAL RESEARCH PURPOSES (U.S. CLS. 1, 5, 6, 10, 26 AND 46).
FIRST USE 10-0-2000; IN COMMERCE 10-0-2000.

CLASS 5—PHARMACEUTICALS

FOR DIAGNOSTIC ASSAYS FOR MEDICAL CLINICAL AND DIAGNOSTIC PURPOSES (U.S. CLS. 6, 18, 44, 46, 51 AND 52).
FIRST USE 10-0-2000; IN COMMERCE 10-0-2000.

HISPANIC RADIO NETWORK

NO CLAIM IS MADE TO THE EXCLUSIVE RIGHT TO USE "RADIO NETWORK", APART FROM THE MARK AS SHOWN.

CLASS 38—COMMUNICATION

FOR RADIO BROADCASTING SERVICES, INCLUDING, BROADCASTING NEWS AND TALK PROGRAMS (U.S. CLS. 100, 101 AND 104).
FIRST USE 2-3-1998; IN COMMERCE 2-3-1998.

CLASS 41—EDUCATION AND ENTERTAINMENT

FOR EDUCATIONAL AND ENTERTAINMENT SERVICES, NAMELY, DEVELOPMENT, PRODUCTION AND SYNDICATION OF NEWS AND TALK RADIO PROGRAMS (U.S. CLS. 100, 101 AND 107).
FIRST USE 1-1-1986; IN COMMERCE 1-1-1986.

2,730,910. PCE PACIFIC, INC., BOTHELL, WA. SN 76-410,528.
FILED P.R. 5-21-2002; AM. S.R. 3-25-2003.

CONTROL LOOP RELIABILITY

CLASS 35—ADVERTISING AND BUSINESS

FOR EVALUATION, PROCESS DESIGN, AND CONSULTING SERVICES IN THE FIELD OF MANUFACTURING EQUIPMENT (U.S. CLS. 100, 101 AND 102).
FIRST USE 12-12-2001; IN COMMERCE 12-12-2001.

CLASS 42—SCIENTIFIC, COMPUTER AND LEGAL SERVICES

FOR DESIGN SERVICES IN THE FIELD OF MANUFACTURING EQUIPMENT IN THE PROCESS INDUSTRIES; TECHNICAL CONSULTATION IN THE FIELD OF MANUFACTURING EQUIPMENT IN THE PROCESS INDUSTRIES; APPLICATION SERVICE PROVIDER SERVICES FEATURING SOFTWARE FOR DATA COLLECTION, DATA STORAGE, DATA RETRIEVAL, DATA SORTING, AND DATA ANALYSIS IN THE FIELD OF MANUFACTURING EQUIPMENT IN THE PROCESS INDUSTRIES (U.S. CLS. 100 AND 101).

FIRST USE 12-12-2001; IN COMMERCE 12-12-2001.

2,730,914. GRAMTEL USA, INC., MISHAWAKA, IN. SN 76-415,010. FILED P.R. 5-30-2002; AM. S.R. 3-17-2003.

INFRASTRUCTURE FOR E-BUSINESS**CLASS 38—COMMUNICATION**

FOR TELECOMMUNICATIONS SERVICES, NAMELY PROVIDING COMMUNICATIONS LINKS TO ONLINE GLOBAL COMPUTER NETWORKS; AND ELECTRONIC STORAGE, TRANSMISSION, AND RETRIEVAL OF DATA, IMAGES, AND DOCUMENTS (U.S. CLS. 100, 101 AND 104).

FIRST USE 9-0-2001; IN COMMERCE 10-0-2001.

CLASS 39—TRANSPORTATION AND STORAGE

FOR EQUIPMENT STORAGE SERVICES, NAMELY, PROVIDING STORAGE OF COMPUTER EQUIPMENT AND DATA STORAGE SERVICES (U.S. CLS. 100 AND 105).

FIRST USE 9-0-2001; IN COMMERCE 10-0-2001.

CLASS 42—SCIENTIFIC, COMPUTER AND LEGAL SERVICES

FOR COMPUTER SERVICES, NAMELY, PROVIDING WEB SITE HOSTING SERVICES; APPLICATION SOFTWARE HOSTING SERVICES; AND DATA SECURITY SERVICES (U.S. CLS. 100 AND 101).

FIRST USE 9-0-2001; IN COMMERCE 10-0-2001.

2,730,941. TRIATON GMBH, KREFELD, FED REP GERMANY. SN 78-044,502. FILED P.R. 1-23-2001; AM. S.R. 1-16-2002.

THE BUSINESSPROCESSOR

PRIORITY CLAIMED UNDER SEC. 44(D) ON FED REP GERMANY APPLICATION NO. 30054851.6, FILED 7-24-2000, REG. NO. 30054851, DATED 11-30-2000, EXPIRES 7-31-2010.

CLASS 9—ELECTRICAL AND SCIENTIFIC APPARATUS

FOR ELECTRICAL, ELECTRONIC AND OPTICAL MEASURING, SIGNALING, CONTROL OR TEACHING EQUIPMENT AND INSTRUMENTS, NAMELY COMPUTERS, COMPUTER MONITORS, VIDEO CAMERAS, VIDEO RECORDERS, AND TELEVISIONS; EQUIPMENT FOR RECORDING, TRANSMITTING, PROCESSING AND REPRODUCING SOUND IMAGES OR DATA, NAMELY RADIOS, TELEVISIONS, COMPACT DISK PLAYERS, TAPE RECORDERS AND TELECOMMUNICATIONS EQUIPMENT IN THE NATURE OF RADIO AND TELEPHONE TRANSMITTERS, COMPUTERS AND PERSONAL DIGITAL ASSISTANT DEVICES CAPABLE OF COMMUNICATION THROUGH TELEPHONE LINES OR BY WIRELESS MEANS; BLANK MACHINE-READABLE DATA RECORDING MEDIA, NAMELY COMPUTER DISKETTES, COMPACT DISKS, AUDIO RECORDING TAPE, VIDEO RECORDING TAPE, AND DIGITAL VIDEO DISKS; VENDING MACHINES AND MECHANISMS FOR COIN-OPERATED EQUIPMENT; DATA PROCESSING EQUIPMENT, NAMELY HANDHELD DATA STORAGE AND COMMUNICATIONS DEVICES, NAMELY, PDAS OR PERSONAL DIGITAL ASSISTANT DEVICES, AND COMPUTERS; ACCESSORY EQUIPMENT FOR A TELEVISION OR FOR OTHER ELECTRONIC EQUIPMENT, NAMELY ELECTRONIC GAME CONSOLES, VIDEO CASSETTE PLAYERS, DIGITAL VIDEO DISK PLAYERS, AND COMPUTER MODEMS FOR CONNECTION TO REMOTE DATABASES AND FOR ELECTRONIC COMMUNICATION; PROGRAMMED MACHINE-READABLE DATA MEDIA NAMELY COMPUTER DISKETTES, COMPACT DISKS, AUDIO RECORDING TAPE, VIDEO RECORDING TAPE, AND DIGITAL VIDEO DISKS FEATURING EDUCATIONAL COMPUTER PROGRAMS PROVIDING INSTRUCTION IN BUSINESS MANAGEMENT SOLUTIONS FOR COMMERCE CONDUCTED OVER THE INTERNET AND ELECTRONIC DATABASES IN THE FIELD OF COMMERCE CONDUCTED OVER THE INTERNET, COMPUTER GAMES, MUSIC, PHOTOGRAPHS AND MOTION PICTURES; EXPOSED CAMERA AND X-RAY FILM; PRERECORDED CASSETTES, CDS, CD-ROMS, TAPES, COMPUTER DISKETTES AND DIGITAL VIDEO DISKS FEATURING EDUCATIONAL RECORDINGS, RECORDINGS FOR ENTERTAINMENT, MUSIC, PHOTOGRAPHS AND MOTION PICTURES; INTERACTIVE, ELECTRONIC, USER-ORIENTED COMPUTER SOFTWARE, NAMELY EDUCATIONAL COMPUTER PROGRAMS AND DATABASES PROVIDING INSTRUCTION IN BUSINESS MANAGEMENT SOLUTIONS FOR COMMERCE CONDUCTED OVER THE INTERNET, COMPUTER GAMES, MUSIC, PHOTOGRAPHS AND MOTION PICTURES FOR EDUCATION AND ENTERTAINMENT; COMPUTER HARDWARE AND SOFTWARE FOR USE IN ARCHIVING DATA (U.S. CLS. 21, 23, 26, 36 AND 38).

CLASS 16—PAPER GOODS AND PRINTED MATTER

FOR STATIONERY; OFFICE SUPPLIES, NAMELY WRITING INSTRUMENTS, HOLDERS FOR DESKTOP CALENDARS AND BLOTTERS, AND RACKS FOR HANGING FILE FOLDERS; PAPER, NAMELY TYPING PAPER, COPIER PAPER AND COMPUTER PAPER, CARDBOARD AND GOODS MADE FROM PAPER AND CARDBOARDS, NAMELY BLOTTERS, FILE FOLDERS, CALENDARS, ENVELOPES, NOTEBOOKS, NOTEPADS, LABELS, PAGE DIVIDERS AND INDEXES; PRINTED MATERIALS, NAMELY BOOKS, MANUALS, JOURNALS AND NEWSLETTERS IN THE FIELDS OF ELECTRONIC COMMUNICATION, DATA STORAGE AND RETRIEVAL, OFFICE AND BUSINESS MANAGEMENT, ADVERTISING, AND EDUCATION AND INSTRUCTION OF CUSTOMERS; BOOKBINDINGS; ADHESIVES FOR PAPER PRODUCTS, STATIONERY OR FOR HOUSEHOLD PURPOSES; PRINTED AND PAPER TEACHING MATERIAL IN THE FIELDS OF ELECTRONIC COMMUNICATION, DATA STORAGE AND RETRIEVAL, OFFICE AND BUSINESS MANAGEMENT, AND EDUCATION AND INSTRUCTION OF CUSTOMERS; PLASTIC PACKAGING MATERIAL, NAMELY FILM, BAGS AND BUBBLE PACK FOR WRAPPING OR PACKAGING; PLAYING CARDS; PRINTING TYPE; PHOTOGRAPHS (U.S. CLS. 2, 5, 22, 23, 29, 37, 38 AND 50).

CLASS 35—ADVERTISING AND BUSINESS

FOR ADVERTISING AND BUSINESS SERVICES, NAMELY BUSINESS MARKETING CONSULTATION SERVICES; MARKET RESEARCH AND ANALYSIS; BUSINESS MANAGEMENT; BUSINESS ADMINISTRATION SERVICES, NAMELY ACCOUNTING AND BOOKKEEPING FOR OTHERS; BUSINESS CONSULTING SERVICES; OFFICE WORK, NAMELY PHOTOCOPYING AND TELEPHONE ANSWERING SERVICES; PREPARATION OF BUSINESS STATISTICAL INFORMATION; BOOKKEEPING; HOLDING AUCTIONS; INVESTIGATIONS INTO BUSINESS MATTERS; PERSONNEL MANAGEMENT AND RECRUITING CONSULTATION SERVICES; TEMPORARY EMPLOYMENT AGENCY SERVICES; REPRODUCTION OF DOCUMENTS; ADVERTISING AGENCY SERVICES, ADVERTISING SERVICE, NAMELY DIRECT MAIL ADVERTISING AND DISTRIBUTION OF SAMPLES OF GOODS FOR OTHERS; NEGOTIATING AND CONCLUDING BUSINESS FOR OTHERS; LEASING OF OFFICE MACHINES AND EQUIPMENT; ORGANIZATION OF EXHIBITIONS FOR COMMERCIAL AND PUBLICITY PURPOSES AS REQUESTED BY CUSTOMERS IN INDUSTRY, ENTERTAINMENT AND EDUCATION FIELDS; PROCUREMENT SERVICES FOR OTHERS, NAMELY, PURCHASING SERVICES IN THE FIELDS OF INSTALLATION AND MAINTENANCE OF BUILDING SYSTEMS AND EQUIPMENT, SUPERVISION OF INSTALLATION AND MAINTENANCE CONTRACTORS, AND ACCOUNTING AND BUSINESS INVOICING SERVICES IN THE FIELD OF BUILDING SYSTEMS AND EQUIPMENT; FACILITIES MANAGEMENT OF TECHNICAL OPERATIONS; TALENT AGENCY SERVICES; PREPARATION OF TECHNICAL EXPERT BUSINESS REPORTS; LEASING OF VENDING MACHINES; OPINION POLLING FOR ADVERTISING OR BUSINESS PURPOSES; PROVISION OF ADVERTISING SPACE FOR OTHERS VIA ELECTRONIC MEDIA, JOURNALS AND NEWSLETTERS FOR COMMERCIAL PURPOSES (U.S. CLS. 100, 101 AND 102).

CLASS 37—CONSTRUCTION AND REPAIR

FOR INSTALLATION, MAINTENANCE AND REPAIR OF TELECOMMUNICATIONS EQUIPMENT; INSTALLATION AND MAINTENANCE OF TECHNICAL EQUIPMENT, NAMELY COMPUTER NETWORKS; INSTALLATION OF THE INFORMATION AND COMMUNICATIONS INFRASTRUCTURE OF BUILDINGS; RESIDENTIAL AND COMMERCIAL CLEANING SERVICES; PLANNING AND ADVICE RELATING TO DESIGN AND CONSTRUCTION WORK; ADAPTION AND IMPLEMENTATION OF COMPUTER HARDWARE (U.S. CLS. 100, 103 AND 106).

CLASS 38—COMMUNICATION

FOR TELECOMMUNICATIONS SERVICES, NAMELY OPERATION OF TELECOMMUNICATIONS NETWORKS; TECHNICAL SUPPORT SERVICES OF AN ONLINE RETAIL STORE, NAMELY PROVIDING TELECOMMUNICATIONS CONNECTIONS TO GLOBAL COMPUTER NETWORK; ONLINE SERVICE PROVIDER, NAMELY PROVIDING MULTIPLE USER ACCESS TO A GLOBAL COMPUTER NETWORK; ONLINE SERVICE PROVIDER, NAMELY TRANSMISSION OF DATA, IMAGES AND DOCUMENTS VIA COMPUTER TERMINAL AND ELECTRONIC MAIL SERVICES; LEASING OF TELECOMMUNICATIONS EQUIPMENT; PROVISION OF INTERNET AND INTRANET COMMUNICATION FACILITIES, NAMELY COLLOCATION SERVICES WHEREBY CUSTOMERS INSTALL TELECOMMUNICATIONS EQUIPMENT IN CONDITIONED EQUIPMENT FACILITIES, AND THE TECHNICAL OPERATION AND ADMINISTRATION OF PREMISES; TELECOMMUNICATIONS AND COMPUTER NETWORK PLANNING (U.S. CLS. 100, 101 AND 104).

CLASS 41—EDUCATION AND ENTERTAINMENT

FOR LEASING OF RADIO, TELEVISION AND VIDEO EQUIPMENT; TRAINING IN THE FIELD OF ELECTRONIC DATA TRANSMISSION, STORAGE AND RETRIEVAL; TRAINING, EDUCATION, NAMELY PROVIDING INSTRUCTION IN BUSINESS MANAGEMENT SOLUTIONS FOR COMMERCE CONDUCTED OVER THE INTERNET, TEACHING, NAMELY CONDUCTING CLASSES, SEMINARS AND WORKSHOPS IN THE FIELD OF ELECTRONIC DATA TRANSMISSION, STORAGE AND RETRIEVAL; PRODUCTION OF RADIO AND TELEVISION PROGRAMS, VIDEOS AND FILMS; RADIO, TELEVISION, VIDEO AND FILM RENTAL; ENTERTAINMENT IN THE NATURE OF VISUAL AND AUDIO PERFORMANCES, AND MUSICAL, VARIETY, NEWS AND COMEDY SHOWS; LIBRARY SERVICES, NAMELY LENDING OF BOOKS, MAGAZINES, NEWSPAPERS, AND PROVIDING A DATABASE CONTAINING A COMPREHENSIVE LISTING OF SCHEDULED RADIO, TELEVISION, VIDEO AND FILM PROGRAMS; PUBLICATION OF BOOKS, MAGAZINES, NEWSPAPERS, JOURNALS AND BROCHURES, ALSO IN ELECTRONIC FORM; PRODUCTION OF RADIO, TELEVISION, VIDEO AND FILM PROGRAMS FOR DISTRIBUTION AND FOR DISTRIBUTION VIA THE GLOBAL COMPUTER NETWORK; ORGANIZATION OF COMMUNITY SPORTING AND CULTURAL ACTIVITIES AND REPORTS OF THE SPORTING EVENTS BY MEANS OF RADIO, TELEVISION, VIDEO OR FILM (U.S. CLS. 100, 101 AND 107).

CLASS 42—SCIENTIFIC, COMPUTER AND LEGAL SERVICES

2,730,956. CERTIFIED LEARNING IN COSMETOLOGY, INC., READING, PA. SN 78-136,766. FILED P.R. 6-18-2002; AM. S.R. 3-14-2003.

FOR COMPUTER SOFTWARE DESIGN FOR OTHERS IN THE FIELD OF DATA PROCESSING AND TELECOMMUNICATIONS; UPDATING OF COMPUTER SOFTWARE; AND PROVIDING A DATABASE FEATURING GENERAL AND LOCAL NEWS, AND INFORMATION OF INTEREST TO SPECIFIC GEOGRAPHIC AREAS; LEASING OF DATA PROCESSING EQUIPMENT, NAMELY COMPUTERS; SOFTWARE DEVELOPMENT FOR OTHERS, NAMELY OF INTERACTIVE ELECTRONIC USER-ORIENTED SOFTWARE; TECHNICAL ADVICE, EXPERTS' ADVISORY SERVICES AND PREPARATION OF TECHNICAL EXPERT REPORTS IN THE FIELD OF COMPUTER SOFTWARE DESIGN; UPDATING OF DATA AND SOFTWARE USING INFORMATION FROM POINT OF SALE TERMINALS; CONSULTATION AND ADVICE IN THE FIELD OF ELECTRONIC MEDIA; ARCHITECTURAL DESIGN; SERVICES OF A PHYSICIST; ENGINEERING SERVICES; DETECTIVE AGENCY SERVICES; LANGUAGE AND BRAILLE TRANSLATIONS; MATERIALS TESTING; ACCOMMODATION SERVICES, NAMELY MAKING RESERVATIONS AND BOOKING FOR TEMPORARY LODGING; MONITORING OF THE TECHNICAL EQUIPMENT INSTALLED IN TELECOMMUNICATIONS FACILITIES; SECURITY GUARD SERVICES; TECHNICAL CONSULTATION AND EXPERT ADVISORY SERVICES IN THE FIELD OF DATA PROCESSING AND TELECOMMUNICATIONS; ONLINE COMPUTER SERVICES, NAMELY PROVIDING A WIDE VARIETY OF GENERAL INFORMATION IN THE FIELDS OF MESSAGES, E-MAIL, VOICE MAIL, DOCUMENTS, FILES, PERSONAL DATA, NEWS, WEATHER, SPORTS, AND TRAVEL BY MEANS OF DATABASES AVAILABLE THROUGH A GLOBAL COMPUTER NETWORK (U.S. CLS. 100 AND 101).

CERTIFIED LEARNING IN COSMETOLOGY

CLASS 16—PAPER GOODS AND PRINTED MATTER

FOR PRINTED MATERIALS, NAMELY, TEXTBOOKS, TEACHERS MANUALS, AND CERTIFICATION TESTS IN THE FIELDS OF COSMETOLOGY, HAIR CUTTING, HAIR DESIGNING, HAIR CHEMISTRY, HAIR COLORING, NAILS, MAKEUP, AND PEOPLE SKILLS (U.S. CLS. 2, 5, 22, 23, 29, 37, 38 AND 50).
FIRST USE 4-0-1998; IN COMMERCE 4-0-1998.

CLASS 42—SCIENTIFIC, COMPUTER AND LEGAL SERVICES

FOR TESTING, ANALYSIS AND EVALUATION OF THE GOODS AND SERVICES OF OTHERS FOR THE PURPOSE OF CERTIFICATION IN THE FIELD OF COSMETOLOGY (U.S. CLS. 100 AND 101).
FIRST USE 4-0-1998; IN COMMERCE 4-0-1988.

* * * * *

SECTION 2.— INTERNATIONAL CLASSIFICATION

The short titles associated below with the international class numbers are terms designed merely for quick identification and are not an official part of the international classification. The full names of international classes are given in section 6.1 of the trademark rules of practice.

The designation "U.S. Cl." appearing in this section refers to the U.S. class in effect prior to Sep. 1, 1973 rather than the international class which applies to applications filed on or after that date. For adoption of international classification see notice in the OFFICIAL GAZETTE of Jun. 26, 1973 (911 O.G. TM 210).

Application in one class

CLASS 2—PAINTS

2,730,936. XEROX CORPORATION, STAMFORD, CT. SN 76-470,276. FILED P.R. 11-26-2002; AM. S.R. 1-29-2003.

CLASS 3—(Continued).

2,730,952. COLGATE-PALMOLIVE COMPANY, NEW YORK, NY. SN 78-119,487. FILED P.R. 4-4-2002; AM. S.R. 2-5-2003.

IT'S COMPATIBLE

FOR TONER AND INKJET CARTRIDGES (U.S. CLS. 6, 11 AND 16).
FIRST USE 4-1-1999; IN COMMERCE 4-1-1999.

CLASS 3—COSMETICS AND CLEANING PREPARATIONS

2,730,851. PROCTER & GAMBLE COMPANY, THE, CINCINNATI, OH. SN 75-656,012. FILED P.R. 3-8-1999; AM. S.R. 7-18-2002.

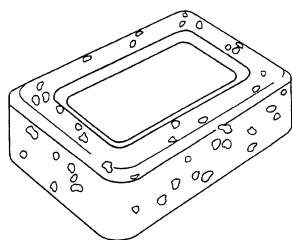

NO CLAIM IS MADE TO THE EXCLUSIVE RIGHT TO USE THE REPRESENTATION OF THE THREE-DIMENSIONAL CONFIGURATION OF A RECTANGULAR-SHAPED TABLET, APART FROM THE MARK AS SHOWN.

THE MARK CONSISTS OF A THREE DIMENSIONAL CONFIGURATION OF A RECTANGULAR-SHAPED SPECKLED TABLET WITH ROUNDED CORNERS, AND A RECTANGULAR, DEPRESSED CENTER PORTION.

FOR AUTOMATIC DISHWASHING DETERGENT (U.S. CLS. 1, 4, 6, 50, 51 AND 52).
FIRST USE 3-20-2000; IN COMMERCE 3-20-2000.

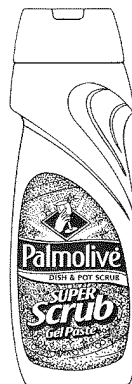

OWNER OF U.S. REG. NOS. 210,594, 2,212,240, AND OTHERS.

NO CLAIM IS MADE TO THE EXCLUSIVE RIGHT TO USE "SCRUB" OR "GEL PASTE", APART FROM THE MARK AS SHOWN.

THE STIPPLING IS FOR SHADING PURPOSES ONLY.
THE MARK CONSISTS OF THE SHAPE OF A BOTTLE WITH A LABEL CONTAINING THE WORDS "PALMOLIVE", "DISH & POT" "SCRUB", "SUPER SCRUB" AND "GEL PASTE", AND A HAND HOLDING A GLASS SUPERIMPOSED AGAINST A QUADRILATERAL DESIGN, STARS, BUBBLES AND SWIRLS.

FOR DISH DETERGENT (U.S. CLS. 1, 4, 6, 50, 51 AND 52).

FIRST USE 11-21-2001; IN COMMERCE 11-21-2001.

CLASS 4—LUBRICANTS AND FUELS

CLASS 4—(Continued).

2,730,848. FUEL FRESH, INC., PHOENIX, AZ. SN 74-730,283.
FILED P.R. 9-18-1995; AM. S.R. 3-14-2003.

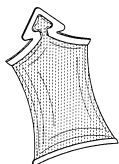

THE DRAWING IS LINED FOR THE COLOR PURPLE,
AND THE COLOR IS CLAIMED AS A FEATURE OF THE
MARK.

FOR PETROLEUM BASED FUEL ADDITIVE (U.S.
CLS. 1, 6 AND 15).

FIRST USE 7-0-2000; IN COMMERCE 7-0-2000.

CLASS 5—PHARMACEUTICALS

2,730,849. METAGENICS, INC., SAN CLEMENTE, CA. SN 75-
470,960. FILED 4-20-1998.

BONE BUILDER

FOR NUTRITIONAL SUPPLEMENTS (U.S. CLS. 6, 18,
44, 46, 51 AND 52).

FIRST USE 3-13-1990; IN COMMERCE 3-13-1990.

2,730,857. AZOCAR, JOSE, SPRINGFIELD, MA. SN 75-
851,893. FILED P.R. 11-18-1999; AM. S.R. 8-29-2002.

RENAL CAP

FOR VITAMIN AND MINERAL SUPPLEMENTS (U.S.
CLS. 6, 18, 44, 46, 51 AND 52).

FIRST USE 3-7-2002; IN COMMERCE 3-7-2002.

2,730,892. ONE LAMBDA, INC., CANOGA PARK, CA. SN 76-
372,186. FILED P.R. 2-20-2002; AM. S.R. 10-31-2002.

LABSCREEN

FOR DIAGNOSTIC CHEMICALS USED IN MEDICAL
LABORATORY TEST PROCEDURES (U.S. CLS. 6, 18, 44,
46, 51 AND 52).

FIRST USE 10-11-2000; IN COMMERCE 10-11-2000.

CLASS 6—METAL GOODS**CLASS 6—(Continued).**

2,730,905. WEISNER STEEL PRODUCTS, INC., ORINDA, CA.
SN 76-403,369. FILED P.R. 5-2-2002; AM. S.R. 3-17-2003.



OWNER OF U.S. REG. NO. 1,219,693.
THE DRAWING IS LINED FOR THE COLORS BLUE AND
TAN.

THE MARK CONSISTS OF THE COLORED SURFACES
OF TWO ADJACENT STRANDS OF WIRE ROPE. THE
ADJACENT STRANDS ARE BLUE AND TAN. THE
DOTTED OUTLINE OF THE GOODS IS INTENDED TO
SHOW THE POSITION OF THE MARK AND IS NOT A
PART OF THE MARK.

FOR WIRE ROPE (U.S. CLS. 2, 12, 13, 14, 23, 25 AND
50).

FIRST USE 8-1-2002; IN COMMERCE 8-1-2002.

CLASS 7—MACHINERY

2,730,852. TAPCO INTERNATIONAL, INC., HOUSTON, TX.
SN 75-693,512. FILED P.R. 4-29-1999; AM. S.R. 2-24-2003.

BOLT-LESS SLIDE VALVE

NO CLAIM IS MADE TO THE EXCLUSIVE RIGHT TO
USE "SLIDE VALVE", APART FROM THE MARK AS
SHOWN.

FOR SLIDE VALVES BEING PARTS OF MACHINES
FOR USE IN HIGH PRESSURE AND HIGH TEMPERA-
TURE REFINERY SERVICE (U.S. CLS. 13, 19, 21, 23, 31,
34 AND 35).

FIRST USE 11-8-1998; IN COMMERCE 11-8-1998.

CLASS 7—(Continued).

2,730,899. XYRON INCORPORATED, SCOTTSDALE, AZ. SN 76-399,998. FILED P.R. 4-25-2002; AM. S.R. 3-24-2003.

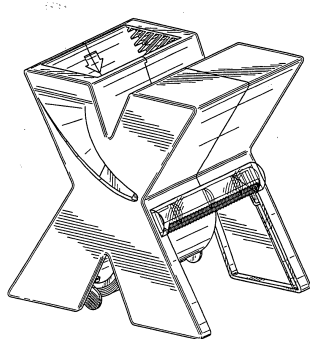

THE LINING IN THE DRAWING IS FOR SHADING PURPOSES ONLY.

THE MARK CONSISTS OF AN X-SHAPED CONFIGURATION OF A LAMINATING MACHINE THAT ENABLES USERS TO TURN CLIP ART, PUNCHES, PHOTOGRAPHS, SCRAP BOOKING, LETTERS AND NUMBERS INTO STICKERS.

FOR DOCUMENT AND IMAGE PROTECTION AND MOUNTING EQUIPMENT FOR USE IN THE ADVERTISING, GRAPHICS AND CRAFT FIELDS, NAMELY, LAMINATING MACHINES FOR HOME AND OFFICE USE AND PARTS THEREFOR AND MACHINES FOR APPLYING PROTECTIVE PLASTIC FILM LAMINATE AND/OR ADHESIVE MOUNT (U.S. CLS. 13, 19, 21, 23, 31, 34 AND 35).

FIRST USE 7-0-2000; IN COMMERCE 8-0-2001.

CLASS 9—ELECTRICAL AND SCIENTIFIC APPARATUS

2,730,855. COMMERCETV CORPORATION, BRAINTREE, MA. SN 75-829,474. FILED P.R. 10-21-1999; AM. S.R. 6-25-2001.

T-COMMERCE

FOR COMPUTER PROGRAMS FOR USE IN CABLE TELEVISION HEAD END AND SET TOP BOX APPLICATIONS FOR FACILITATING ELECTRONIC COMMERCE TRANSACTIONS OVER TELEVISION; HEAD END SERVERS (U.S. CLS. 21, 23, 26, 36 AND 38).

FIRST USE 9-3-1999; IN COMMERCE 9-3-1999.

2,730,863. INTELLOCITY USA, INC., DENVER, CO, BY ASSIGNMENT INTELLOCITY, INC., CAUSEWAY BAY, HONG KONG. SN 76-045,252. FILED P.R. 5-10-2000; AM. S.R. 2-10-2003.

ITV PRODUCER

FOR COMPUTER SOFTWARE FOR USE IN CREATING, DEVELOPING, EDITING AND BROADCASTING INTERACTIVE TELEVISION APPLICATIONS, PACKAGES AND CONTENT (U.S. CLS. 21, 23, 26, 36 AND 38).

FIRST USE 3-1-2001; IN COMMERCE 3-1-2001.

CLASS 9—(Continued).

2,730,869. CEREBROS MEDICAL SYSTEMS, LLC., DUNMORE, PA. SN 76-135,950. FILED P.R. 9-26-2000; AM. S.R. 2-20-2003.

tube.tracker

FOR SOFTWARE FOR USE IN THE TRACKING OF LABORATORY SPECIMENS, NAMELY THE MONITORING OF THE LOCATION AND STATUS OF MEDICAL MATERIAL AND PRODUCTION OF INFORMATION OF THE SAME IN THE FORM OF REPORTS, CHARTS AND GRAPHS (U.S. CLS. 21, 23, 26, 36 AND 38).

FIRST USE 1-5-1999; IN COMMERCE 1-5-1999.

2,730,877. INTELLOCITY USA, INC., DENVER, CO. SN 76-256,424. FILED P.R. 5-11-2001; AM. S.R. 12-6-2002.

ITV CONTENT MANAGER

FOR COMPUTER SOFTWARE FOR USE IN CREATING, DEVELOPING, EDITING AND BROADCASTING INTERACTIVE TELEVISION APPLICATIONS, PACKAGES AND CONTENT (U.S. CLS. 21, 23, 26, 36 AND 38).

FIRST USE 9-0-2000; IN COMMERCE 6-0-2002.

2,730,883. ASTEC INDUSTRIES, INC., CHATTANOOGA, TN. SN 76-288,099. FILED P.R. 7-23-2001; AM. S.R. 1-13-2003.

MILLMANAGER

FOR COMPUTER PROGRAM USED TO ESTIMATE AND MANAGE THE COST OF ROAD MILLING PROJECTS, INCLUDING COSTS FOR OPERATION OF MILLING MACHINES, TRUCKING COSTS, CLEAN UP COSTS, TRAFFIC CONTROL COSTS AND ROAD SWEEPING COSTS (U.S. CLS. 21, 23, 26, 36 AND 38).

FIRST USE 6-29-2001; IN COMMERCE 6-29-2001.

2,730,885. GUERRILLA NEWS NETWORK, INC., NEW YORK, NY. SN 76-304,802. FILED P.R. 8-24-2001; AM. S.R. 10-18-2002.

GUERRILLA NEWS NETWORK

FOR PRERECORDED CDS, DVDS, VIDEO CASSETTE TAPES FEATURING NEWS AND GENERAL INFORMATION (U.S. CLS. 21, 23, 26, 36 AND 38).

FIRST USE 11-0-2001; IN COMMERCE 11-0-2001.

CLASS 9—(Continued).

2,730,886. SEXTON, ROBERT J., MADISON, TN. SN 76-311,394. FILED P.R. 9-10-2001; AM. S.R. 1-10-2003.

FLAT LINK TECHNOLOGY

NO CLAIM IS MADE TO THE EXCLUSIVE RIGHT TO USE "TECHNOLOGY", APART FROM THE MARK AS SHOWN.

FOR ELECTRICAL AUDIO WIRE (U.S. CLS. 21, 23, 26, 36 AND 38).
FIRST USE 3-4-2002; IN COMMERCE 3-4-2002.

2,730,906. MITSUBISHI DIGITAL ELECTRONICS AMERICA, INC., IRVINE, CA. SN 76-406,414. FILED P.R. 5-13-2002; AM. S.R. 4-7-2003.

THE BIG SCREEN COMPANY

Digital

FOR TELEVISION SETS, DVDS, VIDEOCASSETTE RECORDERS AND SATELLITE RECEIVERS (U.S. CLS. 21, 23, 26, 36 AND 38).
FIRST USE 1-20-1999; IN COMMERCE 1-22-1999.

2,730,913. QUICKPEN INTERNATIONAL, CORP., ENGLEWOOD, CO. SN 76-414,200. FILED P.R. 6-3-2002; AM. S.R. 3-31-2003.

PIPEDESIGNER 3D

FOR COMPUTER SOFTWARE PROGRAMS FOR SOLID MODELING AND DESIGN FOR THE FABRICATION AND INSTALLATION OF PIPE FITTINGS, VALVES, PUMPS, EQUIPMENT AND STEEL SHAPES FOR THE PIPING INDUSTRY AND INSTRUCTIONAL MANUALS SOLD THEREWITH (U.S. CLS. 21, 23, 26, 36 AND 38).

FIRST USE 10-22-1999; IN COMMERCE 10-22-1999.

2,730,923. POINT BLANK BODY ARMOR, INC., OAKLAND PARK, FL. SN 76-426,165. FILED P.R. 6-28-2002; AM. S.R. 3-17-2003.

TAC PANTS

NO CLAIM IS MADE TO THE EXCLUSIVE RIGHT TO USE "PANTS", APART FROM THE MARK AS SHOWN.

FOR PROTECTIVE BODY ARMOR, NAMELY BALLISTIC, BULLET, SLASH, AND STAB RESISTANT BODY ARMOR AND PROTECTIVE CLOTHING (U.S. CLS. 21, 23, 26, 36 AND 38).
FIRST USE 9-0-2001; IN COMMERCE 9-0-2001.

CLASS 9—(Continued).

2,730,928. THE FONT BUREAU, INC., BOSTON, MA. AND LEW, KENT, BOSTON, MA. SN 76-437,326. FILED P.R. 8-5-2002; AM. S.R. 3-17-2003.

WHITMAN

FOR TYPE FACE FONTS RECORDED ON MAGNETIC AND OPTICAL MEDIA (U.S. CLS. 21, 23, 26, 36 AND 38).
FIRST USE 3-15-2002; IN COMMERCE 3-15-2002.

2,730,942. CONNECTIVITY SYSTEMS INCORPORATED, WILLIAMSPORT, OH. SN 78-058,744. FILED P.R. 4-17-2001; AM. S.R. 4-15-2003.

TCP/IP FOR VSE

FOR COMPUTER SOFTWARE FOR MAINFRAME COMPUTERS, UTILIZING VIRTUAL STORAGE EXTENDED/ENTERPRISE SYSTEM ARCHITECTURE OPERATING SYSTEMS (U.S. CLS. 21, 23, 26, 36 AND 38).
FIRST USE 4-30-2001; IN COMMERCE 4-30-2001.

2,730,943. AXIS SYSTEMS, INC., SUNNYVALE, CA. SN 78-074,062. FILED P.R. 7-16-2001; AM. S.R. 3-7-2003.

XPERT

FOR INTEGRATED COMPUTER HARDWARE AND SOFTWARE FOR SIMULATION, TESTING AND VERIFICATION OF ELECTRONIC LOGIC AND CIRCUIT DESIGNS (U.S. CLS. 21, 23, 26, 36 AND 38).
FIRST USE 6-22-2001; IN COMMERCE 6-22-2001.

2,730,944. MIDWAY GAMES WEST INC., MILPITAS, CA. SN 78-075,223. FILED P.R. 7-23-2001; AM. S.R. 12-12-2002.

DR. MUTO

THE NAME "DR. MUTO" DOES NOT IDENTIFY A LIVING INDIVIDUAL.

FOR COMPUTER AND VIDEO GAME PROGRAMS IN THE FORM OF CARTRIDGES, DISCS, CD-ROMS, CASSETTES AND TAPES (U.S. CLS. 21, 23, 26, 36 AND 38).
FIRST USE 11-11-2002; IN COMMERCE 11-11-2002.

CLASS 9—(Continued).

2,730,947. STONE, JOSEPH LOUIS, DAVIE, FL. SN 78-081,197. FILED P.R. 8-27-2001; AM. S.R. 4-15-2003.



NO CLAIM IS MADE TO THE EXCLUSIVE RIGHT TO USE "LIVE", APART FROM THE MARK AS SHOWN. FOR PRERECORDED VIDEO TAPES AND COMPACT DISCS FEATURING MUSIC; MUSICAL SOUND VIDEO RECORDINGS (U.S. CLS. 21, 23, 26, 36 AND 38). FIRST USE 5-15-1991; IN COMMERCE 6-15-1991.

2,730,948. CLYDE BERGEMANN INC., ATLANTA, GA. SN 78-081,600. FILED P.R. 8-29-2001; AM. S.R. 1-14-2003.

SMART SENSOR

FOR ELECTRONIC DEVICE USED TO MONITOR AND DETERMINE THE CONDITION OF HEAT TRANSFER SURFACES IN A BOILER (U.S. CLS. 21, 23, 26, 36 AND 38). FIRST USE 11-26-2002; IN COMMERCE 11-26-2002.

2,730,949. APPLIED BIOSYSTEMS/MDS SCIEX INSTRUMENTS, CONCORD, ONTARIO, CANADA. SN 78-089,943. FILED P.R. 10-24-2001; AM. S.R. 4-7-2003.

Q TRAP

FOR SCIENTIFIC AND LABORATORY EQUIPMENT, NAMELY, MASS SPECTROMETER AND OPERATING SOFTWARE THEREFORE, FOR USE IN CHEMICAL AND BIOLOGICAL APPLICATIONS (U.S. CLS. 21, 23, 26, 36 AND 38). FIRST USE 6-19-2002; IN COMMERCE 6-19-2002.

2,730,953. BOSON SOFTWARE, INC., TAMPA, FL. SN 78-119,975. FILED P.R. 4-6-2002; AM. S.R. 2-24-2003.

EROUTER

FOR COMPUTER SOFTWARE FOR USE IN STUDENT TRAINING, WHICH WILL SIMULATE THE INPUT AND OUTPUT CHARACTERISTICS OF A COMPUTER NETWORKING DEVICE OR DEVICES WITHOUT HAVING THE DEVICE PHYSICALLY PRESENT OR ATTACHED (U.S. CLS. 21, 23, 26, 36 AND 38). FIRST USE 3-31-2001; IN COMMERCE 11-30-2002.

CLASS 11—ENVIRONMENTAL CONTROL APPARATUS

CLASS 11—(Continued).

2,730,860. GENERAL ELECTRIC COMPANY, SCHENECTADY, NY. SN 75-936,369. FILED P.R. 3-6-2000; AM. S.R. 3-13-2003.

CONNECT 6

FOR DECORATIVE ELECTRIC LAMP STRINGS AND ELECTRIC LAMPS (U.S. CLS. 13, 21, 23, 31 AND 34). FIRST USE 6-28-2001; IN COMMERCE 6-28-2001.

2,730,878. ASI TECHNOLOGIES, INC., MILWAUKEE, WI. SN 76-258,662. FILED P.R. 5-16-2001; AM. S.R. 1-28-2003.

AIRSEAL

FOR AIR CONTROL AND AIR CONDITIONING APPARATUS, NAMELY AN AIR CURTAIN FOR USE AT ENTRANCE DOORWAYS OF REFRIGERATED, AIR-CONDITIONED, OR HEATED ROOMS IN BUILDINGS (U.S. CLS. 13, 21, 23, 31 AND 34). FIRST USE 5-0-2001; IN COMMERCE 5-0-2001.

2,730,911. HUBBELL INCORPORATED, ORANGE, CT. SN 76-412,975. FILED P.R. 5-21-2002; AM. S.R. 3-19-2003.

PULSE SMART

OWNER OF U.S. REG. NOS. 823,309, 2,432,685, AND OTHERS. FOR ELECTRICAL LIGHTING FIXTURES (U.S. CLS. 13, 21, 23, 31 AND 34). FIRST USE 11-11-2002; IN COMMERCE 11-11-2002.

2,730,917. EVOLUTIONARY PRODUCTS, INC., LOS ANGELES, CA. SN 76-417,538. FILED P.R. 6-3-2002; AM. S.R. 1-29-2003.

SUPERSTYLER

FOR ELECTRONICALLY DRIVEN ROTATING MECHANICAL HAIR BRUSHES (U.S. CLS. 13, 21, 23, 31 AND 34). FIRST USE 10-17-2002; IN COMMERCE 10-17-2002.

CLASS 12—VEHICLES

CLASS 12—(Continued).

2,730,909. EAGLE NATION, INC., PEARLAND, TX. SN 76-410,019. FILED P.R. 5-20-2002; AM. S.R. 3-31-2003.

POWER HEAVY DUTY

NO CLAIM IS MADE TO THE EXCLUSIVE RIGHT TO USE "HEAVY DUTY", APART FROM THE MARK AS SHOWN.

FOR AUTOMOTIVE, VEHICLE AND HEAVY DUTY TRUCK PARTS AND ACCESSORIES, NAMELY, BRAKES, BRAKE SHOES, BRAKE DRUMS, DISC BRAKE PADS, SHOCK ABSORBERS, SUSPENSIONS, SUSPENSION STRUTS, SUSPENSION COIL SPRINGS, WHEEL CYLINDERS, WHEEL BEARINGS, AND VEHICLE CARGO RESTRAINTS, NAMELY FITTED LINERS; AND NEW AND RE-MANUFACTURED AIR AND HYDRAULIC BRAKE SYSTEMS, PARTS AND ACCESSORIES FOR VEHICLES AND HEAVY DUTY TRUCKS, NAMELY, VALVES, COMPRESSORS (U.S. CLS. 19, 21, 23, 31, 35 AND 44).

FIRST USE 7-0-1994; IN COMMERCE 7-0-1994.

2,730,951. TIRECO, INC., COMPTON, CA. SN 78-108,393. FILED P.R. 2-13-2002; AM. S.R. 3-3-2003.

QUALITY ASSURED

FOR TIRES, INNER TUBES FOR VEHICLE WHEELS, INNER TUBE PROTECTOR FLAPS, AND VALVE STEMS FOR TIRES (U.S. CLS. 19, 21, 23, 31, 35 AND 44).

FIRST USE 1-1-2000; IN COMMERCE 1-1-2000.

CLASS 13—FIREARMS

2,730,884. UEE CARTUCHERIA DEPORTIVA SA, IRUNA DE OCA (ALAVA), SPAIN. SN 76-303,921. FILED P.R. 8-22-2001; AM. S.R. 3-25-2002.

KEMEN

FOR SHOT SHELL CARTRIDGES, SHOTGUN SHELL, SLUG, HUNTING SHOT SHELL, COMPETITION SHOT SHELL (U.S. CLS. 2 AND 9).

FIRST USE 7-0-2001; IN COMMERCE 7-0-2001.

CLASS 14—JEWELRY**CLASS 14—(Continued).**

2,730,858. LANGE UHREN GMBH, 01768 GLASHUETTE, FED REP GERMANY. SN 75-883,446. FILED P.R. 12-23-1999; AM. S.R. 12-21-2000.

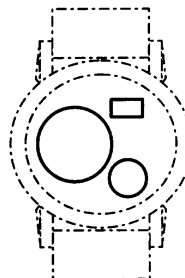

THE MARK CONSISTS OF A CONFIGURATION OF A WATCH FACE CONSISTING OF TWO CIRCLES AND A RECTANGLE. THE LARGE CIRCLE SERVES AS A BORDER FOR THE HOUR AND MINUTE HANDS, THE SMALLER CIRCLE SERVES AS A BORDER FOR THE SECOND HAND, AND THE RECTANGLE SERVES AS THE BORDER FOR TWO NUMERALS INDICATING THE DATE OF THE MONTH. BROKEN LINES ARE USED IN THE DRAWING TO SHOW PLACEMENT OF THE MARK ON THE WATCH. THE MATTER SHOWN BY THE BROKEN LINES IS NOT PART OF THE MARK.

FOR CHRONOMETERS, CHRONOGRAPHS FOR USE AS WATCHES (U.S. CLS. 2, 27, 28 AND 50).

FIRST USE 0-0-1994; IN COMMERCE 0-0-1994.

CLASS 15—MUSICAL INSTRUMENTS

2,730,945. DEAN MARKLEY STRINGS, INC., SANTA CLARA, CA. SN 78-076,000. FILED P.R. 7-26-2001; AM. S.R. 10-28-2002.

NICKELSTEEL

FOR STRINGS FOR MUSICAL INSTRUMENTS (U.S. CLS. 2, 21 AND 36).

FIRST USE 12-31-1999; IN COMMERCE 12-31-1999.

CLASS 16—PAPER GOODS AND PRINTED MATTER

2,730,856. OTTINGER, TRACY S., DBA SUMMERWOOD DESIGNS, RICHMOND, VA. SN 75-835,134. FILED P.R. 11-15-1999; AM. S.R. 4-28-2003.

MOMMY CARDS

NO CLAIM IS MADE TO THE EXCLUSIVE RIGHT TO USE "CARDS", APART FROM THE MARK AS SHOWN.

FOR BUSINESS CARDS (U.S. CLS. 2, 5, 22, 23, 29, 37, 38 AND 50).

FIRST USE 9-1-1999; IN COMMERCE 9-1-1999.

CLASS 16—(Continued).

2,730,864. ROBERTSON, GARY R., MONCTON, CANADA.
SN 76-070,088. FILED P.R. 6-13-2000; AM. S.R. 5-18-2001.

NEW ENGLAND BUSINESS JOURNAL

NO CLAIM IS MADE TO THE EXCLUSIVE RIGHT TO USE "JOURNAL", APART FROM THE MARK AS SHOWN. FOR NEWSPAPER PROMOTING BUSINESSES ON THE EASTERN SEABOARD OF CANADA AND UNITED STATES (U.S. CLS. 2, 5, 22, 23, 29, 37, 38 AND 50).
FIRST USE 9-1-2000; IN COMMERCE 9-1-2000.

2,730,875. CHANCELLOR PUBLICATIONS, INC., MIAMI SHORES, FL. SN 76-226,457. FILED P.R. 3-19-2001; AM. S.R. 6-19-2002.

WHO'S WHO IN YOUTH LEAGUE SOFTBALL

OWNER OF U.S. REG. NO. 2,333,929.
FOR BOOKS IN THE FIELD OF SOFTBALL (U.S. CLS. 2, 5, 22, 23, 29, 37, 38 AND 50).
FIRST USE 2-0-2002; IN COMMERCE 2-0-2002.

2,730,897. ALPINIST, LLC, GLENCOE, IL. SN 76-396,662.
FILED P.R. 4-16-2002; AM. S.R. 2-13-2003.

ALPINIST

FOR PRINTED PUBLICATIONS, NAMELY, MAGAZINES FEATURING MATTERS OF INTEREST TO THOSE IN THE FIELD OF MOUNTAIN CLIMBING (U.S. CLS. 2, 5, 22, 23, 29, 37, 38 AND 50).
FIRST USE 4-1-2002; IN COMMERCE 4-1-2002.

2,730,898. PRESCRIBING REFERENCE, INC., NEW YORK, NY, BY ASSIGNMENT CACTUS COMMUNICATIONS LLC, CEDAR KNOLLS, NJ. SN 76-398,361. FILED P.R. 4-22-2002; AM. S.R. 3-14-2003.

RENAL MEDICINE NEWS

FOR MEDICAL PUBLICATIONS, NAMELY, TRADE JOURNALS IN THE FIELDS OF NEPHROLOGY AND UROLOGY (U.S. CLS. 2, 5, 22, 23, 29, 37, 38 AND 50).
FIRST USE 8-0-2002; IN COMMERCE 8-0-2002.

CLASS 16—(Continued).

2,730,900. MASON, KAREN, ATLANTA, GA. AND JAMES, KENYA, ATLANTA, GA. SN 76-400,236. FILED P.R. 4-22-2002; AM. S.R. 3-26-2003.



NO CLAIM IS MADE TO THE EXCLUSIVE RIGHT TO USE "MAGAZINE", APART FROM THE MARK AS SHOWN. FOR MAGAZINES FEATURING INFORMATION OF GENERAL INTEREST TO YOUNG GIRLS (U.S. CLS. 2, 5, 22, 23, 29, 37, 38 AND 50).
FIRST USE 7-23-2001; IN COMMERCE 7-23-2001.

2,730,915. WELLESLEY FINANCIAL PUBLICATIONS, INC., WELLESLEY, MA. SN 76-415,538. FILED P.R. 6-5-2002; AM. S.R. 2-19-2003.

LIMITED RISK INVESTOR

FOR PERIODICAL PUBLICATIONS, NAMELY, NEWSLETTERS IN THE FIELD OF INVESTMENT (U.S. CLS. 2, 5, 22, 23, 29, 37, 38 AND 50).
FIRST USE 3-31-2002; IN COMMERCE 3-31-2002.

2,730,926. AMERICAN ACADEMY OF OPHTHALMOLOGY, INC., SAN FRANCISCO, CA. SN 76-431,451. FILED P.R. 7-17-2002; AM. S.R. 4-4-2003.

ANIMAL EYES

FOR PRINTED INSTRUCTIONAL, EDUCATIONAL AND TEACHING MATERIALS, NAMELY, WORKSHEETS, GUIDES, PAMPHLETS, BROCHURES, MANUALS, AND EXHIBITS IN THE FIELDS OF EYE CARE, VISION, OPHTHALMOLOGY, AND SCIENCE (U.S. CLS. 2, 5, 22, 23, 29, 37, 38 AND 50).
FIRST USE 2-0-1999; IN COMMERCE 2-0-1999.

2,730,931. PILOT CORPORATION OF AMERICA, TRUMBULL, CT. SN 76-444,466. FILED P.R. 8-28-2002; AM. S.R. 3-14-2003.

CHALKLESS BOARD

NO CLAIM IS MADE TO THE EXCLUSIVE RIGHT TO USE "BOARD", APART FROM THE MARK AS SHOWN. FOR MAGNETICALLY OPERATED WRITING AND DRAWING BOARD ON WHICH THE IMAGE IS CREATED USING A MAGNETIC DEVICE (U.S. CLS. 2, 5, 22, 23, 29, 37, 38 AND 50).
FIRST USE 6-0-2001; IN COMMERCE 4-30-2002.

CLASS 16—(Continued).

2,730,932. INTELLIGENT PRODUCTS INCORPORATED OF ILLINOIS, BURLINGTON, KY. SN 76-446,707. FILED 9-4-2002.

PICK UP MITT

OWNER OF U.S. REG. NO. 1,696,132.
NO CLAIM IS MADE TO THE EXCLUSIVE RIGHT TO USE "MITT", APART FROM THE MARK AS SHOWN.
FOR DISPOSABLE PLASTIC BAGS FOR GENERAL USE, NAMELY, PLASTIC BAGS FOR THE COLLECTION AND CONTAINMENT OF CONTAMINATED MATERIALS USED FOR THE PREVENTION OF HEALTH RISKS (U.S. CLS. 2, 5, 22, 23, 29, 37, 38 AND 50).
FIRST USE 10-23-1992; IN COMMERCE 10-11-2001.

2,730,933. CHIEF LEGAL EXECUTIVE LLC, OAKLAND, CA. SN 76-459,304. FILED P.R. 10-18-2002; AM. S.R. 4-10-2003.

CHIEF LEGAL EXECUTIVE

FOR PRINT PUBLICATIONS, NAMELY MAGAZINES FEATURING HIGH QUALITY CAREER CRITICAL INSIGHT FOR GENERAL COUNSEL OF LARGE COMPANIES, WITH A FOCUS ON TRANSFORMATIONS OF IN-HOUSE LEGAL DEPARTMENTS NECESSARY FOR THE 21ST CENTURY (U.S. CLS. 2, 5, 22, 23, 29, 37, 38 AND 50).
FIRST USE 9-27-2002; IN COMMERCE 9-27-2002.

2,730,934. ASSOCIATION OF GOVERNMENT ACCOUNTANTS, ALEXANDRIA, VA. SN 76-461,166. FILED P.R. 10-18-2002; AM. S.R. 4-16-2003.

CERTIFIED GOVERNMENT FINANCIAL MANAGER TOPICS

FOR PUBLICATIONS, NAMELY NEWSLETTERS CONCERNING THE INTERESTS OF PROFESSIONAL FINANCIAL MANAGERS IN GOVERNMENT SERVICE (U.S. CLS. 2, 5, 22, 23, 29, 37, 38 AND 50).
FIRST USE 4-1-1999; IN COMMERCE 4-1-1999.

2,730,935. ASSOCIATION OF GOVERNMENT ACCOUNTANTS, ALEXANDRIA, VA. SN 76-461,171. FILED P.R. 10-18-2002; AM. S.R. 4-16-2003.

JOURNAL OF GOVERNMENT FINANCIAL MANAGEMENT

NO CLAIM IS MADE TO THE EXCLUSIVE RIGHT TO USE "JOURNAL", APART FROM THE MARK AS SHOWN.
FOR PUBLICATIONS, NAMELY JOURNALS CONCERNING THE INTERESTS OF PROFESSIONAL FINANCIAL MANAGERS IN GOVERNMENT SERVICE (U.S. CLS. 2, 5, 22, 23, 29, 37, 38 AND 50).
FIRST USE 3-1-2001; IN COMMERCE 3-1-2001.

CLASS 16—(Continued).

2,730,946. BLACKWELL, JEFFREY, ERIC, HIGLEY, AZ. SN 78-078,675. FILED P.R. 8-10-2001; AM. S.R. 3-24-2003.

SELLING JOURNAL

NO CLAIM IS MADE TO THE EXCLUSIVE RIGHT TO USE "JOURNAL", APART FROM THE MARK AS SHOWN.
FOR PERIODICALS, NAMELY, MAGAZINES, JOURNALS, AND NEWSLETTERS FEATURING THE TOPIC OF BUSINESS, MANAGEMENT, SALES, MARKETING, ADVERTISING AND PROMOTION PRIMARILY DIRECTED TO PROFESSIONALS IN THE AUTOMOBILE, INSURANCE, FINANCE AND HOUSING INDUSTRIES (U.S. CLS. 2, 5, 22, 23, 29, 37, 38 AND 50).
FIRST USE 9-1-2001; IN COMMERCE 9-1-2001.

2,730,959. BLACK-EYED SUSANS PRESS, PORTLAND, OR. SN 78-182,729. FILED P.R. 11-7-2002; AM. S.R. 4-23-2003.

PLANT LOCATOR

FOR GARDENING REFERENCE BOOKS (U.S. CLS. 2, 5, 22, 23, 29, 37, 38 AND 50).
FIRST USE 5-5-1999; IN COMMERCE 5-5-1999.

CLASS 20—FURNITURE AND ARTICLES NOT OTHERWISE CLASSIFIED

2,730,871. PBM PRODUCTS, INC., GORDONSVILLE, VA. SN 76-159,158. FILED P.R. 11-6-2000; AM. S.R. 12-13-2002.

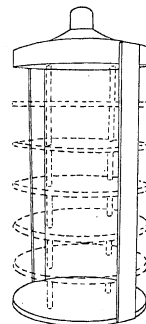

THE STIPPLING SHOWN IN THE DRAWING ATTACHED HERETO IS INTENDED TO SIGNIFY STRUCTURAL ELEMENTS OF THE POINT-OF-PURCHASE DISPLAY AND IS NOT CLAIMED AS A FEATURE OF THE MARK.

THE MARK CONSISTS OF THE OVERALL CONFIGURATION OF A POINT-OF-PURCHASE DISPLAY FOR USE IN RETAIL STORES.

FOR POINT-OF-PURCHASE DISPLAY FOR USE IN RETAIL STORES THROUGHOUT THE U.S. (U.S. CLS. 2, 13, 22, 25, 32 AND 50).

FIRST USE 3-1-1999; IN COMMERCE 3-1-1999.

CLASS 20—(Continued).

2,730,874. HOME GARDENER MANUFACTURING CO., LITITZ, PA. SN 76-194,998. FILED P.R. 1-16-2001; AM. S.R. 3-13-2003.

ANYSIZE CHAIR

NO CLAIM IS MADE TO THE EXCLUSIVE RIGHT TO USE "CHAIR", APART FROM THE MARK AS SHOWN.

FOR FURNITURE PARTS, NAMELY, STRUCTURAL COMPONENTS FOR FURNITURE ASSEMBLIES (U.S. CLS. 2, 13, 22, 25, 32 AND 50).

FIRST USE 12-15-2000; IN COMMERCE 12-15-2000.

2,730,888. ROCKET JEWELRY BOX, INC., BRONX, NY. SN 76-345,274. FILED P.R. 12-3-2001; AM. S.R. 11-19-2002.

THE RED BOX COLLECTION

NO CLAIM IS MADE TO THE EXCLUSIVE RIGHT TO USE "COLLECTION", APART FROM THE MARK AS SHOWN.

FOR JEWELRY BOXES NOT OF METAL (U.S. CLS. 2, 13, 22, 25, 32 AND 50).

FIRST USE 11-0-1997; IN COMMERCE 11-0-1997.

2,730,957. SEALY TECHNOLOGY LLC, TRINITY, NC. SN 78-137,515. FILED P.R. 6-21-2002; AM. S.R. 4-3-2003.

QUILTED INNER PILLOW

FOR MATTRESS COMPONENT, NAMELY FOAM FOR USE IN MATTRESSES (U.S. CLS. 2, 13, 22, 25, 32 AND 50).

FIRST USE 8-0-2001; IN COMMERCE 8-0-2001.

CLASS 21—HOUSEWARES AND GLASS

2,730,862. CLAD HOLDINGS CORP., CANONSBURG, PA. SN 76-033,675. FILED P.R. 4-25-2000; AM. S.R. 6-27-2002.

COPPER-CORE

FOR COOKWARE, NAMELY FRY PANS, SAUCE PANS, SAUCIERS, TAPERED PANS FOR CONCENTRATING LIQUIDS, SAUTE PANS, STOCK POTS, CASSEROLES, PASTA COOKING POTS AND COLANDER INSERTS, BRAZIER PANS, ROASTER PANS, STIR FRY PANS, CHEF'S PANS, PAELLA PANS, OMELETTE PANS, AU GRATIN PANS, BUTTER WARMERS, DOUBLE BOILER INSERTS AND STEAMER INSERTS, AND LIDS FOR ALL OF THE ABOVE, AND GRIDDLE PLATES (U.S. CLS. 2, 13, 23, 29, 30, 33, 40 AND 50).

FIRST USE 6-17-2002; IN COMMERCE 6-17-2002.

CLASS 21—(Continued).

2,730,876. SMITHERS-OASIS COMPANY, CUYAHOGA FALLS, OH. SN 76-247,601. FILED P.R. 4-27-2001; AM. S.R. 3-28-2003.

GARDEN SHAPES

FOR UNFINISHED AND FINISHED TOPIARY SHAPES AND POTS THEREFOR (U.S. CLS. 2, 13, 23, 29, 30, 33, 40 AND 50).

FIRST USE 3-3-2001; IN COMMERCE 5-4-2002.

CLASS 25—CLOTHING

2,730,903. AMERITEX, INC., HAVERFORD, PA. SN 76-400,927. FILED P.R. 4-29-2002; AM. S.R. 3-10-2003.

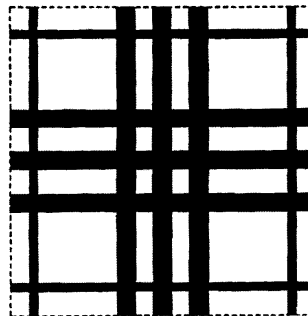

THE MARK CONSISTS OF REPEATING FABRIC PATTERN WHICH APPEARS ON THE GOODS. THE DOTTED LINES ARE NOT A FEATURE OF THE MARK BUT MERELY INDICATE THAT THE MARK IS A REPEATING PATTERN.

FOR SPORTSWEAR, NAMELY, SHIRTS (U.S. CLS. 22 AND 39).

FIRST USE 7-0-2002; IN COMMERCE 7-0-2002.

CLASS 25—(Continued).

2,730,904. AMERITEX, INC., HAVERFORD, PA. SN 76-400,950. FILED P.R. 4-29-2002; AM. S.R. 3-10-2003.

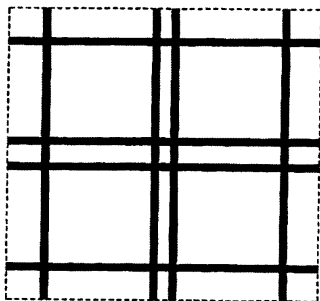

THE MARK CONSISTS OF REPEATING FABRIC PATTERN WHICH APPEARS ON THE GOODS. THE DOTTED LINES ARE NOT A FEATURE OF THE MARK BUT MERELY INDICATE THAT THE MARK IS A REPEATING PATTERN.

FOR SPORTSWEAR, NAMELY, SHIRTS (U.S. CLS. 22 AND 39).

FIRST USE 7-0-2002; IN COMMERCE 7-0-2002.

2,730,907. J. C. PENNEY PRIVATE BRANDS, INC., PLANO, TX. SN 76-406,719. FILED P.R. 4-26-2002; AM. S.R. 3-18-2003.

THE PERFECT BRA

NO CLAIM IS MADE TO THE EXCLUSIVE RIGHT TO USE "BRA", APART FROM THE MARK AS SHOWN. FOR BRAS (U.S. CLS. 22 AND 39). FIRST USE 9-30-2002; IN COMMERCE 9-30-2002.

2,730,954. MISS SELFRIDGE RETAIL LIMITED, LONDON, UNITED KINGDOM. SN 78-126,526. FILED P.R. 5-6-2002; AM. S.R. 1-30-2003.

MISS SELFRIDGE

OWNER OF UNITED KINGDOM REG. NO. 2002266, DATED 2-23-1996, EXPIRES 11-18-2004.

THE NAME "SELFDRIDGE" DOES NOT IDENTIFY A PARTICULAR LIVING INDIVIDUAL.

FOR CLOTHING, NAMELY, BLOUSES, SHIRTS, T-SHIRTS, DRESSES, JUMPERS, CARDIGANS, SKIRTS, TROUSERS, PANTS, JACKETS, COATS, SCARVES, GLOVES, LINGERIE, SUITS, SHORTS, UNDERWEAR, SOCKS, LEGGINGS AND HOSIERY; FOOTWEAR, NAMELY, SHOES, BOOTS, SANDALS, SLIPPERS AND CASUAL SHOES; AND HEADGEAR, NAMELY, HATS AND CAPS (U.S. CLS. 22 AND 39).

CLASS 28—TOYS AND SPORTING GOODS**CLASS 28—(Continued).**

2,730,879. JACOBSON, MARK, PUNTA GORDA, FL. SN 76-262,363. FILED P.R. 5-25-2001; AM. S.R. 1-8-2003.

TROLLING BOBBER

NO CLAIM IS MADE TO THE EXCLUSIVE RIGHT TO USE "BOBBER", APART FROM THE MARK AS SHOWN. FOR SPORTING GOODS, NAMELY A FLOATING, SELF-PROPELLED, MOTORIZED FISHING FLOAT HAVING A FISHING LURE ATTACHED THERETO (U.S. CLS. 22, 23, 38 AND 50).

FIRST USE 2-0-2001; IN COMMERCE 4-0-2001.

2,730,955. ROBINSON, NADINE L., LOS ANGELES, CA. SN 78-127,639. FILED P.R. 5-9-2002; AM. S.R. 4-17-2003.

TRI-LINGO

OWNER OF U.S. REG. NOS. 2,568,612 AND 2,568,613. FOR EDUCATIONAL BINGO GAME FOR DEVELOPING FOREIGN LANGUAGE SKILLS (U.S. CLS. 22, 23, 38 AND 50).

FIRST USE 6-10-1998; IN COMMERCE 9-10-2002.

CLASS 29—MEATS AND PROCESSED FOODS

2,730,912. CHEESE LAND, INC., SEATTLE, WA. SN 76-413,796. FILED P.R. 5-31-2002; AM. S.R. 2-27-2003.

DUTCH VINTAGE

FOR CHEESE (U.S. CL. 46). FIRST USE 10-0-2001; IN COMMERCE 10-0-2001.

CLASS 33—WINES AND SPIRITS

2,730,859. CHATAM INTERNATIONAL INCORPORATED, WILMINGTON, DE. SN 75-931,804. FILED P.R. 2-23-2000; AM. S.R. 12-13-2001.

**ORIGINAL BARTENDERS
COCKTAILS DULCE DE
LECHE**

OWNER OF U.S. REG. NO. 2,161,086. NO CLAIM IS MADE TO THE EXCLUSIVE RIGHT TO USE "COCKTAILS", APART FROM THE MARK AS SHOWN.

FOR ALCOHOLIC COCKTAILS (U.S. CLS. 47 AND 49). FIRST USE 2-5-2001; IN COMMERCE 2-5-2001.

CLASS 33—(Continued).

2,730,938. RENTERIA WINES, LLC, NAPA, CA. SN 76-474,424. FILED 12-12-2002.

RENTERIA

FOR WINE (U.S. CLS. 47 AND 49).
FIRST USE 12-30-1999; IN COMMERCE 12-30-1999.

2,730,958. HALEWOOD INTERNATIONAL BRANDS LIMITED, LIVERSEDGE, UNITED KINGDOM. SN 78-162,653. FILED P.R. 9-10-2002; AM. S.R. 3-31-2003.

PRAHOVA VALLEY

FOR WINES (U.S. CLS. 47 AND 49).
FIRST USE 12-31-2001; IN COMMERCE 12-31-2001.

SERVICE MARKS**CLASS 35—ADVERTISING AND BUSINESS**

2,730,861. MILANIAN, CYRUS, POMPANO BEACH, FL. SN 76-026,188. FILED P.R. 4-17-2000; AM. S.R. 2-28-2003.

**THE NEW ATLANTIC CITY
RESORT HOTEL CASINO
AND THEME PARK**

FOR RESORT, HOTEL, CASINO AND THEME PARK, MANAGEMENT DEVELOPMENT AND MERCHANDISING SERVICES (U.S. CLS. 100, 101 AND 102).
FIRST USE 5-0-2000; IN COMMERCE 5-0-2000.

2,730,887. X-PRESS TRANSCRIPTION, INCORPORATED, LONG BEACH, CA. SN 76-332,396. FILED P.R. 10-31-2001; AM. S.R. 4-3-2003.

**THE RADIOLOGY
SPECIALISTS**

FOR MEDICAL TRANSCRIPTION SERVICES, MESSAGE TRANSCRIPTION, AND STENOGRAPHIC TRANSCRIPTION (U.S. CLS. 100, 101 AND 102).
FIRST USE 1-1-1993; IN COMMERCE 1-1-1993.

CLASS 35—(Continued).

2,730,889. INTERNATIONAL CENTRE FOR RESEARCH IN AGROFORESTRY, NAIROBI, KENYA. SN 76-346,641. FILED P.R. 12-6-2001; AM. S.R. 9-5-2002.

**WORLD AGROFORESTRY
CENTRE**

FOR FOSTERING AND PROMOTING OF AGROFORESTRY WORLDWIDE, NAMELY PROVIDING INFORMATION REGARDING AGROFORESTRY (U.S. CLS. 100, 101 AND 102).
FIRST USE 4-8-2002; IN COMMERCE 4-8-2002.

2,730,891. OWENS, RACHEL A., TUSTIN, CA. AND SORNSTEIN, WILLIAM, TUSTIN, CA. SN 76-367,006. FILED P.R. 2-4-2002; AM. S.R. 1-15-2003.

SUCCESSION STRATEGIES

FOR BUSINESS SUCCESSION PLANNING (U.S. CLS. 100, 101 AND 102).
FIRST USE 11-27-2001; IN COMMERCE 11-27-2001.

2,730,893. RUNZHEIMER INTERNATIONAL LTD., ROCHESTER, WI. SN 76-375,646. FILED P.R. 2-26-2002; AM. S.R. 1-3-2003.

MILEAGEMANAGER

FOR TRACKING REPORTING AND MONITORING OF BUSINESS VEHICLE MILEAGE (U.S. CLS. 100, 101 AND 102).
FIRST USE 8-1-2001; IN COMMERCE 8-1-2001.

2,730,896. THE RETIRED OFFICERS ASSOCIATION, ALEXANDRIA, VA. SN 76-385,316. FILED P.R. 3-18-2002; AM. S.R. 2-28-2003.

**MILITARY OFFICERS
ASSOCIATION OF AMERICA**

NO CLAIM IS MADE TO THE EXCLUSIVE RIGHT TO USE "MILITARY OFFICERS ASSOCIATION", APART FROM THE MARK AS SHOWN.

FOR ASSOCIATION SERVICES; NAMELY, PROMOTING THE INTERESTS OF MILITARY OFFICERS (U.S. CLS. 100, 101 AND 102).
FIRST USE 1-1-2003; IN COMMERCE 1-1-2003.

CLASS 35—(Continued).

2,730,901. PRIVATE LABEL EXECUTIVE GIFTS, INC., CAMPBELL, CA. SN 76-400,483. FILED P.R. 4-26-2002; AM. S.R. 3-20-2003.

PRIVATE LABEL EXECUTIVE GIFTS

FOR ONLINE RETAIL SERVICES, AND MAIL-ORDER CATALOG SERVICES ALL IN THE FIELD OF MERCHANDISE AND PROMOTIONAL PRODUCTS, NAMELY, BEVERAGE ACCESSORIES, WRITING INSTRUMENTS, TRAVEL ACCESSORIES, PREMIUM MINTS, CIGAR ACCESSORIES, GOLF ACCESSORIES, KEY CHAINS, TAPE MEASURES, CLOCKS, PICTURE FRAMES, DESK ACCESSORIES, COMPUTER ACCESSORIES, TELEPHONE ACCESSORIES, COMPACT DISC CASES, EXECUTIVE GIFTS, AND INCENTIVE ITEMS, ALL BEARING COMPANY NAMES, LOGOS, AND TRADEMARKS OF OTHERS (U.S. CLS. 100, 101 AND 102).
FIRST USE 1-8-2001; IN COMMERCE 1-8-2001.

2,730,902. PRIVATE LABEL EXECUTIVE GIFTS, INC., CAMPBELL, CA. SN 76-400,491. FILED P.R. 4-26-2002; AM. S.R. 3-17-2003.



NO CLAIM IS MADE TO THE EXCLUSIVE RIGHT TO USE "PRIVATE LABEL EXECUTIVE GIFTS", APART FROM THE MARK AS SHOWN.

FOR ONLINE RETAIL SERVICES, AND MAIL-ORDER CATALOG SERVICES ALL IN THE FIELD OF MERCHANDISE AND PROMOTIONAL PRODUCTS, NAMELY, BEVERAGE ACCESSORIES, WRITING INSTRUMENTS, TRAVEL ACCESSORIES, PREMIUM MINTS, CIGAR ACCESSORIES, GOLF ACCESSORIES, KEY CHAINS, TAPE MEASURES, CLOCKS, PICTURE FRAMES, DESK ACCESSORIES, COMPUTER ACCESSORIES, TELEPHONE ACCESSORIES, COMPACT DISC CASES, EXECUTIVE GIFTS, AND INCENTIVE ITEMS, ALL BEARING COMPANY NAMES, LOGOS, AND TRADEMARKS OF OTHERS (U.S. CLS. 100, 101 AND 102).
FIRST USE 1-8-2001; IN COMMERCE 1-8-2001.

CLASS 35—(Continued).

2,730,918. CAP GEMINI ERNST & YOUNG U.S. LLC, NEW YORK, NY. SN 76-417,789. FILED P.R. 6-5-2002; AM. S.R. 3-31-2003.

CUSTOMER-DRIVEN TRANSFORMATION

FOR BUSINESS CONSULTING SERVICES IN THE FIELD OF INFORMATION TECHNOLOGY SYSTEMS, AND EVALUATION OF NEW TECHNOLOGIES USED BY OTHERS (U.S. CLS. 100, 101 AND 102).

FIRST USE 9-0-2001; IN COMMERCE 9-0-2001.

2,730,920. MILLION DOLLAR ROUND TABLE, PARK RIDGE, IL. SN 76-420,070. FILED P.R. 6-13-2002; AM. S.R. 12-9-2002.

THE PREMIER ASSOCIATION OF FINANCIAL PROFESSIONALS

NO CLAIM IS MADE TO THE EXCLUSIVE RIGHT TO USE "ASSOCIATION", APART FROM THE MARK AS SHOWN.

FOR ASSOCIATION SERVICES, NAMELY, PROMOTING THE INTERESTS OF LIFE INSURANCE UNDERWRITERS (U.S. CLS. 100, 101 AND 102).

FIRST USE 5-0-2002; IN COMMERCE 5-0-2002.

2,730,930. THOMAS JEFFERSON UNIVERSITY HOSPITALS, INC., PHILADELPHIA, PA. SN 76-442,090. FILED P.R. 8-16-2002; AM. S.R. 4-14-2003.

PHILADELPHIA BOOK FESTIVAL

NO CLAIM IS MADE TO THE EXCLUSIVE RIGHT TO USE "BOOK FESTIVAL", APART FROM THE MARK AS SHOWN.

FOR ARRANGING AND CONDUCTING TRADE SHOW EXHIBITIONS IN THE FIELD OF BOOKS (U.S. CLS. 100, 101 AND 102).

FIRST USE 6-22-2002, THE SERVICE MARK WAS FIRST USED IN A DIFFERENT FORM, NAMELY, PHILADELPHIA BOOK FAIR, IN CONNECTION WITH THE SERVICES AT LEAST AS EARLY AS NOVEMBER 15, 2001; AND WAS FIRST USED IN CONNECTION WITH THE SERVICES RENDERED IN INTERSTATE COMMERCE IN A DIFFERENT FORM, NAMELY, PHILADELPHIA BOOK FAIR, AT LEAST AS EARLY AS NOVEMBER 15, 2001- APPLICANT RESPECTFULLY REQUESTS THAT THIS GENERAL INFORMATION BE PRINTED ON ANY CERTIFICATE OF REGISTRATION THAT MAY ISSUE FROM THIS APPLICATION PURSUANT TO T.M.E.P SECTION 903 08; IN COMMERCE 6-22-2002, THE SERVICE MARK WAS FIRST USED IN A DIFFERENT FORM, NAMELY, PHILADELPHIA

CLASS 35—(Continued).

BOOK FAIR, IN CONNECTION WITH THE SERVICES AT LEAST AS EARLY AS NOVEMBER 15, 2001; AND WAS FIRST USED IN CONNECTION WITH THE SERVICES RENDERED IN INTERSTATE COMMERCE IN A DIFFERENT FORM, NAMELY, PHILADELPHIA BOOK FAIR, AT LEAST AS EARLY AS NOVEMBER 15, 2001- APPLICANT RESPECTFULLY REQUESTS THAT THIS GENERAL INFORMATION BE PRINTED ON ANY CERTIFICATE OF REGISTRATION THAT MAY ISSUE FROM THIS APPLICATION PURSUANT TO T.M.E.P SECTION 903 08.

2,730,937. COAST TO COAST PLACEMENTS, INC., FT. MYERS, FL. SN 76-470,551. FILED P.R. 11-27-2002; AM. S.R. 4-8-2003.

DOCJOBSONLINE

FOR EMPLOYMENT PLACEMENT SERVICES FOR PHYSICIANS; ONLINE PHYSICIAN PLACEMENT SERVICES (U.S. CLS. 100, 101 AND 102).

FIRST USE 8-0-2000; IN COMMERCE 8-0-2000.

CLASS 36—INSURANCE AND FINANCIAL

2,730,908. PANDAS INTERNATIONAL, LITTLETON, CO. SN 76-407,880. FILED P.R. 5-15-2002; AM. S.R. 12-4-2002.

PANDAS INTERNATIONAL

NO CLAIM IS MADE TO THE EXCLUSIVE RIGHT TO USE "INTERNATIONAL", APART FROM THE MARK AS SHOWN.

FOR CHARITABLE FUND RAISING SERVICES TO BENEFIT PANDAS (U.S. CLS. 100, 101 AND 102).
FIRST USE 12-31-2000; IN COMMERCE 12-31-2000.

2,730,919. MERRILL LYNCH & CO., INC., NEW YORK, NY. SN 76-419,850. FILED P.R. 6-12-2002; AM. S.R. 3-27-2003.

GUARANTEED OPTIONAL LIFETIME DISTRIBUTIONS

NO CLAIM IS MADE TO THE EXCLUSIVE RIGHT TO USE "GUARANTEED" AND "DISTRIBUTIONS", APART FROM THE MARK AS SHOWN.

FOR FINANCIAL SERVICES, NAMELY, THE OFFERING OF A VARIABLE ANNUITY WHICH PROVIDES A GUARANTEED MINIMUM INCOME BENEFIT FOR AN ADDITIONAL FEE (U.S. CLS. 100, 101 AND 102).
FIRST USE 10-0-2002; IN COMMERCE 10-0-2002.

2,730,940. BARAJAS, RICHARD, GRAND PRAIRIE, TX. SN 78-031,374. FILED P.R. 10-19-2000; AM. S.R. 11-18-2002.

COMMUNITY BANK OF TEXAS**CLASS 36—(Continued).**

NO CLAIM IS MADE TO THE EXCLUSIVE RIGHT TO USE "COMMUNITY BANK", APART FROM THE MARK AS SHOWN.

FOR BANKING SERVICES (U.S. CLS. 100, 101 AND 102).

FIRST USE 6-1-2001; IN COMMERCE 6-1-2001.

CLASS 37—CONSTRUCTION AND REPAIR

2,730,921. 5 MINUTE ROCK CHIP EXPRESS, INC., GIG HARBOR, WA. SN 76-420,236. FILED P.R. 5-24-2002; AM. S.R. 3-24-2003.

5 MINUTE

FOR AUTOMOBILE REPAIR AND MAINTENANCE, NAMELY, REPAIR OF AUTOMOBILE WINDSHIELDS AND WINDOWS (U.S. CLS. 100, 103 AND 106).

FIRST USE 6-4-2000; IN COMMERCE 3-5-2002.

CLASS 38—COMMUNICATION

2,730,854. NET2PHONE, INC., HACKENSACK, NJ. SN 75-796,436. FILED P.R. 9-8-1999; AM. S.R. 9-28-2001.

PC2PC

FOR DOMESTIC AND LONG DISTANCE TELECOMMUNICATIONS SERVICES IN THE NATURE OF COMPUTER TELEPHONY WHICH ALLOWS PERSONAL COMPUTER USERS TO TRANSMIT VOICE, DATA AND VIDEO VIA THE INTERNET (U.S. CLS. 100, 101 AND 104).

FIRST USE 7-16-1996; IN COMMERCE 7-16-1996.

2,730,881. MDM INTELLECTUAL PROPERTY, LLC, IRVINE, CA. SN 76-276,737. FILED P.R. 6-26-2001; AM. S.R. 12-20-2002.

SPEECHPHONE

FOR VOICE ACTIVATED DIALING AND MESSAGING SERVICES, AND TEXT TO SPEECH SERVICES, NAMELY, ELECTRONIC TRANSMISSION OF TEXT CONVERTED TO HUMAN SPEECH (U.S. CLS. 100, 101 AND 104).

FIRST USE 4-10-2002; IN COMMERCE 6-15-2002.

CLASS 41—EDUCATION AND ENTERTAINMENT

CLASS 41—(Continued).

2,730,868. APPLIQUE SOCIETY, THE, SEATTLE, WA. SN 76-128,323. FILED P.R. 9-15-2000; AM. S.R. 10-1-2001.

THE APPLIQUE' SOCIETY

NO CLAIM IS MADE TO THE EXCLUSIVE RIGHT TO USE "APPLIQUE", APART FROM THE MARK AS SHOWN. THE MARK IS PRESENTED WITHOUT ANY CLAIM AS TO SPECIAL FORM.

FOR TEACHING, NAMELY, CONDUCTING SEMINARS AND WORKSHOPS IN THE FIELD OF APPLIQUE IN QUILTING (U.S. CLS. 100, 101 AND 107).
FIRST USE 8-15-1997; IN COMMERCE 8-15-1997.

2,730,882. LEWIS, D'AMATO, BRISBOIS & BISGAARD, LLP, LOS ANGELES, CA. SN 76-277,407. FILED P.R. 6-26-2001; AM. S.R. 3-24-2003.

TRANSNATIONAL BULLETIN

FOR PUBLICATION, NAMELY, A BULLETIN ON THE SUBJECT MATTER OF INTELLECTUAL PROPERTY AND TECHNOLOGY (U.S. CLS. 100, 101 AND 107).
FIRST USE 0-0-1992; IN COMMERCE 0-0-1992.

2,730,890. DEMETRIOS, EAMES, SANTA MONICA, CA. SN 76-354,484. FILED P.R. 1-2-2002; AM. S.R. 4-17-2003.

WARTIME CALIFORNIA

FOR ENTERTAINMENT SERVICES, NAMELY, PROVIDING A WEBSITE FEATURING FICTIONAL NEWS-LETTERS AND STORIES (U.S. CLS. 100, 101 AND 107).
FIRST USE 12-12-2001; IN COMMERCE 12-12-2001.

2,730,916. PEIRCE COLLEGE, PHILADELPHIA, PA. SN 76-415,835. FILED P.R. 6-4-2002; AM. S.R. 3-24-2003.

PEIRCE ONLINE

NO CLAIM IS MADE TO THE EXCLUSIVE RIGHT TO USE "ONLINE", APART FROM THE MARK AS SHOWN.

FOR EDUCATIONAL SERVICES, NAMELY, PROVIDING COURSES OF INSTRUCTION AT THE COLLEGE AND UNIVERSITY LEVEL VIA THE INTERNET (U.S. CLS. 100, 101 AND 107).
FIRST USE 9-0-2000; IN COMMERCE 9-0-2000.

CLASS 41—(Continued).

2,730,922. CLARK, WILLIAM, JACKSONVILLE, FL. SN 76-425,555. FILED P.R. 6-25-2002; AM. S.R. 4-7-2003.

KARATE FOR KIDS

FOR MARTIAL ARTS AND LIFE SKILLS TRAINING FOR CHILDREN (U.S. CLS. 100, 101 AND 107).
FIRST USE 10-1-1986; IN COMMERCE 10-1-1986.

2,730,925. CHARLES RIVER BROADCASTING COMPANY, WALTHAM, MA. SN 76-428,402. FILED P.R. 7-9-2002; AM. S.R. 4-4-2003.

CLASSICAL CARTOON FESTIVAL

NO CLAIM IS MADE TO THE EXCLUSIVE RIGHT TO USE "CARTOON FESTIVAL", APART FROM THE MARK AS SHOWN.

FOR EDUCATIONAL AND ENTERTAINMENT SERVICES, NAMELY, ORGANIZING AND ARRANGING ARTS FESTIVALS AND EXHIBITIONS (U.S. CLS. 100, 101 AND 107).
FIRST USE 0-0-1999; IN COMMERCE 0-0-1999.

2,730,927. AMERICAN ACADEMY OF OPHTHALMOLOGY, INC., SAN FRANCISCO, CA. SN 76-431,475. FILED P.R. 7-17-2002; AM. S.R. 4-4-2003.

ANIMAL EYES

FOR EDUCATIONAL SERVICES, NAMELY CONDUCTING MEETINGS, LECTURES, SEMINARS, CONFERENCES, WORKSHOPS, EXHIBITS, AND SYMPOSIA IN THE FIELDS OF EYE CARE, OPHTHALMOLOGY, VISION, AND SCIENCE, AND PROVIDING RELATED WRITTEN AND PRERECORDED EDUCATIONAL COURSE MATERIAL TOGETHER THEREWITH (U.S. CLS. 100, 101 AND 107).

FIRST USE 2-0-1999; IN COMMERCE 2-0-1999.

2,730,939. BAILEY, JAMES THOMAS, HOLLYWOOD, CA. SN 76-975,063. FILED P.R. 9-29-2000; AM. S.R. 8-5-2002.

NATIONAL COMEDY THEATRE

FOR IMPROVISATIONAL COMEDY PERFORMANCES IN THEATERS BEFORE LIVE AUDIENCES AS WELL AS TRANSMITTED TO REMOTE AUDIENCES BY ANY MEANS OF COMMUNICATION OR TRANSMISSION VIA TELEVISION, A WORLDWIDE GLOBAL COMPUTER NETWORK, AND ONLINE SERVICE; TRAINING IN IMPROVISATIONAL COMEDY PERFORMANCE TECHNIQUES; PROVIDING INFORMATION AND ENTERTAINMENT SERVICES VIA A GLOBAL COMPUTER NETWORK (U.S. CLS. 100, 101 AND 107).
FIRST USE 8-0-2000; IN COMMERCE 8-0-2000.

CLASS 41—(Continued).

2,730,950. TIME WARNER ENTERTAINMENT COMPANY, L.P., NEW YORK, NY. SN 78-091,430. FILED 11-2-2001.

HIGH SCHOOL REUNION

FOR ENTERTAINMENT SERVICES IN THE NATURE OF LIVE-ACTION, COMEDY, DRAMA AND ANIMATED TELEVISION PROGRAMS; PRODUCTION OF LIVE-ACTION, COMEDY, DRAMA AND ANIMATED TELEVISION PROGRAMS; LIVE-ACTION, COMEDY, DRAMA AND ANIMATED MOTION PICTURE THEATRICAL FILMS; PRODUCTION OF LIVE-ACTION, COMEDY, DRAMA AND ANIMATED MOTION PICTURE THEATRICAL FILMS; THEATRICAL PERFORMANCES BOTH ANIMATED AND LIVE ACTION; COMPUTER SERVICES, NAMELY PROVIDING INFORMATION IN THE FIELD OF ENTERTAINMENT RELATING SPECIFICALLY TO MUSIC, MOVIES AND TELEVISION VIA AN ELECTRONIC GLOBAL COMPUTER NETWORK; COMPUTER SERVICES, NAMELY, PROVIDING DATABASES FEATURING GENERAL INTEREST NEWS, ENTERTAINMENT AND EDUCATIONAL INFORMATION VIA A GLOBAL COMPUTER NETWORK; AND PROVIDING INFORMATION FOR AND ACTUAL ENTERTAINMENT VIA ELECTRONIC GLOBAL COMMUNICATIONS NETWORK IN THE NATURE OF LIVE-ACTION, COMEDY, DRAMA AND ANIMATED PROGRAMS AND PRODUCTION OF LIVE-ACTION COMEDY, ACTION AND ANIMATED MOTION FILMS FOR DISTRIBUTION VIA A GLOBAL COMPUTER NETWORK (U.S. CLS. 100, 101 AND 107).

FIRST USE 1-5-2003; IN COMMERCE 1-5-2003.

CLASS 42—SCIENTIFIC, COMPUTER AND LEGAL SERVICES

2,730,850. VALLEY HEALTH SYSTEM, INC., BEAVER, PA. SN 75-626,726. FILED P.R. 1-25-1999; AM. S.R. 6-24-1999.

MEDICAL EXCELLENCE IN COMMUNITY HEALTH CARE

FOR MEDICAL SERVICES (U.S. CLS. 100 AND 101).
FIRST USE 10-0-1997; IN COMMERCE 10-0-1997.

2,730,853. GROUP IV, INC., PITTSBURGH, PA. SN 75-721,504. FILED P.R. 6-4-1999; AM. S.R. 1-8-2003.

PROFESSIONAL EMPLOYER GROUP

NO CLAIM IS MADE TO THE EXCLUSIVE RIGHT TO USE "GROUP", APART FROM THE MARK AS SHOWN.
FOR EMPLOYEE LEASING SERVICES (U.S. CLS. 100 AND 101).
FIRST USE 5-17-1999; IN COMMERCE 5-17-1999.

CLASS 42—(Continued).

2,730,867. MAGICBELT.COM, INC., DESERT HOT SPRINGS, CA. SN 76-123,833. FILED P.R. 9-8-2000; AM. S.R. 5-13-2002.

INTERNATIONAL MAGNETIC THERAPY ASSOCIATION

NO CLAIM IS MADE TO THE EXCLUSIVE RIGHT TO USE "MAGNETIC THERAPY" AND "ASSOCIATION", APART FROM THE MARK AS SHOWN.

FOR PROVIDING MEDICAL INFORMATION IN THE FIELD OF MAGNETIC THERAPY TREATMENTS AND MAGNETIC THERAPY PRODUCTS (U.S. CLS. 100 AND 101).

FIRST USE 10-19-2000; IN COMMERCE 10-19-2000.

2,730,872. RESEARCH & DIAGNOSTIC ANTIBODIES, BERKELEY, CA. SN 76-161,005. FILED P.R. 11-6-2000; AM. S.R. 8-1-2002.

RISKYGENES.COM

FOR TESTING SERVICES FOR DETECTING MEDICAL CONDITIONS (U.S. CLS. 100 AND 101).
FIRST USE 3-10-2003; IN COMMERCE 3-10-2003.

2,730,880. DAUBLE, STEPHANIE, NEWPORT BEACH, CA. SN 76-267,021. FILED P.R. 6-5-2001; AM. S.R. 2-24-2003.

VINYL DESIGN

NO CLAIM IS MADE TO THE EXCLUSIVE RIGHT TO USE "DESIGN", APART FROM THE MARK AS SHOWN.
FOR DESIGN FOR OTHERS IN THE FIELD OF FURNITURE CONCEPTUAL DESIGN (U.S. CLS. 100 AND 101).
FIRST USE 2-21-2003; IN COMMERCE 2-21-2003.

2,730,894. SAPONARO, JOSEPH, JUPITER, FL. SN 76-379,055. FILED P.R. 3-6-2002; AM. S.R. 1-30-2003.

DRUG STUDY INSTITUTE

FOR MEDICAL AND SCIENTIFIC RESEARCH, NAMELY, CONDUCTING CLINICAL TRIALS (U.S. CLS. 100 AND 101).
FIRST USE 3-1-2002; IN COMMERCE 3-1-2002.

CLASS 42—(Continued).

2,730,895. CENTER FOR THE ELIMINATION OF VIOLENCE IN THE FAMILY, INC., BROOKLYN, NY. SN 76-381,493. FILED P.R. 3-12-2002; AM. S.R. 2-21-2003.

**CENTER AGAINST
DOMESTIC VIOLENCE**

FOR PROMOTING PUBLIC AWARENESS FOR THE NEED TO PREVENT DOMESTIC VIOLENCE AND ASSIST DOMESTIC VIOLENCE VICTIMS (U.S. CLS. 100 AND 101).
FIRST USE 5-0-2002; IN COMMERCE 5-0-2002.

CLASS 42—(Continued).

2,730,924. CHAMPION SOLUTIONS GROUP, INC., BOCA RATON, FL. SN 76-426,325. FILED P.R. 6-28-2002; AM. S.R. 4-1-2003.

SERVERCARE

FOR COMPUTER SYSTEMS ANALYSIS SERVICES, NAMELY QUANTITATIVE AND QUALITATIVE ANALYSIS OF FACTORS RELATING TO THE USE AND OPTIMIZATION OF SERVERS (U.S. CLS. 100 AND 101).
FIRST USE 3-1-2002; IN COMMERCE 4-15-2002.

2,730,929. FULTON ENTERPRISES, LLC, NEW YORK, NY. SN 76-438,397. FILED P.R. 8-7-2002; AM. S.R. 4-2-2003.

**BROOKLYN ICE CREAM
FACTORY**

FOR RETAIL ICE CREAM STORE SERVICES (U.S. CLS. 100 AND 101).
FIRST USE 9-0-2001; IN COMMERCE 9-0-2001.

* * * * *

PRIOR UNITED STATES CLASSIFICATION

APPLICATION IN ONE CLASS

COLLECTIVE MEMBERSHIP MARKS

2,730,870. INTERNATIONAL UNION OF PAINTERS AND ALLIED TRADES, WASHINGTON, DC. SN 76-141,746. FILED P.R. 10-4-2000; AM. S.R. 1-16-2003.

**INTERNATIONAL UNION OF
PAINTERS AND ALLIED
TRADES**

CLASS 200—COLLECTIVE MEMBERSHIP

FOR INDICATING MEMBERSHIP IN A LABOR UNION OF PAINTERS AND ALLIED TRADES (U.S. CL. 200).
FIRST USE 8-0-1999; IN COMMERCE 8-0-1999.

* * * * *

TRADEMARK REGISTRATIONS RENEWED

The designation "U.S. Cl." appearing in this section refers to the U.S. class in effect prior to Sep. 1, 1973 rather than the international class which applies to applications filed on or after that date. For adoption of international classification see notice in the OFFICIAL GAZETTE of Jun. 26, 1973 (911 O.G. TM 210).

90,874.	MISCELLANEOUS DESIGN. U.S. CL. 21. (INT. CLS. 3 AND 11). REG. 4-1-1913.	756,221.	MONCO. U.S. CL. 52. (INT. CL. 3). REG. 9-3-1963.
164,341.	ZENITH (STYLIZED). U.S. CL. 21. (INT. CL. 9). REG. 2-20-1923.	756,374.	CHAMPION DE ARMENT. U.S. CL. 23. (INT. CL. 8). REG. 9-10-1963.
178,829.	SUN-MAID AND DESIGN. U.S. CL. 46. (INT. CLS. 29 AND 30). REG. 1-29-1924.	760,885.	AEROTEX. U.S. CL. 6. (INT. CL. 1). REG. 12-3-1963.
301,583.	UNBRAKO (STYLIZED). U.S. CL. 13. (INT. CL. 6). REG. 3-7-1933.	927,773.	MOLSIV. U.S. CL. 31. (INT. CL. 1). REG. 1-25-1972.
302,696.	STURDICAST (STYLIZED). U.S. CL. 44. (INT. CL. 5). REG. 4-25-1933.	934,106.	REFRANE. U.S. CL. 52. (INT. CL. 3). REG. 5-16-1972.
394,839.	NAVYTEX (STYLIZED). U.S. CL. 14. (INT. CL. 6). REG. 4-28-1942.	939,294.	KERMEL. INT. CL. 1. (U.S. CL. 1). REG. 8-1-1972.
397,545.	INTOXICATION (STYLIZED). U.S. CL. 51. (INT. CL. 3). REG. 9-8-1942.	942,463.	BRITCHES OF GEORGETOWNE AND DESIGN. U.S. CL. 101. (INT. CL. 42). REG. 9-5-1972.
400,088.	DURODI (STYLIZED). U.S. CL. 23. (INT. CL. 7). REG. 2-16-1943.	942,497.	G-ENVIRONMENTAL-MINI-MONITOR. U.S. CL. 26. (INT. CL. 9). REG. 9-5-1972.
400,326.	W-K-M. U.S. CL. 23. (INT. CLS. 6, 7, 8, 9, 11, 12, 16, 21 AND 28). REG. 3-2-1943.	942,838.	BRITCHES OF GEORGETOWNE AND DESIGN. U.S. CL. 39. (INT. CL. 25). REG. 9-12-1972.
400,524.	WITTNAUER. U.S. CL. 27. (INT. CL. 14). REG. 3-16-1943.	950,168.	COLOMER. U.S. CL. 1. (INT. CL. 18). REG. 1-9-1973.
556,245.	DIAMOX. U.S. CL. 18. (INT. CL. 5). REG. 3-18-1952.	952,129.	CALLAWAY. U.S. CL. 42. (INT. CL. 27). REG. 1-30-1973.
558,464.	DIEHL AND DESIGN. U.S. CL. 21 ONLY. (INT. CL. 9). REG. 5-6-1952.	952,699.	CRICKET AND DESIGN. U.S. CL. 37. (INT. CL. 16). REG. 2-6-1973.
570,560.	JUGHEAD. U.S. CL. 38. (INT. CL. 16). REG. 2-17-1953.	954,257.	CHRISTIAN DIOR. U.S. CL. 3. (INT. CL. 18). REG. 3-6-1973.
570,833.	MISCELLANEOUS DESIGN. U.S. CL. 100. (INT. CL. 42). REG. 2-17-1953.	954,415.	DIOR. U.S. CL. 27. (INT. CL. 14). REG. 3-6-1973.
571,370.	VOLCANO AND DESIGN. U.S. CL. 39. (INT. CL. 25). REG. 3-3-1953.	954,428.	STEELSPAN. U.S. CL. 32. (INT. CL. 20). REG. 3-6-1973.
571,615.	H B-4 0. U.S. CL. 6. (INT. CL. 1). REG. 3-10-1953.	954,524.	DAIRY QUEEN AND DESIGN. U.S. CL. 46. (INT. CL. 30). REG. 3-6-1973.
571,669.	WALKYD (STYLIZED). U.S. CL. 6. (INT. CL. 1). REG. 3-10-1953.	954,538.	BREATH SAVERS. U.S. CL. 46. (INT. CL. 30). REG. 3-6-1973.
571,768.	POLY-V (STYLIZED). U.S. CL. 35. (INT. CL. 7). REG. 3-10-1953.	954,574.	GOLDEN EAGLE AND DESIGN. U.S. CL. 46. (INT. CL. 30). REG. 3-6-1973.
572,500.	DIRTEX (STYLIZED). U.S. CL. 52. (INT. CL. 3). REG. 3-31-1953.	954,589.	COEUR-JOIE. U.S. CL. 51. (INT. CL. 3). REG. 3-6-1973.
573,392.	HAEGER (STYLIZED). U.S. CL. 30. (INT. CL. 21). REG. 4-21-1953.	954,853.	SUSPA. U.S. CLS. 13 AND 23. (INT. CLS. 6 AND 7). REG. 3-13-1973.
575,624.	JET (STYLIZED). U.S. CL. 22. (INT. CL. 28). REG. 6-9-1953.	954,945.	RED LINE (STYLIZED). U.S. CL. 21. (INT. CL. 9). REG. 3-13-1973.
575,806.	TECHNIKA (STYLIZED). U.S. CL. 26. (INT. CL. 9). REG. 6-16-1953.	955,078.	FAMILY FASHION. U.S. CL. 28. (INT. CL. 14). REG. 3-13-1973.
576,270.	FOLDOOR AND DESIGN. U.S. CL. 12. (INT. CL. 19). REG. 6-23-1953.	955,262.	JARIT. U.S. CL. 44. (INT. CL. 10). REG. 3-13-1973.
712,632.	MISCELLANEOUS DESIGN. U.S. CL. 102. (INT. CL. 36). REG. 3-14-1961.	955,488.	I AND DESIGN. U.S. CL. 107. (INT. CL. 41). REG. 3-13-1973.
716,737.	MAXOL. U.S. CL. 15. (INT. CL. 4). REG. 6-13-1961.	955,614.	SAMICATHERM. U.S. CL. 21. (INT. CL. 17). REG. 3-20-1973.
736,342.	L AND DESIGN. U.S. CL. 22. (INT. CL. 28). REG. 8-21-1962.	955,703.	FROST. U.S. CL. 23. (INT. CL. 7). REG. 3-20-1973.
744,809.	AMETEK. U.S. CL. 31. (INT. CL. 11). REG. 2-5-1963.	955,962.	FARMER JOHN. U.S. CLS. 105 AND 106. (INT. CLS. 39 AND 40). REG. 3-20-1973.
745,464.	CRUISAIR (STYLIZED). U.S. CL. 34. (INT. CL. 11). REG. 2-19-1963.	956,300.	LONZA. U.S. CLS. 1, 5, 6, 14, 15, 16, 18, 31 AND 46. (INT. CLS. 1, 2, 4, 5, 6, 11 AND 31). REG. 4-3-1973.
746,187.	AERO-CELLS. U.S. CL. 22. (INT. CL. 28). REG. 3-5-1963.	956,427.	GYM-THING. U.S. CL. 22. (INT. CL. 28). REG. 4-3-1973.
746,214.	DUFONTE. U.S. CL. 27. (INT. CL. 14). REG. 3-5-1963.	956,534.	SUBTLE SHAPER. U.S. CL. 39. (INT. CL. 25). REG. 4-3-1973.
746,348.	ENVIRON. U.S. CL. 52. (INT. CL. 3). REG. 3-5-1963.	956,735.	MPS AND DESIGN. U.S. CL. 36 ONLY. (INT. CLS. 9 AND 16). REG. 4-10-1973.
747,435.	S SUD CHEMIE TONSIL AND DESIGN. U.S. CL. 6. (INT. CL. 1). REG. 4-2-1963.	957,009.	ANEUROPLASTIC. U.S. CL. 44. (INT. CL. 10). REG. 4-10-1973.
750,443.	AKG. U.S. CL. 21. (INT. CL. 9). REG. 6-4-1963.	957,237.	SIMOVERT. U.S. CL. 21. (INT. CL. 9). REG. 4-17-1973.
751,900.	PERMA BED. U.S. CL. 12. (INT. CL. 19). REG. 7-2-1963.	957,774.	BIG 40. U.S. CL. 34. (INT. CL. 9). REG. 4-24-1973.
752,031.	DURALUBE. U.S. CL. 23. (INT. CL. 7). REG. 7-2-1963.	957,925.	HILLBILLY. U.S. CL. 46. (INT. CL. 30). REG. 4-24-1973.
753,060.	JOHN HANDY (STYLIZED). U.S. CL. 49. (INT. CL. 33). REG. 7-16-1963.	958,351.	JAZZ. U.S. CL. 2. (INT. CL. 21). REG. 5-8-1973.
		958,913.	MISCO (STYLIZED). U.S. CL. 21. (INT. CL. 9). REG. 5-15-1973.
		959,378.	MAR-LINE. U.S. CL. 32. (INT. CL. 20). REG. 5-22-1973.

- 959,747. COUNTERTORQUE. U.S. CL. 22. (INT. CL. 28). REG. 5-29-1973.
- 959,844. MIGHTY WATT. U.S. CL. 34. (INT. CL. 11). REG. 5-29-1973.
- 960,679. SOLO. U.S. CLS. 2 AND 50. (INT. CLS. 16 AND 20). REG. 6-12-1973.
- 961,644. B AND DESIGN. U.S. CL. 46. (INT. CLS. 29, 30 AND 32). REG. 6-19-1973.
- 961,820. SIDEKICK. U.S. CL. 3. (INT. CL. 18). REG. 6-26-1973.
- 962,284. P AND DESIGN. U.S. CL. 105. (INT. CL. 39). REG. 6-26-1973.
- 963,782. JLC (STYLIZED). U.S. CL. 50. (INT. CL. 20). REG. 7-10-1973.
- 964,060. DALE AND DESIGN. U.S. CL. 21. (INT. CLS. 7, 9, 11, 12 AND 15). REG. 7-17-1973.
- 965,368. ROLOK. U.S. CL. 13. (INT. CL. 6). REG. 8-7-1973.
- 965,574. STRETCH-TITE. U.S. CL. 37. (INT. CL. 16). REG. 8-7-1973.
- 965,714. NATURE VALLEY. U.S. CL. 46. (INT. CL. 30). REG. 8-7-1973.
- 965,860. SUPER JET. U.S. CL. 5. (INT. CL. 1). REG. 8-14-1973.
- 966,538. REPLICA (STYLIZED). U.S. CL. 38. (INT. CL. 16). REG. 8-21-1973.
- 969,456. AMERSITE. U.S. CL. 6. (INT. CL. 1). REG. 10-2-1973.
- 969,470. OXY AND DESIGN. U.S. CL. 6. (INT. CL. 1). REG. 10-2-1973.
- 970,412. IT'S OUR BUSINESS TO PROTECT YOURS. U.S. CL. 102. (INT. CL. 36). REG. 10-9-1973.
- 974,333. BLUE BOY. U.S. CL. 23. (INT. CL. 7). REG. 12-4-1973.
- 974,730. RAIDERS AND DESIGN. U.S. CL. 107. (INT. CL. 41). REG. 12-11-1973.
- 975,685. RAIDERS AND DESIGN. U.S. CL. 107. (INT. CL. 41). REG. 12-25-1973.
- 976,722. TUFFY. U.S. CL. 22. (INT. CL. 28). REG. 1-15-1974.
- 977,120. MISCELLANEOUS DESIGN. U.S. CL. 13. (INT. CL. 6). REG. 1-22-1974.
- 978,362. OXY AND DESIGN. INT. CL. 1. (U.S. CL. 1). REG. 2-12-1974.
- 1,181,824. SOLAIR AND DESIGN. INT. CL. 6. (U.S. CL. 13). REG. 12-15-1981.
- 1,185,305. PERKACIT. INT. CL. 1. (U.S. CL. 6). REG. 1-12-1982.
- 1,196,034. 2+2. INT. CLS. 1, 2, 3, 4 AND 12. (U.S. CLS. 6, 15, 16, 35 AND 52). REG. 5-25-1982.
- 1,199,174. EXAMI-GOWNS (STYLIZED). INT. CL. 10. (U.S. CL. 44). REG. 6-22-1982.
- 1,200,177. RUGER. INT. CLS. 7 AND 12. (U.S. CLS. 19 AND 23). REG. 7-6-1982.
- 1,202,244. AMYCEL (STYLIZED). INT. CL. 31. (U.S. CL. 1). REG. 7-20-1982.
- 1,206,153. CRC. INT. CL. 16. (U.S. CL. 38). REG. 8-24-1982.
- 1,207,109. H HAYWARD AND DESIGN. INT. CL. 11. (U.S. CLS. 13, 21 AND 31). REG. 9-7-1982.
- 1,207,277. BAG-MASTER. INT. CL. 21. (U.S. CLS. 2, 13 AND 50). REG. 9-7-1982.
- 1,208,259. CRC PRESS. INT. CL. 16. (U.S. CL. 38). REG. 9-14-1982.
- 1,209,790. JOHN MEYER AND DESIGN. INT. CL. 25. (U.S. CL. 39). REG. 9-21-1982.
- 1,210,106. MISCELLANEOUS DESIGN. INT. CL. 42. (U.S. CL. 100). REG. 9-21-1982.
- 1,210,550. KNYTEX AND DESIGN. INT. CL. 24. (U.S. CL. 42). REG. 9-28-1982.
- 1,211,313. TRAK-KUT. INT. CL. 7. (U.S. CL. 23). REG. 10-5-1982.
- 1,211,494. SERIES E (STYLIZED). INT. CL. 16. (U.S. CL. 38). REG. 10-5-1982.
- 1,212,411. MISCELLANEOUS DESIGN. INT. CL. 16. (U.S. CL. 38). REG. 10-12-1982.
- 1,213,805. MISCELLANEOUS DESIGN. INT. CLS. 7 AND 16. (U.S. CLS. 21 AND 38). REG. 10-26-1982.
- 1,217,943. ONE STOP SLEEP SHOP AND DESIGN. INT. CL. 42. (U.S. CL. 101). REG. 11-23-1982.
- 1,218,634. COTTON BELT. INT. CL. 39. (U.S. CL. 105). REG. 11-30-1982.
- 1,218,635. COTTON BELT ROUTE AND DESIGN. INT. CL. 39. (U.S. CL. 105). REG. 11-30-1982.
- 1,220,560. BIG-SERT. INT. CLS. 6 AND 8. (U.S. CLS. 13 AND 23). REG. 12-21-1982.
- 1,220,762. MISCELLANEOUS DESIGN. INT. CL. 11. (U.S. CL. 31). REG. 12-21-1982.
- 1,224,445. AMOROSO'S HEARTH-BAKED BREAD & ROLLS. INT. CL. 30. (U.S. CL. 46). REG. 1-18-1983.
- 1,225,224. BRIMLEY STONE. INT. CL. 30. (U.S. CL. 46). REG. 1-25-1983.
- 1,225,724. PHYSIO-CONTROL. INT. CL. 10 ONLY. (U.S. CLS. 26, 39 AND 44). REG. 2-1-1983.
- 1,226,743. STREETGEAR (STYLIZED). INT. CL. 25. (U.S. CL. 39). REG. 2-8-1983.
- 1,227,181. CONDAT. INT. CLS. 1 AND 4. (U.S. CLS. 6 AND 15). REG. 2-15-1983.
- 1,227,658. OMNIFLEX. INT. CL. 28. (U.S. CLS. 22, 23, 38 AND 50). REG. 2-15-1983.
- 1,228,365. HEAT-PAL. INT. CL. 11. (U.S. CLS. 13 AND 34). REG. 2-22-1983.
- 1,228,737. AADVANTAGE AND DESIGN. INT. CL. 39. (U.S. CL. 105). REG. 2-22-1983.
- 1,228,883. I.M.I. AND DESIGN. INT. CL. 1. (U.S. CL. 5). REG. 3-1-1983.
- 1,228,944. F AND DESIGN. INT. CL. 25. (U.S. CL. 39). REG. 3-1-1983.
- 1,228,946. UF (STYLIZED). INT. CL. 25. (U.S. CL. 39). REG. 3-1-1983.
- 1,228,996. 7 AND DESIGN. INT. CL. 41. (U.S. CL. 107). REG. 3-1-1983.
- 1,228,997. 7 AND DESIGN. INT. CL. 41. (U.S. CL. 107). REG. 3-1-1983.
- 1,229,176. ERGON AND DESIGN. INT. CLS. 4, 37, 39, 40 AND 42. (U.S. CLS. 15, 101, 103, 105 AND 106). REG. 3-8-1983.
- 1,229,216. DV. INT. CL. 5. (U.S. CL. 18). REG. 3-8-1983.
- 1,229,257. WATERLOO. INT. CL. 6. (U.S. CL. 13). REG. 3-8-1983.
- 1,229,391. TASH (STYLIZED). INT. CL. 9 ONLY. (U.S. CLS. 21 AND 26). REG. 3-8-1983.
- 1,229,396. DYNIX. INT. CL. 9. (U.S. CL. 38). REG. 3-8-1983.
- 1,229,406. SUNX BEAM SENSOR. INT. CL. 9. (U.S. CLS. 21 AND 26). REG. 3-8-1983.
- 1,229,407. KCC (STYLIZED). INT. CL. 9. (U.S. CLS. 21 AND 26). REG. 3-8-1983.
- 1,229,462. BLUEBERRY. INT. CL. 9. (U.S. CL. 36). REG. 3-8-1983.
- 1,229,479. SEA-STINGER. INT. CL. 9. (U.S. CLS. 21 AND 34). REG. 3-8-1983.
- 1,229,496. LYPURE. INT. CL. 10. (U.S. CLS. 26, 39 AND 44). REG. 3-8-1983.
- 1,229,506. TRANQUILITY. INT. CL. 10. (U.S. CL. 44). REG. 3-8-1983.
- 1,229,558. OCTRON. INT. CL. 11. (U.S. CL. 21). REG. 3-8-1983.
- 1,229,571. PACIFIC AND DESIGN. INT. CL. 12. (U.S. CLS. 19, 21, 23, 31, 35 AND 44). REG. 3-8-1983.
- 1,229,648. JUGGS (STYLIZED). INT. CL. 16. (U.S. CL. 38). REG. 3-8-1983.
- 1,229,650. A AND DESIGN. INT. CL. 16. (U.S. CL. 38). REG. 3-8-1983.
- 1,229,651. ABRAMS. INT. CL. 16. (U.S. CLS. 37 AND 38). REG. 3-8-1983.
- 1,229,663. TRAVEL HOLIDAY (STYLIZED). INT. CL. 16. (U.S. CL. 38). REG. 3-8-1983.
- 1,229,695. 3M (STYLIZED). INT. CL. 16. (U.S. CLS. 37 AND 38). REG. 3-8-1983.
- 1,229,715. MISCELLANEOUS DESIGN. INT. CL. 16. (U.S. CL. 38). REG. 3-8-1983.
- 1,229,759. UA. INT. CL. 16. (U.S. CL. 38). REG. 3-8-1983.
- 1,229,771. SKIDMORE COLLEGE. INT. CLS. 16, 25 AND 41. (U.S. CLS. 38, 39 AND 107). REG. 3-8-1983.
- 1,229,785. UA (STYLIZED). INT. CL. 16. (U.S. CL. 38). REG. 3-8-1983.
- 1,229,786. UNITED ASSOCIATION UNITED STATES CANADA ORGANIZED OCTOBER 11 1889 AND DESIGN. INT. CL. 16. (U.S. CL. 38). REG. 3-8-1983.
- 1,229,789. R.S.V.P. INT. CL. 16. (U.S. CL. 38). REG. 3-8-1983.
- 1,229,804. TUFF-R. INT. CL. 17. (U.S. CL. 12). REG. 3-8-1983.
- 1,229,842. SANGETSU (STYLIZED). INT. CLS. 20, 24 AND 27. (U.S. CLS. 20, 32, 42 AND 50). REG. 3-8-1983.
- 1,229,861. POSTUREMATIC. INT. CL. 20. (U.S. CL. 32). REG. 3-8-1983.
- 1,229,872. ENGLASS. INT. CL. 20. (U.S. CLS. 2, 13, 22, 25, 32 AND 50). REG. 3-8-1983.
- 1,229,973. SINISALO. INT. CLS. 25 AND 28. (U.S. CLS. 22 AND 39). REG. 3-8-1983.

- 1,229,975. NECTAR SPORTS. INT. CL. 25. (U.S. CL. 39). REG. 3-8-1983.
- 1,229,994. SANIBEL SPORT. INT. CL. 25. (U.S. CL. 39). REG. 3-8-1983.
- 1,230,132. HERO AND DESIGN. INT. CL. 29. (U.S. CL. 46). REG. 3-8-1983.
- 1,230,258. PATIENT REFERENCE SYSTEM AND DESIGN. INT. CL. 35. (U.S. CL. 101). REG. 3-8-1983.
- 1,230,260. DIALAMERICA. INT. CL. 35. (U.S. CL. 101). REG. 3-8-1983.
- 1,230,404. THE SHIRT OFF MY BACK AND DESIGN. INT. CL. 40. (U.S. CL. 106). REG. 3-8-1983.
- 1,230,433. THE UNIVERSITY OF TEXAS AT SAN ANTONIO DISCIPLINA PRAESIDIUM CIVITATIS AND DESIGN. INT. CL. 41. (U.S. CL. 107). REG. 3-8-1983.
- 1,230,519. BASEBALL FEVER CATCH IT! (STYLIZED). INT. CL. 42. (U.S. CL. 100). REG. 3-8-1983.
- 1,230,581. SWEA. INT. CL. 42. (U.S. CL. 100). REG. 3-8-1983.
- 1,230,582. RED APPLE. INT. CL. 42. (U.S. CL. 101). REG. 3-8-1983.
- 1,230,609. BENIHANA. INT. CL. 42. (U.S. CL. 100). REG. 3-8-1983.
- 1,230,649. UA (STYLIZED). U.S. CL. 200. REG. 3-8-1983.
- 1,230,725. COOL-TEC. INT. CL. 1. (U.S. CL. 6). REG. 3-15-1983.
- 1,230,766. SILVER STREAK (STYLIZED). INT. CL. 3. (U.S. CLS. 4 AND 51). REG. 3-15-1983.
- 1,230,848. VARI-VIBE. INT. CL. 7. (U.S. CL. 23). REG. 3-15-1983.
- 1,230,896. HOT WIRES. INT. CL. 9. (U.S. CL. 21). REG. 3-15-1983.
- 1,230,982. SUPER 600. INT. CL. 11. (U.S. CL. 13). REG. 3-15-1983.
- 1,231,130. THERMO-HOME. INT. CL. 19. (U.S. CL. 12). REG. 3-15-1983.
- 1,231,289. SEPPELT. INT. CL. 33. (U.S. CL. 47). REG. 3-15-1983.
- 1,231,512. MISCELLANEOUS DESIGN. U.S. CL. 200. REG. 3-15-1983.
- 1,231,527. MEAL PACK. INT. CL. 30. (U.S. CL. 46). REG. 3-15-1983.
- 1,231,781. PISTA. INT. CL. 11. (U.S. CL. 31). REG. 3-22-1983.
- 1,231,869. SIG: AND DESIGN. INT. CL. 16. (U.S. CL. 38). REG. 3-22-1983.
- 1,231,928. SIMCO. INT. CLS. 18 AND 25. (U.S. CLS. 3 AND 39). REG. 3-22-1983.
- 1,232,166. GMD (STYLIZED). INT. CL. 36. (U.S. CL. 102). REG. 3-22-1983.
- 1,232,261. FINE COFFEE & MUCH MORE-. INT. CL. 42. (U.S. CL. 101). REG. 3-22-1983.
- 1,232,466. F FAST AND DESIGN. INT. CL. 5. (U.S. CL. 6). REG. 3-29-1983.
- 1,232,570. H3. INT. CL. 9. (U.S. CL. 26). REG. 3-29-1983.
- 1,232,607. CRITICATH (STYLIZED). INT. CL. 10. (U.S. CL. 44). REG. 3-29-1983.
- 1,232,725. HEALTHFUL HINTS. INT. CL. 16. (U.S. CL. 38). REG. 3-29-1983.
- 1,232,762. ERMENEGILDO ZEGNA. INT. CL. 18. (U.S. CL. 3). REG. 3-29-1983.
- 1,232,771. DKL. INT. CL. 19. (U.S. CL. 12). REG. 3-29-1983.
- 1,232,818. A AND DESIGN. INT. CL. 25. (U.S. CL. 39). REG. 3-29-1983.
- 1,232,989. PRO LIBRA. INT. CLS. 35 AND 41. (U.S. CLS. 101 AND 107). REG. 3-29-1983.
- 1,233,036. UN (STYLIZED). INT. CLS. 37 AND 42. (U.S. CLS. 101 AND 103). REG. 3-29-1983.
- 1,233,214. MISCELLANEOUS DESIGN. INT. CLS. 3, 20, 24, 29, 30 AND 31. (U.S. CLS. 4, 32, 42 AND 46). REG. 4-5-1983.
- 1,234,065. DIP-AN-EGG. INT. CL. 2. (U.S. CL. 6). REG. 4-5-1983.
- 1,234,298. LOHMANN & STOLTERFOHT (STYLIZED). INT. CLS. 7, 9 AND 12. (U.S. CLS. 19, 21, 23, 26, 31, 34 AND 35). REG. 4-12-1983.
- 1,234,299. LS AND DESIGN. INT. CLS. 7, 9 AND 12. (U.S. CLS. 19, 21, 23, 26, 31, 34 AND 35). REG. 4-12-1983.
- 1,235,141. MEFIX. INT. CL. 5. (U.S. CL. 44). REG. 4-19-1983.
- 1,235,379. GRAND MARNIER. INT. CL. 30. (U.S. CL. 46). REG. 4-19-1983.
- 1,235,388. LAZAR'S CHOCOLATE CHEF AND DESIGN. INT. CL. 30. (U.S. CL. 46). REG. 4-19-1983.
- 1,236,101. CASTOSTAR AND DESIGN. INT. CL. 9. (U.S. CL. 21). REG. 5-3-1983.
- 1,236,298. GIFTS IN GOOD TASTE. INT. CLS. 16 AND 42. (U.S. CLS. 38 AND 101). REG. 5-3-1983.
- 1,236,756. THE UNIVERSITY OF TEXAS PERMIAN BASIN AND DESIGN. INT. CL. 41. (U.S. CL. 107). REG. 5-3-1983.
- 1,237,623. TIRES PLUS AUTO SERVICE CENTER (STYLIZED). INT. CL. 35. (U.S. CL. 101). REG. 5-10-1983.
- 1,237,697. MISCELLANEOUS DESIGN. INT. CL. 39. (U.S. CL. 105). REG. 5-10-1983.
- 1,237,985. PERIO CARE. INT. CL. 5. (U.S. CL. 18). REG. 5-17-1983.
- 1,239,018. UCG-BETA SLIDE. INT. CL. 1. (U.S. CL. 6). REG. 5-24-1983.
- 1,240,403. KRAVET. INT. CL. 24. (U.S. CL. 42). REG. 5-31-1983.
- 1,240,593. UNI-MART (STYLIZED). INT. CLS. 37 AND 42. (U.S. CLS. 101 AND 103). REG. 5-31-1983.
- 1,241,956. INTERMEDICS. INT. CL. 10. (U.S. CL. 44). REG. 6-14-1983.
- 1,242,461. DYNASTICK. INT. CL. 1. (U.S. CLS. 5 AND 12). REG. 6-21-1983.
- 1,243,272. MISCELLANEOUS DESIGN. INT. CL. 42. (U.S. CL. 100). REG. 6-21-1983.
- 1,243,637. COLD SEAL. INT. CL. 17. (U.S. CL. 1). REG. 6-28-1983.
- 1,243,854. MISCELLANEOUS DESIGN. INT. CL. 37. (U.S. CLS. 103 AND 106). REG. 6-28-1983.
- 1,244,971. CHANG MEDIUM. INT. CL. 5. (U.S. CL. 6). REG. 7-12-1983.
- 1,245,846. COASTAL. INT. CL. 18. (U.S. CL. 3). REG. 7-19-1983.
- 1,246,063. SWEEP-A-LAWN. INT. CL. 7. (U.S. CL. 23). REG. 7-19-1983.
- 1,246,144. MSL. INT. CL. 1. (U.S. CL. 4). REG. 7-26-1983.
- 1,249,201. LUZIANNE. INT. CL. 30. (U.S. CL. 46). REG. 8-23-1983.
- 1,249,276. BANCOMER. INT. CL. 36. (U.S. CL. 102). REG. 8-23-1983.
- 1,249,668. POSITIP. INT. CL. 9. (U.S. CL. 26). REG. 8-30-1983.
- 1,250,146. UNIVAX-BD. INT. CL. 5. (U.S. CL. 18). REG. 9-6-1983.
- 1,252,369. HERITAGE AND DESIGN. INT. CL. 30. (U.S. CL. 46). REG. 9-27-1983.
- 1,253,506. A-60. INT. CL. 3. (U.S. CL. 52). REG. 10-11-1983.
- 1,253,589. C G AND DESIGN. INT. CLS. 6, 17, 19 AND 22. (U.S. CLS. 7, 12, 13, 14 AND 35). REG. 10-11-1983.
- 1,254,121. PHILLY ROLLS. INT. CL. 30. (U.S. CL. 46). REG. 10-11-1983.
- 1,255,087. SENTINEL MAGNETRONICS. INT. CLS. 6 AND 9. (U.S. CLS. 25 AND 26). REG. 10-25-1983.
- 1,258,352. COIN TOKE. INT. CL. 9. (U.S. CL. 23). REG. 11-22-1983.
- 1,259,292. 3M (STYLIZED). INT. CL. 9. (U.S. CL. 26). REG. 11-29-1983.
- 1,259,447. COVER KEEPER AND DESIGN. INT. CL. 20. (U.S. CL. 2). REG. 11-29-1983.
- 1,261,061. CLEARFIELD. INT. CL. 29. (U.S. CL. 46). REG. 12-13-1983.
- 1,264,004. NOPAK. INT. CL. 7. (U.S. CL. 23). REG. 1-17-1984.
- 1,264,473. M MURRAY (STYLIZED). INT. CL. 37. (U.S. CL. 103). REG. 1-17-1984.
- 1,266,759. MAXI-BLAST. INT. CL. 3. (U.S. CL. 4). REG. 2-14-1984.
- 1,268,062. SMALL WORLD TOYS AND DESIGN. INT. CL. 28. (U.S. CLS. 22, 23, 38 AND 50). REG. 2-21-1984.
- 1,614,210. THE GUARDIAN CASH MANAGEMENT TRUST. INT. CL. 36. (U.S. CLS. 101 AND 102). REG. 9-18-1990.
- 1,657,723. MISCELLANEOUS DESIGN. INT. CL. 42. (U.S. CL. 100). REG. 9-17-1991.
- 1,659,003. RIVER MARKET AND DESIGN. INT. CLS. 25 AND 36. (U.S. CLS. 39, 100, 101 AND 102). REG. 10-1-1991.
- 1,670,211. LIFE PLANNER (STYLIZED). INT. CL. 16. (U.S. CLS. 37 AND 38). REG. 12-31-1991.
- 1,689,141. KRITTER KREATIONS. INT. CL. 28. (U.S. CL. 22). REG. 5-26-1992.
- 1,694,373. P & T WRAP (STYLIZED). INT. CL. 17. (U.S. CL. 1). REG. 6-16-1992.
- 1,695,855. ACCU-WEATHER SAID IT WOULD. INT. CL. 18 ONLY. (U.S. CLS. 1, 2, 3, 22 AND 41). REG. 6-23-1992.

- 1,710,488. I.D. PLEASE. INT. CLS. 41 AND 42. (U.S. CLS. 100 AND 107). REG. 8-25-1992.
- 1,710,981. FUEL-STOR AND DESIGN. INT. CL. 1. (U.S. CL. 6). REG. 9-1-1992.
- 1,710,984. PREMIERE. INT. CL. 1. (U.S. CL. 6). REG. 9-1-1992.
- 1,711,164. VARYPRESS. INT. CL. 7. (U.S. CL. 23). REG. 9-1-1992.
- 1,711,165. CARBOLOY. INT. CL. 7. (U.S. CL. 23). REG. 9-1-1992.
- 1,711,224. CREATIVE WORKS. INT. CLS. 9 AND 16 ONLY. (U.S. CLS. 23, 26 AND 37). REG. 9-1-1992.
- 1,711,364. S SOA AND DESIGN. INT. CL. 9. (U.S. CLS. 23 AND 26). REG. 9-1-1992.
- 1,711,869. RABBIT JR. INT. CL. 25. (U.S. CL. 39). REG. 9-1-1992.
- 1,712,714. DANNER BOB. INT. CL. 25. (U.S. CL. 39). REG. 9-1-1992.
- 1,712,998. YVES SAINT LAURENT. INT. CLS. 6, 9, 14, 16, 18, 24, 25, 28 AND 34 ONLY. (U.S. CLS. 2, 3, 8, 13, 22, 26, 27, 28, 37, 39, 42 AND 50). REG. 9-8-1992.
- 1,712,999. YSL. INT. CLS. 6, 9, 14, 16, 18, 24, 25 AND 34 ONLY. (U.S. CLS. 3, 8, 13, 22, 26, 27, 28, 39, 42 AND 50). REG. 9-8-1992.
- 1,713,160. WA (STYLIZED). INT. CL. 9. (U.S. CLS. 21, 26 AND 36). REG. 9-8-1992.
- 1,713,375. GOOSEBUMPS. INT. CL. 10. (U.S. CL. 44). REG. 9-8-1992.
- 1,713,791. OXFORD CLUB. INT. CL. 25. (U.S. CL. 39). REG. 9-8-1992.
- 1,713,805. B (STYLIZED). INT. CL. 25. (U.S. CLS. 22 AND 39). REG. 9-8-1992.
- 1,713,982. DIETER'S CHOICE AND DESIGN. INT. CL. 30. (U.S. CL. 46). REG. 9-8-1992.
- 1,714,212. ENVIROTAINER. INT. CL. 39. (U.S. CL. 105). REG. 9-8-1992.
- 1,714,384. GEOFFREY BEENE. INT. CL. 42. (U.S. CL. 101). REG. 9-8-1992.
- 1,714,632. MARCH. INT. CL. 9. (U.S. CL. 38). REG. 9-8-1992.
- 1,714,753. E-Z DECK WASH. INT. CL. 3. (U.S. CLS. 6 AND 52). REG. 9-8-1992.
- 1,716,157. RAGU'. INT. CL. 30. (U.S. CL. 46). REG. 9-15-1992.
- 1,716,186. MISCELLANEOUS DESIGN. INT. CL. 30. (U.S. CL. 46). REG. 9-15-1992.
- 1,716,917. CAP AND DESIGN. INT. CL. 42. (U.S. CL. 100). REG. 9-15-1992.
- 1,717,821. DATASCAN. INT. CL. 9. (U.S. CL. 38). REG. 9-22-1992.
- 1,718,243. JOSEF OTTEN (STYLIZED). INT. CL. 24 ONLY. (U.S. CL. 42). REG. 9-22-1992.
- 1,718,268. LOS ANGELES KINGS AND DESIGN. INT. CL. 25. (U.S. CLS. 22 AND 39). REG. 9-22-1992.
- 1,718,731. ADVVANTAGE PLAN. INT. CL. 36. (U.S. CLS. 101 AND 102). REG. 9-22-1992.
- 1,720,830. HEARTS & VOICES. INT. CL. 41. (U.S. CL. 107). REG. 9-29-1992.
- 1,722,019. ARCTIC LINER. INT. CL. 22. (U.S. CL. 2). REG. 10-6-1992.
- 1,722,255. O TASTE AND SEE! MISS RUTH'S AND DESIGN. INT. CL. 30. (U.S. CL. 46). REG. 10-6-1992.
- 1,722,406. DISABLED AND RETIRED FIREFIGHTERS. INT. CL. 36. (U.S. CL. 102). REG. 10-6-1992.
- 1,722,791. CAP. INT. CL. 42. (U.S. CL. 100). REG. 10-6-1992.
- 1,722,793. CHILDREN AWAITING PARENTS. INT. CL. 42. (U.S. CL. 101). REG. 10-6-1992.
- 1,723,168. OASIS. INT. CL. 3. (U.S. CL. 52). REG. 10-13-1992.
- 1,723,856. NIFTY LIFTER. INT. CL. 21. (U.S. CLS. 13 AND 50). REG. 10-13-1992.
- 1,724,536. KOCHKLEEN. INT. CL. 1. (U.S. CL. 6). REG. 10-13-1992.
- 1,726,008. GIAMANCO'S. INT. CLS. 30 AND 42. (U.S. CLS. 46 AND 100). REG. 10-20-1992.
- 1,727,039. S AND DESIGN. INT. CL. 7. (U.S. CLS. 13, 23 AND 35). REG. 10-27-1992.
- 1,727,100. WRITING TO WRITE. INT. CLS. 9 AND 16. (U.S. CL. 38). REG. 10-27-1992.
- 1,730,310. MISCELLANEOUS DESIGN. INT. CL. 14. (U.S. CL. 28). REG. 11-3-1992.
- 1,733,657. DESAYUNO MUSICAL. INT. CL. 41. (U.S. CL. 107). REG. 11-17-1992.
- 1,734,846. MOISTURESHIELD. INT. CL. 19. (U.S. CL. 12). REG. 11-24-1992.
- 1,735,149. TERONG AND DESIGN. INT. CL. 34. (U.S. CL. 17). REG. 11-24-1992.
- 1,736,492. MISCELLANEOUS DESIGN. INT. CL. 16. (U.S. CL. 38). REG. 12-1-1992.
- 1,737,546. FLUIDMOVE. INT. CL. 9. (U.S. CL. 38). REG. 12-1-1992.
- 1,738,196. DISC-PAK. INT. CL. 11. (U.S. CL. 31). REG. 12-8-1992.
- 1,738,454. KIDPALS. INT. CL. 28. (U.S. CL. 22). REG. 12-8-1992.
- 1,743,452. ELEGANT FLOR AGIO FINA TABACOS PRIMEROSTABACS GARANTIS SUPERIEURS AND DESIGN. INT. CL. 34. (U.S. CL. 17). REG. 12-29-1992.
- 1,743,514. CO-CHOICE. INT. CL. 36. (U.S. CLS. 101 AND 102). REG. 12-29-1992.
- 1,743,561. AMERICAN BRIDGE. INT. CL. 37. (U.S. CL. 103). REG. 12-29-1992.
- 1,744,088. HODERS. INT. CL. 14. (U.S. CLS. 27 AND 28). REG. 12-29-1992.
- 1,744,543. JUDITH LEIBER. INT. CL. 18. (U.S. CL. 3). REG. 1-5-1993.
- 1,744,549. ACTIFLUX. INT. CL. 19. (U.S. CL. 12). REG. 1-5-1993.
- 1,744,715. KC CANDY AND DESIGN. INT. CL. 30. (U.S. CL. 46). REG. 1-5-1993.
- 1,744,796. 100 CLUB. INT. CLS. 36 AND 42. (U.S. CLS. 100, 102 AND 107). REG. 1-5-1993.
- 1,745,369. NATURALLY RISING PIZZA. INT. CL. 30. (U.S. CL. 46). REG. 1-5-1993.
- 1,746,297. GUARDIAN. INT. CL. 7. (U.S. CL. 23). REG. 1-12-1993.
- 1,747,105. CT (STYLIZED). INT. CL. 17. (U.S. CL. 1). REG. 1-19-1993.
- 1,747,285. FUN PAK. INT. CL. 30. (U.S. CL. 46). REG. 1-19-1993.
- 1,747,754. MEDIFLECTOR. INT. CL. 11. (U.S. CL. 21). REG. 1-19-1993.
- 1,747,824. FIRSTGEAR AND DESIGN. INT. CL. 25. (U.S. CL. 39). REG. 1-19-1993.
- 1,748,795. PRIORITY ASSIST. INT. CL. 35. (U.S. CL. 101). REG. 1-26-1993.
- 1,750,562. VALUE PRINT INCORPORATED "PRINTING SERVICES-ON TIME" AND DESIGN. INT. CL. 42. (U.S. CLS. 100 AND 101). REG. 2-2-1993.
- 1,750,924. POLY-FILL. INT. CL. 2. (U.S. CL. 16). REG. 2-9-1993.
- 1,751,979. TANGY ZIP. INT. CL. 29. (U.S. CL. 46). REG. 2-9-1993.
- 1,752,090. GREAT FOOD SERVED FAST. INT. CL. 42. (U.S. CL. 100). REG. 2-9-1993.
- 1,752,128. ROOMCARE. INT. CL. 3 ONLY. (U.S. CLS. 4 AND 52). REG. 2-16-1993.
- 1,752,258. TRU-GRIT. INT. CL. 8. (U.S. CLS. 23 AND 44). REG. 2-16-1993.
- 1,752,285. ELGA (STYLIZED). INT. CL. 9. (U.S. CLS. 21 AND 34). REG. 2-16-1993.
- 1,752,446. BERG. INT. CL. 15. (U.S. CL. 36). REG. 2-16-1993.
- 1,752,462. WOOD (STYLIZED). INT. CL. 16. (U.S. CL. 38). REG. 2-16-1993.
- 1,752,665. TERMINATOR. INT. CL. 25. (U.S. CLS. 6, 39 AND 51). REG. 2-16-1993.
- 1,753,290. BASEBALL B.U.M.. INT. CL. 25. (U.S. CL. 39). REG. 2-16-1993.
- 1,753,486. EX-CELL. INT. CL. 1. (U.S. CL. 1). REG. 2-23-1993.
- 1,753,601. M & I. INT. CLS. 7 AND 9. (U.S. CLS. 21, 23 AND 26). REG. 2-23-1993.
- 1,753,787. SERVO FLUSH. INT. CL. 11. (U.S. CL. 13). REG. 2-23-1993.
- 1,753,819. HANDIDET. INT. CL. 13. (U.S. CL. 9). REG. 2-23-1993.
- 1,753,936. SPILLGARD. INT. CL. 20. (U.S. CLS. 2 AND 50). REG. 2-23-1993.
- 1,753,957. COUNTRY COOKIN'. INT. CL. 21. (U.S. CLS. 2 AND 13). REG. 2-23-1993.
- 1,754,018. VAN LATHEM LA PASSEMENTERIE CREATIVE AND DESIGN. INT. CL. 26. (U.S. CL. 40). REG. 2-23-1993.
- 1,754,019. VAN LATHEM LA PASSEMENTERIE CREATIVE. INT. CL. 26. (U.S. CL. 40). REG. 2-23-1993.
- 1,754,104. SINCE 1916 NATHAN'S FAMOUS AND DESIGN. INT. CL. 30. (U.S. CL. 46). REG. 2-23-1993.
- 1,754,133. CONCILIO. INT. CL. 33. (U.S. CL. 47). REG. 2-23-1993.
- 1,754,368. AMERICA'S LOOKING FOR ITS MISSING CHILDREN (STYLIZED). INT. CL. 42. (U.S. CL. 100). REG. 2-23-1993.

- 1,754,533. WINDSTOPPER. INT. CL. 24. (U.S. CL. 42). REG. 2-23-1993.
- 1,754,717. SOFNOLIME. INT. CL. 1. (U.S. CL. 6). REG. 3-2-1993.
- 1,754,846. SOLO (STYLIZED). INT. CLS. 6 AND 21. (U.S. CLS. 2 AND 23). REG. 3-2-1993.
- 1,754,869. AIREGLIDE. INT. CL. 7. (U.S. CL. 23). REG. 3-2-1993.
- 1,754,879. ROBOBAR. INT. CL. 7. (U.S. CL. 23). REG. 3-2-1993.
- 1,754,886. ZGS (STYLIZED). INT. CL. 7. (U.S. CL. 23). REG. 3-2-1993.
- 1,754,887. HYPER-JET. INT. CL. 7. (U.S. CL. 23). REG. 3-2-1993.
- 1,754,908. P PANDUIT QUALITY AND DESIGN. INT. CLS. 8 AND 9. (U.S. CLS. 21 AND 23). REG. 3-2-1993.
- 1,754,944. MACDONALD DETTWILER. INT. CLS. 9 AND 42. (U.S. CLS. 21, 26, 38 AND 100). REG. 3-2-1993.
- 1,754,968. E SCAN. INT. CL. 9. (U.S. CL. 26). REG. 3-2-1993.
- 1,755,003. DIANA. INT. CL. 9. (U.S. CL. 38). REG. 3-2-1993.
- 1,755,082. MARCAD. INT. CL. 9. (U.S. CL. 21). REG. 3-2-1993.
- 1,755,123. MAS-D-TEC. INT. CL. 10. (U.S. CL. 44). REG. 3-2-1993.
- 1,755,142. SUNBEAM. INT. CL. 11. (U.S. CL. 13). REG. 3-2-1993.
- 1,755,271. HAND HUGGERS (STYLIZED). INT. CL. 16. (U.S. CL. 37). REG. 3-2-1993.
- 1,755,411. SPONTEX. INT. CL. 24. (U.S. CL. 42). REG. 3-2-1993.
- 1,755,479. JUDITH LEIBER. INT. CL. 25. (U.S. CL. 39). REG. 3-2-1993.
- 1,755,546. FACUNDO (STYLIZED). INT. CLS. 29 AND 30 ONLY. (U.S. CL. 46). REG. 3-2-1993.
- 1,755,554. INCREDIBLY EDIBLE DELITES, INC. EDIBLE FLORAL CREATIONS AND DESIGN. INT. CL. 29. (U.S. CL. 46). REG. 3-2-1993.
- 1,755,576. DIANA. INT. CL. 30. (U.S. CL. 46). REG. 3-2-1993.
- 1,755,638. SKOAL KEY. INT. CL. 34. (U.S. CL. 17). REG. 3-2-1993.
- 1,755,743. BLUEGRASS CELLULAR. INT. CL. 38. (U.S. CL. 104). REG. 3-2-1993.
- 1,755,744. B BLUEGRASS CELLULAR (STYLIZED). INT. CL. 38. (U.S. CL. 104). REG. 3-2-1993.
- 1,755,820. PATA. INT. CLS. 41 AND 42. (U.S. CLS. 100 AND 107). REG. 3-2-1993.
- 1,755,869. QUEUE SYSTEMS. INT. CL. 42. (U.S. CLS. 100 AND 101). REG. 3-2-1993.
- 1,755,925. MATERNICHEK AND DESIGN. INT. CL. 42. (U.S. CL. 100). REG. 3-2-1993.
- 1,755,971. TRUMP TAJ MAHAL CASINO RESORT. INT. CLS. 41 AND 42. (U.S. CLS. 100 AND 107). REG. 3-2-1993.
- 1,755,993. THE HOT STUFF. INT. CL. 1. (U.S. CL. 6). REG. 3-2-1993.
- 1,756,100. MICRO-LITE. INT. CL. 11. (U.S. CLS. 21 AND 26). REG. 3-2-1993.
- 1,756,174. WEED EATER. INT. CL. 28. (U.S. CL. 22). REG. 3-2-1993.
- 1,756,303. SYNTHALEN. INT. CL. 1 ONLY. (U.S. CL. 6). REG. 3-9-1993.
- 1,756,325. SHER-CLAD. INT. CL. 2. (U.S. CL. 16). REG. 3-9-1993.
- 1,756,370. PARTS PLUS AND DESIGN. INT. CLS. 4 AND 42. (U.S. CLS. 15 AND 101). REG. 3-9-1993.
- 1,756,433. MAXI-DRY (STYLIZED). INT. CL. 6. (U.S. CL. 13). REG. 3-9-1993.
- 1,756,442. KERKER. INT. CL. 12 ONLY. (U.S. CLS. 12 AND 23). REG. 3-9-1993.
- 1,756,457. ASTRO PUNCH. INT. CL. 7. (U.S. CL. 23). REG. 3-9-1993.
- 1,756,525. P PLATINUM COLLECTION AND DESIGN. INT. CL. 9. (U.S. CL. 21). REG. 3-9-1993.
- 1,756,591. ATTS. INT. CL. 9. (U.S. CL. 26). REG. 3-9-1993.
- 1,756,623. GEOSEC. INT. CL. 9. (U.S. CL. 38). REG. 3-9-1993.
- 1,756,651. PULSE-METRIC. INT. CL. 10. (U.S. CL. 44). REG. 3-9-1993.
- 1,756,710. MACHETE. INT. CL. 12. (U.S. CL. 19). REG. 3-9-1993.
- 1,756,717. AX ARMANI EXCHANGE. INT. CLS. 18 AND 25 ONLY. (U.S. CLS. 1, 2, 3, 22, 39 AND 41). REG. 3-9-1993.
- 1,756,765. PANTHERE. INT. CL. 16. (U.S. CL. 37). REG. 3-9-1993.
- 1,756,767. RENEW ANTIQUE. INT. CL. 16. (U.S. CL. 38). REG. 3-9-1993.
- 1,756,770. RETRO 51 1951 AND DESIGN. INT. CL. 16. (U.S. CL. 37). REG. 3-9-1993.
- 1,756,792. PAINT MASTER. INT. CL. 16. (U.S. CLS. 13 AND 29). REG. 3-9-1993.
- 1,756,795. STICK ON STATES OF MEXICO. INT. CL. 16. (U.S. CL. 38). REG. 3-9-1993.
- 1,756,865. RUBB. INT. CL. 19. (U.S. CL. 12). REG. 3-9-1993.
- 1,756,878. STEP 2 AND DESIGN. INT. CL. 20. (U.S. CL. 2). REG. 3-9-1993.
- 1,756,914. MILLENNIUM. INT. CL. 24. (U.S. CL. 42). REG. 3-9-1993.
- 1,756,920. SILPAT. INT. CL. 24. (U.S. CL. 42). REG. 3-9-1993.
- 1,756,923. SUGAR & SPICE. INT. CL. 25. (U.S. CL. 39). REG. 3-9-1993.
- 1,756,951. DOT TO DOT. INT. CL. 25. (U.S. CL. 39). REG. 3-9-1993.
- 1,756,968. LIZARD WIZARD AND DESIGN. INT. CL. 25. (U.S. CL. 39). REG. 3-9-1993.
- 1,757,007. MR. 59. INT. CLS. 28 AND 41. (U.S. CLS. 22 AND 107). REG. 3-9-1993.
- 1,757,027. DELTABELLS. INT. CL. 28. (U.S. CL. 22). REG. 3-9-1993.
- 1,757,032. COLONIAL. INT. CL. 29. (U.S. CL. 46). REG. 3-9-1993.
- 1,757,036. SIX FORTUNE AND DESIGN. INT. CLS. 29 AND 30 ONLY. (U.S. CL. 46). REG. 3-9-1993.
- 1,757,047. OSTENBORG (STYLIZED). INT. CL. 29. (U.S. CL. 46). REG. 3-9-1993.
- 1,757,060. SENIOR BELGIAN WAFFLE SLAM. INT. CL. 30. (U.S. CL. 46). REG. 3-9-1993.
- 1,757,078. SUNDETTE. INT. CL. 30. (U.S. CL. 46). REG. 3-9-1993.
- 1,757,080. ENOFERM. INT. CL. 30. (U.S. CL. 46). REG. 3-9-1993.
- 1,757,121. TEMPERANCE HILL. INT. CL. 33. (U.S. CL. 47). REG. 3-9-1993.
- 1,757,123. CYGNET. INT. CL. 33. (U.S. CL. 47). REG. 3-9-1993.
- 1,757,160. LAB SUPPORT SCIENCE PROFESSIONALS ON ASSIGNMENT AND DESIGN. INT. CL. 35. (U.S. CL. 101). REG. 3-9-1993.
- 1,757,163. FUTUREHEALTH. INT. CL. 35. (U.S. CL. 101). REG. 3-9-1993.
- 1,757,180. CHARTER ONE FINANCIAL. INT. CL. 36. (U.S. CL. 102). REG. 3-9-1993.
- 1,757,264. TOP GUN. INT. CL. 41. (U.S. CL. 107). REG. 3-9-1993.
- 1,757,276. MISCELLANEOUS DESIGN. INT. CL. 41. (U.S. CLS. 101 AND 107). REG. 3-9-1993.
- 1,757,294. THE WASHINGTON CENTER FOR INTERNSHIPS AND ACADEMIC SEMINARS AND DESIGN. INT. CL. 41. (U.S. CL. 107). REG. 3-9-1993.
- 1,757,306. ROCK FOR CHOICE. INT. CL. 41. (U.S. CL. 107). REG. 3-9-1993.
- 1,757,390. MISCELLANEOUS DESIGN. INT. CL. 42. (U.S. CLS. 100 AND 101). REG. 3-9-1993.
- 1,757,448. ASKHAM & TELHAM. INT. CL. 42. (U.S. CLS. 100, 101 AND 103). REG. 3-9-1993.
- 1,757,489. SYSTEMVIEW. INT. CLS. 9 AND 16. (U.S. CLS. 26 AND 38). REG. 3-9-1993.
- 1,757,534. MISCELLANEOUS DESIGN. INT. CL. 5. (U.S. CL. 18). REG. 3-9-1993.
- 1,757,540. FASTPRO. INT. CL. 5. (U.S. CLS. 18 AND 44). REG. 3-9-1993.
- 1,757,547. GOLDEN ALUMINUM AND DESIGN. INT. CL. 6. (U.S. CL. 14). REG. 3-9-1993.
- 1,757,550. BAKER OIL TOOLS A BAKER HUGHES COMPANY AND DESIGN. INT. CL. 7. (U.S. CL. 23). REG. 3-9-1993.
- 1,757,620. SWEET SOMETHINGS. INT. CL. 14. (U.S. CL. 28). REG. 3-9-1993.
- 1,757,626. MARCALCULATE. INT. CL. 16. (U.S. CL. 37). REG. 3-9-1993.
- 1,757,653. SUPERBLOCK. INT. CL. 21. (U.S. CLS. 2 AND 50). REG. 3-9-1993.
- 1,757,730. PRINCES GATE. INT. CL. 36. (U.S. CLS. 101 AND 102). REG. 3-9-1993.
- 1,757,777. REGA. INT. CL. 9. (U.S. CL. 26). REG. 3-9-1993.
- 1,757,835. AUTECH. INT. CLS. 1, 2, 3 AND 7. (U.S. CLS. 6, 16, 23 AND 52). REG. 3-16-1993.
- 1,757,856. T TARRAGO AND DESIGN. INT. CL. 2. (U.S. CLS. 6 AND 16). REG. 3-16-1993.
- 1,757,871. CURAP. INT. CL. 2. (U.S. CL. 16). REG. 3-16-1993.

- 1,757,916. MONROE FLUID TECHNOLOGY AND DESIGN. INT. CLS. 4 AND 7. (U.S. CLS. 15 AND 23). REG. 3-16-1993.
- 1,758,105. INSTOREPLUS. INT. CL. 9. (U.S. CL. 38). REG. 3-16-1993.
- 1,758,169. ARTHRO-KNIFE. INT. CL. 10. (U.S. CL. 44). REG. 3-16-1993.
- 1,758,184. NUOVA SIMONELLI AND DESIGN. INT. CL. 11. (U.S. CLS. 21 AND 34). REG. 3-16-1993.
- 1,758,274. SEBAGO. INT. CL. 16. (U.S. CLS. 37 AND 38). REG. 3-16-1993.
- 1,758,304. GRACE. INT. CL. 16. (U.S. CLS. 2, 5, 22, 23, 29, 37, 38 AND 50). REG. 3-16-1993.
- 1,758,308. "LET'S GET IT STRAIGHT" AND DESIGN. INT. CL. 16. (U.S. CL. 38). REG. 3-16-1993.
- 1,758,357. ACRYLIFE. INT. CL. 19. (U.S. CL. 12). REG. 3-16-1993.
- 1,758,556. BOLNERS FIESTA BRAND AND DESIGN. INT. CL. 30. (U.S. CL. 46). REG. 3-16-1993.
- 1,758,615. VANGUARD. INT. CLS. 31, 36 AND 42. (U.S. CLS. 46, 101 AND 102). REG. 3-16-1993.
- 1,758,732. CASTLE MORTGAGE CORPORATION AND DESIGN. INT. CL. 36. (U.S. CLS. 101 AND 102). REG. 3-16-1993.
- 1,758,791. WIN. INT. CL. 39. (U.S. CL. 105). REG. 3-16-1993.
- 1,758,804. CIRRUS LOGIC AND DESIGN. INT. CLS. 40 AND 42. (U.S. CLS. 100, 101, 103 AND 106). REG. 3-16-1993.
- 1,758,962. LITTLE BEAR TRADING POST. INT. CL. 42. (U.S. CL. 101). REG. 3-16-1993.
- 1,759,128. WEARSHIELD. INT. CL. 9. (U.S. CL. 21). REG. 3-16-1993.
- 1,759,169. FLAT PACK. INT. CL. 16. (U.S. CLS. 5 AND 37). REG. 3-16-1993.
- 1,759,223. ORIGINAL CANTON DELICATE GINGER LIQUEUR. INT. CL. 33. (U.S. CL. 49). REG. 3-16-1993.
- 1,759,256. KNOT SHOP. INT. CL. 42. (U.S. CL. 101). REG. 3-16-1993.
- 1,759,410. AQUA LUBE. INT. CL. 5. (U.S. CL. 18). REG. 3-23-1993.
- 1,759,618. FRACTION FACTORY. INT. CLS. 9 AND 16. (U.S. CLS. 26 AND 38). REG. 3-23-1993.
- 1,759,788. WHAT'S YOUR DIAGNOSIS?. INT. CL. 16. (U.S. CL. 38). REG. 3-23-1993.
- 1,759,880. CLEAN RELEASE. INT. CL. 17. (U.S. CL. 5). REG. 3-23-1993.
- 1,760,064. SIX FORTUNE. INT. CLS. 29 AND 30 ONLY. (U.S. CL. 46). REG. 3-23-1993.
- 1,760,065. MISCELLANEOUS DESIGN. INT. CLS. 29, 30 AND 32. (U.S. CLS. 45 AND 46). REG. 3-23-1993.
- 1,760,237. THE RETIREMENT SOURCE. INT. CL. 36. (U.S. CL. 102). REG. 3-23-1993.
- 1,760,263. READIRATES. INT. CL. 36. (U.S. CL. 102). REG. 3-23-1993.
- 1,760,294. SHELL. INT. CL. 37. (U.S. CL. 103). REG. 3-23-1993.
- 1,760,295. MISCELLANEOUS DESIGN. INT. CL. 37. (U.S. CL. 103). REG. 3-23-1993.
- 1,760,303. KPLC TV. INT. CL. 38. (U.S. CL. 104). REG. 3-23-1993.
- 1,760,400. PIZZA INN AND DESIGN. INT. CL. 42. (U.S. CL. 100). REG. 3-23-1993.
- 1,760,500. WRIGHT'S FARM RESTAURANT BANQUET FACILITY AND DESIGN. INT. CL. 42. (U.S. CL. 100). REG. 3-23-1993.
- 1,760,519. ELS. INT. CLS. 9 AND 11 ONLY. (U.S. CLS. 21, 26 AND 31). REG. 3-23-1993.
- 1,760,625. SIGHTLINE. INT. CL. 9. (U.S. CL. 26). REG. 3-23-1993.
- 1,760,651. ECLIPSE SUN SHADE. INT. CL. 12. (U.S. CL. 19). REG. 3-23-1993.
- 1,760,932. MISCELLANEOUS DESIGN. INT. CL. 4. (U.S. CL. 15). REG. 3-30-1993.
- 1,760,993. PMC. INT. CL. 6. (U.S. CL. 13). REG. 3-30-1993.
- 1,761,031. AUTO PAK. INT. CL. 7. (U.S. CLS. 13 AND 23). REG. 3-30-1993.
- 1,761,099. CASS WORKS (STYLIZED). INT. CL. 9. (U.S. CL. 38). REG. 3-30-1993.
- 1,761,183. MICRO-FRAME. INT. CL. 9. (U.S. CL. 38). REG. 3-30-1993.
- 1,761,278. TURTLE MAGAZINE FOR PRESCHOOL KIDS AND DESIGN. INT. CL. 16. (U.S. CL. 38). REG. 3-30-1993.
- 1,761,481. FAME. INT. CL. 25. (U.S. CL. 39). REG. 3-30-1993.
- 1,761,539. SOGEL CROWN PAC AND DESIGN. INT. CL. 29. (U.S. CL. 46). REG. 3-30-1993.
- 1,761,622. MISCELLANEOUS DESIGN. INT. CL. 34. (U.S. CL. 8). REG. 3-30-1993.
- 1,761,756. RHAPSODY. INT. CL. 41. (U.S. CL. 107). REG. 3-30-1993.
- 1,761,941. MISCELLANEOUS DESIGN. INT. CL. 3. (U.S. CL. 51). REG. 3-30-1993.
- 1,761,983. OIC-IT. INT. CL. 9. (U.S. CL. 38). REG. 3-30-1993.
- 1,762,324. THE NATURAL. INT. CL. 3. (U.S. CL. 52). REG. 4-6-1993.
- 1,762,339. VIGIL LIGHT. INT. CL. 4. (U.S. CL. 15). REG. 4-6-1993.
- 1,762,472. DALLUGE. INT. CL. 8. (U.S. CL. 23). REG. 4-6-1993.
- 1,762,666. DIGIT TRAP. INT. CL. 10. (U.S. CL. 44). REG. 4-6-1993.
- 1,762,717. DODGE AND DESIGN. INT. CL. 12. (U.S. CL. 19). REG. 4-6-1993.
- 1,762,926. CHILI PEPPER AND DESIGN. INT. CL. 25. (U.S. CL. 39). REG. 4-6-1993.
- 1,763,171. JEAN DANFLOU. INT. CL. 33. (U.S. CLS. 47 AND 49). REG. 4-6-1993.
- 1,763,182. CASH. INT. CL. 35. (U.S. CL. 101). REG. 4-6-1993.
- 1,763,569. SUMMER HILL. INT. CL. 3. (U.S. CLS. 51 AND 52). REG. 4-6-1993.
- 1,763,791. SNAP-ON. INT. CL. 35. (U.S. CL. 101). REG. 4-6-1993.
- 1,764,073. SUSUMU (STYLIZED). INT. CL. 9. (U.S. CLS. 21 AND 26). REG. 4-13-1993.
- 1,764,197. MISCELLANEOUS DESIGN. INT. CL. 9. (U.S. CLS. 21 AND 26). REG. 4-13-1993.
- 1,764,316. GEODEPTH. INT. CL. 9. (U.S. CL. 38). REG. 4-13-1993.
- 1,764,337. OMNI-LINK. INT. CL. 10. (U.S. CL. 44). REG. 4-13-1993.
- 1,764,489. ALKORTHERM. INT. CL. 17. (U.S. CLS. 1, 5, 12, 13, 35 AND 50). REG. 4-13-1993.
- 1,764,634. FX. INT. CL. 28. (U.S. CL. 22). REG. 4-13-1993.
- 1,764,775. FRESKOLA AND DESIGN. INT. CL. 32. (U.S. CL. 45). REG. 4-13-1993.
- 1,764,890. AUTO GLASS SPECIALISTS AND DESIGN. INT. CL. 37. (U.S. CL. 103). REG. 4-13-1993.
- 1,765,455. FANTASME. INT. CL. 3. (U.S. CLS. 1, 4, 6, 50, 51 AND 52). REG. 4-20-1993.
- 1,765,564. BRIGGS & STRATTON. INT. CLS. 7 AND 12. (U.S. CLS. 19 AND 23). REG. 4-20-1993.
- 1,766,376. CONQUEST. INT. CL. 42. (U.S. CLS. 100 AND 101). REG. 4-20-1993.
- 1,766,617. MOVIEWORKS. INT. CL. 9. (U.S. CL. 38). REG. 4-20-1993.
- 1,766,626. LABSPEC. INT. CL. 9. (U.S. CL. 26). REG. 4-20-1993.
- 1,766,704. FOTOVIEW. INT. CL. 16. (U.S. CLS. 2 AND 37). REG. 4-20-1993.
- 1,767,668. PUNCH IN INTERNATIONAL. INT. CL. 38. (U.S. CL. 104). REG. 4-27-1993.
- 1,768,007. B BETA LIGHTING AND DESIGN. INT. CL. 11. (U.S. CL. 21). REG. 4-27-1993.
- 1,768,048. WRITING ON TARGET. INT. CL. 16. (U.S. CL. 38). REG. 4-27-1993.
- 1,768,324. COMMON SENSE PARENTING. INT. CL. 41. (U.S. CL. 107). REG. 4-27-1993.
- 1,768,559. MARK 80. INT. CL. 11. (U.S. CLS. 31 AND 34). REG. 5-4-1993.
- 1,768,788. MISCELLANEOUS DESIGN. INT. CL. 29. (U.S. CL. 46). REG. 5-4-1993.
- 1,768,792. GREEK SKY. INT. CL. 29. (U.S. CL. 46). REG. 5-4-1993.
- 1,768,837. COMPAMED. INT. CL. 35. (U.S. CL. 101). REG. 5-4-1993.
- 1,769,065. FRESH 'N SOFT. INT. CL. 3. (U.S. CLS. 6 AND 52). REG. 5-4-1993.
- 1,769,220. SILHOUETTE (STYLIZED). INT. CL. 10. (U.S. CL. 44). REG. 5-4-1993.
- 1,769,576. SURESPERSE. INT. CL. 1. (U.S. CL. 6). REG. 5-11-1993.
- 1,769,808. WILD SANCTUARY. INT. CL. 9. (U.S. CL. 36). REG. 5-11-1993.
- 1,769,824. LABSTATION (STYLIZED). INT. CL. 9. (U.S. CL. 26). REG. 5-11-1993.
- 1,769,844. RYTEC. INT. CL. 9. (U.S. CLS. 12 AND 21). REG. 5-11-1993.

- 1,770,246. MISCELLANEOUS DESIGN. INT. CL. 29. (U.S. CL. 46). REG. 5-11-1993.
- 1,770,331. MELLOW MOON. INT. CL. 32. (U.S. CL. 45). REG. 5-11-1993.
- 1,770,731. SANIWHITE. INT. CL. 7. (U.S. CL. 35). REG. 5-11-1993.
- 1,770,804. ROYAL PRINCE. INT. CL. 21. (U.S. CLS. 29 AND 50). REG. 5-11-1993.
- 1,770,805. ROYAL KNIGHT. INT. CL. 21. (U.S. CLS. 29 AND 50). REG. 5-11-1993.
- 1,771,383. RAIDERS AND DESIGN. INT. CLS. 16 AND 25. (U.S. CLS. 2, 5, 22, 23, 29, 37, 38, 39 AND 50). REG. 5-18-1993.
- 1,771,407. CONNOISSEUR. INT. CL. 16. (U.S. CL. 37). REG. 5-18-1993.
- 1,771,494. THE RAPPER. INT. CL. 20. (U.S. CL. 50). REG. 5-18-1993.
- 1,771,647. CURRY CLASSICS. INT. CL. 29. (U.S. CL. 46). REG. 5-18-1993.
- 1,771,668. GREEK FLAG. INT. CL. 29. (U.S. CL. 46). REG. 5-18-1993.
- 1,771,672. CASA DE FRUTA. INT. CL. 29. (U.S. CL. 46). REG. 5-18-1993.
- 1,771,828. FARMING IS EVERYBODY'S BREAD AND BUTTER. INT. CL. 36. (U.S. CL. 102). REG. 5-18-1993.
- 1,772,089. CASA DE FRUTA. INT. CL. 42. (U.S. CL. 100). REG. 5-18-1993.
- 1,772,177. VITA-SAURUS AND DESIGN. INT. CL. 5. (U.S. CL. 18). REG. 5-18-1993.
- 1,772,978. VEKA. INT. CLS. 17, 19 AND 35. (U.S. CLS. 1, 5, 12, 13, 33, 35, 50, 100, 101 AND 102). REG. 5-25-1993.
- 1,773,058. HAYMAKER. INT. CL. 25. (U.S. CL. 39). REG. 5-25-1993.
- 1,773,066. SNAPPI. INT. CL. 26. (U.S. CL. 40). REG. 5-25-1993.
- 1,773,414. CLEANSLEEVE. INT. CL. 7. (U.S. CL. 23). REG. 5-25-1993.
- 1,773,431. LITESTAK. INT. CL. 9. (U.S. CL. 21). REG. 5-25-1993.
- 1,773,900. BEVERLY HILLS NATURAL. INT. CL. 3. (U.S. CLS. 51 AND 52). REG. 5-25-1993.
- 1,774,061. ABELL. INT. CL. 7. (U.S. CL. 23). REG. 6-1-1993.
- 1,774,222. MISCELLANEOUS DESIGN. INT. CL. 16. (U.S. CLS. 2, 5, 22, 23, 29, 37, 38 AND 50). REG. 6-1-1993.
- 1,774,249. QUIK STRIP. INT. CL. 19. (U.S. CL. 12). REG. 6-1-1993.
- 1,774,640. BLENDPAK (STYLIZED). INT. CL. 9. (U.S. CL. 26). REG. 6-1-1993.
- 1,774,904. RUSTALLOY. INT. CL. 6. (U.S. CL. 13). REG. 6-8-1993.
- 1,774,914. G-DRILL. INT. CL. 7. (U.S. CL. 23). REG. 6-8-1993.
- 1,775,299. MANDARINO AND DESIGN. INT. CL. 25. (U.S. CL. 39). REG. 6-8-1993.
- 1,775,505. TELIA. INT. CL. 38 ONLY. (U.S. CLS. 100, 101 AND 104). REG. 6-8-1993.
- 1,775,608. MISCELLANEOUS DESIGN. INT. CL. 42. (U.S. CL. 100). REG. 6-8-1993.
- 1,775,729. SNUGULATOR. INT. CL. 7. (U.S. CL. 23). REG. 6-8-1993.
- 1,775,845. GPM. INT. CL. 14. (U.S. CL. 28). REG. 6-8-1993.
- 1,776,466. SAINT GERMAIN. INT. CL. 16. (U.S. CL. 38). REG. 6-15-1993.
- 1,776,572. GEORGE MASON UNIVERSITY VIRGINIA A DECLARATION OF RIGHTS 1957 FREEDOM AND LEARNING AND DESIGN. INT. CL. 21. (U.S. CLS. 2, 23, 30, 33, 40 AND 50). REG. 6-15-1993.
- 1,776,577. PREP WIPES. INT. CL. 21. (U.S. CL. 29). REG. 6-15-1993.
- 1,776,639. MISCELLANEOUS DESIGN. INT. CL. 28. (U.S. CL. 22). REG. 6-15-1993.
- 1,777,008. MINIVALVE. INT. CL. 6. (U.S. CLS. 2 AND 23). REG. 6-15-1993.
- 1,777,018. ELECTRO-LUBER. INT. CL. 7. (U.S. CL. 23). REG. 6-15-1993.
- 1,777,149. TRAILMAX. INT. CL. 12. (U.S. CLS. 19 AND 35). REG. 6-15-1993.
- 1,777,165. DINOTOPIA. INT. CL. 16. (U.S. CL. 38). REG. 6-15-1993.
- 1,777,382. PARADIGM. INT. CL. 33. (U.S. CL. 47). REG. 6-15-1993.
- 1,777,642. STERLING DEBONER. INT. CL. 7. (U.S. CL. 23). REG. 6-22-1993.
- 1,777,768. KINDRED COLLECTION. INT. CL. 11. (U.S. CL. 13). REG. 6-22-1993.
- 1,777,912. MISCELLANEOUS DESIGN. INT. CL. 21. (U.S. CLS. 26 AND 29). REG. 6-22-1993.
- 1,778,182. ADD-A-PIECE (STYLIZED). INT. CL. 42. (U.S. CL. 100). REG. 6-22-1993.
- 1,778,291. 21ST CENTURY. INT. CL. 9. (U.S. CLS. 21, 23, 26, 36 AND 38). REG. 6-22-1993.
- 1,778,629. FREAMINE HBC. INT. CL. 5. (U.S. CL. 18). REG. 6-29-1993.
- 1,778,739. SAINT GERMAIN PRESS. INT. CLS. 9 AND 16. (U.S. CLS. 21, 36 AND 38). REG. 6-29-1993.
- 1,778,762. EITS. INT. CL. 9. (U.S. CL. 26). REG. 6-29-1993.
- 1,778,954. LATEX-ITE AIRPORT GRADE. INT. CL. 19. (U.S. CL. 12). REG. 6-29-1993.
- 1,779,266. SEIDO KARATE AND DESIGN. INT. CL. 41. (U.S. CL. 107). REG. 6-29-1993.
- 1,779,812. DOMAINE SERENE. INT. CL. 33. (U.S. CL. 47). REG. 6-29-1993.
- 1,781,457. HOLLANDER. INT. CLS. 20 AND 24. (U.S. CLS. 32 AND 42). REG. 7-13-1993.
- 1,781,602. GUERRERO. INT. CL. 29. (U.S. CL. 46). REG. 7-13-1993.
- 1,781,812. DISPENSTECH (STYLIZED). INT. CL. 41. (U.S. CL. 107). REG. 7-13-1993.
- 1,781,863. REDLINE TRAILER REPAIR PARTS AND DESIGN. INT. CL. 42. (U.S. CL. 101). REG. 7-13-1993.
- 1,781,962. QUIKTRAK. INT. CL. 42. (U.S. CL. 100). REG. 7-13-1993.
- 1,782,354. ERUCICAL. INT. CL. 4. (U.S. CL. 15). REG. 7-20-1993.
- 1,782,364. ACTIFRESH AND DESIGN. INT. CL. 5. (U.S. CL. 6). REG. 7-20-1993.
- 1,782,540. @NALYST. INT. CL. 9. (U.S. CL. 38). REG. 7-20-1993.
- 1,782,874. STREET CHARACTERS. INT. CLS. 35, 37, 40, 41 AND 42. (U.S. CLS. 100, 101, 103, 106 AND 107). REG. 7-20-1993.
- 1,783,166. ENZO GUARD. INT. CL. 1. (U.S. CL. 6). REG. 7-20-1993.
- 1,783,179. AQUATROL. INT. CL. 3. (U.S. CL. 51). REG. 7-20-1993.
- 1,783,218. THE (STYLIZED). INT. CL. 6. (U.S. CL. 13). REG. 7-20-1993.
- 1,783,321. VALENTINE ONE. INT. CL. 9. (U.S. CL. 26). REG. 7-20-1993.
- 1,784,327. CHERRY BOMB. INT. CL. 31. (U.S. CL. 1). REG. 7-27-1993.
- 1,784,540. MAMA'S HOME COOKIN'. INT. CL. 41. (U.S. CL. 107). REG. 7-27-1993.
- 1,785,070. SOLVITOSE. INT. CL. 1. (U.S. CL. 6). REG. 8-3-1993.
- 1,785,640. LONGBOARDS RULE AND DESIGN. INT. CL. 25. (U.S. CL. 39). REG. 8-3-1993.
- 1,785,753. GINO MONTE. INT. CL. 33. (U.S. CL. 47). REG. 8-3-1993.
- 1,785,849. ALLIED AND DESIGN. INT. CL. 37. (U.S. CL. 103). REG. 8-3-1993.
- 1,786,437. ELECTRO ALOE. INT. CL. 5. (U.S. CL. 18). REG. 8-10-1993.
- 1,786,945. EMERALD ISLE. INT. CL. 31. (U.S. CL. 1). REG. 8-10-1993.
- 1,786,955. LITTLE JOHN. INT. CL. 33. (U.S. CL. 49). REG. 8-10-1993.
- 1,787,377. DOGWATCH. INT. CL. 9. (U.S. CL. 21). REG. 8-10-1993.
- 1,787,786. INSERTA-LITE AND DESIGN. INT. CL. 4. (U.S. CL. 15). REG. 8-17-1993.
- 1,788,335. AZTECA (STYLIZED). INT. CL. 30. (U.S. CL. 46). REG. 8-17-1993.
- 1,788,381. ABN AMRO AND DESIGN. INT. CLS. 35 AND 36. (U.S. CLS. 100, 101 AND 102). REG. 8-17-1993.
- 1,788,522. AMERICAN WOMAN'S ECONOMIC DEVELOPMENT CORPORATION. INT. CL. 41. (U.S. CL. 107). REG. 8-17-1993.
- 1,788,619. IT'S FASHION!. INT. CL. 42. (U.S. CL. 101). REG. 8-17-1993.
- 1,788,719. CHEMIDEX. INT. CL. 1. (U.S. CL. 6). REG. 8-17-1993.
- 1,789,000. HITCH-LITE. INT. CL. 11. (U.S. CLS. 19 AND 21). REG. 8-17-1993.
- 1,789,053. OLD MASTERS. INT. CL. 2. (U.S. CL. 16). REG. 8-24-1993.
- 1,789,211. THE MICRO-WEIGH SYSTEM. INT. CL. 9. (U.S. CLS. 23 AND 26). REG. 8-24-1993.

- 1,789,214. ULTRAGAGE. INT. CL. 9. (U.S. CL. 26). REG. 8-24-1993.
- 1,791,983. WHOLEARCHY. INT. CL. 41. (U.S. CL. 107). REG. 9-7-1993.
- 1,792,095. POSIX. U.S. CL. A. REG. 9-7-1993.
- 1,792,215. INSPECTION ONE. INT. CL. 42. (U.S. CL. 100). REG. 9-7-1993.
- 1,792,564. DIAMOND WHITE. INT. CL. 16. (U.S. CL. 37). REG. 9-14-1993.
- 1,792,779. THE BIG BAJA BUCKET. INT. CL. 29. (U.S. CL. 46). REG. 9-14-1993.
- 1,792,832. QUICK THIX. INT. CL. 31. (U.S. CL. 46). REG. 9-14-1993.
- 1,793,121. NADCA. INT. CL. 42. (U.S. CL. 100). REG. 9-14-1993.
- 1,795,185. STORYTELLA. INT. CL. 31. (U.S. CL. 1). REG. 9-28-1993.
- 1,795,197. MISCELLANEOUS DESIGN. INT. CL. 33. (U.S. CL. 47). REG. 9-28-1993.
- 1,795,732. PROFILE. INT. CL. 10. (U.S. CL. 44). REG. 9-28-1993.
- 1,795,739. PREPI. INT. CL. 10. (U.S. CL. 44). REG. 9-28-1993.
- 1,796,479. WESTWAY PELLET PARTNER AND DESIGN. INT. CL. 31. (U.S. CL. 46). REG. 10-5-1993.
- 1,802,257. MISCELLANEOUS DESIGN. INT. CLS. 35 AND 41. (U.S. CLS. 100, 101 AND 107). REG. 11-2-1993.
- 1,805,392. SLIMLINE. INT. CL. 25. (U.S. CL. 39). REG. 11-16-1993.
- 1,805,580. C CANDELA AND DESIGN. INT. CL. 42. (U.S. CL. 100). REG. 11-16-1993.
- 1,805,865. DECIBEL. INT. CL. 9. (U.S. CLS. 21 AND 26). REG. 11-23-1993.
- 1,806,716. CONTOUR. INT. CL. 11. (U.S. CL. 21). REG. 11-23-1993.
- 1,807,699. TRUE DETAILS. INT. CL. 28. (U.S. CL. 22). REG. 11-30-1993.
- 1,808,174. CANDELA. INT. CL. 42. (U.S. CL. 100). REG. 11-30-1993.
- 1,808,588. ARMSTRONG RIDGE. INT. CL. 33. (U.S. CL. 47). REG. 11-30-1993.
- 1,809,131. INDIANAPOLIS COLTS. INT. CLS. 16 AND 25. (U.S. CLS. 2, 5, 22, 23, 29, 37, 38, 39 AND 50). REG. 12-7-1993.
- 1,809,375. SWEET PETITE. INT. CL. 31. (U.S. CLS. 1 AND 46). REG. 12-7-1993.
- 1,810,344. DREWPLEX. INT. CL. 1. (U.S. CL. 6). REG. 12-14-1993.
- 1,810,400. CHAMPION HI-TECH LUBRICANTS ALL FLEET "T" AND DESIGN. INT. CL. 4. (U.S. CL. 15). REG. 12-14-1993.
- 1,810,715. MISCELLANEOUS DESIGN. INT. CLS. 16 AND 25. (U.S. CLS. 2, 5, 22, 23, 29, 37, 38, 39 AND 50). REG. 12-14-1993.
- 1,811,628. KONA KRUNCH. INT. CL. 30. (U.S. CL. 46). REG. 12-14-1993.
- 1,811,964. LINE-R. INT. CL. 9. (U.S. CL. 38). REG. 12-21-1993.
- 1,811,966. MEASURE-UPS. INT. CL. 9. (U.S. CL. 26). REG. 12-21-1993.
- 1,812,085. FRANKLIN SQUARE P-R-E-S-S AND DESIGN. INT. CL. 16. (U.S. CL. 38). REG. 12-21-1993.
- 1,812,132. THE VOICE OF FRANCHISING. INT. CL. 16. (U.S. CL. 38). REG. 12-21-1993.
- 1,812,607. SYLVAN STUDY POWER. INT. CL. 16 ONLY. (U.S. CL. 38). REG. 12-21-1993.
- 1,813,427. SAINTS IN PRAISE. INT. CL. 9 ONLY. (U.S. CLS. 21, 23, 26, 36 AND 38). REG. 12-28-1993.
- 1,813,433. CELTEL. INT. CL. 9. (U.S. CLS. 21 AND 26). REG. 12-28-1993.
- 1,814,448. AQUACRIB. INT. CL. 19. (U.S. CLS. 12, 22 AND 50). REG. 12-28-1993.
- 1,814,485. ARMORGUARD. INT. CL. 28. (U.S. CLS. 22 AND 50). REG. 12-28-1993.
- 1,815,289. MISCELLANEOUS DESIGN. INT. CL. 42. (U.S. CL. 100). REG. 1-4-1994.
- 1,815,899. SAFE-GARD. INT. CL. 17. (U.S. CL. 1). REG. 1-11-1994.
- 1,816,315. CRESTLINE AND DESIGN. INT. CLS. 6 AND 19. (U.S. CLS. 12 AND 13). REG. 1-11-1994.
- 1,816,820. IDEK AND DESIGN. INT. CL. 16. (U.S. CLS. 5 AND 37). REG. 1-18-1994.
- 1,818,169. E AND DESIGN. INT. CL. 36. (U.S. CL. 102). REG. 1-25-1994.
- 1,818,730. PRICE WISE AND DESIGN. INT. CL. 6. (U.S. CL. 14). REG. 2-1-1994.
- 1,819,177. TELEBROKER. INT. CLS. 35 AND 36. (U.S. CLS. 101 AND 102). REG. 2-1-1994.
- 1,819,430. WASTEWORX. INT. CL. 9. (U.S. CL. 38). REG. 2-1-1994.
- 1,821,118. SLICKEDIT. INT. CL. 9. (U.S. CL. 38). REG. 2-15-1994.
- 1,821,901. IT'S JUST LUNCH!. INT. CL. 42. (U.S. CL. 100). REG. 2-15-1994.
- 1,821,902. MISCELLANEOUS DESIGN. INT. CL. 42. (U.S. CL. 100). REG. 2-15-1994.
- 1,823,091. LASERVISION CENTERS. INT. CLS. 35 AND 42. (U.S. CLS. 100 AND 101). REG. 2-22-1994.
- 1,823,143. BUILDERS CLUB. INT. CL. 35. (U.S. CL. 101). REG. 2-22-1994.
- 1,823,737. POLY FEND. INT. CL. 17. (U.S. CLS. 1 AND 50). REG. 2-22-1994.
- 1,823,761. IMAGE. INT. CL. 21. (U.S. CLS. 2 AND 13). REG. 2-22-1994.
- 1,826,355. HEAT MIRROR AND DESIGN. INT. CL. 17. (U.S. CLS. 1 AND 12). REG. 3-15-1994.

* * * * *

TRADEMARK REGISTRATIONS CANCELED

The designation "U.S. Cl." appearing in this section refers to the U.S. class in effect prior to Sep. 1, 1973 rather than the international class which applies to applications filed on or after that date. For adoption of international classification see notice in the OFFICIAL GAZETTE of Jun. 26, 1973 (911 O.G. TM 210).

SECTION 8

- 21,571. J&W.NICHOLSON&CO. SCOTCH WHISKY LONDON AND DESIGN. U.S. CL. 49. REG. 8-9-1892.
- 157,557. PIT (STYLIZED). U.S. CL. 22. REG. 8-8-1922.
- 157,560. P'S & Q'S. (STYLIZED). U.S. CL. 38. REG. 8-8-1922.
- 157,612. MATHEWS (STYLIZED). U.S. CL. 13. REG. 8-8-1922.
- 396,769. R E D I F O N (STYLIZED). U.S. CL. 26. REG. 8-4-1942.
- 396,772. BERGUNA (STYLIZED). INT. CL. 1. REG. 8-4-1942.
- 396,807. TUFHORSE AND DESIGN. U.S. CL. 22. REG. 8-4-1942.
- 396,814. VVFP INC VAL VITA AND DESIGN. U.S. CL. 46. REG. 8-4-1942.
- 396,820. KBS AND DESIGN. U.S. CL. 36. REG. 8-4-1942.
- 396,822. GARDENKRAFT. U.S. CL. 23. REG. 8-4-1942.
- 396,826. SENATOR. U.S. CL. 23. REG. 8-4-1942.
- 396,850. GOLDEN GLOW. U.S. CL. 46. REG. 8-4-1942.
- 396,854. ANIMAL KINGDOM. U.S. CL. 38. REG. 8-4-1942.
- 396,858. KODAK (STYLIZED). U.S. CL. 23. REG. 8-4-1942.
- 396,865. SHEFFALLOY AND DESIGN. U.S. CL. 2. REG. 8-4-1942.
- 396,868. SOYAMAISE (STYLIZED). U.S. CL. 46. REG. 8-4-1942.
- 735,507. PAN X TROL. INT. CL. 1. REG. 8-7-1962.
- 735,517. CHEMSTRAND (STYLIZED). INT. CL. 1. REG. 8-7-1962.
- 735,518. VERSALON. INT. CL. 1. REG. 8-7-1962.
- 735,520. MISCELLANEOUS DESIGN. U.S. CL. 1. REG. 8-7-1962.
- 735,521. KP. U.S. CL. 2. REG. 8-7-1962.
- 735,524. BARCOLENE'S CLOUD 9 AND DESIGN. U.S. CL. 6. REG. 8-7-1962.
- 735,541. VARMEL. U.S. CL. 11. REG. 8-7-1962.
- 735,546. HYDRO NAIL. U.S. CL. 12. REG. 8-7-1962.
- 735,551. ELECTRO-BONDED. U.S. CL. 13. REG. 8-7-1962.
- 735,572. DOME. U.S. CL. 18. REG. 8-7-1962.
- 735,576. RYNALERT. U.S. CL. 18. REG. 8-7-1962.
- 735,586. PERMION. U.S. CL. 21. REG. 8-7-1962.
- 735,596. RFI AND DESIGN. U.S. CL. 21. REG. 8-7-1962.
- 735,608. ELECTRO-SHEAVE. U.S. CL. 23. REG. 8-7-1962.
- 735,611. ALPMA AND DESIGN. U.S. CL. 23. REG. 8-7-1962.
- 735,613. CALOR. U.S. CL. 23. REG. 8-7-1962.
- 735,616. AMERTROL (STYLIZED). U.S. CL. 23. REG. 8-7-1962.
- 735,624. BALAC. U.S. CL. 23. REG. 8-7-1962.
- 735,628. PRES-PAK (STYLIZED). U.S. CL. 23. REG. 8-7-1962.
- 735,629. MORDRAW. U.S. CL. 23. REG. 8-7-1962.
- 735,637. VERBUS. U.S. CL. 26. REG. 8-7-1962.
- 735,647. THERMOMATIC. U.S. CL. 26. REG. 8-7-1962.
- 735,651. OLFACTRON. U.S. CL. 26. REG. 8-7-1962.
- 735,653. MARVELLIQUE (STYLIZED). U.S. CL. 28. REG. 8-7-1962.
- 735,654. PAKULA (STYLIZED). U.S. CL. 28. REG. 8-7-1962.
- 735,655. COMMAND. U.S. CL. 28. REG. 8-7-1962.
- 735,658. MADEMOISELLE DE PARIS. U.S. CL. 28. REG. 8-7-1962.
- 735,672. KLEENEX. U.S. CL. 37. REG. 8-7-1962.
- 735,674. HAMMERMILL MICR CHECK-MATE (STYLIZED). U.S. CL. 37. REG. 8-7-1962.
- 735,686. KIMLARK. U.S. CL. 37. REG. 8-7-1962.
- 735,688. BROOKSHIRE. U.S. CL. 37. REG. 8-7-1962.
- 735,707. PIC 'N PAY. U.S. CL. 39. REG. 8-7-1962.
- 735,710. SALON SET. U.S. CL. 40. REG. 8-7-1962.
- 735,711. "HY-TEX". U.S. CL. 40. REG. 8-7-1962.
- 735,712. BRAGELONNE. U.S. CL. 42. REG. 8-7-1962.
- 735,717. SASHAY (STYLIZED). U.S. CL. 42. REG. 8-7-1962.
- 735,729. M E T A L U X (STYLIZED). U.S. CL. 44. REG. 8-7-1962.
- 735,730. SPEED-CLIP. U.S. CL. 44. REG. 8-7-1962.
- 735,732. SENSITOL. U.S. CL. 44. REG. 8-7-1962.
- 735,738. BEECH-NUT AND DESIGN. U.S. CL. 46. REG. 8-7-1962.
- 735,753. GOLDEN TASTE (STYLIZED). U.S. CL. 46. REG. 8-7-1962.
- 735,756. HOLE 'N' ONE (STYLIZED). U.S. CL. 46. REG. 8-7-1962.
- 735,761. BENCH & FIELD. U.S. CL. 46. REG. 8-7-1962.
- 735,765. SOLU-RATED. U.S. CL. 46. REG. 8-7-1962.
- 735,776. DAPTIL. U.S. CL. 46. REG. 8-7-1962.
- 735,779. LIXY. U.S. CL. 49. REG. 8-7-1962.
- 735,783. VANI-STAIN. U.S. CL. 51. REG. 8-7-1962.
- 735,786. TOTAL. U.S. CL. 51. REG. 8-7-1962.
- 735,790. TENDER TOUCH. U.S. CL. 51. REG. 8-7-1962.
- 735,794. SPREAN. U.S. CL. 52. REG. 8-7-1962.
- 735,802. JIFFY. U.S. CL. 52. REG. 8-7-1962.
- 735,804. MISCELLANEOUS DESIGN. U.S. CL. 100. REG. 8-7-1962.
- 735,810. BLEN-DE-LUXE (STYLIZED). U.S. CL. 106. REG. 8-7-1962.
- 735,818. SALT WATER GEL. INT. CL. 1. REG. 8-7-1962.
- 736,133. CHEEZ WAFFIES. U.S. CL. 46. REG. 8-14-1962.
- 940,542. FASHIONBERRY. U.S. CL. 39. REG. 8-8-1972.
- 1,203,261. AMERICAN GARDEN. INT. CLS. 1, 2 AND 31. REG. 8-3-1982.
- 1,203,263. SEPARADE. INT. CL. 1. REG. 8-3-1982.
- 1,203,265. SEROTEST. INT. CL. 1. REG. 8-3-1982.
- 1,203,266. THIOKOL 800. INT. CL. 1. REG. 8-3-1982.
- 1,203,267. GROW-RICH. INT. CL. 1. REG. 8-3-1982.
- 1,203,269. JWR (STYLIZED). INT. CLS. 1 AND 2. REG. 8-3-1982.
- 1,203,275. ASK ABSOLUTE STAIN KILLER (STYLIZED). INT. CL. 2. REG. 8-3-1982.
- 1,203,278. PIQUE (STYLIZED). INT. CL. 3. REG. 8-3-1982.
- 1,203,280. FLORBATH AND DESIGN. INT. CL. 3. REG. 8-3-1982.
- 1,203,288. CARYL BAKER VISAGE (STYLIZED). INT. CLS. 3, 21, 41 AND 42. REG. 8-3-1982.
- 1,203,293. SKIN PERFECT. INT. CL. 3. REG. 8-3-1982.
- 1,203,294. SCUFF MAGIC. INT. CL. 3. REG. 8-3-1982.
- 1,203,299. 6721. INT. CL. 4. REG. 8-3-1982.
- 1,203,300. 7500. INT. CL. 4. REG. 8-3-1982.
- 1,203,301. 4701. INT. CL. 4. REG. 8-3-1982.
- 1,203,302. 4700. INT. CL. 4. REG. 8-3-1982.
- 1,203,306. SOLGAR - THE NATURAL WAY TO BETTER HEALTH - SOLGAR. INT. CL. 5. REG. 8-3-1982.
- 1,203,311. LIQUITARD. INT. CL. 5. REG. 8-3-1982.
- 1,203,313. ZONITORS. INT. CL. 5. REG. 8-3-1982.
- 1,203,314. FEM-CORT. INT. CL. 5. REG. 8-3-1982.
- 1,203,322. MAST-A-CILLIN. INT. CL. 5. REG. 8-3-1982.
- 1,203,323. PROLAMINE. INT. CL. 5. REG. 8-3-1982.
- 1,203,325. ARTRIN/P. INT. CL. 5. REG. 8-3-1982.

- 1,203,331. GTC FORMULA (STYLIZED). INT. CL. 5. REG. 8-3-1982.
- 1,203,335. WATKINS FARM-PAK SYSTEM AND DESIGN. INT. CL. 5. REG. 8-3-1982.
- 1,203,336. FLY-A-REST. INT. CL. 5. REG. 8-3-1982.
- 1,203,337. ANGIOVUE. INT. CL. 5. REG. 8-3-1982.
- 1,203,341. MISCELLANEOUS DESIGN. INT. CL. 5. REG. 8-3-1982.
- 1,203,342. MYCOSPOR. INT. CL. 5. REG. 8-3-1982.
- 1,203,343. PREGENT. INT. CL. 5. REG. 8-3-1982.
- 1,203,344. MEVANIN-C. INT. CL. 5. REG. 8-3-1982.
- 1,203,347. CYGON. INT. CL. 5. REG. 8-3-1982.
- 1,203,355. MISCELLANEOUS DESIGN. INT. CL. 6. REG. 8-3-1982.
- 1,203,359. KEDLOK. INT. CL. 6. REG. 8-3-1982.
- 1,203,360. CHROMTUNG. INT. CL. 6. REG. 8-3-1982.
- 1,203,374. E AND DESIGN. INT. CL. 7. REG. 8-3-1982.
- 1,203,378. R/BAK (STYLIZED). INT. CL. 7. REG. 8-3-1982.
- 1,203,380. SEE THE DANCING COVER. INT. CL. 7. REG. 8-3-1982.
- 1,203,381. CDR (STYLIZED). INT. CL. 7. REG. 8-3-1982.
- 1,203,383. CHEMEX TRIARC AND DESIGN. INT. CL. 7. REG. 8-3-1982.
- 1,203,385. LERVAD. INT. CLS. 7 AND 20. REG. 8-3-1982.
- 1,203,387. VARICONTROL. INT. CL. 7. REG. 8-3-1982.
- 1,203,388. GLOBE. INT. CL. 7. REG. 8-3-1982.
- 1,203,390. EX-CELL-O MICROMATIC MICRO SIZE AND DESIGN. INT. CL. 7. REG. 8-3-1982.
- 1,203,391. REACH. INT. CL. 7. REG. 8-3-1982.
- 1,203,394. "DOWDCO SPONGE BARREL". INT. CL. 7. REG. 8-3-1982.
- 1,203,401. MAXCLAD. INT. CL. 7. REG. 8-3-1982.
- 1,203,402. VICTORIO. INT. CL. 8. REG. 8-3-1982.
- 1,203,409. PI PRESS INC. AND DESIGN. INT. CLS. 9 AND 16. REG. 8-3-1982.
- 1,203,410. THE LIGHT FANTASTIC. INT. CLS. 9 AND 11. REG. 8-3-1982.
- 1,203,412. FERRANT PACKARD FP AND DESIGN. INT. CL. 9. REG. 8-3-1982.
- 1,203,415. CPV COIFFURE DE PARIS VIDEO AND DESIGN. INT. CLS. 9, 16 AND 41. REG. 8-3-1982.
- 1,203,417. P-STAT AND DESIGN. INT. CL. 9. REG. 8-3-1982.
- 1,203,422. MARK IV. INT. CLS. 9 AND 16. REG. 8-3-1982.
- 1,203,423. THE SOFTWARE TOOLWORKS. INT. CL. 9. REG. 8-3-1982.
- 1,203,432. HAZELTINE AND DESIGN. INT. CL. 9. REG. 8-3-1982.
- 1,203,437. PUMA. INT. CL. 9. REG. 8-3-1982.
- 1,203,440. RAC (STYLIZED). INT. CL. 9. REG. 8-3-1982.
- 1,203,443. COBOL-PLUS. INT. CL. 9. REG. 8-3-1982.
- 1,203,450. MEMBRONICS. INT. CL. 9. REG. 8-3-1982.
- 1,203,453. 3M (STYLIZED). INT. CL. 9. REG. 8-3-1982.
- 1,203,454. GINGIBRAID. INT. CL. 10. REG. 8-3-1982.
- 1,203,455. U-SAMP. INT. CL. 10. REG. 8-3-1982.
- 1,203,459. TMP LEGIA AND DESIGN. INT. CL. 10. REG. 8-3-1982.
- 1,203,460. OUI-LOK (WE-LOCK) (STYLIZED). INT. CLS. 10 AND 26. REG. 8-3-1982.
- 1,203,464. WHEEL-A-WALK. INT. CL. 10. REG. 8-3-1982.
- 1,203,465. PERCOR-DL. INT. CL. 10. REG. 8-3-1982.
- 1,203,470. TRAILBLAZER. INT. CL. 11. REG. 8-3-1982.
- 1,203,471. HARPER AND DESIGN. INT. CL. 11. REG. 8-3-1982.
- 1,203,472. SUSSMAN STEAMER. INT. CL. 11. REG. 8-3-1982.
- 1,203,473. KRAMER ELECTRIC. INT. CL. 11. REG. 8-3-1982.
- 1,203,477. SPRA-RITE. INT. CL. 11. REG. 8-3-1982.
- 1,203,483. PARTICULATOR. INT. CL. 11. REG. 8-3-1982.
- 1,203,485. CITADEL. INT. CL. 11. REG. 8-3-1982.
- 1,203,494. DUKE. INT. CL. 13. REG. 8-3-1982.
- 1,203,495. CO-AX. INT. CL. 13. REG. 8-3-1982.
- 1,203,497. TRUSSARDI AND DESIGN. INT. CLS. 14, 16, 18 AND 34. REG. 8-3-1982.
- 1,203,510. VIP EXTENDED SERVICE CORP. AND DESIGN. INT. CL. 16. REG. 8-3-1982.
- 1,203,513. MICRO-TRAY. INT. CL. 16. REG. 8-3-1982.
- 1,203,514. NATIONAL MEDICAL CAREERS. INT. CLS. 16 AND 41. REG. 8-3-1982.
- 1,203,519. DATA COPY. INT. CL. 16. REG. 8-3-1982.
- 1,203,520. TAPE ID. INT. CL. 16. REG. 8-3-1982.
- 1,203,524. MISCELLANEOUS DESIGN. INT. CL. 16. REG. 8-3-1982.
- 1,203,525. THE HARTFORD. INT. CL. 16. REG. 8-3-1982.
- 1,203,527. HAAGEN-DAZS (STYLIZED). INT. CLS. 16 AND 21. REG. 8-3-1982.
- 1,203,528. ACTION ITEM MEMO AND DESIGN. INT. CL. 16. REG. 8-3-1982.
- 1,203,532. C COLM ENGINEERING AND DESIGN. INT. CLS. 16 AND 42. REG. 8-3-1982.
- 1,203,533. DELTA DIGGER. INT. CL. 16. REG. 8-3-1982.
- 1,203,534. MISCELLANEOUS DESIGN. INT. CL. 16. REG. 8-3-1982.
- 1,203,540. CANDLELIGHT ECSTASY ROMANCES. INT. CL. 16. REG. 8-3-1982.
- 1,203,542. THE INNER WAY (STYLIZED). INT. CL. 16. REG. 8-3-1982.
- 1,203,543. COAL WEEK INTERNATIONAL. INT. CL. 16. REG. 8-3-1982.
- 1,203,544. MATTE TECH. INT. CL. 16. REG. 8-3-1982.
- 1,203,545. HAPPY HANDS. INT. CL. 16. REG. 8-3-1982.
- 1,203,547. SWEET DREAMS AND DESIGN. INT. CL. 16. REG. 8-3-1982.
- 1,203,548. MISCELLANEOUS DESIGN. INT. CL. 16. REG. 8-3-1982.
- 1,203,553. DIMPLE POWER. INT. CLS. 17, 25 AND 28. REG. 8-3-1982.
- 1,203,565. FLESS-COAT (STYLIZED). INT. CL. 19. REG. 8-3-1982.
- 1,203,566. BI BARRETT INDUSTRIES (STYLIZED). INT. CLS. 19 AND 37. REG. 8-3-1982.
- 1,203,567. FIBERCOAT. INT. CL. 19. REG. 8-3-1982.
- 1,203,570. ZEROENERGY. INT. CL. 19. REG. 8-3-1982.
- 1,203,575. TEE PEE AND DESIGN. INT. CLS. 20 AND 21. REG. 8-3-1982.
- 1,203,576. TP AND DESIGN. INT. CLS. 20 AND 21. REG. 8-3-1982.
- 1,203,578. CLUTTER CONTROL WE MAXIMIZE SPACE AND DESIGN. INT. CLS. 20, 37 AND 42. REG. 8-3-1982.
- 1,203,579. NATIONAL CAN. INT. CL. 20. REG. 8-3-1982.
- 1,203,586. WOODSTUFF. INT. CL. 20. REG. 8-3-1982.
- 1,203,587. SHIBUI. INT. CL. 20. REG. 8-3-1982.
- 1,203,591. MUST (STYLIZED). INT. CL. 20. REG. 8-3-1982.
- 1,203,594. THE SOFA WORKS. INT. CLS. 20 AND 42. REG. 8-3-1982.
- 1,203,611. ESSENTIALS. INT. CL. 21. REG. 8-3-1982.
- 1,203,618. QUANPACA. INT. CL. 22. REG. 8-3-1982.
- 1,203,620. DEBYSHIRE. INT. CL. 23. REG. 8-3-1982.
- 1,203,625. PAK-A-ROBE. INT. CL. 24. REG. 8-3-1982.
- 1,203,640. LARRY MAHAN'S HAT COLLECTION. INT. CL. 25. REG. 8-3-1982.
- 1,203,642. BUDDY'S. INT. CL. 25. REG. 8-3-1982.
- 1,203,646. MOUNTAIN FLOWERS BRAND AND DESIGN. INT. CL. 25. REG. 8-3-1982.
- 1,203,649. BALFOUR. INT. CL. 25. REG. 8-3-1982.
- 1,203,653. MISCELLANEOUS DESIGN. INT. CL. 25. REG. 8-3-1982.
- 1,203,656. DAVID CHARLES LONDON AND DESIGN. INT. CL. 25. REG. 8-3-1982.
- 1,203,660. SEA ISLAND. INT. CL. 25. REG. 8-3-1982.
- 1,203,662. GITANO AND DESIGN. INT. CL. 25. REG. 8-3-1982.
- 1,203,673. LADY LLOYD (STYLIZED). INT. CL. 25. REG. 8-3-1982.
- 1,203,675. ADVANCED DUNGEONS & DRAGONS. INT. CL. 25. REG. 8-3-1982.
- 1,203,681. PLAY IT AGAIN. INT. CL. 25. REG. 8-3-1982.
- 1,203,682. FUNDAMENTAL THINGS. INT. CL. 25. REG. 8-3-1982.
- 1,203,687. NANA'S PET. INT. CL. 25. REG. 8-3-1982.
- 1,203,688. BRASS AND DESIGN. INT. CL. 25. REG. 8-3-1982.
- 1,203,689. HUNTING WORLD. INT. CL. 25. REG. 8-3-1982.
- 1,203,695. INACTIVEWARE. INT. CL. 25. REG. 8-3-1982.
- 1,203,696. LOAFER'S GLORY. INT. CL. 25. REG. 8-3-1982.
- 1,203,697. LOAFER'S GLORY INACTIVEWARE BY BAY STREET AND DESIGN. INT. CL. 25. REG. 8-3-1982.

- 1,203,700. EXTRA PLUS. INT. CL. 25. REG. 8-3-1982.
1,203,702. AMERICAN PRIDE. INT. CL. 25. REG. 8-3-1982.
1,203,703. LITTLE LINDA (STYLIZED). INT. CL. 26. REG. 8-3-1982.
1,203,708. CARPET CLASSICS (STYLIZED). INT. CL. 27. REG. 8-3-1982.
1,203,709. ROYAL VELOUR. INT. CL. 27. REG. 8-3-1982.
1,203,710. LA SEIGNEURIE. INT. CL. 27. REG. 8-3-1982.
1,203,712. COUNTRY HEARTH. INT. CL. 27. REG. 8-3-1982.
1,203,713. BRIGHT 'N EASY. INT. CL. 27. REG. 8-3-1982.
1,203,714. HARBOR HILL. INT. CL. 27. REG. 8-3-1982.
1,203,716. TOWN MANOR. INT. CL. 27. REG. 8-3-1982.
1,203,717. ULTRA-COLOR. INT. CL. 27. REG. 8-3-1982.
1,203,723. PLUMBMARK AND DESIGN. INT. CL. 28. REG. 8-3-1982.
1,203,726. GROUNDGAINER. INT. CL. 28. REG. 8-3-1982.
1,203,734. MISCELLANEOUS DESIGN. INT. CL. 28. REG. 8-3-1982.
1,203,744. BABYNURSE (STYLIZED). INT. CL. 28. REG. 8-3-1982.
1,203,747. TASTEE FRESH AND DESIGN. INT. CLS. 29 AND 30. REG. 8-3-1982.
1,203,756. OSO. INT. CL. 29. REG. 8-3-1982.
1,203,763. CONNOISSEUR GOLD. INT. CL. 29. REG. 8-3-1982.
1,203,767. MUNCHROOMS. INT. CL. 29. REG. 8-3-1982.
1,203,773. NELSON'S DUTCH FARMS ICE CREAM "NIX BESSER" AND DESIGN. INT. CL. 30. REG. 8-3-1982.
1,203,776. ISALY'S KLONDIKE CHOCOLATE COVERED ICE CREAM AND DESIGN. INT. CL. 30. REG. 8-3-1982.
1,203,778. FAIRY FRITTERS AND DESIGN. INT. CL. 30. REG. 8-3-1982.
1,203,782. BINGO AND DESIGN. INT. CL. 30. REG. 8-3-1982.
1,203,791. ELECTROBURGER. INT. CL. 30. REG. 8-3-1982.
1,203,793. MILKNIFICENCE. INT. CL. 30. REG. 8-3-1982.
1,203,797. SUN BRAND AND DESIGN. INT. CL. 30. REG. 8-3-1982.
1,203,798. MISCELLANEOUS DESIGN. INT. CL. 30. REG. 8-3-1982.
1,203,810. GREEN SANDS. INT. CL. 32. REG. 8-3-1982.
1,203,813. BRIGHT 'N SUNNY. INT. CL. 32. REG. 8-3-1982.
1,203,814. POPS AND DESIGN. INT. CL. 32. REG. 8-3-1982.
1,203,815. SCHLITZ AND DESIGN. INT. CL. 32. REG. 8-3-1982.
1,203,818. SNOW CROP. INT. CL. 32. REG. 8-3-1982.
1,203,824. KLOSTERSEKT STIFT KLOSTERNEUBURG. INT. CL. 33. REG. 8-3-1982.
1,203,827. ADORANA. INT. CL. 33. REG. 8-3-1982.
1,203,830. MARKSMAN. INT. CL. 34. REG. 8-3-1982.
1,203,832. FARMULATOR. INT. CL. 35. REG. 8-3-1982.
1,203,834. WORDSMITH AND DESIGN. INT. CL. 35. REG. 8-3-1982.
1,203,837. ELITE. INT. CL. 35. REG. 8-3-1982.
1,203,838. M MONEY MARK CONTINENTAL CLUB AND DESIGN. INT. CL. 35. REG. 8-3-1982.
1,203,843. TALENTIA. INT. CL. 35. REG. 8-3-1982.
1,203,845. ACTION. INT. CL. 35. REG. 8-3-1982.
1,203,853. THE BAKER STREET ASSOCIATES. INT. CL. 35. REG. 8-3-1982.
1,203,858. MCS (STYLIZED). INT. CL. 35. REG. 8-3-1982.
1,203,868. MKM (STYLIZED). INT. CL. 35. REG. 8-3-1982.
1,203,870. AA (STYLIZED). INT. CL. 36. REG. 8-3-1982.
1,203,874. KC AND DESIGN. INT. CL. 36. REG. 8-3-1982.
1,203,880. SIGNATURE PLUS. INT. CL. 36. REG. 8-3-1982.
1,203,884. XL AND DESIGN. INT. CL. 36. REG. 8-3-1982.
1,203,887. MISCELLANEOUS DESIGN. INT. CL. 36. REG. 8-3-1982.
1,203,889. CCM. INT. CL. 36. REG. 8-3-1982.
1,203,891. COMMONWEALTH CHECK SYSTEMS. INT. CL. 36. REG. 8-3-1982.
1,203,893. TAX MINIMISER (STYLIZED). INT. CL. 36. REG. 8-3-1982.
1,203,895. DUNSCITE. INT. CL. 36. REG. 8-3-1982.
1,203,896. MISCELLANEOUS DESIGN. INT. CL. 36. REG. 8-3-1982.
1,203,897. OPTIMER 10. INT. CL. 36. REG. 8-3-1982.
1,203,899. ACCIGARD. INT. CL. 36. REG. 8-3-1982.
1,203,902. INDIANA NATIONAL. INT. CL. 36. REG. 8-3-1982.
1,203,903. FRANK B. HALL. INT. CL. 36. REG. 8-3-1982.
1,203,904. FRANK B. HALL AND DESIGN. INT. CL. 36. REG. 8-3-1982.
1,203,905. SAME DAY REPORTER. INT. CL. 36. REG. 8-3-1982.
1,203,908. PMCI SYSTEMS. INT. CL. 37. REG. 8-3-1982.
1,203,918. PRESCO (STYLIZED). INT. CL. 37. REG. 8-3-1982.
1,203,932. ALERT. INT. CL. 37. REG. 8-3-1982.
1,203,942. V VISTATOURS AND DESIGN. INT. CL. 39. REG. 8-3-1982.
1,203,944. PEOPLE LOVE US (STYLIZED). INT. CL. 39. REG. 8-3-1982.
1,203,951. TRANSICONEX. INT. CL. 39. REG. 8-3-1982.
1,203,967. KEN REIGN AND DESIGN. INT. CL. 40. REG. 8-3-1982.
1,203,972. PYRAMID VIDEO AND DESIGN. INT. CL. 41. REG. 8-3-1982.
1,203,979. MASTERS ANGLING TOURNAMENT. INT. CL. 41. REG. 8-3-1982.
1,203,987. BRICK. INT. CL. 41. REG. 8-3-1982.
1,204,002. INTERSKATE. INT. CL. 41. REG. 8-3-1982.
1,204,004. FULL FORCE. INT. CL. 41. REG. 8-3-1982.
1,204,012. CCC CINEMA GROUP (STYLIZED). INT. CL. 41. REG. 8-3-1982.
1,204,015. SEXTON EDUCATIONAL CENTERS AND DESIGN. INT. CL. 41. REG. 8-3-1982.
1,204,016. USA AND DESIGN. INT. CL. 41. REG. 8-3-1982.
1,204,017. U.S. OYAMA KYOKUSHIN KARATE AND DESIGN. INT. CL. 41. REG. 8-3-1982.
1,204,018. MAS OYAMA'S U.S.A. KYOKUSHIN KARATE AND DESIGN. INT. CL. 41. REG. 8-3-1982.
1,204,033. DAY'N NITE. INT. CL. 42. REG. 8-3-1982.
1,204,036. BY MORITZ AND DESIGN. INT. CL. 42. REG. 8-3-1982.
1,204,040. YOUNG FOLKS 2ND TIME AROUND AND DESIGN. INT. CL. 42. REG. 8-3-1982.
1,204,041. KEEPING AMERICA GREEN SINCE 1909. INT. CL. 42. REG. 8-3-1982.
1,204,042. Q QUALITY FARM HOME AUTO AND DESIGN. INT. CL. 42. REG. 8-3-1982.
1,204,043. Q (STYLIZED). INT. CL. 42. REG. 8-3-1982.
1,204,044. Q QUALITY AND DESIGN. INT. CL. 42. REG. 8-3-1982.
1,204,046. BIOCHEM TECHNOLOGY, INC. (STYLIZED). INT. CL. 42. REG. 8-3-1982.
1,204,049. ORTHOPAEDIC INDEX (STYLIZED). INT. CL. 42. REG. 8-3-1982.
1,204,056. LEATHERGRAM. INT. CL. 42. REG. 8-3-1982.
1,204,057. SUPREME DONUTS DAISY FRESH AND DESIGN. INT. CL. 42. REG. 8-3-1982.
1,204,067. SE SELECT EMBRYOS AND DESIGN. INT. CL. 42. REG. 8-3-1982.
1,204,069. HORIZON. INT. CL. 42. REG. 8-3-1982.
1,204,070. SUDAN INTERIOR MISSION. INT. CL. 42. REG. 8-3-1982.
1,204,082. NUTRI-SCAN. INT. CL. 42. REG. 8-3-1982.
1,204,090. MISCELLANEOUS DESIGN. INT. CL. 42. REG. 8-3-1982.
1,204,094. NOBEL MART. INT. CL. 42. REG. 8-3-1982.
1,204,099. CAREER AIDS. INT. CL. 42. REG. 8-3-1982.
1,204,100. BF BIG FRANK AND DESIGN. INT. CL. 42. REG. 8-3-1982.
1,204,105. SETH AND JED (STYLIZED). INT. CL. 42. REG. 8-3-1982.
1,204,106. J. JILL LTD. AND DESIGN. INT. CL. 42. REG. 8-3-1982.
1,204,107. IMPERIAL 400 AND DESIGN. INT. CL. 42. REG. 8-3-1982.
1,204,113. COME IN OUT OF THE COLD. INT. CL. 42. REG. 8-3-1982.
1,204,123. MOUNTAIN MEXICAN FOOD AND DESIGN. INT. CL. 42. REG. 8-3-1982.
1,204,126. SHARI'S (STYLIZED). INT. CL. 42. REG. 8-3-1982.
1,204,127. THE PIPER. INT. CL. 42. REG. 8-3-1982.
1,204,128. ACME AND DESIGN. INT. CL. 42. REG. 8-3-1982.

- 1,204,131. B.A.S.S. CHAPTER FEDERATION AND DESIGN. U.S. CL. 200. REG. 8-3-1982.
- 1,204,134. GUILD OF PROFESSIONAL PAPERHANGERS, INC. AND DESIGN. U.S. CL. 200. REG. 8-3-1982.
- 1,204,137. CANADA MINK AND DESIGN. U.S. CL. A. REG. 8-3-1982.
- 1,204,140. HOW TO BUILD A MILLION DOLLAR PRACTICE: A SYSTEMS APPROACH TO MARKETING CPA. INT. CLS. 16 AND 41. REG. 8-3-1982.
- 1,204,142. MISCELLANEOUS DESIGN. INT. CL. 9. REG. 8-3-1982.
- 1,204,152. CAMPAIGN PRACTICES REPORTS. INT. CL. 16. REG. 8-3-1982.
- 1,204,157. CORK-PLY (STYLIZED). INT. CL. 17. REG. 8-3-1982.
- 1,204,158. LASERFRAME (STYLIZED). INT. CL. 20. REG. 8-3-1982.
- 1,204,164. CHIC 'N MEAT. INT. CL. 30. REG. 8-3-1982.
- 1,204,166. CEDAR CAT. INT. CL. 31. REG. 8-3-1982.
- 1,204,168. MISCELLANEOUS DESIGN. INT. CL. 33. REG. 8-3-1982.
- 1,204,170. INSTITUTE FOR LIFE ENERGY. INT. CL. 41. REG. 8-3-1982.
- 1,204,171. PLUMBING MART. INT. CL. 42. REG. 8-3-1982.
- 1,204,177. IMMUNOLOGIC ASSOCIATES. INT. CL. 42. REG. 8-3-1982.
- 1,225,724. PHYSIO-CONTROL. INT. CLS. 5 AND 9 ONLY. REG. 2-1-1983.
- 1,652,817. MOIST N GRO. INT. CL. 1. REG. 8-6-1991.
- 1,682,278. EM ERIKA MEYEROVICH GALLERY AND DESIGN. INT. CL. 42. REG. 4-7-1992.
- 1,682,716. PASSPORT. INT. CL. 9. REG. 4-14-1992.
- 1,683,781. EZ2C. INT. CL. 16. REG. 4-21-1992.
- 1,683,843. MISCELLANEOUS DESIGN. INT. CL. 25. REG. 4-21-1992.
- 1,683,931. LOST TRAIL. INT. CL. 32. REG. 4-21-1992.
- 1,695,855. ACCU-WEATHER SAID IT WOULD. INT. CL. 9 ONLY. REG. 6-23-1992.
- 1,704,426. TYLER AND DESIGN. INT. CL. 1. REG. 8-4-1992.
- 1,704,433. SURCRUM. INT. CL. 1. REG. 8-4-1992.
- 1,704,443. THE TAPWATER TOUR. INT. CL. 1. REG. 8-4-1992.
- 1,704,455. KRYPROTEK. INT. CLS. 1 AND 20. REG. 8-4-1992.
- 1,704,467. 84 LUMBER. INT. CL. 2. REG. 8-4-1992.
- 1,704,484. PLANISOL - M. INT. CL. 3. REG. 8-4-1992.
- 1,704,488. HAPPY HOLIDAYS. INT. CLS. 3 AND 5. REG. 8-4-1992.
- 1,704,502. OTR. INT. CL. 4. REG. 8-4-1992.
- 1,704,505. DOT. INT. CL. 5. REG. 8-4-1992.
- 1,704,521. NIGOLD. INT. CL. 6. REG. 8-4-1992.
- 1,704,523. PHOENIX FASTENER COMPANY. INT. CL. 6. REG. 8-4-1992.
- 1,704,533. ATSA. INT. CL. 6. REG. 8-4-1992.
- 1,704,534. PROFESSIONAL REMODELER SERIES. INT. CL. 6. REG. 8-4-1992.
- 1,704,536. WALLSAFE (STYLIZED). INT. CL. 6. REG. 8-4-1992.
- 1,704,537. STOWAWAY (STYLIZED). INT. CL. 6. REG. 8-4-1992.
- 1,704,539. MICROTUFF. INT. CL. 6. REG. 8-4-1992.
- 1,704,546. KDC PARTS. INT. CLS. 7 AND 12. REG. 8-4-1992.
- 1,704,550. H HUSQVARNA FOREST & GARDEN AND DESIGN. INT. CL. 7. REG. 8-4-1992.
- 1,704,553. TYCOM. INT. CLS. 7 AND 37. REG. 8-4-1992.
- 1,704,563. DMT. INT. CL. 7. REG. 8-4-1992.
- 1,704,567. TRU-IMAGE. INT. CL. 7. REG. 8-4-1992.
- 1,704,573. RETRACTASTOP. INT. CL. 7. REG. 8-4-1992.
- 1,704,576. INFINITY. INT. CL. 7. REG. 8-4-1992.
- 1,704,580. STELLA AND DESIGN. INT. CL. 7. REG. 8-4-1992.
- 1,704,582. BESTFIT. INT. CLS. 8 AND 14. REG. 8-4-1992.
- 1,704,585. TRUE TEMPER HARDWARE REAL TOOLS FOR KIDS. INT. CL. 8. REG. 8-4-1992.
- 1,704,588. D.I.Y.. INT. CL. 8. REG. 8-4-1992.
- 1,704,597. EXPERTEXT. INT. CLS. 9 AND 42. REG. 8-4-1992.
- 1,704,600. PROMIX. INT. CL. 9. REG. 8-4-1992.
- 1,704,604. PLANTWORKS. INT. CLS. 9 AND 16. REG. 8-4-1992.
- 1,704,611. SPOT. INT. CLS. 9 AND 42. REG. 8-4-1992.
- 1,704,616. H2OPAK AND DESIGN. INT. CL. 9. REG. 8-4-1992.
- 1,704,621. MISCELLANEOUS DESIGN. INT. CL. 9. REG. 8-4-1992.
- 1,704,643. APS AUTECH POWER SYSTEMS (STYLIZED). INT. CL. 9. REG. 8-4-1992.
- 1,704,653. CHROME BRIGHTS. INT. CL. 9. REG. 8-4-1992.
- 1,704,660. TELESRIPT (STYLIZED). INT. CL. 9. REG. 8-4-1992.
- 1,704,664. CYCLOPS COMPAC. INT. CL. 9. REG. 8-4-1992.
- 1,704,667. HOOKED ON COUNTRY (STYLIZED). INT. CL. 9. REG. 8-4-1992.
- 1,704,668. HOOKED ON POLKAS (STYLIZED). INT. CL. 9. REG. 8-4-1992.
- 1,704,678. MICROWAVE EXPLORER. INT. CL. 9. REG. 8-4-1992.
- 1,704,686. IBOC (STYLIZED). INT. CL. 9. REG. 8-4-1992.
- 1,704,699. RETROSKOP. INT. CL. 9. REG. 8-4-1992.
- 1,704,706. MICROSWEET. INT. CL. 9. REG. 8-4-1992.
- 1,704,707. AEA (STYLIZED). INT. CL. 9. REG. 8-4-1992.
- 1,704,711. MULTISOUND. INT. CL. 9. REG. 8-4-1992.
- 1,704,724. CAT-LINKS. INT. CLS. 9 AND 40. REG. 8-4-1992.
- 1,704,725. HIERARCHY. INT. CL. 9. REG. 8-4-1992.
- 1,704,757. SHARPLASE. INT. CL. 10. REG. 8-4-1992.
- 1,704,760. MM MEDALLION VALUE PERFORMANCE QUALITY AND DESIGN. INT. CL. 10. REG. 8-4-1992.
- 1,704,763. MAXRIST. INT. CL. 10. REG. 8-4-1992.
- 1,704,770. CINEPAR. INT. CL. 11. REG. 8-4-1992.
- 1,704,771. THERMOCASE. INT. CL. 11. REG. 8-4-1992.
- 1,704,778. MANHATTAN. INT. CL. 11. REG. 8-4-1992.
- 1,704,779. DF AND DESIGN. INT. CL. 11. REG. 8-4-1992.
- 1,704,782. MISCELLANEOUS DESIGN. INT. CL. 11. REG. 8-4-1992.
- 1,704,785. EVEN GLO. INT. CL. 11. REG. 8-4-1992.
- 1,704,786. MANNHARDT AND DESIGN. INT. CL. 11. REG. 8-4-1992.
- 1,704,799. BROWARD. INT. CLS. 12 AND 36. REG. 8-4-1992.
- 1,704,805. AMTRAN (STYLIZED). INT. CL. 12. REG. 8-4-1992.
- 1,704,811. AUTOZONE. INT. CL. 12. REG. 8-4-1992.
- 1,704,828. REEBOK. INT. CL. 14. REG. 8-4-1992.
- 1,704,830. DENTON (STYLIZED). INT. CL. 14. REG. 8-4-1992.
- 1,704,831. FELLOWSHIP FOUNDRY. INT. CL. 14. REG. 8-4-1992.
- 1,704,832. MISCELLANEOUS DESIGN. INT. CL. 14. REG. 8-4-1992.
- 1,704,837. BEAD IT BY JOTALY. INT. CL. 14. REG. 8-4-1992.
- 1,704,843. HIGH COUNTRY. INT. CL. 14. REG. 8-4-1992.
- 1,704,844. SS AND DESIGN. INT. CL. 14. REG. 8-4-1992.
- 1,704,845. MIRROR-FLEX (STYLIZED). INT. CL. 14. REG. 8-4-1992.
- 1,704,847. EMPRESS CUT AND DESIGN. INT. CL. 14. REG. 8-4-1992.
- 1,704,851. ARTELLE DESIGNS (STYLIZED). INT. CL. 14. REG. 8-4-1992.
- 1,704,853. MISCELLANEOUS DESIGN. INT. CL. 14. REG. 8-4-1992.
- 1,704,860. EDWARD DEBONO'S GENERAL PURPOSE CODE. INT. CL. 16. REG. 8-4-1992.
- 1,704,862. HEALTHWIRE. INT. CL. 16. REG. 8-4-1992.
- 1,704,876. GLOBAL CREATIVITY. INT. CL. 16. REG. 8-4-1992.
- 1,704,891. PATTERN PALS (STYLIZED). INT. CL. 16. REG. 8-4-1992.
- 1,704,893. MISCELLANEOUS DESIGN. INT. CL. 16. REG. 8-4-1992.
- 1,704,894. IMPCTFILM. INT. CL. 16. REG. 8-4-1992.
- 1,704,912. ANCHOR AND DESIGN. INT. CLS. 16 AND 17. REG. 8-4-1992.
- 1,704,913. CARING PEOPLE BIBLE STUDIES. INT. CL. 16. REG. 8-4-1992.
- 1,704,919. WEEKDAYS AT THE FAIR. INT. CL. 16. REG. 8-4-1992.
- 1,704,924. MISCELLANEOUS DESIGN. INT. CL. 16. REG. 8-4-1992.

- 1,704,940. I LOVE NY AND DESIGN. INT. CL. 16. REG. 8-4-1992.
- 1,704,944. R AND DESIGN. INT. CL. 16. REG. 8-4-1992.
- 1,704,945. STRICTLY PERSONAL. INT. CL. 16. REG. 8-4-1992.
- 1,704,949. PONTIAC. INT. CL. 16. REG. 8-4-1992.
- 1,704,958. TRI-LITE PLUS. INT. CL. 16. REG. 8-4-1992.
- 1,704,960. THE CAPEL TRADITION. INT. CL. 16. REG. 8-4-1992.
- 1,704,975. JENST BINDER. INT. CL. 16. REG. 8-4-1992.
- 1,704,979. AMOTECH. INT. CL. 17. REG. 8-4-1992.
- 1,704,982. POLYHOLYN. INT. CL. 17. REG. 8-4-1992.
- 1,704,994. SIZZLER. INT. CL. 18. REG. 8-4-1992.
- 1,704,996. FLEXTech. INT. CL. 18. REG. 8-4-1992.
- 1,704,998. TRIPPER. INT. CL. 18. REG. 8-4-1992.
- 1,705,001. TPT. INT. CL. 19. REG. 8-4-1992.
- 1,705,004. FICON. INT. CL. 19. REG. 8-4-1992.
- 1,705,008. RENU-STRIP. INT. CL. 19. REG. 8-4-1992.
- 1,705,014. RE-BOX "IT" AND DESIGN. INT. CL. 20. REG. 8-4-1992.
- 1,705,016. OUR BABY IMPRESSIONS (STYLIZED). INT. CL. 20. REG. 8-4-1992.
- 1,705,032. REEF READY. INT. CL. 20. REG. 8-4-1992.
- 1,705,037. TENNA-RIDE. INT. CL. 20. REG. 8-4-1992.
- 1,705,047. FLAIR AND DESIGN. INT. CL. 21. REG. 8-4-1992.
- 1,705,048. LEGEND. INT. CL. 21. REG. 8-4-1992.
- 1,705,056. MISCELLANEOUS DESIGN. INT. CL. 21. REG. 8-4-1992.
- 1,705,065. VALZER (STYLIZED). INT. CLS. 22, 23, 24 AND 27. REG. 8-4-1992.
- 1,705,081. GOURMET CLASSICS. INT. CLS. 24 AND 25. REG. 8-4-1992.
- 1,705,082. ULTRACALE. INT. CL. 24. REG. 8-4-1992.
- 1,705,089. HARRY ROSEN. INT. CL. 25. REG. 8-4-1992.
- 1,705,098. JUST GO TO SLEEP!. INT. CL. 25. REG. 8-4-1992.
- 1,705,107. FLEXIFOIL AND DESIGN. INT. CLS. 25 AND 28. REG. 8-4-1992.
- 1,705,111. INTERSCOPE RECORDS. INT. CL. 25. REG. 8-4-1992.
- 1,705,127. CHRISTY HALL. INT. CL. 25. REG. 8-4-1992.
- 1,705,130. BUCKLEY BAY. INT. CL. 25. REG. 8-4-1992.
- 1,705,145. SKI-SHUTTLE. INT. CL. 28. REG. 8-4-1992.
- 1,705,148. DESTINY. INT. CL. 28. REG. 8-4-1992.
- 1,705,153. THEIR FINEST HOUR THE BATTLE OF BRITAIN. INT. CL. 28. REG. 8-4-1992.
- 1,705,154. 'QUALITY-TIME' TOYS. INT. CL. 28. REG. 8-4-1992.
- 1,705,158. SUPER CIRCUS. INT. CL. 28. REG. 8-4-1992.
- 1,705,163. MINERVA. INT. CL. 28. REG. 8-4-1992.
- 1,705,168. Z LEADER AND DESIGN. INT. CL. 28. REG. 8-4-1992.
- 1,705,173. SKINEX. INT. CL. 28. REG. 8-4-1992.
- 1,705,177. PUSH-PEDAL-PULL. INT. CL. 28. REG. 8-4-1992.
- 1,705,186. MALIBU. INT. CL. 28. REG. 8-4-1992.
- 1,705,197. NORTHWATER. INT. CL. 29. REG. 8-4-1992.
- 1,705,208. TREASURE FOODS. INT. CL. 29. REG. 8-4-1992.
- 1,705,221. XLT. INT. CL. 29. REG. 8-4-1992.
- 1,705,225. OCEAN CLASSIC. INT. CL. 29. REG. 8-4-1992.
- 1,705,227. FUL-O-FLAVOR (STYLIZED). INT. CL. 29. REG. 8-4-1992.
- 1,705,228. DIXIE FARM. INT. CL. 29. REG. 8-4-1992.
- 1,705,229. LAKE REGION. INT. CL. 29. REG. 8-4-1992.
- 1,705,231. LA PICCOLINA. INT. CL. 30. REG. 8-4-1992.
- 1,705,232. REAMES FREE. INT. CL. 30. REG. 8-4-1992.
- 1,705,246. JUNGLE BAR (STYLIZED). INT. CL. 30. REG. 8-4-1992.
- 1,705,247. GORILLA BAR (STYLIZED). INT. CL. 30. REG. 8-4-1992.
- 1,705,248. HF CHO FU AND DESIGN. INT. CL. 30. REG. 8-4-1992.
- 1,705,260. HIGH GEAR. INT. CL. 30. REG. 8-4-1992.
- 1,705,274. PROBABLY THE BEST AND DESIGN. INT. CL. 31. REG. 8-4-1992.
- 1,705,278. GOLD CROWN AND DESIGN. INT. CL. 31. REG. 8-4-1992.
- 1,705,295. SALA VIVE. INT. CL. 33. REG. 8-4-1992.
- 1,705,302. PRINCIPESSA GAVI VIGNA REGALE. INT. CL. 33. REG. 8-4-1992.
- 1,705,308. WAREHOUSE EQUIPMENT AND SUPPLY CO. W SIN AND DESIGN. INT. CLS. 35, 37 AND 42. REG. 8-4-1992.
- 1,705,316. "NATIONAL IN SCOPE ... REGIONALLY DIRECTED ... PERSONALLY IN TOUCH". INT. CL. 35. REG. 8-4-1992.
- 1,705,320. LOFS. INT. CL. 35. REG. 8-4-1992.
- 1,705,326. AUTOMATE (STYLIZED). INT. CL. 35. REG. 8-4-1992.
- 1,705,329. SOQNOP. INT. CL. 35. REG. 8-4-1992.
- 1,705,332. MIDCO COMMUNICATIONS, INC. AND DESIGN. INT. CLS. 35, 38 AND 42. REG. 8-4-1992.
- 1,705,338. ON-TRAC. INT. CL. 35. REG. 8-4-1992.
- 1,705,347. DESIGN DYNAMICS. INT. CL. 35. REG. 8-4-1992.
- 1,705,357. BRAMBLES AND DESIGN. INT. CL. 35. REG. 8-4-1992.
- 1,705,358. KEY PRODUCER AND DESIGN. INT. CL. 35. REG. 8-4-1992.
- 1,705,360. AGRIMETRICS. INT. CL. 35. REG. 8-4-1992.
- 1,705,376. ASU AMERICAN SPECIALTY UNDERWRITERS INC. AND DESIGN. INT. CL. 36. REG. 8-4-1992.
- 1,705,386. BRADFORD INTERNATIONAL. INT. CL. 36. REG. 8-4-1992.
- 1,705,391. FIMC AN OLD REPUBLIC COMPANY (STYLIZED). INT. CL. 36. REG. 8-4-1992.
- 1,705,393. MEGA. INT. CL. 36. REG. 8-4-1992.
- 1,705,411. CGA. INT. CL. 36. REG. 8-4-1992.
- 1,705,413. CLASSIC JOINT FIRST-TO-DIE POLICY. INT. CL. 36. REG. 8-4-1992.
- 1,705,417. COMAC SYSTEMS. INT. CL. 37. REG. 8-4-1992.
- 1,705,418. THE VANGUARD PROCESS. INT. CL. 37. REG. 8-4-1992.
- 1,705,421. BFI WASTE SYSTEMS. INT. CL. 37. REG. 8-4-1992.
- 1,705,426. AMS AND DESIGN. INT. CL. 37. REG. 8-4-1992.
- 1,705,429. HEWLETT PACKARD. INT. CL. 37. REG. 8-4-1992.
- 1,705,431. MOBIUS. INT. CL. 37. REG. 8-4-1992.
- 1,705,432. BFI MOBIUS AND DESIGN. INT. CL. 37. REG. 8-4-1992.
- 1,705,434. COMBINING OUR ENERGIES. INT. CLS. 37, 41 AND 42. REG. 8-4-1992.
- 1,705,437. TEKSHOP. INT. CL. 37. REG. 8-4-1992.
- 1,705,443. CHAMBER NET. INT. CLS. 38 AND 42. REG. 8-4-1992.
- 1,705,446. SIGNAL RING. INT. CL. 38. REG. 8-4-1992.
- 1,705,451. MCI HOSTCONNECT. INT. CL. 38. REG. 8-4-1992.
- 1,705,457. VACATION YOUR WAY. INT. CL. 39. REG. 8-4-1992.
- 1,705,465. SMECO. INT. CL. 39. REG. 8-4-1992.
- 1,705,468. CONNEX PIPE SYSTEMS. INT. CL. 40. REG. 8-4-1992.
- 1,705,472. ASK AGAIN. INT. CL. 40. REG. 8-4-1992.
- 1,705,476. WORLD CHAMPIONSHIP BARBECUE COOKING CONTEST MEMPHIS IN MAY INTERNATIONAL FESTIVAL, INC. AND DESIGN. INT. CL. 41. REG. 8-4-1992.
- 1,705,480. THE SCHOOL OF CULINARY ARTS AND DESIGN. INT. CL. 41. REG. 8-4-1992.
- 1,705,481. THE DON COSSACK CHORUS & DANCERS OF AMERICA. INT. CL. 41. REG. 8-4-1992.
- 1,705,503. HUMMER/BIRD CELEBRATION! AND DESIGN. INT. CL. 41. REG. 8-4-1992.
- 1,705,509. MISCELLANEOUS DESIGN. INT. CL. 41. REG. 8-4-1992.
- 1,705,513. SNAKE CHUTE. INT. CL. 41. REG. 8-4-1992.
- 1,705,547. MOUNTAIN BIKE SPECIALISTS AND DESIGN. INT. CL. 42. REG. 8-4-1992.
- 1,705,548. "HAND-MADE FOR THAT PERSONAL TOUCH" (STYLIZED). INT. CL. 42. REG. 8-4-1992.
- 1,705,551. HOME HEALTH PLUS AND DESIGN. INT. CL. 42. REG. 8-4-1992.
- 1,705,561. CARY AUDIO DESIGN (STYLIZED). INT. CL. 42. REG. 8-4-1992.
- 1,705,571. PET SUPPLY DEPOT AND DESIGN. INT. CL. 42. REG. 8-4-1992.
- 1,705,572. CHURCHMART A NATIONWIDE MINISTRY OF CBA OF AMERICA AND DESIGN. INT. CL. 42. REG. 8-4-1992.

- 1,705,584. MISCELLANEOUS DESIGN. INT. CL. 42. REG. 8-4-1992.
- 1,705,588. MOXIE JAVA AND DESIGN. INT. CL. 42. REG. 8-4-1992.
- 1,705,590. F P G INTERNATIONAL AND DESIGN. INT. CL. 42. REG. 8-4-1992.
- 1,705,596. DATA-PROBE. INT. CL. 42. REG. 8-4-1992.
- 1,705,597. KG AND DESIGN. INT. CL. 42. REG. 8-4-1992.
- 1,705,600. DYMALON, INC. AND DESIGN. INT. CL. 42. REG. 8-4-1992.
- 1,705,604. MILLS-PENINSULA HOSPITALS AND DESIGN. INT. CL. 42. REG. 8-4-1992.
- 1,705,607. KEEPING THE FAMILY TOGETHER. INT. CL. 42. REG. 8-4-1992.
- 1,705,614. PROVAR, INC.. INT. CL. 42. REG. 8-4-1992.
- 1,705,617. PLAN PAK (STYLIZED). INT. CL. 42. REG. 8-4-1992.
- 1,705,623. MISCELLANEOUS DESIGN. INT. CL. 42. REG. 8-4-1992.
- 1,705,626. AVIAN SPECIALTIES AND DESIGN. INT. CL. 42. REG. 8-4-1992.
- 1,705,627. SOCIETY OF INDEPENDENT GASOLINE MARKETERS OF AMERICA (STYLIZED). INT. CL. 42. REG. 8-4-1992.
- 1,705,629. HS (STYLIZED). INT. CL. 42. REG. 8-4-1992.
- 1,705,639. EVERYBODY'S SOMEBODY AT TEXANA GRILL (STYLIZED). INT. CL. 42. REG. 8-4-1992.
- 1,705,653. GRAMIE'S PANCAKES AND DESIGN. INT. CL. 42. REG. 8-4-1992.
- 1,705,660. JB'S BAKERY. INT. CL. 42. REG. 8-4-1992.
- 1,705,665. MISCELLANEOUS DESIGN. INT. CL. 42. REG. 8-4-1992.
- 1,705,667. THE GALLEY GAL AND DESIGN. INT. CL. 42. REG. 8-4-1992.
- 1,705,668. ROOTY'S. INT. CL. 42. REG. 8-4-1992.
- 1,705,674. SPECTRUM RENTS. INT. CL. 42. REG. 8-4-1992.
- 1,705,675. CALDOR. INT. CL. 42. REG. 8-4-1992.
- 1,705,679. AAFA AMERICAN ASSOCIATION OF FINANCE & ACCOUNTING. U.S. CL. 200. REG. 8-4-1992.
- 1,705,689. RISC SYSTEM/6000. INT. CLS. 9 AND 16. REG. 8-4-1992.
- 1,705,700. ATC AND DESIGN. INT. CLS. 3 AND 16. REG. 8-4-1992.
- 1,705,701. ADVANTAGE 2000. INT. CLS. 1 AND 7. REG. 8-4-1992.
- 1,705,717. PAMTAK. INT. CL. 1. REG. 8-4-1992.
- 1,705,726. L.A. TAN. INT. CL. 3. REG. 8-4-1992.
- 1,705,731. "I DON'T MAKE WOMEN BEAUTIFUL, I SHOW THEM THEY ALREADY ARE." INT. CL. 3. REG. 8-4-1992.
- 1,705,732. HOLD EVERYTHING. INT. CL. 3. REG. 8-4-1992.
- 1,705,735. SUPER FINISH II-T. INT. CL. 3. REG. 8-4-1992.
- 1,705,737. JUNGAMALS. INT. CL. 3. REG. 8-4-1992.
- 1,705,743. DUOPHASE. INT. CL. 5. REG. 8-4-1992.
- 1,705,748. FLESHTONES. INT. CL. 5. REG. 8-4-1992.
- 1,705,760. ULTRA LAST. INT. CL. 8. REG. 8-4-1992.
- 1,705,764. FOCUS AND DESIGN. INT. CL. 9. REG. 8-4-1992.
- 1,705,767. STX. INT. CL. 9. REG. 8-4-1992.
- 1,705,770. PEDSEAL. INT. CL. 9. REG. 8-4-1992.
- 1,705,784. GC GATE CITY AND DESIGN. INT. CL. 9. REG. 8-4-1992.
- 1,705,785. DYNOMATE. INT. CL. 9. REG. 8-4-1992.
- 1,705,789. ELDORADO. INT. CL. 9. REG. 8-4-1992.
- 1,705,799. THE RELIABLE. INT. CL. 10. REG. 8-4-1992.
- 1,705,800. IVUS AND DESIGN. INT. CL. 10. REG. 8-4-1992.
- 1,705,803. UNISURGE. INT. CL. 10. REG. 8-4-1992.
- 1,705,804. 14K. INT. CL. 10. REG. 8-4-1992.
- 1,705,805. GRAFTASSIST. INT. CL. 10. REG. 8-4-1992.
- 1,705,809. SOFSEAT. INT. CL. 10. REG. 8-4-1992.
- 1,705,812. LIVING WITH THE BEST. INT. CL. 11. REG. 8-4-1992.
- 1,705,813. MAGNUM. INT. CL. 11. REG. 8-4-1992.
- 1,705,819. MUD MACHINE. INT. CL. 12. REG. 8-4-1992.
- 1,705,824. REEMPLAR. INT. CL. 15. REG. 8-4-1992.
- 1,705,827. AMERICAN ROCKERS. INT. CL. 15. REG. 8-4-1992.
- 1,705,840. VALLEY FARE. INT. CL. 16. REG. 8-4-1992.
- 1,705,843. ICENTA. INT. CL. 16. REG. 8-4-1992.
- 1,705,844. AVONOVA. INT. CL. 16. REG. 8-4-1992.
- 1,705,847. MATH AMERICA. INT. CL. 16. REG. 8-4-1992.
- 1,705,849. EXHIBITTALK. INT. CL. 16. REG. 8-4-1992.
- 1,705,853. CUSTOM SEALDON. INT. CL. 19. REG. 8-4-1992.
- 1,705,855. LIVING WITH THE BEST. INT. CL. 19. REG. 8-4-1992.
- 1,705,867. EASY GLIDER. INT. CL. 21. REG. 8-4-1992.
- 1,705,868. MUNCHMATE. INT. CL. 21. REG. 8-4-1992.
- 1,705,875. FREN-Z (STYLIZED). INT. CL. 25. REG. 8-4-1992.
- 1,705,891. INT EST (STYLIZED). INT. CL. 28. REG. 8-4-1992.
- 1,705,898. WEDDING DAY. INT. CL. 28. REG. 8-4-1992.
- 1,705,900. STROLLERS. INT. CL. 28. REG. 8-4-1992.
- 1,705,903. POWER PROP (STYLIZED). INT. CL. 28. REG. 8-4-1992.
- 1,705,904. WALLBANGERS (STYLIZED). INT. CL. 28. REG. 8-4-1992.
- 1,705,912. FLEXERCISER. INT. CL. 28. REG. 8-4-1992.
- 1,705,914. SLUGFEST. INT. CL. 28. REG. 8-4-1992.
- 1,705,936. DON'T PANIC, IT'S ORGANIC. INT. CL. 31. REG. 8-4-1992.
- 1,705,938. HERB PATCH. INT. CL. 31. REG. 8-4-1992.
- 1,705,939. CAT CHOW SPECIAL CARE FORMULA. INT. CL. 31. REG. 8-4-1992.
- 1,705,948. MEDIUM. INT. CL. 35. REG. 8-4-1992.
- 1,705,962. HAA ONE YEAR WARRANTY AND DESIGN. INT. CL. 36. REG. 8-4-1992.
- 1,705,965. UNITERA (STYLIZED). INT. CL. 38. REG. 8-4-1992.
- 1,705,966. METAMODE. INT. CL. 40. REG. 8-4-1992.
- 1,705,968. INNER VOICES. INT. CL. 41. REG. 8-4-1992.
- 1,705,975. Z-PIX COMPUTER GRAPHICS CENTERS. INT. CL. 42. REG. 8-4-1992.
- 1,705,982. SANKEY. INT. CLS. 7 AND 9. REG. 8-4-1992.
- 1,705,984. ELECTRONIC RETAILING SYSTEMS INTERNATIONAL. INT. CLS. 37 AND 42. REG. 8-4-1992.
- 1,705,986. CONFIGURED ENERGY SYSTEMS. INT. CLS. 9 AND 42. REG. 8-4-1992.
- 1,705,987. SUPERAUDIO. INT. CLS. 38 AND 41. REG. 8-4-1992.
- 1,705,988. BOWLING IS ALWAYS FUN! AND DESIGN. INT. CLS. 16 AND 21. REG. 8-4-1992.
- 1,705,992. SILK-STRIP. INT. CL. 5. REG. 8-4-1992.
- 1,705,994. CRUSHER DELUXE. INT. CL. 7. REG. 8-4-1992.
- 1,706,002. THE FINANCIAL ANALYZER. INT. CL. 9. REG. 8-4-1992.
- 1,706,004. INTERLOCKS. INT. CL. 9. REG. 8-4-1992.
- 1,706,015. INTERNATIONAL TRADE SOURCEBOOK. INT. CL. 16. REG. 8-4-1992.
- 1,706,023. THE MOVIE BOOK. INT. CL. 16. REG. 8-4-1992.
- 1,706,025. STUDENTVIEW. INT. CL. 16. REG. 8-4-1992.
- 1,706,026. REAL BRICK AND DESIGN. INT. CL. 19. REG. 8-4-1992.
- 1,706,037. BARTOLO ATHLETIC. INT. CL. 25. REG. 8-4-1992.
- 1,706,038. U.S. RUGGED. INT. CL. 25. REG. 8-4-1992.
- 1,706,055. NEURO-LINGUISTIC SUBLIMINALS. INT. CL. 41. REG. 8-4-1992.
- 1,706,061. CASSETTE-OF-THE-MONTH CLUB. INT. CL. 42. REG. 8-4-1992.
- 1,706,063. AMERICAN SHELL COMPANY. INT. CL. 42. REG. 8-4-1992.
- 1,706,067. PAZZI'S. INT. CL. 42. REG. 8-4-1992.
- 1,755,546. FACUNDO (STYLIZED). INT. CL. 31 ONLY. REG. 3-2-1993.
- 1,756,442. KERKER. INT. CL. 7 ONLY. REG. 3-9-1993.
- 1,780,528. CVS. INT. CL. 35. REG. 7-6-1993.
- 1,886,162. LATINAS. INT. CL. 25. REG. 3-28-1995.
- 1,932,532. EXPOSE (STYLIZED). INT. CLS. 9 AND 16. REG. 11-7-1995.
- 1,938,145. CINCINNATI KITCHEN, BATH & DESIGN SHOW. INT. CL. 35. REG. 11-28-1995.
- 1,947,899. DONALDSON AND DESIGN. INT. CL. 20. REG. 1-16-1996.
- 1,966,367. WAKE NO-MORE. INT. CL. 12. REG. 4-9-1996.
- 1,971,237. A YARD OF BUBBLEGUM AND DESIGN. INT. CL. 30. REG. 4-30-1996.
- 1,971,981. DALLAS BUSINESS REVIEW. INT. CL. 16. REG. 4-30-1996.

- 1,974,294. UGENEX. INT. CLS. 9 AND 10 ONLY. REG. 5-14-1996.
- 1,985,674. IODINE. INT. CL. 41. REG. 7-9-1996.
- 1,986,508. FURNITURE KINGDOM AND DESIGN. INT. CL. 42. REG. 7-16-1996.
- 1,987,238. SWEAT XPRESS, LTD.. INT. CL. 41. REG. 7-16-1996.
- 1,987,846. ALL AMERICAN GIRLS PROFESSIONAL BASEBALL LEAGUE. INT. CL. 14 ONLY. REG. 7-23-1996.
- 1,990,608. GOANNA. INT. CL. 25. REG. 8-6-1996.
- 1,990,609. GEAMATICS AND DESIGN. INT. CLS. 7, 9, 35, 37, 41 AND 42. REG. 8-6-1996.
- 1,990,610. DECOY. INT. CL. 1. REG. 8-6-1996.
- 1,990,612. PAY-LESS COLA AND DESIGN. INT. CL. 32. REG. 8-6-1996.
- 1,990,614. TENMARU (STYLIZED). INT. CL. 42. REG. 8-6-1996.
- 1,990,615. 4 FRONT (STYLIZED). INT. CLS. 35, 36, 41 AND 42. REG. 8-6-1996.
- 1,990,617. IDEA! THE NEWSLETTER FOR MARKETING THINKERS AND DESIGN. INT. CL. 16. REG. 8-6-1996.
- 1,990,618. THE ARTCARD. INT. CL. 36. REG. 8-6-1996.
- 1,990,619. WRANGLER (STYLIZED). INT. CL. 18. REG. 8-6-1996.
- 1,990,622. WRANGLER (STYLIZED). INT. CL. 25. REG. 8-6-1996.
- 1,990,623. VISIONS OF REALITY. INT. CL. 28. REG. 8-6-1996.
- 1,990,624. BIG BALLS AND DESIGN. INT. CL. 25. REG. 8-6-1996.
- 1,990,625. PIQUANT ('PE-KANT) THE TASTE ENHANCER AND DESIGN. INT. CLS. 29 AND 30. REG. 8-6-1996.
- 1,990,627. USTELECENTERS AND DESIGN. INT. CLS. 35 AND 38. REG. 8-6-1996.
- 1,990,632. AVID. INT. CL. 25. REG. 8-6-1996.
- 1,990,634. HYDROTITE. INT. CL. 1. REG. 8-6-1996.
- 1,990,635. COMPUTERMAN. INT. CLS. 9 AND 41. REG. 8-6-1996.
- 1,990,637. THE GEORGE G. GLENNER ALZHEIMER'S FAMILY CENTER. INT. CL. 16. REG. 8-6-1996.
- 1,990,640. TLC AND DESIGN. INT. CL. 41. REG. 8-6-1996.
- 1,990,644. VITAL MAN. INT. CL. 5. REG. 8-6-1996.
- 1,990,645. SUPERSCAN. INT. CL. 9. REG. 8-6-1996.
- 1,990,646. PHYSICIANS' ADVANTAGE AND DESIGN. INT. CL. 35. REG. 8-6-1996.
- 1,990,650. PHASE CHANGE. INT. CL. 4. REG. 8-6-1996.
- 1,990,651. ALPHAMOISS. INT. CL. 3. REG. 8-6-1996.
- 1,990,652. HIMEDIA. INT. CL. 9. REG. 8-6-1996.
- 1,990,655. MISCELLANEOUS DESIGN. INT. CLS. 12, 25 AND 28. REG. 8-6-1996.
- 1,990,658. DUNA. INT. CL. 33. REG. 8-6-1996.
- 1,990,659. THE ROMANCE OF SELLING (STYLIZED). INT. CL. 41. REG. 8-6-1996.
- 1,990,660. DIGITAL MAGIC AND DESIGN. INT. CLS. 41 AND 42. REG. 8-6-1996.
- 1,990,663. STICK 'EM CHIP. INT. CL. 9. REG. 8-6-1996.
- 1,990,664. TQP (STYLIZED). INT. CLS. 6 AND 7. REG. 8-6-1996.
- 1,990,667. CLASSIC AUTO INSURANCE. INT. CL. 36. REG. 8-6-1996.
- 1,990,681. WIN. INT. CL. 36. REG. 8-6-1996.
- 1,990,683. BTS. INT. CL. 42. REG. 8-6-1996.
- 1,990,684. LAGERHEADS BAR & GRILLE AND DESIGN. INT. CL. 42. REG. 8-6-1996.
- 1,990,686. TONKA. INT. CL. 11. REG. 8-6-1996.
- 1,990,689. MISCELLANEOUS DESIGN. INT. CL. 9. REG. 8-6-1996.
- 1,990,691. TORQUE ENGINEERING CORPORATION AND DESIGN. INT. CL. 7. REG. 8-6-1996.
- 1,990,694. KIDS AT PLAY. INT. CL. 41. REG. 8-6-1996.
- 1,990,696. FRAME-NET ENCRYPT. INT. CL. 9. REG. 8-6-1996.
- 1,990,701. NMP2 (STYLIZED). INT. CL. 9. REG. 8-6-1996.
- 1,990,702. MAGIC AND DESIGN. INT. CL. 3. REG. 8-6-1996.
- 1,990,703. IDG BOOKS AND DESIGN. INT. CL. 9. REG. 8-6-1996.
- 1,990,704. INTERELEMENTS (STYLIZED). INT. CL. 25. REG. 8-6-1996.
- 1,990,706. NS/CLIENT. INT. CL. 9. REG. 8-6-1996.
- 1,990,707. INTERNATIONAL AND DESIGN. INT. CL. 25. REG. 8-6-1996.
- 1,990,709. RESIII AND DESIGN. INT. CLS. 39 AND 42. REG. 8-6-1996.
- 1,990,710. AMCI AND DESIGN. INT. CLS. 6 AND 17. REG. 8-6-1996.
- 1,990,711. BASSANINA AND DESIGN. INT. CLS. 7 AND 11. REG. 8-6-1996.
- 1,990,713. LA PIADINA AND DESIGN. INT. CL. 30. REG. 8-6-1996.
- 1,990,715. DELORME MAPPING. INT. CL. 9. REG. 8-6-1996.
- 1,990,716. NUGUARD. INT. CL. 3. REG. 8-6-1996.
- 1,990,717. PEPTITE. INT. CL. 5. REG. 8-6-1996.
- 1,990,718. NORSTAN OPTIMA 800 PLUS. INT. CL. 38. REG. 8-6-1996.
- 1,990,722. S AND DESIGN. INT. CL. 9. REG. 8-6-1996.
- 1,990,725. MICRO-AID. INT. CL. 1. REG. 8-6-1996.
- 1,990,726. EASY OFFICE CONTROL (STYLIZED). INT. CL. 9. REG. 8-6-1996.
- 1,990,728. RAVEN. INT. CL. 12. REG. 8-6-1996.
- 1,990,730. BRIGHTER CHILD SERIES AND DESIGN. INT. CL. 9. REG. 8-6-1996.
- 1,990,731. JOHNNY Q. PUBLIC. INT. CL. 41. REG. 8-6-1996.
- 1,990,732. + AND DESIGN. INT. CL. 42. REG. 8-6-1996.
- 1,990,734. EL LA DESIGN AND DESIGN. INT. CL. 25. REG. 8-6-1996.
- 1,990,735. NONTRAD MARKETING. INT. CL. 35. REG. 8-6-1996.
- 1,990,736. NORTHERN ELEMENTS. INT. CL. 18. REG. 8-6-1996.
- 1,990,737. MARISA NICOLI. INT. CL. 25. REG. 8-6-1996.
- 1,990,741. HCAA (STYLIZED). INT. CL. 41. REG. 8-6-1996.
- 1,990,742. COOL ZONE. INT. CL. 41. REG. 8-6-1996.
- 1,990,745. VISTACAST. INT. CL. 38. REG. 8-6-1996.
- 1,990,747. ARMACRETE. INT. CL. 1. REG. 8-6-1996.
- 1,990,749. GLOBAL FOCUS. INT. CL. 35. REG. 8-6-1996.
- 1,990,750. STYROTECH AND DESIGN. INT. CL. 40. REG. 8-6-1996.
- 1,990,751. TRAVEL DEPOT. INT. CL. 39. REG. 8-6-1996.
- 1,990,752. ACUITY RESIZING. INT. CL. 9. REG. 8-6-1996.
- 1,990,758. BLUE CO.. INT. CL. 25. REG. 8-6-1996.
- 1,990,761. INTERACTIVE READING JOURNEY. INT. CL. 9. REG. 8-6-1996.
- 1,990,762. WATERBORNE TRADE ATLAS. INT. CL. 9. REG. 8-6-1996.
- 1,990,763. HILCO. INT. CLS. 9, 41 AND 42. REG. 8-6-1996.
- 1,990,766. MISCELLANEOUS DESIGN. INT. CL. 30. REG. 8-6-1996.
- 1,990,768. SUPERTERMINAL AND DESIGN. INT. CL. 9. REG. 8-6-1996.
- 1,990,771. WILLIAMS, DIMOND & COMPANY. INT. CL. 39. REG. 8-6-1996.
- 1,990,775. AUTO TRANS. INT. CL. 9. REG. 8-6-1996.
- 1,990,776. FUTURE MEDICINE PUBLISHING. INT. CLS. 9 AND 16. REG. 8-6-1996.
- 1,990,777. LESSTALK. INT. CL. 9. REG. 8-6-1996.
- 1,990,780. THE MORE GAGE PROGRAM AND DESIGN. INT. CL. 36. REG. 8-6-1996.
- 1,990,782. TELESHTTLE. INT. CL. 9. REG. 8-6-1996.
- 1,990,787. IMAGE. INT. CL. 20. REG. 8-6-1996.
- 1,990,788. FLO-TRIATOR. INT. CL. 7. REG. 8-6-1996.
- 1,990,789. FLO-MASTER. INT. CL. 7. REG. 8-6-1996.
- 1,990,791. FLO-WAVE. INT. CL. 7. REG. 8-6-1996.
- 1,990,792. FOODWAYS. INT. CL. 42. REG. 8-6-1996.
- 1,990,793. CALLTALLY. INT. CL. 35. REG. 8-6-1996.
- 1,990,794. CAPSTONE AND DESIGN. INT. CLS. 16 AND 28. REG. 8-6-1996.
- 1,990,797. HEALTH SERVICES WITH MERIT, MEETING EVERY RESOURCE IN THERAPY. INT. CL. 35. REG. 8-6-1996.
- 1,990,798. AMERICAN DREAM MACHINES AND DESIGN. INT. CL. 16. REG. 8-6-1996.
- 1,990,799. FASTITLE. INT. CL. 42. REG. 8-6-1996.

- 1,990,801. SYNCHRONOMICS. INT. CL. 36. REG. 8-6-1996.
 1,990,802. UNDER THE RAINBOW AND DESIGN. INT. CL. 42. REG. 8-6-1996.
 1,990,803. OMNIPRESENTS. INT. CL. 42. REG. 8-6-1996.
 1,990,805. OF COUNSEL, INC.. INT. CL. 35. REG. 8-6-1996.
 1,990,807. SKI BRUNDAGE. INT. CL. 41. REG. 8-6-1996.
 1,990,808. TRIOX. INT. CL. 5. REG. 8-6-1996.
 1,990,810. XL ACTION CONTROLLER. INT. CL. 28. REG. 8-6-1996.
 1,990,813. SMOOTH ROMANCE. INT. CL. 31. REG. 8-6-1996.
 1,990,816. DECIDELA NINA RICCI AND DESIGN. INT. CL. 3. REG. 8-6-1996.
 1,990,817. SYNTU. INT. CL. 9. REG. 8-6-1996.
 1,990,820. KIDS WEAR AND DESIGN. INT. CLS. 25 AND 26. REG. 8-6-1996.
 1,990,824. THE BEAN COUNTER. INT. CL. 16. REG. 8-6-1996.
 1,990,827. MUCHO MANGO. INT. CL. 32. REG. 8-6-1996.
 1,990,830. GAS COOLING ADVISOR. INT. CL. 9. REG. 8-6-1996.
 1,990,831. NOX CONTROL ADVISOR. INT. CL. 9. REG. 8-6-1996.
 1,990,835. BUSINESSLINK. INT. CL. 9. REG. 8-6-1996.
 1,990,836. BIRKATIL. INT. CL. 5. REG. 8-6-1996.
 1,990,840. WORK IT. INT. CLS. 25 AND 41. REG. 8-6-1996.
 1,990,850. PRESENTATION WORLD. INT. CL. 9. REG. 8-6-1996.
 1,990,855. HALON. INT. CL. 9. REG. 8-6-1996.
 1,990,858. BE SMART ABOUT CANDY. INT. CL. 30. REG. 8-6-1996.
 1,990,861. NATURAL GAS POWERED AND DESIGN. INT. CL. 39. REG. 8-6-1996.
 1,990,863. COAL. INT. CL. 41. REG. 8-6-1996.
 1,990,864. LOGFON. INT. CLS. 9 AND 35. REG. 8-6-1996.
 1,990,868. P AND DESIGN. INT. CLS. 3, 30, 32 AND 33. REG. 8-6-1996.
 1,990,870. GEARY SEARFOSS CERTIFIED PUBLIC ACCOUNTANT AND DESIGN. INT. CL. 36. REG. 8-6-1996.
 1,990,872. SOFTWARE LIQUIDATORS. INT. CL. 42. REG. 8-6-1996.
 1,990,876. BAXTER & CHARMING BAXTER AND CHARMING MERCHANTS OF CUSTOM ANIMAL FINERY AND DESIGN. INT. CL. 18. REG. 8-6-1996.
 1,990,877. LIGHTS OUT AND DESIGN. INT. CL. 25. REG. 8-6-1996.
 1,990,878. YOU'RE THE REASON WE FLY. INT. CL. 39. REG. 8-6-1996.
 1,990,881. INTERAG. INT. CLS. 35 AND 42. REG. 8-6-1996.
 1,990,882. N AND DESIGN. INT. CLS. 22, 23 AND 27. REG. 8-6-1996.
 1,990,886. MARY JANE AND DESIGN. INT. CLS. 16, 25 AND 41. REG. 8-6-1996.
 1,990,890. FRAMES FOR LESS AND DESIGN. INT. CL. 42. REG. 8-6-1996.
 1,990,891. THE TIME CAPSULE AND DESIGN. INT. CL. 36. REG. 8-6-1996.
 1,990,894. SLIDE (STYLIZED). INT. CL. 28. REG. 8-6-1996.
 1,990,895. M AND DESIGN. INT. CL. 29. REG. 8-6-1996.
 1,990,897. FLAP AND DESIGN. INT. CL. 6. REG. 8-6-1996.
 1,990,899. THE ELECTRONIC COP. INT. CL. 12. REG. 8-6-1996.
 1,990,900. ANGELITO AND DESIGN. INT. CL. 25. REG. 8-6-1996.
 1,990,901. COLUMBUS (STYLIZED). INT. CLS. 7 AND 9. REG. 8-6-1996.
 1,990,902. MADISON PLANK. INT. CL. 19. REG. 8-6-1996.
 1,990,903. BRUCE LIFETIME WARRANTY AND DESIGN. INT. CL. 19. REG. 8-6-1996.
 1,990,904. ECOSTAMP. INT. CL. 16. REG. 8-6-1996.
 1,990,905. OF THE ESSENCE (STYLIZED). INT. CL. 3. REG. 8-6-1996.
 1,990,909. CELEBRATION COTTAGES. INT. CL. 20. REG. 8-6-1996.
 1,990,910. PACIFICWELL (STYLIZED). INT. CL. 11. REG. 8-6-1996.
 1,990,911. SMART (STYLIZED). INT. CLS. 21, 24, 25 AND 27. REG. 8-6-1996.
 1,990,913. HAIRDANCER. INT. CL. 26. REG. 8-6-1996.
 1,990,914. HELPING SMALL BUSINESSES BECOME BIG BUSINESSES. INT. CL. 35. REG. 8-6-1996.
 1,990,919. TEACHER TO TEACHER CONNECTION. INT. CL. 9. REG. 8-6-1996.
 1,990,921. FIRST IMPRESSIONS. INT. CL. 37. REG. 8-6-1996.
 1,990,922. PAR - 6 AND DESIGN. INT. CLS. 41 AND 42. REG. 8-6-1996.
 1,990,923. LA SALSA AND DESIGN. INT. CL. 42. REG. 8-6-1996.
 1,990,925. BUSINESS MATTERS. INT. CL. 9. REG. 8-6-1996.
 1,990,932. BUSHMASTER. INT. CLS. 10, 12 AND 25. REG. 8-6-1996.
 1,990,933. SDI ZEUS AND DESIGN. INT. CL. 9. REG. 8-6-1996.
 1,990,934. LEARNING DEPOT AND DESIGN. INT. CL. 42. REG. 8-6-1996.
 1,990,935. ELEGANT PERVERSITIES (STYLIZED). INT. CL. 18. REG. 8-6-1996.
 1,990,939. BOPOLOGICAL SOUNDS. INT. CL. 9. REG. 8-6-1996.
 1,990,940. CORRI-SEAL. INT. CL. 3. REG. 8-6-1996.
 1,990,941. COLT AND DESIGN. INT. CL. 16. REG. 8-6-1996.
 1,990,945. ROGER. INT. CL. 9. REG. 8-6-1996.
 1,990,947. GUN FOR HIRE AND DESIGN. INT. CL. 42. REG. 8-6-1996.
 1,990,950. CONSTRUCTION SITE. INT. CL. 20. REG. 8-6-1996.
 1,990,953. LUXURY BOUQUET MIST. INT. CL. 5. REG. 8-6-1996.
 1,990,954. EMERGING MARKET EQUITY AND DESIGN. INT. CL. 36. REG. 8-6-1996.
 1,990,955. SKYSURFER STRIKE FORCE AND DESIGN. INT. CL. 41. REG. 8-6-1996.
 1,990,957. TERENA TRANS-EUROPEAN RESEARCH AND EDUCATION NETWORKING ASSOCIATION AND DESIGN. INT. CL. 42. REG. 8-6-1996.
 1,990,958. NCT NEXT CENTURY TECHNOLOGIES AND DESIGN. INT. CL. 9. REG. 8-6-1996.
 1,990,961. FALLEN ANGELS AND DESIGN. INT. CL. 41. REG. 8-6-1996.
 1,990,963. COO...LA (STYLIZED). INT. CL. 25. REG. 8-6-1996.
 1,990,964. NATIONAL CRAFTS LTD AND DESIGN. INT. CL. 41. REG. 8-6-1996.
 1,990,965. MISCELLANEOUS DESIGN. INT. CL. 41. REG. 8-6-1996.
 1,990,968. WESTERN VALLEY. INT. CL. 29. REG. 8-6-1996.
 1,990,970. PAOLO GIANNINI MADE IN ITALY AND DESIGN. INT. CL. 18. REG. 8-6-1996.
 1,990,973. FIRSTAUDIO. INT. CL. 9. REG. 8-6-1996.
 1,990,974. NEW FRONTIER HEALTH PLAN AND DESIGN. INT. CL. 36. REG. 8-6-1996.
 1,990,975. PARENTS RAISING CHILDREN WITH CHILDREN. INT. CL. 41. REG. 8-6-1996.
 1,990,977. OLD MILWAUKEE RED RED LAGER PREMIUM BEER AND DESIGN. INT. CL. 32. REG. 8-6-1996.
 1,990,979. DANIEL RAY. INT. CL. 18. REG. 8-6-1996.
 1,990,981. BAREFOOT PRESS RHINOCERVS AND DESIGN. INT. CL. 42. REG. 8-6-1996.
 1,990,985. T TWEENERS AND DESIGN. INT. CL. 25. REG. 8-6-1996.
 1,990,986. LOADLINK. INT. CL. 9. REG. 8-6-1996.
 1,990,987. SEIKO. INT. CLS. 9 AND 14. REG. 8-6-1996.
 1,990,988. ...ONE COMPANY IS A STEP BEYOND. (STYLIZED). INT. CL. 42. REG. 8-6-1996.
 1,990,989. LOCH DHU. INT. CL. 33. REG. 8-6-1996.
 1,990,990. COGEL BLUE BOOK. INT. CL. 16. REG. 8-6-1996.
 1,990,991. H A T S HEADWEAR ANNUAL TRADE SOURCE AND DESIGN. INT. CL. 16. REG. 8-6-1996.
 1,990,994. YARD-MAN AND DESIGN. INT. CL. 9. REG. 8-6-1996.
 1,990,995. BALLEEN BOOKSELLERS INTERNATIONAL. INT. CL. 42. REG. 8-6-1996.

- 1,990,998. JIM BANKS PROBATE BUSINESS WORKSHOP. INT. CL. 41. REG. 8-6-1996.
- 1,991,001. THE FRIEND OF THE FAMILY. INT. CL. 18. REG. 8-6-1996.
- 1,991,002. HARRIS SENIOR ADVANTAGE CHECKING. INT. CL. 36. REG. 8-6-1996.
- 1,991,003. THE FRIEND OF THE FAMILY. INT. CL. 28. REG. 8-6-1996.
- 1,991,009. NCBDC NATIONAL COUNCIL OF CERTIFICATION BUILDING DESIGNER AND DESIGN. U.S. CL. B. REG. 8-6-1996.
- 1,991,010. CAMILLE JUMELLE. INT. CL. 25. REG. 8-6-1996.
- 1,991,014. BILGE BOY. INT. CL. 17. REG. 8-6-1996.
- 1,991,015. STAR QUEST-THE REGENCY WARS. INT. CL. 28. REG. 8-6-1996.
- 1,991,018. FITNESS DEPOT. INT. CL. 42. REG. 8-6-1996.
- 1,991,019. CRAFT MAGIC. INT. CL. 28. REG. 8-6-1996.
- 1,991,020. INTERNATIONAL FRUIT. INT. CL. 32. REG. 8-6-1996.
- 1,991,022. HOME DAIRIES. INT. CLS. 29 AND 30. REG. 8-6-1996.
- 1,991,024. PV-26. INT. CL. 9. REG. 8-6-1996.
- 1,991,026. GAMBLERS' BOOKSTORE OF AMERICA. INT. CL. 42. REG. 8-6-1996.
- 1,991,031. CLASSIC SUPER BLEND. INT. CL. 31. REG. 8-6-1996.
- 1,991,033. APPROPRIATE. INT. CL. 30. REG. 8-6-1996.
- 1,991,035. KENTER AND DESIGN. INT. CL. 25. REG. 8-6-1996.
- 1,991,038. THOMAS E. WILSON. INT. CL. 25. REG. 8-6-1996.
- 1,991,039. MISCELLANEOUS DESIGN. INT. CL. 25. REG. 8-6-1996.
- 1,991,041. LIFESTYLE SERIES. INT. CL. 9. REG. 8-6-1996.
- 1,991,042. MISCELLANEOUS DESIGN. INT. CL. 29. REG. 8-6-1996.
- 1,991,051. BENCHMARKING TO MANAGE CHANGE. INT. CL. 42. REG. 8-6-1996.
- 1,991,054. PHARMCOMM. INT. CL. 35. REG. 8-6-1996.
- 1,991,055. ROUTE STAR AND DESIGN. INT. CL. 9. REG. 8-6-1996.
- 1,991,056. ROUTE STAR MVP AND DESIGN. INT. CL. 9. REG. 8-6-1996.
- 1,991,057. MISCELLANEOUS DESIGN. INT. CL. 16. REG. 8-6-1996.
- 1,991,064. POLLEJOS CHICKEN CHICHARRONES CHICKEN SKINS HEALTHY! TASTY CRUNCHY AND DESIGN. INT. CL. 29. REG. 8-6-1996.
- 1,991,065. 1995 URBAN REVOLUTION UR AND DESIGN. INT. CL. 25. REG. 8-6-1996.
- 1,991,067. PROJECT HANGTIME AND DESIGN. INT. CL. 41. REG. 8-6-1996.
- 1,991,068. STARTER ZONE. INT. CL. 41. REG. 8-6-1996.
- 1,991,069. SKILL ZONE. INT. CL. 41. REG. 8-6-1996.
- 1,991,071. MAGNOLIA CHARM. INT. CL. 42. REG. 8-6-1996.
- 1,991,074. COMFORT FIT. INT. CL. 5. REG. 8-6-1996.
- 1,991,075. BIOFLEX. INT. CL. 5. REG. 8-6-1996.
- 1,991,078. GSA ADVANTAGE! AN ON-LINE SHOPPING SERVICE AND DESIGN. INT. CL. 42. REG. 8-6-1996.
- 1,991,082. WL WOMEN AT LARGE DANCE EXERCISE FITNESS IMAGE ENHANCEMENT FOR THE LARGER WOMAN AND DESIGN. INT. CL. 41. REG. 8-6-1996.
- 1,991,088. TREASURY SOURCE ACCOUNT. INT. CL. 36. REG. 8-6-1996.
- 1,991,092. DIAMOND CONSULTING, INC.. INT. CLS. 35, 41 AND 42. REG. 8-6-1996.
- 1,991,095. JEWELCARD. INT. CL. 36. REG. 8-6-1996.
- 1,991,096. NO ORDINARY PEPPERS! AND DESIGN. INT. CL. 30. REG. 8-6-1996.
- 1,991,102. J-MAR. INT. CL. 16. REG. 8-6-1996.
- 1,991,105. VIBRATIONAL HEALING MASSAGE THERAPY AND DESIGN. INT. CL. 41. REG. 8-6-1996.
- 1,991,106. WINNIE WALKER. INT. CL. 10. REG. 8-6-1996.
- 1,991,107. PERFECTLY AMERICAN (STYLIZED). INT. CLS. 9 AND 25. REG. 8-6-1996.
- 1,991,108. LIBERAZIONE. INT. CL. 30. REG. 8-6-1996.
- 1,991,109. BLINDMAN'S HOLIDAY. INT. CL. 41. REG. 8-6-1996.
- 1,991,113. MR. BARBECUE ORIGINAL FLAVOR BARBECUE SAUCE AND DESIGN. INT. CL. 30. REG. 8-6-1996.
- 1,991,114. MERCURISER...ENGINE WITH AN ATTITUDE. INT. CL. 25. REG. 8-6-1996.
- 1,991,116. LIVECHAI. INT. CL. 30. REG. 8-6-1996.
- 1,991,117. THE CAPABILITY YOU NEED, THE COMMITMENT YOU DESERVE. INT. CL. 36. REG. 8-6-1996.
- 1,991,120. BEYOND THE WALL. INT. CL. 9. REG. 8-6-1996.
- 1,991,121. TIRE FORCE AND DESIGN. INT. CL. 42. REG. 8-6-1996.
- 1,991,122. TIRE FORCE. INT. CL. 42. REG. 8-6-1996.
- 1,991,124. TICKETMASTER MUSIC SHOWCASE AND DESIGN. INT. CLS. 35 AND 41. REG. 8-6-1996.
- 1,991,126. STEAK HAS NEVER BEEN DONE LIKE THIS BEFORE. INT. CL. 30. REG. 8-6-1996.
- 1,991,127. BA BRIGHTON ANALYTICAL INC. AND DESIGN. INT. CL. 42. REG. 8-6-1996.
- 1,991,130. THE ORIGINAL SPIEKERMANN'S THREE GENERATIONS SINCE 1919 AND DESIGN. INT. CL. 30. REG. 8-6-1996.
- 1,991,131. RACEDAY. INT. CL. 41. REG. 8-6-1996.
- 1,991,132. MARR LINE. INT. CL. 7. REG. 8-6-1996.
- 1,991,133. CLASSY GLASS, INC. (STYLIZED). INT. CL. 37. REG. 8-6-1996.
- 1,991,135. DCXCHANGE. INT. CLS. 35 AND 38. REG. 8-6-1996.
- 1,991,136. QUICK FIX SNACKS. INT. CLS. 29 AND 30. REG. 8-6-1996.
- 1,991,138. VERTE S'PORT (STYLIZED). INT. CL. 10. REG. 8-6-1996.
- 1,991,145. SMARTRETIREMENT. INT. CL. 36. REG. 8-6-1996.
- 1,991,149. ONE WAY RECALL SYSTEM. INT. CL. 35. REG. 8-6-1996.
- 1,991,152. SO GOOD, CAN WE EVER MAKE ENOUGH!. INT. CL. 30. REG. 8-6-1996.
- 1,991,153. MISCELLANEOUS DESIGN. INT. CL. 32. REG. 8-6-1996.
- 1,991,155. HER MAJESTY'S BLEND. INT. CL. 30. REG. 8-6-1996.
- 1,991,158. FOOT LOCKER ATHLETIC CLUB. INT. CL. 41. REG. 8-6-1996.
- 1,991,161. MISCELLANEOUS DESIGN. INT. CLS. 40 AND 42. REG. 8-6-1996.
- 1,991,162. CAIRNSAIR. INT. CL. 9. REG. 8-6-1996.
- 1,991,163. COURIER. INT. CL. 9. REG. 8-6-1996.
- 1,991,164. CHISHOLM TRAIL AND DESIGN. INT. CL. 42. REG. 8-6-1996.
- 1,991,167. SADESA GROUP. INT. CL. 18. REG. 8-6-1996.
- 1,991,169. POLLIWOG. INT. CL. 41. REG. 8-6-1996.
- 1,991,178. SOLITAIRE. INT. CL. 12. REG. 8-6-1996.
- 1,991,181. BAN HU'U & GIA DINH GOI TIM AND DESIGN. INT. CL. 38. REG. 8-6-1996.
- 1,991,182. GROUT BUSTER. INT. CL. 21. REG. 8-6-1996.
- 1,991,183. T TECHNOLOGY INVESTMENTS AND DESIGN. INT. CL. 42. REG. 8-6-1996.
- 1,991,185. FLEXIENGRAVE. INT. CL. 9. REG. 8-6-1996.
- 1,991,192. SYNERGY CLEAN NORTHWEST MOP AND DESIGN. INT. CL. 21. REG. 8-6-1996.
- 1,991,194. JAWBREAKER. INT. CL. 41. REG. 8-6-1996.
- 1,991,195. BARBARA GERWIT. INT. CL. 3. REG. 8-6-1996.
- 1,991,201. FOAMPAK. INT. CL. 9. REG. 8-6-1996.
- 1,991,202. JINGLE 2 MINGLE AND DESIGN. INT. CL. 42. REG. 8-6-1996.
- 1,991,203. TECHNI-FLOE. INT. CL. 20. REG. 8-6-1996.
- 1,991,204. THE GIFT OF YOUTH. INT. CL. 42. REG. 8-6-1996.
- 1,991,205. BLUE KING. INT. CL. 32. REG. 8-6-1996.
- 1,991,208. MICRO SEPARATOR AND DESIGN. INT. CL. 7. REG. 8-6-1996.
- 1,991,210. MISCELLANEOUS DESIGN. INT. CL. 42. REG. 8-6-1996.
- 1,991,212. LITHO-FLO. INT. CL. 7. REG. 8-6-1996.
- 1,991,214. RELIANCE. INT. CLS. 9 AND 10. REG. 8-6-1996.

- 1,991,215. PURASAN. INT. CL. 11. REG. 8-6-1996.
1,991,217. DREAM BUILDERS. INT. CL. 36. REG. 8-6-1996.
1,991,223. SUMMER SPLASH. INT. CL. 33. REG. 8-6-1996.
1,991,224. THE LAZY BAGEL. INT. CL. 42. REG. 8-6-1996.
1,991,229. INVISIBLE-CELL. INT. CL. 37. REG. 8-6-1996.
1,991,232. TIGER PAWS. INT. CL. 40. REG. 8-6-1996.
1,991,238. GROUND-GRABBER. INT. CL. 20. REG. 8-6-1996.
1,991,241. PLANET ROCK SOUND COLLECTION. INT. CL. 9. REG. 8-6-1996.
1,991,245. THE NON-PROFIT DONET (STYLIZED). INT. CL. 42. REG. 8-6-1996.
1,991,249. FAMILY & FRIENDS AND DESIGN. INT. CL. 14. REG. 8-6-1996.
1,991,250. INFOSCOPE AND DESIGN. INT. CL. 9. REG. 8-6-1996.
1,991,252. BENEFITSOURCE. INT. CL. 36. REG. 8-6-1996.
1,991,260. SCHULER'S. INT. CL. 42. REG. 8-6-1996.
1,991,262. ENTRAKEY. INT. CL. 9. REG. 8-6-1996.
1,991,263. ARMACLEAR. INT. CL. 2. REG. 8-6-1996.
1,991,264. CHEF CENTRE. INT. CL. 11. REG. 8-6-1996.
1,991,265. GERTIE GOOSE. INT. CL. 21. REG. 8-6-1996.
1,991,266. RCM. INT. CL. 36. REG. 8-6-1996.
1,991,271. GUDEBROD BROS CHAMPION SILK AND DESIGN. INT. CL. 23. REG. 8-6-1996.
1,991,274. RPS. INT. CL. 9. REG. 8-6-1996.
1,991,276. SPORT MOP. INT. CL. 21. REG. 8-6-1996.
1,991,284. RODVEN AND DESIGN. INT. CL. 9. REG. 8-6-1996.
1,991,285. IN-A-MINUTE RECORDS AND DESIGN. INT. CL. 9. REG. 8-6-1996.
1,991,287. VENTANA AND DESIGN. INT. CL. 41. REG. 8-6-1996.
1,991,288. R-1 ANATOMICO AND DESIGN. INT. CL. 25. REG. 8-6-1996.
1,991,291. FINESSE. INT. CLS. 21 AND 26. REG. 8-6-1996.
1,991,292. EMBROIDER YOUR WORLD AND DESIGN. INT. CL. 25. REG. 8-6-1996.
1,991,293. PYRO MONSTER. INT. CL. 13. REG. 8-6-1996.
1,991,295. CRAZY CHARLIE HORSE. INT. CL. 28. REG. 8-6-1996.
1,991,299. WATER VIXENS AND DESIGN. INT. CL. 28. REG. 8-6-1996.
1,991,302. MMI AND DESIGN. INT. CLS. 9 AND 10. REG. 8-6-1996.
1,991,307. SEG AND DESIGN. INT. CL. 39. REG. 8-6-1996.
1,991,308. SEG AND DESIGN. INT. CL. 40. REG. 8-6-1996.
1,991,309. SEG AND DESIGN. INT. CL. 41. REG. 8-6-1996.
1,991,310. SEG AND DESIGN. INT. CL. 40. REG. 8-6-1996.
1,991,311. PRESTO. INT. CL. 10. REG. 8-6-1996.
1,991,312. HORN DOG SPORTS GEAR. INT. CL. 25. REG. 8-6-1996.
1,991,314. SMART APPROVAL AND DESIGN. INT. CL. 36. REG. 8-6-1996.
1,991,317. IN-LINE EXCITEMENT. INT. CL. 41. REG. 8-6-1996.
1,991,318. BRIGHT KNIGHT. INT. CL. 11. REG. 8-6-1996.
1,991,319. BOTANICAL THERAPY. INT. CL. 5. REG. 8-6-1996.
1,991,323. TEDDI "T" 3 ON 3 AND DESIGN. INT. CL. 41. REG. 8-6-1996.
1,991,325. LEASEPARTNERS. INT. CL. 36. REG. 8-6-1996.
1,991,326. FORMLOGIC. INT. CL. 9. REG. 8-6-1996.
1,991,327. GTI (STYLIZED). INT. CL. 39. REG. 8-6-1996.
1,991,329. ROCHE-TDM ONLINE (STYLIZED). INT. CL. 5. REG. 8-6-1996.
1,991,330. KING STARBOND. INT. CL. 1. REG. 8-6-1996.
1,991,333. KONSTRUCT-O-PIPE. INT. CL. 6. REG. 8-6-1996.
1,991,335. REPLA-SOL. INT. CL. 5. REG. 8-6-1996.
1,991,336. SYDNEY GREENSHEEP AND DESIGN. INT. CL. 20. REG. 8-6-1996.
1,991,337. CM ACADEMY OF DOG TRAINING. INT. CL. 41. REG. 8-6-1996.
1,991,338. ULTRA-TEX. INT. CLS. 16 AND 19. REG. 8-6-1996.
1,991,340. WOLFCHASE. INT. CL. 37. REG. 8-6-1996.
1,991,341. WOLFCHASE GALLERIA. INT. CL. 37. REG. 8-6-1996.
1,991,344. FFX. INT. CLS. 35 AND 41. REG. 8-6-1996.
1,991,345. CREOLES' MARKET AND DESIGN. INT. CL. 42. REG. 8-6-1996.
1,991,348. E.N.T INCORPORATED (STYLIZED). INT. CL. 18. REG. 8-6-1996.
1,991,349. HOT TOPPERS. INT. CL. 20. REG. 8-6-1996.
1,991,352. OPTICS AND DESIGN. INT. CL. 28. REG. 8-6-1996.
1,991,353. THE INK EATER. INT. CL. 3. REG. 8-6-1996.
1,991,354. TRI-ESCENT II. INT. CL. 2. REG. 8-6-1996.
1,991,355. SAFESERVE AND DESIGN. INT. CL. 21. REG. 8-6-1996.
1,991,356. SWEET DREAMS. INT. CL. 5. REG. 8-6-1996.
1,991,357. SUN COAST. INT. CL. 9. REG. 8-6-1996.
1,991,359. JOSEPH GABRIEL. INT. CL. 25. REG. 8-6-1996.
1,991,360. ED SOLUTIONS AND DESIGN. INT. CL. 36. REG. 8-6-1996.
1,991,362. THE COMMUNICATION PACKAGING EXPERTS. INT. CL. 35. REG. 8-6-1996.
1,991,364. TERRY TOUCH. INT. CL. 25. REG. 8-6-1996.
1,991,368. STERILUBE AND DESIGN. INT. CL. 4. REG. 8-6-1996.
1,991,369. EAGLE EXPRESS. INT. CL. 36. REG. 8-6-1996.
1,991,371. SMOKE CHOPHOUSE & CIGAR EMPORIUM AND DESIGN. INT. CL. 42. REG. 8-6-1996.
1,991,376. ONE HEART...ONE MIND AND DESIGN. INT. CL. 16. REG. 8-6-1996.
1,991,379. CABINETREE AND DESIGN. INT. CL. 40. REG. 8-6-1996.
1,991,381. THE ORIGINAL FARMER'S MILL LIQUID PLANT FOOD AND DESIGN. INT. CL. 1. REG. 8-6-1996.
1,991,383. PHENX. INT. CL. 9. REG. 8-6-1996.
1,991,387. SILENTCOMFORT. INT. CL. 20. REG. 8-6-1996.
1,991,390. MORGAN & MOORE AND DESIGN. INT. CL. 42. REG. 8-6-1996.
1,991,392. MISCELLANEOUS DESIGN. INT. CL. 25. REG. 8-6-1996.
1,991,397. MISCELLANEOUS DESIGN. INT. CL. 16. REG. 8-6-1996.
1,991,398. WE BEGIN WITH NATURE. INT. CL. 42. REG. 8-6-1996.
1,991,402. CATS. INT. CL. 9. REG. 8-6-1996.
1,991,403. COMMUNIPAK AND DESIGN. INT. CL. 35. REG. 8-6-1996.
1,991,406. FIRSTPLACE HEALTH CARE. INT. CL. 42. REG. 8-6-1996.
1,991,407. HEALTHPEACE. INT. CL. 42. REG. 8-6-1996.
1,991,409. MARKET MOVER AND DESIGN. INT. CL. 36. REG. 8-6-1996.
1,991,410. SHOP & DROP AND DESIGN. INT. CL. 36. REG. 8-6-1996.
1,991,411. THE ONLY BOOK. INT. CL. 16. REG. 8-6-1996.
1,991,412. CRAVE CONTROL. INT. CL. 5. REG. 8-6-1996.
1,991,415. MISCELLANEOUS DESIGN. INT. CL. 36. REG. 8-6-1996.
1,991,416. COLOR MOTION. INT. CL. 25. REG. 8-6-1996.
1,991,420. NATWESTBANK (STYLIZED). INT. CL. 36. REG. 8-6-1996.
1,991,421. MISCELLANEOUS DESIGN. INT. CL. 5. REG. 8-6-1996.
1,991,422. 760. INT. CL. 25. REG. 8-6-1996.
1,991,423. DANCETTE. INT. CL. 25. REG. 8-6-1996.
1,991,425. THINK STRAWBRIDGE & CLOTHIER FIRST. INT. CL. 42. REG. 8-6-1996.
1,991,426. 740. INT. CL. 25. REG. 8-6-1996.
1,991,429. PUTTING THE AMATEUR BACK IN RADIO. INT. CL. 9. REG. 8-6-1996.
1,991,430. CALL O' DA WILD. INT. CL. 41. REG. 8-6-1996.
1,991,431. KARATE HELPS KICK DIABETES. INT. CL. 36. REG. 8-6-1996.
1,991,432. PRIME RETURNS. INT. CL. 36. REG. 8-6-1996.
1,991,434. BREATHE EASY. INT. CL. 42. REG. 8-6-1996.
1,991,435. UNISPORTIF. INT. CL. 25. REG. 8-6-1996.
1,991,436. THE NEW ADVENTURES CLUB (STYLIZED). INT. CL. 36. REG. 8-6-1996.
1,991,437. YORK HEALTH SYSTEM AND DESIGN. INT. CL. 42. REG. 8-6-1996.

- 1,991,439. BYMCS WORLDTRADE ONLINE. INT. CL. 42. REG. 8-6-1996.
- 1,991,444. HAND CRAFTED USA BCB AND DESIGN. INT. CL. 18. REG. 8-6-1996.
- 1,991,447. CTSI. INT. CL. 42. REG. 8-6-1996.
- 1,991,448. CHOK-SMOK (STYLIZED). INT. CL. 25. REG. 8-6-1996.
- 1,991,449. ETHERCONNECT. INT. CL. 9. REG. 8-6-1996.
- 1,991,453. MONSTER HALLOWEEN. INT. CL. 42. REG. 8-6-1996.
- 1,991,456. EURO-ETCH. INT. CL. 1. REG. 8-6-1996.
- 1,991,458. MISCELLANEOUS DESIGN. INT. CL. 9. REG. 8-6-1996.
- 1,991,461. OLD HUCKLEBERRY. INT. CL. 33. REG. 8-6-1996.
- 1,991,463. HAWAII'S OWN. INT. CL. 32. REG. 8-6-1996.
- 1,991,468. FLAIR. INT. CL. 5. REG. 8-6-1996.
- 1,991,469. FLOORMASTERS. INT. CL. 40. REG. 8-6-1996.
- 1,991,470. COMBAT. INT. CL. 16. REG. 8-6-1996.
- 1,991,471. XXXXX FIVE-WAY CROSS (STYLIZED). INT. CL. 31. REG. 8-6-1996.
- 1,991,472. BURN STEWART. INT. CL. 33. REG. 8-6-1996.
- 1,991,473. ORTHOMIX AND DESIGN. INT. CL. 10. REG. 8-6-1996.
- 1,991,474. ENSEC AND DESIGN. INT. CLS. 35, 37, 40, 41 AND 42. REG. 8-6-1996.
- 1,991,475. CHECKSMART AND DESIGN. INT. CL. 16. REG. 8-6-1996.
- 1,991,481. BIVOUAC. INT. CL. 25. REG. 8-6-1996.
- 1,991,489. DH. INT. CL. 28. REG. 8-6-1996.
- 1,991,490. COBE BCT. INC.. INT. CL. 10. REG. 8-6-1996.
- 1,991,491. SAMVAC. INT. CLS. 9 AND 11. REG. 8-6-1996.
- 1,991,492. TEDDY & ME. INT. CL. 28. REG. 8-6-1996.
- 1,991,493. HISTORY LAND. INT. CL. 29. REG. 8-6-1996.
- 1,991,494. SINON (STYLIZED). INT. CL. 25. REG. 8-6-1996.
- 1,991,496. MAMATOTO (STYLIZED). INT. CLS. 18, 21 AND 25. REG. 8-6-1996.
- 1,991,497. NEWSHAPE AND DESIGN. INT. CL. 29. REG. 8-6-1996.
- 1,991,498. FIRST LEVEL SUPPORT. INT. CL. 9. REG. 8-6-1996.
- 1,991,499. VIDEO CUBE. INT. CL. 28. REG. 8-6-1996.
- 1,991,502. FINAL LAP. INT. CL. 16. REG. 8-6-1996.
- 1,991,506. MFS ADVANTAGE. INT. CLS. 9 AND 36. REG. 8-6-1996.
- 1,991,507. FOUR SEASONS OF LONDON (STYLIZED). INT. CL. 25. REG. 8-6-1996.
- 1,991,511. ALTEENE (STYLIZED). INT. CL. 24. REG. 8-6-1996.
- 1,991,513. B AND DESIGN. INT. CL. 14. REG. 8-6-1996.
- 1,991,514. U.S.A. READY TO SERVE ECO GUMBO NEW! NET WT. 15 OZ. AND DESIGN. INT. CL. 25. REG. 8-6-1996.
- 1,991,517. JETCAM AND DESIGN. INT. CLS. 9 AND 42. REG. 8-6-1996.
- 1,991,520. INDIANAPOLIS 500 CHAMPIONS COLLECTION AND DESIGN. INT. CLS. 25 AND 28. REG. 8-6-1996.
- 1,991,522. ESTATE SELECT. INT. CL. 31. REG. 8-6-1996.
- 1,991,524. E. RITTER COMMUNICATIONS HOLDINGS, INC. ER (STYLIZED). INT. CLS. 9 AND 42. REG. 8-6-1996.
- 1,991,525. ER E. RITTER TELEPHONE COMPANY (STYLIZED). INT. CL. 38. REG. 8-6-1996.
- 1,991,526. LIQUID SOFTWARE. INT. CLS. 1 AND 3. REG. 8-6-1996.
- 1,991,527. MOPSEY & COTTONTAIL AND DESIGN. INT. CL. 25. REG. 8-6-1996.
- 1,991,530. MSAT. INT. CL. 9. REG. 8-6-1996.
- 1,991,534. CLARITY. INT. CL. 16. REG. 8-6-1996.
- 1,991,537. WE GET PEOPLE MOVING. INT. CL. 37. REG. 8-6-1996.
- 1,991,538. CONDO PLUS AND DESIGN. INT. CL. 36. REG. 8-6-1996.
- 1,991,540. VISIONICS. INT. CL. 9. REG. 8-6-1996.
- 1,991,543. PREFERENCE. INT. CL. 11. REG. 8-6-1996.
- 1,991,553. ROOM WITH A VIEW. INT. CL. 27. REG. 8-6-1996.
- 1,991,555. THE OWL. INT. CL. 9. REG. 8-6-1996.
- 1,991,556. URBAN EYEWEAR. INT. CL. 9. REG. 8-6-1996.
- 1,991,559. BOIS DE ROBLES. INT. CL. 33. REG. 8-6-1996.
- 1,991,563. SATINESQUE. INT. CL. 25. REG. 8-6-1996.
- 1,991,564. NOVELL EMBEDDED SYSTEMS TECHNOLOGY. INT. CLS. 9 AND 16. REG. 8-6-1996.
- 1,991,565. OPTION HMO. INT. CL. 36. REG. 8-6-1996.
- 1,991,566. BABY HEATHER. INT. CL. 28. REG. 8-6-1996.
- 1,991,567. "TOILID". INT. CL. 11. REG. 8-6-1996.
- 1,991,568. COFFEE-TIMES AND DESIGN. INT. CL. 42. REG. 8-6-1996.
- 1,991,570. UPDATE EXPRESS. INT. CL. 35. REG. 8-6-1996.
- 1,991,572. LAKELAND NURSERIES. INT. CL. 42. REG. 8-6-1996.
- 1,991,574. EMPEROR'S COLLECTION. INT. CL. 29. REG. 8-6-1996.
- 1,991,575. GARGAN-TU-JUAN. INT. CL. 21. REG. 8-6-1996.
- 1,991,576. BEAKMAN'S WORLD AND DESIGN. INT. CL. 25. REG. 8-6-1996.
- 1,991,577. BEAKMAN'S WORLD AND DESIGN. INT. CL. 16. REG. 8-6-1996.
- 1,991,579. KOBIE MARKETING. INT. CL. 35. REG. 8-6-1996.
- 1,991,582. SUPER-SIL. INT. CL. 5. REG. 8-6-1996.
- 1,991,583. TONEMATE. INT. CL. 9. REG. 8-6-1996.
- 1,991,584. BASE.ARTS. INT. CL. 9. REG. 8-6-1996.
- 1,991,585. CYMBALE. INT. CL. 31. REG. 8-6-1996.
- 1,991,586. CHIMES. INT. CL. 31. REG. 8-6-1996.
- 1,991,587. MAARSE. INT. CL. 31. REG. 8-6-1996.
- 1,991,588. SUN. INT. CL. 31. REG. 8-6-1996.
- 1,991,590. GUIGNE INT'L DRUMS AND DESIGN. INT. CL. 9. REG. 8-6-1996.
- 1,991,594. TM EXPRESS AND DESIGN. INT. CL. 35. REG. 8-6-1996.
- 1,991,597. FUDGETS. INT. CL. 30. REG. 8-6-1996.
- 1,991,598. FUN N' MOTION. INT. CLS. 25, 41 AND 42. REG. 8-6-1996.
- 1,991,600. GURU GEAR. INT. CL. 25. REG. 8-6-1996.
- 1,991,604. PLANTOWER. INT. CL. 21. REG. 8-6-1996.
- 1,991,605. UP EEZ. INT. CLS. 16 AND 20. REG. 8-6-1996.
- 1,991,607. SNAPSHOTS. INT. CL. 42. REG. 8-6-1996.
- 1,991,611. STUNT RACE FX. INT. CL. 28. REG. 8-6-1996.
- 1,991,612. GCC EXPRESS. INT. CLS. 35 AND 42. REG. 8-6-1996.
- 1,991,614. SPIKEY SEAHORSE. INT. CLS. 25, 35 AND 41. REG. 8-6-1996.
- 1,991,617. BIG FOOT. INT. CL. 21. REG. 8-6-1996.
- 1,991,620. CENTURA. INT. CL. 9. REG. 8-6-1996.
- 1,991,622. POTTY TIME BABY. INT. CL. 28. REG. 8-6-1996.
- 1,991,623. A BREATH OF FRESH AIR. INT. CL. 10. REG. 8-6-1996.
- 1,991,624. MARVEL ALLEGRA. INT. CL. 20. REG. 8-6-1996.
- 1,991,626. THE TRICK TO MASTERING MULTIMEDIA. INT. CL. 9. REG. 8-6-1996.
- 1,991,627. SECURE TRACK. INT. CL. 9. REG. 8-6-1996.
- 1,991,628. HEARTLAND CLASSICS. INT. CL. 29. REG. 8-6-1996.
- 1,991,630. FELICIA'S DELIGHT. INT. CL. 30. REG. 8-6-1996.
- 1,991,631. VS VERY SPECIAL AND DESIGN. INT. CL. 16. REG. 8-6-1996.
- 1,991,632. GOSSARD SUPER-UPLIFT MIRACLE SYSTEM. INT. CL. 25. REG. 8-6-1996.
- 1,991,634. MUTUAL FUNDS WITHOUT THE MYSTERY. INT. CL. 36. REG. 8-6-1996.
- 1,991,635. DRESS & DREAM. INT. CL. 28. REG. 8-6-1996.
- 1,991,636. GALIC. THE NAME BANKERS CAN COUNT ON. INT. CL. 36. REG. 8-6-1996.
- 1,991,637. BABY PRO. INT. CL. 9. REG. 8-6-1996.
- 1,991,639. SILENT LINE. INT. CL. 9. REG. 8-6-1996.
- 1,991,641. MISCELLANEOUS DESIGN. INT. CL. 25. REG. 8-6-1996.
- 1,991,644. S'TRON. INT. CL. 7. REG. 8-6-1996.
- 1,991,645. SPRAYTRON. INT. CL. 7. REG. 8-6-1996.
- 1,991,646. CAPITAL PUNISHMENT. INT. CL. 28. REG. 8-6-1996.
- 1,991,649. FAMILY CHEF. INT. CL. 11. REG. 8-6-1996.
- 1,991,650. SEAFRIENDS. INT. CL. 25. REG. 8-6-1996.
- 1,991,651. TWIN TOWERS. INT. CL. 11. REG. 8-6-1996.
- 1,991,652. AUCTIONVIEW. INT. CL. 35. REG. 8-6-1996.
- 1,991,656. ARACULA. INT. CL. 28. REG. 8-6-1996.

- 1,991,657. RXALLIANCE. INT. CL. 36. REG. 8-6-1996.
 1,991,658. SURFBUG AND DESIGN. INT. CL. 25. REG. 8-6-1996.
 1,991,659. THE TRIUMPH OF THE HUMAN SPIRIT. INT. CL. 25. REG. 8-6-1996.
 1,991,662. MISCELLANEOUS DESIGN. INT. CL. 9. REG. 8-6-1996.
 1,991,664. KEY RACERS. INT. CL. 28. REG. 8-6-1996.
 1,991,665. GERM-O. INT. CL. 16. REG. 8-6-1996.
 1,991,666. GERM-O AND DESIGN. INT. CL. 16. REG. 8-6-1996.
 1,991,667. BEAD & SEAL. INT. CL. 1. REG. 8-6-1996.
 1,991,668. PSL FIRST AND 10. INT. CL. 36. REG. 8-6-1996.
 1,991,670. THUMBELINA. INT. CL. 3. REG. 8-6-1996.
 1,991,671. NET MAG. INT. CL. 16. REG. 8-6-1996.
 1,991,672. RAVE. INT. CL. 9. REG. 8-6-1996.
 1,991,673. MAGNAFILTER. INT. CL. 9. REG. 8-6-1996.
 1,991,675. COMPUTELEVEL. INT. CL. 9. REG. 8-6-1996.
 1,991,677. SHELF-STUD. INT. CL. 21. REG. 8-6-1996.
 1,991,678. 2 FOR ALL SEASONS. INT. CL. 24. REG. 8-6-1996.
 1,991,679. SEALINER. INT. CL. 20. REG. 8-6-1996.
 1,991,680. GREAT WHITE. INT. CL. 9. REG. 8-6-1996.
 1,991,681. THE TWIST YOU CAN'T RESIST!. INT. CL. 30. REG. 8-6-1996.
 1,991,682. FELICIA'S DELIGHT AND DESIGN. INT. CL. 30. REG. 8-6-1996.
 1,991,684. PERSONAL FILE CABINET. INT. CL. 9. REG. 8-6-1996.
 1,991,685. NECKROLL PLUS. INT. CL. 20. REG. 8-6-1996.
 1,991,686. AUROSUD. INT. CL. 1. REG. 8-6-1996.
 1,991,687. RETIRED RESOURCES. INT. CL. 35. REG. 8-6-1996.
 1,991,688. LEUKOVIR. INT. CL. 10. REG. 8-6-1996.
 1,991,690. WHEN YOU'RE THIRSTY FOR A GREAT CANDY. INT. CL. 30. REG. 8-6-1996.
 1,991,693. CADENCE RMM. INT. CL. 18. REG. 8-6-1996.
 1,991,694. BACKFIRE. INT. CL. 42. REG. 8-6-1996.
 1,991,695. POSITRAC. INT. CL. 28. REG. 8-6-1996.
 1,991,697. BOTTLEWEAR. INT. CL. 25. REG. 8-6-1996.
 1,991,698. C-BAR. INT. CLS. 1 AND 19. REG. 8-6-1996.
 1,991,701. ILLTOWN RECORDS, LTD.. INT. CLS. 9 AND 41. REG. 8-6-1996.
 1,991,702. ROCK TV AND DESIGN. INT. CL. 38. REG. 8-6-1996.
 1,991,703. COUNTRY STAR. INT. CL. 28. REG. 8-6-1996.
 1,991,705. IMPORTED FROM NATURE. INT. CL. 30. REG. 8-6-1996.
 1,991,712. TENORS-THE NEXT GENERATION. INT. CL. 9. REG. 8-6-1996.
 1,991,713. MAGNA ZORB. INT. CL. 1. REG. 8-6-1996.
 1,991,715. FREEWAY PIZZA. INT. CL. 42. REG. 8-6-1996.
 1,991,716. SPARKLE KAKES. INT. CL. 30. REG. 8-6-1996.
 1,991,718. HAWAIIAN BREEZE. INT. CL. 30. REG. 8-6-1996.
 1,991,719. TELERAMA. INT. CL. 9. REG. 8-6-1996.
 1,991,721. MEX MEX AND DESIGN. INT. CL. 30. REG. 8-6-1996.
 1,991,723. GRAPHICS XPRESSION. INT. CL. 9. REG. 8-6-1996.
 1,991,724. GATEWAY UTILITY GROUP. INT. CL. 35. REG. 8-6-1996.
 1,991,725. INDEXICON. INT. CL. 9. REG. 8-6-1996.
 1,991,727. URBAN WOOL MERINO COLLECTION. INT. CL. 25. REG. 8-6-1996.
 1,991,728. EMMITT SMITH CHARITIES, INC. 22 AND DESIGN. INT. CL. 36. REG. 8-6-1996.
 1,991,729. LRC TECHNOLOGIES. INT. CL. 42. REG. 8-6-1996.
 1,991,730. DENTAMERICA. INT. CL. 36. REG. 8-6-1996.
 1,991,731. AGES AUCTION-GAUGED EARNINGS SECURITIES AND DESIGN. INT. CL. 36. REG. 8-6-1996.
 1,991,732. EI-Q. INT. CL. 1. REG. 8-6-1996.
 1,991,734. MRS. BUTTERWORTH'S. INT. CL. 30. REG. 8-6-1996.
 1,991,736. NUTRA GREENS. INT. CL. 5. REG. 8-6-1996.
 1,991,737. PRINCIPATO AND DESIGN. INT. CL. 33. REG. 8-6-1996.
 1,991,741. THE MASTERFICHE OF COM. INT. CL. 1. REG. 8-6-1996.
 1,991,745. YIN YANG. INT. CL. 25. REG. 8-6-1996.
 1,991,746. DOMAINE PAUL. INT. CL. 33. REG. 8-6-1996.
 1,991,747. GET... THIS!. INT. CL. 25. REG. 8-6-1996.
 1,991,748. STRAPS. INT. CL. 36. REG. 8-6-1996.
 1,991,749. SUPREME GARDENS. INT. CL. 1. REG. 8-6-1996.
 1,991,750. THE TEXAS ADVENTURE. INT. CL. 16. REG. 8-6-1996.
 1,991,751. CFO MAILBOX. INT. CL. 36. REG. 8-6-1996.
 1,991,752. RINGMOUSE. INT. CL. 9. REG. 8-6-1996.
 1,991,755. UB NETWORKS. INT. CLS. 9, 16, 37 AND 42. REG. 8-6-1996.
 1,991,757. MONSTER MANGO. INT. CL. 32. REG. 8-6-1996.
 1,991,758. STONEWEAVE. INT. CL. 27. REG. 8-6-1996.
 1,991,759. MARY BAKER. INT. CL. 30. REG. 8-6-1996.
 1,991,760. CAP PLAN PRO. INT. CL. 9. REG. 8-6-1996.
 1,991,764. THE CATCH. INT. CL. 18. REG. 8-6-1996.
 1,991,765. ASPHALT AVENGER 3 ON 3 AND DESIGN. INT. CL. 41. REG. 8-6-1996.
 1,991,767. BIG RED TAYLOR GATOR ABSORBENT AND DESIGN. INT. CL. 1. REG. 8-6-1996.
 1,991,768. UTP-HOPPER (STYLIZED). INT. CL. 9. REG. 8-6-1996.
 1,991,771. AUTOLEND AND DESIGN. INT. CL. 36. REG. 8-6-1996.
 1,991,775. MORE CHOICES, LOWER PRICES. INT. CL. 42. REG. 8-6-1996.
 1,991,776. W WETA WE BRING YOU WASHINGTON AND THE WORLD. AND DESIGN. INT. CL. 38. REG. 8-6-1996.
 1,991,777. W WETA AND DESIGN. INT. CL. 38. REG. 8-6-1996.
 1,991,778. SUMMIT VISION. INT. CL. 42. REG. 8-6-1996.
 1,991,779. TOP VALUE FREDY TRAC AND DESIGN. INT. CL. 25. REG. 8-6-1996.
 1,991,781. EZ COOL AND DESIGN. INT. CL. 21. REG. 8-6-1996.
 1,991,784. THE BULL IS TAKIN' CHARGE. INT. CL. 32. REG. 8-6-1996.
 1,991,786. THE SHEPHERD'S STAFF AND DESIGN. INT. CL. 9. REG. 8-6-1996.
 1,991,788. DYNAPEL. INT. CL. 18. REG. 8-6-1996.
 1,991,790. DYNAPOWER. INT. CL. 9. REG. 8-6-1996.
 1,991,791. SPIRIT OF DISCOVERY. INT. CL. 39. REG. 8-6-1996.
 1,991,792. DYNASONICS. INT. CL. 9. REG. 8-6-1996.
 1,991,793. CLUTCH CITY. INT. CL. 9. REG. 8-6-1996.
 1,991,794. EPAC. INT. CL. 9. REG. 8-6-1996.
 1,991,795. V BODYBOARDS. INT. CL. 28. REG. 8-6-1996.
 1,991,796. EDIBLE ACCENTS. INT. CL. 30. REG. 8-6-1996.
 1,991,799. TREAT BREAK. INT. CL. 30. REG. 8-6-1996.
 1,991,803. TRI-ZINC. INT. CL. 3. REG. 8-6-1996.
 1,991,804. CUB AND DESIGN. INT. CL. 11. REG. 8-6-1996.
 1,991,805. ENERACTION. INT. CL. 42. REG. 8-6-1996.
 1,991,806. GROUP 121. INT. CL. 35. REG. 8-6-1996.
 1,991,807. OUR CITY HAS NO LIMITS. INT. CL. 35. REG. 8-6-1996.
 1,991,809. EXCEED. INT. CL. 9. REG. 8-6-1996.
 1,991,810. AMANDA MICHAELS. INT. CL. 25. REG. 8-6-1996.
 1,991,811. E.N.T. LASER INSTITUTE AND DESIGN. INT. CL. 42. REG. 8-6-1996.
 1,991,812. E-MURALS. INT. CL. 40. REG. 8-6-1996.
 1,991,813. FLOR - DELICIOUS. INT. CL. 32. REG. 8-6-1996.
 1,991,814. WINDSATIONS ETC. WINDSOCKS & MORE. INT. CLS. 24 AND 28. REG. 8-6-1996.
 1,991,815. MEDACCESS. INT. CL. 38. REG. 8-6-1996.
 1,991,816. MED ACCESS AND DESIGN. INT. CL. 38. REG. 8-6-1996.
 1,991,817. TROPICAIR. INT. CL. 10. REG. 8-6-1996.
 1,991,818. PITAZZA. INT. CL. 30. REG. 8-6-1996.
 1,991,819. MISCELLANEOUS DESIGN. INT. CL. 14. REG. 8-6-1996.
 1,991,820. EXELTHERM. INT. CL. 17. REG. 8-6-1996.
 1,991,821. FANTASTICO. INT. CLS. 30 AND 32. REG. 8-6-1996.
 1,991,822. CARA MIA. INT. CL. 34. REG. 8-6-1996.
 1,991,823. WINN-DIXIE. INT. CL. 1. REG. 8-6-1996.

- 1,991,825. EL ORGULLO DE MI TIERRA. INT. CL. 29. REG. 8-6-1996.
- 1,991,826. GOOD HOUSEKEEPING. INT. CL. 35. REG. 8-6-1996.
- 1,991,831. CREATIVE ELEMENTS. INT. CL. 25. REG. 8-6-1996.
- 1,991,832. EJ ENTERPRISES (STYLIZED). INT. CLS. 14, 16 AND 21. REG. 8-6-1996.
- 1,991,835. LUSTRA. INT. CL. 17. REG. 8-6-1996.
- 1,991,836. BEAVER HUNT. INT. CL. 9. REG. 8-6-1996.
- 1,991,837. PERFORMA. INT. CL. 29. REG. 8-6-1996.
- 1,991,839. INTO REALITY. INT. CL. 25. REG. 8-6-1996.
- 1,991,841. SANDRO ROSSINI. INT. CL. 25. REG. 8-6-1996.
- 1,991,843. PETFLEX. INT. CL. 18. REG. 8-6-1996.
- 1,991,845. BERRY PATCH MIXED BERRY CEREAL. INT. CL. 30. REG. 8-6-1996.
- 1,991,848. RANGER PATROL. INT. CL. 25. REG. 8-6-1996.
- 1,991,850. SICOSTAB. INT. CL. 1. REG. 8-6-1996.
- 1,991,852. GAME PLANNER. INT. CL. 16. REG. 8-6-1996.
- 1,991,854. SEIZE THE POWER. INT. CL. 9. REG. 8-6-1996.
- 1,991,855. MAPS. INT. CL. 9. REG. 8-6-1996.
- 1,991,856. DISKHELL. INT. CL. 20. REG. 8-6-1996.
- 1,991,858. TEAM CAMO (STYLIZED). INT. CL. 25. REG. 8-6-1996.
- 1,991,861. BABY EVANS. INT. CL. 25. REG. 8-6-1996.
- 1,991,862. WONDER BATH. INT. CL. 11. REG. 8-6-1996.
- 1,991,863. EUROFEATHER. INT. CL. 22. REG. 8-6-1996.
- 1,991,865. QUORUM HOTELS AND RESORTS. INT. CL. 42. REG. 8-6-1996.
- 1,991,866. ELAEON. INT. CL. 29. REG. 8-6-1996.
- 1,991,867. SHIATSU PLUS. INT. CL. 10. REG. 8-6-1996.
- 1,991,869. SAND CIRCUIT. INT. CL. 25. REG. 8-6-1996.
- 1,991,870. PVT. INT. CL. 9. REG. 8-6-1996.
- 1,991,871. TEACHIN' TUNES. INT. CL. 15. REG. 8-6-1996.
- 1,991,874. PUBLIC DOMAIN. INT. CL. 25. REG. 8-6-1996.
- 1,991,876. JUNGLE FRUIT. INT. CL. 30. REG. 8-6-1996.
- 1,991,878. FLAVORBROILED. INT. CLS. 29 AND 30. REG. 8-6-1996.
- 1,991,879. SNACKSTERS. INT. CLS. 29 AND 30. REG. 8-6-1996.
- 1,991,880. BLAZERJET. INT. CL. 9. REG. 8-6-1996.
- 1,991,881. NORTH BY NORTHWEST. INT. CL. 18. REG. 8-6-1996.
- 1,991,883. EPICURE AND DESIGN. INT. CL. 9. REG. 8-6-1996.
- 1,991,885. WE MEASURE QUALITY ONE TRIP AT A TIME. INT. CL. 9. REG. 8-6-1996.
- 1,991,888. INFOLINK. INT. CL. 9. REG. 8-6-1996.
- 1,991,889. DIVS. INT. CL. 36. REG. 8-6-1996.
- 1,991,890. THE BROTHERS GRUNT. INT. CLS. 16 AND 25. REG. 8-6-1996.
- 1,991,893. FOOZLES. INT. CL. 42. REG. 8-6-1996.
- 1,991,897. TROPICAL CRAZE. INT. CL. 30. REG. 8-6-1996.
- 1,991,898. GRAND DELI. INT. CL. 29. REG. 8-6-1996.
- 1,991,899. PROMOTAL. INT. CL. 10. REG. 8-6-1996.
- 1,991,904. D'ORSINI. INT. CL. 3. REG. 8-6-1996.
- 1,991,906. CO SMART. INT. CL. 9. REG. 8-6-1996.
- 1,991,907. ELECTROSTAT. INT. CL. 24. REG. 8-6-1996.
- 1,991,908. ENVIROFELT. INT. CL. 24. REG. 8-6-1996.
- 1,991,913. PET WORTHY. INT. CL. 31. REG. 8-6-1996.
- 1,991,914. SCRUMPLES. INT. CL. 29. REG. 8-6-1996.
- 1,991,915. CRESCENDO. INT. CL. 9. REG. 8-6-1996.
- 1,991,916. MONDO METAL. INT. CL. 28. REG. 8-6-1996.
- 1,991,917. KIDS ROW. INT. CL. 14. REG. 8-6-1996.
- 1,991,918. SCRUBWAY. INT. CLS. 35 AND 37. REG. 8-6-1996.
- 1,991,922. CP COMMUNICATIONS INTERNATIONAL. INT. CL. 38. REG. 8-6-1996.
- 1,991,924. APTREX. INT. CL. 9. REG. 8-6-1996.
- 1,991,925. HYDROXY DI NOTTE COMPLEX. INT. CL. 3. REG. 8-6-1996.
- 1,991,927. WONDER WINGS. INT. CL. 18. REG. 8-6-1996.
- 1,991,931. EVERYBODY'S CATALOG. INT. CL. 9. REG. 8-6-1996.
- 1,991,932. ROAD WARRIOR. INT. CL. 21. REG. 8-6-1996.
- 1,991,933. CALIFORNIA EXIT. INT. CL. 25. REG. 8-6-1996.
- 1,991,934. MISCELLANEOUS DESIGN. INT. CL. 9. REG. 8-6-1996.
- 1,991,935. PREMIER CLASSIC 2000. INT. CL. 16. REG. 8-6-1996.
- 1,991,936. PGI. INT. CL. 1. REG. 8-6-1996.
- 1,991,937. PERFORMANCE IN THE 80'S IS PREVENTION IN THE 90'S. INT. CL. 25. REG. 8-6-1996.
- 1,991,939. TOSS 'N SAUCE. INT. CL. 30. REG. 8-6-1996.
- 1,991,940. MEDEA. INT. CL. 14. REG. 8-6-1996.
- 1,991,942. CALIFORNIA OFFRAMP. INT. CL. 25. REG. 8-6-1996.
- 1,991,943. ULTRAMIX. INT. CL. 9. REG. 8-6-1996.
- 1,991,945. CHILDREN'S HEALTH CARE AND DESIGN. INT. CL. 42. REG. 8-6-1996.
- 1,991,946. DIXIE RECYCLED AND DESIGN. INT. CL. 21. REG. 8-6-1996.
- 1,991,947. HANDI-CLEAN. INT. CL. 9. REG. 8-6-1996.
- 1,991,948. HEALTH TOGS. INT. CL. 25. REG. 8-6-1996.
- 1,991,949. MEDIAPOLL. INT. CL. 35. REG. 8-6-1996.
- 1,991,950. ACTIONAGENT. INT. CL. 9. REG. 8-6-1996.
- 1,991,951. BOWLING. INT. CL. 30. REG. 8-6-1996.
- 1,991,953. CONDUCTOR CARD REVIEW. INT. CL. 36. REG. 8-6-1996.
- 1,991,954. SO YOU WON'T BE LEFT OIL ALONE. INT. CLS. 1 AND 4. REG. 8-6-1996.
- 1,991,955. LOOKIN' FOR A BUSCH. INT. CL. 25. REG. 8-6-1996.
- 1,991,958. STROLLIN' BABY. INT. CL. 28. REG. 8-6-1996.
- 1,991,961. MISCELLANEOUS DESIGN. INT. CL. 29. REG. 8-6-1996.
- 1,991,962. HYDRO-SKIM. INT. CL. 7. REG. 8-6-1996.
- 1,991,963. BIG DICK'S. INT. CL. 32. REG. 8-6-1996.
- 1,991,964. INFOCERF. INT. CL. 38. REG. 8-6-1996.
- 1,991,966. JUST FREEZE IT. INT. CL. 32. REG. 8-6-1996.
- 1,991,967. PHASES. INT. CL. 25. REG. 8-6-1996.
- 1,991,970. LEVERNE. INT. CL. 14. REG. 8-6-1996.
- 1,991,971. PROFILE. INT. CL. 9. REG. 8-6-1996.
- 1,991,974. IMAGIX. INT. CL. 9. REG. 8-6-1996.
- 1,991,975. WAIST-MASTER. INT. CL. 25. REG. 8-6-1996.
- 1,991,976. FRIENDS WORTH SAVING. INT. CLS. 3, 18, 20, 21 AND 24. REG. 8-6-1996.
- 1,991,979. DENT BROTHERS. INT. CL. 37. REG. 8-6-1996.
- 1,991,981. EDAASSIMILATOR. INT. CL. 9. REG. 8-6-1996.
- 1,991,982. CRYSTAL BALLS. INT. CL. 25. REG. 8-6-1996.
- 1,991,983. HOMESTEADER TACKLE AND DESIGN. INT. CL. 28. REG. 8-6-1996.
- 1,991,984. WINTERSURF. INT. CL. 25. REG. 8-6-1996.
- 1,991,985. OUTDOOR FLAVOR IN YOUR BACK YARD AND DESIGN. INT. CL. 11. REG. 8-6-1996.
- 1,991,986. MA'S FAVORITE KENTUCKY FARMS AND DESIGN. INT. CL. 29. REG. 8-6-1996.
- 1,991,987. FELINE PRIME AND DESIGN. INT. CL. 31. REG. 8-6-1996.
- 1,991,988. CANINE PRIME AND DESIGN. INT. CL. 31. REG. 8-6-1996.
- 1,991,991. SPORTSDANA. INT. CL. 25. REG. 8-6-1996.
- 1,991,993. ENSEMBLE. INT. CL. 10. REG. 8-6-1996.
- 1,991,996. PARTNER ACCOUNT. INT. CL. 36. REG. 8-6-1996.
- 1,991,998. TRAVEL FUN. INT. CL. 28. REG. 8-6-1996.
- 1,992,001. CRYPTO-GUARD. INT. CL. 9. REG. 8-6-1996.
- 1,992,004. NNN (STYLIZED). INT. CL. 38. REG. 8-6-1996.
- 1,992,005. PEP. INT. CL. 35. REG. 8-6-1996.
- 1,992,006. GOLDWARE. INT. CL. 9. REG. 8-6-1996.
- 1,992,007. KROMALON. INT. CLS. 1 AND 23. REG. 8-6-1996.
- 1,992,008. WORD FOR WORD. INT. CL. 35. REG. 8-6-1996.
- 1,992,009. AQUAFRESH FLEX OUTRAGEOUS COLORS. INT. CL. 21. REG. 8-6-1996.
- 1,992,010. CAPE. INT. CL. 36. REG. 8-6-1996.
- 1,992,012. MARVELOUS MUGGS AND DESIGN. INT. CLS. 9, 16, 21, 25 AND 42. REG. 8-6-1996.
- 1,992,013. BEANSCENE ESPRESSO AND DESIGN. INT. CL. 30. REG. 8-6-1996.
- 1,992,014. PERSONAL EXCELLENCE AND DESIGN. INT. CL. 16. REG. 8-6-1996.
- 1,992,016. RAYFLATE. INT. CL. 17. REG. 8-6-1996.
- 1,992,017. SIMPLY SECURE. INT. CL. 16. REG. 8-6-1996.
- 1,992,018. STATION WEAR UNIFORMS. INT. CL. 25. REG. 8-6-1996.

- 1,992,019. STATION WORK UNIFORMS. INT. CL. 25. REG. 8-6-1996.
- 1,992,020. ARETE. INT. CL. 28. REG. 8-6-1996.
- 1,992,021. ASK-A-VET. INT. CL. 42. REG. 8-6-1996.
- 1,992,023. MOCHA MOE'S DRIVE-THRU ESPRESSO AND DESIGN. INT. CL. 42. REG. 8-6-1996.
- 1,992,026. BUNNY FINGERS. INT. CL. 25. REG. 8-6-1996.
- 1,992,028. HOLIDAY ORIGINALS. INT. CL. 24. REG. 8-6-1996.
- 1,992,029. SMUD WORKS. INT. CL. 28. REG. 8-6-1996.
- 1,992,030. MARKET IQ. INT. CL. 36. REG. 8-6-1996.
- 1,992,031. SUPER CENTAUR. INT. CL. 7. REG. 8-6-1996.
- 1,992,033. THE BERKSHIRE ESTATE COLLECTION. INT. CL. 11. REG. 8-6-1996.
- 1,992,034. GALLERY PHOTOMOBILE. INT. CL. 20. REG. 8-6-1996.
- 1,992,036. AMUSEMENT CENTER. INT. CL. 28. REG. 8-6-1996.
- 1,992,037. LISTKETTE. INT. CL. 9. REG. 8-6-1996.
- 1,992,038. FOREVER VISION. INT. CL. 38. REG. 8-6-1996.
- 1,992,039. CHISHOLM TRAIL. INT. CL. 42. REG. 8-6-1996.
- 1,992,040. BROWNSTONE BOUTIQUE. INT. CL. 42. REG. 8-6-1996.
- 1,992,042. TOUGH BODIES. INT. CL. 9. REG. 8-6-1996.
- 1,992,044. THE SCREENING ROOM. INT. CL. 42. REG. 8-6-1996.
- 1,992,045. ACCU-DROP. INT. CL. 10. REG. 8-6-1996.
- 1,992,046. DETROIT DIESEL AND DESIGN. INT. CL. 36. REG. 8-6-1996.
- 1,992,047. RAVEN. INT. CL. 32. REG. 8-6-1996.
- 1,992,049. MANSFORD. INT. CL. 25. REG. 8-6-1996.
- 1,992,053. WOLVERINE. INT. CL. 9. REG. 8-6-1996.
- 1,992,054. ESSENSUALS. INT. CL. 25. REG. 8-6-1996.
- 1,992,057. VOLTAIRE. INT. CL. 9. REG. 8-6-1996.
- 1,992,058. SHADOW BARK. INT. CL. 9. REG. 8-6-1996.
- 1,992,059. BOLD PLUS. INT. CL. 3. REG. 8-6-1996.
- 1,992,060. SMARTWRITE CD. INT. CL. 9. REG. 8-6-1996.
- 1,992,061. GREAT FOOD...GREAT SAVINGS...AT A GREAT NEW LOCATION. INT. CL. 42. REG. 8-6-1996.
- 1,992,063. PLAYERNET. INT. CL. 38. REG. 8-6-1996.
- 1,992,064. MJ DESIGNER LINE (STYLIZED). INT. CL. 20. REG. 8-6-1996.
- 1,992,065. MJ DESIGNER LINE (STYLIZED). INT. CL. 31. REG. 8-6-1996.
- 1,992,066. MJ DESIGNER LINE (STYLIZED). INT. CL. 26. REG. 8-6-1996.
- 1,992,067. TEDDY HOLOGRAMS. INT. CL. 30. REG. 8-6-1996.
- 1,992,068. GOLD MASTERMONEY. INT. CL. 36. REG. 8-6-1996.
- 1,992,069. FARMER'S MARKET SKILLET. INT. CL. 29. REG. 8-6-1996.
- 1,992,072. HOME ENVIRONMENT CENTER AND DESIGN. INT. CL. 42. REG. 8-6-1996.
- 1,992,073. ZOSTRIX HP TRIPLE STRENGTH AND DESIGN. INT. CL. 5. REG. 8-6-1996.
- 1,992,078. TRANQUILITY BAY. INT. CLS. 21 AND 24. REG. 8-6-1996.
- 1,992,079. IN-SYNC. INT. CLS. 35 AND 42. REG. 8-6-1996.
- 1,992,080. SPECIAL CREATIONS. INT. CL. 30. REG. 8-6-1996.
- 1,992,081. TRANSITION. INT. CL. 16. REG. 8-6-1996.
- 1,992,082. SECOND WIND. INT. CL. 28. REG. 8-6-1996.
- 1,992,083. HAPPY-BACK. INT. CL. 10. REG. 8-6-1996.
- 1,992,085. SPRING & SUMMER FOR A BUCK. INT. CL. 42. REG. 8-6-1996.
- 1,992,086. SACHI. INT. CL. 28. REG. 8-6-1996.
- 1,992,087. DRIVE 'N EAT. INT. CL. 28. REG. 8-6-1996.
- 1,992,089. SOUND 'N STYLE. INT. CL. 11. REG. 8-6-1996.
- 1,992,090. KESTREL. INT. CL. 9. REG. 8-6-1996.
- 1,992,091. WINKY SAYS. INT. CL. 28. REG. 8-6-1996.
- 1,992,092. PAYROLL DIRECT. INT. CL. 35. REG. 8-6-1996.
- 1,992,093. BIOWEAR. INT. CL. 9. REG. 8-6-1996.
- 1,992,095. MISCELLANEOUS DESIGN. INT. CL. 18. REG. 8-6-1996.
- 1,992,097. STA-SOF ALLIANCE. INT. CL. 28. REG. 8-6-1996.
- 1,992,100. RIBBON CAROUSEL. INT. CL. 28. REG. 8-6-1996.
- 1,992,102. MAXSHARE. INT. CL. 9. REG. 8-6-1996.
- 1,992,103. DYNAZYME (STYLIZED). INT. CL. 11. REG. 8-6-1996.
- 1,992,108. MISCELLANEOUS DESIGN. INT. CL. 38. REG. 8-6-1996.
- 1,992,109. MISCELLANEOUS DESIGN. INT. CL. 36. REG. 8-6-1996.
- 1,992,112. INTEROFFICE EXPRESS. INT. CL. 16. REG. 8-6-1996.
- 1,992,114. BY GEORGE. INT. CL. 14. REG. 8-6-1996.
- 1,992,116. BUSER BOOTS. INT. CL. 25. REG. 8-6-1996.
- 1,992,119. RETS. INT. CL. 9. REG. 8-6-1996.
- 1,992,120. MOOREPAC. INT. CL. 9. REG. 8-6-1996.
- 1,992,121. POWER TOOLS TODAY. INT. CL. 16. REG. 8-6-1996.
- 1,992,123. TOUCH-N-PRINT. INT. CL. 9. REG. 8-6-1996.
- 1,992,124. CHIQUITA TROPICALS. INT. CL. 32. REG. 8-6-1996.
- 1,992,125. SIERRA FALLS. INT. CL. 25. REG. 8-6-1996.
- 1,992,127. HARMONY VALLEY. INT. CL. 30. REG. 8-6-1996.
- 1,992,129. BEBE MODA. INT. CL. 25. REG. 8-6-1996.
- 1,992,130. SNOWMEISTER. INT. CL. 41. REG. 8-6-1996.
- 1,992,131. SEE THE LIGHT. INT. CL. 20. REG. 8-6-1996.
- 1,992,133. KAYLA COYOTE. INT. CL. 28. REG. 8-6-1996.
- 1,992,135. APPLEBY II. INT. CLS. 6 AND 37. REG. 8-6-1996.
- 1,992,136. RANCHER'S TRADITION. INT. CL. 29. REG. 8-6-1996.
- 1,992,137. CEO EDITION. INT. CL. 12. REG. 8-6-1996.
- 1,992,138. PROPARTS. INT. CL. 9. REG. 8-6-1996.
- 1,992,140. FITFORCE. INT. CLS. 9, 16, 41 AND 42. REG. 8-6-1996.
- 1,992,141. AQUA-LITES. INT. CL. 25. REG. 8-6-1996.
- 1,992,142. INTERWEB (STYLIZED). INT. CL. 42. REG. 8-6-1996.
- 1,992,143. DOLORAC. INT. CL. 5. REG. 8-6-1996.
- 1,992,147. HIT THE BEACH. INT. CL. 29. REG. 8-6-1996.
- 1,992,155. SNUGLER. INT. CL. 14. REG. 8-6-1996.
- 1,992,156. LEVELS QUEST. INT. CL. 9. REG. 8-6-1996.
- 1,992,157. LAVA BLAST. INT. CL. 28. REG. 8-6-1996.
- 1,992,158. TIME'S UP!. INT. CL. 9. REG. 8-6-1996.
- 1,992,160. Z-TRAILS. INT. CL. 9. REG. 8-6-1996.
- 1,992,161. ROAD WARS LIBERTY BASE. INT. CL. 28. REG. 8-6-1996.
- 1,992,163. POLLY LOVES BEAR. INT. CL. 28. REG. 8-6-1996.
- 1,992,164. POLLY LOVES PUPPY. INT. CL. 28. REG. 8-6-1996.
- 1,992,166. EXPERTFIT. INT. CL. 9. REG. 8-6-1996.
- 1,992,167. DISCOVERY PICNIC. INT. CL. 28. REG. 8-6-1996.
- 1,992,168. GO GIRL. INT. CL. 26. REG. 8-6-1996.
- 1,992,171. NOVO NORDISK AND DESIGN. INT. CL. 1. REG. 8-6-1996.
- 1,992,172. NATURAL LAYERS. INT. CL. 25. REG. 8-6-1996.
- 1,992,173. NETCRUISER. INT. CL. 9. REG. 8-6-1996.
- 1,992,174. ENIGMA. INT. CL. 9. REG. 8-6-1996.
- 1,992,176. YL BY YAIR AND DESIGN. INT. CL. 25. REG. 8-6-1996.
- 1,992,177. DEAR MOM. INT. CL. 25. REG. 8-6-1996.
- 1,992,180. USA RACING (STYLIZED). INT. CLS. 18 AND 25. REG. 8-6-1996.
- 1,992,181. FOUNTAIN SHAKE (STYLIZED). INT. CL. 30. REG. 8-6-1996.
- 1,992,182. JUMP-RATE. INT. CL. 36. REG. 8-6-1996.
- 1,992,185. MICR MANAGER. INT. CL. 9. REG. 8-6-1996.
- 1,992,186. STUDIO DAYBED. INT. CL. 20. REG. 8-6-1996.
- 1,992,187. ELECTRONIC RATING INFORMATION SERVICE. INT. CL. 36. REG. 8-6-1996.
- 1,992,188. CAREER REVIEW (STYLIZED). INT. CLS. 9 AND 16. REG. 8-6-1996.
- 1,992,189. SALMON ONLY. INT. CL. 28. REG. 8-6-1996.
- 1,992,190. MUSKY ONLY. INT. CL. 28. REG. 8-6-1996.
- 1,992,191. TROUT ONLY. INT. CL. 28. REG. 8-6-1996.
- 1,992,192. MISCELLANEOUS DESIGN. INT. CL. 21. REG. 8-6-1996.
- 1,992,193. MISCELLANEOUS DESIGN. INT. CL. 21. REG. 8-6-1996.
- 1,992,194. SDNSEARCH. INT. CL. 9. REG. 8-6-1996.
- 1,992,196. BARCELO (STYLIZED). INT. CL. 33. REG. 8-6-1996.

- 1,992,197. PRIVATE CARRIER DISTRIBUTION. INT. CL. 35. REG. 8-6-1996.
- 1,992,199. RONDEL RECORDS. INT. CL. 9. REG. 8-6-1996.
- 1,992,200. NEW YORK PRIME. INT. CL. 42. REG. 8-6-1996.
- 1,992,201. MISCELLANEOUS DESIGN. INT. CL. 42. REG. 8-6-1996.
- 1,992,202. LIFELIKE BIRDS. INT. CL. 20. REG. 8-6-1996.
- 1,992,204. BOX 4 FITNESS. INT. CL. 41. REG. 8-6-1996.
- 1,992,208. USA EMPLOYMENT. INT. CL. 35. REG. 8-6-1996.
- 1,992,209. TCP ADDITION. INT. CL. 9. REG. 8-6-1996.
- 1,992,212. PREFERRED BY PROFESSIONALS. INT. CL. 11. REG. 8-6-1996.
- 1,992,213. MCNAUGHTON WEAR. INT. CL. 25. REG. 8-6-1996.
- 1,992,214. COGER. INT. CL. 21. REG. 8-6-1996.
- 1,992,215. PROS ONLINE. INT. CL. 35. REG. 8-6-1996.
- 1,992,217. CLEARWALL. INT. CL. 19. REG. 8-6-1996.
- 1,992,218. NEWPORT RHYTHM & BLUES FESTIVAL. INT. CL. 41. REG. 8-6-1996.
- 1,992,219. FOAM ORGANIZER. INT. CL. 28. REG. 8-6-1996.
- 1,992,220. NEW ROCK ALTERNATIVE. INT. CL. 38. REG. 8-6-1996.
- 1,992,221. SOUTH FLORIDA'S ROCK ALTERNATIVE. INT. CL. 38. REG. 8-6-1996.
- 1,992,222. SOUTH FLORIDA'S NEW ROCK ALTERNATIVE. INT. CL. 38. REG. 8-6-1996.
- 1,992,223. GIRLS CAN PLAY BALL. INT. CL. 25. REG. 8-6-1996.
- 1,992,224. ELECTRONIC ENTERTAINMENT. INT. CL. 28. REG. 8-6-1996.
- 1,992,225. QUALITY PRINTING EXCLUSIVELY FOR THE TRADE. INT. CL. 42. REG. 8-6-1996.
- 1,992,226. MCDERMOTT'S. INT. CL. 30. REG. 8-6-1996.
- 1,992,229. PACABLES. INT. CL. 18. REG. 8-6-1996.
- 1,992,231. NATIONAL MANAGED CARE CONGRESS. INT. CL. 41. REG. 8-6-1996.
- 1,992,232. NATIONAL MANAGED CARE CONFERENCE. INT. CL. 41. REG. 8-6-1996.
- 1,992,608. SCOOTER PRODUCTIONS. INT. CL. 41. REG. 8-13-1996.
- 1,992,675. POWER GAMES. INT. CL. 16 ONLY. REG. 8-13-1996.
- 1,994,393. AD NET INC AND DESIGN. INT. CL. 35. REG. 8-20-1996.
- 2,000,247. PEACEHEALTH. INT. CLS. 35 AND 36 ONLY. REG. 9-10-1996.
- 2,001,126. TEA GARDEN SPRINGS A SPA FOR NURTURING BODY, MIND AND SOUL AND DESIGN. INT. CL. 42. REG. 9-17-1996.
- 2,032,725. MEIN STREET WOK AND DESIGN. INT. CLS. 16 AND 20 ONLY. REG. 1-21-1997.
- 2,033,652. TRAVELPRO AND DESIGN. INT. CL. 28 ONLY. REG. 1-28-1997.
- 2,038,527. MAEIL. INT. CL. 30 ONLY. REG. 2-18-1997.
- 2,039,854. DUOSTAT. INT. CL. 9 ONLY. REG. 2-25-1997.
- 2,042,446. ALL OCCASIONS. INT. CL. 26 ONLY. REG. 3-4-1997.

SECTION 18

- 1,297,914. GOOD STUFF. INT. CL. 30. REG. 9-25-1984.
- 1,371,417. CHEL'SEA II. INT. CL. 25. REG. 11-19-1985.
- 1,471,767. ONECARE AND DESIGN. INT. CL. 42. REG. 1-5-1988.
- 1,493,526. FIRM. INT. CL. 36. REG. 6-21-1988.
- 1,552,277. ADVANTAGE LINE. INT. CL. 38. REG. 8-15-1989.
- 1,826,278. ESPACE. INT. CL. 12. REG. 3-15-1994.
- 1,994,917. HYDRO-PAK. INT. CL. 21. REG. 8-20-1996.
- 2,054,712. DOCUMAGIX. INT. CL. 9. REG. 4-22-1997.
- 2,151,933. PHEASANT BY R.D. GOMEZ AND DESIGN. INT. CL. 34. REG. 4-21-1998.
- 2,198,605. SAMMY THE SNOWMAN. INT. CL. 28. REG. 10-20-1998.
- 2,236,422. AUFHAUSER. INT. CL. 36. REG. 4-6-1999.
- 2,244,429. VIRTUAL PARTNER. INT. CL. 9. REG. 5-11-1999.
- 2,373,684. SNACKITS. INT. CL. 30. REG. 8-1-2000.
- 2,384,307. WEBLEARNING. INT. CL. 41. REG. 9-5-2000.
- 2,387,138. PROMOTE. INT. CL. 5. REG. 9-19-2000.
- 2,466,500. SELECTIONS. INT. CL. 36. REG. 7-3-2001.
- 2,565,867. IN TOUCH WITH TOMORROW. INT. CL. 35. REG. 4-30-2002.
- 2,595,063. PERFECTPRACTICE.MD. INT. CL. 9. REG. 7-16-2002.

INADVERTENTLY ISSUED REGISTRATION NUMBERS

- 2,457,944. PR-1 (STYLIZED). INT. CL. 25. REG. 6-5-2001. RESTORED TO SN 75-591,685.
- 2,509,107. MISCELLANEOUS DESIGN. INT. CLS. 29 AND 32. REG. 11-20-2001.
- 2,543,609. REFLECTIONS OF EBONY. INT. CL. 38. REG. 2-26-2002. RESTORED TO SN 78-027,071.
- 2,651,229. GHG REGISTRY AND DESIGN. INT. CL. 42. REG. 11-19-2002. RESTORED TO SN 76-163,262.
- 2,651,740. GUARDIAN 275. INT. CLS. 6 AND 19. REG. 11-19-2002. RESTORED TO SN 76-329,061.
- 2,656,187. MASTER KITCHEN AND DESIGN. INT. CL. 11. REG. 12-3-2002. RESTORED TO SN 76-314,123.
- 2,659,016. FEMALEV. INT. CL. 5. REG. 12-10-2002. RESTORED TO SN 76-348,215.
- 2,663,026. SHAPES. INT. CL. 29. REG. 12-17-2002. RESTORED TO SN 76-377,160.
- 2,664,943. CYBERNET AND DESIGN. INT. CLS. 9, 35, 36, 38 AND 42. REG. 12-24-2002. RESTORED TO SN 75-610,720.
- 2,669,350. BIG O. INT. CL. 9. REG. 12-31-2002. RESTORED TO SN 78-115,902.

* * * * *

TRADEMARK REGISTRATIONS AMENDED, CORRECTED, ETC.

The designation "U.S. Cl." appearing in this section refers to the U.S. class in effect prior to Sep. 1, 1973 rather than the international class which applies to applications filed on or after that date. For adoption of international classification see notice in the OFFICIAL GAZETTE of Jun. 26, 1973 (911 O.G. TM 210).

Any change to the registration will be indicated at the bottom of each entry under ELEMENTS AMENDED, CORRECTED OR RESTRICTED. With the exception of changes to the goods and services, additions to the registration will appear in asterisks and deletions of the registration will appear in brackets. Elements which are only changed will be listed with no punctuation. As to the goods/services statement, amendments to the goods/services will appear in asterisks and deletions will appear in brackets. In addition if any change to the goods/services occurs, the element "Goods/Services" will be listed under ELEMENTS AMENDED, CORRECTED OR RESTRICTED.

307,550. REG. 10-31-1933. GOLDSMITH & REVERE, INC. (NEW JERSEY CORPORATION) 242 SOUTH DEAN STREET, ENGLEWOOD, NJ, 07631, ASSIGNEE OF; BY ASSIGNMENT, BY ASSIGNMENT, BY ASSIGNMENT BAKER & COMPANY, INC. CORPORATION) NEWARK, NJ, SN 71-339,581. FILED 7-8-1933. PRINCIPAL REGISTER.



INT. CL. 5/U.S. CL. 44
FOR DENTAL ALLOY FOR AMALGAMS.
FIRST USE 6-29-1933; IN COMMERCE 6-29-1933.

ELEMENTS AMENDED
OWNER NAME
OWNER ADDRESS
CITIZENSHIP
ENTITY
ASSIGNMENT/NAME CHANGE
MARK

385,165. REG. 2-18-1941. COCA-COLA COMPANY, THE (DELAWARE CORPORATION) P.O. DRAWER 1734, NAT 1956, ATLANTA, GA, 30301, BY MERGER CITRUS CONCENTRATES, INC. CORPORATION) DUNEDIN, FL, SN 71-436,048. FILED 9-17-1940. PRINCIPAL REGISTER.

SUNFILLED

OWNER OF U.S. REG. NO. 270,123.
INT. CL. 32/U.S. CL. 45
FOR FRUIT JUICES AND CONCENTRATED FRUIT JUICES FOR BEVERAGE PURPOSES, AND MIXTURES OR BASES FOR MAKING ORANGEADE AND GRAPE-FRUITADE.
FIRST USE 5-10-1937; IN COMMERCE 5-10-1937.

ELEMENTS AMENDED
OWNER ADDRESS
MARK

533,664. REG. 11-21-1950. MARLEY COOLING TOWER COMPANY, THE (DELAWARE CORPORATION) 5800 FOXRIDGE DRIVE, MISSION, KS, 66201, SN 71-577,332. FILED 4-18-1949. PRINCIPAL REGISTER.

AQUATOWER

OWNER OF U.S. REG. NO. 399,646.
SEC. 2(F).
INT. CL. 11/U.S. CL. 31
FOR LIQUID COOLING TOWERS AND PARTS THEREOF.
FIRST USE 10-21-1941; IN COMMERCE 10-21-1941.

ELEMENTS AMENDED
MARK

736,342. REG. 8-21-1962. LIONEL L.L.C. (NEW YORK LIMITED LIABILITY COMPANY) 50625 RICHARD W. BLVD., CHESTERFIELD, MI, 48051, BY ASSIGNMENT, BY ASSIGNMENT, BY ASSIGNMENT, BY ASSIGNMENT LIONEL CORPORATION, THE CORPORATION) CHESTERFIELD, MI, SN 72-125,393. FILED 8-4-1961. PRINCIPAL REGISTER.

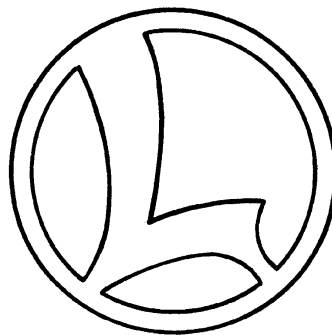

INT. CL. 28/U.S. CL. 22
FOR KIT TOYS.
FIRST USE 3-0-1961; IN COMMERCE 3-0-1961.

ELEMENTS AMENDED
MARK

888,837. REG. 3-31-1970. BOOZ ALLEN HAMILTON INC. (DELAWARE CORPORATION) 101 PARK AVENUE, NEW YORK, NY, 10176, BY CHANGE OF NAME BOOZ ALLEN & HAMILTON INC. CORPORATION) NEW YORK, NY, SN 72-311,547. FILED 11-7-1968. PRINCIPAL REGISTER.

BOOZ ALLEN HAMILTON

INT. CL. 35/U.S. CL. 101

FOR PROFESSIONAL COUNSELLING ON ORGANIZATION AND GENERAL MANAGEMENT PROBLEMS—NAMESLY, IN THE FIELDS OF ORGANIZATIONAL PLANNING, POLICY DEVELOPMENT, OPERATIONS IMPROVEMENT, PRODUCTIVITY IMPROVEMENT, PERSONNEL APPRAISAL AND SELECTION, AND THE LIKE.

FIRST USE 6-1-1942; IN COMMERCE 6-1-1942.

ELEMENTS AMENDED

- *OWNER NAME*
 - *OWNER ADDRESS*
 - *CITIZENSHIP*
 - *ENTITY*
 - *ASSIGNMENT/NAME CHANGE*
- MARK

FOR FISHING TACKLE—NAMESLY, [RODS, REELS AND] LINE.
FIRST USE 8-13-1980; IN COMMERCE 8-13-1980.

ELEMENTS AMENDED

- *OWNER NAME*
 - *OWNER ADDRESS*
 - *CITIZENSHIP*
 - *ENTITY*
 - *ASSIGNMENT/NAME CHANGE*
- MARK

1,228,560. REG. 2-22-1983. AMASIA INTERNATIONAL LTD. (MAURITANIA CORPORATION) 34 THIRD AVENUE, BURLINGTON, MA, 01803, BY ASSIGNMENT CARESSA, INC. CORPORATION) MIAMI, FL, SN 73-311,516. FILED 5-22-1981. PRINCIPAL REGISTER.

ALLURE

OWNER OF U.S. REG. NO. 626,590.
INT. CL. 25/U.S. CL. 39
FOR SHOES.
FIRST USE 2-2-1981; IN COMMERCE 2-27-1981.

ELEMENTS AMENDED

MARK TYPE

1,216,955. REG. 11-16-1982. S & B FOODS INC. (JAPAN CORPORATION) 18-6 NIHONBASHI KABUTO-CHO, CHUO-KU, TOKYO, JAPAN, 103, BY CHANGE OF NAME S&B SHOKUHIN CO., LTD. CORPORATION) NIHONBASHI, CHUO-KU, TOKYO, JAPAN, SN 73-303,419. FILED 3-30-1981. PRINCIPAL REGISTER.



OWNER OF U.S. REG. NOS. 1,054,018 AND 1,149,978.
INT. CL. 29/U.S. CL. 46
FOR SALE OF PRESERVED, PREPARED FOODS—NAMESLY, BEEF FLAVORED CURRY, CHICKEN FLAVORED CURRY.
FIRST USE 10-0-1964; IN COMMERCE 10-0-1964.

ELEMENTS AMENDED
MARK

1,231,974. REG. 3-22-1983. PACO RABANNE PARFUMS (FRANCE JOINT STOCK COMPANY) 6 BOULEVARD DU PARC, NEUILLY SUR SEINE (HAUTS DE SEINE), FRANCE., BY MERGER SOCIETE PACO RABANNE CORPORATION) PARIS, FRANCE, SN 73-074,791. FILED 1-19-1976. PRINCIPAL REGISTER.

paco rabanne

OWNER OF FRANCE REG. NO. 708,606, DATED 6-1-1966. THE NAME "PACO RABANNE" IS A FICTITIOUS NAME OF "FRANCISCO RABANEDA-CUERVO" WHOSE CONTENT IS OF RECORD.

INT. CL. 24/U.S. CL. 42
FOR HANDKERCHIEFS.
FIRST USE 6-0-1966; IN COMMERCE 1-0-1974.

INT. CL. 25/U.S. CL. 39
FOR WEARING APPAREL FOR WOMEN—NAMESLY, SUITS, DRESSES, OVERCOATS, RAINCOATS, SPORT-SUITS AND SPORT-JACKETS, HOSTESS GOWNS, EVENING WRAPS, EVENING GOWNS, FURS IN THE FORM OF COATS, OVERCOATS, STOLES, COLLARS, MUFFS AND HATS, SKIRTS, BLOUSES, CAPES, RIDING HABITS, MUFFLERS, SCARFS, LINGERIE, HOSIERY, STOCKINGS, NECKTIES, GLOVES, APPAREL BELTS, GIRDLES, BRASSIERES, DRESSING-GOWNS, ROMPERS, BATHING SUITS, GARTERS, HATS AND BERETS, SHOES AND SLIPPERS; MEN'S GARMENTS—NAMESLY, SUITS, JACKETS, OVERCOATS, RAINCOATS, MUFFLERS, GLOVES, SCARVES, TIES, BATHING SUITS, HATS AND BERETS, HOSIERY, KNITTED JERSEYS AND JUMPERS; AND UNDERWEAR—NAMESLY, BRIEFS, SLIPS, PANTS, TIGHTS, VESTS, SINGLET, AND T-SHIRTS.

FIRST USE 6-0-1966; IN COMMERCE 1-0-1974.

1,227,658. REG. 2-15-1983. SHAKESPEARE COMPANY (DELAWARE LTD LIAB CO) 3801 WESTMORE DRIVE, COLUMBIA, SC, 29223, BY CHANGE OF NAME SHAKESPEARE COMPANY CORPORATION) COLUMBIA, SC, SN 73-296,056. FILED 2-6-1981. PRINCIPAL REGISTER.

OMNIFLEX

INT. CL. 28/U.S. CLS. 22, 23, 38 AND 50

ELEMENTS AMENDED
MARK

1,240,403. REG. 5-31-1983. KRAVET INC. (DELAWARE CORPORATION) 225 CENTRAL AVENUE SOUTH, BETHPAGE, NY, 11714, BY MERGER KRAVET FABRICS INCORPORATED CORPORATION) BETHPAGE, NY, SN 73-330,125. FILED 9-28-1981. PRINCIPAL REGISTER.

1,652,307. REG. 7-30-1991. T-SYSTEMS INTERNATIONAL, INC. (CALIFORNIA CORPORATION) 7545 CARROLL ROAD, SAN DIEGO, CA, 921212401, SN 74-079,019. FILED 7-13-1990. PRINCIPAL REGISTER.

KRAVET



SEC. 2(F).
INT. CL. 24/U.S. CL. 42
FOR WOVEN, PRINTED, NATURAL AND SYNTHETIC FIBER DECORATIVE FABRICS AND WALL COVERINGS.
FIRST USE 0-0-1961; IN COMMERCE 0-0-1961.

OWNER OF U.S. REG. NOS. 1,105,584 AND 1,118,172.
INT. CL. 11/U.S. CL. 13
FOR DRIP IRRIGATION HOSE.
FIRST USE 8-0-1989; IN COMMERCE 8-0-1989.

ELEMENTS AMENDED
OWNER NAME
OWNER ADDRESS
CITIZENSHIP
ENTITY
ASSIGNMENT/NAME CHANGE
MARK

ELEMENTS AMENDED
MARK

1,634,966. REG. 2-12-1991. BOOZ ALLEN HAMILTON INC. (DELAWARE CORPORATION) 101 PARK AVENUE, NEW YORK, NY, 10178, BY CHANGE OF NAME BOOZ-ALLEN & HAMILTON INC. CORPORATION) NEW YORK, NY, SN 74-054,287. FILED 4-30-1990. PRINCIPAL REGISTER.

1,713,101. REG. 9-8-1992. KIRKBI AG (SWITZERLAND CORPORATION) INTERLEGO A.G. NEUHOFSTRASSE 21, CH-6340, BAAR, SWITZERLAND, BY ASSIGNMENT INTERLEGO A.G. CORPORATION) BAAR, SWITZERLAND, SN 74-227,042. FILED 11-27-1991. PRINCIPAL REGISTER.

BOOZ ALLEN HAMILTON



OWNER OF U.S. REG. NO. 888,837.
INT. CL. 35/U.S. CL. 101
FOR MANAGEMENT CONSULTING SERVICES IN VARIOUS INDUSTRIES AND FIELDS OF BUSINESS, NAMELY, AEROSPACE, DEFENSE, MANUFACTURING, TECHNOLOGY MANAGEMENT, ELECTRONICS, HEALTH CARE, CHEMICALS, PHARMACEUTICALS, GOVERNMENT CONTRACTING, TRANSPORTATION, MARKETING, EDUCATION, BANKING, UTILITIES, INSURANCE, ENERGY, TELECOMMUNICATIONS, AND ENVIRONMENT MANAGEMENT.
FIRST USE 6-1-1942; IN COMMERCE 6-1-1942.
INT. CL. 42/U.S. CLS. 100 AND 101
FOR CONSULTING SERVICES IN THE FIELD OF COMPUTER SYSTEMS DEVELOPMENT, ENGINEERING AND INTEGRATION.
FIRST USE 0-0-1970; IN COMMERCE 0-0-1970.

OWNER OF U.S. REG. NOS. 1,026,871, 1,535,046 AND OTHERS.
INT. CL. 8/U.S. CL. 23
FOR HAND TOOL IN THE NATURE OF A LEVER FOR SEPARATING INTERLOCKING PLASTIC BRICKS.
FIRST USE 0-0-1990; IN COMMERCE 0-0-1990.

ELEMENTS AMENDED
OWNER NAME
OWNER ADDRESS
CITIZENSHIP
ENTITY
ASSIGNMENT/NAME CHANGE
MARK

ELEMENTS AMENDED
ASSIGNMENT/NAME CHANGE
OWNER ADDRESS
MARK
[LINING/STIPPLING STATEMENT]

1,739,986. REG. 12-15-1992. GOLFER'S WAREHOUSE (CONNECTICUT CORPORATION) 216 MURPHY ROAD, HARTFORD, CT, 06114, BY ASSIGNMENT AMERICAN GOLF DESIGN, INC. CORPORATION) SIMSBURY, CT, SN 74-142,201. FILED 2-22-1991. PRINCIPAL REGISTER.



SEC. 2(F).
INT. CL. 28/U.S. CL. 22
FOR GOLF CLUBS.
FIRST USE 1-0-1984; IN COMMERCE 1-0-1984.

ELEMENTS AMENDED
OWNER NAME
OWNER ADDRESS
CITIZENSHIP
ENTITY
ASSIGNMENT/NAME CHANGE
MARK

1,767,365. REG. 4-27-1993. HELLENBRAND, INC. (WISCONSIN CORPORATION) 404 MORAVIAN VALLEY ROAD, P.O. BOX 187, WAUAKEE, WI, 53597, BY CHANGE OF NAME HELLENBRAND WATER CONDITIONERS CO., INC. CORPORATION) WAUNAKEE, WI, SN 74-239,362. FILED 1-22-1992. PRINCIPAL REGISTER.



WATER CONDITIONERS, INC.

NO CLAIM IS MADE TO THE EXCLUSIVE RIGHT TO USE "WATER CONDITIONERS, INC.", APART FROM THE MARK AS SHOWN.

INT. CL. 11/U.S. CLS. 31 AND 34
FOR WATER CONDITIONING UNITS, WATER DISTILLATION UNITS, DOMESTIC COMMERCIAL AND INDUSTRIAL WATER FILTERING UNITS, AND DOMESTIC AND COMMERCIAL WATER PURIFYING UNITS.

FIRST USE 10-9-1991; IN COMMERCE 10-9-1991.

ELEMENTS CORRECTED
OWNER ADDRESS
CITIZENSHIP
ENTITY
ASSIGNMENT/NAME CHANGE
OWNER NAME

1,765,662. REG. 4-20-1993. COMPASSLEARNING, INC. (DELAWARE CORPORATION) 9920 PACIFIC HEIGHTS BLVD, SUITE 500, SAN DIEGO, CA, 92121, BY ASSIGNMENT; BY ASSIGNMENT, BY ASSIGNMENT, BY ASSIGNMENT, BY MERGER, BY CHANGE OF NAME HARTLEY COURSEWARE, INC. CORPORATION) DIMONDALE, MI, SN 74-257,129. FILED 3-19-1992. PRINCIPAL REGISTER.



INT. CL. 9/U.S. CL. 38
FOR EDUCATIONAL COMPUTER SOFTWARE AND RELATED INSTRUCTIONAL MATERIALS SOLD THEREWITH FOCUSING IN THE AREAS OF READING, LANGUAGE, MATH, SCIENCE, WRITING, SOCIAL STUDIES, LIFE AND EMPLOYABILITY SKILLS AND THE LIKE FOR AGES 2 THROUGH ADULT.
FIRST USE 5-0-1981; IN COMMERCE 5-0-1981.

ELEMENTS AMENDED
MARK

1,771,647. REG. 5-18-1993. ARCH FOODS, INC. (NEW JERSEY CORPORATION) 1090 SPRINGFIELD ROAD, UNION, NJ, 07082, SN 74-217,349. FILED 10-31-1991. PRINCIPAL REGISTER.

CURRY CLASSICS

NO CLAIM IS MADE TO THE EXCLUSIVE RIGHT TO USE "CURRY" AND "ENTREES", APART FROM THE MARK AS SHOWN.

INT. CL. 29/U.S. CL. 46
FOR FROZEN PREPARED FOODS; NAMELY, FROZEN FOOD ENTREES PREPARED FROM MEAT, FISH, VEGETABLES AND COMBINATIONS OF THESE.

FIRST USE 5-16-1991; IN COMMERCE 5-16-1991.

ELEMENTS AMENDED
MARK

1,840,549. REG. 6-21-1994. CHATEAU ANNE U.S.A INC. (CALIFORNIA CORPORATION) 800 SOUTH DATE AVE, ALHAMBRA, CA, 91803, SN 74-398,322. FILED 6-7-1993. PRINCIPAL REGISTER.

VINCENT VAN GOGH

INT. CL. 18/U.S. CL. 3
FOR HANDBAGS, PURSES, AND WALLETS.
FIRST USE 3-0-1990; IN COMMERCE 11-0-1992.

ELEMENTS CORRECTED
OWNER NAME

1,916,926. REG. 9-5-1995. NOVA SOUTHEASTERN, INC. (FLORIDA CORPORATION) 3301 COLLEGE AVENUE, FORT LAUDERDALE, FL, 33314, SN 74-552,730. FILED 7-25-1994. PRINCIPAL REGISTER.

NOVA
SOUTHEASTERN
UNIVERSITY

NO CLAIM IS MADE TO THE EXCLUSIVE RIGHT TO USE "UNIVERSITY", APART FROM THE MARK AS SHOWN.

INT. CL. 41/U.S. CL. 107

FOR EDUCATIONAL SERVICES, NAMELY COURSES OF INSTRUCTION AT THE UNIVERSITY LEVEL.

FIRST USE 1-11-1994; IN COMMERCE 1-11-1994.

ELEMENTS CORRECTED
OWNER NAME

1,990,727. REG. 8-6-1996. RESOLVE, INC. (ARIZONA CORPORATION) 4433 EAST BROADWAY BLVD, TUCSON, AZ, 85711, SN 74-581,500. FILED 10-3-1994. PRINCIPAL REGISTER.

Inc.
ReSolve
Real Business Solutions

NO CLAIM IS MADE TO THE EXCLUSIVE RIGHT TO USE "BUSINESS SOLUTIONS" OR "INC.", APART FROM THE MARK AS SHOWN.

INT. CL. 35/U.S. CLS. 100, 101 AND 102

FOR BUSINESS MANAGEMENT CONSULTING.

FIRST USE 11-29-1993; IN COMMERCE 11-29-1993.

INT. CL. 36/U.S. CLS. 100, 101 AND 102

FOR REAL ESTATE LISTING (AND/OR BROKERAGE).

FIRST USE 11-29-1993; IN COMMERCE 11-29-1993.

ELEMENTS CORRECTED
OWNER NAME
OWNER ADDRESS

2,018,885. REG. 11-26-1996. KINTETSU WORLD EXPRESS (U.S.A.), INC. (CALIFORNIA CORPORATION) 100 JERICHO QUADRANGLE, SUITE 326, JERICHO, NY, 11753, BY ASSIGNMENT KINTETSU WORLD EXPRESS, INC. CORPORATION) CHIYODA-KU, TOYKO 100, JAPAN, SN 74-701,056. FILED 7-14-1995. PRINCIPAL REGISTER.

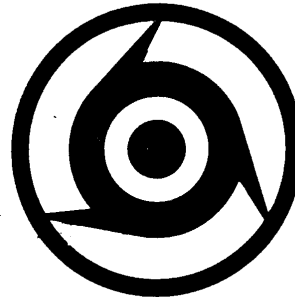

INT. CL. 35/U.S. CLS. 100, 101 AND 102

FOR COMPUTERIZED DATABASE MANAGEMENT, NAMELY, TRACKING INTERNATIONAL FREIGHT AND CARGO SHIPMENTS BY AIR, SEA, TRUCK AND RAIL THROUGH PROVIDING INFORMATION BY SHIPMENT DATE, SCOPE, ORIGIN, DESTINATION, CARRIER, AND CUSTOMER; COMPUTERIZED DATA BASE MANAGEMENT OF WAREHOUSE INVENTORIES, NAMELY, REPLENISHING AND RESETTING STOCK; AND MANAGING VIA COMPUTER THE LOGISTICS RELATED THEREWITH.

FIRST USE 4-27-1995; IN COMMERCE 4-27-1995.

INT. CL. 36/U.S. CLS. 100, 101 AND 102

FOR CREDIT AGENCY; CUSTOMS BROKERAGE SERVICES; BUSINESS BROKERAGE SERVICES IN THE FIELD OF COMMERCIAL AND CONSUMER CREDIT.

FIRST USE 4-27-1995; IN COMMERCE 4-27-1995.

INT. CL. 39/U.S. CLS. 100 AND 105

FOR AIRFREIGHT, OCEAN FREIGHT AND ROAD FREIGHT TRANSPORTATION SERVICES; IMPORT AND EXPORT CARGO HANDLING AND DISTRIBUTION SERVICES; CARGO PICK-UP, LOADING, EN ROUTE STORAGE, UNLOADING AND DELIVERY SERVICES; WAREHOUSING, NAMELY THE RENTING OF WAREHOUSE SPACE AND STORAGE; FREIGHT BROKERAGE.

FIRST USE 4-27-1995; IN COMMERCE 4-27-1995.

ELEMENTS CORRECTED
MARK

2,039,217. REG. 2-18-1997. INTEGRA LIFESCIENCES CORPORATION (DELAWARE CORPORATION) 311C ENTERPRISE DRIVE, PLAINSBORO, NJ, 05836, BY MERGER, BY CHANGE OF NAME COLLA-TEC, INC. CORPORATION) PLAINSBORO, NJ, SN 74-363,946. FILED 3-3-1993. PRINCIPAL REGISTER.

BIOMEND

INT. CL. 5/U.S. CLS. 6, 18, 44, 46, 51 AND 52

FOR ABSORBABLE COLLAGEN MEMBRANE FOR GUIDED TISSUE REGENERATION IN DENTAL SURGERY.

FIRST USE 9-26-1995; IN COMMERCE 9-26-1995.

ELEMENTS CORRECTED

OWNER ADDRESS

ENTITY

ASSIGNMENT/NAME CHANGE

OWNER NAME

CITIZENSHIP

FOR PHYSICAL FITNESS INSTRUCTION, NAMELY, PROVIDING INSTRUCTION IN A COMPREHENSIVE MOVEMENT EXPERIENCE FOR THE BODY, THE MIND, THE BREATH, AND THE SPIRIT.

FIRST USE 2-1-1996; IN COMMERCE 2-1-1996.

ELEMENTS CORRECTED

OWNER NAME

ENTITY

OWNER NAME

CITIZENSHIP

ENTITY

2,047,902. REG. 3-25-1997. DOYLE MUSIC GROUP, INC. (ARIZONA CORPORATION), DBA CANYON RECORDS PRODUCTIONS, 4143 NORTH 16TH STREET, SUITE 6, PHOENIX, AZ, 85016, SN 75-110,309. FILED 5-28-1996. PRINCIPAL REGISTER.

2,069,337. REG. 6-10-1997. BUYERZONE.COM, INC. (DELAWARE CORPORATION) 125 WALNUT STREET, WATERTOWN, MA, 02472, SN 75-100,563. FILED 5-8-1996. PRINCIPAL REGISTER.

CANYON RECORDS

BUYERSZONE

OWNER OF U.S. REG. NOS. 893,749, 1,641,137 AND OTHERS.

NO CLAIM IS MADE TO THE EXCLUSIVE RIGHT TO USE "RECORDS", APART FROM THE MARK AS SHOWN. INT. CL. 42/U.S. CLS. 100 AND 101

FOR RETAIL AND WHOLESALE DISTRIBUTORSHIP SERVICES OF PRERECORDED MUSIC ON COMPACT DISCS, PRERECORDED MAGNETIC TAPE CASSETTES AND PHONOGRAPH RECORDS OF OTHERS.

FIRST USE 10-1-1992; IN COMMERCE 10-1-1992.

INT. CL. 35/U.S. CLS. 100, 101 AND 102

FOR PROVIDING INFORMATION REGARDING BUSINESS PRODUCTS AND SERVICE PROVIDERS, VIA TELEPHONE, VIA A GLOBAL COMPUTER INFORMATION NETWORK, VIA PRINTED REPORTS AND VIA FORMS, DIRECTED TO BUSINESSES MAKING PURCHASING DECISIONS.

FIRST USE 11-17-1995; IN COMMERCE 11-17-1995.

ELEMENTS AMENDED

MARK

DISCLAIMER

ELEMENTS AMENDED

MARK

2,066,858. REG. 6-3-1997. CYCLO INDUSTRIES, L.L.C. (INDIANA LIMITED LIABILITY COMPANY) 10190 RIVERSIDE DRIVE, PALM BEACH GARDENS, FL, 33410, SN 75-090,623. FILED 4-18-1996. PRINCIPAL REGISTER.

2,082,843. REG. 7-29-1997. OPTIMUM TECHNOLOGIES, INC. (MASSACHUSETTS CORPORATION) 68 WEST STREET, SOUTHBRIDGE, MA, 01550, SN 74-685,185. FILED 6-6-1995. PRINCIPAL REGISTER.

ULTRAWELD

OPTIMUM TECHNOLOGIES

INT. CL. 1/U.S. CLS. 1

FOR EPOXY PUTTY.

FIRST USE 2-22-1996; IN COMMERCE 2-22-1996.

NO CLAIM IS MADE TO THE EXCLUSIVE RIGHT TO USE "TECHNOLOGIES", APART FROM THE MARK AS SHOWN.

INT. CL. 42/U.S. CLS. 100 AND 101

FOR ENGINEERING AND PRODUCT DEVELOPMENT SERVICES IN THE FIELD OF OPTO-MECHANICAL AND ELECTRO-OPTICAL INSTRUMENTATION.

FIRST USE 10-0-1994; IN COMMERCE 10-0-1994.

ELEMENTS CORRECTED

ENTITY

ELEMENTS CORRECTED

OWNER NAME

OWNER ADDRESS

2,067,146. REG. 6-3-1997. FLETCHER, RON (UNITED STATES INDIVIDUAL), DBA FLETCHER COREY, 13550 NOGALES DRIVE, DEL MAR, CA, 92014, AND COREY, KATHY (UNITED STATES INDIVIDUAL), DBA FLETCHER COREY, 13550 NOGALES DRIVE, DEL MAR, CA, 92014, SN 75-124,221. FILED 6-24-1996. PRINCIPAL REGISTER.

2,101,407. REG. 9-30-1997. BUSINESS FOR SOCIAL RESPONSIBILITY (D.C. CORPORATION) 609 MISSION STREET, SECOND FLOOR, SAN FRANCISCO, CA, 941053506, SN 75-172,670. FILED 9-26-1996. PRINCIPAL REGISTER.

THE RON FLETCHER WORK

BSR EDUCATION FUND

NO CLAIM IS MADE TO THE EXCLUSIVE RIGHT TO USE "WORK", APART FROM THE MARK AS SHOWN.

THE MARK IDENTIFIES A LIVING INDIVIDUAL WHOSE CONSENT IS OF RECORD.

INT. CL. 41/U.S. CLS. 100, 101 AND 107

OWNER OF U.S. REG. NO. 2,007,954.

NO CLAIM IS MADE TO THE EXCLUSIVE RIGHT TO USE "EDUCATION FUND", APART FROM THE MARK AS SHOWN.

INT. CL. 35/U.S. CLS. 100, 101 AND 102

FOR BUSINESS SERVICES, NAMELY, PROVIDING INFORMATION, TECHNICAL ASSISTANCE AND CONSULTING SERVICES IN THE FIELD OF SOCIALLY RESPONSIBLE BUSINESS PRACTICES; AND BUSINESS NETWORKING SERVICES, NAMELY, CREATING AND FACILITATING NETWORKS BETWEEN COMPANY REPRESENTATIVES.

FIRST USE 1-0-1992; IN COMMERCE 1-0-1992.
INT. CL. 41/U.S. CLS. 100, 101 AND 107

FOR EDUCATIONAL SERVICES, NAMELY, CONDUCTING CONFERENCES, SEMINARS AND OTHER INSTRUCTIONAL PROGRAMS IN THE FIELD OF SOCIALLY RESPONSIBLE BUSINESS PRACTICES AND DISTRIBUTING COURSE MATERIAL IN CONNECTION THEREWITH .

FIRST USE 1-0-1992; IN COMMERCE 1-0-1992.

ELEMENTS CORRECTED
OWNER NAME
OWNER ADDRESS

2,113,115. REG. 11-11-1997. ZODIAC POOL CARE, INC. (FLORIDA CORPORATION) 3420 N.W. 53RD STREET, FORT LAUDERDALE, FL, 33309, BY CHANGE OF NAME BARACUDA INTERNATIONAL CORPORATION CORPORATION) FT. LAUDERDALE, FL, SN 74-729,214. FILED P.R. 9-13-1995; AM. S.R. 8-7-1997. SUPPLEMENTAL REGISTER.

LEAF CATCHER

NO CLAIM IS MADE TO THE EXCLUSIVE RIGHT TO USE "LEAF", APART FROM THE MARK AS SHOWN.

INT. CL. 7/U.S. CLS. 13, 19, 21, 23, 31, 34 AND 35

FOR SWIMMING POOL CLEANING EQUIPEMENT, NAMELY DEBRIS TRAPS FOR USE WITH AN AUTOMATIC POOL VACUUM CLEANER.

FIRST USE 2-7-1995; IN COMMERCE 2-7-1995.

ELEMENTS AMENDED
MARK

2,171,327. REG. 7-7-1998. DZS SOFTWARE SOLUTIONS, INC. (NEW JERSEY CORPORATION) 1661 ROUTE 22 WEST, BOUND BROOK, NJ, 08805, SN 75-312,659. FILED 6-23-1997. PRINCIPAL REGISTER.

CLINPLUS

INT. CL. 9/U.S. CLS. 21, 23, 26, 36 AND 38

FOR COMPUTER SOFTWARE FOR USE IN CONNECTION WITH TRACKING, VALIDATION, SUMMARIZATION AND STATISTICAL ANALYSIS OF PHARMACEUTICAL RESEARCH DATA.

FIRST USE 4-17-1997; IN COMMERCE 4-17-1997.

ELEMENTS CORRECTED
OWNER NAME

2,283,408. REG. 10-5-1999. CONSTELLATION BRANDS, INC. (DELAWARE CORPORATION) 300 WILLOWBROOK OFFICE PARK, FAIRPORT, NY, 11450, BY CHANGE OF NAME CANANDAIGUA BRANDS, INC. CORPORATION) FAIRPORT, NY, SN 75-582,656. FILED 11-4-1998. PRINCIPAL REGISTER.

ARBOR MIST

INT. CL. 33/U.S. CLS. 47 AND 49

FOR WINE, FLAVORED WINES AND WINE-BASED BEVERAGES.

FIRST USE 2-0-1998; IN COMMERCE 5-0-1998.

ELEMENTS AMENDED
OWNER NAME
OWNER ADDRESS
CITIZENSHIP
ENTITY
ASSIGNMENT/NAME CHANGE
DATE OF FIRST USE
DATE OF FIRST USE IN COMMERCE

2,305,437. REG. 1-4-2000. HARTVILLE AUCTION, INC. (OHIO CORPORATION) 940 WEST MAPLE STREET, HARTVILLE, OH, 44632, SN 75-456,844. FILED 3-26-1998. PRINCIPAL REGISTER.

WOOD-CHAT

INT. CL. 42/U.S. CLS. 100 AND 101

FOR PROVIDING ON-LINE FACILITIES FOR REAL TIME INTERACTION WITH OTHER COMPUTER USERS CONCERNING TOPICS RELATED TO WOODWORKING AND WOODWORKING TOOLS ON A GLOBAL COMPUTER INFORMATION NETWORK.

FIRST USE 3-13-1998; IN COMMERCE 3-13-1998.

ELEMENTS CORRECTED
OWNER NAME

2,333,236. REG. 3-21-2000. KELLOGG COMPANY (DELAWARE CORPORATION) ONE KELLOGG SQUARE, P. O. BOX 3599, BATTLE CREEK, MI, 490163599, SN 75-732,581. FILED 6-21-1999. PRINCIPAL REGISTER.

COOKING UP FAMILY TRADITIONS

NO CLAIM IS MADE TO THE EXCLUSIVE RIGHT TO USE COOKING, APART FROM THE MARK AS SHOWN.

INT. CL. 16/U.S. CLS. 2, 5, 22, 23, 29, 37, 38 AND 50

FOR PRINTED RECIPES IN THE FORM OF BOOKLETS, BROCHURES, PAMPHLETS, AND CARDS MARKETED AS A COMPONENT OF FOOD PACKAGING .

FIRST USE 12-0-1991; IN COMMERCE 12-0-1991.

ELEMENTS AMENDED
DISCLAIMER

2,359,067. REG. 6-20-2000. PREDIGE SA (SWITZERLAND JOINT STOCK COMPANY) 196, ROUTE DE COSSONAY, CH-1020 RENENS, SWITZERLAND., SN 75-393,150. FILED 11-19-1997. PRINCIPAL REGISTER.



LES NATURELLES

PRIORITY CLAIMED UNDER SEC. 44(D) ON SWITZERLAND APPLICATION NO. 03929/1997, FILED 5-20-1997, REG. NO. 447339, DATED 12-30-1997, EXPIRES 5-20-2007.

NO CLAIM IS MADE TO THE EXCLUSIVE RIGHT TO USE "LES NATURELLES", APART FROM THE MARK AS SHOWN.

THE ENGLISH TRANSLATION OF THE WORD "LES NATURELLES" IN THE MARK IS "THE NATURALS".

INT. CL. 3/U.S. CLS. 1, 4, 6, 50, 51 AND 52

FOR TOILETRY AND BEAUTY CARE ARTICLES, NAMELY, EYE MAKEUP, FOUNDATION MAKEUP, FACIAL MAKEUP, EYE AND FACIAL MAKEUP REMOVER; SUNTANNING PREPARATIONS, SOAPS; PERFUMERY, NAMELY, COLOGNE, TOILET WATER, EAU DE PERFUME, EAU DE TOILETTE AND PERFUME; COSMETICS, NAMELY LIPSTICK, LIP GLOSS, MASCARA, EYELINER, NAIL POLISH, MAKEUP POWDER, BLUSH, ROUGE, EYE SHADOW, COSMETIC PENCILS; NAIL CARE PREPARATIONS, SKIN MOISTURIZERS, FACIAL CREAMS AND GELS, EXFOLIATING AND TONING GELS, FACIAL CLEANSERS, FACIAL MASQUES, GENTLE FACIAL AND BODY PEELS, HAND LOTIONS, HAND CREAMS, EYE GELS AND CREAMS, BEAUTY MASKS, SKIN CLARIFIERS, WRINKLE REMOVING SKIN CARE PREPARATIONS; HAIR LOTIONS, NAMELY, HAIR SHAMPOOS AND CONDITIONERS, HAIR STYLING GELS AND LOTIONS; ESSENTIAL OILS FOR PERSONAL USE.

FIRST USE ; IN COMMERCE .

INT. CL. 35/U.S. CLS. 100, 101 AND 102

FOR ADVERTISING SERVICES, NAMELY, BUSINESS MARKETING CONSULTING SERVICES; SALES PROMOTION SERVICES, NAMELY, CONDUCTING EMPLOYEE INCENTIVE AWARD PROGRAMS TO PROMOTE ON THE JOB PRODUCTIVITY, SAFETY AND QUALITY; PROMOTING THE SALE OF CREDIT CARD ACCOUNTS THROUGH THE ADMINISTRATION OF INCENTIVE AWARD PROGRAMS; TELEMARKETING; BUSINESS MANAGEMENT AND CONSULTATION SERVICES IN THE FIELD OF BEAUTY, HEALTH CARE AND COSMETICS; RETAIL STORE, WHOLESALE STORE, AND MAIL ORDER SERVICES, ALL FEATURING COSMETIC PRODUCTS; INFORMATION SERVICES, NAMELY, PROVIDING BUSINESS INFORMATION ON THE OPERATION OF RETAIL AND WHOLESALE STORES VIA ELECTRONIC MEANS, AUDIOVISUAL MEANS AND VIA A GLOBAL COMPUTER NETWORK; COMPUTERIZED ON-LINE ORDERING SERVICES IN THE FIELD OF COSMETIC PRODUCTS AND HEALTH CARE; PROVIDING HOME SHOPPING SERVICES IN THE FIELD OF TOILETRY AND BEAUTY CARE ARTICLES BY MEANS OF TELEVISION AND A GLOBAL COMPUTER NETWORK; FRANCHISING, NAMELY, OFFERING TECHNICAL ASSISTANCE IN THE ESTABLISHMENT AND/OR OPERATION OF STORES IN THE FIELD OF COSMETICS AND HEALTH CARE PRODUCTS; AND MULTI-LEVEL NETWORK MARKETING DISTRIBUTORSHIPS FEATURING COSMETICS AND BEAUTY PRODUCTS.

FIRST USE ; IN COMMERCE .

INT. CL. 38/U.S. CLS. 100, 101 AND 104

FOR TELECOMMUNICATIONS SERVICES, NAMELY PROVIDING TELECOMMUNICATIONS CONNECTIONS TO A GLOBAL COMPUTER NETWORK; ELECTRONIC TRANSMISSION OF DATA AND DOCUMENTS VIA COMPUTER TERMINALS; ELECTRONIC ORDER TRANSMISSION FOR RETAIL STORES IN THE FIELD OF TOILETRY AND BEAUTY CARE ARTICLES; CABLE TELEVISION BROADCASTING IN THE FIELD OF BEAUTY AND HEALTH CARE.

FIRST USE ; IN COMMERCE .

INT. CL. 41/U.S. CLS. 100, 101 AND 107

FOR EDUCATIONAL SERVICES, NAMELY, CONDUCTING CLASSES, SEMINARS, CONFERENCES, WORKSHOPS, AND ON-LINE FORUMS IN THE FIELDS OF BEAUTY, HEALTH CARE AND COSMETICS AND IN TECHNIQUES AND THE ART OF APPLICATION OF MAKEUP FOR BEAUTY CARE PERSONNEL AND FOR CUSTOMERS.

FIRST USE ; IN COMMERCE .

INT. CL. 42/U.S. CLS. 100 AND 101

FOR BEAUTY CARE INFORMATION SERVICES FEATURING BEAUTY TIPS AND INFORMATION ON COSMETICS, BEAUTY, THE ART OF MAKEUP APPLICATION, AND HEALTH CARE DISSEMINATED AND TRANSMITTED BY ELECTRONIC MEANS, AUDIOVISUAL MEANS AND BY A GLOBAL COMPUTER NETWORK; PROVIDING COMPUTER SERVICES, NAMELY, PROVIDING ON-LINE FACILITIES FOR REAL TIME INTERACTION WITH OTHER COMPUTER USERS CONCERNING TOPICS OF GENERAL INTEREST IN THE COSMETIC, BEAUTY AND HEALTH CARE FIELD.

FIRST USE ; IN COMMERCE .

ELEMENTS CORRECTED

MARK

FOREIGN REG. EXPIRATION DATE

2,392,676. REG. 10-10-2000. REDEMPTORIST FATHERS (MISSOURI CORPORATION), DBA LIGUORI PUBLICATIONS, ONE LIGUORI DRIVE, LIGUORI, MO, 630579999, SN 75-569,059. FILED 10-13-1998. PRINCIPAL REGISTER.

PASTORALINK

INT. CL. 42/U.S. CLS. 100 AND 101

FOR COMPUTER SERVICES, NAMELY, PROVIDING A WEB SITE AT WHICH USERS CAN VIEW AND PRINT PUBLICATIONS OF OTHERS IN THE FIELD OF RELIGION.

FIRST USE 12-8-1998; IN COMMERCE 12-8-1998.

ELEMENTS CORRECTED

DBA/AKA

OWNER NAME

2,397,355. REG. 10-24-2000. MARS, INCORPORATED (DELAWARE CORPORATION) 6885 ELM STREET, MCLEAN, VA, 221013883, SN 75-716,809. FILED 5-28-1999. PRINCIPAL REGISTER.

M&M' S

OWNER OF U.S. REG. NOS. 396,914, 1,774,366 AND OTHERS.

INT. CL. 25/U.S. CLS. 22 AND 39

FOR FOOTWEAR.

FIRST USE 10-0-1998; IN COMMERCE 10-0-1998.

ELEMENTS CORRECTED

MARK

2,417,355. REG. 1-2-2001. AMERICAN RAILWAY ENGINEERING AND MAINTENANCE-OF-WAY ASSOCIATION, INC. (ILLINOIS NOT-FOR-PROFIT CORPORATION) 8201 CORPORATE DRIVE, SUITE 1125, LANDOVER, MD, 207852230, SN 75-843,649. FILED 11-9-1999. PRINCIPAL REGISTER.

2,441,064. REG. 4-3-2001. MARS, INCORPORATED (DELAWARE CORPORATION) 6885 ELM STREET, MCLEAN, VA, 221013883, SN 76-040,014. FILED 5-3-2000. PRINCIPAL REGISTER.

AREMA

American Railway Engineering and Maintenance-of-Way Association

NO CLAIM IS MADE TO THE EXCLUSIVE RIGHT TO USE "AMERICAN RAILWAY AND MAINTENANCE OF WAY ASSOCIATION", APART FROM THE MARK AS SHOWN.

INT. CL. 16/U.S. CLS. 2, 5, 22, 23, 29, 37, 38 AND 50
FOR PRINTED PUBLICATIONS, NAMELY, NEWSLETTERS, JOURNALS AND BROCHURES, IN THE FIELD OF RAILWAY ENGINEERING.

FIRST USE 9-8-1997; IN COMMERCE 9-8-1997.

INT. CL. 42/U.S. CLS. 100 AND 101
FOR ASSOCIATION SERVICES, NAMELY, PROMOTING THE INTERESTS OF ENGINEERING PROFESSIONALS, SUPPORT PERSONNEL, SUPPLIERS, AND CONSULTANTS IN THE RAILWAY INDUSTRY.

FIRST USE 9-8-1997; IN COMMERCE 9-8-1997.

ELEMENTS AMENDED
MARK

2,419,721. REG. 1-9-2001. CONSTRUCTION COOPERATION AND EDUCATION TRUST, A NEW YORK NOT FOR PROFIT LABOR MANAGEMENT TRUST, THE TRUSTEES COMPRISINGSTEPHEN REMINTON, JOHN CASEY, RONALD POMMERENING, THOMAS J. MCCADDEN, FRANK WIRT, MARTIN POTTER, ROBERT BROWN, GARY ROTH, RICHARD T. HARDY AND GARY SQUIRES, ALL U.S. CITIZENS, THE (NEW YORK NOT FOR PROFIT LABOR MANAGEMENT TRUST) 180 LINDEN OAKS, ROCHESTER, NY, 14625, SN 75-543,431. FILED 8-27-1998. PRINCIPAL REGISTER.

UNICON

INT. CL. 42/U.S. CLS. 100 AND 101
FOR ASSOCIATION SERVICES, NAMELY, PROMOTING THE INTERESTS OF UNIONS AND CONTRACTORS IN THE BUILDING TRADES.

FIRST USE 9-7-1998; IN COMMERCE 10-31-1998.

ELEMENTS CORRECTED
ENTITY



OWNER OF U.S. REG. NOS. 396,914, 1,774,366 AND OTHERS.

INT. CL. 21/U.S. CLS. 2, 13, 23, 29, 30, 33, 40 AND 50
FOR SPOON RESTS, SOAP DISPENSERS, CANDY JARS, COOKIE JARS, SCOURING PAD HOLDERS AND SALT AND PEPPER SHAKERS.

FIRST USE 8-0-1999; IN COMMERCE 8-0-1999.

ELEMENTS CORRECTED
OWNER NAME
CITIZENSHIP

2,452,311. REG. 5-22-2001. VISTA COMPUTER SERVICES INC (NEW JERSEY CORPORATION) 80 COTTONTAIL LANE, SOMERSET, NJ, 08873, SN 75-469,475. FILED 4-17-1998. PRINCIPAL REGISTER.

PUBEASY.COM

INT. CL. 35/U.S. CLS. 100, 101 AND 102
FOR DIGITAL COMMERCE SERVICES FOR THE PUBLISHING INDUSTRY, NAMELY TAKING ON-LINE BOOK ORDERS FOR OTHERS AND COMPUTER DATABASE MANAGEMENT RENDERED IN CONNECTION THEREWITH.

FIRST USE 2-0-1999; IN COMMERCE 2-0-1999.

INT. CL. 36/U.S. CLS. 100, 101 AND 102
FOR PROCESSING ELECTRONIC PAYMENTS IN CONNECTION WITH ON-LINE BOOK ORDERS FOR THE PUBLISHING INDUSTRY.

FIRST USE 2-0-1999; IN COMMERCE 2-0-1999.

ELEMENTS CORRECTED
ASSIGNMENT/NAME CHANGE
OWNER NAME
OWNER ADDRESS
CITIZENSHIP
ENTITY
ASSIGNMENT/NAME CHANGE

2,454,999. REG. 5-29-2001. MARS, INCORPORATED (DELAWARE CORPORATION) 6885 ELM STREET, MCLEAN, VA, 221013883, SN 75-914,265. FILED 2-9-2000. PRINCIPAL REGISTER.

M&M'S

OWNER OF U.S. REG. NOS. 396,914, 1,774,366 AND OTHERS.

INT. CL. 20/U.S. CLS. 2, 13, 22, 25, 32 AND 50

FOR CUSHIONS, NAMELY, STADIUM CUSHIONS, NON-METAL ACRYLIC KEY RINGS, RUBBER KEY RINGS, PLASTIC NOVELTY LICENSE PLATES, CLEAR PLASTIC HOLDERS FOR BADGES.
FIRST USE 2-0-1999; IN COMMERCE 2-0-1999.

ELEMENTS CORRECTED
MARK

2,460,884. REG. 6-19-2001. PRECIMED S.A. (SWITZERLAND COMPANY) L'ECHÉLETTE 7, 2534 ORVIN, SWITZERLAND., BY CHANGE OF NAME PRECIFAR S.A. COMPANY) 2534 ORVIN, SWITZERLAND, SN 75-696,160, FILED 5-3-1999. PRINCIPAL REGISTER.



INT. CL. 10/U.S. CLS. 26, 39 AND 44

FOR SURGICAL INSTRUMENTS AND APPARATUS, NAMELY, REAMERS, HEMISPHERICAL REAMERS, CONICAL REAMERS, REAMER HANDLES, ADAPTERS AND SPARE ADAPTERS FOR USE WITH REAMER HANDLES, POWER TOOLS, DRILLS AND OTHER RELATED DRIVE SHAFTS, COVERS FOR ACETABULAR REAMERS, STRAIGHT AND FLEXIBLE, CANNULATED AND NONCANNULATED INTRAMEDULLARY REAMERS, REAMER GUIDE-WIRE, DRILLS AND TAPS, SCREWS, ANGELED DRIVERS, HAND-HELD INSTRUMENTS, NAMELY T-BARS, STRAIGHT AND FLEXIBLE QUICK-CONNECT SHAFTS AND HANDPIECES, AO (ASSOCIATION FOR OSTEOSYNTHESIS) HAND PIECES, AO (ASSOCIATION OF OSTEOSYNTHESIS) HAND PIECES, AO (ASSOCIATION OF OSTEOSYNTHESIS) T-BARS, FLEXIBLE SHAFTS FOR DRILLS, TAPS AND SCREWDRIVERS; BAYONET TOOLS, SCREWDRIVER HEADS, SCREWDRIVERS, EXTERNAL FIXATION PINS, ADJUSTABLE DRILL GUIDES, PLATES, SAW BLADES, TROCARS, DRILL GUIDES, CHUCKS, BONE CHISELS, RETRACTORS, FORCEPS, METAL AND PLASTIC STERILIZATION TRAYS.
FIRST USE 0-0-1994; IN COMMERCE 0-0-1996.

ELEMENTS CORRECTED
ASSIGNMENT/NAME CHANGE
ASSIGNMENT/NAME CHANGE

2,463,968. REG. 6-26-2001. SUNSET CONGLOMERATE RESTAURANTS, INC. (CALIFORNIA CORPORATION) 8225 SUNSET BOULEVARD, WEST HOLLYWOOD, CA, 90046, SN 76-075,456. FILED 6-22-2000. PRINCIPAL REGISTER.

SADDLE RANCH

INT. CL. 42/U.S. CLS. 100 AND 101
FOR RESTAURANT SERVICES.
FIRST USE 9-30-1999; IN COMMERCE 9-30-1999.

ELEMENTS CORRECTED
OWNER NAME

2,490,332. REG. 9-18-2001. MARS, INCORPORATED (DELAWARE CORPORATION) 6885 ELM STREET, MCLEAN, VA, 221013883, SN 76-020,142. FILED 4-7-2000. PRINCIPAL REGISTER.

M&M'S

OWNER OF U.S. REG. NOS. 396,914, 1,774,366 AND OTHERS.
INT. CL. 21/U.S. CLS. 2, 13, 23, 29, 30, 33, 40 AND 50
FOR PAPER PLATES AND PAPER CUPS.
FIRST USE 3-0-1999; IN COMMERCE 3-0-1999.

ELEMENTS CORRECTED
MARK

2,515,814. REG. 12-4-2001. ASAHI KOGAKU KOGYO KABUSHIKI KAISHA (JAPAN CORPORATION), DBA ASAHI OPTICAL CO., LTD., 36-9, MAENO-CHO 2-CHOME, ITA-BASHI-KU TOKYO, JAPAN, 174, BY ASSIGNMENT PENTAX CORPORATION (CORPORATION) ENGLEWOOD, CO, SN 75-980,935. FILED 4-16-1999. PRINCIPAL REGISTER.



OWNER OF U.S. REG. NOS. 587,247, 648,245 AND 686,614.
INT. CL. 9/U.S. CLS. 21, 23, 26, 36 AND 38
FOR OPTICAL APPARATUS AND INSTRUMENTS, NAMELY, CAMERAS AND LENSES, AND ACCESSORIES THEREFOR, NAMELY, FINDERS, ADAPTERS AND HOLDERS, FILTERS AND SCREENS, SLIDE COPIERS, COPY STANDS, MAGNIFIERS, PHOTO LUPES, SPOT METERS, FOCUSING RINGS, QUICK SHOES, EXTENSION TUBES, GRIPS, FLASHES, LENS CASES, CAMERA CASES AND FILM HOLDERS.
FIRST USE 4-0-1999; IN COMMERCE 4-0-1999.

ELEMENTS CORRECTED
ASSIGNMENT/NAME CHANGE

2,540,304. REG. 2-19-2002. FIBERSPAR CORPORATION (DELAWARE CORPORATION) 28 PATTERSON BROOK ROAD, WEST WAREHAM, MA, 02576, SN 76-248,914. FILED 4-30-2001. PRINCIPAL REGISTER.



OWNER OF U.S. REG. NOS. 1,607,409, 2,032,398 AND 2,377,068.

INT. CL. 17/U.S. CLS. 1, 5, 12, 13, 35 AND 50
FOR PIPES AND TUBES OF REINFORCED SYNTHETIC POLYMER AND CONNECTORS THEREFOR FOR TRANSPORTING FLUIDS IN THE OIL AND PETROLEUM INDUSTRIES; PIPES AND TUBES OF REINFORCED SYNTHETIC POLYMER OF THE COILABLE OR SPOOLABLE TYPE FOR TRANSPORTING FLUIDS IN THE OIL AND PETROLEUM INDUSTRIES; PIPES AND TUBES OF REINFORCED SYNTHETIC POLYMER OF THE COILABLE OR SPOOLABLE TYPE FOR TRANSPORTING FLUIDS IN OIL WELLS AND OTHER DEEP SUBTERRANEAN USES.

FIRST USE 10-27-1997; IN COMMERCE 5-30-1998.

ELEMENTS CORRECTED
CITIZENSHIP

2,545,541. REG. 3-12-2002. SIEMENS NIXDORF INFORMATIONSSYSTEME AG (FED REP GERMANY CORPORATION) HEINZ-NIXDORF-RING 1, PADERBORN, FED REP GERMANY., SN 75-423,331. FILED 1-26-1998. PRINCIPAL REGISTER.

WebFacer

OWNER OF FED REP GERMANY REG. NO. 39710709, DATED 6-4-1997, EXPIRES 3-31-2007.

INT. CL. 9/U.S. CLS. 21, 23, 26, 36 AND 38

FOR DATA PROCESSING PROGRAMS, NAMELY, COMPUTER SOFTWARE FOR INTERFACING, ACCESSING, TRANSFERRING AND CONTROLLING DATA, INFORMATION, IMAGES AND VIDEO AND AUDIO SEQUENCES BY MEANS OF GLOBAL COMPUTER NETWORKS AND OTHER COMPUTER NETWORKS.

FIRST USE ; IN COMMERCE .

INT. CL. 42/U.S. CLS. 100 AND 101

FOR COMPUTER SERVICES, NAMELY, COLLECTION, ORGANIZATION AND TRANSLATION OF DATA, INFORMATION, IMAGES, AND VIDEO AND AUDIO SEQUENCES REGARDING A WIDE RANGE OF INFORMATION; DEVELOPMENT FOR OTHERS OF DATA BASES FOR THE STORAGE AND DISTRIBUTION OF DATA, INFORMATION, IMAGES, AND VIDEO AND AUDIO SEQUENCES REGARDING A WIDE RANGE OF INFORMATION; PROVIDING SEARCH ENGINES WHICH RETRIEVE DATA, INFORMATION, IMAGES AND VIDEO AND AUDIO SEQUENCES FROM COMPUTER NETWORKS; COMPUTER SOFTWARE DESIGN AND DEVELOPMENT FOR OTHERS; INSTALLATION FOR OTHERS OF COMPUTER PROGRAMS FOR DATA PROCESSING; LEASING OF COMPUTER PROGRAMS FOR DATA PROCESSING.

FIRST USE ; IN COMMERCE .

ELEMENTS CORRECTED
[DISCLAIMER]

2,545,896. REG. 3-12-2002. BEHR GMBH & CO. (FED REP GERMANY LIMITED LIABILITY COMPANY) POSTFACH 30 09 20, D-70449 STUTTGART, FED REP GERMANY., SN 75-882,470. FILED 12-29-1999. PRINCIPAL REGISTER.

HEAT UP. COOL DOWN.

PRIORITY CLAIMED UNDER SEC. 44(D) ON FED REP GERMANY APPLICATION NO. 39938851611, FILED 7-3-1999, REG. NO. 39938851, DATED 7-3-1999, EXPIRES 7-31-2009.

INT. CL. 7/U.S. CLS. 13, 19, 21, 23, 31, 34 AND 35

FOR COOLING APPARATUS AND COOLING SYSTEMS FOR INTERNAL COMBUSTION ENGINES AND ALTERNATIVE DRIVES SUCH AS ELECTRIC MOTOR AND FUEL CELL FOR MOTOR VEHICLES, NAMELY, COOLING MODULES, OIL MODULES, EXHAUST GAS RETURN MODULES AND PARTS THEREFOR, NAMELY, COOLANT COOLERS, RADIATORS, REFRIGERANT CONDENSERS, CHARGE AIR COOLERS, OIL COOLERS, FANS AND FAN HOODS, FAN DRIVES, FAN COUPLINGS/CLUTCHES, FLUID FRICTION COUPLINGS AS WELL AS EXHAUST GAS HEAT TRANSFER MEANS, EXHAUST GAS RETURN VALVES, FUEL COOLERS, COOLANT PUMPS, COOLANT HOSES AND AUXILIARY HEATERS .

FIRST USE ; IN COMMERCE .

INT. CL. 9/U.S. CLS. 21, 23, 26, 36 AND 38

FOR SYSTEMS FOR THE MEASUREMENT AND CONTROL OF COOLANT TEMPERATURE IN LAND MOTOR VEHICLES COMPRISING SENSORS, PTC SENSORS AND ACTUATORS, SYSTEMS FOR TEMPERATURE AND CLIMATE CONTROL COMPRISING SENSORS AND ACTUATORS, OPERATING CONTROLLERS AND ELECTRICAL CONTROLLERS, SENSORS FOR MEASURING AIR AND COOLANT TEMPERATURE, PTC AUXILIARY HEATERS AND PTC REGULATORS; LAND VEHICLE INSTRUMENT PANELS COMPRISING DASH CONTROLS; COOLANT THERMOSTATS.

FIRST USE ; IN COMMERCE .

INT. CL. 11/U.S. CLS. 13, 21, 23, 31 AND 34

FOR HEATING, VENTILATION AND AIR CONDITIONING SYSTEMS AND THEIR PARTS FOR AUTOMOTIVE VEHICLES, NAMELY, AIR CONDITIONING SYSTEMS COMPRISING AIR CONDITIONERS, BLOWERS, FAN WHEELS, FAN DRIVES, INDOOR FILTERS, OPERATING CONTROLLERS AND ELECTRICAL CONTROLLERS, PNEUMATIC AND ELECTRICAL ACTUATORS, SENSORS FOR MEASURING AIR AND COOLANT TEMPERATURE, VALVES, HEAT TRANSFER MEANS SUCH AS HEATER CORES, REFRIGERANT EVAPORATORS AND CONDENSERS, PTC AUXILIARY HEATERS AND PTC REGULATORS, REFRIGERANT EXPANSION VALVES, COOLANT PUMPS, AND REFRIGERANT COMPRESSORS, REFRIGERANT TUBING, COLLECTORS AND DRYERS FOR REFRIGERANTS, AIR CONDITIONING COOLING MODULES, AND HEADLIGHTS.

FIRST USE ; IN COMMERCE .
 INT. CL. 12/U.S. CLS. 19, 21, 23, 31, 35 AND 44
 FOR LAND VEHICLE CONSOLE PARTS, NAMELY, AIR VENTS, CROSSBEAMS, WIRING HARNESES, AIR DUCTS, AND BUMPERS/SHOCK ABSORBERS.

FIRST USE ; IN COMMERCE .
 INT. CL. 37/U.S. CLS. 100, 103 AND 106
 FOR MAINTENANCE AND REPAIR OF AUTOMOTIVE ENGINE COOLING SYSTEMS AND HEATING/AIR CONDITIONING SYSTEMS.
 FIRST USE ; IN COMMERCE .

ELEMENTS CORRECTED
 ENTITY

2,553,703. REG. 3-26-2002. DISCOVER FINANCIAL SERVICES, INC. (DELAWARE CORPORATION) 2500 LAKE COOK ROAD, RIVERWOODS, IL, 60015, AND MILLS LIMITED PARTNERSHIP, THE (DELAWARE LIMITED PARTNERSHIP) 1300 WILSON BOULEVARD, SUITE 400, ARLINGTON, VA, 22209, SN 75-929,819. FILED 2-28-2000. PRINCIPAL REGISTER.

DISCOVER MILLS

INT. CL. 36/U.S. CLS. 100, 101 AND 102
 FOR SHOPPING CENTER SERVICES AND LEASING OF SHOPPING MALL SPACE.
 FIRST USE 11-2-2001; IN COMMERCE 11-2-2001.

ELEMENTS CORRECTED
 OWNER ADDRESS

2,575,240. REG. 6-4-2002. GLOBALCLICKS.COM, LTD. (BAHAMAS LTD LIAB CO) 1ST FLOOR, KINGS COURT, BAY STREET, NASSAU, BAHAMAS,, SN 76-037,489. FILED 5-1-2000. PRINCIPAL REGISTER.

GLOBALCLICKS

INT. CL. 38/U.S. CLS. 100, 101 AND 104
 FOR TELECOMMUNICATION GATEWAY SERVICES, NAMELY PROVIDING A WORLD WIDE WEB GATEWAY TO A SUITE OF NETWORK MARKETING SERVICES AND TO THIRD PARTY WEB SITES.
 FIRST USE 1-15-2000; IN COMMERCE 1-15-2000.

ELEMENTS AMENDED
 OWNER NAME
 OWNER ADDRESS
 CITIZENSHIP
 ENTITY

2,575,324. REG. 6-4-2002. SUNSET CONGLOMERATE RESTAURANTS, INC. (CALIFORNIA CORPORATION) 8225 SUNSET BOULEVARD, WEST HOLLYWOOD, CA, 90046, SN 76-074,693. FILED 6-21-2000. PRINCIPAL REGISTER.

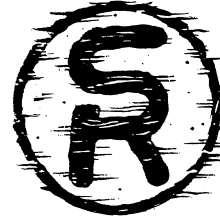

THE LINING IS A FEATURE OF THE MARK AND IS NOT INTENDED TO INDICATE COLOR.
 INT. CL. 42/U.S. CLS. 100 AND 101
 FOR RESTAURANT SERVICES.
 FIRST USE 9-30-1999; IN COMMERCE 9-30-1999.

ELEMENTS CORRECTED
 OWNER NAME

2,577,778. REG. 6-11-2002. JU.CLA.S. S.R.L. (ITALY JOINT STOCK COMPANY WITH LIMITED LIABILITY) LOC. NASSAR 37, 37020 SAN PIETRO IN CARIANO, FRAZ PEDEMONTE (VR), ITALY., SN 76-160,272. FILED 11-6-2000. PRINCIPAL REGISTER.



OWNER OF ERPN CMNTY TM OFC REG. NO. 86561, DATED 5-13-1998, EXPIRES 4-1-2006.

NO CLAIM IS MADE TO THE EXCLUSIVE RIGHT TO USE "JUICE CLARIFICATION SYSTEM", APART FROM THE MARK AS SHOWN.

THE STIPPLING IS FOR SHADING PURPOSES.
 THE MARK CONSISTS OF GREEN LETTERING PLUS A GREEN DESIGN ON A WHITE BACKGROUND. APPLICANT CLAIMS THESE COLORS AS PART OF THE MARK.
 INT. CL. 11/U.S. CLS. 13, 21, 23, 31 AND 34

FOR MICROFILTRATION MACHINES FOR THE WINE-MAKING IN THE FOOD AND DRINK INDUSTRIES; FILTRATION UNITS FOR MUST CLARIFICATION AND FOR WINE STABILIZATION; CARTRIDGES FOR WINE FILTERING MACHINES AND REPLACEMENT PARTS FOR ALL THE AFORESAID GOODS.
 FIRST USE ; IN COMMERCE .

ELEMENTS CORRECTED
 ENTITY

2,581,374. REG. 6-18-2002. BANDAG LICENSING CORPORATION (IOWA CORPORATION) 2905 NORTH HIGHWAY 61, MUSCATINE, IA, 527615886, BY ASSIGNMENT BANDAG INCORPORATED CORPORATION) MUSCATINE, IA, SN 76-160,728. FILED 11-8-2000. PRINCIPAL REGISTER.

2,585,233. REG. 6-25-2002. TEAM ENCOUNTER, LLC (DELAWARE LTD LIAB CO) 2444 TIMES BLVD, SUITE 260, HOUSTON, TX, 77005, BY MERGER ENCOUNTER 2001, LLC CORPORATION) HOUSTON, TX, SN 76-308,438. FILED 8-31-2001. PRINCIPAL REGISTER.

FUELTECH

HUMANITY'S FIRST STARSHIP

INT. CL. 12/U.S. CLS. 19, 21, 23, 31, 35 AND 44
FOR TIRE TREADS FOR RETREADED TIRES.
FIRST USE 7-25-2000; IN COMMERCE 10-16-2000.

INT. CL. 39/U.S. CLS. 100 AND 105
FOR LAUNCHING THE MESSAGES, PHOTOS, HAIR SAMPLES AND OTHER PERSONAL ITEMS OF OTHERS INTO DEEP SPACE VIA SATELLITE.
FIRST USE 7-1-2001; IN COMMERCE 7-1-2001.

ELEMENTS CORRECTED
ASSIGNMENT/NAME CHANGE

ELEMENTS CORRECTED
ASSIGNMENT/NAME CHANGE
OWNER NAME
OWNER ADDRESS
ENTITY

2,582,638. REG. 6-18-2002. TI GROUP AUTOMOTIVE SYSTEMS, L.L.C. (DELAWARE LTD LIAB CO) 12345 EAST NINE MILE ROAD, WARREN, MI, 48090, SN 75-556,724. FILED 9-22-1998. PRINCIPAL REGISTER.

2,585,471. REG. 6-25-2002. BIOSANTE PHARMACEUTICALS, INC. (DELAWARE CORPORATION) 111 BARCLAY BLVD, LINCOLNSHIRE, IL, 60069, BY MERGER BIOSANTE PHARMACEUTICALS, INC. CORPORATION) LINCOLNSHIRE, IL, SN 78-058,343. FILED 4-13-2001. PRINCIPAL REGISTER.

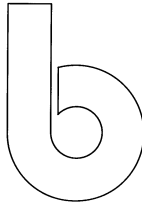

BIOSANTE

INT. CL. 20/U.S. CLS. 2, 13, 22, 25, 32 AND 50
FOR PLASTIC CONNECTOR FITTINGS FOR USE IN AUTOMOTIVE FLUID SYSTEMS.
FIRST USE 1-0-2000; IN COMMERCE 6-0-2001.

INT. CL. 5/U.S. CLS. 6, 18, 44, 46, 51 AND 52
FOR PHARMACEUTICAL PRODUCTS, NAMELY, PREPARATIONS IN THE NATURE OF TRANSDERMAL GELS FOR USE IN THE ADMINISTRATION OF HORMONES.
FIRST USE 11-0-2000; IN COMMERCE 11-0-2000.

ELEMENTS CORRECTED
ASSIGNMENT/NAME CHANGE

ELEMENTS CORRECTED
ASSIGNMENT/NAME CHANGE
OWNER ADDRESS
CITIZENSHIP

2,583,184. REG. 6-18-2002. OPTIMAL ROBOTICS CORP. (CANADA CORPORATION) 4700 DE LA SAVANE, SUITE 101, MONTREAL, QUEBEC, CANADA, H4P 1T7, SN 75-919,150. FILED 2-15-2000. PRINCIPAL REGISTER.

2,588,702. REG. 7-2-2002. YAHOO! INC. (DELAWARE CORPORATION) 701 FIRST AVENUE, SUNNYVALE, CA, 94089, SN 75-365,157. FILED 9-29-1997. PRINCIPAL REGISTER.

U-SCAN CAROUSEL

LIVING ROOM ACTIVE

OWNER OF U.S. REG. NOS. 2,068,706, 2,118,989 AND 2,299,143.
NO CLAIM IS MADE TO THE EXCLUSIVE RIGHT TO USE "CAROUSEL", APART FROM THE MARK AS SHOWN.
INT. CL. 9/U.S. CLS. 21, 23, 26, 36 AND 38
FOR SELF-SERVICE CHECK-OUT SYSTEM COMPRISING A SCANNER AND PAYMENT TENDERING MODULE.
FIRST USE 2-13-2000; IN COMMERCE 6-7-2000.

INT. CL. 9/U.S. CLS. 21, 23, 26, 36 AND 38
FOR COMPUTER SOFTWARE AND MANUALS SOLD THEREWITH AS A UNIT FOR OPTIMIZING GLOBAL COMPUTER NETWORK AND LOCAL COMPUTER NETWORK CONTENT FOR DELIVERY AND DISPLAY ON [AS] TELEVISIONS, AND FOR INTERACTING WITH SUCH CONTENT.
FIRST USE 11-0-1997; IN COMMERCE 11-0-1997.

ELEMENTS CORRECTED
[PRIOR U.S. REGS.]

ELEMENTS CORRECTED
GOODS/SERVICES
ASSIGNMENT/NAME CHANGE

2,590,433. REG. 7-9-2002. HON HAI PRECISION INDUSTRY CO., LTD. (CHINA REPUBLIC OF CHINA) 66-1, CHUNGSHAN RD., TU-CHENG CITY, TAIPEI HSIEN, TAIWAN., SN 76-000,591. FILED 3-15-2000. PRINCIPAL REGISTER.



PRIORITY CLAIMED UNDER SEC. 44(D) ON REPUBLIC OF KOREA APPLICATION NO. 89005851, FILED 2-2-2000, REG. NO. 138158, DATED 2-16-2001, EXPIRES 2-15-2011.

NO CLAIM IS MADE TO THE EXCLUSIVE RIGHT TO USE "IP", APART FROM THE MARK AS SHOWN.

INT. CL. 35/U.S. CLS. 100, 101 AND 102

FOR ADVERTISING SERVICES, NAMELY, PREPARING AND PLACING ADVERTISEMENTS FOR OTHERS AND PREPARING PROMOTIONAL CATALOGS FOR OTHERS; CREATING TRADEMARKS AND TRADE NAMES FOR CORPORATIONS AND CONSULTING SERVICES IN COMPANY AND PRODUCT IDENTITY; MERGERS AND ACQUISITION RELATED CONSULTING SERVICES; PERSONNEL MANAGEMENT CONSULTING SERVICES; MARKET RESEARCH; RENTAL OF OFFICE AUTOMATION EQUIPMENT; PROMOTING THE SALE OF THE GOODS OF OTHERS BY PROVIDING A SHOWROOM AND DISPLAY SERVICE FOR SAMPLES OF SAID GOODS; BUSINESS INVESTIGATIONS; DISSEMINATION OF ADVERTISING FOR OTHERS ONLINE; DATA PROCESSING SERVICES; COMPUTERIZED DATABASE MANAGEMENT; SEARCH, INVESTIGATION AND INQUIRY SERVICES FOR TRADEMARKS, TRADE NAMES, COMPANY NAMES AND DESIGN MATTERS; WATCH SERVICES FOR TRADEMARK, TRADE NAMES, COMPANY NAMES AND DESIGN MATTERS; SERVICES FOR PROVIDING DOCUMENTARY INFORMATION IN THE INDUSTRIAL PROPERTY FIELD; ARRANGING FOR LICENSING OF TRADEMARKS, DESIGNS, KNOW HOW, PATENTS AND RELATED MATTERS .

FIRST USE : IN COMMERCE .

ELEMENTS CORRECTED
CITIZENSHIP
ENTITY

2,590,868. REG. 7-9-2002. MOBILITY TECHNOLOGIES, INC. (DELAWARE CORPORATION) 851 DUPORTAIL RD., SUITE 220, WAYNE, PA, 19087, SN 76-157,681. FILED 10-30-2000. PRINCIPAL REGISTER.

TRAFFIC PULSE

NO CLAIM IS MADE TO THE EXCLUSIVE RIGHT TO USE "TRAFFIC", APART FROM THE MARK AS SHOWN.

INT. CL. 39/U.S. CLS. 100 AND 105

FOR TRAFFIC INFORMATION SERVICES.

FIRST USE 2-5-2001; IN COMMERCE 2-5-2001.

ELEMENTS CORRECTED
ASSIGNMENT/NAME CHANGE

2,595,263. REG. 7-16-2002. MEMPHIS ROCK 'N SOUL, INC. (TENNESSEE NONPROFIT CORPORATION) ONE COMMERCE SQUARE, SUITE 1300, MEMPHIS, TN, 38103, SN 75-981,479. FILED 9-24-1999. PRINCIPAL REGISTER.



NO CLAIM IS MADE TO THE EXCLUSIVE RIGHT TO USE "MEMPHIS ROCK-N-SOULMUSEUM", APART FROM THE MARK AS SHOWN.

INT. CL. 16/U.S. CLS. 2, 5, 22, 23, 29, 37, 38 AND 50

FOR POSTERS, CALENDARS AND POST CARDS.

FIRST USE 4-28-2000; IN COMMERCE 4-28-2000.

INT. CL. 25/U.S. CLS. 22 AND 39

FOR T-SHIRTS, SWEAT SHIRTS, JACKETS, VESTS, HATS AND CAPS.

FIRST USE 4-28-2000; IN COMMERCE 4-28-2000.

INT. CL. 41/U.S. CLS. 100, 101 AND 107

FOR MUSEUM AND EDUCATIONAL SERVICES, NAMELY, PROVIDING EXHIBITIONS AND CONDUCTING EDUCATIONAL WORKSHOPS AND SEMINARS RELATING TO POPULAR AMERICAN MUSIC VIA A GLOBAL COMMUNICATIONS NETWORK.

FIRST USE 4-28-2000; IN COMMERCE 4-28-2000.

ELEMENTS CORRECTED
MARK
DISCLAIMER

2,602,030. REG. 7-30-2002. MOUNTAIN WEST, L.L.C. (IDAHO LTD LIAB CO) 4212 SOUTH HIGHWAY 191, REXBURG, ID, 83440, SN 75-982,033. FILED 5-30-1997. PRINCIPAL REGISTER.

NATURE'S MAGIC

INT. CL. 31/U.S. CLS. 1 AND 46

FOR LANDSCAPING RAW MULCH.

FIRST USE 2-28-2001; IN COMMERCE 2-28-2001.

ELEMENTS CORRECTED
ASSIGNMENT/NAME CHANGE

2,604,688. REG. 8-6-2002. UNDERWRITERS LABORATORIES INC. (DELAWARE CORPORATION) 333 PFINGSTEN ROAD, NORTHBROOK, IL, 600622096, SN 76-329,897. FILED 10-24-2001. PRINCIPAL REGISTER.

WORKING FOR A SAFER WORLD

INT. CL. 42/U.S. CLS. 100 AND 101

FOR PRODUCT SAFETY TESTING AND EVALUATION, AND TESTING AND EVALUATION OF THE GOODS OF OTHERS FOR THE PURPOSE OF CERTIFICATION.

FIRST USE 7-10-2000; IN COMMERCE 7-10-2000.

ELEMENTS CORRECTED
CITIZENSHIP

FOR WASTE TREATMENT, NAMELY, SOLID OR FERMENTABLE WASTE COMPOSTING PROCESSING; RECYCLING OF SOLID OR FERMENTABLE WASTE COMPOSTING; WASTE TREATMENT, NAMELY, SERVICES [FOE] *FOR* PREPROCESSING OF SOLID OR FERMENTABLE WASTE COMPOSTING.

FIRST USE ; IN COMMERCE .

ELEMENTS CORRECTED
GOODS/SERVICES

2,610,238. REG. 8-20-2002. UNIVERSITY FEDERAL CREDIT UNION (UNITED STATES FEDERALLY CHARTERED CREDIT UNION) 3305 STECK AVENUE, AUSTIN, TX, 78757, SN 75-857,437. FILED 11-24-1999. PRINCIPAL REGISTER.

2,613,525. REG. 8-27-2002. NAVIS LOGISTICS NETWORKS, INC. (NEVADA CORPORATION) 5675 DTC BOULEVARD, SUITE 280, GREENWOOD VILLAGE, CO, 80111, BY CHANGE OF NAME, BY CHANGE OF NAME TOTAL LOGISTICS GROUP, INC. CORPORATION) MORAGA, CA, SN 78-016,424. FILED 7-12-2000. PRINCIPAL REGISTER.

WHEELS101.com

NAVIS

INT. CL. 35/U.S. CLS. 100, 101 AND 102

FOR CAR BUYING SERVICES FOR NEW AND USED AUTOMOBILES, PROVIDED TO MEMBERS, NAMELY PROVIDING MEMBERS WITH EXTENSIVE INFORMATION AND ASSISTANCE IN CONNECTION WITH THE CAR-BUYING PURCHASE PROCESS, NAMELY, PROVIDING INFORMATION REGARDING SAFETY AND RELIABILITY OF SPECIFIC MAKES AND MODELS OF VEHICLES, PROVIDING INFORMATION REGARDING THE MAINTENANCE AND SAFETY HISTORIES OF INDIVIDUAL VEHICLES, PROVIDING INFORMATION REGARDING DEALER COSTS FOR NEW VEHICLES, LOCATING SPECIFIC VEHICLES FOR MEMBERS, PROVIDING INFORMATION AND SUGGESTIONS REGARDING BUYING NEW AND USED CARS AND SELLING USED CARS.

FIRST USE 1-1-2000; IN COMMERCE 1-1-2000.

ELEMENTS AMENDED
MARK

INT. CL. 39/U.S. CLS. 100 AND 105

FOR [POSTAL] * MAILING * SERVICES, NAMELY PACKAGING, CRATING, WRAPPING, AND LABELING OF ARTICLES FOR TRANSPORTATION; PARCEL DELIVERY; FREIGHT AND PARCEL TRANSPORTATION BY TRUCK; ARRANGING FOR TRANSPORTATION AND DELIVERY OF THE GOODS OF OTHERS; COURIER SERVICES; WAREHOUSE STORAGE; FURNITURE MOVING; AND MOVING VAN SERVICES.

FIRST USE 1-15-2001; IN COMMERCE 1-15-2001.

ELEMENTS CORRECTED
GOODS/SERVICES
OWNER NAME
ASSIGNMENT/NAME CHANGE

2,612,140. REG. 8-27-2002. VINCI ENVIRONNEMENT (FRANCE SOCIETE ANONYME) 1, COURS FERDINAND DE LESSEPS, 92500 RUEIL-MALMAISON, FRANCE., SN 76-225,886. FILED 3-16-2001. PRINCIPAL REGISTER.

2,619,201. REG. 9-17-2002. PARK SUMMIT REALTY CORP. (NEW YORK CORPORATION) 29 BROADWAY, C/O JEFFRIES AVLON, INC., NEW YORK, NY, 10006, SN 75-293,693. FILED 5-19-1997. PRINCIPAL REGISTER.

MAYFLOWER HOTEL

ECOSILO

OWNER OF FRANCE REG. NO. 00/3052057, DATED 9-18-2000, EXPIRES 9-18-2010.

INT. CL. 7/U.S. CLS. 13, 19, 21, 23, 31, 34 AND 35

FOR MACHINES COMPRISING CONVEYORS, HORIZONTAL SILOS, PADDLES AND MIXER MACHINES USED TO ACCELERATE COMPOSITION OF SOLID OR FERMENTABLE WASTE .

FIRST USE ; IN COMMERCE .

INT. CL. 11/U.S. CLS. 13, 21, 23, 31 AND 34

FOR AERATION AND VENTILATION UNITS FOR ACCELERATED COMPOSTING OF SOLID OR FERMENTABLE WASTE; HUMIDIFIERS FOR ACCELERATED COMPOSITION OF SOLID OR FERMENTABLE WASTE.

FIRST USE ; IN COMMERCE .

INT. CL. 40/U.S. CLS. 100, 103 AND 106

REGISTRATION LIMITED TO THE AREA COMPRISING THE GEOGRAPHIC REGION LOCATED WITHIN THE BOUNDARY OF NEW YORK AND FIFTY (50) MILES IN ALL DIRECTIONS OUTSIDE OF THE BOUNDARY OF NEW YORK CITY. CONCURRENT USE PROCEEDING NO. 1139 WITH APPLICATION SERIAL NO. 75/045605.

NO CLAIM IS MADE TO THE EXCLUSIVE RIGHT TO USE "HOTEL", APART FROM THE MARK AS SHOWN.

INT. CL. 42/U.S. CLS. 100 AND 101

FOR HOTEL SERVICES, NAMELY, RENTAL OF HOTEL ROOMS AND SUITES; CATERING, RESTAURANT AND BAR SERVICES.

FIRST USE 0-0-1926; IN COMMERCE 0-0-1926.

ELEMENTS CORRECTED
DATE OF FIRST USE
DATE OF FIRST USE IN COMMERCE
CONCURRENT USE STATEMENT

2,619,298. REG. 9-17-2002. SMART STORAGE LTD. (ISRAEL CORPORATION) INDUSTRIAL ZONE, P.O. BOX 17, BARKAN, ISRAEL, 44820, BY ASSIGNMENT TZIPA CARMON EXPORT LTD CORPORATION) JERUSALEM 91340, ISRAEL, SN 75-714,375. FILED 5-26-1999. PRINCIPAL REGISTER.

2,620,114. REG. 9-17-2002. ADC SERVICES FULFILLMENT, INC. (NEW JERSEY CORPORATION) 13625 TECHNOLOGY DRIVE, EDEN PRAIRIE, MN, 553442252, BY CHANGE OF NAME COMMTECH CORPORATION CORPORATION) CRANBURY, NJ, SN 76-187,845. FILED 12-29-2000. PRINCIPAL REGISTER.

COSMOS

INT. CL. 19/U.S. CLS. 1, 12, 33 AND 50
FOR CONSTRUCTS AND DEVICES FOR STORAGE PURPOSES INTENDED FOR DO-IT-YOURSELF ASSEMBLY MADE OF PLASTIC MATERIAL, NAMELY STORAGE SHEDS; FENCES MADE OF PLASTIC.
FIRST USE 10-0-1999; IN COMMERCE 10-0-1999.

- ELEMENTS AMENDED
- *OWNER NAME*
- *OWNER ADDRESS*
- *CITIZENSHIP*
- *ENTITY*
- *ASSIGNMENT/NAME CHANGE*

2,619,486. REG. 9-17-2002. AMERICAN CHIROPRACTIC BOARD OF SPORTS PHYSICIANS (IOWA NON-PROFIT CORPORATION) 1820 CENTRAL AVENUE, ESTHERVILLE, IA, 513342409, SN 75-936,187. FILED 3-6-2000. PRINCIPAL REGISTER.

DIPLOMATE AMERICAN CHIROPRACTIC BOARD OF SPORTS PHYSICIANS

OWNER OF U.S. REG. NOS. 2,009,311, 2,009,316 AND 2,016,717.

NO CLAIM IS MADE TO THE EXCLUSIVE RIGHT TO USE "CHIROPRACTIC BOARD OF SPORTS PHYSICIANS", APART FROM THE MARK AS SHOWN.

THE CERTIFICATION MARK AS USED BY AUTHORIZED PERSONS, CERTIFIES: THAT THE INDIVIDUAL DISPLAYING THE MARK IS POSSESSED OF A SATISFACTORY EDUCATIONAL AND EXPERIENTIAL BACKGROUND; HAS PASSED A WRITTEN EXAMINATION ADMINISTERED BY THE AMERICAN CHIROPRACTIC BOARD OF SPORTS PHYSICIANS; AND HAS IN THE PAST PERFORMED, AND CONTINUES TO PERFORM, SERVICES IN THE FIELD OF SPORTS-RELATED CHIROPRACTIC SERVICES AND TREATMENT WHICH MET THE EXACTING STANDARDS OF THE AMERICAN CHIROPRACTIC BOARD OF SPORTS PHYSICIANS.

SEC. 2(F).
INT. CL. B /U.S. CL. B
FOR SPORTS-RELATED CHIROPRACTIC SERVICES AND TREATMENT.
FIRST USE 6-0-1994; IN COMMERCE 6-0-1994.

ELEMENTS CORRECTED
MARK

FASTFLOW

OWNER OF U.S. REG. NO. 2,229,623.
INT. CL. 9/U.S. CLS. 21, 23, 26, 36 AND 38
FOR OPERATIONS SUPPORT SYSTEM CONSISTING OF COMPUTER HARDWARE AND DOWNLOADABLE COMPUTER SOFTWARE FOR USE IN MANAGING BASIC TELECOMMUNICATIONS AND VALUE-ADDED SERVICES PROVIDED BY TELECOMMUNICATIONS COMPANIES THROUGH THE AUTOMATED ADMINISTRATION OF SWITCHES, TRANSMISSION APPARATUS, AND VOICE AND DATA TELECOMMUNICATIONS NETWORKS.

FIRST USE 1-10-1998; IN COMMERCE 9-17-1998.
INT. CL. 38/U.S. CLS. 100, 101 AND 104
FOR COMMUNICATIONS SERVICES, NAMELY PROVIDING TEMPORARY USE OF AN OPERATIONS SUPPORT SYSTEM CONSISTING OF COMPUTER HARDWARE AND COMPUTER SOFTWARE, FOR THE AUTOMATED ADMINISTRATION OF SWITCHES, TRANSMISSION APPARATUS, AND VOICE AND DATA TELECOMMUNICATIONS NETWORKS FOR TELECOMMUNICATIONS SERVICE ORDER MANAGEMENT, INVENTORY MANAGEMENT, AND SERVICE ACTIVATION.

FIRST USE 1-10-1998; IN COMMERCE 9-17-1998.
INT. CL. 42/U.S. CLS. 100 AND 101
FOR NON-DOWNLOADABLE SOFTWARE MADE AVAILABLE OVER THE GLOBAL COMPUTER NETWORK TO MANAGE, MONITOR AND MEASURE TELECOMMUNICATIONS SYSTEMS, AND TECHNICAL CONSULTATION IN THE FIELD OF COMMUNICATIONS, COMPUTER AND COMMUNICATIONS EQUIPMENT CONSULTATION AND TECHNICAL SUPPORT SERVICES, NAMELY, TROUBLESHOOTING OF COMPUTER AND COMMUNICATIONS HARDWARE AND SOFTWARE PROBLEMS BY TELEPHONE, E-MAIL, REMOTE ACCESS TO AFFECTED EQUIPMENT AND PROGRAMS, AND IN PERSON.

FIRST USE 1-10-1998; IN COMMERCE 9-17-1998.

- ELEMENTS CORRECTED
- *ASSIGNMENT/NAME CHANGE*
- OWNER NAME
- OWNER ADDRESS

2,620,121. REG. 9-17-2002. UTILITY CONSULT HINZMAN & KONIG OHG (FED REP GERMANY LIMITED PARTNERSHIP) LENHARTZASTRASSE 7, HAMBURG, FED REP GERMANY, D-20249, BY CHANGE OF NAME UTILITY CONSULT HINZMANN & KONIG OHG (PARTNERSHIP), D-20249 HAMBURG, FED REP GERMANY, SN 76-189,040. FILED 1-3-2001. PRINCIPAL REGISTER.

CHEKKER

PRIORITY CLAIMED UNDER SEC. 44(D) ON FED REP GERMANY APPLICATION NO. 30049981.7/0, FILED 7-5-2000, REG. NO. 30049981, DATED 1-17-2001, EXPIRES 7-31-2010.
INT. CL. 9/U.S. CLS. 21, 23, 26, 36 AND 38

FOR COUNTERS AND METERS, NAMELY, GAS, WATER, ELECTRICAL AND HEATING COUNTERS AND METERS.
FIRST USE ; IN COMMERCE .

2,624,050. REG. 9-24-2002. ASPEN PET PRODUCTS, INC (DELAWARE CORPORATION) 4735 N. FLORENCE STREET, DENVER, CO, 80238, SN 76-242,783. FILED 4-18-2001. PRINCIPAL REGISTER.

ELEMENTS CORRECTED
OWNER NAME
OWNER ADDRESS
CITIZENSHIP
ENTITY
ASSIGNMENT/NAME CHANGE



2,620,290. REG. 9-17-2002. MOVADO LLC (DELAWARE LTD LIAB CO) 501 SILVERSIDE ROAD, WILMINGTON, DE, 19809, BY CHANGE OF NAME MOVADO CORPORATION CORPORATION) WILMINGTON, DE, SN 76-215,564. FILED 2-22-2001. PRINCIPAL REGISTER.

INT. CL. 6/U.S. CLS. 2, 12, 13, 14, 23, 25 AND 50
FOR PET TIEOUTS, NAMELY, METAL STAKES AND METAL CABLES USED TO RESTRAIN PETS.
FIRST USE 0-0-1971; IN COMMERCE 0-0-1971.
INT. CL. 18/U.S. CLS. 1, 2, 3, 22 AND 41
FOR PET COLLARS, NAMELY, ADJUSTABLE COLLARS AND CHAIN COLLARS; PET LEASHES; PET TRAINING LEADS, AND PET CUSHIONS.
FIRST USE 0-0-1971; IN COMMERCE 0-0-1971.
INT. CL. 28/U.S. CLS. 22, 23, 38 AND 50
FOR PET TOYS.
FIRST USE 0-0-1971; IN COMMERCE 0-0-1971.

TERRAZA

THE ENGLISH TRANSLATION OF "TERRAZA" IS "BALCONY".
INT. CL. 14/U.S. CLS. 2, 27, 28 AND 50
FOR WATCHES.
FIRST USE 2-17-1999; IN COMMERCE 2-17-1999.

ELEMENTS CORRECTED
OWNER ADDRESS

ELEMENTS CORRECTED
ASSIGNMENT/NAME CHANGE
OWNER NAME
OWNER ADDRESS
ENTITY

2,624,426. REG. 9-24-2002. TERRYBERRY COMPANY, LLC (MICHIGAN LTD LIAB CO) 2033 OAK INDUSTRIAL DRIVE NE, GRAND RAPIDS, MI, 49505, SN 76-290,570. FILED 7-27-2001. PRINCIPAL REGISTER.

TALISMAN

2,621,246. REG. 9-17-2002. ANIMA - SOCIETA' DI GESTIONE DEL RISPARMIO PER AZIONI OR BRIEFLY "ANIMA S.G.R.P.A." (ITALY CORPORATION) VIA BRERA, 18, 20121 MILANO, ITALY., SN 76-349,984. FILED 12-18-2001. PRINCIPAL REGISTER.

INT. CL. 14/U.S. CLS. 2, 27, 28 AND 50
FOR JEWELRY.
FIRST USE 6-30-1988; IN COMMERCE 6-30-1988.

ELEMENTS CORRECTED
OWNER NAME
ENTITY

ANIMA

OWNER OF ITALY REG. NO. 00698141, DATED 12-23-1996, EXPIRES 8-1-2004.
INT. CL. 36/U.S. CLS. 100, 101 AND 102
FOR CAPITAL INVESTMENT CONSULTATION; FUND INVESTMENT CONSULTATION; MUTUAL FUND BROKERAGE; MUTUAL FUND DISTRIBUTION; MUTUAL FUNDS INVESTMENT; FUNDS INVESTMENT; INVESTMENT OF FUNDS FOR OTHERS; MANAGEMENT OF INVESTMENT FUNDS; INVESTMENT BROKERAGE; CHARITABLE FUND RAISING; MEMORIAL FUND RAISING; ELECTRONIC FUNDS TRANSFER; INVESTMENT CONSULTATION; INVESTMENT ADVICE; INVESTMENT MANAGEMENT; FINANCIAL MANAGEMENT; FINANCIAL PLANNING; FINANCIAL ANALYSIS AND CONSULTATION.

2,625,452. REG. 9-24-2002. CHARLES SCHWAB & CO., INC. (CALIFORNIA CORPORATION) 101 MONTGOMERY STREET, SAN FRANCISCO, CA, 94104, SN 75-602,222. FILED 12-9-1998. PRINCIPAL REGISTER.

SCHWAB SIGNATURE SERVICES PLATINUM

ELEMENTS CORRECTED
FOREIGN REG. EXPIRATION DATE

OWNER OF U.S. REG. NOS. 1,624,773, 2,126,069 AND OTHERS.
NO CLAIM IS MADE TO THE EXCLUSIVE RIGHT TO USE "SERVICES", APART FROM THE MARK AS SHOWN. THE NAME "CHARLES SCHWAB" IDENTIFIES A LIVING INDIVIDUAL WHOSE CONSENT IS OF RECORD.
INT. CL. 36/U.S. CLS. 100, 101 AND 102

FOR BROKERAGE SERVICES IN THE FIELDS OF FINANCIAL SECURITIES, STOCKS, BONDS, MONEY MARKET FUNDS, MUTUAL FUNDS, COMMODITIES, FUTURES, STOCK OPTIONS, AND INDICES OF FINANCIAL SECURITIES; INVESTMENT SERVICES IN THE FIELDS OF FINANCIAL SECURITIES, STOCKS, BONDS, MONEY MARKET FUNDS, MUTUAL FUNDS, COMMODITIES, FUTURES, STOCK OPTIONS, AND INDICES OF FINANCIAL SECURITIES; INVESTMENT ADVICE [AND MANAGEMENT] IN THE FIELDS OF FINANCIAL SECURITIES, STOCKS, BONDS, MUTUAL FUNDS, MONEY MARKET FUNDS, COMMODITIES, FUTURES, STOCK OPTIONS, AND INDICES OF FINANCIAL SECURITIES; SECURITIES BROKERAGE ACCOUNT SERVICES THAT FEATURE AN INTEREST BEARING FEATURE FOR CASH BETWEEN INVESTMENTS, ELECTRONIC CASH TRANSACTIONS AND MARGIN LOAN SERVICES; [CREDIT CARD AND] DEBIT CARD SERVICES; CHECK PROCESSING AND BILL PAYMENT SERVICES; ANNUITY INVESTMENT SERVICES; [FINANCIAL INVESTMENT IN THE FIELD OF VARIABLE INSURANCE;] FINANCIAL INFORMATION PROVIDED BY ELECTRONIC MEANS; [ADMINISTRATION OF EMPLOYEE PENSION PLANS;] FINANCIAL PLANNING; [INSURANCE BROKERAGE;] CASH MANAGEMENT ACCOUNT SERVICES; FIXED INCOME INVESTMENT SERVICES; ELECTRONIC FUNDS TRANSFER; PROVIDING INFORMATION AND ANALYSIS IN THE FIELDS OF FINANCE, ECONOMICS, INVESTMENT, BUSINESS, FINANCIAL PLANNING AND INVESTMENT STRATEGY; PROVIDING FINANCIAL PORTFOLIO MANAGEMENT SERVICES, PROVIDING AND INTERACTIVE ONLINE COMPUTER DATABASE IN THE FIELD OF FINANCIAL PORTFOLIO MANAGEMENT, FINANCIAL DECISION MAKING, INVESTMENT RESEARCH, MONITORING INVESTMENT VALUE AND PERFORMANCE OF INVESTMENTS, ANALYZING INVESTMENT PERFORMANCE, EVALUATING ASSET ALLOCATION, RISK TOLERANCE, FINANCIAL ALTERNATIVE PLANS AND INVESTMENT TIME FRAMES; PROVIDING INFORMATION BY PHONE AND BY ONLINE MEANS IN THE FIELD OF INVESTMENT ACCOUNT INFORMATION AND FINANCIAL RESEARCH; PROVIDING AN ONLINE COMPUTER DATABASE IN THE FIELDS OF INVESTING, FINANCIAL PLANNING, FINANCIAL NEWS, FINANCIAL INFORMATION AND ANALYSIS IN THE FIELDS OF INVESTING, FINANCE, AND FINANCIAL PLANNING.

FIRST USE 2-15-1999; IN COMMERCE 2-15-1999.

ELEMENTS CORRECTED
GOODS/SERVICES

2,626,917. REG. 9-24-2002. A & F TRADEMARK, INC. (DELAWARE CORPORATION) 1105 NORTH MARKET STREET, WILMINGTON, DE, 19801, SN 76-258,313. FILED P.R. 5-17-2001; AM. S.R. 5-23-2002. SUPPLEMENTAL REGISTER.

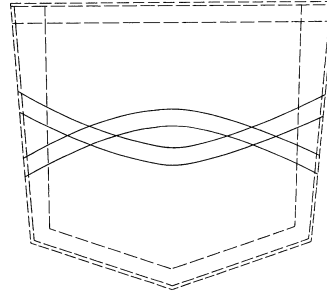

THE MARK CONSISTS OF A PAIR OF DOUBLE-LINED STITCHES, EXTENDING CONTINUOUSLY ACROSS THE REAR POCKET OF THE GOODS. THE STITCHES ARE CURVED, INTERSECTING TWICE, FORMING AN OVAL SHAPE IN THE CENTER OF THE POCKET. THE DOTTED LINES ARE USED TO INDICATE THE POSITIONING OF THE MARK ON THE GOODS AND ARE NOT A FEATURE OF THE MARK.

INT. CL. 25/U.S. CLS. 22 AND 39

FOR CLOTHING, NAMELY, DENIM JEANS SOLD IN SPECIALTY RETAIL CLOTHING STORES, SPECIALTY MAIL ORDER CATALOG AND INTERNET WEBSITE.
FIRST USE 2-0-2001; IN COMMERCE 2-0-2001.

ELEMENTS CORRECTED
DATE OF FIRST USE
DATE OF FIRST USE IN COMMERCE

2,627,285. REG. 10-1-2002. KABUSHIKI KAISHA TEN-ICHI SYOKUHIN SHOJI (TEN-ICHI FOODS TRADING CO., LTD.) (JAPAN CORPORATION) 78-3 IKENOUCI AZA HACHO-ME OOE, OOTSU SHIGA, JAPAN., BY ASSIGNMENT; BY ASSIGNMENT; BY ASSIGNMENT SUZUI, SCOTT T. INDIVIDUAL, DBA TENKAIPPIN HAWAII, INC., HONOLULU, HI, SN 76-081,459. FILED 6-30-2000. PRINCIPAL REGISTER.



THE JAPANESE CHARACTERS IN THE MARK TRANSLITERATE TO "TENKAIPPIN", WHICH CAN TRANSLATE INTO ENGLISH AS "UNRIVALED".

INT. CL. 42/U.S. CLS. 100 AND 101
FOR RESTAURANT SERVICES.
FIRST USE 11-20-2000; IN COMMERCE 11-20-2000.

ELEMENTS CORRECTED
OWNER NAME

2,632,957. REG. 10-8-2002. E. EXCEL INTERNATIONAL, INC. (UTAH CORPORATION) 1198 NORTH SPRING CREEK PLACE, SPRINGVILLE, UT, 84663, SN 76-186,853. FILED 12-27-2000. PRINCIPAL REGISTER.

W.L

INT. CL. 5/U.S. CLS. 6, 18, 44, 46, 51 AND 52
 FOR NUTRITIONAL SUPPLEMENT, NAMELY, FOOD CONCENTRATES IN GELATIN CAPSULES AND TABLETS.
 FIRST USE 1-1-1998; IN COMMERCE 1-1-1998.

ELEMENTS CORRECTED
 MARK TYPE



2,634,189. REG. 10-15-2002. FLUOR CORPORATION (DELAWARE CORPORATION) ONE ENTERPRISE DRIVE, ALISO VIEJO, CA, 92656, BY ASSIGNMENT TRADEMIC INC. CORPORATION) ALISO VIEJO, CA, SN 76-152,393. FILED 10-19-2000. PRINCIPAL REGISTER.

TRADEMC

INT. CL. 35/U.S. CLS. 100, 101 AND 102
 FOR BUSINESS SERVICES, NAMELY, MANAGEMENT AND CONSULTATION IN THE FIELDS OF PROCUREMENT AND SUPPLY CHAIN MANAGEMENT; BUSINESS MANAGEMENT AND CONSULTATION; OUTSOURCING SERVICES FOR OTHERS IN THE FIELDS OF PROCUREMENT AND SUPPLY CHAIN MANAGEMENT, CONTRACT MANAGEMENT, WEB HOSTING, SOFTWARE DESIGN AND INTEGRATION, TECHNOLOGY INFRASTRUCTURE ASSESSMENTS, COMMODITIES ASSESSMENTS, ASSET AND RISK MANAGEMENT, TRAINING, INTEGRATION WITH E-MARKETS; PROCUREMENT, NAMELY, PURCHASING OF CAPITAL GOODS AND COMMON BUSINESS GOODS FOR OTHERS; PROMOTING THE GOODS AND SERVICES OF OTHERS BY PREPARING AND PLACING ADVERTISEMENTS IN AN ELECTRONIC PUBLICATION ACCESSED THROUGH A GLOBAL COMPUTER NETWORK; AND BUSINESS MANAGEMENT ASSISTANCE, NAMELY, PROVIDING TRANSACTIONAL DATA RELATED TO MARKET, SUPPLIER AND PURCHASING TRENDS; PREPARING ADVERTISEMENTS FOR OTHERS IN THE NATURE OF CATALOGS.

FIRST USE 8-29-2000; IN COMMERCE 8-29-2000.
 INT. CL. 42/U.S. CLS. 100 AND 101
 FOR NON-ATTORNEY LEGAL SERVICES, NAMELY CONTRACT MANAGEMENT; TECHNICAL CONSULTING IN THE FIELDS OF WEB HOSTING, SOFTWARE DESIGN AND INTEGRATION, AND TECHNOLOGY INFRASTRUCTURE ASSESSMENTS; COMPUTER SOFTWARE DESIGN FOR OTHERS; INTEGRATION OF COMPUTER SYSTEMS AND NETWORKS; AND PROVIDING TEMPORARY USE OF NON-DOWNLOADABLE SOFTWARE FOR PROCUREMENT AND SUPPLY CHAIN COLLABORATION.
 FIRST USE 8-29-2000; IN COMMERCE 8-29-2000.

ELEMENTS CORRECTED
 ASSIGNMENT/NAME CHANGE
 OWNER NAME
 OWNER ADDRESS

2,634,738. REG. 10-15-2002. SYMPHONIE (FRANCE PUBLIC LIMITED LIABILITY COMPANY) ZONE D'ACTIVITE DU PLATEAU OUEST, 76460 SAINT VALERY EN CAUX, FRANCE., SN 76-295,975. FILED 8-8-2001. PRINCIPAL REGISTER.

Patà choux

NO CLAIM IS MADE TO THE EXCLUSIVE RIGHT TO USE "CHOUX", APART FROM THE MARK AS SHOWN.
 THE ENGLISH TRANSLATION OF "CHOUX" IS "PUFF PASTE".
 INT. CL. 30/U.S. CL. 46
 FOR CAKES, COOKIES, PASTRIES, PETITS FOURS, MACAROONS.
 FIRST USE 2-0-1999; IN COMMERCE 2-0-1999.

ELEMENTS CORRECTED
 OWNER ADDRESS



2,638,451. REG. 10-22-2002. HINDUSTAN LEVER LIMITED (INDIA CORPORATION) HINDUSTAN LEVER HOUSE, 165 BACKBAY RECLAMATION, MUMBAI 400 020, INDIA., SN 76-171,194. FILED 11-27-2000. PRINCIPAL REGISTER.

COCO CARE

NO CLAIM IS MADE TO THE EXCLUSIVE RIGHT TO USE "COCO", APART FROM THE MARK AS SHOWN.
 INT. CL. 29/U.S. CL. 46
 FOR EDIBLE OILS INCLUDING COCONUT OILS.
 FIRST USE 4-1-1991; IN COMMERCE 3-0-1995.

ELEMENTS CORRECTED
 OWNER ADDRESS



2,639,162. REG. 10-22-2002. FORT HILL COMPANY (DELAWARE CORPORATION) MONTCHANIN MILLS, P.O. BOX 192, MONTCHANIN, DE, 19710, SN 76-322,638. FILED 10-9-2001. PRINCIPAL REGISTER.

FOLLOW-THROUGH TOOLS

NO CLAIM IS MADE TO THE EXCLUSIVE RIGHT TO USE "TOOLS", APART FROM THE MARK AS SHOWN.
 INT. CL. 42/U.S. CLS. 100 AND 101
 FOR PROVIDING TEMPORARY USE OF ON-LINE NON-DOWNLOADABLE SOFTWARE TO [ENCORE] * ENCOURAGE *, TRACK, AND ANALYZE ACTIONS TAKEN TO MEET OBJECTIVES SET [A] * AT * PROGRAMS, COURSES, MEETINGS, SESSIONS, CONFERENCES, AND OTHER EVENTS REQUIRING PARTICIPANTS AND ATTENDEES TO TAKE ACTION.
 FIRST USE 3-5-2001; IN COMMERCE 8-9-2001.

ELEMENTS CORRECTED
 GOODS/SERVICES

2,641,558. REG. 10-29-2002. PANAVISION EUROPE LIMITED (UNITED KINGDOM COMPANY) THE OLD HOUSE SHEPPERTON STUDIOS, STUDIOS ROAD, SHEPPERTON, MIDDLESEX, ENGLAND, TW17 0QC, SN 75-874,598. FILED 12-17-1999. PRINCIPAL REGISTER.

CTO

OWNER OF UNITED KINGDOM REG. NO. 2056775, DATED 9-27-1996, EXPIRES 2-24-2006.
 INT. CL. 9/U.S. CLS. 21, 23, 26, 36 AND 38
 FOR PHOTOGRAPHIC AND CAMERA FILTERS.
 FIRST USE ; IN COMMERCE .
 INT. CL. 11/U.S. CLS. 13, 21, 23, 31 AND 34
 FOR FILTERS FOR PHOTOGRAPHIC, CINEMATOGRAPHIC, VIDEO AND PERFORMING ARTS LIGHTING.
 FIRST USE ; IN COMMERCE .

ELEMENTS CORRECTED
 MARK

2,641,824. REG. 10-29-2002. LOURDES, RUIZ TOLEDO, I (UNITED STATES INDIVIDUAL) 1541 BRIKELL AVE, T-110, MIAMI, FL, 33129, SN 76-162,624. FILED 11-9-2000. PRINCIPAL REGISTER.

LA RUBIA PELIGROSA

THE ENGLISH TRANSLATION OF "LA RUBIA PELIGROSA" IS "THE DANGEROUS BLONDE".
 INT. CL. 41/U.S. CLS. 100, 101 AND 107
 FOR ENTERTAINMENT SERVICES, NAMELY ONGOING RADIO AND TELEVISION SEGMENTS ON THE SUBJECT * OF CELEBRITY * NEWS AND GOSSIP.
 FIRST USE 7-0-2000; IN COMMERCE 7-0-2000.

ELEMENTS CORRECTED
 GOODS/SERVICES

2,643,251. REG. 10-29-2002. CHARLES SCHWAB & CO., INC. (CALIFORNIA CORPORATION) 101 MONTGOMERY STREET, SAN FRANCISCO, CA, 94104, SN 75-613,310. FILED 12-29-1998. PRINCIPAL REGISTER.



OWNER OF U.S. REG. NOS. 1,516,641, 2,155,411 AND OTHERS.
 NO CLAIM IS MADE TO THE EXCLUSIVE RIGHT TO USE "SERVICES", APART FROM THE MARK AS SHOWN.
 THE NAME "CHARLES SCHWAB" IDENTIFIES A LIVING INDIVIDUAL WHOSE CONSENT IS OF RECORD.
 INT. CL. 36/U.S. CLS. 100, 101 AND 102

FOR BROKERAGE SERVICES IN THE FIELDS OF FINANCIAL SECURITIES, STOCKS, BONDS, MONEY MARKET FUNDS, MUTUAL FUNDS, COMMODITIES, FUTURES, STOCK OPTIONS, AND INDICES OF FINANCIAL SECURITIES; INVESTMENT SERVICES IN THE FIELDS OF FINANCIAL SECURITIES, STOCKS, BONDS, MONEY MARKET FUNDS, MUTUAL FUNDS, COMMODITIES, FUTURES, STOCK OPTIONS, AND INDICES OF FINANCIAL SECURITIES; INVESTMENT ADVICE [AND MANAGEMENT] IN THE FIELDS OF FINANCIAL SECURITIES, STOCKS, BONDS, MONEY MARKET FUNDS, MUTUAL FUNDS, COMMODITIES, FUTURES, STOCK OPTIONS, AND INDICES OF FINANCIAL SECURITIES; SECURITIES BROKERAGE ACCOUNT SERVICES THAT FEATURE AN INTEREST BEARING FEATURE FOR CASH BETWEEN INVESTMENTS, ELECTRONIC CASH TRANSACTIONS, AND MARGIN LOAN SERVICES; [CREDIT CARD AND] DEBIT CARD SERVICES; CHECK PROCESSING AND BILL PAYMENT SERVICES; ANNUITY INVESTMENT SERVICES; [FINANCIAL INVESTMENT IN THE FIELD OF VARIABLE INSURANCE;] FINANCIAL INFORMATION PROVIDED BY ELECTRONIC MEANS; [ADMINISTRATION OF EMPLOYEE PENSION PLANS;] FINANCIAL PLANNING; [INSURANCE BROKERAGE;] CASH MANAGEMENT ACCOUNT SERVICES; FIXED INCOME INVESTMENT SERVICES; ELECTRONIC FUNDS TRANSFER; PROVIDING INFORMATION AND ANALYSIS IN THE FIELDS OF FINANCE, ECONOMICS, INVESTMENT, BUSINESS, FINANCIAL PLANNING, AND INVESTMENT STRATEGY; PROVIDING FINANCIAL PORTFOLIO MANAGEMENT SERVICES; PROVIDING AN INTERACTIVE ONLINE COMPUTER DATABASE IN THE FIELD OF FINANCIAL PORTFOLIO MANAGEMENT, FINANCIAL DECISION MAKING, INVESTMENT RESEARCH, MONITORING INVESTMENT VALUE AND PERFORMANCE OF INVESTMENTS, ANALYZING INVESTMENT PERFORMANCE, EVALUATING ASSET ALLOCATION, RISK TOLERANCE, FINANCIAL ALTERNATIVE PLANS AND INVESTMENT TIME FRAMES; PROVIDING INFORMATION BY PHONE AND BY ONLINE MEANS IN THE FIELD OF INVESTMENT ACCOUNT INFORMATION AND FINANCIAL RESEARCH; PROVIDING AN ONLINE COMPUTER DATABASE IN THE FIELDS OF INVESTING, FINANCE, FINANCIAL PLANNING, FINANCIAL NEWS, FINANCIAL INFORMATION, AND ANALYSIS IN THE FIELDS OF INVESTING, FINANCE, AND FINANCIAL PLANNING.

FIRST USE 2-15-1999; IN COMMERCE 2-15-1999.
 INT. CL. 41/U.S. CLS. 100, 101 AND 107
 FOR EDUCATIONAL SERVICES, NAMELY, CONDUCTING SEMINARS IN THE FIELDS OF INVESTMENT, FINANCE, [ECONOMICS, BUSINESS,] FINANCIAL PLANNING, PORTFOLIO MANAGEMENT, RETIREMENT PLANNING, MONEY MANAGEMENT, INVESTMENT STRATEGY AND ASSET ALLOCATION.
 FIRST USE 2-15-1999; IN COMMERCE 2-15-1999.

ELEMENTS CORRECTED
 GOODS/SERVICES

2,645,052. REG. 11-5-2002. FEDERATION INTERNATIONALE DE FOOTBALL ASSOCIATION (SWITZERLAND CORPORATION) HITZIGWEG 11, 8032 ZURICH, SWITZERLAND., SN 76-009,738. FILED 3-27-2000. PRINCIPAL REGISTER.

FIFA WORLD CUP

OWNER OF SWITZERLAND REG. NO. 468570, DATED 10-8-1999, EXPIRES 10-8-2009.
 OWNER OF U.S. REG. NOS. 1,420,790 AND 2,352,934.
 INT. CL. 1/U.S. CLS. 1

FOR UNEXPOSED CAMERA, CINEMATOGRAPHIC AND PHOTOGRAPHIC FILMS; CHEMICALS USED IN THE CINEMATOGRAPHIC AND PHOTOGRAPHIC INDUSTRIES; TANNING SUBSTANCES, NAMELY, TANNING AGENTS FOR USE IN THE MANUFACTURE OF LEATHER; ARTIFICIAL SWEETENERS.

FIRST USE ; IN COMMERCE .

INT. CL. 3/U.S. CLS. 1, 4, 6, 50, 51 AND 52

FOR COSMETICS, PARTICULARLY, SOAPS, HAIR LOTIONS, PERFUMES, COLOGNES, PRE-SHAVE AND AFTER SHAVE LOTIONS, SHAVING CREAMS, SHAMPOOS, TOOTHPASTE, DEODORANTS AND ANTIPERSPIRANTS FOR PERSONAL USE, MOUTH WASHES; NON-MEDICATED NOURISHING CREAMS FOR THE SKIN; NON-MEDICATED SKIN CREAMS; HAIR GEL, BEAUTY ADDITIVES, SKIN CLEANSING CREAM; EYE SHADOW; FACE POWDER; COSMETIC PENCILS; SUNSCREEN LOTIONS; CLEANING, POLISHING, SCOURING, ABRASIVE PREPARATIONS FOR HOUSEHOLD PURPOSES, LAUNDRY POWDER DETERGENTS, SYNTHETIC HOUSEHOLD DETERGENTS; SHOE POLISH; WAX, NAMELY, FLOOR WAX.

FIRST USE ; IN COMMERCE .

INT. CL. 4/U.S. CLS. 1, 6 AND 15

FOR LUBRICANTS FOR VEHICLES; AND MOTOR OILS AND FUELS FOR MOTOR VEHICLES, NAMELY, GASOLINE AND DIESEL FUELS; CANDLES, WAXES FOR USE IN THE MANUFACTURE OF CANDLES.

FIRST USE ; IN COMMERCE .

INT. CL. 5/U.S. CLS. 6, 18, 44, 46, 51 AND 52

FOR VEHICLE DEODORIZERS; PHARMACEUTICAL PREPARATIONS FOR THE TREATMENT OF DISORDERS OF THE MOUTH; MEDICATED CHEWING GUM FOR STOPPING SMOKING; MEDICINAL HERBAL TEA, NUTRITIONAL ADDITIVES FOR FOODS FOR MEDICAL AND DIETETIC PURPOSES; VITAMIN PREPARATIONS; FEMININE HYGIENIC PRODUCTS, NAMELY, SANITARY NAPKINS; MATERIALS FOR STOPPING TEETH; DENTAL WAX; FUNGICIDES AND HERBICIDES FOR DOMESTIC USE; MEDICINES FOR THE TREATMENT OF EYE FATIGUE.

FIRST USE ; IN COMMERCE .

INT. CL. 6/U.S. CLS. 2, 12, 13, 14, 23, 25 AND 50

FOR TROPHIES MADE OF COMMON METALS OR THEIR ALLOYS; MONEY CLIPS MADE OF COMMON METALS OR THEIR ALLOYS; DISPENSERS OF KITCHEN TOWELS MADE OF METAL; KEY CHAINS, FIGURINES AND POGS MADE OF COMMON NON-PRECIOUS METAL OR THEIR ALLOYS; STATUES AND SCULPTURES OF COMMON NON-PRECIOUS METAL; KITCHEN ALUMINUM FOIL.

FIRST USE ; IN COMMERCE .

INT. CL. 7/U.S. CLS. 13, 19, 21, 23, 31, 34 AND 35

FOR AERATED BEVERAGE MAKING MACHINES; ELECTRIC BLENDERS FOR HOUSEHOLD PURPOSES; DISH WASHING MACHINES; ELECTRIC CAN OPENERS; ELECTRIC KNIVES; ELECTRIC FOOD PROCESSORS; ELECTRIC FRUIT PRESSES FOR HOUSEHOLD PURPOSES; ELECTRIC KITCHEN MACHINES, NAMELY, DOMESTIC KITCHEN MIXING MACHINES; SEWING MACHINES; VACUUM CLEANERS AND ACCESSORIES THEREFOR, NAMELY, CLEANER HOSES AND NOZZLES; DOMESTIC DISH WASHING MACHINES; DOMESTIC CLOTHES WASHING MACHINES; ELECTRIC WHISKS FOR HOUSEHOLD PURPOSES; AND ELECTRIC CAN OPENERS.

FIRST USE ; IN COMMERCE .

INT. CL. 8/U.S. CLS. 23, 28 AND 44

FOR HAND TOOLS AND HAND-OPERATED IMPLEMENTS, NAMELY, NON-ELECTRIC CAN OPENERS, NAIL CLIPPERS, TWEEZERS, MULTI-FUNCTIONAL KNIVES WITH RETRACTABLE BLADES; ELECTRIC AND NON-ELECTRIC RAZORS; RAZOR BLADES, CUTLERY; DEPILATORY APPLIANCES; CURLING TONGS.

FIRST USE ; IN COMMERCE .

INT. CL. 9/U.S. CLS. 21, 23, 26, 36 AND 38

FOR DECORATIVE MAGNETS; EYEGLASSES; SUNGLASSES; CASES AND CORDS FOR EYEGLASSES AND SUNGLASSES; BINOCULARS; MAGNETS; TELEVISION RECEIVERS; RADIO RECEIVERS; VIDEO RECORDERS; COMPACT DISK PLAYERS; DIGITAL DISK PLAYERS; RECORDABLE VIDEO TAPES, MAGNETIC TAPES, MAGNETIC DISKS, DVDS, FLOPPY DISKS, OPTICAL DISKS, COMPACT DISKS, CD-ROMS AND VIDEO DISKS ALL SOLD EMPTY; PRE-RECORDED VIDEO TAPES, MAGNETIC TAPES, MAGNETIC DISKS, DVDS, FLOPPY DISKS, OPTICAL DISKS, COMPACT DISKS, CD-ROMS AND VIDEO DISKS FEATURING MUSIC; PRE-RECORDED VIDEO TAPES, MAGNETIC TAPES, MAGNETIC DISKS, DVDS, FLOPPY DISKS, OPTICAL DISKS, COMPACT DISKS, CD-ROMS AND VIDEO DISKS FEATURING ANIMATION; PRE-RECORDED VIDEO TAPES, MAGNETIC TAPES, MAGNETIC DISKS, DVDS, FLOPPY DISKS, OPTICAL DISKS, COMPACT DISKS, CD-ROMS AND VIDEO DISKS FEATURING IMAGES; COMPUTERS; MODEMS; ELECTRONIC POCKET TRANSLATORS; ELECTRONIC AGENDAS; SCANNERS; PRINTERS; CALCULATORS AND DATA PROCESSORS; CREDIT CARD VERIFICATION MACHINES; AUTOMATED TELLER MACHINES; FOREIGN EXCHANGE CURRENCY MACHINES; SECURITY ALARMS; LOUDSPEAKERS; VIDEO CAMERAS; CAMCORDERS; FACSIMILE TRANSMISSION MACHINES; TELEPHONES; TELEPHONE ANSWERING MACHINES; VIDEO PHONES; PHOTOCOPY MACHINES; PHOTOGRAPHIC EQUIPMENT, NAMELY, CAMERAS, PROJECTORS, EXPOSED FILMS, FLASH BULBS, CAMERA CASES, BATTERIES AND ACCESSORIES THEREFOR; WINDSOCKS FOR MEASURING WIND; HAND-HELD ELECTRONIC GAMES ADAPTED FOR USE WITH TELEVISION RECEIVERS; VIDEO GAME CARTRIDGES; MULTIMEDIA SOFTWARE RECORDED ON CD-ROM FEATURING MUSIC, SOUND OR IMAGES WHICH MAY BE ANIMATED; PRERECORDED COMPUTER SOFTWARE, NAMELY, SOFTWARE FOR GAMES; MAGNETIC ENCODED CARDS; COMPUTER HARDWARE, NAMELY, MEMORY CARDS AND MICROCHIP CARDS; ELECTRONIC VENDING MACHINES; DIRECTIONAL COMPASSES; MAGNETICALLY ENCODED CARDS, NAMELY, CREDIT CARDS, PREPAID PHONE CARDS, DEBIT CARDS, TRAVEL AND ENTERTAINMENT CARDS AND CHECK GUARANTEE CARDS; AND ELECTRIC IRONS, FLAT IRONS, AND STEAM IRONS.

FIRST USE ; IN COMMERCE .

INT. CL. 10/U.S. CLS. 26, 39 AND 44

FOR PERSONAL DIAGNOSTIC APPLIANCES, NAMELY, EAR THERMOMETERS, BLOOD PRESSURE MEASURING DEVICES AND HEART MONITORS; MEDICAL MEASUREMENT APPARATUS AND INSTRUMENTS; MASSAGE APPARATUS FOR PERSONAL USE; BABY NURSING BOTTLES; CONDOMS; ORTHOPEDIC SUPPORTIVE BANDAGES; ICE AND THERMAL PACKS FOR MEDICAL PURPOSES; PHYSICAL EXERCISE MACHINES FOR MEDICAL PURPOSES; AND MEDICAL DIAGNOSTIC IMAGING EQUIPMENT, NAMELY, X-RAY MACHINES AND MRI DIAGNOSTIC APPARATUS.

FIRST USE ; IN COMMERCE .

INT. CL. 11/U.S. CLS. 13, 21, 23, 31 AND 34

FOR PRODUCTS FOR PURIFICATION AND DEODORIZATION OF THE AIR, NAMELY, SEPARATORS FOR THE CLEANING AND PURIFICATION OF AIR FOR COMMERCIAL AND DOMESTIC USE; PAPER LANTERNS; ELECTRIC LAUNDRY DRYERS; ELECTRIC HAIR DRYERS; PENLIGHTS; FLASHLIGHTS; TABLE LAMPS; DECORATIVE LAMPS; LAMP SHADES; LIGHT BULBS; LIGHTING FIXTURES; REFRIGERATORS; FREEZERS; SPACE HEATERS; AIR CONDITIONERS; AIR PURIFYING UNITS FOR COMMERCIAL AND DOMESTIC USE; OVENS; GAS STOVES; BARBECUE GRILLS; RANGES; MICROWAVE OVENS; ELECTRIC COFFEE MAKERS FOR DOMESTIC USE; ELECTRIC TEA KETTLES; TOASTERS; ELECTRIC DEEP FRYERS; WATER FILTERS FOR DRINKING WATER; BICYCLE LIGHTS; AND DRINK FOUNTAINS.

FIRST USE ; IN COMMERCE .

INT. CL. 12/U.S. CLS. 19, 21, 23, 31, 35 AND 44

FOR SEAT CUSHIONS AS ACCESSORIES FOR AUTOMOBILES; BICYCLES; MOTORBIKES; AUTOMOBILES; TRUCKS; VANS; BUSES; AIRPLANES; BOATS; BALLOONS, AIRSHIPS; PRAMS; STROLLERS; CAR SEATS FOR BABIES OR CHILDREN; AUTOMOBILE ACCESSORIES, NAMELY, SUN SCREEN SHADES; SPORTS RACKS; TIRE COVERS, VEHICLE SEAT COVERS, FITTED AND SEMI FITTED VEHICLE COVERS; FLOOR MATS; ENGINES FOR LAND VEHICLES AND REPLACEMENT PARTS THEREFOR; AND TIRES.

FIRST USE ; IN COMMERCE .

INT. CL. 14/U.S. CLS. 2, 27, 28 AND 50

FOR JEWELRY; WATCHES; CLOCKS; MEDALLIONS; ORNAMENTAL LAPEL PINS; PENDANTS; TEAM AND PLAYER TRADING PINS MADE OF PRECIOUS METALS; TROPHIES MADE OF PRECIOUS METALS; COMMEMORATIVE CUPS AND PLATES, TANKARDS, STATUES AND SCULPTURES, PENDANTS AND POGS, ALL MADE OF PRECIOUS METALS; MEDALLIONS, TIE CLIPS AND TIE PINS NOT MADE OF PRECIOUS METALS; ASHTRAYS AND CIGARETTE CASES MADE OF PRECIOUS METALS; NON-MONETARY COINS.

FIRST USE ; IN COMMERCE .

INT. CL. 16/U.S. CLS. 2, 5, 22, 23, 29, 37, 38 AND 50

FOR TEMPORARY TATTOOS, NAMELY, DECORATIVE TRANSFERS FOR COSMETIC PURPOSES; HOLOGRAMS; PASSPORT HOLDERS; PLASTIC KEY CARDS THAT ARE NOT MAGNETICALLY ENCODED; DISPLAY STANDS FOR SELLING GOODS MADE OF CARDBOARD; GIFT AND PARTY SUPPLIES MADE OF PAPER, NAMELY, NAPKINS, TABLE CLOTHS, BAGS, PRINTED INVITATIONS, GIFT WRAP, COASTERS AND PLACE MATS; PAPER TABLE LINENS; CREPE PAPER; GARBAGE BAGS OF PAPER OR PLASTIC; FOOD STORAGE WRAPPERS; BLANK OR PARTIALLY PRINTED LABELS NOT OF TEXTILES; FLAGS OF PAPER, PENNANTS OF PAPER; HANDKERCHIEFS OF PAPER; TYPEWRITER PAPER; COPYING PAPER; PAPER COFFEE FILTERS; TOWELS OF PAPER; DISPOSABLE PAPER WIPES NOT IMPREGNATED WITH CHEMICALS OR COMPOUNDS; TOILET PAPER; ENVELOPES; BABIES DISPOSABLE DIAPERS OF PAPER; STATIONERY AND SCHOOL SUPPLIES, NAMELY, THEME PADS, NOTEBOOKS, NOTE PAPER, BINDERS, PENS, PENCILS, BALL-POINT PENS, PEN AND PENCIL SETS, POROUS-POINT PENS, ROLLING BALL PENS AND BROAD-TIP MARKERS; PRINTING BLOCKS CORRECTION FLUIDS; RUBBER ERASERS; BOOKENDS; PENCIL SHARPENERS; CALENDARS; ADHESIVE NOTE PAPER; POSTERS; GREETING CARDS; DECALS; HEAT TRANSFER PAPER; COLORING BOOKS AND ACTIVITY BOOKS, MAGAZINES, NEWSPAPERS PICTURE, BOOKS AND JOURNALS FEATURING ATHLETES OR SPORT EVENTS; ROADMAPS; PLAYING CARDS; PRINTED TICKETS; BANK CHECKS; PRINTED TIMETABLES; COLLECTABLE PLAYER TRADING CARDS; BUMPER STICKERS; MOUNTED AND UNMOUNTED PHOTOGRAPHS; PHOTOGRAPH ALBUMS; STATIONERY; CREDIT CARDS, PREPAID PHONE CARDS, DEBIT CARDS, TRAVEL AND ENTERTAINMENT CARDS AND CHECK GUARANTEE CARDS, ALL MADE OF PAPER OR CARDBOARD AND NOT MAGNETICALLY ENCODED; AUTOGRAPH BOOKS, BINDER PAPER; BOOK COVERS; BOOK STANDS; CONFETTI; CHALK; DOCUMENT HOLDERS; PAPER CLIPS; DRAWING PINS; INK; PAINT BOXES; KITCHEN TOWELS OF PAPER; WRITING PAPER; SCRIBBLE PADS; CLIP BOARDS; NOTE-PAD HOLDERS; ADDRESS BOOKS; DECORATIONS FOR PENCILS; STANDS FOR WRITING IMPLEMENTS; INK PADS; RUBBER STAMPS; RULERS; SCORE BOOK SCHEDULES FOR RECORDING RESULTS; ADHESIVE TAPE FOR STATIONERY; OFFICE DISPENSERS FOR ADHESIVE TAPE; STAPLERS; STENCILS; LUMINOUS PAPER; EVENT PROGRAMS; EVENT ALBUMS; STATIONERY SCISSORS; AND BOXED TISSUES MADE OF CARDBOARD.

FIRST USE ; IN COMMERCE .

INT. CL. 18/U.S. CLS. 1, 2, 3, 22 AND 41

FOR UMBRELLAS; PARASOLS; ALL PURPOSE SPORT AND LEISURE BAGS; TRAVELLING BAGS; BACK-PACKS; TOTE BAGS; SCHOOL BAGS; BELT BAGS; HANDBAGS; BEACH BAGS; SUITCASES; VANITY CASES SOLD EMPTY; KEY CASES; SUIT CARRIERS; SOCCER BALL SHAPED BAGS FOR GENERAL USE; WALLETS; PURSES; BRIEF-CASES.

FIRST USE ; IN COMMERCE .

INT. CL. 20/U.S. CLS. 2, 13, 22, 25, 32 AND 50

FOR HOLIDAY ORNAMENTS MADE OF PLASTER, PLASTIC AND/OR WOOD AND NOT INCLUDING CHRISTMAS TREE ORNAMENTS; FOAM NOVELTY ITEMS IN THE NATURE OF FOAM HANDS; SLEEPING BAGS; NON-METAL TROPHIES; KEYHOLDERS MADE OF PLASTIC; HAND HELD MIRRORS; FURNITURE MIRRORS; ARTICLES MADE OF PLASTICS, NAMELY, SOUVENIR STATUES, PLASTIC BADGES THAT ARE NOT ENCODED; CUSHIONS AND FURNITURE SEATS FOR OUTDOOR USE; FURNITURE; COAT HANGERS; FURNITURE DISPLAY RACKS; NON-ELECTRIC FANS FOR PERSONAL USE; DISPLAY STANDS FOR SELLING GOODS NOT MADE OF CARDBOARD; INFLATABLE PUBLICITY OBJECTS; AND NON-METAL DISPENSERS OF KITCHEN TOWELS.

FIRST USE ; IN COMMERCE .

INT. CL. 21/U.S. CLS. 2, 13, 23, 29, 30, 33, 40 AND 50

FOR HOLIDAY ORNAMENTS MADE OF CHINA, CRYSTAL, GLASS, PORCELAIN AND/OR TERRACOTTA AND NOT INCLUDING CHRISTMAS TREE ORNAMENTS; CHINA ORNAMENTS; ALL PURPOSE PORTABLE HOUSEHOLD OR KITCHEN CONTAINERS NOT MADE OF PRECIOUS METALS OR COATED THEREWITH; TANKARDS, MUGS, CUPS AND DRINKING GLASSES, PLATES AND DISHES, COASTERS NOT OF PRECIOUS METALS; BOTTLE OPENERS, BEVERAGE BOTTLES SOLD EMPTY, NON-ELECTRIC COOLERS FOR FOOD AND DRINKS, COMBS AND HAIRBRUSHES, TOOTH BRUSHES; DENTAL FLOSS; STATUES AND SCULPTURES RELATED TO THE SPORT OF SOCCER MADE OF PORCELAIN, TERRACOTTA OR GLASS; AND TEA POTS NOT OF PRECIOUS METAL.

FIRST USE ; IN COMMERCE .

INT. CL. 24/U.S. CLS. 42 AND 50

FOR KITCHEN OVEN MITTS; CLOTH BANNERS AND PENNANTS; BEDDING, NAMELY, SHEETS; CURTAINS; DRAPERIES; QUILTS AND BEDSPREADS; TOWELS AND BATH LINENS; DISH CLOTHS; DISH TOWELS; STADIUM BLANKETS; CLOTH HANDKERCHIEFS; WALL HANGINGS AND ABLE CLOTHS MADE OF TEXTILE; CLOTH LABELS MADE OF TEXTILE; AND BEACH MATS MADE OF TEXTILE.

FIRST USE ; IN COMMERCE .

INT. CL. 25/U.S. CLS. 22 AND 39

FOR FOOTWEAR; HEAD WEAR; CLOTHING, NAMELY, SHIRTS; KNIT SHIRTS; JERSEYS AND TANK TOPS; T-SHIRTS; DRESSES; SKIRTS; UNDERWEAR; SWIMWEAR; SHORTS; PANTS; SWEATERS; CAPS; HATS; SCARVES; VISORS; WARM-UP SUITS; SWEATSHIRTS; JACKETS; UNIFORMS; NECKTIES; WRISTBANDS AND HEADBANDS; GLOVES; APRONS; CLOTH BIBS; PAJAMAS; SOCKS AND HOSIERY; BELTS; SUSPENDERS; AND TODDLER AND INFANT PLAYWEAR; NAMELY, ROMPERS, SUNSUITS, JUMPSUITS, DUNGAREES AND OVERALLS.

FIRST USE ; IN COMMERCE .

INT. CL. 28/U.S. CLS. 22, 23, 38 AND 50

FOR GAMES AND PLAYTHINGS, NAMELY, SPORT BALLS, BOARD GAMES, STUFFED DOLLS, STUFFED ANIMALS, TOY VEHICLES, JIGSAW PUZZLES, BALLOONS, INFLATABLE TOYS; SOCCER EQUIPMENT, NAMELY, BALLS, GLOVES, KNEE PADS, ELBOW PADS AND SHOULDER PADS; SOCCER GOALS, TOY PARTY HATS; AND HAND-HELD ELECTRONIC GAMES OTHER THAN THOSE ADAPTED FOR USE WITH TELEVISION RECEIVERS.

FIRST USE ; IN COMMERCE .

INT. CL. 29/U.S. CL. 46

FOR MEAT; FISH FOR FOOD PURPOSES; POULTRY FOR FOOD PURPOSES; GAME FOR FOOD PURPOSES; MEAT EXTRACTS; PRESERVED AND COOKED FRUITS AND VEGETABLES, EDIBLE OILS AND FATS; POTATO CHIPS, FRENCH FRIED POTATOES; PROCESSED NUTS; JAMS; FRUIT PRESERVES AND JELLIES; MILK; DAIRY PRODUCTS EXCLUDING ICE CREAM, ICE MILK AND FROZEN YOGURT; CHEESE; CANNED FRUITS AND VEGETABLES.

FIRST USE ; IN COMMERCE .

INT. CL. 30/U.S. CL. 46

FOR COFFEE; TEA; COCOA; SUGAR; ARTIFICIAL COFFEE; FLOUR; PREPARATIONS MADE FROM CEREALS, NAMELY, CEREAL BASED SNACK FOOD AND READY TO EAT CEREAL DERIVED FOOD BARS; BREAKFAST CEREALS; PROCESSED CEREALS; BREAD; PASTRIES; CAKES; COOKIES AND CRACKERS; CANDIES; FROZEN CONFECTIONS; RICE; CORN CHIPS; ICE CREAM; HONEY; MUSTARD; VINEGAR; SAUCES; SPICES; SALT; NON NUTRITIONAL FOOD ADDITIVES FOR USE AS FLAVORING; INGREDIENT OR FILLER AND NOT FOR MEDICAL OR DIETETIC PURPOSES.

FIRST USE ; IN COMMERCE .

INT. CL. 31/U.S. CLS. 1 AND 46

FOR UNPROCESSED CEREALS; FOODSTUFF FOR ANIMALS; GRASS SEEDS; FRESH FRUITS, BERRIES, VEGETABLES AND FLOWERS; LITTER FOR ANIMALS; AND NON-ARTIFICIAL TURF.

FIRST USE ; IN COMMERCE .

INT. CL. 32/U.S. CLS. 45, 46 AND 48

FOR BEERS AND ALES, SOFT DRINKS; SYRUPS AND POWDER FOR MAKING SOFT DRINKS; MINERAL AND AERATED WATERS; FRUIT AND VEGETABLE DRINKS AND JUICE; NON-ALCOHOLIC BEERS AND ALES; AND FROZEN FRUIT DRINKS.

FIRST USE ; IN COMMERCE .

INT. CL. 33/U.S. CLS. 47 AND 49

FOR ALCOHOLIC BEVERAGES, NAMELY, WINE, LIQUOR, APERITIFS, CHAMPAGNE, CIDER, BRANDY, WHISKEY, VODKA, GIN, RUM AND TEQUILA.

FIRST USE ; IN COMMERCE .

INT. CL. 34/U.S. CLS. 2, 8, 9 AND 17

FOR MATCHES; LIGHTERS; CIGARETTE CASES AND ASHTRAYS MADE OF NON-PRECIOUS METAL; CIGARETTES; AND TOBACCO.

FIRST USE ; IN COMMERCE .

INT. CL. 35/U.S. CLS. 100, 101 AND 102

FOR DATA PROCESSING SERVICES; PROMOTING SOCCER COMPETITIONS, SOCCER EXHIBITIONS AND SOCCER EVENTS OF OTHERS; EMPLOYMENT AGENCIES; PERSONNEL PLACEMENT AND RECRUITMENT SERVICES; ADVERTISING AGENCY SERVICES; ADVERTISING FOR OTHERS VIA THE INTERNET; DISSEMINATION OF ADVERTISING MATTER FOR OTHERS; RENTAL OF ADVERTISING SPACE ON OUTDOOR BILLBOARDS; PREPARING AND PLACING OUTDOOR ADVERTISING SERVICES FOR OTHERS; TELEVISION ADVERTISING SERVICES FOR OTHERS; PROMOTION AGENCY SERVICES, NAMELY, PROMOTING THE GOODS AND SERVICES OF OTHERS THROUGH THE DISTRIBUTION OF PRINTED AND AUDIO PROMOTIONAL MATERIALS AND BY RENDERING SALES PROMOTION ADVICE; ADVERTISING FOR OTHERS IN THE FORM OF ANIMATION; MARKETING RESEARCH SERVICES; PUBLIC OPINION POLLING SERVICES; PROMOTION OF COMMERCIAL EXHIBITIONS OF OTHERS; COMPUTERIZED ON-LINE RETAIL SERVICES IN THE FIELD OF GENERAL MERCHANDISE; COMPUTERIZED DATABASE MANAGEMENT AND LICENSING OF COMPUTERIZED DATABASES; AND SPORT RECORD AND STATISTICAL INFORMATION SERVICES.

FIRST USE ; IN COMMERCE .

INT. CL. 36/U.S. CLS. 100, 101 AND 102

FOR CREDIT CARD SERVICES; ISSUANCE OF CREDIT CARDS; TRAVELERS CHECK SERVICES; FINANCING SERVICES; BANKING SERVICES, NAMELY, CREDIT AND LOAN SERVICES; INSURANCE UNDERWRITING IN THE FIELD OF LIFE, HEALTH, ACCIDENT, PROPERTY AND CASUALTY.

FIRST USE ; IN COMMERCE .

INT. CL. 37/U.S. CLS. 100, 103 AND 106

FOR AUTOMOBILE SERVICE STATION SERVICES; VEHICLE CLEANING; VEHICLE LUBRICATION; VEHICLE MAINTENANCE AND REPAIR; AND VEHICLE WASHING SERVICES.

FIRST USE ; IN COMMERCE .

INT. CL. 38/U.S. CLS. 100, 101 AND 104

FOR TELECOMMUNICATION SERVICES, NAMELY PERSONAL COMMUNICATION SERVICES VIA MOBILE PHONES, TELEX, ELECTRONIC COMPUTER TERMINALS, TELEGRAPH, TELEPHONE OR FACSIMILE; PAGING BY RADIO, NETWORK CONFERENCING SERVICES, NAMELY, COMMUNICATIONS BY TELEVISION FOR MEETINGS, TELEVISION BROADCASTING; CABLE TELEVISION BROADCASTING; RADIO BROADCASTING.

FIRST USE ; IN COMMERCE .

INT. CL. 39/U.S. CLS. 100 AND 105

FOR ELECTRONIC ARCHIVING FOR OTHERS OF MESSAGES AND DATA; TRAVEL AGENCY SERVICES; BOAT, AIRLINE, RAILWAY, BUS AND VAN TRANSPORTATION SERVICES ALL FOR PASSENGERS AND GOODS; POSTAL SERVICES, NAMELY, PARCEL DELIVERY; COURIER SERVICES; MESSAGE DELIVERY; VEHICLE RENTAL SERVICES; ARRANGING TRAVEL TOURS; TOUR BOAT SERVICES, NAMELY, BOAT CHARTERING AND PROVIDING BOAT CRUISES; WAREHOUSE STORAGE SERVICES; TAXI TRANSPORT SERVICES; FREIGHT SHIPPING SERVICES, NAMELY, FREIGHT FORWARDING AND FREIGHT TRANSPORTATION BY TRUCK, TRAIN, AND AIR; UTILITY SERVICES, NAMELY, TRANSMISSION OF GAS, WATER, AND ELECTRICITY; DELIVERY OF SOLVENTS, PARAFFIN, WAX, BITUMEN AND PETROLEUM WITH THE EXCLUSION OF LIQUID PETROLEUM GAS, BY MOTOR VEHICLE.

FIRST USE ; IN COMMERCE .

INT. CL. 40/U.S. CLS. 100, 103 AND 106

FOR APPAREL OUTFITTER SERVICES, NAMELY, TAILORING; DEVELOPING OF FILMS FOR MOVIES; ENLARGING OF PHOTOGRAPHS, PRINTING OF PHOTOGRAPHS, DEVELOPING OF FILMS FOR PHOTOGRAPH; LEASING OR RENTAL OF MACHINES AND INSTRUMENTS FOR DEVELOPMENT, PRINTING, ENLARGING OR FINISHING FOR PHOTOGRAPHY.

FIRST USE ; IN COMMERCE .

INT. CL. 41/U.S. CLS. 100, 101 AND 107

FOR VIDEOTAPE PRODUCTION; PROVIDING SPORTS RECORDS AND SPORTS STATISTICAL INFORMATION; EDUCATIONAL SERVICES, NAMELY, CONDUCTING CLASSES, SEMINARS, CONFERENCES AND/OR WORKSHOPS IN THE FIELD OF SPORTS AND DISTRIBUTING COURSE MATERIALS IN CONNECTION THEREWITH; ENTERTAINMENT SERVICES, NAMELY, CONDUCTING LOTTERIES FOR OTHERS, SPORTING AND CULTURAL ACTIVITIES, ORGANIZATIONS OF SPORTING AND CULTURAL EVENTS AND ACTIVITIES FOR OTHERS; PROVIDING FACILITIES FOR FOOTBALL AND SOCCER TOURNAMENTS; RENTAL SERVICES FOR AUDIO AND VIDEO EQUIPMENT, RADIO, TELEVISION PROGRAM; PRODUCTION OF ANIMATION MOVIES, PRODUCTION OF ANIMATION TV PROGRAMS, ARRANGING FOR TICKET RESERVATIONS FOR SHOWS AND OTHER ENTERTAINMENT EVENTS; TIMING OF SPORTS EVENTS; ENTERTAINER MANAGING SERVICES.

FIRST USE ; IN COMMERCE .

INT. CL. 42/U.S. CLS. 100 AND 101

FOR WASTE MANAGEMENT SERVICES; LEASING OF TELEPHONE SETS, FACSIMILE; STOCK PHOTOGRAPH SERVICES, NAMELY, LEASING REPRODUCTION RIGHTS OF PHOTOGRAPHS TO OTHERS; PROVIDING OF FOOD AND DRINK, IN PARTICULAR WITH FAST FOOD, IN CAFETERIAS AND RESTAURANTS; CATERING SERVICES, HOTEL RESORT, LODGING AND BOARDING SERVICES; LANGUAGE TRANSLATION SERVICES; PHOTOGRAPHY SERVICES; VIDEOTAPING SERVICES; PRINTING SERVICES; COMPUTE CONSULTING SERVICES, COMPUTER DATA PROGRAMMING FOR OTHERS; GUARD AND SECURITY SERVICES; MEDICAL, DENTAL AND HOSPITAL SERVICES; DRUG TESTING SERVICES; HAIR DRESSING, BARBER AND BEAUTY PARLOR SERVICES; UNIFORM LEASING SERVICES; COMPUTER SOFTWARE DESIGN FOR OTHERS; HOSTING THE WEB SITES OF OTHERS ON THE INTERNET; LICENSING OF INTELLECTUAL PROPERTY RIGHTS.

FIRST USE ; IN COMMERCE .

ELEMENTS CORRECTED
OWNER NAME
OWNER ADDRESS
ASSIGNMENT/NAME CHANGE

2,645,220. REG. 11-5-2002. JU.CLA.S. S.R.L. (ITALY LTD LIAB JT ST CO) LOC. NASSAR 37, 37020 SAN PIETRO IN CARIANO, FRAZ PEDEMONTE (VR), ITALY., SN 76-160,117. FILED 11-6-2000. PRINCIPAL REGISTER.

2,646,094. REG. 11-5-2002. LARRY HARMON PICTURES CORPORATION (CALIFORNIA CORPORATION) 7080 HOLLYWOOD BOULEVARD, HOLLYWOOD, CA, 90028, SN 75-586,441. FILED 11-11-1998. PRINCIPAL REGISTER.

MICRODUE

PRIORITY CLAIMED UNDER SEC. 44(D) ON ITALY APPLICATION NO. FE98C000311, FILED 12-3-1998, REG. NO. 831691, DATED 1-16-2001, EXPIRES 12-3-2008. INT. CL. 7/U.S. CLS. 13, 19, 21, 23, 31, 34 AND 35

FOR ELECTRIC MACHINE THAT INJECTS SMALL AMOUNTS OF OXYGEN IN MUSTS, WINES AND FOOD LIQUIDS FOR IMPROVING THEIR ORGANOLEPTIC FEATURES.

FIRST USE ; IN COMMERCE .

ELEMENTS CORRECTED
FOREIGN REG. DATE

LAUREL & HARDY

OWNER OF U.S. REG. NOS. 2,135,117, 2,166,031 AND 2,185,169.

INT. CL. 16/U.S. CLS. 2, 5, 22, 23, 29, 37, 38 AND 50

FOR [CALENDARS; COMIC BOOKS; COLORING BOOKS; GREETING CARDS; GIFT WRAPPING PAPER; NOTE CARDS; ART PRINTS; LITHOGRAPHIC PRINTS;] CARDBOARD CUTOUT FIGURES.

FIRST USE 6-22-1994; IN COMMERCE 6-22-1994.

ELEMENTS CORRECTED
GOODS/SERVICES

2,645,283. REG. 11-5-2002. MARINE POLYMER TECHNOLOGIES, INC. (MASSACHUSETTS CORPORATION) 107 WATER STREET, DANVERS, MA. 01923, SN 76-203,800. FILED 2-1-2001. PRINCIPAL REGISTER.

2,646,952. REG. 11-5-2002. AMERISERV FINANCIAL, INC. (PENNSYLVANIA CORPORATION) 216 FRANKLIN STREET, JOHNSTOWN, PA, 15901, SN 76-221,484. FILED 3-8-2001. PRINCIPAL REGISTER.

RDH BANDAGE

NO CLAIM IS MADE TO THE EXCLUSIVE RIGHT TO USE "BANDAGE", APART FROM THE MARK AS SHOWN. INT. CL. 5/U.S. CLS. 6, 18, 44, 46, 51 AND 52

FOR WOUND DRESSINGS IMPREGNATED WITH A PHARMACEUTICAL PREPARATION USED TO STOP BLEEDING, PROMOTE WOUND CLOSURE AND AID IN [WOUND] * WOUND * HEALING .

FIRST USE 6-13-2001; IN COMMERCE 6-13-2001.

ELEMENTS CORRECTED
GOODS/SERVICES



INT. CL. 35/U.S. CLS. 100, 101 AND 102
FOR ASSET AND LIABILITY MANAGEMENT SERVICES.

FIRST USE 5-7-2001; IN COMMERCE 5-7-2001.

INT. CL. 36/U.S. CLS. 100, 101 AND 102

FOR BANKING SERVICES; CORPORATE, INSTITUTIONAL AND PERSONAL TRUST SERVICES; FINANCIAL PLANNING AND PORTFOLIO MANAGEMENT; BROKERAGE IN THE FIELDS OF INSURANCE, ANNUITIES AND MUTUAL FUNDS; MORTGAGE BANKING, LENDING AND BROKERAGE SERVICES; ESTATE ADMINISTRATION SERVICES; TITLE INSURANCE SERVICES; MAINTAINING MORTGAGE ESCROW ACCOUNTS; CREDIT LIFE REINSURANCE SERVICES.

FIRST USE 5-7-2001; IN COMMERCE 5-7-2001.

2,645,381. REG. 11-5-2002. SCOTTO'S HOLDING CORP. (NEW YORK CORPORATION) 40 CROSSWAYS PARK DRIVE, WOODBURY, NY, 11797, SN 76-249,776. FILED 5-1-2001. PRINCIPAL REGISTER.

SCOTTO BROTHERS

INT. CL. 35/U.S. CLS. 100, 101 AND 102

FOR ONLINE RETAIL STORE SERVICES FEATURING A COMPLETE LINE OF WEDDING PRODUCTS; AN ONLINE DIRECTORY OF QUALIFIED WEDDING VENDORS; AND PROVIDING FACILITIES FOR BUSINESS CONFERENCES AND GROUP MEETINGS.

FIRST USE 4-0-1998; IN COMMERCE 4-0-1998.

INT. CL. 42/U.S. CLS. 100 AND 101

FOR WEDDING CONSULTATION IN THE FIELDS OF EXPERT INFORMATION AND ADVICE FOR BUDGET SETUP AND TRACKING OF WEDDING FINANCES, TIMING, AND TASK MANAGEMENT FOR WEDDING ARRANGEMENTS, RESTAURANT SERVICES, CATERING SERVICES, COCKTAIL LOUNGE AND BAR SERVICES, PROVIDING BANQUET SOCIAL FUNCTION AND EVENT FACILITIES.

FIRST USE 0-0-1967; IN COMMERCE 12-2-1988.

ELEMENTS CORRECTED
DATE OF FIRST USE
DATE OF FIRST USE IN COMMERCE

ELEMENTS CORRECTED
DATE OF FIRST USE
DATE OF FIRST USE IN COMMERCE

2,647,802. REG. 11-12-2002. ABB FLEXIBLE AUTOMATION AG (SWITZERLAND CORPORATION) BADENERSTASSE 790, 8048 ZURICH, SWITZERLAND., SN 75-859,365. FILED 11-29-1999. PRINCIPAL REGISTER.

FLEXDEFLEASHER

PRIORITY CLAIMED UNDER SEC. 44(D) ON SWITZERLAND APPLICATION NO. 05818/1999, FILED 7-5-1999, REG. NO. 463237, DATED 11-10-1999, EXPIRES 7-5-2009.

INT. CL. 7/U.S. CLS. 13, 19, 21, 23, 31, 34 AND 35

FOR AUTOMATIC, NUMERICALLY CONTROLLED MACHINES FOR MACHINING PROCESSES, NAMELY, MILLING MACHINES, GRINDING MACHINES, CUTTING MACHINES, STAMPING MACHINES, * DEFORMING MACHINES, BENDING MACHINES, WELDING * MACHINES, SOLDERING MACHINES, GLUING MACHINES, HEAT TREATING MACHINES, MACHINE TOOLS, NAMELY, MACHINING CENTERS, SAWS, GRINDERS; INDUSTRIAL ROBOTS; MECHANICAL DEVICES FOR TAKING AND HOLDING WORK PIECES, NAMELY, GRIPPERS AND FIXTURES, TECHNICALLY, ELECTRICALLY, PNEUMATICALLY AND HYDRAULICALLY OPERATED; TOOLS FOR GRINDING, MILLING, AND SAWING OF SURFACES AND EDGES OF CASTED, WELDED, [MACHINES] * MACHINED * , STAMPED AND FORMED PARTS.

FIRST USE ; IN COMMERCE .

INT. CL. 9/U.S. CLS. 21, 23, 26, 36 AND 38

FOR AUTOMATIC, NUMERICALLY CONTROLLED MACHINES FOR MACHINING PROCESSES, NAMELY, 3D DIGITIZER; COMPUTERS FOR CONTROLLING AND STEERING MACHINE TOOLS AND INDUSTRIAL ROBOTS; COMPUTER PROGRAMS FOR THE PROGRAM GENERATION, PROGRAMMING, OPTIMIZATION, SIMULATION, SUPERVISION, TRAINING OF OPERATORS AND SERVICE OF INDUSTRIAL ROBOTS FOR THE OPERATION OF SUCH COMPUTERS; DEVICES FOR ACQUISITION AND AUTOMATIC PROCESSING OF SPATIAL DATA, NAMELY, MANUALLY OR AUTOMATICALLY OPERATED MECHANICAL ARMS AND SCANNING SYSTEMS; AND QUALITY CONTROL MACHINES FOR MEASURING TOLERANCES OF CASTED, WELDED, MACHINED, STAMPED AND FORMED PARTS.

FIRST USE ; IN COMMERCE .

ELEMENTS CORRECTED
GOODS/SERVICES

2,647,866. REG. 11-12-2002. USTOV, INC. (CALIFORNIA CORPORATION), DBA U.S. TRADING COMPANY, 1280 VAN DYKE AVENUE, SAN FRANCISCO, CA, 94124, SN 75-916,750. FILED 2-11-2000. PRINCIPAL REGISTER.

HELLO BEE BEE

INT. CL. 30/U.S. CL. 46

FOR CONFECTIONS, NAMELY, PASTRIES, COOKIES, AND CANDIES.

FIRST USE 3-21-2000; IN COMMERCE 3-21-2000.

ELEMENTS CORRECTED
OWNER ADDRESS

2,648,631. REG. 11-12-2002. PROGRESSIVE GOURMET (MASSACHUSETTS CORPORATION) 114 WYLLIS AVENUE, EVERETT, MA. 02149, SN 76-250,465. FILED 5-3-2001. PRINCIPAL REGISTER.

PROGRESSIVE GOURMET

SEC. 2(F).

INT. CL. 29/U.S. CL. 46

FOR PREPARED MEATS, FISH, POULTRY, AND GAME; PRESERVED, DRIED, AND COOKED FRUITS AND VEGETABLES; PRE-COOKED AND READY-TO-COOK HORS D'OEUVRES, ENTREES, SIDE DISHES CONSISTING PRIMARILY OF MEAT, FISH, POULTRY, VEGETABLES, EGGS AND CHEESES; YOGURT; SNACK FOOD DIPS.

FIRST USE 12-1-1991; IN COMMERCE 12-1-1991.

INT. CL. 30/U.S. CL. 46

FOR BAKED GOODS, NAMELY BREADS, BISCUITS, BAGELS, CAKES, MUFFINS, PASTRIES, PIES, ROLLS, DOUGHNUTS, COOKIES, AND CROISSANTS; CONFECTIONS, [NIAMEY] * NAMELY * BAKERY DESSERTS; FLAVORED ICES; PASTA AND PREPARED PASTA DISHES; SAUCES; AND FROZEN DAIRY DESSERTS, NAMELY, ICE CREAM.

FIRST USE 12-1-1991; IN COMMERCE 12-1-1991.

ELEMENTS CORRECTED
GOODS/SERVICES

2,648,932. REG. 11-12-2002. FIFTH AVENUE OF LONG ISLAND REALTY ASSOCIATES (PARTNERSHIP), 2110 NORTHERN BOULEVARD, MANHASSET, NY, 11030, SN 76-301,113. FILED 8-17-2001. PRINCIPAL REGISTER.

AMERICANA MANHASSET

OWNER OF U.S. REG. NO. 1,771,826.

NO CLAIM IS MADE TO THE EXCLUSIVE RIGHT TO USE "MANHASSET", APART FROM THE MARK AS SHOWN.

INT. CL. 35/U.S. CLS. 100, 101 AND 102

FOR RETAIL STORE SERVICES FEATURING CLOTHING, GREETING CARDS, GIFT WRAP, GIFT CARDS, CALENDARS AND/OR PROVIDING FACILITIES FOR BUSINESS MEETINGS AND CONFERENCES AND/OR ARRANGING AND CONDUCTING BUSINESS CONFERENCES.

FIRST USE 11-0-1997; IN COMMERCE 11-0-1997.

INT. CL. 36/U.S. CLS. 100, 101 AND 102

FOR SHOPPING CENTER SERVICES.

FIRST USE 1-0-2000; IN COMMERCE 1-0-2000.

ELEMENTS CORRECTED
DATE OF FIRST USE
DATE OF FIRST USE IN COMMERCE

2,649,670. REG. 11-12-2002. SILICONSYSTEMS GMBH (FED REP GERMANY LIMITED LIABILITY COMPANY) HAID-UND-NEU-STRASSE 7, D-76131 KARLSRUHE, FED REP GERMANY., AND OASIS DESIGN, INC. (TEXAS CORPORATION) 1101 S. CAPITAL OF TEXAS HIGHWAY, BUILDING B, SUITE 100, AUSTIN, TX, 78746, SN 75-241,863. FILED 2-14-1997. PRINCIPAL REGISTER.

MOST

INT. CL. 9/U.S. CLS. 21, 23, 26, 36 AND 38

FOR COMPUTER HARDWARE AND COMPUTER SOFTWARE FOR THE TRANSFER OF MULTIMEDIA AND CONTROL DATA; COMPUTER HARDWARE AND COMPUTER SOFTWARE FOR SYNCHRONOUS [COMMUNICATIONS] *COMMUNICATIONS*. EITHER POINT TO POINT OR ON A LOCAL AREA NETWORK UTILIZING A RING TOPOLOGY AND USING ANY OF A NUMBER OF DIFFERENT TRANSMISSION MEDIA.

FIRST USE 9-26-1997; IN COMMERCE 9-26-1997.

ELEMENTS CORRECTED
GOODS/SERVICES

2,650,583. REG. 11-12-2002. KURASHIKI BOSEKI KABUSHIKI KAISHA (JAPAN CORPORATION), TA KURABO INDUSTRIES LTD., 7-1, HOMMACHI, KURASHIKI-SHI, OKAYAMA-KEN, JAPAN., SN 76-282,631. FILED 7-10-2001. PRINCIPAL REGISTER.

SPINAIR

INT. CL. 23/U.S. CL. 43
FOR YARNS, THREADS.
FIRST USE 7-25-1984; IN COMMERCE 1-20-2002.

ELEMENTS CORRECTED
DBA/AKA

2,650,662. REG. 11-12-2002. MILLS LIMITED PARTNERSHIP, THE (DELAWARE LIMITED PARTNERSHIP) 1300 WILSON BOULEVARD, SUITE 400, ARLINGTON, VA, 22209, AND DISCOVER FINANCIAL SERVICES, INC. (DELAWARE CORPORATION) 2500 LAKE COOK ROAD, RIVERWOODS, IL, 60015, SN 76-316,806. FILED 9-25-2001. PRINCIPAL REGISTER.

DISCOVER MILLS

INT. CL. 35/U.S. CLS. 100, 101 AND 102
FOR PROMOTING THE USE OF SELECTED CREDIT CARDS THROUGH PROGRAMS OFFERING CONSUMER DISCOUNTS, GIFT CERTIFICATES AND INCENTIVES FOR GOODS AND SERVICES PURCHASED VIA CREDIT CARD.
FIRST USE 11-2-2001; IN COMMERCE 11-2-2001.

ELEMENTS CORRECTED
OWNER NAME
OWNER ADDRESS
CITIZENSHIP
ENTITY

2,652,121. REG. 11-19-2002. SOREMARTEC S.A. (BELGIUM CORPORATION) DREVE DE L'ARC-EN-CIEL 102, 6700 SCHOPPACH-ARLON, BELGIUM., SN 75-483,593. FILED 5-12-1998. PRINCIPAL REGISTER.

FERRERO KÜSSCHEN

THE MARK DOES NOT IDENTIFY A LIVING INDIVIDUAL.

THE WORD "FERRERO" DOES NOT HAVE ANY TRANSLATION. THE ENGLISH TRANSLATION OF "KÜSSCHEN" IS A LITTLE CARESS WITH THE LIPS.

INT. CL. 30/U.S. CL. 46
FOR PRALINES, NAMELY, MILK CHOCOLATE PRALINES WITH WHOLE HAZELNUT CENTER, CHOCOLATE, BISCUITS, CAKES, COLD BAKERY PRODUCTS WITH OR WITHOUT A FILLING AND GLAZING, ICE CREAMS, CANDY PASTRY.
FIRST USE 9-0-1968; IN COMMERCE 5-0-2002.

ELEMENTS CORRECTED
DATE OF FIRST USE

2,652,328. REG. 11-19-2002. ALCHEMIA PTY LTD. (AUSTRALIA CORPORATION) 3 HI-TECH COURT, BRISBANE TECHNOLOGY PARK, EIGHT MILE PLAINS, AUSTRALIA, QLD 4113, SN 75-899,360. FILED 1-19-2000. PRINCIPAL REGISTER.

XENOCARB

INT. CL. 5/U.S. CLS. 6, 18, 44, 46, 51 AND 52
FOR CHEMICAL PREPARATIONS AND CHEMICAL REAGENTS FOR MEDICAL AND VETERINARY USE.
FIRST USE 1-9-2002; IN COMMERCE 1-9-2002.

ELEMENTS CORRECTED
DATE OF FIRST USE
DATE OF FIRST USE IN COMMERCE

2,652,457. REG. 11-19-2002. INSTITUTE FOR MOTIVATIONAL LIVING, INC. (DELAWARE CORPORATION) 3307 WILMINGTON ROAD, NEW CASTLE, PA, 16103, SN 76-089,224. FILED 7-14-2000. PRINCIPAL REGISTER.

THE INSTITUTE FOR MOTIVATIONAL LIVING, INC.

NO CLAIM IS MADE TO THE EXCLUSIVE RIGHT TO USE "INSTITUTE" OR "INC.", APART FROM THE MARK AS SHOWN.

INT. CL. 16/U.S. CLS. 2, 5, 22, 23, 29, 37, 38 AND 50
FOR PRINTED MATERIALS, NAMELY, BOOKLETS CONTAINING INSTRUCTIONAL AND EXPLANATORY TEXT, QUESTIONS, AND INTERPRETIVE DATA FOR USE IN IDENTIFYING INDIVIDUAL BEHAVIOR CHARACTERISTICS.

FIRST USE 6-0-1989; IN COMMERCE 6-0-1989.
INT. CL. 42/U.S. CLS. 100 AND 101
FOR COMPUTER SERVICES, NAMELY, PROVIDING ON-LINE BOOKLETS CONTAINING INSTRUCTIONAL AND EXPLANATORY TEXT, QUESTIONS, AND INTERPRETIVE DATA FOR USE IN IDENTIFYING INDIVIDUAL BEHAVIOR CHARACTERISTICS.
FIRST USE 7-23-2002; IN COMMERCE 7-23-2002.

ELEMENTS CORRECTED
GOODS/SERVICES
INTERNATIONAL CLASS(ES)
MARK TYPE
DATE OF FIRST USE
DATE OF FIRST USE IN COMMERCE

2,653,935. REG. 11-26-2002. HANDS ARE NOT FOR HURTING PROJECT (OREGON NONPROFIT CORPORATION) P.O. BOX 2644, SALEM, OR, 973082644, SN 76-307,368. FILED 8-30-2001. PRINCIPAL REGISTER.

I WILL NOT USE MY HANDS OR MY WORDS FOR HURTING MYSELF OR OTHERS

INT. CL. 41/U.S. CLS. 100, 101 AND 107

FOR EDUCATIONAL SERVICES, NAMELY, CONDUCTING COURSES, WORKSHOPS AND SEMINAR ALL IN THE FIELD OF NON-VIOLENT CONFLICT RESOLUTION.

FIRST USE 7-1-1998; IN COMMERCE 7-1-1998.

ELEMENTS CORRECTED
MARK

2,656,798. REG. 12-3-2002. MY BACKYARD, INC. (WASHINGTON CORPORATION) 1501 NORTH BROADWAY, SUITE 320, WALNUT CREEK, CA, 94596, SN 75-573,527. FILED 10-15-1998. PRINCIPAL REGISTER.

MYBACKYARD

INT. CL. 35/U.S. CLS. 100, 101 AND 102

FOR PROVIDING A WEBSITE ON A GLOBAL COMPUTER NETWORK FEATURING EDUCATIONAL INFORMATION IN THE FIELD OF NATURAL AND ENVIRONMENTALLY FRIENDLY GOODS.

FIRST USE 12-0-1999; IN COMMERCE 12-0-1999.

INT. CL. 42/U.S. CLS. 100 AND 101

FOR PROVIDING A WEBSITE ON A GLOBAL COMPUTER NETWORK FEATURING GENERAL INFORMATION ABOUT NATURAL AND ENVIRONMENTALLY FRIENDLY KITS AND PRODUCTS, NAMELY- KITS FOR HERBAL REMEDIES AND NATURAL HEALTHCARE; RAW MATERIALS TO ENABLE PERSONS TO MAKE BATH AND BEAUTY PRODUCTS AND TO MAKE HERBAL PILLOWS; SEEDS; HERBAL SEASONAL AND AROMA THERAPY KITS CONTAINING BODY OILS, HERBS AND HERBAL SPICES; HEALTH FOODS AND FOODS TO AID IN HEALTHY LIFE STYLES AND STRESS REDUCTION, NAMELY HERBS, GRAINS, SEAWEED AND MUSHROOMS; PROVIDING INFORMATION AND LITERATURE IN THE FIELDS OF NUTRITION HEALTHY LIFE STYLES, STRESS REDUCTION, HOMEOPATHIC AND ALTERNATIVE HEALTH CARE.

FIRST USE 12-0-1999; IN COMMERCE 12-0-1999.

ELEMENTS CORRECTED
MARK

2,657,876. REG. 12-10-2002. WOOLPERT LLP (OHIO LIMITED PARTNERSHIP) 409 EAST MONUMENT AVENUE, DAYTON, OH, 45402, SN 76-095,144. FILED 7-24-2000. PRINCIPAL REGISTER.

SMARTGOV

INT. CL. 9/U.S. CLS. 21, 23, 26, 36 AND 38

FOR COMPUTER SOFTWARE CONTAINING LIBRARIES OF MAP IMAGES AND SOFTWARE FOR SEARCHING AND DISPLAYING SUCH IMAGES; SOFTWARE USED TO COLLECT GLOBAL POSITIONING DATA FOR MAPPING PUBLIC WORKS SYSTEMS; SOFTWARE USED TO COLLECT INFORMATION THAT IS USED TO CREATE MAPS FOR PUBLIC WORKS SYSTEMS, AND SOFTWARE USED TO CONVERT GEOGRAPHIC, ENGINEERING, ARCHITECTURE, LANDSCAPE ARCHITECTURE, PROPERTY RECORD AND MAP DATA FOR MAPPING [PUBIC] *PUBLIC* WORKS SYSTEMS.

FIRST USE 3-17-2000; IN COMMERCE 3-17-2000.

INT. CL. 42/U.S. CLS. 100 AND 101

FOR PROFESSIONAL ENGINEERING, SURVEYING, ARCHITECTURAL DESIGN, ARCHITECTURAL PLANNING, LANDSCAPE ARCHITECTURE AND PHOTOGRAMMETRY SERVICES; CONSULTATION SERVICES IN THE FIELDS OF PROPERTY RECORDS, PARCEL MAPS AND GEOGRAPHIC INFORMATION SYSTEMS; GEOGRAPHIC INFORMATION SYSTEM DESIGN, IMPLEMENTATION, DATA COLLECTION AND CUSTOMIZATION; COMPUTER SERVICES, NAMELY, DESIGNING, PRODUCING, UPDATING AND MAINTAINING ON-LINE COMPUTER DATABASES FOR OTHERS IN THE FIELDS OF PROPERTY RECORDS, PARCEL MAPS AND GEOGRAPHIC INFORMATION SYSTEMS; PROVIDING LIBRARIES OF MAP IMAGES VIA A GLOBAL COMPUTER INFORMATION NETWORK, AND PROVIDING TEMPORARY USE OF NON-DOWNLOADABLE SOFTWARE FOR SEARCHING AND DISPLAYING SUCH IMAGES; AND PROVIDING TEMPORARY USE OF ON-LINE, NON-DOWNLOADABLE SOFTWARE USED TO COLLECT GLOBAL POSITIONING DATA FOR MAPPING PUBLIC WORKS SYSTEMS, TO COLLECT INFORMATION THAT IS USED TO CREATE MAPS FOR PUBLIC WORKS SYSTEMS, AND TO CONVERT GEOGRAPHIC, ENGINEERING, ARCHITECTURE, LANDSCAPE ARCHITECTURE, PROPERTY RECORD AND MAP DATA FOR MAPPING PUBLIC WORKS SYSTEMS.

FIRST USE 3-17-2000; IN COMMERCE 3-17-2000.

ELEMENTS CORRECTED
GOODS/SERVICES

2,659,874. REG. 12-10-2002. I.C.E.D. MANAGEMENT, INC. (DELAWARE CORPORATION) P.O. BOX 8841, WILMINGTON, DE, 19899, SN 75-647,739. FILED 2-25-1999. PRINCIPAL REGISTER.

DIGIKWIK

INT. CL. 16/U.S. CLS. 2, 5, 22, 23, 29, 37, 38 AND 50

FOR PROMOTIONAL, ADVERTISING, AND BUSINESS ASSISTANCE MATERIAL [SAND] *AND* SUPPLIES, NAMELY, MESSAGE AND MEMORANDUM PADS, PAPER AND BUSINESS CARD PACKING BOXES OF CARDBOARD, PAPER BAGS, PRICE LISTS PRINTED FOR USE BY OTHERS, ADVERTISING LITERATURE, BUSINESS CARDS, PAPER WALL SIGNS, THREE RING LOOSE-LEAF BINDERS, MANUALS IN THE FIELD OF OPERATING BUSINESSES, PRINTED FORMS, NEWSLETTERS, BOOKLETS AND BROCHURES FEATURING INFORMATION OF INTEREST TO THE PRINTING INDUSTRY, HEALTH AND FITNESS INFORMATION, AND/OR INFORMATION OF USE TO THE GENERAL PUBLIC REGARDING THEIR PERSONAL AFFAIRS AND LIFE STYLE, ADVERTISING FLYERS PRINTED FOR USE BY OTHERS, PAPERBOARD DISPLAY HOLDERS FOR BOOKLETS AND BROCHURES, COUPONS, PEN DESK SETS, PENS, DICTIONARIES, CALENDARS, POSTCARDS, WRAPPING PAPER, ARTWORK USED FOR REPRODUCTION, INVOICE FORMS, ENVELOPES, BINDERS, CONTINUOUS FORM PAPER, AND LETTERHEAD STATIONERY; AND MAGAZINES PUBLISHED PERIODICALLY FEATURING INFORMATION OF INTEREST TO THE PRINTING INDUSTRY, HEALTH AND FITNESS INFORMATION, AND/OR INFORMATION OF USE TO THE GENERAL PUBLIC REGARDING THEIR PERSONAL AFFAIRS AND LIFE STYLE.

FIRST USE 2-18-2002; IN COMMERCE 3-4-2002.

ELEMENTS CORRECTED
GOODS/SERVICES

2,659,939. REG. 12-10-2002. SPRAYING SYSTEMS COMPANY (ILLINOIS CORPORATION) NORTH AVENUE AT SCHMALE ROAD, P.O. BOX 7900, WHEATON, IL, 60189, SN 75-764,565. FILED 7-30-1999. PRINCIPAL REGISTER.

PULSAJET 6000

INT. CL. 9/U.S. CLS. 21, 23, 26, 36 AND 38
 FOR HIGH SPEED SOLENOID VALVE USED IN PRINTING, [MARKETING] * MARKING * AND COATING OPERATIONS.
 FIRST USE 1-0-2000; IN COMMERCE 1-0-2000.

ELEMENTS CORRECTED
 GOODS/SERVICES

2,660,192. REG. 12-10-2002. FRED MEYER STORES, INC. (DELAWARE CORPORATION) 3800 S.E. 22ND AVENUE, PORTLAND, OR, 97202, BY ASSIGNMENT FRED MEYER, INC. CORPORATION PORTLAND, OR, SN 76-035,624. FILED 4-26-2000. PRINCIPAL REGISTER.

SUGAR & SPICE

INT. CL. 28/U.S. CLS. 22, 23, 38 AND 50
 FOR TOYS, NAMELY DOLLS, DOLL CLOTHING, DOLL BEDS AND STROLLERS; PLASTIC AND METAL TEA SETS AND DINNERWARE SETS; DOLL ACCESSORIES, NAMELY DIAPERS, NURSING BOTTLES, FEEDING UTENSILS, TOY STOVES, TOY SINKS, TOY BROOMS, TOY MOPS, TOY VACUUMS, AND TOY KITCHENWARE.
 FIRST USE 8-1-2000; IN COMMERCE 8-1-2000.

ELEMENTS CORRECTED
 ASSIGNMENT/NAME CHANGE
 OWNER NAME

2,660,769. REG. 12-10-2002. MILLS LIMITED PARTNERSHIP, THE (DELAWARE LIMITED PARTNERSHIP) 1300 WILSON BOULEVARD, SUITE 400, ARLINGTON, VA, 22209, SN 76-316,809. FILED 9-25-2001. PRINCIPAL REGISTER.



INT. CL. 35/U.S. CLS. 100, 101 AND 102
 FOR PROMOTING THE USE OF SELECTED CREDIT CARDS THROUGH PROGRAMS OFFERING CONSUMER DISCOUNTS, GIFT CERTIFICATES AND INCENTIVES FOR GOODS AND SERVICES PURCHASED VIA CREDIT CARD.
 FIRST USE 11-2-2001; IN COMMERCE 11-2-2001.

ELEMENTS CORRECTED
 OWNER NAME
 OWNER ADDRESS
 CITIZENSHIP
 ENTITY

2,660,993. REG. 12-17-2002. CAPE COTTAGE LIMITED (UNITED KINGDOM COMPANY) 101 GRENVILLE COURT, BRITWELL ROAD, BURNHAM, BUCKINGHAMSHIRE SL1 8DF, ENGLAND., SN 75-385,722. FILED 11-6-1997. PRINCIPAL REGISTER.

MANUMISSION

OWNER OF UNITED KINGDOM REG. NO. 2132319, DATED 5-6-1997, EXPIRES 5-6-2007.
 INT. CL. 9/U.S. CLS. 21, 23, 26, 36 AND 38
 FOR PHONOGRAPH RECORDS, AUDIO CASSETTE TAPES AND COMPACT DISCS FEATURING MUSIC; CD-ROMS, VIDEO TAPES AND VIDEO DISCS FEATURING WORKS OF MUSIC COMBINED WITH PHOTOGRAPHIC IMAGES; CINEMATOGRAPHIC FILMS FEATURING WORDS OF MUSIC COMBINED WITH PHOTOGRAPHIC IMAGES; COMPUTER GAME SOFTWARE; VIDEO GAME MACHINES, SOFTWARE DOWNLOADABLE FROM A GLOBAL COMPUTER INFORMATION NETWORK FEATURING GAMES AND SOFTWARE FOR SYNTHESIZING MUSIC AND IMAGES; AND COMPUTER SOFTWARE IN THE NATURE OF SCREENSAVERS.

FIRST USE ; IN COMMERCE .
 INT. CL. 25/U.S. CLS. 22 AND 39
 FOR CLOTHING AND FOOTWEAR, NAMELY, T-SHIRTS, SWEATSHIRTS, UNDERWEAR, SHIRTS, TROUSERS, SINGLET, HATS, CAPS, SNEAKERS AND ATHLETIC TRAINING SHOES.

FIRST USE ; IN COMMERCE .
 INT. CL. 39/U.S. CLS. 100 AND 105
 FOR MAKING ARRANGEMENTS AND RESERVATIONS FOR VACATION AND TRAVEL, NAMELY, TOURS, AIR TRANSPORTATION AND VEHICLE RENTAL.

FIRST USE ; IN COMMERCE .
 INT. CL. 41/U.S. CLS. 100, 101 AND 107
 FOR ORGANIZING, OPERATING AND PROVIDING FACILITIES FOR LIVE PERFORMANCES, NAMELY, NIGHT CLUB EVENTS, DANCE EVENTS, THEATRE, CABARET, MUSICAL PERFORMANCES, PARTIES AND RAVES; PROVIDING FACE PAINTING AND BODY PAINTING FOR OTHERS.

FIRST USE ; IN COMMERCE .
 INT. CL. 42/U.S. CLS. 100 AND 101
 FOR PROVIDING TEMPORARY ACCOMMODATIONS, MAKING ARRANGEMENT AND RESERVATIONS FOR LODGING ACCOMMODATIONS; PROVIDING FOOD AND DRINK; AND CUSTOM DESIGN OF PROMOTIONAL FLYERS AND POSTERS.
 FIRST USE ; IN COMMERCE .

ELEMENTS CORRECTED
 PRIORITY CLAIMED STATEMENT
 [FOREIGN APPLICATION NO.]
 [FOREIGN APPLICATION FILING DATE]

2,661,009. REG. 12-17-2002. SCHUT GEOMETRISCHE MEET-TECHNIEK B.V. (NETHERLANDS CORPORATION) 21, DUINKERKENSTRAAT, 9723 BN GRONINGEN, NETHERLANDS., SN 75-498,278. FILED 5-31-1998. PRINCIPAL REGISTER.

DeMeet

PRIORITY CLAIMED UNDER SEC. 44(D) ON ERP CMNTY TM OFC APPLICATION NO. 769323, FILED 3-12-1998, REG. NO. 769323, DATED 9-1-1999, EXPIRES 3-12-2008.
 INT. CL. 9/U.S. CLS. 21, 23, 26, 36 AND 38

FOR COORDINATE MEASURING MACHINES AND INSTRUMENTS WITH ELECTRONIC CONTROLS AND SOFTWARE FOR MEASURING AND MONITORING SIMPLE AND COMPLEX FORMS, NAMELY - VERY SMALL PARTS, PRODUCT DIMENSIONS THAT CAN BE MEASURED WITH A PROBING SYSTEM OR A CAMERA, AND FLEXIBLE AND OTHER OBJECTS WHERE THE MEASURING FORCE MUST BE ZERO.

FIRST USE ; IN COMMERCE .

ELEMENTS CORRECTED
FOREIGN COUNTRY OF ORIGIN

2,662,637. REG. 12-17-2002. CLOROX COMPANY, THE (DELAWARE CORPORATION) 1221 BROADWAY, OAKLAND, CA, 94612, SN 76-338,091. FILED 11-16-2001. PRINCIPAL REGISTER.

SHELFMASTER

INT. CL. 35/U.S. CLS. 100, 101 AND 102
FOR BUSINESS CONSULTING SERVICES FOR RETAILERS.

FIRST USE 9-30-2001; IN COMMERCE 9-30-2001.

ELEMENTS CORRECTED
MARK TYPE

2,662,764. REG. 12-17-2002. MK DIAMOND PRODUCTS, INC. (CALIFORNIA CORPORATION) 1315 STORM PARKWAY, P.O. BOX 2803, TORRANCE, CA, 905092803, SN 76-353,727. FILED 12-31-2001. PRINCIPAL REGISTER.

GEMKING

INT. CL. 7/U.S. CLS. 13, 19, 21, 23, 31, 34 AND 35
FOR [DIAMOND SAW BLADE FOR CUTTING MASONRY STONE, TILE AND CONCRETE] * CIRCULAR DIAMOND LAPIDARY BLADES FOR CUTTING STONE

* FIRST USE 6-0-1972; IN COMMERCE 8-0-1972.

ELEMENTS AMENDED
GOODS/SERVICES

2,664,562. REG. 12-17-2002. SILICON ACCESS NETWORKS, INC. (DELAWARE CORPORATION) 211 RIVER OAKS PARKWAY, SAN JOSE, CA, 95134, SN 78-001,887. FILED 3-30-2000. PRINCIPAL REGISTER.

SILICON ACCESS NETWORKS

NO CLAIM IS MADE TO THE EXCLUSIVE RIGHT TO USE "SILICON" AND "NETWORKS", APART FROM THE MARK AS SHOWN.

INT. CL. 9/U.S. CLS. 21, 23, 26, 36 AND 38

FOR INTEGRATED CIRCUITS.
FIRST USE 11-0-2001; IN COMMERCE 11-0-2001.

ELEMENTS CORRECTED
OWNER NAME
OWNER ADDRESS

2,665,577. REG. 12-24-2002. MUSTEN & CRUTCHFIELD, INC. (NORTH CAROLINA CORPORATION) P.O. BOX 221, KERNERSVILLE, NC, 27285, SN 76-243,214. FILED 4-19-2001. PRINCIPAL REGISTER.

MUSTEN & CRUTCHFIELD

INT. CL. 29/U.S. CL. 46

FOR PIMENTO CHEESE, LIVER PUDDING, CHICKEN SALAD, CHILI, HAM SALAD, CHICKEN BARBECUE AND PORK BARBECUE.

FIRST USE 0-0-1938; IN COMMERCE 0-0-1970.

ELEMENTS CORRECTED
DATE OF FIRST USE IN COMMERCE

2,665,590. REG. 12-24-2002. KEMMELMEYER, WERNER (FED REP GERMANY INDIVIDUAL) VEILCHENSTRASSE 5, D-83101 THANSAU, FED REP GERMANY., SN 76-247,344. FILED 4-27-2001. PRINCIPAL REGISTER.



INT. CL. 7/U.S. CLS. 13, 19, 21, 23, 31, 34 AND 35

FOR MACHINES, APPARATUSES, INSTRUMENTS AND EQUIPMENT FOR SEPARATING GASEOUS, LIQUID AND SOLID MATERIALS, NAMELY, SCREENING PLANTS, CENTRIFUGES, SEMI PERMEABLE MEMBRANES FOR MACHINES; YEAST TREATMENT AND SEPARATION PLANTS; MACHINES, APPARATUSES, INSTRUMENTS, AND EQUIPMENT FOR FILTERING GASEOUS, LIQUID AND [SOLD] * SOLID * MATERIALS, NAMELY, FILTERS FOR MACHINES IN THE FOOD AND BEVERAGE INDUSTRY; AND FILTER MACHINES PARTS THEREOF, NAMELY, FILTER CLOTHES, CARTRIDGES FOR FILTERING MACHINES, STERILE FILTERS, SEGMENTED FILTERS, AND FILTER MEMBRANES; MACHINE PARTS FOR SEPARATING GASEOUS, LIQUID AND SOLID MATERIALS, NAMELY, SCREENS; YEAST SCREENS; SCREEN HEADS; SIZING SCREENS.

FIRST USE 1-1-1980; IN COMMERCE 1-1-1980.

ELEMENTS CORRECTED
GOODS/SERVICES

2,665,820. REG. 12-24-2002. THE-MAT-COMPANY GERMANY GMBH (FED REP GERMANY LIMITED LIABILITY COMPANY) RUSCHEBRINKSTRASSE 66, D-44143 DORTMUND, FED REP GERMANY., SN 76-299,735. FILED 8-15-2001. PRINCIPAL REGISTER.

SALES.MAT

PRIORITY CLAIMED UNDER SEC. 44(D) ON FED REP GERMANY APPLICATION NO. 30114381.1, FILED 3-3-2001, REG. NO. 30114381, DATED 2-21-2002, EXPIRES 3-31-2011.

INT. CL. 27/U.S. CLS. 19, 20, 37, 42 AND 50

FOR RUGS, FLOOR MATS, FLOOR MATS FOR VEHICLES, LINOLEUM FOR USE ON FLOORS, PROTECTIVE FLOOR COVERINGS, RUBBER BATH MATS, CARPET TILES, CARPET RUNNERS, THROW RUGS, ANTISKID FLOOR MATS, SYNTHETIC LAWN FLOOR COVERINGS, AND PLASTIC WALL COVERINGS.

FIRST USE ; IN COMMERCE .

INT. CL. 35/U.S. CLS. 100, 101 AND 102

FOR ADVERTISING AGENCY SERVICES; BUSINESS MANAGEMENT CONSULTATION SERVICES; PROMOTING THE GOODS AND SERVICES OF OTHERS THROUGH ARRANGING FOR ADVERTISING SPACE ON FLOOR MATS; FIELD SERVICE SUPPORT, NAMELY, BUSINESS DEVELOPMENT SERVICES, NAMELY, PROVIDING START-UP SUPPORT FOR BUSINESSES OF OTHERS; PROVIDING ADVERTISING SPACE FOR ADVERTISING MATS.

FIRST USE ; IN COMMERCE .

INT. CL. 37/U.S. CLS. 100, 103 AND 106

FOR RUG CLEANING OF, NAMELY, CLEANING OF FOOT, DUST TRAP AND DIRT-BLOCKING MATS; INTERIOR AND EXTERIOR CLEANING OF BUILDINGS; IRONING OF LAUNDRY; CLEANING OF WINDOWS; FURNITURE RESTORATION AND REPAIR; PEST CONTROL EXCEPT FOR AGRICULTURAL PURPOSES; LAUNDRY SERVICES FOR CLOTHES; CLEANING OF BUILDING FACADES; RESTORATION OF STRUCTURAL MONUMENTS; CLEANING OF RESIDENTIAL CONSTRUCTIONS; CARPET CLEANING; WINDOW GLASS CLEANING; MAID SERVICES, NAMELY, CLEANING OF BUILDINGS FOR MAINTENANCE PURPOSES; INDUSTRIAL CLEANING, NAMELY, CLEANING OF MACHINES; MAID SERVICES, NAMELY, CLEANING OF SCHOOLS AND DAYCARE CENTERS FOR CHILDREN, GYMS, WORKSHOPS, WASH AND LOCKER ROOMS; INTERIOR CLEANING OF BUILDINGS OF ALL TYPES UPON COMPLETION OF THE CONSTRUCTION WORK; CLEANING OF AIR CONDITIONING INSTALLATIONS, MACHINES, ENGINES, TURNING LATHES AND WORKBENCHES; DUST REMOVAL FROM WALLS, GIRDERS AND ROOF CONSTRUCTIONS; BASIC CLEANING OF LOOSE OR FIXED TEXTILE COVERINGS; SHAMPOOING AND SPRAY EXTRACTION OF CARPETS INCLUDING STAIN REMOVAL; CLEANING OF MEANS OF TRANSPORTATION, NAMELY, CLEANING OF BUSES, STREETCARS, AND RAILWAY CARS; CLEANING OF SWIMMING POOLS, NAMELY, CLEANING OF OUTDOOR AND INDOOR SWIMMING POOLS, SWIMMING POOLS AND AUXILIARY INSTALLATIONS PRIOR TO, DURING AND AFTER THE BATHING SEASON; CLEANING OF LARGE SURFACE AREAS, NAMELY, PARKING BUILDINGS, UNDERGROUND GARAGES, PARKING LOTS, PLANTS, WAREHOUSE AND MACHINE BUILDINGS IN THE INDUSTRIAL AND POWER PLANT FIELDS; PAVEMENT SEALING, NAMELY, BASIC CLEANING AND SEALING OF ASPHALT AND [COMPRESSES] * COMPRESSED * NATURAL ROCK ASPHALT FLOORS; SURFACING, GRINDING AND SEALING OF PARQUET FLOORS; DUST-BINDING SEALING OF COMPOSITION AND CEMENT FLOORS AS WELL AS OF ALL TYPES OF HARD COVERINGS; CLEANING OF WINDOWS AND INDUSTRIAL GLASSWORKS, LIGHTING FIXTURES AND LIGHT ADVERTISING INSTALLATIONS; BUILDING FACADE CLEANING, NAMELY, CLEANING OF OIL AND PAINT COATS, NATURAL STONE, SYNTHETIC STONE, CERAMICS, METAL AND PLASTIC; METAL CLEANING, SPECIFICALLY BASIC CLEANING AND PRESERVATION OF WINDOW FRAMES, FITTINGS, WALL AND CEILING COVERINGS MADE OF ALUMINUM, ANODIZED ALUMINUM, STEEL, COPPER AND BRASS; CLEANING OF GARDEN AND WALKWAY AREAS; CLEANING OF EAVES TROUGHS; WINTER SERVICES, NAMELY, SNOW REMOVAL, GRITTING AGAINST ICING, SNOW PROPELLING; CLEANING OF COMPUTER HARDWARE AND PERIPHERALS, NAMELY, PRINTERS, PLOTTERS, OUTPUT AND REPRODUCTION MEDIA OF ALL TYPES, NAMELY, MOVING ARM DISKS, MAGNETIC AND OPTICAL DRIVES; CLEANING OF AUTO, FOOT AND DIRT TRAP MATS.

FIRST USE ; IN COMMERCE .

ELEMENTS CORRECTED
GOODS/SERVICES
FOREIGN APPLICATION NO.

2,667,489. REG. 12-31-2002. STANDARD CHARTERED PLC (UNITED KINGDOM PUBLIC LIMITED COMPANY) 1 ALDERMANBURY SQUARE, LONDON, EC2V 7SB, ENGLAND., SN 75-506,502. FILED 6-22-1998. PRINCIPAL REGISTER.

Standard Chartered

OWNER OF UNITED KINGDOM REG. NO. 1484153, DATED 3-15-1996, EXPIRES 11-27-2008.

OWNER OF U.S. REG. NO. 1,049,198.

NO CLAIM IS MADE TO THE EXCLUSIVE RIGHT TO USE "CHARTERED", APART FROM THE MARK AS SHOWN.

INT. CL. 36/U.S. CLS. 100, 101 AND 102

FOR BANKING SERVICES, SERVICES IN DEALINGS WITH CURRENCY, NAMELY, CURRENCY EXCHANGE AND ADVICE, CURRENCY EXCHANGE, CREDIT CARD SERVICES, FINANCIAL CUSTODIAL SERVICES AND CUSTODIAL BANKING SERVICES, FINANCIAL TRUSTESHIP SERVICES.

FIRST USE ; IN COMMERCE .

ELEMENTS CORRECTED
PRIOR U.S. REGS.

2,667,778. REG. 12-31-2002. CIM INTERNATIONAL (HK) LTD. (HONG KONG COMPANY) SUCCURSALE DI LUGANO, VIA TESSERETE 10, 6900 LUGANO, SWITZERLAND., SN 76-092,299. FILED S.R. 7-18-2000; AM. P.R. 6-28-2002. PRINCIPAL REGISTER.

AIRCHAMBER

NO CLAIM IS MADE TO THE EXCLUSIVE RIGHT TO USE "AIR CHAMBER", APART FROM THE MARK AS SHOWN.

THE STIPPLING IS A FEATURE OF THE MARK AND DOES NOT INDICATE COLOR.

INT. CL. 19/U.S. CLS. 1, 12, 33 AND 50

FOR INFLATABLE STORAGE SHEDS AND RODS THAT [PROVIDED] * PROVIDE * A FRAMEWORK THERETO, SOLD TOGETHER AS A UNIT.

FIRST USE 11-15-1999; IN COMMERCE 11-15-1999.

ELEMENTS CORRECTED
GOODS/SERVICES

2,667,940. REG. 12-31-2002. ALNOVA TECHNOLOGIES CORPORATION, S.L. (SPAIN CORPORATION) TORRE PICASSO, PLAZA PABLO RUIZ PICASSO, S/N. PISO 24, MADRID, SPAIN., SN 76-163,808. FILED 11-13-2000. PRINCIPAL REGISTER.



PRIORITY CLAIMED UNDER SEC. 44(D) ON ERP N CMNTY TM OFC APPLICATION NO. 001765056, FILED 7-19-2000, REG. NO. 001765056, DATED 9-27-2001, EXPIRES 7-19-2010.

NO CLAIM IS MADE TO THE EXCLUSIVE RIGHT TO USE "TECHNOLOGIES CORPORATION", APART FROM THE MARK AS SHOWN.

THE ATTACHED DRAWING IS LINED FOR COLOR. THE DESIGNATED COLORS ARE A FEATURE OF THE MARK.

THE DESIGN OF A TARGET WITH AN ARROW PROTRUDING THEREFROM NEXT TO THE WORD ALNOVA AND THE SHADED CIRCLE BESIDE THE WORDS TECHNOLOGIES CORPORATION ARE YELLOW AND THE WORDS TECHNOLOGIES CORPORATION ARE REPRESENTED IN THE COLOR BLACK. THE WORD ALNOVA IS REPRESENTED IN THE COLOR BLUE. THE MARK CONSISTS OF THE WORDS "ALNOVA TECHNOLOGIES CORPORATION" IN STYLIZED FORM WITH A CIRCLE BESIDE THE WORDS "TECHNOLOGIES CORPORATION" AND A DESIGN OF A TARGET WITH AN ARROW PROTRUDING THEREFROM NEXT TO THE WORD "ALNOVA".

INT. CL. 9/U.S. CLS. 21, 23, 26, 36 AND 38

FOR DATA PROCESSING EQUIPMENT, NAMELY, RECORDED COMPUTER PROGRAMS AND COMPUTER SOFTWARE ENABLING THE MANAGEMENT AND ADMINISTRATION OF UNIVERSAL BANKING SERVICES, INTERNET AND ONLINE BANKING, TRADING OF SECURITIES, BUSINESS ORGANIZATION MANAGEMENT, AND CUSTOMER RELATION MANAGEMENT, ALL FOR USE IN THE FINANCIAL SERVICES INDUSTRY; AND RECORDED COMPUTER PROGRAMS AND COMPUTER SOFTWARE FOR COMPUTER SOFTWARE PROGRAMMING AND DEVELOPMENT.

FIRST USE ; IN COMMERCE .
INT. CL. 42/U.S. CLS. 100 AND 101

FOR INFORMATION TECHNOLOGY RELATED SERVICES, NAMELY, THE DESIGN OF COMPUTER PROGRAMS AND SOFTWARE FOR OTHERS.

FIRST USE ; IN COMMERCE .

ELEMENTS CORRECTED
OWNER ADDRESS

2,668,725. REG. 12-31-2002. LORENZ, GUNTER (FED REP GERMANY INDIVIDUAL) AM REHLINGSBACH 25, D-61381 FRIEDRICHSDORF, FED REP GERMANY., SN 76-354,421. FILED 1-2-2002. PRINCIPAL REGISTER.

ANEK

OWNER OF FED REP GERMANY REG. NO. 30065506, DATED 6-6-2001, EXPIRES 8-31-2010.

INT. CL. 11/U.S. CLS. 13, 21, 23, 31 AND 34

FOR APPARATUS AND [PART] *PARTS* THEREOF FOR WASTE WATER TREATMENT, SEWAGE SLUDGE TREATMENT, AND WATER REFINEMENT, NAMELY, WATER FILTERS, WATER PURIFIERS, WASTE WATER PURIFICATION UNITS, WATER PURIFICATION UNITS; SEWAGE TREATMENT PLANTS.

FIRST USE ; IN COMMERCE .
INT. CL. 37/U.S. CLS. 100, 103 AND 106

FOR PLANNING AND CONSTRUCTION OF SEWAGE PLANTS AND WATER REFINEMENT [PANTS] *PLANTS*.

FIRST USE ; IN COMMERCE .
INT. CL. 42/U.S. CLS. 100 AND 101

FOR [ENGINEER] * ENGINEERING* SERVICES RELATING TO SEWAGE PLANTS AND WATER REFINEMENT PLANTS; ENGINEERING SERVICES, TECHNICAL CONSULTATION SERVICES IN THE FIELD OF WASTE WATER TREATMENT, SEWAGE SLUDGE TREATMENT, AND WATER REFINEMENT.

FIRST USE ; IN COMMERCE .

ELEMENTS CORRECTED
GOODS/SERVICES

2,670,873. REG. 1-7-2003. DCS IPAL CONSULTANTS INC. (CANADA CORPORATION) 1043 AUTOROUTE CHOMEDEY, LAVAL, QUEBEC, CANADA, H7W 4V3, SN 76-019,184. FILED 4-6-2000. PRINCIPAL REGISTER.

DCS

PRIORITY CLAIMED UNDER SEC. 44(D) ON CANADA APPLICATION NO. 1043458, FILED 1-19-2000, REG. NO. TMA555644, DATED 12-19-2001, EXPIRES 12-19-2016.

INT. CL. 41/U.S. CLS. 100, 101 AND 107

FOR TRAINING SERVICES IN THE USE OF CONVEYORS, [PACK AGING] *PACKAGING * LINES, AND AUTOMATED APPARATUS IN THE FIELD OF [HARDHOOD] * AGRIFOOD * , BEVERAGES, PHARMACEUTICAL AND INDUSTRY.

FIRST USE 0-0-1991; IN COMMERCE 0-0-1991.

INT. CL. 42/U.S. CLS. 100 AND 101

FOR ENGINEERING AND TECHNICAL CONSULTATION SERVICES IN THE FIELD OF CONVEYORS, PACKAGING LINES, AND AUTOMATED APPARATUS IN THE FIELD OF AGRIFOOD, BEVERAGES, PHARMACEUTICAL AND INDUSTRY.

FIRST USE 0-0-1991; IN COMMERCE 0-0-1991.

ELEMENTS CORRECTED
GOODS/SERVICES

2,671,770. REG. 1-7-2003. ORCA INTERACTIVE LTD. (ISRAEL CORPORATION) 22 ZARHIN ST, POB 220, IND AREA, RA'ANANA 43662, ISRAEL., SN 76-355,206. FILED 1-7-2002. PRINCIPAL REGISTER.

XBIP

INT. CL. 38/U.S. CLS. 100, 101 AND 104

FOR TELECOMMUNICATIONS SERVICES, NAMELY, LOCAL AND LONG DISTANCE TRANSMISSION OF VOICE, DATA, GRAPHICS BY MEANS OF TELEPHONE, TELEGRAPHIC, CABLE, AND SATELLITE TRANSMISSIONS; AND ELECTRONIC, ELECTRIC, AND DIGITAL TRANSMISSION OF VOICE, DATA, IMAGES, SIGNALS, AND MESSAGES.

FIRST USE 10-1-2000; IN COMMERCE 10-1-2000.

ELEMENTS CORRECTED
OWNER ADDRESS

2,671,797. REG. 1-7-2003. LAWSON CONSULTING GROUP, INC. (PENNSYLVANIA CORPORATION) 1356 GWYNE-DALE WAY, LANSDALE, PA, 194465366, SN 76-361,037. FILED 1-22-2002. PRINCIPAL REGISTER.

2,674,091. REG. 1-14-2003. WORKPLACE HEALTH, INC. (ALASKA CORPORATION) 10220 SW GREENBURG RD., STE. 210, PORTLAND, OR, 972235530, SN 76-256,479. FILED 5-11-2001. PRINCIPAL REGISTER.

TACTOOLS

INT. CL. 16/U.S. CLS. 2, 5, 22, 23, 29, 37, 38 AND 50
FOR BUSINESS MANAGEMENT AND SUPERVISORIAL SELF-ASSESSMENT TOOLS, NAMELY, QUESTIONNAIRES AND OTHER PRINTED MATERIALS, FOR THE PURPOSE OF PROMOTING PROFESSIONAL DEVELOPMENT.
FIRST USE 10-2-2001; IN COMMERCE 10-2-2001.

ELEMENTS CORRECTED
MARK



2,672,502. REG. 1-7-2003. PLANET CONSULTING, INC. (DELAWARE CORPORATION) 11225 DAVENPORT STREET, OMAHA, NE, 68154, BY CHANGE OF NAME PLANET 2000 SOFTWARE, INC. CORPORATION) OMAHA, NE, SN 75-702,294. FILED 5-10-1999. PRINCIPAL REGISTER.

PLANET CONSULTING

OWNER OF U.S. REG. NO. 2,197,434.
NO CLAIM IS MADE TO THE EXCLUSIVE RIGHT TO USE "CONSULTING", APART FROM THE MARK AS SHOWN.
INT. CL. 42/U.S. CLS. 100 AND 101
FOR COMPUTER-RELATED CONSULTING SERVICES.
FIRST USE 6-1-1999; IN COMMERCE 6-1-1999.

ELEMENTS CORRECTED
ASSIGNMENT/NAME CHANGE



2,673,047. REG. 1-7-2003. WESLEY ALLEN INC. (CALIFORNIA CORPORATION) 1001 EAST 60TH STREET, LOS ANGELES, CA, 90001, SN 76-248,623. FILED 4-30-2001. PRINCIPAL REGISTER.

ROMANTIC BEDS FOR LIFE

NO CLAIM IS MADE TO THE EXCLUSIVE RIGHT TO USE "BEDS", APART FROM THE MARK AS SHOWN.
INT. CL. 20/U.S. CLS. 2, 13, 22, 25, 32 AND 50
FOR BRASS AND IRON FRAME FURNITURE — NAMELY, HEADBOARDS, FOOTBOARDS, CANOPIES, BEDFRAMES, [SOFA BEDS,] DAY BEDS, NIGHT TABLES, BENCHES, [DESKS, ETAGERES,] COAT STANDS, [PLANT STANDS IN THE NATURE OF FURNITURE, WALL RACKS,] TOWEL RACKS, BED-SPREAD RACKS, EASELS IN THE NATURE OF FURNITURE AND CHEVEL MIRRORS.
FIRST USE 8-12-2002; IN COMMERCE 8-12-2002.

ELEMENTS CORRECTED
GOODS/SERVICES

LABWIRE

INT. CL. 35/U.S. CLS. 100, 101 AND 102
FOR PROVIDING INFORMATION, ANALYSIS AND CONSULTATION IN THE [FILED] * FIELD * OF HUMAN ASSET AND PERSONNEL MANAGEMENT VIA A GLOBAL COMPUTER INFORMATION NETWORK; PROVIDING ON-LINE SALES, MARKETING AND OPERATIONAL INFORMATION, NAMELY, BILLING, PAYMENT, ORDERING AND PROMOTIONAL INFORMATION FOR CLINICAL AND MEDICAL LABORATORIES AND THEIR CUSTOMERS; AND PROVIDING ON-LINE SALES, MARKETING AND OPERATIONAL INFORMATION, NAMELY, TEST RESULTS, FOR CLINICAL AND MEDICAL LABORATORIES AND THEIR CUSTOMERS.
FIRST USE 12-1-2000; IN COMMERCE 12-1-2000.

INT. CL. 41/U.S. CLS. 100, 101 AND 107
FOR PROVIDING TRAINING IN THE FIELD OF HUMAN ASSET AND PERSONNEL MANAGEMENT.
FIRST USE 12-1-2000; IN COMMERCE 12-1-2000.
INT. CL. 42/U.S. CLS. 100 AND 101
FOR PROVIDING LABORATORY AND HEALTH INFORMATION VIA A GLOBAL COMPUTER INFORMATION NETWORK.
FIRST USE 12-1-2000; IN COMMERCE 12-1-2000.

ELEMENTS CORRECTED
GOODS/SERVICES



2,674,248. REG. 1-14-2003. CAP GEMINI ERNST & YOUNG U.S. LLC (DELAWARE LIMITED LIABILITY COMPANY) 750 SEVENTH AVENUE, 18TH FLOOR, NEW YORK, NY, 10019, SN 76-301,078. FILED 8-17-2001. PRINCIPAL REGISTER.

THE ART OF ACCELERATION IN THE CONNECTED ECONOMY

INT. CL. 35/U.S. CLS. 100, 101 AND 102
FOR BUSINESS CONSULTING SERVICES.
FIRST USE 5-0-2000; IN COMMERCE 5-0-2000.

ELEMENTS CORRECTED
OWNER ADDRESS

2,675,833. REG. 1-21-2003. PULSAR S.R.L. (ITALY CORPORATION) 25, VIA BUOZZI, I-40013 CASTEL MAGGIORE - BOLOGNA, ITALY., SN 75-673,138. FILED 3-31-1999. PRINCIPAL REGISTER.

2,676,031. REG. 1-21-2003. COMPAGNIE DAHER (FRANCE COMPANY) 10, PLACE DE LA JOLIETTE, ATRIUM 102, 13002 MARSEILLE, FRANCE., SN 76-010,329. FILED 3-27-2000. PRINCIPAL REGISTER.

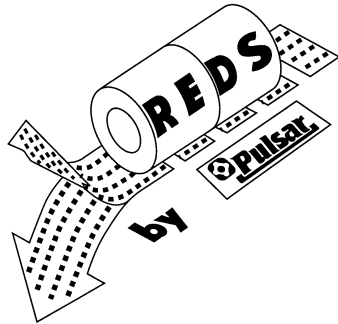

PRIORITY CLAIMED UNDER SEC. 44(D) ON ITALY APPLICATION NO. B098C000809, FILED 10-9-1998, REG. NO. 00827627, DATED 10-26-2000, EXPIRES 10-9-2008.

THE STIPPLING SHOWN IN THE DRAWING IS A FEATURE OF THE MARK AND IS NOT INTENDED TO INDICATE COLOR.

THE MARK CONSISTS IN PART OF THE REPRESENTATION OF A ROLL OF ALUMINUM ON A STYLIZED CONVEYOR BELT.

INT. CL. 7/U.S. CLS. 13, 19, 21, 23, 31, 34 AND 35

FOR CONVEYING EQUIPMENT FOR LOADING AND UNLOADING MATERIALS, NAMELY, FRICTIONAL ROLLER BELT CONVEYORS, [FRICTIONAL ROLLER BELT CONVEYORS,] FRICTIONAL ROLLER FLIGHT CONVEYORS, APRON CONVEYORS, RUBBER BELT CONVEYORS, CHAIN CONVEYORS WITH LAMELLAR ELEMENTS, ARTICULATE-PLATE CONVEYORS, FULLY ARTICULATED CHAIN CONVEYORS, LIFT-AND-SWING SYSTEM CONVEYORS * , * LIFT-AND-STEP SYSTEM CONVEYORS, PIVOTING PAWL-TYPE CONVEYORS, STEEP BELT CONVEYORS.

FIRST USE ; IN COMMERCE .

INT. CL. 9/U.S. CLS. 21, 23, 26, 36 AND 38

FOR ELECTRONIC UNITS FOR CONTROLLING EQUIPMENT USED TO CONVEY PAPER AND ALUMINUM IN THE FOOD INDUSTRY, AUTOMATION INDUSTRY, PACKAGING INDUSTRY, TISSUE INDUSTRY AND TO NECK CONVEYOR .

FIRST USE ; IN COMMERCE .

ELEMENTS CORRECTED
GOODS/SERVICES
LINING/STIPPLING STATEMENT

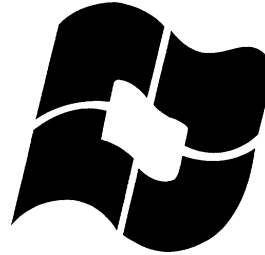

PRIORITY CLAIMED UNDER SEC. 44(D) ON FRANCE APPLICATION NO. 99819271, FILED 10-22-1999, REG. NO. 99819271, DATED 10-22-1999, EXPIRES 10-22-2009.

THE MARK CONSISTS OF A DESIGN ROUGHLY IN THE FORM OF A RECTANGLE CONSISTING OF THICK WAVY BANDS..

INT. CL. 6/U.S. CLS. 2, 12, 13, 14, 23, 25 AND 50

FOR METAL CONTAINERS FOR STORAGE AND TRANSPORTATION OF [FOODS] * GOODS*, METAL STORAGE DRUMS, METAL FLUID STORAGE TANKS; FLOATING METAL CONTAINERS FOR THE STORAGE AND TRANSPORTATION OF GOODS; METAL PALLETS FOR LOADING AND TRANSPORTING GOODS.

FIRST USE ; IN COMMERCE .

INT. CL. 20/U.S. CLS. 2, 13, 22, 25, 32 AND 50

FOR CONTAINERS FOR THE STORAGE AND TRANSPORTATION OF GOODS NAMELY CONTAINERS NOT OF METAL; FLOATING CONTAINERS FOR THE STORAGE AND TRANSPORTATION OF GOODS, NAMELY CONTAINERS NOT OF METAL FOR COMMERCIAL USE; PALLETS NOT OF METAL FOR LOADING AND TRANSPORTING GOODS.

FIRST USE ; IN COMMERCE .

INT. CL. 36/U.S. CLS. 100, 101 AND 102

FOR FIRE INSURANCE UNDERWRITING, ACCIDENT INSURANCE UNDERWRITING, MARINE INSURANCE UNDERWRITING; INSURANCE UNDERWRITING IN THE FIELD OF SHIPPING AND TRANSPORTATION; INSURANCE UNDERWRITING IN THE FIELD OF SHIPPING AND TRANSPORTATION FOR THE PURPOSE OF INSURING PEOPLE AGAINST LOSSES RESULTING FROM THE POSSIBLE DAMAGE OF GOODS DURING TRANSPORTATION.

FIRST USE ; IN COMMERCE .

INT. CL. 37/U.S. CLS. 100, 103 AND 106

FOR HARBOR CONSTRUCTION; CONSTRUCTION PLANNING; CONSTRUCTION SUPERVISION; [PRINTERS] *PRINTED* CIRCUIT BOARD AND ELECTRONIC CARD REPAIR SERVICES FOR OTHERS; CONSTRUCTION, MAINTENANCE AND REPAIR OF [WAREHOUSE] * WAREHOUSES* FOR OTHERS; REPAIR AND MAINTENANCE SERVICES OF TRUCKS, TRACTORS, FORK LIFTS, AND DAMAGED STORAGE CONTAINERS.

FIRST USE ; IN COMMERCE .

INT. CL. 38/U.S. CLS. 100, 101 AND 104

FOR TELECOMMUNICATION GATEWAY SERVICES; PROVIDING TELECOMMUNICATIONS CONNECTIONS TO A GLOBAL COMPUTER NETWORK; ELECTRONIC MAIL SERVICES; IMAGE AND INFORMATION TRANSMISSION OVER A GLOBAL COMPUTER NETWORK.

FIRST USE ; IN COMMERCE .

INT. CL. 39/U.S. CLS. 100 AND 105

FOR MOVING STORAGE SERVICES FOR OTHERS, NAMELY, DELIVERY AND REMOVAL SERVICES, HAULING SERVICES, *TOWING SERVICES,* TRANSPORT OF FREIGHT BY SEA AIR, LAND AND RIVER; PACKING, REPACKING, COVERING, PARCELLING, BAGGING, UNBAGGING; TRANSPORT BROKERAGE SERVICES, WAREHOUSING SERVICES NAMELY GENERAL STORAGE SERVICES; WAREHOUSE AND STORAGE SPACE RENTAL SERVICES, RENTAL OF GARAGE SPACE AND WAREHOUSING CONTAINER, CARGO HANDLING, CARGO UNLOADING, RENTAL SERVICES, NAMELY, RENTAL OF TRANSPORT VEHICLES, NAMELY TRUCKS, TRAILERS, VANS, MOVING VANS.

FIRST USE ; IN COMMERCE .

ELEMENTS CORRECTED
DESCRIPTION OF MARK
GOODS/SERVICES

2,678,707. REG. 1-21-2003. THUNDERPOWER, LLC (DELAWARE LIMITED LIABILITY COMPANY) COROPORATION TRUST CENTER, 1209 ORANGE STREET, WILMINGTON, DE. 19801, SN 76-090,147. FILED 7-17-2000. PRINCIPAL REGISTER.

THUNDERPOWER

INT. CL. 12/U.S. CLS. 19, 21, 23, 31, 35 AND 44
FOR BUSES AND STRUCTURAL PARTS THEREOF; FUEL CELL AND HYBRID FUEL CELL/ELECTRIC DRIVELINES FOR LAND VEHICLES.
FIRST USE 6-0-2002; IN COMMERCE 6-0-2002.

ELEMENTS CORRECTED
OWNER ADDRESS

2,677,856. REG. 1-21-2003. COPIA: THE AMERICAN CENTER FOR WINE, FOOD & THE ARTS (CALIFORNIA NON-PROFIT PUBLIC BENEFIT CORPORATION) 500 FIRST STREET, NAPA, CA, 94559, SN 76-396,795. FILED 4-16-2002. PRINCIPAL REGISTER.

BREAD & BUTTER

INT. CL. 16/U.S. CLS. 2, 5, 22, 23, 29, 37, 38 AND 50
FOR PRINTS AND PUBLICATIONS; NAMELY, NEWSLETTERS IN THE FIELDS OF WINE FOOD AND THE ARTS.
FIRST USE 9-9-1999; IN COMMERCE 9-9-1999.

ELEMENTS CORRECTED
OWNER NAME

2,679,239. REG. 1-21-2003. WATKINS, MARGARET D. (UNITED STATES INDIVIDUAL) 4366 SKYLAND DRIVE, ATLANTA, GA, 30342, SN 78-101,391. FILED P.R. 1-8-2002; AM. S.R. 5-30-2002. SUPPLEMENTAL REGISTER.

JOB TALK

NO CLAIM IS MADE TO THE EXCLUSIVE RIGHT TO USE "TALK", APART FROM THE MARK AS SHOWN.
INT. CL. 41/U.S. CLS. 100, 101 AND 107
FOR ENTERTAINMENT IN THE NATURE OF ONGOING RADIO * PROGRAMS * IN THE FIELD OF CAREER DEVELOPMENT AND TRENDS.
FIRST USE 9-14-2002; IN COMMERCE 9-14-2002.

ELEMENTS CORRECTED
GOODS/SERVICES

2,678,651. REG. 1-21-2003. GLOBAL MOTORSPORT GROUP, INC. (DELAWARE CORPORATION) 16100 JACQUELINE COURT, MORGAN HILL, CA, 950375598, SN 76-023,642. FILED 4-11-2000. PRINCIPAL REGISTER.



NO CLAIM IS MADE TO THE EXCLUSIVE RIGHT TO USE "MADE IN U.S.A.", APART FROM THE MARK AS SHOWN.
INT. CL. 12/U.S. CLS. 19, 21, 23, 31, 35 AND 44
FOR STRUCTURAL PARTS FOR MOTORCYCLE CHASSIS, OIL TANKS, SUSPENSION SHOCKS, FRAMES, AND[SWINGARM] * SWINGARM * SUSPENSION SYSTEMS .
FIRST USE 9-28-2000; IN COMMERCE 9-28-2000.

ELEMENTS CORRECTED
GOODS/SERVICES

2,681,359. REG. 1-28-2003. UNIVERSITY FEDERAL CREDIT UNION (UNITED STATES FEDERALLY CHARTERED CREDIT UNION) 3305 STECK AVENUE, AUSTIN, TX, 78757, SN 78-119,873. FILED 4-5-2002. PRINCIPAL REGISTER.

THE FIRST STEP TO YOUR NEW HOME.

INT. CL. 36/U.S. CLS. 100, 101 AND 102
FOR HOUSE BUYING SERVICES, NAMELY PROVIDING MEMBERS WITH EXTENSIVE INFORMATION AND ASSISTANCE IN CONNECTION WITH THE HOME BUYING PURCHASE PROCESS; MORTGAGE LENDING SERVICES, NAMELY PROVIDING RESIDENTIAL LOANS, LOAN REFINANCING, HOME EQUITY LOANS AND LINES OF CREDIT.
FIRST USE 4-1-2001; IN COMMERCE 4-1-2001.

ELEMENTS AMENDED
MARK

2,681,505. REG. 1-28-2003. EYGN LIMITED (BAHAMAS CORPORATION) ONE MONTAGUE PLACE, EAST BAY STREET, NASSAU, BAHAMAS., BY ASSIGNMENT ERNST & YOUNG U.S. LLP (DELAWARE), NEW YORK, NY, SN 75-649,453. FILED 3-1-1999. PRINCIPAL REGISTER.

CYBER PROCESS CERTIFICATION

NO CLAIM IS MADE TO THE EXCLUSIVE RIGHT TO USE "CERTIFICATION", APART FROM THE MARK AS SHOWN.

THE CERTIFICATION MARK, AS USED BY AUTHORIZED PERSONS, CERTIFIES THAT THEIR WEB SITES MEET STANDARDS OR TESTS OF PROCESSES AND CONTROLS WITH REGARD TO INFORMATION SECURITY, PRIVACY, INTERNAL CONTROLS, PERFORMANCE MEASUREMENTS AND PERFORMANCE RELIABILITY.

INT. CL. B /U.S. CL. B

FOR WEB SITES ON A GLOBAL COMPUTER NETWORK.

FIRST USE 4-8-1997; IN COMMERCE 4-8-1997.

ELEMENTS CORRECTED
ASSIGNMENT/NAME CHANGE
OWNER NAME
OWNER ADDRESS
CITIZENSHIP
ENTITY

FOR INSULATION AND INSULATION GOODS FOR APPLIANCES, INDUSTRIAL MACHINERY, FURNACES, BOILERS, TANKS, AIR DUCTS AND PIPES, FOR HEATING, VENTILATION AND AIR-CONDITIONING EQUIPMENT, FOR HEAT INSULATION, SOUND INSULATION AND/OR FOR INSULATING AGAINST ENERGY LOSSES, CONDENSATION AND/OR MECHANICAL DAMAGE, NAMELY PLASTICS INSULATING MATERIAL, RUBBER INSULATING MATERIAL, ELASTOMERIC INSULATING MATERIAL, FOAMED PLASTICS INSULATING MATERIAL, FOAMED ELASTOMERIC INSULATING MATERIAL, INSULATING FOAM, INSULATING COATINGS, INSULATING CLADDING, INSULATING TUBES, SHEETS, ROLLS, BANDS AND TAPES, INSULATING PAINTS, INSULATING METAL COATINGS, INSULATING ALUMINUM COATINGS, INSULATING METAL FOILS, INSULATING PROTECTIVE FOILS, INSULATED PIPE CLIPS AND SUPPORTS, HANGERS FOR FASTENING INSULATION TO SURFACES, INSULATED DUCT SUPPORTS AND CARRIERS, INSULATED DUCTS, DUCTING, DUCTING ELEMENTS, ELBOWS AND SECTIONS; INSULATION AND INSULATION GOODS FOR USE IN BUILDING AND CONSTRUCTION; PLASTIC GOODS, PLASTIC FOAM, ELASTOMERIC FOAM AND THERMOPLASTICS FOAM, ALL FOR USE IN INSULATION, IN THE FORM OF BLOCKS, PANELS, BOARDS, SHEETS, RODS, TUBES, STRIPS, TAPES, BANDS, ROLLS AND OTHER FORMS; ADHESIVE MATERIAL FOR INDUSTRIAL OR COMMERCIAL USE, NAMELY ADHESIVE BANDS OR TAPES; PACKING AND PADDING MATERIALS FOR PROTECTING ARTICLES AGAINST DAMAGE DURING TRANSPORTATION AND/OR SHIPMENT.

FIRST USE ; IN COMMERCE .

ELEMENTS CORRECTED
OWNER NAME
OWNER ADDRESS

2,685,994. REG. 2-11-2003. ALLEN, KEITH W. SR. (UNITED STATES INDIVIDUAL) 1128 WOODHOLLOW DRIVE, MARIETTA, GA. 30067, SN 76-370,988. FILED 2-14-2002. PRINCIPAL REGISTER.

SHOWBALL

INT. CL. 28/U.S. CLS. 22, 23, 38 AND 50

FOR SPORTS MEMORABILIA TOY NOVELTY ITEMS, NAMELY REPLICAS OF BASEBALLS, FOOTBALLS, BASKETBALLS, SOCCER BALLS, VOLLEYBALLS, TENNIS BALLS, SOFTBALLS, BOXING GLOVES, HOCKEY PUCKS, MEGAPHONES, SPORTS HELMETS AND RACE [CARE] * CAR * WHEELS.

FIRST USE 11-0-1991; IN COMMERCE 12-0-1993.

ELEMENTS CORRECTED
GOODS/SERVICES

2,685,240. REG. 2-11-2003. ARMACELL UK LIMITED (UNITED KINGDOM CORPORATION) ARMSTRONG HOUSE, 38 MARKET SQUARE, UXBRIDGE, MIDDLESEX, UNITED KINGDOM, UB8 1NG, BY CHANGE OF NAME; BY CHANGE OF NAME; BY CHANGE OF NAME ARMSTRONG INSULATION PRODUCTS LIMITED CORPORATION) UXBRIDGE, MIDDLESEX, UNITED KINGDOM, SN 76-072,261. FILED 6-16-2000. PRINCIPAL REGISTER.

ARMACELL

2,688,972. REG. 2-18-2003. SPOTLIFE INC. (DELAWARE CORPORATION) 1950 LESLIE STREET, SAN MATEO, CA, 94403, BY CHANGE OF NAME; BY CHANGE OF NAME RUBICON SOFTWARE, INC. CORPORATION) SAN FRANCISCO, CA, SN 75-899,531. FILED 1-20-2000. PRINCIPAL REGISTER.

SPOTLIFE

PRIORITY CLAIMED UNDER SEC. 44(D) ON UNITED KINGDOM APPLICATION NO. 2217583, FILED 12-17-1999, REG. NO. 2217583, DATED 11-10-2000, EXPIRES 12-17-2009. INT. CL. 17/U.S. CLS. 1, 5, 12, 13, 35 AND 50

INT. CL. 38/U.S. CLS. 100, 101 AND 104

FOR VIDEO BROADCASTING OVER THE GLOBAL
COMPUTER INFORMATION NETWORK.
FIRST USE 1-0-2000; IN COMMERCE 4-0-2000.

2,694,539. REG. 3-11-2003. MERZ + CO. GMBH & CO. (FED
REP GERMANY LIMITED PARTNERSHIP) ECKENHEI-
MER LANDSTRASSE 100-104, 60318 FRANKFURT AM
MAIN, FED REP GERMANY., SN 76-134,970. FILED 9-25-
2000. PRINCIPAL REGISTER.

ELEMENTS CORRECTED
ASSIGNMENT/NAME CHANGE
OWNER NAME

SIGNIFICANT

2,689,603. REG. 2-25-2003. DOOSAN HEAVY INDUSTRIES &
CONSTRUCTION CO., LTD. (REPUBLIC OF KOREA
CORPORATION) 555 GUYGOK-DONG, CHANGEEN-
SHI, GYUNGNAM, REPUBLIC OF KOREA., SN 75-
530,178. FILED 8-3-1998. PRINCIPAL REGISTER.

PRIORITY CLAIMED UNDER SEC. 44(D) ON FED REP
GERMANY APPLICATION NO. 30050113, FILED 7-6-2000,
REG. NO. 30050113, DATED 3-1-2001, EXPIRES 7-31-2010.
INT. CL. 10/U.S. CLS. 26, 39 AND 44
FOR ARTIFICIAL TEETH.



ELEMENTS CORRECTED
ENTITY

OWNER OF REPUBLIC OF KOREA REG. NO. 27874,
DATED 7-19-1995, EXPIRES 7-19-2005.
INT. CL. 37/U.S. CLS. 100, 103 AND 106

2,694,540. REG. 3-11-2003. MERZ + CO. GMBH & CO. (FED
REP GERMANY LIMITED LIABILITY) ECKENHEIMER
LANDSTRASSE 100-104, 60318 FRANKFURT AM MAIN,
FED REP GERMANY., SN 76-134,971. FILED 9-25-2000.
PRINCIPAL REGISTER.

FOR CONSTRUCTION SERVICES, NAMELY, ROAD
AND HIGHWAY CONSTRUCTION, SUBWAY CON-
STRUCTION, RIVER BANKING, PIPELINE CONSTRU-
CTION, PIPELINE INSTALLATION, PIPELINE
MAINTENANCE, THERMAL POWER PLANT CON-
STRUCTION, APARTMENT CONSTRUCTION, COM-
MERCIAL BUILDING CONSTRUCTION,
CONSTRUCTION OF POWER GENERATION PLANTS,
CONSTRUCTION OF INDUSTRIAL PLANTS, FACTORY
CONSTRUCTION SERVICES, ASPHALTING, AIR CON-
DITIONING APPARATUS INSTALLATION AND RE-
PAIR.

FIRST USE : IN COMMERCE .

ARTEGRAL

PRIORITY CLAIMED UNDER SEC. 44(D) ON FED REP
GERMANY APPLICATION NO. 30050111, FILED 7-5-2000,
REG. NO. 30050111, DATED 1-18-2000, EXPIRES 7-31-2010.
INT. CL. 10/U.S. CLS. 26, 39 AND 44
FOR ARTIFICIAL TEETH.

ELEMENTS CORRECTED
ASSIGNMENT/NAME CHANGE

ELEMENTS CORRECTED
ENTITY

* * * * *

TRADEMARK REGISTRATIONS—NEW CERTIFICATES

New Certificates issued under section 7(e) of the Trademark Act of 1946 for the unexpired term of the original registrations.

1,244,209. EMTROL AND DESIGN. INT. CL. 7. EMTROL CORPORATION, HAUPPAUGE, NY. REG. 7-5-1983. NEW CERT. SEC. 7(C) TO EMTROL LLC, HAUPPAUGE, NY.

CL. 38. J. H. EVANS, INC., TURLOCK, CA. REG. 9-25-2001. NEW CERT. SEC. 7(C) TO EVANS COMMUNICATIONS, TURLOCK, CA.

2,071,687. EVANSNET. INT. CL. 42. J. H. EVANS, INC., TURLOCK, CA. REG. 6-17-1997. NEW CERT. SEC. 7(C) TO EVANS COMMUNICATIONS, TURLOCK, CA.

2,498,266. E EVANS TELEPHONE AND DESIGN. INT. CL. 38. J. H. EVANS, INC., TURLOCK, CA. REG. 10-16-2001. NEW CERT. SEC. 7(C) TO EVANS TELEPHONE COMPANY, TURLOCK, CA.

2,318,039. EVANS COMPANIES. INT. CL. 38. J. H. EVANS, INC., TURLOCK, CA. REG. 2-15-2000. NEW CERT. SEC. 7(C) TO EVANS COMMUNICATIONS, TURLOCK, CA.

2,612,023. HARMLESS HAZARDS. INT. CL. 42. INFORMATION DECISION TECHNOLOGIES LLC, BEDFORD, NH. REG. 8-27-2002. NEW CERT. SEC. 7(C) TO HARMLESS HAZARDS TRAINING, LLC, BEDFORD, NH.

2,492,548. EVANS COMMUNICATIONS AND DESIGN. INT.

* * * * *

INDEX OF REGISTRANTS

JUNE 24, 2003

(Registered; Renewed; Canceled; Amended, Corrected, etc.; New Certificates; 12c Publications.)

The designation "U.S. Cl." appearing in this section refers to the U.S. class in effect prior to Sep. 1, 1973 rather than the international class which applies to applications filed on or after that date. For adoption of international classification see notice in the OFFICIAL GAZETTE of Jun. 26, 1973 (911 O.G. TM 210).

;U.S. SMOKELESS TOBACCO MANUFACTURING LIMITED PARTNERSHIP, NASHVILLE, TN, UNITED STATES TOBACCO MANUFACTURING COMPANY INC., GREENWICH, CT:
1,755,638. REN. 5-15-03. INT. CL. 34.
@STAKE, INC., CAMBRIDGE, MA:
2,730,068, MULTIPLE CLASS, INT. CLS. 35 AND 42.
"CERAMIKA ARTYSTYCZNA" SPOLDZIELNIA REKODZIELA ARTYSTYCZNEGO, 59-700 BOLESLAWIEC, POLAND:
1,992,192, CANC. INT. CL. 21.
1,992,193, CANC. INT. CL. 21.
A & A VELASCO SERVICES, INC., HOUSTON, TX:
1,991,779, CANC. INT. CL. 25.
A & F TRADEMARK, INC., WILMINGTON, DE:
2,626,917, COR. INT. CL. 25.
A PERFECT DAY DJ, LLC, RALEIGH, NC:
2,729,080, PUB. 4-1-2003. INT. CL. 41.
A RETIRED COLLECTION, LLC, LONGBOAT KEY, FL:
2,728,694, PUB. 4-1-2003. INT. CL. 35.
A. FINKL & SONS CO., CHICAGO, IL, A. FINKL & SONS COMPANY, CHICAGO, IL:
400,088. REN. 5-15-03. U.S. CL. 23 (INT. CL. 7).
A. G., INC., FORT LAUDERDALE, FL, DBA LUCIEN PICCARD, LUCIEN PICCARD WATCH CORPORATION, NEW YORK, NY:
746,214. REN. 5-13-03. U.S. CL. 27 (INT. CL. 14).
A.G. EDWARDS & SONS, INC., ST. LOUIS, MO:
1,991,731, CANC. INT. CL. 36.
A.J. PRINDLE & CO., LLC, NOVI, MI FROM FORD MOTOR COMPANY, DEARBORN, MI:
2,730,591, INT. CL. 35.
A.T.S. ELECTRO-LUBE LTD., DELTA, BRITISH COLUMBIA, CANADA:
1,777,018. REN. 5-11-03. INT. CL. 7.
A&E TELEVISION NETWORKS, NEW YORK, NY:
2,729,743, INT. CL. 41.
2,729,787, INT. CL. 28.
A-KORN ROLLER, INC., CHICAGO, IL:
1,704,567, CANC. INT. CL. 7.
AAFA, INC., CHARLOTTE, NC:
1,705,679, CANC. U.S. CL. 200.
ABB FLEXIBLE AUTOMATION AG, 8048 ZURICH, SWITZERLAND:
2,647,802, COR. MULTIPLE CLASS, INT. CLS. 7 AND 9.
ABBOTT LABORATORIES, ABBOTT PARK, IL:
2,729,465, MULTIPLE CLASS, INT. CLS. 5 AND 10.
2,730,563, INT. CL. 16.
ABBOTT-INTERFAST CORPORATION, WHEELING, IL:
2,729,771, INT. CL. 6.
ABELL ELEVATOR INTERNATIONAL, LOUISVILLE, KY:
1,774,061. REN. 5-16-03. INT. CL. 7.
ABERLE, KATHERINE J., NOVATO, CA:
2,728,916, PUB. 4-1-2003. INT. CL. 14.
ABITIBI-CONSOLIDATED INC., MONTREAL, QUEBEC, CANADA:
2,728,462, PUB. 4-1-2003. MULTIPLE CLASS, INT. CLS. 1, 16 AND 19.
ABN AMRO HOLDING N.V., 1082 PP AMSTERDAM, NETHERLANDS:
1,788,381. REN. 5-16-03. MULTIPLE CLASS, INT. CLS. 35 AND 36.
ABRAMS LITTLE-GILL LOBERFELD TISHMAN & WITTY PC, BOSTON, MA:
2,729,577, INT. CL. 35.
ABS LICENSE, S.A. DE C.V., GARCIA, N.L. 66000, MEXICO:
2,728,903, PUB. 3-4-2003. INT. CL. 16.
ABSOLUTE COATINGS, INC., BRONX, NY:
1,203,275, CANC. INT. CL. 2.
ABSORBAKLEEN, L.L.C., MINSTER, OH:
2,730,371, INT. CL. 1.
ABUNDANT LIFE CHRISTIAN CENTRE, INC., MARGATE, FL:
2,729,219, PUB. 4-1-2003. INT. CL. 45.
ACCEL8 TECHNOLOGY CORPORATION, DENVER, CO:
2,729,545, INT. CL. 9.
ACCESS VG, L.L.C., SALT LAKE CITY, UT:
2,728,747, PUB. 4-1-2003. INT. CL. 35.
ACCLIVUS CORPORATION, DALLAS, TX:
1,203,528, CANC. INT. CL. 16.
ACCO WORLD CORPORATION, LINCOLNSHIRE, IL:
2,728,721, PUB. 7-9-2002. INT. CL. 9.
ACCU-WEATHER, INC., STATE COLLEGE, PA:
1,695,855. REN. 5-15-03. INT. CL. 18.
1,695,855, CANC. INT. CL. 9.
ACCUSESS ENVIRONMENTAL, INC., BATON ROUGE, LA:
2,730,340, INT. CL. 42.
ACE HARDWARE CORPORATION, OAK BROOK, IL:
2,730,275, INT. CL. 2.
ACEROS TROQUELADOS, S.A. DE C.V., CP 44940 GUADAJALARA, JALISCO, MEXICO:
1,704,533, CANC. INT. CL. 6.
ACKERLEY COMMUNICATIONS, INC., SEATTLE, WA:
1,991,067, CANC. INT. CL. 41.
ACRYLIFE, INC., WYTHEVILLE, VA:
1,758,357. REN. 5-14-03. INT. CL. 19.
ACTS RETIREMENT-LIFE COMMUNITIES, INC., WEST POINT, PA:
2,730,509, INT. CL. 44.
ACUITY BRANDS, INC., ATLANTA, GA, NATIONAL SERVICE INDUSTRIES, INC., ATLANTA, GA:
1,806,716. REN. 5-10-03. INT. CL. 11.
ACURVA, LLC, LAYTON, UT:
2,729,936, INT. CL. 27.
ACUSHNET COMPANY, FAIRHAVEN, MA:
1,992,097, CANC. INT. CL. 28.
1,992,141, CANC. INT. CL. 25.
ACXIOM CORPORATION, CONWAY, AR TO ACXIOM RTC, INC., SAN DIEGO, CA:
1,705,320, CANC. INT. CL. 35.
AD-NET, INC., MONTGOMERY, TX:
1,994,393, CANC. INT. CL. 35.
ADAMS-MILLIS CORPORATION, GREENSBORO, NC:
1,203,702, CANC. INT. CL. 25.
ADAPTIVE INDUSTRIES, INC., BUHL, ID:
2,728,817, PUB. 4-1-2003. INT. CL. 9.
ADBRAINTAGE, S.A., 08970 SANT JOAN DESPI, SPAIN:
2,728,697, PUB. 4-1-2003. INT. CL. 42.
ADC TELECOMMUNICATIONS, INC., MINNETONKA, MN:
2,729,815, INT. CL. 9.
ADE CORPORATION, WESTWOOD, MA:
1,789,214. REN. 5-16-03. INT. CL. 9.

- ADELMAN, STUART J., ST. LOUIS PARK, MN:
1,704,851, CANC. INT. CL. 14.
- ADESSO INC., NEW YORK, NY:
2,728,755, PUB. 4-1-2003. MULTIPLE CLASS, INT. CLS. 11 AND 20.
- ADEZA BIOMEDICAL CORPORATION, SUNNYVALE, CA:
2,730,680, MULTIPLE CLASS, INT. CLS. 9 AND 10.
- ADIDAS INTERNATIONAL B.V., 1006 BB AMSTERDAM, NETHERLANDS:
2,730,135, INT. CL. 28.
- ADP, INC., ROSELAND, NJ:
2,729,344, PUB. 4-1-2003. INT. CL. 35.
- ADTECH SOLUTIONS, LLC, ALPHARETTA, GA:
2,730,694, INT. CL. 9.
- ADV MARKETING GROUP, INC., STAMFORD, CT:
1,990,914, CANC. INT. CL. 35.
- ADVANCE ENERGY TECHNOLOGIES, INC., CLIFTON PARK, NY:
1,203,570, CANC. INT. CL. 19.
- ADVANCE MAGAZINE PUBLISHERS INC., NEW YORK, NY, BON APPETIT PUBLISHING CORP., LOS ANGELES, CA:
1,229,789, REN. 5-16-03. INT. CL. 16.
- ADVANCED BRAIN TECHNOLOGIES, LLC, OGDEN, UT:
2,728,508, PUB. 4-1-2003. INT. CL. 41.
- ADVANCED ENERGY INDUSTRIES, INC., FORT COLLINS, CO:
1,704,706, CANC. INT. CL. 9.
- ADVANCED ENVIRONMENTAL RECYCLING TECHNOLOGIES, INC., SPRINGDALE, AR:
1,734,846, REN. 5-15-03. INT. CL. 19.
- ADVANCED METAL COMPONENTS, INC., MENLO PARK, CA:
1,990,710, CANC. MULTIPLE CLASS, INT. CLS. 6 AND 17.
- ADVANETRIX, INC., WOODBRIDGE, VA:
2,729,205, PUB. 4-1-2003. INT. CL. 42.
- ADVANTIS TECHNOLOGIES, INC., ALPHARETTA, GA:
2,730,203, INT. CL. 1.
- ADVERTISING.COM, INC., BALTIMORE, MD FROM TEKNOSURF.COM, INC., BALTIMORE, MD:
2,729,571, INT. CL. 35.
- AEG AKTIENGESSELLSCHAFT, D-6000 FRANKFURT 70, FED REP GERMANY:
1,990,609, CANC. MULTIPLE CLASS, INT. CLS. 7, 9, 35, 37, 41 AND 42.
- AEQUITRON MEDICAL, INC., MINNEAPOLIS, MN:
1,991,623, CANC. INT. CL. 10.
- AERO DESIGN AND MANUFACTURING COMPANY, INC., DULUTH, MN:
2,730,215, INT. CL. 35.
- AESTHETICA SKIN CARE CORPORATION, SANTA BARBARA, CA:
2,729,269, PUB. 4-1-2003. MULTIPLE CLASS, INT. CLS. 3 AND 5.
- AETHER SYSTEMS, INC., OWINGS MILLS, MD:
2,730,597, INT. CL. 9.
- AETNA INC., BLUE BELL, PA:
2,730,747, INT. CL. 36.
- AFFIBODY TECHNOLOGY AB, 113 47 STOCKHOLM, SWEDEN:
2,730,093, INT. CL. 42.
- AFFINITY INTERNET, INC., EL SEGUNDO, CA:
2,729,756, MULTIPLE CLASS, INT. CLS. 35, 38 AND 42.
- AFFORDABLE SUPPLEMENTS, INC., WICHITA, KS:
2,728,915, PUB. 4-1-2003. INT. CL. 35.
- AF2 ENTERPRISES LLC, CHICAGO, IL:
2,728,699, PUB. 4-1-2003. INT. CL. 16.
- AGCO CORPORATION, DULUTH, GA, GALLENBERG EQUIPMENT, INC., ANTIGO, WI:
1,754,869, REN. 5-10-03. INT. CL. 7.
- AGE WAVE, L.L.C., EMERYVILLE, CA:
2,729,372, INT. CL. 35.
- AGING EXCELLENCE, INC., PORTLAND, ME:
2,729,613, MULTIPLE CLASS, INT. CLS. 39 AND 42.
- AGIO SIGARENFABRIEKEN N.V., 5525 AR DUIZEL, NETHERLANDS:
1,743,452, REN. 5-14-03. INT. CL. 34.
- AGRIBANK, FCB, ST. PAUL, MN, AGRIBANK, FCB, ST. PAUL, MN, DBA FARM CREDIT SERVICES:
1,771,828, REN. 5-15-03. INT. CL. 36.
- AGRICULTURAL GAS COMPANY, THE, HUDSON, WI:
2,730,422, INT. CL. 42.
- AGRIMETRICS ASSOCIATES, INC., CHESTER, VA:
1,705,360, CANC. INT. CL. 35.
- AHEP FOUNDERS, LLC, EDINA, MN:
2,728,757, PUB. 4-1-2003. INT. CL. 36.
- AI SIGNAL RESEARCH, INC., HUNTSVILLE, AL:
2,729,492, INT. CL. 9.
- AIKEN CHEMICAL COMPANY, INC., GREENVILLE, SC:
2,729,280, PUB. 4-1-2003. INT. CL. 3.
- AIR CANADA, MONTREAL H4Y 1H4, CANADA:
1,990,709, CANC. MULTIPLE CLASS, INT. CLS. 39 AND 42.
- AIR SUPPLY INTERNATIONAL PTY LTD, NOOSAVILLE, QUEENSLAND 4566, AUSTRALIA:
2,728,966, PUB. 4-1-2003. INT. CL. 11.
- AIRE SERV HEATING & AIR CONDITIONING, INC., WACO, TX:
2,729,724, INT. CL. 37.
- AIRNEX COMMUNICATIONS, INC., SAN RAMON, CA:
2,729,045, PUB. 4-1-2003. INT. CL. 38.
- AIRSPRAY INTERNATIONAL, POMPANO BEACH, FL:
1,761,941, REN. 5-10-03. INT. CL. 3.
- AIRXCEL, INC., WICHITA, KS:
2,728,803, PUB. 4-1-2003. MULTIPLE CLASS, INT. CLS. 9 AND 11.
- AKG ACOUSTICS GMBH, WIEN, AUSTRIA, ELECTRONIC APPLICATIONS, INC., WILTON, CT:
750,443, REN. 5-13-03. U.S. CL. 21 (INT. CL. 9).
- AKZO NOBEL CHEMICALS B.V., AMERSFOORT, NETHERLANDS, AKZO CHEMIE NEDERLAND B.V., AMERSFOORT, NETHERLANDS:
1,185,305, REN. 5-14-03. INT. CL. 1.
- AKZO NOBEL COATINGS INC., LOUISVILLE, KY:
1,991,354, CANC. INT. CL. 2.
- ALBERTSON'S, INC., BOISE, ID:
2,729,799, MULTIPLE CLASS, INT. CLS. 3 AND 4.
- ALBERTVILLE QUALITY FOODS, INC., ALBERTVILLE, AL:
2,728,821, PUB. 4-1-2003. INT. CL. 29.
- ALBION LABORATORIES, INC., CLEARFIELD, UT:
1,991,335, CANC. INT. CL. 5.
- 2,730,714, MULTIPLE CLASS, INT. CLS. 1, 5 AND 40.
- ALCHEMIA PTY LTD., EIGHT MILE PLAINS, AUSTRALIA:
2,652,328, COR. INT. CL. 5.
- ALCO INDUSTRIES, INC., OAKDALE, PA, DBA STYLETTE:
2,730,044, INT. CL. 18.
- ALCOA INC., PITTSBURGH, PA:
2,729,233, PUB. 4-1-2003. INT. CL. 11.
- ALCON UNIVERSAL LTD., CH-6331 HUNENBERG, SWITZERLAND:
2,729,190, PUB. 4-1-2003. INT. CL. 10.
- ALE HOUSE MANAGEMENT, INC., JUPITER, FL:
2,728,881, PUB. 4-1-2003. INT. CL. 43.
- ALETA ENTERPRISES, INC. DBA VISIONS UNLIMITED, WOODBRIDGE, VA:
2,729,184, PUB. 4-1-2003. INT. CL. 41.
- ALEXANDER O'NEILL HAAS & MARTIN, INC., ATLANTA, GA:
1,991,245, CANC. INT. CL. 42.
- ALKOR GMBH KUNSTSTOFFE, 9 D-81479 MUNCHEN, FED REP GERMANY:
1,764,489, REN. 5-15-03. INT. CL. 17.
- ALL AMERICAN GIRLS PROFESSIONAL BASEBALL LEAGUE PLAYERS ASSOCIATION, INC., TOMS RIVER, NJ:
1,987,846, CANC. INT. CL. 14.
- ALL FELT PRODUCTS INC, GENOA, IL:
1,991,907, CANC. INT. CL. 24.
- 1,991,908, CANC. INT. CL. 24.
- ALL GROUP, INC., FORT COLLINS, CO:
1,991,039, CANC. INT. CL. 25.
- ALLEN TELECOM INC., BEACHWOOD, OH, ALLEN TELECOM GROUP, INC., SOLON, OH:
1,805,865, REN. 5-10-03. INT. CL. 9.

- ALLEN, KEITH W. SR., MARIETTA, GA:
2,685,994, COR. INT. CL. 28.
- ALLEN'S TV CABLE SERVICE, INC., MORGAN CITY, LA:
2,728,681, PUB. 4-1-2003. MULTIPLE CLASS, INT. CLS. 38
AND 42.
- ALLERGY CENTERS, INC., ST. LOUIS, MO:
1,991,811, CANC. INT. CL. 42.
- ALLEY CAT ALLIES, WASHINGTON, DC:
2,729,182, PUB. 4-1-2003. MULTIPLE CLASS, INT. CLS.
16, 35, 41 AND 44.
- ALLIANCE CAPITAL MANAGEMENT L.P., NEW YORK,
NY:
1,991,634, CANC. INT. CL. 36.
- ALLIANCE PHARMACEUTICAL CORP., SAN DIEGO, CA:
2,728,557, PUB. 4-1-2003. INT. CL. 5.
2,728,601, PUB. 4-1-2003. INT. CL. 5.
- ALLIED BUILDING SERVICE COMPANY OF DETROIT,
INC., DETROIT, MI:
1,785,849, REN. 5-14-03. INT. CL. 37.
- ALLISON-ERWIN COMPANY, CHARLOTTE, NC:
1,203,708, CANC. INT. CL. 27.
- ALLOY, INC., NEW YORK, NY:
2,728,958, PUB. 4-1-2003. INT. CL. 16.
- ALLSTATE INSURANCE COMPANY, NORTHBROOK, IL:
712,632, REN. 5-16-03. U.S. CL. 102 (INT. CL. 36).
- ALLSTATES GLOBAL KARATE DO, INC., NEW YORK, NY,
DBA WORLD SEIDO KARATE ORGANIZATION:
1,779,266, REN. 5-16-03. INT. CL. 41.
- ALLTECH, INC., NICHOLASVILLE, KY:
2,728,783, PUB. 4-1-2003. INT. CL. 31.
- ALLTRADE TOOLS LLC, LONG BEACH, CA:
2,729,026, PUB. 4-1-2003. INT. CL. 8.
- ALMAR SALES CO., INC., NEW YORK, NY:
1,203,703, CANC. INT. CL. 26.
- ALNOVA TECHNOLOGIES CORPORATION, S.L., 28020
MADRID, SPAIN:
2,667,940, COR. MULTIPLE CLASS, INT. CLS. 9 AND 42.
- ALPERT, PAUL S, MORGAN HILL, CA:
2,729,350, PUB. 4-1-2003. INT. CL. 16.
- ALPHA DELTA PI SORORITY, ATLANTA, GA:
570,833, REN. 5-15-03. U.S. CL. 100 (INT. CL. 42).
- ALPHA SYSTEMES, 77290 MITRY-MORY, FRANCE:
1,990,651, CANC. INT. CL. 3.
- ALPINE STORMWATER MANAGEMENT COMPANY, GA-
HANNA, OH:
2,728,830, PUB. 4-1-2003. INT. CL. 11.
- ALPINIST, LLC, GLENCOE, IL:
2,730,897, INT. CL. 16.
- ALPMA ALPENLAND-MASCHINENBAUGESELLSCHAFT
HAIN & CO. K.G., POST RAMERBERG, FED REP
GERMANY:
735,611, CANC. U.S. CL. 23.
- ALSTOM, 75116 PARIS, FRANCE:
2,728,524, PUB. 4-30-2002. INT. CL. 9.
2,728,525, PUB. 4-30-2002. INT. CL. 9.
- ALTARATIONS, LLC, FAYETTEVILLE, NC:
2,729,583, INT. CL. 16.
- ALTERRA HOLDINGS CORPORATION, TIGARD, OR,
CAMBRIDGE INDUSTRIES, LTD., NORTHBROOK, IL:
1,711,224, REN. 5-16-03. MULTIPLE CLASS, INT. CLS. 9
AND 16.
- ALVAREZ, ALICIA, BELL GARDENSS, CA:
2,728,546, PUB. 4-1-2003. MULTIPLE CLASS, INT. CLS.
35, 37 AND 42.
- ALVORD, JOEL B., BOSTON, MA:
2,729,369, INT. CL. 36.
- ALWAYS B.B. INT'L, INC., LOS ANGELES, CA:
2,729,261, PUB. 4-1-2003. INT. CL. 5.
- AMACAI INFORMATION CORPORATION, VIENNA, VA:
2,729,224, PUB. 4-1-2003. INT. CL. 35.
- AMANA SOCIETY, AMANA, IA, DBA AMANA PRODUCTS,
AMANA FURNITURE SHOP, AMANA MEAT SHOP, AND
AMANA WOOLEN MILLS:
1,233,214, REN. 5-16-03. MULTIPLE CLASS, INT. CLS. 3,
20, 24, 29, 30 AND 31.
- AMBIANCE, INC., MIDDLEBURG HEIGHTS, OH:
2,728,825, PUB. 4-1-2003. INT. CL. 35.
2,728,826, PUB. 4-1-2003. INT. CL. 35.
2,728,827, PUB. 4-1-2003. INT. CL. 35.
- AMCRAFT BUILDING PRODUCTS CO., INC., BELOIT, WI:
2,730,797, INT. CL. 19.
- AMEGNIZIN, LOUIS, 77700 BAILLY ROMAINVILLIERS,
FRANCE:
2,730,233, INT. CL. 3.
- AMENAZA TECHNOLOGIES LIMITED, CALGARY, AL-
BERTA T2P 3M7, CANADA:
2,728,624, PUB. 4-1-2003. MULTIPLE CLASS, INT. CLS. 9,
16, 35, 41 AND 42.
- AMERICAN ACADEMY OF OPHTHALMOLOGY, INC.,
SAN FRANCISCO, CA:
2,730,926, INT. CL. 16.
2,730,927, INT. CL. 41.
- AMERICAN AGIP CO., INC., CABOT, PA:
2,730,401, INT. CL. 4.
- AMERICAN AIRLINES, INC., DALLAS/FT. WORTH AIR-
PORT, TX:
1,228,737, REN. 5-10-03. INT. CL. 39.
- AMERICAN AIRLINES, INC., DFW AIRPORT, TX:
2,728,688, PUB. 4-1-2003. INT. CL. 36.
- AMERICAN AXLE & MANUFACTURING, INC., DETROIT,
MI:
2,729,441, INT. CL. 12.
- AMERICAN BANKERS INSURANCE ASSOCIATION, WA-
SHINGTON, DC:
2,729,800, MULTIPLE CLASS, INT. CLS. 35 AND 42.
- AMERICAN BANKERS LIFE ASSURANCE COMPANY OF
FLORIDA, MIAMI, FL:
1,203,899, CANC. INT. CL. 36.
- AMERICAN BRIDGE HOLDING COMPANY, CORAOPOL-
IS, PA, CONTINENTAL INVESTMENT CORP. B.V., 1077
XX AMSTERDAM, NETHERLANDS:
1,743,561, REN. 5-13-03. INT. CL. 37.
- AMERICAN CHAMBER OF COMMERCE EXECUTIVES,
INC., ALEXANDRIA, VA:
1,705,443, CANC. MULTIPLE CLASS, INT. CLS. 38 AND
42.
- AMERICAN CHIROPRACTIC BOARD OF SPORTS PHYSI-
CIANS, ESTHERVILLE, IA:
2,619,486, COR. U.S. CL. B.
- AMERICAN COLLEGE OF PHYSICIANS -AMERICAN SO-
CIETY OF INTERNAL MEDICINE, PHILADELPHIA, PA:
2,728,740, PUB. 4-1-2003. INT. CL. 16.
- AMERICAN CONTRACTORS ALLIANCE, INC., MT. LAUR-
EL, NJ:
2,729,162, PUB. 4-1-2003. INT. CL. 35.
- AMERICAN CREW, INC., DENVER, CO:
2,728,745, PUB. 4-1-2003. INT. CL. 3.
- AMERICAN CYANAMID COMPANY, MADISON, NJ,
AMERICAN CYANAMID COMPANY, NEW YORK 20,
NY:
556,245, REN. 5-12-03. U.S. CL. 18 (INT. CL. 5).
- AMERICAN CYANAMID COMPANY, WAYNE, NJ:
1,203,347, CANC. INT. CL. 5.
- AMERICAN DAIRY QUEEN CORPORATION, EDINA, MN:
954,524, REN. 5-16-03. U.S. CL. 46 (INT. CL. 30).
- AMERICAN DIETETIC ASSOCIATION, CHICAGO, IL:
2,728,832, PUB. 4-1-2003. INT. CL. 41.
2,728,833, PUB. 4-1-2003. MULTIPLE CLASS, INT. CLS. 36
AND 41.
- AMERICAN DIGITAL SYSTEMS, INC., SUDBURY, MA:
1,991,274, CANC. INT. CL. 9.
- AMERICAN EAGLE GROUP, INC., DALLAS, TX:
1,991,369, CANC. INT. CL. 36.
- AMERICAN EDUCATION PUBLISHING COMPANY,
WORTHINGTON, OH:
1,990,730, CANC. INT. CL. 9.
- AMERICAN EXPRESS COMPANY, NEW YORK, NY:
2,729,926, INT. CL. 39.
- AMERICAN FIBERS AND YARNS COMPANY, CHAPEL
HILL, NC:
2,729,539, MULTIPLE CLASS, INT. CLS. 23 AND 40.

- AMERICAN FOUNDATION FOR SURGERY OF THE HAND, AURORA, CO:
1,705,509, CANC. INT. CL. 41.
- AMERICAN GOLF DESIGN, INC., SIMSBURY, CT TO GOLFERS WAREHOUSE, HARTFORD, CT:
1,739,986, AM. INT. CL. 28.
- AMERICAN HEALTH DATA INSTITUTE, INC., INDIANAPOLIS, IN:
2,729,334, PUB. 4-1-2003. INT. CL. 35.
- AMERICAN HEALTHWAYS, INC., NASHVILLE, TN:
2,730,331, INT. CL. 35.
- AMERICAN HOME PRODUCTS CORPORATION, NEW YORK, NY, DBA WYETH LABORATORIES:
735,776, CANC. U.S. CL. 46.
- AMERICAN INSTITUTE OF BUILDING DESIGN, WESTPORT, CT:
1,991,009, CANC. U.S. CL. B.
- AMERICAN INSTITUTES FOR RESEARCH IN THE BEHAVIORAL SCIENCES, WASHINGTON, DC:
2,728,641, PUB. 4-1-2003. INT. CL. 35.
- AMERICAN INTERNATIONAL GROUP, INC., NEW YORK, NY, AMERICAN INTERNATIONAL LIFE ASSURANCE COMPANY OF NEW YORK, NEW YORK, NY:
1,232,166, REN. 5-10-03. INT. CL. 36.
- AMERICAN LIBRARY ASSOCIATION, CHICAGO, IL:
2,728,973, PUB. 4-1-2003. INT. CL. 16.
- AMERICAN METALSTITCH REPAIR & MACHINE WORKS, INC., BROOKLYN, NY TO JEANINE, DOLLEAR T., MATAWAN, NJ:
1,705,426, CANC. INT. CL. 37.
- AMERICAN NURSES ASSOCIATION, INC., WASHINGTON, DC:
2,728,890, PUB. 4-1-2003. INT. CL. 35.
- AMERICAN POWER CONVERSION CORP., WEST KINGSTON, RI, AMERICAN POWER CONVERSION CORP., WEST KINGSTON, RI:
1,811,964, REN. 5-16-03. INT. CL. 9.
- AMERICAN POWER CONVERSION CORP., WEST KINGSTON, RI, AMERICAN POWER CONVERSION CORP., WEST KINGSTON, RI:
1,811,966, REN. 5-16-03. INT. CL. 9.
- AMERICAN PROMOTIONAL EVENTS, INC., FLORENCE, AL:
1,991,293, CANC. INT. CL. 13.
1,991,453, CANC. INT. CL. 42.
- AMERICAN RAILWAY ENGINEERING AND MAINTENANCE-OF-WAY ASSOCIATION, INC., LANDOVER, MD:
2,417,355, AM. MULTIPLE CLASS, INT. CLS. 16 AND 42.
- AMERICAN SERVICE FINANCE, INC., DENVER, CO, DBA ASF INTERNATIONAL, INC.:
2,728,792, PUB. 4-1-2003. MULTIPLE CLASS, INT. CLS. 35 AND 36.
- AMERICAN SHELL COMPANY, INC., KNOXVILLE, TN:
1,706,063, CANC. INT. CL. 42.
- AMERICAN SIMMENTAL ASSOCIATION, BOZEMAN, MT:
2,729,715, INT. CL. 42.
- AMERICAN SPECIALTY UNDERWRITERS INC., STONEHAM, MA:
1,705,376, CANC. INT. CL. 36.
- AMERICAN SPORTS DESIGN COMPANY, SPRINGBORO, OH:
2,730,072, INT. CL. 12.
- AMERICAN STORES COMPANY, SALT LAKE CITY, UT:
1,204,128, CANC. INT. CL. 42.
1,992,127, CANC. INT. CL. 30.
- AMERICAN TISSUE CORPORATION, HAUPPAUGE, NY:
1,705,700, CANC. MULTIPLE CLASS, INT. CLS. 3 AND 16.
- AMERICAN TRANSPORTATION CORPORATION, CONWAY, AR:
1,704,805, CANC. INT. CL. 12.
- AMERICAN WOMAN'S ECONOMIC DEVELOPMENT CORPORATION, NEW YORK, NY:
1,788,522, REN. 5-10-03. INT. CL. 41.
- AMERICUS STOCK PROCESS CORP., WILMINGTON, DE:
1,991,889, CANC. INT. CL. 36.
- AMERIDENT INC., PITTSBURGH, PA:
1,991,730, CANC. INT. CL. 36.
- AMERIHEALTH SERVICES, INCORPORATED, BOSTON, MA:
1,990,797, CANC. INT. CL. 35.
- AMERILAB TECHNOLOGIES, INC., NEW HOPE, MN:
2,729,092, PUB. 4-1-2003. INT. CL. 5.
2,729,094, PUB. 4-1-2003. INT. CL. 5.
- AMERISERV FINANCIAL, INC., JOHNSTOWN, PA:
2,646,952, COR. MULTIPLE CLASS, INT. CLS. 35 AND 36.
- AMERISERV FINANCIAL, INC., JOHNSON, PA FROM USBANCORP, INC., JOHNSTOWN, PA:
2,730,051, MULTIPLE CLASS, INT. CLS. 35 AND 36.
- AMERISURE MUTAL INSURANCE COMPANY, FARMINGTON HILLS, MI FROM MICHIGAN MUTUAL INSURANCE COMPANY, FARMINGTON HILLS, MI, DBA AMERISURE COMPANIES:
2,729,688, MULTIPLE CLASS, INT. CLS. 35 AND 36.
- AMERITEC CORPORATION, COVINA, CA:
1,991,915, CANC. INT. CL. 9.
- AMERITEX, INC., HAVERFORD, PA:
2,730,903, INT. CL. 25.
2,730,904, INT. CL. 25.
- AMERSHAM BIOSCIENCES AB, UPPSALA, SWEDEN FROM AMERSHAM PHARMACIA BIOTECH AB, SE-751 84 UPPSALA, SWEDEN:
2,729,687, MULTIPLE CLASS, INT. CLS. 1 AND 9.
- AMES, MORGAN, BEVERLY HILLS, CA:
1,705,968, CANC. INT. CL. 41.
- AMETEK, INC., PAOLI, PA:
744,809, REN. 5-14-03. U.S. CL. 31 (INT. CL. 11).
- AMFAC GARDEN PRODUCTS, BURLINGAME, CA:
1,203,261, CANC. MULTIPLE CLASS, INT. CLS. 1, 2 AND 31.
- AMH CANADA LTD., RIMOUSKI, QUEBEC, CANADA, AMERICAN MACHINE & HYDRAULICS, INC., THOUSAND OAKS, CA:
974,333, REN. 5-15-03. U.S. CL. 23 (INT. CL. 7).
- AMIABLE TECHNOLOGIES, INC., PHILADELPHIA, PA:
1,991,185, CANC. INT. CL. 9.
- AMITY LEATHER PRODUCTS COMPANY, WEST BEND, WI:
961,820, REN. 5-16-03. U.S. CL. 3 (INT. CL. 18).
- AMOCO OIL COMPANY, CHICAGO, IL:
1,704,979, CANC. INT. CL. 17.
- AMOROSO'S BAKING COMPANY, PHILADELPHIA, PA:
1,224,445, REN. 5-14-03. INT. CL. 30.
1,254,121, REN. 5-14-03. INT. CL. 30.
- AMPRO INDUSTRIES, INC., BRADLEY, MI:
1,705,938, CANC. INT. CL. 31.
- AMS HOLDINGS, INC., SANTA ANA, CA:
2,729,067, PUB. 4-1-2003. INT. CL. 39.
- AMS RESEARCH CORPORATION, MINNETONKA, MN FROM AMERICAN MEDICAL SYSTEMS, INC., MINNETONKA, MN:
2,730,788, INT. CL. 10.
- AMS SERVICES, INC., WINDSOR, CT:
2,728,855, PUB. 4-1-2003. INT. CL. 36.
2,728,857, PUB. 4-1-2003. INT. CL. 36.
- AMSTED INDUSTRIES INCORPORATED, CHICAGO, IL, DIAMOND CHAIN COMPANY, INC., INDIANAPOLIS, IN:
752,031, REN. 5-16-03. U.S. CL. 23 (INT. CL. 7).
- AMT MACHINE SYSTEMS LTD., COLUMBUS, OH:
2,729,253, PUB. 4-1-2003. INT. CL. 9.
- AMX MANAGEMENT, INC., DALLAS, TX:
2,729,088, PUB. 4-1-2003. INT. CL. 37.
- AMYCEL, INC., WATSONVILLE, CA, AMFAC FOODS, INC., SAN JUAN BAUTISTA, CA:
1,202,244, REN. 5-10-03. INT. CL. 31.
- ANADOLU EFES TECHNICAL AND MANAGEMENT CONSULTANCY N.V., CURACAO, NETHERLD ANTILLES:
2,729,833, INT. CL. 32.
2,729,882, INT. CL. 32.
- ANAHEIM ANGELS L.P., ANAHEIM, CA, GOLDEN WEST BASEBALL COMPANY, ANAHEIM, CA:
1,232,818, REN. 5-16-03. INT. CL. 25.
- ANALYTICAL SPECTRAL DEVICES, INC., BOULDER, CO:
1,766,626, REN. 5-14-03. INT. CL. 9.

ANALYTICON AG BIOTECHNOLOGIE . PHARMAZIE,
10589 BERLIN, FED REP GERMANY:
2,728,472, PUB. 4-1-2003. MULTIPLE CLASS, INT. CLS. 1,
5 AND 9.

ANAMAX CORPORATION, GREEN BAY, WI:
2,728,689, PUB. 4-1-2003. INT. CL. 40.

ANCHOR CONTINENTAL, INC., COLUMBIA, SC:
1,704,912, CANC. MULTIPLE CLASS, INT. CLS. 16 AND
17.

ANDEL JEWELRY, LLC, LONG ISLAND CITY, NY:
2,730,417, INT. CL. 14.

ANDERS LERVAD & SON A/S, ASKOV, DENMARK:
1,203,385, CANC. MULTIPLE CLASS, INT. CLS. 7 AND
20.

ANDERSON AND ANDERSON INSURANCE BROKERS,
INC., NEWPORT BEACH, CA:
1,203,870, CANC. INT. CL. 36.

ANDERSON, DAVE E., SHAWNEE MISSION, MO:
2,729,979, INT. CL. 35.

ANDIN INTERNATIONAL INC., NEW YORK, NY:
1,704,837, CANC. INT. CL. 14.

ANDRE PROST, INC., OLD SAYBROOK, CT:
1,991,721, CANC. INT. CL. 30.

ANHEUSER-BUSCH, INCORPORATED, ST. LOUIS, MO:
1,991,955, CANC. INT. CL. 25.

ANIMA - SOCIETA' DI GESTIONE DEL RISPARMIO PER
AZIONI OR BRIEFLY "ANIMA S.G.R.P.A.", 20121 MILA-
NO, ITALY:
2,621,246, COR. INT. CL. 36.

ANITA LEWIS, NEW YORK, NY, DBA CAREER REVIEW
INCORPORATED:
1,992,188, CANC. MULTIPLE CLASS, INT. CLS. 9 AND
16.

ANNUITY BOARD OF THE SOUTHERN BAPTIST CON-
VENTION, DALLAS, TX:
1,718,731, REN. 5-10-03. INT. CL. 36.

ANSCHUTZ MANCHESTER HOCKEY, LLC, LOS AN-
GELES, CA:
2,729,937, MULTIPLE CLASS, INT. CLS. 21, 25, 28 AND
41.

ANSOFT CORPORATION, PITTSBURGH, PA:
1,704,678, CANC. INT. CL. 9.

ANSWER SYSTEMS, INC., CANOGA PARK, CA:
1,203,422, CANC. MULTIPLE CLASS, INT. CLS. 9 AND
16.

ANTARCTICA SYSTEMS INC., VANCOUVER B.C, CANA-
DA:
2,729,610, INT. CL. 42.
2,729,611, INT. CL. 9.

APACHE TECHNOLOGIES, INC., DAYTON, OH:
2,729,316, PUB. 4-1-2003. INT. CL. 9.

APEX INSURANCE COMPANY LIMITED, SCHENECTADY,
NY:
2,659,016, CANC. IIRN. RESTORED TO S.N. 76-348,215.

APOGEE HOLDINGS, INC., HOUSTON, TX:
2,730,752, MULTIPLE CLASS, INT. CLS. 35 AND 36.

APPLEBEE'S INTERNATIONAL, INC., OVERLAND PARK,
KS:
2,729,844, INT. CL. 33.

APPLEBY SYSTEMS, INC., YORK, PA:
1,992,135, CANC. MULTIPLE CLASS, INT. CLS. 6 AND
37.

APPLETON PAPERS INC., APPLETON, WI:
2,730,105, INT. CL. 16.

APPLI-TEC, INC., HAVERHILL, MA:
2,729,526, INT. CL. 1.

APPLIED BIOSYSTEMS/MDS SCIEX INSTRUMENTS, CON-
CORD, ONTARIO, CANADA:
2,730,949, INT. CL. 9.

APPLIED COMPUTER TECHNIQUES, INC., SALT LAKE
CITY, UT:
1,704,616, CANC. INT. CL. 9.

APPLIED SYSTEMS INTELLIGENCE, INC., ROSWELL, GA:
2,730,793, INT. CL. 9.

APPLIQUE SOCIETY, THE, SEATTLE, WA:
2,730,868, INT. CL. 41.

AQUA GLASS CORPORATION, ADAMSVILLE, TN:
2,730,504, INT. CL. 11.

AQUARIA, INC., MOORPARK, CA:
2,730,520, INT. CL. 1.

AQUEDUCT, INC., ALISO VIEJO, CA FROM BUYNOW
INC., ALISO VIEJO, CA:
2,729,856, MULTIPLE CLASS, INT. CLS. 35 AND 42.

AQUILA MERCHANT SERVICES, INC., KANSAS CITY, MO
FROM UTILICORP HOLDINGS INC., KANSAS CITY, MO:
2,729,627, MULTIPLE CLASS, INT. CLS. 36 AND 39.

ARAG INSURANCE COMPANY, DES MOINES, IA:
2,729,569, INT. CL. 36.

ARC SECOND, INC., STERLING, VA:
2,729,651, INT. CL. 9.

ARCH FOODS, INC., UNION, NJ:
1,771,647, REN. 5-16-03. INT. CL. 29.
1,771,647, AM. INT. CL. 29.

ARCHIE COMIC PUBLICATIONS, INC., MAMARONECK,
NY, ARCHIE COMIC PUBLICATIONS, INC., NEW YORK,
NY:
570,560, REN. 5-10-03. U.S. CL. 38 (INT. CL. 16).

AREL, RICHARD, ST-LEONARD D'ASTON, QUEBEC, CA-
NADA:
2,730,084, INT. CL. 8.

ARENA FOOTBALL LEAGUE LLC, CHICAGO, IL:
2,730,484, INT. CL. 41.

ARENA FOOTBALL LEAGUE, LLC, CHICAGO, IL:
2,730,414, MULTIPLE CLASS, INT. CLS. 16, 25 AND 41.

ARES-SERONO N.V. AMSTERDAM, SUCCURSALE DE
GENEVE, GENEVA, SWITZERLAND:
1,203,265, CANC. INT. CL. 1.

ARIS MULTIMEDIA ENTERTAINMENT, INC., MARINA
DEL REY, CA:
1,991,499, CANC. INT. CL. 28.

ARKOPHARMA S.A., CARROS, FRANCE:
2,730,603, INT. CL. 16.

ARMACELL UK LIMITED, UXBRIDGE, MIDDLESEX,
UNITED KINGDOM TO ARMSTRONG INSULATION
PRODUCTS LIMITED, UXBRIDGE, MIDDLESEX, UNI-
TED KINGDOM:
2,685,240, COR. INT. CL. 17.

ARMOUR-DIAL, INC., PHOENIX, AZ TO DIAL CORPORA-
TION, THE, PHOENIX, AZ:
1,203,293, CANC. INT. CL. 3.

ARMSTRONG, LANCE, AUSTIN, TX:
2,729,652, MULTIPLE CLASS, INT. CLS. 14, 25 AND 30.

ARNOLD, DANIEL, LOS ANGELES, CA:
1,991,658, CANC. INT. CL. 25.

AROMATIC RESEARCH & TECHNOLOGY, LC., PAYSON,
UT, DBA YOUNG LIVING ESSENTIAL OILS:
2,729,112, PUB. 4-1-2003. INT. CL. 5.

ARR-MAZ PRODUCTS, INC., WINTER HAVEN, FL:
1,990,747, CANC. INT. CL. 1.

ART ASYLUM, INC. THE, BROOKLYN, NY:
2,730,706, INT. CL. 28.

ARTHUR D. LITTLE, INC., CAMBRIDGE, MA:
735,804, CANC. U.S. CL. 100.

ARTISAN ENTERTAINMENT INC., SANTA MONICA, CA:
2,730,141, INT. CL. 9.

ASAHI FOODS CO., LTD., KUMIYAMA-CHO, KUSE-GUN,
KYOTO, JAPAN:
2,729,413, INT. CL. 30.

ASCENT TECHNOLOGY, INC., CAMBRIDGE, MA:
2,730,672, INT. CL. 9.

ASERRADEROS ARAUCO S.A., LAS CONDES, SANTIAGO,
CHILE:
2,730,276, INT. CL. 19.

ASHLAND INC., COVINGTON, KY, DREW CHEMICAL
CORPORATION, BOONTON, NJ:
969,456, REN. 5-13-03. U.S. CL. 6 (INT. CL. 1).

ASHLAND INC., COVINGTON, KY, ASHCHEM I.P., INC.,
DUBLIN, OH:
1,769,576, REN. 5-14-03. INT. CL. 1.
1,810,344, REN. 5-14-03. INT. CL. 1.

ASHLAND INC., COVINGTON, KY:
2,730,126, INT. CL. 5.

ASHMORE LIMITED, NEW BRUNSWICK, CANADA:
2,730,194, INT. CL. 19.

ASI TECHNOLOGIES, INC., MILWAUKEE, WI:
2,730,878, INT. CL. 11.

- ASK-A-DOC, INC., BURR RIDGE, IL:
1,757,390. REN. 5-16-03. INT. CL. 42.
- ASKHAM & TELHAM, LTD., WICKFORD, RI:
1,757,448. REN. 5-16-03. INT. CL. 42.
- ASPECT TELECOMMUNICATIONS CORPORATION, SAN JOSE, CA:
1,991,950. CANC. INT. CL. 9.
- ASPEN ENVIRONMENTAL, LTD., MUKILTEO, WA:
2,728,772. PUB. 4-1-2003. INT. CL. 40.
- ASPEN PET PRODUCTS, INC., DENVER, CO:
2,624,050. COR. MULTIPLE CLASS, INT. CLS. 6, 18 AND 28.
- ASPHALT MATERIALS, INC., INDIANAPOLIS, IN:
2,729,669. INT. CL. 19.
- ASSOCIATED BABY IMPRESSIONS, LTD., KELOWNA, BRITISH COLUMBIA, CANADA:
1,705,016. CANC. INT. CL. 20.
- ASSOCIATED HYGIENIC PRODUCTS, LLC, DULUTH, GA:
2,730,382. INT. CL. 16.
- ASSOCIATION AUTOMOTIVE AFTERMARKET DISTRIBUTORS, MEMPHIS, TN, PARTS, INC., MEMPHIS, TN:
1,756,370. REN. 5-16-03. MULTIPLE CLASS, INT. CLS. 4 AND 42.
- ASSOCIATION FOR AMERICAN HEALTH SPECIALISTS, MEXICO, MO:
2,729,698. INT. CL. 5.
- ASSOCIATION FOR CHALLENGE COURSE TECHNOLOGY, INC., MARTIN, MI:
2,730,696. INT. CL. 35.
- ASSOCIATION OF AUTOMOTIVE AFTERMARKET DISTRIBUTORS, MEMPHIS, TN:
2,729,514. INT. CL. 16.
- ASSOCIATION OF GOVERNMENT ACCOUNTANTS, ALEXANDRIA, VA:
2,730,934. INT. CL. 16.
2,730,935. INT. CL. 16.
- ASTEC INDUSTRIES, INC., CHATTANOOGA, TN:
2,730,883. INT. CL. 9.
- ASTRUP COMPANY, THE, CLEVELAND, OH:
1,181,824. REN. 5-12-03. INT. CL. 6.
- ASTUTE NETWORKS, INC., SAN DIEGO, CA:
2,730,173. INT. CL. 9.
- AT&T CORP., NEW YORK, NY:
1,990,745. CANC. INT. CL. 38.
1,992,108. CANC. INT. CL. 38.
1,992,109. CANC. INT. CL. 36.
2,730,692. INT. CL. 36.
2,730,782. INT. CL. 9.
- ATC CHEMICALS INC., BURLINGTON, ONTARIO, CANADA:
1,750,924. REN. 5-15-03. INT. CL. 2.
- ATHOC, INC., SAN FRANCISCO, CA:
2,729,848. INT. CL. 42.
- ATI TECHNOLOGIES, INC., THORNHILL, ONTARIO, CANADA:
1,991,723. CANC. INT. CL. 9.
- ATICO INTERNATIONAL USA INC., FORT LAUDERDALE, FL:
2,730,538. MULTIPLE CLASS, INT. CLS. 11, 20, 21 AND 26.
- ATKINSON, PATRICK J., BISMARCK, ND:
2,728,922. PUB. 4-1-2003. INT. CL. 37.
- ATOTECH DEUTSCHLAND GMBH, D-10553 BERLIN, FED REP GERMANY:
1,991,686. CANC. INT. CL. 1.
- ATTENZA.COM, INC., DALLAS, TX:
2,729,924. MULTIPLE CLASS, INT. CLS. 9 AND 42.
- AUCTIONWORKS.COM, INC., ATLANTA, GA:
2,730,433. INT. CL. 35.
- AUDIOTEK ELECTRONICS CORP., BROOKLYN, NY:
1,991,809. CANC. INT. CL. 9.
- AUGAT, INC., MANSFIELD, MA:
1,705,764. CANC. INT. CL. 9.
- AUGERSCOPE, INC., SYLMAR, CA:
1,761,031. REN. 5-16-03. INT. CL. 7.
- AURAFIN CORPORATION, SUNRISE, FL:
1,704,845. CANC. INT. CL. 14.
- AURIA CORPORATION, EDEN PRAIRIE, MN FROM QTECH SYSTEMS, INC., EDEN PRAIRIE, MN:
2,729,709. MULTIPLE CLASS, INT. CLS. 35 AND 41.
- AUSTIN DIVERSIFIED PRODUCTS, INC., HARVEY, IL:
2,728,995. PUB. 4-1-2003. INT. CL. 3.
- AUSTIN INDUSTRIAL COATINGS CORPORATION, MT. LEBANON, PA:
1,203,567. CANC. INT. CL. 19.
- AUSTIN, EMILY, SCOTTSDALE, AZ:
1,991,982. CANC. INT. CL. 25.
- AUTEC POWER SYSTEMS, INC., CHATSWORTH, CA:
1,704,643. CANC. INT. CL. 9.
- AUTEC, INC., STATESVILLE, NC, INTERNATIONAL AUTOCARE SERVICES, INC., STATESVILLE, NC:
1,757,835. REN. 5-16-03. MULTIPLE CLASS, INT. CLS. 1, 2, 3 AND 7.
- AUTO GLASS COMPONENTS, INC., CEDAR RAPIDS, IA:
2,729,351. PUB. 4-1-2003. INT. CL. 12.
- AUTO GLASS SPECIALISTS, INC., MADISON, WI:
1,764,890. REN. 5-14-03. INT. CL. 37.
- AUTO-SPARES CANADA INC., EDMONTON, AB T5S 1H7, CANADA:
2,728,824. PUB. 4-1-2003. MULTIPLE CLASS, INT. CLS. 9 AND 11.
- AUTOMATIC STEAM PRODUCTS CORP., LONG ISLAND CITY, NY:
1,203,472. CANC. INT. CL. 11.
- AUTOTECHNIK, INC., LOUISVILLE, KY:
2,730,200. INT. CL. 20.
- AVALON PHOTONICS, LTD., SWITZERLAND:
2,729,760. MULTIPLE CLASS, INT. CLS. 9, 14 AND 42.
- AVEDIS ZILDJIAN CO., NORWELL, MA:
2,730,485. INT. CL. 15.
- AVENUE, INC., THE, WILMINGTON, DE:
2,729,509. INT. CL. 26.
- AVERY DENNISON CORPORATION, PASADENA, CA:
2,730,564. INT. CL. 9.
- AVIAN SPECIALTIES, FT. LAUDERDALE, FL TO VENTURMED, INC., FT. LAUDERDALE, FL:
1,705,626. CANC. INT. CL. 42.
- AVID SPORTSWEAR, INC., CARSON, CA:
1,990,632. CANC. INT. CL. 25.
- AVON PRODUCTS, INC., NEW YORK, NY:
2,730,787. INT. CL. 3.
- AWADA, YEHA, LAS VEGAS, NV:
2,730,236. INT. CL. 41.
- AXIOM SYSTEMS LTD., BERKSHIRE RG41 5HU, ENGLAND:
2,729,928. INT. CL. 9.
- AXIS SYSTEMS, INC., SUNNYVALE, CA:
2,730,943. INT. CL. 9.
- AXON INSTRUMENTS, INC., UNION CITY, CA:
2,730,268. INT. CL. 9.
- AXT, INC., FREMONT, CA FROM AMERICAN XTAL TECHNOLOGY, INC., FREMONT, CA:
2,729,624. INT. CL. 1.
- AYALA, J. LUIS, NASHVILLE, TN:
2,730,193. INT. CL. 42.
- AZOCAR, JOSE, SPRINGFIELD, MA:
2,730,857. INT. CL. 5.
- AZTECA FOODS, INC., CHICAGO, IL:
1,788,335. REN. 5-13-03. INT. CL. 30.
- AZUMA FOODS INTERNATIONAL INC. U.S.A., HAYWARD, CA:
2,728,561. PUB. 4-1-2003. INT. CL. 30.
- B STORM, INC., AMHERST, OH:
2,729,662. INT. CL. 3.
- B. BRAUN MEDICAL, INC., BETHELEM, PA, MCGAW, INC., IRVINE, CA:
1,778,629. REN. 5-10-03. INT. CL. 5.
- B. SEPELT & SONS LIMITED, ARTARMON NSW 2064, AUSTRALIA:
1,231,289. REN. 5-13-03. INT. CL. 33.
- B.A.S.S., INC., MONTGOMERY, AL:
1,204,131. CANC. U.S. CL. 200.
- B.V.T.V., INC., MARSTONS MILLS, MA:
2,728,552. PUB. 4-1-2003. MULTIPLE CLASS, INT. CLS. 37 AND 42.

- B-CHIC, INC., NEW YORK, NY:
2,730,756, INT. CL. 35.
- BABCOCK & WILCOX COMPANY, THE, NEW ORLEANS, LA:
2,728,787, PUB. 4-1-2003. INT. CL. 42.
2,728,790, PUB. 4-1-2003. INT. CL. 42.
- BABE, INC., BRISBANE, CA:
1,992,129, CANC. INT. CL. 25.
- BABY GOLD JEWELRY, INC., EAST HANOVER, NJ:
1,757,620, REN. 5-16-03. INT. CL. 14.
- BAD IMAGE, INC., BRIDGEPORT, IL:
1,991,858, CANC. INT. CL. 25.
- BADGE-A-MINIT, LTD., OGLESBY, IL:
2,729,022, PUB. 4-1-2003. INT. CL. 8.
- BAILEY, JAMES THOMAS, HOLLYWOOD, CA:
2,730,939, INT. CL. 41.
- BAKER & COMPANY, INC., NEWARK, NJ TO GOLDSMITH & REVERE, INC., ENGLEWOOD, NJ:
307,550, AM. U.S. CL. 44.
- BAKER & TAYLOR, INC., CHARLOTTE, NC:
2,730,077, INT. CL. 35.
- BAKER HUGHES INCORPORATED, HOUSTON, TX:
1,757,550, REN. 5-14-03. INT. CL. 7.
2,730,577, INT. CL. 42.
- BAKER, BRUCE W., SACRAMENTO, CA:
2,729,000, PUB. 4-1-2003. INT. CL. 25.
- BALANCE DESIGNS, INC., MANCHESTER CENTER, VT:
2,729,429, MULTIPLE CLASS, INT. CLS. 25 AND 28.
- BALATONBOGLARI BORGAZDASAGI RT, BALATONBOGLAR, HUNGARY:
1,990,658, CANC. INT. CL. 33.
- BALD MOUNTAIN FARMS, INC., MCALESTER, OK:
2,729,875, INT. CL. 31.
- BALLANTINE GROUP, INC., THE, FRANKLIN, NJ:
1,991,149, CANC. INT. CL. 35.
- BALLARD, NORMAN, NEW YORK, NY:
2,729,401, INT. CL. 41.
- BALLET MAKERS, INC., TOTOWA, NJ:
1,991,423, CANC. INT. CL. 25.
- BALLINGER GOLD, INC., NEW YORK, NY FROM BIMOTEUR, INC., NEW YORK, NY:
2,730,149, INT. CL. 25.
- BALLY TOTAL FITNESS HOLDING CORPORATION, CHICAGO, IL:
2,730,263, INT. CL. 41.
- BANCNET INC., CLEVELAND, OH:
1,990,988, CANC. INT. CL. 42.
- BANDAG INCORPORATED, MUSCATINE, IA TO BANDAG INCORPORATED, MUSCATINE, IA:
2,581,374, COR. INT. CL. 12.
- BANFI PRODUCTS CORPORATION, OLD BROOKVILLE, NY, DBA BANFI VINTNERS:
1,705,302, CANC. INT. CL. 33.
- BANG GOLF INC., MONTEBELLO, CA:
2,728,968, PUB. 4-1-2003. INT. CL. 28.
- BANKERS SYSTEMS, INC., ST. CLOUD, MN:
2,728,518, PUB. 4-1-2003. INT. CL. 9.
- BANKSIA PRODUCTIONS PTY LIMITED, GREENWICH, NEW SOUTH WALES, AUSTRALIA:
2,729,386, INT. CL. 41.
- BANTAM DOUBLEDAY DELL PUBLISHING GROUP, INC.:
1,203,540, CANC. INT. CL. 16.
1,203,548, CANC. INT. CL. 16.
- BANTAM DOUBLEDAY DELL PUBLISHING GROUP, INC., NEW YORK, NY:
1,704,893, CANC. INT. CL. 16.
- BANTAM DOUBLEDAY DELL PUBLISHING GROUP, INC., NEW YORK, NY:
1,203,547, CANC. INT. CL. 16.
- BARACUDA INTERNATIONAL CORPORATION, FT. LAUDERDALE, FL TO ZODIAC POOL CARE, INC., FORT LAUDERDALE, FL:
2,113,115, AM. INT. CL. 7.
- BARAJAS, RICHARD, GRAND PRAIRIE, TX:
2,730,940, INT. CL. 36.
- BARCELO & CO., C. POR A., SANTO DOMINGO, DOMINICAN REP:
1,992,196, CANC. INT. CL. 33.
- BARCOLENE COMPANY, THE, HOLBROOK, MA:
735,524, CANC. U.S. CL. 6.
- BARKLEY EVERGREEN & PARTNERS, INC., KANSAS CITY, MO:
2,728,677, PUB. 4-1-2003. INT. CL. 35.
- BARLITE, INC., SAN ANTONIO, TX, AKA BARRETT INDUSTRIES:
1,203,566, CANC. MULTIPLE CLASS, INT. CLS. 19 AND 37.
- BARNARD INVESTMENTS, LLC, PASADENA, CA:
2,729,802, INT. CL. 16.
- BARNES & NOBLE, INC., NEW YORK, NY:
2,730,036, MULTIPLE CLASS, INT. CLS. 9, 14, 16, 18 AND 21.
- BARNIE'S COFFEE & TEA COMPANY, INC., ORLANDO, FL:
2,729,797, INT. CL. 30.
- BARR LABORATORIES, INC., POMONA, NY:
2,730,140, INT. CL. 5.
- BARRERE, WILLIAM, G., LAKE FOREST PARK, WA:
2,729,295, PUB. 4-1-2003. INT. CL. 42.
- BARRETT, ROBIN E., SOLANA BEACH, CA, DBA 'QUALITY-TIME' TOYS:
1,705,154, CANC. INT. CL. 28.
- BARRY'S JEWELERS INCORPORATED, MONROVIA, CA:
1,991,095, CANC. INT. CL. 36.
- BASF AKTIENGESELLSCHAFT, LUDWIGSHAFEN AM RHEIN, FED REP GERMANY:
2,729,759, INT. CL. 5.
- BASF AKTIENGESELLSCHAFT, FED REP GERMANY:
2,729,781, INT. CL. 1.
- BASF LACKE + FARBEN AG, 48165 MUENSTER, FED REP GERMANY:
1,991,850, CANC. INT. CL. 1.
- BASSIN' AMERICA INC., PORT JEFFERSON STATION, NY, DBA BASSIN' USA:
2,730,686, INT. CL. 41.
- BASTEL, VICTORIA (DOLPHINA), SANTA MONICA, CA:
2,729,850, INT. CL. 25.
- BATH UNLIMITED, INC., PASSAIC, NJ, MELARD MANUFACTURING CORPORATION, PASSAIC, NJ:
1,753,787, REN. 5-16-03. INT. CL. 11.
- BAUER & SCHAURTE KARCHER GMBH, NEUSS (RHINE), FED REP GERMANY:
735,637, CANC. U.S. CL. 26.
- BAUSCH & LOMB INCORPORATED, ROCHESTER, NY:
1,232,570, REN. 5-16-03. INT. CL. 9.
- BAXTER & CHARMING LTD., CARPENTERSVILLE, IL:
1,990,876, CANC. INT. CL. 18.
- BAY GULF CREDIT UNION, TAMPA, FL:
2,728,731, PUB. 4-1-2003. INT. CL. 36.
- BAY STREET SHIRT SOCIETY, LTD., MONROE, NC:
1,203,695, CANC. INT. CL. 25.
1,203,696, CANC. INT. CL. 25.
1,203,697, CANC. INT. CL. 25.
- BAYER AKTIENGESELLSCHAFT, D-51368 LEVERKUSEN-BAYERWERK, FED REP GERMANY:
2,387,138, CANC. INT. CL. 5.
- BAYER CORPORATION, PITTSBURGH, PA:
2,730,826, INT. CL. 5.
2,730,827, INT. CL. 10.
- BAYER POLYMERS LLC, PITTSBURGH, PA FROM BAYER CORPORATION, PITTSBURGH, PA:
2,730,759, INT. CL. 1.
2,730,839, INT. CL. 17.
2,730,840, INT. CL. 17.
- BAZELL TECHNOLOGIES CORPORATION, CONCORD, CA:
1,991,208, CANC. INT. CL. 7.
- BBC INTERNATIONAL LTD., BOCA RATON, FL:
2,729,733, INT. CL. 25.
- BBVA BANCOMER, S.A. INSTITUCION DE BANCA MULTIPLE, GRUPO FINANCIERO BBVA BANCOMER, MEXICO CITY 03339, MEXICO, BANCOMER, S.A., MEXICO CITY 12, MEXICO:
1,249,276, REN. 5-10-03. INT. CL. 36.

- BDSP, INC., RHEINBECK, NY, GREENWICH WORKSHOP, INC., THE, TRUMBULL, CT:
1,777,165. REN. 5-13-03. INT. CL. 16.
- BEACON NETWORKS, INC.:
See— PELAGO NETWORKS, INC..
- BEALL, RICHARD W. (SKIP) III, HERMOSA BEACH, CA:
1,785,640. REN. 5-10-03. INT. CL. 25.
- BEANSCENE ESPRESSO, INC., AGOURA, CA:
1,992,013. CANC. INT. CL. 30.
- BEAR VALLEY FOODS, ALBANY, CA:
1,231,527. REN. 5-16-03. INT. CL. 30.
- BEATRICE FOODS CO., CHICAGO, IL:
1,203,782. CANC. INT. CL. 30.
- BEAUTE CREATEURS (SOCIETE ANONYME), PARIS, FRANCE:
2,729,186. PUB. 4-1-2003. INT. CL. 3.
- BEAUTY BAZAR, INC., PALO ALTO, CA:
2,729,991. INT. CL. 42.
- BEAVER PLASTICS LTD., EDMONTON, ALBERTA, CANADA:
1,757,653. REN. 5-10-03. INT. CL. 21.
- BECKER, DUANE WM., WATKINS, MN:
2,730,007. INT. CL. 6.
- BECTON DICKINSON CRITICAL CARE SYSTEMS PTE LTD., FRANKLIN LAKES, NJ, GOULD INC., ROLLING MEADOWS, IL:
1,232,607. REN. 5-10-03. INT. CL. 10.
- BECTON, DICKINSON AND COMPANY, FRANKLIN LAKES, NJ:
2,730,480. MULTIPLE CLASS, INT. CLS. 5, 9 AND 10.
- BEDDING EXPERTS, INC., CAROL STREAM, IL:
2,730,307. INT. CL. 35.
- BEDFORD INDUSTRIES, INC., WORTHINGTON, MN:
2,730,128. INT. CL. 22.
- BEECH FINANCIAL SERVICES, LLC, STRATHAM, NH:
2,729,297. PUB. 4-1-2003. INT. CL. 36.
- BEECHAM INC., BRISTOL, TN:
1,203,322. CANC. INT. CL. 5.
1,203,325. CANC. INT. CL. 5.
- BEEVINWOOD, INC., WEST MANCHESTER, OH:
2,730,175. INT. CL. 11.
- BEHR GMBH & CO., D-70449 STUTTGART, FED REP GERMANY:
2,545,896. COR. MULTIPLE CLASS, INT. CLS. 7, 9, 11, 12 AND 37.
- BEIERSDORF AKTIENGESELLSCHAFT, 20245 HAMBURG, FED REP GERMANY:
2,728,777. PUB. 4-1-2003. INT. CL. 3.
- BELLRINGER SUPPLY CORPORATION, AMITYVILLE, NY:
2,729,185. PUB. 4-1-2003. INT. CL. 16.
- BELLSOUTH INTELLECTUAL PROPERTY CORPORATION, WILMINGTON, DE:
2,729,607. INT. CL. 16.
- BELMONT METALS, INC., BROOKLYN, NY, JACKSON-WHEELER METALS SERVICE, INC., NEW YORK, NY:
394,839. REN. 5-15-03. U.S. CL. 14 (INT. CL. 6).
- BEN & JERRY'S HOMEMADE HOLDINGS, INC., BURLINGTON, VT:
2,730,655. INT. CL. 1.
2,730,697. INT. CL. 30.
- BENCHMARK, INC., WYANDOTTE, MI:
1,203,263. CANC. INT. CL. 1.
- BENDATA INC., COLORADO SPRINGS, CO:
1,991,498. CANC. INT. CL. 9.
- BENEFIT RESOURCES INC., ROCHESTER, NY:
2,730,137. INT. CL. 9.
- BENELOGIC, LLC, TIMONIUM, MD:
2,729,242. PUB. 4-1-2003. MULTIPLE CLASS, INT. CLS. 35 AND 36.
- BENETTON SPORTSYSTEM USA, INC., BORDENTOWN, NJ:
2,730,426. INT. CL. 28.
- BENJAMIN FRANKLIN LITERARY AND MEDICAL SOCIETY, INC., THE, INDIANAPOLIS, IN:
1,761,278. REN. 5-14-03. INT. CL. 16.
- BENNINGTON GOLF COMPANY, INC., IRVINE, CA:
1,992,219. CANC. INT. CL. 28.
- BERENDSEN FLUID POWER, INC., TULSA, OK:
2,728,773. PUB. 4-1-2003. MULTIPLE CLASS, INT. CLS. 7, 9, 11 AND 17.
- BERG BOWS, BLOOMINGTON, IN:
1,752,446. REN. 5-14-03. INT. CL. 15.
- BERGEN BRUNSWIG CORPORATION, ORANGE, CA:
1,991,054. CANC. INT. CL. 35.
- BERINGER BLASS WINE ESTATES COMPANY, NAPA, CA:
2,730,515. INT. CL. 33.
2,730,516. INT. CL. 33.
- BERKEBILE OIL COMPANY, INC., THE, SOMERSET, PA:
1,196,034. REN. 5-14-03. MULTIPLE CLASS, INT. CLS. 1, 2, 3, 4 AND 12.
1,710,981. REN. 5-14-03. INT. CL. 1.
1,723,168. REN. 5-13-03. INT. CL. 3.
- BERLEX LABORATORIES, INC., WAYNE, NJ:
1,990,640. CANC. INT. CL. 41.
- BERMAN LEATHERCRAFT, INC.:
1,204,056. CANC. INT. CL. 42.
- BERNATELLO'S PIZZA, INC., MAPLE LAKE, MN FROM DADCO DIVERSIFIED, INC., EAU CLAIRE, WI:
2,729,506. INT. CL. 30.
- BERNHARDT INDUSTRIES, INC., LENOIR, NC:
1,203,587. CANC. INT. CL. 20.
- BERNSTEIN & SONS SHIRT CORP., NEW YORK, NY:
1,203,649. CANC. INT. CL. 25.
- BEST FRIENDS ANIMAL SANCTUARY, KANAB, UT:
2,729,039. PUB. 4-1-2003. INT. CL. 36.
- BEST PROCESS, INC., ROGERS, AR:
2,729,484. INT. CL. 5.
- BETTER HEALTHLAB, INC., WEST NEW YORK, NJ:
2,728,464. PUB. 7-24-2001. MULTIPLE CLASS, INT. CLS. 5, 11 AND 32.
- BEUTLICH, INC., CHICAGO, IL:
1,203,343. CANC. INT. CL. 5.
1,203,344. CANC. INT. CL. 5.
- BEVERAGE MARKETING USA, INC., LARCHMONT, NY:
1,990,827. CANC. INT. CL. 32.
- BEVERLY HILLS NATURAL PRODUCTS, INC., LOS ANGELES, CA:
1,773,900. REN. 5-13-03. INT. CL. 3.
- BH FITNESS AND RECREATION, INC., BROOKLYN, NY:
2,728,988. PUB. 4-1-2003. INT. CL. 35.
- BHEND, MARC Y.J., LYNNWOOD, WA:
2,729,366. INT. CL. 30.
- BI PROPERTIES I INC., GREENSBORO, NC:
2,730,024. INT. CL. 27.
2,730,318. INT. CL. 27.
2,730,387. INT. CL. 24.
- BIC CORPORATION, MILFORD, CT:
1,761,622. REN. 5-14-03. INT. CL. 34.
- BIENES RAICES METROPOLITANOS, S.A. DE C.V., MEXICO CITY, MEXICO:
2,730,353. INT. CL. 32.
- BIFFS, INC., SHAKOPEE, MN:
2,728,589. PUB. 4-1-2003. INT. CL. 9.
- BIG BALL SPORTS, INC., HOUSTON, TX:
1,990,624. CANC. INT. CL. 25.
- BIG BOB GIBSON BAR-B-Q, INC., DECATUR, AL:
2,730,062. INT. CL. 42.
- BIG WEST CORPORATION, CITY OF CORONA, CA:
2,729,062. PUB. 4-1-2003. INT. CL. 37.
- BIG WING WONG RESTAURANT, INC., NEW YORK, NY:
2,728,866. PUB. 4-1-2003. INT. CL. 43.
- BIGGUS, GLEN, GLEN ELLYN, IL:
2,729,604. INT. CL. 42.
- BIMBO BAKERIES USA, INC., FORT WORTH, TX:
2,728,896. PUB. 4-1-2003. INT. CL. 30.
- BINNEY & SMITH INC., EASTON, PA:
2,730,372. INT. CL. 16.
- BIO-THERAPEUTICS, LTD., GREEN BAY, WI, DBA PHYTOPHARMICA:
1,991,075. CANC. INT. CL. 5.
- BIOCENTER, INC., OAK CREEK, WI:
1,991,713. CANC. INT. CL. 1.
- BIOCHEM TECHNOLOGY, INC., MALVERN, PA:
1,204,046. CANC. INT. CL. 42.

BIOENHANCE TECHNOLOGIES, INC., SALISBURY, MD:
2,730,432, INT. CL. 5.

BIOSAFETY SYSTEMS, INC., SAN DIEGO, CA:
1,991,214, CANC. MULTIPLE CLASS, INT. CLS. 9 AND
10.

BIOSANTE PHARMACEUTICALS, INC., LINCOLNSHIRE,
IL TO BIOSANTE PHARMACEUTICALS, INC., LINCOLN-
SHIRE, IL:
2,585,471, COR. INT. CL. 5.

BIOSUN SYSTEMS CORPORATION, MAPLE GROVE, MN:
2,730,675, INT. CL. 1.

BIOSYS, INC., COLUMBIA, MD:
1,990,610, CANC. INT. CL. 1.

BIOWARE CORP., EDMONTON, ALBERTA, CANADA:
2,730,731, INT. CL. 9.

BIRDS OF A FEATHER, INT'L., LIGHTHOUSE POINT, FL:
2,729,061, PUB. 4-1-2003. INT. CL. 35.

BIRNBAUM; SEYMOUR, WOODLAND HILLS, CA, DBA
BIG FRANK:
1,204,100, CANC. INT. CL. 42.

BLACK & DECKER CORPORATION, THE, TOWSON, MD:
1,992,121, CANC. INT. CL. 16.

BLACK ENTERTAINMENT TELEVISION, INC., WASHING-
TON, DC:
2,730,234, INT. CL. 41.

BLACK-EYED PEA U.S.A., INC., DALLAS, TX:
1,991,164, CANC. INT. CL. 42.
1,992,039, CANC. INT. CL. 42.

BLACK-EYED SUSANS PRESS, PORTLAND, OR:
2,730,959, INT. CL. 16.

BLACKBOARD INC., WASHINGTON, DC:
2,729,998, INT. CL. 9.

BLACKHAM, ROSE, DENVER, CO:
2,729,803, INT. CL. 41.

BLACKHAWK LEATHER LTD., MILWAUKEE, WI:
1,704,994, CANC. INT. CL. 18.

BLACKWELL NORTH AMERICA, INC., LAKE OSWEGO,
OR:
1,990,995, CANC. INT. CL. 42.

BLACKWELL, JEFFREY, ERIC, HIGLEY, AZ:
2,730,946, INT. CL. 16.

BLACKWRAP SPORTS, INC, SAN DIEGO, CA:
2,728,586, PUB. 4-1-2003. MULTIPLE CLASS, INT. CLS. 28
AND 37.

BLAKELY, TIMOTHY D., CAMERON, NC:
2,729,149, PUB. 4-1-2003. INT. CL. 16.

BLANEY, MICHAEL JOHN, SANTA MONICA, CA:
2,729,528, INT. CL. 16.

BLINDMAN'S HOLIDAY, ITHACA, NY:
1,991,109, CANC. INT. CL. 41.

BLOCK FINANCIAL CORPORATION, KANSAS CITY, MO:
1,991,953, CANC. INT. CL. 36.

BLOOMING PRAIRIE COOPERATIVE WAREHOUSE, IOWA
CITY, IA:
2,729,163, PUB. 4-1-2003. MULTIPLE CLASS, INT. CLS. 35
AND 41.

BLUE CROSS AND BLUE SHIELD OC MASSACHUSETTS,
INC., BOSTON, MA:
1,704,862, CANC. INT. CL. 16.

BLUE FEATHER PRODUCTS, INC., ASHLAND, OR:
1,991,605, CANC. MULTIPLE CLASS, INT. CLS. 16 AND
20.

BLUE FOX SOLUTIONS, INC., MARIETTA, GA:
2,728,774, PUB. 4-1-2003. INT. CL. 42.

BLUE PRODUCTION, BRUSSELS, BELGIUM:
1,947,899, CANC. INT. CL. 20.

BLUE RIDGE PAPER PRODUCTS, INC., CANTON, NC:
2,728,786, PUB. 4-1-2003. INT. CL. 16.

BLUE SEAL FEEDS, INC., LONDONDERRY, NH:
2,730,777, INT. CL. 31.
2,730,778, INT. CL. 31.

BLUEBERRY BLVD., LLC, AMITYVILLE, NY:
2,730,561, INT. CL. 25.

BLUECROSS BLUESHIELD OF TENNESSEE, CHATTA-
NOOGA, TN:
2,729,257, PUB. 4-1-2003. INT. CL. 36.

BLUEGRASS CELLULAR, INC., ELIZABETHTOWN, KY:
1,755,743, REN. 5-10-03. INT. CL. 38.
1,755,744, REN. 5-10-03. INT. CL. 38.

BLUNT WRAP U.S.A., INC., COVINGTON, LA:
2,728,858, PUB. 4-1-2003. INT. CL. 25.

BNP PARIBAS, 75009 PARIS, FRANCE:
2,728,559, PUB. 8-20-2002. MULTIPLE CLASS, INT. CLS.
9, 35, 36 AND 38.

BOARD MACHINING COMPANY, RALEIGH, NC:
2,729,446, INT. CL. 7.

BOARD OF COOPERATIVE EDUCATIONAL SERVICES,
FIRST SUPERVISORY DISTRICT OF MONROE COUNTY,
NEW YORK (MONROE #1 BOCES), FAIRPORT, NY:
2,728,864, PUB. 4-1-2003. INT. CL. 41.

BOARD OF REGENTS OF THE UNIVERSITY OF TEXAS
SYSTEM, AUSTIN, TX:
1,236,756, REN. 5-16-03. INT. CL. 41.

BOARD OF REGENTS, THE UNIVERSITY OF TEXAS
SYSTEM, AUSTIN, TX:
1,230,433, REN. 5-16-03. INT. CL. 41.

BOB EVANS FARMS, INC., COLUMBUS, OH:
1,992,069, CANC. INT. CL. 29.

BOCA FOODS COMPANY, MADISON, WI:
2,730,751, INT. CL. 29.

BODY SHOP INTERNATIONAL PLC, THE, WEST SUSSEX
BN17 6LS, ENGLAND:
1,991,496, CANC. MULTIPLE CLASS, INT. CLS. 18, 21
AND 25.

BODY WISE INTERNATIONAL, INC., TUSTIN, CA:
1,786,437, REN. 5-10-03. INT. CL. 5.

BOEING MANAGEMENT COMPANY, SEAL BEACH, CA
FROM BOEING COMPANY, THE, SEATTLE, WA:
2,729,455, INT. CL. 28.

BOLLER, ANDREW, CH-8126 ZUMIKON, SWITZERLAND:
1,990,939, CANC. INT. CL. 9.

BOLNER'S FIESTA PRODUCTS, INC., SAN ANTONIO, TX:
1,758,556, REN. 5-12-03. INT. CL. 30.

BOMATIC, INC., ONTARIO, CA:
1,203,575, CANC. MULTIPLE CLASS, INT. CLS. 20 AND
21.
1,203,576, CANC. MULTIPLE CLASS, INT. CLS. 20 AND
21.

BONAR PLASTICS INC., WEST CHICAGO, IL:
1,705,014, CANC. INT. CL. 20.

BONT FOOTWEAR PTY LTD, NEW SOUTH WALES 2194,
AUSTRALIA FROM BONT SKATES PTY LTD, NEW
SOUTH WALES 2194, AUSTRALIA:
2,729,493, MULTIPLE CLASS, INT. CLS. 25 AND 28.

BONUS.COM INC., PALO ALTO, CA:
2,729,286, PUB. 4-1-2003. INT. CL. 41.

BOOGIES, INC., ROCHESTER, MN, DBA LITTLE BEAR
TRADING POST:
1,758,962, REN. 5-10-03. INT. CL. 42.

BOOTH, DANIEL, ITHACA, NY:
1,991,719, CANC. INT. CL. 9.

BOOZ ALLEN & HAMILTON INC., NEW YORK, NY TO
BOOZ ALLEN HAMILTON INC., NEW YORK, NY:
888,837, AM. U.S. CL. 101.

BOOZ-ALLEN & HAMILTON INC., NEW YORK, NY TO
BOOZ ALLEN HAMILTON INC., NEW YORK, NY:
1,634,966, AM. MULTIPLE CLASS, INT. CLS. 35 AND 42.

BORAL INDUSTRIES INC., ROSWELL, GA:
2,729,972, INT. CL. 1.

BORDEN, INC., COLUMBUS, OH:
736,133, CANC. U.S. CL. 46.

BORGHESE TRADEMARKS INC., WILMINGTON, DE:
1,991,925, CANC. INT. CL. 3.

BOSHART, DAVID, FORT MYERS, FL, DBA NATIONAL
ART PUBLISHING:
1,990,904, CANC. INT. CL. 16.

BOSON SOFTWARE, INC., TAMPA, FL:
2,730,953, INT. CL. 9.

BOTHHAND ENTERPRISE INC., TAINAN, TAIWAN:
2,729,646, INT. CL. 9.

BOYD COFFEE COMPANY, PORTLAND, OR:
1,232,261, REN. 5-15-03. INT. CL. 42.

- BRADY CAMPAIGN TO PREVENT GUN VIOLENCE, WASHINGTON, DC FROM HANDGUN CONTROL, INC., WASHINGTON, DC:
2,728,516, PUB. 4-1-2003. MULTIPLE CLASS, INT. CLS. 16, 18, 21, 25, 26, 36 AND 42.
- BRAIN POWER INCORPORATED, MIAMI, FL:
1,991,107, CANC. MULTIPLE CLASS, INT. CLS. 9 AND 25.
- BRAINSVILLE.COM, BERKELEY, CA:
2,730,583, MULTIPLE CLASS, INT. CLS. 9, 41 AND 42.
- BRAKE SENTRY, LLC, ASHEVILLE, NC FROM FLEET MAINTENANCE TECHNOLOGIES, INC., PANAMA CITY, FL:
2,729,530, INT. CL. 12.
- BRAMBLES INDUSTRIES LIMITED, NEW SOUTH WALES 2000, AUSTRALIA:
1,705,357, CANC. INT. CL. 35.
- BRAND X INC., THAYER, MO:
2,730,457, INT. CL. 31.
- BRANDSIDE CORPORATION, SAN MATEO, CA:
2,730,466, INT. CL. 35.
- BREAKTHROUGH COMMUNICATIONS, INC., NORTH-BROOK, IL:
2,730,104, INT. CL. 35.
- BREAKTHROUGHS ABROAD, INC., ESTES PARK, CO:
2,729,962, MULTIPLE CLASS, INT. CLS. 41 AND 42.
- BRICK/GOOD HIGH MUSIC, ATLANTA, GA:
1,203,987, CANC. INT. CL. 41.
- BRIGATO, CRUMOLO DELLE ABB. (VI), ITALY:
1,991,513, CANC. INT. CL. 14.
- BRIGGS & STRATTON CORPORATION, WAUWATOSA, WI. BRIGGS & STRATTON CORPORATION, WAUWATOSA, WI:
1,765,564, REN. 5-10-03. MULTIPLE CLASS, INT. CLS. 7 AND 12.
- BRIGGS & STRATTON CORPORATION, WAUWATOSA, WI:
2,730,201, INT. CL. 7.
- BRIGHT BEGINNINGS, DENVER, CO:
2,729,407, INT. CL. 41.
- BRIGHTON ANALYTICAL, INC., BRIGHTON, MI:
1,991,127, CANC. INT. CL. 42.
- BRIGHTPOINT, INC., INDIANAPOLIS, IN:
2,729,911, MULTIPLE CLASS, INT. CLS. 35, 36, 37, 39 AND 42.
- BRIMMS INC., TONAWANDA, NY:
735,783, CANC. U.S. CL. 51.
- BRINSTER, TRAVIS S., TEMPE, AZ:
1,991,169, CANC. INT. CL. 41.
- BRITCHES OF GEORGETOWNE, INC., WASHINGTON, DC, CANTERBURY TALES, INC., HERDON, VA:
942,463, REN. 5-13-03. U.S. CL. 101 (INT. CL. 42).
942,838, REN. 5-13-03. U.S. CL. 39 (INT. CL. 25).
- BRITISH STEEL LIMITED:
See—CORUS UK LIMITED.
- BRONCHICK, WILLIAM, AURORA, CO:
2,728,575, PUB. 4-1-2003. MULTIPLE CLASS, INT. CLS. 41 AND 42.
- BRONNER ENTERPRISES, INC., BRIDGEPORT, MI, DBA NU CLEAN PRODUCTS:
1,990,716, CANC. INT. CL. 3.
- BRONSON PHARMACEUTICAL, LA CANADA, CA:
1,203,331, CANC. INT. CL. 5.
- BROOKTROUT, INC., NEEDHAM, MA:
2,730,211, INT. CL. 9.
- BROWARD MARINE, INC., FT. LAUDERDALE, FL:
1,704,799, CANC. MULTIPLE CLASS, INT. CLS. 12 AND 36.
- BROWN, AGATHA, ORANJESTAD, ARUBA:
2,730,711, INT. CL. 3.
- BROWN, LINDSEY M., MARIETTA, GA AND BROWN, JUDITH W., MARIETTA, GA:
2,729,378, INT. CL. 16.
- BROWNING SEED, INC., PLAINVIEW, TX:
1,991,471, CANC. INT. CL. 31.
- BROWNING-FERRIS INDUSTRIES, INC., HOUSTON, TX:
1,705,421, CANC. INT. CL. 37.
1,705,431, CANC. INT. CL. 37.
1,705,432, CANC. INT. CL. 37.
- BRUCE DAU FARMS, SANTA CRUZ, CA:
1,705,274, CANC. INT. CL. 31.
- BRUCE FOODS CORPORATION, NEW IBERIA, LA:
961,644, REN. 5-10-03. U.S. CL. 46 (INT. CLS. 29, 30 AND 32).
- BRUNDAGE MOUNTAIN COMPANY, MCCALL, ID:
1,990,807, CANC. INT. CL. 41.
- BRUNSWICK CORPORATION, SKOKIE, IL:
1,756,710, REN. 5-16-03. INT. CL. 12.
- BRUNSWICK CORPORATION, LAKE FOREST, IL:
1,991,114, CANC. INT. CL. 25.
- BRYAN CAVE LLP, ST. LOUIS, MO:
2,729,608, INT. CL. 42.
- BRYAN, BRUCE, BEVERLY HILLS, CA:
2,729,450, INT. CL. 28.
- BRYAN, CHRISTOPHER A., VALLEJO, CA:
1,992,204, CANC. INT. CL. 41.
- BUCHANAN INGERSOLL PROFESSIONAL CORPORATION, PITTSBURGH, PA:
2,729,862, MULTIPLE CLASS, INT. CLS. 36 AND 42.
- BUCKSHOT, INC., WILMINGTON, NC:
2,730,269, INT. CL. 6.
- BUENA VISTA UNIVERSITY, STORM LAKE, IA:
2,728,852, PUB. 4-1-2003. INT. CL. 41.
- BUFFALO GUYS, LLC, THE, ELK MOUNTAIN, WY FROM GREAT PLAINS BISON CO. LLC, ELK MOUNTAIN, WY:
2,730,491, INT. CL. 29.
- BUFFETT, JIMMY, KEY WEST, FL:
2,729,442, MULTIPLE CLASS, INT. CLS. 18, 20, 21, 24, 25 AND 28.
2,730,407, INT. CL. 29.
- BUFFTREE BUILDING COMPANY, INC., NEW BEDFORD, MA:
2,729,564, INT. CL. 36.
- BUGATTI, CHARLES, SARASOTA, FL AND BUGATTI, STEPHANIE, SARASOTA, FL:
2,728,726, PUB. 4-1-2003. INT. CL. 3.
- BUGLE BOY INDUSTRIES, INC., SIMI VALLEY, CA:
1,991,422, CANC. INT. CL. 25.
1,991,426, CANC. INT. CL. 25.
- BUILD-A-BEAR WORKSHOP, INC., ST. LOUIS, MO FROM BUILD-A-BEAR WORKSHOP, L.L.C., ST. LOUIS, MO:
2,729,448, INT. CL. 28.
2,729,572, INT. CL. 28.
- BUILDERS CLUB, INC., MINNEAPOLIS, MN:
1,823,143, REN. 5-15-03. INT. CL. 35.
- BUKOWSKI DESIGNS USA, INC., FULLERTON, CA:
1,992,180, CANC. MULTIPLE CLASS, INT. CLS. 18 AND 25.
- BULGARTABAC HOLDING AD, 1000 SOFIA, BULGARIA:
2,729,747, INT. CL. 34.
- BULGARTABAC HOLDING AD AND NIKOLAI SIMEONOV MALINOV PARTNERSHIP, THE, 1000 SOFIA, BULGARIA:
2,729,891, INT. CL. 34.
- BULLDOG SAUCE KABUSHIKI KAISHA, CHUO-KU, TOKYO, JAPAN, TA BULL-DOG SAUCE CO., LTD.:
2,729,748, INT. CL. 30.
- BUM EQUIPMENT LLC, MENDHAM, NJ:
1,226,743, REN. 5-16-03. INT. CL. 25.
- BUM EQUIPMENT LLC, MENDHAM, NJ, CHAUVIN INTERNATIONAL LTD., LOS ANGELES, CA:
1,753,290, REN. 5-16-03. INT. CL. 25.
- BURBERRY LIMITED, LONDON, SW1Y 4DQ, GB, UNITED KINGDOM:
2,728,709, PUB. 4-1-2003. INT. CL. 24.
- BUREAU OF TRANSLATION SERVICES, INC., HADDONFIELD, NJ:
1,990,683, CANC. INT. CL. 42.
- BURES, FRANK, WINONA, MN:
1,232,725, REN. 5-10-03. INT. CL. 16.
- BURGESS-CASSLER, ANTHONY, VANCOUVER, WA:
2,729,264, PUB. 4-1-2003. INT. CL. 42.

- BURN STEWART DISTILLERS PLC, GLASGOW, UNITED KINGDOM:
1,991,472, CANC. INT. CL. 33.
- BURTON CORPORATION, THE, BURLINGTON, VT:
2,728,608, PUB. 4-1-2003. INT. CL. 41.
- BURWYN, INC., WESTON, MA:
1,990,737, CANC. INT. CL. 25.
- BUSHNELL CORPORATION, OVERLAND PARK, KS:
1,992,058, CANC. INT. CL. 9.
- BUSINESS ENGINE CORPORATION, SAN FRANCISCO, CA, MICRO-FRAME TECHNOLOGIES, INC., ONTARIO, CA:
1,761,183. REN. 5-16-03. INT. CL. 9.
- BUSINESS FOR SOCIAL RESPONSIBILITY, SAN FRANCISCO, CA:
2,101,407, COR. MULTIPLE CLASS, INT. CLS. 35 AND 41.
- BUSINESS MATTERS INCORPORATED, WALTHAM, MA:
1,990,925, CANC. INT. CL. 9.
- BUSINESS PROCESS OUTSOURCING LTD., PORT LOUIS, MAURITIUS FROM BPO SERVICES INC., NEW YORK, NY:
2,729,773, INT. CL. 35.
- BUSS AG, BASEL, SWITZERLAND:
1,991,491, CANC. MULTIPLE CLASS, INT. CLS. 9 AND 11.
- BUYERZONE.COM, INC., WATERTOWN, MA:
2,069,337, AM. INT. CL. 35.
- BUYLINKONLINE.COM CORPORATION, SANTA FE SPRINGS, CA:
2,729,480, MULTIPLE CLASS, INT. CLS. 9 AND 35.
- BVS ENTERTAINMENT, INC., LOS ANGELES, CA:
2,729,152, PUB. 4-1-2003. INT. CL. 28.
- C & C FIBERGLASS COMPONENTS, INC., BRISTOL, RI:
2,728,991, PUB. 4-1-2003. INT. CL. 12.
- C & F FOODS INC., CITY OF INDUSTRY, CA:
1,991,825, CANC. INT. CL. 29.
- C & G CATERING AND SPECIALTY PRODUCTS CO., NEW ORLEANS, LA:
1,722,255. REN. 5-14-03. INT. CL. 30.
- C & M KNITTING MILLS, INC., RIDGEWOOD, NY:
1,991,967, CANC. INT. CL. 25.
- C S SPORTSWEAR, INC., AGOURA HILLS, CA:
1,991,839, CANC. INT. CL. 25.
- C. A. WELLS, INC., SHELBY TOWNSHIP, MI, FOTOSHOW, MINNEAPOLIS, MN:
1,766,704. REN. 5-14-03. INT. CL. 16.
- C. P. INDUSTRIES, SALT LAKE CITY, UT:
1,710,984. REN. 5-14-03. INT. CL. 1.
- C.E.C. INDUSTRIAL CONSULTANTS INC., RICHMOND-HILL, ONTARIO, CANADA:
2,728,514, PUB. 4-1-2003. INT. CL. 9.
- C.I. KASEI CO. LTD., TOKYO, 104, JAPAN:
1,990,634, CANC. INT. CL. 1.
- C.K.L. DISTRIBUTING COMPANY, INC., WESTLAKE, OH:
1,991,355, CANC. INT. CL. 21.
- C/HCA, INC., NASHVILLE, TN:
2,729,895, INT. CL. 42.
- CABOULI, PAULINE, CHAPPAQUA, NY:
2,730,012, INT. CL. 35.
- CACIOLI, LISA, NORTH HAVEN, CT:
2,730,496, INT. CL. 16.
2,730,497, INT. CL. 41.
- CACTUS COMMUNICATIONS LLC:
See— PRESCRIBING REFERENCE, INC..
- CADILLAC SHOE PRODUCTS INC, WIXOM, MI:
1,752,665. REN. 5-13-03. INT. CL. 25.
- CADOPENER.COM, LLC, PROSPECT, CT:
2,729,331, PUB. 4-1-2003. INT. CL. 42.
- CAE VANGUARD, INC., MINNEAPOLIS, MN:
1,705,418, CANC. INT. CL. 37.
- CAFE MOTO, SAN DIEGO, CA:
2,728,465, PUB. 4-1-2003. INT. CL. 30.
- CAI INC, GEORGETOWN, MA:
2,730,829, INT. CL. 2.
2,730,830, INT. CL. 2.
2,730,833, INT. CL. 2.
- CAIRNRYAN AB, S-102 31 STOCKHOLM, SWEDEN:
1,932,532, CANC. MULTIPLE CLASS, INT. CLS. 9 AND 16.
- CAIRNS & BROTHER INC., CLIFTON, NJ:
1,991,162, CANC. INT. CL. 9.
1,991,163, CANC. INT. CL. 9.
- CAKE BOX INC, LAFAYETTE, CA:
2,729,145, PUB. 4-1-2003. INT. CL. 30.
- CAL INDIA FOODS INTERNATIONAL, CHINO, CA, DBA SPECIALTY ENZYMES AND BIOCHEMICALS CO.:
2,730,000, INT. CL. 1.
- CALDAHO SNACKS, INC., FOUNTAIN VALLEY, CA:
1,991,136, CANC. MULTIPLE CLASS, INT. CLS. 29 AND 30.
- CALDOR CORPORATION, THE, NORWALK, CT:
1,705,675, CANC. INT. CL. 42.
- CALIFORNIA K-9 ACADEMY, INC., BURBANK, CA, RODRIGUEZ, HOWARD, BURBANK, CA, DBA CALIFORNIA K-9 ACADEMY:
1,757,276. REN. 5-16-03. INT. CL. 41.
- CALIFORNIA MEDICAL ASSOCIATION, SAN FRANCISCO, CA:
1,990,646, CANC. INT. CL. 35.
- CALL O' DA WILD, NEW YORK, NY:
1,991,430, CANC. INT. CL. 41.
- CALLAWAY GOLF COMPANY, CARLSBAD, CA:
2,730,748, INT. CL. 28.
- CALOR S.A., LYON, FRANCE:
735,613, CANC. U.S. CL. 23.
- CAMILLE JUMELLE CO. INC., PALM SPRINGS, CA:
1,991,010, CANC. INT. CL. 25.
- CAMP GOOD DAYS & SPECIAL TIMES, INC., MENDON, NY:
1,991,323, CANC. INT. CL. 41.
- CAMPBELL, CLINTON D., CHELAN, WA:
1,705,936, CANC. INT. CL. 31.
- CANADA LIFE ASSURANCE COMPANY, THE, ATLANTA, GA:
2,729,307, PUB. 4-1-2003. INT. CL. 36.
- CANADA MINK BREEDERS ASSOCIATION, MISSISSAUGA, ONTARIO, CANADA:
1,204,137, CANC. U.S. CL. A.
- CANADELLE LIMITED PARTNERSHIP, MONTREAL, QUEBEC, CANADA:
2,730,568, INT. CL. 25.
- CANANDAIGUA BRANDS, INC., FAIRPORT, NY TO CONSTELLATION BRANDS, INC., FAIRPORT, NY:
2,283,408, AM. INT. CL. 33.
- CANDA ENTERPRISE CO. LTD., BURNABY B.C., CANADA:
1,757,036. REN. 5-16-03. MULTIPLE CLASS, INT. CLS. 29 AND 30.
- CANDA ENTERPRISE CO. LTD., BURNABY, BRITISH COLUMBIA, CANADA:
1,760,064. REN. 5-15-03. MULTIPLE CLASS, INT. CLS. 29 AND 30.
- CANDA ENTERPRISE CO. LTD., BURNABY BRITISH COLUMBIA, CANADA:
1,760,065. REN. 5-15-03. MULTIPLE CLASS, INT. CLS. 29, 30 AND 32.
- CANNON ASSOCIATES, SAN LUIS OBISPO, CA:
2,728,892, PUB. 4-1-2003. MULTIPLE CLASS, INT. CLS. 37 AND 42.
- CAP GEMINI ERNST & YOUNG U.S. LLC, NEW YORK, NY:
2,674,248, COR. INT. CL. 35.
2,730,918, INT. CL. 35.
- CAPE COTTAGE LIMITED, BUCKINGHAMSHIRE SL1 8DF, ENGLAND:
2,660,993, COR. MULTIPLE CLASS, INT. CLS. 9, 25, 39, 41 AND 42.
- CAPEL, INCORPORATED, TROY, NC:
1,704,960, CANC. INT. CL. 16.
- CAPITAL HEALTH SYSTEM SERVICES, HARRISBURG, PA:
1,991,406, CANC. INT. CL. 42.
- CAPITAL ONE FINANCIAL CORPORATION, GLEN ALLEN, VA:
2,730,809, INT. CL. 36.

- CAPRI SUN, INC., SAN MATEO, CA:
2,730,738, INT. CL. 32.
- CAPX CORPORATION, INC., MIAMI BEACH, FL:
1,991,771, CANC. INT. CL. 36.
- CARBOLOY INC., WARREN, MI:
1,711,165, REN. 5-15-03, INT. CL. 7.
- CARDIAC PATHWAYS CORPORATION, SUNNYVALE, CA:
1,991,993, CANC. INT. CL. 10.
- CARDREADY INTERNATIONAL, INC., CULVER CITY, CA:
2,729,416, INT. CL. 36.
- CARDSOFT INTERNATIONAL PTY LIMITED, MANLY NSW 2095, AUSTRALIA:
2,729,502, MULTIPLE CLASS, INT. CLS. 9 AND 42.
- CARESSA, INC., MIAMI, FL TO AMASIA INTERNATIONAL LTD., BURLINGTON, MA:
1,228,560, AM. INT. CL. 25.
- CARL CORPOATION, DENVER, CO:
1,991,931, CANC. INT. CL. 9.
- CARL CORPORATION, DENVER, CO:
1,991,934, CANC. INT. CL. 9.
- CARL-ZEISS-STIFTUNG, WUERTTEMBERG, FED REP GERMANY, DBA CARL ZEISS:
1,704,699, CANC. INT. CL. 9.
- CARL-ZEISS-STIFTUNG, 73446 OBERKOCHEN, FED REP GERMANY, DBA CARL ZEISS:
2,728,691, PUB. 4-1-2003, INT. CL. 9.
- CARLEY, TORRANCE, CA:
1,747,754, REN. 5-13-03, INT. CL. 11.
- CARMOTIVE, LLC, SACRAMENTO, CA FROM WICKLAND OIL COMPANY, SACRAMENTO, CA:
2,730,428, INT. CL. 37.
- CARNIVAL AIR LINES, INC., DANIA, FL:
1,990,878, CANC. INT. CL. 39.
- CARNIVAL CRUISE LINES, INC., MIAMI, FL:
1,203,944, CANC. INT. CL. 39.
- CAROLINA SOFTWARE INC., WILMINGTON, NC:
1,819,430, REN. 5-11-03, INT. CL. 9.
- CARR, ADAM, YORK, PA AND CARR, BRIAN, YORK, PA AND CARR, ERIC, YORK, PA:
2,729,175, PUB. 4-1-2003, INT. CL. 41.
- CARRIER CORPORATION, SYRACUSE, NY, WHITE CONSOLIDATED INDUSTRIES, INC., CLEVELAND, OH:
1,220,762, REN. 5-16-03, INT. CL. 11.
- CARTER-WALLACE, INC., NEW YORK, NY:
735,576, CANC. U.S. CL. 18.
- CARTER, GARTH, MINERSVILLE, UT:
2,729,408, MULTIPLE CLASS, INT. CLS. 16 AND 25.
- CARTIER INCORPORATED, NEW YORK, NY:
1,203,591, CANC. INT. CL. 20.
- CARTIER INTERNATIONAL B.V., AMSTERDAM, NETHERLANDS:
1,756,765, REN. 5-14-03, INT. CL. 16.
- CARY AUDIO DESIGN, INC., CARY, NC:
1,705,561, CANC. INT. CL. 42.
- CASA DE FRUTA, HOLLISTER, CA:
1,771,672, REN. 5-16-03, INT. CL. 29.
1,772,089, REN. 5-16-03, INT. CL. 42.
- CASCADE ENGINEERING, INC., GRAND RAPIDS, MI:
2,730,411, INT. CL. 37.
2,730,469, INT. CL. 37.
- CASEMARK, INC., WILMINGTON, DE:
2,729,013, PUB. 4-1-2003, INT. CL. 8.
- CASHFLOW TECHNOLOGIES, INC., PARADISE VALLEY, AZ:
2,729,449, INT. CL. 41.
- CASIO KEISANKI KABUSHIKI KAISHA, SHIBUYA-KU, TOKYO, JAPAN, DBA CASIO COMPUTER CO., LTD.:
2,729,600, INT. CL. 15.
- CASPIAN TRADITION S.A., WATERLOO, BELGIUM:
2,728,598, PUB. 5-7-2002, INT. CL. 29.
- CAST & CREW PAYROLL, INC. AND ELECTRONIC MEDIA RESEARCH GROUP, INC., BURBANK, CA:
1,991,949, CANC. INT. CL. 35.
- CASTLE MORTGAGE CORPORATION, BIRMINGHAM, AL:
1,758,732, REN. 5-12-03, INT. CL. 36.
- CAT-LINKS, INC., SANTA ANA, CA:
1,704,724, CANC. MULTIPLE CLASS, INT. CLS. 9 AND 40.
- CATHEDRAL CANDLE COMPANY, SYRACUSE, NY:
1,787,786, REN. 5-11-03, INT. CL. 4.
- CATHOLIC TELECOM, LLC, ATLANTA, GA:
2,730,180, MULTIPLE CLASS, INT. CLS. 38 AND 42.
- CATO CORPORATION, THE, CHARLOTTE, NC:
1,788,619, REN. 5-13-03, INT. CL. 42.
- CAVAS DEL CONDE S.A., BUENOS AIRES, ARGENTINA:
2,730,060, INT. CL. 33.
2,730,061, INT. CL. 33.
- CD GARDEN INC., STEVENSON, WA:
2,730,593, INT. CL. 9.
- CEBECO INTERNATIONAL SEEDS, INC., HALSEY, OR:
2,730,050, INT. CL. 31.
- CELEBRATION HALLOWEEN, INC., INDIANAPOLIS, IN:
2,729,320, PUB. 4-1-2003, INT. CL. 3.
- CELESTRON INTERNATIONAL, TORRANCE, CA:
1,204,142, CANC. INT. CL. 9.
- CELLEX MANUFACTURING INC., LONDON, ONTARIO, CANADA:
1,704,771, CANC. INT. CL. 11.
- CELLOMICS, INC., PITTSBURGH, PA:
2,729,890, INT. CL. 9.
2,730,242, INT. CL. 9.
- CENICEROS, DANA, OJAI, CA AND CENICEROS, DAWN, OJAI, CA AND CENICEROS, JAMES G., OJAI, CA AND CENICEROS, PEGGY, OJAI, CA:
1,991,514, CANC. INT. CL. 25.
- CENTAPH INC., BOLTON, MA:
2,730,800, INT. CL. 42.
- CENTEK INDUSTRIES, INC., THOMASVILLE, GA:
2,730,486, INT. CL. 7.
- CENTER FOR THE ELIMINATION OF VIOLENCE IN THE FAMILY, INC., BROOKLYN, NY:
2,730,895, INT. CL. 42.
- CENTER FOR WORK REHABILITATION, INC., LAFAYETTE, LA:
2,729,198, PUB. 4-1-2003, INT. CL. 44.
- CENTERRE HEALTHCARE CORPORATION, ST. LOUIS, MO:
2,730,808, INT. CL. 44.
- CENTOCOR, INC., MALVERN, PA:
2,730,005, INT. CL. 42.
- CENTRAL COMPOUNDING COMPANY, CHICAGO, IL:
735,541, CANC. U.S. CL. 11.
- CENTRAL IMPULSORA, S.A. DE C.V., MEXICO CITY, MEXICO FROM MRS BAIRD'S BAKERIES BUSINESS TRUST, FORT WORTH, TX:
2,728,487, PUB. 4-1-2003, MULTIPLE CLASS, INT. CLS. 30 AND 40.
- CENTRAL NATIONAL-GOTTESMAN INC., PURCHASE, NY:
1,756,767, REN. 5-16-03, INT. CL. 16.
1,758,274, REN. 5-16-03, INT. CL. 16.
- CENTRAL SPRINKLER CORPORATION, LANSDALE, PA:
1,704,621, CANC. INT. CL. 9.
- CENTRE NATIONAL DE LA RECHERCHE SCIENTIFIQUE, 75794 PARIS CEDEX 16, FRANCE:
2,728,537, PUB. 7-9-2002, MULTIPLE CLASS, INT. CLS. 35, 38 AND 39.
- CENTRIC MEDIA, INC., BERKELEY, CA:
2,729,543, INT. CL. 42.
2,729,671, INT. CL. 42.
- CEREBROS MEDICAL SYSTEMS, LLC., DUNMORE, PA:
2,730,869, INT. CL. 9.
- CEREP SA, 75007 PARIS, FRANCE:
2,729,462, INT. CL. 42.
- CERRO TORRE CO., LTD, SEOUL, REPUBLIC OF KOREA AND SIM, BON SOO, SEOUL, REPUBLIC OF KOREA:
2,729,710, MULTIPLE CLASS, INT. CLS. 18, 25 AND 28.
- CERTAINTED CORP., VALLEY FORGE, PA:
2,728,977, PUB. 4-1-2003, INT. CL. 19.
- CERTAINTED CORPORATION, VALLEY FORGE, PA:
1,705,853, CANC. INT. CL. 19.
- CERTEK SOFTWARE DESIGNS, INC., PLAINFIELD, NJ:
2,729,547, INT. CL. 9.

- CERTIFIED LEARNING IN COSMETOLOGY, INC., READING, PA:
2,730,956, MULTIPLE CLASS, INT. CLS. 16 AND 42.
- CERTIPORT, INC., AMERICAN FORK, UT FROM NIVO INTERNATIONAL CORPORATION, AMERICAN FORK, UT:
2,730,168, MULTIPLE CLASS, INT. CLS. 41 AND 42.
- CFAS, L.L.C., PISCATAWAY, NJ:
2,728,962, PUB. 4-1-2003. INT. CL. 16.
- CFI MANUFACTURING, INC., SARASOTA, FL:
2,730,195, MULTIPLE CLASS, INT. CLS. 18 AND 20.
- CHAFFIN INC., PALM BEACH GARDENS, FL:
1,990,684, CANC. INT. CL. 42.
- CHAMP INDUSTRIES, INC., NEW YORK, NY:
2,729,142, PUB. 4-1-2003. INT. CL. 7.
- CHAMPION BRANDS, L.L.C., CLINTON, MO, LOWE OIL COMPANY, CLINTON, MO:
1,810,400. REN. 5-10-03. INT. CL. 4.
- CHAMPION INTERNATIONAL CORPORATION, STAMFORD, CT:
1,203,519, CANC. INT. CL. 16.
- CHAMPION SOLUTIONS GROUP, INC., BOCA RATON, FL:
2,730,924, INT. CL. 42.
- CHANCELLOR PUBLICATIONS, INC., MIAMI SHORES, FL:
2,730,875, INT. CL. 16.
- CHANDLER, HERMAN L., JR., ROSELLE, NJ, DBA UNIFIED DELEGATION OF INTELLIGENT GENTLEMEN AND MAYES, DENNIS, ROSELLE, NJ, DBA UNIFIED DELEGATION OF INTELLIGENT GENTLEMEN AND ROBINSON, CHRISTOPHER O., ROSELLE, NJ, DBA UNIFIED DELEGATION OF INTELLIGENT GENTLEMEN AND SEGARS, TOMMIE, ROSELLE, NJ, DBA UNIFIED DELEGATION OF INTELLIGENT GENTLEMEN AND TATE, LARRY, ROSELLE, NJ, DBA UNIFIED DELEGATION OF INTELLIGENT GENTLEMEN:
2,729,385, INT. CL. 25.
- CHANDRASEKHAR, MEERA, COLUMBIA, MO:
2,730,755, INT. CL. 9.
- CHANNEL ISLANDS CREAM LIQUEURS, ST. PETER PORT, GUERNSEY, CHANNEL ISLANDS:
1,991,461, CANC. INT. CL. 33.
- CHANNELLOCK, INC., MEADVILLE, PA, CHAMPION DE ARMENT TOOL COMPANY, MEADVILLE, PA:
756,374. REN. 5-10-03. U.S. CL. 23 (INT. CL. 8).
- CHAPIN, HOWARD DAY, EDMONDS, WA:
2,730,638, INT. CL. 9.
- CHAPMAN, DIANE YVONNE, ALISO VIEJO, CA, DBA WORDS TO YOUR ADVANTAGE:
2,730,819, INT. CL. 16.
- CHARGED INJECTION CORPORATION, MONMOUTH JUNCTION, NJ:
1,991,644, CANC. INT. CL. 7.
1,991,645, CANC. INT. CL. 7.
- CHARLES RIVER BROADCASTING COMPANY, WALTHAM, MA:
2,730,925, INT. CL. 41.
- CHARLES SCHWAB & CO., INC., SAN FRANCISCO, CA:
1,819,177. REN. 5-15-03. MULTIPLE CLASS, INT. CLS. 35 AND 36.
2,625,452, COR. INT. CL. 36.
2,643,251, COR. MULTIPLE CLASS, INT. CLS. 36 AND 41.
2,729,517, INT. CL. 16.
- CHARLOTTE CONVENTION AND VISITORS BUREAU, INC., CHARLOTTE, NC:
1,991,807, CANC. INT. CL. 35.
- CHARONNAT, LEAL ROYCE, BERKELEY, CA:
1,705,623, CANC. INT. CL. 42.
- CHARTER ONE FINANCIAL INC., CLEVELAND, OH:
1,757,180. REN. 5-14-03. INT. CL. 36.
- CHASE MANHATTAN CORPORATION, THE, NEW YORK, NY:
1,203,905, CANC. INT. CL. 36.
- CHASE PRODUCTS COMPANY, MAYWOOD, IL:
2,728,895, PUB. 4-1-2003. MULTIPLE CLASS, INT. CLS. 3, 4 AND 5.
- CHASE, ALLISON, HALF MOON BAY, CA, DBA VENTANA PICTURES:
1,991,287, CANC. INT. CL. 41.
- CHATAM INTERNATIONAL INCORPORATED, WILMINGTON, DE:
1,759,223. REN. 5-16-03. INT. CL. 33.
2,730,859, INT. CL. 33.
- CHATEAU ANNE U.S.A INC., ALHAMBRA, CA:
1,840,549, COR. INT. CL. 18.
- CHATHAM IMPORTS, INC., NEW YORK, NY:
1,991,153, CANC. INT. CL. 32.
- CHAUNCEY, THOMAS, SAN FRANCISCO, CA:
2,730,055, INT. CL. 41.
- CHEESE LAND, INC., SEATTLE, WA:
2,730,912, INT. CL. 29.
- CHEMI S.P.A., CINISELLO BALSAMO (MILAN), ITALY:
2,730,410, INT. CL. 1.
- CHEMICAL BANKING CORPORATION, NEW YORK, NY:
1,990,780, CANC. INT. CL. 36.
- CHEMICAL RESEARCH CORPORATION, ATLANTA, GA:
1,990,940, CANC. INT. CL. 3.
- CHERNE INDUSTRIES INCORPORATED, MINNEAPOLIS, MN:
2,730,517, INT. CL. 11.
- CHESAPEAKE BAY BREWING COMPANY, LA PLATA, MD:
2,729,706, INT. CL. 32.
- CHESAPEAKE SPECIALTY PRODUCTS, INC., BALTIMORE, MD:
2,728,951, PUB. 4-1-2003. INT. CL. 1.
- CHEVIOT BRIDGE PTY LTD, MELBOURNE, VICTORIA 3004, AUSTRALIA:
2,729,810, INT. CL. 33.
- CHEVRONTEXACO CORPORATION, SAN FRANCISCO, CA:
2,729,246, PUB. 4-1-2003. INT. CL. 16.
- CHF INDUSTRIES, INC., NEW YORK, NY FROM CHF INDUSTRIES, INC., NEW YORK, NY:
2,729,985, INT. CL. 24.
- CHICAGO CODING SYSTEMS, INC., ST. CHARLES, IL:
2,729,522, MULTIPLE CLASS, INT. CLS. 9 AND 16.
- CHICAGO DECAL COMPANY, CHICAGO, IL:
1,203,450, CANC. INT. CL. 9.
- CHICAGO DIETETIC SUPPLY, INC., LA GRANGE, IL:
396,868, CANC. U.S. CL. 46.
- CHICAGO STOCK EXCHANGE, INCORPORATED, CHICAGO, IL:
2,729,947, INT. CL. 9.
- CHICKASAW BANC HOLDING COMPANY, YUKON, OK:
2,730,684, INT. CL. 36.
- CHIEF AUTO PARTS, INC., SEAGOVILLE, TX:
1,705,760, CANC. INT. CL. 8.
- CHIEF LEGAL EXECUTIVE LLC, OAKLAND, CA:
2,730,933, INT. CL. 16.
- CHILDREN AWAITING PARENTS, INC., ROCHESTER, NY:
1,716,917. REN. 5-13-03. INT. CL. 42.
1,722,791. REN. 5-13-03. INT. CL. 42.
1,722,793. REN. 5-10-03. INT. CL. 42.
- CHILDS & ALBERT, INC., RING DIVISION, VALENCIA, CA:
1,754,886. REN. 5-16-03. INT. CL. 7.
- CHINA NATIONAL NATIVE PRODUCE AND ANIMAL BY-PRODUCTS IMPORT AND EXPORT CORPORATION, PEKING, CHINA:
1,203,646, CANC. INT. CL. 25.
- CHINA TRADE & RESEARCH, INC., GOLETA, CA:
1,992,049, CANC. INT. CL. 25.
- CHIQUITA BRANDS, INC., CINCINNATI, OH:
1,992,124, CANC. INT. CL. 32.
- CHIRICO, DUANE, DALLAS, GA:
2,729,303, PUB. 4-1-2003. INT. CL. 41.
- CHIRON CORPORATION, EMERYVILLE, CA:
1,991,421, CANC. INT. CL. 5.
- CHLORKING, INC., CHAMBLEE, GA:
2,729,014, PUB. 4-1-2003. INT. CL. 7.
- CHOATE, NICK, MOORE, OK:
2,728,954, PUB. 4-1-2003. INT. CL. 27.

- CHOCTAW NATION OF OKLAHOMA, DURANT, OK:
2,729,223, PUB. 4-1-2003. INT. CL. 43.
- CHOI, JAE K., CERRITOS, CA:
2,729,950, INT. CL. 16.
- CHOICE HOTELS INTERNATIONAL, INC., SILVER SPRING, MD:
2,729,999, INT. CL. 42.
- CHOICE ONE COMMUNICATIONS, INC., ROCHESTER, NY:
2,729,597, INT. CL. 42.
- CHOO CHOO IMPORTS, PORTLAND, OR:
2,729,879, INT. CL. 20.
- CHORHERRENSTIFT KLOSTERNEUBURG STIFTSBETRIEBE GESELLSCHAFT M.B.H., KLOSTERNEUBURG NIEDEROSTERREICH, AUSTRIA, DBA STIFT KLOSTERNEUBURG:
1,203,824, CANC. INT. CL. 33.
- CHOU, ALEC, TAINAN CITY, TAIWAN:
2,729,598, INT. CL. 28.
- CHR. STORZ GMBH & CO. KG, TUTTLINGEN, FED REP GERMANY:
2,728,732, PUB. 4-1-2003. INT. CL. 30.
- CHRISTIAN DIOR COUTURE, S.A., 75008 PARIS, FRANCE, CHRISTIAN DIOR, SOCIETE A RESPONSABILITE LIMITEE, PARIS, FRANCE:
954,257, REN. 5-10-03. U.S. CL. 3 (INT. CL. 18).
- CHRISTIAN DIOR, S.A., 75008 PARIS, FRANCE, CHRISTIAN DIOR, SOCIETE A RESPONSABILITELIMITEE, PARIS, FRANCE:
954,415, REN. 5-10-03. U.S. CL. 27 (INT. CL. 14).
- CHRISTIAN LE BRET, 75017, PARIS, FRANCE:
2,728,582, PUB. 6-25-2002. INT. CL. 35.
- CHRISTIAN NETWORK, INC., THE, CLEARWATER, FL:
2,728,806, PUB. 4-1-2003. INT. CL. 38.
- CHRISTIAN, JANICE, WEST CHESTER, PA:
2,730,481, INT. CL. 35.
- CHRISTIE, BRIAN, FAIRFAX, VA:
2,730,612, INT. CL. 18.
- CHRISTOPHER CORPORATION, THE, MICHIGAN CITY, IN:
1,704,998, CANC. INT. CL. 18.
- CHRISTY REFRACTORIES COMPANY, L.L.C., ST. LOUIS, MO:
2,729,860, INT. CL. 19.
- CHUM LIMITED, TORONTO, ONTARIO, M4T 1Y1, CANADA:
2,728,485, PUB. 4-1-2003. INT. CL. 41.
- CHUNSHENG, LIU, XUPU JIANGSU 21190, CHINA:
2,565,867, CANC. INT. CL. 35.
- CHURCH & DWIGHT COMPANY, GREEN RIVER, WY, CHURCH & DWIGHT COMPANY, GREEN RIVER, WY:
1,769,065, REN. 5-10-03. INT. CL. 3.
- CHURCH & DWIGHT COMPANY, GREEN RIVER, WY:
2,729,277, PUB. 4-1-2003. INT. CL. 3.
- CHURCH BROTHERS COLLISION REPAIR, LLC, INDIANAPOLIS, IN:
2,729,104, PUB. 4-1-2003. INT. CL. 37.
- CIA. IGUACU DE CAFE SOLUVEL, CORNELIO PROCOPIO, PARANA, BRAZIL:
2,728,770, PUB. 4-1-2003. INT. CL. 30.
- CIBER, INC., GREENWOOD VILLAGE, CO:
2,730,136, INT. CL. 35.
- CIGNA INTELLECTUAL PROPERTY, INC., WILMINGTON, DE FROM CIGNA CORPORATION, PHILADELPHIA, PA:
2,729,527, MULTIPLE CLASS, INT. CLS. 9, 35 AND 42.
- CIM INTERNATIONAL (HK) LTD., 6900 LUGANO, SWITZERLAND:
2,667,778, COR. INT. CL. 19.
- CINCINNATI GASKET, PACKING & MANUFACTURING, INC., CINCINNATI, OH:
1,253,589, REN. 5-16-03. MULTIPLE CLASS, INT. CLS. 6, 17, 19 AND 22.
- CINEASTRAL PRODUCTIONS, INC., OCEANSIDE, CA:
2,729,239, PUB. 4-1-2003. INT. CL. 41.
- CINEMA GROUP, INC., LOS ANGELES, CA:
1,204,012, CANC. INT. CL. 41.
- CINEMAR CORPORATION, BEAVERTON, OR:
1,990,850, CANC. INT. CL. 9.
- CINQ, LTD., NEW YORK, NY:
2,730,253, INT. CL. 25.
- CIRCLE OF FRIENDS, LLC, CHATSWORTH, CA:
2,728,935, PUB. 4-1-2003. INT. CL. 3.
- CIRCOL.NET, INC., CARMEL, IN:
2,730,115, INT. CL. 35.
- CIRCUIT CITY STORES WEST COAST, INC., WALNUT, CA:
2,729,888, INT. CL. 36.
- CIRIO DEL MONTE ITALIA S.P.A., 00187 ROMA, ITALY:
2,728,799, PUB. 4-1-2003. INT. CL. 29.
- CIRRUS LOGIC, INC., AUSTIN, TX:
1,758,804, REN. 5-11-03. MULTIPLE CLASS, INT. CLS. 40 AND 42.
- CIT GROUP/BUSINESS CREDIT, INC., THE, NEW YORK, NY FROM CONTINENTAL SPRAYERS INTERNATIONAL, INC., ST. PETERS, MO:
2,729,397, INT. CL. 21.
- CITGO PETROLEUM CORPORATION, TULSA, OK:
2,730,774, INT. CL. 4.
- CITICORP, NEW YORK, NY:
1,991,088, CANC. INT. CL. 36.
- CITICORP SECURITIES, INC., NEW YORK, NY:
1,991,748, CANC. INT. CL. 36.
- CITIZEN TOKEI KABUSHIKI KAISHA, TOKYO, JAPAN, TA CITIZEN WATCH CO., LTD.:
1,991,819, CANC. INT. CL. 14.
- CITIZENS AND SOUTHERN NATIONAL BANK, THE, ATLANTA, GA:
1,203,880, CANC. INT. CL. 36.
- CITIZENS FINANCIAL GROUP, INC., PROVIDENCE, RI:
2,729,472, INT. CL. 36.
- CITIZENS' SCHOLARSHIP FOUNDATION OF AMERICA, INC., ST. PETER, MN:
2,729,120, PUB. 4-1-2003. INT. CL. 36.
2,729,124, PUB. 4-1-2003. INT. CL. 36.
- CITRUS CONCENTRATES, INC., DUNEDIN, FL TO COCA-COLA COMPANY, THE, ATLANTA, GA:
385,165, AM. U.S. CL. 45.
- CLAD HOLDINGS CORP., CANONSBURG, PA:
2,730,862, INT. CL. 21.
- CLARE, PAMELA, POTOMAC, MD:
2,729,110, PUB. 4-1-2003. INT. CL. 41.
- CLARIANT GMBH, 65926 FRANKFURT, FED REP GERMANY:
2,729,631, INT. CL. 1.
- CLARION MARKETING GROUP, INC., LENEXA, KS:
2,730,113, INT. CL. 41.
- CLARK BROS. FARMING, DOS PALOS, CA:
1,705,278, CANC. INT. CL. 31.
- CLARK, WILLIAM, JACKSONVILLE, FL:
2,730,922, INT. CL. 41.
- CLAYTON HOLDINGS LIMITED, ROTORUA, NEW ZEALAND:
2,728,671, PUB. 4-1-2003. INT. CL. 19.
2,728,672, PUB. 4-1-2003. INT. CL. 19.
2,728,673, PUB. 4-1-2003. INT. CL. 19.
2,728,674, PUB. 4-1-2003. INT. CL. 19.
2,728,675, PUB. 4-1-2003. INT. CL. 19.
2,728,676, PUB. 4-1-2003. INT. CL. 19.
- CLEANPIX, INC., CALGARY, ALBERTA, CANADA FROM VIGNEAULT, NELSON, CALGARY ALBERTA, T2G 3M3, CANADA:
2,730,110, INT. CL. 35.
- CLEARSNAP, INC., ANACORTES, WA:
2,729,267, PUB. 4-1-2003. INT. CL. 16.
2,729,341, PUB. 4-1-2003. INT. CL. 16.
- CLEVO CO., SAN-CHUNG CITY, TAIPEI COUNTY, TAIWAN:
2,729,504, INT. CL. 9.
- CLICKNSSETTLE.COM, INC., GREAT NECK, NY FROM NAM CORPORATION, GREAT NECK, NY:
2,729,592, INT. CL. 42.
- CLOROX COMPANY, THE, OAKLAND, CA:
2,662,637, COR. INT. CL. 35.
- CLOUGHERTY PACKING CO., LOS ANGELES, CA:
955,962, REN. 5-16-03. MULTIPLE CLASS, U.S. CLS. 105 (INT. CL. 39) AND 106 (INT. CL. 40).

- CLUB COULOIR ACTIONWEAR INC., VANCOUVER, B.C., CANADA:
2,730,621, INT. CL. 25.
- CLUTTER CONTROL INC., FARMINGTON HILLS, MI:
1,203,578, CANC. MULTIPLE CLASS, INT. CLS. 20, 37 AND 42.
- CLYDE BERGEMANN INC., ATLANTA, GA:
2,730,948, INT. CL. 9.
- CM PUBLISHING LIMITED PARTNERSHIP, DARIEN, CT,
CM PUBLISHING LIMITED PARTNERSHIP, DARIEN, CT:
1,759,788, REN. 5-10-03, INT. CL. 16.
- CMP MEDIA LLC, MANHASSET, NY FROM CMP MEDIA INC., MANHASSET, NY:
2,729,839, INT. CL. 42.
- CNA FINANCIAL CORPORATION, CHICAGO, IL:
2,729,096, PUB. 4-1-2003, MULTIPLE CLASS, INT. CLS. 35 AND 36.
- CNA HOLDINGS, INC., SUMMIT, NJ:
2,730,613, INT. CL. 22.
- CNF INC., PALO ALTO, CA:
2,728,926, PUB. 4-1-2003, MULTIPLE CLASS, INT. CLS. 35 AND 39.
- CO.DON AKTIENGESSELLSCHAFT, 14513 TELTOW, FED REP GERMANY:
2,728,600, PUB. 4-1-2003, MULTIPLE CLASS, INT. CLS. 10, 40 AND 42.
- COAL, SANTA MONICA, CA:
1,990,863, CANC. INT. CL. 41.
- COAST TO COAST PLACEMENTS, INC., FT. MYERS, FL:
2,730,937, INT. CL. 35.
- COASTAL PET PRODUCTS, INC., ALLIANCE, OH:
1,245,846, REN. 5-16-03, INT. CL. 18.
2,728,956, PUB. 4-1-2003, INT. CL. 6.
- COBE LABORATORIES, INC., LAKEWOOD, CO:
1,991,490, CANC. INT. CL. 10.
- COBRA COMPLIANCE SYSTEMS, INC., COLDWATER, MI:
2,730,334, INT. CL. 36.
- COCA-COLA COMPANY, THE, ATLANTA, GA:
1,203,818, CANC. INT. CL. 32.
2,730,476, INT. CL. 32.
- COCCO JRH, INC., FT. LAUDERDALE, FL:
1,991,371, CANC. INT. CL. 42.
- COCOWEB.COM, LLC, SHREWSBURY, MA:
2,729,199, PUB. 4-1-2003, INT. CL. 9.
- COFFEE EXPRESS CO., PLYMOUTH, MI:
2,728,458, PUB. 4-1-2003, MULTIPLE CLASS, INT. CLS. 21, 25 AND 30.
- COFFEE TIMES, INC., NEW YORK, NY:
1,991,568, CANC. INT. CL. 42.
- COFFEY INVESTMENTS, L.L.C., HOUSE SPRINGS, MO:
2,730,088, INT. CL. 16.
- COGER INDUSTRIES, INC., LAS VEGAS, NV:
1,992,214, CANC. INT. CL. 21.
- COGNAC GAUTIER S.A., 16140 AIGRE, FRANCE, MARIE BRIZARD ET ROGER, INC., NEW YORK, NY:
1,763,171, REN. 5-14-03, INT. CL. 33.
- COGNIS CORPORATION, CINCINNATI, OH:
2,729,992, INT. CL. 1.
- COIN ACCEPTORS, INC., ST. LOUIS, MO:
2,730,506, INT. CL. 9.
- COLDER PRODUCTS COMPANY, ST. PAUL, MN:
2,729,487, INT. CL. 17.
- COLE & ASHCROFT, INC., HOUSTON, TX:
2,729,976, INT. CL. 16.
- COLEMAN COMPANY, INC., THE, WICHITA, KS:
1,991,985, CANC. INT. CL. 11.
- COLGATE-PALMOLIVE COMPANY, NEW YORK, NY:
2,730,952, INT. CL. 3.
- COLLA-TEC, INC., PLAINSBORO, NJ TO COLLA-TEC, INC., PLAINSBORO, NJ:
2,039,217, COR. INT. CL. 5.
- COLLEGIATE LICENSING COMPANY, THE, ATLANTA, GA:
2,730,556, INT. CL. 35.
- COLLIER, LANCE, CLEVELAND, OH:
2,730,383, INT. CL. 41.
- COLM ENGINEERING INC., CHERRY HILL, NJ:
1,203,532, CANC. MULTIPLE CLASS, INT. CLS. 16 AND 42.
- COLOMER MUNMANY, S.A., 08500 VIC (BARCELONA), SPAIN:
950,168, REN. 5-12-03, U.S. CL. 1 (INT. CL. 18).
- COLONIAL LIFE & ACCIDENTIAL INSURANCE COMPANY, COLUMBIA, SC:
2,730,258, INT. CL. 36.
- COLOPLAST CORP., MARIETTA, GA:
2,730,412, INT. CL. 10.
- COLORADO COMMODITIES MANAGEMENT CORPORATION, ENGLEWOOD, CO:
1,203,889, CANC. INT. CL. 36.
- COLORAMICS, LLC, HILLIARD, OH:
2,729,227, PUB. 4-1-2003, INT. CL. 20.
- COLORLAB COSMETICS, INC., ROCKFORD, IL:
2,730,518, INT. CL. 3.
- COLORYTE INC., NORCROSS, GA:
2,729,384, MULTIPLE CLASS, INT. CLS. 9, 10, 16, 40 AND 42.
- COLUMBIA PICTURES TELEVISION, INC., CULVER CITY, CA:
2,730,364, INT. CL. 41.
- COLUMBIA SPORTSWEAR NORTH AMERICA, INC., PORTLAND, OR:
2,729,263, PUB. 4-1-2003, INT. CL. 20.
- COLUMBUS CIRCLE INVESTORS, STAMFORD, CT:
2,729,914, INT. CL. 36.
2,729,915, INT. CL. 36.
2,729,917, INT. CL. 36.
- COLUMBUS PROFIVAC GMBH REINIGUNGSMASCHINEN, D-70372 STUTTGART, FED REP GERMANY:
1,990,901, CANC. MULTIPLE CLASS, INT. CLS. 7 AND 9.
- COMBINED TALENTS, INC., HARLAN, IN:
2,729,741, INT. CL. 11.
- COMBY, HOUILLES, FRANCE:
2,729,275, PUB. 4-1-2003, MULTIPLE CLASS, INT. CLS. 10 AND 16.
- COMFORT, INC., TORRANCE, CA:
1,991,392, CANC. INT. CL. 25.
- COMMERCETV CORPORATION, BRAINTREE, MA:
2,730,855, INT. CL. 9.
- COMMONWEALTH CLINICAL SYSTEMS, INC., CHARLOTTESVILLE, VA, COMMONWEALTH CLINICAL SYSTEMS, INC., CHARLOTTESVILLE, VA:
1,230,258, REN. 5-15-03, INT. CL. 35.
- COMMTECH CORPORATION, CRANBURY, NJ TO COMMTECH CORPORATION, CRANBURY, NJ:
2,620,114, COR. MULTIPLE CLASS, INT. CLS. 9, 38 AND 42.
- COMMUNICATION DEVELOPMENT COMPANY, INC., WEST DES MOINES, IA:
1,766,376, REN. 5-16-03, INT. CL. 42.
- COMMUNICATION SOCIETY LLC, CARY, IL:
2,729,581, INT. CL. 35.
- COMMUNIPAK INC., ST. LOUIS, MO:
1,991,362, CANC. INT. CL. 35.
1,991,403, CANC. INT. CL. 35.
- COMMUNITY HEALTH ACCESS PROJECT, INC., MANSFIELD, OH:
2,728,801, PUB. 4-1-2003, MULTIPLE CLASS, INT. CLS. 41 AND 44.
- COMOPHARM LIMITED, CAMBRIDGSHIRE, ENGLAND, DBA FLEXIFOIL INTERNATIONAL:
1,705,107, CANC. MULTIPLE CLASS, INT. CLS. 25 AND 28.
- COMPAGNIE DAHER, 13002 MARSEILLE, FRANCE:
2,676,031, COR. MULTIPLE CLASS, INT. CLS. 6, 20, 36, 37, 38 AND 39.
- COMPANYDNA INC., RICHMOND HILL, ONTARIO, CANADA FROM IRECOGNIZE INC., RICHMOND HILL, ONTARIO, CANADA:
2,728,536, PUB. 4-1-2003, MULTIPLE CLASS, INT. CLS. 35 AND 42.
- COMPASS AMERICA, INC., RESTON, VA:
1,991,051, CANC. INT. CL. 42.

- COMPASS BANCSHARES, INC., BIRMINGHAM, AL:
2,729,434, INT. CL. 36.
- COMPONENTA OYJ, 00100 HELSINKI, FINLAND:
2,728,523, PUB. 10-22-2002. MULTIPLE CLASS, INT. CLS.
6, 7, 12 AND 40.
- COMPUCOM SYSTEMS, INC., DALLAS, TX:
2,730,545, INT. CL. 42.
- COMPUSERVE INCORPORATED, COLUMBUS, OH:
1,990,696, CANC. INT. CL. 9.
- COMPUSPEAK, INC., OLATHE, KS:
1,991,870, CANC. INT. CL. 9.
- COMPUTER AND COMMUNICATION TECHNOLOGIES
INC., COLORADO SPRINGS, CO:
2,729,191, PUB. 11-5-2002. INT. CL. 35.
- COMPUTER ASSOCIATES INTERNATIONAL, INC., ISLAN-
DIA, NY:
1,992,017, CANC. INT. CL. 16.
- COMPUTER SCIENCES CORPORATION, EL SEGUNDO,
CA:
2,730,377, INT. CL. 9.
- COMPUTER TECHNOLOGY INC., FOREST HILLS, NY:
2,729,262, PUB. 4-1-2003. INT. CL. 9.
- COMRIE, FREDERICK G., DEL MAR, CA AND COMRIE,
JOHN G., DEL MAR, CA:
2,730,461, INT. CL. 20.
- COMROAD AG, MUNCHEN, FED REP GERMANY:
2,730,029, INT. CL. 9.
- CONAGRA GROCERY PRODUCTS COMPANY, IRVINE,
CA:
2,729,108, PUB. 4-1-2003. INT. CL. 41.
- CONAGRA, INC., OMAHA, NE:
1,992,080, CANC. INT. CL. 30.
- CONAIR CIP, INC., STAMPFORD, CT FROM CONAIR
CORPORATION, STAMPFORD, CT:
2,730,687, INT. CL. 7.
- CONAIR CORPORATION, STAMPFORD, CT:
1,704,653, CANC. INT. CL. 9.
- CONAIRCIP, INC., STAMPFORD, CT:
2,729,355, PUB. 4-1-2003. INT. CL. 11.
- CONCEPT ENGINEERING GMBH, 79111 FREIBURG, FED
REP GERMANY:
2,730,420, INT. CL. 9.
- CONCILIO S.P.A., 38060 VOLANO (TRENTO), ITALY, CON-
CILIO VINI S.P.A., 38060 VOLANO - (TRENTO), ITALY:
1,754,133, REN. 5-14-03. INT. CL. 33.
- CONCORDIA PUBLISHING HOUSE, ST. LOUIS, MO:
1,991,786, CANC. INT. CL. 9.
- CONDAT, S.A., CHASSE, RHONE, FRANCE:
1,227,181, REN. 5-10-03. MULTIPLE CLASS, INT. CLS. 1
AND 4.
- CONDO PLUS, INC., WALL, NJ:
1,991,538, CANC. INT. CL. 36.
- CONFERENCE BOARD, INC., THE, NEW YORK, NY:
1,802,257, REN. 5-11-03. MULTIPLE CLASS, INT. CLS. 35
AND 41.
- CONFIGURED ENERGY SYSTEMS, INC., PLYMOUTH,
MN:
1,705,986, CANC. MULTIPLE CLASS, INT. CLS. 9 AND
42.
- CONFISH, INC., ISOLA, MS:
2,728,698, PUB. 4-1-2003. INT. CL. 29.
- CONFLUENCE TECHNOLOGIES, INC., PITTSBURGH, PA:
2,729,628, INT. CL. 9.
- CONFLUENT PHOTONICS CORPORATION, ANDOVER,
MA:
2,729,904, INT. CL. 40.
- CONFOTI, SUNNYVALE, CA:
2,730,783, INT. CL. 28.
- CONGOLEUM CORPORATION, LAWRENCEVILLE, NJ:
1,203,712, CANC. INT. CL. 27.
1,203,713, CANC. INT. CL. 27.
1,203,714, CANC. INT. CL. 27.
- CONGOLEUM CORPORATION, KEARNY, NJ:
1,203,716, CANC. INT. CL. 27.
- CONGOLEUM CORPORATION, LAWRENCEVILLE, NJ:
1,203,717, CANC. INT. CL. 27.
- CONGRESSIONAL QUARTERLY, INC., WASHINGTON,
DC:
1,204,152, CANC. INT. CL. 16.
- CONGRUENCY INC., ROCHELLE PARK, NJ:
2,729,578, INT. CL. 9.
- CONMED CORPORATION, UTICA, NY:
2,729,585, INT. CL. 10.
- CONNECTIVITY SYSTEMS INCORPORATED, WILLIAM-
SPORT, OH:
2,730,942, INT. CL. 9.
- CONOPCO, INC., NEW YORK, NY, DBA VAN DEN BERGH
FOODS COMPANY:
1,991,734, CANC. INT. CL. 30.
- CONOPCO, INC., CHICAGO, IL, DBA HELENE CURTIS:
2,729,520, INT. CL. 3.
- CONSECO, INC., CARMEL, IN:
2,729,387, MULTIPLE CLASS, INT. CLS. 35, 38, 39, 41
AND 42.
- CONSERVATIVE BAPTIST ASSOCIATION OF AMERICA,
WHEATON, IL:
1,705,572, CANC. INT. CL. 42.
- CONSOLIDATED CHEMEX CORPORATION, CINNAMIN-
SON, NJ:
1,203,383, CANC. INT. CL. 7.
- CONSTRUCTION COOPERATION AND EDUCATION
TRUST, A NEW YORK NOT FOR PROFIT LABOR
MANAGEMENT TRUST, THE TRUSTEES COMPRISING
STEPHEN REMINTON, JOHN CASEY, RONALD POM-
MERENING, THOMAS J. MCCADDEN, FRANK WIRT,
MARTIN POTTER, ROBERT BROWN, GARY ROTH,
RICHARD T. HARDY AND GARY SQUIRES, ALL U.S.
CITIZENS, THE, ROCHESTER, NY:
2,419,721, COR. INT. CL. 42.
- CONSTRUCTION PRODUCTS, INC. OF TENNESSEE,
JACKSON, TN:
2,730,843, INT. CL. 19.
- CONTAINER TECHNOLOGY, INC., SANTA BARBARA, CA:
2,730,019, INT. CL. 20.
- CONTROL DATA CORPORATION, MINNEAPOLIS, MN:
1,203,845, CANC. INT. CL. 35.
- CONWAY BANK, N.A., CONWAY SPRINGS, KS:
2,728,778, PUB. 4-1-2003. INT. CL. 36.
- COODER, RY, BEVERLY HILLS, CA:
2,729,414, INT. CL. 9.
- COOPER CAMERON CORPORATION, HOUSTON, TX, W-
K-M COMPANY, INC., HOUSTON, TX:
400,326, REN. 5-10-03, U.S. CL. 23 (INT. CLS. 6, 7, 8, 9, 11,
12, 16, 21 AND 28).
- COOPER TIRE & RUBBER COMPANY, FINDLAY, OH:
1,991,178, CANC. INT. CL. 12.
- COOPERATIEVE VERKOOP- EN PRODUCTIEVERENI-
GING VAN AARDAPPELMEEL EN DERIVATEN
"AVEBE" B.A., 9641 GK VEENDAM, NETHERLANDS:
1,785,070, REN. 5-16-03. INT. CL. 1.
- COOPERVISION, INC., PLEASANTON, CA:
1,705,472, CANC. INT. CL. 40.
- COPIA: THE AMERICAN CENTER FOR WINE, FOOD &
THE ARTS, NAPA, CA:
2,677,856, COR. INT. CL. 16.
- COPYRIGHT CLEARANCE CENTER, INC., DANVERS, MA:
2,729,734, INT. CL. 42.
- CORBYS DISTILLERIES LIMITED, MONTREAL, QUEBEC
H3A 3L6, CANADA:
2,729,393, INT. CL. 33.
- CORDELIA LIGHTING, INC., RANCHO DOMINGUEZ, CA:
2,730,255, INT. CL. 11.
- CORDOVA, JO ANN B., HESPERIA, CA AND CORDOVA,
ROBERT P., HESPERIA, CA, DBA STRICTLY PERSONAL:
1,704,945, CANC. INT. CL. 16.
- COREAD CORPORATION, REDONDO BEACH, CA:
2,730,708, INT. CL. 16.
- CORPORATE TRAVEL MANAGEMENT, INC., OAK
BROOK TERRACE, IL:
1,705,326, CANC. INT. CL. 35.
- CORR WIRELESS COMMUNICATIONS, LLC, ONEONTA,
AL:
2,728,927, PUB. 4-1-2003. INT. CL. 38.

CORREA, LUIS RODRIGO, AMSTERDAM 1017 NX, NETHERLANDS, TA OTAZU:
2,728,594, PUB. 4-1-2003. INT. CL. 14.

CORUS UK LIMITED, LONDON, ENGLAND FROM BRITISH STEEL LIMITED, LONDON, GREAT BRITAIN:
2,728,507, PUB. 4-1-2003. MULTIPLE CLASS, INT. CLS. 1, 6, 7, 9, 11, 16, 19, 39 AND 40.

CORWIN, ANN, LAGUNA NIGUEL, CA:
2,729,445, INT. CL. 41.

COSMETIC TECHNOLOGIES CORPORATION, MIAMI, FL:
2,730,619, INT. CL. 3.

COSMETICS LABORATORIES PTE LTD, SINGAPORE:
1,991,497, CANC. INT. CL. 29.

COSMOS BROADCASTING CORPORATION, GREENVILLE, SC:
1,760,303, REN. 5-16-03. INT. CL. 38.

COST PLUS MARKETING SERVICES, INC., OAKLAND, CA:
2,729,966, INT. CL. 30.
2,730,162, INT. CL. 30.
2,730,163, INT. CL. 29.
2,730,769, INT. CL. 29.

COSTCO WHOLESALE CORPORATION, ISSAQUAH, WA:
2,729,125, PUB. 4-1-2003. INT. CL. 5.

COSTE, JEAN-CLAUDE CHRISTIAN, 75001 - PARIS, FRANCE:
2,729,206, PUB. 4-1-2003. INT. CL. 3.

COUNCIL OF IVY GROUP PRESIDENTS, PRINCETON, NJ:
2,728,923, PUB. 4-1-2003. INT. CL. 18.

COUNCIL OF OHIO COLLEGES OF PHARMACY, COLUMBUS, OH:
1,231,869, REN. 5-16-03. INT. CL. 16.

COUNCIL ON GOVERNMENTAL ETHICS LAWS, LOS ANGELES, CA:
1,990,990, CANC. INT. CL. 16.

COUNT ON ME, L.L.C., PASSAIC, NJ:
2,729,115, PUB. 4-1-2003. INT. CL. 35.

COUNTESS MARA, INC., HIGHLAND, NY:
940,542, CANC. U.S. CL. 39.

COURISTAN, INC., NEW YORK, NY, AKA UNITED STATES CARPET CO.:
1,203,709, CANC. INT. CL. 27.

COURTAULDS TEXTILES (HOLDINGS) LIMITED, MANCHESTER M28 5WR, ENGLAND:
1,991,632, CANC. INT. CL. 25.

COWAN, GLORIA L., SARASOTA, FL:
1,991,276, CANC. INT. CL. 21.

COX COMMUNICATIONS, INC., ATLANTA, GA:
2,729,673, INT. CL. 38.

CP MEDICAL, PORTLAND, OR:
2,728,847, PUB. 4-1-2003. INT. CL. 10.

CPG PRODUCTS CORP., MINNEAPOLIS, MN:
157,557, CANC. U.S. CL. 22.

CR/PL, L.P., EVANSTON, IL:
1,992,212, CANC. INT. CL. 11.

CRABTREE & EVELYN, LTD., WOODSTOCK, CT, SCARBOROUGH AND COMPANY, INC., MILFORD, NH:
1,763,569, REN. 5-11-03. INT. CL. 3.

CRABTREE & EVELYN, LTD., WOODSTOCK, CT:
1,991,398, CANC. INT. CL. 42.

CRAMER, PATRICIA ANN, SAN FRANCISCO, CA:
1,991,105, CANC. INT. CL. 41.

CRANE CO., NEW YORK, NY:
1,203,485, CANC. INT. CL. 11.

CRANE PLASTICS SIDING LLC, COLUMBUS, OH:
2,730,584, INT. CL. 19.

CRC PRESS LLC, BOCA RATON, FL, CRC PRESS, INC., BOCA RATON, FL:
1,206,153, REN. 5-16-03. INT. CL. 16.

CRC PRESS, LLC, BOCA RATON, FL, CRC PRESS, INC., BOCA RATON, FL:
1,208,259, REN. 5-16-03. INT. CL. 16.

CREATIVE AGE PUBLICATIONS, INC., VAN NUYS, CA:
2,728,619, PUB. 4-1-2003. INT. CL. 16.

CREATIVE APPAREL CONCEPTS, INC., MINNEAPOLIS, MN:
2,730,171, INT. CL. 25.
2,730,172, INT. CL. 25.

CREATIVE COLLECTIBLE CONCEPTS, INC., CHARLOTTE, NC:
1,992,131, CANC. INT. CL. 20.

CREATIVE LABORATORIES, INC., EAGAN, MN:
1,705,726, CANC. INT. CL. 3.

CREATIVE MARKETING INTERNATIONAL CORP., WEST CHICAGO, IL:
1,991,314, CANC. INT. CL. 36.

CREATIVE PARTIES, LTD., BETHESDA, MD:
1,991,317, CANC. INT. CL. 41.

CREATIVE SCIENCE SYSTEMS, INC., CAMPBELL, CA:
2,729,894, INT. CL. 9.

CREATIVE TECHNOLOGY LTD., SINGAPORE 609921, SINGAPORE:
2,728,765, PUB. 4-1-2003. INT. CL. 9.

CREATIVE TECHNOLOGY LTD., SINGAPORE, SINGAPORE:
2,729,255, PUB. 4-1-2003. INT. CL. 9.

CREATIVE TECHNOLOGY LTD., SINGAPORE 609921, SINGAPORE:
2,730,442, INT. CL. 9.
2,730,443, INT. CL. 15.

CREDIT BUREAU OF RICHMOND, VA., INC., RICHMOND, VA:
1,203,891, CANC. INT. CL. 36.

CREOLES, INC., BIRMINGHAM, AL:
1,991,345, CANC. INT. CL. 42.

CRESCOMM, INC., MIAMI, FL:
2,730,008, INT. CL. 39.

CRICKET PUBLISHING CO., BATTLE CREEK, MI:
952,699, REN. 5-13-03. U.S. CL. 37 (INT. CL. 16).

CRITICS' CHOICE VIDEO, INC., CHICAGO, IL:
1,706,023, CANC. INT. CL. 16.

CRM CONSULTANTS, INC., CARROLLTON, TX, DBA COMAC AND DBA COMAC SYSTEMS:
1,705,417, CANC. INT. CL. 37.

CROSSLAYER NETWORKS, INC, FREMONT, CA:
2,730,685, INT. CL. 9.

CROSSROADS ESPRESSO, INC., BURLINGAME, CA:
1,991,821, CANC. MULTIPLE CLASS, INT. CLS. 30 AND 32.

CROWN PLUMBING SPECIALTIES, INC., DALLAS, TX:
1,204,171, CANC. INT. CL. 42.

CRUISEPHONE, INC., POMPANO BEACH, FL:
1,991,922, CANC. INT. CL. 38.

CRUSHPROOF TUBING COMPANY, MCCOMB, OH:
1,747,105, REN. 5-13-03. INT. CL. 17.

CRYPTOMETRICS, INC., CRESTWOOD, NY:
2,730,402, MULTIPLE CLASS, INT. CLS. 9, 36 AND 38.

CS UNITEC, INC., NORWALK, CT:
2,729,012, PUB. 4-1-2003. INT. CL. 7.

CSA, INC., TIVERTON, RI, DBA CONTROL SYSTEMS ANALYSIS, INC.:
1,706,004, CANC. INT. CL. 9.

CSG SYSTEMS, INC., ENGLEWOOD, CO:
2,728,975, PUB. 4-1-2003. MULTIPLE CLASS, INT. CLS. 9, 35 AND 42.
2,728,976, PUB. 4-1-2003. MULTIPLE CLASS, INT. CLS. 9, 35 AND 42.

CTECH AG, CH-7001 CHUR, SWITZERLAND:
2,729,415, INT. CL. 8.

CULBERTSON, DONALD, KANSAS CITY, MO:
1,705,584, CANC. INT. CL. 42.

CUMA PRODUCTS, L.L.C., RIVERTON, UT:
2,729,054, PUB. 4-1-2003. INT. CL. 31.

CUMBERLAND SWAN HOLDINGS, INC., SMYRNA, TN:
2,730,536, INT. CL. 5.

CUNDY, INC., FORT LAUDERDALE, FL:
2,730,665, INT. CL. 36.

CURIOUS GRAPE CORPORATION, THE, FALLS CHURCH, VA:
2,730,089, INT. CL. 35.

CURL CORPORATION, CAMBRIDGE, MA:
2,730,575, INT. CL. 9.
2,730,758, INT. CL. 9.

CUSHMAN & PEARL COMPANY, THE, FORT PIERCE, FL:
1,991,522, CANC. INT. CL. 31.

- CUSTOM BUILDING PRODUCTS, SEAL BEACH, CA:
2,729,918, INT. CL. 19.
- CUTTING EDGE SOFTWARE, INC., DALLAS, TX:
2,729,867, INT. CL. 9.
- CYBERNET INTERNET-DIENSTLEISTUNGEN AG, 81929 MUNCHEN, FED REP GERMANY:
2,664,943, CANC. IIRN. RESTORED TO S.N. 75-610,720.
- CYCLO INDUSTRIES, L.L.C., PALM BEACH GARDENS, FL:
2,066,858, COR. INT. CL. 1.
- CYCLO MANUFACTURING COMPANY, DENVER, CO:
2,730,108, INT. CL. 6.
- CYCLODEXTRIN TECHNOLOGIES DEVELOPMENT, INC., GAINESVILLE, FL:
1,991,033, CANC. INT. CL. 30.
- CYGNUS ENTERTAINMENT, INC., ORLANDO, FL:
2,730,673, INT. CL. 9.
- CYLEX, INC., COLUMBIA, MD:
2,730,866, MULTIPLE CLASS, INT. CLS. 1 AND 5.
- CYPTRON, INC., ATLANTA, GA:
2,729,424, INT. CL. 9.
- CYTEC TECHNOLOGY CORP, WILMINGTON, DE, AMERICAN CYANAMID COMPANY, WAYNE, NJ:
760,885. REN. 5-10-03. U.S. CL. 6 (INT. CL. 1).
- CYTHEREA CORP., LONDON, ONTARIO, CANADA:
2,730,261, INT. CL. 3.
- D & D FINANCIAL CORPORATION, CALABASAS, CA TO CHILDREN'S WONDERLAND, INC., AGOURA, CA:
1,705,607, CANC. INT. CL. 42.
- D & D GROUP PTY LTD, BROOKVALE, NEW SOUTH WALES, 2100, AUSTRALIA:
2,728,906, PUB. 4-1-2003. INT. CL. 20.
- D. J. ARDORE, INC., BOONTON TOWNSHIP, NJ:
2,729,574, INT. CL. 35.
- DABBIERO, FRANK A., BERTHOUD, CO:
2,730,775, INT. CL. 25.
- DAEWOO INTERNATIONAL (AMERICA) CORP., CARLSTADT, NJ:
1,203,437, CANC. INT. CL. 9.
- DAIDO METAL CO., LTD., KITA-KU, NAGOYA, JAPAN:
2,730,032, INT. CL. 7.
- DAIMLER CHRYSLER CORPORATION, AUBURN HILLS, MI, CHRYSLER CORPORATION, HIGHLAND PARK, MI:
1,762,717. REN. 5-10-03. INT. CL. 12.
- DAIMLER CHRYSLER CORPORATION, AUBURN HILLS, MI FROM CHRYSLER CORPORATION, AUBURN HILLS, MI:
2,729,404, INT. CL. 20.
- DAIMLERCHRYSLER AG, 70567 STUTTGART, FED REP GERMANY, DAIMLER-MOTOREN-GESELLSCHAFT, UNTERTURKHEIM, FED REP GERMANY:
90,874. REN. 5-15-03. U.S. CL. 21 (INT. CLS. 3 AND 11).
- DAIMLERCHRYSLER AG, 70567 STUTTGART, FED REP GERMANY:
2,728,736, PUB. 4-1-2003. MULTIPLE CLASS, INT. CLS. 12, 28 AND 37.
- DAIMLERCHRYSLER CORPORATION, AUBURN HILLS, MI:
2,730,605, INT. CL. 12.
2,730,735, INT. CL. 12.
2,730,784, INT. CL. 12.
2,730,801, INT. CL. 12.
- DAKOTA TECHNOLOGIES, INC., GAITHERSBURG, MD:
1,992,138, CANC. INT. CL. 9.
- DALE MEDICAL PRODUCTS, INC., PLAINVILLE, MA:
2,730,146, INT. CL. 10.
- DALLAS SEMICONDUCTOR CORPORATION, DALLAS, TX:
1,990,663, CANC. INT. CL. 9.
- DALLMANN-JONES, ANTHONY S., FOND DU LAC, WI:
2,730,388, INT. CL. 16.
- DALTON ENTERPRISES, INC., CHESHIRE, CT:
1,778,954. REN. 5-10-03. INT. CL. 19.
- DAMW SERVICES LLC, SUGAR HILL, GA:
2,730,210, INT. CL. 43.
- DAN MEISSNER'S CABINETREE CORPORATION, PONTIAC, MI:
1,991,379, CANC. INT. CL. 40.
- DANA CORPORATION, TOLEDO, OH:
1,991,667, CANC. INT. CL. 1.
2,730,610, INT. CL. 6.
- DANIELE, PETER J., ALLENWOOD, NJ:
2,730,436, INT. CL. 42.
- DANNER, INC., PORTLAND, OR, DANNER SHOE MANUFACTURING CO., PORTLAND, OR:
1,712,714. REN. 5-16-03. INT. CL. 25.
- DANSTAR FERMENT A.G., ZUG, SWITZERLAND:
1,757,080. REN. 5-13-03. INT. CL. 30.
- DARIGOLD, INC., SEATTLE, WA:
1,991,022, CANC. MULTIPLE CLASS, INT. CLS. 29 AND 30.
- DASHA RESTAURANT GROUP, LLC, NEW YORK, NY:
2,730,322, INT. CL. 42.
- DATAHIVE, LLC, MANCHESTER, NH:
2,730,631, INT. CL. 42.
- DATAMATIC, INC., RICHARDSON, TX:
1,991,055, CANC. INT. CL. 9.
1,991,056, CANC. INT. CL. 9.
- DATASCOPE CORP., PARAMUS, NJ:
1,203,465, CANC. INT. CL. 10.
- DATAVANTAGE CORPORATION, SOLON, OH, STR, INC., AKRON, OH:
1,758,105. REN. 5-15-03. INT. CL. 9.
- DAUBLE, STEPHANIE, NEWPORT BEACH, CA:
2,730,880, INT. CL. 42.
- DAVEY TREE EXPERT COMPANY, THE, KENT, OH:
1,204,041, CANC. INT. CL. 42.
- DAVID CHARLES CHILDRENS WEAR LIMITED, LONDON W1, ENGLAND:
1,203,656, CANC. INT. CL. 25.
- DAVIDSON, HARVEY D., ORINDA, CA:
1,990,813, CANC. INT. CL. 31.
- DAVIS, CHARLES, LOS GATOS, CA:
1,991,600, CANC. INT. CL. 25.
- DAVIS, SHAWN, MCKEES ROCKS, PA:
2,729,676, INT. CL. 6.
- DAWE'S, L.L.C., ARLINGTON HEIGHTS, IL, DAWE'S, INC., CHICAGO, IL, AKA DAWE'S LABORATORIES:
1,229,216. REN. 5-16-03. INT. CL. 5.
- DAY AND NITE FOOD MARTS, INC., SHOREWOOD, IL:
1,204,033, CANC. INT. CL. 42.
- DAYTON HUDSON CORPORATION, MINNEAPOLIS, MN:
1,992,078, CANC. MULTIPLE CLASS, INT. CLS. 21 AND 24.
- DAZEY CORPORATION, INDUSTRIAL AIRPORT, KS:
1,992,089, CANC. INT. CL. 11.
- DBWIRED, INC., BERLIN, CT:
2,729,271, PUB. 4-1-2003. INT. CL. 36.
- DC COMICS, NEW YORK, NY:
2,730,169, INT. CL. 28.
- DCS IPAL CONSULTANTS INC., LAVAL, QUEBEC, CANADA:
2,670,873, COR. MULTIPLE CLASS, INT. CLS. 41 AND 42.
- DDS, CO., SAN CARLOS, CA:
2,729,077, PUB. 4-1-2003. INT. CL. 20.
- DE NEDERLANDSE ORGANISATIE VOOR TOEGEPAST-NATUURWETENSCHAPPELIJK ONDERZOEK TNO, 2682 VK DELFT, NETHERLANDS:
1,755,003. REN. 5-14-03. INT. CL. 9.
- DE RUITER'S NIEUWE ROZEN B.V., 1424 PL DE KWAKEL, NETHERLANDS:
2,728,868, PUB. 4-1-2003. INT. CL. 31.
- DE WAFELBAKKERS, INC., NORTH LITTLE ROCK, AR:
2,729,907, INT. CL. 30.
- DEALER MARKETING SERVICES, INC., ROCK ISLAND, IL:
2,730,818, INT. CL. 42.
- DEAN FOODS COMPANY, FRANKLIN PARK, IL:
1,705,229, CANC. INT. CL. 29.
- DEAN INTELLECTUAL PROPERTY SERVICES, L.P., DALLAS, TX FROM SUIZA DAIRY GROUP, L.P., DALLAS, TX:
2,730,611, INT. CL. 30.
- DEAN MARKLEY STRINGS, INC., SANTA CLARA, CA:
2,730,945, INT. CL. 15.

- DECIPHER INC., NORFOLK, VA:
2,729,475, MULTIPLE CLASS, INT. CLS. 16 AND 28.
- DECISION SUPPORT ASSOCIATES, INC., WILMINGTON, DE:
2,729,156, PUB. 4-1-2003. INT. CL. 9.
- DECK AMERICA, INC., WOODBRIDGE, VA:
2,729,767, INT. CL. 20.
- DEERE & COMPANY, MOLINE, IL:
2,729,763, INT. CL. 12.
2,729,766, INT. CL. 7.
- DEFLECTA-SHIELD ACCESORIES, INC., HOWE, IN FROM DELTA III, INC., HOWE, IN:
2,730,254, INT. CL. 12.
- DEGUSSA AKTIENGESELLSCHAFT:
See—DEGUSSA-HULS AKTIENGESELLSCHAFT.
- DEGUSSA-HULS AKTIENGESELLSCHAFT, 60311 FRANKFURT, FED REP GERMANY FROM DEGUSSA AKTIENGESELLSCHAFT, 60311 FRANKFURT, FED REP GERMANY:
2,728,470, PUB. 11-16-1999. INT. CL. 5.
- DEIO CORPORATION, FINLAND FROM INSTRUMENTARIUM CORPORATION, FIN-00510 HELSINKI, FINLAND:
2,729,876, MULTIPLE CLASS, INT. CLS. 9, 37, 39, 41 AND 42.
- DEL PHARMACEUTICALS, INC., UNIONDALE, NY:
2,730,448, INT. CL. 5.
- DELECTA FRUIT CC, WESTERN CAPE, SOUTH AFRICA:
2,730,645, INT. CL. 31.
- DELKOR SYSTEMS, INC., MINNEAPOLIS, MN:
2,730,709, MULTIPLE CLASS, INT. CLS. 7 AND 16.
- DELOITTE & TOUCHE, NEW YORK, NY:
1,990,615, CANC. MULTIPLE CLASS, INT. CLS. 35, 36, 41 AND 42.
- DELORME PUBLISHING COMPANY, INC., FREEPORT, ME:
1,990,715, CANC. INT. CL. 9.
- DELPHI CONSULTING GROUP, INC., BOSTON, MA:
2,728,584, PUB. 7-30-2002. INT. CL. 42.
- DELPINE PRODUCTIONS, 75008 PARIS, FRANCE:
2,728,618, PUB. 4-1-2003. MULTIPLE CLASS, INT. CLS. 9, 28, 35, 38, 41 AND 42.
- DELTA DRILLING COMPANY, TYLER, TX TO DELTAUS CORPORATION, TYLER, TX:
1,203,533, CANC. INT. CL. 16.
- DELUXE VENDING SERVICE INC., FAIRMONT, MN:
1,705,994, CANC. INT. CL. 7.
- DEMANDTEC, INC., SAN CARLOS, CA:
2,730,812, MULTIPLE CLASS, INT. CLS. 35 AND 42.
- DEMETRIOS, EAMES, SANTA MONICA, CA:
2,730,890, INT. CL. 41.
- DENTON JEWELRY, INC., PACIFIC PALISADES, CA:
1,704,830, CANC. INT. CL. 14.
- DENTON, SANDRA L., PINON HILLS, CA, DBA MADE FOR YOU PRODUCTS:
1,789,000. REN. 5-16-03. INT. CL. 11.
- DENTSPLY RESEARCH & DEVELOPMENT CORP., MILFORD, DE:
1,795,732. REN. 5-13-03. INT. CL. 10.
- DENTSPLY RESEARCH & DEVELOPMENT CORP., LOS ANGELES, DE, TDP, INC., TULSA, OK:
1,795,739. REN. 5-13-03. INT. CL. 10.
- DEPUY INTERNATIONAL LIMITED, LEEDS LS11 8DT, ENGLAND, DENTSPLY RESEARCH & DEVELOPMENT CORP., MILFORD, DE:
957,009. REN. 5-16-03. U.S. CL. 44 (INT. CL. 10).
- DERMA SCIENCES, INC., OLD FORGE, PA:
1,991,803, CANC. INT. CL. 3.
- DERR, DEDRIC M., LOVELAND, CO:
1,991,979, CANC. INT. CL. 37.
- DESA INTERNATIONAL INC., BOWLING GREEN, KY:
2,730,238, MULTIPLE CLASS, INT. CLS. 7, 8, 9 AND 11.
- DESCENDENTS PARTNERS, FORT COLLINS, CO:
1,991,057, CANC. INT. CL. 16.
- DESCENT CONTROL, INC., FORT SMITH, AR:
1,778,291. REN. 5-16-03. INT. CL. 9.
- DESERT SCENTS LLC, ALBUQUERQUE, NM:
2,729,632, INT. CL. 3.
- DESIGN DESIGN, INC., GRAND RAPIDS, MI:
2,730,654, INT. CL. 35.
- DESIGN HOUSE, INC., GERMANTOWN, WI:
1,704,778, CANC. INT. CL. 11.
- DESIGNERS FOUNTAIN, INC., BELL, CA TO JIMWAY, INC., RANCHO DOMINGUEZ, CA:
1,704,779, CANC. INT. CL. 11.
- DESIGNS BY THE SEA, INC., COLORADO SPRINGS, CO:
2,728,626, PUB. 4-1-2003. INT. CL. 14.
- DESIGNWORKS JEWELRY GROUP LTD., LONG ISLAND CITY, NY FROM ORIGINAL DESIGNS INC., LONG ISLAND CITY, NY:
2,730,482, INT. CL. 14.
- DETECTOR ELECTRONICS CORPORATION, MINNEAPOLIS, MN:
2,729,494, INT. CL. 9.
- DETROIT DIESEL CORPORATION, DETROIT, MI:
1,992,046, CANC. INT. CL. 36.
- DEUTSCHE BANK SECURITIES, INC., NEW YORK, NY:
2,728,838, PUB. 4-1-2003. INT. CL. 36.
- DEUTSCHE GRAMMOPHON GESELLSCHAFT MBH, HAMBURG, FED REP GERMANY, MPS-RECORDS GMBH MUSIKPRODUKTION SCHWARZWALD, 773 VILLINGEN, FED REP GERMANY:
956,735. REN. 5-13-03. U.S. CL. 36 (INT. CLS. 9 AND 16).
- DFB PHARMACEUTICALS, INC., SAN ANTONIO, TX FROM DFB HOLDING, INC., SAN ANTONIO, TX:
2,729,761, INT. CL. 42.
2,729,768, INT. CL. 40.
- DFO, INC., SPARTANBURG, SC, DENNY'S, INC., SANTA ANA, CA:
1,757,060. REN. 5-11-03. INT. CL. 30.
- DIAL BRANDS, INC., SCOTTSDALE, AZ:
2,729,798, INT. CL. 5.
2,730,690, INT. CL. 5.
2,730,691, INT. CL. 5.
- DIALAMERICA MARKETING INC., MAHWAH, NJ:
1,230,260. REN. 5-16-03. INT. CL. 35.
- DIAMCO, LLC, SHORT HILLS, NJ:
2,729,865, INT. CL. 14.
- DIAMINTANGIBLES INTERNATIONAL, LTD., NASSAU, BAHAMAS:
2,730,521, INT. CL. 14.
- DIAMOND CONSULTING, INC., OAKBROOK, IL:
1,991,092, CANC. MULTIPLE CLASS, INT. CLS. 35, 41 AND 42.
- DIAMOND OIL WELL DRILLING COMPANY, MIDLAND, TX:
1,203,394, CANC. INT. CL. 7.
- DIASONICS ULTRASOUND, INC., SANTA CLARA, CA:
1,705,800, CANC. INT. CL. 10.
- DICKENS, FRANK E., CORPUS CHRISTIE, TX, DBA INTERNATIONAL DANCE SHOES, USA:
1,990,707, CANC. INT. CL. 25.
- DIE-TECH INDUSTRIES, INC., CARROLLTON, GA:
2,728,937, PUB. 4-1-2003. INT. CL. 21.
2,728,938, PUB. 4-1-2003. INT. CL. 21.
- DIEHL AKO STIFTUNG & CO., KG, WANGEN, GERMAN DEM REP, DIEHL MANUFACTURING COMPANY, NEW YORK, NY:
558,464. REN. 5-14-03. U.S. CL. 21 (INT. CL. 9).
- DIGITAL IMPACT, INC., SAN MATEO, CA:
2,730,294, INT. CL. 9.
- DIGITAL LATIN AMERICA, LLC, BOCA RATON, FL:
2,729,835, INT. CL. 38.
- DIGITCARE CORPORATION, LOS ANGELES, CA:
2,729,093, PUB. 4-1-2003. INT. CL. 10.
- DILLON, ROBERT B., RICHMOND, VA:
1,992,223, CANC. INT. CL. 25.
- DIOSYNTH B.V., AB OSS, NETHERLANDS:
2,728,556, PUB. 4-16-2002. INT. CL. 1.
- DIPPIN' DOTS, INC., PADUCAH, KY:
2,728,563, PUB. 4-1-2003. INT. CL. 30.
- DIRECTV, INC., EL SEGUNDO, CA:
2,730,341, INT. CL. 38.

- DIRIENZO, RICHARD J., POWAY, CA, DIRIENZO, JOSEPH P., OCEANSIDE, CA, DBA THE ROCKIN' BAJA LOBSTER AND DIRIENZO, RICHARD J., OCEANSIDE, CA, DBA THE ROCKIN' BAJA LOBSTER:
1,792,779, REN. 5-16-03, INT. CL. 29.
- DIRTBANC, LLC, WEBSTER GROVES, MO:
2,730,550, INT. CL. 36.
- DISCOUNT OPTICS, INC., BOCA RATON, FL:
2,729,251, PUB. 4-1-2003, INT. CL. 16.
- DISCOVER FINANCIAL SERVICES, INC., RIVERWOODS, IL AND MILLS LIMITED PARTNERSHIP, THE, ARLINGTON, VA:
2,553,703, COR. INT. CL. 36.
- DISCOVERY COMMUNICATIONS, INC., BETHESDA, MD:
2,728,785, PUB. 4-1-2003, INT. CL. 41.
- DISCOVERY CRUISES, INC., FT. LAUDERDALE, FL TO DISCOVERY MANAGEMENT INC., FT. LAUDERDALE, FL:
1,705,457, CANC. INT. CL. 39.
- DISCOVERY ZONE L.P., CHICAGO, IL:
1,991,068, CANC. INT. CL. 41.
1,991,069, CANC. INT. CL. 41.
- DISTRIBUTIVE SOFTWARE, INC., FREDERICKSBURG, VA:
2,728,905, PUB. 4-1-2003, INT. CL. 9.
- DISTRIBUTORS PROCESSING, INC., PORTERVILLE, CA:
1,990,725, CANC. INT. CL. 1.
- DIVERSIFIED PRODUCTS CORPORATION, OPELIKA, AL:
1,991,695, CANC. INT. CL. 28.
- DIXON VALVE & COUPLING COMPANY, CHESTER-TOWN, MD:
2,728,768, PUB. 4-1-2003, INT. CL. 7.
- DLJ LONG TERM INVESTMENT CORPORATION, CHICAGO, IL:
2,728,996, PUB. 4-1-2003, INT. CL. 36.
2,729,004, PUB. 4-1-2003, INT. CL. 36.
- DNA (HOUSEMARKS) LIMITED, LONDON, UNITED KINGDOM:
2,729,328, PUB. 4-1-2003, INT. CL. 28.
- DOBLE ENGINEERING COMPANY, WATERTOWN, MA:
2,729,902, INT. CL. 9.
- DOCK HEIGHT ADJUSTMENT, INC., HOLLAND, MI:
2,730,602, INT. CL. 6.
- DOCK PRODUCTS CANADA INC., LONDON, ONTARIO N6M 1A3, CANADA:
2,728,819, PUB. 4-1-2003, INT. CL. 7.
2,728,820, PUB. 4-1-2003, INT. CL. 17.
- DOCUCORP INTERNATIONAL, INC., DALLAS, TX:
2,729,589, MULTIPLE CLASS, INT. CLS. 38, 39, 41 AND 42.
- DOCUMAGIX, INC., SAN JOSE, CA:
1,991,684, CANC. INT. CL. 9.
2,054,712, CANC. INT. CL. 9.
- DOGWATCH INC., NATICK, MA, KING, FREDERICK P., WAYLAND, MA:
1,787,377, REN. 5-16-03, INT. CL. 9.
- DOM ENTERPRISES MFG. LTD., TORONTO, ONTARIO, CANADA:
1,705,173, CANC. INT. CL. 28.
- DOMINIK RECHNER, VANCOUVER, BRITISH COLUMBIA, CANADA, DBA BUG'Z EYE PRODUCTIONS:
2,728,506, PUB. 4-1-2003, MULTIPLE CLASS, INT. CLS. 9 AND 16.
- DOMINION RESOURCES, INC., RICHMOND, VA:
2,729,680, MULTIPLE CLASS, INT. CLS. 35, 36, 37 AND 39.
- DOMINO'S PIZZA PMC, INC., ANN ARBOR, MI:
2,730,796, INT. CL. 29.
- DON COSSACK CHORUS & DANCERS OF AMERICA, INC., THE, FAIR LAWN, NJ:
1,705,481, CANC. INT. CL. 41.
- DONALD F. DICKERSON ASSOCIATES, INC., VAN NUYS, CA:
1,210,106, REN. 5-14-03, INT. CL. 42.
- DONLD BRUCE & CO., CHICAGO, IL:
735,655, CANC. U.S. CL. 28.
- DORIS DILLON CENTER, THE, NEW YORK, NY:
2,730,425, INT. CL. 41.
- DOSKOCIL MANUFACTURING COMPANY, INC., ARLINGTON, TX:
2,729,002, PUB. 4-1-2003, INT. CL. 19.
- DOUGHERTY, MICHAEL, AURORA, CO:
2,728,496, PUB. 4-1-2003, INT. CL. 42.
- DOUGLAS MATHESON & CO., INC., SAN LUIS OBISPO, CA:
2,730,348, INT. CL. 42.
- DOUGLAS SHAW & ASSOCIATES, WHEATON, IL:
2,728,897, PUB. 4-1-2003, INT. CL. 36.
- DOULOS LIMITED, HAMPSHIRE, UNITED KINGDOM:
2,729,135, PUB. 4-1-2003, MULTIPLE CLASS, INT. CLS. 9, 16, 41 AND 42.
- DOW CHEMICAL COMPANY, THE, MIDLAND, MI, CELOTEX CORPORATION, THE, TAMPA, FL:
1,229,804, REN. 5-14-03, INT. CL. 17.
- DOYLE MUSIC GROUP, INC., PHOENIX, AZ, DBA CANYON RECORDS PRODUCTIONS:
2,047,902, AM. INT. CL. 42.
- DR. JOHANNES HEIDENHAIN GMBH, 83301 TRAUNREUT, FED REP GERMANY:
1,249,668, REN. 5-16-03, INT. CL. 9.
- DRAPER DBS, PERKASIE, PA:
2,730,391, INT. CL. 20.
- DREYER'S GRAND ICE CREAM, INC., OAKLAND, CA:
2,729,617, INT. CL. 30.
- DRUHE, DENNIS P., TUCSON, AZ:
1,990,732, CANC. INT. CL. 42.
- DRYSPACE, INC., CEDAR RAPIDS, IA:
2,729,021, PUB. 4-1-2003, INT. CL. 37.
- DSI TOYS, INC., HOUSTON, TX:
2,730,440, MULTIPLE CLASS, INT. CLS. 8 AND 28.
- DTE SMITH BRANCH, LLC, ANN ARBOR, MI:
2,730,014, INT. CL. 4.
- DTMC, INC., FRANKLIN PARK, IL:
2,730,047, INT. CL. 29.
- DUALREACH, DANA POINT, CA:
2,729,193, PUB. 4-1-2003, MULTIPLE CLASS, INT. CLS. 35, 41 AND 45.
- DUALSTAR ENTERTAINMENT GROUP, LLC, LOS ANGELES, CA:
2,729,031, PUB. 4-1-2003, INT. CL. 9.
- DUGGAL COLOR PROJECTS, INC., NEW YORK, NY:
1,991,812, CANC. INT. CL. 40.
- DULAC, SERGE, KISSIMMEE, FL:
2,730,277, INT. CL. 41.
- DUMKE, ARTHUR W., OSHKOSH, WI:
1,705,843, CANC. INT. CL. 16.
- DUN & BRADSTREET CORPORATION, THE, NEW YORK, NY:
1,203,895, CANC. INT. CL. 36.
- DUNLOP SLAZENGER GROUP AMERICAS INC., GREENVILLE, SC:
2,730,217, INT. CL. 28.
- DUNN EDWARDS CORPORATION, LOS ANGELES, CA:
1,991,935, CANC. INT. CL. 16.
- DUPEY MANAGEMENT CORPORATION, COPPELL, TX, DBA MJDESIGNS:
1,992,064, CANC. INT. CL. 20.
1,992,065, CANC. INT. CL. 31.
1,992,066, CANC. INT. CL. 26.
- DURA-LUBE CORP., FLUSHING, NY:
1,991,954, CANC. MULTIPLE CLASS, INT. CLS. 1 AND 4.
- DURO DYNE CORPORATION, BAY SHORE, NY:
1,242,461, REN. 5-10-03, INT. CL. 1.
- DUTY FREE ASSOCIATES - D F A, 92200 NEUILLY SUR SEINE, FRANCE:
2,728,607, PUB. 4-1-2003, MULTIPLE CLASS, INT. CLS. 29, 30, 32, 33, 34 AND 42.
- DYLEX LIMITED, TORONTO, ONTARIO, CANADA TO HARRY ROSEN INC., TORONTO, ONTARIO, CANADA:
1,705,089, CANC. INT. CL. 25.
- DYMALON, INC., TIMONIUM, MD:
1,705,600, CANC. INT. CL. 42.
- DYNACRAFT INDUSTRIES INC., ENGLISHTOWN, NJ, TA BACK TO NATURE PRODUCTS CO.:
2,730,441, INT. CL. 2.

DYNAMIC MEASUREMENT GROUP, INC., EUGENE, OR:
2,729,165, PUB. 4-1-2003. INT. CL. 16.

DYNAMIC TECHNOLOGIES, INC., BURTONSVILLE, MD,
DBA OCEAN SYSTEMS:
2,729,593, INT. CL. 9.

DYNAMOTIVE CANADA CORPORATION, VANCOUVER,
BRITISH COLUMBIA, CANADA:
1,991,790, CANC. INT. CL. 9.
1,991,792, CANC. INT. CL. 9.

DYNASTY CONSOLIDATED INDUSTRIES, INC., DALLAS,
TX:
2,729,276, PUB. 4-1-2003. INT. CL. 20.
2,729,289, PUB. 4-1-2003. INT. CL. 20.
2,729,315, PUB. 4-1-2003. INT. CL. 20.
2,729,317, PUB. 4-1-2003. INT. CL. 20.

DYROTECH INDUSTRIES, INC., WASHINGTON COURT
HOUSE, OH:
1,991,835, CANC. INT. CL. 17.

DZS SOFTWARE SOLUTIONS, INC., BOUND BROOK, NJ:
2,171,327, COR. INT. CL. 9.

E. EXCEL INTERNATIONAL, INC., SPRINGVILLE, UT:
2,632,957, COR. INT. CL. 5.

E. I. DU PONT DE NEMOURS AND COMPANY, WILMING-
TON, DE:
1,705,812, CANC. INT. CL. 11.
1,705,855, CANC. INT. CL. 19.
1,992,093, CANC. INT. CL. 9.

E. R. SQUIBB & SONS, INC., PRINCETON, NJ:
1,203,337, CANC. INT. CL. 5.

E. RITTER & COMPANY, MARKED TREE, AR:
1,991,524, CANC. MULTIPLE CLASS, INT. CLS. 9 AND
42.
1,991,525, CANC. INT. CL. 38.

E.H.L. IMPORTS CORP., BROOKLYN, NY:
2,730,324, INT. CL. 25.

E.I. DU PONT DE NEMOURS AND COMPANY, WILMING-
TON, DE:
2,730,076, INT. CL. 1.

E.N.T INCORPORATED, CULVER CITY, CA:
1,991,348, CANC. INT. CL. 18.

E&B GIFTWARE, LLC, YONKERS, NY:
2,728,921, PUB. 4-1-2003. INT. CL. 20.

E*TRADE GROUP, INC., MENLO PARK, CA:
2,729,546, INT. CL. 38.

E-TON DYNAMICS TECHNOLOGY INDUSTRY CO., LTD.,
TAINAN, TAIWAN:
2,729,913, INT. CL. 12.

EAGLE & TAYLOR COMPANY, BOARDMAN, OH:
1,704,534, CANC. INT. CL. 6.

EAGLE FLIGHT ENTERPRISE, INC., BELLINGHAM, WA:
2,728,979, PUB. 4-1-2003. INT. CL. 35.

EAGLE NATION, INC., PEARLAND, TX:
2,730,909, INT. CL. 12.

EAGLE SNACKS, INC., ST. LOUIS, MO:
1,992,147, CANC. INT. CL. 29.

EARLE, MICHAEL L., SAN MARINO, CA:
1,991,473, CANC. INT. CL. 10.

EARTH & OCEAN SPORTS, INC., HYANNIS, MA:
1,991,646, CANC. INT. CL. 28.

EARTHRISE TRADING CO., PETALUMA, CA, DBA
EARTHNET:
1,991,736, CANC. INT. CL. 5.

EAST ASIATIC COMPANY, INC., THE, LOS ANGELES, CA:
735,753, CANC. U.S. CL. 46.

EAST COAST CONSULTING GROUP LLC, PHILADEL-
PHIA, PA:
2,729,786, MULTIPLE CLASS, INT. CLS. 35 AND 41.

EAST COAST FURNITURE DISTRIBUTORS OF TAMPA,
INC., GAINESVILLE, FL:
1,986,508, CANC. INT. CL. 42.

EASTERN COMPANY, THE, NAUGATUCK, CT:
2,728,622, PUB. 4-1-2003. INT. CL. 6.

EASTMAN KODAK COMPANY, ROCHESTER, NY:
396,858, CANC. U.S. CL. 23.
1,991,741, CANC. INT. CL. 1.

EASY LIFT CARE PRODUCTS, INC., HOUSTON, TX:
1,991,862, CANC. INT. CL. 11.

EBAY INC., SAN JOSE, CA:
2,729,649, INT. CL. 16.

ECCMA ELECTRONIC COMMERCE CODE MANAGE-
MENT ASSOCIATION, BETHLEHEM, PA:
2,728,957, PUB. 4-1-2003. INT. CL. 41.

ECNEXT, INC., POWELL, OH:
2,728,648, PUB. 4-1-2003. INT. CL. 35.

ECO-TEC LIMITED, PICKERING, ONTARIO, CANADA:
1,991,456, CANC. INT. CL. 1.

ECOAG INITIATIVES INC., HIGH RIVER, ALBERTA,
CANADA:
2,728,483, PUB. 9-17-2002. MULTIPLE CLASS, INT. CLS. 1
AND 31.

ECOLAB INC., ST. PAUL, MN:
2,730,743, INT. CL. 3.

ECOMMERCE LICENSING GROUP LLC, NESHANIC STA-
TION, NJ:
2,730,622, MULTIPLE CLASS, INT. CLS. 35 AND 42.

ECP INCORPORATED, BURR RIDGE, IL:
2,729,016, PUB. 4-1-2003. INT. CL. 37.

ECUAVEGETAL, S.A., JUJAN-BABAHOYO, PROVINCIA DE
LOS RIOS, ECUADOR:
1,755,546, REN. 5-10-03. MULTIPLE CLASS, INT. CLS. 29
AND 30.
1,755,546, CANC. INT. CL. 31.

EDIBLE ACCENTS, INC., DALLAS, TX:
1,991,796, CANC. INT. CL. 30.

EDMONTON MANUFACTURING COMPANY, ROCHE-
STER, IN:
1,992,018, CANC. INT. CL. 25.
1,992,019, CANC. INT. CL. 25.

EDUCATION MANAGEMENT CORPORATION, PITTS-
BURGH, PA:
1,705,480, CANC. INT. CL. 41.

EDUCATIONAL DIRECTORIES UNLIMITED, INC., CHE-
STER, PA:
2,728,751, PUB. 4-1-2003. INT. CL. 35.

EDUCATIONAL INSIGHTS, INC., CARSON, CA:
2,729,789, INT. CL. 9.

EDWARD JAY LEVENSON, INC., EL MONTE, CA:
1,991,832, CANC. MULTIPLE CLASS, INT. CLS. 14, 16
AND 21.

EICHROM INDUSTRIES, INC., DARIEN, IL:
1,991,732, CANC. INT. CL. 1.

EIDOS INTERACTIVE LIMITED, WIMBLEDON, LONDON,
SW19 3RU, UNITED KINGDOM:
2,729,661, INT. CL. 16.

EIFFEL DESIGN, INC., DEERFIELD BEACH, FL TO TRA-
VELPRO INTERNATIONAL, INC., BOCA RATON, FL:
2,033,652, CANC. INT. CL. 28.

EKCO PRODUCTS, INC., WHEELING, IL:
735,551, CANC. U.S. CL. 13.

EL TERRIFICO, LLC, MEMPHIS, TN:
2,730,030, INT. CL. 35.

EL-LA DESIGN, INC., NEW YORK, NY:
1,990,734, CANC. INT. CL. 25.

ELAN INTERNATIONAL LTD., INDIANAPOLIS, IN:
2,728,631, PUB. 4-1-2003. INT. CL. 3.

ELARASYS, INC., SCHAUMBURG, IL:
2,728,771, PUB. 4-1-2003. INT. CL. 35.

ELBAZ, GABRIEL, MONTREAL, PROVINCE OF QUEBEC,
CANADA, SOGELCO INTERNATIONAL INC., MON-
TREAL, QUEBEC, CANADA:
1,761,539, REN. 5-10-03. INT. CL. 29.

ELECTRICAL FASTENERS CO., INC., BRIDGEVIEW, IL:
2,730,789, INT. CL. 35.

ELECTRO CHEMICAL FINISHING CO., WYOMING, MI:
2,730,689, INT. CL. 12.

ELECTROLUX HOME PRODUCTS, INC., CLEVELAND, DE
FROM WCI OUTDOOR PRODUCTS, INC., CLEVELAND,
OH:
2,730,572, INT. CL. 7.

ELECTROLUX ORIGO AKTIEBOLAG, HALMSTAD, SWE-
DEN, ORIGOVERKEN I HALMSTAD AB, HALMSTAD,
SWEDEN:
1,228,365, REN. 5-16-03. INT. CL. 11.

ELECTRONIC CHARTS COMPANY, INC., SEATTLE, WA:
2,728,967, PUB. 4-1-2003. INT. CL. 9.

- ELECTRONIC IMAGING SYSTEMS OF AMERICA, INC., ROLLING MEADOWS, IL:
2,730,256, INT. CL. 42.
2,730,257, INT. CL. 42.
- ELECTRONIC RETAILING SYSTEMS INTERNATIONAL, INC., STAMFORD, CT:
1,705,984, CANC. MULTIPLE CLASS, INT. CLS. 37 AND 42.
- ELECTRONIC SALESMASTERS, INC., BEACHWOOD, OH:
1,705,329, CANC. INT. CL. 35.
- ELEIKO SPORT AB, HALMSTAD, SWEDEN:
2,728,907, PUB. 4-1-2003. INT. CL. 28.
- ELEKTA AB (PUBL), SE - 103 93 STOCKHOLM, SWEDEN:
2,729,846, INT. CL. 9.
- ELEKTROTEK INC., HOLLYWOOD, FL:
2,729,525, INT. CL. 9.
- ELEMENT K ONLINE LLC, ROCHESTER, NY:
2,730,478, INT. CL. 41.
- ELF AQUITAINE PRODUCTION, SOCIETE ANONYME, COURBEVOIE, FRANCE:
1,990,864, CANC. MULTIPLE CLASS, INT. CLS. 9 AND 35.
- ELF ATOCHEM NORTH AMERICA, INC., PHILADELPHIA, PA:
1,991,468, CANC. INT. CL. 5.
- ELFIN EQUITY COMPANY, L.L.C., ELMHURST, IL:
2,373,684, CANC. INT. CL. 30.
- ELITE INDUSTRIES, LTD., RAMAT-GAN, ISRAEL:
1,991,799, CANC. INT. CL. 30.
- ELLIAS, DAANISH, MUMBAI, INDIA:
2,729,889, INT. CL. 35.
- ELLIS CORPORATION, CHICAGO, IL:
1,203,374, CANC. INT. CL. 7.
- ELMHURST MEMORIAL HOSPITAL, ELMHURST, IL:
1,781,962, REN. 5-16-03. INT. CL. 42.
- ELP COMMUNICATIONS, CULVER CITY, CA:
1,991,576, CANC. INT. CL. 25.
1,991,577, CANC. INT. CL. 16.
- ELRON ELECTRONIC INDUSTRIES LTD., HAIFA, ISRAEL:
1,992,004, CANC. INT. CL. 38.
- EMERACHEM LLC, KNOXVILLE, TN:
2,730,252, MULTIPLE CLASS, INT. CLS. 1, 7 AND 40.
- EMERALD LABORATORIES, INC., CARLSBAD, CA:
1,991,356, CANC. INT. CL. 5.
- EMERSON ELECTRIC CO., ST. LOUIS, MO:
2,730,846, INT. CL. 7.
- EMH REGIONAL MEDICAL CENTER, ELYRIA, OH:
1,990,975, CANC. INT. CL. 41.
- EMI CHRISTIAN MUSIC GROUP INC., BRENTWOOD, TN, SPARROW CORPORATION, THE, BRENTWOOD, TN:
1,813,427, REN. 5-16-03. INT. CL. 9.
- EMINENCE SPEAKER LLC, EMINENCE, KY:
2,729,357, PUB. 4-1-2003. INT. CL. 9.
- EMLER, DON, RANCHO DOMINGUEZ, CA:
2,729,548, INT. CL. 12.
- EMMITT, INC, PENSACOLA, FL:
1,991,728, CANC. INT. CL. 36.
- EMPRESA NACIONAL BAZAN DE CONSTRUCCIONES NAVALES MILITARES, S.A., MADRID, SPAIN:
2,729,136, PUB. 4-1-2003. MULTIPLE CLASS, INT. CLS. 7 AND 11.
- EMPRESA NACIONAL DE TELECOMUNICACIONES S.A., SANTIAGO, CHILE:
2,730,369, INT. CL. 42.
- EMTROL LLC, HAUPPAUGE, NY:
1,244,209 NEW CERT. 6-24-2003. INT. CL. 7.
- ENCOUNTER 2001, LLC, HOUSTON, TX TO ENCOUNTER 2001, LLC, HOUSTON, TX:
2,585,233, COR. INT. CL. 39.
- ENCOURAGE MARKETING, LLC, SANTA MONICA, CA:
2,729,007, PUB. 4-1-2003. INT. CL. 35.
2,729,008, PUB. 4-1-2003. INT. CL. 35.
- ENERBANK USA, SALT LAKE CITY, UT FROM CMS CAPITAL CORP., DEARBORN, MI:
2,730,039, INT. CL. 36.
- ENERGY AND PROPULSION SYSTEMS, ASBESTOS (QUEBEC), CANADA:
2,730,230, INT. CL. 9.
- ENERGY INTERNATIONAL, INC., BELLEVUE, WA:
1,990,830, CANC. INT. CL. 9.
1,990,831, CANC. INT. CL. 9.
- ENFORCE-IT!, LLC, HOUSTON, TX:
2,729,020, PUB. 4-1-2003. INT. CL. 36.
- ENGLISH GLASS COMPANY LIMITED, LEICESTER, ENGLAND:
1,229,872, REN. 5-12-03. INT. CL. 20.
- ENIGMA INFORMATION RETRIEVAL SYSTEMS, LTD., BNEI-BRAK, ISRAEL:
1,992,174, CANC. INT. CL. 9.
- ENLIGHT CORPORATION, TAOYUAN HSIEN, TAIWAN:
2,729,244, PUB. 4-1-2003. INT. CL. 9.
- ENPRIA, INC., PORTLAND, OR:
2,728,784, PUB. 4-1-2003. MULTIPLE CLASS, INT. CLS. 35 AND 42.
- ENSEC, INC., BOCA RATON, FL:
1,991,474, CANC. MULTIPLE CLASS, INT. CLS. 35, 37, 40, 41 AND 42.
- ENTERPRISE NETWORK SYSTEMS, EAGAN, MN:
1,992,142, CANC. INT. CL. 42.
- ENTERTAINMENT LIGHTING SERVICES, SUN VALLEY, CA, J C ENTERTAINMENT LIGHTING SERVICES, INC., NORTH HOLLYWOOD, CA:
1,760,519, REN. 5-15-03. MULTIPLE CLASS, INT. CLS. 9 AND 11.
- ENTERTAINMENT PUBLICATIONS, INC., TROY, MI:
1,704,919, CANC. INT. CL. 16.
- ENTHONE INCORPORATED, WEST HAVEN, CT:
735,794, CANC. U.S. CL. 52.
- ENTRAVISION COMMUNICATIONS CORPORATION, WEST, SANTA MONICA, CA:
2,729,015, PUB. 4-1-2003. INT. CL. 38.
- ENVIRONMENTAL RESOURCES TRUST, INC., WASHINGTON, DC:
2,651,229, CANC. IIRN. RESTORED TO S.N. 76-163,262.
2,728,576, PUB. 4-1-2003. INT. CL. 35.
- ENVIROTAINER SERVICES, INC., IRVING, TX, ENVIROTAINER LEASING, LTD., SAN DIEGO, CA:
1,714,212, REN. 5-10-03. INT. CL. 39.
- ENVOYWORLDWIDE, INC., BEDFORD, MA FROM MESSAGEBLASTER.COM, INC, BILLERICA, MA:
2,729,769, INT. CL. 38.
- ENZ (U.S.A.), INC., SOUTH ELGIN, IL:
2,729,974, INT. CL. 7.
- EPHORLIFE, LLC, SALT LAKE CITY, UT:
2,729,920, INT. CL. 5.
- EPIPOPE, INC., BEAVERTON, OR, DBA IMMUNOLOGIC ASSOCIATES:
1,204,177, CANC. INT. CL. 42.
- EQUIPMENT SYSTEMS & DEVICES, INC., FT. WASHINGTON, PA:
1,258,352, REN. 5-13-03. INT. CL. 9.
- EQUITY GROUP INVESTMENTS, L.L.C., CHICAGO, IL, EQUITY GROUP INVESTMENTS, INC., CHICAGO, IL:
1,818,169, REN. 5-16-03. INT. CL. 36.
- EQUITY TITLE & CLOSING SERVICES, INC., EAST PROVIDENCE, RI:
2,729,614, INT. CL. 36.
- ERB INDUSTRIES, INC., WOODSTOCK, GA:
1,761,481, REN. 5-15-03. INT. CL. 25.
- EREREN, SAIP, PLACENTIA, CA, DBA TERRY TOWN:
1,991,364, CANC. INT. CL. 25.
- ERGOBAY, LLC, PENSACOLA, FL:
2,729,301, PUB. 4-1-2003. INT. CL. 35.
- ERGON, INC., JACKSON, MS:
1,229,176, REN. 5-15-03. MULTIPLE CLASS, INT. CLS. 4, 37, 39, 40 AND 42.
- ERGONAUTS: PERFORMANCE TECHNOLOGISTS LLC, BEREA, KY:
2,728,640, PUB. 4-1-2003. INT. CL. 35.
- ERIKA MEYEROVICH GALLERY INC., SAN FRANCISCO, CA:
1,682,278, CANC. INT. CL. 42.
- ERLICH & FRIED, BROOKLYN, NY:
2,728,835, PUB. 4-1-2003. INT. CL. 32.

ERMENEGILDO ZEGNA CORPORATION, ENGLEWOOD, NJ:
1,232,762. REN. 5-15-03. INT. CL. 18.

ERNST & YOUNG U.S. LLP, NEW YORK, NY TO ERNST & YOUNG U.S. LLP, NEW YORK, NY:
2,681,505. COR. U.S. CL. B.

EROOMSYSTEM TECHNOLOGIES, INC., LAS VEGAS, NV:
2,729,716. INT. CL. 9.

ERUCES, INC., LENEXA, KS:
2,729,146. PUB. 4-1-2003. INT. CL. 9.

ERWIN PEARL, INC., NEW YORK, NY:
2,730,046. INT. CL. 14.

ESAB GROUP, INC., FLORENCE, SC:
2,729,909. INT. CL. 7.

ESPA INTERNATIONAL (UK) LIMITED, FARNHAM, SURREY, UNITED KINGDOM:
2,729,428. MULTIPLE CLASS, INT. CLS. 3, 24, 35, 41 AND 42.

ESPARZA, JAVIER RUIZ, CHULA VISTA, CA:
2,729,036. PUB. 4-1-2003. INT. CL. 44.

ESPEED, INC., NEW YORK, NY:
2,729,582. MULTIPLE CLASS, INT. CLS. 9 AND 38.

ESPERION THERAPEUTICS, INC., ANN ARBOR, MI:
2,729,399. INT. CL. 5.

ESTES-COX CORP., PENROSE, CO FROM CENTURI CORPORATION, PENROSE, CO:
2,729,944. INT. CL. 28.

ET INDUSTRIES INC., TORONTO, ONTARIO, CANADA:
2,729,620. INT. CL. 9.

ETABLISSEMENTS FERNAND BERCHET, S.A., OYONNAX, FRANCE:
1,203,744. CANC. INT. CL. 28.

ETERNAL PRODUCTIONS, INC., ST. LOUIS, MO, DBA ETERNAL ENTERTAINMENT:
2,729,064. PUB. 4-1-2003. INT. CL. 41.

ETHIX CORPORATION, THE, WAYNE, PA:
1,990,681. CANC. INT. CL. 36.

ETS GUY DEMARLE, 59136 WAVRIN, FRANCE:
1,756,920. REN. 5-12-03. INT. CL. 24.

ETS. LUCIEN VAN LATHM, 59242 TEMPLEUVE, FRANCE:
1,754,018. REN. 5-14-03. INT. CL. 26.
1,754,019. REN. 5-15-03. INT. CL. 26.

EURAND INTERNATIONAL S.P.A., 20100 MILANO, ITALY:
2,729,877. INT. CL. 42.

EURAND S.P.A., CITY OF CINISELLO BALSAMO, MILAN, ITALY:
1,203,311. CANC. INT. CL. 5.

EUTECTIC CORPORATION, MENOMONEE FALLS, WI:
1,236,101. REN. 5-10-03. INT. CL. 9.

EVE HOLDINGS INC., WILMINGTON, DE:
2,730,207. INT. CL. 34.

EVENFLO COMPANY, INC., VANDALIA, OH:
2,730,529. INT. CL. 12.

EVENSTAD, KENNETH L., WAYZATA, MN:
1,779,812. REN. 5-16-03. INT. CL. 33.

EVERDRY MARKETING & MANAGEMENT, INC., MACEDONIA, OH:
2,729,996. INT. CL. 37.

EVEREADY BATTERY COMPANY, INC., ST. LOUIS, MO:
2,730,042. INT. CL. 11.

EVERSON, THOMAS J., OMAHA, NE:
2,728,997. PUB. 4-1-2003. INT. CL. 35.

EVERYTHING FOR LOVE, INC., PINE MOUNTAIN, CA:
2,730,822. INT. CL. 10.

EVETS CORPORATION, SAN CLEMENTE, CA:
2,729,028. PUB. 4-1-2003. INT. CL. 15.

EVOLUTIONARY PRODUCTS, INC., LOS ANGELES, CA:
2,730,917. INT. CL. 11.

EX-CELL-O CORPORATION, TROY, MI TO MICROMATIC OPERATIONS INC., HOLLAND, MI:
1,203,390. CANC. INT. CL. 7.

EXAMEN, INC., SACRAMENTO, CA:
2,730,249. INT. CL. 42.
2,730,250. INT. CL. 9.

EXAMI-GOWNS INC., BALTIMORE, MD, BLUME; PATRICIA, BALTIMORE, MD, DBA EXAMI-GOWNS:
1,199,174. REN. 5-14-03. INT. CL. 10.

EXCEL SPORTS SCIENCE, INC., EUGENE, OR:
1,757,027. REN. 5-10-03. INT. CL. 28.

EXCELLENCE QUEST, INC., LOGAN, UT:
1,990,659. CANC. INT. CL. 41.

EXCEPTIONAL PRODUCTS, INC., DALLAS, TX:
1,705,912. CANC. INT. CL. 28.

EXELTHERM INC., CORNWALL, ONTARIO, CANADA:
1,991,820. CANC. INT. CL. 17.

EXHIBITGROUP, INC., PHOENIX, AZ:
1,705,849. CANC. INT. CL. 16.

EXPAND INTERNATIONAL AB, STOCKHOLM, SWEDEN:
2,729,871. INT. CL. 20.

EXPERTEXT SYSTEMS LTD., TORONTO, ONTARIO, CANADA:
1,704,597. CANC. MULTIPLE CLASS, INT. CLS. 9 AND 42.

EXPRESS FITNESS, LLC, PARAMUS, NJ:
2,663,026. CANC. IIRN. RESTORED TO S.N. 76-377,160.

EXPRESS MODEL TRADING 129(PROPRIETARY) LIMITED, PRETORIA, SOUTH AFRICA, SNAPPI HOLDINGS (PTY) LIMITED, PRETORIA, TRANSVAAL PROVINCE, SOUTH AFRICA:
1,773,066. REN. 5-15-03. INT. CL. 26.

EXTERIOR SYSTEMS, INC., MACEDONIA, OH:
2,730,528. INT. CL. 19.

EXTREME NETWORKS, INC., SANTA CLARA, CA:
2,728,532. PUB. 1-2-2001. INT. CL. 9.

EYE DESIGN TATTOO STUDIOS, INC., VIRGINIA BEACH, VA, DBA I AM TATTOOS.COM:
2,729,229. PUB. 4-1-2003. INT. CL. 44.

EYES ADRIFT, LLC, BELLEVUE, WA:
2,729,006. PUB. 4-1-2003. INT. CL. 41.

EZGREEN ASSOCIATES, LLC, KINGSPORT, TN:
2,730,705. INT. CL. 31.

F. KORBEL & BROS., INC., GUERNEVILLE, CA:
1,808,588. REN. 5-15-03. INT. CL. 33.

F.M. SYSTEMS LIMITED, DUBLIN 18, IRELAND:
2,728,616. PUB. 4-1-2003. MULTIPLE CLASS, INT. CLS. 9, 16, 35 AND 42.

F.N.B. CORPORATION, HERMITAGE, PA:
2,729,172. PUB. 4-1-2003. INT. CL. 36.

FABRY GLOVE AND MITTEN COMPANY, GREEN BAY, WI, DBA SARANAC GLOVE COMPANY:
1,706,038. CANC. INT. CL. 25.

FADA INDUSTRIES, INC., LONG ISLAND CITY, NY:
1,991,917. CANC. INT. CL. 14.

FAHLGREN, STEVEN M., ORLANDO, FL:
2,730,527. INT. CL. 42.

FAIRCHILD PUBLICATIONS INC., NEW YORK, NY:
2,728,880. PUB. 4-1-2003. INT. CL. 16.

FAIRFIELD LINE, INC., FAIRFIELD, IA, FAIRFIELD GLOVE CO., FAIRFIELD, IA:
571,370. REN. 5-15-03. U.S. CL. 39 (INT. CL. 25).

FAIRFINISH CORPORATION, CHARLOTTE, NC:
1,991,469. CANC. INT. CL. 40.

FAIRMONT SNACKS GROUP, INC., INDEPENDENCE, OH:
2,729,931. INT. CL. 29.

FAIRYTALE FRAGRANCES, INC., COOPER CITY, FL:
1,991,670. CANC. INT. CL. 3.

FALLBROOK NATIONAL BANK, FALLBROOK, CA:
2,729,728. INT. CL. 36.

FALLEN ANGELS, THE, EAGLE, WI:
1,990,961. CANC. INT. CL. 41.

FAMIGLIA INTERNATIONAL, INC., NEW YORK, NY:
2,729,930. MULTIPLE CLASS, INT. CLS. 29, 30 AND 42.

FAMOUS PACIFIC DESSERT COMPANY, THE, SEATTLE, WA:
1,705,246. CANC. INT. CL. 30.
1,705,247. CANC. INT. CL. 30.

FANCIES, LTD., ERIE, PA:
1,991,390. CANC. INT. CL. 42.

FARIBAULT WOOLEN MILL COMPANY, FARIBAULT, MN:
1,203,625. CANC. INT. CL. 24.

FARM SERVICE COOPERATIVE, HARLAN, IA:
2,730,419. INT. CL. 31.

FARMERS MILL PRODUCTS, INC., RIVER RIDGE, LA:
1,991,381. CANC. INT. CL. 1.

- FARNAM COMPANIES, INC., PHOENIX, AZ:
2,729,435, INT. CL. 21.
2,730,810, INT. CL. 5.
2,730,811, INT. CL. 5.
- FARRELL-GOFF, INC.:
1,204,166, CANC. INT. CL. 31.
- FAST INDUSTRIES, LTD., FT. LAUDERDALE, FL, FAST CHEMICAL PRODUCTS CORPORATION, FT. LAUDERDALE, FL:
1,232,466, REN. 5-13-03, INT. CL. 5.
- FASTPRO INTERNATIONAL, INC., KANSAS CITY, KS, FIRST AID, INC., KANSAS CITY, KS:
1,757,540, REN. 5-14-03, INT. CL. 5.
- FAT CAT, INC., WILLISTON, VT:
2,730,398, INT. CL. 28.
- FATHER FLANAGAN'S BOYS' HOME, BOYS TOWN, NE:
1,768,324, REN. 5-12-03, INT. CL. 41.
- FAUCET-QUEENS INC., THE, VERNON HILLS, IL:
2,730,404, MULTIPLE CLASS, INT. CLS. 6, 8, 9 AND 22.
- FCI AMERICAS TECHNOLOGY, INC., RENO, NV:
2,729,745, INT. CL. 9.
- FEDERAL PAPER BOARD COMPANY, INC., MONTVALE, NJ:
1,203,513, CANC. INT. CL. 16.
- FEDERAL SIGNAL CORPORATION, OAK BROOK, IL:
1,773,431, REN. 5-12-03, INT. CL. 9.
- FEDERATED MUTUAL INSURANCE COMPANY, OWATONNA, MN:
970,412, REN. 5-16-03, U.S. CL. 102 (INT. CL. 36).
- FEDERATION INTERNATIONALE DE FOOTBALL ASSOCIATION, 8032 ZURICH, SWITZERLAND:
2,645,052, COR. MULTIPLE CLASS, INT. CLS. 1, 3, 4, 5, 6, 7, 8, 9, 10, 11, 12, 14, 16, 18, 20, 21, 24, 25, 28, 29, 30, 31, 32, 33, 34, 35, 36, 37, 38 AND OTHERS.
- FEEL GOLF CO., INC., SALINAS, CA:
2,728,932, PUB. 4-1-2003, INT. CL. 28.
- FEKETE ASSOCIATES INC., CALGARY, AB T2P 0M2, CANADA:
2,729,630, INT. CL. 9.
- FEL-PRO INCORPORATED, SKOKIE, IL:
1,204,157, CANC. INT. CL. 17.
- FELDMAN, IRA, POTOMAC, MD:
2,729,373, INT. CL. 35.
- FEMINIST MAJORITY, BEVERLY HILLS, CA, FEMINIST MAJORITY FOUNDATION, THE, LOS ANGELES, CA:
1,757,306, REN. 5-16-03, INT. CL. 41.
- FEMPRO INC., DRUMMONDVILLE, QUEBEC, CANADA:
2,728,581, PUB. 7-9-2002, INT. CL. 5.
- FERNANDO'S FOODS CORPORATION, LA PALMA, CA:
2,729,899, INT. CL. 29.
- FERRARA PAN CANDY CO., INC., FOREST PARK, IL:
2,729,314, PUB. 4-1-2003, INT. CL. 25.
2,729,515, INT. CL. 30.
- FERRARA, JOSEPH, SPRINGFIELD, MA:
2,729,183, PUB. 4-1-2003, INT. CL. 41.
- FERRARO FOODS, INC., SOUTH PLAINFIELD, NJ:
2,729,501, INT. CL. 29.
- FERRIS INDUSTRIES, INC., MUNNSVILLE, NY:
2,729,176, PUB. 4-1-2003, INT. CL. 7.
- FESTIVAL PRODUCTIONS, INC., NEW YORK, NY:
1,992,218, CANC. INT. CL. 41.
- FEULING, JAMES J., VENTURA, CA:
1,990,932, CANC. MULTIPLE CLASS, INT. CLS. 10, 12 AND 25.
- FIAT AUTO S.P.A., 10135 TORINO, ITALY:
2,728,595, PUB. 4-1-2003, INT. CL. 12.
- FIBERSPAR CORPORATION, WEST WAREHAM, MA:
2,540,304, COR. INT. CL. 17.
- FICON, INC., PICAYUNE, MS:
1,705,004, CANC. INT. CL. 19.
- FIELDPOINT BV, 1017 PP AMSTERDAM, NETHERLANDS:
2,729,459, INT. CL. 3.
- FIESTA PALMS LLC, NORTH LAS VEGAS, NV:
2,729,772, INT. CL. 41.
- FIFTEEN GROUP, LLC, MIAMI BEACH, FL:
2,729,311, PUB. 4-1-2003, INT. CL. 36.
- FIFTH AVENUE OF LONG ISLAND REALTY ASSOCIATES, MANHASSET, NY:
2,648,932, COR. MULTIPLE CLASS, INT. CLS. 35 AND 36.
- FIGI'S, INC., MARSHFIELD, WI:
1,236,298, REN. 5-16-03, MULTIPLE CLASS, INT. CLS. 16 AND 42.
- FILM TECHNOLOGIES INTERNATIONAL, INC., ST. PETERSBURG, FL, ITD INDUSTRIES, INC., ST. PETERSBURG, FL, DBA METALLIZED PRODUCTS:
1,815,899, REN. 5-10-03, INT. CL. 17.
- FINANCIAL COUNSELING RESOURCES, LLC, LOS ALAMITOS, CA:
2,729,052, PUB. 4-1-2003, INT. CL. 36.
- FINANCIAL EDUCATION, INC., ST. PAUL, MN:
2,728,708, PUB. 4-1-2003, INT. CL. 9.
- FINANCIAL TIMES LIMITED, THE, LONDON SE1 9HL, ENGLAND:
2,729,363, INT. CL. 16.
- FINANCIERE ELYSEES BALZAC, 75008 PARIS, FRANCE, SPONTEX, 75008 PARIS, FRANCE:
1,755,411, REN. 5-12-03, INT. CL. 24.
- FINANZ ST. HONORE B.V., 1017 CG AMSTERDAM, NETHERLANDS:
2,729,921, INT. CL. 3.
- FINDLEY, MARY, EUGENE, OR, DBA NORTHWEST MOP:
1,991,192, CANC. INT. CL. 21.
- FINEST THINGS ONLINE LLC, NEW YORK, NY:
2,729,758, INT. CL. 35.
- FINEST THINGS ONLINE LLC, SOMERS, NY:
2,730,082, INT. CL. 42.
- FINSAGE INC., ROUND ROCK, TX FROM FINSAGE.COM INC., ROUND ROCK, TX:
2,729,774, INT. CL. 36.
2,729,775, INT. CL. 36.
2,729,776, INT. CL. 36.
- FIREMAN'S FUND INSURANCE COMPANY, NOVATO, CA:
1,992,010, CANC. INT. CL. 36.
- FIRST BANK AND TRUST, NEW ORLEANS, LA:
1,990,618, CANC. INT. CL. 36.
- FIRST CHOICE POWER, INC., FORT WORTH, TX:
2,729,817, MULTIPLE CLASS, INT. CLS. 35, 39 AND 42.
- FIRST FEDERAL LINCOLN BANK, LINCOLN, NE:
2,728,633, PUB. 4-1-2003, INT. CL. 36.
- FIRST HORIZON PHARMACEUTICAL CORPORATION, ROSWELL, GA FROM SANOFI-SYNTHELABO, INC., NEW YORK, NY:
2,729,886, INT. CL. 5.
- FIRST NATIONAL SUPERMARKETS, INC., MAPLE HEIGHTS, OH:
1,204,082, CANC. INT. CL. 42.
- FIRST PREMIUM SERVICES, INC., DEERFIELD, IL:
1,991,432, CANC. INT. CL. 36.
- FIRST PRESBYTERIAN SCHOOL, ARCADIA, CA:
2,730,336, INT. CL. 41.
- FIRSTENERGY CORP., AKRON, OH:
2,728,804, PUB. 4-1-2003, MULTIPLE CLASS, INT. CLS. 35, 36, 37, 38, 39 AND 42.
- FISHER-PRICE, INC., EAST AURORA, NY:
1,990,820, CANC. MULTIPLE CLASS, INT. CLS. 25 AND 26.
1,991,635, CANC. INT. CL. 28.
- FITEL USA CORPORATION, NORCOSS, GA FROM SPECTRAN SPECIALTY OPTICS COMPANY, AVON, CT:
2,729,498, INT. CL. 9.
- FITEL USA CORPORATION, NORCORSS, GA FROM LUCENT TECHNOLOGIES INC., MURRAY HILL, NJ:
2,730,595, INT. CL. 9.
- FITNESS DEPOT INC., ETOBICOKE, ONTARIO, M9W 1B3, CANADA:
1,991,018, CANC. INT. CL. 42.
- FITNESS EQUIPMENT SERVICES, L.L.C., SALT LAKE CITY, UT:
2,730,380, INT. CL. 28.
- FITNESS QUEST INC., CANTON, OH:
2,730,231, INT. CL. 28.
2,730,232, INT. CL. 28.

- FLA ORTHOPEDICS, INC., MIRAMAR, FL:
2,728,989, PUB. 4-1-2003. INT. CL. 12.
- FLAT OUT SPORTS, LLC, ANN ARBOR, MI:
2,729,900, INT. CL. 25.
- FLAVIA'S LEGACY, LLC, SANTA BARBARA, CA:
2,728,767, PUB. 4-1-2003. INT. CL. 16.
2,729,313, PUB. 4-1-2003. INT. CL. 20.
- FLEETBOSTON FINANCIAL CORPORATION, BOSTON, MA:
2,728,942, PUB. 4-1-2003. INT. CL. 36.
- FLENTS PRODUCTS CO., INC., NORWALK, CT:
1,992,045, CANC. INT. CL. 10.
- FLESHTONES PRODUCTS COMPANY, INC., HACKENSACK, NJ:
1,705,748, CANC. INT. CL. 5.
- FLETCHER, RON, DEL MAR, CA, DBA FLETCHER COREY AND COREY, KATHY, DEL MAR, CA, DBA FLETCHER COREY:
2,067,146, COR. INT. CL. 41.
- FLEXCON COMPANY, INC., SPENCER, MA:
1,704,894, CANC. INT. CL. 16.
2,730,574, MULTIPLE CLASS, INT. CLS. 16 AND 17.
- FLEXEN, L.L.C., ANSONIA, CT:
1,991,843, CANC. INT. CL. 18.
- FLEXIBLE STEEL LACING COMPANY, DOWNERS GROVE, IL:
1,774,904, REN. 5-14-03. INT. CL. 6.
- FLINT HILLS RESOURCES, LP, WICHITA, KS FROM KOCH PETROLEUM GROUP, L.P., WICHITA, KS:
2,729,511, INT. CL. 4.
- FLINT INK CORPORATION, DETROIT, MI:
1,991,353, CANC. INT. CL. 3.
- FLO-PAC CORPORATION, MINNEAPOLIS, MN:
2,730,011, INT. CL. 21.
- FLOORUNIVERSE, INC., ATLANTA, GA FROM SURFACEEXCHANGE, INC., ATLANTA, GA, DBA FLOORUNIVERSE, INC.:
2,728,615, PUB. 4-1-2003. INT. CL. 35.
- FLORBATH-PROFUMI DI PARMA S.P.A., PARMA, ITALY:
1,203,280, CANC. INT. CL. 3.
- FLOREZ, EDWARD ROBERT, CHICAGO, IL:
1,990,801, CANC. INT. CL. 36.
- FLORIDA CITRUS MARKETERS COOPERATIVE CORPORATION, FT. PIERCE, FL:
1,991,813, CANC. INT. CL. 32.
- FLORISTS' TRANSWORLD DELIVERY, INC., DOWNERS GROVE, IL:
2,729,940, MULTIPLE CLASS, INT. CLS. 38 AND 42.
- FLOWERY BEAUTY PRODUCTS, INC., DANBURY, CT, COLUMBIA MANICURE MFG. CO., INC., GREENWICH, CT:
1,230,766, REN. 5-10-03. INT. CL. 3.
- FLOWERVE MANAGEMENT COMPANY, IRVING, TX, DURIRON COMPANY, INC., THE, DAYTON, OH:
1,746,297, REN. 5-16-03. INT. CL. 7.
- FLYER GRAPHICS INC., RIVERSIDE, CA:
1,992,225, CANC. INT. CL. 42.
- FLYTLIE, KNUT, DK-7100 VEJLE, DENMARK:
2,729,679, INT. CL. 42.
- FMC CORPORATION, CHICAGO, IL:
1,990,728, CANC. INT. CL. 12.
- FMC CORPORATION, PHILADELPHIA, PA:
2,730,056, INT. CL. 40.
- FOAMEX L.P., LINWOOD, PA:
2,730,770, INT. CL. 17.
- FONDAZIONE TEATRO ALLA SCALA DI MILANO, 2 - 20121 MILANO, ITALY:
2,728,493, PUB. 9-17-2002. MULTIPLE CLASS, INT. CLS. 3, 6, 8, 9, 11, 14, 15, 16, 18, 20, 21, 24, 25, 26, 28, 30, 32, 33, 34, 35, 36, 38, 39, 41 AND 42.
- FOODWAYS, INC., CHICAGO, IL:
1,990,792, CANC. INT. CL. 42.
- FOOT LEVELERS, INC., ROANOKE, VA:
2,729,626, INT. CL. 10.
- FOOTWEAR UNLIMITED, INC., FENTON, MO:
1,886,162, CANC. INT. CL. 25.
- FOOZLES INCORPORATED, NEW BRUNSWICK, NJ:
1,991,893, CANC. INT. CL. 42.
- FOR PET'S SAKE, INC., SEATTLE, WA:
2,729,383, INT. CL. 42.
- FORD MODELS, INC., NEW YORK, NY:
2,730,669, INT. CL. 41.
- FORD MOTOR COMPANY, DEARBORN, MI:
1,768,048, REN. 5-12-03. INT. CL. 16.
- FOREMOST-MCKESSON, INC., SAN FRANCISCO, CA:
735,765, CANC. U.S. CL. 46.
- FOREST GROUP NEDERLAND B.V., 7418 EK DEVENTER, NETHERLANDS:
2,729,813, INT. CL. 20.
- FOREVER LIVING PRODUCTS INTERNATIONAL, INC., PHOENIX, AZ:
1,992,038, CANC. INT. CL. 38.
- FORINSTANCE.COM LLC, INDIANAPOLIS, IN, DBA QUOVIX:
2,730,468, INT. CL. 9.
- FORMAN MILLS, INC., PENNSAUKEN, NJ:
2,729,916, INT. CL. 35.
- FORMATION TECHNOLOGIES, SAN DIEGO, CA:
2,729,288, PUB. 4-1-2003. INT. CL. 9.
- FORT HILL COMPANY, MONTCHANIN, DE:
2,639,162, COR. INT. CL. 42.
2,729,310, PUB. 4-1-2003. INT. CL. 42.
- FORWARD STEP THE LEARNING COALITION, LOS ANGELES, CA:
2,730,606, INT. CL. 16.
- FOSSIL, INC., RICHARDSON, TX:
2,730,465, INT. CL. 9.
- FOSTER INDUSTRIES, INC., NEW YORK, NY:
1,203,660, CANC. INT. CL. 25.
- FOSTER, JULIE ELIZABETH, SUFFOLK IP 13 6 AE, UNITED KINGDOM:
2,728,733, PUB. 4-1-2003. INT. CL. 3.
- FOTOBALL USA, INC., SAN DIEGO, CA:
2,730,459, INT. CL. 28.
- FOUNDATION FOR EDUCATIONAL FUNDING, INC., LINCOLN, NE:
1,991,360, CANC. INT. CL. 36.
- FOUNDATION ONE INSURANCE SERVICES, LTD., FRISCO, TX:
2,730,512, INT. CL. 36.
- FOUNDATIONIP, LLC, MINNEAPOLIS, MN FROM PORTFOLIO, INC., MINNEAPOLIS, MN:
2,730,627, INT. CL. 9.
- FOUNDSTONE, INC., IRVINE, CA:
2,730,587, INT. CL. 42.
- FOUR SEASONS OF LONDON PLC, LONDON, ENGLAND:
1,991,507, CANC. INT. CL. 25.
- FOX POOL CORPORATION, YORK, PA:
1,259,447, REN. 5-15-03. INT. CL. 20.
- FOXMARK MEDIA, LLC, CHATTANOOGA, TN:
2,730,181, INT. CL. 35.
- FPG INTERNATIONAL CORP., NEW YORK, NY TO FPG INTERNATIONAL LLC, NEW YORK, NY:
1,705,590, CANC. INT. CL. 42.
- FRANK B. HALL & CO. INC., BRIARCLIFF MANOR, NY:
1,203,903, CANC. INT. CL. 36.
1,203,904, CANC. INT. CL. 36.
- FRANKENMUTH BAVARIAN INN, INC., FRANKENMUTH, MI:
1,776,639, REN. 5-10-03. INT. CL. 28.
- FRANKLIN HEALTH, INC., UPPER SADDLE RIVER, NJ:
2,729,549, MULTIPLE CLASS, INT. CLS. 35 AND 42.
- FRANKLIN, ELIZABETH, SAN FRANCISCO, CA:
2,729,559, INT. CL. 16.
- FRANZREB, MARK S., SIMPSONVILLE, SC:
1,991,991, CANC. INT. CL. 25.
- FRANZUS COMPANY INC., BEACON FALLS, CT:
1,992,229, CANC. INT. CL. 18.
- FRAZEE INDUSTRIES, INC., SAN DIEGO, CA:
2,729,296, PUB. 4-1-2003. INT. CL. 2.
- FRAZIER CLOTHING CO., INC., NEW YORK, NY:
2,730,308, INT. CL. 25.
- FRED & TED ENTERTAINMENT, INC., BOSTON, MA:
2,729,318, PUB. 4-1-2003. INT. CL. 35.

- FRED MEYER, INC., PORTLAND, OR TO FRED MEYER, INC., PORTLAND, OR:
2,660,192, COR. INT. CL. 28.
- FRED S. KAHN COMPANY, INC., NASHVILLE, TN:
1,203,700, CANC. INT. CL. 25.
- FREDERIKSEN; CHRISTIAN, SAN FRANCISCO, CA:
1,204,140, CANC. MULTIPLE CLASS, INT. CLS. 16 AND 41.
- FREED INTERNATIONAL, INC., FORT WORTH, TX:
1,705,827, CANC. INT. CL. 15.
- FREFLEXRX, LLC., LA JOLLA, CA:
2,728,579, PUB. 4-1-2003. INT. CL. 41.
- FREI, GREGORY M., SALT LAKE CITY, UT, DBA ZERO GRAVITY:
1,991,416, CANC. INT. CL. 25.
- FREIXENET, S.A., BARCELONA, SPAIN:
1,705,295, CANC. INT. CL. 33.
- FRENCH, JOHN R., SAN DIEGO, CA:
2,729,364, INT. CL. 11.
- FRESH CHOICE, INC., MORGAN HILL, CA:
2,729,672, INT. CL. 42.
- FRESH GOURMET COMPANY, LOS ANGELES, CA:
1,991,939, CANC. INT. CL. 30.
- FRESH SOFTWARE COMPANY, THE, CORAL GABLES, FL:
1,992,158, CANC. INT. CL. 9.
- FRESKOLA CORP., REGO PARK, NY:
1,764,775, REN. 5-15-03. INT. CL. 32.
- FRETWELL-DOWNING INFORMATICS LIMITED, SHEFFIELD, UNITED KINGDOM:
2,729,898, INT. CL. 9.
- FRIEDMAN, HARVEY, BEVERLY HILLS, CA:
2,730,569, INT. CL. 35.
2,730,570, INT. CL. 39.
2,730,571, INT. CL. 40.
- FROMALP AG, CH-3052 ZOLLIKOFEN-, SWITZERLAND:
2,728,484, PUB. 8-7-2001. MULTIPLE CLASS, INT. CLS. 29, 30 AND 31.
- FRONTIER TOURS, INC., CARSON CITY, NV:
1,203,942, CANC. INT. CL. 39.
- FROST INCORPORATED, GRAND RAPIDS, MI:
955,703, REN. 5-16-03. U.S. CL. 23 (INT. CL. 7).
- FRUITSOURCE CONFECTIONS, INC., SANTA CRUZ, CA:
1,990,858, CANC. INT. CL. 30.
- FUEL FRESH, INC., PHOENIX, AZ:
2,730,848, INT. CL. 4.
- FUJI FOODS U.S., INC., DENVER, CO:
1,992,136, CANC. INT. CL. 29.
- FUJI HUNGT PHOOTGRAPHIC CHEMICALS, INC., ALLENTOWN, NJ, ANCHOR/LITH-KEM-KO, INC., ORANGE PARK, FL:
1,253,506, REN. 5-14-03. INT. CL. 3.
- FUJI SEIKO LIMITED, TOYOTA AICHE, JAPAN:
1,774,914, REN. 5-12-03. INT. CL. 7.
- FULL FORCE, BROOKLYN, NY:
1,204,004, CANC. INT. CL. 41.
- FULTON ENTERPRISES, LLC, NEW YORK, NY:
2,730,929, INT. CL. 42.
- FUN N' MOTION, INC., MT. LAUREL, NJ:
1,991,598, CANC. MULTIPLE CLASS, INT. CLS. 25, 41 AND 42.
- FUNDTECH CORPORATION, SAN FRANCISCO, CA:
1,992,194, CANC. INT. CL. 9.
- FUNTRONICS, INC., LOUISVILLE, KY:
2,730,016, INT. CL. 28.
- FUR VAULT INC, THE, NEW YORK, NY:
1,204,113, CANC. INT. CL. 42.
- FURNITURE GOLDMINE OF VIRGINIA, INC., FALLS CHURCH, VA:
2,730,444, INT. CL. 35.
- FUSIONPOINT TECHNOLOGIES CORP., BERGENFIELD, NJ:
2,729,089, PUB. 4-1-2003. INT. CL. 9.
- FUTURE MEDICINE PUBLISHING INC., PUYALLUP, WA:
1,990,776, CANC. MULTIPLE CLASS, INT. CLS. 9 AND 16.
- FUTUREHEALTH CORPORATION, TIMONIUM, MD:
1,757,163, REN. 5-13-03. INT. CL. 35.
- G.C. HANFORD MANUFACTURING COMPANY, SYRACUSE, NY:
2,729,284, PUB. 4-1-2003. INT. CL. 5.
- G.O. INTERNATIONAL, INC., TEANECK, NJ:
2,729,901, INT. CL. 5.
- G.P.M. INTERNATIONAL, INC., SPRINGDALE, AR:
1,990,968, CANC. INT. CL. 29.
- G.T. CAPITAL MANAGEMENT, INC., SAN FRANCISCO, CA:
1,990,954, CANC. INT. CL. 36.
- G.T. DISTRIBUTORS, INC., ROSSVILLE, GA:
2,729,840, INT. CL. 9.
- GA MODEFINE S.A., MENDRISIO CH-6850, SWITZERLAND:
1,756,717, REN. 5-15-03. MULTIPLE CLASS, INT. CLS. 18 AND 25.
- GABBERTS INC., EDINA, MN:
2,728,837, PUB. 4-1-2003. INT. CL. 42.
- GABEL, BENJAMIN, D-60431 FRANKFURT/MAIN, FED REP GERMANY AND STEINMEYER, KATHARINA, D-60598 FRANKFURT/MAIN, FED REP GERMANY AND KASTNER, LARS, D-60318 FRANKFURT/MAIN, FED REP GERMANY AND GEKTIDIS, MARCOS, D-60431 FRANKFURT/MAIN, FED REP GERMANY:
2,728,656, PUB. 4-1-2003. INT. CL. 9.
- GABRIEL, PETER, WILTSHIRE SN13 8PL, UNITED KINGDOM:
2,728,592, PUB. 4-1-2003. MULTIPLE CLASS, INT. CLS. 9, 25 AND 41.
- Gaelco, S.A., BARCELONA, SPAIN:
2,730,185, MULTIPLE CLASS, INT. CLS. 9 AND 28.
- GAGLIANO, RICHARD J., GIG HARBOR, WA:
2,730,187, INT. CL. 6.
- GALLAND HENNING NOPAK, INC., MILWAUKEE, WI:
1,264,004, REN. 5-15-03. INT. CL. 7.
- GARCIA, GINES J., MAYWOOD, NJ:
2,729,001, PUB. 4-1-2003. INT. CL. 36.
- GARDEN COMPLEMENTS, INC., KANSAS CITY, MO:
1,252,369, REN. 5-16-03. INT. CL. 30.
- GARDENS ALIVE, INC., LAWRENCEBURG, IN FROM MYSEASONS.COM, INC., PEORIA, IL:
2,729,570, INT. CL. 35.
- GARNER TRANSPORTATION, INC., MILTON, WA:
1,991,327, CANC. INT. CL. 39.
- GARRETSON, JOHN E., PARADISE VALLEY, AZ:
2,729,863, INT. CL. 21.
- GARRETT, LAMONT, CHICAGO, IL:
2,730,240, INT. CL. 25.
- GARVEY PROCESSING, INC., ST. CHARLES, IL:
2,730,235, INT. CL. 5.
- GAS GRABBER INC., CHAPEL HILL, NC:
2,729,949, INT. CL. 9.
- GATE CITY EQUIPMENT COMPANY, INC., ROSWELL, GA:
1,705,784, CANC. INT. CL. 9.
- GAYLE MARTZ, INC., NEW YORK, NY:
2,729,400, INT. CL. 31.
- GE MORTGAGE HOLDINGS, LLC, RALEIGH, NC:
2,729,144, PUB. 4-1-2003. INT. CL. 36.
- GEDISTILLEERD EN WIJN GROEP NEDERLAND B.V., RD ZOETERMEER, NETHERLANDS:
1,203,827, CANC. INT. CL. 33.
- GEERLINGS & WADE, INC., CANTON, MA:
1,991,746, CANC. INT. CL. 33.
- GEERPRES, INC., MUSKEGON, MI:
1,770,804, REN. 5-13-03. INT. CL. 21.
1,770,805, REN. 5-13-03. INT. CL. 21.
- GEIBERGER, AL, PALM DESERT, CA:
1,757,007, REN. 5-16-03. MULTIPLE CLASS, INT. CLS. 28 AND 41.
- GEKL TECHNOLOGIES, INC., KANSAS CITY, MO:
2,728,822, PUB. 4-1-2003. INT. CL. 42.
- GEM PLATINUM MFG. CO., NEW YORK, NY:
1,775,845, REN. 5-16-03. INT. CL. 14.
- GEMDIAM CORP.:
See—KRISTALL JEWELER, INC..

GEN-X SPORTS SARL, CHATEL ST. DENIS, SWITZERLAND, RAM GOLF CORPORATION, MELROSE PARK, IL:
1,764,634. REN. 5-10-03. INT. CL. 28.

GENCORP INC., FAIRLAWN, OH:
1,991,553, CANC. INT. CL. 27.

GENDERM CORPORATION, LINCOLNSHIRE, IL:
1,992,073, CANC. INT. CL. 5.
1,992,143, CANC. INT. CL. 5.

GENE JOHNSON, INC., SAINT AUGUSTINE, FL:
2,730,741, INT. CL. 42.

GENENCOR INTERNATIONAL, INC., PALO ALTO, CA:
1,783,166. REN. 5-15-03. INT. CL. 1.

GENERAL ATOMICS, SAN DIEGO, CA:
1,991,964, CANC. INT. CL. 38.

GENERAL BINDING CORPORATION, SKOKIE, IL:
2,730,828, INT. CL. 17.

GENERAL ELECTRIC COMPANY, SCHENECTADY, NY:
2,730,720, INT. CL. 7.
2,730,860, INT. CL. 11.

GENERAL FOODS CORPORATION, WHITE PLAINS, NY:
1,203,653, CANC. INT. CL. 25.

GENERAL MILLS, INC., MINNEAPOLIS, MN:
965,714. REN. 5-10-03. U.S. CL. 46 (INT. CL. 30).

GENERAL MOTORS ACCEPTANCE CORPORATION, DETROIT, MI:
2,730,651, INT. CL. 36.

GENERAL MOTORS CORPORATION, DETROIT, MI:
1,704,782, CANC. INT. CL. 11.
1,704,949, CANC. INT. CL. 16.
1,705,789, CANC. INT. CL. 9.
1,736,492. REN. 5-16-03. INT. CL. 16.

GENERAL RE CORPORATION, STAMFORD, CT:
2,729,609, INT. CL. 36.

GENERAL SERVICES ADMINISTRATION, ARLINGTON, VA:
1,991,078, CANC. INT. CL. 42.

GENESIS LLP, SAN FRANCISCO, CA:
2,729,324, PUB. 4-1-2003. INT. CL. 42.

GENESIS MICROCHIP INC., MARKHAM, ONTARIO, CANADA:
1,990,752, CANC. INT. CL. 9.

GENESYS CONSULTING SERVICES, INC., ALBANY, NY:
2,729,009, PUB. 4-1-2003. INT. CL. 35.

GENLYTE THOMAS GROUP LLC, LEWISVILLE, KY:
2,730,475, INT. CL. 9.

GENMAR INDUSTRIES, INC., MINNEAPOLIS, MN:
2,729,396, INT. CL. 12.

GENTEK BUILDING PRODUCTS, INC., CLEVELAND, OH:
2,728,990, PUB. 4-1-2003. INT. CL. 6.

GENTEX CORPORATION, ZEELAND, MI:
2,729,965, MULTIPLE CLASS, INT. CLS. 9 AND 11.

GENUINE SAVAGE, INC., ALTAMONTE SPRINGS, FL:
1,991,765, CANC. INT. CL. 41.

GEO SPECIALTY CHEMICALS, INC., CLEVELAND, OH:
2,730,715, INT. CL. 1.

GEOFFREY BEENE, INC., NEW YORK, NY:
1,714,384. REN. 5-15-03. INT. CL. 42.

GEOFFREY, INC., PARAMUS, NJ:
2,730,663, INT. CL. 28.

GEORGE C. ROGGE AGENCY, INC., MERRILLVILLE, IN:
1,990,667, CANC. INT. CL. 36.

GEORGE G. GLENNER ALZHEIMER'S FAMILY CENTER, INCORPORATED, THE, SAN DIEGO, CA:
1,990,637, CANC. INT. CL. 16.

GEORGE MASON UNIVERSITY, FAIRFAX, VA:
1,776,572. REN. 5-14-03. INT. CL. 21.

GEORGE P. JOHNSON COMPANY, AUBURN HILLS, MI:
2,730,184, INT. CL. 42.

GEORGIANO, JOSEPH, HICKSVILLE, NY AND MATH, IRWIN, GREENVALE, NY:
2,729,982, INT. CL. 9.

GEOSPAN CORPORATION, MAPLE GROVE, MN:
2,728,658, PUB. 4-1-2003. MULTIPLE CLASS, INT. CLS. 9, 35 AND 40.

GEOSPATIAL TECHNOLOGIES, INC., SANTA ANA, CA:
2,728,753, PUB. 4-1-2003. INT. CL. 42.

GERHARD KLAPP COSMETICS E.K., 37235 HESSISCH LICHTENAU, FED REP GERMANY:
2,728,717, PUB. 4-1-2003. INT. CL. 3.

GERI-CARE PRODUCTS, MIDDLESEX, NJ:
1,991,074, CANC. INT. CL. 5.

GERSTL, KAREN, MANALAPAN, NJ:
2,729,809, MULTIPLE CLASS, INT. CLS. 35 AND 42.

GERSTUNG INTERNATIONAL SPORT EDUCATION, INC., BALTIMORE, MD, GERSTUNG INTERNATIONAL SPORT EDUCATION, INC., BALTIMORE, MD:
956,427. REN. 5-10-03. U.S. CL. 22 (INT. CL. 28).

GERWIT, BARBARA, FORT LAUDERDALE, FL:
1,991,195, CANC. INT. CL. 3.

GETMAN GROUP INC., THE, BALTIMORE, MD:
1,991,475, CANC. INT. CL. 16.

GETTAGRIPE RESOURCE SYSTEMS, INC., RICHFIELD, MN FROM INDEPENDENT DIVERSIFIED REAL ESTATE SERVICES, INC., RICHFIELD, MN:
2,730,742, INT. CL. 35.

GETTYS GROUP INC., THE, CHICAGO, IL:
2,730,549, MULTIPLE CLASS, INT. CLS. 37 AND 42.

GFI HOLDINGS, INC., SAN JOSE, CA:
2,730,120, INT. CL. 29.

GG&T CORPORATION, ASHEVILLE, NC:
2,729,150, PUB. 4-1-2003. INT. CL. 30.

GIAMANCO'S INC, BATON ROUGE, LA:
1,726,008. REN. 5-14-03. MULTIPLE CLASS, INT. CLS. 30 AND 42.

GIANNINI, PAOLO, ATLANTA, GA:
1,990,970, CANC. INT. CL. 18.

GIANT UNION COMPANY, INC., INDUSTRY, CA:
2,729,076, PUB. 4-1-2003. INT. CL. 30.

GIFT CERTIFICATE CENTER, INC., THE, MINNEAPOLIS, MN:
1,991,612, CANC. MULTIPLE CLASS, INT. CLS. 35 AND 42.

GILHEANY, STEPHEN, J, MANHATTAN BEACH, CA:
2,729,177, PUB. 4-1-2003. INT. CL. 35.

GILLETTE COMPANY, THE, BOSTON, MA:
396,826, CANC. U.S. CL. 23.

GILMOUR MANUFACTURING COMPANY, SOMERSET, PA:
1,203,477, CANC. INT. CL. 11.

GINS, CATHY, NEW YORK, NY:
2,729,486, INT. CL. 3.

GIRO, INC., TULSA, OK:
2,729,249, PUB. 4-1-2003. INT. CL. 42.

GIROD CORPORATION, THE, NEW ORLEANS, LA, WM. B. REILY & COMPANY, INC., NEW ORLEANS, LA:
1,249,201. REN. 5-10-03. INT. CL. 30.

GIST COMMUNICATIONS, INC., NEW YORK, NY:
2,729,319, PUB. 4-1-2003. INT. CL. 9.

GITANO LICENSING, LTD., WILMINGTON, DE:
1,203,662, CANC. INT. CL. 25.

GIZMO GYPSIES, SANTA CLARA, CA:
2,728,460, PUB. 4-1-2003. INT. CL. 9.

GLADON COMPANY, INC., MILWAUKEE, WI:
2,729,161, PUB. 4-1-2003. INT. CL. 22.

GLASS, LISA, WASHINGTON, DC:
2,730,319, INT. CL. 35.

GLASSY GLASS, INC., DALLAS, TX:
1,991,133, CANC. INT. CL. 37.

GLEASON WORKS, THE, ROCHESTER, NY:
735,624, CANC. U.S. CL. 23.

GLENWOOD DESIGNS, RANCHO DOMINGUEZ, CA:
2,729,168, PUB. 4-1-2003. INT. CL. 11.

GLOBAL CREATIVITY CORPORATION, MILL VALLEY, CA:
1,704,876, CANC. INT. CL. 16.

GLOBAL EXECUTIVE TRAVEL SELECTIONS, INC., NEW YORK, NY:
2,729,713, MULTIPLE CLASS, INT. CLS. 39 AND 42.

GLOBAL MOTORSPORT GROUP, INC., MORGAN HILL, CA:
2,678,651, COR. INT. CL. 12.

GLOBAL NOMADS GROUP, DALLAS, TX:
2,728,986, PUB. 4-1-2003. INT. CL. 38.

- GLOBAL TECHNOLOGY ASSOCIATES, SAN FRANCISCO, CA:
2,728,944, PUB. 4-1-2003. INT. CL. 35.
- GLOBAL TRADE INFORMATION SERVICES, INC., COLUMBIA, SC:
1,990,762, CANC. INT. CL. 9.
- GLOBAL TRADZ, INC., WATERVILLE, OH:
2,729,170, PUB. 4-1-2003. INT. CL. 36.
- GLOBALCLICKS.COM, LTD., NASSAU, BAHAMAS:
2,575,240, AM. INT. CL. 38.
- GLOBE INTERNATIONAL INC., BUFFALO, NY:
1,203,388, CANC. INT. CL. 7.
- GLOBETRENDS, INC., CATHAM, NJ:
2,730,683, INT. CL. 30.
- GLOCK, INC., SMYRNA, GA:
2,729,287, PUB. 4-1-2003. INT. CL. 8.
- GLYCON CORP., TECUMSEH, MI:
2,729,207, PUB. 4-1-2003. INT. CL. 7.
- GOBECO ENTERPRISES, LLC, ARCADIA, CA:
1,991,435, CANC. INT. CL. 25.
- GODSPEAKS, INC., ATLANTA, GA:
2,728,513, PUB. 1-14-2003. INT. CL. 42.
- GOEDE, ROGER A, ZEBULON, NC:
2,730,765, INT. CL. 35.
- GOLDEN EAGLE SYRUP CO., INC., FAYETTE, AL, GOLDEN EAGLE SYRUP MANUFACTURING COMPANY, INC., FAYETTE, AL:
954,574, REN. 5-10-03. U.S. CL. 46 (INT. CL. 30).
- GOLDEN OAK MARKETING, INC., COTTONWOOD, AZ:
1,994,917, CANC. INT. CL. 21.
- GOLDENTREE ASSET MANAGEMENT LP, NEW YORK, NY:
2,729,780, INT. CL. 36.
- GOLDMAN, JANET, NEW YORK, NY:
2,729,542, INT. CL. 16.
- GOLDMAR ENTERPRISES, INC., ORLANDO, FL FROM MARGO UNLIMITED, INC., NEW PORT RICHEY, FL:
2,730,314, MULTIPLE CLASS, INT. CLS. 30 AND 35.
- GOLDMARK, FRANCES, NEW HOPE, PA:
2,729,971, INT. CL. 3.
- GOLDSTAR CO., LTD., SEOUL, REPUBLIC OF KOREA:
1,990,652, CANC. INT. CL. 9.
- GOLDSTEIN, JERRY, HOUSTON, TX, DBA "BRACING INTERNATIONAL":
2,729,078, PUB. 4-1-2003. INT. CL. 9.
- GOLF COURSE BUILDERS ASSOCIATION OF AMERICA, INC., LINCOLN, NE:
2,728,952, PUB. 4-1-2003. INT. CL. 35.
- GOLF DIGEST/TENNIS, INC., TRUMBULL, CT:
1,992,130, CANC. INT. CL. 41.
- GOLF HOST RESORTS, INC., DURANGO, CO, GOLF HOSTS INTERNATIONAL, INC., TARPON SPRINGS, FL, DBA INNISBROOK ASSOCIATES:
955,488, REN. 5-16-03. U.S. CL. 107 (INT. CL. 41).
- GOLFER'S FOOTPRINT, INC., THE, MERIDIAN, ID:
2,730,190, INT. CL. 28.
- GOLFOLOGIST, LLC, THE, FLANDERS, NJ:
2,729,306, PUB. 4-1-2003. INT. CL. 44.
- GOOD HEALTH NATURAL FOODS, INC., NORTHPORT, NY:
2,729,656, INT. CL. 29.
- GOOD UNITED CO., TAIPEI, TAIWAN:
2,730,766, INT. CL. 28.
- GOODMARK USA INC., BOCA RATON, FL FROM PARTY SUCCESS INC., BOCA RATON, FL:
2,729,622, MULTIPLE CLASS, INT. CLS. 2, 3 AND 28.
- GOODTIMES HOME VIDEO CORP., NEW YORK, NY:
1,992,042, CANC. INT. CL. 9.
- GOODYEAR TIRE & RUBBER COMPANY, THE, AKRON, OH, RAYBESTOS-MANHATTAN, INC., PASSAIC, NJ:
571,768, REN. 5-12-03. U.S. CL. 35 (INT. CL. 7).
- GOODYEAR TIRE & RUBBER COMPANY, THE, AKRON, OH:
2,730,816, INT. CL. 7.
- GOOSEBUMPS PRODUCTS, INC., LONGWOOD, FL:
1,713,375, REN. 5-16-03. INT. CL. 10.
- GOPHER SHOOTER'S SUPPLY COMPANY, INCORPORATED, FARIBAUT, MN TO FORESTER PRODUCTS, INC., LANARK, IL:
1,203,495, CANC. INT. CL. 13.
- GORDON-DARBY SYSTEMS, INCORPORATED, LOUISVILLE, KY:
1,756,591, REN. 5-16-03. INT. CL. 9.
1,778,762, REN. 5-16-03. INT. CL. 9.
- GORI & ZUCCHI, INC., NEW YORK, NY:
1,991,940, CANC. INT. CL. 14.
- GOYA FOODS, INC., SECAUCUS, NJ:
1,755,576, REN. 5-15-03. INT. CL. 30.
- GRACE MCNAMARA, INC., ST. PAUL, MN:
2,730,274, INT. CL. 16.
- GRAHAM V. LEDGERWOOD, COSTA MESA, CA:
2,729,420, MULTIPLE CLASS, INT. CLS. 9, 16, 41 AND 42.
- GRAHAM, GIA A., ARLINGTON HEIGHTS, IL:
2,728,860, PUB. 4-1-2003. INT. CL. 16.
- GRAHAM, SCOTT, SAN ANTONIO, TX, DBA FAIRGREEN GOLF:
2,730,283, INT. CL. 41.
- GRAIN PROCESS ENTERPRISES LIMITED, SCARBOROUGH, ONTARIO, CANADA:
1,225,224, REN. 5-10-03. INT. CL. 30.
- GRAMTEL USA, INC., MISHAWAKA, IN:
2,730,914, MULTIPLE CLASS, INT. CLS. 38, 39 AND 42.
- GRANT LLOYD BERRY, INC., ARMONK, NY:
2,730,540, INT. CL. 3.
- GRAPHIC SURGERY, LLC, SYRACUSE, NY:
2,728,653, PUB. 4-1-2003. INT. CL. 42.
- GRAPHICS DEPARTMENT, INC., MINNEAPOLIS, MN TO Z-PIX COMPUTER GRAPHICS CENTERS, INC., ST. LOUIS PARK, MN:
1,705,975, CANC. INT. CL. 42.
- GRAPHLINE, INC., TAMARAC, FL, DBA DUOSTAT COMPANY:
2,039,854, CANC. INT. CL. 9.
- GRASCO, S.A., BOGOTA, COLOMBIA:
2,730,223, INT. CL. 29.
- GRAY; STEVEN S., EXCELSIOR, MN:
1,204,123, CANC. INT. CL. 42.
- GRAYSTONE BLOCK COMPANY, INC., MODESTO, CA:
2,729,412, INT. CL. 19.
- GREAT AMERICAN LIFE INSURANCE COMPANY, CINCINNATI, OH:
1,991,636, CANC. INT. CL. 36.
- GREAT LAKES PRODUCTS, INC., BIG BEND, WI:
1,814,448, REN. 5-10-03. INT. CL. 19.
- GREAT WALLENDAS, INC., THE, SARASOTA, FL:
2,730,041, INT. CL. 41.
- GREATER WASHINGTON EDUCATIONAL TELECOMMUNICATIONS ASSOCIATION, INC., ARLINGTON, VA:
1,991,776, CANC. INT. CL. 38.
1,991,777, CANC. INT. CL. 38.
- GREEN SANDS S.A., FRIBOURG, SWITZERLAND:
1,203,810, CANC. INT. CL. 32.
- GREENBAUM, DAVID, J., NEW YORK, NY:
2,730,825, INT. CL. 16.
- GREENBAX ENTERPRISES, INC., CHARLESTON, SC:
1,818,730, REN. 5-16-03. INT. CL. 6.
- GREENBRIER BASKET COMPANY, LLC, WICHITA, KS:
2,728,544, PUB. 4-1-2003. INT. CL. 21.
- GREENE TWEED OF DELAWARE, INC., WILMINGTON, DE:
2,728,611, PUB. 4-1-2003. MULTIPLE CLASS, INT. CLS. 7 AND 17.
- GREENE, TWEED OF DELAWARE, INC., WILMINGTON, DE:
2,728,735, PUB. 4-1-2003. INT. CL. 17.
- GREIN, JERI, DES PLAINES, IL, DBA JBG IMAGEMAKER:
2,730,328, INT. CL. 39.
- GRESHAM COSMETICS PTY LTD, MURRARRIE, QUEENSLAND, 4172, AUSTRALIA:
2,728,714, PUB. 4-1-2003. INT. CL. 3.
- GRESSCO, LTD., WAUNAKEE, WI, MAR-LINE DISPLAYS, INC., PORT CHESTER, NY:
959,378, REN. 5-13-03. U.S. CL. 32 (INT. CL. 20).

- GRIST MILL CO., LAKEVILLE, MN:
1,297,914, CANC. INT. CL. 30.
- GROCHOCINSKI, GROCHOCINSKI & LLOYD, LTD., ORLAND PARK, IL:
2,730,262, INT. CL. 42.
- GROSJEAN, DIAHNE, NEW YORK, NY:
2,728,871, PUB. 4-1-2003. INT. CL. 9.
- GROUNDED INC., SEATTLE, WA:
2,730,815, INT. CL. 25.
- GROUP III INTERNATIONAL LTD., FORT LAUDERDALE, FL:
1,704,996, CANC. INT. CL. 18.
- GROUP IV, INC., PITTSBURGH, PA:
2,730,853, INT. CL. 42.
- GROW-RICH ORGANIC FERTILIZERS LIMITED, OLD-CASTLE, ONTARIO, CANADA:
1,203,267, CANC. INT. CL. 1.
- GROWMARK, INC., BLOOMINGTON, IL:
1,203,832, CANC. INT. CL. 35.
- GRUBER, STEVEN A., PALM BAY, FL, DBA DYFLAM:
2,729,635, INT. CL. 16.
- GRUMA CORPORATION, IRVING, TX, GUERRERO MEXICAN FOODS, INC., WALNUT, CA:
1,781,602, REN. 5-15-03. INT. CL. 29.
- GRUPO MASSIMO DUTTI, S.A., 15142 ARTEIXO (LA CORUNA), SPAIN:
2,729,362, MULTIPLE CLASS, INT. CLS. 3 AND 25.
- GRUPO SAYER, S.A. DE C.V., APASEO EL ALTO, QUERTARO 38511, MEXICO:
2,730,467, INT. CL. 2.
- GUARD FINANCIAL GROUP, INC., WILKES-BARRE, PA:
2,730,579, INT. CL. 36.
- GUARDIAN LIFE INSURANCE COMPANY OF AMERICA, THE, NEW YORK, NY:
1,614,210, REN. 5-15-03. INT. CL. 36.
- GUDEBROD, INC., POTTSTOWN, PA:
1,991,271, CANC. INT. CL. 23.
- GUERRILLA NEWS NETWORK, INC., NEW YORK, NY:
2,730,885, INT. CL. 9.
- GUIDEPOSTS ASSOCIATES, INC., CARMEL, NY:
1,991,534, CANC. INT. CL. 16.
- GUIGNE INTERNATIONAL LIMITED, PARADISE, NEW-FOUNDLAND, CANADA:
1,991,590, CANC. INT. CL. 9.
- GUILMARTIN, NANCE, IPSWICH, MA:
2,728,992, PUB. 4-1-2003. INT. CL. 41.
- GUINOT, PARIS, FRANCE:
2,730,721, INT. CL. 3.
- GUITRON CORPORATION, THE, VERDUN, PROVINCE OF QUEBEC, H3E 1T6, CANADA:
2,729,389, INT. CL. 15.
- GUMBALL GOURMET, LLC, IDAHO FALLS, ID:
2,730,259, INT. CL. 30.
- GUPTA CORPORATION, MENLO PARK, CA:
1,991,620, CANC. INT. CL. 9.
- GUSTAFSON, L.L.C., PLANO, TX:
2,730,566, INT. CL. 5.
- GUTHY-RENKER CORPORATION, PALM DESERT, CA:
2,729,563, INT. CL. 3.
- GUYSON CORPORATION OF U.S.A., SARATOGA SPRINGS, NY:
1,991,132, CANC. INT. CL. 7.
- GW INTERNATIONAL INC., CARLSBAD, CA FROM GRAHAM WEBB INTERNATIONAL LIMITED PARTNERSHIP, CARLSBAD, CA:
2,730,147, INT. CL. 3.
- GYM-MARK, INC., BURLINGAME, CA:
2,728,955, PUB. 4-1-2003. MULTIPLE CLASS, INT. CLS. 12, 21, 22 AND 26.
- GYROTONIC SALES CORPORATION, NEW YORK, NY:
2,729,612, INT. CL. 25.
2,729,653, MULTIPLE CLASS, INT. CLS. 28 AND 41.
- H & H INDUSTRIES, INC., ELMWOOD, IL:
2,730,474, INT. CL. 11.
- H. BRINKHAUS GMBH & CO. KG, D-48231 WARENDORF, FED REP GERMANY:
2,729,660, MULTIPLE CLASS, INT. CLS. 20, 22 AND 24.
- H.C. STARCK GMBH & CO. KG, GOSLAR, FED REP GERMANY:
2,728,580, PUB. 4-16-2002. MULTIPLE CLASS, INT. CLS. 1, 6 AND 9.
- H-D MICHIGAN, INC., ANN ARBOR, MI:
2,730,239, INT. CL. 42.
- H-TECH, INC., WILMINGTON, DE, HAYWARD MANUFACTURING CO. INC., ELIZABETH, NJ:
1,207,109, REN. 5-15-03. INT. CL. 11.
- HACHETTE FILIPACCHI MEDIA U.S., INC., NEW YORK, NY, TRAVEL MAGAZINE, INC., FLORAL PARK, NY:
1,229,663, REN. 5-13-03. INT. CL. 16.
- HACKADAY, ROBERT, LONG BEACH, CA:
2,730,191, INT. CL. 28.
- HAEGER INDUSTRIES, INC., DUNDEE, IL:
573,392, REN. 5-16-03. U.S. CL. 30 (INT. CL. 21).
- HAGEMEYER NORTH AMERICA, INC., ALPHARETTA, GA:
2,729,030, PUB. 4-1-2003. INT. CL. 35.
- Haidar, ANWAR, ARLINGTON, VA AND Haidar, BASSEL, ARLINGTON, VA AND Haidar, HOUSSAM, ARLINGTON, VA:
2,730,313, INT. CL. 9.
- HAIGHTS CROSS COMMUNICATIONS, INC., WHITE PLAINS, NY:
2,729,861, MULTIPLE CLASS, INT. CLS. 9 AND 16.
- HALE PRODUCTS, INC., CONSHOHOCKEN, PA:
1,991,201, CANC. INT. CL. 9.
- HALEWOOD INTERNATIONAL BRANDS LIMITED, LIVERSEDEGE, UNITED KINGDOM:
2,730,958, INT. CL. 33.
- HALL, LARRY R., KINGSTON SPRINGS, TN:
2,729,074, PUB. 4-1-2003. INT. CL. 41.
- HALLIBURTON ENERGY SERVICES, INC., HOUSTON, TX FROM ONEOFFSHORE, INC., HOUSTON, TX:
2,728,650, PUB. 4-1-2003. INT. CL. 42.
- HALLIBURTON ENERGY SERVICES, INC., CARROLLTON, TX:
2,730,267, INT. CL. 42.
- HALLMARK LICENSING, INC., KANSAS CITY, MO:
2,729,701, INT. CL. 26.
- HALO PRODUCTS INC., SAN DIEGO, CA:
1,992,100, CANC. INT. CL. 28.
- HALOGEN LIGHTING PRODUCTS CORPORATION, KANEVILLE, IL:
2,730,530, INT. CL. 11.
- HALSTEAD HOLDINGS, LLC, NEW YORK, NY:
2,728,652, PUB. 4-1-2003. INT. CL. 36.
- HAMAMASTU CORPORATION, BRIDGEWATER, NJ:
2,729,403, MULTIPLE CLASS, INT. CLS. 7 AND 11.
- HAMMERMILL PAPER COMPANY, ERIE, PA:
735,674, CANC. U.S. CL. 37.
- HAMPTON INDUSTRIES, INC., KINSTON, NC:
1,990,758, CANC. INT. CL. 25.
- HANDGUN CONTROL, INC.:
See— BRADY CAMPAIGN TO PREVENT GUN VIOLENCE.
- HANDS ARE NOT FOR HURTING PROJECT, SALEM, OR:
2,653,935, COR. INT. CL. 41.
- HANKOOK TIRE CO., LTD., SEOUL, 135-723, REPUBLIC OF KOREA:
2,730,026, INT. CL. 12.
- HANOVER CATALOG HOLDINGS, INC., WEEHAWKEN, NJ:
1,991,265, CANC. INT. CL. 21.
- HANOVER DIRECT, INC., WEEHAWKEN, NJ:
1,991,572, CANC. INT. CL. 42.
- HANSEN BEVERAGE COMPANY, ANAHEIM, CA:
1,991,705, CANC. INT. CL. 30.
- HARBOR BRANCH OCEANOGRAPHIC INSTITUTION, INC., FORT PIERCE, FL:
2,730,701, INT. CL. 29.
- HARDHAT TECHNOLOGIES, INC., WILMINGTON, NC:
2,730,296, INT. CL. 35.
- HARDIE IRRIGATION, LANDSCAPE DIVISION, CARSON CITY, CA TO TORO COMPANY, THE, RIVERSIDE, CA:
1,704,686, CANC. INT. CL. 9.

- HARDINGER, CHARLES A., MILWAUKEE, WI:
1,991,856, CANC. INT. CL. 20.
- HARDY, C.T., SAFTEY HARBOR, FL:
2,730,562, INT. CL. 10.
- HARMAN INTERNATIONAL INDUSTRIES, INCORPORATED, NORTHRIDGE, CA:
2,730,807, INT. CL. 9.
- HARPER ELECTRIC FURNACE CORPORATION, LANCASTER, NY:
1,203,471, CANC. INT. CL. 11.
- HARPER'S MAGAZINE FOUNDATION, NEW YORK, NY:
1,812,085, REN. 5-15-03, INT. CL. 16.
- HARRIS ELECTRONIC DESIGN AUTOMATION, INC., FISHERS, NY:
1,991,981, CANC. INT. CL. 9.
- HARRIS RESEARCH, INC., LOGAN, UT:
1,762,324, REN. 5-16-03, INT. CL. 3.
- HARRIS TRUST AND SAVINGS BANK, CHICAGO, IL:
1,991,002, CANC. INT. CL. 36.
2,730,004, INT. CL. 36.
- HARRIS, PAUL ROBERT, EDINA, MN:
2,729,202, PUB. 4-1-2003, INT. CL. 35.
- HARRIS, REN J., OAKVILLE, CA AND HARRIS, MARILYN L., OAKVILLE, CA:
1,777,382, REN. 5-10-03, INT. CL. 33.
- HARRY N. ABRAMS, INCORPORATED, NEW YORK, NY:
1,229,650, REN. 5-16-03, INT. CL. 16.
1,229,651, REN. 5-16-03, INT. CL. 16.
- HART PRODUCTIONS, INC., CINCINNATI, OH:
1,938,145, CANC. INT. CL. 35.
- HARTEN JEWELRY CO., INC., LOS ANGELES, CA:
1,730,310, REN. 5-14-03, INT. CL. 14.
- HARTFORD FIRE INSURANCE COMPANY, HARTFORD, CT:
1,203,524, CANC. INT. CL. 16.
1,203,525, CANC. INT. CL. 16.
1,991,117, CANC. INT. CL. 36.
2,730,323, INT. CL. 36.
- HARTLE MEDIA, LLC, SAN FRANCISCO, CA:
2,730,009, INT. CL. 16.
- HARTLEY COURSEWARE, INC., DIMONDALE, MI TO COMPASSLEARNING, INC., SAN DIEGO, CA:
1,765,662, AM. INT. CL. 9.
- HARTMAN, BARBARA J., LYNCH STATION, VA AND HARTMAN, MARTIN A., LYNCH STATION, VA:
1,991,096, CANC. INT. CL. 30.
- HARTVILLE AUCTION, INC., HARTVILLE, OH:
2,305,437, COR. INT. CL. 42.
- HARVEY PHILLIPS FOUNDATION, INC., BLOOMINGTON, IN:
2,729,072, PUB. 4-1-2003, INT. CL. 41.
- HASBRO, INC., PAWTUCKET, RI:
2,728,965, PUB. 4-1-2003, INT. CL. 28.
2,730,033, INT. CL. 9.
- HASCO I.A. LIMITED, EARTH CITY, MO:
2,729,754, INT. CL. 40.
- HAT TRICK PRODUCTIONS LTD., LONDON W1V 3PH, ENGLAND:
2,729,127, PUB. 5-21-2002, INT. CL. 25.
- HAWAIIAN BREEZE, INC., PINELLAS PARK, FL:
1,991,718, CANC. INT. CL. 30.
- HAWAIIAN SUN PRODUCTS, INC., HONOLULU, HI:
1,811,628, REN. 5-10-03, INT. CL. 30.
- HAWK, ANTHONY, SAN JUAN CAPISTRANO, CA:
2,728,758, PUB. 4-1-2003, INT. CL. 9.
- HAWTHORNE MOUNTAIN VINEYARDS (2000) LTD.:
See—HAWTHORNE MOUNTAIN VINEYARDS LTD.
- HAWTHORNE MOUNTAIN VINEYARDS LTD., NIAGARA FALLS, ONTARIO, CANADA FROM HAWTHORNE MOUNTAIN VINEYARDS (2000) LTD., NIAGARA FALLS, ONTARIO, CANADA:
2,728,549, PUB. 4-1-2003, INT. CL. 33.
- HAZELTINE CORPORATION, GREENLAWN, NY:
1,203,432, CANC. INT. CL. 9.
- HBD INDUSTRIES, INC., DUBLIN, OH:
1,770,731, REN. 5-12-03, INT. CL. 7.
- HEAD ACQUISITION, L.P., CHICAGO, IL FROM URBAN SHOPPING CENTERS, INC., CHICAGO, IL:
2,730,865, MULTIPLE CLASS, INT. CLS. 35 AND 36.
- HEADLEE SYSTEMS, INC., NOVI, MI:
1,991,885, CANC. INT. CL. 9.
- HEALTH & FITNESS PUBLISHING, INC., HOUSTON, TX:
2,730,295, INT. CL. 41.
- HEALTH COST CONSULTANTS, INC., CHANTILLY, VA, HEALTH COST CONSULTANTS, INC., VIENNA, VA:
1,755,925, REN. 5-12-03, INT. CL. 42.
- HEALTH NET OF CALIFORNIA, INC., WOODLAND HILLS, CA FROM HEALTH NET, WOODLAND HILLS, CA:
2,729,806, MULTIPLE CLASS, INT. CLS. 35, 36, 41 AND 42.
- HEALTH NET, INC., WOODLAND HILLS, CA:
2,730,393, MULTIPLE CLASS, INT. CLS. 16 AND 41.
2,730,543, INT. CL. 16.
- HEALTH SERVICES CORPORATION OF AMERICA, CAPE GIRARDEAU, MO:
1,705,316, CANC. INT. CL. 35.
- HEALTH TOGS, INC., OAKHURST, NJ:
1,991,948, CANC. INT. CL. 25.
- HEALTH VIEW EYE CARE CENTERS, S.C., MEDFORD, WI:
2,729,858, INT. CL. 35.
2,729,859, INT. CL. 35.
- HEALTH-DRI SYSTEMS, INC., LINCOLNTON, NC:
1,991,641, CANC. INT. CL. 25.
- HEALTHPEACE, WASHINGTON, DC:
1,991,407, CANC. INT. CL. 42.
- HEALTHSOUTH, BIRMINGHAM, AL:
2,730,537, MULTIPLE CLASS, INT. CLS. 16, 25, 41 AND 42.
- HEALTHTEX APPAREL CORP., WILMINGTON, DE:
2,730,834, MULTIPLE CLASS, INT. CLS. 9 AND 25.
- HEALTHWISE, INCORPORATED, BOISE, ID:
2,729,980, MULTIPLE CLASS, INT. CLS. 9 AND 42.
- HEARST CORPORATION, THE, NEW YORK, NY:
1,705,844, CANC. INT. CL. 16.
1,991,826, CANC. INT. CL. 35.
- HEB GROCERY COMPANY, LP, SAN ANTONIO, TX:
2,728,904, PUB. 4-1-2003, INT. CL. 44.
2,728,909, PUB. 4-1-2003, INT. CL. 35.
- HEBLY, ADRIAAN, HILVERSUM, NETHERLANDS:
2,730,551, INT. CL. 35.
- HEDSTROM CORPORATION, BEDFORD, PA:
1,992,036, CANC. INT. CL. 28.
- HEER, ALFRED, CH-8344 BARETSWIL, SWITZERLAND:
1,990,897, CANC. INT. CL. 6.
- HEIDELBERGER DRUCKMASCHINEN AKTIENGESELLSCHAFT, 69115 HEIDELBERG, FED REP GERMANY:
2,728,568, PUB. 4-30-2002, MULTIPLE CLASS, INT. CLS. 7 AND 9.
2,728,744, PUB. 4-1-2003, INT. CL. 9.
- HEITER, STEFANIE, JULIANE, TOWNSEND, MA:
2,729,338, PUB. 4-1-2003, INT. CL. 41.
- HELENE CURTIS INDUSTRIES, INC., CHICAGO, IL:
735,790, CANC. U.S. CL. 51.
- HELENE CURTIS, INC., CHICAGO, IL:
1,991,291, CANC. MULTIPLE CLASS, INT. CLS. 21 AND 26.
- HELLAS BAKERY AND PITA, INC., TARPON SPRINGS, FL:
2,728,929, PUB. 4-1-2003, INT. CL. 30.
2,728,930, PUB. 4-1-2003, INT. CL. 35.
- HELLENBRAND WATER CONDITIONERS CO., INC., WAUNAKEE, WI TO HELLENBRAND WATER CONDITIONERS CO., INC., WAUNAKEE, WI:
1,767,365, COR. INT. CL. 11.
- HELP THE AGED, LONDON N1 9UZ, ENGLAND:
2,728,597, PUB. 4-1-2003, MULTIPLE CLASS, INT. CLS. 16 AND 36.
- HEMASURE INC., MARLBOROUGH, MA:
1,991,688, CANC. INT. CL. 10.
- HENKEL CONSUMER ADHESIVES, INC., AVON, OH, MANCO, INC., AVON, OH:
1,759,169, REN. 5-10-03, INT. CL. 16.
1,759,880, REN. 5-10-03, INT. CL. 17.

HENKEL CORPORATION, MINNEAPOLIS, MN:
735,518, CANC. U.S. CL. 1.

HERAEUS-KULZER, INC., ARMONK, NY, J.F. JELENKO & COMPANY, INC., NEW YORK, NY:
302,696. REN. 5-10-03. U.S. CL. 44 (INT. CL. 5).

HERBA LAB INC., VANCOUVER, BRITISH COLUMBIA, CANADA FROM HERBACEUTICAL SKIN CARE LTD., VANCOUVER, BRITISH COLUMBIA, CANADA:
2,729,411, INT. CL. 3.

HERBALANIMALS, INC., BETHESDA, MD:
1,991,336, CANC. INT. CL. 20.

HERCULES INCORPORATED, WILMINGTON, DE:
1,705,717, CANC. INT. CL. 1.

HERITAGE EXPOSITION SERVICES, INC., SAINT LOUIS, MO:
2,728,845, PUB. 4-1-2003. MULTIPLE CLASS, INT. CLS. 35, 39 AND 43.

HERITAGE QUARTET, MOUNT PLEASANT, AR:
2,728,934, PUB. 4-1-2003. INT. CL. 41.

HERMAN MILLER, INC., ZEELAND, MI:
2,729,718, INT. CL. 35.

HERNANDEZ-DIAZ, LEONOR, 28925 ALCORCON, MADRID, SPAIN:
1,991,035, CANC. INT. CL. 25.

HERNANDEZ, ROLANDO, MIAMI, FL:
2,730,657, INT. CL. 42.

HERO, 5600 LENZBURG, SWITZERLAND, CONSERVES HERO LENZBOURG, LENZBOURG, SWITZERLAND:
1,230,132. REN. 5-16-03. INT. CL. 29.

HEROIX CORPORATION, NEWTON, MA:
2,729,942, INT. CL. 9.

HERSHEY CREAMERY COMPANY, HARRISBURG, PA:
2,729,075, PUB. 4-1-2003. INT. CL. 30.

HEWLETT-PACKARD COMPANY, PALO ALTO, CA:
1,705,429, CANC. INT. CL. 37.
1,991,924, CANC. INT. CL. 9.

HIDEAWAYS, LLC, SURPRISE, AZ:
2,730,464, INT. CL. 37.

HIGH COTTON DIRECT MARKETING, INC., BIRMINGHAM, AL:
2,728,695, PUB. 4-1-2003. INT. CL. 35.

HIGH PERFORMANCE FITNESS, INC., HOUSTON, TX:
2,729,100, PUB. 4-1-2003. INT. CL. 5.

HIGH POINT KNITTING, NEW YORK, NY:
1,705,875, CANC. INT. CL. 25.

HIGHLAND SYSTEMS INTERNATIONAL, INC., BROOKLYN, NY:
1,705,629, CANC. INT. CL. 42.

HIJK, CARLSBAD, CA:
2,728,734, PUB. 4-1-2003. INT. CL. 9.

HILCO TECHNOLOGIES, INC., EARTH CITY, MO:
1,990,763, CANC. MULTIPLE CLASS, INT. CLS. 9, 41 AND 42.

HILL, MIRIAM JACKIE, KIHEI, HI AND CORRICK, STEPHEN KELLEY, KIHEI, HI TO HILL, TRIANA JACKIE, KIHEI, HI:
1,706,055, CANC. INT. CL. 41.

HILL, RICHARD D., PHOENIX, AZ, DBA DANCING BEAR IRON WORKS:
2,728,797, PUB. 3-11-2003. INT. CL. 6.

HINDUSTAN LEVER LIMITED, MUMBAI 400 020, INDIA:
2,638,451, COR. INT. CL. 29.

HINKLEY LIGHTING INCORPORATED, CLEVELAND, OH:
2,728,994, PUB. 4-1-2003. INT. CL. 16.

HIPWELL MANUFACTURING COMPANY, PITTSBURGH, PA:
1,203,470, CANC. INT. CL. 11.

HIRST INVESTMENT MANAGEMENT INC., HEATHROW, FL:
2,728,875, PUB. 4-1-2003. INT. CL. 36.

HISPANIC BROADCASTING CORPORATION, DALLAS, TX, VIVA AMERICA MEDIA GROUP, MIAMI, FL:
1,733,657. REN. 5-15-03. INT. CL. 41.

HISPANIC RADIO NETWORK, LLC., WASHINGTON, DC:
2,730,873, MULTIPLE CLASS, INT. CLS. 38 AND 41.

HITCHCOCK CHAIR CO., LTD., THE, NEW HARTFORD, CT FROM HITCHCOCK HOLDING CO., NEW HARTFORD, CT:
2,729,623, INT. CL. 35.

HODERS CO. LTD., SAN PO KONG, KOWLOON, HONG KONG:
1,744,088. REN. 5-15-03. INT. CL. 14.

HOFFMAN, M. MILTON, MUNCY, PA, DBA THE HOFFMAN SEED & GRAIN CO.:
735,520, CANC. U.S. CL. 1.

HOFFMANN-LA ROCHE INC., NUTLEY, NJ:
1,991,329, CANC. INT. CL. 5.

HOFFMANN-LA ROCHE INC., NUTLEY, NJ FROM HLR TECHNOLOGY CORPORATION, NUTLEY, NJ:
2,730,123, INT. CL. 42.

HOKUSHIN SEIKI CO., LTD., TOKYO, JAPAN:
2,728,678, PUB. 4-1-2003. INT. CL. 7.

HOLCOMB & HOKE MFG. CO., INC., INDIANAPOLIS, IN, HOLCOMB & HOKE MFG. CO., INC., INDIANAPOLIS, IN:
576,270. REN. 5-16-03. U.S. CL. 12 (INT. CL. 19).

HOLLAND, DAVID, BOWLING GREEN, KY:
2,729,159, PUB. 4-1-2003. INT. CL. 20.

HOLLANDER HOME FASHIONS CORP., BOCA RATON, FL:
1,781,457. REN. 5-16-03. MULTIPLE CLASS, INT. CLS. 20 AND 24.

HOLMBERG COMPANY, INC., MINNEAPOLIS, MN:
2,728,684, PUB. 4-1-2003. INT. CL. 16.

HOLUB, CRAIG S., LIVELY, ONTARIO, CANADA:
2,729,719, INT. CL. 28.

HOME CARE ASSOCIATION OF AMERICA, INC., JACKSONVILLE, FL:
1,990,741, CANC. INT. CL. 41.

HOME ENVIRONMENT CENTER FRANCHISE, INC., MINNEAPOLIS, MN:
1,992,072, CANC. INT. CL. 42.

HOME GARDENER MANUFACTURING CO., LITITZ, PA:
2,730,874, INT. CL. 20.

HOMEDICS, INC., KEEGO HARBOR, MI:
2,729,467, INT. CL. 10.

HOMEOWNERS GROUP, INC., HOLLYWOOD, FL:
1,705,962, CANC. INT. CL. 36.

HOMER TLC, INC., CLAYMONT, DE:
2,730,350, INT. CL. 19.

HOMESTORE.COM, INC., WESTLAKE VILLAGE, CA:
2,729,959, MULTIPLE CLASS, INT. CLS. 35, 36, 37, 39 AND 42.

HON FU FOODS CO., LTD., PAN-CHIAO CITY, TAIPEI HSIEN, TAIWAN:
1,705,248, CANC. INT. CL. 30.

HON HAI PRECISION INDUSTRY CO., LTD., TAIWAN:
2,590,433, COR. INT. CL. 35.

HONICORP, INC., NEW YORK, NY:
1,991,652, CANC. INT. CL. 35.

HOOVER-HAWLEY ASSOCIATES, INC., FORT WAYNE, IN:
2,729,256, PUB. 4-1-2003. INT. CL. 21.

HOPE CHEMICAL SUPPLEMENTS, L.L.C., LAKE BLUFF, IL:
2,730,427, INT. CL. 5.

HORIBA LTD., MINAMI-KU, KYOTO, JAPAN:
2,729,897, INT. CL. 9.

HORIBA, LTD., KYOTO, JAPAN:
2,730,178, MULTIPLE CLASS, INT. CLS. 9, 10 AND 37.

HORIZON HEALTH CORPORATION, LEWISVILLE, TX:
2,730,165, INT. CL. 42.

HORIZON RESOURCES, INC., HOUSTON, TX:
1,204,069, CANC. INT. CL. 42.

HORMEL FOODS, LLC, AUSTIN, MN:
2,729,123, PUB. 4-1-2003. MULTIPLE CLASS, INT. CLS. 29 AND 30.

HOROWITZ, SUSAN, NEW YORK, NY:
2,730,608, INT. CL. 28.

HORSESHOE GAMING HOLDING CORP., TINLEY PARK, IL:
2,728,851, PUB. 4-1-2003. INT. CL. 41.

- HOS DEVELOPMENT CORPORATION, LITCHFIELD, IL,
SCHUTT MANUFACTURING COMPANY, LITCHFIELD,
IL:
1,814,485. REN. 5-10-03. INT. CL. 28.
- HOT RODS MOTORCYCLE & AUTO PARTS CORPORATION,
URBANDALE, IA:
2,729,456. INT. CL. 7.
- HOTEL SOFTWARE SYSTEMS, LTD., PORTLAND, OR:
2,729,705. INT. CL. 39.
- HOUGHTON MIFFLIN COMPANY, BOSTON, MA:
1,705,847. CANC. INT. CL. 16.
- HOUSE OF GIVING, PHOENIX, AZ:
2,728,878. PUB. 4-1-2003. INT. CL. 36.
- HOUSE OF THE LORD, THE, AKRON, OH:
2,728,841. PUB. 4-1-2003. INT. CL. 41.
2,728,842. PUB. 4-1-2003. INT. CL. 9.
2,728,843. PUB. 4-1-2003. INT. CL. 45.
- HOUSE, DEBORAH A., WHEATON, IL:
2,728,873. PUB. 4-1-2003. MULTIPLE CLASS, INT. CLS. 35
AND 36.
- HOUSER, PETE J, BERKELEY, CA:
2,729,151. PUB. 4-1-2003. INT. CL. 9.
- HOUSEWEARS, INC., NILES, IL:
1,705,081. CANC. MULTIPLE CLASS, INT. CLS. 24 AND
25.
- HOUSTON INTERWEB DESIGN, INC., HOUSTON, TX:
2,729,580. INT. CL. 42.
- HOWARD FERTILIZER COMPANY, ORLANDO, FL:
2,729,247. PUB. 4-1-2003. INT. CL. 1.
2,729,248. PUB. 4-1-2003. INT. CL. 1.
- HOWARD, JOY, A. ST. LOUIS, MO:
2,729,323. PUB. 4-1-2003. INT. CL. 41.
- HOWELL, RICHARD L., JR., YORBA LINDA, CA:
2,730,095. INT. CL. 7.
- HP INTELLECTUAL CORP., WILMINGTON, DE:
2,730,596. INT. CL. 7.
- HP INTELLECTUAL CORP., WILMINGTON, CT:
2,730,614. INT. CL. 11.
- HRD PRESS, INC., AMHERST, MA:
2,730,493. INT. CL. 35.
- HRS INTERNET, LLC, SHELBYVILLE, IN, DBA LIGHT-
BOUND:
2,729,285. PUB. 4-1-2003. MULTIPLE CLASS, INT. CLS. 38
AND 42.
- HUBBELL INCORPORATED, ORANGE, CT:
2,730,911. INT. CL. 11.
- HUFFY CORPORATION, MIAMISBURG, OH:
2,729,179. PUB. 4-1-2003. INT. CL. 12.
- HUGHES ELECTRONICS CORPORATION, EL SEGUNDO,
CA:
2,730,396. INT. CL. 38.
- HUGHES NEW YORK INCORPORATED, ATLANTA, GA:
2,730,473. INT. CL. 5.
- HUGHES SUPPLY IP, INC., WILMINGTON, DE FROM
HUGHES SUPPLY MANAGEMENT SERVICES, INC.,
ORLANDO, FL:
2,729,726. INT. CL. 7.
- HUMAN KINETICS PUBLISHERS, INC., CHAMPAIGN, IL:
1,992,140. CANC. MULTIPLE CLASS, INT. CLS. 9, 16, 41
AND 42.
- HUMANA INC., LOUISVILLE, KY:
1,991,657. CANC. INT. CL. 36.
- HUMANA, INC., LOUISVILLE, KY, CHOICE BENEFITS
ADMINISTRATION, INC., CINCINNATI, OH, DBA
CHOICE CARE:
1,743,514. REN. 5-16-03. INT. CL. 36.
- HUMANERGY, INC., MARSHALL, MI:
2,729,070. PUB. 4-1-2003. INT. CL. 41.
2,729,071. PUB. 4-1-2003. INT. CL. 41.
- HUMANEYES TECHNOLOGIES, LTD., 91904 JERUSALEM,
ISRAEL:
2,728,629. PUB. 4-1-2003. INT. CL. 9.
- HUMMINGBIRD LTD., NORTH YORK, ONTARIO M2H
2W1, CANADA:
2,730,144. INT. CL. 9.
- HUNG HSIANG BEDDING CO., LTD., TAOYUAN HSIEN,
TAIWAN:
2,730,635. INT. CL. 20.
- HUNT HOLDINGS, INC., WILMINGTON, DE:
2,729,309. PUB. 4-1-2003. INT. CL. 16.
- HUNT-WESSON FOODS, INC., FULLERTON, CA:
396,814. CANC. U.S. CL. 46.
- HUNTER DOUGLAS INC., UPPER SADDLE RIVER, NJ:
2,730,107. INT. CL. 17.
- HUNTER ENGINEERING COMPANY, BRIDGETON, MO:
2,730,216. INT. CL. 9.
- HUNTER FAN COMPANY, MEMPHIS, TN:
1,991,543. CANC. INT. CL. 11.
1,992,033. CANC. INT. CL. 11.
2,729,348. PUB. 4-1-2003. INT. CL. 11.
2,729,932. INT. CL. 11.
- HUNTER PACIFIC LIMITED, TORTOLA, BR. VIRGIN IS-
LANDS:
2,729,573. INT. CL. 13.
- HUNTING WORLD INCORPORATED, NEW YORK, NY:
1,203,689. CANC. INT. CL. 25.
- HURRELL, LEONA, SURREY, BRITISH COLUMBIA, V3R
7T3, CANADA:
2,728,497. PUB. 4-1-2003. INT. CL. 21.
- HUSQVARNA AKTIEBOLAG, STOCKHOLM, SWEDEN:
1,704,550. CANC. INT. CL. 7.
- HWA YUAN FOODS CO., LTD., WU CHI CHEN, TAI-
CHUNG HSIEN, TAIWAN:
2,729,595. MULTIPLE CLASS, INT. CLS. 29 AND 30.
- HWE, INC., NORTH HOLLYWOOD, CA:
1,991,867. CANC. INT. CL. 10.
- HYDRO-AIR ENGINEERING, INC., ST. LOUIS, MO:
735,546. CANC. U.S. CL. 12.
- HYPER CORPORATION, PLEASANTON, CA:
2,730,656. INT. CL. 9.
- HYPERFORMIX, INC., AUSTIN, TX, FORMERLY SCIEN-
TIFIC & ENGINEERING SOFTWARE, INC.:
2,729,729. INT. CL. 9.
- I.C.E.D. MANAGEMENT, INC., WILMINGTON, DE:
2,659,874. COR. INT. CL. 16.
- I.C.O.N. LINE, INC., WOODLAND HILLS, CA:
2,730,303. INT. CL. 3.
- I'M THIRD FOUNDATION, BRANSON, MO:
1,991,217. CANC. INT. CL. 36.
- IAA TRUST COMPANY, BLOOMINGTON, IL:
1,203,893. CANC. INT. CL. 36.
- IAMINDEPENDENT.COM, INC., TENAFLY, NJ:
2,730,017. INT. CL. 35.
- IBOXX LIMITED, LONDON EC2V 6AD, ENGLAND:
2,728,723. PUB. 4-1-2003. INT. CL. 36.
- IBP FOODS CO., THE, SPRINGDALE, AR, TAV BRANDS,
INC., LAS VEGAS, NV:
1,757,032. REN. 5-15-03. INT. CL. 29.
- ICONOVEX, BLOOMINGTON, MN:
1,991,725. CANC. INT. CL. 9.
- ICONVERSE.COM, INC., SUDBURY, MA:
2,729,711. INT. CL. 9.
- ICP ELECTRONICS INC., SHI-CHI CITY, TAIPEI HSIEN,
TAIWAN:
2,730,153. INT. CL. 9.
- IDEAL HEALTH, INC., PORTSMOUTH, NH:
2,729,101. PUB. 4-1-2003. INT. CL. 5.
2,729,102. PUB. 4-1-2003. INT. CL. 5.
- IDEASPHERE, INC., WAYLAND, MA:
2,730,824. INT. CL. 35.
- IGLOO PRODUCTS CORP., HOUSTON, TX:
1,705,048. CANC. INT. CL. 21.
1,705,868. CANC. INT. CL. 21.
- IHELPHYOU, INC., MT. PLEASANT, SC:
2,729,218. PUB. 4-1-2003. INT. CL. 35.
- IJL HOLDINGS CORPORATION, SAN DIEGO, CA, IT'S
JUST LUNCH! INC., CHICAGO, IL:
1,821,901. REN. 5-16-03. INT. CL. 42.
1,821,902. REN. 5-16-03. INT. CL. 42.
- ILLINOIS MUTUAL LIFE INSURANCE CO., PEORIA, IL:
2,730,403. INT. CL. 36.
- ILLINOIS TOOL WORKS INC., GLENVIEW, IL, MILLER
ELECTRIC MFG. CO., APPLETON, WI:
957,774. REN. 5-10-03. U.S. CL. 34 (INT. CL. 9).

ILLINOIS TOOL WORKS INC., GLENVIEW, IL, ELGA AKTIEBOLAG, S-433 25 PARTILLE, SWEDEN:
1,752,285. REN. 5-10-03. INT. CL. 9.

ILLINOIS TOOL WORKS INC., GLENVIEW, IL:
2,729,252, PUB. 4-1-2003. INT. CL. 2.

ILLTOWN RECORDS, LTD., ORANGE, NJ:
1,991,701, CANC. MULTIPLE CLASS, INT. CLS. 9 AND 41.

IMAGESURE LLC, CHICAGO, IL:
2,729,854, INT. CL. 35.

IMAGIX CORPORATION, BEAVERTON, OR:
1,991,974, CANC. INT. CL. 9.

IMDB, INC., SEATTLE, WA:
2,730,592, INT. CL. 35.

IMDISI, INC., WAYNE, PA:
2,728,894, PUB. 4-1-2003. INT. CL. 16.

IMP, INC., SAN JOSE, CA:
1,991,794, CANC. INT. CL. 9.

IMPACT CONFECTIONS, INC., COLORADO SPRINGS, CO:
2,728,872, PUB. 4-1-2003. INT. CL. 30.

IMPACT REGISTERS, INC., LARGO, FL, IMPACT REGISTERS, INC., CHAMPAIGN, IL:
942,497. REN. 5-15-03. U.S. CL. 26 (INT. CL. 9).

IMPECCABLE TASTES FINE CATERING, INC., SACRAMENTO, CA:
2,729,103, PUB. 4-1-2003. INT. CL. 43.

IMPERIAL PIPE CORPORATION, TORONTO, ONTARIO, CANADA:
2,730,315, INT. CL. 17.

IMPERIAL TOY CORPORATION, LOS ANGELES, CA:
1,991,916, CANC. INT. CL. 28.

IMPERIAL 400 NATIONAL, INC., ARLINGTON, VA:
1,204,107, CANC. INT. CL. 42.

IN HOME HEALTH, INC., MINNETONKA, MN:
1,705,551, CANC. INT. CL. 42.

INCHCAPE SHIPPING SERVICES, INC., MOBILE, AL:
1,990,771, CANC. INT. CL. 39.

INCO LIMITED, TORONTO, ONTARIO, CANADA:
1,704,521, CANC. INT. CL. 6.

INCREDIBLY EDIBLE DELITES, INC., BROOMALL, PA:
1,755,554. REN. 5-14-03. INT. CL. 29.

INDEX INDUSTRIES, INC., GRAND RAPIDS, MI:
1,704,502, CANC. INT. CL. 4.

INDEX NEWSPAPERS LLC, SEATTLE, WA FROM LOADED-FOR-BEAR PUBLISHING CO., SEATTLE, WA:
2,729,678, INT. CL. 16.

INDIAN INDUSTRIES, INC., EVANSVILLE, IN:
2,729,454, INT. CL. 19.

INDIANA NATIONAL BANK, THE, INDIANAPOLIS, IN:
1,203,902, CANC. INT. CL. 36.

INDIANAPOLIS COLTS, INC., INDIANAPOLIS, IN:
1,809,131. REN. 5-16-03. MULTIPLE CLASS, INT. CLS. 16 AND 25.
1,810,715. REN. 5-16-03. MULTIPLE CLASS, INT. CLS. 16 AND 25.

INDIANAPOLIS MOTOR SPEEDWAY CORPORATION, SPEEDWAY, IN:
1,991,520, CANC. MULTIPLE CLASS, INT. CLS. 25 AND 28.

INDIANAPOLIS MOTOR SPEEDWAY CORPORATION, INDIANAPOLIS, IN:
2,729,453, INT. CL. 41.

INDOPCO, INC., BRIDGEWATER, NJ, DBA NATIONAL STARCH & CHEMICAL COMPANY:
2,730,719, INT. CL. 1.

INDUSTRIA CHIMICA GENERAL SNC, 41100 MODENA, ITALY:
2,729,531, INT. CL. 1.

INDUSTRIAL COATINGS GROUP, INC., CHICAGO, IL:
1,704,982, CANC. INT. CL. 17.

INDUSTRIAL LINK, INC., BROOKLYN, NY:
2,729,079, PUB. 4-1-2003. INT. CL. 29.

INDUSTRIAS AUXILIARES FAUS, S.L., 46700 GANDIA, SPAIN:
2,729,447, INT. CL. 19.

INDUSTRIAS DE CHOCOLATE LACTA S/A, SAO PAULO-SP, BRAZIL:
1,991,951, CANC. INT. CL. 30.

INDUSTRIAS MARCA, S.A., 08907 L' HOPITALET DE LLOBREGAT, SPAIN:
2,730,487, INT. CL. 2.

INFOGRAMES, INC., NEW YORK, NY:
2,728,983, PUB. 4-1-2003. INT. CL. 9.

INFOPOWER CORPORATION, ARCADIA, CA:
2,729,148, PUB. 4-1-2003. INT. CL. 9.

INFORMATION BUILDERS, INC., NEW YORK, NY:
1,992,156, CANC. INT. CL. 9.

INFORMATION DECISION TECHNOLOGIES LLC, BEDFORD, NH TO HARMLESS HAZARDS TRAINING, LLC, BEDFORD, NH:
2,612,023 NEW CERT. 6-24-2003. INT. CL. 42.

INFORMATION HANDLING SERVICES INC., ENGLEWOOD, CO:
1,774,222. REN. 5-10-03. INT. CL. 16.

INFORMATION PRESENTATION TECHNOLOGIES, INC., SAN LUIS OBISPO, CA:
1,990,777, CANC. INT. CL. 9.

INFOTRIEVER, INC., TORONTO, ONTARIO M4R 1K8, CANADA:
2,728,931, PUB. 4-1-2003. INT. CL. 9.

INFOVISION TECHNOLOGIES, WESTBOROUGH, MA:
1,991,627, CANC. INT. CL. 9.

INGALLS, QUINN & JOHNSON, BOSTON, MA:
1,991,806, CANC. INT. CL. 35.

INGATE SYSTEMS AB, 117 27 STOCKHOLM, SWEDEN:
2,730,293, INT. CL. 9.

INGE-GLAS GMBH & CO. KG, 96465 NEUSTADT B. COBURG, FED REP GERMANY:
2,729,849, INT. CL. 28.

INGERSOLL-RAND COMPANY, WOODCLIFF LAKE, NJ:
2,730,710, INT. CL. 42.

INJECTION FOOTWEAR CORP., MIAMI, FL:
1,991,745, CANC. INT. CL. 25.

INNER WAY, THE, HOMELAND, CA:
1,203,542, CANC. INT. CL. 16.

INNERCOOL THERAPIES, INC., SAN DIEGO, CA:
2,730,010, INT. CL. 10.

INNOMAX CORPORATION, DENVER, CO:
2,728,651, PUB. 4-1-2003. INT. CL. 20.

INNOMEDIA PTE LTD., SINGAPORE 117684, SINGAPORE:
2,730,066, INT. CL. 9.

INNOTEK, INC., GARRETT, IN:
2,729,551, INT. CL. 9.

INNOVA INC., DAVENPORT, IA:
2,729,905, INT. CL. 25.

INNOVATION FACTORY, INC., HAVERTOWN, PA:
2,730,327, INT. CL. 8.

INNOVATIVE SAFETY TECHNOLOGIES, INC., PORTLAND, OR FROM INNOVATIVE SAFETY TECHNOLOGIES, LLC, WEST LINN, OR:
2,730,681, INT. CL. 9.

INNOVATIVE SOLUTIONS AND TECHNOLOGIES, LLC, BOZEMAN, MT:
2,729,300, PUB. 4-1-2003. INT. CL. 9.

INSIGHTFUL CORPORATION, SEATTLE, WA:
2,730,385, INT. CL. 42.
2,730,386, INT. CL. 42.

INSPECTION ONE, INC., SOUTHAMPTON, PA, HOUSEMASTER OF AMERICA, INC., BOUND BROOK, NJ:
1,792,215. REN. 5-14-03. INT. CL. 42.

INSTITUTE FOR MOTIVATIONAL LIVING, INC., NEW CASTLE, PA:
2,652,457, COR. MULTIPLE CLASS, INT. CLS. 16 AND 42.

INSTITUTE OF ELECTRICAL AND ELECTRONICS ENGINEERS, INC., THE, PISCATAWAY, NJ:
1,792,095. REN. 5-15-03. U.S. CL. A.

INTAGLIO VIVI-COLOR ALLIANCE, LTD., SCHILLER PARK, IL:
1,991,161, CANC. MULTIPLE CLASS, INT. CLS. 40 AND 42.

INTEC CORPORATION, CLARK, NJ:
2,728,478, PUB. 4-1-2003. MULTIPLE CLASS, INT. CLS. 18, 25 AND 28.

INTEC MANAGEMENT, INC., GRAND RAPIDS, MI:
1,990,934, CANC. INT. CL. 42.

- INTEGRAL MEDIA, 90000 BELFORT, FRANCE:
2,728,644, PUB. 4-1-2003. MULTIPLE CLASS, INT. CLS. 9, 35, 38, 39 AND 41.
- INTEGRATED HEALTHSYSTEMS, INC., KANSAS CITY, MO:
1,991,252, CANC. INT. CL. 36.
- INTEGRATED INFORMATION SYSTEMS, INC., TEMPE, AZ:
2,728,504, PUB. 4-1-2003. INT. CL. 41.
2,728,553, PUB. 4-1-2003. INT. CL. 9.
- INTEGRATED INFORMATION TECHNOLOGY CORPORATION, DENVER, CO:
2,729,211, PUB. 4-1-2003. MULTIPLE CLASS, INT. CLS. 37 AND 42.
- INTEGRITY MEDIA, INC., MOBILE, AL FROM INTEGRITY INCORPORATED, MOBILE, AL:
2,730,733, MULTIPLE CLASS, INT. CLS. 9 AND 16.
- INTEGRITY TOYS, INC., JERSEY CITY, NJ:
2,730,362, INT. CL. 28.
- INTELTECH INTERNATIONAL CORPORATION, SOUTH SALEM, NY:
1,991,113, CANC. INT. CL. 30.
- INTELLIDEN, INC., COLORADO SPRINGS, CO:
2,730,470, INT. CL. 9.
2,730,471, INT. CL. 9.
- INTELLIGENT MEETINGS CORP., MASHPEE, MA:
2,728,632, PUB. 4-1-2003. INT. CL. 38.
- INTELLIGENT PRODUCTS INCORPORATED OF ILLINOIS, BURLINGTON, KY:
2,730,932, INT. CL. 16.
- INTELLOCITY USA, INC., DENVER, CO FROM INTELLOCITY, INC., CAUSEWAY BAY, HONG KONG:
2,730,863, INT. CL. 9.
- INTELLOCITY USA, INC., DENVER, CO:
2,730,877, INT. CL. 9.
- INTELLOCITY, INC.:
See— INTELLOCITY USA, INC..
- INTER-BRIGHT INC., CITY OF INDUSTRY, CA:
2,730,450, INT. CL. 25.
- INTER-CONTINENTAL HOTELS CORPORATION, ATLANTA, GA:
2,729,250, PUB. 4-1-2003. INT. CL. 3.
- INTER-VARSITY CHRISTIAN FELLOWSHIP OF THE UNITED STATES OF AMERICA, MADISON, WI:
1,704,913, CANC. INT. CL. 16.
- INTERACTIVE SOLUTIONS, INC., PLEASANTO, CA:
1,766,617, REN. 5-15-03. INT. CL. 9.
- INTERELEMENTS, INC., LOS ANGELES, CA:
1,990,704, CANC. INT. CL. 25.
- INTERLEGO A.G., BAAR, SWITZERLAND TO KIRKBI AG, BAAR, SWITZERLAND:
1,713,101, AM. INT. CL. 8.
- INTERMEDICS, INC., ST. PAUL, MN:
1,241,956, REN. 5-10-03. INT. CL. 10.
- INTERNATIONAL AGRICULTURAL & FOOD INDUSTRIES, LTD., ROSWELL, GA:
1,990,881, CANC. MULTIPLE CLASS, INT. CLS. 35 AND 42.
- INTERNATIONAL BUSINESS MACHINES CORPORATION, ARMONK, NY, SANTA CRUZ OPERATION, INC., THE, SANTA CRUZ, CA:
1,229,396, REN. 5-14-03. INT. CL. 9.
- INTERNATIONAL BUSINESS MACHINES CORPORATION, ARMONK, NY:
1,704,604, CANC. MULTIPLE CLASS, INT. CLS. 9 AND 16.
1,705,689, CANC. MULTIPLE CLASS, INT. CLS. 9 AND 16.
- INTERNATIONAL BUSINESS MACHINES CORPORATION, ARMONK, NY, INTERNATIONAL BUSINESS MACHINES CORPORATION, ARMONK, NY:
1,727,100, REN. 5-16-03. MULTIPLE CLASS, INT. CLS. 9 AND 16.
- INTERNATIONAL BUSINESS MACHINES CORPORATION, ARMONK, NY:
1,757,489, REN. 5-11-03. MULTIPLE CLASS, INT. CLS. 9 AND 16.
- INTERNATIONAL CENTRE FOR RESEARCH IN AGRO-FORESTRY, NAIROBI, KENYA:
2,730,889, INT. CL. 35.
- INTERNATIONAL DATA GROUP, INC., FRAMINGHAM, MA:
1,990,703, CANC. INT. CL. 9.
1,992,224, CANC. INT. CL. 28.
2,729,128, PUB. 4-1-2003. MULTIPLE CLASS, INT. CLS. 16 AND 42.
2,729,130, PUB. 4-1-2003. INT. CL. 16.
- INTERNATIONAL ELECTRONICS, INC., VANCOUVER, WA:
2,728,738, PUB. 4-1-2003. INT. CL. 9.
- INTERNATIONAL FRANCHISE ASSOCIATION, WASHINGTON, DC:
1,812,132, REN. 5-10-03. INT. CL. 16.
- INTERNATIONAL FRUIT, INC., WINTER PARK, FL:
1,991,020, CANC. INT. CL. 32.
- INTERNATIONAL GAMCO, INC., OMAHA, NE:
1,705,158, CANC. INT. CL. 28.
1,991,295, CANC. INT. CL. 28.
- INTERNATIONAL MARKETING INCORPORATED, CHAMBERSBURG, PA:
1,228,883, REN. 5-16-03. INT. CL. 1.
- INTERNATIONAL PUBLISHING CO. OF AMERICA, INC., MIAMI SPRINGS, FL:
2,728,690, PUB. 4-1-2003. INT. CL. 16.
- INTERNATIONAL PUBLISHING GROUP, LARCHMONT, NY:
1,992,014, CANC. INT. CL. 16.
- INTERNATIONAL SEAFOOD DISTRIBUTORS, INC., HAYES, VA:
1,705,225, CANC. INT. CL. 29.
- INTERNATIONAL TRUCK INTELLECTUAL PROPERTY COMPANY, LLC, WARRENVILLE, IL FROM INTERNATIONAL TRUCK AND ENGINE CORPORATION, CHICAGO, IL:
2,729,636, INT. CL. 37.
- INTERNATIONAL UNION OF PAINTERS AND ALLIED TRADES, WASHINGTON, DC:
2,730,870, U.S. CL. 200.
- INTERNATIONAL WHOLESALE SERVICE, INC., LAKE HAVASU CITY, AZ:
2,729,019, PUB. 4-1-2003. MULTIPLE CLASS, INT. CLS. 20 AND 21.
- INTERNATIONAL WOMEN'S FORUM, WASHINGTON, DC:
2,728,948, PUB. 4-1-2003. INT. CL. 35.
- INTERNET TRUCKSTOP LLC, NEW PLYMOUTH, ID:
2,730,616, MULTIPLE CLASS, INT. CLS. 39 AND 42.
- INTERNET VENTURES LLC, FARMINGTON HILLS, MI:
2,730,445, INT. CL. 35.
- INTERNET.COM CORPORATION:
See— JUPITERMEDIA CORPORATION.
- INTEROFFICE EXPRESS, L.L.C., FAIRFAX, VA:
1,992,112, CANC. INT. CL. 16.
- INTERPUBLIC GROUP OF COMPANIES, INC., THE, NEW YORK, NY:
2,730,664, INT. CL. 35.
- INTERSCOPE RECORDS, INC., LOS ANGELES, CA TO INTERSCOPE RECORDS, INC., LOS ANGELES, CA:
1,705,111, CANC. INT. CL. 25.
- INTERSPORT FASHIONS WEST, INC., TUSTIN, CA:
1,747,824, REN. 5-16-03. INT. CL. 25.
- INTERXION HOLDING N.V., 1438 BC OUDE MEER, NETHERLANDS:
2,728,548, PUB. 7-9-2002. INT. CL. 38.
- INTEX CORPORATION, GREENSBORO, NC:
2,729,643, INT. CL. 24.
- INTRACORP, INC., MIAMI, FL:
1,990,794, CANC. MULTIPLE CLASS, INT. CLS. 16 AND 28.

- INTUIT INC., MOUNTAIN VIEW, CA:
 2,729,118, PUB. 4-1-2003. INT. CL. 25.
 2,729,119, PUB. 4-1-2003. INT. CL. 9.
 2,729,121, PUB. 4-1-2003. INT. CL. 35.
 2,729,122, PUB. 4-1-2003. INT. CL. 16.
 2,729,358, PUB. 4-1-2003. INT. CL. 39.
 2,729,359, PUB. 4-1-2003. INT. CL. 9.
 2,729,360, PUB. 4-1-2003. INT. CL. 36.
 2,729,866, MULTIPLE CLASS, INT. CLS. 35 AND 42.
- INTUNE CORPORATION, VENTURA, CA:
 2,729,426, INT. CL. 28.
- INVACARE CORPORATION, ELYRIA, OH, PIN DOT PRODUCTS, NILES, IL:
 1,769,220. REN. 5-12-03. INT. CL. 10.
- INVENSYS PLC, LONDON, UNITED KINGDOM:
 2,729,212, PUB. 4-1-2003. INT. CL. 9.
- INVITROGEN CORPORATION, CARLSBAD, CA:
 2,729,601, MULTIPLE CLASS, INT. CLS. 1, 9 AND 42.
- IPC CORPORATION LTD., SINGAPORE 1953, SINGAPORE:
 1,991,626, CANC. INT. CL. 9.
- IPENDENCE, INC, DRAPER, UT:
 2,730,842, INT. CL. 9.
- IPSCO INC., REGINA, SASKATCHEWAN, CANADA:
 2,728,756, PUB. 4-1-2003. INT. CL. 40.
- IPSUM NETWORKS, INC., NEWTON, PA FROM GUERIN, ROCH, NEWTOWN SQUARE, PA:
 2,730,021, MULTIPLE CLASS, INT. CLS. 9, 37 AND 42.
- IQNAVIGATOR, INC., DENVER, CO:
 2,729,752, MULTIPLE CLASS, INT. CLS. 9 AND 42.
- I RECOGNIZE INC.:
See—COMPANYDNA INC.
- IRON AGE CORPORATION, PITTSBURGH, PA:
 2,730,271, MULTIPLE CLASS, INT. CLS. 25 AND 35.
- IRVINE SCIENTIFIC SALES COMPANY, INC., SANTA ANA, CA, HANA MEDIA, INC., BERKELEY, CA:
 1,244,971. REN. 5-15-03. INT. CL. 5.
- ISACO INTERNATIONAL CORPORATION, MIAMI, FL:
 1,991,841, CANC. INT. CL. 25.
- ISK AMERICAS INCORPORATED, CONCORD, OH, ISK BIOTECH CORPORATION, MENTOR, OH:
 1,757,871. REN. 5-16-03. INT. CL. 2.
- ISOLATED DATA SYSTEMS, L.L.C, NORMAN, OK:
 2,728,742, PUB. 4-1-2003. INT. CL. 36.
- ISPROCKET, INC., WALNUT CREEK, CA:
 2,728,543, PUB. 4-1-2003. INT. CL. 35.
- ISUPPLI CORP., EL SEGUNDO, CA:
 2,729,245, PUB. 4-1-2003. INT. CL. 35.
- ITG INC.:
See—ITG SOFTWARE, INC.
- ITG SOFTWARE, INC., SANTA MONICA, CA FROM ITG INC., NEW YORK, NY:
 2,728,498, PUB. 4-1-2003. INT. CL. 9.
- ITT GRINNELL VALVE CO., INC., PROVIDENCE, RI:
 157,612, CANC. U.S. CL. 13.
- ITT MANUFACTURING ENTERPRISES, INC., WILMINGTON, DE:
 2,729,427, MULTIPLE CLASS, INT. CLS. 37 AND 42.
- ITT RICHTER CHEMIE-TECHNIK GMBH, 47906 KEMPEN, FED REP GERMANY:
 2,728,704, PUB. 4-1-2003. MULTIPLE CLASS, INT. CLS. 7, 9 AND 11.
- IXIA, CALABASAS, CA:
 2,728,762, PUB. 4-1-2003. INT. CL. 9.
- J. & W. NICHOLSON & CO. LIMITED, LONDON, ENGLAND:
 21,571, CANC. U.S. CL. 49.
- J. BOUCHON Y COMPANIA LIMITADA, SANTIAGO, CHILE:
 2,729,200, PUB. 4-1-2003. INT. CL. 33.
- J. C. PENNEY COMPANY, INC., DALLAS, NY:
 1,203,726, CANC. INT. CL. 28.
- J. C. PENNEY PRIVATE BRANDS, INC., PLANO, TX:
 2,730,907, INT. CL. 25.
- J. G. BANKS, INC., LOS ALAMITOS, CA:
 1,990,998, CANC. INT. CL. 41.
- J. H. EVANS, INC., TURLOCK, CA TO EVANS COMMUNICATIONS, TURLOCK, CA:
 2,071,687 NEW CERT. 6-24-2003. INT. CL. 42.
 2,318,039 NEW CERT. 6-24-2003. INT. CL. 38.
 2,492,548 NEW CERT. 6-24-2003. INT. CL. 38.
- J. H. EVANS, INC., TURLOCK, CA TO EVANS TELEPHONE COMPANY, TURLOCK, CA:
 2,498,266 NEW CERT. 6-24-2003. INT. CL. 38.
- J. JAMNER SURGICAL INSTRUMENTS, INC., HAWTHORNE, NY:
 955,262. REN. 5-16-03. U.S. CL. 44 (INT. CL. 10).
- J. L. CLARK, INC., ROCKFORD, IL, J. L. CLARK MANUFACTURING CO., ROCKFORD, IL:
 963,782. REN. 5-16-03. U.S. CL. 50 (INT. CL. 20).
- J. L. PRESCOTT CO., PASSAIC, NJ:
 735,802, CANC. U.S. CL. 52.
- J. P. STEVENS & CO., INC., NEW YORK, NY:
 735,717, CANC. U.S. CL. 42.
- J.C. PENNEY PRIVATE BRANDS, INC., PLANO, TX, J. C. PENNEY COMPANY, INC., PLANO, TX:
 956,534. REN. 5-15-03. U.S. CL. 39 (INT. CL. 25).
- J.C.E.C. COMPANY, INC., KENDALL PARK, NJ:
 2,729,892, INT. CL. 10.
- J.P. ORIGINAL INTERNATIONAL, INC., COMMERCE, CA:
 1,990,963, CANC. INT. CL. 25.
- J.R. WOOD, INC., ATWATER, CA, AKA FLAVORLAND FOODS USA:
 1,705,227, CANC. INT. CL. 29.
- J.W. SINGER & SONS LTD., SOMERSET BA11 4RW, ENGLAND:
 2,729,827, INT. CL. 9.
- J.W.R., INC., PALSO HEIGHTS, IL:
 1,705,653, CANC. INT. CL. 42.
- JACK DANIEL'S PROPERTIES, INC., SAN RAFAEL, CA:
 2,729,690, INT. CL. 16.
- JACK HAYS, INC., COLORADO SPRINGS, CO:
 1,760,651. REN. 5-12-03. INT. CL. 12.
- JACKIE ROBINSON PARK OF FAME, INC., STAMFORD, CT:
 2,728,538, PUB. 4-1-2003. INT. CL. 41.
- JACKSON NATIONAL LIFE INSURANCE COMPANY, LANSING, MI:
 2,729,864, INT. CL. 36.
- JACKSON NATIONAL LIVE INSURANCE COMPANY, LANSING, MI:
 2,730,316, INT. CL. 36.
- JACKSON, BRUCE E., NOVELTY, OH:
 2,729,532, INT. CL. 28.
- JACKSON, HAL, NEW YORK, NY:
 2,729,025, PUB. 4-1-2003. INT. CL. 41.
- JACKSON, LAWRENCE H., WADDELL, AZ:
 2,729,425, INT. CL. 1.
- JACKSON, MARY Y., WASHINGTON, DC:
 2,730,573, INT. CL. 42.
- JACOB RITTER GMBH, D-64395 BRENSBACH, FED REP GERMANY:
 2,730,057, INT. CL. 16.
- JACOBSON, MARK, PUNTA GORDA, FL:
 2,730,879, INT. CL. 28.
- JADE PRODUCTS, INC., EAST HAMPSTEAD, NH:
 1,991,429, CANC. INT. CL. 9.
- JAFRA COSMETICS INTERNATIONAL, INC., WESTLAKE VILLAGE, CA:
 2,730,456, INT. CL. 3.
- JAIN, KRISHNA M., KALAMAZOO, MI:
 1,705,805, CANC. INT. CL. 10.
- JAMES INDUSTRIES, INC., HOLLIDAYSBURG, PA:
 2,730,148, MULTIPLE CLASS, INT. CLS. 9, 16 AND 28.
- JAMES RIVER CORPORATION OF VIRGINIA, RICHMOND, VA:
 735,688, CANC. U.S. CL. 37.
- JAMES RIVER PAPER COMPANY, INC., NORWALK, CT:
 1,991,946, CANC. INT. CL. 21.
- JAMES T. POWELL ASSOCIATES, INC., LOS ANGELES, CA:
 1,203,381, CANC. INT. CL. 7.
- JAMES, STACY MARIE, DUBLIN, OH:
 2,730,740, INT. CL. 42.

- JAMISON BEDDING, INC., FRANKLIN, TN:
2,729,068, PUB. 4-1-2003. INT. CL. 20.
- JANIN GROUP, INC., NAPERVILLE, IL:
2,729,292, PUB. 4-1-2003. INT. CL. 10.
- JANUS DEVELOPMENT GROUP, INC., GREENVILLE, NC:
2,730,722, INT. CL. 10.
- JAPAN TOBACCO INC., TOKYO, JAPAN:
2,729,451, INT. CL. 34.
- JAQUA GIRLS, INC., SANTA BARBARA, CA:
2,729,618, INT. CL. 3.
- JARMAC GROUP, INC., THE, SOUTH EASTON, MA:
2,729,468, INT. CL. 35.
- JAROCH, MICHAEL E., LITTLETON, CO:
2,729,720, INT. CL. 41.
- JAS. D. EASTON, INC., VAN NUYS, CA:
2,730,794, INT. CL. 28.
- JASC SOFTWARE, INC., EDEN PRAIRIE, MN:
2,730,488, INT. CL. 9.
- JASMAN, INC., ITASCA, IL:
2,730,001, INT. CL. 28.
- JAVAKITTY MEDIA, INC., DECATUR, GA:
2,729,194, PUB. 4-1-2003. INT. CL. 9.
- JAWBREAKER, SAN FRANCISCO, CA:
1,991,194, CANC. INT. CL. 41.
- JAYCO, INC., MIDDLEBURY, IN:
2,730,065, INT. CL. 12.
- JAYS FOODS, L.L.C., CHICAGO, IL:
2,730,002, MULTIPLE CLASS, INT. CLS. 29 AND 30.
- JAYTEX OF CANADA LTD., TORONTO, ONTARIO M6A
2W4, CANADA:
1,991,481, CANC. INT. CL. 25.
- JB'S RESTAURANTS, INC., ANAHEIM, CA:
1,705,660, CANC. INT. CL. 42.
- JCM AMERICAN CORPORATION, LAS VEGAS, NV:
2,730,723, INT. CL. 9.
- JDR APPAREL GROUP, LLC, NEW YORK, NY:
2,729,814, INT. CL. 25.
- JEAN GRAYSON'S BROWNSTONE STUDIO, INC., NEW
YORK, NY:
1,992,040, CANC. INT. CL. 42.
- JEFFREY A. STERN & ASSOCIATES, INC., SANTA MON-
ICA, CA:
1,991,397, CANC. INT. CL. 16.
- JEFFREY NORTON PUBLISHERS, INC., GUILFORD, CT,
DBA AUDIO-FORUM:
1,706,061, CANC. INT. CL. 42.
- JENIFER HOUSE ACQUISITION, INC., GREAT BARRING-
TON, MA:
1,204,105, CANC. INT. CL. 42.
- JENIFER HOUSE ACQUISITION, INC., HINGHAM, MA:
1,204,106, CANC. INT. CL. 42.
- JENNINGS, WILLIAM M., VIENNA, VA:
1,991,434, CANC. INT. CL. 42.
- JEOL LTD., AKISHIMA, TOKYO 196-8558, JAPAN:
2,730,378, INT. CL. 9.
- JEROME ALEXANDER GLOBAL, INC., N. MIAMI, FL:
2,728,775, PUB. 4-1-2003. INT. CL. 3.
- JERRI CERAMIC ARTS, INC., CHARLOTTE, NC:
1,203,734, CANC. INT. CL. 28.
- JETBLUE AIRWAYS CORPORATION, KEW GARDENS, NY:
2,729,240, PUB. 4-1-2003. INT. CL. 39.
- JFC, INC., ST. CLOUD, MN:
2,730,458, INT. CL. 29.
- JOANNOU, CHRISTOS E., VIENNA, VA:
2,729,216, PUB. 4-1-2003. INT. CL. 5.
- JOB CONNECTION, INC., THE, EL PASO, TX:
2,730,158, MULTIPLE CLASS, INT. CLS. 35 AND 42.
- JOBSCOPE CORPORATION, THE, GREENVILLE, SC:
1,991,250, CANC. INT. CL. 9.
- JOBSITE TRAILER CORPORATION, ROCHESTER, IN:
2,728,481, PUB. 4-1-2003. INT. CL. 19.
- JOCKEY INTERNATIONAL, INC., KENOSHA, WI:
2,730,837, INT. CL. 25.
- JOE BOXER CORPORATION, SAN FRANCISCO, CA:
1,705,098, CANC. INT. CL. 25.
- JOE RAPP, INC., VALLEY STREAM, NY:
1,771,494, REN. 5-12-03. INT. CL. 20.
- JOE SPIEKERMANN'S SWISS BREAD FACTORY, UNION
CITY, NJ:
1,991,130, CANC. INT. CL. 30.
- JOHANN BIRKART INT. SPEDITION GMB & CO. KG, D-
63741 ASCHAFFENBURG, FED REP GERMANY:
2,728,476, PUB. 1-14-2003. INT. CL. 39.
- JOHANSEN, CINDA, PALM SPRINGS, CA:
1,991,412, CANC. INT. CL. 5.
- JOHN CHARLES DESIGNS, INC., CERRITOS, CA:
1,992,186, CANC. INT. CL. 20.
- JOHN HINE LIMITED, ALDERSHOT, HAMPSHIRE, ENG-
LAND:
1,990,909, CANC. INT. CL. 20.
- JOHN MANUFACTURING LTD., KWUN TONG, KOW-
LOON, HONG KONG:
2,728,612, PUB. 4-1-2003. INT. CL. 11.
- JOHN MCLURE PTY LTD., NORTH BEACH WA 6920,
AUSTRALIA, TA IFX W.A.:
2,728,705, PUB. 4-1-2003. INT. CL. 16.
- JOHN ROUZEE GREEN CO., INC., THE, YORK, SC:
1,203,723, CANC. INT. CL. 28.
- JOHN WOOLFE RACING LTD., BEDFORD, ENGLAND:
1,203,269, CANC. MULTIPLE CLASS, INT. CLS. 1 AND 2.
- JOHN'S IMPORT FOODS, INC., CHICAGO, IL:
1,768,792, REN. 5-10-03. INT. CL. 29.
- 1,771,668, REN. 5-10-03. INT. CL. 29.
- JOHNS-BYRNE COMPANY, NILES, IL:
1,203,853, CANC. INT. CL. 35.
- JOHNSON & JOHNSON, NEW BRUNSWICK, NJ:
735,730, CANC. U.S. CL. 44.
2,729,431, INT. CL. 10.
2,730,297, INT. CL. 3.
2,730,625, INT. CL. 10.
2,730,626, INT. CL. 10.
- JOHNSON CONTROLS BATTERY GROUP, INC., MILWAU-
KEE, WI:
2,728,637, PUB. 4-1-2003. INT. CL. 9.
2,728,700, PUB. 4-1-2003. INT. CL. 9.
2,728,701, PUB. 4-1-2003. INT. CL. 9.
2,728,702, PUB. 4-1-2003. INT. CL. 9.
2,728,703, PUB. 4-1-2003. INT. CL. 9.
- JOHNSON PUMP (UK) LIMITED, EASTBOURNE, EAST
SUSSEX, UNITED KINGDOM:
2,729,167, PUB. 4-1-2003. INT. CL. 7.
- JOHNSON, BARTHOLOMEW, FAIRFIELD, CA, DBA BAR-
TOLO ATHLETIC:
1,706,037, CANC. INT. CL. 25.
- JOHNSON, RAYMOND O., MORROW, GA:
2,729,836, MULTIPLE CLASS, INT. CLS. 30 AND 42.
- JOHNSON DIVERSEY, INC., STURTEVANT, WI, BASF
WYANDOTTE CORPORATION, WYANDOTTE, MI:
934,106, REN. 5-14-03. U.S. CL. 52 (INT. CL. 3).
- JOHNSON DIVERSEY, INC., STURTEVANT, WI, DIVERSEY
CORPORATION, MISSISSAUGA, PROVINCE OF ONTAR-
IO, CANADA:
1,752,128, REN. 5-13-03. INT. CL. 3.
- JOICO LABORATORIES, INC., CITY OF INDUSTRY, CA:
2,730,781, INT. CL. 3.
- JONAS; HENRY, PALISADES PARK, NJ:
735,658, CANC. U.S. CL. 28.
- JONATHAN SPROUTS, INC., EAST FREETOWN, MA:
2,729,659, INT. CL. 31.
- JONES INTERNATIONAL, LTD., ENGLEWOOD, CO:
1,705,987, CANC. MULTIPLE CLASS, INT. CLS. 38 AND
41.
- JONES OF DALLAS MANUFACTURING, INC., DALLAS,
TX:
1,371,417, CANC. INT. CL. 25.
- JONES, DUNN & COMPANY, MACEDONIA, OH:
2,730,317, INT. CL. 36.
- JONES, GEORGIA A., SONORA, CA:
2,729,157, PUB. 4-1-2003. MULTIPLE CLASS, INT. CLS. 38
AND 41.
- JONES, STEPHEN J., PROVO, UT:
1,991,312, CANC. INT. CL. 25.
- JORGE ALEJANDRO VON SON GALLUT, CHULA VISTA,
CA, DBA MEXICATESSEN:
1,990,625, CANC. MULTIPLE CLASS, INT. CLS. 29 AND

30.
JOSE CANEPA Y CIA. LTDA., CERRILLOS SANTIAGO, CHILE:
2,729,948, INT. CL. 33.
- JOSE EBER INC., NEW YORK, NY TO EBER, JOSE, LOS ANGELES, CA:
1,705,731, CANC. INT. CL. 3.
- JOSEF OTTEN GESELLSCHAFT M.B.H., A-6845 HOHENEMS, AUSTRIA:
1,718,243, REN. 5-15-03, INT. CL. 24.
- JOSEPH A. HARDY & ASSOCIATES, EIGHTY-FOUR, PA:
1,704,467, CANC. INT. CL. 2.
- JOSTENS LEARNING CORPORATION, SAN DIEGO, CA:
1,990,919, CANC. INT. CL. 9.
- JOSTENS, INC., MINNEAPOLIS, MN:
1,990,742, CANC. INT. CL. 41.
- JOYCE, JOHN J., NASHVILLE, TN:
1,985,674, CANC. INT. CL. 41.
- JRH BIOSCIENCES, INC., LENEXA, KS, PORTON INTERNATIONAL PLC, LONDON W1V 9FN, ENGLAND:
1,753,486, REN. 5-10-03, INT. CL. 1.
- JSC FEDERAL CREDIT UNION, HOUSTON, TX:
2,730,699, INT. CL. 36.
- JU.CLA.S. S.R.L., FRAZ PEDEMONTE (VR), ITALY:
2,577,778, COR. INT. CL. 11.
2,645,220, COR. INT. CL. 7.
- JUDITH LIEBER IP LLC, NEW YORK, NY, JUDITH LEIBER, INC., NEW YORK, NY:
1,744,543, REN. 5-15-03, INT. CL. 18.
1,755,479, REN. 5-15-03, INT. CL. 25.
- JUPITERMEDIA CORPORATION, DARIEN, CT FROM INTERNET.COM CORPORATION, DARIEN, CT:
2,728,565, PUB. 4-1-2003, INT. CL. 42.
- JUST FOR MOMS, RESEDA, CA:
2,730,736, INT. CL. 10.
- K & L TRADING CORP., FLUSHING, NY:
1,991,042, CANC. INT. CL. 29.
- K & M ASSOCIATES, PROVIDENCE, RI:
2,042,446, CANC. INT. CL. 26.
- K. AUFHAUSER & COMPANY, INC., NEW YORK, NY:
2,236,422, CANC. INT. CL. 36.
- K. KYSER COMPANY, FARMERS BRANCH, TX:
2,730,640, INT. CL. 35.
- K.C. CONFECTIONERY, LTD., COUVA, TRINIDAD/TOBAGO:
1,744,715, REN. 5-16-03, INT. CL. 30.
- K.C.C. SHOKAI LIMITED, NADA-KU, KOBE, JAPAN:
1,229,407, REN. 5-16-03, INT. CL. 9.
- K-TEL INTERNATIONAL, INC., MINNEAPOLIS, MN:
1,704,667, CANC. INT. CL. 9.
1,704,668, CANC. INT. CL. 9.
- K-2 CORPORATION, VASHON, WA:
2,729,302, PUB. 4-1-2003, INT. CL. 28.
2,730,209, INT. CL. 28.
- K/P CORPORATION, SAN RAMON, CA:
2,728,499, PUB. 4-1-2003, MULTIPLE CLASS, INT. CLS. 16, 25, 35 AND 42.
- KABOLA HEATING SYSTEMS MACHINEFABRIEK GEBRS. POST BV, 4321 TX OUDEWATER, NETHERLANDS:
2,728,836, PUB. 4-1-2003, INT. CL. 11.
- KABUSHIKI KAISHA HATTORI SEIKO, CHUO-KU, TOKYO, JAPAN, TA SEIKO CORPORATION:
1,990,987, CANC. MULTIPLE CLASS, INT. CLS. 9 AND 14.
- KABUSHIKI KAISHA NAGATANEN, 2-CHOME, MINATO-KU TOKYO, JAPAN:
1,990,614, CANC. INT. CL. 42.
- KABUSHIKI KAISHA OHMORIYA (OHMORIYA CO., LTD.), FUKUSHIMA-KU, OSAKA, JAPAN:
1,768,788, REN. 5-10-03, INT. CL. 29.
- KABUSHIKI KAISHA OHMORIYA (OHMORIYA CO., LTD), FUKUSHIMA-KU, OSAKA, JAPAN:
1,770,246, REN. 5-10-03, INT. CL. 29.
- KABUSHIKI KAISHA PERSON'S, TOKYO, JAPAN, DBA PERSON'S CO., LTD.:
2,729,421, INT. CL. 28.
- KABUSHIKI KAISHA SONY COMPUTER ENTERTAINMENT, MINATO-KU, TOKYO, JAPAN, TA SONY COMPUTER ENTERTAINMENT INC.:
2,730,542, INT. CL. 25.
- KABUSHIKI KAISHA SQUARE, TOKYO, JAPAN, TA SQUARE CO., LTD.:
2,730,129, INT. CL. 9.
- KABUSHIKI KAISHA SSK (SSK CORPORATION), MINAMI-KU, OSAKA-SHI, OSAKA-FU, JAPAN:
1,203,553, CANC. MULTIPLE CLASS, INT. CLS. 17, 25 AND 28.
- KABUSHIKI KAISHA TEN-ICHI SYOKUHIN SHOJI (TEN-ICHI FOODS TRADING CO., LTD.), OOTSU SHIGA, JAPAN TO SUZUI, SCOTT T., HONOLULU, HI, DBA TENKAIPPIN HAWAII, INC.:
2,627,285, COR. INT. CL. 42.
- KABUSHIKI KAISHA TOYOTA CHUO KENKYUSHO, AI-CHI, JAPAN:
2,730,594, INT. CL. 9.
- KABUSHIKI KAISHA YAKULT HONSHA, MINATO-KU, TOKYO, JAPAN:
2,509,107, CANC. IIRN.
- KAHLIL GIBRAN CENTENNIAL FOUNDATION, WASHINGTON, DC:
1,705,597, CANC. INT. CL. 42.
- KALIL BOTTLING CO., TUCSON, AZ:
2,729,552, INT. CL. 32.
- KANTEK INC., E. ROCKAWAY, NY:
1,991,752, CANC. INT. CL. 9.
- KAPP, STEPHEN L., LA MESA, CA:
1,991,805, CANC. INT. CL. 42.
- KAPRIELIAN BROS. PACKING CO., REEDLEY, CA:
2,729,048, PUB. 4-1-2003, INT. CL. 31.
- KARATE HELPS KICK DIABETES, MCLEAN, VA:
1,991,431, CANC. INT. CL. 36.
- KAUTZ, WILLIAM R., GENEVA, IL:
2,729,440, INT. CL. 42.
- KAWAI AMERICA CORPORATION, COMPTON, CA:
2,729,725, INT. CL. 15.
- KAYON CORPORATION, CHARLESTON, SC:
2,729,834, INT. CL. 35.
- KAZTO CORPORATION, INC., THE, NEW YORK, NY:
1,704,853, CANC. INT. CL. 14.
- KEATON'S BARBECUE, INC., CLEVELAND, NC:
2,728,829, PUB. 4-1-2003, INT. CL. 43.
- KEDDCO MFG. LTD., SARNIA, ONTARIO, CANADA:
1,203,359, CANC. INT. CL. 6.
- KEENE SANITARY SUPPLY, INC., SAN LEANDRO, CA:
2,728,876, PUB. 4-1-2003, INT. CL. 16.
- KELLOGG COMPANY, BATTLE CREEK, MI:
1,747,285, REN. 5-10-03, INT. CL. 30.
2,333,236, AM. INT. CL. 16.
- KELLWOOD COMPANY, CHESTERFIELD, MO:
1,991,810, CANC. INT. CL. 25.
- KEMMELMEYER, WERNER, D-83101 THANSAU, FED REP GERMANY:
2,665,590, COR. INT. CL. 7.
- KENDLE INTERNATIONAL, INC., CINCINNATI, OH:
2,729,538, INT. CL. 42.
- KENNAMETAL INC., LATROBE, PA:
1,203,360, CANC. INT. CL. 6.
- KENNEBEC, INC., DURANGO, CO, DBA MOUNTAIN BIKE SPECIALISTS TO ZINK COMPANY, DURANGO, CO:
1,705,547, CANC. INT. CL. 42.
- KENNEDY, JOHN C., SPRINGFIELD, MA, CARA FOODS, LTD., WEST SPRINGFIELD, MA:
1,713,982, REN. 5-14-03, INT. CL. 30.
- KENTUCKY BISON CO., GOSHEN, KY:
2,730,415, INT. CL. 29.
- KENTUCKY CENTRAL LIFE INSURANCE COMPANY, LEXINGTON, KY:
1,203,874, CANC. INT. CL. 36.
- KENYON PIECE DYEWORKS, INC., THE, KENYON, RI:
735,810, CANC. U.S. CL. 106.
- KENYON PIECE DYEWORKS, INC., THE, KENYON, RI, AKA KENYON INDUSTRIES:
1,203,967, CANC. INT. CL. 40.

- KEOGLER, MORGAN & COMPANY, INC., ATLANTA, GA:
1,991,996, CANC. INT. CL. 36.
- KERIO TECHNOLOGIES INC., SANTA CLARA, CA:
2,729,226, PUB. 4-1-2003. INT. CL. 9.
- KERMEL SAS, 68000 COLMAR, FRANCE, SOCIETE RHO-
DIACETA, PARIS, FRANCE:
939,294. REN. 5-14-03. U.S. CL. 1 (INT. CLS. 1 AND 17).
- KERRY GROUP PLC, TRALEE, COUNTY KERRY, IRE-
LAND:
2,729,405, INT. CL. 1.
- KERRY NO. II, L.L.C., CHICAGO, IL:
1,706,067, CANC. INT. CL. 42.
- KERZNER INTERNATIONAL NORTH AMERICA, INC.,
LINWOOD, NJ FROM SUN INTERNATIONAL NORTH
AMERICA, INC., ATLANTIC CITY, NJ:
2,728,527, PUB. 4-1-2003. MULTIPLE CLASS, INT. CLS.
39, 41 AND 42.
- KESS INDUSTRIAL PRODUCTS, INC., MIAMI, FL:
2,728,928, PUB. 4-1-2003. INT. CL. 3.
- KETTER, KATHLEEN G., SARASOTA, FL:
1,992,021, CANC. INT. CL. 42.
- KETTLE FOODS, INC., SALEM, OR FROM SOKOLOFF,
MARTIN, NEW YORK, NY:
2,729,540, INT. CL. 30.
- KEYCORP. CLEVELAND, OH:
2,730,031, INT. CL. 36.
- KEYSTONE BROADCASTING SYSTEM, INC., CHICAGO,
IL:
396,820, CANC. U.S. CL. 36.
- KEYSTROKE TECHNOLOGY SOLUTIONS, INC., SEATTLE,
WA:
2,730,609, INT. CL. 9.
- KFC CORPORATION, LOUISVILLE, KY:
2,729,326, PUB. 4-1-2003. MULTIPLE CLASS, INT. CLS.
16, 29 AND 43.
- KGR, INC., LAWRENCE, MA:
1,705,127, CANC. INT. CL. 25.
- KHOJA, FELICIA, S, SHERMAN OAKS, CA:
2,729,304, PUB. 4-1-2003. INT. CL. 16.
- KID SAFE POOL NETS, INC., FORT LAUDERDALE, FL:
2,730,552, INT. CL. 22.
- KIDDESIGNS, INC., RAHWAY, NJ:
1,991,871, CANC. INT. CL. 15.
- KIDSPACE CORPORATION, BETHLEHEM, PA:
2,730,750, MULTIPLE CLASS, INT. CLS. 41 AND 42.
- KILBY, RICHARD LAWRENCE, RALEIGH, NC, DBA
BAREFOOT PRESS:
1,990,981, CANC. INT. CL. 42.
- KILEY, BARBARA WEBER, YORBA LINDA, CA:
2,730,704, INT. CL. 20.
- KIM, KEVIN SAN, GARDEN GROVE, CA:
2,729,107, PUB. 4-1-2003. INT. CL. 5.
- KIM, STEVEN, LEUCADIA, CA:
1,990,985, CANC. INT. CL. 25.
- KIMBERLY-CLARK CORPORATION, NEENAH, WI:
735,672, CANC. U.S. CL. 37.
735,686, CANC. U.S. CL. 37.
2,728,865, PUB. 4-1-2003. INT. CL. 16.
- KIMBERLY-CLARK WORLDWIDE, INC., NEENAH, WI
FROM KIMBERLY-CLARK CORPORATION, NEENAH,
WI:
2,730,356, INT. CL. 21.
- KINEMATRICS, INC., PASADENA, CA:
2,728,718, PUB. 4-1-2003. INT. CL. 9.
- KINETICS INDUSTRIES INC., TRENTON, NJ:
2,730,244, INT. CL. 9.
- KINETRONICS CORPORATION, SARASOTA, FL:
2,728,902, PUB. 4-1-2003. INT. CL. 8.
- KING KOIL LICENSING COMPANY, INC., SAINT PAUL,
MN:
1,990,787, CANC. INT. CL. 20.
- KING PLASTIC CORPORATION, VENICE, FL:
1,991,330, CANC. INT. CL. 1.
- KING RANCH, INC., HOUSTON, TX:
2,729,291, PUB. 4-1-2003. INT. CL. 12.
- KINGMAN INTERNATIONAL CORPORATION, BALDWIN
PARK, CA:
2,730,310, INT. CL. 28.
- KINGPORT INTERNATIONAL CORPORATION, EVAN-
STON, IL:
1,991,881, CANC. INT. CL. 18.
- KINGSDOWN, INC., MEBANE, NC:
2,730,079, INT. CL. 35.
- KINKO'S VENTURES, INC., VENTURA, CA:
2,729,533, INT. CL. 9.
- KINNEY SHOE CORPORATION, NEW YORK, NY:
1,991,158, CANC. INT. CL. 41.
- KINNIKINNIK DESIGNS, INC., COLORADO SPRINGS, CO:
1,991,764, CANC. INT. CL. 18.
- KINTETSU WORLD EXPRESS (U.S.A.), INC., ROSLYN
HEIGHTS, NY:
1,705,338, CANC. INT. CL. 35.
- KINTETSU WORLD EXPRESS, INC., CHIYODA-KU, TOY-
KO 100, JAPAN TO KINTETSU WORLD EXPRESS, INC.,
CHIYODA-KU, TOYKO 100, JAPAN:
2,018,885, COR. MULTIPLE CLASS, INT. CLS. 35, 36
AND 39.
- KIT & KABOODLE PET CARE SERVICE, LLC, LEESBURG,
VA:
2,728,683, PUB. 10-15-2002. INT. CL. 42.
- KIWI BRANDS INC., DOUGLASSVILLE, PA:
1,203,294, CANC. INT. CL. 3.
- KLIKLOK CORPORATION, GREENWICH, CT:
735,628, CANC. U.S. CL. 23.
- KLOTHES KORP, INC., NORTH BERGEN, NJ:
1,991,359, CANC. INT. CL. 25.
- KNAPP, MILTON L., QUARTZSITE, AZ AND KNAPP,
PEGGY F., QUARTZSITE, AZ, DBA KRITTER KREA-
TORS:
1,689,141, REN. 5-13-03. INT. CL. 28.
- KNIGHT, ERIC, WEST ALLIS, WI, DBA FRAMES FOR
LESS:
1,990,890, CANC. INT. CL. 42.
- KNITCRAFT CORPORATION, WINONA, MN:
1,203,618, CANC. INT. CL. 22.
- KNUTSON MORTGAGE CORPORATION, BLOOMING-
TON, MN:
1,991,409, CANC. INT. CL. 36.
1,991,410, CANC. INT. CL. 36.
- KOBIE MARKETING, INC., ST. PETERSBURG, FL:
1,991,579, CANC. INT. CL. 35.
- KOCH MEMBRANE SYSTEMS, INC., WILMINGTON, MA,
KOCH MEMBRANE SYSTEMS, INC., WILMINGTON,
MA:
1,724,536, REN. 5-13-03. INT. CL. 1.
- KOCH-GLITSCH, LP, WICHITA, KS, GLITSCH, INC., DAL-
LAS, TX:
1,777,008, REN. 5-10-03. INT. CL. 6.
- KOHL'S ILLINOIS, INC., AURORA, IL:
2,730,205, INT. CL. 35.
- KOHN, JOEL M., SAN FRANCISCO, CA:
1,990,635, CANC. MULTIPLE CLASS, INT. CLS. 9 AND
41.
- KOMAR, RAYMOND A, PORT CHARLOTTE, FL:
2,730,831, INT. CL. 35.
- KOMATSU AMERICA INTERNATIONAL COMPANY, VER-
NON HILLS, IL:
1,704,546, CANC. MULTIPLE CLASS, INT. CLS. 7 AND
12.
- KONINKLIJE BORSUMIJ WEHRY N.V., HAGUE, NETHER-
LANDS:
1,203,830, CANC. INT. CL. 34.
- KONINKLIJKE PHILIPS ELECTRONICS N.V., EINDHO-
VEN, NETHERLANDS:
2,729,606, INT. CL. 9.
- KOO, LIN SHEN, SALEM, OR, DBA TEMPERANCE HILL
VINEYARDS:
1,757,121, REN. 5-16-03. INT. CL. 33.
- KOOL STOP INTERNATIONAL, INC., LAKE OSWEGO, OR:
2,730,505, INT. CL. 12.
- KORD INDUSTRIAL, INC., WIXOM, MI:
1,991,333, CANC. INT. CL. 6.
- KOREA HEAVY INDUSTRIES & CONSTRUCTION CO.,
LTD, KYUNGSANGNAM-DO 641-792, REPUBLIC OF
KOREA:
2,689,603, COR. INT. CL. 37.

- KORRIS PRODUCTS, INC., LA GRANGE PARK, IL:
735,521, CANC. U.S. CL. 2.
- KOSE CORPORATION, CHUO-KU, TOKYO, JAPAN:
2,729,685, INT. CL. 3.
- KOTA CORPORATION, THE, MEDFIELD, MA:
2,730,489, MULTIPLE CLASS, INT. CLS. 25 AND 28.
- KOVALIC, ROBERT J., MADISON, WI:
2,730,555, INT. CL. 16.
- KRAFT FOODS HOLDINGS, INC., NORTHFIELD, IL,
BEECH-NUT, INC., NEW YORK, NY:
954,538, REN. 5-10-03. U.S. CL. 46 (INT. CL. 30).
- KRAFT FOODS HOLDINGS, INC., NORTHFIELD, IL,
KRAFT GENERAL FOODS, INC., GLENVIEW, IL:
1,751,979, REN. 5-10-03. INT. CL. 29.
- KRAFT PIZZA COMPANY, NORTHFIELD, IL, JACK'S
FROZEN PIZZA, INC., LITTLE CHUTE, WI:
1,745,369, REN. 5-10-03. INT. CL. 30.
- KRAMER TRENTON COMPANY, TRENTON, NJ:
1,203,473, CANC. INT. CL. 11.
- KRAMER; HYMAN, BRONX, NY:
1,203,380, CANC. INT. CL. 7.
- KRAUSS-MAFFEI AG:
*See— KRAUSS-MAFFEI KUNSTSTOFFTECHNIK
GMBH.*
- KRAUSS-MAFFEI KUNSTSTOFFTECHNIK GMBH, 80997
MUNCHEN, FED REP GERMANY FROM KRAUSS-
MAFFEI AG, 80997 MUNCHEN, FED REP GERMANY:
2,728,471, PUB. 1-11-2000. INT. CL. 7.
- KRAVET FABRICS INCORPORATED, BETHPAGE, NY TO
KRAVET INC., BETHPAGE, NY:
1,240,403, AM. INT. CL. 24.
- KRAVET INC., BETHPAGE, NY, KRAVET FABRICS IN-
CORPORATED, BETHPAGE, NY:
1,240,403, REN. 5-13-03. INT. CL. 24.
- KREBS ENGINEERS, TUCSON, AZ:
1,657,723, REN. 5-15-03. INT. CL. 42.
- KRISTALL JEWELER, INC., BEVERLY HILLS, CA FROM
GEMDIAM CORP., LOS ANGELES, CA:
2,728,636, PUB. 4-1-2003. INT. CL. 14.
- KROEGER, DANIEL E., HAYWARD, CA:
1,203,455, CANC. INT. CL. 10.
- KRUPP BILSTEIN GMBH, D-58256 ENNEPETAL, FED REP
GERMANY:
2,729,034, PUB. 4-1-2003. MULTIPLE CLASS, INT. CLS. 9
AND 12.
- KRYPTONICS, INC., LOUISVILLE, CO:
1,991,352, CANC. INT. CL. 28.
- KULICK, LORIE, CROWN POINT, IN:
2,729,439, INT. CL. 28.
- KUN NAN ENTERPRISE LTD., LEE LIN VILLAGE, TAN
TZU, TAICHUNG HSIEN, TAIWAN:
1,705,148, CANC. INT. CL. 28.
- KURASHIKI BOSEKI KABUSHIKI KAISHA, OKAYAMA-
KEN, JAPAN, TA KURABO INDUSTRIES LTD.:
2,650,583, COR. INT. CL. 23.
- KWIECIENSKI, RICHARD, HOMOSASSA, FL:
2,730,114, INT. CL. 28.
- L. A. DREYFUS COMPANY, SOUTH PLAINFIELD, NJ:
396,772, CANC. U.S. CL. 1.
- L.B. EVANS' SON COMPANY LIMITED PARTNERSHIP,
FITCHBURG, MA:
1,991,861, CANC. INT. CL. 25.
- L.C. LICENSING, INC., NEW YORK, NY:
2,729,655, INT. CL. 25.
2,730,151, INT. CL. 3.
2,730,463, INT. CL. 25.
- L.F.P., INC., BEVERLY HILLS, CA:
1,991,836, CANC. INT. CL. 9.
- L&P PROPERTY MANAGEMENT COMPANY, CHICAGO,
IL:
1,991,651, CANC. INT. CL. 11.
- L&P PROPERTY MANAGEMENT COMPANY, SOUTH
GATE, CA:
2,728,888, PUB. 4-1-2003. INT. CL. 20.
2,728,910, PUB. 4-1-2003. INT. CL. 12.
- L-3 COMMUNICATIONS SECURITY AND DETECTION
SYSTEMS CORPORATION CALIFORNIA, WOBURN,
MA, ASTROPHYSICS RESEARCH CORPORATION,
LONG BEACH, CA:
1,754,968, REN. 5-16-03. INT. CL. 9.
- L'OREAL, PARIS, FRANCE:
2,730,040, INT. CL. 3.
- L'OREAL USA CREATIVE, INC., NEW YORK, NY:
2,730,374, INT. CL. 3.
2,730,523, INT. CL. 3.
- LA CANASTA FURNISHINGS, INC., CORONA, CA:
2,728,669, PUB. 4-1-2003. INT. CL. 35.
- LA PICCOLINA & CO. INC., AVONDALE ESTATES, GA:
1,705,231, CANC. INT. CL. 30.
- LA SALSA HOLDING CO., LOS ANGELES, CA:
1,990,923, CANC. INT. CL. 42.
- LA SEIGNEURIE, S.A., BOBIGNY, FRANCE:
1,203,710, CANC. INT. CL. 27.
- LABOR BIRKMAYER UND MED-INFO GESELLSCHAFT
M.B.H., A-1090 VIENNA, AUSTRIA:
1,990,836, CANC. INT. CL. 5.
- LABORATOIRE GARNIER & CIE, 75008 PARIS, FRANCE:
2,728,867, PUB. 4-1-2003. INT. CL. 3.
- LABWARE, LTD., WILMINGTON, DE:
1,769,824, REN. 5-13-03. INT. CL. 9.
- LADDER CO., LTD., TAIPEI, TAIWAN, DBA LADDER
PUBLISHING CO., LTD. AND DBA LADDER MULTI-
MEDIA CO. LTD.:
2,729,367, INT. CL. 9.
- LADY BURD EXCLUSIVE COSMETICS, INC., FARMING-
DALE, NY:
2,730,143, INT. CL. 3.
- LADYLIKE, CALABASAS, CA:
2,729,707, INT. CL. 18.
- LAILA, INC., LOS ANGELES, CA:
2,730,544, INT. CL. 3.
- LAIN, JAMES D., PADUCAH, KY:
2,730,022, INT. CL. 7.
- LAKE ERIE SCREW CORPORATION, LAKEWOOD, OH:
2,729,507, INT. CL. 6.
- LAKE HAYES VINEYARD LIMITED, ARROWTOWN, NEW
ZEALAND:
2,728,813, PUB. 4-1-2003. INT. CL. 33.
- LAKE PACKING CO., INC., LOTTSBURG, NORTHUMBER-
LAND, VA:
1,991,493, CANC. INT. CL. 29.
- LAKELAND REGIONAL HEALTH SYSTEMS, INC., LAKE-
LAND, FL:
2,728,686, PUB. 4-1-2003. INT. CL. 42.
- LAMOTTE CHEMICAL PRODUCTS COMPANY, CHESTER-
TOWN, MD:
1,704,443, CANC. INT. CL. 1.
- LAMPBLASTER, INC., HIALEAH, FL:
2,729,430, MULTIPLE CLASS, INT. CLS. 35 AND 42.
- LAN-HOPPER SYSTEMS, INC., ATLANTA, GA:
1,991,768, CANC. INT. CL. 9.
- LANCE MFG. LLC, CHARLOTTE, NC:
2,730,817, INT. CL. 30.
- LANCOME PARFUMS ET BEAUTE & CIE, PARIS, FRANCE:
2,728,796, PUB. 4-1-2003. INT. CL. 3.
2,728,831, PUB. 4-1-2003. INT. CL. 3.
- LAND INSTRUMENTS INTERNATIONAL, INC., BRISTOL,
PA:
1,704,664, CANC. INT. CL. 9.
- LAND O'FROST, INC., LANSING, IL:
1,991,898, CANC. INT. CL. 29.
- LANDMARK ENTERTAINMENT GROUP, NORTH HOLLY-
WOOD, CA:
1,991,656, CANC. INT. CL. 28.
- LANGE UHREN GMBH, 01768 GLASHUETTE, FED REP
GERMANY:
2,730,858, INT. CL. 14.
- LANNYTE COMPANY, INC., HOUSTON, TX:
2,729,293, PUB. 4-1-2003. INT. CL. 35.
- LANTECH INC., LOUISVILLE, KY:
1,203,391, CANC. INT. CL. 7.

- LARRY HARMON PICTURES CORPORATION, HOLLYWOOD, CA:
2,646,094, COR. INT. CL. 16.
- LARRY K. WALDEN AND KAREN B. WALDEN PARTNERSHIP, THE DBA VIDALIA'S BEST:
See—MANNING FARMS, INC.
- LARRY MAHAN, INC., LOS ANGELES, CA:
1,203,640, CANC. INT. CL. 25.
- LASER INSTITUTE OF AMERICA, INC., ORLANDO, FL:
2,728,891, PUB. 4-1-2003, INT. CL. 41.
- LASER VISION CENTERS, INC., ST. LOUIS, MO:
1,823,091, REN. 5-10-03, MULTIPLE CLASS, INT. CLS. 35 AND 42.
- LASERCRAFT, INC., SANTA ROSA, CA:
1,204,158, CANC. INT. CL. 20.
- LASERMASTER CORPORATION, EDEN PRAIRIE, MN:
1,990,855, CANC. INT. CL. 9.
- LASERTECHNICS, INC., ALBUQUERQUE, NM:
1,991,880, CANC. INT. CL. 9.
- LAUNDRY-MATE, INC., OCCIDENTAL, CA:
1,705,347, CANC. INT. CL. 35.
- LAURENT-PERRIER, 51150 TOURS-SUR-MAINE, FRANCE FROM VVE LAURENT-PERRIER & CO., 51100 REIMS, FRANCE:
2,728,463, PUB. 6-11-2002, MULTIPLE CLASS, INT. CLS. 16, 38 AND 42.
- LAURIN PUBLISHING CO, INC., PITTSFIELD, MA, OPTICAL PUBLISHING CO., INC., THE, PITTSFIELD, MA:
1,229,715, REN. 5-14-03, INT. CL. 16.
- LAWSON CONSULTING GROUP, INC., LANSDALE, PA:
2,671,797, COR. INT. CL. 16.
- LAYFIELD GROUP LIMITED, RICHMOND, BRITISH COLUMBIA, CANADA. LAYFIELD PLASTICS (1978) LTD., EDMONTON ALBERTA T5M 3C5, CANADA:
1,722,019, REN. 5-14-03, INT. CL. 22.
- LAZAR'S CHOCOLATE, INC., GREAT NECK, NY:
1,235,388, REN. 5-12-03, INT. CL. 30.
- LAZY BAGEL, INC., THE, RICHMOND, VA:
1,991,224, CANC. INT. CL. 42.
- LCC INCORPORATED, ARLINGTON, VA:
1,991,530, CANC. INT. CL. 9.
- LCJ ENTERPRISES LLC, ST. LOUIS, MO:
2,730,700, INT. CL. 35.
- LEARNING COMPANY, THE, FREMONT, CA:
1,990,761, CANC. INT. CL. 9.
- LEASE PARTNERS, INC., BURLINGAME, CA:
1,991,325, CANC. INT. CL. 36.
- LEE SENG HENG FISH'S GRAVY & CANNING FACTORY LIMITED, HONG KONG, HONG KONG:
1,203,797, CANC. INT. CL. 30.
- LEGAL SEA FOODS, INC., ALLSTON, MA:
2,728,972, PUB. 4-1-2003, INT. CL. 43.
- LEHRCO INC., GREENVILLE, SC:
1,991,014, CANC. INT. CL. 17.
- LEINER HEALTH SERVICES CORP., CARSON, CA:
2,729,893, MULTIPLE CLASS, INT. CLS. 35 AND 42.
- LENTZ, ROBERT A., COLUMBUS, OH:
1,991,751, CANC. INT. CL. 36.
- LEON, MICHAEL C, LOS ANGELES, CA:
2,729,192, PUB. 4-1-2003, INT. CL. 25.
- LEONARD PARFUMS, 75008 PARIS, FRANCE:
2,730,298, INT. CL. 3.
- LEOPARD COMMUNICATIONS, BOULDER, CO:
2,730,375, INT. CL. 16.
- LEPAGE BAKERIES, INC., AUBURN, ME:
1,705,260, CANC. INT. CL. 30.
- LETZER, SALLY, CALABASA, CA:
2,729,371, INT. CL. 41.
- LEUSCHNER, DAVID, MONTVERDE, FL:
2,728,911, PUB. 4-1-2003, INT. CL. 41.
- LEVANTUR, S.A., 30008 MURCIA, SPAIN:
2,730,227, INT. CL. 42.
- LEVER BROTHERS COMPANY, NEW YORK, NY:
396,850, CANC. U.S. CL. 46.
- LEWIS, D'AMATO, BRISBOIS & BISGAARD, LLP, LOS ANGELES, CA:
2,730,882, INT. CL. 41.
- LG INFORMATION & COMMUNICATIONS, LTD., SEOUL, REPUBLIC OF KOREA:
2,728,587, PUB. 4-1-2003, INT. CL. 9.
- LIBBY, BUDD O., ATLANTA, GA:
1,990,798, CANC. INT. CL. 16.
- LIBERMAN BROADCASTING, INC., BURBANK, CA:
2,730,212, MULTIPLE CLASS, INT. CLS. 38 AND 41.
- LIBERTY FUND, INC., INDIANAPOLIS, IN:
2,729,508, MULTIPLE CLASS, INT. CLS. 16 AND 41.
- LIBERTY UNIVERSITY, LYNCHBURG, VA:
2,729,188, PUB. 4-1-2003, INT. CL. 41.
- LIEBERMANN, RAANAN, NORTH HAVEN, CT:
2,729,586, MULTIPLE CLASS, INT. CLS. 9, 38 AND 41.
- LIEBHERR-HOLDING GMBH, D-88400 BIBERACH AN DER RISS, FED REP GERMANY:
2,728,707, PUB. 4-1-2003, INT. CL. 11.
- LIFE ENERGY PROCESS, INC., SHERMAN OAKS, CA, DBA INSTITUTE FOR LIFE ENERGY, SABETTI, STEPHANO, SHERMAN OAKS, CA, DBA LIFE ENERGY MEDIA:
1,791,983, REN. 5-11-03, INT. CL. 41.
- LIFE PLUS INTERNATIONAL, BATESVILLE, AR, SUNLIFE HEALTH, INC., BATESVILLE, AR:
1,772,177, REN. 5-12-03, INT. CL. 5.
- LIFEBEAT INC, NEW YORK, NY, HEARTS AND VOICES, INC., NEW YORK, NY:
1,720,830, REN. 5-14-03, INT. CL. 41.
- LIFEGROWTH CORPORATION, MISSISSAUGA, ONTARIO, CANADA:
2,728,805, PUB. 4-1-2003, INT. CL. 45.
- LIFELIKE BIRDS, INC., WEST CORNWALL, CT:
1,992,202, CANC. INT. CL. 20.
- LIFEPLANNER LLC, CASTLE ROCK, CO, FREE METHODIST PUBLISHING HOUSE, INDIANAPOLIS, IN, DBA LIGHT AND LIFE PRESS:
1,670,211, REN. 5-14-03, INT. CL. 16.
- LIFESPAN BIOSCIENCES, INC., SEATTLE, WA:
2,729,370, INT. CL. 9.
- LIGHTNING2, LLC, SOUTH BURLINGTON, VT:
2,730,667, MULTIPLE CLASS, INT. CLS. 10 AND 25.
- LIGHTS OUT, INC., MIAMI BEACH, FL:
1,990,877, CANC. INT. CL. 25.
- LIMING, TREESA V.B., SPRINGFIELD, OH:
1,705,037, CANC. INT. CL. 20.
- LINCOLN FINANCIAL ADVISORS CORPORATION, HARTFORD, CT:
2,729,243, PUB. 4-1-2003, INT. CL. 35.
- LINCOLN GLOBAL, INC., MONTEREY PARK, CA, LINCOLN ELECTRIC COMPANY, THE, CLEVELAND, OH:
1,759,128, REN. 5-14-03, INT. CL. 9.
- LINCOLN LOGS LTD., CHESTERTOWN, NY:
1,231,130, REN. 5-16-03, INT. CL. 19.
- LINDEN CORPORATION, WILMINGTON, DE:
1,991,665, CANC. INT. CL. 16.
1,991,666, CANC. INT. CL. 16.
- LINDEN OAKS CORPORATION, WILMINGTON, DE:
2,729,973, INT. CL. 29.
- LINDLEY, JERRY ALAN, FOUNTAIN VALLEY, CA:
2,728,940, PUB. 4-1-2003, INT. CL. 30.
- LINDSEY, B. SCOTT, LUCILE, ID AND LINDSEY, ANNETTE, LUCILE, ID:
1,991,983, CANC. INT. CL. 28.
- LINE ART, INC., NEW YORK, NY:
2,729,499, INT. CL. 10.
- LINE 6, INC., AGOURA HILLS, CA:
2,729,066, PUB. 4-1-2003, INT. CL. 9.
- LINEAR MEASUREMENT INSTRUMENTS CORPORATION, BYRON, MI:
2,729,417, INT. CL. 9.
- LINKSHARE CORPORATION, NEW YORK, NY:
2,728,566, PUB. 4-1-2003, INT. CL. 35.
- LINNET GEOMATIC INTERNATIONAL INC., WINNIPEG, MANITOBA R3C 3T1, CANADA:
2,729,737, INT. CL. 9.
- LINVATEC CORPORATION, LARGO, FL:
1,758,169, REN. 5-16-03, INT. CL. 10.
1,762,666, REN. 5-10-03, INT. CL. 10.
2,730,453, INT. CL. 10.

- LIONEL CORPORATION, THE, CHESTERFIELD, MI TO LIONEL L.L.C., CHESTERFIELD, MI:
736,342, AM. U.S. CL. 22.
- LIONEL L.L.C., CHESTERFIELD, MI, LIONEL CORPORATION, THE, CHESTERFIELD, MI:
736,342. REN. 5-15-03. U.S. CL. 22 (INT. CL. 28).
- LIPSCHULTZ, LEVIN & GRAY, L.L.C., NORTHBROOK, IL:
1,990,824, CANC. INT. CL. 16.
- LIPTON INVESTMENTS, INC., WILMINGTON, DE, CONOPCO, INC., GREENWICH, CT, DBA RAGU' FOODS CO.:
1,716,157. REN. 5-13-03. INT. CL. 30.
- LIPTON INVESTMENTS, INC., WILMINGTON, DE:
2,728,706, PUB. 4-1-2003. INT. CL. 30.
- LIQUID CONTROL CORPORATION, NORTH CANTON, OH:
1,781,812. REN. 5-16-03. INT. CL. 41.
- LISA FRANK, INC., TUCSON, AZ:
2,730,637, INT. CL. 16.
- LITE-FORM, INC., SIOUX CITY, IA:
1,774,249. REN. 5-16-03. INT. CL. 19.
- LITTLE SIX, INC., PRIOR LAKE, MN:
2,730,381, INT. CL. 42.
- LIU, LOUISE YAN, MONTEREY PARK, CA, DBA LOUISE INVESTMENT GROUP:
1,991,494, CANC. INT. CL. 25.
- LIVECHAI, INC., BOULDER, CO:
1,991,116, CANC. INT. CL. 30.
- LIVETV, LLC, IRVINE, CA:
2,730,013, INT. CL. 38.
- LIYUAN FOODS CO., LTD., HEBEI, CHINA:
2,728,776, PUB. 4-1-2003. INT. CL. 29.
- LLOYD SPORTSWEAR CO., INC., NEW YORK, NY:
1,203,673, CANC. INT. CL. 25.
- LMK ENTERPRISES, INC., OTTAWA, IL:
2,728,791, PUB. 4-1-2003. INT. CL. 37.
- LOADLINK, INCORPORATED, LISLE, IL:
1,990,986, CANC. INT. CL. 9.
- LOCKARD, KENNETH GERALD, CHARLOTTE, NC:
1,991,637, CANC. INT. CL. 9.
- LOCKHEED CORPORATION, BURBANK, CA:
1,203,932, CANC. INT. CL. 37.
- LOCKHEED MARTIN CORPORATION, BETHESDA, MD:
2,730,092, INT. CL. 13.
- LOCKMASTERS, INC., NICHOLASVILLE, KY:
2,728,850, PUB. 4-1-2003. MULTIPLE CLASS, INT. CLS. 9 AND 41.
- LOFIELD CORP., CORNELIA, GA:
2,730,127, INT. CL. 35.
- LOGICEASE SOLUTIONS, INC., BURLINGAME, CA:
2,729,049, PUB. 4-1-2003. INT. CL. 9.
- LOHMANN & STOLTERFOHT GMBH, WITTEN, FED REP GERMANY, LOHMANN & STOLTERFOHT GMBH, WITTEN, FED REP GERMANY:
1,234,298. REN. 5-10-03. MULTIPLE CLASS, INT. CLS. 7, 9 AND 12.
1,234,299. REN. 5-10-03. MULTIPLE CLASS, INT. CLS. 7, 9 AND 12.
- LOLITA'S RESTAURANTS, INC., CHULA VISTA, CA, DBA LOLITA'S TACO SHOP:
2,729,352, PUB. 4-1-2003. INT. CL. 43.
2,729,353, PUB. 4-1-2003. INT. CL. 43.
- LONG & SCOTT FARMS, INC., MOUNT DORA, FL:
2,730,282, INT. CL. 31.
- LONGEVITY RESEARCH, INC., MEDIA, PA:
2,729,203, PUB. 4-1-2003. INT. CL. 44.
2,729,204, PUB. 4-1-2003. INT. CL. 44.
- LONGWOOD MANUFACTURING, INC., BROOKLYN, NY:
1,992,168, CANC. INT. CL. 26.
- LONZA LTD., BASEL, SWITZERLAND:
956,300. REN. 5-16-03. MULTIPLE CLASS, U.S. CLS. 1 (INT. CL. 31), 5 (INT. CL. 1), 6 (INT. CLS. 1, 2 AND 5), 14 (INT. CL. 6), 15 (INT. CL. 4), 16 (INT. CL. 2), 18 (INT. CL. 5), 31 (INT. CL. 11) AND 46 (INT. CL. 1).
- LORD, BISSELL & BROOK, CHICAGO, IL:
2,729,939, MULTIPLE CLASS, INT. CLS. 16, 41 AND 42.
- LORENZ, GUNTER, D-61381 FRIEDRICHSDORF, FED REP GERMANY:
2,668,725, COR. MULTIPLE CLASS, INT. CLS. 11, 37 AND 42.
- LORIMAR S.A.C., LIMA, PERU:
2,728,946, PUB. 4-1-2003. INT. CL. 43.
- LORIN INDUSTRIES, INC., MUSKEGON, MI:
2,730,125, INT. CL. 6.
- LOS ANGELES KINGS HOCKEY CLUB, L.P., THE, LOS ANGELES, CA, L. A. KINGS LIMITED, INGLEWOOD, CA:
1,718,268. REN. 5-16-03. INT. CL. 25.
- LOS ANGELES RINGBINDER COMPANY, NEWBURY PARK, CA:
2,729,955, INT. CL. 16.
- LOS ANGELES RINGBINDER CORP., NEWBURY PARK, CA, DBA LOS ANGELES RINGBINDER COMPANY:
1,704,975, CANC. INT. CL. 16.
- LOS ANGELES TIMES COMMUNICATIONS LLC, LOS ANGELES, CA:
2,730,693, INT. CL. 35.
- LOUDER; DARRELL E., DOVER, DE:
1,203,896, CANC. INT. CL. 36.
- LOUISBURG CIDER MILL, INC., LOUISBURG, KS:
1,683,931, CANC. INT. CL. 32.
- LOUISIANA REMEDIATION CO., INC., NEW ORLEANS, LA:
1,991,729, CANC. INT. CL. 42.
- LOUISVILLE GAS AND ELECTRIC COMPANY, LOUISVILLE, KY:
1,990,861, CANC. INT. CL. 39.
- LOURDES, RUIZ TOLEDO, I, MIAMI, FL:
2,641,824, COR. INT. CL. 41.
- LOURENSFORD LEASING (PTY) LTD, SOMERSET-WEST, 7130, SOUTH AFRICA:
2,729,983, INT. CL. 33.
- LOVABLE COMPANY, THE, BUFORD, GA:
1,991,563, CANC. INT. CL. 25.
- LOVING WORKS CORPORATION, SILVER SPRING, MD:
2,730,547, INT. CL. 42.
- LOWE, SANDRA MICHELLE, DALLAS, TX:
2,728,945, PUB. 4-1-2003. INT. CL. 41.
- LOYALTY MANAGEMENT GROUP CANADA INC., NORTH YORK, ONTARIO, CANADA:
2,728,461, PUB. 4-1-2003. MULTIPLE CLASS, INT. CLS. 16, 25, 35, 39 AND 42.
- LSP LEADER SPORT PRODUCTS INC., ESSEX, NY:
1,705,168, CANC. INT. CL. 28.
- LTW WHOLESALE, INC., SCHUYLKILL HAVEN, PA, DBA LTL HOME PRODUCTS, INC.:
2,728,750, PUB. 4-1-2003. INT. CL. 20.
- LTM CORPORATION OF AMERICA, SUN VALLEY, CA:
1,704,770, CANC. INT. CL. 11.
- LUBRICATION ENGINEERS, INC., FT. WORTH, TX:
1,203,299, CANC. INT. CL. 4.
1,203,300, CANC. INT. CL. 4.
1,203,301, CANC. INT. CL. 4.
1,203,302, CANC. INT. CL. 4.
- LUBRIZOL PERFORMANCE SYSTEMS INC., ROSWELL, GA, GATE CITY EQUIPMENT COMPANY, INC., ROSWELL, GA:
1,774,640. REN. 5-12-03. INT. CL. 9.
- LUCASARTS ENTERTAINMENT COMPANY LLC, SAN RAFAEL, CA:
1,705,153, CANC. INT. CL. 28.
- LUCASEY MANUFACTURING CORPORATION, OAKLAND, CA:
1,760,625. REN. 5-13-03. INT. CL. 9.
- LUCASFILM LTD., NICASIO, CA:
2,729,615, INT. CL. 41.
- LUCKY U CORPORATION, CHESTER, NY:
1,991,694, CANC. INT. CL. 42.
- LUGGAGE STORE, INC., THE, BOSTON, MA:
1,990,751, CANC. INT. CL. 39.
- LUMISOURCE, INC., ELK GROVE VILLAGE, IL:
2,728,657, PUB. 4-1-2003. INT. CL. 11.
- LUNDQUIST, ROBERT, MINNEAPOLIS, MN:
1,991,349, CANC. INT. CL. 20.
- LUO, JIAN, SAN MATEO, CA, DBA EASYMOTION.COM:
2,729,129, PUB. 3-11-2003. MULTIPLE CLASS, INT. CLS. 9 AND 42.

- LUSID TECHNOLOGIES, INC., SANDY, UT:
2,728,724, PUB. 4-1-2003. INT. CL. 2.
- LWB REFRACTORIES COMPANY, YORK, PA, AKA LWB REFRACTORIES, J. E. BAKER COMPANY, THE, YORK, PA:
1,232,771. REN. 5-16-03. INT. CL. 19.
- LYDALL, INC., MANCHESTER, CT, LYDALL, INC., MANCHESTER, CT:
1,229,496. REN. 5-15-03. INT. CL. 10.
- LYLE ANDERSON COMPANY, INC., THE, SCOTTSDALE, AZ:
2,730,446, INT. CL. 42.
- LYONDELL PETROCHEMICAL COMPANY, HOUSTON, TX:
1,992,007, CANC. MULTIPLE CLASS, INT. CLS. 1 AND 23.
- M & I ELECTRIC INDUSTRIES, INC., BEAUMONT, TX:
1,753,601. REN. 5-11-03. MULTIPLE CLASS, INT. CLS. 7 AND 9.
- M. & B. PACKAGING, INC., GREENWOOD, MS:
1,991,677, CANC. INT. CL. 21.
- M.B. FOSTER ASSOCIATES LIMITED, CHESTERVILLE, ONTARIO K0C 1H0, CANADA:
2,728,603, PUB. 4-1-2003. MULTIPLE CLASS, INT. CLS. 9, 16 AND 42.
- M.T.C., INC., SAN ANTONIO, TX:
1,815,289. REN. 5-16-03. INT. CL. 42.
- M-PACT WORLDWIDE L.L.C., EUDORA, KS:
2,728,749, PUB. 4-1-2003. INT. CL. 10.
- MACDONALD, DETTWILER AND ASSOCIATES LTD., RICHMOND, BRITISH COLUMBIA, CANADA:
1,754,944. REN. 5-16-03. MULTIPLE CLASS, INT. CLS. 9 AND 42.
- MACK AND MOORE, INC., MINNEAPOLIS, MN:
2,730,264, INT. CL. 25.
- MACK, WILLIAM, HAUPPAUGE, NY:
1,990,947, CANC. INT. CL. 42.
- MACKIE DESIGNS INCORPORATED, WOODINVILLE, WA:
1,991,943, CANC. INT. CL. 9.
- MADDOX, KAREN, LOUISVILLE, KY, DBA FAITH UNLIMITED ENTERPRISES:
1,705,548, CANC. INT. CL. 42.
- MADIKATE, INC., THATCHER, AZ, DBA EASTERN ARIZONA GLASS AND E.A GLASS:
2,729,702, INT. CL. 37.
- MADISON CHEMICAL INDUSTRIES INC., MILTON, ONTARIO L9T 3Y5, CANADA:
2,729,091, PUB. 4-1-2003. INT. CL. 2.
- MAEIL DAIRY INDUSTRY CO., LTD., SEOUL, REPUBLIC OF KOREA:
2,038,527, CANC. INT. CL. 30.
- MAGANA, CARLOS ALBERTO CHAVIRA, GUADALAJARA, JAL., MEXICO:
1,990,900, CANC. INT. CL. 25.
- MAGICBELT.COM, INC., DESERT HOT SPRINGS, CA:
2,730,867, INT. CL. 42.
- MAGIX COMPUTER PRODUCTS INTERNATIONAL CORP., RENO, NV:
1,990,726, CANC. INT. CL. 9.
- MAGNA-FILTER INTERNATIONAL, INC., MARIETTA, OH:
1,991,673, CANC. INT. CL. 9.
- MAGNET COMMUNICATIONS LLC, NEW YORK, NY FROM CREAMER DICKSON BASFORD, LLC, NEW YORK, NY:
2,730,557, INT. CL. 35.
- MAGNET INTERACTIVE STUDIOS, INC., WASHINGTON, DC:
1,991,120, CANC. INT. CL. 9.
- MAGNOLIA CHARM, INC., PONTE VEDRA BEACH, FL:
1,991,071, CANC. INT. CL. 42.
- MAHARISHI AYURVEDA PRODUCTS INTERNATIONAL INC., LANCASTER, MA:
1,990,644, CANC. INT. CL. 5.
- MAINLINE INDUSTRIES INCORPORATED, SPRINGFIELD, MA:
1,776,577. REN. 5-16-03. INT. CL. 21.
- MAINSTREAM AMERICA, INC., TAYLOR, PA:
1,990,872, CANC. INT. CL. 42.
- MAISON DE VENOGÉ, EPERNAY (MARNE), FRANCE:
1,204,168, CANC. INT. CL. 33.
- MAISON JOSEPH BATTAT LTEE., MONTREAL, QUEBEC, CANADA:
1,738,454. REN. 5-14-03. INT. CL. 28.
- MAJESTIC ENTERTAINMENT, INC., LAKE SUCCESS, NY:
1,992,199, CANC. INT. CL. 9.
- MAJOR INDUSTRIES, INC., WAUSAU, WI:
2,651,740, CANC. IIRN. RESTORED TO S.N. 76-329,061.
- MAJOR LEAGUE BASEBALL PROPERTIES, INC., NEW YORK, NY, MAJOR LEAGUE BASEBALL PROMOTION CORPORATION, NEW YORK, NY:
1,230,519. REN. 5-16-03. INT. CL. 42.
- MAJOR LEAGUE BASEBALL PROPERTIES, INC., NEW YORK, NY:
2,729,489, INT. CL. 9.
- MAKITA U.S.A., INC., LA MIRADA, CA:
2,728,978, PUB. 4-1-2003. INT. CL. 9.
2,728,981, PUB. 4-1-2003. INT. CL. 7.
- MALANGA, KEVIN, WEST ORANGE, NJ:
2,729,648, INT. CL. 3.
- MANAGEMENT COMPUTER SERVICES, INC., COLUMBUS, OH:
1,203,858, CANC. INT. CL. 35.
- MANDARINO INTERNATIONAL S.A., HELIOUPOLIS, 16346 ATHENS, GREECE:
1,775,299. REN. 5-15-03. INT. CL. 25.
- MANIFATTURA LANE GAETANO MARZOTTO & FIGLI S.P.A., 36078 VALDAGNO (VICENZA), ITALY:
2,729,712, INT. CL. 23.
- MANLEY LABORATORIES INCORPORATED, CHINO, CA:
2,729,137, PUB. 4-1-2003. INT. CL. 9.
- MANNA PRO CORPORATION, ST. LOUIS, MO:
1,991,031, CANC. INT. CL. 31.
- MANNHARDT, INC., CHICAGO, IL TO MANNHARDT, INC., KOHLER, WI:
1,704,786, CANC. INT. CL. 11.
- MANNING FARMS, INC., UVALDA, GA FROM LARRY K. WALDEN AND KAREN B. WALDEN PARTNERSHIP, THE, SOPERTON, GA, DBA VIDALIA'S BEST:
2,728,474, PUB. 4-1-2003. INT. CL. 30.
- MANNING, SELVAGE & LEE, INC., NEW YORK, NY:
2,730,514, INT. CL. 35.
- MAPP PRODUCTIONS, INC., MOUNT DORA, FL:
2,729,941, INT. CL. 9.
- MARATHON ELECTRIC MANUFACTURING CORPORATION, WAUSAU, WI:
1,213,805. REN. 5-15-03. MULTIPLE CLASS, INT. CLS. 7 AND 16.
- MARCAL PAPER MILLS, INC., ELMWOOD PARK, NJ:
1,757,626. REN. 5-16-03. INT. CL. 16.
- MARCOA PUBLISHING, INC., SAN DIEGO, CA:
1,971,981, CANC. INT. CL. 16.
- MARIBEL'S SWEETS, INC., NEW YORK, NY:
2,729,059, PUB. 4-1-2003. INT. CL. 30.
- MARIMELJ ENTERTAINMENT GROUP, LLC, SILVER SPRING, MD:
2,728,899, PUB. 4-1-2003. MULTIPLE CLASS, INT. CLS. 9 AND 41.
- MARINE POLYMER TECHNOLOGIES, INC., DANVERS, MA:
2,645,283, COR. INT. CL. 5.
- MARINER INTERNATIONAL TRAVEL, INC., CLEARWATER, FL:
2,729,645, MULTIPLE CLASS, INT. CLS. 12, 35, 37 AND 39.
- MARJORIE BRODY, JENKINTOWN, PA:
2,728,908, PUB. 4-1-2003. INT. CL. 41.
- MARKANNA STUDIOS, INC., ALBANY, CA, DBA MVB FONTS:
2,729,040, PUB. 4-1-2003. INT. CL. 9.
2,729,041, PUB. 4-1-2003. INT. CL. 9.
2,729,042, PUB. 4-1-2003. INT. CL. 9.
- MARKER 29 PRODUCE, INC., ONANCOCK, VA:
2,730,273, INT. CL. 31.

- MARLEE ELECTRONICS CORPORATION, PHILADELPHIA, PA:
1,991,262, CANC. INT. CL. 9.
- MARLEY COOLING TECHNOLOGIES, INC., OVERLAND PARK, KS FROM MARLEY COOLING TOWER COMPANY, THE, OVERLAND PARK, KS:
2,730,265, INT. CL. 11.
- MARLEY COOLING TOWER COMPANY, THE, MISSION, KS:
533,664, AM. U.S. CL. 31.
- MAROTTA, FRED, SAN DIEGO, CA, DBA THE REPAIR ZONE:
2,729,349, PUB. 4-1-2003. INT. CL. 15.
- MAROTTA, PAUL DAVID, BURLINGAME, CA:
2,729,237, PUB. 4-1-2003. INT. CL. 42.
- MARS, INCORPORATED, MCLEAN, VA:
2,397,355, COR. INT. CL. 25.
2,441,064, COR. INT. CL. 21.
2,454,999, COR. INT. CL. 20.
2,490,332, COR. INT. CL. 21.
- MARSHALL GOLDSMITH INCORPORATED, RANCHO SANTA FE, CA:
2,730,649, INT. CL. 35.
- MARSHALL INDUSTRIES COMPOSITES, LIMA, OH:
1,991,698, CANC. MULTIPLE CLASS, INT. CLS. 1 AND 19.
- MARSHALL SOLUTIONS, INC., OAK PARK, IL:
2,728,614, PUB. 4-1-2003. INT. CL. 35.
- MARTEK BIOSCIENCES BOULDER CORPORATION, BOULDER, CO FROM OMEGATECH INC., BOULDER, CO:
2,729,644, INT. CL. 29.
- MARTEK, LLC, PERU, IN:
2,730,139, INT. CL. 30.
- MARTHA STEWART LIVING OMNIMEDIA, INC., NEW YORK, NY:
2,729,596, INT. CL. 11.
- MARTIN, DOROTHY, R., SILVER SPRING, MD:
1,704,891, CANC. INT. CL. 16.
- MARTIN'S FEED MILLS, INC., NEW PARIS, IN:
735,761, CANC. U.S. CL. 46.
- MARTINI & ROSSI CORPORATION, NEW YORK, NY:
735,779, CANC. U.S. CL. 49.
- MARVEL CHARACTERS, INC., LOS ANGELES, CA:
2,729,265, PUB. 4-1-2003. INT. CL. 16.
- MARVEL GROUP, INC., THE, CHICAGO, IL:
1,991,624, CANC. INT. CL. 20.
- MARVELLA, INC., NEW YORK, NY:
735,653, CANC. U.S. CL. 28.
- MARVELOUS MUGGS, INC., MOOSIC, PA:
1,992,012, CANC. MULTIPLE CLASS, INT. CLS. 9, 16, 21, 25 AND 42.
- MARX, ROSEMARIE, D-85104 PFORRING-WACKERSTEIN, FED REP GERMANY:
1,992,001, CANC. INT. CL. 9.
- MARYLAND PUBLIC BROADCASTING COMMISSION, OWINGS MILLS, MD:
2,730,525, INT. CL. 41.
- MAS, OYAMA'S KARATE, INC., FAIRFIELD, CT TO OYAMA, SHIGERU, FAIRFIELD, CT:
1,204,016, CANC. INT. CL. 41.
1,204,017, CANC. INT. CL. 41.
1,204,018, CANC. INT. CL. 41.
- MASON, KAREN, ATLANTA, GA AND JAMES, KENYA, ATLANTA, GA:
2,730,900, INT. CL. 16.
- MASSACHUSETTS FINANCIAL SERVICES COMPANY, BOSTON, MA:
1,991,506, CANC. MULTIPLE CLASS, INT. CLS. 9 AND 36.
2,728,662, PUB. 4-1-2003. INT. CL. 16.
- MASSACHUSETTS MUTINY, TAUNTON, MA:
2,729,139, PUB. 1-21-2003. MULTIPLE CLASS, INT. CLS. 16 AND 25.
- MASSENGILL, R. KEMP, POWAY, CA:
1,991,204, CANC. INT. CL. 42.
- MASTERCARD INTERNATIONAL INCORPORATED, NEW YORK, NY:
1,992,068, CANC. INT. CL. 36.
- MASTERCARD INTERNATIONAL INCORPORATED, PURCHASE, NY:
2,729,633, INT. CL. 9.
- MASTERS ANGLING TOURNAMENT, RIVIERA BEACH, FL:
1,203,979, CANC. INT. CL. 41.
- MASTERS PRODUCTS, INC., ORANGE CITY, IA:
1,789,053, REN. 5-15-03. INT. CL. 2.
- MASTERWEAR CORPORATION, NEW YORK, NY:
1,991,975, CANC. INT. CL. 25.
- MATSUI MANUFACTURING CO., LTD., MINAMI-KU, OSAKA, JAPAN:
1,704,580, CANC. INT. CL. 7.
- MATSUSHITA ELECTRIC INDUSTRIAL CO., LTD., KADOMA-SHI, OSAKA, JAPAN:
1,756,525, REN. 5-13-03. INT. CL. 9.
- MATSUSHITA ELECTRIC INDUSTRIAL CO., LTD., OSAKA-FU, JAPAN:
2,729,874, INT. CL. 9.
- MATTE TECH INDUSTRIES, INC., NORTH CHELMSFORD, MA:
1,203,544, CANC. INT. CL. 16.
- MATTEC CORPORATION, MELROSE, WI:
2,729,181, PUB. 4-1-2003. INT. CL. 18.
- MATTEL, INC., EL SEGUNDO, CA:
1,705,898, CANC. INT. CL. 28.
1,991,566, CANC. INT. CL. 28.
1,991,703, CANC. INT. CL. 28.
1,991,958, CANC. INT. CL. 28.
1,991,998, CANC. INT. CL. 28.
1,992,029, CANC. INT. CL. 28.
1,992,082, CANC. INT. CL. 28.
1,992,086, CANC. INT. CL. 28.
1,992,087, CANC. INT. CL. 28.
1,992,091, CANC. INT. CL. 28.
1,992,133, CANC. INT. CL. 28.
1,992,161, CANC. INT. CL. 28.
1,992,163, CANC. INT. CL. 28.
1,992,164, CANC. INT. CL. 28.
1,992,167, CANC. INT. CL. 28.
2,730,586, INT. CL. 28.
2,730,644, INT. CL. 28.
2,730,679, INT. CL. 28.
- MAURICE SPORTING GOODS, INC., NORTHBROOK, IL:
1,992,189, CANC. INT. CL. 28.
1,992,190, CANC. INT. CL. 28.
1,992,191, CANC. INT. CL. 28.
- MAVETY MEDIA GROUP LTD., NEW YORK, NY, HUDSON COMMUNICATIONS, INC., NEW YORK, NY:
1,229,648, REN. 5-11-03. INT. CL. 16.
- MAXBASE, INC., TEANECK, NJ:
1,992,102, CANC. INT. CL. 9.
- MAXI-BLAST, INC., SOUTH BEND, IN:
1,266,759, REN. 5-16-03. INT. CL. 3.
- MAXIMUM STRATEGY, INC., MILPITAS, CA:
1,991,971, CANC. INT. CL. 9.
- MAYER LABORATORIES, INC., OAKLAND, CA:
1,759,410, REN. 5-14-03. INT. CL. 5.
- MAYSTEEL LLC, MENOMONEE FALLS, WI:
2,730,821, INT. CL. 9.
- MAZZA GRAZIANO, MONTEGRANARO (ASCOLI PICE-NO), ITALY:
2,457,944, CANC. IIRN. RESTORED TO S.N. 75-591,685.
- MAZZO, INC., HONOLULU, HI:
1,991,795, CANC. INT. CL. 28.
- MBV, INC., WILMINGTON, DE, ADVO-SYSTEMS, INC., WINDSOR, CT:
1,754,368, REN. 5-13-03. INT. CL. 42.
- MBV, INC., WILMINGTON, DE:
1,992,197, CANC. INT. CL. 35.
- MCAULEY'S, INC., MEMPHIS, TN:
1,990,953, CANC. INT. CL. 5.
- MCC NATIONAL BROCKORAGE, INC., TAMPA, FL:
2,729,235, PUB. 4-1-2003. INT. CL. 36.

- MCCAULEY, JACK B., WARREN, MI:
2,729,694, INT. CL. 41.
- MCDONALD, RUSHION, HOUSTON, TX:
2,728,823, PUB. 4-1-2003. INT. CL. 41.
- MCDONALD'S CORPORATION, OAK BROOK, IL:
1,992,061, CANC. INT. CL. 42.
- MCFARLAND, JAMES NORMAN, TORRANCE, CA:
2,729,138, PUB. 4-1-2003. INT. CL. 41.
- MCG MARKETING CONSULTANTS GROUP, INC., NEW YORK, NY:
2,729,464, INT. CL. 21.
- MCGLADREY & PULLEN, NEW YORK, NY:
1,990,945, CANC. INT. CL. 9.
- MCGRAW-HILL COMPANIES, INC., THE, NEW YORK, NY, MACMILLAN PUBLISHING CO., INC., NEW YORK, NY:
1,211,494, REN. 5-14-03. INT. CL. 16.
- MCGRAW-HILL COMPANIES, INC., THE, NEW YORK, DE, IDEAL SCHOOL SUPPLY CORPORATION, SUNNYVALE, CA:
1,759,618, REN. 5-15-03. MULTIPLE CLASS, INT. CLS. 9 AND 16.
- MCGRAW-HILL COMPANIES, INC., THE, NEW YORK, NY:
2,730,224, INT. CL. 41.
- MCGRAW-HILL, INC., NEW YORK, NY:
1,203,543, CANC. INT. CL. 16.
1,992,187, CANC. INT. CL. 36.
- MCGUIRE, LYNNE CAMILLE, KANSAS CITY, MO:
2,728,963, PUB. 4-1-2003. INT. CL. 18.
- MCI COMMUNICATIONS CORPORATION, WASHINGTON, DC:
1,705,451, CANC. INT. CL. 38.
1,991,181, CANC. INT. CL. 38.
- MCKEE FOODS CORPORATION:
See— MCKEE FOODS KINGMAN, INC.
- MCKEE FOODS KINGMAN, INC., KINGMAN, AZ FROM MCKEE FOODS CORPORATION, COLLEGE DALE, TN:
2,728,844, PUB. 4-1-2003. INT. CL. 30.
- MCKENZIE SPORTS PRODUCTS INC., GRANITE QUARRY, NC:
2,729,005, PUB. 4-1-2003. INT. CL. 28.
- MCKINLEY, KEVIN, EAU CLAIRE, WI:
2,729,963, MULTIPLE CLASS, INT. CLS. 9, 16 AND 41.
- MCKINNON ENTERPRISES, SAN DIEGO, CA:
2,729,035, PUB. 4-1-2003. INT. CL. 16.
- MCNAMARA, J. PATRICK, TEHACHAPI, CA:
1,991,026, CANC. INT. CL. 42.
- MCPINTO & ASSOCIATES, INC., SARASOTA, FL:
1,990,799, CANC. INT. CL. 42.
- MCQUAIG GROUP INC., THE, TORONTO, ONTARIO, CANADA:
1,704,860, CANC. INT. CL. 16.
- MCQUEEN ENTERPRISES, BONITA, CA:
1,990,702, CANC. INT. CL. 3.
- MDM INTELLECTUAL PROPERTY, LLC, IRVINE, CA:
2,730,881, INT. CL. 38.
- MDU RESOURCES GROUP, INC., BISMARCK, ND:
2,729,169, PUB. 4-1-2003. MULTIPLE CLASS, INT. CLS. 35, 37 AND 39.
- MEAD CORPORATION, THE, DAYTON, OH:
2,730,321, INT. CL. 16.
- MEASUREMENT SPECIALTIES, INC., FAIRFIELD, NJ:
2,730,020, INT. CL. 9.
- MECCANICA MARCON S.R.L., (VICENZA), ITALY:
1,990,711, CANC. MULTIPLE CLASS, INT. CLS. 7 AND 11.
- MECHANICS CUSTOM TOOLS CORPORATION, WILMINGTON, DE:
1,991,210, CANC. INT. CL. 42.
- MEDACCESS CORPORATION, LEXINGTON, MA:
1,991,815, CANC. INT. CL. 38.
1,991,816, CANC. INT. CL. 38.
- MEDBOUND BILLING SOLUTIONS, INC., ENTERPRISE, UT:
2,728,795, PUB. 4-1-2003. INT. CL. 35.
- MEDFAB CORPORATION, OLDSMAR, FL:
2,728,680, PUB. 4-1-2003. INT. CL. 17.
- MEDIAPOLL, BURBANK, CA:
1,992,005, CANC. INT. CL. 35.
- MEDICAL LASER TECHNOLOGIES, INC., SALEM, NH:
2,728,918, PUB. 4-1-2003. INT. CL. 44.
- MEDICAL LITERATURE REVIEW CORPORATION, MIDDLE VILLAGE, NY:
1,204,049, CANC. INT. CL. 42.
- MEDICAL MANAGER RESEARCH & DEVELOPMENT, INC., ALACHUA, FL:
2,729,510, INT. CL. 9.
- MEDICAL SOFTWARE SOLUTIONS, INC., SANDY, UT:
2,595,063, CANC. INT. CL. 9.
- MEDICINELODGE, INC., LOGAN, UT:
2,728,882, PUB. 4-1-2003. INT. CL. 42.
- MEDIMEDIA USA, INC., TETERBORO, NJ FROM QUADRANT HEALTHCOM INC., CHATHAM, NJ:
2,730,034, INT. CL. 35.
- MEDIQUE COSMETICS INC., ALBERTA T2P 1B2, CANADA:
2,730,241, INT. CL. 3.
- MEDITERRANEAN NUTRITION, LTD., GR-184 53 NIKEA, GREECE:
1,991,866, CANC. INT. CL. 29.
- MEDSTAT GROUP, INC., THE, ANN ARBOR, MI, MEDSTAT SYSTEMS, INC., ANN ARBOR, MI:
1,717,821, REN. 5-16-03. INT. CL. 9.
- MEDTRONIC INC., MINNEAPOLIS, MN:
2,730,633, INT. CL. 41.
2,730,729, INT. CL. 10.
- MEDTRONIC PHYSIO-CONTROL CORP., REDMOND, WA, PHYSIO-CONTROL CORPORATION, REDMOND, WA:
1,225,724, REN. 5-14-03. INT. CL. 10.
- MEDTRONIC, INC., MINNEAPOLIS, MN:
1,705,804, CANC. INT. CL. 10.
2,730,598, INT. CL. 10.
2,730,634, INT. CL. 41.
- MEGABANK OF ARAPAHOE, ENGLEWOOD, CO:
1,992,092, CANC. INT. CL. 35.
- MEINEKE DISCOUNT MUFFLER SHOPS, INC., CHARLOTTE, NC:
2,728,887, PUB. 4-1-2003. INT. CL. 41.
- MELALEUCA, INC., IDAHO FALLS, ID:
2,729,322, PUB. 4-1-2003. INT. CL. 5.
- MELLANOX TECHNOLOGIES, INC., SANTA CLARA, CA:
2,729,808, INT. CL. 9.
- MELLON EQUITY ASSOCIATES, LLP, PITTSBURGH, PA:
2,728,800, PUB. 4-1-2003. INT. CL. 36.
- MELVILLE CORPORATION, RYE, NY:
1,992,116, CANC. INT. CL. 25.
- MELVILLE, JOSHUA K., LOWER BURRELL, PA:
2,729,173, PUB. 4-1-2003. INT. CL. 11.
- MEMPHIS IN MAY INTERNATIONAL FESTIVAL, INC., MEMPHIS, TN:
1,705,476, CANC. INT. CL. 41.
- MEMPHIS ROCK 'N SOUL, INC., MEMPHIS, TN:
2,595,263, COR. MULTIPLE CLASS, INT. CLS. 16, 25 AND 41.
- MENARD, INC., EAU CLAIRE, WI:
2,728,933, PUB. 4-1-2003. INT. CL. 6.
- MENASHA CORPORATION, NEENAH, WI FROM COOKSON PLASTIC MOLDING CORP., LATHAM, NY:
2,729,717, INT. CL. 20.
- MENDELSON & ASSOCIATES, INC., LOS ANGELES, CA:
955,078, REN. 5-11-03. U.S. CL. 28 (INT. CL. 14).
- MENNEN COMPANY, THE, MORRISTOWN, NJ:
735,786, CANC. U.S. CL. 51.
- MENTICE, GOTHENBURG, SWEDEN FROM PROSOLVIA CLARUS AB, GOTHENBURG, SWEDEN:
2,729,395, INT. CL. 41.
- MERCANTILE BANCORPORATION INC., ST. LOUIS, MO:
1,203,897, CANC. INT. CL. 36.
- MERCANTILE STORES COMPANY, INC., FAIRFIELD, OH:
2,198,605, CANC. INT. CL. 28.
- MERCEDES MEDICAL, INC., TALLEVAST, FL:
1,991,302, CANC. MULTIPLE CLASS, INT. CLS. 9 AND 10.
- MERCER TOOL CORP., NEW YORK, NY:
2,729,804, INT. CL. 8.
- MERCHANT ATM PARTNERS, MINNEAPOLIS, MN:
2,729,234, PUB. 4-1-2003. MULTIPLE CLASS, INT. CLS. 9 AND 36.

- MERCK & CO., INC., WHITEHOUSE STATION, NJ:
2,730,094, INT. CL. 5.
- MERCURY COMPUTER SYSTEMS, INC., CHELMSFORD, MA:
2,730,772, INT. CL. 9.
2,730,773, INT. CL. 9.
- MERCURY ENTERPRISES, INC., CLEARWATER, FL:
1,764,337, REN. 5-16-03, INT. CL. 10.
- MEREDITH CORPORATION, DES MOINES, IA:
1,752,462, REN. 5-16-03, INT. CL. 16.
- MEREY, DAISY, WEST PALM BEACH, FL:
2,729,098, PUB. 4-1-2003, INT. CL. 5.
- MERIT MEDICAL SYSTEMS, INC., SOUTH JORDAN, UT:
1,704,760, CANC. INT. CL. 10.
- MERIT PAPER CORPORATION, FARMINGDALE, NY:
2,730,237, INT. CL. 16.
- MERITAGE TECHNOLOGIES, INC., COLUMBUS, OH:
2,729,749, INT. CL. 42.
- MERITUS INDUSTRIES INC., FAIRFIELD, NJ:
1,705,900, CANC. INT. CL. 28.
- MERRILL LYNCH & CO., INC., NEW YORK, NY:
2,730,919, INT. CL. 36.
- MERZ + CO. GMBH & CO., 60318 FRANKFURT AM MAIN, FED REP GERMANY:
2,694,539, COR. INT. CL. 10.
2,694,540, COR. INT. CL. 10.
- MESKER-CLARK, INC., HAZELWOOD, MO:
1,203,355, CANC. INT. CL. 6.
- MESSE DUSSELDORF GMBH, 40474 DUSSELDORF, FED REP GERMANY:
1,768,837, REN. 5-14-03, INT. CL. 35.
- METABOLIFE INTERNATIONAL, INC., SAN DIEGO, CA:
2,729,838, INT. CL. 30.
- METAGENICS, INC., SAN CLEMENTE, CA:
2,730,219, INT. CL. 5.
2,730,849, INT. CL. 5.
- METER S.P.A., 10070 ROBASSOMERO - TORINO, ITALY:
2,729,354, PUB. 4-1-2003, INT. CL. 7.
- METRIS DIRECT, INC., MINNETONKA, MN:
2,728,682, PUB. 4-1-2003, INT. CL. 36.
- METROPOLITAN NEWSCLIPS SERVICE, INC., ST. LOUIS, MO:
2,728,917, PUB. 4-1-2003, INT. CL. 35.
- MFC GROUP, INC., THE, TELFORD, PA:
1,203,460, CANC. MULTIPLE CLASS, INT. CLS. 10 AND 26.
- MGI PHARMA, INC., MINNETONKA, MN:
2,729,432, INT. CL. 5.
- MI CASA ES SU CASA, INC., NEW YORK, NY:
2,728,739, PUB. 4-1-2003, MULTIPLE CLASS, INT. CLS. 41 AND 43.
- MIAMI SPORTSWEAR COMPANY, INC., HIALEAH, FL, SCHNELL; MARTIN, HIALEAH, FL, DBA THE SANIBEL COMPANY:
1,229,994, REN. 5-15-03, INT. CL. 25.
- MIAMI SUBS OF DELAWARE INC., FORT LAUDERDALE, FL:
1,752,090, REN. 5-16-03, INT. CL. 42.
- MIAMI TERMINAL SERVICES, INC., MIAMI, FL:
1,203,951, CANC. INT. CL. 39.
- MICASA TRADING CORPORATION, MIAMI, FL, DBA IMPEX SYSTEMS GROUP, INC.:
2,730,157, INT. CL. 6.
- MICHAEL, MIELOCK J., PLAINFIELD, IL:
2,730,757, INT. CL. 32.
- MICHAELS STORES, INC., IRVING, TX FROM 5931 BUSINESS TRUST, A DELAWARE BUSINESS TRUST, THE SOLE TRUSTEE BEING PNC BANK, WILMINGTON, DE:
2,730,052, INT. CL. 40.
- MICHAELS, KEVIN S., HICKSVILLE, NY:
2,730,670, INT. CL. 41.
- MICHAELSON, PAUL R., LAS VEGAS, NV:
2,729,368, INT. CL. 41.
- MICHEL, JEANINE, OAKLAND, NJ:
2,729,513, INT. CL. 10.
- MICRO BEEF TECHNOLOGIES, LTD., AMARILLO, TX, MICRO CHEMICAL, INC., AMARILLO, TX, AKA MCI:
1,789,211, REN. 5-16-03, INT. CL. 9.
- MICRO-LITE, INC., THREE RIVERS, MA:
1,756,100, REN. 5-14-03, INT. CL. 11.
- MICRODENTAL LABORATORIES, DUBLIN, CA:
2,730,814, INT. CL. 10.
- MICROSOFT CORPORATION, REDMOND, WA:
1,992,063, CANC. INT. CL. 38.
2,729,524, INT. CL. 9.
2,730,599, INT. CL. 41.
2,730,847, INT. CL. 9.
- MIDCO COMMUNICATIONS, INC., SIOUX FALLS, SD:
1,705,332, CANC. MULTIPLE CLASS, INT. CLS. 35, 38 AND 42.
- MIDDENDORF MEATS AND QUALITY FOODS, INC., ST. LOUIS, MO:
1,990,895, CANC. INT. CL. 29.
- MIDEA MASTER DISTRIBUTION, INC., ALHAMBRA, CA:
2,656,187, CANC. IIRN. RESTORED TO S.N. 76-314,123.
- MIDWAY GAMES WEST INC., MILPITAS, CA:
2,730,944, INT. CL. 9.
- MILACRON INDUSTRIAL PRODUCTS, INC., LIVONIA, MI, CINCINNATI MILACRON INC., CINCINNATI, OH:
1,246,144, REN. 5-12-03, INT. CL. 1.
- MILANIAN, CYRUS, POMPANO BEACH, FL:
2,730,861, INT. CL. 35.
- MILANOWSKI, WARREN, BOISE, ID:
2,729,033, PUB. 4-1-2003, INT. CL. 9.
- MILAZZO INDUSTRIES INC., PORT BLANCHARD PITTS- STON, PA:
1,755,993, REN. 5-16-03, INT. CL. 1.
- MILCHEM INCORPORATED, HOUSTON, TX:
735,818, CANC. U.S. CL. 1.
- MILES INC., ELKHART, IN:
1,203,342, CANC. INT. CL. 5.
- MILES KIMBALL COMPANY, OSHKOSH, WI:
1,991,607, CANC. INT. CL. 42.
- MILES LABORATORIES INC., ELKHART, IN:
735,572, CANC. U.S. CL. 18.
- MILESTONE GOLF ENTERPRISES, JESSUP, MD:
2,730,454, INT. CL. 28.
- MILEXIMUM NATURAL PRODUCTS, INC., GUTHRIE, OK:
2,728,488, PUB. 7-16-2002, INT. CL. 5.
- MILITARY MODEL DISTRIBUTORS, INC., CARROLLTON, TX, DBA MMD THE PLASTIC PLACE:
1,807,699, REN. 5-10-03, INT. CL. 28.
- MILLIKEN & COMPANY, NEW YORK, NY, DEERING MILLIKEN, INC., NEW YORK, NY:
952,129, REN. 5-12-03, U.S. CL. 42 (INT. CL. 27).
- MILLIKEN & COMPANY, NEW YORK, NY:
1,756,914, REN. 5-10-03, INT. CL. 24.
- MILLION DOLLAR ROUND TABLE, PARK RIDGE, IL:
2,730,920, INT. CL. 35.
- MILLIPORE CORPORATION, BILLERICA, MA:
2,730,576, INT. CL. 11.
- MILLIPORE CORPORATION, BEDFORD, MA:
2,730,845, INT. CL. 9.
- MILLS LIMITED PARTNERSHIP, THE, ARLINGTON, VA AND DISCOVER FINANCIAL SERVICES, INC., RIVER- WOODS, IL:
2,650,662, COR. INT. CL. 35.
2,660,769, COR. INT. CL. 35.
- MILLS LIMITED PARTNERSHIP, THE, ARLINGTON, VA FROM OPRY MILLS LIMITED PARTNERSHIP, ARLING- TON, VA:
2,729,519, INT. CL. 36.
- MILLS-PENINSULA HEALTH SYSTEM, BURLINGAME, CA:
1,705,604, CANC. INT. CL. 42.
- MIMRAN GROUP INC., TORONTO, ONTARIO, CANADA:
2,728,492, PUB. 6-11-2002, MULTIPLE CLASS, INT. CLS. 3, 4 AND 5.
- MINADO CO., INC., LITTLE FERRY, NJ:
2,728,660, PUB. 4-1-2003, INT. CL. 35.
- MINDCREST, INC., CHICAGO, IL:
2,729,896, INT. CL. 35.
- MINERALS TECHNOLOGIES INC., NEW YORK, NY:
1,704,539, CANC. INT. CL. 6.

- MINERVA FOOTBALL CO., LTD., THE, ST. ALBANS, HERTFORDSHIRE AL4 9QT, ENGLAND:
1,705,163, CANC. INT. CL. 28.
- MINNESOTA CHILDREN'S HEALTH, INC., MINNEAPOLIS, MN:
1,991,945, CANC. INT. CL. 42.
- MINNESOTA MINING AND MANUFACTURING COMPANY, ST. PAUL, MN, AKA 3M:
1,203,453, CANC. INT. CL. 9.
- MINNESOTA SAFETY COUNCIL, INC., ST. PAUL, MN:
2,729,970, MULTIPLE CLASS, INT. CLS. 16, 41 AND 42.
- MINNETONKA BRANDS, INC., EDEN PRAIRIE, MN:
2,730,532, INT. CL. 3.
- MINOLTA KABUSHIKI KAISHA (MINOLTA CO., LTD.), OSAKA-SHI, JAPAN:
2,730,725, INT. CL. 9.
- MINUTEMAN INTERNATIONAL, INC., ADDISON, IL, PARKER SWEEPER COMPANY, SPRINGFIELD, OH:
1,246,063, REN. 5-16-03, INT. CL. 7.
- MIRACLE CANDLE COMPANY, LAREDO, TX:
2,730,245, INT. CL. 4.
- MIRADOR SYSTEMS INC., DURHAM, NC:
2,730,225, INT. CL. 9.
- MIRAMAR TRADING INTERNATIONAL, MONTEREY, CA:
1,991,966, CANC. INT. CL. 32.
- MIRSEPASSI, SADEGH, ENCINO, CA:
2,729,037, PUB. 4-1-2003, INT. CL. 37.
- MISCO/MINNEAPOLIS SPEAKER COMPANY, INC., MINNEAPOLIS, MN, DIGRE, CLIFFORD B., MINNEAPOLIS, MN, DBA MINNEAPOLIS SPEAKER COMPANY:
954,945, REN. 5-16-03, U.S. CL. 21 (INT. CL. 9),
958,913, REN. 5-16-03, U.S. CL. 21 (INT. CL. 9).
- MISGUIDED GAMES, INC., HUDSON, OH:
2,730,199, INT. CL. 28.
- MISS SELFRIDGE RETAIL LIMITED, LONDON, UNITED KINGDOM:
2,730,954, INT. CL. 25.
- MISSOURI EMPLOYERS MUTUAL INSURANCE, COLUMBIA, MO:
2,729,634, INT. CL. 16.
- MITSUBISHI DIGITAL ELECTRONICS AMERICA, INC., IRVINE, CA:
2,730,906, INT. CL. 9.
- MITSUBISHI ELECTRIC CORPORATION, TOKYO, JAPAN:
2,728,646, PUB. 4-1-2003, MULTIPLE CLASS, INT. CLS. 7, 9, 11, 12, 37, 38, 41 AND 42.
- MITSUBISHI ENPITSU KABUSHIKI KAISHA, SHINAGAWA-KU, TOYKO, JAPAN:
2,730,266, INT. CL. 16.
- MITSUBISHI MOTORS NORTH AMERICA, INC., CYPRESS, CA FROM MITSUBISHI MOTOR SALES OF AMERICA, INC., CYPRESS, CA:
2,729,375, INT. CL. 12,
2,730,045, INT. CL. 12.
- MITSUBISHI RAYON KABUSHIKI KAISHA, CHUO-KU, TOKYO, JAPAN, TA MITSUBISHI RAYON CO., LTD.:
1,705,065, CANC. MULTIPLE CLASS, INT. CLS. 22, 23, 24 AND 27.
- MIZUNO USA, INC., NORCROSS, GA:
2,730,395, INT. CL. 28.
- MJR INDUSTRIES, INC., MENOMINEE, MI:
1,704,785, CANC. INT. CL. 11.
- MK DIAMOND PRODUCTS, INC., TORRANCE, CA:
2,662,764, AM. INT. CL. 7.
- MKM CONSULTANTS, INC., CHICAGO, IL:
1,203,868, CANC. INT. CL. 35.
- MOBILE MAMMAL PRODUCTIONS, INC., ATLANTA, GA:
2,730,492, INT. CL. 41.
- MOBULAR TECHNOLOGIES, INC., HUNTSVILLE, AL:
2,729,060, PUB. 4-1-2003, INT. CL. 42.
- MOCHA MOTION, INC., NAPA, CA:
1,992,023, CANC. INT. CL. 42.
- MODERN CONCRETE, OTTSVILLE, PA:
2,730,182, INT. CL. 19.
- MODERN MEMOIRS, AMHERST, MA:
2,728,947, PUB. 4-1-2003, INT. CL. 41.
- MODERNFOLD, INC., NEW CASTLE, IN:
1,704,536, CANC. INT. CL. 6,
1,704,537, CANC. INT. CL. 6.
- MOEN INCORPORATED, NORTH OLMSTED, OH:
2,730,588, MULTIPLE CLASS, INT. CLS. 6 AND 21,
2,730,589, MULTIPLE CLASS, INT. CLS. 6 AND 21.
- MOHAWK BRANDS, INC., WILMINGTON, DE:
2,730,798, INT. CL. 27,
2,730,799, INT. CL. 27.
- MOLECULAR PRODUCTS LIMITED, THAXTED, ESSEX, CM6 2LT, ENGLAND:
1,754,717, REN. 5-16-03, INT. CL. 1.
- MOLNLYCKE HEALTH CARE AB, GOTEBOG, SWEDEN, MOLNLYCKE AB, GOTEBOG, SWEDEN:
1,235,141, REN. 5-10-03, INT. CL. 5.
- MOLNLYCKE HEALTH CARE AB, GOTEBOG, SWEDEN:
2,729,217, PUB. 4-1-2003, INT. CL. 5.
- MOMO PANACHE LIMITED PARTNERSHIP, SAN ANTONIO, TX:
2,728,630, PUB. 4-1-2003, INT. CL. 35.
- MONARI FEDERZONI S.P.A., MODENA, ITALY:
2,728,545, PUB. 4-1-2003, INT. CL. 30.
- MONDEX INTERNATIONAL LIMITED, LONDON EC4M 5SQ, ENGLAND:
2,729,392, INT. CL. 9.
- MONEY-MARK CONSULTANTS, INC., ST. PAUL, MN:
1,203,837, CANC. INT. CL. 35,
1,203,838, CANC. INT. CL. 35.
- MONROE FLUID TECHNOLOGY, INC., HILTON, NY:
1,757,916, REN. 5-10-03, MULTIPLE CLASS, INT. CLS. 4 AND 7.
- MONROVIA NURSERY COMPANY, AZUSA, CA:
1,784,327, REN. 5-10-03, INT. CL. 31,
1,786,945, REN. 5-10-03, INT. CL. 31.
- MONSANTO COMPANY, ST. LOUIS, MO:
735,517, CANC. U.S. CL. 1,
1,992,103, CANC. INT. CL. 11.
- MONSTER CABLE PRODUCTS, INC., BRISBANE, CA, MONSTER CABLE PRODUCTS, INC., BRISBANE, CA:
1,230,896, REN. 5-13-03, INT. CL. 9.
- MONSTER CABLE PRODUCTS, INC., BRISBANE, CA:
2,728,729, PUB. 4-1-2003, INT. CL. 9.
- MONTAGUE COMPANY, THE, HAYWARD, CA:
1,991,804, CANC. INT. CL. 11.
- MONTANA PACIFIC, INC., BILLINGS, MT:
2,728,789, PUB. 4-1-2003, INT. CL. 9.
- MONTECASTELLI SELECTIONS LTD., NEW YORK, NY:
2,730,724, INT. CL. 33.
- MONTEREY MUSHROOMS, INC., SANTA CRUZ, CA:
1,203,767, CANC. INT. CL. 29.
- MONTGOMERY CHEMICAL INC., GLOUCESTER CITY, NJ, MONTGOMERY CHEMICAL COMPANY, JENKINTOWN, PA:
756,221, REN. 5-16-03, U.S. CL. 52 (INT. CL. 3).
- MOORE BUSINESS FORMS, INC., GRAND ISLAND, NY:
1,705,948, CANC. INT. CL. 35,
1,992,120, CANC. INT. CL. 9.
- MOORE, RANDAL D., SAN LEANDRO, CA, DBA FELLOWSHIP FOUNDRY:
1,704,831, CANC. INT. CL. 14.
- MORENO SOCIEDAD ANONIMA, 14006 CORDOBA, SPAIN:
2,730,309, INT. CL. 33.
- MORESA, S.A. DE C.V., MEXICO, D.F., MEXICO:
2,729,512, INT. CL. 16.
- MORGAN CONSTRUCTION COMPANY, WORCESTER, MA:
735,629, CANC. U.S. CL. 23.
- MORGAN STANLEY, NEW YORK, NY FROM MORGAN STANLEY DEAN WITTER & CO., NEW YORK, NY:
2,729,993, MULTIPLE CLASS, INT. CLS. 9, 16, 35 AND 36,
2,730,102, INT. CL. 36.
- MORGAN STANLEY DEAN WITTER & CO., NEW YORK, NY, MORGAN STANLEY & CO. INCORPORATED, NEW YORK, NY:
1,757,730, REN. 5-16-03, INT. CL. 36.
- MORINAGA & CO., LTD., TOKYO, JAPAN:
2,728,491, PUB. 6-11-2002, MULTIPLE CLASS, INT. CLS. 30 AND 32.

- MORITZ; JEFF W., OREGON, OH, DBA LANDSCAPE DESIGN BY MORITZ:
1,204,036, CANC. INT. CL. 42.
- MORNING STAR INTERNATIONAL, INC., BRENTWOOD, TN:
2,729,082, PUB. 4-1-2003. MULTIPLE CLASS, INT. CLS. 9, 16 AND 35.
- MORSE, GREG, ARLINGTON, TX:
2,730,727, INT. CL. 36.
- MORTON INTERNATIONAL, INC., CHICAGO, IL:
1,705,701, CANC. MULTIPLE CLASS, INT. CLS. 1 AND 7.
- MORTON THIOKOL, INC., NEWTON, PA:
1,203,266, CANC. INT. CL. 1.
- MORTON, MARK ALISON, COLUMBUS, OH:
2,728,620, PUB. 4-1-2003. INT. CL. 41.
- MOSCOW INTERBANK CURRENCY EXCHANGE, MOSCOW, RUSSIAN FEDERATIO:
2,728,500, PUB. 4-30-2002. MULTIPLE CLASS, INT. CLS. 9, 14, 16, 35, 36 AND 42.
2,728,501, PUB. 4-30-2002. MULTIPLE CLASS, INT. CLS. 9, 14, 16, 35, 36 AND 42.
2,728,502, PUB. 4-30-2002. MULTIPLE CLASS, INT. CLS. 9, 14, 16, 35, 36 AND 42.
2,728,503, PUB. 4-30-2002. MULTIPLE CLASS, INT. CLS. 9, 14, 16, 35, 36 AND 42.
- MOSS; JAMES H., LA HONDA, CA:
1,229,462, REN. 5-12-03. INT. CL. 9.
- MOSS, LISA AVA, OAKLAND, CA:
1,990,905, CANC. INT. CL. 3.
- MOTHERS AGAINST DRUNK DRIVING, IRVING, TX:
2,730,301, INT. CL. 42.
- MOTIC INSTRUMENTS INC., RICHMOND, B.C., CANADA:
2,730,702, INT. CL. 9.
- MOTION MEDIA TECHNOLOGY LIMITED, BRISTOL, UNITED KINGDOM:
2,728,551, PUB. 7-2-2002. MULTIPLE CLASS, INT. CLS. 9, 38 AND 42.
- MOTOROLA, INC., SCHAUMBURG, IL:
1,991,041, CANC. INT. CL. 9.
- MOUNT SINAI HOSPITAL MEDICAL CENTER, CHICAGO, IL:
1,990,802, CANC. INT. CL. 42.
- MOUNTAIN GREENERY, L.L.C., OKLAHOMA CITY, OK:
2,730,477, INT. CL. 36.
- MOVADO CORPORATION, WILMINGTON, DE TO MOVADO CORPORATION, WILMINGTON, DE:
2,620,290, COR. INT. CL. 14.
- MOXIE JAVA INTERNATIONAL, INC., BOISE, ID:
1,705,588, CANC. INT. CL. 42.
- MOXTEK, INC., OREM, UT:
2,728,617, PUB. 4-1-2003. INT. CL. 9.
- MPC CONTAINMENT SYSTEMS, LTD., CHICAGO, IL:
1,753,936, REN. 5-10-03. INT. CL. 20.
- MRS BAIRD'S BAKERIES BUSINESS TRUST:
See—CENTRAL IMPULSORA, S.A. DE C.V..
- MS ARTIST PRODUCTS, INC.:
See—TAMBORINE ENTERTAINMENT AMERICA, INC..
- MS FOODS, INC., MINNEAPOLIS, MN:
1,992,181, CANC. INT. CL. 30.
- MT. MCKINLEY MANAGERS, L.L.C., LIBERTY CORNER, NJ:
2,729,755, INT. CL. 36.
- MTD PRODUCTS INC, CLEVELAND, OH:
1,990,994, CANC. INT. CL. 9.
- MTS, INCORPORATED, WEST SACRAMENTO, CA:
2,728,798, PUB. 4-1-2003. MULTIPLE CLASS, INT. CLS. 9 AND 16.
- MUIR, MICHAEL, SANTA MONICA, CA:
2,728,987, PUB. 4-1-2003. INT. CL. 28.
- MUKENBRUN, CEM, CLIFFSIDE PARK, NJ:
1,991,822, CANC. INT. CL. 34.
- MULTIACTIVE TECHNOLOGIES INC., VANCOUVER, BRITISH COLUMBIA, CANADA:
2,728,473, PUB. 5-21-2002. MULTIPLE CLASS, INT. CLS. 9 AND 42.
- MULTIMEDIA CATALOG SYSTEMS, BATON ROUGE, LA:
2,729,968, INT. CL. 9.
- MULTNOMAH PUBLISHERS, INC., SISTERS, OR:
2,730,116, INT. CL. 16.
2,730,117, INT. CL. 16.
- MUNA FEDERAL CREDIT UNION, MERIDIAN, MS:
2,729,290, PUB. 4-1-2003. INT. CL. 36.
- MUNDER FUNDS, INC., THE, BIRMINGHAM, MI:
2,728,639, PUB. 4-1-2003. INT. CL. 36.
- MURDOCH, EUAN FORSYTH, SALISBURY, QUEENSLAND, AUSTRALIA AND MURDOCH, BARBARA KAYE, SALISBURY, QUEENSLAND, AUSTRALIA:
1,990,608, CANC. INT. CL. 25.
- MURIGENICS, INC., HERCULES, CA:
2,730,792, INT. CL. 42.
- MURPHY-PHOENIX COMPANY, THE, NEW YORK, NY FROM COLGATE-PALMOLIVE COMPANY, NEW YORK, NY:
2,730,745, INT. CL. 3.
- MURPHY, GERALD B., INDIANOLA, IA:
2,730,098, INT. CL. 36.
2,730,099, INT. CL. 36.
- MURRAY CONSTRUCTION CO., INC., SPRINGFIELD, NJ:
1,264,473, REN. 5-15-03. INT. CL. 37.
- MUSIC PEOPLE, INC., THE, OAKLAND, CA:
1,991,285, CANC. INT. CL. 9.
- MUSTEN & CRUTCHFIELD, INC., KERNERSVILLE, NC:
2,665,577, COR. INT. CL. 29.
- MWCA, INC., REXBURG, ID:
2,602,030, COR. INT. CL. 31.
- MY BACKYARD, INC., WALNUT CREEK, CA:
2,656,798, COR. MULTIPLE CLASS, INT. CLS. 35 AND 42.
- MY FAVORITE COMPANY, INC., VENICE, CA:
2,730,768, INT. CL. 28.
- MYLEGALPROBLEM, INC., PITTSBURGH, PA:
2,729,807, INT. CL. 42.
- MYRON ZUCKER, INC., ROYAL OAK, MI:
1,764,197, REN. 5-16-03. INT. CL. 9.
1,813,433, REN. 5-15-03. INT. CL. 9.
- MYSTIQUE SHOPPER, OCEANSIDE, NY:
2,728,886, PUB. 4-1-2003. INT. CL. 35.
- MYTECH SYSTEMS CORP., ZION, IL:
1,991,583, CANC. INT. CL. 9.
- N.C.A., LTD., OR-YEHUDA 60200, ISRAEL:
1,991,604, CANC. INT. CL. 21.
- N.O.E'. NUOVA ORGANIZZAZIONE ENOLOGICA SOC. C. A R.L., 38040 RAVINA (TRENTO), ITALY:
1,991,737, CANC. INT. CL. 33.
- NABISCO HOLDINGS CORP., PARSIPPANY, NJ:
1,991,876, CANC. INT. CL. 30.
1,991,897, CANC. INT. CL. 30.
- NABISCO, INC., PARSIPPANY, NJ:
1,990,766, CANC. INT. CL. 30.
1,991,126, CANC. INT. CL. 30.
1,991,152, CANC. INT. CL. 30.
1,992,067, CANC. INT. CL. 30.
- NAIDU, RAVI M., FORNEY, TX:
1,991,567, CANC. INT. CL. 11.
- NAMCO CYBERTAINMENT INC., BENSENVILLE, IL:
2,730,229, INT. CL. 41.
- NAMCO HOMETEK INC., SAN JOSE, CA:
2,730,531, MULTIPLE CLASS, INT. CLS. 9 AND 16.
- NAMKUNG PROMOTIONS INC., COSTA MESA, CA:
1,991,664, CANC. INT. CL. 28.
- NANAIMO SHIPYARD LTD., NANAIMO, BRITISH COLUMBIA V9S 4C9, CANADA FROM ALLSOP, JON, BRITISH COLUMBIA V9F 9J8, CANADA:
2,729,591, INT. CL. 12.
- NANNETTE MANUFACTURING COMPANY, INC., PHILADELPHIA, PA:
1,203,687, CANC. INT. CL. 25.
- NANOGRAM CORPORATION, FREMONT, CA:
2,729,398, INT. CL. 1.
- NANOPHASE TECHNOLOGIES CORPORATION, BURR RIDGE, IL:
2,729,746, MULTIPLE CLASS, INT. CLS. 1 AND 6.
- NASDAQ STOCK MARKET, INC., THE, WASHINGTON, DC:
2,730,075, INT. CL. 36.

- NASHVILLE HOCKEY CLUB LIMITED PARTNERSHIP, NASHVILLE, TN:
2,730,071, INT. CL. 41.
- NATAN, MICHAEL J., MOUNTAIN VIEW, CA:
2,729,566, INT. CL. 9.
- NATHAN'S FAMOUS SYSTEMS, INC., WESTBURY, NY, NATHAN'S FAMOUS, INC., WESTBURY, NY:
1,754,104, REN. 5-16-03, INT. CL. 30.
- NATIONAL ASSOCIATION OF CONVENIENCE STORES, ALEXANDRIA, VA:
1,710,488, REN. 5-13-03, MULTIPLE CLASS, INT. CLS. 41 AND 42.
- NATIONAL ASSOCIATION OF TAX PROFESSIONALS, APPLETON, WI:
2,730,138, U.S. CL. 200.
- NATIONAL BASEBALL HALL OF FAME AND MUSEUM, INC., COOPERSTOWN, NY:
2,730,311, INT. CL. 25.
2,730,312, INT. CL. 41.
- NATIONAL BROADCASTING COMPANY, INC., NEW YORK, NY:
2,729,987, INT. CL. 41.
2,729,988, INT. CL. 36.
2,729,989, INT. CL. 41.
2,729,990, INT. CL. 36.
- NATIONAL BULK FOOD DISTRIBUTORS, INC., TAYLOR, MI:
2,728,649, PUB. 4-1-2003, INT. CL. 30.
- NATIONAL CAN CORPORATION, CHICAGO, IL:
1,203,579, CANC. INT. CL. 20.
- NATIONAL CRAFTS LTD., CHAMBERSBURG, PA:
1,990,964, CANC. INT. CL. 41.
1,990,965, CANC. INT. CL. 41.
- NATIONAL CRITICAL CARE INSTITUTE OF EDUCATION, RAMONA, CA:
1,992,231, CANC. INT. CL. 41.
1,992,232, CANC. INT. CL. 41.
- NATIONAL ELECTRICAL CONTRACTORS ASSOCIATION, BETHESDA, MD:
2,728,814, PUB. 4-1-2003, MULTIPLE CLASS, U.S. CL. 200 INT. CL. 16.
- NATIONAL ENTERTAINMENT COLLECTIBLES ASSOCIATION INC, KENILWORTH, NJ:
2,730,802, INT. CL. 28.
- NATIONAL GUILD OF PROFESSIONAL PAPERHANGERS, INC., MERION STATION, PA:
1,204,134, CANC. U.S. CL. 200.
- NATIONAL HEARING AID DISTRIBUTORS, INC., BOSTON, MA:
1,991,582, CANC. INT. CL. 5.
- NATIONAL INDEPENDENT AUTOMOBILE DEALERS ASSOCIATION, ARLINGTON, TX:
2,730,628, INT. CL. 41.
- NATIONAL MARINE ELECTRONICS ASSOCIATION, INC., NEW BERN, NC:
2,730,206, MULTIPLE CLASS, INT. CLS. 9, 16 AND 42.
- NATIONAL PEDICULOSIS ASSOCIATION, INC., NEEDHAM, MA:
2,729,374, INT. CL. 41.
- NATIONAL PUBLISHERS OF THE BLACK HILLS, INC., ELMSFORD, NY:
1,203,514, CANC. MULTIPLE CLASS, INT. CLS. 16 AND 41.
- NATIONAL RAILROAD PASSENGER CORPORATION, WASHINGTON, DC:
2,729,085, PUB. 4-1-2003, INT. CL. 9.
2,729,086, PUB. 4-1-2003, INT. CL. 20.
- NATIONAL SAFETY APPAREL, INC., CLEVELAND, OH:
2,728,893, PUB. 4-1-2003, INT. CL. 9.
- NATIONAL STARCH AND CHEMICAL INVESTMENT HOLDING CORPORATION, NEW CASTLE, DE, NATIONAL STARCH AND CHEMICAL CORPORATION, NEW YORK, NY:
965,860, REN. 5-13-03, U.S. CL. 5 (INT. CL. 1).
- NATIONAL TECHNICAL SYSTEMS, INC., CALABASAS, CA:
2,729,044, PUB. 4-1-2003, INT. CL. 35.
- NATIONAL VALEDICTORIAN SOCIETY, LOUVIERS, CO:
2,729,377, INT. CL. 9.
- NATIONAL WESTMINSTER BANK PLC, LONDON EC2P 2BP, ENGLAND:
1,991,420, CANC. INT. CL. 36.
- NATURA, LLC, ASHLAND, OR:
2,729,105, PUB. 4-1-2003, INT. CL. 5.
2,729,106, PUB. 4-1-2003, INT. CL. 5.
- NATURAL WORLD DEVELOPMENT LIMITED, KOWLOON, HONG KONG, HONG KONG:
2,730,786, INT. CL. 18.
- NATUREL, LLC, ONTARIO, CA:
2,730,067, INT. CL. 33.
- NATURESMART, LLC, BOHEMIA, NY:
2,729,266, PUB. 4-1-2003, INT. CL. 5.
2,729,268, PUB. 4-1-2003, INT. CL. 5.
- NATURIZE BIOSCIENCES, INC., JACKSONVILLE, FL:
2,729,109, PUB. 4-1-2003, INT. CL. 1.
- NAUTICA APPAREL, INC., NEW YORK, NY:
2,730,498, INT. CL. 20.
2,730,499, INT. CL. 24.
- NAVIDI, NOOSHIN, AUSTIN, TX:
2,729,038, PUB. 4-1-2003, INT. CL. 16.
- NAVIDUL, S.A., TORRIJOS (TOLEDO), SPAIN:
2,729,134, PUB. 4-1-2003, INT. CL. 29.
- NAVIS LOGISTICS GROUP, INC, GREENWOOD VILLAGE, CO TO TOTAL LOGISTICS GROUP, INC., MORAGA, CA:
2,613,525, COR. INT. CL. 39.
- NBTY, INC., BOHEMIA, NY:
2,730,226, INT. CL. 5.
- NCHAKO, LENA P., WASHINGTON, DC AND NCHAKO, COLIN N., WASHINGTON, DC:
2,729,153, PUB. 4-1-2003, INT. CL. 36.
- NEAT GROUP, INC., THE WOODLANDS, TX:
2,728,623, PUB. 4-1-2003, MULTIPLE CLASS, INT. CLS. 9 AND 42.
- NECTAR SPORTS, INC., FORT LAUDERDALE, FL, MACNABB; GARY M., ENCINITAS, CA:
1,229,975, REN. 5-15-03, INT. CL. 25.
- NEI CANADA LIMITED, TORONTO, ONTARIO, CANADA:
1,203,412, CANC. INT. CL. 9.
- NELCO, INC., GREEN BAY, WI:
1,992,185, CANC. INT. CL. 9.
- NELSON'S ICE CREAM, INC., ROYERSFORD, PA:
1,203,773, CANC. INT. CL. 30.
- NEO GEN SCREENING, INC., BRIDGEVILLE, PA:
2,730,413, INT. CL. 42.
- NESTLE PURINA PETCARE COMPANY, ST. LOUIS, MO FROM RALSTON PURINA COMPANY, ST. LOUIS, MO:
2,730,615, INT. CL. 31.
- NETCALL TELECOM, INCORPORATED, GLOUCESTER, MA:
2,728,628, PUB. 4-1-2003, MULTIPLE CLASS, INT. CLS. 38 AND 42.
- NETCOM ON-LINE COMMUNICATIONS SERVICES, SAN JOSE, CA:
1,992,173, CANC. INT. CL. 9.
- NETNEARU CORP., BRYAN, TX:
2,728,520, PUB. 4-1-2003, INT. CL. 9.
2,728,521, PUB. 4-1-2003, INT. CL. 9.
- NETSOFT, LAGUNA HILLS, CA:
1,990,706, CANC. INT. CL. 9.
- NETWORK GROUP, THE, JACKSON, MS:
1,992,047, CANC. INT. CL. 32.
- NETWORK PRODUCTS CORPORATION, PASADENA, CA:
1,990,701, CANC. INT. CL. 9.
- NET2PHONE, INC., HACKENSACK, NJ:
2,730,854, INT. CL. 38.
- NEUENHAUSER MASCHINENBAU GMBH & CO. KG, 49828 NEUENHAUS, FED REP GERMANY:
2,730,300, INT. CL. 7.
- NEUMANN, JERRY B., NEW BERN, NC:
2,730,345, INT. CL. 6.
- NEURO-REFLEX THERAPY INSTITUTE, INC., MODESTO, CA:
2,728,638, PUB. 4-1-2003, INT. CL. 42.
- NEUTROGENA CORPORATION, LOS ANGELES, CA:
2,729,650, INT. CL. 3.

NEVER SUMMER INDUSTRIES, INC., DENVER, CO:
2,728,730, PUB. 4-1-2003. MULTIPLE CLASS, INT. CLS. 25
AND 28.

NEW COLT HOLDING CORPORATION, NEW YORK, NY:
1,990,941, CANC. INT. CL. 16.

NEW ENGLAND ELECTRIC RAILWAY HISTORICAL SO-
CIETY, INC., KENNEBUNKPORT, ME:
1,203,791, CANC. INT. CL. 30.

NEW ENGLAND TEA & COFFEE CO., INC., MALDEN, MA:
1,203,798, CANC. INT. CL. 30.

NEW ENGLAND VENTURES, INC., FARMINGTON, CT:
1,991,671, CANC. INT. CL. 16.

NEW LINE PRODUCTIONS, INC., NEW YORK, NY:
2,730,841, INT. CL. 28.

NEW MEDIA STRATEGIES, INC., WASHINGTON, D.C., DC:
2,729,325, PUB. 4-1-2003. INT. CL. 35.

NEW MEXICO STATE UNIVERSITY BOARD OF REGENTS,
LAS CRUCES, NM:
2,728,599, PUB. 4-1-2003. INT. CL. 41.

NEW REVENUE SOLUTIONS, LLC, ATLANTA, GA:
2,728,591, PUB. 4-1-2003. MULTIPLE CLASS, INT. CLS. 9,
16 AND 35.

NEW YORK STATE DEPARTMENT OF ECONOMIC DE-
VELOPMENT, ALBANY, NY:
1,704,940, CANC. INT. CL. 16.

NEW YORK STOCK EXCHANGE, INC, NEW YORK, NY:
2,728,540, PUB. 4-1-2003. INT. CL. 9.

NEW YORK ZOOLOGICAL SOCIETY, NEW YORK, NY:
396,854, CANC. U.S. CL. 38.

NEWCHANGE LTD., LONDON, UNITED KINGDOM:
2,729,132, PUB. 9-17-2002. MULTIPLE CLASS, INT. CLS.
9, 16, 35 AND 42.

NEWCOMB OIL CO. LLC, BARDSTOWN, KY:
2,730,064, MULTIPLE CLASS, INT. CLS. 4 AND 35.

NEWELL OPERATING COMPANY, FREEPOR, IL, EZ
PAINTR CORPORATION, MILWAUKEE, WI:
1,756,792, REN. 5-12-03. INT. CL. 16.

NEWFIRST NATIONAL BANK, EL CAMPO, TX:
2,729,241, PUB. 4-1-2003. INT. CL. 36.

NEWSOM DESIGNS, LLC, DALLAS, TX:
2,729,699, INT. CL. 35.

NEXT CENTURY TECHNOLOGIES, INC., EDEN PRAIRIE,
MN:
1,990,958, CANC. INT. CL. 9.

NFO WORLDWIDE, INC., TOLEDO, OH:
2,728,901, PUB. 4-1-2003. INT. CL. 35.

NIBCO INC., ELKHART, IN:
977,120, REN. 5-10-03. U.S. CL. 13 (INT. CL. 6).

NICEWONGER CO., INC., THE, VANCOUVER, WA:
1,991,108, CANC. INT. CL. 30.

NICHOLS ALUMINUM - GOLDEN, INC., HOUSTON, TX,
GOLDEN ALUMINUM COMPANY, SAN ANTONIO, TX:
1,757,547, REN. 5-10-03. INT. CL. 6.

NICK'S CIGAR COMPANY, MIAMI LAKES, FL, DBA
TABACALERA PERDOMO S.A.:
2,729,095, PUB. 4-1-2003. INT. CL. 34.

NIDEC TOSOK CORPORATION, KANAGAWA, JAPAN:
2,729,143, PUB. 4-1-2003. MULTIPLE CLASS, INT. CLS. 7
AND 9.

NIKON INC., MELVILLE, NY:
1,992,053, CANC. INT. CL. 9.
1,992,090, CANC. INT. CL. 9.

NINTENDO OF AMERICA INC., REDMOND, WA:
1,991,611, CANC. INT. CL. 28.

NIPPON DENKI KABUSHIKI KAISHA, TOKYO, JAPAN,
DBA NEC CORPORATION:
2,730,292, INT. CL. 9.

NIPSON, BELFONT, FRANCE, BULL S.A., 75116 PARIS,
FRANCE:
1,711,164, REN. 5-13-03. INT. CL. 7.

NIRO-PLAN AG, CH-4663 AARBURG, SWITZERLAND,
EMCO LIMITED, WOODBRIDGE, ONTARIO L4L 4P6,
CANADA, DBA KINDRED INDUSTRIES:
1,777,768, REN. 5-10-03. INT. CL. 11.

NISSAN NORTH AMERICA, INC., GARDENA, CA:
2,728,869, PUB. 4-1-2003. INT. CL. 35.

NITEO PARTNERS, INC., NEW YORK, NY:
2,730,339, MULTIPLE CLASS, INT. CLS. 35 AND 42.

NLP IP COMPANY, WILMINGTON, DE:
2,730,344, MULTIPLE CLASS, INT. CLS. 16 AND 42.

NO FADE COATINGS, INC., PARAMOUNT, CA, DBA
ALLEGRO INDUSTRIES:
1,704,763, CANC. INT. CL. 10.

NOBEL, INC., DENVER, CO TO NOBEL/SYSCO FOOD
SERVICES COMPANY, DENVER, CO:
1,204,094, CANC. INT. CL. 42.

NOBLEWORKS, INC., HOBOKEN, NJ:
2,730,522, INT. CL. 16.

NOFRIENDS, SAN DIEGO, CA:
2,728,818, PUB. 4-1-2003. MULTIPLE CLASS, INT. CLS. 9
AND 25.

NONTRAD MARKETING GROUP, NORWALK, CT:
1,990,735, CANC. INT. CL. 35.

NOODLE TIME INC. (BENIHANA OF TOKYO, INC.),
TERRACE, MI, BENIHANA OF TOKYO, INC., MIAMI, FL:
1,230,609, REN. 5-16-03. INT. CL. 42.

NOODLES BY LEONARDO, INC., DEVILS LAKE, ND:
2,729,981, INT. CL. 30.

NOOFFICE INVEST AS, N-6021 ALESUND, NORWAY:
2,728,490, PUB. 9-17-2002. MULTIPLE CLASS, INT. CLS.
9, 20, 25, 28, 35 AND 42.

NOON IMPORT-EXPORT SALES, INC., DANVILLE, CA:
2,730,642, MULTIPLE CLASS, INT. CLS. 5 AND 31.
2,730,643, MULTIPLE CLASS, INT. CLS. 5 AND 31.

NORCLIFF THAYER INC., TUCKAHOE, NY:
1,203,313, CANC. INT. CL. 5.

NORCROSS SAFETY PRODUCTS, L.L.C., ROCK ISLAND,
IL:
2,729,337, PUB. 4-1-2003. INT. CL. 9.

NORD FEDER GMBH & CO. KG WOHNTEXTILIEN, 70327
STUTTGART-UNTERTURKHEIM, FED REP GERMANY:
2,728,494, PUB. 9-17-2002. MULTIPLE CLASS, INT. CLS.
20 AND 24.
2,728,495, PUB. 9-17-2002. INT. CL. 24.

NORDEN LABORATORIES, INC., LINCOLN, NE TO PFI-
ZER INC., NEW YORK, NY:
1,705,743, CANC. INT. CL. 5.

NORDSON CORPORATION, WESTLAKE, OH, ASYMTOTIC
TECHNOLOGIES, INC., CARLSBAD, CA:
1,737,546, REN. 5-15-03. INT. CL. 9.

NORDSON CORPORATION, WESTLAKE, OH:
1,773,414, REN. 5-16-03. INT. CL. 7.

NORLUX CORP., CAROL STREAM, IL:
2,728,693, PUB. 4-1-2003. INT. CL. 9.

NORSTAN NETWORK SERVICES, INC., MAPLE GROVE,
MN:
1,990,718, CANC. INT. CL. 38.

NORTH AMERICAN COMPANY FOR LIFE AND HEALTH
INSURANCE, CHICAGO, IL:
1,705,413, CANC. INT. CL. 36.

NORTH AMERICAN DIE CASTING ASSOCIATION, ROSE-
MONT, IL:
1,793,121, REN. 5-16-03. INT. CL. 42.

NORTH AMERICAN ENCLOSURES, INC., CENTRAL ISLIP,
NY:
1,992,034, CANC. INT. CL. 20.

NORTH CAROLINA SPEEDWAY, INC., ROCKINGHAM,
NC:
2,728,769, PUB. 4-1-2003. INT. CL. 25.

NORTH SHORE BANK, FSB, BROOKFIELD, WI:
2,730,791, INT. CL. 36.

NORTH SHORE SLEEPWORLD, INC., CORAM, NY:
1,217,943, REN. 5-15-03. INT. CL. 42.

NORTHEAST EQUITY MANAGEMENT, LLC, PORT WA-
SHINGTON, NY:
2,730,023, INT. CL. 36.

NORTHERN SAFETY CO., INC., FRANKFORT, NY:
2,730,776, INT. CL. 9.

NORTHERN STATES POWER COMPANY, EAU CLAIRE,
WI:
1,705,434, CANC. MULTIPLE CLASS, INT. CLS. 37, 41
AND 42.

NORTHLICH, INC., CINCINNATI, OH:
2,729,997, MULTIPLE CLASS, INT. CLS. 41 AND 42.

- NORTHWATER PRODUCTS LIMITED, PLUM POINT, NEWFOUNDLAND, CANADA:
1,705,197, CANC. INT. CL. 29.
- NORTON MCNAUGHTON OF SQUIRE, INC., NEW YORK, NY:
1,992,213, CANC. INT. CL. 25.
- NORWALK VAULT COMPANY OF BRIDGEPORT, INC., THE, BRIDGEPORT, CT:
1,704,455, CANC. MULTIPLE CLASS, INT. CLS. 1 AND 20.
- NOVA MEASURING INSTRUMENTS LTD., REHOVOT 76100, ISRAEL:
2,728,571, PUB. 9-17-2002. INT. CL. 9.
- NOVA SOUTHEASTERN, INC., FORT LAUDERDALE, FL:
1,916,926, COR. INT. CL. 41.
- NOVALIS FIBRES, 69003 LYON, FRANCE:
1,990,882, CANC. MULTIPLE CLASS, INT. CLS. 22, 23 AND 27.
- NOVARTIS AG, BASEL, SWITZERLAND:
2,730,763, INT. CL. 39.
- NOVELL, INC., PROVO, UT:
1,991,564, CANC. MULTIPLE CLASS, INT. CLS. 9 AND 16.
- NOVEMBAL, 92592 LEVALLOIS PERRET, FRANCE:
2,729,960, MULTIPLE CLASS, INT. CLS. 17 AND 20.
- NOVEON IP HOLDINGS CORP., CLEVELAND, OH:
2,730,519, INT. CL. 1.
- NOVO NORDISK A/S, DK-2880 BAGSVAERD, DENMARK:
1,992,171, CANC. INT. CL. 1.
- NOVOSTE CORPORATION, NORCROSS, GA:
2,729,376, INT. CL. 10.
- NOXELL CORPORATION, HUNT VALLEY, MD:
2,730,707, INT. CL. 3.
- NSF INTERNATIONAL, INC., ANN ARBOR, MI:
2,729,793, MULTIPLE CLASS, INT. CLS. 16 AND 35.
- NSI NURSING SOLUTIONS, INC., LITITZ, PA:
2,728,613, PUB. 4-1-2003. INT. CL. 35.
- NU SKIN INTERNATIONAL, INC., PROVO, UT:
2,730,836, INT. CL. 3.
- NULAB, INC., CLEARWATER, FL:
2,729,851, INT. CL. 5.
- NULAID FOODS, INC., RIPON, CA:
1,991,913, CANC. INT. CL. 31.
- NUSKIN INTERNATIONAL, INC., PROVO, UT:
1,705,737, CANC. INT. CL. 3.
- NUT FACTORY, LTD., THE, ALBANY, NY:
1,203,778, CANC. INT. CL. 30.
- NUVISIONS INTERNATIONAL, INC., MILFORD, PA:
2,729,270, PUB. 4-1-2003. INT. CL. 9.
- NVIDIA CORPORATION, SANTA CLARA, CA:
2,729,964, INT. CL. 9.
- NYLINT CORPORATION, ROCKFORD, IL:
1,705,903, CANC. INT. CL. 28.
1,705,904, CANC. INT. CL. 28.
- NYP CORP, MYRTLE BEACH, SC:
1,992,200, CANC. INT. CL. 42.
- O.M.T. OFFICINA MECCANICA TOLENTINATE - S.N.C. DI OTTAVI NANDO & C., BELFORTE DEL CHIANTI (MC), ITALY:
1,758,184, REN. 5-16-03. INT. CL. 11.
- O'SHAUGHNESSY, THOMAS MICHAEL, WINTER PARK, FL:
1,990,694, CANC. INT. CL. 41.
- OAK-MITSUI INC., CAMDEN, SC:
2,729,488, INT. CL. 17.
- OAKLAND RAIDERS, ALAMEDA, CA, OAKLAND RAIDERS, OAKLAND, CA:
974,730, REN. 5-10-03. U.S. CL. 107 (INT. CL. 41).
975,685, REN. 5-15-03. U.S. CL. 107 (INT. CL. 41).
- OAKLAND RAIDERS, ALAMEDA, CA, OAKLAND RAIDERS PROFESSIONAL FOOTBALL CLUB, LTD., OAKLAND, CA:
1,228,996, REN. 5-10-03. INT. CL. 41.
1,228,997, REN. 5-10-03. INT. CL. 41.
- OAKLAND RAIDERS, ALAMEDA, CA, LOS ANGELES RAIDERS, EL SEGUNDO, CA:
1,771,383, REN. 5-10-03. MULTIPLE CLASS, INT. CLS. 16 AND 25.
- OBERTHUR GAMING TECHNOLOGIES CORP., SAN ANTONIO, TX:
2,730,048, INT. CL. 41.
- OBLIO TELECOM, INC., RICHARDSON, TX:
2,728,573, PUB. 4-1-2003. INT. CL. 16.
- OCCIDENTAL PETROLEUM CORPORATION, LOS ANGELES, CA, OCCIDENTAL PETROLEUM CORPORATION, LOS ANGELES, CA:
969,470, REN. 5-10-03. U.S. CL. 6 (INT. CL. 1).
- OCCIDENTAL PETROLEUM CORPORATION, LOS ANGELES, CA:
978,362, REN. 5-15-03. U.S. CL. 1 (INT. CL. 1).
- OCEAN PACIFIC APPAREL CORP., IRVINE, CA:
1,991,869, CANC. INT. CL. 25.
1,991,984, CANC. INT. CL. 25.
- OCEANAIR AG, 1820 MONTREUX, SWITZERLAND:
1,705,386, CANC. INT. CL. 36.
- OCEANIC SYSTEMS, INC., GARLAND, TX:
1,705,032, CANC. INT. CL. 20.
- OCUSOFT, INC., RICHMOND, TX:
2,730,220, INT. CL. 5.
- OCWEN FINANCIAL CORPORATION, WEST PALM BEACH, FL:
2,729,544, INT. CL. 9.
- OEM OF CONNECTICUT, INC., EAST HARTFORD, CT:
2,730,648, INT. CL. 35.
- OF COUNSEL, INC., KANSAS CITY, MO:
1,990,805, CANC. INT. CL. 35.
- OFFLINE HOLDINGS CORPORATION, NEW YORK, NY:
2,730,416, INT. CL. 41.
- OGDEN MANUFACTURING CO., A SUBSIDIARY OF CHROMALOX, INC., ARLINGTON HEIGHTS, IL, OGDEN MANUFACTURING COMPANY, CHICAGO, IL:
959,844, REN. 5-11-03. U.S. CL. 34 (INT. CL. 11).
- OGLE, GEORGE B. II, CAPISTRANO BEACH, CA:
2,730,281, INT. CL. 20.
- OHIO CASUALTY INSURANCE COMPANY, THE, HAMILTON, OH:
1,705,358, CANC. INT. CL. 35.
- OHIO MATTRESS COMPANY LICENSING & COMPONENTS GROUP, THE, CHICAGO, IL:
1,203,594, CANC. MULTIPLE CLASS, INT. CLS. 20 AND 42.
- OHIO STATE BAR ASSOCIATION, COLUMBUS, OH:
2,728,479, PUB. 1-7-2003. U.S. CL. B.
- OLD REPUBLIC LIFE INSURANCE COMPANY, CHICAGO, IL:
1,705,391, CANC. INT. CL. 36.
- OLDE DISCOUNT CORPORATION, DETROIT, MI:
1,991,145, CANC. INT. CL. 36.
- OLDHAM SAW CO., INC., WEST JEFFERSON, NC:
2,728,879, PUB. 4-1-2003. INT. CL. 7.
- OLEIFICI COLAVITA S.P.A., 00040 POMEZIA (ROMA), ITALY:
2,729,762, INT. CL. 29.
- OLSZEWSKI, DONALD J., PENFIELD, PA AND OLSZEWSKI, RITA V., PENFIELD, PA:
2,730,142, INT. CL. 6.
- OMNI PRESENTS & CO., INC., NORFOLK, VA:
1,990,803, CANC. INT. CL. 42.
- OMNISYS, INC., GREENVILLE, TX:
1,704,660, CANC. INT. CL. 9.
- OMNITI, INC., LAUREL, MD:
2,730,214, INT. CL. 9.
- OMS INVESTMENTS, INC., WILMINGTON, DE:
2,730,134, INT. CL. 7.
2,730,197, INT. CL. 31.
- OMX, INC., LAS VEGAS, NV:
2,729,721, INT. CL. 35.
2,729,722, INT. CL. 35.
2,729,723, INT. CL. 35.
- ON ASSIGNMENT, INC., CALABASAS, CA, TEMPORARY PROFESSIONAL SUPPORT, INC., CANOGA PARK, CA:
1,757,160, REN. 5-16-03. INT. CL. 35.
- ONE HEART . . . ONE MIND, L.L.C., REXBURG, ID:
1,991,376, CANC. INT. CL. 16.
- ONE LAMBDA, INC., CANOGA PARK, CA:
2,730,892, INT. CL. 5.

- ONE TO ONE FITNESS, INC., MCLEAN, VA:
2,730,361, INT. CL. 41.
- ONECARE, INC., ATLANTA, GA:
1,471,767, CANC. INT. CL. 42.
- ONEOFFSHORE, INC.:
See— HALLIBURTON ENERGY SERVICES, INC.
- ONEPATH NETWORKS, INC., PRINCETON, NJ FROM
FOXCORP, INC., PRINCETON, NJ:
2,729,605, INT. CL. 9.
- OPPORTUNITIES FOR LEARNING, INC., CHATSWORTH,
CA:
1,204,099, CANC. INT. CL. 42.
- OPRYLAND USA INC., NASHVILLE, TN:
1,991,131, CANC. INT. CL. 41.
- OPTICAL COATING LABORATORY, INC., SANTA ROSA,
CA:
1,705,966, CANC. INT. CL. 40.
- OPTIMAL ROBOTICS CORP., MONTREAL, QUEBEC, CA-
NADA:
2,583,184, COR. INT. CL. 9.
- OPTIMAL ROBOTICS CORP., MONTREAL, QUEBEC H4P
1T7, CANADA:
2,728,754, PUB. 4-1-2003. INT. CL. 9.
- OPTIMUM POWER CONVERSION, INC., IRVINE, CA:
2,730,804, INT. CL. 9.
- OPTIMUM TECHNOLOGIES, INC., STURBRIDGE, MA:
2,082,843, COR. INT. CL. 42.
- OPUS HEALTHCARE SOLUTIONS, INC., AUSTIN, TX:
2,730,553, INT. CL. 9.
- ORBIMED ADVISORS LLC, NEW YORK, NY:
2,728,642, PUB. 11-6-2001. INT. CL. 36.
- ORCA INTERACTIVE LTD., IND-ZONE HERZELIYYA
46733, ISRAEL:
2,671,770, COR. INT. CL. 38.
- ORCHARD YARN AND THREAD COMPANY INC., NEW
YORK, NY, AKA LION BRAND YARN COMPANY:
1,203,620, CANC. INT. CL. 23.
- ORCHID BIOSCIENCES, INC., PRINCETON, NJ FROM
ORCHID BIOCOMPUTER, INC., PRINCETON, NJ:
2,729,663, MULTIPLE CLASS, INT. CLS. 1, 9 AND 42.
- ORE-IDA FOODS, INC., BOISE, ID:
1,991,628, CANC. INT. CL. 29.
- OREGON PUBLIC BROADCASTING, PORTLAND, OR:
2,728,716, PUB. 4-1-2003. MULTIPLE CLASS, INT. CLS. 38
AND 41.
- ORICA EXPLOSIVES TECHNOLOGY PTY LTD., MEL-
BOURNE, VICTORIA, 3001, AUSTRALIA, ICI CANADA
INC., NORTH YORK, ONTARIO, CANADA:
1,753,819, REN. 5-15-03. INT. CL. 13.
- OROAMERICA, INC., BURBANK, CA:
2,729,796, INT. CL. 14.
- ORTHO-FLEX SADDLE CO., INC., NEVADA, MO:
1,991,693, CANC. INT. CL. 18.
- OSRAM SYLVANIA INC., DANVERS, MA, GTE PRODUCTS
CORPORATION, STAMFORD, CT:
1,229,558, REN. 5-15-03. INT. CL. 11.
- OTTINGER, TRACY S., RICHMOND, VA, DBA SUMMER-
WOOD DESIGNS:
2,730,856, INT. CL. 16.
- OTTO JOS. KLIER MUSIKINSTRUMENTE GMBH, D-91088
BUBENREUTH, FED REP GERMANY:
2,730,370, INT. CL. 15.
- OTWELL INTERNATIONAL CORPORATION, BREMEN,
GA:
1,761,983, REN. 5-16-03. INT. CL. 9.
- OUTDOOR LIFE NETWORK, L.L.C., STAMFORD, CT:
2,729,788, INT. CL. 41.
- OUTDOOR RESEARCH INCORPORATED, SEATTLE, WA:
1,705,145, CANC. INT. CL. 28.
- OUTPOST TRADING AG, 4123 ALISEHWIL, SWITZER-
LAND:
2,729,744, INT. CL. 9.
- OVERSEAS MILITARY SALES CORPORATION, WOOD-
BURY, NY:
1,748,795, REN. 5-14-03. INT. CL. 35.
- OVERSEAS SEAFOOD OPERATIONS INC., DEERFIELD
BEACH, FL:
1,203,756, CANC. INT. CL. 29.
- OWENS-CORNING FIBERGLAS TECHNOLOGY INC., SUM-
MIT, IL, PROFORM INC., MINNEAPOLIS, MN:
1,210,550, REN. 5-12-03. INT. CL. 24.
- OWENS, RACHEL A., TUSTIN, CA AND SORNSTEIN,
WILLIAM, TUSTIN, CA:
2,730,891, INT. CL. 35.
- OXFORD GLOBAL RESOURCES, INC., BEVERLY, MA:
2,729,053, PUB. 4-1-2003. INT. CL. 35.
- OXIS HEALTH PRODUCTS, INC., PORTLAND, OR:
2,729,495, INT. CL. 3.
- O2 MICRO INTERNATIONAL LIMITED, GRAND CAY-
MAN, CAYMAN ISLANDS FROM O2MICRO, INC., SAN-
TA CLARA, CA:
2,730,567, INT. CL. 9.
- P.M. SALES, LLC, BRIDGEWATER, NJ:
2,729,258, PUB. 4-1-2003. INT. CL. 30.
- P-STAT, INC., PRINCETON, NJ:
1,203,417, CANC. INT. CL. 9.
- PACIFIC ASIA TRAVEL ASSOCIATION, SAN FRANCISCO,
CA:
1,755,820, REN. 5-12-03. MULTIPLE CLASS, INT. CLS. 41
AND 42.
- PACIFIC COAST FEATHER COMPANY, SEATTLE, WA:
1,991,863, CANC. INT. CL. 22.
- PACIFIC COAST PUBLISHING, INC., TACOMA, WA:
1,991,411, CANC. INT. CL. 16.
- PACIFIC CYCLE, LLC, VERNON HILLS, IL:
2,729,278, PUB. 4-1-2003. INT. CL. 12.
2,729,279, PUB. 4-1-2003. INT. CL. 12.
- PACIFIC DIGITAL CORPORATION, IRVINE, CA:
2,729,084, PUB. 4-1-2003. INT. CL. 9.
- PACIFIC FITNESS CORPORATION, SANTA FE SPRINGS,
CA:
1,705,186, CANC. INT. CL. 28.
- PACIFIC INDUSTRIAL CO., LTD., OGAKI-SHI, GIFU-KEN,
JAPAN:
1,229,571, REN. 5-13-03. INT. CL. 12.
- PACIFIC PLANT FARM INC., SNOHOMISH, WA, DBA
HENRY'S PLANT FARM:
1,795,185, REN. 5-16-03. INT. CL. 31.
- PACIFICHEALTH LABORATORIES, INC., WOODBRIDGE,
NJ:
2,730,358, INT. CL. 16.
- PACO CORPORATION, KYUNGGI-DO, 469-801, REPUBLIC
OF KOREA:
2,728,621, PUB. 4-1-2003. INT. CL. 16.
- PACO RABANNE PARFUMS, NEUILLY-SUR-SEINE
(HAUTS DE SEINE), FRANCE:
2,728,663, PUB. 4-1-2003. INT. CL. 3.
- PACTIV CORPORATION, LAKE FOREST, IL, PACKAGING
CORPORATION OF AMERICA, EVANSTON, IL:
1,753,957, REN. 5-16-03. INT. CL. 21.
- PACTIV CORPORATION, LAKE FOREST, IL:
2,728,839, PUB. 4-1-2003. INT. CL. 21.
- PAIK, CHUL, PASADENA, CA, DBA BYMCS:
1,991,439, CANC. INT. CL. 42.
- PAK ENTERPRISES, INC., MARTINSVILLE, NJ:
1,991,630, CANC. INT. CL. 30.
1,991,682, CANC. INT. CL. 30.
- PAKULA AND COMPANY, CHICAGO, IL:
735,654, CANC. U.S. CL. 28.
- PAL CELLULAR GROUP, INC., CHICAGO, IL:
1,991,229, CANC. INT. CL. 37.
- PAMARCO INCORPORATED, ROSELLE, NJ:
1,991,212, CANC. INT. CL. 7.
- PAN AMERICAN FOOD COMPANY, INC., LOUISVILLE,
KY:
1,991,986, CANC. INT. CL. 29.
- PAN OPTICS, INC., MOORESTOWN, NJ:
1,991,556, CANC. INT. CL. 9.
- PANAVISION EUROPE LIMITED, MIDDLESEX, ENG-
LAND:
2,641,558, COR. MULTIPLE CLASS, INT. CLS. 9 AND 11.
- PANDAS INTERNATIONAL, LITTLETON, CO:
2,730,908, INT. CL. 36.
- PANDUIT CORP., TINLEY PARK, IL:
1,754,908, REN. 5-10-03. MULTIPLE CLASS, INT. CLS. 8
AND 9.

- PANTHER BREWING COMPANY, WESTWOOD, MA:
2,729,478, INT. CL. 32.
- PANTONE, INC., CARLSTADT, NJ:
2,730,299, INT. CL. 9.
- PANTRY, INC., THE, SANFORD, NC:
2,730,524, INT. CL. 32.
- PAPER MAGIC GROUP, INC., THE, WILMINGTON, DE,
SPEARHEAD INDUSTRIES, INC., MINNEAPOLIS, MN:
1,234,065, REN. 5-10-03, INT. CL. 2.
- PAR 6 ORIGINALS, INC., BROOMFIELD, CO:
1,990,922, CANC. MULTIPLE CLASS, INT. CLS. 41 AND
42.
- PARADIGM GENETICS, INC., RESEARCH TRIANGLE
PARK, NC:
2,729,410, MULTIPLE CLASS, INT. CLS. 1 AND 42.
- PARADIGM GEOPHYSICAL CORP., HOUSTON, TX, COG-
NISEIS DEVELOPMENT, INC., HOUSTON, TX:
1,756,623, REN. 5-15-03, INT. CL. 9.
- PARADIGM GEOPHYSICAL CORP., HOUSTON, TX,
GRANT TENSOR GEOPHYSICAL CORPORATION,
HOUSTON, TX:
1,764,316, REN. 5-15-03, INT. CL. 9.
- PARADIGM-TREX, LLC, SAN DIEGO, CA:
2,730,366, INT. CL. 10.
- PARAGON FEDERAL CREDIT UNION, WASHINGTON
TOWNSHIP, NJ:
2,730,325, INT. CL. 36.
- PARAGRAPH DEVELOPMENT CORPORATION, ATLAN-
TA, GA:
2,729,452, MULTIPLE CLASS, INT. CLS. 9 AND 42.
- PARALLEL CONSULTANTS, INC., RYDAL, PA:
2,729,946, INT. CL. 35.
- PARAMOUNT PARKS INC., CHARLOTTE, NC:
2,730,354, INT. CL. 41.
- PARE B.V., 9482 WE TYNAARLO, NETHERLANDS:
1,990,979, CANC. INT. CL. 18.
- PARFUMS CHRISTIAN DIOR, S.A., 75008 PARIS, FRANCE:
2,729,523, INT. CL. 3.
- PARFUMS GIVENCHY, 92300 LEVALLOIS PERRET,
FRANCE:
2,729,458, INT. CL. 3.
- PARFUMS NINA RICCI, 75008 PARIS, FRANCE:
1,990,816, CANC. INT. CL. 3.
- PARFUMS NINA RICCI S.A., 75008 PARIS, FRANCE, NINA
RICCI, S.A.R.L., PARIS, FRANCE:
954,589, REN. 5-13-03, U.S. CL. 51 (INT. CL. 3).
- PARFUMS TED LAPIDUS S.A., 75016 PARIS, FRANCE:
1,765,455, REN. 5-10-03, INT. CL. 3.
- PARIS PRESENTS INCORPORATED, GURNEE, IL:
1,991,976, CANC. MULTIPLE CLASS, INT. CLS. 3, 18, 20,
21 AND 24.
- PARK SUMMIT REALTY CORP., NEW YORK, NY:
2,619,201, COR. INT. CL. 42.
- PARK, HYUN, LOS ANGELES, CA:
2,730,196, INT. CL. 18.
- PARKER, HARRY, LEXINGTON, SC:
1,784,540, REN. 5-13-03, INT. CL. 41.
- PARRISH, WALTER L., EUGENE, OR:
1,991,970, CANC. INT. CL. 14.
- PAULA DORF COSMETICS, INC., NEW YORK, NY:
2,729,704, INT. CL. 3.
- PAXSON BROADCASTING OF MIAMI LIMITED PART-
NERSHIP, CLEARWATER, FL:
1,992,220, CANC. INT. CL. 38.
1,992,221, CANC. INT. CL. 38.
1,992,222, CANC. INT. CL. 38.
- PAYCO AMERICAN CORPORATION, BROOKFIELD, WI:
1,780,528, CANC. INT. CL. 35.
- PAYDAR PROPERTIES, INC., SAN DIEGO, CA:
2,728,950, PUB. 4-1-2003, INT. CL. 41.
- PAYER ISRAEL GLASS LTD., MA'ALE EFRAYIM, ISRAEL:
2,730,624, INT. CL. 3.
- PAYLESS SHOESOURCE WORLDWIDE, INC., TOPEKA, KS:
2,730,676, INT. CL. 35.
- PAYOUT, LLC, WASHINGTON, DC:
2,730,360, INT. CL. 36.
- PBM PRODUCTS, INC., GORDONSVILLE, VA:
2,730,871, INT. CL. 20.
- PCC SPECIALTY PRODUCTS, INC., WEXFORD, PA, ASTRO
PUNCH CORPORATION, SANTA FE SPRINGS, CA:
1,756,457, REN. 5-13-03, INT. CL. 7.
- PCE PACIFIC, INC., BOTHELL, WA:
2,730,910, MULTIPLE CLASS, INT. CLS. 35 AND 42.
- PCI TECHNOLOGIES INC., AJAX, ONTARIO, LIS 6W6,
CANADA:
2,729,700, INT. CL. 9.
- PEARSON EDUCATION, INC, UPPER SADDLE RIVER, NJ:
2,729,055, PUB. 4-1-2003, INT. CL. 28.
- PECORA ASSOCIATED MILLS, INC., NEW YORK, NY:
1,713,791, REN. 5-16-03, INT. CL. 25.
- PECORARO, SHARON A., HUDSON, OH:
2,728,713, PUB. 4-1-2003, INT. CL. 30.
- PEERLESS HEATER COMPANY, INC., BOYERTOWN, PA:
2,728,793, PUB. 4-1-2003, INT. CL. 11.
- PEETERS PRODUKTEN B.V., 4705 RT ROOSENDAAL,
NETHERLANDS:
2,728,659, PUB. 4-1-2003, INT. CL. 29.
- PEGASUS LABORATORIES, INC, PENSACOLA, FL:
2,729,934, INT. CL. 5.
- PEGASUS TECHNOLOGIES LTD., TEL-AVIV 64703, IS-
RAEL:
1,991,555, CANC. INT. CL. 9.
- PEI LICENSING, INC., MIAMI, FL:
2,729,330, PUB. 4-1-2003, INT. CL. 3.
- PEIRCE COLLEGE, PHILADELPHIA, PA:
2,730,916, INT. CL. 41.
- PEKING HANDICRAFT, INC., SOUTH SAN FRANCISCO,
CA:
2,730,406, INT. CL. 24.
- PELAGO NETWORKS, INC., MARLBOROUGH, MA FROM
BEACON NETWORKS, INC., MARLBOROUGH, MA:
2,728,578, PUB. 4-1-2003, INT. CL. 9.
2,729,811, INT. CL. 42.
- PENN MAID FOODS, INC., PHILADELPHIA, PA:
1,991,837, CANC. INT. CL. 29.
- PENNZOIL-QUAKER STATE COMPANY, HOUSTON, TX,
SOUTH PENN OIL COMPANY, OIL CITY, PA:
716,737, REN. 5-13-03, U.S. CL. 15 (INT. CL. 4).
- PENRAY COMPANIES, INC., THE, WHEELING, IL, PEN-
RAY COMPANY, WHEELING, IL:
1,230,725, REN. 5-13-03, INT. CL. 1.
- PENTAX CORPORATION, ENGLEWOOD, CO TO PENTAX
CORPORATION, ENGLEWOOD, CO:
2,515,814, COR. INT. CL. 9.
- PEOPLES STATE BANK, THE, EAST BERLIN, PA:
1,991,436, CANC. INT. CL. 36.
- PEPSICO, INC., PURCHASE, NY:
1,991,759, CANC. INT. CL. 30.
2,730,835, INT. CL. 32.
- PERETZ, HOWARD G., WATCHUNG, NJ:
2,729,922, INT. CL. 28.
- PERFECT FIT INDUSTRIES, INC., MONROE, NC:
1,991,685, CANC. INT. CL. 20.
- PERLAROM S.A., B-1348 LOUVAIN-LA-NUEVE, BELGIUM:
1,990,868, CANC. MULTIPLE CLASS, INT. CLS. 3, 30, 32
AND 33.
- PERMATEX, INC., HARTFORD, CT:
2,730,326, INT. CL. 3.
- PERREAULT, GILLES, FRAMPTON (QUEBEC), CANADA:
1,991,238, CANC. INT. CL. 20.
- PERRY, SCOTT E., LOS ANGELES, CA:
2,730,754, INT. CL. 35.
- PERSOFT, INC., MADISON, WI:
1,992,209, CANC. INT. CL. 9.
- PET SPICE, INC., FITCHBURG, MA:
2,730,167, INT. CL. 31.
- PETCO ANIMAL SUPPLIES, INC., SAN DIEGO, CA:
1,705,571, CANC. INT. CL. 42.
2,730,698, INT. CL. 35.
- PETER BAUERNSCHMID JUN., TEISENDORF, FED REP
GERMANY, PEERLESS CAMERA STORES, INC., NEW
YORK, NY:
575,806, REN. 5-12-03, U.S. CL. 26 (INT. CL. 9).
- PETERSEN, PAUL, NEW YORK, NY:
2,729,953, INT. CL. 30.

- PETERSON, BRAD, EL CAJON, CA AND CINCOTTA, JOHN, SANTEE, CA:
2,730,620, INT. CL. 29.
- PETREN ENTERPRISES, ALEXANDRIA, VA:
2,730,501, INT. CL. 35.
- PETROFORM INC., FERNANDINA BEACH, FL, CALGENE CHEMICAL, INC., SKOKIE, IL:
1,782,354, REN. 5-10-03, INT. CL. 4.
- PETROLEUM RESERVOIR DATA, INC., ANCHORAGE, AK, DBA PETREDAT:
1,705,596, CANC. INT. CL. 42.
- PFI, LLC, PAWTUCKET, RI, PAWTUCKET FASTENERS, L.P., PAWTUCKET, RI:
1,760,993, REN. 5-10-03, INT. CL. 6.
- PFIZER INC., NEW YORK, NY:
2,728,812, PUB. 4-1-2003, INT. CL. 44.
2,729,664, INT. CL. 5.
- PHARMACIA BIOTECH AB, S-751 82 UPPSALA, SWEDEN:
1,991,402, CANC. INT. CL. 9.
- PHARMICHEM, INC., MENLO PARK, CA:
2,729,259, PUB. 4-1-2003, INT. CL. 5.
- PHEASANT INTERNATIONAL, INC., LAS VEGAS, NV:
2,151,933, CANC. INT. CL. 34.
- PHILIPS ELECTRONICS NORTH AMERICA CORPORATION, NEW YORK, NY:
2,730,018, INT. CL. 11.
- PHOENIX FASTENER COMPANY, CHICAGO, IL:
1,704,523, CANC. INT. CL. 6.
- PHOENIX MARKETING, INC., BELLEVUE, WA:
1,991,205, CANC. INT. CL. 32.
- PHOTOMETRICS, LTD., TUCSON, AZ:
1,991,855, CANC. INT. CL. 9.
- PHYSIO-CONTROL CORPORATION, REDMOND, WA TO MEDTRONIC PHYSIO-CONTROL CORP., REDMOND, WA:
1,225,724, CANC. MULTIPLE CLASS, INT. CLS. 5 AND 9.
- PI PRESS, INC., HONOLULU, HI:
1,203,409, CANC. MULTIPLE CLASS, INT. CLS. 9 AND 16.
- PIC 'N PAY STORES, INC., MATTHEWS, NC:
735,707, CANC. U.S. CL. 39.
- PICNIC TIME, INC., MOORPARK, CA:
2,730,083, INT. CL. 21.
- PIEDMONT NATURAL GAS COMPANY, INC., CHARLOTTE, NC:
2,729,147, PUB. 4-1-2003, INT. CL. 39.
- PIGUE; PAUL W., BEAUMONT, TX, DBA PRESCO RENTALS:
1,203,918, CANC. INT. CL. 37.
- PIKE, DAILEY D., VAN NUYS, CA:
2,730,771, INT. CL. 41.
- PILLOWTEX CORPORATION, DALLAS, TX:
1,991,678, CANC. INT. CL. 24.
1,992,028, CANC. INT. CL. 24.
- PILLSBURY COMPANY, THE, MINNEAPOLIS, MN:
1,203,527, CANC. MULTIPLE CLASS, INT. CLS. 16 AND 21.
- PILOT CORPORATION OF AMERICA, TRUMBULL, CT:
2,730,931, INT. CL. 16.
- PINELO, FELIX, MIAMI, FL:
1,991,288, CANC. INT. CL. 25.
- PINNACLE FOODS BRANDS CORPORATION, MILLSBORO, DE:
2,729,347, PUB. 4-1-2003, INT. CL. 29.
- PIONEER DESIGNS INC., BOWLING GREEN, KY:
1,991,182, CANC. INT. CL. 21.
- PIONEER KABUSHIKI KAISHA, TOKYO 153-8654, JAPAN, DBA PIONEER CORPORATION:
2,729,912, INT. CL. 9.
- PIQUANTE INTERNATIONAL LIMITED, TORTOLA, BR. VIRGIN ISLANDS:
2,729,883, MULTIPLE CLASS, INT. CLS. 29 AND 30.
- PIRON, DAVID, 4841 HENRI-CHAPPELLE, BELGIUM:
2,728,459, PUB. 10-3-2000, MULTIPLE CLASS, INT. CLS. 9, 16 AND 28.
- PIROPOS, L.L.C., PARKVILLE, MO:
2,728,711, PUB. 8-20-2002, INT. CL. 43.
- PIVOTAL CENTURY PLAZA HOTEL, LLC, PHOENIX, AZ:
2,730,097, INT. CL. 25.
- PIZZA INN, INC., THE COLONY, TX:
1,760,400, REN. 5-10-03, INT. CL. 42.
- PIZZA RANCH, INC., HULL, IA:
2,729,254, PUB. 4-1-2003, INT. CL. 43.
- PIZZERIA UNO CORPORATION, WILMINGTON, DE:
2,729,828, INT. CL. 29.
- PLANET CASH, LLC, ST. LOUIS, MO:
2,728,759, PUB. 4-1-2003, INT. CL. 38.
- PLANET PROPAGANDA, INC., MADISON, WI FROM PLANET DESIGN COMPANY, MADISON, WI:
2,729,657, MULTIPLE CLASS, INT. CLS. 35, 41 AND 42.
- PLANET 2000 SOFTWARE, INC., OMAHA, NE TO PLANET 2000 SOFTWARE, INC., OMAHA, NE:
2,672,502, COR. INT. CL. 42.
- PLANISOL, INC., ENGLEWOOD CLIFFS, NJ:
1,704,484, CANC. INT. CL. 3.
- PLASTICS DESIGNERS & CONSULTANTS GMBH, WAGENSTRAAT, SWITZERLAND:
1,705,047, CANC. INT. CL. 21.
- PLAY IT AGAIN APPAREL, INC., SECAUCUS, NJ:
1,203,681, CANC. INT. CL. 25.
1,203,682, CANC. INT. CL. 25.
- PLAY LIKE THE PROS, LLC, EDGEWOOD, KY:
2,730,176, INT. CL. 9.
- PLEASANT COMPANY, MIDDLETON, WI:
2,728,998, PUB. 4-1-2003, MULTIPLE CLASS, INT. CLS. 16 AND 28.
2,729,073, PUB. 4-1-2003, INT. CL. 9.
- PLEXIENT, LLC, NEW YORK, NY:
2,730,367, INT. CL. 36.
- PLMCO ADVISORS LP, STAMFORD, CT:
2,729,667, INT. CL. 36.
- PLOUFFE & STUFF, INC., PLYMOUTH, MI:
1,704,505, CANC. INT. CL. 5.
- PLUA POWER, INC., LATHAM, NY FROM PLUG POWER, INC., LATHAM, NY:
2,729,567, INT. CL. 9.
- PLUG POWER, INC., LATHAM, NY FROM PLUG POWER, LLC, LATHAM, NY:
2,729,568, INT. CL. 9.
- PLUM CREEK PHARMACEUTICALS, INC., AMARILLO, TX:
2,730,003, INT. CL. 5.
- PNC BANK, NEW ENGLAND, BOSTON, MA:
1,705,411, CANC. INT. CL. 36.
- POCRAL INC., CORAL SPRINGS, FL:
1,992,081, CANC. INT. CL. 16.
- PODD, VICTOR I., BOCA RATON, FL AND PODD, STEPHEN D., NORTH HERO, VT:
1,991,679, CANC. INT. CL. 20.
- POINT BLANK BODY ARMOR, INC., OAKLAND PARK, FL:
2,728,925, PUB. 4-1-2003, INT. CL. 9.
2,730,923, INT. CL. 9.
- POLAROID CORPORATION, CAMBRIDGE, MA:
1,991,936, CANC. INT. CL. 1.
- POLISH FOLKLORE IMPORT CO., INC., CHICAGO, IL:
2,729,047, PUB. 4-1-2003, INT. CL. 29.
- POLITZER & HANEY, INC., NEWTON, MA:
2,728,710, PUB. 4-1-2003, INT. CL. 36.
- POLO INDUSTRIES, INC., NEW ORLEANS, LA, AKA XL XTENDED LIFE EQUIPMENT WARRANTY COMPANY:
1,203,884, CANC. INT. CL. 36.
- POLYMER ENGINEERING CORPORATION, OXNARD, CA:
2,730,578, INT. CL. 1.
- POLYVINYL FILMS, INC., SUTTON, MA:
965,574, REN. 5-10-03, U.S. CL. 37 (INT. CL. 16).
- POMAIR TRADING INC., ROAD TOWN, TORTOLA, BR. VIRGIN ISLANDS:
2,729,732, INT. CL. 9.
- POPPE, INC., PARAGOULD, AR:
1,770,331, REN. 5-15-03, INT. CL. 32.
- POPSICLE INDUSTRIES, INC., ENGLEWOOD, NJ:
735,756, CANC. U.S. CL. 46.
- PORJAI ENTERPRISES, INC., SAN ANTONIO, TX:
2,729,273, PUB. 4-1-2003, INT. CL. 43.

- PORT OF PORTLAND, THE, PORTLAND, OR:
962,284. REN. 5-16-03. U.S. CL. 105 (INT. CL. 39).
- PORTER, INC., DECATUR, IN:
2,729,281, PUB. 4-1-2003. INT. CL. 12.
- POSCH, LEOPOLD, RENNERSDORF 48, AUSTRIA, DBA
POSCH INNOVATIVER MASCHINENBAU U. HANDEL:
2,728,467, PUB. 4-1-2003. MULTIPLE CLASS, INT. CLS. 7,
29, 30, 31, 32 AND 33.
- POSS, WALTER, SAN FRANCISCO, CA:
2,729,562, MULTIPLE CLASS, INT. CLS. 16 AND 25.
- POSSIBLE DREAMS, LTD., FOXBORO, MA:
2,729,677, INT. CL. 28.
- POST GLOVER RESISTORS, INC., ERLANGER, KY:
2,730,006, INT. CL. 9.
- POST POINT SOFTWARE, INC., BELLINGHAM, WA:
2,729,332, PUB. 4-1-2003. INT. CL. 9.
- POWELL ELECTRICAL MANUFACTURING COMPANY,
HOUSTON, TX:
1,991,024, CANC. INT. CL. 9.
- POWER SERVICE PRODUCTS, INC., WEATHERFORD, TX:
2,729,681, INT. CL. 1.
- PPM INFORMATION SOLUTIONS, INC., MISSION, KS:
2,728,645, PUB. 6-25-2002. INT. CL. 9.
- PQ CORPORATION, VALLEY FORGE, PA:
157,560, CANC. U.S. CL. 38.
- PRAIRIE BUSINESS CREDIT, INC., NAPERVILLE, IL:
2,728,585, PUB. 4-1-2003. INT. CL. 36.
- PRATT, GREGORY JOHN, JACKSONVILLE, FL, DBA
SNEAKERS SPORTS GRILLE:
2,729,131, PUB. 4-1-2003. INT. CL. 42.
- PRECIFAR S.A., 2534 ORVIN, SWITZERLAND TO PRECI-
FAR S.A., 2534 ORVIN, SWITZERLAND:
2,460,884, COR. INT. CL. 10.
- PRECISION DRILLING CORPORATION, CALGARY, AL-
BERTA, CANADA:
2,729,208, PUB. 4-1-2003. MULTIPLE CLASS, INT. CLS.
37, 40 AND 42.
- PRECISION FABRICATED INSULATION COMPANY, KA-
LAMAZOO, MI:
1,694,373. REN. 5-14-03. INT. CL. 17.
- PREDIGE SA, CH-1020 RENENS, SWITZERLAND:
2,359,067, COR. MULTIPLE CLASS, INT. CLS. 3, 35, 38, 41
AND 42.
- PREMIERE PRODUCTS, INC., LA CRESCENTA, CA:
1,783,179. REN. 5-14-03. INT. CL. 3.
- PRESCRIBING REFERENCE, INC., NEW YORK, NY FROM
CACTUS COMMUNICATIONS LLC, CEDAR KNOLLS,
NJ:
2,730,898, INT. CL. 16.
- PRESERVATION TECHNOLOGIES, L.P., CRANBERRY
TOWNSHIP, PA:
2,730,500, INT. CL. 1.
- PRESNELL ASSOCIATES, INC., LOUISVILLE, KY:
2,730,430, MULTIPLE CLASS, INT. CLS. 37 AND 42.
- PREVALENT DEVICES LLC, NISKAYUNA, NY:
2,730,511, INT. CL. 9.
- PREVENTIVE MAINTENANCE CO., INC., SCHILLER
PARK, IL:
1,203,908, CANC. INT. CL. 37.
- PRINCIPLE BUSINESS ENTERPRISES, INC., DUNBRIDGE,
OH:
1,229,506. REN. 5-16-03. INT. CL. 10.
- PRINTMARK INDUSTRIES, INC., HAZLETON, PA:
2,730,078, INT. CL. 25.
- PRISMA ENTERTAINMENT LLC, WEST LOS ANGELES,
CA:
2,730,646, INT. CL. 42.
- PRIVATE LABEL EXECUTIVE GIFTS, INC., CAMPBELL,
CA:
2,730,901, INT. CL. 35.
2,730,902, INT. CL. 35.
- PRO LIBRA ASSOCIATES, MAPLEWOOD, NJ:
1,232,989. REN. 5-16-03. MULTIPLE CLASS, INT. CLS. 35
AND 41.
- PRO-HEALTH, INC., BATESVILLE, AR, SUNLIFE HEALTH,
INC., BATESVILLE, AR, DBA VITA-SAURUS:
1,757,534. REN. 5-12-03. INT. CL. 5.
- PRO-MED PRODUCTS, INC., ATLANTA, GA:
2,729,160, PUB. 4-1-2003. INT. CL. 35.
- PROCTER & GAMBLE COMPANY, THE, CINCINNATI, OH:
1,992,059, CANC. INT. CL. 3.
2,729,056, PUB. 4-1-2003. INT. CL. 3.
2,730,760, INT. CL. 3.
2,730,832, INT. CL. 5.
2,730,851, INT. CL. 3.
- PRODUCT SPECIALTIES INC, WYNCOTE, PA:
1,705,988, CANC. MULTIPLE CLASS, INT. CLS. 16 AND
21.
- PRODUCTION ENGINEERED PRODUCTS, INC., STER-
LING, IL:
1,230,848. REN. 5-16-03. INT. CL. 7.
- PRODUCTION TRENDS, INC., CERRITOS, CA:
1,991,933, CANC. INT. CL. 25.
1,991,942, CANC. INT. CL. 25.
- PRODUCTOS ALIMENTICIOS GALLO S.L., BARCELONA,
SPAIN, PAGAL INTERNATIONAL INC., MILWAUKEE,
WI:
1,716,186. REN. 5-16-03. INT. CL. 30.
- PRODUCTS FINISHING CORP., BROOKLYN, NY:
1,203,464, CANC. INT. CL. 10.
- PROFESSIONAL LAW ENFORCEMENT ASSOCIATION,
INC., TROY, MI:
2,728,980, PUB. 4-1-2003. INT. CL. 36.
- PROFESSIONALS ONLINE INTERNATIONAL L.L.C., NOVI,
MI:
1,992,215, CANC. INT. CL. 35.
- PROGRESS WATCH AG., 2503 BIEL, SWITZERLAND:
2,729,541, INT. CL. 14.
- PROGRESSIVE GOURMET, EVERETT, MA:
2,648,631, COR. MULTIPLE CLASS, INT. CLS. 29 AND
30.
- PROMOTAL USA, INC., DEERFIELD BEACH, FL:
1,991,899, CANC. INT. CL. 10.
- PROTEIN TECHNOLOGIES INTERNATIONAL, INC., ST.
LOUIS, MO, DBA PROTEIN TECHNOLOGIES INTERNA-
TIONAL, DBA PROTEIN TECHNOLOGIES INTERNA-
TIONAL:
1,652,817, CANC. INT. CL. 1.
- PROTEIN TECHNOLOGIES INTERNATIONAL, INC., ST.
LOUIS, MO:
1,991,961, CANC. INT. CL. 29.
- PROVAR, INCORPORATED, BALTIMORE, MD:
1,705,614, CANC. INT. CL. 42.
- PROVIDE, PROVIDE L.L.C., NEW YORK, NY:
2,729,824, INT. CL. 3.
2,729,825, INT. CL. 3.
- PROVIDENCE IMPORTING CO., PROVIDENCE, RI:
1,992,114, CANC. INT. CL. 14.
- PRUDENTIAL INSURANCE COMPANY OF AMERICA,
THE, NEWARK, NJ:
1,991,668, CANC. INT. CL. 36.
- PSC PUBLICATIONS LTD., NEW YORK, NY:
1,203,545, CANC. INT. CL. 16.
- PSC TECHNOLOGIES, INC., CARNEGIE, PA, PREMIER
SERVICES CORPORATION, KING OF PRUSSIA, PA:
1,744,549. REN. 5-12-03. INT. CL. 19.
- PT COUPLING COMPANY, INC., ENID, OK:
1,756,433. REN. 5-12-03. INT. CL. 6.
- PT. BEA SARI JELITA, SEMARANG, INDONESIA:
2,730,761, INT. CL. 3.
- PTS PIC, CHESHIRE WA7 1TL, UNITED KINGDOM:
2,728,605, PUB. 4-1-2003. MULTIPLE CLASS, INT. CLS. 9,
35 AND 42.
- PTS PLC, CHESHIRE WA7 1TL, UNITED KINGDOM:
2,728,606, PUB. 4-1-2003. MULTIPLE CLASS, INT. CLS. 9,
35 AND 42.
- PUBLICIS USA HOLDINGS, INC., DALLAS, TX:
2,730,035, INT. CL. 35.
- PUBLIX SUPER MARKETS, INC, LAKELAND, FL:
2,729,422, INT. CL. 29.
- PUBLIX SUPER MARKETS, INC., LAKELAND, FL:
2,729,423, INT. CL. 29.
- PULPDENT CORPORATION OF AMERICA, WATERTOWN,
MA:
1,237,985. REN. 5-13-03. INT. CL. 5.

- PULSAR S.R.L., I-40013 CASTEL MAGGIORE - BOLOGNA, ITALY:
2,675,833, COR. MULTIPLE CLASS, INT. CLS. 7 AND 9.
- PULSE METRIC, INC., SAN DEIGO, CA, PULSE-METRIC, INC, SAN DIEGO, CA:
1,756,651. REN. 5-14-03. INT. CL. 10.
- PUNCH IN INTERNATIONAL, NEW YORK, NY:
1,767,668. REN. 5-14-03. INT. CL. 38.
- PUROLATER PRODUCTS AIR FILTRATION COMPANY, HENDERSON, NC, PUROLATOR PRODUCTS COMPANY, TULSA, OK:
1,768,559. REN. 5-15-03. INT. CL. 11.
- PURPLE PIN DESIGNS LIMITED, KWUN TONG, HONG KONG:
2,730,090, INT. CL. 25.
- PYRAMID VIDEO INCORPORATED, WASHINGTON, DC:
1,203,972, CANC. INT. CL. 41.
- P2P LINK LLC, FARMINGTON, CT:
2,729,046, PUB. 4-1-2003. MULTIPLE CLASS, INT. CLS. 9, 35 AND 36.
- QBE INSURANCE GROUP LIMITED, SYDNEY, NEW SOUTH WALES 2000, AUSTRALIA:
1,991,415, CANC. INT. CL. 36.
- QBIOGENE, INC., CARLSBAD, CA:
2,728,764, PUB. 4-1-2003. MULTIPLE CLASS, INT. CLS. 1 AND 5.
- QL SYSTEMS LIMITED:
See—QUICKLAW INC.
- QOSINA CORP., EDGEWOOD, NY:
1,777,912. REN. 5-15-03. INT. CL. 21.
- QSC, INC., WILMINGTON, DE:
1,778,182. REN. 5-12-03. INT. CL. 42.
1,991,878, CANC. MULTIPLE CLASS, INT. CLS. 29 AND 30.
- QUALCOMM INCORPORATED, SAN DIEGO, CA:
2,730,647, INT. CL. 42.
- QUALITY FOOD CENTERS, INC., BELLEVUE, WA:
1,992,226, CANC. INT. CL. 30.
- QUALITY STORES, INC., NORTH MUSKEGON, MI:
1,204,042, CANC. INT. CL. 42.
1,204,043, CANC. INT. CL. 42.
1,204,044, CANC. INT. CL. 42.
- QUESTA ENGINEERING CORPORATION, GOLDEN, CO:
2,730,717, INT. CL. 42.
- QUEUE SYSTEMS, INC., COLUMBIA, SC:
1,755,869. REN. 5-14-03. INT. CL. 42.
- QUICK CHICK RACING, LLC., BROOMFIELD, CO:
2,730,790, INT. CL. 25.
- QUICKLAW INC., KINGSTON, ONTARIO K7L 5J8, CANADA FROM QL SYSTEMS LIMITED, KINGSTON, ONTARIO, K7L 5J8, CANADA:
2,728,454, PUB. 4-1-2003. MULTIPLE CLASS, INT. CLS. 9, 35 AND 42.
- QUICKPEN INTERNATIONAL, CORP., ENGLEWOOD, CO:
2,730,913, INT. CL. 9.
- QUINTERO, JAYNE, FOX POINT, WI:
2,730,823, INT. CL. 25.
- QUINTIN & CO., INC., STEAMBOAT SPRINGS, CO, QUINTIN, LUCIEN I., BOYES HOT SPRINGS, CA, DBA QUINTIN & CO., INC.:
1,735,149. REN. 5-14-03. INT. CL. 34.
- QUORUM PROPERTIES, LOS ANGELES, CA:
1,991,559, CANC. INT. CL. 33.
- QVC, INC., WEST CHESTER, PA:
1,991,727, CANC. INT. CL. 25.
2,730,037, INT. CL. 35.
- QVS, INC., EDINA, MN:
1,706,025, CANC. INT. CL. 16.
- R & D MANUFACTURING INC., ELK GROVE, CA:
2,730,320, INT. CL. 7.
- R & M REFRIGERATED, INC., MIAMI, FL:
2,729,069, PUB. 4-1-2003. INT. CL. 31.
- R & S SALES CORP., NEW YORK, NY:
1,992,125, CANC. INT. CL. 25.
- R RIEVELEY & ASSOCIATES, BLAINE, WA:
2,730,746, INT. CL. 3.
- R. D. ROGERS, INC., SIOUX FALLS, SD:
1,705,177, CANC. INT. CL. 28.
- R. H. KEENAN COMPANY, ST. HELENA, CA:
2,730,164, INT. CL. 33.
- R.C. OLMSTEAD, INC., COLUMBUS, OH:
2,728,519, PUB. 3-11-2003. MULTIPLE CLASS, INT. CLS. 9, 35 AND 42.
- RA BRANDS, L.L.C., MADISON, NC:
2,730,202, INT. CL. 20.
- RACINE RAILROAD PRODUCTS, INC., RACINE, WI:
1,211,313. REN. 5-10-03. INT. CL. 7.
- RACINE, SOCIETE A RESPONSABILITE LIMITEE, NICE, ALPES-MARITIMES, FRANCE:
735,712, CANC. U.S. CL. 42.
- RADIOMETRICS CORPORATION, BOULDER, CO:
2,728,627, PUB. 4-1-2003. INT. CL. 9.
- RAI RESEARCH CORPORATION, HAUPPAUGE, LONG ISLAND, NY:
735,586, CANC. U.S. CL. 21.
- RAINBOW DISPLAYS, INC., ENDICOTT, NY:
2,728,610, PUB. 4-1-2003. INT. CL. 9.
- RAINBOW HOME RENTALS, INC., CANFIELD, OH TO RAINBOW RENTALS, INC., CANFIELD, OH:
1,705,674, CANC. INT. CL. 42.
- RAINBOW INVESTMENT GROUP, HOUSTON, TX, DBA AUSTIN RAGE:
2,730,660, INT. CL. 25.
- RAINBOW LIFEGARD PRODUCTS, INC., EL MONTE, CA:
1,991,962, CANC. INT. CL. 7.
- RAINFINITY, SAN JOSE, CA:
2,729,336, PUB. 4-1-2003. INT. CL. 9.
- RALPH A. HILLER, COMPANY, EXPORT, PA:
2,730,179, MULTIPLE CLASS, INT. CLS. 35, 37, 40 AND 42.
- RALSTON PURINA COMPANY, ST. LOUIS, MO TO PURINA MILLS, INC., ST. LOUIS, MO:
1,203,336, CANC. INT. CL. 5.
- RALSTON PURINA COMPANY, ST. LOUIS, MO:
1,705,939, CANC. INT. CL. 31.
- RANDOLPH, STEVEN J., NORTHRIDGE, CA:
2,730,513, INT. CL. 16.
- RANDTOY, INC., ROSWELL, GA:
1,991,241, CANC. INT. CL. 9.
- RANIDAE INTERNATIONAL, INC., SYOSSET, NY:
1,991,831, CANC. INT. CL. 25.
- RANK HOTELS NORTH AMERICA, DALLAS, TX:
1,991,865, CANC. INT. CL. 42.
- RAPP POLYMERE GMBH, D-72072 TUBINGEN, FED REP GERMANY:
2,729,792, INT. CL. 1.
- RAPPIN PRINTS, TEMPLE HILLS, MD:
1,991,065, CANC. INT. CL. 25.
- RARITAN ENGINEERING COMPANY, INC., MILLVILLE, NJ:
1,991,215, CANC. INT. CL. 11.
- RAWLINGS SPORTING GOODS COMPANY, INC., FENTON, MO:
2,729,058, PUB. 4-1-2003. INT. CL. 28.
2,729,356, PUB. 4-1-2003. INT. CL. 28.
- RAWLINGS SPORTING GOODS COMPANY, INC., ST. LOUIS, MO:
2,729,764, MULTIPLE CLASS, INT. CLS. 24 AND 25.
- RAYCHEM CORPORATION, MENLO PARK, CA:
1,992,016, CANC. INT. CL. 17.
- RAYSTONE PRODUCTIONS, INC., LOS ANGELES, CA:
2,728,959, PUB. 4-1-2003. INT. CL. 16.
- RAYTHEON COMPANY, LEXINGTON, MA:
2,730,124, INT. CL. 42.
- RCM GENERAL CORPORATION, SAN FRANCISCO, CA:
1,991,266, CANC. INT. CL. 36.
- READING EXCELLENT AND DISCOVERY FOUNDATION, INC., NEW YORK, NY:
2,729,090, PUB. 4-1-2003. INT. CL. 41.
- READING JANE'S WAY INC., LAGUNA NIGUEL, CA:
2,729,753, INT. CL. 16.
- REAL PROPERTY SOLUTIONS GROUP, JACKSONVILLE, FL FROM INTERIOR STRATEGIES, INC., JACKSONVILLE, FL, DBA REAL PROPERTY SOLUTIONS:
2,730,087, INT. CL. 36.

- REAMES FOODS, INC., COLUMBUS, IA:
1,705,232, CANC. INT. CL. 30.
- RECORDING FOR THE BLIND & DYSLEXIC INCORPORATED, PRINCETON, NJ:
2,728,766, PUB. 4-1-2003. INT. CL. 9.
- RECYCLED PAPERBOARD INC. OF CLIFTON, CLIFTON, NJ:
1,704,924, CANC. INT. CL. 16.
- RED APPLE SUPERMARKETS, INC., NEW YORK, NY:
1,230,582, REN. 5-16-03. INT. CL. 42.
- RED DEVIL, INC., UNION, NJ:
1,704,588, CANC. INT. CL. 8.
- RED OWL STORES, INC., MINNEAPOLIS, MN:
1,203,747, CANC. MULTIPLE CLASS, INT. CLS. 29 AND 30.
- REDEMPTORIST FATHERS, LIGUORI, MO, DBA LIGUORI PUBLICATIONS:
2,392,676, COR. INT. CL. 42.
- REDIFON LIMITED, LONDON, ENGLAND:
396,769, CANC. U.S. CL. 26.
- REDKEN LABORATORIES, INC., CANOGA PARK, CA:
1,203,278, CANC. INT. CL. 3.
- REDMOND, MARY LOU, INDIAN, AK:
1,756,951, REN. 5-11-03. INT. CL. 25.
- REDNECK, INC., SPRINGFIELD, MO:
1,781,863, REN. 5-15-03. INT. CL. 42.
- REEBOK INTERNATIONAL LIMITED, BOLTON, BL1 1PP, LANCASHIRE, ENGLAND TO REEBOK SPORTS LIMITED, UXBRIDGE, MIDDLESEX, ENGLAND:
1,704,828, CANC. INT. CL. 14.
- REED ELSEVIER INC., NEWTON, MA:
1,991,344, CANC. MULTIPLE CLASS, INT. CLS. 35 AND 41.
- REESE ENGINEERING LIMITED, PALMERSTON NORTH, NEW ZEALAND:
2,729,469, INT. CL. 7.
- REESO TILES, INC., SAN ANTONIO, TX:
2,729,097, PUB. 4-1-2003. INT. CL. 35.
- REGAL WARE, INC., KEWASKUM, WI:
1,823,761, REN. 5-15-03. INT. CL. 21.
- REGENT INTERNATIONAL, INC., CARY, IL TO JING MEI INDUSTRIAL HOLDINGS LIMITED, RAROTONGA, COOK ISLANDS, COOK ISLANDS:
1,974,294, CANC. MULTIPLE CLASS, INT. CLS. 9 AND 10.
- REGIE NATIONALE DES USINES RENAULT, FRANCE TO RENAULT, BOULOGNE-BILLANCOURT, FRANCE:
1,826,278, CANC. INT. CL. 12.
- REGIS CORPORATION, MINNEAPOLIS, MN:
1,705,732, CANC. INT. CL. 3.
- REHABILITATION GROUP, P.A., THE, SAN ANTONIO, TX:
1,775,608, REN. 5-10-03. INT. CL. 42.
- REICHHOLD, INC., DURHAM, NC, REICHHOLD CHEMICALS, INC., DURHAM, NC:
571,669, REN. 5-10-03. U.S. CL. 6 (INT. CL. 1).
- REINOL-JANEK CHEMICALS (PTY) LTD., GAUTENG, SOUTH AFRICA:
2,730,204, INT. CL. 3.
- RELIANCE COMM/TEC CORPORATION, CLEVELAND, OH TO RELTEC CORPORATION, CLEVELAND, OH:
1,705,770, CANC. INT. CL. 9.
- RELIANT ENERGY, INCORPORATED, HOUSTON, TX:
2,729,638, INT. CL. 42.
- REMO, INC., VALENCIA, CA:
1,705,824, CANC. INT. CL. 15.
- RENAISSANCE HERBS, INC., CHATSWORTH, CA:
2,730,483, INT. CL. 5.
- RENDEZVOUS COLORADO, LLC, DENVER, CO FROM MARYVALE VILLAGE LLC, DENVER, CO:
2,729,695, INT. CL. 37.
- RENNCO INC., HOMER, MI:
2,730,154, INT. CL. 7.
- RENTERIA WINES, LLC, NAPA, CA:
2,730,938, INT. CL. 33.
- REPLICA PUBLISHING INC., MIAMI, FL:
966,538, REN. 5-14-03. U.S. CL. 38 (INT. CL. 16).
- REPUBLIC BANK & TRUST COMPANY, LOUISVILLE, KY:
2,729,225, PUB. 4-1-2003. INT. CL. 36.
- REPUBLIC OF TEA, INC., THE, NOVATO, CA:
2,730,630, INT. CL. 30.
- REPUBLIC WELDING CO., LOUISVILLE, KY, DBA REPUBLIC MACHINE:
2,729,299, PUB. 4-1-2003. INT. CL. 7.
- REQUEST FOODS, INC., HOLLAND, MI:
2,728,949, PUB. 4-1-2003. INT. CL. 30.
- RESEARCH & DIAGNOSTIC ANTIBODIES, BERKELEY, CA:
2,730,872, INT. CL. 42.
- RESEARCH INVESTMENT NETWORK, INC., IRVINE, CA FROM RICOS INTERNATIONAL, INC., IRVINE, CA:
2,729,884, MULTIPLE CLASS, INT. CLS. 35, 36 AND 42.
2,730,302, MULTIPLE CLASS, INT. CLS. 35, 36 AND 42.
- RESERVE MANAGEMENT CORPORATION, NEW YORK, NY:
2,729,975, INT. CL. 36.
- RESOLVE, INC., TUCSON, AZ:
1,990,727, COR. MULTIPLE CLASS, INT. CLS. 35 AND 36.
- RESTAURA, INC., PHOENIX, AZ:
1,704,944, CANC. INT. CL. 16.
- RESULTE UNIVERSAL LLC, DALLAS, TX FROM RESULTE UNIVERSAL, LLC, DALLAS, TX:
2,730,408, INT. CL. 35.
- RETAIL SERVICES, INC., DALLAS, TX:
2,729,477, INT. CL. 35.
- RETCO, INC., BRECKENRIDGE, CO:
1,230,404, REN. 5-16-03. INT. CL. 40.
- RETEK, INC., MINNEAPOLIS, MN:
2,728,570, PUB. 4-1-2003. MULTIPLE CLASS, INT. CLS. 35, 38 AND 42.
- RETIRED RESOURCES LLC, KIRKWOOD, MO:
1,991,687, CANC. INT. CL. 35.
- RETIREMENT SOURCE, INC., THE, CINCINNATI, OH:
1,760,237, REN. 5-16-03. INT. CL. 36.
- RETIREMENT SYSTEM GROUP INC., NEW YORK, NY:
2,729,708, INT. CL. 36.
- RETRO 1951, INC., RICHARDSON, TX, KARTSOTIS, GEORGE, DALLAS, TX, DBA PERFORMANCE RESOURCES:
1,756,770, REN. 5-16-03. INT. CL. 16.
- RETS, INC., ST. LOUIS, MO:
1,992,119, CANC. INT. CL. 9.
- REVIEW SERVICES, INC., FAIRFAX STATION, VA:
2,728,577, PUB. 4-1-2003. MULTIPLE CLASS, INT. CLS. 9, 16 AND 41.
- REVLON CONSUMER PRODUCTS CORPORATION, NEW YORK, NY:
2,730,795, INT. CL. 3.
2,730,813, INT. CL. 3.
- REYNOLDS CONSUMER PRODUCTS, INC., RICHMOND, VA, DBA PRESTO PRODUCTS COMPANY:
1,991,311, CANC. INT. CL. 10.
- RFI CORPORATION, BAY SHORE, NY:
735,596, CANC. U.S. CL. 21.
- RFV HOLDINGS LTD., TORTOLA, BR. VIRGIN ISLANDS:
2,729,579, INT. CL. 36.
- RHAPSODY INTERNATIONAL, LTD., MASSAPEQUA, NY:
1,761,756, REN. 5-16-03. INT. CL. 41.
- RHODIA, 92512 BOULOGNE BILLANCOURT CEDEX, FRANCE:
2,730,130, INT. CL. 1.
- RICO; EZEQUIEL, VILLA PARK, CA:
1,207,277, REN. 5-16-03. INT. CL. 21.
- RIDDELL, INC., CHICAGO, IL:
746,187, REN. 5-13-03. U.S. CL. 22 (INT. CL. 28).
- RIDGLASS MANUFACTURING COMPANY, INC., FRESNO, CA:
2,730,379, INT. CL. 19.
- RIDGWAYS LIMITED, EDINBURGH, EH3 7NE, SCOTLAND:
1,991,155, CANC. INT. CL. 30.
- RIEDEL, EDWIN H., SAN JOSE, CA:
1,992,083, CANC. INT. CL. 10.
- RIGHT ANGLE RESEARCH, INC., CHICAGO, IL:
1,990,891, CANC. INT. CL. 36.

- RIGONI USA, INC., OXFORD, CT:
2,730,330, INT. CL. 29.
- RINGER CORPORATION, EDEN PRAIRIE, MN:
1,991,749, CANC. INT. CL. 1.
- RINKY-DINK, INC., HADLEY, MA:
1,204,002, CANC. INT. CL. 41.
- RIP LLC, IDAHO FALLS, ID FROM VINCENT, JAMES D.,
BLACKFOOT, ID AND VINCENT, CECILY C. PEARSON,
BLACKFOOT, ID:
2,730,222, INT. CL. 28.
- RISK LABORATORIES, MARIETTA, GA:
2,729,274, PUB. 4-1-2003. INT. CL. 9.
- RITE-HITE HOLDING CORPORATION, MILWAUKEE, WI:
2,729,906, INT. CL. 24.
- RITZ HOTEL, LIMITED, THE, LONDON, UNITED KING-
DOM:
2,728,529, PUB. 4-16-2002. INT. CL. 24.
- RIVER MARKET VENTURE I L.P., KANSAS CITY, MO,
RIVER MARKET VENTURE, KANSAS CITY, MO:
1,659,003. REN. 5-16-03. MULTIPLE CLASS, INT. CLS. 25
AND 36.
- RIVERINA WINES PTY LTD, GRIFFITH, AUSTRALIA:
2,729,201, PUB. 4-1-2003. INT. CL. 33.
- RIVERWOOD INTERNATIONAL CORPORATION, ATLAN-
TA, GA:
2,729,691, INT. CL. 35.
- RJN GROUP, INC., WHEATON, IL, RJN COMPUTER
SERVICES, INC., WHEATON, IL:
1,761,099. REN. 5-14-03. INT. CL. 9.
- ROB LIEFELD, INC., ANAHEIM, CA:
1,991,470, CANC. INT. CL. 16.
- ROBERT G. SNYDER CONTRACTORS, INC., RALEIGH,
NC:
2,730,558, INT. CL. 37.
- ROBERTSON, GARY R., MONCTON, CANADA:
2,730,864, INT. CL. 16.
- ROBICON CORPORATION, NEW KENSINGTON, PA:
2,730,027, MULTIPLE CLASS, INT. CLS. 7, 9, 37 AND 42.
- ROBINSON, NADINE L., LOS ANGELES, CA:
2,730,955, INT. CL. 28.
- ROCHE DIAGNOSTICS CORPORATION, INDIANAPOLIS,
IN:
2,729,232, PUB. 4-1-2003. INT. CL. 5.
- ROCK TELEVISION NETWORK, INC., LEVITTOWN, NY:
1,991,702, CANC. INT. CL. 38.
- ROCKET BALL, LTD., HOUSTON, TX:
1,991,793, CANC. INT. CL. 9.
- ROCKET JEWELRY BOX, INC., BRONX, NY:
2,730,888, INT. CL. 20.
- ROCKHURST UNIVERSITY CONTINUING EDUCATION
CENTER, INC., SHAWNEE MISSION, KS, DBA COMP ED
SOLUTIONS:
2,728,808, PUB. 4-1-2003. INT. CL. 41.
- ROCKMAN CO., COMMERCE, CA:
2,730,349, INT. CL. 30.
- ROCKPORT COMPANY, LLC, THE, CANTON, MA:
2,729,783, INT. CL. 25.
- ROCKPORT/FULTON AREA CHAMBER OF COMMERCE,
TOURISM & DEVELOPMENT COUNCIL, ROCKPORT,
TX:
1,705,503, CANC. INT. CL. 41.
- ROCKWELL INDUSTRIES INC., MIAMI, FL:
1,990,910, CANC. INT. CL. 11.
- ROCKWOOD RETAINING WALLS INC., ROCHESTER, MN:
2,729,018, PUB. 4-1-2003. INT. CL. 19.
- ROCKWOOL INTERNATIONAL A/S, DK-2640 HEDEHU-
SENE, DENMARK:
2,728,802, PUB. 4-1-2003. INT. CL. 44.
- ROCKY SHOES & BOOTS, INC., NELSONVILLE, OH:
2,730,726, INT. CL. 25.
- RODAN & FIELDS, LLC, OAKLAND, CA:
2,730,355, MULTIPLE CLASS, INT. CLS. 3 AND 5.
- RODEL, INC., NEWARK, DE:
1,991,526, CANC. MULTIPLE CLASS, INT. CLS. 1 AND 3.
- RODMAN, LINDA, LONG BEACH, CA:
2,729,438, INT. CL. 12.
- RODVEN RECORDS, INC., MIAMI, FL:
1,991,284, CANC. INT. CL. 9.
- ROGERS CORPORATION, ROGERS, CT:
1,203,378, CANC. INT. CL. 7.
- ROGERS, EDGAR LYNN, SHREVEPORT, LA:
2,728,593, PUB. 4-1-2003. INT. CL. 41.
- ROHM AMERICA LLC, PISCATAWAY, NJ FROM SILIKAL
NORTH AMERICA, INC., WATERBURY, CT, DBA SILI-
KAL RESIN SYSTEMS:
2,729,873, INT. CL. 1.
- ROKEACH FOOD CORPORATION, NEWARK, NJ:
2,730,734, INT. CL. 32.
- ROLLFLEX MANUFACTURING, INC., FOSTORIA, MI:
1,991,138, CANC. INT. CL. 10.
- ROMANTASY, INC., SAN FRANCISCO, CA:
1,990,935, CANC. INT. CL. 18.
- RONALD T. CRAWFORD AND RICKY R. MANLEY,
PARTNERSHIP, THE, FINDLAY, OH:
1,992,137, CANC. INT. CL. 12.
- ROOTY'S MANAGEMENT, INC., SAN ANTONIO, TX:
1,705,668, CANC. INT. CL. 42.
- ROSS SYSTEMS (UK) LIMITED, NORTHAMPTON, GB2
NN1-1UD, UNITED KINGDOM:
1,704,600, CANC. INT. CL. 9.
- ROTEX TEXTILHANDEL UND PRODUKTIONSGE-
SELLSCHAFT MBH, D-40219 DUSSELDORF, FED REP
GERMANY:
2,728,874, PUB. 4-1-2003. INT. CL. 25.
- ROTH KASE U.S.A., LTD., MONROE, WI:
1,757,047. REN. 5-16-03. INT. CL. 29.
- ROTH, DAVID C., DALLAS, TX AND ROTH, BARBARA J.,
DALLAS, TX:
2,729,738, MULTIPLE CLASS, INT. CLS. 16 AND 25.
- ROTH, ERIC M., DEERFIELD, IL:
2,728,743, PUB. 4-1-2003. INT. CL. 9.
- ROUSH PRODUCTS COMPANY, INC., MINNEAPOLIS, MN,
ROUSH BAKERY PRODUCTS CO., INC., SACRAMENTO,
CA:
957,925. REN. 5-10-03. U.S. CL. 46 (INT. CL. 30).
- ROYAL RUBBER & MANUFACTURING COMPANY,
SOUTH GATE, CA:
1,991,758, CANC. INT. CL. 27.
- RUBB, INC., SANFORD, ME:
1,756,865. REN. 5-16-03. INT. CL. 19.
- RUBY-SPEARS PRODUCTIONS, BURBANK, CA:
1,990,955, CANC. INT. CL. 41.
- RUDOLPH INTERNATIONAL, INC., BREA, CA:
1,752,258. REN. 5-10-03. INT. CL. 8.
- RUGER INDUSTRIES, INC., DOVER, OH, RUGER EQUIP-
MENT, INC., UHRICHSVILLE, OH:
1,200,177. REN. 5-15-03. MULTIPLE CLASS, INT. CLS. 7
AND 12.
- RULESTREAM CORPORATION, MAYFIELD HEIGHTS, OH
FROM NAVION SOFTWARE CORP., MAYFIELD
HEIGHTS, OH:
2,730,399, INT. CL. 9.
- RUNTIME REVOLUTION, EDINBURGH, UNITED KING-
DOM:
2,729,603, MULTIPLE CLASS, INT. CLS. 9 AND 16.
- RUNZHEIMER INTERNATIONAL LTD., ROCHESTER, WI:
2,730,893, INT. CL. 35.
- RUSSO, ANDREW P. LO, SANTA BARBARA, CA:
2,729,978, INT. CL. 41.
- RUTH CORP., HONOLULU, HI, DBA HAWAIIAN JUICE
INDUSTRIES:
1,991,463, CANC. INT. CL. 32.
- RUUD LIGHTING, INC., RACINE, WI:
1,768,007. REN. 5-14-03. INT. CL. 11.
- RYKOFF - SEXTON, INC., LOS ANGELES, CA:
1,203,763, CANC. INT. CL. 29.
- RYTEC CORPORATION, JACKSON, WI:
1,769,844. REN. 5-10-03. INT. CL. 9.
- S & H COMPUTER SYSTEMS, INC., NASHVILLE, TN:
1,203,443, CANC. INT. CL. 9.
- S F HOTEL COMPANY, L.P., WICHITA, KS:
1,705,665, CANC. INT. CL. 42.
- S SQUARED L.L.C., CHICAGO, IL:
2,729,394, INT. CL. 38.

- S. C. JOHNSON & SON, INC., RACINE, WI:
2,729,312, PUB. 4-1-2003. INT. CL. 5.
2,730,451, INT. CL. 3.
- S. C. JOHNSON HOME STORAGE, INC., RACINE, WI:
2,729,419, INT. CL. 21.
- S.A. DE EXPORTACIONES SUDAMERICANAS, BUENOS AIRES, ARGENTINA:
1,991,167, CANC. INT. CL. 18.
- S.I. SYSTEMS LTD., CALGARY, ALBERTA, CANADA:
2,728,562, PUB. 4-1-2003. INT. CL. 35.
- S&B SHOKUHIN CO., LTD., NIHONBASHI, CHUO-KU, TOKYO, JAPAN TO S & B FOODS INC., TOKYO, JAPAN:
1,216,955, AM. INT. CL. 29.
- SAATCHI & SAATCHI NORTH AMERICA, INC., NEW YORK, NY:
2,728,974, PUB. 4-1-2003. INT. CL. 41.
- SABETTI, STEPHANO, SHERMAN OAKS, CA, DBA INSTITUTE FOR LIFE ENERGY:
1,204,170, CANC. INT. CL. 41.
- SAE SILVER ARROW ESTABLISHMENT, 9490 VADUZ, LIECHTENSTEIN:
2,729,683, MULTIPLE CLASS, INT. CLS. 25 AND 32.
- SAFE USA, INC., CANNON FALLS, MN:
2,729,958, INT. CL. 9.
- SAFEWAY INC., PLEASANTON, CA:
2,730,368, INT. CL. 35.
- SAGA LEISURE LIMITED, FOLKESTONE, KENT CT20 1AZ, ENGLAND:
1,991,791, CANC. INT. CL. 39.
- SAHAGIAN & ASSOCIATES, INC., OAK PARK, IL:
1,971,237, CANC. INT. CL. 30.
- SAINT GERMAIN FOUNDATION, SCHAUMBURG, IL:
1,776,466, REN. 5-10-03. INT. CL. 16.
1,778,739, REN. 5-10-03. MULTIPLE CLASS, INT. CLS. 9 AND 16.
- SALEH, HUSNI, LOS ANGELES, CA, DBA SALEH SPORTSWEAR TO H SALEH & SONS, INC., LOS ANGELES, CA:
1,705,130, CANC. INT. CL. 25.
- SALEM CORPORATION, PITTSBURGH, PA:
1,203,483, CANC. INT. CL. 11.
- SALES DIRECTOR, LLC, HOUSTON, TX:
2,729,857, INT. CL. 9.
- SALMING, BORJE, S-421 23 VISTRA FROLUNDA, SWEDEN:
2,728,602, PUB. 4-1-2003. INT. CL. 28.
- SALTON, INC., LAKE FOREST, IL:
2,730,767, INT. CL. 7.
- SALU, INC., PORTLAND, OR:
2,730,632, MULTIPLE CLASS, INT. CLS. 35 AND 42.
- SALVAGI, RAGHUNANDAN S., NEW HAVEN, CT:
2,729,801, MULTIPLE CLASS, INT. CLS. 35 AND 42.
- SAMSUNG ELECTRO-MECHANICS CO., LTD., SUWON-SI, KYUNGKI-DO, REPUBLIC OF KOREA:
2,730,112, INT. CL. 9.
- SAMSUNG ELECTRONICS CO., LTD., KYUNGKI-DO, REPUBLIC OF KOREA:
2,729,923, INT. CL. 11.
- SAN ANTONIO LIGHTHOUSE, SAN ANTONIO, TX:
1,816,820, REN. 5-15-03. INT. CL. 16.
- SANCHEZ, BAUDILIO, LOS ANGELES, CA:
1,991,064, CANC. INT. CL. 29.
- SAND TIRES UNLIMITED, INC., TEMECULA, CA:
1,705,819, CANC. INT. CL. 12.
- SANDBERG & SIKORSKI DIAMOND CORP., NEW YORK, NY:
2,728,853, PUB. 4-1-2003. INT. CL. 14.
- SANDHOLDT, PETER W., SAN RAMON, CA, DBA GET... THIS:
1,991,747, CANC. INT. CL. 25.
- SANDMAR MARKETING, NEW CASTLE, PA:
2,728,809, PUB. 4-1-2003. INT. CL. 29.
2,728,810, PUB. 4-1-2003. INT. CL. 29.
- SANDOZ LTD., BASLE, SWITZERLAND:
1,203,314, CANC. INT. CL. 5.
- SANFORD, L.P., BELLWOOD, IL, BEROL CORPORATION, BRENTWOOD, TN:
1,755,271, REN. 5-16-03. INT. CL. 16.
- SANGETSU CO., LTD., NISHI-KU, NAGOYA-SHI, JAPAN:
1,229,842, REN. 5-16-03. MULTIPLE CLASS, INT. CLS. 20, 24 AND 27.
- SANITIZED INC., NEW PRESTON, CT:
1,782,364, REN. 5-15-03. INT. CL. 5.
- SANKEY VENDING LIMITED, BILSTON, WEST MIDLANDS WV14 0LF, ENGLAND TO WITTENBERG A/S, 5000 ODENSE C, DENMARK:
1,705,982, CANC. MULTIPLE CLASS, INT. CLS. 7 AND 9.
- SANOFI - SYNTHELABO, F - 75013 PARIS, FRANCE:
2,728,505, PUB. 4-17-2001. INT. CL. 5.
- SAPONARO, JOSEPH, JUPITER, FL:
2,730,894, INT. CL. 42.
- SAPPI GRATKORN GMBH, A-8101 GRATKORN, AUSTRIA:
2,729,927, INT. CL. 16.
- SAPPINGTON, JOHN C., SAN FRANCISCO, CA, DBA BASE.ARTS:
1,991,584, CANC. INT. CL. 9.
- SARA LEE CORPORATION, WINSTON-SALEM, NC:
2,729,238, PUB. 4-1-2003. INT. CL. 29.
2,729,479, INT. CL. 25.
2,730,617, INT. CL. 25.
- SARAMAR CORPORATION, DOVER, DE:
1,991,879, CANC. MULTIPLE CLASS, INT. CLS. 29 AND 30.
- SARAMAR, L.L.C., CHICAGO, IL:
2,730,559, INT. CL. 30.
2,730,661, INT. CL. 25.
- SARASOTA COUNTY PUBLIC HOSPITAL BOARD, SARASOTA, FL:
2,728,848, PUB. 4-1-2003. INT. CL. 44.
- SASSY PRODUCT DEVELOPMENT AND MARKETING, INC., LAFAYETTE, CA:
2,730,737, INT. CL. 28.
- SAVANT, INC., MIDLAND, MI:
2,728,970, PUB. 4-1-2003. INT. CL. 42.
2,728,971, PUB. 4-1-2003. INT. CL. 42.
- SAVE-A-LOT FOOD STORES, INC., EARTH CITY, MO:
2,730,183, INT. CL. 30.
- SAVOGRAN COMPANY, THE, NORWOOD, MA:
572,500, REN. 5-10-03. U.S. CL. 52 (INT. CL. 3).
- SAWYER, WILLIAM P., CINCINNATI, OH:
2,730,534, MULTIPLE CLASS, INT. CLS. 3, 5 AND 16.
2,730,535, MULTIPLE CLASS, INT. CLS. 3, 5 AND 16.
- SAZERAC COMPANY, INC., NEW ORLEANS, LA, DBA JOHN HANDY CO.:
753,060, REN. 5-14-03. U.S. CL. 49 (INT. CL. 33).
- SCALFANI, CHARLES J., LAGUNA NIGUEL, CA:
2,730,150, INT. CL. 9.
- SCAN, INC., NEW YORK, NY:
2,728,863, PUB. 4-1-2003. INT. CL. 42.
- SCHAWK, INC., DES PLAINES, IL:
2,730,539, INT. CL. 9.
- SCHENECTADY INTERNATIONAL, INC., SCHENECTADY, NY:
2,730,218, INT. CL. 1.
- SCHERING AKTIENGESELLSCHAFT, BERLIN, FED REP GERMANY:
2,728,475, PUB. 12-12-2000. INT. CL. 5.
- SCHERING AKTIENGESELLSCHAFT, 13342 BERLIN, FED REP GERMANY:
2,728,482, PUB. 5-22-2001. INT. CL. 5.
- SCHERING-PLOUGH HEALTHCARE PRODUCTS, INC., MEMPHIS, TN:
2,730,423, INT. CL. 3.
- SCHERING-PLOUGH VETERINARY CORPORATION, RENO, NV, SCHERING CORPORATION, KENILWORTH, NJ:
1,250,146, REN. 5-16-03. INT. CL. 5.
- SCHMID LABORATORIES, INC., LITTLE FALLS, NJ:
735,732, CANC. U.S. CL. 44.
- SCHMOOZE-N-POOCH A LA CART, INC., CINCINNATI, OH:
2,730,342, INT. CL. 44.
- SCHNEE-MOREHEAD BUSINESS TRUST, IRVING, TX, BIDDLE COMPANY, THE, ST. LOUIS, MO:
751,900, REN. 5-15-03. U.S. CL. 12 (INT. CL. 19).
- SCHNEIDER, DAVID L., SAN DIEGO, CA:
2,728,920, PUB. 4-1-2003. INT. CL. 35.

- SCHOEFFLER, DANIEL A., HUNTINGTON, NY:
2,729,714, INT. CL. 38.
- SCHOENBART, BILL, SANTA CRUZ, CA:
1,991,319, CANC. INT. CL. 5.
- SCHOLASTIC INC., NEW YORK, NY:
2,728,924, PUB. 4-1-2003. INT. CL. 16.
- SCHOOL LINK, INC., SANFORD, NC:
2,728,509, PUB. 4-1-2003. MULTIPLE CLASS, INT. CLS. 9,
38 AND 41.
- SCHOOL SPECIALTY SUPPLY, INC., SALINA, KS:
1,203,534, CANC. INT. CL. 16.
- SCHOOL SPECIALTY, INC., APPLETON, WI:
2,730,228, INT. CL. 2.
- SCHREIBER TECHNOLOGIES, INC., GREEN BAY, WI,
CLEARFIELD CHEESE COMPANY, INC., CURWENS-
VILLE, PA:
1,261,061, REN. 5-16-03. INT. CL. 29.
- SCHRODER MASCHINENBAU KG, 33824 WERTHER, FED
REP GERMANY:
2,728,654, PUB. 4-1-2003. INT. CL. 7.
- SCHROEDER, PAUL WINSTON, AUSTIN, TX:
2,729,298, PUB. 4-1-2003. INT. CL. 41.
- SCHUESSLER KNITTING MILLS INC., CHICAGO, IL:
1,991,697, CANC. INT. CL. 25.
- SCHUHAM, STACEY D., BOULDER, CO:
1,992,008, CANC. INT. CL. 35.
- SCHULER'S, INC., MARSHALL, MI:
1,991,260, CANC. INT. CL. 42.
- SCHUMACKER & COMPANY, SUNRISE, FL:
2,730,452, INT. CL. 28.
- SCHUNK GMBH & CO. KG., D-74348 LAUFFEN/NECKAR,
FED REP GERMANY:
2,729,822, INT. CL. 7.
2,729,823, INT. CL. 7.
- SCHUSTER, JAN, POMPAÑO BEACH, FL:
2,730,739, INT. CL. 41.
- SCHUT GEOMETRISCHE MEETTECHNIEK B.V., 9723 BN
GRONINGEN, NETHERLANDS:
2,661,009, COR. INT. CL. 9.
- SCHWEIZERISCHE ISOLA-WERKE (THE SWISS INSULAT-
ING WORKS, LTD.), BREITENBACH, SWITZERLAND:
955,614, REN. 5-16-03. U.S. CL. 21 (INT. CL. 17).
- SCIENDA, LLC, ORANGEBURG, CA:
2,730,677, MULTIPLE CLASS, INT. CLS. 37 AND 41.
- SCIENTIFIC ECOLOGY GROUP, INC., THE, OAK RIDGE,
TN:
1,991,307, CANC. INT. CL. 39.
1,991,308, CANC. INT. CL. 40.
1,991,309, CANC. INT. CL. 41.
1,991,310, CANC. INT. CL. 40.
- SCOLDING LOCKS CORPORATION, APPLETON, WI:
735,710, CANC. U.S. CL. 40.
- SCOLIOSIS ASSOCIATION, INC., THE, BOCA RATON, FL:
1,758,308, REN. 5-12-03. INT. CL. 16.
- SCOOTERTUNES, INCORPORATED, IRVING, TX:
1,992,608, CANC. INT. CL. 41.
- SCOTIACHEMCO INCORPORATED, BEDFORD, NOVA
SCOTIA B4B 1J5, CANADA:
1,991,263, CANC. INT. CL. 2.
- SCOTTO'S HOLDING CORP., WOODBURY, NY:
2,645,381, COR. MULTIPLE CLASS, INT. CLS. 35 AND
42.
- SCOTTRADE, INC., ST. LOUIS, MO:
2,729,327, PUB. 4-1-2003. INT. CL. 36.
- SCRUBWAY, INC., WAYNE, PA:
1,991,918, CANC. MULTIPLE CLASS, INT. CLS. 35 AND
37.
- SCULLY SIGNAL COMPANY, WILMINGTON, MA:
2,728,715, PUB. 4-1-2003. INT. CL. 9.
- SCULLY, GLENN, SEATTLE, WA AND SCULLY, LOUISE,
SEATTLE, WA:
2,729,321, PUB. 4-1-2003. INT. CL. 25.
- SEA FRIENDS INCORPORATED, FREEPORT, NY:
1,991,650, CANC. INT. CL. 25.
- SEA WORLD, INC., ST. LOUIS, MO:
2,729,340, PUB. 4-1-2003. INT. CL. 16.
- SEABOARD SHIPPING COMPANY LIMITED, NORTH
VANCOUVER, BRITISH COLUMBIA, CANADA:
1,237,697, REN. 5-10-03. INT. CL. 39.
- SEABROOK MEDICAL SYSTEMS, INC., CINCINNATI, OH:
1,991,817, CANC. INT. CL. 10.
- SEALED AIR CORPORATION (US), SADDLE BROOK, NJ,
SEALED AIR CORPORATION, SADDLE BROOK, NJ:
1,243,637, REN. 5-14-03. INT. CL. 17.
- SEALY TECHNOLOGY LLC, TRINITY, NC, SEALY, IN-
CORPORATED, CHICAGO, IL:
954,428, REN. 5-14-03. U.S. CL. 32 (INT. CL. 20).
1,229,861, REN. 5-14-03. INT. CL. 20.
- SEALY TECHNOLOGY LLC, TRINITY, NC:
2,730,957, INT. CL. 20.
- SEARFOSS, GEARY, DULUTH, MN:
1,990,870, CANC. INT. CL. 36.
- SEARS, ROEBUCK AND CO., HOFFMAN ESTATES, IL:
1,991,947, CANC. INT. CL. 9.
2,729,342, PUB. 4-1-2003. INT. CL. 7.
2,729,666, INT. CL. 25.
2,730,106, INT. CL. 36.
- SEATTLE YACHT CLUB, SEATTLE, WA:
1,683,843, CANC. INT. CL. 25.
- SEATTLE'S BEST COFFEE LLC, SEATTLE, WA:
2,729,692, INT. CL. 30.
- SECURITY ASSOCIATES INTERNATIONAL, INC., AR-
LINGTON HEIGHTS, IL:
2,729,961, INT. CL. 42.
- SECURITY STATE SAVINGS BANK, LAS VEGAS, NV:
2,729,829, INT. CL. 36.
- SEITENBACHER GMBH & CO., NATURKOST, D-74722
BUCHEN, FED REP GERMANY:
2,728,572, PUB. 4-16-2002. MULTIPLE CLASS, INT. CLS.
29 AND 30.
- SEITZSCHENK FILTERSYSTEMS GMBH, 55543 BAD
KREUZNACH, FED REP GERMANY:
2,728,725, PUB. 4-1-2003. MULTIPLE CLASS, INT. CLS. 1,
7, 11 AND 17.
2,728,727, PUB. 4-1-2003. INT. CL. 11.
- SELA2, INC., MAHWAH, NJ FROM SKILA, INC., MAH-
WAH, NJ:
2,729,491, INT. CL. 42.
- SELECT EMBRYOS, INC., PLAIN CITY, OH:
1,204,067, CANC. INT. CL. 42.
- SELECT HOME DESIGNS HOLDINGS COMPANY, VAN-
COUVER, CANADA:
1,705,617, CANC. INT. CL. 42.
- SELECT SOFTWARE SERVICES, TUCSON, AZ:
1,992,166, CANC. INT. CL. 9.
- SELECTION NEW PLANT SARL, 06603 ANTIBES CEDEX,
FRANCE:
1,991,587, CANC. INT. CL. 31.
- SELECTION NEW PLANT, SARL, 06603 ANTIBES CEDEX,
FRANCE:
1,991,585, CANC. INT. CL. 31.
1,991,586, CANC. INT. CL. 31.
1,991,588, CANC. INT. CL. 31.
- SELECTMARK, INC., WILMINGTON, DE:
2,728,883, PUB. 4-1-2003. MULTIPLE CLASS, INT. CLS. 41
AND 44.
- SELLECK; EDWARD H., LIGHTHOUSE POINT, FL, DBA
POPS, FLORIDA:
1,203,814, CANC. INT. CL. 32.
- SELLNER MANUFACTURING CO., INC., FARIBAULT,
MN:
2,730,359, INT. CL. 28.
- SELLSTROM MANUFACTURING CO., PALATINE, IL:
1,704,573, CANC. INT. CL. 7.
- SELUX CORPORATION, HIGHLAND, NY:
2,730,565, INT. CL. 11.
- SEMBLEX CORPORATION, ELMHURST, IL, NL INDUS-
TRIES, INC., NEW YORK, NY:
965,368, REN. 5-16-03. U.S. CL. 13 (INT. CL. 6).
- SEMCO, INC., HOUSTON, TX:
1,990,788, CANC. INT. CL. 7.
1,990,789, CANC. INT. CL. 7.
1,990,791, CANC. INT. CL. 7.

- SEMICONDUCTOR ENERGY LABORATORY CO., LTD., KANAGAWA-KEN, 243-0036, JAPAN:
2,728,533, PUB. 9-24-2002. MULTIPLE CLASS, INT. CLS. 9, 10, 11, 12 AND 28.
- SENIOR INVESTMENTS AG, 8201 SCHAFFHAUSEN, SWITZERLAND:
2,728,779, PUB. 4-1-2003. INT. CL. 17.
- SENIOR PSYCHOLOGY SERVICES, INC., SAN DIEGO, CA:
2,730,434, INT. CL. 42.
- SENIORNET, SAN FRANCISCO, CA:
2,729,845, MULTIPLE CLASS, INT. CLS. 38, 41 AND 42.
- SENSTAR-STELLAR CORPORATION, KANATA ONTARIO, CANADA:
2,729,490, MULTIPLE CLASS, INT. CLS. 9 AND 42.
- SENTINEL DIVERSIFIED INDUSTRIES, INC., EAST FARMINGDALE, NY:
1,255,087, REN. 5-16-03. MULTIPLE CLASS, INT. CLS. 6 AND 9.
- SEQUEL SECURITY SYSTEMS INC., DEERFIELD, IL:
1,990,899, CANC. INT. CL. 12.
- SERVICE IDEAS, INC., WOODBURY, MN:
2,729,343, PUB. 4-1-2003. INT. CL. 21.
- SERVICOR, INC., SAN CARLOS, CA:
1,992,217, CANC. INT. CL. 19.
- SERVO MAGNETICS INCORPORATED, CANOGA PARK, CA:
2,728,919, PUB. 4-1-2003. MULTIPLE CLASS, INT. CLS. 7 AND 9.
- SETTEF S.P.A., RESANA (TREVISO), ITALY:
1,203,565, CANC. INT. CL. 19.
- SEXTON EDUCATIONAL PROGRAMS, INC., NEW YORK, NY:
1,204,015, CANC. INT. CL. 41.
- SEXTON, ROBERT J., MADISON, TN:
2,730,886, INT. CL. 9.
- SEYMOUR HOUSEWARES CORPORATION, SEYMOUR, IN:
1,991,617, CANC. INT. CL. 21.
- SFR CORPORATION, BUTTE, MT:
2,729,777, INT. CL. 1.
- SHADOWLINE INCORPORATED, MORGANTON, NC:
1,992,054, CANC. INT. CL. 25.
- SHAKESPEARE COMPANY, COLUMBIA, SC, SHAKESPEARE COMPANY, COLUMBIA, SC:
1,227,658, REN. 5-13-03. INT. CL. 28.
- SHAKESPEARE COMPANY, COLUMBIA, SC TO SHAKESPEARE COMPANY, COLUMBIA, SC:
1,227,658, AM. INT. CL. 28.
- SHALOM INTERNATIONAL CORPORATION, CARTERETTE, NJ:
2,730,431, INT. CL. 26.
- SHANGHAI JAHWA UNITED CO., LTD, SHANGHAI, CHINA:
2,728,665, PUB. 4-1-2003. INT. CL. 3.
- SHANNON GROUP, INC., THE, BRENTWOOD, TN:
1,990,686, CANC. INT. CL. 11.
- SHAPEWARE CORPORATION, SEATTLE, WA:
1,990,689, CANC. INT. CL. 9.
- SHAPIRO, KENNETH H., DAYTON, OH, DBA TALENTIA:
1,203,843, CANC. INT. CL. 35.
- SHAREHOLDER SERVICES GROUP, INC., THE, BOSTON, MA:
1,991,135, CANC. MULTIPLE CLASS, INT. CLS. 35 AND 38.
- SHARI'S MANAGEMENT CORPORATION, TIGARD, OR:
1,204,126, CANC. INT. CL. 42.
- SHARP IMAGE GAMING, INC., CHATSWORTH, CA:
2,730,462, INT. CL. 9.
- SHARPLAN LASERS, INC., ALLENDALE, NJ:
1,704,757, CANC. INT. CL. 10.
- SHEESLEY, JOHN M., SAN ANTONIO, TX:
2,730,346, MULTIPLE CLASS, INT. CLS. 37 AND 39.
- SHEFFIELD TUBE CORPORATION, THE, NEW LONDON, CT:
396,865, CANC. U.S. CL. 2.
- SHELL OIL COMPANY, HOUSTON, TX:
2,729,474, MULTIPLE CLASS, INT. CLS. 9 AND 42.
- SHELL RADEMARK MANAGEMENT BV, THE HAGUE, NETHERLANDS, SHELL OIL COMPANY, HOUSTON, TX:
1,760,295, REN. 5-16-03. INT. CL. 37.
- SHELL TRADEMARK MANAGEMENT BV, THE HAGUE, NETHERLANDS, SHELL OIL COMPANY, HOUSTON, TX:
1,760,932, REN. 5-15-03. INT. CL. 4.
- SHELL TRADEMARK MANAGEMENT BV, THE HAGUE, NETHERLANDS, SHELL OIL COMPANY, HOUSTON, TX:
1,760,294, REN. 5-16-03. INT. CL. 37.
- SHEPHERD COLOR COMPANY, THE, CINCINNATI, OH:
2,730,243, INT. CL. 2.
- SHERATON CORPORATION, THE, WHITE PLAINS, NY:
2,728,722, PUB. 4-1-2003. INT. CL. 43.
- SHERMAN; COREY-LEE, FREEPORT, NY AND SHERMAN; ELIZABETH, BROOKLYN, NY, DBA METALUX PRODUCTS:
735,729, CANC. U.S. CL. 44.
- SHERWIN-WILLIAMS COMPANY, THE, CLEVELAND, OH:
2,730,718, INT. CL. 2.
- SHERYL'S CHOCOLATE CREATIONS, INC., HICKSVILLE, NY:
2,730,600, INT. CL. 30.
- SHILOH TRUST, AN ARKANSAS TRUST, THE TRUSTEE COMPRISING JAMES JANOSCH, A U.S. CITIZEN, THE, SULPHUR SPRINGS, AR:
2,728,535, PUB. 4-1-2003. MULTIPLE CLASS, INT. CLS. 29 AND 30.
- SHIPLEY COMPANY, LLC, MARLBOROUGH, MA:
2,730,526, INT. CL. 1.
- SHIPSHAPES, LLC, ANNAPOLIS, MD:
2,730,623, INT. CL. 28.
- SHIPSTINE LTD., MINNEAPOLIS, MN:
1,991,818, CANC. INT. CL. 30.
- SHIRWIN KNOWLEDGE & LEARNING SYSTEMS, INC., EDMONTON, ALBERTA, CANADA:
2,730,712, MULTIPLE CLASS, INT. CLS. 9 AND 42.
- SHISEIDO COMPANY, LTD., TOKYO, JAPAN:
2,730,455, INT. CL. 3.
- SHONHOLTZ, SIGMUND R., WEST HOLLYWOOD, CA, DBA SECOND TIME AROUND WATCH CO.:
2,730,096, INT. CL. 42.
- SHOUT! TOYS, LLC, WATCHUNG, NJ:
2,730,495, INT. CL. 28.
- SHOWMART MANGEMENT LTD., TORONTO, ONTARIO, M5V 1J9, CANADA:
2,728,512, PUB. 4-1-2003. INT. CL. 30.
- SHURE INCORPORATED, EVANSTON, IL, SHURE BROTHERS INCORPORATED, EVANSTON, IL:
1,755,082, REN. 5-12-03. INT. CL. 9.
- SICHUAN CHENGDU QUANXING GROUP CO., LTD., SICHUAN PROVIDENCE, PEOPLES REPUBLIC OF, CHINA:
2,729,670, INT. CL. 33.
- SICPA HOLDING S.A., SWITZERLAND:
2,728,554, PUB. 4-1-2003. MULTIPLE CLASS, INT. CLS. 2, 9, 16, 38, 39 AND 42.
2,728,555, PUB. 4-1-2003. MULTIPLE CLASS, INT. CLS. 2, 9, 16, 38, 39 AND 42.
- SIDNEY L. EISENBAUM, M.D., PROF. L.L.C., AURORA, CO:
2,729,790, INT. CL. 42.
- SIEMENS AKTIENGESELLSCHAFT, D-8000 MUNICH 2, FED REP GERMANY:
957,237, REN. 5-11-03. U.S. CL. 21 (INT. CL. 9).
- SIEMENS AKTIENGESELLSCHAFT, MUNCHEN, FED REP GERMANY:
2,728,748, PUB. 9-17-2002. INT. CL. 10.
- SIEMENS NIXDORF INFORMATIONSSYSTEME AG, PADERBORN, FED REP GERMANY:
2,545,541, COR. MULTIPLE CLASS, INT. CLS. 9 AND 42.
- SIERRA TAHOE BANCORP, TRUCKEE, CA:
2,728,456, PUB. 4-1-2003. INT. CL. 36.
- SIGNATURE EYEWEAR, INC., INGLEWOOD, CA:
2,729,518, INT. CL. 9.
- SIGNATURE FINANCIAL/MARKETING, INC., WILMINGTON, DE:
1,992,085, CANC. INT. CL. 42.

- SILENT WITNESS ENTERPRISES LTD., SURREY, BRITISH COLUMBIA V3S 4G5, CANADA:
2,728,635, PUB. 4-1-2003. INT. CL. 9.
- SILICH, CHERYL ANN, INDIANAPOLIS, IN:
2,729,365, INT. CL. 28.
- SILICON ACCESSTECHNOLOGY, INC., SAN JOSE, CA:
2,664,562, COR. INT. CL. 9.
- SILICON MOTION, INC., SAN JOSE, CA:
2,729,812, INT. CL. 9.
- SILICONSYSTEMS GMBH, D-76131 KARLSRUHE, FED REP GERMANY AND OASIS DESIGN, INC., AUSTIN, TX:
2,649,670, COR. INT. CL. 9.
- SILKE VOGELMANN-SINE, PH.D., INC., HONOLULU, HI:
2,729,945, INT. CL. 9.
- SILVER DOLLAR CITY, INC., BRANSON, MO:
2,730,658, INT. CL. 41.
- SILVER LAW INC., FT. LAUDERDALE, FL FROM SILVER, JUDITH A, FT LAUDERDALE, FL:
2,730,546, INT. CL. 42.
- SILVER LAW INC., FT. LAUDERDALE, FL FROM SILVER, JUDITH A., FT. LAUDERDALE, FL:
2,730,548, INT. CL. 42.
- SILVER STAR JEWELRY MFR. LTD., T.S.T. KOWLOON, HONG KONG:
1,704,832, CANC. INT. CL. 14.
- SIM USA INCORPORATED, CHARLOTTE, NC:
1,204,070, CANC. INT. CL. 42.
- SIMCO STORES, INC., TETERBORO, NJ, SIMCO STORES, INC., RIDGEFIELD, NJ:
1,231,928, REN. 5-15-03. MULTIPLE CLASS, INT. CLS. 18 AND 25.
- SIMONDS INDUSTRIES INC., FITCHBURG, MA:
1,992,031, CANC. INT. CL. 7.
- SINGER, RICHARD FRANCIS, JR., DERWOOD, MD:
2,729,621, INT. CL. 10.
- SINISALO SPORT OY, PUOLANKA, FINLAND, URHEILU-SINISALO OY, PUOLANKA, FINLAND:
1,229,973, REN. 5-16-03. MULTIPLE CLASS, INT. CLS. 25 AND 28.
- SIRIOS CAPITAL MANAGEMENT, L.P., BOSTON, MA:
2,729,463, INT. CL. 36.
- SISTERS OF ST. FRANCIS OF SYLVANIA, OHIO, SYLVANIA, OH:
2,729,868, INT. CL. 42.
- SISTERS OF ST. JOSEPH OF PEACE, HEALTH AND HOSPITAL SERVICES, BELLEVUE, WA TO PEACE-HEALTH, BELLEVUE, WA:
2,000,247, CANC. MULTIPLE CLASS, INT. CLS. 35 AND 36.
- SITE-SPECIFIC TECHNOLOGY DEVELOPMENT GROUP, INC., STILLWATER, OK:
2,729,171, PUB. 4-1-2003. INT. CL. 9.
- SIX COUNTINENTS HOTELS, INC., ATLANTA, GA FROM BASS HOTELS & RESORTS, INC., ATLANTA, GA:
2,730,641, INT. CL. 35.
- SIX FLAGS THEME PARKS INC.:
1,705,513, CANC. INT. CL. 41.
- SIX FLAGS THEME PARKS, INC., ARLINGTON, TX:
2,729,689, MULTIPLE CLASS, INT. CLS. 30 AND 35.
- SKATEBOARD WORLD INDUSTRIES, INC., EL SEGUNDO, CA:
2,729,795, MULTIPLE CLASS, INT. CLS. 25 AND 28.
- SKIDATA AG, A-5083 GARTENAU, AUSTRIA:
2,729,625, MULTIPLE CLASS, INT. CLS. 6, 9, 14, 16 AND 20.
- SKIDMORE COLLEGE, SARATOGA SPRINGS, NY:
1,229,771, REN. 5-16-03. MULTIPLE CLASS, INT. CLS. 16, 25 AND 41.
- SKINNY PIGEON, INC., FOREST HILLS, NY:
2,729,195, PUB. 4-1-2003. INT. CL. 42.
- SKOLAR INC., PALO ALTO, CA FROM E-SKOLAR, INC., PALO ALTO, CA:
2,729,742, INT. CL. 42.
- SLEEP SOLUTIONS INDUSTRIES, INC., ATLANTA, GA:
1,991,387, CANC. INT. CL. 20.
- SLEEPMED, INCORPORATED, BOSTON, MA:
2,729,557, MULTIPLE CLASS, INT. CLS. 10 AND 42.
- SLICKEDIT, INC., MORRISVILLE, NC, MICROEDGE INC., RALEIGH, NC:
1,821,118, REN. 5-15-03. INT. CL. 9.
- SLOAN, LINDA, LITTLETON, CO FROM BRUEMMER, MARGARET A., LITTLETON, CO AND SLOAN, LINDA, LITTLETON, CO:
2,730,601, INT. CL. 25.
- SLOTZNICK, BENJAMIN, MT. GRETN, PA:
2,728,849, PUB. 4-1-2003. MULTIPLE CLASS, INT. CLS. 9 AND 38.
- SLURRY EXPLOSIVE CORPORATION, OKLAHOMA CITY, OK:
2,730,192, INT. CL. 13.
- SMALL WORLD TOYS, CULVER CITY, CA:
1,268,062, REN. 5-13-03. INT. CL. 28.
- SMART COMPANY OF AMERICA, INC., NEW YORK, NY:
1,990,911, CANC. MULTIPLE CLASS, INT. CLS. 21, 24, 25 AND 27.
- SMART INVENTIONS, INC., PARAMOUNT, CA:
2,728,670, PUB. 4-1-2003. MULTIPLE CLASS, INT. CLS. 16, 21, 24 AND 35.
- SMART STORAGE, INC., ANDOVER, MA:
1,992,060, CANC. INT. CL. 9.
- SMARTCOMS, INC., LYNN, MA:
2,728,939, PUB. 4-1-2003. INT. CL. 38.
- SMEAD MANUFACTURING COMPANY, HASTINGS, MN:
2,730,384, INT. CL. 16.
- SMITH & LOVELESS, INC., LENEXA, KS, SMITH & LOVELESS, INC., LENEXA, KS:
1,231,781, REN. 5-13-03. INT. CL. 11.
- SMITH & LOVELESS, INC., LENEXA, KS:
2,730,329, INT. CL. 11.
- SMITH BROTHERS ROPING SUPPLIES INC., DENTON, TX:
1,204,090, CANC. INT. CL. 42.
- SMITH, MICHAEL A., COLUMBUS, OH:
2,729,390, INT. CL. 14.
- SMITHERS-OASIS COMPANY, CUYAHOGA FALLS, OH:
2,730,876, INT. CL. 21.
- SMITHKLINE BEECHAM BIOLOGICALS S.A., RIXENSART, BELGIUM:
2,730,703, INT. CL. 5.
- SMITHKLINE BEECHAM CORPORATION, PHILADELPHIA, PA:
1,992,009, CANC. INT. CL. 21.
- SMYERS, DANIEL J, BOXBOROUGH, MA:
2,729,213, PUB. 4-1-2003. INT. CL. 19.
- SNACKS TO YOU, INC., HANOVER, PA:
2,730,100, INT. CL. 40.
- SNAP-ON TECHNOLOGIES, INC., LINCOLNSHIRE, IL, SNAP-ON TOOLS CORPORATION, KENOSHA, WI:
1,763,791, REN. 5-16-03. INT. CL. 35.
- SNE ENTERPRISES, INC., MOSINEE, WI:
1,816,315, REN. 5-16-03. MULTIPLE CLASS, INT. CLS. 6 AND 19.
- SNOWDEN, WILLIAM C. III, HYANNIS, MA:
1,991,963, CANC. INT. CL. 32.
- SNYDER, PAUL E., MIAMI, FL:
2,730,639, INT. CL. 11.
- SOA, INC., PROVIDENCE, RI, SOFTAL OF AMERICA, INC., PAWTUCKET, RI:
1,711,364, REN. 5-14-03. INT. CL. 9.
- SOCIAL ENTERPRISE, INC., SAN RAFAEL, CA:
2,729,770, MULTIPLE CLASS, INT. CLS. 9 AND 36.
- SOCIAL ENTERPRISES, INC., SAN RAFAEL, CA:
2,729,943, MULTIPLE CLASS, INT. CLS. 9 AND 36.
- SOCIAL SOLUTIONS, INC., HALF MOON BAY, CA:
2,730,585, INT. CL. 35.
- SOCIEDAD AGRICOLA LO ARCAJA LTDA., SANTIAGO, CHILE:
2,728,583, PUB. 6-11-2002. INT. CL. 33.
- SOCIETE ANONYME, COMPAGNIE FRANCAISE DES PARFUMS D'ORSAY, LA COURNEUVE, FRANCE:
397,545, REN. 5-12-03. U.S. CL. 51 (INT. CL. 3).
- SOCIETE D'EDITIONS MODERNES PARISIENNE SEMP, PARIS, FRANCE:
1,203,415, CANC. MULTIPLE CLASS, INT. CLS. 9, 16 AND 41.

- SOCIETE DE PARTICIPATIONS ET D'INVESTISSEMENTS DE MOTELS, 75755 PARIS CEDEX 15, FRANCE: 2,729,575, INT. CL. 42.
- SOCIETE DES PRODUITS MARNIER-LAPOSTOLLE, 75008 PARIS, FRANCE: 1,235,379, REN. 5-10-03, INT. CL. 30.
- SOCIETE DES PRODUITS NESTLE S.A., 1800, VEVEY, SWITZERLAND: 735,738, CANC. U.S. CL. 46.
- SOCIETE DES PRODUITS NESTLE S.A., VEVEY, SWITZERLAND: 1,203,793, CANC. INT. CL. 30.
- SOCIETE PACO RABANNE, PARIS, FRANCE TO PACO RABANNE PARFUMS, NEUILLY SUR SEINE (HAUTS DE SEINE), FRANCE: 1,231,974, AM. MULTIPLE CLASS, INT. CLS. 24 AND 25.
- SOCIETY OF INDEPENDENT GASOLINE MARKETERS OF AMERICA, RESTON, VA: 1,705,627, CANC. INT. CL. 42.
- SOCIETY OF MEXICAN AMERICAN ENGINEERS AND SCIENTISTS, THE, SANTA ANA, CA: 2,728,760, PUB. 4-1-2003, INT. CL. 41.
- SOFTWARE DYNAMICS, INCORPORATED, CHATSWORTH, CA: 1,990,933, CANC. INT. CL. 9.
- SOFTWARE PARTNERS/32, INC., TOPSFIELD, MA: 1,704,725, CANC. INT. CL. 9.
- SOFTWARE TOOLWORKS, LTD., THE, SHERMAN OAKS, CA, AKA THE SOFTWARE TOOLWORKS: 1,203,423, CANC. INT. CL. 9.
- SOL SCHARGEL, INC., NEW YORK, NY: 1,704,844, CANC. INT. CL. 14.
- SOLA INTERNATIONAL INC., SUNNYVALE, CA: 2,729,935, INT. CL. 35.
- SOLGAR CO., INC., LYNBROOK, NY: 1,203,306, CANC. INT. CL. 5.
- SOLO CUP COMPANY, HIGHLAND PARK, IL, SOLO CUP COMPANY, URBANA, IL: 960,679, REN. 5-13-03, MULTIPLE CLASS, U.S. CLS. 2 (INT. CLS. 16 AND 20) AND 50 (INT. CL. 16).
- SOLO CUP COMPANY, HIGHLAND PARK, IL: 1,754,846, REN. 5-14-03, MULTIPLE CLASS, INT. CLS. 6 AND 21.
- SOLO, ALAN J., BROOKLYN, NY: 1,991,927, CANC. INT. CL. 18.
1,992,095, CANC. INT. CL. 18.
- SOLUTIA INC., ST. LOUIS, MO, MONSANTO CHEMICAL COMPANY, ST. LOUIS 4, MO: 571,615, REN. 5-10-03, U.S. CL. 6 (INT. CL. 1).
- SONY CORPORATION, TOKYO, JAPAN: 1,991,662, CANC. INT. CL. 9.
- SONY MUSIC ENTERTAINMENT INC., NEW YORK, NY: 1,991,883, CANC. INT. CL. 9.
- SOREMARTEC S.A., 6700 SCHOPPACH-ARLON, BELGIUM: 2,652,121, COR. INT. CL. 30.
- SORENSEN MEDIA, INC., SALT LAKE CITY, UT: 2,729,675, INT. CL. 38.
- SORTINO, FRANK, MENLO PARK, CA: 1,992,160, CANC. INT. CL. 9.
- SOUND INVENTIONS, INC., LYNNWOOD, WA: 1,991,781, CANC. INT. CL. 21.
- SOUND PRESS LLC, THE, CINCINNATI, OH: 2,730,170, MULTIPLE CLASS, INT. CLS. 9 AND 41.
- SOUNDTUBE ENTERTAINMENT, INC., PARK CITY, UT: 2,729,952, INT. CL. 9.
- SOUTH CITY MANAGEMENT GROUP II, LLC, ATLANTA, GA: 2,730,247, INT. CL. 42.
2,730,400, INT. CL. 42.
- SOUTH COAST TUMOR INSTITUTE, SAN DIEGO, CA: 1,991,760, CANC. INT. CL. 9.
- SOUTH MILL MUSHROOM SALES, INC., KENNETT SQUARE, PA: 2,729,847, INT. CL. 31.
- SOUTHEAST CASKET DISTRIBUTORS AND FUNERAL SUPPLIES, INC., MACON, GA: 2,730,604, INT. CL. 20.
- SOUTHEASTERN UNITED MEDIGROUP, INC., LOUISVILLE, KY: 1,991,565, CANC. INT. CL. 36.
- SOUTHERN BUSINESS COMMUNICATIONS, INC., NORCROSS, GA: 2,730,156, INT. CL. 35.
- SOUTHERN MARYLAND ELECTRIC COOPERATIVE, INC., HUGHESVILLE, MD: 1,705,465, CANC. INT. CL. 39.
- SOUTHERN SALES & MARKETING GROUP, INC., ATLANTA, GA: 2,729,908, MULTIPLE CLASS, INT. CLS. 18 AND 22.
- SOUTHERN STATES COOPERATIVE, INCORPORATED, RICHMOND, VA: 2,729,565, INT. CL. 35.
- SOUTHPAW TRADING LTD., CORTLANDT MANOR, NY: 2,729,023, PUB. 4-1-2003, INT. CL. 25.
2,729,024, PUB. 4-1-2003, INT. CL. 25.
- SOUTHWALL TECHNOLOGIES INC., PALO ALTO, CA: 1,826,355, REN. 5-15-03, INT. CL. 17.
- SOUTHWORTH COMPANY, AGAWAM, MA, FOX RIVER PAPER COMPANY, APPLETON, WI: 1,771,407, REN. 5-16-03, INT. CL. 16.
1,792,564, REN. 5-16-03, INT. CL. 16.
- SOVEX NATURAL FOODS, INC., COLLEGEDALE, TN: 1,991,845, CANC. INT. CL. 30.
- SOYA FASHIONS INC., NEW YORK, NY: 1,992,176, CANC. INT. CL. 25.
- SPACESAVER CORPORATION, FORT ATKINSON, WI: 2,730,472, INT. CL. 20.
- SPACETEC IMC CORPORATION, LOWELL, MA: 1,991,854, CANC. INT. CL. 9.
- SPANWORKS, INC., SAN RAMON, CA: 2,729,956, INT. CL. 9.
- SPARLING, INC., SEATTLE, WA: 1,805,580, REN. 5-16-03, INT. CL. 42.
1,808,174, REN. 5-16-03, INT. CL. 42.
- SPC RESOURCES, INC., WILMINGTON, DE: 2,730,070, INT. CL. 19.
- SPECIALTIES INC., MURRAY, UT, DBA POWER GAMES INTERNATIONAL: 1,992,675, CANC. INT. CL. 16.
- SPECIALTY FINANCIAL, RENO, NV: 2,729,925, INT. CL. 36.
- SPECTRUM CONTROL, INC., ERIE, PA: 2,728,643, PUB. 4-1-2003, INT. CL. 9.
- SPECTRUM FINANCIAL SOLUTIONS, LLC., RED BANK, NY: 2,730,145, INT. CL. 36.
- SPEEDBAR, INC., GRAND CAYMAN, CAYMAN ISLANDS: 1,704,811, CANC. INT. CL. 12.
- SPEEDLINE TECHNOLOGIES, INC., FRANKLIN, MA: 2,730,780, INT. CL. 9.
- SPEEDWISE, LLC, DOUGLAS, MI: 2,728,900, PUB. 4-1-2003, INT. CL. 40.
- SPEIRS, GREGORY, BRONXVILLE, NY: 2,729,402, INT. CL. 25.
- SPENCE TRANSPORTATION, INC., MARLBOROUGH, MA: 2,730,291, INT. CL. 39.
- SPENCER; ANNETTE, MARGATE, FL, DBA YOUNG FOLKS' 2ND TIME AROUND: 1,204,040, CANC. INT. CL. 42.
- SPENGMANN, BRIAN F., ST. LOUIS, MO: 2,729,684, INT. CL. 36.
- SPERRY MARINE INC., CHARLOTTESVILLE, VA: 1,990,645, CANC. INT. CL. 9.
- SPICE ENTERTAINMENT, INC., CHICAGO, IL: 2,729,537, INT. CL. 9.
- SPICE TIME FOODS, INC., BROOKLYN, NY: 1,204,164, CANC. INT. CL. 30.
- SPIDER COURT, INC., WINDSOR, ONTARIO, CANADA: 2,729,938, INT. CL. 19.
- SPINAL CONCEPTS, INC., AUSTIN, TX: 2,729,308, PUB. 4-1-2003, INT. CL. 10.
- SPINUSA, INC., CARLISLE, MA: 2,728,666, PUB. 4-1-2003, INT. CL. 41.
2,728,667, PUB. 4-1-2003, INT. CL. 41.

- SPORTS AUTHORITY MICHIGAN, INC., THE, FORT LAUDERDALE, FL:
2,729,853, INT. CL. 35.
- SPORTS EXPRESS, L.L.C., HOUSTON, TX:
2,730,054, MULTIPLE CLASS, INT. CLS. 35 AND 39.
- SPORTS SIMULATION INC., NEW YORK, NY:
1,991,489, CANC. INT. CL. 28.
- SPORTSAIR, INC., DALLAS, TX:
2,729,345, PUB. 4-1-2003. INT. CL. 25.
- SPOTLIFE INC., SAN MATEO, CA TO RUBICON SOFTWARE, INC., SAN FRANCISCO, CA:
2,688,972, COR. INT. CL. 38.
- SPRAGUE ENERGY CORPORATION, PORTSMOUTH, NH:
2,729,505, INT. CL. 4.
- SPRAYING SYSTEMS COMPANY, WHEATON, IL:
2,659,939, COR. INT. CL. 9.
- SPRAYMAX, INC., TYLER, TX:
2,729,210, PUB. 4-1-2003. INT. CL. 37.
- SPRINGS INDUSTRIES, INC., FORT MILL, SC:
1,705,082, CANC. INT. CL. 24.
- SPRINT CORPORATION, WESTWOOD, KS:
1,705,446, CANC. INT. CL. 38.
- SPS TECHNOLOGIES, INC., JENKINTOWN, PA, STANDARD PRESSED STEEL COMPANY, JENKINTOWN, PA:
301,583. REN. 5-10-03. U.S. CL. 13 (INT. CL. 6).
- SPY OPTIC, INC., CARLSBAD, CA:
1,992,057, CANC. INT. CL. 9.
- SRAM CORPORATION, CHICAGO, IL FROM ROCKSHOX, INC., COLORADO SPRINGS, CO:
2,730,510, INT. CL. 12.
- SRL, INC., CAMBRIDGE, MA:
1,991,848, CANC. INT. CL. 25.
- SRS HOTELS STEINGENBERGER RESERVATION SERVICE, INC., NEW YORK, NY:
1,990,749, CANC. INT. CL. 35.
- SRS LABS, INC., SANTA ANA, CA:
2,728,752, PUB. 4-1-2003. INT. CL. 9.
- SSANG YONG MOTOR COMPANY, KYUNGGI-DO, REPUBLIC OF KOREA:
2,730,662, INT. CL. 12.
- ST. CROIX COLLECTIBLES, INC., HUDSON, WI:
2,730,304, INT. CL. 16.
- ST. JOE COMPANY, THE, JACKSONVILLE, FL:
2,729,880, INT. CL. 41.
- ST. LAURENT PAPER PRODUCTS CORP., WEST POINT, VA:
1,704,958, CANC. INT. CL. 16.
- ST. NICHOLAS MUSIC INC., NEW YORK, NY:
2,728,719, PUB. 4-1-2003. INT. CL. 35.
2,728,720, PUB. 4-1-2003. INT. CL. 35.
- STA-RITE INDUSTRIES, INC., DELAVAN, WI:
1,991,680, CANC. INT. CL. 9.
- STAF MANUFACTURING, INC., PHOENIX, AZ:
2,729,189, PUB. 4-1-2003. INT. CL. 6.
- STAG'S LEAP WINE CELLARS, NAPA, CA:
1,795,197. REN. 5-10-03. INT. CL. 33.
- STANDARD CHARTERED PLC, LONDON, EC2V 7SB, ENGLAND:
2,667,489, COR. INT. CL. 36.
- STANDARD PROCESS INC., PALMYRA, WI:
2,730,337, INT. CL. 5.
- STANDARD REGISTER COMPANY, THE, DAYTON, OH:
1,992,123, CANC. INT. CL. 9.
- STANLEY ELECTRIC CO., LTD., MEGURO-KU, TOKYO, JAPAN:
2,729,869, INT. CL. 9.
- STANLEY WORKS, THE, NEW BRITAIN, CT:
1,990,775, CANC. INT. CL. 9.
1,991,675, CANC. INT. CL. 9.
- STANTON, ALBERT C. JR., ANNAPOLIS, MD:
2,730,365, INT. CL. 25.
- STAR CUTTER COMPANY, FARMINGTON HILLS, MI:
2,729,460, MULTIPLE CLASS, INT. CLS. 2, 7 AND 10.
- STAR INDUSTRIES, INC., SYOSETT, NY:
1,785,753. REN. 5-16-03. INT. CL. 33.
1,786,955. REN. 5-16-03. INT. CL. 33.
- STAR-KIST FOODS, INC., NEWPORT, KY:
1,991,987, CANC. INT. CL. 31.
1,991,988, CANC. INT. CL. 31.
- STARCRAFT CORPORATION, GOSHEN, IN:
2,728,999, PUB. 4-1-2003. INT. CL. 12.
- STARKEY LABORATORIES, INC., EDEN PRAIRIE, MN:
2,729,113, PUB. 4-1-2003. INT. CL. 10.
2,729,114, PUB. 4-1-2003. INT. CL. 10.
2,729,116, PUB. 4-1-2003. INT. CL. 10.
2,729,117, PUB. 4-1-2003. INT. CL. 10.
- STARLIGHT RUNNER ENTERTAINMENT, INC., NEW YORK, NY:
2,729,736, INT. CL. 41.
- STARLITE MEDIA LLC, NEW YORK, NY:
2,730,357, INT. CL. 35.
- STARS RESTAURANTS CORP., OKLAHOMA CITY, OK:
2,730,629, INT. CL. 42.
- STATE OF MIND MUZIC, ATLANTA, GA:
2,730,762, INT. CL. 41.
- STATE STREET BOSTON CORPORATION, BOSTON, MA:
1,992,030, CANC. INT. CL. 36.
- STATE STREET CORPORATION, BOSTON, MA:
2,729,339, PUB. 4-1-2003. INT. CL. 36.
- STATE STREET RESEARCH & MANAGEMENT COMPANY, BOSTON, MA:
2,730,363, INT. CL. 36.
- STATHOULIS, JOANNE, DOWNEY, CA, DBA FRISCO'S CAR HOP DRIVE-IN:
2,728,453, PUB. 8-9-1994. INT. CL. 42.
- STAVO INDUSTRIES, INC., KINGSTON, NY, DBA ALSOP ENGINEERING COMPANY:
1,738,196. REN. 5-14-03. INT. CL. 11.
- STD MANUFACTURING, LTD., KWAI CHUNG, N.T, HONG KONG:
2,729,550, INT. CL. 9.
- STEELE, CODY, SOLANA BEACH, CA:
2,729,791, INT. CL. 25.
- STEELTORCH SOFTWARE, INC., NASHUA, NH:
2,729,969, INT. CL. 9.
- STEIN ROE INVESTMENT COUNSEL LLC, CHICAGO, IL:
2,730,177, INT. CL. 36.
- STELLA GUAPA, INC., BEVERLY HILLS, CA:
2,729,409, INT. CL. 3.
- STENAU, GEORG, D-41460 NEUSS, FED REP GERMANY, DBA ELYSIAN ACCESSORIES GEORG STENAU:
1,990,913, CANC. INT. CL. 26.
- STENFELDT, JAMES L., CARBON CLIFF, IL:
1,991,337, CANC. INT. CL. 41.
- STEP 2 COMPANY, THE, STREETSBORO, OH, STEP 2 CORPORATION, TWINSBURG, OH:
1,756,878. REN. 5-14-03. INT. CL. 20.
- STERI-LUBE INTERNATIONAL, LTD., SCOTTSDALE, AZ:
1,991,368, CANC. INT. CL. 4.
- STERIDYNE CORPORATION, RIVIERA BEACH, FL:
1,705,809, CANC. INT. CL. 10.
- STERIS INC., TEMECULA, CA, VESTAL LABORATORIES, INC., ST. LOUIS, MO:
746,348. REN. 5-16-03. U.S. CL. 52 (INT. CL. 3).
- STERLING FINANCIAL CORPORATION, SPOKANE, WA:
1,992,182, CANC. INT. CL. 36.
- STERLING INDUSTRIES PLC., LONDON EL 9AR, ENGLAND:
1,727,039. REN. 5-10-03. INT. CL. 7.
- STERLING MANUFACTURING COMPANY, INC., RIVERTON, KS, INDUSTRIAL MAINTENANCE AND MACHINING, INC., MIAMI, OK:
1,777,642. REN. 5-16-03. INT. CL. 7.
- STERN, IVAN, STRUCKHAUSEN 27, FED REP GERMANY AND KING, WILLIAM STEVENSON, STRUCKHAUSEN 27, FED REP GERMANY:
1,991,517, CANC. MULTIPLE CLASS, INT. CLS. 9 AND 42.
- STEVENS-KNOX & ASSOCIATES, INC., NEW YORK, NY:
1,992,037, CANC. INT. CL. 9.
- STEVENSON, RICHARD L., NEWPORT BEACH, CA:
2,729,457, INT. CL. 3.
- STEVERSON; LUTHER S., NEW HEBRON, MS:
1,203,642, CANC. INT. CL. 25.

- STILTENDE GENIUS S.R.L., I-44012 BONDENO (FE), ITALY:
2,729,381, INT. CL. 24.
- STO CORP., ATLANTA, GA:
2,730,188, INT. CL. 2.
- STODDARD, PAMELA NOLIE, PLACERVILLE, CA:
2,730,081, INT. CL. 35.
- STOKES, ABIGAIL, NEW YORK, NY:
2,728,517, PUB. 4-1-2003. MULTIPLE CLASS, INT. CLS. 35 AND 41.
- STOLLER WHOLESALE WINES & SPIRITS, INC., FRANKLIN PARK, IL:
2,729,668, INT. CL. 33.
- STOLTZ, DENA K., LORRAINE, KS, DBA APEX INNOVATIONS:
2,729,272, PUB. 4-1-2003. INT. CL. 16.
- STONE BENNETT CORPORATION, CARROLLTON, TX:
1,705,785, CANC. INT. CL. 9.
- STONE, JOSEPH LOUIS, DAVIE, FL:
2,730,947, INT. CL. 9.
- STORELLI, JOHN, FORT LAUDERDALE, FL:
2,729,910, INT. CL. 28.
- STOSIC, ILIJA, HONOLULU, HI:
1,991,448, CANC. INT. CL. 25.
- STRASBURGER ENTERPRISES, INC., TEMPLE, TX:
1,990,612, CANC. INT. CL. 32.
- STRATEGIC BRANDS INTERNATIONAL LLC, WESTPORT, CT:
2,730,221, INT. CL. 3.
- STRATIFY, INC., MOUNTAIN VIEW, CA FROM PURPLEYOGI, INC., MOUNTAIN VIEW, CA:
2,730,284, MULTIPLE CLASS, INT. CLS. 9 AND 42.
- STRAWBRIDGE & CLOTHIER, PHILADELPHIA, PA:
1,991,425, CANC. INT. CL. 42.
- STREET CHARACTERS, INC., CALGARY, ALBERTA, CANADA:
1,782,874, REN. 5-12-03. MULTIPLE CLASS, INT. CLS. 35, 37, 40, 41 AND 42.
- STREULI SALES, INC., COLFAX, NC:
2,729,674, INT. CL. 19.
- STROH BREWERY COMPANY, THE, DETROIT, MI:
1,203,815, CANC. INT. CL. 32.
1,990,977, CANC. INT. CL. 32.
1,991,784, CANC. INT. CL. 32.
- STROHL & ASSOCIATES, INC., MUNSTER, IN:
1,992,026, CANC. INT. CL. 25.
- STRUCTURAL DESKTOP INCORPORATED, VAN BUREN, AR FROM BURROUGH-BRASUELL CORP., VAN BUREN, AR:
2,729,841, INT. CL. 9.
- STUDIO RTA, INC., PICO RIVERA, CA:
2,728,647, PUB. 4-1-2003. INT. CL. 20.
- STURIALE, NITA, CAMBRIDGE, MA:
2,729,155, PUB. 4-1-2003. INT. CL. 42.
- STYROTECH, INC., MINNEAPOLIS, MN:
1,990,750, CANC. INT. CL. 40.
- SUBERI BROTHERS, INC., NEW YORK, NY:
1,704,847, CANC. INT. CL. 14.
- SUD-CHEMIE A.G., 80333 MUENCHEN, FED REP GERMANY:
747,435, REN. 5-10-03. U.S. CL. 6 (INT. CL. 1).
- SUMITOMO RUBBER INDUSTRIES, LTD., KOBE-SHI, HYOGO, JAPAN:
1,777,149, REN. 5-13-03. INT. CL. 12.
- SUMMERS-ARMSTRONG, SHONDRA, LAS VEGAS, NV:
2,730,590, INT. CL. 25.
- SUMMIT SEED, INC., MANTENO, IL:
2,730,246, INT. CL. 1.
- SUMMIT TECHNOLOGY, INC., WALTHAM, MA:
1,991,778, CANC. INT. CL. 42.
- SUN COAST, INC., MYRTLE BEACH, SC:
1,991,357, CANC. INT. CL. 9.
- SUN FUNG ELECTRONICS CO., LTD., FO TAN, SHATIN, N.T., HONG KONG:
1,990,973, CANC. INT. CL. 9.
- SUN INTERNATIONAL NORTH AMERICA, INC.:
See—KERZNER INTERNATIONAL NORTH AMERICA, INC..
- SUN MOUNTAIN SPORTS, INC., MISSOULA, MT:
1,992,020, CANC. INT. CL. 28.
- SUN TOME TRADING CORP., LOS ANGELES, CA:
2,729,141, PUB. 4-1-2003. INT. CL. 12.
- SUN-MAID GROWERS OF CALIFORNIA, KINGSBURG, CA, SUN-MAID RAISIN GROWERS, FRESNO, CA:
178,829, REN. 5-12-03. U.S. CL. 46 (INT. CLS. 29 AND 30).
- SUNBEAM PRODUCTS, INC., BOCA RATON, FL, SUNBEAM CORPORATION, PITTSBURGH, PA:
1,755,142, REN. 5-15-03. INT. CL. 11.
- SUNBEAM PRODUCTS, INC., FT. LAUDERDALE, FL:
1,991,264, CANC. INT. CL. 11.
- SUNEX INTERNATIONAL, INC., GREENVILLE, SC:
2,730,332, MULTIPLE CLASS, INT. CLS. 3 AND 7.
- SUNKIST GROWERS, INC., SHERMAN OAKS, CA:
2,728,834, PUB. 4-1-2003. INT. CL. 39.
- SUNPENTOWN INTERNATIONAL INC., CITY OF INDUSTRY, CA:
2,729,665, INT. CL. 11.
- SUNRISE INCORPORATED, TOKYO, JAPAN:
2,669,350, CANC. IIRN. RESTORED TO S.N. 78-115,902.
- SUNSET CONGLOMERATE RESTAURANTS, INC., WEST HOLLYWOOD, CA:
2,463,968, COR. INT. CL. 42.
2,575,324, COR. INT. CL. 42.
- SUNSHINE DAYCARE CENTER, TEMPLE HILLS, MD:
2,729,951, INT. CL. 42.
- SUNX LIMITED, KASUGAI-SHI, AICHI, JAPAN, SUNX KABUSHIKI KAISHA, TACHIKAWA-SHI, TOKYO, JAPAN:
1,229,406, REN. 5-13-03. INT. CL. 9.
- SUPER BOUNCE, INC., HOUSTON, TX:
2,729,140, PUB. 4-1-2003. INT. CL. 35.
- SUPERIOR ACCESS INSURANCE SERVICES, INC., IRVINE, CA:
2,728,486, PUB. 4-1-2003. INT. CL. 36.
- SUPERIORLAND SKI CLUB, MARQUETTE, MI:
2,728,664, PUB. 4-1-2003. INT. CL. 41.
- SUPERTRAPP INDUSTRIES, INC., WEST SACRAMENTO, CA:
1,756,442, REN. 5-16-03. INT. CL. 12.
1,756,442, CANC. INT. CL. 7.
- SUPPLEE, JOHN, STERLING, VA, DBA THE SUPPLEE GROUP:
2,729,503, INT. CL. 35.
- SUPPLY RESOURCES INC., NEW YORK, NY:
735,711, CANC. U.S. CL. 40.
- SUPPLY TECH, INC., ANN ARBOR, MI:
1,705,767, CANC. INT. CL. 9.
- SUPPORTKIDS, INC., AUSTIN, TX:
2,730,155, INT. CL. 36.
- SUPPORTSOFT, INC., REDWOOD CITY, CA FROM SERVICE911.COM, INC., DALLAS, TX:
2,729,784, INT. CL. 42.
- SURE-SEAL, LLC, TACOMA, WA:
2,728,794, PUB. 4-1-2003. INT. CL. 11.
- SURFACEEXCHANGE, INC. DBA FLOORUNIVERSE, INC.:
See—FLOORUNIVERSE, INC..
- SURFCONTROL PLC, CONGLETON, CHESHIRE, UNITED KINGDOM:
2,728,569, PUB. 4-1-2003. INT. CL. 9.
- SURF2THIS, INC., WAUKESHA, WI FROM WALLACEBRENT CORPORATION, WAUKESHA, WI:
2,730,650, MULTIPLE CLASS, INT. CLS. 9, 41 AND 42.
- SURGICAL SOLUTIONS LLC, VALENCIA, CA:
2,730,405, INT. CL. 10.
- SURVIVOR PRODUCTIONS, LLC, LOS ANGELES, CA:
2,730,028, INT. CL. 9.
- SUSPA HOLDING GMBH, D-90518 ALTENDORF, FED REP GERMANY, SUSPA FEDERUNGSTECHNIK G.M.B.H., 8503 ALTENDORF, NEAR NURNBERG, FED REP GERMANY:
954,853, REN. 5-15-03. MULTIPLE CLASS, U.S. CLS. 13 (INT. CL. 6) AND 23 (INT. CL. 7).
- SUSUMU COMPANY, LTD., KYOTO, JAPAN:
1,764,073, REN. 5-11-03. INT. CL. 9.

- SUTTER HOME WINERY, ST. HELENA, CA, DBA TRINCHERO FAMILY ESTATES:
2,729,881, INT. CL. 33.
- SUZUKI MOTOR CORPORATION, SHIZUOKA-PREF. 432-8611, JAPAN:
2,730,248, INT. CL. 12.
- SUZUKI, MINORU, NEWPORT BEACH, CA:
1,990,894, CANC. INT. CL. 28.
- SWAN SPEAKER SYSTEM INC., MONTEREY PARK, CA:
2,730,659, INT. CL. 9.
- SWANSON VINEYARDS & WINERY, INC., OAKVILLE, CA, DBA SWANSON VINEYARDS:
1,757,123, REN. 5-14-03, INT. CL. 33.
- SWARTZ, HENRY LEE, INDIANAPOLIS, IN:
2,728,828, PUB. 4-1-2003, INT. CL. 41.
- SWEAT XPRESS, LTD., MYRTLE BEACH, SC:
1,987,238, CANC. INT. CL. 41.
- SWEDE-O, INC., NORTH BRANCH, MN:
2,730,394, INT. CL. 10.
- SWEDISH WOMEN'S EDUCATIONAL ASSOCIATION INTERNATIONAL, INC., LAS VEGAS, NV, SWEDISH WOMEN'S EDUCATIONAL ASSOCIATION, RANCHO PALOS VERDES, CA:
1,230,581, REN. 5-16-03, INT. CL. 42.
- SWEETHEART CUP COMPANY, INC., OWINGS MILLS, MD, OWENS-ILLINOIS, INC., TOLEDO, OH:
958,351, REN. 5-16-03, U.S. CL. 2 (INT. CL. 21).
- SWIMC, INC., WILMINGTON, DE, SHERWIN-WILLIAMS COMPANY, THE, CLEVELAND, OH:
1,756,325, REN. 5-16-03, INT. CL. 2.
- SWISS PRETZEL SHOPS, INC., SOUTHFIELD, MI:
1,991,681, CANC. INT. CL. 30.
- SYLVAN LEARNING SYSTEMS, BALTIMORE, MD, SYLVAN KEE SYSTEMS, INC., COLUMBIA, MD:
1,812,607, REN. 5-10-03, INT. CL. 16.
- SYMPHONIE, 76460 SAINT VALERY EN CAUX, FRANCE:
2,634,738, COR. INT. CL. 30.
- SYMTRON TECHNOLOGY, INC., TAIPEI, TAIWAN:
2,730,580, INT. CL. 9.
2,730,581, INT. CL. 9.
2,730,582, INT. CL. 9.
2,730,607, INT. CL. 9.
- SYNCFUSION, INC., CARY, NC:
2,730,409, INT. CL. 9.
- SYNERGY INTERNATIONAL, INC., WAUKESHA, WI:
1,704,563, CANC. INT. CL. 7.
- SYNOPSIS, INC., MOUNTAIN VIEW, CA:
1,992,079, CANC. MULTIPLE CLASS, INT. CLS. 35 AND 42.
- SYNTU TECHNOLOGIES CORPORATION, EDEN PRAIRIE, MN:
1,990,817, CANC. INT. CL. 9.
- SYSCO CORPORATION, HOUSTON, TX:
1,991,574, CANC. INT. CL. 29.
2,032,725, CANC. MULTIPLE CLASS, INT. CLS. 16 AND 20.
2,728,452, PUB. 4-1-2003, MULTIPLE CLASS, INT. CLS. 25, 29, 30 AND 35.
2,728,941, PUB. 4-1-2003, INT. CL. 30.
- SYSTEM INTEGRATORS, INC, SACRAMENTO, CA:
1,990,722, CANC. INT. CL. 9.
- SYSTEMS AFFILIATES, LTD., CHICAGO, IL:
1,991,874, CANC. INT. CL. 25.
- T & J ENTERPRISES, L.L.C., MORGAN CITY, LA:
2,728,885, PUB. 4-1-2003, INT. CL. 37.
- T & L NIFTY PRODUCTS, INC., BRAHAM, MN, T & L TURKEY LIFTER, INC., CIRCLE PINES, MN:
1,723,856, REN. 5-16-03, INT. CL. 21.
- T.A.C. GROUP, INC., WESTWOOD, MA, JONES APPAREL GROUP, INC., BRISTOL, PA:
1,209,790, REN. 5-14-03, INT. CL. 25.
- T.I. & ASSOCIATES, WILLOUGHBY HILLS, OH:
2,729,180, PUB. 4-1-2003, INT. CL. 22.
- T.W. ENTERPRISES, LTD., ST. CLOUD, MN FROM T.W. ENTERPRISES, LTD., ST. CLOUD, MN:
2,730,160, INT. CL. 3.
- T-SHOP, INC., BIRMINGHAM, AL:
1,705,437, CANC. INT. CL. 37.
- T-SYSTEMS INTERNATIONAL, INC., SAN DIEGO, CA:
1,652,307, AM. INT. CL. 11.
- T/M INDUSTRIAL SUPPLY, INC., ERIE, PA:
1,754,887, REN. 5-14-03, INT. CL. 7.
- TAB PRODUCTS CO., PALO ALTO, CA:
1,203,520, CANC. INT. CL. 16.
- TABLE TOYS, INC., HOUSTON, TX:
1,990,950, CANC. INT. CL. 20.
- TAC HOLDINGS, INC., FT. WORTH, TX:
1,991,102, CANC. INT. CL. 16.
- TACO TIME INTERNATIONAL, INC., PORTLAND, OR:
1,991,575, CANC. INT. CL. 21.
- TAHARI, ELIE, NEW YORK, NY:
2,730,541, MULTIPLE CLASS, INT. CLS. 14, 18, 25 AND 35.
- TAIWAN HOPAX CHEMICALS MANUFACTURING COMPANY LIMITED, FENG SHAN, KAOHSIUNG, TAIWAN:
1,991,631, CANC. INT. CL. 16.
- TAIWAN HOPAX CHEMICALS MFG. CO., LTD., KAOHSIUNG, TAIWAN:
2,730,058, INT. CL. 16.
- TAIWAN PET COMB ENTERPRISES CO., LTD., CHANGHUA, HSIEN, TAIWAN:
2,730,260, MULTIPLE CLASS, INT. CLS. 8 AND 21.
- TAKARA SHUZO, CO., LTD., FUSHIMI-KU, KYOTO, JAPAN:
2,729,658, INT. CL. 33.
- TALK TEENS, INC., CORAL GABLES, FL:
2,729,470, INT. CL. 41.
- TAMBORINE ENTERTAINMENT AMERICA, INC., NEW YORK, NY FROM MS ARTIST PRODUCTS, INC., SHINJUKU-KU TOKYO 160, JAPAN:
2,728,510, PUB. 4-1-2003, MULTIPLE CLASS, INT. CLS. 16 AND 41.
- TAMMES, BARBARA, 1066 DJ AMSTERDAM, NETHERLANDS:
2,728,655, PUB. 4-1-2003, MULTIPLE CLASS, INT. CLS. 3, 30 AND 32.
- TANGO TWIRL CO., SEATTLE, WA:
2,728,870, PUB. 4-1-2003, INT. CL. 16.
- TAPCO INTERNATIONAL, INC., HOUSTON, TX:
2,730,852, INT. CL. 7.
- TARAC AUSTRALIA PTY LTD, NURIOOTPA, SOUTH AUSTRALIA, AUSTRALIA:
2,728,596, PUB. 6-11-2002, MULTIPLE CLASS, INT. CLS. 3, 5, 29, 30 AND 32.
- TARRAGO BRANDS, S.L., 08240 MANRESA (BARCELONA), SPAIN, TARRAGO GRACIA, JOAQUIN, MANRESA (BARCELONA), SPAIN:
1,757,856, REN. 5-16-03, INT. CL. 2.
- TASH INTERNATIONAL INC., AJAX, ONTARIO, CANADA, TASH INC., TORONTO, ONTARIO, CANADA:
1,229,391, REN. 5-14-03, INT. CL. 9.
- TASTY BAKING COMPANY, PHILADELPHIA, PA:
1,991,716, CANC. INT. CL. 30.
- TAYLOR ENVIRONMENTAL PRODUCTS, INC., LOUISVILLE, MS:
1,991,767, CANC. INT. CL. 1.
- TAYLOR MADE ENVIRONMENTAL, INC., RICHMOND, VA, MARINE DEVELOPMENT COMPANY, RICHMOND, VA:
745,464, REN. 5-13-03, U.S. CL. 34 (INT. CL. 11).
- TCBY ENTERPRISES, INC., LITTLE ROCK, AR:
1,757,078, REN. 5-11-03, INT. CL. 30.
- TE MATA ESTATE WINERY LIMITED, HAVELOCK NORTH, NEW ZEALAND:
2,728,625, PUB. 1-7-2003, INT. CL. 33.
- TEA GARDEN SPRINGS, MILL VALLEY, CA:
2,001,126, CANC. INT. CL. 42.
- TEAL RIVER INDUSTRIES, MILWAUKEE, WI:
1,991,299, CANC. INT. CL. 28.
- TEALUXE, INC., FRANKLIN, MA:
2,729,739, MULTIPLE CLASS, INT. CLS. 21 AND 30.
- TEAM TIRES PLUS, LTD, CLEARWATER, FL, TIRES PLUS LTD., MINNEAPOLIS, MN:
1,237,623, REN. 5-16-03, INT. CL. 35.

- TEAMMATES FOR KIDS FOUNDATION, LITTLETON, CO:
2,730,373, MULTIPLE CLASS, INT. CLS. 25 AND 36.
2,730,376, MULTIPLE CLASS, INT. CLS. 25 AND 36.
- TECH HACKERS, INC., NEW YORK, NY:
1,782,540, REN. 5-13-03, INT. CL. 9.
- TECHNI-FLOE INC., ATHENS, TN:
1,991,203, CANC. INT. CL. 20.
- TECHNOLOGY INVESTMENTS, INC., TAMPA, FL:
1,991,183, CANC. INT. CL. 42.
- TECHNOWLEDGE NETWORKS, INC., CARSON CITY, NV:
2,730,636, INT. CL. 9.
- TECNOL MEDICAL PRODUCTS, INC., FT. WORTH, TX:
1,705,799, CANC. INT. CL. 10.
- TECNOL, INC., NORTH RICHLAND HILLS, TX TO TECNOL MEDICAL PRODUCTS, INC., FORT WORTH, TX:
1,705,992, CANC. INT. CL. 5.
- TECSEC, INCORPORATED, VIENNA, VA:
2,729,534, INT. CL. 9.
- TEK-NEK TOYS INTERNATIONAL, INC., MOKENA, IL:
2,730,503, INT. CL. 28.
- TEKNOW, INC., PHOENIX, AZ:
1,991,383, CANC. INT. CL. 9.
- TELAIRE SYSTEMS, INC., GOLETA, CA:
1,991,906, CANC. INT. CL. 9.
- TELARC INTERNATIONAL CORPORATION, BEACHWOOD, OH:
1,991,712, CANC. INT. CL. 9.
- TELECOMMUTING ADVANTAGE GROUP, INC., SAN FRANCISCO, CA:
2,730,279, INT. CL. 35.
2,730,280, INT. CL. 41.
- TELECORDIA TECHNOLOGIES, INC., MORRISTOWN, NJ, BELL COMMUNICATIONS RESEARCH, INC., MORRISTOWN, NJ:
1,714,632, REN. 5-15-03, INT. CL. 9.
- TELEDYNE INDUSTRIES, INC., LOS ANGELES, CA:
735,647, CANC. U.S. CL. 26.
735,651, CANC. U.S. CL. 26.
1,203,401, CANC. INT. CL. 7.
- TELEDYNE INDUSTRIES, INC., FORT COLLINS, CO, DBA TELEDYNE WATER PIK:
1,991,932, CANC. INT. CL. 21.
- TELEMEDIA NETWORK, INC., LOS ANGELES, CA:
1,991,202, CANC. INT. CL. 42.
- TELEMEDIC SYSTEMS, INC., REDMOND, WA:
2,729,485, INT. CL. 9.
- TELESHUTTLE CORPORATION, NEW YORK, NY:
1,990,782, CANC. INT. CL. 9.
- TELIA AB, S-123 86 FARSTA, SWEDEN, TELEVERKET, S-123 86 FARSTA, SWEDEN:
1,775,505, REN. 5-10-03, INT. CL. 38.
- TELIOS PHARMACEUTICALS, INC., SAN DIEGO, CA:
1,990,717, CANC. INT. CL. 5.
- TELLURIDE CLOTHING COMPANY, INC., NEWTON, MA FROM CAMBRIDGE DRY GOODS COMPANY, INC., NEWTON, MA:
2,729,361, MULTIPLE CLASS, INT. CLS. 18 AND 25.
- TELOGY NETWORKS INC., GERMANTOWN, MD:
2,730,447, INT. CL. 9.
- TELUTION, INC., CHICAGO, IL FROM TELUTION L.L.C., CHICAGO, IL:
2,729,382, MULTIPLE CLASS, INT. CLS. 9 AND 42.
- TELUX-PIONEER INC., WOODSIDE, NY:
1,704,843, CANC. INT. CL. 14.
- TEMPO RESEARCH CORPORATION, VISTA, CA:
1,704,707, CANC. INT. CL. 9.
- TENNESSEE VALLEY FEDERAL CREDIT UNION, CHATTANOOGA, TN:
2,729,222, PUB. 4-1-2003, INT. CL. 36.
- TERARECON, INC., SAN MATEO, CA:
2,729,158, PUB. 4-1-2003, INT. CL. 9.
- TERESPONDO.COM, INC., KEY BISCAYNE, FL:
2,728,984, PUB. 4-1-2003, INT. CL. 35.
- TERMI-MESH AUSTRALIA PTY LTD., MALAGA, WESTERN AUSTRALIA, AUSTRALIA:
2,728,530, PUB. 4-1-2003, MULTIPLE CLASS, INT. CLS. 6 AND 37.
2,728,531, PUB. 4-1-2003, MULTIPLE CLASS, INT. CLS. 6 AND 37.
- TERNES REGISTER SYSTEM, INC., ST. PAUL, MN:
1,704,576, CANC. INT. CL. 7.
- TEROG MANUFACTURING CO., STEPHEN, MN:
1,775,729, REN. 5-14-03, INT. CL. 7.
- TERRACE SECURITY COMPANY, HOUSTON, TX:
2,729,682, INT. CL. 42.
- TERREL H. BELL AND ASSOCIATES, EDUCATIONAL CONSULTANTS, SALT LAKE CITY, UT:
2,730,073, INT. CL. 9.
- TERRY'S TIRE TOWN, INC., ALLIANCE, OH:
2,729,556, INT. CL. 35.
- TERRYBERRY COMPANY, LLC, GRAND RAPIDS, MI:
2,624,426, COR. INT. CL. 14.
- TEST RITE PRODUCTS CORPORATION, BUENA PARK, CA:
2,729,919, INT. CL. 8.
- TETCO, INC., SAN ANTONIO, TX:
2,729,282, PUB. 4-1-2003, MULTIPLE CLASS, INT. CLS. 35 AND 37.
- TETRA LAVAL HOLDINGS & FINANCE S.A., CH-1009 PULLY, SWITZERLAND:
2,729,388, INT. CL. 11.
- TEVA PHARMACEUTICALS USA, INC., NORTH WALES, PA:
2,730,118, INT. CL. 5.
2,730,119, INT. CL. 5.
- TEXANA GRILL OF TENNESSEE, INC., DALLAS, TX:
1,705,639, CANC. INT. CL. 42.
- TEXAS ADVENTURE, INC., SAN ANTONIO, TX:
1,991,750, CANC. INT. CL. 16.
- TEXAS ENCORE MATERIALS, INC., KANSAS CITY, MO:
2,730,186, INT. CL. 17.
- TEXAS MEDICAL PRODUCTS, INC., HOUSTON, TX:
1,203,459, CANC. INT. CL. 10.
- TEXAS NEW MEXICO POWER COMPANY, FORT WORTH, TX:
2,729,830, MULTIPLE CLASS, INT. CLS. 36, 39 AND 42.
- TEXAS UTILITIES INTEGRATED SOLUTIONS, INC., DALLAS, TX:
2,466,500, CANC. INT. CL. 36.
- TEXLOC HOLDINGS, INC., FORT WORTH, TX:
2,728,590, PUB. 8-20-2002, MULTIPLE CLASS, INT. CLS. 9 AND 17.
- TGC, INC., ORLANDO, FL:
2,728,668, PUB. 4-1-2003, MULTIPLE CLASS, INT. CLS. 35 AND 41.
- THANG LONG METAL WARES COMPANY, HANOI, VIETNAM:
2,729,221, PUB. 4-1-2003, INT. CL. 21.
- THE ASSOCIATION OF BONE AND JOINT SURGEONS, ROSEMONT, IL:
2,729,220, PUB. 4-1-2003, MULTIPLE CLASS, INT. CLS. 35 AND 41.
- THE BAILEY GROUP, INC., ATLANTA, GA:
2,729,283, PUB. 4-1-2003, INT. CL. 41.
- THE BOYDS COLLECTION, LTD., MCSHERRYSTOWN, PA:
2,730,159, INT. CL. 20.
- THE CORRAL, WILLIAMSPORT, PA:
2,728,856, PUB. 4-1-2003, INT. CL. 41.
- THE FLATLANDERS UNLIMITED, LTD., AUSTIN, TX:
2,728,912, PUB. 4-1-2003, MULTIPLE CLASS, INT. CLS. 9 AND 41.
- THE FONT BUREAU, INC., BOSTON, MA AND LEW, KENT, BOSTON, MA:
2,730,928, INT. CL. 9.
- THE LUBRIZOL CORPORATION, WICKLIFFE, OH, CHEMIRON CORPORATION, PASO ROBLES, CA:
1,788,719, REN. 5-12-03, INT. CL. 1.
- THE MEAD CORPORATION, DAYTON, OH:
2,729,017, PUB. 4-1-2003, INT. CL. 16.
- THE MUSEUM IN THE STREETS, LLC, CUSHING, ME:
2,728,993, PUB. 4-1-2003, INT. CL. 41.
- THE MUSEUM OF SCIENCE AND INDUSTRY, CHICAGO, IL:
2,728,685, PUB. 4-1-2003, MULTIPLE CLASS, INT. CLS. 9, 21, 25 AND 41.

THE NEW MAGNA-BON CORP., INC., OKEECHOBEE, FL:
2,729,111, PUB. 4-1-2003. INT. CL. 5.

THE PROCTER & GAMBLE COMPANY, CINCINNATI, OH:
2,729,057, PUB. 4-1-2003. MULTIPLE CLASS, INT. CLS. 3
AND 21.

THE REEL THING, INC., SANTA MONICA, CA:
2,728,558, PUB. 4-1-2003. INT. CL. 40.

THE RETIRED OFFICERS ASSOCIATION, ALEXANDRIA,
VA:
2,730,896, INT. CL. 35.

THE SEIBELS BRUCE GROUP, INC., COLUMBIA, SC:
2,729,027, PUB. 4-1-2003. INT. CL. 36.

THE STEEL ALLIANCE, INC., PITTSBURGH, PA. AMER-
ICAN IRON AND STEEL INSTITUTE, WASHINGTON,
DC:
1,243,272. REN. 5-16-03. INT. CL. 42.

THE 7S' ENTERPRISES, INC., HONOLULU, HI:
2,728,936, PUB. 4-1-2003. INT. CL. 5.

THE-MAT-COMPANY GERMANY GMBH, D-44143 DORT-
MUND, FED REP GERMANY:
2,665,820, COR. MULTIPLE CLASS, INT. CLS. 27, 35
AND 37.

THEORIS, INC., CARMEL, IN FROM SOFTWARE SY-
NERGY, INC., FISHERS, IN:
2,729,757, INT. CL. 42.

THERAPEUTIC INNOVATIONS, L.L.C., FT. MITCHELL,
KY:
2,729,535, INT. CL. 10.

THERMO LABSYSTEMS OY, HELSINKI, FINLAND FROM
LABSYSTEMS OY (2), FIN-00881, HELSINKI, FINLAND:
2,729,731, INT. CL. 9.

THERMO NICOLET CORPORATION, MADISON, WI:
1,757,777. REN. 5-13-03. INT. CL. 9.

THETA CHI FRATERNITY, INC., INDIANAPOLIS, IN,
GRAND CHAPTER OF THETA CHI FRATERNITY,
INCORPORATED, THE, TRENTON, NJ:
1,231,512. REN. 5-15-03. U.S. CL. 200.

THIELEN MARKETING, INC, BUFFALO, MN:
2,728,741, PUB. 4-1-2003. INT. CL. 28.

THOMAS & BETTS CORPORATION, MEMPHIS, TN:
1,991,318, CANC. INT. CL. 11.

THOMAS H. CROOK, III, PH.D., OXFORD, MD FROM
PSYCHOLOGIX, INC., SCOTTSDALE, AZ:
2,729,476, INT. CL. 5.

THOMAS JEFFERSON UNIVERSITY HOSPITALS, INC.,
PHILADELPHIA, PA:
2,730,930, INT. CL. 35.

THOMBAS COMPANY, LLC, THE, ALPHARETTA, GA:
2,729,471, MULTIPLE CLASS, INT. CLS. 19 AND 20.

THOMPSON MEDICAL COMPANY, INC., NEW YORK, NY:
1,203,323, CANC. INT. CL. 5.

THOMPSON, KRISTIN INGA, HALFWAY, OR:
1,990,655, CANC. MULTIPLE CLASS, INT. CLS. 12, 25
AND 28.

THOMSON INFORMATION LECENSING, CLAYMONT,
DE, SCRIBNER BOOK COMPANIES, THE, NEW YORK,
NY:
1,212,411. REN. 5-10-03. INT. CL. 16.

THOR TECH, INC., LAS VEGAS, NV:
2,728,574, PUB. 7-9-2002. INT. CL. 12.

THOTWAVE TECHNOLOGIES, LLC, CARY, NC:
2,730,490, MULTIPLE CLASS, INT. CLS. 35 AND 42.

THRONEBURG, JAMES L., STATESVILLE, NC:
1,991,937, CANC. INT. CL. 25.

THRUSTMASTER, INC., TIGARD, OR:
1,990,810, CANC. INT. CL. 28.

THUNDERPOWER, LLC, WILMINGTON, DE:
2,678,707, COR. INT. CL. 12.

THYSSENKRUPP STAHL AG, 47166 DUISBURG, FED REP
GERMANY:
2,728,884, PUB. 1-21-2003. INT. CL. 6.

TI GROUP AUTOMOTIVE SYSTEMS CORPORATION, CASS
CITY, MI:
2,582,638, COR. INT. CL. 20.

TICKETMASTER CORPORATION, LOS ANGELES, CA:
1,991,124, CANC. MULTIPLE CLASS, INT. CLS. 35 AND
41.

TIDEWATER INC., NEW ORLEANS, LA:
2,728,960, PUB. 4-1-2003. INT. CL. 39.
2,728,961, PUB. 4-1-2003. INT. CL. 39.

TIE RACK STORES, INC., MARKHAM, ONTARIO, L3R 9R6,
CANADA, BIGSBY & KRUTHERS TIE SHOPS, INC.,
CHICAGO, IL:
1,759,256. REN. 5-12-03. INT. CL. 42.

TIGER PAWS FLOOR SAFETY SYSTEMS, INC., FORT
CALHOUN, NE:
1,991,232, CANC. INT. CL. 40.

TIGGON CORPORATION, DALLAS, TX:
2,729,081, PUB. 4-1-2003. INT. CL. 9.

TIHANY, ADAM, NEW YORK, NY AND ANTONUCCI,
FRANCESCO, NEW YORK, NY, DBA ADAM TIHANY
INTERNATIONAL:
1,990,713, CANC. INT. CL. 30.

TILDENWOODS CORPORATION, PURCELLVILLE, VA:
2,730,554, MULTIPLE CLASS, INT. CLS. 9 AND 42.

TILLOTSON CORPORATION, BOSTON, MA, AKA BEST
MANUFACTURING CO.:
2,729,032, PUB. 4-1-2003. MULTIPLE CLASS, INT. CLS. 9
AND 10.

TIMBERLINE STRATEGIES, INC., KANSAS CITY, MO:
1,990,617, CANC. INT. CL. 16.

TIME DOMAIN CORPORATION, HUNTSVILLE, AL:
2,730,049, INT. CL. 9.

TIME FASTNER COMPANY, INC., RENO, NV, TIME
FASTENER CO., SOUTH EL MONTE, CA:
1,220,560. REN. 5-16-03. MULTIPLE CLASS, INT. CLS. 6
AND 8.

TIME INC., NEW YORK, NY:
2,730,502, INT. CL. 9.

TIME WARNER ENTERTAINMENT COMPANY, L.P., NEW
YORK, NY:
2,730,950, INT. CL. 41.

TIME WARNER INC., NEW YORK, NY:
2,729,500, INT. CL. 35.

TIRE FORCE, INC., ALPHARETTA, GA:
1,991,121, CANC. INT. CL. 42.
1,991,122, CANC. INT. CL. 42.

TIRECO, INC., COMPTON, CA:
2,730,951, INT. CL. 12.

TISHCON CORP., WESTBURY, NY:
2,729,885, INT. CL. 3.

TISHERMAN, WILLIAM R., KATONAH, NY:
2,728,913, PUB. 4-1-2003. INT. CL. 43.
2,728,914, PUB. 4-1-2003. INT. CL. 43.

TIVOLI INDUSTRIES, INC., SANTA ANA, CA:
1,203,410, CANC. MULTIPLE CLASS, INT. CLS. 9 AND
11.

TLC CANDLE CORP., MAYFIELD, KY:
2,729,590, INT. CL. 35.

TM ACQUISITION CORP., LAS VEGAS, NV, ELECTRONIC
REALTY ASSOCIATES, L.P., SHAWNEE MISSION, KS:
1,757,264. REN. 5-14-03. INT. CL. 41.

TMG LIFE INSURANCE COMPANY, BROOKFIELD, WI:
1,990,974, CANC. INT. CL. 36.

TMI, INC., HOUSTON, TX:
2,730,803, INT. CL. 37.
2,730,805, MULTIPLE CLASS, INT. CLS. 36 AND 37.
2,730,806, MULTIPLE CLASS, INT. CLS. 36 AND 37.

TMW MARKETING COMPANY, INC., FREMONT, CA:
2,729,629, MULTIPLE CLASS, INT. CLS. 35, 38 AND 42.

TNEMEC COMPANY INC., KANSAS CITY, MO:
2,730,333, INT. CL. 19.

TOEI ANIMATION CO., INC., TOKYO, 162, JAPAN:
2,730,397, INT. CL. 28.

TOG SHOP, INC., THE, AMERICUS, GA:
1,773,058. REN. 5-14-03. INT. CL. 25.

TOKAI BANK OF CALIFORNIA, LOS ANGELES, CA:
1,705,393, CANC. INT. CL. 36.

TOMMY ARMOUR GOLF COMPANY, TORONTO, ONTAR-
IO:
2,729,063, PUB. 4-1-2003. INT. CL. 28.

TOMOTHERAPY INCORPORATED, MADISON, WI:
2,729,994, INT. CL. 10.
2,729,995, MULTIPLE CLASS, INT. CLS. 9 AND 10.

- TOMY INCORPORATED, FUTABA-GUN FUKUSHIMA-KEN, JAPAN:
2,729,087, PUB. 4-1-2003. INT. CL. 10.
- TONG HWEI ENTERPRISE CO., LTD., YUNG AN, KAOHSIUNG, TAIWAN:
1,783,218. REN. 5-16-03. INT. CL. 6.
- TONKA CORPORATION, PAWTUCKET, RI:
1,992,157, CANC. INT. CL. 28.
- TOPIC RADIO, INC., RESEARCH TRIANGLE PARK, NC:
2,730,043, INT. CL. 42.
- TOPPE CALIFORNIA INC., LOS ANGELES, CA:
1,762,926. REN. 5-16-03. INT. CL. 25.
- TORAY KABUSHIKI KAISHA, CHUO-KU, TOKYO, JAPAN:
1,991,511, CANC. INT. CL. 24.
- TORNOS S.A., 2740 MOUTIER, SWITZERLAND, TORNOS-BECHLER S.A., 2740 MOUTIER, SWITZERLAND:
1,754,879. REN. 5-10-03. INT. CL. 7.
- TORO COMPANY, THE, BLOOMINGTON, MN, TORO COMPANY, THE, MINNEAPOLIS, MN:
1,230,982. REN. 5-13-03. INT. CL. 11.
- TORQUE ENGINEERING CORP., ELKHART, IN:
1,990,691, CANC. INT. CL. 7.
- TOSCANY, INC., NEW YORK, NY:
1,203,611, CANC. INT. CL. 21.
- TOTES ISOTONER CORPORATION, CINCINNATI, OH:
2,729,639, INT. CL. 7.
2,729,640, INT. CL. 9.
2,729,641, INT. CL. 11.
2,729,642, INT. CL. 22.
- TOUCHSTONE APPLIED SCIENCE ASSOCIATES, INC., BREWSTER, NY:
2,729,967, INT. CL. 16.
- TOUR TOGETHER, INC., ASPEN, CO:
2,729,379, MULTIPLE CLASS, INT. CLS. 35 AND 41.
- TOY BIZ, INC., NEW YORK, NY:
1,991,622, CANC. INT. CL. 28.
- TRACIE MARTYN INTERNATIONAL, LLC, NEW YORK, NY:
2,730,507, INT. CL. 3.
- TRADE AM INTERNATIONAL, INC., NORCROSS, GA:
1,991,444, CANC. INT. CL. 18.
- TRADE SERVICE CORPORATION, SAN DIEGO, CA:
1,991,570, CANC. INT. CL. 35.
- TRADEMC INC., ALISO VIEJO, CA TO TRADEMIC INC., ALISO VIEJO, CA:
2,634,189, COR. MULTIPLE CLASS, INT. CLS. 35 AND 42.
- TRAFFIC.COM, INC., WAYNE, PA:
2,590,868, COR. INT. CL. 39.
- TRANS UNION CORPORATION, CHICAGO, IL TO TRANS-UNION L.L.C., CHICAGO, IL:
1,682,716, CANC. INT. CL. 9.
- TRANS WORLD TECHNOLOGIES, INC., PASADENA, CA, DBA COMPUTRON:
1,992,006, CANC. INT. CL. 9.
- TRANS-EUROPEAN RESEARCH AND EDUCATION NETWORKING ASSOCIATION, AMSTERDAM, NETHERLANDS:
1,990,957, CANC. INT. CL. 42.
- TRANS-TRADE, INC., GRAPEVINE, TX:
2,729,305, PUB. 4-1-2003. INT. CL. 39.
- TRANSACTIVE TECHNOLOGIES, INC., SEATTLE, WA:
1,990,768, CANC. INT. CL. 9.
- TRANSAMERICA MAILINGS, INC., CLEVELAND, OH:
1,991,904, CANC. INT. CL. 3.
- TRANSAMERICA OCCIDENTAL LIFE INSURANCE COMPANY, LOS ANGELES, CA:
2,728,788, PUB. 4-1-2003. INT. CL. 36.
- TRANSAMERICA REAL ESTATE TAX SERVICE, INC., DALLAS, TX FROM TRANSAMERICA CORPORATION, SAN FRANCISCO, CA:
2,729,482, INT. CL. 36.
- TRANSFORM PHARMACEUTICALS, INC., CAMBRIDGE, MA:
2,729,558, INT. CL. 42.
- TRANSGENOMIC, INC., SAN JOSE, CA:
2,729,599, INT. CL. 9.
- TRANSNATIONAL NEWS COMPANY, INC., UNION, WV:
2,729,697, INT. CL. 9.
- TRANSTEL COMMUNICATIONS, INC., SALT LAKE CITY, UT:
2,730,111, INT. CL. 38.
- TRASK, RAIFORD G III, WRIGHTSVILLE BEACH, NC:
2,730,713, INT. CL. 28.
- TRAUTH, DIANE, VERNON, CA, DBA RABBIT RABBIT RABBIT DESIGNS AND DBA RABBIT RABBIT RABBIT:
1,711,869. REN. 5-14-03. INT. CL. 25.
- TRAVEL GUIDE, INC., CHARLOTTESVILLE, VA:
2,729,933, INT. CL. 16.
- TRAVELLER'S MEDICAL AND VACCINATION CENTRE PTY LTD, ADELAIDE, SOUTH AUSTRALIA 5000, AUSTRALIA:
2,728,528, PUB. 7-9-2002. MULTIPLE CLASS, INT. CLS. 5, 9, 16 AND 42.
- TREASURE FOODS, INC., SALT LAKE CITY, UT:
1,705,208, CANC. INT. CL. 29.
- TREAT ENTERTAINMENT, INC., FLORENCE, AL:
1,991,502, CANC. INT. CL. 16.
- TRENDMASTERS, INC., ST. LOUIS, MO:
2,729,616, INT. CL. 28.
- TRIANGLE PACIFIC CORP, DALLAS, TX:
1,990,903, CANC. INT. CL. 19.
- TRIANGLE PACIFIC CORP., DALLAS, TX:
1,990,902, CANC. INT. CL. 19.
- TRIATON GMBH, KREFELD, FED REP GERMANY:
2,730,941, MULTIPLE CLASS, INT. CLS. 9, 16, 35, 37, 38, 41 AND 42.
- TRIBECA FILM CENTER, INC., NEW YORK, NY:
2,728,511, PUB. 4-1-2003. MULTIPLE CLASS, INT. CLS. 35 AND 36.
- TRIBORO QUILT MANUFACTURING CORPORATION, WHITE PLAINS, NY:
1,992,177, CANC. INT. CL. 25.
- TRIDENT CORPORATION, BOSTON, MA:
1,966,367, CANC. INT. CL. 12.
- TRILOG GROUP, S.A.R.L., BEIRUT, LEBANON:
2,729,740, INT. CL. 9.
- TRINITY VILLAGE HOMELESS REDEVELOPMENT CENTER, RANCHO CUCAMONGA, CA:
2,729,832, MULTIPLE CLASS, INT. CLS. 41 AND 42.
- TRIOX, INC., ST. PETERSBURG, FL:
1,990,808, CANC. INT. CL. 5.
- TRIPLE E B.V., 3572 AX UTRECHT, NETHERLANDS:
2,729,903, INT. CL. 2.
- TRIPLE PLAY TECHNOLOGIES, L.L.C., BATON ROUGE, LA:
2,729,436, INT. CL. 4.
- TRIPLETT, LINDA J., BELLEVUE, WA:
2,728,609, PUB. 4-1-2003. INT. CL. 4.
- TRIS PHARMA, INC., WEST WINDSOR, NJ:
2,729,831, INT. CL. 42.
- TRITIUM TECHNOLOGY INC., UNIONDALE, NY:
2,730,286, INT. CL. 36.
2,730,287, INT. CL. 36.
2,730,288, INT. CL. 36.
2,730,289, INT. CL. 36.
- TROJAN FOOD STUFF CO., LTD., TAIPEI, TAIWAN:
2,730,688, INT. CL. 30.
- TROLMAN, GLASER & LICHTMAN, P.C., NEW YORK, NY:
2,728,969, PUB. 4-1-2003. INT. CL. 42.
- TROPICANA PRODUCTS, INC., BRADENTON, FL:
2,730,716, INT. CL. 32.
- TROPOS INSTITUTE, INC., IRVING, TX:
2,729,178, PUB. 4-1-2003. INT. CL. 9.
- TROSMAN, INC., NEW YORK, NY:
2,730,533, INT. CL. 18.
- TRUCK-LITE CO., FALCONER, NY:
2,729,821, INT. CL. 11.
- TRUCK-LITE CO., INC, FALCONER, NY:
2,729,818, INT. CL. 11.
- TRUCK-LITE CO., INC., FALCONER, NY:
2,729,819, INT. CL. 11.
2,729,820, INT. CL. 11.
- TRUE TEMPER HARDWARE COMPANY, CAMP HILL, PA:
1,704,585, CANC. INT. CL. 8.

- TRUMP, DONALD J., NEW YORK, NY:
1,755,971. REN. 5-15-03. MULTIPLE CLASS, INT. CLS. 41 AND 42.
- TRUSSARDI S.P.A., ALME, BERGAMO, ITALY:
1,203,497. CANC. MULTIPLE CLASS, INT. CLS. 14, 16, 18 AND 34.
- TRUST DIGITAL, LLC, FAIRFAX, VA:
2,729,050. PUB. 4-1-2003. INT. CL. 9.
- TRUSTEES OF THE WAI LAN YOGA TRUST, PORT HUENEME, CA:
2,729,584. MULTIPLE CLASS, INT. CLS. 25 AND 41.
- TSR, INC., LAKE GENEVA, WI:
1,203,675. CANC. INT. CL. 25.
- TSR, L.P., NEW YORK, NY:
1,992,044. CANC. INT. CL. 42.
- TUNSTALL TELECOM LIMITED, DN14 OHR WEST YORKSHIRE, ENGLAND:
2,728,746. PUB. 4-1-2003. INT. CL. 9.
- TUPP, INC., WASHINGTON, DC, DBA THAIPOON RESTAURANT:
2,728,953. PUB. 4-1-2003. INT. CL. 43.
- TURN MINISTRIES, INC., THE, SPRINGFIELD, MO:
1,990,731. CANC. INT. CL. 41.
- TURNER NETWORK TELEVISION LP, LLLP, ATLANTA, GA:
2,730,063. INT. CL. 25.
- TURNSTYLE RECORDS, GARDENA, CA:
2,729,536. INT. CL. 40.
- TURTLE BEACH SYSTEMS, INC., YORK, PA:
1,704,711. CANC. INT. CL. 9.
- TVTAXI.COM, INC., FT. LAUDERDALE, FL:
2,729,765. MULTIPLE CLASS, INT. CLS. 9 AND 42.
- TWECO PORODUCTS, INC., ST. LOUIS, MO, ARCAIR COMPANY, THE, LANCASTER, OH:
1,229,479. REN. 5-16-03. INT. CL. 9.
- TWIN LABORATORIES INC., HAUPPAUGE, NY:
2,729,521. INT. CL. 5.
- TY INC., OAK BROOK, IL:
2,730,653. INT. CL. 28.
- TYCO PLAYTIME, INC., NEW YORK, NY:
1,991,019. CANC. INT. CL. 28.
- TYCOM LIMITED PARTNERSHIP, SANTA ANA, CA:
1,704,553. CANC. MULTIPLE CLASS, INT. CLS. 7 AND 37.
- TYLER ENTERPRISES OF ELWOOD, INC., ELWOOD, IL:
1,704,426. CANC. INT. CL. 1.
- TZIPA CARMON EXPORT LTD, JERUSALEM 91340, ISRAEL TO SMART STORAGE LTD., BARKAN, ISRAEL:
2,619,298. AM. INT. CL. 19.
- TZU CHI TELEVISION, TAIPEI, CHINA:
2,730,189. INT. CL. 38.
- U S WEST MARKETING RESOURCES GROUP, INC., ENGLEWOOD, CO:
1,990,793. CANC. INT. CL. 35.
- U.S. ARCHITECTURAL AND TRANSPORTATION BARRIERS COMPLIANCE BOARD, WASHINGTON, DC:
2,730,335. MULTIPLE CLASS, INT. CLS. 41 AND 42.
- U.S. BRICK, INC., OWOSSO, MI TO REAL BRICK PRODUCTS, INC., PERRY, MI:
1,706,026. CANC. INT. CL. 19.
- U.S. BUREAU OF THE CENSUS U.S. DEPARTMENT OF COMMERCE, WASHINGTON, DC:
1,991,447. CANC. INT. CL. 42.
- U.S. DESIGN SYSTEMS, INC., WESTLAKE VILLAGE, CA:
1,204,057. CANC. INT. CL. 42.
- U.S. DISABLED ATHLETES FUND, INC., ATLANTA, GA:
1,991,659. CANC. INT. CL. 25.
- U.S. DYNAMIC INDUSTRY GROUP, INC., TORRANCE, CA:
2,729,164. PUB. 4-1-2003. MULTIPLE CLASS, INT. CLS. 25 AND 28.
- U.S. ENVIRONMENTAL PROTECTION AGENCY, WASHINGTON, DC AND U.S. DEPARTMENT OF TRANSPORTATION, WASHINGTON, DC:
2,728,692. PUB. 4-1-2003. MULTIPLE CLASS, INT. CLS. 35 AND 41.
- UBI SOFT, INC., SAN FRANCISCO, CA:
2,729,406. INT. CL. 9.
- UBS AG, CH 8001, SWITZERLAND:
2,729,782. INT. CL. 9.
2,729,842. INT. CL. 9.
2,729,843. INT. CL. 9.
- UBS PAINWEBBER INC., WEEHAWKEN, NJ:
2,730,152. INT. CL. 36.
- UCC INDUSTRIES, INC., SAN DIMAS, CA, AKA ULTRA CAR CARE PRODUCTS:
1,705,735. CANC. INT. CL. 3.
- UEE CARTUCHERIA DEPORTIVA SA, IRUNA DE OCA (ALAVA), SPAIN:
2,730,884. INT. CL. 13.
- ULKER GIDA SANAYI VE TICARET A.S., 34015 TOPKAPI ISTANBUL, TURKEY:
2,730,272. INT. CL. 30.
- ULRICH, JUDSON WESLEY, MINNEAPOLIS, MN:
1,756,968. REN. 5-13-03. INT. CL. 25.
- ULTRA POLY, INC., TACOMA, WA:
1,823,737. REN. 5-16-03. INT. CL. 17.
- ULTRA-TEX SURFACES, INC., FALLBROOK, CA:
1,991,338. CANC. MULTIPLE CLASS, INT. CLS. 16 AND 19.
- UMBRA INC., BUFFALO, NY:
2,728,859. PUB. 4-1-2003. INT. CL. 35.
- UMI COMPANY, ANN ARBOR, MI:
1,990,835. CANC. INT. CL. 9.
- UMPQUA VALLEY WINERY, ROSEBURG, OR, DBA CALLAHAN RIDGE WINERY:
1,991,223. CANC. INT. CL. 33.
- UNCLE BEN'S, INC., VERNON, CA:
2,729,957. MULTIPLE CLASS, INT. CLS. 29 AND 30.
- UNCLE REMUS RESTAURANT, INC., CHICAGO, IL:
2,728,943. PUB. 4-1-2003. INT. CL. 43.
- UNDERPINNING & FOUNDATION CONSTRUCTORS, INC., MASPETH, NY:
1,705,001. CANC. INT. CL. 19.
- UNDERWOOD & SON, LLC, SOMIS, CA, AGRICULTURAL INNOVATION AND TRADE, INC., SOMIS, CA, DBA UNDERWOOD RANCHES:
1,809,375. REN. 5-14-03. INT. CL. 31.
- UNDERWRITERS LABORATORIES INC., NORTHBROOK, IL:
2,604,688. COR. INT. CL. 42.
- UNGER ENTERPRISES, INC., BRIDGEPORT, CT:
1,705,867. CANC. INT. CL. 21.
- UNGERMANN-BASS, INC., SANTA CLARA, CA:
1,991,755. CANC. MULTIPLE CLASS, INT. CLS. 9, 16, 37 AND 42.
- UNI-MARTS OF AMERICA, INC., NEWARK, DE, UNIMARTS, INC., STATE COLLEGE, PA:
1,233,036. REN. 5-16-03. MULTIPLE CLASS, INT. CLS. 37 AND 42.
- UNI-MARTS OF AMERICA, INC., NEWARK, DE, UNIMARTS OF AMERICA, INC., NEWARK, DE:
1,240,593. REN. 5-16-03. MULTIPLE CLASS, INT. CLS. 37 AND 42.
- UNICOMPANY S.R.L., ROME, ITALY:
2,729,837. INT. CL. 3.
- UNILEVER N.V., 3013 AL ROTTERDAM, NETHERLANDS:
1,203,776. CANC. INT. CL. 30.
- UNIMEASURE, INC., CORVALLIS, OR:
2,728,861. PUB. 4-1-2003. INT. CL. 9.
2,728,862. PUB. 4-1-2003. INT. CL. 9.
- UNION FORK AND HOE COMPANY, THE, COLUMBUS, OH:
396,822. CANC. U.S. CL. 23.
- UNION PACIFIC RAILROAD COMPANY, OMAHA, NE, ST. LOUIS SOUTHWESTERN RAILWAY COMPANY, SAN FRANCISCO, CA, AKA COTTON BELT ROUTE, AND COTTON BELT:
1,218,634. REN. 5-14-03. INT. CL. 39.
- UNION PACIFIC RAILROAD COMPANY, OMAHA, NE, ST. LOUIS SOUTHWESTERN RAILWAY COMPANY, SAN FRANCISCO, CA, AKA COTTON BELT ROUTE AND COTTON BELT:
1,218,635. REN. 5-15-03. INT. CL. 39.

- UNION PLANTERS BANK, NATIONAL ASSOCIATION, DECATUR, AL FROM E S ROBBINS CORPORATION, MUSCLE SHOALS, AL:
2,729,750, INT. CL. 19.
- UNIQUE MEDIA, INCORPORATED, TORONTO, ONTARIO, CANADA:
2,729,561, INT. CL. 16.
- UNISURGE INC., PALO ALTO, CA TO UNISURGE HOLDINGS, INC., NORCROSS, GA:
1,705,803, CANC. INT. CL. 10.
- UNITED ASSOCIATION OF JOURNEYMEN AND APPRENTICES OF THE PLUMBING AND PIPE FITTING INDUSTRY OF THE UNITED STATES AND CANADA, WASHINGTON, DC:
1,229,759, REN. 5-14-03, INT. CL. 16.
1,229,785, REN. 5-14-03, INT. CL. 16.
1,229,786, REN. 5-14-03, INT. CL. 16.
1,230,649, REN. 5-14-03, U.S. CL. 200.
- UNITED CONSORTIUM, SHERMAN OAKS, CA:
2,728,634, PUB. 4-1-2003, INT. CL. 5.
- UNITED DISTILLERS PLC, EDINBURGH EH12 6JW, UNITED KINGDOM:
1,990,989, CANC. INT. CL. 33.
- UNITED GENETICS SEEDS CO., HOLLISTER, CA:
2,729,133, PUB. 4-1-2003, INT. CL. 31.
- UNITED GUARANTY CORPORATION, GREENSBORO, NC, UNITED GUARANTY RESIDENTIAL INSURANCE COMPANY, INC., GREENSBORO, NC:
1,760,263, REN. 5-10-03, INT. CL. 36.
- UNITED LIFE AGENCY SERVICES, L.L.C., GARDEN CITY, NY:
2,729,029, PUB. 4-1-2003, INT. CL. 36.
- UNITED PAN-EUROPE COMMUNICATIONS N.V., 1076 EE AMSTERDAM, NETHERLANDS:
2,728,477, PUB. 4-30-2002, MULTIPLE CLASS, INT. CLS. 9, 38, 41 AND 42.
- UNITED PUBLISHING, INC., RIVER GROVE, IL:
1,722,406, REN. 5-16-03, INT. CL. 36.
- UNITED REFINING COMPANY, WARREN, PA:
1,991,537, CANC. INT. CL. 37.
- UNITED STATES FIGURE SKATING ASSOCIATION, THE, COLORADO SPRINGS, CO:
2,728,712, PUB. 4-1-2003, MULTIPLE CLASS, U.S. CL. 200 INT. CLS. 35 AND 41.
- UNITED STATES FILTER CORPORATION, PALM DESERT, CA:
2,729,433, INT. CL. 40.
- UNITED STATES LEATHER, INC., MILWAUKEE, WI:
1,991,788, CANC. INT. CL. 18.
- UNITED STATES MARKETING CORPORATION, HUNTINGTON STATION, NY:
2,729,043, PUB. 4-1-2003, INT. CL. 9.
- UNITED STATES POSTAL SERVICE, WASHINGTON, DC:
2,729,461, INT. CL. 41.
- UNITED STATES SHOE CORPORATION, THE, CINCINNATI, OH:
1,992,201, CANC. INT. CL. 42.
- UNITERRA, INC., CHICAGO, IL:
1,705,965, CANC. INT. CL. 38.
- UNIVERSAL HEALTH SERVICES, INC., KING OF PRUSSIA, PA:
2,729,003, PUB. 4-1-2003, INT. CL. 44.
- UNIVERSAL INDUSTRIES CORPORATION, COLUMBUS, MS:
1,203,813, CANC. INT. CL. 32.
- UNIVERSAL STUDIOS, INC., UNIVERSAL CITY, CA:
2,728,687, PUB. 12-3-2002, INT. CL. 41.
- UNIVERSAL SYSTEM DESIGNS, WAELDER, TX:
2,728,964, PUB. 4-1-2003, INT. CL. 9.
- UNIVERSAL TV DISTRIBUTION HOLDINGS LLC, UNIVERSAL CITY, CA FROM STUDIOS USA TELEVISION DISTRIBUTION LLC, WEST HOLLYWOOD, CA:
2,730,695, INT. CL. 41.
- UNIVERSITY ATHLETIC ASSOCIATION, INC., GAINESVILLE, FL:
1,228,944, REN. 5-16-03, INT. CL. 25.
1,228,946, REN. 5-14-03, INT. CL. 25.
- UNIVERSITY FEDERAL CREDIT UNION, AUSTIN, TX:
2,610,238, AM. INT. CL. 35.
2,681,359, AM. INT. CL. 36.
- UNIVERSITY OF SOUTHERN CALIFORNIA, LOS ANGELES, CA:
2,728,515, PUB. 4-1-2003, INT. CL. 28.
- UNIVERSITY OF WASHINGTON, SEATTLE, WA:
2,730,109, INT. CL. 41.
- UNTAMED RECORDS, LLC, NEWPORT NEWS, VA:
2,729,230, PUB. 4-1-2003, INT. CL. 41.
- UNZ & CO., INC., JERSEY CITY, NJ:
1,706,015, CANC. INT. CL. 16.
- UOP LLC, DES PLAINES, IL, UNION CARBIDE CORPORATION, NEW YORK, NY:
927,773, REN. 5-15-03, U.S. CL. 31 (INT. CL. 1).
- UP THE CREEK RESTAURANTS, INC., DULUTH, GA:
2,729,794, INT. CL. 42.
- URBAN & ASSOCIATES, INC., SHARON, MA:
1,763,182, REN. 5-13-03, INT. CL. 35.
- URBAN SHOPPING CENTERS, INC.:
See—HEAD ACQUISITION, L.P.
- URBAN TELEVISION NETWORK, INC., MARINA DEL RAY, CA:
2,729,391, INT. CL. 16.
- UROLOGY SPECIALISTS, P.C., WATERBURY, CT, DBA CONNECTICUT CENTER FOR CONTINENCE:
2,730,338, INT. CL. 42.
- URRA CO., INC., MERCER, PA:
2,728,898, PUB. 4-1-2003, INT. CL. 35.
- USA EMPLOYMENT, INC., ST. PETERSBURG, FL:
1,992,208, CANC. INT. CL. 35.
- USANM CORPORATION, CITY OF INDUSTRY, CA:
1,991,527, CANC. INT. CL. 25.
- USTELECENTERS, INC., BOSTON, MA:
1,990,627, CANC. MULTIPLE CLASS, INT. CLS. 35 AND 38.
- USTOV, INC., SAN FRANCISCO, CA, DBA U.S. TRADING COMPANY:
2,647,866, COR. INT. CL. 30.
- UTILITY AUTOMATION INTEGRATORS, INC., HUNTSVILLE, AL:
2,728,889, PUB. 4-1-2003, INT. CL. 9.
- UTILITY CONSULT HINZMANN & KONIG OHG, D-20249 HAMBURG, FED REP GERMANY TO UTILITY CONSULT HINZMANN & KONIG OHG, D-20249 HAMBURG, FED REP GERMANY:
2,620,121, COR. INT. CL. 9.
- V SECRET CATALOGUE, INC., WILMINGTON, DE:
2,729,647, INT. CL. 25.
- VAIL SUMMIT RESORT, INC., VAIL, CO, BRECKENRIDGE SKI CORPORATION, BRECKENRIDGE, CO:
1,713,805, REN. 5-15-03, INT. CL. 25.
- VALDOVINOS, JESUS, SAN DIEGO, CA:
2,729,346, PUB. 4-1-2003, INT. CL. 41.
- VALENTINE RESEARCH, INC., CINCINNATI, OH:
1,783,321, REN. 5-16-03, INT. CL. 9.
- VALENTINO, STEPHEN, NOVOTO, CA:
2,728,985, PUB. 4-1-2003, INT. CL. 41.
- VALLEY HEALTH SYSTEM, INC., BEAVER, PA:
2,730,850, INT. CL. 42.
- VALLEY OIL COMPANY, LLC, SALEM, OR:
2,728,737, PUB. 4-1-2003, INT. CL. 35.
- VALLEY ROLLER COMPANY, INC., MANSFIELD, TX:
2,728,761, PUB. 4-1-2003, INT. CL. 17.
- VALSPAR CORPORATION, THE, MINNEAPOLIS, MN:
2,730,618, INT. CL. 2.
- VALUE PRINT, INCORPORATED, CLINTON, CT:
1,750,562, REN. 5-16-03, INT. CL. 42.
- VAN HOUSE, LARRY H., SOMERVILLE, NJ:
1,991,914, CANC. INT. CL. 29.
- VAN R DENTAL PRODUCTS, INC., LOS ANGELES, CA:
1,203,454, CANC. INT. CL. 10.
- VAN SCYOC'S AUTO ADDICTION INC., ALLENTOWN, PA:
2,728,840, PUB. 4-1-2003, INT. CL. 35.
- VANCE'S FOODS, INC., SOLDOTNA, AK:
2,729,554, INT. CL. 29.

VANGUARD INTERNATIONAL, INC., ISSAQUAH, WA,
VANGUARD TRADING SERVICES, INC., MERCER IS-
LAND, WA:
1,758,615. REN. 5-10-03. MULTIPLE CLASS, INT. CLS. 31,
36 AND 42.

VANMOOR, ARTHUR, BOCA RATON, FL:
2,730,069, MULTIPLE CLASS, INT. CLS. 12 AND 28.

VARIFORM, INC., KEARNEY, MO:
2,729,154, PUB. 4-1-2003. INT. CL. 19.

VAST RESOURCES, INC., SAN FERNANDO, CA:
2,730,560, INT. CL. 5.

VAUGHAN & BUSHNELL MANUFACTURING COMPANY,
HEBRON, IL, DALLUGE, GERALD, SANTA ANA, CA:
1,762,472. REN. 5-14-03. INT. CL. 8.

VBS, INC., SIOUX CENTER, IA:
2,730,343, INT. CL. 9.

VEB KOMBINAT POLYGRAPH "WERNER LAMBERZ"
LEIPZIG, LEIPZIG, GERMAN DEM REP:
1,203,387, CANC. INT. CL. 7.

VECTURA GROUP, INC., PITTSBURGH, PA TO CONNEX
PIPE SYSTEMS, INC., TROUTVILLE, VA:
1,705,468, CANC. INT. CL. 40.

VEJAR, RACHEL D., POMPANO BEACH, FL:
1,705,667, CANC. INT. CL. 42.

VEKA AKTIENGESELLSCHAFT, D-48324 SENDENHORST,
FED REP GERMANY, VEKA GMBH, D-4415 SENDEN-
HORST, FED REP GERMANY:
1,772,978. REN. 5-16-03. MULTIPLE CLASS, INT. CLS. 17,
19 AND 35.

VENETIAN CASINO RESORT, LLC, LAS VEGAS, NV FROM
LAS VEGAS SANDS, INC., LAS VEGAS, NV:
2,729,637, INT. CL. 42.

VENNETTI, RALPH S., BENSENVILLE, IL:
2,730,053, INT. CL. 42.

VENTANA MEDICAL SYSTEMS, INC., TUCSON, AZ:
2,729,751, MULTIPLE CLASS, INT. CLS. 1 AND 5.

VENTURA, FRED, ARROYO GRANDE, CA AND VEN-
TURA, MARNE, ARROYO GRANDE, CA:
2,728,534, PUB. 4-1-2003. INT. CL. 9.

VENVEST, INC., ST. LOUIS, MO:
2,730,421, INT. CL. 37.

VERIFICATION TECHNOLOGIES, INC., CENTERBROOK,
CT:
2,729,529, INT. CL. 42.

VERISITY DESIGN, INC., MOUNTAIN VIEW, CA:
2,729,481, INT. CL. 9.

VERNIN, JACQUES, F-77000 MELUN, FRANCE:
2,728,457, PUB. 8-20-2002. MULTIPLE CLASS, INT. CLS. 3
AND 5.

VERTIFLEX INCORPORATED, NORTHBROOK, IL:
2,729,560, INT. CL. 20.

VIACOM INTERNATIONAL INC., NEW YORK, NY:
1,991,890, CANC. MULTIPLE CLASS, INT. CLS. 16 AND
25.
2,729,516, INT. CL. 41.

VIBRAM S.P.A., ALBIZZATE VARESE, ITALY:
2,730,749, INT. CL. 25.

VICAM, L.P., WATERTOWN, MA:
2,730,085, INT. CL. 5.

VICORP RESTAURANTS, INC., DENVER, CO:
2,730,131, INT. CL. 30.

VICTOR INNOVATEX INC., VILLE DE ST-GEORGES,
QUEBEC G6A 1K1, CANADA:
2,730,038, INT. CL. 40.

VICTOR UNITED, INC., CHICAGO, IL:
396,807, CANC. U.S. CL. 22.

VICTORY COLLECTIBLES, LTD., ST. CHARLES, IL:
2,728,781, PUB. 4-1-2003. INT. CL. 20.

VIEWPOINT INTERNATIONAL, INC., NEW YORK, NY:
2,729,260, PUB. 4-1-2003. INT. CL. 25.

VIGOR COMPANY, L.P., NEW YORK, NY TO GROBET
FILE COMPANY OF AMERICA, INC., CARLSTADT, NJ:
1,704,582, CANC. MULTIPLE CLASS, INT. CLS. 8 AND
14.

VIGOR SPORTS, INC., CERRITOS, CA:
1,991,672, CANC. INT. CL. 9.

VILLA PORTOFINO I, LLC, PALM DESERT, CA:
2,729,619, INT. CL. 42.

VILLAGE HOMES OF COLORADO, INC., LITTLETON, CO:
1,990,921, CANC. INT. CL. 37.

VILLAGE SAVINGS ASSOCIATION, HOUSTON, TX:
1,203,887, CANC. INT. CL. 36.

VINCI ENVIRONNEMENT, 92500 RUEIL-MALMAISON,
FRANCE:
2,612,140, COR. MULTIPLE CLASS, INT. CLS. 7, 11 AND
40.

VIP EXTENDED SERVICE CORP., METAIRIE, LA:
1,203,510, CANC. INT. CL. 16.

VIRBAC CORPORTION, FORT WORTH, TX FROM BLUE
RIDGE PHARMACEUTICALS, INC., GREENSBORO, NC:
2,730,166, INT. CL. 5.

VIRBAC S.A., 06511 CARROS CEDEX, FRANCE:
2,729,444, INT. CL. 5.

VIRGO PUBLISHING, INC., SCOTTSDALE, AZ:
1,990,991, CANC. INT. CL. 16.

VIRIV CORP., BROOKFIELD, WI:
2,729,696, INT. CL. 40.

VIRTUAL TECHNOLOGY CORPORATION, ALEXANDRIA,
VA:
2,728,468, PUB. 4-1-2003. INT. CL. 9.

VISAGE COSMETICS LIMITED, DOWNVIEW, TORONTO,
ONTARIO, CANADA:
1,203,288, CANC. MULTIPLE CLASS, INT. CLS. 3, 21, 41
AND 42.

VISHAY DALE ELECTRONICS, INC., COLUMBUS, NE,
DALE ELECTRONICS, INC., COLUMBUS, NE:
964,060. REN. 5-13-03. U.S. CL. 21 (INT. CLS. 7, 9, 11, 12
AND 15).

VISIBLE WORLD, INC., NEW YORK, NY:
2,730,101, MULTIPLE CLASS, INT. CLS. 35, 38 AND 40.

VISIONICS CORPORATION, VADNAIS HEIGHTS, MN:
1,991,540, CANC. INT. CL. 9.

VISIONS OF REALITY CORPORATION, SOUTH SAN
FRANCISCO, CA:
1,990,623, CANC. INT. CL. 28.

VISTA COMPUTER SERVICES INC, SOMERSET, NJ:
2,452,311, COR. MULTIPLE CLASS, INT. CLS. 35 AND
36.

VISTEON CORPORATION, DEARBORN, MI FROM FORD
MOTOR COMPANY, DEARBORN, MI:
2,729,483, MULTIPLE CLASS, INT. CLS. 40 AND 42.

VISUAL INSPECTION TECHNOLOGIES, INC., FLANDERS,
NJ:
1,704,611, CANC. MULTIPLE CLASS, INT. CLS. 9 AND
42.

VITA CRAFT CORPORATION, SHAWNEE, KS:
2,729,977, INT. CL. 21.

VITA CUBE SYSTEMS, INC., DENVER, CO:
2,730,015, INT. CL. 5.
2,730,785, INT. CL. 5.

VITAFORT INC., LOS ANGELES, CA:
1,991,597, CANC. INT. CL. 30.

VITAL PROCESSING SERVICES, LLC, TEMPE, AZ:
2,729,727, INT. CL. 35.

VITALECT, INC., MOUNTAIN VIEW, CA:
2,729,855, INT. CL. 9.

VITANTONIO MFG. CO., EASTLAKE, OH:
1,203,402, CANC. INT. CL. 8.

VITANUTRA, INC., YOUNGSTOWN, OH:
2,730,449, INT. CL. 5.

VOLPE AND KOENIG, P.C., PHILADELPHIA, PA:
2,729,872, MULTIPLE CLASS, INT. CLS. 41 AND 42.

VOLVO PENTA OF THE AMERICAS, INC., CHESAPEAKE,
VA:
2,728,877, PUB. 4-1-2003. INT. CL. 12.

VOTIVO, LTD., SEATTLE, WA:
2,728,815, PUB. 4-1-2003. INT. CL. 3.
2,728,816, PUB. 4-1-2003. INT. CL. 4.

VOUGHT, ELIZABETH, C., MALIBU, CA:
2,729,231, PUB. 4-1-2003. INT. CL. 21.

VOXWARE, INC., PRINCETON, NJ:
2,729,594, INT. CL. 9.

VOYAGE TELECOM, INC., WYCKOFF, NJ:
2,729,333, PUB. 4-1-2003. INT. CL. 16.

- VREDESTEIN RUBBER RECYCLING B.V., 6219 PE MAAS-TRICHT, NETHERLANDS:
1,704,433, CANC. INT. CL. 1.
- VVE LAURENT-PERRIER & CO.:
See—LAURENT-PERRIER.
- W. L. GORE & ASSOCIATES, INC., NEWARK, DE:
1,754,533, REN. 5-13-03, INT. CL. 24.
1,991,639, CANC. INT. CL. 9.
- W. M. BARR & COMPANY, INC., MEMPHIS, TN, DARE MARKETING, INC., KILL DEVIL HILLS, NC:
1,714,753, REN. 5-15-03, INT. CL. 3.
- W. R. GRACE & CO.-CONN., COLUMBIA, MD:
1,758,304, REN. 5-13-03, INT. CL. 16.
2,730,074, INT. CL. 1.
- W.K. KELLOGG FOUNDATION, BATTLE CREEK, MI:
2,728,588, PUB. 4-1-2003, MULTIPLE CLASS, INT. CLS. 16, 36, 41 AND 42.
- W.R. MEADOWS, INC., ELGIN, IL:
1,705,008, CANC. INT. CL. 19.
- WACOAL AMERICA, INC., NEW YORK, NY, WACOAL AMERICA, INC., NEW YORK, NY:
1,805,392, REN. 5-15-03, INT. CL. 25.
- WALCO INTERNATIONAL, INC., GRAPEVINE, TX:
2,730,779, INT. CL. 5.
- WALDE, INC., ARLINGTON, VA:
2,730,730, INT. CL. 9.
- WALL STREET INSTITUTE KFT, H-2623 KISMAROS, HUNGARY:
2,728,469, PUB. 8-31-1999, MULTIPLE CLASS, INT. CLS. 16 AND 41.
- WALLING, JIM, CALGARY, ALBERTA:
2,730,728, MULTIPLE CLASS, INT. CLS. 20 AND 21.
- WALLY WHALE STUDIOS, INC., VIRGINIA BEACH, VA:
1,991,614, CANC. MULTIPLE CLASS, INT. CLS. 25, 35 AND 41.
- WALMIC CORPORATION, ANZA, CA:
1,756,795, REN. 5-16-03, INT. CL. 16.
- WALTERS, CHARLES R., WASHINGTON, DC:
2,730,732, MULTIPLE CLASS, INT. CLS. 36 AND 41.
- WALTERS, TENNYSON O., ENGLEWOOD CLIFFS, NJ:
2,730,678, MULTIPLE CLASS, INT. CLS. 9, 16 AND 41.
- WAMPOLE LABORATORIES, INC., PRINCETON, NJ, CARTER-WALLACE, INC., NEW YORK, NY:
1,239,018, REN. 5-14-03, INT. CL. 1.
- WAPCOM INC., 42504 NETANYA, ISRAEL:
2,729,852, INT. CL. 9.
- WAREHOUSE EQUIPMENT AND SUPPLY COMPANY INC., BIRMINGHAM, AL:
1,705,308, CANC. MULTIPLE CLASS, INT. CLS. 35, 37 AND 42.
- WARNACO INC., BRIDGEPORT, CT:
1,203,688, CANC. INT. CL. 25.
- WARNER BROS. RECORDS INC., BURBANK, CA:
1,713,160, REN. 5-12-03, INT. CL. 9.
- WARNER ELECTRIC BRAKE & CLUTCH COMPANY, SOUTH BELOIT, IL:
735,608, CANC. U.S. CL. 23.
- WARNER-LAMBERT COMPANY, MORRIS PLAINS, NJ:
1,991,690, CANC. INT. CL. 30.
- WARRIOR SOLUTIONS, INC., BOULDER, CO:
2,729,587, INT. CL. 9.
- WARWICK MILLS, INC., NEW IPSWICH, NH:
2,730,161, INT. CL. 12.
- WASHINGTON APPLE COMMISSION, WENATCHEE, WA FROM WASHINGTON STATE APPLE ADVERTISING COMMISSION, WENATCHEE, WA, AKA WASHINGTON APPLE COMMISSION:
2,730,278, MULTIPLE CLASS, INT. CLS. 31 AND 35.
- WASHINGTON CENTER FOR INTERNSHIPS AND ACADEMIC SEMINARS, THE, WASHINGTON, DC:
1,757,294, REN. 5-15-03, INT. CL. 41.
- WASHINGTON HARDWOODS, INC., SEATTLE, WA:
2,730,121, INT. CL. 19.
- WASHINGTON MUTUAL BANK, SEATTLE, WA:
1,991,001, CANC. INT. CL. 18.
1,991,003, CANC. INT. CL. 28.
- WATER PIK, INC., NEWPORT BEACH, CA:
2,730,103, INT. CL. 11.
- WATERBOR BURN AND CANCER FOUNDATION, THE, NEW YORK, NY:
2,729,984, INT. CL. 35.
- WATERLOO INDUSTRIES, INC., WATERLOO, IA, WATERLOO INDUSTRIES, INC., WATERLOO, IA:
1,229,257, REN. 5-15-03, INT. CL. 6.
- WATKINS INCORPORATED, WINONA, MN:
1,203,335, CANC. INT. CL. 5.
- WATKINS MANUFACTURING CORPORATION, VISTA, CA:
2,730,437, INT. CL. 11.
2,730,438, INT. CL. 11.
2,730,439, INT. CL. 11.
- WATKINS MOTOR LINES, INC., LAKELAND, FL:
1,758,791, REN. 5-10-03, INT. CL. 39.
- WATKINS, MARGARET D., ATLANTA, GA:
2,679,239, COR. INT. CL. 41.
- WATROUS, LES, P, ORANGE, CA:
2,729,215, PUB. 4-1-2003, INT. CL. 37.
- WATSON PHARMACEUTICALS, INC., CORONA, CA:
2,728,728, PUB. 4-1-2003, INT. CL. 5.
- WAVESMITH NETWORKS, INC., ACTON, MA:
2,730,352, INT. CL. 9.
- WAVE7 OPTICS, INC., ALPHARETTA, GA:
2,730,389, INT. CL. 9.
2,730,390, INT. CL. 9.
- WAYNE ENTERPRISES, BEVERLY HILLS, CA:
1,203,494, CANC. INT. CL. 13.
- WE'RE IN STITCHES, INC., TAMPA, FL:
1,991,292, CANC. INT. CL. 25.
- WEATHERFORD/LAMB, INC., HOUSTON, TX:
2,728,763, PUB. 4-1-2003, MULTIPLE CLASS, INT. CLS. 6, 7 AND 9.
- WEATHERVANE RETAIL CORP., THE, NEW BRITAIN, CT:
1,204,127, CANC. INT. CL. 42.
- WEBLEARNING, LLC, MORGAN HILL, CA:
2,384,307, CANC. INT. CL. 41.
- WEBUNWIRED, LLC, MARSHALLTOWN, IA:
2,729,214, PUB. 4-1-2003, INT. CL. 38.
- WEEKEND EXERCISE COMPANY, INC., THE, SAN DIEGO, CA:
1,992,172, CANC. INT. CL. 25.
- WEINGARTEN, SHLOMY, LAS VEGAS, NV:
1,991,715, CANC. INT. CL. 42.
- WEINS, JANINE J., LEBANON, NH:
2,729,197, PUB. 4-1-2003, INT. CL. 35.
- WEISMAN ENTERPRISES, INC., MINNEAPOLIS, MN:
2,729,294, PUB. 4-1-2003, INT. CL. 35.
- WEISNER STEEL PRODUCTS, INC., ORINDA, CA:
2,730,905, INT. CL. 6.
- WEISS, ARVIN STANLEY, DENVER, CO:
2,729,174, PUB. 4-1-2003, INT. CL. 37.
- WELLESLEY FINANCIAL PUBLICATIONS, INC., WELLESLEY, MA:
2,730,915, INT. CL. 16.
- WELLS FARGO & COMPANY, SAN FRANCISCO, CA:
1,493,526, CANC. INT. CL. 36.
- WELLS LAMONT CORPORATION, NILES, IL:
2,730,305, INT. CL. 25.
- WELLS, TIMOTHY, DERWOOD, MD:
2,730,668, INT. CL. 42.
- WELLSPAN HEALTH, YORK, PA:
2,728,854, PUB. 4-1-2003, MULTIPLE CLASS, INT. CLS. 35, 42, 44 AND 45.
- WERIL INSTRUMENTOS MUSICAIS LTDA., FRANCO DA ROCHA, SP, BRAZIL:
2,729,010, PUB. 4-1-2003, INT. CL. 15.
2,729,011, PUB. 4-1-2003, INT. CL. 15.
- WESCOR, INC., LOGAN, UT:
1,755,123, REN. 5-13-03, INT. CL. 10.
- WESLEY ALLEN INC., LOS ANGELES, CA:
2,673,047, COR. INT. CL. 20.
- WESSEN INDUSTRIES LIMITED, HONG KONG, HONG KONG:
2,729,196, PUB. 4-1-2003, INT. CL. 21.
- WEST AGRO, INC., KANSAS CITY, MO:
1,203,341, CANC. INT. CL. 5.

WEST VISTA COMMUNICATIONS INC., ASHLAND, OR:
2,728,807, PUB. 4-1-2003. INT. CL. 16.

WESTBROOK FINANCIAL ADVISERS, INC., WATCHUNG, NJ:
1,706,002, CANC. INT. CL. 9.

WESTERFIELD, DIVINA K., CARMEL, IN:
2,730,424, INT. CL. 41.

WESTERN FAMILY FOODS, INC., TIGARD, OR:
1,705,840, CANC. INT. CL. 16.

WESTERN FILAMENT, INC., GRAND JUNCTION, CO,
COLLINS, JOHN S., LOS ANGELES, CA, DBA TRULINE
GLASS ROD MFG. CO.:
976,722, REN. 5-16-03. U.S. CL. 22 (INT. CL. 28).

WESTERN TELE-COMMUNICATIONS, INC., ENGLE-
WOOD, CO:
1,552,277, CANC. INT. CL. 38.

WESTERN TRIMMING CORPORATION, CHATSWORTH,
CA:
1,991,249, CANC. INT. CL. 14.

WESTFIELD LICENSING COMPANY, HENDERSON, NV,
LONGINES-WITTNAUER WATCH CO., INC., NEW
YORK, NY:
400,524, REN. 5-16-03. U.S. CL. 27 (INT. CL. 14).

WESTINGHOUSE ELECTRIC CORPORATION, PITTS-
BURGH, PA:
1,991,724, CANC. INT. CL. 35.

WESTPORT CORPORATION, PINE BROOK, NJ:
2,730,820, INT. CL. 24.

WESTWARD PARTS SERVICES LTD., RED DEER, ALBER-
TA, CANADA:
1,990,664, CANC. MULTIPLE CLASS, INT. CLS. 6 AND 7.

WESTWAY TRADING CORPORATION, NEW ORLEANS,
LA, CARGILL, INCORPORATED, WAYZATA, MN:
1,792,832, REN. 5-16-03. INT. CL. 31.

WESTWAY TRADING CORPORATION, NEW ORLEANS,
LA:
1,796,479, REN. 5-16-03. INT. CL. 31.

WHATMAN INTERNATIONAL LIMITED, KENT, ENG-
LAND:
1,203,440, CANC. INT. CL. 9.

WHEELER, FRANK A. JR., SCOTTSDALE, AZ:
1,990,650, CANC. INT. CL. 4.

WHETSTONE CANDY COMPANY, INC., ST. AUGUSTINE,
FL:
2,730,479, INT. CL. 30.

WHITAKER CORPORATION, THE, WILMINGTON, DE:
1,991,449, CANC. INT. CL. 9.

WHITE BUFFALO GAMES, POWAY, CA:
1,991,015, CANC. INT. CL. 28.

WHITE CONSOLIDATED INDUSTRIES, INC., CLEVE-
LAND, OH:
735,616, CANC. U.S. CL. 23.
1,756,174, REN. 5-14-03. INT. CL. 28.

WHITE KNIGHT FLUID HANDLING, INCORPORATED,
HEMLOCK, MI:
2,730,666, MULTIPLE CLASS, INT. CLS. 16 AND 41.
2,730,674, INT. CL. 7.

WHITE, BLAINE, A'MMON, BALTIMORE, MD:
2,729,187, PUB. 4-1-2003. INT. CL. 25.

WHITE, JAMES E., PLEASANT HILL, CA AND KOZEL,
LINDA, PLEASANT HILL, CA:
2,730,744, INT. CL. 28.

WHITE, RICKY D., CLAYTON, CA:
2,730,347, INT. CL. 9.

WHITEHALL DALLAS CORPORATION, IOWA PARK, TX:
2,729,083, PUB. 4-1-2003. INT. CL. 9.

WHITEHEAD BROTHERS COMPANY, FLORHAM PARK,
NJ:
735,507, CANC. U.S. CL. 1.

WHY PLAN, ALPINE, UT:
1,991,852, CANC. INT. CL. 16.

WILCOX, GEORGE L., MINNEAPOLIS, MN:
2,729,418, INT. CL. 38.

WILD BRAIN, INC., SAN FRANCISCO, CA:
2,729,703, INT. CL. 41.

WILD MARKS, INC., LAS VEGAS, NV:
2,729,236, PUB. 4-1-2003. INT. CL. 30.

WILD PLANET TOYS, INC., SAN FRANCISCO, CA:
2,729,693, INT. CL. 28.

WILD SANCTUARY COMMUNICATIONS, INC., GLEN
ELLEN, CA:
1,769,808, REN. 5-16-03. INT. CL. 9.

WILDLIFE INNOVATIONS, INC., WYOMING, MN:
2,728,846, PUB. 4-1-2003. INT. CL. 28.

WILFER, HANS-PETER, D-08258 MARKNEUKIRCHEN,
FED REP GERMANY:
2,729,602, INT. CL. 15.

WILL & BAUMER, INC., LIVERPOOL, NY:
1,762,339, REN. 5-15-03. INT. CL. 4.

WILLAKENZIE ESTATE, INC., YAMHILL, OR:
2,730,351, INT. CL. 33.

WILLERT HOME PRODUCTS, INC., ST. LOUIS, MO:
1,704,488, CANC. MULTIPLE CLASS, INT. CLS. 3 AND 5.

WILLIAMS ELECTRONICS GAMES, INC., CHICAGO, IL:
1,705,914, CANC. INT. CL. 28.

WILLIAMS, EMMANUEL R., PARK FOREST, IL, E. R.
WILLIAMS CO., INC., PARK FOREST, IL:
1,756,923, REN. 5-10-03. INT. CL. 25.

WILLIAMSON & ASSOCIATES, INC., SEATTLE, WA:
2,729,735, INT. CL. 9.

WILSON FOODS CORPORATION, OKLAHOMA CITY, OK
TO THORN APPLE VALLEY, INC., SOUTHFIELD, MI:
1,705,228, CANC. INT. CL. 29.

WILSON SPORTING GOODS CO., CHICAGO, IL, WILSON
SPORTING GOODS CO., CHICAGO, IL:
575,624, REN. 5-16-03. U.S. CL. 22 (INT. CL. 28).

WILSON SPORTING GOODS CO., CHICAGO, IL:
959,747, REN. 5-16-03. U.S. CL. 22 (INT. CL. 28).
1,991,038, CANC. INT. CL. 25.

WILSON, TRACEY B., ORCHARD PARK, NY:
2,728,982, PUB. 4-1-2003. INT. CL. 41.

WIMAN BEVERAGE COMPANY, INC., BRISBANE, CA:
1,991,757, CANC. INT. CL. 32.

WINCORP INTERNATIONAL, INC., MEDLEY, FL:
2,730,122, INT. CL. 30.

WINCUP HOLDING, INC., PHOENIX, AZ:
1,705,056, CANC. INT. CL. 21.

WINDMERE CORPORATION, MIAMI LAKES, FL:
1,705,813, CANC. INT. CL. 11.
1,991,649, CANC. INT. CL. 11.

WINDMOLLER & HOLSCHER KG, D-49525, LENGERICH,
FED REP GERMANY:
2,729,126, PUB. 4-1-2003. INT. CL. 7.

WINDS OF FIRE DANCE MINISTRY, INC., BELLVILLE,
OH:
2,730,494, INT. CL. 16.

WINDSATIIONS, INC., SLATON, TX:
1,991,814, CANC. MULTIPLE CLASS, INT. CLS. 24 AND
28.

WINE SENSE PARK AVENUE, INC., ROCHESTER, NY:
2,728,782, PUB. 4-1-2003. INT. CL. 35.

WING ENTERPRISES, INC., SPRINGVILLE, UT:
2,729,730, INT. CL. 28.

WINGATE, MATTHEW J., DURHAM, NH:
2,730,418, INT. CL. 12.

WINN-DIXIE STORES, INC., JACKSONVILLE, FL:
1,991,775, CANC. INT. CL. 42.
1,991,823, CANC. INT. CL. 1.

WINNIE WALKER COMPANY, CAPE CORAL, FL:
1,991,106, CANC. INT. CL. 10.

WINSTON LABORATORIES, INC., VERNON HILLS, IL:
2,729,437, INT. CL. 5.

WINTER PARK RECREATIONAL ASSOCIATION, WINTER
PARK, CO:
1,990,886, CANC. MULTIPLE CLASS, INT. CLS. 16, 25
AND 41.

WIRED.MD, PORTLAND, OR:
2,729,335, PUB. 4-1-2003. INT. CL. 44.

WISE PUBLISHING, INC., CHICAGO, IL:
2,244,429, CANC. INT. CL. 9.

WOLFCCHASE GALLERIA LIMITED PARTNERSHIP, CHI-
CAGO, IL:
1,991,340, CANC. INT. CL. 37.
1,991,341, CANC. INT. CL. 37.

- WOLPA, MARK, BERKELEY, CA:
2,729,496, INT. CL. 30.
2,729,497, INT. CL. 30.
- WOLVERINE WORLD WIDE, INC., ROCKFORD, MI:
2,730,285, INT. CL. 35.
- WOMEN AT LARGE SYSTEMS, INC., YAKIMA, WA:
1,991,082, CANC. INT. CL. 41.
- WOMENS CARE RESOURCES, INC., BRANDON, FL:
1,991,888, CANC. INT. CL. 9.
- WONDER-FORM INC., ST. LEONARD, QUEBEC, CANADA:
2,729,816, INT. CL. 25.
- WONG, SHARON M., WESTERVILLE, OH, DBA READY SET SELL:
2,728,547, PUB. 4-1-2003. MULTIPLE CLASS, INT. CLS. 16 AND 42.
- WOODCARE COMPANY, CROWN POINT, IN:
2,729,228, PUB. 4-1-2003. INT. CL. 2.
- WOODRUFF PROPERTIES, LTD., MARIETTA, GA:
2,728,679, PUB. 4-1-2003. INT. CL. 33.
- WOODSON INCORPORATED, LITITZ, PA:
2,728,541, PUB. 4-1-2003. INT. CL. 7.
- WOODSTUFF MANUFACTURING, INC., PHOENIX, AZ:
1,203,586, CANC. INT. CL. 20.
- WOOLCOTT & COMPANY, I. P., INC., ARLINGTON, VA:
1,991,594, CANC. INT. CL. 35.
- WOOLPERT LLP, DAYTON, OH:
2,657,876, COR. MULTIPLE CLASS, INT. CLS. 9 AND 42.
- WOOLWORTH CANADA INC., WESTON, ONTARIO, CANADA:
1,990,736, CANC. INT. CL. 18.
- WORDSMITH, INC., FAIRFAX, VA:
1,203,834, CANC. INT. CL. 35.
- WORK IT COMPANY, WASHINGTON, DC:
1,990,840, CANC. MULTIPLE CLASS, INT. CLS. 25 AND 41.
- WORKBOX, INC., SAN FRANCISCO, CA:
2,730,392, INT. CL. 9.
- WORKPLACE HEALTH, INC., PORTLAND, OR:
2,674,091, COR. MULTIPLE CLASS, INT. CLS. 35, 41 AND 42.
- WORLD BAZAARS, INC., LOS ANGELES, CA:
1,991,492, CANC. INT. CL. 28.
- WORLD BLACK BELT, INC., TARZANA, CA:
2,729,778, INT. CL. 5.
- WORLD TEAM TENNIS, INC., CHICAGO, IL:
2,729,686, INT. CL. 16.
- WORLD WIDE PACKETS, INC., VERADALE, WA:
2,730,025, INT. CL. 9.
- WORLDWIDE INTEGRATED RESOURCES, INC., COMMERCE, CA:
2,729,954, INT. CL. 21.
- WRANGLER APPAREL CORP., WILMINGTON, DE:
1,990,619, CANC. INT. CL. 18.
1,990,622, CANC. INT. CL. 25.
- WRIGHT & LATO, INC., EAST ORANGE, NJ:
1,992,155, CANC. INT. CL. 14.
- WRIGHT BRAND FOODS, INC., VERNON, TX:
1,705,221, CANC. INT. CL. 29.
- WRIGHT STRATEGIES, INC., SOLANA BEACH, CA:
1,991,326, CANC. INT. CL. 9.
- WRIGHT'S FARM CORP., HARRISVILLE, RI:
1,760,500, REN. 5-15-03. INT. CL. 42.
- WRQ, INC., SEATTLE, WA:
2,729,887, INT. CL. 9.
- WU, TAMMIE P., NEW YORK, NY:
2,729,654, INT. CL. 11.
- WYCKOFF, PETER J., SUNLAND, CA:
2,729,065, PUB. 4-1-2003. INT. CL. 30.
- WYETH, MADISON, NJ FROM AMERICAN HOME PRODUCTS CORPORATION, MADISON, NJ:
2,730,671, INT. CL. 5.
- WYNDHAM IP CORPORATION, WILMINGTON, DE:
2,730,198, INT. CL. 35.
- X M INTERNATIONAL, L.L.C., SALT LAKE CITY, UT:
2,730,753, INT. CL. 5.
- X PRIZE FOUNDATION, INC., ROCKVILLE, MD:
2,729,380, INT. CL. 16.
- X-PRESS TRANSCRIPTION, INCORPORATED, LONG BEACH, CA:
2,730,887, INT. CL. 35.
- XACTWARE, INC., OREM, UT:
2,730,270, INT. CL. 37.
- XCITEC GMBH, D-85609 ASCHHEIM B. MUENCHEN, FED REP GERMANY:
2,729,209, PUB. 4-1-2003. INT. CL. 9.
- XDIMENSIONAL TECHNOLOGIES, INC., BREA, CA:
2,729,785, INT. CL. 42.
2,729,826, INT. CL. 42.
- XENCOR, INC., MONROVIA, CA:
2,730,132, INT. CL. 5.
2,730,133, INT. CL. 1.
- XENOGEN CORPORATION, ALAMEDA, CA:
2,729,588, INT. CL. 31.
- XEROX CORPORATION, STAMFORD, CT:
2,730,936, INT. CL. 2.
- XFI CORPORATION, BETHESDA, MD:
2,729,555, INT. CL. 42.
- XPAYS, INC., SAN FRANCISCO, CA:
2,730,086, MULTIPLE CLASS, INT. CLS. 9, 18, 28 AND 35.
2,730,844, INT. CL. 25.
- XSRECORDS, INC., NASHVILLE, TN:
2,730,764, INT. CL. 9.
- XYRON INCORPORATED, SCOTTSDALE, AZ:
2,730,899, INT. CL. 7.
- Y-TEX CORPORATION, CODY, WY:
2,729,099, PUB. 4-1-2003. INT. CL. 5.
- YAHOO! INC., SUNNYVALE, CA:
2,588,702, COR. INT. CL. 9.
- YAKIMA CHIEF RANCHES, INC., SUNNYSIDE, WA:
2,729,466, INT. CL. 32.
- YAKIRA, L.L.C., SOUTH RIVER, NJ:
2,729,329, PUB. 4-1-2003. INT. CL. 25.
- YALE UNIVERSITY, NEW HAVEN, CT:
2,728,526, PUB. 4-1-2003. MULTIPLE CLASS, INT. CLS. 36 AND 37.
2,729,986, MULTIPLE CLASS, INT. CLS. 41 AND 42.
- YAMAHA HATSUDOKI KABUSHIKI KAISHA, SHIZUOKA-KEN, JAPAN:
2,729,929, INT. CL. 12.
- YAMHILL'S SOUTHERN EXPOSURE, LTD., NEWBERG, OR:
2,730,213, INT. CL. 35.
- YASU CORPORATION, HONOLULU, HI, DBA THE RUNNING ROOM:
2,728,455, PUB. 4-1-2003. MULTIPLE CLASS, INT. CLS. 25 AND 35.
- YATRA CORPORATION, MINNEAPOLIS, MN:
2,729,576, INT. CL. 9.
- YEAGER, LISA, MISSOULA, MT:
2,730,290, INT. CL. 5.
- YEOWARD, WILLIAM BERNARD, WARRINER GARDENS, LONDON, UNITED KINGDOM:
2,728,567, PUB. 4-1-2003. MULTIPLE CLASS, INT. CLS. 6, 11, 14, 20, 21, 24 AND 27.
- YNOBE, INC., LARGO, MD:
2,543,609, CANC. IIRN. RESTORED TO S.N. 78-027,071.
- YOKOHAMA RUBBER CO., LTD., THE, MINATO-KU, TOKYO, JAPAN:
1,705,891, CANC. INT. CL. 28.
- YOON, RICHARD, G., NEWARK, DE:
2,730,652, INT. CL. 16.
- YORK HEALTH SYSTEM, YORK, PA:
1,991,437, CANC. INT. CL. 42.
- YORK WALLCOVERINGS, INC., YORK, PA:
2,730,508, INT. CL. 27.
- YOUNG LIFE, COLORADO SPRINGS, CO:
2,728,539, PUB. 4-1-2003. INT. CL. 25.
- YOUNG, ALEX L. INDUSTRY, CA, DBA NARS (NATIONAL ACADEMIC RESEARCH SERVICES) DBA WORLDSAVERS:
2,728,466, PUB. 4-1-2003. MULTIPLE CLASS, INT. CLS. 16 AND 35.
- YOUR COMPANY COLLECTION, INC., DAYTON, OH:
2,729,779, INT. CL. 42.

YOUR CONNECTION, INC., LOS ANGELES, CA:
2,730,435, INT. CL. 25.

YOURNOVEL.COM, INC., RALEIGH, NC:
2,729,166, PUB. 4-1-2003. INT. CL. 41.

YUGEN KAISHA COSMIC WONDER, OSAKA, 541-0059, JAPAN:
2,728,661, PUB. 4-1-2003. INT. CL. 25.

YUPITERU INDUSTRIES CO., LTD., TOKYO, JAPAN:
1,991,458, CANC. INT. CL. 9.

YVES SAINT LAURENT FRANCE B.V., 1096 HA, AMSTERDAM, NETHERLANDS, YVES SAINT LAURENT FASHION B.V., 1000 BL AMSTERDAM, NETHERLANDS:
1,712,998, REN. 5-12-03. MULTIPLE CLASS, INT. CLS. 6, 9, 14, 16, 18, 24, 25, 28 AND 34.

YVES SAINT LAURENT FRANCE B.V., 1096 HA AMSTERDAM, NETHERLANDS, YVES SAINT LAURENT FASHION B.V., 1077 XX AMSTERDAM, NETHERLANDS:
1,712,999, REN. 5-10-03. MULTIPLE CLASS, INT. CLS. 6, 9, 14, 16, 18, 24, 25 AND 34.

Z-STRIPE, INC., LAKELAND, FL:
2,728,564, PUB. 12-3-2002. INT. CL. 37.

ZARRELLA, CARMINE, STATEN ISLAND, NY:
2,729,443, INT. CL. 20.

ZEBRA IMAGING, INC., PFLUGERVILLE, TX:
2,729,878, INT. CL. 9.

ZEFFIRINO S.N.C. DI BELLONI ZEFFIRINO & C., I-16121 GENOVA, ITALY:
2,728,480, PUB. 4-30-2002. MULTIPLE CLASS, INT. CLS. 29, 30, 31, 32, 33 AND 42.

ZENITH ELECTRONICS CORPORATION, LINCOLNSHIRE, IL, CHICAGO RADIO LABORATORY, CHICAGO, IL:
164,341, REN. 5-10-03. U.S. CL. 21 (INT. CL. 9).

ZEON CORPORATION, CHIYODA-KU, TOKYO, JAPAN FROM NIPPON ZEON CO., LTD., CHIYODA-KU, TOKYO, JAPAN:
2,729,553, MULTIPLE CLASS, INT. CLS. 1, 3, 17 AND 30.

ZEPTOSENS AG, CH-4108 WITERSWIL, SWITZERLAND:
2,730,059, INT. CL. 9.

ZERO-KNOWLEDGE SYSTEMS, INC., MONTREAL, QUEBEC, CANADA:
2,728,560, PUB. 4-1-2003. MULTIPLE CLASS, INT. CLS. 9 AND 42.

ZEVEK, INC., SALT LAKE CITY, UT:
2,730,208, INT. CL. 10.

ZHERKA, SELIM, MOUNT VERNON, NY:
2,728,550, PUB. 4-1-2003. MULTIPLE CLASS, INT. CLS. 9, 35 AND 41.

ZIEBART INTERNATIONAL CORPORATION, TROY, MI:
1,243,854, REN. 5-10-03. INT. CL. 37.

ZINGY, INC., NEW YORK, NY:
2,730,682, MULTIPLE CLASS, INT. CLS. 38 AND 41.

ZION, GARY RANDALL, BETHESDA, MD:
2,730,251, INT. CL. 42.

ZIPPMARK, INC., WILMINGTON, DE:
2,728,696, PUB. 4-1-2003. INT. CL. 35.

ZOT NEDERLAND B.V., 1096 AR AMSTERDAM, NETHERLANDS:
2,730,080, INT. CL. 10.

ZSERVE CORPORATION, SPRINGVILLE, UT:
2,730,091, INT. CL. 42.

ZUREL GROUP B.V., AALSMEER, NETHERLANDS:
2,728,780, PUB. 4-1-2003. INT. CL. 31.

1ST SOURCE BANK, SOUTH BEND, IN:
2,729,805, INT. CL. 35.

100 CLUB, INC., THE, HOUSTON, TX:
1,744,796, REN. 5-10-03. MULTIPLE CLASS, INT. CLS. 36 AND 42.

1081002 ONTARIO LIMITED, RICHMOND HILL, ONTARIO, CANADA:
2,728,522, PUB. 1-8-2002. MULTIPLE CLASS, INT. CLS. 35, 37, 40 AND 42.

1443412 ONTARIO INC., OTTAWA, ONTARIO:
2,728,604, PUB. 4-1-2003. INT. CL. 42.

20TH CENTURY PLASTICS, INC., LOS ANGELES, CA:
1,683,781, CANC. INT. CL. 16.

24/7 EASY CLEAN, INC., ASHEBORO, NC:
2,729,473, INT. CL. 37.

3 RIVERS CONNECT, PITTSBURGH, PA:
2,730,460, INT. CL. 35.

3CRAZYLADIES, PALMDALE, CA:
2,730,838, INT. CL. 16.

3D MICROCOMPUTERS WHOLESALE & DISTRIBUTION (CANADA) INC., MARKHAM, ONTARIO, L3P 1W3, CANADA:
2,728,489, PUB. 4-1-2003. INT. CL. 9.

3DNA CORP., TORONTO, ONTARIO, ONTARIO:
2,729,870, MULTIPLE CLASS, INT. CLS. 9 AND 42.

3M COMPANY, ST. PAUL, MN, MINNESOTA MINING AND MANUFACTURING COMPANY, ST. PAUL, MN, AKA 3M:
1,229,695, REN. 5-15-03. INT. CL. 16.

3M COMPANY, ST. PAUL, MN, MINNESOTA MINING AND MANUFACTURING COMPANY, SAINT PAUL, MN, AKA 3M:
1,259,292, REN. 5-11-03. INT. CL. 9.

3M COMPANY, ST. PAUL, MN:
2,729,051, PUB. 4-1-2003. MULTIPLE CLASS, INT. CLS. 16 AND 26.

3V PARTECIPAZIONI INDUSTRIALI S.P.A., 20121 MILANO, ITALY, DESITALIA PARTECIPAZIONI INDUSTRIALI S.P.A., 20121 MILANO, ITALY:
1,756,303, REN. 5-16-03. INT. CL. 1.

4LIFE RESEARCH, L.C., SANDY, UT:
2,730,174, INT. CL. 35.
2,730,306, INT. CL. 5.
2,730,429, INT. CL. 5.

4MC ACQUISITION CORP., BURBANK, CA:
1,990,660, CANC. MULTIPLE CLASS, INT. CLS. 41 AND 42.

4MOST ENTERPRISES, LLC, WHIPPANY, NJ:
2,728,811, PUB. 4-1-2003. INT. CL. 41.

5 MINUTE ROCK CHIP EXPRESS, INC., GIG HARBOR, WA:
2,730,921, INT. CL. 37.

* * * * *