

MARKS PUBLISHED FOR OPPOSITION

The following marks are published in compliance with section 12(a) of the Trademark Act of 1946. Applications for the registration of marks in more than one class have been filed as provided in section 30 of said act as amended by Public Law 772, 87th Congress, approved Oct. 9, 1962, 76 Stat. 769. Opposition under section 13 may be filed within thirty days of the date of this publication. See rules 2.101 to 2.105.

A separate fee of two hundred dollars for opposing each mark in each class must accompany the opposition.

SECTION 1.— INTERNATIONAL CLASSIFICATION

The short titles associated below with the international class numbers are terms designed merely for quick identification and are not an official part of the international classification. The full names of international classes are given in section 6.1 of the trademark rules of practice.

The designation "U.S. Cl." appearing in this section refers to the U.S. class in effect prior to Sep. 1, 1973 rather than the international class which applies to applications filed on or after that date. For adoption of international classification see notice in the OFFICIAL GAZETTE of Jun. 26, 1973 (911 O.G. TM 210).

Application in more than one class

SN 75-253,801. NAV CANADA, OTTAWA, ONTARIO, CANADA, FILED 3-7-1997.



PRIORITY CLAIMED UNDER SEC. 44(D) ON CANADA APPLICATION NO. 825466, FILED 10-9-1996, REG. NO. 573401, DATED 1-10-2003, EXPIRES 1-10-2018.

OWNER OF U.S. REG. NO. 2,268,063.

NO CLAIM IS MADE TO THE EXCLUSIVE RIGHT TO USE "CANADA", APART FROM THE MARK AS SHOWN.

THE MARK CONSISTS IN PART OF THE FANCIFUL REPRESENTATION OF AN AIRCRAFT IN FLIGHT.

CLASS 38—COMMUNICATION

FOR RADIO COMMUNICATION SERVICES FOR AIRCRAFT NAVIGATION; SATELLITE AND ELECTRONIC TRANSMISSION OF MESSAGES AND DATA FOR AIRCRAFT NAVIGATION; OPERATION OF COMMUNICATIONS FACILITIES AND NETWORKS FOR AIRCRAFT NAVIGATION (U.S. CLS. 100, 101 AND 104).

CLASS 39—TRANSPORTATION AND STORAGE

FOR AIR TRAFFIC CONTROL AND AIRCRAFT NAVIGATION SERVICES; NAMELY, AIRCRAFT NAVIGATION INFORMATION SERVICES; FLIGHT INFORMATION SERVICES; PROVIDING INFORMATION TO THIRD PARTIES REGARDING AIR TRAVEL AND AIR TRAFFIC NAVIGATION AND CONTROL BY MEANS OF A GLOBAL COMPUTER INFORMATION NETWORK; ON-LINE SERVICES, NAMELY, PROVIDING INFORMATION TO THIRD PARTIES REGARDING AIR TRAVEL AND AIR TRAFFIC NAVIGATION AND CONTROL; OPERATION OF AIR TRAFFIC CENTERS, TERMINAL CONTROL UNITS AND CONTROL TOWERS; OPERATION OF FACILITIES FOR AIRCRAFT NAVIGATION AND AUTOMATED FLIGHT DATA RECORDING AND DISPLAY SYSTEMS (U.S. CLS. 100 AND 105).

CLASS 41—EDUCATION AND ENTERTAINMENT

FOR EDUCATIONAL AND TRAINING SERVICES RELATING TO AIR NAVIGATION, AERONAUTICS AND AIR TRAFFIC CONTROL, NAMELY, PROVIDING CLASSES, COURSES, WORKSHOPS, SEMINARS, CONFERENCES, DEMONSTRATIONS, COMPUTER-BASED TRAINING AND DISTRIBUTION OF EDUCATIONAL MATERIALS IN CONNECTION THEREWITH (U.S. CLS. 100, 101 AND 107).

CLASS 42—SCIENTIFIC, COMPUTER AND LEGAL SERVICES

FOR OPERATING FACILITIES FOR SURVEILLANCE AND RADAR DETECTION OF AIRCRAFT; ESTABLISHING AND PROMOTING OPERATIONAL EFFICIENCY AND SAFETY OF AIR NAVIGATION AND AIR TRAFFIC CONTROL, NAMELY, REVIEWING STANDARDS AND PRACTICES OF AIR NAVIGATION AND AIR TRAFFIC CONTROL TO ASSURE OPERATIONAL EFFICIENCY AND COMPLIANCE WITH SAFETY LAWS AND REGULATIONS AND SUPPORT SERVICES RELATED TO SAFE AIRCRAFT OPERATIONS IN THE NATURE OF TECHNICAL SUPERVISION, INSPECTION AND CONSULTING RELATING THERETO; TECHNICAL CONSULTING AND RESEARCH AND DEVELOPMENT SERVICES IN THE FIELD OF AIR NAVIGATION AND AIR TRAFFIC CONTROL SYSTEMS; EMERGENCY ASSISTANCE RELATING TO AIR TRAFFIC CONTROL, NAMELY, PROVIDING EMERGENCY AIR TRAFFIC CONSULTATION, ARRANGING FOR THE DISPATCH OF EMERGENCY VEHICLES AND STAFF AND MONITORING AND NOTIFYING EMERGENCY AND MEDICAL FACILITIES; AVIATION WEATHER REPORTING AND FORECASTING SERVICES (U.S. CLS. 100 AND 101).

SN 75-266,546. NIPPON DENSHIN DENWA KABUSHIKI KAISHA, DBA NIPPON TELEGRAPH AND TELEPHONE CORPORATION, TOKYO, JAPAN, FILED 3-31-1997.

<http://www.ntt.net>

OWNER OF U.S. REG. NOS. 2,436,071 AND 2,515,991.

CLASS 9—ELECTRICAL AND SCIENTIFIC APPARATUS

FOR BLANK MAGNETIC DATA CARRIERS; BLANK RECORDING DISKS; AND BLANK OPTICAL DISKS; AUTOMATIC VENDING MACHINES AND MECHANISMS FOR COIN OPERATED APPARATUS; CASH REGISTERS; CALCULATING MACHINES, DATA PROCESSORS AND COMPUTERS; ADDING MACHINES; MAGNETIC CODED CARDS; CENTRAL PROCESSING UNITS; BLANK COMPACT DISKS; PRERECORDED COMPACT DISKS FEATURING COMPUTER SOFTWARE FOR GENERAL LEDGER, ACCOUNT MANAGEMENT, CASH MANAGEMENT, INVENTORY CONTROL, FINANCIAL TRANSACTION PROCESSING AND CUSTOMER ORDER PROCESSING; PRERECORDED COMPACT DISKS FEATURING COMPUTER SOFTWARE FOR USE IN THE FOLLOWING COMMUNICATIONS APPLICATIONS, TRANSMITTAL AND PROCESSING OF TEXT, IMAGES, SOUND, DATA AND NUMERIC CHARACTERS; PRERECORDED COMPACT DISKS FEATURING COMPUTER SOFTWARE FOR DESIGNING LARGE SCALE INTEGRATED CIRCUITS; PRERECORDED COMPACT DISKS FEATURING COMPUTER SOFTWARE FOR PROCESSING GRAPHICS; PRERECORDED COMPACT DISKS FEATURING COMPUTER SOFTWARE FOR DATA PROCESSING; COMPUTER OPERATING PROGRAMS; COMPUTER SOFTWARE OR PROGRAMS FOR TELECOMMUNICATIONS SWITCHES AND VOICE MAIL AND MESSAGING, TO PROCESS VOICE, VIDEO, FACSIMILE AND DATA, FOR ACCESSING A GLOBAL COMPUTER NETWORK OR INTERACTIVE COMPUTER COMMUNICATIONS NETWORK PROVIDING INFORMATION ON A WIDE VARIETY OF TOPICS OF PUBLIC INTEREST, FOR COMPUTER DATA DELIVERY, ENCRYPTING AND DECRYPTING SYSTEM TO INTERFACE WITH CABLE TELEVISION NETWORKS; COMPUTER SOFTWARE FOR USE IN DATABASE MANAGEMENT, FOR USE AS A SPREADSHEET, FOR WORD PROCESSING, TELECOMMUNICATION, DRAWING PICTURES FOR CHILDREN AND CRYPTOGRAPHY IN A WIDE VARIETY OF FIELDS, INCLUDING MOVIES, GAMES, MUSIC, EDUCATION, SPORTS, BUSINESS AND ECONOMY; COMPUTER SOFTWARE AND PROGRAMS FOR USE IN THE FIELDS OF ELECTRONIC PAYMENTS, ELECTRONIC SOFTWARE SALES, DEMOGRAPHIC INFORMATION AND ENCRYPTION/DECRYPTION OF INFORMATION, FOR PROCESSING CREDIT CARD TRANSACTIONS IN THE FIELD OF ELECTRONIC COMMERCE; COMPUTER SOFTWARE AND PROGRAMS FOR FACILITATING COMPUTER AIDED DESIGN AND LARGE SCALE INTEGRATED CIRCUIT DESIGN, FOR AUTOMATIC ORDER CYCLE PROCESSES BETWEEN RETAILERS AND MANUFACTURERS; BLANK MAGNETIC DATA CARRIERS; BLANK OPTICAL DATA CARRIERS; BLANK FLOPPY DISKS FOR COMPUTERS; BLANK MAGNETIC TAPES; TRANSMITTERS OF TELEPHONE OR RADIO ELECTRONIC SIGNALS; TELEPHONE TRANSMITTERS; COMPUTER SOFTWARE FOR ACCESSING A GLOBAL COMPUTER NETWORK OR INTERACTIVE COMPUTER COMMUNICATIONS NETWORK PROVIDING INFORMATION ON A WIDE VARIETY OF TOPICS OF PUBLIC INTEREST; PRERECORDED VIDEO TAPES, PRERECORDED VIDEO DISKS, RECORDED CD ROM DISKS AND PRERECORDED AUDIO TAPES IN A WIDE VARIETY OF FIELDS INCLUDING MUSIC AND GENERAL INFORMATION IN THE NATURE OF MOVIES, EDUCATION, MUSIC SPORTS, BUSINESS AND ECONOMY; DOWNLOADABLE SOFTWARE, NAMELY, COMPUTER SOFTWARE FOR WORD PROCESSING, DATA MANAGEMENT AND ACCESSING A GLOBAL COMPUTER NETWORK, INTERACTIVE COMPUTER COMMUNICATIONS NETWORK WHICH PROVIDES INFORMATION ON A WIDE VARIETY OF TOPICS OF PUBLIC INTEREST IN THE FIELDS OF BUSINESS, COMPUTER, CULTURE, ELECTRONIC COMMERCE AND WIDE VARIETY OF FIELDS THAT MAY BE DOWNLOADED FROM A COMPUTER NETWORK (U.S. CLS. 21, 23, 26, 36 AND 38).

CLASS 35—ADVERTISING AND BUSINESS

FOR PROVIDING INFORMATION RELATING TO ADVERTISEMENTS, TO THE SALE OF GOODS, TO SHOPS CLASSIFIED BY THE TYPE OF BUSINESS, AND TO SALES VOLUME TRACKING; PROVIDING BUSINESS INFORMATION; PROVIDING COMMERCIAL INFORMATION; ADVERTISING FOR OTHERS; MANAGEMENT OF EXHIBITIONS PROMOTING NEW PRODUCTS OF OTHERS; RENTAL OF EXHIBITION SITES FOR ADVERTISING PURPOSES; TELEPHONE ANSWERING SERVICES; SECRETARIAL AGENCY SERVICES FOR RECEIVING TELEPHONE CALLS; MARKET RESEARCH VIA A COMPUTER DATA BASE; BUSINESS MANAGEMENT AND CONSULTATION; PLANNING OF SALES PROMOTION AND ADVERTISING; PROVIDING TELEPHONE DIRECTORY INFORMATION (U.S. CLS. 100, 101 AND 102).

CLASS 36—INSURANCE AND FINANCIAL

FOR PROVIDING ELECTRONIC COMMERCE SERVICES, NAMELY, TELECOMMUNICATION PREPAID DEBIT CARD SERVICES, ON-LINE FINANCIAL PLANNING, RESEARCH AND ANALYSIS SERVICES, FINANCIAL SERVICES, NAMELY, AGENCIES FOR COLLECTING CHARGES FOR INFORMATION PROVIDERS RENDERED BY TELECOMMUNICATION FEE COLLECTING SYSTEM, PREPAID STORED VALUE CARD SERVICES FOR PAYMENT OF TELEPHONE CALLS, SUBWAY AND BUS AND RAILROAD FARES, BRIDGE AND TUNNEL TOLLS, MERCHANDISE COSTS AND LOW VALUE ELECTRONIC DEBIT TRANSACTIONS (U.S. CLS. 100, 101 AND 102).

CLASS 37—CONSTRUCTION AND REPAIR

FOR INSTALLATION, REPAIR AND MAINTENANCE OF COMMUNICATION EQUIPMENT FOR CONTROL IN BUILDINGS, TELECOMMUNICATION SYSTEMS, TELECOMMUNICATION FACILITIES, DATA COMMUNICATION FACILITIES, COMPUTER SYSTEMS; PROVIDING INFORMATION RELATING TO CONSTRUCTION (U.S. CLS. 100, 103 AND 106).

CLASS 38—COMMUNICATION

FOR TELECOMMUNICATIONS GATEWAY SERVICES, NAMELY, PROVIDING TELECOMMUNICATIONS CONNECTIONS TO A GLOBAL COMPUTER NETWORK; DIGITAL INTERACTIVE COMMUNICATION, NAMELY, DIGITAL TRANSMISSION OF INTERACTIVE TELEVISION, AUDIO, PRINT DOCUMENTS, MESSAGES NOT INCLUDING COMPUTER GAMES; INTEGRATED SERVICES DIGITAL NETWORK; TELEVISION BROADCASTING; CABLE TELEVISION BROADCASTING; TRANSMISSION OF NEWS IN VISUAL IMAGES AND TEXT TO REPORTERS AND NEWS AGENCIES VIA CABLE TELEVISION BROADCASTING AND CLOSED CIRCUIT TELEVISION; AUDIO AND VIDEO TELECONFERENCING; ELECTRONIC TRANSMISSION OF MESSAGES; ELECTRONIC VOICE MESSAGING, NAMELY, THE RECORDING, STORAGE AND SUBSEQUENT TRANSMISSION OF VOICE MESSAGES BY TELEPHONE; FACSIMILE TRANSMISSION; TELEPHONE COMMUNICATION SERVICES; TELECOMMUNICATION SERVICES, NAMELY, ELECTRONIC TRANSMISSION OF DATA, IMAGES, AND DOCUMENTS VIA COMPUTER TERMINALS; COMPUTER-AIDED TRANSMISSION OF MESSAGES AND IMAGES; SATELLITE COMMUNICATION SERVICES; TRANSMISSION OF IMAGES BY COMMUNICATION SATELLITES; PROVIDING INFORMATION RELATING TO TELECOMMUNICATIONS, DATA COMMUNICATIONS, AND BROADCASTING; ELECTRONIC TRANSMISSION OF INFORMATION IN A WIDE VARIETY OF FIELDS BY TELECOMMUNICATION, NAMELY, VIA TELEPHONE, TELEVISION, SATELLITE AND OPTICAL FIBER; TELECOMMUNICATIONS SERVICES, NAMELY, PROVIDING COMMUNICATION BY TELEGRAPH, COMPUTER TERMINAL, VIDEOTEXT AND VALUE-ADDED NETWORK OR VAN SERVICES; TELETEXT SERVICES; RADIO PAGING SERVICES; TELEPHONE PAGING SERVICES; TELEPRINTING; RENTAL AND OF TELECOMMUNICATION EQUIPMENT IN GENERAL; PROVIDING A VALUE-ADDED COMMUNICATION NETWORK, FOR USE BY OTHERS IN PROVIDING

ON-LINE RETAIL SERVICES, VIA A SATELLITE OR TELECOMMUNICATION CIRCUIT (U.S. CLS. 100, 101 AND 104).

CLASS 41—EDUCATION AND ENTERTAINMENT

FOR PRODUCTION OF TELEVISION PROGRAMS BY USING COMPUTER GRAPHICS; DEVELOPMENT AND DISSEMINATION OF EDUCATIONAL MATERIALS FOR CHILDREN USING COMPUTERS; PROVIDING INFORMATION RELATING TO EDUCATION AND ENTERTAINMENT, MOVIES, SPORTS, CONCERTS, SCENIC SPOTS, PLACES OF HISTORIC INTEREST, AND RECREATION; THEATRICAL BOOKING AGENCIES; TRAINING IN THE USE AND OPERATION OF COMPUTERS, WORD PROCESSORS, CAMERAS AND TELECOMMUNICATION APPARATUS; PUBLICATION OF BOOKS, MAGAZINES; PROVIDING A COMPUTER GAME THAT MAY BE ACCESSED NETWORK-WIDE BY NETWORK USERS; RENTAL AND LEASING OF TELEVISION GAME TOYS; RENTAL OF AMUSEMENT FACILITIES EQUIPPED WITH GAMES; EDUCATION PROVIDED BY TELEPHONE, IN THE FIELD OF SALES TECHNIQUE; EDUCATIONAL SERVICES, NAMELY, CONDUCTING SEMINARS IN THE FIELD OF INFORMATION PROCESSING; VOCATIONAL EDUCATION IN THE FIELD OF TELECOMMUNICATION TECHNIQUE; ARRANGING AND CONDUCTING EDUCATIONAL SEMINARS, SYMPOSIA AND CONFERENCES; ORGANIZING EXHIBITIONS FOR CULTURAL AND EDUCATIONAL PURPOSES; RENTAL OF RECORDED MAGNETIC TAPES, GAME CARTRIDGES, MAGNETIC DISKS AND OPTICAL RECORDING MEDIA IN WHICH GAME PROGRAMS ARE RECORDED, VIDEOTAPES, SOUND RECORDINGS, RADIOS AND TELEVISIONS; LIBRARIES (U.S. CLS. 100, 101 AND 107).

CLASS 42—SCIENTIFIC, COMPUTER AND LEGAL SERVICES

FOR COMPUTER SERVICES, NAMELY, PROVIDING DATABASES AND DATABASES IN THE NATURE OF BULLETIN BOARDS ALL FEATURING RESEARCH AND REFERENCE MATERIALS IN THE FIELD OF BUSINESS, FINANCE, NEWS, WEATHER, SPORTS, ENTERTAINMENT, TRAVEL, SHOPPING, COMPUTING, COMPUTER SOFTWARE, MUSIC, THEATER, MOVIES, GAMES, HOBBIES, COMPUTER SUPPORT EDUCATION, LIFE STYLES AND GENERAL INTEREST; PROVIDING A WEB SITE AND HOME PAGE OF INFORMATION IN THE FIELDS OF SHOPPING, COMPUTING, COMPUTER SOFTWARE, HOBBIES, COMPUTER SUPPORT EDUCATION, LIFE STYLES AND GENERAL INTEREST; CONSULTATION, DESIGN, RESEARCH AND DEVELOPMENT IN THE FIELDS OF COMPUTER SYSTEMS AND UPDATING OF COMPUTER NETWORKS; UPDATING OF COMPUTER SOFTWARE; COMPUTER PROGRAMMING FOR OTHERS; RENTAL AND LEASING OF COMPUTERS; RENTAL OF COMPUTER SOFTWARE; PROVIDING COMPUTER SOFTWARE IN THE FIELD OF BUSINESS, COMPUTER, CULTURE, ELECTRONIC COMMERCE AND A WIDE RANGE OF FIELDS THAT MAY BE DOWNLOADED FROM A GLOBAL COMPUTER NETWORK; DESIGNING AND HOSTING HOME PAGES ON A COMPUTER NETWORK FOR OTHERS; COMPUTER SERVICES, NAMELY, PROVIDING AN INTEGRATED DATABASE FEATURING COMPANY EMPLOYMENT, PRODUCT AND FINANCIAL INFORMATION; PROVIDING MULTIPLE-USER ACCESS TO A GLOBAL COMPUTER INFORMATION NETWORK FOR THE TRANSFER AND DISSEMINATION OF A WIDE RANGE OF INFORMATION; CONSTRUCTION DRAFTING, ARCHITECTURAL DESIGN, ENGINEERING, DRAFTING; RESEARCH AND DEVELOPMENT OF PRODUCTS FOR OTHERS; TECHNICAL ANALYSIS AND TESTING OF PRODUCTS FOR OTHERS; TECHNICAL ANALYSIS, TESTING AND CONSULTATION IN THE FIELD OF CONSTRUCTION AND OPERATION OF NETWORKS; INTEGRATION SERVICES OF GLOBAL, INTERNATIONAL, AND PERSONAL COMPUTER LOCAL AREA COMMUNICATION NETWORKS; DESIGN AND DEVELOPMENT FOR OTHERS IN THE FIELD OF TELECOMMUNICATION INSTALLATIONS AND TELECOMMUNICATIONS NETWORKS; PROVIDING INFORMATION IN A WIDE VARIETY OF TOPICS OF PUBLIC INTEREST VIA AN

INTERACTIVE COMPUTER COMMUNICATION NETWORK AND A GLOBAL COMPUTER NETWORK; PROVIDING INFORMATION IN A WIDE VARIETY OF FIELDS BY MEANS OF A GLOBAL COMPUTER INFORMATION NETWORK; CONSULTATION IN THE FIELDS OF INTELLECTUAL PROPERTY, COMPUTER HARDWARE, AND ARCHITECTURE; PROVIDING FACILITIES FOR EXHIBITION; PROVIDING MULTIPLE-USER ACCESS TO A COMPUTER OR ELECTRONIC BULLETIN BOARD IN THE FIELDS OF FASHION, ENTERTAINMENT, HEALTH, LIFESTYLE AND OTHER TOPICS OF GENERAL INTERESTS; COMPUTER SERVICES, NAMELY, PROVIDING ON-LINE NEWSPAPER ARTICLES AND DOCUMENTARY INFORMATION IN A VARIETY OF FIELDS; COMPUTER SERVICES, NAMELY, PROVIDING ON-LINE MAGAZINES IN THE FIELDS OF FASHION, ENTERTAINMENT, HEALTH, LIFESTYLE AND OTHER TOPICS OF GENERAL INTEREST; COMPUTER SERVICES, NAMELY, PROVIDING ON-LINE FACILITIES FOR REAL-TIME INTERACTION WITH OTHER COMPUTER USERS CONCERNING TOPICS OF GENERAL INTEREST IN THE NATURE OF CHAT ROOM; COMPUTER SERVICES, NAMELY, PROVIDING ELECTRONIC LIBRARY SERVICES WHICH FEATURE NEWSPAPERS, MAGAZINES, PHOTOGRAPHS AND PICTURES VIA AN ON-LINE COMPUTER NETWORK; PROVIDING INFORMATION IN A WIDE VARIETY OF FIELDS BY TELECOMMUNICATION, NAMELY, VIA TELEPHONE, TELEVISION, SATELLITE AND OPTICAL FIBER (U.S. CLS. 100 AND 101).

SN 75-274,806. AVK/SEG HOLDING GMBH & CO. KOMMANDITGESELLSCHAFT, 47906 KEMPEN, FED REP GERMANY, FILED 4-15-1997.

CONCYCLE

CLASS 7—MACHINERY

FOR (BASED ON 44(E) ELECTRICAL MACHINERY, NAMELY, ELECTRICAL POWER GENERATORS, ELECTRIC MOTORS, (BASED ON INTENT TO USE) ELECTRIC POWER FILTERS, AND (BASED ON 44(E) CONVERTERS COMPRISED OF ELECTRIC GENERATORS AND ELECTRIC MOTORS AND HAVING VARIABLE SPEEDS AND CONSTANT OUTPUT FREQUENCIES FOR HIGH POWER APPLICATION (U.S. CLS. 13, 19, 21, 23, 31, 34 AND 35).

CLASS 9—ELECTRICAL AND SCIENTIFIC APPARATUS

FOR (BASED ON 44(E)) ELECTRIC POWER CONTROLLERS; APPARATUS FOR STORING ELECTRIC ENERGY, NAMELY, BATTERIES AND CAPACITORS (U.S. CLS. 21, 23, 26, 36 AND 38).

SN 75-287,107. INTEVEP, S.A., CARACAS 1070A, VENEZUELA, FILED 5-6-1997.

AQUACONVERSION

OWNER OF VENEZUELA REG. NO. 5724-97, DATED 1-23-1998, EXPIRES 1-23-2008.

OWNER OF VENEZUELA REG. NO. 96-677, DATED 3-7-1997, EXPIRES 3-7-2007.

CLASS 1—CHEMICALS

FOR CATALYST FOR USE IN THE TREATING OF HEAVY HYDROCARBON FEEDSTOCKS WITH STEAM TO UPGRADE THE FEEDSTOCK INTO MORE VALUABLE LOWER BOILING POINT HYDROCARBON PRODUCTS (U.S. CLS. 1, 5, 6, 10, 26 AND 46).

FIRST USE 5-4-2001; IN COMMERCE 5-4-2001.

CLASS 37—CONSTRUCTION AND REPAIR

FOR (BASED ON FOREIGN REGISTRATION)—TECHNICAL MODIFICATION OF VISBREAKING EQUIPMENT FOR USE IN THE TREATMENT OF HEAVY HYDROCARBON FEEDSTOCKS IN THE PRESENCE OF A CATALYST AND STEAM TO UPGRADE THE FEEDSTOCK INTO MORE VALUABLE LOWER BOILING POINT HYDROCARBON PRODUCTS (U.S. CLS. 100, 103 AND 106).

SN 75-356,508. SWATCH AG (SWATCH SA) (SWATCH LTD.), BIENNE, SWITZERLAND, FILED 9-15-1997.

THE IMPRECISION CLUB

OWNER OF SWITZERLAND REG. NO. 440596, DATED 11-20-1996, EXPIRES 11-20-2006.

NO CLAIM IS MADE TO THE EXCLUSIVE RIGHT TO USE "CLUB", APART FROM THE MARK AS SHOWN.

CLASS 14—JEWELRY

FOR WATCHES AND PARTS THEREOF; WATCH CASES; WATCH DIALS; AND WATCH BRACELETS (U.S. CLS. 2, 27, 28 AND 50).

CLASS 16—PAPER GOODS AND PRINTED MATTER

FOR NEWSPAPERS AND MAGAZINES IN THE FIELD OF COMPANY NEWS AND WATCH PRODUCT INFORMATION FOR MEMBERS (U.S. CLS. 2, 5, 22, 23, 29, 37, 38 AND 50).

CLASS 38—COMMUNICATION

FOR ELECTRONIC TRANSMISSION OF WRITTEN AND PICTORIAL PRODUCT INFORMATION (U.S. CLS. 100, 101 AND 104).

CLASS 42—SCIENTIFIC, COMPUTER AND LEGAL SERVICES

FOR PROVIDING WATCH FASHION, WATCH COLLECTORS', AND WATCH PRODUCT INFORMATION; AND PROVIDING AN ON-LINE MAGAZINE FEATURING WATCH FASHION, WATCH COLLECTION, AND WATCH PRODUCT INFORMATION (U.S. CLS. 100 AND 101).

SN 75-356,509. SWATCH AG (SWATCH SA) (SWATCH LTD.), BIENNE, SWITZERLAND, FILED 9-15-1997.

CLUB DES IMPRECIS

OWNER OF SWITZERLAND REG. NO. 440,593, DATED 11-20-1996, EXPIRES 11-20-2006.

NO CLAIM IS MADE TO THE EXCLUSIVE RIGHT TO USE "CLUB", APART FROM THE MARK AS SHOWN.

"DES IMPRECIS" CAN BE TRANSLATED INTO ENGLISH AS "THE IMPRECISION".

CLASS 14—JEWELRY

FOR WATCHES AND PARTS THEREOF; WATCH CASES; WATCH DIALS; AND WATCH BRACELETS (U.S. CLS. 2, 27, 28 AND 50).

CLASS 16—PAPER GOODS AND PRINTED MATTER

FOR NEWSPAPERS AND MAGAZINES IN THE FIELD OF COMPANY NEWS AND WATCH PRODUCT INFORMATION FOR MEMBERS (U.S. CLS. 2, 5, 22, 23, 29, 37, 38 AND 50).

CLASS 38—COMMUNICATION

FOR ELECTRONIC TRANSMISSION OF WRITTEN AND PICTORIAL PRODUCT INFORMATION (U.S. CLS. 100, 101 AND 104).

CLASS 42—SCIENTIFIC, COMPUTER AND LEGAL SERVICES

FOR PROVIDING WATCH FASHION, WATCH COLLECTORS', AND WATCH PRODUCT INFORMATION; AND PROVIDING AN ON-LINE MAGAZINE FEATURING WATCH FASHION, WATCH COLLECTION, AND WATCH PRODUCT INFORMATION (U.S. CLS. 100 AND 101).

SN 75-356,511. SWATCH AG (SWATCH SA) (SWATCH LTD.), BIENNE, SWITZERLAND, FILED 9-15-1997.

CLUB DEGLI IMPRECISI

OWNER OF SWITZERLAND REG. NO. 440,595, DATED 5-26-1997, EXPIRES 11-20-2006.

NO CLAIM IS MADE TO THE EXCLUSIVE RIGHT TO USE "CLUB", APART FROM THE MARK AS SHOWN.

"DEGLI IMPRECISI" CAN BE TRANSLATED INTO ENGLISH AS "THE IMPRECISION".

CLASS 14—JEWELRY

FOR WATCHES AND PARTS THEREOF; WATCH CASES; WATCH DIALS; AND WATCH BRACELETS (U.S. CLS. 2, 27, 28 AND 50).

CLASS 16—PAPER GOODS AND PRINTED MATTER

FOR NEWSPAPERS AND MAGAZINES IN THE FIELD OF COMPANY NEWS AND WATCH PRODUCT INFORMATION FOR MEMBERS (U.S. CLS. 2, 5, 22, 23, 29, 37, 38 AND 50).

CLASS 38—COMMUNICATION

FOR ELECTRONIC TRANSMISSION OF WRITTEN AND PICTORIAL PRODUCT INFORMATION (U.S. CLS. 100, 101 AND 104).

CLASS 42—SCIENTIFIC, COMPUTER AND LEGAL SERVICES

FOR PROVIDING WATCH FASHION, WATCH COLLECTORS', AND WATCH PRODUCT INFORMATION; AND PROVIDING AN ON-LINE MAGAZINE FEATURING WATCH FASHION, WATCH COLLECTION, AND WATCH PRODUCT INFORMATION (U.S. CLS. 100 AND 101).

SN 75-469,772. BAYER AKTIENGESELLSCHAFT, D-51368 LEVERKUSEN-BAYERWERK, FED REP GERMANY, FILED 4-17-1998.

B-ADL SCALE

OWNER OF FED REP GERMANY REG. NO. 39806883, DATED 4-2-1998, EXPIRES 2-29-2008.
NO CLAIM IS MADE TO THE EXCLUSIVE RIGHT TO USE "SCALE", APART FROM THE MARK AS SHOWN.

CLASS 9—ELECTRICAL AND SCIENTIFIC APPARATUS

FOR ELECTRICAL, ELECTRONIC, MAGNETIC, AND OPTICAL STORAGE MEDIA, NAMELY, BLANK CD-ROMS, VIDEO DISCS, VIDEO CASSETTES, AND AUDIO CASSETTES; A SERIES OF PRE-RECORDED CD-ROMS, VIDEO DISCS, VIDEO CASSETTES, AND AUDIO CASSETTES, FEATURING MEDICAL QUESTIONNAIRES AND METHODOLOGICAL INSTRUCTIONS FOR CONDUCTING PATIENT INTERVIEWS (U.S. CLS. 21, 23, 26, 36 AND 38).

CLASS 16—PAPER GOODS AND PRINTED MATTER

FOR PRINTED MATTER, NAMELY, PAMPHLETS CONTAINING MEDICAL QUESTIONNAIRES, AND METHODOLOGICAL INSTRUCTIONS FOR CONDUCTING PATIENT INTERVIEWS (U.S. CLS. 2, 5, 22, 23, 29, 37, 38 AND 50).

SN 75-536,775. VERIFY INTERNATIONAL N.V., WILLEMSTAD, CURACAO, NETHERLAND ANTILLES, FILED 8-17-1998.

VERILEX

OWNER OF BENELUX REG. NO. 0605980, DATED 6-5-1997, EXPIRES 6-5-2007.

CLASS 35—ADVERTISING AND BUSINESS

FOR ADVERTISING AGENCIES, NAMELY, UPDATING ADVERTISING MATERIAL; BUSINESS RESEARCH IN THE FIELD OF ADVERTISING (U.S. CLS. 100, 101 AND 102).

FIRST USE 11-1-1997; IN COMMERCE 1-30-2001.

CLASS 42—SCIENTIFIC, COMPUTER AND LEGAL SERVICES

FOR COMPUTER SOFTWARE DESIGN FOR OTHERS; PACKAGING DESIGN FOR OTHERS (U.S. CLS. 100 AND 101).

FIRST USE 11-4-1997; IN COMMERCE 1-30-2001.

SN 75-539,862. LPG SYSTEMS, 26000 VALENCE, FRANCE, FILED 10-30-1999.

ENDERMO

PRIORITY CLAIMED UNDER SEC. 44(D) ON FRANCE APPLICATION NO. 98721882, FILED 3-4-1998, REG. NO. 98721882, DATED 3-4-1998, EXPIRES 3-4-2008.

OWNER OF FRANCE REG. NO. 96626186, DATED 5-15-1996, EXPIRES 5-15-2006.

OWNER OF U.S. REG. NO. 2,161,594.

CLASS 41—EDUCATION AND ENTERTAINMENT

FOR HEALTH CLUB SERVICES; GYMNASIUM INSTRUCTIONS; EDUCATIONAL SERVICE, NAMELY, COURSES OF INSTRUCTION IN THE FIELD OF MASSAGE AND BEAUTY CARE (U.S. CLS. 100, 101 AND 107).

CLASS 42—SCIENTIFIC, COMPUTER AND LEGAL SERVICES

FOR MASSAGE SERVICES, HEALTH CARE SERVICES, PHYSICAL THERAPY AND BEAUTY SALON SERVICES (U.S. CLS. 100 AND 101).

SN 75-544,694. LUFTHANSA TECHNIK AG, D-22335 HAMBURG, FED REP GERMANY, FILED 8-28-1998.

TES

PRIORITY CLAIMED UNDER SEC. 44(D) ON FED REP GERMANY APPLICATION NO. 398110891, FILED 2-28-1998, REG. NO. 39811089, DATED 7-30-1998, EXPIRES 2-29-2008.

CLASS 6—METAL GOODS

FOR FULL LINE OF METAL AIRCRAFT FITTINGS (U.S. CLS. 2, 12, 13, 14, 23, 25 AND 50).

CLASS 35—ADVERTISING AND BUSINESS

FOR PROCUREMENT, NAMELY PURCHASING AND LEASING OF FLIGHT PERSONNEL, TECHNICAL GROUND PERSONNEL AND NON-TECHNICAL GROUND PERSONNEL SERVICES (U.S. CLS. 100, 101 AND 102).

CLASS 37—CONSTRUCTION AND REPAIR

FOR AIRCRAFT REPAIR AND MAINTENANCE, NAMELY PERFORMED BY AIRCRAFT ENGINEERS, FLIGHT ENGINEERS, FLIGHT MECHANICS AND INTERIOR DESIGNERS; REPAIR AND MAINTENANCE, FOR THIRD PARTIES, OF AIRCRAFT POWER PLANTS, AIRCRAFT ENGINES, AIRCRAFT ELECTRONIC AND OPTICAL EQUIPMENT AND AIRCRAFT MOTOR DRIVE MECHANISMS; RENOVATION OF AIRCRAFT AND PARTS THEREOF; MODERNIZATION OF AIRCRAFT AND PARTS THEREOF; IMPROVEMENT AND RENOVATION OF AIRCRAFT CABIN FURNISHING (U.S. CLS. 100, 103 AND 106).

CLASS 39—TRANSPORTATION AND STORAGE

FOR PROVIDING TRADE INFORMATION, NAMELY THROUGH THE COMPILATION AND SUPPLY OF INFORMATION VIA A GLOBAL COMPUTER NETWORK ON TECHNICAL INNOVATIONS RELATING TO AIRCRAFT OR PARTS THEREOF; STORAGE AND TRANSPORTATION BY AIR, RAIL, SEA AND ROAD OF MATERIAL REQUIRED FOR SERVICING, MAINTENANCE, REPAIR AND THE CONVERSION AND MODERNIZATION OF AIRCRAFT; TOWING SERVICES FOR AIRCRAFT; LEASING OF AIRCRAFT POWER PLANTS AND COMPONENTS OR PARTS THEREOF (U.S. CLS. 100 AND 105).

CLASS 40—MATERIAL TREATMENT

FOR MODIFICATION OF AIRCRAFT TO THE SPECIFICATION OF OTHERS, NAMELY, FROM COMMERCIAL/PASSENGER AIRCRAFT TO FREIGHTER/TANKER OR PRIVATE PASSENGER AIRCRAFT AND/OR VICE VERSA; CONVERSION OF AIRCRAFT FROM PROPELLER TO JET PROPULSION AIRCRAFT (U.S. CLS. 100, 103 AND 106).

CLASS 41—EDUCATION AND ENTERTAINMENT

FOR INITIAL AND ONGOING TRAINING OF FLIGHT AND GROUND PERSONNEL EMPLOYED BY THE COMPANY OR THIRD PARTIES IN THE USE OF EQUIPMENT ON AIRCRAFT AND EQUIPMENT FOR AIRCRAFT GROUND HANDLERS AND EQUIPMENT FOR AIRCRAFTING (U.S. CLS. 100, 101 AND 107).

CLASS 42—SCIENTIFIC, COMPUTER AND LEGAL SERVICES

FOR INTERIOR DESIGN FOR AIRCRAFT; INSPECTION OF AIRCRAFT AND PARTS THEREOF; TECHNICAL CONSULTATION AND RESEARCH IN THE FIELD OF AVIATION, INCLUDING ADVICE ON THE PURCHASE AND SALE OF AIRCRAFT; PRODUCT DEVELOPMENT, NAMELY PRODUCTION AND DEVELOPMENT OF EDP INSPECTION AND OVERHAUL PROGRAMS FOR AIRCRAFT AND PARTS THEREOF; DEVELOPMENT OF NON-EDP DEPENDENT INSPECTION PROGRAMS FOR AIRCRAFT AND PARTS THEREOF (U.S. CLS. 100 AND 101).

SN 75-562,840. MACPHEE, KATHLEEN, CHARLOTTE-TOWN, PEI, CANADA, FILED 10-1-1998.

PHONOBET

PRIORITY CLAIMED UNDER SEC. 44(D) ON CANADA APPLICATION NO. 873,949, FILED 4-1-1998, REG. NO. TMA544126, DATED 4-25-2001, EXPIRES 4-25-2016.

CLASS 9—ELECTRICAL AND SCIENTIFIC APPARATUS

FOR PRE-RECORDED CD-ROM'S FOR USE IN ASSOCIATION WITH READING AND WRITING INSTRUCTIONS, PRE-RECORDED COMPUTER DISKS, PRE-RECORDED AUDIO AND VIDEO TAPES FOR USE IN ASSOCIATION WITH READING AND WRITING INSTRUCTION, CHILDREN'S EDUCATIONAL COMPUTER SOFTWARE USED IN ASSOCIATION WITH READING AND WRITING INSTRUCTION; PRE-PACKAGED SETS OF EDUCATIONAL MATERIALS COMPOSED OF PRE-RECORDED AUDIO AND VIDEO TAPES, INSTRUCTIONAL MANUALS, WORD LISTS, FLASH CARDS, READING CARDS, GAME CARDS, LESSON PLAN SHEETS, BOOKLETS, TEST SOLD AS A UNIT THEREFOR (U.S. CLS. 21, 23, 26, 36 AND 38).

CLASS 16—PAPER GOODS AND PRINTED MATTER

FOR PRINTED MANUALS, BOOKS AND EDUCATIONAL PROGRAM MATERIALS, NAMELY, BOOKLETS, WORK SHEETS, WORK BOOKS, FLASH CARDS, READING CARDS; PRINTED PRE-DESIGNED EDUCATIONAL PROGRAM MATERIALS UTILIZED IN A FORMATTED TEACHING PLAN FOR ENHANCING READING AND WRITING SKILLS; PRINTED TEACHING MATERIALS IN THE FORM OF PRINTED WORK BOOK GAMES, WORD LISTS; TEST; TEACHING AIDS, NAMELY, PRE-PRINTED ROTARY WHEELS, CHARTS, SYLLABLE SHEETS, ACTIVITY BOOKS; PRIMER, ALPHABET BOOKS, PRINTED ALPHABET MATERIALS, NAMELY, PLATES, SHEETS, FLASHCARDS, READING CARDS; TEACHING MATERIALS IN THE FORM OF EDUCATIONAL PAMPHLETS; DEVICE USED TO HOLD AND DISPLAY ALPHABET CARDS (U.S. CLS. 2, 5, 22, 23, 29, 37, 38 AND 50).

CLASS 28—TOYS AND SPORTING GOODS

FOR EDUCATION CARD GAMES; EQUIPMENT SOLD AS A UNIT FOR PLAYING EDUCATIONAL CARD GAMES; EQUIPMENT SOLD AS A UNIT FOR PLAYING EDUCATIONAL BOARD GAMES (U.S. CLS. 22, 23, 38 AND 50).

SN 75-575,487. PROMOTIONAL PARTNERS GROUP, LTD., CHAI WAN, HONG KONG, FILED 10-26-1998.



NO CLAIM IS MADE TO THE EXCLUSIVE RIGHT TO USE "PROMOTIONAL PARTNERS WORLDWIDE", APART FROM THE MARK AS SHOWN.

CLASS 35—ADVERTISING AND BUSINESS

FOR ADVERTISING SERVICES, NAMELY, PROMOTING THE GOODS AND SERVICES OF OTHERS BY DEVELOPING, CREATING, PREPARING AND PLACING ADVERTISEMENTS; DEVELOPING EXECUTING AND EVALUATION OF PROMOTIONAL CAMPAIGNS FOR BUSINESS; BUSINESS CONSULTATION SERVICES, NAMELY NEGOTIATION THE LICENSING OF PROPERTY FOR PROMOTION; BUSINESS MANAGEMENT SUPERVISION AND MONITORING OF PRODUCT MANUFACTURING; STRATEGIC BUSINESS MARKETING CONSULTATION; BUSINESS MERCHANDISING DISPLAY SERVICES; CARTOON CHARACTER LICENSING; CHARACTER LICENSING (U.S. CLS. 100, 101 AND 102).

FIRST USE 4-11-1997; IN COMMERCE 4-11-1997.

CLASS 42—SCIENTIFIC, COMPUTER AND LEGAL SERVICES

FOR CREATIVE GRAPHIC ART DESIGN SERVICES (U.S. CLS. 100 AND 101).

FIRST USE 4-11-1997; IN COMMERCE 4-11-1997.

SN 75-633,163. TV GLOBO LTDA, RIO DE JANEIRO - 22460 - 010, BRAZIL, FILED 2-2-1999.

FOOTBRASIL

OWNER OF BRAZIL REG. NO. 821363590, DATED 5-28-2002, EXPIRES 5-28-2012.

OWNER OF BRAZIL REG. NO. 821363603, DATED 5-28-2002, RENEWED AS REG. NO. 3, EXPIRES 5-28-2012.

CLASS 38—COMMUNICATION

FOR TELEVISION BROADCASTING (U.S. CLS. 100, 101 AND 104).

CLASS 41—EDUCATION AND ENTERTAINMENT

FOR ENTERTAINMENT SERVICES, NAMELY, ONGOING TELEVISION PROGRAMS IN THE FIELD OF SPORTS AND VARIETY SHOWS; ORGANIZING AND CONDUCTING SPORTS EVENTS; PRODUCING TELEVISION PROGRAMS IN THE FIELD OF SPORTS, AND PRODUCING VARIETY SHOWS (U.S. CLS. 100, 101 AND 107).

SN 75-639,989. TRAVELSCAPE, INC., BELLEVUE, WA. BY MERGER, BY CHANGE OF NAME TRAVELSCAPE.COM, INC., LAS VEGAS, NV. FILED 2-12-1999.



OWNER OF U.S. REG. NO. 1,864,967.

CLASS 39—TRANSPORTATION AND STORAGE

FOR TRAVEL AGENCY SERVICES, NAMELY, MAKING RESERVATIONS AND BOOKINGS FOR TRANSPORTATION AND CAR RENTALS (U.S. CLS. 100 AND 105).

FIRST USE 5-1-1998; IN COMMERCE 7-24-1998.

CLASS 42—SCIENTIFIC, COMPUTER AND LEGAL SERVICES

FOR TRAVEL AGENCY SERVICES, NAMELY, MAKING RESERVATIONS AND BOOKINGS FOR TEMPORARY LODGING (U.S. CLS. 100 AND 101).

FIRST USE 5-1-1998; IN COMMERCE 7-24-1998.

SN 75-640,661. REBUS GROUP PLC, PETERBOROUGH PE3 6JY, UNITED KINGDOM, FILED 2-16-1999.

REBUS**CLASS 16—PAPER GOODS AND PRINTED MATTER**

FOR PRINTED MATTER, NAMELY, BROCHURES ABOUT COMPUTERS, COMPUTER SOFTWARE, AND THE INSURANCE AND REINSURANCE INDUSTRY (U.S. CLS. 2, 5, 22, 23, 29, 37, 38 AND 50).

CLASS 35—ADVERTISING AND BUSINESS

FOR COMPUTERIZED BUSINESS INFORMATION STORAGE AND RETRIEVAL SERVICES; COMPUTERIZED ACCOUNTING; COMPUTERIZED DATABASE MANAGEMENT; COMPUTERIZED DATA PROCESSING; AND BUSINESS MANAGEMENT ADVICE AND CONSULTANCY (U.S. CLS. 100, 101 AND 102).

CLASS 36—INSURANCE AND FINANCIAL

FOR INSURANCE SERVICES, NAMELY INSURANCE AGENCIES, BROKERAGE AND UNDERWRITING, ALL IN THE FIELDS OF HOME, PROPERTY, CASUALTY, LIFE, LIABILITY, MARINE, FIRE, AND AUTOMOBILE INSURANCE, REINSURANCE SERVICES IN THE FIELD OF HOME, PROPERTY, CASUALTY, LIFE, MARINE, FIRE AND AUTOMOBILE INSURANCE, AND INSURANCE UNDERWRITING (U.S. CLS. 100, 101 AND 102).

CLASS 37—CONSTRUCTION AND REPAIR

FOR INSTALLATION, REPAIR AND MAINTENANCE OF COMPUTERS AND COMPUTER APPARATUS AND EQUIPMENT (U.S. CLS. 100, 103 AND 106).

CLASS 40—MATERIAL TREATMENT

FOR CUSTOM MANUFACTURE OF COMPUTERS AND COMPUTER APPARATUS AND EQUIPMENT FOR OTHERS (U.S. CLS. 100, 103 AND 106).

CLASS 42—SCIENTIFIC, COMPUTER AND LEGAL SERVICES

FOR COMPUTER SERVICES, NAMELY DESIGN AND DEVELOPMENT OF COMPUTER SOFTWARE FOR OTHERS; COMPUTER PROGRAMMING FOR OTHERS; TECHNICAL SUPPORT SERVICES, NAMELY TROUBLESHOOTING OF COMPUTER SOFTWARE PROBLEMS VIA TELEPHONE, E-MAIL, GLOBAL COMPUTER NETWORK, AND IN PERSON (U.S. CLS. 100 AND 101).

SN 75-672,299. SOFTSPIKES, INC., GAITHERSBURG, MD. BY ASSIGNMENT RAYMOND, DAVID, TOLLAND, CT. FILED 3-31-1999.

BLACK WIDOW GOLF

NO CLAIM IS MADE TO THE EXCLUSIVE RIGHT TO USE "GOLF", APART FROM THE MARK AS SHOWN.

CLASS 25—CLOTHING

FOR GOLF SHIRTS, GOLF HATS, GOLF JACKETS, AND GOLF SWEATERS (U.S. CLS. 22 AND 39).

FIRST USE 7-0-1984; IN COMMERCE 7-0-1984.

CLASS 28—TOYS AND SPORTING GOODS

FOR GOLF CLUBS, CLUB HEADS, CLUB SHAFTS, CLUB INSERTS, IRONS, PUTTERS, TEES, HEAD COVERS FOR GOLF CLUBS, GRIPS FOR GOLF CLUBS, GOLF GLOVES, GOLF BAGS, GOLF BAG COVERS, GOLF BAG TAGS, AND GOLF BALLS (U.S. CLS. 22, 23, 38 AND 50).

FIRST USE 7-0-1984; IN COMMERCE 7-0-1984.

SN 75-719,979. NIPPON THERMOSTAT CO., LTD, TOKYO, JAPAN, FILED 6-3-1999.

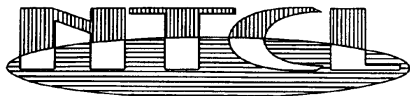

PRIORITY CLAIMED UNDER SEC. 44(D) ON JAPAN APPLICATION NO. 103516/1998, FILED 12-4-1998, REG. NO. 4596060, DATED 8-16-2002, EXPIRES 8-16-2012.

THE DRAWING IS LINED FOR THE COLORS RED AND BLUE-GREEN.

CLASS 6—METAL GOODS

FOR METAL HINGES FOR A DOOR HAVING THERMO-SENSOR, METAL VENTILATION DUCTS AND METAL MANUALLY OPERATED VENTILATION DAMPERS (U.S. CLS. 2, 12, 13, 14, 23, 25 AND 50).

CLASS 7—MACHINERY

FOR MACHINE PARTS, NAMELY, OIL FLOW CONTROL VALVE, AIR FLOW CONTROL VALVE, AND HOT WATER CUT-OFF VALVE; MACHINE PARTS, NAMELY, AUTOMATIC MIXING VALVE, THERMAL VALVE, ELECTRIC VALVE, ELECTRIC PROPORTIONING VALVE, THERMAL PRESSURE VALVE, THERMAL CONTROLLING VALVE, AUTOMATIC TEMPERATURE EXCHANGING VALVE, LOW TEMPERATURE MOVING VALVE, ELECTRIC MIXING VALVE, FLOW SWITCH, CONSTANT FLOW VALVE, PRESSURE REDUCING VALVE, AND BACK FLOW VALVE; LAND-VEHICLE FUEL-INJECTION AND CARBURETOR COMPONENTS, NAMELY, THROTTLE BODY, AUTOMATIC CHOKE, CONTROLLED COMBUSTION SYSTEM CONSISTING OF INTAKE AIR TEMPERATURE CONTROLLING VALVE FOR INTERNAL COMBUSTION ENGINE, AND CARBURETOR HEATER, EXHAUST BRAKING DEVICE, NAMELY MUFFLERS FOR ENGINES AND MOTORS OF LAND VEHICLES; EXHAUST GAS CIRCULATING VALVE FOR ENGINES AND MOTORS OF LAND VEHICLES (U.S. CLS. 13, 19, 21, 23, 31, 34 AND 35).

CLASS 9—ELECTRICAL AND SCIENTIFIC APPARATUS

FOR TEMPERATURE CONTROLLING UNIT FOR FLOOR HEATING SYSTEM; AUTOMOTIVE SWITCHES AND CONTROLS, NAMELY, PRESSURE SWITCH, NAMELY, OIL-PRESSURE SWITCH, IDLE SPEED CONTROL VALVE, AND COOLING WATER TEMPERATURE CONTROL SWITCH, THERMOSTAT, THERMAL SWITCH, THERMO-SENSOR, THERMO-ELEMENT, PRESSURE SENSOR, REMOTE-CONTROLLED THERMOSTAT, AND BIMETAL SWITCH, ALL FOR LAND-VEHICLE (U.S. CLS. 21, 23, 26, 36 AND 38).

CLASS 11—ENVIRONMENTAL CONTROL APPARATUS

FOR VENTILATOR HAVING GRILLES BEING OPENED OR SHUT BY MEANS FOR ACTING OF WAX SEALED IN A WAX CASE WHICH MAY SWELL OR SHRINK ACCORDING TO THE ATMOSPHERIC TEMPERATURE, VENTILATION LOUVERS, PLUMBING FITTINGS, NAMELY, AUTOMATIC FREEZE-PREVENTING PETCOCK, FREEZE-PREVENTING VALVE OF EXTERNAL HOSE BIBBS, THERMAL CONTROL UNIT FOR AUTOMATIC MIXING VALVE, WATER-HAMMER PREVENTION DEVICE FOR DECREASING SOUND OF WATER-HAMMER BY MEANS OF RELEASING WATER PRESSURE FROM A SMALL HOLE WHICH IS FORMED IN A VALVE OF A BIN-COCK, AND HEAT PRESERVING PANEL CONSISTING OF WAX SEALED INTO PANELS FOR PRESERVING HEAT, COOLING FAN FOR CENTRAL PROCESSING UNIT OF COMPUTER, COOLING FAN FOR CENTRAL PROCESSING UNIT OF COMPUTER OF DEVICE AS LIKE ELECTRICAL COMMUNICATION MACHINES AND APPARATUS HAVING COMPUTER AS CONTROLLING MEANS (U.S. CLS. 13, 21, 23, 31 AND 34).

CLASS 12—VEHICLES

FOR ELECTRIC CARS AND STRUCTURAL PARTS THEREOF (U.S. CLS. 19, 21, 23, 31, 35 AND 44).

CLASS 20—FURNITURE AND ARTICLES NOT OTHERWISE CLASSIFIED

FOR INTERIOR WINDOW BLINDS MADE OF METAL (U.S. CLS. 2, 13, 22, 25, 32 AND 50).

SN 75-743,434. TBG DEVELOPMENT LLC, CLAYTON, MO. FILED 7-6-1999.

HEALTH BY DESIGN

CLASS 35—ADVERTISING AND BUSINESS

FOR OPERATION OF HEALTH, WELLNESS AND FITNESS CENTERS FOR OTHERS; CONTRACT MANAGEMENT OF HEALTH, WELLNESS AND FITNESS CENTERS FOR OTHERS (U.S. CLS. 100, 101 AND 102).

CLASS 36—INSURANCE AND FINANCIAL

FOR FINANCING SERVICES FOR PURCHASERS AND OWNERS OF HEALTH, WELLNESS AND FITNESS CENTERS (U.S. CLS. 100, 101 AND 102).

SN 75-775,692. CANADA MARITIME AGENCIES LIMITED, MONTREAL, QUEBEC, CANADA, FILED 8-13-1999.

CP SHIPS LOGISTICS (NORTH AMERICA)

NO CLAIM IS MADE TO THE EXCLUSIVE RIGHT TO USE "SHIPS LOGISTICS (NORTH AMERICA)", APART FROM THE MARK AS SHOWN.

CLASS 35—ADVERTISING AND BUSINESS

FOR CONTAINER FLEET MANAGEMENT SERVICES; INLAND TRANSPORT MANAGEMENT SERVICES (U.S. CLS. 100, 101 AND 102).

CLASS 37—CONSTRUCTION AND REPAIR

FOR REPAIR OF CONTAINERS (U.S. CLS. 100, 103 AND 106).

CLASS 39—TRANSPORTATION AND STORAGE

FOR INLAND TRANSPORT SERVICES; STORAGE AND TRANSPORT OF EMPTY CONTAINERS BY TRUCK, BARGE, FERRY, BOAT, RAIL, OR COMBINATION THEREOF (U.S. CLS. 100 AND 105).

SN 75-775,991. QWEST VIDEO, INC., BEVERLY HILLS, CA. FILED 8-13-1999.

Q'S JOOK JOINT

NO CLAIM IS MADE TO THE EXCLUSIVE RIGHT TO USE "JOOK JOINT" AS TO CLASS 42 ONLY, APART FROM THE MARK AS SHOWN.

CLASS 9—ELECTRICAL AND SCIENTIFIC APPARATUS

FOR SOUND AND VIDEO RECORDINGS, ALL FEATURING MUSIC AND ENTERTAINMENT; MOTION PICTURES FEATURING MUSIC AND ENTERTAINMENT (U.S. CLS. 21, 23, 26, 36 AND 38).

CLASS 16—PAPER GOODS AND PRINTED MATTER

FOR POSTERS; MAGAZINES, FEATURING INFORMATION ON LIVE MUSICAL EVENTS, MUSIC ENTERTAINMENT, SOUND AND VIDEO RECORDINGS, SPORTING EVENTS, THEATRICAL EVENTS, CURRENT EVENTS, NEWS, FOOD, RESTAURANTS, BARS, CABARETS, HOTELS, RESORTS AND CASINOS; SERIES OF NON FICTION BOOKS PERTAINING TO A VARIETY OF TOPICS; COMIC BOOKS, BUMPER STICKERS; STICKERS; CALENDARS; PENCIL SHARPENERS; PENCIL CASES; ACTIVITY BOOKS 3- RING BINDERS; NOTEBOOKS; STATIONERY CONSISTING OF WRITING PAPER AND ENVELOPES MEMO PADS; WRITING TABLETS; PAPER TABLE CLOTHS; PAPER NAPKINS; PENCILS ERASERS; COLORING BOOKS; WRITING PENS; NON-CALIBRATED RULERS; PAPER WEIGHTS; PAPER COASTERS; AND PAPER MATS (U.S. CLS. 2, 5, 22, 23, 29, 37, 38 AND 50).

CLASS 21—HOUSEWARES AND GLASS

FOR BEVERAGeware, PLATES, CUPS, SAUCERS, DINNERWARE (U.S. CLS. 2, 13, 23, 29, 30, 33, 40 AND 50).

CLASS 25—CLOTHING

FOR CLOTHING FOR MEN, WOMEN AND CHILDREN, NAMELY SHIRTS, JACKETS, SWEATERS, PANTS, FOOTWEAR, BELTS, T-SHIRTS, SOCKS, COORDINATED SHIRTS, JACKETS AND SLACKS, TENNIS SHOES, SWEAT SHIRTS, JERSEYS, SHORTS, JOGGING SUITS, SWEAT PANTS, HATS/CAPS, SCARVES, GLOVES, HOSE, NECKTIES, RAINWEAR, PAJAMAS, ROBES, NIGHT SHIRTS, THERMAL UNDERWEAR, HEADBANDS, AND WRISTBANDS (U.S. CLS. 22 AND 39).

CLASS 34—SMOKERS' ARTICLES

FOR MATCHES, ASHTRAYS, CIGARETTE LIGHTERS NOT OF PRECIOUS METAL (U.S. CLS. 2, 8, 9 AND 17).

CLASS 38—COMMUNICATION

FOR RADIO AND CABLE TELEVISION BROADCASTING SERVICES; VIDEO BROADCASTING SERVICES AND VIDEO ON DEMAND TRANSMISSION SERVICES (U.S. CLS. 100, 101 AND 104).

CLASS 41—EDUCATION AND ENTERTAINMENT

FOR ENTERTAINMENT SERVICES, NAMELY, PERIODIC TELEVISION PROGRAMS, FEATURING MUSICAL EVENTS, MUSICAL BASED ENTERTAINMENT, SPORTING EVENTS, THEATRICAL EVENTS, NEWS AND TALK SHOWS; PRODUCTION AND DISTRIBUTION OF TELEVISION PROGRAMS AND MOTION PICTURES FOR OTHERS; TELEVISION PROGRAMMING AND CABLE TELEVISION PROGRAMMING SERVICES; PROVIDING MUSICAL ENTERTAINMENT SERVICES (U.S. CLS. 100, 101 AND 107).

CLASS 42—SCIENTIFIC, COMPUTER AND LEGAL SERVICES

FOR RESTAURANT, BAR, CAFE AND CABARET SERVICES; PROVIDING INFORMATION ON RESTAURANTS AND DINING VIA A GLOBAL COMPUTER NETWORK (U.S. CLS. 100 AND 101).

SN 75-784,769. NEMESIS TECHNOLOGIES, INC, FREDERICKSBURG, VA. FILED 8-25-1999.

NEMESIS**CLASS 9—ELECTRICAL AND SCIENTIFIC APPARATUS**

FOR SOFTWARE FOR SECURITY MANAGEMENT CONTROL, CENTRALIZED SECURITY MONITORING, DISTRIBUTED NETWORK ANALYSIS, MANAGING SECURITY SOFTWARE CONTROLS, NETWORK DECEPTION, NETWORK SERVICE ENHANCEMENT, INFORMATION SECURITY, NETWORK SECURITY, COMPUTER APPLICATION AND OPERATING SYSTEM SECURITY, INFORMATION ASSURANCE, COMPUTER NETWORK DEFENSE, COMPUTER SECURITY AUDITING, NETWORK INTRUSION INVESTIGATION, SYSTEM INTRUSION DETECTION, NETWORK FIREWALL SYSTEMS, NAMELY, SOFTWARE SYSTEMS COMPRISING INTRUSION DETECTION SOFTWARE DESIGNED TO PREVENT UNAUTHORIZED ACCESS TO OR FROM A PRIVATE NETWORK, NETWORK ANALYSIS, ENSURING NETWORK RELIABILITY, NETWORK MONITORING, VULNERABILITY TESTING, AUDIT AND LOG ANALYSIS, TELEPHONY SECURITY, INTERNET SECURITY, E-COMMERCE SECURITY, AND FINANCIAL TRANSACTION SECURITY FOR USE IN CONNECTION WITH INTERNET AND INTRANET APPLICATIONS; COMPUTER HARDWARE AND INTRUSION DETECTION HARDWARE FOR USE IN CONNECTION WITH INTERNET AND INTRANET APPLICATIONS IN THE FIELDS OF SECURITY MANAGEMENT, NETWORK FIREWALL SYSTEMS, MONITORING AND AUDITING SYSTEMS ALL EXCLUDING THE VEHICLE SECURITY FIELD (U.S. CLS. 21, 23, 26, 36 AND 38).

CLASS 42—SCIENTIFIC, COMPUTER AND LEGAL SERVICES

FOR ENGINEERING AND TECHNICAL CONSULTATION IN THE FIELD OF DESIGNING, BUILDING, EQUIPPING, TESTING, AND RESEARCH AND DEVELOPMENT IN THE FIELD OF COMMERCIAL AND GOVERNMENT COMPUTER SECURITY SOFTWARE AND HARDWARE PRODUCTS AND SERVICES EXCLUDING THE VEHICLE SECURITY FIELD (U.S. CLS. 100 AND 101).

SN 75-790,877. BENSUSSEN DEUTSCH & ASSOCIATES, WOODINVILLE, WA. FILED 9-2-1999.

Your Merchandise Agency

NO CLAIM IS MADE TO THE EXCLUSIVE RIGHT TO USE "MERCHANDISE AGENCY", APART FROM THE MARK AS SHOWN.

CLASS 35—ADVERTISING AND BUSINESS

FOR ADVERTISING AGENCIES; DEVELOPMENT OF PROMOTIONAL MATERIALS, NAMELY, MATERIALS BEARING LOGOS AND SLOGANS OF OTHERS; PROMOTIONAL CAMPAIGNS FOR BUSINESSES; COOPERATIVE ADVERTISING AND MARKETING; CATALOGUE SERVICES FEATURING GENERAL CONSUMER, BUSINESS, OFFICE, COMPUTER AND ENTERTAINMENT RELATED PRODUCTS BEARING THE LOGOS AND SLOGANS OF OTHERS DIRECT MAIL ADVERTISING SERVICES; CUSTOM AND LOGO BRAND IDENTITY DEVELOPMENT (U.S. CLS. 100, 101 AND 102).

FIRST USE 1-1-1992; IN COMMERCE 1-1-1992.

CLASS 42—SCIENTIFIC, COMPUTER AND LEGAL SERVICES

FOR PRODUCT DEVELOPMENT, GRAPHIC ART DESIGN, APPAREL DESIGN SERVICES AND DESIGN OF NEW PRODUCTS FOR OTHERS IN THE FIELD OF SUPPLYING GENERAL CONSUMER, BUSINESS, OFFICE, COMPUTER AND ENTERTAINMENT RELATED GOODS AND SERVICES; GRAPHIC DESIGN SERVICES, NAMELY, PRINTING, PACKAGING AND GRAPHIC ART DESIGN (U.S. CLS. 100 AND 101).

FIRST USE 1-1-1992; IN COMMERCE 1-1-1992.

SN 75-814,179. DEEP CANYON ASSOCIATES, LLC, INDIAN WELLS, CA. FILED 10-4-1999.



THE RESERVE CLUB

NO CLAIM IS MADE TO THE EXCLUSIVE RIGHT TO USE "CLUB", APART FROM THE MARK AS SHOWN.

CLASS 16—PAPER GOODS AND PRINTED MATTER

FOR GOLF BOOKS AND MAGAZINES, GOLF SCORE CARDS, PENS, PENCILS, GOLF YARDAGE BOOKS, CALENDARS, PLASTIC AND PAPER BAGS FOR MERCHANDISE PACKAGING (U.S. CLS. 2, 5, 22, 23, 29, 37, 38 AND 50).

FIRST USE 1-16-1996; IN COMMERCE 1-16-1996.

CLASS 28—TOYS AND SPORTING GOODS

FOR SPORTING GOODS, NAMELY, GOLF BAGS, GOLF BALL MARKERS, GOLF BALL RETRIEVERS, GOLF BALLS, GOLF CLUB HEADS, GOLF CLUB INSERTS, GOLF CLUB SHAFTS, GOLF CLUBS, GRIP TAPES FOR GOLF CLUBS, HAND GRIPS FOR GOLF CLUBS, HEAD COVERS FOR GOLF CLUBS, DIVOT REPAIR TOOL FOR GOLFERS, GOLF GLOVES, GOLF BAG COVERS, GOLF BAG TAGS, NON-MOTORIZED GOLF CARTS, GOLF BALL MARKERS, GOLF IRONS, GOLF PUTTERS, GOLF PUTTER COVERS AND GOLF TEES (U.S. CLS. 22, 23, 38 AND 50).

FIRST USE 1-16-1996; IN COMMERCE 1-16-1996.

CLASS 36—INSURANCE AND FINANCIAL

FOR REAL ESTATE BROKERAGE OF INDIVIDUAL RESIDENTIAL REAL PROPERTY LOTS (U.S. CLS. 100, 101 AND 102).

FIRST USE 1-16-1996; IN COMMERCE 1-16-1996.

CLASS 37—CONSTRUCTION AND REPAIR

FOR LAND DEVELOPMENT, NAMELY, PLANNING AND LAYING OUT OF A RESIDENTIAL HOUSING DEVELOPMENT, GOLF COURSE AND COUNTRY CLUB (U.S. CLS. 100, 103 AND 106).

FIRST USE 1-16-1996; IN COMMERCE 1-16-1996.

CLASS 41—EDUCATION AND ENTERTAINMENT

FOR RECREATIONAL SERVICES, NAMELY, A PRIVATE COUNTRY CLUB, INCLUDING PROFESSIONAL GOLF AND TENNIS INSTRUCTION (U.S. CLS. 100, 101 AND 107).

FIRST USE 1-16-1996; IN COMMERCE 1-16-1996.

SN 75-834,845. BROADBAND INNOVATIONS, INC., SAN DIEGO, CA. BY CHANGE OF NAME MULTICHANNEL COMMUNICATION SCIENCES, INC., SAN DIEGO, CA. FILED 10-29-1999.

BROADBAND INNOVATIONS

NO CLAIM IS MADE TO THE EXCLUSIVE RIGHT TO USE "BROADBAND", APART FROM THE MARK AS SHOWN.

CLASS 9—ELECTRICAL AND SCIENTIFIC APPARATUS

FOR DATA AND VIDEO TRANSMISSION COMPONENTS AND ELECTRICAL CIRCUITS FOR USE IN CONNECTION WITH DIGITAL RF SYSTEMS, NAMELY DIGITAL VIDEO OR DATA TRANSMITTERS, MULTICHANNEL MODULATORS AND GENERATORS, AND CABLE MODEM TERMINATION SYSTEMS (U.S. CLS. 21, 23, 26, 36 AND 38).

CLASS 42—SCIENTIFIC, COMPUTER AND LEGAL SERVICES

FOR PROVIDING DESIGN, TESTING, AND SIMULATIONS SERVICES FOR OTHERS IN THE FIELD OF DIGITAL RF SYSTEMS, WHICH ARE DIGITAL VIDEO OR DATA TRANSMITTERS, MULTICHANNEL MODULATORS AND GENERATORS, AND CABLE MODEM TERMINATION SYSTEMS (U.S. CLS. 100 AND 101).

SN 75-851,683. TRUENORTH, L.L.C., BEL AIR, MD. FILED 11-17-1999.

SN 75-900,861. SOCIETY OF CHEMICAL INDUSTRY, LONDON, SW1X 8PS, ENGLAND, FILED 1-20-2000.



SCI

CLASS 35—ADVERTISING AND BUSINESS

FOR BUSINESS CONSULTING SERVICES; NAMELY, BUSINESS DATA PROCESSING SERVICES, BUSINESS RESEARCH SERVICES, BUSINESS MANAGEMENT CONSULTING SERVICES, BUSINESS CONSULTING SERVICES, BUSINESS PROCESS RE-ENGINEERING SERVICES, PREPARING BUSINESS REPORTS, AND BUSINESS ACQUISITIONS AND MERGER CONSULTATION SERVICES (U.S. CLS. 100, 101 AND 102).
FIRST USE 5-12-1999; IN COMMERCE 5-12-1999.

PRIORITY CLAIMED UNDER SEC. 44(D) ON UNITED KINGDOM APPLICATION NO. 2203355, FILED 7-20-1999, REG. NO. 2203355, DATED 10-4-2002, EXPIRES 7-20-2009.

CLASS 36—INSURANCE AND FINANCIAL

FOR FINANCIAL CONSULTING SERVICES; NAMELY, FINANCIAL DATA PROCESSING SERVICES, CREDIT BUREAU DATA EVALUATION SERVICES, FINANCIAL ANALYSIS AND CONSULTATION SERVICES, PROVISION OF FINANCIAL INFORMATION BY ELECTRONIC MEANS, AND FINANCIAL RESEARCH SERVICES (U.S. CLS. 100, 101 AND 102).
FIRST USE 5-12-1999; IN COMMERCE 5-12-1999.

CLASS 9—ELECTRICAL AND SCIENTIFIC APPARATUS

FOR DOWNLOADABLE ELECTRONIC PUBLICATIONS IN THE NATURE OF BOOKS, NEWSLETTERS, MAGAZINES, JOURNALS, REPORTS, RESEARCH PAPERS, TREATISES, DISSERTATIONS, POLICY PAPERS AND NEWSPAPERS FEATURING INFORMATION IN THE FIELD OF SCIENCE, ENGINEERING, AND THE COMMERCIAL, ENVIRONMENTAL, INDUSTRIAL AND PUBLIC POLICY APPLICATIONS OF SCIENCE AND ENGINEERING; DOWNLOADABLE INFORMATION IN ELECTRONIC FORM SUPPLIED ON-LINE OR FROM FACILITIES ACCESSIBLE VIA THE INTERNET, IN THE FIELD OF SCIENCE, ENGINEERING, AND THE COMMERCIAL, ENVIRONMENTAL, INDUSTRIAL AND PUBLIC POLICY APPLICATIONS OF SCIENCE AND ENGINEERING; COMPUTER SOFTWARE FOR USE IN ALLOWING ENCODED INFORMATION AND PUBLICATIONS TO BE DOWNLOADED FROM A COMPUTER NETWORK AND DE-CODED; COMPUTER SOFTWARE TO ENABLE ACCESS TO DATABASES AND THE INTERNET; COMPUTER SOFTWARE TO ENABLE SEARCHING OF DATABASES AND THE INTERNET; DOWNLOADABLE ELECTRONICALLY-STORED DATA IN THE FIELD OF SCIENCE, ENGINEERING, AND THE COMMERCIAL, ENVIRONMENTAL, INDUSTRIAL AND PUBLIC POLICY APPLICATIONS OF SCIENCE AND ENGINEERING; DOWNLOADABLE BUSINESS DIRECTORIES, BUSINESS LISTINGS AND PROMOTIONAL MATERIALS SUPPLIED IN ELECTRONIC FORM, ON-LINE OR FROM FACILITIES ACCESSIBLE VIA THE INTERNET; PRE-RECORDED CD-ROMS, DVDS AND COMPUTER DISKS IN THE FIELDS OF SCIENCE AND ENGINEERING; INTERACTIVE COMPUTER SOFTWARE USED TO ENABLE THE INTERACTIVE PURSUIT, UNDERSTANDING AND APPLICATION OF THE SUBJECTS OF SCIENCE AND ENGINEERING, AND THE COMMERCIAL, ENVIRONMENTAL, INDUSTRIAL AND PUBLIC POLICY APPLICATIONS OF SCIENCE AND ENGINEERING (U.S. CLS. 21, 23, 26, 36 AND 38).

SN 75-888,285. NIIT LIMITED, NEW DELHI-110 -020, INDIA, FILED 1-6-2000.



NO CLAIM IS MADE TO THE EXCLUSIVE RIGHT TO USE "ELECTRONIC MANAGEMENT", APART FROM THE MARK AS SHOWN.

CLASS 41—EDUCATION AND ENTERTAINMENT

FOR EDUCATIONAL SERVICES, NAMELY CONDUCTING CLASSES, SEMINARS, AND CONFERENCES AND WORKSHOPS IN THE FIELD OF COMPUTER HARDWARE AND SOFTWARE USAGE AND INFORMATION TECHNOLOGY (U.S. CLS. 100, 101 AND 107).

CLASS 42—SCIENTIFIC, COMPUTER AND LEGAL SERVICES

FOR COMPUTER CONSULTING SERVICES, TECHNICAL CONSULTATION FOR OTHERS IN THE FIELD OF COMPUTER AIDED ENGINEERING AND ENGINEERING DRAWINGS, DESIGN OF COMPUTER SOFTWARE AND COMPUTER HARDWARE FOR OTHERS AND COMPUTER PROGRAMMING FOR OTHERS; COMPUTER SOFTWARE CONSULTING SERVICES; COMPUTER SOFTWARE WRITING SERVICES FOR OTHERS (U.S. CLS. 100 AND 101).

CLASS 16—PAPER GOODS AND PRINTED MATTER

FOR PRINTED PUBLICATIONS, NAMELY BOOKS, TREATISES, LECTURE PAPERS, PAMPHLETS, ARTICLES, NEWSLETTERS, JOURNALS, MAGAZINES, REPORTS, RESEARCH PAPERS, DISSERTATIONS, POLICY PAPERS AND NEWSPAPERS FEATURING INFORMATION IN THE FIELD OF SCIENCE, ENGINEERING, AND THE COMMERCIAL, ENVIRONMENTAL, INDUSTRIAL AND PUBLIC POLICY APPLICATIONS OF SCIENCE AND ENGINEERING; POSTERS, UNMOUNTED PHOTOGRAPHS, PRINTED CERTIFICATES, PRINTED CARDS, PRINTED PAPER BANNERS, PRINTED NOTICES; ALL RELATING TO OR FOR THE BENEFIT OF SCIENCE, SCIENTISTS, ENGINEERS, ENGINEERING OR TO OR FOR THE COMMERCIAL, ENVIRONMENTAL, INDUSTRIAL OR PUBLIC POLICY APPLICATIONS OF SCIENCE OR ENGINEERING (U.S. CLS. 2, 5, 22, 23, 29, 37, 38 AND 50).

CLASS 41—EDUCATION AND ENTERTAINMENT

FOR EDUCATION AND TRAINING SERVICES OFFERED BY WAY OF SEMINARS, MAIL CORRESPONDENCE, ON-LINE, PERSONAL ATTENDANCE COURSES, DISCUSSION GROUPS AND LECTURES IN THE FIELD OF SCIENCE, ENGINEERING, AND THE COMMERCIAL, ENVIRONMENTAL, INDUSTRIAL AND PUBLIC POLICY APPLICATIONS OF SCIENCE AND ENGINEERING; SERVICES OF AN ACADEMIC INSTITUTION, NAMELY ARRANGING AND CONDUCTING EDUCATION AND TRAINING SERVICES IN THE FIELD OF SCIENCE, ENGINEERING, AND THE COMMERCIAL, ENVIRONMENTAL, INDUSTRIAL AND PUBLIC POLICY APPLICATIONS OF SCIENCE AND ENGINEERING, THE EVALUATION OF ACADEMIC ACHIEVEMENT, THE PROVISION OF AWARDS FOR ACADEMIC ACHIEVEMENT, FACILITATING CONTINUED INTERACTION BETWEEN GRADUATES AND MEMBERS OF ACADEMIC INSTITUTIONS, AND PASSING ON INFORMATION GARNERED FROM GRADUATES AND MEMBERS OF ACADEMIC INSTITUTIONS; ENTERTAINMENT SERVICES, NAMELY ARRANGING AND CONDUCTING COMPETITION AND AWARD CEREMONIES RECOGNIZING ACHIEVEMENT IN THE FIELDS OF SCIENCE AND ENGINEERING; ORGANIZING AND CONDUCTING SEMINARS, LECTURES AND EDUCATIONAL CONFERENCES, SHOWS, PERFORMANCES AND DEMONSTRATIONS; ELECTRONIC PUBLISHING SERVICES, NAMELY PUBLICATION OF TEXT AND GRAPHIC WORKS OF OTHERS IN THE FIELDS OF SCIENCE AND ENGINEERING; PUBLICATION OF BOOKS, NEWSLETTERS, AND MAGAZINES IN THE FIELDS OF SCIENCE AND ENGINEERING; PRODUCTION OF FILMS, VIDEOS, TELEVISION PROGRAMS AND SOUND RECORDINGS; ORGANIZATION OF STUDY TOURS AND INDUSTRIAL, INFORMATION OR EDUCATIONAL VISITS; ALL RELATING TO OR FOR THE BENEFIT OF SCIENCE, SCIENTISTS, ENGINEERS, ENGINEERING OR TO OR FOR THE COMMERCIAL, ENVIRONMENTAL, INDUSTRIAL OR PUBLIC POLICY APPLICATIONS OF SCIENCE OR ENGINEERING (U.S. CLS. 100, 101 AND 107).

SN 75-919,125. MELLON HR SOLUTIONS LLC, PITTSBURGH, PA. BY ASSIGNMENT; BY CHANGE OF NAME; BY ASSIGNMENT; BY MERGER PRICEWATERHOUSECOOPERS LLP, NEW YORK, NY. FILED 2-15-2000.

UNIFI**CLASS 35—ADVERTISING AND BUSINESS**

FOR HUMAN RESOURCE SERVICES, NAMELY, CONSULTING AND OUTSOURCING SERVICES IN THE FIELD OF PERSONNEL MANAGEMENT; PERSONAL MANAGEMENT SERVICES, NAMELY, ADVISING OTHERS IN EMPLOYEE PERFORMANCE AND COMPENSATION PLANS, RETIREMENT, CAPITAL ACCUMULATION AND HEALTH AND WELFARE BENEFITS, HUMAN RESOURCE RE-ENGINEERING AND COMMUNICATIONS TO AND WITH EMPLOYEES (U.S. CLS. 100, 101 AND 102).

CLASS 36—INSURANCE AND FINANCIAL

FOR PROVIDING INFORMATION TO EMPLOYEES AND THEIR FAMILIES REGARDING FINANCIAL, BANKING AND BROKERAGE SERVICES AVAILABLE AS PART OF THEIR BENEFITS PLANS; PROVIDING INFORMATION TO EMPLOYEES AND THEIR FAMILIES REGARDING INSURANCE AVAILABLE AS PART OF THEIR PLANS, NAMELY IN THE FIELD OF HOME, ACCIDENT, LIFE, FIRE, HEALTH, DISABILITY, LONG TERM CARE, AND GROUP LEGAL SERVICES; ADMINISTRATION OF PRE-PAID HEALTH CARE PLANS; ADMINISTRATION OF EMPLOYEE BENEFIT AND PAYROLL PLANS (U.S. CLS. 100, 101 AND 102).

CLASS 42—SCIENTIFIC, COMPUTER AND LEGAL SERVICES

FOR HEALTH CARE SERVICES, NAMELY, PROVIDING INFORMATION TO EMPLOYEES AND THEIR FAMILIES REGARDING HEALTH CARE SERVICES AVAILABLE AS PART OF THEIR BENEFIT PLANS (U.S. CLS. 100 AND 101).

SN 75-916,728. DSNW, INC., SEATTLE, WA. FILED 2-11-2000.

WORD OF WEB**CLASS 35—ADVERTISING AND BUSINESS**

FOR COMPUTER SERVICES, NAMELY, PROVIDING BUSINESS RATING AND REFERRAL INFORMATION VIA A COMPUTER NETWORK OR GLOBAL COMMUNICATION NETWORK (U.S. CLS. 100, 101 AND 102).

FIRST USE 9-0-1998; IN COMMERCE 9-0-1998.

CLASS 42—SCIENTIFIC, COMPUTER AND LEGAL SERVICES

FOR COMPUTER SERVICES, NAMELY, PROVIDING SEARCH ENGINES FOR RETRIEVING, ORGANIZING AND PUBLISHING INFORMATION CONCERNING PRODUCTS, BUSINESSES, AND SERVICES VIA A COMPUTER NETWORK OR A GLOBAL COMMUNICATION NETWORK, AND FOR SOLICITING SUCH INFORMATION FROM OTHERS (U.S. CLS. 100 AND 101).

FIRST USE 9-0-1998; IN COMMERCE 9-0-1998.

SN 75-919,147. PRICEWATERHOUSECOOPERS GLOBAL HUMAN RESOURCES SOLUTIONS LLC, ATLANTA, GA. BY MERGER; BY ASSIGNMENT; BY CHANGE OF NAME; BY ASSIGNMENT PRICEWATERHOUSECOOPERS LLP, NEW YORK, NY. FILED 2-15-2000.

UNIFI.COM**CLASS 35—ADVERTISING AND BUSINESS**

FOR HUMAN RESOURCE SERVICES, NAMELY, CONSULTING AND OUTSOURCING SERVICES IN THE FIELD OF PERSONNEL MANAGEMENT; PERSONAL MANAGEMENT SERVICES, NAMELY, ADVISING OTHERS IN EMPLOYEE PERFORMANCE AND COMPENSATION PLANS, RETIREMENT, CAPITAL ACCUMULATION AND HEALTH AND WELFARE BENEFITS, HUMAN RESOURCE RE-ENGINEERING AND COMMUNICATIONS TO AND WITH EMPLOYEES (U.S. CLS. 100, 101 AND 102).

CLASS 36—INSURANCE AND FINANCIAL

FOR PROVIDING INFORMATION TO EMPLOYEES AND THEIR FAMILIES REGARDING FINANCIAL, BANKING AND BROKERAGE SERVICES AVAILABLE AS PART OF THEIR BENEFITS PLANS; PROVIDING INFORMATION TO EMPLOYEES AND THEIR FAMILIES REGARDING INSURANCE AVAILABLE AS PART OF THEIR BENEFIT PLANS, NAMELY IN THE FIELD OF HOME, ACCIDENT, LIFE, FIRE, HEALTH, DISABILITY, LONG TERM CARE, AND GROUP LEGAL SERVICES; ADMINISTRATION OF PRE-PAID HEALTH CARE PLANS; ADMINISTRATION OF EMPLOYEE BENEFIT AND PAYROLL PLANS (U.S. CLS. 100, 101 AND 102).

CLASS 42—SCIENTIFIC, COMPUTER AND LEGAL SERVICES

FOR HEALTH CARE SERVICES, NAMELY, PROVIDING INFORMATION TO EMPLOYEES AND THEIR FAMILIES REGARDING HEALTH CARE SERVICES AVAILABLE AS PART OF THEIR BENEFIT PLANS (U.S. CLS. 100 AND 101).

SN 75-920,991. CARGILL, INCORPORATED, WAYZATA, MN. FILED 2-16-2000.

ROOSTER.COM**CLASS 35—ADVERTISING AND BUSINESS**

FOR ELECTRONIC RETAILING SERVICES VIA COMPUTER FEATURING AGRICULTURAL PRODUCTS AND SERVICES (U.S. CLS. 100, 101 AND 102).

CLASS 42—SCIENTIFIC, COMPUTER AND LEGAL SERVICES

FOR PROVIDING AGRICULTURAL INFORMATION VIA A WEB SITE ON GLOBAL COMPUTER INFORMATION NETWORKS (U.S. CLS. 100 AND 101).

SN 75-950,725. WAVE 5, INC, NASHVILLE, TN. FILED 3-2-2000.

PERPETUAL MARKETING

NO CLAIM IS MADE TO THE EXCLUSIVE RIGHT TO USE "MARKETING", APART FROM THE MARK AS SHOWN.

CLASS 9—ELECTRICAL AND SCIENTIFIC APPARATUS

FOR DOWNLOADABLE COMPUTER SOFTWARE FOR USE BY THE NETWORK OR MULTI-LEVEL MARKETING INDUSTRY FOR TRAINING IN THE MARKETING, RECRUITING, AND DEVELOPMENT ASPECTS OF NETWORK OR MULTI-LEVEL MARKETING, AND INSTRUCTIONAL TRAINING MATERIALS SOLD THEREWITH (U.S. CLS. 21, 23, 26, 36 AND 38).

CLASS 41—EDUCATION AND ENTERTAINMENT

FOR TRAINING IN THE MARKETING, RECRUITING, AND DEVELOPMENT ASPECTS OF NETWORK OR MULTI-LEVEL MARKETING, AND TRAINING SERVICES IN THE FIELD OF THE NETWORK OR MULTI-LEVEL MARKETING INDUSTRY CONDUCTED VIA THE INTERNET, AND DISTRIBUTING TRAINING MATERIALS IN CONNECTION THEREWITH (U.S. CLS. 100, 101 AND 107).

SN 75-955,389. PARK LI MANAGEMENT SIMULATIONS, INC., DBA MANAGEMENT SIMULATIONS, INC., NORTHFIELD, IL. BY ASSIGNMENT SMITH, DANIEL, NORTHFIELD, IL. FILED 3-8-2000.

CAPSIM.COM**CLASS 9—ELECTRICAL AND SCIENTIFIC APPARATUS**

FOR EDUCATIONAL SOFTWARE THAT ENABLES SIMULATIONS OF BUSINESS MANAGEMENT TECHNIQUES IN THE FIELD OF BUSINESS MANAGEMENT EDUCATION, AND USER MANUALS SOLD AS A UNIT (U.S. CLS. 21, 23, 26, 36 AND 38).

CLASS 42—SCIENTIFIC, COMPUTER AND LEGAL SERVICES

FOR PROVIDING TEMPORARY USE OF ON-LINE NON-DOWNLOADABLE EDUCATIONAL SOFTWARE THAT ENABLES SIMULATIONS OF BUSINESS MANAGEMENT TECHNIQUES IN THE FIELD OF BUSINESS MANAGEMENT EDUCATION (U.S. CLS. 100 AND 101).

SN 75-980,468. UNITED STATES POSTAL SERVICE, WASHINGTON, DC. FILED 8-27-1999.

PC POSTAGE

OWNER OF U.S. REG. NOS. 253,863 AND 2,537,762.

CLASS 2—PAINTS

FOR COLORANTS FOR USE IN THE MANUFACTURE OF PRINTING INK (U.S. CLS. 6, 11 AND 16).

CLASS 16—PAPER GOODS AND PRINTED MATTER

FOR PRINTER INK RIBBONS; STATIONERY; ENVELOPES; PAPER ENVELOPES FOR PACKAGING; PAPER USED FOR TICKETING, STATIONERY, ENVELOPES, MAILING LABELS, CHECKS, RECEIPTS, GIFT CERTIFICATES, PAPER GREETING CARDS AND PAPER POST CARDS (U.S. CLS. 2, 5, 22, 23, 29, 37, 38 AND 50).

SN 75-982,564. BATTLEBOTS, INC., NOVATO, CA. FILED 2-6-2001.

BATTLEBOTS

OWNER OF U.S. REG. NO. 2,397,203.

CLASS 20—FURNITURE AND ARTICLES NOT OTHERWISE CLASSIFIED

FOR PLASTIC AND NON-METAL COLLECTIBLE KEY CHAINS FEATURING ROBOTIC CHARACTERS AND VEHICLES (U.S. CLS. 2, 13, 22, 25, 32 AND 50).
FIRST USE 11-6-2001; IN COMMERCE 11-6-2001.

CLASS 21—HOUSEWARES AND GLASS

FOR PLASTIC SPORTS BOTTLES SOLD EMPTY AND PLASTIC CUPS FEATURING ROBOTIC CHARACTERS AND VEHICLES AND NON-METAL PIGGY BANKS (U.S. CLS. 2, 13, 23, 29, 30, 33, 40 AND 50).
FIRST USE 11-6-2001; IN COMMERCE 11-6-2001.

SN 75-983,317. TRANSCANADA PIPELINES LTD., CALGARY, ALBERTA T2P 4K5, CANADA, FILED 4-20-1999.



PRIORITY CLAIMED UNDER SEC. 44(D) ON CANADA APPLICATION NO. 1005484, FILED 2-17-1999, REG. NO. TMA563500, DATED 6-17-2002, EXPIRES 6-17-2017.

CLASS 35—ADVERTISING AND BUSINESS

FOR (BASED ON 44(D) PRIORITY APPLICATION) BUSINESS, MARKETING, AND CONSULTING SERVICES IN THE ENERGY FIELD (U.S. CLS. 100, 101 AND 102).

CLASS 39—TRANSPORTATION AND STORAGE

FOR (BASED ON 44(D) PRIORITY APPLICATION) TRANSMISSION OF NATURAL GAS AND PETROLEUM THROUGH PIPELINES; UTILITY SERVICES, NAMELY, TRANSMISSION OF ELECTRICITY (U.S. CLS. 100 AND 105).

SN 76-015,135. ACCPAC INTERNATIONAL, INC., PLEASANTON, CA. FILED 3-30-2000.

E.ADVANTAGE SUITE

NO CLAIM IS MADE TO THE EXCLUSIVE RIGHT TO USE "SUITE", APART FROM THE MARK AS SHOWN.

CLASS 9—ELECTRICAL AND SCIENTIFIC APPARATUS

FOR COMPUTER SOFTWARE FOR USE IN THE FIELD OF PERSONAL AND BUSINESS FINANCE, NAMELY SOFTWARE FOR ACCESSING FINANCIAL INFORMATION, NAMELY GENERAL LEDGER, ACCOUNTS PAYABLE, ACCOUNTS RECEIVABLE, PURCHASE ORDER, SALES ORDER, PAYROLL, AND BANK RECONCILIATION RECORDS; E-COMMERCE SOFTWARE TO ALLOW USERS TO PERFORM ELECTRONIC BUSINESS TRANSACTIONS AND REVIEW FINANCIAL INFORMATION VIA ELECTRONIC COMMUNICATION NETWORKS, NAMELY, THE GLOBAL COMPUTER NETWORK, AND USER MANUALS SOLD AS A UNIT THEREWITH (U.S. CLS. 21, 23, 26, 36 AND 38).
FIRST USE 3-31-1998; IN COMMERCE 3-31-1998.

CLASS 36—INSURANCE AND FINANCIAL

FOR COMPUTER SERVICES, NAMELY, HOSTING FINANCIAL DATABASES OVER GLOBAL COMPUTER COMMUNICATIONS NETWORKS FEATURING INFORMATION IN THE FIELD OF PERSONAL AND BUSINESS FINANCE (U.S. CLS. 100, 101 AND 102).
FIRST USE 3-31-1998; IN COMMERCE 3-31-1998.

SN 76-024,620. BLUE ZONE SOLUTIONS, INC., VANCOUVER, BRITISH COLUMBIA, CANADA, BY ASSIGNMENT BLUE ZONE INTERNATIONAL INC., BRIDGETOWN, BARBADOS, FILED 4-13-2000.

BZ

CLASS 35—ADVERTISING AND BUSINESS

FOR BUSINESS MANAGEMENT PLANNING AND BUSINESS CONSULTING IN STRATEGIC PLANNING AND MANAGEMENT SERVICES TO THE BROADCASTING INDUSTRY DEALING WITH THE BROADCASTING OF INTERACTIVE CONTENT (U.S. CLS. 100, 101 AND 102).

CLASS 42—SCIENTIFIC, COMPUTER AND LEGAL SERVICES

FOR PROVIDING INTERACTIVE SOFTWARE DEVELOPMENT SERVICES TO THE BROADCASTING INDUSTRY AND RECEIVERS OF INTERACTIVE BROADCASTING CONTENT, NAMELY DESIGNING AND CUSTOMIZING USER INTERFACES FOR THE BROADCASTING AND RECEIVING OF INTERACTIVE CONTENT (U.S. CLS. 100 AND 101).

SN 76-028,891. ATTENTION TO DETAIL LIMITED, BIRMINGHAM, WEST MIDLANDS, ENGLAND, FILED 4-18-2000.

ATD

OWNER OF ERPN CMNTY TM OFC REG. NO. 1621234, DATED 7-3-2001, EXPIRES 7-3-2011.

CLASS 9—ELECTRICAL AND SCIENTIFIC APPARATUS

FOR COMPUTER GAME SOFTWARE; VIDEO GAME SOFTWARE; VIDEO GAME CARTRIDGES; VIDEO GAME DISCS; VIDEO GAME INTERACTIVE CONTROL FLOOR PADS AND MATS; VIDEO GAME INTERACTIVE REMOTE CONTROL UNITS; VIDEO GAME JOYSTICKS; VIDEO GAME MACHINES FOR USE WITH TELEVISIONS; VIDEO GAME MACHINES FOR USE WITH TELEVISIONS; VIDEO GAME TAPE CASSETTES; COMPUTER GAME CARTRIDGES; COMPUTER GAME CASSETTES; COMPUTER GAME DISCS; COMPUTER GAME EQUIPMENT CONTAINING MEMORY DEVICES, NAMELY, DISCS, COMPUTER GAME JOYSTICKS; COMPUTER GAME PROGRAMS; COMPUTER GAMES TAPES (U.S. CLS. 21, 23, 26, 36 AND 38).

CLASS 28—TOYS AND SPORTING GOODS

FOR STAND ALONE VIDEO GAMES (U.S. CLS. 22, 23, 38 AND 50).

SN 76-056,139. QUANTUM DIGITAL SOLUTIONS CORPORATION, MARINA DEL REY, CA. FILED 5-19-2000.

QUANTUM DIGITAL SOLUTIONS**CLASS 9—ELECTRICAL AND SCIENTIFIC APPARATUS**

FOR TELECOMMUNICATIONS HARDWARE, NAMELY, COMPUTER PERIPHERALS CONTAINING DIGITAL SIGNAL PROCESSORS AND/OR CENTRAL PROCESSING UNITS SPECIFICALLY DESIGNED FOR THE PURPOSES OF ENCODING AND/OR DECODING DIGITIZED DATA OF ALL KINDS FOR PURPOSES OF TELECOMMUNICATIONS; AND FORMATTED COMPUTER DISKETTES, ELECTRONICALLY, MAGNETICALLY AND OPTICALLY ENCODED TOKENS, AND MACHINE READABLE CARDS, ALL CONTAINING ENCODED COMMUNICATIONS AND/OR CONTAINING DIGITIZED DATA THAT HAS BEEN ENCODED FOR THE PURPOSES OF FACILITATING THE SECURE COMMUNICATION OF DATA (U.S. CLS. 21, 23, 26, 36 AND 38).

CLASS 42—SCIENTIFIC, COMPUTER AND LEGAL SERVICES

FOR TELECOMMUNICATION SERVICES, NAMELY, PROVIDING SECURED AND ENCODED TRANSMISSION OF DIGITIZED INFORMATION AND/OR COMMUNICATIONS OF ALL KINDS THROUGH TELECOMMUNICATIONS SYSTEMS OR COMPUTER NETWORKS (U.S. CLS. 100 AND 101).

SN 76-047,644. MARIO TRICOCI HAIR SALON AND DAY SPAS, INC., PHOENIX, AZ. FILED 5-12-2000.

MARIO TRICOCI HAIR SALONS AND DAY SPAS

NO CLAIM IS MADE TO THE EXCLUSIVE RIGHT TO USE "HAIR SALONS AND DAY SPAS", APART FROM THE MARK AS SHOWN.

THE NAME "MARIO TRICOCI" DOES NOT IDENTIFY A LIVING INDIVIDUAL.

CLASS 3—COSMETICS AND CLEANING PREPARATIONS

FOR HAIR CARE STYLING PREPARATIONS, NAMELY, HAIR GEL, HAIR MOUSSE AND HAIR LOTION; COLORING PRODUCTS, NAMELY, HAIR DYES (U.S. CLS. 1, 4, 6, 50, 51 AND 52).

CLASS 42—SCIENTIFIC, COMPUTER AND LEGAL SERVICES

FOR PERSONAL CARE SERVICES IN THE NATURE OF HAIR STYLING, CUTTING, CONDITIONING AND COLORING; SKIN CARE SALONS, MASSAGE THERAPIES, NAIL MANICURING SERVICES, FOOT TREATMENTS, NAMELY, PEDICURES, AND BODY, HAND AND FOOT TREATMENTS, NAMELY, BODY, HAND AND FOOT WAXING; HEALTH SPA SERVICES INCLUDING AROMATHERAPY, BODY WRAPS, SKIN PEELS, INCLUDING FACIAL PEELS, AND MILK THERAPY IN THE NATURE OF MILK BATHS (U.S. CLS. 100 AND 101).

SN 76-059,031. THE NASDAQ STOCK MARKET, INC., NEW YORK, NY. FILED 5-30-2000.

MARKETSITE

SEC. 2(F).

CLASS 36—INSURANCE AND FINANCIAL

FOR PROVIDING A MEDIA AND INFORMATION CENTER FOR THE PURPOSE OF DISPLAYING AND DISSEMINATING NEWS AND INFORMATION RELATED TO FINANCE AND INVESTING, NAMELY MARKET QUOTES, COMPANY INFORMATION AND INDUSTRY TRENDS (U.S. CLS. 100, 101 AND 102).

FIRST USE 4-7-1997; IN COMMERCE 4-7-1997.

CLASS 41—EDUCATION AND ENTERTAINMENT

FOR PROVIDING SERVICES TO MEDIA PRODUCERS AND NEWS SERVICES IN THE NATURE OF A BROADCAST STUDIO (U.S. CLS. 100, 101 AND 107).

FIRST USE 4-7-1997; IN COMMERCE 4-7-1997.

SN 76-065,126. IBIDLIVE N.V., RIJSWIJK, NETHERLANDS, FILED 6-7-2000.

IBIDLIVE

OWNER OF BENELUX REG. NO. 657499, DATED 12-22-1999, EXPIRES 12-22-2009.

CLASS 35—ADVERTISING AND BUSINESS

FOR HOSTING AUCTIONS AND PUBLIC SALES BY WAY OF A GLOBAL COMPUTER NETWORK AND BY TELEVISION; BUSINESS CONSULTING SERVICES; BUSINESS MANAGEMENT SERVICES (U.S. CLS. 100, 101 AND 102).

CLASS 41—EDUCATION AND ENTERTAINMENT

FOR TELEVISION SHOW PRODUCTION; ENTERTAINMENT SERVICES, NAMELY, PROVIDING A TELEVISION PROGRAM IN THE FIELD OF AUCTIONS VIA GLOBAL COMPUTER NETWORK (U.S. CLS. 100, 101 AND 107).

SN 76-069,728. PRIMEDIA BUSINESS MAGAZINES & MEDIA INC., OVERLAND PARK, KS. BY CHANGE OF NAME INTERTEC PUBLISHING CORPORATION, OVERLAND PARK, KS. FILED 6-14-2000.

I-PROMOTE**CLASS 16—PAPER GOODS AND PRINTED MATTER**

FOR MAGAZINE ABOUT PROMOTION OPPORTUNITIES OF INTERNET AND RELATED TECHNOLOGIES (U.S. CLS. 2, 5, 22, 23, 29, 37, 38 AND 50).
FIRST USE 9-0-1999; IN COMMERCE 9-0-1999.

CLASS 42—SCIENTIFIC, COMPUTER AND LEGAL SERVICES

FOR ONLINE MAGAZINE ABOUT PROMOTION OPPORTUNITIES OF INTERNET AND RELATED TECHNOLOGIES VIA A GLOBAL COMPUTER NETWORK (U.S. CLS. 100 AND 101).

SN 76-084,012. BUSINESS INTERACTIF, 92110 CLICHY, FRANCE, FILED 7-6-2000.

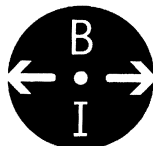

Business Interactif

PRIORITY CLAIMED UNDER SEC. 44(D) ON FRANCE APPLICATION NO. 003000492, FILED 1-7-2000, REG. NO. 003000492, DATED 1-7-2000, EXPIRES 1-7-2010.

NO CLAIM IS MADE TO THE EXCLUSIVE RIGHT TO USE "BUSINESS", APART FROM THE MARK AS SHOWN.
THE MARK CONSISTS OF A SOLID RED CIRCLE WITH WHITE LETTERS AND SYMBOLS INSIDE THE CIRCLE. APPLICANT CLAIMS THE COLOR RED AS A FEATURE OF THE MARK.

THE ENGLISH TRANSLATION OF "INTERACTIF" IS "INTERACTIVE".

CLASS 35—ADVERTISING AND BUSINESS

FOR ADVERTISING SERVICES, NAMELY, DISSEMINATION OF ON-LINE ADVERTISING ON DATA COMMUNICATION NETWORKS AND PURCHASING ADVERTISING TIME SLOTS ON DATA COMMUNICATION NETWORKS FOR OTHERS; COMPUTERIZED DATABASE MANAGEMENT, NAMELY, COMPILATION AND SYSTEMIZATION OF INFORMATION ON COMPUTER DATABASES (U.S. CLS. 100, 101 AND 102).

CLASS 38—COMMUNICATION

FOR TELECOMMUNICATION SERVICES, NAMELY, PROVIDING TELECOMMUNICATIONS CONNECTIONS TO DATA COMMUNICATION NETWORKS, TELECOMMUNICATIONS GATEWAY SERVICES, AUDIO TELECONFERENCING SERVICES, VIDEO TELECONFERENCING SERVICES, PROVIDING MULTIPLE USER ACCESS TO DATA COMMUNICATION NETWORKS, ELECTRONIC MAIL SERVICES, COMPUTER-AIDED TRANSMISSION OF MESSAGES AND IMAGES; PROVIDING INFORMATION IN THE FIELD OF TELECOMMUNICATIONS BY DATA COMMUNICATIONS NETWORKS (U.S. CLS. 100, 101 AND 104).

CLASS 42—SCIENTIFIC, COMPUTER AND LEGAL SERVICES

FOR COMPUTER SERVICES, NAMELY, COMPUTER SYSTEM DESIGN, CREATING, MAINTAINING AND HOSTING WEB SITES FOR OTHERS; DESIGNING, INSTALLING, UPDATING AND MAINTAINING COMPUTER SOFTWARE, COMPUTER PROGRAMMING, DATA SEARCH AND RECOVERY; LEASING CONSULTANCY IN THE FIELD OF DATA COMMUNICATION NETWORKS AND WEB SITES; COMPUTER SYSTEMS AND WEB SITE DEVELOPMENT ANALYSIS (U.S. CLS. 100 AND 101).

SN 76-094,529. ETHENTICA INCORPORATED, LAKE FOREST, CA. FILED 7-19-2000.

ETHENTICATOR**CLASS 9—ELECTRICAL AND SCIENTIFIC APPARATUS**

FOR BIOMETRIC SENSORS AND READING DEVICES, NAMELY, FINGERPRINT, FACE AND RETINAL SCANNERS; BIOMETRICS ENABLED SYSTEMS COMPRISING BIOMETRIC SENSORS AND READING DEVICES, COMPUTER PERIPHERALS, COMPUTER HARDWARE, INTERNET APPLIANCES, AND ACCESS CONTROL DEVICES; COMPUTER SOFTWARE FOR SECURITY AND VERIFICATION OF IDENTITY AND CREDENTIALS; SMART CARD FOR SECURITY AND VERIFICATION OF IDENTITY AND CREDENTIALS; COMPUTER SOFTWARE USED TO GAIN ACCESS TO VARIOUS SOFTWARE APPLICATIONS USING BIOMETRIC AND VERIFICATION TECHNOLOGIES; AND DOWNLOADABLE ELECTRONIC PUBLICATIONS IN THE NATURE OF TECHNICAL INFORMATION BULLETINS IN THE FIELD OF BIOMETRIC TECHNOLOGY USED FOR PRIVACY AND SECURITY PURPOSES (U.S. CLS. 21, 23, 26, 36 AND 38).

CLASS 35—ADVERTISING AND BUSINESS

FOR GENERAL BUSINESS CONSULTATION SERVICES; AND BUSINESS CONSULTATION SERVICES IN THE FIELD OF E-COMMERCE; RETAIL STORE AND ONLINE RETAIL SERVICES FEATURING BIOMETRIC AND VERIFICATION TECHNOLOGIES (U.S. CLS. 100, 101 AND 102).

CLASS 42—SCIENTIFIC, COMPUTER AND LEGAL SERVICES

FOR PROVIDING BIOMETRIC AND VERIFICATION SECURITY SERVICES NAMELY, MONITORING AND CONTROLLING ACCESS TO THE SECURITY AND COMPUTER SYSTEMS OF OTHERS, AND VERIFICATION OF IDENTITY AND CREDENTIALS OF OTHERS USING BIOMETRIC TECHNOLOGY; COMPUTER SERVICES NAMELY, COMPUTER CONSULTATION AND DESIGN OF COMPUTER SOFTWARE APPLICATIONS FOR OTHERS USING BIOMETRIC TECHNOLOGY TO AUTHENTICATE USER'S IDENTITIES, AND PROVIDING USE OF ON-LINE, NON-DOWNLOADABLE COMPUTER SOFTWARE USED TO AUTHENTICATE USER'S IDENTITIES THROUGH USE OF BIOMETRIC TECHNOLOGY; APPLICATION SERVICE PROVIDER FEATURING SOFTWARE USED FOR ACCESS CONTROL USING BIOMETRIC TECHNOLOGY; COMPUTER SERVICES, NAMELY PROVIDING ON-LINE INFORMATION IN THE NATURE OF TECHNICAL INFORMATION BULLETINS VIA A GLOBAL COMPUTER NETWORK IN THE FIELD OF BIOMETRICS (U.S. CLS. 100 AND 101).

CLASS 6—METAL GOODS

FOR PREFABRICATED METAL STRUCTURES, NAMELY SUNROOMS, SUN PORCHES, BALCONIES, GARAGES, CARPORTS AND CYCLE PORTS; METAL GOODS, NAMELY, FENCES, SHUTTERS, GATE DOORS, PORCHES, AND DOOR FRAMES; METAL BUILDING FITTINGS, NAMELY, EXTERIOR BLINDS, METAL TRANSPORTABLE HOME GREENHOUSES (U.S. CLS. 2, 12, 13, 14, 23, 25 AND 50).

CLASS 19—NON-METALLIC BUILDING MATERIALS

FOR PREFABRICATED NON-METAL STRUCTURES, NAMELY ARBORS, SUNROOMS, SUN PORCHES, BALCONIES, CARPORTS, GARAGES, CYCLE PORTS, BI-CYCLE SHEDS, PORCHES FOR BUILDINGS; NON-METAL TRANSPORTABLE HOME GREENHOUSES; NON-METAL GOODS, NAMELY, FENCES, SHUTTERS, GATE DOORS AND PALINGS; STONE MONUMENTS (U.S. CLS. 1, 12, 33 AND 50).

SN 76-095,641. ELLISDON CORPORATION, MISSISSAUGA, ONTARIO L5B 2V2, CANADA, BY CHANGE OF NAME ELLIS-DON CORPORATION, MISSISSAUGA, ONTARIO, L5B 2V2, CANADA, FILED 7-25-2000.

EDGEBUILDER

PRIORITY CLAIMED UNDER SEC. 44(D) ON CANADA APPLICATION NO. 1062926, FILED 6-9-2000, REG. NO. 581366, DATED 5-12-2003, EXPIRES 5-12-2018.

CLASS 9—ELECTRICAL AND SCIENTIFIC APPARATUS

FOR COMPUTER SOFTWARE FOR THE MONITORING AND MANAGEMENT OF CONSTRUCTION PROJECT INFORMATION (U.S. CLS. 21, 23, 26, 36 AND 38).

CLASS 37—CONSTRUCTION AND REPAIR

FOR PROVIDING ONLINE INFORMATION IN THE FIELD OF CONSTRUCTION PROJECTS FOR INTERNAL AND EXTERNAL USE (U.S. CLS. 100, 103 AND 106).

SN 76-112,313. PORT OF BELLINGHAM, BELLINGHAM, WA. FILED 8-17-2000.

BELLWETHER ON THE BAY**CLASS 35—ADVERTISING AND BUSINESS**

FOR PREPARING PROMOTIONAL AND MERCHANDISING MATERIAL FOR OTHERS; RETAIL STORES AND GIFT SHOPS FEATURING JEWELRY, WATCHES, BOOKS, STATIONERY, CALENDARS, WRITING MATERIAL, GLASSWARE, DINNERWARE, KITCHENWARE, BOARD GAMES, COMPUTER GAMES, COMPUTERS, SOFTWARE, HARDWARE MERCHANDISE, GROCERIES, FURNITURE, OFFICE SUPPLIES, DRUG STORE MERCHANDISE, ART AND ART SUPPLIES, TOYS, AND ARTS AND CRAFTS MERCHANDISE (U.S. CLS. 100, 101 AND 102).

CLASS 36—INSURANCE AND FINANCIAL

FOR LEASING REAL ESTATE, NAMELY, LEASING OFFICE SPACE, APARTMENTS, RESTAURANTS, COFFEE SHOPS, RETAIL STORES, GIFT SHOPS, AND SHOPPING MALL SPACE (U.S. CLS. 100, 101 AND 102).

CLASS 37—CONSTRUCTION AND REPAIR

FOR LAND DEVELOPMENT SERVICES, NAMELY, PLANNING AND LAYING OUT OF RESIDENTIAL AND/OR COMMERCIAL COMMUNITIES; INSTALLATION OF INFRASTRUCTURE, NAMELY, UTILITIES, SEWERS, LIGHTING; ROAD CONSTRUCTION; LICENSING TRADEMARK TO OTHERS IN RESIDENTIAL AND/OR COMMUNITIES WHERE THE LAND DEVELOPMENT SERVICES ARE RENDERED (U.S. CLS. 100, 103 AND 106).

SN 76-104,925. TOYO EXTERIOR KABUSHIKI KAISHA, TOKYO 160, JAPAN, FILED 8-8-2000.



OWNER OF JAPAN REG. NO. 2158984, DATED 8-31-1989, EXPIRES 8-31-2009.

CLASS 42—SCIENTIFIC, COMPUTER AND LEGAL SERVICES

FOR RESORT LODGING SERVICES; RESTAURANT SERVICES; CONCIERGE SERVICES FOR OTHERS COMPRISING MAKING REQUESTED PERSONAL ARRANGEMENTS AND RESERVATIONS AND PROVIDING CUSTOMER-SPECIFIC INFORMATION TO MEET INDIVIDUAL NEEDS RENDERED TOGETHER IN A MOTEL, HOTEL, APARTMENT COMPLEX, BUSINESS CONFERENCE FACILITY, SYMPOSIUM, GROUP MEETING FACILITY, AND A SHOPPING CENTER; ARCHITECTURAL DESIGN SERVICES; AND SECURITY GUARD SERVICES (U.S. CLS. 100 AND 101).

SN 76-112,314. PORT OF BELLINGHAM, BELLINGHAM, WA. FILED 8-17-2000.

BELLWETHER

CLASS 35—ADVERTISING AND BUSINESS

FOR PREPARING PROMOTIONAL AND MERCHANDISING MATERIAL FOR OTHERS; RETAIL STORES AND GIFT SHOPS FEATURING JEWELRY, WATCHES, BOOKS, STATIONERY, CALENDARS, WRITING MATERIAL, GLASSWARE, DINNERWARE, KITCHENWARE, BOARD GAMES, COMPUTER GAMES, COMPUTERS, SOFTWARE, HARDWARE MERCHANDISE, GROCERIES, FURNITURE, OFFICE SUPPLIES, DRUG STORE MERCHANDISE, ART AND ART SUPPLIES, TOYS, AND ARTS AND CRAFTS MERCHANDISE (U.S. CLS. 100, 101 AND 102).

CLASS 36—INSURANCE AND FINANCIAL

FOR LEASING REAL ESTATE, NAMELY, LEASING OFFICE SPACE, APARTMENTS, RESTAURANTS, COFFEE SHOPS, RETAIL STORES, GIFT SHOPS, AND SHOPPING MALL SPACE (U.S. CLS. 100, 101 AND 102).

CLASS 37—CONSTRUCTION AND REPAIR

FOR LAND DEVELOPMENT SERVICES, NAMELY, PLANNING AND LAYING OUT OF RESIDENTIAL AND/OR COMMERCIAL COMMUNITIES; INSTALLATION OF INFRASTRUCTURE, NAMELY, UTILITIES, SEWERS, LIGHTING; ROAD CONSTRUCTION; LICENSING OTHERS IN RESIDENTIAL AND/OR COMMUNITIES WHERE THE LAND DEVELOPMENT SERVICES ARE RENDERED (U.S. CLS. 100, 103 AND 106).

CLASS 42—SCIENTIFIC, COMPUTER AND LEGAL SERVICES

FOR RESORT LODGING SERVICES; RESTAURANT SERVICES; CONCIERGE SERVICES FOR OTHERS COMPRISING MAKING REQUESTED PERSONAL ARRANGEMENTS AND RESERVATIONS AND PROVIDING CUSTOMER-SPECIFIC INFORMATION TO MEET INDIVIDUAL NEEDS RENDERED TOGETHER IN A MOTEL, HOTEL, APARTMENT COMPLEX, BUSINESS CONFERENCE FACILITY, SYMPOSIUM, GROUP MEETING FACILITY, AND A SHOPPING CENTER; ARCHITECTURAL DESIGN SERVICES; AND SECURITY GUARD SERVICES (U.S. CLS. 100 AND 101).

SN 76-117,401. RUNNER'S EDGE, INCORPORATED, MELROSE, MA. FILED 8-28-2000.

TEAM EDGE

NO CLAIM IS MADE TO THE EXCLUSIVE RIGHT TO USE "TEAM", APART FROM THE MARK AS SHOWN.

CLASS 35—ADVERTISING AND BUSINESS

FOR PHYSICIAN REFERRAL NETWORK SERVICES (U.S. CLS. 100, 101 AND 102).
FIRST USE 7-1-1997; IN COMMERCE 7-1-1997.

CLASS 41—EDUCATION AND ENTERTAINMENT

FOR EDUCATIONAL SERVICES, NAMELY, CONDUCTING SEMINARS AND WORKSHOPS IN THE FIELD OF RUNNING, FITNESS AND WALKING; PROVIDING TRAINING ADVICE IN THE FIELD OF RUNNING, WALKING, HEALTH AND FITNESS; ORGANIZING AND CONDUCTING SOCIAL EVENTS FOR RUNNERS, WALKERS, HEALTH CARE PROVIDERS (U.S. CLS. 100, 101 AND 107).
FIRST USE 1-1-1997; IN COMMERCE 1-1-1997.

SN 76-123,598. CARGILL, INCORPORATED, WAYZATA, MN. FILED 9-8-2000.

ROOSTER CALL

CLASS 35—ADVERTISING AND BUSINESS

FOR ELECTRONIC RETAILING SERVICES VIA COMPUTER FEATURING AGRICULTURAL COMMODITIES, EQUIPMENT, AND FARMING ASSISTANCE SERVICES (U.S. CLS. 100, 101 AND 102).

CLASS 42—SCIENTIFIC, COMPUTER AND LEGAL SERVICES

FOR PROVIDING AGRICULTURAL INFORMATION VIA A WEB SITE ON GLOBAL COMPUTER INFORMATION NETWORKS (U.S. CLS. 100 AND 101).

SN 76-125,009. FLEET CREDIT CARD SERVICES, L.P., HORSHAM, PA. FILED 9-8-2000.

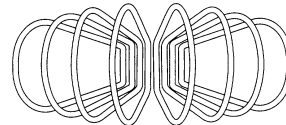

CLASS 9—ELECTRICAL AND SCIENTIFIC APPARATUS

FOR MAGNETIC ENCODED CARDS AND CARDS CONTAINING AN INTEGRATED CIRCUIT CHIP, NAMELY, SMART CARDS; MULTI-APPLICATION COMPUTER SOFTWARE OPERATING SYSTEMS FOR USE WITH SMART CARDS; SMART CARD READERS; COMPUTER SOFTWARE DESIGNED TO ENABLE SMART CARDS TO INTERACT WITH TERMINALS AND READERS; TELECOMMUNICATIONS EQUIPMENT, NAMELY, POINT OF SALE TRANSACTION TERMINALS AND COMPUTER SOFTWARE FOR TRANSMITTING, DISPLAYING AND STORING TRANSACTION, IDENTIFICATION AND FINANCIAL INFORMATION FOR USE IN THE FINANCIAL SERVICE INDUSTRY (U.S. CLS. 21, 23, 26, 36 AND 38).

CLASS 35—ADVERTISING AND BUSINESS

FOR PROMOTING THE GOODS AND SERVICES OF OTHERS THROUGH INCENTIVE AND LOYALTY PROGRAMS; PROVIDING FACILITIES FOR BUSINESS MEETINGS (U.S. CLS. 100, 101 AND 102).

CLASS 36—INSURANCE AND FINANCIAL

FOR FINANCIAL SERVICES, NAMELY, PROVIDING CREDIT CARD, DEBIT CARD, CHARGE CARD AND STORED VALUE SMART CARD SERVICES; ELECTRONIC FUNDS TRANSFER AND CURRENCY EXCHANGE SERVICES; CREDIT CARD TRANSACTION PROCESSING SERVICES; FINANCIAL EXCHANGE SERVICES NAMELY, THE SECURE EXCHANGE OF ELECTRONIC CASH OVER PUBLIC COMPUTER NETWORKS TO FACILITATE ELECTRONIC COMMERCE; ELECTRONIC FUNDS TRANSFER, SMART CARDS AND ELECTRONIC CASH SERVICES, NAMELY, CURRENCY EXCHANGE IN A SECURE ENVIRONMENT OVER GLOBAL ELECTRONIC COMMUNICATIONS NETWORKS; VERIFICATION OF SECURED FINANCIAL EXCHANGE TRANSACTIONS OVER COMPUTER NETWORKS INCLUDING THE GLOBAL ELECTRONIC COMMUNICATIONS NETWORK; TRAVELERS CHECK ISSUANCE SERVICES, MONEY ORDER SERVICES, BANKING SERVICES, INVESTMENT BANKING SERVICES, MILITARY BANKING SERVICES, FINANCIAL SERVICES FOR TRAVELERS NAMELY FOREIGN REMITTANCE SERVICES, MUTUAL FUND INVESTMENT SERVICES; PROVIDING AN INTERACTIVE WEB SITE FEATURING INFORMATION IN THE FIELD OF FINANCIAL INFORMATION (U.S. CLS. 100, 101 AND 102).

CLASS 39—TRANSPORTATION AND STORAGE

FOR TRANSPORTATION RESERVATIONS SERVICES FEATURING ELECTRONIC TICKETING VIA SMART CARDS (U.S. CLS. 100 AND 105).

CLASS 41—EDUCATION AND ENTERTAINMENT

FOR PROVIDING CONVENTION FACILITIES FOR EDUCATIONAL PURPOSES (U.S. CLS. 100, 101 AND 107).

CLASS 42—SCIENTIFIC, COMPUTER AND LEGAL SERVICES

FOR ELECTRONIC AUTHENTICATION AND IDENTIFICATION OF PHYSICAL PERSONS FOR THIRD PARTIES AND VERIFICATION OF DIGITAL SIGNATURES FOR THIRD PARTIES VIA THE GLOBAL ELECTRONIC COMMUNICATIONS NETWORK (U.S. CLS. 100 AND 101).

SN 76-125,027. CARGILL, INCORPORATED, WAYZATA, MN. FILED 9-8-2000.



NO CLAIM IS MADE TO THE EXCLUSIVE RIGHT TO USE ".COM", APART FROM THE MARK AS SHOWN. THE LINING ON THE IMAGE OF THE SUN AND THE WORD-PART "ROOSTER" IS INTENDED TO REPRESENT THE COLOR RED.

CLASS 35—ADVERTISING AND BUSINESS

FOR ELECTRONIC RETAILING SERVICES VIA COMPUTER FEATURING AGRICULTURAL COMMODITIES, EQUIPMENT AND FARMING ASSISTANCE SERVICES (U.S. CLS. 100, 101 AND 102).

CLASS 42—SCIENTIFIC, COMPUTER AND LEGAL SERVICES

FOR PROVIDING AGRICULTURAL INFORMATION VIA A WEB SITE ON GLOBAL COMPUTER INFORMATION NETWORKS (U.S. CLS. 100 AND 101).

SN 76-125,028. CARGILL, INCORPORATED, WAYZATA, MN. FILED 9-8-2000.



NO CLAIM IS MADE TO THE EXCLUSIVE RIGHT TO USE ".COM", APART FROM THE MARK AS SHOWN.

CLASS 35—ADVERTISING AND BUSINESS

FOR ELECTRONIC RETAILING SERVICES VIA COMPUTER FEATURING AGRICULTURAL COMMODITIES, EQUIPMENT AND FARMING ASSISTANCE SERVICES (U.S. CLS. 100, 101 AND 102).

CLASS 42—SCIENTIFIC, COMPUTER AND LEGAL SERVICES

FOR PROVIDING AGRICULTURAL INFORMATION VIA A WEB SITE ON GLOBAL COMPUTER INFORMATION NETWORKS (U.S. CLS. 100 AND 101).

SN 76-125,029. CARGILL, INCORPORATED, WAYZATA, MN. FILED 9-8-2000.

ROOSTER INSIGHTS

CLASS 35—ADVERTISING AND BUSINESS

FOR ELECTRONIC RETAILING SERVICES VIA COMPUTER FEATURING AGRICULTURAL COMMODITIES, EQUIPMENT, AND FARMING ASSISTANCE SERVICES (U.S. CLS. 100, 101 AND 102).

CLASS 42—SCIENTIFIC, COMPUTER AND LEGAL SERVICES

FOR PROVIDING AGRICULTURAL INFORMATION VIA A WEB SITE ON GLOBAL COMPUTER INFORMATION NETWORKS (U.S. CLS. 100 AND 101).

SN 76-125,030. CARGILL, INCORPORATED, WAYZATA, MN. FILED 9-8-2000.

ROOSTER POLL

CLASS 35—ADVERTISING AND BUSINESS

FOR ELECTRONIC RETAILING SERVICES VIA COMPUTER FEATURING AGRICULTURAL COMMODITIES, EQUIPMENT, AND FARMING ASSISTANCE SERVICES (U.S. CLS. 100, 101 AND 102).

CLASS 42—SCIENTIFIC, COMPUTER AND LEGAL SERVICES

FOR PROVIDING AGRICULTURAL INFORMATION VIA A WEB SITE ON GLOBAL COMPUTER INFORMATION NETWORK (U.S. CLS. 100 AND 101).

SN 76-125,033. CARGILL, INCORPORATED, WAYZATA, MN. FILED 9-8-2000.



NO CLAIM IS MADE TO THE EXCLUSIVE RIGHT TO USE ".COM", APART FROM THE MARK AS SHOWN. THE IMAGE OF THE SUN AND THE WORD-PART "ROOSTER" ARE RED.

CLASS 35—ADVERTISING AND BUSINESS

FOR ELECTRONIC RETAILING SERVICES VIA COMPUTER FEATURING AGRICULTURAL COMMODITIES, EQUIPMENT AND FARMING ASSISTANCE SERVICES (U.S. CLS. 100, 101 AND 102).

CLASS 42—SCIENTIFIC, COMPUTER AND LEGAL SERVICES

FOR PROVIDING AGRICULTURAL INFORMATION VIA A WEB SITE ON GLOBAL COMPUTER INFORMATION NETWORKS (U.S. CLS. 100 AND 101).

SN 76-125,034. CARGILL, INCORPORATED, WAYZATA, MN. FILED 9-8-2000.



NO CLAIM IS MADE TO THE EXCLUSIVE RIGHT TO USE ".COM", APART FROM THE MARK AS SHOWN.

CLASS 35—ADVERTISING AND BUSINESS

FOR ELECTRONIC RETAILING SERVICES VIA COMPUTER FEATURING AGRICULTURAL COMMODITIES, EQUIPMENT AND FARMING ASSISTANCE SERVICES (U.S. CLS. 100, 101 AND 102).

CLASS 42—SCIENTIFIC, COMPUTER AND LEGAL SERVICES

FOR PROVIDING AGRICULTURAL INFORMATION VIA A WEB SITE ON GLOBAL COMPUTER INFORMATION NETWORKS (U.S. CLS. 100 AND 101).

SN 76-125,197. LEND LEASE CORPORATION LIMITED, SYDNEY, NEW SOUTH WALES, 2000, AUSTRALIA, FILED 9-8-2000.



PRIORITY CLAIMED UNDER SEC. 44(D) ON AUSTRALIA APPLICATION NO. 836333, FILED 5-24-2000, REG. NO. 836333, DATED 5-24-2000, EXPIRES 5-24-2010. OWNER OF U.S. REG. NOS. 2,187,018 AND 2,194,491.

CLASS 9—ELECTRICAL AND SCIENTIFIC APPARATUS

FOR COMPUTER SOFTWARE FOR USE IN PROJECT MANAGEMENT (U.S. CLS. 21, 23, 26, 36 AND 38).

CLASS 36—INSURANCE AND FINANCIAL

FOR FINANCIAL CONSULTATION SERVICES RELATING TO THE FINANCING OF CIVIL WORKS AND INFRASTRUCTURE PROJECTS; REAL ESTATE MANAGEMENT FOR SHOPPING CENTERS, RETAIL STORES AND MULTI-STORY OFFICE BUILDINGS; ARRANGING FINANCING SERVICES FOR THE PURCHASE OF OR INVESTMENT IN REAL ESTATE BY OTHERS; FINANCIAL MANAGEMENT (U.S. CLS. 100, 101 AND 102).

CLASS 37—CONSTRUCTION AND REPAIR

FOR CONSULTATION AND CONSTRUCTION MANAGEMENT SERVICES RELATING TO COMMERCIAL AND RESIDENTIAL REAL ESTATE CONSTRUCTION PROJECTS; SUPERVISION OF CONSTRUCTION MANAGEMENT FOR COMMERCIAL AND RESIDENTIAL REAL ESTATE CONSTRUCTION PROJECTS; MAINTENANCE AND REPAIR OF COMMERCIAL AND RESIDENTIAL BUILDINGS; RENTAL OF CONSTRUCTION EQUIPMENT; PROVIDING INFORMATION IN THE FIELD OF CONSTRUCTION PROJECT MANAGEMENT AND CONSTRUCTION VIA THE INTERNET OR COMPUTER NETWORKS; PLANNING COMMERCIAL AND RESIDENTIAL REAL ESTATE CONSTRUCTION; CONSTRUCTION MACHINERY MAINTENANCE (U.S. CLS. 100, 103 AND 106).

CLASS 42—SCIENTIFIC, COMPUTER AND LEGAL SERVICES

FOR ENGINEERING; CIVIL ENGINEERING, DESIGN ENGINEERING, ARCHITECTURAL DESIGN; CONSULTATION IN THE FIELD OF ARCHITECTURE AND ENVIRONMENTAL DESIGN; CONSTRUCTION ENGINEERING; BUILDING DESIGN SERVICES IN THE FIELD OF RESIDENTIAL AND COMMERCIAL DEVELOPMENT; INTERIOR DECORATING; DESIGN FOR NEW PRODUCT DEVELOPMENT; COMPUTER SOFTWARE DESIGN FOR OTHERS; LAND SURVEYING; LANDSCAPE GARDENING (U.S. CLS. 100 AND 101).

SN 76-133,528. TEMPLE ARTS, INC., BRITISH COLUMBIA V0H 1H0, CANADA, FILED S.R. 9-22-2000; AM. P.R. 12-21-2001.

SN 76-135,352. SOLVAY (SOCIETE ANONYME), B-1050 BRUSSELS, BELGIUM, FILED 9-26-2000.



OWNER OF CANADA REG. NO. TMA563244, DATED 6-10-2002, EXPIRES 6-10-2017.

CLASS 18—LEATHER GOODS

FOR BAGS; NAMELY, SPORT AND TOTE BAGS FOR CARRYING PAPERS AND PERSONAL ITEMS (U.S. CLS. 1, 2, 3, 22 AND 41).
FIRST USE 4-0-2000; IN COMMERCE 4-2-2000.

CLASS 25—CLOTHING

FOR CLOTHING; NAMELY, VESTS, JACKETS, SWEAT TOPS AND SHIRTS, SWEAT PANTS, SHIRTS, T-SHIRTS, CARGO PANTS, SPORTS SHORTS, AND CAPS (U.S. CLS. 22 AND 39).
FIRST USE 2-0-2000; IN COMMERCE 2-0-2000.

SN 76-134,939. EYE-ONS CORPORATION, TORONTO, ONTARIO, M5V 1R9, CANADA, FILED 9-25-2000.

VOKEN

PRIORITY CLAIMED UNDER SEC. 44(D) ON CANADA APPLICATION NO. 1073213, FILED 8-31-2000, REG. NO. TMA576970, DATED 3-4-2003, EXPIRES 3-4-2018.

CLASS 9—ELECTRICAL AND SCIENTIFIC APPARATUS

FOR COMPUTER SOFTWARE FOR GENERATING INTERACTIVE MEDIA CAMPAIGNS FOR WEBSITES, NAMELY INTERNET SPECIFIC ADVERTISING MEDIA FORMATS AND ONLINE CAMPAIGN MANAGEMENT (U.S. CLS. 21, 23, 26, 36 AND 38).

CLASS 35—ADVERTISING AND BUSINESS

FOR BUSINESS MARKETING CONSULTING SERVICES, BUSINESS CONSULTATION SERVICES, NAMELY PROVIDING INTERNET E-COMMERCE SOLUTIONS FOR WEBSITE OWNERS AND BUSINESS (U.S. CLS. 100, 101 AND 102).



PRIORITY CLAIMED UNDER SEC. 44(D) ON BENELUX APPLICATION NO. 0971064, FILED 8-11-2000, REG. NO. 0668865, DATED 8-11-2000, EXPIRES 8-11-2010.

OWNER OF U.S. REG. NOS. 267,770, 1,578,435 AND OTHERS.

CLASS 1—CHEMICALS

FOR CHEMICALS FOR USE IN INDUSTRY, SCIENCE, AGRICULTURE, HORTICULTURE AND FORESTRY, NAMELY, ALLYL CHLORIDE, BARIUM, CALCIUM CHLORIDE, CAPROLACTONE, CAUSTIC SODA, CHLORINE, DICHLORETHANE, EPICHLOROHYDRIN, FERIC CHLORIDE, FLUORINATED ORGANIC INTERMEDIATES, FLUORINE, GLYCEROL, HYDROCHLORIC ACID, HYDROCHLOROFLUOROCARBONS, HYDROGEN, HYDROGEN PEROXIDE, MAGNESIUM CARBONATE, INORGANIC FLUORIDES, PERACETIC ACID, PRECIPITATED CALCIUM CHLORIDE, SALT, SODIUM BICARBONATE, SODIUM HYPOCHLORITE, SODIUM PERBORATE, SODIUM PERCARBONATE, STRONTIUM ALL FOR USE IN THE MANUFACTURE OF A WIDE VARIETY OF GOODS; UNPROCESSED ARTIFICIAL AND SYNTHETIC RESINS AND UNPROCESSED PLASTICS ALL FOR USE IN BLOW MOULDING AND INJECTION PROCESSES; UNPROCESSED ARTIFICIAL AND SYNTHETIC RESINS AND UNPROCESSED PLASTICS ALL FOR USE IN THE MANUFACTURE OF PIPES, SHEETING, BUILDING MATERIALS, PACKAGING, CONSUMER PRODUCTS; UNPROCESSED ARTIFICIAL AND SYNTHETIC RESINS AND UNPROCESSED PLASTICS ALL FOR USE IN THE ELECTRICITY, ELECTRONICS, AUTOMOTIVE AND TEXTILE INDUSTRY; MANURES; FIRE EXTINGUISHING COMPOSITIONS; TEMPERING AND SOLDERING CHEMICALS FOR USE IN METALWORKING OR SOLDERING; CHEMICAL SUBSTANCES FOR PRESERVING FOODSTUFFS (U.S. CLS. 1, 5, 6, 10, 26 AND 46).

CLASS 5—PHARMACEUTICALS

FOR PHARMACEUTICAL PREPARATIONS FOR THE TREATMENT OF PSYCHIATRIC, CARDIOLOGICAL, GASTROENTEROLOGICAL AND GYNECOLOGICAL DISORDERS; SANITARY PREPARATIONS USED FOR STERILIZING MEDICAL EQUIPMENT USED FOR TREATING PSYCHIATRIC, CARDIOLOGICAL, GASTROENTEROLOGICAL AND GYNECOLOGICAL DISORDERS; DIETETIC SUBSTANCES ADAPTED FOR MEDICAL USE, NAMELY DIETARY SUPPLEMENTS; MEDICAL PLASTERS; MATERIALS FOR DRESSINGS, NAMELY BURN, SURGICAL AND WOUND DRESSINGS; ALL-PURPOSE DISINFECTANTS AND ALL-PURPOSE SANITIZERS; MATERIALS FOR STOPPING TEETH; DENTAL WAX; FUNGICIDES AND HERBICIDES FOR AGRICULTURAL AND FOR DOMESTIC USE; PREPARATIONS FOR DESTROYING VERMIN (U.S. CLS. 6, 18, 44, 46, 51 AND 52).

SN 76-146,464. STERILOX TECHNOLOGIES, INC., MOUNT OLIVE, NJ. FILED 10-13-2000.

AQUALOX

CLASS 1—CHEMICALS

FOR CHEMICAL USED IN INDUSTRY, AGRICULTURE AND SCIENCE, FOR USE IN THE MANUFACTURE OF STERILIZING AND DISINFECTANTS SOLUTIONS, RINSE WATERS, NAMELY, BACTERIA-FREE WATERS USED TO REMOVE STERILIZING AND DISINFECTING SOLUTIONS WITHOUT RECONTAMINATION BY BACTERIA, SUPER-OXIDISED WATER AN BIOCIDAL SOLUTIONS; DRIED CRYSTALLINE SALT FOR THE MANUFACTURE OF STERILIZING AND DISINFECTANT SOLUTIONS; CHEMICAL SUBSTANCES FOR PRESERVING FOODSTUFFS; RINSE WATERS, NAMELY, BACTERIA-FREE WATERS USED TO REMOVE STERILIZING AND DISINFECTING SOLUTIONS WITHOUT RECONTAMINATION BY BACTERIA, AND SUPER-OXIDISED WATER FOR USE IN FOOD PROCESSING, AGRICULTURE, WATER TREATMENT AND OTHER NON-MEDICAL ENVIRONMENT, NAMELY, FOR DISINFECTION OF LABORATORIES, CROPS, WORKING SURFACES, FOOD PROCESSING AREAS, AND FOR ELIMINATING BACTERIA IN THE PIPEWORK OF INDUSTRIAL COOLING TOWERS; CHEMICALS USED IN DECONTAMINATION OF POTABLE WATER SUPPLIES, SWIMMING POOLS, WASTEWATER, COOLING TOWERS, LABORATORIES, INDUSTRIAL WATER, CROPS, WATER SUPPLIES, SUPPLIES, WORKING SURFACES, FOOD PROCESSING AREAS, FOR REDUCTION OF MICRO-ORGANISMS IN MEAT, POULTRY AND FISH PRODUCTS, FOR REDUCING THE RISK OF DISEASE IN TREATED PRODUCTS, TO INCREASE SHELF-LIFE OF TREATED PRODUCTS, FOR THE BREAKDOWN OF BACTERIAL BIOFILM, AND FOR ELIMINATING BACTERIA IN THE PIPEWORK OF INDUSTRIAL COOLING TOWERS; EXCLUDING INDUSTRIAL CORROSION INHIBITORS, RUST PREVENTATIVES, WATER-BASED ADHESIVES OR PREPARATIONS FOR CLEANING, POLISHING OR WAXING AUTOMOTIVE SURFACES (U.S. CLS. 1, 5, 6, 10, 26 AND 46).

CLASS 5—PHARMACEUTICALS

FOR VETERINARY AND SANITARY PREPARATIONS FOR KILLING MICRO-ORGANISMA, PATHOGENS, BACTERIA, FUNGI, VIRUSES AND SPORES; DIETETIC SUBSTANCES ADAPTED FOR MEDICAL USE; FUNGICIDES; ALL-PURPOSE STERILIZING AND DISINFECTANT SOLUTIONS; STERILIZING AND DISINFECTANT SOLUTIONS FOR USE IN FOOD PROCESSING, AGRICULTURE, WATER TREATMENT AND MEDICAL AND NON-MEDICAL ENVIRONMENTS; ALL-PURPOSE DISINFECTANTS; ALL-PURPOSE RINSE WATERS, NAMELY, BACTERIA-FREE WATERS USED TO REMOVE STERILIZING AND DISINFECTING SOLUTIONS WITHOUT RECONTAMINATION BY BACTERIA AND SUPER-OXIDISED WATER; RINSE WATERS, NAMELY, BACTERIA-FREE WATERS USED TO REMOVE STERILIZING AND DISINFECTING SOLUTIONS WITHOUT RECONTAMINATION BY BACTERIA, AND SUPER-OXIDISED WATER FOR USE IN MEDICAL ENVIRONMENTS; BIOCIDAL SOLUTIONS FOR STERILIZING AND DISINFECTING; BIOCIDES FOR THE STERILIZATION OF INSTRUMENTS; STERILIZATION AND DISINFECTION CHEMICALS FOR USE WITH MEDICAL DEVICES; CHEMICALS USED IN DECONTAMINATION (U.S. CLS. 6, 18, 44, 46, 51 AND 52).

CLASS 10—MEDICAL APPARATUS

FOR STERILIZATION AND DISINFECTION APPARATUS AND INSTRUMENT FOR MEDICAL USE; APPARATUS AND INSTRUMENTS FOR PRODUCING ALL-PURPOSE STERILIZING AND DISINFECTION SOLUTIONS, SUPER-OXIDISED WATER AND RINSE WATER, NAMELY, BACTERIA-FREE WATERS USED TO REMOVE STERILIZING AND DISINFECTING SOLUTIONS WITHOUT RECONTAMINATION BY BACTERIA, FOR USE IN MEDICAL ENVIRONMENTS; PARTS AND FITTINGS FOR ALL OF THE AFORESAID GOODS (U.S. CLS. 26, 39 AND 44).

CLASS 11—ENVIRONMENTAL CONTROL APPARATUS

FOR STERILIZATION AND DISINFECTION APPARATUS AND INSTRUMENTS FOR NON-MEDICAL USE; APPARATUS AND INSTRUMENT FOR PRODUCING ALL-PURPOSE STERILIZING AND DISINFECTION SOLUTION, SUPER-OXIDISED WATER AND RINSE WATER, NAMELY, BACTERIA-FREE WATER USED TO REMOVE STERILIZING AND DISINFECTING SOLUTIONS WITHOUT RECONTAMINATION BY BACTERIA; APPARATUS AND INSTRUMENTS FOR PRODUCING ALL-PURPOSE STERILIZING AND DISINFECTION SOLUTIONS, SUPER-OXIDISED WATER AND RINSE WATER, NAMELY, BACTERIA-FREE WATERS USED TO REMOVE STERILIZING AND DISINFECTING SOLUTIONS WITHOUT RECONTAMINATION BY BACTERIA, FOR USE IN FOOD PROCESSING, WATER TREATMENT, AGRICULTURE AND OTHER NON-MEDICAL ENVIRONMENTS, NAMELY, LABORATORIES, CROPS, WORKING SURFACES, FOOD PROCESSING AREAS, AND FOR ELIMINATING BACTERIA IN THE PIPEWORK OF INDUSTRIAL COOLING TOWERS; PARTS AND FITTING FOR ALL OF THE AFORESAID GOODS DISINFECTION APPARATUS AND INSTRUMENTS FOR MEDICAL USE (U.S. CLS. 13, 21, 23, 31 AND 34).

SN 76-148,265. TEAMWARE GROUP OY, FIN-00390 HELSINKI, FINLAND, FILED 10-17-2000.

TEAMCARE

CLASS 9—ELECTRICAL AND SCIENTIFIC APPARATUS

FOR COMPUTER SOFTWARE FOR USE IN ACCESSING COMMUNICATIONS NETWORKS SUCH AS THE GLOBAL COMPUTER INFORMATION NETWORK AND INTERNAL COMPUTER INFORMATION NETWORKS, COMMUNICATING INFORMATION BETWEEN FACILITIES ON THE GLOBAL COMPUTER INFORMATION NETWORK OR ON AN INTERNAL COMPUTER INFORMATION NETWORK, CREATING AND UPDATING HOME PAGES AND WEB PAGES ON THE GLOBAL COMPUTER INFORMATION NETWORK OR ON AN INTERNAL INFORMATION NETWORK, ELECTRONIC DOCUMENT STORAGE AND RETRIEVAL, WORK PROCESSING, CREATING AND UPDATING ELECTRONIC CALENDARS, DIARIES, NOTICE BOARDS AND BUSINESS CARDS, CREATING AND DEVELOPING USER-DEFINED SOFTWARE DATABASES, RELATIONAL DATABASE MANAGEMENT, INTEGRATING COMPUTER HARDWARE AND SOFTWARE IN A LOCAL AREA NETWORK AND FOR USE IN ANALYZING COMPUTER SOFTWARE USAGE INFORMATION; COMPUTER SOFTWARE OF THE ABOVE DESCRIPTION AND USER MANUALS SOLD TOGETHER AS A UNIT (U.S. CLS. 21, 23, 26, 36 AND 38).

CLASS 38—COMMUNICATION

FOR COMPUTER SERVICES NAMELY PROVIDING MULTIPLE-USER ACCESS TO A GLOBAL COMPUTER INFORMATION NETWORK (U.S. CLS. 100, 101 AND 104).

CLASS 42—SCIENTIFIC, COMPUTER AND LEGAL SERVICES

FOR COMPUTER SERVICES, NAMELY, DESIGNING AND DEVELOPING, UPDATING AND MAINTAINING WEBSITES FOR OTHERS; UPDATING AND MAINTENANCE OF COMPUTER SOFTWARE; COMPUTER PROGRAMMING FOR OTHERS; RENTAL AND LEASING OF COMPUTERS AND COMPUTER SOFTWARE; AND COMPUTER AND COMPUTER SOFTWARE CONSULTATION (U.S. CLS. 100 AND 101).

SN 76-153,532. E2 TECH LIMITED, BRIDGE OF DON ABERDEEN AB23 8EF, UNITED KINGDOM, FILED 10-25-2000.

E2TECH

PRIORITY CLAIMED UNDER SEC. 44(D) ON ERPN CMNTY TM OFC APPLICATION NO. 001625300, FILED 4-25-2000, REG. NO. 001625300, DATED 7-23-2002, EXPIRES 4-25-2010.

SN 76-151,237. WOOD GROUP GAS TURBINES LTD, DYCE, ABERDEEN AB21 7GA, UNITED KINGDOM, FILED 10-20-2000.



PRIORITY CLAIMED UNDER SEC. 44(D) ON UNITED KINGDOM APPLICATION NO. 2230190, FILED 4-20-2000, REG. NO. 2230190B, DATED 9-7-2001, EXPIRES 4-20-2010.

THE STIPPLING SHOWN IN THE DRAWING IS A FEATURE OF THE MARK AND IS NOT INTENDED TO INDICATE COLOR.

CLASS 6—METAL GOODS

FOR NUTS, BOLTS, WASHERS, TIE BOLTS AND PIPES, ALL MADE OF METAL (U.S. CLS. 2, 12, 13, 14, 23, 25 AND 50).

CLASS 7—MACHINERY

FOR INDUSTRIAL TURBINES; NAMELY, INDUSTRIAL GAS TURBINES; PARTS AND FITTINGS FOR THE AFORESAID GOODS FOR MACHINES, NAMELY, TURBINE ROTOR BLADES, TURBINE NOZZLE GUIDE VANES, TURBINE CASES, HOUSINGS, SEALS, TURBINE DISCS, TURBINE SHAFTS, COMPRESSOR ROTOR BLADES, COMPRESSOR STATOR VANES, COMPRESSOR SHAFTS, COMPRESSOR DISCS, GEARS, GEAR-WHEELS, GEAR SHAFTS, ROLLER BEARINGS, SLEEVE BEARINGS, COMPRESSOR CASES, COMBUSTION CHAMBERS, SEALS, SEAL HOUSINGS, DIAPHRAGMS, PINS, DOWELS, SPACERS, HEAT SHIELDS, THRUST WASHERS, THRUST BEARINGS, THERMOCOUPLES, CONTROLLERS, VALVES, MOTORS, FUEL PUMPS, OIL PUMPS, INTAKE AND EXHAUST MANIFOLDS (U.S. CLS. 13, 19, 21, 23, 31, 34 AND 35).

CLASS 11—ENVIRONMENTAL CONTROL APPARATUS

FOR LIQUID AND GAS FUEL BURNERS (U.S. CLS. 13, 21, 23, 31 AND 34).

CLASS 37—CONSTRUCTION AND REPAIR

FOR MAINTENANCE, REPAIR AND INSTALLATION OF INDUSTRIAL TURBINES AND INDUSTRIAL GAS TURBINE ENGINES FOR MACHINES AND PARTS AND FITTINGS THEREFOR; PROVIDING INFORMATION IN THE FIELD OF MAINTENANCE, REPAIR AND INSTALLATION OF INDUSTRIAL TURBINES AND INDUSTRIAL GAS TURBINES FOR MACHINES (U.S. CLS. 100, 103 AND 106).

CLASS 6—METAL GOODS

FOR PIPES, PIPEWORK AND TUBES OF METAL; METAL PRODUCTS, NAMELY, METAL CONDUITS, METAL CLADDING, LINER HANGERS, SANDSCREENS, SLOTTED TUBULARS, PERFORATED TUBULARS, METAL MANDRELS FOR USE IN OILWELLS, METAL PIPE CLIPS, METAL PIPE CONNECTORS, METAL PIPE COUPLINGS AND JOINTS, METAL PIPE FITTINGS, METAL PLUGS, AND CASINGS FOR USE IN OIL WELLS; WELLBORE LINERS; EXPANDABLE PIPES AND TUBES OF METAL; PIPE AND TUBULAR EXPANDER DEVICES OF METAL, NAMELY, EXPANSION CONES FOR USE WITHIN BOREHOLES AND OILWELLS TO EXPAND PIPES AND TUBULARS; METAL ANCHORS AND INFLATABLE METAL ANCHORS FOR USE IN ANCHORING PIPES AND TUBULARS; COLLARS OF METAL FOR FASTENING PIPES AND TUBES; JUNCTIONS OF METAL FOR PIPES AND TUBES; LININGS OF METAL; REINFORCING MATERIALS OF METAL FOR PIPES AND TUBES; METAL SLEEVES; PARTS AND FITTINGS FOR THE AFORESAID GOODS (U.S. CLS. 2, 12, 13, 14, 23, 25 AND 50).

CLASS 7—MACHINERY

FOR GAS AND OIL FIELD APPARATUS, MACHINE TOOLS, MACHINES AND ARTICLES, NAMELY, POWER-OPERATED EXPANDABLE TUBULAR SYSTEMS CONSISTING OF EXPANDABLE LINERS AND LINER HANGERS, ANCHORS AND INFLATABLE ANCHORS, HYDRAULIC PIPE AND EXPANSION CONES; PARTS AND FITTINGS FOR THE AFORESAID GOODS (U.S. CLS. 13, 19, 21, 23, 31, 34 AND 35).

CLASS 17—RUBBER GOODS

FOR EXPANDABLE PLASTIC PIPES (U.S. CLS. 1, 5, 12, 13, 35 AND 50).

CLASS 37—CONSTRUCTION AND REPAIR

FOR INSPECTION, MAINTENANCE, INSTALLATION, REPAIR, REFURBISHMENT AND RENTAL OF OIL-FIELD EXPLOITATION EQUIPMENT IN THE COURSE OF CONSTRUCTION, NAMELY, PIPES, PIPEWORK AND TUBES OF METAL, METAL CONDUITS, METAL CLADDING, LINER HANGERS, SANDSCREENS, SLOTTED TUBULARS, PERFORATED TUBULARS, METAL MANDRELS FOR USE IN OILWELLS, METAL PIPE CLIPS, METAL PIPE CONNECTORS, METAL PIPE COUPLINGS AND JOINTS, METAL PIPE FITTINGS, METAL PLUGS, AND CASINGS FOR USE IN OIL WELLS, WELLBORE LINERS, EXPANDABLE PIPES AND TUBES OF METAL, PIPE AND TUBULAR EXPANDER DEVICES OF METAL, ANCHORS AND INFLATABLE ANCHORS FOR USE IN ANCHORING PIPES, COLLARS OF METAL FOR FASTENING PIPES AND TUBES, JUNCTIONS OF METAL FOR PIPES AND TUBES, LININGS OF METAL, REINFORCING MATERIALS OF METAL FOR PIPES AND TUBES, SLEEVES (METAL HARDWARE); ON-SITE AND OFF-SITE INSPECTION, MAINTENANCE, INSTALLATION, REPAIR, REFURBISHMENT AND RENTAL OF PIPES, TUBULARS, ARTICLES, TOOLS, MACHINES AND APPARATUS FOR COMPLETING AND ALLOWING PRODUCTION FROM BOREHOLES; ON-SITE AND OFF-SITE INSPECTION, MAINTENANCE, INSTALLATION, REPAIR, REFURBISHMENT AND RENTAL OF GAS AND OILFIELD PIPES, TUBULARS, ARTICLES, TOOLS, MACHINES AND APPARATUS; COMPLETION OF AND PRODUCTION FROM BOREHOLES, NAMELY,

MAINTENANCE, INSTALLATION AND REPAIR OF CASING, LINING, CLADDING, METAL TUBULARS AND PIPES, EXPANSION OF METAL TUBULARS, SANDSCREENS, LINER HANGERS, SLOTTED TUBULARS, PERFORATED TUBULARS; CASING AND LINING OF BOREHOLES; ON-SITE AND OFF-SITE INSPECTION, MAINTENANCE, INSTALLATION, REPAIR, REFURBISHMENT AND RENTAL OF MANMADE STRUCTURES USED IN AND AROUND BOREHOLES; EXPLOITATION SERVICES, NAMELY, OIL, GAS AND WATER WELL CASING, LINING AND DRILL PIPE INSTALLATION AND REPAIR; INFORMATION AND ADVISORY SERVICES IN RELATION TO THE FOREGOING (U.S. CLS. 100, 103 AND 106).

CLASS 42—SCIENTIFIC, COMPUTER AND LEGAL SERVICES

FOR OILFIELD EXPLORATION, ENGINEERING AND CONSULTANCY SERVICES RELATING TO GAS AND OILFIELD EXPLOITATION; DESIGN AND CONSULTANCY SERVICES RELATING TO GAS AND OILFIELD EXPLOITATION, NAMELY, DESIGN OF EXPANDER DEVICES AND CONES, DESIGN OF BOREHOLES AND WELLBORES, CONSULTANCY SERVICES REGARDING THE INSTALLATION OF EXPANDABLE TUBULARS, CONSULTANCY SERVICES RELATING TO THE INSTALLATION OF CASING, CLADDING, LINING, SANDSCREENS, SLOTTED TUBULARS AND PERFORATED TUBULARS; INFORMATION AND ADVISORY SERVICES IN RELATION TO THE AFORESAID SERVICES (U.S. CLS. 100 AND 101).

SN 76-159,426. BYRN, ANNE, NASHVILLE, TN. FILED 11-1-2000.

THE CAKE MIX DOCTOR

NO CLAIM IS MADE TO THE EXCLUSIVE RIGHT TO USE "CAKE MIX", APART FROM THE MARK AS SHOWN. THE NAME SHOWN IN THE MARK IDENTIFIES ANNE BYRN, WHOSE CONSENT IS OF RECORD.
SEC. 2(F).

CLASS 16—PAPER GOODS AND PRINTED MATTER

FOR SERIES OF NONFICTION BOOKS, NAMELY, RECIPE BOOKS CONTAINING DESSERT AND CONFECTION PREPARATION INSTRUCTIONS (U.S. CLS. 2, 5, 22, 23, 29, 37, 38 AND 50).
FIRST USE 10-20-1999; IN COMMERCE 10-20-1999.

CLASS 42—SCIENTIFIC, COMPUTER AND LEGAL SERVICES

FOR PROVIDING INFORMATION IN THE FIELD OF DESSERTS AND CONFECTIONS PREPARATIONS VIA A GLOBAL COMPUTER NETWORK (U.S. CLS. 100 AND 101).
FIRST USE 2-1-2000; IN COMMERCE 2-1-2000.

SN 76-162,615. PET EXTREME, INC., TURLOCK, CA. BY ASSIGNMENT WESTERN RANCH PLAZA LLC, TURLOCK, CA. FILED 11-9-2000.

PET EXTREME

NO CLAIM IS MADE TO THE EXCLUSIVE RIGHT TO USE "PET", APART FROM THE MARK AS SHOWN.

CLASS 28—TOYS AND SPORTING GOODS

FOR FULL RANGE OF PET TOYS, PLAYTHINGS, AND EXERCISE EQUIPMENT (U.S. CLS. 22, 23, 38 AND 50).

CLASS 31—NATURAL AGRICULTURAL PRODUCTS

FOR FULL RANGE OF PET FOOD (U.S. CLS. 1 AND 46).

SN 76-164,355. MEDIA-X SYSTEMS INC, OTTAWA, ONTARIO, CANADA, FILED 11-13-2000.

ETEACHER

PRIORITY CLAIMED UNDER SEC. 44(D) ON CANADA APPLICATION NO. 1,026,429, FILED 8-20-1999, REG. NO. 566906, DATED 9-4-2002, EXPIRES 9-4-2017.

CLASS 9—ELECTRICAL AND SCIENTIFIC APPARATUS

FOR COMPUTER SOFTWARE FOR USE IN DATABASE MANAGEMENT IN THE TRACKING AND ANALYSIS OF STUDENT'S GRADES, ATTENDANCE, BEHAVIOR AND PERFORMANCE DATA AND GENERATING REPORTS AND FORM LETTERS; DOWNLOADABLE ELECTRONIC PUBLICATIONS IN THE NATURE OF MAGAZINES, TRAINING MANUALS AND GUIDES IN THE FIELD OF STUDENT EVALUATION PROCEDURES AND TOOLS (U.S. CLS. 21, 23, 26, 36 AND 38).

CLASS 16—PAPER GOODS AND PRINTED MATTER

FOR PRINTED PUBLICATIONS NAMELY MAGAZINES, TRAINING MANUALS AND GUIDES IN THE FIELD OF STUDENT EVALUATION PROCEDURES AND TOOLS (U.S. CLS. 2, 5, 22, 23, 29, 37, 38 AND 50).

CLASS 41—EDUCATION AND ENTERTAINMENT

FOR TRAINING SERVICES, NAMELY CONDUCTING SEMINARS, TUTORIALS AND WORKSHOPS IN THE FIELD OF STUDENT EVALUATION PROCEDURES AND TOOLS (U.S. CLS. 100, 101 AND 107).

SN 76-172,657. SABRITEC, INC., IRVINE, CA. FILED 11-29-2000.

SABRITEC

CLASS 9—ELECTRICAL AND SCIENTIFIC APPARATUS

FOR ELECTRICAL GOODS, NAMELY, TRIAXIAL CONTACTS, COAXIAL CONTACTS, ELECTRONIC CONNECTORS, FILTER CONNECTORS, COAXIAL CONNECTORS, CABLE ASSEMBLIES, TRIAXIAL CONNECTORS AND FIBER-OPTIC CONNECTORS (U.S. CLS. 21, 23, 26, 36 AND 38).

FIRST USE 0-0-1983; IN COMMERCE 0-0-1983.

CLASS 40—MATERIAL TREATMENT

FOR MANUFACTURE OF ELECTRICAL APPARATUS TO THE ORDER AND SPECIFICATION OF OTHERS (U.S. CLS. 100, 103 AND 106).

FIRST USE 0-0-1983; IN COMMERCE 0-0-1983.

CLASS 42—SCIENTIFIC, COMPUTER AND LEGAL SERVICES

FOR DESIGN OF ELECTRICAL APPARATUS FOR OTHERS (U.S. CLS. 100 AND 101).

FIRST USE 0-0-1980; IN COMMERCE 0-0-1980.

CLASS 35—ADVERTISING AND BUSINESS

FOR BUSINESS MARKETING CONSULTING SERVICES; BUSINESS MARKET RESEARCH; MARKET ANALYSIS; BUSINESS MANAGEMENT AND BUSINESS ORGANIZATION CONSULTING; RENTAL OF OFFICE EQUIPMENT; AND PREPARING AND PLACING ADVERTISEMENTS FOR OTHERS VIA THE INTERNET; DATA PROCESSING (U.S. CLS. 100, 101 AND 102).

CLASS 38—COMMUNICATION

FOR PROVIDING MULTIPLE USER ACCESS TO A GLOBAL COMPUTER NETWORK; INTERNET PHONE SERVICE; AND ELECTRONIC TRANSMISSION OF MESSAGES AND DATA (U.S. CLS. 100, 101 AND 104).

CLASS 42—SCIENTIFIC, COMPUTER AND LEGAL SERVICES

FOR PROVIDING INFORMATION VIA INTERNET WEB SITES IN THE FIELD OF GENERAL NEWS; COMPUTER RENTAL SERVICES; COMPUTER SERVICES, NAMELY, COMPUTER PROGRAMMING FOR OTHERS AND INSTALLATION OF COMPUTER SOFTWARE FOR PROVIDING AND ENCODING OF SPEECH AND DATA CONNECTIONS; AND COMPUTER CONSULTATION (U.S. CLS. 100 AND 101).

SN 76-172,768. D7K DEUTSCHLAND GMBH, 20097 HAMBURG, FED REP GERMANY, FILED 11-29-2000.

FORMULA "N"

PRIORITY CLAIMED UNDER SEC. 44(D) ON FED REP GERMANY APPLICATION NO. 30058070.338, FILED 8-4-2000, REG. NO. 30058070, DATED 1-23-2001, EXPIRES 8-31-2010.

SN 76-173,020. CFI OF WISCONSIN, INC., DBA CENTURY FOODS INTERNATIONAL, SPARTA, WI. FILED 11-29-2000.

CLASS 9—ELECTRICAL AND SCIENTIFIC APPARATUS

FOR ELECTRONIC APPARATUS AND INSTRUMENTS, NAMELY, APPARATUS FOR ELECTRONIC AND/OR OPTICAL DATA PROCESSING AND/OR REMOTE DATA TRANSMISSION, NAMELY, IDSN CARDS, MODEMS, SWITCHING EQUIPMENT, TELEPHONE APPARATUS, NAMELY, TELEPHONES, IP TELEPHONES (FOR INTERNET USE) AND IP DEVICES, NAMELY ANALOG TELEPHONE ADAPTORS; LEAST COST ROUTERS, AND SWITCHING AND ENCODING SYSTEMS FOR CARRIERS AND/OR PROVIDERS COMPRISING INDUSTRIAL PERSONAL COMPUTERS; APPARATUS FOR RECORDING, TRANSMITTING, AND REPRODUCING DATA, SOUND AND IMAGES, NAMELY, STEREO SYSTEMS, COMPRISING DVD-PLAYERS, CD-PLAYERS, VIDEO RECORDERS, AUDIO RECORDERS, CAMCORDERS, VIDEO CAMERAS, CD DRIVES, DVD DRIVES, DISKETTE DRIVES, RADIO RECEIVERS AND RADIO TRANSMITTERS, TELEVISION RECEIVERS, AND WIRELESS TELEPHONES; BLANK MAGNETIC RECORDING MEDIA, NAMELY, VIDEO CASSETTES, DISKETTES, HARD-DISCS, MAGNETIC TAPES, MAGNETIC CASSETTE TAPES, AND MAGNETIC CARDS; BLANK OPTICAL RECORDING MEDIA, NAMELY, CDS, AND DVDS; DATA PROCESSING APPARATUS, NAMELY, COMPUTERS; COMPUTER PERIPHERALS, NAMELY, PRINTERS, SCANNERS, MODEMS, AND DISPLAY SCREENS; COMPUTER PROGRAMS, NAMELY, DATA AND DATA PROCESSING PROGRAMS, STORED ON MAGNETIC, OPTICAL AND OTHER RECORDING MEDIA, IN THE FIELD OF TELECOMMUNICATION, INFORMATION AND MESSAGE TRANSMISSION, AND DATA TRANSMISSION (U.S. CLS. 21, 23, 26, 36 AND 38).

CLASS 25—CLOTHING

FOR CLOTHING, NAMELY, T-SHIRTS, SWEATSHIRTS, AND CAPS; FOOTWEAR; HEAD WEAR (U.S. CLS. 22 AND 39).

CLASS 28—TOYS AND SPORTING GOODS

FOR HAND-HELD UNITS FOR PLAYING ELECTRONIC GAMES (U.S. CLS. 22, 23, 38 AND 50).

**CENTURY FOODS
NUTRITIONALS**

NO CLAIM IS MADE TO THE EXCLUSIVE RIGHT TO USE "FOOD NUTRITIONALS", APART FROM THE MARK AS SHOWN.

CLASS 5—PHARMACEUTICALS

FOR DIETARY AND NUTRITIONAL SUPPLEMENTS (U.S. CLS. 6, 18, 44, 46, 51 AND 52).

FIRST USE 1-10-2000; IN COMMERCE 1-10-2000.

CLASS 35—ADVERTISING AND BUSINESS

FOR PACKING OF DIETARY AND NUTRITIONAL SUPPLEMENTS TO THE ORDER AND SPECIFICATION OF OTHERS AND PRIVATE LABELING SERVICES PROVIDED ONLY AS A COMPONENT OF THE PACKAGING SERVICES; ORDER FULFILLMENT SERVICES FOR OTHERS, NAMELY, RECEIVING ORDERS, PROCESSING ORDERS, AND PREPARING MERCHANDISE ORDERS FOR SHIPMENT (U.S. CLS. 100, 101 AND 102).

FIRST USE 1-10-2000; IN COMMERCE 1-10-2000.

CLASS 40—MATERIAL TREATMENT

FOR CUSTOM MANUFACTURE OF DIETARY AND NUTRITIONAL SUPPLEMENTS (U.S. CLS. 100, 103 AND 106).

FIRST USE 1-10-2000; IN COMMERCE 1-10-2000.

CLASS 42—SCIENTIFIC, COMPUTER AND LEGAL SERVICES

FOR CONSULTING SERVICES IN THE FIELD OF DIETARY AND NUTRITIONAL SUPPLEMENT PRODUCT DEVELOPMENT AND PROCESSING (U.S. CLS. 100 AND 101).

FIRST USE 1-10-2000; IN COMMERCE 1-10-2000.

SN 76-180,892. ZED INSTRUMENTS, HERSHAM, SURREY
KT12 3PD, ENGLAND, FILED 12-14-2000.

SN 76-181,613. ENEL S.P.A., 137, ROME, ITALY, FILED 12-15-
2000.

ZED



OWNER OF ITALY REG. NO. 00824442, DATED 9-21-2000,
EXPIRES 5-4-2010.

THE MARK CONSISTS OF THE WORDING "ENEL.FTL"
IN TYPE LETTERS IN THE COLOR BLUE, PRECEDED BY
A FANCIFUL REPRESENTATION OF A TREE COLORED
IN ORANGE, WHOSE BRANCHES ARE STYLIZED RAYS
OF LIGHT OR FLAMES OF ENERGY.

PRIORITY CLAIMED UNDER SEC. 44(D) ON UNITED
KINGDOM APPLICATION NO. 2237041, FILED 6-23-2000,
REG. NO. 2237041, DATED 7-13-2001, EXPIRES 6-23-2010.

PRIORITY CLAIMED UNDER SEC. 44(D) ON UNITED
KINGDOM APPLICATION NO. 2227400A, FILED 3-28-2000,
REG. NO. 2227400A, DATED 10-20-2000, EXPIRES 3-28-2010.

CLASS 7—MACHINERY

FOR LASER ENGRAVING MACHINES FOR USE IN
THE FIELD OF FLEXOGRAPHIC AND TEXTILE PRINT-
ING; LASER-ENGRAVED CERAMIC ANILOX ROLLS
FOR USE WITH PRINTING MACHINES; PARTS AND
FITTINGS FOR THE AFORESAID GOODS (U.S. CLS. 13,
19, 21, 23, 31, 34 AND 35).

CLASS 9—ELECTRICAL AND SCIENTIFIC APPARATUS

FOR TUNNEL BORING GUIDANCE INSTRUMENTS
AND SYSTEMS, NAMELY, LASERS USED TO PROVIDE
MEASUREMENTS FOR GUIDING TUNNEL BORING
EQUIPMENT; TARGET UNITS COMPRISING OPTICAL
LENSES, LIGHT SENSITIVE ELECTRONIC SENSORS,
COMPUTER HARDWARE AND SOFTWARE FOR RE-
CEIVING AND READING DATA FROM LASERS FOR
USE IN THE FIELD OF TUNNEL BORING; THEODO-
LITES; RING PLACER UNITS COMPRISING COMPU-
TER HARDWARE AND SOFTWARE FOR THE
CALCULATION AND DISPLAY OF THE POSITION
AND ORIENTATION OF TAPERED RING SUPPORT
STRUCTURES FOR THE LINING OF TUNNELS; ELEC-
TRONIC CONTROLS FOR STEERING SYSTEMS,
NAMELY, AN ELECTRONIC CONTROL LINKED TO A
TUNNEL BORING MACHINE'S OPERATING SYSTEM
TO ENABLE THE USER TO STEER THE MACHINE
FOLLOWING A SPECIFIED GUIDANCE PLAN; AR-
TICULATION INTERFACE UNITS FOR ALLOWING
USE OF THE TUNNEL GUIDANCE SYSTEM ON DOU-
BLE SHIELDED TUNNEL BORING MACHINES; RADIO
MODEM LINK COMPRISING RADIO TRANSMITTERS
AND RECEIVERS AND ASSOCIATED ELECTRONIC
BOARDS USED TO RELAY INFORMATION FROM
THE INSTRUMENTATION ON THE FRONT OF THE
TUNNEL BORING MACHINE TO THE SURVEY EQUIP-
MENT MOUNTED WITHIN THE COMPLETED TUN-
NEL; REPEATER UNIT COMPRISING ELECTRONIC
CIRCUIT BOARDS TO RECEIVE, AMPLIFY AND
TRANSMIT CABLE BOUND SIGNALS FROM THE
TUNNEL BORING MACHINE TO THE SURFACE; IN-
TERFACE UNIT COMPRISING ELECTRONIC CIRCUIT
BOARD FOR THE CONTROL OF THE THEODOLITE
LOCATED ON THE WALL OF THE COMPLETED
TUNNEL; COMPUTER HARDWARE AND COMPUTER
SOFTWARE OPERATING SOFTWARE FOR USE WITH
THE ABOVE; IMPACT PRINTERS; LASER PRINTERS;
ELECTRONIC CONTROLLERS FOR LASER PRINTERS;
COMPUTER PRINTER APPARATUS, NAMELY, HIGH
RESOLUTION IMAGE SETTERS; PARTS AND FIT-
TINGS FOR THE AFORESAID (U.S. CLS. 21, 23, 26, 36
AND 38).

CLASS 4—LUBRICANTS AND FUELS

FOR ANTHRACITES, CHARCOAL BRIQUETTES,
FIREWOOD, FUEL FOR AIRCRAFTS AND SHIPS, FUEL
FOR MOTOR VEHICLES, NAMELY, GASOLINE, DIE-
SEL, AND LIQUID PROPANE GAS; FUEL OIL, DIESEL
FUELS, GASOLINE, NAPHTHA, ALL PURPOSE PENE-
TRATING OIL, CRUDE OIL, FUEL OIL, AND PARAF-
FIN (U.S. CLS. 1, 6 AND 15).

CLASS 35—ADVERTISING AND BUSINESS

FOR BUSINESS ACQUISITION CONSULTATION (U.S.
CLS. 100, 101 AND 102).

CLASS 36—INSURANCE AND FINANCIAL

FOR BUSINESS BROKERAGE, COMMODITIES
BROKERAGE, COMMODITIES EXCHANGE, PROVID-
ING PRICE QUOTATIONS (U.S. CLS. 100, 101 AND 102).

CLASS 39—TRANSPORTATION AND STO- RAGE

FOR BARGE TRANSPORT; BOAT CHARTERING;
FREIGHT BROKERAGE; HARBOR CRANE UNLOAD-
ING; FREIGHT FORWARDING; FREIGHT SHIP
TRANSPORT; FREIGHT TRANSPORT BY SHIP, RAIL-
WAY, BARGE, TRUCK; RAILWAY TRANSPORT (U.S.
CLS. 100 AND 105).

SN 76-182,329. ZF LEMFORDER METALLWAREN AG, 32351
STEMWEDE-DIELINGEN, FED REP GERMANY, FILED
12-18-2000.

FAHRBARES CHASSIS

PRIORITY CLAIMED UNDER SEC. 44(D) ON ERP
CMNTY TM OFC APPLICATION NO. 001795707, FILED 8-
7-2000, REG. NO. 001795707, DATED 4-24-2002, EXPIRES 8-7-
2010.

NO CLAIM IS MADE TO THE EXCLUSIVE RIGHT TO
USE "CHASSIS", APART FROM THE MARK AS SHOWN.

CLASS 7—MACHINERY

FOR INTERNAL COMBUSTION ENGINE FANS,
AUTOMOBILE CIRCULATION FANS, MOTOR VEHICLE
POWER TRANSMISSIONS AND MOTOR VEHICLE TOR-
QUE TRANSMISSIONS (U.S. CLS. 13, 19, 21, 23, 31, 34
AND 35).

CLASS 9—ELECTRICAL AND SCIENTIFIC APPARATUS

FOR LAND VEHICLE ELECTRICAL SYSTEMS NAMELY ELECTRIC VOLTAGE REGULATORS, ELECTRIC CURRENT REGULATORS, TILT, PITCH OR ROLL COMPENSATING VEHICLE LEVEL CONTROLLERS, JOINT AND BALL AND SOCKET JOINT WEAR AND ABRASION MEASURERS, DAMPING CHARACTERISTIC SETTABLE ENGINE MOUNT HYDRAULIC DAMPERS, STEERING AND WHEEL POSITION CONTROLLERS AND WHEEL SPRING RATE CONTROLLERS (U.S. CLS. 21, 23, 26, 36 AND 38).

CLASS 12—VEHICLES

FOR AUTOMOBILES, TRUCKS AND MOTOR CYCLES AND PARTS AND ACCESSORIES THEREFOR NAMELY— WHEEL GUIDANCE SYSTEMS COMPRISED OF JOINTS, BALL-AND-SOCKET JOINTS, CARDAN JOINTS; STEERING SYSTEMS, COMPRISED OF STEERING WHEELS, STEERING COLUMNS, STEERING SHAFTS, AIR BAG HOUSINGS, FRAME TO VEHICLE AXLE STEERING TRIANGLES; WHEEL SUSPENSION SYSTEMS COMPRISED OF RADIUS ARMS, SUSPENSION SPRINGS AND JOINTS, COIL SPRINGS, LEAF SPRINGS, CHASSIS MOUNTS, SUSPENSION CONTROL ARMS, SHACKLES, BALL STUDS, PLASTIC BALL SEATS, SEALING BOOTS, SHOCK ABSORBERS, JOINT BARS, TORSION BARS, CONNECTION RODS, TRACK RODS, LONGITUDINAL CONTROL ARMS, SUSPENSION ARMS, ANGLED CONTROL ARMS, TIE BARS, TIE RODS, MOUNTS WHEEL JOINTS, BEARINGS, RUBBER BEARINGS, ELASTOMER BEARINGS, PENDULUM SUPPORT STABILIZERS, WHEEL SUPPORTS, CROSSBEAMS, LONGITUDINAL BEAM STABILIZER BARS, PANHARD RODS; AXLES; AXLE BEARINGS AND PARTS THEREFOR; CHASSIS BEARINGS; JOINTS; BALL-AND-SOCKET JOINTS, UNIVERSAL JOINTS, CARDAN JOINTS AND STRUCTURAL PARTS THEREFOR; STEERING WHEELS, STEERING COLUMNS AND STRUCTURAL PARTS THEREFOR; PROPELLER SHAFTS; VIBRATION DAMPENING TRIANGLES; STABILIZER TRIANGLES; TILT AVOIDANCE TRIANGLES; PITCH AVOIDANCE TRIANGLES; ROLL AVOIDANCE TRIANGLES; TRANSVERSE STABILIZER TRIANGLES; RACK AND PINION STEERING BOX STEERING TRIANGLES; OIL TANKS; AIR BAG HOUSING; SAFETY BELTS AND STRUCTURAL PARTS THEREFOR; AUTOMATIC SEAT BELT WINDERS AND PARTS THEREFOR; FLEXIBLE TUBES, PIN AND SOCKET CONNECTORS; SHOCK ABSORBERS; BRAKE ACTUATORS; BRAKE PEDALS; DISK BRAKES; BRAKE LINES; AUTOMATIC AND MANUAL TRANSMISSIONS FOR LAND VEHICLES; STRUCTURAL PARTS FOR TRANSMISSIONS, NAMELY, VEHICLE MECHANICAL TRANSMISSION CONTROLLERS, VEHICLE MECHANICAL TRANSMISSION REGULATORS, VEHICLE TRANSMISSION GEAR SHIFTERS AND STRUCTURAL PARTS THEREFOR, MECHANICAL, VEHICLE AUTOMATIC AND ELECTRONIC GEAR SHIFTERS, SHIFT LINKAGES AND GEAR SHIFTING LEVERS; RUBBER-METAL PARTS FOR VIBRATION DAMPING, NAMELY, STRUCTURE BORNE NOISE SEALERS, SLIDING STRUCTURE BORNE NOISE SEALERS; METAL VEHICLE SPRINGS; RUBBER VEHICLE SPRINGS; DIFFERENTIALS; POWER DIVIDERS; FUEL TANKS; FUEL LINES; CHASSIS AND STRUCTURAL PARTS THEREFOR; AUTOMOBILE BODIES AND STRUCTURAL PARTS THEREFOR; GEARS AND PARTS THEREFOR; DRIVE GEARS; WHEEL CARRIERS; AND LEVEL EQUALIZERS (U.S. CLS. 19, 21, 23, 31, 35 AND 44).

SN 76-182,417. JOHNSON ATELIER AND SCHOOL OF SCULPTURE, MERCERVILLE, NJ. FILED 12-18-2000.

JOHNSON ATELIER

THE NAME "JOHNSON ATELIER" REFERS TO "J. SEWARD JOHNSON" WHICH IDENTIFIES A LIVING INDIVIDUAL WHOSE CONSENT IS OF RECORD.

SEC. 2(F) AS TO "ATELIER".

CLASS 40—MATERIAL TREATMENT

FOR CUSTOM FABRICATION OF SCULPTURES TO THE ORDER AND SPECIFICATION OF OTHERS (U.S. CLS. 100, 103 AND 106).

FIRST USE 9-0-1974; IN COMMERCE 9-0-1974.

CLASS 42—SCIENTIFIC, COMPUTER AND LEGAL SERVICES

FOR ART DESIGN SERVICES, NAMELY, SCULPTURE DESIGN; ARCHITECTURAL DESIGN; COMPUTER SERVICES, FEATURING A PROCESS THAT LASER SCANS AND DIMENSIONALIZED OBJECTS, INFORMATION OR DESIGNS VIA A COMPUTER; COMPUTER AIDED DESIGN OF THREE-DIMENSIONAL DESIGNS; AND CONSULTATION IN THE FIELD OF SCULPTURE DESIGN; ARCHITECTURAL DESIGN, COMPUTER SERVICES FEATURING A PROCESS THAT LASER SCANS AND DIMENSIONALIZED OBJECTS, INFORMATION OR DESIGNS VIA COMPUTERS, AND COMPUTER AIDED DESIGN (U.S. CLS. 100 AND 101).

FIRST USE 9-0-1974; IN COMMERCE 9-0-1974.

SN 76-187,605. FASTSCOUT LIMITED, WESTERN AUSTRALIA, AUSTRALIA, FILED 12-29-2000.

FASTSCOUT

PRIORITY CLAIMED UNDER SEC. 44(D) ON AUSTRALIA APPLICATION NO. 840871, FILED 6-29-2000, REG. NO. 840871, DATED 6-29-2000, EXPIRES 6-29-2010.

CLASS 9—ELECTRICAL AND SCIENTIFIC APPARATUS

FOR COMPUTER SOFTWARE AND PROGRAMS, NAMELY COMPUTER OPERATING SOFTWARE AND PROGRAMS FOR COMPUTER NETWORKS INCLUDING THE INTERNET AND THE WORLDWIDE WEB; COMPUTER SOFTWARE FOR SEARCHING AND RETRIEVING INFORMATION, SITES AND OTHER RESOURCES ON COMPUTER NETWORKS, AND COMPUTER SOFTWARE IN THE FORM OF A DIRECTORY OF INFORMATION, SITES AND RESOURCES AVAILABLE ON COMPUTER NETWORKS; FILTERING SOFTWARE THAT FILTERS, MONITORS, SEARCHES, TRACKS, REPORTS, ANALYZES, CLASSIFIES AND BLOCKS INFORMATION, POSTINGS, MESSAGES AND FILES ON COMPUTER NETWORKS; COMPUTER SOFTWARE AND PROGRAMS FOR FACILITATING BUSINESS-TO-BUSINESS TRANSACTIONS USING THE INTERNET AND THE WORLDWIDE WEB; COMPUTER DATABASE MANAGEMENT SOFTWARE; COMPUTER HARDWARE; COMPUTER FIRMWARE; COMPUTERS; AND COMPUTER PERIPHERALS (U.S. CLS. 21, 23, 26, 36 AND 38).

CLASS 35—ADVERTISING AND BUSINESS

FOR BUSINESS AND COMMERCIAL INFORMATION DIRECTORY SERVICES; PROVIDING A WEBSITE FEATURING BUSINESS INFORMATION; PROMOTING THE GOODS AND SERVICES OF OTHERS BY PREPARING AND PLACING ADVERTISEMENTS OVER A GLOBAL COMPUTER NETWORK (U.S. CLS. 100, 101 AND 102).

CLASS 38—COMMUNICATION

FOR PROVIDING MULTIPLE-USER ACCESS TO A GLOBAL COMPUTER INFORMATION NETWORK, AND TELECOMMUNICATIONS GATEWAY SERVICES; ELECTRONIC COMMUNICATION SERVICES, NAMELY TELECOMMUNICATION AND ELECTRONIC TRANSMISSION OF INFORMATION, WEB PAGES, COMPUTER PROGRAMS AND OTHER DATA; PROVISION OF TELECOMMUNICATIONS ACCESS AND LINKS TO COMPUTER DATABASES, NAMELY WEB SITES ON THE INTERNET AND THE WORLDWIDE WEB; ELECTRONIC MAIL SERVICES; INSTANT ELECTRONIC MAIL SERVICES; VIDEO CHAT SERVICES; VIDEO CONFERENCING SERVICES (U.S. CLS. 100, 101 AND 104).

CLASS 42—SCIENTIFIC, COMPUTER AND LEGAL SERVICES

FOR COMPUTER SERVICES, NAMELY CREATING INDEXES OF INFORMATION, SITES AND OTHER RESOURCES AVAILABLE ON THE COMPUTER NETWORKS AND CREATING INDEXES OF BUSINESS INFORMATION, BUSINESS SITES AND OTHER BUSINESS RESOURCES AVAILABLE ON COMPUTER NETWORKS FOR OTHERS; SEARCHING AND RETRIEVING INFORMATION, SITES AND OTHER RESOURCES AVAILABLE ON COMPUTER NETWORKS; PROVIDING ON-LINE LINKS TO INFORMATION, SITES AND OTHER RESOURCES AVAILABLE ON COMPUTER NETWORKS; PROVIDING FILTERING SERVICES TO ACCESS PROVIDERS AND USERS OF THE GLOBAL COMPUTER INFORMATION NETWORK FOR THE PURPOSE OF RESTRICTING USERS' ACCESS TO CERTAIN MATERIALS BASED ON CONTENT (U.S. CLS. 100 AND 101).

SN 76-189,277. ZENTRUM FUR EUROPISCHE WIRTSCHAFTSFORSCHUNG GMBH (ZEW) MANNHEIM, D-68161 MANNHEIM, FED REP GERMANY, FILED 1-3-2001.

ZEW

OWNER OF FED REP GERMANY REG. NO. 2037880, DATED 6-8-1993, EXPIRES 2-29-2012.

CLASS 9—ELECTRICAL AND SCIENTIFIC APPARATUS

FOR MICROFILMS AND MICROFICHES AND PRE-RECORDED MACHINE-READABLE DATA CARRIERS, NAMELY, MAGNETIC TAPES AND MAGNETIC DISKS FEATURING DATABASES AND PROGRAMS IN THE FIELDS OF FINANCE, COMMERCE AND SOCIAL SCIENCE (U.S. CLS. 21, 23, 26, 36 AND 38).

CLASS 16—PAPER GOODS AND PRINTED MATTER

FOR PERIODICALLY APPEARING BUSINESS, MANAGEMENT, ECONOMICAL, FINANCIAL, COMMERCIAL, PERSONNEL, LABOR AND SOCIAL SCIENCE JOURNALS; SERIAL AND NON-SERIAL PUBLICATIONS IN THE FORM OF BOOKS, LEAFLETS, BROCHURES AND COMPUTER PRINTOUTS ON PAPER ON THE SUBJECT OF FINANCE, COMMERCE AND SOCIAL SCIENCE (U.S. CLS. 2, 5, 22, 23, 29, 37, 38 AND 50).

CLASS 35—ADVERTISING AND BUSINESS

FOR PROVIDING STATISTICAL INFORMATION IN THE FIELDS OF SOCIAL AND ECONOMIC SCIENCE AND IN FINANCIAL SCIENCE; RESEARCH IN THE FIELDS OF PERSONNEL, ECONOMIC MANAGEMENT, LABOR MARKETS, INDUSTRIAL ECONOMICS, ENVIRONMENTAL AND RESOURCE ECONOMICS, AND COMPANY MANAGEMENT; PROVIDING AN ON-LINE COMPUTER DATABASE IN THE FIELD OF PERSONNEL, ECONOMIC MANAGEMENT, LABOR MARKETS, INDUSTRIAL ECONOMICS, ENVIRONMENTAL AND RESOURCE ECONOMICS, AND COMPANY MANAGEMENT (U.S. CLS. 100, 101 AND 102).

CLASS 36—INSURANCE AND FINANCIAL

FOR RESEARCH IN THE FIELD OF FINANCE; PROVIDING AN ON-LINE COMPUTER DATABASE IN THE FIELD OF FINANCE (U.S. CLS. 100, 101 AND 102).

CLASS 41—EDUCATION AND ENTERTAINMENT

FOR ARRANGING EDUCATIONAL EVENTS IN THE NATURE OF WORKSHOPS AND CLASSES, SEMINARS AND CONFERENCES IN THE FIELDS OF FINANCE, ECONOMICS, SOCIAL SCIENCE, BUSINESS AND MANAGEMENT; PUBLICATION JOURNALS, WRITTEN SERIES AND OTHER DOCUMENTS HAVING A FINANCIAL, ECONOMIC AND SOCIAL SCIENTIFIC CONTENT (U.S. CLS. 100, 101 AND 107).

CLASS 42—SCIENTIFIC, COMPUTER AND LEGAL SERVICES

FOR EVALUATION AND VERIFICATION OF PERIODICALLY APPEARING JOURNALS, SERIAL AND NONSERIAL PUBLICATIONS OF OTHERS SUCH AS REPORTS, DISSERTATIONS, BROCHURES, CONFERENCE LECTURES ON PAPER AND MISCELLANEOUS MACHINE-READABLE SUPPORTS, IN EACH CASE WITH A MAINLY SOCIAL, FINANCIAL AND ECONOMIC SCIENCE CONTENT; THE DEVELOPMENT, PRODUCTION, IMPROVEMENT AND UPDATING OF COMPUTER PROGRAMS FOR OTHERS FOR TEXT AND DATA PROCESSING OF TECHNICAL EXPERT OPINIONS; LANGUAGE TRANSLATIONS SERVICES; CONSULTATION AND PROVIDING EXPERT OPINIONS IN THE FIELDS OF ECONOMIC LAW, FINANCIAL LAW, LABOR LAW AND SOCIAL LAW; AND WRITTEN TEXT EDITING OF JOURNALS, WRITTEN SERIES AND OTHER DOCUMENTS HAVING A FINANCIAL, ECONOMIC AND SOCIAL SCIENTIFIC CONTENT (U.S. CLS. 100 AND 101).

SN 76-196,726. CLARK, JESSICA R, FENWICK ISLAND, DE.
FILED 1-18-2001.



CLASS 21—HOUSEWARES AND GLASS

FOR HOUSEWARES AND GLASS, NAMELY GLASS FLOWER POTS AND TERRACOTTA FLOWER POTS (U.S. CLS. 2, 13, 23, 29, 30, 33, 40 AND 50).
FIRST USE 12-0-1997; IN COMMERCE 7-0-2000.

CLASS 25—CLOTHING

FOR CLOTHING, NAMELY SHIRTS, SWEATSHIRTS, HATS, CAPS AND OUTERWEAR, NAMELY, JACKETS AND PULLOVERS (U.S. CLS. 22 AND 39).
FIRST USE 12-0-1997; IN COMMERCE 7-0-2000.



SN 76-201,376. NEDSTAT B.V., 1112 XC DIEMEN, NETHERLANDS, FILED 1-29-2001.

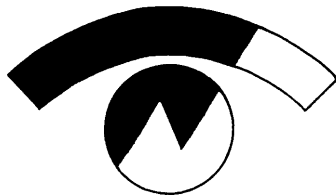

PRIORITY CLAIMED UNDER SEC. 44(D) ON BENELUX APPLICATION NO. 970243, FILED 7-31-2000, REG. NO. 0673185, DATED 7-31-2000, EXPIRES 7-31-2010.

CLASS 9—ELECTRICAL AND SCIENTIFIC APPARATUS

FOR COMPUTER SOFTWARE FOR USE IN THE FIELD OF MATHEMATICAL AND STATISTICAL DATA ANALYSIS; COMPUTER HARDWARE, NAMELY, COMPUTERS AND COMPUTER ACCESSORIES, NAMELY KEYBOARDS, MONITORS, MOUSE, AND MODEMS; ELECTRONIC INSTRUMENTS USED FOR THE RECORDING, TRANSMISSION AND COPYING OF NEWS BULLETINS, INTERNET MESSAGES, STATISTICAL DATA, AND AUDIOVISUAL IMAGES, NAMELY COMPUTERS, TELEPHONES, SET TOP BOXES, TELEVISIONS, FACSIMILE MACHINES, MODEMS, MODEM HUBS, ELECTRONIC MODEM SWITCHES, AND CD RECORDERS, ELECTRONIC INSTRUMENTS USED TO ACCESS THE INTERNET AND TELECOMMUNICATIONS AND COMMUNICATION NETWORKS, NAMELY, COMPUTERS, TELEPHONES, SET TOP BOXES, TELEVISIONS, FACSIMILE MACHINES, MODEMS, MODEM HUBS, ELECTRONIC MODEM SWITCHES, AND CD RECORDERS; ELECTRONIC INSTRUMENTS USED TO TRANSMIT, RECEIVE AND RECORD MATHEMATICAL AND STATISTICAL DATA, NAMELY, COMPUTERS, TELEPHONES, SET TOP BOXES, TELEVISIONS, FACSIMILE MACHINES, MODEMS, MODEM HUBS, ELECTRONIC MODEM SWITCHES, AND CD RECORDERS; BLANK FLOPPY DISKS FOR STORING ELECTRONIC DATA AND AUDIOVISUAL IMAGES; TELECOMMUNICATIONS EQUIPMENT, NAMELY, MOBILE PHONES, TOP BOXES, ALSO KNOWN AS SET TOP BOXES, TELEPHONES, AND TELEVISIONS (U.S. CLS. 21, 23, 26, 36 AND 38).

CLASS 35—ADVERTISING AND BUSINESS

FOR PROVIDING THE SERVICE OF COLLECTING AND COLLATING MATHEMATICAL AND STATISTICAL DATA FOR OTHERS; DEVELOPING AND CONDUCTING CONSUMER MARKET SURVEYS FOR OTHERS; PROVIDING STATISTICAL AND CUSTOMER INFORMATION FOR OTHERS FOR ADVERTISING, PROMOTIONAL AND MARKETING PURPOSES; PROVIDING MATHEMATICAL AND STATISTICAL DATA COLLECTION AND ANALYSIS SERVICES FOR OTHERS; COMPUTERIZED ON-LINE RETAIL SERVICES FEATURING SOFTWARE AND HARDWARE, NAMELY COMPUTERS, MODEMS AND ROUTERS; BUSINESS ORGANIZATIONAL CONSULTATION; MARKET RESEARCH AND ANALYSIS; PROMOTING THE CONCERTS OF OTHERS; ARRANGING AND CONDUCTING TRADE SHOW EXHIBITIONS IN THE FIELD OF COMPUTER HARDWARE AND SOFTWARE, E-BUSINESS, TELECOMMUNICATIONS, MARKETING STATISTICS AND ANALYSIS (U.S. CLS. 100, 101 AND 102).

CLASS 38—COMMUNICATION

FOR TELECOMMUNICATION SERVICES, NAMELY, PROVIDING TELEPHONE SERVICE AND ELECTRONIC TRANSMISSION OF NEWS REPORTS, TEXT MESSAGES, MATHEMATICAL AND STATISTICAL DATA AND AUDIOVISUAL IMAGES VIA COMPUTER TERMINALS; PROVIDING MULTIPLE-USER ACCESS TO GLOBAL COMPUTER AND TELECOMMUNICATION NETWORKS; PROVIDING MULTIPLE-USER INTERNET ACCESS; ELECTRONIC TRANSMISSION OF DATA AND DOCUMENTS VIA COMPUTER TERMINALS; ELECTRONIC TRANSMISSION OF MESSAGES AND DATA VIA COMMUNICATIONS NETWORKS; STREAMING OF AUDIO AND VIDEO MATERIAL ON THE INTERNET; PROVIDING MULTIPLE-USER ACCESS TO AREA NETWORKS AND THE INTERNET; RADIO AND TELEVISION BROADCASTING; RENTAL OF EQUIPMENT FOR USE IN THE FIELDS OF TELECOMMUNICATIONS; TELECOMMUNICATIONS CONSULTATION (U.S. CLS. 100, 101 AND 104).

CLASS 41—EDUCATION AND ENTERTAINMENT

FOR PUBLICATION OF BOOKS, GUIDES, NEWSLETTERS, NEWSPAPERS AND MAGAZINES; EDUCATIONAL SERVICES, NAMELY, CONDUCTING CLASSES, LECTURES AND SEMINARS IN THE FIELD OF COMPUTER HARDWARE AND SOFTWARE, E-BUSINESS, TELECOMMUNICATIONS, MARKETING STATISTICS AND ANALYSIS; CONCERT BOOKING; MOTION PICTURE FILM PRODUCTION; PRODUCTION OF RADIO AND TELEVISION PROGRAMS; VIDEOTAPE PRODUCTION; RENTAL OF RADIOS AND TELEVISIONS (U.S. CLS. 100, 101 AND 107).

CLASS 42—SCIENTIFIC, COMPUTER AND LEGAL SERVICES

FOR REGISTRATION OF DOMAIN NAMES FOR IDENTIFICATION OF USERS ON THE INTERNET; RENTAL OF COMPUTERS AND COMPUTER PERIPHERALS; RENTAL OF COMPUTER SOFTWARE; PROGRAMMING, INSTALLING, MAINTAINING, DESIGNING, DEVELOPING AND UPDATING OF SOFTWARE FOR OTHERS; SCIENTIFIC AND INDUSTRIAL RESEARCH; RESEARCH AND DEVELOPMENT OF NEW PRODUCTS AND SERVICES FOR THIRD PARTIES; COMPUTER EQUIPMENT CONSULTATION; LEASING COMPUTER INSTRUMENTS USED FOR ACCESSING THE INTERNET (U.S. CLS. 100 AND 101).

SN 76-201,495. NEDSTAT B.V., 1112 XC DIEMEN, NETHERLANDS, FILED 1-29-2001.

we're on your site

PRIORITY CLAIMED UNDER SEC. 44(D) ON BENELUX APPLICATION NO. 969969, FILED 7-27-2000, REG. NO. 0670848, DATED 7-27-2000, EXPIRES 7-27-2010.

CLASS 9—ELECTRICAL AND SCIENTIFIC APPARATUS

FOR COMPUTER SOFTWARE FOR USE IN THE FIELD OF MATHEMATICAL AND STATISTICAL DATA ANALYSIS; COMPUTER HARDWARE, NAMELY, COMPUTERS AND COMPUTER ACCESSORIES, NAMELY KEYBOARDS, MONITORS, MOUSE, AND MODEMS; ELECTRONIC INSTRUMENTS USED FOR THE RECORDING, TRANSMISSION AND COPYING OF NEWS BULLETINS, INTERNET MESSAGES, STATISTICAL DATA, AND AUDIOVISUAL IMAGES, NAMELY COMPUTERS, TELEPHONES, SET TOP BOXES, TELEVISIONS, FACSIMILE MACHINES, MODEMS, MODEM HUBS, ELECTRONIC MODEM SWITCHES, AND CD RECORDERS, ELECTRONIC INSTRUMENTS USED TO ACCESS THE INTERNET AND TELECOMMUNICATIONS AND COMMUNICATION NETWORKS, NAMELY, COMPUTERS, TELEPHONES, SET TOP BOXES, TELEVISIONS, FACSIMILE MACHINES, MODEMS, MODEM HUBS, ELECTRONIC MODEM SWITCHES, AND CD RECORDERS; ELECTRONIC INSTRUMENTS USED TO TRANSMIT, RECEIVE AND RECORD MATHEMATICAL AND STATISTICAL DATA, NAMELY, COMPUTERS, TELEPHONES, SET TOP BOXES, TELEVISIONS, FACSIMILE MACHINES, MODEMS, MODEM HUBS, ELECTRONIC MODEM SWITCHES, AND CD RECORDERS; BLANK FLOPPY DISKS FOR STORING ELECTRONIC DATA AND AUDIOVISUAL IMAGES; TELECOMMUNICATIONS EQUIPMENT, NAMELY, MOBILE PHONES, TOP BOXES, ALSO KNOWN AS SET TOP BOXES, TELEPHONES, AND TELEVISIONS (U.S. CLS. 21, 23, 26, 36 AND 38).

CLASS 35—ADVERTISING AND BUSINESS

FOR PROVIDING THE SERVICE OF COLLECTING AND COLLATING MATHEMATICAL AND STATISTICAL DATA FOR OTHERS; DEVELOPING AND CONDUCTING CONSUMER MARKET SURVEYS FOR OTHERS; PROVIDING STATISTICAL AND CUSTOMER INFORMATION FOR OTHERS FOR ADVERTISING, PROMOTIONAL AND MARKETING PURPOSES; PROVIDING MATHEMATICAL AND STATISTICAL DATA COLLECTION AND ANALYSIS SERVICES FOR OTHERS; COMPUTERIZED ON-LINE RETAIL SERVICES FEATURING SOFTWARE AND HARDWARE, NAMELY COMPUTERS, MODEMS AND ROUTERS; BUSINESS ORGANIZATIONAL CONSULTATION; MARKET RESEARCH AND ANALYSIS; PROMOTING THE CONCERTS OF OTHERS; ARRANGING AND CONDUCTING TRADE SHOW EXHIBITIONS IN THE FIELD OF COMPUTER HARDWARE AND SOFTWARE, E-BUSINESS, TELECOMMUNICATIONS, MARKETING STATISTICS AND ANALYSIS (U.S. CLS. 100, 101 AND 102).

CLASS 38—COMMUNICATION

FOR TELECOMMUNICATION SERVICES, NAMELY, PROVIDING TELEPHONE SERVICE AND ELECTRONIC TRANSMISSION OF NEWS REPORTS, TEXT MESSAGES, MATHEMATICAL AND STATISTICAL DATA AND AUDIOVISUAL IMAGES VIA COMPUTER TERMINALS; PROVIDING MULTIPLE-USER ACCESS TO GLOBAL COMPUTER AND TELECOMMUNICATION NETWORKS; PROVIDING MULTIPLE-USER INTERNET ACCESS; ELECTRONIC TRANSMISSION OF DATA AND DOCUMENTS VIA COMPUTER TERMINALS; ELECTRONIC TRANSMISSION OF MESSAGES AND DATA VIA COMMUNICATIONS NETWORKS; STREAMING OF AUDIO AND VIDEO MATERIAL ON THE INTERNET; PROVIDING MULTIPLE-USER ACCESS TO AREA NETWORKS AND THE INTERNET; RADIO AND TELEVISION BROADCASTING; RENTAL OF EQUIPMENT FOR USE IN THE FIELDS OF TELECOMMUNICATIONS; TELECOMMUNICATIONS CONSULTATION (U.S. CLS. 100, 101 AND 104).

CLASS 41—EDUCATION AND ENTERTAINMENT

FOR PUBLICATION OF BOOKS, GUIDES, NEWSLETTERS, NEWSPAPERS AND MAGAZINES; EDUCATIONAL SERVICES, NAMELY, CONDUCTING CLASSES, LECTURES AND SEMINARS IN THE FIELD OF COMPUTER HARDWARE AND SOFTWARE, E-BUSINESS, TELECOMMUNICATIONS, MARKETING STATISTICS AND ANALYSIS; CONCERT BOOKING; MOTION PICTURE FILM PRODUCTION; PRODUCTION OF RADIO AND TELEVISION PROGRAMS; VIDEOTAPE PRODUCTION; RENTAL OF RADIOS AND TELEVISIONS (U.S. CLS. 100, 101 AND 107).

CLASS 42—SCIENTIFIC, COMPUTER AND LEGAL SERVICES

FOR REGISTRATION OF DOMAIN NAMES FOR IDENTIFICATION OF USERS ON THE INTERNET; RENTAL OF COMPUTERS AND COMPUTER PERIPHERALS; RENTAL OF COMPUTER SOFTWARE; PROGRAMMING, INSTALLING, MAINTAINING, DESIGNING, DEVELOPING AND UPDATING OF SOFTWARE FOR OTHERS; SCIENTIFIC AND INDUSTRIAL RESEARCH; RESEARCH AND DEVELOPMENT OF NEW PRODUCTS AND SERVICES FOR THIRD PARTIES; COMPUTER EQUIPMENT CONSULTATION; LEASING COMPUTER INSTRUMENTS USED FOR ACCESSING THE INTERNET (U.S. CLS. 100 AND 101).

SN 76-201,496. NEDSTAT B.V., 1112 XC DIEMEN, NETHERLANDS, FILED 1-29-2001.

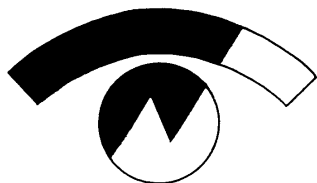

PRIORITY CLAIMED UNDER SEC. 44(D) ON BENELUX APPLICATION NO. 970241, FILED 7-31-2000, REG. NO. 0673184, DATED 7-31-2000, EXPIRES 7-30-2010.

THE MARK CONSISTS OF THE LEFT SIDE OF THE CRESCENT IS YELLOW. THE TOP PORTION OF THE CIRCLE IS PURPLE AND THE BOTTOM HALF OF THE CIRCLE IS YELLOW.

CLASS 9—ELECTRICAL AND SCIENTIFIC APPARATUS

FOR COMPUTER SOFTWARE FOR USE IN THE FIELD OF MATHEMATICAL AND STATISTICAL DATA ANALYSIS; COMPUTER HARDWARE, NAMELY, COMPUTERS AND COMPUTER ACCESSORIES, NAMELY, KEYBOARDS, MONITORS, MOUSE, AND MODEMS; ELECTRONIC INSTRUMENTS USED FOR THE RECORDING, TRANSMISSION AND COPYING OF NEWS BULLETINS, INTERNET MESSAGES, STATISTICAL DATA, AND AUDIOVISUAL IMAGES, NAMELY COMPUTERS, TELEPHONES, SET TOP BOXES, TELEVISIONS, FACSIMILE MACHINES, MODEMS, MODEM HUBS, ELECTRONIC MODEM SWITCHES, AND CD RECORDERS; ELECTRONIC INSTRUMENTS USED TO ACCESS THE INTERNET AND TELECOMMUNICATIONS AND COMMUNICATION NETWORKS, NAMELY, COMPUTERS, TELEPHONES, SET TOP BOXES, TELEVISIONS, FACSIMILE MACHINES, MODEMS, MODEM HUBS, ELECTRONIC MODEM SWITCHES, AND CD RECORDERS; ELECTRONIC INSTRUMENTS USED TO TRANSMIT, RECEIVE AND RECORD MATHEMATICAL AND STATISTICAL DATA, NAMELY, COMPUTERS, TELEPHONES, SET TOP BOXES, TELEVISIONS, FACSIMILE MACHINES, MODEMS, MODEM HUBS, ELECTRONIC MODEM SWITCHES, AND CD RECORDERS; BLANK FLOPPY DISKS FOR STORING ELECTRONIC DATA AND AUDIOVISUAL IMAGES; TELECOMMUNICATIONS EQUIPMENT, NAMELY, MOBILE PHONES, TOP BOXES, ALSO KNOWN AS SET TOP BOXES, TELEPHONES, AND TELEVISIONS (U.S. CLS. 21, 23, 26, 36 AND 38).

CLASS 35—ADVERTISING AND BUSINESS

FOR PROVIDING THE SERVICE OF COLLECTING AND COLLATING MATHEMATICAL AND STATISTICAL DATA FOR OTHERS; DEVELOPING AND CONDUCTING CONSUMER MARKET SURVEYS FOR OTHERS; PROVIDING STATISTICAL AND CUSTOMER INFORMATION FOR OTHERS FOR ADVERTISING, PROMOTIONAL AND MARKETING PURPOSES; PROVIDING MATHEMATICAL AND STATISTICAL DATA COLLECTION AND ANALYSIS SERVICES FOR OTHERS; COMPUTERIZED ON-LINE RETAIL SERVICES FEATURING SOFTWARE AND HARDWARE, NAMELY COMPUTERS, MODEMS AND ROUTERS; BUSINESS ORGANIZATIONAL CONSULTATION; MARKET RESEARCH AND ANALYSIS; PROMOTING THE CONCERTS OF OTHERS; ARRANGING AND CONDUCTING TRADE SHOW EXHIBITIONS IN THE FIELD OF COMPUTER HARDWARE AND SOFTWARE, E-BUSINESS, TELECOMMUNICATIONS, MARKETING STATISTICS AND ANALYSIS (U.S. CLS. 100, 101 AND 102).

CLASS 38—COMMUNICATION

FOR TELECOMMUNICATION SERVICES, NAMELY, PROVIDING TELEPHONE SERVICE AND ELECTRONIC TRANSMISSION OF NEWS REPORTS, TEXT MESSAGES, MATHEMATICAL AND STATISTICAL DATA AND AUDIOVISUAL IMAGES VIA COMPUTER TERMINALS; PROVIDING MULTIPLE-USER ACCESS TO GLOBAL COMPUTER AND TELECOMMUNICATION NETWORKS; PROVIDING MULTIPLE-USER INTERNET ACCESS; ELECTRONIC TRANSMISSION OF DATA AND DOCUMENTS VIA COMPUTER TERMINALS; ELECTRONIC TRANSMISSION OF MESSAGES AND DATA VIA COMMUNICATIONS NETWORKS; STREAMING OF AUDIO AND VIDEO MATERIAL ON THE INTERNET; PROVIDING MULTIPLE-USER ACCESS TO AREA NETWORKS AND THE INTERNET; RADIO AND TELEVISION BROADCASTING; RENTAL OF EQUIPMENT FOR USE IN THE FIELDS OF TELECOMMUNICATIONS; TELECOMMUNICATIONS CONSULTATION (U.S. CLS. 100, 101 AND 104).

CLASS 41—EDUCATION AND ENTERTAINMENT

FOR PUBLICATION OF BOOKS, GUIDES, NEWSLETTERS, NEWSPAPERS AND MAGAZINES; EDUCATIONAL SERVICES, NAMELY, CONDUCTING CLASSES, LECTURES AND SEMINARS IN THE FIELD OF COMPUTER HARDWARE AND SOFTWARE, E-BUSINESS, TELECOMMUNICATIONS, MARKETING STATISTICS AND ANALYSIS; CONCERT BOOKING; MOTION PICTURE FILM PRODUCTION; PRODUCTION OF RADIO AND TELEVISION PROGRAMS; VIDEOTAPE PRODUCTION; RENTAL OF RADIOS AND TELEVISIONS (U.S. CLS. 100, 101 AND 107).

CLASS 42—SCIENTIFIC, COMPUTER AND LEGAL SERVICES

FOR REGISTRATION OF DOMAIN NAMES FOR IDENTIFICATION OF USERS ON THE INTERNET; RENTAL OF COMPUTERS AND COMPUTER PERIPHERALS; RENTAL OF COMPUTER SOFTWARE; PROGRAMMING, INSTALLING, MAINTAINING, DESIGNING, DEVELOPING AND UPDATING OF SOFTWARE FOR OTHERS; SCIENTIFIC AND INDUSTRIAL RESEARCH; RESEARCH AND DEVELOPMENT OF NEW PRODUCTS AND SERVICES FOR THIRD PARTIES; COMPUTER EQUIPMENT CONSULTATION; LEASING COMPUTER INSTRUMENTS USED FOR ACCESSING THE INTERNET (U.S. CLS. 100 AND 101).

SN 76-205,897. OPTICAL ASSOCIATES, INCORPORATED, MILPITAS, CA. FILED 2-5-2001.



OWNER OF U.S. REG. NO. 1,139,848.

CLASS 7—MACHINERY

FOR SEMICONDUCTOR MANUFACTURING MACHINES, NAMELY, OPTICAL EDGE BEAD REMOVAL SYSTEMS USING EITHER A FLOOD EXPOSURE SYSTEM OR A FIBER OPTIC CABLES IN COMBINATION WITH AN EDGE TRACKING HEAD FOR EXPOSING PHOTO RESIST ALONG THE EDGE PORTIONS OF WAFERS; AND DISK DRIVE MEDIA TRANSPORT SYSTEMS COMPOSED OF CONVEYORS AND INDUSTRIAL ROBOTS FOR MOVING THE MEDIA INTO AND OUT OF SEMICONDUCTOR PROCESSING MACHINES (U.S. CLS. 13, 19, 21, 23, 31, 34 AND 35).

FIRST USE 4-0-1978; IN COMMERCE 4-0-1978.

CLASS 9—ELECTRICAL AND SCIENTIFIC APPARATUS

FOR METERS AND PROBES FOR THE MEASUREMENT AND ANALYSIS OF ULTRAVIOLET LIGHT; LASER METERS FOR MEASURING PULSE ENERGY IN PHOTOLITHOGRAPHY STEPPERS OR STEP AND SCAN SYSTEMS IN THE PROCESSING OF SEMICONDUCTORS; AND MASK ALIGNERS FOR ALIGNING SUBSTRATES AND MASKS FOR EXPOSURE TO ULTRAVIOLET LIGHT FOR IN THE PROCESSING OF SEMICONDUCTORS (U.S. CLS. 21, 23, 26, 36 AND 38).

FIRST USE 4-0-1978; IN COMMERCE 4-0-1978.

CLASS 11—ENVIRONMENTAL CONTROL APPARATUS

FOR ULTRAVIOLET LIGHT SOURCES AND COMPONENTS THEREOF, ALL SOLD AS A UNIT FOR USE IN THE PROCESSING OF SEMICONDUCTORS, NAMELY ELECTRIC POWER SUPPLIES, ULTRAVIOLET LIGHTS, SHUTTERS AND TIMERS; FLOOD EXPOSURE SYSTEMS COMPOSED OF LAMPS, REFLECTORS, MIRRORS, SHUTTERS, OPTICAL INTEGRATORS AND COLLIMATING LENSES FOR EXPOSING OBJECTS TO A FIELD OF UNIFORM ULTRAVIOLET LIGHT IN PHOTOLITHOGRAPHIC PROCESSING OF SEMICONDUCTORS (U.S. CLS. 13, 21, 23, 31 AND 34).

FIRST USE 4-0-1978; IN COMMERCE 4-0-1978.

CLASS 41—EDUCATION AND ENTERTAINMENT

FOR EDUCATIONAL SERVICES, NAMELY, CONDUCTING CLASSES, SEMINARS LIVE AND OVER THE INTERNET IN THE FIELDS OF TRADING CO2 CREDITS, ENVIRONMENTAL CONSERVATION, ENVIRONMENTAL AWARENESS, LAND MANAGEMENT, LAND DEVELOPMENT AND NATURAL RESOURCE MANAGEMENT; COMPUTER TRAINING IN THE FIELDS OF CO2 CREDITS, ENVIRONMENTAL CONSERVATION, ENVIRONMENTAL AWARENESS, LAND MANAGEMENT, LAND DEVELOPMENT AND NATURAL RESOURCE MANAGEMENT; PUBLICATION OF BOOKS, PERIODICALS, MANUALS AND TRAINING MATERIALS (U.S. CLS. 100, 101 AND 107).

CLASS 42—SCIENTIFIC, COMPUTER AND LEGAL SERVICES

FOR PROVIDING TECHNICAL CONSULTATION AND RESEARCH SERVICES IN THE FIELDS OF TRADING CO2 CREDITS, ENVIRONMENTAL CONSERVATION, ENVIRONMENTAL AWARENESS, LAND MANAGEMENT, NATURAL RESOURCE MANAGEMENT AND NATURAL RESOURCE CONSERVATION; COMPUTER SERVICES, NAMELY, PROVIDING ONLINE BOOKS, PERIODICALS, MANUALS AND TRAINING MATERIALS IN THE FIELDS OF CO2 CREDITS, ENVIRONMENTAL AWARENESS, LAND MANAGEMENT, NATURAL RESOURCE MANAGEMENT AND NATURAL RESOURCE CONSERVATION (U.S. CLS. 100 AND 101).

SN 76-211,565. RIE ASSOCIATES LIMITED, LONDON, ENGLAND, FILED 2-16-2001.

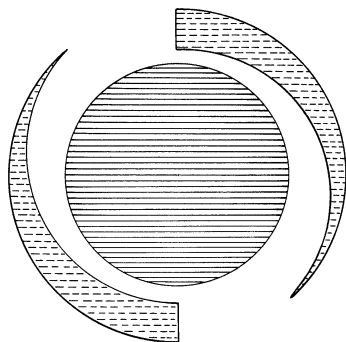

THE DRAWING IS LINED FOR THE COLOR(S) BLUE AND GRAY.

THE MARK CONSISTS OF A BLUE CIRCLE BORDERED BY TWO GRAY FANCIFUL DESIGNS.

CLASS 35—ADVERTISING AND BUSINESS

FOR BUSINESS CONSULTATION; BUSINESS RESEARCH; BUSINESS INFORMATION TO OTHERS IN THE FIELD OF ENVIRONMENTAL CONSERVATION; PROVIDING BUSINESS INFORMATION TO OTHERS ABOUT A TRADING SYSTEM IN WHICH THE COMMODITY TRADED IS CO2 CREDITS (U.S. CLS. 100, 101 AND 102).

CLASS 36—INSURANCE AND FINANCIAL

FOR CHARITABLE FUND RAISING IN THE FIELD OF ENVIRONMENTAL CONSERVATION; INVESTMENT OF FUNDS FOR OTHERS IN BUSINESSES THAT TRADE CO2 CREDITS AND CONSERVE AND RESTORE THE ENVIRONMENT (U.S. CLS. 100, 101 AND 102).

SN 76-213,788. SESAME WORKSHOP, NEW YORK, NY, FILED 2-20-2001.

MAX

CLASS 9—ELECTRICAL AND SCIENTIFIC APPARATUS

FOR MUSICAL SOUND RECORDINGS, VIDEO RECORDINGS, AUDIO RECORDINGS, VIDEO DISCS, CD-ROMS AND SOFTWARE, ALL FEATURING INFORMATION AND ENTERTAINMENT OF GENERAL INTEREST TO CHILDREN, PARENTS AND FAMILIES, ALL SOLD IN CONNECTION WITH A PROPRIETARY CHILDREN'S TELEVISION SERIES (U.S. CLS. 21, 23, 26, 36 AND 38).

CLASS 16—PAPER GOODS AND PRINTED MATTER

FOR BOOKS AND MAGAZINES FEATURING INFORMATION AND ENTERTAINMENT FOR CHILDREN, PARENTS AND FAMILIES; POSTERS; ACTIVITY KITS COMPRISED PRIMARILY OF CHILDREN'S BOOKS AND MAGAZINES AND STICKERS, AND CROSSWORD AND JIGSAW PUZZLES AND EDUCATIONAL, CARD AND BOARD GAMES; CALENDARS (U.S. CLS. 2, 5, 22, 23, 29, 37, 38 AND 50).

CLASS 25—CLOTHING

FOR CLOTHING SOLD IN CONNECTION WITH A PROPRIETARY CHILDREN'S TELEVISION SERIES, NAMELY, MEN'S, WOMEN'S, CHILDREN'S AND INFANT'S CLOTHING, NAMELY, SHIRTS, T-SHIRTS, TANK TOPS, PANTS, OVERALLS, JACKETS, SOCKS, LEGGINGS, SLEEPERS, SNOWSUITS, SLEEPWEAR, LOUNGEWEAR, JUMPERS, COATS, DRESSES, SKIRTS, UNDERWEAR, SWEATERS, SWIM WEAR, CLOTHING TIES, VEST, SHORTS, CLOTHING MUFFLERS, SCARVES, HEAD WEAR, FOOTWEAR, CLOTHING BELTS, SUSPENDERS, RAINCOATS, SMOCKS, HALLOWEEN AND CHRISTMAS COSTUMES, AND WORK-OUT CLOTHES, NAMELY, SWEATSHIRTS, GYM SHORTS, AND GYM SUITS (U.S. CLS. 22 AND 39).

CLASS 28—TOYS AND SPORTING GOODS

FOR TOYS AND GAMES SOLD IN CONNECTION WITH A PROPRIETARY CHILDREN'S TELEVISION SERIES, NAMELY, CARD GAMES, MANIPULATIVE GAMES, HAND HELD UNITS FOR PLAYING ELECTRONIC GAMES, PLUSH TOYS, SQUEEZE TOYS, TOY FIGURES, BATH TOYS, BEACH TOYS, MULTIPLE ACTIVITY BABY TOYS, PUPPETS, TOY FILM CARTRIDGES AND VIEWERS, DOLLS, BEAN BAGS, PULL TOYS, BABY RATTLES, RIDE-ON TOYS, ELECTRONIC LEARNING TOYS, TOY SCOOTERS, WIND UP TOYS, BALLOONS, TOY BUILDING BLOCKS, CONSTRUCTION TOYS, AND PUZZLES; AND CHRISTMAS TREE DECORATIONS, CHRISTMAS TREE ORNAMENTS, CHRISTMAS TREE SKIRTS, ALL SOLD IN CONNECTION WITH A PROPRIETARY CHILDREN'S TELEVISION SERIES (U.S. CLS. 22, 23, 38 AND 50).

CLASS 41—EDUCATION AND ENTERTAINMENT

FOR ENTERTAINMENT PROVIDED IN CONNECTION WITH A PROPRIETARY CHILDREN'S TELEVISION SERIES IN THE NATURE OF AN ONGOING TELEVISION SERIES FEATURING INFORMATION AND ENTERTAINMENT DIRECTED TO CHILDREN, PARENTS AND FAMILIES; PROVIDING INFORMATION AND ENTERTAINMENT OF GENERAL INTEREST TO CHILDREN, PARENTS AND FAMILIES VIA A GLOBAL COMPUTER NETWORK, PROVIDED IN CONNECTION WITH A PROPRIETARY CHILDREN'S TELEVISION SERIES (U.S. CLS. 100, 101 AND 107).

SN 76-214,512. GELEK, NGAWANG, ANN ARBOR, MI. FILED 2-16-2001.



Jewel Heart

CLASS 9—ELECTRICAL AND SCIENTIFIC APPARATUS

FOR CD'S CONTAINING LECTURES ABOUT TIBETAN BUDDHISM AND MEDITATION (U.S. CLS. 21, 23, 26, 36 AND 38).

FIRST USE 8-1-1989; IN COMMERCE 6-1-1991.

CLASS 16—PAPER GOODS AND PRINTED MATTER

FOR PRINTED MATERIALS, NAMELY BOOKS, MAGAZINES, BROCHURES AND NEWSLETTERS CONCERNING TIBETAN BUDDHISM AND MEDITATION (U.S. CLS. 2, 5, 22, 23, 29, 37, 38 AND 50).

FIRST USE 8-1-1989; IN COMMERCE 8-1-1991.

CLASS 25—CLOTHING

FOR T-SHIRTS (U.S. CLS. 22 AND 39).
FIRST USE 8-1-1989; IN COMMERCE 8-1-1991.

SN 76-220,866. SAIL LABS TECHNOLOGY AG, A-1040 WIEN, AUSTRIA, BY ASSIGNMENT SAIL LABS GMBH, 81541 MUNCHEN, FED REP GERMANY, FILED 3-5-2001.

ClearTalk

PRIORITY CLAIMED UNDER SEC. 44(D) ON ERPN CMNTY TM OFC APPLICATION NO. 1843960, FILED 9-7-2000, REG. NO. 1843960, DATED 10-16-2001, EXPIRES 9-7-2010.

CLASS 9—ELECTRICAL AND SCIENTIFIC APPARATUS

FOR COMPUTER SOFTWARE FOR RECORDING OF AUDIO IN BUSINESS MEETINGS WITH SPECIAL EMPHASIS ON PRODUCING HIGH-QUALITY RECORDINGS FOR THE USE IN SPEECH RECOGNITION APPLICATIONS (U.S. CLS. 21, 23, 26, 36 AND 38).

CLASS 42—SCIENTIFIC, COMPUTER AND LEGAL SERVICES

FOR COMPUTER SERVICES; NAMELY, SOFTWARE PROGRAMMING SERVICES FOR OTHERS (U.S. CLS. 100 AND 101).

SN 76-225,682. AUTOWEB.COM, INC., SANTA CLARA, CA. FILED 3-16-2001.

AIC AUTOANALYST

NO CLAIM IS MADE TO THE EXCLUSIVE RIGHT TO USE "AUTO ANALYST", APART FROM THE MARK AS SHOWN.

CLASS 35—ADVERTISING AND BUSINESS

FOR PROVIDING AN ONLINE WEB SITE FOR CONSUMERS AND PROFESSIONALS FEATURING AUTOMOBILE AND MOTOR VEHICLE CONSUMER INFORMATION, NAMELY SELECTION, AVAILABILITY, PRICING, QUOTATIONS, COMPARISONS, AND SALES INFORMATION AND CONSUMER PRODUCT INFORMATION CONCERNING MOTOR VEHICLE WARRANTIES, REPAIR AND MAINTENANCE, PARTS, CUSTOMIZATION AND SERVICES; PROVIDING AUTOMOTIVE AND VEHICULAR CONSUMER AND PRODUCT INFORMATION VIA A GLOBAL COMPUTER NETWORK RELATING TO VEHICLES FOR SALE, VALUATION OF VEHICLES FOR PURCHASERS, CONSUMERS, WHOLESALERS AND RETAIL DEALERS, SPECIFICATION AND PERFORMANCE REVIEWS OF VEHICLES FOR PURCHASERS, CONSUMERS, WHOLESALERS AND RETAIL DEALERS, AVAILABILITY OF VEHICLE PARTS AND ACCESSORIES FOR INTERESTED CONSUMERS, WHOLESALERS AND RETAIL DEALERS, AND AUTOMOTIVE TRADE INFORMATION AND GENERAL AUTOMOTIVE INDUSTRY NEWS; PROVIDING ADVERTISING, MARKETING AND PROMOTION SERVICES TO OTHERS, NAMELY THE DISSEMINATION OF ADVERTISING FOR OTHERS, PROMOTING THE GOODS AND SERVICES OF OTHERS THROUGH THE DISTRIBUTION OF ONLINE ADVERTISEMENTS, PROVIDING A WEBSITE WHEREIN USERS CAN LINK TO THE WEBSITES OF THE MERCHANTS AND PROVIDING PRINT, RADIO AND TELEVISION ADVERTISING, INCENTIVE AWARDS, AND CROSS-PROMOTION AND REFERRAL PROGRAMS; E-COMMERCE SERVICES NAMELY PROVIDING ONLINE RETAIL STORE SERVICES IN THE FIELD OF AUTOMOBILES AND MOTOR VEHICLES; AUTOMOBILE AND MOTOR VEHICLE DEALERSHIPS REFERRAL SERVICES PROVIDED LOCALLY, REMOTELY AND OVER THE INTERNET AND VIA COMPUTER AND DATA COMMUNICATIONS NETWORKS (U.S. CLS. 100, 101 AND 102).

CLASS 42—SCIENTIFIC, COMPUTER AND LEGAL SERVICES

FOR COMPUTER SOFTWARE DESIGN FOR OTHERS; COMPUTER CONSULTATION; MAINTENANCE OF COMPUTER SOFTWARE; MAINTENANCE AND UPDATING OF COMPUTER SOFTWARE AND COMPUTER SERVICES, NAMELY, CREATING, MAINTAINING AND HOSTING WEB SITES FOR A GLOBAL COMPUTER NETWORK FOR OTHERS FOR THE PURPOSE OF ADVERTISING AUTOMOBILES AND OTHER VEHICLES FOR SALE OR LEASE, PROVIDING AUTOMOTIVE-RELATED SERVICES AND PROVIDING GENERAL INFORMATION AND SPECIFICATIONS ABOUT AUTOMOBILES AND OTHER VEHICLES, AND PARTS, ACCESSORIES AND SERVICES FOR AUTOMOBILES AND OTHER VEHICLES; PROVIDING ELECTRONIC AND COMPUTER BASED PRODUCT RESEARCH IN THE FIELD OF AUTOMOBILES AND MOTOR VEHICLES (U.S. CLS. 100 AND 101).

SN 76-227,685. FORMULA FRANCHISING ITALIANO, L.L.C., MIAMI, FL. FILED 3-21-2001.

BACIO

THE ENGLISH TRANSLATION OF "BACIO" IS "KISS".

CLASS 30—STAPLE FOODS

FOR ICE CREAM (U.S. CL. 46).

CLASS 35—ADVERTISING AND BUSINESS

FOR FRANCHISING, NAMELY, OFFERING TECHNICAL ASSISTANCE IN THE ESTABLISHMENT AND/OR OPERATION OF ICE CREAM PARLORS; RETAIL STORE FEATURING GELATO (U.S. CLS. 100, 101 AND 102).

CLASS 42—SCIENTIFIC, COMPUTER AND LEGAL SERVICES

FOR INTERIOR DECORATION CONSULTATION, NAMELY SIGN, EQUIPMENT AND FIXTURE PLACEMENT TO ALLOW FOR THE MOST ERGONOMICALLY EFFICIENT AND MARKETABLE OPERATION OF ICE CREAM PARLORS; CATERING SERVICES; ICE CREAM PARLORS (U.S. CLS. 100 AND 101).

SN 76-227,893. REED ELSEVIER INC., NEWTON, MA. FILED 3-20-2001.

REED ELSEVIER

THE NAME "REED ELSEVIER" DOES NOT IDENTIFY A LIVING INDIVIDUAL.

CLASS 9—ELECTRICAL AND SCIENTIFIC APPARATUS

FOR COMPUTER DISKS, DVDS, VIDEOTAPES AND CD-ROMS FEATURING INFORMATION IN THE FIELDS OF BUSINESS, INDUSTRY, EDUCATION, ACADEMICS, GOVERNMENT, LAW, TAX, AGRICULTURAL AND BIOLOGICAL SCIENCES, ARTS AND HUMANITIES, HEALTH, CHEMISTRY AND CHEMICAL ENGINEERING, COMPUTER SCIENCE, EARTH AND PLANETARY SCIENCES, ECONOMICS, BUSINESS AND MANAGEMENT, ENGINEERING, ENERGY AND TECHNOLOGY, ENVIRONMENTAL SCIENCES, LIFE SCIENCES, MATERIALS SCIENCES, MATHEMATICS, MEDICINE, NEUROSCIENCE, PHARMACOLOGY, PHARMACEUTICAL SCIENCE AND TOXICOLOGY, PHYSICS AND ASTRONOMY, SOCIAL AND BEHAVIORAL SCIENCES, AUTOMOTIVE AND TRUCKING, BOOK PUBLISHING, BUILDING AND CONSTRUCTION, DESIGN, DESIGN ENGINEERING, ELECTRONICS DESIGN AND COMMUNICATIONS, ELECTRONICS MANUFACTURING, IN-STAT RESEARCH, ENTERTAINMENT COMMUNICATIONS AND MEDIA, FOOD AND PACKAGING, FOODSERVICE AND LODGING, GIFTS, JEWELRY AND HOME TEXTILES, MANUFACTURING PROCESSES, MANUFACTURING PRODUCTS, PRINTING AND CONVERTING, PROCESSING, RETAIL HOME FURNISHINGS, SCIENTIFIC AND MEDICAL INFORMATION, SUPPLY CHAIN, TELEVISION AND TELECOM, VARIETY, ACCOUNTANCY AND BUSINESS INFORMATION, ADMINISTRATION, AGRICULTURE, BUILDING AND CONSTRUCTION INFORMATION, HEALTHCARE, HORTICULTURE, HOTEL AND CATERING, LOGISTICS, RETAIL, TECHNICS, TOURISM, ACCOUNTANCY, AIR TRANSPORT, BANKING, CATERING, CHEMICALS, COMPUTING, CONSTRUCTION, ELECTRICAL, ELECTRONICS, INDUSTRIAL AND COMMERCIAL INFORMATION, MOTOR TRADE, OFFICE EQUIPMENT, OPTICAL, PERSONAL CARE, PERSONNEL AND OCCUPATIONAL HEALTH, PROFESSIONAL, PROPERTY, RAILWAYS, RECRUITMENT, ROAD HAULAGE, SCIENCE, SHIPPING, SOCIAL SERVICES, TELEVISION, UTILITIES, AEROSPACE AND DEFENSE, INFORMATION CONCERNING AGRICULTURAL, FORESTRY AND NATURAL RESOURCES, ARTS AND ENTERTAINMENT, BOOKS AND PUBLISHING, BUILDINGS, PROPERTY AND INTERIOR DESIGN, ELECTRONICS AND ELECTRICAL ENGINEERING, ENGINEERING, MANUFACTURING AND PROCESSING, FOODSERVICE AND HOSPITALITY, INFORMATION TECHNOLOGY AND COMMUNICATIONS, MARKETING, BUSINESS AND TRAINING, SAFETY AND SECURITY, SPORTS, LEISURE AND HEALTH, TRADE SHOWS, CONFERENCES, COMPUTERIZED INFORMA-

TION STORAGE AND RETRIEVAL SERVICES, ADVERTISING, NEWS, RESEARCH, EMPLOYMENT, RECRUITING AND A WIDE VARIETY OF TOPICS OF GENERAL INTEREST; COMPUTER SOFTWARE FOR ACCESSING COMPUTERIZED DATABASES; COMPUTER SOFTWARE, NAMELY, WORD PROCESSING SOFTWARE; INTERNET ACCESS SOFTWARE; SOFTWARE FOR PROVIDING ACCESS TO PROPRIETARY DATABASES ONLINE; COMPUTER SOFTWARE FOR ACCESSING DATABASES OF INFORMATION ON A WIDE VARIETY OF TOPICS; SOFTWARE THAT ENABLES USERS TO ELECTRONICALLY FILE DOCUMENTS WITH COURTS AND GOVERNMENT AGENCIES; SPREADSHEET SOFTWARE; SOFTWARE TO SEARCH AND DISPLAY CHARGES INCURRED FOR ONLINE RESEARCH; SOFTWARE THAT PERFORMS LEGAL CITATION VERIFICATION; SOFTWARE THAT SELECTS AND DISPLAYS CITATIONS OF RELATED CASES AND OTHER LEGAL MATERIALS; SOFTWARE FOR PRODUCING TABLES OF AUTHORITIES IN THE FIELD OF LAW; AND BOOKKEEPING SOFTWARE; COMPUTER PROGRAMS, NAMELY, DATABASE COMPUTER PROGRAMS RECORDED ON MAGNETIC TAPES AND DISCS, FOR USE IN THE FIELDS OF MULTIMEDIA, BUSINESS, PUBLISHING, SCIENCE, ENGINEERING, EMPLOYMENT, RECRUITING, LAW AND RELIGION; MULTI-MEDIA SOFTWARE FOR USE IN CREATING PRESENTATIONS, MANAGING DATABASES AND ACCESSING AND DISPLAYING INFORMATION IN THE FIELDS OF BUSINESS, INDUSTRY, EDUCATION, ACADEMICS, GOVERNMENT, LAW, TAX, AGRICULTURAL AND BIOLOGICAL SCIENCES, ARTS AND HUMANITIES, HEALTH, CHEMISTRY AND CHEMICAL ENGINEERING, COMPUTER SCIENCE, EARTH AND PLANETARY SCIENCES, ECONOMICS, BUSINESS AND MANAGEMENT, ENGINEERING, ENERGY AND TECHNOLOGY, ENVIRONMENTAL SCIENCES, LIFE SCIENCES, MATERIALS SCIENCES, MATHEMATICS, MEDICINE, NEUROSCIENCE, PHARMACOLOGY, PHARMACEUTICAL SCIENCE AND TOXICOLOGY, PHYSICS AND ASTRONOMY, SOCIAL AND BEHAVIORAL SCIENCES, AUTOMOTIVE AND TRUCKING, BOOK PUBLISHING, BUILDING AND CONSTRUCTION, DESIGN, DESIGN ENGINEERING, ELECTRONICS DESIGN AND COMMUNICATIONS, ELECTRONICS MANUFACTURING, IN-STAT RESEARCH, ENTERTAINMENT COMMUNICATIONS AND MEDIA, FOOD AND PACKAGING, FOODSERVICE AND LODGING, GIFTS, JEWELRY AND HOME TEXTILES, MANUFACTURING PROCESSES, MANUFACTURING PRODUCTS, PRINTING AND CONVERTING, PROCESSING, RETAIL HOME FURNISHINGS, SCIENTIFIC AND MEDICAL INFORMATION, SUPPLY CHAIN, TELEVISION AND TELECOM, VARIETY, ACCOUNTANCY AND BUSINESS INFORMATION, ADMINISTRATION, AGRICULTURE, BUILDING AND CONSTRUCTION INFORMATION, HEALTHCARE, HORTICULTURE, HOTEL AND CATERING, LOGISTICS, RETAIL, TECHNICS, TOURISM, ACCOUNTANCY, AIR TRANSPORT, BANKING, CATERING, CHEMICALS, COMPUTING, CONSTRUCTION, ELECTRICAL, ELECTRONICS, INDUSTRIAL AND COMMERCIAL INFORMATION, MOTOR TRADE, OFFICE EQUIPMENT, OPTICAL, PERSONAL CARE, PERSONNEL AND OCCUPATIONAL HEALTH, PROFESSIONAL, PROPERTY, RAILWAYS, RECRUITMENT, ROAD HAULAGE, SCIENCE, SHIPPING, SOCIAL SERVICES, TELEVISION, UTILITIES, AEROSPACE AND DEFENSE, INFORMATION CONCERNING AGRICULTURAL, FORESTRY AND NATURAL RESOURCES, ARTS AND ENTERTAINMENT, BOOKS AND PUBLISHING, BUILDINGS, PROPERTY AND INTERIOR DESIGN, ELECTRONICS AND ELECTRICAL ENGINEERING, ENGINEERING, MANUFACTURING AND PROCESSING, FOODSERVICE AND HOSPITALITY, INFORMATION TECHNOLOGY AND COMMUNICATIONS, MARKETING, BUSINESS AND TRAINING, SAFETY AND SECURITY, SPORTS, LEISURE AND HEALTH, TRADE SHOWS, CONFERENCES, COMPUTERIZED INFORMATION STORAGE AND RETRIEVAL SERVICES, ADVERTISING, NEWS, RESEARCH, EMPLOYMENT, RECRUITING AND A WIDE VARIETY OF TOPICS OF GENERAL INTEREST; DOWNLOADABLE ELECTRONIC PUBLICATIONS IN THE NATURE OF JOURNALS, BOOKS, BROCHURES, LEAFLETS, MANUALS, PUBLICITY TEXTS, TEXT BOOKS, REFERENCE MATERIALS, NEWSLETTERS, ATLASES AND MAGAZINES IN THE FIELDS OF BUSINESS, INDUSTRY, EDUCATION, ACADEMICS, GOVERNMENT, LAW, TAX, AGRICULTURAL

AND BIOLOGICAL SCIENCES, ARTS AND HUMANITIES, HEALTH, CHEMISTRY AND CHEMICAL ENGINEERING, COMPUTER SCIENCE, EARTH AND PLANETARY SCIENCES, ECONOMICS, BUSINESS AND MANAGEMENT, ENGINEERING, ENERGY AND TECHNOLOGY, ENVIRONMENTAL SCIENCES, LIFE SCIENCES, MATERIALS SCIENCES, MATHEMATICS, MEDICINE, NEUROSCIENCE, PHARMACOLOGY, PHARMACEUTICAL SCIENCE AND TOXICOLOGY, PHYSICS AND ASTRONOMY, SOCIAL AND BEHAVIORAL SCIENCES, AUTOMOTIVE AND TRUCKING, BOOK PUBLISHING, BUILDING AND CONSTRUCTION, DESIGN, DESIGN ENGINEERING, ELECTRONICS DESIGN AND COMMUNICATIONS, ELECTRONICS MANUFACTURING, IN-STAT RESEARCH, ENTERTAINMENT COMMUNICATIONS AND MEDIA, FOOD AND PACKAGING, FOODSERVICE AND LODGING, GIFTS, JEWELRY AND HOME TEXTILES, MANUFACTURING PROCESSES, MANUFACTURING PRODUCTS, PRINTING AND CONVERTING, PROCESSING, RETAIL HOME FURNISHINGS, SCIENTIFIC AND MEDICAL INFORMATION, SUPPLY CHAIN, TELEVISION AND TELECOM, VARIETY, ACCOUNTANCY AND BUSINESS INFORMATION, ADMINISTRATION, AGRICULTURE, BUILDING AND CONSTRUCTION INFORMATION, HEALTHCARE, HORTICULTURE, HOTEL AND CATERING, LOGISTICS, RETAIL, TECHNICS, TOURISM, ACCOUNTANCY, AIR TRANSPORT, BANKING, CATERING, CHEMICALS, COMPUTING, CONSTRUCTION, ELECTRICAL, ELECTRONICS, INDUSTRIAL AND COMMERCIAL INFORMATION, MOTOR TRADE, OFFICE EQUIPMENT, OPTICAL, PERSONAL CARE, PERSONNEL AND OCCUPATIONAL HEALTH, PROFESSIONAL, PROPERTY, RAILWAYS, RECRUITMENT, ROAD HAULAGE, SCIENCE, SHIPPING, SOCIAL SERVICES, TELEVISION, UTILITIES, AEROSPACE AND DEFENSE, INFORMATION CONCERNING AGRICULTURAL, FORESTRY AND NATURAL RESOURCES, ARTS AND ENTERTAINMENT, BOOKS AND PUBLISHING, BUILDINGS, PROPERTY AND INTERIOR DESIGN, ELECTRONICS AND ELECTRICAL ENGINEERING, ENGINEERING, MANUFACTURING AND PROCESSING, FOODSERVICE AND HOSPITALITY, INFORMATION TECHNOLOGY AND COMMUNICATIONS, MARKETING, BUSINESS AND TRAINING, SAFETY AND SECURITY, SPORTS, LEISURE AND HEALTH, TRADE SHOWS, CONFERENCES, COMPUTERIZED INFORMATION STORAGE AND RETRIEVAL SERVICES, ADVERTISING, NEWS, RESEARCH, EMPLOYMENT, RECRUITING AND A WIDE VARIETY OF TOPICS OF GENERAL INTEREST; ELECTRONIC PUBLICATIONS, NAMELY, JOURNALS, BOOKS, BROCHURES, LEAFLETS, MANUALS, PUBLICITY TEXTS, TEXT BOOKS, REFERENCE MATERIALS, NEWSLETTERS, ATLASES AND MAGAZINES FEATURING INFORMATION CONCERNING BUSINESS, INDUSTRY, EDUCATION, ACADEMICS, GOVERNMENT, LAW, TAX, AGRICULTURAL AND BIOLOGICAL SCIENCES, ARTS AND HUMANITIES, HEALTH, CHEMISTRY AND CHEMICAL ENGINEERING, COMPUTER SCIENCE, EARTH AND PLANETARY SCIENCES, ECONOMICS, BUSINESS AND MANAGEMENT, ENGINEERING, ENERGY AND TECHNOLOGY, ENVIRONMENTAL SCIENCES, LIFE SCIENCES, MATERIALS SCIENCES, MATHEMATICS, MEDICINE, NEUROSCIENCE, PHARMACOLOGY, PHARMACEUTICAL SCIENCE AND TOXICOLOGY, PHYSICS AND ASTRONOMY, SOCIAL AND BEHAVIORAL SCIENCES, AUTOMOTIVE AND TRUCKING, BOOK PUBLISHING, BUILDING AND CONSTRUCTION, DESIGN, DESIGN ENGINEERING, ELECTRONICS DESIGN AND COMMUNICATIONS, ELECTRONICS MANUFACTURING, IN-STAT RESEARCH, ENTERTAINMENT COMMUNICATIONS AND MEDIA, FOOD AND PACKAGING, FOODSERVICE AND LODGING, GIFTS, JEWELRY AND HOME TEXTILES, MANUFACTURING PROCESSES, MANUFACTURING PRODUCTS, PRINTING AND CONVERTING, PROCESSING, RETAIL HOME FURNISHINGS, SCIENTIFIC AND MEDICAL INFORMATION, SUPPLY CHAIN, TELEVISION AND TELECOM, VARIETY, ACCOUNTANCY AND BUSINESS INFORMATION, ADMINISTRATION, AGRICULTURE, BUILDING AND CONSTRUCTION INFORMATION, HEALTHCARE, HORTICULTURE, HOTEL AND CATERING, LOGISTICS, RETAIL, TECHNICS, TOURISM, ACCOUNTANCY, AIR TRANSPORT, BANKING, CATERING, CHEMICALS, COMPUTING, CONSTRUCTION, ELECTRICAL, ELECTRONICS, INDUSTRIAL AND COMMERCIAL

CIAL INFORMATION, MOTOR TRADE, OFFICE EQUIPMENT, OPTICAL, PERSONAL CARE, PERSONNEL AND OCCUPATIONAL HEALTH, PROFESSIONAL, PROPERTY, RAILWAYS, RECRUITMENT, ROAD HAULAGE, SCIENCE, SHIPPING, SOCIAL SERVICES, TELEVISION, UTILITIES, AEROSPACE AND DEFENSE, INFORMATION CONCERNING AGRICULTURAL, FORESTRY AND NATURAL RESOURCES, ARTS AND ENTERTAINMENT, BOOKS AND PUBLISHING, BUILDINGS, PROPERTY AND INTERIOR DESIGN, ELECTRONICS AND ELECTRICAL ENGINEERING, ENGINEERING, MANUFACTURING AND PROCESSING, FOODSERVICE AND HOSPITALITY, INFORMATION TECHNOLOGY AND COMMUNICATIONS, MARKETING, BUSINESS AND TRAINING, SAFETY AND SECURITY, SPORTS, LEISURE AND HEALTH, TRADE SHOWS, CONFERENCES, COMPUTERIZED INFORMATION STORAGE AND RETRIEVAL SERVICES, ADVERTISING, NEWS, RESEARCH, EMPLOYMENT, RECRUITING AND A WIDE VARIETY OF TOPICS OF GENERAL INTEREST RECORDED ON COMPUTER DISKS, DVDS, VIDEOTAPES AND CD-ROMS (U.S. CLS. 21, 23, 26, 36 AND 38).

CLASS 16—PAPER GOODS AND PRINTED MATTER

FOR PUBLICATIONS, NAMELY, JOURNALS, BOOKS, BROCHURES, LEAFLETS, MANUALS, PUBLICITY TEXTS, TEXT BOOKS, REFERENCE MATERIALS, NEWSLETTERS, ATLASES, MAGAZINES AND PRINTED GUIDES ON A WIDE VARIETY OF TOPICS; DIARIES; PRINTED TIMETABLES, PRINTED INSTRUCTIONAL AND TEACHING MATERIALS DEALING WITH A VARIETY OF SUBJECTS (U.S. CLS. 2, 5, 22, 23, 29, 37, 38 AND 50).

CLASS 35—ADVERTISING AND BUSINESS

FOR ARRANGING AND CONDUCTING TRADE SHOWS IN THE FIELDS OF AEROSPACE AND DEFENSE, ART, AUTOMOBILES AND AUTOMOTIVE ENGINEERING, AGRICULTURE, BOOKS AND PUBLISHING, BUILDING AND CONSTRUCTION, BROADCASTING AND TELEVISION, CHEMICAL AND PROCESS ENGINEERING, CONVERTING, COMPUTERS AND INFORMATION TECHNOLOGY, TELECOMMUNICATIONS, CRAFTS, DESIGN, EDUCATION AND LANGUAGE TRAINING, ELECTRICAL, ELECTRONICS AND ELECTRICAL ENGINEERING, ENGINEERING, ENTERTAINMENT, ENVIRONMENT AND WATER, ENERGY, FASHION, FINANCE, RETAIL FOOD, HOTEL AND RETAIL FOOD SERVICE, FOOD PROCESSING AND MANUFACTURING, FURNITURE, GIFTS AND SOUVENIRS, HARDWARE, HOUSEWARES AND ALLIED PRODUCTS, HEALTHCARE, COMMERCIAL AND DOMESTIC INTERIOR DESIGN, JEWELRY, LABORATORY EQUIPMENT, MACHINERY AND MANUFACTURING, MARKETING, MINING, MUSIC, MATERIALS HANDLING, TRANSPORTATION AND DISTRIBUTION, OFFICE EQUIPMENT AND SUPPLIES, OPTICAL, OIL AND GAS, PACKAGING, PHARMACEUTICALS AND COSMETICS, PLASTICS, PRINTING, PROPERTY AND REAL ESTATE, SECURITY AND SAFETY, SPORTS AND RECREATION, TEST MEASUREMENT INSPECTION AND QUALITY CONTROL, TEXTILES, WATER ENGINEERING, WOODWORKING AND FORESTRY; ARRANGING AND CONDUCTING BUSINESS CONFERENCES; PUBLICATION OF PUBLICITY TEXTS; PROVISION AND DISTRIBUTION OF ONLINE PUBLICITY TEXTS OF OTHERS (U.S. CLS. 100, 101 AND 102).

CLASS 41—EDUCATION AND ENTERTAINMENT

FOR ARRANGING AND CONDUCTING EDUCATIONAL CONFERENCES, CONVENTIONS AND EXHIBITIONS; CONDUCTING EDUCATIONAL AND TRAINING CLASSES IN THE USE OF COMPUTERIZED INFORMATION RETRIEVAL SERVICES; PUBLICATION SERVICES, NAMELY, PUBLICATION OF JOURNALS, BOOKS, BROCHURES, LEAFLETS, MANUALS, TEXT BOOKS, REFERENCE MATERIALS, NEWSLETTERS, ATLASES AND MAGAZINES IN HARD COPY, ELECTRONIC FORM AND ON VARIOUS TYPES OF MEDIA; ELECTRONIC PUBLISHING SERVICES, NAMELY, PUBLICATION OF TEXT AND GRAPHIC WORKS OF OTHERS ON CD-ROMS FEATURING INFORMATION IN THE FIELDS OF BUSINESS, INDUSTRY, EDUCATION, ACADEMICS, GOVERNMENT, LAW, TAX, AGRICULTURAL AND BIOLOGICAL SCIENCES, ARTS AND HUMANITIES, HEALTH, CHEMISTRY AND CHEMICAL ENGINEERING, COMPUTER SCIENCE, EARTH AND PLANETARY SCIENCES, ECONOMICS, BUSINESS AND MANAGEMENT, ENGINEERING, ENERGY AND TECHNOLOGY, ENVIRONMENTAL SCIENCES, LIFE SCIENCES, MATERIALS SCIENCES, MATHEMATICS, MEDICINE, NEUROSCIENCE, PHARMACOLOGY, PHARMACEUTICAL SCIENCE AND TOXICOLOGY, PHYSICS AND ASTRONOMY, SOCIAL AND BEHAVIORAL SCIENCES, AUTOMOTIVE AND TRUCKING, BOOK PUBLISHING, BUILDING AND CONSTRUCTION, DESIGN, DESIGN ENGINEERING, ELECTRONICS DESIGN AND COMMUNICATIONS, ELECTRONICS MANUFACTURING, IN-STAT RESEARCH, ENTERTAINMENT COMMUNICATIONS AND MEDIA, FOOD AND PACKAGING, FOODSERVICE AND LODGING, GIFTS, JEWELRY AND HOME TEXTILES, MANUFACTURING PROCESSES, MANUFACTURING PRODUCTS, PRINTING AND CONVERTING, PROCESSING, RETAIL HOME FURNISHINGS, SCIENTIFIC AND MEDICAL, SUPPLY CHAIN, TELEVISION AND TELECOM, VARIETY, ACCOUNTANCY AND BUSINESS, ADMINISTRATION, AGRICULTURE, BUILDING AND CONSTRUCTION, HEALTHCARE, HORTICULTURE, HOTEL AND CATERING, LOGISTICS, RETAIL, TECHNICS, TOURISM, ACCOUNTANCY, AIR TRANSPORT, BANKING, CATERING, CHEMICALS, COMPUTING, CONSTRUCTION, ELECTRICAL, ELECTRONICS, INDUSTRIAL AND COMMERCIAL, MOTOR TRADE, OFFICE EQUIPMENT, OPTICAL, PERSONAL CARE, PERSONNEL AND OCCUPATIONAL HEALTH, PROFESSIONAL, PROPERTY, RAILWAYS, RECRUITMENT, ROAD HAULAGE, SCIENCE, SHIPPING, SOCIAL SERVICES, TELEVISION, UTILITIES, AEROSPACE AND DEFENSE, AGRICULTURAL, FORESTRY AND NATURAL RESOURCES, ARTS AND ENTERTAINMENT, BOOKS AND PUBLISHING, BUILDINGS, PROPERTY AND INTERIOR DESIGN, ELECTRONICS AND ELECTRICAL ENGINEERING, ENGINEERING, MANUFACTURING AND PROCESSING, FOODSERVICE AND HOSPITALITY, INFORMATION TECHNOLOGY AND COMMUNICATIONS, MARKETING, BUSINESS AND TRAINING, SAFETY AND SECURITY, SPORTS, LEISURE AND HEALTH, TRADE SHOWS, CONFERENCES, COMPUTERIZED INFORMATION STORAGE AND RETRIEVAL SERVICES, ADVERTISING, NEWS, RESEARCH, EMPLOYMENT, RECRUITING AND A WIDE VARIETY OF TOPICS OF GENERAL INTEREST (U.S. CLS. 100, 101 AND 107).

CLASS 42—SCIENTIFIC, COMPUTER AND LEGAL SERVICES

FOR COMPUTER SERVICES, NAMELY PROVIDING ON-LINE JOURNALS, BOOKS, BROCHURES, LEAFLETS, TEXT BOOKS, REFERENCE MATERIALS, NEWSLETTERS, ATLASES AND MAGAZINES IN THE FIELDS OF BUSINESS, INDUSTRY, EDUCATION, ACADEMICS, GOVERNMENT, LAW, TAX, AGRICULTURAL AND BIOLOGICAL SCIENCES, ARTS AND HUMANITIES, HEALTH, CHEMISTRY AND CHEMICAL ENGINEERING, COMPUTER SCIENCE, EARTH AND PLANETARY SCIENCES, ECONOMICS, BUSINESS AND MANAGEMENT, ENGINEERING, ENERGY AND TECHNOLOGY, ENVIRONMENTAL SCIENCES, LIFE SCIENCES, MATERIALS SCIENCES, MATHEMATICS, MEDICINE, NEUROSCIENCE, PHARMACOLOGY, PHARMACEUTICAL SCIENCE AND TOXICOLOGY, PHYSICS AND ASTRON-

OMY, SOCIAL AND BEHAVIORAL SCIENCES, AUTOMOTIVE AND TRUCKING, BOOK PUBLISHING, BUILDING AND CONSTRUCTION, DESIGN, DESIGN ENGINEERING, ELECTRONICS DESIGN AND COMMUNICATIONS, ELECTRONICS MANUFACTURING, IN-STAT RESEARCH, ENTERTAINMENT COMMUNICATIONS AND MEDIA, FOOD AND PACKAGING, FOODSERVICE AND LODGING, GIFTS, JEWELRY AND HOME TEXTILES, MANUFACTURING PROCESSES, MANUFACTURING PRODUCTS, PRINTING AND CONVERTING, PROCESSING, RETAIL HOME FURNISHINGS, SCIENTIFIC AND MEDICAL, SUPPLY CHAIN, TELEVISION AND TELECOM, VARIETY, ACCOUNTANCY AND BUSINESS, ADMINISTRATION, AGRICULTURE, BUILDING AND CONSTRUCTION, HEALTHCARE, HORTICULTURE, HOTEL AND CATERING, LOGISTICS, RETAIL, TECHNICS, TOURISM, ACCOUNTANCY, AIR TRANSPORT, BANKING, CATERING, CHEMICALS, COMPUTING, CONSTRUCTION, ELECTRICAL, ELECTRONICS, INDUSTRIAL AND COMMERCIAL, MOTOR TRADE, OFFICE EQUIPMENT, OPTICAL, PERSONAL CARE, PERSONNEL AND OCCUPATIONAL HEALTH, PROFESSIONAL, PROPERTY, RAILWAYS, RECRUITMENT, ROAD HAULAGE, SCIENCE, SHIPPING, SOCIAL SERVICES, TELEVISION, UTILITIES, AEROSPACE AND DEFENSE, AGRICULTURAL, FORESTRY AND NATURAL RESOURCES, ARTS AND ENTERTAINMENT, BOOKS AND PUBLISHING, BUILDINGS, PROPERTY AND INTERIOR DESIGN, ELECTRONICS AND ELECTRICAL ENGINEERING, ENGINEERING, MANUFACTURING AND PROCESSING, FOODSERVICE AND HOSPITALITY, INFORMATION TECHNOLOGY AND COMMUNICATIONS, MARKETING, BUSINESS, AND TRAINING, SAFETY AND SECURITY, SPORTS, LEISURE AND HEALTH, TRADE SHOWS, CONFERENCES, COMPUTERIZED INFORMATION STORAGE AND RETRIEVAL SERVICES, ADVERTISING, NEWS, RESEARCH, EMPLOYMENT, RECRUITING AND A WIDE VARIETY OF TOPICS OF GENERAL INTEREST (U.S. CLS. 100 AND 101).

CHEMICALS, COMPUTING, CONSTRUCTION, ELECTRICAL, ELECTRONICS, INDUSTRIAL AND COMMERCIAL INFORMATION, MOTOR TRADE, OFFICE EQUIPMENT, OPTICAL, PERSONAL CARE, PERSONNEL AND OCCUPATIONAL HEALTH, PROFESSIONAL, PROPERTY, RAILWAYS, RECRUITMENT, ROAD HAULAGE, SCIENCE, SHIPPING, SOCIAL SERVICES, TELEVISION, UTILITIES, AEROSPACE AND DEFENSE, INFORMATION CONCERNING AGRICULTURAL, FORESTRY AND NATURAL RESOURCES, ARTS AND ENTERTAINMENT, BOOKS AND PUBLISHING, BUILDINGS, PROPERTY AND INTERIOR DESIGN, ELECTRONICS AND ELECTRICAL ENGINEERING, ENGINEERING, MANUFACTURING AND PROCESSING, FOODSERVICE AND HOSPITALITY, INFORMATION TECHNOLOGY AND COMMUNICATIONS, MARKETING, BUSINESS AND TRAINING, SAFETY AND SECURITY, SPORTS, LEISURE AND HEALTH, TRADE SHOWS, CONFERENCES, COMPUTERIZED INFORMATION STORAGE AND RETRIEVAL SERVICES, ADVERTISING, NEWS, RESEARCH, EMPLOYMENT, RECRUITING AND A WIDE VARIETY OF TOPICS OF GENERAL INTEREST; COMPUTER SOFTWARE FOR ACCESSING COMPUTERIZED DATABASES; COMPUTER SOFTWARE, NAMELY, WORD PROCESSING SOFTWARE; INTERNET ACCESS SOFTWARE; SOFTWARE FOR PROVIDING ACCESS TO PROPRIETARY DATABASES ONLINE; COMPUTER SOFTWARE FOR ACCESSING DATABASES OF INFORMATION ON A WIDE VARIETY OF TOPICS; SOFTWARE THAT ENABLES USERS TO ELECTRONICALLY FILE DOCUMENTS WITH COURTS AND GOVERNMENT AGENCIES; SPREADSHEET SOFTWARE; SOFTWARE TO SEARCH AND DISPLAY CHARGES INCURRED FOR ONLINE RESEARCH; SOFTWARE THAT PERFORMS LEGAL CITATION VERIFICATION; SOFTWARE THAT SELECTS AND DISPLAYS CITATIONS OF RELATED CASES AND OTHER LEGAL MATERIALS; SOFTWARE FOR PRODUCING TABLES OF AUTHORITIES IN THE FIELD OF LAW; AND BOOK-KEEPING SOFTWARE; COMPUTER PROGRAMS, NAMELY, DATABASE COMPUTER PROGRAMS RECORDED ON MAGNETIC TAPES AND DISCS, FOR USE IN THE FIELDS OF MULTIMEDIA, BUSINESS, PUBLISHING, SCIENCE, ENGINEERING, EMPLOYMENT, RECRUITING, LAW AND RELIGION; MULTIMEDIA SOFTWARE FOR USE IN CREATING PRESENTATIONS, MANAGING DATABASES AND ACCESSING AND DISPLAYING INFORMATION IN THE FIELDS OF BUSINESS, INDUSTRY, EDUCATION, ACADEMICS, GOVERNMENT, LAW, TAX, AGRICULTURAL AND BIOLOGICAL SCIENCES, ARTS AND HUMANITIES, HEALTH, CHEMISTRY AND CHEMICAL ENGINEERING, COMPUTER SCIENCE, EARTH AND PLANETARY SCIENCES, ECONOMICS, BUSINESS AND MANAGEMENT, ENGINEERING, ENERGY AND TECHNOLOGY, ENVIRONMENTAL SCIENCES, LIFE SCIENCES, MATERIALS SCIENCES, MATHEMATICS, MEDICINE, NEUROSCIENCE, PHARMACOLOGY, PHARMACEUTICAL SCIENCE AND TOXICOLOGY, PHYSICS AND ASTRONOMY, SOCIAL AND BEHAVIORAL SCIENCES, AUTOMOTIVE AND TRUCKING, BOOK PUBLISHING, BUILDING AND CONSTRUCTION, DESIGN, DESIGN ENGINEERING, ELECTRONICS DESIGN AND COMMUNICATIONS, ELECTRONICS MANUFACTURING, IN-STAT RESEARCH, ENTERTAINMENT COMMUNICATIONS AND MEDIA, FOOD AND PACKAGING, FOODSERVICE AND LODGING, GIFTS, JEWELRY AND HOME TEXTILES, MANUFACTURING PROCESSES, MANUFACTURING PRODUCTS, PRINTING AND CONVERTING, PROCESSING, RETAIL HOME FURNISHINGS, SCIENTIFIC AND MEDICAL INFORMATION, SUPPLY CHAIN, TELEVISION AND TELECOM, VARIETY, ACCOUNTANCY AND BUSINESS INFORMATION, ADMINISTRATION, AGRICULTURE, BUILDING AND CONSTRUCTION INFORMATION, HEALTHCARE, HORTICULTURE, HOTEL AND CATERING, LOGISTICS, RETAIL, TECHNICS, TOURISM, ACCOUNTANCY, AIR TRANSPORT, BANKING, CATERING, CHEMICALS, COMPUTING, CONSTRUCTION, ELECTRICAL, ELECTRONICS, INDUSTRIAL AND COMMERCIAL INFORMATION, MOTOR TRADE, OFFICE EQUIPMENT, OPTICAL, PERSONAL CARE, PERSONNEL AND OCCUPATIONAL HEALTH, PROFESSIONAL, PROPERTY, RAILWAYS, RECRUITMENT, ROAD HAULAGE, SCIENCE, SHIPPING, SOCIAL SERVICES, TELEVISION, UTILITIES, AEROSPACE AND DEFENSE, INFORMATION CONCERNING AGRICULTURAL, FORESTRY AND NATURAL RESOURCES,

SN 76-227,894. REED ELSEVIER INC., NEWTON, MA. FILED 3-20-2001.

REED

CLASS 9—ELECTRICAL AND SCIENTIFIC APPARATUS

FOR COMPUTER DISKS, DVDS, VIDEOTAPES AND CD-ROMS FEATURING INFORMATION IN THE FIELDS OF BUSINESS, INDUSTRY, EDUCATION, ACADEMICS, GOVERNMENT, LAW, TAX, AGRICULTURAL AND BIOLOGICAL SCIENCES, ARTS AND HUMANITIES, HEALTH, CHEMISTRY AND CHEMICAL ENGINEERING, COMPUTER SCIENCE, EARTH AND PLANETARY SCIENCES, ECONOMICS, BUSINESS AND MANAGEMENT, ENGINEERING, ENERGY AND TECHNOLOGY, ENVIRONMENTAL SCIENCES, LIFE SCIENCES, MATERIALS SCIENCES, MATHEMATICS, MEDICINE, NEUROSCIENCE, PHARMACOLOGY, PHARMACEUTICAL SCIENCE AND TOXICOLOGY, PHYSICS AND ASTRONOMY, SOCIAL AND BEHAVIORAL SCIENCES, AUTOMOTIVE AND TRUCKING, BOOK PUBLISHING, BUILDING AND CONSTRUCTION, DESIGN, DESIGN ENGINEERING, ELECTRONICS DESIGN AND COMMUNICATIONS, ELECTRONICS MANUFACTURING, IN-STAT RESEARCH, ENTERTAINMENT COMMUNICATIONS AND MEDIA, FOOD AND PACKAGING, FOODSERVICE AND LODGING, GIFTS, JEWELRY AND HOME TEXTILES, MANUFACTURING PROCESSES, MANUFACTURING PRODUCTS, PRINTING AND CONVERTING, PROCESSING, RETAIL HOME FURNISHINGS, SCIENTIFIC AND MEDICAL INFORMATION, SUPPLY CHAIN, TELEVISION AND TELECOM, VARIETY, ACCOUNTANCY AND BUSINESS INFORMATION, ADMINISTRATION, AGRICULTURE, BUILDING AND CONSTRUCTION INFORMATION, HEALTHCARE, HORTICULTURE, HOTEL AND CATERING, LOGISTICS, RETAIL, TECHNICS, TOURISM, ACCOUNTANCY, AIR TRANSPORT, BANKING, CATERING,

ARTS AND ENTERTAINMENT, BOOKS AND PUBLISHING, BUILDINGS, PROPERTY AND INTERIOR DESIGN, ELECTRONICS AND ELECTRICAL ENGINEERING, ENGINEERING, MANUFACTURING AND PROCESSING, FOODSERVICE AND HOSPITALITY, INFORMATION TECHNOLOGY AND COMMUNICATIONS, MARKETING, BUSINESS AND TRAINING, SAFETY AND SECURITY, SPORTS, LEISURE AND HEALTH, TRADE SHOWS, CONFERENCES, COMPUTERIZED INFORMATION STORAGE AND RETRIEVAL SERVICES, ADVERTISING, NEWS, RESEARCH, EMPLOYMENT, RECRUITING AND A WIDE VARIETY OF TOPICS OF GENERAL INTEREST; DOWNLOADABLE ELECTRONIC PUBLICATIONS IN THE NATURE OF JOURNALS, BOOKS, BROCHURES, LEAFLETS, MANUALS, PUBLICITY TEXTS, TEXT BOOKS, REFERENCE MATERIALS, NEWSLETTERS, ATLASES AND MAGAZINES IN THE FIELDS OF BUSINESS, INDUSTRY, EDUCATION, ACADEMICS, GOVERNMENT, LAW, TAX, AGRICULTURAL AND BIOLOGICAL SCIENCES, ARTS AND HUMANITIES, HEALTH, CHEMISTRY AND CHEMICAL ENGINEERING, COMPUTER SCIENCE, EARTH AND PLANETARY SCIENCES, ECONOMICS, BUSINESS AND MANAGEMENT, ENGINEERING, ENERGY AND TECHNOLOGY, ENVIRONMENTAL SCIENCES, LIFE SCIENCES, MATERIALS SCIENCES, MATHEMATICS, MEDICINE, NEUROSCIENCE, PHARMACOLOGY, PHARMACEUTICAL SCIENCE AND TOXICOLOGY, PHYSICS AND ASTRONOMY, SOCIAL AND BEHAVIORAL SCIENCES, AUTOMOTIVE AND TRUCKING, BOOK PUBLISHING, BUILDING AND CONSTRUCTION, DESIGN, DESIGN ENGINEERING, ELECTRONICS DESIGN AND COMMUNICATIONS, ELECTRONICS MANUFACTURING, IN-STAT RESEARCH, ENTERTAINMENT COMMUNICATIONS AND MEDIA, FOOD AND PACKAGING, FOODSERVICE AND LODGING, GIFTS, JEWELRY AND HOME TEXTILES, MANUFACTURING PROCESSES, MANUFACTURING PRODUCTS, PRINTING AND CONVERTING, PROCESSING, RETAIL HOME FURNISHINGS, SCIENTIFIC AND MEDICAL INFORMATION, SUPPLY CHAIN, TELEVISION AND TELECOM, VARIETY, ACCOUNTANCY AND BUSINESS INFORMATION, ADMINISTRATION, AGRICULTURE, BUILDING AND CONSTRUCTION INFORMATION, HEALTHCARE, HORTICULTURE, HOTEL AND CATERING, LOGISTICS, RETAIL, TECHNICS, TOURISM, ACCOUNTANCY, AIR TRANSPORT, BANKING, CATERING, CHEMICALS, COMPUTING, CONSTRUCTION, ELECTRICAL, ELECTRONICS, INDUSTRIAL AND COMMERCIAL INFORMATION, MOTOR TRADE, OFFICE EQUIPMENT, OPTICAL, PERSONAL CARE, PERSONNEL AND OCCUPATIONAL HEALTH, PROFESSIONAL, PROPERTY, RAILWAYS, RECRUITMENT, ROAD HAULAGE, SCIENCE, SHIPPING, SOCIAL SERVICES, TELEVISION, UTILITIES, AEROSPACE AND DEFENSE, INFORMATION CONCERNING AGRICULTURAL, FORESTRY AND NATURAL RESOURCES, ARTS AND ENTERTAINMENT, BOOKS AND PUBLISHING, BUILDINGS, PROPERTY AND INTERIOR DESIGN, ELECTRONICS AND ELECTRICAL ENGINEERING, ENGINEERING, MANUFACTURING AND PROCESSING, FOODSERVICE AND HOSPITALITY, INFORMATION TECHNOLOGY AND COMMUNICATIONS, MARKETING, BUSINESS AND TRAINING, SAFETY AND SECURITY, SPORTS, LEISURE AND HEALTH, TRADE SHOWS, CONFERENCES, COMPUTERIZED INFORMATION STORAGE AND RETRIEVAL SERVICES, ADVERTISING, NEWS, RESEARCH, EMPLOYMENT, RECRUITING AND A WIDE VARIETY OF TOPICS OF GENERAL INTEREST; ELECTRONIC PUBLICATIONS, NAMELY, JOURNALS, BOOKS, BROCHURES, LEAFLETS, MANUALS, PUBLICITY TEXTS, TEXT BOOKS, REFERENCE MATERIALS, NEWSLETTERS, ATLASES AND MAGAZINES FEATURING INFORMATION CONCERNING BUSINESS, INDUSTRY, EDUCATION, ACADEMICS, GOVERNMENT, LAW, TAX, AGRICULTURAL AND BIOLOGICAL SCIENCES, ARTS AND HUMANITIES, HEALTH, CHEMISTRY AND CHEMICAL ENGINEERING, COMPUTER SCIENCE, EARTH AND PLANETARY SCIENCES, ECONOMICS, BUSINESS AND MANAGEMENT, ENGINEERING, ENERGY AND TECHNOLOGY, ENVIRONMENTAL SCIENCES, LIFE SCIENCES, MATERIALS SCIENCES, MATHEMATICS, MEDICINE, NEUROSCIENCE, PHARMACOLOGY, PHARMACEUTICAL SCIENCE AND TOXICOLOGY, PHYSICS AND ASTRONOMY, SOCIAL AND BEHAVIORAL SCIENCES, AUTOMOTIVE AND TRUCKING, BOOK PUBLISHING, BUILDING AND CON-

STRUCTION, DESIGN, DESIGN ENGINEERING, ELECTRONICS DESIGN AND COMMUNICATIONS, ELECTRONICS MANUFACTURING, IN-STAT RESEARCH, ENTERTAINMENT COMMUNICATIONS AND MEDIA, FOOD AND PACKAGING, FOODSERVICE AND LODGING, GIFTS, JEWELRY AND HOME TEXTILES, MANUFACTURING PROCESSES, MANUFACTURING PRODUCTS, PRINTING AND CONVERTING, PROCESSING, RETAIL HOME FURNISHINGS, SCIENTIFIC AND MEDICAL INFORMATION, SUPPLY CHAIN, TELEVISION AND TELECOM, VARIETY, ACCOUNTANCY AND BUSINESS INFORMATION, ADMINISTRATION, AGRICULTURE, BUILDING AND CONSTRUCTION INFORMATION, HEALTHCARE, HORTICULTURE, HOTEL AND CATERING, LOGISTICS, RETAIL, TECHNICS, TOURISM, ACCOUNTANCY, AIR TRANSPORT, BANKING, CATERING, CHEMICALS, COMPUTING, CONSTRUCTION, ELECTRICAL, ELECTRONICS, INDUSTRIAL AND COMMERCIAL INFORMATION, MOTOR TRADE, OFFICE EQUIPMENT, OPTICAL, PERSONAL CARE, PERSONNEL AND OCCUPATIONAL HEALTH, PROFESSIONAL, PROPERTY, RAILWAYS, RECRUITMENT, ROAD HAULAGE, SCIENCE, SHIPPING, SOCIAL SERVICES, TELEVISION, UTILITIES, AEROSPACE AND DEFENSE, INFORMATION CONCERNING AGRICULTURAL, FORESTRY AND NATURAL RESOURCES, ARTS AND ENTERTAINMENT, BOOKS AND PUBLISHING, BUILDINGS, PROPERTY AND INTERIOR DESIGN, ELECTRONICS AND ELECTRICAL ENGINEERING, ENGINEERING, MANUFACTURING AND PROCESSING, FOODSERVICE AND HOSPITALITY, INFORMATION TECHNOLOGY AND COMMUNICATIONS, MARKETING, BUSINESS AND TRAINING, SAFETY AND SECURITY, SPORTS, LEISURE AND HEALTH, TRADE SHOWS, CONFERENCES, COMPUTERIZED INFORMATION STORAGE AND RETRIEVAL SERVICES, ADVERTISING, NEWS, RESEARCH, EMPLOYMENT, RECRUITING AND A WIDE VARIETY OF TOPICS OF GENERAL INTEREST RECORDED ON COMPUTER DISKS, DVDS, VIDEOTAPES AND CD-ROMS (U.S. CLS. 21, 23, 26, 36 AND 38).

CLASS 16—PAPER GOODS AND PRINTED MATTER

FOR PUBLICATIONS, NAMELY, JOURNALS, BOOKS, BROCHURES, LEAFLETS, MANUALS, PUBLICITY TEXTS, TEXT BOOKS, REFERENCE MATERIALS, NEWSLETTERS, ATLASES, MAGAZINES AND PRINTED GUIDES ON A WIDE VARIETY OF TOPICS; DIARIES; PRINTED TIMETABLES, PRINTED INSTRUCTIONAL AND TEACHING MATERIALS DEALING WITH A VARIETY OF SUBJECTS (U.S. CLS. 2, 5, 22, 23, 29, 37, 38 AND 50).

CLASS 35—ADVERTISING AND BUSINESS

FOR ARRANGING AND CONDUCTING TRADE SHOWS IN THE FIELDS OF AEROSPACE AND DEFENSE, ART, AUTOMOBILES AND AUTOMOTIVE ENGINEERING, AGRICULTURE, BOOKS AND PUBLISHING, BUILDING AND CONSTRUCTION, BROADCASTING AND TELEVISION, CHEMICAL AND PROCESS ENGINEERING, CONVERTING, COMPUTERS AND INFORMATION TECHNOLOGY, TELECOMMUNICATIONS, CRAFTS, DESIGN, EDUCATION AND LANGUAGE TRAINING, ELECTRICAL, ELECTRONICS AND ELECTRICAL ENGINEERING, ENGINEERING, ENTERTAINMENT, ENVIRONMENT AND WATER, ENERGY, FASHION, FINANCE, RETAIL FOOD, HOTEL AND RETAIL FOOD SERVICE, FOOD PROCESSING AND MANUFACTURING, FURNITURE, GIFTS AND SOUVENIRS, HARDWARE, HOUSEWARES AND ALLIED PRODUCTS, HEALTHCARE, COMMERCIAL AND DOMESTIC INTERIOR DESIGN, JEWELRY, LABORATORY EQUIPMENT, MACHINERY AND MANUFACTURING, MARKETING, MINING, MUSIC, MATERIALS HANDLING, TRANSPORTATION AND

DISTRIBUTION, OFFICE EQUIPMENT AND SUPPLIES, OPTICAL, OIL AND GAS, PACKAGING, PHARMACEUTICALS AND COSMETICS, PLASTICS, PRINTING, PROPERTY AND REAL ESTATE, SECURITY AND SAFETY, SPORTS AND RECREATION, TEST MEASUREMENT INSPECTION AND QUALITY CONTROL, TEXTILES, WATER ENGINEERING, WOODWORKING AND FORESTRY; ARRANGING AND CONDUCTING BUSINESS CONFERENCES; PUBLICATION OF PUBLICITY TEXTS; PROVISION AND DISTRIBUTION OF ON-LINE PUBLICITY TEXTS OF OTHERS (U.S. CLS. 100, 101 AND 102).

CLASS 41—EDUCATION AND ENTERTAINMENT

FOR ARRANGING AND CONDUCTING EDUCATIONAL CONFERENCES, CONVENTIONS AND EXHIBITIONS; CONDUCTING EDUCATIONAL AND TRAINING CLASSES IN THE USE OF COMPUTERIZED INFORMATION RETRIEVAL SERVICES; PUBLICATION SERVICES, NAMELY, PUBLICATION OF JOURNALS, BOOKS, BROCHURES, LEAFLETS, MANUALS, TEXT BOOKS, REFERENCE MATERIALS, NEWSLETTERS, ATLASES AND MAGAZINES IN HARD COPY, ELECTRONIC FORM AND ON VARIOUS TYPES OF MEDIA; ELECTRONIC PUBLISHING SERVICES, NAMELY, PUBLICATION OF TEXT AND GRAPHIC WORKS OF OTHERS ON CD-ROMS FEATURING INFORMATION IN THE FIELDS OF BUSINESS, INDUSTRY, EDUCATION, ACADEMICS, GOVERNMENT, LAW, TAX, AGRICULTURAL AND BIOLOGICAL SCIENCES, ARTS AND HUMANITIES, HEALTH, CHEMISTRY AND CHEMICAL ENGINEERING, COMPUTER SCIENCE, EARTH AND PLANETARY SCIENCES, ECONOMICS, BUSINESS AND MANAGEMENT, ENGINEERING, ENERGY AND TECHNOLOGY, ENVIRONMENTAL SCIENCES, LIFE SCIENCES, MATERIALS SCIENCES, MATHEMATICS, MEDICINE, NEUROSCIENCE, PHARMACOLOGY, PHARMACEUTICAL SCIENCE AND TOXICOLOGY, PHYSICS AND ASTRONOMY, SOCIAL AND BEHAVIORAL SCIENCES, AUTOMOTIVE AND TRUCKING, BOOK PUBLISHING, BUILDING AND CONSTRUCTION, DESIGN, DESIGN ENGINEERING, ELECTRONICS DESIGN AND COMMUNICATIONS, ELECTRONICS MANUFACTURING, IN-STAT RESEARCH, ENTERTAINMENT COMMUNICATIONS AND MEDIA, FOOD AND PACKAGING, FOODSERVICE AND LODGING, GIFTS, JEWELRY AND HOME TEXTILES, MANUFACTURING PROCESSES, MANUFACTURING PRODUCTS, PRINTING AND CONVERTING, PROCESSING, RETAIL HOME FURNISHINGS, SCIENTIFIC AND MEDICAL, SUPPLY CHAIN, TELEVISION AND TELECOM, VARIETY, ACCOUNTANCY AND BUSINESS, ADMINISTRATION, AGRICULTURE, BUILDING AND CONSTRUCTION, HEALTHCARE, HORTICULTURE, HOTEL AND CATERING, LOGISTICS, RETAIL, TECHNICS, TOURISM, ACCOUNTANCY, AIR TRANSPORT, BANKING, CATERING, CHEMICALS, COMPUTING, CONSTRUCTION, ELECTRICAL, ELECTRONICS, INDUSTRIAL AND COMMERCIAL, MOTOR TRADE, OFFICE EQUIPMENT, OPTICAL, PERSONAL CARE, PERSONNEL AND OCCUPATIONAL HEALTH, PROFESSIONAL, PROPERTY, RAILWAYS, RECRUITMENT, ROAD HAULAGE, SCIENCE, SHIPPING, SOCIAL SERVICES, TELEVISION, UTILITIES, AEROSPACE AND DEFENSE, AGRICULTURAL, FORESTRY AND NATURAL RESOURCES, ARTS AND ENTERTAINMENT, BOOKS AND PUBLISHING, BUILDINGS, PROPERTY AND INTERIOR DESIGN, ELECTRONICS AND ELECTRICAL ENGINEERING, ENGINEERING, MANUFACTURING AND PROCESSING, FOODSERVICE AND HOSPITALITY, INFORMATION TECHNOLOGY AND COMMUNICATIONS, MARKETING, BUSINESS AND TRAINING, SAFETY AND SECURITY, SPORTS, LEISURE AND HEALTH, TRADE SHOWS, CONFERENCES, COMPUTERIZED INFORMATION STORAGE AND RETRIEVAL SERVICES, ADVERTISING, NEWS, RESEARCH, EMPLOYMENT, RECRUITING AND A WIDE VARIETY OF TOPICS OF GENERAL INTEREST (U.S. CLS. 100, 101 AND 107).

CLASS 42—SCIENTIFIC, COMPUTER AND LEGAL SERVICES

FOR COMPUTER SERVICES, NAMELY, PROVIDING ON-LINE JOURNALS, BOOKS, BROCHURES, LEAFLETS, MANUALS, TEXT BOOKS, REFERENCE MATERIALS, NEWSLETTERS, ATLASES AND MAGAZINES IN THE FIELDS OF BUSINESS, INDUSTRY, EDUCATION, ACADEMICS, GOVERNMENT, LAW, TAX, AGRICULTURAL AND BIOLOGICAL SCIENCES, ARTS AND HUMANITIES, HEALTH, CHEMISTRY AND CHEMICAL ENGINEERING, COMPUTER SCIENCE, EARTH AND PLANETARY SCIENCES, ECONOMICS, BUSINESS AND MANAGEMENT, ENGINEERING, ENERGY AND TECHNOLOGY, ENVIRONMENTAL SCIENCES, LIFE SCIENCES, MATERIALS SCIENCES, MATHEMATICS, MEDICINE, NEUROSCIENCE, PHARMACOLOGY, PHARMACEUTICAL SCIENCE AND TOXICOLOGY, PHYSICS AND ASTRONOMY, SOCIAL AND BEHAVIORAL SCIENCES, AUTOMOTIVE AND TRUCKING, BOOK PUBLISHING, BUILDING AND CONSTRUCTION, DESIGN, DESIGN ENGINEERING, ELECTRONICS DESIGN AND COMMUNICATIONS, ELECTRONICS MANUFACTURING, IN-STAT RESEARCH, ENTERTAINMENT COMMUNICATIONS AND MEDIA, FOOD AND PACKAGING, FOODSERVICE AND LODGING, GIFTS, JEWELRY AND HOME TEXTILES, MANUFACTURING PROCESSES, MANUFACTURING PRODUCTS, PRINTING AND CONVERTING, PROCESSING, RETAIL HOME FURNISHINGS, SCIENTIFIC AND MEDICAL, SUPPLY CHAIN, TELEVISION AND TELECOM, VARIETY, ACCOUNTANCY AND BUSINESS, ADMINISTRATION, AGRICULTURE, BUILDING AND CONSTRUCTION, HEALTHCARE, HORTICULTURE, HOTEL AND CATERING, LOGISTICS, RETAIL, TECHNICS, TOURISM, ACCOUNTANCY, AIR TRANSPORT, BANKING, CATERING, CHEMICALS, COMPUTING, CONSTRUCTION, ELECTRICAL, ELECTRONICS, INDUSTRIAL AND COMMERCIAL, MOTOR TRADE, OFFICE EQUIPMENT, OPTICAL, PERSONAL CARE, PERSONNEL AND OCCUPATIONAL HEALTH, PROFESSIONAL, PROPERTY, RAILWAYS, RECRUITMENT, ROAD HAULAGE, SCIENCE, SHIPPING, SOCIAL SERVICES, TELEVISION, UTILITIES, AEROSPACE AND DEFENSE, AGRICULTURAL, FORESTRY AND NATURAL RESOURCES, ARTS AND ENTERTAINMENT, BOOKS AND PUBLISHING, BUILDINGS, PROPERTY AND INTERIOR DESIGN, ELECTRONICS AND ELECTRICAL ENGINEERING, ENGINEERING, MANUFACTURING AND PROCESSING, FOODSERVICE AND HOSPITALITY, INFORMATION TECHNOLOGY AND COMMUNICATIONS, MARKETING, BUSINESS, AND TRAINING, SAFETY AND SECURITY, SPORTS, LEISURE AND HEALTH, TRADE SHOWS, CONFERENCES, COMPUTERIZED INFORMATION STORAGE AND RETRIEVAL SERVICES, ADVERTISING, NEWS, RESEARCH, EMPLOYMENT, RECRUITING AND A WIDE VARIETY OF TOPICS OF GENERAL INTEREST (U.S. CLS. 100 AND 101).

SN 76-228,386, EDIT TECHNOLOGIES LIMITED, LIVERPOOL L2 4XE, UNITED KINGDOM, FILED 3-21-2001.



PRIORITY CLAIMED UNDER SEC. 44(D) ON UNITED KINGDOM APPLICATION NO. 2246963, FILED 9-28-2000, REG. NO. 2246963, DATED 5-25-2001, EXPIRES 9-28-2010.

CLASS 9—ELECTRICAL AND SCIENTIFIC APPARATUS

FOR CINEMATOGRAPHIC FILMS ON A VARIETY OF ENTERTAINMENT THEMES; VIDEO RECORDINGS ON A VARIETY OF ENTERTAINMENT THEMES; AND PRE-RECORDED AUDIO RECORDINGS ON VARIOUS MEDIA, NAMELY, AUDIO TAPES, VIDEO TAPES, COMPACT DISKS, DVDS, COMPUTER DISKS, CD-ROMS FEATURING A VARIETY OF ENTERTAINMENT THEMES; APPARATUS, NAMELY, MULTIMEDIA TERMINALS FOR USE IN CONNECTION WITH PERSONALIZED, INTERACTIVE TELEVISION PROGRAMMING AND SET-TOP BOXES FOR USE IN CONNECTION WITH PERSONALIZED, INTERACTIVE TELEVISION PROGRAMMING AND COMPUTER HARDWARE FOR USE IN CONNECTION WITH PERSONALIZED, INTERACTIVE TELEVISION PROGRAMMING; COMPUTER PROGRAMS FOR PRODUCING, RECORDING, TRANSFERRING, PROCESSING AND EDITING SOUND AND IMAGES ALL RELATING TO PRE-RECORDED TELEVISION PROGRAMMES AND LIVE TELEVISION PROGRAMMES, AND INSTRUCTIONAL MANUALS PROVIDED THEREWITH; BLANK RECORDABLE DATA STORAGE MEDIA, NAMELY, AUDIO CASSETTES AND VIDEO CASSETTES, DISKS IN THE NATURE OF FLOPPY DISCS, AUDIO DISKS, CD ROMS AND DVDS; BLANK MAGNETIC AND OPTICAL DATA CARRIERS; PRE-RECORDED AUDIO CASSETTES, VIDEO CASSETTES, FLOPPY DISCS, AUDIO DISCS, CD ROMS AND DVDS FEATURING A VARIETY OF ENTERTAINMENT THEMES AND TELEVISION PROGRAMS AND RADIO PROGRAMS (U.S. CLS. 21, 23, 26, 36 AND 38).

CLASS 16—PAPER GOODS AND PRINTED MATTER

FOR BOOKS ON A VARIETY OF ENTERTAINMENT THEMES AND PRINTED MATTER, NAMELY, POSTERS, NEWSLETTERS, MAGAZINES DEALING WITH THE SUBJECT MATTER ON A VARIETY OF ENTERTAINMENT THEMES; PRINTED, INSTRUCTIONAL AND TEACHING MATERIALS, NAMELY, DEALING WITH THE SUBJECT MATTER OF COMPUTERS AND COMPUTER PROGRAMS, PRODUCING AND RECORDING AND TRANSFERRING AND PROCESSING AND EDITING SOUND AND IMAGES ALL RELATING TO PRE-RECORDED TELEVISION PROGRAMMES AND LIVE TELEVISION PROGRAMMES (U.S. CLS. 2, 5, 22, 23, 29, 37, 38 AND 50).

CLASS 38—COMMUNICATION

FOR BROADCASTING SERVICES, NAMELY, TELEVISION BROADCASTING AND BROADCASTING PROGRAMS VIA THE INTERNET; TELECOMMUNICATION SERVICES, NAMELY, ELECTRONIC TRANSMISSION OF DIGITAL INFORMATION, MESSAGES AND IMAGES VIA COMPUTER TERMINALS ALL RELATING TO PRE-RECORDED TELEVISION PROGRAMMES AND LIVE TELEVISION PROGRAMMES (U.S. CLS. 100, 101 AND 104).

CLASS 40—MATERIAL TREATMENT

FOR PROCESSING OF SOUND AND IMAGES, NAMELY, FOR USE IN MOTION PICTURE FILMS AND TELEVISION PROGRAMS AND RADIO PROGRAMS ON A VARIETY OF ENTERTAINMENT THEMES; PROCESSING OF CINEMATOGRAPHIC FILMS, NAMELY, ON A VARIETY OF ENTERTAINMENT THEMES; PROCESSING OF VIDEO AND AUDIO RECORDINGS RELATING TO PRE-RECORDED TELEVISION PROGRAMMES AND LIVE TELEVISION PROGRAMMES, NAMELY, ON A VARIETY OF ENTERTAINMENT THEMES; PROCESSING OF DIGITAL INFORMATION, NAMELY, DIGITAL IMAGES AND DIGITAL SOUNDS RELATING TO PRE-RECORDED TELEVISION PROGRAMMES AND LIVE TELEVISION PROGRAMMES, NAMELY, ON A VARIETY OF ENTERTAINMENT THEMES; PROCESSING OF RECORDED RADIO AND TELEVISION PROGRAMS, NAMELY, ON A VARIETY OF ENTERTAINMENT THEMES; TRANSFER OF SOUND AND IMAGES RELATING TO PRE-RECORDED TELEVISION PROGRAMMES AND LIVE TELEVISION PROGRAMMES TO VIDEO OR AUDIO TAPE OR TO OTHER MEDIA (U.S. CLS. 100, 103 AND 106).

CLASS 41—EDUCATION AND ENTERTAINMENT

FOR PRODUCTION OF MOTION PICTURE FILMS, VIDEO AND AUDIO RECORDINGS AND RECORDED RADIO AND TELEVISION PROGRAMS; RECORDING STUDIOS FOR PRODUCING, RECORDING, TRANSFERRING, PROCESSING AND EDITING SOUND AND IMAGES ALL RELATING TO PRE-RECORDED TELEVISION PROGRAMMES AND LIVE TELEVISION PROGRAMMES; VIDEO EDITING, NAMELY, EDITING SOUND AND IMAGES FOR PRE-RECORDED TELEVISION PROGRAMMES AND LIVE TELEVISION PROGRAMMES; CINEMATOGRAPHIC FILM EDITING; EDITING AUDIO RECORDINGS FOR PRE-RECORDED TELEVISION PROGRAMMES AND LIVE TELEVISION PROGRAMMES; EDITING DIGITAL INFORMATION, NAMELY, DIGITAL IMAGES AND DIGITAL SOUNDS FOR PRE-RECORDED TELEVISION PROGRAMMES AND LIVE TELEVISION PROGRAMMES, NAMELY, IN THE NATURE OF SUBJECT MATTER ON A VARIETY OF ENTERTAINMENT THEMES; EDITING RECORDED RADIO AND TELEVISION PROGRAMS (U.S. CLS. 100, 101 AND 107).

SN 76-229,953. GEORG LINGENBRINK GMBH & CO., 22761 HUMBURG, FED REP GERMANY, FILED 3-26-2001.

BOD**CLASS 9—ELECTRICAL AND SCIENTIFIC APPARATUS**

FOR HOUSE MARK FOR ELECTRONIC PUBLICATIONS, NAMELY PRINTER'S COPIES OF BOOKS, PERIODICALS, JOURNALS, NEWSPAPERS IN DIGITIZED FORM, RECORDED ON CD-ROMS, FLOPPY DISKS, MAGNETIC TAPE, HARD DRIVES, DVD'S, HIGH DENSITY FLOPPY BOOK DRIVES, MEMORY STICKS (U.S. CLS. 21, 23, 26, 36 AND 38).

CLASS 16—PAPER GOODS AND PRINTED MATTER

FOR HOUSE MARK FOR PRINTED PRODUCTS, NAMELY BOOKS, PERIODICALS, JOURNALS, NEWSPAPERS, PRINTER'S COPIES FOR BOOKS, PERIODICALS, JOURNALS, NEWSPAPERS IN WRITING (U.S. CLS. 2, 5, 22, 23, 29, 37, 38 AND 50).

CLASS 41—EDUCATION AND ENTERTAINMENT

FOR PUBLICATION OF BOOKS, PERIODICALS, JOURNALS AND NEWSPAPERS; ELECTRONIC PUBLISHING SERVICES, NAMELY, PUBLICATION OF TEXT AND GRAPHICS WORKS OF OTHERS ON CD-ROMS, FLOPPY DISKS, AND MAGNETIC TAPE HARD DRIVES, DVD'S, HIGH DENSITY FLOPPY BOOK DRIVES, MEMORY STICKS (U.S. CLS. 100, 101 AND 107).

CLASS 42—SCIENTIFIC, COMPUTER AND LEGAL SERVICES

FOR LEASING ACCESS TIME TO A COMPUTER DATA BASE COMPRISED OF TEXTS, GRAPHICS, AUDIOVISUAL AND MULTIMEDIA INFORMATION, DOCUMENTS, DATA BANKS AND COMPUTER PROGRAMS IN A VARIETY OF TOPICS (U.S. CLS. 100 AND 101).

SN 76-236,353. INTEGRINAUTICS CORPORATION, MENLO PARK, CA. FILED 4-6-2001.

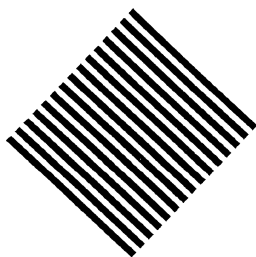

THE STIPPLING IS A FEATURE OF THE MARK.
THE MARK CONSISTS OF A SQUARE DIAMOND SHAPE COMPOSED OF DIAGONAL LINES SLANTING DOWNWARD FROM LEFT TO RIGHT, WHICH LINES FADE FROM SOLID TO NOTHING AS THEY REACH THE LOWER RIGHT POSITION.

CLASS 7—MACHINERY

FOR AUTOMATED AGRICULTURAL MACHINERY, NAMELY, HARVESTERS AND TRACTOR-TOWED FERTILIZER APPLICATORS PARTLY OR FULLY OPERATED BY SATELLITE SIGNALS FOR THE PRECISE NAVIGATION THEREOF (U.S. CLS. 13, 19, 21, 23, 31, 34 AND 35).

CLASS 9—ELECTRICAL AND SCIENTIFIC APPARATUS

FOR SATELLITE NAVIGATIONAL SYSTEMS AND COMPONENTS THEREFOR, NAMELY, GLOBAL POSITIONING SYSTEMS AND SATELLITE-CARRIER-SIGNAL RECEIVERS, TRANSMITTERS, ANTENNAE, CONTROL UNITS AND PROCESSORS, FOR THE PRECISE NAVIGATION AND AUTOMATED CONTROL OF FARMING VEHICLES; COMPUTER SOFTWARE FOR USE IN GENERATING AND PROCESSING SATELLITE CARRIER SIGNALS FOR THE PRECISE NAVIGATION AND AUTOMATED CONTROL OF FARMING VEHICLES (U.S. CLS. 21, 23, 26, 36 AND 38).

CLASS 12—VEHICLES

FOR AUTOMATED FARM VEHICLES, NAMELY, TRACTORS AND UTILITY VEHICLES FOR SURVEYING, PARTLY OR FULLY OPERATED BY SATELLITE SIGNALS FOR THE PRECISE NAVIGATION THEREOF (U.S. CLS. 19, 21, 23, 31, 35 AND 44).

SN 76-238,195. CALFRAC WELL SERVICES LTD., CALGARY, ALBERTA, CANADA, FILED 4-9-2001.



PRIORITY CLAIMED UNDER SEC. 44(D) ON CANADA APPLICATION NO. 1,081,239, FILED 11-3-2000, REG. NO. TMA579275, DATED 4-9-2003, EXPIRES 4-9-2018.

THE STIPPLING IS FOR SHADING PURPOSES ONLY AND IS NOT A FEATURE OF THE MARK.

CLASS 1—CHEMICALS

FOR ACIDIZING FLUIDS, NAMELY, HYDROCHLORIC ACID, HYDROFLUORIC ACID AND ANY OF THESE ACIDS BLENDED WITH ONE OR MORE OF INHIBITORS, DEMULSIFIERS AND SURFACTANTS FOR USE IN OIL AND GAS WELL STIMULATION; FRACTURING FLUIDS, NAMELY, GELLANTS, WATER, OIL, ALCOHOL, NITROGEN AND CARBON DIOXIDE, AND ANY OF THESE FLUIDS BLENDED WITH ONE OR MORE INHIBITORS, DEMULSIFIERS, SURFACTANTS AND PROPPANTS FOR HIGH PRESSURE FRACTURE TREATMENTS IN OIL AND GAS WELLS (U.S. CLS. 1, 5, 6, 10, 26 AND 46).

CLASS 37—CONSTRUCTION AND REPAIR

FOR OIL AND GAS WELL COILED TUBING INSTALLATION (U.S. CLS. 100, 103 AND 106).

CLASS 40—MATERIAL TREATMENT

FOR OIL AND GAS WELL FRACTURING AND STIMULATION SERVICES USING GELLANTS, ACIDS, NITROGEN, CARBON DIOXIDE AND PROPPANTS (U.S. CLS. 100, 103 AND 106).

CLASS 42—SCIENTIFIC, COMPUTER AND LEGAL SERVICES

FOR CHEMIST SERVICES IN THE FIELD OF OIL AND GAS WELL FRACTURING AND ACIDIZING; AND ENGINEERING SERVICES IN THE FIELD OF OIL AND GAS WELL FRACTURING, ACIDIZING AND COILED TUBING SERVICES (U.S. CLS. 100 AND 101).

SN 76-241,226. MOMO'S KITCHEN LTD., RICHMOND, BRITISH COLUMBIA V6J 2C9, CANADA, FILED 4-16-2001.

MO

PRIORITY CLAIMED UNDER SEC. 44(D) ON CANADA APPLICATION NO. 1,088,840, FILED 1-12-2001, REG. NO. TMA570649, DATED 11-12-2002, EXPIRES 11-12-2017.

CLASS 29—MEATS AND PROCESSED FOODS

FOR NON-ALCOHOLIC VEGETABLE-BASED FOOD BEVERAGES; SOYBEAN MILK, NAMELY, VEGETABLE-BASED MILK SUBSTITUTE MADE FROM SOYA BEANS; TOFU, CANNED OR DRIED SOYBEAN CURD, SOYBEAN-BASED YOGURT; SOYBEAN-BASED FOOD PRODUCTS, NAMELY, VEGETABLE PATTIES, VEGETABLE WIENERS, VEGETABLE SAUSAGES, SOYBEAN-BASED MEAT AND FISH SUBSTITUTES, NAMELY, SIMULATED SOYBEAN-BASED CHICKEN, SOYBEAN-BASED BEEF, SOYBEAN-BASED PORK, FISH AND SIMULATED ANIMAL INNARDS, NAMELY, HEARTS, KIDNEY, LIVER, TRIPE AND PATE (U.S. CL. 46).

CLASS 30—STAPLE FOODS

FOR SOYBEAN-BASED PUDDING, CUSTARD, ICE CREAM AND FROZEN YOGURT, NON-DAIRY NOODLES AND PASTA, SOYBEAN-BASED VEGETABLE DUMPLINGS (U.S. CL. 46).

CLASS 32—LIGHT BEVERAGES

FOR SOYBEAN-BASED NON-CARBONATED NON-ALCOHOLIC DRINKS, NAMELY, FRUIT AND VEGETABLE JUICE BEVERAGES, CONCENTRATES FOR MAKING NON-CARBONATED AND NON-ALCOHOLIC BEVERAGES, NAMELY, FRUIT AND VEGETABLE JUICE BEVERAGES, EXTRACTS OF FRUITS AND SOYBEANS FOR MAKING NON-ALCOHOLIC, NON-CARBONATED DRINKS, NAMELY FRUIT AND VEGETABLE JUICE BEVERAGES (U.S. CLS. 45, 46 AND 48).

SN 76-246,209. UNI-CHARM CORPORATION, KAWANOE-SHI, EHIME-KEN, JAPAN, FILED 4-25-2001.



PRIORITY CLAIMED UNDER SEC. 44(D) ON JAPAN APPLICATION NO. 2000-119921, FILED 11-6-2000, REG. NO. 4585647, DATED 7-12-2002, EXPIRES 7-2-2012.

OWNER OF U.S. REG. NOS. 1,865,527 AND 1,867,962.
THE STIPLING IN THE DRAWING IS FOR SHADING PURPOSES ONLY AND IS NOT INTENDED TO INDICATE COLOR.

CLASS 5—PHARMACEUTICALS

FOR MENSTRUATION NAPKINS AND PADS; SANITARY LINERS; SANITARY PANTS AND KNICKERS; MENSTRUATION TAMPONS; DIAPERS FOR INCONTINENCE; ABSORBENT PADS FOR INCONTINENCE; ABSORBENT PANTS FOR INCONTINENCE; SANITARY MASKS; ABSORBENT COTTON; PHARMACEUTICAL PREPARATIONS, NAMELY, ANTIHEMORRHOIDS, EMMENAGOGUES, URINARY DISINFECTANTS, DERMATICS FOR PURULENCE, ANTI-DERMOINFECTIVES, DISINFECTANTS, CATAPLASMS, ANALGESICS, ANTI-PRURITIC AGENTS, MEDICAL SOAPS, MEDICATED BABY OILS, MEDICATED BABY POWDERS, MEDICATED BATH PREPARATIONS, VITAMIN PREPARATIONS, CHONDROITIN PREPARATIONS, DEODORANTS NOT FOR PERSONAL USE, AND POWDERED MILK FOR USE AS FORMULA FOR BABIES (U.S. CLS. 6, 18, 44, 46, 51 AND 52).

CLASS 16—PAPER GOODS AND PRINTED MATTER

FOR DISPOSABLE DIAPERS FOR BABIES; TISSUE PAPER; WET TISSUE MADE OF NONWOVEN FABRIC, WET TISSUE MADE OF PAPER; PAPER TOWELS AND PAPER HANDKERCHIEFS (U.S. CLS. 2, 5, 22, 23, 29, 37, 38 AND 50).

SN 76-243,805. NETHUB, 92200 NEUILLY SUR SEINE, FRANCE, BY ASSIGNMENT DELTA INTER MANAGEMENT, 92200 NEUILLY SUR SEINE, FRANCE, FILED 4-23-2001.

NETHUB

PRIORITY CLAIMED UNDER SEC. 44(D) ON FRANCE APPLICATION NO. 3064832, FILED 11-14-2000, REG. NO. 3064832, DATED 11-14-2000, EXPIRES 11-14-2010.

CLASS 12—VEHICLES

FOR VEHICLES, NAMELY, BICYCLES AND STRUCTURAL PARTS THEREFOR (U.S. CLS. 19, 21, 23, 31, 35 AND 44).

CLASS 35—ADVERTISING AND BUSINESS

FOR ADVERTISING AGENCY SERVICES FOR OTHERS, BUSINESS CONSULTATION, NAMELY, MANAGEMENT AND ORGANIZATIONAL CONSULTATION SERVICES FOR COMMERCIAL AND INDUSTRIAL COMPANIES; BUSINESS APPRAISAL SERVICES; BUSINESS MARKETING SERVICES, NAMELY, CONDUCTING MARKETING SURVEYS, RESEARCH AND ANALYSIS; BUSINESS MANAGEMENT CONSULTATION FOR PROFESSIONALS (U.S. CLS. 100, 101 AND 102).

CLASS 42—SCIENTIFIC, COMPUTER AND LEGAL SERVICES

FOR COMPUTER SOFTWARE DESIGN FOR OTHERS IN THE FIELD OF CYCLING (U.S. CLS. 100 AND 101).

SN 76-247,925. NORD-SUD VERLAG AG, 8625 GOSSAU, SWITZERLAND, FILED 4-26-2001.

NIGHT SKY BOOKS

NO CLAIM IS MADE TO THE EXCLUSIVE RIGHT TO USE "BOOKS", APART FROM THE MARK AS SHOWN.

CLASS 9—ELECTRICAL AND SCIENTIFIC APPARATUS

FOR CHILDREN'S MULTIMEDIA EDUCATION AND ENTERTAINMENT SOFTWARE FOUND IN PRE-RECORDED MAGNETIC, MAGNETO-OPTICAL AND OPTICAL CARRIERS FOR SOUND, IMAGE AND DATA; CHILDREN'S VIDEO GAMES FOUND IN DATA CARRIERS; CHILDREN'S RECORDS, CDS, SOUND RECORDING AND DIGITAL AUDIO TAPES, SOUND CASSETTES (COMPACT CASSETTES), VIDEO DISKS (IMAGE DISKS), VIDEO CASSETTES AND TAPES FOR EDUCATION AND ENTERTAINMENT PURPOSES (U.S. CLS. 21, 23, 26, 36 AND 38).

CLASS 16—PAPER GOODS AND PRINTED MATTER

FOR CHILDREN'S PRINTED MATTER, NAMELY, NEWSPAPERS, JOURNALS, MAGAZINES, BROCHURES, LEAFLETS, BOOKS, PLACARDS, AND POSTERS REGARDING CHILDREN'S EDUCATION AND ENTERTAINMENT (U.S. CLS. 2, 5, 22, 23, 29, 37, 38 AND 50).

CLASS 41—EDUCATION AND ENTERTAINMENT

FOR PUBLICATION OF PRINTED MATTER, NAMELY, BOOKS (U.S. CLS. 100, 101 AND 107).

CLASS 35—ADVERTISING AND BUSINESS

FOR ARRANGING AND CONDUCTING TRADE SHOWS AND EXHIBITIONS IN THE FIELD OF INTERIOR DESIGN, FURNISHINGS AND ARCHITECTURE (U.S. CLS. 100, 101 AND 102).
FIRST USE 6-0-2001; IN COMMERCE 6-0-2001.

CLASS 41—EDUCATION AND ENTERTAINMENT

FOR EDUCATIONAL SERVICES, NAMELY, ARRANGING AND CONDUCTING CONFERENCES IN THE FIELD OF INTERIOR DESIGN, FURNISHINGS AND ARCHITECTURE (U.S. CLS. 100, 101 AND 107).
FIRST USE 6-0-2001; IN COMMERCE 6-0-2001.

SN 76-248,336. MERCHANDISE MART PROPERTIES, INC., CHICAGO, IL. FILED 4-30-2001.

ONE OF A KIND SHOW AND SALE

NO CLAIM IS MADE TO THE EXCLUSIVE RIGHT TO USE "SHOW AND SALE", APART FROM THE MARK AS SHOWN.

CLASS 35—ADVERTISING AND BUSINESS

FOR ARRANGING AND CONDUCTING TRADE SHOWS AND EXHIBITIONS IN THE FIELD OF INTERIOR DESIGN, FURNISHINGS AND ARCHITECTURE (U.S. CLS. 100, 101 AND 102).
FIRST USE 3-0-2001; IN COMMERCE 3-0-2001.

CLASS 41—EDUCATION AND ENTERTAINMENT

FOR EDUCATIONAL SERVICES, NAMELY, ARRANGING AND CONDUCTING CONFERENCES IN THE FIELD OF INTERIOR DESIGN, FURNISHINGS AND ARCHITECTURE (U.S. CLS. 100, 101 AND 107).
FIRST USE 3-0-2001; IN COMMERCE 3-0-2001.

SN 76-250,040. MAGNA PAPER LLC, MENDON, MA. FILED 5-2-2001.

MAGNA

CLASS 2—PAINTS

FOR MAGNETIC INTERIOR PAINT (U.S. CLS. 6, 11 AND 16).

CLASS 16—PAPER GOODS AND PRINTED MATTER

FOR FLEXIBLE MAGNETIC CHALKBOARD FOR HOME AND SCHOOL USE; MAGNETIC BOARD FOR DISPLAYING CRAFTS; MAGNETIC PAPER (U.S. CLS. 2, 5, 22, 23, 29, 37, 38 AND 50).

CLASS 28—TOYS AND SPORTING GOODS

FOR EQUIPMENT SOLD AS A UNIT FOR PLAYING BOARD GAMES, NAMELY, MAGNETIC GAME BOARDS AND SURFACES; FLEXIBLE MAGNETIC TOY CHALKBOARDS (U.S. CLS. 22, 23, 38 AND 50).

SN 76-248,337. MERCHANDISE MART PROPERTIES, INC., CHICAGO, IL. FILED 4-30-2001.



**one
of a kind
show and sale**

NO CLAIM IS MADE TO THE EXCLUSIVE RIGHT TO USE "SHOW AND SALE", APART FROM THE MARK AS SHOWN.

SN 76-258,381. FORESIGHT HOLDINGS, INC., LAKE OSWEGO, OR. FILED 5-16-2001.

NERVANA

CLASS 16—PAPER GOODS AND PRINTED MATTER

FOR PRINTED MATERIALS AND PUBLICATIONS, NAMELY, BOOKS, MAGAZINES, ARTICLES, NEWSLETTERS, BROCHURES, MANUALS, REPORTS, SUMMARIES, DATA SHEETS, WHITE PAPERS, AND CATALOGS IN THE FIELDS OF COMPUTER AND INFORMATION TECHNOLOGY (U.S. CLS. 2, 5, 22, 23, 29, 37, 38 AND 50).

CLASS 37—CONSTRUCTION AND REPAIR

FOR INSTALLATION, MAINTENANCE, AND REPAIR OF COMPUTER HARDWARE, COMPUTER PERIPHERALS, COMPUTER SYSTEMS, AND COMPUTER NETWORKS (U.S. CLS. 100, 103 AND 106).

CLASS 38—COMMUNICATION

FOR ELECTRONIC MAIL SERVICES, NAMELY, MESSAGE FILTERING, PROCESSING, AND DELIVERY OF ELECTRONIC MAIL; TELECOMMUNICATIONS SERVICES, NAMELY AUTOMATED TELECOMMUNICATIONS SERVICE, NAMELY ROUTING AND FORWARDING VOICE AND DATA COMMUNICATIONS VIA ELECTRONIC, ELECTRIC, TELEPHONE AND DIGITAL TRANSMISSION; ELECTRONIC, ELECTRIC, WIRELESS, AND DIGITAL TRANSMISSION OF DATA, SOUND, AND VIDEO COMMUNICATIONS; ELECTRONIC MAIL SERVICES; PROVIDING MULTIPLE-USER ACCESS TO A GLOBAL COMPUTER INFORMATION NETWORK; ELECTRONIC TRANSMISSION OF MESSAGES AND DATA; ELECTRONIC TRANSMISSION OF DATA AND DOCUMENTS VIA COMPUTER TERMINALS (U.S. CLS. 100, 101 AND 104).

CLASS 39—TRANSPORTATION AND STORAGE

FOR STORAGE SERVICES IN CONNECTION WITH ELECTRONIC MEDIA, NAMELY, IMAGES, TEXT, AND AUDIO DATA; ELECTRONIC STORAGE OF VOICE AND DATA COMMUNICATIONS (U.S. CLS. 100 AND 105).

CLASS 41—EDUCATION AND ENTERTAINMENT

FOR EDUCATIONAL AND TRAINING SERVICES, NAMELY, CLASSES, SEMINARS, CONFERENCES AND WORKSHOPS IN THE OPERATION AND USE OF COMPUTER HARDWARE AND SOFTWARE SYSTEMS; EDUCATIONAL SERVICES, NAMELY, CONDUCTING WORKSHOPS AND SEMINARS RELATED TO COMPUTER SOFTWARE DESIGN AND DEVELOPMENT (U.S. CLS. 100, 101 AND 107).

CLASS 42—SCIENTIFIC, COMPUTER AND LEGAL SERVICES

FOR COMPUTER SYSTEM AND SOFTWARE CONSULTATION; COMPUTER SERVICES, NAMELY, DESIGNING, DEVELOPING AND UPDATING COMPUTER SYSTEMS AND SOFTWARE FOR OTHERS; COMPUTER SERVICES, NAMELY, DESIGNING AND IMPLEMENTING WEB SITES FOR OTHERS; HOSTING THE WEB SITES OF OTHERS ON A COMPUTER SERVER FOR A GLOBAL COMPUTER NETWORK; COMPUTER SERVICES, NAMELY, PROVIDING SEARCH AND ANALYSIS ENGINES FOR OBTAINING AND ANALYZING DATA AND INFORMATION ON A GLOBAL COMPUTER NETWORK; TECHNICAL SUPPORT SERVICES FOR OTHERS, NAMELY, TROUBLESHOOTING OF COMPUTER HARDWARE AND SOFTWARE PROBLEMS OF COMPUTER NETWORK USERS VIA TELEPHONE, EMAIL, AND REMOTE OR LOCALIZED COMPUTER NETWORK; INSTALLATION, MAINTENANCE, AND REPAIR OF COMPUTER SOFTWARE (U.S. CLS. 100 AND 101).

SN 76-258,855. DISCOVERY COMMUNICATIONS, INC., BETHESDA, MD. FILED 5-18-2001.

THE SCIENCE CHANNEL

OWNER OF U.S. REG. NOS. 2,181,302 AND 2,207,515.
NO CLAIM IS MADE TO THE EXCLUSIVE RIGHT TO USE "CHANNEL", APART FROM THE MARK AS SHOWN. SEC. 2(F).

CLASS 38—COMMUNICATION

FOR TELEVISION BROADCASTING SERVICES (U.S. CLS. 100, 101 AND 104).
FIRST USE 6-12-2001; IN COMMERCE 6-12-2001.

CLASS 41—EDUCATION AND ENTERTAINMENT

FOR ENTERTAINMENT AND EDUCATIONAL SERVICES, NAMELY THE PRODUCTION OF VIDEO TAPES, CD ROMS, DVDS, AUDIO TAPES, AND TELEVISION PROGRAMMING (U.S. CLS. 100, 101 AND 107).
FIRST USE 6-12-2001; IN COMMERCE 6-12-2001.

SN 76-267,690. DYNAMITE FALLS ADVENTURE GOLF, INC., FAIRFIELD, NJ. FILED 6-7-2001.

DYNAMITE FALLS**CLASS 25—CLOTHING**

FOR CLOTHING, NAMELY, CHILDREN'S WEAR, NAMELY, T-SHIRTS, SWEATSHIRTS, SWEATPANTS, AND JUMPSUITS, CAPS, HATS, SHORTS, NAMELY, GYM SHORTS, AND SWEAT SHORTS, WIND-RESISTANT JACKETS AND OUTWEAR JACKETS, FOOTWEAR, GYM SUITS, JOGGING SUITS AND SWEAT SUITS, PULLOVERS AND SWEATERS (U.S. CLS. 22 AND 39).

CLASS 41—EDUCATION AND ENTERTAINMENT

FOR ENTERTAINMENT SERVICES IN THE NATURE OF A MINIATURE GOLF COURSE; AN AMUSEMENT CENTER FEATURING MINIATURE GOLF AND AN AMUSEMENT ARCADE; PARTY PLANNING; AND PROVIDING A MINIATURE GOLF FACILITY HAVING AN ADVENTURE THEME THEREIN (U.S. CLS. 100, 101 AND 107).

SN 76-268,279. SUBURBAN PROPANE, L.P., WHIPPANY, NJ. FILED 6-7-2001.

SUBURBAN CYLINDER EXPRESS

NO CLAIM IS MADE TO THE EXCLUSIVE RIGHT TO USE "CYLINDER EXPRESS", APART FROM THE MARK AS SHOWN.

CLASS 35—ADVERTISING AND BUSINESS

FOR FRANCHISING, NAMELY, OFFERING TECHNICAL ASSISTANCE IN THE ESTABLISHMENT AND/OR OPERATION OF DISTRIBUTORSHIPS FEATURING THE SALE AND DISTRIBUTION OF PROPANE GAS AND PROPANE RELATED EQUIPMENT (U.S. CLS. 100, 101 AND 102).
FIRST USE 11-0-2001; IN COMMERCE 11-0-2001.

CLASS 37—CONSTRUCTION AND REPAIR

FOR INSTALLATION OF PROPANE GAS CYLINDERS (U.S. CLS. 100, 103 AND 106).
FIRST USE 4-0-2001; IN COMMERCE 4-0-2001.

CLASS 39—TRANSPORTATION AND STORAGE

FOR PROVIDING SERVICES, NAMELY, THE PICK-UP, DELIVERY, EXCHANGE OF PROPANE GAS CYLINDERS (U.S. CLS. 100 AND 105).
FIRST USE 4-0-2001; IN COMMERCE 4-0-2001.

SN 76-269,164. PIERRE FABRE S.A., PARIS, FRANCE, BY CHANGE OF NAME BIOMERIEUX PIERRE FABRE, MARCY L'ETOILE, FRANCE, FILED 6-8-2001.

GALEXEL

OWNER OF FRANCE REG. NO. 94511160, DATED 3-9-1994, EXPIRES 3-9-2004.
OWNER OF U.S. REG. NO. 1,931,062.

CLASS 3—COSMETICS AND CLEANING PREPARATIONS

FOR TOILET, SKIN AND DEODORANT SOAPS; PERFUME AND COLOGNE; ESSENTIAL OILS FOR PERSONAL USE; COSMETICS, NAMELY SKIN CREAMS, OILS, GELS, MILKS, LOTIONS AND EMULSIONS, MAKEUP; HAIR CARE PREPARATIONS, NAMELY, CREAMS, GELS, AND LOTIONS; DENTIFRICES (U.S. CLS. 1, 4, 6, 50, 51 AND 52).

CLASS 5—PHARMACEUTICALS

FOR DERMATOLOGICALS FOR THE HYGIENE AND CARE OF THE SKIN AND HAIR; DIETARY SUPPLEMENTS; BABY FOODS (U.S. CLS. 6, 18, 44, 46, 51 AND 52).

SN 76-270,375. RAGINGWIRE TELECOMMUNICATIONS, INC., SACRAMENTO, CA. FILED 6-12-2001.



NO CLAIM IS MADE TO THE EXCLUSIVE RIGHT TO USE "TELECOMMUNICATIONS", APART FROM THE MARK AS SHOWN.

CLASS 37—CONSTRUCTION AND REPAIR

FOR INSTALLATION OF COMPUTER NETWORKS; COMPUTER INSTALLATION AND REPAIR; INSTALLATION OF COMPUTER SYSTEMS; INSTALLATION OF SECURITY SYSTEMS TO LIMIT USERS ACCESS TO COMPUTER NETWORKS AND WEBSITES (U.S. CLS. 100, 103 AND 106).

FIRST USE 3-0-2001; IN COMMERCE 3-0-2001.

CLASS 38—COMMUNICATION

FOR TELECOMMUNICATION SERVICES, NAMELY, PROVIDING HIGH SPEED ACCESS TO COMPUTER NETWORKS FOR THE ELECTRONIC TRANSMISSION AND RECEPTION OF INFORMATION; PROVIDING MULTIPLE-USER ACCESS TO A GLOBAL COMPUTER INFORMATION NETWORK (U.S. CLS. 100, 101 AND 104).

FIRST USE 3-0-2001; IN COMMERCE 3-0-2001.

CLASS 42—SCIENTIFIC, COMPUTER AND LEGAL SERVICES

FOR COMPUTER PROJECT MANAGEMENT SERVICES; COMPUTER SERVICES, NAMELY, MANAGING WEBSITES FOR OTHERS; INSTALLATION OF COMPUTER SOFTWARE; MONITORING THE COMPUTER SYSTEMS OF OTHERS AND PROVIDING BACK-UP COMPUTER SYSTEMS AND FACILITIES; COMPUTER SERVICES, NAMELY, DATA RECOVERY SERVICES; DATA WAREHOUSING; REMOTE MONITORING OF COMPUTER SYSTEMS TO PROVIDE AUTOMATICALLY TRIGGERED REAL-TIME BACKUP NETWORK SERVICES; CO-LOCATION SERVICES, NAMELY, LEASING OF FACILITIES FOR COMPUTERS; ON-SITE MONITORING OF COMPUTER SYSTEMS; MONITORING SECURITY SYSTEMS TO LIMIT ACCESS TO COMPUTER NETWORKS AND WEBSITES; TECHNICAL SUPPORT SERVICES, NAMELY, TROUBLESHOOTING OF COMPUTER SOFTWARE AND HARDWARE PROBLEMS VIA THE INTERNET, TELEPHONE, E-MAIL, AND IN PERSON (U.S. CLS. 100 AND 101).

FIRST USE 3-0-2001; IN COMMERCE 3-0-2001.

SN 76-274,898. CELLGLIDE, INC., WILMINGTON, DE. FILED 6-21-2001.

CELLGLIDE

PRIORITY CLAIMED UNDER SEC. 44(D) ON ISRAEL APPLICATION NO. 146881, FILED 2-14-2001, REG. NO. 146880, DATED 4-3-2003, EXPIRES 2-14-2008.

PRIORITY CLAIMED UNDER SEC. 44(D) ON ISRAEL APPLICATION NO. 146879, FILED 2-19-2001, REG. NO. 146878, DATED 4-3-2003, EXPIRES 2-19-2008.

CLASS 9—ELECTRICAL AND SCIENTIFIC APPARATUS

FOR COMPUTER SOFTWARE AND COMPUTER HARDWARE, AND COMPUTER SOFTWARE AND COMPUTER HARDWARE COMBINATIONS, FOR PROVIDING AND DISTRIBUTING DATA SERVICES OVER CELLULAR NETWORKS AND RELATED WIDE AREA AND WIRELESS NETWORKS (U.S. CLS. 21, 23, 26, 36 AND 38).

CLASS 38—COMMUNICATION

FOR ELECTRONIC COMPILATION AND TRANSMISSION OF DATA SERVICES OVER CELLULAR NETWORKS AND RELATED WIDE AREA AND WIRELESS NETWORKS (U.S. CLS. 100, 101 AND 104).

SN 76-277,542. AUTONOMY CORPORATION PLC, CAMBRIDGE CB4 0WZ, UNITED KINGDOM, FILED 6-28-2001.

VOICE SUITE

PRIORITY CLAIMED UNDER SEC. 44(D) ON UNITED KINGDOM APPLICATION NO. 2265080, FILED 3-21-2001, REG. NO. 2140291, DATED 11-28-2002, EXPIRES 3-21-2011.

CLASS 9—ELECTRICAL AND SCIENTIFIC APPARATUS

FOR COMPUTER SOFTWARE FOR OBTAINING AND PROCESSING OF MULTIMEDIA DATA; COMPUTER SOFTWARE FOR LOCATING AND DOWNLOADING MULTIMEDIA DATA STORED ON COMPUTER SYSTEMS, COMPUTER NETWORKS AND THE INTERNET; COMPUTER SOFTWARE WHICH IDENTIFIES IDEAS, CONCEPTS AND PROFILE INFORMATION IN DOCUMENTS AND FILES OBTAINED FROM THE INTERNET; COMPUTER SOFTWARE FOR RETRIEVING MULTIMEDIA DATA; COMPUTER SOFTWARE THAT AUTOMATICALLY IDENTIFIES, DOWNLOADS, AND DISTRIBUTES MULTIMEDIA INFORMATION BASED ON USER-SPECIFIED CRITERIA; COMPUTER SOFTWARE FOR CATALOGING, ARCHIVING, AUTOMATICALLY GENERATING TEXT SUMMARIES, AND CONDUCTING TEXT-BASED SEARCHES OF BROADCAST NEWS, DIGITAL TELEVISION TRANSMISSIONS, CONVERGENT MEDIA FILES AND TRANSMISSIONS, AND NEWS AND INFORMATION GENERATED AND TRANSMITTED IN REAL-TIME (U.S. CLS. 21, 23, 26, 36 AND 38).

CLASS 35—ADVERTISING AND BUSINESS

FOR LICENSING OF COMPUTER SOFTWARE USED TO OBTAIN AND PROCESS MULTIMEDIA DATA (U.S. CLS. 100, 101 AND 102).

CLASS 42—SCIENTIFIC, COMPUTER AND LEGAL SERVICES

FOR COMPUTER SERVICES, NAMELY, INSTALLATION, MAINTENANCE AND TECHNICAL CONSULTING RELATED TO COMPUTER SOFTWARE FOR OBTAINING AND PROCESSING OF MULTIMEDIA DATA; COMPUTER SERVICES, NAMELY, DOWNLOADING AND GENERATING TEXT PROFILES AND SUMMARIES OF MULTIMEDIA DATA OBTAINED FROM COMPUTER NETWORKS AND THE INTERNET FOR OTHERS; COMPUTER SERVICES, NAMELY, PROVIDING TEMPORARY USE OF ON-LINE NON-DOWNLOADABLE COMPUTER SOFTWARE FOR GENERATING TEXT SUMMARIES AND PROFILES OF MULTIMEDIA DOCUMENTS AND DATA OBTAINED FROM COMPUTER SYSTEMS, COMPUTER NETWORKS, AND THE INTERNET; COMPUTER SERVICES, NAMELY, PROVIDING TEMPORARY USE OF ON-LINE NON-DOWNLOADABLE COMPUTER SOFTWARE USED TO CATALOG, ARCHIVE, AND ALLOW TEXT-BASED SEARCHING OF MULTIMEDIA DOCUMENTS AND DATA DOWNLOADED FROM THE INTERNET; COMPUTER SERVICES, NAMELY PROVIDING TEMPORARY USE OF ON-LINE NON-DOWNLOADABLE COMPUTER SOFTWARE FOR PERFORMING CONCEPT MATCHING, NAMELY, SEARCHING DATA AND RETURNING REFERENCES TO DOCUMENTS THAT ARE CONCEPTUALLY RELATED TO THE CONTENT IDENTIFIED AS THE INITIAL REFERENCE (U.S. CLS. 100 AND 101).

SN 76-284,995. JAMES D. STELLA ENTERPRISES, ARLINGTON HEIGHTS, IL. FILED 7-13-2001.



NO CLAIM IS MADE TO THE EXCLUSIVE RIGHT TO USE "CATCH PHOTO RELEASE", APART FROM THE MARK AS SHOWN.

THE STIPPLING AND THE LINING ARE FEATURES OF THE MARK AND ARE NOT INTENDED TO INDICATE COLOR, IRRESPECTIVE OF THE GREEN SHADE.

CLASS 16—PAPER GOODS AND PRINTED MATTER

FOR DECALS; AND STICKERS (U.S. CLS. 2, 5, 22, 23, 29, 37, 38 AND 50).
FIRST USE 6-0-1999; IN COMMERCE 1-0-2001.

CLASS 25—CLOTHING

FOR T-SHIRTS (U.S. CLS. 22 AND 39).
FIRST USE 6-0-1999; IN COMMERCE 1-0-2001.

CLASS 41—EDUCATION AND ENTERTAINMENT

FOR PROVIDING INFORMATION ON-LINE RELATING TO RECREATIONAL FISHING IN THE FIELDS OF CATCHING, HANDLING, AND MANAGING MUSKIES (U.S. CLS. 100, 101 AND 107).
FIRST USE 6-0-1999; IN COMMERCE 1-0-2001.

SN 76-291,926. HYPERLAST LIMITED, BIRCH VALE, HIGH PEAK, UNITED KINGDOM, FILED 7-30-2001.

HYPERLAST

PRIORITY CLAIMED UNDER SEC. 44(D) ON ERPNTY TM OFC APPLICATION NO. 2239564, FILED 5-31-2001, REG. NO. 2239564, DATED 5-31-2001, EXPIRES 5-31-2010.

OWNER OF UNITED KINGDOM REG. NO. 1070305, DATED 11-4-1976, EXPIRES 11-4-2007.

OWNER OF UNITED KINGDOM REG. NO. 1069533, DATED 10-18-1976, EXPIRES 10-18-2007.

CLASS 1—CHEMICALS

FOR CHEMICAL PREPARATIONS CONTAINING POLYURETHANE ELASTOMERS FOR USE IN THE MANUFACTURE OF COATINGS AND FINISHING COMPOSITIONS; CHEMICAL PREPARATIONS FOR USE IN MANUFACTURING COATINGS AND FINISHINGS; PLASTIC MOLDING COMPOUNDS FOR USE IN THE MANUFACTURE OF PROTECTIVE COATINGS OF LIQUID PLASTIC MATERIALS AND MOLDING MATERIALS MADE FROM POLYURETHANE ELASTOMERS (U.S. CLS. 1, 5, 6, 10, 26 AND 46).

CLASS 2—PAINTS

FOR INTERIOR AND EXTERIOR PAINTS; VARNISHES OTHER THAN INSULATING VARNISH; LACQUERS IN THE NATURE OF A COATING; EMULSIONS, ENAMELS AND POLYURETHANE COATINGS, ALL IN THE NATURE OF HOUSE PAINTS; BACTERICIDAL PAINTS; COATINGS IN THE NATURE OF PAINT; PRESERVATIVES AGAINST RUST IN THE NATURE OF A COATING; PLASTIC AND ELASTOMER COATINGS IN THE NATURE OF PAINT; ELASTOMER PAINT-TYPE COATINGS FOR OIL PIPES, ELASTOMER COATINGS FOR OIL PIPES HAVING THERMAL AND PROTECTIVE INSULATION PROPERTIES; THERMAL AND PROTECTIVE INSULATING PAINT-TYPE COATINGS FOR PIPES (U.S. CLS. 6, 11 AND 16).

CLASS 37—CONSTRUCTION AND REPAIR

FOR WASTE MANAGEMENT, NAMELY, SOLID WASTE DISPOSAL SERVICES (U.S. CLS. 100, 103 AND 106).

CLASS 39—TRANSPORTATION AND STORAGE

FOR PUBLIC UTILITY SERVICES, NAMELY, TRANSMISSION AND DISTRIBUTION OF ELECTRICITY, GAS AND WATER SERVICES (U.S. CLS. 100 AND 105).

CLASS 40—MATERIAL TREATMENT

FOR GENERATION OF ELECTRICITY (U.S. CLS. 100, 103 AND 106).

SN 76-293,957. BESSER GEHEN GMBH, 53604 BAN HONNEF, FED REP GERMANY, FILED 8-1-2001.



PRIORITY CLAIMED UNDER SEC. 44(D) ON FED REP GERMANY APPLICATION NO. 30106657,4/1, FILED 2-1-2001, REG. NO. 30106657, DATED 5-29-2002, EXPIRES 2-28-2011.

OWNER OF U.S. REG. NO. 2,484,549.

CLASS 16—PAPER GOODS AND PRINTED MATTER

FOR PRINTED MATTER, NAMELY, PROSPECTUSES, MAGAZINES, FOLDERS, AND BROCHURES IN THE FIELD OF FOOT CARE, ORTHOPEDICS, AND CHIROPODY (U.S. CLS. 2, 5, 22, 23, 29, 37, 38 AND 50).

CLASS 25—CLOTHING

FOR FOOTWEAR, NAMELY, SHOES, BOOTS, SANDALS, CLOGS, SLIPPERS, MULES, WATER SHOES, ATHLETIC SHOES; FOOTWEAR PARTS AND ACCESSORIES, NAMELY, INSOLES, INNER SOLES, FOOTBEDS, OUTER SOLES, PREFORMED SHELLS, INSOLE SHELLS, SOFT INSOLES, LEATHER UPPERS OF FOOTWEAR; CLOTHING, NAMELY, HEAD WEAR, BELTS, COATS, JACKETS, DRESSES, GLOVES, NECKWEAR, SLACKS, PANTS, SHIRTS, BLOUSES, SHORTS, SKIRTS, SLEEPWEAR, SOCKS, STOCKINGS, SUITS, SWEATERS, SUSPENDERS, UNDERGARMENTS (U.S. CLS. 22 AND 39).

SN 76-295,813. CITY OF TALLAHASSEE, TALLAHASSEE, FL. FILED 8-6-2001.

YOUR OWN UTILITIES

NO CLAIM IS MADE TO THE EXCLUSIVE RIGHT TO USE "UTILITIES", APART FROM THE MARK AS SHOWN.

SN 76-296,686. PEDRI, JEAN-ROCH, 75017 PARIS, FRANCE, FILED 7-12-2001.

V.I.P. ROOM OF JEAN-ROCH

PRIORITY CLAIMED UNDER SEC. 44(D) ON FRANCE APPLICATION NO. 013108373, FILED 6-25-2001, REG. NO. 013108373, DATED 6-25-2001, EXPIRES 6-25-2011.

NO CLAIM IS MADE TO THE EXCLUSIVE RIGHT TO USE "ROOM", APART FROM THE MARK AS SHOWN.

THE NAME "JEAN-ROCH" IDENTIFIES A LIVING INDIVIDUAL WHOSE CONSENT IS OF RECORD.

CLASS 9—ELECTRICAL AND SCIENTIFIC APPARATUS

FOR APPARATUS FOR RECORDING, TRANSMISSION, OR REPRODUCTION OF SOUND OR IMAGES, NAMELY, CINEMATOGRAPHIC CAMERAS, CAMCORDERS, TAPE RECORDERS, VIDEO RECORDERS, ENGRAVERS, SOUND RECORDING CARRIERS, AND MIXING BOARD; MAGNETIC DATA CARRIERS, CASSETTES, MAGNETIC TAPES, MAGNETIC DISKS, VIDEO CASSETTES, SOUND RECORDING CARRIERS, SOUND RECORDING STRIPS, CINEMATOGRAPHIC FILMS, MECHANICAL RECORDING CARRIERS, NAMELY ANALOGICAL OR DIGITAL DISCS, AUDIO-VIDEO COMPACT DISCS, AND AUDIO DATA-PROCESSING CARRIERS SUCH AS MP-3 AUDIO FILE, ALL SOLD PRE-RECORDED WITH MUSIC AND/OR VIDEO CLIPS (U.S. CLS. 21, 23, 26, 36 AND 38).

CLASS 25—CLOTHING

FOR CLOTHING, NAMELY DRESSES, CHASUBLES, SKIRTS, SHIRTS, BLOUSES, TEE-SHIRTS, SHORTS, TROUSERS, JEANS, SUITS, JOGGINGS, DRESSING GOWNS, PULLOVERS, SWEATERS, WAISTCOATS, JACKETS, JUMPERS, UNDERSHIRTS, TANK TOPS, VESTS, GAITERS, COATS, PARKAS, OVERALLS, OVERCOATS, BELTS, NECKTIES, GLOVES, SCARVES, BANDANAS, PAREOS, BATHROBES, BATHING SUITS, PAJAMAS, PANTS, BRASSIERES, SLIPS, COLLARS, SOCKS, STOCKINGS, SHOES, BELTS, CAPS AND HATS (U.S. CLS. 22 AND 39).

CLASS 41—EDUCATION AND ENTERTAINMENT

FOR ENTERTAINMENT SERVICES, NAMELY, DISCOTHEQUE SERVICES, PRODUCTION OF SHOWS, AUDIO-VIDEO PRODUCTION, VIDEOTAPE FILM-PRODUCTION, RECORDING STUDIO SERVICES (U.S. CLS. 100, 101 AND 107).

CLASS 42—SCIENTIFIC, COMPUTER AND LEGAL SERVICES

FOR PROVIDING OF FOOD AND DRINK, NAMELY, COCKTAIL LOUNGE SERVICES, RESTAURANTS, NIGHTCLUB SERVICES (U.S. CLS. 100 AND 101).

SN 76-297,323. LIDL STIFTUNG & CO. KG, 74172 NECKARSULM, FED REP GERMANY, FILED 8-9-2001.

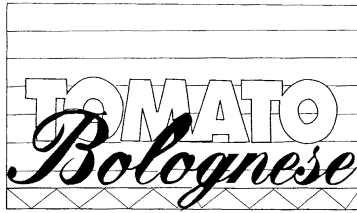

OWNER OF FED REP GERMANY REG. NO. 2080890, DATED 10-14-1994, EXPIRES 4-5-2004.

NO CLAIM IS MADE TO THE EXCLUSIVE RIGHT TO USE "TOMATO BOLOGNESE", APART FROM THE MARK AS SHOWN.

THE MARK IS LINED FOR THE COLORS YELLOW AND RED. COLOR IS NOT CLAIMED AS A FEATURE OF THE MARK.

CLASS 29—MEATS AND PROCESSED FOODS

FOR MEAT, FISH, POULTRY AND GAME, ALSO DEEP FROZEN; MEAT EXTRACTS; MEAT, SAUSAGE, FISH, FRUIT AND VEGETABLES PRESERVES; PREPARED MEALS MAINLY CONSISTING OF MEAT, FISH, GAME AND/OR VEGETABLES, ALSO DEEP FROZEN (U.S. CL. 46).

CLASS 30—STAPLE FOODS

FOR PREPARED MEALS MAINLY CONSISTING OF RICE OR FARINACEOUS PASTES, ALSO DEEP FROZEN (U.S. CL. 46).

SN 76-300,529. GELAMEN LIMITED, AUCKLAND, NEW ZEALAND, FILED 8-16-2001.

GELAMEN

PRIORITY CLAIMED UNDER SEC. 44(D) ON NEW ZEALAND APPLICATION NO. 643487, FILED 8-13-2001, REG. NO. 643487, DATED 2-14-2002, EXPIRES 8-13-2008.

PRIORITY CLAIMED UNDER SEC. 44(D) ON NEW ZEALAND APPLICATION NO. 643486, FILED 8-13-2001, REG. NO. 643486, DATED 2-14-2002, EXPIRES 8-13-2008.

CLASS 9—ELECTRICAL AND SCIENTIFIC APPARATUS

FOR COMPUTER SOFTWARE FOR DATABASE MANAGEMENT, DATABASE MANAGEMENT OF KNOWN INFORMATION FOR GENERAL USE AND DOCUMENT MANAGEMENT; SOFTWARE IN THE FIELD OF BUSINESS, FOR DATABASE MANAGEMENT, DATABASE MANAGEMENT OF KNOWN INFORMATION FOR GENERAL USE AND DOCUMENT MANAGEMENT; PRE-RECORDED COMPACT DISCS FEATURING SOFTWARE FOR DATABASE MANAGEMENT, DOCUMENT MANAGEMENT AND DATABASE MANAGEMENT OF KNOWN INFORMATION FOR GENERAL USE; FLOPPY DISCS CONTAINING SOFTWARE FOR DATABASE MANAGEMENT, DOCUMENT MANAGEMENT AND DATABASE MANAGEMENT OF KNOWN INFORMATION FOR GENERAL USE (U.S. CLS. 21, 23, 26, 36 AND 38).

CLASS 42—SCIENTIFIC, COMPUTER AND LEGAL SERVICES

FOR SOFTWARE DESIGN AND DEVELOPMENT SERVICES FOR OTHERS; INFORMATION TECHNOLOGY CONSULTANCY (U.S. CLS. 100 AND 101).

SN 76-301,925. KOMET PRAZISIONSWERKZEUGE ROBERT BREUNING GMBH, 74354 BESIGHEIM, FED REP GERMANY, FILED 8-17-2001.

KOMET

OWNER OF FED REP GERMANY REG. NO. 39645880, DATED 9-10-2001, EXPIRES 10-31-2006.

OWNER OF U.S. REG. NOS. 1,693,989 AND 1,967,862. A TRANSLATION OF THE WORD "KOMET" IS "COMET".

CLASS 7—MACHINERY

FOR POWER OPERATED TOOLS, NAMELY, CUTTING TOOLS WITH INTEGRATED OR REMOVABLE CUTTERS OF HARD CUTTING MATERIALS, INCLUDING BORING AND REBORING TOOLS, SUPER FINISH TURNING TOOLS, FRICTION TOOLS, SINK AND COUNTERSINK TOOLS, TURNING TOOLS, GROOVING TOOLS, THREAD CUTTING TOOLS; MANUALLY AND POWER ADJUSTABLE POWER OPERATED TOOLS, NAMELY, POWER OPERATED FACING HEADS; WORK HOLDING FIXTURES, WORK PIECE FIXTURES; POWER OPERATED SAWS; SAW BLADE AND SAW ATTACHMENTS OF HARD CUTTING MATERIALS FOR THE AFORESAID SAWS, TOOL HOLDING FIXTURE AND ADAPTERS, NAMELY SPINDLE FLANGE ATTACHMENTS, TAPER SHANKS, CHUCKS, LENGTHENING AND REDUCING PIECES FOR TOOLS, MODULAR MOUNTED TOOLS WITH COUPLINGS BEING POINTS OF INTERSECTION AND SEPARATION FOR THE MANUAL AND MECHANICAL COUPLING OF TOOLS AND MACHINE TOOL SPINDLES, CLAMPS FOR USE WITH MACHINE TOOLS, CUTTER INSERTS; THROWAWAY CARBIDE INDEXABLE INSERTS AND TURNING CHISELS OF HARD CUTTING MATERIALS; TOOL HOLDERS WITH INTEGRATED OR REPLACEABLE CUTTERS; INCLUDING THROWAWAY CARBIDE INDEXABLE INSERTS, TURNING CHISELS, TOOL AND ASSEMBLY INSERTS AND HOLDERS, SUPER FINISH TURNING INSERTS, AND REPLACEMENT PARTS THEREFOR, NAMELY BOLTS, CLAMPS AND SCREWS; MACHINE TOOL SPINDLES; DRIVE MECHANISMS, IN PARTICULAR ACTUATORS (U.S. CLS. 13, 19, 21, 23, 31, 34 AND 35).

CLASS 9—ELECTRICAL AND SCIENTIFIC APPARATUS

FOR DATA LOGGERS, TRANSDUCERS AND DATA RECORDER FOR TOOL DATA; ADJUSTING GAUGES AND ADJUSTING MACHINES FOR ADJUSTING AND ALIGNING TOOLS FOR THE AFORESAID GOODS; WIREBOUND AND WIRELESS ELECTRONIC ENERGY AND DATA LOGGERS, TRANSMITTERS, TRANSDUCERS AND DATA CONTROLLERS AND RECORDERS, DATA TRANSLATORS FOR TOOLS; COMPUTER PROGRAMS RECORDED ON DATA CARRIERS, IN PARTICULAR FOR HANDLING, CONTROLLING AND ADJUSTING THE AFORESAID GOODS; COMPUTERS IN PARTICULAR FOR HANDLING, CONTROLLING AND ADJUSTING THE AFORESAID GOODS (U.S. CLS. 21, 23, 26, 36 AND 38).

CLASS 42—SCIENTIFIC, COMPUTER AND LEGAL SERVICES

FOR PROGRAMMING FOR OTHERS, RENTAL AND MAINTENANCE OF DATA PROCESSING PROGRAMS, NAMELY FOR HANDLING, MANAGEMENT AND ADJUSTING THE AFORESAID GOODS; PLANNING, DEVELOPMENT, INSTALLATION AND IMPLEMENTATION OF COMPUTER SOFTWARE FOR TOOLS (U.S. CLS. 100 AND 101).

SN 76-302,663. HOME INTERIORS & GIFTS, INC., CARR-ROLLTON, TX. FILED 8-20-2001.

DECORATING LIVES

NO CLAIM IS MADE TO THE EXCLUSIVE RIGHT TO USE "DECORATING", APART FROM THE MARK AS SHOWN.

CLASS 14—JEWELRY

FOR GIFTABLES, NAMELY ORNAMENTAL PINS (U.S. CLS. 2, 27, 28 AND 50).
FIRST USE 6-1-2001; IN COMMERCE 6-20-2001.

CLASS 21—HOUSEWARES AND GLASS

FOR HOUSEWARES AND GIFTABLES, NAMELY GLASSES, CUPS, DISHES, PITCHERS, BOWLS, SERVING PLATTERS, COFFEE POTS NOT OF PRECIOUS METAL, TEA POTS NOT OF PRECIOUS METAL; WALL DECORATIONS MADE OF CERAMICS OR GLASS; VASES MADE OF CERAMIC OR GLASS; NON-ELECTRIC CANDLE SCONCES, CANDLEHOLDERS NOT OF PRECIOUS METAL AND NON-ELECTRIC CANDELABRAS NOT OF PRECIOUS METAL; FIGURINES AND STATUETTES MADE OF CHINA, CERAMIC AND/OR PORCELAIN [BASED ON INTENT TO USE] (U.S. CLS. 2, 13, 23, 29, 30, 33, 40 AND 50).

CLASS 35—ADVERTISING AND BUSINESS

FOR BUSINESS INFORMATION, ADVICE AND CONSULTATION IN THE FIELDS OF DIRECT SALES ORGANIZATION, PLANNING AND ESTABLISHMENT AND/OR OPERATION OF A BUSINESS SPECIALIZING IN THE SALE OF HOUSEWARES AND GIFTS; RENDERING TECHNICAL AID AND ASSISTANCE IN THE ESTABLISHMENT AND/OR OPERATION OF A BUSINESS SPECIALIZING IN THE SALE OF HOUSEWARES AND GIFTS; RETAIL STORE SERVICES, ON-LINE RETAIL STORE SERVICES AND MAIL ORDER CATALOG SERVICES FEATURING HOME INTERIOR DECORATIONS AND GIFTS (U.S. CLS. 100, 101 AND 102).
FIRST USE 6-1-2001; IN COMMERCE 6-20-2001.

CLASS 41—EDUCATION AND ENTERTAINMENT

FOR DEVELOPMENT AND DISSEMINATION OF EDUCATIONAL MATERIALS FOR OTHERS IN THE ESTABLISHMENT AND/OR OPERATION OF A BUSINESS SPECIALIZING IN THE SALE OF HOUSEWARES AND GIFTS (U.S. CLS. 100, 101 AND 107).

FIRST USE 6-1-2001; IN COMMERCE 6-20-2001.

SN 76-306,437. SCHNEIDER ELECTRIC INDUSTRIES SA, RUEIL-MAISON, FRANCE, FILED 8-30-2001.

SENSIDE

OWNER OF FRANCE REG. NO. 003069303, DATED 12-1-2000, EXPIRES 12-1-2010.

CLASS 9—ELECTRICAL AND SCIENTIFIC APPARATUS

FOR SCIENTIFIC, ELECTRIC, ELECTRONIC APPARATUS AND INSTRUMENTS FOR THE TRANSPORT, CONDUCTION, DISTRIBUTION, TRANSFORMATION, ACCUMULATION, REGULATION, FILTERING, MEASURING, SIGNALING, CONTROL OR OPERATION OF ELECTRIC CURRENT, NAMELY, AC DRIVES; RECTIFIERS; SEMICONDUCTORS; ELECTRIC RELAYS; CONDENSERS; INDUCTANCES; CIRCUIT BREAKERS; ELECTRIC SWITCHES; CONTACTORS; AUTOMATION PRODUCTS, NAMELY PROGRAMMABLE LOGIC CONTROLLERS; CONTROL PANELS FOR ELECTRICAL DISTRIBUTION; STATIC CONVERTERS; ELECTRONIC PROGRAMMERS; BATTERIES; ELECTRIC ACCUMULATORS; SUPPLY, FILTERING, TRANSFORMATION, MAINTENANCE AND STORAGE APPARATUS OF ELECTRIC ENERGY, NAMELY TRANSFORMERS AND POWER LOGIC MONITORS; COMPUTER SOFTWARE AND COMPUTER PROGRAMS FOR ELECTRICAL DISTRIBUTION CONTROL AND FOR INDUSTRIAL AUTOMATION AND COMPUTER HARDWARE ASSOCIATED TO SUCH APPARATUSES (U.S. CLS. 21, 23, 26, 36 AND 38).

CLASS 37—CONSTRUCTION AND REPAIR

FOR ELECTRICAL INSTALLATION SERVICES, NAMELY REPAIR SERVICES FOR ELECTRICAL DISTRIBUTION AND CONTROL AND INDUSTRIAL AUTOMATION APPARATUS; MAINTENANCE AND REPAIR SERVICES PROVIDED ON AN ELECTRONIC SITE ACCESSIBLE VIA COMPUTER NETWORKS AND THE WORLD WIDE WEB THROUGH THE INTERNET, NAMELY PREVENTIVE MAINTENANCE AND DIAGNOSTICS FOR ELECTRICAL DISTRIBUTION AND INDUSTRIAL AUTOMATION APPARATUS (U.S. CLS. 100, 103 AND 106).

CLASS 42—SCIENTIFIC, COMPUTER AND LEGAL SERVICES

FOR TECHNICAL SUPPORT SERVICES, NAMELY REMOTE TROUBLESHOOTING OF ELECTRICAL DISTRIBUTION AND INDUSTRIAL AUTOMATION APPARATUS PROVIDED ON AN ELECTRONIC SITE ACCESSIBLE VIA COMPUTER NETWORKS AND THE WORLD WIDE WEB THROUGH THE INTERNET; COMMUNICATIONS SERVICES PROVIDED VIA COMPUTER NETWORKS AND THE WORLD WIDE WEB AND THROUGH THE INTERNET, NAMELY PROVIDING DATABASES OF TECHNICAL INFORMATION FOR ELECTRICAL DISTRIBUTION AND INDUSTRIAL AUTOMATION APPARATUS (U.S. CLS. 100 AND 101).

SN 76-306,688. L&P PROPERTY MANAGEMENT COMPANY, SOUTH GATE, CA. FILED 8-29-2001.

LP 9000

OWNER OF U.S. REG. NO. 2,045,662.

CLASS 6—METAL GOODS

FOR SPRING WIRE; METAL HARDWARE, NAMELY, SPRINGS; METAL TUBING, NAMELY, WELDED STEEL TUBING; METAL CASTINGS, NAMELY, ALUMINUM DIE CASTINGS; METAL CASTERS; METAL CLIPS FOR FURNITURE AND BEDDING SPRING SECUREMENTS (U.S. CLS. 2, 12, 13, 14, 23, 25 AND 50).

CLASS 17—RUBBER GOODS

FOR RESILIENT URETHANE FOAM FOR USE IN THE MANUFACTURE OF BEDDING AND FURNITURE (U.S. CLS. 1, 5, 12, 13, 35 AND 50).

CLASS 19—NON-METALLIC BUILDING MATERIALS

FOR WALL PANELS NOT OF METAL (U.S. CLS. 1, 12, 33 AND 50).

CLASS 20—FURNITURE AND ARTICLES NOT OTHERWISE CLASSIFIED

FOR BEDDING MATTRESSES AND MATTRESS FOUNDATIONS, AND COMPONENTS OF SAME, NAMELY, SPRINGS AND INSULATOR PADS; FURNITURE COMPONENTS, NAMELY, PLASTIC CASTERS, SPRING ASSEMBLIES, MOLDED PLASTIC BASES AND MOTION CONTROL MECHANISMS FOR FURNITURE, NAMELY, CHAIR CONTROLS, MOTION FURNITURE MECHANISMS AND MECHANISMS FOR ADJUSTABLE HEIGHT WORK TABLES; METAL BED RAILS AND BED FRAMES; CHAIR ROCKER BASES AND SPRINGS; CHAIR SEAT AND BACK SPRINGS; BUNK BEDS; DAYBEDS; ELECTRIC BEDS; PEDESTAL BED BASES; ROLLAWAY BEDS; TRUNDLE BEDS; WOODEN BED HEADBOARDS; AND MERCHANDISING DISPLAY RACKS (U.S. CLS. 2, 13, 22, 25, 32 AND 50).

CLASS 22—CORDAGE AND FIBERS

FOR SYNTHETIC FIBER, WOOL AND COTTON CUSHIONING MATERIALS FOR USE IN THE MANUFACTURE OF BEDDING AND FURNITURE (U.S. CLS. 1, 2, 7, 19, 22, 42 AND 50).

CLASS 27—FLOOR COVERINGS

FOR CARPET PADDING (U.S. CLS. 19, 20, 37, 42 AND 50).

SN 76-307,202. GOLDINER, ARTHUR HOWARD, GROVER BEACH, CA. FILED 8-30-2001.

RUFF-GRIP

CLASS 10—MEDICAL APPARATUS

FOR EXERCISE CONDITIONING AND REHABILITATION DEVICES FOR HUMAN PHALANGES, NAMELY DEVICES HAVING A RAISED ABRASIVE SURFACE FOR SIMULATING GUITAR STRINGS USED TO CONDITION HUMAN AND CALLOUS HUMAN FINGERS (U.S. CLS. 26, 39 AND 44).

CLASS 15—MUSICAL INSTRUMENTS

FOR MUSICAL INSTRUMENT ACCESSORIES, NAMELY, DEVICES HAVING A RAISED ABRASIVE SURFACE SIMULATING GUITAR STRINGS USED TO CONDITION AND CALLOUS HUMAN FINGERS (U.S. CLS. 2, 21 AND 36).

SN 76-307,214. GOLDINER, ARTHUR HOWARD, GROVER BEACH, CA. FILED 8-30-2001.

RUFF-CAPS

CLASS 10—MEDICAL APPARATUS

FOR EXERCISE CONDITIONING AND REHABILITATION DEVICES FOR HUMAN PHALANGES, NAMELY DEVICES HAVING A RAISED ABRASIVE SURFACE FOR SIMULATING GUITAR STRINGS USED TO CONDITION HUMAN AND CALLOUS HUMAN FINGERS (U.S. CLS. 26, 39 AND 44).

CLASS 15—MUSICAL INSTRUMENTS

FOR MUSICAL INSTRUMENT ACCESSORIES, NAMELY, DEVICES HAVING A RAISED ABRASIVE SURFACE SIMULATING GUITAR STRINGS USED TO CONDITION AND CALLOUS HUMAN FINGERS (U.S. CLS. 2, 21 AND 36).

SN 76-311,028. BOARD OF REGENTS OF THE UNIVERSITY OF WISCONSIN SYSTEM, THE, MADISON, WI. FILED 9-10-2001.



OWNER OF U.S. REG. NOS. 1,660,898, 2,344,923 AND OTHERS.
SEC. 2(F) AS TO "THE UNIVERSITY OF WISCONSIN MADISON".

CLASS 25—CLOTHING

FOR CLOTHING, NAMELY, LONG SLEEVE AND SHORT SLEEVE T-SHIRTS, TANK TOPS, FLEECE TOPS, SWEATSHIRTS, CAPS, HATS, SOCKS, NIGHT SHIRTS, BIBS, INFANTS' ONE-PIECE SUITS, INFANTS' T-SHIRTS, AND INFANTS' SWEATSHIRTS (U.S. CLS. 22 AND 39).

CLASS 41—EDUCATION AND ENTERTAINMENT

FOR EDUCATIONAL SERVICES, NAMELY, CONDUCTING LECTURES, COURSES, WORKSHOPS, SEMINARS AND CONFERENCES AT THE UNIVERSITY UNDERGRADUATE, GRADUATE AND POST-GRADUATE LEVELS, AND CONDUCTING EXTENSION COURSES AND COMMUNITY SERVICE LECTURES AND WORKSHOPS; ENTERTAINMENT SERVICES, NAMELY, SPORTS EXHIBITIONS, THEATRICAL PRODUCTIONS, PUBLIC LECTURES, ART EXHIBITIONS, MUSICAL CONCERTS, DANCE AND BALLET PERFORMANCES, AND MOTION PICTURE EXHIBITIONS (U.S. CLS. 100, 101 AND 107).

SN 76-312,583, NATIONAL ROADS & MOTORISTS' ASSOCIATION LIMITED, SYDNEY, NEW SOUTH WALES 2000, AUSTRALIA, FILED 9-17-2001.



OWNER OF AUSTRALIA REG. NO. 508842, DATED 4-17-1989, EXPIRES 4-17-2006.

OWNER OF AUSTRALIA REG. NO. 508841, DATED 4-17-1989, EXPIRES 4-17-2006.

OWNER OF AUSTRALIA REG. NO. 508838, DATED 4-17-1989, EXPIRES 4-17-2006.

OWNER OF AUSTRALIA REG. NO. 653818, DATED 2-21-1995, EXPIRES 2-21-2005.

THE LINING IS A FEATURE OF THE MARK AND DOES NOT INDICATE COLOR.

CLASS 9—ELECTRICAL AND SCIENTIFIC APPARATUS

FOR AUTOMOTIVE BATTERIES; BATTERY CHARGERS; AUTOMOTIVE ELECTRICAL, NAMELY CABLE JUMP LEADS, ALTERNATORS, AND CAR NAVIGATION COMPUTERS; COMMUNICATIONS EQUIPMENT, NAMELY COMMUNICATIONS SERVERS AND TELEPHONES; AND SATELLITE NAVIGATION SYSTEM, NAMELY A GLOBAL POSITIONING SYSTEM (U.S. CLS. 21, 23, 26, 36 AND 38).

CLASS 16—PAPER GOODS AND PRINTED MATTER

FOR PAPER, NAMELY COMPUTER PAPER; STATIONERY; BOOKS, NAMELY A SERIES OF NON-FICTION BOOKS FEATURING INFORMATION ON TRAVEL, MAPS, MOTOR VEHICLES, MOTOR VEHICLE MAINTENANCE AND/OR SAFETY, INSURANCE AND FINANCE, LOG BOOKS, NEWSPAPERS FOR GENERAL CIRCULATION; JOURNALS, PERIODICALS, PAMPHLETS AND DIRECTORIES ALL CONCERNING FINANCIAL MATTERS, INSURANCE, TRAVEL, MOTOR VEHICLE MAINTENANCE AND/OR SAFETY, MAPS, AND PRINTED CHARTS (U.S. CLS. 2, 5, 22, 23, 29, 37, 38 AND 50).

CLASS 37—CONSTRUCTION AND REPAIR

FOR VEHICLE REPAIR SERVICE, VEHICLE SERVICING, AND ROAD SERVICE FOR VEHICLES (U.S. CLS. 100, 103 AND 106).

CLASS 39—TRANSPORTATION AND STORAGE

FOR TRAVEL AGENCY SERVICES, CONSISTING OF INFORMATION ABOUT JOURNEYS; VEHICLE TOWING SERVICES (U.S. CLS. 100 AND 105).

CLASS 42—SCIENTIFIC, COMPUTER AND LEGAL SERVICES

FOR VEHICLE INSPECTION SERVICES (U.S. CLS. 100 AND 101).

SN 76-313,057, PIERRE FABRE S.A., PARIS, FRANCE, BY CHANGE OF NAME BIOMERIEUX PIERRE FABRE, 69280 MARCY L'ETOILE, FRANCE, FILED 9-17-2001.

ILEXEL

OWNER OF FRANCE REG. NO. 94539581, DATED 9-30-1994, EXPIRES 9-30-2004.

CLASS 3—COSMETICS AND CLEANING PREPARATIONS

FOR TOILET SOAPS; PERFUMES; ESSENTIAL OILS FOR PERSONAL USE; COSMETICS, NAMELY SKIN CREAMS, OILS, GELS, MILKS, LOTIONS AND EMULSIONS, MAKEUP; HAIR CARE PREPARATIONS, NAMELY CREAMS, GELS AND LOTIONS; DENTIFRICES (U.S. CLS. 1, 4, 6, 50, 51 AND 52).

CLASS 5—PHARMACEUTICALS

FOR PHARMACEUTICAL PREPARATIONS FOR USE IN CARDIOANGIOLOGY, NEUROLOGY, PSYCHIATRY, ONCOLOGY, PNEUMOLOGY, ASTHMA AND DERMATOLOGY (WITH THE EXCLUSION OF PRODUCTS FOR THE TREATMENT OF RHEUMATISM AND INFLAMMATIONS OF THE SOFT TISSUE) (U.S. CLS. 6, 18, 44, 46, 51 AND 52).

SN 76-320,903, PUMA AG RUDOLF DASSLER SPORT, HERZOGENAURACH, D-91074, FED REP GERMANY, FILED 10-3-2001.

BLACK STATION

PRIORITY CLAIMED UNDER SEC. 44(D) ON ERPNTY TM OFC APPLICATION NO. 002324788, FILED 8-1-2001, REG. NO. 2324788, DATED 9-10-2002, EXPIRES 8-10-2011.

NO CLAIM IS MADE TO THE EXCLUSIVE RIGHT TO USE "BLACK", APART FROM THE MARK AS SHOWN.

CLASS 18—LEATHER GOODS

FOR LEATHER AND IMITATION LEATHER SOLD IN BULK, LEATHER AND IMITATION LEATHER GOODS, NAMELY, DUFFEL BAGS, BACKPACKS, BOOK BAGS, PURSES, POCKET WALLETS, BRIEFCASES, HANDBAGS, SUITCASES, KEY CASES, CARRY-ON BAGS, TRAVELING BAGS, SHOPPING BAGS, LUGGAGE GRIP BAGS, BAGS FOR MERCHANDISE PACKAGING, SPORTS BAGS, KNAPSACKS, SCHOOL BAGS, WAIST BAGS, TOILETRY BAGS SOLD EMPTY; TRUNKS AND OVERNIGHT CASES, UMBRELLAS, PARASOLS AND WALKING STICKS (U.S. CLS. 1, 2, 3, 22 AND 41).

CLASS 25—CLOTHING

FOR CLOTHING, NAMELY SPORTS AND LEISURE SUITS, TRAINING SUITS, WARM-UP SUITS, ALL-WEATHER SUITS, NAMELY WATER RESISTANT SUITS AND FOUL WEATHER GEAR, PULLOVERS, JERSEYS, JACKETS, SWEATSHIRTS, SHORTS, SHIRTS, PANTS, T-SHIRTS, TOPS, SKIRTS, SOCKS, WRISTBANDS, ATHLETIC UNIFORMS, BLOUSONS, TURTLENECKS, CAMISOLES, SWEATERS, CARDIGANS, WRAPS, COVER-UPS, COATS, DRESSES, BLOUSES, UNDERWEAR, TANK TOPS, TROUSERS, TIGHTS, BATHING SUITS, NECKERCHIEFS, SCARFS, BELTS, FOOTWEAR, AND HEADWEAR (U.S. CLS. 22 AND 39).

CLASS 28—TOYS AND SPORTING GOODS

FOR GYMNASIAC AND SPORTING ARTICLES, NAMELY HANDGRIPS FOR GRIPPING GYMNASIAC EQUIPMENT, WRISTBANDS, LANYARDS FOR NON-PROTECTIVE PURPOSES, BASKETBALLS, SOCCER BALLS, FOOTBALLS, VOLLEYBALLS, HANDBALLS, BASEBALLS, BOWLING BALLS; PUMPS AND BALL NEEDLES FOR INFLATING SPORTS BALLS; TENNIS BALL GRIP BAGS, MAT BAGS FOR HOLDING YOGA AND EXERCISE MATS, SOCCER BALL BAGS, BASKETBALL BAGS, FOOTBALL BAGS, VOLLEYBALL BAGS, HANDBALL BAGS; SHINGUARDS FOR ATHLETIC USE; KNEE, ELBOW AND ANKLE SUPPORTS FOR ATHLETIC USE; GOALKEEPERS GLOVES, BOXING GLOVES, BASEBALL GLOVES; TENNIS RACKETS, CRICKET BATS, GOLF CLUBS, HOCKEY STICKS; BOWLING BAGS AND BAGS, CASES AND COVERS FOR ALL OF THE FOLLOWING, TENNIS RACKETS, TABLE TENNIS PADDLES, BADMINTON RACKETS, SQUASH RACKETS, CRICKET BATS, GOLF CLUBS AND HOCKEY STICKS; ROLLER SKATES, ICE SKATES; TABLES AND NETS FOR TABLE TENNIS (U.S. CLS. 22, 23, 38 AND 50).

SN 76-321,525. CORIL HOLDINGS LTD., CALGARY, ALBERTA T2P 3V4, CANADA, FILED 10-4-2001.

Coril Holdings Ltd.

PRIORITY CLAIMED UNDER SEC. 44(D) ON CANADA APPLICATION NO. 1,104,418, FILED 5-29-2001, REG. NO. TMA580160, DATED 4-29-2003, EXPIRES 4-29-2018.

NO CLAIM IS MADE TO THE EXCLUSIVE RIGHT TO USE "HOLDINGS LTD.", APART FROM THE MARK AS SHOWN.

CLASS 36—INSURANCE AND FINANCIAL

FOR COMMERCIAL REAL ESTATE SERVICES, NAMELY, COMMERCIAL REAL ESTATE DEVELOPMENT AND COMMERCIAL REAL ESTATE MANAGEMENT; PROVIDING FINANCIAL SERVICES, NAMELY, FINANCIAL PORTFOLIO MANAGEMENT, FINANCIAL INVESTMENT AND FINANCIAL RESEARCH (U.S. CLS. 100, 101 AND 102).

CLASS 37—CONSTRUCTION AND REPAIR

FOR RAILROAD MAINTENANCE SERVICES; CONSTRUCTION MANAGEMENT SERVICES (U.S. CLS. 100, 103 AND 106).

CLASS 39—TRANSPORTATION AND STORAGE

FOR OPERATION OF A GAS PIPELINE SYSTEM FOR THE TRANSPORTATION OF OIL (U.S. CLS. 100 AND 105).

CLASS 42—SCIENTIFIC, COMPUTER AND LEGAL SERVICES

FOR MINING SERVICES; OIL AND GAS EXPLORATION (U.S. CLS. 100 AND 101).

SN 76-324,142. DEGUSSA AG, 40474 DUESSELDORF, FED REP GERMANY, FILED 10-11-2001.

DEGUSSA.

OWNER OF FED REP GERMANY REG. NO. 30115836, DATED 7-11-2001, EXPIRES 3-31-2011.

CLASS 1—CHEMICALS

FOR PHOTOGRAPHIC CHEMICALS; CHEMICALS FOR USE IN THE MANUFACTURE OF ADHESIVES, PAPER, PLASTICS, RUBBER, TIRES, PHARMACEUTICALS, CATALYSTS, COSMETICS, PAINTS, FERTILIZERS, NUTRIENTS, ANIMAL FEEDSTUFFS, CERAMICS; CHEMICAL PREPARATIONS FOR THE IMPROVEMENT AND DECONTAMINATION OF SOIL, FOR SILAGE PREPARATIONS; PLASTIC MOLDING COMPOUNDS FOR USE IN PLASTIC PREPARATIONS; PLASTIC MOLDING COMPOUNDS FOR USE IN PLASTIC EXTRUSION OPERATIONS; UNSATURATED POLYESTER RESINS, POLYESTER ACRYLATES, HIGH SOLID POLYESTERS, POLYMERIZATION CATALYSTS FOR THE PLASTIC INDUSTRY; CHEMICAL PREPARATIONS FOR WOOD PRESERVATION; BLEACHING AND OXIDIZING AGENTS FOR THE PULP, PAPER AND TEXTILES; CHEMICAL ADDITIVES FOR RUBBER MIXTURES, CO-AGENTS FOR SYNTHETIC RUBBER VULCANIZATION; POLYSACCHARIDES FOR THE FOOD INDUSTRY; CHEMICAL SUBSTANCES FOR THE MANUFACTURE OF ANIMAL NUTRITION FEED; LYSINE, METHIONINE, THREONINE, NICOTINAMIDE, NICOTINIC ACID, CALCIUM FORMIATE; CHEMICAL PRODUCTS, NAMELY, CATALYSTS AND CATALYST SUPPORTS FOR USE IN THE PRODUCTION OF INDUSTRIAL CHEMICALS; PRECIOUS METAL CATALYSTS USED FOR ELECTROCHEMICAL REACTIONS IN FUEL CELLS; CATALYSTS AND CATALYTIC COATINGS FOR GENERATION AND PURIFICATION OF GASES, ESPECIALLY OF HYDROGEN-CONTAINING GASES IN STATIONARY FUEL CELL SYSTEMS AND FUEL-CELL-DRIVEN VEHICLES; CHEMICAL PRODUCTS FOR INDUSTRIAL USE, NAMELY, POLYMERIZATION CATALYSTS, AUXILIARIES FOR THE FIBER INDUSTRY AS WELL AS FIXERS IN THE PHOTO INDUSTRY; SILICA AND SILICATES AS SUPPORT FOR CATALYSTS AND FOR ACTIVE INGREDIENTS FOR USE IN THE MANUFACTURE OF SPECIALTY AND INTERMEDIATE CHEMICALS AND AS CATALYSTS FOR THE POLYMERIZATION OF OLEFINS FOR USE IN THE MANUFACTURE OF POLYOLEFINS IN THE PACKAGING, BUILDING AND TEXTILE INDUSTRIES; SILICA AND SILICATES AS SUPPORT FOR CATALYSTS AND ACTIVE INGREDIENTS AND AS A CATALYST FOR THE POLYMERIZATION OF OLEFINS FOR USE IN THE MANUFACTURE OF POLYETHYLENE, POLYPROPYLENE AND SPECIALTY CHEMICALS IN THE CHEMICAL, PETROCHEMICAL, PLASTICS, AND PHARMACEUTICAL INDUSTRIES; CHEMICAL PREPARATIONS, NAMELY, KNITTED MULTILAYER CATALYSTS IN GAUZE FORM MADE OF PRECIOUS METAL ALLOYS AND MIXED WITH CHEMICAL AGENTS FOR USE IN THE MANUFACTURE OF INDUSTRIAL CHEMICALS; FINELY DIVIDED SILICA, NAMELY, CATALYSTS FOR INDUSTRIAL USE, NAMELY, AS A FILLER FOR NATURAL AND SYNTHETIC RUBBERS FOR USE IN THE MANUFACTURE OF PLASTICS, ELASTOMERS AND RUBBER PRODUCTS; AS A THICKENING AGENT FOR LIQUID SYSTEMS FOR USE IN ORGANIC RESINS AND DEFOAMER FORMULATIONS; AS AN ADDITIVE TO IMPART FREE-FLOWING PROPERTIES TO POWDERS FOR USE IN THE CHEMICAL INDUSTRY AND IN MANUFACTURE OF ANIMAL FEED; AS A CARRIER AND ADSORBER FOR CATALYSTS FOR USE IN THE REFINING AND POLYMER INDUSTRY; CATA-

LYSTS AND CHELATES FOR THE PRODUCTION AND CLEANING OF GASES IN THE CHEMICAL AND AUTOMOTIVE INDUSTRY; EMISSION CONTROL CATALYSTS FOR INTERNAL COMBUSTION ENGINES, FOR POWER PLANTS AND FOR INDUSTRIAL EXHAUST GASES; CARBON BLACK FOR INDUSTRIAL PURPOSES FOR RUBBER, TIRE AND PLASTIC INDUSTRIES, HIGHLY DISPERSED METAL OXIDES, SILICAS AND SILICATES FOR FILLING MATERIALS AND ADDITIVES, IN PARTICULAR FOR NATURAL SYNTHETIC RUBBER AND SILICONE RUBBER AS WELL AS FOR PLASTICS, FOR PAPER, FOR PRINTING INKS, FOR PAINTS AND LACQUERS; THIXOTROPING AGENTS, SEDIMENTATION RETARDERS AND MATTING AGENTS AS CHEMICAL PREPARATIONS FOR INDUSTRIAL PURPOSES; CHEMICAL CARRIER SUBSTANCES FOR DETERGENTS AND ANIMAL FOODSTUFFS; CHEMICAL FILLING AND THICKENING AGENTS FOR COSMETICS AND PHARMACEUTICAL PRODUCTS; CHEMICAL SEALING AGENTS FOR ADHESIVES AND PUTTIES; CHEMICAL AGENTS, NAMELY, SILICA AND SILICA COMPOUNDS FOR MAKING SUBSTANCES FREE-FLOWING, MORE VISCOUS AND STREWABLE; CHEMICAL ANTI-ADHESIVES FOR PLASTIC FOILS SYNTHETIC RESINS AND UNPROCESSED PLASTIC MATERIALS, IN THE FORM OF POWDERS, LIQUIDS AND PASTES, FOR USE AS FILLING MATERIALS, ORTHOPEDIC RESINS FOR THE MANUFACTURE OF ARTIFICIAL LIMBS; CARBON BLACK FOR USE AS A FILLER IN THE MANUFACTURE OF NATURAL RUBBER, CARBON BLACK FOR USE AS A FILLER IN THE MANUFACTURE OF SYNTHETIC RUBBER AND PLASTICS (U.S. CLS. 1, 5, 6, 10, 26 AND 46).

CLASS 2—PAINTS

FOR PAINT FOR INTERIOR AND EXTERIOR USE; VARNISH; LACQUERS IN THE NATURE OF A COATING; RUST PRESERVATIVES IN THE NATURE OF A COATING; WOOD PRESERVATIVES; COLORANTS FOR USE IN THE MANUFACTURE OF CONCRETE, METAL, WOOD, GLASS, CERAMIC AND PLASTICS; ROAD MARKING PAINTS, PAINTS FOR USE ON SHIPS, POLYMER MASTER BATCHES, PIGMENT-PASTES AND DISPERSIONS, CERAMIC COLORS, GLASS COLORS, COLOR GLAZING, ORNAMENT ENAMELS, PRECIOUS METAL PREPARATIONS FOR THE DECORATION OF PORCELAIN, STONWARE, GLASS AND ENAMEL; MORDANT FOR USE IN METAL AND ELECTRONIC INDUSTRY; NATURAL RESINS FOR USE IN THE MANUFACTURE OF ADHESIVES AND TIRES; METALS IN FOIL AND POWDER FORM FOR PAINTERS, DECORATORS, AND ARTISTS (U.S. CLS. 6, 11 AND 16).

CLASS 3—COSMETICS AND CLEANING PREPARATIONS

FOR LAUNDRY BLEACH; LAUNDRY DETERGENTS; ALL PURPOSE CLEANING PREPARATIONS; SCOURING LIQUIDS; LIQUID SOAPS FOR HANDS, FACE AND BODY; HAND SOAP, DEODORANT SOAP, DISINFECTANT SOAP; PERFUME; COSMETICS, NAMELY, POWDERS, MAȘCARA AND ROUGE; HAIR LOTIONS; TOOTH PASTE, DENTIFRICES, ESSENTIAL OILS (U.S. CLS. 1, 4, 6, 50, 51 AND 52).

CLASS 4—LUBRICANTS AND FUELS

FOR INDUSTRIAL OILS, GENERAL PURPOSE GREASES; ALL PURPOSE AUTOMOTIVE, INDUSTRIAL LUBRICANTS; FUEL FOR MOTOR VEHICLES, NAMELY GASOLINE, DIESEL; DUST ABSORBING, WETTING AND BINDING COMPOSITIONS, FOR USE IN ROAD BUILDING, SWEEPING, DUSTLAYING (U.S. CLS. 1, 6 AND 15).

CLASS 5—PHARMACEUTICALS

FOR INFUSIONS CONTAINING AMINO ACIDS AND VITAMIN PREPARATIONS, DEODORIZERS FOR AIR, ROOM AND PLASTICS, DIETARY SUPPLEMENTS; ALL PURPOSE DISINFECTANTS; PREPARATIONS FOR DESTROYING VERMIN; AGRICULTURAL FUNGICIDES; AGRICULTURAL HERBICIDES; ANIMAL FEED ADDITIVE FOR USE AS A NUTRITIONAL SUPPLEMENT; BABY FOOD; MEDICAL PLASTERS; MATERIALS FOR DRESSINGS, NAMELY, GAUZE, WOUND, BURN AND SURGICAL DRESSINGS (U.S. CLS. 6, 18, 44, 46, 51 AND 52).

CLASS 6—METAL GOODS

FOR ALLOYS USED FOR CASTING; INGOTS OF COMMON METAL; METAL BUILDING FLASHING; METAL RAILWAY TIES; NON-ELECTRIC CABLES OF COMMON METAL; NON-ELECTRIC MULTI STRAND WIRES (U.S. CLS. 2, 12, 13, 14, 23, 25 AND 50).

CLASS 9—ELECTRICAL AND SCIENTIFIC APPARATUS

FOR COMPUTER PROGRAMS FOR USE IN DATA BASE MANAGEMENT AND FOR USE AS A SPREADSHEET; ELECTRICAL PARTS AND ELECTRICALLY DIRECTABLE LIQUIDS FOR LCD COMPUTER MONITORS; COMPUTERS, CALCULATING MACHINES, NAMELY CALCULATORS (U.S. CLS. 21, 23, 26, 36 AND 38).

CLASS 11—ENVIRONMENTAL CONTROL APPARATUS

FOR WATER FILTERING UNITS FOR DOMESTIC, COMMERCIAL AND INDUSTRIAL USE; WATER FOUNTAINS; SEPARATORS FOR THE CLEANING AND PURIFICATION OF AIR; SEPARATORS FOR THE CLEANING AND PURIFICATION OF GASES; WATER PURIFICATION UNITS (U.S. CLS. 13, 21, 23, 31 AND 34).

CLASS 17—RUBBER GOODS

FOR PLASTIC IN THE FORM OF BARS, BLOCKS, PELLETS, RODS, SHEETS AND TUBES FOR USE IN MANUFACTURING; PLASTIC PACKING FOR SHIPPING CONTAINERS; INSULATING FELT; INSULATING PLASTER; INSULATING SLEEVES FOR POWER LINES (U.S. CLS. 1, 5, 12, 13, 35 AND 50).

CLASS 19—NON-METALLIC BUILDING MATERIALS

FOR NON-METAL BUILDING MATERIALS, NAMELY, ACRYLIC, POLYCARBONATE, POLYVINYL AND POLYPROPYLENE SHEETS FOR ROOFING, CARPORTS, ROOM SEPARATIONS ELEMENTS, BALCONY AND RAILING PANELS, TERRACE ROOFS, CONSERVATORIES, GREEN HOUSES, SPORTS FACILITIES, INDUSTRIAL BUILDINGS; PRECAST POLYMER ELEMENTS AND ARTIFICIAL STONE AND MARBLE; COMPOSITIONS, NAMELY, GLASS GRANULES FOR ROAD MARKING AND INDUSTRIAL FLOORING; PLASTER; MORTAR, NON-METAL FLOORS; NON-METALLIC RIGID PIPES FOR BUILDINGS, NAMELY, COMPRESSED AIR PIPE FITTINGS, FLEXIBLE PIPES, AND PLASTIC PIPES (U.S. CLS. 1, 12, 33 AND 50).

CLASS 29—MEATS AND PROCESSED FOODS

FOR MEAT EXTRACT; PRESERVED, DRIED AND COOKED FRUITS AND VEGETABLES; JELLIES, JAMS, STEWED FRUIT, MILK AND MILK PRODUCTS, NAMELY, DAIRY PRODUCTS EXCLUDING ICE CREAM, ICE MILK AND FROZEN YOGURT; EDIBLE OILS AND FATS; SALAD DRESSINGS; FRUIT PECTIN (U.S. CL. 46).

CLASS 30—STAPLE FOODS

FOR COFFEE AND TEA; DECAFFEINATED COFFEE AND TEA; COCOA; SUGAR, YEAST; BAKING POWDER; SALT; MUSTARD; VINEGAR; SPICES; ICE; CONDIMENTS, NAMELY, BARBECUE SAUCE, CHILI SAUCE, HOT SAUCE, SOY SAUCE, CATSUP, MAYONNAISE; FOOD ADDITIVES FOR NON-NUTRITIONAL PURPOSES, FOR USE AS A FLAVORING INGREDIENT OR FILLER; BASIC INGREDIENTS AND PREPARATIONS FOR THE MEAT, FAT AND PICKLES PROCESSION AND FOR THE PRODUCTION OF READY-TO-SERVE MEALS; NATURAL SWEETENERS, BREAKFAST CEREAL, CEREAL BASED SNACK FOOD, PROCESSED CEREALS; READY TO EAT, CEREALS DERIVED FOOD BARS; FLAVORED ICES; SPICES; MIXTURES AND PREPARATIONS FOR THE BUTCHER, FAT AND COOKERY INDUSTRIES, NAMELY FOOD ADDITIVES FOR NON-NUTRITIONAL PURPOSES FOR USE AS A FLAVORING, INGREDIENT OR FILLER; FLAVORED AND SWEETENED GELATIN (U.S. CL. 46).

CLASS 31—NATURAL AGRICULTURAL PRODUCTS

FOR AGRICULTURAL SEEDS, LIVING PLANTS; FRESH FRUITS, UNPROCESSED FRUITS; FRESH VEGETABLES; UNPROCESSED VEGETABLES; ANIMAL FEED; ANIMAL FOODSTUFFS; UNPROCESSED CEREALS (U.S. CLS. 1 AND 46).

CLASS 32—LIGHT BEVERAGES

FOR FRUIT DRINKS AND JUICES; NON-ALCOHOLIC FRUIT EXTRACTS USED IN THE PREPARATION OF FOOD AND BEVERAGES; SYRUPS AND OTHER PREPARATIONS FOR MAKING BEVERAGES, PARTICULARLY FRUIT DRINKS, EXTRACTS OF HOPS FOR MAKING BEER (U.S. CLS. 45, 46 AND 48).

CLASS 33—WINES AND SPIRITS

FOR FLAVORING ADDITIVES FOR NON-NUTRITIONAL PURPOSES SOLD AS AN INTEGRAL COMPONENT OF ALCOHOLIC BEVERAGES; HOP EXTRACTS FOR ALCOHOLIC BEVERAGES (U.S. CLS. 47 AND 49).

CLASS 34—SMOKERS' ARTICLES

FOR TEXTURANTS, AROMAS, FLAVORING ADDITIVES FOR NON-NUTRITIONAL PURPOSES SOLD AS AN INTEGRAL COMPONENT OF TOBACCO (U.S. CLS. 2, 8, 9 AND 17).

CLASS 35—ADVERTISING AND BUSINESS

FOR ADVERTISING AGENCIES, NAMELY, PROMOTING THE SERVICES OF OTHERS THROUGH THE DISTRIBUTION OF PRINTED AND AUDIO PROMOTIONAL MATERIAL AND BY RENDERING SALES PROMOTION ADVICE; PLACING ADVERTISEMENT FOR OTHERS; PREPARING ADVERTISEMENTS FOR OTHERS; BUSINESS MANAGEMENT, BUSINESS MANAGEMENT SUPERVISION; BUSINESS MANAGEMENT PLANNING; BUSINESS MANAGEMENT CONSULTATION; BUSINESS ADMINISTRATION, BUSINESS CONSULTING, NAMELY, ORGANIZATIONAL ASSISTANCE FOR THE FOUNDATION OF NEW FIRMS (U.S. CLS. 100, 101 AND 102).

CLASS 40—MATERIAL TREATMENT

FOR METAL TREATMENT; WASTE TREATMENT; WATER TREATMENT; SOIL TREATMENT AND PAPER TREATMENT (U.S. CLS. 100, 103 AND 106).

CLASS 42—SCIENTIFIC, COMPUTER AND LEGAL SERVICES

FOR FOOD PREPARATION; RESTAURANTS; BAR SERVICES; SALAD BARS, SNACK BARS, PROVIDING TEMPORARY HOUSING ACCOMMODATIONS; HOTELS; MOTELS; HEALTH CARE; COSMETICIAN SERVICES; VETERINARY SERVICES; AGRICULTURAL ADVICE; VERMIN EXTERMINATION FOR AGRICULTURE; SCIENTIFIC RESEARCH; LABORATORY RESEARCH IN CHEMISTRY; COMPUTER PROGRAMMING FOR OTHERS; CHEMIST SERVICES; CHEMICAL ANALYSIS; CHEMICAL LABORATORIES (U.S. CLS. 100 AND 101).

SN 76-326,275. JAM MUSICAL INDUSTRIES, MEDFORD, NJ. FILED 10-17-2001.

RADIOTAKEOVER**CLASS 35—ADVERTISING AND BUSINESS**

FOR MANAGEMENT OF PERFORMING AND RECORDING ARTISTS, GROUPS, AND BANDS; PROMOTING THE CONCERTS OF OTHERS; PROMOTING THE MUSICAL SOUND RECORDINGS OF OTHERS; PROMOTING THE SALE OF GOODS AND SERVICES OF MUSICAL PERFORMING AND RECORDING ARTISTS, GROUPS, AND BANDS THROUGH THE DISSEMINATION OF ADVERTISING MATTER; CREATION OF PROMOTIONAL PRODUCTS AND ADVERTISING MATERIALS FOR MUSICIANS AND MUSICAL ACTS AND OTHER ARTISTIC OR MUSICAL PERFORMERS (U.S. CLS. 100, 101 AND 102).

FIRST USE 11-23-1999; IN COMMERCE 11-23-1999.

CLASS 38—COMMUNICATION

FOR TRANSMISSION OF LIVE MUSIC AND SOUND RECORDINGS OVER A GLOBAL COMPUTER NETWORK (U.S. CLS. 100, 101 AND 104).

FIRST USE 11-23-1999; IN COMMERCE 11-23-1999.

SN 76-326,680. VERITE MULTIMEDIA, INC., DRAPER, UT. FILED 10-17-2001.



NO CLAIM IS MADE TO THE EXCLUSIVE RIGHT TO USE "INC.", APART FROM THE MARK AS SHOWN.

CLASS 35—ADVERTISING AND BUSINESS

FOR PREPARING ADVERTISEMENTS, PROMOTIONAL MATERIALS AND AUDIO VISUAL PRESENTATIONS FOR USE IN ADVERTISING FOR OTHERS; BUSINESS MARKETING CONSULTING SERVICES; PRODUCTION OF PRINT, FILM, RADIO AND TELEVISION COMMERCIALS FOR OTHERS; DEVELOPING PROMOTIONAL CAMPAIGNS FOR BUSINESS; DESIGNING AND PREPARING MULTIMEDIA PROMOTIONAL AND MARKETING MATERIALS FOR OTHERS; BUSINESS MARKETING CONSULTING SERVICES (U.S. CLS. 100, 101 AND 102).

FIRST USE 2-0-1999; IN COMMERCE 2-0-1999.

CLASS 42—SCIENTIFIC, COMPUTER AND LEGAL SERVICES

FOR PROVIDING ON-LINE ACCESS TO AND CUSTOM DEVELOPMENT OF COMPUTER SOFTWARE FOR REGISTERING AND ENROLLING PARTICIPANTS VIA THE INTERNET FOR SEMINARS, BUSINESS EVENTS, PRODUCT REGISTRATION LISTS, CONTESTS AND SURVEYS, COMPUTER SOFTWARE FOR ADMINISTERING AND SCORING TESTS AND CERTIFICATION EXAMINATIONS VIA THE INTERNET, COMPUTER SOFTWARE APPLICATIONS ENABLING USERS TO MODIFY AND MAINTAIN BUSINESS WEB SITES ON THE INTERNET, AND E-COMMERCE SOFTWARE ENABLING THIRD PARTIES TO SELL GOODS AND PERFORM ELECTRONIC BUSINESS TRANSACTIONS VIA THE INTERNET; DEVELOPING, HOSTING AND MAINTAINING WEB SITES FOR OTHERS; GRAPHIC AND INTERACTIVE MULTIMEDIA DESIGN SERVICES FOR OTHERS; DESIGN OF MULTIMEDIA MARKETING COMMUNICATIONS FOR OTHERS FOR DISSEMINATION BY VIDEOS, COMPACT DISCS, AND ON COMPUTERS VIA THE INTERNET, DESIGN OF LOGOS, TRADEMARKS AND SERVICE MARKS, BUSINESS CARDS AND LETTERHEAD FOR OTHERS (U.S. CLS. 100 AND 101).

FIRST USE 2-0-1999; IN COMMERCE 2-0-1999.

SN 76-330,525. PATEL, PRAVINBHAI RAMBHAI, AHMEDABAD GUJARAT, INDIA, FILED 10-22-2001.



SN 76-330,007. FLINT HILLS RESOURCES, LP, WICHITA, KS. BY CHANGE OF NAME KOCH PETROLEUM GROUP, L.P., WICHITA, KS. FILED 10-26-2001.

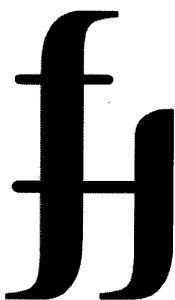

THE ENGLISH TRANSLATION OF "PARTH" IS "ARJUN (A HINDU NAME)".

CLASS 1—CHEMICALS

FOR PETROCHEMICALS FOR USE IN THE MANUFACTURE OF LUBRICANTS, ELECTRICAL FLUIDS AND FUELS; CHEMICALS USED AS BASE OILS OR ADDITIVES FOR USE IN THE MANUFACTURE OF LUBRICANTS, ELECTRICAL FLUIDS AND OILS (U.S. CLS. 1, 5, 6, 10, 26 AND 46).

CLASS 4—LUBRICANTS AND FUELS

FOR REFINED PETROLEUM PRODUCTS, NAMELY, GASOLINE, AVIATION FUEL, DIESEL FUEL, JET FUEL, RACING FUEL, KEROSENE, HEATING OIL, FUEL OIL, PETROLEUM COKE, VACUUM GAS OIL, NAPHTHA AND OTHER GASOLINE BLEND STOCKS (U.S. CLS. 1, 6 AND 15).

CLASS 19—NON-METALLIC BUILDING MATERIALS

FOR ASPHALT (U.S. CLS. 1, 12, 33 AND 50).

CLASS 40—MATERIAL TREATMENT

FOR FUEL REFINING SERVICES (U.S. CLS. 100, 103 AND 106).

CLASS 29—MEATS AND PROCESSED FOODS

FOR PRESERVED, DRIED AND COOKED FRUITS AND VEGETABLES, EDIBLE OIL AND FATS, DAIRY PRODUCTS, NAMELY, MILK POWDER, MILK, BUTTERMILK, GHEE, CURD, YOGURT, CHEESE, COTTAGE CHEESE, FRUIT SAUCES, MEAT EXTRACTS, MEAT, FISH, POULTRY, JELLIES, JAMS (U.S. CL. 46).

CLASS 30—STAPLE FOODS

FOR TEA, COCOA, SUGAR, RICE, GRAIN AND CHICORY BASED COFFEE SUBSTITUTES, FLOURS AND PREPARATION MADE FROM CEREALS, NAMELY, FLOUR MIXES FOR PREPARING SNACKS, SWEETS AND INDIAN FOODS, NAMELY, GOTA INSTANT MIX, KHAMAN INSTANT MIX, DALWADA INSTANT MIX, DHOKLA INSTANT MIX, DOSA INSTANT MIX, GULAB JAMUN INSTANT MIX, PIZZA INSTANT MIX, MATHIA INSTANT MIX, FAFDA INSTANT MIX, JALEBI INSTANT MIX, LADOO INSTANT MIX, BREAD, BISCUIT, CAKES, PASTRY AND CONFECTIONARY, NAMELY, INDIAN SWEETS SUGAR CANDIES, HONEY, TREACLE, YEAST, BAKING POWDER, SALT, MUSTARD, PEPPER, SAUCES AND SPICES OF IN POWDER FORM OR NON-POWDERED FORM, NAMELY, SPICE MIXTURES OF ONE OR MORE SPICES POWDERED OR OTHERWISE, RICE (U.S. CL. 46).

CLASS 31—NATURAL AGRICULTURAL PRODUCTS

FOR AGRICULTURAL, HORTICULTURAL AND FORESTRY PRODUCTS AND GRAINS, NAMELY UNPROCESSED WHEAT, UNPROCESSED BARLEY, UNPROCESSED PULSES, UNPROCESSED OAT, UNPROCESSED MAIZE CEREALS, LIVE ANIMALS, FRESH FRUITS AND VEGETABLES, SEEDS OF SPICES, OILS, BIRDS, FRESH GRASS, NATURAL PLANTS AND FLOWERS, FOODS STUFFS FOR ANIMALS (U.S. CLS. 1 AND 46).

SN 76-340,686. I-FLEX SOLUTIONS LIMITED, MAHARASHTRA, INDIA, FILED 11-21-2001.

PrimeSourcing

CLASS 9—ELECTRICAL AND SCIENTIFIC APPARATUS

FOR COMPUTER SOFTWARE FOR USE IN COLLECTING, INTEGRATING, AND ANALYZING FINANCIAL DATA, ALLOWING ACCESS TO BANKING AND INVESTMENT ACCOUNTS AND INSURANCE PROGRAMS, CONDUCTING BANKING AND FINANCIAL TRANSACTIONS AND ACCESSING FINANCIAL INFORMATION, BANKING RECORDS AND SERVICES OVER COMPUTER AND COMMUNICATION NETWORKS; COMPUTER E-COMMERCE SOFTWARE, NAMELY, APPLICATION SOFTWARE, DATABASE MANAGEMENT SOFTWARE, AND SOFTWARE ENGINEERING KNOWLEDGE MANAGEMENT PROGRAMS, TO ALLOW USERS TO PERFORM ELECTRONIC BUSINESS TRANSACTIONS VIA A GLOBAL COMPUTER NETWORK (U.S. CLS. 21, 23, 26, 36 AND 38).

CLASS 36—INSURANCE AND FINANCIAL

FOR FINANCIAL, BANKING AND INSURANCE CONSULTATION; E-COMMERCE CONSULTATION IN THE BANKING AND FINANCE INDUSTRIES (U.S. CLS. 100, 101 AND 102).

CLASS 42—SCIENTIFIC, COMPUTER AND LEGAL SERVICES

FOR INFORMATION TECHNOLOGY AND INTERNET CONSULTATION (U.S. CLS. 100 AND 101).

SN 76-342,559. LIPHA, LYON, FRANCE, FILED 11-28-2001.

GLUCOCHOICE

PRIORITY CLAIMED UNDER SEC. 44(D) ON FRANCE APPLICATION NO. 013109352, FILED 7-3-2001, REG. NO. 013109352, DATED 7-3-2001, EXPIRES 7-3-2011.

CLASS 3—COSMETICS AND CLEANING PREPARATIONS

FOR SKIN AND BODY SOAP; PERFUME; ESSENTIAL OILS FOR PERSONAL USE; COSMETICS; HAIR LOTIONS; DENTIFRICES (U.S. CLS. 1, 4, 6, 50, 51 AND 52).

CLASS 5—PHARMACEUTICALS

FOR NUTRACEUTICALS AND PHARMACEUTICALS PREPARATIONS FOR PREVENTION AND TREATMENT OF DIABETES AND COMPLICATIONS THEREOF; FOOD SUPPLEMENTS; DIETETIC PRODUCTS FOR MEDICINAL PURPOSES, NAMELY, FOOD AND HERBAL SUPPLEMENTS; MEDICAL PREPARATIONS FOR SLIMMING, NAMELY, DIET PILLS; MEDICINAL HERBS AND OILS FOR MEDICAL PURPOSES, MEDICINAL INFUSIONS IN THE NATURE OF MEDICINAL HERBS; SUGAR REPLACEMENTS FOR MEDICAL PURPOSES; DIETETIC, LOW CALORIE AND SUGAR-FREE FOODS FOR MEDICALLY RESTRICTED AND DIABETIC DIETS; NUTRACEUTICALS AND PHARMACEUTICALS FOR THE CARE, HYGIENE, PROTECTION AND TREATMENT OF IRRITATED, INFLAMED AND SQUAMOUS SKINS, AND SEBORRHEIC DERMATITIS, SENSITIVE, GREASY OR DRY SKINS, ACNE PRONE SKIN, PSORIASIS AND COMPLICATIONS THEREOF; NUTRACEUTICALS AND PHARMACEUTICALS FOR THE TREATMENT OF THE HAIR AND OF THE SCALP,

NAMELY, HAIR OIL, HAIR REMEDIES, HAIR PRESERVATION TREATMENT, DANDRUFF CREAM, HAIR GEL, HAIR LOTION, HAIR REMEDIES, HAIR PRESERVATION TREATMENT DANDRUFF CREAM, HAIR GEL, HAIR LOTION, HAIR MOUSSE, HAIR CONDITIONER, HAIR TONIC, HAIR MOISTURIZER, HAIR CREAM AND SHAMPOOS; PHARMACEUTICAL AND NUTRACEUTICAL PREPARATIONS FOR REDUCTION OF PIGMENTARY MARKS OF THE SKIN; PHARMACEUTICAL AND NUTRACEUTICAL PREPARATIONS FOR ANTI-SKIN AGING; MEDICATED SKIN CREAMS; PHARMACEUTICAL, NUTRACEUTICAL AND MEDICAL PREPARATIONS FOR SLIMMING PURPOSES, NAMELY DIETARY SUPPLEMENTS, NUTRITIONAL SUPPLEMENTS, FOOD SUPPLEMENTS, DIETARY DRINK MIX FOR USE AS A MEAL REPLACEMENT, NUTRITIONAL DIETARY SUPPLEMENTS USEFUL FOR WEIGHT CONTROL, NUTRITIONAL DIETARY SUPPLEMENTS USEFUL FOR GLUCOSE LEVEL CONTROL, WEIGHT CONTROL PREPARATIONS, NAMELY VITAMIN AND MINERAL SUPPLEMENTS, VITAMIN SUPPLEMENTS, ORAL AND TOPICAL APPLICATIONS IN LIQUID, OINTMENT, GEL, CREAM, LOTION, TINCTURE, AEROSOL, TABLET, CAPSULE AND POWDER FORM FOR USE AS PHARMACEUTICALS FOR SLIMMING AND WEIGHT LOSS; DIETARY, AND NUTRITIONAL SUPPLEMENTS, GLUCOSE BALANCING DIETARY AND NUTRITIONAL SUPPLEMENTS; PHARMACEUTICAL AND NUTRACEUTICAL PREPARATIONS FOR SKIN CARE; FOR EPIDERMIS DISORDERS, FOR BLOOD DISORDERS, FOR RESPIRATORY ORGAN DISORDERS, NAMELY, PREVENTION AND TREATMENT OF ASTHMA, CHRONIC OBSTRUCTIVE PULMONARY DISEASE, BRONCHITIS AND OTHER RESPIRATORY AILMENTS, AND FOR THE RELIEF OF BRONCHOSPASMS; ANTIBIOTICS; PHARMACEUTICALS TO LOWER BLOOD GLUCOSE LEVELS AND FOR PREVENTION AND TREATMENT OF DIABETES AND COMPLICATIONS THEREOF; VITAMIN PREPARATIONS; PHARMACEUTICAL AGENTS FOR ACTIVATING CELLULAR FUNCTIONING; ANTI-INFLAMMATORY PHARMACEUTICALS AGENTS; PHARMACEUTICAL AGENTS FOR DIGESTIVE ORGANS; PHARMACEUTICALS, NAMELY DRUGS FOR CIRCULATORY ORGANS; CEREBRAL AND PERIPHERAL ANTI-ISCHEMIC DRUGS, PHARMACEUTICAL FOR THE PREVENTION AND TREATMENT OF HYPERTENSION, ANGINA PECTORIS AND ACUTE MYOCARDIAL INFARCTION; DRUGS FOR ALLERGIES, DRUGS FOR CENTRAL AND PERIPHERAL NERVOUS SYSTEM DISORDERS; ANALGESICS, SOPORIFICS, TRANQUILIZERS; DRUGS FOR THE PREVENTION AND TREATMENT OF ANXIETY DISORDERS, OF INSOMNIA; TUMOR SUPPRESSING PHARMACEUTICAL AGENTS; PHARMACEUTICAL PREPARATION IN THE NATURE OF DIGESTIVE AIDS, DRUGS FOR THE PREVENTION AND TREATMENT OF OSTEOARTHRITIS AND RHEUMATOID ARTHRITIS, ALL PURPOSE DISINFECTANTS FOR HYGIENE PURPOSES, MEDICATED BATH PREPARATIONS, NAMELY BATH SALTS; MEDICATED POMADES; FOOD FOR BABIES; MEDICAL PLASTERS; WOUND DRESSING; DENTAL WAX; ALL PURPOSE DISINFECTANTS; HERBAL TEAS FOR MEDICINAL PURPOSES (U.S. CLS. 6, 18, 44, 46, 51 AND 52).

CLASS 10—MEDICAL APPARATUS

FOR SURGICAL APPARATUS AND INSTRUMENTS, NAMELY, SCALPELS, BLADES, STAPLERS, KNIVES FOR SURGICAL PURPOSES, SPLINTS, CAPS, CLIPS, COMPRESSES, COMPRESSORS, CUTLERY, DRAPES, GLOVES GOWNS; SURGICAL INSTRUMENTS FOR USE IN ORTHOPEDIC, NEUROLOGICAL, VASCULAR, THORACIC, AND GASTROINTESTINAL SURGERY; MEDICAL APPARATUS AND INSTRUMENTS, NAMELY, AIR PILLOWS FOR MEDICAL USE, AUTOCLAVES FOR MEDICAL USE, BREATH GAS ANALYZERS FOR MEDICAL DIAGNOSIS; DRAINAGE TUBES FOR MEDICAL PURPOSES; ELECTROMAGNETIC MEDICAL DIAGNOSTIC IMAGERY APPARATUS; FORCEPS FOR MEDICAL USE; LASERS FOR MEDICAL USE; MEDICAL APPARATUS FOR DIAGNOSING SUS-

PECTED HEART ATTACKS; CARBON DIOXIDE INDICATORS; MEDICAL ELECTRODES; RADIOLOGICAL APPARATUS FOR MEDICAL PURPOSES; VETERINARY APPARATUS AND INSTRUMENTS, NAMELY, SCALPELS, CLIPS, CUTLERY, LAMPS, SYRINGES USED FOR INJECTING FLUID VACCINES; ARTIFICIAL LIMBS, EYES AND TEETH; ORTHOPEDIC ARTICLES, NAMELY, ORTHOPEDIC BELTS, BRACES, FOOTWEAR, SOLES, JOINT IMPLANTS, SUPPORT BANDAGES; ORTHOPEDIC SUPPORTS; PLASTER CASTS FOR ORTHOPEDIC PURPOSES, ORTHOPEDIC SPLINTS; SUTURE MATERIALS (U.S. CLS. 26, 39 AND 44).

SN 76-342,717. TIME ART DEVELOPMENT LIMITED, KOWLOON, HONG KONG, FILED 11-28-2001.

URBAN MYTH

CLASS 3—COSMETICS AND CLEANING PREPARATIONS

FOR LAUNDRY BLEACH, LAUNDRY DETERGENT, LAUNDRY PRE-SOAK; GENERAL PURPOSE CLEANING, POLISHING, AND ABRASIVE LIQUIDS, GENERAL PURPOSE SCOURING POWDERS; ESSENTIAL OILS FOR PERSONAL USE, HAIR LOTIONS; DENTIFRICES; COSMETICS, LIPSTICKS, LIP GLOSS, LIP LINERS, BLUSHERS, EYE SHADOWS, EYEBROW PENCILS, EYELINER PENCILS, MASCARA, POWDER FOUNDATIONS, BASES FOR MAKE-UP, LIQUID FOUNDATIONS; MAKE-UP POWDERS, MAKE-UP FOUNDATIONS, MAKE-UP REMOVING PREPARATIONS, SUN TAN COSMETICS, COSMETICS PREPARATIONS FOR SKIN AND BODY, NAIL CARE PREPARATIONS, NAIL POLISH, NAIL POLISH REMOVERS, FALSE EYELASHES, FALSE NAILS, COTTON BUDS AND COTTON WOOL FOR COSMETIC PURPOSES, COSMETIC SOAPS, COSMETIC BATHING ADDITIVES AND PREPARATIONS FOR THE BATH, NAMELY, BATH SALTS AND BATHING GELS, COSMETIC KITS COMPOSED PRIMARILY OF THE AFORESAID COSMETIC ITEMS; LOTIONS, SKIN TONERS, MILKY LOTIONS, FACIAL CREAMS, SKIN-WHITENING CREAMS, EYE GELS, EYE CREAMS, EXFOLIATING CREAMS, BEAUTY MASKS, FACIAL SCRUBS, SKIN MOISTURIZERS, MOISTURIZING GELS AND ESSENTIAL OILS FOR THE SKIN; TOILETRIES, NAMELY, TISSUE IMPREGNATED WITH COSMETIC LOTIONS, FACIAL CLEANSING PREPARATIONS FOR TOILETRY PURPOSES, TOILET WATER, HAIR CARE PREPARATIONS, HAIR SHAMPOOS, HAIR RINSES, HAIR SPRAYS, HAIR CREAMS, HAIR GEL, SKIN SOAPS, SHOWER GELS, HAND WASHING LOTIONS, BATH OILS; PERFUMERY, NAMELY, PERFUMES, EAU DE COLOGNES, AFTER SHAVE PREPARATIONS, AFTER SHAVE LOTIONS, SHAVING SOAP, SHAVING GELS, SHAVING CREAMS, PERSONAL DEODORANT, ANTIPERSPIRANTS, SUN TANNING PREPARATIONS, SUN BLOCK (U.S. CLS. 1, 4, 6, 50, 51 AND 52).

CLASS 29—MEATS AND PROCESSED FOODS

FOR MEAT, FISH, POULTRY AND GAME; MEAT EXTRACTS; PRESERVED, DRIED AND COOKED FRUITS AND VEGETABLES; JELLIES, JAMS, FRUIT SAUCES; EGGS, MILK, YOGURT, MILK-BASED BEVERAGES; EDIBLE OILS AND FATS; DIETETIC FOOD PACKAGE COMBINATIONS CONSISTING PRIMARILY OF MEAT, FISH, POULTRY AND GAME; DRIED AND COOKED FRUITS AND VEGETABLES; DIETETIC EDIBLE OILS AND FATS, FRUIT PRESERVES (U.S. CL. 46).

CLASS 14—JEWELRY

FOR RINGS, EARRINGS, NECKLACES, BRACELETS, BROOCHES, PINS, TIE CLIPS, TIE PINS, ALL THE FOREGOING OF PRECIOUS METAL AND STONES; TIME PIECES, NAMELY, CLOCKS, WATCHES AND CHRONOGRAPHS FOR USE AS WATCHES, WATCH BANDS, WATCH CHAINS, WRIST WATCHES, STOP WATCHES; JEWELRY, COSTUME JEWELRY, COSTUME JEWELRY; JEWELRY OF IMITATION GOLD AND SILVER; JEWELRY OF DIAMONDS, PEARLS, STERLING SILVER, GOLD AND SILVER, PRECIOUS METAL, PRECIOUS STONES, PLATINUM, SEMI-PRECIOUS STONES; JEWELRY CASES OF PRECIOUS METAL; VASES OF PRECIOUS METAL (U.S. CLS. 2, 27, 28 AND 50).

CLASS 30—STAPLE FOODS

FOR COFFEE, TEA, COCOA, SUGAR, RICE, TAPIOCA, SAGO, ARTIFICIAL COFFEE; FLOUR, BREAD, HONEY, TREACLE; YEAST, BAKING POWDER; SALT, MUSTARD; VINEGAR, SAUCES; SPICES AND ICE; BREAKFAST CEREALS, CEREAL BASED SNACK FOOD, PROCESSED CEREALS, READY TO EAT, CEREAL DERIVED FOOD BARS; PASTRIES; FLAVORED ICES OR FRUIT ICE; CONFECTIONERY, NAMELY, FROZEN CONFECTIONS, CANDY, CONFECTIONERY CANDY FOR BAKING; SAUCES, NAMELY, TOMATO SAUCES, BARBECUE SAUCES, CHEESE SAUCE, CHILI SAUCE, HOT SAUCE; DIETETIC PRODUCTS, NAMELY, DIETARY RICE CAKES, DIETARY COFFEE-BASED BEVERAGES CONTAINING MILK; DIETARY COCOA MIXES; DIETARY TAPIOCA; DIETARY WHEAT GERM (U.S. CL. 46).

CLASS 18—LEATHER GOODS

FOR WRIST-MOUNTING PURSES; LEATHER AND IMITATION LEATHER SOLD IN BULK; ANIMAL SKINS, ANIMAL HIDES; TRUNKS AND TRAVELING BAGS; UMBRELLAS, PARASOLS, AND WALKING STICKS; WHIPS, HARNESS AND SADDLERY; DUFFEL BAGS, ALL-PURPOSE BAGS, WALLETS, BUSINESS CARD CASES; MESH SHOPPING BAGS, COSMETIC BAGS SOLD EMPTY; LEATHER BAGS, LEATHER WALLETS, LEATHER BUSINESS CARDS CASES; LEATHER SHOPPING BAGS, LEATHER COSMETIC BAGS SOLD EMPTY, LEATHER TRAVEL BAGS (U.S. CLS. 1, 2, 3, 22 AND 41).

CLASS 24—FABRICS

FOR BED COVERINGS AND BED LINEN, NAMELY, COTTON BED BLANKETS, WOOL BED BLANKETS, BED SPREADS, BED SHEETS, BED QUILTS; PILLOW SHAMS, PILLOW SLIPS, PILLOW COVERS, PILLOW CASES; DUVET COVERS; TABLE COVERS, NAMELY, TABLE LINEN, TABLE CLOTHS NOT OF PAPER, TABLE MATS NOT OF PAPER, TABLE LINEN, NAMELY, TABLE MATS AND TABLE NAPKINS (U.S. CLS. 42 AND 50).

CLASS 25—CLOTHING

FOR CLOTHING FOR WOMEN, NAMELY, T-SHIRTS, SKIRTS, PANTS, SHORTS, SHIRTS, DRESSES, JACKETS, VESTS, COATS, SCARVES, HATS, BRASSIERES, PANTIES, HOSIERY, PAJAMAS, BATHROBES; CLOTHING FOR MEN, NAMELY, T-SHIRTS, PANTS, SHORTS, SHIRTS, JACKETS, VESTS, COATS, SCARVES, HATS, PAJAMAS, BATHROBES, UNDERWEAR; FOOTWEAR FOR MEN AND WOMEN; HEAD WEAR (U.S. CLS. 22 AND 39).

CLASS 35—ADVERTISING AND BUSINESS

FOR ADVERTISING SERVICES FOR OTHERS; BUSINESS MANAGEMENT; BUSINESS ADMINISTRATION; COMPUTERIZED FILE MANAGEMENT; WORD PROCESSING; RETAIL AND WHOLESALE STORE SERVICES ALL IN THE FIELDS OF CLOTHING, FOOTWEAR, EYEWEAR, TEXTILE, TEXTILE GOODS, BED AND TABLE COVERS, BAGS, WALLETS, CARD CASES, HANDBAGS, TRAVEL BAGS MADE OF LEATHER, TRAVEL BAGS MADE OF IMITATION LEATHER, COSTUME JEWELRY, TIME PIECES, BOOKS, MAGAZINES, STATIONERY, ANTIQUES, OBJECTS OF ART, FURNITURE AND ANTIQUE FURNITURE, COSMETICS, PERFUMES, COLOGNES, HAIR CARE ITEMS, EYE CARE ITEMS, SKIN CARE ITEMS, PERSONAL CARE ITEMS, HOUSEHOLD PRODUCTS, ARTICLES OF GLASSWARE, FOOD AND DRINKS, ALCOHOLIC AND NONALCOHOLIC DRINKS, HEALTH FOOD AND SNACKS; PROCUREMENT FOR OTHERS, NAMELY PURCHASING CLOTHING, FOOTWEAR, EYEWEAR, TEXTILES, TEXTILE GOODS, BED AND TABLE COVERS, BAGS, WALLETS, CARD CASES, HANDBAGS, TRAVEL BAGS MADE OF LEATHER, TRAVEL BAGS MADE OF IMITATION LEATHER, COSTUME JEWELRY, TIME PIECES, BOOKS, MAGAZINES, STATIONERY, ANTIQUES, OBJECTS OF ART, FURNITURE AND ANTIQUE FURNITURE, COSMETICS, PERFUMES, COLOGNES, HAIR CARE ITEMS, EYE CARE ITEMS, SKIN CARE ITEMS, PERSONAL CARE ITEMS, HOUSEHOLD PRODUCTS, ARTICLES OF GLASS WARE, FOOD AND DRINKS, ALCOHOLIC AND NONALCOHOLIC DRINKS, HEALTH FOOD AND SNACKS; IMPORT AND EXPORT AGENCY (U.S. CLS. 100, 101 AND 102).

SN 76-342,994. OMS INVESTMENTS, INC., WILMINGTON, DE. FILED 11-29-2001.

MAKE YOUR OWN MIRACLES

OWNER OF U.S. REG. NOS. 668,868, 2,345,472 AND OTHERS.

CLASS 1—CHEMICALS

FOR LAWN AND GARDEN FERTILIZER FOR DOMESTIC USE; PLANT FOOD; FERTILIZER IN THE FORM OF SPIKES FOR HOUSEPLANTS, OUTDOOR PLANTS, TREES, AND SHRUBBERY FOR DOMESTIC USE; PEAT FERTILIZER; COMPOSTS; HUMUS; LOAM; MANURE; POTTING SOIL, SOIL CONDITIONERS, SOIL AMENDMENTS, GROWING MEDIA FOR PLANTS, ALL FOR DOMESTIC USE (U.S. CLS. 1, 5, 6, 10, 26 AND 46).

CLASS 5—PHARMACEUTICALS

FOR HERBICIDES FOR DOMESTIC USE (U.S. CLS. 6, 18, 44, 46, 51 AND 52).

CLASS 7—MACHINERY

FOR MECHANICAL SPREADERS FOR SEED AND DRY LAWN CHEMICALS (U.S. CLS. 13, 19, 21, 23, 31, 34 AND 35).

CLASS 21—HOUSEWARES AND GLASS

FOR FERTILIZER MIXERS AND SPRAYERS ATTACHED TO GARDEN HOSES (U.S. CLS. 2, 13, 23, 29, 30, 33, 40 AND 50).

CLASS 31—NATURAL AGRICULTURAL PRODUCTS

FOR FLOWER, VEGETABLE, PLANT AND GRASS SEEDS; LIVING PLANTS (U.S. CLS. 1 AND 46).

CLASS 42—SCIENTIFIC, COMPUTER AND LEGAL SERVICES

FOR PROVIDING INFORMATION VIA THE INTERNET ON LAWN CARE AND LANDSCAPE GARDENING, INCLUDING HOW TO USE AND APPLY FERTILIZERS, HERBICIDES, FUNGICIDES, INSECTICIDES, GRASS SEED, FLOWER SEED, GARDEN SEEDS, PLANT FOOD, POTTING SOIL, SOIL, SOIL CONDITIONERS AND AMENDMENTS AND GROUND COVER; PROVIDING INFORMATION VIA THE INTERNET ON THE USE OF EQUIPMENT FOR THE LAWN AND GARDEN; PROVIDING ADVICE AND INFORMATION VIA THE INTERNET ON FLOWERS AND THEIR CARE (U.S. CLS. 100 AND 101).

SN 76-347,058. HALLIBURTON ENERGY SERVICES, INC., CARROLLTON, TX. FILED 9-28-2001.

INSITE ANYWHERE

OWNER OF U.S. REG. NOS. 2,354,358, 2,621,210 AND OTHERS.

CLASS 38—COMMUNICATION

FOR ELECTRONIC TRANSMISSION AND RETRIEVAL OF DATA DRILLING INFORMATION FOR THE ONSHORE AND OFFSHORE OIL AND GAS INDUSTRY (U.S. CLS. 100, 101 AND 104).
FIRST USE 8-31-1996; IN COMMERCE 8-31-1996.

CLASS 42—SCIENTIFIC, COMPUTER AND LEGAL SERVICES

FOR ON-LINE DATABASE ON GLOBAL COMPUTER NETWORKS AND INTRANETS FEATURING DRILLING INFORMATION FOR THE ONSHORE AND OFFSHORE OIL AND GAS INDUSTRY (U.S. CLS. 100 AND 101).
FIRST USE 8-31-1996; IN COMMERCE 8-31-1996.

SN 76-347,145. DEUTSCHE MESSE AG, D-30521 HANNOVER, FED REP GERMANY, FILED 12-11-2001.

SN 76-349,846. MEDALLIST MARINE, LLC, JUPITER, FL. FILED 12-18-2001.

CeMAT



OWNER OF FED REP GERMANY REG. NO. 1,017,069, DATED 4-23-1981, EXPIRES 3-31-2011.
OWNER OF U.S. REG. NOS. 2,133,680 AND 2,145,607.

CLASS 35—ADVERTISING AND BUSINESS

FOR ORGANIZATION TRADE FAIRS AND EXHIBITIONS IN THE FIELD OF INDUSTRY, SPECIFICALLY, MATERIALS HANDLING AND LOGISTICS; CONSULTATION SERVICES REGARDING PARTICIPATION IN AND PRODUCT DISPLAY AT TRADE FAIRS AND EXHIBITIONS; CONDUCTING PUBLIC OPINION POOLS FOR BUSINESS PURPOSES AND ADVERTISING (U.S. CLS. 100, 101 AND 102).

CLASS 41—EDUCATION AND ENTERTAINMENT

FOR PUBLISHING BOOKS, NEWSPAPERS, JOURNALS, AND CATALOGS ON THE SUBJECT OF TRADE FAIRS AND EXHIBITIONS (U.S. CLS. 100, 101 AND 107).

SN 76-349,188. THREEWIDE.COM, INC., MORGANTOWN, WV. FILED 12-14-2001.

**PROPERTY, STRUCTURE,
ROOM**

CLASS 35—ADVERTISING AND BUSINESS

FOR LICENSING OF COMPUTER SOFTWARE (U.S. CLS. 100, 101 AND 102).

CLASS 42—SCIENTIFIC, COMPUTER AND LEGAL SERVICES

FOR APPLICATION SERVICE PROVIDER FEATURING SOFTWARE IN THE FIELD OF REAL ESTATE FOR ENTERING, MANAGING, ORGANIZING AND DISPLAYING PROPERTY DATA; INSTALLATION OF COMPUTER SOFTWARE; TECHNICAL SUPPORT SERVICES, NAMELY, TROUBLESHOOTING OF COMPUTER HARDWARE AND SOFTWARE PROBLEMS; COMPUTER CONSULTATION; MAINTENANCE AND REPAIR OF COMPUTER SOFTWARE; UPDATING OF COMPUTER SOFTWARE FOR OTHERS (U.S. CLS. 100 AND 101).

CLASS 35—ADVERTISING AND BUSINESS

FOR BOAT DEALERSHIPS; RETAIL STORES IN THE FIELD OF BOATS, BOATING EQUIPMENT AND ACCESSORIES, FISHING, DIVING, SAILING, AND RECREATIONAL SPORTS EQUIPMENT AND APPAREL; MARINA MANAGEMENT (U.S. CLS. 100, 101 AND 102).

CLASS 37—CONSTRUCTION AND REPAIR

FOR REAL ESTATE DEVELOPMENT, NAMELY, DEVELOPING AND CONSTRUCTING MARINAS; BOAT MAINTENANCE AND SERVICE; BOAT REPAIR SERVICES (U.S. CLS. 100, 103 AND 106).

CLASS 39—TRANSPORTATION AND STORAGE

FOR MARINA SERVICES (U.S. CLS. 100 AND 105).

CLASS 42—SCIENTIFIC, COMPUTER AND LEGAL SERVICES

FOR RESTAURANT AND BAR SERVICES; RESTAURANT CARRY-OUT SERVICES (U.S. CLS. 100 AND 101).

SN 76-350,078. LABORATOIRES DE BIOLOGIE VEGETALE YVES ROCHER, 56200 LA GACILLY, FRANCE, FILED 12-18-2001.

BIO SPECIFIC
ACTIVE
SENSITIVE

NO CLAIM IS MADE TO THE EXCLUSIVE RIGHT TO USE "SENSITIVE", APART FROM THE MARK AS SHOWN.

CLASS 3—COSMETICS AND CLEANING PREPARATIONS

FOR SOAPS, NAMELY HAND SOAPS, PERFUMED SOAPS, AND MOISTURIZING SOAPS; PERFUMES; COLOGNES; EAUX DE TOILETTE; ESSENTIAL OILS FOR PERSONAL USE, NAMELY PERFUMED OILS AND AROMATHERAPY OILS; HAIR CARE PREPARATIONS, NAMELY SHAMPOOS, CONDITIONING TREATMENTS, LOTIONS, HAIR SPRAYS, HAIR BLEACH, MOUSSE AND GELS; NON-MEDICATED COSMETICS, NAMELY MAKEUP AND SKIN CARE PREPARATIONS FOR MOISTURIZING, CLEANSING AND IMPROVING THE APPEARANCE OF THE BODY AND FACE, NAMELY FACE, HAND, BODY, AND FOOT CREAMS, LOTIONS, TONERS, GELS AND SCRUBS, ANTI-WRINKLE AND ANTI-AGING PREPARATIONS, CREAMS AND LOTIONS FOR CELLULITE REDUCTION, FACIAL MAKEUP, FOUNDATION CREAMS AND LOTIONS, FACE POWDER, BLUSH AND ROUGE, EYE MAKEUP, EYE LINERS, EYE SHADOWS, MASCARA, LIPSTICKS, LIP GLOSSES, LIP PENCILS, LIP LINERS AND NAIL ENAMELS; ORAL HYGIENE PRODUCTS, NAMELY TOOTH PASTE AND NON-MEDICATED MOUTH WASH OR RINSE; PERSONAL DEODORANTS; BATH AND SHOWER PRODUCTS, NAMELY BATH SALTS, BATH CRYSTALS, BATH OILS, BATH MILKS AND BATH GELS; ROOM FRAGRANCES, NAMELY PERFUMED ROOM SPRAYS, FRAGRANCE EMITTING WICKS, SCENTED CERAMIC STONES, INCENSE, AND SCENTED WOOD CHIPS; SCENTED POTPOURRI; AND PRODUCTS FOR SCENTING LINEN AND LINGERIE, NAMELY, SACHETS AND SCENTED WATER FOR USE IN IRONS (U.S. CLS. 1, 4, 6, 50, 51 AND 52).

CLASS 4—LUBRICANTS AND FUELS

FOR SCENTED CANDLES (U.S. CLS. 1, 6 AND 15).

CLASS 42—SCIENTIFIC, COMPUTER AND LEGAL SERVICES

FOR HAIR AND BEAUTY SALON SERVICES AND BEAUTY CONSULTING SERVICES (U.S. CLS. 100 AND 101).

SN 76-350,211. METSATEOLLISUUS RY (FINNISH FOREST INDUSTRIES FEDERATION), 00171 HELSINKI, FINLAND, FILED 12-17-2001.

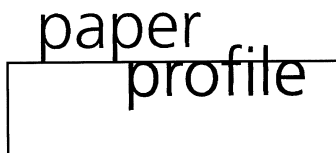

PRIORITY CLAIMED UNDER SEC. 44(D) ON FINLAND APPLICATION NO. T200101961, FILED 6-15-2001.

NO CLAIM IS MADE TO THE EXCLUSIVE RIGHT TO USE "PAPER", APART FROM THE MARK AS SHOWN.

THE MARK CONSISTS OF THE WORD "PAPER" IN GREEN, THE WORD "PROFILE" IN BLACK ON A GREEN BACKGROUND.

CLASS 1—CHEMICALS

FOR PAPER PULP AND WOOD PULP FOR MANUFACTURING PURPOSES; CHEMICALS FOR USE IN THE MANUFACTURE OF PAPER (U.S. CLS. 1, 5, 6, 10, 26 AND 46).

CLASS 16—PAPER GOODS AND PRINTED MATTER

FOR BOOK PAPER, PRINTING PAPER, WRITING PAPER, TISSUE, PAPERBOARD, CARTON BOARD, UNCOATED MECHANICAL PAPER, DIRECTORY PAPER, TOILET PAPER, PAPER TOWELS, FACIAL TISSUES, PAPER HANDKERCHIEFS, PAPER TABLECLOTHS, PAPER CLEANSING TISSUES, INDUSTRIAL PAPER TOWELS; WOOD FREE PAPERS, NAMELY, UNCOATED WOOD FREE PAPERS, COATED WOOD FREE PAPERS, CUT SIZE PAPER (U.S. CLS. 2, 5, 22, 23, 29, 37, 38 AND 50).

CLASS 200—COLLECTIVE MEMBERSHIP

FOR INDICATING MEMBERSHIP IN AN ASSOCIATION OF THE FINNISH FOREST INDUSTRY.

SN 76-350,390. PHRASOR SCIENTIFIC, INC., DUARTE, CA. FILED 12-18-2001.

NANOCLEAN**CLASS 7—MACHINERY**

FOR MACHINES FOR CLEANING HIGH-TECHNOLOGY MANUFACTURING AND DEVICE SURFACES, NAMELY, SEMICONDUCTOR MANUFACTURING SURFACES, MICROELECTROMECHANICAL SYSTEM (MEMS) MANUFACTURING SURFACES, SENSOR HEADS, SPACE INSTRUMENTATION SURFACES, SATELLITE INSTRUMENTATION SURFACES, SOLAR CELLS, AND ELECTRICAL CONTACT SURFACES, USING HIGH-VELOCITY LIQUID PARTICLE CLUSTERS (U.S. CLS. 13, 19, 21, 23, 31, 34 AND 35).

CLASS 37—CONSTRUCTION AND REPAIR

FOR CLEANING OF HIGH-TECHNOLOGY MANUFACTURING AND DEVICE SURFACES, NAMELY SEMICONDUCTOR MANUFACTURING SURFACES, MICROELECTROMECHANICAL SYSTEM (MEMS) MANUFACTURING SURFACES, SENSOR HEADS, SPACE INSTRUMENTATION SURFACES, SATELLITE INSTRUMENTATION SURFACES, SOLAR CELLS, AND ELECTRICAL CONTACT SURFACES (U.S. CLS. 100, 103 AND 106).

SN 76-351,074. DE-GOL, GINO, SOUTH STAFFORDSHIRE, WV6 7RP, UNITED KINGDOM, AND DE-GOL, EILEEN, SOUTH STAFFORDSHIRE, WV6 7RP, UNITED KINGDOM, FILED 12-20-2001.

ROBOCOASTER

PRIORITY CLAIMED UNDER SEC. 44(D) ON UNITED KINGDOM APPLICATION NO. 2273187, FILED 6-21-2001, REG. NO. 2273187, DATED 6-21-2001, EXPIRES 6-21-2011.

CLASS 9—ELECTRICAL AND SCIENTIFIC APPARATUS

FOR COMPUTER HARDWARE AND SOFTWARE FOR CONTROLLING AMUSEMENT AND THEME PARK RIDES (U.S. CLS. 21, 23, 26, 36 AND 38).

CLASS 25—CLOTHING

FOR CLOTHING, NAMELY, SHIRTS, T-SHIRTS, SWEATSHIRTS, SWEATERS, JACKETS, COATS, PANTS, SWEATPANTS, TROUSERS, SHORTS, TIES, UNDERWEAR, SLEEPWEAR, PAJAMAS, SOCKS, STOCKINGS, TIGHTS, BOOTS, SHOES, SNEAKERS, SANDALS, FLIP FLOPS, SLIPPERS, HATS, CAPS, SUN VISORS AND BANDANAS (U.S. CLS. 22 AND 39).

CLASS 28—TOYS AND SPORTING GOODS

FOR AMUSEMENT AND THEME PARK RIDES AND PARTS RELATING THERETO (U.S. CLS. 22, 23, 38 AND 50).

CLASS 41—EDUCATION AND ENTERTAINMENT

FOR ENTERTAINMENT SERVICES, NAMELY, PROVIDING AMUSEMENT AND THEME PARK RIDES, ATTRACTIONS AND SERVICES (U.S. CLS. 100, 101 AND 107).

SN 76-352,413. CENTER FOR WOMEN'S BUSINESS RESEARCH, WASHINGTON, DC. FILED 12-26-2001.

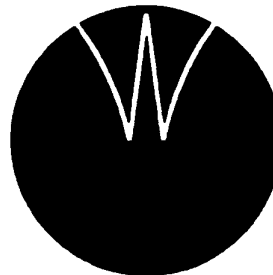
**CLASS 16—PAPER GOODS AND PRINTED MATTER**

FOR PRINTED MATERIALS, NAMELY PRINTED BUSINESS RESEARCH REPORTS, PORTFOLIOS, NAMELY POCKET FOLDERS FOR PRINTED PROMOTIONAL MATERIALS THAT CONTAIN STATIONERY, NEWSLETTERS FEATURING INFORMATION CONCERNING WOMEN'S BUSINESS ISSUES, PRESS RELEASES FEATURING INFORMATION CONCERNING WOMEN'S BUSINESS ISSUES, BROCHURES ABOUT WOMEN'S BUSINESS ISSUES AND QUESTIONNAIRES IN THE FIELD OF WOMEN'S BUSINESS ISSUES (U.S. CLS. 2, 5, 22, 23, 29, 37, 38 AND 50).

FIRST USE 8-13-2001; IN COMMERCE 8-13-2001.

CLASS 35—ADVERTISING AND BUSINESS

FOR PROVIDING A WEBSITE FEATURING INFORMATION IN THE FIELD OF WOMEN'S BUSINESS ISSUES; PROVIDING AN ON-LINE COMPUTER DATABASE IN THE FIELD OF WOMEN'S BUSINESS ISSUES; BUSINESS RESEARCH AND INFORMATION SERVICES, NAMELY CONDUCTING RESEARCH AND DISSEMINATING INFORMATION ON WOMEN BUSINESS OWNERS, THEIR ENTERPRISES AND WOMEN'S BUSINESS ISSUES (U.S. CLS. 100, 101 AND 102).

FIRST USE 8-13-2001; IN COMMERCE 8-13-2001.

CLASS 41—EDUCATION AND ENTERTAINMENT

FOR CONDUCTING SEMINARS TO DISSEMINATE INFORMATION ABOUT WOMEN BUSINESS OWNERS, THEIR ENTERPRISES AND WOMEN'S BUSINESS ISSUES (U.S. CLS. 100, 101 AND 107).

FIRST USE 8-13-2001; IN COMMERCE 8-13-2001.

SN 76-351,558. MORGAN STANLEY, NEW YORK, NY. BY CHANGE OF NAME MORGAN STANLEY DEAN WITTER & CO., NEW YORK, NY. FILED 12-21-2001.

AQUEDUCT

CLASS 36—INSURANCE AND FINANCIAL

FOR INVESTMENT SERVICES, NAMELY, SECURITIES BROKERAGE SERVICES WHICH ALLOW CUSTOMERS TO TRADE SECURITIES BY PHONE ORDERS AND ELECTRONICALLY EXECUTE TRADES ON-LINE BY COMPUTER (U.S. CLS. 100, 101 AND 102).

CLASS 42—SCIENTIFIC, COMPUTER AND LEGAL SERVICES

FOR PROVIDING TEMPORARY USE OF ON-LINE NON-DOWNLOADABLE SOFTWARE FOR THE EXECUTION OF SECURITIES TRADES VIA THE INTERNET (U.S. CLS. 100 AND 101).

SN 76-353,691. NORTHLIGHT, LLC, SEATTLE, WA. FILED 12-31-2001.

SIGN2ME

CLASS 9—ELECTRICAL AND SCIENTIFIC APPARATUS

FOR INSTRUCTIONAL MATERIALS INTENDED TO TEACH ADULTS AND CHILDREN TO COMMUNICATE THROUGH THE USE OF SIGNS DERIVED FROM NATIVE SIGN LANGUAGES, EITHER ALONE, SIMULTANEOUSLY WITH SPOKEN LANGUAGE, AND TO MUSIC, SUCH MATERIALS CONSISTING OF VIDEOTAPES (U.S. CLS. 21, 23, 26, 36 AND 38).

FIRST USE 8-24-1998; IN COMMERCE 3-11-1999.

CLASS 16—PAPER GOODS AND PRINTED MATTER

FOR INSTRUCTIONAL MATERIALS INTENDED TO TEACH ADULTS AND CHILDREN TO COMMUNICATE THROUGH THE USE OF SIGNS DERIVED FROM NATIVE SIGN LANGUAGES, EITHER ALONE, SIMULTANEOUSLY WITH SPOKEN LANGUAGE, AND TO MUSIC, SUCH MATERIALS CONSISTING OF POSTERS, BOOKS FOR ADULTS AND TRAINING MANUALS (U.S. CLS. 2, 5, 22, 23, 29, 37, 38 AND 50).

FIRST USE 8-24-1998; IN COMMERCE 3-11-1999.

SN 76-353,787. NATIONAL LIBRARY OF MEDICINE, THE, BETHESDA, MD. FILED 1-2-2002.

NCCAM**CLASS 41—EDUCATION AND ENTERTAINMENT**

FOR LIBRARY SERVICES, NAMELY, COLLECTION, ORGANIZATION AND DISSEMINATION, BOTH ON-SITE AND OFF-SITE, OF BOOKS, JOURNALS, AUDIO-VISUAL AND OTHER MATERIALS IN THE FIELDS OF BIOMEDICINE, RESEARCH, BIOTECHNOLOGY, TOXICOLOGY, ENVIRONMENTAL ISSUES, PUBLIC HEALTH, HEALTH CARE AND RELATED SCIENCES (U.S. CLS. 100, 101 AND 107).

FIRST USE 10-20-2000; IN COMMERCE 10-20-2000.

CLASS 42—SCIENTIFIC, COMPUTER AND LEGAL SERVICES

FOR PROVIDING COMPUTER ON-LINE DATABASES AND DATA BANKS CONTAINING INFORMATION IN THE FIELDS OF MEDICAL RESEARCH, BIOTECHNOLOGY, TOXICOLOGY, ENVIRONMENTAL ISSUES (U.S. CLS. 100 AND 101).

FIRST USE 10-20-2000; IN COMMERCE 10-20-2000.

SN 76-354,323. NABEL CO., LTD., NAGAOKAKYO-CITY, KYOTO 617-0836, JAPAN, FILED 1-3-2002.



OWNER OF U.S. REG. NO. 1,489,870.

THE MARK CONSISTS, IN PART, OF THE LETTER "N" IN STYLIZED FORM. THE MARK INCLUDES ROYAL BLUE COLOR IN THE SHADED PORTION OF THE STYLIZED LETTER "N". THE WORD PORTION OF THE MARK IS IN THE COLOR BLACK.

CLASS 7—MACHINERY

FOR AGRICULTURAL AND HORTICULTURAL PROCESSING MACHINERY, NAMELY, EGG, FRUIT, VEGETABLE AND FLOWER PACKING MACHINES AND APPARATUS, NAMELY, PACK LOADERS, FILLERS FOR INSERTING EGGS INTO EGG CARTONS, TRANSFERS FOR ARRANGING EGGS ON AN ASSEMBLY LINE AND TRANSFERRING THEM INTO CARTONS, PACK ASSEMBLERS, PACK DISPENSERS, TRAY DISPENSERS AND PACK LABELERS; RINSING MACHINES FOR USE IN THE PROCESSING OF EGGS, FRUIT, VEGETABLES AND FLOWERS (U.S. CLS. 13, 19, 21, 23, 31, 34 AND 35).

CLASS 9—ELECTRICAL AND SCIENTIFIC APPARATUS

FOR GRADING MACHINES FOR USE IN THE PROCESSING OF EGGS, FRUIT, VEGETABLES AND FLOWERS; EGG CANDLERS (U.S. CLS. 21, 23, 26, 36 AND 38).

CLASS 11—ENVIRONMENTAL CONTROL APPARATUS

FOR DRYERS FOR USE IN THE PROCESSING OF EGGS, FRUIT, VEGETABLES AND FLOWERS (U.S. CLS. 13, 21, 23, 31 AND 34).

SN 76-354,894. SPOTTED ZEBRA, INC., WILLIAMS, OR. FILED 12-31-2001.

THREE STORY LIVING**CLASS 9—ELECTRICAL AND SCIENTIFIC APPARATUS**

FOR PRE-RECORDED VIDEOTAPES IN THE FIELD OF RELIGION (U.S. CLS. 21, 23, 26, 36 AND 38).

CLASS 16—PAPER GOODS AND PRINTED MATTER

FOR PRINTED INSTRUCTIONAL EDUCATIONAL AND TEACHING MATERIALS IN THE FIELD OF RELIGION; BOOKS IN THE FIELD OF RELIGION; EDUCATIONAL MATERIALS IN THE FIELD OF RELIGION, NAMELY A KIT COMPRISED OF PRINTED INSTRUCTIONAL EDUCATIONAL AND TEACHING MATERIALS, BOOKS, PLAYING CARDS, AND VIDEOTAPES SOLD AS A UNIT (U.S. CLS. 2, 5, 22, 23, 29, 37, 38 AND 50).

SN 76-357,487. INOGEN ENVIRONMENTAL ALLIANCE, INC., MINNEAPOLIS, MN. FILED 1-10-2002.

THE GLOBAL CONNECTIONS TO ACHIEVE SUPERIOR LOCAL RESULTS

CLASS 35—ADVERTISING AND BUSINESS

FOR BUSINESS CONSULTING SERVICES CONCERNING THE COORDINATION OF MARKETING AND ADVERTISING OF ENVIRONMENTAL CONSULTATION AND REMEDIATION SERVICES VIA ELECTRONIC COMMUNICATIONS; BUSINESS CONSULTATION AND ADVICE CONCERNING ENVIRONMENTAL STRATEGIES, SEMINARS, AND DIRECT MARKETING; PROVIDING INFORMATION VIA AN ON-LINE COMPUTER DATABASE IN THE FIELD OF BUSINESS CONSULTATION CONCERNING ENVIRONMENTAL ISSUES (U.S. CLS. 100, 101 AND 102).

CLASS 40—MATERIAL TREATMENT

FOR ENVIRONMENTAL REMEDIATION SERVICES, NAMELY, SOIL, AIR, WASTE AND WATER TREATMENT SERVICES; ENVIRONMENTAL MANAGEMENT CONSULTING SERVICES CONCERNING SOIL, AIR, WASTE AND WATER TREATMENT (U.S. CLS. 100, 103 AND 106).

CLASS 41—EDUCATION AND ENTERTAINMENT

FOR EDUCATIONAL SERVICES, NAMELY, CONDUCTING SEMINARS AND TRAINING SERVICES IN THE FIELD OF ENVIRONMENTAL MANAGEMENT, PROTECTION AND REMEDIATION (U.S. CLS. 100, 101 AND 107).

CLASS 42—SCIENTIFIC, COMPUTER AND LEGAL SERVICES

FOR REVIEWING BUSINESS STANDARDS AND PRACTICES TO ASSURE COMPLIANCE WITH ENVIRONMENTAL LAWS AND REGULATIONS; ENVIRONMENTAL RISK MANAGEMENT CONSULTING; AND INDUSTRIAL ANALYSIS AND RESEARCH SERVICES CONCERNING NATURAL RESOURCES AND ENVIRONMENTAL REMEDIATION COST RECOVERY ACTIONS IN THE PETROLEUM, FOREST PRODUCTS, CHEMICAL AND GENERAL MANUFACTURING INDUSTRIES (U.S. CLS. 100 AND 101).

SN 76-359,230. MERAK SRL, 70017 PUTIGNANO (BA), ITALY, FILED 1-16-2002.

BELTION

PRIORITY CLAIMED UNDER SEC. 44(D) ON ERPNTY TM OFC APPLICATION NO. 002397396, FILED 10-3-2001, REG. NO. 2397396, DATED 12-19-2002, EXPIRES 10-3-2011.

CLASS 32—LIGHT BEVERAGES

FOR NON-ALCOHOLIC DRINKS, NAMELY, SOFT DRINKS MADE WITH ALMONDS, AND FRUIT DRINKS; SYRUPS FOR MAKING DRINKS (U.S. CLS. 45, 46 AND 48).
FIRST USE 3-13-1996; IN COMMERCE 3-13-1996.

CLASS 33—WINES AND SPIRITS

FOR LIQUEURS, DISTILLED SPIRITS, ALCOHOLIC APERITIF BITTERS, BITTERS, HERBS LIQUEURS (U.S. CLS. 47 AND 49).
FIRST USE 3-13-1996; IN COMMERCE 3-13-1996.

SN 76-359,969. SEDLAK, PAULETTE, WESTMORELAND COUNTY, PA. FILED 1-11-2002.

C.H.E.W.S. COMPLETE HEALTH ENERGY WEIGHT SYSTEM

NO CLAIM IS MADE TO THE EXCLUSIVE RIGHT TO USE "COMPLETE HEALTH ENERGY WEIGHT SYSTEM", APART FROM THE MARK AS SHOWN.

CLASS 5—PHARMACEUTICALS

FOR FOOD NUTRITIONAL SUPPLEMENTS (U.S. CLS. 6, 18, 44, 46, 51 AND 52).
FIRST USE 11-1-1998; IN COMMERCE 6-1-1999.

CLASS 41—EDUCATION AND ENTERTAINMENT

FOR EDUCATIONAL SERVICES, NAMELY CONDUCTING ONLINE EXHIBITIONS AND DISPLAYS AND INTERACTIVE EXHIBITS IN THE FIELD OF HEALTH (U.S. CLS. 100, 101 AND 107).
FIRST USE 11-1-1998; IN COMMERCE 6-1-1999.

SN 76-361,778. DAILMER CRYSLER AG, 70567 STUTTGART, FED REP GERMANY, FILED 1-22-2002.

C 38

PRIORITY CLAIMED UNDER SEC. 44(D) ON FED REP GERMANY APPLICATION NO. 30146185.612, FILED 8-1-2001, REG. NO. 30146185, DATED 10-22-2001, EXPIRES 8-31-2011.

OWNER OF U.S. REG. NOS. 2,248,690, 2,252,472 AND 2,442,133.

NO CLAIM IS MADE TO THE EXCLUSIVE RIGHT TO USE "38", APART FROM THE MARK AS SHOWN.

CLASS 12—VEHICLES

FOR AUTOMOBILES AND THEIR STRUCTURAL PARTS (U.S. CLS. 19, 21, 23, 31, 35 AND 44).

CLASS 28—TOYS AND SPORTING GOODS

FOR TOY MODEL AUTOMOBILES (U.S. CLS. 22, 23, 38 AND 50).

CLASS 37—CONSTRUCTION AND REPAIR

FOR REPAIR AND MAINTENANCE OF AUTOMOBILES (U.S. CLS. 100, 103 AND 106).

SN 76-362,642. RADIANCE TECHNOLOGIES, LOS ALTOS, CA. FILED 1-24-2002.

TRUEDELIVERY

CLASS 9—ELECTRICAL AND SCIENTIFIC APPARATUS

FOR COMPUTER HARDWARE; COMPUTER SOFTWARE FOR MANAGED DELIVERY OF DIGITAL DOCUMENTS, DATA SETS AND MEDIA FILES; COMPUTER SOFTWARE UTILIZING DIGITAL LOGISTICS TECHNOLOGIES THAT OPTIMIZE THE STORAGE CAPACITY AND EFFICIENCY OF ENTERPRISE NETWORKS; COMPUTER SOFTWARE FOR WEB BROWSING; COMPUTER SOFTWARE FOR DISTRIBUTED CONTENT MIGRATION; COMPUTER SOFTWARE FOR SCHEDULING AND PROVIDING DOWNLOADS FROM COMPUTER NETWORKS AND NETWORKED SERVERS; COMPUTER SOFTWARE FOR CACHING AND STORAGE OF DIGITAL ASSETS, AUDIO CONTENT, VIDEO CONTENT, IMAGES, COMPUTER AIDED DESIGN FILES, DATA SETS, OTHER COMPUTER SOFTWARE, DOCUMENTS, COMPUTER FILES, WEB PAGES, TEXT, GRAPHICS, DATABASES, AND AUDIOVISUAL CONTENT; COMPUTER SOFTWARE FOR CONTENT MANAGEMENT; COMPUTER SOFTWARE FOR REMAPPING OF URLS; CONTENT PROVIDER SOFTWARE TOOLKITS THAT ALLOW CUSTOMIZATION OF THE USER INTERFACE FOR COMPUTER SOFTWARE; DIGITAL CONTENT MANAGEMENT HARDWARE AND SOFTWARE; STORAGE DEVICES, NAMELY, HARD DISK DRIVES, MAGNETIC TAPE DRIVES, OPTICAL STORAGE DEVICES, NAMELY, BLANK OPTICAL DISCS, BLANK CD-ROMS AND BLANK DVDS; BLANK MAGNETIC DATA CARRIERS; BLANK MAGNETIC TAPES FOR THE STORAGE OF COMPUTER DATA; BLANK SMART CARDS; DIGITAL CONTENT STORAGE MEDIA, NAMELY, BLANK CD-ROMS, BLANK DVDS, AND BLANK VIDEOTAPES (U.S. CLS. 21, 23, 26, 36 AND 38).

CLASS 41—EDUCATION AND ENTERTAINMENT

FOR ENTERTAINMENT SERVICES, NAMELY, PROVIDING COMPUTER GAMES VIA THE INTERNET AND VIA OTHER WIRED AND WIRELESS COMPUTER AND COMMUNICATION NETWORKS (U.S. CLS. 100, 101 AND 107).

CLASS 42—SCIENTIFIC, COMPUTER AND LEGAL SERVICES

FOR DIGITAL CONTENT AGGREGATION, NAMELY, GATHERING AND ORGANIZING DIGITAL CONTENT FOR BROADCAST VIA THE INTERNET FROM ONE LOCATION (U.S. CLS. 100 AND 101).

SN 76-362,659. BASICLUX RECORDS, LLC, ATLANTA, GA. FILED 1-25-2002.

MADISON PARK

CLASS 9—ELECTRICAL AND SCIENTIFIC APPARATUS

FOR SOUND RECORDINGS, PRERECORDED COMPACT DISCS, AUDIO CASSETTES AND PRERECORDED VIDEO CASSETTES, AND PHONOGRAPH RECORDS ALL FEATURING MUSIC (U.S. CLS. 21, 23, 26, 36 AND 38).

FIRST USE 4-1-2000; IN COMMERCE 1-1-2001.

CLASS 41—EDUCATION AND ENTERTAINMENT

FOR (BASED ON INTENT TO USE) ENTERTAINMENT SERVICES, NAMELY, LIVE PERFORMANCES BY A MUSICAL GROUP (U.S. CLS. 100, 101 AND 107).

SN 76-363,111. WEIDER PUBLICATIONS, INC., WOODLAND HILLS, CA. FILED 1-25-2002.

SHAPE BRAND FRANCHISE ENCYCLOPEDIA

OWNER OF U.S. REG. NOS. 1,495,154, 2,189,911 AND OTHERS.

NO CLAIM IS MADE TO THE EXCLUSIVE RIGHT TO USE "BRAND FRANCHISE ENCYCLOPEDIA", APART FROM THE MARK AS SHOWN.

CLASS 9—ELECTRICAL AND SCIENTIFIC APPARATUS

FOR PRE-RECORDED CD-ROMS, AUDIO AND VIDEO CASSETTES FEATURING INFORMATION RELATED TO EDITORIAL CONTENT, ADVERTISING, CIRCULATION, MARKETING, PUBLICITY, NEW MEDIA AND RESEARCH PERTAINING TO A HEALTH AND FITNESS MAGAZINE (U.S. CLS. 21, 23, 26, 36 AND 38).

CLASS 16—PAPER GOODS AND PRINTED MATTER

FOR PRINTED MATTER, NAMELY A SET OF UPDATABLE BINDERS CONTAINING INFORMATION RELATED TO EDITORIAL CONTENT, ADVERTISING, CIRCULATION, MARKETING, PUBLICITY, NEW MEDIA AND RESEARCH PERTAINING TO A HEALTH AND FITNESS MAGAZINE (U.S. CLS. 2, 5, 22, 23, 29, 37, 38 AND 50).

CLASS 35—ADVERTISING AND BUSINESS

FOR COMPUTER SERVICES, NAMELY, PROVIDING ON-LINE BUSINESS INFORMATION IN THE NATURE OF EDITORIAL CONTENT, ADVERTISING, CIRCULATION, MARKETING, PUBLICITY, NEW MEDIA AND RESEARCH PERTAINING TO A HEALTH AND FITNESS MAGAZINE, VIA A GLOBAL COMMUNICATION INFORMATION NETWORK SITE (U.S. CLS. 100, 101 AND 102).

SN 76-363,793. ENFIS LIMITED, SWANSEA SA1 8PH, UNITED KINGDOM, FILED 1-28-2002.

ENFIS

CLASS 8—HAND TOOLS

FOR PHOTOTHERAPY MACHINES FOR USE IN DEPILATION DEVICES (U.S. CLS. 23, 28 AND 44).

CLASS 9—ELECTRICAL AND SCIENTIFIC APPARATUS

FOR OPTO-ELECTRONIC APPARATUS AND DEVICES, NAMELY LASERS, LIGHT-EMITTING DIODES, LIGHT-EMITTING DIODE ARRAYS, LASER DIODE ARRAYS AND LASER DIODES (U.S. CLS. 21, 23, 26, 36 AND 38).

CLASS 10—MEDICAL APPARATUS

FOR MEDICAL DEVICES SELECTIVELY EMPLOYING LAMPS, LIGHTS, LASERS AND LIGHT-EMITTING DIODES IN THE TREATMENT OF VASCULAR BLEMISHES AND ACNE; MEDICAL DEVICES SELECTIVELY EMPLOYING LAMPS, LIGHTS, LASERS AND LIGHT-EMITTING DIODES IN THE PHOTO-ACTIVE TREATMENT OF WRINKLE REMOVAL AND TREATMENT OF VASCULAR BLEMISHES AND ACNE; MEDICAL PHOTOTHERAPY DEVICES FOR WRINKLE REMOVAL AND TREATMENT OF VASCULAR BLEMISHES AND ACNE (U.S. CLS. 26, 39 AND 44).

CLASS 42—SCIENTIFIC, COMPUTER AND LEGAL SERVICES

FOR RESEARCH AND CONSULTANCY SERVICES IN THE FIELD OF LIGHTING APPARATUS AND INSTRUMENTS, OPTOELECTRONICS, OPTOELECTRICAL TECHNOLOGY AND MEDICAL TECHNOLOGY (U.S. CLS. 100 AND 101).



SN 76-364,332. WERZ, INC., NEW YORK, NY. FILED 1-29-2002.

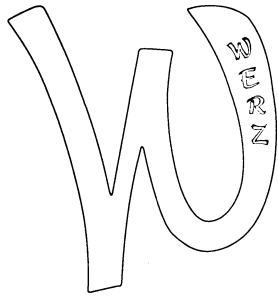

CLASS 14—JEWELRY

FOR COSTUME JEWELRY (U.S. CLS. 2, 27, 28 AND 50).

CLASS 18—LEATHER GOODS

FOR HANDBAGS AND POCKETBOOKS (U.S. CLS. 1, 2, 3, 22 AND 41).



SN 76-365,163. HAINBUCH GMBH SPANNENDE TECHNIK, ERDMANNHAEUSER STRASSE 57, FED REP GERMANY, FILED 2-1-2002.

HAINBUCH

PRIORITY CLAIMED UNDER SEC. 44(D) ON FED REP GERMANY APPLICATION NO. 30147109.6-0, FILED 8-4-2001, REG. NO. 30147109, DATED 2-21-2002, EXPIRES 8-31-2011.

CLASS 7—MACHINERY

FOR CLAMPING DEVICES FOR MACHINE TOOLS, NAMELY, THREE JAW CHUCKS, COLLET CHUCKS AND PARTS THEREFOR, NAMELY, BASIC BODIES AND CLAMPING HEADS; STATIONARY CHUCKS AND PARTS THEREFOR, NAMELY, CHUCK BODIES AND CLAMPING HEADS; POWER TOOLS, NAMELY, ARBORS, CLAMPING BUSHINGS, COLLETS, MANDRELS FOR CLAMPING WORK-PIECES AND PARTS THEREFOR, NAMELY, MANDREL BODIES, CLAMPING BUSHINGS AND CLAMPING BOLTS; FEED FINGERS FOR MACHINE TOOLS; BAR GUIDANCES FOR BAR-FED WORK-PIECES ON MACHINE TOOLS; TOOL-CHANGING FIXTURES, NAMELY, PNEUMATICALLY OPERATED CHANGING FIXTURES FOR CHANGING CLAMP HEADS (U.S. CLS. 13, 19, 21, 23, 31, 34 AND 35).

CLASS 8—HAND TOOLS

FOR MANUALLY OPERATED CLAMPING DEVICES, NAMELY, THREE JAW CHUCKS, COLLET CHUCKS, STATIONARY CHUCKS, ARBORS, MANDRELS FOR CLAMPING WORK-PIECES, CLAMPING BUSHINGS; TOOL-CHANGING FIXTURES, NAMELY, MANUALLY OPERATED CHANGING FIXTURES FOR CHANGING CLAMPING HEADS (U.S. CLS. 23, 28 AND 44).

CLASS 40—MATERIAL TREATMENT

FOR MANUFACTURING OF PRECISION PARTS, ESPECIALLY FOR CLAMPING DEVICES, TO THE ORDER AND SPECIFICATION OF OTHERS (U.S. CLS. 100, 103 AND 106).

CLASS 42—SCIENTIFIC, COMPUTER AND LEGAL SERVICES

FOR CONSULTATION IN THE FIELD OF PLANNING AND DESIGNING CLAMPING DEVICES (U.S. CLS. 100 AND 101).



SN 76-365,932. THINKING STRINGS, LLC, SOUTH ORANGE, NJ. FILED 2-2-2002.

THINKING STRINGS

CLASS 9—ELECTRICAL AND SCIENTIFIC APPARATUS

FOR COMPUTER SOFTWARE FOR BUILDING AND EXECUTING INTERACTIVE MULTIMEDIA TRAINING AND EDUCATIONAL PROGRAMS AND TESTS THEREFOR, WITH RELATED MANUALS, WORKBOOKS AND TEXTS, SOLD AS A UNIT (U.S. CLS. 21, 23, 26, 36 AND 38).

FIRST USE 9-0-1998; IN COMMERCE 9-0-1998.

CLASS 16—PAPER GOODS AND PRINTED MATTER

FOR PRINTED TRADE AND EDUCATIONAL BOOKS, WORKBOOKS, PAMPHLETS, BOOKLETS, PRINTED TESTS, TEST MANUALS, SCORE REPORTS AND INSTRUCTIONAL MANUALS FEATURING THE NATURAL, PHYSICAL AND SOCIAL SCIENCES, THE ARTS AND THE HUMANITIES, SOLD INDIVIDUALLY OR IN KITS (U.S. CLS. 2, 5, 22, 23, 29, 37, 38 AND 50).

FIRST USE 9-0-1998; IN COMMERCE 9-0-1998.

CLASS 35—ADVERTISING AND BUSINESS

FOR PREPARING AUDIO-VISUAL DISPLAYS IN THE FIELD OF CORPORATE BUSINESS TRAINING (U.S. CLS. 100, 101 AND 102).

FIRST USE 9-0-1998; IN COMMERCE 9-0-1998.

CLASS 41—EDUCATION AND ENTERTAINMENT

FOR PROVIDING ENTERTAINMENT AND EDUCATIONAL INFORMATION IN THE FIELDS OF THE NATURAL, PHYSICAL AND SOCIAL SCIENCES, THE ARTS AND THE HUMANITIES; EDUCATION AND TRAINING, NAMELY, PROVIDING ACADEMIC COURSES AT THE PRIMARY, SECONDARY, COLLEGE AND POST-GRADUATE LEVEL, AND VOCATIONAL TRAINING IN THE FIELDS OF THE ARTS, SCIENCES, HUMANITIES AND VOCATIONS; EDUCATIONAL TESTING; DEVELOPING EDUCATIONAL PROGRAMS FOR OTHERS IN THE FIELD OF THE NATURAL, PHYSICAL AND SOCIAL SCIENCES, THE ARTS AND THE HUMANITIES; CONSULTATION IN THE FIELD OF DEVELOPING EDUCATIONAL TRAINING AND RESEARCH PROGRAMS; PREPARING EDUCATIONAL AUDIO-VISUAL DISPLAYS IN THE FIELD OF THE NATURAL, PHYSICAL AND SOCIAL SCIENCES, THE ARTS AND THE HUMANITIES (U.S. CLS. 100, 101 AND 107).

FIRST USE 9-0-1998; IN COMMERCE 9-0-1998.

SN 76-367,288. THOROUGHbred TIMES COMPANY, INC., LEXINGTON, KY. FILED 2-5-2002.

THOROUGHbred TIMES TODAY

OWNER OF U.S. REG. NOS. 1,916,404, 2,582,491 AND OTHERS.
SEC. 2(F) AS TO "THOROUGHbred" AND "THOROUGHbred RECORD".

CLASS 16—PAPER GOODS AND PRINTED MATTER

FOR PERIODIC PUBLICATIONS, NAMELY, MAGAZINES, JOURNALS AND NEWSLETTERS, IN THE FIELD OF EQUINE SPECIES (U.S. CLS. 2, 5, 22, 23, 29, 37, 38 AND 50).

CLASS 41—EDUCATION AND ENTERTAINMENT

FOR PROVIDING ON-LINE, PERIODIC PUBLICATIONS, NAMELY, MAGAZINES, JOURNALS AND NEWSLETTERS, IN THE FIELD OF EQUINE SPECIES (U.S. CLS. 100, 101 AND 107).

SN 76-367,944. WINTERSKOV, BO, DK-5800 NYBORG, DENMARK, FILED 2-7-2002.

NoStop!

CLASS 19—NON-METALLIC BUILDING MATERIALS

FOR ROAD SURFACE MATERIALS, NAMELY ASPHALT, BITUMEN BASED ASPHALT SEALANTS, TAR BASED ASPHALT SEALANTS, BITUMINOUS BASED ROAD SURFACING MATERIAL AND ASPHALT ROAD SURFACING COMPOSITIONS AND ROAD MARKING MATERIALS, NAMELY ROAD MARKING SHEETS AND STRIPS AND GLASS GRANULES FOR MARKING ROADS (U.S. CLS. 1, 12, 33 AND 50).

CLASS 37—CONSTRUCTION AND REPAIR

FOR APPLICATION OF ROAD SURFACE MATERIALS AND ROAD MARKING MATERIALS (U.S. CLS. 100, 103 AND 106).

SN 76-369,012. SAN FRANCISCO MARITIME NATIONAL PARK ASSOCIATION, SAN FRANCISCO, CA. FILED S.R. 2-7-2002; AM. P.R. 6-17-2003.

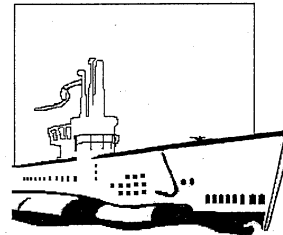

CLASS 25—CLOTHING

FOR T-SHIRTS (U.S. CLS. 22 AND 39).
FIRST USE 10-3-2000; IN COMMERCE 10-3-2000.

CLASS 41—EDUCATION AND ENTERTAINMENT

FOR EDUCATION AND ENTERTAINMENT SERVICES, NAMELY, PROVIDING COURSES, SEMINARS, LECTURES, WORKSHOPS, CONFERENCES AND DEMONSTRATIONS IN THE FIELD OF MARITIME RELATED ACTIVITIES FEATURING MARITIME EDUCATIONAL PROGRAMS FOR CHILDREN AND ADULTS, LIVE THEATRICAL PERFORMANCE RELATED TO MARITIME FEATURING CHANTEYMEN AND COSTUMED ROLE-PLAYERS; BOAT-BUILDING CLASSES; EDUCATION SERVICES, NAMELY, CONDUCTING YOUTH EDUCATION PROGRAMS IN THE FIELD OF MARITIME AND ASSOCIATED HISTORICAL AND CULTURAL SUBJECTS; EDUCATION SERVICES, NAMELY, CONDUCTING PROGRAMS FOR OLDER ADULTS IN THE FIELD MARITIME AND ASSOCIATED HISTORICAL AND CULTURAL SUBJECTS; MUSEUM SERVICES, FEATURING EXHIBITS, FILM AND INTERPRETIVE PROGRAMS RELATING TO MARITIME AND ASSOCIATED HISTORICAL AND CULTURAL SUBJECTS (U.S. CLS. 100, 101 AND 107).
FIRST USE 10-4-2000; IN COMMERCE 10-4-2000.

CLASS 43—HOTEL AND RESTAURANT SERVICES

FOR FACILITY RENTAL SERVICES, NAMELY, PROVIDING BANQUET AND SOCIAL FUNCTION FACILITIES FOR SPECIAL OCCASIONS (U.S. CLS. 100 AND 101).
FIRST USE 3-21-2001; IN COMMERCE 3-21-2001.

SN 76-369,033. ALLEN, DONALD V., CULVER CITY, CA.
FILED 2-11-2002.

CLASS 3—COSMETICS AND CLEANING PREPARATIONS

FOR HAIR CARE PREPARATIONS, SOAPS, SHAMPOOS, FACE CREAMS, FOOT CREAMS, FACIAL CLEANSERS AND SKIN CLEANERS (U.S. CLS. 1, 4, 6, 50, 51 AND 52).

CLASS 9—ELECTRICAL AND SCIENTIFIC APPARATUS

FOR EYEGLASSES, INCLUDING SUNGLASSES (U.S. CLS. 21, 23, 26, 36 AND 38).

CLASS 25—CLOTHING

FOR SHIRTS, T-SHIRTS, COATS, HATS AND TIES (U.S. CLS. 22 AND 39).

SN 76-369,797. SPELLBOUND RECORDS LLC, LOS ANGELES, CA. FILED 2-11-2002.

VOCAB RECORDS

NO CLAIM IS MADE TO THE EXCLUSIVE RIGHT TO USE "RECORDS", APART FROM THE MARK AS SHOWN.

CLASS 9—ELECTRICAL AND SCIENTIFIC APPARATUS

FOR MUSICAL SOUND RECORDINGS, PRE-RECORDED PHONOGRAPH RECORDS, PRERECORDED AUDIO AND VIDEO TAPES, PRE-RECORDED AUDIO AND VIDEO CASSETTES, COMPACT DISCS, DVD'S, COMPUTER SOFTWARE DOWNLOADABLE FROM A GLOBAL COMPUTER NETWORK OR RECORDED ON DISCS, CD-ROMS AND OTHER MAGNETIC, OPTICAL, ELECTRONIC, OR MACHINE-READABLE MEDIA, PRE-RECORDED AUDIO-VISUAL RECORDS IN ANALOG DISC AND DIGITAL DISC CONFIGURATIONS, PRE-RECORDED ANALOG MAGNETIC TAPES AND DIGITAL MAGNETIC TAPES, ALL CONTAINING MUSIC AND FEATURING AUDIO AND VISUAL RECORDINGS OF MUSICAL PERFORMANCES AND OTHER ENTERTAINMENT EVENTS (U.S. CLS. 21, 23, 26, 36 AND 38).

CLASS 25—CLOTHING

FOR CLOTHING FOR MEN, WOMEN AND CHILDREN, NAMELY T-SHIRTS, SHIRTS, BLOUSES, LONG SLEEVE SHIRTS, PANTS, TROUSERS, NECKTIES, SWEATSHIRTS, JERSEYS, SWEAT PANTS, JOGGING SUITS, WRIST BANDS, PAJAMAS, ROBES, NIGHT SHIRTS, NIGHT GOWNS, RAINCOATS, JEANS, BELTS, SCARVES, GLOVES, UNDERWEAR, BOXER SHORTS, SWIM WEAR, SOCKS, HOSIERY, TIGHTS, LEOTARDS, TANK TOPS, SHORTS, JACKETS, COATS; FOOTWEAR, NAMELY SHOES, BOOTS, ATHLETIC SHOES, SANDALS AND SLIPPERS; AND HEADGEAR, NAMELY HATS, CAPS, HEADBANDS, SUN VISORS (U.S. CLS. 22 AND 39).

CLASS 35—ADVERTISING AND BUSINESS

FOR TALENT AGENCY SERVICES, NAMELY, MANAGEMENT OF MUSICAL PERFORMING ARTISTS AND SONG-WRITERS (U.S. CLS. 100, 101 AND 102).

CLASS 41—EDUCATION AND ENTERTAINMENT

FOR ENTERTAINMENT SERVICES, NAMELY ARRANGING AND CONDUCTING LIVE CONCERTS BY MUSICAL GROUPS; PROMOTING THE CONCERTS OF OTHERS; MUSIC PUBLISHING SERVICES; MUSIC COMPOSITION, COMPILATION AND TRANSCRIPTION FOR OTHERS; PRODUCTION AND DISTRIBUTION OF MUSIC FOR OTHERS; AUDIO RECORDING AND PRODUCTION AND RECORD PRODUCTION; SONG-WRITING SERVICES; MOTION PICTURE SONG PRODUCTION (U.S. CLS. 100, 101 AND 107).

SN 76-371,232. FATCHETT, BARRY KEITH, DBA MY PET, BARTLETT, TN. FILED 2-14-2002.

NO CLAIM IS MADE TO THE EXCLUSIVE RIGHT TO USE "PET", APART FROM THE MARK AS SHOWN.

CLASS 21—HOUSEWARES AND GLASS

FOR COFFEE MUGS AND DOG BOWLS (U.S. CLS. 2, 13, 23, 29, 30, 33, 40 AND 50).

CLASS 28—TOYS AND SPORTING GOODS

FOR STUFFED TOY ANIMALS (U.S. CLS. 22, 23, 38 AND 50).

SN 76-371,714. LOUDEYE CORP., SEATTLE, WA. BY CHANGE OF NAME LOUDEYE TECHNOLOGIES, INC., SEATTLE, WA. FILED 2-15-2002.

CLASS 38—COMMUNICATION

FOR DISTRIBUTING AND HOSTING STREAMED AUDIO AND VIDEO CONTENT; WEBCASTING AND WEB CONFERENCING; AND SATELLITE AND TERRESTRIAL DIGITAL RADIO RE-BROADCASTING VIA THE INTERNET (U.S. CLS. 100, 101 AND 104).
FIRST USE 2-15-2002; IN COMMERCE 2-15-2002.

CLASS 39—TRANSPORTATION AND STORAGE

FOR DIGITAL MUSIC ARCHIVES SERVICES (U.S. CLS. 100 AND 105).
FIRST USE 2-15-2002; IN COMMERCE 2-15-2002.

CLASS 40—MATERIAL TREATMENT

FOR DIGITAL COMPRESSION OF AUDIO, VIDEO, AND OTHER DIGITAL MEDIA CONTENT (U.S. CLS. 100, 103 AND 106).

FIRST USE 2-15-2002; IN COMMERCE 2-15-2002.

CLASS 42—SCIENTIFIC, COMPUTER AND LEGAL SERVICES

FOR PROVIDING DIGITAL MEDIA SERVICES, NAMELY, PROVIDING AN ELECTRONIC DATABASE OF METADATA FOR DATA CONCERNING THE TITLE, ARTIST AND DISCOGRAPHY OF AUDIO AND VIDEO MEDIA; HOSTING A WEBSITE FOR STREAMING MEDIA; AND DIGITAL MEDIA CONSULTING SERVICES (U.S. CLS. 100 AND 101).

FIRST USE 2-14-2002; IN COMMERCE 2-14-2002.

CLASS 45—PERSONAL SERVICES

FOR DIGITAL FINGERPRINTING (U.S. CLS. 100 AND 101).

FIRST USE 2-15-2002; IN COMMERCE 2-15-2002.

SN 76-372,032, OLDCASTLE GLASS, INC., PLANO, TX. FILED 2-19-2002.

GLASSELECT**CLASS 12—VEHICLES**

FOR GLASS FOR VEHICLE WINDOWS (U.S. CLS. 19, 21, 23, 31, 35 AND 44).

CLASS 19—NON-METALLIC BUILDING MATERIALS

FOR GLASS, NAMELY, GLASS FOR WINDOWS AND DOORS (NON-VEHICLE), AND GLASS FOR BUILDINGS (U.S. CLS. 1, 12, 33 AND 50).

CLASS 20—FURNITURE AND ARTICLES NOT OTHERWISE CLASSIFIED

FOR GLASS FOR USE AS FURNITURE PARTS (U.S. CLS. 2, 13, 22, 25, 32 AND 50).

SN 76-375,118, FIRST INTERNET TRAVEL, INC., MAHWAH, NJ. FILED 2-26-2002.



FIRST INTERNET TRAVEL.com

NO CLAIM IS MADE TO THE EXCLUSIVE RIGHT TO USE "INTERNET TRAVEL.COM", APART FROM THE MARK AS SHOWN.

THE STIPPLING SHOWN IN THE DRAWING IS FOR SHADING PURPOSES ONLY.

CLASS 39—TRANSPORTATION AND STORAGE

FOR TRAVEL AGENCY SERVICES, NAMELY, MAKING DISCOUNT RESERVATIONS AND BOOKINGS FOR TRANSPORTATION BY AIRLINES AND FOR AUTO RENTALS, VIA TOLL FREE TELEPHONE ACCESS AND A GLOBAL COMPUTER NETWORK (U.S. CLS. 100 AND 105).

CLASS 43—HOTEL AND RESTAURANT SERVICES

FOR TRAVEL AGENCY SERVICES, NAMELY, MAKING DISCOUNT RESERVATIONS AND BOOKINGS FOR TEMPORARY LODGING IN HOTELS, VIA TOLL FREE TELEPHONE ACCESS AND A GLOBAL COMPUTER NETWORK (U.S. CLS. 100 AND 101).

SN 76-375,334, DONG YANG SCIENCE CO, LTD., KYUNG-KI-DO, REPUBLIC OF KOREA, FILED 2-25-2002.

**CLASS 7—MACHINERY**

FOR KITCHEN MACHINES, NAMELY ELECTRIC MIXERS, ELECTRIC FOAM MAKERS, ELECTRIC MILLS, ELECTRIC FOOD PROCESSORS, MACHINES FOR MAKING SHAVED ICE AND ELECTRIC BLENDERS (U.S. CLS. 13, 19, 21, 23, 31, 34 AND 35).

CLASS 9—ELECTRICAL AND SCIENTIFIC APPARATUS

FOR ELECTRIC VENDING MACHINES AND ELECTROLYSERS (U.S. CLS. 21, 23, 26, 36 AND 38).

CLASS 11—ENVIRONMENTAL CONTROL APPARATUS

FOR WATER PURIFIERS, WATER FILTERS, WATER STERILIZERS, ELECTRIC COFFEE PERCOLATORS, MILK STERILIZERS, FREEZERS, WATER COOLERS, WATER IONIZERS (U.S. CLS. 13, 21, 23, 31 AND 34).

CLASS 21—HOUSEWARES AND GLASS

FOR KITCHEN MACHINES, NAMELY, NON-ELECTRIC MIXERS, NON-ELECTRIC BLENDERS, STRAINERS FOR HOUSEHOLD PURPOSES, TEA STRAINERS NOT OF METAL, NON-ELECTRIC COFFEE PERCOLATORS NOT OF METAL, THERMAL INSULATED CONTAINERS FOR FOOD AND BEVERAGES, THERMAL INSULATED BOTTLES, PORTABLE COOLERS, THERMALLY INSULATED FLASKS FOR WATER AND WATER FLASKS (U.S. CLS. 2, 13, 23, 29, 30, 33, 40 AND 50).

SN 76-375,443. MISSISSIPPI BAND OF CHOCTAW INDIANS, CHOCTAW, MS. FILED 2-25-2002.

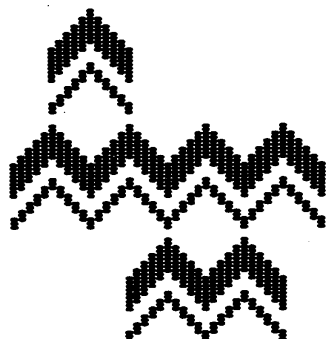

CLASS 35—ADVERTISING AND BUSINESS

FOR PROCUREMENT, NAMELY, PURCHASING ALL GOODS AND SERVICES FOR GOVERNMENT AGENCIES; PERSONNEL MANAGEMENT; PERSONNEL PLACEMENT AND RECRUITMENT; MANAGEMENT AND CONSULTATION IN THE FIELD OF HUMAN FACTORS ENGINEERING; ADMINISTRATION OF CULTURAL AND EDUCATIONAL EXCHANGE PROGRAMS; ACCOUNT AUDITING; PROMOTING THE ECONOMIC DEVELOPMENT IN CHOCTAW MISSISSIPPI (U.S. CLS. 100, 101 AND 102).

FIRST USE 0-0-1970; IN COMMERCE 0-0-1970.

CLASS 36—INSURANCE AND FINANCIAL

FOR BUSINESS FINANCE PROCUREMENT SERVICES; PROVIDING COLLEGE SCHOLARSHIPS; PROVIDING EDUCATIONAL SCHOLARSHIPS; HOUSING AGENCIES (U.S. CLS. 100, 101 AND 102).

FIRST USE 0-0-1970; IN COMMERCE 0-0-1970.

CLASS 37—CONSTRUCTION AND REPAIR

FOR CONSTRUCTION MANAGEMENT; REAL ESTATE DEVELOPMENT; LAND DEVELOPMENT SERVICES, NAMELY, PLANNING AND LAYING OUT OF RESIDENTIAL AND/OR COMMERCIAL COMMUNITIES (U.S. CLS. 100, 103 AND 106).

FIRST USE 0-0-1970; IN COMMERCE 0-0-1970.

CLASS 39—TRANSPORTATION AND STORAGE

FOR MASS TRANSIT FOR THE GENERAL PUBLIC; STORAGE SERVICES FOR ARCHIVING DATABASES, IMAGES AND OTHER ELECTRONIC DATA; PUBLIC UTILITIES IN THE NATURE OF SUPPLYING WATER; PUBLIC UTILITY SERVICES IN THE NATURE OF WATER DISTRIBUTION; PUBLIC UTILITY SERVICES IN THE NATURE OF ELECTRICITY DISTRIBUTION; PUBLIC UTILITY SERVICES; PUBLIC UTILITY SERVICES IN THE NATURE OF NATURAL GAS DISTRIBUTION; CHARITABLE SERVICES, NAMELY, PROVIDING TRANSPORTATION TO THE ELDERLY OR HANDICAPPED PERSONS (U.S. CLS. 100 AND 105).

FIRST USE 0-0-1970; IN COMMERCE 0-0-1970.

CLASS 41—EDUCATION AND ENTERTAINMENT

FOR PROVIDING FACILITIES FOR RECREATION ACTIVITIES; RECREATIONAL CAMPS; RECREATIONAL PARK SERVICES; MUSEUMS; PROVIDING COURSES OF INSTRUCTION AT THE PRIMARY AND HIGH SCHOOL; EDUCATIONAL SERVICES IN THE NATURE OF EMPLOYMENT TRAINING; RECREATIONAL PARK SERVICES; ZOOS (U.S. CLS. 100, 101 AND 107).

FIRST USE 0-0-1970; IN COMMERCE 0-0-1970.

CLASS 42—SCIENTIFIC, COMPUTER AND LEGAL SERVICES

FOR URBAN PLANNING; LEGAL SERVICES (U.S. CLS. 100 AND 101).

FIRST USE 0-0-1970; IN COMMERCE 0-0-1970.

CLASS 43—HOTEL AND RESTAURANT SERVICES

FOR PROVIDING TEMPORARY HOUSING ACCOMMODATIONS; PUBLIC HOUSING SERVICES; ARRANGING TEMPORARY HOUSING ACCOMMODATIONS; EMERGENCY SHELTER SERVICES, NAMELY, PROVIDING TEMPORARY HOUSING; PROVIDING ELDER CARE AND DAY CARE; EMERGENCY SHELTER SERVICES, NAMELY, PROVIDING TEMPORARY HOUSING (U.S. CLS. 100 AND 101).

FIRST USE 0-0-1970; IN COMMERCE 0-0-1970.

CLASS 44—MEDICAL, BEAUTY AND AGRICULTURAL SERVICES

FOR HEALTH CARE; AGRICULTURAL ADVICE; MEDICAL EVALUATION SERVICES, NAMELY, FUNCTIONAL ASSESSMENT PROGRAM FOR PATIENTS RECEIVING MEDICAL REHABILITATION SERVICES FOR PURPOSES OF GUIDING TREATMENT AND ASSESSING PROGRAM EFFECTIVENESS; PHYSICAL REHABILITATION; PROVIDING MENTAL REHABILITATION FACILITIES; PROVIDING PHYSICAL REHABILITATION FACILITIES; REHABILITATION OF ALCOHOL ADDICTED PATIENTS; REHABILITATION OF DRUG ADDICTED PATIENTS; REHABILITATION OF NARCOTIC ADDICTED PATIENTS; FOOD NUTRITION CONSULTATION; NUTRITION COUNSELING; PSYCHOLOGICAL COUNSELING (U.S. CLS. 100 AND 101).

FIRST USE 0-0-1970; IN COMMERCE 0-0-1970.

CLASS 45—PERSONAL SERVICES

FOR CASE MANAGEMENT SERVICES, NAMELY, COORDINATION OF LEGAL, SOCIAL AND PSYCHOLOGICAL SERVICES FOR DOMESTICALLY ABUSED PERSONS; POLICE AND CIVIL PROTECTION SERVICES; POLICE PROTECTION; FIRE FIGHTING (U.S. CLS. 100 AND 101).

FIRST USE 0-0-1970; IN COMMERCE 0-0-1970.

SN 76-375,493. BRETON S.P.A., 31030 CASTELLO DI GODEGO (TREVISO), ITALY, FILED 2-26-2002.

METALQUARTZ

PRIORITY CLAIMED UNDER SEC. 44(D) ON ITALY APPLICATION NO. TV2001C00006, FILED 10-24-2001, REG. NO. 00861186, DATED 10-24-2001, EXPIRES 10-24-2021.

CLASS 6—METAL GOODS

FOR METAL BUILDING MATERIAL, NAMELY, STEEL STRUCTURES FOR MACHINE TOOLS, NAMELY BEDS, BASEMENTS, VERTICAL RODS AND GIRDERS FILLED WITH A MASS OF NATURAL OR ARTIFICIAL COMPOSITE STONE MATERIAL (U.S. CLS. 2, 12, 13, 14, 23, 25 AND 30).

CLASS 7—MACHINERY

FOR MACHINES AND MACHINE TOOLS, NAMELY NUMERICAL CONTROL MACHINING CENTERS CONSTITUTED BY METAL COMPONENTS FILLED WITH A MASS OF NATURAL OR ARTIFICIAL COMPOSITE STONE MATERIAL (U.S. CLS. 13, 19, 21, 23, 31, 34 AND 35).

CLASS 19—NON-METALLIC BUILDING MATERIALS

FOR NON-METALLIC BUILDING MATERIALS, NAMELY, NATURAL OR ARTIFICIAL COMPOSITE STONE MATERIALS, USED TO FILL METALLIC STRUCTURES OF MACHINE TOOLS SUCH AS BEDS, BASEMENTS, VERTICAL RODS AND GIRDERS (U.S. CLS. 1, 12, 33 AND 50).

SN 76-377,182. STARBUCKS U.S. BRANDS CORPORATION, BURLINGAME, CA. FILED 3-1-2002.

CHILL PATROL**CLASS 29—MEATS AND PROCESSED FOODS**

FOR MILK, FLAVORED MILK AND MILK BASED BEVERAGES (U.S. CL. 46).

CLASS 30—STAPLE FOODS

FOR GROUND AND WHOLE BEAN COFFEE, COCOA, TEA, HERBAL TEA FOR FOOD PURPOSES; COFFEE, TEA, COCOA AND ESPRESSO BEVERAGES AND BEVERAGES MADE WITH A BASE OF COFFEE AND/OR ESPRESSO; POWDERED CHOCOLATE AND VANILLA, FLAVORING SYRUP; BAKERY GOODS, NAMELY, MUFFINS, SCONES, BISCUITS, COOKIES, PASTRIES, GRANOLA AND CEREAL DERIVED FOOD BARS, BREADS AND READY-TO-MAKE MIXES OF THE SAME; READY-TO-DRINK COFFEE; ICE CREAM, MILKSHAKES AND FROZEN CONFECTIONS; CHOCOLATE AND CANDY (U.S. CL. 46).

CLASS 32—LIGHT BEVERAGES

FOR CONCENTRATES, SYRUPS OR POWDERS USED IN THE PREPARATION OF MILK-BASED FOOD BEVERAGES, AND COFFEE, COCOA OR CHOCOLATE-BASED BEVERAGES (U.S. CLS. 45, 46 AND 48).

CLASS 43—HOTEL AND RESTAURANT SERVICES

FOR RESTAURANTS, CAFES, CAFETERIAS, SNACK BARS AND COFFEE BARS; FOOD PREPARATION AND CARRY-OUT RESTAURANTS (U.S. CLS. 100 AND 101).

SN 76-377,342. FELLOWSHIP OF ACTIVISTS TO EMBRACE HUMANITY (FATEH), STREAMWOOD, IL. FILED 3-2-2002.

**CLASS 36—INSURANCE AND FINANCIAL**

FOR CHARITABLE FUND RAISING SERVICES, PROVIDING FUNDS FOR HEALTH, WELFARE, EDUCATION, RECREATION AND OTHER SOCIAL SERVICES (U.S. CLS. 100, 101 AND 102).

FIRST USE 11-1-1996; IN COMMERCE 11-1-1996.

CLASS 41—EDUCATION AND ENTERTAINMENT

FOR EDUCATIONAL SERVICES, NAMELY, ORGANIZING AND CONDUCTING SEMINARS AND MEETINGS RELATED TO HUMAN DEVELOPMENT; OPERATING RECREATIONAL CAMPS AND DIRECTING RECREATIONAL CAMP ACTIVITIES; CREATING EDUCATIONAL RESEARCH TOOLS AND RESOURCE MATERIALS, NAMELY, INDEXES, ABSTRACTS, TRANSLATIONS, BOOKS, ARTICLES AND MAGAZINES IN THE FIELD OF RELIGIOUS SERVICES; ELEEMOSYNARY SERVICES, NAMELY, PROVIDING EDUCATION AND RECREATIONAL SERVICES FOR INDIVIDUALS (U.S. CLS. 100, 101 AND 107).

FIRST USE 11-1-1996; IN COMMERCE 11-1-1996.

SN 76-377,510. CALIFORNIA ALMOND GROWERS EXCHANGE, DBA BLUE DIAMOND GROWERS, SACRAMENTO, CA. FILED 3-4-2002.

GROWERS' CHOICE**CLASS 29—MEATS AND PROCESSED FOODS**

FOR PROCESSED NUTS (U.S. CL. 46).

CLASS 31—NATURAL AGRICULTURAL PRODUCTS

FOR UNPROCESSED NUTS (U.S. CLS. 1 AND 46).

SN 76-379,107. SKINNERS WHOLESALE NURSERIES, INC., JACKSONVILLE, FL. FILED 3-6-2002.



NO CLAIM IS MADE TO THE EXCLUSIVE RIGHT TO USE "NURSERIES", APART FROM THE MARK AS SHOWN.

THE WORDS "SKINNER NURSERIES" TO THE RIGHT OF A LOGO HAVING SWIRL DESIGN WITH A LEAF APPEARING IN THE LOWER LEFT PORTION.

CLASS 35—ADVERTISING AND BUSINESS

FOR PLANT NURSERIES FEATURING PLANTS, WOODY ORNAMENTALS, SHRUBS, TREES AND FLOWERS; DISTRIBUTORSHIP IN THE FIELD OF PLANTS, WOODY ORNAMENTAL, SHRUBS, TREES AND FLOWERS (U.S. CLS. 100, 101 AND 102).

FIRST USE 0-0-1991; IN COMMERCE 0-0-1991.

CLASS 39—TRANSPORTATION AND STORAGE

FOR DELIVERY OF PLANTS, WOODY ORNAMENTALS, SHRUBS, TREES AND FLOWERS (U.S. CLS. 100 AND 105).

FIRST USE 0-0-1991; IN COMMERCE 0-0-1991.

SN 76-379,161. WITZENMANN GMBH, D-75175 PFORZHEIM, FED REP GERMANY, FILED 3-7-2002.

SN 76-380,051. AGRILINK HOLDINGS PTY LTD., HILTON, SOUTH AUSTRALIA 5033, AUSTRALIA, FILED 3-8-2002.

HYDRAFLON

OWNER OF FED REP GERMANY REG. NO. 2,044,629, DATED 3-18-1993, EXPIRES 3-31-2013.

OWNER OF U.S. REG. NOS. 929,868, 1,877,401 AND 2,236,358.

CLASS 6—METAL GOODS

FOR PIPES, HOSES, FLEXIBLE TUBES, AND FITTINGS THEREFOR, MADE OF METAL, FOR USE IN A VARIETY OF INDUSTRIES (U.S. CLS. 2, 12, 13, 14, 23, 25 AND 50).

CLASS 17—RUBBER GOODS

FOR PIPES, HOSES, AND FLEXIBLE TUBES MADE OF PLASTICS FOR USE IN A VARIETY OF INDUSTRIES; INNER LININGS AND OUTER CASINGS, MADE OF PLASTICS FOR USE WITH METALLIC PIPES, HOSES, AND FITTINGS (U.S. CLS. 1, 5, 12, 13, 35 AND 50).

SN 76-380,050. AGRILINK HOLDINGS PTY LTD., HILTON, SOUTH AUSTRALIA 5033, AUSTRALIA, FILED 3-8-2002.

AGWISE

CLASS 35—ADVERTISING AND BUSINESS

FOR BUSINESS MANAGEMENT AND BUSINESS CONSULTATION, INCLUDING THE GENERATION, COMPILATION AND MANAGEMENT OF INFORMATION, DOCUMENTS AND DATA; STRATEGIC BUSINESS PLANNING (U.S. CLS. 100, 101 AND 102).

CLASS 36—INSURANCE AND FINANCIAL

FOR AGRICULTURAL RISK MANAGEMENT (U.S. CLS. 100, 101 AND 102).

CLASS 44—MEDICAL, BEAUTY AND AGRICULTURAL SERVICES

FOR AGRICULTURAL MANAGEMENT AND CONSULTATION IN CONNECTION THEREWITH, INCLUDING THE GENERATION, COMPILATION AND MANAGEMENT OF AGRICULTURAL INFORMATION, DOCUMENTS AND DATA, INCLUDING ALL ASPECTS OF THE MANAGEMENT OF IRRIGATION AND SOIL CONDITIONING ACTIVITIES; ENVIRONMENTAL MANAGEMENT; FARM MANAGEMENT; LAND MANAGEMENT; AND STRATEGIC AGRICULTURAL AND ENVIRONMENTAL PLANNING (U.S. CLS. 100 AND 101).



CLASS 35—ADVERTISING AND BUSINESS

FOR BUSINESS MANAGEMENT AND BUSINESS CONSULTATION, INCLUDING THE GENERATION, COMPILATION AND MANAGEMENT OF INFORMATION, DOCUMENTS AND DATA; STRATEGIC BUSINESS PLANNING (U.S. CLS. 100, 101 AND 102).

CLASS 36—INSURANCE AND FINANCIAL

FOR AGRICULTURAL RISK MANAGEMENT (U.S. CLS. 100, 101 AND 102).

CLASS 44—MEDICAL, BEAUTY AND AGRICULTURAL SERVICES

FOR AGRICULTURAL MANAGEMENT AND CONSULTATION IN CONNECTION THEREWITH, INCLUDING THE GENERATION, COMPILATION AND MANAGEMENT OF AGRICULTURAL INFORMATION, DOCUMENTS AND DATA, INCLUDING ALL ASPECTS OF THE MANAGEMENT OF IRRIGATION AND SOIL CONDITIONING ACTIVITIES; ENVIRONMENTAL MANAGEMENT; FARM MANAGEMENT; LAND MANAGEMENT; AND STRATEGIC AGRICULTURAL AND ENVIRONMENTAL PLANNING (U.S. CLS. 100 AND 101).

SN 76-380,145. NATURALLY YOURS, LLC, NEW YORK, NY, FILED 3-11-2002.

FAST & EASY

CLASS 35—ADVERTISING AND BUSINESS

FOR BUSINESS MANAGEMENT AND BUSINESS CONSULTATION, INCLUDING THE GENERATION, COMPILATION AND MANAGEMENT OF INFORMATION, DOCUMENTS AND DATA; STRATEGIC BUSINESS PLANNING (U.S. CLS. 100, 101 AND 102).

CLASS 36—INSURANCE AND FINANCIAL

FOR AGRICULTURAL RISK MANAGEMENT (U.S. CLS. 100, 101 AND 102).

CLASS 44—MEDICAL, BEAUTY AND AGRICULTURAL SERVICES

FOR AGRICULTURAL MANAGEMENT AND CONSULTATION IN CONNECTION THEREWITH, INCLUDING THE GENERATION, COMPILATION AND MANAGEMENT OF AGRICULTURAL INFORMATION, DOCUMENTS AND DATA, INCLUDING ALL ASPECTS OF THE MANAGEMENT OF IRRIGATION AND SOIL CONDITIONING ACTIVITIES; ENVIRONMENTAL MANAGEMENT; FARM MANAGEMENT; LAND MANAGEMENT; AND STRATEGIC AGRICULTURAL AND ENVIRONMENTAL PLANNING (U.S. CLS. 100 AND 101).

CLASS 5—PHARMACEUTICALS

FOR VITAMIN SUPPLEMENTS (U.S. CLS. 6, 18, 44, 46, 51 AND 52).
FIRST USE 2-1-2003; IN COMMERCE 2-1-2003.

CLASS 16—PAPER GOODS AND PRINTED MATTER

FOR PRINTED GUIDES RELATING TO HEALTH, FITNESS, WEIGHT REDUCTION AND DIET PLANNING (U.S. CLS. 2, 5, 22, 23, 29, 37, 38 AND 50).
FIRST USE 5-0-2001; IN COMMERCE 5-0-2001.

CLASS 41—EDUCATION AND ENTERTAINMENT

FOR HEALTH, FITNESS AND ATHLETIC CLUB SERVICES; CONDUCTING EXERCISE CLASSES; EDUCATION SERVICES, NAMELY CONDUCTING SEMINARS AND GROUP INSTRUCTION IN THE FIELD OF NUTRITION AND DIETARY MANAGEMENT, AND EXERCISE AND PHYSICAL FITNESS (U.S. CLS. 100, 101 AND 107).
FIRST USE 5-0-2001; IN COMMERCE 5-0-2001.

SN 76-380,951. UNIVERSITY OF NEW HAVEN, WEST HAVEN, CT. FILED 3-12-2002.

SN 76-381,680. METRO/THEBE, INC., RANCHO DOMINGUEZ, CA. FILED 3-4-2002.

**UNIVERSITY OF NEW
HAVEN WE MAKE
TOMORROW**



NO CLAIM IS MADE TO THE EXCLUSIVE RIGHT TO USE "UNIVERSITY OF NEW HAVEN", APART FROM THE MARK AS SHOWN.

CLASS 16—PAPER GOODS AND PRINTED MATTER

FOR PUBLICATION AND PRINTED MATTER, NAMELY, POSTERS, BULLETINS, BROCHURES AND MAGAZINES, IN THE FIELD OF COLLEGE AND GRADUATE EDUCATION PROGRAMS; ADDRESS BOOKS; PHOTO AND STAMP ALBUMS; PAPER BAGS; PAPER BANNERS; COLORING AND CHILDREN'S EDUCATIONAL PICTURE BOOKS; CALENDARS; GREETING, NOTE AND BLANK CARDS; PLAYING CARDS; PEN AND PENCIL CASES; BOOK COVERS; DECALS; DESK SETS AND DESK TOP ORGANIZERS; PERSONAL POCKET ORGANIZERS; DESK TOP AND POCKET DIARIES; DESKTOP AND POCKET ADDRESS AND PHONE BOOKS; DECORATIVE PHONE CARDS; BATHROOM AND FACIAL TISSUES; PAPER NAPKINS; TISSUE PAPER; PAPER PLACE MATS; PEN AND PENCIL HOLDERS; RUBBER STAMPS; PENCILS; ERASERS; MARKERS; NOTEBOOKS; STATIONERY; PICTURES AND POSTERS; WRAPPING PAPER; WRITING AND NOTE PADS; BULLETIN BOARDS; ENVELOPES; MOUNTED AND UN-MOUNTED PHOTOGRAPHS; PRE-PRINTED PAPER STICKERS AND PRE-PRINTED STICKER COLLECTOR ALBUMS; PARTY GAME BOOKS; CHALK BOARDS FOR SCHOOL AND HOME USE; MAGNETIC BOARDS; PENCIL TOP ORNAMENTS; PAPER TABLE CLOTHS; PAPER NAME BADGES; DOOR AND YARD SIGNS MADE OF PAPER; PAPER GIFT BAGS; BLANK AND PRINTED THEME BOOKS; STATIONERY-TYPE PORTFOLIOS; BINDERS; STUDY KITS COMPRISED PRIMARILY OF PLASTIC POUCH, PENCIL, RULER AND ERASER; BLANK AND PRINTED ASSIGNMENT BOOKS; SCRIBBLE DRAWING TABLETS; CONSTRUCTION PAPER; MEMO PADS; DOODLE WRITING PADS; ART PADS; PAPER SIGN-IN SHEETS; STAMP AND ROLLER SETS COMPRISED PRIMARILY OF STAMPS AND ROLLERS MADE OF RUBBER AND PLASTIC; LAP BOARDS FOR READING AND WRITING; FOLDERS, CLIP BOARDS; POSTCARDS; BOOKENDS AND PAPERWEIGHTS (U.S. CLS. 2, 5, 22, 23, 29, 37, 38 AND 50).

CLASS 25—CLOTHING

FOR CLOTHING, FOOTWEAR AND HEADGEAR, NAMELY, SWEATSHIRTS, SWEATPANTS, FLEECE TOPS AND BOTTOMS, HATS, CAPS, T-SHIRTS, ATHLETIC JERSEYS, JACKETS, PARKAS, SHIRTS, PANTS, JEANS, BOXER SHORTS, SHORTS, AEROBIC AND EXERCISE WEAR, NAMELY, PANTS AND JACKETS FOR RUNNING AND JOGGING, SOCKS, SCARVES, GLOVES, SLEEPWEAR, ROBES, SWEATERS, WARM-UP SUITS, WIND SUITS, RAINWEAR, SNEAKERS, AND INFANT SETS COMPRISING HATS, SHIRTS, PANTS, SOCKS, AND ONE-PIECE OUTFITS (U.S. CLS. 22 AND 39).

THE STIPPLING IS FOR SHADING PURPOSES.

CLASS 7—MACHINERY

FOR SMALL ELECTRICAL APPLIANCES, NAMELY, JUICE EXTRACTOR (U.S. CLS. 13, 19, 21, 23, 31, 34 AND 35).

CLASS 11—ENVIRONMENTAL CONTROL APPARATUS

FOR SMALL ELECTRICAL APPLIANCES, NAMELY SANDWICH PRESS, ELECTRIC WOK, ELECTRIC BLENDER, ELECTRIC GRILL, TOASTER, MUFFIN MAKER, WAFFLE MAKER, HOT WATER URN, ELECTRIC FRY-PAN, ELECTRIC SKILLET, ELECTRIC KETTLE, ELECTRIC DEEP FRYER, RICE COOKERS AND FRENCH FRYERS (U.S. CLS. 13, 21, 23, 31 AND 34).

CLASS 21—HOUSEWARES AND GLASS

FOR DINNERWARE, HOUSEWARES, NAMELY, FOLDING BED MEAL TRAYS, ICE BUCKETS, TEA KETTLES, INSULATED BOTTLES, MIXING BOWLS, SALAD BOWLS, SALAD SPINNERS, CANDLE HOLDERS NOT OF PRECIOUS METAL, MIXING BOWLS, BREAD TRAYS, BAKING ACCESSORIES NAMELY, SPRING FORM PANS, COLANDERS, DOUBLE BOILERS, COOLING RACKS, SAUCERS, COOKIE SHEETS, MUFFIN PANS, CAKE PANS, PIE PANS, LOAF PANS; SERVING ACCESSORIES; NAMELY, PITCHERS, GRAVY BOATS, BARBECUE ACCESSORIES; NAMELY, BARBECUE GRILLS, FISH BASKETS, BARBECUE BASKETS, COOKWARE; NAMELY, POTS AND PANS, NAMELY, BROILER PANS, NON-ELECTRIC BROILER/ROASTER PANS, NON-ELECTRIC ROASTER/STEAMER PANS, NON-ELECTRIC STEAMER/POACHER PANS, STOVE TOP GRILLS, FRYING PANS, WOKS AND WOK SKILLETS, ROASTING PANS, STOCK POTS AND TEA POTS, BUFFETWARE; NAMELY, PASTRY SERVERS, PIE SERVERS, SERVING FORKS, SOUP LADLES, SERVING SPOONS, GLASSWARE; NAMELY, PITCHERS AND VASES, BOWLS, CREAM AND SUGAR SETS, BEER MUGS, PLASTIC FOOD STORAGE CONTAINERS (U.S. CLS. 2, 13, 23, 29, 30, 33, 40 AND 50).

SN 76-382,012. SCHLUMBERGER SYSTEMES SA, 92120
MONTROUGE, FRANCE, FILED 3-14-2002.

REPORTSTREAM

CLASS 9—ELECTRICAL AND SCIENTIFIC APPARATUS

FOR COMPUTER SOFTWARE, NAMELY SOFTWARE FOR CONSOLIDATING, INTEGRATING AND ENCODING ENTERPRISE RESOURCES PLANNING DATA, FINANCIAL DATA WAREHOUSING, AND FINANCIAL DATA MANAGEMENT; MAGNETIC TAPES AND MAGNETIC AND OPTICAL DISCS CONTAINING SOFTWARE FOR CONSOLIDATING, INTEGRATING, AND ENCODING ENTERPRISE RESOURCES PLANNING DATA, FINANCIAL DATA WAREHOUSING, AND FINANCIAL DATA MANAGEMENT (U.S. CLS. 21, 23, 26, 36 AND 38).

CLASS 38—COMMUNICATION

FOR COMPUTER NETWORK SERVICES, NAMELY PROVIDING MULTI-USER ACCESS TO A GLOBAL COMPUTER NETWORK FOR ELECTRONIC TRANSMISSION OF DIGITAL FINANCIAL DATA (U.S. CLS. 100, 101 AND 104).

CLASS 42—SCIENTIFIC, COMPUTER AND LEGAL SERVICES

FOR COMPUTER PROGRAMMING FOR OTHERS (U.S. CLS. 100 AND 101).

SN 76-383,063. MBM TECHNOLOGY LIMITED, BRIGHTON
BN1 9HU, UNITED KINGDOM, FILED 3-14-2002.



NO CLAIM IS MADE TO THE EXCLUSIVE RIGHT TO USE "TECHNOLOGY", APART FROM THE MARK AS SHOWN.

THE MARK CONSISTS IN PART, OF A SERIES OF CASCADING TRIANGLES.

CLASS 7—MACHINERY

FOR MACHINES, NAMELY, PNEUMATIC, ELECTRIC AND HYDRAULIC MOTORS FOR MACHINES, HYDRAULIC, LINEAR AND PNEUMATIC ACTUATORS, AND PARTS FOR ALL THE FOREGOING (U.S. CLS. 13, 19, 21, 23, 31, 34 AND 35).

FIRST USE 0-0-1994; IN COMMERCE 0-0-1994.

CLASS 9—ELECTRICAL AND SCIENTIFIC APPARATUS

FOR MAGNETIC DATA CARRIERS; DATA PROCESSING EQUIPMENT, NAMELY COMPUTERS AND MICROPROCESSORS; COMPUTER HARDWARE; COMPUTER PERIPHERALS; RUGGEDIZED ELECTRONIC DATA STORAGE DEVICES, NAMELY, DISK DRIVES AND NON-VOLATILE ELECTRONIC MEMORIES; RUGGEDIZED COMPUTER HARDWARE, NAMELY, PRINTERS, KEYPADS, DISPLAYS, PERIPHERALS AND PARTS THEREFOR; PROTECTIVE HOUSINGS FOR COMPUTER EQUIPMENT AND PARTS THEREFOR; CABLE HARNESSSES AND CABLE ASSEMBLIES; ELECTRONIC CIRCUIT BOARDS; FLEXIBLE PRINTED CIRCUITS; ELECTRO-OPTICAL AND ELECTROMAGNETIC SCANNING SYSTEM DRIVES AND CONTROLS; ELECTRONIC CONTROLS FOR ELECTRONIC MOTORS; STEPPING MOTORS; BRUSHLESS DIRECT-CURRENT ELECTRONIC MOTORS; ELECTRIC ACTUATORS AND POSITION SENSORS, NAMELY, LINEAR ELECTRIC ACTUATORS, ROTARY ELECTRIC ACTUATORS, LINEAR ELECTRONIC POSITION ENCODERS, ROTARY ELECTRONIC POSITION ENCODERS, ELECTROMAGNETIC POSITION ENCODERS, ELECTRO-OPTICAL POSITION ENCODERS; ANTI-SHOCK AND ANTI-VIBRATION MOUNTINGS, HERMETIC AND ELECTROMAGNETIC-COMPATABILITY HARDENED ENCLOSURES, ALL FOR ELECTRONIC AND ELECTRICAL CIRCUIT BOARDS, GYROSCOPES, VISUAL DISPLAY UNITS, MAGNETIC DISK DRIVES AND COMPUTER HARDWARE (U.S. CLS. 21, 23, 26, 36 AND 38).

FIRST USE 0-0-1994; IN COMMERCE 0-0-1994.

CLASS 12—VEHICLES

FOR LAND VEHICLES AND STRUCTURAL PARTS THEREFOR; SHIPS, BOATS AND MARINE CRAFT AND STRUCTURAL PARTS THEREFOR; SPACE VEHICLES AND STRUCTURAL PARTS THEREFOR AND AIRCRAFT AND STRUCTURAL PARTS THEREFOR (U.S. CLS. 19, 21, 23, 31, 35 AND 44).

FIRST USE 0-0-1994; IN COMMERCE 0-0-1994.

CLASS 13—FIREARMS

FOR FIREARMS AND PARTS THEREFOR; AMMUNITION, PROJECTILES AND PARTS THEREFOR; WEAPONS CARRIAGE AND RELEASE EQUIPMENT, NAMELY, MISSILE LAUNCHERS, AIRCRAFT STORES DISPENSERS/EJECTORS, BOMB RACKS, LUGS FOR AIR LAUNCHED WEAPONS, AIR CRAFT PYLON ACCESSORIES; WEAPONS ARMING AND INTERFACE EQUIPMENT; ACTUATORS FOR MISSILE LAUNCHERS AND AIRCRAFT STORES DISPENSERS/EJECTORS; PYROTECHNIC GAS ACTUATORS (U.S. CLS. 2 AND 9).

FIRST USE 0-0-1994; IN COMMERCE 0-0-1994.

CLASS 42—SCIENTIFIC, COMPUTER AND LEGAL SERVICES

FOR ENGINEERING SERVICES; DESIGN OF MECHANICAL, ELECTRO-MECHANICAL, ELECTRICAL, ELECTRONIC AND CONTROL EQUIPMENT FOR AIRBORNE WEAPONS; DESIGN OF FLEXIBLE PRINTED CIRCUITS (U.S. CLS. 100 AND 101).

FIRST USE 0-0-1994; IN COMMERCE 0-0-1994.

SN 76-384,159. LANGEL, THOMAS H., MANHATTAN, MT. FILED 1-10-2002.

SN 76-386,388. ARO, 72500 CHATEAU DU LOIR, FRANCE, FILED 3-21-2002.

TAKER TRACKER

CLASS 35—ADVERTISING AND BUSINESS

FOR PROVIDING REFERRALS FOR PARTIES FOR THE PURPOSE OF EXCHANGING INTELLECTUAL PROPERTY, PERSONAL PROPERTY, REAL ESTATE, AND OTHER FORMS OF TANGIBLES AND INTANGIBLES; PROVIDING AN ON-LINE DIRECTORY TO INTELLECTUAL PROPERTY, PERSONAL PROPERTY, REAL ESTATE, AND OTHER FORMS OF TANGIBLES AND INTANGIBLES AVAILABLE FOR EXCHANGE; AND OPERATING AN ON-LINE MARKETPLACE AT WHICH OWNERS MAY EXCHANGE INTELLECTUAL PROPERTY, PERSONAL PROPERTY, AND OTHER FORMS OF TANGIBLES AND INTANGIBLES (U.S. CLS. 100, 101 AND 102).

CLASS 36—INSURANCE AND FINANCIAL

FOR OPERATING AN ON-LINE MARKETPLACE AT WHICH OWNERS MAY EXCHANGE REAL ESTATE (U.S. CLS. 100, 101 AND 102).



SN 76-385,097. LABOR NOW, LLC, MINOT, ND. FILED 3-18-2002.



NO CLAIM IS MADE TO THE EXCLUSIVE RIGHT TO USE "LABOR", APART FROM THE MARK AS SHOWN. THE STIPPLING IS FOR SHADING PURPOSES ONLY.

CLASS 16—PAPER GOODS AND PRINTED MATTER

FOR PRINTED PAPER SIGNS, STATIONERY, PRINTED FORMS, PRINTED MAIL RESPONSE CARDS AND PENS RELATING TO TEMPORARY LABOR SERVICES (U.S. CLS. 2, 5, 22, 23, 29, 37, 38 AND 50).

CLASS 21—HOUSEWARES AND GLASS

FOR COFFEE MUGS (U.S. CLS. 2, 13, 23, 29, 30, 33, 40 AND 50).

CLASS 28—TOYS AND SPORTING GOODS

FOR T-SHIRTS, CAPS, JACKETS, AND SHIRTS (U.S. CLS. 22, 23, 38 AND 50).

PRIORITY CLAIMED UNDER SEC. 44(D) ON FRANCE APPLICATION NO. 013124280, FILED 10-4-2001, REG. NO. 013124280, DATED 10-4-2001, EXPIRES 10-4-2011. OWNER OF U.S. REG. NOS. 1,163,417, 2,301,356 AND 2,306,897.

CLASS 7—MACHINERY

FOR ELECTRIC, GAS-OPERATED, AND LASER WELDING MACHINES AND THEIR COMPONENTS; ELECTRIC, GAS-OPERATED, AND LASER WELDING MACHINES FOR THE MANUFACTURE, MAINTENANCE AND REPAIR OF VEHICLES; ELECTRIC, GAS-OPERATED, AND LASER WELDING PLIER MACHINES; ELECTRIC, GAS-OPERATED, AND LASER WELDING PLIER MACHINES FOR USE IN THE AUTOMOBILE FIELD; ELECTRIC, GAS-OPERATED, AND LASER WELDING GUN MACHINES; ELECTRIC, GAS-OPERATED, AND LASER WELDING GUN MACHINES FOR USE IN THE AUTOMOBILE FIELD; ARMS AS PARTS FOR WELDING MACHINES; ELECTRICAL WELDING MACHINES; ELECTRICAL WELDING APPARATUS AND COMPONENTS, NAMELY, ELECTRIC ARC WELDING MACHINES, ELECTRIC WELDING MACHINES, GAS OPERATED WELDING MACHINES AND LASER WELDING MACHINES (U.S. CLS. 13, 19, 21, 23, 31, 34 AND 35).

CLASS 8—HAND TOOLS

FOR NON-ELECTRIC, HAND-HELD GUNS AND WELDING PLIERS (U.S. CLS. 23, 28 AND 44).

CLASS 9—ELECTRICAL AND SCIENTIFIC APPARATUS

FOR ELECTRICAL WELDING PROGRAMMABLE CONTROLS (U.S. CLS. 21, 23, 26, 36 AND 38).

SN 76-387,654. CHATAM INTERNATIONAL INCORPORATED, WILMINGTON, DE. FILED 3-27-2002.

SN 76-388,248. PRESTON, FRANCES W., NEW YORK, NY. FILED 3-26-2002.

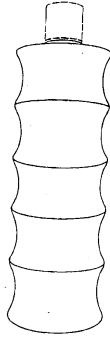

THE MARK CONSISTS OF A THREE-DIMENSIONAL CONFIGURATION OF THE CONTAINER FOR THERE GODS IN THE SHAPE OF A STYLIZED BOTTLE, NAMELY, A CYLINDRICAL SHAPED BOTTLE HAVING WIDE AND EVENLY SPACED RIBBING WITH A CURVED OR CONCAVE WALL BETWEEN THE RIBS.

CLASS 32—LIGHT BEVERAGES

FOR BREWED MALT-BASED ALCOHOLIC BEVERAGE IN THE NATURE OF A BEER (U.S. CLS. 45, 46 AND 48).

CLASS 33—WINES AND SPIRITS

FOR LIQUEUR (U.S. CLS. 47 AND 49).

SN 76-387,660. ABB OFFSHORE SYSTEMS INC., HOUSTON, TX. FILED 3-27-2002.

**SOLUTION ORIENTED,
PEOPLE DRIVEN**

CLASS 40—MATERIAL TREATMENT

FOR CUSTOM MANUFACTURING OF OFFSHORE DRILLING AND PRODUCTION EQUIPMENT (U.S. CLS. 100, 103 AND 106).

CLASS 42—SCIENTIFIC, COMPUTER AND LEGAL SERVICES

FOR CUSTOM DESIGN OF OFFSHORE DRILLING AND PRODUCTION EQUIPMENT (U.S. CLS. 100 AND 101).



CLASS 14—JEWELRY

FOR JEWELRY (U.S. CLS. 2, 27, 28 AND 50).
FIRST USE 0-0-1995; IN COMMERCE 0-0-1995.

CLASS 18—LEATHER GOODS

FOR DUFFEL BAGS (U.S. CLS. 1, 2, 3, 22 AND 41).
FIRST USE 0-0-1995; IN COMMERCE 0-0-1995.

CLASS 25—CLOTHING

FOR CLOTHING, NAMELY, JACKETS, LONG-SLEEVED AND SHORT-SLEEVED T-SHIRTS, GLOVES, HATS (U.S. CLS. 22 AND 39).
FIRST USE 0-0-1995; IN COMMERCE 0-0-1995.

CLASS 36—INSURANCE AND FINANCIAL

FOR CHARITABLE FUND RAISING SERVICES (U.S. CLS. 100, 101 AND 102).
FIRST USE 0-0-1995; IN COMMERCE 0-0-1995.

SN 76-388,310. VIVENDI UNIVERSAL, 75008 PARIS, FRANCE, FILED 3-28-2002.

VIVEN'UP

PRIORITY CLAIMED UNDER SEC. 44(D) ON FRANCE APPLICATION NO. 312397901, FILED 10-2-2001, REG. NO. 013123979, DATED 10-2-2001, EXPIRES 10-2-2011.

CLASS 35—ADVERTISING AND BUSINESS

FOR BUSINESS PLANNING AND SUPERVISION IN THE NATURE OF FACILITATING ASSISTANCE TO INDUSTRIAL AND COMMERCIAL UNDERTAKINGS IN RUNNING THEIR BUSINESS MANAGEMENT AND ORGANIZATION CONSULTING; ACCOUNTING SERVICES; BUSINESS CONSULTING AND MANAGEMENT; PERSONNEL MANAGEMENT AND PERSONNEL MANAGEMENT CONSULTING; BUSINESS AND MARKET RESEARCH; CONDUCTING BUSINESS RESEARCH AND MARKET RESEARCH SURVEYS; PERSONNEL RECRUITMENT (U.S. CLS. 100, 101 AND 102).

CLASS 36—INSURANCE AND FINANCIAL

FOR FINANCIAL RESEARCH, ANALYSIS AND CONSULTATION REGARDING FINANCIAL AFFAIRS AND MATTERS; FINANCIAL MANAGEMENT AND PLANNING REGARDING FINANCIAL AFFAIRS AND MATTERS; CAPITAL INVESTMENT CONSULTATION; FINANCING SERVICES IN THE NATURE OF FACILITATING FINANCIAL ACQUISITIONS IN COMPANIES; FINANCIAL SPONSORSHIP AND FUNDING OF CHARITABLE AND PHILANTHROPIC PROGRAMS AND EVENTS (U.S. CLS. 100, 101 AND 102).

CLASS 37—CONSTRUCTION AND REPAIR

FOR INSTALLATION AND REPAIR AIR CONDITIONING EQUIPMENT AND APPARATUS, WATER DISTRIBUTION AND TREATMENT EQUIPMENT AND APPARATUS, HEATING EQUIPMENT AND APPARATUS AND ENERGY PRODUCTION AND DISTRIBUTION EQUIPMENT AND APPARATUS; PROVIDING INFORMATION IN THE FIELD OF BUILDING CONSTRUCTION AND REPAIR; CLEANING OF BUILDINGS AND ROADS; MAINTENANCE AND REPAIR OF BUILDINGS AND ROADS (U.S. CLS. 100, 103 AND 106).

CLASS 38—COMMUNICATION

FOR TELECOMMUNICATIONS SERVICES, NAMELY PERSONAL COMMUNICATION SERVICES VIA THE GLOBAL COMPUTER NETWORK; TELECOMMUNICATIONS GATEWAY SERVICES; PROVIDING TELECOMMUNICATIONS CONNECTIONS TO A GLOBAL COMPUTER NETWORK; ELECTRONIC TRANSMISSION OF MESSAGES AND DATA; PROVIDING INFORMATION IN THE FIELD OF TELECOMMUNICATIONS (U.S. CLS. 100, 101 AND 104).

CLASS 39—TRANSPORTATION AND STORAGE

FOR TRANSPORT BROKERAGE; TRANSPORT BY AIR, RAIL, BOAT AND TRUCK; PUBLIC UTILITIES IN THE NATURE OF SUPPLYING WATER; PUBLIC UTILITIES IN THE NATURE OF WATER DISTRIBUTION; PUBLIC UTILITY SERVICES IN THE NATURE OF ELECTRICITY DISTRIBUTION; DISTRIBUTION OF ENERGY; TRANSPORTING SPECIAL WASTE; CARGO UNLOADING IN THE NATURE OF SPECIAL WASTE; PROVIDING INFORMATION IN THE FIELD OF TRANSPORT SERVICES; PROVIDING INFORMATION REGARDING PUBLIC UTILITIES IN THE NATURE OF SUPPLYING WATER, WATER DISTRIBUTION, ELECTRICITY DISTRIBUTION AND DISTRIBUTION OF ENERGY; PROVIDING INFORMATION IN THE FIELD OF TRANSPORT SERVICES REGARDING WASTE AND TRASH (U.S. CLS. 100 AND 105).

CLASS 40—MATERIAL TREATMENT

FOR AIR PURIFICATION AND COOLING SERVICES; WASTE TREATMENT, TRANSFORMATION AND MANAGEMENT SERVICES; ENVIRONMENTAL REMEDIATION SERVICES, NAMELY, SOIL, WASTE AND/OR WATER TREATMENT SERVICES; DESTRUCTION OF WASTE; PRODUCTION OF ENERGY; PROVIDING INFORMATION IN THE FIELD OF AIR PURIFICATION, WASTE TREATMENT AND TRANSFORMATION, WASTE DESTRUCTION, WATER TREATMENT AND PURIFICATION AND PRODUCTION OF ENERGY; SORTING OF WASTE AND RECYCLABLE MATERIAL (U.S. CLS. 100, 103 AND 106).

CLASS 41—EDUCATION AND ENTERTAINMENT

FOR TRAINING IN THE FIELD OF NEW TECHNOLOGY, NAMELY, GLOBAL NETWORKS AND THE INTERNET, INTRANETS, SATELLITE AND WIRELESS COMMUNICATIONS, EQUIPMENT FOR AIR PURIFICATION AND COOLING, ENVIRONMENTAL REMEDIATION, SOIL, WATER AND WASTE TREATMENT, DISTRIBUTION, COLLECTION, MANAGEMENT, DISPOSAL AND RECYCLING, SORTING OF WASTE AND RECYCLABLE MATERIALS AND THE PRODUCTION OF ENERGY, ELECTRICITY, WATER, GAS AND HEATING; EDUCATIONAL SERVICES, NAMELY, TRAINING AND USE IN THE OPERATION OF NEW TECHNOLOGIES, NAMELY, COMPUTERS, TELEPHONES AND TELEPHONY, GLOBAL NETWORKS AND THE INTERNET, INTRANETS, SATELLITE NETWORKS AND WIRELESS COMMUNICATIONS NETWORKS, EQUIPMENT FOR USE IN THE PRODUCTION AND DISTRIBUTION OF ENERGY, AIR PURIFICATION AND COOLING, ENVIRONMENTAL REMEDIATION, SOIL, WATER AND WASTE TREATMENT, DISTRIBUTION, COLLECTION, MANAGEMENT, DISPOSAL AND RECYCLING; EDUCATIONAL SERVICES, NAMELY, ORGA-

NIZING, CONDUCTING AND TRAINING OTHERS TO ORGANIZE AND CONDUCT CLASSES, SEMINARS, CONFERENCES, WORKSHOPS IN THE FIELDS OF BUSINESS, ACCOUNTING AND FINANCE, TRANSPORTATION AND TRAVEL, CONSTRUCTION AND BUILDING, SCIENCE, FILM, THEATRE AND CINEMA, MUSIC AND ART, NEW TECHNOLOGIES AND TELECOMMUNICATIONS, PUBLIC UTILITIES, AIR PURIFICATION AND COOLING, WATER TREATMENT AND DISPOSAL OF WASTE MATERIALS, THE PRODUCTION OF ENERGY, NAMELY, ELECTRICITY, WATER GAS AND HEATING, ENVIRONMENTAL LAWS, REGULATIONS AND ORDINANCES; PREPARING AND DISTRIBUTING COURSE MATERIALS IN CONNECTION THEREWITH (U.S. CLS. 100, 101 AND 107).

CLASS 42—SCIENTIFIC, COMPUTER AND LEGAL SERVICES

FOR PATENT AGENCY AND INDUSTRIAL PROPERTY CONSULTATION; LICENSING OF INTELLECTUAL PROPERTY; INTELLECTUAL PROPERTY CONSULTATION; CHEMICAL AND BACTERIOLOGIC RESEARCH AND CONSULTATION; PROVIDING INFORMATION IN THE FIELD OF ENVIRONMENTAL PROTECTION IN THE NATURE OF REVIEWING STANDARDS AND PRACTICES TO ASSURE COMPLIANCE WITH ENVIRONMENTAL ZONING, LAWS AND REGULATIONS; TECHNICAL CONSULTATION AND RESEARCH IN THE FIELD OF ENVIRONMENTAL REMEDIATION, NAMELY, WATER, SOIL AND WASTE TREATMENT, DISTRIBUTION, COLLECTION, MANAGEMENT, DISPOSAL AND RECYCLING; TECHNICAL CONSULTATION AND RESEARCH IN THE FIELD OF PRODUCTION OF ENERGY, ELECTRICITY, WATER, GAS AND HEATING, NEW TECHNOLOGY AND TELECOMMUNICATIONS, GLOBAL NETWORKS AND THE INTERNET, INTRANETS, SATELLITE AND WIRELESS COMMUNICATIONS NETWORKS, DATA-PROCESSING AND COMPUTER PROGRAMMING AND ENGINEERING (U.S. CLS. 100 AND 101).

SN 76-388,993, ADVANCED FIBER TECHNOLOGIES (AFT) INCOME FUND, QUEBEC, CANADA, FILED 3-28-2002.

**CLASS 7—MACHINERY**

FOR MACHINE PARTS FOR SCREENING EQUIPMENT, NAMELY, SCREENS, SCREEN PLATES, SCREEN CYLINDERS, SCREEN BASKETS AND SCREEN ROTORS USED IN MACHINERY FOR SORTING, SCREENING, FRACTIONATING, AND SEPARATING SOLIDS FROM FLUIDS; MACHINE PARTS FOR REFINING EQUIPMENT, NAMELY REFINER PLATES USED IN MACHINERY FOR REFINING SOLIDS FOR PULP AND PAPER PRODUCTION (U.S. CLS. 13, 19, 21, 23, 31, 34 AND 35).

CLASS 9—ELECTRICAL AND SCIENTIFIC APPARATUS

FOR SOFTWARE USED IN THE MONITORING, CONTROL AND OPTIMIZATION OF SCREENING EQUIPMENT AND MACHINERY USED IN PULP AND PAPER PRODUCTION; SOFTWARE USED IN THE MONITORING, CONTROL AND OPTIMIZATION OF REFINING EQUIPMENT AND MACHINERY USED IN PULP AND PAPER PRODUCTION (U.S. CLS. 21, 23, 26, 36 AND 38).

CLASS 37—CONSTRUCTION AND REPAIR

FOR MAINTENANCE, REPAIR, REFURBISHING, RESURFACING AND RE-INSTALLATION OF SCREENING AND RELATED MACHINERY AND EQUIPMENT USED IN PULP AND PAPER PRODUCTION; MAINTENANCE, REPAIR, REFURBISHING, RESURFACING AND RE-INSTALLATION OF REFINING AND OTHER RELATED MACHINERY AND EQUIPMENT USED IN PULP AND PAPER PRODUCTION (U.S. CLS. 100, 103 AND 106).

CLASS 42—SCIENTIFIC, COMPUTER AND LEGAL SERVICES

FOR TECHNICAL CONSULTATION IN THE FIELD OF ENGINEERING, NAMELY, PROVIDING ASSESSMENTS, SIMULATIONS AND OPTIMIZED PROCESS SOLUTIONS OF SCREENING AND REFINING PROCESSES USED IN PULP AND PAPER PRODUCTION; MAINTENANCE, REPAIR AND RE-INSTALLATION OF SOFTWARE RELATED TO SCREENING USED IN PULP AND PAPER PRODUCTION; MAINTENANCE, REPAIR AND RE-INSTALLATION OF SOFTWARE RELATED TO REFINING USED IN PULP AND PAPER PRODUCTION (U.S. CLS. 100 AND 101).

SN 76-389,083. PEACEBEANS KABUSHIKI KAISHA, TOKYO 101-0032, JAPAN, FILED 3-29-2002.



SN 76-389,081. PEACEBEANS KABUSHIKI KAISHA, TOKYO 101-0032, JAPAN, FILED 3-29-2002.

PEACEBEANS**CLASS 29—MEATS AND PROCESSED FOODS**

FOR MILK PRODUCTS, NAMELY, BEAN MILK, CHEESE, BUTTER, YOGURT, MEAT PRODUCTS, NAMELY, SAUSAGES, HAM, HAMBURGER MEAT, HOT DOG MEAT, STEAK AND MEAT CROQUETTES; PREPARED FISH PRODUCTS, NAMELY, PREPARED FISH, FISH CAKES, NAMELY, KAMABOKO, FISH CAKES, NAMELY, CHIKUWA, FISH CAKES, NAMELY, HANPEN AND FISH CAKES, NAMELY, TSUMIRE; EGGS; STEWS, SOUPS, POTATO AU GRATIN AND PACKAGED ENTREES CONSISTING PRIMARILY OF MEAT (U.S. CL. 46).

CLASS 30—STAPLE FOODS

FOR CURRY, PREPARATIONS OF CONFECTIONERY AND BREAD, NAMELY, FREEZABLE LIQUID FOR USE IN MAKING FROZEN CONFECTIONS, FROZEN CONFECTIONS, PEANUT BUTTER CONFECTIONERY CHIPS, BREAD, BREAD STICKS, FOOD PACKAGE COMBINATIONS CONSISTING PRIMARILY OF BREAD, CRACKERS AND/OR COOKIES, BREAD ROLLS, STUFFING MIXES CONTAINING BREAD; ICE CREAMS, ICE MONAKA, NAMELY, ICE CREAM WRAPPED IN PASTRY SHELLS; SOFT ICE CREAMS; SHERBETS; PREPARED FOODS OF CEREALS, NAMELY, PROCESSED PLANT BASED GRAINS; WORCESTERSHIRE SAUCE, GRAVY SAUCE, KETCHUP, SOY SAUCE, VINEGAR, SOBA NOODLES SAUCE, FOOD DRESSINGS, NAMELY, SALAD DRESSING, EDIBLE OILS, COOKING OILS, FOOD ADDITIVES FOR NON-NUTRITIONAL PURPOSES FOR USE AS A FLAVORING, INGREDIENT OR FILLER, MAYONNAISE, BARBECUE SAUCE, CHINESE MEAT DUMPLINGS, SANDWICHES, SUSHI, STEAMED BUN WITH MEAT, HAMBURGER SANDWICHES, PIZZAS, PACKAGED ENTREES CONSISTING PRIMARILY OF PASTA OR RICE, HOT DOG SANDWICHES, MEAT PIES, RAVIOLIS, SWEETENED FLAVORED GELATIN DESSERTS, PUDDINGS AND CAKES (U.S. CL. 46).

COLOR IS CLAIMED AS A FEATURE OF THE MARK. THE LEAVES COMPONENT OF THE DRAWING ARE IN THE COLOR GREEN, THE STEM OF THE LEAVES IS IN THE COLOR ORANGE, THE GLOBE COMPONENT OF THE DRAWING IS DUAL COLORED, WITH THE LEFT HALF OF THE GLOBE IN THE COLOR BLUE, SCORED WITH WHITE LINES AND THE RIGHT HALF OF THE GLOBE IN THE COLOR ORANGE.

THE MARK CONSISTS OF A GLOBE SUBDIVIDED VERTICALLY WITH THE LEFT HALF HAVING A BLUE COLOR SUBDIVIDED INTO A FEW LONGITUDINAL AND LATITUDE LINES. THE RIGHT HALF OF THE VERTICAL SUBDIVISION IS ORANGE IN COLOR WITH ONE SHADE MARK GENERALLY FOLLOWING ABOUT TWO THIRDS OF THE OUTER DIAMETER. FROM A POINT NEAR THE BOTTOM OF THE GLOBE A SWEEPING ORANGE STEM EXTENDS OUTSIDE AND AROUND THE RIGHT HALF OF THE VERTICAL SUBDIVISION AND BACK TOWARD THE TOP OF THE GLOBE AND ABOVE THE GLOBE. THE ORANGE STEM TERMINATES IN A PAIR OF GREEN LEAVES, ONE OF WHICH IS GENERALLY ALIGNED WITH THE FINAL EXTENT OF THE ORANGE STEM AND ANOTHER WHICH IS ABOUT HALF THE LENGTH OF THE LONGER LEAF AND BEARS A FORTY FIVE DEGREE ANGLE TO THE BROWN STEM.

CLASS 29—MEATS AND PROCESSED FOODS

FOR MILK PRODUCTS, NAMELY, BEAN MILK, CHEESE, BUTTER, YOGURT, MEAT PRODUCTS, NAMELY, SAUSAGES, HAM, HAMBURGER MEAT, HOT DOG MEAT, STEAK AND MEAT CROQUETTES; PREPARED FISH PRODUCTS, NAMELY, PREPARED FISH, FISH CAKES, NAMELY, KAMABOKO, FISH CAKES, NAMELY, CHIKUWA, FISH CAKES, NAMELY, HANPEN AND FISH CAKES, NAMELY, TSUMIRE; EGGS; STEWS, SOUPS, POTATO AU GRATIN AND PACKAGED ENTREES CONSISTING PRIMARILY OF MEAT (U.S. CL. 46).

CLASS 30—STAPLE FOODS

FOR CURRY, PREPARATIONS OF CONFECTIONERY AND BREAD, NAMELY, FREEZABLE LIQUID FOR USE IN MAKING FROZEN CONFECTIONS, FROZEN CONFECTIONS, PEANUT BUTTER CONFECTIONERY CHIPS, BREAD, BREAD STICKS, FOOD PACKAGE COMBINATIONS CONSISTING PRIMARILY OF BREAD, CRACKERS AND/OR COOKIES, BREAD ROLLS, STUFFING MIXES CONTAINING BREAD; ICE CREAMS, ICE MONAKA, NAMELY, ICE CREAM WRAPPED IN PASTRY SHELLS; SOFT ICE CREAMS; SHERBETS; PREPARED FOODS OF CEREALS, NAMELY, PROCESSED PLANT BASED GRAINS; WORCESTERSHIRE SAUCE, GRAVY SAUCE, KETCHUP, SOY SAUCE, VINEGAR, SOBA NOODLES SAUCE, FOOD DRESSINGS, NAMELY, SALAD DRESSING, EDIBLE OILS, COOKING OILS, FOOD ADDITIVES FOR NON-NUTRITIONAL PURPOSES FOR USE AS A FLAVORING, INGREDIENT OR FILLER, MAYONNAISE, BARBECUE SAUCE, CHINESE MEAT DUMPLINGS, SANDWICHES, SUSHI, STEAMED BUN WITH MEAT, HAMBURGER SANDWICHES, PIZZAS, PACKAGED ENTREES CONSISTING PRIMARILY OF PASTA OR RICE, HOT DOG SANDWICHES, MEAT PIES, RAVIOLIS, SWEETENED FLAVORED GELATIN DESSERTS, PUDDINGS AND CAKES (U.S. CL. 46).

SN 76-389,336. OIL DEPOT, LLC, BRAINTREE, MA. FILED 4-1-2002.

OILDEPOT**CLASS 4—LUBRICANTS AND FUELS**

FOR FUEL OIL, NAMELY, HOME HEATING OIL (U.S. CLS. 1, 6 AND 15).

CLASS 35—ADVERTISING AND BUSINESS

FOR DISTRIBUTORSHIPS IN THE FIELD OF FUEL OIL AND RELATED FUEL OIL PRODUCTS (U.S. CLS. 100, 101 AND 102).

CLASS 37—CONSTRUCTION AND REPAIR

FOR MAINTENANCE SERVICES IN THE FIELD OF FUEL OIL AND FUEL OIL RELATED PRODUCTS, NAMELY, MAINTENANCE SERVICES FOR FURNACES, HOT WATER HEATERS, AND HEATING SYSTEMS (U.S. CLS. 100, 103 AND 106).

SN 76-391,129. KEELER LTD, BERKSHIRE, UNITED KINGDOM, FILED 4-4-2002.

EASYEYE

PRIORITY CLAIMED UNDER SEC. 44(D) ON UNITED KINGDOM APPLICATION NO. 2279025, FILED 8-25-2001.

CLASS 9—ELECTRICAL AND SCIENTIFIC APPARATUS

FOR DOWNLOADABLE ELECTRONIC PUBLICATIONS IN THE NATURE OF REPORTS, INSTRUCTION MANUALS AND PRODUCT SPECIFICATIONS IN THE FIELD OF OPTICAL LENSES, TONOMETERS AND OPHTHALMOSCOPES (U.S. CLS. 21, 23, 26, 36 AND 38).

CLASS 10—MEDICAL APPARATUS

FOR OPHTHALMOLOGIC AND OPTOMETRIC APPARATUS AND INSTRUMENTS, NAMELY OPHTHALMOSCOPES AND TONOMETERS; REPLACEMENT PARTS, REPLACEMENT FITTINGS, AND CASES ADAPTED FOR ALL THE AFORESAID GOODS (U.S. CLS. 26, 39 AND 44).

CLASS 16—PAPER GOODS AND PRINTED MATTER

FOR PRINTED MATTER, NAMELY BOOKS, MANUALS, PRODUCT LISTINGS AND LISTINGS OF PRODUCT SPECIFICATIONS RELATING TO OPTICS, OPHTHALMOLOGY, OPTICAL INSTRUMENTS, OPHTHALMOLOGIC APPARATUS AND INSTRUMENTS, TONOMETERS, LENSES, EYE TESTS OR TREATMENT OF THE EYE; EDUCATIONAL PUBLICATIONS, NAMELY, TRAINING MANUALS IN THE FIELDS OF OPTICS, OPHTHALMOLOGY, OPTICAL INSTRUMENTS, OPHTHALMOLOGIC APPARATUS AND INSTRUMENTS, TONOMETERS, LENSES, EYE TESTS OR TREATMENT OF THE EYE; PERIODICALS, MAGAZINES, AND TECHNICAL AND OPERATING MANUALS, ALL RELATING TO OPTICS, OPHTHALMOLOGY, OPTICAL INSTRUMENTS, OPHTHALMOLOGIC APPARATUS AND INSTRUMENTS, TONOMETERS, LENSES, EYE TESTS OR TREATMENT OF THE EYE (U.S. CLS. 2, 5, 22, 23, 29, 37, 38 AND 50).

SN 76-391,386. GEORGE SHOE CORP., HSINCHU HSIEN, TAIWAN, FILED 4-4-2002.

GCI**CLASS 14—JEWELRY**

FOR JEWELRY, NAMELY, BROOCHES, NECKLACES, BRACELETS, RINGS, EARRINGS, EAR PENDANTS, EARRING CLIPS, IMITATION PEARLS, ARTIFICIAL JEWELRY; ALLOYS OF PRECIOUS METAL SOLD IN BULK (U.S. CLS. 2, 27, 28 AND 50).

CLASS 18—LEATHER GOODS

FOR WALLETS; LEATHER HANDBAGS; FANNY PACKS; WAIST PACKS; SHOE BAGS FOR TRAVEL; BRIEFCASES; KEY CASES; HANDBAGS; PARASOLS; AND PURSES (U.S. CLS. 1, 2, 3, 22 AND 41).

SN 76-391,613. CITY OF CALGARY, THE, CALGARY, CANADA, FILED 4-4-2002.

GREENMAX

OWNER OF CANADA REG. NO. 549,848, DATED 8-16-2001, EXPIRES 8-16-2016.

CLASS 35—ADVERTISING AND BUSINESS

FOR PROMOTING PUBLIC AWARENESS OF THE NEED TO REDUCE THE ENVIRONMENTAL IMPACT OF PRODUCING ELECTRICITY BY PROMOTING THE USE OF ELECTRICITY FROM ENVIRONMENTALLY FRIENDLY SOURCES IN THE NATURE OF PROMOTING THE CREATION, DEVELOPMENT AND EXPANSION OF ENVIRONMENTALLY FRIENDLY ENERGY SOURCES BY PROVIDING LONG TERM CONTRACTS FOR THE PRODUCTION OF ENVIRONMENTALLY FRIENDLY ENERGY (U.S. CLS. 100, 101 AND 102).

CLASS 39—TRANSPORTATION AND STORAGE

FOR PUBLIC UTILITY SERVICES IN THE NATURE OF DISTRIBUTION OF ELECTRICAL POWER TO RESIDENTIAL AND COMMERCIAL CUSTOMERS; CONSULTING IN THE FIELD OF THE SUPPLY AND DISTRIBUTION OF ELECTRICAL ENERGY ARISING FROM ENVIRONMENTALLY FRIENDLY SOURCES (U.S. CLS. 100 AND 105).

CLASS 40—MATERIAL TREATMENT

FOR COMPUTER SERVICES, NAMELY, PROVIDING A WEBSITE FEATURING INFORMATION IN THE FIELD OF ENERGY RESOURCES, NAMELY, ENVIRONMENTALLY FRIENDLY ENERGY PRODUCTION (U.S. CLS. 100, 103 AND 106).

CLASS 41—EDUCATION AND ENTERTAINMENT

FOR EDUCATIONAL SERVICES, NAMELY CONDUCTING SEMINARS AND LECTURES IN THE FIELD OF ENVIRONMENTALLY FRIENDLY ENERGY SOURCES AND DISTRIBUTING COURSE MATERIALS, NAMELY, PRINTED EDUCATIONAL MATERIALS, IN CONNECTION THEREWITH (U.S. CLS. 100, 101 AND 107).

SN 76-392,059. INTERNET BILLING COMPANY, LLC, DEERFIELD BEACH, FL. FILED 4-5-2002.



NO CLAIM IS MADE TO THE EXCLUSIVE RIGHT TO USE "WEB PLEDGE", APART FROM THE MARK AS SHOWN.

THE STIPPLING IS FOR SHADING PURPOSES ONLY.

CLASS 35—ADVERTISING AND BUSINESS

FOR PROMOTING PUBLIC AWARENESS OF ORGANIZATIONS CONCERNED WITH THE ABUSE AND EXPLOITATION OF MISSING CHILDREN (U.S. CLS. 100, 101 AND 102).

FIRST USE 8-15-2001; IN COMMERCE 8-15-2001.

CLASS 36—INSURANCE AND FINANCIAL

FOR CHARITABLE FUND RAISING SERVICES VIA A GLOBAL COMPUTER NETWORK, NAMELY, ACCEPTING AND ADMINISTERING CONTRIBUTOR DIRECTED CHARITABLE DONATIONS FOR NON-PROFIT, FOR PROFIT AND CHARITABLE ORGANIZATIONS (U.S. CLS. 100, 101 AND 102).

FIRST USE 8-15-2001; IN COMMERCE 8-15-2001.

SN 76-392,281. BIGFOOT COMMUNICATIONS (HONG KONG) LIMITED, HONG KONG, FILED 4-5-2002.

BIGFOOT**CLASS 38—COMMUNICATION**

FOR TELECOMMUNICATION SERVICES, NAMELY PERSONAL AND BUSINESS COMMUNICATION SERVICES; ELECTRONIC MAIL SERVICES (U.S. CLS. 100, 101 AND 104).

FIRST USE 2-22-1996; IN COMMERCE 2-22-1996.

CLASS 42—SCIENTIFIC, COMPUTER AND LEGAL SERVICES

FOR GLOBAL COMPUTER SYSTEM DOMAIN NAME REGISTRATIONS SERVICES; WEB HOSTING (U.S. CLS. 100 AND 101).

FIRST USE 2-1-2002; IN COMMERCE 2-1-2002.

SN 76-394,000. IRON MOUNTAIN INCORPORATED, BOSTON, MA. FILED 4-10-2002.

**ENTERPRISE VALUE
ARCHIVES ARCHITECTURE**

NO CLAIM IS MADE TO THE EXCLUSIVE RIGHT TO USE "ARCHIVES ARCHITECTURE", APART FROM THE MARK AS SHOWN.

CLASS 35—ADVERTISING AND BUSINESS

FOR COMPUTERIZED MANAGEMENT OF DIGITAL AND ELECTRONIC INFORMATION, DOCUMENTS AND RECORDS, NAMELY, COMPUTERIZED MANAGEMENT OF E-MAILS, ELECTRONIC DOCUMENTS AND DATA USED TO E-COMMERCE TRANSACTIONS, ELECTRONIC STATEMENTS, OFFICE DOCUMENTS, VOICE, INTERNET, AND VIDEO CONTENT; COMPUTERIZED, ELECTRONIC AND ON-LINE INDEXING AUDIT TRACKING AND MANAGEMENT OF DOCUMENTS AND DATA (U.S. CLS. 100, 101 AND 102).

FIRST USE 8-2-2001; IN COMMERCE 8-2-2001.

CLASS 39—TRANSPORTATION AND STORAGE

FOR ARCHIVING AND STORAGE OF DIGITAL AND ELECTRONIC INFORMATION, DOCUMENTS AND RECORDS, NAMELY ARCHIVING AND STORAGE OF E-MAILS, ELECTRONIC DOCUMENTS AND DATA USED IN E-COMMERCE TRANSACTIONS, ELECTRONIC STATEMENTS, OFFICE DOCUMENTS, VOICE, INTERNET, AND VIDEO CONTENT, AND DATA FEATURING RETRIEVAL SERVICES FOR SUCH E-MAILS, ELECTRONIC DOCUMENTS AND DATA (U.S. CLS. 100 AND 105).

FIRST USE 8-2-2001; IN COMMERCE 8-2-2001.

CLASS 42—SCIENTIFIC, COMPUTER AND LEGAL SERVICES

FOR VIRUS SCANNING SERVICES FOR ELECTRONIC INFORMATION AND TRANSMISSIONS; LEGAL, REGULATORY AND BUSINESS COMPLIANCE MANAGEMENT IN THE FIELD OF ELECTRONIC DATA MANAGEMENT (U.S. CLS. 100 AND 101).

FIRST USE 8-2-2001; IN COMMERCE 8-2-2001.

SN 76-396,462. GASTI-VERPACKUNGSMASCHINEN GMBH, D-74523 SCHWABISCH HALL, FED REP GERMANY, FILED 4-16-2002.

GASTI

PRIORITY CLAIMED UNDER SEC. 44(D) ON ERPN CMNTY TM OFC APPLICATION NO. 002421238, FILED 10-22-2001, REG. NO. 002421238, DATED 4-1-2003, EXPIRES 10-22-2011.

CLASS 7—MACHINERY

FOR PACKAGING MACHINES FOR USE IN THE FOOD PROCESSING AND PACKAGING INDUSTRY, NAMELY, MACHINES FOR PRODUCING PACKAGING MATERIALS, PACKAGING SUPPLY MACHINES, OPENERS, UNPACKING MACHINES, AUTOMATIC SORTING MACHINES, FEEDING AND ASSEMBLY MACHINES, PRESSES, MACHINES FOR OUTER PACKAGING, FILLING MACHINES, SEALING MACHINES, FILLING AND FOLDING MACHINES, FILLING AND SCREWING MACHINES, FILLING AND SEALING MACHINES, FILING AND SNAP-ON LID APPLYING MACHINES, FILLING AND CRIMPING MACHINES, FILL-SEAL AND CRIMPING MACHINES, FILLING AND SEALING AND SNAP-ON LID APPLYING MACHINES, FORM-FILL-SEAL MACHINES FOR PLASTIC CUPS, FORM-FILL SEAL MACHINES FOR PLASTIC BOTTLES, FORM-FILL-SEAL AND SNAP-ON LID APPLYING MACHINES FOR PLASTIC CUPS, FORM FILL SEALING MACHINES FOR ALUMINUM CUPS, FORM-FILL-SEAL AND SNAP ON LID APPLYING MACHINES FOR CARDBOARD AND PAPER, AND COUPLERS FOR LINKING THE FOREGOING MACHINES TO ONE ANOTHER; MACHINES FOR CLEANING CUPS AND OTHER MACHINES IN THE FOOD PROCESSING AND PACKAGING INDUSTRY (U.S. CLS. 13, 19, 21, 23, 31, 34 AND 35).

CLASS 11—ENVIRONMENTAL CONTROL APPARATUS

FOR MACHINES FOR DRYING AND STERILIZING CUPS AND MACHINES IN THE FOOD PROCESSING AND PACKAGING INDUSTRY (U.S. CLS. 13, 21, 23, 31 AND 34).

SN 76-398,293. AEOLUS MEDICAL, INC., WALTHAM, MA, FILED 4-22-2002.

FREEDOMWEAR

CLASS 9—ELECTRICAL AND SCIENTIFIC APPARATUS

FOR COLD WEATHER HEALTH MASKS FOR PROTECTING ASTHMATICS FROM THE ASTHMA-INDUCING EFFECTS OF COLD AIR ON THE LUNGS, ALLERGY MASKS FOR PROTECTING ALLERGY SUFFERERS FROM THE EFFECTS OF POLLEN AND OTHER ALLERGENS, AND RESPIRATORY MASKS FOR PROTECTING THE WEARER FROM THE DEBILITATING EFFECTS OF INDUSTRIAL PARTICULATES AND AIR POLLUTANTS, ALL FOR NON-MEDICAL PURPOSES (U.S. CLS. 21, 23, 26, 36 AND 38).

CLASS 10—MEDICAL APPARATUS

FOR MEDICAL PRODUCTS, NAMELY, COLD WEATHER HEALTH MASKS FOR PROTECTING ASTHMATICS FROM THE ASTHMA-INDUCING EFFECTS OF COLD AIR ON THE LUNGS, ALLERGY MASKS FOR PROTECTING ALLERGY SUFFERERS FROM THE EFFECTS OF POLLEN AND OTHER ALLERGENS, AND RESPIRATORY MASKS FOR PROTECTING THE WEARER FROM THE DEBILITATING EFFECTS OF INDUSTRIAL PARTICULATES AND AIR POLLUTANTS, ALL FOR MEDICAL PURPOSES (U.S. CLS. 26, 39 AND 44).

SN 76-399,383. ALPHAMEDICA, INC., TARRYTOWN, NY, FILED 4-23-2002.

SCORE IT

CLASS 41—EDUCATION AND ENTERTAINMENT

FOR HEALTH CARE EDUCATIONAL SERVICES, NAMELY, CONDUCTING CLASSES, CONFERENCES, SEMINARS AND WORKSHOPS FOR HEALTH CARE PROFESSIONALS IN THE FIELD OF DIAGNOSING PATIENTS WHO ARE AT RISK FOR DEVELOPING DEEP VEIN THROMBOSIS, AND DISTRIBUTING COURSE MATERIALS AND TEACHING AIDS IN CONNECTION THEREWITH (U.S. CLS. 100, 101 AND 107).

CLASS 42—SCIENTIFIC, COMPUTER AND LEGAL SERVICES

FOR SCIENTIFIC RESEARCH SERVICES DEVOTED TO IMPROVING THE DIAGNOSIS OF PATIENTS WHO ARE AT RISK OF DEVELOPING DEEP VEIN THROMBOSIS (U.S. CLS. 100 AND 101).

CLASS 44—MEDICAL, BEAUTY AND AGRICULTURAL SERVICES

FOR MEDICAL INFORMATION SERVICES, NAMELY, PROVIDING INFORMATION TO HEALTH CARE PROFESSIONALS IN THE FIELD OF DIAGNOSING PATIENTS WHO ARE AT RISK FOR DEVELOPING DEEP VEIN THROMBOSIS (U.S. CLS. 100 AND 101).

SN 76-399,938. ROMAC INDUSTRIES, INC., DALLAS, NC, FILED 4-23-2002.

HAYS FLUID CONTROLS

NO CLAIM IS MADE TO THE EXCLUSIVE RIGHT TO USE "FLUID CONTROLS", APART FROM THE MARK AS SHOWN.
SEC. 2(F).

CLASS 9—ELECTRICAL AND SCIENTIFIC APPARATUS

FOR ELECTRICALLY OPERATED VALVES; FLOW METERS; FLOW SWITCHES; AUTOMATIC BALANCING VALVES; MANUAL BALANCING VALVES (U.S. CLS. 21, 23, 26, 36 AND 38).

FIRST USE 5-1-1986; IN COMMERCE 5-1-1986.

CLASS 11—ENVIRONMENTAL CONTROL APPARATUS

FOR HVAC HOSE KITS, NAMELY PLUMBING FITTINGS AND HOSES USED TO CONNECT A UNITARY DEVICE TO A HYDRONIC SYSTEM; HVAC PIPING PACKAGES, NAMELY PLUMBING FITTINGS USED TO CONNECT A TERMINAL DEVICE TO A HYDRONIC SYSTEM (U.S. CLS. 13, 21, 23, 31 AND 34).

FIRST USE 5-1-1986; IN COMMERCE 5-1-1986.

SN 76-402,861. SOFTWARE SAFETY TECHNOLOGY SERVICES, INC., MORRISVILLE, NC. FILED 4-30-2002.

Reduced Risk

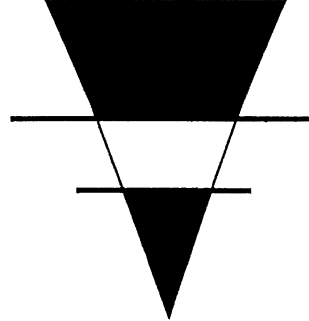

SN 76-402,528. WEKA FACHZEITSCHRIFTEN-VERLAG GMBH, FED REP GERMANY, FILED 5-1-2002.

EMBEDDED WORLD

OWNER OF FED REP GERMANY REG. NO. 30027783, DATED 9-5-2000, EXPIRES 4-30-2010.

NO CLAIM IS MADE TO THE EXCLUSIVE RIGHT TO USE "EMBEDDED", APART FROM THE MARK AS SHOWN.

CLASS 9—ELECTRICAL AND SCIENTIFIC APPARATUS

FOR PRE-RECORDED DATA CARRIERS AND STORAGE DEVICES, NAMELY, CDS, CD-ROMS, DVDS, AND FLOPPY DISCS CONTAINING INFORMATION ABOUT EMBEDDED TECHNOLOGY, FAIRS, EXHIBITIONS, OR SYMPOSIA IN THE FIELD OF EMBEDDED TECHNOLOGY; PRE-RECORDED VIDEO AND AUDIO CASSETTES CONTAINING INFORMATION ABOUT EMBEDDED TECHNOLOGY, FAIRS, EXHIBITIONS, OR SYMPOSIA IN THE FIELD OF EMBEDDED TECHNOLOGY; DOWNLOADABLE ELECTRONIC PUBLICATIONS, NAMELY, LEAFLETS CONTAINING INFORMATION ABOUT EMBEDDED TECHNOLOGY, FAIRS, EXHIBITIONS, OR SYMPOSIA IN THE FIELD OF EMBEDDED TECHNOLOGY; ELECTRONIC PUBLICATIONS RECORDED ON COMPUTER MEDIA, NAMELY, LEAFLETS CONTAINING INFORMATION ABOUT EMBEDDED TECHNOLOGY, FAIRS, EXHIBITIONS, OR SYMPOSIA IN THE FIELD OF EMBEDDED TECHNOLOGY (U.S. CLS. 21, 23, 26, 36 AND 38).

CLASS 16—PAPER GOODS AND PRINTED MATTER

FOR PRINTED MATTER, NAMELY, BOOKS, MAGAZINES, NEWSLETTERS, MANUALS, BROCHURES, LEAFLETS, PRINTED GUIDES, CATALOGS AND ADDRESS LIST ABOUT EMBEDDED TECHNOLOGY FOR FAIRS, EXHIBITIONS, AND SYMPOSIA IN THE FIELD OF EMBEDDED TECHNOLOGY; PRINTED MATTER, NAMELY, BOOKS, MAGAZINES, NEWSLETTERS, MANUALS, BROCHURES, LEAFLETS, PRINTED GUIDES, CATALOGS AND ADDRESS LISTS FEATURING INFORMATIONAL MATERIAL ABOUT EMBEDDED TECHNOLOGY FOR FAIRS, EXHIBITIONS, AND SYMPOSIA IN THE FIELD OF EMBEDDED TECHNOLOGY (U.S. CLS. 2, 5, 22, 23, 29, 37, 38 AND 50).

CLASS 35—ADVERTISING AND BUSINESS

FOR ORGANIZING, ARRANGING, AND CONDUCTING TRADESHOW EXHIBITIONS AND TRADE FAIRS IN THE FIELD OF EMBEDDED ELECTRONICS (U.S. CLS. 100, 101 AND 102).

NO CLAIM IS MADE TO THE EXCLUSIVE RIGHT TO USE "REDUCED RISK", APART FROM THE MARK AS SHOWN.

CLASS 9—ELECTRICAL AND SCIENTIFIC APPARATUS

FOR COMPUTER SOFTWARE AND PERIPHERALS FOR USE IN THE AREA OF SAFETY AND SECURITY REQUIREMENTS FOR COMPUTER-CONTROLLED EQUIPMENT (U.S. CLS. 21, 23, 26, 36 AND 38).

FIRST USE 3-1-2002; IN COMMERCE 3-1-2002.

CLASS 42—SCIENTIFIC, COMPUTER AND LEGAL SERVICES

FOR COMPUTER CONSULTATION SERVICES IN THE AREA OF SAFETY AND SECURITY REQUIREMENTS FOR COMPUTER-CONTROLLED EQUIPMENT, NAMELY, ASSISTING IN THE DEVELOPMENT OF ENHANCED PROCESSES FOR SOFTWARE SAFETY AND SECURITY AND PROVIDING GUIDANCE FOR PURCHASING SPECIFICATIONS (U.S. CLS. 100 AND 101).

FIRST USE 3-1-2002; IN COMMERCE 3-1-2002.

SN 76-403,885. DIESEL ENGINE TRANSFORMATIONS, LLC, PHILADELPHIA, PA. FILED 5-6-2002.

GREEN COAT

NO CLAIM IS MADE TO THE EXCLUSIVE RIGHT TO USE "COAT", APART FROM THE MARK AS SHOWN.

CLASS 2—PAINTS

FOR METALLIC COATINGS FOR INTERNAL COMBUSTION ENGINES AND ENGINE COMPONENTS; CATALYTIC COATINGS; SURFACE RESTORATION COATINGS FOR INTERNAL COMBUSTION ENGINES (U.S. CLS. 6, 11 AND 16).

CLASS 37—CONSTRUCTION AND REPAIR

FOR REBUILDING INTERNAL COMBUSTION ENGINES; RESTORING INTERNAL COMBUSTION ENGINES; DEPOSITION OF METALLIC COATINGS ON ENGINE COMPONENTS; ENGINE COMPONENT COATING SERVICES; INTERNAL COMBUSTION ENGINE EMISSION REDUCTION SERVICES (U.S. CLS. 100, 103 AND 106).

SN 76-404,470. INAMED CORPORATION, SANTA BARBARA, CA. FILED 5-7-2002.



OWNER OF U.S. REG. NOS. 2,545,046 AND 2,582,017.

CLASS 5—PHARMACEUTICALS

FOR HOUSE MARK USED FOR A FULL LINE OF PHARMACEUTICAL PRODUCTS USED IN CONNECTION WITH BREAST AESTHETIC, FACIAL AESTHETIC AND RECONSTRUCTION, FACIAL AESTHETIC AND ANTI-OBESITY SURGERY (U.S. CLS. 6, 18, 44, 46, 51 AND 52).

CLASS 10—MEDICAL APPARATUS

FOR HOUSE MARK USED FOR A FULL LINE OF MEDICAL DEVICES USED IN CONNECTION WITH BREAST AESTHETIC, FACIAL AESTHETIC AND RECONSTRUCTION, FACIAL AESTHETIC AND ANTI-OBESITY SURGERY (U.S. CLS. 26, 39 AND 44).

CLASS 41—EDUCATION AND ENTERTAINMENT

FOR HOUSE MARK USED IN CONNECTION WITH PATIENT EDUCATION SERVICES, NAMELY, LECTURES, SEMINARS, CLASSES AND EDUCATIONAL CONFERENCES, IN THE FIELD OF BREAST AESTHETIC, FACIAL AESTHETIC AND RECONSTRUCTION, FACIAL AESTHETIC AND ANTI-OBESITY SURGERY (U.S. CLS. 100, 101 AND 107).

CLASS 44—MEDICAL, BEAUTY AND AGRICULTURAL SERVICES

FOR HOUSE MARK USED IN CONNECTION WITH INFORMATIONAL SERVICES IN THE FIELD OF BREAST AESTHETIC AND RECONSTRUCTION, FACIAL AESTHETIC AND ANTI-OBESITY SURGERY (U.S. CLS. 100 AND 101).

SN 76-404,485. UNITEDHEALTH GROUP INCORPORATED, MINNETONKA, MN. FILED 5-7-2002.



CLASS 35—ADVERTISING AND BUSINESS

FOR MEDICAL INSURANCE CLAIMS ADMINISTRATION AND PROCESSING SERVICES AND UTILIZATION REVIEW SERVICES (U.S. CLS. 100, 101 AND 102). FIRST USE 4-15-2002; IN COMMERCE 4-15-2002.

CLASS 44—MEDICAL, BEAUTY AND AGRICULTURAL SERVICES

FOR PROVIDING HEALTH INFORMATION TO HEALTH CARE PROVIDERS (U.S. CLS. 100 AND 101). FIRST USE 4-15-2002; IN COMMERCE 4-15-2002.

SN 76-404,821. CITIZENSHIP THROUGH SPORTS ALLIANCE, INC., OLATHE, KS. FILED 5-9-2002.

STAY IN BOUNDS

CLASS 16—PAPER GOODS AND PRINTED MATTER

FOR PRINTED MATERIALS, NAMELY, LAMINATED CARDS, POSTERS, BOOKLETS, INFORMATIONAL BROCHURES AND FLIERS AND CERTIFICATES ALL FEATURING INFORMATION ABOUT SPORTSMANSHIP, LEADERSHIP, CITIZENSHIP AND ETHICAL CONDUCT IN THE FIELD OF ATHLETICS (U.S. CLS. 2, 5, 22, 23, 29, 37, 38 AND 50). FIRST USE 10-17-2000; IN COMMERCE 10-17-2000.

CLASS 41—EDUCATION AND ENTERTAINMENT

FOR PROVIDING EDUCATIONAL PRESENTATIONS AND WORKSHOPS ABOUT SPORTSMANSHIP, LEADERSHIP, CITIZENSHIP AND ETHICAL CONDUCT IN THE AREA OF ATHLETICS AND THE PROVISION OF AWARDS TO THOSE DEMONSTRATING EXCELLENCE IN THIS FIELD (U.S. CLS. 100, 101 AND 107). FIRST USE 10-17-2000; IN COMMERCE 10-17-2000.

SN 76-405,318. BINNEY & SMITH INC., EASTON, PA. FILED 5-6-2002.

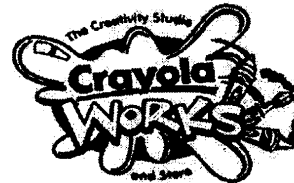

OWNER OF U.S. REG. NOS. 1,418,480, 1,468,224 AND 1,653,698.

NO CLAIM IS MADE TO THE EXCLUSIVE RIGHT TO USE "AND STORE", APART FROM THE MARK AS SHOWN.

CLASS 16—PAPER GOODS AND PRINTED MATTER

FOR ART AND CRAFT PAINT KITS (U.S. CLS. 2, 5, 22, 23, 29, 37, 38 AND 50).

CLASS 25—CLOTHING

FOR CLOTHING, NAMELY PANTS, SHIRTS, SHORTS, T-SHIRTS, COVERALLS, PLAYSUITS, DRESSES, HATS, HEADWEAR, NECKTIES, UNDERWEAR, PAJAMAS, SHOES AND STOCKINGS (U.S. CLS. 22 AND 39).

CLASS 35—ADVERTISING AND BUSINESS

FOR RETAIL STORE SERVICES FEATURING PAINTS, CRAYONS, MARKERS, CHALK, MODELING CLAY, ART SUPPLIES, HOBBY KITS, AND OTHER RELATED GOODS, AND APPAREL (U.S. CLS. 100, 101 AND 102).

CLASS 43—HOTEL AND RESTAURANT SERVICES

FOR RESTAURANT SERVICES (U.S. CLS. 100 AND 101).

SN 76-405,531. JIANG, MARYE W., NEW YORK, NY. FILED 5-10-2002.

SN 76-406,579. TRANSTECH PHARMA, INC., HIGH POINT, NC. FILED 5-9-2002.

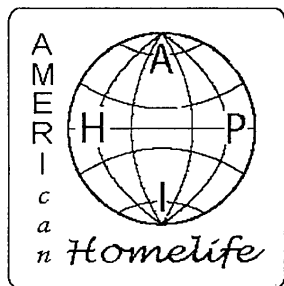

NO CLAIM IS MADE TO THE EXCLUSIVE RIGHT TO USE "AMERICAN", APART FROM THE MARK AS SHOWN.

CLASS 35—ADVERTISING AND BUSINESS

FOR PROVIDING A WEBSITE OF GLOBAL COMMUNICATIONS NETWORKS FEATURING INFORMATION PROMOTING AMERICAN HERITAGE AND DEMOCRACY (U.S. CLS. 100, 101 AND 102).

CLASS 41—EDUCATION AND ENTERTAINMENT

FOR PROVIDING ONLINE BOOKS IN THE FIELD OF AMERICAN HERITAGE AND DEMOCRACY; EDUCATIONAL SERVICES, NAMELY, VOLUNTEERS CONDUCTING SEMINARS PROMOTING BUSINESS OPPORTUNITIES IN THE FIELD OF AMERICAN HERITAGE AND DEMOCRACY (U.S. CLS. 100, 101 AND 107).



CLASS 40—MATERIAL TREATMENT

FOR SYNTHESIS AND PURIFICATION OF DRUG-LIKE COMPOUNDS FOR OTHERS FOR THE PURPOSE OF DISCOVERING AUTHENTIC CLINICAL DRUG CANDIDATES, AND CONSULTATION SERVICES RELATED THERETO (U.S. CLS. 100, 103 AND 106).

FIRST USE 6-0-2000; IN COMMERCE 6-0-2000.

CLASS 42—SCIENTIFIC, COMPUTER AND LEGAL SERVICES

FOR PHARMACEUTICAL DRUG DEVELOPMENT SERVICES AND CONSULTATION SERVICES RELATED THERETO; PHARMACEUTICAL RESEARCH SERVICES FOR THE DISCOVERY OF AUTHENTIC CLINICAL DRUG CANDIDATES, NAMELY, DESIGN, ANALYSIS, TESTING, OPTIMIZATION, AND PROFILING OF DRUG-LIKE COMPOUNDS; PHARMACEUTICAL DRUG CHEMICAL ANALYSIS SERVICES AND ASSAY SERVICES FOR OTHERS; CHEMICAL LABORATORY SERVICES; AND PHARMACEUTICAL RESEARCH SERVICES FOR OTHERS IN THE NATURE OF DATABASE DEVELOPMENT SERVICES AND DESIGN OF SOFTWARE DEVELOPMENT TOOLS, SEARCH ENGINES, DATA MINING SOFTWARE, AND COMPUTER MODELS (U.S. CLS. 100 AND 101).

FIRST USE 6-0-2000; IN COMMERCE 6-0-2000.

SN 76-406,577. TRANSTECH PHARMA, INC., HIGH POINT, NC. FILED 5-9-2002.

SN 76-406,798. INFOPROS DRAKELEY-SMITH, CITRUS HEIGHTS, CA. FILED 5-9-2002.

TRANSTECH PHARMA

CLASS 40—MATERIAL TREATMENT

FOR SYNTHESIS AND PURIFICATION OF DRUG-LIKE COMPOUNDS FOR OTHERS FOR THE PURPOSE OF DISCOVERING AUTHENTIC CLINICAL DRUG CANDIDATES, AND CONSULTATION SERVICES RELATED THERETO (U.S. CLS. 100, 103 AND 106).

FIRST USE 12-0-1998; IN COMMERCE 11-0-1999.

CLASS 42—SCIENTIFIC, COMPUTER AND LEGAL SERVICES

FOR PHARMACEUTICAL DRUG DEVELOPMENT SERVICES AND CONSULTATION SERVICES RELATED THERETO; PHARMACEUTICAL RESEARCH SERVICES FOR THE DISCOVERY OF AUTHENTIC CLINICAL DRUG CANDIDATES, NAMELY, DESIGN, ANALYSIS, TESTING, OPTIMIZATION, AND PROFILING OF DRUG-LIKE COMPOUNDS; PHARMACEUTICAL DRUG CHEMICAL ANALYSIS SERVICES AND ASSAY SERVICES FOR OTHERS; CHEMICAL LABORATORY SERVICES; AND PHARMACEUTICAL RESEARCH SERVICES FOR OTHERS IN THE NATURE OF DATABASE DEVELOPMENT SERVICES AND DESIGN OF SOFTWARE DEVELOPMENT TOOLS, SEARCH ENGINES, DATA MINING SOFTWARE, AND COMPUTER MODELS (U.S. CLS. 100 AND 101).

FIRST USE 12-0-1998; IN COMMERCE 11-0-1999.

INFOPROS

CLASS 35—ADVERTISING AND BUSINESS

FOR DIRECT MARKETING ADVERTISING FOR OTHERS; ADVERTISING SERVICES, NAMELY CREATING CORPORATE LOGOS FOR OTHERS; PREPARATION OF CUSTOM ADVERTISEMENTS AND CUSTOM PROMOTIONAL PRODUCTS FOR OTHERS IN THE NATURE OF BROCHURES, CD INSERTS, PRODUCT DATA SHEETS, TECHNICAL SALES PROPOSALS, PRESS RELEASES, SALES LETTERS, NEWSLETTERS, QUICK REFERENCE GUIDES, LOGOS AND MARKETING PACKETS; MULTI-MEDIA PRODUCT DEMONSTRATIONS; EMPLOYMENT COUNSELING AND RECRUITING AND EMPLOYMENT PLACEMENT SERVICES (U.S. CLS. 100, 101 AND 102).

FIRST USE 2-1-1995; IN COMMERCE 2-15-1995.

CLASS 41—EDUCATION AND ENTERTAINMENT

FOR PUBLICATION OF BROCHURES, CD INSERTS, PRODUCT DATA SHEETS, TECHNICAL SALES PROPOSALS, PRESS RELEASES, SALES LETTERS, NEWSLETTERS, QUICK REFERENCE GUIDES, LOGOS AND MARKETING PACKETS (U.S. CLS. 100, 101 AND 107).

FIRST USE 2-1-1995; IN COMMERCE 2-15-1995.

SN 76-406,824. BARILLA ALIMENTARE S.P.A., PARMA PR, ITALY, FILED 5-2-2002.

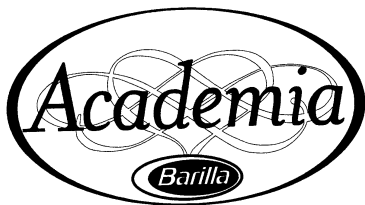

PRIORITY CLAIMED UNDER SEC. 44(D) ON ITALY APPLICATION NO. MI2002C00332, FILED 3-29-2002, REG. NO. 00867120, DATED 3-16-2002, EXPIRES 3-29-2012.

THE MARK CONSISTS OF THE WORDS "ACADEMIA BARILLA". THE WORD "ACADEMIA" IS IN UPPER AND LOWER CASE LETTERS AND IS BLUE. BLUE RIBBON DESIGNS APPEAR IN THE BACKGROUND OF THE WORD "ACADEMIA". THE WORD "BARILLA" IS WHITE. THE WORD "BARILLA" IS SURROUNDED BY A RED OVAL AND A WHITE OUTER OVAL. BOTH THE RED OVAL AND WHITE OUTER OVAL APPEAR IN A LARGER OVAL OUTLINED IN RED. THE ENTIRE MARK APPEARS IN A BLUE OVAL. THE COLORS WHITE, RED, BLUE AND LIGHT BLUE ARE CLAIMED.

THE WORD "ACADEMIA" IS A VARIATION OF THE ITALIAN WORD ACCADEMIA. THE ENGLISH TRANSLATION OF "ACCADEMIA" IS "ACADEMY".

CLASS 29—MEATS AND PROCESSED FOODS

FOR MEAT, FISH, POULTRY AND GAME; MEAT EXTRACTS; PRESERVED, DRIED AND COOKED FRUITS AND VEGETABLES; JELLIES, JAMS, FRUIT COMPOTES; EGGS, MILK AND MILK BASED DAIRY PRODUCTS, EXCLUDING ICE CREAM, ICE MILK AND FROZEN YOGURT; EDIBLE OILS AND FATS (U.S. CL. 46).

CLASS 30—STAPLE FOODS

FOR COFFEE, TEA, COCOA, SUGAR, RICE, TAPIOCA, SAGO, GRAIN BASED AND CHICORY BASED COFFEE SUBSTITUTES; FLOUR AND PREPARATIONS MADE FROM CEREALS, BREAD, PASTRY AND CONFECTIONERY, NAMELY, CANDY; FLAVORED ICES; HONEY, TREACLE; YEAST, BAKING POWDER; SALT, MUSTARD; VINEGAR, CONDIMENT SAUCES; SPICES; ICE (U.S. CL. 46).

CLASS 32—LIGHT BEVERAGES

FOR BEERS; MINERAL AND AERATED WATERS AND OTHER NON-ALCOHOLIC DRINKS, NAMELY LEMONADES AND ORANGE JUICES; FRUIT DRINKS AND FRUIT JUICES; SYRUPS AND OTHER PREPARATIONS FOR MAKING BEVERAGES (U.S. CLS. 45, 46 AND 48).

CLASS 33—WINES AND SPIRITS

FOR ALCOHOLIC BEVERAGES, NAMELY WINES AND LIQUORS, EXCEPT BEER (U.S. CLS. 47 AND 49).

SN 76-407,053. BRAVOSOLUTION S.P.A., 24100 BERGAMO, ITALY, FILED 5-9-2002.

BRAVOSOLUTION

PRIORITY CLAIMED UNDER SEC. 44(D) ON ITALY APPLICATION NO. MI2002C00136, FILED 2-12-2002, REG. NO. 00867115, DATED 5-16-2002, EXPIRES 2-12-2012.

CLASS 19—NON-METALLIC BUILDING MATERIALS

FOR BUILDING MATERIALS, NAMELY, BUILDING STONES, HYDRAULIC CEMENT, MORTAR, CONCRETE, NATURAL OR INDUSTRIAL HYDRAULIC BINDERS, SILICEOUS OR CALCAREOUS AGGREGATES, NON-AGRICULTURAL BUILDING LIME, GRANITE SANDS, SANDSTONE FOR BUILDING, ARTIFICIAL STONES, BUILDING GLASS PANELS, AND TERRA COTTA (U.S. CLS. 1, 12, 33 AND 50).

CLASS 35—ADVERTISING AND BUSINESS

FOR BUSINESS CONSULTING SERVICES IN THE FIELD OF ELECTRONIC COMMERCE (U.S. CLS. 100, 101 AND 102).

CLASS 37—CONSTRUCTION AND REPAIR

FOR BUILDING CONSTRUCTION AND REPAIR; INSTALLATION OF APPLIANCES, INSULATION AND OTHER COMPONENTS OF BUILDINGS, CONSULTING SERVICES IN THE FIELD OF BUILDING CONSTRUCTION (U.S. CLS. 100, 103 AND 106).

CLASS 38—COMMUNICATION

FOR TELECOMMUNICATION SERVICES, NAMELY, PROVIDING GATEWAY LINKS BETWEEN BUSINESS AND THEIR CUSTOMERS VIA THE INTERNET (U.S. CLS. 100, 101 AND 104).

CLASS 42—SCIENTIFIC, COMPUTER AND LEGAL SERVICES

FOR CONSULTING SERVICES IN THE FIELD OF THE ELECTRONIC AND COMPUTER ASPECTS OF PROVIDING ELECTRONIC COMMERCE SERVICES (U.S. CLS. 100 AND 101).

SN 76-407,089. BORALEX INC., MONTREAL, QUEBEC, CANADA, FILED 5-10-2002.

BORALEX

CLASS 35—ADVERTISING AND BUSINESS

FOR BUSINESS SERVICES, NAMELY, FACILITIES MANAGEMENT OF HYDROELECTRIC, NATURAL GAS COGENERATION, WOOD RESIDUE THERMAL AND COGENERATION, AND WIND POWER STATIONS, AND OTHER KINDS OF POWER STATIONS (U.S. CLS. 100, 101 AND 102).

FIRST USE 0-0-1995; IN COMMERCE 7-0-1998.

CLASS 37—CONSTRUCTION AND REPAIR

FOR CONSTRUCTION, CONSTRUCTION MANAGEMENT AND CONSTRUCTION PLANNING OF ENERGY PROJECTS (U.S. CLS. 100, 103 AND 106).

FIRST USE 0-0-1995; IN COMMERCE 7-0-1998.

SN 76-407,161. ONLINE DOCUMENTS, INC., HOUSTON, TX. FILED 5-10-2002.



NO CLAIM IS MADE TO THE EXCLUSIVE RIGHT TO USE "ONLINE DOCUMENTS, INC.", APART FROM THE MARK AS SHOWN.
THE STIPPLING IS FOR SHADING PURPOSES.

CLASS 9—ELECTRICAL AND SCIENTIFIC APPARATUS

FOR COMPUTER SOFTWARE FOR THE CREATION, MANAGEMENT AND DELIVERY OF COMPLIANT MORTGAGE DOCUMENTS, AND THAT FACILITATES THIRD PARTY REVIEW THEREOF (U.S. CLS. 21, 23, 26, 36 AND 38).
FIRST USE 1-1-2002; IN COMMERCE 1-1-2002.

CLASS 36—INSURANCE AND FINANCIAL

FOR PROVIDING AN ON-LINE DATABASE IN THE FIELD OF COMPLIANT MORTGAGE DOCUMENTS AND FORMS (U.S. CLS. 100, 101 AND 102).
FIRST USE 1-1-2002; IN COMMERCE 1-1-2002.

CLASS 9—ELECTRICAL AND SCIENTIFIC APPARATUS

FOR CASES, ALBUMS, BAGS, STORAGE TRAYS, POCKETS, AND SLEEVES FOR COMPACT DISCS, COMPACT DISC PLAYERS, BLANK DVDS, PRE-RECORDED DVDS, DVD PLAYERS, BLANK AUDIO CASSETTES, PRE-RECORDED AUDIO CASSETTES, AUDIO CASSETTE PLAYERS, MINIDISCS, MINIDISC PLAYERS, BLANK DIGITAL AUDIO TAPES, PRE-RECORDED DIGITAL AUDIO TAPES, BLANK DIGITAL DISKS, PRE-RECORDED DIGITAL DISKS, DIGITAL MEDIA PLAYERS, MP3 PLAYERS, VIDEO/COMPUTER GAME DISCS, PERSONAL ORGANIZERS, PORTABLE TELEPHONES, TWO-WAY RADIOS, CAR STEREOs, COMPUTERS, BLANK CD-ROMS, PRE-RECORDED CD-ROMS, BLANK FLOPPY DISCS, PRE-RECORDED FLOPPY DISCS, SOLID-STATE MEMORY CARDS, BLANK VIDEOCASSETTES, PRE-RECORDED VIDEOCASSETTES, CAMERAS, AND CAMCORDERS; COMPUTER MOUSE PADS; WRIST RESTS; COMPUTER CABLE TIE WRAPS AND CORD TIE WRAPS (U.S. CLS. 21, 23, 26, 36 AND 38).

CLASS 18—LEATHER GOODS

FOR LUGGAGE, NAMELY, DUFFEL BAGS, ROLLING DUFFEL BAGS, WHEELED UPRIGHT BAGS, BACKPACKS, SHOULDER BAGS, AND BRIEFCASES; WALLETs, BILLFOLDS; BRIEFCASE-TYPE PORTFOLIOS (U.S. CLS. 1, 2, 3, 22 AND 41).

SN 76-407,485. CASE LOGIC, INC., LONGMONT, CO. FILED 5-14-2002.



THE STIPPLING AND LINING SHOWN IN THE DRAWING ARE FEATURES OF THE MARK AND ARE NOT INTENDED TO INDICATE COLOR.

THE MARK CONSISTS OF A STYLIZED DEPICTION OF A HUMAN TALKING ON A TELEPHONE, WITH CLOUDS IN THE BACKGROUND.

SN 76-407,484. CASE LOGIC, INC., LONGMONT, CO. FILED 5-14-2002.



THE STIPPLING AND LINING SHOWN IN THE DRAWING ARE FEATURES OF THE MARK AND ARE NOT INTENDED TO INDICATE COLOR.

THE MARK CONSISTS OF A STYLIZED DEPICTION OF A HUMAN HOLDING A CAMERA, WITH CLOUDS IN THE BACKGROUND.

CLASS 9—ELECTRICAL AND SCIENTIFIC APPARATUS

FOR CASES, ALBUMS, BAGS, STORAGE TRAYS, POCKETS, AND SLEEVES FOR COMPACT DISCS, COMPACT DISC PLAYERS, BLANK DVDS, PRE-RECORDED DVDS, DVD PLAYERS, BLANK AUDIO CASSETTES, PRE-RECORDED AUDIO CASSETTES, AUDIO CASSETTE PLAYERS, MINIDISCS, MINIDISC PLAYERS, BLANK DIGITAL AUDIO TAPES, PRE-RECORDED DIGITAL AUDIO TAPES, BLANK DIGITAL DISKS, PRE-RECORDED DIGITAL DISKS, DIGITAL MEDIA PLAYERS, MP3 PLAYERS, VIDEO/COMPUTER GAME DISCS, PERSONAL ORGANIZERS, PORTABLE TELEPHONES, TWO-WAY RADIOS, CAR STEREOs, COMPUTERS, BLANK CD-ROMS, PRE-RECORDED CD-ROMS, BLANK FLOPPY DISCS, PRE-RECORDED FLOPPY DISCS, SOLID-STATE MEMORY CARDS, BLANK VIDEOCASSETTES, PRE-RECORDED VIDEOCASSETTES, CAMERAS, AND CAMCORDERS; COMPUTER MOUSE PADS; WRIST RESTS; COMPUTER CABLE TIE WRAPS AND CORD TIE WRAPS (U.S. CLS. 21, 23, 26, 36 AND 38).

CLASS 18—LEATHER GOODS

FOR LUGGAGE, NAMELY, DUFFEL BAGS, ROLLING DUFFEL BAGS, WHEELED UPRIGHT BAGS, BACK PACKS, SHOULDER BAGS, AND BRIEFCASES; WALLET, BILLFOLDS; BRIEFCASE-TYPE PORTFOLIOS (U.S. CLS. 1, 2, 3, 22 AND 41).

SN 76-408,003. THE ROCO CORPORATION, BATON ROUGE, LA. FILED 5-14-2002.



NO CLAIM IS MADE TO THE EXCLUSIVE RIGHT TO USE "RESCUE", APART FROM THE MARK AS SHOWN.

CLASS 6—METAL GOODS

FOR METAL HARDWARE USED FOR RESCUE EQUIPMENT, NAMELY, PULLEYS, ROPE GRABS AND FRICTION HARDWARE FOR CONTROLLING DESCENT (U.S. CLS. 2, 12, 13, 14, 23, 25 AND 50).
FIRST USE 11-10-1988; IN COMMERCE 11-10-1988.

CLASS 39—TRANSPORTATION AND STORAGE

FOR RESCUE SERVICES, NAMELY PROVIDING SERVICES TO RESCUE PERSONS FROM PERILOUS SITUATIONS (U.S. CLS. 100 AND 105).
FIRST USE 11-10-1988; IN COMMERCE 11-10-1988.

CLASS 41—EDUCATION AND ENTERTAINMENT

FOR EDUCATIONAL SERVICES, NAMELY, CONDUCTING CLASSES AND SEMINARS ON HOW TO RESCUE OTHERS FROM PERILOUS SITUATIONS (U.S. CLS. 100, 101 AND 107).
FIRST USE 11-10-1988; IN COMMERCE 11-10-1988.

SN 76-408,967. HARELL REMODELING, INC., MOUNTAIN VIEW, CA. FILED 5-17-2002.

WE NEVER FORGET IT'S YOUR HOME

CLASS 37—CONSTRUCTION AND REPAIR

FOR RESIDENTIAL CONSTRUCTION AND RENOVATION (U.S. CLS. 100, 103 AND 106).
FIRST USE 3-28-2002; IN COMMERCE 3-28-2002.

CLASS 42—SCIENTIFIC, COMPUTER AND LEGAL SERVICES

FOR RESIDENTIAL BUILDING DESIGN (U.S. CLS. 100 AND 101).
FIRST USE 3-28-2002; IN COMMERCE 3-28-2002.

SN 76-412,059. FOUR STAR INTERNATIONAL TRADING COMPANY, TAIPEI, TAIWAN, FILED 5-24-2002.

ENCHANTED CHRISTMAS

NO CLAIM IS MADE TO THE EXCLUSIVE RIGHT TO USE "CHRISTMAS", APART FROM THE MARK AS SHOWN.

CLASS 21—HOUSEWARES AND GLASS

FOR CHRISTMAS DECOR ITEMS, NAMELY, CERAMIC, PORCELAIN VILLAGE HOUSES AND ACCESSORIES THEREOF; NATIVITY SETS OF GLASS, PORCELAIN AND CERAMIC; DECORATIVE ORNAMENTS; TABLE TOP CERAMICS, MADE FROM PORCELAIN, NAMELY, MUGS, PLATTERS, SALT AND PEPPER SHAKERS AND CANDY DISHES; WALL HANGINGS MADE FROM PORCELAIN (U.S. CLS. 2, 13, 23, 29, 30, 33, 40 AND 50).
FIRST USE 6-0-2000; IN COMMERCE 6-0-2000.

CLASS 28—TOYS AND SPORTING GOODS

FOR DECORATIONS FOR CHRISTMAS TREES, NAMELY, ARTIFICIAL CHRISTMAS GARLANDS, CHRISTMAS STOCKINGS, CHRISTMAS TREE ORNAMENTS EXCEPT CONFECTIONERY OR ILLUMINATION ARTICLES; GLASS BALLS FILLED WITH WATER AND GLITTER OR ARTIFICIAL SNOW THAT DEPICT CHRISTMAS SCENES; CHRISTMAS TREE SKIRTS; CHRISTMAS TREE STANDS; ARTIFICIAL CHRISTMAS TREES (U.S. CLS. 22, 23, 38 AND 50).
FIRST USE 6-0-2000; IN COMMERCE 6-0-2000.

SN 76-412,097. LARRY, WACHS, PACIFIC PALISADES, CA. FILED 5-24-2002.

THE REGULAR GUYS

CLASS 9—ELECTRICAL AND SCIENTIFIC APPARATUS

FOR SERIES OF COMPACT DISCS FEATURING SHORT COMEDIC SKETCHES AND MUSICAL AND OTHER PARODIES (U.S. CLS. 21, 23, 26, 36 AND 38).
FIRST USE 8-1-1995; IN COMMERCE 8-1-1995.

CLASS 41—EDUCATION AND ENTERTAINMENT

FOR ENTERTAINMENT SERVICES, NAMELY, RADIO PROGRAMS FEATURING PERFORMANCES BY RADIO PERSONALITIES; LIVE AND RECORDED PERFORMANCES BY RADIO PERSONALITIES; CABLE BROADCASTS; TELEVISION BROADCASTS; SATELLITE RADIO; AND INTERNET RADIO (U.S. CLS. 100, 101 AND 107).
FIRST USE 8-1-1995; IN COMMERCE 8-1-1995.

SN 76-412,273. NORFOLK SOUTHERN CORPORATION,
NORFOLK, VA. FILED 5-14-2002.



OWNER OF U.S. REG. NO. 1,312,661.

CLASS 35—ADVERTISING AND BUSINESS

FOR TRANSPORTATION LOGISTICS SERVICES, NAMELY, PLANNING AND SCHEDULING SHIPMENTS FOR USERS OF TRANSPORTATION SERVICES (U.S. CLS. 100, 101 AND 102).

FIRST USE 3-17-2003; IN COMMERCE 3-17-2003.

CLASS 39—TRANSPORTATION AND STORAGE

FOR PROVIDING INFORMATION VIA THE INTERNET IN THE FIELD OF TRANSPORTATION OF FREIGHT BY TRAIN, TRUCK, OR BOAT (U.S. CLS. 100 AND 105).

FIRST USE 3-17-2003; IN COMMERCE 3-17-2003.

SN 76-412,841. GULFSTREAM TRADING, LLC, MCADENVILLE, NC. FILED 5-22-2002.



CARSTARPHEN

CERTIFIED 100% SEA ISLAND COTTON

NO CLAIM IS MADE TO THE EXCLUSIVE RIGHT TO USE "CERTIFIED 100% SEA ISLAND COTTON", APART FROM THE MARK AS SHOWN.

THE MARK CONSISTS OF A CREST WITH GREYHOUND DOGS, HUNTING HORN, AND BIRD (CRANE) DESIGNS.

CLASS 23—YARNS AND THREADS

FOR YARNS MADE OF SEA ISLAND COTTON GROWN IN THE WEST INDIES (U.S. CL. 43).

FIRST USE 11-7-2001; IN COMMERCE 11-7-2001.

CLASS 25—CLOTHING

FOR CLOTHING MADE OF SEA ISLAND COTTON GROWN IN THE WEST INDIES, NAMELY, T-SHIRTS, DRESS SHIRTS, POLO SHIRTS, SPORT SHIRTS, SWEATSHIRTS, SWEATPANTS, WARMUP SUITS, DRESSES, SKIRTS, BLOUSES, SWEATERS, SHORTS, COATS, JACKETS, SUITS, RAINCOATS, HATS, VISORS, PANTS, BELTS, SHOES, TIES, SCARVES, GLOVES, STOCKINGS, UNDERWEAR, BRAS, BOXER SHORTS, BRIEFS, PANTIES, SLEEPWEAR, AND SWIMWEAR (U.S. CLS. 22 AND 39).

FIRST USE 11-7-2001; IN COMMERCE 11-7-2001.

SN 76-415,006. STYLEX, INC., KANSAS CITY, MO. FILED 5-30-2002.

STYLEX

OWNER OF U.S. REG. NO. 2,007,950.

CLASS 3—COSMETICS AND CLEANING PREPARATIONS

FOR HAIR CARE PREPARATIONS; NAMELY, HAIR CLEANER, SHAMPOO, CONDITIONER, HAIR SPRAY, HAIR STYLING MOUSSE, HAIRPIECE CLEANER, HAIRPIECE REMOVER AND HAIRPIECE ADHESIVE REMOVER; SKIN LOTION; AND COLOGNE (U.S. CLS. 1, 4, 6, 50, 51 AND 52).

FIRST USE 4-0-2000; IN COMMERCE 4-0-2000.

CLASS 26—FANCY GOODS

FOR HAIRPIECES AND HAIRPIECE TAPE (U.S. CLS. 37, 39, 40, 42 AND 50).

FIRST USE 4-0-2000; IN COMMERCE 4-0-2000.

CLASS 35—ADVERTISING AND BUSINESS

FOR RETAIL STORE SERVICES IN THE FIELD OF HAIR CARE PREPARATIONS, SKIN LOTIONS, COLOGNES, WIGS, TOUPEES, AND OTHER TYPES OF HAIRPIECES (U.S. CLS. 100, 101 AND 102).

FIRST USE 4-0-2000; IN COMMERCE 4-0-2000.

CLASS 40—MATERIAL TREATMENT

FOR FITTING OF ARTIFICIAL AND NATURAL HAIRPIECES TO THE SCALP TO CORRECT BALDNESS (U.S. CLS. 100, 103 AND 106).

FIRST USE 4-0-2000; IN COMMERCE 4-0-2000.

CLASS 42—SCIENTIFIC, COMPUTER AND LEGAL SERVICES

FOR CUSTOM DESIGN OF ARTIFICIAL AND NATURAL HAIRPIECES (U.S. CLS. 100 AND 101).

FIRST USE 4-0-2000; IN COMMERCE 4-0-2000.

CLASS 44—MEDICAL, BEAUTY AND AGRICULTURAL SERVICES

FOR HAIR STYLING SALON SERVICES AND HAIR REPLACEMENT SERVICES (U.S. CLS. 100 AND 101).

FIRST USE 4-0-2000; IN COMMERCE 4-0-2000.

SN 76-415,457. AIR PACIFIC LTD., NADI, FIJI, FILED 6-4-2002.



OWNER OF U.S. REG. NOS. 1,552,288 AND 2,006,686.
NO CLAIM IS MADE TO THE EXCLUSIVE RIGHT TO USE "AIR" AND "FIJI'S INTERNATIONAL AIRLINE", APART FROM THE MARK AS SHOWN.

THE MARK CONSISTS OF AN AIRPLANE TAIL FIN STRIPED WITH THE COLORS BLUE, MAGENTA, ORANGE AND YELLOW FROM LEFT TO RIGHT.

CLASS 12—VEHICLES

FOR MOTORIZED BAGGAGE CARTS; LAND VEHICLES, NAMELY TRUCKS; AND AIRCRAFT (U.S. CLS. 19, 21, 23, 31, 35 AND 44).

FIRST USE 9-1-1998; IN COMMERCE 9-1-1998.

CLASS 16—PAPER GOODS AND PRINTED MATTER

FOR STATIONARY, CORPORATE LETTERHEAD, PAPER NAPKINS, PAPER TICKETS AND ITINERARIES (U.S. CLS. 2, 5, 22, 23, 29, 37, 38 AND 50).

FIRST USE 9-1-1998; IN COMMERCE 9-1-1998.

CLASS 39—TRANSPORTATION AND STORAGE

FOR AIR TRANSPORTATION SERVICES, NAMELY PROVIDING RESERVATION AND TICKETING SERVICES VIA COMPUTERS AND THE INTERNET FOR TRANSPORTATION OF PERSONS, PROPERTY AND MAIL BY AIR, TELEPHONE RESERVATION SERVICES, AIRLINE PASSENGER CHECK-IN SERVICES, GATE HANDLING AND AIRCRAFT BOARDING SERVICES, PRIORITY SEATING SERVICES FOR AIRLINE PASSENGERS, AND PROVIDING TRANSPORTATION AND TRAVEL-RELATED INFORMATION (U.S. CLS. 100 AND 105).

FIRST USE 9-1-1998; IN COMMERCE 9-1-1998.

SN 76-415,688, WM. WRIGLEY JR. COMPANY, CHICAGO, IL. FILED 5-31-2002.

BEYOND BREATH

NO CLAIM IS MADE TO THE EXCLUSIVE RIGHT TO USE "BREATH", APART FROM THE MARK AS SHOWN.

CLASS 3—COSMETICS AND CLEANING PREPARATIONS

FOR BREATH FRESHENING AND BREATH CLEANSERS, NAMELY, NON-MEDICATED DISSOLVING STRIPS (U.S. CLS. 1, 4, 6, 50, 51 AND 52).

CLASS 29—MEATS AND PROCESSED FOODS

FOR FOOD TOPPINGS, NAMELY, FRUIT TOPPINGS, NUT TOPPINGS AND WHIPPED TOPPINGS (U.S. CL. 46).

CLASS 30—STAPLE FOODS

FOR BREATH FRESHENING CONFECTIONERY, NAMELY, CANDY MINTS AND CHEWING GUM (U.S. CL. 46).

CLASS 32—LIGHT BEVERAGES

FOR NON-ALCOHOLIC FRUIT EXTRACTS USED IN THE PREPARATION OF BEVERAGES; SMOOTHIES (U.S. CLS. 45, 46 AND 48).

SN 76-416,126. TOP SECRET PRODUCTS, LLC, LOS ANGELES, CA. FILED 5-31-2002.

STEP INTO LIQUID**CLASS 9—ELECTRICAL AND SCIENTIFIC APPARATUS**

FOR PRERECORDED VIDEO TAPES FEATURING ELECTRONIC GAMES; CHILDREN'S INTERACTIVE, MULTI-MEDIA ENTERTAINMENT AND EDUCATIONAL SOFTWARE COMPRISED OF TEXT, GRAPHICS, AUDIO-VIDEO AND ANIMATION FOR USE WITH COMPUTERS, AND VIDEO OUTPUT DEVICES, NAMELY, ELECTRONIC GAME CONSOLES; ELECTRONIC GAME PROGRAMS; VIDEO GAME CARTRIDGES AND DISCS; PRE-RECORDED CD-ROMS FEATURING ELECTRONIC GAMES, COMPUTER GAME PROGRAMS, VIDEO GAME SOFTWARE AND COMPUTER GAME SOFTWARE; SOFTWARE FOR STREAMING AUDIO AND VISUAL MATERIAL VIA THE INTERNET (U.S. CLS. 21, 23, 26, 36 AND 38).

CLASS 16—PAPER GOODS AND PRINTED MATTER

FOR BOOKS, NAMELY CHILDREN'S BOOKS, COLORING BOOKS, COMIC BOOKS, NOTE BOOKS, PICTURE BOOKS, STORY BOOKS, SERIES OF FICTION BOOKS, CHILDREN'S ACTIVITY BOOKS; POSTERS (U.S. CLS. 2, 5, 22, 23, 29, 37, 38 AND 50).

CLASS 25—CLOTHING

FOR CLOTHING ITEMS NAMELY, MEN'S WOMEN'S AND CHILDREN'S JACKETS, SHIRTS, PANTS, SHOES, CAPS, SOCKS, UNDERWEAR AND OUTERWEAR NAMELY CLOTH JACKETS, CLOTH RAIN COATS, VINYL RAIN COATS, DENIM JACKETS, LEATHER JACKETS AND SWEATERS (U.S. CLS. 22 AND 39).

CLASS 28—TOYS AND SPORTING GOODS

FOR ATHLETIC SPORTING GOODS, NAMELY, ATHLETIC WRIST AND JOINT SUPPORTS, BODY BOARDS, BASEBALL BATS, BOXING GLOVES, DART BOARDS, ELBOW PADS FOR ATHLETIC USE, FLYING DISCS, FOOT BALLS, HOCKEY STICKS, PLAYGROUND BALLS, SHIN GUARDS FOR ATHLETIC USE, SKIS, SNOW BOARDS, SOCCER BALLS, SURFBOARDS, SWIM FINS, VOLLEYBALLS; ELECTRONIC GAMES, NAMELY, ELECTRONIC TOY BATTLE GAMES; CARD GAMES, ACTION FIGURES, DOLLS, PLAY SETS COMPRISED OF PLAY DOLLS AND PLAY HOUSES; TRADING CARDS (U.S. CLS. 22, 23, 38 AND 50).

CLASS 38—COMMUNICATION

FOR SERVICES FOR INTERNET DELIVERY OF MUSIC AND VIDEO, NAMELY, STREAMING OF AUDIO AND VISUAL MUSIC AND VIDEO VIA THE INTERNET (U.S. CLS. 100, 101 AND 104).

CLASS 41—EDUCATION AND ENTERTAINMENT

FOR MOTION PICTURE FILM PRODUCTION; MOTION PICTURE DISTRIBUTION; SOUND TRACK PRODUCTION, TELEVISION PROGRAMMING (U.S. CLS. 100, 101 AND 107).

SN 76-419,326. KVP FALCON PLASTIC BELTING, INC., RANCHO CORDOVA, CA. FILED 6-10-2002.

SN 76-420,419. PRECISION INDUSTRIAL AUTOMATION INCORPORATED, CINCINNATI, OH. FILED 6-11-2002.

THE SPIRAL PROS

NO CLAIM IS MADE TO THE EXCLUSIVE RIGHT TO USE "SPIRAL", APART FROM THE MARK AS SHOWN.

CLASS 37—CONSTRUCTION AND REPAIR

FOR INSTALLATION AND REPAIR OF PLASTIC CONVEYOR BELTS FOR INDUSTRIAL APPLICATIONS (U.S. CLS. 100, 103 AND 106).

CLASS 42—SCIENTIFIC, COMPUTER AND LEGAL SERVICES

FOR TECHNICAL CONSULTATION IN THE FIELD OF PLASTIC CONVEYOR BELTS FOR INDUSTRIAL APPLICATIONS; AND DESIGN FOR OTHERS IN THE FIELD OF PLASTIC CONVEYOR BELTS FOR INDUSTRIAL APPLICATIONS (U.S. CLS. 100 AND 101).

SN 76-419,445. THE KONG COMPANY LLC, GOLDEN, CO. FILED 6-11-2002.

SMYLOS

CLASS 3—COSMETICS AND CLEANING PREPARATIONS

FOR DENTAL CARE PRODUCTS FOR PETS, NAMELY, TOOTHPASTE (U.S. CLS. 1, 4, 6, 50, 51 AND 52).

CLASS 5—PHARMACEUTICALS

FOR PET FOOD SUPPLEMENTS, PET MEDICATIONS TO TREAT ANXIETY (U.S. CLS. 6, 18, 44, 46, 51 AND 52).

CLASS 31—NATURAL AGRICULTURAL PRODUCTS

FOR PET FOOD, PET FOOD TREATS (U.S. CLS. 1 AND 46).

SN 76-419,745. CARGIL INTERNATIONAL CORP., MIAMI, FL. FILED 6-12-2002.

STERLING

CLASS 7—MACHINERY

FOR ELECTRIC FOOD BLENDERS, MIXERS, ELECTRIC RICE COOKERS AND ELECTRIC JUICERS (U.S. CLS. 13, 19, 21, 23, 31, 34 AND 35).

CLASS 11—ENVIRONMENTAL CONTROL APPARATUS

FOR COFFEE MAKERS, ELECTRIC TOASTERS, ELECTRIC TOASTER OVENS, MICROWAVE OVENS FOR COOKING, SANDWICH MAKERS, BUFFETS, NAMELY ELECTRIC AND NON-ELECTRIC APPLIANCES FOR WARMING FOODS (U.S. CLS. 13, 21, 23, 31 AND 34).

PRECISION

OWNER OF U.S. REG. NOS. 1,827,918 AND 1,879,367. SEC. 2(F).

CLASS 40—MATERIAL TREATMENT

FOR CUSTOM MANUFACTURING AND PROTOTYPE FABRICATION OF AUTOMATIC ASSEMBLY AND/OR TEST SYSTEMS FOR USE IN MANUFACTURING PLANTS IN THE AUTOMOTIVE, CONSUMER PRODUCTS, MEDICAL, ELECTRONICS AND HVAC INDUSTRIES (U.S. CLS. 100, 103 AND 106). FIRST USE 11-0-1962; IN COMMERCE 11-0-1962.

CLASS 42—SCIENTIFIC, COMPUTER AND LEGAL SERVICES

FOR CUSTOM DESIGN AND DEVELOPMENT OF AUTOMATIC ASSEMBLY AND/OR TEST SYSTEMS FOR USE IN MANUFACTURING PLANTS IN THE AUTOMOTIVE, CONSUMER PRODUCTS, MEDICAL, ELECTRONICS AND HVAC INDUSTRIES (U.S. CLS. 100 AND 101). FIRST USE 11-0-1962; IN COMMERCE 11-0-1962.

SN 76-421,137. FRIENDS OF TRUTH, INC., SILVER SPRING, MD. FILED 6-12-2002.

FRIENDS OF TRUTH

CLASS 41—EDUCATION AND ENTERTAINMENT

FOR EDUCATIONAL AND INFORMATIONAL SERVICES, NAMELY, PROVIDING AN ON-LINE NEWSLETTER IN THE FIELD OF RELIGION AND PROVIDING ON LINE CLASSES IN THE FIELD OF RELIGION (U.S. CLS. 100, 101 AND 107).

CLASS 42—SCIENTIFIC, COMPUTER AND LEGAL SERVICES

FOR LEGAL SERVICES, NAMELY, PROVIDING LEGAL RESEARCH AND LITIGATION SUPPORT TO OTHERS (U.S. CLS. 100 AND 101).

SN 76-421,725. RHM LIMITED, BUCKINGHAMSHIRE SL7 1TJ, UNITED KINGDOM, FILED 6-17-2002.

RHM BETTER FOODS FOR A BETTER LIFE

PRIORITY CLAIMED UNDER SEC. 44(D) ON UNITED KINGDOM APPLICATION NO. 2300329, FILED 5-11-2002, REG. NO. 2300329, DATED 5-11-2002, EXPIRES 5-11-2012.

CLASS 29—MEATS AND PROCESSED FOODS

FOR MEAT, FISH, POULTRY AND GAME; MEAT EXTRACTS; PRESERVED DRIED AND COOKED FRUIT AND VEGETABLES; JELLIES, JAMS, CHEESE SPREADS, FRUIT BASED SPREADS, MEAT BASED SPREADS, VEGETABLE BASED SPREADS; EGGS, MILK, CHEESE, YOGURT AND YOGURT BASED BEVERAGES; FRUIT PRESERVES; PICKLES; EDIBLE OILS AND FATS; FRUIT SAUCES; FROZEN, PREPARED AND PACKAGED MEALS CONSISTING PRIMARILY OF MEAT, FISH POULTRY OR VEGETABLES; CANDIED FRUIT SNACKS; FRUIT AND SOY BASED SNACK FOOD; FRUIT BASED SNACK FOOD, POTATO BASED SNACK FOODS, PROTEIN BASED-NUTRIENT DENSE SNACK BARS; SNACK DIPS AND SNACK FOOD DIPS EXCLUDING SALSA AND OTHER SAUCES USED AS DIPS; SNACK MIX CONSISTING PRIMARILY OF PROCESSED FRUITS, PROCESSED NUTS AND/OR RAISINS; SOUPS (U.S. CL. 46).

CLASS 30—STAPLE FOODS

FOR COFFEE, TEA, COCOA, RICE, TAPIOCA, SAGO, COFFEE SUBSTITUTE, FLOUR; BREAKFAST CEREALS, CEREAL BASED SNACK FOOD, PROCESSED CEREALS, READY TO EAT CEREAL DERIVED FOOD BARS; PASTA; BREAD; SANDWICHES; BISCUITS; PUDDINGS, DESSERT SOUFFLES, BAKERY DESSERTS, FLAVORED SWEETENED GELATIN DESSERTS, CAKES, PASTRIES; FROZEN YOGURT; CONFECTIONERY CHIPS FOR BAKING, FREEZABLE LIQUID FOR USE IN MAKING FROZEN CONFECTIONS, FROZEN CONFECTIONERY, PEANUT BUTTER CONFECTIONERY CHIPS; FLAVORED ICES; HONEY; SPREADS; TREACLE; YEAST; BAKING POWDER; SALT, MUSTARD, PEPPER, VINEGAR, SAUCES, SPICES; GRAVY AND GRAVY MIXES; FROZEN, PREPARED, AND PACKAGED MEALS CONSISTING PRIMARILY OF PASTA OR RICE; CHEESE FLAVORED SNACKS, PUFFED CORN SNACKS, CEREAL BASED SNACK FOOD, GRANOLA BASED SNACK BARS, RICE BASED SNACK BARS; SNACK MIX CONSISTING PRIMARILY OF CRACKERS, PRETZELS, CANDIED NUTS AND/OR POPPED POPCORN; WHEAT BASED SNACK BARS; FOOD FLAVORINGS OF NON ESSENTIAL OILS (U.S. CL. 46).

SN 76-421,739. FEUCHT, THOMAS, STUTTGART 70469, FED REP GERMANY, AND KULLMAN, ROBERT, LEBANON, NJ. FILED 6-17-2002.



NO CLAIM IS MADE TO THE EXCLUSIVE RIGHT TO USE "THE ORIGINAL" OR "HOTEL", APART FROM THE MARK AS SHOWN.

CLASS 35—ADVERTISING AND BUSINESS

FOR ADVERTISING AGENCIES, BUSINESS MANAGEMENT, BUSINESS ADMINISTRATION, AND OFFICE MANAGEMENT SERVICES; FRANCHISING OF ACCOMMODATION AND CATERING SERVICES, NAMELY, ACTING AS AGENT FOR LICENSES AND ECONOMIC AND TECHNICAL KNOW-HOW IN ACCOMMODATION AND CATERING UNDERTAKINGS; LICENSING OF PROPERTY RIGHTS IN THE NATURE OF THEME HOTELS AND THEME RESTAURANTS (U.S. CLS. 100, 101 AND 102).

CLASS 43—HOTEL AND RESTAURANT SERVICES

FOR HOTEL, CATERING, AND BAR SERVICES (U.S. CLS. 100 AND 101).

SN 76-421,839. GENPAT 77 PHARMACOGENETICS AG, 10115 BERLIN, FED REP GERMANY, FILED 6-17-2002.

GENPAT 77

OWNER OF FED REP GERMANY REG. NO. 1671254, DATED 7-23-2001, EXPIRES 7-23-2011.

CLASS 3—COSMETICS AND CLEANING PREPARATIONS

FOR PERFUME; PERFUMERY, NAMELY, EAU DE TOILETTE AND COLOGNES; ESSENTIAL OILS FOR PERSONAL USE; HAIR LOTIONS; AND DENTIFRICES (U.S. CLS. 1, 4, 6, 50, 51 AND 52).

CLASS 5—PHARMACEUTICALS

FOR PHARMACEUTICAL, VETERINARY AND SANITARY PREPARATIONS, NAMELY, ANTICOAGULANTS, ANTI-DEPRESSANTS, ANTIBIOTICS, ANTIHYPERTENSIVES, ANTIPHLOGISTICS, ANTIRHEUMATICS, ANTI-OXIDANTS, CHEMOTHERAPEUTICS, DIURETICS, ANTIARRHYTHMICS, ANTIASHTHMATICS, ANTIALLERGICS, ANTICHOLINERGICS, ANTICONVULSANTS, ANTIEMETICS, FIBRINOLYTICS, ANTI-INFLAMMATORY PREPARATIONS, ANTIPROLIFERATIVES, ANTI-PYRETICS, ANTIVIRAL PREPARATIONS, ANTITHROMBOTICS; PHARMACEUTICAL PREPARATIONS FOR THE TREATMENT OF DIABETES AND INSOMNIA; VETERINARY VACCINES FOR DOGS; BLOOD SUBSTITUTE FOR ANIMAL USE; SANITARY PREPARATIONS, NAMELY, SANITARY PADS AND SANITARY NAPKINS (U.S. CLS. 6, 18, 44, 46, 51 AND 52).

CLASS 42—SCIENTIFIC, COMPUTER AND LEGAL SERVICES

FOR MEDICAL SERVICES, NAMELY, MEDICAL LABORATORIES; MEDICAL AND SCIENTIFIC RESEARCH, NAMELY, CONDUCTING CLINICAL TRIALS; MEDICAL RESEARCH; SCIENTIFIC RESEARCH AND INDUSTRIAL PRODUCT RESEARCH (U.S. CLS. 100 AND 101).

SN 76-422,228. AMERICAN PRODUCTS COMPANY, CORONA, CA. FILED 6-19-2002.

PERFORMANCE STYLE ATTITUDE

CLASS 11—ENVIRONMENTAL CONTROL APPARATUS

FOR DRIVING LIGHTS, NAMELY, ICY HOT FOG LIGHTS, SUPER WHITE HEADLIGHT BULBS, AND ULTRA WHITE HEADLIGHT BULBS; AUTOMOBILE LIGHTS AND ACCESSORIES, NAMELY, NEON LIGHTS, LIGHT EMITTING DIODES (LED'S), CLEAR REPLACEMENT LENSES FOR VEHICLE FRONT MARKER LIGHT AND REAR TAIL LIGHTS, HIGH INTENSITY DISCHARGE ELECTRONIC COLORED LIGHT BULBS (U.S. CLS. 13, 21, 23, 31 AND 34).

FIRST USE 11-0-1999; IN COMMERCE 11-0-1999.

CLASS 12—VEHICLES

FOR AUTOMOBILE AND TRUCK ACCESSORIES, NAMELY, ENGINE GRLLLES; AUTOMOBILE AND TRUCK FIBERGLASS BODY PARTS, NAMELY, TUBE WORKS SIDEBARS FOR TRUCKS; DASHBOARDS AND REPLACEMENT DASHBOARDS; VEHICLE PARTS, NAMELY, SIDE MIRRORS, ANTI-THEFT VEHICLE DOOR LOCKS, AND WHEEL DISC SIMULATORS FOR WHEEL DECORATION; WHEEL DISC RIM FOR DECORATION; KNOBS FOR SHIFTERS, PEDALS AND PEDAL COVERS (U.S. CLS. 19, 21, 23, 31, 35 AND 44).

FIRST USE 11-0-1999; IN COMMERCE 11-0-1999.

SN 76-422,494. GATES, MCDONALD & COMPANY, HILLIARD, OH. FILED 6-18-2002.

MEDPROSOLUTIONS

CLASS 35—ADVERTISING AND BUSINESS

FOR WORKERS' COMPENSATION AND DISABILITY PROGRAM SERVICES, NAMELY, MEDICAL CASE MANAGEMENT, NAMELY, MEDICAL COST MANAGEMENT AND COST OF TREATMENT ANALYSIS; JOB ANALYSIS, JOB MODIFICATION CONSULTING, JOB DEVELOPMENT AND PLACEMENT, LOSS OF EARNING CAPACITY EVALUATIONS; FEE BILL REVIEW, HOSPITAL BILL REVIEW; ONE-ON-ONE COUNSELING, NAMELY, OFFERING ADVICE REGARDING WORKERS' COMPENSATION AND DISABILITY-RELATED TOPICS (U.S. CLS. 100, 101 AND 102).

FIRST USE 5-19-1999; IN COMMERCE 5-19-1999.

CLASS 41—EDUCATION AND ENTERTAINMENT

FOR WORKERS' COMPENSATION AND DISABILITY PROGRAM SERVICES, NAMELY, VOCATIONAL TESTING AND VOCATIONAL ASSESSMENT (U.S. CLS. 100, 101 AND 107).

FIRST USE 5-19-1999; IN COMMERCE 5-19-1999.

CLASS 44—MEDICAL, BEAUTY AND AGRICULTURAL SERVICES

FOR WORKERS' COMPENSATION AND DISABILITY PROGRAM SERVICES IN THE MEDICAL FIELD, NAMELY, ERGONOMIC STUDY, VOCATIONAL REHABILITATION, MEDICAL REVIEW OF PATIENTS' MEDICAL FILES, PROVIDING AND MANAGING PPO HEALTHCARE PROVIDER NETWORKS, MEDICAL UTILIZATION AND MANAGEMENT, NAMELY, MEDICAL ASSESSMENT; DISEASE MANAGEMENT, NAMELY, ASSESSMENT OF ILLNESS, DEVELOPMENT OF TREATMENT PLANS; LONG TERM HEALTH LIFE CARE PLANNING (U.S. CLS. 100 AND 101).

FIRST USE 5-19-1999; IN COMMERCE 5-19-1999.

SN 76-422,544. KEILLOR, GARRISON, ST. PAUL, MN. FILED 6-17-2002.

GUY NOIR

THE NAME "GUY NOIR" DOES NOT IDENTIFY A LIVING INDIVIDUAL.

CLASS 9—ELECTRICAL AND SCIENTIFIC APPARATUS

FOR PRERECORDED AUDIO CASSETTE TAPES AND COMPACT DISCS FEATURING DRAMATIC AND COMEDIC WORKS (U.S. CLS. 21, 23, 26, 36 AND 38).

FIRST USE 10-28-1994; IN COMMERCE 10-28-1994.

CLASS 28—TOYS AND SPORTING GOODS

FOR BOBBLE HEAD DOLLS (U.S. CLS. 22, 23, 38 AND 50).

FIRST USE 3-18-2002; IN COMMERCE 3-18-2002.

CLASS 41—EDUCATION AND ENTERTAINMENT

FOR ENTERTAINMENT SERVICES IN THE NATURE OF AN ONGOING RADIO SERIES FEATURING COMEDIC AND DRAMATIC PERFORMANCES (U.S. CLS. 100, 101 AND 107).

FIRST USE 4-9-1994; IN COMMERCE 4-9-1994.

SN 76-422,694. MAAG PUMP SYSTEMS TEXTRON, INC., CHARLOTTE, NC. BY ASSIGNMENT DAVID BROWN HYDRAULICS, INC., CHARLOTTE, NC. FILED 6-17-2002.

HYDRECO

CLASS 7—MACHINERY

FOR MACHINE PARTS, NAMELY, PUMPS FOR DELIVERING FLUID UNDER PRESSURE, FLUID PRESSURE MOTORS, VALVES FOR CONTROLLING FLOW OF FLUID, AND UNITARY FLUID PRESSURE POWER SYSTEMS, CONSISTING PRIMARILY OF A RESERVOIR AND ONE OR MORE OF THE ABOVE NAMED DEVICES, GEAR MOTORS, HYDRAULIC PUMPS, HYDRAULIC VALVES, AND HYDRAULIC OPERATED MECHANISMS AND FITTINGS, ADAPTED AS ACCESSORIES FOR MORE COMPREHENSIVE MACHINES IN THE NATURE OF TRACTOR HOISTS HYDRAULICALLY OPERATED, LIFTING AND PULLING JACKS, TRACTOR IMPLEMENT OPERATING MACHINERY (U.S. CLS. 13, 19, 21, 23, 31, 34 AND 35).

FIRST USE 7-1-1935; IN COMMERCE 7-1-1935.

CLASS 11—ENVIRONMENTAL CONTROL APPARATUS

FOR STEAM VALVES AND STEMS THEREFOR (U.S. CLS. 13, 21, 23, 31 AND 34).
FIRST USE 7-1-1935; IN COMMERCE 7-1-1935.

CLASS 20—FURNITURE AND ARTICLES NOT OTHERWISE CLASSIFIED

FOR (BASED ON USE IN COMMERCE) AND (BASED ON 44(E)) MATTRESSES, PILLOWS, CUSHIONS, SPRING MATTRESSES (U.S. CLS. 2, 13, 22, 25, 32 AND 50).
FIRST USE 5-0-2001; IN COMMERCE 6-0-2001.

SN 76-422,838. BOARD OF TRUSTEES OF THE UNIVERSITY OF ALABAMA; FOR THE UNIVERSITY OF ALABAMA AT BIRMINGHAM, BIRMINGHAM, AL. FILED 6-19-2002.

CLASS 22—CORDAGE AND FIBERS

FOR (BASED ON 44(E)) CUSHIONING NOT OF RUBBER OR PLASTIC IN THE NATURE OF STUFFING FOR MATTRESSES, PILLOWS, CUSHIONS, SPRING MATTRESSES (U.S. CLS. 1, 2, 7, 19, 22, 42 AND 50).

CHILDREN AND YOUTH SICKLE NETWORK

NO CLAIM IS MADE TO THE EXCLUSIVE RIGHT TO USE "NETWORK", APART FROM THE MARK AS SHOWN. SEC. 2(F).

SN 76-424,850. ELECTROMED TECHNOLOGIES, INC., CHICAGO, IL. FILED 6-24-2002.

CLASS 42—SCIENTIFIC, COMPUTER AND LEGAL SERVICES

FOR MEDICAL RESEARCH AND PROVIDING INFORMATION IN THE FIELD OF MEDICAL RESEARCH (U.S. CLS. 100 AND 101).
FIRST USE 12-0-1997; IN COMMERCE 12-0-1997.

EMT**CLASS 9—ELECTRICAL AND SCIENTIFIC APPARATUS**

FOR SMOKING CESSATION KIT COMPRISED OF A SPECIALLY PROGRAMMED PORTABLE ELECTRONIC DEVICE, NAMELY, COMPUTER HARDWARE, AND INSTRUCTION BOOK (U.S. CLS. 21, 23, 26, 36 AND 38).

CLASS 44—MEDICAL, BEAUTY AND AGRICULTURAL SERVICES

FOR HOSPITAL SERVICES, HEALTH CARE SERVICES, MEDICAL SERVICES, PROVIDING HEALTH INFORMATION AND MEDICAL INFORMATION, AND PROVIDING HEALTH AND MEDICAL COUNSELING (U.S. CLS. 100 AND 101).
FIRST USE 12-0-1997; IN COMMERCE 12-0-1997.

CLASS 14—JEWELRY

FOR WATCHES, AND SMOKING CESSATION KIT COMPRISED OF SPECIALLY PROGRAMMED WATCH AND INSTRUCTION BOOKLET (U.S. CLS. 2, 27, 28 AND 50).

SN 76-422,951. GOMMAGOMMA S.R.L., CARONNO PERTUSELLA - VARESE, ITALY, FILED 6-19-2002.

SN 76-424,908. THORNTON OIL CORPORATION, LOUISVILLE, KY. FILED 6-26-2002.

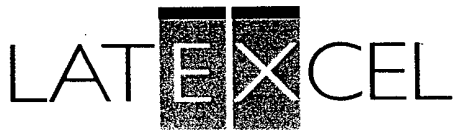

The logo for LATEXCEL features the word "LATEXCEL" in a bold, sans-serif font. The letters "L", "A", "T", "E", and "C" are in white, while the letters "X" and "E" are filled with a dense, stippled pattern. The "X" and "E" are positioned between two vertical black bars.

FUNDWORKS

OWNER OF ITALY REG. NO. 851348, DATED 9-12-2001, EXPIRES 4-13-2011.

THE STIPPLING IN THE DRAWING IS A FEATURE OF THE MARK AND IS NOT INTENDED TO CLAIM ANY PARTICULAR COLOR.

CLASS 35—ADVERTISING AND BUSINESS

FOR CHARITABLE FUNDRAISING SERVICES, NAMELY, ISSUING GIFT CARDS FOR THE PURCHASE OF RETAIL CONVENIENCE STORE PRODUCTS WHICH RAISE MONEY FOR NON-PROFIT ORGANIZATIONS (U.S. CLS. 100, 101 AND 102).

CLASS 17—RUBBER GOODS

FOR (BASED ON USE IN COMMERCE) AND (BASED ON 44(E)) RAW OR PARTLY PROCESSED GUM, LATEX AND RUBBER FOR USE IN THE MANUFACTURE OF MATTRESSES, PILLOWS, CUSHIONS, SPRING MATTRESSES; CUSHIONING MADE OF RUBBER OF PLASTIC IN THE NATURE OF STUFFING FOR MATTRESSES, PILLOWS, CUSHIONS, SPRING MATTRESSES (U.S. CLS. 1, 5, 12, 13, 35 AND 50).
FIRST USE 5-0-2001; IN COMMERCE 6-0-2001.

CLASS 36—INSURANCE AND FINANCIAL

FOR CHARITABLE FUNDRAISING SERVICES, NAMELY, ISSUING DEBIT CARDS AND CREDIT CARDS FOR THE PURCHASE OF RETAIL CONVENIENCE STORE PRODUCTS WHICH RAISE MONEY FOR NON-PROFIT ORGANIZATIONS (U.S. CLS. 100, 101 AND 102).

SN 76-425,142. JOVID DESIGNS LLC, KENTFIELD, CA.
FILED 6-25-2002.

HEAR GEAR

CLASS 9—ELECTRICAL AND SCIENTIFIC APPARATUS

FOR RADIOS, PERSONAL CASSETTE, CD AND MP3 PLAYERS, TELEPHONES, WALKIE-TALKIES, MOTORCYCLE HELMETS AND SPORT HELMETS (U.S. CLS. 21, 23, 26, 36 AND 38).

CLASS 25—CLOTHING

FOR HEADWEAR, NAMELY, HATS, CAPS, EARWARMERS, AND HEADBANDS (U.S. CLS. 22 AND 39).

SN 76-425,332. NITTO DENKO CORPORATION, IBARAKI-SHI, OSAKA-FU, JAPAN, FILED 6-25-2002.

GLOBAL NICHE TOP

CLASS 9—ELECTRICAL AND SCIENTIFIC APPARATUS

FOR POLARIZING FILM FOR LIQUID CRYSTAL DISPLAYS (U.S. CLS. 21, 23, 26, 36 AND 38).

CLASS 17—RUBBER GOODS

FOR ELECTRIC INSULATING TAPE; RESIN IN EXTRUDED FORM FOR USE WITH SEMICONDUCTOR SEALS (U.S. CLS. 1, 5, 12, 13, 35 AND 50).

SN 76-425,920. TUCKER ROCKY CORPORATION, INC., WILMINGTON, DE. FILED 6-27-2002.



NO CLAIM IS MADE TO THE EXCLUSIVE RIGHT TO USE "EXTREME PERFORMANCE", APART FROM THE MARK AS SHOWN.

THE NAME "A.J. MCCLAIN" DOES NOT IDENTIFY A PARTICULAR LIVING INDIVIDUAL.

CLASS 11—ENVIRONMENTAL CONTROL APPARATUS

FOR MOTORCYCLE LIGHTS (U.S. CLS. 13, 21, 23, 31 AND 34).

CLASS 12—VEHICLES

FOR MOTORCYCLES, AND PARTS THEREOF, NAMELY, HANDLEBARS, GRIPS, MIRRORS, EXHAUST SYSTEMS WINDSHIELDS AND WHEELS (U.S. CLS. 19, 21, 23, 31, 35 AND 44).

CLASS 18—LEATHER GOODS

FOR LUGGAGE (U.S. CLS. 1, 2, 3, 22 AND 41).

SN 76-426,110. CARAT FRANCE, 92400 COURBEVOIE, FRANCE, FILED 6-28-2002.

POSTERSCOPE

OWNER OF FRANCE REG. NO. 013121964, DATED 9-10-2001, EXPIRES 9-10-2011.

CLASS 35—ADVERTISING AND BUSINESS

FOR ADVERTISING AGENCIES; COMMERCIAL AND INDUSTRIAL MANAGEMENT ASSISTANCE; BUSINESS MANAGEMENT CONSULTATION; CONDUCTING MARKETING STUDIES; BUSINESS MARKETING CONSULTING SERVICES (U.S. CLS. 100, 101 AND 102).

CLASS 38—COMMUNICATION

FOR COMMUNICATIONS SERVICES, NAMELY, TRANSMITTING STREAMED SOUND AND AUDIO-VISUAL RECORDINGS VIA THE INTERNET; PROVIDING TELECOMMUNICATIONS CONNECTIONS TO A GLOBAL COMPUTER NETWORK; ELECTRONIC TRANSMISSION OF MESSAGES AND DATA (U.S. CLS. 100, 101 AND 104).

SN 76-426,380. KNAPE & VOGT MANUFACTURING COMPANY, GRAND RAPIDS, MI. FILED 7-1-2002.



OWNER OF U.S. REG. NO. 2,338,432.

CLASS 9—ELECTRICAL AND SCIENTIFIC APPARATUS

FOR COMPUTER ACCESSORIES, NAMELY, ADJUSTABLE KEYBOARD MECHANISM AND PLATFORMS; ADJUSTABLE MOUSE PLATFORMS; COMBINATION KEYBOARD/MOUSE PLATFORMS; SPECIALTY COMPUTER PLATFORMS; COMPUTER STANDS SPECIFICALLY DESIGNED TO HOLD A COMPUTER; COMPUTER WORKSTATIONS COMPRISING CPU HOLDER; ADJUSTABLE TABLES; AND COMPUTER MONITOR ARMS (U.S. CLS. 21, 23, 26, 36 AND 38).

FIRST USE 12-31-1999; IN COMMERCE 12-31-1999.

CLASS 11—ENVIRONMENTAL CONTROL APPARATUS

FOR APPARATUS FOR LIGHTING, NAMELY, DESK LAMPS, DESK LIGHTS AND TASK LIGHTS (U.S. CLS. 13, 21, 23, 31 AND 34).

FIRST USE 12-31-1999; IN COMMERCE 12-31-1999.

CLASS 21—HOUSEWARES AND GLASS

FOR FURNITURE, NAMELY, ADJUSTABLE WORK TABLES AND ADJUSTABLE FOOTRESTS FOR OFFICE WORKSPACES (U.S. CLS. 2, 13, 23, 29, 30, 33, 40 AND 50).

FIRST USE 12-31-1999; IN COMMERCE 12-31-1999.

SN 76-426,915. LIFETIME HOAN CORPORATION, WESTBURY, NY. FILED 7-1-2002.

KNIFE VAULT

NO CLAIM IS MADE TO THE EXCLUSIVE RIGHT TO USE "KNIFE", APART FROM THE MARK AS SHOWN.

CLASS 8—HAND TOOLS

FOR KITCHEN HAND TOOLS AND CUTLERY ITEMS, NAMELY, KNIVES, CLEAVERS, SHARPENING STEELS, KITCHEN SHEARS, AND SETS COMPRISED OF THE ABOVE-MENTIONED ITEMS (U.S. CLS. 23, 28 AND 44).

CLASS 21—HOUSEWARES AND GLASS

FOR STORAGE BLOCKS FOR KITCHEN HAND TOOLS AND KNIVES (U.S. CLS. 2, 13, 23, 29, 30, 33, 40 AND 50).

SN 76-427,397. APE INCORPORATED, GREENVILLE, SC. FILED 6-25-2002.

APE**CLASS 4—LUBRICANTS AND FUELS**

FOR LAMP OIL, NAMELY, TREATED LAMP OILS AND LAMP OILS CONTAINING OIL OF CITRONELLA AND BLENDED WITH EXTRACTED ELEMENTS OF THE BLACK WALNUT; WAX CANDLES; LIQUID CANDLE OILS; PATIO TORCHES; COLORED FIRE TORCHES (U.S. CLS. 1, 6 AND 15).

FIRST USE 1-23-2002; IN COMMERCE 1-23-2002.

CLASS 5—PHARMACEUTICALS

FOR INSECT REPELLANTS (U.S. CLS. 6, 18, 44, 46, 51 AND 52).

FIRST USE 3-1-1988; IN COMMERCE 1-23-2000.

CLASS 10—MEDICAL APPARATUS

FOR PROTECTIVE FOOTWEAR IN THE NATURE OF ORTHOPEDIC FOOTWEAR (U.S. CLS. 26, 39 AND 44).

FIRST USE 1-12-1996; IN COMMERCE 1-12-1999.

CLASS 11—ENVIRONMENTAL CONTROL APPARATUS

FOR OIL LAMPS; LAMP CARTRIDGES CONTAINING LAMP OIL (U.S. CLS. 13, 21, 23, 31 AND 34).

FIRST USE 4-22-1999; IN COMMERCE 4-22-2000.

CLASS 22—CORDAGE AND FIBERS

FOR BRAIDED SYNTHETIC FIBER ROPES; WOVEN PLASTIC CARGO STRAPS; ROPE, NAMELY, SPORT ROPE, CLIMBING ROPE, RESCUE ROPE, WATER ROPE, UTILITY ROPE, AND GENERAL PURPOSE ROPE (U.S. CLS. 1, 2, 7, 19, 22, 42 AND 50).

FIRST USE 4-1-1995; IN COMMERCE 4-1-2001.

CLASS 25—CLOTHING

FOR CLOTHING, NAMELY, SWIM WEAR; HEAVY WEATHER GARMENT WEAR IN THE NATURE OF JACKETS; RAIN WEAR; HEADGEAR IN THE NATURE OF HATS; BANDANNAS; UNDERGARMENT WEAR; SPORTS WEAR IN THE NATURE OF SPORT SHIRTS, PULLOVERS, JACKETS; SANDALS AND FOOTWEAR (U.S. CLS. 22 AND 39).

FIRST USE 1-12-1996; IN COMMERCE 1-12-1999.

CLASS 28—TOYS AND SPORTING GOODS

FOR GENERAL WATER SPORTS AND SNOW SPORTS EQUIPMENT AND PARTS THEREOF, NAMELY, SURFBOARDS, BODY BOARDS, SNOW BOARDS, SKI WAX AND SURF BOARD WAX, HANDLE GRIPS FOR SPORTING EQUIPMENT (U.S. CLS. 22, 23, 38 AND 50).

FIRST USE 2-1-1980; IN COMMERCE 2-1-1980.

SN 76-427,398. APE INCORPORATED, GREENVILLE, SC. FILED 6-25-2002.

APE**CLASS 3—COSMETICS AND CLEANING PREPARATIONS**

FOR CLEANERS AND CONDITIONERS FOR LEATHER, VINYL AND TIRES; VEHICLE WASHES, WAXES AND POLISHES; DEGREASING PREPARATIONS NOT USED IN MANUFACTURING PROCESSES FOR COMMERCIAL, INDUSTRIAL AND HOUSEHOLD USE; ALL PURPOSE CLEANERS; POLYMER SEALANT FOR CLEANING, SHINING AND PROTECTING VINYL AND RUBBER AUTOMOBILE SURFACES; RUST REMOVING PREPARATIONS (U.S. CLS. 1, 4, 6, 50, 51 AND 52).

FIRST USE 5-1-1999; IN COMMERCE 5-1-1999.

CLASS 6—METAL GOODS

FOR METAL ENGINE STANDS; WIRE ROPE SLING ASSEMBLIES (U.S. CLS. 2, 12, 13, 14, 23, 25 AND 50).

FIRST USE 1-10-2000; IN COMMERCE 1-10-2000.

CLASS 7—MACHINERY

FOR STANDS FOR MACHINES, NAMELY, METAL JACK STANDS, LIFTING FLOOR JACK STANDS AND UNDER HOIST STANDS; ROLL UNDER HYDRAULIC JACKS; ELECTRIC POWER TOOLS, NAMELY, DRILLS, SANDERS, GRINDERS, ENGRAVERS, POLISHERS NOT FOR USE ON FLOORS, WRENCHES AND SHEARS; HYDRAULIC POWER TOOLS, NAMELY, SPRAYERS, AIR BRUSHES, RIVET GUNS AND RIVETERS; PNEUMATIC AND AIR POWER TOOLS AND ACCESSORIES, NAMELY AIR RATCHETS, AIR WRENCHES, AIR DRILLS, AIR COMPRESSORS, BENCH GRINDERS, CUT-OFF TOOLS, BUFFERS, SCRAPERS, SCREWDRIVERS, PUNCH AND FLANGE TOOLS, RIVET GUNS AND RIVETERS, AIR NIBBLERS, AIR SAWS, AIR SAW AND FILE TOOLS, AIR SANDERS, POLISHERS NOT FOR USE ON FLOORS AND AIR HAMMERS; POWER DRILL BITS; TOOL BITS FOR MACHINES; POWER TOOLS, NAMELY, SHANKS AND BURRS; MACHINE PARTS, NAMELY, BLADES AND FILES; ABRASIVE SANDER BELTS FOR POWER OPERATED SANDERS AND PADS FOR USE THEREWITH; SANDING SHOES FOR POWER OPERATED SANDERS; POWER CHUCKS; ABRASIVE AND GRINDING WHEELS FOR POWER OPERATED SANDERS; DISC HOLDERS, AIR FITTINGS AND COUPLERS ALL FOR POWER OPERATED MACHINE TOOLS; POWER TIRE CHUCKS; POWER CHUCK KEYS; POWER OPERATED DRILLS, DRILL SHARPENERS, DRILL GAUGES, HOLE SAWS, CUTTERS, PULLERS, OILER AND GREASE GUNS, BODY STRAIGHTENERS, RATCHETING BOX WRENCHES AND PARTS AND FITTINGS FOR THE AFORESAID GOODS; POWER-OPERATED LIFTS, HOISTS AND JACKS FOR MOTOR VEHICLES; ENGINE STANDS; POWER FLOOR CRANES; HYDRAULIC WHEEL DOLLIES; HYDRAULIC PRESSES AND JACKS AND PARTS AND FITTINGS FOR THE AFORESAID GOODS; ENGINE CLEANING MACHINES, NAMELY, MOTOR-OPERATED STEAM CLEANERS, COLD WATER PRESSURE WASHERS, FLOOR WASHING MACHINES IN THE NATURE OF CONCRETE CLEANERS, MULTI-PURPOSE HIGH POWER PRESSURE WASHERS AND PARTS AND FITTINGS FOR THE AFORESAID GOODS; POWER PARTS WASHERS; ELECTRIC SANDBLASTING MACHINES; ELECTRIC WELDING MACHINES AND PARTS AND FITTINGS FOR THE AFORESAID GOODS (U.S. CLS. 13, 19, 21, 23, 31, 34 AND 35).

FIRST USE 1-1-1979; IN COMMERCE 1-1-1980.

CLASS 8—HAND TOOLS

FOR STANDS FOR HAND JACKS; PRY BARS; ROLL UNDER HAND JACKS; SHARPENING STONES; HAND TOOLS, NAMELY, SOCKET SETS, INDIVIDUAL IMPACT SOCKETS, SCREWDRIVER SETS, WRENCH SETS, TELESCOPIC WRENCHES AND RATCHETS, WRECKING BARS, NAIL PULLERS, CROW BARS, DIGGING BARS AND SLATE BARS; HAND TOOLS DESIGNED FOR LIFTING AND CARRYING AND MOVING LARGE OBJECTS, NAMELY, CLAMPS (U.S. CLS. 23, 28 AND 44).

FIRST USE 1-12-2000; IN COMMERCE 1-12-2000.

SN 76-428,505. VPI CORP., WILMINGTON, DE. FILED 7-8-2002.

ACTIVSPORT

OWNER OF U.S. REG. NO. 2,034,150.

CLASS 18—LEATHER GOODS

FOR BACKPACKS (U.S. CLS. 1, 2, 3, 22 AND 41).

CLASS 25—CLOTHING

FOR CLOTHING, NAMELY, UNDERWEAR, SOCKS, FOOTWEAR, HATS, GLOVES AND SCARVES (U.S. CLS. 22 AND 39).

SN 76-428,571. ARROWHEAD DENTAL LABORATORY, INC., SANDY, UT. FILED 7-8-2002.

**DR Dick
Barnes
group**

NO CLAIM IS MADE TO THE EXCLUSIVE RIGHT TO USE "DR." AND "GROUP", APART FROM THE MARK AS SHOWN.

THE MARK IDENTIFIES A PARTICULAR LIVING INDIVIDUAL WHOSE WRITTEN CONSENT IS OF RECORD.

CLASS 35—ADVERTISING AND BUSINESS

FOR CONSULTATION IN THE FIELD OF DENTAL PRACTICE DEVELOPMENT AND MANAGEMENT (U.S. CLS. 100, 101 AND 102).

FIRST USE 12-31-2000; IN COMMERCE 12-31-2000.

CLASS 41—EDUCATION AND ENTERTAINMENT

FOR PROVIDING CONTINUING DENTAL EDUCATION COURSES; CONDUCTING WORKSHOPS AND SEMINARS FOR DENTAL PROFESSIONALS ON DENTAL TECHNIQUES (U.S. CLS. 100, 101 AND 107).

FIRST USE 12-31-2000; IN COMMERCE 12-31-2000.

SN 76-429,006. OHDS, INC., PITTSBURGH, PA. FILED 7-10-2002.



OWNER OF U.S. REG. NOS. 2,108,767 AND 2,136,666.

NO CLAIM IS MADE TO THE EXCLUSIVE RIGHT TO USE "ORIGINAL HOT DOG SHOP", APART FROM THE MARK AS SHOWN.

CLASS 30—STAPLE FOODS

FOR FOOD, NAMELY FRANKFURTER SANDWICHES (U.S. CL. 46).

FIRST USE 6-21-1988; IN COMMERCE 6-21-1988.

CLASS 43—HOTEL AND RESTAURANT SERVICES

FOR RESTAURANT SERVICES (U.S. CLS. 100 AND 101).

FIRST USE 6-21-1988; IN COMMERCE 6-21-1988.

SN 76-429,017. BABY BOOM CONSUMER PRODUCTS, INC., NEW YORK, NY. FILED 7-10-2002.



NO CLAIM IS MADE TO THE EXCLUSIVE RIGHT TO USE "BEBE", APART FROM THE MARK AS SHOWN. THE ENGLISH TRANSLATION OF THE MARK IS "PRECIOUS BABY".

CLASS 11—ENVIRONMENTAL CONTROL APPARATUS

FOR LAMPS AND NIGHT LIGHTS (U.S. CLS. 13, 21, 23, 31 AND 34).

CLASS 24—FABRICS

FOR BEDDING, NAMELY, BEDSPREADS, SHEETS, COMFORTER COVERS, BLANKETS AND PILLOWS; TOWELS, WASH CLOTHS, AND WALL ART, NAMELY, TEXTILE WALL HANGINGS (U.S. CLS. 42 AND 50).

CLASS 25—CLOTHING

FOR CLOTH BABY BIBS (U.S. CLS. 22 AND 39).

CLASS 28—TOYS AND SPORTING GOODS

FOR TOYS, NAMELY, TOY MOBILES, TOY SCULPTURES AND DOLLS; TOY GIFT SETS COMPRISING TOY BANKS, SNOW GLOBES, AND MUSICAL PULL TOYS (U.S. CLS. 22, 23, 38 AND 50).

SN 76-429,708. APPLIED NANOTECHNOLOGIES, INC., CHAPEL HILL, NC. FILED 7-12-2002.

ANI

CLASS 40—MATERIAL TREATMENT

FOR MANUFACTURE AND FABRICATION TO THE ORDER AND/OR SPECIFICATION OF OTHERS OF PURIFIED CARBON NANOTUBES, CARBON NANOTUBE THIN FILMS, AND NANOSTRUCTURED MATERIALS (U.S. CLS. 100, 103 AND 106).

FIRST USE 6-0-2001; IN COMMERCE 6-0-2001.

CLASS 42—SCIENTIFIC, COMPUTER AND LEGAL SERVICES

FOR PRODUCT AND SCIENTIFIC RESEARCH, PRODUCT DEVELOPMENT, AND APPLICATION DEVELOPMENT SERVICES INVOLVING CARBON NANOTUBES, CARBON NANOTUBE DEVICES, AND NANOSTRUCTURED MATERIALS (U.S. CLS. 100 AND 101).

FIRST USE 6-0-2001; IN COMMERCE 6-0-2001.

SN 76-429,768. DAVILA SARL, CH 1007 LAUSANNE, SWITZERLAND, FILED 7-9-2002.

DRACULA'S COIN

PRIORITY CLAIMED UNDER SEC. 44(D) ON SWITZERLAND APPLICATION NO. 05611/2002, FILED 6-25-2002, REG. NO. 502909, DATED 5-9-2002, EXPIRES 6-25-2012.

NO CLAIM IS MADE TO THE EXCLUSIVE RIGHT TO USE "COIN", APART FROM THE MARK AS SHOWN.

CLASS 16—PAPER GOODS AND PRINTED MATTER

FOR PRINTED MATTER, NAMELY, POSTERS, PAMPHLETS, BOOKLETS AND PROSPECTUSES CONCERNING TOURISM, SOUVENIRS, ROMANIA AND MONEY (U.S. CLS. 2, 5, 22, 23, 29, 37, 38 AND 50).

CLASS 25—CLOTHING

FOR CLOTHING, NAMELY, PANTS, SHIRTS AND SHORTS; FOOTWEAR; HEADGEAR, NAMELY, HATS AND CAPS (U.S. CLS. 22 AND 39).

SN 76-429,906. ZEFON INTERNATIONAL, INC., OCALA, FL. FILED 7-3-2002.

ZEFON

CLASS 9—ELECTRICAL AND SCIENTIFIC APPARATUS

FOR AIR MONITORING, SAMPLING AND TESTING DEVICES, NAMELY, ELECTRONIC METERS, MONITORS AND DETECTORS FOR MEASURING AND TESTING AIR QUALITY INCLUDING AIRBORNE AND SETTLED COMPOSITION, GAS MONITORS, AIR SAMPLING PUMPS, PARTICLE COUNTERS, PHOTO IONIZATION DETECTORS, MOISTURE METERS, HUMIDITY/TEMPERATURE DETECTORS, AIR VELOCITY METERS, CARBON MONOXIDE AND CARBON DIOXIDE DETECTORS, DETECTOR TUBES, TEMPERATURE PROBES, SOUND METERS, LIGHT METERS, CALIBRATION DEVICES FOR ALL OF THE FOREGOING, BULK SAMPLING EQUIPMENT, AIR QUALITY SAMPLING CASSETTES, FILTERS AND ACCESSORIES FOR ALL OF THE FOREGOING (U.S. CLS. 21, 23, 26, 36 AND 38).

FIRST USE 11-0-1990; IN COMMERCE 3-0-1991.

CLASS 10—MEDICAL APPARATUS

FOR MEDICAL DEVICES, NAMELY, TUBING FOR ANESTHETIC GAS SAMPLING, BLOOD PRESSURE CUFFS, AND ATTACHMENT DEVICES FOR SECURING PATIENT TUBES, CATHETERS AND LINES (U.S. CLS. 26, 39 AND 44).

FIRST USE 11-0-1990; IN COMMERCE 3-0-1991.

CLASS 40—MATERIAL TREATMENT

FOR CUSTOM MANUFACTURING FOR OTHERS IN THE FIELD OF INJECTION MOLDING (U.S. CLS. 100, 103 AND 106).

FIRST USE 11-0-1990; IN COMMERCE 3-0-1991.

CLASS 42—SCIENTIFIC, COMPUTER AND LEGAL SERVICES

FOR DESIGN OF NEW PRODUCTS FOR OTHERS (U.S. CLS. 100 AND 101).

FIRST USE 11-0-1990; IN COMMERCE 3-0-1991.

SN 76-430,439. ONDEO NALCO COMPANY, NAPERVILLE, IL. FILED 7-15-2002.

SN 76-431,559. BUSINESS TRAVEL INTERNATIONAL GMBH, D-40212 DUSSELDORF, FED REP GERMANY, FILED 7-12-2002.

SOLUTIONS DIRECT

NO CLAIM IS MADE TO THE EXCLUSIVE RIGHT TO USE "DIRECT", APART FROM THE MARK AS SHOWN.

CLASS 35—ADVERTISING AND BUSINESS

FOR COMPUTERIZED ON-LINE ORDERING SERVICES FEATURING WATER TREATMENT CHEMICALS (U.S. CLS. 100, 101 AND 102).

FIRST USE 10-10-2001; IN COMMERCE 10-10-2001.

CLASS 40—MATERIAL TREATMENT

FOR PROVIDING INFORMATION IN THE FIELDS OF MUNICIPAL WASTEWATER, ODOR CONTROL AND DRINKING WATER MANAGEMENT, VIA THE INTERNET (U.S. CLS. 100, 103 AND 106).

FIRST USE 10-10-2001; IN COMMERCE 10-10-2001.

SN 76-430,680. TURNER ENTERPRISES, INC., ATLANTA, GA. FILED 7-12-2002.

TURNER RANCHES

CLASS 18—LEATHER GOODS

FOR LUGGAGE, TRAVEL BAGS, BACKPACKS, HANDBAGS, SHOULDER BAGS, PURSES, TOTE BAGS, SUITCASES, ATTACHE CASES, BRIEFCASES, WALLET, AND BILLFOLDS (U.S. CLS. 1, 2, 3, 22 AND 41).

CLASS 25—CLOTHING

FOR CLOTHING, NAMELY, SLACKS, SHORTS, JEANS, SHIRTS, TIES, COATS, SOCKS, SPORT JACKETS, JACKETS, SWEATERS, BELTS, DRESSES, SKIRTS, BLOUSES, JUMPSUITS, PANTS, BLAZERS, T-SHIRTS, SWEATSHIRTS, SWEATPANTS, WARM-UP SUITS, WRISTBANDS, SWIMSUITS, PAJAMAS, JUMPERS, ROBES, GLOVES, HATS, KERCHIEFS AND UNDERWEAR; AND FOOTWEAR (U.S. CLS. 22 AND 39).

SN 76-430,763. WAL-MART STORES, INC., BENTONVILLE, AR. FILED 7-12-2002.

SHOP AND COMPARE

CLASS 14—JEWELRY

FOR JEWELRY (U.S. CLS. 2, 27, 28 AND 50).

CLASS 16—PAPER GOODS AND PRINTED MATTER

FOR CIRCULARS FOR MAILING AND BAR CODE LABELS (U.S. CLS. 2, 5, 22, 23, 29, 37, 38 AND 50).



OWNER OF ERPN CMNTY TM OFC REG. NO. 002042935, DATED 5-2-2002, EXPIRES 1-16-2011.

NO CLAIM IS MADE TO THE EXCLUSIVE RIGHT TO USE "HOSPITALITY CLUB MEMBER", APART FROM THE MARK AS SHOWN.

CLASS 35—ADVERTISING AND BUSINESS

FOR DIRECT MARKETING ADVERTISING FOR OTHERS; BUSINESS CONSULTATION (U.S. CLS. 100, 101 AND 102).

CLASS 39—TRANSPORTATION AND STORAGE

FOR ORGANIZING AND ARRANGING TRAVEL, NAMELY, ARRANGING FOR TRAVEL VISAS, PASSPORTS AND TRAVEL DOCUMENTS FOR PERSONS TRAVELING ABROAD (U.S. CLS. 100 AND 105).

CLASS 43—HOTEL AND RESTAURANT SERVICES

FOR TRAVEL AGENCY SERVICES, NAMELY, MAKING RESERVATIONS AND BOOKING FOR TEMPORARY LODGING; PROVIDING FOOD AND DRINK, NAMELY, RESTAURANT AND BAR SERVICES; TEMPORARY ACCOMMODATION SERVICES, NAMELY, HOTEL SERVICES (U.S. CLS. 100 AND 101).

SN 76-431,849. SIR VIVOR, INC., RANCHO SANTA FE, CA. FILED 7-18-2002.



CLASS 9—ELECTRICAL AND SCIENTIFIC APPARATUS

FOR COMPUTER SOFTWARE FOR ACCOUNT INITIALIZATION, ACCESS, AND MAINTENANCE USED IN THE FIELD OF FINANCIAL MANAGEMENT, INVESTMENTS, AND TRUSTS, AND INSTRUCTIONAL MANUALS DISTRIBUTED THEREWITH (U.S. CLS. 21, 23, 26, 36 AND 38).

CLASS 36—INSURANCE AND FINANCIAL

FOR SERVICES IN THE FIELD OF FINANCIAL MANAGEMENT, INVESTMENTS AND TRUSTS, NAMELY, FINANCIAL PLANNING, MANAGEMENT, AND TRUST ADMINISTRATION (U.S. CLS. 100, 101 AND 102).

SN 76-432,300. SCUBA FUEL COMPANY, ALPHARETTA, GA. FILED 7-19-2002.

SCUBA FUEL

CLASS 30—STAPLE FOODS

FOR GRAIN-BASED AND GRANOLA-BASED SNACK BARS; PROCESSED CEREALS; SNACK CRACKERS, NAMELY CRACKERS AND CHEESE COMBINATIONS; CRACKERS (U.S. CL. 46).

CLASS 32—LIGHT BEVERAGES

FOR SPORTS DRINKS, BOTTLED WATER, CARBONATED DRINKING WATER, CARBONATED NATURAL SOFT DRINKS (U.S. CLS. 45, 46 AND 48).

SN 76-432,523. LEVY (IP) LIMITED PARTNERSHIP, CHICAGO, IL. FILED 7-19-2002.

A FAMILY OF PASSIONATE RESTAURATEURS

CLASS 35—ADVERTISING AND BUSINESS

FOR CONCESSION STANDS FEATURING FOOD AND BEVERAGES (U.S. CLS. 100, 101 AND 102).

CLASS 42—SCIENTIFIC, COMPUTER AND LEGAL SERVICES

FOR PRODUCT DEVELOPMENT CONSULTATION IN THE RESTAURANT, FOOD SERVICE AND FOOD CONCESSION INDUSTRY (U.S. CLS. 100 AND 101).

CLASS 43—HOTEL AND RESTAURANT SERVICES

FOR RESTAURANT, LOUNGE, COCKTAIL AND BAR SERVICES; CONSULTING SERVICES IN THE FIELD OF RESTAURANT SERVICES, NAMELY PROVIDING STRATEGIC CONCEPT CREATION, OPERATIONAL EXPERTISE AND MENU AND FOOD DEVELOPMENT IN THE FOOD SERVICE AND HOSPITALITY INDUSTRIES (U.S. CLS. 100 AND 101).

SN 76-433,299. TAHOE LONGBOARDS, LLC, TRUCKEE, CA. FILED 7-23-2002.



NO CLAIM IS MADE TO THE EXCLUSIVE RIGHT TO USE "TAHOE LONGBOARDS", APART FROM THE MARK AS SHOWN.

THE LINING IS A FEATURE OF THE MARK AND DOES NOT INDICATE COLOR.

CLASS 25—CLOTHING

FOR SHIRTS AND HATS (U.S. CLS. 22 AND 39). FIRST USE 9-1-1998; IN COMMERCE 9-1-1998.

CLASS 28—TOYS AND SPORTING GOODS

FOR LONGBOARD SKATEBOARDS (U.S. CLS. 22, 23, 38 AND 50). FIRST USE 9-1-1998; IN COMMERCE 9-1-1998.

SN 76-433,356. TRADEAMBASSADORS, LLC, WASHINGTON, DC. FILED 7-18-2002.

TRADEAMBASSADORS

CLASS 35—ADVERTISING AND BUSINESS

FOR EVENT MANAGEMENT SERVICES FOR BUSINESS ORGANIZATIONS AND GROUPS, NAMELY, ORGANIZING AND FACILITATING BUSINESS MEETINGS AND CORPORATE EVENTS, CONDUCTED VIA A GLOBAL COMPUTER NETWORK; ARRANGING AND ORGANIZING EXPOSITIONS, CONFERENCES, CONVENTIONS, FAIRS AND EXHIBITIONS FOR BUSINESS ORGANIZATIONS AND GROUPS VIA A GLOBAL COMPUTER NETWORK; ADVERTISING SERVICES FOR BUSINESS ORGANIZATIONS AND GROUPS CONDUCTED VIA A GLOBAL COMPUTER NETWORK; MARKETING ANALYSIS AND RESEARCH; ORGANIZING PARTICIPATION IN BUSINESS AND TRADE EXPOSITIONS, CONFERENCES, CONVENTIONS, FAIRS AND EXHIBITIONS, NAMELY, SOLICITATION OF PARTICIPANTS, AND PROVIDING AND PROCESSING APPLICATIONS FOR PARTICIPANTS, VIA A GLOBAL COMPUTER NETWORK; BUSINESS NETWORKING AND BUSINESS CONSULTATION, NAMELY, FACILITATING AND COORDINATING BUSINESS DEVELOPMENT OPPORTUNITIES FOR OTHERS (U.S. CLS. 100, 101 AND 102).

CLASS 38—COMMUNICATION

FOR PROVIDING ON-LINE CHAT ROOMS FOR TRANSMISSION OF MESSAGES AMONG COMPUTER USERS CONCERNING BUSINESS AND TRADE; PROVIDING ELECTRONIC MAIL, INSTANT MESSAGING, TRANSMISSION OF MESSAGES FEATURING ENCRYPTION, VIDEO AND AUDIO CONFERENCING SERVICES, DOCUMENT SHARING SERVICES, AND AUDIO AND VIDEO WEBCASTING SERVICES TO BUSINESS ORGANIZATIONS AND GROUPS VIA A GLOBAL COMPUTER NETWORK; PROVIDING CONFERENCE RECORDING SERVICES TO BUSINESS ORGANIZATIONS AND GROUPS OVER A GLOBAL COMPUTER NETWORK VIA A DEDICATED WEB SITE (U.S. CLS. 100, 101 AND 104).

CLASS 42—SCIENTIFIC, COMPUTER AND LEGAL SERVICES

FOR PROVIDING TEMPORARY USE OF ON-LINE NON-DOWNLOADABLE SOFTWARE FOR MANAGING AND DISPLAYING DIGITAL CONTENT RELATING TO BUSINESS AND TRADE; HOSTING THE WEB SITES OF OTHERS ON A COMPUTER SERVER FOR A GLOBAL COMPUTER NETWORK (U.S. CLS. 100 AND 101).

SN 76-433,435. JOONBUG PRODUCTIONS, INC., NEW YORK, NY. FILED 7-23-2002.

SN 76-434,849. AVENTIS CROPS SCIENCE SA, LYON, FRANCE, FILED 7-26-2002.

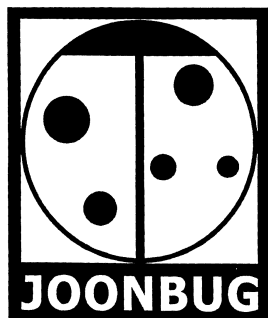

COLOR IS CLAIMED AS A FEATURE OF THE MARK. THE LARGE ROUND IMAGE INSIDE THE SQUARE IS COLORED IN RED AND THE DOTS INSIDE THE ROUND IMAGE ARE COLORED IN BLACK.

CLASS 35—ADVERTISING AND BUSINESS

FOR PROMOTING THE PARTIES AND SPECIAL EVENTS OF OTHERS (U.S. CLS. 100, 101 AND 102).
FIRST USE 1-15-2002; IN COMMERCE 1-15-2002.

CLASS 41—EDUCATION AND ENTERTAINMENT

FOR PARTY PLANNING, SPECIAL EVENTS PLANNING; PHOTOGRAPHY SERVICES, NAMELY, PHOTOGRAPHING INDIVIDUALS AT PARTIES AND OTHER EVENTS (U.S. CLS. 100, 101 AND 107).
FIRST USE 1-15-2002; IN COMMERCE 1-15-2002.

SN 76-433,523. BERGAMO, PETER J., WOLCOTT, CT. FILED 7-22-2002.

GRABIT

CLASS 7—MACHINERY

FOR POWER DRILL BITS FOR REMOVING DAMAGED SCREWS (U.S. CLS. 13, 19, 21, 23, 31, 34 AND 35).
FIRST USE 10-25-2002; IN COMMERCE 11-1-2002.

CLASS 8—HAND TOOLS

FOR DRILL BITS FOR HAND DRILLS AND HAND MANIPULATED CHUCKS FOR REMOVING DAMAGED SCREWS (U.S. CLS. 23, 28 AND 44).
FIRST USE 10-25-2002; IN COMMERCE 11-1-2002.



PRIORITY CLAIMED UNDER SEC. 44(D) ON FRANCE APPLICATION NO. 023173473, FILED 7-10-2002, REG. NO. 023173473, DATED 7-10-2002, EXPIRES 7-10-2012.
OWNER OF U.S. REG. NO. 2,277,149.

CLASS 1—CHEMICALS

FOR SEED TREATMENT FOR AGRICULTURAL AND DOMESTIC USE (U.S. CLS. 1, 5, 6, 10, 26 AND 46).

CLASS 5—PHARMACEUTICALS

FOR FUNGICIDE FOR SEED TREATMENT FOR AGRICULTURAL AND DOMESTIC USE (U.S. CLS. 6, 18, 44, 46, 51 AND 52).

CLASS 44—MEDICAL, BEAUTY AND AGRICULTURAL SERVICES

FOR PROVIDING INFORMATION IN THE FIELD OF AGRICULTURE, VIA COMPUTER; PROVIDING A COMPUTER DATABASE IN THE FIELD OF AGRICULTURE (U.S. CLS. 100 AND 101).

SN 76-435,525. TOSOH CORPORATION, YAMAGUCHI, JAPAN, FILED 7-25-2002.

TOSOH BIOTECH

NO CLAIM IS MADE TO THE EXCLUSIVE RIGHT TO USE "BIOTECH", APART FROM THE MARK AS SHOWN.

CLASS 1—CHEMICALS

FOR GEL FOR LIQUID CHROMATOGRAPHY, PACKED COLUMN FOR LIQUID CHROMATOGRAPHY AND BUFFER FOR LIQUID CHROMATOGRAPHY (U.S. CLS. 1, 5, 6, 10, 26 AND 46).

CLASS 5—PHARMACEUTICALS

FOR REAGENTS FOR IMMUNOLOGICAL DIAGNOSTIC ANALYZERS, NAMELY, REAGENT FOR IMMUNOASSAYS (U.S. CLS. 6, 18, 44, 46, 51 AND 52).

CLASS 9—ELECTRICAL AND SCIENTIFIC APPARATUS

FOR APPARATUS FOR LIQUID CHROMATOGRAPHY AND GEL PACKED COLUMN FOR LIQUID CHROMATOGRAPHY (U.S. CLS. 21, 23, 26, 36 AND 38).

CLASS 10—MEDICAL APPARATUS

FOR CLINICAL MEDICAL LABORATORY EQUIPMENT, NAMELY AN AUTOMATED IMMUNOASSAY ANALYZER AND PARTS THEREFOR (U.S. CLS. 26, 39 AND 44).

SN 76-435,758. EGALAXY MULTIMEDIA INC., TORONTO, ONTARIO, CANADA, FILED 7-30-2002.

SPORTS NEVER LOOKED SO GOOD

CLASS 25—CLOTHING

FOR CLOTHING, NAMELY T-SHIRTS, SWEAT-SHIRTS, HATS AND CAPS (U.S. CLS. 22 AND 39).

CLASS 41—EDUCATION AND ENTERTAINMENT

FOR PRODUCTION OF CABLE SPORTS NEWSCASTS; PRODUCTION AND DISTRIBUTION OF CABLE TELEVISION PROGRAMMING, PRODUCTION AND DISTRIBUTION OF TELEVISION PROGRAMMING VIA SATELLITE, PRODUCING AND DISTRIBUTING AUDIO AND VISUAL PROGRAMMING IN THE FIELD OF ENTERTAINMENT VIA THE INTERNET (U.S. CLS. 100, 101 AND 107).

SN 76-435,936. MISSRY ASSOCIATES INC., DUNELLEN, NJ. FILED 7-29-2002.

EVERYTHING CHRISTMAS

NO CLAIM IS MADE TO THE EXCLUSIVE RIGHT TO USE "CHRISTMAS", APART FROM THE MARK AS SHOWN.

CLASS 26—FANCY GOODS

FOR ARTIFICIAL FLOWERS AND FLORAL ARRANGEMENTS, AND ORNAMENTAL BOWS AND RIBBONS MADE OF TEXTILE FOR DECORATION (U.S. CLS. 37, 39, 40, 42 AND 50).

CLASS 28—TOYS AND SPORTING GOODS

FOR CHRISTMAS DECORATIONS, NAMELY, PLUSH TOY DOLLS AND ARTIFICIAL CHRISTMAS GARLANDS (U.S. CLS. 22, 23, 38 AND 50).

SN 76-436,054. UNICALIBROS PUBLISHING CORP., MIAMI, FL. FILED 7-26-2002.



CLASS 9—ELECTRICAL AND SCIENTIFIC APPARATUS

FOR PRERECORDED AUDIOCASSETTES, COMPACT DISCS AND DIGITAL AUDIO TAPES FEATURING A VARIETY OF TOPICS OF FICTION AND NON-FICTION (U.S. CLS. 21, 23, 26, 36 AND 38).

CLASS 16—PAPER GOODS AND PRINTED MATTER

FOR PUBLICATIONS, NAMELY, A SERIES OF FICTION AND NON-FICTION BOOKS ON A VARIETY OF TOPICS (U.S. CLS. 2, 5, 22, 23, 29, 37, 38 AND 50).

CLASS 35—ADVERTISING AND BUSINESS

FOR WHOLESALE AND RETAIL DISTRIBUTORSHIP AND COMPUTERIZED ON-LINE RETAIL SERVICES IN THE FIELD OF PRE-RECORDED AUDIOCASSETTES, COMPACT DISCS, CD-ROMS AND BOOKS (U.S. CLS. 100, 101 AND 102).

SN 76-436,102. TRI-STATE HOSPITAL SUPPLY CORPORATION, HOWELL, MI. FILED 7-30-2002.

CENTURION

OWNER OF U.S. REG. NOS. 1,206,998 AND 1,588,678.

CLASS 16—PAPER GOODS AND PRINTED MATTER

FOR BLANK OR PARTIALLY PRINTED PAPER LABELS (U.S. CLS. 2, 5, 22, 23, 29, 37, 38 AND 50). FIRST USE 6-30-1992; IN COMMERCE 6-30-1992.

CLASS 20—FURNITURE AND ARTICLES NOT OTHERWISE CLASSIFIED

FOR PLASTIC LABELS (U.S. CLS. 2, 13, 22, 25, 32 AND 50). FIRST USE 6-30-1992; IN COMMERCE 6-30-1992.

CLASS 42—SCIENTIFIC, COMPUTER AND LEGAL SERVICES

FOR LABEL DESIGN SERVICES FOR OTHERS (U.S. CLS. 100 AND 101). FIRST USE 6-30-1992; IN COMMERCE 6-30-1992.

SN 76-436,167. L.R.A., L.L.C., OKLAHOMA CITY, OK. FILED 7-31-2002.



CLASS 41—EDUCATION AND ENTERTAINMENT

FOR ENTERTAINMENT SERVICES, NAMELY, PRODUCING A SERIES OF RADIO AND TELEVISION SHOWS FEATURING MUSIC (U.S. CLS. 100, 101 AND 107).

CLASS 43—HOTEL AND RESTAURANT SERVICES

FOR RESTAURANT SERVICES; NAMELY, RESTAURANT, BAR AND GRILL (U.S. CLS. 100 AND 101).

SN 76-436,416. OCEAN INSTITUTE, DANA POINT, CA.
FILED 7-31-2002.



NO CLAIM IS MADE TO THE EXCLUSIVE RIGHT TO USE "OCEAN INSTITUTE", APART FROM THE MARK AS SHOWN.

CLASS 16—PAPER GOODS AND PRINTED MATTER

FOR PRINTED MATTER, NAMELY INFORMATIONAL BROCHURES, COURSE CATALOGS, STUDY GUIDES, BOOKLETS, WORKSHEETS, AND PRINTED PROGRAMS ALL ABOUT THE MARINE SCIENCES, MARITIME HISTORY AND RELATED PRESENTATIONS, PRODUCTIONS AND PERFORMANCES (U.S. CLS. 2, 5, 22, 23, 29, 37, 38 AND 50).

FIRST USE 2-26-2002; IN COMMERCE 2-26-2002.

CLASS 25—CLOTHING

FOR CLOTHING, NAMELY SHIRTS, SWEATSHIRTS, PANTS, SHORT PANTS, HATS, VISORS, AND JACKETS (U.S. CLS. 22 AND 39).

FIRST USE 2-26-2002; IN COMMERCE 2-26-2002.

CLASS 41—EDUCATION AND ENTERTAINMENT

FOR EDUCATIONAL SERVICES, NAMELY, PROVIDING COURSES, CLASSES, LECTURES, WORKSHOPS, AND OTHER PRESENTATIONS, PRODUCTIONS AND PERFORMANCES ALL ABOUT THE MARINE SCIENCES AND MARITIME HISTORY; PROVIDING ON-LINE VIA THE INTERNET AN EDUCATIONAL WEB SITE ABOUT MARITIME HISTORY (U.S. CLS. 100, 101 AND 107).

FIRST USE 2-26-2002; IN COMMERCE 2-26-2002.

SN 76-436,533. J. J. KELLER & ASSOCIATES, INC., NEENAH, WI. FILED 8-1-2002.



NO CLAIM IS MADE TO THE EXCLUSIVE RIGHT TO USE "EASY", APART FROM THE MARK AS SHOWN.

CLASS 9—ELECTRICAL AND SCIENTIFIC APPARATUS

FOR ELECTRONIC PUBLICATIONS, NAMELY, BOOKS, RECORDED ON CD-ROM FEATURING INFORMATION ON OCCUPATIONAL SAFETY, HUMAN RESOURCES, MOTOR-CARRIER OPERATIONS AND ENVIRONMENTAL REGULATIONS, LAWS, AND BEST PRACTICES (U.S. CLS. 21, 23, 26, 36 AND 38).

FIRST USE 4-0-2002; IN COMMERCE 4-0-2002.

CLASS 41—EDUCATION AND ENTERTAINMENT

FOR PROVIDING TEMPORARY USE OF ON-LINE, NON-DOWNLOADABLE CONTENT, NAMELY, BOOKS AND REPORTS, IN THE FIELD OF OCCUPATIONAL SAFETY, HUMAN RESOURCES, MOTOR-CARRIER OPERATIONS AND ENVIRONMENTAL REGULATIONS, LAWS, AND BEST PRACTICES (U.S. CLS. 100, 101 AND 107).

FIRST USE 1-4-2002; IN COMMERCE 1-4-2002.

SN 76-436,944. MGE ENERGY, INC., MADISON, WI. FILED 8-1-2002.



NO CLAIM IS MADE TO THE EXCLUSIVE RIGHT TO USE "ENERGY", APART FROM THE MARK AS SHOWN.

CLASS 35—ADVERTISING AND BUSINESS

FOR PROCUREMENT, NAMELY, PURCHASING ELECTRIC POWER AND NATURAL GAS FOR OTHERS; BUSINESS MANAGEMENT AND CONSULTATION SERVICES IN THE FIELDS OF ENERGY, ENERGY SERVICES, AND ELECTRICAL UTILITIES; BILLING SERVICES IN THE ENERGY FIELDS; PROVIDING ENERGY USAGE MANAGEMENT AND INFORMATION; PROVIDING ENERGY AUDITING AND INFORMATION; OPERATION OF A BUSINESS FOR OTHERS, NAMELY, OPERATION OF INDEPENDENT POWER PLANTS AND COGENERATION FACILITIES; PROVIDING INFORMATION REGARDING BILLING SERVICES FOR OTHERS; UTILITY BILL MANAGEMENT SERVICES, NAMELY, TRACKING, REPORTING, ANALYZING AND DELIVERING ENERGY INFORMATION IN THE FORM OF UTILITY BILLS AND UTILITY METER DATA RATE SCHEDULES (U.S. CLS. 100, 101 AND 102).

CLASS 36—INSURANCE AND FINANCIAL

FOR PROVIDING ENERGY BROKERAGE AND INFORMATION; PROVIDING BILL PAYMENT SERVICES AND INFORMATION (U.S. CLS. 100, 101 AND 102).

CLASS 37—CONSTRUCTION AND REPAIR

FOR CONSTRUCTION SERVICES, NAMELY, CONSTRUCTING STRUCTURES AND FACILITIES FOR USE IN THE ELECTRIC POWER AND GAS INDUSTRIES; MINING EXTRACTION OF COAL AND OTHER FOSSIL FUELS (U.S. CLS. 100, 103 AND 106).

CLASS 39—TRANSPORTATION AND STORAGE

FOR PUBLIC UTILITY SERVICES; UTILITY SERVICES, NAMELY, TRANSMISSION OF ELECTRICITY (U.S. CLS. 100 AND 105).

CLASS 40—MATERIAL TREATMENT

FOR GENERATION OF AND PRODUCTION OF ELECTRICITY AND ENERGY VIA POWER PLANTS AND COGENERATION FACILITIES (U.S. CLS. 100, 103 AND 106).

SN 76-437,088. CHRISTIAN DIOR COUTURE, S.A., 75008
PARIS, FRANCE, FILED 8-2-2002.



OWNER OF FRANCE REG. NO. 023149400, DATED 2-21-2002, EXPIRES 2-21-2012.

THE STIPPLING SHOWN IN THE DRAWING IS A FEATURE OF THE MARK AND NOT INTENDED TO INDICATE COLOR.

CLASS 9—ELECTRICAL AND SCIENTIFIC APPARATUS

FOR OPTICAL APPARATUS AND INSTRUMENTS, NAMELY, SPECTACLES, SUNGLASSES, ANTI-GLARE SPECTACLES, SPORT SPECTACLES, SPECTACLE GLASSES, SPECTACLE CASES, MONOCLES, BINOCULARS, LORGNETTES, SPECTACLE FRAMES, LORNETTE FRAMES; CONTACT LENSES, CONTACT LENS CASES, SPECTACLE CLEANING CLOTHS; SPECIALTY HOLDERS FOR CARRYING PHONES (U.S. CLS. 21, 23, 26, 36 AND 38).

CLASS 14—JEWELRY

FOR PRECIOUS METALS IN GENERAL AND THEIR ALLOYS SOLD IN BULK; PRECIOUS METALS AND THEIR ALLOYS SOLD AT RETAIL; JEWELRY, PRECIOUS GEMSTONES, CHARMS, MEDALS; HOROLOGICAL AND CHRONOMETRIC INSTRUMENTS, NAMELY, WATCHES, CLOCKS AND WRIST WATCHES, CASES FOR WATCHES, CLOCKS AND WRIST WATCHES (U.S. CLS. 2, 27, 28 AND 50).

CLASS 18—LEATHER GOODS

FOR PRODUCTS IN LEATHER AND IMITATION LEATHER, NAMELY—LEATHER KEY CHAINS, SATCHELS, HANDBAGS, RUCKSACKS, TRUNKS AND LUGGAGE, MONEYBAGS, TRAVELING BAGS AND LUGGAGE, DRAWSTRING POUCHES, ATTACHE CASES, SMALL MAKEUP CASES SOLD EMPTY, SMALL CASES FOR DOCUMENTS, TRAVELING CASES, TOILET AND MAKEUP CASES SOLD EMPTY, PURSES, WALLETS, BRIEF CASES, DOCUMENT CASES, BUSINESS CARD CASES, STRAPS FOR LUGGAGE AND HANDBAGS, WALKING STICKS, WHIPS AND SADDLERY; UMBRELLAS AND PARASOLS (U.S. CLS. 1, 2, 3, 22 AND 41).

CLASS 25—CLOTHING

FOR CLOTHING FOR USE BY MEN, WOMEN AND CHILDREN, NAMELY, ANORAKS; APRONS; ASCOTS; BABUSHKAS; BANDANAS; BATHING SUITS; BATH-ROBES; BELTS; BLAZERS; BLOUSES; BLOUSONS; BODYSUITS BOLEROS; BOOTS; BOXER SHORTS; BRASIERES; BRIEFS; BABY BUNTINGS; CAFTANS; CAMISOLES; CAPES; CAPS; CARDIGANS; CHEMISES; CLOGS; CLOTH DIAPERS; FUR COATS; SUIT COATS; TOP COATS; CORSELETS; CULOTTES; DRESSES; EARMUFFS; GALOSHES; GARTER BELTS; GIRDLES; GLOVES; NIGHTGOWNS; HALTER TOPS; HATS; HEADBANDS; HOSIERY; JACKETS; JEANS; JOGGING SUITS; JUMPERS; JUMPSUITS; KERCHIEFS; KIMONOS; LEGGINGS; LEOTARDS; NECKTIES; NECKWEAR; NEGLIGES; NIGHTSHIRTS; OVERALLS; OVERCOATS; OVERSHOES; PAJAMAS; PANTIES; PANTS; PANTSUITS; PANTYHOSE; PARKAS; PEDAL PUSHERS; PEIGNOIRS; PINAFORES; PLAYSUITS; POCKET SQUARES; PONCHOS; PULLOVERS; RAINCOATS; SANDALS; SCARVES; SHAWLS; SHIRTS; SHORTS; UNDERSHIRTS; SHOES; SWEAT SHORTS; SKIRTS; SKI SUITS; SLACKS; SNOWSUITS; SOCKS; SPORT COATS; SPORT SHIRTS; STOCKINGS; STOLEES; SUITS; SUSPENDERS; SWEAT PANTS; SWEATSHIRTS; SWEATERS; T-SHIRTS; TROUSERS; TUXEDOS; UNDERPANTS; VESTS; VESTED SUITS; AND WARM-UP SUITS (U.S. CLS. 22 AND 39).

SN 76-437,221. COMPAGNIE GERVAIS DANONE, 92300
LEVALLOIS-PERRET, FRANCE, FILED 8-5-2002.



OWNER OF FRANCE REG. NO. 013084358, DATED 2-21-2001, EXPIRES 2-21-2011.

NO CLAIM IS MADE TO THE EXCLUSIVE RIGHT TO USE "CREME" AND "YAOURT", APART FROM THE MARK AS SHOWN.

THE MARK IS LINED FOR THE COLORS RED AND BLUE.

THE ENGLISH TRANSLATION OF "CREME" IS "CREAM". THE ENGLISH TRANSLATION OF "YAOURT" IS "YOGURT".

CLASS 29—MEATS AND PROCESSED FOODS

FOR DAIRY PRODUCTS, NAMELY, YOGURTS (U.S. CL. 46).

CLASS 30—STAPLE FOODS

FOR DESSERTS, NAMELY, MILKY DESSERTS, CREAMS AND DESSERT CREAMS (U.S. CL. 46).

SN 76-437,410. INVISION TECHNOLOGIES, NEWARK, CA. FILED 8-5-2002.

SN 76-437,416. INVISION TECHNOLOGIES, NEWARK, CA. FILED 8-5-2002.

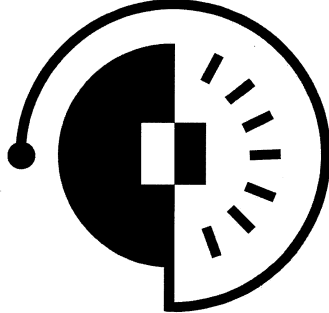

OWNER OF U.S. REG. NO. 2,030,463.

CLASS 42—SCIENTIFIC, COMPUTER AND LEGAL SERVICES

FOR ANALYSIS AND CONSULTATION SERVICES, NAMELY, DESIGNING INDUSTRIAL MATERIAL HANDLING SYSTEMS WITH THE CAPABILITY TO SCAN MATERIALS AND GENERATE IMAGES TO IDENTIFY AND DETECT CONCEALED OBJECTS, DEFECTS OR INTERNAL PROPERTIES; AND QUALITY CONTROL FOR OTHERS IN THE NATURE OF PROVIDING SCANNING AND/OR IMAGING OF MATERIALS TO DETECT CONCEALED OBJECTS, DEFECTS OR INTERNAL PROPERTIES (U.S. CLS. 100 AND 101).

CLASS 45—PERSONAL SERVICES

FOR PROVIDING SECURITY SCREENING SERVICES IN THE NATURE OF PROVIDING SCANNING AND/OR IMAGING OF MATERIALS TO DETECT CONCEALED OBJECTS, DEFECTS OR INTERNAL PROPERTIES (U.S. CLS. 100 AND 101).

CLASS 42—SCIENTIFIC, COMPUTER AND LEGAL SERVICES

FOR ANALYSIS AND CONSULTATION SERVICES, NAMELY, DESIGNING INDUSTRIAL MATERIAL HANDLING SYSTEMS WITH THE CAPABILITY TO SCAN MATERIALS AND GENERATE IMAGES TO IDENTIFY AND DETECT CONCEALED OBJECTS, DEFECTS OR INTERNAL PROPERTIES; AND QUALITY CONTROL FOR OTHERS IN THE NATURE OF PROVIDING SCANNING AND/OR IMAGING OF MATERIALS TO DETECT CONCEALED OBJECTS, DEFECTS OR INTERNAL PROPERTIES (U.S. CLS. 100 AND 101).

CLASS 45—PERSONAL SERVICES

FOR PROVIDING SECURITY SCREENING SERVICES IN THE NATURE OF PROVIDING SCANNING AND/OR IMAGING OF MATERIALS TO DETECT CONCEALED OBJECTS, DEFECTS OR INTERNAL PROPERTIES (U.S. CLS. 100 AND 101).

SN 76-437,413. INVISION TECHNOLOGIES, NEWARK, CA. FILED 8-5-2002.

SN 76-438,262. LEISURE PASS GROUP LIMITED, THE, LONDON, W1P 3AE, UNITED KINGDOM, FILED 8-7-2002.

INVISION

PHILADELPHIA PASS

OWNER OF U.S. REG. NO. 2,030,463.

CLASS 42—SCIENTIFIC, COMPUTER AND LEGAL SERVICES

FOR ANALYSIS AND CONSULTATION SERVICES, NAMELY, DESIGNING INDUSTRIAL MATERIAL HANDLING SYSTEMS WITH THE CAPABILITY TO SCAN MATERIALS AND GENERATE IMAGES TO IDENTIFY AND DETECT CONCEALED OBJECTS, DEFECTS OR INTERNAL PROPERTIES; AND QUALITY CONTROL FOR OTHERS IN THE NATURE OF PROVIDING SCANNING AND/OR IMAGING OF MATERIALS TO DETECT CONCEALED OBJECTS, DEFECTS OR INTERNAL PROPERTIES (U.S. CLS. 100 AND 101).

CLASS 45—PERSONAL SERVICES

FOR PROVIDING SECURITY SCREENING SERVICES IN THE NATURE OF PROVIDING SCANNING AND/OR IMAGING OF MATERIALS TO DETECT CONCEALED OBJECTS, DEFECTS OR INTERNAL PROPERTIES (U.S. CLS. 100 AND 101).

NO CLAIM IS MADE TO THE EXCLUSIVE RIGHT TO USE "PHILADELPHIA", APART FROM THE MARK AS SHOWN.

CLASS 16—PAPER GOODS AND PRINTED MATTER

FOR NONENCODED PREPAID ADMISSION CARDS FOR ENTRY INTO A VARIETY OF ATTRACTIONS AND ACTIVITIES; TRAVEL GUIDEBOOKS; FLYERS IN THE FIELD OF TRAVEL; AND POSTERS (U.S. CLS. 2, 5, 22, 23, 29, 37, 38 AND 50).

CLASS 41—EDUCATION AND ENTERTAINMENT

FOR ENTERTAINMENT SERVICES, NAMELY, PROVIDING PREPAID ADMISSION CARDS FOR ENTRY INTO A VARIETY OF ATTRACTIONS AND ACTIVITIES (U.S. CLS. 100, 101 AND 107).

SN 76-438,263. THE LEISURE PASS GROUP LIMITED, LONDON, W1P 3AE, UNITED KINGDOM, FILED 8-7-2002.

LEISURE PASS

CLASS 16—PAPER GOODS AND PRINTED MATTER

FOR NONENCODED PREPAID ADMISSION CARDS FOR ENTRY INTO A VARIETY OF ATTRACTIONS AND ACTIVITIES; TRAVEL GUIDEBOOKS; FLYERS IN THE FIELD OF TRAVEL; AND POSTERS (U.S. CLS. 2, 5, 22, 23, 29, 37, 38 AND 50).

CLASS 41—EDUCATION AND ENTERTAINMENT

FOR ENTERTAINMENT SERVICES, NAMELY, PROVIDING PREPAID ADMISSION CARDS FOR ENTRY INTO A VARIETY OF ATTRACTIONS AND ACTIVITIES (U.S. CLS. 100, 101 AND 107).

SN 76-438,264. LEISURE PASS GROUP LIMITED, THE, LONDON, W1P 3AE, UNITED KINGDOM, FILED 8-7-2002.

NEW YORK PASS

NO CLAIM IS MADE TO THE EXCLUSIVE RIGHT TO USE "NEW YORK", APART FROM THE MARK AS SHOWN.

CLASS 16—PAPER GOODS AND PRINTED MATTER

FOR NONENCODED PREPAID ADMISSION CARDS FOR ENTRY INTO A VARIETY OF ATTRACTIONS AND ACTIVITIES; TRAVEL GUIDEBOOKS; FLYERS IN THE FIELD OF TRAVEL; AND POSTERS (U.S. CLS. 2, 5, 22, 23, 29, 37, 38 AND 50).

CLASS 41—EDUCATION AND ENTERTAINMENT

FOR ENTERTAINMENT SERVICES, NAMELY, PROVIDING PREPAID ADMISSION CARDS FOR ENTRY INTO A VARIETY OF ATTRACTIONS AND ACTIVITIES (U.S. CLS. 100, 101 AND 107).

SN 76-438,265. LEISURE PASS GROUP LIMITED, THE, LONDON, W1P 3AE, UNITED KINGDOM, FILED 8-7-2002.

BOSTON PASS

NO CLAIM IS MADE TO THE EXCLUSIVE RIGHT TO USE "BOSTON", APART FROM THE MARK AS SHOWN.

CLASS 16—PAPER GOODS AND PRINTED MATTER

FOR NONENCODED PREPAID ADMISSION CARDS FOR ENTRY INTO A VARIETY OF ATTRACTIONS AND ACTIVITIES; TRAVEL GUIDEBOOKS; FLYERS IN THE FIELD OF TRAVEL; AND POSTERS (U.S. CLS. 2, 5, 22, 23, 29, 37, 38 AND 50).

CLASS 41—EDUCATION AND ENTERTAINMENT

FOR ENTERTAINMENT SERVICES, NAMELY, PROVIDING PREPAID ADMISSION CARDS FOR ENTRY INTO A VARIETY OF ATTRACTIONS AND ACTIVITIES (U.S. CLS. 100, 101 AND 107).

SN 76-438,266. LEISURE PASS GROUP LIMITED, THE, LONDON, W1P 3AE, UNITED KINGDOM, FILED 8-7-2002.

WASHINGTON D.C. PASS

NO CLAIM IS MADE TO THE EXCLUSIVE RIGHT TO USE "WASHINGTON D.C.", APART FROM THE MARK AS SHOWN.

CLASS 16—PAPER GOODS AND PRINTED MATTER

FOR NONENCODED PREPAID ADMISSION CARDS FOR ENTRY INTO A VARIETY OF ATTRACTIONS AND ACTIVITIES; TRAVEL GUIDEBOOKS; FLYERS IN THE FIELD OF TRAVEL; AND POSTERS (U.S. CLS. 2, 5, 22, 23, 29, 37, 38 AND 50).

CLASS 41—EDUCATION AND ENTERTAINMENT

FOR ENTERTAINMENT SERVICES, NAMELY, PROVIDING PREPAID ADMISSION CARDS FOR ENTRY INTO A VARIETY OF ATTRACTIONS AND ACTIVITIES (U.S. CLS. 100, 101 AND 107).

SN 76-438,458. URTH CAFFE CORPORATION, CULVER CITY, CA. FILED 8-6-2002.

URTH CAFFE

NO CLAIM IS MADE TO THE EXCLUSIVE RIGHT TO USE "CAFFE", APART FROM THE MARK AS SHOWN. THE WORD CAFFE IS "COFFEE" AND "COFFEE BEAN" IN ITALIAN.

CLASS 30—STAPLE FOODS

FOR COFFEE; COFFEE BEANS, TEA, TEA LEAVES, FRUIT TEA, HERBAL TEA, HERBAL TEA BLENDS, FLAVORED TEA; DESSERT GIFT PACKAGES COMPOSED PRIMARILY OF PASTRIES, CAKES, AND BAKERY GOODS; GIFT PACKAGES COMPOSED PRIMARILY OF COFFEE, TEA, BAKERY GOODS AND CAKES (U.S. CL. 46).

CLASS 35—ADVERTISING AND BUSINESS

FOR BAKERY SHOP SERVICES (U.S. CLS. 100, 101 AND 102).

CLASS 43—HOTEL AND RESTAURANT SERVICES

FOR RESTAURANT SERVICES; COFFEE HOUSE SERVICES (U.S. CLS. 100 AND 101).

SN 76-438,531. LOS ANGELES COUNTY OFFICE OF EDUCATION, DOWNEY, CA. FILED 8-5-2002.

SN 76-438,957. NSPIRED NATURAL FOODS, INC., SAN LEANDRO, CA. FILED 8-9-2002.



NO CLAIM IS MADE TO THE EXCLUSIVE RIGHT TO USE "READING SUCCESS NETWORK", APART FROM THE MARK AS SHOWN.

CLASS 16—PAPER GOODS AND PRINTED MATTER

FOR TRAINING MANUALS IN THE FIELD OF READING INSTRUCTION (U.S. CLS. 2, 5, 22, 23, 29, 37, 38 AND 50).

FIRST USE 7-8-1996; IN COMMERCE 7-8-1996.

CLASS 41—EDUCATION AND ENTERTAINMENT

FOR TRAINING SERVICES IN THE FIELD OF READING INSTRUCTION FOR KINDERGARTEN TO THIRD GRADE TEACHERS (U.S. CLS. 100, 101 AND 107).

FIRST USE 7-8-1996; IN COMMERCE 7-8-1996.

SN 76-438,928. F J BENJAMIN HOLDINGS LTD, SINGAPORE 258332, SINGAPORE, FILED 8-6-2002.

RAOUL

CLASS 9—ELECTRICAL AND SCIENTIFIC APPARATUS

FOR MEN'S SUNGLASSES (U.S. CLS. 21, 23, 26, 36 AND 38).

CLASS 14—JEWELRY

FOR MEN'S WATCHES (U.S. CLS. 2, 27, 28 AND 50).

CLASS 18—LEATHER GOODS

FOR POCKET WALLETS, RUCKSACKS, SUITCASES, TRAVELING BAGS, ATTACHE CASES, BACKPACKS, AND BRIEFCASES (U.S. CLS. 1, 2, 3, 22 AND 41).

CLASS 25—CLOTHING

FOR MEN'S CLOTHING, NAMELY, SHIRTS, PANTS, SOCKS, AND UNDERGARMENTS; ARTICLES OF CLOTHING MADE OF LEATHER, NAMELY, LEATHER JACKETS, LEATHER COATS, LEATHER SUITS, AND LEATHER PANTS; MEN'S SHOES (U.S. CLS. 22 AND 39).

SKINNY

OWNER OF U.S. REG. NOS. 911,254 AND 1,589,176.

CLASS 5—PHARMACEUTICALS

FOR LOW CALORIE GRAIN-BASED MEAL REPLACEMENT BARS (U.S. CLS. 6, 18, 44, 46, 51 AND 52).

CLASS 30—STAPLE FOODS

FOR PROCESSED CEREAL-DERIVED FOOD PRODUCT TO BE USED AS A BREAKFAST CEREAL OR SNACK FOOD; READY-TO-EAT CEREAL-DERIVED FOOD BARS (U.S. CL. 46).

SN 76-439,039. CAROLINE YORK WORLD OF ART INC., ST. PETERSBURG, FL. FILED 8-9-2002.



THE NAME "CAROLINE YORK" IDENTIFIES A LIVING INDIVIDUAL WHOSE CONSENT IS OF RECORD.

CLASS 35—ADVERTISING AND BUSINESS

FOR ART AGENCY SERVICES; REPRESENTING ARTIST; PROMOTING ARTIST BY PROVIDING A WEBSITE ON GLOBAL COMPUTER NETWORK SHOWCASING FINE WORKS OF ART CREATED BY REGISTERED ARTIST; PROVIDING A WEB SITE ON GLOBAL COMPUTER NETWORK WHEREBY BUYERS OF ARTIST WORKS AND SERVICES LOCATE AND RECEIVE QUOTATIONS; PROMOTING GALLERIES BY PROVIDING A WEBSITE ON GLOBAL COMPUTER NETWORK SHOW CASING GALLERIES HAVING FINE WORKS OF ART; AND PROVIDING A WEB SITE ON GLOBAL COMPUTER NETWORK LISTING COMMUNITY SERVICE AGENCIES AND NOT-FOR-PROFIT ORGANIZATIONS (U.S. CLS. 100, 101 AND 102).

FIRST USE 8-6-2002; IN COMMERCE 8-6-2002.

CLASS 36—INSURANCE AND FINANCIAL

FOR ART BROKERAGE (U.S. CLS. 100, 101 AND 102).

FIRST USE 8-6-2002; IN COMMERCE 8-6-2002.

CLASS 41—EDUCATION AND ENTERTAINMENT

FOR PROVIDING WEBSITE LISTING OF CULTURAL ARTS EVENTS IN THE LOCAL OF REPRESENTED ARTIST; AND PROVIDING A WEBSITE LISTING OF GALLERIES (U.S. CLS. 100, 101 AND 107).

FIRST USE 8-6-2002; IN COMMERCE 8-6-2002.

SN 76-439,323. CONSILIENT TECHNOLOGIES CORPORATION, ST. JOHN'S, NEWFOUNDLAND, CANADA, FILED 8-8-2002.

SN 76-439,357. INTERSOURCE DEVELOPMENT COMPANY, GARLAND, TX. FILED 8-12-2002.

CONSILIENT

CLASS 9—ELECTRICAL AND SCIENTIFIC APPARATUS

FOR PEER TO PEER INTERNET INFRASTRUCTURE SOFTWARE; COMPUTER SOFTWARE TO EXTEND DESKTOP APPLICATIONS; EMAIL EXTENSION SOFTWARE, THIRD PARTY SOFTWARE INTERFACES, SECURITY AND COMPRESSION FUNCTIONS FOR WIRELESS COMMUNICATION; NETWORK TRAFFIC MONITORING, SOFTWARE APPLICATIONS FOR THE EXTENSION OF ENTERPRISE APPLICATIONS FOR WIRELESS DEVICES; SOFTWARE USER INTERFACE APPLICATIONS FOR HANDHELD MOBILE COMPUTING DEVICES; SOFTWARE APPLICATIONS FOR WIRELESS HAND-HELD DEVICES; MIDDLEWARE COMPONENTS FOR HAND-HELD COMPUTING DEVICES ALL THE FOREGOING IS DESIGNED TO PROVIDE ACCESS TO DATA AND TO TRADITIONAL DESKTOP APPLICATIONS BY MEANS OF WIRELESS DEVICES FOR USE BY MOBILE REMOTE OR OFF-SITE WORKERS (U.S. CLS. 21, 23, 26, 36 AND 38).

CLASS 42—SCIENTIFIC, COMPUTER AND LEGAL SERVICES

FOR CONSULTING SERVICES IN THE FIELD OF DESIGN, SELECTION, IMPLEMENTATION AND USE OF COMPUTER HARDWARE AND SOFTWARE SYSTEMS FOR OTHERS AND TECHNICAL SUPPORT SERVICES NAMELY TROUBLESHOOTING AND COMPUTER HARDWARE AND SOFTWARE PROBLEMS (U.S. CLS. 100 AND 101).

SN 76-439,331. TROJAN TECHNOLOGIES INC., LONDON, ONTARIO, CANADA, FILED 8-8-2002.

TROJAN UV DOSIMETER

NO CLAIM IS MADE TO THE EXCLUSIVE RIGHT TO USE "UV DOSIMETER", APART FROM THE MARK AS SHOWN.

CLASS 9—ELECTRICAL AND SCIENTIFIC APPARATUS

FOR COMPUTER HARDWARE AND SOFTWARE FOR MEASURING DOSE DELIVERY IN A FLUID TREATMENT SYSTEM (U.S. CLS. 21, 23, 26, 36 AND 38).

CLASS 42—SCIENTIFIC, COMPUTER AND LEGAL SERVICES

FOR TECHNICAL SUPPORT SERVICES, NAMELY, TROUBLE SHOOTING AND MONITORING OF COMPUTER HARDWARE AND SOFTWARE, AS WELL AS NETWORK SYSTEMS THAT SUPPORT FLUID TREATMENT SYSTEMS (U.S. CLS. 100 AND 101).

ALLSET

CLASS 7—MACHINERY

FOR POWER TOOL ACCESSORIES, NAMELY ADJUSTABLE NON-ROTATING GUIDE AND FULLY ADJUSTABLE CUTTING DEPTH ATTACHMENT TO AN EXISTENT FLEXIBLE SHAFT HANDPIECE USED IN THE MANUFACTURING OF FINE JEWELRY AND HOBBY CRAFTS (U.S. CLS. 13, 19, 21, 23, 31, 34 AND 35).
FIRST USE 10-14-1992; IN COMMERCE 2-0-1993.

CLASS 8—HAND TOOLS

FOR ACCESSORIES FOR MANUALLY-OPERATED TOOLS, NAMELY ADJUSTABLE NON-ROTATING GUIDE AND FULLY ADJUSTABLE CUTTING DEPTH ATTACHMENT TO AN EXISTENT FLEXIBLE SHAFT HANDPIECE USED IN THE MANUFACTURING OF FINE JEWELRY AND HOBBY CRAFTS (U.S. CLS. 23, 28 AND 44).
FIRST USE 10-14-1992; IN COMMERCE 2-0-1993.

SN 76-439,458. EMPLOYEE SERVICES MANAGEMENT ASSOCIATION, OAK BROOK, IL. FILED 8-12-2002.

ONMYTIME

CLASS 35—ADVERTISING AND BUSINESS

FOR COMPUTERIZED ON-LINE ORDERING SERVICES FEATURING CLOTHING, BOOKS AND TOYS (U.S. CLS. 100, 101 AND 102).
FIRST USE 5-19-2002; IN COMMERCE 5-19-2002.

CLASS 39—TRANSPORTATION AND STORAGE

FOR CAR RENTAL, ARRANGING CRUISES AND TRAVEL TOURS AND MAKING RESERVATIONS AND BOOKINGS FOR TRANSPORTATION (U.S. CLS. 100 AND 105).
FIRST USE 5-19-2002; IN COMMERCE 5-19-2002.

CLASS 41—EDUCATION AND ENTERTAINMENT

FOR ARRANGING TICKET RESERVATIONS FOR SHOWS AND OTHER ENTERTAINMENT EVENTS AND SPECIAL EVENT PLANNING (U.S. CLS. 100, 101 AND 107).
FIRST USE 5-19-2002; IN COMMERCE 5-19-2002.

CLASS 43—HOTEL AND RESTAURANT SERVICES

FOR MAKING RESERVATIONS AND BOOKINGS FOR TEMPORARY LODGING (U.S. CLS. 100 AND 101).
FIRST USE 5-19-2002; IN COMMERCE 5-19-2002.

SN 76-440,395. VITAMIN DISCOUNT CENTER, INC., TAMPA, FL. FILED 8-8-2002.

SN 76-440,734. ARENA FOOTBALL LEAGUE LLC, CHICAGO, IL. FILED 8-15-2002.



OWNER OF U.S. REG. NO. 2,478,881.
NO CLAIM IS MADE TO THE EXCLUSIVE RIGHT TO USE "VITAMIN DISCOUNT CENTER", APART FROM THE MARK AS SHOWN.

THE MARK CONSISTS OF DOUBLE OVAL WITH THE OUTER OVAL IN YELLOW, OUTLINED BY THE COLOR BLUE, THE INNER OVAL IN THE COLOR BLUE, AND THE WORDS "VITAMIN DISCOUNT CENTER" IN THE COLOR YELLOW.
SEC. 2(F).

CLASS 5—PHARMACEUTICALS

FOR VITAMINS AND NUTRITIONAL SUPPLEMENTS (U.S. CLS. 6, 18, 44, 46, 51 AND 52).
FIRST USE 8-18-1998; IN COMMERCE 10-8-1998.

CLASS 35—ADVERTISING AND BUSINESS

FOR RETAIL DRUG STORE SERVICES (U.S. CLS. 100, 101 AND 102).
FIRST USE 8-18-1998; IN COMMERCE 10-8-1998.



SN 76-440,647. OCEAN SPRAY CRANBERRIES, INC., LAKEVILLE-MIDDLEBORO, MA. FILED 8-15-2002.



OWNER OF U.S. REG. NOS. 1,960,131, 2,093,144 AND OTHERS.

CLASS 29—MEATS AND PROCESSED FOODS

FOR DRIED CRANBERRIES, FRUIT SAUCES, JELLIES, JAMS AND FRUIT PRESERVES (U.S. CL. 46).

CLASS 31—NATURAL AGRICULTURAL PRODUCTS

FOR FRESH FRUIT AND FRESH CRANBERRIES (U.S. CLS. 1 AND 46).



OWNER OF U.S. REG. NOS. 1,855,376 AND 2,303,390.
NO CLAIM IS MADE TO THE EXCLUSIVE RIGHT TO USE "ARENA FOOTBALL LEAGUE", APART FROM THE MARK AS SHOWN.

CLASS 16—PAPER GOODS AND PRINTED MATTER

FOR PRINTED ANNUAL MEDIA GUIDES CONTAINING INFORMATION ABOUT FOOTBALL, GENERAL MERCHANDISE CATALOGS, BUMPER STICKERS, WRITING PADS AND PENS, PENCILS, TRADING CARDS, POSTERS, PAPER PENNANTS, POST CARDS, CALENDARS, PAPER STICKERS, APPLIQUES IN THE FORM OF DECALS, PRINTED EVENT ADMISSION TICKETS AND GREETING CARDS- ALL SOLD IN RELATION TO THE GAME OF INDOOR PROFESSIONAL AMERICAN-STYLE FOOTBALL (U.S. CLS. 2, 5, 22, 23, 29, 37, 38 AND 50).

CLASS 25—CLOTHING

FOR MEN'S, WOMEN'S AND CHILDREN'S CLOTHING, NAMELY, PLAYER UNIFORMS, NAMELY FOOTWEAR, JERSEY TOPS AND PANTS; CHEERLEADER UNIFORMS; REPLICAS UNIFORM SHIRTS, COACHES' CAPS, WOOL HATS, PAINTERS' CAPS, BASEBALL CAPS, VISORS, HEADBANDS, BELTS, T-SHIRTS, TANK TOPS, GOLF SHIRTS, SWEATERS, SWEATSHIRTS, LEATHER JACKETS, NECKTIES, COATS, SHORTS, SWEATPANTS, PANTS, SOCKS AND UNDERWEAR- ALL SOLD IN RELATION TO INDOOR PROFESSIONAL AMERICAN-STYLE FOOTBALL (U.S. CLS. 22 AND 39).



SN 76-441,289. PARSEK S.R.L., VIA ATERNO, 44, ITALY, FILED 8-19-2002.



OWNER OF ITALY REG. NO. 853839, DATED 10-31-2001, EXPIRES 5-10-2021.

NO CLAIM IS MADE TO THE EXCLUSIVE RIGHT TO USE "BASS AMPLIFIER", APART FROM THE MARK AS SHOWN.

THE WORDS "MARK BASS" DOES NOT IDENTIFY A PARTICULAR LIVING INDIVIDUAL.

CLASS 9—ELECTRICAL AND SCIENTIFIC APPARATUS

FOR COIN-OPERATED MUSICAL JUKE BOXES (U.S. CLS. 21, 23, 26, 36 AND 38).

CLASS 15—MUSICAL INSTRUMENTS

FOR MUSICAL INSTRUMENTS IN GENERAL (U.S. CLS. 2, 21 AND 36).

SN 76-442,930. RICHFIELD WINDOW COVERINGS, INC., DBA NIEN MADE (U.S.A.), INC., CERRITOS, CA. FILED 8-22-2002.

KÜLBATH

THE MARK IS PRESENTED WITHOUT ANY CLAIM AS TO SPECIAL FORM.

CLASS 21—HOUSEWARES AND GLASS

FOR HOUSEWARES AND GLASS, AND BATHROOM ACCESSORIES, NAMELY, TUMBLERS, GLASS STORAGE JARS, MUGS; BATHROOM ACCESSORIES, NAMELY, SHOWER CADDIES, TOWEL RINGS, BARS AND RODS; WASTEPAPER BASKETS, TOOTHBRUSH HOLDERS, SOAP DISHES, LOTION DISPENSERS, LOTION PUMPS, TOILET BRUSH HOLDERS, TISSUE BOX COVERS, TOILET BRUSHES, SPONGES FOR HOUSEHOLD USE; TOILET TISSUE HOLDERS; SPONGES AND SCRUB BRUSHES FOR PERSONAL HYGIENIC USE, FACIAL SPONGES FOR APPLYING MAKEUP; HAIR BRUSHES; AND POT CLEANING BRUSHES (U.S. CLS. 2, 13, 23, 29, 30, 33, 40 AND 50).

CLASS 24—FABRICS

FOR SHOWER CURTAINS; SHOWER CURTAIN LINERS; BATHROOM CURTAINS; SINK SKIRTS, BATH TUB SKIRTS; TOWELS; FABRIC TOILET SEAT AND LID COVERS, AND FABRIC TOILET WATER TANK COVERS (U.S. CLS. 42 AND 50).

SN 76-442,933. RICHFIELD WINDOW COVERINGS, INC., DBA NIEN MADE (U.S.A.), INC., CERRITOS, CA. FILED 8-22-2002.

XÄWER

THE MARK IS PRESENTED WITHOUT ANY CLAIM AS TO SPECIAL FORM.

CLASS 21—HOUSEWARES AND GLASS

FOR HOUSEWARES AND GLASS, AND BATHROOM ACCESSORIES, NAMELY, TUMBLERS, GLASS STORAGE JARS, MUGS; BATHROOM ACCESSORIES, NAMELY, SHOWER CADDIES, TOWEL RINGS, BARS AND RODS; WASTEPAPER BASKETS, TOOTHBRUSH HOLDERS, SOAP DISHES, LOTION DISPENSERS, LOTION PUMPS, TOILET BRUSH HOLDERS, TISSUE BOX COVERS, TOILET BRUSHES, TOILET TISSUE HOLDERS; SPONGES FOR HOUSEHOLD USE; SPONGES AND SCRUB BRUSHES FOR PERSONAL HYGIENIC USE, FACIAL SPONGES FOR APPLYING MAKEUP; HAIR BRUSHES; AND POT CLEANING BRUSHES (U.S. CLS. 2, 13, 23, 29, 30, 33, 40 AND 50).

CLASS 24—FABRICS

FOR SHOWER CURTAINS; SHOWER CURTAIN LINERS; BATHROOM CURTAINS; SINK SKIRTS, BATH TUB SKIRTS; TOWELS; FABRIC TOILET SEAT AND LID COVERS, AND FABRIC TOILET WATER TANK COVERS (U.S. CLS. 42 AND 50).

SN 76-443,787. PARK B. SMITH, INC., NEW YORK, NY. FILED 8-22-2002.

NEW NATURALS

NO CLAIM IS MADE TO THE EXCLUSIVE RIGHT TO USE "NATURALS", APART FROM THE MARK AS SHOWN.

CLASS 20—FURNITURE AND ARTICLES NOT OTHERWISE CLASSIFIED

FOR SHADES AND WINDOW BLINDS; INTERIOR WINDOW BLINDS, NAMELY, FABRIC WINDOW BLINDS (U.S. CLS. 2, 13, 22, 25, 32 AND 50).

CLASS 24—FABRICS

FOR WINDOW TREATMENTS, NAMELY, CURTAINS, SWAG, DRAPERIES, FABRIC VALANCES, DRAPERY LINENS, SHEETS, BLANKETS, COMFORTERS, BLANKET THROWS, AFGHANS, COVERLETS, DUVETS, SHAMS, DUST RUFFLES, PLACE MATS MADE OF FABRIC, RUNNERS MADE OF FABRIC, NAPKINS MADE OF FABRIC, KITCHEN TOWELS, POT HOLDERS, OVEN MITTS (U.S. CLS. 42 AND 50).

CLASS 27—FLOOR COVERINGS

FOR RUGS (U.S. CLS. 19, 20, 37, 42 AND 50).

SN 76-443,975. CLASSICS CHICAGO, INC., THE, CHICAGO, IL. FILED 8-23-2002.



OWNER OF U.S. REG. NOS. 1,826,424, 2,297,384 AND OTHERS.

THE STIPPLING IN THE DRAWING REPRESENTS SHADING.

CLASS 3—COSMETICS AND CLEANING PREPARATIONS

FOR BODY LOTION, BATH GEL, BATH SOAP, TALCUM POWDER, POTPOURRI, SACHETS, PERFUME, EAU DE TOILETTE, LIQUID CLEANING PREPARATIONS FOR LINGERIE AND DELICATE CLOTHING (U.S. CLS. 1, 4, 6, 50, 51 AND 52).

FIRST USE 0-0-1996; IN COMMERCE 0-0-1996.

CLASS 5—PHARMACEUTICALS

FOR ROOM DEODORIZERS (U.S. CLS. 6, 18, 44, 46, 51 AND 52).

FIRST USE 0-0-1996; IN COMMERCE 0-0-1996.

CLASS 14—JEWELRY

FOR COSTUME JEWELRY (U.S. CLS. 2, 27, 28 AND 50).
FIRST USE 0-0-1996; IN COMMERCE 0-0-1996.

CLASS 18—LEATHER GOODS

FOR HANDBAGS AND WALLETS (U.S. CLS. 1, 2, 3, 22 AND 41).
FIRST USE 0-0-1996; IN COMMERCE 0-0-1996.

CLASS 24—FABRICS

FOR TOWELS AND RECEIVING BLANKETS (U.S. CLS. 42 AND 50).
FIRST USE 0-0-1996; IN COMMERCE 0-0-1996.

CLASS 25—CLOTHING

FOR MEN'S, WOMEN'S AND CHILDREN'S CLOTHING AND ACCESSORIES, NAMELY, DRESSES, SUITS, BLOUSES, SHIRTS, KNIT TOPS, SLACKS, TIES, JACKETS, SWEATERS, TROUSERS, PANTS, JEANS, SWIMWEAR, SHORTS, JUMPERS, BLAZERS, SUITS, COATS, RAINCOATS, RAINSLICKERS, SPORT COATS, VESTS, SHOES, NECKWEAR, SOCKS, UNDERWEAR, PAJAMAS, ROBES, BELTS, HATS, CAPS, GLOVES, SCARVES, JACKETS, SKIRTS, ANORAKS, POLO SHIRTS; INFANTS' AND TODDLERS' CLOTHING, NAMELY, OVERALLS, ROMPERS, BABY BIBS NOT OF PAPER, CAP AND BOOTIE SETS, BOOTS AND SHOES; WOMEN'S INTIMATE APPAREL; NAMELY, PANTIES, BRAS, SLIPS, HOSIERY, PETTICOATS, BLOOMERS, CAMISOLES, BODYSUITS, NIGHTGOWNS, PAJAMAS, ROBES BED JACKETS, AND LOUNGE WEAR (U.S. CLS. 22 AND 39).
FIRST USE 0-0-1996; IN COMMERCE 0-0-1996.

CLASS 35—ADVERTISING AND BUSINESS

FOR RETAIL STORE SERVICES AND MAIL ORDER CATALOG SERVICES IN THE FIELD OF MEN'S, WOMEN'S AND CHILDREN'S CLOTHING AND ACCESSORIES; ONLINE RETAIL STORE SERVICES FEATURING MEN'S, WOMEN'S AND CHILDREN'S CLOTHING AND ACCESSORIES; RETAIL DEPARTMENT STORE SERVICES AND MAIL ORDER SERVICES IN THE FIELD OF MEN'S, WOMEN'S AND CHILDREN'S APPAREL AND ACCESSORIES (U.S. CLS. 100, 101 AND 102).
FIRST USE 0-0-1996; IN COMMERCE 0-0-1996.

CLASS 35—ADVERTISING AND BUSINESS

FOR PROCUREMENT, NAMELY, PURCHASING ELECTRIC POWER AND NATURAL GAS FOR OTHERS; BUSINESS MANAGEMENT AND CONSULTATION SERVICES IN THE FIELDS OF ENERGY, ENERGY SERVICES, AND ELECTRICAL UTILITIES; BILLING SERVICES IN THE ENERGY FIELDS; PROVIDING ENERGY USAGE MANAGEMENT AND INFORMATION; PROVIDING ENERGY AUDITING AND INFORMATION; OPERATION OF A BUSINESS FOR OTHERS, NAMELY, OPERATION OF INDEPENDENT POWER PLANTS AND COGENERATION FACILITIES; PROVIDING INFORMATION REGARDING BILLING SERVICES FOR OTHERS; UTILITY BILL MANAGEMENT SERVICES, NAMELY, TRACKING, REPORTING, ANALYZING AND DELIVERING ENERGY INFORMATION IN THE FORM OF UTILITY BILLS AND UTILITY METER DATA RATE SCHEDULES (U.S. CLS. 100, 101 AND 102).
FIRST USE 8-12-2002; IN COMMERCE 8-12-2002.

CLASS 36—INSURANCE AND FINANCIAL

FOR PROVIDING ENERGY BROKERAGE AND INFORMATION; PROVIDING BILL PAYMENT SERVICES AND INFORMATION (U.S. CLS. 100, 101 AND 102).
FIRST USE 8-12-2002; IN COMMERCE 8-12-2002.

CLASS 37—CONSTRUCTION AND REPAIR

FOR CONSTRUCTION SERVICES, NAMELY, CONSTRUCTING STRUCTURES AND FACILITIES FOR USE IN THE ELECTRIC POWER AND GAS INDUSTRIES; MINING EXTRACTION OF COAL AND OTHER FOSSIL FUELS (U.S. CLS. 100, 103 AND 106).
FIRST USE 8-12-2002; IN COMMERCE 8-12-2002.

CLASS 39—TRANSPORTATION AND STORAGE

FOR PUBLIC UTILITY SERVICES; UTILITY SERVICES, NAMELY, TRANSMISSION OF ELECTRICITY (U.S. CLS. 100 AND 105).
FIRST USE 8-12-2002; IN COMMERCE 8-12-2002.

CLASS 40—MATERIAL TREATMENT

FOR GENERATION OF AND PRODUCTION OF ELECTRICITY AND ENERGY VIA POWER PLANTS AND COGENERATION FACILITIES (U.S. CLS. 100, 103 AND 106).
FIRST USE 8-12-2002; IN COMMERCE 8-12-2002.

SN 76-444,125. MGE ENERGY, INC., MADISON, WI. FILED 8-22-2002.



MGE
ENERGY

NO CLAIM IS MADE TO THE EXCLUSIVE RIGHT TO USE "ENERGY", APART FROM THE MARK AS SHOWN.

SN 76-444,126. MGE ENERGY, INC., MADISON, WI. FILED 8-22-2002.

MGE ENERGY

NO CLAIM IS MADE TO THE EXCLUSIVE RIGHT TO USE "ENERGY", APART FROM THE MARK AS SHOWN.

CLASS 35—ADVERTISING AND BUSINESS

FOR PROCUREMENT, NAMELY, PURCHASING ELECTRIC POWER AND NATURAL GAS FOR OTHERS; BUSINESS MANAGEMENT AND CONSULTATION SERVICES IN THE FIELDS OF ENERGY, ENERGY SERVICES, AND ELECTRICAL UTILITIES; BILLING SERVICES IN THE ENERGY FIELDS; PROVIDING ENERGY USAGE MANAGEMENT AND INFORMATION; PROVIDING ENERGY AUDITING AND INFORMATION; OPERATION OF A BUSINESS FOR OTHERS, NAMELY, OPERATION OF INDEPENDENT POWER PLANTS AND COGENERATION FACILITIES; PROVIDING INFORMATION REGARDING BILLING SERVICES FOR OTHERS; UTILITY BILL MANAGEMENT SERVICES, NAMELY, TRACKING, REPORTING, ANALYZING AND DELIVERING ENERGY INFORMATION IN THE FORM OF UTILITY BILLS AND UTILITY METER DATA RATE SCHEDULES (U.S. CLS. 100, 101 AND 102).
FIRST USE 8-12-2002; IN COMMERCE 8-12-2002.

CLASS 36—INSURANCE AND FINANCIAL

FOR PROVIDING ENERGY BROKERAGE AND INFORMATION; PROVIDING BILL PAYMENT SERVICES AND INFORMATION (U.S. CLS. 100, 101 AND 102).
FIRST USE 8-12-2002; IN COMMERCE 8-12-2002.

CLASS 37—CONSTRUCTION AND REPAIR

FOR CONSTRUCTION SERVICES, NAMELY, CONSTRUCTING STRUCTURES AND FACILITIES FOR USE IN THE ELECTRIC POWER AND GAS INDUSTRIES; MINING EXTRACTION OF COAL AND OTHER FOSSIL FUELS (U.S. CLS. 100, 103 AND 106).
FIRST USE 8-12-2002; IN COMMERCE 8-12-2002.

CLASS 39—TRANSPORTATION AND STORAGE

FOR PUBLIC UTILITY SERVICES; UTILITY SERVICES, NAMELY, TRANSMISSION OF ELECTRICITY (U.S. CLS. 100 AND 105).
FIRST USE 8-12-2002; IN COMMERCE 8-12-2002.

CLASS 40—MATERIAL TREATMENT

FOR GENERATION OF AND PRODUCTION OF ELECTRICITY AND ENERGY VIA POWER PLANTS AND COGENERATION FACILITIES (U.S. CLS. 100, 103 AND 106).
FIRST USE 8-12-2002; IN COMMERCE 8-12-2002.

SN 76-444,241. AMERICAN COLOR GRAPHICS, INC., DBA AMERICAN COLOR, BRENTWOOD, TN. FILED 8-26-2002.

COLORSTOR**CLASS 35—ADVERTISING AND BUSINESS**

FOR COMPUTER SERVICES, NAMELY PROVIDING BUSINESS ADVICE TO OTHERS IN ONLINE PHOTOGRAPHIC ASSET MANAGEMENT (U.S. CLS. 100, 101 AND 102).

CLASS 42—SCIENTIFIC, COMPUTER AND LEGAL SERVICES

FOR COMPUTER SERVICES, NAMELY PROVIDING TECHNICAL ADVICE TO OTHERS IN ONLINE PHOTOGRAPHIC ASSET MANAGEMENT (U.S. CLS. 100 AND 101).

SN 76-444,243. AMERICAN COLOR GRAPHICS, INC., DBA AMERICAN COLOR, BRENTWOOD, TN. FILED 8-26-2002.

COLORLOCK**CLASS 35—ADVERTISING AND BUSINESS**

FOR BUSINESS CONSULTING SERVICES IN THE FIELD OF DESIGN, SELECTION, IMPLEMENTATION AND USE OF COMPUTER HARDWARE AND SOFTWARE SYSTEMS TO ESTABLISH STANDARDS FOR PHOTOGRAPHIC IMAGING EQUIPMENT AND LIGHTING TO IMPROVE IMAGE QUALITY FOR OTHERS (U.S. CLS. 100, 101 AND 102).

CLASS 42—SCIENTIFIC, COMPUTER AND LEGAL SERVICES

FOR TECHNICAL CONSULTING SERVICES IN THE FIELD OF DESIGN, SELECTION, IMPLEMENTATION AND USE OF COMPUTER HARDWARE AND SOFTWARE SYSTEMS TO ESTABLISH STANDARDS FOR PHOTOGRAPHIC IMAGING EQUIPMENT AND LIGHTING TO IMPROVE IMAGE QUALITY FOR OTHERS (U.S. CLS. 100 AND 101).

SN 76-446,286. PREMIER WASTEWATER INTERNATIONAL, INC., LAS VEGAS, NV. FILED 8-30-2002.

**DYNAMIC AEROBIC
CONDITIONER**

NO CLAIM IS MADE TO THE EXCLUSIVE RIGHT TO USE "AEROBIC CONDITIONER", APART FROM THE MARK AS SHOWN.

CLASS 11—ENVIRONMENTAL CONTROL APPARATUS

FOR WASTEWATER TREATMENT SYSTEMS AND STRUCTURAL PARTS THEREFOR, BIOREACTOR FOR USE IN THE TREATMENT OF WASTEWATER AND STRUCTURAL PARTS THEREFOR (U.S. CLS. 13, 21, 23, 31 AND 34).

CLASS 35—ADVERTISING AND BUSINESS

FOR MANAGEMENT AND OPERATION OF WASTEWATER TREATMENT SYSTEMS (U.S. CLS. 100, 101 AND 102).

CLASS 40—MATERIAL TREATMENT

FOR ENVIRONMENTAL REMEDIATION SERVICES, NAMELY, WASTEWATER TREATMENT SERVICE (U.S. CLS. 100, 103 AND 106).

SN 76-446,287. PREMIER WASTEWATER INTERNATIONAL, INC., LAS VEGAS, NV. FILED 8-30-2002.

DAC

CLASS 11—ENVIRONMENTAL CONTROL APPARATUS

FOR WASTEWATER TREATMENT SYSTEMS AND STRUCTURAL PARTS THEREFOR, BIOREACTOR FOR USE IN THE TREATMENT OF WASTEWATER AND STRUCTURAL PARTS THEREFOR (U.S. CLS. 13, 21, 23, 31 AND 34).

CLASS 35—ADVERTISING AND BUSINESS

FOR MANAGEMENT AND OPERATION OF WASTEWATER TREATMENT SYSTEMS (U.S. CLS. 100, 101 AND 102).

CLASS 40—MATERIAL TREATMENT

FOR ENVIRONMENTAL REMEDIATION SERVICES, NAMELY, WASTEWATER TREATMENT SERVICE (U.S. CLS. 100, 103 AND 106).

SN 76-446,422. ARCH WOOD PROTECTION, INC., SMYRNA, GA. FILED 9-3-2002.



THE DRAWING IS LINED FOR THE COLOR(S) BLUE.

CLASS 2—PAINTS

FOR CHEMICAL WOOD PRESERVATIVES TO PREVENT DECAY, DETERIORATION, INSECT DAMAGE AND ROT (U.S. CLS. 6, 11 AND 16).

CLASS 19—NON-METALLIC BUILDING MATERIALS

FOR WOOD BEAMS, TRIM, LUMBER, PLYWOOD AND ORIENTED STRAND BOARD, ALL TREATED TO PREVENT DECAY, DETERIORATION, INSECT DAMAGE AND ROT (U.S. CLS. 1, 12, 33 AND 50).

CLASS 40—MATERIAL TREATMENT

FOR CHEMICAL TREATMENT OF WOOD TO PREVENT DECAY, DETERIORATION, INSECT DAMAGE AND ROT (U.S. CLS. 100, 103 AND 106).

SN 76-446,445. CORAL HOTELS & RESORTS, SANTO DOMINGO, DOMINICAN REP. FILED 9-3-2002.

CORAL HOTELS & RESORTS

NO CLAIM IS MADE TO THE EXCLUSIVE RIGHT TO USE "HOTELS & RESORTS", APART FROM THE MARK AS SHOWN.

CLASS 35—ADVERTISING AND BUSINESS

FOR HOTEL MANAGEMENT AND OPERATION OF HOTELS FOR OTHERS; PROMOTING THE SALE OF HOTEL SERVICES OF OTHERS THROUGH DISTRIBUTION OF PRINTED MATERIAL (U.S. CLS. 100, 101 AND 102).

CLASS 43—HOTEL AND RESTAURANT SERVICES

FOR HOTEL AND RESTAURANT SERVICES (U.S. CLS. 100 AND 101).

SN 76-446,580. NEW PENDULUM CORP., WILMINGTON, DE. FILED 9-3-2002.

PIG

OWNER OF U.S. REG. NOS. 1,429,718, 2,275,570 AND OTHERS.

CLASS 4—LUBRICANTS AND FUELS

FOR PETROLEUM-BASED ABSORBENT AND ADSORBENT COMPOSITIONS FOR SORBING LIQUIDS IN INDUSTRIAL WORK SPACES (U.S. CLS. 1, 6 AND 15).
FIRST USE 0-0-1987; IN COMMERCE 0-0-1987.

CLASS 16—PAPER GOODS AND PRINTED MATTER

FOR CATALOGS FEATURING FACILITY SAFETY, MAINTENANCE, FILTRATION AND MATERIAL HANDLING PRODUCTS, SYNTHETIC AND NATURAL ABSORBENTS, ABSORBENT SOCKS, PADS, MATS AND WIPES FOR ABSORBING LIQUID SPILLS, DRIPS, AND OVERSPRAY, AND RELATED ITEMS FOR INDUSTRIAL, COMMERCIAL AND HOUSEHOLD USE (U.S. CLS. 2, 5, 22, 23, 29, 37, 38 AND 50).
FIRST USE 0-0-1987; IN COMMERCE 0-0-1987.

CLASS 17—RUBBER GOODS

FOR FULL LINE OF ABSORBENT SOCKS, PILLOWS, DIKES, PANS, SKIMMERS AND PULP FOR CONTAINING INDUSTRIAL LEAKS AND SPILLS; ABSORBENT PADS FOR CONTAINING OIL SPILLS AND DISPENSERS FOR USE THEREWITH; POLYURETHANE BERMS USED AS BARRIERS FOR CONTAINING MACHINE FLUIDS, LEAKS AND SPILLS (U.S. CLS. 1, 5, 12, 13, 35 AND 50).
FIRST USE 0-0-1987; IN COMMERCE 0-0-1987.

CLASS 20—FURNITURE AND ARTICLES NOT OTHERWISE CLASSIFIED

FOR WASTE HANDLING EQUIPMENT, NAMELY, NON-METAL DRUMS FOR CONTAINING LIQUIDS, NON-METAL SPILL DECKS USED TO SUPPORT STORAGE DRUMS AND CONTAIN POTENTIAL LEAKS (U.S. CLS. 2, 13, 22, 25, 32 AND 50).
FIRST USE 0-0-1992; IN COMMERCE 0-0-1992.

CLASS 21—HOUSEWARES AND GLASS

FOR CLEANING WIPES MADE OF SYNTHETIC AND NATURAL ABSORBENT TEXTILES FOR ABSORBING LIQUIDS; FUNNELS USED TO DRAIN LIQUIDS INTO STORAGE DRUMS (U.S. CLS. 2, 13, 23, 29, 30, 33, 40 AND 50).
FIRST USE 0-0-1990; IN COMMERCE 0-0-1990.

CLASS 27—FLOOR COVERINGS

FOR ABSORBENT AND ADSORBENT MATS FOR COMMERCIAL AND INDUSTRIAL USE IN ABSORBING LIQUID SPILLS AND LEAKS; POLYURETHANE MATS FOR SEALING OFF GRATES, DRAINS, STORM DRAINS AND MANHOLES AGAINST PASSAGE OF SURFACE LIQUIDS (U.S. CLS. 19, 20, 37, 42 AND 50).

FIRST USE 0-0-1987; IN COMMERCE 0-0-1987.

CLASS 35—ADVERTISING AND BUSINESS

FOR DISTRIBUTORSHIP, CATALOG ORDER, MAIL ORDER, AND ONLINE DISTRIBUTORSHIP FEATURING FACILITY SAFETY, MAINTENANCE, FILTRATION AND MATERIAL HANDLING PRODUCTS, SYNTHETIC AND NATURAL ABSORBENTS, ABSORBENT SOCKS, PADS, MATS AND WIPES FOR ABSORBING LIQUID SPILLS, DRIPS, AND OVERSPRAY, AND RELATED ITEMS FOR INDUSTRIAL, COMMERCIAL AND HOUSEHOLD USE (U.S. CLS. 100, 101 AND 102).

FIRST USE 0-0-1987; IN COMMERCE 0-0-1987.

SN 76-446,643. NEW PENDULUM CORP., WILMINGTON, DE. FILED 9-3-2002.



OWNER OF U.S. REG. NOS. 1,429,718, 2,275,570 AND OTHERS.

CLASS 4—LUBRICANTS AND FUELS

FOR PETROLEUM-BASED ABSORBENT AND ADSORBENT COMPOSITIONS FOR SORBING LIQUIDS IN INDUSTRIAL WORK SPACES (U.S. CLS. 1, 6 AND 15).

FIRST USE 0-0-1987; IN COMMERCE 0-0-1987.

CLASS 16—PAPER GOODS AND PRINTED MATTER

FOR CATALOGS FEATURING FACILITY SAFETY, MAINTENANCE, FILTRATION AND MATERIAL HANDLING PRODUCTS, SYNTHETIC AND NATURAL ABSORBENTS, ABSORBENT SOCKS, PADS, MATS AND WIPES FOR ABSORBING LIQUID SPILLS, DRIPS, AND OVERSPRAY, AND RELATED ITEMS FOR INDUSTRIAL, COMMERCIAL AND HOUSEHOLD USE (U.S. CLS. 2, 5, 22, 23, 29, 37, 38 AND 50).

FIRST USE 0-0-1987; IN COMMERCE 0-0-1987.

CLASS 17—RUBBER GOODS

FOR FULL LINE OF ABSORBENT SOCKS, PILLOWS, DIKES, PANS, SKIMMERS AND PULP FOR CONTAINING INDUSTRIAL LEAKS AND SPILLS; ABSORBENT PADS FOR CONTAINING OIL SPILLS AND DISPENSERS FOR USE THEREWITH; POLYURETHANE BERMS USED AS BARRIERS FOR CONTAINING MACHINE FLUIDS, LEAKS AND SPILLS (U.S. CLS. 1, 5, 12, 13, 35 AND 50).

FIRST USE 0-0-1987; IN COMMERCE 0-0-1987.

CLASS 20—FURNITURE AND ARTICLES NOT OTHERWISE CLASSIFIED

FOR WASTE HANDLING EQUIPMENT, NAMELY, NON-METAL DRUMS FOR CONTAINING LIQUIDS, NON-METAL SPILL DECKS USED TO SUPPORT STORAGE DRUMS AND CONTAIN POTENTIAL LEAKS (U.S. CLS. 2, 13, 22, 25, 32 AND 50).

FIRST USE 0-0-1992; IN COMMERCE 0-0-1992.

CLASS 21—HOUSEWARES AND GLASS

FOR CLEANING WIPES MADE OF SYNTHETIC AND NATURAL ABSORBENT TEXTILES FOR ABSORBING LIQUIDS; FUNNELS USED TO DRAIN LIQUIDS INTO STORAGE DRUMS (U.S. CLS. 2, 13, 23, 29, 30, 33, 40 AND 50).

FIRST USE 0-0-1990; IN COMMERCE 0-0-1990.

CLASS 27—FLOOR COVERINGS

FOR ABSORBENT AND ADSORBENT MATS FOR COMMERCIAL AND INDUSTRIAL USE IN ABSORBING LIQUID SPILLS AND LEAKS; POLYURETHANE MATS FOR SEALING OFF GRATES, DRAINS, STORM DRAINS AND MANHOLES AGAINST PASSAGE OF SURFACE LIQUIDS (U.S. CLS. 19, 20, 37, 42 AND 50).

FIRST USE 0-0-1987; IN COMMERCE 0-0-1987.

CLASS 35—ADVERTISING AND BUSINESS

FOR DISTRIBUTORSHIP, CATALOG ORDER, MAIL ORDER, AND ONLINE DISTRIBUTORSHIP FEATURING FACILITY SAFETY, MAINTENANCE, FILTRATION AND MATERIAL HANDLING PRODUCTS, SYNTHETIC AND NATURAL ABSORBENTS, ABSORBENT SOCKS, PADS, MATS AND WIPES FOR ABSORBING LIQUID SPILLS, DRIPS, AND OVERSPRAY, AND RELATED ITEMS FOR INDUSTRIAL, COMMERCIAL AND HOUSEHOLD USE (U.S. CLS. 100, 101 AND 102).

FIRST USE 0-0-1987; IN COMMERCE 0-0-1987.

SN 76-447,768. SONY COMPUTER ENTERTAINMENT AMERICA INC., FOSTER CITY, CA. FILED 9-9-2002.

CIVILIZATION IS ONLY SKIN DEEP

CLASS 9—ELECTRICAL AND SCIENTIFIC APPARATUS

FOR COMPUTER GAME SOFTWARE AND VIDEO GAME SOFTWARE (U.S. CLS. 21, 23, 26, 36 AND 38).

CLASS 41—EDUCATION AND ENTERTAINMENT

FOR OPERATING A REAL TIME GAME FOR OTHERS OVER GLOBAL AND LOCAL AREA COMPUTER NETWORKS (U.S. CLS. 100, 101 AND 107).

SN 76-447,895. IN TOUCH MINISTRIES, INC., ATLANTA, GA. FILED 9-9-2002.

CHARLES STANLEY INSTITUTE

NO CLAIM IS MADE TO THE EXCLUSIVE RIGHT TO USE "INSTITUTE", APART FROM THE MARK AS SHOWN. THE NAME "CHARLES STANLEY" IDENTIFIES A PARTICULAR LIVING INDIVIDUAL WHOSE CONSENT IS OF RECORD.

CLASS 9—ELECTRICAL AND SCIENTIFIC APPARATUS

FOR PRE-RECORDED AUDIO AND VIDEO CASSETTES, CDS, CD-ROMS, DVD ROMS AND EDUCATIONAL SOFTWARE FOR USE IN A TEACHING MINISTRY IN THE FIELDS OF RELIGION, SPIRITUALITY, ETHICS, SOCIAL ISSUES AND LIFESTYLE (U.S. CLS. 21, 23, 26, 36 AND 38).

CLASS 16—PAPER GOODS AND PRINTED MATTER

FOR PRINTED EDUCATIONAL MATERIALS FOR USE IN A TEACHING MINISTRY IN THE FIELDS OF RELIGION, SPIRITUALITY, ETHICS, SOCIAL ISSUES AND LIFESTYLE, NAMELY, NEWSLETTERS, MAGAZINES, BOOKS AND PAMPHLETS (U.S. CLS. 2, 5, 22, 23, 29, 37, 38 AND 50).

SN 76-447,911. ORDER EXECUTION SERVICES, LLC, PRINCETON, NJ. FILED 9-9-2002.

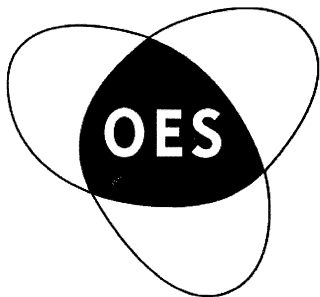

CLASS 35—ADVERTISING AND BUSINESS

FOR ORDER FULFILLMENT SERVICES, NAMELY, PROVIDING ON-LINE FACILITIES FEATURING TRANSACTION ORDER ENTRY, ORDER ROUTING AND ORDER CONFIRMATION SERVICES IN THE FIELD OF SECURITIES (U.S. CLS. 100, 101 AND 102). FIRST USE 7-1-2002; IN COMMERCE 7-1-2002.

CLASS 36—INSURANCE AND FINANCIAL

FOR BROKERAGE IN THE FIELD OF SECURITIES; SECURITIES TRANSACTION PROCESSING SERVICES, NAMELY, EXECUTING CUSTOMER ORDERS TO BUY AND SELL SECURITIES; PROVIDING AN ON-LINE ELECTRONIC WEBSITE ACCESSIBLE VIA THE INTERNET IN THE FIELD OF SECURITIES EXCHANGE, NAMELY, PROVIDING AN ON-LINE WEBSITE FOR SECURITIES ORDER EXECUTION SERVICES, FINANCIAL MARKET ACCESS SERVICES, DAY-TRADING ORDER EXECUTION SERVICES, AND SECURITIES TRADING SERVICES TO CUSTOMERS; FINANCIAL INFORMATION PROVIDED BY ELECTRONIC MEANS, NAMELY, PROVIDING FINANCIAL INFORMATION TO THE EXECUTION OF SECURITIES TRANSACTIONS BY ELECTRONIC MEANS (U.S. CLS. 100, 101 AND 102). FIRST USE 7-1-2002; IN COMMERCE 7-1-2002.

SN 76-448,202. NEXTEL COMMUNICATIONS, INC., RESTON, VA. FILED 9-4-2002.

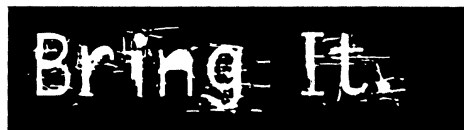

CLASS 9—ELECTRICAL AND SCIENTIFIC APPARATUS

FOR EQUIPMENT USED IN PROVIDING TELECOMMUNICATIONS SERVICES, NAMELY, MOBILE RADIOS, TWO-WAY RADIOS, CELLULAR TELEPHONES, DIGITAL CELLULAR TELEPHONES, MOBILE TELEPHONES, ELECTRONIC HANDHELD UNITS FOR THE WIRELESS RECEIPT AND/OR TRANSMISSION OF VOICE, DATA, VIDEO AND PICTURES; DISPATCH RADIOS, PAGERS, MOBILE DISPATCH RADIOS, MOBILE DATA RECEIVERS; HARDWARE AND SOFTWARE FOR USE IN COMMUNICATIONS NETWORKS, NAMELY, INTERNET PROTOCOL AND TELECOMMUNICATIONS NETWORK TRANSMITTERS, RECEIVERS, CONVERTERS, AND ROUTERS WHICH ALLOW THE USER TO SEND VOICE, DATA, PICTURES, MUSIC AND VIDEO OVER WIRELESS NETWORKS (U.S. CLS. 21, 23, 26, 36 AND 38).

CLASS 28—TOYS AND SPORTING GOODS

FOR HAND HELD UNIT FOR PLAYING ELECTRONIC GAMES (U.S. CLS. 22, 23, 38 AND 50).

CLASS 38—COMMUNICATION

FOR TELECOMMUNICATION SERVICES, NAMELY, PROVIDING VOICE, DATA, PICTURES, MUSIC AND VIDEO VIA WIRELESS NETWORKS AND TWO-WAY RADIO DISPATCHING SERVICES, ELECTRONIC TRANSMISSION OF VOICE, TEXT, IMAGES, DATA AND INFORMATION BY MEANS OF TWO-WAY RADIOS, MOBILE RADIOS, CELLULAR TELEPHONES, DIGITAL CELLULAR TELEPHONES, MOBILE TELEPHONES, ELECTRONIC HANDHELD UNITS FOR THE WIRELESS RECEIPT AND/OR TRANSMISSION OF VOICE, DATA, VIDEO AND PICTURES; DISPATCH RADIOS, AND PAGERS; PAGING SERVICES; MOBILE TELEPHONE COMMUNICATION SERVICES; WIRELESS INTERNET ACCESS SERVICES; AND WIRELESS DATA SERVICES FOR MOBILE ELECTRONIC HAND HELD UNITS FOR THE PURPOSE OF SENDING AND RECEIVING VIA A WIRELESS NETWORK, ELECTRONIC MAIL, FACSIMILES, DATA, IMAGES, INFORMATION, TEXT, NUMERIC MESSAGING AND TEXT MESSAGING AND FOR ACCESSING A GLOBAL COMMUNICATIONS NETWORK (U.S. CLS. 100, 101 AND 104).

SN 76-448,654. EMHART LLC, NEWARK, DE. FILED 8-22-2002.

HELI-COIL

OWNER OF U.S. REG. NOS. 399,390, 759,898 AND OTHERS.

CLASS 7—MACHINERY

FOR POWER TOOLS FOR INSTALLING HELICAL INSERTS, NAMELY, TAPS, PREWINDERS, MANDRELS, SPACERS, AND TANG BREAK-OFF TOOLS (U.S. CLS. 13, 19, 21, 23, 31, 34 AND 35).

CLASS 8—HAND TOOLS

FOR HAND TOOLS FOR INSTALLING AND EXTRACTING HELICAL INSERTS, NAMELY, TAPS, PREWINDERS, MANDRELS, EXTRACTORS, AND TANG BREAK-OFF TOOLS (U.S. CLS. 23, 28 AND 44).

SN 76-449,061. TROPISCAPES, INC., DBA PAVERCONNECTION, KATY, TX. FILED 9-11-2002.

PAVERCONNECTION

CLASS 37—CONSTRUCTION AND REPAIR

FOR ARBOR AND GAZEBO CONSTRUCTION SERVICES; INSTALLATION OF IRRIGATION AND SPRINKLER SYSTEMS; PAVING CONTRACTOR SERVICES FOR PAVEMENT, BRICK AND STONE WALK WAYS, DRIVE WAYS AND PATIOS (U.S. CLS. 100, 103 AND 106). FIRST USE 6-3-1997; IN COMMERCE 6-3-1997.

CLASS 44—MEDICAL, BEAUTY AND AGRICULTURAL SERVICES

FOR LANDSCAPE GARDENING (U.S. CLS. 100 AND 101). FIRST USE 6-3-1997; IN COMMERCE 6-3-1997.

SN 76-449,518. BISMUTH, GUY M., 75019 PARIS, FRANCE, FILED 9-13-2002.



OWNER OF FRANCE REG. NO. 013129137, DATED 11-2-2001, EXPIRES 11-2-2011.
NO CLAIM IS MADE TO THE EXCLUSIVE RIGHT TO USE "PARIS", APART FROM THE MARK AS SHOWN.
THE MARK CONSISTS, IN PART, OF THE NUMERAL "55", AND THE TERMS "H+ PARIS", WITHIN A CIRCLE DESIGN AND DESIGN.

CLASS 3—COSMETICS AND CLEANING PREPARATIONS

FOR COSMETICS AND SKIN CARE PREPARATIONS, NAMELY, SOAPS, SKIN AND BODY CREAMS, SKIN AND EYE GELS, AND SKIN AND BODY LOTIONS; HAIR CARE PREPARATIONS, NAMELY, HAIR SHAMPOOS, HAIR CONDITIONERS, HAIR RELAXERS, HAIR STRAIGHTENING PREPARATIONS, AND HAIR MOUSSE; AND MEDICATED EXFOLIATING SOAPS (U.S. CLS. 1, 4, 6, 50, 51 AND 52). FIRST USE 10-31-2000; IN COMMERCE 4-23-2001.

CLASS 5—PHARMACEUTICALS

FOR MEDICATED SKIN CARE PREPARATIONS, NAMELY, MEDICATED EXFOLIATING SOAPS, AND SKIN, FACIAL AND BODY CREAMS, GELS AND LOTIONS (U.S. CLS. 6, 18, 44, 46, 51 AND 52). FIRST USE 10-31-2000; IN COMMERCE 4-23-2001.

SN 76-450,347. JOB-SITE EQUIPMENT CORP., WARWICK, RI. FILED 9-17-2002.



SEC. 2(F).

CLASS 35—ADVERTISING AND BUSINESS

FOR RETAIL DEALERSHIPS FEATURING EARTH MOVING MACHINES (U.S. CLS. 100, 101 AND 102). FIRST USE 0-0-1994; IN COMMERCE 0-0-1994.

CLASS 37—CONSTRUCTION AND REPAIR

FOR RENTAL AND SERVICING OF EARTH MOVING MACHINES (U.S. CLS. 100, 103 AND 106). FIRST USE 0-0-1994; IN COMMERCE 0-0-1994.

SN 76-450,365. X CONCEPTS, LLC, ESCONDIDO, CA. FILED 9-17-2002.

S.K.U.M.M. SUPER KINETIC ULTRA MAGNETIC MEN

OWNER OF U.S. REG. NO. 2,673,070.
NO CLAIM IS MADE TO THE EXCLUSIVE RIGHT TO USE "MAGNETIC MEN", APART FROM THE MARK AS SHOWN.

CLASS 9—ELECTRICAL AND SCIENTIFIC APPARATUS

FOR SOFTWARE, NAMELY, VIDEO GAME SOFTWARE; PRE-RECORDED CD-ROMS, CARTRIDGES, DVD'S AND DISCS, ALL FEATURING VIDEO GAMES; VIDEOTAPES, DVD'S AND CD-ROMS FEATURING CARTOONS (U.S. CLS. 21, 23, 26, 36 AND 38).

CLASS 16—PAPER GOODS AND PRINTED MATTER

FOR COMIC BOOKS, PICTURE BOOKS, DRAWING BOOKS, COLORING BOOKS, AND ACTIVITY BOOKS, POSTERS, TRADING CARDS, MOUNTED PHOTOGRAPHS, UNMOUNTED PHOTOGRAPHS, MAGAZINES RELATED TO ACTION SPORTS, NAMELY, JOUSTING, TILTING, SKATEBOARDING, SNOWBOARDING, BICYCLING, MOTORCYCLING (U.S. CLS. 2, 5, 22, 23, 29, 37, 38 AND 50).

SN 76-450,707. M-QUBE, INC., BOSTON, MA. FILED 9-18-2002.

M-QUBE**CLASS 9—ELECTRICAL AND SCIENTIFIC APPARATUS**

FOR COMPUTER SOFTWARE FOR DESIGNING, TARGETING, TESTING, EXECUTING AND MANAGING MOBILE MARKETING AND MESSAGING CAMPAIGNS FOR USE IN THE WIRELESS DISTRIBUTION OF DATA (U.S. CLS. 21, 23, 26, 36 AND 38).

FIRST USE 7-7-2002; IN COMMERCE 7-7-2002.

CLASS 38—COMMUNICATION

FOR WIRELESS DIGITAL MESSAGING (U.S. CLS. 100, 101 AND 104).

FIRST USE 7-7-2002; IN COMMERCE 7-7-2002.

CLASS 42—SCIENTIFIC, COMPUTER AND LEGAL SERVICES

FOR CONSULTING SERVICES IN THE FIELD OF DESIGN, IMPLEMENTATION AND USE OF COMPUTER SOFTWARE SYSTEMS FOR OTHERS (U.S. CLS. 100 AND 101).

FIRST USE 7-7-2002; IN COMMERCE 7-7-2002.

SN 76-452,121. HARTZ MOUNTAIN CORPORATION, THE, SECAUCUS, NJ. BY MERGER HTZ INVESTMENT CORP., WILMINGTON, DE. FILED 9-24-2002.

COMMITTED TO THE HUMAN-ANIMAL BOND**CLASS 1—CHEMICALS**

FOR WATER FILTERING MATERIALS, NAMELY, FIBER FLOSS AND FILTER CHARCOAL; AND ADDITIVES FOR AQUARIUM WATER, NAMELY, SALT; WATER PURIFYING CHEMICALS FOR AQUARIUMS IN TABLETS, LIQUID AND/OR SPRAY FORM (U.S. CLS. 1, 5, 6, 10, 26 AND 46).

CLASS 3—COSMETICS AND CLEANING PREPARATIONS

FOR DETERGENT FOR REMOVING STAINS FROM RUGS AND CARPETS HAVING INCIDENTAL DEODORANT PROPERTIES; SHAMPOOS, SOAPS AND CONDITIONERS FOR PETS (U.S. CLS. 1, 4, 6, 50, 51 AND 52).

CLASS 5—PHARMACEUTICALS

FOR VITAMINS FOR PETS; FLEA KILLING COLLARS FOR PETS; FLEA AND TICK DIP, FLEA AND TICK SPRAY, POWDER, AND REPELLENTS FOR PETS, INSECTICIDAL SHAMPOOS AND SOAPS FOR PETS, FLEA AND TICK CARPET POWDER, WORMERS FOR PETS, NAMELY, MEDICATED PREPARATIONS TO RID PETS OF DIGESTIVE TRACT PARASITES, HAIR BALL REMEDIES FOR CATS AND ANTI-ITCH MEDICINE FOR AQUARIUM FISH, FLEA AND TICK ERADICATION PRODUCT IN CAPSULE FORM TO BE INGESTED BY DOGS; FLEA AND TICK TOPICAL ERADICATION PREPARATION; FLEA AND TICK DROPS FOR CATS; FLEA AND TICK DROPS FOR DOGS; VITAMINS FOR CATS AND DOGS; WORMERS FOR CATS AND DOGS; INSECTICIDAL SHAMPOOS FOR DOGS (U.S. CLS. 6, 18, 44, 46, 51 AND 52).

CLASS 6—METAL GOODS

FOR METAL STAKES FOR PETS (U.S. CLS. 2, 12, 13, 14, 23, 25 AND 50).

CLASS 7—MACHINERY

FOR AQUARIUM PUMPS (U.S. CLS. 13, 19, 21, 23, 31, 34 AND 35).

CLASS 8—HAND TOOLS

FOR HAND TOOLS FOR PICKING UP PET ANIMAL'S EXCREMENTS, NAMELY, SHOVELS, TROWELS, SPADES AND TONGS; NAIL FILES FOR ANIMAL PETS, PET PEDICURE INSTRUMENTS; HAND TOOLS, NAMELY, AQUARIUM SCRAPERS (U.S. CLS. 23, 28 AND 44).

CLASS 9—ELECTRICAL AND SCIENTIFIC APPARATUS

FOR PET ACCESSORIES, NAMELY, WHISTLES USED FOR CALLING DOGS; AQUARIUM THERMOMETERS; ELECTRIC MECHANISM FOR ATTRACTING AND TRAPPING FLEAS (U.S. CLS. 21, 23, 26, 36 AND 38).

CLASS 11—ENVIRONMENTAL CONTROL APPARATUS

FOR WATER FILTERS; AQUARIUM HEATERS; AQUARIUM LIGHTS; LIGHTING EQUIPMENT, NAMELY, LIGHT BULBS, STRIPLIGHTS, FULL HOOD LIGHTS, AND CANOPY LIGHTS, HEATING EQUIPMENT, NAMELY, HEATERS; WATER SUPPLY; SANITARY EQUIPMENT, NAMELY SPONGE FILTERS, ELECTRICALLY DRIVEN WATER PUMPS, AND UNDER-GRAVEL FILTERS; LIGHT REFLECTORS FOR ATTACHMENT TO TANKS AND WATER EJECTING SIPHONS (U.S. CLS. 13, 21, 23, 31 AND 34).

CLASS 16—PAPER GOODS AND PRINTED MATTER

FOR AQUARIUM TANKS; DECORATIVE BACK-GROUNDS FOR AQUARIUM TANKS, AQUARIUM ORNAMENTS; AQUARIUM FITTINGS AND ACCESSORIES, NAMELY, STANDS, AIR RELEASE STONES, FIBRE FLOSS, ARTIFICIAL LANDSCAPE, CREATING STONE AND ORNAMENTS, BREEDING TRAPS AND ARTIFICIAL BREEDING GRASS, AND SCREEN COVERS OF AQUARIUMS; GRAVEL PAPER FOR BIRD CAGES, LINER BAGS FOR CAT LITTER PANS; AQUARIUM FISH NETS; PUBLICATIONS, NAMELY, INFORMATIONAL PAMPHLETS ABOUT AQUARIUMS, AQUARIUM FISH, BIRDS, HAMSTERS, GERBILS AND GUINEA PIGS; NON-ABRASIVE LINE BAGS FOR CAT LITTER PANS (U.S. CLS. 2, 5, 22, 23, 29, 37, 38 AND 50).

CLASS 17—RUBBER GOODS

FOR AQUARIUM SEALANTS AND PLASTIC PIPES, VALVES AND PIPE CONNECTORS FOR AQUARIUMS (U.S. CLS. 1, 5, 12, 13, 35 AND 50).

SN 76-453,717. NORESKO, LLC, WESTBOROUGH, MA. FILED 9-30-2002.

CLASS 18—LEATHER GOODS

FOR DOG ACCESSORIES, NAMELY, COLLARS, LEADS AND HARNESSSES; CLOTHING FOR PET ANIMALS; PET PILLOWS AND RAWHIDE CHEWS FOR DOGS; RAWHIDE CHEWS FOR PETS, COLLARS, LEADS AND HARNESSSES FOR PETS, CHAIN LEADS, CHOKE COLLARS, TIE-OUT CHAINS (U.S. CLS. 1, 2, 3, 22 AND 41).

CLASS 20—FURNITURE AND ARTICLES NOT OTHERWISE CLASSIFIED

FOR PORTABLE BEDS FOR PETS; BEDS AND PILLOWS FOR PETS; NON-METAL STAKES FOR PETS (U.S. CLS. 2, 13, 22, 25, 32 AND 50).

CLASS 21—HOUSEWARES AND GLASS

FOR PET BRUSHES AND COMBS; CAT LITTER PANS, PET FEEDING DISHES, WATER BOTTLES FOR SMALL ANIMAL PETS, PET FOOD CAN COVERS, BIRD BATH, BIRD FOOD AND WATER CUPS, BIRD CAGES AND THE STANDS THEREFOR; CAGES FOR PETS, NAMELY, HOUSING/PLAYING ENVIRONMENT FOR SMALL ANIMAL PETS AND PARTS THEREFOR (U.S. CLS. 2, 13, 23, 29, 30, 33, 40 AND 50).

CLASS 26—FANCY GOODS

FOR ARTIFICIAL PLANTS FOR AQUARIUMS AND PET RESTRAINING STAKE (U.S. CLS. 37, 39, 40, 42 AND 50).

CLASS 28—TOYS AND SPORTING GOODS

FOR DOG CHEW TOYS MADE OF ANIMAL HIDE FOR EXERCISING TEETH AND THE GUMS AND DOG SQUEAK TOYS; PET TOYS, NAMELY, TOYS FOR DOGS, CATS, BIRDS, HAMSTERS, AND GERBILS (U.S. CLS. 22, 23, 38 AND 50).

CLASS 31—NATURAL AGRICULTURAL PRODUCTS

FOR FOOD FOR ANIMAL PETS, NAMELY, DOGS, CATS, HAMSTERS, GERBILS, GUINEA PIGS, RABBITS, CUTTLEBONE FOR BIRDS, BIRDS, TROPICAL AND AQUARIUM FISH AND CEDAR SHAVINGS FOR SMALL ANIMAL PETS (U.S. CLS. 1 AND 46).

CLASS 35—ADVERTISING AND BUSINESS

FOR PROVIDING COMMERCIAL INFORMATION IN THE FIELD OF PET PRODUCTS RENDERED BY MEANS OF A COMPUTER INFORMATION NETWORK (U.S. CLS. 100, 101 AND 102).

CLASS 42—SCIENTIFIC, COMPUTER AND LEGAL SERVICES

FOR PROVIDING TECHNICAL INFORMATION IN THE FIELD OF PET PRODUCTS RENDERED BY MEANS OF A COMPUTER INFORMATION NETWORK (U.S. CLS. 100 AND 101).

N O R E S C O

OWNER OF U.S. REG. NOS. 1,801,283, 2,410,235 AND 2,410,236.

CLASS 35—ADVERTISING AND BUSINESS

FOR BUSINESS MANAGEMENT SERVICES, NAMELY, IMPLEMENTING SERVICES FOR ENERGY CONSERVATION ON BEHALF OF RESIDENTIAL, COMMERCIAL, INSTITUTIONAL, AND MUNICIPAL AND GOVERNMENT ENERGY CONSUMERS, DEMAND-SIDE MANAGEMENT PROGRAM DESIGN AND IMPLEMENTATION SERVICES FOR ENERGY CONSERVATION; NEGOTIATING CONTRACTS WITH LOCAL AND OUT-OF-STATE ENERGY SUPPLIERS AND ENERGY SERVICE PROVIDERS, ON BEHALF OF RESIDENTIAL, COMMERCIAL, INSTITUTIONAL, AND MUNICIPAL ENERGY CONSUMERS; BUSINESS CONSULTATION IN THE FIELD OF EFFICIENT ENERGY USE, POWER DEMAND, POWER CONTROL, AND BUILDING AND FACILITIES MANAGEMENT FOR OTHERS; PROCUREMENT, NAMELY PURCHASING ENERGY FOR OTHERS; AND OPERATION OF A BUSINESS FOR OTHERS, NAMELY, INDEPENDENT PLANT OPERATIONS (U.S. CLS. 100, 101 AND 102).

FIRST USE 3-1-2002; IN COMMERCE 3-1-2002.

CLASS 37—CONSTRUCTION AND REPAIR

FOR CONSTRUCTION OF CENTRAL ENERGY FACILITIES FOR OTHERS (U.S. CLS. 100, 103 AND 106).

FIRST USE 3-1-2002; IN COMMERCE 3-1-2002.

SN 76-453,724. NORESKO, LLC, WESTBOROUGH, MA. FILED 9-30-2002.

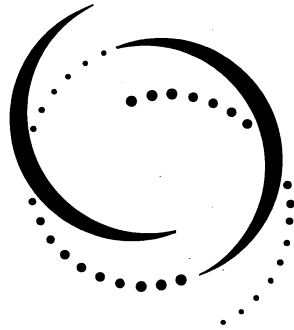

CLASS 35—ADVERTISING AND BUSINESS

FOR BUSINESS MANAGEMENT SERVICES, NAMELY, IMPLEMENTING SERVICES FOR ENERGY CONSERVATION ON BEHALF OF RESIDENTIAL, COMMERCIAL, INSTITUTIONAL, AND MUNICIPAL AND GOVERNMENT ENERGY CONSUMERS, DEMAND-SIDE MANAGEMENT PROGRAM DESIGN AND IMPLEMENTATION SERVICES FOR ENERGY CONSERVATION; NEGOTIATING CONTRACTS WITH LOCAL AND OUT-OF-STATE ENERGY SUPPLIERS AND ENERGY SERVICE PROVIDERS, ON BEHALF OF RESIDENTIAL, COMMERCIAL, INSTITUTIONAL, AND MUNICIPAL ENERGY CONSUMERS; BUSINESS CONSULTATION IN THE FIELD OF EFFICIENT ENERGY USE, POWER DEMAND, POWER CONTROL, AND BUILDING AND FACILITIES MANAGEMENT FOR OTHERS; PROCUREMENT, NAMELY PURCHASING ENERGY FOR OTHERS; AND OPERATION OF A BUSINESS FOR OTHERS, NAMELY, INDEPENDENT PLANT OPERATIONS (U.S. CLS. 100, 101 AND 102).

FIRST USE 3-1-2002; IN COMMERCE 3-1-2002.

CLASS 37—CONSTRUCTION AND REPAIR

FOR CONSTRUCTION OF CENTRAL ENERGY FACILITIES (U.S. CLS. 100, 103 AND 106).

FIRST USE 3-1-2002; IN COMMERCE 3-1-2002.

SN 76-454,662. CORPORATIVO INTERNACIONAL MEXICANO, S. DE R.L. DE C.V., COL. LOMAS DE CHAPULTEPEC, MEXICO, FILED 9-26-2002.



OWNER OF U.S. REG. NO. 1,157,500 AND OTHERS. THE ENGLISH TRANSLATION OF "MI COCINA" IS "MY KITCHEN".

CLASS 29—MEATS AND PROCESSED FOODS

FOR DEHYDRATED LEGUMES (U.S. CL. 46).

CLASS 30—STAPLE FOODS

FOR BREAKFAST CEREALS; MIXED PROCESSED CEREALS (U.S. CL. 46).

CLASS 31—NATURAL AGRICULTURAL PRODUCTS

FOR UNPROCESSED CEREALS (U.S. CLS. 1 AND 46).

SN 76-455,659. LUMINA FOUNDATION FOR EDUCATION, INC., INDIANAPOLIS, IN. FILED 10-3-2002.

ILLUMINATIONS

OWNER OF U.S. REG. NO. 2,597,515.

CLASS 9—ELECTRICAL AND SCIENTIFIC APPARATUS

FOR ELECTRONIC PUBLICATIONS NAMELY NEWSLETTERS, RECORDED ON COMPUTER MEDIA AND DOWNLOADABLE VIA COMPUTER NETWORKS, IN THE FIELD OF ACCESS TO AND SUCCESS IN POST-SECONDARY EDUCATION (U.S. CLS. 21, 23, 26, 36 AND 38).

FIRST USE 1-0-2002; IN COMMERCE 1-0-2002.

CLASS 16—PAPER GOODS AND PRINTED MATTER

FOR PRINTED PUBLICATIONS, NAMELY NEWSLETTERS, IN THE FIELD OF ACCESS TO AND SUCCESS IN POST-SECONDARY EDUCATION (U.S. CLS. 2, 5, 22, 23, 29, 37, 38 AND 50).

FIRST USE 1-0-2002; IN COMMERCE 1-0-2002.

SN 76-455,989. ING USA HOLDING CORPORATION, WILMINGTON, DE. FILED 10-2-2002.

PLANET ORANGE

CLASS 36—INSURANCE AND FINANCIAL

FOR PROVIDING AN INTERACTIVE WEB SITE FEATURING INFORMATION FOR CHILDREN IN THE FIELD OF BANKING AND FINANCIAL SERVICES (U.S. CLS. 100, 101 AND 102).

CLASS 41—EDUCATION AND ENTERTAINMENT

FOR EDUCATIONAL SERVICES, NAMELY PROVIDING A WEB SITE WITH GAMES AND LEARNING ACTIVITIES TO HELP CHILDREN UNDERSTAND MONEY MATTERS AND FINANCIAL MATTERS, EARNING, SAVING, BUDGETING AND INVESTING (U.S. CLS. 100, 101 AND 107).

SN 76-456,464. TR MOLGANO LANDSCAPING, INC., STAMFORD, CT. FILED 10-7-2002.

TR MOLGANO

THE MARK IDENTIFIES A LIVING INDIVIDUAL WHOSE CONSENT IS OF RECORD.

CLASS 37—CONSTRUCTION AND REPAIR

FOR MASONRY AND SNOW REMOVAL SERVICES (U.S. CLS. 100, 103 AND 106).
FIRST USE 6-1-1986; IN COMMERCE 6-1-1986.

CLASS 44—MEDICAL, BEAUTY AND AGRICULTURAL SERVICES

FOR RESIDENTIAL AND COMMERCIAL LANDSCAPE GARDENING AND LAWN MAINTENANCE (U.S. CLS. 100 AND 101).
FIRST USE 6-1-1986; IN COMMERCE 6-1-1986.

SN 76-456,673. THE PROCTER & GAMBLE COMPANY, CINCINNATI, OH. FILED 10-8-2002.



THE MARK CONSISTS OF A STYLIZED DESIGN OF THE WORDS "CLUB HERBAL" WITH ONE LETTER "B" OVERLAPPING "CLUB" AND "HERBAL".

CLASS 41—EDUCATION AND ENTERTAINMENT

FOR PROVIDING AN ON-LINE NEWSLETTER RELATING TO BEAUTY AND PERSONAL CARE SUBJECTS AND FEATURING HAIR CARE AND SKIN CARE PRODUCTS VIA A GLOBAL COMPUTER NETWORK (U.S. CLS. 100, 101 AND 107).
FIRST USE 5-0-2001; IN COMMERCE 5-0-2001.

CLASS 44—MEDICAL, BEAUTY AND AGRICULTURAL SERVICES

FOR PROVIDING ON-LINE INFORMATION IN THE FIELD OF BEAUTY, HAIR CARE AND SKIN CARE (U.S. CLS. 100 AND 101).
FIRST USE 7-1-1999; IN COMMERCE 7-1-1999.

SN 76-456,888. GOLDHIL HOME MEDIA INTERNATIONAL, INC., THOUSAND OAKS, CA. FILED 10-7-2002.

SACRED YOGA PRACTICE

NO CLAIM IS MADE TO THE EXCLUSIVE RIGHT TO USE "YOGA PRACTICE", APART FROM THE MARK AS SHOWN.

CLASS 9—ELECTRICAL AND SCIENTIFIC APPARATUS

FOR VIDEO TAPES, VIDEO DISCS AND DVDS IN THE FIELD OF YOGA (U.S. CLS. 21, 23, 26, 36 AND 38).

CLASS 35—ADVERTISING AND BUSINESS

FOR MAIL ORDER CATALOG SERVICES FEATURING VIDEO TAPES, VIDEO DISCS AND DVDS IN THE FIELD OF YOGA; AND COMPUTER ORDERING SERVICES PERTAINING TO VIDEO TAPES, VIDEO DISCS AND DVDS IN THE FIELD OF YOGA (U.S. CLS. 100, 101 AND 102).

SN 76-456,919. RICHELL U.S.A., INC., GRAND PRAIRIE, TX. FILED 10-8-2002.

ORGANIZE!**CLASS 20—FURNITURE AND ARTICLES NOT OTHERWISE CLASSIFIED**

FOR NON-METAL STORAGE UNITS WITH OR WITHOUT WHEELS; NON-METAL STORAGE DRAWERS; NON-METAL STORAGE CABINETS; DRAWER SYSTEMS CONSISTING OF WOOD FRAMES AND PLASTIC DRAWERS; DRAWER SYSTEMS CONSISTING OF NON-METAL FRAMES AND DRAWERS; PLASTIC LAUNDRY HAMPERS; NON-METAL STORAGE CABINETS FOR HOUSEHOLD AND KITCHEN USE (U.S. CLS. 2, 13, 22, 25, 32 AND 50).
FIRST USE 4-8-2002; IN COMMERCE 4-8-2002.

CLASS 21—HOUSEWARES AND GLASS

FOR PLASTIC CONTAINERS FOR HOUSEHOLD AND KITCHEN USE (U.S. CLS. 2, 13, 23, 29, 30, 33, 40 AND 50).
FIRST USE 4-8-2002; IN COMMERCE 4-8-2002.

SN 76-456,977. FOUNDTON COMPANY LIMITED, KOWLOON, HONG KONG, FILED 10-7-2002.



OWNER OF U.S. REG. NO. 2,390,769.

CLASS 11—ENVIRONMENTAL CONTROL APPARATUS

FOR FLASHLIGHTS, AND HANDS-FREE FLASHLIGHTS TO BE WORN ON THE HEAD (U.S. CLS. 13, 21, 23, 31 AND 34).
FIRST USE 9-0-1997; IN COMMERCE 9-0-1997.

CLASS 20—FURNITURE AND ARTICLES NOT OTHERWISE CLASSIFIED

FOR FOLDING CHAIRS AND TABLES (U.S. CLS. 2, 13, 22, 25, 32 AND 50).
FIRST USE 9-0-1997; IN COMMERCE 9-0-1997.

SN 76-457,462. DEITS, KATIE, NORTH PALM BEACH, FL.
FILED 10-10-2002.

SN 76-459,964. SEABAIT LIMITED, NORTHUMBERLAND
NE63 9NW, UNITED KINGDOM, FILED 10-10-2002.

BIOGRAPHY BOX

NO CLAIM IS MADE TO THE EXCLUSIVE RIGHT TO USE "BOX", APART FROM THE MARK AS SHOWN.

CLASS 6—METAL GOODS

FOR SCULPTURES MADE OF NON-PRECIOUS METAL WHICH REPRESENT LIFE STORIES AND ACHIEVEMENTS (U.S. CLS. 2, 12, 13, 14, 23, 25 AND 50).

CLASS 19—NON-METALLIC BUILDING MATERIALS

FOR SCULPTURES MADE OF CEMENT, MARBLE, AND STONE WHICH REPRESENT LIFE STORIES AND ACHIEVEMENTS (U.S. CLS. 1, 12, 33 AND 50).

CLASS 20—FURNITURE AND ARTICLES NOT OTHERWISE CLASSIFIED

FOR SCULPTURES MADE OF PLASTIC AND WOOD WHICH REPRESENT LIFE STORIES AND ACHIEVEMENTS (U.S. CLS. 2, 13, 22, 25, 32 AND 50).

CLASS 21—HOUSEWARES AND GLASS

FOR SCULPTURES MADE OF CRYSTAL, EARTH-ENWARE, GLASS, PORCELAIN, AND TERRA COTTA WHICH REPRESENT LIFE STORIES AND ACHIEVEMENTS (U.S. CLS. 2, 13, 23, 29, 30, 33, 40 AND 50).

SN 76-457,586. AUTOVENTURES, INC., BURBANK, CA.
FILED 10-7-2002.

SMOKIN' JACKS KANSAS CITY BARBEQUE

NO CLAIM IS MADE TO THE EXCLUSIVE RIGHT TO USE "KANSAS CITY BARBECUE", APART FROM THE MARK AS SHOWN.

CLASS 30—STAPLE FOODS

FOR BARBECUE SEASONING, BARBECUE SAUCE, AND SEASONING AND SPICES, NAMELY, BARBECUE RUBS (U.S. CL. 46).
FIRST USE 4-15-2002; IN COMMERCE 4-15-2002.

CLASS 43—HOTEL AND RESTAURANT SERVICES

FOR RESTAURANTS, CATERING (U.S. CLS. 100 AND 101).
FIRST USE 4-15-2002; IN COMMERCE 4-15-2002.



PRIORITY CLAIMED UNDER SEC. 44(D) ON UNITED KINGDOM APPLICATION NO. 2297606, FILED 4-11-2002, REG. NO. 2297606, DATED 4-11-2002, EXPIRES 4-11-2012.

CLASS 28—TOYS AND SPORTING GOODS

FOR DEAD FISHING BAIT; DEAD WORMS (U.S. CLS. 22, 23, 38 AND 50).

CLASS 31—NATURAL AGRICULTURAL PRODUCTS

FOR LIVE FISHING BAIT; LIVE WORMS; LIVE WORMS FOR MEDICAL, SCIENTIFIC AND TESTING PURPOSES (U.S. CLS. 1 AND 46).

SN 76-461,119. CESIM LTD, HELSINKI, FINLAND, FILED
10-24-2002.

CESIM

CLASS 9—ELECTRICAL AND SCIENTIFIC APPARATUS

FOR COMPUTER PROGRAM FOR BUSINESS MANAGEMENT TRAINING; WEB BASED COMPUTER SOFTWARE PLATFORM WHICH ALLOWS INSTRUCTORS AND PARTICIPANTS TO CONDUCT SIMULATION BUSINESS MANAGEMENT TRAINING INDEPENDENTLY OF TIME AND GEOGRAPHICAL LOCATION (U.S. CLS. 21, 23, 26, 36 AND 38).

CLASS 41—EDUCATION AND ENTERTAINMENT

FOR EDUCATIONAL SERVICES, NAMELY CONDUCTING ON-LINE EXHIBITIONS AND DISPLAYS AND INTERACTIVE EXHIBITS IN THE FIELD OF SIMULATION-AIDED BUSINESS MANAGEMENT TRAINING AND BUSINESS MANAGEMENT DECISION SUPPORT SOLUTIONS (U.S. CLS. 100, 101 AND 107).

SN 76-461,162. KERZNER INTERNATIONAL LIMITED,
NASSAU, BAHAMAS, FILED 10-18-2002.

ONE & ONLY

CLASS 36—INSURANCE AND FINANCIAL

FOR REAL ESTATE MANAGEMENT SERVICES (U.S. CLS. 100, 101 AND 102).

CLASS 41—EDUCATION AND ENTERTAINMENT

FOR HEALTH CLUB SERVICES, NAMELY PROVIDING INSTRUCTIONS AND EQUIPMENT IN THE FIELD OF PHYSICAL EXERCISE; PROVIDING SPORTS FACILITIES AND TENNIS COURT FACILITIES; ENTERTAINMENT IN THE NATURE OF GOLF AND TENNIS TOURNAMENTS; GOLF CLUB SERVICES; GOLF CADDIE SERVICES (U.S. CLS. 100, 101 AND 107).

CLASS 43—HOTEL AND RESTAURANT SERVICES

FOR PROVIDING RESORT HOTELS AND LODGING SERVICES; TRAVEL AGENCY SERVICES, NAMELY MAKING RESERVATIONS AND BOOKINGS FOR TEMPORARY LODGING; RESTAURANT AND BAR SERVICES (U.S. CLS. 100 AND 101).

SN 76-461,164. KERZNER INTERNATIONAL LIMITED, NASSAU, BAHAMAS, FILED 10-18-2002.

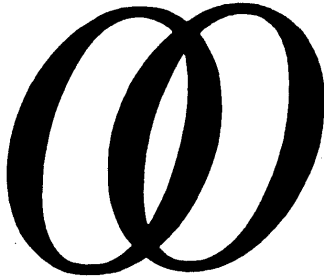

CLASS 36—INSURANCE AND FINANCIAL

FOR REAL ESTATE MANAGEMENT SERVICES (U.S. CLS. 100, 101 AND 102).

CLASS 41—EDUCATION AND ENTERTAINMENT

FOR HEALTH CLUB SERVICES, NAMELY PROVIDING INSTRUCTIONS AND EQUIPMENT IN THE FIELD OF PHYSICAL EXERCISE; PROVIDING SPORTS FACILITIES AND TENNIS COURT FACILITIES; ENTERTAINMENT IN THE NATURE OF GOLF AND TENNIS TOURNAMENTS; GOLF CLUB SERVICES; GOLF CADDIE SERVICES (U.S. CLS. 100, 101 AND 107).

CLASS 43—HOTEL AND RESTAURANT SERVICES

FOR PROVIDING RESORT HOTELS AND LODGING SERVICES; TRAVEL AGENCY SERVICES, NAMELY MAKING RESERVATIONS AND BOOKINGS FOR TEMPORARY LODGING; RESTAURANT AND BAR SERVICES (U.S. CLS. 100 AND 101).

SN 76-461,924. ING USA HOLDING CORPORATION, WILMINGTON, DE. FILED 10-24-2002.

SOUTH SPENDING

NO CLAIM IS MADE TO THE EXCLUSIVE RIGHT TO USE "SPENDING", APART FROM THE MARK AS SHOWN.

CLASS 36—INSURANCE AND FINANCIAL

FOR PROVIDING AN INTERACTIVE WEB SITE FEATURING INFORMATION FOR CHILDREN IN THE FIELD OF BANKING AND FINANCIAL SERVICES (U.S. CLS. 100, 101 AND 102).
FIRST USE 10-15-2002; IN COMMERCE 10-15-2002.

CLASS 41—EDUCATION AND ENTERTAINMENT

FOR EDUCATIONAL SERVICES, NAMELY PROVIDING A WEB SITE WITH GAMES AND LEARNING ACTIVITIES TO HELP CHILDREN UNDERSTAND MONEY MATTERS AND FINANCIAL MATTERS, EARNING, SAVING, BUDGETING AND INVESTING (U.S. CLS. 100, 101 AND 107).
FIRST USE 10-15-2002; IN COMMERCE 10-15-2002.

SN 76-464,004. FUJISAWA HEALTHCARE, INC., DEERFIELD, IL. FILED 11-4-2002.

COMMITTED TO HER HEART

CLASS 9—ELECTRICAL AND SCIENTIFIC APPARATUS

FOR PRE-RECORDED VIDEOTAPES AND AUDIO TAPES, CD'S AND DVD'S FEATURING INFORMATION ON HEART DISEASES AND TREATMENT THEREOF (U.S. CLS. 21, 23, 26, 36 AND 38).
FIRST USE 5-1-2002; IN COMMERCE 5-1-2002.

CLASS 16—PAPER GOODS AND PRINTED MATTER

FOR PRINTED MATERIAL, NAMELY BROCHURES, BOOKLETS AND FACT SHEETS PERTAINING TO HEART DISEASES AND TREATMENT THEREOF (U.S. CLS. 2, 5, 22, 23, 29, 37, 38 AND 50).
FIRST USE 5-1-2002; IN COMMERCE 5-1-2002.

CLASS 41—EDUCATION AND ENTERTAINMENT

FOR PROVIDING EDUCATIONAL SERVICES, NAMELY CONDUCTING CLASSES, SEMINARS AND CONFERENCES IN CONNECTION WITH HEART DISEASES AND TREATMENT THEREOF; DEVELOPMENT AND DISSEMINATION OF EDUCATIONAL MATERIALS FOR OTHERS ON HEART DISEASES AND TREATMENTS THEREOF (U.S. CLS. 100, 101 AND 107).
FIRST USE 5-1-2002; IN COMMERCE 5-1-2002.

CLASS 44—MEDICAL, BEAUTY AND AGRICULTURAL SERVICES

FOR PROVIDING INFORMATION SERVICES AND ON-LINE INFORMATION SERVICES IN CONNECTION WITH HEART DISEASES AND TREATMENT THEREOF (U.S. CLS. 100 AND 101).
FIRST USE 5-1-2002; IN COMMERCE 5-1-2002.

SN 76-464,018. ECO LATINO, LLC, AUGUSTA, GA. FILED 11-4-2002.

ECO LATINO

NO CLAIM IS MADE TO THE EXCLUSIVE RIGHT TO USE "LATINO", APART FROM THE MARK AS SHOWN.

CLASS 16—PAPER GOODS AND PRINTED MATTER

FOR PRINTED MATERIALS, NAMELY MAGAZINES CONCERNING HISPANIC CULTURE AND HERITAGE (U.S. CLS. 2, 5, 22, 23, 29, 37, 38 AND 50).
FIRST USE 8-8-2002; IN COMMERCE 10-1-2002.

CLASS 41—EDUCATION AND ENTERTAINMENT

FOR PROVIDING AN ONLINE MAGAZINE OF NEWS, ENTERTAINMENT, SHOPPING AND DINING FOR HISPANICS (U.S. CLS. 100, 101 AND 107).
FIRST USE 8-8-2002; IN COMMERCE 10-1-2002.

SN 76-465,197. FOCUS ON THE FAMILY, COLORADO SPRINGS, CO. FILED 11-7-2002.

**CLASS 16—PAPER GOODS AND PRINTED MATTER**

FOR PRINTED MATERIALS, SPECIFICALLY BROCHURES AND DIRECTORIES FEATURING INFORMATION OF INTEREST TO PASTORS AND THEIR FAMILIES (U.S. CLS. 2, 5, 22, 23, 29, 37, 38 AND 50).
FIRST USE 8-1-2000; IN COMMERCE 8-1-2000.

CLASS 45—PERSONAL SERVICES

FOR PROVIDING MINISTERIAL INFORMATION TO PASTORS AND THEIR FAMILIES VIA A GLOBAL COMPUTER NETWORK (U.S. CLS. 100 AND 101).
FIRST USE 6-23-2000; IN COMMERCE 6-23-2000.

SN 76-465,640. WINCO FIREWORKS UTAH, L.L.C., PRAIRIE VILLAGE, KS. FILED 11-8-2002.



NO CLAIM IS MADE TO THE EXCLUSIVE RIGHT TO USE "CRACKER", APART FROM THE MARK AS SHOWN.

CLASS 13—FIREARMS

FOR FIREWORKS (U.S. CLS. 2 AND 9).
FIRST USE 12-31-1989; IN COMMERCE 12-31-1989.

CLASS 35—ADVERTISING AND BUSINESS

FOR RETAIL FIREWORKS STAND SERVICES (U.S. CLS. 100, 101 AND 102).
FIRST USE 12-31-1989; IN COMMERCE 12-31-1989.

SN 76-465,748. PELLA CORPORATION, PELLA, IA. FILED 11-12-2002.

DURACAST**CLASS 19—NON-METALLIC BUILDING MATERIALS**

FOR NON-METAL DOORS AND WINDOWS (U.S. CLS. 1, 12, 33 AND 50).

CLASS 37—CONSTRUCTION AND REPAIR

FOR INSTALLATION, REPAIR, AND MAINTENANCE OF WINDOWS AND DOORS (U.S. CLS. 100, 103 AND 106).

CLASS 40—MATERIAL TREATMENT

FOR CUSTOM MANUFACTURE OF WINDOWS AND DOORS (U.S. CLS. 100, 103 AND 106).

SN 76-466,000. THE TERMINAL CORPORATON, TIMONIUM, MD. FILED 11-8-2002.

INTERLOGEX**CLASS 35—ADVERTISING AND BUSINESS**

FOR LOGISTIC SERVICES FOR AIR, LAND, RAIL AND SEA SHIPPERS AND TRANSPORTERS, NAMELY, INVENTORY CONTROL BY MEANS OF A GLOBAL COMPUTER NETWORK, FOR AIR, LAND, RAIL AND SEA SHIPPERS AND TRANSPORT OF FREIGHT; AND PROVIDING CONSULTATION FOR THE FOREGOING; LOGISTIC SERVICES NAMELY, ARRANGING FOR AIR, LAND, RAIL AND SEA SHIPPING TRANSPORTING OF FREIGHT BY MEANS OF GLOBAL COMPUTER NETWORK (U.S. CLS. 100, 101 AND 102).

FIRST USE 7-1-2002; IN COMMERCE 7-22-2002.

CLASS 39—TRANSPORTATION AND STORAGE

FOR LOGISTIC SERVICES FOR AIR, LAND, RAIL AND SEA SHIPPERS AND TRANSPORTERS, NAMELY, WAREHOUSING SERVICES; AND PROVIDING CONSULTATION FOR THE FOREGOING (U.S. CLS. 100 AND 105).

FIRST USE 7-1-2002; IN COMMERCE 7-22-2002.

CLASS 42—SCIENTIFIC, COMPUTER AND LEGAL SERVICES

FOR PROVIDING TECHNICAL CONSULTING SERVICES CONDUCTED BY MEANS OF A GLOBAL COMPUTER NETWORK IN THE FIELD OF LOGISTICS FOR AIR, LAND, RAIL AND SEA SHIPPING AND TRANSPORT OF FREIGHT (U.S. CLS. 100 AND 101).

FIRST USE 7-1-2002; IN COMMERCE 7-22-2002.

SN 76-466,001. THE TERMINAL CORPORATON, TIMONIUM, MD. FILED 11-8-2002.



CLASS 35—ADVERTISING AND BUSINESS

FOR LOGISTIC SERVICES FOR AIR, LAND, RAIL AND SEA SHIPPERS AND TRANSPORTERS, NAMELY, INVENTORY CONTROL BY MEANS OF A GLOBAL COMPUTER NETWORK, FOR AIR, LAND, RAIL AND SEA SHIPPERS AND TRANSPORT OF FREIGHT; AND PROVIDING CONSULTATION WITH THE FOREGOING; LOGISTIC SERVICES NAMELY, ARRANGING FOR AIR, LAND, RAIL AND SEA SHIPPING TRANSPORTING OF FREIGHT BY MEANS OF GLOBAL COMPUTER NETWORK (U.S. CLS. 100, 101 AND 102).

FIRST USE 7-1-2002; IN COMMERCE 7-22-2002.

CLASS 39—TRANSPORTATION AND STORAGE

FOR LOGISTIC SERVICES FOR AIR, LAND, RAIL AND SEA SHIPPERS AND TRANSPORTERS, NAMELY, WAREHOUSING SERVICES; AND PROVIDING CONSULTATION FOR THE FOREGOING (U.S. CLS. 100 AND 105).

FIRST USE 7-1-2002; IN COMMERCE 7-22-2002.

CLASS 42—SCIENTIFIC, COMPUTER AND LEGAL SERVICES

FOR PROVIDING TECHNICAL CONSULTING SERVICES CONDUCTED BY MEANS OF A GLOBAL COMPUTER NETWORK IN THE FIELD OF LOGISTICS FOR AIR, LAND, RAIL AND SEA SHIPPING AND TRANSPORT OF FREIGHT (U.S. CLS. 100 AND 101).

FIRST USE 7-1-2002; IN COMMERCE 7-22-2002.

SN 76-466,761. UNITED STATES LUGE ASSOCIATION, LAKE PLACID, NY. FILED 11-14-2002.

THE FASTEST SPORT ON ICE

CLASS 16—PAPER GOODS AND PRINTED MATTER

FOR POSTERS AND BROCHURES ABOUT THE SPORT OF LUGE (U.S. CLS. 2, 5, 22, 23, 29, 37, 38 AND 50).

CLASS 25—CLOTHING

FOR CLOTHING, NAMELY, T-SHIRTS, POLO SHIRTS, GOLF SHIRTS, SWEATSHIRTS, SWEATPANTS, SWEATERS, FLEECE PULLOVERS, FLEECE VESTS, JACKETS, CAPS, VISORS, AND FLEECE HATS (U.S. CLS. 22 AND 39).

SN 76-468,528. PRINTGLOBE, INC., AUSTIN, TX. FILED 11-20-2002.



CLASS 40—MATERIAL TREATMENT

FOR PRINTING; PRINTING SERVICES PROVIDED ON-LINE; DESIGN PRINTING FOR OTHERS; CUSTOMIZED PRINTING OF COMPANY NAMES AND LOGOS FOR PROMOTIONAL AND ADVERTISING PURPOSES ON THE GOODS OF OTHERS (U.S. CLS. 100, 103 AND 106).

FIRST USE 10-15-2002; IN COMMERCE 10-15-2002.

CLASS 42—SCIENTIFIC, COMPUTER AND LEGAL SERVICES

FOR GRAPHIC ART DESIGN SERVICES; DESIGN OF WEB SITES FOR OTHERS (U.S. CLS. 100 AND 101).

FIRST USE 10-15-2002; IN COMMERCE 10-15-2002.

SN 76-469,037. LEE, ANTHONY, HOUSTON, TX. FILED 11-21-2002.

PARADISE FROZEN CUSTARD

NO CLAIM IS MADE TO THE EXCLUSIVE RIGHT TO USE "FROZEN CUSTARD", APART FROM THE MARK AS SHOWN.

CLASS 30—STAPLE FOODS

FOR FROZEN CUSTARD (U.S. CL. 46).

CLASS 43—HOTEL AND RESTAURANT SERVICES

FOR RESTAURANT SERVICES FEATURING FROZEN CUSTARD (U.S. CLS. 100 AND 101).

SN 76-470,164. FRANK M. BOOTH, INC., MARYSVILLE, CA. FILED 11-18-2002.

OUR PERFORMANCE BUILDS RELATIONSHIPS

CLASS 37—CONSTRUCTION AND REPAIR

FOR CONSTRUCTION SERVICES; NAMELY, MECHANICAL BUILDING CONSTRUCTION SERVICES, CONSTRUCTION AND INSTALLATION OF MECHANICAL SYSTEMS; CONSTRUCTION AND INSTALLATION OF PLUMBING, PIPING, AND SHEET METAL SYSTEMS (U.S. CLS. 100, 103 AND 106).

FIRST USE 7-15-1984; IN COMMERCE 7-15-1984.

CLASS 40—MATERIAL TREATMENT

FOR SHEET METAL FABRICATION AND FINISHING SERVICES (U.S. CLS. 100, 103 AND 106).
FIRST USE 7-15-1984; IN COMMERCE 7-15-1984.

SN 76-471,661. SAMSUNG ELECTRONICS CO., LTD., SUWON-CITY, KYUNGKI-DO, REPUBLIC OF KOREA, FILED 11-21-2002.

CLASS 42—SCIENTIFIC, COMPUTER AND LEGAL SERVICES

FOR MECHANICAL SYSTEM DESIGN AND ENGINEERING SERVICES FOR OTHERS; DESIGN AND ENGINEERING OF PLUMBING, PIPING, AND SHEET METAL SYSTEMS FOR OTHERS (U.S. CLS. 100 AND 101).

FIRST USE 7-15-1984; IN COMMERCE 7-15-1984.

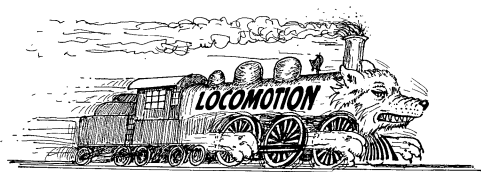

SN 76-470,292. BRUGLIO, JOSEPH, CAVECREEK, AZ. FILED 11-26-2002.

**CLASS 10—MEDICAL APPARATUS**

FOR SEXUAL STIMULATION APPARATUS, NAMELY, MACHINE WITH RETRACTABLE PENISES (U.S. CLS. 26, 39 AND 44).

CLASS 25—CLOTHING

FOR HATS AND T-SHIRTS (U.S. CLS. 22 AND 39).

THE MARK CONSISTS OF A ROYAL BLUE RECTANGULAR BACKGROUND IN WHICH THE WORD "FUN-CLUB" APPEARS. "CLUB" IS IN ALL WHITE LETTERING. IN "FUN", THE "F" IS ORANGE, THE "U" IS RED, AND THE "N" IS A LIGHT BLUE.

CLASS 35—ADVERTISING AND BUSINESS

FOR RETAIL SALES VIA DIRECT SOLICITATION BY SALES AGENTS IN THE FIELD OF CELLULAR PHONES, STORAGE BATTERIES, STORAGE BATTERY CHARGERS, EARPHONES, PRINTERS, COMMUNICATION CABLES, COMPUTERS (U.S. CLS. 100, 101 AND 102).

SN 76-470,728. NAMEPROTECT INC., MADISON, WI. FILED 11-27-2002.

NAMEPROTECT

OWNER OF U.S. REG. NO. 2,343,408.

CLASS 38—COMMUNICATION

FOR CELLULAR PHONE COMMUNICATION SERVICES; PROVIDING ON-LINE ELECTRONIC BULLETIN BOARDS FOR TRANSMISSION OF MESSAGES AMONG COMPUTER USERS ON THE SUBJECTS OF MOBILE PHONES, ENTERTAINMENT, MOVIES, MUSIC, HEALTH, AND ELECTRONIC PRODUCTS; ELECTRONIC TRANSMISSION OF DATA AND DOCUMENTS VIA COMPUTER TERMINALS; ELECTRONIC DELIVERY OF IMAGES AND PHOTOGRAPHS VIA A GLOBAL COMPUTER NETWORK; ELECTRONIC, ELECTRIC, AND DIGITAL TRANSMISSION OF VOICES, DATA, IMAGES, SIGNALS, AND MESSAGES; ELECTRONIC MAIL SERVICES; SERVICES OF PROVIDING ACCESS TO STREAMED SOUND AND AUDIO-VISUAL RECORDINGS OR MULTIMEDIA CONTENTS APPLICABLE FOR CELLULAR PHONES VIA THE INTERNET (U.S. CLS. 100, 101 AND 104).

CLASS 35—ADVERTISING AND BUSINESS

FOR TRADEMARK MONITORING SERVICES; CONSULTING IN THE FIELD OF TRADEMARKS, NAMELY, PROVIDING SOLUTIONS FOR OTHERS SEEKING TO PROTECT AND MONITOR THEIR BRANDS, PRODUCTS AND SERVICES; CONDUCTING MARKET RESEARCH VIA THE INTERNET TO LOCATE BUSINESS, MARKET AND INTELLECTUAL PROPERTY DATA (U.S. CLS. 100, 101 AND 102).

FIRST USE 12-31-1998; IN COMMERCE 12-31-1998.

CLASS 42—SCIENTIFIC, COMPUTER AND LEGAL SERVICES**CLASS 42—SCIENTIFIC, COMPUTER AND LEGAL SERVICES**

FOR RESEARCH AND CONSULTING SERVICES IN THE FIELD OF INTELLECTUAL PROPERTY; CONTENT PROVIDER OF INFORMATION IN THE FIELD OF INTELLECTUAL PROPERTY BY MEANS OF A GLOBAL COMPUTER NETWORK (U.S. CLS. 100 AND 101).

FIRST USE 12-31-1998; IN COMMERCE 12-31-1998.

FOR HOSTING OF DIGITAL CONTENTS APPLICABLE FOR CELLULAR PHONES AND MOBILE COMMUNICATION APPLIANCES VIA THE INTERNET OR GLOBAL COMPUTER NETWORKS; HOSTING OF DIGITAL CONTENTS FOR HEALTH, HOUSE KEEPING, CULTURE AND ELECTRONIC PRODUCTS VIA THE INTERNET OR ON COMPUTER NETWORKS; HOSTING THE WEB SITES OF OTHERS ON A GLOBAL COMPUTER NETWORK OPERATING INTERNET COMMUNITIES OR WEB SITES FOR CELLULAR PHONE USERS; RENTAL OF COMPUTERS (U.S. CLS. 100 AND 101).

SN 76-473,756. DREAMWORKS L.L.C., UNIVERSAL CITY, CA. FILED 12-10-2002.

GINGY

CLASS 9—ELECTRICAL AND SCIENTIFIC APPARATUS

FOR MOUSE PADS, HOLDERS FOR COMPACT DISCS, COMPUTER GAME CARTRIDGES, COMPUTER GAME CASSETTES, AND COMPUTER GAME TAPES; VIDEO GAME CARTRIDGES, VIDEO GAME CASSETTES; PRERECORDED AUDIO CASSETTES, PRERECORDED VIDEO CASSETTES, PRERECORDED AUDIO TAPES, PRERECORDED VIDEO TAPES, AND PRERECORDED DISCS, ALL FEATURING MUSIC AND MOTION PICTURE SOUND TRACKS; CD ROM AND DVD PROGRAMS FEATURING MUSIC AND MOTION PICTURE SOUND TRACKS; PRERECORDED COMPUTER SOFTWARE PROGRAMS FEATURING MUSIC AND MOTION PICTURE SOUND TRACKS; INTERACTIVE MULTIMEDIA SOFTWARE PROGRAMS FOR ENTERTAINMENT; INTERACTIVE MULTI-MEDIA SOFTWARE FOR PLAYING GAMES; MAGNETS AND SUNGLASSES (U.S. CLS. 21, 23, 26, 36 AND 38).

CLASS 16—PAPER GOODS AND PRINTED MATTER

FOR PAPER PARTY DECORATIONS; PAPER PARTY SUPPLIES, NAMELY, PAPER PARTY HATS, PAPER NAPKINS, PAPER PLACE MATS, GIFTWRAPPING PAPER AND PAPER GIFT WRAPPING RIBBONS, PAPER GIFT WRAP BOWS, PAPER TABLE CLOTHS AND PAPER PARTY BAGS; CHILDREN'S ACTIVITY BOOKS, CHILDREN'S STORYBOOKS, COMIC BOOKS, COLORING BOOKS, BOOK MARKS, LOOSE LEAF BINDERS, STATIONERY-TYPE PORTFOLIOS, SPIRAL BOUND NOTEBOOKS, NOTE PADS OR WRITING PADS, DIARIES, DAILY PLANNERS, CALENDARS, SCRAPBOOK ALBUMS, SKETCHBOOK ALBUMS, PHOTOGRAPH ALBUMS, STICKER ALBUMS, STICKERS, DECALS, STAMP PADS OR INKING PADS, RUBBER STAMPS, HEAT APPLIED APPLIQUES MADE OF PAPER, TEMPORARY TATTOOS, SLATEBOARDS, PENCILS, PENS, PENCIL ERASERS, DECORATIVE PENCIL-TOP ORNAMENTS, PEN CASES AND PENCIL CASES, PEN BOXES AND PENCIL BOXES, PENCIL SHARPENERS, CHALK, MARKERS, POSTERS, POSTCARDS, TRADING CARDS, GREETING CARDS, PENNANTS MADE OF PAPER, PAINTING SETS FOR CHILDREN; ARTS AND CRAFTS PAINT KITS; STUDY KITS, CONSISTING OF PENCIL ERASERS, DRAWING RULERS, PENCIL SHARPENERS AND PENCIL CASE; STATIONERY PACKS CONSISTING OF WRITING PAPER, ENVELOPES, MARKERS, AND STENCILS; AND ACTIVITY KITS CONSISTING OF STICKERS AND STAMPS (U.S. CLS. 2, 5, 22, 23, 29, 37, 38 AND 50).

CLASS 25—CLOTHING

FOR SHIRTS AND TOPS, DRESSES, SKIRTS, PANTS, TROUSERS, JEANS, SHORTS, ROMPERS, OVERALLS, SWEATSHIRTS AND SWEAT PANTS, SWEATSUITS, GLOVES, CAPS AND HATS, SUSPENDERS, TIES, COATS AND JACKETS, HOSIERY, SHOES, BOOTS, SLIPPERS, PAJAMAS, ROBES, SLEEPSHIRTS, SLEEPWEAR, UNDERWEAR, HALLOWEEN COSTUMES, AND CLOTH BABY BIBS (U.S. CLS. 22 AND 39).

CLASS 28—TOYS AND SPORTING GOODS

FOR PLAYING CARDS, ACTION FIGURES AND ACCESSORIES THEREFOR, BATHTUB TOYS, KITES, TOY BUILDING BLOCKS, BOARD GAMES, COSTUME MASKS, HAND-HELD UNIT FOR PLAYING ELECTRONIC GAMES, DIE CAST MINIATURE TOY VEHICLES, DOLLS, DOLL ACCESSORIES, DOLL CLOTHING, BEAN BAG DOLLS, BENDABLE PLAY FIGURES, FLYING DISKS, INFLATABLE VINYL PLAY FIGURES, JIGSAW PUZZLES, MARBLES, PLUSH TOYS, PUPPETS, RIDE-ON TOYS, SKATEBOARDS, BALLOONS, ROLLER-SKATES, TOY BANKS, WATER SQUIRTING TOYS, STUFFED TOYS, TOY VEHICLES, CHRISTMAS TREE ORNAMENTS; PINBALL MACHINES AND MODEL CRAFT KITS OF TOY FIGURES (U.S. CLS. 22, 23, 38 AND 50).

SN 76-474,084. PONY OF THE AMERICAS CLUB, INC., INDIANAPOLIS, IN. FILED 12-12-2002.

POA

CLASS 9—ELECTRICAL AND SCIENTIFIC APPARATUS

FOR VIDEO RECORDINGS FEATURING HORSES AND HORSEMANSHIP (U.S. CLS. 21, 23, 26, 36 AND 38). FIRST USE 9-1-2002; IN COMMERCE 9-1-2002.

CLASS 16—PAPER GOODS AND PRINTED MATTER

FOR BOOKS FEATURING HORSES AND HORSEMANSHIP; COLORING BOOKS, PICTURE PRINTS, AND MAGAZINES CONCERNING HORSES AND HORSEMANSHIP (U.S. CLS. 2, 5, 22, 23, 29, 37, 38 AND 50).

FIRST USE 9-1-2002; IN COMMERCE 9-1-2002.

CLASS 18—LEATHER GOODS

FOR LUGGAGE, NAMELY, WAIST PACKS AND BRIEF CASES (U.S. CLS. 1, 2, 3, 22 AND 41). FIRST USE 9-1-2002; IN COMMERCE 9-1-2002.

CLASS 21—HOUSEWARES AND GLASS

FOR MUGS (U.S. CLS. 2, 13, 23, 29, 30, 33, 40 AND 50). FIRST USE 9-1-2002; IN COMMERCE 9-1-2002.

CLASS 25—CLOTHING

FOR CLOTHING, NAMELY, HATS, SHIRTS, SWEATSHIRTS (U.S. CLS. 22 AND 39). FIRST USE 9-1-2002; IN COMMERCE 9-1-2002.

SN 76-474,490. BOARD OF GOVERNORS OF THE COLORADO STATE UNIVERSITY SYSTEM, BY AND THROUGH COLORADO STATE UNIVERSITY, THE, FORT COLLINS, CO. FILED 12-11-2002.



NO CLAIM IS MADE TO THE EXCLUSIVE RIGHT TO USE "COCINA SALUDABLE" AND "THE HEALTHY KITCHEN", APART FROM THE MARK AS SHOWN.
THE ENGLISH TRANSLATION OF "COCINA SALUDABLE" IS "HEALTHY KITCHEN".

CLASS 9—ELECTRICAL AND SCIENTIFIC APPARATUS

FOR COMPUTER SOFTWARE PROVIDING EDUCATION IN THE FIELD OF NUTRITION, HEALTH, FOOD SAFETY, FOOD SPENDING AND MENU PLANNING (U.S. CLS. 21, 23, 26, 36 AND 38).
FIRST USE 0-0-1995; IN COMMERCE 0-0-1996.

CLASS 16—PAPER GOODS AND PRINTED MATTER

FOR FLIP CHARTS, MANUALS, POSTERS, AND BROCHURES IN THE FIELD OF NUTRITION, HEALTH, FOOD SAFETY, FOOD SPENDING AND MENU PLANNING (U.S. CLS. 2, 5, 22, 23, 29, 37, 38 AND 50).
FIRST USE 0-0-1994; IN COMMERCE 0-0-1994.

SN 76-474,545. WORLD THREADS, INC., MIAMI, FL. FILED 12-6-2002.

EBERJEY

CLASS 25—CLOTHING

FOR WOMEN'S CLOTHING, NAMELY LINGERIE; UNDERWEAR; SLEEPWEAR; SPORTSWEAR, NAMELY SHORTS, PANTS, T-SHIRTS AND SWEAT SUITS; MATERNITY APPAREL, NAMELY SLEEPWEAR, LOUNGEWEAR, UNDERWEAR, LINGERIE, T-SHIRTS AND PANTS; AND SWIMWEAR (U.S. CLS. 22 AND 39).
FIRST USE 1-1-1997; IN COMMERCE 1-1-1997.

CLASS 35—ADVERTISING AND BUSINESS

FOR RETAIL STORES FEATURING WOMEN'S CLOTHING, NAMELY LINGERIE; UNDERWEAR; SLEEPWEAR; SPORTSWEAR, NAMELY SHORTS, PANTS, T-SHIRTS AND SWEAT SUITS; MATERNITY APPAREL, NAMELY SLEEPWEAR, LOUNGEWEAR, UNDERWEAR, LINGERIE, T-SHIRTS AND PANTS; AND SWIMWEAR (U.S. CLS. 100, 101 AND 102).
FIRST USE 1-1-1997; IN COMMERCE 1-1-1997.

SN 76-475,943. NATIONAL RAILROAD PASSENGER CORPORATION, WASHINGTON, DC. FILED 12-17-2002.



OWNER OF U.S. REG. NOS. 2,033,491, 2,523,279 AND OTHERS.

CLASS 16—PAPER GOODS AND PRINTED MATTER

FOR PAPERWEIGHTS; PENS; PEN HOLDERS; STATIONERY-TYPE PORTFOLIOS; PERSONAL ORGANIZERS; PASSPORT HOLDERS; PENCILS; LETTER OPENERS; CALENDARS; AND CHILDREN'S ARTS AND CRAFTS DRAWING KITS COMPRISED OF STENCILS, CRAYONS, PENCILS, PENCIL SHARPENERS, MEMO PADS AND ACTIVITY BOOKS ALL SOLD TOGETHER IN AN ACCOMPANYING CARRYING CASE (U.S. CLS. 2, 5, 22, 23, 29, 37, 38 AND 50).
FIRST USE 11-0-2001; IN COMMERCE 11-0-2001.

CLASS 20—FURNITURE AND ARTICLES NOT OTHERWISE CLASSIFIED

FOR NON-METAL TRAIN TICKET HOLDERS (U.S. CLS. 2, 13, 22, 25, 32 AND 50).
FIRST USE 11-0-2001; IN COMMERCE 11-0-2001.

SN 76-475,948. NATIONAL RAILROAD PASSENGER CORPORATION, WASHINGTON, DC. FILED 12-17-2002.



OWNER OF U.S. REG. NOS. 2,033,491, 2,523,279 AND OTHERS.

CLASS 16—PAPER GOODS AND PRINTED MATTER

FOR PAPERWEIGHTS; PENS; PEN HOLDERS; STATIONERY-TYPE PORTFOLIOS; PERSONAL ORGANIZERS; PASSPORT HOLDERS; PENCILS; LETTER OPENERS; CALENDARS; AND CHILDREN'S ARTS AND CRAFTS DRAWING KITS COMPRISED OF STENCILS, CRAYONS, PENCILS, PENCIL SHARPENERS, MEMO PADS AND ACTIVITY BOOKS ALL SOLD TOGETHER IN AN ACCOMPANYING CARRYING CASE (U.S. CLS. 2, 5, 22, 23, 29, 37, 38 AND 50).
FIRST USE 11-0-2001; IN COMMERCE 11-0-2001.

CLASS 20—FURNITURE AND ARTICLES NOT OTHERWISE CLASSIFIED

FOR NON-METAL TRAIN TICKET HOLDERS (U.S. CLS. 2, 13, 22, 25, 32 AND 50).
FIRST USE 11-0-2001; IN COMMERCE 11-0-2001.

SN 76-476,418. PEARSON EDUCATION, INC., UPPER SADDLE RIVER, NJ. FILED 12-17-2002.

WHERE SCIENCE COMES TO LIFE**CLASS 38—COMMUNICATION**

FOR PROVIDING ON-LINE CHAT ROOMS AND ELECTRONIC BULLETIN BOARDS VIA THE INTERNET FOR REAL TIME INTERACTION BETWEEN AND TRANSMISSION OF MESSAGES AMONG COMPUTER USERS CONCERNING EDUCATIONAL COURSE MANAGEMENT, NAMELY, TEXTBOOKS, GRADEBOOKS, HOMEWORK ASSIGNMENTS, BULLETIN BOARD QUESTIONS, TESTS AND QUIZZES IN THE HIGHER EDUCATION MARKET (U.S. CLS. 100, 101 AND 104).

CLASS 41—EDUCATION AND ENTERTAINMENT

FOR EDUCATIONAL SERVICES, NAMELY, PROVIDING A COURSE MANAGEMENT DATABASE ACCESSED VIA THE INTERNET THAT PROVIDES EDUCATIONAL TOOLS, EDUCATIONAL CONTENT AND MATERIALS, NAMELY, TEXTBOOKS, GRADEBOOKS, LECTURE NOTES, HOMEWORK ASSIGNMENTS, TESTS AND QUIZZES FOR TEACHERS TO USE IN COMBINATION WITH THEIR OWN MATERIALS TO CREATE, MANAGE AND DISSEMINATE CUSTOMIZED COURSES IN THE FIELD OF PSYCHOLOGY IN THE HIGHER EDUCATION MARKET (U.S. CLS. 100, 101 AND 107).

SN 76-476,835. FEDERAL EXPRESS CORPORATION, MEMPHIS, TN. FILED 12-16-2002.

RELAX. IT'S FEDEX.

OWNER OF U.S. REG. NOS. 971,028, 2,217,593 AND OTHERS.

CLASS 35—ADVERTISING AND BUSINESS

FOR COMPUTERIZED TRACKING AND TRACING OF DOCUMENTS, PACKAGES AND FREIGHT IN TRANSIT (U.S. CLS. 100, 101 AND 102).

CLASS 39—TRANSPORTATION AND STORAGE

FOR PICK-UP, STORAGE, TRANSPORTATION, AND DELIVERY OF DOCUMENTS, PACKAGES AND FREIGHT BY LAND OR AIR (U.S. CLS. 100 AND 105).

SN 76-478,044. WARWICK VALLEY TELEPHONE COMPANY, DBA WVT COMMUNICATIONS, WARWICK, NY. FILED 12-23-2002.

YOUR GUIDE FOR BETTER LIVING

NO CLAIM IS MADE TO THE EXCLUSIVE RIGHT TO USE "GUIDE", APART FROM THE MARK AS SHOWN.

CLASS 16—PAPER GOODS AND PRINTED MATTER

FOR TELEPHONE DIRECTORIES LISTING AND DESCRIBING GOODS AND SERVICES OFFERED PRIMARILY BY OTHER ORGANIZATIONS AND DIRECTED TO WOMEN (U.S. CLS. 2, 5, 22, 23, 29, 37, 38 AND 50).

CLASS 35—ADVERTISING AND BUSINESS

FOR ADVERTISING SERVICES, NAMELY PROVIDING ADVERTISING SPACE IN TELEPHONE DIRECTORIES DIRECTED TO WOMEN (U.S. CLS. 100, 101 AND 102).

CLASS 41—EDUCATION AND ENTERTAINMENT

FOR ONLINE TELEPHONE DIRECTORIES LISTING AND DESCRIBING GOODS AND SERVICES OFFERED PRIMARILY BY OTHER ORGANIZATIONS AND DIRECTED TO WOMEN (U.S. CLS. 100, 101 AND 107).

SN 76-478,811. CHANDARIA, SACHEN, NAIROBI, KENYA. FILED 12-27-2002.

MOVE-IT**CLASS 16—PAPER GOODS AND PRINTED MATTER**

FOR ADHESIVE TAPES FOR STATIONERY OR HOUSEHOLD PURPOSES (U.S. CLS. 2, 5, 22, 23, 29, 37, 38 AND 50).

CLASS 17—RUBBER GOODS

FOR ADHESIVE TAPE FOR INDUSTRIAL OR COMMERCIAL PACKING USE (U.S. CLS. 1, 5, 12, 13, 35 AND 50).

SN 76-479,198. RIZO-LOPEZ FOODS, INC., RIVERBANK, CA. FILED 12-30-2002.



THE MARK CONSISTS OF A BOLD CAPITAL LETTER "R" WITH A BOLD CAPITAL LETTER "L". INSIDE THE LETTER "R" IS A PICTURE OF A COW'S HEAD.

CLASS 29—MEATS AND PROCESSED FOODS

FOR DAIRY PRODUCTS EXCLUDING ICE CREAM, ICE MILK AND FROZEN YOGURT; DRIED BEANS; MEATS, NAMELY SAUSAGE (U.S. CL. 46).
FIRST USE 1-1-2002; IN COMMERCE 1-1-2002.

CLASS 30—STAPLE FOODS

FOR DAIRY PRODUCTS, NAMELY ICE CREAM, ICE MILK AND FROZEN YOGURT (U.S. CL. 46).
FIRST USE 1-1-2002; IN COMMERCE 1-1-2002.

SN 76-479,322. SOBOL FASHION PRODUCTIONS, INC., PLANTATION, FL. FILED 12-31-2002.

CITYSTYLE

NO CLAIM IS MADE TO THE EXCLUSIVE RIGHT TO USE "CITY" OR "STYLE", APART FROM THE MARK AS SHOWN.

CLASS 35—ADVERTISING AND BUSINESS

FOR ARRANGING AND CONDUCTING TRADE SHOWS IN THE FIELD OF FASHION (U.S. CLS. 100, 101 AND 102).
FIRST USE 12-27-2002; IN COMMERCE 12-27-2002.

CLASS 41—EDUCATION AND ENTERTAINMENT

FOR FASHION SHOWS (U.S. CLS. 100, 101 AND 107).
FIRST USE 12-27-2002; IN COMMERCE 12-27-2002.

SN 76-480,036. ADALIS CORPORATION, VANCOUVER, WA. FILED 1-3-2003.

ADALIS**CLASS 35—ADVERTISING AND BUSINESS**

FOR DEVELOPING PROMOTIONAL CAMPAIGNS FOR BUSINESS (U.S. CLS. 100, 101 AND 102).
FIRST USE 6-30-2002; IN COMMERCE 7-31-2002.

CLASS 40—MATERIAL TREATMENT

FOR CUSTOMIZED PRINTING OF COMPANY NAMES, LOGOS AND MESSAGES FOR PROMOTIONAL AND ADVERTISING PURPOSES ON THE GOODS OF OTHERS (U.S. CLS. 100, 103 AND 106).
FIRST USE 6-30-2002; IN COMMERCE 7-31-2002.

SN 76-480,056. THE ORANGE BOWL COMMITTEE, INC., MIAMI, FL. FILED 1-2-2003.

THE PATCH**CLASS 16—PAPER GOODS AND PRINTED MATTER**

FOR PRINTED MATERIAL, NAMELY NEWSLETTERS ON THE GAME OF FOOTBALL (U.S. CLS. 2, 5, 22, 23, 29, 37, 38 AND 50).

CLASS 41—EDUCATION AND ENTERTAINMENT

FOR ENTERTAINMENT SERVICES; NAMELY, ORGANIZING AND CONDUCTING PARTIES AND SPECIAL EVENTS (U.S. CLS. 100, 101 AND 107).

SN 76-480,637. FRICKER'S PROGRESSIVE CONCEPTS, INC., WEST CARROLLTON, OH. FILED 1-7-2003.

NAKEDLY**CLASS 29—MEATS AND PROCESSED FOODS**

FOR CHICKEN WINGS, ENTREES, SIDE DISHES AND APPETIZERS CONSISTING PRIMARILY OF CHICKEN FOR CONSUMPTION ON AND OFF THE PREMISES; CHICKEN SALADS FOR CONSUMPTION ON AND OFF THE PREMISES (U.S. CL. 46).

CLASS 30—STAPLE FOODS

FOR SAUCES AND CHICKEN SANDWICHES FOR CONSUMPTION ON AND OFF THE PREMISES (U.S. CL. 46).

CLASS 43—HOTEL AND RESTAURANT SERVICES

FOR RESTAURANT SERVICES (U.S. CLS. 100 AND 101).

SN 76-480,773. YMC CO., LTD, SHIMOGYO-KU, KYOTO, 600-8106, JAPAN, FILED 12-31-2002.

PRO C18 RS

NO CLAIM IS MADE TO THE EXCLUSIVE RIGHT TO USE "C18", APART FROM THE MARK AS SHOWN.

CLASS 1—CHEMICALS

FOR CHEMICALS, NAMELY, PACKING FOR CHROMATOGRAPHY COLUMNS (U.S. CLS. 1, 5, 6, 10, 26 AND 46).
FIRST USE 8-21-2002; IN COMMERCE 8-21-2002.

CLASS 9—ELECTRICAL AND SCIENTIFIC APPARATUS

FOR CHROMATOGRAPHY COLUMNS (U.S. CLS. 21, 23, 26, 36 AND 38).
FIRST USE 8-21-2002; IN COMMERCE 8-21-2002.

SN 76-481,017. AMERICAN ASSOCIATION FOR THE STUDY OF LIVER DISEASES, ALEXANDRIA, VA. FILED 1-8-2003.

AMERICAN ASSOCIATION FOR THE STUDY OF LIVER DISEASES

SEC. 2(F).

CLASS 16—PAPER GOODS AND PRINTED MATTER

FOR PUBLICATIONS, NAMELY, NEWSLETTERS, MAGAZINES AND JOURNALS IN THE FIELD OF HEPATOLOGY (U.S. CLS. 2, 5, 22, 23, 29, 37, 38 AND 50).
FIRST USE 3-0-1950; IN COMMERCE 3-0-1950.

CLASS 35—ADVERTISING AND BUSINESS

FOR ASSOCIATION SERVICES, NAMELY, PROMOTING EDUCATIONAL AND SCIENTIFIC NEEDS OF PHYSICIANS, RESEARCHERS, AND SCIENTISTS IN THE FIELD OF HEPATOLOGY; ORGANIZING, PLANNING AND CONDUCTING BUSINESS EVENTS; NAMELY, CONVENTIONS, ANNUAL MEETING, TRADE SHOWS, EXHIBITIONS AND CONFERENCES IN THE FIELD OF HEPATOLOGY (U.S. CLS. 100, 101 AND 102).
FIRST USE 3-0-1950; IN COMMERCE 3-0-1950.

CLASS 41—EDUCATION AND ENTERTAINMENT

FOR EDUCATIONAL SERVICES, NAMELY, SPONSORING, ARRANGING, PLANNING, CONDUCTING MEDICAL EDUCATIONAL CONFERENCES, COURSES, SEMINARS, AND WORKSHOPS IN THE FIELDS OF HEPATOLOGY AND HEPATOLOGY PRACTICE GUIDELINES; PROVIDING ONLINE PUBLICATIONS, NAMELY, NEWSLETTERS, MAGAZINES AND JOURNALS IN THE FIELD OF HEPATOLOGY (U.S. CLS. 100, 101 AND 107).
FIRST USE 3-0-1950; IN COMMERCE 3-0-1950.

SN 76-481,091. PIG IMPROVEMENT COMPANY UK LIMITED, OXFORDSHIRE OX13 5NA, ENGLAND, FILED 1-8-2003.

CAMBOROUGH

OWNER OF ERPN CMNTY TM OFC REG. NO. 190843, DATED 11-17-1998, EXPIRES 4-1-2006.
OWNER OF U.S. REG. NOS. 950,573, 2,023,255 AND 2,024,011.

CLASS 5—PHARMACEUTICALS

FOR ANIMAL SEMEN (U.S. CLS. 6, 18, 44, 46, 51 AND 52).

CLASS 29—MEATS AND PROCESSED FOODS

FOR MEAT AND MEAT EXTRACTS; FISH, POULTRY AND GAME, NONE BEING LIVE (U.S. CL. 46).

SN 76-481,838. SAMMY'S MANAGEMENT CO., INC., PENSACOLA, FL. FILED 1-10-2003.

SAMMY'S**CLASS 41—EDUCATION AND ENTERTAINMENT**

FOR ADULT ENTERTAINMENT NIGHT CLUB SERVICES (U.S. CLS. 100, 101 AND 107).
FIRST USE 0-0-1974; IN COMMERCE 0-0-1974.

CLASS 43—HOTEL AND RESTAURANT SERVICES

FOR BAR SERVICES (U.S. CLS. 100 AND 101).
FIRST USE 0-0-1974; IN COMMERCE 0-0-1974.

SN 76-481,858. MOOBELLA, LLC, TAUNTON, MA. FILED 1-13-2003.

QUICK. FRESH. NOW! WOW!**CLASS 11—ENVIRONMENTAL CONTROL APPARATUS**

FOR MACHINE THAT MAKES AND DISPENSES DAIRY AND NON-DAIRY FROZEN CONFECTIONS (U.S. CLS. 13, 21, 23, 31 AND 34).

CLASS 30—STAPLE FOODS

FOR LIQUID MIX USED TO MAKE DAIRY AND NON-DAIRY FROZEN CONFECTIONS; DAIRY AND NON-DAIRY FROZEN CONFECTIONS (U.S. CL. 46).

SN 76-481,864. COOGI PARTNERS, LLC, LAKE SUCCESS, NY. FILED 1-13-2003.

COOGI

OWNER OF U.S. REG. NOS. 1,499,662 AND 1,946,161.

CLASS 12—VEHICLES

FOR AUTOMOTIVE ACCESSORIES, NAMELY, WHEELS, SHIFT KNOBS, FITTED AND SEMI-FITTED CAR COVERS AND CAR BRAS, PEDAL PADS AND TIRE COVERS (U.S. CLS. 19, 21, 23, 31, 35 AND 44).

CLASS 24—FABRICS

FOR TEXTILE ARTICLES NOT INCLUDED IN OTHER CLASSES, NAMELY, PILLOW CASES, PILLOW SHAMS, TOWELS, BED SHEETS, BED SKIRTS, COMFORTERS, SHOWER CURTAINS, BED SPREADS, WASHCLOTHS, DUST RUFFLES, WINDOW CURTAINS, DRAPERIES AND BED BLANKETS (U.S. CLS. 42 AND 50).

CLASS 27—FLOOR COVERINGS

FOR VEHICLE FLOOR MATS (U.S. CLS. 19, 20, 37, 42 AND 50).

SN 76-482,142. AMERICAN SAW & MFG. COMPANY, INC., EAST LONGMEADOW, MA. FILED 1-13-2003.

LENOX LIGHTNING**CLASS 7—MACHINERY**

FOR POWER SAW BLADES (U.S. CLS. 13, 19, 21, 23, 31, 34 AND 35).

CLASS 8—HAND TOOLS

FOR HAND TOOLS, NAMELY SAWS (U.S. CLS. 23, 28 AND 44).

SN 76-483,253. Q-BIKE LIGHT BICYCLE CO., LTD., YUNG HE CITY, TAIPEI HSIEN, TAIWAN, FILED 1-17-2003.



SN 76-482,407. GREEN CANYON CORPORATION, WILMINGTON, DE. FILED 1-13-2003.

CDI RPM

OWNER OF U.S. REG. NOS. 1,052,098, 2,287,862 AND OTHERS.

CLASS 35—ADVERTISING AND BUSINESS

FOR DATA PROCESSING SERVICES, EMPLOYMENT AGENCY SERVICES, LONG TERM AND SHORT TERM PLACEMENT OF CONSULTANTS, MANAGEMENT, MARKETING, PROFESSIONAL, LEGAL, ACCOUNTING, FINANCIAL, ADMINISTRATIVE, SALES, OFFICE AND CLERICAL PERSONNEL, TECHNICAL, ELECTRONIC DATA PROCESSING SUPPORT, PROGRAMMERS AND OTHER COMPUTER PERSONNEL, ENGINEERING AND INDUSTRIAL PERSONNEL AND THE MANAGEMENT OF SUCH PLACEMENTS FOR OTHERS (U.S. CLS. 100, 101 AND 102).

CLASS 37—CONSTRUCTION AND REPAIR

FOR SHORT TERM COMPUTER HARDWARE MAINTENANCE (U.S. CLS. 100, 103 AND 106).

CLASS 42—SCIENTIFIC, COMPUTER AND LEGAL SERVICES

FOR SHORT TERM COMPUTER SOFTWARE MAINTENANCE, TECHNICAL CONSULTING AND SUPPORT SERVICES IN THE FIELDS OF DATA PROCESSING, SOFTWARE ENGINEERING, SOFTWARE DESIGN, HARDWARE ENGINEERING, HARDWARE DESIGN AND COMPUTER PROGRAMMING, COMPUTER SOFTWARE DESIGN FOR OTHERS, COMPUTER AIDED DESIGN (CAD), NAMELY, PROVIDING DESIGN, DRAFTING, AND LEGACY CONVERSION SERVICES, ENGINEERING, DRAFTING AND DESIGN SERVICE FOR OTHERS IN THE FIELDS OF ELECTRONICS, CHEMICALS, AUTOMOBILES, PETROLEUM, PHARMACEUTICALS, AIRCRAFT, NAVAL ENGINEERING AND DESIGN, AND POWER PLANTS (U.S. CLS. 100 AND 101).

CLASS 12—VEHICLES

FOR BICYCLES; BICYCLE BELLS; BICYCLE SADDLES; BICYCLE STANDS; BICYCLE PUMPS; RIMS FOR BICYCLE WHEELS; BICYCLE PARTS, NAMELY, PEDALS, BRAKES, CHAINS, HANDLE BARS, FORKS AND CHANGE-SPEED GEARS; VELOCIPEDES; TRICYCLES; RACKS AND PARTS THEREOF FOR BICYCLES FOR CARRYING LUGGAGE (U.S. CLS. 19, 21, 23, 31, 35 AND 44).

FIRST USE 9-1-2002; IN COMMERCE 9-1-2002.

CLASS 25—CLOTHING

FOR CLOTHING, NAMELY T-SHIRTS, SHIRTS, JERSEYS, JACKETS, PANTS, SHOES, SOCKS, HATS, GLOVES AND SCARFS (U.S. CLS. 22 AND 39).

FIRST USE 9-1-2002; IN COMMERCE 9-1-2002.

SN 76-483,259. FLOWERS, INC., BOGART, GA. FILED 1-17-2003.

CLASS 28—TOYS AND SPORTING GOODS

FOR LATEX BALLOONS (U.S. CLS. 22, 23, 38 AND 50).
FIRST USE 8-1-2002; IN COMMERCE 9-3-2002.

CLASS 35—ADVERTISING AND BUSINESS

FOR DISTRIBUTORSHIP SERVICES IN THE FIELD OF BALLOONS AND BALLOON ACCESSORIES, GIFTS AND GIFT ACCESSORIES, AND FLORAL SUPPLIES, INCLUDING BALLOONS, PLUSH TOY ANIMALS, MUGS, GIFTS, GIFT PACKAGING AND RELATED GIFT ACCESSORIES (U.S. CLS. 100, 101 AND 102).
FIRST USE 6-17-2002; IN COMMERCE 6-17-2002.

SN 76-483,407. APPLETON INTERNATIONAL, INC., APPLETON, WI. FILED 1-21-2003.

APPLECARE

CLASS 35—ADVERTISING AND BUSINESS

FOR CUSTOMER SERVICE IN THE FIELD OF PAPER MANUFACTURING MACHINERY (U.S. CLS. 100, 101 AND 102).

FIRST USE 11-2-2002; IN COMMERCE 11-2-2002.

CLASS 42—SCIENTIFIC, COMPUTER AND LEGAL SERVICES

FOR TECHNICAL CONSULTATION SERVICES IN THE FIELD OF PAPER MANUFACTURING MACHINERY (U.S. CLS. 100 AND 101).

FIRST USE 11-2-2002; IN COMMERCE 11-2-2002.

SN 76-483,882. TRILEGIANT CORPORATION., NORWALK, CT. FILED 1-17-2003.

EVENT PRIVILEGES

NO CLAIM IS MADE TO THE EXCLUSIVE RIGHT TO USE "EVENT", APART FROM THE MARK AS SHOWN.

CLASS 35—ADVERTISING AND BUSINESS

FOR CONSUMER MEMBERSHIP PROGRAM ENTITLING THE PARTICIPANTS TO RECEIVE DISCOUNTS, SAVINGS AND SPECIAL DEALS ON SPORTING EVENTS AND SHOWS, CONCERTS AND OTHER LIVE ENTERTAINMENT EVENTS; PROMOTING THE SALE OF THE GOODS AND SERVICES OF OTHERS BY CONDUCTING CONTESTS AND DRAWINGS IN CONNECTION WITH OBTAINING TICKETS TO SPORTING EVENTS AND SHOWS, CONCERTS AND OTHER LIVE ENTERTAINMENT EVENTS; PROMOTING THE SALE OF THE GOODS AND SERVICES OF OTHERS BY ARRANGING MEETINGS BETWEEN CONSUMER MEMBERSHIP PROGRAM PARTICIPANTS AND MEMBERS OF MUSICAL GROUPS AND OTHER ENTERTAINERS AND CELEBRITIES; AND PROVIDING ALL OF THE FOREGOING SERVICES ELECTRONICALLY BY MEANS OF THE INTERNET (U.S. CLS. 100, 101 AND 102).

CLASS 41—EDUCATION AND ENTERTAINMENT

FOR TICKET RESERVATION SERVICES FOR SPORTING EVENTS AND SHOWS, CONCERTS AND OTHER LIVE ENTERTAINMENT EVENTS AND PROVIDING TICKETS IN CONNECTION THEREWITH; CONDUCTING CONTESTS AND DRAWINGS FOR ENTERTAINMENT PURPOSES IN CONNECTION WITH OBTAINING TICKETS TO THE FOREGOING EVENTS; ENTERTAINMENT SERVICES, NAMELY, ARRANGING MEETINGS FOR ENTERTAINMENT PURPOSES BETWEEN CLUB MEMBERS AND MEMBERS OF MUSICAL GROUPS AND OTHER ENTERTAINERS AND CELEBRITIES; AND PROVIDING ALL OF THE FOREGOING SERVICES ELECTRONICALLY BY MEANS OF THE INTERNET (U.S. CLS. 100, 101 AND 107).

SN 76-483,949. CENEX HARVEST STATES COOPERATIVES, INVER GROVE HEIGHTS, MN. FILED 1-17-2003.

OUR ENERGY COMES THROUGH.

CLASS 4—LUBRICANTS AND FUELS

FOR MOTOR FUELS, LUBRICATING OILS AND GREASES FOR VEHICLES AND MACHINES AND PROPANE AND HEATING FUELS FOR INDUSTRIAL, RECREATIONAL, AGRICULTURAL, RESIDENTIAL AND TRANSPORTATION USE (U.S. CLS. 1, 6 AND 15).

FIRST USE 12-0-2001; IN COMMERCE 12-0-2001.

CLASS 25—CLOTHING

FOR CLOTHING AND SPECIALTY ITEMS - NAMELY, CAPS, SWEATERS, SHIRTS AND JACKETS (U.S. CLS. 22 AND 39).

FIRST USE 12-0-2001; IN COMMERCE 12-0-2001.

CLASS 35—ADVERTISING AND BUSINESS

FOR RETAIL CONVENIENCE STORE SERVICES (U.S. CLS. 100, 101 AND 102).

FIRST USE 12-0-2001; IN COMMERCE 12-0-2001.

CLASS 37—CONSTRUCTION AND REPAIR

FOR GASOLINE STATION SERVICES (U.S. CLS. 100, 103 AND 106).

FIRST USE 12-0-2001; IN COMMERCE 12-0-2001.

SN 76-484,848. CONMAT GROUP, INC., HARRISONBURG, VA. FILED 1-27-2003.

CONROCK

CLASS 19—NON-METALLIC BUILDING MATERIALS

FOR PREMIXED CONCRETE AND SAND, GRAVEL AND CRUSHED AGGREGATE FOR CONSTRUCTION AND REPAIR (U.S. CLS. 1, 12, 33 AND 50).

CLASS 39—TRANSPORTATION AND STORAGE

FOR SERVICES RELATING TO THE DELIVERY BY TRUCK OF PREMIXED CONCRETE, SAND, GRAVEL, AND CRUSHED AGGREGATE FOR CONSTRUCTION AND REPAIR (U.S. CLS. 100 AND 105).

SN 76-484,863. COSRICH GROUP, INC., BLOOMFIELD, NJ. FILED 1-24-2003.

LITTLE MISTER

CLASS 3—COSMETICS AND CLEANING PREPARATIONS

FOR BOY'S GROOMING PRODUCTS, NAMELY, AFTER SHAVE COLOGNE AND SOAP (U.S. CLS. 1, 4, 6, 50, 51 AND 52).

CLASS 8—HAND TOOLS

FOR RAZORS (U.S. CLS. 23, 28 AND 44).

CLASS 21—HOUSEWARES AND GLASS

FOR SHAVING BRUSHES AND COMBS (U.S. CLS. 2, 13, 23, 29, 30, 33, 40 AND 50).

SN 76-485,384. WAL-MART STORES, INC., BENTONVILLE, AR. FILED 1-28-2003.

SECRET TREASURES**CLASS 20—FURNITURE AND ARTICLES NOT OTHERWISE CLASSIFIED**

FOR MIRRORS (U.S. CLS. 2, 13, 22, 25, 32 AND 50).

CLASS 21—HOUSEWARES AND GLASS

FOR BATH BRUSHES (U.S. CLS. 2, 13, 23, 29, 30, 33, 40 AND 50).

SN 76-485,767. SAMBA, LLC, NEW YORK, NY. FILED 1-22-2003.

FAVELA

THE ENGLISH TRANSLATION OF THE PORTUGUESE WORD "FAVELA" IS "SLUM".

CLASS 42—SCIENTIFIC, COMPUTER AND LEGAL SERVICES

FOR HOTEL SERVICES (U.S. CLS. 100 AND 101).

CLASS 43—HOTEL AND RESTAURANT SERVICES

FOR RESTAURANT SERVICES (U.S. CLS. 100 AND 101).

SN 76-485,833. PEM MANAGEMENT, INC., WILMINGTON, DE. FILED 1-29-2003.

**CLASS 6—METAL GOODS**

FOR FASTENERS, NAMELY METAL TUBULAR RIVETS WITH INTERNAL THREADS (U.S. CLS. 2, 12, 13, 14, 23, 25 AND 50).
FIRST USE 11-30-1983; IN COMMERCE 11-30-1983.

CLASS 7—MACHINERY

FOR POWERED HAND TOOLS FOR THE INSTALLATION OF FASTENERS, NAMELY METAL TUBULAR RIVETS WITH INTERNAL THREADS (U.S. CLS. 13, 19, 21, 23, 31, 34 AND 35).
FIRST USE 11-30-1983; IN COMMERCE 11-30-1983.

SN 76-486,065. GOOD DEED USA, INC., WINSTON-SALEM, NC. FILED 1-30-2003.

GOOD DEED HUMANITY**CLASS 29—MEATS AND PROCESSED FOODS**

FOR APPLE SAUCE, BACON, BACON FLAVORED BITS, BAKED BEANS, DRIED BEANS, BEEF, SOY-BASED BEVERAGES USED AS A MILK SUBSTITUTE, DAIRY-BASED FOOD BEVERAGES, VEGETABLE-BASED FOOD BEVERAGES, BOLOGNA, BOUILLON, SOUP BROTH, BUTTER, PEANUT BUTTER, FRUIT-BASED FILLINGS FOR CAKES AND PIES, CHEESE, CHEESE AND CRACKER COMBINATIONS, CHEESE SPREADS, MARASCHINO CHERRIES, CHICKEN, CHILI WITH BEANS, CHILI WITHOUT BEANS, FRUIT CHIPS, POTATO CHIPS, CHOCOLATE MILK, CHOWDER, COOKING OIL, SALAD OIL, VEGETABLE OIL, CORNED BEEF, CORNED BEEF HASH, COTTAGE CHEESE, CRANBERRY SAUCE, CREAM, WHIPPING CREAM, CREAM CHEESE, NON-DAIRY CREAMER, DAIRY-BASED DIPS, CANDIED NUTS, EGG SUBSTITUTES, EGGS, FROZEN, PREPARED AND PACKAGED ENTREES AND MEALS CONSISTING PRIMARILY OF MEAT, FISH, POULTRY OR VEGETABLES, FISH, FRENCH FRIED POTATOES, FRUIT PRESERVES, FRUIT TOPPINGS, FRUIT-BASED SNACK FOODS, CANNED FRUITS, DRIED FRUITS, FROZEN FRUITS, HAM, HAMBURGER MEAT, HOT DOG MEAT, JAMS, JELLIES, JERKY, LARD, LUNCHEON MEATS, MARGARINE, MEAT, MEAT-BASED SPREADS, MEAT SUBSTITUTES, MILK, NUTS, TOMATO PASTE, PICKLES, INSTANT POTATOES, PROCESSED POTATOES, PORK, POULTRY, RAISINS, SALAMI, SAUERKRAUT, SAUSAGES, SEAFOOD, SHORTENING, SOUPS, SOUP MIXES, SOUR CREAM, TOFU, TURKEY, FROZEN VEGETABLES, CANNED VEGETABLES, DAIRY-BASED WHIPPED TOPPING AND YOGURT (U.S. CL. 46).

CLASS 30—STAPLE FOODS

FOR BAGELS, BAKERY PRODUCTS, MIXES FOR MAKING BAKERY PRODUCTS, BAKING POWDER, BAKING SODA, BARBECUE SAUCE, BISCUITS, BREAD, BREAD STICKS, BREAKFAST CEREALS, BUBBLE GUM, BUNS, BURRITOS, CAKE DECORATIONS, CAKE MIXES, CAKES, CANDY, CANDY CAKE DECORATIONS, CANDY COATED POPCORN, CAPERS, CARAMEL POPCORN, CARAMELS, CATSUP, CEREAL BASED SNACK FOOD, READY-TO-EAT CEREAL DERIVED FOOD BARS, CHEESE FLAVORED PUFFED CORN SNACKS, CHEESE SAUCE, CHEWING GUM, DRIED CHILI PEPPERS, CHILI SAUCE, CHOCOLATE CHIPS, CORN CHIPS, TORTILLA CHIPS, CHOCOLATE, HOT CHOCOLATE, CHOCOLATE COVERED NUTS, CHOCOLATE POWDER, CHOCOLATE SYRUP, CHOCOLATE TOPPING, CHOCOLATE-BASED FILLINGS FOR CAKES AND PIES, CHOW MEIN NOODLES, COCOA, COCOA MIXES, COFFEE, COFFEE SUBSTITUTES, CONES FOR ICE CREAM, CONFECTIONERY CHIPS FOR BAKING, COOKIES, CORN DOGS, CORN MEAL, CORN SYRUP, COUSCOUS, CRACKER AND CHEESE COMBINATIONS, CRACKERS, CREPES, CUSTARD-BASED FILLINGS FOR CAKES AND PIES, CUSTARDS, DOUGH, DOUGHNUTS, DUMPLINGS, FROZEN, PREPARED AND PACKAGED ENTREES AND MEALS CONSISTING PRIMARILY OF PASTA OR RICE, FLAVORING SYRUP, FLOUR, FOOD ADDITIVES FOR NON-NUTRITIONAL PURPOSES FOR USE AS A FLAVORING, INGREDIENT OR FILLER, FROSTING MIXES, FROSTINGS, FROZEN CONFECTIONS, FROZEN CUSTARDS, FROZEN YOGURT, FRUIT ICE, FRUIT PIES, FLAVORED GELATINS, GLAZED POP-

CORN, PROCESSED GRAINS, GRANOLA, GRANOLA-BASED SNACK BARS, GRAVIES, GRAVY MIXES, HAM GLAZE, HERBAL TEA, PROCESSED HERBS, HONEY, HORSERADISH, HOT SAUCE, ICE, ICE CREAM, ICE CREAM SUBSTITUTE, SOY-BASED ICE CREAM SUBSTITUTE, ICE MILK, ICING, ICING MIXES, KETCHUP, LASAGNA, LICORICE, NON-MEDICATED LOZENGES, MACARONI, MACARONI AND CHEESE, MACARONI SALAD, MAPLE SYRUP, MARINADES, MARSHMALLOW TOPPING, MARSHMALLOWS, MAYONNAISE, MEAT PIES, MEAT TENDERIZERS, MILKSHAKES, BASES FOR MAKING MILKSHAKES, MINCEMEAT PIES, CANDY MINTS, MOLASSES, MUFFINS, MUSTARD, NATURAL SWEETENER, NOODLES, OATMEAL, PROCESSED OATS, ROLLED OATS, PANCAKE MIXES, PANCAKE SYRUP, PANCAKES, PASTA, PASTA SALAD, PASTA SHELLS, PASTRIES, PEANUT BUTTER CONFECTIONERY CHIPS, PICKLE RELISH, PIES, PIMIENTO USED AS A CONDIMENT, PIZZA, PIZZA CRUST, PIZZA DOUGH, PIZZA SAUCE, POPPED POPCORN, PROCESSED POPCORN, POT PIES, PRETZELS, PUDDINGS, QUICHE, RAVIOLI, RELISH, RICE, RICE-BASED SNACK FOODS, ROLLS, SALAD DRESSINGS, SALSA, SANDWICHES, SAUCES, SEASONED COATING FOR MEAT, FISH AND POULTRY, SEASONINGS, SHERBET, SNACK MIX CONSISTING PRIMARILY OF CRACKERS, PRETZELS, CANDIED NUTS AND/OR POPPED POPCORN, SORBET, SOY SAUCE, SPAGHETTI, SPAGHETTI AND MEATBALLS, SPAGHETTI SAUCE, SPICES, STUFFING MIXES CONTAINING BREAD, SUGAR, NATURAL SWEETENERS, TABLE SYRUP, TACO CHIPS, TACO SHELLS, TAPIOCA, TARTAR SAUCE, TEA, THICKENING AGENTS FOR USE IN COOKING, TOMATO SAUCE, TOPPING SYRUP, TORTILLA SHELLS, TORTILLAS, VANILLA, VINEGAR, WAFERS, WAFFLES, WHEAT-BASED SNACK FOODS AND YEAST, SALAD DRESSINGS, TOMATO SAUCE (U.S. CL. 46).

CLASS 32—LIGHT BEVERAGES

FOR ALE, BEER, SWEET CIDER, NON-ALCOHOLIC COCKTAIL MIXES, COLAS, FRUIT DRINKS, FRUIT FLAVORED SOFT DRINKS, FRUIT JUICE CONCENTRATES, FRUIT JUICES, FRUIT NECTARS, FRUIT PUNCH, FRUIT-BASED SOFT DRINKS FLAVORED WITH TEA, LEMONADE, SYRUP FOR MAKING LEMONADE, MALT LIQUOR, MINERAL WATER, NON-ALCOHOL MALT BEVERAGE, POWDERS, CONCENTRATES OR SYRUPS USED IN THE PREPARATION OF SOFT DRINKS, SELTZER WATER, SODA WATER, SOFT DRINKS, SPORTS DRINKS, SPRING WATER, VEGETABLE JUICE, DRINKING WATER AND SPRING WATER (U.S. CLS. 45, 46 AND 48).

SN 76-486,126. AUSTRALIAN WINE AND BRANDY CORPORATION, ADELAIDE, AUSTRALIA, FILED 1-27-2003.



THE MARK CONSISTS OF A PICTURE OF A KANGAROO IN THE CENTER OF A SUN, A LANDSCAPE, GRAPES, A WINE BOTTLE, A WINE GLASS AND CHEESE.

CLASS 35—ADVERTISING AND BUSINESS

FOR ASSOCIATION SERVICES, NAMELY, ADVERTISING AND PROMOTION OF AUSTRALIAN FOOD AND WINE; PROMOTING THE INTERESTS OF THE AUSTRALIAN WINE INDUSTRY AND MEMBER WINERIES; PROMOTING TOURISM IN AUSTRALIA RELATING TO THE WINE INDUSTRY (U.S. CLS. 100, 101 AND 102).

FIRST USE 1-0-2002; IN COMMERCE 1-0-2002.

CLASS 41—EDUCATION AND ENTERTAINMENT

FOR ORGANIZING AND CONDUCTING WINE AND FOOD TASTING EVENTS AND FESTIVALS; CONDUCTING EDUCATIONAL LECTURES AND CLASSES ON TOPICS RELATING TO AUSTRALIAN WINE AND THE AUSTRALIAN WINE MAKING INDUSTRY (U.S. CLS. 100, 101 AND 107).

FIRST USE 1-0-2002; IN COMMERCE 1-0-2002.

SN 76-486,127. AUSTRALIAN WINE AND BRANDY CORPORATION, ADELAIDE, AUSTRALIA, FILED 1-27-2003.

G'DAY IN A GLASS

CLASS 35—ADVERTISING AND BUSINESS

FOR ASSOCIATION SERVICES, NAMELY, ADVERTISING AND PROMOTION OF AUSTRALIAN FOOD AND WINE; PROMOTING THE INTERESTS OF THE AUSTRALIAN WINE INDUSTRY AND MEMBER WINERIES; PROMOTING TOURISM IN AUSTRALIA RELATING TO THE WINE INDUSTRY (U.S. CLS. 100, 101 AND 102).

FIRST USE 6-0-1998; IN COMMERCE 6-0-1998.

CLASS 41—EDUCATION AND ENTERTAINMENT

FOR ORGANIZING AND CONDUCTING WINE AND FOOD TASTING EVENTS AND FESTIVALS; CONDUCTING EDUCATIONAL LECTURES AND CLASSES ON TOPICS RELATING TO AUSTRALIAN WINE AND THE AUSTRALIAN WINE MAKING INDUSTRY (U.S. CLS. 100, 101 AND 107).

FIRST USE 6-0-1998; IN COMMERCE 6-0-1998.

SN 76-486,362. TRILEGIANT CORPORATION, NORWALK, CT. FILED 1-29-2003.

SN 76-486,753. METRO ONE TELECOMMUNICATIONS, INC., BEAVERTON, OR. FILED 2-3-2003.

EVENTPRIVILEGES.COM

CLASS 35—ADVERTISING AND BUSINESS

FOR CONSUMER MEMBERSHIP PROGRAM ENTITLING THE PARTICIPANTS TO RECEIVE DISCOUNTS, SAVINGS AND SPECIAL DEALS ON SPORTING EVENTS AND SHOWS, CONCERTS AND OTHER LIVE ENTERTAINMENT EVENTS; PROMOTING THE SALE OF THE GOODS AND SERVICES OF OTHERS BY CONDUCTING CONTESTS AND DRAWINGS IN CONNECTION WITH OBTAINING TICKETS TO SPORTING EVENTS AND SHOWS, CONCERTS AND OTHER LIVE ENTERTAINMENT EVENTS; PROMOTING THE SALE OF THE GOODS AND SERVICES OF OTHERS BY ARRANGING MEETINGS BETWEEN CONSUMER MEMBERSHIP PROGRAM PARTICIPANTS AND MEMBERS OF MUSICAL GROUPS AND OTHER ENTERTAINERS AND CELEBRITIES; AND PROVIDING ALL OF THE FOREGOING SERVICES ELECTRONICALLY BY MEANS OF THE INTERNET (U.S. CLS. 100, 101 AND 102).

CLASS 41—EDUCATION AND ENTERTAINMENT

FOR TICKET RESERVATION SERVICES FOR SPORTING EVENTS AND SHOWS, CONCERTS AND OTHER LIVE ENTERTAINMENT EVENTS AND PROVIDING TICKETS IN CONNECTION THEREWITH; CONDUCTING CONTESTS AND DRAWINGS FOR ENTERTAINMENT PURPOSES IN CONNECTION WITH OBTAINING TICKETS TO THE FOREGOING EVENTS; ENTERTAINMENT SERVICES, NAMELY, ARRANGING MEETINGS FOR ENTERTAINMENT PURPOSES BETWEEN CLUB MEMBERS AND MEMBERS OF MUSICAL GROUPS AND OTHER ENTERTAINERS AND CELEBRITIES; AND PROVIDING ALL OF THE FOREGOING SERVICES ELECTRONICALLY BY MEANS OF THE INTERNET (U.S. CLS. 100, 101 AND 107).

SN 76-486,481. PACIFIC COAST BUILDING PRODUCTS, INC., SACRAMENTO, CA. FILED 1-31-2003.

PNEUCRAFT

CLASS 6—METAL GOODS

FOR METAL FASTENERS, NAMELY, STAPLES FOR CONSTRUCTION OR INDUSTRIAL USE, NAILS, AND SCREWS (U.S. CLS. 2, 12, 13, 14, 23, 25 AND 50).

CLASS 7—MACHINERY

FOR POWER TOOLS, NAMELY, NAILERS, STAPLERS, AND SCREW GUNS (U.S. CLS. 13, 19, 21, 23, 31, 34 AND 35).

CLASS 8—HAND TOOLS

FOR MANUALLY OPERATED HAND TOOLS, NAMELY, HAMMER TACKERS (U.S. CLS. 23, 28 AND 44).



CLASS 41—EDUCATION AND ENTERTAINMENT

FOR ENTERTAINMENT INFORMATION SERVICES, NAMELY, PROVIDING INFORMATION ON NATIONAL, REGIONAL AND LOCAL SPORTING EVENTS, INCLUDING BASEBALL, BASKETBALL, FOOTBALL, HOCKEY, SOFTBALL, SOCCER, TENNIS, AND TRACK AND FIELD (U.S. CLS. 100, 101 AND 107).

FIRST USE 1-16-2003; IN COMMERCE 1-16-2003.

CLASS 42—SCIENTIFIC, COMPUTER AND LEGAL SERVICES

FOR CONDUCTING SEARCHES VIA A COMPUTER NETWORK IN ORDER TO FIND SPORTING EVENTS, INCLUDING BASEBALL, BASKETBALL, FOOTBALL, HOCKEY, SOFTBALL, SOCCER, TENNIS, AND TRACK AND FIELD, WHICH ARE WITHIN THE PARAMETERS OF USERS' SPECIFIED SEARCH CRITERIA AND REPORTING THE RESULTS OF THE SEARCHES TO USERS (U.S. CLS. 100 AND 101).

FIRST USE 1-16-2003; IN COMMERCE 1-16-2003.

SN 76-487,144. TIME4 MEDIA, INC., NEW YORK, NY. FILED 2-3-2003.



CLASS 38—COMMUNICATION

FOR RADIO AND TELEVISION BROADCASTING SERVICES (U.S. CLS. 100, 101 AND 104).

CLASS 41—EDUCATION AND ENTERTAINMENT

FOR RADIO AND TELEVISION PROGRAMS ON TOPICS OF HUNTING, FISHING, CAMPING AND OUTDOOR SPORTS; RADIO AND TELEVISION PROGRAMMING SERVICES; AND PROVIDING INFORMATION VIA THE INTERNET ON TOPICS OF HUNTING, FISHING, CAMPING AND OUTDOOR SPORTS (U.S. CLS. 100, 101 AND 107).

SN 76-487,323. BARBER, GARY C., NEWAYGO, MI. FILED 1-31-2003.

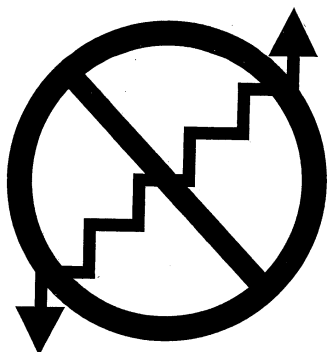

CLASS 20—FURNITURE AND ARTICLES NOT OTHERWISE CLASSIFIED

FOR PLASTIC KEY CHAINS, PLASTIC NOVELTY LICENSE PLATES (U.S. CLS. 2, 13, 22, 25, 32 AND 50).

CLASS 21—HOUSEWARES AND GLASS

FOR MUGS (U.S. CLS. 2, 13, 23, 29, 30, 33, 40 AND 50).

CLASS 25—CLOTHING

FOR CLOTHING, NAMELY HATS, CAPS, JACKETS, AND SHIRTS (U.S. CLS. 22 AND 39).

CLASS 28—TOYS AND SPORTING GOODS

FOR GOLF BALLS, FLYING DISKS (U.S. CLS. 22, 23, 38 AND 50).

SN 76-487,859. THE CONSOLIDATION GROUP, INC., LAKE MILLS, WI. FILED 2-6-2003.

BEANZ N' BONZ

CLASS 35—ADVERTISING AND BUSINESS

FOR FRANCHISING, NAMELY, OFFERING TECHNICAL ASSISTANCE IN THE ESTABLISHMENT AND/OR OPERATION OF RESTAURANTS (U.S. CLS. 100, 101 AND 102).

CLASS 43—HOTEL AND RESTAURANT SERVICES

FOR RESTAURANT SERVICES (U.S. CLS. 100 AND 101).

SN 76-492,418. METEORLOGIX, LLC, BURNSVILLE, MN. FILED 2-14-2003.

MXWEATHERSPAN X

CLASS 9—ELECTRICAL AND SCIENTIFIC APPARATUS

FOR COMPUTER HARDWARE AND COMPUTER SOFTWARE FOR DISPLAYING WEATHER INFORMATION (U.S. CLS. 21, 23, 26, 36 AND 38).

CLASS 42—SCIENTIFIC, COMPUTER AND LEGAL SERVICES

FOR WEATHER FORECASTING AND REPORTING SERVICES (U.S. CLS. 100 AND 101).

SN 76-494,695. MARY KAY INC., DALLAS, TX. FILED 2-21-2003.

PARTNERSHIPS OF THE HEART

CLASS 35—ADVERTISING AND BUSINESS

FOR PROMOTING THE GOODS AND SERVICES OF COMPANIES THAT MAKE CHARITABLE DONATIONS TO AN AFFILIATED FOUNDATION (U.S. CLS. 100, 101 AND 102).

FIRST USE 7-16-2001; IN COMMERCE 7-16-2001.

CLASS 36—INSURANCE AND FINANCIAL

FOR CHARITABLE FUNDRAISING SERVICES (U.S. CLS. 100, 101 AND 102).

FIRST USE 7-16-2001; IN COMMERCE 7-16-2001.

SN 76-498,089. MARKET AMERICA, INC., GREENSBORO, NC. FILED 2-13-2003.

OPC-3

CLASS 3—COSMETICS AND CLEANING PREPARATIONS

FOR SKIN CARE PRODUCTS, NAMELY FACIAL CREAMS AND LOTIONS (U.S. CLS. 1, 4, 6, 50, 51 AND 52).

CLASS 5—PHARMACEUTICALS

FOR PET FOOD SUPPLEMENTS (U.S. CLS. 6, 18, 44, 46, 51 AND 52).

SN 76-975,503. FGG SERVICE S.R.L., 20122 MILANO, ITALY, BY CHANGE OF NAME LANDSCAPE TRAVEL S.R.L., 20122 MILANO, ITALY, FILED 7-20-2001.

CAFÉ VOYAGE

NO CLAIM IS MADE TO THE EXCLUSIVE RIGHT TO USE "CAFE" IN CONNECTION WITH THE SERVICES LISTED IN INTERNATIONAL CLASS 42 ONLY, AND "VOYAGE" IN CONNECTION WITH THE SERVICES LISTED IN INTERNATIONAL CLASS 39 ONLY, APART FROM THE MARK AS SHOWN.

CLASS 36—INSURANCE AND FINANCIAL

FOR TRAVEL AGENCY SERVICES, NAMELY, ISSUING TRAVELER'S CHECKS (U.S. CLS. 100, 101 AND 102).

CLASS 38—COMMUNICATION

FOR COMMUNICATIONS SERVICES, NAMELY, TRANSMITTING STREAMED SOUND AND AUDIO-VISUAL RECORDING VIA THE INTERNET; ELECTRONIC TRANSMISSION OF MESSAGE AND DATA, TELECOMMUNICATION SERVICES, NAMELY, PROVIDING MULTIPLE USER ACCESS TO THE INTERNET (U.S. CLS. 100, 101 AND 104).

CLASS 39—TRANSPORTATION AND STORAGE

FOR ARRANGING FOR TRAVEL VISAS, PASSPORTS AND TRAVEL DOCUMENTS FOR PERSONS TRAVELING ABROAD; ARRANGING TRAVEL TOURS; ARRANGING TOURS AS A BONUS PROGRAM FOR CREDIT CARD CUSTOMERS; MAKING RESERVATIONS AND BOOKINGS FOR TRANSPORTATION; TRAVEL BOOKING AGENCIES; TRAVEL CLUBS; TRAVEL GUIDE SERVICES; TRAVEL INFORMATION SERVICES (U.S. CLS. 100 AND 105).

CLASS 42—SCIENTIFIC, COMPUTER AND LEGAL SERVICES

FOR RESTAURANT SERVICES, BAR SERVICES, SELF-SERVICE RESTAURANTS, HOTEL SERVICES; TRAVEL AGENCY SERVICES, NAMELY MAKING RESERVATIONS AND BOOKINGS FOR TEMPORARY LODGING (U.S. CLS. 100 AND 101).

SN 76-975,602. FATCHETT, BARRY KEITH, DBA MY PET, BARTLETT, TN. FILED 2-14-2002.



NO CLAIM IS MADE TO THE EXCLUSIVE RIGHT TO USE "PET", APART FROM THE MARK AS SHOWN.

CLASS 16—PAPER GOODS AND PRINTED MATTER

FOR STICKERS (U.S. CLS. 2, 5, 22, 23, 29, 37, 38 AND 50).

CLASS 25—CLOTHING

FOR SHIRTS (U.S. CLS. 22 AND 39).

SN 76-975,709. GIANT BRANDS, INC., WILMINGTON, DE. FILED 5-13-2002.

GIANT

OWNER OF U.S. REG. NO. 1,406,293 AND OTHERS.

CLASS 1—CHEMICALS

FOR ARTIFICIAL SWEETENER AND DISTILLED WATER (U.S. CLS. 1, 5, 6, 10, 26 AND 46).

CLASS 4—LUBRICANTS AND FUELS

FOR CHARCOAL BRIQUETTES, CHARCOAL LIGHTER FLUID, FIREWOOD, CANDLES, MINERAL OIL FOR USE AS A LUBRICANT AND MOTOR OIL (U.S. CLS. 1, 6 AND 15).

CLASS 5—PHARMACEUTICALS

FOR ALL-PURPOSE DISINFECTANTS, FEMININE HYGIENE PADS, ADULT DIAPERS, INCONTINENCE PADS, TAMPONS, LUBRICATING JELLY FOR PERSONAL USE, ANTISEPTIC CREAM, BANDAGE OR GAUZE PADS, CAR DEODORIZER, CARPET DEODORIZER, COLD, ALLERGY, FLU OR SINUS MEDICATIONS, DENTURE ADHESIVES, DIETARY SUPPLEMENTS, ENEMA PREPARATIONS, EPSOM SALTS, EYE DROPS, HEMORRHOID SUPPOSITORIES, HOUSEHOLD DEODORIZERS, HYDROGEN PEROXIDE FOR MEDICAL USE, INSECTICIDES FOR AGRICULTURAL AND DOMESTIC USE, LAXATIVES, LICE TREATMENT AND SHAMPOO, MEDICATED PADS, MUSCLE RUB, NASAL SPRAY, NUTRITIONAL DRINKS FOR USE AS A MEAL REPLACEMENT, PAIN RELIEF MEDICATIONS, PETROLEUM JELLY FOR MEDICAL USE, PREGNANCY TEST KITS FOR HOME USE, RUBBING ALCOHOL, STOOL SOFTENER MEDICATIONS, INCONTINENCE UNDERPADS AND INCONTINENCE GARMENTS, VITAMIN AND HERB SUPPLEMENTS FOR MEDICINAL PURPOSES, WITCH HAZEL (U.S. CLS. 6, 18, 44, 46, 51 AND 52).

CLASS 6—METAL GOODS

FOR ALUMINUM FOIL (U.S. CLS. 2, 12, 13, 14, 23, 25 AND 50).

CLASS 7—MACHINERY

FOR VACUUM CLEANER BAGS (U.S. CLS. 13, 19, 21, 23, 31, 34 AND 35).

CLASS 8—HAND TOOLS

FOR TABLEWARE, NAMELY, KNIVES, FORKS AND SPOONS OF PLASTIC, NON-ELECTRIC RAZORS AND RAZOR BLADES (U.S. CLS. 23, 28 AND 44).

CLASS 9—ELECTRICAL AND SCIENTIFIC APPARATUS

FOR CAMERAS AND THERMOMETERS FOR DOMESTIC USE (U.S. CLS. 21, 23, 26, 36 AND 38).

CLASS 11—ENVIRONMENTAL CONTROL APPARATUS

FOR ELECTRIC LIGHT BULBS (U.S. CLS. 13, 21, 23, 31 AND 34).

CLASS 13—FIREARMS

FOR FIRE STARTER (U.S. CLS. 2 AND 9).

CLASS 16—PAPER GOODS AND PRINTED MATTER

FOR PAPER NAPKINS, FACIAL TISSUE, BATHROOM TISSUE, PAPER TOWELS, PLASTIC FOOD STORAGE BAGS FOR HOUSEHOLD USE, PLASTIC TRASH BAGS, PAPER BAGS, PAPER COFFEE FILTERS, WAX PAPER, PLASTIC WRAP, DISPOSABLE DIAPERS, DISPOSABLE TRAINING PANTS, ALMANACS, ENVELOPES, GLUES FOR STATIONERY OR HOUSEHOLD USE, BOND PAPER, PAPER FREEZER WRAP, TRANSPARENT TAPE FOR HOUSEHOLD USE, TRANSPARENT TAPE FOR STATIONERY, UNRULED WRITING TABLETS (U.S. CLS. 2, 5, 22, 23, 29, 37, 38 AND 50).

CLASS 20—FURNITURE AND ARTICLES NOT OTHERWISE CLASSIFIED

FOR DRINKING STRAWS (U.S. CLS. 2, 13, 22, 25, 32 AND 50).

CLASS 21—HOUSEWARES AND GLASS

FOR SCOURING SPONGES, SPONGES FOR HOUSEHOLD PURPOSES, PLASTIC CUPS, PAPER CUPS, FOAM CUPS, PLASTIC PLATES, PAPER PLATES, FOAM PLATES, PLASTIC BOWLS, FOAM BOWLS, DENTAL FLOSS, HAIR COMBS, NON-ELECTRIC TOOTHBRUSHES, PLASTIC GLASSES, TUMBLERS AND MUGS, HOUSEHOLD WORK GLOVES FOR GENERAL USE (U.S. CLS. 2, 13, 23, 29, 30, 33, 40 AND 50).

CLASS 29—MEATS AND PROCESSED FOODS

FOR CHEESE, CHEESE SPREAD, CHEESE AND CRACKER COMBINATIONS, MILK, BUTTERMILK, CHOCOLATE MILK, SOY MILK, CREAM, HALF AND HALF, NON-DAIRY CREAMER, CREAM CHEESE, COTTAGE CHEESE, SOUR CREAM, YOGURT, WHIPPED TOPPING, BUTTER, BUTTER SUBSTITUTES, MARGARINE, EGG SUBSTITUTE, EGGNOG, EGGS, DAIRY-BASED DIPS, DIPS, SHELLED AND/OR ROASTED NUTS, CANNED FRUITS, DRIED FRUITS, FROZEN FRUITS, FRUIT SAUCES, FRUIT SNACKS, CANNED VEGETABLES, FROZEN VEGETABLES, DRIED VEGETABLES, FROZEN BERRIES, PROCESSED POTATOES, FRESH FISH, FROZEN FISH, CANNED FISH, PROCESSED CHICKEN, PICKLES, PROCESSED OLIVES, FROZEN ONION RINGS, PEANUT BUTTER, APPLE BUTTER, JAM, JELLY, FRUIT PRESERVES, FRUIT-BASED PIE FILLINGS, APPLESAUCE, CRANBERRY SAUCE, FLAKED COCONUT, DRIED BEANS, CANNED SOUPS, DRIED SOUP MIXES, VEGETABLE OILS FOR COOKING, FRANKS, LUNCHEON MEATS, FRESH AND PROCESSED SHRIMP AND SEAFOOD, VEGETABLE SALADS, GARDEN SALADS, POTATO SALADS, FRESH, CANNED, PROCESSED OR FROZEN MEATS, BACON, BACON-FLAVORED VEGETABLE PROTEIN BITS, AND FROZEN ENTREES CONSISTING OF MEAT, FISH, POULTRY AND VEGETABLES (U.S. CL. 46).

CLASS 30—STAPLE FOODS

FOR BREAD, BAGELS, PITA, FROZEN WAFFLES, FROZEN PANCAKES, FROZEN STRUDEL, ROLLS, FROZEN BREAD DOUGH, SOFT PRETZELS, FRESH OR FROZEN PIZZA, FROZEN ENTREES CONSISTING PRIMARILY OF PASTA, ICE CREAM, CONES FOR ICE CREAM, FROZEN CONFECTIONS, FROZEN YOGURT, ICE MILK, SHERBETS, PASTA, PREPARED PIE CRUST, REFRIGERATED DOUGH FOR BISCUITS, ROLLS, BREADSTICKS AND PIZZA CRUST, TORTILLAS, TACO SHELLS, REFRIGERATED COOKIE DOUGH, COOKIES, CANDIES, CRACKERS, CAKES, CHEESECAKES, CAKE MIXES, PIES, MARSHMALLOWS, HONEY, BREADCRUMBS, SEASONED COATINGS FOR MEAT, FISH AND POULTRY, CROUTONS, STUFFING MIXES CONTAINING BREAD, FLAVORED, SWEETENED GELATIN, PUDDING, PREPARED CAKE FROSTING AND FROSTING MIXES, CHOCOLATE CHIPS FOR BAKING, FLOUR, BAKING SODA, BAKING POWDER, CORN STARCH, SUGAR, BROWN SUGAR, SALT, PANCAKE SYRUP, PANCAKE MIXES, MIXES FOR MAKING BAKERY GOODS, SPICES, EXTRACTS USED FOR FLAVORING NOT OF ESSENTIAL OILS, COFFEE, TEA, COCOA, CHOCOLATE SYRUP, PROCESSED UNPOPPED POPCORN, GRAVY, KETCHUP, MUSTARD, PICKLE RELISH, PICANTE SAUCE, SOY SAUCE, HOT SAUCE, PIZZA SAUCE, TERIYAKI SAUCE, BARBECUE SAUCE, WORCESTERSHIRE SAUCE, COCKTAIL SAUCE, TARTAR SAUCE, SPAGHETTI SAUCE, TOMATO SAUCE, PASTA SAUCE, SALSA, MAYONNAISE, SALAD DRESSINGS, VINEGAR, BREAKFAST CEREAL, CEREAL-BASED SNACK BARS, WHEAT-BASED SNACK BARS, PROCESSED OATS AND OATMEAL, GRITS, BREAKFAST PASTRIES, RICE, RICE CAKES, PACKAGED MIXES CONSISTING PRIMARILY OF PASTA OR RICE, RICE SALADS, CANNED PREPARED FOODS CONSISTING PRIMARILY OF PASTA, BAGGED ICE, PASTA SALADS, DELI SANDWICHES, CORN-BASED SNACK FOODS (U.S. CL. 46).

CLASS 31—NATURAL AGRICULTURAL PRODUCTS

FOR CAT FOOD, CAT LITTER, DOG FOOD, DOG BISCUITS, EDIBLE DOG TREATS, BIRD SEED, UNPROCESSED POTATOES, AND FRESH TOMATOES (U.S. CLS. 1 AND 46).

CLASS 32—LIGHT BEVERAGES

FOR CARBONATED SOFT DRINKS, SPRING WATER, DRINKING WATER, FRUIT-FLAVORED WATER, SELTZER WATER, MINERAL WATER, TONIC WATER, FRUIT JUICES, FRUIT-FLAVORED DRINKS, CONCENTRATES, SYRUPS OR POWDERS USED IN THE PREPARATION OF SOFT DRINKS, SWEET CIDER, AND VEGETABLE JUICE BEVERAGES (U.S. CLS. 45, 46 AND 48).

CLASS 34—SMOKERS' ARTICLES

FOR MATCHES (U.S. CLS. 2, 8, 9 AND 17).

SN 78-016,981. AXYZ INTERNATIONAL INC., BURLINGTON, ONTARIO, CANADA, FILED 7-17-2000.

AXYZ

OWNER OF CANADA REG. NO. TMA571878, DATED 12-6-2002, EXPIRES 12-6-2017.

CLASS 7—MACHINERY

FOR COMPUTERIZED NUMERIC CONTROL (CNC) MACHINES, NAMELY, GANTRY STYLE ROBOTIC SYSTEMS COMPRISED OF BASES AND VACUUM CHAMBER BEDS, GANTRIES, SERVO DRIVES AND MOTORS, CARRIAGES, TOOL CHANGER CAROUSELS, TOOL HOLDERS, ROUTERS, LATHES, GRINDERS, MILLS, HORIZONTAL AND VERTICAL MACHINING CENTERS, PRESSES, DRILLS, TAPPING DRILLS, PLANERS, SANDERS, ENGRAVERS, SPINDLES, PLUNGE BITS, ROUTER BITS, VINYL KNIVES, PENS, AUTOMATIC STUD WELDERS, VACUUM SYSTEMS COMPRISED OF VACUUM PUMPS AND BLOWERS, BRUSHES AND SWarf COLLECTION TOOLS, LASER CUTTERS, PLASMA SYSTEMS COMPRISED OF PLASMA CUTTERS, MISTING UNITS COMPRISED OF MICRO DROP NOZZLES, PULSE GENERATORS, AND LIQUID METERING PUMPS, GEL DISPENSERS AND LUBRICATORS, ELECTRICAL PANELS AND SUB-CONSOLES, PROFILE DIGITIZERS, SURFACE SENSORS, PERSONAL COMPUTERS, MICROPROCESSORS, AND/OR COAXIAL AND SERIAL PORT CONNECTIONS, PROGRAMMABLE FOR MANIPULATING AND CONTROLLING MATERIAL HANDLING, PROCESSING AND INSPECTION TOOLS IN THREE DIMENSIONS, AND REPLACEMENT PARTS FOR SUCH MACHINES (U.S. CLS. 13, 19, 21, 23, 31, 34 AND 35).

FIRST USE 3-26-1990; IN COMMERCE 3-26-1990.

CLASS 9—ELECTRICAL AND SCIENTIFIC APPARATUS

FOR COMPUTER SOFTWARE FOR USE IN OPERATING COMPUTERIZED NUMERIC CONTROL (CNC) MACHINES, NAMELY, GANTRY STYLE ROBOTIC SYSTEMS COMPRISED OF BASES AND VACUUM CHAMBER BEDS, GANTRIES, SERVO DRIVES AND MOTORS, CARRIAGES, TOOL CHANGER CAROUSEL, STOOL HOLDERS, ROUTERS, LATHES, GRINDERS, MILLS, HORIZONTAL AND VERTICAL MACHINING CENTERS, PRESSES, DRILLS, TAPPING DRILLS, PLANERS, SANDERS, ENGRAVERS, SPINDLES, PLUNGE BITS, ROUTER BITS, VINYL KNIVES, PENS, AUTOMATIC STUD WELDERS, VACUUM SYSTEMS COMPRISED OF VACUUM PUMPS AND BLOWERS, BRUSHES AND SWarf COLLECTION TOOLS, LASER CUTTERS, PLASMA SYSTEMS COMPRISED OF PLASMA CUTTERS, MISTING UNITS COMPRISED OF MICRO DROP NOZZLES, PULSE GENERATORS, AND LIQUID METERING PUMPS, GEL DISPENSERS AND LUBRICATORS, ELECTRICAL PANELS AND SUB-CONSOLES, PROFILE DIGITIZERS, SURFACE SENSORS, PERSONAL COMPUTERS, MICROPROCESSORS, AND/OR COAXIAL AND SERIAL PORT CONNECTIONS, PROGRAMMABLE FOR MANIPULATING AND CONTROLLING MATERIAL HANDLING, PROCESSING AND INSPECTION TOOLS IN THREE DIMENSIONS (U.S. CLS. 21, 23, 26, 36 AND 38).

FIRST USE 3-26-1990; IN COMMERCE 3-26-1990.

CLASS 37—CONSTRUCTION AND REPAIR

FOR REPAIR, MAINTENANCE AND REBUILD SERVICES FOR COMPUTERIZED NUMERIC CONTROL (CNC) MACHINES, NAMELY, GANTRY STYLE ROBOTIC SYSTEMS COMPRISED OF BASES AND VACUUM CHAMBER BEDS, GANTRIES, SERVO DRIVES AND MOTORS, CARRIAGES, TOOL CHANGER CAROUSELS, TOOL HOLDERS, ROUTERS, LATHES, GRINDERS, MILLS, HORIZONTAL AND VERTICAL MACHINING CENTERS, PRESSES, DRILLS, TAPPING DRILLS, PLANERS, SANDERS, ENGRAVERS, SPINDLES, PLUNGE BITS, ROUTER BITS, VINYL KNIVES, PENS, AUTOMATIC STUD WELDERS, VACUUM SYSTEMS COMPRISED OF VACUUM PUMPS AND BLOWERS, BRUSHES AND SWarf COLLECTION TOOLS, LASER CUTTERS, PLASMA SYSTEMS COMPRISED OF PLASMA CUTTERS, MISTING UNITS COMPRISED OF MICRO DROP NOZZLES, PULSE GENERATORS, AND LIQUID METERING PUMPS, GEL DISPENSERS AND LUBRICATORS, ELECTRICAL PANELS AND SUB-CONSOLES, PROFILE DIGITIZERS, SURFACE SENSORS, PERSONAL COMPUTERS, MICROPROCESSORS, AND/OR COAXIAL AND SERIAL PORT CONNECTIONS, PROGRAMMABLE FOR MANIPULATING AND CONTROLLING MATERIAL HANDLING, PROCESSING AND INSPECTIONS TOOLS IN THREE DIMENSIONS (U.S. CLS. 100, 103 AND 106).

FIRST USE 3-26-1990; IN COMMERCE 3-26-1990.

SN 78-023,010. ROY, SPEED & ROSS LTD., BURLINGTON, ONTARIO, CANADA, FILED 8-25-2000.

REGISTRATION FEE PROGRAM

PRIORITY CLAIMED UNDER SEC. 44(D) ON CANADA APPLICATION NO. 1,049,343, FILED 3-6-2000, REG. NO. 558704, DATED 3-1-2002, EXPIRES 3-1-2017.

NO CLAIM IS MADE TO THE EXCLUSIVE RIGHT TO USE "PROGRAM", APART FROM THE MARK AS SHOWN.

CLASS 9—ELECTRICAL AND SCIENTIFIC APPARATUS

FOR VEHICLE TRACKING DEVICES, NAMELY, RADIO EMISSION TRANCEIVERS FOR LOCATION OF STOLEN VEHICLES (U.S. CLS. 21, 23, 26, 36 AND 38).

CLASS 12—VEHICLES

FOR ANTI-THEFT DEVICES, NAMELY, ANTI-THEFT LOCKS FOR USE ON THE STEERING WHEELS OF AUTOMOBILES, TRUCKS AND OTHER VEHICLES, AND STARTER DISABLERS FOR USE IN AUTOMOBILES, TRUCKS AND OTHER VEHICLES TO INTERRUPT THE FLOW OF ELECTRICITY THROUGH IGNITION CIRCUITRY IN ORDER TO PREVENT VEHICLE THEFT (U.S. CLS. 19, 21, 23, 31, 35 AND 44).

CLASS 36—INSURANCE AND FINANCIAL

FOR GAP, CREDIT AND PAYMENT PROTECTION INSURANCE, AND PROVIDING WARRANTIES, OTHERWISE THAN EXTENDED WARRANTIES, ON TIRES (U.S. CLS. 100, 101 AND 102).

SN 78-029,805. THE MUSOS LIMITED, MAIDSTONE, KENT ME14 1TG, UNITED KINGDOM, FILED 10-9-2000.



PRIORITY CLAIMED UNDER SEC. 44(D) ON UNITED KINGDOM APPLICATION NO. 2244438, FILED 9-4-2000, REG. NO. 2244438, DATED 2-9-2001, EXPIRES 9-4-2010.

CLASS 9—ELECTRICAL AND SCIENTIFIC APPARATUS

FOR VIDEO GAME MACHINES FOR USE WITH TELEVISIONS; COMPUTER MEMORIES; COMPUTER OPERATING PROGRAMS; COMPUTER PERIPHERAL DEVICES; COMPUTER PROGRAMS AND COMPUTER SOFTWARE, NAMELY COMMUNICATIONS SOFTWARE FOR CONNECTING COMPUTER NETWORK USERS, GLOBAL COMPUTER NETWORKS; COMPUTER COMMUNICATIONS SOFTWARE TO ALLOW CUSTOMERS TO ACCESS BANK ACCOUNT INFORMATION AND TRANSACT BANK BUSINESS; COMPUTER E-COMMERCE SOFTWARE TO ALLOW USERS TO PERFORM ELECTRONIC BUSINESS TRANSACTIONS VIA A GLOBAL COMPUTER NETWORK; COMPUTER GAME SOFTWARE; COMPUTER GRAPHICS SOFTWARE; COMPUTER SEARCH ENGINE SOFTWARE; COMPUTER SOFTWARE FOR USE IN DATABASE MANAGEMENT, FOR USE AS A SPREADSHEET, FOR WORD PROCESSING; COMPUTER SOFTWARE FOR ACCESSING INFORMATION DIRECTORIES THAT MAY BE DOWNLOADED FROM THE GLOBAL COMPUTER NETWORK; COMPUTER SOFTWARE FOR APPLICATION AND DATABASE INTEGRATION; COMPUTER SOFTWARE TO AUTOMATE DATA WAREHOUSING; COMPUTER SOFTWARE TO ENHANCE THE AUDIO-VISUAL CAPABILITIES OF MULTIMEDIA APPLICATIONS, NAMELY, FOR THE INTEGRATION OF TEXT, AUDIO, GRAPHICS, STILL IMAGES AND MOVING PICTURES; COMPUTER TELEPHONY SOFTWARE TO ENABLE TELEPHONE ACTIVITIES TO BE PERFORMED THROUGH A COMPUTER; DATA COMPRESSION SOFTWARE; DATABASE MANAGEMENT SOFTWARE FOR GENERAL USE; DESKTOP PUBLISHING SOFTWARE; EDUCATIONAL SOFTWARE FEATURING INSTRUCTION IN SPORTS AND ENTERTAINMENT; GRAPHICAL USER INTERFACE SOFTWARE; INTERACTIVE VIDEO GAMES OF VIRTUAL REALITY COMPRISED OF COMPUTER HARDWARE AND SOFTWARE; VIDEO GAME SOFTWARE; VIRTUAL REALITY GAME SOFTWARE; WEBSITE DEVELOPMENT SOFTWARE; DATA PROCESSING APPARATUS; COMPUTER GAME DISCS; COMPUTER DISC DRIVES; COMPUTER MONITORS; GAMING EQUIPMENT, NAMELY, SLOT MACHINES WITH OR WITHOUT VIDEO OUTPUT; AUDIO DISC FEATURING MUSIC;

PHONOGRAPH RECORDS FEATURING MUSIC; BLANK VIDEO CASSETTES; VIDEO GAME CARTRIDGES; VIDEO TAPES; MINIDISCS FEATURING MUSIC; MINIDISC PLAYERS; AUDIO CASSETTES FEATURING MUSIC; CDS FEATURING MUSIC; CD PLAYERS; DVDS FEATURING AUDIO, MUSIC, VIDEO, TEXT, GRAPHICS, STILL IMAGES AND MOVING PICTURES IN RELATION TO SPORT, FASHION AND MUSIC AND CELEBRITIES THEREOF; DVD PLAYERS; VIDEO RECORDINGS, VIDEO DISCS, DVDS AND CD-ROMS FEATURING EDUCATIONAL AND INFORMATIVE CONTENT IN RELATION TO SPORT, FASHION AND MUSIC AND CELEBRITIES THEREOF; GAMES; MUSICAL RECORDINGS; ENTERTAINMENT CONTENT IN THE NATURE OF AUDIO AND VIDEO COMEDY RECORDINGS; AUDIO STORIES; BLANK VIDEO DISCS; CDUS; BLANK AUDIO TAPES; SCREENSAVER PROGRAMS FOR COMPUTERS (U.S. CLS. 21, 23, 26, 36 AND 38).

CLASS 15—MUSICAL INSTRUMENTS

FOR MUSICAL INSTRUMENTS AND CARRYING CASES FOR MUSICAL INSTRUMENTS AND PARTS AND FITTINGS THEREFOR (U.S. CLS. 2, 21 AND 36).

CLASS 16—PAPER GOODS AND PRINTED MATTER

FOR COLLECTORS ALBUMS, NAMELY COIN ALBUMS; MEMORY BOOKS; SCRAPBOOK ALBUMS; STAMP ALBUMS; WEDDING ALBUMS AND PHOTOGRAPH ALBUMS; ALMANACS; DIARIES; PERSONAL ORGANIZERS; ADDRESS BOOKS; CALENDARS; AUTOGRAPH BOOKS; ARTISTS' MATERIALS, NAMELY ART ETCHINGS, ART MOUNTS, ART PADS, ART PAPER, ART PICTURES, ART PRINTS, COLORED CRAFT AND ART SAND, GRAPHIC ART REPRODUCTIONS, PHOTOGRAPHIC OR ART MOUNT, PRINTED ART REPRODUCTIONS; PAINT BRUSHES, STATIONERY; PAINTING SETS; PRINTING AND DRAWING SETS COMPRISED OF DRAWING BOARDS, DRAWING BRUSHES, DRAWING CURVES, DRAWING INSTRUMENTS, DRAWING PADS, DRAWING PAPER, DRAWING PENCILS, DRAWING RULERS, DRAWING SHIELDS, DRAWING SQUARES, DRAWING TEMPLATES, DRAWING TRAYS; WRITING INSTRUMENTS NAMELY PENS, BALL PENS, FELT PENS, NIB PENS, PENCILS AND MECHANICAL PENCILS AND INKS; PAPERS BAGS; LOOSE LEAF BINDERS; MAPS; PRINTED PLANS AND CHARTS; BINDER NOTE BOOKS; LOOSE LEAF NOTE BOOKS, NOTE BOOKS, SPIRAL NOTE BOOKS, WIRE-BOUND BOOKS, PORTFOLIO NOTEBOOKS, ACTIVITY BOOKS, STATISTICAL BOOKS AND WORD NOTE BOOKS; WRITING PADS AND PRINTING BLOCKS; PAMPHLETS AND BROCHURES IN RELATION TO SPORTING AND ENTERTAINMENT EVENTS, INCLUDING LIVE PERFORMANCES OF MUSICAL BANDS AND MUSICIANS, LIVE MUSIC CONCERTS, AWARDS, SPORTING RESULTS, SPORT AND ENTERTAINMENT PERSONALITIES; PRINTED PUBLICATIONS, NAMELY, JOURNALS, NEWSPAPERS, COMIC STRIPS, MANUALS, HANDBOOKS, CATALOGUES, REFERENCE BOOKS AND MAGAZINES, ALL IN RELATION TO SPORT AND ENTERTAINMENT IN GENERAL, SPORTING AND ENTERTAINMENT EVENTS AND SPORT AND ENTERTAINMENT PERSONALITIES; COMMEMORATIVE GAME PROGRAMS AND SPORTING AND ENTERTAINMENT EVENT PROGRAMS; PROGRAM BINDERS, BOOKS IN RELATION TO SPORTING AND ENTERTAINMENT EVENTS, INCLUDING LIVE PERFORMANCES OF MUSICAL BANDS AND MUSICIANS, LIVE MUSIC CONCERTS, AWARDS, SPORTING RESULTS, SPORT AND ENTERTAINMENT PERSONALITIES; BOOK COVERS; BOOK ENDS; PEN BOXES; PEN CASES; PENCIL CASES; PEN STANDS; PENCIL STANDS; PEN TRAYS; PENCIL TRAYS; BUSINESS CARDS; COLLECTOR'S TRADING CARDS; GREETING CARDS; NOTE CARDS; BIRTHDAY CARDS; ORDINARY PLAYING CARDS; POSTCARDS AND PICTURE POSTCARDS; RUBBER AND DOCUMENT STAMPS AND COMMEMORATIVE STAMPS; WORD FLASH CARDS; PAPER CLIPS AND MAGNETIC CLIPS; ENVELOPES; RUBBER ERASERS; FILES; FOLDERS; CARDS HOLDERS; MEMO HOLDERS; LOOSE LEAF PAPERS; PRINTED INSTRUCTIONAL AND TEACHING MATERI-

ALS; DESK PADS, PAPER COASTERS; PAPER NAPKINS AND SERVIETTES; BLOTTERS, PADS OF PAPER; MENUS; REPORT PAPERS; PRINTED LABEL NOT OF TEXTILE; WRITING PAPERS; UNMOUNTED AND MOUNTED PHOTOGRAPHS; PLASTIC PAGES FOR HOLDING PHOTOGRAPHS; LETTER RACKS; OFFICE RULERS; STICKERS, TRADING STICKERS AND STICKER ALBUMS; BUMPER STICKERS; ADHESIVE TAPES FOR STATIONERY OR HOUSEHOLD PURPOSES; IRON-ON AND PLASTIC TRANSFERS, DECALS; PLASTIC BUBBLE PACKS FOR WRAPPING OR PACKAGING; GIFT WRAPPING PAPER; FOOD AND COIN WRAPPERS; BLANK PAPER TAPE AND CARDS FOR USE IN RECORDING DATA PROCESSING COMPUTER PROGRAMS; SCRATCH PADS; ENTERTAINMENT TRADING CARDS; GIFT TAGS; GIFTS VOUCHERS; MEMO PADS; PORTRAITS; PRINTS; PAINTINGS; PICTURES AND POSTERS; BOOKLETS IN RELATION TO SPORTING AND ENTERTAINMENT EVENTS, INCLUDING LIVE PERFORMANCES OF MUSICAL BANDS AND MUSICIANS, LIVE MUSIC CONCERTS, AWARDS, SPORTING RESULTS, SPORT AND ENTERTAINMENT PERSONALITIES; BOXES OF CARDBOARD OR PAPER, CARDBOARD; CARDBOARD CONTAINERS; CARDBOARD TUBES; GRAPHIC REPRODUCTIONS; PRICE TICKETS; PRINTED TIMETABLE; PAPER RIBBONS; PAPER SHEETS; FLAGS OF PAPER; PENNANTS OF PAPER; HOLDERS FOR CHECKBOOKS, PASSPORTS, AND DIARIES; PAPER NAME BADGES; PAPER AND PLASTIC MATS; FIGURINES AND ORNAMENTS OF EITHER PAPER OR PAPIER MACHE; PRINTED INVITATIONS; PRINTED PAPER SIGNS AND BANNERS; BOOKMARKS (U.S. CLS. 2, 5, 22, 23, 29, 37, 38 AND 50).

CLASS 25—CLOTHING

FOR ARTICLES OF CLOTHING, NAMELY, SHIRTS, T-SHIRTS, SINGLETS, VESTS, JUMPERS, TIES, CRAVATS, SCARVES, SOCKS, BELTS, SWEATSHIRTS, JACKETS, SLAZERS, JERSEYS, SWEATERS, SKIRTS, DRESSES, GOWNS, BLOUSES, POLO SHIRTS, CARDIGANS, PANTS, BOXER SHORTS, TROUSERS, SHORTS, JEANS, SWEATPANTS, LEGGINGS, RAINWEAR, OVERCOATS, WATERPROOF JACKETS, WATERPROOF TROUSERS, SWEAT BANDS, GLOVES AND MITTENS, WRIST BANDS, BRACES, PYJAMAS, ARTICLES OF UNDERWEAR FOR MEN AND WOMEN, BATHROBES, BATHING SUITS, WETSUITS, UNITARDS, PANTS AND SUITS MADE OF SWEAT ABSORBENT MATERIAL, RIDING TOPS AND BREECHES, PULLOVERS, PARKAS, TRACKSUITS AND TRAINING SUITS, GLOVES; HEADWEAR, NAMELY, CAPS, HATS, SUN VISORS, BANDANAS, AND HEADBANDS; FOOTWEAR, NAMELY, SANDALS, TRAINING SHOES; BOOTS, SPORTS SHOES, SPORTS BOOTS, INCLUDING FOOTBALL BOOTS, WELLINGTON BOOTS AND NON-ORTHOPEDIC SHOE AND BOOT INSERTED TO PREVENT CLIPPING (U.S. CLS. 22 AND 39).

CLASS 41—EDUCATION AND ENTERTAINMENT

FOR CASINO AND GAMING SERVICES; PROVIDING CASINO FACILITIES; ENTERTAINMENT NAMELY, LIVE PERFORMANCES BY A MUSICAL BAND; RENTAL OF STADIUM FACILITIES; PROVIDING FACILITIES FOR RECREATION ACTIVITIES; CONCERT BOOKING; ORGANIZING AND RUNNING OF FAN CLUBS FOR MUSIC, INDIVIDUALS AND BANDS IN THE MUSIC INDUSTRY; PUBLICATIONS OF MUSIC AND TEXTS; MUSIC PUBLISHING; ORGANIZATION OF MUSIC AND ENTERTAINMENT EVENTS, COMPETITIONS AND ACTIVITIES, NAMELY AUTOMOBILE RACES, BASEBALL GAMES, BASKETBALL GAMES, BOXING CONTESTS, DANCE PERFORMANCES, GOLF TOURNAMENTS, TENNIS TOURNAMENTS; GYMNASIATIC PERFORMANCES, HOCKEY GAMES, LASER SHOWS, LIGHT SHOWS, MAGIC SHOWS, ORCHESTRA PERFORMANCES, FASHION SHOWS, FOOTBALL GAMES, TRACK AND FIELD COMPETITIONS, WEIGHT LIFTING COMPETITIONS, WRESTLING CONTESTS, YACHT RACES, TENNIS TOURNAMENTS, THEATRE PRODUCTIONS, PERFORMANCES BY MUSICAL BANDS AND ROCK GROUPS, DISCOTHEQUES, GYMNASIATIC AND DANCE PERFORMANCES AND MUSICAL, VARIETY, NEWS AND COMEDY SHOWS; LIGHTING PRODUCTION; PREPARATION OF SPECIAL

EFFECTS; WRESTLING CLUB; COMPETITIONS IN THE FIELD OF ATHLETICS AND GENERAL SPORTING ACTIVITIES, PERSONAL APPEARANCES BY MOVIE STARS, SPORTS CELEBRITIES AND MUSIC CELEBRITIES; PROVIDING MOTIVATIONAL SPEAKERS; ETHNIC FESTIVALS; FIREWORKS DISPLAYS; FAIRS AND PARTIES; EXHIBITIONS FOR VARIOUS SPORTING AND ENTERTAINMENT ACTIVITIES; VIDEO TAPE FILM PRODUCTION; RENTAL OF VIDEO TAPES; DISTRIBUTION OF TELEVISION PROGRAMS FOR OTHERS; TELEVISION PROGRAM SYNDICATION; TELEVISION SHOW PRODUCTION; RADIO ENTERTAINMENT PRODUCTION; DISTRIBUTION OF RADIO PROGRAMS FOR OTHERS; MOTION PICTURE FILM PRODUCTION; AUDIO RECORDING AND PRODUCTION; SOUND RECORDING STUDIOS; RENTAL OF CINEMA FILMS; VIDEOTAPE PRODUCTION; RENTAL OF COMPUTER VIDEO GAMES; ARRANGING AND CONDUCTING EDUCATIONAL CONFERENCES, CONGRESSES, LECTURES, SEMINARS, SYMPOSIUMS, AND WORKSHOPS TO TEACH AND ASSIST ADULTS AND CHILDREN TO WRITE, PERFORM, UNDERSTAND AND APPRECIATE MUSIC; ENTERTAINMENT IN THE NATURE OF AUTOMOBILE RACES, BASEBALL GAMES, BASKETBALL GAMES, BOXING CONTESTS, DANCE PERFORMANCES, GOLF TOURNAMENTS, TENNIS TOURNAMENTS; GYMNASTIC PERFORMANCES, HOCKEY GAMES, LASER SHOWS, LIGHT SHOWS, MAGIC SHOWS, ORCHESTRA PERFORMANCES, FASHION SHOWS, FOOTBALL GAMES, TRACK AND FIELD COMPETITIONS, WEIGHT LIFTING COMPETITIONS, WRESTLING CONTESTS, YACHT RACES, TENNIS TOURNAMENTS, THEATER PRODUCTIONS, PRERECORDED JOKE-, SPORT- AND ENTERTAINMENT-ORIENTED MESSAGES BY TELEPHONE, ON-GOING RADIO AND TELEVISION PROGRAMS IN THE FIELD OF NEWS, COMEDY, VARIETY; AUTOMOBILE, DOG, HORSE, YACHT RACES, SOCCER GAMES; VISUAL AND AUDIO PERFORMANCES, NAMELY, LIVE PERFORMANCES BY MUSICAL BANDS, LIVE PERFORMANCES BY ROCK GROUPS, DISCOTHEQUES, GYMNASTIC AND DANCE PERFORMANCES AND MUSICAL, VARIETY, NEWS AND COMEDY SHOWS; LIGHTING PRODUCTION; PREPARATION OF SPECIAL EFFECTS; WRESTLING CLUB; COMPETITIONS IN THE FIELD OF ATHLETICS AND GENERAL SPORTING ACTIVITIES; ENTERTAINMENT SERVICES, NAMELY PERSONAL APPEARANCES BY MOVIE STARS, SPORTS CELEBRITIES AND MUSIC CELEBRITIES; PROVIDING MOTIVATIONAL SPEAKERS; ETHNIC FESTIVALS; PROVIDING AN ON-LINE COMPUTER GAMES; PROVIDING A RADIO AND TELEVISION PROGRAM IN THE FIELD OF SPORT AND ENTERTAINMENT VIA A GLOBAL COMPUTER NETWORK; FIREWORKS DISPLAYS; PRODUCTION AND DISTRIBUTION OF A GAME SHOW, TELEVISION NEWS SHOWS, CONDUCTING CONTESTS, FAIRS AND PARTIES; PROVIDING A WEBSITE FEATURING MUSICAL PERFORMANCES, MUSICAL VIDEOS, RELATED FILM CLIPS, PHOTOGRAPHS, AND OTHER MULTIMEDIA MATERIALS; RADIO ENTERTAINMENT PRODUCTION; ORGANIZING EXHIBITIONS FOR VARIOUS SPORTING AND ENTERTAINMENT ACTIVITIES; RADIO ENTERTAINMENT SERVICES, NAMELY RADIO PROGRAMS FEATURING PERFORMANCES BY MOVIE STARS, SPORTS CELEBRITIES AND MUSIC CELEBRITIES; MULTIMEDIA ENTERTAINMENT SOFTWARE PRODUCTION SERVICES; CHILDREN'S ENTERTAINMENT AND AMUSEMENT CENTERS, NAMELY, INTERACTIVE PLAY AREAS; ENTERTAINMENT NAMELY, LIVE MUSIC CONCERTS; DISCOTHEQUE SERVICES (U.S. CLS. 100, 101 AND 107).

SN 78-032,880. DESTINA.CA INC., MONTREAL, QUEBEC H4Y 1A3, CANADA, BY CHANGE OF NAME 3809951 CANADA INC., MONTREAL, CANADA, FILED 10-30-2000.

DESTINA

PRIORITY CLAIMED UNDER SEC. 44(D) ON CANADA APPLICATION NO. 1077834, FILED 10-10-2000, REG. NO. TNA5474239, DATED 1-23-2003, EXPIRES 1-23-2018.

CLASS 35—ADVERTISING AND BUSINESS

FOR COMPUTERIZED ONLINE ELECTRONIC RETAIL STORE SERVICES IN THE FIELD OF TRAVEL RELATED ITEMS, NAMELY, LUGGAGE, TRAVEL GADGETS, SUNDRIES, CURRENCY CONVERTERS, AND CLOTHING (U.S. CLS. 100, 101 AND 102).

CLASS 39—TRANSPORTATION AND STORAGE

FOR TRAVEL AGENCY SERVICES, NAMELY MAKING RESERVATIONS AND BOOKINGS FOR TRANSPORTATION; PROVIDING TRAVEL INFORMATION AND INFORMATION CONCERNING TRANSPORTATION AND RESERVATION AND BOOKINGS FOR TRANSPORTATION OVER COMPUTER NETWORKS AND GLOBAL COMMUNICATION NETWORKS; PROVIDING ONLINE INFORMATION PERTAINING TO TRAVEL AND TRAVEL DESTINATIONS (U.S. CLS. 100 AND 105).

CLASS 42—SCIENTIFIC, COMPUTER AND LEGAL SERVICES

FOR TRAVEL AGENCY SERVICES, NAMELY MAKING RESERVATIONS AND BOOKINGS FOR TEMPORARY LODGING; PROVIDING INFORMATION CONCERNING TEMPORARY LODGING AND RESERVATIONS AND BOOKINGS FOR TEMPORARY LODGING OVER COMPUTER NETWORKS AND GLOBAL COMMUNICATION NETWORKS (U.S. CLS. 100 AND 101).

SN 78-034,995. RG INTERNATIONAL LIMITED, WANCHAI, HONG KONG, FILED 11-13-2000.



CLASS 3—COSMETICS AND CLEANING PREPARATIONS

FOR COSMETICS, NAMELY, FOUNDATIONS, FACE POWDERS, COMPACTS AND CONCEALERS; LIPSTICKS AND LIP BALM; EYE SHADOWS AND EYE LINERS; MASCARA; BLUSH; MAKEUP REMOVERS; SKIN CLEANSERS, LOTIONS, AND CREAMS; SKIN MOISTURIZERS; TONERS AND FRESHENERS; MASKS AND SCRUBS; TOILETRIES, NAMELY, BODY TALC, BATH FOAM AND BUBBLE BATH; FACIAL AND BODY SCRUBS; FACIAL MASKS, SKIN TONING PREPARATIONS; SKIN EXFOLIANTS; SKIN MOISTURIZERS; PERFUMERY, NAMELY, PERFUME OILS AND PERFUME; ESSENTIAL OILS FOR PERSONAL USE; HAIR CARE PREPARATIONS AND HAIR LOTIONS; HAIR CLEANING PREPARATIONS; ANTIMICROBIAL AND ANTIBACTERIAL LIQUID SOAPS FOR HANDS, FACE AND BODY; DENITRIFIES (U.S. CLS. 1, 4, 6, 50, 51 AND 52).

CLASS 24—FABRICS

FOR TEXTILE AND TEXTILE GOODS, NAMELY, PILLOW COVERS, PLACE MATS AND NAPKINS; BED COVERS, NAMELY, BLANKETS, SHEETS AND BEDSPREADS; TABLE COVERS, NAMELY, TABLE LINEN AND FABRIC TABLE RUNNERS; UNFITTED FURNITURE COVERINGS OF TEXTILE AND PLASTIC; CURTAINS; TOWELS; UPHOLSTERY FABRICS; WALL HANGINGS OF TEXTILE; WOOLEN FABRICS (U.S. CLS. 42 AND 50).

CLASS 25—CLOTHING

FOR CLOTHING, NAMELY, JACKETS, COATS, SUITS, PAJAMAS, ROBES, VESTS, SHIRTS, T-SHIRTS, SWEATERS, DRESSES, PANTS, SHORTS, SKIRTS, JUMPERS, UNDERGARMENTS, SOCKS, HOSIERY AND HATS; FOOTWEAR; AND HEADWEAR (U.S. CLS. 22 AND 39).

CLASS 26—FANCY GOODS

FOR RIBBONS; BRAIDS; HAIR PINS, HAIR BOWS, COLOURING CAPS, NAMELY, HAIR FROSTING CAPS, HAIR TRESSES, NAMELY, HAIR PIECES; ORNAMENTS FOR HAIR; BROOCHES FOR CLOTHING NOT OF PRECIOUS METAL AND NOT BEING IMITATION JEWELRY, BUCKLES, NAMELY, TO BE USED ON CLOTHING, FOOTWEAR, AND BAGS (U.S. CLS. 37, 39, 40, 42 AND 50).

CLASS 28—TOYS AND SPORTING GOODS

FOR DOLLS AND DOLL ACCESSORIES, SOFT SCULPTURE TOYS, STUFFED TOYS, CHILDREN'S MULTIPLE ACTIVITY TOYS, ELECTRIC ACTION TOYS, BATH TOYS, INFANT DEVELOPMENT TOYS, MUSICAL TOYS, BOARD GAMES, CARD GAMES, ARCADE GAMES; TOY ACTION FIGURES AND ACCESSORIES THEREFOR; ELECTRONIC EDUCATIONAL GAME MACHINES FOR CHILDREN; DECORATIONS FOR CHRISTMAS TREES (U.S. CLS. 22, 23, 38 AND 50).

SN 78-062,250. AREMIDES INSTITUT ZUR ENTWICKLUNG ERFOLGREICHER GESUNDHEITS- UND FREIZEIT-ERLEBNISANLAGEN GMBH, REITH IM ALPBACHTAL, AUSTRIA, FILED 5-7-2001.

THERMARIVM

PRIORITY CLAIMED UNDER SEC. 44(D) ON ERPN CMNTY TM OFC APPLICATION NO. 001985332, FILED 12-4-2000.

CLASS 3—COSMETICS AND CLEANING PREPARATIONS

FOR COSMETICS, SOAPS, PERFUMERY, ESSENTIAL OILS FOR PERSONAL USE, HAIR LOTIONS (U.S. CLS. 1, 4, 6, 50, 51 AND 52).

CLASS 10—MEDICAL APPARATUS

FOR MEDICAL APPARATUSES AND INSTALLATIONS FOR THERMAL THERAPY, NAMELY ELECTRICALLY HEATED CUSHIONS FOR MEDICAL USE, GALVANIC THERAPEUTIC UNITS FOR THERMAL THERAPY; THERMOELECTRIC COMPRESSES AND DEVICES FOR EMITTING INFRARED RADIATION, NAMELY, INFRARED RADIATORS, SUN LAMPS OR RED LIGHT LAMPS; SAUNAS FOR THERMAL THERAPY USE (U.S. CLS. 26, 39 AND 44).

CLASS 11—ENVIRONMENTAL CONTROL APPARATUS

FOR SPAS IN THE NATURE OF HEATED POOLS; STEAM BATHS; SHOWER ENCLOSURES; WHIRLPOOL BATHS; HEATING INSTALLATIONS, NAMELY HEATING FACILITIES FOR BATH ROOMS, NAMELY HOT TUBS OR RADIATORS; UNITS FOR BATHS, NAMELY, BATH TUBS, SHOWERS, BATH HEATERS FOR USE IN BATH ROOMS; GAS GENERATORS; HOT AIR UNITS, NAMELY HAIR DRYERS, HOT AIR BATHS, NAMELY ROOMS FILLED WITH HOT AIR; WATER HEATERS FOR COMMERCIAL USE, ELECTRIC BLANKETS NOT FOR MEDICAL PURPOSES, HEATING UNITS USING SOLID, LIQUID OR GASEOUS FUEL, NAMELY OIL-FIRED BOILERS, OVENS AND/OR FIREPLACES, HEATING CUSHIONS NOT FOR MEDICAL PURPOSES; HEATING SHELLS/BARRELS, NAMELY HEATING FURNACES, PORTABLE ELECTRIC SPACE HEATERS; ELECTRIC HOT PLATES; ELECTRIC RADIATORS FOR HEATING BUILDINGS; HOT WATER HEATERS; TRANSPORTABLE STALLS FOR TURKISH BATHS; AIR CONDITIONERS; SITZ BATH TUBS; SOLAR OVENS FOR DOMESTIC COOKING; ELECTRIC FOOT WARMERS; IMMERSION HEATERS; INCINERATORS; HEAT PUMPS AND HEAT EXCHANGERS; HEATER HOUSINGS; BATH TUB ENCLOSURES (U.S. CLS. 13, 21, 23, 31 AND 34).

SN 78-047,617. ELIZABETH DANE, INC., OXFORD, NJ. FILED 2-9-2001.

FROM ELIZABETH'S GARDEN**CLASS 3—COSMETICS AND CLEANING PREPARATIONS**

FOR AROMATHERAPY OILS, AROMATHERAPY PRODUCTS, NAMELY, AROMATHERAPY CREAMS, OILS, LOTIONS, AROMATHERAPY PILLOWS COMPRISING POTPOURRI IN FABRIC CONTAINERS—BEAUTY PRODUCTS, NAMELY, ANTIBACTERIAL SOAPS, LIQUID SOAPS FOR HANDS, FACE AND BODY, SKIN SOAP, ANTI-AGING CREAMS, BODY CREAMS, EYE CREAMS, FACE CREAMS, LIP CREAM, NAIL CREAM, BATH GELS, HAIR GELS, SHOWER GELS, STYLING GELS, BABY OILS, SHAMPOO (U.S. CLS. 1, 4, 6, 50, 51 AND 52).

CLASS 30—STAPLE FOODS

FOR HEALTH FOODS, NAMELY, GRANOLA BASED SNACK BARS, HERB TEAS, HERBAL TEAS (U.S. CL. 46).

CLASS 19—NON-METALLIC BUILDING MATERIALS

FOR NON-METALLIC CONSTRUCTION MATERIALS AND CONSTRUCTION PARTS FOR HEAT TREATMENT CHAMBERS, NAMELY, WOOD BEAMS, CONSTRUCTION LUMBER, CONSTRUCTION MATERIALS, NAMELY, LUMBER, PLYWOOD; PANELS FOR CONSTRUCTION, NAMELY, WALL BOARD, PLASTER BOARD, PARTICLE BOARD, BOARD MATERIALS MADE OF POLYETHELENE USED AS A WOOD SUBSTITUTE, BUILDING STONES, ROOF COVERINGS, NAMELY, SHINGLES, TARRED ROOFING PAPER, ASPHALT ROOFING PAPER, SLATE, TILES; CONCRETE, XYOLITE FOR USE IN COMMERCIAL CONSTRUCTION, ASPHALT, SHEATHING BOARDS, TARRED FELT, DRAINAGE PIPES, WINDOWS, GLASS PANES, WOOD VENEERS, VENEER WOOD FOR USE IN COMMERCIAL CONSTRUCTION; LUMBER, PANELING FOR USE IN COMMERCIAL CONSTRUCTION; TILES FOR CONSTRUCTION, PARQUET WOOD FLOORING, PLYWOOD, NON-METAL CEILING PANELS, BROWNSTONE GUTTER PIPES, AND WOOD MOLDINGS FOR USE IN CONSTRUCTION (U.S. CLS. 1, 12, 33 AND 50).

CLASS 35—ADVERTISING AND BUSINESS

FOR MANAGEMENT FOR OTHERS OF FACILITIES FOR VAPOR BATHS, SAUNAS AND ROOMS FOR THERMAL THERAPY; MANAGEMENT FOR OTHERS OF MASSAGE AND THERAPEUTIC FACILITIES (U.S. CLS. 100, 101 AND 102).

CLASS 37—CONSTRUCTION AND REPAIR

FOR CONSTRUCTION SERVICES, NAMELY, PLANNING AND CUSTOM CONSTRUCTION OF SWIMMING POOLS, THERMAL SPRINGS, SAUNA FACILITIES, THERMAL FACILITIES, BEAUTY FACILITIES, MASSAGE AND THERAPEUTIC FACILITIES (U.S. CLS. 100, 103 AND 106).

SN 78-071,478. INSYNC ELECTRONICS CORPORATION, BATON ROUGE, LA. FILED 6-28-2001.

SAFETYARD**CLASS 9—ELECTRICAL AND SCIENTIFIC APPARATUS**

FOR ELECTRICAL LOW VOLTAGE DISTRIBUTION SYSTEM FOR OUTDOOR HOME AND GARDENS. (U.S. CLS. 21, 23, 26, 36 AND 38).

CLASS 11—ENVIRONMENTAL CONTROL APPARATUS

FOR LOW VOLTAGE WATER PUMPS FOR WATER GARDENS AND FOUNTAINS. (U.S. CLS. 13, 21, 23, 31 AND 34).

SN 78-074,552. COMFORT SOLUTIONS, INC., EDINA, MN. FILED 7-18-2001.

DOCTOR DIRECT**CLASS 10—MEDICAL APPARATUS**

FOR PILLOWS, CUSHIONS, RESTS, WEDGES, SUPPORTS AND MATTRESSES FOR MEDICAL USE (U.S. CLS. 26, 39 AND 44).

CLASS 20—FURNITURE AND ARTICLES NOT OTHERWISE CLASSIFIED

FOR PILLOWS; CUSHIONS; RESTS FOR THE NECK, BACK, LEGS OR FEET; PREGNANCY RESTS; SUPPORTS FOR THE NECK, BACK OR LEGS FOR USE WITH BEDS, CHAIRS AND AUTOMOBILE SEATS; WEDGES MADE OF FOAM OR FIBER FOR USE AS BODY SUPPORTS; AND MATTRESSES (U.S. CLS. 2, 13, 22, 25, 32 AND 50).

SN 78-075,895. THE TEMPLAR COMPANY PLC, DORKING, UNITED KINGDOM, FILED 7-26-2001.

HAPPY SNAPPY

PRIORITY CLAIMED UNDER SEC. 44(D) ON ERPN CMNTY TM OFC APPLICATION NO. 2088599, FILED 2-9-2001, REG. NO. 2088599, DATED 6-3-2002, EXPIRES 2-9-2011.

CLASS 16—PAPER GOODS AND PRINTED MATTER

FOR PRINTED MATTER, NAMELY, BOOKS, MAGAZINES AND NEWSLETTERS FOR CHILDREN; PAPER HATS, PAPER NAPKINS, PARTY INVITATIONS AND STICKERS; AND GREETING CARDS (U.S. CLS. 2, 5, 23, 29, 37, 38 AND 50).

CLASS 21—HOUSEWARES AND GLASS

FOR LUNCHEON BOXES; PAPER PLATES; TABLEWARE, NAMELY, PLATES, SAUCERS, DISHES, BOWLS, EGG CUPS, NAPKIN HOLDERS, DRINKING GLASSES, CUPS, MUGS, CHILDREN'S DRINKING CUPS, JUGS, TEAPOTS NOT OF PRECIOUS METALS, SALT AND PEPPER SHAKERS, MEAL TRAYS AND SERVING TRAYS NOT OF PRECIOUS METALS (U.S. CLS. 2, 13, 23, 29, 30, 33, 40 AND 50).

CLASS 25—CLOTHING

FOR ARTICLES OF CLOTHING FOR CHILDREN, NAMELY, T-SHIRTS, SHIRTS, BLOUSES, JACKETS, PULLOVERS, TROUSERS, PANTS, SHORTS, SKIRTS, UNDERWEAR, VESTS, JUMPER SUITS, SINGLE-PIECE OUTFITS FOR BABIES, COATS; HEADWEAR FOR CHILDREN, NAMELY, HATS, CAPS AND BONNETS; FOOTWEAR FOR CHILDREN, NAMELY, SHOES, BOOTS, SLIPPERS AND SOCKS; NIGHTWEAR (U.S. CLS. 22 AND 39).

CLASS 28—TOYS AND SPORTING GOODS

FOR TOYS, GAMES AND PLAYTHINGS, NAMELY, JIGSAW PUZZLES, BOARD GAMES, PLUSH TOYS, TOY CROCKERY AND CUTLERY; ELECTRONIC TOYS AND GAMES, NAMELY, ELECTRONIC EDUCATIONAL GAMES AND AIDS AND ARCADE-TYPE ELECTRONIC GAMES, NOT INCLUDING VIDEO GAMES (U.S. CLS. 22, 23, 38 AND 50).

SN 78-081,847. FORD MOTOR COMPANY, DEARBORN, MI. FILED 8-30-2001.

FORD INFORMATION XCHANGE

OWNER OF U.S. REG. NOS. 74,530, 2,034,369 AND OTHERS.

NO CLAIM IS MADE TO THE EXCLUSIVE RIGHT TO USE "INFORMATION EXCHANGE", APART FROM THE MARK AS SHOWN.

CLASS 35—ADVERTISING AND BUSINESS

FOR ONLINE DATABASES TO TRACK AND SCHEDULE APPOINTMENTS IN THE FIELD OF MOTOR VEHICLES, ONLINE DATABASES FOR INVENTORY CONTROL IN THE FIELD OF MOTOR VEHICLES, ONLINE DATABASES FOR COST ESTIMATING AND BILLING FOR PARTS AND SERVICE IN THE FIELD OF MOTOR VEHICLES, ONLINE DATABASES FEATURING VEHICLE INFORMATION, VEHICLE RECALL HISTORY AND RECALL NOTIFICATIONS (U.S. CLS. 100, 101 AND 102).

CLASS 37—CONSTRUCTION AND REPAIR

FOR ONLINE DATABASES FEATURING VEHICLE REPAIR HISTORY, ONLINE DATABASES FEATURING TECHNICAL SERVICE BULLETINS REGARDING REPAIRS AND MAINTENANCE FOR VEHICLES (U.S. CLS. 100, 103 AND 106).

CLASS 42—SCIENTIFIC, COMPUTER AND LEGAL SERVICES

FOR ONLINE DATABASES FEATURING CUSTOMER INFORMATION IN THE FIELD OF MOTOR VEHICLES, AND ONLINE DATABASES AND NON-DOWNLOADABLE SOFTWARE FOR CUSTOMER RELATIONSHIP MANAGEMENT (U.S. CLS. 100 AND 101).

SN 78-083,488. APPROVED AERONAUTICS, L.L.C., SAN DIEGO, CA. FILED 9-11-2001.



Approved Aeronautics, LLC

NO CLAIM IS MADE TO THE EXCLUSIVE RIGHT TO USE "AERONAUTICS LLC", APART FROM THE MARK AS SHOWN.

CLASS 7—MACHINERY

FOR AIRCRAFT ENGINES AND REPLACEMENT PARTS THEREFOR, NAMELY, ENGINE BEARINGS, ENGINE INSULATION, HYDRAULIC PUMPS (U.S. CLS. 13, 19, 21, 23, 31, 34 AND 35).

CLASS 12—VEHICLES

FOR REPLACEMENT PARTS FOR AIRCRAFT, NAMELY, HYDRAULIC PUMPS FOR LANDING GEAR, DISC BRAKES, SEATS AND PARTS THEREFOR, MUD FLAPS, PROPELLERS AND PARTS THEREFOR (U.S. CLS. 19, 21, 23, 31, 35 AND 44).

SN 78-084,105. SALEEBY, JOHN M, CLAYTON, MO. FILED 9-16-2001.



NO CLAIM IS MADE TO THE EXCLUSIVE RIGHT TO USE "FINANCIAL" AND "PRIVATE MONEY MANAGEMENT", APART FROM THE MARK AS SHOWN.

THE MARK CONSISTS OF A REPRESENTATION OF A LOUNGING GORILLA THAT IS SMOKING A CIGAR. THE WORDING "GARGANTUAN FINANCIAL PRIVATE MONEY MANAGEMENT" APPEARS ABOVE THE DESIGN ELEMENT WITHIN THE MARK.

CLASS 36—INSURANCE AND FINANCIAL

FOR COMMODITY TRADING FOR OTHERS; BROKERAGE IN THE FIELD OF EQUITIES; AND FINANCIAL MANAGEMENT IN THE AREAS OF EQUITIES (U.S. CLS. 100, 101 AND 102).

CLASS 41—EDUCATION AND ENTERTAINMENT

FOR EDUCATIONAL SERVICES, NAMELY, CONDUCTING SEMINARS IN THE FIELD OF TRADING AND MONEY MANAGEMENT AND DISTRIBUTING COURSE MATERIALS IN THE NATURE OF BOOKS AND SOFTWARE IN CONNECTION THEREWITH (U.S. CLS. 100, 101 AND 107).

SN 78-090,874. EASYGROUP IP LICENSING LIMITED, CAMDEN, LONDON, UNITED KINGDOM, FILED 10-30-2001.



easyInternetCafé

the cheapest way to get online

PRIORITY CLAIMED UNDER SEC. 44(D) ON UNITED KINGDOM APPLICATION NO. 2281721, FILED 9-26-2001, REG. NO. 2281721, DATED 3-15-2002, EXPIRES 9-26-2011.

CLASS 38—COMMUNICATION

FOR PROVIDING A HIGH SPEED ACCESS TO AREA NETWORKS AND A GLOBAL COMPUTER INFORMATION NETWORK, AND PROVIDING MULTIPLE USER ACCESS TO A GLOBAL COMPUTER INFORMATION NETWORK (U.S. CLS. 100, 101 AND 104).

CLASS 42—SCIENTIFIC, COMPUTER AND LEGAL SERVICES

FOR PROVIDING TEMPORARY HOUSING ACCOMMODATIONS; PROVISION OF FOOD AND DRINK, NAMELY, TAKE-OUT OR EATING-IN RESTAURANT SERVICES; CATERING; HOTEL, RESTAURANT, CAFE AND BAR SERVICES; RESERVATION SERVICES, NAMELY, MAKING HOTEL RESERVATIONS FOR OTHERS; PROVIDING FACILITIES FOR EXHIBITIONS AND CONFERENCES IN HOTELS; METEOROLOGICAL INFORMATION SERVICES, NAMELY, WEATHER FORECASTING AND WEATHER REPORTING SERVICES; HAIR DRESSING SERVICES; RENTAL OF CLOTHING; CONSULTANCY IN THE FIELD OF COMPUTER SOFTWARE FIRMWARE, HARDWARE AND INFORMATION TECHNOLOGY; COMPUTER SOFTWARE, FIRMWARE, HARDWARE AND INFORMATION TECHNOLOGY SYSTEMS DESIGN FOR OTHERS AND COMPUTER PROGRAMMING SERVICES FOR OTHERS; RENTAL OF ELECTRIC AND ELECTRONIC GOODS, NAMELY, COMPUTER SOFTWARE, FIRMWARE, HARDWARE; SECURITY GUARD SERVICES; DESIGNING AND IMPLEMENTING WEB PAGES FOR OTHERS; HOSTING, CREATING AND MAINTAINING WEBSITES FOR OTHERS; PROVIDING TEMPORARY USE OF NON-DOWNLOADABLE SOFTWARE FOR USE IN A COMPUTER DATABASE FOR OBTAINING INFORMATION RELATING TO INTERNET SERVICES, CONSULTANCY AND ADVICE RELATING TO THE EVALUATION, CHOOSING AND IMPLEMENTATION OF COMPUTER SOFTWARE, FIRMWARE, HARDWARE, INFORMATION TECHNOLOGY AND OF DATA PROCESSING SYSTEMS; PROVISION OF INFORMATION RELATING TO TECHNICAL MATTERS, NAMELY, COMPUTER AND THE INTERNET, LEGAL MATTERS, NAMELY, LEGAL SERVICES, INFORMATION TECHNOLOGY, NAMELY, COMPUTERS, DATA COMMUNICATIONS, NETWORKS, COMPUTER SOFTWARE AND HARDWARE; ALL THE AFORESAID SERVICES PROVIDED VIA TELECOMMUNICATION NETWORKS, BY ONLINE DELIVER AND BY WAY OF THE INTERNET AND THE WORLDWIDE WEB (U.S. CLS. 100 AND 101).

SN 78-091,497. SITA ADVANCED TRAVEL SOLUTIONS LIMITED, GODALMING SURREY GU7 1XE, ENGLAND, BY CHANGE OF NAME EQUANT APPLICATION SERVICES LIMITED, SURREY, ENGLAND, FILED 11-2-2001.

iTravelAutomate

PRIORITY CLAIMED UNDER SEC. 44(D) ON ERP CMNTY TM OFC APPLICATION NO. 2345262, FILED 8-20-2001, REG. NO. 002345262, DATED 8-20-2001, EXPIRES 8-20-2011.

CLASS 9—ELECTRICAL AND SCIENTIFIC APPARATUS

FOR COMPUTER SOFTWARE FOR USE IN DATABASE MANAGEMENT, FOR FACILITATING, DEVELOPING AND IMPLEMENTING ELECTRONIC COMMERCE TRANSACTIONS, AND FOR BUSINESS PROCESS AUTOMATION, ALL IN THE FIELD OF GENERAL USE; AND INSTRUCTION MANUALS AND PUBLICATIONS IN ELECTRONIC FORMAT SOLD TOGETHER THEREWITH AS A UNIT (U.S. CLS. 21, 23, 26, 36 AND 38).

FIRST USE 1-0-2000; IN COMMERCE 1-0-2000.

CLASS 42—SCIENTIFIC, COMPUTER AND LEGAL SERVICES

FOR COMPUTER PROGRAMMING FOR OTHERS; COMPUTER SYSTEMS ANALYSIS; TECHNICAL RESEARCH IN THE FIELD OF COMPUTER PROGRAMMING; CONSULTANCY SERVICES RELATING TO THE DESIGN AND INSTALLATION OF COMPUTERS; CONSULTANCY SERVICES IN THE FIELD OF COMPUTER HARDWARE AND SOFTWARE; APPLICATION SOFTWARE INSTALLATION SERVICES; MAINTENANCE OF COMPUTER SOFTWARE; AND TECHNICAL SUPPORT, NAMELY, MONITORING OF NETWORK SYSTEMS (U.S. CLS. 100 AND 101).

FIRST USE 1-0-2000; IN COMMERCE 1-0-2000.

SN 78-091,378. SYNGENTA CROP PROTECTION, INC., GREENSBORO, NC. FILED 11-2-2001.

CITADEL

OWNER OF U.S. REG. NO. 1,963,235.

SN 78-092,504. XELION SIM S.P.A., MILAN, ITALY, FILED 11-9-2001.

CLASS 1—CHEMICALS

FOR ADJUVANTS FOR USE WITH PESTICIDES (U.S. CLS. 1, 5, 6, 10, 26 AND 46).

X PLATFORM

CLASS 5—PHARMACEUTICALS

FOR PESTICIDES FOR AGRICULTURAL USE (U.S. CLS. 6, 18, 44, 46, 51 AND 52).

PRIORITY CLAIMED UNDER SEC. 44(D) ON ITALY APPLICATION NO. RM2001C00281, FILED 5-10-2001, REG. NO. 00852055, DATED 5-10-2001, EXPIRES 5-10-2011.

CLASS 35—ADVERTISING AND BUSINESS

FOR BUSINESS APPRAISALS; BUSINESS AUDITING; BUSINESS CONSULTING IN THE FIELDS OF ORGANIZATION, MANAGEMENT, EFFICIENCY, AND DATABASE CONSTRUCTION; ORGANIZING EXHIBITIONS FOR A WIDE RANGE OF BUSINESSES FOR COMMERCIAL OR ADVERTISING PURPOSES; CONDUCTING BUSINESS AND MARKETING RESEARCH SURVEYS FOR OTHERS (U.S. CLS. 100, 101 AND 102).

CLASS 36—INSURANCE AND FINANCIAL

FOR BANKING; MORTGAGE BANKING; CREDIT CARD SERVICES; INVESTMENT BROKERAGE SERVICES; FINANCING SERVICES; FINANCIAL ANALYSIS AND CONSULTATION; CAPITAL INVESTMENT CONSULTATION BY MEANS OF THE INTERNET; BAIL BONDING (U.S. CLS. 100, 101 AND 102).

SN 78-097,627. HERITAGE MURGERBON CORPORATION LTD, NAKOMPATHOM, THAILAND, FILED 12-10-2001.



NO CLAIM IS MADE TO THE EXCLUSIVE RIGHT TO USE "NUT", APART FROM THE MARK AS SHOWN.

THE MARK CONSISTS OF THE WORDING "NUT WALKER" AND A DESIGN FEATURING A SMILING NUT WITH HANDS AND FEET.

CLASS 29—MEATS AND PROCESSED FOODS

FOR SNACKS, NAMELY, DRIED, ROASTED, SALTED, AND SWEETENED NUTS; DRIED SOYBEANS, PROCESSED WATERMELON SEEDS AND PROCESSED PINE NUTS, PISTACHIO NUTS, MACADAMIA NUTS, CASHEW NUTS, PECAN NUTS, HAZEL NUTS AND ALMOND NUTS; PROCESSED FRUITS AND DRIED FRUITS; DRIED BEANS, PROCESSED PEAS (U.S. CL. 46).

FIRST USE 1-15-1990; IN COMMERCE 4-8-1992.

CLASS 30—STAPLE FOODS

FOR SNACKS, NAMELY, POPPED POPCORN; READY TO EAT PROCESSED FOODS, NAMELY, CRACKERS, PRETZELS, POPCORN, NAMELY, MICROWAVE POPCORN, POPPED POPCORN, PROCESSED UNPOPPED POPCORN, RICE, PROCESSED WHEAT AND PROCESSED CORN SNACKS, CANDY NUTS, NAMELY, CHOCOLATE-COVERED NUTS, CANDY, CHOCOLATE, CAKES AND BISCUITS, WHEAT CEREALS, RICE CEREALS, AND CORN CEREALS (U.S. CL. 46).

FIRST USE 1-15-1990; IN COMMERCE 4-8-1992.

SN 78-095,114. ENVIROSCRUB TECHNOLOGIES CORPORATION, BLOOMINGTON, MN. FILED 11-26-2001.

PAHLMANITE**CLASS 1—CHEMICALS**

FOR COMPOUNDS IN THE NATURE OF CHEMICAL SORBENTS USED FOR THE REMOVAL AND CAPTURE OF POLLUTANTS; CHEMICAL COMPOUNDS OBTAINED FROM THE PROCESSING OF CHEMICAL SORBENTS USED FOR THE REMOVAL OF POLLUTANTS FROM WASTE, INDUSTRIAL AND COMBUSTION GASES (U.S. CLS. 1, 5, 6, 10, 26 AND 46).

CLASS 11—ENVIRONMENTAL CONTROL APPARATUS

FOR POLLUTION CONTROL AND REMOVAL UNITS AND SCRUBBERS IN THE FIELD OF ENVIRONMENTAL CONTROL, AND WASTE STREAM REDUCTION (U.S. CLS. 13, 21, 23, 31 AND 34).

CLASS 42—SCIENTIFIC, COMPUTER AND LEGAL SERVICES

FOR CONSULTING IN THE FIELD OF POLLUTION AND ENVIRONMENTAL CONTROL, WASTE STREAM REDUCTION, AND GENERATION OF USEFUL, MARKETABLE PRODUCTS FROM POLLUTANTS REMOVED FROM WASTE, INDUSTRIAL, AND COMBUSTION GASES (U.S. CLS. 100 AND 101).

SN 78-099,705. PREVOST CAR INC., STE-CLAIRE, QUEBEC, FILED 12-21-2001.

PREVOST MOTORCOACHES

OWNER OF U.S. REG. NO. 1,172,166.

NO CLAIM IS MADE TO THE EXCLUSIVE RIGHT TO USE "MOTORCOACHES", APART FROM THE MARK AS SHOWN.

SEC. 2(F).

CLASS 35—ADVERTISING AND BUSINESS

FOR RETAIL STORE SERVICES FEATURING BUSES (U.S. CLS. 100, 101 AND 102).

CLASS 36—INSURANCE AND FINANCIAL

FOR PROVIDING EXTENDED WARRANTIES ON HIGHWAY MOTOR HOMES (U.S. CLS. 100, 101 AND 102).

CLASS 40—MATERIAL TREATMENT

FOR CUSTOMIZED MANUFACTURE OF BUSES FOR OTHERS (U.S. CLS. 100, 103 AND 106).

SN 78-100,807. GHEN CORPORATION, GIFU-KEN, JAPAN, FILED 1-3-2002.

OVALGEN

CLASS 5—PHARMACEUTICALS

FOR PHARMACEUTICAL PREPARATIONS COMPRISING ANTIBODY DERIVED FROM EGGS USED IN THE TREATMENT OF ALLERGIES, DIGESTIVE DISORDERS, SKIN DISEASES, METABOLIC DISORDERS, TUMORS, PARASITE INFESTATIONS, ORAL DISEASES, CHRONIC INFLAMMATION DISEASES, RESPIRATORY DISEASES, UROGENITAL DISEASES, ANAL DISEASES, CIRCULATORY DISEASES, HAIR CONDITIONS AND PERIPHERAL NERVE DISEASES, AND DIAGNOSTIC PREPARATIONS FOR CLINICAL OR MEDICAL LABORATORY USE (U.S. CLS. 6, 18, 44, 46, 51 AND 52).

CLASS 29—MEATS AND PROCESSED FOODS

FOR FOOD PRODUCTS, NAMELY EGGS AND PROCESSED EGG PRODUCTS; OTHER PRODUCTS BASED ON EGGS, NAMELY LIQUID EGGS AND POWDERED EGGS (U.S. CL. 46).

SN 78-101,706. REEFDALE PTY LTD, BRAESIDE VICTORIA, AUSTRALIA, FILED 1-9-2002.

TAS

PRIORITY CLAIMED UNDER SEC. 44(D) ON AUSTRALIA APPLICATION NO. 884139, FILED 7-31-2001.
PRIORITY CLAIMED UNDER SEC. 44(D) ON AUSTRALIA APPLICATION NO. 884139, FILED 7-31-2001.
PRIORITY CLAIMED UNDER SEC. 44(D) ON AUSTRALIA APPLICATION NO. 884139, FILED 7-31-2001.

CLASS 6—METAL GOODS

FOR METAL PALLETS FOR SCREEN PRINTING MACHINE (U.S. CLS. 2, 12, 13, 14, 23, 25 AND 50).
FIRST USE 0-0-1985; IN COMMERCE 0-0-1985.

CLASS 7—MACHINERY

FOR SCREEN PRINTING MACHINES AND PARTS THEREOF; FLASH CURE UNITS FOR SCREEN PRINTING; PALLET LOADERS FOR SCREEN PRINTING MACHINES AND PALLET UNLOADERS FOR SCREEN PRINTING MACHINES (U.S. CLS. 13, 19, 21, 23, 31, 34 AND 35).
FIRST USE 0-0-1985; IN COMMERCE 0-0-1985.

CLASS 9—ELECTRICAL AND SCIENTIFIC APPARATUS

FOR SCREEN PRINTING MACHINE ELECTRICAL CONTROLLERS AND SOFTWARE FOR CONTROLLING THE OPERATION OF SCREEN PRINTING MACHINES (U.S. CLS. 21, 23, 26, 36 AND 38).
FIRST USE 0-0-1985; IN COMMERCE 0-0-1985.

CLASS 37—CONSTRUCTION AND REPAIR

FOR REPAIR AND MAINTENANCE OF SCREEN PRINTING MACHINES, PALLETS FOR SCREEN PRINTING MACHINES, FLASH CURE UNITS FOR SCREEN PRINTING, PALLET LOADERS FOR SCREEN PRINTING MACHINES AND PALLETS UNLOADERS FOR SCREEN PRINTING MACHINES (U.S. CLS. 100, 103 AND 106).
FIRST USE 0-0-1985; IN COMMERCE 0-0-1985.

SN 78-106,176. TRIANGLE SOFTWARE CORPORATION, DBA COTTON GRAPHICS, DUNWOODY, GA. FILED 2-1-2002.

COTTON GRAPHICS

NO CLAIM IS MADE TO THE EXCLUSIVE RIGHT TO USE "COTTON" AND "GRAPHICS", APART FROM THE MARK AS SHOWN.

CLASS 25—CLOTHING

FOR T-SHIRTS, GOLF SHIRTS, POLO SHIRTS, CAPS, JACKETS, TOTE BAGS, AND APRONS MADE IN WHOLE OR SUBSTANTIAL PART OF COTTON (U.S. CLS. 22 AND 39).
FIRST USE 9-1-1994; IN COMMERCE 9-1-1994.

CLASS 40—MATERIAL TREATMENT

FOR SCREEN PRINTING AND EMBROIDERY OF CLOTHING AND ACCESSORIES INCLUDING T-SHIRTS, GOLF SHIRTS, POLO SHIRTS, CAPS, AND OTHER SPORTSWEAR; IMPRINTING OF COFFEE MUGS, WATER BOTTLES, AND OTHER PROMOTIONAL OR PREMIUM ITEMS (U.S. CLS. 100, 103 AND 106).
FIRST USE 9-1-1994; IN COMMERCE 9-1-1994.

SN 78-106,693. MARIFIN BEHEER B.V., KRIMPEN AAN DE LEK, NETHERLANDS, FILED 2-4-2002.

BARKE

PRIORITY CLAIMED UNDER SEC. 44(D) ON BENELUX APPLICATION NO. 994816, FILED 8-6-2001, REG. NO. 0699910, DATED 8-6-2001, EXPIRES 8-6-2011.

CLASS 9—ELECTRICAL AND SCIENTIFIC APPARATUS

FOR ELECTRONIC CONTROLS FOR MOTORS AND STEERING GEARS (U.S. CLS. 21, 23, 26, 36 AND 38).

CLASS 12—VEHICLES

FOR BOAT RUDDERS, AND PARTS THEREFOR; BOAT RUDDER PARTS, NAMELY, RUDDER BLADES, RUDDER TRUNKS, RUDDER STOCK, UPPER AND LOWER RUDDER STOCK BEARINGS, RUDDER FLAPS, GEAR BOXES FOR RUDDER FLAPS; PROPELLERS FOR BOATS, AND PARTS THEREFOR; STRUCTURAL PARTS FOR BOATS, NAMELY, STEERING WHEELS, STEERING NOZZLES AND PARTS THEREFOR, STEERING GEAR AND PARTS THEREFOR, JET PIPES, AND OTHER STRUCTURAL PARTS FOR BOATS (U.S. CLS. 19, 21, 23, 31, 35 AND 44).

SN 78-107,000. HAFNER, BRENDA, LEAWOOD, KS. FILED 2-5-2002.

SOUL TEACHINGS

NO CLAIM IS MADE TO THE EXCLUSIVE RIGHT TO USE "TEACHINGS", APART FROM THE MARK AS SHOWN.

CLASS 16—PAPER GOODS AND PRINTED MATTER

FOR SERIES OF INSPIRATIONAL BOOKS IN THE FIELD OF DIRECTING PEOPLE TO THEIR SPIRITUAL POWER, FEATURING THE USE OF TRADITIONAL AND NON-TRADITIONAL HEALING METHODS; PRINTED ARTICLES, COLUMNS OR SECTIONS THAT ARE SEPARATELY SOLD, SYNDICATED OR OFFERED FOR SYNDICATION AND PRINTED MATERIALS, NAMELY, NEWSLETTERS, ALL IN THE FIELD OF DIRECTING PEOPLE TO THEIR SPIRITUAL POWER. (U.S. CLS. 2, 5, 22, 23, 29, 37, 38 AND 50).

SN 78-107,628. FERRARI S.P.A., MODENA, ITALY, FILED 2-8-2002.

575M Maranello

CLASS 41—EDUCATION AND ENTERTAINMENT

FOR EDUCATIONAL SERVICES, NAMELY, CONDUCTING SEMINARS IN THE FIELD OF DIRECTING PEOPLE TO THEIR SPIRITUAL POWER, INCLUDING THE USE OF TRADITIONAL AND NON-TRADITIONAL HEALING METHODS (U.S. CLS. 100, 101 AND 107).

PRIORITY CLAIMED UNDER SEC. 44(D) ON ITALY APPLICATION NO. TO2002C00032, FILED 2-6-2002, REG. NO. 868076, DATED 2-6-2002, EXPIRES 2-6-2022.

OWNER OF U.S. REG. NOS. 2,005,616 AND 2,248,482.

CLASS 44—MEDICAL, BEAUTY AND AGRICULTURAL SERVICES

FOR CONSULTATION SERVICES IN THE FIELD OF DIRECTING PEOPLE TO THEIR SPIRITUAL POWER, INCLUDING THE USE OF TRADITIONAL AND NON-TRADITIONAL HEALING METHODS (U.S. CLS. 100 AND 101).

CLASS 12—VEHICLES

FOR LAND MOTOR VEHICLES, NAMELY, MOTOR CARS, AUTOMOBILES AND SPORT CARS, AND STRUCTURAL PARTS AND ACCESSORIES THEREOF SOLD AS A UNIT; ENGINES FOR LAND VEHICLES; TRANSMISSIONS FOR LAND VEHICLES, SUSPENSION SYSTEMS FOR LAND VEHICLES; BRAKES FOR LAND VEHICLES; MOTOR BIKES (U.S. CLS. 19, 21, 23, 31, 35 AND 44).

CLASS 28—TOYS AND SPORTING GOODS

FOR TOY MODELS AND COLLECTION MODELS REPRODUCING AUTOMOBILES AND OTHER VEHICLES; REAL SIZE REPLICAS OF AUTOMOBILES FOR ENTERTAINMENT AND EXHIBITION PURPOSES; GAME PUZZLES; HAND-HELD UNITS FOR PLAYING ELECTRONIC GAMES, STAND ALONE VIDEOGAME MACHINES, COIN OR COUNTER OPERATED ARCADE GAME MACHINES, NONE OF THE FOREGOING BEING FOR USE WITH TELEVISION RECEIVERS, AND PARTS AND FITTINGS SOLD AS A UNIT FOR THE AFORESAID GAMES (U.S. CLS. 22, 23, 38 AND 50).

CLASS 37—CONSTRUCTION AND REPAIR

FOR AUTOMOBILE REPAIR AND MAINTENANCE, AUTOMOBILE BODY REPAIR WORK FOR MOTOR CARS (U.S. CLS. 100, 103 AND 106).

SN 78-107,301. NORCOM INFORMATION TECHNOLOGY AG, MUNICH, FED REP GERMANY, FILED 2-7-2002.

NGS ACCESSMINDER**CLASS 9—ELECTRICAL AND SCIENTIFIC APPARATUS**

FOR COMPUTER PROGRAMS AND COMPUTER SOFTWARE FOR AUTHENTICATION PROCESSES IN THE FIELD OF DATA SECURITY (U.S. CLS. 21, 23, 26, 36 AND 38).

SN 78-111,371. GENERAL ELECTRIC COMPANY, FAIRFIELD, CT. FILED 2-27-2002.

MODSPACE**CLASS 35—ADVERTISING AND BUSINESS**

FOR DATA PROCESSING SERVICES IN THE FIELD OF DATA SECURITY; BUSINESS MANAGEMENT CONSULTATION (U.S. CLS. 100, 101 AND 102).

CLASS 6—METAL GOODS

FOR PORTABLE METAL BUILDINGS (U.S. CLS. 2, 12, 13, 14, 23, 25 AND 50).

CLASS 42—SCIENTIFIC, COMPUTER AND LEGAL SERVICES

FOR COMPUTER PROGRAMMING FOR OTHERS IN THE FIELD OF DATA SECURITY; UPDATING OF COMPUTER SOFTWARE IN THE FIELD OF DATA SECURITY FOR OTHERS; MAINTENANCE OF COMPUTER SOFTWARE AND COMPUTER CONSULTATION IN THE FIELD OF DATA SECURITY (U.S. CLS. 100 AND 101).

CLASS 19—NON-METALLIC BUILDING MATERIALS

FOR PORTABLE NON-METAL BUILDINGS (U.S. CLS. 1, 12, 33 AND 50).

CLASS 39—TRANSPORTATION AND STORAGE

FOR LEASING OF PORTABLE METAL AND PORTABLE NON-METAL BUILDINGS FOR USE AS STORAGE (U.S. CLS. 100 AND 105).

CLASS 43—HOTEL AND RESTAURANT SERVICES

FOR LEASING OF PORTABLE METAL AND PORTABLE NON-METAL BUILDINGS FOR USE AS TEMPORARY CLASSROOMS, COMMERCIAL SPACE, CONSTRUCTION OFFICES, AND LABORATORIES (U.S. CLS. 100 AND 101).

SN 78-111,808. PETS 'N PEOPLE, INC., ROLLING HILLS ESTATES, CA. FILED 2-28-2002.

NATURE'S MIRACLE

OWNER OF U.S. REG. NOS. 1,321,689, 2,727,180 AND OTHERS.

CLASS 3—COSMETICS AND CLEANING PREPARATIONS

FOR COMBINATION CLEANERS AND DEODORIZERS FOR LITTER BOXES AND PET CAGES; COMBINATION CLEANERS AND DEODORIZERS FOR USE ON PETS, NAMELY DANDER REMOVER AND DEODORIZER; GROOMING PREPARATIONS FOR USE ON PETS, NAMELY PET WIPES THAT CLEAN COATS AND PAWS (U.S. CLS. 1, 4, 6, 50, 51 AND 52).

FIRST USE 3-1-1990; IN COMMERCE 3-1-1990.

CLASS 5—PHARMACEUTICALS

FOR ANIMAL AND PET CARE AND MAINTENANCE PRODUCTS, NAMELY PET REPELLANT, COMBINATION DEODORIZING PREPARATION AND SOLIDIFYING AGENT FOR USE ON ANIMAL VOMIT AND EXCREMENT (U.S. CLS. 6, 18, 44, 46, 51 AND 52).

FIRST USE 9-26-1986; IN COMMERCE 9-26-1986.

SN 78-112,499. RDS SKATE SUPPLY, LTD., NORTH VANCOUVER BC, CANADA, BY ASSIGNMENT RED DRAGON SKATEBOARD CORP., NORTH VANCOUVER, BC, CANADA, FILED 3-4-2002.

RDS

PRIORITY CLAIMED UNDER SEC. 44(D) ON CANADA APPLICATION NO. 1114593, FILED 9-4-2001.

CLASS 18—LEATHER GOODS

FOR WALLETS, DAYPACKS, BACKPACKS, ALL-PURPOSE SPORTS AND ATHLETIC BAGS (U.S. CLS. 1, 2, 3, 22 AND 41).

FIRST USE 2-0-1997; IN COMMERCE 2-0-1997.

CLASS 25—CLOTHING

FOR CLOTHING, NAMELY, T-SHIRTS, JACKETS, PANTS, HATS, SHIRTS, SOCKS, SLEEPWEAR, SWIMWEAR, AND BELTS. (U.S. CLS. 22 AND 39).

FIRST USE 6-0-1996; IN COMMERCE 6-0-1996.

CLASS 28—TOYS AND SPORTING GOODS

FOR SPORTING GOODS, NAMELY, SKATEBOARDS, SKATEBOARD DECKS, SKATEBOARD TRUCKS, SKATEBOARD WHEELS, SKATEBOARD WHEEL ASSEMBLIES AND PARTS AND FITTINGS FOR ANY THEREOF; SKATEBOARD BUMPERS, BEARINGS, RAILS, SHOCK ABSORBERS AND PADS; SNOWBOARDS, SNOWBOARD BINDINGS AND PARTS THEREFOR; SAFETY PADDING AND PROTECTIVE PADDING FOR SKATEBOARDING AND SNOWBOARDING; TOYS, NAMELY, MINIATURE SKATEBOARDS AND MINIATURE SKATEBOARD PARTS (U.S. CLS. 22, 23, 38 AND 50).

FIRST USE 2-0-1997; IN COMMERCE 2-0-1997.

CLASS 35—ADVERTISING AND BUSINESS

FOR RETAIL STORE SERVICES, ONLINE RETAIL STORE SERVICES AND MAIL ORDER CATALOGUE SERVICES FEATURING SKATEBOARDS AND PARTS AND ACCESSORIES THEREFOR, SNOWBOARDS, SNOWBOARD BINDINGS AND PARTS THEREFOR, AND CLOTHING AND ACCESSORIES. (U.S. CLS. 100, 101 AND 102).

FIRST USE 5-0-1996; IN COMMERCE 5-0-1996.

SN 78-113,655. ACCENT BUSINESS SERVICES, INC., VANCOUVER, WA. FILED 3-8-2002.

accent
Business Services, Inc.

NO CLAIM IS MADE TO THE EXCLUSIVE RIGHT TO USE "BUSINESS SERVICES, INC.", APART FROM THE MARK AS SHOWN.

CLASS 9—ELECTRICAL AND SCIENTIFIC APPARATUS

FOR COMPUTER FIRMWARE FOR USE IN DATABASE MANAGEMENT, PROJECT MANAGEMENT, BUSINESS ADMINISTRATION; SPECIALLY DESIGNED COMPUTER PROGRAMS ADAPTED FOR CUSTOMER SPECIFIC USES, NAMELY PROJECT MILESTONES AND PROJECT FLOW DETERMINATION (U.S. CLS. 21, 23, 26, 36 AND 38).

FIRST USE 12-31-1997; IN COMMERCE 12-31-1997.

CLASS 35—ADVERTISING AND BUSINESS

FOR EMPLOYMENT PLACEMENT AND STAFFING; BUSINESS CONSULTATION; BUSINESS DEVELOPMENT SERVICES, NAMELY, PROVIDING STARTUP CONSULTING SERVICES FOR BUSINESSES OF OTHERS; SOFTWARE SYSTEM EVALUATION AND INFRASTRUCTURE EVALUATION; BUSINESS MANAGEMENT AND CONSULTATION; BUSINESS MANAGEMENT PLANNING; BUSINESS PLANNING; BUSINESS PROCESS RE-ENGINEERING SERVICES; CONSULTING SERVICES IN THE FIELD OF THE PURCHASE OF COMPUTER HARDWARE AND SOFTWARE SYSTEMS FOR BUSINESSES (U.S. CLS. 100, 101 AND 102).

FIRST USE 12-31-1997; IN COMMERCE 12-31-1997.

CLASS 42—SCIENTIFIC, COMPUTER AND LEGAL SERVICES

FOR CONSULTING SERVICES IN THE FIELD OF DESIGN, PURCHASE, SELECTION, IMPLEMENTATION AND USE OF COMPUTER HARDWARE AND SOFTWARE SYSTEMS FOR BUSINESSES; SOFTWARE SYSTEMS EVALUATION AND EVALUATION OF EXISTING CUSTOMER SOFTWARE PLATFORMS (U.S. CLS. 100 AND 101).

FIRST USE 12-31-1997; IN COMMERCE 12-31-1997.

SN 78-114,178. SIMMONS, CHRISTOPHER, REDONDO BEACH, CA. FILED 3-12-2002.

NEOTROPE

OWNER OF U.S. REG. NO. 2,514,592.

CLASS 35—ADVERTISING AND BUSINESS

FOR ADVERTISING AGENCY SERVICES; PUBLIC RELATIONS SERVICES; PUBLICITY AGENCY SERVICES; DIRECT MARKETING ADVERTISING SERVICES; BUSINESS CONSULTING; BUSINESS MARKETING CONSULTING SERVICES MARKET RESEARCH; SALES PROMOTION SERVICES, NAMELY PROMOTING THE GOODS AND SERVICES OF OTHERS THROUGH THE DISTRIBUTION OF PRINTED, ELECTRONIC, VIDEO, AND AUDIO PROMOTIONAL MATERIALS AND BY RENDERING SALES PROMOTIONAL ADVICE; AND PLANNING AND PREPARING ADVERTISING OF OTHERS, PURCHASE AND PROCUREMENT OF MEDIA TIME, PLANNING AND RESEARCH OF PRINT, RADIO, TELEVISION, AND ELECTRONIC ADVERTISING MEDIA USE; CREATING CORPORATE LOGOS FOR OTHERS; CREATING CORPORATE AND BRAND IDENTITY FOR OTHERS; DISSEMINATION OF ADVERTISING MATTER, AND DISSEMINATION OF ADVERTISING FOR OTHERS VIA THE INTERNET (U.S. CLS. 100, 101 AND 102).

FIRST USE 0-0-1996; IN COMMERCE 0-0-1996.

CLASS 42—SCIENTIFIC, COMPUTER AND LEGAL SERVICES

FOR CONSULTING SERVICES RELATING TO THE CREATION, DESIGN, DEVELOPMENT AND IMPLEMENTATION OF WEBSITES AND INTERACTIVE COMPUTER DATABASES; AND CUSTOM SOFTWARE AND USER INTERFACE DESIGN SERVICES FOR OTHERS; GRAPHIC DESIGN SERVICES FOR OTHERS; AND PACKAGING AND PRODUCT DESIGN FOR OTHERS (U.S. CLS. 100 AND 101).

FIRST USE 0-0-1996; IN COMMERCE 0-0-1996.

SN 78-116,169. CLAIRSON, INC., NEWARK, DE. FILED 3-20-2002.

DESIGNXPRESSIONS**CLASS 6—METAL GOODS**

FOR SUPPORT BRACKETS, RODS, POLES, BARS, RAILS, WALL SUPPORTS ALL MADE OF METAL AND METAL MOUNTING AND SUPPORT HARDWARE, NAMELY, SCREWS, WALL CLIPS, WALL CLEATS, WALL HOOKS, AND TOGGLE BOLTS, SOLD INDIVIDUALLY AND IN COMBINATION (U.S. CLS. 2, 12, 13, 14, 23, 25 AND 50).

CLASS 20—FURNITURE AND ARTICLES NOT OTHERWISE CLASSIFIED

FOR SHELVES, SHELVING UNITS, SHELF KITS COMPRISING SHELVES, MOUNTING BRACKETS AND SUPPORT HARDWARE, SOLD INDIVIDUALLY AND IN COMBINATION (U.S. CLS. 2, 13, 22, 25, 32 AND 50).

SN 78-118,278. LEGEND DESIGN TECHNOLOGY, INC., SUNNYVALE, CA. FILED 3-28-2002.

Legend
Design Technology

NO CLAIM IS MADE TO THE EXCLUSIVE RIGHT TO USE "DESIGN TECHNOLOGY", APART FROM THE MARK AS SHOWN.

THE STIPLING IS A FEATURE OF THE MARK AND DOES NOT INTEND TO INDICATE COLOR.

CLASS 9—ELECTRICAL AND SCIENTIFIC APPARATUS

FOR COMPUTER SOFTWARE DEVELOPMENT TOOLS (U.S. CLS. 21, 23, 26, 36 AND 38).

FIRST USE 9-30-1996; IN COMMERCE 9-30-1996.

CLASS 42—SCIENTIFIC, COMPUTER AND LEGAL SERVICES

FOR COMPUTER SOFTWARE DEVELOPMENT; COMPUTER SOFTWARE DESIGN FOR OTHERS (U.S. CLS. 100 AND 101).

FIRST USE 9-30-1996; IN COMMERCE 9-30-1996.

SN 78-118,771. RANDSTAD HOLDING N.V., DIEMEN, NETHERLANDS, FILED 4-1-2002.

WORKANISER

PRIORITY CLAIMED UNDER SEC. 44(D) ON BENELUX APPLICATION NO. 1005660, FILED 2-19-2002, REG. NO. 0704113, DATED 2-19-2002, EXPIRES 2-19-2012.

CLASS 35—ADVERTISING AND BUSINESS

FOR RECRUITMENT OF PERSONNEL; TEMPORARY STAFF DEPLOYMENT; EMPLOYMENT OF PERSONNEL; SECONDMENT OF PERSONNEL, NAMELY, PUTTING TEMPORARY WORKERS TO WORK; ADVICE IN THE FIELD OF STAFFING MATTERS; TAKING CARE OF THE ADMINISTRATION, IN PARTICULAR, SALARY AND PERSONNEL ADMINISTRATION; EMPLOYMENT FINDING AND ADVICE IN THE FIELD OF STAFF AND STAFF MATTERS; OUTPLACEMENT; INTERIM MANAGEMENT OF BUSINESS FOR OTHERS; PROJECT MANAGEMENT OF BUSINESS FOR OTHERS; SELECTION OF PERSONNEL FOR OTHERS; BUSINESS MANAGEMENT AND ORGANIZATION CONSULTANCY; ALL AFOREMENTIONED SERVICES ALSO PROVIDED VIA THE INTERNET (U.S. CLS. 100, 101 AND 102).

CLASS 41—EDUCATION AND ENTERTAINMENT

FOR EDUCATIONAL SERVICES, NAMELY, TEACHING IN THE FIELD OF STAFFING SERVICES AND INSTRUCTION VIA WORKSHOPS IN THE FIELD OF STAFFING SERVICES, ALL AFOREMENTIONED SERVICES ALSO PROVIDED VIA THE INTERNET (U.S. CLS. 100, 101 AND 107).

CLASS 42—SCIENTIFIC, COMPUTER AND LEGAL SERVICES

FOR PROVIDING INFORMATION IN THE FIELD OF NATURAL BIOLOGICAL PRODUCTS, NAMELY, PROVIDING ANALYTICAL PROFILES OF NATURAL BIOLOGICAL PRODUCTS; AND RESEARCH AND DEVELOPMENT FOR OTHERS IN THE FIELD OF NATURAL BIOLOGICAL PRODUCTS; PROVIDING RESEARCH, ANALYSIS AND CONSULTATION IN THE FIELDS OF CHEMICALS, BIOLOGY, BACTERIOLOGY AND MICROBIOLOGY (U.S. CLS. 100 AND 101).
FIRST USE 4-15-2002; IN COMMERCE 6-20-2002.

SN 78-121,710. CLAYTON I.D.S., INC., COLUMBUS, OH. FILED 4-15-2002.

SN 78-125,866. SECET LLC, WILMINGTON, DE. FILED 5-2-2002.

Mobil  *E.M.S.*

ac@t-x

NO CLAIM IS MADE TO THE EXCLUSIVE RIGHT TO USE "MOBIL" AND "E.M.S.", APART FROM THE MARK AS SHOWN.

CLASS 9—ELECTRICAL AND SCIENTIFIC APPARATUS

FOR COMPUTER SOFTWARE FOR FIELD DATA COLLECTION FOR USE WITH MOBILE COMPUTERS AND LAPTOPS FOR THE PURPOSE OF PROVIDING THE TRANSMISSION OF EMERGENCY MEDICAL SERVICE INFORMATION TO OTHER COMPUTERS AT LATER TIME AND FOR PROVIDING WIRELESS INFORMATION MANAGEMENT APPLICATIONS TO THESE COMPUTERS (U.S. CLS. 21, 23, 26, 36 AND 38).
FIRST USE 1-15-2002; IN COMMERCE 3-5-2002.

CLASS 9—ELECTRICAL AND SCIENTIFIC APPARATUS

FOR COMPUTER SOFTWARE THAT ENABLES USERS TO SEARCH, REVIEW, BUY, SELL, AND LICENSE PATENTS AND OTHER INTELLECTUAL PROPERTY, AND TO SOURCE DATA RELATED TO PATENTS AND OTHER INTELLECTUAL PROPERTY AND USER MANUALS SOLD THEREWITH; COMPUTER SOFTWARE FOR USE IN INTELLECTUAL ASSET MANAGEMENT, NAMELY SOFTWARE FOR SEARCHING, IDENTIFYING, ORGANIZING, ANALYZING, PROTECTING AND MANAGING INTELLECTUAL PROPERTY ASSETS AND USER MANUALS SOLD THEREWITH; COMPUTER SOFTWARE, NAMELY APPLICATION PROGRAMS FOR USE IN RESEARCH AND DEVELOPMENT OF NEW PRODUCTS AND SERVICES, BUSINESS PLANNING, BUSINESS MANAGEMENT, ADVERTISING AND MARKETING OF GOODS AND SERVICES, MAINTAINING SALES RECORDS, CONTRACT CREATION AND ADMINISTRATION, CUSTOMER MANAGEMENT, PROJECT MANAGEMENT, FINANCIAL MANAGEMENT, CUSTOMER SERVICE, MAINTENANCE OF CUSTOMER AND BUSINESS RECORDS, AND HUMAN CAPITAL MANAGEMENT, AND USER MANUALS SOLD THEREWITH; COMPUTER SOFTWARE FOR USE IN WORD PROCESSING, FOR ELECTRONIC MAIL, ADDRESS BOOK, CALENDAR, TASK AND EVENT SCHEDULING, RECORDING NOTES, ELECTRONIC SPREADSHEET, TRANSFERRING DATA TO AND FROM DATABASES AND TO AND FROM COMPUTER PROGRAMS AND COMPUTER FILES, DESKTOP PUBLISHING, DOCUMENT SCANNING, OPTICAL CHARACTER RECOGNITION, IMAGE EDITING, GRAPHICS CREATION AND EDITING, DRAWING, COMPUTER AIDED DESIGN AND DRAFTING, CREATION OF MULTIMEDIA PRESENTATIONS AND USER MANUALS SOLD THEREWITH; COMPUTER SOFTWARE FOR DOCUMENT AUTHORIZING, STORAGE, MANAGEMENT, RETRIEVAL, VERSION HISTORY TRACKING OF DRAFTS OF CONTRACTS AND BUSINESS DOCUMENTS, FOR AUTOMATICALLY NOTIFYING USERS WHEN DOCUMENTS HAVE BEEN UPDATED, PROFILING OF USERS, COMPUTER ACCESS CONTROL, AND COMPUTER SECURITY AND USER MANUALS SOLD THEREWITH; COMPUTER SOFTWARE USED IN THE FIELDS OF PROFESSIONAL SERVICES ADMINISTRATION, NAMELY MAINTAINING TIME AND BILLING RECORDS, ACCOUNTING, AUDITING, BOOKKEEPING, HUMAN RESOURCES MANAGEMENT AND PAYROLL RECORDS AND USER MANUALS SOLD THEREWITH; SOFTWARE FOR SEARCHING, RETRIEVING, FILTERING AND CATEGORIZING DOCUMENTS FROM COMPUTER NETWORKS, INCLUDING GLOBAL COMPUTER INFORMATION NETWORKS; COMPUTER SOFTWARE FOR USE IN ESTABLISHING AND MANAGING ONLINE INFORMATION GATEWAYS AND WEBSITES

CLASS 42—SCIENTIFIC, COMPUTER AND LEGAL SERVICES

FOR (BASED ON INTENT TO USE) PROVIDING TEMPORARY USE OF NON-DOWNLOADABLE SOFTWARE FOR CONNECTING USERS TO A GLOBAL COMPUTER NETWORK (U.S. CLS. 100 AND 101).

SN 78-122,258. ADVANCED GENE TECH CORP., TAI-CHUNG CITY, TAIWAN, FILED 4-17-2002.

AGTC

CLASS 9—ELECTRICAL AND SCIENTIFIC APPARATUS

FOR TEST KITS FOR USE IN IDENTIFYING BIOLOGICALLY ACTIVE INGREDIENTS FROM HERBS; BLANK COMPACT DISCS, BLANK MAGNETIC DISKS; AND, PRERECORDED COMPACT DISCS AND MAGNETIC DISKS BEARING CHEMICAL AND BIOLOGICAL DATA (U.S. CLS. 21, 23, 26, 36 AND 38).
FIRST USE 4-15-2002; IN COMMERCE 6-20-2002.

CONTAINING LINKS TO OTHER WEBSITES FOR USE IN ENABLING BUSINESSES TO REACH CUSTOMERS, PARTNERS, SUPPLIERS AND EMPLOYEES; COMPUTER SOFTWARE FOR USE IN E-COMMERCE BUSINESS APPLICATIONS, NAMELY SOFTWARE FOR ESTABLISHING, ORGANIZING AND MANAGING RELATIONSHIPS WITH CUSTOMERS, SUPPLIERS, PARTNERS, AND EMPLOYEES VIA INTEGRATED EXTRANET, INTRANET, AND INTERNET SITES; COMPUTER SOFTWARE TO ALLOW USERS TO PERFORM SECURE ELECTRONIC BUSINESS TRANSACTIONS VIA A GLOBAL COMPUTER NETWORK; COMPUTER SOFTWARE AND COMPUTER HARDWARE FOR USE IN CREATING, TRANSLATING, AND ADAPTING WEBSITES, WEBSITE CONTENT, OTHER SOFTWARE APPLICATIONS, DATA, DATABASES, AND INFORMATION FOR DELIVERY TO AND USE WITH WIRELESS COMMUNICATION DEVICES AND OTHER COMMUNICATIONS AND NETWORKING DEVICES; COMPUTER SOFTWARE FOR CREATING, EDITING AND MANAGING WEB SITES AND INTRANET SITES; COMPUTER SOFTWARE FOR COLLECTING AND MANAGING DATA, PERFORMING DATA ANALYSIS, CONDUCTING STUDIES, AND CREATING AND GENERATING REPORTS IN THE FIELDS OF NEW TECHNOLOGY INNOVATION, INTELLECTUAL PROPERTY, LAW, FINANCE, INVESTMENTS, HUMAN CAPITAL MANAGEMENT, BUSINESS MANAGEMENT, SALES, MARKETING, BUSINESS AND TECHNOLOGY (U.S. CLS. 21, 23, 26, 36 AND 38).

CLASS 16—PAPER GOODS AND PRINTED MATTER

FOR PRINTED MATERIALS, NAMELY MANUALS, JOURNALS, MAGAZINES, NEWSLETTERS, BROCHURES, PAMPHLETS, LEAFLETS AND PRINTED INSTRUCTIONAL MATERIALS IN THE FIELD OF NEW TECHNOLOGY INNOVATION, INTELLECTUAL PROPERTY, LAW, FINANCES, INVESTMENT, HUMAN CAPITAL MANAGEMENT, BUSINESS MANAGEMENT, SALES TECHNIQUES, ADVERTISING AND MARKETING, BUSINESS AND TECHNOLOGY; STATIONERY; WRITING INSTRUMENTS, NAMELY, PENS, BALL POINT PENS AND PENCILS; DIARIES; ADDRESS BOOKS (U.S. CLS. 2, 5, 22, 23, 29, 37, 38 AND 50).

CLASS 35—ADVERTISING AND BUSINESS

FOR SHAREHOLDER RECORD KEEPING SERVICES, NAMELY, RECORDING, REGISTERING AND MAINTAINING THE TRANSFERS AND OWNERSHIP OF INTELLECTUAL PROPERTY, SECURITIES, STOCKS AND SHARES AND CONFIRMING THE CORRESPONDENCE TO BUYER'S AND SELLER'S TRADES ON A STOCK EXCHANGE; AUDITING AND VALUATION OF INTELLECTUAL PROPERTY; BUSINESS MANAGEMENT AND BUSINESS CONSULTING AND ADVISORY SERVICES IN THE FIELDS OF NEW TECHNOLOGY INNOVATION, CORPORATE DEVELOPMENT, CORPORATE ALLIANCES, JOINT VENTURES, MERGERS, ACQUISITIONS, TRADE SALES, HUMAN CAPITAL MANAGEMENT, INTERIM MANAGEMENT, PERSONNEL RECRUITMENT; SALES TECHNIQUES, MARKETING, MARKET RESEARCH, PUBLIC RELATIONS, ACCOUNTING, BUSINESS AUDITING, TAX; PROVIDING AND OPERATING AN ONLINE MARKETPLACE FOR SELLERS OF GOODS AND SERVICES TO REVIEW, BUY, AND SELL PATENTS AND OTHER INTELLECTUAL PROPERTY VIA A GLOBAL COMPUTER NETWORK; ADVERTISING AND PROMOTIONAL SERVICES, NAMELY CREATING CORPORATE AND BRAND IDENTITY FOR OTHERS, PREPARING AUDIO-VISUAL PRESENTATIONS FOR USE IN ADVERTISING; ADVERTISING SLOGAN AND CARTOON CHARACTER LICENSING; THE RENTAL OF ADVERTISING SPACE; ELECTRONIC BILLBOARD ADVERTISING; DISSEMINATION OF ADVERTISING FOR OTHERS VIA THE INTERNET; PROVIDING TELEVISION ADVERTISING FOR OTHERS; AND THE ORGANIZING, ARRANGING, CONDUCTING AND PROMOTING TRADE SHOW EXHIBITIONS AND BUSINESS CONFERENCES IN THE FIELDS OF NEW TECHNOLOGY INNOVATION, INTELLECTUAL PROPERTY, FINANCES, INVESTMENTS, HUMAN CAPITAL MAN-

AGEMENT, BUSINESS, MANAGEMENT, SALES TECHNIQUES AND MARKETING (U.S. CLS. 100, 101 AND 102).

CLASS 36—INSURANCE AND FINANCIAL

FOR INTELLECTUAL PROPERTY RIGHTS BROKERAGE SERVICES; INVESTMENT ADVICE AND CONSULTATION AND INVESTMENT MANAGEMENT SERVICES; FINANCIAL CONSULTING AND ADVISORY SERVICES, NAMELY, CORPORATE FINANCING SERVICES, INCLUDING VENTURE CAPITAL FINANCING, MERGER AND ACQUISITION FINANCING, ARRANGING LOANS FROM SEVERAL SOURCES FOR OTHERS, PRIVATE PLACEMENT SERVICES FOR DEBT AND EQUITY, AND INITIAL PUBLIC OFFERINGS AND CORPORATE FINANCING ADVISORY SERVICES; FINANCIAL VALUATION SERVICES IN THE AREAS OF BUSINESS ENTERPRISES, INTELLECTUAL PROPERTY, VALUATION OF LICENSING RIGHTS, BUSINESS ASSETS, BUSINESS INVENTORIES, BUSINESS EQUIPMENT AND REAL ESTATE; PROVIDING FINANCIAL INFORMATION IN THE NATURE OF BUSINESS SHARE PRICES; PREPARATION, LISTING AND QUOTATION OF STOCK EXCHANGE PRICES AND INDICES; FINANCIAL INFORMATION MANAGEMENT AND ANALYSIS SERVICES; COMMODITIES AND FINANCIAL EXCHANGE SERVICES, NAMELY, PROVIDING A FINANCIAL MARKET FOR THE TRADING OF INTELLECTUAL PROPERTY, SECURITIES, STOCKS, SHARES, OPTIONS AND WARRANTS; FINANCIAL PORTFOLIO MANAGEMENT; SETTLEMENT SERVICES, NAMELY, SETTLEMENT OF TRADES ON A STOCK EXCHANGE (U.S. CLS. 100, 101 AND 102).

CLASS 42—SCIENTIFIC, COMPUTER AND LEGAL SERVICES

FOR INTELLECTUAL PROPERTY CONSULTATION, NAMELY, INTELLECTUAL PROPERTY STRATEGY; LEGAL SERVICES, NAMELY, INTELLECTUAL PROPERTY PROTECTION AND INTELLECTUAL PROPERTY MANAGEMENT; SCIENTIFIC AND TECHNOLOGICAL SERVICES, NAMELY, INDUSTRIAL RESEARCH AND ANALYSIS SERVICES; LEGAL SERVICES; LEGAL SERVICES, NAMELY, INTELLECTUAL PROPERTY MANAGEMENT, PROTECTION, MONITORING, ENFORCEMENT AND CONSULTING SERVICES; TECHNOLOGY TRANSFER SERVICES, NAMELY, LICENSING AND TRANSFER OF INTELLECTUAL PROPERTY; REGISTRATION AND LICENSING OF PATENTS AND OTHER INTELLECTUAL PROPERTY; PROVIDING INFORMATION VIA A WEB SITE FEATURING AN INTERACTIVE INTELLECTUAL PROPERTY INFORMATION AND RESEARCH SERVICE VIA A GLOBAL COMPUTER NETWORK; PROVIDING AN ON-LINE COMPUTER DATABASE FEATURING PATENTS AND OTHER INTELLECTUAL PROPERTY THAT MAY BE SEARCHED, REVIEWED, BOUGHT, SOLD AND LICENSED; COMPUTER SERVICES, NAMELY, PROVIDING SEARCH ENGINES FOR OBTAINING DATA RELATED TO PATENTS AND OTHER INTELLECTUAL PROPERTY; INFORMATION TECHNOLOGY MANAGEMENT, NAMELY MANAGING COMPUTER SOFTWARE APPLICATIONS FOR OTHERS; CONSULTATION IN THE FIELD OF INFORMATION TECHNOLOGY AND THE GLOBAL COMPUTER INFORMATION NETWORK; CONSULTING SERVICES IN THE FIELD OF DESIGN, DEVELOPMENT, SELECTION, IMPLEMENTATION AND USE OF COMPUTER HARDWARE, COMPUTER SOFTWARE AND TELECOMMUNICATIONS SYSTEMS FOR OTHERS; HOSTING THE WEB SITES OF OTHERS ON A COMPUTER SERVER FOR A GLOBAL COMPUTER NETWORK; COMPUTER SERVICES, NAMELY, DESIGNING AND DEVELOPING WEBSITES FOR OTHERS (U.S. CLS. 100 AND 101).

SN 78-131,369. CXR BIOSCIENCES LIMITED, EDINBURGH, UNITED KINGDOM, FILED 5-28-2002.

CXR BIOSCIENCES

PRIORITY CLAIMED UNDER SEC. 44(D) ON ERPN CMNTY TM OFC APPLICATION NO. 002484400, FILED 11-30-2001, REG. NO. 002484400, DATED 3-20-2003, EXPIRES 11-30-2011.

NO CLAIM IS MADE TO THE EXCLUSIVE RIGHT TO USE "BIOSCIENCES", APART FROM THE MARK AS SHOWN.

CLASS 1—CHEMICALS

FOR CHEMICAL OR BIOCHEMICAL PRODUCTS FOR RESEARCH PURPOSES, NAMELY, ANTIBODIES, INTERFERONS, PRECURSORS FOR IN VITRO GENETIC ENGINEERING USE AND POLYPEPTIDES; CHEMICALS OR BIOCHEMICALS FOR BIOTECHNOLOGICAL RESEARCH, NAMELY, ANTIBODIES, INTERFERONS, PRECURSORS FOR IN VITRO GENETIC ENGINEERING USE AND POLYPEPTIDES; CHEMICALS OR BIOCHEMICALS FOR USE IN SCIENTIFIC RESEARCH, NAMELY, ANTIBODIES, INTERFERONS, PRECURSORS FOR IN VITRO GENETIC ENGINEERING USE AND POLYPEPTIDES; DIAGNOSTIC PREPARATIONS, OTHER THAN FOR MEDICAL OR VETERINARY USE, NAMELY, ANTIBODIES, INTERFERONS, PRECURSORS FOR IN VITRO GENETIC ENGINEERING USE AND POLYPEPTIDES; REAGENTS FOR IN VITRO OR IN VIVO USE, OTHER THAN FOR MEDICAL USE; CHEMICAL OR BIOCHEMICALS FOR USE IN THE MANUFACTURE OF DRUGS, NAMELY, ANTIBODIES, INTERFERONS, PRECURSORS FOR IN VITRO GENETIC ENGINEERING USE AND POLYPEPTIDES; BIOLOGICAL PREPARATIONS FOR LABORATORY PURPOSES OR FOR SCIENTIFIC PURPOSES, NAMELY, ANTIBODIES, INTERFERONS, PRECURSORS FOR IN VITRO GENETIC ENGINEERING USE AND POLYPEPTIDES; AND SUBSTANCES PRODUCED BY CHEMICAL ENGINEERING, BUT NOT FOR MEDICAL USE, NAMELY, ANTIBODIES, INTERFERONS, PRECURSORS FOR IN VITRO GENETIC ENGINEERING USE AND POLYPEPTIDES (U.S. CLS. 1, 5, 6, 10, 26 AND 46).

CLASS 5—PHARMACEUTICALS

FOR BIOCHEMICAL PREPARATIONS FOR MEDICAL USE IN THE NATURE OF ANTIBODIES, INTERFERONS, PRECURSORS FOR IN VITRO GENETIC ENGINEERING USE AND POLYPEPTIDES; BIOTECHNOLOGICAL PREPARATIONS FOR VETERINARY USE IN THE NATURE OF ANTIBODIES, INTERFERONS, PRECURSORS FOR IN VITRO GENETIC ENGINEERING USE AND POLYPEPTIDES; CHEMICAL OR BIOCHEMICAL OR BIOCHEMICAL PRODUCTS FOR MEDICAL OR VETERINARY PURPOSES OR RESEARCH IN THE NATURE OF ANTIBODIES, INTERFERONS, PRECURSORS FOR IN VITRO GENETIC ENGINEERING USE AND POLYPEPTIDES; CLINICAL DIAGNOSTIC REAGENTS; MEDICAL AND VETERINARY REAGENTS FOR MEDICAL LABORATORY USE; BIOACTIVE SUBSTANCES OBTAINED FROM ANIMALS OR BY SYNTHESIS, NAMELY ANTIBODIES, INTERFERONS, PRECURSORS FOR IN VITRO GENETIC ENGINEERING USE AND POLYPEPTIDES; AND BIOLOGICAL SUBSTANCES FOR MEDICAL USE, NAMELY ANTIBODIES, INTERFERONS, PRECURSORS FOR IN VITRO GENETIC ENGINEERING USE AND POLYPEPTIDES (U.S. CLS. 6, 18, 44, 46, 51 AND 52).

CLASS 9—ELECTRICAL AND SCIENTIFIC APPARATUS

FOR APPARATUS FOR CARRYING OUT ASSAYS, NAMELY, CHROMATOGRAPHY APPARATUS, ELECTROPHORESIS APPARATUS, SPECTROSCOPY APPARATUS, MICROARRAYS AND TISSUE CULTURE APPARATUS; APPARATUS FOR SCIENTIFIC USE, NAMELY, CHROMATOGRAPHY APPARATUS, ELECTROPHORESIS APPARATUS, SPECTROSCOPY APPARATUS, MICROARRAYS, TISSUE CULTURE APPARATUS AND BIOREACTORS; APPARATUS FOR RESEARCH PURPOSES, NAMELY CHROMATOGRAPHY APPARATUS, ELECTROPHORESIS APPARATUS, SPECTROSCOPY APPARATUS, MICROARRAYS AND TISSUE CULTURE APPARATUS; DIAGNOSTIC APPARATUS FOR SCIENTIFIC USE, NAMELY, CHROMATOGRAPHY APPARATUS; DIAGNOSTIC APPARATUS FOR SCIENTIFIC USE, NAMELY, CHROMATOGRAPHY APPARATUS; ELECTROPHORESIS APPARATUS, SPECTROSCOPY APPARATUS, MICROARRAYS AND TISSUE CULTURE APPARATUS; AND ELECTROPHORESIS APPARATUS, SPECTROSCOPY APPARATUS, MICROARRAYS AND TISSUE CULTURE APPARATUS (U.S. CLS. 21, 23, 26, 36 AND 38).

CLASS 42—SCIENTIFIC, COMPUTER AND LEGAL SERVICES

FOR BIOTECHNOLOGICAL RESEARCH; SCIENTIFIC RESEARCH; SERVICES FOR ASSESSING THE SAFETY OR EFFICIENCY OF MEDICAL, VETERINARY OR SCIENTIFIC RESEARCH DRUGS; MEDICAL RESEARCH; CONSULTANCY SERVICES RELATING TO THE DEVELOPMENT OF DENTAL, MEDICAL AND SCIENTIFIC PRODUCTS; ADVISORY SERVICES RELATING TO THE DESIGN OF SAFETY PROGRAMS; ADVISORY AND CONSULTANCY SERVICES RELATING TO SCIENTIFIC, MEDICAL AND VETERINARY REGULATORY PROCEDURES AND REQUIREMENTS (U.S. CLS. 100 AND 101).

SN 78-131,443. PEAC, SAN DIEGO, CA. FILED 5-28-2002.



THE STIPPLING IS FOR SHADING PURPOSES ONLY.

CLASS 41—EDUCATION AND ENTERTAINMENT

FOR EDUCATION SERVICES, NAMELY, CLASSES AND LECTURES ON THE SUBJECT OF PARROTS AND PARROT CARE (U.S. CLS. 100, 101 AND 107).

FIRST USE 1-1-1996; IN COMMERCE 1-1-1996.

CLASS 45—PERSONAL SERVICES

FOR OPERATION OF AN ADOPTION CENTER FOR PARROTS COMBINED WITH HANDS ON TRAINING FOR APPLICANTS ON THE SUBJECT OF PARROT CARE (U.S. CLS. 100 AND 101).
FIRST USE 1-1-1996; IN COMMERCE 1-1-1996.

SN 78-133,491. AMERICAN COLLEGE OF ENDODONTISTS, MESA, AZ. BY ASSIGNMENT CARLSON, EDWARD, H., MESA, AZ. FILED 6-5-2002.



NO CLAIM IS MADE TO THE EXCLUSIVE RIGHT TO USE "AMERICAN COLLEGE OF ENDODONTISTS FOUNDED 2002", APART FROM THE MARK AS SHOWN. THE MARK CONSISTS OF THE WORDS "AMERICAN COLLEGE OF ENDODONTISTS FOUNDED 2000" ENCIRCLING A TRIANGLE CONTAINING A MODIFIED CADUCEUS.

SN 78-132,787. NEW ENGLAND DOOR CORPORATION, CANTON, MA. FILED 6-3-2002.



CLASS 16—PAPER GOODS AND PRINTED MATTER

FOR PRINTED PUBLICATIONS, NAMELY, NEWSLETTERS DIRECTED TOWARD THE FIELD OF ENDODONTIA AND ISSUES OF INTEREST TO ENDODONTISTS (U.S. CLS. 2, 5, 22, 23, 29, 37, 38 AND 50).

CLASS 35—ADVERTISING AND BUSINESS

FOR ASSOCIATION SERVICES, NAMELY, PROMOTING THE INTERESTS OF ENDODONTISTS; BUSINESS AND PROFESSIONAL RATING AND REFERRAL SERVICES, NAMELY, PROVIDING OTHERS WITH RATINGS AND REFERRALS FOR ENDODONTISTS (U.S. CLS. 100, 101 AND 102).

CLASS 41—EDUCATION AND ENTERTAINMENT

FOR ONLINE PUBLICATIONS, NAMELY, DIGITAL NEWSLETTERS DIRECTED TOWARD THE FIELD OF ENDODONTIA AND ISSUES OF INTEREST TO ENDODONTISTS (U.S. CLS. 100, 101 AND 107).

NO CLAIM IS MADE TO THE EXCLUSIVE RIGHT TO USE "DOOR" AND "USA", APART FROM THE MARK AS SHOWN.
SEC. 2(F) AS TO "NEW ENGLAND".

CLASS 6—METAL GOODS

FOR METAL GARAGE DOORS (U.S. CLS. 2, 12, 13, 14, 23, 25 AND 50).
FIRST USE 7-0-2001; IN COMMERCE 7-0-2001.

SN 78-134,468. U.S. TOOL GRINDING, INC., DESLOGE, MO. FILED 6-10-2002.

US TOOL

CLASS 9—ELECTRICAL AND SCIENTIFIC APPARATUS

FOR ELECTRONIC DOOR OPENERS (U.S. CLS. 21, 23, 26, 36 AND 38).
FIRST USE 7-0-2001; IN COMMERCE 7-0-2001.

OWNER OF U.S. REG. NOS. 1,209,525, 1,212,939 AND 2,122,936.
NO CLAIM IS MADE TO THE EXCLUSIVE RIGHT TO USE "TOOL", APART FROM THE MARK AS SHOWN.
SEC. 2(F).

CLASS 19—NON-METALLIC BUILDING MATERIALS

FOR NON-METAL GARAGE DOORS (U.S. CLS. 1, 12, 33 AND 50).
FIRST USE 7-0-2001; IN COMMERCE 7-0-2001.

CLASS 7—MACHINERY

FOR POWER CUTTING TOOLS AND TOOL HOLDERS FOR MACHINE TOOLS (U.S. CLS. 13, 19, 21, 23, 31, 34 AND 35).
FIRST USE 12-6-1988; IN COMMERCE 12-6-1988.

CLASS 35—ADVERTISING AND BUSINESS

FOR DISTRIBUTORSHIP SERVICES FEATURING POWER CUTTING AND ABRASIVE TOOLS, GAUGES, TOOLING COMPONENTS, WORKHOLDING, METAL-WORKING FLUIDS AND CHEMICALS, SAWS, HAND/POWER TOOLS, TOOL ROOM SUPPLIES, AIRCRAFT SPECIALTY PRODUCTS, BRUSHES, SAFETY PRODUCTS, STORAGE PRODUCTS, AND TOOL DISPENSING SYSTEMS AND TOOL CRIB MANAGEMENT SOFTWARE (U.S. CLS. 100, 101 AND 102).

FIRST USE 12-6-1988; IN COMMERCE 12-6-1988.

CLASS 37—CONSTRUCTION AND REPAIR

FOR CONDITIONING AND REPAIRING CUTTING TOOLS FOR OTHERS (U.S. CLS. 100, 103 AND 106).

FIRST USE 12-6-1988; IN COMMERCE 12-6-1988.

SN 78-136,179. POLYPHALT, INC., TORONTO, ONTARIO, CANADA, FILED 6-17-2002.

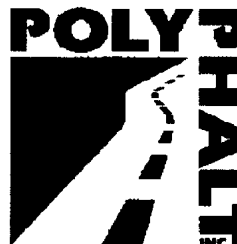

OWNER OF U.S. REG. NO. 1,334,310.
NO CLAIM IS MADE TO THE EXCLUSIVE RIGHT TO USE "INC.", APART FROM THE MARK AS SHOWN.

CLASS 1—CHEMICALS

FOR BITUMINOUS CHEMICAL COMPOSITIONS FOR USE IN THE MANUFACTURE OF CONSTRUCTION MATERIALS AND SURFACES, SUCH AS COMMERCIAL, INDUSTRIAL AND RESIDENTIAL ROOFING, WATERPROOFING AND PAVING (U.S. CLS. 1, 5, 6, 10, 26 AND 46).

FIRST USE 12-31-2000; IN COMMERCE 12-31-2000.

CLASS 40—MATERIAL TREATMENT

FOR CHEMICAL PROCESSING SERVICES, NAMELY, MANUFACTURE OF BITUMINOUS CHEMICAL COMPOSITIONS TO THE ORDER AND/OR SPECIFICATION OF OTHERS FOR USE IN THE MANUFACTURE OF CONSTRUCTION MATERIALS AND SURFACES SUCH AS ROOFING, WATERPROOFING AND PAVING (U.S. CLS. 100, 103 AND 106).

FIRST USE 12-31-2000; IN COMMERCE 12-31-2000.

CLASS 42—SCIENTIFIC, COMPUTER AND LEGAL SERVICES

FOR CONSULTATION, RESEARCH, AND DEVELOPMENT, IN THE FIELD OF BITUMINOUS CHEMICAL COMPOSITIONS FOR USE IN THE MANUFACTURE OF CONSTRUCTION MATERIALS AND SURFACES SUCH AS ROOFING, WATERPROOFING AND PAVING (U.S. CLS. 100 AND 101).

FIRST USE 12-31-2000; IN COMMERCE 12-31-2000.

SN 78-134,992. PARK LI MANAGEMENT SIMULATIONS, INC., DBA MANAGEMENT SIMULATIONS, INC., NORTHFIELD, IL. FILED 6-12-2002.

MANAGEMENT SIMULATIONS

NO CLAIM IS MADE TO THE EXCLUSIVE RIGHT TO USE "SIMULATIONS", APART FROM THE MARK AS SHOWN.
SEC. 2(F).

CLASS 9—ELECTRICAL AND SCIENTIFIC APPARATUS

FOR COMPUTER GAME SOFTWARE FOR EDUCATIONAL PURPOSES (U.S. CLS. 21, 23, 26, 36 AND 38).

FIRST USE 0-0-1985; IN COMMERCE 0-0-1985.

CLASS 41—EDUCATION AND ENTERTAINMENT

FOR PROVIDING AN ON-LINE COMPUTER GAME FOR EDUCATIONAL PURPOSES (U.S. CLS. 100, 101 AND 107).

FIRST USE 0-0-1985; IN COMMERCE 0-0-1985.

CLASS 42—SCIENTIFIC, COMPUTER AND LEGAL SERVICES

FOR PROVIDING TEMPORARY USE OF ON-LINE NON-DOWNLOADABLE COMPUTER SOFTWARE THAT ENABLES USERS TO PERFORM BUSINESS FUNCTIONS IN THE CONTEXT OF IMAGINARY FACT PATTERNS IN THE FIELD OF BUSINESS EDUCATION (U.S. CLS. 100 AND 101).

FIRST USE 0-0-1985; IN COMMERCE 0-0-1985.

SN 78-137,052. KEMISTRE 8 LLC, NEW YORK, NY. FILED 6-19-2002.

AKDMKS

OWNER OF U.S. REG. NO. 2,564,126.

CLASS 18—LEATHER GOODS

FOR ALL PURPOSE SPORT BAGS; ALL-PURPOSE ATHLETIC BAGS; TOTE BAGS, SHOULDER BAGS, TRAVEL ACCESSORY BAGS, CREDIT CARD HOLDERS, CREDIT CARD CASES, HANDBAGS, BEACH BAGS, BRIEF BAGS, COSMETIC BAGS SOLD EMPTY, RUCKSACKS, TRAVELING BAGS, SUITCASES, WALLET, PURSES, ZIPPED WALLETS, BILLFOLD WALLETS, BOOK BAGS, BACKPACKS, DUFFEL BAGS, KEYCASES, UMBRELLAS, BACKPACKS, BILLFOLDS, COSMETIC BAGS SOLD EMPTY, BRIEFCASES, BRIEFCASE TYPE PORTFOLIOS, ATTACHES, BUSINESS CARD CASES, CHANGE PURSES, FANNY PACKS, GYM BAGS, KEY CASES, KNAPSACKS, LUGGAGE, POCKETBOOKS, SCHOOL BAGS, STRAPS FOR HANDBAGS AND LUGGAGE AND ACCESSORIES USED THEREWITH, NAMELY, SHOULDER STRAP PADS, HOLDERS, AND POUCHES; GOODS MADE OF LEATHER AND IMITATIONS OF LEATHER, NAMELY, KEY CHAINS, HANDBAGS, WALLETS, CASES, BILLFOLDS, COSMETIC BAGS SOLD EMPTY, BRIEFCASES, BRIEFCASE TYPE PORTFOLIOS, ATTACHES, TOTES, TRUNKS AND TRAVELING BAGS; GARMENT BAGS FOR TRAVEL; SHOE BAGS FOR TRAVEL (U.S. CLS. 1, 2, 3, 22 AND 41).

FIRST USE 8-1-1999; IN COMMERCE 1-1-2000.

CLASS 25—CLOTHING

FOR CLOTHING AND APPAREL FOR MEN, WOMEN, YOUNG ADULTS, CHILDREN AND INFANTS, NAMELY SHIRTS, EMBROIDERED SHIRTS, TEE SHIRTS, SHORTS, SPORT SHIRTS, SWEATSHIRTS, SWEATPANTS, SOCKS, VESTS, BELTS, LOUNGEWEAR, SLEEPWEAR, UNDERGARMENTS, UNDERPANTS, UNDERSHIRTS, BATHROBES, UNDERWEAR, SWIMSUITS, BEACH COVER-UPS, WARM-UP SUITS, JACKETS, JERSEYS, TANK TOPS, SWEATERS, PANTS, JEANS, VESTS, SUITS, SPORT COATS, COATS, HEAD BANDS, OVERCOATS, RAIN COATS, TOP COATS, JACKETS, PARKAS, TIES, BOW TIES, NECKWEAR, VESTS, SCARVES, BANDANNAS, PAJAMAS, NIGHT SHIRTS, SUSPENDERS, GLOVES, HEADWEAR, HATS, BASEBALL CAPS, EMBROIDERED CAPS, KNITTED HATS, FOOTWEAR, SHOES, SLIPPERS, BOOTS, SANDALS, SNEAKERS, BODY SUITS, JUMPSUITS; CLOTHING FOR WOMEN AND YOUNG ADULTS, NAMELY, BRASSIERES, BUS-TIERS, CAMISOLES, CHEMISES, CORSELETTES, CORSETS, FOUNDATION GARMENTS, DRESSING GOWNS, DUSTERS, GARTER BELTS, GIRDLES, HOUSECOATS, LINGERIE, NEGLIGEES, NIGHT GOWNS, NIGHT SHIRTS, PAJAMAS, PEIGNOIRS, ROBES, TEDDIES, PANTIES, BLOUSES, DRESSES, SKIRTS, TOPS, SCARVES, SARONGS, HALTER TOPS, HOSIERY, JUMPERS, SHAWLS, STOLERS, SCARVES, SHRUGS, BOLEROS, AND WRAPS; INFANTWEAR (U.S. CLS. 22 AND 39).

FIRST USE 8-1-1999; IN COMMERCE 1-1-2000.

SN 78-137,156. SCHIBECI, ANTHONY RICHARD, WATSONIA, AUSTRALIA, FILED 6-19-2002.

POLYPLANER

OWNER OF AUSTRALIA REG. NO. 874100, DATED 4-30-2001, EXPIRES 4-30-2011.

CLASS 6—METAL GOODS

FOR METAL MANDRELS FOR CUTTING, DRILLING, MILLING, PROFILING AND POLISHING STEPS IN CONCRETE, STEPS IN ASPHALT, YELLOW & WHITE LINES, FACTORY FLOORS, THERMOPLASTIC WHITE LINES, TIMBERS, EPOXIES, RESINS, MORTARS, PLASTICS, STENCILED CONCRETE, PLASTIC AND CERAMIC ROAD REFLECTORS AND EXPOSED AGGREGATE FINISH ON CONCRETE (U.S. CLS. 2, 12, 13, 14, 23, 25 AND 50).

CLASS 7—MACHINERY

FOR MACHINES, NAMELY, FLOOR AND ROADWAY SURFACE PREPARATION EQUIPMENT FOR CUTTING, DRILLING, MILLING, PROFILING AND POLISHING STEPS IN CONCRETE, STEPS IN ASPHALT, YELLOW & WHITE LINES, FACTORY FLOORS, THERMOPLASTIC WHITE LINES, TIMBERS, EPOXIES, RESINS, MORTARS, PLASTICS, STENCILED CONCRETE, PLASTIC AND CERAMIC ROAD REFLECTORS AND EXPOSED AGGREGATE FINISH ON CONCRETE; DRUMS FOR CUTTING AND MILLING ALL PAVEMENT TYPES INCLUDING ASPHALT, CONCRETE, REINFORCED PAVEMENTS AND HEAVY LIMESTONE; ROAD SURFACE AND CONCRETE SURFACE REMOVAL MACHINES, NAMELY, SCABBLERS, SCARIFIERS AND ERADICATORS (U.S. CLS. 13, 19, 21, 23, 31, 34 AND 35).

SN 78-137,414. WILD MARKS, INC., LAS VEGAS, NV. FILED 6-20-2002.

NATURE'S FRESH

OWNER OF U.S. REG. NO. 2,224,071.

CLASS 3—COSMETICS AND CLEANING PREPARATIONS

FOR HAIR CARE PRODUCTS, NAMELY, SHAMPOO AND CONDITIONER; HAIR CARE PREPARATIONS; SKIN LOTION; FACIAL LOTION; BODY LOTION; HAND LOTION; BATH GEL; SHOWER GEL; SOAP, NAMELY SKIN SOAP; BATHING ADDITIVES, NAMELY BUBBLE BATH AND BATH OIL; NON-MEDICATED BATH SALTS; BATH LOTION; BATH BEADS; BATH BOMBS; BATH CRYSTALS (U.S. CLS. 1, 4, 6, 50, 51 AND 52).

CLASS 5—PHARMACEUTICALS

FOR NUTRITIONAL SUPPLEMENTS; HERBAL SUPPLEMENTS; MINERAL SUPPLEMENTS; VITAMINS; VITAMIN SUPPLEMENTS (U.S. CLS. 6, 18, 44, 46, 51 AND 52).

SN 78-137,512. NORDDEUTSCHE SEEKABELWERKE GMBH & CO. KG, NORDENHAM, FED REP GERMANY, FILED 6-21-2002.

NSW

OWNER OF ERPN CMNTY TM OFC REG. NO. 217836, DATED 11-19-1999, EXPIRES 4-1-2006.

CLASS 7—MACHINERY

FOR BELTS, NAMELY, PROFILE BELTS, ROUND BELTS, TOOTHED BELTS AND V-BELTS, FOR NON-VEHICLE MACHINERY DRIVING PURPOSES AND FOR CONVEYORS (U.S. CLS. 13, 19, 21, 23, 31, 34 AND 35).

CLASS 9—ELECTRICAL AND SCIENTIFIC APPARATUS

FOR ELECTRIC CABLES AND LEADS, NAMELY, HIGH-VOLTAGE CABLES, MAINS CURRENT CABLES, TELECOMMUNICATION CABLES, HIGH FREQUENCY CABLES, SEA CABLES, AERIAL CABLES, INSULATED WIRES, ALL THE AFOREMENTIONED CABLES, LEADS AND WIRES MADE OF OR INCLUDING METAL CONDUCTORS AND/OR OPTICAL WAVE GUIDES, AMPLIFIERS, ELECTRICAL AND OPTICAL CONNECTORS, CABLE COUPLINGS AND CONNECTORS (U.S. CLS. 21, 23, 26, 36 AND 38).

SN 78-137,513. NORDDEUTSCHE SEEKABELWERKE GMBH & CO. KG, NORDENHAM, FED REP GERMANY, FILED 6-21-2002.

CLASS 11—ENVIRONMENTAL CONTROL APPARATUS

FOR EQUIPMENT AND APPARATUS OPERATED MECHANICALLY, BIOLOGICALLY AND/OR BY OXIDATION, AND FOR TREATING LIQUIDS AND/OR GASES, NAMELY, BIOLOGICAL SEWAGE TREATMENT PLANTS, FILTERS, TRICKLING FILTERS, ROTATION IMMERSION BODIES, AND PERCOLATING BEDS (U.S. CLS. 13, 21, 23, 31 AND 34).

CLASS 17—RUBBER GOODS

FOR GRID PIPES, NET-LIKE PIPES, NET-LIKE TUBES AND NETS OF PLASTIC; ELECTRONIC INSULATING MATERIAL IN THE FORM OF PIPES, FLEXIBLE TUBES, FILMS, BANDS, RODS AND SLABS OF PLASTIC; FILMS, STRIPS, PIPES AND FLEXIBLE TUBES BEING SEMI-FINISHED GOODS OF PLASTIC; FILMS, STRIPS, PIPES AND FLEXIBLE TUBES OF PLASTIC FOR PACKAGING AND/OR INSULATION; PLASTIC FILTER PIPES FOR MECHANICALLY SEPARATING MATERIALS; PIPE, TUBE AND/OR STRIP SHAPED DISTANCE PIECES OF PLASTIC FOR PLACING IN, ON AND BETWEEN ADJOINING OBJECTS; TUBES, STRIPS AND NETS OF PLASTIC TO PROTECT OR WRAP OBJECTS; COLUMN PACKINGS OF PLASTIC AND STRIPS OF MATERIAL OF THERMOPLASTIC SYNTHETIC MATERIAL FOR TREATING FLUIDS AND/OR BEING THERMOPLASTIC SYNTHETIC BASE MATERIAL FOR USE IN PROCESS TECHNOLOGY INSTALLATIONS, NAMELY FOR BIOLOGICAL TREATMENT OF WASTE WATER AND FOR INDUSTRIAL PROCESSES INCLUDING ABSORPTION, DESORPTION, DISTILLATION, RECTIFICATION, EXTRACTION AND GAS AND AIR WASHERS (U.S. CLS. 1, 5, 12, 13, 35 AND 50).

CLASS 19—NON-METALLIC BUILDING MATERIALS

FOR PROTECTIVE GRATING OF PLASTIC FOR GUTTERS (U.S. CLS. 1, 12, 33 AND 50).

CLASS 37—CONSTRUCTION AND REPAIR

FOR INSTALLATION AND LAYING OF CABLES AND LEADS, IN PARTICULAR SEA CABLES; MAINTENANCE AND REPAIR OF CABLES AND LEADS, IN PARTICULAR UNDERWATER CABLES AND AMPLIFIER STATIONS (U.S. CLS. 100, 103 AND 106).

CLASS 42—SCIENTIFIC, COMPUTER AND LEGAL SERVICES

FOR TECHNICAL CONSULTANCY, DESIGN AND PLANNING OF MUNICIPAL AND INDUSTRIAL INSTALLATIONS FOR TREATING LIQUIDS AND GASES; UNDERWATER STRUCTURE INSPECTION SERVICES, NAMELY SURVEILLANCE OF CABLES AND LEADS, IN PARTICULAR UNDERWATER CABLES AND AMPLIFIER STATIONS (U.S. CLS. 100 AND 101).

POLY-NET

OWNER OF ERPN CMNTY TM OFC REG. NO. 217810, DATED 8-1-2000, EXPIRES 4-1-2006.

CLASS 11—ENVIRONMENTAL CONTROL APPARATUS

FOR GRID-TYPE FILTER PIPES AND FILTER TUBES FOR SEPARATING MATERIALS MECHANICALLY IN AGRICULTURAL APPLICATIONS FOR THE PROTECTION AND IRRIGATION OF PLANTS AND TREES (U.S. CLS. 13, 21, 23, 31 AND 34).

CLASS 16—PAPER GOODS AND PRINTED MATTER

FOR PLASTIC NET-LIKE TUBES AND STRIPS FOR PACKAGING (U.S. CLS. 2, 5, 22, 23, 29, 37, 38 AND 50).

CLASS 17—RUBBER GOODS

FOR GRID PIPES, NET-LIKE PIPES, NETS, NET-LIKE TUBES AND NET-LIKE STRIPS OF PLASTIC; GRID PIPES, NET-LIKE PIPES, NETS, NET-LIKE TUBES AND NET-LIKE STRIPS OF PLASTIC BEING DISTANCE PIECES AND FOR SURFACE PROTECTION; GRID-TYPE TOWER PACKING, MADE OF PIPE SECTIONS, FOR MOVING MICROORGANISMS OR SIMILAR MATTER FOR THE BIOLOGICAL TREATMENT OF FLUIDS; GRID-TYPE PIPES, NET-LIKE TUBE AND STRIPS FOR USE IN MOVING MICROORGANISMS OR SIMILAR MATTER ACROSS LONG-DISTANCES; SEMI-FINISHED PLASTIC IN THE FORM OF GRID PIPES, NET-LIKE PIPES, NET-LIKE TUBES, AND NET-LIKE STRIPS FOR FURTHER PROCESSING IN MANUFACTURING PLANTS (U.S. CLS. 1, 5, 12, 13, 35 AND 50).

CLASS 19—NON-METALLIC BUILDING MATERIALS

FOR PROTECTIVE GRATING PRIMARILY MADE OF PLASTIC FOR GUTTERS (U.S. CLS. 1, 12, 33 AND 50).

SN 78-138,951. BROWN, FORREST C., DALLAS, TX. FILED 6-26-2002.



CLASS 3—COSMETICS AND CLEANING PREPARATIONS

FOR NON-MEDICATED SKIN CARE PREPARATIONS, NAMELY, DAY CREAM MOISTURIZER, NIGHT CREAM MOISTURIZER, CLEANSER, VITAMIN C, AND SERUM RETINOL (U.S. CLS. 1, 4, 6, 50, 51 AND 52).
FIRST USE 10-1-1999; IN COMMERCE 10-1-1999.

CLASS 5—PHARMACEUTICALS

FOR MEDICATED SKIN CARE PREPARATIONS, NAMELY, DAY CREAM MOISTURIZER, NIGHT CREAM MOISTURIZER, CLEANSER, VITAMIN C, AND SERUM RETINOL (U.S. CLS. 6, 18, 44, 46, 51 AND 52).
FIRST USE 10-1-1999; IN COMMERCE 10-1-1999.

SN 78-139,280. GREEN MOUNTAIN ENERGY COMPANY, AUSTIN, TX. FILED 6-27-2002.



**Green
Mountain
Energy**

NO CLAIM IS MADE TO THE EXCLUSIVE RIGHT TO USE "ENERGY", APART FROM THE MARK AS SHOWN.

THE MARK CONSISTS OF A STYLIZED RENDITION OF TWO GREEN MOUNTAINS OUTLINED IN WHITE, SET AGAINST A BLUE SKY, AND THE DESIGNATED COLORS ARE A FEATURE OF THE MARK.

CLASS 35—ADVERTISING AND BUSINESS

FOR CONSULTING SERVICES WITH RESPECT TO ENERGY USE AND MANAGEMENT (U.S. CLS. 100, 101 AND 102).
FIRST USE 1-0-2002; IN COMMERCE 1-0-2002.

CLASS 39—TRANSPORTATION AND STORAGE

FOR NON-REGULATED UTILITY SERVICES, NAMELY THE TRANSMISSION OF ELECTRICITY, OIL, NATURAL GAS AND PROPANE (U.S. CLS. 100 AND 105).
FIRST USE 1-0-2002; IN COMMERCE 1-0-2002.

SN 78-139,329. GRAND VIRTUAL, INC., CAMBRIDGE, MA. FILED 6-27-2002.

GRAND VIRTUAL

NO CLAIM IS MADE TO THE EXCLUSIVE RIGHT TO USE "VIRTUAL", APART FROM THE MARK AS SHOWN.

CLASS 38—COMMUNICATION

FOR TELECOMMUNICATIONS SERVICES NAMELY, PROVIDING TELECOMMUNICATIONS CONNECTIONS TO A GLOBAL COMPUTER NETWORK (U.S. CLS. 100, 101 AND 104).
FIRST USE 6-25-1997; IN COMMERCE 6-25-1997.

CLASS 42—SCIENTIFIC, COMPUTER AND LEGAL SERVICES

FOR APPLICATIONS SERVICE PROVIDER HOSTING COMPUTER SOFTWARE APPLICATIONS FOR USE BY OTHERS IN PROVIDING ACCESS TO ONLINE ENTERTAINMENT SERVICES (U.S. CLS. 100 AND 101).
FIRST USE 6-25-1997; IN COMMERCE 6-25-1997.

SN 78-139,332. NH HOTELS, S.A., MADRID, SPAIN, FILED 6-27-2002.

nh
HOTELS

NO CLAIM IS MADE TO THE EXCLUSIVE RIGHT TO USE "HOTELS", APART FROM THE MARK AS SHOWN.

CLASS 39—TRANSPORTATION AND STORAGE

FOR TRAVEL AGENCY SERVICES, NAMELY, PROVIDING INFORMATION ON VACATIONS AND EVENTS (U.S. CLS. 100 AND 105).

CLASS 41—EDUCATION AND ENTERTAINMENT

FOR ENTERTAINMENT SERVICES, NAMELY, LIVE PERFORMANCES BY A MUSICAL GROUP; CASINO GAMING; AND GOLF COURSE SERVICES (U.S. CLS. 100, 101 AND 107).

CLASS 43—HOTEL AND RESTAURANT SERVICES

FOR HOTEL, MOTEL AND RESORT HOTEL SERVICES, NAMELY, PROVIDING LODGING; MAKING RESERVATIONS FOR OTHERS; HOTEL RESTAURANT, BAR, AND CATERING SERVICES; HOTEL FOOD AND BEVERAGE PREPARATION SERVICES (U.S. CLS. 100 AND 101).

CLASS 44—MEDICAL, BEAUTY AND AGRICULTURAL SERVICES

FOR BEAUTY SALON AND HAIRDRESSING SERVICES (U.S. CLS. 100 AND 101).

CLASS 45—PERSONAL SERVICES

FOR HOTEL CONCIERGE SERVICES, NAMELY, PROVIDING CUSTOMER SPECIFIC INFORMATION TO MEET THE INDIVIDUAL NEEDS RENDERED TOGETHER WHILE LODGING IN A HOTEL (U.S. CLS. 100 AND 101).

SN 78-142,027. LIBERTY LEAGUE INTERNATIONAL, L.L.C., SCOTTSDALE, AZ. FILED 7-8-2002.



NO CLAIM IS MADE TO THE EXCLUSIVE RIGHT TO USE "LEAGUE INTERNATIONAL", APART FROM THE MARK AS SHOWN.

THE STIPPLING IS FOR SHADING PURPOSES.

SN 78-140,769. COWAN, JEFF, INDIANAPOLIS, IN. FILED 7-2-2002.

I WASN'T BORN THIS WAY**CLASS 25—CLOTHING**

FOR CLOTHING, NAMELY, T-SHIRTS, BUTTON SHIRTS AND HATS (U.S. CLS. 22 AND 39).

CLASS 41—EDUCATION AND ENTERTAINMENT

FOR CONDUCTING WORKSHOPS AND SEMINARS IN SALES TRAINING AND DISTRIBUTING BOOKS AND PRE-RECORDED AUDIO AND VIDEO TAPE COURSE MATERIALS IN CONNECTION THEREWITH (U.S. CLS. 100, 101 AND 107).

CLASS 9—ELECTRICAL AND SCIENTIFIC APPARATUS

FOR EDUCATIONAL MATERIALS, NAMELY, CD ROMS AND DVDS FEATURING EDUCATIONAL MATERIALS IN THE FIELDS OF PERSONAL DEVELOPMENT, SELF-HELP, AND GENERAL BUSINESS DEVELOPMENT (U.S. CLS. 21, 23, 26, 36 AND 38).

FIRST USE 6-7-2001; IN COMMERCE 7-1-2001.

CLASS 16—PAPER GOODS AND PRINTED MATTER

FOR PRINTED EDUCATIONAL MATERIALS IN THE FIELDS OF PERSONAL DEVELOPMENT, SELF-HELP, AND GENERAL BUSINESS DEVELOPMENT (U.S. CLS. 2, 5, 22, 23, 29, 37, 38 AND 50).

FIRST USE 6-7-2001; IN COMMERCE 7-1-2001.

CLASS 41—EDUCATION AND ENTERTAINMENT

FOR DEVELOPMENT AND DISSEMINATION OF EDUCATIONAL MATERIALS OF OTHERS, NAMELY, CD ROMS, DVDS, AND OTHER DIGITAL AND/OR ELECTRONIC MEDIA, AND PRINTED EDUCATIONAL MATERIALS IN THE FIELDS OF PERSONAL DEVELOPMENT, SELF-HELP, AND GENERAL BUSINESS DEVELOPMENT; AND EDUCATIONAL SERVICES, NAMELY, ARRANGING AND CONDUCTING SEMINARS FEATURING LIVE LECTURES IN THE FIELDS OF PERSONAL DEVELOPMENT, SELF-HELP AND GENERAL BUSINESS DEVELOPMENT, AND DISTRIBUTION OF COURSE MATERIALS IN CONNECTION THEREWITH (U.S. CLS. 100, 101 AND 107).

FIRST USE 6-7-2001; IN COMMERCE 7-1-2001.

SN 78-140,990. GRANDE CHEESE COMPANY, BROWNSVILLE, WI. FILED 7-3-2002.

THE ADVOCATE OF THE INDEPENDENT**CLASS 35—ADVERTISING AND BUSINESS**

FOR BUSINESS MANAGEMENT CONSULTING SERVICES FOR THE RESTAURANT AND EATING ESTABLISHMENT INDUSTRY IN THE NATURE OF FOOD COST/PRICE PLANNING AND TRACKING, MENU PLANNING, FOOD STORAGE AND PREPARATION, PRODUCT PROMOTION; PROVIDING BUSINESS INFORMATION REGARDING THE FOOD INDUSTRY; PREPARING AND PLACING ADVERTISEMENTS FOR OTHERS (U.S. CLS. 100, 101 AND 102).

CLASS 41—EDUCATION AND ENTERTAINMENT

FOR TRAINING SERVICES FOR THE RESTAURANT AND EATING ESTABLISHMENT INDUSTRY IN THE NATURE OF FOOD PREPARATION (U.S. CLS. 100, 101 AND 107).

SN 78-142,247. NATIVE SCENTS, INC., TAOS, NM. FILED 7-9-2002.

NATIVE SCENTS

NO CLAIM IS MADE TO THE EXCLUSIVE RIGHT TO USE "SCENTS", APART FROM THE MARK AS SHOWN.

CLASS 3—COSMETICS AND CLEANING PREPARATIONS

FOR TRADITIONAL NATIVE AMERICAN PRODUCTS, NAMELY; INCENSE, ESSENTIAL OILS FOR PERSONAL USE, ESSENTIAL OILS FOR USE IN SCENTED PRODUCTS, EYE PILLOWS CONTAINING FRAGRANCES AND BATH SALTS (U.S. CLS. 1, 4, 6, 50, 51 AND 52).

FIRST USE 7-17-1988; IN COMMERCE 7-17-1988.

CLASS 30—STAPLE FOODS

FOR TRADITIONAL NATIVE AMERICAN PRODUCTS, NAMELY; HERBAL TEA (U.S. CL. 46). FIRST USE 7-17-1988; IN COMMERCE 7-17-1988.

SN 78-144,332. WEST VIRGINIA WESLEYAN COLLEGE, BUCKHANNON, WV. FILED 7-16-2002.

SN 78-142,274. ARMAJARO HOLDINGS LIMITED, LONDON, UNITED KINGDOM, FILED 7-9-2002.

ARMAJARO**CLASS 31—NATURAL AGRICULTURAL PRODUCTS**

FOR UNPROCESSED COCOA BEANS; UNPROCESSED COFFEE BEANS; UNPROCESSED BEANS; UNPROCESSED GRAINS FOR EATING; AND AGRICULTURAL SEEDS (U.S. CLS. 1 AND 46).

NO CLAIM IS MADE TO THE EXCLUSIVE RIGHT TO USE "WEST VIRGINIA WESLEYAN COLLEGE", APART FROM THE MARK AS SHOWN.

CLASS 36—INSURANCE AND FINANCIAL

FOR PROVISION OF FINANCIAL INFORMATION; TRADING IN FUTURES; FINANCIAL EXCHANGE SERVICES IN THE FIELD OF COMMODITIES TRADING; EXCHANGE MARKET SERVICES RELATING TO COMMODITY FUTURES CONTRACTS; FINANCIAL SERVICES IN THE FIELD OF SECURITIES AND BONDS, NAMELY, AGENCIES IN THE FIELD OF SECURITIES AND BONDS; ADVISORY SERVICES IN THE FIELD OF FINANCIAL INVESTMENT; MONETARY EXCHANGE (U.S. CLS. 100, 101 AND 102).

CLASS 25—CLOTHING

FOR CLOTHING, NAMELY, T-SHIRTS, SHIRTS, SWEATSHIRTS, SWEATPANTS, JACKETS, COATS, SHORTS, TIES, SCARFS, CAPS, HATS, VISORS, SOCKS, AND SLEEPWEAR (U.S. CLS. 22 AND 39). FIRST USE 10-1-1998; IN COMMERCE 10-1-1998.

CLASS 41—EDUCATION AND ENTERTAINMENT

FOR EDUCATIONAL SERVICES, NAMELY PROVIDING COURSES OF HIGHER EDUCATION AT THE COLLEGE LEVEL (U.S. CLS. 100, 101 AND 107). FIRST USE 10-1-1998; IN COMMERCE 10-1-1998.

SN 78-143,600. ATOMIC ENERGY OF CANADA LIMITED, MISSISSAUGA, ONTARIO, FILED 7-12-2002.

SMART CANDU

OWNER OF U.S. REG. NO. 1,412,203.

SN 78-144,340. RICHMOND HOLDINGS LIMITED, LA CORVEE ALDERNEY, CHANNEL ISLANDS, FILED 7-16-2002.

CRAZY NUMBERS

NO CLAIM IS MADE TO THE EXCLUSIVE RIGHT TO USE "NUMBERS", APART FROM THE MARK AS SHOWN.

CLASS 9—ELECTRICAL AND SCIENTIFIC APPARATUS

FOR ELECTRONIC APPARATUS, NAMELY SENSORS, COMPUTER HARDWARE, AND SOFTWARE DESIGNED TO PERMIT THE REMOTE MONITORING OF CURRENT CONDITIONS OF PROCESSES OR EQUIPMENT IN NUCLEAR FACILITIES TO DETERMINE IMMEDIATE OR FUTURE ACTIONS TO PROPERLY MAINTAIN THESE PROCESSES OR EQUIPMENT (U.S. CLS. 21, 23, 26, 36 AND 38).

CLASS 9—ELECTRICAL AND SCIENTIFIC APPARATUS

FOR DOWNLOADABLE COMPUTER GAME PROGRAMS (U.S. CLS. 21, 23, 26, 36 AND 38).

CLASS 42—SCIENTIFIC, COMPUTER AND LEGAL SERVICES

FOR REMOTE MONITORING OF CURRENT CONDITIONS OF PROCESSES OR EQUIPMENT IN NUCLEAR FACILITIES TO DETERMINE IMMEDIATE OR FUTURE ACTIONS TO PROPERLY MAINTAIN THESE PROCESSES OR EQUIPMENT (U.S. CLS. 100 AND 101).

CLASS 41—EDUCATION AND ENTERTAINMENT

FOR GAMING SERVICES, NAMELY, PROVIDING LOTTERIES, SWEEPSTAKES, GAMES OF CHANCE, BETTING POOLS, NUMBER GAMES AND CONTESTS; PROVIDING ON-LINE INTERACTIVE REAL TIME COMPUTER GAMES; PROVIDING COMPUTER GAMES THAT MAY BE ACCESSED VIA COMPUTER NETWORKS, INTRANETS, OR THE INTERNET, NAMELY PROVIDING ONLINE COMPUTER GAMES (U.S. CLS. 100, 101 AND 107).

SN 78-144,788. BROWN, HOWARD T., VENTURA, CA.
FILED 7-17-2002.

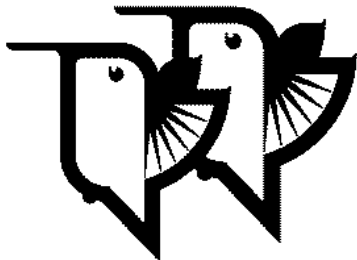

CLASS 18—LEATHER GOODS

FOR BAGS, NAMELY SHOULDER BAGS, TOTE BAGS, TRAVEL BAGS, COSMETIC BAGS SOLD EMPTY, AND PURSES (U.S. CLS. 1, 2, 3, 22 AND 41).

CLASS 25—CLOTHING

FOR CLOTHING, NAMELY SHIRTS, T-SHIRTS, TANK TOPS, SWEATERS, SWEATSHIRTS, JACKETS, PANTS, HATS, GLOVES, MITTENS, SCARVES AND SOCKS (U.S. CLS. 22 AND 39).

SN 78-145,081. FISERV, INC., BROOKFIELD, WI. FILED 7-18-2002.

IMAGESOFT

CLASS 35—ADVERTISING AND BUSINESS

FOR LICENSING OF COMPUTER SOFTWARE FOR DOCUMENT IMAGING, STORAGE, ARCHIVAL, RETRIEVAL, AND MANAGEMENT (U.S. CLS. 100, 101 AND 102).

FIRST USE 1-1-1996; IN COMMERCE 1-1-1996.

CLASS 42—SCIENTIFIC, COMPUTER AND LEGAL SERVICES

FOR TECHNICAL COMPUTER SUPPORT SERVICES, NAMELY MONITORING OF COMPUTER SYSTEM PERFORMANCE, TROUBLESHOOTING COMPUTER SOFTWARE AND COMPUTER HARDWARE PROBLEMS, COMPUTER SYSTEM PROBLEM DIAGNOSTICS AND REPORTING, AND COMPUTER CRASH DATA RECOVERY SERVICES (U.S. CLS. 100 AND 101).

FIRST USE 1-1-1996; IN COMMERCE 1-1-1996.

SN 78-145,753. ATLANTA FALCONS FOOTBALL CLUB, LLC, FLOWERY BRANCH, GA. FILED 7-19-2002.

FALCONS LANDING

OWNER OF U.S. REG. NOS. 826,565, 826,566 AND 1,164,961.

CLASS 35—ADVERTISING AND BUSINESS

FOR PROMOTING THE GOODS AND SERVICES OF OTHERS BY ARRANGING FOR SPONSORS TO AFFILIATE THEIR GOODS AND SERVICES WITH VARIOUS FOOTBALL PERSONALITIES AND THE SPORT OF FOOTBALL; RENTAL OF ADVERTISING SPACE; PROMOTING THE GOODS AND SERVICES OF OTHERS THROUGH PROMOTIONAL CONTESTS, THE DISTRIBUTION OF DISCOUNT CARDS, AND ORGANIZING EXHIBITIONS TO PROMOTE SPONSORS (U.S. CLS. 100, 101 AND 102).

CLASS 41—EDUCATION AND ENTERTAINMENT

FOR ENTERTAINMENT SERVICES IN THE NATURE OF FOOTBALL GAMES, ORGANIZING PROFESSIONAL FOOTBALL EXHIBITIONS; PROVIDING SPORTS INFORMATION VIA A GLOBAL COMPUTER NETWORK; ORGANIZATION OF SPORTS EVENTS; FAN CLUB SERVICES; EDUCATIONAL SERVICES, NAMELY PHYSICAL EDUCATION PROGRAMS AND SEMINARS IN THE FIELD OF FOOTBALL; ENTERTAINMENT SERVICES, NAMELY, LIVE PERFORMANCES BY A MUSICAL BAND AND DANCE PERFORMANCES PROVIDED IN CONJUNCTION WITH SPORTS EVENTS; PRODUCTION OF RADIO AND TELEVISION PROGRAMS, EXHIBITIONS, COMPETITIONS AND MUSICAL, COMEDY AND DANCE PERFORMANCES BEFORE LIVE AUDIENCES AND IN STADIA; ORGANIZING SPORTING EXHIBITIONS FOR FANS TO VIEW INTERACTIVE DISPLAYS OF PROFESSIONAL FOOTBALL ACTIVITIES AND PARTICIPATE IN FOOTBALL ACTIVITIES; ENTERTAINMENT SERVICES, NAMELY, PERSONAL APPEARANCES BY PROFESSIONAL FOOTBALL PLAYERS AND CONDUCTING CONTESTS AT SPORTING EXHIBITS; ENTERTAINMENT SERVICES, NAMELY, PRODUCTION OF TELEVISION PROGRAMS FEATURING PROFESSIONAL FOOTBALL GAMES (U.S. CLS. 100, 101 AND 107).

SN 78-146,067. CRITTENTON HOSPITAL, ROCHESTER, MI.
FILED 7-22-2002.

CRITTENTON HOSPITAL

NO CLAIM IS MADE TO THE EXCLUSIVE RIGHT TO USE "HOSPITAL", APART FROM THE MARK AS SHOWN.

CLASS 35—ADVERTISING AND BUSINESS

FOR RETAIL PHARMACY SERVICES; PHYSICIAN REFERRALS; MEDICAL REFERRALS (U.S. CLS. 100, 101 AND 102).

FIRST USE 12-31-1967; IN COMMERCE 12-31-1967.

CLASS 36—INSURANCE AND FINANCIAL

FOR ADMINISTRATION OF PRE-PAID HEALTH CARE PLANS; CHARITABLE FUND RAISING (U.S. CLS. 100, 101 AND 102).

FIRST USE 12-31-1967; IN COMMERCE 12-31-1967.

CLASS 41—EDUCATION AND ENTERTAINMENT

FOR WORKSHOPS AND SEMINARS IN THE FIELD OF HEALTH CARE (U.S. CLS. 100, 101 AND 107).

FIRST USE 12-31-1967; IN COMMERCE 12-31-1967.

CLASS 44—MEDICAL, BEAUTY AND AGRICULTURAL SERVICES

FOR HOSPITALS; MEDICAL SERVICES; HEALTH CARE; EMERGENCY MEDICAL ASSISTANCE; DRUG SCREENING FOR SUBSTANCE ABUSE; PSYCHOLOGICAL COUNSELING; PSYCHOLOGICAL CONSULTATION; PHYSICAL REHABILITATION (U.S. CLS. 100 AND 101).

FIRST USE 12-31-1967; IN COMMERCE 12-31-1967.

CLASS 35—ADVERTISING AND BUSINESS

FOR BUSINESS RESEARCH AND BUSINESS CONSULTING SERVICES IN THE FIELD OF GRADING, EVALUATING, AND ASSESSING THE EFFECTIVENESS OF WRITTEN OR MULTIMEDIA BUSINESS AND PROFESSIONAL COMMUNICATIONS (U.S. CLS. 100, 101 AND 102).

FIRST USE 6-9-2002; IN COMMERCE 6-9-2002.

SN 78-146,175. ORGANIC AND NATURE HOLDING COMPANY, COLLEGE POINT, NY. FILED 7-22-2002.

**CLASS 1—CHEMICALS**

FOR SOIL CONDITIONERS FOR AGRICULTURAL, DOMESTIC AND HORTICULTURAL USE; COMPOST ACTIVATOR; PLANT GROWTH REGULATOR FOR AGRICULTURAL USE; POND CLARIFIERS, NAMELY NATURALLY OCCURRING BACTERIA, ENZYMES, BUFFERS AND DISPERSING AGENTS THAT PROCESS THESE WASTES INTO WATER AND HARMLESS, ODORLESS GAS; DEGREASING PREPARATIONS FOR USE IN VEHICLES (U.S. CLS. 1, 5, 6, 10, 26 AND 46).

FIRST USE 5-4-2001; IN COMMERCE 5-16-2001.

CLASS 3—COSMETICS AND CLEANING PREPARATIONS

FOR ANTI-BACTERIAL SOAP; DEODORANT SOAP; HAND SOAP; TOILET SOAP; INSECTICIDE SOAP; CLEANERS, NAMELY CARPET CLEANER, UPHOLSTERY CLEANERS AND ALL-PURPOSE CLEANERS; ORGANIC STAIN REMOVERS; DEGREASING PREPARATION NOT USED IN MANUFACTURING FOR USE WITH VEHICLES; FLOOR CLEANING PREPARATIONS AND FLOOR WAX; GREASE TRAP CLEANING PREPARATION; FLOOR CLEANING PREPARATION; CLEANING PREPARATION FOR CONCRETE (U.S. CLS. 1, 4, 6, 50, 51 AND 52).

FIRST USE 5-4-2001; IN COMMERCE 5-16-2001.

SN 78-146,202. CALIBRATED PERFORMANCE SOLUTIONS, LLC, MARIETTA, GA. FILED 7-22-2002.

**CALIBRATED
COMMUNICATION**

NO CLAIM IS MADE TO THE EXCLUSIVE RIGHT TO USE "COMMUNICATION", APART FROM THE MARK AS SHOWN.

CLASS 9—ELECTRICAL AND SCIENTIFIC APPARATUS

FOR (BASED ON INTENT TO USE) COMPUTER SOFTWARE FOR GRADING, EVALUATING, AND ASSESSING THE EFFECTIVENESS OF WRITTEN OR MULTIMEDIA BUSINESS AND PROFESSIONAL COMMUNICATIONS (U.S. CLS. 21, 23, 26, 36 AND 38).

SN 78-146,594. MERVYN'S BRANDS, INC., MINNEAPOLIS, MN. FILED 7-23-2002.

FRENCH LAUNDRY

OWNER OF U.S. REG. NO. 2,570,917.

CLASS 14—JEWELRY

FOR JEWELRY, NAMELY, EARRINGS, NECKLACES AND BRACELETS (U.S. CLS. 2, 27, 28 AND 50).

CLASS 25—CLOTHING

FOR WOMEN'S CLOTHING, NAMELY, SKIRTS, SHORTS, DRESSES AND JACKETS (U.S. CLS. 22 AND 39).

SN 78-147,163. ROSEN HOTELS AND RESORTS, INC., ORLANDO, FL. FILED 7-24-2002.



NO CLAIM IS MADE TO THE EXCLUSIVE RIGHT TO USE "GOLF CLUB", APART FROM THE MARK AS SHOWN.

THE LINING IS A FEATURE OF THE MARK AND DOES NOT INDICATE COLOR.

CLASS 41—EDUCATION AND ENTERTAINMENT

FOR COUNTRY CLUBS (U.S. CLS. 100, 101 AND 107).

CLASS 43—HOTEL AND RESTAURANT SERVICES

FOR HOTEL AND RESORT HOTEL SERVICES (U.S. CLS. 100 AND 101).

SN 78-147,186. THE TAUBMAN COMPANY LLC, BLOOMFIELD HILLS, MI. FILED 7-24-2002.

SN 78-147,682. GENICA CORPORATION, OCEANSIDE, CA. FILED 7-25-2002.



STONY POINT FASHION PARK

THE MARK CONSISTS OF A BLACK AND WHITE SQUARE WITH A LEAF DESIGN IN THE CENTER.

CLASS 35—ADVERTISING AND BUSINESS

FOR PROMOTION AND ADVERTISING SERVICES FOR LESSEES OF SHOPPING CENTERS, OFFICE SPACE AND HOTELS (U.S. CLS. 100, 101 AND 102).

CLASS 36—INSURANCE AND FINANCIAL

FOR REAL ESTATE MANAGEMENT OF SHOPPING MALLS, OFFICE BUILDINGS, RESIDENTIAL FACILITIES AND HOTEL FACILITIES; LEASING OF SHOPPING MALL, COMMERCIAL AND OFFICE FACILITIES, RESIDENTIAL FACILITIES AND HOTEL SPACE; REAL ESTATE AGENCY AND BROKERAGE SERVICES (U.S. CLS. 100, 101 AND 102).

CLASS 37—CONSTRUCTION AND REPAIR

FOR DEVELOPMENT IN THE NATURE OF PLANNING AND LAYING OUT OF SHOPPING MALLS, COMMERCIAL AND OFFICE FACILITIES, RESIDENTIAL FACILITIES AND HOTELS (U.S. CLS. 100, 103 AND 106).

SN 78-147,386. SOLUCIENT, LLC, EVANSTON, IL. FILED 7-25-2002.

ACTION O-I

NO CLAIM IS MADE TO THE EXCLUSIVE RIGHT TO USE "O-I", APART FROM THE MARK AS SHOWN.

CLASS 9—ELECTRICAL AND SCIENTIFIC APPARATUS

FOR COMPUTER SOFTWARE USED FOR DATABASE MANAGEMENT AND ANALYSIS IN THE FIELD OF THE FINANCIAL MANAGEMENT AND OPERATIONAL IMPROVEMENT OF HEALTH CARE SERVICES (U.S. CLS. 21, 23, 26, 36 AND 38).

CLASS 42—SCIENTIFIC, COMPUTER AND LEGAL SERVICES

FOR PROVIDING TEMPORARY USE OF ON-LINE NON-DOWNLOADABLE SOFTWARE FOR DATABASE MANAGEMENT AND ANALYSIS IN THE FIELD OF THE FINANCIAL MANAGEMENT AND OPERATIONAL IMPROVEMENT OF HEALTH CARE SERVICES (U.S. CLS. 100 AND 101).

FIRESTACK

CLASS 9—ELECTRICAL AND SCIENTIFIC APPARATUS

FOR COMPUTER HARDWARE, NAMELY, CABLES, CD-ROM DRIVES, CD-RW DRIVES, CPU COOLING FANS, COMPUTERS, COMPUTER SECURITY DEVICES NAMELY, OPTICAL SCANNERS AND FINGER PRINT SCANNERS, DIGITAL CAMERAS AND CAMCORDERS, DVD DRIVES, FLOPPY DRIVES, HARD DISKS, HARD DRIVES, INPUT DEVICES NAMELY JOYSTICKS, OPTICAL MOUSE AND TABLETS, KEYBOARDS, MEMORY, MICROPROCESSORS, MODEMS, MONITORS, MOTHERBOARDS, NETWORKING SWITCHES AND HUBS, NETWORKING CARD, NOTEBOOK COMPUTERS, PRINTERS, POWER SUPPLIES, SCANNERS, SOUND CARDS, VIDEO CARDS AND VIDEO CONFERENCE AND CAPTURE CARES; COMPUTER SOFTWARE, NAMELY, DRIVERS AND APPLICATIONS DESIGNED SPECIFICALLY TO ENABLE USE OF THE COMPUTER HARDWARE WITH THIRD PARTY COMPUTER OPERATING SYSTEM SOFTWARE (U.S. CLS. 21, 23, 26, 36 AND 38).

CLASS 35—ADVERTISING AND BUSINESS

FOR PROVIDING WHOLESALE AND RETAIL STORE SERVICES TO CUSTOMERS FEATURING COMPUTER HARDWARE, SOFTWARE AND PERIPHERALS, VIA A WEBSITE (U.S. CLS. 100, 101 AND 102).

SN 78-148,251. FRANK'S NURSERY & CRAFTS INC., TROY, MI. BY ASSIGNMENT FRANKS NURSERY & CRAFTS, INC., TROY, MI. FILED 7-29-2002.

HOLIDAY TREASURES

NO CLAIM IS MADE TO THE EXCLUSIVE RIGHT TO USE "HOLIDAY", APART FROM THE MARK AS SHOWN.

CLASS 20—FURNITURE AND ARTICLES NOT OTHERWISE CLASSIFIED

FOR HOLIDAY MERCHANDISE, NAMELY, CHRISTMAS DECORATIONS AND ORNAMENTS NOT INTENDED TO BE USED ON A CHRISTMAS TREE IN THE NATURE OF FIGURES, FIGURINES, AND STATUETTES MADE OF PLASTIC, WAX, WOOD, BONE, IVORY, FABRICS AND PLASTER (U.S. CLS. 2, 13, 22, 25, 32 AND 50).

CLASS 21—HOUSEWARES AND GLASS

FOR HOLIDAY MERCHANDISE, NAMELY, CHRISTMAS DECORATIONS AND ORNAMENTS NOT INTENDED TO BE USED ON A CHRISTMAS TREE IN THE NATURE OF FIGURES, FIGURINES, AND STATUETTES MADE OF CERAMIC, CHINA, GLASS OR PORCELAIN (U.S. CLS. 2, 13, 23, 29, 30, 33, 40 AND 50).

CLASS 26—FANCY GOODS

FOR ARTIFICIAL FLOWERS AND FLOWER ARRANGEMENTS AND PARTS THEREFOR (U.S. CLS. 37, 39, 40, 42 AND 50).

CLASS 28—TOYS AND SPORTING GOODS

FOR CHRISTMAS TREE DECORATIONS AND ORNAMENTS (U.S. CLS. 22, 23, 38 AND 50).

CLASS 31—NATURAL AGRICULTURAL PRODUCTS

FOR NATURAL AGRICULTURAL PRODUCTS, NAMELY, LIVE PLANTS AND FLOWERS INCLUDING PERENNIALS AND ANNUALS (U.S. CLS. 1 AND 46).

SN 78-148,917. COOLSAINTS.COM, L.L.C., OREM, UT. FILED 7-30-2002.

SN 78-148,697. SMS MEER GMBH, MONCHENGLADBACH, FED REP GERMANY, FILED 7-30-2002.

FORGEBASE

PRIORITY CLAIMED UNDER SEC. 44(D) ON FED REP GERMANY APPLICATION NO. 30204203.2/0, FILED 1-30-2002, REG. NO. 30204203, DATED 7-23-2002, EXPIRES 1-30-2012.

CLASS 9—ELECTRICAL AND SCIENTIFIC APPARATUS

FOR ELECTRICAL CONTROLLERS FOR OPEN-DIE FORGING PRESSES; COMPUTERS; COMPUTER PROGRAMS FOR THE CONTROL AND ADJUSTMENT OF METAL FORMING MACHINES (U.S. CLS. 21, 23, 26, 36 AND 38).

CLASS 42—SCIENTIFIC, COMPUTER AND LEGAL SERVICES

FOR COMPUTER SOFTWARE CONSULTATION REGARDING COMPUTER PROGRAMS FOR THE CONTROL AND ADJUSTMENT OF METAL FORMING MACHINES IN THE FIELD OF METAL FORMING MACHINES; DEVELOPMENT OF COMPUTER SOFTWARE FOR DATA PROCESSING (U.S. CLS. 100 AND 101).

SN 78-148,840. C2 MEDIA LTD., LONDON, UNITED KINGDOM, FILED 7-30-2002.

LOP.COM**CLASS 35—ADVERTISING AND BUSINESS**

FOR ADVERTISING AND MARKETING FOR OTHERS BY MEANS OF A GLOBAL COMPUTER NETWORK, NAMELY, DISSEMINATION OF ADVERTISING FOR OTHERS VIA THE INTERNET; AUCTION SERVICES BY MEANS OF A GLOBAL COMPUTER NETWORK; INTERNET DIRECTORY SERVICES; PROVIDING DIRECTORIES OF CONTENT AVAILABLE ON A GLOBAL COMPUTER NETWORK; ONLINE CLASSIFIED AD SERVICES; ONLINE DIRECTORY SERVICES TO HELP LOCATE PEOPLE, BUSINESSES, ORGANIZATIONS, PHONE NUMBERS, ADDRESSES AND ELECTRONIC MAIL ADDRESSES; PROMOTION OF WEB SITES FOR OTHERS BY PLACING ADVERTISING ON THE INTERNET (U.S. CLS. 100, 101 AND 102).
FIRST USE 1-24-2001; IN COMMERCE 1-24-2001.

CLASS 42—SCIENTIFIC, COMPUTER AND LEGAL SERVICES

FOR COMPUTER SERVICES, NAMELY PROVIDING A SEARCH ENGINE FOR OBTAINING INFORMATION FROM A GLOBAL COMPUTER NETWORK (U.S. CLS. 100 AND 101).
FIRST USE 1-24-2001; IN COMMERCE 1-24-2001.

**CLASS 25—CLOTHING**

FOR CLOTHING, NAMELY, SHIRTS, SHORTS, HATS, AND PANTS (U.S. CLS. 22 AND 39).
FIRST USE 5-13-2002; IN COMMERCE 5-13-2002.

CLASS 45—PERSONAL SERVICES

FOR ONLINE DATING SERVICES (U.S. CLS. 100 AND 101).
FIRST USE 5-13-2002; IN COMMERCE 5-13-2002.

SN 78-148,990. WASHOE EQUIPMENT, DBA SUNOPTICS PRISMATIC SKYLIGHTS, SACRAMENTO, CA. FILED 7-30-2002.

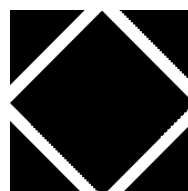
**SUNOPTICS****CLASS 6—METAL GOODS**

FOR METAL SKYLIGHTS (U.S. CLS. 2, 12, 13, 14, 23, 25 AND 50).
FIRST USE 3-1-1984; IN COMMERCE 3-1-1984.

CLASS 19—NON-METALLIC BUILDING MATERIALS

FOR PLASTIC SKYLIGHTS (U.S. CLS. 1, 12, 33 AND 50).
FIRST USE 3-1-1984; IN COMMERCE 3-1-1984.

SN 78-150,465. SNELL, DAVID R, KIRKLAND, WA. FILED 8-2-2002.

LIVEDRIVE**CLASS 9—ELECTRICAL AND SCIENTIFIC APPARATUS**

FOR CRUISE CONTROLS FOR MOTOR VEHICLES (U.S. CLS. 21, 23, 26, 36 AND 38).

CLASS 12—VEHICLES

FOR STEERING WHEELS, BRAKE CONTROLS FOR MOTOR VEHICLES, THROTTLE CONTROLS FOR MOTOR VEHICLES (U.S. CLS. 19, 21, 23, 31, 35 AND 44).

SN 78-151,644. MANGO KING ENTERPRISES, INC., NEW YORK, NY. FILED 8-7-2002.

U PAY ME**CLASS 9—ELECTRICAL AND SCIENTIFIC APPARATUS**

FOR PRE-RECORDED CD'S AND AUDIO TAPES FEATURING MUSIC (U.S. CLS. 21, 23, 26, 36 AND 38).

CLASS 25—CLOTHING

FOR CLOTHING, NAMELY, SHIRTS, T-SHIRTS, SWEATPANTS, SWEATSHIRTS, JACKETS, SHORTS, HEADWEAR, FOOTWEAR (U.S. CLS. 22 AND 39).

CLASS 35—ADVERTISING AND BUSINESS

FOR PROMOTING THE CONCERTS OF OTHERS; PROMOTING THE SALE OF AUDIO GOODS OF OTHERS THROUGH DISTRIBUTION OF PRINTED MATERIAL AND PROMOTIONAL CONTESTS (U.S. CLS. 100, 101 AND 102).

CLASS 41—EDUCATION AND ENTERTAINMENT

FOR AUDIO RECORDING AND RECORD PRODUCTION; ENTERTAINMENT SERVICES, NAMELY, LIVE PERFORMANCES BY A MUSICAL BAND (U.S. CLS. 100, 101 AND 107).

SN 78-151,663. SKYBOX SECURITY, INC., BURLINGTON, MA. FILED 8-7-2002.

SKYBOX**CLASS 35—ADVERTISING AND BUSINESS**

FOR BUSINESS CONSULTATION, NAMELY, EVALUATION AND MANAGEMENT OF INFORMATION, ASSET AND SECURITY RISKS; BUSINESS RESEARCH, ANALYSIS AND DEVELOPMENT OF INFORMATION, ASSET AND SECURITY RISK REDUCTION SOLUTIONS AND TOOLS; BUSINESS CONSULTATION, NAMELY, DEVELOPMENT, IMPLEMENTATION AND MANAGEMENT OF BUSINESS INFORMATION, ASSET AND SECURITY RISK POLICIES AND SOLUTIONS (U.S. CLS. 100, 101 AND 102).

CLASS 36—INSURANCE AND FINANCIAL

FOR ASSET RISK ASSESSMENT, NAMELY, VALUATION OF BUSINESS ASSETS (U.S. CLS. 100, 101 AND 102).

CLASS 42—SCIENTIFIC, COMPUTER AND LEGAL SERVICES

FOR DESIGN, DEVELOPMENT, IMPLEMENTATION AND PROJECT MANAGEMENT OF COMPUTER SOFTWARE AND HARDWARE USED FOR INFORMATION, ASSET AND SECURITY RISK SOLUTIONS; NON-DOWNLOADABLE SOFTWARE USED TO ASSESS, EVALUATE, MANAGE AND DEVELOP SOLUTIONS TO INFORMATION, ASSET AND SECURITY RISKS (U.S. CLS. 100 AND 101).

SN 78-151,666. SKYBOX SECURITY, INC., BURLINGTON, MA. FILED 8-7-2002.



The logo for skybox security features the word "skybox" in a bold, lowercase, sans-serif font. The letter "o" in "skybox" is stylized with a horizontal line through its center. Below "skybox", the word "security" is written in a smaller, lowercase, sans-serif font.

NO CLAIM IS MADE TO THE EXCLUSIVE RIGHT TO USE "SECURITY", APART FROM THE MARK AS SHOWN.

CLASS 35—ADVERTISING AND BUSINESS

FOR BUSINESS CONSULTATION, NAMELY, EVALUATION AND MANAGEMENT OF INFORMATION, ASSET AND SECURITY RISKS; BUSINESS RESEARCH, ANALYSIS AND DEVELOPMENT OF INFORMATION, ASSET AND SECURITY RISK REDUCTION SOLUTIONS AND TOOLS; BUSINESS CONSULTATION, NAMELY, DEVELOPMENT, IMPLEMENTATION AND MANAGEMENT OF BUSINESS INFORMATION, ASSET AND SECURITY RISK POLICIES AND SOLUTIONS. (U.S. CLS. 100, 101 AND 102).

CLASS 36—INSURANCE AND FINANCIAL

FOR ASSET RISK ASSESSMENT, NAMELY, VALUATION OF BUSINESS ASSETS (U.S. CLS. 100, 101 AND 102).

CLASS 42—SCIENTIFIC, COMPUTER AND LEGAL SERVICES

FOR DESIGN, DEVELOPMENT, IMPLEMENTATION AND PROJECT MANAGEMENT OF COMPUTER SOFTWARE AND HARDWARE USED FOR INFORMATION, ASSET AND SECURITY RISK SOLUTIONS; NON-DOWNLOADABLE SOFTWARE USED TO ASSESS, EVALUATE, MANAGE AND DEVELOP SOLUTIONS TO INFORMATION, ASSET AND SECURITY RISKS (U.S. CLS. 100 AND 101).

SN 78-151,856. GEN-PROBE INCORPORATED, SAN DIEGO, CA. FILED 8-7-2002.



The logo for APTIMA COMBO 2 features the word "APTIMA" in a bold, uppercase, sans-serif font. To its right, the word "COMBO" is written in a larger, bold, uppercase, sans-serif font. Below "COMBO", the number "2" is written in a very large, bold, uppercase, sans-serif font. A thick horizontal line runs underneath the "COMBO" and "2" text.

OWNER OF U.S. REG. NO. 2,432,113.
THE MARK CONSISTS OF THE WORDS AND NUMBERS "APTIMA", "COMBO" AND "2"; AND THE DESIGN OF A DOUBLE HELIX.

CLASS 5—PHARMACEUTICALS

FOR DIAGNOSTIC REAGENTS FOR CLINICAL OR MEDICAL LABORATORY USE AND GENETIC PROBE ASSAY KITS COMPRISING DIAGNOSTIC REAGENTS FOR CLINICAL OR MEDICAL LABORATORY USE (U.S. CLS. 6, 18, 44, 46, 51 AND 52).

FIRST USE 9-24-2001; IN COMMERCE 10-12-2001.

CLASS 10—MEDICAL APPARATUS

FOR SPECIMEN HANDLING DEVICES FOR MEDICAL DIAGNOSTIC USE, NAMELY, PIPETTES, SPECIMEN COLLECTION SWABS, AND SPECIMEN COLLECTION AND TRANSPORT VIALS, FOR COLLECTING, HANDLING AND TRANSPORTING CLINICAL SPECIMENS; KITS COMPRISING PIPETTES, SPECIMEN COLLECTION SWABS, AND SPECIMEN COLLECTION AND TRANSPORT VIALS, FOR COLLECTING, HANDLING AND TRANSPORTING CLINICAL SPECIMENS FOR MEDICAL DIAGNOSTIC USE (U.S. CLS. 26, 39 AND 44).

FIRST USE 9-24-2001; IN COMMERCE 10-12-2001.

SN 78-152,004. ELODA, INC., MONTREAL, CANADA, FILED 8-7-2002.

ELODA**CLASS 35—ADVERTISING AND BUSINESS**

FOR ADVERTISING SERVICES VIA GLOBAL COMPUTER NETWORK, NAMELY, PROMOTING THE COMMERCIAL PRODUCTS AND/OR SERVICES OF VENDORS, SUPPLIERS AND MANUFACTURERS THROUGH THE PROVISION OF ON-DEMAND BROADCASTS AND RICH MEDIA ADVERTISEMENTS TO CONSUMERS; PROVIDING MEDIA MONITORING AND INTELLIGENCE SERVICES, NAMELY, MONITORING BUSINESS ACTIVITIES AND ADVERTISING CONTENT, MONITORING AND INDEXING COMPETITOR ADVERTISING ACTIVITIES; PROVIDING MEDIA PLACEMENT AUDIT SERVICES TO THE ADVERTISING INDUSTRY AND/OR ITS CLIENTS, NAMELY BY INDEXING OF ALL ADVERTISING SPOTS AIRING ON TELEVISION NETWORKS AND LOCAL STATIONS; PROVIDING ON-LINE UNBIASED CONSUMER INFORMATION VIA ON-LINE, ON-DEMAND VIEWING OF BROADCAST AND RICH MEDIA ADVERTISEMENTS PROMOTING THE PRODUCTS AND/OR SERVICES OF OTHERS TO ENABLE COMPARATIVE SHOPPING AND THE PROVISION OF LINKS AND/OR CONTACT INFORMATION ENABLING COMMUNICATION WITH VENDORS, SUPPLIERS AND MANUFACTURERS OF THE ADVERTISED PRODUCT OR SERVICE FOR THE PURCHASE OF SUCH PRODUCT AND/OR SERVICE (U.S. CLS. 100, 101 AND 102).

CLASS 40—MATERIAL TREATMENT

FOR PROVIDING MEDIA PLACEMENTS AUDIT SERVICES TO THE ADVERTISING INDUSTRY AND/OR ITS CLIENTS, NAMELY BY DIGITIZING/COMPRESSION OF ALL ADVERTISING SPOTS AIRING ON TELEVISION NETWORKS AND LOCAL STATIONS (U.S. CLS. 100, 103 AND 106).

CLASS 42—SCIENTIFIC, COMPUTER AND LEGAL SERVICES

FOR PROVIDING MEDIA PLACEMENT AUDIT SERVICES TO THE ADVERTISING INDUSTRY AND/OR ITS CLIENTS, NAMELY, BY AUTOMATED RECOGNITION AND RETRIEVAL OF ALL ADVERTISING SPOTS AIRING ON TELEVISION NETWORKS AND LOCAL STATIONS (U.S. CLS. 100 AND 101).

SN 78-152,064. SURFMET, INC., SAN JOSE, CA. FILED 8-7-2002.

THE WAVE MAGAZINE

OWNER OF U.S. REG. NO. 2,675,615.
NO CLAIM IS MADE TO THE EXCLUSIVE RIGHT TO USE "MAGAZINE", APART FROM THE MARK AS SHOWN.

CLASS 9—ELECTRICAL AND SCIENTIFIC APPARATUS

FOR DOWNLOADABLE ELECTRONIC MAGAZINES FEATURING LOCAL AND REGIONAL NEWS, ENTERTAINMENT, CULTURAL EVENTS, AND CURRENT EVENTS (U.S. CLS. 21, 23, 26, 36 AND 38).

CLASS 16—PAPER GOODS AND PRINTED MATTER

FOR MAGAZINES FEATURING LOCAL AND REGIONAL NEWS, ENTERTAINMENT, CULTURAL EVENTS, AND CURRENT EVENTS (U.S. CLS. 2, 5, 22, 23, 29, 37, 38 AND 50).

SN 78-152,972. STAFFWARE PUBLIC LIMITED COMPANY, MAIDENHEAD, UNITED KINGDOM, FILED 8-9-2002.

STAFFWARE

OWNER OF U.S. REG. NOS. 1,977,931 AND 2,301,448.

CLASS 41—EDUCATION AND ENTERTAINMENT

FOR EDUCATIONAL SERVICES, NAMELY, PROVIDING SEMINARS, CLASSES, COURSES AND WORKSHOPS IN THE FIELD OF DEVELOPING AND SUPPLYING SOFTWARE TO IMPLEMENT BUSINESS PROCESSES (U.S. CLS. 100, 101 AND 107).

FIRST USE 10-11-1985; IN COMMERCE 10-11-1985.

CLASS 42—SCIENTIFIC, COMPUTER AND LEGAL SERVICES

FOR COMPUTER CONSULTATION SERVICES IN THE FIELD OF COMPUTERS, COMPUTER SOFTWARE, COMPUTER PROGRAMMING AND ORGANIZATION IN THE FIELD OF DATA PROCESSING (U.S. CLS. 100 AND 101).

FIRST USE 10-11-1985; IN COMMERCE 10-11-1985.

SN 78-153,511. BROOKS BROTHERS, INC., NEW YORK, NY. FILED 8-12-2002.

BROOKS CLASSICS

OWNER OF U.S. REG. NOS. 1,835,798 AND 2,634,532.
NO CLAIM IS MADE TO THE EXCLUSIVE RIGHT TO USE "CLASSICS", APART FROM THE MARK AS SHOWN.

CLASS 25—CLOTHING

FOR CLOTHING, NAMELY, SHIRTS, TOPS, SWEATERS, JACKETS, PANTS, SUITS, BOTTOMS, SOCKS, HATS AND CAPS; SHOES; SHORTS, COATS, NECKTIES, UNDERWEAR, VESTS, ROBES, HOSIERY, SKIRTS, DRESSES, LOUNGEWEAR, SCARVES, RAINWEAR, TROUSERS, ASCOTS, TIES, OUTER SHIRTS NAMELY EVENING, DRESS, POLO, AND SPORTS SHIRTS, COLLARS, PAJAMAS, ROBES, SMOKING JACKETS, DRESSING GOWNS, MUFFLERS, GLOVES, HOSE, BELTS, SUSPENDERS, GARTERS, BOOTS, SLIPPERS, SHOES, OVERSHOES, BEACH WEAR, SWIMWEAR, FORMAL WEAR, NAMELY JACKETS, PANTS, SUITS, SHIRTS, SHOES, CUMMERBUNDS, TIES, SUSPENDERS AND GOWNS (U.S. CLS. 22 AND 39).

CLASS 35—ADVERTISING AND BUSINESS

FOR RETAIL STORE SERVICES, MAIL ORDER SERVICES AND COMPUTERIZED ON-LINE ORDERING AND RETAIL SERVICES VIA A COMPUTER NETWORK FEATURING A WIDE VARIETY OF CONSUMER GOODS (U.S. CLS. 100, 101 AND 102).

SN 78-153,702. S.A. LUCIEN GEORGELIN, SOCIETE ANONYME, VIRAZEIL, FRANCE, FILED 8-13-2002.

LUCIEN GEORGELIN

OWNER OF FRANCE REG. NO. 003017677, DATED 3-23-2000, EXPIRES 3-23-2010.

THE NAME IN THE MARK IDENTIFIES A LIVING INDIVIDUAL WHOSE CONSENT IS OF RECORD.

CLASS 29—MEATS AND PROCESSED FOODS

FOR JAMS, JELLIES, FRUIT SAUCES, PRESERVED FRUITS AND VEGETABLES, DRIED FRUITS AND VEGETABLES, COOKED FRUITS AND VEGETABLES, NAMELY, FRUIT COULIS, FRUIT IN SYRUP, VEGETABLE PUREE; SWEET PREPARATIONS BASED ON MILK PRODUCTS, SPREADS OR PASTES, NAMELY, CREAMS, YOGURTS, MILK MARMALADE (U.S. CL. 46).

CLASS 30—STAPLE FOODS

FOR PASTRIES, HONEY, ICE FOR REFRESHMENT, FLAVORED ICES, SPICES, COFFEE, TEA, COCOA, SUGAR, FLOUR, BREAKFAST CEREALS, CEREAL BASED SNACK FOOD, BREAD (U.S. CL. 46).

CLASS 31—NATURAL AGRICULTURAL PRODUCTS

FOR FRESH MUSHROOMS (U.S. CLS. 1 AND 46).

CLASS 32—LIGHT BEVERAGES

FOR FRUIT DRINKS AND FRUIT JUICES, SYRUPS FOR MAKING FRUIT-BASED BEVERAGES (U.S. CLS. 45, 46 AND 48).

SN 78-154,503. DEAN INTELLECTUAL PROPERTY SERVICES II, L.P., DALLAS, TX. BY ASSIGNMENT DTMC, INC., FRANKLIN PARK, IL. FILED 8-15-2002.



OWNER OF U.S. REG. NO. 2,424,140.
THE STIPPLING IS FOR SHADING PURPOSES ONLY.
THE MARK CONSISTS OF A RIVER FLOWING FROM A MOUNTAIN.

CLASS 29—MEATS AND PROCESSED FOODS

FOR DAIRY PRODUCTS, NAMELY, MILK, HALF AND HALF, EGG NOG, COTTAGE CHEESE, CHEESE, CHEESE SUBSTITUTES, CREAM, CREAMERS, BUTTER, MARGARINE, EGG-SUBSTITUTES, YOGURT, FLAVORED SNACK DIPS, EXCLUDING SALSA AND OTHER SAUCES USED AS DIPS; NON-DAIRY DIPS, VEGETABLE BASED DIPS, PICKLES, PROCESSED PICKLED PEPPERS, WHEY-BASED FOOD BEVERAGES, WHIPPED CREAM, LIGHT CREAM, WHIPPED TOPPINGS, DAIRY AND VEGETABLE BASED WHIPPED TOPPING; NON-DAIRY REFRIGERATED SOY PROTEIN FOODS, NAMELY, SOY-BASED BEVERAGES, TOFU, SOY-BASED YOGURT, SOY-BASED AND WHEAT-GLUTEN-BASED MEAT SUBSTITUTES (U.S. CL. 46).

CLASS 30—STAPLE FOODS

FOR ICE CREAM, ICE CREAM NOVELTIES, ICINGS, COFFEE AND ICED TEA, TEA; SAUCES, NAMELY WHITE, HOLLANDAISE, CHEESE, SHRIMP AND TARTAR, PUDDING, BOILED CUSTARD, FROZEN CONFECTIONS, SHERBET, SHAKES, RELISHES, SALAD DRESSING AND MAYONNAISE (U.S. CL. 46).

CLASS 32—LIGHT BEVERAGES

FOR NON-ALCOHOLIC BEVERAGES, NAMELY FRUIT JUICES, NECTARS, LEMONADE, FRUIT DRINKS, FRUIT PUNCH, AND BOTTLED DRINKING WATER (U.S. CLS. 45, 46 AND 48).

SN 78-154,545. MGA FILMS, INC., FORT COLLINS, CO. FILED 8-15-2002.

STARLESS**CLASS 9—ELECTRICAL AND SCIENTIFIC APPARATUS**

FOR PRERECORDED MEDIA, NAMELY, CDS, DVDS, VIDEOTAPES AND AUDIOTAPES FEATURING MUSIC AND MUSIC VIDEOS; COMPUTER PROGRAMS FOR USE IN COMPUTER GAMES (U.S. CLS. 21, 23, 26, 36 AND 38).

CLASS 41—EDUCATION AND ENTERTAINMENT

FOR ENTERTAINMENT SERVICES, NAMELY, PRODUCTION AND DISTRIBUTION OF MOVIES, TELEVISION PROGRAMS, RADIO PROGRAMS AND INTERNET PROGRAMS FOR OTHERS; AUDIO RECORDING AND PRODUCTION SERVICES; PROVIDING WEB SITES FEATURING MUSICAL PERFORMANCES, MUSIC VIDEOS AND MOVIES; LIVE PERFORMANCES BY A MUSICAL BAND, LIVE MUSIC CONCERTS, LIVE PERFORMANCES BY MUSICAL ARTISTS, RECORD PRODUCTION; RECORDING AND SOUND RECORDING STUDIOS (U.S. CLS. 100, 101 AND 107).

CLASS 42—SCIENTIFIC, COMPUTER AND LEGAL SERVICES

FOR COMPUTER SOFTWARE DESIGN FOR OTHERS, NAMELY DESIGNING BUSINESS FORMS SOFTWARE, WORKFLOW SOFTWARE, INTERACTIVE DATABASES AND WEBSITE LINK SOFTWARE, ALL IN A CD-ROM FORMAT AND ALL FOR USE IN CREATING IMPLEMENTING AND MAINTAINING CORPORATE INFORMATION, PRESENTATION MATERIALS, CONTACT INFORMATION AND OTHER RELEVANT SALES AND MARKETING INFORMATION USED TO CUSTOMIZE AND AUTOMATE BUSINESS PROCESSES; COMPUTER SERVICES, NAMELY, DESIGNING WEB SITES FOR OTHERS; GRAPHIC ART DESIGN, FOR USE ON BUSINESS CARDS AND PROMOTIONAL MATERIALS FOR OTHERS IN A CD-ROM FORMAT (U.S. CLS. 100 AND 101).

FIRST USE 2-1-2001; IN COMMERCE 2-1-2001.

SN 78-154,721. GEN-PROBE INCORPORATED, SAN DIEGO, CA. FILED 8-15-2002.

SN 78-155,338. DWELLERY LTD. CO., ORLANDO, FL. FILED 8-19-2002.

APTIMA COMBO 2

OWNER OF U.S. REG. NO. 2,432,113.

CLASS 5—PHARMACEUTICALS

FOR DIAGNOSTIC REAGENTS FOR CLINICAL OR MEDICAL LABORATORY USE AND GENETIC PROBE ASSAY KITS COMPRISING DIAGNOSTIC REAGENTS FOR CLINICAL OR MEDICAL LABORATORY USE (U.S. CLS. 6, 18, 44, 46, 51 AND 52).

FIRST USE 9-24-2001; IN COMMERCE 10-12-2001.

CLASS 16—PAPER GOODS AND PRINTED MATTER

FOR PRINTED MATERIALS, NAMELY, CATALOGS IN THE FIELD OF CONSUMER HOME PRODUCTS (U.S. CLS. 2, 5, 22, 23, 29, 37, 38 AND 50).

CLASS 10—MEDICAL APPARATUS

FOR SPECIMEN HANDLING DEVICES FOR MEDICAL DIAGNOSTIC USE, NAMELY, PIPETTES, SPECIMEN COLLECTION SWABS, AND SPECIMEN COLLECTION AND TRANSPORT VIALS, FOR COLLECTING, HANDLING AND TRANSPORTING CLINICAL SPECIMENS; KITS COMPRISING PIPETTES, SPECIMEN COLLECTION SWABS, AND SPECIMEN COLLECTION AND TRANSPORT VIALS, FOR COLLECTING, HANDLING AND TRANSPORTING CLINICAL SPECIMENS FOR MEDICAL DIAGNOSTIC USE (U.S. CLS. 26, 39 AND 44).

FIRST USE 9-24-2001; IN COMMERCE 10-12-2001.

CLASS 35—ADVERTISING AND BUSINESS

FOR MAIL ORDER CATALOG SERVICES AND RETAIL STORE SERVICES PROVIDED OVER THE INTERNET IN THE FIELD OF CONSUMER HOME PRODUCTS (U.S. CLS. 100, 101 AND 102).

SN 78-154,784. DIGICARD PLUS, LLC., DANBURY, CT. FILED 8-15-2002.

DIGICARD PLUS**CLASS 35—ADVERTISING AND BUSINESS**

FOR PRODUCTION OF TELEVISION COMMERCIALS; PREPARING PROMOTIONAL AND MERCHANDISING MATERIALS FOR OTHERS (U.S. CLS. 100, 101 AND 102).

FIRST USE 2-1-2001; IN COMMERCE 2-1-2001.

SN 78-155,509. OMAR KASSEM ALESAYI MARKETING CO. LTD., JEDDAH 21492, SAUDI ARABIA, FILED 8-19-2002.



THE MARK CONSISTS OF THE WORD "ROTANA" IN LATIN AND ARABIC.
THE TRANSLITERATION OF THE MARK IS "ROTANA".

CLASS 29—MEATS AND PROCESSED FOODS

FOR MEAT, FISH POULTRY AND GAME; MEAT EXTRACTS; PRESERVED, DRIED AND COOKED FRUITS AND VEGETABLES; JAMS, EGGS, MILK AND DAIRY PRODUCTS EXCLUDING ICE CREAM, ICE MILK AND FROZEN YOGURT; EDIBLE OILS AND FATS; FRUIT PRESERVES (U.S. CL. 46).

CLASS 30—STAPLE FOODS

FOR COFFEE AND TEA, TAPIOCA, SAGO, FLOUR, BREAD, BISCUITS, CAKES, PASTRY, FLAVORED ICES, HONEY, TREACLE, YEAST, BAKING POWDER, SALT, MUSTARD, PEPPER, VINEGAR, SAUCES, SPICES (U.S. CL. 46).

CLASS 31—NATURAL AGRICULTURAL PRODUCTS

FOR AGRICULTURAL-HORTICULTURAL AND FORESTRY PRODUCTS, NAMELY, UNPROCESSED WHEAT AND UNDRRESSED TIMBER; FRESH FRUITS AND VEGETABLES; LIVE PLANTS AND FLOWERS; FOODSTUFFS FOR ANIMALS (U.S. CLS. 1 AND 46).

CLASS 32—LIGHT BEVERAGES

FOR NON-ALCOHOLIC MINERAL AND AERATED WATERS; TABLE SYRUPS AND SYRUPS FOR MAKING SOFT DRINKS (U.S. CLS. 45, 46 AND 48).

SN 78-155,533. BALL CHAIN MANUFACTURING CO., DBA BCM CORPORATION, MOUNT VERNON, NY. FILED 8-19-2002.

SHIMMERSCREEN**CLASS 6—METAL GOODS**

FOR METAL BALL CHAIN FOR USE IN HOME DESIGN AS ARCHITECTURAL TREATMENT OR AS DESIGN ELEMENTS (U.S. CLS. 2, 12, 13, 14, 23, 25 AND 50).

CLASS 20—FURNITURE AND ARTICLES NOT OTHERWISE CLASSIFIED

FOR DECORATIVE METAL BEAD CURTAINS; ROOM DIVIDER SCREENS MADE OF METAL BALL CHAIN (U.S. CLS. 2, 13, 22, 25, 32 AND 50).

CLASS 24—FABRICS

FOR WINDOW CURTAINS MADE FROM METAL BALL CHAIN (U.S. CLS. 42 AND 50).

SN 78-155,808. EUROCINE AB, STOCKHOLM, SWEDEN, FILED 8-20-2002.

EUROCINE

PRIORITY CLAIMED UNDER SEC. 44(D) ON SWEDEN APPLICATION NO. 201445, FILED 3-1-2002, REG. NO. 356439, DATED 6-14-2002, EXPIRES 6-14-2012.

CLASS 1—CHEMICALS

FOR CHEMICAL REAGENTS FOR MEDICAL RESEARCH USE; REAGENTS FOR TESTING THE STERILITY OF MEDICAL EQUIPMENT; CHEMICAL REAGENTS FOR TESTING THE STERILITY OF PHARMACEUTICALS AND INJECTABLE SOLUTIONS; CHEMICAL REAGENTS FOR MEDICAL SCIENTIFIC RESEARCH PURPOSES (U.S. CLS. 1, 5, 6, 10, 26 AND 46).

CLASS 5—PHARMACEUTICALS

FOR VACCINES AND SERA; VACCINES FOR NASAL ADMINISTRATION; INHALERS FILLED WITH VACCINES; ADJUVANTS FOR USE WITH VACCINES; PHARMACEUTICAL PREPARATIONS FOR USE IN THE PREVENTION OF VIRAL INFECTIONS; PHARMACEUTICAL PREPARATIONS, NAMELY, ANTIVIRALS AND ANTI-INFECTIVES; CLINICAL MEDICAL REAGENTS; MEDICAL DIAGNOSTIC REAGENTS; NOSE DROPS; NOSE SPRAYS; PHARMACEUTICAL PREPARATIONS FOR INCREASING RESISTANCE TO INFECTION BY DIPHTHERIA, TETANUS, PERTUSSIS, TUBERCULOSIS, HANTAVIRUS, HIV AND INFLUENZA (U.S. CLS. 6, 18, 44, 46, 51 AND 52).

CLASS 42—SCIENTIFIC, COMPUTER AND LEGAL SERVICES

FOR SCIENTIFIC AND TECHNOLOGICAL SERVICES AND RESEARCH AND DESIGN RELATING THERETO, NAMELY, BIOLOGICAL, BACTERIOLOGICAL AND CHEMICAL RESEARCH; INDUSTRIAL ANALYSIS AND RESEARCH SERVICES, NAMELY, CHEMICAL SCIENTIFIC RESEARCH SERVICES; CHEMICAL ANALYSIS; CHEMISTRY SERVICES; LICENSING OF SCIENTIFIC RESEARCH RESULTS AND INTELLECTUAL PROPERTY; PROFESSIONAL CONSULTANCY RELATED TO VACCINES AND SERA (U.S. CLS. 100 AND 101).

SN 78-156,147. LUDWIG, LESTER F., BELMONT, CA. FILED 8-21-2002.

SMALL CAGED TREE**CLASS 41—EDUCATION AND ENTERTAINMENT**

FOR ENTERTAINMENT SERVICES, NAMELY, MUSICAL COMPOSITION AND LIVE MUSICAL PERFORMANCE FOR OTHERS, AND MUSICAL AND AUDIO PRODUCTION FOR RECORDS, VIDEOS, CASSETTES, COMPACT DISCS, MAGNETIC STORAGE MEDIA, ELECTRONIC STORAGE MEDIA, OPTICAL STORAGE MEDIA IN CONNECTION THEREWITH; PROVIDING MUSICAL AND AUDIO RECORDINGS VIA A GLOBAL COMPUTER NETWORK; AND EDUCATIONAL RESEARCH AND DEVELOPMENT OF EDUCATIONAL MATERIALS IN THE FIELDS OF ACOUSTICS, PSYCHOLOGY, MATHEMATICS, MUSIC, AND ETHNIC TRADITIONS (U.S. CLS. 100, 101 AND 107).

FIRST USE 4-8-2003; IN COMMERCE 4-8-2003.

CLASS 42—SCIENTIFIC, COMPUTER AND LEGAL SERVICES

FOR PRODUCT RESEARCH AND DEVELOPMENT OF NEW TECHNOLOGIES AND THEORIES FOR OTHERS IN THE FIELDS OF ACOUSTICS, PSYCHOLOGY, MATHEMATICS, MUSICAL SYSTEMS, AND ETHNIC TRADITIONS (U.S. CLS. 100 AND 101).

FIRST USE 4-8-2003; IN COMMERCE 4-8-2003.

SN 78-156,395. THE TJX COMPANIES, INC., FRAMINGHAM, MA. FILED 8-21-2002.

A PERFECT OCCASION

CLASS 16—PAPER GOODS AND PRINTED MATTER

FOR PAPER PRODUCTS, NAMELY, JOURNALS REGARDING WINE; HOSTESS SETS PRINCIPALLY COMPRISING PAPER GUEST TOWELS, PAPER NAPKINS AND PAPER COASTERS (U.S. CLS. 2, 5, 22, 23, 29, 37, 38 AND 50).

CLASS 21—HOUSEWARES AND GLASS

FOR BARWARE, NAMELY, COASTERS NOT OF PAPER AND NOT TABLE LINEN, DRINKS STIRRERS, COCKTAIL PICK FORKS, ICE BUCKETS, CORK SCREWS, WINE COOLERS, WINE CHARMS, DECORATIVE CORK BOTTLE STOPPERS NOT OF PRECIOUS METAL, COCKTAIL SHAKERS, PARTY PICKS, NAPKIN RINGS NOT OF PRECIOUS METAL, PLACECARD HOLDERS, NOT OF PRECIOUS METAL, TABLECLOTH WEIGHTS, NOT OF PRECIOUS METAL, FOOD SPREADERS, SALT AND PEPPER SHAKERS, PLASTIC BEVERAGE WARE (U.S. CLS. 2, 13, 23, 29, 30, 33, 40 AND 50).

SN 78-158,192. HELENA CHEMICAL COMPANY, COLLIERVILLE, TN. FILED 8-27-2002.

LINEMAN

CLASS 1—CHEMICALS

FOR FERTILIZERS AND ADJUVANTS FOR AGRICULTURAL, COMMERCIAL, AND DOMESTIC USE (U.S. CLS. 1, 5, 6, 10, 26 AND 46).

CLASS 5—PHARMACEUTICALS

FOR HERBICIDES FOR AGRICULTURAL, COMMERCIAL, AND DOMESTIC USE (U.S. CLS. 6, 18, 44, 46, 51 AND 52).

SN 78-158,523. STANNAH STAIRLIFTS LIMITED, ANDOVER, HAMPSHIRE, UNITED KINGDOM, FILED 8-28-2002.

STAIRTRACKER

OWNER OF UNITED KINGDOM REG. NO. 2282137, DATED 3-15-2002, EXPIRES 10-2-2011.

CLASS 7—MACHINERY

FOR ELEVATORS; STAIR LIFTS; ESCALATORS; MOVING WALKWAYS AND STAIRCASES AND PARTS THEREFOR (U.S. CLS. 13, 19, 21, 23, 31, 34 AND 35).

CLASS 9—ELECTRICAL AND SCIENTIFIC APPARATUS

FOR SURVEYING, PHOTOGRAPHIC AND OPTICAL APPARATUS AND INSTRUMENTS, NAMELY, CALIBRATION BOARDS, CARPENTER LEVELS, PLUM LEVELS; SURVEYOR'S LEVELS, DIGITAL CAMERAS, ELECTRIC AND ELECTRONIC SENSORS FOR SURVEYING STAIRCASES; COMPUTER HARDWARE AND SOFTWARE FOR VERIFYING IMAGES IN ORDER TO DESIGN, CREATE, MANUFACTURE AND INSTALL STAIR LIFTS AND ELEVATORS, FOR USE IN SURVEYING AND ESTIMATING (U.S. CLS. 21, 23, 26, 36 AND 38).

CLASS 37—CONSTRUCTION AND REPAIR

FOR MAINTENANCE, CONSTRUCTION AND REPAIR OF ELEVATORS, STAIR LIFTS, ESCALATORS AND MOVING WALKWAYS, MAINTENANCE AND INSTALLATION OF STAIR LIFTS (U.S. CLS. 100, 103 AND 106).

CLASS 41—EDUCATION AND ENTERTAINMENT

FOR PHOTOGRAPHY SERVICES (U.S. CLS. 100, 101 AND 107).

CLASS 42—SCIENTIFIC, COMPUTER AND LEGAL SERVICES

FOR CALIBRATION, MEASURING AND SURVEYING SERVICES IN THE FIELD OF ESTIMATING AND INSTALLATION AND CALIBRATING ESCALATORS, STAIR LIFTS AND ELEVATORS; CONDUCTING ENGINEERING SURVEYS VIA ELECTRONIC MEANS; DESIGN FOR OTHERS IN THE FIELD OF ELEVATORS, ESCALATORS, STAIR LIFTS, AND TOOLS AND EQUIPMENT FOR SUCH USE; COMPUTERIZED ARCHITECTURAL DESIGN SERVICES IN THE FIELD OF ESCALATORS, STAIR LIFTS AND ELEVATORS (U.S. CLS. 100 AND 101).

SN 78-158,970. KOZMEZ L.L.C., MOUNTAIN VIEW, CA. FILED 8-28-2002.

KOZMEZ

CLASS 3—COSMETICS AND CLEANING PREPARATIONS

FOR POLYMER SEALANTS FOR PROTECTING VEHICLE SURFACES; VEHICLE CLEANING PREPARATIONS USED TO CLEAN VEHICLE SURFACES; VEHICLE CLEANING PREPARATIONS USED TO WASH VEHICLE SURFACES (U.S. CLS. 1, 4, 6, 50, 51 AND 52).

CLASS 35—ADVERTISING AND BUSINESS

FOR COMPUTERIZED ON-LINE RETAIL SERVICES IN THE FIELD OF VEHICLE GOODS; RETAIL STORE SERVICES IN THE FIELD OF VEHICLE GOODS; WHOLESALE STORE SERVICES IN THE FIELD OF VEHICLE GOODS; IMPORT SERVICES IN THE FIELD OF VEHICLE GOODS (U.S. CLS. 100, 101 AND 102).

CLASS 37—CONSTRUCTION AND REPAIR

FOR VEHICLE CLEANING, WASHING, DETAILING AND PRESERVATION (U.S. CLS. 100, 103 AND 106).

SN 78-158,976. KOZMEZ L.L.C., MOUNTAIN VIEW, CA.
FILED 8-28-2002.



CLASS 3—COSMETICS AND CLEANING PREPARATIONS

FOR POLYMER SEALANTS FOR PROTECTING VEHICLE SURFACES; VEHICLE CLEANING PREPARATIONS USED TO CLEAN VEHICLE SURFACES; VEHICLE CLEANING PREPARATIONS USED TO WASH VEHICLE SURFACES (U.S. CLS. 1, 4, 6, 50, 51 AND 52).

CLASS 35—ADVERTISING AND BUSINESS

FOR COMPUTERIZED ON-LINE RETAIL SERVICES IN THE FIELD OF VEHICLE GOODS; RETAIL STORE SERVICES IN THE FIELD OF VEHICLE GOODS; WHOLESALE STORE SERVICES IN THE FIELD OF VEHICLE GOODS; IMPORT SERVICES IN THE FIELD OF VEHICLE GOODS (U.S. CLS. 100, 101 AND 102).

CLASS 37—CONSTRUCTION AND REPAIR

FOR VEHICLE CLEANING, WASHING, DETAILING AND PRESERVATION (U.S. CLS. 100, 103 AND 106).

SN 78-159,384. DEUTSCHE BANK AG, D-60325 FRANKFURT AM MAIN, FED REP GERMANY, FILED 8-29-2002.

DB REAL ESTATE

PRIORITY CLAIMED UNDER SEC. 44(D) ON FED REP GERMANY APPLICATION NO. 30210556.5/3, FILED 3-1-2002, REG. NO. 30210556, DATED 3-22-2002, EXPIRES 3-31-2012.

OWNER OF U.S. REG. NOS. 1,761,673, 2,577,082 AND OTHERS.

NO CLAIM IS MADE TO THE EXCLUSIVE RIGHT TO USE "REAL ESTATE", APART FROM THE MARK AS SHOWN.

CLASS 35—ADVERTISING AND BUSINESS

FOR BUSINESS MANAGEMENT CONSULTING SERVICES; BUSINESS MANAGEMENT AND ADMINISTRATION SERVICES, NAMELY, PROVIDING BUSINESS ASSISTANCE IN THE EXECUTION OF REAL ESTATE AND COMMERCIAL TRANSACTIONS; CONSULTATION SERVICES IN THE OPERATION AND MANAGEMENT OF AN INDUSTRIAL AND TRADING COMPANY (U.S. CLS. 100, 101 AND 102).

CLASS 36—INSURANCE AND FINANCIAL

FOR FINANCIAL AND MONETARY SERVICES, NAMELY, MONETARY EXCHANGE TRANSACTIONS, A FULL RANGE OF BANKING SERVICES IN THE NATURE OF MORTGAGE, ONLINE BANKING, SALES, FINANCING AND SECURING OF CREDIT RISKS, ISSUE OF CREDIT CARDS, GRANTING OF CREDITS ON CONSUMER GOODS, COLLECTION OF ACCOUNTS RECEIVABLE, ISSUE OF TRAVELER CHEQUES, SECURITIES BROKERAGE, CURRENCY EXCHANGE TRANSACTIONS, INVESTMENT TRANSACTIONS, CREDIT COUNSELING, CREDIT BROKERAGE, INQUIRES ON MONEY TRANSACTIONS, SAFEKEEPING OF VALUABLES IN SAFES, INVESTMENT AND FINANCIAL SERVICES IN THE NATURE OF MUTUAL FUNDS, SECURITIES, ASSET MANAGEMENT, ANNUITIES TRANSACTIONS; REAL PROPERTY MANAGEMENT SERVICES, NAMELY, REAL PROPERTY FINANCING, ACQUISITIONS, BROKERAGE, RENTAL, LEASING AND REAL ESTATE MANAGEMENT; PROVIDING INFORMATION IN THE AREA OF FINANCIAL AND REAL PROPERTY SERVICES VIA ELECTRONIC MEDIA, ESPECIALLY THE INTERNET (U.S. CLS. 100, 101 AND 102).

CLASS 38—COMMUNICATION

FOR TELECOMMUNICATION SERVICES, NAMELY TRANSMITTING INFORMATION IN THE AREAS OF FINANCIAL AND REAL PROPERTY SERVICES VIA ELECTRONIC MEDIA, ESPECIALLY THE INTERNET (U.S. CLS. 100, 101 AND 104).

SN 78-161,332. F. SCHUMACHER & CO., NEW YORK, NY.
FILED 9-6-2002.

DECORATORS WALK

OWNER OF U.S. REG. NOS. 872,754 AND 2,328,606.
SEC. 2(F) AS TO "DECORATORS".

CLASS 24—FABRICS

FOR FABRICS FOR USE IN INTERIOR FURNISHINGS, BEDSPREADS, CURTAIN FABRIC, UPHOLSTERY FABRIC AND FABRIC FOR WALL COVERINGS (U.S. CLS. 42 AND 50).

FIRST USE 2-28-1964; IN COMMERCE 2-28-1964.

CLASS 27—FLOOR COVERINGS

FOR WALLPAPER (U.S. CLS. 19, 20, 37, 42 AND 50).
FIRST USE 2-28-1964; IN COMMERCE 2-28-1964.

SN 78-162,476. KOLLA HAMBURG OVERSEAS IMPORT GMBH & CO. KG, HAMBURG, FED REP GERMANY,
FILED 9-10-2002.

BGMB – Brazilian Grape Marketing Board

PRIORITY CLAIMED UNDER SEC. 44(D) ON FED REP GERMANY APPLICATION NO. 30223811.531, FILED 5-13-2002, REG. NO. 30223811, DATED 8-1-2002, EXPIRES 5-31-2012.

NO CLAIM IS MADE TO THE EXCLUSIVE RIGHT TO USE "BRAZILIAN GRAPE" FRESH FRUITS AND VEGETABLES AND LIVE PLANTS AND FLOWERS AND OTHER NON-ALCOHOLIC DRINKS, NAMELY, FRUIT DRINKS AND FRUIT JUICES AND CONCENTRATES, SYRUPS OR POWDERS USED IN THE PREPARATIONS OF SOFT DRINKS, FRUIT DRINKS, AND FRUIT JUICES, APART FROM THE MARK AS SHOWN.

CLASS 31—NATURAL AGRICULTURAL PRODUCTS

FOR AGRICULTURAL, HORTICULTURAL AND FORESTRY PRODUCTS, NAMELY, AGRICULTURAL GRAINS FOR PLANTING; LIVE ANIMALS; FRESH FRUITS AND VEGETABLES; AGRICULTURAL SEEDS; LIVE PLANTS AND FLOWERS; FOODSTUFFS FOR ANIMALS; MALT FOR BREWING (U.S. CLS. 1 AND 46).

CLASS 32—LIGHT BEVERAGES

FOR BEERS; MINERAL AND AERATED WATERS; OTHER NON-ALCOHOLIC DRINKS, NAMELY, FRUIT DRINKS AND FRUIT JUICES; CONCENTRATES, SYRUPS OR POWDERS USED IN THE PREPARATIONS OF SOFT DRINKS, FRUIT DRINKS AND FRUIT JUICES (U.S. CLS. 45, 46 AND 48).

SN 78-163,243. PHOENIX INTANGIBLES HOLDING COMPANY, GREENVILLE, DE. FILED 9-12-2002.

KNOWASIS KNAVIGATOR

NO CLAIM IS MADE TO THE EXCLUSIVE RIGHT TO USE "NAVIGATOR", APART FROM THE MARK AS SHOWN.

CLASS 9—ELECTRICAL AND SCIENTIFIC APPARATUS

FOR COMPUTER SOFTWARE FOR KNOWLEDGE-BASED MANAGEMENT FOR ANALYZING DATA OF RETAILERS IN THE RETAILING INDUSTRY (U.S. CLS. 21, 23, 26, 36 AND 38).

CLASS 35—ADVERTISING AND BUSINESS

FOR BUSINESS CONSULTATION SERVICES IN THE FIELD OF KNOWLEDGE-BASED MANAGEMENT (U.S. CLS. 100, 101 AND 102).

SN 78-163,712. INDUSTRIAL THERMOSET PLASTICS, INC., MENTOR, OH. FILED 9-13-2002.

IT PLASTICS

NO CLAIM IS MADE TO THE EXCLUSIVE RIGHT TO USE "PLASTICS", APART FROM THE MARK AS SHOWN.

CLASS 7—MACHINERY

FOR CONVEYOR PARTS, NAMELY, CHUTE LINERS; PLASTIC DIE STRIPPERS; DIAPHRAGM CHECK VALVES OR PUMPS; WIPERS FOR APPLICATION OR REMOVAL OF MATERIAL (U.S. CLS. 13, 19, 21, 23, 31, 34 AND 35).

FIRST USE 3-18-1999; IN COMMERCE 3-18-1999.

CLASS 20—FURNITURE AND ARTICLES NOT OTHERWISE CLASSIFIED

FOR POLYURETHANE CLIPS AND RESTRAINTS FOR SECURING TOOLS USED IN THE TRANSPORTATION INDUSTRY (U.S. CLS. 2, 13, 22, 25, 32 AND 50).

FIRST USE 3-18-1999; IN COMMERCE 3-18-1999.

CLASS 40—MATERIAL TREATMENT

FOR POTTING, ENCAPSULATION AND COATING OF ELECTRONIC COMPONENTS AND SENSITIVE CIRCUITRY (U.S. CLS. 100, 103 AND 106).

FIRST USE 3-18-1999; IN COMMERCE 3-18-1999.

SN 78-163,996. DELAWARE RIVER JOINT TOLL BRIDGE COMMISSION, MORRISVILLE, PA. FILED 9-13-2002.

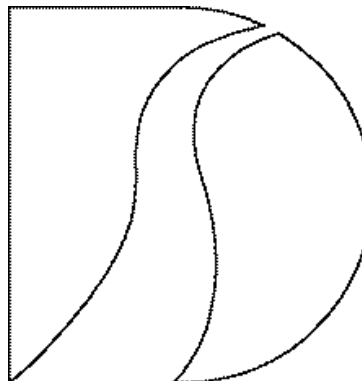

THE MARK CONSISTS OF A STYLIZED LETTER "D" HAVING LEFT AND RIGHT PORTIONS SEPARATED BY A WAVY BAND WHERE THE LEFT PORTION IS GREEN AND THE RIGHT PORTION IS YELLOW.

CLASS 36—INSURANCE AND FINANCIAL

FOR HIGHWAY TOLL COLLECTION SERVICES (U.S. CLS. 100, 101 AND 102).

CLASS 39—TRANSPORTATION AND STORAGE

FOR OPERATION OF BRIDGES; PROVIDING A PRIVATE HIGHWAY FOR OTHERS (U.S. CLS. 100 AND 105).

SN 78-165,011. HSI SERVICE CORP., NEWARK, DE. FILED 9-17-2002.

MARKETONE**CLASS 16—PAPER GOODS AND PRINTED MATTER**

FOR PRINTED MATTER, NAMELY, INFORMATIONAL BROCHURES, INFORMATIONAL FLYERS, AND INFORMATIONAL LEAFLETS IN THE FIELD OF DENTAL AND MEDICAL PRODUCTS (U.S. CLS. 2, 5, 22, 23, 29, 37, 38 AND 50).

CLASS 35—ADVERTISING AND BUSINESS

FOR PROMOTING THE SALE OF DENTAL AND MEDICAL EQUIPMENT AND DENTAL AND MEDICAL SUPPLIES OF OTHERS THROUGH THE DISTRIBUTION OF PRINTED MATERIAL, GIFT CERTIFICATES, DISCOUNT COUPONS AND PURCHASING CREDITS (U.S. CLS. 100, 101 AND 102).

SN 78-165,286. MIDLAND RESEARCH LABORATORIES, INC., LENEXA, KS. FILED 9-18-2002.

SANIRINSE

CLASS 1—CHEMICALS

FOR CHEMICAL PREPARATIONS, NAMELY, SODIUM CHLORITE, SODIUM HYPOCHLORITE, HYDROCHLORIC ACID AND CHLORINE DIOXIDE SOLUTIONS FOR PATHOGEN REDUCTION (U.S. CLS. 1, 5, 6, 10, 26 AND 46).

CLASS 7—MACHINERY

FOR CHEMICAL GENERATORS AND SPRAY SYSTEMS COMPRISING POWER OPERATED PUMPS, PUMP CONTROLLERS, NOZZLES, TUBING AND VALVES (U.S. CLS. 13, 19, 21, 23, 31, 34 AND 35).

CLASS 41—EDUCATION AND ENTERTAINMENT

FOR PROVIDING TRAINING IN THE USE, HANDLING AND OPERATION OF CHEMICAL GENERATORS, SPRAY SYSTEMS AND CHEMICAL PREPARATIONS (U.S. CLS. 100, 101 AND 107).

CLASS 9—ELECTRICAL AND SCIENTIFIC APPARATUS

FOR PRE-RECORDED ELECTRONIC MEDIA, NAMELY CD-ROMS AND COMPUTER SOFTWARE, FEATURING INFORMATION ABOUT TREATMENT AND MANAGEMENT OF ASTHMA AND OTHER RESPIRATORY DISEASES (U.S. CLS. 21, 23, 26, 36 AND 38).

CLASS 16—PAPER GOODS AND PRINTED MATTER

FOR PRINTED MATTER, NAMELY NEWSLETTERS AND BROCHURES, FEATURING INFORMATION ABOUT TREATMENT AND MANAGEMENT OF ASTHMA AND OTHER RESPIRATORY DISEASES (U.S. CLS. 2, 5, 22, 23, 29, 37, 38 AND 50).

CLASS 44—MEDICAL, BEAUTY AND AGRICULTURAL SERVICES

FOR MEDICAL SERVICES IN THE FIELD OF ASTHMA AND OTHER RESPIRATORY DISEASES; PROVIDING INFORMATION ABOUT TREATMENT AND MANAGEMENT OF ASTHMA AND OTHER RESPIRATORY DISEASES (U.S. CLS. 100 AND 101).

SN 78-166,171. SEALY TECHNOLOGY LLC, TRINITY, NC. FILED 9-20-2002.

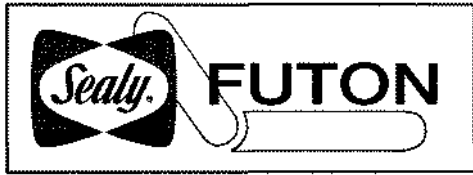

OWNER OF U.S. REG. NOS. 426,168 AND 677,335. NO CLAIM IS MADE TO THE EXCLUSIVE RIGHT TO USE "FUTON", APART FROM THE MARK AS SHOWN.

CLASS 20—FURNITURE AND ARTICLES NOT OTHERWISE CLASSIFIED

FOR FUTON MATTRESS BED FRAMES (U.S. CLS. 2, 13, 22, 25, 32 AND 50).

CLASS 24—FABRICS

FOR FUTON MATTRESS COVERS (U.S. CLS. 42 AND 50).

SN 78-166,753. ASTRAZENECA AB, SODERTALJE, SWEDEN, FILED 9-23-2002.

KIDS UNLIMITED

NO CLAIM IS MADE TO THE EXCLUSIVE RIGHT TO USE "KIDS", APART FROM THE MARK AS SHOWN.

SN 78-171,118. NEA PORTAL COMPANY, WASHINGTON, DC. FILED 10-4-2002.

OWL.ORG OUR WEB LOCATION FOR EDUCATION

CLASS 35—ADVERTISING AND BUSINESS

FOR ONLINE RETAIL AND MAIL ORDER SERVICES IN THE FIELD OF MERCHANDISE DIRECTED TO TEACHERS AND OTHER EDUCATION PROFESSIONALS; DIRECTORY SERVICES TO HELP LOCATE PEOPLE, PLACES, ORGANIZATIONS, PHONE NUMBERS, HOME PAGES, AND ELECTRONIC MAIL ADDRESSES OF PARTICULAR INTEREST TO TEACHERS AND OTHER EDUCATION PROFESSIONALS; PROMOTING THE GOODS AND SERVICES OF OTHERS BY PROVIDING HYPERTEXT LINKS TO THE WEB SITES OF OTHERS (U.S. CLS. 100, 101 AND 102). FIRST USE 8-1-2002; IN COMMERCE 8-1-2002.

CLASS 38—COMMUNICATION

FOR PROVIDING MULTIPLE-USER ACCESS TO A GLOBAL COMPUTER INFORMATION NETWORK; TELECOMMUNICATION SERVICES, NAMELY, PROVIDING TELECOMMUNICATIONS CONNECTIONS VIA GLOBAL COMPUTER COMMUNICATIONS NETWORKS AND COMPUTER NETWORKS FOR TEACHERS AND OTHER EDUCATION PROFESSIONALS; ELECTRONIC TRANSMISSION OF DATA, IMAGES, AND DOCUMENTS VIA COMPUTER TERMINALS AND NETWORKS; PROVIDING E-MAIL SERVICES FOR TEACHERS AND OTHER EDUCATION PROFESSIONALS; PROVIDING ON-LINE ELECTRONIC BULLETIN BOARDS AND CHAT ROOMS FOR TRANSMISSION OF MESSAGES AMONG COMPUTER USERS, NAMELY, TEACHERS AND OTHER EDUCATION PROFESSIONALS, CONCERNING TRAINING AND EDUCATION (U.S. CLS. 100, 101 AND 104). FIRST USE 8-1-2002; IN COMMERCE 8-1-2002.

CLASS 41—EDUCATION AND ENTERTAINMENT

FOR PROVIDING EDUCATIONAL INFORMATION, NAMELY, INFORMATION RELATING TO LESSON PLANS AND TEACHING TIPS, CLASSROOM MANAGEMENT STRATEGIES, EDUCATIONAL NEWS, PROFESSIONAL DEVELOPMENT, LIFESTYLE RESOURCES, AND ASSOCIATION NEWS TO TEACHERS AND OTHER EDUCATION PROFESSIONALS; CAREER COUNSELING, NAMELY, VOCATIONAL GUIDANCE TO TEACHERS AND OTHER EDUCATION PROFESSIONALS; TRAINING SERVICES IN THE FIELD OF TEACHING AND EDUCATION FOR TEACHERS AND OTHER EDUCATION PROFESSIONALS (U.S. CLS. 100, 101 AND 107).
FIRST USE 8-1-2002; IN COMMERCE 8-1-2002.

SN 78-171,714. VIDEOJET TECHNOLOGIES INC., WOOD DALE, IL. FILED 10-7-2002.

VIDEOJET DATAFLEX

OWNER OF U.S. REG. NOS. 873,692, 2,695,961 AND OTHERS.

CLASS 9—ELECTRICAL AND SCIENTIFIC APPARATUS

FOR THERMAL TRANSFER IMAGING AND RECORDING SYSTEMS, NAMELY THERMAL TRANSFER OVERPRINTERS (U.S. CLS. 21, 23, 26, 36 AND 38).
FIRST USE 1-0-2002; IN COMMERCE 1-0-2002.

CLASS 16—PAPER GOODS AND PRINTED MATTER

FOR PRINTER RIBBONS USED IN THERMAL TRANSFER OVERPRINTERS (U.S. CLS. 2, 5, 22, 23, 29, 37, 38 AND 50).
FIRST USE 7-0-2002; IN COMMERCE 7-0-2002.

SN 78-173,452. KAO KABUSHIKI KAISHA, TA KAO CORPORATION, CHUO-KU, TOKYO 103-8210, JAPAN, FILED 10-11-2002.

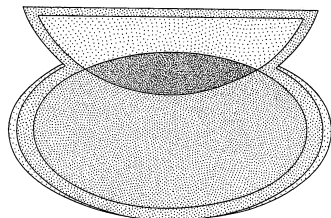

THE STIPPLING IS FOR SHADING PURPOSES ONLY.

CLASS 5—PHARMACEUTICALS

FOR NUTRITIONAL SUPPLEMENTS, HERBAL SUPPLEMENTS, VITAMIN SUPPLEMENTS, MINERAL SUPPLEMENTS, VITAMIN AND MINERAL SUPPLEMENTS, DIETARY SUPPLEMENTS, DIETARY FOOD SUPPLEMENTS AND FOOD SUPPLEMENTS, ALL IN BAR FORM; MEAL REPLACEMENT DRINKS AND POWDERS (U.S. CLS. 6, 18, 44, 46, 51 AND 52).

CLASS 29—MEATS AND PROCESSED FOODS

FOR COOKING OIL, VEGETABLE OIL SPREAD, MARGARINE, MARGARINE SUBSTITUTES; SOUPS; FROZEN ENTREES CONSISTING PRIMARILY OF MEAT, FISH, POULTRY OR VEGETABLES (U.S. CL. 46).

CLASS 30—STAPLE FOODS

FOR SALAD DRESSING, MAYONNAISE, BAKERY GOODS, PIZZA, SAUCES (U.S. CL. 46).

SN 78-174,073. ACADEMY, LTD., KATY, TX. FILED 10-14-2002.

BRAVA**CLASS 18—LEATHER GOODS**

FOR ATHLETIC AND ALL-PURPOSE SPORT EQUIPMENT BAGS (U.S. CLS. 1, 2, 3, 22 AND 41).

CLASS 21—HOUSEWARES AND GLASS

FOR WATER BOTTLES SOLD EMPTY (U.S. CLS. 2, 13, 23, 29, 30, 33, 40 AND 50).

CLASS 25—CLOTHING

FOR SCRIMMAGE VESTS FOR USE IN SPORTS (U.S. CLS. 22 AND 39).

CLASS 28—TOYS AND SPORTING GOODS

FOR SPORTING GOODS AND SPORTS EQUIPMENT, NAMELY, SOCCER GOAL POSTS AND NETS, SOCCER BALLS, SOCCER TRAINERS IN THE NATURE OF DEVICES USED FOR LEARNING TO KICK AND HANDLE THE SOCCER BALL, SHIN GUARDS FOR USE IN THE GAME OF SOCCER, ACCESSORIES FOR USE IN SOCCER, NAMELY, LINEMAN FLAGS, REFEREE KITS COMPOSED OF A WHISTLE AND RED AND YELLOW PENALTY CARDS, PUMPS FOR INFLATING SPORTS BALLS, SOCCER PLAYER GLOVES, FIELD EQUIPMENT FOR USE IN SPORTS, NAMELY, ATHLETIC FIELD MARKERS (U.S. CLS. 22, 23, 38 AND 50).

SN 78-174,352. GIANNA ROSE ATELIER, INC., FOUNTAIN VALLEY, CA. FILED 10-15-2002.

RED PEARL

NO CLAIM IS MADE TO THE EXCLUSIVE RIGHT TO USE "RED", APART FROM THE MARK AS SHOWN.

CLASS 3—COSMETICS AND CLEANING PREPARATIONS

FOR SOAPS, NAMELY, DECORATIVE HAND SOAPS; PERFUMERY, ESSENTIAL OILS FOR PERSONAL USE, COSMETICS, HAIR LOTIONS; BAR SOAP FOR PERSONAL HYGIENE, FOAMING MILK BATH, HAND AND BODY LOTION, LIQUID HAND SOAP, BATH SOAPS, BATH CUBES, SOAP PETALS FOR DECORATIVE USE, PERFUMED BATH OIL CAPSULES, NON-MEDICATED BATH FIZZES; SKIN SOAP; BODY CREAM; BODY SCRUB; BATH SALTS (U.S. CLS. 1, 4, 6, 50, 51 AND 52).

CLASS 4—LUBRICANTS AND FUELS

FOR CANDLES (U.S. CLS. 1, 6 AND 15).

SN 78-174,493. SOUTHERN GAS ASSOCIATION, DALLAS, TX. FILED 10-15-2002.

SN 78-176,015. BLUEGREEN CORPORATION, BOCA RATON, FL. FILED 10-18-2002.

CTN, THE ENERGY NETWORK

NO CLAIM IS MADE TO THE EXCLUSIVE RIGHT TO USE "THE ENERGY NETWORK", APART FROM THE MARK AS SHOWN.

CLASS 38—COMMUNICATION

FOR BROADCAST OF TELEVISION PROGRAMS (U.S. CLS. 100, 101 AND 104).
FIRST USE 5-12-1992; IN COMMERCE 5-12-1992.

CLASS 41—EDUCATION AND ENTERTAINMENT

FOR PRODUCTION OF TELEVISION PROGRAMS (U.S. CLS. 100, 101 AND 107).
FIRST USE 5-12-1992; IN COMMERCE 5-12-1992.

GO WHERE THE WIND TAKES YOU

CLASS 36—INSURANCE AND FINANCIAL

FOR VACATION REAL ESTATE TIME-SHARING SERVICES (U.S. CLS. 100, 101 AND 102).

CLASS 39—TRANSPORTATION AND STORAGE

FOR ONLINE TRAVEL BOOKING AGENCIES; ONLINE TRAVEL AGENCY SERVICES, NAMELY, MAKING RESERVATIONS AND BOOKINGS FOR TRANSPORTATION (U.S. CLS. 100 AND 105).

CLASS 43—HOTEL AND RESTAURANT SERVICES

FOR TRAVEL AGENCY SERVICES, NAMELY, MAKING RESERVATIONS AND BOOKINGS FOR TEMPORARY LODGING (U.S. CLS. 100 AND 101).

SN 78-174,603. INTERNATIONAL TRUCK INTELLECTUAL PROPERTY COMPANY, LLC, WARRENVILLE, IL. FILED 10-15-2002.



OWNER OF U.S. REG. NOS. 2,381,360, 2,603,473 AND OTHERS.

CLASS 12—VEHICLES

FOR MUD FLAPS FOR VEHICLES (U.S. CLS. 19, 21, 23, 31, 35 AND 44).
FIRST USE 4-0-2001; IN COMMERCE 4-0-2001.

CLASS 27—FLOOR COVERINGS

FOR FLOOR MATS FOR VEHICLES (U.S. CLS. 19, 20, 37, 42 AND 50).
FIRST USE 4-0-2001; IN COMMERCE 4-0-2001.

SN 78-176,548. PATRICK HIGGINS, COLUMBUS, OH. FILED 10-21-2002.

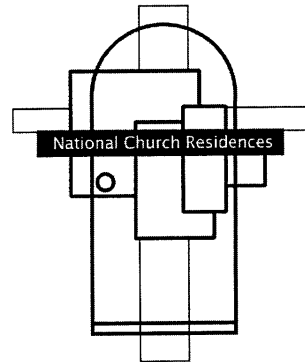

NO CLAIM IS MADE TO THE EXCLUSIVE RIGHT TO USE "NATIONAL" AND "RESIDENCES", APART FROM THE MARK AS SHOWN.

THE MARK CONSISTS OF THE WORDING NATIONAL CHURCH RESIDENCES AND THE DESIGN OF A DOOR SYMBOL IN THE FOREGROUND; A CROSS SYMBOL IN THE BACKGROUND; AND A DOORKNOB SYMBOL. FOUR COLORED PANELS (RED PMS 201; BLUE PMS 280; GREEN PMS 3298; GOLD PMS 132) ARE ALSO PRESENT, CENTERED AND OVERLAID ON THE CROSS AND DOOR SYMBOL, IN THE FOLLOWING ORDER, LEFT TO RIGHT; RED PANEL: FAR LEFT BLUE PANEL: CENTER GREEN PANEL: RIGHT OF CENTER BLUE PANEL GOLD PANEL: FAR RIGHT.

CLASS 36—INSURANCE AND FINANCIAL

FOR LAND ACQUISITION, NAMELY, REAL ESTATE BROKERAGE; LEASING OF APARTMENTS; CHARITABLE FUND RAISING; APARTMENT HOUSE MANAGEMENT; REAL ESTATE ACQUISITION SERVICES; RENTAL OF APARTMENTS. (U.S. CLS. 100, 101 AND 102).

CLASS 37—CONSTRUCTION AND REPAIR

FOR CHARITABLE SERVICES, NAMELY, RENOVATING AND CONSTRUCTING HOMES FOR LOW INCOME FAMILIES; REAL ESTATE DEVELOPMENT. (U.S. CLS. 100, 103 AND 106).

CLASS 43—HOTEL AND RESTAURANT SERVICES

FOR PROVIDING ASSISTED LIVING FACILITIES; PROVIDING CONGREGATE LIVING FACILITIES; PUBLIC HOUSING SERVICES. (U.S. CLS. 100 AND 101).

CLASS 44—MEDICAL, BEAUTY AND AGRICULTURAL SERVICES

FOR NURSING CARE; NURSING HOMES; HEALTH CARE; HOME HEALTH CARE SERVICES; (U.S. CLS. 100 AND 101).

CLASS 42—SCIENTIFIC, COMPUTER AND LEGAL SERVICES

FOR COMPUTER SERVICES, FOR OTHERS, NAMELY— COMPUTER HARDWARE DEVELOPMENT; COMPUTER SOFTWARE DESIGN, DEVELOPMENT, INSTALLATION, MAINTENANCE, REPAIR AND UPDATING; COMPUTER PROGRAMMING; COMPUTER CODE CONVERSION; DATA CONVERSION OF COMPUTER PROGRAM DATA OR INFORMATION; COMPUTER SYSTEMS AND NETWORK ANALYSIS AND DESIGN; INTEGRATION OF COMPUTER SYSTEMS AND NETWORKS; CONSULTING SERVICES IN THE FIELD OF DESIGN, SELECTION, IMPLEMENTATION AND USE OF COMPUTER HARDWARE AND SOFTWARE SYSTEMS FOR OTHERS; COMPUTER GRAPHICS SERVICES; DESIGNING, CREATING, IMPLEMENTING, HOSTING, MANAGING, MAINTAINING AND DISPLAYING WEB OR NETWORK PAGES AND WEB OR NETWORK SITES FOR OTHERS; REGISTERING DOMAIN NAMES FOR IDENTIFICATION OF USERS ON A GLOBAL COMPUTER NETWORK; PROVIDING SEARCH ENGINES FOR OBTAINING DATA ON A GLOBAL COMPUTER NETWORK; CREATING INDEXES OF INFORMATION, SITES AND OTHER RESOURCES AVAILABLE ON COMPUTER NETWORKS; REDIRECTING ELECTRONIC MAIL TO CHANGED PERSONAL ELECTRONIC ADDRESS; CUSTOMIZED SEARCHING, NAMELY, PROVIDING INFORMATION AT THE SPECIFIC REQUEST OF END-USERS BY MEANS OF TELEPHONE OR GLOBAL COMPUTER NETWORKS; COMPUTER PROJECT MANAGEMENT SERVICES; ON-LINE BATCH COMPUTER SERVICES; MONITORING THE COMPUTER SYSTEMS OF OTHERS FOR TECHNICAL PURPOSES AND PROVIDING BACK-UP COMPUTER PROGRAMS AND FACILITIES; COMPUTER DIAGNOSTIC SERVICES; TROUBLESHOOTING OF COMPUTER HARDWARE AND SOFTWARE PROBLEMS; COMPUTER DISASTER RECOVERY PLANNING; COMPUTER DATA RECOVERY SERVICES; AND APPLICATION SERVICE PROVIDER (ASP) SERVICES, NAMELY, HOSTING COMPUTER SOFTWARE APPLICATIONS OF OTHERS (U.S. CLS. 100 AND 101).

FIRST USE 7-1-1988; IN COMMERCE 7-1-1988.

SN 78-177,965. MICROASSIST, INC., AUSTIN, TX. FILED 10-24-2002.

MICROASSIST

SN 78-179,077. PAUL HARTMANN AG, HEIDENHEIM, FED REP GERMANY, FILED 10-28-2002.

CLASS 37—CONSTRUCTION AND REPAIR

FOR INSTALLATION, MAINTENANCE, REPAIR AND UPGRADING OF COMPUTER HARDWARE, COMPUTER SYSTEMS, AND COMPUTER NETWORKS (U.S. CLS. 100, 103 AND 106).

FIRST USE 7-1-1988; IN COMMERCE 7-1-1988.

CLASS 38—COMMUNICATION

FOR PROVIDING MULTIPLE-USER ACCESS AND TELECOMMUNICATIONS CONNECTIONS TO A GLOBAL COMPUTER INFORMATION NETWORK (U.S. CLS. 100, 101 AND 104).

FIRST USE 7-1-1988; IN COMMERCE 7-1-1988.

CLASS 41—EDUCATION AND ENTERTAINMENT

FOR COMPUTER EDUCATION TRAINING SERVICES, SCHEDULING OF PROGRAMS ON A GLOBAL COMPUTER NETWORK, AND ON-LINE LIBRARY SERVICES, NAMELY, PROVIDING ELECTRONIC LIBRARY SERVICES WHICH FEATURE NEWSPAPERS, MAGAZINES, PHOTOGRAPHS AND PICTURES VIA AN ON-LINE COMPUTER NETWORK (U.S. CLS. 100, 101 AND 107).

FIRST USE 7-1-1988; IN COMMERCE 7-1-1988.

CATHOFIX

PRIORITY CLAIMED UNDER SEC. 44(D) ON FED REP GERMANY APPLICATION NO. 30220692.2/0, FILED 4-29-2002, REG. NO. 30220692, DATED 1-17-2003, EXPIRES 4-30-2012.

CLASS 5—PHARMACEUTICALS

FOR MEDICAL PLASTERS, BURN DRESSINGS, SURGICAL DRESSINGS, WOUND DRESSINGS, BANDAGES, NAMELY, ADHESIVE BANDAGES, ADHESIVE FOR BANDAGES FOR SKIN WOUNDS, BANDAGES FOR SKIN WOUNDS, SURGICAL BANDAGES, AND BANDS FOR MEDICAL USE, WOUND CARE MATERIAL, NAMELY, GRANULAR MATERIAL IN THE NATURE OF GAUZE TO APPLY ONTO OR INSERT INTO WOUNDS, MEDICATED COMPRESSES, SWABS, TAMPONS, COTTON WOOL FOR MEDICAL PURPOSES, GAUZE BANDAGES, FIXING BANDAGES, UNIVERSAL BANDAGES, FOAM RUBBER BANDAGES, ADHESIVE BANDAGES, BANDAGES IMPREGNATED WITH OINTMENTS, AND READY-TO-USE BANDAGES (U.S. CLS. 6, 18, 44, 46, 51 AND 52).

CLASS 10—MEDICAL APPARATUS

FOR ORTHOPEDIC SUPPORT BANDAGES, PLASTER CASTS FOR ORTHOPEDIC PURPOSES, COMPRESSION BANDAGES, PADDED ELASTIC BANDAGES, TUBULAR BANDAGES, ELASTIC NET BANDAGES, PADDING BANDAGES, ELASTIC BANDAGES, ELASTICATED TUBULAR BANDAGES, COMPRESSION STOCKINGS FOR ORTHOPEDIC USE (U.S. CLS. 26, 39 AND 44).

SN 78-180,532. CANDLEMAN CORPORATION, BRAINERD, MN. FILED 10-31-2002.

OWNER OF U.S. REG. NOS. 1,757,142, 2,268,661 AND OTHERS.

CLASS 4—LUBRICANTS AND FUELS

FOR CANDLES; WICKS FOR OIL LAMPS; LAMP OIL (U.S. CLS. 1, 6 AND 15).
FIRST USE 1-31-1992; IN COMMERCE 1-31-1992.

CLASS 11—ENVIRONMENTAL CONTROL APPARATUS

FOR OIL LAMPS (U.S. CLS. 13, 21, 23, 31 AND 34).
FIRST USE 1-31-1992; IN COMMERCE 1-31-1992.

CLASS 21—HOUSEWARES AND GLASS

FOR CANDLE HOLDERS NOT OF PRECIOUS METAL (U.S. CLS. 2, 13, 23, 29, 30, 33, 40 AND 50).
FIRST USE 1-31-1992; IN COMMERCE 1-31-1992.

CLASS 35—ADVERTISING AND BUSINESS

FOR FRANCHISING, NAMELY, RENDERING TECHNICAL ASSISTANCE IN THE ESTABLISHMENT AND/OR OPERATION OF CANDLE SHOPS (U.S. CLS. 100, 101 AND 102).
FIRST USE 11-1-1991; IN COMMERCE 11-1-1991.

SN 78-181,728. DREAMTOWER, LLC, MONTECITO, CA. FILED 11-5-2002.

DREAMTOWER INN

OWNER OF U.S. REG. NOS. 2,600,843 AND 2,600,844.

CLASS 9—ELECTRICAL AND SCIENTIFIC APPARATUS

FOR MOTION PICTURE FILMS FEATURING MUSICAL, THEATRICAL AND/OR DRAMATIC PERFORMANCES AND ENTERTAINMENT; MOTION PICTURE FILMS FOR BROADCAST ON TELEVISION FEATURING MUSICAL, THEATRICAL AND/OR DRAMATIC PERFORMANCES AND ENTERTAINMENT; PRERECORDED VINYL RECORDS, AUDIOCASSETTE TAPES, AUDIO-VIDEO TAPES, AUDIO VIDEO CASSETTES, AUDIO VIDEO DISCS, LASER DISCS, DIGITAL AUDIO TAPES, AND DVDS FEATURING MUSIC, THEATRICAL AND/OR DRAMATIC PERFORMANCES AND ENTERTAINMENT; SHORT MOTION PICTURE FILM CASSETTES FEATURING MUSICAL, THEATRICAL AND/OR DRAMATIC PERFORMANCES TO BE USED WITH HAND-HELD VIEWERS OR PROJECTORS; DOWNLOADABLE MUSICAL SOUND RECORDINGS; DOWNLOADABLE VIDEO RECORDINGS FEATURING THEATRICAL AND MUSICAL PERFORMANCES; MOUSE PADS; EYEGLASSES, SUNGLASSES AND CASES THEREFOR; VINYL RECORDS, AUDIOCASSETTE TAPES, AUDIO-VIDEO TAPES, AUDIO VIDEO CASSETTES, AUDIO VIDEO DISCS, LASER DISCS, DIGITAL AUDIO TAPES, AND DVDS, ALL FEATURING MUSICAL, THEATRICAL AND/OR DRAMATIC PERFORMANCES AND ENTERTAINMENT, PACKAGED WITH BOOKLETS AND SOLD AS A UNIT; COMPUTER PROGRAMS, NAMELY, SOFTWARE LINKING DIGITIZED VIDEO AND AUDIO MEDIA TO A GLOBAL COMPUTER INFORMATION NETWORK; MULTIMEDIA SOFTWARE RECORDED ON CD-ROM FEATURING MUSICAL AND THEATRICAL ENTERTAINMENT; AND DECORATIVE MAGNETS. (U.S. CLS. 21, 23, 26, 36 AND 38).

CLASS 35—ADVERTISING AND BUSINESS

FOR RETAIL STORE SERVICES, ONLINE RETAIL STORE SERVICES, MAIL ORDER CATALOGUE SERVICES, AND DISTRIBUTORSHIP SERVICES FEATURING PRERECORDED VINYL RECORDS, AUDIOCASSETTE TAPES, AUDIO-VIDEO TAPES, AUDIO VIDEO CASSETTES, AUDIO VIDEO DISCS, LASER DISCS, DIGITAL AUDIO TAPES, AND DVDS FEATURING MUSIC, THEATRICAL AND/OR DRAMATIC PERFORMANCES AND ENTERTAINMENT, SHORT MOTION PICTURE FILM CASSETTES FEATURING MUSICAL, THEATRICAL AND/OR DRAMATIC PERFORMANCES, MOUSE PADS, EYEGLASSES, SUNGLASSES AND CASES THEREFOR, VINYL RECORDS, AUDIOCASSETTE TAPES, AUDIO-VIDEO TAPES, AUDIO VIDEO CASSETTES, AUDIO VIDEO DISCS, LASER DISCS, DIGITAL AUDIO TAPES, AND DVDS, ALL FEATURING MUSICAL, THEATRICAL AND/OR DRAMATIC PERFORMANCES AND ENTERTAINMENT, PACKAGED WITH BOOKLETS AND SOLD AS A UNIT, BOOKS, CLOTHING, HEADWEAR AND RELATED FASHION ACCESSORIES, POSTERS, ARTWORK, JEWELRY, PENS AND PENCILS, DECORATIVE MAGNETS, CALENDARS, SONG BOOKS, SOUVENIR BOOKS, SHEET MUSIC, STAGE BILLS, PHOTOGRAPHS, STATIONERY, NAMELY, ENVELOPES, NOTE PADS, NOTE PAPER, POSTCARDS, AND WRITING PAPER, PAPER GIFT WRAPPING, PLAYING CARDS, HOME FURNISHINGS, TOYS, GAMES, AND SOUVENIRS. (U.S. CLS. 100, 101 AND 102).

CLASS 41—EDUCATION AND ENTERTAINMENT

FOR ENTERTAINMENT SERVICES, NAMELY PRODUCTION OF MUSICALS, CONCERTS, STAGE SHOWS, DRAMATIC PERFORMANCES, TELEVISION PROGRAMS AND FILMS; ENTERTAINMENT INFORMATION SERVICES, NAMELY PROVIDING ON-LINE INFORMATION PERTAINING TO THEATRICAL PERFORMANCES, STAGE ENTERTAINMENT AND MUSICALS; EDUCATIONAL INFORMATION SERVICES NAMELY PROVIDING ON-LINE INFORMATION PERTAINING TO THEATRICAL PERFORMANCES, STAGE ENTERTAINMENT AND MUSICALS; PUBLICATION OF ELECTRONIC AND ON-LINE BOOKS, JOURNALS, ELECTRONIC ARTWORK AND IMAGES; ARRANGING FOR TICKET RESERVATIONS FOR SHOWS AND OTHER ENTERTAINMENT EVENTS; PROVIDING ON-LINE PRERECORDED DIGITAL MUSIC BY MEANS OF A WEBSITE ON THE INTERNET. (U.S. CLS. 100, 101 AND 107).

SN 78-182,969. CLIO DESIGNS INCORPORATED, LEXINGTON, MA. FILED 11-7-2002.

CLIO DESIGNS

NO CLAIM IS MADE TO THE EXCLUSIVE RIGHT TO USE "DESIGNS", APART FROM THE MARK AS SHOWN.

CLASS 8—HAND TOOLS

FOR GOOD FOR PERSONAL CARE, NAMELY, NON-ELECTRIC RAZORS, SHAVERS, BATTERY-OPERATED SHAVERS, NOSE AND EAR HAIR TRIMMERS AND EYEBROW TRIMMERS (U.S. CLS. 23, 28 AND 44).

CLASS 9—ELECTRICAL AND SCIENTIFIC APPARATUS

FOR BODY FAT ANALYZERS (U.S. CLS. 21, 23, 26, 36 AND 38).

CLASS 21—HOUSEWARES AND GLASS

FOR GOODS FOR PERSONAL CARE, NAMELY, TOOTHBRUSHES, AND HAIR BRUSHES AND COMBS (U.S. CLS. 2, 13, 23, 29, 30, 33, 40 AND 50).

SN 78-183,726. ROUTEONE LLC, SOUTHFIELD, MI. FILED 11-11-2002.



NO CLAIM IS MADE TO THE EXCLUSIVE RIGHT TO USE "SPEED. ACCESS.", APART FROM THE MARK AS SHOWN.

CLASS 36—INSURANCE AND FINANCIAL

FOR FINANCIAL AND INSURANCE SERVICES, NAMELY PROVIDING CREDIT APPLICATION INFORMATION, CREDIT DECISION INFORMATION, ELECTRONIC CONTRACTING AND ELECTRONIC SIGNATURES; PROVIDING A WEBSITE THAT RENDERS CREDIT DECISIONS TO AND FROM FINANCIAL SOURCES; LEASING AND RENTAL FINANCING IN THE FIELD OF VEHICLE LEASE-PURCHASE FINANCING (U.S. CLS. 100, 101 AND 102).

CLASS 42—SCIENTIFIC, COMPUTER AND LEGAL SERVICES

FOR APPLICATION SERVICES PROVIDER (ASP) FEATURING SOFTWARE USED FOR PROVIDING CREDIT APPLICATION INFORMATION, CREDIT DECISION INFORMATION, ELECTRONIC CONTRACTING AND ELECTRONIC SIGNATURES AND RENDERING CREDIT DECISIONS TO AND FROM FINANCIAL SOURCES (U.S. CLS. 100 AND 101).

SN 78-183,790. HORIZON ORGANIC HOLDING CORPORATION, LONGMONT, CO. FILED 11-11-2002.

RACHEL'S ORGANIC

NO CLAIM IS MADE TO THE EXCLUSIVE RIGHT TO USE "ORGANIC", APART FROM THE MARK AS SHOWN.

CLASS 29—MEATS AND PROCESSED FOODS

FOR HOUSE MARK FOR ORGANIC FRESH AND FROZEN PRODUCTS FROM ORGANIC FARMS AND DAIRIES, NAMELY, MILK, HALF AND HALF, FLAVORED MILK, CREAMS, YOGURT, CHEESE, CREAM CHEESE, BUTTER, SOUR CREAM, COTTAGE CHEESE, EGGS (U.S. CL. 46).

CLASS 32—LIGHT BEVERAGES

FOR ORGANIC FRUIT JUICES (U.S. CLS. 45, 46 AND 48).

SN 78-184,485. SMITHKLINE BEECHAM CORPORATION, PHILADELPHIA, PA. FILED 11-13-2002.

BRIDGINGCARE**CLASS 9—ELECTRICAL AND SCIENTIFIC APPARATUS**

FOR DOWNLOADABLE COMPUTER SOFTWARE FOR USE BY PHYSICIANS TO IMPLEMENT PATIENT POPULATION MANAGEMENT THROUGH PATIENT SCHEDULING AND MAINTAINING DATA REGARDING PATIENT PROFILES AND TO ASSIST IN MANAGING PHYSICIAN PRACTICES THROUGH PATIENT AND PHYSICIAN DATA PROFILING AND SCHEDULING (U.S. CLS. 21, 23, 26, 36 AND 38).

CLASS 42—SCIENTIFIC, COMPUTER AND LEGAL SERVICES

FOR NON-DOWNLOADABLE COMPUTER SOFTWARE FOR USE BY PHYSICIANS TO IMPLEMENT PATIENT POPULATION MANAGEMENT THROUGH PATIENT SCHEDULING AND MAINTAINING DATA REGARDING PATIENT PROFILES AND TO ASSIST IN MANAGING PHYSICIAN PRACTICES THROUGH PATIENT AND PHYSICIAN DATA PROFILING AND SCHEDULING (U.S. CLS. 100 AND 101).

CLASS 44—MEDICAL, BEAUTY AND AGRICULTURAL SERVICES

FOR HEALTH INFORMATION SERVICES, NAMELY, PROVIDING INFORMATION TO ASSIST PHYSICIANS IN THE MANAGEMENT OF PATIENTS AND OF PHYSICIAN PRACTICES (U.S. CLS. 100 AND 101).

SN 78-185,545. TARGET BRANDS, INC., MINNEAPOLIS, MN. FILED 11-15-2002.

ACCLAIM**CLASS 24—FABRICS**

FOR BATH LINENS, NAMELY, WASHCLOTHS, HAND TOWELS, BATH TOWELS, AND BATH SHEETS (U.S. CLS. 42 AND 50).

CLASS 27—FLOOR COVERINGS

FOR BATH RUGS (U.S. CLS. 19, 20, 37, 42 AND 50).

SN 78-188,846. ISAKSON/BARNHART RETIREMENT DEVELOPMENT CO., LLC, NORCROSS, GA. FILED 11-26-2002.

PARK SPRINGS**CLASS 36—INSURANCE AND FINANCIAL**

FOR CONTINUING CARE RETIREMENT COMMUNITY OFFERING INDEPENDENT LIVING, NAMELY THE RENTAL OF SINGLE-FAMILY HOMES, DUPLEXES AND APARTMENTS (U.S. CLS. 100, 101 AND 102).

CLASS 43—HOTEL AND RESTAURANT SERVICES

FOR CONTINUING CARE RETIREMENT COMMUNITY OFFERING ASSISTED LIVING, NAMELY PROVIDING ASSISTED LIVING FACILITIES AND RETIREMENT HOME SERVICES (U.S. CLS. 100 AND 101).

CLASS 44—MEDICAL, BEAUTY AND AGRICULTURAL SERVICES

FOR CONTINUING CARE RETIREMENT COMMUNITY OFFERING SKILLED NURSING CARE, INCLUDING DEMENTIA AND ALZHEIMER'S NURSING CARE (U.S. CLS. 100 AND 101).

SN 78-189,062. WON-DOOR CORPORATION, SALT LAKE CITY, UT. FILED 11-26-2002.

STEELCURTAIN**CLASS 6—METAL GOODS**

FOR METAL FIRE DOORS (U.S. CLS. 2, 12, 13, 14, 23, 25 AND 50).

FIRST USE 7-23-2002; IN COMMERCE 7-23-2002.

CLASS 9—ELECTRICAL AND SCIENTIFIC APPARATUS

FOR SECURITY DOOR SYSTEM COMPRISING ELECTRONIC DOOR OPENERS/CLOSERS, ELECTRONIC LOCKS, BURGLAR ALARMS, ELECTRONIC ACCESS CONTROLS FOR MOTORS AND COMPUTER SOFTWARE TO MONITOR AND OPERATE THE DOORS (U.S. CLS. 21, 23, 26, 36 AND 38).

FIRST USE 7-23-2002; IN COMMERCE 7-23-2002.

SN 78-189,316. CYNTHIA BOXRUD, M.D., LLC, SANTA MONICA, CA. FILED 11-26-2002.

EVERA**CLASS 3—COSMETICS AND CLEANING PREPARATIONS**

FOR SKIN CARE PRODUCTS NAMELY, MOISTURIZERS, CLEANSERS, TONER, MAKE-UP, MAKE-UP REMOVER, SKIN LIGHTENER, MASCARA, LIP STICK, BROW PENCILS, FACE FIRING COMPLEX, FACE AND EYE CREAMS. (U.S. CLS. 1, 4, 6, 50, 51 AND 52).

CLASS 24—FABRICS

FOR BED AND BATH LINENS NAMELY, SHEETS, PILLOWS, PILLOW COVERS, BLANKETS, MATTRESS COVERS, TOWELS, COMFORTERS AND DUVET COVERS (U.S. CLS. 42 AND 50).

SN 78-190,261. PARTNERS IN LEADERSHIP, LLC, TEMECULA, CA. FILED 12-2-2002.

CULTURAL BELIEFS**CLASS 35—ADVERTISING AND BUSINESS**

FOR BUSINESS SERVICES, NAMELY, BUSINESS CONSULTATION SERVICES, AND BUSINESS MANAGEMENT SERVICES (U.S. CLS. 100, 101 AND 102).

FIRST USE 1-0-1993; IN COMMERCE 1-0-1993.

CLASS 41—EDUCATION AND ENTERTAINMENT

FOR TRAINING SERVICES, NAMELY, CONDUCTING SEMINARS, WORKSHOPS, AND ONE-ON-ONE TRAINING IN THE FIELDS OF BUSINESS MANAGEMENT AND BUSINESS OPERATIONS (U.S. CLS. 100, 101 AND 107).

FIRST USE 1-0-1993; IN COMMERCE 1-0-1993.

SN 78-190,447. BOEING MANAGEMENT COMPANY, SEAL BEACH, CA. FILED 12-2-2002.

SN 78-191,752. LAPTOP INC., DBA GLOBAL COMPUTERS, SAN JOSE, CA. FILED 12-5-2002.

DC-10

OWNER OF U.S. REG. NO. 2,598,417.

CLASS 9—ELECTRICAL AND SCIENTIFIC APPARATUS

FOR COMPUTER GAME PROGRAMS, COMPUTER FLIGHT SIMULATION SOFTWARE PROGRAMS, MOUSEPADS AND SUNGLASSES (U.S. CLS. 21, 23, 26, 36 AND 38).

CLASS 25—CLOTHING

FOR SHIRTS, HEADWEAR AND FOOTWEAR, JACKETS, SWEATSHIRTS. (U.S. CLS. 22 AND 39).

SN 78-191,674. CUMMINS NPOWER LLC, ST. PAUL, MN. FILED 12-5-2002.



CLASS 35—ADVERTISING AND BUSINESS

FOR DISTRIBUTORSHIPS IN THE FIELD OF INTERNAL COMBUSTION ENGINES AND PARTS THEREFOR (U.S. CLS. 100, 101 AND 102).

CLASS 37—CONSTRUCTION AND REPAIR

FOR MAINTENANCE AND REPAIR OF INTERNAL COMBUSTION ENGINES AND PARTS THEREFOR (U.S. CLS. 100, 103 AND 106).

KEEPING YOU MOBILE

CLASS 9—ELECTRICAL AND SCIENTIFIC APPARATUS

FOR LAPTOP COMPUTERS AND ACCESSORIES THEREFOR, NAMELY, AC ADAPTORS, LAPTOP COMPUTER BATTERIES, LAPTOP COMPUTER CARRYING CASES, MEMORY CARDS FOR PERSONAL COMPUTERS, MEMORY MODULES IN THE NATURE OF RAM MEMORY FOR LAPTOP COMPUTERS, COMPUTER DISC DRIVES, CD-ROM DRIVES FOR LAPTOP COMPUTERS AND DVD DRIVES FOR LAPTOP COMPUTERS; COMPUTER HARDWARE (U.S. CLS. 21, 23, 26, 36 AND 38).

CLASS 35—ADVERTISING AND BUSINESS

FOR ONLINE RETAIL SERVICES FEATURING LAPTOP COMPUTERS, COMPUTER HARDWARE AND ACCESSORIES. (U.S. CLS. 100, 101 AND 102).

SN 78-193,476. TOTAL ADMINISTRATIVE SERVICES CORPORATION, MADISON, WI. FILED 12-11-2002.

COBRATODAY

CLASS 35—ADVERTISING AND BUSINESS

FOR SERVICES CONSISTING OF TRACKING AND MONITORING HEALTH INSURANCE COMPLIANCE UNDER THE CONSOLIDATED OMNIBUS BUDGET RECONCILIATION ACT; PREPARING MONTHLY BUSINESS ACCOUNT REPORTS ON THIRD PARTY HEALTH INSURANCE COMPLIANCE UNDER THE CONSOLIDATED OMNIBUS BUDGET RECONCILIATION ACT (U.S. CLS. 100, 101 AND 102).

FIRST USE 10-1-2002; IN COMMERCE 10-1-2002.

CLASS 36—INSURANCE AND FINANCIAL

FOR ADMINISTRATION OF PREPAID HEALTH CARE PLANS FOR SMALL BUSINESS WORKERS AND THEIR FAMILIES WHO LOSE THEIR HEALTH BENEFITS AND CHOOSE TO CONTINUE GROUP HEALTH BENEFITS PROVIDED BY THEIR GROUP HEALTH PLAN FOR LIMITED PERIODS OF TIME UNDER THE CONSOLIDATED OMNIBUS BUDGET RECONCILIATION ACT (U.S. CLS. 100, 101 AND 102).

FIRST USE 10-1-2002; IN COMMERCE 10-1-2002.

SN 78-196,071. BAYER CORPORATION, PITTSBURGH, PA. FILED 12-19-2002.

Clinitek

OWNER OF U.S. REG. NOS. 1,019,268, 2,230,478 AND OTHERS.

CLASS 5—PHARMACEUTICALS

FOR MEDICAL DIAGNOSTIC REAGENTS FOR CLINICAL LABORATORY USE FOR THE ANALYSIS OF BODY FLUIDS (U.S. CLS. 6, 18, 44, 46, 51 AND 52).

CLASS 10—MEDICAL APPARATUS

FOR MEDICAL DIAGNOSTIC INSTRUMENTS FOR THE ANALYSIS OF BODY FLUIDS, NAMELY, URINE CHEMISTRY ANALYSERS. (U.S. CLS. 26, 39 AND 44).

SN 78-196,746. WIDEVINE TECHNOLOGIES, INC., SEATTLE, WA. FILED 12-20-2002.

CYPHER DCP

NO CLAIM IS MADE TO THE EXCLUSIVE RIGHT TO USE "CYPHER", APART FROM THE MARK AS SHOWN.

CLASS 9—ELECTRICAL AND SCIENTIFIC APPARATUS

FOR SOFTWARE FOR DETECTING AND PREVENTING MEDIA CONTENT INFRINGEMENTS, FEATURING ENCRYPTION SOFTWARE FOR PROVIDING SECURE DISTRIBUTION OF MEDIA CONTENT AND INFORMATION, ALL FOR MEDIA CONTENT PROVIDERS, RETAILERS, OTHER BUSINESSES AND CONSUMERS (U.S. CLS. 21, 23, 26, 36 AND 38).

CLASS 38—COMMUNICATION

FOR ELECTRONIC TRANSMISSION OF DATA FEATURING ENCRYPTION FOR SECURE DISTRIBUTION OF MEDIA CONTENT AND INFORMATION, ALL FOR MEDIA CONTENT PROVIDERS, RETAILERS, OTHER BUSINESSES AND CONSUMERS (U.S. CLS. 100, 101 AND 104).

CLASS 42—SCIENTIFIC, COMPUTER AND LEGAL SERVICES

FOR SOFTWARE INSTALLATION, DESIGN AND MAINTENANCE FOR SOFTWARE IN THE FIELDS OF ENCRYPTION OF MEDIA CONTENT, FEATURING SOFTWARE FOR DETECTING AND PREVENTING MEDIA CONTENT INFRINGEMENTS AND SECURE DISTRIBUTION OF INFORMATION, ALL FOR MEDIA CONTENT PROVIDERS, RETAILERS, OTHER BUSINESSES AND CONSUMERS (U.S. CLS. 100 AND 101).

SN 78-197,667. FORBO INTERNATIONAL SA, EGLISAU, SWITZERLAND, FILED 12-24-2002.

FORBO

OWNER OF SWITZERLAND REG. NO. 446,426, DATED 4-30-1997, EXPIRES 4-30-2007.
OWNER OF U.S. REG. NOS. 1,044,265, 2,617,176 AND OTHERS.

CLASS 1—CHEMICALS

FOR ADHESIVES, GLUES AND RESINS FOR INDUSTRIAL USE; CHEMICALS FOR INDUSTRIAL USE - NAMELY, POLYMER FLOCCULENTS, PROTEIN COLLOIDS, EPOXIDIZED OILS AND HALOGENATED VEGETABLE OILS, AND BONE MEAL FOR USE IN AGRICULTURE AND INDUSTRY; EMULSION COPOLYMERS AND TERPOLYMERS OF VINYL ACETATE AND ETHYLENE AND OTHER COMONOMERS FOR USE IN THE BUILDING PRODUCTS INDUSTRY, THE NON-WOVEN TEXTILE INDUSTRY, THE CARPET INDUSTRY, PAPER INDUSTRY, AND IN THE ADHESIVE AND SEALANT INDUSTRY IN THE MANUFACTURE OF ADHESIVES, BINDERS, CAULKING COMPOUNDS, SEALANTS, PAINTS, AND COATINGS; RESIN EMULSIONS FOR POLYVINYL ACETATE ADHESIVES; POLYVINYL ACETATE ADHESIVES; WATERBORNE POLYURETHANE RESIN DISPERSIONS WHICH CAN BE COMPOUNDED TO FORM GLASS FIBER SIZING, ADHESIVES AND THE LIKE; STRUCTURAL ADHESIVE FOR USE IN THE TRANSPORTATION, MARINE AND CONSTRUCTION INDUSTRIES; UNPROCESSED ARTIFICIAL RESINS, NAMELY ACRYLIC EMULSIONS FOR USE IN THE MANUFACTURE OF COATINGS; HOT MELT ADHESIVES FOR ADHERING WOOD, METAL, PLASTICS, AND OTHER LIKE SURFACES; CLEANING PREPARATIONS USED TO REMOVE BUILD-UP OF HOT MELT URETHANE ADHESIVES FROM ADHESIVE-APPLYING APPARATUS; HOT MELT ADHESIVES IN A PASTILLE FORM FOR USE IN THE BOOKBINDING, GRAPHIC ARTS, PACKAGING, PULP AND PAPER AND AUTOMOTIVE INDUSTRIES; DRY ADHESIVE PARTICLES FOR MANUFACTURING USE TO BE MELTED AND APPLIED TO TEXTILE FABRICS; WATERBORNE ADHESIVE FOR USE IN TEXTILE COATING APPLICATIONS; WATERBORNE POLYMER-LATEX COATING FOR USE IN TEXTILE COATING APPLICATIONS; HOT MELT ADHESIVES FOR USE IN THE BOOKBINDING INDUSTRY; ADHESIVE FOR USE ON LABELS (U.S. CLS. 1, 5, 6, 10, 26 AND 46).

CLASS 7—MACHINERY

FOR MACHINES FOR MANUFACTURING ENDLESS CONNECTIONS FOR STRAPS AND DRIVING BELTS; POWER OPERATED MACHINES FOR APPLYING ADHESIVES TO CORRUGATED PAPER FOR USE IN THE LAMINATING INDUSTRY; MACHINES FOR PROCESSING AND TRANSFORMING PLASTIC MATERIALS; CONVEYOR BELTS AND BELT CONVEYORS FOR THE TRANSPORT OF ALL KINDS OF GOODS; BELTS, MECHANICAL BANDS AND TRANSMISSION RIBBONS FOR MACHINES AND ENGINES (U.S. CLS. 13, 19, 21, 23, 31, 34 AND 35).

CLASS 17—RUBBER GOODS

FOR INSULATING MATERIALS IN THE FORM OF POLYURETHANE FOAM OR FILM FOR USE AS BUILDING INSULATION; STOPPING MATERIALS IN THE FORM OF SILICON FOAM OR SILICON RUBBER, ESPECIALLY FOR USE IN BUILDING CONSTRUCTION, AIR CONDITIONING TECHNOLOGY, AUTOMOTIVE INDUSTRY; MOULD PREVENTING, ELASTIC SILICONE SEALANT, FOR SEALING OF WALL/FLOOR CONNECTIONS; SEMI-FINISHED ARTIFICIAL AND SYNTHETIC RESINS IN BARS, BLOCKS, PELLETS, RODS, SHEETS AND TUBES FOR GENERAL INDUSTRIAL USE OR SEMI-FINISHED ARTIFICIAL AND SYNTHETIC RESINS IN EXTRUDED FORM FOR GENERAL INDUSTRIAL USE; PLASTIC FILM AND SHEETS FOR USE IN GLASS LAMINATIONS, FOR USE IN TINTED, LAMINATED OR REFLECTIVE HOME OR AUTO WINDOWS, FOR USE IN SEALING AND INSULATING, OR FOR USE IN PHOTOGRAPHY AND GRAPHIC ARTS (U.S. CLS. 1, 5, 12, 13, 35 AND 50).

SN 78-198,670. NIC, INC., OVERLAND, KS. FILED 12-30-2002.

THE PEOPLE BEHIND EGOVERNMENT

CLASS 35—ADVERTISING AND BUSINESS

FOR OPERATION OF A BUSINESS FOR OTHERS, NAMELY, THE OPERATION OF COMPUTER NETWORKS OWNED BY OTHERS TO CONDUCT ELECTRONIC GOVERNMENT TRANSACTIONS AND EXCHANGE INFORMATION BETWEEN GOVERNMENT AND CITIZENS, BUSINESSES, OR OTHER GOVERNMENTS; CONSULTING SERVICES RELATED THERETO; COMPUTERIZED DATABASE MANAGEMENT; BUSINESS CONSULTING SERVICES RELATED TO COMPUTERIZED DATABASE MANAGEMENT; BUSINESS CONSULTING SERVICES RELATED TO BACK OFFICE COMPUTER SYSTEMS INTEGRATION SERVICES FOR GOVERNMENT COMPUTER NETWORKS; PROVIDING A WEB SITE AT WHICH USERS CAN OFFER GOODS AND SERVICES FOR SALE AND BUY GOODS AND SERVICES OFFERED BY OTHERS, IN THE FIELD OF GOVERNMENT PROCUREMENT; AUCTIONEERING SERVICES IN THE FIELD OF GOVERNMENT PROCUREMENT; COMPUTERIZED ON-LINE ORDERING SERVICES VIA A GLOBAL COMPUTER INFORMATION NETWORK IN THE FIELD OF GOVERNMENT PROCUREMENT, AND CONSULTING SERVICES RELATED THERETO (U.S. CLS. 100, 101 AND 102).

CLASS 38—COMMUNICATION

FOR OPERATION OF COMPUTER NETWORKS FOR THE ELECTRONIC TRANSMISSION OF MESSAGES AND DATA BETWEEN GOVERNMENT AND CITIZENS, BUSINESSES, OR OTHER GOVERNMENTS, AND CONSULTING SERVICES RELATED THERETO (U.S. CLS. 100, 101 AND 104).

CLASS 42—SCIENTIFIC, COMPUTER AND LEGAL SERVICES

FOR BACK OFFICE COMPUTER SYSTEMS INTEGRATION SERVICES FOR GOVERNMENT COMPUTER NETWORKS; COMPUTER SERVICES, NAMELY, DESIGNING AND DEVELOPING SOFTWARE AND COMPUTER NETWORKS FOR OTHERS FOR THE PURPOSES OF CONDUCTING ELECTRONIC TRANSACTIONS, EXCHANGING INFORMATION BETWEEN GOVERNMENT AND CITIZENS, BUSINESSES, OR OTHER GOVERNMENTS, AND FOR THE PURPOSES OF COMPUTERIZED DATABASE MANAGEMENT AND BACK OFFICE COMPUTER SYSTEMS INTEGRATION; COMPUTER CONSULTING SERVICES RELATED TO ALL THE FOREGOING (U.S. CLS. 100 AND 101).

SN 78-199,296. DE FERRARI, JEFFERSON L, PORTLAND, OR. FILED 1-2-2003.

ONE JOHNNY'S CROW

CLASS 9—ELECTRICAL AND SCIENTIFIC APPARATUS

FOR SOUND RECORDINGS FEATURING MUSIC (U.S. CLS. 21, 23, 26, 36 AND 38).

CLASS 25—CLOTHING

FOR SHIRTS, CAPS (U.S. CLS. 22 AND 39).

CLASS 41—EDUCATION AND ENTERTAINMENT

FOR THE PRESENTATION OF LIVE MUSIC FOR ENTERTAINMENT (U.S. CLS. 100, 101 AND 107).

SN 78-200,765. M&R MARKING SYSTEMS, INC., PISCATAWAY, NJ. FILED 1-7-2003.

ULTIMARK

CLASS 7—MACHINERY

FOR MACHINES FOR MANUFACTURING MARKING STRUCTURES FOR HAND STAMPS (U.S. CLS. 13, 19, 21, 23, 31, 34 AND 35).

FIRST USE 1-31-2002; IN COMMERCE 1-31-2002.

CLASS 16—PAPER GOODS AND PRINTED MATTER

FOR HAND STAMPS AND HAND STAMP INK (U.S. CLS. 2, 5, 22, 23, 29, 37, 38 AND 50).

FIRST USE 1-31-2002; IN COMMERCE 1-31-2002.

SN 78-200,780. GRAY MATTER HOLDINGS, LLC, BALTIMORE, MD. FILED 1-7-2003.

FTB

CLASS 9—ELECTRICAL AND SCIENTIFIC APPARATUS

FOR SUNGLASSES; EYEGLASSES (U.S. CLS. 21, 23, 26, 36 AND 38).

CLASS 25—CLOTHING

FOR CLOTHING, NAMELY, TOPS AND BOTTOMS, JACKETS; COATS; WARM-UP SUITS; SWEATSUITS; SWEAT PANTS; SWEATSHIRTS; SWEATERS; BLAZERS; VESTS; PANTS; TROUSERS; SLACKS; SHORTS; UNDERWEAR; THERMAL UNDERWEAR; SWIMWEAR; LOUNGEWEAR; HEADWEAR, NAMELY, EAR WARMERS, EAR MUFFS, HEADBANDS AND HATS; GLOVES; MITTENS; SCARVES; WRISTBANDS; SKIWEAR; TIGHTS; FOUL WEATHER GEAR; BEACH WEAR; UNITARDS; BODY SUITS; FISHING VESTS AND WADERS; SLEEPWEAR; ROBES; CAFTANS; NECKWEAR; OVERALLS; OVERCOATS; PANTSUITS; SUITS; SUIT COATS; RAINWEAR; SASHES; BELTS; SHAWLS; SOCKS; AND FOOTWEAR, NAMELY, SHOES, BOOTS, AND SANDALS. (U.S. CLS. 22 AND 39).

SN 78-200,838. SIMMONS, PAT, SURPRISE, AZ. FILED 1-7-2003.

PAT SIMMONS GOLF

NO CLAIM IS MADE TO THE EXCLUSIVE RIGHT TO USE "GOLF", APART FROM THE MARK AS SHOWN.

THE NAME "PAT SIMMONS" IDENTIFIES A LIVING INDIVIDUAL WHOSE CONSENT IS OF RECORD.

CLASS 25—CLOTHING

FOR CLOTHING, NAMELY, GOLF SHIRTS, GOLF PANTS, GOLF SHOES, GOLF SWEATERS, GOLF VESTS, SLACKS, JACKETS, T-SHIRTS, SOCKS, TURTLE-NECK SWEATERS, AND WIND-RESISTANT JACKETS (U.S. CLS. 22 AND 39).

CLASS 28—TOYS AND SPORTING GOODS

FOR SPORTING GOODS, NAMELY, GOLF CLUBS, GOLF PUTTERS, GOLF CLUB SHAFTS, GOLF CLUB HEADS, GOLF BALLS, GOLF BAGS, GOLF TEES, GOLF CLUB, HEAD AND PUTTER COVERS, AND GOLF GLOVES (U.S. CLS. 22, 23, 38 AND 50).

SN 78-200,921. LEAPFROG ENTERPRISES, INC., EMERYVILLE, CA. FILED 1-7-2003.

TOGETHER TOUCH**CLASS 16—PAPER GOODS AND PRINTED MATTER**

FOR INFANT AND CHILDREN'S BOOKS (U.S. CLS. 2, 5, 22, 23, 29, 37, 38 AND 50).

CLASS 28—TOYS AND SPORTING GOODS

FOR INFANT AND CHILDREN'S MULTIPLE ACTIVITY TOYS AND ELECTRONIC GAME MACHINES (U.S. CLS. 22, 23, 38 AND 50).

SN 78-200,923. LEAPFROG ENTERPRISES, INC., EMERYVILLE, CA. FILED 1-7-2003.

TOGETHER TIME**CLASS 16—PAPER GOODS AND PRINTED MATTER**

FOR INFANT AND CHILDREN'S BOOKS (U.S. CLS. 2, 5, 22, 23, 29, 37, 38 AND 50).

CLASS 28—TOYS AND SPORTING GOODS

FOR INFANT AND CHILDREN'S MULTIPLE ACTIVITY TOYS AND ELECTRONIC GAME MACHINES (U.S. CLS. 22, 23, 38 AND 50).

SN 78-201,103. RATH, MATTHIAS, NL-7609 KL ALMELO, NETHERLANDS, FILED 1-8-2003.

PEOPLE-HELP-PEOPLE

OWNER OF ERPN CMNTY TM OFC REG. NO. 002470482, DATED 4-11-2002, EXPIRES 4-11-2012.

CLASS 5—PHARMACEUTICALS

FOR PHARMACEUTICAL PREPARATIONS FOR USE IN THE TREATMENT OF HEART DISEASE AND HEART CONDITIONS, DIABETES, MENSTRUAL DISORDERS, BLOOD PRESSURE PROBLEMS, CARDIOVASCULAR PROBLEMS, LIPID METABOLISM DISORDERS, ASTHMA, ARTHRITIS, ARTHROSIS, TINNITUS, PERIODONTOSIS, ANEMIA, CELL DEFICIENCIES, AND CANCER; VITAMINS AND MINERALS FOR MEDICAL PURPOSES; FOOD SUPPLEMENTS FOR NON-MEDICAL PURPOSES, CONSISTING PRIMARILY OF VITAMINS, AMINO ACIDS AND TRACE ELEMENTS; DIETETIC SUPPLEMENTS FOR NON-MEDICAL USE, NAMELY AMINO ACIDS AND TRACE ELEMENTS IN THE NATURE OF DIETARY SUPPLEMENTS; NUTRITIONALLY FORTIFIED BEVERAGES (U.S. CLS. 6, 18, 44, 46, 51 AND 52).

CLASS 16—PAPER GOODS AND PRINTED MATTER

FOR PRINTED MATERIALS, NAMELY BOOKS, PAMPHLETS, MAGAZINES, JOURNALS, NEWSPAPERS, AND PRINTED TEACHING AND EDUCATIONAL MATERIALS, IN THE FIELDS OF HEALTH CARE, PREVENTATIVE HEALTH CARE, NUTRITIONAL SUPPLEMENTS, DIETARY SUPPLEMENTS, VITAMINS AND MINERAL SUPPLEMENTS (U.S. CLS. 2, 5, 22, 23, 29, 37, 38 AND 50).

CLASS 41—EDUCATION AND ENTERTAINMENT

FOR EDUCATION AND TRAINING, NAMELY CLASSES, SEMINARS, CONFERENCES AND WORKSHOPS, IN THE FIELDS OF HEALTH CARE, PREVENTIVE HEALTH CARE AND NUTRITIONAL SUPPLEMENTS (U.S. CLS. 100, 101 AND 107).

CLASS 42—SCIENTIFIC, COMPUTER AND LEGAL SERVICES

FOR SCIENTIFIC RESEARCH SERVICES (U.S. CLS. 100 AND 101).

CLASS 44—MEDICAL, BEAUTY AND AGRICULTURAL SERVICES

FOR MEDICAL SERVICES; PHYSICIAN SERVICES; CONSULTATION SERVICES IN THE FIELDS OF PREVENTATIVE HEALTH CARE, HEALTH CARE AND NUTRITION (U.S. CLS. 100 AND 101).

SN 78-201,721. TOSHIBA AMERICA INFORMATION SYSTEMS, INC., IRVINE, CA. FILED 1-9-2003.

SURFHIERE**CLASS 9—ELECTRICAL AND SCIENTIFIC APPARATUS**

FOR COMPUTER HARDWARE AND SOFTWARE FOR MULTIPLE-USER HIGH SPEED WIRELESS ACCESS TO GLOBAL COMPUTER INFORMATION NETWORKS FOR THE TRANSFER AND DISSEMINATION OF INFORMATION (U.S. CLS. 21, 23, 26, 36 AND 38).

CLASS 38—COMMUNICATION

FOR PROVIDING MULTIPLE-USER HIGH SPEED WIRELESS ACCESS TO GLOBAL COMPUTER INFORMATION NETWORKS (U.S. CLS. 100, 101 AND 104).

SN 78-201,824. DOT RED NEW YORK, INC., DOUGLSTON, NY. FILED 1-9-2003.



CLASS 9—ELECTRICAL AND SCIENTIFIC APPARATUS

FOR CELLULAR PHONE CASE, LAPTOP COMPUTER CARRYING BAG, PDA CARRYING CASE (U.S. CLS. 21, 23, 26, 36 AND 38).

CLASS 18—LEATHER GOODS

FOR UNISEX HAND BAG, LUGGAGE, BACKPACK, TRAVEL BAG, DOCUMENT CASES (U.S. CLS. 1, 2, 3, 22 AND 41).

SN 78-202,039. FALLON, TIMOTHY R., BOILING SPRINGS, SC. FILED 1-10-2003.

FTW RANCH

OWNER OF U.S. REG. NO. 2,416,760.
NO CLAIM IS MADE TO THE EXCLUSIVE RIGHT TO USE "RANCH", APART FROM THE MARK AS SHOWN.

CLASS 41—EDUCATION AND ENTERTAINMENT

FOR PROVIDING IN THE NATURE OF HUNTING PRESERVES, GUN FIRING RANGE AND SKEET RANGE (U.S. CLS. 100, 101 AND 107).
FIRST USE 11-30-1996; IN COMMERCE 11-30-1996.

CLASS 43—HOTEL AND RESTAURANT SERVICES

FOR RESORT LODGING SERVICES (U.S. CLS. 100 AND 101).
FIRST USE 11-30-1996; IN COMMERCE 11-30-1996.

SN 78-202,343. LECLAIR, ROBERT, S, HUMBLE, TX. FILED 1-11-2003.

HOLYBEARS

OWNER OF U.S. REG. NO. 2,419,868.

CLASS 9—ELECTRICAL AND SCIENTIFIC APPARATUS

FOR PRE-RECORDED VIDEO TAPES, AUDIO TAPES, DVD'S, AND COMPACT DISKS FEATURING CHILDREN'S ENTERTAINMENT AND EDUCATIONAL PROGRAMMING (U.S. CLS. 21, 23, 26, 36 AND 38).

CLASS 16—PAPER GOODS AND PRINTED MATTER

FOR CHILDREN'S BOOKS, STATIONARY, DIARIES, COLORING BOOKS, GIFTWRAP, AND STICKERS (U.S. CLS. 2, 5, 22, 23, 29, 37, 38 AND 50).

CLASS 25—CLOTHING

FOR MEN'S, WOMEN'S AND CHILDREN'S CLOTHING, NAMELY T-SHIRTS, SWEATSHIRTS, SLEEPWEAR, CAPS, AND HATS (U.S. CLS. 22 AND 39).

SN 78-203,086. HALL, RICK, PEORIA, AZ. FILED 1-14-2003.

CONVEYIST

CLASS 36—INSURANCE AND FINANCIAL

FOR BROKERAGE OF REAL ESTATE, APPRAISAL OF REAL ESTATE, MANAGEMENT OF REAL ESTATE, ACQUISITION OF REAL ESTATE (U.S. CLS. 100, 101 AND 102).

CLASS 42—SCIENTIFIC, COMPUTER AND LEGAL SERVICES

FOR REAL ESTATE CLOSING SERVICES; LEGAL SERVICES IN THE FIELD OF REAL ESTATE (U.S. CLS. 100 AND 101).

SN 78-204,069. WARDLEY INVESTMENTS LLP, ST. ANDREW GUERNSEY, BR.VIRGIN ISLANDS, FILED 1-16-2003.

DOOLEY AND PALS

CLASS 9—ELECTRICAL AND SCIENTIFIC APPARATUS

FOR PRE-RECORDED AUDIO AND VIDEO CASSETTES, COMPACTS DISCS AND DIGITAL VIDEO DISCS FEATURING ANIMATED CHARACTERS FROM A TELEVISION SERIES AND MOVIES (U.S. CLS. 21, 23, 26, 36 AND 38).

CLASS 16—PAPER GOODS AND PRINTED MATTER

FOR BOOKS FEATURING ANIMATED CHARACTERS; CHILDREN'S ACTIVITY BOOKS, COLORING BOOKS; STICKERS; POSTERS; TRADING CARDS; COMIC BOOKS; AND PRINTED INSTRUCTIONAL TEACHING MATERIALS IN THE AREAS OF SPELLING, READING, WRITING, COUNTING, ARITHMETIC, HEALTH, HYGIENE AND SAFETY (U.S. CLS. 2, 5, 22, 23, 29, 37, 38 AND 50).

CLASS 25—CLOTHING

FOR CLOTHING, NAMELY, T-SHIRTS, SWEATSHIRTS, GYM SHORTS, CHILDREN'S UNDERWEAR, JACKETS, SNEAKERS, CAPS AND HALLOWEEN COSTUMES (U.S. CLS. 22 AND 39).

CLASS 28—TOYS AND SPORTING GOODS

FOR TOYS, NAMELY, STUFFED PLUSH AND CLOTH DOLLS; COUNTING TOYS, NAMELY NUMBER TEACHING GAMES AND TOYS CONSISTING OF PLASTIC, CLOTH OR PLUSH NUMBERS; TOYS USED TO TEACH READING AND WRITING; ARTICULATED AND NON-ARTICULATED DOLLS, BENDABLE AND NON-BENDABLE ACTION FIGURES IN ALL SIZES AND ACCESSORIES AND CLOTHING THEREFOR; CARDBOARD PUZZLES (U.S. CLS. 22, 23, 38 AND 50).

CLASS 41—EDUCATION AND ENTERTAINMENT

FOR ENTERTAINMENT SERVICES IN THE NATURE OF LIVE SHOWS AND A SERIES OF PRE-RECORDED TELEVISION SHOWS AND MOVIES FEATURING ANIMATED AND LIVE ACTION CHARACTERS (U.S. CLS. 100, 101 AND 107).

SN 78-205,930. PACIFIC SUNWEAR OF CALIFORNIA, ANAHEIM, CA. FILED 1-22-2003.

LILU**CLASS 3—COSMETICS AND CLEANING PREPARATIONS**

FOR PERFUME, COLOGNE, SCENTED BODY SPRAY (U.S. CLS. 1, 4, 6, 50, 51 AND 52).

CLASS 25—CLOTHING

FOR MEN, WOMEN AND CHILDREN'S APPAREL, NAMELY, HATS, CAPS, VISORS, HOODS, BERETS, HEAD BANDS, SWEAT BANDS, EAR MUFFS, GLOVES, MITTENS, WRIST BANDS, SUSPENDERS, BELTS, SOCKS, STOCKINGS, PANTYHOSE, BODYSUITS, LEOTARDS, LEGGINGS, SWEAT SOCKS, THERMAL SOCKS, SHOES, SNEAKERS, GALOSHES, WADERS, BOOTS, SANDALS, SLIPPERS, KERCHIEFS, SCARVES, MUFFLERS, BANDANNAS, NECKERCHIEFS, VESTS, PAJAMAS, ROBES, KIMONOS, CAFTANS, SMOCKS, APRONS, BOXER SHORTS, BRIEFS, UNDERPANTS, CORSETS, CORSELETS, GIRDLES, BRASSIERES, BUSTIERS, CHEMISES, TEDDIES, CAMISOLES, SLIPS, NEGLIGENCE, PEIGNOIRS, SHIRTS, BLOUSES, KNIT TOPS, DRESSES, SKIRTS, JUMPSUITS, PANT SUITS, ROMPERS, SWIMMING TRUNKS, WET SUITS, THERMAL UNDERWEAR, UNDERSHIRTS, TUNICS, TANK TOPS, COTTON WOVEN SHIRTS, KNIT SHIRTS, POLO SHIRTS, T-SHIRTS, SWEAT SHIRTS, CREW NECK SWEATERS, V-NECK SWEATERS, TURTLENECK SWEATERS, CARDIGANS, SUITS, JOGGING SUITS, SHORTS, SWEAT SHORTS, JEANS, PANTS, SLACKS, TROUSERS, SWEAT PANTS, SKI SUITS, SKI PANTS, SKI BIBS, CAPES, SHAWLS, BLAZERS, WAISTCOATS, RAIN COATS, OVERCOATS, TOP COATS, SPORT COATS, PARKAS, BOLERO JACKETS, JACKETS, WIND RESISTANT JACKETS, OUTER JACKETS, LEATHER JACKETS, SKI JACKETS, FLANNEL JACKETS, WOOL JACKETS, POLYESTER WOVEN SHIRTS, RAYON WOVEN SHIRTS, WOOL WOVEN SHIRTS, LEATHER COATS, ELASTIC WAIST SHORTS, FIXED WAIST SHORTS, DENIM SHORTS, AND DENIM JACKETS. (U.S. CLS. 22 AND 39).

SN 78-204,329. VISTAR CORPORATION, CENTENNIAL, CO. FILED 1-17-2003.

ENGLEWOOD FARMS

NO CLAIM IS MADE TO THE EXCLUSIVE RIGHT TO USE "FARMS", APART FROM THE MARK AS SHOWN.

CLASS 29—MEATS AND PROCESSED FOODS

FOR DAIRY PRODUCTS EXCLUDING ICE CREAM, ICE MILK, AND FROZEN YOGURT (U.S. CL. 46).

CLASS 30—STAPLE FOODS

FOR ICE CREAM, ICE MILK, AND FROZEN YOGURT (U.S. CL. 46).

SN 78-205,562. BERTEK PHARMACEUTICALS INC., MORGANTOWN, WV. FILED 1-21-2003.

S.P.I.R.I.T.**CLASS 9—ELECTRICAL AND SCIENTIFIC APPARATUS**

FOR PRERECORDED VIDEO TAPES FEATURING INFORMATION ON THE IMPORTANCE OF PREGNANCY PREVENTION WHILE UNDERGOING TREATMENT WITH A PHARMACEUTICAL PREPARATION ASSOCIATED WITH FETAL ABNORMALITIES (U.S. CLS. 21, 23, 26, 36 AND 38).

CLASS 16—PAPER GOODS AND PRINTED MATTER

FOR PRINTED INSTRUCTIONAL AND EDUCATIONAL MATERIALS USED FOR COUNSELING DOCTORS TO PROVIDE PATIENTS WITH INFORMATION ON THE IMPORTANCE OF PREGNANCY PREVENTION WHILE UNDERGOING TREATMENT WITH A PHARMACEUTICAL PREPARATION ASSOCIATED WITH FETAL ABNORMALITIES (U.S. CLS. 2, 5, 22, 23, 29, 37, 38 AND 50).

CLASS 44—MEDICAL, BEAUTY AND AGRICULTURAL SERVICES

FOR COUNSELING DOCTORS TO PROVIDE PATIENTS WITH INFORMATION ON THE IMPORTANCE OF PREGNANCY PREVENTION WHILE UNDERGOING TREATMENT WITH A PHARMACEUTICAL PREPARATION ASSOCIATED WITH FETAL ABNORMALITIES (U.S. CLS. 100 AND 101).

SN 78-206,049. THE WASHINGTON UNIVERSITY, ST. LOUIS, MO. FILED 1-22-2003.

**CLASS 16—PAPER GOODS AND PRINTED MATTER**

FOR EDUCATIONAL AND TEACHING PUBLICATIONS, NAMELY, NEWSLETTERS, EVENT PROGRAMS, POSTERS, SPORTS EVENT SCHEDULES, AND SPORTS MEDIA GUIDES, ALL IN THE FIELD OF UNIVERSITY ATHLETICS (U.S. CLS. 2, 5, 22, 23, 29, 37, 38 AND 50).
FIRST USE 0-0-1995; IN COMMERCE 0-0-1995.

CLASS 41—EDUCATION AND ENTERTAINMENT

FOR ENTERTAINMENT SERVICES, NAMELY, ATHLETIC FOOTBALL, BASKETBALL, BASEBALL, SOCCER, TENNIS, VOLLEYBALL, SWIMMING, AND TRACK AND FIELD EVENTS (U.S. CLS. 100, 101 AND 107).

FIRST USE 0-0-1995; IN COMMERCE 0-0-1995.

SN 78-206,090. MARKETING RESULTS LTD., COLUMBUS, OH. FILED 1-22-2003.

DURA SEAL**CLASS 6—METAL GOODS**

FOR ALUMINUM FOIL AND METAL FOIL (U.S. CLS. 2, 12, 13, 14, 23, 25 AND 50).

CLASS 16—PAPER GOODS AND PRINTED MATTER

FOR WRAPPING PAPER, PLASTIC WRAP, PLASTIC TRASH BAGS, PLASTIC GARBAGE BAGS, PLASTIC SANDWICH BAGS, PLASTIC FOOD STORAGE BAGS FOR HOUSEHOLD USE, PLASTIC SHOPPING BAGS, PLASTIC BAGS FOR MERCHANDISE PACKAGING, PLASTIC BAGS FOR HOUSEHOLD USE, PLASTIC BAGS FOR PACKAGING, PLASTIC BAGS FOR PACKING, GENERAL PURPOSE PLASTIC BAGS, AND PAPER BAGS (U.S. CLS. 2, 5, 22, 23, 29, 37, 38 AND 50).

CLASS 21—HOUSEWARES AND GLASS

FOR PORTABLE PLASTIC CONTAINERS FOR STORING HOUSEHOLD AND KITCHEN GOODS (U.S. CLS. 2, 13, 23, 29, 30, 33, 40 AND 50).

SN 78-206,894. JACOB LEINENKUGEL BREWING CO., INC., CHIPPEWA FALLS, WI. FILED 1-24-2003.

LEINIE LODGE

OWNER OF U.S. REG. NOS. 1,554,969, 2,641,155 AND OTHERS.

CLASS 21—HOUSEWARES AND GLASS

FOR BEVERAGE GLASSWARE, MUGS, COASTERS, CUPS (U.S. CLS. 2, 13, 23, 29, 30, 33, 40 AND 50).
FIRST USE 0-0-1999; IN COMMERCE 0-0-1999.

CLASS 32—LIGHT BEVERAGES

FOR BEER (U.S. CLS. 45, 46 AND 48).
FIRST USE 4-0-1990; IN COMMERCE 4-0-1990.

CLASS 41—EDUCATION AND ENTERTAINMENT

FOR ENTERTAINMENT SERVICES, NAMELY SPONSORING MUSICAL CONCERTS; TOURIST ENTERTAINMENT SERVICES, NAMELY PROVIDING AND MAINTAINING AN INFORMATION AND GUIDE CENTER FOR A BREWERY (U.S. CLS. 100, 101 AND 107).
FIRST USE 8-0-2002; IN COMMERCE 8-0-2002.

SN 78-206,899. READING IS FUNDAMENTAL, INC., WASHINGTON, DC. FILED 1-24-2003.

CLUB RIF

OWNER OF U.S. REG. NOS. 1,075,006 AND 2,623,466.

CLASS 16—PAPER GOODS AND PRINTED MATTER

FOR PUBLICATIONS, NAMELY, BOOKS, GUIDES AND LESSON PLANS FOR USE IN CONDUCTING COMPREHENSIVE READING AND LITERACY PROGRAMS WHICH PAIR TEENS AS MENTORS WITH YOUNGER CHILDREN (U.S. CLS. 2, 5, 22, 23, 29, 37, 38 AND 50).

FIRST USE 12-31-1988; IN COMMERCE 9-25-2002.

CLASS 41—EDUCATION AND ENTERTAINMENT

FOR EDUCATIONAL SERVICES, NAMELY, CONDUCTING COMPREHENSIVE READING AND LITERACY PROGRAMS WHICH PAIR TEENS AS MENTORS WITH YOUNGER CHILDREN (U.S. CLS. 100, 101 AND 107).

FIRST USE 12-31-1988; IN COMMERCE 9-25-2002.

SN 78-206,946. PARIS PRESENTS INCORPORATED, GURNEE, IL. FILED 1-24-2003.

DAILY LUXURIES**CLASS 3—COSMETICS AND CLEANING PREPARATIONS**

FOR HOT AND COLD REUSABLE EYE COMPRESSES FOR BEAUTY AND COSMETIC USES, PUMICE STONES FOR PERSONAL USE, AND CUTICLE PUMICE STICKS (U.S. CLS. 1, 4, 6, 50, 51 AND 52).

FIRST USE 3-31-2002; IN COMMERCE 3-31-2002.

CLASS 8—HAND TOOLS

FOR MANICURE AND PEDICURE IMPLEMENTS, NAMELY, FOOT FILES, NAIL PUSHERS, NAIL BUFFERS, NAIL BUFFER BLOCKS, CUTICLE STICKS, AND PEDICURE WANDS (U.S. CLS. 23, 28 AND 44).

FIRST USE 3-31-2002; IN COMMERCE 3-31-2002.

CLASS 10—MEDICAL APPARATUS

FOR NON-ELECTRIC MASSAGERS (U.S. CLS. 26, 39 AND 44).

FIRST USE 3-31-2002; IN COMMERCE 3-31-2002.

CLASS 20—FURNITURE AND ARTICLES NOT OTHERWISE CLASSIFIED

FOR INFLATABLE BATH PILLOWS AND FOAM TOE SEPARATORS FOR USE IN PEDICURES (U.S. CLS. 2, 13, 22, 25, 32 AND 50).

FIRST USE 3-31-2002; IN COMMERCE 3-31-2002.

CLASS 21—HOUSEWARES AND GLASS

FOR BATH BRUSHES, BATH SPONGES, NAIL BRUSHES, FOOT EXFOLIATING PADS AND BODY SCRUBBING PUFFS (U.S. CLS. 2, 13, 23, 29, 30, 33, 40 AND 50).

FIRST USE 3-31-2002; IN COMMERCE 3-31-2002.

CLASS 24—FABRICS

FOR WASH CLOTHS, WASHING MITTS AND BODY WASHING STRAPS (U.S. CLS. 42 AND 50).
FIRST USE 3-31-2002; IN COMMERCE 3-31-2002.

CLASS 25—CLOTHING

FOR CLOTHING, NAMELY COTTON GLOVES FOR USE AFTER APPLYING MOISTURIZING LOTIONS, COTTON BOOTIES FOR USE AFTER APPLYING MOISTURIZING LOTIONS AND SLEEP MASKS (U.S. CLS. 22 AND 39).

FIRST USE 3-31-2002; IN COMMERCE 3-31-2002.

SN 78-207,466. COURVOISIER S.A., JARNAC, FRANCE,
FILED 1-27-2003.

COURVOISIER

OWNER OF U.S. REG. NO. 1,473,896.

CLASS 29—MEATS AND PROCESSED FOODS

FOR FRUIT TOPPING, NUT TOPPING, FRUITS PREPARED IN ALCOHOL. (U.S. CL. 46).

CLASS 30—STAPLE FOODS

FOR MUSTARD, SAUCES, COFFEE CONCENTRATE, CAPPUCCINO MIX, TOPPING SYRUP, CHOCOLATE TOPPING. (U.S. CL. 46).

SN 78-207,543. TRAVERS; SCOTT A., NEW YORK, NY,
FILED 1-27-2003.

**COIN COLLECTOR'S
SURVIVAL MANUAL**

NO CLAIM IS MADE TO THE EXCLUSIVE RIGHT TO USE "COIN COLLECTOR'S", APART FROM THE MARK AS SHOWN.

CLASS 9—ELECTRICAL AND SCIENTIFIC APPARATUS

FOR SOFTWARE FEATURING INFORMATION ON COIN COLLECTING CONTAINED ON CD-ROM (U.S. CLS. 21, 23, 26, 36 AND 38).

FIRST USE 6-16-1997; IN COMMERCE 6-16-1997.

CLASS 16—PAPER GOODS AND PRINTED MATTER

FOR BOOKS, NAMELY A COIN COLLECTING REFERENCE WHICH IS UPDATED AND HAS BEEN PRINTED IN MULTIPLE EDITIONS; (U.S. CLS. 2, 5, 22, 23, 29, 37, 38 AND 50).

FIRST USE 4-6-1984; IN COMMERCE 4-6-1984.

SN 78-207,613. METRO-GOLDWYN-MAYER STUDIOS INC.,
SANTA MONICA, CA. FILED 1-27-2003.

LEGALLY BLONDE**CLASS 9—ELECTRICAL AND SCIENTIFIC APPARATUS**

FOR MOTION PICTURE FILMS FEATURING ENTERTAINMENT, NAMELY, COMEDY, DRAMA, ANIMATION, ROMANCE AND/OR ACTION/ADVENTURE; PRE-RECORDED AUDIO AND VIDEO TAPES, VIDEO DISCS AND DVDS FEATURING ENTERTAINMENT, NAMELY, COMEDY, DRAMA, ANIMATION, ROMANCE, AND/OR ACTION/ADVENTURE; AND MUSICAL SOUND RECORDINGS. (U.S. CLS. 21, 23, 26, 36 AND 38).

CLASS 41—EDUCATION AND ENTERTAINMENT

FOR ENTERTAINMENT SERVICES, NAMELY, PRODUCTION AND DISTRIBUTION OF THEATRICAL MOTION PICTURES ON FILM, VIDEOTAPE CASSETTES, VIDEODISCS AND DVDS. (U.S. CLS. 100, 101 AND 107).

SN 78-208,078. CHANNING BETE COMPANY, INC., SOUTH
DEERFIELD, MA. FILED 1-28-2003.

JOURNEY TO CHANGE**CLASS 9—ELECTRICAL AND SCIENTIFIC APPARATUS**

FOR SERIES OF PRERECORDED CD'S AND AUDIO CASSETTES IN ENGLISH AND SPANISH ON THE TOPIC OF DOMESTIC VIOLENCE (U.S. CLS. 21, 23, 26, 36 AND 38).

CLASS 16—PAPER GOODS AND PRINTED MATTER

FOR PRINTED INSTRUCTIONAL, EDUCATIONAL, AND TEACHING MATERIALS IN ENGLISH AND SPANISH ON THE TOPIC OF DOMESTIC VIOLENCE (U.S. CLS. 2, 5, 22, 23, 29, 37, 38 AND 50).

SN 78-208,082. NATIONAL HOT ROD ASSOCIATION, GLEN-
DORA, CA. FILED 1-28-2003.

IGNITE YOUR SENSES**CLASS 35—ADVERTISING AND BUSINESS**

FOR ASSOCIATION SERVICES, NAMELY, PROMOTING THE INTERESTS OF HOT ROD AND RACING CAR ENTHUSIASTS AND PROMOTING SPORTSMANSHIP AMONG HOT ROD AND RACING CAR ENTHUSIASTS. (U.S. CLS. 100, 101 AND 102).

CLASS 41—EDUCATION AND ENTERTAINMENT

FOR ENTERTAINMENT SERVICES, NAMELY, ORGANIZING AND CONDUCTING SPORTING EVENTS AND AUTOMOBILE RACES. (U.S. CLS. 100, 101 AND 107).

SN 78-208,118. THE ENCORE GROUP, INC., SAN DIEGO, CA. FILED 1-28-2003.

SN 78-208,363. FREMANTLE MEDIA NORTH AMERICA, INC., SANTA MONICA, CA. FILED 1-29-2003.

BUGALUMP

CLASS 17—RUBBER GOODS

FOR FIGURINES MADE OF RUBBER (U.S. CLS. 1, 5, 12, 13, 35 AND 50).

CLASS 28—TOYS AND SPORTING GOODS

FOR PLUSH AND STUFFED TOYS (U.S. CLS. 22, 23, 38 AND 50).

SN 78-208,175. TENNECO AUTOMOTIVE OPERATING COMPANY INC., LAKE FOREST, IL. FILED 1-29-2003.

DNX

CLASS 7—MACHINERY

FOR EXHAUST SYSTEM COMPONENTS FOR AUTOMOBILES, NAMELY, MUFFLERS, CATALYTIC CONVERTERS, EXHAUST PIPES, ADAPTOR PIPES, TAIL PIPES, TAIL PIPE REDUCERS, TAIL PIPE SPOUTS AND TAIL PIPE TIPS (U.S. CLS. 13, 19, 21, 23, 31, 34 AND 35).

CLASS 12—VEHICLES

FOR MOTOR VEHICLE SUSPENSION PARTS FOR AUTOMOBILES, NAMELY, SHOCK ABSORBERS, STRUTS, BUSHINGS, STEERING STABILIZERS AND SPRINGS (U.S. CLS. 19, 21, 23, 31, 35 AND 44).

SN 78-208,351. MASSACHUSETTS INSTITUTE OF TECHNOLOGY, CAMBRIDGE, MA. FILED 1-29-2003.

MIT TECHTIME

CLASS 9—ELECTRICAL AND SCIENTIFIC APPARATUS

FOR DOWNLOADABLE COMPUTER SOFTWARE AND INSTRUCTIONAL MATERIALS FOR USE IN EVENT MANAGEMENT (U.S. CLS. 21, 23, 26, 36 AND 38).

CLASS 42—SCIENTIFIC, COMPUTER AND LEGAL SERVICES

FOR COMPUTER SUPPORT SERVICES, NAMELY, PROVIDING TROUBLESHOOTING OF COMPUTER SOFTWARE PROBLEMS VIA TELEPHONE, E-MAIL, VIA REMOTE ACCESS AND IN PERSON (U.S. CLS. 100 AND 101).

LIVE LIKE AN IDOL

CLASS 35—ADVERTISING AND BUSINESS

FOR PROMOTING THE SALE OF THE GOODS AND SERVICES OF OTHERS BY PROVIDING INCENTIVES IN THE NATURE OF SWEEPSTAKES. (U.S. CLS. 100, 101 AND 102).

CLASS 41—EDUCATION AND ENTERTAINMENT

FOR ENTERTAINMENT SERVICES IN THE NATURE OF CONDUCTING SWEEPSTAKES GAMES. (U.S. CLS. 100, 101 AND 107).

SN 78-208,512. ARIZANT HEALTHCARE INC., EDEN PRAIRIE, MN. FILED 1-29-2003.

ARIZANT

CLASS 5—PHARMACEUTICALS

FOR WOUND COVERS; WARMING SYSTEMS FOR WOUNDS CONSISTING PRIMARILY OF WOUND COVERS IN THE NATURE OF BANDAGES FOR WARMING AND PROTECTING WOUNDS. (U.S. CLS. 6, 18, 44, 46, 51 AND 52).

CLASS 10—MEDICAL APPARATUS

FOR MEDICAL APPARATUS FOR HUMAN AND VETERINARY USE, NAMELY, BODY TEMPERATURE MANAGEMENT PRODUCTS COMPRISING FORCED AIR WARMING AND COOLING SYSTEMS FOR PATIENTS, BLOOD AND IV FLUIDS THAT PRIMARILY CONSIST OF A THERMAL UNIT, HOSE, TUBING, BODY COVER, BLANKET OR PATIENT GARMENT AND CONTROLS THEREFOR; FLUID AND BLOOD WARMING DEVICES AND DISPOSABLE ADMINISTRATION SETS; MEDICAL APPARATUS FOR WOUND MANAGEMENT, NAMELY WARMING SYSTEMS FOR WOUNDS THAT PRIMARILY CONSIST OF A WOUND COVER, A THERMAL UNIT, A TEMPERATURE CONTROL UNIT, A POWER SOURCE AND CONTROLS THEREFOR, AND WOUND COVERS SOLD FOR USE AS A COMPONENT OF A WOUND THERAPY SYSTEM CONSISTING PRIMARILY OF A WOUND COVER, A THERMAL UNIT, A TEMPERATURE CONTROL UNIT, A POWER SOURCE, AND CONTROLS THEREFOR. (U.S. CLS. 26, 39 AND 44).

SN 78-208,526. AETHER SYSTEMS, INC., OWINGS MILLS, MD. FILED 1-29-2003.

GEOLOGIC

CLASS 9—ELECTRICAL AND SCIENTIFIC APPARATUS

FOR COMPUTER HARDWARE AND SOFTWARE FOR COMMUNICATING TO AND FROM VEHICLES, VESSELS AND OTHER MOBILE ASSETS (U.S. CLS. 21, 23, 26, 36 AND 38).

CLASS 38—COMMUNICATION

FOR COMMUNICATION SERVICES, NAMELY, PROVIDING WIRELESS TELECOMMUNICATIONS LINKS TO AND FROM VEHICLES, VESSELS, AND OTHER MOBILE ASSETS (U.S. CLS. 100, 101 AND 104).

SN 78-208,779. RYERSON TULL PROCUREMENT CORPORATION, CHICAGO, IL. FILED 1-30-2003.

SN 78-208,775. RYERSON TULL PROCUREMENT CORPORATION, CHICAGO, IL. FILED 1-30-2003.

THE BIG FIVE**CLASS 6—METAL GOODS**

FOR STEEL IN BAR, ROD, SHEET, AND BLOCK FORM, METAL ROAD AND GARDEN CURBING, STEEL REINFORCING BARS FOR USE IN CONCRETE, STEEL FLOOR PLATES AND SAFETY TREAD PLATES, STRUCTURAL STEEL TUBING, EXPANDED STEEL SHEETS FOR REINFORCING PLASTER, CORRUGATED STEEL SHEETS, CORRUGATED STEEL SHEETS FOR CONSTRUCTION PURPOSES, NAMELY, IN THE WALL AND ROOF SECTION OF BUILDINGS, STAINLESS STEEL SOLD IN BULK, CASTINGS OF STAINLESS STEEL, METAL CONSTRUCTION MATERIALS NAMELY, BAR, ROD, SHEET, AND BLOCK SHAPES, ROAD AND GARDEN CURBING, ROOFING AND ALUMINUM SIDING, RAILS, REINFORCED BARS FOR USE IN CONCRETE, WIRE NETTING AND SPIRALS FOR REINFORCING CONCRETE, METAL FLOOR PLATES AND SAFETY TREAD PLATES, METAL OPEN FLOORING AND GRATING, METAL CAISSON RINGS, METAL STRUCTURAL TUBING, METAL EXPANDED SHEETS AND GRATING, METAL PERFORATED SHEETS, METAL MECHANICAL TUBING, METAL THREADED TUBING AND BARS, METAL ANGLE IRONS, METAL CHAIN, METAL PIPE AND PIPE FITTINGS, WIRE ROPE, IRON, STEEL, AND ALUMINUM FOR USE IN FURTHER MANUFACTURING METAL PLATES AND SHEETS, METAL BARS AND BILLETS, CARBON STEEL, ALLOY STEEL, TOOL STEEL, STRIP STEEL, SPRING STEEL, DRILL STEEL, MACHINERY STEEL, SCREW STEEL, BABBITT METAL SOLD IN BULK FOR FURTHER MANUFACTURING, SOLDER, STAINLESS STEEL, FORGINGS, COLD ROLLED STEEL, FLAME CUT METAL SHAPES, FLAME CUT STEEL SHAPES, METAL BANDS AND HOOPS, WIRE, SHAFTING, MACHINED RINGS AND DISCS (U.S. CLS. 2, 12, 13, 14, 23, 25 AND 50).

CLASS 6—METAL GOODS

FOR STEEL IN BAR, ROD, SHEET, AND BLOCK FORM, METAL ROAD AND GARDEN CURBING, STEEL REINFORCING BARS FOR USE IN CONCRETE, STEEL FLOOR PLATES AND SAFETY TREAD PLATES, STRUCTURAL STEEL TUBING, EXPANDED STEEL SHEETS FOR REINFORCING PLASTER, CORRUGATED STEEL SHEETS, CORRUGATED STEEL SHEETS FOR CONSTRUCTION PURPOSES, NAMELY, IN THE WALL AND ROOF SECTION OF BUILDINGS, STAINLESS STEEL SOLD IN BULK, CASTINGS OF STAINLESS STEEL, METAL CONSTRUCTION MATERIALS NAMELY, BAR, ROD, SHEET, AND BLOCK SHAPES, ROAD AND GARDEN CURBING, ROOFING AND ALUMINUM SIDING, RAILS, REINFORCED BARS FOR USE IN CONCRETE, WIRE NETTING AND SPIRALS FOR REINFORCING CONCRETE, METAL FLOOR PLATES AND SAFETY TREAD PLATES, METAL OPEN FLOORING AND GRATING, METAL CAISSON RINGS, METAL STRUCTURAL TUBING, METAL EXPANDED SHEETS AND GRATING, METAL PERFORATED SHEETS, METAL MECHANICAL TUBING, METAL THREADED TUBING AND BARS, METAL ANGLE IRONS, METAL CHAIN, METAL PIPE AND PIPE FITTINGS, WIRE ROPE, IRON, STEEL, AND ALUMINUM FOR USE IN FURTHER MANUFACTURING METAL PLATES AND SHEETS, METAL BARS AND BILLETS, CARBON STEEL, ALLOY STEEL, TOOL STEEL, STRIP STEEL, SPRING STEEL, DRILL STEEL, MACHINERY STEEL, SCREW STEEL, BABBITT METAL SOLD IN BULK FOR FURTHER MANUFACTURING, SOLDER, STAINLESS STEEL, FORGINGS, COLD ROLLED STEEL, FLAME CUT METAL SHAPES, FLAME CUT STEEL SHAPES, METAL BANDS AND HOOPS, WIRE, SHAFTING, MACHINED RINGS AND DISCS (U.S. CLS. 2, 12, 13, 14, 23, 25 AND 50).

CLASS 17—RUBBER GOODS

FOR PLASTICS, NAMELY, THERMOPLASTICS IN ROD, SHEET, TUBE, PIPE AND COIL FORM, THERMOSETS IN ROD, SHEET, TUBE AND MOLDED BEARING FORM, FIBERGLASS IN ROD, PROFILE, SHEET, MOLDED GRATING, WEIR AND BAFFLE FORM, ALL FOR USE IN FURTHER MANUFACTURE OR CONSTRUCTION AND PLASTIC HEADS FOR PRESSURE VESSELS AND TANKS (U.S. CLS. 1, 5, 12, 13, 35 AND 50).

CLASS 17—RUBBER GOODS

FOR PLASTICS, NAMELY, THERMOPLASTICS IN ROD, SHEET, TUBE, PIPE AND COIL FORM, THERMOSETS IN ROD, SHEET, TUBE AND MOLDED BEARING FORM, FIBERGLASS IN ROD, PROFILE, SHEET, MOLDED GRATING, WEIR AND BAFFLE FORM, ALL FOR USE IN FURTHER MANUFACTURE OR CONSTRUCTION AND PLASTIC HEADS FOR PRESSURE VESSELS AND TANKS (U.S. CLS. 1, 5, 12, 13, 35 AND 50).

CLASS 40—MATERIAL TREATMENT

FOR FABRICATION, PREPARATION, AND TREATMENT OF METALS AND METAL PRODUCTS COMPRISING FLAME CUTTING, SAWING, THREADING, PUNCHING, BENDING, WELDING, DRILLING, GRINDING, AND SHEARING, AND FABRICATION, PREPARATION, AND TREATMENT OF PLASTICS COMPRISING OF MILLING, SANDING, TURNING, INJECTION MOLDING, VACUUM FORMING AND SPECIAL EXTRUSIONS (U.S. CLS. 100, 103 AND 106).

CLASS 40—MATERIAL TREATMENT

FOR FABRICATION, PREPARATION, AND TREATMENT OF METALS AND METAL PRODUCTS COMPRISING FLAME CUTTING, SAWING, THREADING, PUNCHING, BENDING, WELDING, DRILLING, GRINDING, AND SHEARING, AND FABRICATION, PREPARATION, AND TREATMENT OF PLASTICS COMPRISING OF MILLING, SANDING, TURNING, INJECTION MOLDING, VACUUM FORMING AND SPECIAL EXTRUSIONS (U.S. CLS. 100, 103 AND 106).

SN 78-209,140. SIARE'S INTERNATIONAL (U.S.A.), INC.,
NEW YORK, NY. FILED 1-30-2003.

KOOKIN

CLASS 18—LEATHER GOODS

FOR LEATHER GOODS—NAMELY, BRIEFCASES, BRIEFCASE-TYPE PORTFOLIOS, ATTACHE CASES, TRAVEL BAGS, LUGGAGE, COSMETIC CASES SOLD EMPTY, DUFFEL BAGS, SHOULDER BAGS, HANG BAGS, WALLETS AND KEY CASES (U.S. CLS. 1, 2, 3, 22 AND 41).

CLASS 25—CLOTHING

FOR MEN'S WOMEN'S AND CHILDREN'S JACKETS, SHIRTS, COATS, VESTS, SKIRTS, OVERCOATS, SWEATERS, CULOTTES, GOWNS, PANTS, TROUSERS, SUITS, SCARVES, CLOTHING BELTS, HATS, GLOVES, SOCKS, TIES, NECKTIES, SHOES, BOOTS AND SKI BOOT BAGS (U.S. CLS. 22 AND 39).

SN 78-209,470. ATLANTIC PUBLIC MEDIA, WOODS HOLE,
MA. FILED 1-31-2003.

TRANSOM

CLASS 9—ELECTRICAL AND SCIENTIFIC APPARATUS

FOR PRE-RECORDED RECORDINGS ON RECORDS, COMPACT DISCS, TAPES, AND VIDEOS FEATURING INFORMATION IN THE FIELD OF GENERAL NEWS CONCERNING POLITICS, POLICY, BUSINESS, TECHNOLOGY, ENTERTAINMENT, ARTS AND LEISURE (U.S. CLS. 21, 23, 26, 36 AND 38).

CLASS 16—PAPER GOODS AND PRINTED MATTER

FOR BOOKS, MAGAZINES AND JOURNALS IN THE FIELDS OF GENERAL NEWS CONCERNING POLITICS, POLICY, BUSINESS, TECHNOLOGY, ENTERTAINMENT, ARTS AND LEISURE (U.S. CLS. 2, 5, 22, 23, 29, 37, 38 AND 50).

CLASS 41—EDUCATION AND ENTERTAINMENT

FOR ENTERTAINMENT SERVICES, NAMELY, PROVIDING RADIO PROGRAMS IN THE FIELD OF GENERAL NEWS CONCERNING POLITICS, POLICY, BUSINESS, TECHNOLOGY, ENTERTAINMENT, ARTS AND LEISURE (U.S. CLS. 100, 101 AND 107).

SN 78-209,990. TRUSERV CORPORATION, CHICAGO, IL.
FILED 2-3-2003.

truStart²

OWNER OF U.S. REG. NO. 2,582,485.

CLASS 9—ELECTRICAL AND SCIENTIFIC APPARATUS

FOR COMPUTER SOFTWARE FOR INVENTORY CONTROL, ORDERING AND ADVERTISEMENT PREPARATION (U.S. CLS. 21, 23, 26, 36 AND 38).

CLASS 35—ADVERTISING AND BUSINESS

FOR COMPUTERIZED INVENTORY CONTROL, ORDERING AND ADVERTISEMENT PREPARATION (U.S. CLS. 100, 101 AND 102).

SN 78-209,998. TM ACQUISITION CORP., LAS VEGAS, NV.
FILED 2-3-2003.

SOCRATES

CLASS 9—ELECTRICAL AND SCIENTIFIC APPARATUS

FOR SOFTWARE FOR USE BY HOTELS AND MOTELS TO CALCULATE ROOM RATES AND DISCOUNTS (U.S. CLS. 21, 23, 26, 36 AND 38).

CLASS 35—ADVERTISING AND BUSINESS

FOR FRANCHISING SERVICES, NAMELY, OFFERING TECHNICAL ASSISTANCE IN THE ESTABLISHMENT AND/OR OPERATION OF MOTELS AND HOTELS (U.S. CLS. 100, 101 AND 102).

SN 78-210,104. EXTERIOR DESIGNS, INC., HUDSON, OH.
FILED 2-3-2003.

EXTREMITY WORKOUT

NO CLAIM IS MADE TO THE EXCLUSIVE RIGHT TO USE "WORKOUT", APART FROM THE MARK AS SHOWN.

CLASS 9—ELECTRICAL AND SCIENTIFIC APPARATUS

FOR PRERECORDED VIDEO TAPES FEATURING PHYSICAL FITNESS (U.S. CLS. 21, 23, 26, 36 AND 38).

CLASS 41—EDUCATION AND ENTERTAINMENT

FOR PROVIDING PHYSICAL FITNESS INSTRUCTION, NAMELY, EXERCISE PROGRAMS (U.S. CLS. 100, 101 AND 107).

SN 78-210,110. TAYLOR-LISTUG, INC., EL CAJON, CA.
FILED 2-3-2003.

ES1

CLASS 9—ELECTRICAL AND SCIENTIFIC APPARATUS

FOR ELECTRONIC SOUND AND VIBRATION SENSORS, PICKUPS, TRANSDUCERS, AND AMPLIFIERS FOR MUSICAL INSTRUMENTS (U.S. CLS. 21, 23, 26, 36 AND 38).

CLASS 15—MUSICAL INSTRUMENTS

FOR MUSICAL INSTRUMENTS, NAMELY, GUITARS; AND CARRYING CASES FOR MUSICAL INSTRUMENTS (U.S. CLS. 2, 21 AND 36).

SN 78-212,225. PARIS PRESENTS INCORPORATED, GURNEE, IL. FILED 2-7-2003.



SN 78-211,592. NEW BELGIUM BREWING COMPANY, INC., FORT COLLINS, CO. FILED 2-6-2003.

TAKE A LITTLE TRIP**CLASS 12—VEHICLES**

FOR BICYCLES (U.S. CLS. 19, 21, 23, 31, 35 AND 44). FIRST USE 1-31-2001; IN COMMERCE 1-31-2001.

CLASS 32—LIGHT BEVERAGES

FOR FERMENTED MALT BEVERAGES, NAMELY, BEER AND ALE (U.S. CLS. 45, 46 AND 48). FIRST USE 12-0-2002; IN COMMERCE 12-0-2002.

CLASS 3—COSMETICS AND CLEANING PREPARATIONS

FOR HOT AND COLD REUSABLE EYE COMPRESSES FOR BEAUTY AND COSMETIC USES, PUMICE STONES FOR PERSONAL USE, AND CUTICLE PUMICE STICKS (U.S. CLS. 1, 4, 6, 50, 51 AND 52). FIRST USE 3-31-2002; IN COMMERCE 3-31-2002.

CLASS 8—HAND TOOLS

FOR MANICURE AND PEDICURE IMPLEMENTS, NAMELY, FOOT FILES, NAIL PUSHERS, NAIL BUFFERS, NAIL BUFFER BLOCKS, CUTICLE STICKS, AND PEDICURE WANDS (U.S. CLS. 23, 28 AND 44). FIRST USE 3-31-2002; IN COMMERCE 3-31-2002.

CLASS 10—MEDICAL APPARATUS

FOR NON-ELECTRIC MASSAGERS (U.S. CLS. 26, 39 AND 44). FIRST USE 3-31-2002; IN COMMERCE 3-31-2002.

SN 78-211,822. ARIZANT HEALTHCARE INC., EDEN PRAIRIE, MN. FILED 2-6-2003.

**CLASS 20—FURNITURE AND ARTICLES NOT OTHERWISE CLASSIFIED**

FOR INFLATABLE BATH PILLOWS AND FOAM TOE SEPARATORS FOR USE IN PEDICURES (U.S. CLS. 2, 13, 22, 25, 32 AND 50). FIRST USE 3-31-2002; IN COMMERCE 3-31-2002.

CLASS 21—HOUSEWARES AND GLASS

FOR BATH BRUSHES, BATH SPONGES, NAIL BRUSHES, FOOT EXFOLIATING PADS AND BODY SCRUBBING PUFFS (U.S. CLS. 2, 13, 23, 29, 30, 33, 40 AND 50). FIRST USE 3-31-2002; IN COMMERCE 3-31-2002.

CLASS 5—PHARMACEUTICALS

FOR WOUND COVERS; WARMING SYSTEMS FOR WOUNDS CONSISTING PRIMARILY OF WOUND COVERS IN THE NATURE OF BANDAGES FOR WARMING AND PROTECTING WOUNDS. (U.S. CLS. 6, 18, 44, 46, 51 AND 52).

CLASS 24—FABRICS

FOR WASH CLOTHS, WASHING MITTS AND BODY WASHING STRAPS (U.S. CLS. 42 AND 50). FIRST USE 3-31-2002; IN COMMERCE 3-31-2002.

CLASS 10—MEDICAL APPARATUS

FOR MEDICAL APPARATUS FOR HUMAN AND VETERINARY USE, NAMELY, BODY TEMPERATURE MANAGEMENT PRODUCTS COMPRISING FORCED AIR WARMING AND COOLING SYSTEMS FOR PATIENTS, BLOOD AND IV FLUIDS THAT PRIMARILY CONSIST OF A THERMAL UNIT, HOSE, TUBING, BODY COVER, BLANKET OR PATIENT GARMENT AND CONTROLS THEREFOR; FLUID AND BLOOD WARMING DEVICES AND DISPOSABLE ADMINISTRATION SETS; MEDICAL APPARATUS FOR WOUND MANAGEMENT, NAMELY WARMING SYSTEMS FOR WOUNDS THAT PRIMARILY CONSIST OF A WOUND COVER, A THERMAL UNIT, A TEMPERATURE CONTROL UNIT, A POWER SOURCE AND CONTROLS THEREFOR, AND WOUND COVERS SOLD FOR USE AS A COMPONENT OF A WOUND THERAPY SYSTEM CONSISTING PRIMARILY OF A WOUND COVER, A THERMAL UNIT, A TEMPERATURE CONTROL UNIT, A POWER SOURCE, AND CONTROLS THEREFOR. (U.S. CLS. 26, 39 AND 44).

CLASS 25—CLOTHING

FOR CLOTHING, NAMELY COTTON GLOVES FOR USE AFTER APPLYING MOISTURIZING LOTIONS, COTTON BOOTIES FOR USE AFTER APPLYING MOISTURIZING LOTIONS AND SLEEP MASKS (U.S. CLS. 22 AND 39). FIRST USE 3-31-2002; IN COMMERCE 3-31-2002.

SN 78-213,632. MARKETING AND CREATIVE SALES, INC., CHESTERFIELD, MO. FILED 2-11-2003.

FETCH AND REWARD**CLASS 28—TOYS AND SPORTING GOODS**

FOR PET TOYS (U.S. CLS. 22, 23, 38 AND 50).

CLASS 31—NATURAL AGRICULTURAL PRODUCTS

FOR PET FOOD (U.S. CLS. 1 AND 46).

SN 78-250,700. ZIFF DAVIS PUBLISHING HOLDINGS INC., NEW YORK, NY. FILED 5-16-2003.

SN 78-219,056. MAGASCHONI APPAREL GROUP, INC., NEW YORK, NY. FILED 2-26-2003.

MAKE COOL STUFF WORK

M-A-G BY MAGASCHONI

CLASS 18—LEATHER GOODS

FOR CLUTCHES, SHOULDER BAGS, PURSES, HAND BAGS, COSMETIC BAGS SOLD EMPTY, TOTE BAGS, SADDLE BAGS, BACKPACKS, GYM BAGS, DUFFLE BAGS, TRAVEL BAGS, ROLL BAGS, SLING BAGS, COIN PURSES, DRAWSTRING POUCHES, OVERNIGHT BAGS, WALLETS AND KEY CASES (U.S. CLS. 1, 2, 3, 22 AND 41).

CLASS 16—PAPER GOODS AND PRINTED MATTER

FOR PRINT PUBLICATIONS, NAMELY, MAGAZINES IN THE FIELDS OF TECHNOLOGY, COMPUTERS AND COMPUTING (U.S. CLS. 2, 5, 22, 23, 29, 37, 38 AND 50).

CLASS 41—EDUCATION AND ENTERTAINMENT

FOR ONLINE PUBLICATIONS, NAMELY, ONLINE MAGAZINES IN THE FIELDS OF TECHNOLOGY, COMPUTERS AND COMPUTING (U.S. CLS. 100, 101 AND 107).

CLASS 25—CLOTHING

FOR FOOTWEAR (U.S. CLS. 22 AND 39).

* * * * *

SECTION 2.— INTERNATIONAL CLASSIFICATION

The short titles associated below with the international class numbers are terms designed merely for quick identification and are not an official part of the international classification. The full names of international classes are given in section 6.1 of the trademark rules of practice.

The designation "U.S. Cl." appearing in this section refers to the U.S. class in effect prior to Sep. 1, 1973 rather than the international class which applies to applications filed on or after that date. For adoption of international classification see notice in the OFFICIAL GAZETTE of Jun. 26, 1973 (911 O.G. TM 210).

Application in one class

CLASS 1—CHEMICALS

SN 75-473,142. FMC CORPORATION, PHILADELPHIA, PA.
FILED 4-23-1998.

DURAMIDE

FOR GELS USED IN ELECTROPHORESIS PROCEDURES (U.S. CLS. 1, 5, 6, 10, 26 AND 46).
FIRST USE 6-18-2002; IN COMMERCE 6-18-2002.

SN 75-896,497. FURFURAL ESPAROL, S.A., 30820 ALCANTARILLA (MURCIA), SPAIN, FILED 1-11-2000.



THE STIPPLING IN THE DRAWING APPEARS TO BE FOR SHADING PURPOSES ONLY.

FOR INDUSTRIAL CHEMICAL PRODUCTS FOR SCIENCE, NAMELY, CELLS FOR SCIENTIFIC, LABORATORY OR MEDICAL RESEARCH; REAGENTS FOR SCIENTIFIC OR MEDICAL RESEARCH USE; INDUSTRIAL CHEMICAL PRODUCTS FOR PHOTOGRAPHY NAMELY, PHOTOGRAPHIC CHEMICALS; UNEXPOSED PHOTOGRAPHIC FILM, SENSITIZED PHOTOGRAPHIC FILM, SODIUM HYPOSULFATE FOR AGRICULTURAL AND HORTICULTURAL USE; CHARCOAL FOR HORTICULTURAL PURPOSES; FERTILIZERS FOR HORTICULTURE; PLANT PROTECTION SOLUTIONS USED TO KILL BACTERIA FOR AGRICULTURAL AND HORTICULTURAL USE; SOIL CONDITIONING COMPOSITIONS; TREE FERTILIZERS FOR FORESTRY USE; ARTIFICIAL RESINS IN RAW STATE FOR USE IN THE MANUFACTURE OF ADHESIVES, PAINTS, COSMETICS AND PLASTIC MOLDING COMPOUNDS; ARTIFICIAL RESINS FOR MOLDING AND INJECTION MOLDING PURPOSES; RAW PLASTIC MOLDING COMPOUNDS FOR USE IN PLASTIC EXTRUSION OPERATIONS; RAW PLASTIC MOLDING COMPOUNDS FOR USE IN THE MANUFACTURE OF MOLDED PLASTIC ARTICLES; RAW PLASTIC MOLDING COMPOUNDS FOR USE IN THE MANUFACTURE OF PLASTIC SHEETS AND FILMS, POLYURETHANE FOAM FORMING COMPOSITIONS FOR AGRICULTURAL AND HORTICULTURAL USE; SOIL FERTILIZERS FOR DOMESTIC AND AGRICULTURAL USE; CHEMICAL ADJUVANTS FOR USE WITH PESTICIDES; SOIL CONDITIONERS FOR HORTICULTURAL USE; PEAT; PLANT FOOD; PHOSPHATE FERTILIZERS IN AGRICULTURAL AND HORTICULTURAL USE; NITROGEN

CLASS 1—(Continued).

FERTILIZERS IN AGRICULTURAL AND HORTICULTURAL USE; CALCIUM FERTILIZERS IN AGRICULTURAL AND HORTICULTURAL USE, POTASSIUM FERTILIZERS IN AGRICULTURAL AND HORTICULTURAL USE; FIRE EXTINGUISHING COMPOSITIONS; CHEMICAL PREPARATIONS USED TO TEMPER METAL AND FOR USE IN METAL WELDING; SOLDERING CHEMICALS; CHEMICAL PRODUCTS FOR THE PRESERVATION OF FOOD, NAMELY, MOLD INHIBITOR FOR USE IN THE PRESERVATION OF FOOD, MOLD INHIBITOR FOR FOOD; CHEMICAL FOOD PRESERVATIVES; ADHESIVES FOR USE IN THE MANUFACTURE OF FURNITURE, ADHESIVES FOR USE IN THE MANUFACTURE OF PLYWOOD, ADHESIVES FOR USE IN THE MANUFACTURE OF WALL COVERINGS, ADHESIVES FOR APPLYING WALL COVERINGS, ADHESIVES FOR APPLYING FLOOR TILES, ADHESIVES FOR USE IN THE MANUFACTURE OF SURGICAL BANDAGES, ADHESIVES FOR USE IN THE BINDING BOOKS; ADHESIVES FOR USE IN CONSTRUCTION INDUSTRIES; ADHESIVES FOR USE IN INTERIOR DECORATING; ADHESIVES FOR USE IN TRANSPORTATION INDUSTRIES; ADHESIVES FOR THE GARMENT INDUSTRIES; ADHESIVES FOR THE PAPER PROCESSING INDUSTRIES; ADHESIVES FOR USE PRODUCTION OF LAMINATES; ADHESIVES USED IN PACKAGING INDUSTRY; ADHESIVE CEMENTS FOR RUBBER ATTACHMENT FOR USE IN CONSTRUCTION INDUSTRIES; EPOXY GLUE FOR GENERAL BONDING AND REPAIR PURPOSES; INULIN FOR USE AS RAW MATERIAL IN THE MANUFACTURE OF OTHER GOODS (U.S. CLS. 1, 5, 6, 10, 26 AND 46).

SN 76-124,307. CP KELCO U.S., INC., WILMINGTON, DE.
FILED 9-8-2000.

CP KELCO

FOR CHEMICAL INGREDIENTS USED IN FURTHER MANUFACTURE IN THE PERSONAL CARE INDUSTRY, NAMELY, CARRAGEENAN, GELLAN GUM, PECTIN AND XANTHAN GUM (U.S. CLS. 1, 5, 6, 10, 26 AND 46).

CLASS 1—(Continued).

SN 76-124,308. CP KELCO U.S., INC., WILMINGTON, DE.
FILED 9-8-2000.

CP KELCO

OWNER OF U.S. REG. NOS. 47,888, 2,264,747 AND OTHERS.

FOR CHEMICAL INGREDIENTS USED IN FURTHER MANUFACTURE IN THE AGROCHEMICAL, CONSTRUCTION, OIL FIELD, OTHER INDUSTRIAL FIELDS, AND PHARMACEUTICALS, NAMELY, CARRAGEENAN, GELLAN GUM, PECTIN AND XANTHAN GUM (U.S. CLS. 1, 5, 6, 10, 26 AND 46).

SN 76-124,310. CP KELCO U.S., INC., WILMINGTON, DE.
FILED 9-8-2000.



OWNER OF U.S. REG. NOS. 407,888, 865,849 AND 2,264,747.

FOR CHEMICAL INGREDIENTS USED IN FURTHER MANUFACTURE IN THE PERSONAL CARE INDUSTRY, NAMELY, CARRAGEENAN, GELLAN GUM, PECTIN AND XANTHAN GUM (U.S. CLS. 1, 5, 6, 10, 26 AND 46).

SN 76-124,311. CP KELCO U.S., INC., WILMINGTON, DE.
FILED 9-8-2000.

CP KELCO

FOR INGREDIENTS USED IN THE MANUFACTURE OF FOOD, NAMELY UNPROCESSED CELLULOSE DERIVATIVES (U.S. CLS. 1, 5, 6, 10, 26 AND 46).

SN 76-124,417. CP KELCO U.S., INC., WILMINGTON, DE.
FILED 9-8-2000.



FOR CHEMICAL INGREDIENTS USED IN THE MANUFACTURE OF FOODS, NAMELY, CARRAGEENAN, GELLAN GUM, PECTIN, XANTHAN GUM, WHY AND CELLULOSE DERIVATIVES (U.S. CLS. 1, 5, 6, 10, 26 AND 46).

CLASS 1—(Continued).

SN 76-125,073. CP KELCO U.S., INC., WILMINGTON, DE.
FILED 9-8-2000.



OWNER OF U.S. REG. NOS. 407,888, 2,264,747 AND OTHERS.

FOR CHEMICAL INGREDIENTS USED IN FURTHER MANUFACTURE IN THE AGROCHEMICAL, CONSTRUCTION, OIL FIELD AND OTHER INDUSTRIAL FIELDS AND PHARMACEUTICALS, NAMELY, CARRAGEENAN, GELLAN GUM, PECTIN AND XANTHAN GUM (U.S. CLS. 1, 5, 6, 10, 26 AND 46).

SN 76-179,153. JOHNSON MATTHEY PLC, LONDON, SW1
5BQ, UNITED KINGDOM, FILED 12-12-2000.

PUREGUARD

FOR CHEMICALS FOR USE IN INDUSTRY, NAMELY SEMICONDUCTOR FABRICATION, HEAT TREATING ATMOSPHERES, ISOTOPE SEPARATION, MANUFACTURING PROCESSES AND RESEARCH AND DEVELOPMENT; CHEMICAL PREPARATIONS FOR ABSORBING AND REACTING WITH MINOR GASEOUS IMPURITIES IN GASES FOR INDUSTRIAL MANUFACTURING; CHEMICAL GETTERS FOR USE IN REMOVING GASEOUS IMPURITIES FROM GASES IN SEMICONDUCTOR FABRICATION, HEAT TREATING ATMOSPHERES, ISOTOPE SEPARATION, MANUFACTURING PROCESSES AND RESEARCH AND DEVELOPMENT; CATALYSTS AND ABSORBENTS FOR USE IN REMOVING GASEOUS IMPURITIES FROM GASES IN SEMICONDUCTOR FABRICATION, HEAT TREATING ATMOSPHERES, ISOTOPE SEPARATION, MANUFACTURING PROCESSES AND RESEARCH AND DEVELOPMENT; AND METAL CONTAINERS, SOLD FULL, CONTAINING CHEMICALS FOR ABSORBING AND REACTING WITH MINOR GASEOUS IMPURITIES IN GASES FOR INDUSTRIAL MANUFACTURING (U.S. CLS. 1, 5, 6, 10, 26 AND 46).

SN 76-320,437. SEPREX (SA), CHAMPIGNEULLES,
FRANCE, FILED 10-1-2001.

CYCLOTRIN

PRIORITY CLAIMED UNDER SEC. 44(D) ON FRANCE APPLICATION NO. 309215701, FILED 3-29-2001, REG. NO. 013092157, DATED 3-29-2001, EXPIRES 3-28-2011.

FOR FOOD CHEMICALS, DIETETIC, COSMETIC, DERMATOLOGY, PHARMACY, HUMAN OR VETERINARY, INCORPORATION MOLECULES HOSTS, FOR EXAMPLE CYCLODEXTRINS MODIFIED OR NOT WITH CHEMICALS, FOR WITHIN OF WHICH ARE INSERTED MOLECULES INTEREST FOOD, DIETETIC, COSMETIC, DERMATOLOGICAL OR PHARMACEUTICAL PRODUCTS INCORPORATING MOLECULES HOSTS, FOR EXAMPLE CYCLODEXTRINS MODIFIED OR NOT WITH CHEMICALS, FOR WITHIN OF WHICH ARE INSERTED MOLECULES INTEREST COSMETIC, DERMATOLOGICAL OR PHARMACEUTICAL, INTENDED FOR COSMETIC, DERMATOLOGY, PHARMACY, HUMAN OR VETERINARY (U.S. CLS. 1, 5, 6, 10, 26 AND 46).

CLASS 1—(Continued).

SN 76-321,153. E.O.U.I.P. INTERNATIONAL INC., BAIE D'URFE, QUEBEC, CANADA, FILED 10-3-2001.

PAPEO

PRIORITY CLAIMED UNDER SEC. 44(D) ON CANADA APPLICATION NO. 1098965, FILED 4-6-2001, REG. NO. TMA580056, DATED 4-29-2003, EXPIRES 4-29-2018.

THE MARK "PAPEO" IS NOT A WORD IN ANY LANGUAGE AND DOES NOT HAVE AN ENGLISH TRANSLATION.

FOR POLYETHYLENE OXIDE BASED CHEMICALS FOR USE AS A RETENTION AID ON PAPER MAKING MACHINES (U.S. CLS. 1, 5, 6, 10, 26 AND 46).

SN 76-358,742. C.P. HALL COMPANY, THE, CHICAGO, IL. FILED 1-15-2002.

HALLBRITE SPECTRASOLV

OWNER OF U.S. REG. NO. 2,090,138.
FOR SOLVENTS AND EMOLLIENTS FOR USE AS INGREDIENTS IN THE MANUFACTURE OF COMPOSITIONS THAT ARE TOPICALLY APPLIED TO THE SKIN, SUCH AS SUNSCREENS, ANTIPERSPIRANTS, AND DEODORANTS (U.S. CLS. 1, 5, 6, 10, 26 AND 46).

SN 76-358,743. C.P. HALL COMPANY, THE, CHICAGO, IL. FILED 1-15-2002.

SPECTRASOLV

FOR SOLVENTS AND EMOLLIENTS FOR USE AS INGREDIENTS IN THE MANUFACTURE OF COMPOSITIONS THAT ARE TOPICALLY APPLIED TO THE SKIN, SUCH AS SUNSCREENS, ANTIPERSPIRANTS, AND DEODORANTS (U.S. CLS. 1, 5, 6, 10, 26 AND 46).

SN 76-412,777. CENTRAL WELDING SUPPLY, INC., LYNNWOOD, MA. FILED 5-22-2002.

XPRESS CRYOGENICS

NO CLAIM IS MADE TO THE EXCLUSIVE RIGHT TO USE "CRYOGENICS", APART FROM THE MARK AS SHOWN.

FOR SPECIALTY AND HIGH PURITY BULK GASES FOR THE BIOTECHNOLOGY INDUSTRY, LABORATORY RESEARCH, ELECTRONICS MANUFACTURING, AND HIGH-DEFINITION LASER-CUTTING APPLICATIONS (U.S. CLS. 1, 5, 6, 10, 26 AND 46).

FIRST USE 1-1-2002; IN COMMERCE 1-1-2002.

CLASS 1—(Continued).

SN 76-414,129. BJ SERVICES COMPANY, U.S.A., HOUSTON, TX. BY ASSIGNMENT OSCA, INC., LAFAYETTE, LA. FILED 5-30-2002.



FOR CHEMICALS FOR USE IN OIL AND GAS RECOVERY, NAMELY, POLYMER AND NON-POLYMER BASED FRACTURING FLUIDS, DRILL-IN FLUIDS, WORKOVER FLUIDS AND SAND CONTROL FLUIDS; CHEMICAL ADDITIVES, NAMELY, CORROSION INHIBITORS, SCALE INHIBITORS, BIOCIDES, SURFACTANTS, LOST CIRCULATION MATERIALS AND DEFOAMERS (U.S. CLS. 1, 5, 6, 10, 26 AND 46).

FIRST USE 12-0-1983; IN COMMERCE 12-0-1983.

SN 76-435,422. ETABLISSEMENTS V.MANE FILS, 06620 LE BAR-SUR-LOUP, FRANCE, FILED 7-24-2002.

AMBRONE

PRIORITY CLAIMED UNDER SEC. 44(D) ON FRANCE APPLICATION NO. 023144097, FILED 1-28-2002, REG. NO. 023144097, DATED 1-28-2002, EXPIRES 1-28-2012.

FOR CHEMICALS FOR USE IN THE MANUFACTURE OF COSMETICS AND PERFUMERY (U.S. CLS. 1, 5, 6, 10, 26 AND 46).

SN 76-436,474. QUIKRETE COMPANIES, INC., THE, ATLANTA, GA. FILED 7-29-2002.

SPRAYWELD

FOR SOLVENT COMPOSITION, NAMELY, SOLVENT WELD CEMENT FOR JOINING PVC, CPVC AND ABS PLASTIC PIPES AND FITTINGS (U.S. CLS. 1, 5, 6, 10, 26 AND 46).

SN 76-443,176. ATOTECH DEUTSCHLAND GMBH, 10553 BERLIN, FED REP GERMANY, FILED 8-23-2002.

AUROCOR

OWNER OF FED REP GERMANY REG. NO. 853,114, DATED 12-19-1968, EXPIRES 1-31-2008.

FOR FINE GOLD BATH FOR QUALITY FINE GOLD PLATING ON SINGLE PIECES OR BULK LOTS (U.S. CLS. 1, 5, 6, 10, 26 AND 46).

CLASS 1—(Continued).

SN 76-456,060. ANATRACE, INC., MAUMEE, OH. FILED 10-4-2002.

ANZERGENT

FOR CHEMICALS, NAMELY, A GROUP OF DETERGENTS THAT LACK CONDUCTIVITY IN SOLUTION, LACK ELECTROPHORETIC MOBILITY, DO NOT POSSESS A NET CHARGE AND DO NOT BIND TO ION EXCHANGE POLYMERS, FOR USE IN SCIENTIFIC RESEARCH (U.S. CLS. 1, 5, 6, 10, 26 AND 46).

FIRST USE 1-14-2000; IN COMMERCE 8-24-2000.

SN 76-456,061. ANATRACE, INC., MAUMEE, OH. FILED 10-4-2002.

ANAMEG

FOR CHEMICALS FOR BIOLOGICAL RESEARCH USE, NAMELY, METHYL-6-0-(N-HEPTYCARBAMOYLX-D)-GLUCOPYRANOSIDE, USEFUL AS A SURFACE ACTIVE AGENT IN THE BIOLOGICAL SCIENCES (U.S. CLS. 1, 5, 6, 10, 26 AND 46).

FIRST USE 7-14-1998; IN COMMERCE 8-18-1998.

SN 76-456,062. ANATRACE, INC., MAUMEE, OH. FILED 10-4-2002.

CYFOS

FOR DIAGNOSTIC REAGENTS, NAMELY, DETERGENTS FOR USE IN BIOLOGICAL AND BIOCHEMICAL SCIENTIFIC RESEARCH, COMBINING A PHOSPHOLIPID HEAD GROUP WITH AN ALIPHATIC TAIL CONTAINING A CYCLOHEXYL GROUP (U.S. CLS. 1, 5, 6, 10, 26 AND 46).

FIRST USE 2-15-1999; IN COMMERCE 6-22-2000.

SN 76-460,543. SCHILL & SEILACHER "STRUKTOL" AKTIENGESELLSCHAFT, D-22113 HAMBURG, FED REP GERMANY, FILED 10-10-2002.

PERMALEASE

FOR CHEMICALS USED IN INDUSTRY, NAMELY RELEASE AGENTS FOR USE IN THE RUBBER, PLASTIC AND METAL PROCESSING INDUSTRY (U.S. CLS. 1, 5, 6, 10, 26 AND 46).

FIRST USE 4-0-1992; IN COMMERCE 7-0-1995.

SN 76-471,910. HPI PRODUCTS CORP, ASTON, PA. FILED 12-3-2002.

PANEL-TAC

FOR ADHESIVE SPRAY FOR USE ON CONCRETE (U.S. CLS. 1, 5, 6, 10, 26 AND 46).

FIRST USE 9-23-2002; IN COMMERCE 9-25-2002.

CLASS 1—(Continued).

SN 76-485,745. SONOTECH, INC., BELLINGHAM, WA. FILED 1-27-2003.

SONOGLIDE

FOR LIQUID ULTRASONIC COUPLANT FOR USE IN NONDESTRUCTIVE TESTING (U.S. CLS. 1, 5, 6, 10, 26 AND 46).

FIRST USE 10-1-1997; IN COMMERCE 10-1-1997.

SN 76-498,094. MIDWESTERN BIO-AG PRODUCTS & SERVICES, INC., BLUE MOUNDS, WI. FILED 2-11-2003.

FERTICAL

FOR BLENDED AND PELLETIZED CALCIUM PRODUCT TO BE USED AS A SOIL AMENDMENT AND FERTILIZER FOR AGRICULTURAL USE (U.S. CLS. 1, 5, 6, 10, 26 AND 46).

SN 78-025,308. SARTOMER TECHNOLOGY COMPANY, INC., EXTON, PA. FILED 9-11-2000.

SARCURE

FOR CHEMICALS, NAMELY, PHOTOINITIATORS FOR USE IN THE FURTHER MANUFACTURE OF INKS, ADHESIVES, COATINGS, PLASTICS, AND ELASTOMERS (U.S. CLS. 1, 5, 6, 10, 26 AND 46).

SN 78-107,911. CIBA SPECIALTY CHEMICALS CORPORATION, TARRYTOWN, NY. FILED 2-11-2002.

PERGASPEED

FOR CHEMICALS USED IN THE PAPER INDUSTRY NAMELY, SENSITIZERS, DEVELOPERS, STABILIZERS FOR PRODUCTION AND OUTFITTING OF PAPER, AND HEAT SENSITIVE/THERMAL PAPER (U.S. CLS. 1, 5, 6, 10, 26 AND 46).

SN 78-140,821. PROTOMETRIX, INC., GUILFORD, CT. FILED 7-2-2002.

PROTOARRAY

FOR ARRAY OF PROTEINS ON A SURFACE FOR SCIENTIFIC OR MEDICAL RESEARCH USE (U.S. CLS. 1, 5, 6, 10, 26 AND 46).

CLASS 1—(Continued).

SN 78-148,898. GENERAL ELECTRIC COMPANY, SCHE-
NECTADY, NY. FILED 7-30-2002.

GENOX

FOR CHEMICAL ADDITIVES, NAMELY POLYMER
ADDITIVES FOR PLASTIC RESINS FOR USE IN THE
MANUFACTURE OF A WIDE VARIETY OF GOODS IN
THE PLASTICS AND CHEMICAL INDUSTRIES (U.S.
CLS. 1, 5, 6, 10, 26 AND 46).

FIRST USE 1-1-2001; IN COMMERCE 1-1-2001.

SN 78-153,088. PRAIRIE NORTH INCORPORATED, EDEN
PRAIRIE, MN. FILED 8-11-2002.

SPIRIT PFC

FOR CHEMICAL ADDITIVES FOR FUEL TREAT-
MENT, NAMELY, FUEL CATALYST AND PURIFICA-
TION USED FOR GASOLINE AND DIESEL FUELS (U.S.
CLS. 1, 5, 6, 10, 26 AND 46).

FIRST USE 2-24-2000; IN COMMERCE 2-24-2000.

SN 78-157,447. BECKMAN COULTER, INC., FULLERTON,
CA. FILED 8-23-2002.

AccuTnI

FOR IMMUNODIAGNOSTIC REAGENT KITS (U.S.
CLS. 1, 5, 6, 10, 26 AND 46).

FIRST USE 6-8-2001; IN COMMERCE 6-8-2001.

SN 78-166,875. ASSOCIATES OF CAPE COD, INC., FAL-
MOUTH, MA. FILED 9-23-2002.

PYROSATE

OWNER OF U.S. REG. NOS. 1,069,662, 1,977,362 AND
OTHERS.

FOR LIMULUS AMEBOCYTE LYSATE KIT FOR THE
DETECTION OF BACTERIAL ENDOTOXINS IN WATER
AND DIALYSATE (U.S. CLS. 1, 5, 6, 10, 26 AND 46).

SN 78-183,128. ALOHA PETROLEUM, LTD., HONOLULU,
HI. FILED 11-8-2002.

POWER KING

FOR CHEMICAL PETROLEUM FUEL ADDITIVES
FOR GASOLINE, DIESEL, AND OTHER FUELS (U.S.
CLS. 1, 5, 6, 10, 26 AND 46).

CLASS 1—(Continued).

SN 78-186,949. REXIUS FOREST BY-PRODUCTS, INC.,
EUGENE, OR. FILED 11-20-2002.

ECOBLANKET

FOR GROUND COVERING IN THE NATURE OF A
MIXTURE COMPOSED PRIMARILY OF COMPOST,
MULCH, FIBER, AND OTHER MATERIAL CONTAIN-
ING ORGANIC MATTER FOR USE IN CONTAINING
AND CONTROLLING SOIL EROSION AND SEDIMENT
AND POLLUTANT RUNOFF, MOST COMMONLY USED
IN THE LANDSCAPING, CONSTRUCTION, AGRICUL-
TURE, FARMING, EROSION CONTROL AND STORM
WATER MANAGEMENT, AND ENVIRONMENTAL
PROTECTION AND REMEDIATION INDUSTRIES (U.S.
CLS. 1, 5, 6, 10, 26 AND 46).

FIRST USE 10-15-2001; IN COMMERCE 10-15-2001.

SN 78-187,934. ONA ELECTRO-EROSION, S.A., DURANGO
(VIZCAYA), SPAIN, FILED 11-22-2002.



FOR CHEMICALS FOR USE IN THE MANUFACTURE
OF DIELECTRICS AND ACIDS FOR USE IN AN
ELECTROERODING PROCESS (U.S. CLS. 1, 5, 6, 10, 26
AND 46).

FIRST USE 7-0-2001; IN COMMERCE 3-0-2002.

SN 78-193,925. GRANDE CHEESE COMPANY, BROWNS-
VILLE, WI. FILED 12-12-2002.

**WPC ... THE WHEY NATURE
INTENDED**

NO CLAIM IS MADE TO THE EXCLUSIVE RIGHT TO
USE "WPC", APART FROM THE MARK AS SHOWN.

FOR LACTOSE, DRY WHEY, REDUCED LACTOSE
WHEY, WHEY PROTEIN CONCENTRATE FOR USE IN
THE MANUFACTURE OF FOODS, MEDICINES, AND
ANIMAL FOODSTUFFS (U.S. CLS. 1, 5, 6, 10, 26 AND 46).

FIRST USE 1-17-2003; IN COMMERCE 1-17-2003.

SN 78-197,160. TRENHOLM, JEFFREY SCOTT, EAST WIND-
SOR, NJ. FILED 12-22-2002.

**JT'S MEGA-STEAM SMOKE
FLUID**

NO CLAIM IS MADE TO THE EXCLUSIVE RIGHT TO
USE "SMOKE FLUID", APART FROM THE MARK AS
SHOWN.

FOR SMOKE GENERATING FLUID FOR USE WITH
MODEL TRAINS (U.S. CLS. 1, 5, 6, 10, 26 AND 46).

FIRST USE 10-10-2002; IN COMMERCE 10-10-2002.

CLASS 1—(Continued).

SN 78-200,831. WEYERHAEUSER COMPANY, FEDERAL WAY, WA. FILED 1-7-2003.

ARBORITE

FOR CHEMICALS, NAMELY, FERTILIZERS FOR AGRICULTURAL USE (U.S. CLS. 1, 5, 6, 10, 26 AND 46).

SN 78-205,943. BECTON, DICKINSON AND COMPANY, FRANKLIN LAKES, NJ. FILED 1-22-2003.



FOR CHEMICAL AND BIOLOGICAL REAGENTS AND PREPARED LABORATORY MEDIA FOR SCIENTIFIC PURPOSES (U.S. CLS. 1, 5, 6, 10, 26 AND 46).
FIRST USE 4-30-2000; IN COMMERCE 4-30-2000.

SN 78-206,496. M & G USA CORPORATION, APPLEROVE, WV. FILED 1-23-2003.

REPETE

FOR POLYESTER RESINS FOR USE IN THE MANUFACTURE OF PLASTIC CONTAINERS, SHEETS AND FILMS (U.S. CLS. 1, 5, 6, 10, 26 AND 46).
FIRST USE 5-2-2002; IN COMMERCE 5-2-2002.

SN 78-207,542. ROXLOR, LLC, WILMINGTON, DE. FILED 1-27-2003.

BAKEFLORA

OWNER OF U.S. REG. NO. 2,550,365.
FOR PRE-BIOTIC DIETARY FIBERS USED IN THE MANUFACTURE OF NUTRITIONAL PRODUCTS FOR ADULTS AND CHILDREN, DIETARY SUPPLEMENTS, AND PHARMACEUTICAL AND VETERINARY AND FOOD PRODUCTS (U.S. CLS. 1, 5, 6, 10, 26 AND 46).
FIRST USE 9-9-2002; IN COMMERCE 9-9-2002.

SN 78-208,250. QUELLZ PRODUCTS, INC., DAYTON, OH. FILED 1-29-2003.

QUELLZ

FOR ENZYMATIC COMPOSITION FOR USE IN WASTE DISPOSAL APPLICATIONS (U.S. CLS. 1, 5, 6, 10, 26 AND 46).
FIRST USE 2-19-2000; IN COMMERCE 2-19-2000.

CLASS 1—(Continued).

SN 78-208,392. W.R. GRACE & CO.-CONN., COLUMBIA, MD. FILED 1-29-2003.

ESE

FOR CHEMICAL ADDITIVES FOR USE IN PROCESSING CEMENT AND IMPROVING THE QUALITY. (U.S. CLS. 1, 5, 6, 10, 26 AND 46).

SN 78-210,645. M & G USA CORPORATION, SHARON CENTER, OH. FILED 2-4-2003.

ACTITUF

FOR POLYESTER RESINS FOR USE IN THE MANUFACTURE OF PLASTIC CONTAINERS, SHEETS AND FILMS (U.S. CLS. 1, 5, 6, 10, 26 AND 46).

CLASS 2—PAINTS

SN 76-414,852. DAIKIN INDUSTRIES, LTD., OSAKA, JAPAN, FILED 5-30-2002.

FTONE

PRIORITY CLAIMED UNDER SEC. 44(D) ON JAPAN APPLICATION NO. 2002-29103, FILED 4-10-2002, REG. NO. 4650746, DATED 3-7-2003, EXPIRES 3-7-2013.

FOR FLUORO-COATINGS FOR STONE, CONCRETE OR BRICKS PROTECTION; EXTERIOR PAINTS; VARNISHES AND LACQUERS IN THE NATURE OF COATINGS (U.S. CLS. 6, 11 AND 16).

SN 76-417,760. MOTOR CITY FLOORING, L.L.C., DETROIT, MI. FILED 6-5-2002.

MUSCLEFLECK

FOR FLOOR COATINGS FOR PROVIDING DECORATIVE AND ANTI-SLIP SURFACE (U.S. CLS. 6, 11 AND 16).
FIRST USE 8-0-2001; IN COMMERCE 8-0-2001.

CLASS 2—(Continued).

SN 76-434,436. BASF CORPORATION, MOUNT OLIVE, DE.
FILED 7-24-2002.



THE MARK CONSISTS OF THE LETTERS "ECO" AND THE NUMBER "2" AND THE WORDS "ECOLOGY" AND "ECONOMY" PLACED ON A WATER DROPLET DESIGN WITHIN A BACKGROUND CIRCLE.

FOR PAINTS FOR USE IN THE AUTOMOTIVE INDUSTRY; COATINGS FOR USE IN AUTOMOBILE FINISHING (U.S. CLS. 6, 11 AND 16).

SN 76-469,940. FAUX EFFECTS INC., VERO BEACH, FL.
FILED 11-25-2002.

AQUA FINISHING SOLUTIONS

NO CLAIM IS MADE TO THE EXCLUSIVE RIGHT TO USE "FINISHING SOLUTIONS", APART FROM THE MARK AS SHOWN.

FOR DECORATIVE COMPOSITIONS AND FINISHES (U.S. CLS. 6, 11 AND 16).

FIRST USE 0-0-1993; IN COMMERCE 0-0-1993.

SN 78-210,150. THE FLOOD COMPANY, HUDSON, OH.
FILED 2-3-2003.

FLOOD... IT PENETRATES, IT STICKS, IT LASTS.

FOR PAINT ADDITIVES; COATINGS IN THE NATURE OF EXTERIOR WOOD FINISHES; PRIMERS FOR PREPARING SURFACES TO BE PAINTED (U.S. CLS. 6, 11 AND 16).

CLASS 2—(Continued).

SN 78-210,154. THE FLOOD COMPANY, HUDSON, OH.
FILED 2-3-2003.

FLOOD... PENETRATION, ADHESION, DURABILITY.

FOR PAINT ADDITIVES; COATINGS IN THE NATURE OF EXTERIOR WOOD FINISHES; PRIMERS FOR PREPARING SURFACES TO BE PAINTED (U.S. CLS. 6, 11 AND 16).

SN 78-215,544. MIKEL AND COMPANY, CANTON, GA.
FILED 2-17-2003.

DR. MOLD SEAL

FOR COATINGS IN THE NATURE OF PRIMER FOR USE ON SURFACES, NAMELY, WALLS, FLOORS, CEILINGS, AND FOR USE IN PAINT (U.S. CLS. 6, 11 AND 16).

FIRST USE 3-0-2002; IN COMMERCE 3-0-2002.

CLASS 3—COSMETICS AND CLEANING PREPARATIONS

SN 76-065,037. ORALENE, INC., NEW YORK, NY. FILED 5-30-2000.

OGO

FOR TOOTH GEL, TOOTH PASTE AND TOOTH POLISH (U.S. CLS. 1, 4, 6, 50, 51 AND 52).

SN 76-119,799. ESTEE LAUDER INC., NEW YORK, NY.
FILED 8-30-2000.

PRIVATE SPA COLLECTION

OWNER OF U.S. REG. NO. 1,019,780.
NO CLAIM IS MADE TO THE EXCLUSIVE RIGHT TO USE "SPA COLLECTION", APART FROM THE MARK AS SHOWN.

FOR BODY OIL, BODY MOISTURIZER, BATH/SHOWER GEL, HAND AND FOOT MASK, DEEP CONDITIONING HAIR MASK, BUBBLING CREME BATH, AND SUGAR SCRUBS (U.S. CLS. 1, 4, 6, 50, 51 AND 52).
FIRST USE 3-1-2001; IN COMMERCE 3-1-2001.

CLASS 3—(Continued).

SN 76-186,765. FOUR-T CORPORATION, PAPILLION, NE.
FILED 12-27-2000.

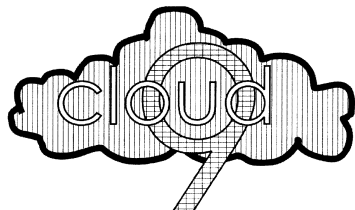

THE CLOUD PORTION OF THE MARK IS LINED FOR THE COLOR RED. THE NUMBER "9" IN THE MARK IS LINED FOR THE COLOR YELLOW. NO CLAIM IS MADE TO COLOR.

THE MARK CONSISTS OF A CLOUD DESIGN AND THE WORDS "CLOUD 9".

FOR INCENSE (U.S. CLS. 1, 4, 6, 50, 51 AND 52).
FIRST USE 12-1-2000; IN COMMERCE 12-1-2000.

SN 76-279,035. ANTONIO BANDERAS LIMITED, JERSEY CHANNEL ISLAND, JE4 8QL, GREAT BRITAIN, FILED 7-2-2001.

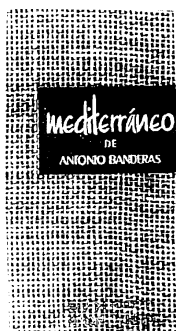

THE LINING IS A FEATURE OF THE MARK AND DOES NOT INDICATE COLOR.

THE NAME IN THE MARK IDENTIFIES A LIVING INDIVIDUAL WHOSE CONSENT IS OF RECORD.

THE ENGLISH TRANSLATION OF "MEDITERRANEO" IS "MEDITERRANEAN".

FOR PERFUME, AFTER SHAVE BALM, AFTER SHAVE LOTION; ESSENTIAL OILS FOR PERSONAL USE; COSMETIC SOAP, TALCUM POWDER, SHAMPOOS AND OTHER HAIR LOTIONS, BATH GELS AND SALTS, BODY DEODORANTS AND TOOTHPASTE (U.S. CLS. 1, 4, 6, 50, 51 AND 52).

SN 76-318,037. BIOTHERM, MC-98000 MONACO, MONACO, FILED 9-20-2001.

DAY OUT

FOR SUN CARE PREPARATIONS, NAMELY, SUN BLOCK PREPARATIONS, AFTER-SUN LOTIONS, SUN CARE LOTIONS, SUN CREAMS, SUN SCREEN PREPARATIONS, AND SUNTANNING PREPARATIONS (U.S. CLS. 1, 4, 6, 50, 51 AND 52).

CLASS 3—(Continued).

SN 76-346,259. CASTER, 75008 PARIS, FRANCE, FILED 12-6-2001.

PHYTOLISSE

OWNER OF FRANCE REG. NO. 1,501,573, DATED 7-3-1998, EXPIRES 7-3-2008.

FOR PERFUMERY PRODUCTS, NAMELY, PERFUME EXTRACT, TOILET WATER; ESSENTIAL OILS FOR PERSONAL USE; COSMETICS; HAIR CARE PRODUCTS, NAMELY, HAIR CREAMS, HAIR LOTIONS, HAIR GELS, HAIR FOAMS, BALMS FOR THE HAIR; SHAMPOOS FOR THE HAIR; HAIR WAVING AND HAIR SETTING PRODUCTS; HAIR SPRAYS; BEAUTY PRODUCTS, NAMELY, SKIN CREAMS AND SKIN LOTIONS (U.S. CLS. 1, 4, 6, 50, 51 AND 52).

SN 76-347,330. JO MALONE LIMITED, LONDON SW11 4XW, ENGLAND, FILED 12-7-2001.

JO MALONE

OWNER OF U.S. REG. NOS. 2,020,243 AND 2,456,668.
FOR COSMETICS (U.S. CLS. 1, 4, 6, 50, 51 AND 52).

SN 76-348,264. BIOTHERM, MC-98000 MONACO, MONACO, FILED 12-12-2001.

HYDRA FLEX

PRIORITY CLAIMED UNDER SEC. 44(D) ON MONACO APPLICATION NO. 01/22,717, FILED 8-9-2001, REG. NO. 23008, DATED 10-30-2001, EXPIRES 8-9-2011.

FOR COSMETICS, NAMELY CREAMS, MILKS, LOTIONS, GELS AND POWDERS FOR THE FACE, THE BODY AND THE HANDS (U.S. CLS. 1, 4, 6, 50, 51 AND 52).

CLASS 3—(Continued).

SN 76-363,247. WELLA CORPORATION, THE, WOODLAND HILLS, CA. BY ASSIGNMENT WELLA AKTIENGESELLSCHAFT, 64274 DARMSTADT, FED REP GERMANY, FILED 1-24-2002.



OWNER OF FED REP GERMANY REG. NO. 30073050, DATED 2-22-2001, EXPIRES 9-30-2010.
OWNER OF U.S. REG. NOS. 575,177, 838,030 AND OTHERS.

NO CLAIM IS MADE TO THE EXCLUSIVE RIGHT TO USE "HAIR", APART FROM THE MARK AS SHOWN.

THE STIPPLING SHOWN IN THE DRAWING IS A FEATURE OF THE MARK AND NOT INTENDED TO INDICATE COLOR.

FOR HAIR CARE PREPARATIONS, NAMELY, SHAMPOOS AND HAIR CONDITIONERS; HAIR STYLING AND FINISHING PRODUCTS, NAMELY, HAIR SPRAYS, SPRAY GELS, MOUSSES, CREAMS, LOTIONS, POMADES AND WAXES; AND HAIR AND SCALP TREATMENTS, NAMELY, RESTRUCTURIZERS AND SCALP CONDITIONERS (U.S. CLS. 1, 4, 6, 50, 51 AND 52).

SN 76-404,979. WALDSTEIN, LAURIE, BEVERLY HILLS, CA. AND ZINBERG, LESLIE, BEVERLY HILLS, CA. FILED 5-8-2002.

PINK AND BLUE

FOR SUN BLOCK, DIAPER SKIN CREAM, DIAPER SKIN OINTMENT, BABY'S BODY WASH FOR THE SKIN, BABY'S MOISTURIZER FOR THE SKIN, AND COLOGNE (U.S. CLS. 1, 4, 6, 50, 51 AND 52).

SN 76-406,052. S & S CAR CARE, NORTH CANTON, OH. FILED 5-6-2002.

EXPRESS WAX

NO CLAIM IS MADE TO THE EXCLUSIVE RIGHT TO USE "WAX", APART FROM THE MARK AS SHOWN.
FOR AUTOMOBILE WAX DIRECTED TO COMMERCIAL USERS (U.S. CLS. 1, 4, 6, 50, 51 AND 52).
FIRST USE 10-17-2001; IN COMMERCE 10-17-2001.

SN 76-410,951. WESTFALIA-SURGE, INC., NAPERVILLE, IL. FILED 5-20-2002.

ACIDSAN

FOR ACID DETERGENT WITH GERMICIDE FOR CLEAN-IN-PLACE, CIP, SYSTEMS ON DAIRY FARMS (U.S. CLS. 1, 4, 6, 50, 51 AND 52).

CLASS 3—(Continued).

SN 76-423,641. L'OREAL, PARIS, FRANCE, FILED 6-24-2002.

COULEUR EXPERTE

NO CLAIM IS MADE TO THE EXCLUSIVE RIGHT TO USE "COULEUR", APART FROM THE MARK AS SHOWN. THE FOREIGN WORDING IN THE MARK TRANSLATES INTO ENGLISH AS "EXPERT COLOR".
FOR HAIR COLOR (U.S. CLS. 1, 4, 6, 50, 51 AND 52).

SN 76-425,178. BIOPRACTIC GROUP II, INC., PHILLIPSBURG, NJ. FILED 6-27-2002.

FOOT MIRACLE

OWNER OF U.S. REG. NOS. 1,558,715, 1,559,497 AND OTHERS.

NO CLAIM IS MADE TO THE EXCLUSIVE RIGHT TO USE "FOOT", APART FROM THE MARK AS SHOWN.
FOR FOOT AND BODY CREAM (U.S. CLS. 1, 4, 6, 50, 51 AND 52).
FIRST USE 10-26-1987; IN COMMERCE 10-26-1987.

SN 76-427,075. NAMASTE LABORATORIES, LLC, BLUE ISLAND, IL. FILED 7-2-2002.

ORGANIC & ROOT Stimulator



OWNER OF U.S. REG. NOS. 2,124,517 AND 2,570,801.
NO CLAIM IS MADE TO THE EXCLUSIVE RIGHT TO USE "ORGANIC", APART FROM THE MARK AS SHOWN. THE MARK CONSISTS IN PART OF THE DESIGN OF SIX RAINDROPS.
SEC. 2(F) AS TO "ORGANIC ROOT STIMULATOR".
FOR HAIR CARE PREPARATIONS (U.S. CLS. 1, 4, 6, 50, 51 AND 52).

CLASS 3—(Continued).

SN 76-429,328. MASAN CORP., MIAMI, FL. FILED 7-10-2002.



OWNER OF U.S. REG. NOS. 1,644,880, 2,208,972 AND 2,222,585.

NO CLAIM IS MADE TO THE EXCLUSIVE RIGHT TO USE "COLONIA" OR "COLOGNE", APART FROM THE MARK AS SHOWN.

THE MARK CONSISTS IN PART OF THE DESIGN OF A MAN IN A TUXEDO HOLDING A COIN, ANOTHER MAN IN A TUXEDO HOLDING PAPER CURRENCY, AND A HAND HOLDING A DOLLAR SIGN.

THE ENGLISH TRANSLATIONS OF "COLONIA" AND "DON DINERO" ARE "COLOGNE" AND "MR. MONEY".

FOR PERFUME, TOILET WATER, COLOGNE (U.S. CLS. 1, 4, 6, 50, 51 AND 52).

FIRST USE 2-25-2002; IN COMMERCE 2-25-2002.

CLASS 3—(Continued).

SN 76-433,139. FAIPA COSMETICS S.R.L., 00040 POMEZIA - ROME, ITALY, FILED 7-19-2002.



FOR HAIR DYES; PREPARATIONS FOR BLEACHING AND OTHER SUBSTANCES FOR WASHING, NAMELY LAUNDRY BLEACH; SOAPS; PERFUMES; ESSENTIAL OILS FOR PERSONAL USE; COSMETICS; HAIR LOTIONS AND DENTIFRICE (U.S. CLS. 1, 4, 6, 50, 51 AND 52).

FIRST USE 5-30-2002; IN COMMERCE 5-30-2002.

SN 76-433,440. SMITH, MINDI, DBA S.L.U.T. COSMETICS, RESEDA, CA. FILED 7-23-2002.

**S.EXY L.OVELY U.NIQUE
T.IMELESS**

SN 76-433,013. FAIPA COSMETICS S.R.L., 00040 POMEZIA - ROME, ITALY, FILED 7-19-2002.

sicura  professional

NO CLAIM IS MADE TO THE EXCLUSIVE RIGHT TO USE "PROFESSIONAL", APART FROM THE MARK AS SHOWN.

FOR HAIR DYES; PREPARATIONS FOR BLEACHING HAIR AND HAIR WASHING PREPARATIONS; ALL PURPOSE CLEANING, POLISHING, GREASE REMOVING AND ABRADING PREPARATIONS; BODY SOAPS; FACE SOAPS; PERFUMERY; ESSENTIAL OILS FOR PERSONAL USE; COSMETICS HAIR LOTIONS; TOOTH PASTE (U.S. CLS. 1, 4, 6, 50, 51 AND 52).

FIRST USE 5-30-2002; IN COMMERCE 5-30-2002.

OWNER OF U.S. REG. NO. 2,421,257.

FOR BEAUTY PRODUCTS, COSMETICS, SKIN CARE PRODUCTS AND ACCESSORIES, NAMELY, LIPSTICKS, LIP GLOSSES/STAINS, NAIL COLORS, EYE SHADOWS, EYE SHADOWS AND EYE SHADOW APPLICATOR/BRUSH, SOLD AS A UNIT, EYE COLOR DUST, EYE LINERS, FOUNDATIONS, CONCEALERS, MAKE-UP COVER STICKS, BLUSHES AND BLUSH APPLICATOR/BRUSH, SOLD AS A UNIT, BRONZERS AND BRONZER APPLICATOR/BRUSH, SOLD AS A UNIT, FACE POWDERS AND FACE POWDER APPLICATOR/BRUSH, SOLD AS A UNIT, MASCARAS, GLITTER BODY GELS, VITAMIN E STICKS FOR LIPS AND AROUND EYES, HAIR MASCARAS, LIP AND EYE PENCILS, SKIN CARE CLEANSERS, SKIN MASQUES, SKIN TONERS, SKIN LOTIONS/CREAMS, SKIN MOISTURIZERS, SKIN EXFOLIATORS, SOAPS, FRAGRANCED BODY SPRAYS AND MISTS, EAU DE TOILETTE, PERFUME, COLOGNE, FRAGRANCED BODY WASH AND SHOWER GELS, EYE GELS/CREAMS, BODY/FACE MISTS, AND COSMETIC CASES CONTAINING AN ASSORTMENT OF THE AFOREMENTIONED GOODS (U.S. CLS. 1, 4, 6, 50, 51 AND 52).

FIRST USE 8-1-1999; IN COMMERCE 4-6-2000.

CLASS 3—(Continued).

SN 76-433,441. SMITH, MINDI, DBA S.L.U.T. COSMETICS, RESEDA, CA. FILED 7-23-2002.

**...WHERE QUALITY NEVER
LOOKS CHEAP**

FOR BEAUTY PRODUCTS, COSMETICS, SKIN CARE PRODUCTS AND ACCESSORIES, NAMELY, LIPSTICKS, LIP GLOSSES/STAINS, NAIL COLORS, EYE SHADOWS, EYE SHADOWS AND EYE SHADOW APPLICATOR/BRUSH, SOLD AS A UNIT, EYE COLOR DUST, EYE LINERS, FOUNDATIONS, CONCEALERS, MAKE-UP COVER STICKS, BLUSHES AND BLUSH APPLICATOR/BRUSH, SOLD AS A UNIT, BRONZERS AND BRONZER APPLICATOR/BRUSH, SOLD AS A UNIT, FACE POWDERS AND FACE POWDER APPLICATOR/BRUSH, SOLD AS A UNIT, MASCARAS, GLITTER BODY GELS, VITAMIN E STICKS FOR LIPS AND AROUND EYES, HAIR MASCARAS, LIP AND EYE PENCILS, SKIN CARE CLEANSERS, SKIN MASQUES, SKIN TONERS, SKIN LOTIONS/CREAMS, SKIN MOISTURIZERS, SKIN EXFOLIATORS, SOAPS, FRAGRANCED BODY SPRAYS AND MISTS, EAU DE TOILETTE, PERFUME, COLOGNE, FRAGRANCED BODY WASH AND SHOWER GELS, EYE GELS/CREAMS, BODY/FACE MISTS, AND COSMETIC CASES CONTAINING AN ASSORTMENT OF THE AFOREMENTIONED GOODS (U.S. CLS. 1, 4, 6, 50, 51 AND 52).

FIRST USE 8-1-1999; IN COMMERCE 4-6-2000.

SN 76-436,206. TOWNLEY INC., NEW YORK, NY. FILED 7-29-2002.

HEAD 2 TOE

FOR COSMETICS, NAMELY, LIP GLOSS, NAIL POLISH, BODY GLITTER, BODY GLITTER GEL, AND EYE SHADOW (U.S. CLS. 1, 4, 6, 50, 51 AND 52).

CLASS 3—(Continued).

SN 76-436,345. CHIUN SHIU ENTERPRISE CO., LTD., YUAN LI TOWN, MIAOLI COUNTY, TAIWAN, FILED 7-31-2002.



DAINTY DESIGN

NO CLAIM IS MADE TO THE EXCLUSIVE RIGHT TO USE "DESIGN", APART FROM THE MARK AS SHOWN.

THE MARK, CONSISTS OF IN PART, THE STYLIZED LETTERS "DD".

FOR COSMETICS, NAMELY, TONERS, SKIN TONERS, SKIN LOTIONS, FACIAL LOTIONS, SUN CARE LOTIONS, COMPACTS CONTAINING MAKE-UP, FOUNDATION, SOAPS, CONCEALERS, SHAMPOOS, FACE CREAMS, SKIN LIGHTENING CREAMS, SKIN WHITENING CREAMS, AGE SPOT REDUCING CREAMS, BEAUTY MASKS, BODY MASKS, POLISHING POWDERS, HAIR MASCARA, MASCARA, SKIN CLEANSING CREAM, SKIN CLEANSING LOTION, NAIL POLISH, NAIL POLISH REMOVER, HAIR CONDITIONERS, HAIR WAVING LOTION, TOILET SOAP, PERFUME, LIPSTICK, EYE SHADOW, FALSE NAILS, EYEBROW PENCILS, DENTIFRICES; ESSENTIAL OILS FOR COSMETIC USE; MAKE-UP KITS COMPRISED OF LIPSTICK, LIP GLOSS, FACIAL CLEANSING LOTIONS (U.S. CLS. 1, 4, 6, 50, 51 AND 52).

FIRST USE 5-1-2002; IN COMMERCE 5-1-2002.

SN 76-444,344. SHISEIDO COMPANY, LTD., CHOU-KU TOKYO, JAPAN, FILED 8-28-2002.

CRYSTALLIZING STRAIGHT

NO CLAIM IS MADE TO THE EXCLUSIVE RIGHT TO USE "STRAIGHT", APART FROM THE MARK AS SHOWN.

FOR NON-MEDICATED SKIN CARE PREPARATIONS; HAIR CARE PREPARATIONS; BODY CARE PRODUCTS, NAMELY, BODY SOAPS, BODY CREAMS, BODY LOTIONS, BODY POWDERS, NON-MEDICATED DEODORANTS AND ANTI-PERSPIRANTS; SUNCARE PRODUCTS, NAMELY, SUNSCREEN, SUN BLOCK AND SUN TANNING PREPARATIONS; PREPARATIONS TO PROTECT THE SKIN FROM THE SUN; BATH PRODUCTS, NAMELY, BATH BEADS, BATH FOAM, BATH GELS, BATH LOTION, BATH OIL, BATH POWDER, AND NON-MEDICATED BATH SALTS; PERFUME, COLOGNE, COSMETICS AND MAKEUP (U.S. CLS. 1, 4, 6, 50, 51 AND 52).

CLASS 3—(Continued).

SN 76-449,758. SHRADER CANADA LIMITED, OAKVILLE, ONTARIO, L6L 6K1, CANADA, FILED 9-12-2002.



PRIORITY CLAIMED UNDER SEC. 44(D) ON CANADA APPLICATION NO. 1132598, FILED 3-12-2002.

NO CLAIM IS MADE TO THE EXCLUSIVE RIGHT TO USE "SERIES" AND "DISC", APART FROM THE MARK AS SHOWN.

FOR CLEANING PREPARATIONS FOR USE ON THE ROTORS OF ALL DISC BRAKE-EQUIPPED MOUNTAIN BIKES TO REMOVE BOTH OIL-BASED AND WATER-BASED CONTAMINANTS FROM THE ROTOR SURFACES, ENHANCING BRAKING PERFORMANCE AND REDUCING DISC ROTOR AND BRAKE PAD WEAR (U.S. CLS. 1, 4, 6, 50, 51 AND 52).

FIRST USE 1-3-2002; IN COMMERCE 1-3-2002.

SN 76-453,565. CHERUKURI, RAMA KRISHNA, STATEN ISLAND, NY. FILED 9-27-2002.

AMERICAN ROMANCE

FOR PERFUMES IN SPRAY AND NON SPRAY FORM; AFTER SHAVE LOTION IN SPRAY AND NON SPRAY FORM; BODY LOTIONS; HAND SOAP, LIQUID SOAPS FOR HANDS, FACE AND BODY SOAP, SHAVING SOAP, PERSONAL DEODORANT SPRAY AND SHOWER GELS (U.S. CLS. 1, 4, 6, 50, 51 AND 52).

SN 76-456,729. WEST, ELLERY, LAWNSDALE, CA. FILED 10-7-2002.

LOTION TO GO

NO CLAIM IS MADE TO THE EXCLUSIVE RIGHT TO USE "LOTION", APART FROM THE MARK AS SHOWN.

FOR COSMETIC SKIN LOTIONS (U.S. CLS. 1, 4, 6, 50, 51 AND 52).

FIRST USE 7-26-2002; IN COMMERCE 9-17-2002.

CLASS 3—(Continued).

SN 76-458,080. CONRAN, JASPER, LONDON W2 3NA, UNITED KINGDOM, FILED 10-15-2002.

JASPER CONRAN

OWNER OF U.S. REG. NO. 2,590,884.

FOR PERFUMED TOILET SOAPS; SKIN SOAP; DEODORANT SOAP; COSMETIC SOAP; HAND SOAPS; LIQUID SOAPS FOR THE HANDS, FACE AND BODY; PERFUMERY; ESSENTIAL OILS FOR PERSONAL USE; COSMETICS; HAIR LOTIONS; DENTIFRICES; AFTER-SHAVE LOTIONS; AFTERSHAVE BALMS; NON-MEDICATED BATH SALTS; CLEANSING PREPARATIONS, NAMELY, SKIN CLEANSING PREPARATIONS, CLEANSING PREPARATIONS FOR THE FACE AND BODY, CLEANSING MILKS, CLEANSING LOTIONS, CLEANSING GELS, CLEANSING CREAMS; COSMETIC CREAMS AND LOTIONS, NAMELY, COSMETIC CREAMS AND LOTIONS FOR THE FACE, BODY AND HANDS, EYE LOTIONS, BODY MOISTURIZING LOTIONS, FACE MOISTURIZING LOTIONS; PERSONAL DEODORANTS; HAIR SPRAYS; HAIR WAX, HAIR GEL; HAIR STYLING PREPARATIONS, MAKE UP; MAKE UP REMOVER; POTPOURRI; HAIR SHAMPOOS AND HAIR CONDITIONERS; SHAVING PREPARATIONS; SHOWER GEL; BATH FOAM; MOISTURIZING PREPARATIONS FOR THE FACE AND BODY; SUN TANNING AND BRONZING PREPARATIONS; TOILETRIES, NAMELY, TOILETRIES IN THE FORM OF BODY CREAMS AND LOTIONS, MOISTURIZING CREAMS AND LOTIONS, SKIN CREAMS AND LOTIONS, SKIN TONING LOTIONS, SKIN FIRMING CREAMS AND LOTIONS (U.S. CLS. 1, 4, 6, 50, 51 AND 52).

SN 76-459,592. TOM TAILOR AG, 22453 HAMBURG, FED REP GERMANY, FILED 10-8-2002.

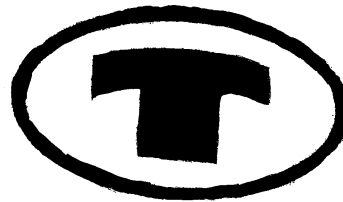

PRIORITY CLAIMED UNDER SEC. 44(D) ON FED REP GERMANY APPLICATION NO. 30229874.6/2, FILED 6-18-2002, REG. NO. 30229874, DATED 9-17-2002, EXPIRES 6-30-2012.

OWNER OF U.S. REG. NOS. 2,321,382 AND 2,442,245.
FOR TOILET PREPARATION; NAMELY, PERFUMES, EAU DE PARFUM, BODY LOTION, BATH GEL, EAU DE TOILETT (U.S. CLS. 1, 4, 6, 50, 51 AND 52).

CLASS 3—(Continued).

SN 76-467,280. BREWER, LORINDA, BIG TIMBER, MT. FILED 11-15-2002.



THE STIPPLING IN THE DRAWING IS A FEATURE OF THE MARK AND IS NOT INTENDED TO INDICATE COLOR.

FOR SKIN, BODY, FACE AND HAND LOTIONS AND CREAMS; PERFUMES; DUSTING POWDER; NON-MEDICATED LIP, HAND, AND FOOT BALMS; BATH SALTS; PERFUMED BODY OILS AND SCRUBS, AND DENTIFRICES (U.S. CLS. 1, 4, 6, 50, 51 AND 52).
FIRST USE 1-2-2000; IN COMMERCE 1-2-2000.

SN 76-469,103. PALM BEACH TAN, INC., CARROLLTON, TX. FILED 11-21-2002.

PALM BEACH TAN

OWNER OF U.S. REG. NO. 1,918,556.
FOR EXFOLIATING SKIN LOTIONS; SELF-TANNING LOTIONS; TAN ENHANCING MOISTURIZING LOTIONS; SUN-TANNING PREPARATIONS; SUN SCREEN; SKIN MOISTURIZER; LOTIONS, NAMELY, SKIN LOTION AND HAND LOTION; AND SKIN CARE PREPARATIONS (U.S. CLS. 1, 4, 6, 50, 51 AND 52).

SN 76-470,434. RICHARDS DISTRIBUTING, INC., MELBOURNE, FL. FILED 11-25-2002.

F*UGLY

OWNER OF U.S. REG. NO. 2,148,077.
FOR SUNCARE LOTIONS, OILS AND GELS, AFTER SUN ALOES, ALOE GELS, SHAMPOOS, CONDITIONERS AND SHOWER GELS (U.S. CLS. 1, 4, 6, 50, 51 AND 52).
FIRST USE 7-19-2002; IN COMMERCE 7-19-2002.

SN 76-470,437. TORSO, INC., MELBOURNE, FL. FILED 11-25-2002.

TORSO

FOR SUNCARE LOTIONS, OILS AND GELS, AFTER SUN ALOES, ALOE GELS, SHAMPOOS, CONDITIONERS AND SHOWER GELS (U.S. CLS. 1, 4, 6, 50, 51 AND 52).
FIRST USE 2-11-1998; IN COMMERCE 2-11-1998.

CLASS 3—(Continued).

SN 76-472,940. VITAMIN A INDUSTRIES INC., VANCOUVER BRITISH COLUMBIA, CANADA, FILED 11-25-2002.



FOR SHAMPOOS, SETTING LOTIONS AND GELS, HAIRSPRAYS, HAIR MOISTURE SPRAYS, POMADES, WAXES, WAX STICKS, SHAMPOO BARS, AND SOAPS; KITS SOLD AS A UNIT AND COMPRISED OF SHAMPOOS, SETTING LOTIONS AND GELS, HAIRSPRAYS, HAIR MOISTURE SPRAYS, POMADES, WAXES, WAX STICKS, SHAMPOO BARS, SOAPS, COMBS, ORNAMENTAL BEADS, AND ORNAMENTAL SLEEVES (U.S. CLS. 1, 4, 6, 50, 51 AND 52).
FIRST USE 9-30-1998; IN COMMERCE 9-30-1998.

SN 76-473,380. VITAMIN A INDUSTRIES INC., VANCOUVER BRITISH COLUMBIA, V5N 5Y1, CANADA, FILED 11-25-2002.

KNOTTY BOY

FOR SHAMPOOS, SETTING LOTIONS AND GELS, HAIRSPRAYS, HAIR MOISTURE SPRAYS, POMADES, WAXES, WAX STICKS, SHAMPOO BARS, AND SOAPS; KITS SOLD AS A UNIT AND COMPRISED OF SHAMPOOS, SETTING LOTIONS AND GELS, HAIRSPRAYS, HAIR MOISTURE SPRAYS, POMADES, WAXES, WAX STICKS, SHAMPOO BARS, SOAPS, COMBS, ORNAMENTAL BEADS, AND ORNAMENTAL SLEEVES (U.S. CLS. 1, 4, 6, 50, 51 AND 52).
FIRST USE 9-30-1998; IN COMMERCE 9-30-1998.

SN 76-473,559. TAMANONI, INC., TAMPA, FL. FILED 12-9-2002.

NONISOFT

FOR BODY LOTION (U.S. CLS. 1, 4, 6, 50, 51 AND 52).
FIRST USE 4-25-2002; IN COMMERCE 4-25-2002.

CLASS 3—(Continued).

SN 76-478,289. ROB ROY COIFFURES INCORPORATED, WORCESTER, MA. FILED 12-26-2002.



OWNER OF U.S. REG. NO. 1,704,483.
THE MARK CONSISTS OF A CIRCLE CONTAINING A HALF MOON AND PYLON WITH THE WORD "ABSTRACTS" PRINTED BELOW.

FOR HAIR CARE PREPARATIONS, NAMELY, SHAMPOO, CONDITIONERS, FINISHING HAIR GELS, STYLING AIDS, NAMELY, HAIR MOUSSE, HAIR SPRAY AND NON-AEROSOL HAIR SPRAY (U.S. CLS. 1, 4, 6, 50, 51 AND 52).

FIRST USE 5-4-2000; IN COMMERCE 5-4-2000.

SN 76-478,464. BUCHHOLZ, JOENA C., DBA SILK'N SHEA, PORTLAND, OR. AND BUCHHOLZ, HERM J., DBA SILK'N SHEA, PORTLAND, OR. FILED 12-20-2002.

SILK'N SHEA

NO CLAIM IS MADE TO THE EXCLUSIVE RIGHT TO USE "SHEA", APART FROM THE MARK AS SHOWN.

FOR SOAPS AND COSMETICS, NAMELY SOAPS FOR USE ON HANDS, FACE, HAIR AND BODY; AND COSMETICS, NAMELY ESSENTIAL OILS AND ESSENTIAL OIL BLENDS FOR PERSONAL USE, ESSENTIAL OILS FOR USE IN THE MANUFACTURE OF SOAPS AND COSMETICS, NON-MEDICATED BATH SALTS, LIP BALM, CUTICLE CREAM, MASSAGE OIL, CREAMS, BALMS, LOTIONS AND MOISTURIZERS FOR USE ON FACE, HANDS, FEET, SKIN, HAIR AND BODY; AND SOAPS, LOTIONS, CREAMS AND BALMS FOR BABIES AND CHILDREN (U.S. CLS. 1, 4, 6, 50, 51 AND 52).

FIRST USE 12-1-1999; IN COMMERCE 8-18-2001.

SN 76-478,465. SOAP FAIRY, INC., THE, LEWES, DE. FILED 12-20-2002.

**CLEANING UP THE WORLD
ONE PERSON AT A TIME**

FOR SOAPS AND COSMETICS, NAMELY SOAPS FOR USE ON HANDS, FACE, HAIR AND BODY; AND COSMETICS, NAMELY NON-MEDICATED LOOSE BATH SALTS, NON-MEDICATED BATH SALTS IN SOLID FORM COMPOSED OF EFFERVESCENT MATERIALS, EMOLLIENTS, MOISTURIZERS AND OILS, LIP BALM, CREAMS, BALMS, LOTIONS AND MOISTURIZERS FOR USE ON FACE, HANDS, FEET, SKIN, HAIR AND BODY (U.S. CLS. 1, 4, 6, 50, 51 AND 52).

FIRST USE 1-1-1999; IN COMMERCE 1-1-1999.

CLASS 3—(Continued).

SN 76-481,346. RHOADES, DEAN L., BEVERLY HILLS, CA. FILED 1-9-2003.

JEWELATHERAPY

FOR ANTI-WINKLE CREAM, EYE CREAM, FACE CREAM, SKIN MOISTURIZER, SKIN MOISTURIZER MASKS, HYDRATING SKIN MOISTURIZERS; LOTIONS, NAMELY, SKIN LOTIONS, FACIAL LOTIONS, BODY LOTION; FACIAL CLEANSERS, SKIN CLEANSERS; AND TONERS (U.S. CLS. 1, 4, 6, 50, 51 AND 52).

SN 76-481,767. FRAM MULTI-SOURCES, INC., MONROE TOWNSHIP, NJ. FILED 1-7-2003.

COLOR 4 YOU

NO CLAIM IS MADE TO THE EXCLUSIVE RIGHT TO USE "COLOR", APART FROM THE MARK AS SHOWN.

FOR COSMETICS AND CLEANING PREPARATIONS, NAMELY ADHESIVES FOR ATTACHING ARTIFICIAL FINGERNAILS, FALSE NAILS, FINGERNAIL SCULPTURING OVERLAYS, HAND CREAM, HAND LOTIONS, HAND SOAPS, NAIL BUFFING PREPARATIONS, NAIL CARE PREPARATIONS, NAIL CREAM, NAIL ENAMELS, NAIL GLITTER, NAIL GROOMING PRODUCTS, NAMELY, TIPS, GLUE, LACQUER AND GLITTER, NAIL HARDENERS, NAIL POLISH, NAIL POLISH BASE COAT, NAIL POLISH REMOVER, NAIL POLISH TOP COAT, NAIL STRENGTHENERS, AND NAIL TIPS (U.S. CLS. 1, 4, 6, 50, 51 AND 52).

SN 76-483,919. COSMOPAK INTERNATIONAL LTD., TORONTO, BR.VIRGIN ISLANDS, FILED 1-17-2003.

LIQUI-F-EYES MAKEUP

NO CLAIM IS MADE TO THE EXCLUSIVE RIGHT TO USE "MAKEUP", APART FROM THE MARK AS SHOWN.

FOR COSMETICS, NAMELY EYESHADOW (U.S. CLS. 1, 4, 6, 50, 51 AND 52).

SN 76-484,055. BRITE GROUP, LLC, THE, ROCHESTER, NY. FILED 1-21-2003.

**CAPTAIN JOHN'S BOAT
BRITE**

NO CLAIM IS MADE TO THE EXCLUSIVE RIGHT TO USE "BOAT", APART FROM THE MARK AS SHOWN.

FOR MARINE VEHICLE CLEANER AND POLISH (U.S. CLS. 1, 4, 6, 50, 51 AND 52).

FIRST USE 7-0-2001; IN COMMERCE 10-24-2002.

CLASS 3—(Continued).

SN 76-485,237. ENTRECAP CORPORATION, DBA FING'RS, CAMARILLO, CA. FILED 1-24-2003.

SUPER NATURAL

FOR ARTIFICIAL FINGERNAILS (U.S. CLS. 1, 4, 6, 50, 51 AND 52).

CLASS 3—(Continued).

SN 78-056,219. WEAVER, DAVID, J., MURRELLS INLET, SC. FILED 4-2-2001.



FOR SKIN ABRASIVE PREPARATIONS (U.S. CLS. 1, 4, 6, 50, 51 AND 52).

SN 76-485,362. ROYAL SERVICES, INC., JACKSONVILLE, FL. FILED 1-27-2003.

ERADICATE

FOR COMMERCIAL AND INDUSTRIAL LIQUID TILE AND GROUT STRIPPER FOR REMOVING PAINTS AND SEALERS FROM TILE SURFACES (U.S. CLS. 1, 4, 6, 50, 51 AND 52).

FIRST USE 12-3-2002; IN COMMERCE 12-3-2002.

SN 78-092,110. PANTRESSE, INC., CANTON, MA. FILED 11-7-2001.

BETTER THAN BLONDE!

FOR HAIR CARE PREPARATIONS, NAMELY, SHAMPOO, CONDITIONER, STYLING GEL, HAIR SPRAY, HAIR GEL, HAIRSTYLING PREPARATIONS, POMADES, HAIR MOUSE, AND HAIR COLOR (U.S. CLS. 1, 4, 6, 50, 51 AND 52).

SN 76-485,608. CIRCLE OF FRIENDS PRODUCTS, LLC, CHATSWORTH, CA. FILED 1-29-2003.

Tommy & Sean
Home Run
Root Beer

SN 78-111,611. PHILOSOPHY, INC., PHOENIX, AZ. FILED 2-28-2002.

CONDITION ME

FOR SHOWER GEL (U.S. CLS. 1, 4, 6, 50, 51 AND 52). FIRST USE 3-0-2002; IN COMMERCE 3-0-2002.

FOR MAKE-UP KITS COMPRISED OF LIPSTICK, LIP GLOSS, LIP LINER, LIP BALM, BLUSH, FOUNDATION, EYE SHADOW, EYE LINER, MASCARA, CONCEALER, COSMETIC PENCILS, AND FACIAL POWDER; COSMETICS, NAMELY, LIPSTICK, LIP GLOSS, LIP LINER, LIP BALM, BLUSH, FOUNDATION, EYE SHADOW, EYE LINER, MASCARA, CONCEALER, COSMETIC PENCILS, AND FACIAL POWDER; FRAGRANCES, NAMELY, PERFUME, COLOGNE, AND AFTER-SHAVE; NON-MEDICATED SKIN CARE PRODUCTS, NAMELY, SOAP, SCRUBS, TONER, CONDITIONER, EXFOLIATORS, SKIN CLARIFIER, WRINKLE REMOVING SKIN CARE PREPARATIONS, AND MOISTURIZER; FACE AND BODY LOTION, CREAM, OIL, GEL AND SPRAY; SUN SCREEN PREPARATIONS, NAMELY, LOTION, CREAM, GEL, AND SPRAY; NON-MEDICATED FACE AND BODY SKIN LIGHTENER; HAIR CARE PRODUCTS, NAMELY, SHAMPOO, CONDITIONER, RINSE, GEL, MOUSSE, SPRAY AND TONIC; BATH CARE PRODUCTS, NAMELY, SOAP, NON-MEDICATED BATH SALTS, CRYSTALS, BEADS, GEL, OIL, POWDER, AND BUBBLE BATH; SCENTED HEAD-TO-TOE BODY WASH; NAIL CARE PREPARATIONS, NAMELY, CUTICLE CREAM, CUTICLE REMOVING PREPARATIONS, NAIL ENAMEL, NAIL POLISH, NAIL POLISH REMOVER, NAIL POLISH BASE COAT, NAIL POLISH TOP COAT, AND NAIL STRENGTHENERS; PERSONAL DEODORANT (U.S. CLS. 1, 4, 6, 50, 51 AND 52).

SN 76-485,948. CIRCLE OF FRIENDS PRODUCTS, LLC, CHATSWORTH, CA. FILED 1-29-2003.

Heidi & Niklas
Yodel-ay-he-

FOR HAND AND BODY LOTION (U.S. CLS. 1, 4, 6, 50, 51 AND 52). FIRST USE 11-0-2001; IN COMMERCE 11-0-2001.

CLASS 3—(Continued).

SN 78-113,329. HOLYFIELD, LOUISE, DALLAS, TX. FILED 3-7-2002.

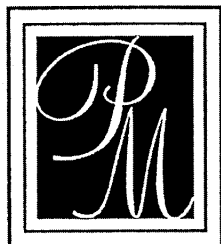

PRESLEY MORGAN

THE NAME "PRESLEY MORGAN RANSBERGER" IDENTIFIES A LIVING INDIVIDUAL WHOSE CONSENT IS OF RECORD.

FOR FACIAL SKIN CARE PRODUCTS, NAMELY, FACIAL LOTIONS, FACIAL CLEANSERS, FACIAL SCRUBBING FOAM; BODY CARE PREPARATIONS, NAMELY, BODY LOTION, BODY CLEANSER, BODY SCRUBBING FOAM (U.S. CLS. 1, 4, 6, 50, 51 AND 52).

FIRST USE 8-19-2002; IN COMMERCE 8-19-2002.

SN 78-140,395. FD MANAGEMENT, INC., WILMINGTON, DE. FILED 7-1-2002.

FIRST DEFENSE

FOR ANTI-OXIDANT MOISTURIZING AND HYDRATING SKIN AND BODY CREAM AND LOTION WITH SUNSCREEN PROTECTION (U.S. CLS. 1, 4, 6, 50, 51 AND 52).

SN 78-144,403. TRUESCENTS, LLC, SEATTLE, WA. FILED 7-16-2002.

GOT BALM?

OWNER OF U.S. REG. NO. 2,633,344. NO CLAIM IS MADE TO THE EXCLUSIVE RIGHT TO USE "BALM", APART FROM THE MARK AS SHOWN.

FOR SKIN LOTION, HAND LOTION, BODY LOTION, AND AFTER SHAVE LOTION (U.S. CLS. 1, 4, 6, 50, 51 AND 52).

FIRST USE 1-1-2002; IN COMMERCE 1-1-2002.

CLASS 3—(Continued).

SN 78-149,282. BODYOLOGY, INC., LAWRENCE, NY. FILED 7-31-2002.

HOT TAMALE

FOR HAIR CARE PREPARATIONS, HAIR STYLING PREPARATIONS, SKIN, FACIAL, AND DENTAL AND ORAL HYGIENE PREPARATIONS, NAMELY, SHAMPOOS, CONDITIONERS AND NON-MEDICATED SERUMS, HAIR GELS, HAIR MOUSSE, HAIR BALMS, HAIR SPRAYS, TOOTHPASTE AND MOUTHWASH, AND SKIN LOTIONS AND CREAMS; DENTIFRICES, HAND, NAIL, AND FOOT AND BODY CARE PREPARATIONS, NAMELY, NAIL CARE PREPARATIONS, HAND CREAMS, AND NON-MEDICATED FOOT CREAM AND BODY EMULSIONS; COSMETICS AND TOILETRIES, NAMELY, PERSONAL DEODORANTS AND ANTI-PERSPIRANTS; MAKE UP; PERFUME AND SCENTED PRODUCTS, NAMELY, SCENTED BODY SPRAY, HOME FRAGRANCE, AND POTPOURRI; SUN BLOCK AND SCREEN PREPARATIONS AND TANNING PREPARATIONS, NAMELY, SUNTAN LOTIONS, OILS AND SKIN GELS FOR ACCELERATING, ENHANCING OR EXTENDING TANS (U.S. CLS. 1, 4, 6, 50, 51 AND 52).

SN 78-156,848. LG HOUSEHOLD & HEALTH CARE LTD., SEOUL 150-721, REPUBLIC OF KOREA, FILED 8-22-2002.

OSYUNIA

FOR SKIN LOTION; TOILET WATER; PERFUMES; HAND AND BODY SOAP IN POWDER FORM; LAUNDRY BLEACH; HAIR SHAMPOO; FABRIC SOFTENER RINSE; CLEANING PREPARATIONS, NAMELY, DETERGENT RINSES FOR CLOTHES, HAIR RINSE; TOILET SOAPS; TOOTH PASTE (U.S. CLS. 1, 4, 6, 50, 51 AND 52).

SN 78-162,493. CONOPCO, INC., CHICAGO, IL. FILED 9-10-2002.

AXE APOLLO

OWNER OF U.S. REG. NOS. 2,667,299 AND 2,700,941. FOR ANTI-PERSPIRANT AND DEODORANT. (U.S. CLS. 1, 4, 6, 50, 51 AND 52).

SN 78-162,906. THE PROCTER & GAMBLE COMPANY, CINCINNATI, OH. FILED 9-11-2002.

VERTICAL BLAST

FOR HAIR CARE PREPARATIONS, NAMELY, SHAMPOO AND HAIR GEL; NON-MEDICATED SKIN CARE PREPARATIONS, NAMELY, BODY WASH; ANTI-PERSPIRANTS AND DEODORANTS (U.S. CLS. 1, 4, 6, 50, 51 AND 52).

CLASS 3—(Continued).

SN 78-163,339. RECKITT & COLMAN (OVERSEAS) LIMITED, HULL, UNITED KINGDOM, FILED 9-12-2002.

EXPRESS ROLL ON

NO CLAIM IS MADE TO THE EXCLUSIVE RIGHT TO USE "ROLL ON", APART FROM THE MARK AS SHOWN.

FOR NON-MEDICATED PREPARATIONS FOR PERSONAL USE, NAMELY MOISTURIZING CREAMS, GELS, LOTIONS AND MOUSSES FOR USE PRIOR AND SUBSEQUENT TO SHAVING; DEPILATORY PREPARATIONS, WAXES, EXFOLIANTS (U.S. CLS. 1, 4, 6, 51 AND 52).

SN 78-165,561. SARAH P. RICHMAN, DBA AESTHETIC IMAGERY, LOS ANGELES, CA. FILED 9-18-2002.

AESTHETIC IMAGERY

FOR COSMETICS, HAIR CARE PREPARATIONS AND SKIN CARE PREPARATIONS (U.S. CLS. 1, 4, 6, 50, 51 AND 52).

FIRST USE 6-28-1989; IN COMMERCE 6-28-1989.

SN 78-166,329. GRAHAM WEBB INTERNATIONAL, INC., CARLSBAD, CA. FILED 9-20-2002.

curl catalyst

NO CLAIM IS MADE TO THE EXCLUSIVE RIGHT TO USE "CURL", APART FROM THE MARK AS SHOWN.

FOR HAIR CARE PRODUCTS, NAMELY CURLY HAIR GEL (U.S. CLS. 1, 4, 6, 50, 51 AND 52).

FIRST USE 12-2-2002; IN COMMERCE 12-2-2002.

SN 78-180,953. GLIPTONE MANUFACTURING, INC., ROKONKOMA, NY. FILED 11-1-2002.

BODY BAR

NO CLAIM IS MADE TO THE EXCLUSIVE RIGHT TO USE "BAR", APART FROM THE MARK AS SHOWN.

FOR PAINT SURFACE PREPARATION USED TO RIP OFF AND REMOVE SMALL CONTAMINANTS SUCH AS EMBEDDED DIRT, BUG RESIDUE, HARDENED TREE SAP, INDUSTRIAL FALLOUT, RAIL DUST AND ANY OTHER PARTICLES THAT MIGHT INTERFERE WITH THE EFFECTIVE WAXING, POLISHING PAINTING OR OTHER TREATMENTS OF VEHICLE EXTERIORS (U.S. CLS. 1, 4, 6, 50, 51 AND 52).

CLASS 3—(Continued).

SN 78-187,041. JUVENESSE BY ELAINE GAYLE, INC., CHICAGO, IL. FILED 11-20-2002.

BEWITCHING

FOR PERFUMES, COLOGNES, SCENTED BODY LOTIONS, SCENTED BODY DUSTING POWDERS, SCENTED HAND LOTIONS, SCENTED HAND SOAPS, AFTER SHAVE LOTIONS, AND SCENTED BATH GELS AND BATH OILS (U.S. CLS. 1, 4, 6, 50, 51 AND 52).

SN 78-187,939. SEDONA PRODUCTS INTERNATIONAL, LLC, COTTONWOOD, AZ. FILED 11-22-2002.



NO CLAIM IS MADE TO THE EXCLUSIVE RIGHT TO USE "HIGHEST AND QUALITY", APART FROM THE MARK AS SHOWN.

THE MARK CONSISTS OF THE WORD "CRYSTALUX" IN CAPITALIZED STYLIZED FONT, CENTERED BELOW A CROWN CONTAINED WITHIN TWO LAUREL LEAVES JOINED AT THE STEM WITH THE WORDS "HIGHEST QUALITY" IN STYLIZED FONT CENTERED ABOVE THE CROWN.

FOR NATURAL DEODORANTS; LIQUID AND SOLID HANDS, FACE AND BODY SOAPS; BATH CAPSULES AND GELS; AROMATHERAPY OILS AND LOTIONS; HANDS, FEET AND BODY LOTIONS (U.S. CLS. 1, 4, 6, 50, 51 AND 52).

FIRST USE 9-1-2002; IN COMMERCE 9-1-2002.

SN 78-190,083. KISS MY FACE, GARDINER, NY. FILED 12-2-2002.

FILTHY RICH

FOR AFTER SHAVE LOTIONS, ASTRINGENTS FOR COSMETIC PURPOSES AND SKIN TONERS, BATH CRYSTALS, BATH OILS AND SALTS, BODY AND FACIAL LOTIONS, FACIAL CLEANSERS, HAIR CONDITIONERS, DEODORANTS FOR PERSONAL USE, ESSENTIAL OILS FOR PERSONAL USE, EYE MAKE UP, FACIAL AND BODY EXFOLIATING LOTION, FACIAL SCRUBS, FACIAL CLEANSERS, FACIAL CREAM, UNMEDICATED FOOT CREAM, HAIR CREME RINSES, HAIR MASQUES, HAND CREAM, LIQUID AND BAR SOAP FOR FACE, HANDS, AND BODY, FACIAL MASKS, MASSAGE OIL, MOISTURIZING BODY SPRAYS, NON-MEDICATED SKIN SERUMS, SHAMPOOS, SHOWER GEL AND BATH GEL; STYLING GEL FOR HAIR (U.S. CLS. 1, 4, 6, 50, 51 AND 52).

CLASS 3—(Continued).

SN 78-191,687. INDIGO WILD, L.L.C., KANSAS CITY, MO. FILED 12-5-2002.

ZUM KISS

OWNER OF U.S. REG. NO. 2,279,380.
FOR NON-MEDICATED LIP BALM (U.S. CLS. 1, 4, 6, 50, 51 AND 52).
FIRST USE 10-0-2000; IN COMMERCE 10-0-2000.

SN 78-191,689. INDIGO WILD, L.L.C., KANSAS CITY, MO. FILED 12-5-2002.

ZUM MIST

OWNER OF U.S. REG. NO. 2,279,380.
NO CLAIM IS MADE TO THE EXCLUSIVE RIGHT TO USE "MIST", APART FROM THE MARK AS SHOWN.
FOR SCENTED ROOM SPRAYS, BODY SPRAYS AND SCENTED LINEN SPRAYS (U.S. CLS. 1, 4, 6, 50, 51 AND 52).
FIRST USE 3-8-2002; IN COMMERCE 3-8-2002.

SN 78-195,306. COSMETIC TREASURES, INC., WESTMONT, IL. FILED 12-17-2002.

DEAD SEA TIME

NO CLAIM IS MADE TO THE EXCLUSIVE RIGHT TO USE "DEAD SEA", APART FROM THE MARK AS SHOWN.
FOR COSMETICS (U.S. CLS. 1, 4, 6, 50, 51 AND 52).

SN 78-195,323. COSMETIC TREASURES, INC., WESTMONT, IL. FILED 12-17-2002.

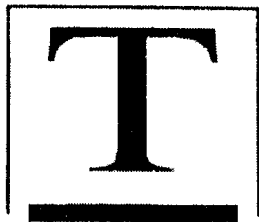

FOR COSMETICS (U.S. CLS. 1, 4, 6, 50, 51 AND 52).

CLASS 3—(Continued).

SN 78-198,719. ONLINE BY DESIGN, LLC, CORDOVA, TN. FILED 12-30-2002.

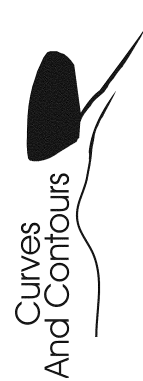

THE MARK CONSISTS, IN PART, OF THE PARTIAL SILHOUETTE OF THE BACK OF A WOMAN WITH AN UPRaised ARM.

FOR NON-MEDICATED SKIN CARE AND CLEANING PREPARATIONS, NAMELY, CREAM, MILK, LOTION, SERUM, GEL, MOUSSE, SPRAY, AND OIL FOR MOISTURIZING THE FULL BODY, FACE AND EYES; FOR THE REDUCTION OF SCARS, STRETCH MARKS, SPIDER VEINS, CELLULITE AND OTHER SKIN BLEMISHES; FOR ANTI-AGING AND ANTI-WRINKLE PURPOSES; FOR SUNTANNING, SUN BLOCK, AFTER-SUN CARE, SELF AND SUNLESS TANNING; FOR BODY, CHEST, FACE, HANDS, FEET; AND FOR FIRING AND SMOOTHING THE BUSTLINE; AND SKIN SOAP (U.S. CLS. 1, 4, 6, 50, 51 AND 52).

FIRST USE 10-0-2000; IN COMMERCE 9-0-2001.

SN 78-200,462. AQUALIS, LLC, MIAMI, FL. FILED 1-6-2003.

AQUALIS

THE ENGLISH TRANSLATION OF THE WORDS "AQUA" AND "LIS" IN THE MARK IS "WATER" AND "IRIS OR LILY".

FOR PERFUMES, TOILETTE WATER, COLOGNE, EAU DE COLOGNE, EAU DE PARFUM, EAU DE TOILETTE, SHOWER GELS, BODY LOTIONS, BODY SPRAYS, SHAVING FOAMS, SHAVING CREAMS, AFTERSHAVE LOTION, SHAVING GELS, BATH GELS, FOAM BATHS, SOAPS FOR PERSONAL USE, HAIR SHAMPOOS, HAIR CONDITIONERS, BATH OIL, BATH SALTS, BODY OIL, BUBBLE BATH, FRAGRANCES FOR PERSONAL USE (U.S. CLS. 1, 4, 6, 50, 51 AND 52).

SN 78-201,007. PROCTER & GAMBLE COMPANY, THE, CINCINNATI, OH. FILED 1-8-2003.

SK-II WHITENING SOURCE

NO CLAIM IS MADE TO THE EXCLUSIVE RIGHT TO USE "WHITENING SOURCE", APART FROM THE MARK AS SHOWN.

FOR NON-MEDICATED SKIN CARE PREPARATIONS (U.S. CLS. 1, 4, 6, 50, 51 AND 52).

CLASS 3—(Continued).

SN 78-202,088. GAP (APPAREL) INC., SAN FRANCISCO, CA. FILED 1-10-2003.

COOL GROOVE

FOR COLOGNE, EAU DE TOILETTE, PERFUME, EAU DE PARFUM, FACE AND BODY LOTION, HAND AND BODY SOAP, BODY CREME, BODY SOUFFLE, LIQUID HAND SOAP, INCENSE, POTPOURRI, FRAGRANCE BALM; MAKE-UP, BLUSH, ROUGE, FACE POWDER, EYE SHADOW, EYE MAKE-UP, EYELINER, MASCARA, EYEBROW PENCIL, NAIL POLISH, NAIL GLITTER, LIP GLOSS, LIPSTICK, LIP LINER, LIP LACQUER, LIP BALM, BUBBLE BATH, BATH BEADS, BATH BOMBS, BATH AND SHOWER GEL, BATH SALTS, BATH OIL, BATH POWDER, FACE AND BODY SCRUB, FACIAL MASK, TONER, ASTRINGENT, BODY MIST, BODY SHIMMER AND GLITTER, SHIMMER POWDER, SKIN MOISTURIZER, FOOT SCRUB, FOOT LOTION, SOAP, AROMATHERAPY OIL, AROMATHERAPY LOTION, AROMATHERAPY CREAM, SUNTAN LOTION, MASSAGE OIL, SHAMPOO, HAIR CONDITIONER, SKIN CLEANSER, ESSENTIAL OILS FOR PERSONAL USE, BODY OIL, MASSAGE OIL, DENTIFRICES (U.S. CLS. 1, 4, 6, 50, 51 AND 52).

SN 78-202,104. GAP (APPAREL) INC., SAN FRANCISCO, CA. FILED 1-10-2003.

GLAM GROOVE

FOR COLOGNE, EAU DE TOILETTE, PERFUME, EAU DE PARFUM, FACE AND BODY LOTION, HAND AND BODY SOAP, BODY CREME, BODY SOUFFLE, LIQUID HAND SOAP, INCENSE, POTPOURRI, FRAGRANCE BALM; MAKE-UP, BLUSH, ROUGE, FACE POWDER, EYE SHADOW, EYE MAKE-UP, EYELINER, MASCARA, EYEBROW PENCIL, NAIL POLISH, NAIL GLITTER, LIP GLOSS, LIPSTICK, LIP LINER, LIP LACQUER, LIP BALM, BUBBLE BATH, BATH BEADS, BATH BOMBS, BATH AND SHOWER GEL, BATH SALTS, BATH OIL, BATH POWDER, FACE AND BODY SCRUB, FACIAL MASK, TONER, ASTRINGENT, BODY MIST, BODY SHIMMER AND GLITTER, SHIMMER POWDER, SKIN MOISTURIZER, FOOT SCRUB, FOOT LOTION, SOAP, AROMATHERAPY OIL, AROMATHERAPY LOTION, AROMATHERAPY CREAM, SUNTAN LOTION, MASSAGE OIL, SHAMPOO, HAIR CONDITIONER, SKIN CLEANSER, ESSENTIAL OILS FOR PERSONAL USE, BODY OIL, MASSAGE OIL, DENTIFRICES (U.S. CLS. 1, 4, 6, 50, 51 AND 52).

SN 78-203,418. PACIFIC WORLD CORPORATION, LAKE FOREST, CA. FILED 1-15-2003.

LASHSTAY

FOR FALSE EYELASHES AND FALSE EYELASH ADHESIVES (U.S. CLS. 1, 4, 6, 50, 51 AND 52).

CLASS 3—(Continued).

SN 78-204,155. FINCHDALE, LTD., DOUGLAS, ISLE OF MAN, UNITED KINGDOM, FILED 1-16-2003.

GUINOT

OWNER OF U.S. REG. NOS. 1,285,719 AND 2,672,243. FOR COSMETICS (U.S. CLS. 1, 4, 6, 50, 51 AND 52). FIRST USE 4-30-1972; IN COMMERCE 4-30-1972.

SN 78-206,067. PHILOSOPHY, INC., PHOENIX, AZ. FILED 1-22-2003.

SURFER GIRL

FOR MAKE-UP KITS COMPRISED OF LIPSTICK, LIP GLOSS, LIP LINER, LIP BALM, BLUSH, FOUNDATION, EYE SHADOW, EYE LINER, MASCARA, CONCEALER, COSMETIC PENCILS, AND FACIAL POWDER; COSMETICS, NAMELY, LIPSTICK, LIP GLOSS, LIP LINER, LIP BALM, BLUSH, FOUNDATION, EYE SHADOW, EYE LINER, MASCARA, CONCEALER, COSMETIC PENCILS, AND FACIAL POWDER; FRAGRANCES, NAMELY, PERFUME, COLOGNE, AND AFTER-SHAVE; NON-MEDICATED SKIN CARE PRODUCTS, NAMELY, SOAP, SCRUBS, TONER, CONDITIONER, EXFOLIATORS, SKIN CLARIFIER, WRINKLE REMOVING SKIN CARE PREPARATIONS, AND MOISTURIZER; FACE AND BODY LOTION, CREAM, OIL, GEL AND SPRAY; SUN SCREEN PREPARATIONS, NAMELY, LOTION, CREAM, GEL, AND SPRAY; NON-MEDICATED FACE AND BODY SKIN LIGHTENER; HAIR CARE PRODUCTS, NAMELY, SHAMPOO, CONDITIONER, RINSE, GEL, MOUSSE, SPRAY AND TONIC; BATH CARE PRODUCTS, NAMELY, SOAP, SALTS, CRYSTALS, BEADS, GEL, OIL, POWDER, AND BUBBLE BATH; SCENTED HEAD-TO-TOE BODY WASH; NAIL CARE PREPARATIONS, NAMELY, CUTICLE CREAM, CUTICLE REMOVING PREPARATIONS, NAIL ENAMEL, NAIL POLISH, NAIL POLISH REMOVER, NAIL POLISH BASE COAT, NAIL POLISH TOP COAT, AND NAIL STRENGTHENERS; PERSONAL DEODORANT (U.S. CLS. 1, 4, 6, 50, 51 AND 52).

CLASS 3—(Continued).

SN 78-206,075. PHILOSOPHY, INC., PHOENIX, AZ. FILED 1-22-2003.

PLAN A

FOR MAKE-UP KITS COMPRISED OF LIPSTICK, LIP GLOSS, LIP LINER, LIP BALM, BLUSH, FOUNDATION, EYE SHADOW, EYE LINER, MASCARA, CONCEALER, COSMETIC PENCILS, AND FACIAL POWDER; COSMETICS, NAMELY, LIPSTICK, LIP GLOSS, LIP LINER, LIP BALM, BLUSH, FOUNDATION, EYE SHADOW, EYE LINER, MASCARA, CONCEALER, COSMETIC PENCILS, AND FACIAL POWDER; FRAGRANCES, NAMELY, PERFUME, COLOGNE, AND AFTER-SHAVE; NON-MEDICATED SKIN CARE PRODUCTS, NAMELY, SOAP, SCRUBS, TONER, CONDITIONER, EXFOLIATORS, SKIN CLARIFIER, WRINKLE REMOVING SKIN CARE PREPARATIONS, AND MOISTURIZER; FACE AND BODY LOTION, CREAM, OIL, GEL AND SPRAY; SUN SCREEN PREPARATIONS, NAMELY, LOTION, CREAM, GEL, AND SPRAY; NON-MEDICATED FACE AND BODY SKIN LIGHTENER; HAIR CARE PRODUCTS, NAMELY, SHAMPOO, CONDITIONER, RINSE, GEL, MOUSSE, SPRAY AND TONIC; BATH CARE PRODUCTS, NAMELY, SOAP, SALTS, CRYSTALS, BEADS, GEL, OIL, POWDER, AND BUBBLE BATH; SCENTED HEAD-TO-TOE BODY WASH; NAIL CARE PREPARATIONS, NAMELY, CUTICLE CREAM, CUTICLE REMOVING PREPARATIONS, NAIL ENAMEL, NAIL POLISH, NAIL POLISH REMOVER, NAIL POLISH BASE COAT, NAIL POLISH TOP COAT, AND NAIL STRENGTHENERS; PERSONAL DEODORANT (U.S. CLS. 1, 4, 6, 50, 51 AND 52).

SN 78-206,080. PACIFIC SUNWEAR OF CALIFORNIA, ANAHEIM, CA. FILED 1-22-2003.

KIRRA

FOR PERFUME, COLOGNE, SCENTED BODY SPRAY (U.S. CLS. 1, 4, 6, 50, 51 AND 52).

SN 78-206,531. PROCTER & GAMBLE COMPANY, THE, CINCINNATI, OH. FILED 1-23-2003.

SHINE SHIELD

FOR RINSE AGENT FOR AUTOMATIC DISH-WASHERS. (U.S. CLS. 1, 4, 6, 50, 51 AND 52).

SN 78-206,599. ONE PASS, LLC., HOLLISTER, CA. FILED 1-23-2003.

CALIFORNIA WET

NO CLAIM IS MADE TO THE EXCLUSIVE RIGHT TO USE "CALIFORNIA", APART FROM THE MARK AS SHOWN.

FOR CLEANING, POLISHING, SCOURING, AND ABRASIVE PREPARATIONS FOR AUTOMOBILES, BOATS, RECREATIONAL VEHICLES, TRAILERS, MOTORCYCLES, TRUCKS, AND AIRCRAFT. (U.S. CLS. 1, 4, 6, 50, 51 AND 52).

CLASS 3—(Continued).

SN 78-206,860. BC INTERNATIONAL COSMETIC & IMAGE SERVICES, INC., WILMINGTON, DE. FILED 1-24-2003.

THICKEN THIN

FOR NON-MEDICATED HAIR CARE PREPARATIONS (U.S. CLS. 1, 4, 6, 50, 51 AND 52).

SN 78-206,866. BC INTERNATIONAL COSMETIC & IMAGE SERVICES, INC., WILMINGTON, DE. FILED 1-24-2003.

STIMULATION

FOR NON-MEDICATED HAIR CARE PREPARATIONS (U.S. CLS. 1, 4, 6, 50, 51 AND 52).

SN 78-207,483. MAKE-UP ART COSMETICS INC., NEW YORK, NY. FILED 1-27-2003.

POWERPOINT

FOR COSMETICS (U.S. CLS. 1, 4, 6, 50, 51 AND 52).

SN 78-207,768. BC INTERNATIONAL COSMETIC & IMAGE SERVICES, INC., WILMINGTON, DE. FILED 1-28-2003.

SHOW OF HANDS

FOR SKIN MOISTURIZER AND EXFOLIATOR (U.S. CLS. 1, 4, 6, 50, 51 AND 52).

FIRST USE 1-31-2001; IN COMMERCE 1-31-2001.

SN 78-207,793. L'OREAL USA CREATIVE, INC., NEW YORK, NY. FILED 1-28-2003.

SOFTSTAY

FOR COSMETICS, NAMELY, LIPSTICK. (U.S. CLS. 1, 4, 6, 50, 51 AND 52).

SN 78-208,021. L'OREAL USA CREATIVE, INC., NEW YORK, NY. FILED 1-28-2003.

INFINITE CURVES

FOR COSMETICS, NAMELY, MASCARA. (U.S. CLS. 1, 4, 6, 50, 51 AND 52).

CLASS 3—(Continued).

SN 78-208,033. NUTRI PHARMACEUTICALS, INC., LAS VEGAS, NV. FILED 1-28-2003.



FOR ESSENTIAL OIL POWDERS FOR USE IN THE MANUFACTURE OF NUTRITIONAL AND FOOD SUPPLEMENTS AND ANIMAL SUPPLEMENTS (U.S. CLS. 1, 4, 6, 50, 51 AND 52).
FIRST USE 11-27-2002; IN COMMERCE 12-2-2002.

SN 78-208,053. NATURE'S FORMULA, INC., CARROLLTON, TX. FILED 1-28-2003.

B-BRONZE

FOR TANNING PRODUCTS, NAMELY – SUN TAN LOTION, SUN TAN CREME, SUN TAN GEL, SUN TAN OIL, SUNLESS TANNING LOTION, SUNLESS TANNING CREME, SUNLESS TANNING GEL, TAN MAXIMIZER, TANNING INTENSIFIER, SKIN MOISTURIZER (U.S. CLS. 1, 4, 6, 50, 51 AND 52).

SN 78-208,212. THE FLOOD COMPANY, HUDSON, OH. FILED 1-29-2003.

FLOOD

OWNER OF U.S. REG. NOS. 1,263,897, 2,463,813 AND OTHERS.
FOR SURFACE PREPARATIONS FOR WOOD SURFACES TO BE PAINTED OR STAINED IN THE NATURE OF SURFACE CLEANERS (U.S. CLS. 1, 4, 6, 50, 51 AND 52).
FIRST USE 2-9-1970; IN COMMERCE 2-9-1970.

SN 78-208,224. ZOTOS INTERNATIONAL, INC., DARIEN, CT. FILED 1-29-2003.

SLICKLINE

FOR HAIR CARE PRODUCTS NAMELY, SHAMPOO, CONDITIONER, AND HAIR SPRAY. (U.S. CLS. 1, 4, 6, 50, 51 AND 52).

CLASS 3—(Continued).

SN 78-208,225. FLOOD COMPANY, THE, HUDSON, OH. FILED 1-29-2003.



OWNER OF U.S. REG. NOS. 1,263,897, 2,567,298 AND OTHERS.
FOR SURFACE PREPARATIONS FOR WOOD SURFACES TO BE PAINTED OR STAINED IN THE NATURE OF SURFACE CLEANERS (U.S. CLS. 1, 4, 6, 50, 51 AND 52).
FIRST USE 2-9-1970; IN COMMERCE 2-9-1970.

SN 78-209,081. NOXELL CORPORATION, HUNT VALLEY, MD. FILED 1-30-2003.

EVERLITES

FOR COSMETICS, NAMELY, LIPSTICK (U.S. CLS. 1, 4, 6, 50, 51 AND 52).

SN 78-210,033. SOFT SHEEN/CARSON, INC., CHICAGO, IL. FILED 2-3-2003.

LET'S JAM!

OWNER OF U.S. REG. NO. 1,516,142.
FOR HAIR GELS (U.S. CLS. 1, 4, 6, 50, 51 AND 52).
FIRST USE 2-1-1988; IN COMMERCE 2-1-1988.

CLASS 4—LUBRICANTS AND FUELS

SN 75-983,318. AMERICAN REFINING GROUP, CONSHOHOCKEN, PA. FILED 9-4-1997.

BRAD PENN

"BRAD PENN" DOES NOT IDENTIFY A LIVING INDIVIDUAL AND IS ARBITRARY.
FOR MOTOR OILS (U.S. CLS. 1, 6 AND 15).
FIRST USE 9-0-1997; IN COMMERCE 9-0-1997.

CLASS 4—(Continued).

SN 76-289,033. GLOBAL AROMATICS, INC., CONCORD, CA. FILED 7-20-2001.

LUMASCENT

FOR CANDLES (U.S. CLS. 1, 6 AND 15).

SN 76-335,638. LUBRICATION TECHNOLOGIES, INC., GOLDEN VALLEY, MN. BY CHANGE OF NAME; BY ASSIGNMENT KOCH PETROLEUM GROUP, L.P., WICHITA, KS. FILED 11-8-2001.



OWNER OF U.S. REG. NO. 2,306,780.
NO CLAIM IS MADE TO THE EXCLUSIVE RIGHT TO USE "100" AND "UNLEADED RACING FUEL", APART FROM THE MARK AS SHOWN.
FOR UNLEADED GASOLINE FUEL FOR MOTOR VEHICLES (U.S. CLS. 1, 6 AND 15).
FIRST USE 3-1-1999; IN COMMERCE 3-1-1999.

SN 76-439,069. CASTROL LIMITED, WILTSHIRE SN3 1 RE, ENGLAND, FILED 8-8-2002.

MULTICUT

FOR INDUSTRIAL METALWORKING FLUIDS, NAMELY, CUTTING OILS AND MACHINE LUBRICATING OILS (U.S. CLS. 1, 6 AND 15).
FIRST USE 1-5-1999; IN COMMERCE 1-5-1999.

SN 76-451,740. RUG DOCTOR, L.P., PLANO, TX. FILED 9-16-2002.

NATURE'S ESSENCE WITHIN

FOR CANDLES (U.S. CLS. 1, 6 AND 15).
FIRST USE 10-11-2001; IN COMMERCE 10-11-2001.

CLASS 4—(Continued).

SN 78-153,884. PREMIER INDUSTRIAL PRODUCTS, LLC, ANKENY, IA. FILED 8-13-2002.



FOR COMBINED PENETRANT, LUBRICANT, RUST-LOOSENING, AND CORROSION INHIBITOR LIQUID COMPOUND (U.S. CLS. 1, 6 AND 15).
FIRST USE 8-1-2002; IN COMMERCE 8-1-2002.

SN 78-196,235. PANAMA JACK INTERNATIONAL, INC., ORLANDO, FL. FILED 12-19-2002.

PANAMA JACK

OWNER OF U.S. REG. NOS. 1,325,935, 1,354,252 AND OTHERS.
FOR SCENTED CANDLES (U.S. CLS. 1, 6 AND 15).

SN 78-202,693. STENS CORPORATION, BRILLION, WI. FILED 1-13-2003.

Sten Mix

FOR LUBRICANT FOR TWO AND FOUR CYCLE ENGINES, SUCH AS LAWN MOWERS, SNOW BLOWERS, CHAIN SAWS, TILLERS, TRIMMERS, GO-CARTS, MINI-BIKES AND THE LIKE (U.S. CLS. 1, 6 AND 15).
FIRST USE 10-6-2000; IN COMMERCE 10-6-2000.

SN 78-207,589. AG ENVIRONMENTAL PRODUCTS, L.L.C., OMAHA, NE. FILED 1-27-2003.

SOYCLEAR

FOR CANDLES MADE WITH A SOYBEAN OIL METHYL ESTER BASE (U.S. CLS. 1, 6 AND 15).
FIRST USE 6-6-2000; IN COMMERCE 6-6-2000.

CLASS 4—(Continued).

SN 78-207,914. BP P.L.C., LONDON, UNITED KINGDOM, FILED 1-28-2003.

ASPIRA

THE ENGLISH TRANSLATION OF THE WORD "ASPIRA" IS "EXERTS".

FOR DIESEL FUELS AND DIESEL EMULSION FUELS; NON-CHEMICAL ADDITIVES FOR DIESEL FUELS AND DIESEL EMULSION FUELS (U.S. CLS. 1, 6 AND 15).

SN 78-208,004. S. C. JOHNSON & SON, INC., RACINE, WI. FILED 1-28-2003.

GLISTENING SNOW

FOR CANDLES. (U.S. CLS. 1, 6 AND 15).

SN 78-208,484. LANCASTER COLONY CORPORATION, COLUMBUS, OH. FILED 1-29-2003.

SIMPLE PATHS

FOR CANDLES (U.S. CLS. 1, 6 AND 15).

CLASS 5—PHARMACEUTICALS

SN 76-124,309. CP KELCO U.S., INC., WILMINGTON, DE. FILED 9-8-2000.

CP KELCO

OWNER OF U.S. REG. NOS. 87,682, 2,264,747 AND OTHERS.

FOR NUTRITIONAL INGREDIENTS OR FILLERS USED IN THE FURTHER MANUFACTURE OF PHARMACEUTICALS, NAMELY, CARRAGEENAN, GELLAN GUM, PECTIN AND XANTHAN GUM (U.S. CLS. 6, 18, 44, 46, 51 AND 52).

CLASS 5—(Continued).

SN 76-125,063. CP KELCO U.S., INC., WILMINGTON, DE. FILED 9-8-2000.



FOR NUTRITIONAL AND/OR NON-NUTRITIONAL INGREDIENTS OR FILLERS USED IN THE FURTHER MANUFACTURE OF PHARMACEUTICALS, NAMELY, CARRAGEENAN, GELLAN GUM, PECTIN AND XANTHAN GUM (U.S. CLS. 6, 18, 44, 46, 51 AND 52).

SN 76-132,086. GOLF NUTRITION, INC., PHOENIX, AZ. FILED 9-21-2000.

CADDY BAR

NO CLAIM IS MADE TO THE EXCLUSIVE RIGHT TO USE "BAR", APART FROM THE MARK AS SHOWN. FOR HEALTH FOOD NUTRITIONAL SUPPLEMENTS (U.S. CLS. 6, 18, 44, 46, 51 AND 52). FIRST USE 1-16-2001; IN COMMERCE 1-26-2001.

SN 76-197,230. BIO-TECHNOLOGY GENERAL CORP., EAST BRUNSWICK, NJ. FILED 1-22-2001.

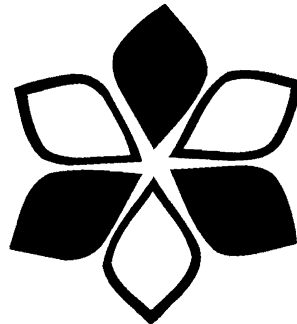

THE MARK CONSISTS IN PART OF A FLOWER DESIGN. FOR PHARMACEUTICAL COMPOSITION SUITABLE FOR TREATMENT OF CONDITIONS RESPONSIVE TO ADMINISTRATION OF HORMONES OR HORMONE DERIVATIVES (U.S. CLS. 6, 18, 44, 46, 51 AND 52).

CLASS 5—(Continued).

SN 76-203,801. MARINE POLYMER TECHNOLOGIES, INC., DANVERS, MA. FILED 2-1-2001.

SYDENT

FOR PHARMACEUTICAL PREPARATIONS USED TO STOP BLEEDING, PROMOTE WOUND CLOSURE AND AID IN WOUND HEALING (U.S. CLS. 6, 18, 44, 46, 51 AND 52).

SN 76-356,971. ORAHEALTH CORPORATION, MERCER ISLAND, WA. FILED 1-8-2002.

CANKERMELTS

NO CLAIM IS MADE TO THE EXCLUSIVE RIGHT TO USE "CANKER", APART FROM THE MARK AS SHOWN.
FOR PHARMACEUTICAL PREPARATION IN THE FORM OF A SOFT, ADHERENT PATCH THAT SLOWLY DISSOLVES IN THE MOUTH TO RELEASE A MEDICATION USED TO TREAT CANKER SORES (U.S. CLS. 6, 18, 44, 46, 51 AND 52).

SN 76-358,911. YAMANOUCHI PHARMACEUTICAL CO., LTD., CHUO-KU, TOKYO, JAPAN, FILED 1-16-2002.

Solquate

FOR PHARMACEUTICAL PREPARATIONS AS VASOPRESSIN RECEPTOR ANTAGONISTS (U.S. CLS. 6, 18, 44, 46, 51 AND 52).

CLASS 5—(Continued).

SN 76-366,515. NOVODIETA, S.L., CASTELLON, SPAIN, FILED 2-5-2002.

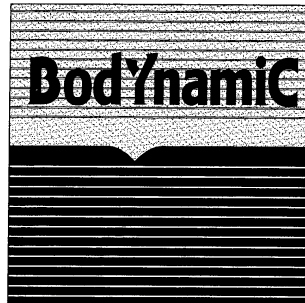

PRIORITY CLAIMED UNDER SEC. 44(D) ON ERPN CMNTY TM OFC APPLICATION NO. 2072056, FILED 2-5-2001, REG. NO. 002072056, DATED 2-24-2003, EXPIRES 2-5-2011.

THE STIPPLING AROUND THE WORD "BODYNAMIC" INDICATES GREY COLOR; AND THE BLACK HORIZONTAL LINES GOING THROUGH THE STIPPLING ARE IN WHITE.

THE WORD "BODYNAMIC" AND THE BLACK HORIZONTAL LINES BELOW ARE IN RED; THE WHITE HORIZONTAL LINES WITHIN THE BLACK ARE IN BLACK COLOR.

FOR DIETARY FOOD SUPPLEMENTS TO MEET THE EXPENDITURE OF INTENSE MUSCULAR EFFORT NAMELY IN THE FORM OF POWDER, LIQUIDS, STICKS, CAPSULES AND PILLS (U.S. CLS. 6, 18, 44, 46, 51 AND 52).

SN 76-381,810. IVC INDUSTRIES, INC., FREEHOLD, NJ. FILED 3-13-2002.

SOY Balance

NO CLAIM IS MADE TO THE EXCLUSIVE RIGHT TO USE "SOY", APART FROM THE MARK AS SHOWN.

FOR VITAMINS AND FOOD SUPPLEMENTS (U.S. CLS. 6, 18, 44, 46, 51 AND 52).

SN 76-386,350. ASTRAZENECA AB, S 151 85 SODERTALJE, SWEDEN, FILED 3-21-2002.

VIZELDA

PRIORITY CLAIMED UNDER SEC. 44(D) ON SWEDEN APPLICATION NO. 02-01875, FILED 3-14-2002, REG. NO. 358724, DATED 11-26-2002, EXPIRES 11-26-2012.

FOR PHARMACEUTICAL PREPARATIONS AND SUBSTANCES FOR THE TREATMENT OF RHEUMATOID ARTHRITIS (U.S. CLS. 6, 18, 44, 46, 51 AND 52).

CLASS 5—(Continued).

SN 76-394,338. EZ VILLE, LTD., RONKONKOMA, NY. FILED 4-8-2002.

REVIVEXXX

FOR HERBAL SUPPLEMENT IN THE FORM OF A LIQUID TO BE INGESTED BY MEN AND WOMEN TO ACHIEVE GREATER SEXUAL ENERGY (U.S. CLS. 6, 18, 44, 46, 51 AND 52).
FIRST USE 4-0-2001; IN COMMERCE 9-0-2001.

SN 76-399,329. EZ VILLE, LTD., RONKONKOMA, NY. FILED 4-22-2002.

REVIVEXXX

FOR HERBAL SUPPLEMENTS (U.S. CLS. 6, 18, 44, 46, 51 AND 52).

SN 76-404,004. DOW AGROSCIENCES LLC, INDIANAPOLIS, IN. FILED 5-6-2002.

INTREPID 80 WP

NO CLAIM IS MADE TO THE EXCLUSIVE RIGHT TO USE "80 WP", APART FROM THE MARK AS SHOWN.
FOR AGRICULTURAL INSECTICIDES, NAMELY INSECT GROWTH REGULATORS USED ONLY IN COMMERCIAL AGRICULTURAL APPLICATIONS AND SOLD ONLY THROUGH COMMERCIAL AGRICULTURAL DISTRIBUTORS FOR USE ON COTTON AND POME FRUITS (U.S. CLS. 6, 18, 44, 46, 51 AND 52).
FIRST USE 7-12-2000; IN COMMERCE 7-12-2000.

SN 76-404,005. DOW AGROSCIENCES LLC, INDIANAPOLIS, IN. FILED 5-6-2002.

INTREPID 80WSP

NO CLAIM IS MADE TO THE EXCLUSIVE RIGHT TO USE "80WSP", APART FROM THE MARK AS SHOWN.
FOR AGRICULTURAL INSECTICIDES, NAMELY INSECT GROWTH REGULATORS USED ONLY IN COMMERCIAL AGRICULTURAL APPLICATIONS AND SOLD ONLY THROUGH COMMERCIAL AGRICULTURAL DISTRIBUTORS FOR USE ON COTTON AND POME FRUITS (U.S. CLS. 6, 18, 44, 46, 51 AND 52).
FIRST USE 7-12-2000; IN COMMERCE 7-12-2000.

CLASS 5—(Continued).

SN 76-404,006. DOW AGROSCIENCES LLC, INDIANAPOLIS, IN. FILED 5-6-2002.

INTREPID 2F

NO CLAIM IS MADE TO THE EXCLUSIVE RIGHT TO USE "2F", APART FROM THE MARK AS SHOWN.
FOR AGRICULTURAL INSECTICIDES, NAMELY INSECT GROWTH REGULATORS USED ONLY IN COMMERCIAL AGRICULTURAL APPLICATIONS AND SOLD ONLY THROUGH COMMERCIAL AGRICULTURAL DISTRIBUTORS FOR USE ON COTTON AND POME FRUITS (U.S. CLS. 6, 18, 44, 46, 51 AND 52).
FIRST USE 9-0-2000; IN COMMERCE 9-0-2000.

SN 76-411,991. FLY FREE ZONE, INC., DBA FLY FREE ZONE, LOS ANGELES, CA. FILED 5-24-2002.

FLY FREE ZONE

NO CLAIM IS MADE TO THE EXCLUSIVE RIGHT TO USE "FLY", APART FROM THE MARK AS SHOWN.
FOR INSECT REPELLANTS AND INSECTICIDES FOR DOMESTIC USE, ALL IN THE NATURE OF COLLARS AND NECK BANDS OR LEG BANDS FOR DOMESTICATED ANIMALS TO REPEL INSECTS IN PROXIMITY TO THE ANIMAL (U.S. CLS. 6, 18, 44, 46, 51 AND 52).
FIRST USE 3-18-2002; IN COMMERCE 3-18-2002.

SN 76-426,240. FUJISAWA PHARMACEUTICAL CO., LTD., CHUO-KU, OSAKA, JAPAN, FILED 6-26-2002.

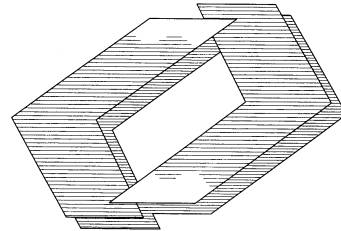

PRIORITY CLAIMED UNDER SEC. 44(D) ON JAPAN APPLICATION NO. 2002051807, FILED 6-21-2002, REG. NO. 4658493, DATED 4-4-2003, EXPIRES 4-4-2013.
THE LINING DEPICTED IN APPLICANT'S DRAWING IS LINED FOR THE COLOR BLUE.
FOR PHARMACEUTICAL PREPARATIONS, NAMELY ANTIFUNGAL PREPARATIONS (U.S. CLS. 6, 18, 44, 46, 51 AND 52).

SN 76-430,336. URUS INDUSTRIAL CORPORATION, DBA KOOLATRON, BRANTFORD ONTARIO, CANADA, FILED 7-12-2002.

PURE PERFECTION

FOR ACNE TREATMENT PREPARATIONS, NAMELY, FACIAL CLEANSERS, FACIAL CREAMS AND FACIAL MASKS (U.S. CLS. 6, 18, 44, 46, 51 AND 52).

CLASS 5—(Continued).

SN 76-439,022. OPTIGENE-X, LLC, SHREWSBURY, NJ.
FILED 8-9-2002.

XTEND

FOR DIETARY SUPPLEMENTS FOR IMPROVEMENT OF CHOLESTEROL RATIOS, INCREASE OF ENERGY LEVELS, IMPROVEMENT OF IMMUNE FUNCTION AND REDUCTION OF DNA AND FREE RADICAL DAMAGE (U.S. CLS. 6, 18, 44, 46, 51 AND 52).
FIRST USE 4-15-2002; IN COMMERCE 4-15-2002.

SN 76-440,093. ERNST MUHLBAUER GMBH & CO. KG, D-25870 NORDERFRIEDRICHSKOOG, FED REP GERMANY, FILED 8-14-2002.

ECUSPHERE

OWNER OF FED REP GERMANY REG. NO. 2091609, DATED 2-8-1995, EXPIRES 4-4-2004.

FOR (BASED ON INTENT TO USE) DENTISTRY PRODUCTS, NAMELY MATERIALS FOR MAKING DENTAL FILLINGS AND MATERIALS FOR MAKING DENTAL IMPRESSIONS; CASTING AND IMPRESSION MATERIALS FOR DENTISTRY; MATERIALS FOR MOUNTING OF DENTAL PRODUCTS, NAMELY, DENTAL CEMENT; PHARMACEUTICAL PREPARATIONS FOR USE IN DENTISTRY AND TOOTH CARE PRODUCTS, NAMELY, FOR THE TREATMENT OF TEETH AND GUM DISEASE (BASED ON 44(E)) DENTISTRY PRODUCTS, NAMELY MATERIALS FOR MAKING DENTAL FILLINGS AND MATERIALS FOR MAKING DENTAL IMPRESSIONS (U.S. CLS. 6, 18, 44, 46, 51 AND 52).

SN 76-443,583. LIFE SOURCE, INC., ABINGDON, MD.
FILED 8-16-2002.

BIOSCULPT
EXTREME

FOR DIETARY SUPPLEMENT TO AID IN MUSCLE DEVELOPMENT (U.S. CLS. 6, 18, 44, 46, 51 AND 52).
FIRST USE 2-1-2002; IN COMMERCE 2-1-2002.

SN 76-448,184. HALPRIN, ROBERT, FT. LAUDERDALE, FL.
FILED 9-9-2002.

BUPREGEN

FOR PHARMACEUTICAL PREPARATIONS AND SUBSTANCES, NAMELY, ANALGESICS ADMINISTERED BY INJECTION (U.S. CLS. 6, 18, 44, 46, 51 AND 52).
FIRST USE 4-5-2002; IN COMMERCE 4-5-2002.

CLASS 5—(Continued).

SN 76-449,727. METAGENICS, INC., SAN CLEMENTE, CA.
FILED 9-6-2002.

ACTIVCOAT

FOR DIETARY SUPPLEMENTS; FOOD FOR MEDICALLY RESTRICTED DIETS; FOOD FOR ENTERAL FEEDING (U.S. CLS. 6, 18, 44, 46, 51 AND 52).

SN 76-467,575. NUTRITION RESOURCE, LAKEPORT, CA.
FILED 11-15-2002.

WATER_x

FOR MEDICATED SKIN CARE KIT COMPRISED OF ANTIBIOTIC OINTMENT, BANDAGES FOR SKIN WOUNDS, DIARRHEA MEDICATION, EAR DROPS, NASAL SPRAY PREPARATIONS (U.S. CLS. 6, 18, 44, 46, 51 AND 52).

SN 76-478,961. BRAIN QUICKEN, LLC, #77 MOUNTAIN VIEW, CA. FILED 12-23-2002.

BODYQUICK

FOR HERBAL CONCENTRATES FOR DIETARY SUPPLEMENTS; VITAMIN SUPPLEMENTS OF HERBAL OR ORGANIC COMPOUNDS (U.S. CLS. 6, 18, 44, 46, 51 AND 52).

FIRST USE 5-26-2001; IN COMMERCE 5-26-2001.

SN 76-478,962. BRAIN QUICKEN, LLC, #77 MOUNTAIN VIEW, CA. FILED 12-23-2002.

BRAINQUICK

FOR HERBAL CONCENTRATES FOR DIETARY SUPPLEMENTS; VITAMIN SUPPLEMENTS OF HERBAL OR ORGANIC COMPOUNDS (U.S. CLS. 6, 18, 44, 46, 51 AND 52).

FIRST USE 5-26-2001; IN COMMERCE 5-26-2001.

SN 76-478,964. BRAIN QUICKEN, LLC, #77 MOUNTAIN VIEW, CA. FILED 12-23-2002.

COGNAMINE

FOR HERBAL CONCENTRATES FOR DIETARY SUPPLEMENTS; VITAMIN SUPPLEMENTS OF HERBAL OR ORGANIC COMPOUNDS (U.S. CLS. 6, 18, 44, 46, 51 AND 52).

FIRST USE 5-26-2001; IN COMMERCE 5-26-2001.

CLASS 5—(Continued).

SN 76-478,990. ROBINSON, RACE, DETROIT, MI. FILED 12-23-2002.

HANDI DANDI

FOR HAND SANITIZING LIQUID GEL FOR HOUSEHOLD USE (U.S. CLS. 6, 18, 44, 46, 51 AND 52).
FIRST USE 1-10-2002; IN COMMERCE 5-1-2002.

SN 76-486,948. CURIUM PHARMACEUTICALS, INC., MOUNTAIN VIEW, CA. FILED 1-23-2003.

FOLLIX

FOR HAIR GROWTH STIMULANTS, PHARMACEUTICAL PREPARATION FOR TREATMENT OF HAIR LOSS, NUTRACEUTICALS FOR TREATMENT OF HAIR LOSS, DIETARY SUPPLEMENT, NUTRITION SUPPLEMENT (U.S. CLS. 6, 18, 44, 46, 51 AND 52).

SN 76-487,451. CELEBRITY POWER PRODUCTS, INC., NEW YORK, NY. FILED 1-23-2003.

STARZONE

FOR COSMETICS AND NON-MEDICATED SKIN CARE PREPARATIONS, NAMELY, SKIN CLEANSERS, SKIN TONERS, EYE CREAMS, EYE GELS, MOISTURIZERS, DAY CREAMS AND OILS, NIGHT CREAMS, MASSAGE CREAMS, TINTED MOISTURIZERS AND HEATING BODY CREAMS, SKIN GELS, LIP CREAMS, FIRING CREAMS, BODY CREAMS, SCENTED CREAMS, HAND AND FOOT CREAMS, FACE CREAMS, BODY SCRUBS, FACE SCRUBS, MASKS, FOUNDATION MAKE-UP, NAIL AND HAND CREAM, BATH AND SHOWER GEL AND FOAM, BUBBLE BATH, SUN TANNING AND SELF-TANNING GELS AND LOTIONS, ANTI-WRINKLE CREAM, NAIL POLISHES, NAIL REMOVAL POLISHES AND NON-MEDICATED HAIR CARE PREPARATIONS (U.S. CLS. 6, 18, 44, 46, 51 AND 52).

SN 76-492,608. MSP SINGAPORE COMPANY, LLC, SINGAPORE, FILED 2-25-2003.

GOLTOR

FOR CARDIOVASCULAR PREPARATIONS (U.S. CLS. 6, 18, 44, 46, 51 AND 52).

SN 76-492,610. MSP SINGAPORE COMPANY, LLC, THE CONCOURSE NO. 13-05/06, SINGAPORE, FILED 2-25-2003.

ULTRIZOR

FOR CARDIOVASCULAR PREPARATIONS (U.S. CLS. 6, 18, 44, 46, 51 AND 52).

CLASS 5—(Continued).

SN 76-492,611. MSP SINGAPORE COMPANY, LLC, THE CONCOURSE NO. 13-05/06, SINGAPORE, FILED 2-25-2003.

VYTORIN

FOR CARDIOVASCULAR PREPARATIONS (U.S. CLS. 6, 18, 44, 46, 51 AND 52).

SN 76-492,612. MSP SINGAPORE COMPANY, LLC, THE CONCOURSE NO. 13-05/06, SINGAPORE, FILED 2-25-2003.

VITORIN

FOR CARDIOVASCULAR PREPARATIONS (U.S. CLS. 6, 18, 44, 46, 51 AND 52).

SN 76-492,615. MSP SINGAPORE COMPANY, LLC, THE CONCOURSE NO. 13-05/06, SINGAPORE, FILED 2-25-2003.

INEGY

FOR CARDIOVASCULAR PREPARATIONS (U.S. CLS. 6, 18, 44, 46, 51 AND 52).

SN 76-493,026. NRS NUTRITION RESOURCE SERVICES, INC., BETHLEHEM, PA. FILED 2-3-2003.

AMINO-TECH

FOR FOOD SUPPLEMENTS (U.S. CLS. 6, 18, 44, 46, 51 AND 52).
FIRST USE 9-18-1993; IN COMMERCE 9-18-1993.

SN 78-001,204. AXXIMA PHARMACEUTICALS AG, 82152 MARTINSRIED, FED REP GERMANY, FILED 3-27-2000.

FIREWALLS AGAINST INFECTIONS

OWNER OF FED REP GERMANY REG. NO. 30090034, DATED 12-31-2000, EXPIRES 12-31-2010.

NO CLAIM IS MADE TO THE EXCLUSIVE RIGHT TO USE "INFECTIONS", APART FROM THE MARK AS SHOWN.

FOR PHARMACEUTICAL PREPARATIONS FOR USE IN THE TREATMENT AND PROPHYLAXIS OF INFECTIOUS DISEASES AND PATHOLOGICAL EFFECTS (U.S. CLS. 6, 18, 44, 46, 51 AND 52).

CLASS 5—(Continued).

SN 78-078,806. PROTHERA, INC., PLEASANTON, CA. FILED 8-12-2001.

PROTHERA

FOR NUTRITIONAL SUPPLEMENTS (U.S. CLS. 6, 18, 44, 46, 51 AND 52).
FIRST USE 9-5-2001; IN COMMERCE 9-5-2001.

SN 78-107,832. WELLQUEST INTERNATIONAL, INC., NEW YORK, NY. FILED 2-9-2002.

XTRASLIM

FOR NUTRITIONAL SUPPLEMENTS (U.S. CLS. 6, 18, 44, 46, 51 AND 52).

SN 78-108,193. ALTANA PHARMA AG, KONSTANZ, FED REP GERMANY, BY CHANGE OF NAME BYK GULDEN LOMBERG CHEMISCHE FABRIK GMBH, KONSTANZ, FED REP GERMANY, FILED 2-12-2002.

KERT

FOR PHARMACEUTICAL PREPARATIONS FOR THE TREATMENT OF GASTRO-INTESTINAL DISEASES AND CONDITIONS, PHARMACEUTICAL PREPARATIONS FOR THE TREATMENT OF RESPIRATORY DISEASES AND CONDITIONS (U.S. CLS. 6, 18, 44, 46, 51 AND 52).

SN 78-108,194. ALTANA PHARMA AG, KONSTANZ, FED REP GERMANY, BY CHANGE OF NAME BYK GULDEN LOMBERG CHEMISCHE FABRIK GMBH, KONSTANZ, FED REP GERMANY, FILED 2-12-2002.

MONIRA

FOR PHARMACEUTICAL PREPARATIONS FOR THE TREATMENT OF GASTRO-INTESTINAL DISEASES AND CONDITIONS, PHARMACEUTICAL PREPARATIONS FOR THE TREATMENT OF RESPIRATORY DISEASES AND CONDITIONS (U.S. CLS. 6, 18, 44, 46, 51 AND 52).

SN 78-111,058. BAYER AKTIENGESELLSCHAFT, LEVERKUSEN, FED REP GERMANY, FILED 2-26-2002.

QUICKBAYT

FOR INSECTICIDES, PESTICIDES, INSECT BAITS AND FUNGICIDES FOR VETERINARY, AGRICULTURAL, DOMESTIC, PROFESSIONAL USE AND FOR APPLICATION IN AND AROUND STRUCTURES (U.S. CLS. 6, 18, 44, 46, 51 AND 52).

CLASS 5—(Continued).

SN 78-122,985. GREAT EARTH COMPANIES, INC., HICKSVILLE, NY. FILED 4-19-2002.

LOSE IT YOUR WAY

FOR DIETARY AND NUTRITIONAL SUPPLEMENTS, MEAL REPLACEMENTS AND MEAL REPLACEMENT DRINK MIXES (U.S. CLS. 6, 18, 44, 46, 51 AND 52).
FIRST USE 0-0-1997; IN COMMERCE 0-0-1997.

SN 78-142,917. LABORATOIRES SUISSES, S.A., PANAMA CITY, PANAMA, FILED 7-11-2002.

DRINK & SHRINK

FOR DIETARY SUPPLEMENTS AND MEAL REPLACEMENT DRINKS (U.S. CLS. 6, 18, 44, 46, 51 AND 52).
FIRST USE 8-31-2002; IN COMMERCE 8-31-2002.

SN 78-143,104. BIOPOLYMER ENGINEERING, INC., EAGAN, MN. FILED 7-11-2002.

SCIENCE BASICS

FOR DIETARY SUPPLEMENTS, NUTRITIONAL SUPPLEMENTS, AND NUTRACEUTICALS FOR USE AS DIETARY SUPPLEMENTS (U.S. CLS. 6, 18, 44, 46, 51 AND 52).

SN 78-144,687. GENITOPE CORPORATION, REDWOOD CITY, CA. FILED 7-17-2002.

DURAVAX

FOR BIOPHARMACEUTICAL PREPARATIONS USED TO TREAT CANCER IN HUMANS, NAMELY, INDIVIDUALIZED CANCER TREATMENTS PREPARED SPECIFICALLY FOR EACH INDIVIDUAL PATIENT FROM WHOM BIOPSY TUMOR TISSUE HAS BEEN RECEIVED (U.S. CLS. 6, 18, 44, 46, 51 AND 52).

CLASS 5—(Continued).

SN 78-145,292. PFIZER INC., NEW YORK, NY. FILED 7-18-2002.

GLADORA

FOR PHARMACEUTICAL PREPARATIONS FOR THE TREATMENT OF CARDIOVASCULAR DISEASE, CENTRAL NERVOUS SYSTEM DISEASES AND DISORDERS, NEUROLOGICAL DISORDERS, UROLOGICAL, UROGENITAL AND URINARY DISORDERS, GASTROINTESTINAL DISORDERS, MUSCULOSKELETAL DISORDERS, ALLERGIES, DIABETES, HYPERTENSION, ERECTILE DYSFUNCTION, SEXUAL DYSFUNCTION, STROKE, CANCER, MIGRAINES, PAIN, OBESITY, INFLAMMATION AND INFLAMMATORY DISEASES, RESPIRATORY AND INFECTIOUS DISEASES, AND IMMUNOLOGICAL, BACTERIAL, VIRAL AND FUNGAL DISORDERS; PHARMACEUTICAL PREPARATIONS, NAMELY, CHOLESTEROL PREPARATIONS, SMOKING CESSATION PREPARATIONS, DERMATOLOGICAL PREPARATIONS (U.S. CLS. 6, 18, 44, 46, 51 AND 52).

SN 78-148,941. AMERICAN GENRX CORP., STAMFORD, CT. FILED 7-30-2002.

AMERICAN GENRX

NO CLAIM IS MADE TO THE EXCLUSIVE RIGHT TO USE "AMERICAN", APART FROM THE MARK AS SHOWN. FOR PHARMACEUTICAL PREPARATIONS, NAMELY, PRESCRIPTION ANALGESICS AND ANTI-BIOTICS, AND PRESCRIPTION DRUGS FOR USE IN THE TREATMENT OF NUTRITIONAL DISORDERS, HEART DISEASE AND ULCERS, AND PEDIATRIC FORMULATIONS OF THE FOREGOING PHARMACEUTICALS (U.S. CLS. 6, 18, 44, 46, 51 AND 52).

SN 78-149,189. WELLQUEST INTERNATIONAL, INC., NEW YORK, NY. FILED 7-31-2002.

TRI-MEGA

FOR DIETARY SUPPLEMENTS FOR ENHANCEMENT OF MALE SEXUAL PERFORMANCE (U.S. CLS. 6, 18, 44, 46, 51 AND 52).

SN 78-150,955. NBTY, INC., BOHEMIA, NY. FILED 8-5-2002.

XTREMEPLEX

FOR NUTRITIONAL SUPPLEMENTS (U.S. CLS. 6, 18, 44, 46, 51 AND 52).

CLASS 5—(Continued).

SN 78-153,677. BOEHRINGER INGELHEIM INTERNATIONAL GMBH, INGELHEIM AM RHEIN, FED REP GERMANY, FILED 8-13-2002.

TPV

PRIORITY CLAIMED UNDER SEC. 44(D) ON FED REP GERMANY APPLICATION NO. 30211194.8, FILED 3-5-2002, REG. NO. 30211194, DATED 6-14-2002, EXPIRES 3-31-2012. FOR ANTIVIRAL PREPARATIONS (U.S. CLS. 6, 18, 44, 46, 51 AND 52).

SN 78-157,653. BOEHRINGER INGELHEIM INTERNATIONAL GMBH, INGELHEIM AM RHEIN, FED REP GERMANY, FILED 8-26-2002.



OWNER OF U.S. REG. NO. 671,422. THE STIPPLING SHOWN IN THE DRAWING IS FOR SHADING PURPOSES ONLY. FOR PHARMACEUTICAL PREPARATIONS, NAMELY A LAXATIVE (U.S. CLS. 6, 18, 44, 46, 51 AND 52).

SN 78-161,531. NOVARTIS AG, BASEL, SWITZERLAND, FILED 9-6-2002.

CYCLAIR

OWNER OF SWITZERLAND REG. NO. 453792, DATED 8-13-1998, EXPIRES 5-8-2008. FOR PHARMACEUTICAL PREPARATIONS, NAMELY, INHALERS FOR ADMINISTERING MEDICATIONS FOR USE AS AN IMMUNOSUPPRESSANT, SOLD TOGETHER AS A UNIT WITH THE MEDICATIONS (U.S. CLS. 6, 18, 44, 46, 51 AND 52).

SN 78-161,540. NOVARTIS AG, BASEL, SWITZERLAND, FILED 9-6-2002.

AEROMUNE

OWNER OF SWITZERLAND REG. NO. 453793, DATED 8-13-1998, EXPIRES 5-8-2008. FOR INHALERS FOR ADMINISTERING MEDICATIONS FOR USE AS AN IMMUNOSUPPRESSANT, SOLD TOGETHER AS A UNIT WITH THE MEDICATIONS; IMMUNOSUPPRESSANTS FOR USE IN LUNG TRANSPLANT THERAPY (U.S. CLS. 6, 18, 44, 46, 51 AND 52).

CLASS 5—(Continued).

SN 78-176,703. ASTRAZENECA AB, SODERTALJE, SWEDEN, FILED 10-21-2002.

ALMANZA

OWNER OF SWEDEN REG. NO. 327582, DATED 7-24-1998, EXPIRES 7-24-2008.

OWNER OF U.S. REG. NO. 2,286,921.

FOR PHARMACEUTICAL PREPARATIONS AND SUBSTANCES FOR THE PREVENTION AND TREATMENT OF DISEASES AND DISORDERS OF THE RESPIRATORY SYSTEM, CENTRAL NERVOUS SYSTEM, PERIPHERAL NERVOUS SYSTEM, CARDIOVASCULAR SYSTEM, GASTROINTESTINAL SYSTEM; PHARMACEUTICAL PREPARATIONS AND SUBSTANCES FOR USE IN PAIN CONTROL, ARTHRITIS, ANAESTHESIA, ONCOLOGY, INFECTION, INFLAMMATION, UROLOGY, GYNECOLOGY; PHARMACEUTICAL PREPARATIONS AND SUBSTANCES FOR THE TREATMENT AND PREVENTION OF DIABETES (U.S. CLS. 6, 18, 44, 46, 51 AND 52).

SN 78-176,908. BRADLEY PHARMACEUTICALS, INC., FAIRFIELD, NJ. FILED 10-22-2002.

AnaMantle HC

OWNER OF U.S. REG. NO. 578,300.

NO CLAIM IS MADE TO THE EXCLUSIVE RIGHT TO USE "HC", APART FROM THE MARK AS SHOWN.

FOR DERMATOLOGICAL PREPARATION, NAMELY, AN ANTI-INFLAMMATORY ANESTHETIC FOR RELIEF OF PAIN, SORENESS AND DISCOMFORT DUE TO PRURITUS ANI, PRURITUS VULVAE, HEMORRHOIDS, ANAL FISSURES, AND SIMILAR CONDITIONS OF THE SKIN AND MUCOUS MEMBRANES (U.S. CLS. 6, 18, 44, 46, 51 AND 52).

FIRST USE 1-0-2003; IN COMMERCE 1-0-2003.

SN 78-181,020. JARROW FORMULAS, INC., LOS ANGELES, CA. FILED 11-1-2002.

MIBRAIN RELIEF

FOR DIETARY AND NUTRITIONAL SUPPLEMENTS (U.S. CLS. 6, 18, 44, 46, 51 AND 52).

SN 78-181,856. HEBESSENTIALS LLC, WESTON, FL. FILED 11-5-2002.

Hebesentials

FOR VITAMINS AND NUTRITIONAL SUPPLEMENTS (U.S. CLS. 6, 18, 44, 46, 51 AND 52).

CLASS 5—(Continued).

SN 78-184,185. WYETH, MADISON, NJ. FILED 11-12-2002.



THE STIPPLING IS A FEATURE OF THE MARK. THE MARK CONSISTS OF A DEPICTION OF A SLEEPING FICTIONAL CREATURE.

FOR PHARMACEUTICAL PREPARATIONS FOR TREATING GASTRO-INTESTINAL DISEASES AND DISORDERS (U.S. CLS. 6, 18, 44, 46, 51 AND 52).

FIRST USE 6-0-2000; IN COMMERCE 6-0-2000.

SN 78-192,659. NOVARTIS AG, BASEL, SWITZERLAND, FILED 12-9-2002.

MAALOX TOTAL STOMACH RELIEF

OWNER OF U.S. REG. NOS. 549,313 AND 1,949,046.

NO CLAIM IS MADE TO THE EXCLUSIVE RIGHT TO USE "STOMACH RELIEF", APART FROM THE MARK AS SHOWN.

FOR ANTACID (U.S. CLS. 6, 18, 44, 46, 51 AND 52).

SN 78-195,406. BAYER AKTIENGESELLSCHAFT, LEVERKUSEN-BAYERWERK, FED REP GERMANY, FILED 12-17-2002.

VERAFLOX

FOR VETERINARY PREPARATIONS FOR THE TREATMENT OF BACTERIAL INFECTIONS (U.S. CLS. 6, 18, 44, 46, 51 AND 52).

SN 78-195,961. ARBOR INTERNATIONAL, DENVER, CO. FILED 12-18-2002.

ELEVATE

FOR HERBAL EXTRACT FOR USE AS A DIETARY SUPPLEMENT (U.S. CLS. 6, 18, 44, 46, 51 AND 52).

CLASS 5—(Continued).

SN 78-196,143. ABRICA LLLP, SUNRISE, FL. FILED 12-19-2002.



NO CLAIM IS MADE TO THE EXCLUSIVE RIGHT TO USE "PHARMACEUTICALS", APART FROM THE MARK AS SHOWN.

FOR PHARMACEUTICAL PREPARATIONS, NAMELY, SOLID, ORAL AND TRANSDERMAL DOSE FORMS FOR TREATMENT OF A VARIETY OF CONDITIONS, NAMELY, DEPRESSION, HIGH BLOOD PRESSURE, INFECTIONS AND PAIN MANAGEMENT (U.S. CLS. 6, 18, 44, 46, 51 AND 52).

SN 78-198,678. SUPERGEN, INC., DUBLIN, CA. FILED 12-30-2002.

DOXO EXTRA

NO CLAIM IS MADE TO THE EXCLUSIVE RIGHT TO USE "DOXO", APART FROM THE MARK AS SHOWN.

FOR PHARMACEUTICAL PREPARATIONS THAT CONTAIN DOXORUBICIN FOR THE TREATMENT OF CANCER (U.S. CLS. 6, 18, 44, 46, 51 AND 52).

SN 78-198,974. COLLINS, DANIEL, R., SAGAMORE, MA. FILED 12-31-2002.

PESTAWAY

FOR DELIVERY DEVICE CONTAINING AN ACTIVE AGENT INSECT REPELLENT FOR APPLYING THE INSECT REPELLANT TO CLOTHES AS PART OF THE DRYING CYCLE OF A CLOTHES DRYER (U.S. CLS. 6, 18, 44, 46, 51 AND 52).

SN 78-199,273. CHINA STAR INVESTMENT GROUP, ALHAMBRA, CA. FILED 1-1-2003.

MAGIC CAPSULE

NO CLAIM IS MADE TO THE EXCLUSIVE RIGHT TO USE "CAPSULE", APART FROM THE MARK AS SHOWN.

FOR DIETARY SUPPLEMENT IN THE FORM OF CAPSULES (U.S. CLS. 6, 18, 44, 46, 51 AND 52).

CLASS 5—(Continued).

SN 78-199,673. UNITED PHOSPHORUS, INC., TRENTON, NJ. FILED 1-3-2003.

ALPHANEX HERBICIDE

NO CLAIM IS MADE TO THE EXCLUSIVE RIGHT TO USE "HERBICIDE", APART FROM THE MARK AS SHOWN. FOR AGRICULTURAL PESTICIDE (U.S. CLS. 6, 18, 44, 46, 51 AND 52).

SN 78-200,835. TARO PHARMACEUTICALS U.S.A., INC., HAWTHORNE, NY. FILED 1-7-2003.

DESICORT

FOR TOPICAL PHARMACEUTICAL PREPARATION FOR THE TREATMENT OF VARIOUS SKIN CONDITIONS (U.S. CLS. 6, 18, 44, 46, 51 AND 52).

SN 78-201,696. VALE ENTERPRISES, INC., DENVER, CO. FILED 1-9-2003.

VALE SOLUTION

OWNER OF U.S. REG. NOS. 2,540,348 AND 2,611,651. NO CLAIM IS MADE TO THE EXCLUSIVE RIGHT TO USE "SOLUTION", APART FROM THE MARK AS SHOWN. FOR DIETARY SUPPLEMENT TO HELP CLEANSE THE BODY OF TOXINS (U.S. CLS. 6, 18, 44, 46, 51 AND 52).

FIRST USE 12-24-2002; IN COMMERCE 12-24-2002.

SN 78-203,442. VIACOM INTERNATIONAL INC., NEW YORK, NY. FILED 1-15-2003.

KRABBY PATTIES

FOR ADHESIVE BANDAGES FOR SKIN WOUNDS (U.S. CLS. 6, 18, 44, 46, 51 AND 52).

SN 78-203,609. ALCON, INC., CH-6331 HUNENBERG, SWITZERLAND, FILED 1-15-2003.

VIGAMOX

FOR ANTI-INFECTIVE PHARMACEUTICAL PREPARATION FOR OPHTHALMIC AND OTORHINOLARYNGOLOGICAL USE (U.S. CLS. 6, 18, 44, 46, 51 AND 52).

CLASS 5—(Continued).

SN 78-203,618. ALCON, INC., CH-6331 HUNENBERG, SWITZERLAND, FILED 1-15-2003.

AMZIG

FOR ANTI-INFECTIVE PHARMACEUTICAL PREPARATION FOR OPHTHALMIC AND OTORHINOLARYNGOLOGICAL USE (U.S. CLS. 6, 18, 44, 46, 51 AND 52).

SN 78-203,625. ALCON, INC., CH-6331 HUNENBERG, SWITZERLAND, FILED 1-15-2003.

XOEYVA

FOR ANTI-INFECTIVE PHARMACEUTICAL PREPARATION FOR OPHTHALMIC AND OTORHINOLARYNGOLOGICAL USE (U.S. CLS. 6, 18, 44, 46, 51 AND 52).

SN 78-204,149. WINDOW ROCK ENTERPRISES, INC., YORBA LINDA, CA. FILED 1-16-2003.

CORAL CALCIUM ESSENTIALS

NO CLAIM IS MADE TO THE EXCLUSIVE RIGHT TO USE "CORAL CALCIUM", APART FROM THE MARK AS SHOWN.
FOR CORAL CALCIUM FOR USE AS A DIETARY SUPPLEMENT (U.S. CLS. 6, 18, 44, 46, 51 AND 52).

SN 78-205,519. VIRBAC CORPORATION, FORT WORTH, TX. FILED 1-21-2003.

MARACYN PLUS

OWNER OF U.S. REG. NOS. 921,839 AND 1,451,743.
FOR ANTIBIOTIC LIQUID RECOMMENDED FOR THE TREATMENT OF POPEYE, GILL DISEASE, FIN AND TAIL ROT, DROPSY, SEPTICEMIA, SECONDARY AND INTERNAL INFECTIONS (U.S. CLS. 6, 18, 44, 46, 51 AND 52).
FIRST USE 11-15-2002; IN COMMERCE 11-15-2002.

SN 78-205,705. LABORATOIRES SUISSES, S.A., PANAMA CITY, PANAMA, FILED 1-22-2003.

SNACK AND SHRINK

NO CLAIM IS MADE TO THE EXCLUSIVE RIGHT TO USE "SNACK", APART FROM THE MARK AS SHOWN.
FOR DIET SUPPLEMENT SNACK BARS AND MEAL REPLACEMENT DRINKS (U.S. CLS. 6, 18, 44, 46, 51 AND 52).

CLASS 5—(Continued).

SN 78-205,975. NOVARTIS AG, BASEL, SWITZERLAND, FILED 1-22-2003.

SANDOZ

FOR HOUSE MARK FOR A FULL LINE OF PHARMACEUTICAL PREPARATIONS. (U.S. CLS. 6, 18, 44, 46, 51 AND 52).

SN 78-206,390. JOHNSON & JOHNSON, NEW BRUNSWICK, NJ. FILED 1-23-2003.

PHELSPAR

FOR FUNGICIDES (U.S. CLS. 6, 18, 44, 46, 51 AND 52).

SN 78-206,403. JOHNSON & JOHNSON, NEW BRUNSWICK, NJ. FILED 1-23-2003.

PHILABUSTER

FOR FUNGICIDES (U.S. CLS. 6, 18, 44, 46, 51 AND 52).

SN 78-206,782. ROBERTSON, TIM, RUSSELLVILLE, AR. FILED 1-24-2003.

SMELLY SOCK(S)

FOR SCENTED OR FRAGRANCED SOCKS USED AS A ROOM DEODORIZER (U.S. CLS. 6, 18, 44, 46, 51 AND 52).

SN 78-206,838. ALLOSOURCE, CENTENNIAL, CO. FILED 1-24-2003.

ALLOFUSE

FOR BONE COMPOSITIONS FOR IMPLANTATION (U.S. CLS. 6, 18, 44, 46, 51 AND 52).

SN 78-206,846. BEAUMONT PRODUCTS, INC., KENNESAW, GA. FILED 1-24-2003.

ZING!

OWNER OF U.S. REG. NO. 2,223,057.
FOR AIR FRESHENER. (U.S. CLS. 6, 18, 44, 46, 51 AND 52).

CLASS 5—(Continued).

SN 78-207,007. ACTIV USA, INCORPORATED, DALLAS, TX. FILED 1-24-2003.

BURNSTUFF

FOR ANTISEPTIC AND TOPICAL ANALGESIC (U.S. CLS. 6, 18, 44, 46, 51 AND 52).
FIRST USE 5-0-2001; IN COMMERCE 5-0-2001.

SN 78-207,441. MEDPOINTE HEALTHCARE INC., SOMERSET, NJ. FILED 1-27-2003.

TUSSIZONE-12

FOR COUGH MEDICINE (U.S. CLS. 6, 18, 44, 46, 51 AND 52).
FIRST USE 8-31-2001; IN COMMERCE 8-31-2001.

SN 78-207,720. WYETH HOLDINGS CORPORATION, MADISON, NJ. FILED 1-28-2003.

TRIPLE-E FT

FOR EQUINE VACCINES (U.S. CLS. 6, 18, 44, 46, 51 AND 52).
FIRST USE 12-1-1999; IN COMMERCE 12-1-1999.

SN 78-207,887. AAIPHARMA, LLC, WILMINGTON, NC. FILED 1-28-2003.

M.V.I. ADULT

OWNER OF U.S. REG. NOS. 1,094,190, 1,179,782 AND 2,702,155.
NO CLAIM IS MADE TO THE EXCLUSIVE RIGHT TO USE "ADULT", APART FROM THE MARK AS SHOWN.
FOR MULTI-VITAMINS FOR INFUSION (U.S. CLS. 6, 18, 44, 46, 51 AND 52).

SN 78-208,095. ADVANDX, INC., CONCORD, MA. FILED 1-28-2003.

ADVANDX

FOR DIAGNOSTIC REAGENTS FOR IN VITRO USE IN BIOCHEMISTRY, CLINICAL CHEMISTRY AND MICROBIOLOGY (U.S. CLS. 6, 18, 44, 46, 51 AND 52).

CLASS 5—(Continued).

SN 78-208,273. S. C. JOHNSON & SON, INC., RACINE, WI. FILED 1-29-2003.

COUNTRY FRESH

FOR INSECTICIDES (U.S. CLS. 6, 18, 44, 46, 51 AND 52).
FIRST USE 1-1-1992; IN COMMERCE 1-1-1992.

SN 78-208,413. FMC CORPORATION, PHILADELPHIA, PA. FILED 1-29-2003.

CARBINE

FOR PREPARATIONS FOR THE DESTRUCTION OF VERMIN AND WEEDS, PESTICIDES, HERBICIDES AND FUNGICIDES (U.S. CLS. 6, 18, 44, 46, 51 AND 52).

SN 78-208,718. UNIVERSITY OF FLORIDA, GAINESVILLE, FL. FILED 1-30-2003.

SAFE-START

FOR INFANT FORMULA, NAMELY, SYNTHETIC FORMULA FOR PREMATURE INFANTS. (U.S. CLS. 6, 18, 44, 46, 51 AND 52).

SN 78-208,720. NATURES BENEFIT, INC., NEWARK, NJ. FILED 1-30-2003.

MENOPLAN

FOR VITAMINS, NUTRITIONAL SUPPLEMENTS AND NUTRICEUTICALS (U.S. CLS. 6, 18, 44, 46, 51 AND 52).

CLASS 5—(Continued).

SN 78-209,006. AGOURON PHARMACEUTICALS, INC., SAN DIEGO, CA. FILED 1-30-2003.

DELITY

FOR PHARMACEUTICAL PREPARATIONS FOR THE TREATMENT OF CARDIOVASCULAR DISEASE, CENTRAL NERVOUS SYSTEM DISEASES AND DISORDERS, NEUROLOGICAL DISORDERS, UROLOGICAL DISORDERS, UROGENITAL DISORDERS, GASTROINTESTINAL DISORDERS, MUSCULOSKELETAL DISORDERS, ALLERGIES, DIABETES, HYPERTENSION, ERECTILE DYSFUNCTION, SEXUAL DYSFUNCTION, STROKE, CANCER, MIGRAINES, PAIN, OBESITY, INFLAMMATION, INFLAMMATORY DISEASES, RESPIRATORY DISEASES, INFECTIOUS DISEASES, IMMUNOLOGICAL DISORDERS, VIRAL DISORDERS, FUNGAL DISORDERS; PHARMACEUTICAL PREPARATIONS, NAMELY, CHOLESTEROL PREPARATIONS, SMOKING CESSATION PREPARATIONS, DERMATOLOGICAL PREPARATIONS, GYNECOLOGICAL PREPARATIONS, OSTEOPOROSIS PREPARATIONS, OPHTHALMOLOGICAL PREPARATIONS, PREPARATIONS FOR THE TREATMENT OF HIV AND AIDS (U.S. CLS. 6, 18, 44, 46, 51 AND 52).

SN 78-209,024. AGOURON PHARMACEUTICALS, INC., SAN DIEGO, CA. FILED 1-30-2003.

VESNUA

FOR PHARMACEUTICAL PREPARATIONS FOR THE TREATMENT OF IMMUNOLOGICAL DISORDERS, VIRAL DISORDERS, HIV AND AIDS (U.S. CLS. 6, 18, 44, 46, 51 AND 52).

SN 78-209,027. AGOURON PHARMACEUTICALS, INC., SAN DIEGO, CA. FILED 1-30-2003.

ZIQUA

FOR PHARMACEUTICAL PREPARATIONS FOR THE TREATMENT OF IMMUNOLOGICAL DISORDERS, VIRAL DISORDERS, HIV AND AIDS (U.S. CLS. 6, 18, 44, 46, 51 AND 52).

SN 78-209,343. S. C. JOHNSON & SON, INC., RACINE, WI. FILED 1-31-2003.

NATURE'S COLLECTION

NO CLAIM IS MADE TO THE EXCLUSIVE RIGHT TO USE "COLLECTION", APART FROM THE MARK AS SHOWN.

FOR AIR FRESHENERS. (U.S. CLS. 6, 18, 44, 46, 51 AND 52).

CLASS 5—(Continued).

SN 78-209,628. NATURE'S BENEFIT, INC., NEWARK, NJ. FILED 1-31-2003.

ANTIPOROSIS

FOR NUTRITIONAL SUPPLEMENTS CONTAINING MINERALS, VITAMINS AND MICRONUTRIENTS (U.S. CLS. 6, 18, 44, 46, 51 AND 52).
FIRST USE 7-9-2002; IN COMMERCE 7-9-2002.

SN 78-209,641. NPS PHARMACEUTICALS, INC., SALT LAKE CITY, UT. FILED 1-31-2003.

PREOTACT

FOR PHARMACEUTICAL PREPARATIONS FOR THE TREATMENT OR PREVENTION OF GASTROINTESTINAL DISORDERS, INFECTIOUS DISEASES, DISEASES INVOLVING VARYING LEVELS OF CALCIUM IN CELLS AND OUTSIDE CELLS, NEUROLOGICAL OR OTHER CENTRAL NERVOUS SYSTEM DISORDERS, ENDOCRINE DISORDERS, OR BONE METABOLISM DISORDERS; PHARMACEUTICAL PREPARATIONS FOR USE IN ANALGESIA (U.S. CLS. 6, 18, 44, 46, 51 AND 52).

SN 78-209,644. NATURE'S BENEFIT, INC., NEWARK, NJ. FILED 1-31-2003.

ARTHROTRIM

FOR DIETARY SUPPLEMENT CONTAINING VITAMINS, MINERALS AND NUTRACEUTICALS (U.S. CLS. 6, 18, 44, 46, 51 AND 52).
FIRST USE 4-2-2002; IN COMMERCE 4-2-2002.

SN 78-209,649. NPS PHARMACEUTICALS, INC., SALT LAKE CITY, UT. FILED 1-31-2003.

OSTACT

FOR PHARMACEUTICAL PREPARATIONS FOR THE TREATMENT OR PREVENTION OF GASTROINTESTINAL DISORDERS, INFECTIOUS DISEASES, DISEASES INVOLVING VARYING LEVELS OF CALCIUM IN CELLS AND OUTSIDE CELLS, NEUROLOGICAL OR OTHER CENTRAL NERVOUS SYSTEM DISORDERS, ENDOCRINE DISORDERS, OR BONE METABOLISM DISORDERS; PHARMACEUTICAL PREPARATIONS FOR USE IN ANALGESIA (U.S. CLS. 6, 18, 44, 46, 51 AND 52).

CLASS 5—(Continued).

SN 78-209,652. NPS PHARMACEUTICALS, INC., SALT LAKE CITY, UT. FILED 1-31-2003.

RECALZA

FOR PHARMACEUTICAL PREPARATIONS FOR THE TREATMENT OR PREVENTION OF GASTROINTESTINAL DISORDERS, INFECTIOUS DISEASES, DISEASES INVOLVING VARYING LEVELS OF CALCIUM IN CELLS AND OUTSIDE CELLS, NEUROLOGICAL OR OTHER CENTRAL NERVOUS SYSTEM DISORDERS, ENDOCRINE DISORDERS, OR BONE METABOLISM DISORDERS; PHARMACEUTICAL PREPARATIONS FOR USE IN ANALGESIA (U.S. CLS. 6, 18, 44, 46, 51 AND 52).

SN 78-209,657. NPS PHARMACEUTICALS, INC., SALT LAKE CITY, UT. FILED 1-31-2003.

ZYSTUS

FOR PHARMACEUTICAL PREPARATIONS FOR THE TREATMENT OR PREVENTION OF GASTROINTESTINAL DISORDERS, INFECTIOUS DISEASES, DISEASES INVOLVING VARYING LEVELS OF CALCIUM IN CELLS AND OUTSIDE CELLS, NEUROLOGICAL OR OTHER CENTRAL NERVOUS SYSTEM DISORDERS, ENDOCRINE DISORDERS, OR BONE METABOLISM DISORDERS; PHARMACEUTICAL PREPARATIONS FOR USE IN ANALGESIA (U.S. CLS. 6, 18, 44, 46, 51 AND 52).

SN 78-210,030. SOLUTIONS INTERNATIONAL, LLC, LINDON, UT. FILED 2-3-2003.

CORE FOUR

FOR FOOD SUPPLEMENTS, NAMELY HERB COMPOSITIONS, COLLOIDAL SILVER AND NON PRESCRIPTION MEDICATIONS FOR METABOLISM AND MUSCLE DEVELOPMENT (U.S. CLS. 6, 18, 44, 46, 51 AND 52).
FIRST USE 5-15-2002; IN COMMERCE 5-15-2002.

SN 78-212,626. MENTOR CORPORATION, SANTA BARBARA, CA. FILED 2-9-2003.

ISOSTRAND

FOR BIOSORBABLE TUBULAR CARRIER CONTAINING BRACHYTHERAPY SEEDS (U.S. CLS. 6, 18, 44, 46, 51 AND 52).

CLASS 5—(Continued).

SN 78-213,926. NEWPORT DIRECT RESPONSE, LLC, NEWPORT BEACH, CA. FILED 2-12-2003.

ZYLOPAIN

FOR TOPICAL ANALGESIC PAIN RELIEF CREAM AND DIETARY SUPPLEMENTS (U.S. CLS. 6, 18, 44, 46, 51 AND 52).

SN 78-213,943. SUGARBERTH, INC., DBA ALLIED PHARMACEUTICAL, MELBOURNE, FL. FILED 2-12-2003.

XANTHOX

FOR HERBAL SUPPLEMENT (U.S. CLS. 6, 18, 44, 46, 51 AND 52).

SN 78-216,260. G. D. SEARLE LLC, SKOKIE, IL. FILED 2-19-2003.

CELEBREX FLASHMELT

FOR PHARMACEUTICAL PREPARATIONS NAMELY, ONCOLOGICAL PREPARATIONS, ANALGESICS AND ANTI-INFLAMMATORIES (U.S. CLS. 6, 18, 44, 46, 51 AND 52).

SN 78-216,263. G. D. SEARLE LLC, SKOKIE, IL. FILED 2-19-2003.

CELEBREX SPEEDYMELT

FOR PHARMACEUTICAL PREPARATIONS NAMELY, ONCOLOGICAL PREPARATIONS, ANALGESICS AND ANTI-INFLAMMATORIES (U.S. CLS. 6, 18, 44, 46, 51 AND 52).

SN 78-216,268. G. D. SEARLE LLC, SKOKIE, IL. FILED 2-19-2003.

CELEBREX SWIFTMELT

OWNER OF U.S. REG. NO. 2,307,888.
FOR PHARMACEUTICAL PREPARATIONS NAMELY, ONCOLOGICAL PREPARATIONS, ANALGESICS AND ANTI-INFLAMMATORIES (U.S. CLS. 6, 18, 44, 46, 51 AND 52).

CLASS 5—(Continued).

SN 78-216,272. G. D. SEARLE LLC, SKOKIE, IL. FILED 2-19-2003.

CELEBREX X-MELT

OWNER OF U.S. REG. NO. 2,307,888.
FOR PHARMACEUTICAL PREPARATIONS NAMELY,
ONCOLOGICAL PREPARATIONS, ANALGESICS AND
ANTI-INFLAMMATORIES (U.S. CLS. 6, 18, 44, 46, 51
AND 52).

SN 78-216,276. G. D. SEARLE LLC, SKOKIE, IL. FILED 2-19-2003.

CELEBREX LIQUESCE

OWNER OF U.S. REG. NO. 2,307,888.
FOR PHARMACEUTICAL PREPARATIONS NAMELY,
ONCOLOGICAL PREPARATIONS, ANALGESICS AND
ANTI-INFLAMMATORIES (U.S. CLS. 6, 18, 44, 46, 51
AND 52).

SN 78-239,975. NOVARTIS AG, BASEL, SWITZERLAND,
FILED 4-21-2003.

TRIAMINIC

OWNER OF U.S. REG. NOS. 589,662, 1,244,111 AND
OTHERS.
FOR COUGH, COLD AND ALLERGY PREPARATIONS
(U.S. CLS. 6, 18, 44, 46, 51 AND 52).
FIRST USE 3-18-1953; IN COMMERCE 3-18-1953.

CLASS 6—METAL GOODS

SN 75-530,177. DOOSAN HEAVY INDUSTRIES & CON-
STRUCTION CO., LTD., GYUNGNAM, REPUBLIC OF
KOREA, BY CHANGE OF NAME KOREA HEAVY
INDUSTRIES & CONSTRUCTION CO., LTD., KYUNG-
SANGNAM-DO 641-792, REPUBLIC OF KOREA, FILED 8-
3-1998.



OWNER OF REPUBLIC OF KOREA REG. NO. 311610,
DATED 4-17-1995, EXPIRES 4-17-2005.

FOR CAST STEEL IN BAR, ROD, OR WIRE FORM
FOR FURTHER MANUFACTURE; METAL CHILL
MOLDS FOR USE IN MANUFACTURE AND CON-
STRUCTION; METAL SILOS; AND METAL FITTINGS
FOR COMPRESSED AIR DUCTS; METAL STORAGE
TANKS, SOLD EMPTY; METAL PRESSURE WATER
TANKS (U.S. CLS. 2, 12, 13, 14, 23, 25 AND 50).

SN 76-258,608. EMHART INC., NEWARK, DE. FILED 5-17-2001.

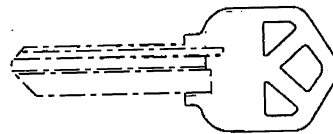

OWNER OF U.S. REG. NO. 1,745,338.
THE DOTTED LINES SHOWN IN THE DRAWING
REPRESENT THE SHAFT OF THE KEY WHICH IS NOT
PART OF THE MARK.

THE MARK CONSISTS OF THE LETTER "K" INCORPORATED
INTO THE HEAD OF THE KEY WHICH IS
FORMED BY THREE TRIANGULAR SHAPES CUT INTO
THE HEAD OF THE KEY; TWO OF THE SHAPES ARE ON
TOP OF AND BELOW ONE ANOTHER, WHILE THE THIRD
IS PERPENDICULAR TO THE OTHER TWO.

SEC. 2(F).
FOR METAL DOOR HARDWARE, NAMELY, KNOBS,
LEVERS, LEVERSETS, HANDLES, HANDLE SETS,
DEAD BOLTS KEYS AND KEY BLANKS (U.S. CLS. 2,
12, 13, 14, 23, 25 AND 50).
FIRST USE 0-0-1957; IN COMMERCE 0-0-1957.

CLASS 6—(Continued).

SN 76-311,663. CAROSELLI, CAROL, PITTSBURGH, PA. AND WANG, MAY, PITTSBURGH, PA. FILED 9-12-2001.

THE LITTLE HOOKER

FOR HANDBAG AND SCARF HOLDERS, NAMELY, METAL HOOKS USED TO TEMPORARILY HOLD CLOTHING ARTICLES, NAMELY, HANDBAGS AND SCARVES, FOR DOMESTIC USE (U.S. CLS. 2, 12, 13, 14, 23, 25 AND 50).

SN 76-333,899. CUSTOM HOME ACCESSORIES, INC., SACRAMENTO, CA. FILED 11-5-2001.



NO CLAIM IS MADE TO THE EXCLUSIVE RIGHT TO USE "CUSTOM HOME ACCESSORIES", APART FROM THE MARK AS SHOWN.

FOR NON-LUMINOUS AND NON-MECHANICAL METAL SIGNS, NAMELY, STREET SIGNS, STREET MARKERS, TRAFFIC SIGNS, PARKING SIGNS, SIGN POSTS, ADDRESS SIGNS, GOLF SIGNS AND INFORMATION SIGNS; METAL MAILBOXES AND MAILBOX POSTS; METAL WEATHERVANES; METAL NAME PLATES; AND METAL ATTACHING DEVICES, NAMELY, BOLTS, CLIPS, AND BRACKETS (U.S. CLS. 2, 12, 13, 14, 23, 25 AND 50).

FIRST USE 10-0-1995; IN COMMERCE 4-0-1997.

SN 76-418,801. EXTECH EXTERIOR TECHNOLOGIES, INC., PITTSBURGH, PA. FILED 6-15-2002.

STORMTECH

FOR METAL OVER GLAZING AND INNER GLAZING HURRICANE WINDOWS, SECURITY METAL WINDOWS AND METAL SHUTTERS (U.S. CLS. 2, 12, 13, 14, 23, 25 AND 50).

FIRST USE 4-15-1994; IN COMMERCE 4-15-1994.

SN 76-419,288. KAYDON ACQUISITION XI, INC., ANN ARBOR, MI. FILED 6-11-2002.

THE ULTIMATE SOLDER

NO CLAIM IS MADE TO THE EXCLUSIVE RIGHT TO USE "SOLDER", APART FROM THE MARK AS SHOWN. SEC. 2(F).

FOR SOLDER CONTAINING PRIMARILY TIN AND LEAD (U.S. CLS. 2, 12, 13, 14, 23, 25 AND 50).

FIRST USE 0-0-1984; IN COMMERCE 0-0-1984.

CLASS 6—(Continued).

SN 76-421,680. TAENSA S.A., GUAYAQUIL, ECUADOR, FILED 6-18-2002.

TAENSA

FOR METAL BOTTLE CAPS FOR BEVERAGES AND LIQUORS, NAMELY CROWN CAPS, TWIST OFF CROWN CAPS, AND ALUMINUM ROLL ONS (U.S. CLS. 2, 12, 13, 14, 23, 25 AND 50).

FIRST USE 6-0-1996; IN COMMERCE 8-0-2001.

SN 76-423,142. OUTOKUMPU OYJ, FIN-02200 ESPOO, FINLAND, FILED 6-26-2002.

MARATHON STRIP

NO CLAIM IS MADE TO THE EXCLUSIVE RIGHT TO USE "STRIP", APART FROM THE MARK AS SHOWN.

FOR COPPER AND COPPER ALLOY SOLD IN STRIP FORM FOR USE FURTHER MANUFACTURING (U.S. CLS. 2, 12, 13, 14, 23, 25 AND 50).

SN 76-423,143. OUTOKUMPU OYJ, FIN-02200 ESPOO, FINLAND, FILED 6-26-2002.

μSTRIP

FOR COPPER AND COPPER ALLOY SOLD IN STRIP FORM FOR USE FURTHER MANUFACTURING (U.S. CLS. 2, 12, 13, 14, 23, 25 AND 50).

SN 76-423,144. OUTOKUMPU OYJ, FIN-02200 ESPOO, FINLAND, FILED 6-26-2002.

VLS STRIP

NO CLAIM IS MADE TO THE EXCLUSIVE RIGHT TO USE "STRIP", APART FROM THE MARK AS SHOWN.

FOR COPPER AND COPPER ALLOY SOLD IN STRIP FORM FOR USE FURTHER MANUFACTURING (U.S. CLS. 2, 12, 13, 14, 23, 25 AND 50).

CLASS 6—(Continued).

SN 76-424,433. ENGINEERED SAFETY PRODUCTS, LLC, EL MONTE, CA. FILED 6-24-2002.

HIGH SCREEN

NO CLAIM IS MADE TO THE EXCLUSIVE RIGHT TO USE "SCREEN", APART FROM THE MARK AS SHOWN.

FOR METAL CLOSURES FOR ROADWAY AND GUTTER DRAINS IN THE NATURE OF METAL PANELS WHICH ARE NORMALLY CLOSED TO EXCLUDE SOLID TRASH, BUT WHICH OPEN IN RESPONSE TO SUFFICIENT WATER FLOW RATES FROM THE ROADWAY OR GUTTER (U.S. CLS. 2, 12, 13, 14, 23, 25 AND 50).

SN 76-425,296. DOWNHOLE PRODUCTS PLC, ABERDEEN AB12 4YA, UNITED KINGDOM, FILED 6-21-2002.

PATHFINDER

PRIORITY CLAIMED UNDER SEC. 44(D) ON UNITED KINGDOM APPLICATION NO. 2288968, FILED 12-22-2001, REG. NO. 2288968, DATED 6-7-2002, EXPIRES 12-22-2011.

FOR ARTICLES AND TUBES OF METAL ALL FOR USE IN WATER, OIL AND GAS EXPLORATION AND PRODUCTION, NAMELY PIPES, CASING ANTI LINER, WELLBORE AND CENTRALIZER LOCKS, GUIDE SHOES AND METAL CEMENT SHOES, COMPONENT PARTS AND FITTINGS FOR ALL THE AFORESAID GOODS (U.S. CLS. 2, 12, 13, 14, 23, 25 AND 50).

SN 76-426,349. PETER MEIER, INC., KERNERSVILLE, NC. FILED 6-28-2002.

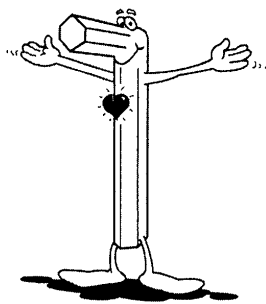

FOR CONNECTOR AND FURNITURE HARDWARE, NAMELY, METAL SCREWS, METAL DRAWER PULLS, METAL DRAWER RUNNERS, METAL CASTORS, METAL SWIVELS, METAL LATCHES, METAL HINGES, METAL STRIKE PLATES, METAL NAIL GLIDES, METAL LEVELERS, METAL DOOR STOPS, METAL COVER CAPS, METAL SHELF SUPPORTS, METAL WING NUTS, METAL WASHERS, METAL HEX NUTS, METAL SOCKETS, METAL HANGER BOLTS, METAL EURO-SCREWS AND METAL SYSTEM SCREWS (U.S. CLS. 2, 12, 13, 14, 23, 25 AND 50).

FIRST USE 12-31-1990; IN COMMERCE 12-31-1990.

CLASS 6—(Continued).

SN 76-426,535. OUTOKUMPU OYJ, FIN-02200 ESPOO, FINLAND, FILED 6-27-2002.

OVC FORMRITE

FOR WIRES MADE FROM COPPER OR COPPER ALLOYS FOR USE IN THE FURTHER MANUFACTURE OF ELECTRICAL DEVICES AND COMPONENTS (U.S. CLS. 2, 12, 13, 14, 23, 25 AND 50).

SN 76-444,627. SLIDE SYSTEMS, LLC, CANASTOTA, NY. FILED 8-26-2002.

ROLLERBOX

FOR METAL STORAGE BOXES FOR TRUCKS (U.S. CLS. 2, 12, 13, 14, 23, 25 AND 50).

FIRST USE 8-0-1999; IN COMMERCE 8-0-1999.

SN 76-461,346. RESTEK CORPORATION, BELLEFONTE, PA. FILED 10-23-2002.

SULFINERT

FOR COATINGS IN THE NATURE OF PASSIVATION COATINGS SOLD AS AN INTEGRAL COMPONENT OF STEEL AND STEEL SURFACES (U.S. CLS. 2, 12, 13, 14, 23, 25 AND 50).

FIRST USE 11-30-1999; IN COMMERCE 11-30-1999.

SN 76-462,962. KOBRA FORMEN GMBH, D-08484 LENGENFELD, FED REP GERMANY, FILED 10-31-2002.

DYNAMIC MOLD INSERT

NO CLAIM IS MADE TO THE EXCLUSIVE RIGHT TO USE "MOLD INSERT", APART FROM THE MARK AS SHOWN.

FOR METALLIC MOLD INSERTS USED IN MACHINES THAT MANUFACTURE COMPACTED AND MOLDED CONCRETE STONES AND BLOCKS (U.S. CLS. 2, 12, 13, 14, 23, 25 AND 50).

FIRST USE 3-0-2000; IN COMMERCE 3-0-2000.

CLASS 6—(Continued).

SN 76-468,789. ULTRA ALUMINUM MANUFACTURING INC., WHITMORE LAKE, MI. FILED 11-20-2002.

“Ultra Fence”

NO CLAIM IS MADE TO THE EXCLUSIVE RIGHT TO USE "FENCE", APART FROM THE MARK AS SHOWN.

FOR ORNAMENTAL ALUMINUM FENCES, RESIDENTIAL, COMMERCIAL AND INDUSTRIAL (U.S. CLS. 2, 12, 13, 14, 23, 25 AND 50).

FIRST USE 7-9-1996; IN COMMERCE 6-1-1997.

SN 76-481,820. RIGIDIZED METALS CORPORATION, BUFFALO, NY. FILED 1-13-2003.

RIGI-TILE

OWNER OF U.S. REG. NOS. 409,319, 2,495,044 AND OTHERS.

FOR STRUCTURALLY REINFORCED FERROUS AND NON-FERROUS METAL SHEETS AND TILES (U.S. CLS. 2, 12, 13, 14, 23, 25 AND 50).

SN 76-484,148. PROSPECT FASTENER CORPORATION, WAUCONDA, IL. FILED 1-23-2003.

WE DO RINGS AROUND THE COMPETITION

OWNER OF U.S. REG. NO. 2,047,660.
FOR THREADED AND NON-THREADED METAL FASTENERS (U.S. CLS. 2, 12, 13, 14, 23, 25 AND 50).
FIRST USE 3-31-2002; IN COMMERCE 3-31-2002.

SN 76-486,035. FEDERAL SIGNAL CORPORATION, OAK BROOK, IL. FILED 1-30-2003.

STINGER XL

OWNER OF U.S. REG. NO. 1,839,220.
NO CLAIM IS MADE TO THE EXCLUSIVE RIGHT TO USE "XL", APART FROM THE MARK AS SHOWN.
FOR TIRE DEFLATING DEVICES FOR USE BY LAW ENFORCEMENT PERSONNEL TO STOP A FLEEING VEHICLE; NAMELY, METAL SPIKES HELD IN AN EXPANDABLE FRAME (U.S. CLS. 2, 12, 13, 14, 23, 25 AND 50).

CLASS 6—(Continued).

SN 76-487,340. FASCO AMERICA, INC., MUSCLE SHOALS, AL. FILED 2-4-2003.

FASCO/BECK

FOR FASTENERS AND STAPLES MADE OF METAL FOR USE IN UPHOLSTERY AND INSULATION (U.S. CLS. 2, 12, 13, 14, 23, 25 AND 50).

FIRST USE 12-1-1991; IN COMMERCE 12-1-1991.

SN 76-489,051. MSE STUDIO EQUIPMENT, INC., BURBANK, CA. FILED 2-3-2003.

HOLLYWOOD GRIP

FOR METAL MECHANICAL CLAMPS FOR COUPLING STILL, MOTION PICTURE AND VIDEO CAMERAS, LIGHTS AND MICROPHONES TO STANDS AND TRIPODS FOR MOTION PICTURE, VIDEO AND STILL PHOTOGRAPHY APPLICATIONS (U.S. CLS. 2, 12, 13, 14, 23, 25 AND 50).

SN 76-493,038. LEIFHEIT INTERNATIONAL USA, INC., MELVILLE, NY. FILED 1-27-2003.

HOMESTEP

FOR ALUMINUM STEP LADDERS AND STEP STOOLS (U.S. CLS. 2, 12, 13, 14, 23, 25 AND 50).
FIRST USE 9-1-2001; IN COMMERCE 9-1-2001.

SN 78-108,145. CAGLE, PATRICK R., ARENZVILLE, IL. AND LEISCHNER, HENRY G., MT. STERLING, IL. FILED 2-12-2002.

TORSION TAMER

FOR METAL RESILIENT CONNECTORS FOR CRANK OPERATED ROLLERS (U.S. CLS. 2, 12, 13, 14, 23, 25 AND 50).

FIRST USE 12-15-2001; IN COMMERCE 2-19-2002.

SN 78-141,159. IDEAL STEEL & BUILDERS' SUPPLIES, INC., HAMBURG, MI. FILED 7-3-2002.

IDEAL SHIELD

NO CLAIM IS MADE TO THE EXCLUSIVE RIGHT TO USE "SHIELD", APART FROM THE MARK AS SHOWN.
FOR METAL GUARD RAILS, HAND RAILS AND STANCHION COVERS, ALL OF WHICH ARE PLASTIC COATED (U.S. CLS. 2, 12, 13, 14, 23, 25 AND 50).

FIRST USE 10-1-1991; IN COMMERCE 10-1-1991.

CLASS 6—(Continued).

SN 78-163,214. J.F. TOOL, INC., ROCKFALL, CT. FILED 9-12-2002.

TRIMDECOR

FOR METAL ARCHITECTURAL PANELS FOR USE WITH FACIA AND GUTTERS (U.S. CLS. 2, 12, 13, 14, 23, 25 AND 50).

FIRST USE 6-27-2002; IN COMMERCE 6-27-2002.

SN 78-189,532. CHENG, DARA, SAN DIEGO, CA. FILED 11-27-2002.

STOVE-BE-SAFE

FOR METAL SAFETY HARDWARE, NAMELY STOVE CONTROL KNOB COVERS (U.S. CLS. 2, 12, 13, 14, 23, 25 AND 50).

SN 78-191,555. CLIPPERTON COMPANY, SATELLITE BEACH, FL. FILED 12-5-2002.

ROLLERRINGS

FOR METAL SHOWER CURTAIN RINGS (U.S. CLS. 2, 12, 13, 14, 23, 25 AND 50).

FIRST USE 9-30-1992; IN COMMERCE 9-30-1992.

SN 78-197,831. GALVAK, SA. DE C. V., SAN NICOLAS DE LOS GARZA, MEXICO, FILED 12-26-2002.

GALVADUAL 600

PRIORITY CLAIMED UNDER SEC. 44(D) ON MEXICO APPLICATION NO. 567,987, FILED 9-27-2002, REG. NO. 767749, DATED 9-27-2002, EXPIRES 9-27-2012.

FOR ULTRA-LIGHT GALVANIZED STEEL FOR USE IN AUTOMOBILES (U.S. CLS. 2, 12, 13, 14, 23, 25 AND 50).

SN 78-204,092. BALL CORPORATION, BROOMFIELD, CO. FILED 1-16-2003.

BULL'S EYE

FOR METAL CANS AND CAN ENDS (U.S. CLS. 2, 12, 13, 14, 23, 25 AND 50).

CLASS 6—(Continued).

SN 78-205,891. HEB GROCERY COMPANY, L.P., SAN ANTONIO, TX. FILED 1-22-2003.

HOME SOLUTIONS

FOR NAILS (U.S. CLS. 2, 12, 13, 14, 23, 25 AND 50).

SN 78-208,502. CRAJAX, INC., MITCHELL, SD. FILED 1-29-2003.

WINDWANGER

FOR SWIVEL ATTACHMENT PRIMARILY MADE OF METAL USED TO DISPLAY FLAGS, WINDSOCKS AND THE LIKE (U.S. CLS. 2, 12, 13, 14, 23, 25 AND 50).

FIRST USE 6-0-2002; IN COMMERCE 12-6-2002.

CLASS 7—MACHINERY

SN 76-238,714. SUBSEA MUDLIFT DRILLING COMPANY L.L.C., HOUSTON, TX. FILED 3-22-2001.

SMD

FOR OFFSHORE DRILLING EQUIPMENT, NAMELY, DRILLING FLUID PUMPS, BLOWOUT PREVENTERS, AND WELLHEADS; PARTS OF OFFSHORE DRILLING MACHINES, NAMELY, CONTROL VALVES, SUBSEA DIVERTERS, AND SUBSEA FLUID ACCUMULATORS (U.S. CLS. 13, 19, 21, 23, 31, 34 AND 35).

SN 76-263,700. DEUTZ AKTIENGESELLSCHAFT, 51063 COLOGNE, FED REP GERMANY, FILED 5-29-2001.

COGENTAINER

PRIORITY CLAIMED UNDER SEC. 44(D) ON FED REP GERMANY APPLICATION NO. 30088275.0, FILED 12-1-2000, REG. NO. 30088275, DATED 1-8-2001, EXPIRES 12-31-2010.

FOR STATIONARY INTERNAL COMBUSTION ENGINES FOR POWER GENERATION, NAMELY, NEW AND REBUILT DIESEL AND GAS ENGINES AND PARTS THEREFOR (U.S. CLS. 13, 19, 21, 23, 31, 34 AND 35).

CLASS 7—(Continued).

SN 76-265,838. ADVANCE DENKI KOUGYOU KABUSHIKI KAISHA, AICHI-KEN, JAPAN, FILED 6-1-2001.

ADVANCE

PRIORITY CLAIMED UNDER SEC. 44(D) ON JAPAN APPLICATION NO. 3998/2001, FILED 1-22-2001, REG. NO. 4658569, DATED 4-4-2003, EXPIRES 4-4-2013.

FOR PNEUMATIC AND HYDRAULIC PUMPS AND VALVES FOR USE IN SUPPLYING PURIFIED WATER AND CHEMICALS DURING THE MANUFACTURING PROCESS OF SEMICONDUCTOR MATERIALS, CHEMICALS AND MEDICINAL PRODUCTS (U.S. CLS. 13, 19, 21, 23, 31, 34 AND 35).

SN 76-267,691. KABUSHIKI KAISHA NIHON SEIKOSHO, AKA JAPAN STEEL WORKS, LTD., CHIYODA-KU, TOKYO, JAPAN, FILED 6-7-2001.

Mediamaster

PRIORITY CLAIMED UNDER SEC. 44(D) ON JAPAN APPLICATION NO. 2001-044628, FILED 5-17-2001, REG. NO. 4574752, DATED 6-7-2002, EXPIRES 6-7-2012.

FOR INJECTION MOLDING MACHINES, EXTRUSION MOLDING MACHINES, COMPRESSION MOLDING MACHINES, PLASTIC PROCESSING MACHINES, PARTS OF ALL THE AFORESAID GOODS (U.S. CLS. 13, 19, 21, 23, 31, 34 AND 35).

SN 76-301,926. GARAGE DOCTORS LIMITED, THE CANARY WHARF, LONDON E14 4HJ, UNITED KINGDOM, FILED 8-17-2001.

GD 500

PRIORITY CLAIMED UNDER SEC. 44(D) ON ERP CMNTY TM OFC APPLICATION NO. 2325884, FILED 8-1-2001, REG. NO. 2325884, DATED 4-14-2003, EXPIRES 8-1-2011.

FOR MACHINES FOR THE PREPARATION AND LAYING OF FLOORS (U.S. CLS. 13, 19, 21, 23, 31, 34 AND 35).

CLASS 7—(Continued).

SN 76-302,235. ESTERLINE TECHNOLOGIES CORPORATION, BELLEVUE, WA. FILED 8-17-2001.

ESTERLINE

FOR MACHINE COUPLINGS AND BELTS; AUTOMATED DRILLING, ROUTING AND MATERIAL HANDLING EQUIPMENT, NAMELY, CONVEYERS, STACKERS, ACCUMULATORS, RACKS, DIVERTERS, FEEDERS AND LOADERS; FABRICATION MACHINES FOR THE PRODUCTION OF PRINTED CIRCUIT BOARDS; AUTOMATED PUNCHING AND CUTTING MACHINES; POWER OPERATED COPER, NOTCHER, AND BENDER PRESSES AND POWER OPERATED SHEARERS FOR SHEET, PLATE AND STRUCTURAL STEEL FABRICATION; MACHINE AND AUTOMATED TOOLS FOR SHEET, PLATE AND STRUCTURAL STEEL FABRICATION, NAMELY, AUTOMATED PRESSES, AUTOMATED DUPLICATORS, AUTOMATED DRILLING MACHINES, FABRICATION MACHINES FOR STEEL; LASER DRILLING MACHINES; ROUTING MACHINES; COMBINED LASER DRILLING AND ROUTING MACHINES; BRUSHED AND BRUSHLESS MOTORS FOR MACHINES; STEPPER MOTORS FOR MACHINES; MACHINE PARTS, NAMELY, ENGINE CONTROL SUB-ASSEMBLIES; GEARHEADS (U.S. CLS. 13, 19, 21, 23, 31, 34 AND 35).

FIRST USE 0-0-1967; IN COMMERCE 6-0-2001.

SN 76-325,657. VITEX SYSTEMS, INC., SAN JOSE, CA. FILED 10-16-2001.

GUARDIAN SYSTEMS

NO CLAIM IS MADE TO THE EXCLUSIVE RIGHT TO USE "SYSTEMS", APART FROM THE MARK AS SHOWN.

FOR BARRIER VACUUM DEPOSITION SYSTEM COMPRISED OF A SINGLE VACUUM CHAMBER OR SEQUENTIAL VACUUM CHAMBERS DESIGNED TO DEPOSIT MULTI-LAYER THIN FILM COATINGS COMPOSED OF POLYMER LAYERS AND CERAMIC LAYERS, ONE OR MORE CHAMBERS INCLUDING A UV OR ELECTRON BEAM CURING STATION FOR THE CURING OF MONOMER INTO POLYMER, A LOAD LOCK OR LOAD LOCK(S) TO ALLOW FOR TRANSFER OF THE MATERIAL TO BE COATED TO THE MULTI-LAYER THIN FILM BARRIER COATING DEPOSITION EQUIPMENT, AND COMPUTERIZED PROCESS CONTROL EQUIPMENT TO MONITOR AND CONTROL THE MULTI-LAYER THIN FILM AND ASSOCIATED PROCESSES (U.S. CLS. 13, 19, 21, 23, 31, 34 AND 35).

CLASS 7—(Continued).

SN 76-349,533. SHAYA, EYTAN, KIRYAT GAT 82000, ISRAEL, FILED 12-18-2001.

**SILENT EXHAUST INDUSTRIES**

NO CLAIM IS MADE TO THE EXCLUSIVE RIGHT TO USE "SILENT EXHAUST INDUSTRIES", APART FROM THE MARK AS SHOWN.

FOR AUTOMOTIVE ENGINE MUFFLERS (U.S. CLS. 13, 19, 21, 23, 31, 34 AND 35).

SN 76-389,019. SAMES TECHNOLOGIES, 38240 MEYLAN, FRANCE, FILED 4-1-2002.

ACCUSPEED

OWNER OF FRANCE REG. NO. 99830.971, DATED 12-20-1999, EXPIRES 12-20-2009.

FOR PAINT SPRAYER CHANGE STATIONS FOR AUTOMATIC PAINTING INSTALLATIONS (U.S. CLS. 13, 19, 21, 23, 31, 34 AND 35).

SN 76-389,351. VALIANT CORPORATION, WINDSOR, ONTARIO N8N 5A8, CANADA, FILED 3-28-2002.

AQUA CANNON

FOR MACHINES FOR CLEANING INTERNAL COMBUSTION ENGINE COMPONENTS (U.S. CLS. 13, 19, 21, 23, 31, 34 AND 35).

SN 76-396,585. INSTALLER SUPPLY INC., TAMPA, FL. FILED 4-16-2002.



FOR OIL, AIR, FUEL AND TRANSMISSION FILTERS FOR AUTOMOBILE AND TRUCK MOTORS AND ENGINES (U.S. CLS. 13, 19, 21, 23, 31, 34 AND 35).

FIRST USE 2-10-2002; IN COMMERCE 2-10-2002.

CLASS 7—(Continued).

SN 76-414,131. BJ SERVICES COMPANY, U.S.A., HOUSTON, TX. BY ASSIGNMENT OSCA, INC., LAFAYETTE, LA. FILED 5-30-2002.



FOR DEVICES THAT STIMULATE, FRACTURE, SAND CONTROL AND GRAVEL PACK FORMATIONS FOR USE IN OIL AND GAS COMPLETION, NAMELY, PUMPS, PACKERS, VALVES, ISOLATION SLEEVES, SCREENS, SLIDING SLEEVES, FLOW METERS, CHOKES, THROUGH FLOW LINE TOOLS, MULTI-LATERAL COMPLETION EQUIPMENT, COUPLINGS AND CONNECTORS FOR USE IN RETRIEVING DOWN-HOLE TUBULARS; DEVICES USED IN COIL TUBING OPERATIONS, NAMELY, NITROGEN PUMPS, FLUID PUMPS, MOBILE NITROGEN PUMPING UNITS, NOZZLES, JETTING TOOLS, PHASE SEPARATOR TOOLS, CEMENTING TOOLS, LATERAL ENTRY TOOLS, SOLID REMOVAL TOOLS, SOLID TRANSPORT TOOLS, AND WASHING TOOLS; DOWNHOLE COMPLETION TOOLS (U.S. CLS. 13, 19, 21, 23, 31, 34 AND 35).

FIRST USE 12-0-1985; IN COMMERCE 12-0-1985.

SN 76-414,929. EARTH TOOL COMPANY, L.L.C., OCONOMOWOC, WI. FILED 6-5-2002.



OWNER OF U.S. REG. NO. 2,688,675.

THE LINING IS A FEATURE OF THE MARK AND DOES NOT INDICATE COLOR.

FOR TOOLS CONNECTED TO A HORIZONTAL BORING MACHINE FOR BURSTING UNDERGROUND PIPES AND ENLARGING UNDERGROUND BORES (U.S. CLS. 13, 19, 21, 23, 31, 34 AND 35).

FIRST USE 3-31-2002; IN COMMERCE 3-31-2002.

CLASS 7—(Continued).

SN 76-417,069. HENSLEY INDUSTRIES, INC., DALLAS, TX. FILED 6-6-2002.



FOR MACHINE PARTS, NAMELY, WEAR PARTS, ATTACHMENTS AND GROUND ENGAGING TOOLS, ALL FOR EARTH MOVING EQUIPMENT; BUCKETS, REPLACEMENT LIPS FOR BUCKETS, TEETH, ADAPTERS, CHEEK PLATES, BASE PLATES, AND ASSEMBLIES OF THESE PARTS FOR POWER OPERATED BUCKETS, EXCAVATORS, SCOOPS, SHOVELS, AND LOADERS (U.S. CLS. 13, 19, 21, 23, 31, 34 AND 35).

SN 76-423,250. THE GATES CORPORATION, DENVER, CO. FILED 6-20-2002.

TUBEMEDIC

FOR VEHICLE, MACHINE AND MOTOR RADIATOR REPAIR KITS CONSISTING OF RADIATOR OVERFLOW TUBES, "O" RINGS, PLUGS, DRILL BIT, TAP, CUTTING TOOL AND DRILL STOP; VEHICLE, MACHINE AND MOTOR RADIATOR REPAIR KIT REFILL PACKS CONSISTING OF RADIATOR OVERFLOW TUBES AND PLUGS (U.S. CLS. 13, 19, 21, 23, 31, 34 AND 35).

SN 76-428,858. LA SAN MARCO DI FRANCESCO BUGATTI & C. - S.A.P.A., LUMEZZANE (BRESCIA), ITALY, FILED 7-5-2002.

PICCHI

THE ITALIAN WORD "PICCHI" IS TRANSLATED IN ENGLISH TO "WOODPECKERS".

FOR BORING MACHINES; PARTS OF MACHINES NAMELY CONVEYORS; DIE-CUTTING MACHINES; DIE-STAMPING MACHINES; DRILLING MACHINES AND PARTS THEREFOR; LATHES; PARTS OF MACHINES NAMELY LOADERS; UNLOADERS; METAL AND OTHER MATERIAL WORKING MACHINES, NAMELY MACHINING CENTERS; MILLING MACHINES; INDUSTRIAL ROBOTS; BROACHING MACHINES; GRINDING MACHINES USED FOR SMOOTHING METALLIC CYLINDERS; SUPERFINISHING MACHINES WITH DIAMOND TOOLS USED FOR POLISHING METALS AND PVC; TAPPING MACHINES; TRANSFER MACHINES, NAMELY MULTIPROCESSING WORKING MACHINES TRANSFERRING PIECES FROM A WORK'S PROCESSING TO ANOTHER (U.S. CLS. 13, 19, 21, 23, 31, 34 AND 35).

CLASS 7—(Continued).

SN 76-430,703. COLUMBIA MARKING TOOLS, INC., HARRISON TOWNSHIP, MI. FILED 7-15-2002.



NO CLAIM IS MADE TO THE EXCLUSIVE RIGHT TO USE "COLUMBIA MARKING TOOLS", APART FROM THE MARK AS SHOWN.

FOR INDUSTRIAL MARKING MACHINES FOR USE IN AFFIXING A VARIETY OF WORDED, LETTERED AND/OR NUMERICAL DESIGNATIONS TO A VARIETY OF METAL AND PLASTIC MATERIALS AND PRODUCTS (U.S. CLS. 13, 19, 21, 23, 31, 34 AND 35).

FIRST USE 1-18-1994; IN COMMERCE 2-17-1994.

SN 76-431,256. ITT INDUSTRIES, INC., WHITE PLAINS, NY. FILED 7-12-2002.

VTP SERIES

NO CLAIM IS MADE TO THE EXCLUSIVE RIGHT TO USE "SERIES", APART FROM THE MARK AS SHOWN.

FOR VERTICAL TURBINE PUMPS (U.S. CLS. 13, 19, 21, 23, 31, 34 AND 35).

SN 76-431,258. ITT INDUSTRIES, INC., WHITE PLAINS, NY. FILED 7-12-2002.

SERIES 1536

NO CLAIM IS MADE TO THE EXCLUSIVE RIGHT TO USE "SERIES", APART FROM THE MARK AS SHOWN.

FOR CENTRIFUGAL PUMPS (U.S. CLS. 13, 19, 21, 23, 31, 34 AND 35).

SN 76-431,262. AMERICAN SAW & MFG. COMPANY, INC., EAST LONGMEADOW, MA. FILED 7-12-2002.

GRIT IRON

OWNER OF U.S. REG. NO. 1,601,915.
FOR POWER SAW BLADES (U.S. CLS. 13, 19, 21, 23, 31, 34 AND 35).

CLASS 7—(Continued).

SN 76-431,986. PETERSON, FRED, JEFFERSON, OH. FILED 7-11-2002.

SAFE SHIELD

NO CLAIM IS MADE TO THE EXCLUSIVE RIGHT TO USE "SHIELD", APART FROM THE MARK AS SHOWN.

FOR SAFETY GUARD FOR USE WITH LAWN MOWER AND LAWN TRIMMING EQUIPMENT, NAMELY, A DISK SHAPED PLASTIC SAFETY GUARD WHICH ATTACHES TO A LAWN MOWER AND LAWN TRIMMING EQUIPMENT AND PREVENTS GRASS AND OTHER DEBRIS FROM BEING EXPELLED UPWARD TOWARDS THE EQUIPMENT USER OR IN ANY OTHER DIRECTION (U.S. CLS. 13, 19, 21, 23, 31, 34 AND 35).

SN 76-432,762. LYNX ENTERPRISES, INC., FAIRFIELD, OH. FILED 7-22-2002.

DRUM-BUSTER

FOR POWER OPERATED EQUIPMENT CONSISTING OF SPRAY GUNS, STEAM GUNS, VALVES, WANDS, PROPORTION CONTROL VALVES, AIR DRIVEN FOAMERS, TANKS, AND TANK STANDS USED TO APPLY CLEANING PREPARATIONS, STRIPPING PREPARATIONS, SEALER PREPARATIONS, AND LUBRICANT PREPARATIONS TO A WIDE VARIETY OF SURFACES (U.S. CLS. 13, 19, 21, 23, 31, 34 AND 35).

FIRST USE 8-23-1998; IN COMMERCE 8-23-1998.

SN 76-434,570. MHT MOLD & HOTRUNNER TECHNOLOGY AG, 65239 HOCHHEIM, FED REP GERMANY, FILED 7-25-2002.

HOLI-MOLD

FOR MACHINES FOR PROCESSING PLASTICS; NAMELY, HOTRUNNERS, HOTRUNNER MACHINES, MOLDS, INJECTION MOLDS AND MACHINES FOR PROCESSING PLASTICS FOR MANUFACTURING PACKING CONTAINERS OF PLASTIC MATERIAL (U.S. CLS. 13, 19, 21, 23, 31, 34 AND 35).

CLASS 7—(Continued).

SN 76-435,466. LOCK ANTRIEBSTECHNIK GMBH, ERTINGEN, FED REP GERMANY, FILED 7-25-2002.

LOCK

FOR MACHINES, POWERED APPLIANCES AND MACHINE COMPONENTS FOR LIFTING AND ADJUSTMENT, NAMELY; HOISTS, ELECTRICAL DRIVES, IN PARTICULAR SHUTTER DOOR DRIVES, PLATFORM DRIVES, WINDOW AND SHADING DRIVES FOR BUILDINGS, GREENHOUSES AND STABLES, WINDING DRIVES, OVERLOAD SAFE GUARDS OF FORCES OR MOMENTS, JACKS, CABLE WINCHES, CHAIN WINCHES, GEAR MECHANISMS, WORM GEAR MECHANISMS, RACK MECHANISMS, TOOTHED BELT MECHANISMS, SPINDLE GEARS, GEARS, WORMS, THREADED SPINDLES, RACKS, SPROCKETS, CABLE DRUMS, CABLE ROLLERS, CRANKS, DRIVE SHAFTS, BEARINGS, BEARING BLOCKS, DEVICES FOR TORQUE TRANSMISSION NOT FOR LAND VEHICLES, CLUTCHES, CARDAN SHAFTS, TELESCOPIC CARDAN SHAFTS, DRIVE BELTS, DRIVE CHAINS, MOTORS AND GEARED MOTORS NOT FOR LAND VEHICLES, TUBE MOTORS (U.S. CLS. 13, 19, 21, 23, 31, 34 AND 35).

SN 76-438,034. CIMESTENT, INC., HOUSTON, TX. FILED 8-2-2002.

PROSTENT 1

FOR CUTTING MACHINE FOR USE IN THE MANUFACTURE OF MEDICAL STENTS (U.S. CLS. 13, 19, 21, 23, 31, 34 AND 35).

FIRST USE 0-0-1999; IN COMMERCE 0-0-1999.

SN 76-438,036. CIMESTENT, INC., HOUSTON, TX. FILED 8-2-2002.

PROSTENT 2

FOR CUTTING MACHINE FOR USE IN THE MANUFACTURE OF MEDICAL STENTS (U.S. CLS. 13, 19, 21, 23, 31, 34 AND 35).

SN 76-439,044. BRIDGESTONE INDUSTRIAL PRODUCTS AMERICA, INC., NASHVILLE, TN. FILED 8-9-2002.

EXPANGATE

FOR AUTOMATED INFLATABLE POLYMERIC BLADDERS AND ASSOCIATED CONTROL AND SUPPORT EQUIPMENT, NAMELY PROGRAMMABLE LOGIC CONTROLLERS AND INFLATION MECHANISMS, DISPOSED IN LARGE CONDUITS, NAMELY SEWERS AND HIGHWAY CONDUITS, FOR PURPOSED OF FLOW CONTROL AND DIVERSION AND FLOOD CONTROL (U.S. CLS. 13, 19, 21, 23, 31, 34 AND 35).

FIRST USE 5-0-1992; IN COMMERCE 5-0-1992.

CLASS 7—(Continued).

SN 76-440,459. PORTER-CABLE CORPORATION, JACKSON, TN. FILED 8-14-2002.

REDEFINING PERFORMANCE

FOR AIR COMPRESSORS; POWER TOOLS AND PARTS THEREOF; NAMELY, TABLE SAWS, ABRASIVE CUT-OFF MACHINES, CIRCULAR SAWS, TRIM SAWS, BAND SAWS, BAYONET SAWS, MITER SAWS, RECIPROCATING SAWS, DRILLS, DRILL PRESSES, IMPACT DRIVERS, MAGNETIC DRILL PRESSES HAMMER DRILLS, CORDLESS DRILLS, ANGLE DRILLS, DRY-WALL TOOLS, IN THE NATURE OF DRYWALL DRIVERS, CUTOUT TOOL AND DRYWALL POWER SANDERS, FASTENER/SCREWDRIVERS, POWER TAPERS, IMPACT WRENCHES, RATCHET WRENCHES, SHEARS, PAINT REMOVERS, POCKET CUTTERS, CHIPPER/CLEANERS, ROUTERS AND ROUTER/SHAPERS, POWER PLANES, POWER PLANERS, RANDOM ORBIT SANDERS, DISC SANDERS, FINISHING SANDERS, BELT SANDERS, BELT SANDERS WITH DUST PICKUP, BENCH GRINDERS, SANDER/GRINDERS, SANDER/POLISHERS, POLISHERS, NIBBLERS, PLATE JOINERS, EDGE JOINERS, LAMINATE TRIMMERS, LAMINATE SLITERS, LOCK MORTISERS AND REPLACEMENT PARTS FOR THE FOREGOING POWER TOOLS; POWER SAW BLADES, DRILL BITS AND ROUTER BITS; ROTARY HAMMERS; CIRCULAR POWER SAW ACCESSORIES; NAMELY, DUST COLLECTION BAG ASSEMBLY, VACUUM HOSE ASSEMBLY AND DUST NOZZLE ASSEMBLY, BLADE WRENCHES, CUTTING GUIDES AND DRIP GUIDES; DOVETAIL JIGS; DUST COLLECTION ATTACHMENTS FOR POWER TOOLS; ELECTRIC BAND SAW ACCESSORIES; NAMELY, SAW STAND AND PORTABLE VISE; ELECTRIC SANDER ACCESSORIES; NAMELY, REPLACEMENT PADS, ABRASIVE PAPER ROLLS, BELTS AND DISCS, AND PAPER ROLL DISPENSER; ELECTRIC SANDER/GRINDER/POLISHER ACCESSORIES; NAMELY, PADS, DISCS AND RELATED MOUNTING HARDWARE, AND WIRE BRUSHES; ELECTRIC PLATE JOINER ACCESSORIES; NAMELY, TILT FENCE, PLATE JOINING BISCUITS AND REPLACEMENT BLADES; ELECTRIC PLANE ACCESSORIES; NAMELY, PLANE CUTTERS, BEVEL PLANNING FENCES, GRINDING WHEELS, AND WRENCHES FOR PLANES; DOOR HANGING KIT CONSISTING OF POWER OPERATED PLANE, HINGE BUTT TEMPLATE, MORTISING BIT, LOCKNUT, TEMPLATE GUIDE AND STEEL CARRYING CASE; HEAT GUNS; NAILERS; PRE-WIRED TABLES WITH ADJUSTABLE FENCES FOR SUPPORTING ROUTERS AND SHAPERS; POWER STAPLERS; TEMPLATES FOR USE WITH ROUTING TOOLS, MORTISE AND TENON JIGS; STAIR TEMPLATES; PNEUMATIC POWER TOOLS, NAMELY NAILERS, STAPLERS, ANGLE ROTARY TOOL, CUT-OFF TOOL FOR CUTTING SHEET METAL, BOLTS AND FIBERGLASS, GRINDERS, RECIPROCATING SAWS, SHEARS, IMPACT WRENCHES, HAMMERS, SANDERS, DRILLS, WRENCHES, RATCHETS (U.S. CLS. 13, 19, 21, 23, 31, 34 AND 35).

SN 76-443,997. OCEAN CONSTRUCTION SUPPLIES LIMITED, VANCOUVER, BRITISH COLUMBIA, CANADA, FILED 8-26-2002.

ENVIROGUARD

PRIORITY CLAIMED UNDER SEC. 44(D) ON CANADA APPLICATION NO. 1135743, FILED 3-28-2002.

FOR WASH-OUT CONTAINMENT SYSTEM COMPRISING TRUCK-MOUNTABLE CONTAINERS, HOSES AND PUMPS (U.S. CLS. 13, 19, 21, 23, 31, 34 AND 35).

FIRST USE 1-0-2001; IN COMMERCE 1-0-2001.

CLASS 7—(Continued).

SN 76-446,340. BARRY GRANT, INC., DAHLONEGA, GA. FILED 9-3-2002.

KING DEMON

FOR CARBURETORS FOR HIGH PERFORMANCE INTERNAL COMBUSTION ENGINES (U.S. CLS. 13, 19, 21, 23, 31, 34 AND 35).

FIRST USE 12-0-1998; IN COMMERCE 8-0-1999.

SN 76-450,984. KRUPP DRAUZ GMBH, D-74076 HEILBRONN, FED REP GERMANY, FILED 7-11-2002.

IMPULSDRAUZ

FOR MACHINE-OPERATED TOOLS FOR FABRICATING, ASSEMBLING AND REPAIRING MOTOR VEHICLE PARTS; MACHINING CENTERS AND HAND-HELD POWER TOOLS, NAMELY, HAMMERS, THREADERS, DRILL BITS, GRINDERS, BUFFERS, POLISHERS, SAWS, SCREW DRIVERS, AND EXTENSIONS (U.S. CLS. 13, 19, 21, 23, 31, 34 AND 35).

FIRST USE 6-1-2002; IN COMMERCE 6-1-2002.

SN 76-452,419. HYDROTECHNOLOGIES, INC., IRVINE, CA. FILED 9-23-2002.

ERGOFLEX

FOR COMMERCIAL AND INDUSTRIAL MULTI-PURPOSE HIGH PRESSURE WASHERS AND VACUUM CLEANERS FOR CLEANING TILE, GROUT, LINOLEUM, TILE PAVED SURFACES, STONE, AND NATURAL AND SYNTHETIC SURFACES (U.S. CLS. 13, 19, 21, 23, 31, 34 AND 35).

SN 76-456,584. ALINE HEAT SEAL CORPORATION, CERRITOS, CA. FILED 10-8-2002.

ALINE HEAT SEAL CORPORATION

NO CLAIM IS MADE TO THE EXCLUSIVE RIGHT TO USE "HEAT SEAL CORPORATION", APART FROM THE MARK AS SHOWN.

FOR THERMAL IMPULSE AND CONSTANT HEAT SEALERS FOR SEALING FULL RANGE OF THERMOPLASTIC MATERIALS (U.S. CLS. 13, 19, 21, 23, 31, 34 AND 35).

FIRST USE 10-1-2002; IN COMMERCE 10-1-2002.

CLASS 7—(Continued).

SN 76-460,015. PETERS MACHINERY INC., CHICAGO, IL. FILED 10-15-2002.

Peters

OWNER OF U.S. REG. NOS. 739,327, 739,328 AND 2,149,691.

FOR MACHINES FOR USE IN THE BAKING AND PACKAGING FIELDS, NAMELY, PACKAGING MACHINES AND CONVEYORS AND PARTS THEREFOR (U.S. CLS. 13, 19, 21, 23, 31, 34 AND 35).

FIRST USE 1-0-2000; IN COMMERCE 1-0-2000.

SN 76-461,416. CIRCLE MACHINE COMPANY, MONROVIA, CA. FILED 10-21-2002.

GROOVIT

FOR CUTTING AND GROOVING TOOLS, AND REPLACEMENT INSERTS THEREFOR, ALL FOR USE WITH METAL-WORKING MACHINE TOOLS (U.S. CLS. 13, 19, 21, 23, 31, 34 AND 35).

FIRST USE 10-1-2002; IN COMMERCE 10-1-2002.

SN 76-465,543. DOTHAN INC., SEMMES, AL. FILED 11-12-2002.

ELIMINATOR

THE MARK CONSISTS OF THE DESIGN OF A STYLIZED END VIEW OF A PULVERIZING MACHINE.

FOR MACHINES, NAMELY, PULVERIZERS FOR SOLID MATERIALS, DRILL CUTTINGS, AGRICULTURAL PRODUCTS AND VARIOUS TYPES OF MINERALS (U.S. CLS. 13, 19, 21, 23, 31, 34 AND 35).

FIRST USE 0-0-1997; IN COMMERCE 0-0-1997.

CLASS 7—(Continued).

SN 76-467,379. ELLIOTT TURBOMACHINERY CO., INC., JEANNETTE, PA. FILED 11-15-2002.

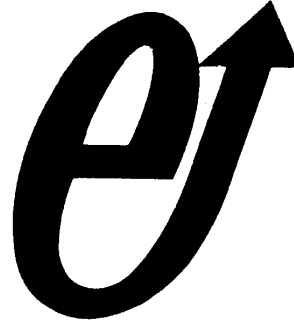

OWNER OF U.S. REG. NOS. 826,816, 1,651,711 AND 1,652,958.

FOR AIR FILTERS FOR AIR COMPRESSORS (U.S. CLS. 13, 19, 21, 23, 31, 34 AND 35).

SN 76-467,381. ELLIOTT TURBOMACHINERY CO., INC., JEANNETTE, PA. FILED 11-15-2002.

ELLIOTT

OWNER OF U.S. REG. NOS. 1,024,506, 1,671,618 AND OTHERS.

FOR AIR FILTERS FOR AIR COMPRESSORS (U.S. CLS. 13, 19, 21, 23, 31, 34 AND 35).

SN 76-467,383. ELLIOTT TURBOMACHINERY CO., INC., JEANNETTE, PA. FILED 11-15-2002.

ELLIOTT

OWNER OF U.S. REG. NOS. 1,024,506, 1,671,618 AND OTHERS.

FOR AIR FILTERS FOR AIR COMPRESSORS (U.S. CLS. 13, 19, 21, 23, 31, 34 AND 35).

SN 76-470,390. BELT POWER CORPORATION, SMYRNA, GA. FILED 11-29-2002.

BELT POWER CORPORATION

NO CLAIM IS MADE TO THE EXCLUSIVE RIGHT TO USE "BELT" AND "CORPORATION", APART FROM THE MARK AS SHOWN.

FOR CONVEYOR BELTS AND STRUCTURAL PARTS THEREFOR (U.S. CLS. 13, 19, 21, 23, 31, 34 AND 35).

FIRST USE 1-1-1989; IN COMMERCE 1-1-1989.

CLASS 7—(Continued).

SN 76-472,942. AERO TOOL INC., OAKVILLE, ONTARIO L6H 2R4, CANADA, FILED 11-25-2002.

AEROWERKS

FOR DISHWASHING CONVEYORS; DISHWASHING MACHINE SYSTEMS COMPRISED OF TRAY CONVEYORS AND DISH TABLES; GRAVITY CONVEYORS USED FOR THE TRANSPORT OF RACKS DISHES; POWER ROLLERS FOR TRANSPORT OF STACKS OF TRAYS AND RACKS OF DISHES FOR COMMERCIAL AND INSTITUTIONAL USE (U.S. CLS. 13, 19, 21, 23, 31, 34 AND 35).

FIRST USE 1-31-2003; IN COMMERCE 4-30-2003.

SN 76-473,299. JETWORLD INC., SOUTH EL MONTE, CA. FILED 12-6-2002.

INVIDIA

FOR LAND VEHICLE PARTS, NAMELY, EXHAUST PIPES FOR VEHICLES, EXHAUST MANIFOLDS FOR ENGINES, HEADERS AS PART OF VEHICLE EXHAUST SYSTEMS, SILENCERS AS PART OF VEHICLE EXHAUST SYSTEMS, CAMSHAFTS FOR VEHICLE ENGINES, CONNECTING HOSES FOR VEHICLE RADIATORS, OIL COOLERS, PUSH RODS, ROCKER ARMS, ENGINE CAM PROTECTORS, INTAKE MANIFOLDS, AND CAM COVERS (U.S. CLS. 13, 19, 21, 23, 31, 34 AND 35).

FIRST USE 11-5-2002; IN COMMERCE 11-5-2002.

SN 76-478,949. LEACH COMPANY, INC., OSHKOSH, WI. FILED 12-30-2002.

FASTPAK

FOR HYDRAULIC COMPACTING MECHANISM USED ON REFUSE COLLECTION VEHICLES (U.S. CLS. 13, 19, 21, 23, 31, 34 AND 35).

SN 76-482,081. STANLEY LOGISTICS, INC., NEW BRITAIN, CT. FILED 1-13-2003.

STANLEY

FOR POWER TOOLS, NAMELY, CORDLESS SCREW-DRIVERS (U.S. CLS. 13, 19, 21, 23, 31, 34 AND 35). FIRST USE 9-0-2002; IN COMMERCE 9-0-2002.

CLASS 7—(Continued).

SN 76-482,082. STANLEY LOGISTICS, INC., NEW BRITAIN, CT. FILED 1-13-2003.



FOR POWER TOOLS, NAMELY, CORDLESS SCREW-DRIVERS (U.S. CLS. 13, 19, 21, 23, 31, 34 AND 35). FIRST USE 9-0-2002; IN COMMERCE 9-0-2002.

SN 76-486,309. ROTO-ROOTER CORPORATION, WEST DES MOINES, IA. FILED 1-31-2003.

DIAMOND FLEX

FOR SEWER CLEANING MACHINE CABLE, CABLE ENDS, CHUCKS, CUTTING BLADES, AND SPLICE CORES (U.S. CLS. 13, 19, 21, 23, 31, 34 AND 35). FIRST USE 1-0-1996; IN COMMERCE 1-0-1996.

SN 76-487,106. LITE-PREP SURFACE PREPARATION EQUIPMENT, LLC, TALLMADGE, OH. FILED 2-3-2003.



FOR POWER OPERATED MACHINES FOR FINISHING, SURFACING, GRINDING, POLISHING AND SANDING DISKS FOR USE WITH POWER OPERATED MACHINES FOR FINISHING, SURFACING, LEVELING AND SANDING WALLS AND FLOORS (U.S. CLS. 13, 19, 21, 23, 31, 34 AND 35).

CLASS 7—(Continued).

SN 76-487,326. VAN DER STAHL SCIENTIFIC, INC., WRIGHTWOOD, CA. FILED 2-4-2003.

MINTA

FOR INDUSTRIAL PACKAGING MACHINES; INDUSTRIAL PACKAGING MACHINES WITH VACUUM SEALERS; INDUSTRIAL PACKAGING MACHINES WITH PACKAGE PRINTING AND LABELING CAPABILITIES; INDUSTRIAL PACKAGING MACHINES FOR FLEXIBLE PACKAGING (U.S. CLS. 13, 19, 21, 23, 31, 34 AND 35).
FIRST USE 1-1-2003; IN COMMERCE 1-1-2003.

SN 76-487,409. ISCAR LTD., TEFEN 24959, ISRAEL, FILED 2-3-2003.



FOR CUTTING TOOLS, NAMELY MILLING CUTTERS, END-MILLS, BALL NOSE END-MILLS, PLUNGERS, DRILLS, REAMERS, BORING TOOLS, TURNING TOOLS AND GROOVING TOOLS, FOR USE WITH POWER OPERATED MACHINES (U.S. CLS. 13, 19, 21, 23, 31, 34 AND 35).

SN 76-487,445. BLUE LINE EQUIPMENT, LLC, PRESCOTT, AZ. FILED 2-5-2003.

CHAMP

FOR CARPET CLEANING MACHINES (U.S. CLS. 13, 19, 21, 23, 31, 34 AND 35).

SN 78-116,484. MID-USA CYCLE PARTS, INC., ST. LOUIS, MO. FILED 3-21-2002.



NO CLAIM IS MADE TO THE EXCLUSIVE RIGHT TO USE "MOTORCYCLE PARTS", APART FROM THE MARK AS SHOWN.

FOR MOTORCYCLE PARTS, NAMELY, MOTORCYCLE ENGINE PARTS, NAMELY, ENGINE CYLINDERS, ROCKER ARM COVERS, ROCKER ARMS, VALVE GUIDES, PISTONS, PISTON PINS AND LOCK RINGS, HYDRAULIC TAPPET INSERTS, TAPPET BLOCK COVERS, GEAR COVERS, ELECTRONIC IGNITIONS, IGNITION TIMER COVERS, CONNECTING RODS, AND OIL PUMP COVERS (U.S. CLS. 13, 19, 21, 23, 31, 34 AND 35).

CLASS 7—(Continued).

SN 78-126,885. ZXZ USA, INC., WAUSAU, WI. FILED 5-7-2002.

ZXZ

FOR MACHINE PARTS, NAMELY, BEARINGS AND BUSHINGS (U.S. CLS. 13, 19, 21, 23, 31, 34 AND 35).

SN 78-137,154. SCHIBECI, ANTHONY RICHARD, WATSONIA, AUSTRALIA, FILED 6-19-2002.

SCHIBECI

OWNER OF AUSTRALIA REG. NO. 874102, DATED 4-30-2001, EXPIRES 4-30-2011.

FOR MACHINES, NAMELY, FLOOR AND ROADWAY SURFACE PREPARATION EQUIPMENT FOR CUFFING, DRILLING, MILLING, PROFILING AND POLISHING STEPS IN CONCRETE, STEPS IN ASPHALT, YELLOW AND WHITE LINES, FACTORY FLOORS, THERMOPLASTIC WHITE LINES, TIMBERS, EPOXIES, RESINS, MORTARS, PLASTICS, STENCILED CONCRETE, PLASTIC AND CERAMIC ROAD REFLECTORS AND EXPOSED AGGREGATE FINISH ON CONCRETE; DRUMS FOR CUTTING AND MILLING ALL PAVEMENT TYPES INCLUDING ASPHALT, CONCRETE, REINFORCED PAVEMENTS AND HEAVY LIMESTONE; ROAD SURFACE AND CONCRETE SURFACE REMOVAL MACHINES, NAMELY, SCABBLERS, SCARIFIERS AND ERADICATORS; PORTABLE AND MOBILE EARTH HOLE DRILLING MACHINES AND PARTS THEREFOR, NAMELY, MOUNTING FRAMES, MOUNTING BRACKETS, AND EARTH AUGERS; FLOOR AND ROADWAY SURFACE PREPARATION MACHINES, NAMELY, CUTTERS, PLANERS, GRINDERS, SAWS, AND PNEUMATIC TOOLS, NAMELY, SCRAPERS, CHISELS AND MOIL POINTS; ROTARY ASPHALT CUTTING BLADES FOR FLOOR AND ROADWAY SURFACE PREPARATION MACHINES; CUTTING FLAILS FOR SURFACE PLANERS; GRINDER STONES AND WIRE BRUSHES FOR INDUSTRIAL SURFACE GRINDERS; INDUSTRIAL VACUUM CLEANERS; DIAMOND BLADES FOR INDUSTRIAL RANDOM CRACK SAWS; BLADES AND CHISELS FOR INDUSTRIAL PNEUMATIC POWERED TOOLS (U.S. CLS. 13, 19, 21, 23, 31, 34 AND 35).

SN 78-137,640. REGITAR U.S.A. INC., MONTGOMERY, AL. FILED 6-21-2002.

REGITAR U.S.A.

NO CLAIM IS MADE TO THE EXCLUSIVE RIGHT TO USE "U.S.A.", APART FROM THE MARK AS SHOWN.

FOR AUTOMOTIVE PARTS NAMELY IGNITION MODULES, RECTIFIERS, DIODES, PICKUP COILS, DISTRIBUTOR CAPS, ROTORS, POINTS CONDENSERS, SOLENOID COMPONENTS OF ENGINES, RESISTORS (U.S. CLS. 13, 19, 21, 23, 31, 34 AND 35).

FIRST USE 12-3-1987; IN COMMERCE 12-3-1987.

CLASS 7—(Continued).

SN 78-146,742. INTERROLL HOLDING AG, SAN ANTONINO, CHILE, FILED 7-23-2002.

ROLLERDRIVE

FOR DRIVING UNITS AND DEVICES FOR CONVEYOR SYSTEMS, COMPOSED PRIMARILY OF ACTUATED CONVEYING ROLLERS WITH INTEGRATED ELECTRIC MOTOR AND NON-ACTUATED CONVEYOR ROLLERS, PHOTO SENSORS, DRIVE BELTS, BELT CONVEYORS OR DRIVING CHAINS (U.S. CLS. 13, 19, 21, 23, 31, 34 AND 35).

FIRST USE 6-1-2001; IN COMMERCE 6-1-2001.

SN 78-147,958. OCEAN MACHINERY, INC., FORT LAUDERDALE, FL. FILED 7-26-2002.

FICEP

FOR STEEL FABRICATING MACHINERY AND PARTS THEREFOR; BEAM DRILLS AND PARTS THEREFOR; ANGLE PUNCHING MACHINES AND PARTS THEREFOR; PLATE PUNCHING MACHINES AND PARTS THEREFOR (U.S. CLS. 13, 19, 21, 23, 31, 34 AND 35).

FIRST USE 3-30-1995; IN COMMERCE 3-30-1995.

SN 78-148,864. APPLIED MATERIALS, INC., SANTA CLARA, CA. FILED 7-30-2002.

MEGACLEAN

FOR SEMICONDUCTOR WAFER PROCESSING MACHINES, OPERATIONAL SOFTWARE, AND COMPONENTS; NAMELY, EPITAXIAL REACTORS, CHEMICAL VAPOR DEPOSITION REACTORS, PHYSICAL VAPOR DEPOSITION REACTORS, PLASMA ETCHERS, ION IMPLANTERS, WAFER CLEANING EQUIPMENT AND CHEMICAL MECHANICAL POLISHERS; ALL FOR THE PROCESSING AND PRODUCTION OF SEMICONDUCTOR SUBSTRATES, THIN FILMS, SILICON DISCS AND WAFERS (U.S. CLS. 13, 19, 21, 23, 31, 34 AND 35).

SN 78-155,298. SCHUENEMAN, KEN, TREVOR, WI. FILED 8-18-2002.

FIRST

FOR AUTOMOTIVE FUEL INJECTION SYSTEM, NAMELY, TUNED PORT INJECTION ASSEMBLY CONSISTING OF A BASE MANIFOLD WITH 8 MULTI-POINT FUEL INJECTORS, PLENUM, REMOVABLE TUNED RUNNERS, THROTTLE BODY AND TWO PRESSURIZED FUEL RAILS (U.S. CLS. 13, 19, 21, 23, 31, 34 AND 35).

CLASS 7—(Continued).

SN 78-159,234. LIBERTY PROCESS EQUIPMENT, INC., ARLINGTON HEIGHTS, IL. FILED 8-29-2002.



FOR PROGRESSIVE CAVITY PUMPS, THREE ROTOR PUMPS, TWIN GEARED PUMPS, HOSE PUMPS, CLOSE-COUPLED NON-SUBMERSIBLE CENTRIFUGAL PUMPS, AND PARTS THEREFOR (U.S. CLS. 13, 19, 21, 23, 31, 34 AND 35).

FIRST USE 5-1-2000; IN COMMERCE 5-1-2000.

SN 78-177,797. SLIDE SYSTEMS, LLC, CANASTOTA, NY. FILED 10-24-2002.

LIFE ROLLS ON

FOR BEARINGS AND BEARING ASSEMBLIES; SLIDING AND ROLLING MECHANISMS AND COMPONENTS FOR TRUCK ACCESSORIES; LINEAR BEARINGS (U.S. CLS. 13, 19, 21, 23, 31, 34 AND 35).

SN 78-184,650. IDEA FACTORY, INC., MENOMONEE FALLS, WI. FILED 11-13-2002.

PLUG N SPRAY

FOR CLEANING SYSTEM FOR BATH TUBS, SHOWERS AND SINKS COMPRISED OF A DIVERTER VALVE INSTALLED ON OR ATTACHED TO A WATER SUPPLY AND A HOSE THAT ATTACHES TO THE DIVERTER VALVE (U.S. CLS. 13, 19, 21, 23, 31, 34 AND 35).

SN 78-188,727. EDGETEC INTERNATIONAL PTY LTD, MT OMMANEY QLD, AUSTRALIA, FILED 11-25-2002.

KERBMATE

FOR POWER OPERATED TOOLS, NAMELY, LAWN AND GARDEN EDGERS AND CONCRETE LANDSCAPING EDGERS (U.S. CLS. 13, 19, 21, 23, 31, 34 AND 35).

CLASS 7—(Continued).

SN 78-193,900. AQUA PRODUCTS, INC., CEDAR GROVE, NJ. FILED 12-12-2002.

POWER HANDI-VAC

NO CLAIM IS MADE TO THE EXCLUSIVE RIGHT TO USE "POWER", APART FROM THE MARK AS SHOWN. FOR SWIMMING POOL VACUUMS (U.S. CLS. 13, 19, 21, 23, 31, 34 AND 35).

SN 78-199,447. HOOVER COMPANY, THE, NORTH CANTON, OH. FILED 1-2-2003.

DUAL V

FOR FLOOR CARE APPLIANCES, NAMELY, VACUUM CLEANERS, CARPET EXTRACTORS, BARE FLOOR CLEANING MACHINES, CARPET SHAMPOOERS, FLOOR POLISHERS, AND PARTS AND ACCESSORIES THEREFORE (U.S. CLS. 13, 19, 21, 23, 31, 34 AND 35).

SN 78-199,942. IDEAVILLAGE LLC, FAIRFIELD, NJ. FILED 1-3-2003.

WHIZZER

FOR ELECTRIC SCISSORS (U.S. CLS. 13, 19, 21, 23, 31, 34 AND 35).
FIRST USE 1-25-2003; IN COMMERCE 1-25-2003.

SN 78-205,466. AIDA-DAYTON TECHNOLOGIES CORPORATION, DAYTON, OH. FILED 1-21-2003.

SERVOPRO

FOR POWER OPERATED MECHANICAL METAL-FORMING PRESS INCORPORATING A SERVO MOTOR (U.S. CLS. 13, 19, 21, 23, 31, 34 AND 35).

CLASS 7—(Continued).

SN 78-206,069. MOUNTAIN WEST ATTACHMENTS, INC., LOGAN, UT. FILED 1-22-2003.



FOR EARTHMOVING, ROADBUILDING, MINING, AND AGRICULTURAL MACHINERY - NAMELY, SLOPEBOARDS, RIPPERS, COMPACTOR/CRUSHERS, MOLDBOARDS, HYDRAULIC CYLINDERS, AND PARTS FOR SAID EQUIPMENT UTILIZED WITH WHEEL AND TRACK-TYPE TRACTORS (U.S. CLS. 13, 19, 21, 23, 31, 34 AND 35).

FIRST USE 6-29-2000; IN COMMERCE 7-6-2000.

SN 78-206,900. COMBUSTION COMPONENTS ASSOCIATES, INC., MONROE, CT. FILED 1-24-2003.

ELIM-NOX

FOR EMISSION REDUCTION UNITS FOR MOTORS AND ENGINES, NAMELY, CATALYTIC CONVERTERS FOR MOBILE VEHICLE APPLICATIONS (U.S. CLS. 13, 19, 21, 23, 31, 34 AND 35).

SN 78-206,956. MARATHON ASHLAND PETROLEUM LLC, FINDLAY, OH. FILED 1-24-2003.

HYMELT

FOR GASIFIERS, NAMELY, HYDROGEN GAS GENERATING MACHINES THAT UTILIZE MOLTEN METAL FOR USE IN COMMERCIAL AND INDUSTRIAL PROCESSES (U.S. CLS. 13, 19, 21, 23, 31, 34 AND 35).

SN 78-207,555. SALTON, INC., LAKE FOREST, IL. FILED 1-27-2003.

POWER WITHOUT BOUNDARIES

FOR VACUUM CLEANERS AND PARTS AND ATTACHMENTS THEREFORE. (U.S. CLS. 13, 19, 21, 23, 31, 34 AND 35).

CLASS 7—(Continued).

SN 78-208,301. NORPAC EQUIPMENT SALES LTD., LANGLEY BRITISH COLUMBIA, CANADA, FILED 1-29-2003.

NORGUIDE

FOR BAND SAW GUIDES (U.S. CLS. 13, 19, 21, 23, 31, 34 AND 35).
FIRST USE 3-0-1978; IN COMMERCE 3-0-1978.

SN 78-209,442. GATES CORPORATION, THE, DENVER, CO. FILED 1-31-2003.

ELIMINATOR

FOR POWER TRANSMISSION BELTS FOR MACHINES, MOTORS AND ENGINES USED IN INDUSTRIAL APPLICATIONS; AND TIMING BELTS FOR MACHINES, MOTORS AND ENGINES USED IN INDUSTRIAL APPLICATIONS (U.S. CLS. 13, 19, 21, 23, 31, 34 AND 35).

SN 78-213,643. NUTOOL, INC., MILPITAS, CA. FILED 2-11-2003.

SOFTPOLISH

FOR SEMICONDUCTOR MANUFACTURING MACHINES; SEMICONDUCTOR SUBSTRATES MANUFACTURING MACHINES; AND SEMICONDUCTOR WAFER PROCESSING MACHINES. (U.S. CLS. 13, 19, 21, 23, 31, 34 AND 35).

CLASS 8—HAND TOOLS

SN 76-196,639. INNOVATOOL, INC., PASCOAG, RI. FILED 1-22-2001.

INNOVATOOL

FOR MANUALLY OPERATED HAND TOOLS FOR HOUSEHOLD, MACHINERY, AND VEHICLE MAINTENANCE AND REPAIR, NAMELY WRENCHES, SPRING REMOVERS AND LOAM SIFTERS (U.S. CLS. 23, 28 AND 44).

CLASS 8—(Continued).

SN 76-364,709. GARNER, TIM, DBA T & K ENTERPRISES, LIVE OAK, CA. AND GARNER, KATHY, DBA T & K ENTERPRISES, LIVE OAK, CA. FILED 1-29-2002.

POKE 'N PLUG

FOR MANUALLY OPERATED HAND TOOLS COMPRISED OF A PLASTIC FLANGE WITH A POINT, USED IN CONJUNCTION WITH PLASTIC TUBES, USED TO PIERCE HOLES IN THE TUBES FOR INSTALLING BRANCH PASSAGEWAYS FROM THE TUBES (U.S. CLS. 23, 28 AND 44).
FIRST USE 10-3-2001; IN COMMERCE 10-3-2001.

SN 76-365,985. INFAR INDUSTRIAL CO., LTD., CHANG-HWA, 566, TAIWAN, FILED 2-1-2002.

PROGEAR

THE MARK CONSISTS OF "PROGEAR" WITH THE "O" IN THE FORM OF A GEAR.

FOR HAND TOOLS NAMELY; SPANNERS NAMELY RATCHET SPANNERS, OPEN-ENDED SPANNERS AND CLOSED-ENDED SPANNERS; RATCHET WRENCHES; SCREWDRIVERS; PLIERS; NAIL TACKERS; HAMMERS; LOCKING TOOLS NAMELY CLAMPS AND GRIPPERS; DRIVING HEADS FOR SPANNERS, AND TAP AND DIE SETS (U.S. CLS. 23, 28 AND 44).

FIRST USE 7-1-2001; IN COMMERCE 4-30-2002.

SN 76-417,128. DELTA INTERNATIONAL MACHINERY CORP., NORTH JACKSON, TN. FILED 5-28-2002.

DELTA

FOR HAND TOOLS FOR TIGHTENING AND LOOSENING NAMELY SOCKETS, PLIERS, WRENCHES, RATCHETS, SCREWDRIVERS; BITS FOR HAND DRILLS; AND HAND TOOLS NAMELY TURNING TOOLS, GOUGES, CHISELS AND SCRAPERS (U.S. CLS. 23, 28 AND 44).

FIRST USE 6-0-1986; IN COMMERCE 6-0-1986.

CLASS 8—(Continued).

SN 76-419,227. APOGEE ENTERPRISES, INC., BLOOMINGTON, MN. FILED 6-11-2002.

THE EXPANDER

OWNER OF U.S. REG. NO. 1,983,144.
SEC. 2(F).
FOR MANUALLY- OPERATED TOOL FOR REMOVING VEHICLE WINDSHIELD OR GLASS (U.S. CLS. 23, 28 AND 44).
FIRST USE 4-4-1995; IN COMMERCE 4-4-1995.

SN 76-456,435. SEGAL MFG., INC., FOX RIVER GROVE, IL. FILED 10-7-2002.

GUTTER SENSE

NO CLAIM IS MADE TO THE EXCLUSIVE RIGHT TO USE "GUTTER", APART FROM THE MARK AS SHOWN.
FOR HAND TOOL FOR CLEANING RAIN GUTTERS (U.S. CLS. 23, 28 AND 44).
FIRST USE 10-2-2002; IN COMMERCE 10-2-2002.

SN 76-466,668. CAMPBELL, WILLIAM F., ROCKFORD, IL. FILED 11-13-2002.

SMART VISE

NO CLAIM IS MADE TO THE EXCLUSIVE RIGHT TO USE "VISE", APART FROM THE MARK AS SHOWN.
FOR ELECTRICAL WIRING AND CONDUIT TOOLS, NAMELY, METAL VISES (U.S. CLS. 23, 28 AND 44).

SN 76-474,448. IVY CLASSIC INDUSTRIES, INC., ELMSFORD, NY. FILED 12-11-2002.

""Rapid Reload""

FOR UTILITY KNIVES AND BLADES FOR UTILITY KNIVES (U.S. CLS. 23, 28 AND 44).
FIRST USE 10-1-2002; IN COMMERCE 10-1-2002.

SN 76-482,027. WAHL CLIPPER CORPORATION, STERLING, IL. FILED 1-13-2003.

SHOW PRO

FOR ELECTRIC HAIR CLIPPERS FOR ANIMALS (U.S. CLS. 23, 28 AND 44).

CLASS 8—(Continued).

SN 76-482,090. JINN YEONG INDUSTRIAL CO., LTD., TAIPEI HSIEN, TAIWAN, FILED 1-13-2003.



FOR FOLDING KNIVES, HUNTING KNIVES, DIVE KNIVES AND FISHING KNIVES (U.S. CLS. 23, 28 AND 44).

SN 76-482,987. KADY, RICHARD, SHREWSBURY, MA. FILED 1-17-2003.

SPREADERTRAX

FOR PART FOR A HAND OPERATED SPREADER THAT IS ADAPTED TO CONTAIN MARKING SUBSTANCES AND DROPS THE SUBSTANCE ALONG THE PATH OF A FERTILIZER APPLICATOR (U.S. CLS. 23, 28 AND 44).

SN 76-484,078. RONAN TOOLS, INC., SAN JACINTO, CA. FILED 1-21-2003.

CLEVER CLEAVER

NO CLAIM IS MADE TO THE EXCLUSIVE RIGHT TO USE "CLEAVER", APART FROM THE MARK AS SHOWN.
FOR MANUALLY OPERATED, HANDHELD KITCHEN CUTTING DEVICE IN THE NATURE OF A SCISSOR/KNIFE COMBINATION (U.S. CLS. 23, 28 AND 44).

SN 76-484,430. JAMES F. PARKER TRUST, CHATTANOOGA, TN. FILED 1-21-2003.



FOR POCKET KNIVES AND HUNTING KNIVES (U.S. CLS. 23, 28 AND 44).
FIRST USE 11-15-1974; IN COMMERCE 11-15-1974.

CLASS 8—(Continued).

SN 76-486,046. NAUTITOOL, INC., BROOKLYN, NY. FILED 1-30-2003.

NAUTITOOL

FOR HAND TOOLS; NAMELY, PLIERS, ADJUSTABLE PLIERS, LOCKING PLIERS, SCREWDRIVERS, SCREWDRIVERS WITH REMOVEABLE TIPS, SCREWDRIVER TIPS, NUT DRIVERS, HANDLES AND ATTACHMENTS FOR HAND SOCKET WRENCHES, WRENCHES, ADJUSTABLE WRENCHES, SOCKET WRENCHES, PIPE WRENCHES, TORQUE AND HEXAGONAL WRENCHES, HAMMERS, CHISELS, FOLDING KNIVES, KNIVES WITH RETRACTABLE BLADES, HAND SAWS, HACK SAWS FOR METAL, WOOD, AND PLASTIC, SAW BLADES, HAND DRILL, BITS FOR HAND DRILLS, HAND-HELD SCRAPERS, RASPS, FILES, HAND-OPERATED SHEARS, MULTI-PURPOSE COMBINATION HAND TOOLS, SPECIFICALLY A HAND TOOL COMBINING TWO OR MORE OF THE AFOREMENTIONED HAND TOOLS IN ONE UNIT, WITH ONE OR MORE REMOVEABLE COMPONENT THAT CAN BE USED SEPARATELY (U.S. CLS. 23, 28 AND 44).
FIRST USE 11-1-1992; IN COMMERCE 11-1-1992.

SN 78-130,414. AMERICAN GRIP INCORPORATED, SUN VALLEY, CA. FILED 5-22-2002.

SIDEWINDER 150

NO CLAIM IS MADE TO THE EXCLUSIVE RIGHT TO USE "150", APART FROM THE MARK AS SHOWN.

FOR MANUALLY-OPERATED LIGHTING CRANK STANDS FOR GRIP AND SET LIGHTING EQUIPMENT FOR USE IN THE MOTION PICTURE AND ENTERTAINMENT INDUSTRY (U.S. CLS. 23, 28 AND 44).

SN 78-198,159. TWEEZERMAN CORPORATION, GLEN COVE, NY. FILED 12-27-2002.

TWEEZERMAN MEN

OWNER OF U.S. REG. NOS. 1,960,228 AND 2,358,431.
FOR MANICURE, PEDICURE, FACIAL, SKIN CARE AND HAIR CUTTING IMPLEMENTS, NAMELY, TWEEZERS, NAIL CLIPPERS, HAIR CUTTING SCISSORS, MOUSTACHE SCISSORS, NOSE AND EAR HAIR SCISSORS, CUTICLE AND HANGNAIL NIPPERS, NAIL FILES, NAIL CLIPPERS, TOE NAIL CLIPPERS ARTIFICIAL NAIL CUTTERS, CALLUS CUTTERS, CALLUS RASPS, WHITEHEAD AND BLACKHEAD REMOVERS, NOSE HAIR TRIMMERS, CUTICLE KNIVES, HANGNAIL CLIPPERS, NAIL SCISSORS, FOLDING NAIL CLIPPERS AND FOLDING SCISSORS, SCISSORS USED FOR CUTTING HAIR ON THE BODY (U.S. CLS. 23, 28 AND 44).

CLASS 8—(Continued).

SN 78-200,940. DEMON INTERNATIONAL, OREM, UT. FILED 1-7-2003.



FOR HAND TOOLS, NAMELY, SCREWDRIVERS, WRENCHES, SCRAPERS, IRONS FOR MELTING WAX, PLIERS FOR SERVICING SNOWBOARDS AND SNOWBOARDING EQUIPMENT; SNOWBOARD BINDING TOOLS, NAMELY SCREWDRIVERS, WRENCHES AND PLIERS, POCKET DRIVERS, RATCHETING DRIVERS AND BITS FOR DRIVERS (U.S. CLS. 23, 28 AND 44).
FIRST USE 6-1-1999; IN COMMERCE 1-27-2001.

SN 78-206,590. EMERSON, ERNEST, TORRANCE, CA. AND EMERSON, MARY, TORRANCE, CA. FILED 1-23-2003.

HARD WEAR

NO CLAIM IS MADE TO THE EXCLUSIVE RIGHT TO USE "HARDWARE", APART FROM THE MARK AS SHOWN.

FOR SIDE ARMS, NOT INCLUDING FIREARMS, NAMELY SPORTING KNIVES, UTILITY KNIVES, COMBAT KNIVES, POLICE AND MILITARY KNIVES (U.S. CLS. 23, 28 AND 44).

FIRST USE 3-0-2002; IN COMMERCE 1-10-2003.

SN 78-209,662. ACME UNITED CORPORATION, FAIRFIELD, CT. FILED 1-31-2003.

SCISSOR CRITTERS

NO CLAIM IS MADE TO THE EXCLUSIVE RIGHT TO USE "SCISSOR", APART FROM THE MARK AS SHOWN.
FOR SCISSORS (U.S. CLS. 23, 28 AND 44).

CLASS 9—ELECTRICAL AND SCIENTIFIC APPARATUS

SN 74-455,040. HEALTH INTERNATIONAL CORPORATION, ST. PETERSBURG, FL. BY ASSIGNMENT TONY LITTLE ENTERPRISES, INC., ST. PETERSBURG, FL. FILED 11-8-1993.



FOR PRERECORDED VIDEO AND AUDIO CASSETTE TAPES FEATURING EXERCISE INSTRUCTION AND FITNESS TRAINING (U.S. CLS. 21 AND 36).
FIRST USE 1-4-1991; IN COMMERCE 1-4-1991.

SN 74-637,398. MTI, INC., HILLSBORO, OR. FILED 2-22-1995.

ONSCREEN

SEC. 2(F).
FOR COMPUTER SOFTWARE FOR SWITCHING AND DISPLAYING INDIVIDUAL COMPONENTS OF AUDIO, VIDEO AND HOME ENTERTAINMENT SYSTEMS (U.S. CLS. 21, 23, 26, 36 AND 38).
FIRST USE 3-30-1995; IN COMMERCE 3-30-1995.

SN 75-256,360. CYBERNET SYSTEMS CORPORATION, ANN ARBOR, MI. FILED 3-13-1997.

CYBERNET.COM

OWNER OF U.S. REG. NO. 1,738,079.
FOR COMPUTER SYSTEMS COMPRISED OF COMPUTER HARDWARE INCLUDING ELECTRO-OPTICAL LOCATION AND TARGETING SENSORS, ROBOTIC CONTROL UNITS, AND PERSONAL HANDHELD AND WEARABLE COMPUTING DEVICES, AND COMPUTER SOFTWARE FOR ROBOTIC CONTROL UNITS, VIRTUAL REALITY SYSTEMS, COMPUTER-BASED TRAINING SIMULATIONS, CREATING OF COMPUTER GRAPHICS, HUMAN-COMPUTER INTERACTION, INERTIAL NAVIGATION SYSTEMS, COMPUTER VISION SYSTEMS, COMPUTER NETWORK CONNECTIVITY, OBJECT TRACKING, PARACHUTE AUTOMATIC OPENING DEVICES, AND COGNITIVE WORKLOAD MEASUREMENT (U.S. CLS. 21, 23, 26, 36 AND 38).
FIRST USE 10-21-1992; IN COMMERCE 10-21-1992.

SN 75-288,845. MEGATECH ELECTRO INC., GRAND-MERE, QUEBEC, CANADA, FILED 5-8-1997.

MEGALINK

PRIORITY CLAIMED UNDER SEC. 44(D) ON CANADA APPLICATION NO. 842449, FILED 4-16-1997, REG. NO. 575307, DATED 2-10-2003, EXPIRES 2-10-2018.
FOR ELECTRICAL MODULE NAMED MULTIPLEXOR FOR MOTOR VEHICLES (U.S. CLS. 21, 23, 26, 36 AND 38).

CLASS 9—(Continued).

SN 75-360,861. ELRON SOFTWARE, INC., CAMBRIDGE, MA. BY ASSIGNMENT ON TECHNOLOGY CORPORATION, CAMBRIDGE, MA. FILED 9-22-1997.

INTERNET MANAGER

NO CLAIM IS MADE TO THE EXCLUSIVE RIGHT TO USE "INTERNET", APART FROM THE MARK AS SHOWN.
SEC. 2(F).
FOR COMPUTER SOFTWARE FOR MONITORING AND CONTROLLING ACCESS TO GLOBAL NETWORKS, LOCAL AREA NETWORKS, AND WIDE AREA NETWORKS (U.S. CLS. 21, 23, 26, 36 AND 38).
FIRST USE 7-1-1996; IN COMMERCE 7-1-1996.

SN 75-578,207. E-LYSIUM TRANSACTION SYSTEMS INC., MIAMI, FL. FILED 10-26-1998.



THE MARK CONSISTS IN PART OF A STYLIZED LETTER "E" SUPERIMPOSED ON A CIRCLE DESIGN WHICH CONTAINS DEPICTIONS OF A BODY OF WATER, A WALL, FIRE AND THE SKY.

FOR COMPUTER PROGRAMS FOR TRANSACTION PROCESSING, NAMELY BILLING, ESTABLISHING THE FINANCIAL AMOUNTS FROM DEBIT AND CREDIT TRANSACTIONS, COMPUTING AND DISPLAYING AMOUNTS OWED AND PAID ACCORDING TO ACCOUNTING PROCEDURES, AND MANAGING AND MONITORING OF ACCOUNTS IN A PREPAID PAYMENT MARKETING SYSTEM FOR A GLOBAL COMPUTER NETWORK ACCESS, AND FOR CONDUCTING A SYSTEM FOR PAYING IN ADVANCE FOR ITEMS AND SERVICES IN E-COMMERCE USING TELEPHONY VIA ACCESS TO A GLOBAL COMPUTER NETWORK, FACILITATING ELECTRONIC FUND TRANSFERS, AND E-COMMERCE SOFTWARE TO ALLOW USERS TO PERFORM ELECTRONIC BUSINESS TRANSACTIONS VIA A GLOBAL COMPUTER NETWORK (U.S. CLS. 21, 23, 26, 36 AND 38).

SN 75-587,106. STONE, ADAM, DBA DIGITAL TOOLS, CLYDE, CA. FILED 11-12-1998.

DIGITOOLS

FOR COMPUTER SOFTWARE FOR USE IN CONSTRUCTION INDUSTRY LOGISTICS PROCESSES, NAMELY, THE DESIGN, ENGINEERING, BIDDING, PROGRAMMING AND CONSTRUCTION OF COMPONENTS IN RESIDENTIAL AND COMMERCIAL STRUCTURES (U.S. CLS. 21, 23, 26, 36 AND 38).
FIRST USE 8-1-1998; IN COMMERCE 10-9-1998.

CLASS 9—(Continued).

SN 75-615,989. MATSUSHITA ELECTRIC INDUSTRIAL CO., LTD., OSAKA PREFECTURE, JAPAN, FILED 1-5-1999.

MEDIA PASSPORT

NO CLAIM IS MADE TO THE EXCLUSIVE RIGHT TO USE "MEDIA", APART FROM THE MARK AS SHOWN.

FOR TUNERS FOR CABLE TV, TUNERS FOR TERRESTRIAL BROADCAST, TUNERS FOR SATELLITE BROADCAST, TELEVISION DISPLAYS, TELEVISION RECEIVERS, DECODERS FOR VIDEO SIGNAL, DECODERS FOR AUDIO SIGNAL, PERSONAL COMPUTERS, INTERFACE TO SWITCH BETWEEN AUDIO-VIDEO-COMPUTER APPARATUS AND CONTROL AUDIO-VIDEO-COMPUTER APPARATUS (U.S. CLS. 21, 23, 26, 36 AND 38).

SN 75-691,100. INTEGRATED DATA CONTROL INC., SAN ANTONIO, TX. FILED 4-26-1999.

NAME IT AND CLAIM IT

FOR COMPUTER SOFTWARE FOR DATABASE CREATION AND MANAGEMENT OF DIGITAL FILES AND IMAGES DOWNLOADED FROM THE INTERNET, CREATED BY COMPUTERS AND STORED ON INTRANETS AND FOR FULL TEXT INDEXING AND SEARCHING THE TEXT IN THE DATABASES (U.S. CLS. 21, 23, 26, 36 AND 38).

SN 75-764,810. LANGNER COMMUNICATIONS AG, D-22359 HAMBURG, FED REP GERMANY, BY CHANGE OF NAME LANGNER GESELLSCHAFT FUR DATENTECHNIK GMBH, D-22359 HAMBURG, FED REP GERMANY, FILED 7-30-1999.

FACTORYXML

PRIORITY CLAIMED UNDER SEC. 44(D) ON FED REP GERMANY APPLICATION NO. 39932480.1, FILED 6-7-1999, REG. NO. 39932480, DATED 11-22-2001, EXPIRES 6-30-2009.

FOR COMPUTER HARDWARE AND SOFTWARE FOR DATA EXCHANGE BETWEEN FACTORY AUTOMATION SOFTWARE AND HARDWARE AND BUSINESS SOFTWARE APPLICATION (U.S. CLS. 21, 23, 26, 36 AND 38).

CLASS 9—(Continued).

SN 75-789,173. NIPPON DENSHIN DENWA KABUSHIKI KAISHA, DBA NIPPON TELEGRAPH AND TELEPHONE CORPORATION, TOKYO, JAPAN, FILED 8-31-1999.



PRIORITY CLAIMED UNDER SEC. 44(D) ON JAPAN APPLICATION NO. 11-46902, FILED 5-31-1999, REG. NO. 4388667, DATED 6-2-2000, EXPIRES 6-2-2010.

OWNER OF U.S. REG. NO. 2,568,744.

NO CLAIM IS MADE TO THE EXCLUSIVE RIGHT TO USE "COMMUNICATIONS", APART FROM THE MARK AS SHOWN.

THE DRAWING IS LINED FOR THE COLORS GOLD AND BLUE.

FOR BLANK MAGNETIC DATA CARRIERS; BLANK RECORDING DISKS; AUTOMATIC VENDING MACHINES AND MECHANISMS FOR COIN OPERATED APPARATUS; CASH REGISTERS; CALCULATING MACHINES; DATA PROCESSORS AND COMPUTERS; FIRE-EXTINGUISHERS; ELECTRICAL WIRES AND CABLES; BATTERIES; ELECTRICAL CONTROLLERS; ELECTRIC ACCUMULATORS; ACCUMULATOR BOXES; ACOUSTIC COUPLERS; ADDING MACHINES; ANTENNAS; ANTI-INTRUSION ALARMS, FIRE AND BURGLAR ALARMS; AMMETERS; SOUND AMPLIFIERS; STEREO AMPLIFIERS; BATTERY BOXES; BATTERY CHARGERS; SIGNAL BELLS; JUNCTION SLEEVES FOR ELECTRIC CABLES; MOTION PICTURE CAMERAS; VIDEO CAMERAS; 35 MM CAMERAS; PHOTOGRAPHIC CAMERAS; MAGNETIC CODED CARDS; CENTRAL PROCESSING UNITS; CIRCUIT BREAKERS; CIRCUIT CLOSERS; ELECTROMAGNETIC COILS; COMMUTATORS; BLANK COMPACT DISKS; PRERECORDED COMPACT DISKS FEATURING COMPUTER SOFTWARE FOR GENERAL LEDGER, ACCOUNT MANAGEMENT, CASH MANAGEMENT, INVENTORY CONTROL, FINANCIAL TRANSACTION PROCESSING AND CUSTOMER ORDER PROCESSING; COMMUNICATION SOFTWARE FOR CONNECTING COMPUTER NETWORK USERS AND GLOBAL COMPUTER NETWORKS; COMPUTER E-COMMERCE SOFTWARE TO ALLOW CUSTOMERS TO PERFORM ELECTRONIC BUSINESS TRANSACTIONS VIA A GLOBAL COMPUTER NETWORK; PRERECORDED COMPACT DISKS FEATURING COMPUTER SOFTWARE FOR DESIGNING LARGE SCALE INTEGRATED CIRCUITS; PRERECORDED COMPACT DISKS FEATURING COMPUTER SOFTWARE FOR PROCESSING GRAPHICS; PRERECORDED COMPACT DISKS FEATURING COMPUTER SOFTWARE FOR DATA PROCESSING; COMPUTER OPERATING PROGRAMS; VIDEO GAME SOFTWARE; EDUCATIONAL SOFTWARE FEATURING INSTRUCTIONS IN DATA PROCESSING, TELECOMMUNICATION TECHNIQUE AND SALES TECHNIQUE; COMPUTER SOFTWARE FOR USE IN THE FIELDS OF ELECTRONIC PAYMENTS, ELECTRONIC SOFTWARE SALES, DEMOGRAPHIC INFORMATION AND ENCRYPTION/DECRYPTION OF INFORMATION, FOR ACCESSING ELECTRONIC COMMERCE, FOR FACILITATING COMPUTER AIDED DESIGN AND LARGE SCALE INTEGRATED CIRCUIT DESIGN, FOR AUTOMATIC ORDER CYCLE PROCESSES BETWEEN RETAILERS AND MANUFACTURERS; ELECTRICAL CONNECTORS; BLANK OPTICAL DATA CARRIERS; ELECTRONIC PENS; BLANK FLOPPY DISKS FOR COMPUTERS; INTEGRATED CIRCUITS; INTERCOMS; COMPUTER INTERFACE BOARDS; INVERTERS; BLANK MAGNETIC TAPES; OPTICAL DISCS; OPTICAL FILTERS; OPTICAL MIRRORS; OPTICAL SCANNERS; TELEPHONE RECEIVERS; AUDIO AND VIDEO RECEIVERS; ELECTRIC RESISTORS; SEMI-CONDUCTORS; SHEATHS FOR ELECTRICAL CABLES; TELEPHONE AND RADIO TRANSMITTERS; TELEPHONE TRANSMITTERS; TELEGRAPH WIRES; TELEPHONE WIRES; FACSIMILE MACHINES; PORTABLE TELEPHONES; WIRELESS TELEPHONES; WIRELESS ANTENNAS AND MASTS THEREFOR; COMPUTER SOFTWARE USED TO

CLASS 9—(Continued).

CONNECT VARIOUS COMPUTERS; CELLULAR TELEPHONES; RADIO PAGERS; COMPUTER TERMINALS FOR TELECONFERENCE; PRERECORDED VIDEO TAPES, PRERECORDED VIDEO DISKS, PRERECORDED CD ROM DISKS, PRERECORDED AUDIO TAPES FEATURING ENTERTAINMENT AND GENERAL INFORMATION, NAMELY, MUSIC, VAUDEVILLES, PLAYS, COMIC CHATS, SPEECHES AND LECTURES; VOLTMETERS; LARGE SCALE INTEGRATED CIRCUIT TESTERS; DIGITAL TELEPHONES; MODEMS; DIGITAL AMPLIFIERS; ALTERNATING/DIRECT-DIRECT/ALTERNATING CONVERTERS; LARGE SCALE INTEGRATED CIRCUIT; FIBER OPTICS; FIBER OPTIC CABLES; CONNECTORS FOR FIBER OPTIC CABLES; FIBER OPTIC LIGHT AND IMAGE CONDUITS; TIMERS FOR TELEPHONE CALLS; COUNTERS FOR TELEPHONE CALLS; ERROR RATE COUNTERS FOR TELEPHONE TRANSMISSION LINES; OPTICAL PULSE COUNTERS AND OPTICAL POWER METERS; WORD PROCESSORS; RADIOS; ROUTERS; TIME DIVISION MULTIPLEXING; APPARATUS FOR ASSEMBLING DATA OR VOICE IN CONVENTIONAL PROTOCOL INTO A FRAME FORMAT OF THE FRAME RELAY INTERFACE AND FOR DISASSEMBLING DATA OR VOICE IN A FRAME FORMAT OF THE FRAME RELAY INTERFACE INTO CONVENTIONAL PROTOCOL (BEING A TELECOMMUNICATION APPARATUS); FIREWALL; PROTOCOL OR LAN ANALYZERS IN THE NATURE OF COMPUTER SOFTWARE FOR WATCHING THE PERFORMANCE (OR ABILITY) OF LAN AND FOR ANALYZING TROUBLE OR TROUBLE-SHOOTING; BLANK CASSETTE TAPES; PRERECORDED CASSETTE TAPES FEATURING MUSIC VAUDEVILLES, PLAYS, COMIC CHATS, SPEECHES AND LECTURES; BLANK CD-ROMS; VIDEO GAME MACHINES FOR USE WITH TELEVISION (U.S. CLS. 21, 23, 26, 36 AND 38).

SN 75-880,059. RANDOLPH, ROBERT M., TULSA, OK. FILED 1-4-2000.

IMPAC

FOR DECISIONAL COMPUTER SOFTWARE, BASED ON THE THINKING PROCESS, THAT PROVIDES CRITICAL PATH ANALYSIS INFORMATION FOR USE IN MAKING BUSINESS MANAGEMENT AND LIFE MANAGEMENT DECISIONS, AND USER MANUALS SOLD THEREWITH (U.S. CLS. 21, 23, 26, 36 AND 38).
FIRST USE 5-28-1981; IN COMMERCE 5-28-1981.

SN 75-896,483. SKYWRITER COMMUNICATIONS INC., SCARBOROUGH, ONTARIO, CANADA, FILED 12-30-1999.

WOMEN WISE

PRIORITY CLAIMED UNDER SEC. 44(D) ON CANADA APPLICATION NO. 1,027,879, FILED 9-3-1999, REG. NO. TMA582209, DATED 5-22-2003, EXPIRES 5-22-2013.
FOR COMPUTER SOFTWARE FOR ENTERTAINMENT AND EDUCATIONAL PURPOSES FEATURING A COMBINATION OF INTERACTIVE ADVENTURE AND GAMES (U.S. CLS. 21, 23, 26, 36 AND 38).

CLASS 9—(Continued).

SN 75-906,868. OVO USA LLC, WORCESTER, MA. FILED 2-1-2000.

OVO

FOR PROTECTIVE HELMETS FOR WINTER SPORTS; PROTECTIVE HELMETS FOR SKIING AND SNOWBOARDING (U.S. CLS. 21, 23, 26, 36 AND 38).

SN 75-983,228. UNITED STATES POSTAL SERVICE, WASHINGTON, DC. FILED 8-27-1999.

PC POSTAGE

OWNER OF U.S. REG. NOS. 253,863 AND 2,537,762.
SEC. 2(F).

FOR COMPUTER E-COMMERCE SOFTWARE TO ALLOW USERS TO PERFORM ELECTRONIC BUSINESS TRANSACTIONS VIA A GLOBAL COMPUTER NETWORK; COMPUTER SOFTWARE FOR USE IN RECEIVING AND PRINTING POSTAGE VALUE; COMPUTER SOFTWARE FOR SUPPLYING POSTAGE THAT MAY BE DOWNLOADED FROM A GLOBAL COMPUTER NETWORK; COMPUTER HARDWARE; COMPUTER PRINTERS FOR SUPPLYING POSTAGE; COMMUNICATIONS SOFTWARE FOR CONNECTING COMPUTER NETWORK USERS AND TO ALLOW CUSTOMERS TO ACCESS FINANCIAL ACCOUNT AND TRANSACT FINANCIAL BUSINESS; COMPUTER SOFTWARE FOR PERFORMING ON-LINE FINANCIAL TRANSACTION SERVICES USING THE GLOBAL COMPUTER NETWORK; COMPUTER HARDWARE, NAMELY, SECURE CRYPTOGRAPHIC MODULES FOR STORING PRIVATE KEYS AND FOR DIGITALLY SIGNING MESSAGES REPRESENTING MONETARY, POSTAGE OR OTHER VALUE; COMPUTERS; COMPUTER SOFTWARE FOR USE IN OPERATING AND MAINTAINING A COMPUTER DATABASE IN THE FIELD OF POSTAGE; POSTAGE-EVIDENCING DEVICES AND ELECTRONIC POSTAGE METERS, AND PARTS, FITTINGS AND TESTING APPARATUS THEREFOR; SEMICONDUCTORS; COMPUTER HARDWARE, NAMELY, MICROPROCESSORS; INTEGRATED CIRCUITS; MICROCOMPUTERS; COMPUTER CHIPSETS; COMPUTER MOTHERBOARDS AND DAUGHTERBOARDS; COMPUTER GRAPHICS BOARDS; COMPUTER NETWORKING HARDWARE, NAMELY, COMPUTER NETWORK ADAPTERS, SWITCHERS THAT ALLOW SWITCHING BETWEEN SERVER AND WORKSTATIONS, ROUTERS AND HUBS; ELECTRONIC APPARATUS CONSISTING OF COMPUTER HARDWARE, COMPUTER PERIPHERALS AND COMPUTER SOFTWARE FOR PERMITTING CONSUMERS TO ACCESS A GLOBAL COMPUTER NETWORK; COMPUTER PERIPHERALS, NAMELY, COMPUTER KEYBOARDS, TRACKBALLS, VIDEO APPARATUS AND MOUSE DEVICES; COMPUTER INPUT DEVICES, NAMELY COMPUTER MONITORS; VIDEO CIRCUIT BOARDS; COMPUTER HARDWARE AND PERIPHERALS FOR RECORDING, PROCESSING, RECEIVING, REPRODUCING, TRANSMITTING, MODIFYING, COMPRESSING, DECOMPRESSING, BROADCASTING, MERGING AND ENHANCING SOUND, VIDEO IMAGES, GRAPHICS AND DATA AND PARTS FOR ALL THE AFORESAID GOODS; AND USER MANUALS FOR USE THEREWITH, AND SOLD AS A UNIT WITH EACH THE AFORESAID GOODS (U.S. CLS. 21, 23, 26, 36 AND 38).

FIRST USE 11-0-1996; IN COMMERCE 11-0-1996.

CLASS 9—(Continued).

SN 76-079,203. ZUMBACH ELECTRONIC AG, CH 2552 ORPUND, SWITZERLAND, FILED 6-27-2000.

PROFILEMASTER

OWNER OF ERPN CMNTY TM OFC REG. NO. 1718220, DATED 8-17-2001, EXPIRES 6-21-2010.

FOR OPTICAL PROFILE MEASURING AND CONTROL SYSTEM AND EQUIPMENT COMPRISED OF LASERS, SOLID STATE CAMERAS, VIDEO CAMERAS, PROCESSORS, AND A DISPLAY UNIT AND A KEYBOARD; PRODUCTION LINE PROFILE MEASURING AND CONTROL MACHINES; APPARATUS AND INSTRUMENTS FOR THE OPTICAL AND LASER-OPTICAL MEASUREMENT OF CABLES, TUBES, PROFILES, WIRES AND PIPES, AND FOR THE ENTRY, PROCESSING AND OUTPUT OF DATA RELATING THERETO, AND FOR PRODUCTION LINE PROCESS CONTROL (U.S. CLS. 21, 23, 26, 36 AND 38).

SN 76-111,222. DECADE SYSTEMS CORPORATION, PONTE VEDRA BEACH, FL. FILED 8-17-2000.

DECADESYSTEMS

FOR COMPUTER SOFTWARE, NAMELY, DOWNLOADABLE COMPUTER SOFTWARE DESIGNED FOR USE IN THE FIELD OF INFORMATION LOGISTICS FOR DATA INTEGRATION AGGREGATION, TRANSLATION, TRANSMISSION AND PROCESSING FOR THE TRANSFER OF INFORMATION BETWEEN INTERNAL SYSTEMS, DATABASES, AND SERVICE PROVIDERS (U.S. CLS. 21, 23, 26, 36 AND 38).

FIRST USE 0-0-1992; IN COMMERCE 0-0-1992.

SN 76-138,580. KABUSHIKI KAISHA SONY COMPUTER ENTERTAINMENT, TA SONY COMPUTER ENTERTAINMENT INC., TOKYO 107-0052, JAPAN, FILED 9-29-2000.

DEBUGGING STATION

NO CLAIM IS MADE TO THE EXCLUSIVE RIGHT TO USE "DEBUGGING", APART FROM THE MARK AS SHOWN.

FOR AMUSEMENT APPARATUS ADAPTED FOR USE WITH TELEVISION RECEIVERS ONLY, NAMELY, VIDEO PLAYERS, VIDEO GAME PLAYERS, AND VIDEO GAME PROGRAMMING HARDWARE; COMPACT DISC PLAYERS, AND VIDEO GAME PROGRAMMING HARDWARE; COMPACT DISC PLAYERS FOR AUDIO; COMPACT DISC PLAYERS; CONTROLLERS FOR VIDEO GAMES ADAPTED FOR USE WITH TELEVISION RECEIVERS ONLY; VIDEO GAME SOFTWARE; OPTICAL DISCS, CD-ROMS, AND DVDS FEATURING VIDEO GAME SOFTWARE AND VIDEO GAME PROGRAMMING SOFTWARE (U.S. CLS. 21, 23, 26, 36 AND 38).

CLASS 9—(Continued).

SN 76-142,580. ANTIFERENCE LIMITED, LICHFIELD, WS13 7SB, UNITED KINGDOM, FILED 10-10-2000.

SILVER SENSOR

NO CLAIM IS MADE TO THE EXCLUSIVE RIGHT TO USE "SENSOR", APART FROM THE MARK AS SHOWN.

FOR TELEVISION AND RADIO SIGNAL RECEIVING APPARATUS, NAMELY INDOOR ANTENNAS, OUTDOOR ANTENNAS, UHF ANTENNAS, VHF ANTENNAS, FM ANTENNAS, HDTV ANTENNAS, YAGI ANTENNAS, LOG-PERIODIC ANTENNAS, PASSIVE ANTENNAS, AMPLIFIED ANTENNAS; SIGNAL AMPLIFIERS, SIGNAL DISTRIBUTION AMPLIFIERS AND MASTHEAD AMPLIFIERS ALL FOR USE WITH TELEVISION AND RADIO SIGNALING; REMOTE CONTROL EXTENDERS, POWER SUPPLIES, SIGNAL COMBINERS, SIGNAL SPLITTERS, SIGNAL COMBINER/SPLITTERS, SIGNAL FILTERS, SIGNAL DIPLEXERS; WALL PLATES, OUTLET BOXES, ELECTRICAL CONNECTORS, ATTENUATORS, TERMINATORS, BRACKETS, CLAMPS, CABLE, AND LEADS SOLD AS A UNIT; STRUCTURAL AND MOUNTING PARTS OF TELEVISION AND RADIO SIGNALING RECEIVING APPARATUS, NAMELY ANTENNA DEPOLE ASSEMBLIES AND PARTS THEREFOR, DIRECTOR AND REFLECTOR ELEMENTS AND ASSEMBLIES THEREFOR, BALUN PANELS, CAPACITOR BOARDS, ELECTRICAL TERMINALS AND CONNECTORS, AMPLIFIERS, SUB-ASSEMBLIES THEREFOR, ANTENNA CLAMPS AND FITTINGS THEREFOR, WALL-PLATE SUB-ASSEMBLIES AND COMPONENTS THEREFOR, SURFACE OUTLET SUB-ASSEMBLIES AND COMPONENTS THEREFOR, TURN PARTS, METAL PRESSING AND ELECTRICAL SUB-ASSEMBLIES FOR ANTENNA AND SIGNAL HANDLING DEVICES, METAL PLASTIC AND ELECTRONIC COMPONENTS AND SUB-ASSEMBLIES FOR PARTS THEREFOR (U.S. CLS. 21, 23, 26, 36 AND 38).

FIRST USE 2-0-2000; IN COMMERCE 2-0-2000.

SN 76-144,254. STONWARE, INC., INDIANAPOLIS, IN. FILED 10-11-2000.

STONWAREB2B

FOR COMPUTER SOFTWARE WHICH ALLOWS BUSINESSES TO PROVIDE EXTRANET SERVICES AND COMPUTER SOFTWARE FOR EDUCATION AND TRAINING IN THE FIELD OF PROVIDING INTERNET SERVICES (U.S. CLS. 21, 23, 26, 36 AND 38).

SN 76-148,411. MITCHELL, ALBERTO, VAN NUYS, CA. FILED 10-16-2000.

PLATINO RECORDS

NO CLAIM IS MADE TO THE EXCLUSIVE RIGHT TO USE RECORDS, APART FROM THE MARK AS SHOWN.

THE ENGLISH TRANSLATION OF "PLATINO" IS "PLATINUM".

FOR SERIES OF PRE-RECORDED PHONOGRAPH RECORDS, AUDIO CASSETTES, VIDEO CASSETTES, AND COMPACT DISCS FEATURING MUSIC; PRE-RECORDED VIDEOTAPES FEATURING MUSIC (U.S. CLS. 21, 23, 26, 36 AND 38).

FIRST USE 0-0-1996; IN COMMERCE 0-0-1996.

CLASS 9—(Continued).

SN 76-158,502. CONCEPT TECHNOLOGIES (R&D) LTD, POOLE, UNITED KINGDOM, FILED 11-1-2000.

ELATA

PRIORITY CLAIMED UNDER SEC. 44(D) ON ERPNTY TM OFC APPLICATION NO. 1778182, FILED 7-27-2000, REG. NO. 1778182, DATED 4-25-2002, EXPIRES 7-27-2010.

FOR COMPUTER MIDDLEWARE SOFTWARE WHICH ENABLES MOBILE COMMUNICATIONS DEVICE, NAMELY, CELLULAR TELEPHONES, PERSONAL DIGITAL ASSISTANTS, LAPTOP COMPUTERS, SET TOP BOXES AND SMART CARDS, TO EXCHANGE CONTENT IN THE FORM OF DIGITAL DATA WITH REMOTE SOURCES, NAMELY, WEB SERVERS, FILE REPOSITORIES, VIDEOS AND LEGACY SYSTEMS (U.S. CLS. 21, 23, 26, 36 AND 38).

SN 76-183,903. PREVAIL CORPORATION, DBA SYNERGISTICS, CINCINNATI, OH. FILED 12-20-2000.

AUTHORITI

FOR GENERAL PURPOSE CONNECTIVITY SOFTWARE USED TO ESTABLISH AND MANAGE CONNECTIONS BETWEEN MULTIPLE COMPUTER PLATFORMS AND MULTIPLE DATABASES TO GATHER, ORGANIZE, INTEGRATE AND CONTEXTUALIZE INTERNAL AND EXTERNAL DATA (U.S. CLS. 21, 23, 26, 36 AND 38).

SN 76-185,385. HARRIS CORPORATION, MELBOURNE, FL. FILED 12-21-2000.

NETBOSS

FOR COMPUTER SOFTWARE AND MANUALS AND DOCUMENTATION DISTRIBUTED THEREWITH NAMELY, OPERATIONAL SUPPORT SYSTEMS SOFTWARE FOR MANAGEMENT OF COMPUTER NETWORKS OF TELECOMMUNICATIONS SERVICE PROVIDERS NAMELY, MODULAR SOFTWARE APPLICATIONS THAT PROVIDE TELECOMMUNICATIONS SERVICE ASSURANCE FUNCTIONALITY NAMELY, TELECOMMUNICATIONS NETWORK FAULT MANAGEMENT AND TELECOMMUNICATIONS NETWORK PERFORMANCE MANAGEMENT (U.S. CLS. 21, 23, 26, 36 AND 38).

FIRST USE 9-20-2000; IN COMMERCE 9-20-2000.

CLASS 9—(Continued).

SN 76-188,689. KURT J. LESKER COMPANY, CLAIRTON, PA. FILED 1-2-2001.

SPECTROS

FOR SINGLE CHAMBER RESEARCH AND DEVELOPMENT SYSTEM, COMPRISED OF A DEPOSITION CHAMBER, A SUBSTRATE FIXTURE, A VACUUM PUMP AND GAUGE, AND SPACES FOR ORGANIC AND THERMAL EVAPORATION SOURCES FOR USE IN INVESTIGATING DEPOSITION METHODS AND CHARACTERISTICS OF ORGANIC AND POLYMERIC LIGHT EMITTING DEVICES (OLED AND PLED) AND OTHER RELATED MATERIALS (U.S. CLS. 21, 23, 26, 36 AND 38).

FIRST USE 6-9-2000; IN COMMERCE 8-0-2000.

SN 76-190,212. SKRAMEDART INC., TORONTO, ONTARIO M5H 2V1, CANADA, FILED 1-5-2001.

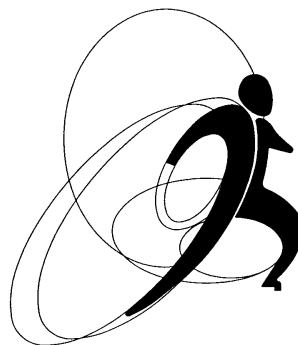

PRIORITY CLAIMED UNDER SEC. 44(D) ON CANADA APPLICATION NO. 1079281, FILED 10-19-2000, REG. NO. TMA579282, DATED 4-9-2003, EXPIRES 4-9-2018.

FOR COMPUTER SOFTWARE USED FOR INVESTMENT PORTFOLIO MANAGEMENT AND ADMINISTRATION IN THE FIELD OF INVESTMENT SERVICES (U.S. CLS. 21, 23, 26, 36 AND 38).

SN 76-214,177. TRECENTI TECHNOLOGIES, INC., IBARAKI-KEN 312-0034, JAPAN, FILED 2-22-2001.



PRIORITY CLAIMED UNDER SEC. 44(D) ON JAPAN APPLICATION NO. 2001-8864, FILED 2-5-2001, REG. NO. 4559103, DATED 4-12-2002, EXPIRES 4-12-2012.

NO CLAIM IS MADE TO THE EXCLUSIVE RIGHT TO USE "TECHNOLOGIES", APART FROM THE MARK AS SHOWN.

FOR SEMICONDUCTOR PRODUCTS AND DEVICES, NAMELY, INTEGRATED CIRCUITS, TRANSISTORS, DIODES, OPTOELECTRONIC DEVICES (U.S. CLS. 21, 23, 26, 36 AND 38).

CLASS 9—(Continued).

SN 76-222,289. AIPTEK, INC., LAKE FOREST, CA. FILED 3-9-2001.

EPIPHANY

FOR MAGNETIC CODED CARD READERS; VIDEO CAMERAS, VIDEO TELEPHONES, MULTI-PURPOSE DIGITAL CAMERAS; PHOTOGRAPHIC CAMERAS AND COMPUTER SOFTWARE FOR PHOTO AND VIDEO PROCESSING; ELECTRONIC DIGITIZER PADS AND STYLUS PENS; SOFTWARE TEMPLATES FOR USE IN ELECTRONIC DIGITIZER PADS; ELECTRONIC WHITEBOARDS; OPTICAL DISCS CONTAINING COMPUTER SOFTWARE FOR CONNECTING AND CONTROLLING DIGITAL CAMERAS, WEBCAMS, AND/OR GRAPHIC TABLETS; OPTICAL DISCS CONTAINING COMPUTER SOFTWARE FOR USE IN COLLECTING, STORING, EDITING, PROCESSING, VIEWING, PRINTING, TRANSMITTING, AND MANIPULATING DATA AND INFORMATION FROM DIGITAL CAMERAS, WEBCAMS, AND/OR GRAPHIC TABLETS; OPTICAL SCANNERS; AND MODEMS (U.S. CLS. 21, 23, 26, 36 AND 38).

SN 76-238,525. INFOGRAMS, INC., NEW YORK, NY. FILED 4-9-2001.

FREDDI FISH AND THE CASE OF THE CREATURE OF CORAL COVE

FOR INTERACTIVE MULTIMEDIA GAME SOFTWARE FOR USE ON PERSONAL COMPUTERS AND ELECTRONIC GAME-PLAYING UNITS (U.S. CLS. 21, 23, 26, 36 AND 38).

SN 76-263,939. DRESSYOURPHONE.COM, INC., MIAMI, FL. FILED 5-29-2001.

DRESSYOURPHONE.COM

FOR WIRELESS CELLULAR TELEPHONE ACCESSORIES, NAMELY, ANTENNAS, BELT CLIP KITS COMPRISED OF CELLULAR TELEPHONE HOLSTERS WITH BELT ATTACHMENTS AND PLASTIC CLIPS, CELLULAR TELEPHONE COVERS, CELLULAR TELEPHONE CASES AND PORTABLE HANDS FREE KITS COMPRISED OF HOLSTERS, ADAPTORS, EXTENSIONS AND MICROPHONES (U.S. CLS. 21, 23, 26, 36 AND 38). FIRST USE 4-1-2001; IN COMMERCE 5-1-2001.

SN 76-264,561. GARCIA, EDDIE M., EDINA, MN. FILED 5-31-2001.

TYMLINK

FOR GLOBAL TIME CALCULATORS, NAMELY, A ROTATING DIAL USED TO CALCULATE INTERNATIONAL TIME ZONES (U.S. CLS. 21, 23, 26, 36 AND 38). FIRST USE 10-17-2002; IN COMMERCE 10-17-2002.

CLASS 9—(Continued).

SN 76-279,241. INSIDSESESSIONS, L.L.C., UNIVERSAL CITY, CA. FILED 7-2-2001.

INSIDSESESSIONS

FOR PRE-RECORDED EDUCATIONAL VIDEO TAPES, VIDEO CASSETTES, DVDS, AND CD ROMS, ALL FEATURING TELEVISION PROGRAMS ABOUT ENTERTAINMENT BUSINESSES IN THE FIELDS OF PUBLISHING, MOTION PICTURE FILMS, TELEVISION AND MUSIC PUBLISHING; COMPUTER SOFTWARE FEATURING PRE-RECORDED EDUCATIONAL DVDS AND CD ROMS ABOUT ENTERTAINMENT BUSINESSES IN THE FIELDS OF PUBLISHING, MOTION PICTURE FILMS, TELEVISION AND MUSIC PUBLISHING; PRE-RECORDED EDUCATIONAL AUDIO TAPES CONTAINING EDUCATIONAL INFORMATION ABOUT THE MUSIC BUSINESS AND MUSIC PUBLISHING; COMPUTER SOFTWARE AND MANUALS SOLD AS A UNIT CONTAINING EDUCATIONAL MATERIALS ABOUT MUSIC AND MUSIC PUBLISHING; EDUCATIONAL COMPUTER SOFTWARE FOR THE CREATION AND DELIVERY OF COURSES OF INSTRUCTION IN THE FIELDS OF MUSIC AND PUBLISHING VIA A GLOBAL INFORMATION NETWORK (U.S. CLS. 21, 23, 26, 36 AND 38).

SN 76-295,034. QUEBECOR WORLD INC., MONTREAL, QUEBEC, CANADA, FILED 8-6-2001.

COFICIO

PRIORITY CLAIMED UNDER SEC. 44(D) ON CANADA APPLICATION NO. 1104702, FILED 5-30-2001, REG. NO. TMA578963, DATED 4-4-2003, EXPIRES 4-4-2018.

FOR COMPUTER SOFTWARE TO ENHANCE THE AUDIO-VISUAL CAPABILITIES OF MULTIMEDIA APPLICATIONS, NAMELY, FOR THE INTEGRATION OF TEXT, GRAPHICS, STILL IMAGES AND MOVING PICTURES, VIA A PRIVATE NETWORK OR THE INTERNET (U.S. CLS. 21, 23, 26, 36 AND 38).

FIRST USE 4-0-2001; IN COMMERCE 4-0-2001.

SN 76-295,035. QUEBECOR WORLD INC., MONTREAL, QUEBEC, CANADA, FILED 8-6-2001.

I-FICIENT

PRIORITY CLAIMED UNDER SEC. 44(D) ON CANADA APPLICATION NO. 1,104,992, FILED 5-31-2001, REG. NO. 578946, DATED 4-4-2003, EXPIRES 4-4-2018.

FOR COMPUTER SOFTWARE FOR THE REPRODUCTION OF LOW-RESOLUTION PROXY IMAGES AND PAGE PRODUCTION PROCESS USED IN THE AUTOMATED PUBLISHING SYSTEMS (U.S. CLS. 21, 23, 26, 36 AND 38).

FIRST USE 4-0-2001; IN COMMERCE 4-0-2001.

CLASS 9—(Continued).

SN 76-295,506. INTEGRAL SOLUTIONS, INC., ROYAL OAK, MI. FILED 8-6-2001.

MIGRATOR 2001

INFO-TO-GO!

NO CLAIM IS MADE TO THE EXCLUSIVE RIGHT TO USE "MIGRATOR", APART FROM THE MARK AS SHOWN. THE WORD "MIGRATOR" IS FUTURA FONT, ALL CAPS AND COLORED PANTONE REFLEX BLUE. THE PHRASE "INFO-TO-GO!" IS IN BLACK FUTURA FONT. THE NUMBER "2001" IS IN BLACK. THE LINE IS IN RED.

FOR COMPUTER SOFTWARE PROGRAM ALLOWING USERS TO WORK OFFSITE ON DATA EXTRACTED FROM THE MAIN FILE AND TO SYNCHRONIZE ANY CHANGES MADE OFFSITE WITH THE CONTENTS OF THE ORIGINAL FILE WITHOUT LOSS OF DATA (U.S. CLS. 21, 23, 26, 36 AND 38).

FIRST USE 6-1-2000; IN COMMERCE 6-1-2000.

SN 76-319,086. HUBBARD & WELLS, INC., DBA HUBBARD ONE, CHICAGO, IL. FILED 10-1-2001.

Q A CONNECT

FOR DATABASE MANAGEMENT SOFTWARE MODULE FOR QUERYING, TALLYING AND ARCHIVING USER-DEFINED INFORMATION USED BY BUSINESSES AND LAW FIRMS (U.S. CLS. 21, 23, 26, 36 AND 38).

FIRST USE 8-1-2001; IN COMMERCE 8-1-2001.

SN 76-323,445. SHARP ELECTRONICS CORPORATION, MAHWAH, NJ. FILED 10-9-2001.

BLUESTREAK

FOR SEMICONDUCTORS; COMPUTER HARDWARE; INTEGRATED CIRCUITS; CIRCUIT BOARDS; MICRO CONTROLLERS; MICROPROCESSORS; MACRO CELLS; APPLICATION SPECIFIC INTEGRATED CIRCUITS; SYSTEM ON CHIPS COMPRISED OF INTEGRATED CIRCUITS; MICROCOMPUTER; BUS INTERFACES (U.S. CLS. 21, 23, 26, 36 AND 38).

CLASS 9—(Continued).

SN 76-331,467. IMAGEPERT, INC., NASHUA, NH. FILED 10-30-2001.



FOR IMAGE QUALITY INSPECTION SYSTEMS, NAMELY, HARDWARE AND SOFTWARE WHICH ENABLES FULLY AUTOMATED, OBJECTIVE, QUALITATIVE IMAGE QUALITY ANALYSIS USED BY IMAGING COMPANIES IN RESEARCH AND DEVELOPMENT, PRODUCTION AND QUALITY CONTROL ENVIRONMENTS FOR PRINTING EQUIPMENT AND CONSUMABLES, NAMELY, PAPER, INK AND TONER (U.S. CLS. 21, 23, 26, 36 AND 38).

FIRST USE 9-30-1993; IN COMMERCE 9-30-1993.

SN 76-331,559. FOX RACING, INC., MORGAN HILL, CA. FILED 10-29-2001.

SHIFT RACING

NO CLAIM IS MADE TO THE EXCLUSIVE RIGHT TO USE "RACING", APART FROM THE MARK AS SHOWN.

FOR PRESSURE AIR GAUGES, MOTORCYCLE AND SAFETY HELMETS AND PROTECTIVE CLOTHING FOR MOTORCYCLISTS AND CYCLISTS; PRERECORDED AUDIO AND VIDEO TAPES, DISCS AND CASSETTES FEATURING SPORTS (U.S. CLS. 21, 23, 26, 36 AND 38).

SN 76-337,019. BIZ INTERACTIVE ZONE, INC., IRVINE, CA. BY ASSIGNMENT SSP SOLUTIONS, IRVINE, CA. FILED 11-13-2001.

SSP SOLUTIONS

FOR COMPUTER HARDWARE, NAMELY READERS AND PROCESSORS; AND COMPUTER SOFTWARE FOR USE IN DATABASE MANAGEMENT, MONETIZATION, FINANCIAL TRANSACTIONS, INFORMATION AND IDENTITY AUTHENTICATION, DATA MANAGEMENT, DATA SECURITY AND DATA ENCRYPTION (U.S. CLS. 21, 23, 26, 36 AND 38).

SN 76-338,353. DUCKWORTH, SHANNON L, HOUSTON, TX. FILED 11-16-2001.



FOR SHIRTS, CAPS, SWEATSHIRTS, CLOTHING NAMELY BASEBALL CAPS, SWEATSHIRTS, AND T-SHIRTS (U.S. CLS. 21, 23, 26, 36 AND 38).

CLASS 9—(Continued).

SN 76-342,128. LIGHTSCAPE NETWORKS LTD., PETACH
TIKVA 49517, ISRAEL, FILED 11-28-2001.

PIONEERS OF THE S I N G L E - A R C H I T E C T U R E A P P R O A C H

PRIORITY CLAIMED UNDER SEC. 44(D) ON ISRAEL
APPLICATION NO. 150392, FILED 6-28-2001, REG. NO.
150392, DATED 6-28-2001, EXPIRES 6-28-2011.

NO CLAIM IS MADE TO THE EXCLUSIVE RIGHT TO
USE THE WORDING "SINGLE ARCHITECTURE" OR THE
WORD "APPROACH", APART FROM THE MARK AS
SHOWN.

FOR OPTICAL TELECOMMUNICATION EQUIP-
MENT, NAMELY OPTICAL SPLITTERS, OPTICAL COM-
BINERS, OPTICAL FILTERS, OPTICAL
MULTIPLEXERS, OPTICAL TRANSMITTERS, TRANS-
CEIVERS, OPTICAL RECEIVERS, TRANSPONDERS, RE-
PEATERS, OPTICAL AMPLIFIERS, CONTROLLERS FOR
OPTICAL TELECOMMUNICATION NETWORKS, DIGI-
TAL PROCESSORS FOR OPTICAL TELECOMMUNICA-
TION NETWORKS, ROUTERS, BRIDGES, HUBS, STARS,
SWITCHES FOR OPTICAL TELECOMMUNICATION
NETWORKS, CROSS-CONNECTS; TRANSMISSION
EQUIPMENT, NAMELY OPTICAL MULTIPLEXERS,
CROSS-CONNECTS, FIBERS, DISPERSION FIBERS,
COMPENSATION FIBERS; OPTICAL TRANSMITTERS,
TRANSCIEVERS, AND OPTICAL RECEIVERS, TRANS-
PONDERS, SIGNAL REPEATERS; POWER SUPPLIERS
FOR OPTICAL TELECOMMUNICATION NETWORKS;
CONNECTORS FOR OPTICAL TELECOMMUNICATION
NETWORKS; VOICE, VIDEO AND DATA TRANSMI-
SSION SYSTEMS, NAMELY SIGNAL HANDLING HARD-
WARE AND SOFTWARE FOR TRANSMITTING,
RECEIVING AND DELIVERING VOICE, VIDEO AND
DATA COMMUNICATIONS OVER TRANSMISSION
MEDIA IN OPTICAL TELECOMMUNICATION NET-
WORKS, NAMELY FIBER OPTIC, COAX TRANSMI-
SSION LINES; NETWORK MANAGEMENT SYSTEMS IN
OPTICAL TELECOMMUNICATION NETWORKS,
NAMELY COMPUTER HARDWARE AND SOFTWARE
FOR PLANNING, MANAGING AND CONTROLLING
VOICE, VIDEO AND DATA COMMUNICATION OVER
TRANSMISSION MEDIA IN OPTICAL TELECOMMUNI-
CATION NETWORKS, NAMELY FIBER OPTIC, COAX
TRANSMISSION LINES; NETWORK ANALYSIS HARD-
WARE AND SOFTWARE FOR MONITORING COMMU-
NICATIONS IN OPTICAL TELECOMMUNICATION
NETWORKS BETWEEN NETWORK ELEMENTS; NET-
WORK PLANNING SOFTWARE TO DESIGN OR REDE-
SIGN OPTICAL TELECOMMUNICATIONS NETWORKS;
HARDWARE AND SOFTWARE FOR INTELLIGENT
OPTICAL NETWORKING; FIBER OPTIC TRANSPORT
EQUIPMENT FOR BROADBAND CONNECTIVITY
USING WAVE DIVISION MULTIPLEXING, NAMELY
OPTICAL NETWORK INTERFACES, CROSS-CONNECTS
AND FIBER OPTIC DATA LINKS; AND SOFTWARE
FOR THE OPERATION OF ALL THE AFORESAID
GOODS (U.S. CLS. 21, 23, 26, 36 AND 38).

CLASS 9—(Continued).

SN 76-345,568. RICE LAKE WEIGHING SYSTEMS, INC.,
RICE LAKE, WI. FILED 12-4-2001.



NO CLAIM IS MADE TO THE EXCLUSIVE RIGHT TO
USE "WEIGHING SYSTEMS", APART FROM THE MARK
AS SHOWN.

THE MARK IS LINED FOR THE COLOR RED.

SEC. 2(F).

FOR MECHANICAL AND ELECTRICAL SCALES AND
ACCESSORIES SOLD IN CONNECTION THEREWITH,
NAMELY ELECTRICAL ADAPTORS, CONNECTORS,
CABLES, INTERFACES, SWITCHES, RELAYS, AND
TRANSMITTERS; SPECIFIC GRAVITY KITS; KEY-
BOARDS; SCANNERS; INDICATORS AND REMOTE
DISPLAYS, NAMELY LIGHT INDICATORS, LIGHT
EMITTING DIODES, LIQUID CRYSTAL, EXPLOSION
PROOF INDICATORS AND DISPLAYS, WIRELESS AND
CABLE DISPLAYS; CARRYING CASES, PROTECTIVE
ENCLOSURES; POWER SYSTEMS, NAMELY SOLAR
POWER SYSTEMS, BATTERY PACKS, AND ELECTRICAL
POWER SUPPLIES; CALIBRATION KITS; SAMPLE
PANS, PLANERS, SCOOPS, BOWLS AND BOATS; TEST
TUBES; ROLLER CONVEYORS; WIRELESS REMOTE
CONTROLS; AUTOMATIC SHUTOFF CONTROLS; CUT-
TING BOARDS; BARRIER KITS; TEMPERATURE AD-
JUSTMENT KITS; SOFTWARE, NAMELY
AUTOMATION SOFTWARE, DATA COLLECTION
SOFTWARE, CALIBRATION SOFTWARE AND OPER-
ATING SOFTWARE; DIGITAL TO ANALOG CONVER-
TORS; COMPUTER CABLES AND ADAPTERS;
IONIZING BLOWERS; ANTIMAGNETIC SHIELDS; CON-
TROLLERS, NAMELY ZERO LANGUAGE CONTROL-
LERS, BATCH CONTROLLERS, BULK WEIGHING
CONTROLLERS AND TRUCK SCALE CONTROLLERS;
TRAFFIC LIGHT KITS; CABLE AND WIRELESS MOD-
EMS; ANTENNAS; LOOP DETECTORS; CARD READ-
ERS; SORTERS, CLASSIFIERS AND COUNTERS;
INTERCOM SYSTEMS; SERIAL PROTOCOL CONVER-
TORS; ALARMS; USB PORT TO SERIAL PORT CON-
VERTERS; RAIL TRANSIENT PROTECTOR AND FUSE;
ETHERNET SERVERS; BRIDGE SENSORS; HOSTILE
ENVIRONMENT AND WEIGHT INDICATORS; EXCI-
TER, SENSOR, COMMUNICATION AND SIGNAL BAR-
RIERS; LOAD CELLS, NAMELY S-BEAM, SINGLE
ENDED BEAM AND DOUBLE ENDED BEAM LOAD
CELLS AND SINGLE POINT LOAD CELLS; JUNCTION
BOXES, NAMELY EXCITATION TRIM, SIGNAL TRIM
AND CELL; WEIGHTS; SENSORS; COMPRESSION
DISCS AND CANISTERS; SURGE PROTECTORS; AC
AND DC TRANSIT PROTECTORS; POWER INVERTORS;
VOLTAGE REGULATORS; PRINTERS AND PRINTER
ENCLOSURES; REWINDERS; BAR CODE VERIFIERS;
WEIGH MODULES; AND, MOUNTING STANDS, HANG-
ERS, BRACKETS, PLATES, SWIVELS AND COLUMNS
AND MOUNTING HARDWARE (U.S. CLS. 21, 23, 26, 36
AND 38).

FIRST USE 11-18-1994; IN COMMERCE 11-18-1994.

CLASS 9—(Continued).

SN 76-345,627. RICE LAKE WEIGHING SYSTEMS, INC., RICE LAKE, WI. FILED 12-4-2001.

RICE LAKE WEIGHING SYSTEMS

NO CLAIM IS MADE TO THE EXCLUSIVE RIGHT TO USE "WEIGHING SYSTEMS", APART FROM THE MARK AS SHOWN.

SEC. 2(F).

FOR MECHANICAL AND ELECTRICAL SCALES AND ACCESSORIES SOLD IN CONNECTION THEREWITH, NAMELY ELECTRICAL ADAPTORS, CONNECTORS, CABLES, INTERFACES, SWITCHES, RELAYS, AND TRANSMITTERS; SPECIFIC GRAVITY KITS; KEYBOARDS; SCANNERS; INDICATORS AND REMOTE DISPLAYS, NAMELY LIGHT INDICATORS, LIGHT EMITTING DIODES, LIQUID CRYSTAL, EXPLOSION PROOF INDICATORS AND DISPLAYS, WIRELESS AND CABLE DISPLAYS; CARRYING CASES, PROTECTIVE ENCLOSURES; POWER SYSTEMS, NAMELY SOLAR POWER SYSTEMS, BATTERY PACKS, AND ELECTRICAL POWER SUPPLIES; CALIBRATION KITS; SAMPLE PANS, PLANERS, SCOOPS, BOWLS AND BOATS; TEST TUBES; ROLLER CONVEYORS; WIRELESS REMOTE CONTROLS; AUTOMATIC SHUTOFF CONTROLS; CUTTING BOARDS; BARRIER KITS; TEMPERATURE ADJUSTMENT KITS; SOFTWARE, NAMELY AUTOMATION SOFTWARE, DATA COLLECTION SOFTWARE, CALIBRATION SOFTWARE AND OPERATING SOFTWARE; DIGITAL TO ANALOG CONVERTERS; COMPUTER CABLES AND ADAPTERS; IONIZING BLOWERS; ANTIMAGNETIC SHIELDS; CONTROLLERS, NAMELY ZERO LANGUAGE CONTROLLERS, BATCH CONTROLLERS, BULK WEIGHING CONTROLLERS AND TRUCK SCALE CONTROLLERS; TRAFFIC LIGHT KITS; CABLE AND WIRELESS MODEMS; ANTENNAS; LOOP DETECTORS; CARD READERS; SORTERS, CLASSIFIERS AND COUNTERS; INTERCOM SYSTEMS; SERIAL PROTOCOL CONVERTERS; ALARMS; USB PORT TO SERIAL PORT CONVERTERS; RAIL TRANSIENT PROTECTOR AND FUSE; ETHERNET SERVERS; BRIDGE SENSORS; HOSTILE ENVIRONMENT AND WEIGHT INDICATORS; EXCITER, SENSOR, COMMUNICATION AND SIGNAL BARRIERS; LOAD CELLS, NAMELY S-BEAM, SINGLE ENDED BEAM AND DOUBLE ENDED BEAM LOAD CELLS AND SINGLE POINT LOAD CELLS; JUNCTION BOXES, NAMELY EXCITATION TRIM, SIGNAL TRIM AND CELL; WEIGHTS; SENSORS; COMPRESSION DISCS AND CANISTERS; SURGE PROTECTORS; AC AND DC TRANSIT PROTECTORS; POWER INVERTORS; VOLTAGE REGULATORS; PRINTERS AND PRINTER ENCLOSURES; REWINDERS; BAR CODE VERIFIERS; WEIGH MODULES; AND, MOUNTING STANDS, HANGERS, BRACKETS, PLATES, SWIVELS AND COLUMNS AND MOUNTING HARDWARE (U.S. CLS. 21, 23, 26, 36 AND 38).

FIRST USE 11-18-1994; IN COMMERCE 11-18-1994.

CLASS 9—(Continued).

SN 76-351,088. HEIDELBERGER DRUCKMASCHINEN AG, D-69115 HEIDELBERG, FED REP GERMANY, FILED 12-20-2001.

AXISCONTROL

PRIORITY CLAIMED UNDER SEC. 44(D) ON FED REP GERMANY APPLICATION NO. 30137297.7/0, FILED 6-20-2001, REG. NO. 30137297, DATED 8-3-2001, EXPIRES 6-30-2011.

FOR ELECTRONIC MEASURING DEVICES, NAMELY, INK FEED MEASURING UNIT, COLOR REGISTER MEASURING UNITS, PAPER FEED AND SKEW MEASURING UNITS, IN-REGISTER MEASURING UNITS, DENSITOMETERS, COLORIMETERS, AND SPECTROPHOTOMETERS FOR USE IN OFFSET PRINTING TECHNOLOGY (U.S. CLS. 21, 23, 26, 36 AND 38).

SN 76-351,241. FIDELIA TECHNOLOGY, INC., PRINCETON, NJ. BY ASSIGNMENT FIDELIA, INC., DENVER, CO. FILED 12-14-2001.

FIDELIA NETVIGIL

"FIDELIA" IS A LATIN TERM MEANING AN "EARTH-ENWARE VASE OR POT".

FOR COMPUTER SOFTWARE PROGRAMS DESIGNED TO MONITOR AND REPORT PERFORMANCE OF COMPUTER NETWORKS, NAMELY, BANDWIDTH, NETWORK AVAILABILITY, NETWORK DOWN TIME, NETWORK SPEED AND EFFICIENCY, AND PERFORMANCE OF COMPUTER AND TELECOMMUNICATIONS DEVICES ON A COMPUTER NETWORK (U.S. CLS. 21, 23, 26, 36 AND 38).

FIRST USE 9-15-2001; IN COMMERCE 10-1-2001.

SN 76-352,403. SCHLAGE LOCK COMPANY, COLORADO SPRINGS, CA. BY MERGER KRYPTONITE CORPORATION, CANTON, MA. FILED 12-26-2001.

NEW YORK LOCK

OWNER OF U.S. REG. NO. 2,189,522.

NO CLAIM IS MADE TO THE EXCLUSIVE RIGHT TO USE "LOCK", APART FROM THE MARK AS SHOWN.

FOR LOCKS AND SECURITY EQUIPMENT OF AN ULTRA-HIGH-SECURITY NATURE DESIGNED FOR USE IN HIGH THEFT-RISK AREAS SUCH AS LARGE CITIES OR THE LIKE NAMELY, ELECTRONIC LOCKING MECHANISMS, ALARMS, MOTION DETECTORS, INTEGRATED ELECTRO-MECHANICAL LOCKS, ELECTRONIC VEHICLE LOCKS, PERSONAL SECURITY DEVICES SUCH AS AN ALARM TO BE CARRIED ON ONE'S PERSON (U.S. CLS. 21, 23, 26, 36 AND 38).

CLASS 9—(Continued).

SN 76-364,511. PERRY, MARION, DBA WORD WORTH, EAST AURORA, NY. FILED 1-28-2002.

WORD WORTH

OWNER OF U.S. REG. NO. 1,827,819.
FOR DOWNLOADABLE ELECTRONIC PUBLICATION IN THE NATURE OF AN ON-LINE MONTHLY MAGAZINE IN THE FIELDS OF CURRENT EVENTS, ARTS AND SCIENCES (U.S. CLS. 21, 23, 26, 36 AND 38).
FIRST USE 10-25-2000; IN COMMERCE 10-25-2000.

SN 76-365,058. FIREMAN'S FUND INSURANCE COMPANY, NOVATO, CA. FILED 1-28-2002.

ICUSTOMER SERIES

NO CLAIM IS MADE TO THE EXCLUSIVE RIGHT TO USE "SERIES", APART FROM THE MARK AS SHOWN.
FOR MULTIMEDIA SOFTWARE RECORDED ON CD-ROM IN THE FIELD OF INSURANCE; COMMUNICATIONS SOFTWARE RECORDED ON CD-ROM FOR CONNECTING TO INSURANCE SERVICES ON AN EXTRANET (U.S. CLS. 21, 23, 26, 36 AND 38).

SN 76-365,676. US DATAWORKS, INC., HOUSTON, TX. FILED 2-1-2002.

RCKWORKS

FOR COMPUTER SOFTWARE FOR AUTOMATED CLEARING HOUSE (ACH) TRANSACTIONAL PROCESSING (U.S. CLS. 21, 23, 26, 36 AND 38).

SN 76-365,677. US DATAWORKS, INC., HOUSTON, TX. FILED 2-1-2002.

REMITWORKS

FOR COMPUTER SOFTWARE FOR AUTOMATED CLEARING HOUSE (ACH) TRANSACTIONAL PROCESSING (U.S. CLS. 21, 23, 26, 36 AND 38).

SN 76-365,678. US DATAWORKS, INC., HOUSTON, TX. FILED 2-1-2002.

RETURNWORKS

FOR COMPUTER SOFTWARE FOR AUTOMATED CLEARING HOUSE (ACH) TRANSACTIONAL PROCESSING (U.S. CLS. 21, 23, 26, 36 AND 38).

CLASS 9—(Continued).

SN 76-365,679. US DATAWORKS, INC., HOUSTON, TX. FILED 2-1-2002.

MICRWORKS

FOR COMPUTER SOFTWARE FOR AUTOMATED CLEARING HOUSE (ACH) TRANSACTIONAL PROCESSING (U.S. CLS. 21, 23, 26, 36 AND 38).

SN 76-366,688. KH TECHNOLOGY CORPORATION, GRAND CAYMAN, CAYMAN ISLANDS, FILED 2-5-2002.

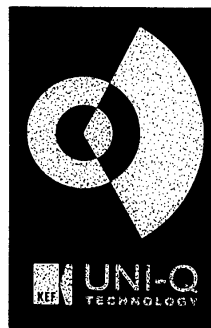

OWNER OF U.S. REG. NOS. 1,671,603 AND 2,292,485.
NO CLAIM IS MADE TO THE EXCLUSIVE RIGHT TO USE "TECHNOLOGY", APART FROM THE MARK AS SHOWN.

THE STIPLING IS A FEATURE OF THE MARK AND DOES NOT INDICATE COLOR.

FOR LOUDSPEAKERS; APPARATUS AND INSTRUMENTS FOR THE PRODUCTION OF AUDIO SIGNALS, NAMELY, MICROPHONES, HEADPHONES, COMPACT DISC PLAYERS, VIDEO DISC PLAYERS, ELECTRONICS SIGNAL PROCESSORS, EQUALIZERS, ELECTRONIC CROSS-OVERS, DIGITAL TO ANALOG CONVERTERS AND DIGITAL SIGNAL PROCESSORS, SURROUND SOUND PROCESSORS, SOUND MIXERS; PARTS FOR THESE PRODUCTS (U.S. CLS. 21, 23, 26, 36 AND 38).
FIRST USE 1-14-1992; IN COMMERCE 1-14-1992.

SN 76-368,752. LEVITON MANUFACTURING CO., INC., LITTLE NECK, NY. FILED 2-8-2002.

DIMENSION

FOR SWITCHBOARDS AND CONSOLES FOR CONTROLLING LIGHTING LEVELS FROM INCANDESCENT AND DISCHARGE LIGHTING SOURCES IN THEATER, TELEVISION, MOTION PICTURE, ARCHITECTURAL, COMMERCIAL AND INDUSTRIAL APPLICATIONS; ELECTRICAL WIRING DEVICES, NAMELY, SWITCHES, RECEPTACLES, AND LIGHTING CONTROLS (U.S. CLS. 21, 23, 26, 36 AND 38).
FIRST USE 12-7-1984; IN COMMERCE 12-7-1984.

CLASS 9—(Continued).

SN 76-369,624. ARNOLD WORLDWIDE, BOSTON, MA. FILED 1-29-2002.

GUERRILLA INTELLIGENCE

FOR INTERNET BASED SOFTWARE FOR SCHEDULING, PLANNING AND EVALUATING TOUR EVENTS (U.S. CLS. 21, 23, 26, 36 AND 38).

SN 76-370,333. KOSTA, CHARLES, HAVERHILL, MA. FILED 2-11-2002.

CYBOCAT

FOR COMPUTER SOFTWARE FOR CONTROLLING COOPERATING AUTONOMOUS SOFTWARE AGENTS (U.S. CLS. 21, 23, 26, 36 AND 38).

FIRST USE 7-29-1995; IN COMMERCE 11-0-2001.

SN 76-381,049. ALSTOM, 75116 PARIS, FRANCE, FILED 3-11-2002.

FIPWARE

PRIORITY CLAIMED UNDER SEC. 44(D) ON FRANCE APPLICATION NO. 013120688, FILED 9-12-2001, REG. NO. 013120688, DATED 4-30-2002, EXPIRES 9-12-2011.

FOR ELECTRONIC APPARATUS, NAMELY, ELECTRONIC FREQUENCY METERS, COMPUTER PERIPHERAL DEVICES, ELECTRONIC NOTICE BOARDS, TRANSISTORS, PRINTED CIRCUITS, MICRO-PROCESSORS, MODEMS, DATA PROCESSORS; INTERFACES USED TO BUILD, IMPLEMENT, AND/OR CONNECT COMPUTERS THROUGH DEDICATED INTERFACE CARDS, BLANK OPTICAL DISCS, FIBER OPTIC CABLES, ELECTRICAL CABLES, COMPUTER CABLES, ETHERNET CABLES (U.S. CLS. 21, 23, 26, 36 AND 38).

SN 76-382,617. AMBERPOINT, INC., OAKLAND, CA. BY CHANGE OF NAME EDGILITY SOFTWARE, INC., OAKLAND, CA. FILED 3-14-2002.

AMBERPOINT

FOR ENTERPRISE SOFTWARE, NAMELY, COMPUTER SOFTWARE FOR USE IN DEPLOYING SOFTWARE TO OTHER COMPUTERS VIA THE INTERNET, DIAGNOSTIC SOFTWARE FOR MANAGING THE OPERATIONS OF OTHER COMPUTER PROGRAMS AND WEBSITES, AND UTILITIES SOFTWARE FOR USE IN EXTENDING OTHER APPLICATIONS AND WEB-BASED SERVICES WITH NEW MANAGEMENT AND SECURITY CAPABILITIES (U.S. CLS. 21, 23, 26, 36 AND 38).

CLASS 9—(Continued).

SN 76-382,790. T. D. SOFT COMMUNICATIONS, LTD., HERZLIYA 46410, ISRAEL, FILED 3-13-2002.

TDGATE

FOR MULTIMEDIA COMPUTER GATEWAY HARDWARE AND GATEWAY SOFTWARE FOR ENABLING TELEPHONY COMMUNICATION OVER BROADBAND NETWORKS (U.S. CLS. 21, 23, 26, 36 AND 38).

SN 76-383,078. ERIC DURRANCE, INCORPORATED, TALLAHASSEE, FL. FILED 3-18-2002.

BIG DISMAL

FOR SERIES OF MUSICAL SOUND AND VIDEO RECORDINGS (U.S. CLS. 21, 23, 26, 36 AND 38). FIRST USE 5-18-2001; IN COMMERCE 5-18-2001.

SN 76-384,506. DESIGNER CORDS, INC., HARAHAN, LA. FILED 3-19-2002.



NO CLAIM IS MADE TO THE EXCLUSIVE RIGHT TO USE "CORDS" AND "DECORATIVE CORD COVERS", APART FROM THE MARK AS SHOWN.

THE MARK IS LINED FOR THE COLOR PINK. FOR DECORATIVE COVERINGS FOR ELECTRICAL CORDS (U.S. CLS. 21, 23, 26, 36 AND 38).

FIRST USE 7-1-2001; IN COMMERCE 7-1-2001.

SN 76-390,451. BTICINO S.P.A., 20154 MILANO, ITALY, FILED 4-3-2002.

MAGIC TT

OWNER OF ITALY REG. NO. 851364, DATED 9-17-2001, EXPIRES 5-28-2011.

FOR ELECTRIC AND ELECTRONIC APPARATUS FOR THE CONTROL, THE REGULATION, THE TRANSMISSION, THE RECEPTION, THE REPRODUCTION, THE PROCESSING AND THE PRODUCTION OF SOUNDS, IMAGES, DATA AND INFORMATION, NAMELY SWITCHES, DEVIATORS, COMMUTATORS, ELECTRIC PLUGS AND SOCKETS, CARTRIDGES AND WIRE TYPE FUSES, FUSE HOLDERS, LAMP HOLDERS FOR FILAMENT AND FLUORESCENT LAMPS, ELECTRIC BELLS IN GENERAL, BELLS FOR TWO OR MORE TONES, CIRCUIT BREAKERS, ISOLATORS, SOLID STATE SWITCHES, MOTOR STARTERS, REMOTE MOTOR STARTERS, ELECTRIC PANEL BOARDS, DISTRIBUTION BOARDS, COMMAND AND CONTROL BOARDS, WHETHER COMBINABLE OR NOT, CONTROL DESKS, COMBINABLE CONTROL DESKS, GANGED TERMINAL BLOCKS, DERIVATION BOXES, TERMINALS, PILOT AND WARNING LAMPS, APPARATUS AND BOARDS FOR SIGNALING AND WARNING, SIGNALIZATION APPARATUS AND BOARDS

CLASS 9—(Continued).

WITH GUIDE-LAMPS AND ACCESSORIES, APPARATUS FOR DETECTING ELECTRIC CURRENT LEAKAGE, PHASE TEST APPARATUS, THERMOSTATS, SUNSET SWITCHES, LEVEL SIGNALERS, PRESSURE SIGNALERS AND LIMIT SWITCHES, RELAYS, TIMERS AND TIMER SWITCHES, ELECTRONIC FLASHES, DIMERS, EARTH LEAKAGE CIRCUIT BREAKERS, ELECTRIC TRANSFORMERS, REMOTE CONTROL SWITCHES, TELECOMMUNICATION APPARATUS WITH OR WITHOUT AMPLIFICATION, RELAY PANELS OR BOARDS, PRINCIPAL AND AUXILIARY POSTS AND SHUNTS FOR VOICE TRANSMISSIONS, ELECTRIC DOOR SPEAKERS, TELEPHONES, ENTRANCE DIRECTORIES FOR BUILDINGS, NAMELY, LUMINOUS SIGNS, ILLUMINATED EXIT SIGNS; RADIO SETS FOR LOCATING PERSONNEL, LOUD SPEAKER INSTALLATIONS, TELEVISION DOOR SPEAKERS; VIDEOPHONES, CLOSED-CIRCUIT TELEVISION SETS FOR CIVIL AND INDUSTRIAL USE, MICROSWITCHES, LIMIT SWITCHES; ELECTRIC CONDUCTORS AND CABLES; FIBER-OPTIC CABLES (U.S. CLS. 21, 23, 26, 36 AND 38).

SN 76-391.617. WIGGLES TOURING PTY LIMITED, THE, NEW SOUTH WALES, 2022, AUSTRALIA, FILED 4-4-2002.

WIGGLY SAFARI

FOR COMPUTER SOFTWARE PROGRAMS, COMPACT DISCS, AUDIO CASSETTES, PHONOGRAPH RECORDS, DIGITAL VIDEO DISCS (DVD) AND PRE-RECORDED VIDEO TAPES FEATURING ENTERTAINMENT FOR CHILDREN, NAMELY, MUSIC, STORIES, COSTUMED CHARACTERS AND ANIMATION; PRE-RECORDED AUDIO AND AUDIO VISUAL DEVICES, NAMELY, COMPACT DISCS (READ-ONLY MEMORY), DIGITAL VIDEO DISCS (DVD), VIDEO RECORDINGS, AUDIO RECORDINGS AND VIDEO DISCS RECORDINGS FEATURING ENTERTAINMENT FOR CHILDREN, NAMELY, MUSIC, STORIES, COSTUMED CHARACTERS AND ANIMATION; PRE-RECORDED MULTIMEDIA PUBLICATIONS, NAMELY, INTERACTIVE COMPACT DISCS (READ-ONLY MEMORY), DIGITAL VIDEO DISCS (DVD), VIDEO DISK RECORDINGS AND AUDIO RECORDINGS FEATURING ENTERTAINMENT FOR CHILDREN, NAMELY, MUSIC, STORIES, COSTUMED CHARACTERS AND ANIMATION; VIDEOTAPES FEATURING ANIMATED CARTOONS; BLANK DIGITAL AUDIO TAPES AND DIGITAL VIDEOTAPES; COMPUTER AND VIDEO GAME DISKS AND CARTRIDGES; EYE WEAR, NAMELY, SPECTACLES, EYEGLASSES, SUNGLASSES AND EYEGLASS FRAMES; BINOCULARS; JUKE BOXES; LIFE JACKETS; DECORATIVE REFRIGERATOR MAGNETS; AUDIO RECORDERS; VIDEO RECORDERS; SOUND AMPLIFIERS; AUDIO TAPE CASSETTE PLAYERS, VIDEO CASSETTE PLAYERS, PHONOGRAPH RECORD PLAYERS, COMPACT DISC PLAYERS; RADIOS; TELEVISION SETS (U.S. CLS. 21, 23, 26, 36 AND 38).

CLASS 9—(Continued).

SN 76-391.916. NETAC TECHNOLOGY CO., LTD., SHENZHEN, CHINA, FILED 4-5-2002.

FOR DATA PROCESSORS; COMPUTER MEMORY UNITS; COMPUTER PERIPHERAL DEVICES; COMPUTER SOFTWARE FOR OPERATING DRIVING DEVICE, FOR COMPUTER SYSTEM START-UP, ORGANIZING FILES, FOR DATA DISTRIBUTION OVER A COMPUTER INTRANET, FOR USER CERTIFICATION, ENCRYPTING AND DECRYPTING DATA, FOR GRANTING USER CONTROL OVER COMPUTER APPLICATIONS, FOR DATA COMPRESSION AND DECOMPRESSION, FOR DISK FORMATTING, FOR CONVERTING DISK ATTRIBUTES INTO OTHER FORMATS; MICROPROCESSORS; CENTRAL PROCESSING UNITS; PERSONAL DIGITAL ASSISTANTS; NOTEBOOK COMPUTERS; ELECTRONIC SIGNAL TRANSMITTERS; INTERNAL TELECOMMUNICATION APPARATUS, NAMELY, COMPUTER HARDWARE STORAGE MEMORIES FOR USE IN WIRELESS ACCESS TO INTERNET VIA GPRS, WIRELESS PC CARDS, WIRELESS MOBILE TELEPHONES, WIRELESS ACCESS POINTS, WIRELESS MOBILE TEXT MESSENGERS, WIRELESS COMPUTER HARDWARE USED TO ACCESS COMPUTER NETWORKS; RADIOTELEPHONY SETS, NAMELY, RADIOTELEPHONY TRANSMITTERS, RADIOTELEPHONY RECEIVERS, RADIOTELEPHONY TRANSMITTING AND RECEIVING DEVICES, MOBILE PHONES, PORTABLE TELEPHONES; MODEMS (U.S. CLS. 21, 23, 26, 36 AND 38).

SN 76-392.393. ESSENTIAL GEAR, INC., GREENFIELD, MA, FILED 4-5-2002.

NO CLAIM IS MADE TO THE EXCLUSIVE RIGHT TO USE "ULTRA" AND "PERSONAL LED KEYCHAIN LIGHT", APART FROM THE MARK AS SHOWN.

FOR LIGHT EMITTING DIODE BATTERY POWERED KEYCHAIN LIGHTS, NAMELY, FLASHLIGHTS (U.S. CLS. 21, 23, 26, 36 AND 38).

FIRST USE 1-30-2002; IN COMMERCE 1-30-2002.

CLASS 9—(Continued).

SN 76-393,356. BROADMAX TECHNOLOGIES, INC., CITY OF INDUSTRY, CA. FILED 4-5-2002.

WebM@X

FOR TELECOMMUNICATION EQUIPMENT, NAMELY, MODEMS, COMPUTER NETWORK ROUTERS AND HOME HUBS, TELEPHONES WITH INTERNET ACCESS, GATEWAYS, NAMELY, BROADBAND INTERNET DIGITAL WEBPHONES; COMPUTER HARDWARE (U.S. CLS. 21, 23, 26, 36 AND 38).
FIRST USE 1-8-2002; IN COMMERCE 1-8-2002.

SN 76-397,055. RUBICONSOF, INC., SAN MATEO, CA. FILED 4-17-2002.

RUBICONSOF EDM

NO CLAIM IS MADE TO THE EXCLUSIVE RIGHT TO USE "EDM", APART FROM THE MARK AS SHOWN.
FOR SOFTWARE FOR FORECASTING, PLANNING, MONITORING AND MANAGING PRODUCT DEMAND AND RELATED INVENTORY (U.S. CLS. 21, 23, 26, 36 AND 38).

SN 76-398,055. TECTURA CORPORATION, TEMPE, AZ. BY ASSIGNMENT SELECT SYSTEMS, LLC, SAN MATEO, CA. FILED 4-19-2002.

ReQlogic

FOR COMPUTER SOFTWARE USED FOR INITIATING, MODIFYING AND MANAGING PURCHASE REQUISITIONS FOR A BUSINESS ENTERPRISE, EXECUTING ON EITHER A GLOBAL OR LOCAL COMPUTER NETWORK (U.S. CLS. 21, 23, 26, 36 AND 38).
FIRST USE 3-10-2002; IN COMMERCE 3-10-2002.

CLASS 9—(Continued).

SN 76-398,351. SILENT WITNESS ENTERPRISES LTD., SURREY, BRITISH COLUMBIA V3S 4G5, CANADA, FILED 4-22-2002.

DIGITAL CHAPERONE

NO CLAIM IS MADE TO THE EXCLUSIVE RIGHT TO USE "DIGITAL", APART FROM THE MARK AS SHOWN.

FOR SECURITY, MONITORING AND SURVEILLANCE SYSTEMS FOR INSIDE AND OUTSIDE PREMISES COMPRISED OF VIDEO CAMERAS, DECOY VIDEO CAMERAS, DIGITAL VIDEO CAMERAS, WIRELESS DIGITAL VIDEO CAMERAS, NETWORKED DIGITAL VIDEO CAMERAS, VIDEO CAMERA HOUSING ASSEMBLIES, DECOY VIDEO CAMERA ASSEMBLIES, VIDEO TAPE RECORDERS, DIGITAL VIDEO RECORDERS AND VIDEO MONITORS; AND PARTS AND ACCESSORIES THEREFORE, NAMELY WIRING HARNESSES, MOUNTING HARDWARE, MOUNTING LOCK BOXES, AND CAMERA CARRYING BAGS; AND COMPONENTS FOR SECURITY, MONITORING AND SURVEILLANCE SYSTEMS, NAMELY VIDEO CAMERAS, DECOY VIDEO CAMERAS, DIGITAL VIDEO CAMERAS, WIRELESS DIGITAL VIDEO CAMERAS, NETWORKED DIGITAL VIDEO CAMERAS, VIDEO CAMERA HOUSING ASSEMBLIES, DECOY VIDEO CAMERA HOUSING ASSEMBLIES, VIDEO TAPE RECORDERS AND VIDEO MONITORS; AND PARTS AND ACCESSORIES THEREFORE, NAMELY WIRING HARNESSES, MOUNTING HARDWARE, MOUNTING LOCK BOXES AND CAMERA CARRYING BAGS (U.S. CLS. 21, 23, 26, 36 AND 38).
FIRST USE 5-8-2002; IN COMMERCE 5-8-2002.

SN 76-401,574. NICK BOLTON LIMITED, CHRISTCHURCH, NEW ZEALAND, FILED 4-29-2002.

MAILWASHER

PRIORITY CLAIMED UNDER SEC. 44(D) ON NEW ZEALAND APPLICATION NO. 655674, FILED 4-17-2002.

FOR DOWNLOADABLE COMPUTER SOFTWARE FOR THE WRITING, SENDING, STORAGE, PROCESSING, AND MANAGEMENT OF EMAIL AND OTHER FORMS OF COMMUNICATIONS; DOWNLOADABLE COMPUTER SOFTWARE FOR THE WRITING, SENDING, STORAGE, PROCESSING, AND MANAGEMENT OF FILES, DOCUMENTS AND IMAGES; DOWNLOADABLE COMPUTER SOFTWARE FOR THE IDENTIFICATION, PREVENTION OF AND PROTECTION AGAINST UNSOLICITED EMAIL AND OTHER INTENTIONAL MISUSE AND UNAUTHORIZED PENETRATION OF COMPUTERS, COMPUTER SYSTEMS AND COMPUTER NETWORKS; DOWNLOADABLE COMPUTER SOFTWARE FOR THE SURVEILLANCE OF COMPUTERS, COMPUTER SYSTEMS AND COMPUTER NETWORKS; DOWNLOADABLE COMPUTER SOFTWARE FOR THE IDENTIFICATION AND REMOVAL OF COMPUTER VIRUSES; DOWNLOADABLE COMPUTER SOFTWARE FOR THE PROVISION OF INFORMATION RELATING TO THE AFORESAID (U.S. CLS. 21, 23, 26, 36 AND 38).
FIRST USE 8-15-2001; IN COMMERCE 8-18-2001.

CLASS 9—(Continued).

SN 76-406,597. CASE LOGIC, INC., LONGMONT, CO. FILED 5-9-2002.



THE STIPPLING AND LINING SHOWN IN THE DRAWING ARE FEATURES OF THE MARK AND ARE NOT INTENDED TO INDICATE COLOR.

THE MARK CONSISTS OF A STYLIZED DEPICTION OF A HUMAN HOLDING A VIDEO CAMERA, WITH CLOUDS IN THE BACKGROUND.

FOR CASES, ALBUMS, BAGS, STORAGE TRAYS, POCKETS, AND SLEEVES FOR COMPACT DISCS, COMPACT DISC PLAYERS, BLANK DVDS, PRE-RECORDED DVDS, DVD PLAYERS, BLANK AUDIO CASSETTES, PRE-RECORDED AUDIO CASSETTES, AUDIO CASSETTE PLAYERS, MLNIDISCS, MLNIDISC PLAYERS, BLANK DIGITAL AUDIO TAPES, PRE-RECORDED DIGITAL AUDIO TAPES, BLANK DIGITAL DISKS, PRE-RECORDED DIGITAL DISKS, DIGITAL MEDIA PLAYERS, MP3 PLAYERS, VIDEO/COMPUTER GAME DISCS, PERSONAL ORGANIZERS, PORTABLE TELEPHONES, TWO-WAY RADIOS, CAR STEREOS, COMPUTERS, BLANK CD-ROMS, PRE-RECORDED CD-ROMS, BLANK FLOPPY DISCS, PRE-RECORDED FLOPPY DISCS, SOLID STATE MEMORY CARDS, BLANK VIDEOCASSETTES, PRE-RECORDED VIDEO CASSETTES, CAMERAS, AND CAMCORDERS; COMPUTER MOUSE PADS; WRIST RESTS; ELECTRICAL AND COMPUTER CABLE TIE WRAPS AND ELECTRICAL AND COMPUTER CORD TIE WRAPS (U.S. CLS. 21, 23, 26, 36 AND 38).

FIRST USE 2-0-2002; IN COMMERCE 2-0-2002.

SN 76-407,255. REISNER, ROBERT J., ADDISON, IL. FILED 5-9-2002.

THE AUDIT SAFE

NO CLAIM IS MADE TO THE EXCLUSIVE RIGHT TO USE "SAFE", APART FROM THE MARK AS SHOWN.

FOR ELECTRONIC SAFE FEATURING SOFTWARE WHICH TRACKS RECORD OF USE (U.S. CLS. 21, 23, 26, 36 AND 38).

CLASS 9—(Continued).

SN 76-407,296. BEST BUY CONCEPTS, INC., EDEN PRAIRIE, MN. FILED 5-3-2002.

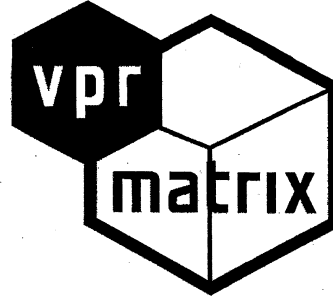

OWNER OF U.S. REG. NO. 2,699,788.
NO CLAIM IS MADE TO THE EXCLUSIVE RIGHT TO USE MATRIX, APART FROM THE MARK AS SHOWN.

FOR COMPUTERS AND RELATED ELECTRONIC PRODUCTS IN THE NATURE OF PERSONAL COMPUTERS, DESKTOP COMPUTERS, LAPTOP COMPUTERS, KEYBOARDS AND COMPUTER MICE (U.S. CLS. 21, 23, 26, 36 AND 38).

FIRST USE 1-17-2002; IN COMMERCE 1-17-2002.

SN 76-411,582. QBE TECHNOLOGIES, INC., IRVINE, CA. FILED 5-23-2002.

E-PETALS

FOR PORTABLE, HANDHELD PERSONAL COMPUTERS; COMPUTER PERIPHERALS AND OPERATING SOFTWARE FOR USE WITH PORTABLE, HANDHELD PERSONAL COMPUTERS (U.S. CLS. 21, 23, 26, 36 AND 38).

SN 76-415,995. ENVENERGY, INC., CARPINTERIA, CA. FILED 6-6-2002.

MEDIATOR FRAMEWORK

NO CLAIM IS MADE TO THE EXCLUSIVE RIGHT TO USE "FRAMEWORK", APART FROM THE MARK AS SHOWN.

FOR OPTIMIZED COMPUTER SOFTWARE USED IN CONNECTION WITH AN EMBEDDED COMPUTER SERVER FOR GATHERING DATA FROM GAS, ELECTRIC AND WATER UTILITY REVENUE METERS, AND FROM FACILITY DEVICES, SUCH AS AIR CONDITIONERS, ROOF-TOP UNITS, LIGHTING CONTROL SYSTEMS, SECURITY SYSTEMS, AND THE LIKE, AND FOR ENABLING COMMUNICATION OF THIS DATA OVER COMPUTER NETWORKS (U.S. CLS. 21, 23, 26, 36 AND 38).

CLASS 9—(Continued).

SN 76-416,140. ACTEL CORPORATION, SUNNYVALE, CA. FILED 5-31-2002.



Accelerator

FOR INTEGRATED CIRCUITS (U.S. CLS. 21, 23, 26, 36 AND 38).

SN 76-416,240. PRESCIENT SYSTEMS, INC., WEST CHESTER, PA. FILED 5-31-2002.

PRESCIENT XEI

OWNER OF U.S. REG. NO. 2,337,820.
FOR COMPUTER SOFTWARE, NAMELY, SOFTWARE FOR USE IN SUPPLY CHAIN MANAGEMENT, SUPPLY CHAIN PLANNING, ESTIMATING FUTURE SALES OF INVENTORY, PLANNING INVENTORY REQUIREMENTS, PLANNING MANUFACTURING REQUIREMENTS, PLANNING MANUFACTURING SCHEDULING, COORDINATING WAREHOUSE OPERATIONS, REPLENISHING INVENTORY, GENERATING ORDERS FOR ADDITIONAL INVENTORY, PLANNING TRANSPORTATION REQUIREMENTS, AND COORDINATING CUSTOMER AND VENDOR REQUIREMENTS, TOGETHER WITH INSTRUCTIONAL MANUALS ASSOCIATED THEREWITH, SOLD AS A UNIT (U.S. CLS. 21, 23, 26, 36 AND 38).

FIRST USE 3-0-2001; IN COMMERCE 3-0-2001.

SN 76-417,649. INFOTREND TECHNOLOGY, INC., SANTA CLARA, CA. FILED 6-3-2002.

ISEMS

FOR SET OF COMPUTER SOFTWARE CODES FOR CONTROLLING AND OPERATING ARRAYS OF COMPUTER HARDWARE SUBSYSTEMS (U.S. CLS. 21, 23, 26, 36 AND 38).

FIRST USE 11-16-1999; IN COMMERCE 11-16-1999.

CLASS 9—(Continued).

SN 76-424,670. LUXOTTICA LEASING S.P.A., 32021 AGORDO (BL), ITALY, FILED 6-24-2002.



arnette

PRIORITY CLAIMED UNDER SEC. 44(D) ON ITALY APPLICATION NO. IT-B02002C00, FILED 5-23-2002, REG. NO. 00874245, DATED 9-5-2002, EXPIRES 5-23-2012.

OWNER OF U.S. REG. NOS. 2,129,391 AND 2,156,141.

FOR SUNGLASSES, EYEGLASSES, PROTECTIVE EYEWEAR, NAMELY, GOGGLES, MASKS AND GLASSES FOR MOTORCYCLISTS, MOTOR RACERS, SCOOTERISTS, CYCLISTS, SNOW BOARDERS, PILOTS, CANOEISTS, SKATERS AND BOXERS; LENSES FOR EYEGLASSES AND MASKS; FRAMES AND CASES FOR EYEGLASSES AND EYEWEAR MASKS; CHAINS FOR EYEGLASSES; CONTACT LENSES; MAGNIFYING GLASSES; BINOCULARS; PROTECTIVE HELMETS FOR MOTORCYCLISTS, MOTOR RACERS, SCOOTERISTS, CYCLISTS, SKIERS, SNOW BOARDERS, PILOTS, CANOEISTS, SKATERS AND BOXERS; PROTECTIVE CLOTHING AND GLOVES FOR MOTORCYCLISTS, MOTOR RACERS, SCOOTERISTS, CYCLISTS, SKIERS, SNOW BOARDERS, PILOTS, CANOEISTS, SKATERS AND BOXERS (U.S. CLS. 21, 23, 26, 36 AND 38).

SN 76-425,081. WARNER BROS. ENTERTAINMENT INC., BURBANK, CA. BY ASSIGNMENT TIME WARNER ENTERTAINMENT COMPANY, L.P., NEW YORK, NY. FILED 6-27-2002.



OWNER OF U.S. REG. NOS. 1,518,038, 2,385,851 AND OTHERS.

THE MARK CONSISTS OF A STYLIZED REPRESENTATION OF THE LETTERS "W" AND "B" ON A SWIRLING STARS AND STRIPES BACKGROUND.

FOR MOTION PICTURE FILMS FEATURING COMEDY, DRAMA, ACTION, ADVENTURE AND/OR ANIMATION, AND MOTION PICTURE FILMS FOR BROADCAST ON TELEVISION FEATURING COMEDY, DRAMA, ACTION, ADVENTURE AND/OR ANIMATION; PRERECORDED VINYL RECORDS, PRERECORDED AUDIOTAPES, AUDIO-VIDEO TAPES, AUDIO VIDEO CASSETTES, AUDIO VIDEO DISCS, AND DIGITAL VERSATILE DISCS FEATURING MUSIC, COMEDY, DRAMA, ACTION, ADVENTURE, AND/OR ANIMATION; STEREO HEADPHONES; BATTERIES; CORDLESS TELEPHONES; HAND-HELD CALCULATORS; AUDIO CASSETTE AND CD PLAYERS; CD ROM GAMES; HAND-HELD KARAOKE PLAYERS, TELEPHONE AND/OR RADIO PAGERS; SHORT MOTION PICTURE FILM CASSETTES FEATURING COMEDY, DRAMA, ACTION, ADVENTURE AND/OR ANIMATION TO BE USED WITH HAND-HELD VIEWERS OR PROJECTORS; VIDEO CASSETTE RECORDERS

CLASS 9—(Continued).

AND PLAYERS, COMPACT DISC PLAYERS, DIGITAL AUDIO TAPE RECORDERS AND PLAYERS, ELECTRONIC DIARIES; RADIOS; MOUSE PADS; EYEGLASSES, SUNGLASSES AND CASES THEREFORE; AUDIO TAPES FEATURING COMEDY, DRAMA, ACTION ADVENTURE, ANIMATION AND MUSIC INFORMATION AND BOOKLETS SOLD THEREWITH; COMPUTER PROGRAMS, NAMELY, SOFTWARE LINKING DIGITIZED VIDEO AND AUDIO MEDIA TO A GLOBAL COMPUTER INFORMATION NETWORK; GAME EQUIPMENT SOLD AS A UNIT FOR PLAYING A PARLOR-TYPE COMPUTER GAME; VIDEO AND COMPUTER GAME PROGRAMS; VIDEO GAME CARTRIDGES AND CASSETTES; CELLULAR TELEPHONE ACCESSORIES, NAMELY HANDS-FREE ACCESSORIES, COVERS FOR CELLULAR TELEPHONE RECEIVERS NOT MADE OF PAPER AND CELLULAR TELEPHONE FACE COVERS; ENCODED MAGNETIC CARDS, PHONE CARDS, CREDIT CARDS, CASH CARDS, DEBIT CARDS AND MAGNETIC KEY CARDS; AND DECORATIVE MAGNETS (U.S. CLS. 21, 23, 26, 36 AND 38).

SN 76-425,860. TRANSUNION L.L.C., CHICAGO, IL. FILED 6-27-2002.

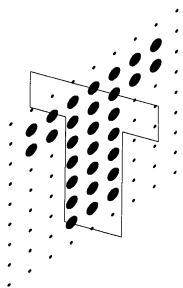

FOR COMPUTER SOFTWARE FOR USE IN BUSINESS APPLICATIONS, NAMELY, FOR USE IN INFORMATION MANAGEMENT, INFORMATION PROCESSING, INFORMATION AND DATABASE MANAGEMENT, FOR COMPILING MARKETING DEMOGRAPHICS, FOR MAKING MAILING LISTS, FOR VERIFYING CONSUMER CREDIT, FOR INSURANCE RISK MANAGEMENT, FOR LENDING AND INSURANCE RISK MANAGEMENT, AND FOR DATABASE MANAGEMENT AND THE MANAGEMENT OF THE DATA AND INFORMATION OF OTHERS, AND PRINTED MATERIAL, NAMELY, DOCUMENTATION AND INSTRUCTION MANUALS, ALL SOLD AS A UNIT THEREWITH; COMPUTER SOFTWARE TO PERFORM COMPUTERIZED PRINT AND DATA SELECTION, ARRANGEMENT AND PRESENTATION, IN THE FIELDS OF CONSUMER CREDIT REPORTING AND REAL ESTATE APPRAISALS, AND FOR USE IN CONNECTION WITH REAL PROPERTY DATA COMPILED FROM PUBLIC RECORDS, MARKETING DEMOGRAPHICS, AND MAILING LISTS (U.S. CLS. 21, 23, 26, 36 AND 38).

FIRST USE 5-0-2001; IN COMMERCE 5-0-2001.

CLASS 9—(Continued).

SN 76-426,085. CARL-ZEISS-STIFTUNG, DBA CARL ZEISS, FED REP GERMANY, FILED 6-28-2002.

PLATE::EXPLORER

PRIORITY CLAIMED UNDER SEC. 44(D) ON FED REP GERMANY APPLICATION NO. 30204142.7/0, FILED 1-30-2002, REG. NO. 30204142, DATED 4-2-2002, EXPIRES 1-31-2012.

FOR MICROSCOPES AND PARTS THEREOF; OPTICAL READERS FOR USE IN LABORATORIES; LABORATORY EQUIPMENT FOR THE ADDITION AND WITHDRAWAL OF LIQUIDS, NAMELY, PIPETTERS, WASHERS, DISPENSERS, AND PINS USED TO TRANSFER SMALL QUANTITIES OF LIQUIDS FROM ONE PLACE TO ANOTHER; LABORATORY EQUIPMENT CONSISTING OF CONTAINERS USED TO STORE PLATES AND INCUBATORS FOR STORING SPECIMENS, PIERCERS USED TO OPEN PLATES, PIPETTE SHAKERS AND CENTRIFUGES; SOFTWARE USED TO CONTROL ALL THE AFORESAID GOODS (U.S. CLS. 21, 23, 26, 36 AND 38).

SN 76-427,548. MANTRA FILMS INC., SOUTH MONICA, CA. BY ASSIGNMENT MANTRA ENTERTAINMENT, INC., SANTA MONICA, CA. FILED 7-5-2002.

GUYS GONE WILD

OWNER OF U.S. REG. NO. 2,411,851.

FOR PRE-RECORDED VIDEO TAPES AND DVD'S, ALL FEATURING MOVIES AND TELEVISION PROGRAMS OF ALL KINDS (U.S. CLS. 21, 23, 26, 36 AND 38).

SN 76-428,743. WEBER, BRYAN TIMOTHY, CHESTER SPRINGS, PA. AND WEBER, KYLE ANDREW, CHESTER SPRINGS, PA. AND SHARKEY, IAN MICHAEL, CHESTER SPRINGS, PA. AND SHARKEY, TERENCE JOSEPH, CHESTER SPRINGS, PA. FILED 7-9-2002.

JIMSON WEED

FOR MUSICAL SOUND RECORDINGS AND VIDEO RECORDINGS FEATURING MUSICAL PERFORMANCES (U.S. CLS. 21, 23, 26, 36 AND 38).

FIRST USE 0-0-1998; IN COMMERCE 0-0-1998.

SN 76-428,744. DIGI INTERNATIONAL INC., MINNETONKA, MN. FILED 7-9-2002.

WATCHPORT

OWNER OF U.S. REG. NOS. 1,663,848, 2,522,453 AND OTHERS.

FOR ENVIRONMENTAL MONITORING SYSTEMS COMPRISED OF COMPUTER HARDWARE, SOFTWARE, ELECTRONIC SENSORS AND CAMERAS, ALL USED TO MONITOR AND COLLECT DATA AND TRANSMIT IT TO A HOST OR A REMOTE COMPUTER SYSTEM, USED TO PROVIDE ALERTS IN THE CASE OF TRIGGERING EVENTS, FOR USE IN APPLICATIONS SUCH AS MANUFACTURING, MEDICAL, POINT-OF-SALE APPLICATIONS SUCH AS KIOSKS AND ATMS AND SURVEILLANCE (U.S. CLS. 21, 23, 26, 36 AND 38).

CLASS 9—(Continued).

SN 76-428,866. THE AUTOMATION PARTNERSHIP (CAMBRIDGE) LIMITED, HERTFORDSHIRE SG8 5WY, UNITED KINGDOM, FILED 7-5-2002.

PICOTUBE

PRIORITY CLAIMED UNDER SEC. 44(D) ON GREAT BRITAIN APPLICATION NO. 2290303, FILED 2-17-2002, REG. NO. 2290303, DATED 12-6-2002, EXPIRES 1-17-2012.

FOR LABORATORY STORAGE TUBES, NAMELY, VESSELS FOR STORING PHARMACEUTICAL, BIOLOGICAL AND CHEMICAL SAMPLES (U.S. CLS. 21, 23, 26, 36 AND 38).

SN 76-429,089. TRANSENDA INTERNATIONAL, LLC, REDMOND, WA. FILED 7-10-2002.

TR_xIAL

FOR COMPUTER SOFTWARE FOR WORKFLOW PROCESSING FOR THE HEALTHCARE INDUSTRY (U.S. CLS. 21, 23, 26, 36 AND 38).

SN 76-431,509. HYPERCOM CORPORATION, PHOENIX, AZ. FILED 7-17-2002.

HYPERSAFE

FOR COMPUTER SOFTWARE SOLD AS AN INTEGRAL COMPONENT OF ELECTRONIC POINT OF SALE TERMINALS, NAMELY, OPERATIONS SYSTEM SOFTWARE FOR POINT OF SALE TERMINALS; COMPUTER SOFTWARE FOR FACILITATING ELECTRONIC FINANCIAL TRANSACTIONS; COMPUTER SOFTWARE FOR PROVIDING CRYPTOGRAPHIC SECURITY; COMPUTER SOFTWARE FOR FACILITATING AND SUPPORTING ELECTRONIC SIGNATURE AND RECEIPT CAPTURE, E-MAIL, ON-SCREEN ADVERTISING, INTERACTIVE ELECTRONIC COUPONS AND CASH MANAGEMENT REPORTING, ALL FOR USE AT A CARD PAYMENT TERMINAL; COMPUTER SOFTWARE FOR EXECUTING CREDIT, DEBIT, EBT AND SMART CARD TRANSACTIONS (U.S. CLS. 21, 23, 26, 36 AND 38).
FIRST USE 4-2-2002; IN COMMERCE 5-7-2002.

SN 76-434,137. SHIPCOM WIRELESS, INC., HOUSTON, TX. FILED 7-25-2002.

SHIPCOM WIRELESS

OWNER OF U.S. REG. NO. 2,576,220.
NO CLAIM IS MADE TO THE EXCLUSIVE RIGHT TO USE "WIRELESS", APART FROM THE MARK AS SHOWN.
FOR SOFTWARE I) ENABLING INTERFACE BETWEEN ENTERPRISE APPLICATIONS AND WIRELESS ACCESS BY MOBILE DEVICES AND II) INTEGRATING ENTERPRISE APPLICATIONS (U.S. CLS. 21, 23, 26, 36 AND 38).
FIRST USE 11-16-2001; IN COMMERCE 11-16-2001.

CLASS 9—(Continued).

SN 76-435,308. QUALCOMM INCORPORATED, SAN DIEGO, CA. FILED 7-29-2002.

CAIT

FOR REAL-TIME DATA COLLECTION SOFTWARE TOOL FOR COLLECTING DATA USEFUL IN THE DEVELOPMENT, DEBUGGING AND OPTIMIZATION OF A CARRIER'S TELECOMMUNICATION NETWORK, SUCH AS A CDMA TELECOMMUNICATION NETWORK, AND RELATED INFRASTRUCTURE AND HANDSETS; A SOFTWARE TOOL FOR USE WITH A WIRELESS COMMUNICATION CELLULAR AND PERSONAL COMMUNICATION SERVICES SYSTEM FOR POST-PROCESSING THE COLLECTED DATA TO CONDUCT PERFORMANCE AND DIAGNOSTIC TESTING OF THE TELECOMMUNICATIONS NETWORK, AND FOR ESTABLISHING AN INTERFACE BETWEEN A COMPUTER THAT IS USED FOR PROCESSING, RECORDING AND ARCHIVING THE COLLECTED DATA AND A MOBILE COMMUNICATIONS DEVICE, SUCH AS A TEST PHONE, THAT HAS BEEN CONFIGURED TO COLLECT SUCH DATA FROM RECEIVED ELECTROMAGNETIC SIGNALS; SOFTWARE FOR USE IN THE GENERATION OF SIMULATED CALL TRAFFIC, AND FOR PERFORMANCE MONITORING OF RADIO FREQUENCIES, FOR SIGNALING AND MESSAGING TESTING FOR WIRELESS COMMUNICATIONS APPARATUS, NAMELY, WIRELESS BASE STATIONS AND WIRELESS TERMINALS; AND USER MANUALS SOLD THEREWITH AS A UNIT (U.S. CLS. 21, 23, 26, 36 AND 38).
FIRST USE 10-21-1998; IN COMMERCE 6-11-1999.

SN 76-435,864. VISIOMATIC GMBH, D-70499 STUTTGART, FED REP GERMANY, FILED 7-31-2002.

VISIPAD

OWNER OF FED REP GERMANY REG. NO. 30126331, DATED 5-21-2001, EXPIRES 4-25-2011.
FOR INPUT AND OUT PUT DEVICES, NAMELY, TOUCH SCREEN MONITORS AND REMOTE CONTROLS FOR USE IN THE AUTOMATION OF TECHNICAL MANAGEMENT OF BUILDINGS, HOUSES AND OFFICES, AND ALSO FOR USE IN THE AUTOMATION OF TECHNOLOGY IN THE FIELDS OF TELECOMMUNICATION AND ENTERTAINMENT (U.S. CLS. 21, 23, 26, 36 AND 38).

SN 76-435,930. LABCONCO CORPORATION, KANSAS CITY, MO. FILED 7-29-2002.

PROTECTOR XSTREAM

OWNER OF U.S. REG. NOS. 1,597,256, 2,001,408 AND 2,581,640.
SEC. 2(F) AS TO "PROTECTOR".
FOR LABORATORY FUME HOODS (U.S. CLS. 21, 23, 26, 36 AND 38).
FIRST USE 2-0-2002; IN COMMERCE 7-8-2002.

CLASS 9—(Continued).

SN 76-436,053. APPFLUENT TECHNOLOGY, INC., ARLINGTON, VA. BY CHANGE OF NAME INFOCRUISER, INC., ARLINGTON, VA. FILED 7-26-2002.

APPFLUENT

FOR COMPUTER SOFTWARE FOR TEMPORARILY STORING DATA IN A CACHE; COMPUTER SOFTWARE FOR EFFICIENTLY TRANSFERRING DATA BETWEEN SOFTWARE APPLICATIONS AND DATABASES; COMMUNICATIONS SOFTWARE, NAMELY SOFTWARE USED TO ACCESS, VIEW AND TRANSMIT INFORMATION AND DATA FROM GLOBAL COMPUTER NETWORKS; COMPUTER SOFTWARE FOR SEARCHING, RETRIEVING, ARCHIVING AND TRANSMITTING INFORMATION AND DOCUMENTS ON A GLOBAL COMPUTER NETWORK OR LOCAL AREA NETWORK; COMPUTER HARDWARE, NAMELY, CPU'S, CIRCUIT BOARDS, DISK DRIVES, BACKPLANES, DISK CONTROLLERS, NETWORK INTERFACES, POWER SUPPLIES, FANS AND RAM DRIVES; AND USER MANUALS AND DOCUMENTS SOLD AS A UNIT THEREWITH (U.S. CLS. 21, 23, 26, 36 AND 38).
FIRST USE 9-0-2002; IN COMMERCE 9-0-2002.

CLASS 9—(Continued).

SN 76-437,262. SURUGA SEIKI CO., LTD., SHIZUOKA-KEN 424-8566, JAPAN, FILED 7-31-2002.



NO CLAIM IS MADE TO THE EXCLUSIVE RIGHT TO USE "SEIKI", APART FROM THE MARK AS SHOWN. THE ENGLISH TRANSLATION OF "SEIKI" IS "PRECISION MACHINE".

FOR OPTICAL EQUIPMENT AND RESEARCH EQUIPMENT FOR USE WITH MICROSCOPES, IN THE NATURE OF 'STAGES' TO ACCURATELY POSITION THE VITAL PARTS FOR RESEARCH AND DEVELOPMENT INTO LENSES, MIRRORS, ELEMENTS AND FIBERS, AND 'HOLDERS' TO HOLD THE PARTS, NAMELY, LASER HOLDERS, PINHOLE HOLDERS, FILTER HOLDERS, LENS HOLDERS, MIRROR HOLDERS, POLARIZER HOLDERS, PRISM HOLDERS; LINEAR MOVEMENT GUIDES FOR X-AXIS STAGES, X-Y AXES STAGES, ELECTRIC X-Y STAGES FOR MICROSCOPES, X-Y-Z AXES STAGES, Z-AXIS STAGES FOR ALIGNMENT OF OPTICAL AXIS OF CAMERAS; ROTATIONAL STAGES; AUTOMATIC AXIS ALIGNMENT MACHINES FOR ALIGNING OPTICAL FIBERS AUTOMATICALLY AND MICROMANIPULATORS, NAMELY, TOOLS TO MOVE AND FIX SAMPLES WHILE USING A MICROSCOPE (U.S. CLS. 21, 23, 26, 36 AND 38).
FIRST USE 7-0-1996; IN COMMERCE 8-0-1997.

SN 76-437,701. MITAC TECHNOLOGY CORPORATION, HSINCHU, TAIWAN, CHINA, FILED 8-2-2002.



SN 76-437,158. MORROW TECHNOLOGIES CORPORATION, LARGO, FL. FILED 8-2-2002.

JANUS

FOR ELECTRONIC COMPUTERIZED INFORMATION DISPLAY BOARDS AND ITEMS FOR USE THEREWITH, NAMELY, PROGRAMMING COMPUTERS WITH PROGRAMMING SOFTWARE, AND OPERATOR MANUALS SOLD AS A UNIT THEREWITH (U.S. CLS. 21, 23, 26, 36 AND 38).
FIRST USE 4-23-1985; IN COMMERCE 4-23-1985.

OWNER OF U.S. REG. NO. 2,207,136.
FOR COMPUTERS; PORTABLE COMPUTERS; NOTEBOOK COMPUTERS; COMPUTER FIRMWARE, NAMELY SYSTEM INTERFACE AND INPUT/OUTPUT FIRMWARE FOR COMPUTERS; COMPUTER KEYBOARDS; MICROCOMPUTERS; COMPUTER MOTHERBOARDS; CD-ROM DRIVES; COMPUTER MICE; COMPUTER DISK DRIVERS; TAPES RECORDED WITH COMPUTER PROGRAMS FOR USE IN WORD PROCESSING AND ACCOUNTING; TAPES RECORDED WITH COMPUTER GAME PROGRAMS; DISKS RECORDED WITH COMPUTER PROGRAMS FOR USE IN WORD PROCESSING AND ACCOUNTING; DISKS RECORDED WITH COMPUTER GAME PROGRAMS; COMPUTER MONITORS; PERSONAL DIGITAL ASSISTANTS; MODEMS AND ETHERNET PC CARDS; NETWORK INTERFACE CONTROLLERS; SEMI-CONDUCTORS; COMPUTER INTERFACE CARDS; INTEGRATED CIRCUITS; COMPUTER OPERATING SOFTWARE; COMPUTER SOFTWARE FOR USE IN WORD PROCESSING AND ACCOUNTING; AND COMPUTER GAME SOFTWARE (U.S. CLS. 21, 23, 26, 36 AND 38).

CLASS 9—(Continued).

SN 76-437,750. MORROW TECHNOLOGIES CORPORATION, LARGO, FL. FILED 8-5-2002.

RAVEN

FOR COMPUTER SOFTWARE USED FOR MONITORING, TESTING AND MEASURING RADIO FREQUENCY SIGNALS IN THE FIELD OF SIGNALS INTELLIGENCE AND INTERFERENCE INVESTIGATION (U.S. CLS. 21, 23, 26, 36 AND 38).

SN 76-437,919. NATIONAL FOOTBALL LEAGUE, NEW YORK, NY. FILED 8-5-2002.

NFL QUARTERBACK GREATS

NO CLAIM IS MADE TO THE EXCLUSIVE RIGHT TO USE "QUARTERBACK GREATS", APART FROM THE MARK AS SHOWN.

FOR FOOTBALL HELMETS, REPLICA MINIATURE FOOTBALL HELMETS, TELEPHONES, SPECIALTY HOLSTER FOR CARRYING CELL PHONES, NAMELY, CELL PHONE STRAPS, COVERS FOR CELL PHONE RECEIVERS NOT MADE OF PAPER, PRE-PAID TELEPHONE CALLING CARDS, MAGNETICALLY ENCODED, MAGNETICALLY ENCODED CREDIT CARDS, DECORATIVE MAGNETS, COMPACT DISCS, TAPES, PRE-RECORDED VIDEOTAPES AND DVD'S FEATURING THE SPORT OF FOOTBALL, COMPUTER GAME SOFTWARE, VIDEO GAME CARTRIDGES AND DISKS, COMPUTER MOUSE PADS, CAMERA CASES, SUNGLASSES, EYEGLASS CASES, EYEGLASS CHAINS, BINOCULARS, AND ELECTRIC LIGHT SWITCH PLATES (U.S. CLS. 21, 23, 26, 36 AND 38).

SN 76-441,836. CREAIVIS GESELLSCHAFT FUR TECHNOLOGIE UND INNOVATION MBH, D-45764 MARL, FED REP GERMANY, FILED 8-13-2002.

SEPARION

PRIORITY CLAIMED UNDER SEC. 44(D) ON FED REP GERMANY APPLICATION NO. 30230462.2/1, FILED 6-21-2002, REG. NO. 30230462, DATED 7-25-2002, EXPIRES 6-30-2012.

FOR BATTERY SEPARATORS: MEMBRANE FILMS TO SEPARATE THE ANODE FROM THE CATHODE IN BATTERIES (U.S. CLS. 21, 23, 26, 36 AND 38).

SN 76-442,123. VOX SANCTUS, LLC, SAN DIEGO, CA. FILED 8-19-2002.

VOX SANCTUS

THE ENGLISH TRANSLATION OF THE LATIN WORDING "VOX SANCTUS" IS "VOICE OF THE SACRED".

FOR PRE-RECORDED COMPACT DISCS, AUDIO-TAPES, AND DOWNLOADABLE SOUND RECORDINGS FEATURING RELIGIOUS MATTER (U.S. CLS. 21, 23, 26, 36 AND 38).

CLASS 9—(Continued).

SN 76-442,769. GOEHRING, MICHEAL D., JUD, ND. FILED 8-22-2002.

ALERT-DOG SYSTEMS

NO CLAIM IS MADE TO THE EXCLUSIVE RIGHT TO USE "SYSTEMS", APART FROM THE MARK AS SHOWN.

FOR EMERGENCY MEDICAL RESPONSE APPARATUS COMPRISED OF RADIO FREQUENCY TRANSMITTERS AND RECEIVERS (U.S. CLS. 21, 23, 26, 36 AND 38). FIRST USE 7-8-2002; IN COMMERCE 7-8-2002.

SN 76-444,026. EBNER INDUSTRIEUFENBAU GESELLSCHAFT M.B.H., 4021 LINZ, AUSTRIA, FILED 8-27-2002.

VISUAL FURNACES

NO CLAIM IS MADE TO THE EXCLUSIVE RIGHT TO USE "FURNACES", APART FROM THE MARK AS SHOWN.

FOR COMPUTER SOFTWARE FOR MONITORING AND SUPERVISING THE PROCESS OF INDUSTRIAL OVENS (U.S. CLS. 21, 23, 26, 36 AND 38).

SN 76-444,534. NALGE NUNC INTERNATIONAL CORPORATION, ROCHESTER, NY. FILED 8-28-2002.

RESMER

FOR DURABLE, IMPACT-RESISTANT, CHEMICAL-RESISTANT LABORATORY PRODUCTS MOLDED FROM ENGINEERING PLASTIC RESIN SUITABLE FOR HIGH TEMPERATURE APPLICATIONS, NAMELY, TEST TUBE RACKS, STORAGE BOXES, TRAYS AND ORGANIZERS (U.S. CLS. 21, 23, 26, 36 AND 38).

SN 76-445,413. XAWARE, INC., COLORADO SPRINGS, CO. FILED 8-30-2002.



FOR COMPUTER SOFTWARE FOR USE IN DATA ACCESS, EXTRACTING, CONVERTING, TRANSLATING AND RE-RENDERING OF ELECTRONIC DATA TO XML FROM DATABASES, APPLICATIONS, AND FILE SYSTEMS (U.S. CLS. 21, 23, 26, 36 AND 38).

FIRST USE 11-15-1999; IN COMMERCE 11-15-1999.

CLASS 9—(Continued).

SN 76-445,774. PINTO, CHRISTINE, SAN DIEGO, CA. FILED 8-12-2002.

UKIYO

THE ENGLISH TRANSLATION OF "UKIYO" IS "THE FLOATING WORLD".

FOR CD-ROMS FOR ENTERTAINMENT, FEATURING PRERECORDED MUSIC AND DIALOGUE, VIDEO GAMES, STORIES, VISUALS SUCH AS ART AND INTERACTIVE MEDIA, ANIMATION, AND PHOTOGRAPHIC IMAGES (U.S. CLS. 21, 23, 26, 36 AND 38).

SN 76-445,897. ARROYO OPTICS, INC., SANTA MONICA, CA. FILED 8-28-2002.

ULTRAFILTER

FOR OPTICAL COMMUNICATIONS EQUIPMENT FOR WAVELENGTH DIVISION MULTIPLEXED SIGNALS, NAMELY DEVICES FOR SEPARATING AND CONTROLLING INDIVIDUAL CHANNELS IN THE MULTIPLEXED SIGNAL (U.S. CLS. 21, 23, 26, 36 AND 38).

SN 76-446,034. MANLLO KURI, RICARDO JOSE, SAN PEDRO GARZA GARCIA, NUEVO LEON, MEXICO, FILED 8-29-2002.

NICHO HINOJOSA

PRIORITY CLAIMED UNDER SEC. 44(D) ON MEXICO APPLICATION NO. 545310, FILED 4-19-2002, REG. NO. 772157, DATED 4-19-2002, EXPIRES 4-19-2012.

THE NAME "NICHO HINOJOSA" IDENTIFIES THE STAGE NAME OF A LIVING INDIVIDUAL WHOSE CONSENT IS OF RECORD.

FOR PRERECORDED AUDIO TAPES FEATURING MUSIC, PRERECORDED DIGITAL AUDIO TAPES FEATURING MUSIC, PRERECORDED VIDEO TAPES FEATURING MUSIC AND MUSICAL PERFORMANCES, COMPACT DISCS FEATURING MUSIC, DVDS FEATURING MUSIC AND MUSICAL PERFORMANCES (U.S. CLS. 21, 23, 26, 36 AND 38).

SN 76-446,828. NSM MUSIC GROUP LTD., LEEDS, UNITED KINGDOM, FILED 9-4-2002.

PHOENIX

FOR AUDIO AND VIDEO JUKEBOXES FEATURING HARDWARE AND SOFTWARE FOR ACCESSING AND TRANSMITTING INFORMATION FOR DOWNLOADING, STORING, DISSEMINATING, SELECTING AND PLAYING AUDIO AND VIDEO MUSICAL INFORMATION (U.S. CLS. 21, 23, 26, 36 AND 38).

CLASS 9—(Continued).

SN 76-448,393. SYSTEMAXX, TORONTO, ONTARIO, CANADA, FILED 9-10-2002.

APPLIMAXX

FOR COMPUTER SOFTWARE FOR CUSTOMER RELATIONSHIP MANAGEMENT, WORKPLACE EFFICIENCY MANAGEMENT, AND QUALITY CONTROL MANAGEMENT AND E-COMMERCE SOFTWARE TO ALLOW USERS TO PERFORM ELECTRONIC BUSINESS TRANSACTIONS IN MULTIPLE CURRENCIES AND LANGUAGES VIA A GLOBAL COMPUTER NETWORK, ALL IN THE FIELD OF BUSINESS MANAGEMENT (U.S. CLS. 21, 23, 26, 36 AND 38).

SN 76-449,217. WICKS BUSINESS INFORMATION LLC, FAIRFIELD, CT. FILED 9-9-2002.



NO CLAIM IS MADE TO THE EXCLUSIVE RIGHT TO USE "INVESTOR", APART FROM THE MARK AS SHOWN.

FOR DOWNLOADABLE SOFTWARE, NAMELY, COMPUTERIZED DATABASES CONTAINING INFORMATION CONCERNING FINANCING VENTURE CAPITAL TRANSACTIONS, VENTURE CAPITAL COMPANIES, INSTITUTIONAL AND OTHER INVESTORS AND ENTITIES THAT SERVE AND PARTICIPATE IN THE INVESTMENT COMMUNITY (U.S. CLS. 21, 23, 26, 36 AND 38).

SN 76-452,899. FLEX-O-LITE, INC., ST. CHARLES, MO. FILED 9-20-2002.



NO CLAIM IS MADE TO THE EXCLUSIVE RIGHT TO USE "SERVICES & MATERIALS COMPANY", APART FROM THE MARK AS SHOWN.

FOR PROTECTIVE CLOTHING; HIGHWAY SAFETY DEVICES, NAMELY, CHANNELIZERS, BARRICADES, DRUMS, CONES, SAFETY WARNING LIGHTS, LUMINOUS PLASTIC SIGNS AND SIGN STANDS THEREFORE, WARNING FLAGS, WARNING TRIANGLES, AND VERTICAL LUMINOUS PANEL SIGNS (U.S. CLS. 21, 23, 26, 36 AND 38).

CLASS 9—(Continued).

SN 76-453,100. AMX CORPORATION, RICHARDSON, TX. FILED 9-26-2002.

MODERO

FOR TOUCH PANEL PRODUCT, NAMELY, USER INTERFACE THAT OFFERS GREATER SCREEN RESOLUTION, BETTER GRAPHICS AND REFINED EXTERIOR (U.S. CLS. 21, 23, 26, 36 AND 38).

SN 76-453,301. TONE COMMANDER SYSTEMS, INC., MUKILTEO, WA. FILED 9-23-2002.

TONE COMMANDER

NO CLAIM IS MADE TO THE EXCLUSIVE RIGHT TO USE "TONE", APART FROM THE MARK AS SHOWN.

FOR TELECOMMUNICATIONS EQUIPMENT, NAMELY, TELEPHONES, ATTENDANT CONSOLES, NT1 ISDN NETWORK TERMINATION DEVICES, TELECOM POWER SUPPLIES, BATTERY BACKUP DEVICES, E9-1-1 SYSTEMS, AND OPERATIONAL, SUPPORT, AND APPLICATIONS SOFTWARE TO WORK WITH ALL OF THE AFORESAID GOODS (U.S. CLS. 21, 23, 26, 36 AND 38).

FIRST USE 6-7-1972; IN COMMERCE 6-7-1972.

SN 76-454,762. WATERLOO MAPLE INC., WATERLOO, ONTARIO, CANADA, FILED 9-24-2002.

MAPLESOFT

PRIORITY CLAIMED UNDER SEC. 44(D) ON CANADA APPLICATION NO. 1151945, FILED 9-6-2002.

OWNER OF U.S. REG. NO. 1,385,087.

FOR ANALYTICAL SOFTWARE FOR SCIENTISTS, ENGINEERS, AND MATHEMATICIANS FOR SOLVING MATHEMATICAL PROBLEMS (U.S. CLS. 21, 23, 26, 36 AND 38).

SN 76-456,371. SONY KABUSHIKI KAISHA, TA SONY CORPORATION, TOKYO, JAPAN, FILED 9-30-2002.

SHURIKEN

THE ENGLISH TRANSLATION OF "SHURIKEN" IS "THROWING KNIFE".

FOR AUDIO SPEAKERS, AUDIO AMPLIFIERS AND SUB-WOOFERS (U.S. CLS. 21, 23, 26, 36 AND 38).

SN 76-458,762. LION APPAREL, INC., DAYTON, OH. FILED 10-17-2002.

LEGACY

FOR PROTECTIVE HELMETS FOR FIREFIGHTERS (U.S. CLS. 21, 23, 26, 36 AND 38).

FIRST USE 1-1-2000; IN COMMERCE 1-1-2000.

CLASS 9—(Continued).

SN 76-458,831. SACTHLER CORPORATION OF AMERICA, FREEPORT, NY. FILED 10-15-2002.

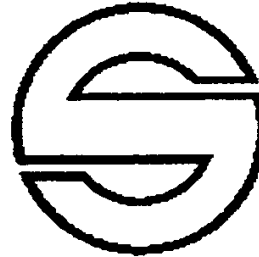

FOR PHOTOGRAPHIC LIGHTING EQUIPMENT; NAMELY, LIGHTS, REFLECTORS, BATTERIES, REFLECTOR UMBRELLAS, LIGHT STANDS, BATTERY CHARGERS, AC/DC ADAPTERS, FILTERS, DIFFUSERS, LIGHT PHOTOMETERS AND PARTS THEREOF (U.S. CLS. 21, 23, 26, 36 AND 38).

FIRST USE 3-0-1989; IN COMMERCE 3-0-1989.

SN 76-459,073. RADIANT DATA CORPORATION, NIWOT, CO. FILED 10-15-2002.



FOR COMPUTER SOFTWARE NAMELY FOR REPLICATING STORED DATA AND ACCESSING, DISTRIBUTING AND SHARING REPLICATED DATA FOR USE IN DATA STORAGE INDUSTRIES (U.S. CLS. 21, 23, 26, 36 AND 38).

SN 76-459,233. MDTEKNIX, INC., HOUSTON, TX. FILED 10-18-2002.

MDTEKNIX

FOR COMPUTER SOFTWARE FOR COLLECTING PATIENT DATA AND MANAGING PATIENT'S HEALTH RECORDS (U.S. CLS. 21, 23, 26, 36 AND 38).

SN 76-459,517. RENEWVIA, INC., SEATTLE, WA. FILED 10-21-2002.

INTER-VIA

FOR SELF PROMOTIONAL CD-ROM FOR JOB SEEKERS (U.S. CLS. 21, 23, 26, 36 AND 38).

CLASS 9—(Continued).

SN 76-460,017. KABUSHIKI KAISHA ONWARD KASHIYAMA, CHUO-KU, TOKYO, JAPAN, FILED 10-15-2002.

i c B

FOR EYEGLASSES, SUNGLASSES, CONTACT LENSES, CONTACT LENS CASES, SWIMMING GOGGLES, CASES FOR GLASSES, WIPERS FOR GLASSES, LENSES FOR GLASSES, FRAMES FOR GLASSES, PROCESSED GLASS FOR LENSES (EXCLUDING THOSE FOR BUILDING USE), AND PARTS THEREFORE (U.S. CLS. 21, 23, 26, 36 AND 38).

SN 76-461,347. NXI COMMUNICATIONS, INC., SALT LAKE CITY, UT. FILED 10-23-2002.

NEXTALK

FOR COMPUTER SOFTWARE FOR TEXT, VOICE, AND VIDEO COMMUNICATIONS OVER INTERNET-PROTOCOL BASED AND SWITCH-BASED NETWORKS, SUCH AS LOCAL AREA NETWORKS, PUBLIC SWITCHED TELEPHONE NETWORKS, AND COMPUTER GLOBAL NETWORKS, NAMELY, SOFTWARE FOR INTERNET PROTOCOL COMMUNICATION AND COMMUNICATION USING TELEPHONY EQUIPMENT (U.S. CLS. 21, 23, 26, 36 AND 38).

FIRST USE 5-30-1994; IN COMMERCE 5-30-1994.

SN 76-463,155. ARISTOCRAT TECHNOLOGIES, INC., LAS VEGAS, NV. FILED 12-16-2002.

THE GOOD, THE BAD AND THE MONEY

FOR GAMING DEVICES, NAMELY, GAMING MACHINES AND ASSOCIATED SOFTWARE FOR USE THEREWITH (U.S. CLS. 21, 23, 26, 36 AND 38).

FIRST USE 9-17-2002; IN COMMERCE 9-17-2002.

SN 76-464,878. TIMEOUT SOFTWARE, INC., PORTLAND, OR. FILED 10-31-2002.

TIMEOUT

FOR COMPUTER SOFTWARE FOR USE IN CONJUNCTION WITH ELECTRONIC MESSAGING SOFTWARE TO TRACK TIME FOR PROFESSIONALS (U.S. CLS. 21, 23, 26, 36 AND 38).

FIRST USE 9-0-2001; IN COMMERCE 9-0-2001.

CLASS 9—(Continued).

SN 76-468,800. SIMMONS, RUSSELL, NEW YORK, NY. FILED 11-20-2002.

**RUSSELL SIMMONS DEF
POETRY JAM ON
BROADWAY**

OWNER OF U.S. REG. NOS. 1,790,206, 2,361,626 AND OTHERS.

NO CLAIM IS MADE TO THE EXCLUSIVE RIGHT TO USE "POETRY" AND "ON BROADWAY", APART FROM THE MARK AS SHOWN.

FOR MUSICAL SOUND RECORDINGS; AUDIO-VISUAL RECORDINGS, NAMELY, COMPACT DISCS, TAPE CASSETTES, AUDIO CASSETTES, AUDIO TAPES, AUDIO DISCS, RECORDS, CD-ROMS, VIDEO TAPES, VIDEO CASSETTES, VIDEO DISCS, DVDS, DATS, AND LASER DISCS, ALL FEATURING POETRY AND LITERARY READINGS, COMEDY, MUSICAL AND DRAMATIC PERFORMANCES; DOWNLOADABLE ELECTRONIC PUBLICATIONS IN THE NATURE OF BOOKS, BOOKLETS, MAGAZINES, JOURNALS, MANUALS, BROCHURES, LEAFLETS, PAMPHLETS AND NEWSLETTERS, ALL FEATURING NEWS, POETRY AND LITERARY WORKS, COMEDY, MUSICAL AND DRAMATIC WORKS; ELECTRONIC PUBLICATIONS, NAMELY, BOOKS, BOOKLETS, MAGAZINES, JOURNALS, MANUALS, BROCHURES, LEAFLETS, PAMPHLETS AND NEWSLETTERS, ALL IN THE FIELD OF NEWS, POETRY, DRAMA, COMEDY AND MUSIC, ALL OF WHICH RECORDED ON CD-ROMS, DISKETTES, FLOPPY DISKS, VIDEO CASSETTES, AND MAGNETIC TAPES; MAGNETS; DECORATIVE MAGNETS; REFRIGERATOR MAGNETS; NOVELTY MAGNETS; MOUSE PADS; COMPACT DISC CASES; FITTED CASES FOR STORAGE AND TRANSPORTATION, NAMELY, CASES FOR COMPACT DISCS, AUDIO CASSETTES, VIDEO CASSETTES, CD-ROMS, HOME VIDEO GAMES, HOME VIDEO GAME ACCESSORIES, COMPUTERS, COMPUTER ACCESSORIES, CAMERAS, CAMCORDERS AND PORTABLE PHONES; COMPUTER CARRYING CASES; WRIST RESTS AND SUPPORTS FOR COMPUTER MOUSE USERS; WRIST RESTS FOR COMPUTER PRODUCTS; COMPUTER KEYBOARD WRIST PADS; EYEWEAR; SUNGLASSES; EYEGLASSES; EYEGLASS FRAMES; EYEGLASS, SUNGLASS AND SPECTACLE CASES; EYEGLASS, SUNGLASS AND SPECTACLE STRAPS; EYEGLASS, SUNGLASS AND SPECTACLE CHAINS; EYEGLASS, SUNGLASS AND SPECTACLE CLEANING CLOTHS (U.S. CLS. 21, 23, 26, 36 AND 38).

SN 76-469,701. STORAGEFLEX INC., MARKHAM ONTARIO, CANADA, FILED 11-15-2002.

LEGACY

FOR COMPUTER DATA STORAGE SYSTEMS AND DEVICES COMPRISING MAGNETO-OPTICAL, TAPE AND HARD DRIVE HARD DISKS; TAPE BACKUP COMPRISING AN INTERNAL DRIVE MECHANISM, ELECTRICAL POWER SUPPLY AND CABLING; DISK BACKUP SYSTEMS COMPRISING HARD DISKS, ELECTRICAL POWER SUPPLIES, CABLING AND TRANSMISSION BUS; AND INTEGRATED STORAGE SUBSYSTEMS COMPRISING MAGNETO-OPTICAL DISKS, TAPE BACKUP DRIVES, CD-ROM UNITS, ELECTRICAL POWER SUPPLIES, CABLING AND TRANSMISSION BUS (U.S. CLS. 21, 23, 26, 36 AND 38).

FIRST USE 2-27-2002; IN COMMERCE 2-27-2002.

CLASS 9—(Continued).

SN 76-470,376. DECK TECH MAINTENANCE, INC., CLEVELAND, OH. FILED 11-29-2002.

YOUR MATH BUDDY

NO CLAIM IS MADE TO THE EXCLUSIVE RIGHT TO USE "MATH", APART FROM THE MARK AS SHOWN.

FOR EDUCATIONAL COMPUTER SOFTWARE, NAMELY, INTERACTIVE, MULTI-MEDIA SOFTWARE PROVIDING EDUCATIONAL TRAINING, TESTING, ASSESSMENT AND REMEDIATION IN THE FIELD OF MATHEMATICS TO BE USED IN PRESCHOOL, ELEMENTARY, SECONDARY AND COLLEGIATE LEVELS (U.S. CLS. 21, 23, 26, 36 AND 38).

FIRST USE 10-1-2002; IN COMMERCE 10-1-2002.

SN 76-471,471. ESPINOSA, EDDIE, ANAHEIM, CA. FILED 11-18-2002.

HEART & HARP

FOR PHONOGRAPH RECORDS, DVD'S, CD'S, AUDIO CASSETTE TAPES, AND VHS VIDEO CASSETTE TAPES FEATURING MUSIC (U.S. CLS. 21, 23, 26, 36 AND 38).

SN 76-471,490. ADVANCED NEURO DYNAMICS, INC., HONOLULU, HI. FILED 11-29-2002.

ACCELERATED NLP TRAINING SERIES

OWNER OF U.S. REG. NOS. 1,835,057, 2,074,604 AND 2,238,010.

NO CLAIM IS MADE TO THE EXCLUSIVE RIGHT TO USE "TRAINING SERIES", APART FROM THE MARK AS SHOWN.

SEC. 2(F).

FOR PRERECORDED VIDEO TAPES FEATURING LECTURES IN THE FIELD OF SELF-IMPROVEMENT AND PRERECORDED AUDIO TAPES FEATURING LECTURES IN THE FIELD OF SELF-IMPROVEMENT (U.S. CLS. 21, 23, 26, 36 AND 38).

FIRST USE 1-31-1997; IN COMMERCE 1-31-1997.

SN 76-471,765. EASTWOOD, CLINT, LOS ANGELES, CA. FILED 11-22-2002.

CLINT EASTWOOD

OWNER OF U.S. REG. NOS. 2,480,485 AND 2,480,486.

FOR GAMING PRODUCTS, NAMELY, SLOT MACHINES, VIDEO LOTTERY TERMINALS, AND CURRENCY AND CREDIT OPERATED SLOT MACHINES AND GAMING DEVICES, NAMELY, GAMING MACHINES FOR USE IN GAMING ESTABLISHMENTS (U.S. CLS. 21, 23, 26, 36 AND 38).

CLASS 9—(Continued).

SN 76-472,272. DWIGHT YOAKAM PRODUCTIONS, INC., LOS ANGELES, CA. FILED 12-4-2002.



NO CLAIM IS MADE TO THE EXCLUSIVE RIGHT TO USE "RECORDS", APART FROM THE MARK AS SHOWN.

FOR AUDIO AND VISUAL RECORDINGS, NAMELY RECORDS, CASSETTES, COMPACT DISCS, VIDEOS, DVDS, CD-ROMS IN THE FIELD OF ENTERTAINMENT (U.S. CLS. 21, 23, 26, 36 AND 38).

SN 76-472,975. CROWN FINANCIAL MINISTRIES, INC., GAINESVILLE, GA. FILED 12-9-2002.

FINANCIAL HOPE

NO CLAIM IS MADE TO THE EXCLUSIVE RIGHT TO USE "FINANCIAL", APART FROM THE MARK AS SHOWN.

FOR PRERECORDED AUDIO CASSETTES, PRERECORDED VIDEOCASSETTES, MULTIMEDIA AND INTERACTIVE SOFTWARE, CDS, DVDS, AND CD-ROMS, ALL IN THE FIELDS OF CONSUMER CREDIT, DEBT RECOVERY, MONEY AND DEBT MANAGEMENT, BUDGETING, PERSONAL INVESTING, AND RELIGIOUS AND BIBLICAL MONEY PRINCIPLES, AND COUNSELING AND CONSULTATION THEREOF (U.S. CLS. 21, 23, 26, 36 AND 38).

SN 76-473,066. ICP ELECTRONICS, INC., SHI CHI CITY, TAIPEI HSIEN 221, TAIWAN, FILED 12-2-2002.



NO CLAIM IS MADE TO THE EXCLUSIVE RIGHT TO USE "PCI", "ISA", "AGP", OR "BUS ARCHITECTURE", APART FROM THE MARK AS SHOWN.

FOR COMPUTER ADD-ON CARD, LAN CARD, FLOATING-POINT PROCESSOR, PLOTTER CONTROL CARD, ROM CHIP, MOTHER BOARD, ACCELERATOR CARD, GRAPHIC ACCELERATOR CARD, IMAGE CARD, VIDEO CAPTURE CARD, VGA CARD, AUDIO CARD, UNCOMPRESSION CARD, VIDEO CARD, FAX CARD, ADD-ON CARD, MEMORY CARD, INDUSTRIAL COMPUTER BACKPLANE, COMPUTER, COMPUTER WORKSTATION (U.S. CLS. 21, 23, 26, 36 AND 38).

CLASS 9—(Continued).

SN 76-473,398. ENLO TECHNOLOGY CO., LTD., KAOHSIUNG, TAIWAN, FILED 11-26-2002.

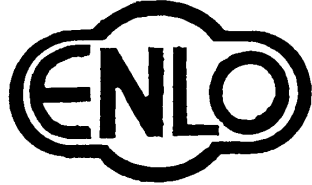

FOR ELECTRONIC DEVICE COOLER FANS; CPU COOLER FANS; CPU COOLERS; HARD FERRITE MAGNETS; SOFT FERRITE MAGNETS (U.S. CLS. 21, 23, 26, 36 AND 38).

CLASS 9—(Continued).

SN 76-475,342. LAGARDE, INCORPORATED, OLATHE, KS. FILED 12-13-2002.



OWNER OF U.S. REG. NOS. 2,546,056 AND 2,679,342. SEC. 2(F). FOR COMPUTER SOFTWARE USED BY BUSINESSES TO CONDUCT ELECTRONIC COMMERCE OVER A NETWORK (U.S. CLS. 21, 23, 26, 36 AND 38). FIRST USE 11-1-2002; IN COMMERCE 11-1-2002.

SN 76-473,645. CADRE STEEL DETAILING, INC., KELSO, WA. FILED 12-6-2002.



THE MARK CONSISTS OF A DESIGN OF A CROSS-SECTION OF A STEEL BEAM REPRESENTING THE LETTER "I" AND LOCATED IN FRONT OF THE TERM "XMANAGER". FOR COMPUTER SOFTWARE FOR MANAGING CONSTRUCTION PROJECTS FOR VARIOUS STRUCTURES (U.S. CLS. 21, 23, 26, 36 AND 38).

SN 76-475,651. DIGITAL ACCESSORIES CORPORATION, JACKSONVILLE, FL. FILED 12-16-2002.



NO CLAIM IS MADE TO THE EXCLUSIVE RIGHT TO USE "VOICE", APART FROM THE MARK AS SHOWN. FOR DICTATION MACHINES (U.S. CLS. 21, 23, 26, 36 AND 38). FIRST USE 4-1-2000; IN COMMERCE 9-0-2000.

SN 76-474,572. GPB ENTERPRISES, INC., CITY OF INDUSTRY, CA. FILED 12-9-2002.



NO CLAIM IS MADE TO THE EXCLUSIVE RIGHT TO USE "POWER", APART FROM THE MARK AS SHOWN. FOR COMPUTER PARTS, NAMELY, POWER SUPPLY (U.S. CLS. 21, 23, 26, 36 AND 38). FIRST USE 10-1-2001; IN COMMERCE 10-1-2001.

SN 76-475,803. WARDROP, TERESA, BRENTWOOD, TN. FILED 12-17-2002.



NO CLAIM IS MADE TO THE EXCLUSIVE RIGHT TO USE "SCAN", APART FROM THE MARK AS SHOWN. FOR COMPUTER SOFTWARE PROVIDING AN ELECTRONIC FILING CABINET, USED AS A MEANS OF STORAGE, INDEXING AND RETRIEVAL OF DOCUMENTS AND IMAGES (U.S. CLS. 21, 23, 26, 36 AND 38).

SN 76-474,837. ADAPTED WAVE TECHNOLOGIES, INC., POWAY, CA. FILED 12-10-2002.



NO CLAIM IS MADE TO THE EXCLUSIVE RIGHT TO USE "DIGITAL", APART FROM THE MARK AS SHOWN. FOR DOWNLOADABLE VIDEO AND AUDIO RECORDINGS FEATURING MUSIC AND ENTERTAINMENT (U.S. CLS. 21, 23, 26, 36 AND 38).

SN 76-475,812. CAPO, INC., ORMOND BEACH, FL. FILED 12-17-2002.

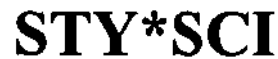

FOR EYEWEAR, NAMELY, SUNGLASSES (U.S. CLS. 21, 23, 26, 36 AND 38).

CLASS 9—(Continued).

SN 76-475,813. CAPO, INC., ORMOND BEACH, FL. FILED 12-17-2002.

STYLE*SCIENCE

FOR EYEWEAR, NAMELY, SUNGLASSES (U.S. CLS. 21, 23, 26, 36 AND 38).

SN 76-476,786. WOODHEAD INDUSTRIES, INC., NORTH-BROOK, IL. FILED 12-19-2002.

MICRO-PUSH

OWNER OF U.S. REG. NO. 1,450,560.
FOR ELECTRICAL CONNECTORS (U.S. CLS. 21, 23, 26, 36 AND 38).

SN 76-478,683. PIXELTOOLS CORP, CUPERTINO, CA. FILED 12-23-2002.

EXPERT-DVD

FOR COMPUTER SOFTWARE FOR VIDEO PROCESSING (U.S. CLS. 21, 23, 26, 36 AND 38).
FIRST USE 6-4-1998; IN COMMERCE 9-25-1998.

SN 76-478,721. THE EASTERN COMPANY, DBA ILLINOIS LOCK COMPANY, NAUGATUCK, CT. FILED 12-24-2002.

ILLINOIS LOCK

OWNER OF U.S. REG. NOS. 639,987 AND 766,194.
NO CLAIM IS MADE TO THE EXCLUSIVE RIGHT TO USE "LOCK", APART FROM THE MARK AS SHOWN. SEC. 2(F) AS TO "ILLINOIS".
FOR ELECTRICALLY AND ELECTRONICALLY CONTROLLED LOCKS AND PARTS THEREOF; ELECTRO-MECHANICAL LOCKS AND PARTS THEREOF; AND REMOTE CONTROLS THEREFOR (U.S. CLS. 21, 23, 26, 36 AND 38).
FIRST USE 12-10-2002; IN COMMERCE 12-10-2002.

SN 76-478,896. JOHN C. ERNST CO., INC., DOVER, NJ. FILED 12-26-2002.

KNOW THE FLOW

FOR FLOW METERS, SIGHT FLOW INDICATORS, SIGHT WINDOWS, EJECTORS, AND LEVEL GAUGES FOR MEASURING FLUIDS IN THE FIELD OF SANITATION, PETROCHEMICAL, CHEMICAL, PHARMACEUTICALS AND POWER (U.S. CLS. 21, 23, 26, 36 AND 38).
FIRST USE 10-1-2002; IN COMMERCE 10-1-2002.

CLASS 9—(Continued).

SN 76-479,261. D—SKIN, LLC, WEST CHICAGO, IL. FILED 12-30-2002.

SNAPS ON PLAYS ON ALWAYS ON

FOR PROTECTIVE PLASTIC COVERS FOR THE READ SIDE OF OPTICAL DISCS (U.S. CLS. 21, 23, 26, 36 AND 38).

SN 76-479,302. DEFINITIVE INK, LTD., NEW YORK, NY. FILED 12-31-2002.

CITYREADS

FOR DOWNLOADABLE AUDIO, VIDEO AND MULTI-MEDIA RECORDINGS, PRE-RECORDED AUDIOCASSETTES, VIDEOCASSETTES AND CD-ROMS, ALL CONTAINING WALKING TOURS OF HISTORIC AND INTERESTING PLACES, AND PRINTED MATERIALS SOLD THEREWITH AS A UNIT (U.S. CLS. 21, 23, 26, 36 AND 38).

SN 76-479,850. INTELLISEEK, INC., CINCINNATI, OH. FILED 1-2-2003.

INTELLISEEK

FOR SOFTWARE FOR SEARCHING, RETRIEVING, MANAGING, ANALYZING, AND TRACKING INFORMATION AND RELEVANT KNOWLEDGE ACROSS MULTIPLE, DISPARATE INFORMATION SOURCES, INCLUDING THE GLOBAL COMPUTER NETWORK, EXTRANETS, INTRANETS, DATABASES (U.S. CLS. 21, 23, 26, 36 AND 38).
FIRST USE 4-30-1998; IN COMMERCE 4-30-1998.

SN 76-479,863. INNOVENTIONS ENTERPRISES LTD., FARMINGDALE, NY. FILED 1-2-2003.

XPANDR

FOR SUNGLASSES (U.S. CLS. 21, 23, 26, 36 AND 38).

SN 76-480,040. NORDOST MARKETING COMPANY, INC., ASHLAND, MA. FILED 1-3-2003.

VALHALLA

FOR INTERCONNECT CABLES (U.S. CLS. 21, 23, 26, 36 AND 38).
FIRST USE 1-31-2001; IN COMMERCE 1-31-2001.

CLASS 9—(Continued).

SN 76-480,045. MEDIWARE INFORMATION SYSTEMS, INC., LENEXA, KS. FILED 1-3-2003.



OWNER OF U.S. REG. NOS. 2,112,695, 2,426,518 AND 2,426,523.
FOR COMPUTER SOFTWARE FOR USE IN HOSPITALS, WHICH ENABLES DOCTORS TO PRESCRIBE DRUGS FROM A PATIENT'S HOSPITAL BEDSIDE USING A PDA OR COMPUTER, AND COMMUNICATES WITH THE HOSPITAL'S PHARMACY (U.S. CLS. 21, 23, 26, 36 AND 38).

SN 76-480,047. NORDOST MARKETING COMPANY, INC., ASHLAND, MA. FILED 1-3-2003.

VALHALLA

FOR INTERCONNECT CABLES (U.S. CLS. 21, 23, 26, 36 AND 38).
FIRST USE 1-31-2001; IN COMMERCE 1-31-2001.

SN 76-481,559. KONINKLIJKE PHILIPS ELECTRONICS N.V., EINDHOVEN, NETHERLANDS, FILED 1-9-2003.

MATCHBOX

OWNER OF U.S. REG. NO. 2,590,232.
FOR ELECTRONIC BALLASTS (U.S. CLS. 21, 23, 26, 36 AND 38).
FIRST USE 4-19-2002; IN COMMERCE 5-13-2002.

CLASS 9—(Continued).

SN 76-481,616. KOFAX IMAGE PRODUCTS, INC., IRVINE, CA. FILED 1-10-2003.



OWNER OF U.S. REG. NO. 2,364,535.
FOR COMPUTER SOFTWARE AND HARDWARE FOR DOCUMENT IMAGE PROCESSING, NAMELY, MANAGING, SCANNING, CAPTURING, MANIPULATING, SORTING, INDEXING, STORING, DISPLAYING AND PRINTING IMAGES AND TEXTURAL INFORMATION STORED IN A PERSONAL COMPUTER (U.S. CLS. 21, 23, 26, 36 AND 38).
FIRST USE 6-0-1990; IN COMMERCE 6-0-1990.

SN 76-483,053. SCHERING-PLOUGH HEALTHCARE PRODUCTS, INC., MEMPHIS, TN. FILED 1-17-2003.

COPPERTONE SPECTRA 3

OWNER OF U.S. REG. NO. 1,371,057.
FOR SUNGLASSES (U.S. CLS. 21, 23, 26, 36 AND 38).

SN 76-483,723. GASTON BATTERY INDUSTRIAL LIMITED, KWAI CHUNG, HONG KONG, FILED 1-21-2003.



FOR BATTERIES, BATTERY CHARGERS (U.S. CLS. 21, 23, 26, 36 AND 38).
FIRST USE 0-0-1997; IN COMMERCE 0-0-1998.

SN 76-484,363. SORONTI, INC., DRAPER, UT. FILED 1-22-2003.

VIRTUAL PRESENCE MADE SIMPLE

NO CLAIM IS MADE TO THE EXCLUSIVE RIGHT TO USE "VIRTUAL", APART FROM THE MARK AS SHOWN.
FOR COMPUTER PERIPHERALS AND HARDWARE FOR REMOTELY CONTROLLING COMPUTERS (U.S. CLS. 21, 23, 26, 36 AND 38).

CLASS 9—(Continued).

SN 76-484,450. TEMPO RESEARCH CORPORATION, VISTA, CA. FILED 1-22-2003.

MARKER-MATE

FOR ELECTROMAGNETIC FIELD LOCATORS AND DETECTORS USED FOR LOCATING AND DETECTING OBJECTS THAT EMIT AN ELECTROMAGNETIC FIELD (U.S. CLS. 21, 23, 26, 36 AND 38).

SN 76-484,703. KABUSHIKI KAISHA TOSHIBA, DBA TOSHIBA CORPORATION, MINATO-KU, TOKYO, JAPAN, FILED 1-24-2003.

GIGABEAT

OWNER OF JAPAN REG. NO. 4608293, DATED 9-27-2002, EXPIRES 9-27-2012.

FOR PORTABLE DIGITAL AUDIO PLAYERS (U.S. CLS. 21, 23, 26, 36 AND 38).

SN 76-484,844. PARADIGM ELECTRONICS INCORPORATED, MISSISSAUGA, ONTARIO, CANADA, FILED 1-27-2003.

ATOM

FOR LOUDSPEAKERS (U.S. CLS. 21, 23, 26, 36 AND 38).
FIRST USE 12-15-1992; IN COMMERCE 12-15-1992.

SN 76-484,971. ROCHESTER GAUGES, INC., DALLAS, TX. FILED 1-28-2003.

VISIBLE

FOR LIQUID LEVEL MEASURING DEVICES, NAMELY, GAUGES FOR LIQUIDS AND LIQUIFIED COMPRESSED GASSES (U.S. CLS. 21, 23, 26, 36 AND 38).
FIRST USE 0-0-1946; IN COMMERCE 0-0-1946.

SN 76-485,141. FIRST INTERNATIONAL COMPUTER OF AMERICA, FREMONT, CA. FILED 1-27-2003.

SLATEVISION

FOR COMPUTER HARDWARE, NAMELY TABLET PERSONAL COMPUTERS (U.S. CLS. 21, 23, 26, 36 AND 38).
FIRST USE 1-14-2003; IN COMMERCE 1-14-2003.

CLASS 9—(Continued).

SN 76-485,182. APERTEC, INC., TAIPEI, TAIWAN, FILED 1-27-2003.



FOR UNINTERRUPTIBLE POWER SYSTEM COMPRISING GROUNDED OUTLETS WITH FULL-TIME SURGE PROTECTION AND OTHER GROUNDED OUTLETS HAVING SURGE PROTECTION AND BATTERY BACK-UP, AND COMPUTER SOFTWARE FOR USE IN CONNECTION THEREWITH; BATTERIES; BATTERY CHARGERS; ELECTRICAL POWER SUPPLIES; INVERTERS; VOLTAGE SURGE PROTECTORS; MODEMS; NETWORKING PRODUCTS, NAMELY, LAN ADAPTER CARDS (U.S. CLS. 21, 23, 26, 36 AND 38).

SN 76-485,184. APERTEC, INC., TAIPEI, TAIWAN, FILED 1-27-2003.

APERSMART

FOR UNINTERRUPTIBLE POWER SYSTEM COMPRISING GROUNDED OUTLETS WITH FULL-TIME SURGE PROTECTION AND OTHER GROUNDED OUTLETS HAVING SURGE PROTECTION AND BATTERY BACK-UP, AND COMPUTER SOFTWARE FOR USE IN CONNECTION THEREWITH; BATTERIES; BATTERY CHARGERS; ELECTRICAL POWER SUPPLIES; INVERTERS; VOLTAGE SURGE PROTECTORS; MODEMS; NETWORKING PRODUCTS, NAMELY, LAN ADAPTER CARDS (U.S. CLS. 21, 23, 26, 36 AND 38).

SN 76-485,185. APERTEC, INC., TAIPEI, TAIWAN, FILED 1-27-2003.

APERSAVE

FOR UNINTERRUPTIBLE POWER SYSTEM COMPRISING GROUNDED OUTLETS WITH FULL-TIME SURGE PROTECTION AND OTHER GROUNDED OUTLETS HAVING SURGE PROTECTION AND BATTERY BACK-UP, AND COMPUTER SOFTWARE FOR USE IN CONNECTION THEREWITH; BATTERIES; BATTERY CHARGERS; ELECTRICAL POWER SUPPLIES; INVERTERS; VOLTAGE SURGE PROTECTORS; MODEMS; NETWORKING PRODUCTS, NAMELY, LAN ADAPTER CARDS (U.S. CLS. 21, 23, 26, 36 AND 38).

SN 76-485,402. EQUIP TRACK, INC., BELLAIRE, TX. FILED 1-27-2003.

TRURESULTS

FOR COMPUTER SOFTWARE, NAMELY, SOFTWARE FOR GENERATING REPORTS FROM DATABASES (U.S. CLS. 21, 23, 26, 36 AND 38).

CLASS 9—(Continued).

SN 76-485,487. PHASE FORWARD INCORPORATED, WALTHAM, MA. FILED 1-28-2003.

INFORM

OWNER OF U.S. REG. NOS. 2,582,163 AND 2,584,476. FOR COMPUTER SOFTWARE USED IN THE MANAGEMENT OF CLINICAL TRIALS OF PHARMACEUTICAL PRODUCTS AND MEDICAL DEVICES AND MANAGEMENT OF DATA RESULTING THEREFROM (U.S. CLS. 21, 23, 26, 36 AND 38).
FIRST USE 7-7-1998; IN COMMERCE 7-7-1998.

SN 76-485,499. INTERSTATE INDUSTRIES, INC., LOVINGSTON, VA. FILED 1-28-2003.

GATEWAY EXPERIENCE

FOR PRERECORDED AUDIO CASSETTE TAPES AND COMPACT DISCS FEATURING INSTRUCTIONS AND MATERIALS FOR AIDING EXPANDED AWARENESS AND SELF-DISCOVERY, STRESS MANAGEMENT, FEAR CONTROL, POSITIVE THINKING, COMMUNICATION WITH OTHERS, IMPROVING PERFORMANCE, AND PROFOUND RELAXATION (U.S. CLS. 21, 23, 26, 36 AND 38).

FIRST USE 7-15-1981; IN COMMERCE 7-15-1981.

SN 76-485,500. STUDENT LOAN MARKETING ASSOCIATION, RESTON, VA. FILED 1-28-2003.

PORTSS

FOR COMPUTER PROGRAMS PROVIDED TO FINANCIAL INSTITUTIONS TO ASSIST THEM IN ORIGINATING, SERVICING AND MANAGING THEIR EDUCATION LOAN PORTFOLIOS (U.S. CLS. 21, 23, 26, 36 AND 38).

FIRST USE 3-0-1984; IN COMMERCE 3-0-1984.

SN 76-485,541. DREAM GIRLS, INC., TAMPA, FL. BY ASSIGNMENT MOTORSPORTS MARKETING, LLC, TAMPA, FL. FILED 1-28-2003.

FAST & WILD

FOR PRERECORDED VIDEO TAPES AND DVDS FEATURING AUTOMOTIVE AND MOTORCYCLE STREET RACING (U.S. CLS. 21, 23, 26, 36 AND 38).

SN 76-485,800. MULTIMEDIA GAMES, INC., AUSTIN, TX. FILED 1-29-2003.

CAST OF THOUSANDS

FOR GAMING MACHINES FOR PLAYING ELECTRONIC BINGO GAMES AND ELECTRONIC GAMES OF CHANCE (U.S. CLS. 21, 23, 26, 36 AND 38).

CLASS 9—(Continued).

SN 76-485,929. MULTIMEDIA GAMES, INC., AUSTIN, TX. FILED 1-29-2003.

FISHIN' FOR DOLLARS

FOR GAMING MACHINES FOR PLAYING ELECTRONIC BINGO GAMES AND ELECTRONIC GAMES OF CHANCE (U.S. CLS. 21, 23, 26, 36 AND 38).

SN 76-485,930. MULTIMEDIA GAMES, INC., AUSTIN, TX. FILED 1-29-2003.

NO LIMIT FISHIN'

FOR GAMING MACHINES FOR PLAYING ELECTRONIC BINGO GAMES AND ELECTRONIC GAMES OF CHANCE (U.S. CLS. 21, 23, 26, 36 AND 38).

SN 76-485,957. ROCKBESTOS-SURPRENANT CABLE CORP., CLINTON, MA. FILED 1-29-2003.

ROCKBESTOS-SURPRENANT

FOR ELECTRICAL WIRE AND CABLE (U.S. CLS. 21, 23, 26, 36 AND 38).

FIRST USE 3-14-1997; IN COMMERCE 3-14-1997.

SN 76-486,074. GOJO INDUSTRIES, INC., AKRON, OH. FILED 1-30-2003.

HITACTILE

FOR PROTECTIVE GLOVES FOR INDUSTRIAL USE (U.S. CLS. 21, 23, 26, 36 AND 38).

SN 76-486,408. HUNTRON, INC., MILL CREEK, WA. FILED 1-27-2003.

SIGASSIST

FOR COMPUTER SOFTWARE FOR USE IN ELECTRONIC TEST INSTRUMENTS FOR PRINTED CIRCUIT ASSEMBLIES (U.S. CLS. 21, 23, 26, 36 AND 38).
FIRST USE 2-0-2000; IN COMMERCE 7-30-2002.

CLASS 9—(Continued).

SN 76-487,243. SUNGARD BUSINESS INTEGRATION LTD., HERZLIYA 46852, ISRAEL, FILED 2-4-2003.

MINT

FOR COMPUTER SOFTWARE USED BY FINANCIAL SERVICES PROVIDERS TO INTEGRATE THE ORDERING, ORDER MATCHING SETTLEMENT, ACCOUNTING AND REPORTING OF FINANCIAL INSTRUMENT TRADES (U.S. CLS. 21, 23, 26, 36 AND 38).

FIRST USE 1-0-1998; IN COMMERCE 1-0-1998.

SN 76-488,879. SECOND CHANCE BODY ARMOR, INC., CENTRAL LAKE, MI. FILED 1-24-2003.

RANGE MASTER

FOR PROTECTIVE ARMORED CLOTHING; NAMELY, CONCEALED BULLET-RESISTANT PANELS USED IN BODY ARMOR (U.S. CLS. 21, 23, 26, 36 AND 38).

FIRST USE 11-4-2002; IN COMMERCE 11-4-2002.

SN 76-491,712. MANAGEGREAT, INC., PHOENIX, AZ. FILED 2-21-2003.

GOALCENTRIX

FOR BUSINESS MANAGEMENT SOFTWARE, NAMELY SOFTWARE FOR MANAGING WORKERS, TEAMS AND BUSINESSES AND FOR SHARING INFORMATION AND KNOWLEDGE (U.S. CLS. 21, 23, 26, 36 AND 38).

SN 76-492,672. MEDIA FUSION CO., LTD., OSAKA, JAPAN, FILED 2-24-2003.

ESTERRA

FOR DATABASE MANAGEMENT SOFTWARE FOR GENERAL USE (U.S. CLS. 21, 23, 26, 36 AND 38).

SN 76-492,951. INFOGRAMES, INC., NEW YORK, NY. FILED 1-17-2003.

DARKNESS

FOR INTERACTIVE MULTIMEDIA GAME SOFTWARE FOR USE ON PERSONAL COMPUTERS AND ELECTRONIC GAME-PLAYING UNITS (U.S. CLS. 21, 23, 26, 36 AND 38).

CLASS 9—(Continued).

SN 76-494,320. DREAM GIRLS, INC., TAMPA, FL. BY ASSIGNMENT MOTORSPORTS MARKETING, LLC, TAMPA, FL. FILED 3-3-2003.

FAST AND WILD

FOR PRERECORDED VIDEO TAPES AND DVDS FEATURING AUTOMOTIVE AND MOTORCYCLE STREET RACING (U.S. CLS. 21, 23, 26, 36 AND 38).

SN 76-522,338. MEADWESTVACO CORPORATION, STAMFORD, CT. FILED 6-5-2003.



FOR REFRIGERATOR MAGNETS (U.S. CLS. 21, 23, 26, 36 AND 38).

SN 76-522,342. MEADWESTVACO CORPORATION, STAMFORD, CT. FILED 6-5-2003.

CORNERSTONE

FOR REFRIGERATOR MAGNETS (U.S. CLS. 21, 23, 26, 36 AND 38).

SN 78-024,423. EATONI ERGONOMICS, INC., NEW YORK, NY. BY ASSIGNMENT GUTOWITZ, HOWARD, ANDREW, NEW YORK CITY, NY. FILED 9-5-2000.

TONEMAIL

FOR SYSTEMS FOR ALPHANUMERIC TEXT ENTRY, NAMELY, HAND-HELD AND DESKTOP COMPUTER INPUT KEYBOARDS ARE KEYPADS; AND GENERAL-PURPOSE COMPUTER SOFTWARE FOR PREDICTIVE TEXT ENTRY (U.S. CLS. 21, 23, 26, 36 AND 38).

CLASS 9—(Continued).

SN 78-059,578. PICO TECHNOLOGY LIMITED, ST. NEOTS CAMBRIDGESHIRE, UNITED KINGDOM, FILED 4-20-2001.

PICO TECHNOLOGY

NO CLAIM IS MADE TO THE EXCLUSIVE RIGHT TO USE "TECHNOLOGY", APART FROM THE MARK AS SHOWN.

FOR COMPUTER PERIPHERALS, AND COMPUTER SOFTWARE FOR USE BY SCIENTISTS, ENGINEERS AND TECHNICIANS IN EMULATING TESTING AND MEASURING EQUIPMENT, NAMELY OSCILLOSCOPES, SPECTRUM ANALYZERS, VOLTMETERS, CHART RECORDERS, FREQUENCY METERS, LOGIC ANALYZERS, DATA LOGGERS, HUMIDITY METERS, PH METERS, LIGHT METERS, AND SOUND LEVEL METERS (U.S. CLS. 21, 23, 26, 36 AND 38).

SN 78-059,674. EVOLVE PRODUCTS, INC., IRVINE, CA. FILED 4-20-2001.

GUIDE REMOTE

NO CLAIM IS MADE TO THE EXCLUSIVE RIGHT TO USE "REMOTE", APART FROM THE MARK AS SHOWN. SEC. 2(F).

FOR REMOTE CONTROLS UNITS FOR TELEVISION SETS AND OTHER AUDIO AND VIDEO ENTERTAINMENT SYSTEMS, NAMELY RADIOS, VIDEO CASSETTE RECORDERS, DVD PLAYERS, COMPACT DISC PLAYERS (U.S. CLS. 21, 23, 26, 36 AND 38).

FIRST USE 5-3-2001; IN COMMERCE 5-3-2001.

SN 78-064,469. PROGRESS SOFTWARE CORPORATION, BEDFORD, MA. FILED 5-18-2001.

OPENEDGE

FOR COMPUTER SOFTWARE IN THE FIELD OF INFORMATION TECHNOLOGY FOR USE IN THE DEVELOPMENT, DEPLOYMENT, INTEGRATION AND MANAGEMENT OF BUSINESS APPLICATIONS OVER LOCAL AREA, WIDE AREA, AND LOCAL COMPUTER NETWORKS AND MANUALS SOLD TOGETHER THEREWITH (U.S. CLS. 21, 23, 26, 36 AND 38).

CLASS 9—(Continued).

SN 78-097,761. D&S SYSTEMS, INC., YORK, PA. FILED 12-11-2001.

TRAAC-PAC

FOR MEDICATION PACKAGING SYSTEM COMPRISED PRIMARILY OF ELECTRONIC COMPONENTS, NAMELY, A CENTRAL PROCESSING UNIT, BATTERY, LCD DISPLAY, ELECTRONIC CIRCUIT BOARD, BREAKAWAY TRACES AND DATA OUTPUT COMPONENT FOR COMMUNICATION WITH A COMPUTER SOFTWARE PROGRAM AND DATABASE, AND ALSO COMPRISED OF PAPER AND FOIL PACKAGING FOR MEDICATION DOSES, USED FOR THE PURPOSE OF CAPTURING DOSING HISTORY AND PROVIDING RECORDED COMPLIANCE INFORMATION ABOUT THE TIMING OF A PATIENT'S MEDICATION DOSING TO PHYSICIANS, PHARMACISTS AND REGULATORY AUTHORITIES (U.S. CLS. 21, 23, 26, 36 AND 38).

SN 78-098,867. SKYLINE PRODUCTS, INC., COLORADO SPRINGS, CO. FILED 12-18-2001.

ITS-GRADE

FOR LARGE SCALE PROGRAMMABLE ELECTRONIC VARIABLE MESSAGE SIGN SYSTEMS COMPRISING EITHER ONE OR MORE MODULAR DISPLAY PANELS CONTAINING A MATRIX OF ILLUMINATED PIXELS OR ONE OR MORE SCROLLING FILM MODULES AND COMPUTER HARDWARE AND OPERATING SOFTWARE FOR CONTROLLING EITHER OF SAID SYSTEMS (U.S. CLS. 21, 23, 26, 36 AND 38).

FIRST USE 12-18-2001; IN COMMERCE 5-9-2003.

SN 78-101,882. XYBO SYSTEMS INC., MARKHAM, ONTARIO, CANADA, FILED 1-10-2002.

WIRELESSCONTACT

FOR COMPUTER SOFTWARE THAT ENABLES WIRELESS DEVICES, NAMELY, CELL-PHONE, PDAS AND TWO-WAY PAGERS, TO ACCESS THE USER'S CUSTOMER RELATIONSHIP MANAGEMENT AND CONTACT MANAGEMENT DATA RELATED TO CUSTOMERS, SUPPLIERS, AND OTHER BUSINESS CONTACTS (U.S. CLS. 21, 23, 26, 36 AND 38).

FIRST USE 7-0-2001; IN COMMERCE 7-0-2001.

SN 78-105,304. VIRTUAL MUSCLE RESEARCH NETWORK, LTD., NEW YORK, NY. FILED 1-28-2002.

VIRTUAL MUSCLE

OWNER OF U.S. REG. NO. 2,125,815.

FOR DOWNLOADABLE ELECTRONIC PUBLICATIONS IN THE NATURE OF NEWSLETTERS IN THE FIELDS OF NUTRITION, EXERCISE, HEALTH, DIET, WEIGHT TRAINING, PHYSICAL FITNESS, BODY BUILDING, WEIGHT MAINTENANCE AND DIETARY SUPPLEMENTS (U.S. CLS. 21, 23, 26, 36 AND 38).

FIRST USE 1-1-2000; IN COMMERCE 1-1-2000.

CLASS 9—(Continued).

SN 78-108,662. TRUSTED MEDIA NETWORKS, INC., SEATTLE, WA. FILED 2-13-2002.



TrustedMedia
NETWORKS, INC

NO CLAIM IS MADE TO THE EXCLUSIVE RIGHT TO USE "NETWORKS, INC", APART FROM THE MARK AS SHOWN.

FOR COMPUTER SOFTWARE FOR DISTRIBUTING ELECTRONIC MEDIA BY ENCODING AND TRANSMITTING OVER LOCAL AND GLOBAL INFORMATION NETWORKS (U.S. CLS. 21, 23, 26, 36 AND 38).

FIRST USE 2-11-2002; IN COMMERCE 2-11-2002.

SN 78-111,630. FOSS ELECTRIC A/S, 3400 HILLEROD, DENMARK, FILED 2-28-2002.

PROCESSCAN

PRIORITY CLAIMED UNDER SEC. 44(D) ON ERP N CMNTY TM OFC APPLICATION NO. 002481976, FILED 11-28-2001.

FOR SCIENTIFIC, ELECTRIC, PHOTOGRAPHIC, CINEMATOGRAPHIC APPARATUS AND INSTRUMENTS AND APPARATUS, NAMELY SPECTROMETERS FOR ANALYZING, MEASURING AND CONTROLLING FOR USE IN THE FOOD, BEVERAGE, DAIRY, MICROBIOLOGICAL AND PHARMACEUTICAL INDUSTRY AND FOR USE IN LABORATORIES; INSTRUMENTS FOR WEIGHING, MEASURING AND CHECKING SUPERVISION, CONTROLLING, AND ANALYZING, NAMELY SPECTROMETERS FOR DETERMINATION OF THE CONTENT OF FAT, PROTEIN, LACTOSE, ACIDITY, TOTAL SOLIDS, BRIX AND MOISTURE FOR USE IN THE FOOD, BEVERAGE, DAIRY, MICROBIOLOGICAL AND PHARMACEUTICAL INDUSTRY AND FOR USE IN LABORATORIES; APPARATUS FOR RECORDING, TRANSMISSION AND REPRODUCTION OF SOUND OR IMAGES, NAMELY, SPECTROMETERS FOR USE IN THE FOOD, BEVERAGE, DAIRY AND MICROBIOLOGICAL AND PHARMACEUTICAL INDUSTRY AND IN LABORATORIES; PRERECORDED MAGNETIC DATA CARRIERS, FEATURING COMPUTER SOFTWARE FOR STEERING AND CONTROLLING ANALYZING, MEASURING AND CONTROLLING APPARATUS AND INSTRUMENTS; CALCULATING MACHINES AND DATA PROCESSING EQUIPMENT AND COMPUTERS; RECORDED COMPUTER SOFTWARE FOR USE IN CONNECTION WITH THE MENTIONED APPARATUS AND INSTRUMENTS; PARTS AND ACCESSORIES FOR ALL THE ABOVE MENTIONED GOODS (U.S. CLS. 21, 23, 26, 36 AND 38).

FIRST USE 1-1-2001; IN COMMERCE 1-1-2001.

SN 78-122,566. GILMER, GEORGE T., CONROE, TX. FILED 4-18-2002.

TACVIEW

FOR SMALL DIGITAL CAMERAS ATTACHED TO POLES TO BE USED TO SAFELY SEARCH FOR HIDDEN SUSPECTS, CONTRABAND, ETC (U.S. CLS. 21, 23, 26, 36 AND 38).

FIRST USE 9-8-2001; IN COMMERCE 9-8-2001.

CLASS 9—(Continued).

SN 78-123,211. TRIGUARD GROUP, LLC, NEEDHAM, MA. FILED 4-22-2002.

**TRIGUARD ADVANTAGE
SECURITY SYSTEM**

OWNER OF U.S. REG. NO. 2,678,742.

NO CLAIM IS MADE TO THE EXCLUSIVE RIGHT TO USE "SECURITY SYSTEMS", APART FROM THE MARK AS SHOWN.

FOR FACILITIES MANAGEMENT SOFTWARE, NAMELY SOFTWARE TO CONTROL BUILDING ENVIRONMENTAL, ACCESS AND SECURITY SYSTEMS; PERSONAL SECURITY ALARMS (U.S. CLS. 21, 23, 26, 36 AND 38).

FIRST USE 11-15-2002; IN COMMERCE 11-15-2002.

SN 78-125,739. DELL COMPUTER CORPORATION, ROUND ROCK, TX. FILED 5-2-2002.



FOR FEATURE OF COMPUTER HARDWARE IN THE NATURE OF A LIGHT ON THE MONITOR OR KEYBOARD THAT INDICATES WHEN THE WIRELESS FUNCTION IS OPERATIONAL. (U.S. CLS. 21, 23, 26, 36 AND 38).

SN 78-136,240. OMEGA SOFTWARE TECHNOLOGIES, INC., HOUSTON, TX. FILED 6-17-2002.

OVERDRAFT PRO

NO CLAIM IS MADE TO THE EXCLUSIVE RIGHT TO USE "OVERDRAFT", APART FROM THE MARK AS SHOWN.

FOR ADAPTIVE STRATEGY-BASED SOFTWARE FOR AUTOMATING BUSINESS IN THE BANKING, FINANCIAL, AND INSURANCE INDUSTRIES (U.S. CLS. 21, 23, 26, 36 AND 38).

CLASS 9—(Continued).

SN 78-136,778. MICROSOFT CORPORATION, REDMOND, WA. FILED 6-18-2002.

BREACH

FOR COMPUTER GAME SOFTWARE FOR USE ON COMPUTERS AND VIDEO GAME PLAYERS; PRERECORDED VIDEOTAPES, AUDIO TAPES, CDS AND DVDS FEATURING SOUND AND VIDEO IN THE FIELDS OF MUSIC, LIVE ACTION PROGRAMS, MOTION PICTURES AND ANIMATED CARTOONS; MOTION PICTURE FILMS FEATURING COMEDY, DRAMA, ACTION, ADVENTURE AND ANIMATION; MOTION PICTURE FILMS FOR BROADCAST ON TELEVISION FEATURING COMEDY, DRAMA, ACTION, ADVENTURE AND ANIMATION; COMPUTER GAME CARTRIDGES; COMPUTER GAME CASSETTES; COMPUTER GAME TAPES; VIDEO GAME CARTRIDGES; AND VIDEO GAME CASSETTES (U.S. CLS. 21, 23, 26, 36 AND 38).

SN 78-138,943. HARTING ELECTRIC GMBH & CO. KG, ESPELKAMP, FED REP GERMANY, FILED 6-26-2002.

HAN-COMPACT

PRIORITY CLAIMED UNDER SEC. 44(D) ON FED REP GERMANY APPLICATION NO. 30203476.5, FILED 1-28-2002, REG. NO. 30203476, DATED 1-28-2002, EXPIRES 1-31-2012.

OWNER OF U.S. REG. NOS. 1,433,636 AND 2,260,305.
FOR HOUSINGS FOR ELECTRICAL CONNECTOR-INSERTS.; HOUSINGS FOR ELECTRICAL CONNECTOR-INSERTS. (U.S. CLS. 21, 23, 26, 36 AND 38).

SN 78-140,143. DIVERSIFIED SCIENTIFIC, INC., BIRMINGHAM, AL. FILED 6-30-2002.

CRYSTALSCORE

FOR COMPUTER PROGRAMS FOR USE IN ANALYZING PROTEIN CRYSTALLIZATION IMAGES AS TAKEN IN REAL-TIME DURING A PROTEIN - REAGENT EXPERIMENT (U.S. CLS. 21, 23, 26, 36 AND 38).
FIRST USE 10-25-2000; IN COMMERCE 0-0-2001.

SN 78-140,323. TECMARK CORPORATION, MENTOR, OH. FILED 7-1-2002.

LIFE  **LINE**

FOR VEHICLE ALARMS, NAMELY A SAFETY DOOR ALARM FOR SENSING AN OBJECT CAUGHT IN A DOOR (U.S. CLS. 21, 23, 26, 36 AND 38).

CLASS 9—(Continued).

SN 78-140,607. CONCENTRIC SPHERES, INC., NORTH KINGSTOWN, RI. FILED 7-2-2002.

CARRIERWAVE

FOR COMPUTER SOFTWARE FOR USE IN CUSTOMER RELATIONSHIP MANAGEMENT AND WEB MESSAGING (U.S. CLS. 21, 23, 26, 36 AND 38).

SN 78-141,304. CAMPUS PIPELINE, INC., SALT LAKE CITY, UT. FILED 7-3-2002.

LUMINIS

FOR COMPUTER SOFTWARE, SOLD DIRECTLY TO EDUCATIONAL INSTITUTIONS, FOR INTEGRATING SYSTEMS, APPLICATIONS AND DATABASES AND FOR MANAGING INFORMATION STORED IN A DATABASE; COMPUTER SOFTWARE, SOLD DIRECTLY TO EDUCATIONAL INSTITUTIONS, FOR PROVIDING CENTRALIZED AND CUSTOMIZED ACCESS VIA A GLOBAL COMMUNICATIONS NETWORK TO CAMPUS INFORMATION, SERVICES AND COMMUNITIES AND FOR CHANNELIZING WEB-BASED INFORMATION, THROUGH A GLOBAL OR OTHER COMMUNICATIONS NETWORK (U.S. CLS. 21, 23, 26, 36 AND 38).

SN 78-141,316. ITERATION SOFTWARE, INC., MOUNTAIN VIEW, CA. FILED 7-3-2002.

ITERATION SOFTWARE

NO CLAIM IS MADE TO THE EXCLUSIVE RIGHT TO USE "SOFTWARE", APART FROM THE MARK AS SHOWN.
FOR SOFTWARE FOR REAL-TIME REPORTING AND DELIVERY OF INFORMATION NAMELY, SOFTWARE FOR THE REAL-TIME UPDATE OF DATA FOR DELIVERY IN AN ENTERPRISE NETWORK (U.S. CLS. 21, 23, 26, 36 AND 38).

SN 78-141,946. TOOLS4EVER BV, 3741 GP BAARN, NETHERLANDS, FILED 7-8-2002.

TOOLS4EVER

FOR COMPUTER SOFTWARE, NAMELY, SOFTWARE FOR NETWORK ADMINISTRATION, SOFTWARE FOR DISK QUOTA MANAGEMENT AND SOFTWARE FOR MANAGEMENT OF USER ACCOUNTS AND ASSOCIATED RESOURCES; COMPUTER SOFTWARE FOR COMPUTER NETWORK TRACKING, MONITORING, ANALYSIS AND MANAGEMENT; COMPUTER SOFTWARE AND COMPUTER SOFTWARE TOOLS USED FOR CONVERTING USER ACCOUNT RELATED DATA AND INFORMATION IN A NETWORK ENVIRONMENT; COMPUTER SOFTWARE USED BY SYSTEM ADMINISTRATORS AND HELPDESK EMPLOYEES TO OBTAIN TIMELY NETWORK RESOURCE STATUS INFORMATION (U.S. CLS. 21, 23, 26, 36 AND 38).
FIRST USE 11-1-1999; IN COMMERCE 11-1-1999.

CLASS 9—(Continued).

SN 78-144,195. G.C. LEAK DETECTORS PTY LIMITED, WEST GOSFORD, NSW, AUSTRALIA, FILED 7-16-2002.



OWNER OF AUSTRALIA REG. NO. 712795, DATED 7-24-1996, EXPIRES 7-24-2006.

THE MARK CONSISTS OF THE STYLIZED LETTERING "GC".

FOR LEAK DETECTION EQUIPMENT, NAMELY, ELECTRONICALLY CONTROLLED, PNEUMATIC AND MECHANICAL DEVICES FOR THE DETECTION OF LEAKS IN HOLLOW ARTICLES (U.S. CLS. 21, 23, 26, 36 AND 38).

FIRST USE 0-0-1996; IN COMMERCE 5-0-1998.

SN 78-144,930. WARNER BROS. ENTERTAINMENT INC., BURBANK, CA. BY ASSIGNMENT; BY ASSIGNMENT TIME WARNER ENTERTAINMENT COMPANY, L.P., NEW YORK, NY. FILED 7-17-2002.

TOON LAB

NO CLAIM IS MADE TO THE EXCLUSIVE RIGHT TO USE "TOON", APART FROM THE MARK AS SHOWN.

FOR MOTION PICTURE FILMS FEATURING COMEDY, DRAMA, ACTION, ADVENTURE AND/OR ANIMATION, AND MOTION PICTURE FILMS FOR BROADCAST ON TELEVISION FEATURING COMEDY, DRAMA, ACTION, ADVENTURE AND/OR ANIMATION; PRERECORDED VINYL RECORDS, AUDIO TAPES, AUDIO-VIDEO TAPES, AUDIO VIDEO CASSETTES, AUDIO VIDEO DISCS, AND DIGITAL VERSATILE DISCS FEATURING MUSIC, COMEDY, DRAMA, ACTION, ADVENTURE, AND/OR ANIMATION; STEREO HEADPHONES; BATTERIES; CORDLESS TELEPHONES; HAND-HELD CALCULATORS; AUDIO CASSETTE AND CD PLAYERS; CD ROM GAMES; HAND-HELD KARAOKE PLAYERS, TELEPHONE AND/OR RADIO PAGERS; SHORT MOTION PICTURE FILM CASSETTES FEATURING COMEDY, DRAMA, ACTION, ADVENTURE AND/OR ANIMATION TO BE USED WITH HAND-HELD VIEWERS OR PROJECTORS; VIDEO CASSETTE RECORDERS AND PLAYERS, COMPACT DISC PLAYERS, DIGITAL AUDIO TAPE RECORDERS

CLASS 9—(Continued).

AND PLAYERS, ELECTRONIC DIARIES; RADIOS; MOUSE PADS; EYEGLASSES, SUNGLASSES AND CASES THEREFORE; BOOKLETS FEATURING COMEDY, DRAMA, ACTION, ADVENTURE, ANIMATION AND MUSIC INFORMATION SOLD WITH AUDIO TAPES, AS A UNIT FEATURING COMEDY, DRAMA, ACTION ADVENTURE, ANIMATION AND MUSIC INFORMATION; COMPUTER PROGRAMS, NAMELY, SOFTWARE LINKING DIGITIZED VIDEO AND AUDIO MEDIA TO A GLOBAL COMPUTER INFORMATION NETWORK; GAME EQUIPMENT SOLD AS A UNIT FOR PLAYING A PARLOR-TYPE COMPUTER GAME; VIDEO AND COMPUTER GAME PROGRAMS; VIDEO GAME CARTRIDGES AND CASSETTES; CELLULAR TELEPHONE ACCESSORIES, NAMELY HANDS-FREE ACCESSORIES, CELLULAR TELEPHONE COVERS AND CELLULAR TELEPHONE FACE COVERS; ENCODED MAGNETIC CARDS, PHONE CARDS, CREDIT CARDS, CASH CARDS, DEBIT CARDS AND MAGNETIC KEY CARDS; AND DECORATIVE MAGNETS. (U.S. CLS. 21, 23, 26, 36 AND 38).

SN 78-145,110. CARDIOSOFT, L.P., HOUSTON, TX. FILED 7-18-2002.

ENCARDIA

FOR MEDICAL EQUIPMENT, NAMELY, COMPUTER HARDWARE AND SOFTWARE, SOLD AS AN INTEGRAL COMPONENT THEREFORE, FOR USE IN INTERPRETING, STORING, PRESENTING, AND COMMUNICATING ECG DATA AND RELATED INFORMATION (U.S. CLS. 21, 23, 26, 36 AND 38).

SN 78-145,189. GALLS INC., LEXINGTON, KY. FILED 7-18-2002.

STREETTHUNDER

FOR EMERGENCY AND SAFETY EQUIPMENT; NAMELY, ELECTRONIC CONTROL APPARATUS FOR REGULATING LIGHTS, SIREN, RADIO, RADAR AND OTHER ELECTRIC EQUIPMENT IN LAW ENFORCEMENT, FIRE AND PUBLIC SAFETY VEHICLES (U.S. CLS. 21, 23, 26, 36 AND 38).

FIRST USE 7-1-1994; IN COMMERCE 7-1-1994.

SN 78-148,188. SIEMENS AKTIENGESELLSCHAFT, MUNICH, FED REP GERMANY, FILED 7-28-2002.

CT56

FOR TELEPHONES, MOBILE TELEPHONES, ELECTRIC ACCUMULATORS, BATTERIES, AUTOMOBILE ACCESSORIES FOR MOBILE TELEPHONES, NAMELY, SUPPORTS, HANDS-FREE SETS, CHARGING CABLES, CHARGING UNITS, CHARGING STATIONS, HEADSETS, MOUSE DEVICES, NAMELY, COMPUTER CURSER CONTROL DEVICES, NAMELY, COMPUTER MOUSE (U.S. CLS. 21, 23, 26, 36 AND 38).

CLASS 9—(Continued).

SN 78-148,540. ELECTROCOIN LEISURE (S. WALES) LIMITED, LONDON, UNITED KINGDOM, FILED 7-29-2002.

BAR-X

FOR GAMING MACHINES, SLOT MACHINES (U.S. CLS. 21, 23, 26, 36 AND 38).

SN 78-148,572. IGT, RENO, NV. FILED 7-29-2002.

EKEY

FOR COMPUTER HARDWARE FOR STORING, PROTECTING, AND ACCESSING DATA AND SOFTWARE FOR USE IN CONNECTION WITH GAMING MACHINES. (U.S. CLS. 21, 23, 26, 36 AND 38).

CLASS 9—(Continued).

SN 78-148,859. MINOLTA KABUSHIKI KAISHA (MINOLTA CO., LTD.), OSAKA-SHI, UNITED STATES, FILED 7-30-2002.

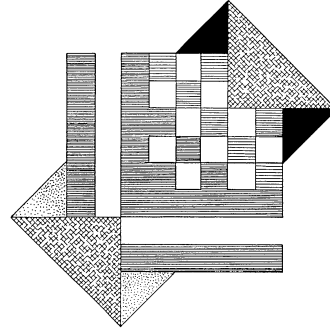

THE DRAWING IS LINED FOR THE COLOR(S) BLUE AND ORANGE. THE STIPPLING INDICATES SHADING.

FOR SOFTWARE FOR CONTROLLING IMAGE FORMING APPARATUS, NAMELY, SOFTWARE FOR CONTROLLING COPYING MACHINES, COMPUTER PRINTERS, FACSIMILES, MULTIFUNCTIONAL PRODUCTS HAVING FUNCTIONS OF COPYING, PRINTING AND SCANNING, IMAGE SCANNERS, FILM SCANNERS OR DIGITAL CAMERAS; SOFTWARE FOR CONNECTING A NETWORK WITH IMAGE FORMING APPARATUS, NAMELY, SOFTWARE FOR CONNECTING COPYING MACHINES, COMPUTER PRINTERS, FACSIMILES, MULTIFUNCTIONAL PRODUCTS HAVING FUNCTIONS OF COPYING, PRINTING AND SCANNING, IMAGE SCANNERS, FILM SCANNERS OR DIGITAL CAMERAS WITH THE COMPUTER NETWORK; SOFTWARE FOR USE IN IMAGE FORMING APPARATUS, NAMELY, GRAPHIC SOFTWARE OR IMAGE EDITING SOFTWARE FOR USE IN COPYING MACHINES, COMPUTER PRINTERS, FACSIMILES, MULTIFUNCTIONAL PRODUCTS HAVING FUNCTIONS OF COPYING, PRINTING AND SCANNING, IMAGE SCANNERS, FILM SCANNERS OR DIGITAL CAMERAS; ELECTRO-PHOTOGRAPHIC COPYING MACHINES; PRINTERS, NAMELY, COMPUTER PRINTERS, LASER PRINTERS, INK-JET PRINTERS, DOT-IMPACT PRINTERS OR THERMAL-HEAD PRINTERS; FACSIMILE MACHINES; MULTIFUNCTIONAL PRODUCTS HAVING FUNCTIONS OF COPYING, PRINTING AND SCANNING (U.S. CLS. 21, 23, 26, 36 AND 38).

SN 78-149,683. MCKESSON CORPORATION, SAN FRANCISCO, CA. FILED 8-1-2002.

AUTOLINK

FOR COMPUTER SOFTWARE FOR PHARMACY AUTOMATION, NAMELY COMPUTER SOFTWARE FOR USE IN OPERATING AUTOMATION EQUIPMENT TO COUNT, DISPENSE, REPLENISH, AND TRACK MEDICATION AND FOR USE IN PREPARING REPORTS ON MEDICATION INVENTORY AND PHARMACY PERSONNEL ACTIVITY (U.S. CLS. 21, 23, 26, 36 AND 38).

CLASS 9—(Continued).

SN 78-150,086. CUBICLE DECOR, LLC, LOUISVILLE, KY. FILED 8-2-2002.

CUBE BUCKS

NO CLAIM IS MADE TO THE EXCLUSIVE RIGHT TO USE "BUCKS", APART FROM THE MARK AS SHOWN.

FOR COUPONS WHICH ARE USED ELECTRONICALLY THAT ACT AS MARKETING DEVICES USED AS AN INCENTIVE FOR INDIVIDUALS TO PURCHASE RETAIL GOODS, NAMELY ITEMS SUITABLE FOR BUSINESS CUBICLES, OFFICES AND OTHER BUSINESS ENVIRONMENTS; COUPONS WHICH ARE USED ELECTRONICALLY THAT CAN BE USED TO RECEIVE DISCOUNTS ON DECOR FOR CUBICLES AND OFFICES, NAMELY, STATUES, GLASSWARE, DOLLS, HOLIDAY DECORATIONS, GENERAL OFFICE SUPPLIES, FLOWER STANDS, HERITAGE DECORATIONS, LAMPS, FANS, PICTURES, PICTURE FRAMES, POSTERS, AND THE LIKE (U.S. CLS. 21, 23, 26, 36 AND 38).

SN 78-150,455. ENIGMA GAMES, MEMPHIS, TN. FILED 8-2-2002.

ΡΛΠΤΗΣΘΠ

FOR COMPUTER SOFTWARE GAMES, COMPUTER SOFTWARE GAME PROGRAMS, COMPUTER GAME CARTRIDGES AND CD-ROM DISCS FEATURING VIDEO GAMES FOR ENTERTAINMENT USES, AND USER MANUALS SOLD AS A UNIT (U.S. CLS. 21, 23, 26, 36 AND 38).

SN 78-151,002. INTERNATIONAL MICROWAVE CORPORATION, EAST NORWALK, CT. FILED 8-5-2002.

WATCHTOWER

FOR VIDEO SURVEILLANCE SYSTEMS COMPRISING VIDEO CAMERAS, VIDEO MONITORS, AND OPERATING HARDWARE AND SOFTWARE (U.S. CLS. 21, 23, 26, 36 AND 38).

SN 78-151,005. INTERNATIONAL MICROWAVE CORPORATION, EAST NORWALK, CT. FILED 8-5-2002.

IMC WATCHTOWER

FOR VIDEO SURVEILLANCE SYSTEMS COMPRISING VIDEO CAMERAS, VIDEO MONITORS, AND OPERATING HARDWARE AND SOFTWARE (U.S. CLS. 21, 23, 26, 36 AND 38).

CLASS 9—(Continued).

SN 78-151,241. FLARION TECHNOLOGIES, INC., BEDMINSTER, NJ. FILED 8-6-2002.

MAKE THE INTERNET MOVE

FOR TELECOMMUNICATIONS EQUIPMENT, NAMELY, BASE STATIONS, RADIOS, MODEMS, TERMINALS, COMMUNICATIONS CHIP SETS, APPLICATION SPECIFIC INTEGRATED CIRCUITS (ASICS), CELLULAR TELEPHONES, ROUTERS, WIRELESS LOCAL AREA NETWORK (LAN) CARDS, AND MODEMS USED IN WIRELESS DATA ACCESS NETWORKS; COMPUTER SOFTWARE TO FACILITATE WIRELESS INTERNET ACCESS (U.S. CLS. 21, 23, 26, 36 AND 38).
FIRST USE 1-0-2002; IN COMMERCE 1-0-2002.

SN 78-151,249. LEDBETTER, GARY, L, MONTGOMERY, AL. FILED 8-6-2002.

BALLOON CALCULATOR

SEC. 2(F).
FOR COMPUTER SOFTWARE FOR ESTIMATING THE AMOUNT AND COST OF BALLOONS USED IN DECORATING JOBS (U.S. CLS. 21, 23, 26, 36 AND 38).
FIRST USE 11-10-1997; IN COMMERCE 11-10-1997.

SN 78-151,306. IMMERSION CORPORATION, SAN JOSE, CA. FILED 8-6-2002.

CYBERTOUCH

FOR COMPUTER SYSTEM COMPRISED OF HARDWARE AND SOFTWARE INCORPORATING TACTILE STIMULATORS TO PROVIDE FORCE AND TACTILE SENSATION TO THE HAND (U.S. CLS. 21, 23, 26, 36 AND 38).
FIRST USE 2-28-1996; IN COMMERCE 2-28-1996.

CLASS 9—(Continued).

SN 78-151,669. SKYBOX SECURITY, INC., BURLINGTON, MA. FILED 8-7-2002.

skybox
security

NO CLAIM IS MADE TO THE EXCLUSIVE RIGHT TO USE "SECURITY", APART FROM THE MARK AS SHOWN.

FOR SOFTWARE FOR INFORMATION ASSET, SECURITY, THREAT AND VULNERABILITY RISK ASSESSMENT, EVALUATION AND MANAGEMENT IN THE FIELD OF ELECTRONIC INFORMATION SECURITY; COMPUTER SOFTWARE USED TO DEVELOP INFORMATION TECHNOLOGY SOLUTIONS FOR REDUCING INFORMATION, ASSET, AND SECURITY THREATS AND INFORMATION TECHNOLOGY VULNERABILITY RISKS FOR BUSINESSES; SOFTWARE FOR DESIGNING AND DEVELOPING INFORMATION AVAILABILITY, INTEGRITY AND SECURITY SOLUTIONS (U.S. CLS. 21, 23, 26, 36 AND 38).

SN 78-151,824. RUTKEVITZ, BEN, BRONX, NY. AND LEE, MITCHELL P., BRONX, NY. FILED 8-7-2002.

WEIGHTERASER

FOR DECORATIVE REFRIGERATOR MAGNET THAT CONTAINS PRINTED NUTRITIONAL INFORMATION IN A CHART FORMAT; AND PRERECORDED VIDEO TAPES FEATURING FITNESS AND NUTRITIONAL INFORMATION (U.S. CLS. 21, 23, 26, 36 AND 38).

SN 78-152,266. UNIVERSAL BUSINESS MATRIX, LLC, SAMMAMISH, WA. FILED 8-8-2002.

UBmatrix
automating data exchange

NO CLAIM IS MADE TO THE EXCLUSIVE RIGHT TO USE "AUTOMATING DATA EXCHANGE", APART FROM THE MARK AS SHOWN.

FOR SOFTWARE THAT AUTOMATICALLY CAPTURES DATA FROM VIRTUALLY ANY APPLICATION AND CONVERTS THE DATA INTO COMMON GLOBAL LANGUAGES SUCH AS XML AND ITS DERIVATIVES, XBRL, EBXML, HXML (U.S. CLS. 21, 23, 26, 36 AND 38).

CLASS 9—(Continued).

SN 78-154,576. MACHINETALKER, INC., GOLETA, CA. FILED 8-15-2002.

TINYTALKER

FOR COMPUTER SOFTWARE AND HARDWARE FOR USE IN NETWORKING MACHINES, NAMELY STAND-ALONE EXTERNAL HARD-WIRED OR WIRELESS MODULES COMPRISING MICROCONTROLLERS THAT FACILITATE SELF CONFIGURING NETWORKS FOR SHARING AND PROCESSING INFORMATION AMONG MODULES (U.S. CLS. 21, 23, 26, 36 AND 38).

SN 78-160,093. SVANTE BJORK AB, KUNGSBACKA, SWEDEN, FILED 9-3-2002.

DOTCHECKER

FOR INSTRUMENTS FOR DETECTION, INSPECTION, MEASURING AND ANALYSIS OF CONTAMINANTS IN RAW MATERIAL FOR POWER CABLES (U.S. CLS. 21, 23, 26, 36 AND 38).

SN 78-160,650. KOSAN CRISPLANT A/S, AARHUS N, DENMARK, FILED 9-4-2002.

KOSAN CRISPLANT

OWNER OF DENMARK REG. NO. VR200104491, DATED 11-7-2001, EXPIRES 11-7-2011.

THE NAME DOES NOT IDENTIFY A LIVING INDIVIDUAL.

FOR ELECTRIC AND ELECTRONIC APPARATUS AND INSTRUMENTS FOR FILLING GAS INTO SYSTEMS FOR GAS CYLINDERS, NAMELY COMPUTER SOFTWARE AND HARDWARE, CONTROL EQUIPMENT, AND MEASURING AND CONTROL APPARATUS; APPARATUS AND INSTRUMENTS FOR DOSING AND MEASURING OF AS WELL AS FOR WEIGHING AND PRESSURE TESTING OF GAS CYLINDERS (U.S. CLS. 21, 23, 26, 36 AND 38).

CLASS 9—(Continued).

SN 78-161,021. MARINANGELI, MARCO, WEST HOLLYWOOD, CA. FILED 9-5-2002.



NO CLAIM IS MADE TO THE EXCLUSIVE RIGHT TO USE "MUSIC", APART FROM THE MARK AS SHOWN. FOR SERIES OF PRE-RECORDED COMPACT DISCS FEATURING MUSIC (U.S. CLS. 21, 23, 26, 36 AND 38).

SN 78-161,248. MARSH, STEVEN JOHN, GLOUCESTER GLOS, UNITED KINGDOM, FILED 9-6-2002.

XCLONE

FOR COMPUTER SOFTWARE FOR THE CLONING AND REPLICATION OF DATA AND APPLICATIONS SOFTWARE, FOR USE IN THE COMMERCIAL AND FINANCE SECTOR (U.S. CLS. 21, 23, 26, 36 AND 38).

SN 78-161,542. OLYMPUS OPTICAL CO., LTD., SHIBUYA-KU TOKYO, JAPAN, FILED 9-6-2002.



THE MARK CONSISTS OF A BLUE SQUARE WITH THE WORDS "FOUR THIRDS" WITH A DESIGN ELEMENT WITHIN THE SQUARE.

FOR DIGITAL CAMERAS, INTERCHANGEABLE LENSES FOR DIGITAL CAMERAS AND PARTS AND ACCESSORIES, NAMELY LENS CAPS, LENS HOODS, FLASHES, REMOTE CONTROLS, EXTENSION LENSES, BATTERIES, AC ADAPTERS, CAMERA CASES, MEMORY CARDS, TRIPODS, LENS FILTERS AND CAMERA STRAPS (U.S. CLS. 21, 23, 26, 36 AND 38).

CLASS 9—(Continued).

SN 78-162,507. COOGI PARTNERS, LLC, BROOKLYN, NY. BY ASSIGNMENT COOGI NOMINEES PTY LTD (ADMINISTRATORS APPOINTED), ABBOTSFORD, AUSTRALIA, FILED 9-10-2002.

COOGI

FOR EYEWEAR, NAMELY SUNGLASSES AND EYE GLASSES (U.S. CLS. 21, 23, 26, 36 AND 38).

SN 78-162,622. GAMEHOUSE, INC., SEATTLE, WA. FILED 9-10-2002.

SUPER TEXTTWIST

NO CLAIM IS MADE TO THE EXCLUSIVE RIGHT TO USE "SUPER", APART FROM THE MARK AS SHOWN.

FOR DOWNLOADABLE ELECTRONIC GAMES SOFTWARE FOR PLAYING GAMES OVER COMPUTER NETWORKS (U.S. CLS. 21, 23, 26, 36 AND 38).

FIRST USE 10-0-2001; IN COMMERCE 10-0-2001.

SN 78-163,172. FARSTONE TECHNOLOGY INC., IRVINE, CA. FILED 9-11-2002.

SYSTEMSPY

FOR COMPUTER HARDWARE, NAMELY, COMPUTERS, MICROCOMPUTERS, IC MOTHERBOARDS, HARD DRIVES, MAGNETIC OPTICAL DRIVES, CD-ROM DRIVES, PRINTERS, PLOTTERS, CD-RECORDING DRIVES, FLOPPY DISC DRIVES, CACHE RANDOM ACCESS MEMORY CONTROLLERS, COMPUTER INTERFACE CONTROLLERS; COMPUTER FIRMWARE FOR SNAPSHOT RECORDING, CHAT RECORDING, KEYSTROKE RECORDING, EMAIL RECORDING, WEBSITE RECORDING AND MACHINE STATUS RECORDING; COMPUTER UTILITY PROGRAMS; COMPUTER OPERATING SYSTEM SOFTWARE; COMPUTER SOFTWARE FOR MONITORING COMPUTER HARDWARE; PERSONAL DIGITAL ASSISTANTS, BLANK COMPUTER HARD DISKS, CD REWRITEABLE DISK DRIVES, COMPUTER PRINTERS AND RAM MEMORY CARD UNITS; COMPUTER FIRMWARE FOR EXAMINING INFORMATION OF COMPUTER DATA; COMPUTER SOFTWARE FOR PROVIDING COMPUTER-AIDED TEACHING AT A REMOTE COMPUTER TERMINAL, CHOOSING AND TAKING COURSES ON DEMAND, AND TAKING EXAMS ON A COMPUTER; MULTIMEDIA SOFTWARE FOR AUDIO AND VIDEO CONFERENCING, BROADCASTING VIDEO PROGRAMS AND AUDIO PROGRAMS, AND ACCESSING CDS; COMPUTER SOFTWARE FOR SNAPSHOT RECORDING, CHAT RECORDING, KEYSTROKE RECORDING, EMAIL RECORDING, WEBSITE RECORDING AND MACHINE STATUS RECORDING; COMPUTER SOFTWARE FOR EXAMINING INFORMATION OF COMPUTER DATA; COMPUTER SOFTWARE FOR WEB BROWSING ON A GLOBAL COMPUTER NETWORK, CREATING AND MODIFYING WEB PAGES, DISK CACHING AND CD-ROM CACHING; CACHE MANAGEMENT SYSTEMS, NAMELY A CONTROLLER, HIGH AND LOW SPEED DIGITAL STORAGE MEMORIES; COMPUTER FIRMWARE FOR MONITORING COMPUTER HARDWARE; AND COMPUTER SOFTWARE FOR CONNECTING PERSONAL COMPUTERS TO THE GLOBAL COMPUTER NETWORK (U.S. CLS. 21, 23, 26, 36 AND 38).

CLASS 9—(Continued).

SN 78-165,681. HORST SIEDLE GMBH & CO. KG, FURT-WANGEN, FED REP GERMANY, FILED 9-19-2002.

DYMOS

PRIORITY CLAIMED UNDER SEC. 44(D) ON FED REP GERMANY APPLICATION NO. 302223679, FILED 5-2-2002, REG. NO. 3022236, DATED 7-23-2002, EXPIRES 5-31-2012.

FOR INTERFACES FOR MAGNETOSTRICTIVE POSITION MEASURING SENSORS FOR USE IN THE FIELD OF INDUSTRIAL MACHINES, SUCH AS, INJECTION MOLDING MACHINES, MACHINES FOR PRESSING, STAMPING, BENDING, AND BEADING OF METAL; STONE WORKING MACHINES; MACHINES FOR PAPER INDUSTRY FOR PAPER MANUFACTURING; MACHINES FOR GLASS WORKING; PACKAGING MACHINES; METAL WORKING MACHINES, NAMELY, PUNCH PRESSES, TURRET PRESSES, SHEET FABRICATION MACHINES, PRINTING PRESSES, PRINTING ROLLERS, WEAVING MACHINES, GLASS GRINDING MACHINES, AND ROBOTS (U.S. CLS. 21, 23, 26, 36 AND 38).

SN 78-170,029. PDM SYSTEMS INC., AUBURN, AL. FILED 10-2-2002.

SMARTSOCKET

FOR ELECTROMECHANICAL RELAYS (U.S. CLS. 21, 23, 26, 36 AND 38).
FIRST USE 8-5-2002; IN COMMERCE 10-2-2002.

SN 78-171,049. DESIGNTECH INTERNATIONAL, INC., SPRINGFIELD, VA. FILED 10-4-2002.

BACK-UP ALERT

SEC. 2(F).
FOR VEHICULAR WARNING ALARMS AND LIGHTS FOR USE IN WARNING OTHERS WHEN A VEHICLE IS BACKING UP (U.S. CLS. 21, 23, 26, 36 AND 38).
FIRST USE 0-0-1991; IN COMMERCE 0-0-1991.

SN 78-171,810. GAME SOURCE, INC., DBA GAME SOURCE, SUNSET HILLS, MO. BY CHANGE OF NAME VIRTUAL VIDEO VISIONS, INC., SUNSET HILLS, MO. FILED 10-7-2002.

GAME SOURCE

NO CLAIM IS MADE TO THE EXCLUSIVE RIGHT TO USE "GAME", APART FROM THE MARK AS SHOWN.
FOR VIDEO GAME SOFTWARE (U.S. CLS. 21, 23, 26, 36 AND 38).

CLASS 9—(Continued).

SN 78-173,345. STYLEEASE SOFTWARE, LLC, APTOS, CA. FILED 10-11-2002.

StyleEase

FOR COMPUTER SOFTWARE FOR USE WITH WORD PROCESSING PROGRAMS TO FORMAT DOCUMENTS AND BIBLIOGRAPHIC INFORMATION IN SPECIFIC FORMATS. (U.S. CLS. 21, 23, 26, 36 AND 38).
FIRST USE 4-12-2000; IN COMMERCE 9-0-2000.

SN 78-173,428. PRO GROUP, INC., ENGLEWOOD, CO. FILED 10-11-2002.

PROVEN ALKALINE

NO CLAIM IS MADE TO THE EXCLUSIVE RIGHT TO USE "ALKALINE", APART FROM THE MARK AS SHOWN.
FOR BATTERIES AND BATTERY CHARGERS (U.S. CLS. 21, 23, 26, 36 AND 38).
FIRST USE 4-30-2003; IN COMMERCE 4-30-2003.

SN 78-174,003. ZENOGRAPHICS, IRVINE, CA. FILED 10-14-2002.

CODECHANNEL

FOR CLIENT/SERVER SOFTWARE FOR THE INSTALLATION, LOCALIZATION, AND MAINTENANCE OF COMPUTER SOFTWARE (U.S. CLS. 21, 23, 26, 36 AND 38).
FIRST USE 9-16-2002; IN COMMERCE 9-16-2002.

SN 78-174,319. PRIVATE BUSINESS INC., BRENTWOOD, TN. FILED 10-15-2002.



NO CLAIM IS MADE TO THE EXCLUSIVE RIGHT TO USE "LINE MANAGER", APART FROM THE MARK AS SHOWN.
FOR DOWNLOADABLE COMPUTER SOFTWARE FOR MONITORING AND OPERATING ACCOUNTS AT FINANCIAL INSTITUTIONS (U.S. CLS. 21, 23, 26, 36 AND 38).
FIRST USE 10-1-2002; IN COMMERCE 10-1-2002.

CLASS 9—(Continued).

SN 78-174,385. CREATIVE TECHNOLOGY LTD., SINGAPORE, SINGAPORE, FILED 10-15-2002.

I-TRIGUE

FOR COMPUTER HARDWARE; COMPUTER PERIPHERALS; AMPLIFIERS, RADIO AMPLIFYING TUBES, AMPLIFYING VALVES, ACOUSTIC COUPLERS, ACOUSTIC DIAPHRAGMS, AND LOUDSPEAKERS; COMPUTER SOFTWARE TO CONTROL AND IMPROVE COMPUTER AND AUDIO EQUIPMENT SOUND QUALITY; COMPUTER SOFTWARE FOR THE STORAGE, REPRODUCTION, TRANSMISSION AND EDITING OF SOUND; ELECTRONIC AUDIO COMPONENTS, NAMELY, AMPLIFIERS, AUDIO RECEIVERS, STEREO RECEIVERS, STEREO LOUDSPEAKERS, DIGITAL AUDIO AND VIDEO PLAYERS, AND COMPACT DISC PLAYERS (U.S. CLS. 21, 23, 26, 36 AND 38).

FIRST USE 11-0-2002; IN COMMERCE 11-0-2002.

SN 78-174,919. OPTION CARE, INC., BUFFALO GROVE, IL. FILED 10-16-2002.

IEMPHYSYS

FOR SOFTWARE FOR USE IN DATABASE MANAGEMENT THAT PROVIDES CLINICAL AND REIMBURSEMENT FEATURES IN THE FIELDS OF HOME INFUSION AND OTHER HOME MEDICAL THERAPY (U.S. CLS. 21, 23, 26, 36 AND 38).

SN 78-175,323. MEDIA RECOVERY, INC., DALLAS, TX. FILED 10-17-2002.

SHOCKSWITCH

SEC. 2(F).
FOR DETECTORS FOR MONITORING IMPACTS (U.S. CLS. 21, 23, 26, 36 AND 38).

FIRST USE 2-27-1993; IN COMMERCE 2-27-1993.

SN 78-175,628. PROTECTIVE COATING DEVELOPMENTS, INC., TINTON FALLS, NJ. FILED 10-17-2002.

KORKAP

FOR PLASTIC-COATED ELECTRICAL CONDUIT; ELECTRICAL CONDUIT FITTINGS; AND ELECTRICAL CONDUIT SUPPORTS, NAMELY, STRAPS, HANGERS, STRUTS, CLAMPS, AN U-BOLTS, AND FITTINGS THEREFOR (U.S. CLS. 21, 23, 26, 36 AND 38).

FIRST USE 9-11-1967; IN COMMERCE 11-21-1967.

CLASS 9—(Continued).

SN 78-176,786. EONFOCUS, LLC, CANTON, MI. FILED 10-21-2002.

DIGITAL LANGUAGE PAL

NO CLAIM IS MADE TO THE EXCLUSIVE RIGHT TO USE "DIGITAL LANGUAGE", APART FROM THE MARK AS SHOWN.

FOR CASSETTE RECORDER, CD PLAYER, DIGITAL MP3 SOLID-STATE PLAYER, AND ELECTRONIC INSTRUMENTS NAMELY, A HAND-HELD ELECTRONIC DEVICE OR OTHER DIGITAL FORMAT PLAYER WITH EMBEDDED DIGITAL MEMORY FOR LANGUAGE LEARNING, SPEECH THERAPY, OR OTHER LEARNING AND ENTERTAINMENT PURPOSES (U.S. CLS. 21, 23, 26, 36 AND 38).

FIRST USE 9-28-2002; IN COMMERCE 10-17-2002.

SN 78-177,520. HEYMAN, ALFRED, J., NASHVILLE, TN. FILED 10-23-2002.

PARACODER

FOR COMPUTER PROGRAMS WHICH GENERATE SOURCE CODE FOR DATABASE COMPUTER PROGRAMS (U.S. CLS. 21, 23, 26, 36 AND 38).

FIRST USE 10-23-2002; IN COMMERCE 10-23-2002.

SN 78-177,642. SYNTEL, LLC, JONESBORO, AR. FILED 10-23-2002.



OWNER OF U.S. REG. NO. 2,684,974.

NO CLAIM IS MADE TO THE EXCLUSIVE RIGHT TO USE "AUTOMAIL" AND "USA", APART FROM THE MARK AS SHOWN.

FOR COMPUTER SOFTWARE FOR FORMATTING AND ORGANIZING NAMES AND ADDRESSES TO MEET POSTAL SERVICE AUTOMATION STANDARDS (U.S. CLS. 21, 23, 26, 36 AND 38).

FIRST USE 6-30-1999; IN COMMERCE 6-30-1999.

SN 78-177,833. TAXTIME USA, INC., BINGHAM FARMS, MI. FILED 10-24-2002.

CITY EXPRESS

NO CLAIM IS MADE TO THE EXCLUSIVE RIGHT TO USE "CITY", APART FROM THE MARK AS SHOWN.

FOR SOFTWARE FOR USE TO PERFORM ACCOUNTING FUNCTIONS (U.S. CLS. 21, 23, 26, 36 AND 38).

FIRST USE 0-0-1995; IN COMMERCE 0-0-1995.

CLASS 9—(Continued).

SN 78-179,037. GATHAN GRAHAM MUSIC, INC., NORMAN, OK. FILED 10-28-2002.

MUSIC THAT SPEAKS PEACE TO YOUR SOUL

FOR MUSICAL SOUND RECORDINGS IN THE FIELD OF INSTRUMENTAL PIANO (U.S. CLS. 21, 23, 26, 36 AND 38).

FIRST USE 9-1-2001; IN COMMERCE 9-1-2001.

SN 78-181,476. BULLANT STUDIOS PTY LTD, MELBOURNE, VICTORIA, AUSTRALIA, FILED 11-4-2002.

LEGEND HAS IT

FOR INTERACTIVE VIDEO GAME SOFTWARE FOR ENTERTAINMENT PURPOSES (U.S. CLS. 21, 23, 26, 36 AND 38).

FIRST USE 3-1-2002; IN COMMERCE 8-1-2002.

SN 78-182,101. TOPE, MICHAEL, A, COLUMBIA, MD. FILED 11-5-2002.

COOPERATIVE DIVERSITY

FOR WIRELESS TELECOMMUNICATIONS EQUIPMENT, NAMELY, WIRELESS TELEPHONES, PAGERS, AND PERSONAL DIGITAL ASSISTANTS; WIRELESS ADHOC NETWORKING EQUIPMENT, NAMELY, WIRELESS APPLICATION PROTOCOL RECEIVERS AND TRANSMITTERS, DATA TRANSCEIVERS, TELECOMMUNICATIONS SWITCHES, RADIO TRANSMITTERS AND RADIO RECEIVERS, ANTENNAS, SIGNAL TRANSFER POINT SERVERS, WIRELESS LOCAL LOOPS, HOME LOCATION REGISTERS, CONVERTERS FOR DIGITAL AND ANALOG FREQUENCY CONVERSIONS, HIGH SPEED DIGITAL ROUTERS, MODEMS, SWITCHES AND MULTIPLEXERS; AND COMPUTER SOFTWARE USED TO EVALUATE THE INTEGRITY OF RECEIVERS AND NETWORK DEVICES PRIOR TO INSTALLING THEM INTO A WIRELESS COMMUNICATIONS SYSTEM (U.S. CLS. 21, 23, 26, 36 AND 38).

CLASS 9—(Continued).

SN 78-183,753. LEAPFROG ENTERPRISES, INC., EMERYVILLE, CA. FILED 11-11-2002.



FOR CD-ROMS AND AUDIOTAPES FEATURING EDUCATIONAL LESSONS AND GAMES IN THE FIELD OF MATH, SCIENCE, LANGUAGE ARTS, ART, GEOGRAPHY, MUSIC GEOLOGY, READING, PHONICS, SOCIAL STUDIES, AND GENERAL TRIVIA; EDUCATIONAL SKILLS DEVELOPMENT AND ASSESSMENT SOFTWARE FOR EDUCATORS AND PARENTS DESIGNED FOR USE IN CONJUNCTION WITH LEARNING DEVICES FOR CHILDREN, NAMELY, SOFTWARE, AVAILABLE ON CD-ROM, SOFTWARE CARTRIDGES, AND DOWNLOADABLE SOFTWARE FROM A REMOTE COMPUTER LOCATION, THAT DEVELOPS, ASSESSES, AND PRESCRIBES ACADEMIC SKILL LEVELS IN THE FIELDS OF MATH, SCIENCE, LANGUAGE ARTS, ART, GEOGRAPHY, GEOLOGY, READING, PHONICS, SOCIAL STUDIES, AND GENERAL TRIVIA (U.S. CLS. 21, 23, 26, 36 AND 38).

SN 78-184,590. MAXIM TECHNOLOGY PTY LIMITED, SYDNEY, AUSTRALIA, FILED 11-13-2002.

INPROTECH

PRIORITY CLAIMED UNDER SEC. 44(D) ON AUSTRALIA APPLICATION NO. 2699866, FILED 5-16-2002.

FOR COMPUTER SOFTWARE, INCLUDING COMPUTER SOFTWARE FOR USE IN THE FIELD OF INTELLECTUAL PROPERTY PRACTICE AND RECORDS MANAGEMENT (U.S. CLS. 21, 23, 26, 36 AND 38).

SN 78-184,626. BOSTON ACOUSTICS, INC., PEABODY, MA. FILED 11-13-2002.

KORTEC

FOR TWEETERS (U.S. CLS. 21, 23, 26, 36 AND 38).
FIRST USE 12-0-1994; IN COMMERCE 12-0-1994.

CLASS 9—(Continued).

SN 78-184,868. SCHNEDLER, DAVID E., PALO ALTO, CA.
FILED 11-13-2002.

METARI

FOR DISPENSERS THAT COUNT OR MEASURE OUTPUT FOR USE WITH FOODS (U.S. CLS. 21, 23, 26, 36 AND 38).

SN 78-188,569. STALEY, JACQUELINE J., TAMPA, FL.
FILED 11-25-2002.

JACKIE O

THE MARK IS A NICKNAME OF THE APPLICANT, WHOSE CONSENT IS EVIDENCED BY SIGNING THE APPLICATION.

FOR SERIES OF MUSICAL SOUND RECORDINGS (U.S. CLS. 21, 23, 26, 36 AND 38).

SN 78-189,120. BLACKHAWK-PAS, INC, GREENVILLE, SC.
FILED 11-26-2002.

PAS VISION

OWNER OF U.S. REG. NOS. 2,642,087 AND 2,697,184.
FOR COMPUTER SOFTWARE FOR ANALYZING PIPE (U.S. CLS. 21, 23, 26, 36 AND 38).

SN 78-189,455. VERAMARK TECHNOLOGIES, INC., PITTSFORD, NY. FILED 11-27-2002.

VERASMART

FOR COMPUTER SOFTWARE FOR TELECOMMUNICATIONS MANAGEMENT, NAMELY FOR PROCESSING VOICE AND DATA CALL DETAIL AND BILLING RECORDS, SERVICE AND MAINTENANCE RECORDS AND EQUIPMENT LOCATION AND INVENTORY RECORDS (U.S. CLS. 21, 23, 26, 36 AND 38).
FIRST USE 4-30-2003; IN COMMERCE 4-30-2003.

SN 78-191,489. REDCLOVER NETWORKS, INC., SUNNYVALE, CA. FILED 12-5-2002.

TRANSDAPTOR

FOR OPTICAL TRANSPONDERS (U.S. CLS. 21, 23, 26, 36 AND 38).

CLASS 9—(Continued).

SN 78-191,753. LAPTOP INC., DBA GLOBAL COMPUTERS, SAN JOSE, CA. FILED 12-5-2002.

PORTABLE1

FOR LAPTOP COMPUTERS AND ACCESSORIES THEREFOR, NAMELY, AC ADAPTORS, LAPTOP COMPUTER BATTERIES, LAPTOP COMPUTER CARRYING CASES, MEMORY CARDS FOR PERSONAL COMPUTERS, MEMORY MODULES IN THE NATURE OF RAM MEMORY FOR LAPTOP COMPUTERS, COMPUTER DISC DRIVES, CD-ROM DRIVES FOR LAPTOP COMPUTERS AND DVD DRIVES FOR LAPTOP COMPUTERS; COMPUTER HARDWARE (U.S. CLS. 21, 23, 26, 36 AND 38).

SN 78-191,875. WNBA ENTERPRISES, LLC, SECAUCUS, NJ.
FILED 12-6-2002.

SAN ANTONIO SILVER STARS

OWNER OF U.S. REG. NOS. 2,202,058, 2,547,062 AND OTHERS.

NO CLAIM IS MADE TO THE EXCLUSIVE RIGHT TO USE "SAN ANTONIO", APART FROM THE MARK AS SHOWN.

FOR PRE-RECORDED AUDIO, VIDEO, COMPUTER AND LASER DISCS, PRE-RECORDED AUDIO AND VIDEO CASSETTES, PRE-RECORDED AUDIO AND VIDEO TAPES, PRE-RECORDED COMPACT DISCS, PRE-RECORDED COMPUTER DISCS, ALL RELATED TO BASKETBALL; COMPUTER ACCESSORIES, NAMELY MOUSE PADS, MICE, DISC CASES, COMPUTER CARRY-ON CASES, KEYBOARD WRIST PADS, COMPUTER MONITOR CARDBOARD FRAMES, ALL RELATED TO BASKETBALL; COMPUTER PROGRAMS FOR VIEWING INFORMATION, STATISTICS OR TRIVIA ABOUT BASKETBALL; COMPUTER SOFTWARE, NAMELY SCREEN SAVERS FEATURING BASKETBALL THEMES, COMPUTER SOFTWARE TO ASSESS AND VIEW COMPUTER WALLPAPER, COMPUTER BROWSERS, COMPUTER SKINS AND COMPUTER CURSORS; COMPUTER GAME SOFTWARE; VIDEO GAME SOFTWARE, VIDEO GAME CARTRIDGES AND VIDEO GAME MACHINES FOR USE WITH TELEVISIONS; RADIO AND TELEPHONES; BINOCULARS; SUNGLASSES; EYEGLASS FRAMES; EYEWEAR STRAPS AND CHAINS; EYEGLASS AND SUNGLASS CASES; MAGNETS; DISPOSABLE CAMERAS; CREDIT CARDS AND PRE-PAID TELEPHONE CALLING CARDS MAGNETICALLY ENCODED, DOWNLOADABLE VIDEO RECORDINGS, VIDEO STREAM RECORDINGS, AND AUDIO RECORDINGS IN THE FIELD OF BASKETBALL PROVIDED OVER THE INTERNET; DOWNLOADABLE COMPUTER SOFTWARE FOR VIEWING DATABASES OF INFORMATION, STATISTICAL INFORMATION, TRIVIA, POLLING INFORMATION, AND INTERACTIVE POLLING IN THE FIELD OF BASKETBALL PROVIDED OVER THE INTERNET; DOWNLOADABLE COMPUTER GAME SOFTWARE; VIDEO GAME PROGRAMS, INTERACTIVE VIDEO GAMES AND TRIVIA GAME SOFTWARE PROVIDED OVER THE INTERNET; DOWNLOADABLE COMPUTER SOFTWARE FOR USE AS SCREEN SAVERS, WALLPAPER, BROWSERS, SKINS, AVATARS AND CURSORS OVER THE INTERNET; DOWNLOADABLE ELECTRONIC PUBLICATIONS IN THE NATURE OF MAGAZINES, NEWSLETTERS, COLORING BOOKS, GAME SCHEDULES ALL IN THE FIELD OF BASKETBALL PROVIDED OVER THE INTERNET; DOWNLOADABLE CATALOGS PROVIDED OVER THE INTERNET FEATURING AN ARRAY OF BASKETBALL-THEMED PRODUCTS; DOWNLOADABLE GREETING CARDS PROVIDED OVER THE INTERNET (U.S. CLS. 21, 23, 26, 36 AND 38).

CLASS 9—(Continued).

SN 78-192,220. ULTIMATE TECHNOLOGY CORPORATION, VICTOR, NY. FILED 12-7-2002.



OWNER OF U.S. REG. NOS. 2,022,127 AND 2,023,727.
NO CLAIM IS MADE TO THE EXCLUSIVE RIGHT TO USE "TECHNOLOGY", APART FROM THE MARK AS SHOWN.

THE STIPPLING IS FOR SHADING PROPOSES ONLY AND DOES NOT INDICATE COLOR.

FOR POINT OF SALE ELECTRONIC TERMINALS, SOLD WITH OR WITHOUT CASH DRAWERS, POINT OF SALE ELECTRONIC DISPLAYS, ELECTRONIC POINT OF SALE CUSTOMER DISPLAYS, ELECTRONIC POINT OF SALE POLE DISPLAYS, POINT OF SALE AND COMPUTER KEYBOARDS, BAR CODE SCANNERS, MAGNETIC CARD READERS, RECEIPT PRINTERS, COMPUTERS, COMPUTER MONITORS, TOUCH SCREEN DISPLAYS, ELECTRICAL CABLES, POWER SUPPLIES, AND COMPUTER SOFTWARE FOR OPERATING, DIAGNOSING AND PROGRAMMING THE AFORESAID GOODS (U.S. CLS. 21, 23, 26, 36 AND 38).

SN 78-193,344. ULTIMODULE, INC., SANTA CLARA, CA. FILED 12-11-2002.

ULTIMODULE

FOR SEMICONDUCTOR DEVICES AND SOFTWARE PROVIDED IN PRINTED CIRCUIT BOARDS AS TESTED HARDWARE MODULES FOR CONTROLLING FUNCTIONS IN INDUSTRIAL AUTOMATION EQUIPMENT (U.S. CLS. 21, 23, 26, 36 AND 38).

SN 78-193,400. THE POWERHOUSE, LLC, ORLANDO, FL. FILED 12-11-2002.

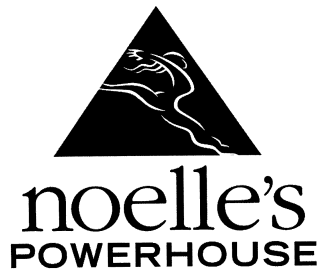

FOR VIDEO DISKS AND VIDEO TAPES FEATURING EXERCISE INSTRUCTION (U.S. CLS. 21, 23, 26, 36 AND 38).

CLASS 9—(Continued).

SN 78-194,808. MAXTOR CORPORATION, MILPITAS, CA. FILED 12-16-2002.

MAXADAPT

OWNER OF U.S. REG. NO. 2,702,248.
FOR ELECTRONIC SIGNAL FILTRATION HARDWARE SOLD AS AN INTEGRAL COMPONENT OF COMPUTER DISK DRIVES (U.S. CLS. 21, 23, 26, 36 AND 38).

FIRST USE 5-2-2002; IN COMMERCE 5-2-2002.

SN 78-195,444. FI-SHOCK, INC., KNOXVILLE, TN. FILED 12-17-2002.

POND GUARDIAN

NO CLAIM IS MADE TO THE EXCLUSIVE RIGHT TO USE "POND", APART FROM THE MARK AS SHOWN.

FOR ANIMAL DETERRENCE SYSTEM, NAMELY, ELECTRIC FENCE KITS FOR FISH AND POND PROTECTION, COMPRISED OF WIRE, WIRE SUPPORTS, AND A POWER SUPPLY. (U.S. CLS. 21, 23, 26, 36 AND 38).

SN 78-196,057. M. D. COMPUTER CONSULTANTS, INC, EL SEGUNDO, CA. FILED 12-19-2002.



THE MARK CONSISTS OF THE LETTERS, "ONNX", AND MALE FIGURE DESIGN.

FOR COMPUTER SOFTWARE PROGRAMS FOR MANAGING MEDICAL OFFICE SCHEDULING AND BILLING BUT WHICH MAY ALSO BE USED IN OTHER PROFESSIONAL PRACTICES (U.S. CLS. 21, 23, 26, 36 AND 38).

FIRST USE 9-22-2002; IN COMMERCE 9-22-2002.

CLASS 9—(Continued).

SN 78-196,855. KSERO CORPORATION, INC., RICHMOND, VA. FILED 12-20-2002.

METANON: THE BIOCODE ADVENTURE

THE WORD "METANON" IS A DERIVATIVE OF THE GREEK WORDS FOR "CHANGE" OR "CONVERSION".

FOR COMPUTER SOFTWARE AND INSTRUCTIONAL MANUALS SOLD AS A UNIT, NAMELY, VIDEO GAME SOFTWARE, VIDEO GAME PROGRAMS, VIDEO GAME CARTRIDGES, ELECTRONIC GAME SOFTWARE, ELECTRONIC GAME PROGRAMS, AND ELECTRONIC GAME CARTRIDGES, PERTAINING TO SCIENTIFIC AND COGNITIVE DEVELOPMENT; PLAYER-OPERATED ELECTRONIC CONTROLLERS FOR ELECTRONIC VIDEO GAME MACHINES; VIDEO GAME CARTRIDGE STORAGE BOXES; HOLDERS, CARRIERS AND CARRYING CASES FOR VIDEO GAME SYSTEMS (U.S. CLS. 21, 23, 26, 36 AND 38).

SN 78-197,100. HELMER LABS, INC., NOBLESVILLE, IN. FILED 12-21-2002.

SEROSPIN

FOR CENTRIFUGE USED FOR SEROLOGY TESTING BY BLOOD TRANSFUSION CENTERS (U.S. CLS. 21, 23, 26, 36 AND 38).

FIRST USE 10-22-2002; IN COMMERCE 10-22-2002.

SN 78-197,495. EARTHSEA MANAGEMENT, INC., SAUSALITO, CA. FILED 12-23-2002.

REAL MYSTIC

FOR AUDIO COMPACT DISCS FEATURING MUSIC (U.S. CLS. 21, 23, 26, 36 AND 38).

SN 78-198,304. HULLEON RECORDS, INC., FERNDALE, MI. FILED 12-27-2002.

JUSTUS BOYZ

NO CLAIM IS MADE TO THE EXCLUSIVE RIGHT TO USE "BOYS", APART FROM THE MARK AS SHOWN.

FOR MUSICAL SOUND RECORDINGS; PRE-RECORDED AUDIO-VISUAL RECORDINGS FEATURING MUSIC (U.S. CLS. 21, 23, 26, 36 AND 38).

SN 78-198,313. IGT, RENO, NV. FILED 12-27-2002.

SNOW GLOBES

FOR GAMING MACHINES, NAMELY, SLOT MACHINES OR LOTTERY TERMINALS WITH OR WITHOUT VIDEO OUTPUT. (U.S. CLS. 21, 23, 26, 36 AND 38).

CLASS 9—(Continued).

SN 78-198,324. DUGAN, CHRIS, PLEASANT HILL, CA. FILED 12-27-2002.

THE EFLECTION

FOR SERIES OF MUSICAL SOUND RECORDINGS (U.S. CLS. 21, 23, 26, 36 AND 38).

FIRST USE 5-8-2001; IN COMMERCE 1-15-2003.

SN 78-198,851. MID-USA CYCLE PARTS, INC., ST. LOUIS, MO. FILED 12-31-2002.

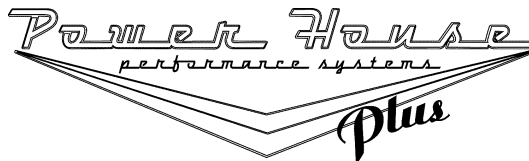

NO CLAIM IS MADE TO THE EXCLUSIVE RIGHT TO USE "PERFORMANCE SYSTEMS", APART FROM THE MARK AS SHOWN.

FOR ELECTRICAL COMPONENTS OF MOTORCYCLES, NAMELY, BATTERIES (U.S. CLS. 21, 23, 26, 36 AND 38).

SN 78-198,920. NATIONAL INSTRUMENTS CORPORATION, AUSTIN, TX. FILED 12-31-2002.

RIO

THE WORD "RIO" IS TRANSLATED TO MEAN "RIVER".

FOR MODULAR COMPUTER HARDWARE AND SOFTWARE FOR USE IN THE FIELDS OF INDUSTRIAL AUTOMATION AND SCIENTIFIC AND ENGINEERING DATA ACQUISITION, CONTROL AND ANALYSIS, AND FOR CONTROLLING AND MONITORING INDUSTRIAL PLANTS, AUTOMATED MACHINERY, AND FOR PORTABLE DATA ACQUISITION, AND INSTRUCTION MANUALS SOLD THEREWITH (U.S. CLS. 21, 23, 26, 36 AND 38).

SN 78-199,054. AUDIO STREAM, INC., HILLIARD, OH. FILED 12-31-2002.

PENNY KARAOKE

NO CLAIM IS MADE TO THE EXCLUSIVE RIGHT TO USE "KARAOKE", APART FROM THE MARK AS SHOWN.

FOR HOME ENTERTAINMENT ON COMPACT DISCS AND GRAPHICS (CD AND G) IN THE NATURE OF SING-A-LONGS ACCOMPANIED BY MUSIC (U.S. CLS. 21, 23, 26, 36 AND 38).

CLASS 9—(Continued).

SN 78-199,103. GARMIN LTD., GEORGE TOWN, CAYMAN ISLANDS, FILED 12-31-2002.

PANTRACK

FOR PORTABLE HANDHELD ELECTRONIC DEVICES, NAMELY, GLOBAL POSITIONING SYSTEM RECEIVERS (GPS); SOFTWARE FOR USE IN A GPS RECEIVER FOR ALLOWING STORED TRACKS TO BE VIEWED, MANIPULATED BY USER-ENTRY, OR NAVIGATED (U.S. CLS. 21, 23, 26, 36 AND 38).

SN 78-199,171. SACHS, GEORGE A., SYLVAN LAKE, MI. FILED 12-31-2002.

RP-MILL

FOR INDUSTRIAL CONTROL COMPUTER SOFTWARE, NAMELY, SOFTWARE USED TO CREATE THREE-DIMENSIONAL FABRICATIONS OF TANGIBLE PROTOTYPES FROM COMPUTER-GENERATED MODELS, PARTICULARLY THOSE STORED IN THE FORMAT KNOWN AS STL (U.S. CLS. 21, 23, 26, 36 AND 38).

SN 78-199,818. GOD'S HOUSE OF PRAYER, INC., SOUTHLAKE, TX. FILED 1-3-2003.

MAXIMIZED FAMILY

NO CLAIM IS MADE TO THE EXCLUSIVE RIGHT TO USE "FAMILY", APART FROM THE MARK AS SHOWN.
FOR SOUND RECORDINGS AND VIDEO RECORDINGS FEATURING RELIGIOUS INSTRUCTION (U.S. CLS. 21, 23, 26, 36 AND 38).

SN 78-199,823. GOD'S HOUSE OF PRAYER, INC., SOUTHLAKE, TX. FILED 1-3-2003.

MAXIMIZED WOMANHOOD

NO CLAIM IS MADE TO THE EXCLUSIVE RIGHT TO USE "WOMANHOOD", APART FROM THE MARK AS SHOWN.
FOR SOUND RECORDINGS AND VIDEO RECORDINGS FEATURING RELIGIOUS INSTRUCTION (U.S. CLS. 21, 23, 26, 36 AND 38).

SN 78-199,830. GOD'S HOUSE OF PRAYER, INC., SOUTHLAKE, TX. FILED 1-3-2003.

MAXIMIZED CHILDREN

NO CLAIM IS MADE TO THE EXCLUSIVE RIGHT TO USE "CHILDREN", APART FROM THE MARK AS SHOWN.
FOR SOUND RECORDINGS AND VIDEO RECORDINGS FEATURING RELIGIOUS INSTRUCTION (U.S. CLS. 21, 23, 26, 36 AND 38).

CLASS 9—(Continued).

SN 78-199,835. GOD'S HOUSE OF PRAYER, INC., SOUTHLAKE, TX. FILED 1-3-2003.

MAXIMIZED TEENS

NO CLAIM IS MADE TO THE EXCLUSIVE RIGHT TO USE "TEENS", APART FROM THE MARK AS SHOWN.
FOR SOUND RECORDINGS AND VIDEO RECORDINGS FEATURING RELIGIOUS INSTRUCTION (U.S. CLS. 21, 23, 26, 36 AND 38).

SN 78-199,841. GOD'S HOUSE OF PRAYER, INC., SOUTHLAKE, TX. FILED 1-3-2003.

MAJORING IN MEN

FOR SOUND RECORDINGS AND VIDEO RECORDINGS FEATURING RELIGIOUS INSTRUCTION (U.S. CLS. 21, 23, 26, 36 AND 38).

SN 78-199,868. GOD'S HOUSE OF PRAYER, INC., SOUTHLAKE, TX. FILED 1-3-2003.

MAXIMIZED MANHOOD

NO CLAIM IS MADE TO THE EXCLUSIVE RIGHT TO USE "MANHOOD", APART FROM THE MARK AS SHOWN.
FOR SOUND RECORDINGS AND VIDEO RECORDINGS FEATURING RELIGIOUS INSTRUCTION (U.S. CLS. 21, 23, 26, 36 AND 38).

SN 78-200,100. FIELDISOFT TECHNOLOGIES, LLC, BOTHELL, WA. FILED 1-5-2003.

**FIELDISOFT
TECHNOLOGIES, LLC**

NO CLAIM IS MADE TO THE EXCLUSIVE RIGHT TO USE "TECHNOLOGIES, LLC", APART FROM THE MARK AS SHOWN.
FOR COMPUTER SOFTWARE DESIGNED TO PROVIDE FIELD FORCE AUTOMATION SOLUTIONS, NAMELY, TO PERFORM DATA INSPECTIONS, DATA COLLECTIONS, AND MAINTENANCE OF CRITICAL PRODUCTION FIELD-ASSETS/NETWORK INFRASTRUCTURE FOR ELECTRIC, GAS, WATER, TELECOMMUNICATIONS AND BROADBAND COMPANIES (U.S. CLS. 21, 23, 26, 36 AND 38).

CLASS 9—(Continued).

SN 78-200,864. GRETAG-MACBETH HOLDING, AG, 8150 REGENSDORF, SWITZERLAND, FILED 1-7-2003.



OWNER OF U.S. REG. NO. 1,374,605.
NO CLAIM IS MADE TO THE EXCLUSIVE RIGHT TO USE "COLOR", APART FROM THE MARK AS SHOWN.
THE STIPPLING IS INTENDED TO INDICATE COLOR, BUT NO PARTICULAR COLOR IS CLAIMED AS A FEATURE OF THE MARK.
FOR ELECTRONIC SPECTROPHOTOMETER FOR REFLECTIVE AND/OR TRANSMISSIVE COLOR MEASUREMENT (U.S. CLS. 21, 23, 26, 36 AND 38).

SN 78-200,924. PTP SERVICES LLC, SAN FRANCISCO, CA. FILED 1-7-2003.

FLAGSHIP ENERGY

NO CLAIM IS MADE TO THE EXCLUSIVE RIGHT TO USE "ENERGY", APART FROM THE MARK AS SHOWN.
FOR COMPUTER PROGRAMS FOR RISK MANAGEMENT AND TRADING OF ENERGY COMMODITIES, CONTROL AND MANAGEMENT OF POWER AND UTILITY FACILITIES, AND ENERGY CONSUMPTION AND CONSERVATION BY ENERGY CUSTOMERS; COMPUTER PROGRAMS FOR EVALUATING, MONITORING, MANAGING, CONTROLLING, SUPPLYING, CONVERTING, CONDITIONING AND TESTING ENERGY OPERATIONS, USAGE, POWER QUALITY AND ENERGY EFFICIENCY WITHIN INDUSTRIAL AND BUSINESS ENVIRONMENTS, AND MANUALS SOLD AS A UNIT. (U.S. CLS. 21, 23, 26, 36 AND 38).

SN 78-200,974. COMPUTERIZED SECURITY SYSTEMS, INC., COSTA MESA, CA. FILED 1-8-2003.

SAM

FOR SOFTWARE FOR RECORDING AND CONTROLLING ENTRY ACCESS THROUGH AN ELECTRONIC LOCKING SYSTEM (U.S. CLS. 21, 23, 26, 36 AND 38).

CLASS 9—(Continued).

SN 78-201,381. VECCHIO, MICHAEL JOSEPH, HILLSBOROUGH, NJ. FILED 1-8-2003.

PASSERBY

FOR MUSICAL SOUND RECORDINGS AND MUSICAL VIDEO RECORDINGS (U.S. CLS. 21, 23, 26, 36 AND 38).
FIRST USE 0-0-1992; IN COMMERCE 0-0-1994.

SN 78-201,665. FUTREX, INC., GAITHERSBURG, MD. FILED 1-9-2003.

BODYOMETRY

FOR FITNESS AND WELLNESS ASSESSMENT SOFTWARE (U.S. CLS. 21, 23, 26, 36 AND 38).
FIRST USE 1-28-2003; IN COMMERCE 1-28-2003.

SN 78-201,673. KRONE DIGITAL COMMUNICATIONS INC., SIDNEY, NE. FILED 1-9-2003.

AIRES

THE ENGLISH TRANSLATION OF "AIRES" IS "AIRS".
FOR ELECTRICAL WIRE, CABLE AND CONNECTORS THEREFOR (U.S. CLS. 21, 23, 26, 36 AND 38).
FIRST USE 2-0-2003; IN COMMERCE 2-0-2003.

SN 78-202,012. REVIVIO, INC., LEXINGTON, MA. FILED 1-10-2003.

TIME IMAGE

FOR COMPUTER HARDWARE AND SOFTWARE TO ENSURE DATA SECURITY, NAMELY, CONTINUOUS DATA BACK-UP, ON-LINE DATA BACKUP, DATA RECOVERY, SECURE VAULTING, AND DISASTER RECOVERY; FEATURE OF COMPUTER HARDWARE AND SOFTWARE TO ENSURE DATA SECURITY, NAMELY, CONTINUOUS DATA BACK-UP, ON-LINE DATA BACKUP, DATA RECOVERY, SECURE VAULTING, AND DISASTER RECOVERY (U.S. CLS. 21, 23, 26, 36 AND 38).

CLASS 9—(Continued).

SN 78-202,016. REVIVIO, INC., LEXINGTON, MA. FILED 1-10-2003.

TIME STORE

FOR COMPUTER HARDWARE AND SOFTWARE TO ENSURE DATA SECURITY, NAMELY, CONTINUOUS DATA BACK-UP, ON-LINE DATA BACKUP, DATA RECOVERY, SECURE VAULTING, AND DISASTER RECOVERY; FEATURE OF COMPUTER HARDWARE AND SOFTWARE TO ENSURE DATA SECURITY, NAMELY, CONTINUOUS DATA BACK-UP, ON-LINE DATA BACKUP, DATA RECOVERY, SECURE VAULTING, AND DISASTER RECOVERY (U.S. CLS. 21, 23, 26, 36 AND 38).

SN 78-202,659. ITT INDUSTRIES, INC., WHITE PLAINS, NY. FILED 1-13-2003.

HYDROVAR

FOR ELECTRONIC MOTOR CONTROLS FOR MATCHING ELECTRIC MOTOR OUTPUT TO APPLICATION REQUIREMENTS (U.S. CLS. 21, 23, 26, 36 AND 38).

SN 78-203,344. COGNIO, INC., GAITHERSBURG, MD. FILED 1-15-2003.

PROPHET

FOR SEMICONDUCTOR INTEGRATED CIRCUITS AND COMPONENTS, NAMELY, EVALUATION CIRCUIT BOARDS FOR RADIO COMMUNICATION APPLICATIONS (U.S. CLS. 21, 23, 26, 36 AND 38).

SN 78-203,444. BALLY GAMING INTERNATIONAL, INC., LAS VEGAS, NV. FILED 1-15-2003.

SCATTER TIME

FOR GAMING DEVICES, NAMELY, SLOT MACHINES, WITH OR WITHOUT VIDEO OUTPUT (U.S. CLS. 21, 23, 26, 36 AND 38).

SN 78-203,464. THE GAME TREE, LAS VEGAS, NV. FILED 1-15-2003.

SWEET THING

FOR COMPUTER GAME SOFTWARE, COMPUTER GAME PROGRAMS, AND USER MANUALS SOLD THEREWITH; GAMING EQUIPMENT, NAMELY, GAMING MACHINES AND GAME SOFTWARE USED THEREWITH (U.S. CLS. 21, 23, 26, 36 AND 38).

CLASS 9—(Continued).

SN 78-203,470. GAME TREE, THE, LAS VEGAS, NV. FILED 1-15-2003.

CANDY RAIN

FOR COMPUTER GAME SOFTWARE, COMPUTER GAME PROGRAMS, AND USER MANUALS SOLD THEREWITH; GAMING EQUIPMENT, NAMELY, GAMING MACHINES AND GAME SOFTWARE USED THEREWITH. (U.S. CLS. 21, 23, 26, 36 AND 38).

SN 78-203,571. COMPREHENSIVE LOSS MANAGEMENT, INC., PLYMOUTH, MN. FILED 1-15-2003.

RAPID CULTURAL SHIFT

FOR COMPUTER SOFTWARE FOR BUSINESS MANAGEMENT PURPOSES THAT IS USED BY EMPLOYERS TO MANAGE JOB PERFORMANCE, TO PROVIDE INFORMATION REGARDING JOB REQUIREMENTS AND COMPLETION OF ASSIGNMENTS AND PROJECTS, TO ASSURE ACCEPTABLE LEVELS OF JOB PERFORMANCE, AND TO HELP EMPLOYERS WITH TRAINING, COMMUNICATIONS, EMPLOYEE ACCOUNTABILITY, AND EMPLOYEE REWARDS AND RECOGNITION (U.S. CLS. 21, 23, 26, 36 AND 38).

SN 78-204,079. GSI LUMONICS CORPORATION, BILLERICA, MA. FILED 1-16-2003.

SCRIBESMART

FOR LASER BEAM CONTROLS AND PARTS THEREFOR (U.S. CLS. 21, 23, 26, 36 AND 38).

SN 78-204,133. KRONE DIGITAL COMMUNICATIONS INC., SIDNEY, NE. FILED 1-16-2003.

THE SHAPE OF THINGS TO COME

FOR ELECTRICAL WIRE, CABLE AND CONNECTORS THEREFOR. (U.S. CLS. 21, 23, 26, 36 AND 38).

CLASS 9—(Continued).

SN 78-204,144. AT&T CORP., NEW YORK, NY. FILED 1-16-2003.



OWNER OF U.S. REG. NOS. 1,330,186, 2,722,609 AND OTHERS.

THE STIPPLING IS FOR SHADING PURPOSES.

THE MARK CONSISTS OF A TWO-DIMENSIONAL REPRESENTATION OF A FANCIFUL THREE-DIMENSIONAL GLOBE, LINED TO SPECIFY THE COLOR BLUE, ALONG WITH THE LETTERS "AT&T".

FOR TELECOMMUNICATIONS HUBS AND SWITCHES; WIRELINE ROUTERS; WIRELESS ROUTERS; STANDALONE WIRELESS ACCESS POINTS; INTEGRATED ROUTERS WHICH INCLUDE A MODEM; DIGITAL SUBSCRIBER LINE MODEMS OTHERWISE KNOWN AS DSL MODEMS, CABLE MODEMS AND SATELLITE MODEMS THAT INTERFACE DIRECTLY WITH DIGITAL SUBSCRIBER LINE OTHERWISE KNOWN AS DSL, SATELLITE DATA OR CABLE BROADBAND DATA SERVICES; NETWORK INTERFACE CARD ADAPTORS OTHERWISE KNOWN AS NIC ADAPTORS; PRINT SERVERS; RJ 45 TRANSMISSION CABLES; TELEPHONE LINE FILTERS; TELECOMMUNICATION COUPLERS; TELECOMMUNICATIONS MODULAR PLUGS; CORDED AND CORDLESS WIRELINE TELECONFERENCING TELEPHONES (U.S. CLS. 21, 23, 26, 36 AND 38).

SN 78-204,674. LOYALTY MATRIX, INC., SAN FRANCISCO, CA. FILED 1-17-2003.

MATRIXOPTIMIZER

FOR COMPUTER SOFTWARE PLATFORM FOR CUSTOMER INTELLIGENCE ANALYTICS (U.S. CLS. 21, 23, 26, 36 AND 38).

FIRST USE 11-0-2001; IN COMMERCE 2-0-2002.

SN 78-204,821. MEDZILLA, INC., MARYSVILLE, WA. FILED 1-18-2003.

MATCHZILLA

FOR COMPUTER SOFTWARE FOR USE IN DATA SEARCHING, RETRIEVING, MANAGEMENT AND DELIVERY RELATING TO DATA AND KNOWLEDGE MANAGEMENT, NEW MEDIA AND E-COMMERCE SOFTWARE APPLICATIONS IN THE FIELD OF TEXT COMPREHENSION TOOLS. (U.S. CLS. 21, 23, 26, 36 AND 38).

CLASS 9—(Continued).

SN 78-204,827. PERKINELMER, INC., WELLESLEY, MA. FILED 1-18-2003.

TOFWORKS

FOR COMPUTER SOFTWARE FOR OPERATING MASS SPECTROMETRY INSTRUMENTS AND FOR COLLECTING, ANALYZING AND REPORTING MASS SPECTROMETRY DATA; AND USER MANUALS PACKAGED AS A UNIT THEREWITH (U.S. CLS. 21, 23, 26, 36 AND 38).

SN 78-205,157. QUALITY PRODUCTS, INC., MIAMI, FL. FILED 1-20-2003.



NO CLAIM IS MADE TO THE EXCLUSIVE RIGHT TO USE "MICRO", APART FROM THE MARK AS SHOWN.

FOR CASES AND HOLDERS FOR USE AS CELLULAR TELEPHONE ACCESSORIES, NAMELY SPECIALTY HOLSTERS FOR CARRYING CELLULAR TELEPHONES (U.S. CLS. 21, 23, 26, 36 AND 38).

SN 78-205,384. COLORENG INC., SALEM, NH. FILED 1-21-2003.

FLOWMASTER

FOR AUTOMATIC COLORANT DISPENSERS (U.S. CLS. 21, 23, 26, 36 AND 38).

FIRST USE 5-7-2001; IN COMMERCE 5-7-2001.

SN 78-205,444. SPECTORSOFT CORPORATION, VERO BEACH, FL. FILED 1-21-2003.

SPECTOR PRO

OWNER OF U.S. REG. NO. 2,473,318.

FOR INTERNET MONITORING AND SURVEILLANCE SOFTWARE, NAMELY, COMPUTER SOFTWARE FOR RECORDING AND TRACKING A PERSON'S ACTIVITIES ON THE INTERNET AND PERSONAL COMPUTERS, INCLUDING E-MAIL CONTENT, WEB SITES, CHAT/INSTANT MESSAGES, KEYSTROKES AND SCREEN SNAPSHOTS (U.S. CLS. 21, 23, 26, 36 AND 38).

FIRST USE 8-0-2001; IN COMMERCE 9-2-2001.

CLASS 9—(Continued).

SN 78-205,740. MILLER, SCOTT A., MORRISVILLE, PA.
FILED 1-22-2003.

MICROJAZZ

FOR MUSICAL SOUND RECORDINGS (U.S. CLS. 21,
23, 26, 36 AND 38).

SN 78-205,922. GRAPHIC MICROSYSTEMS, INC., SUNNY-
VALE, CA. FILED 1-22-2003.

COLORQUICK

FOR COLOR MEASUREMENT APPARATUS AND
CLOSED LOOP COLOR CONTROL APPARATUS FOR
PRINTING PRESSES (U.S. CLS. 21, 23, 26, 36 AND 38).
FIRST USE 4-30-1995; IN COMMERCE 4-30-1995.

SN 78-205,979. TOSHIBA AMERICA CONSUMER PRO-
DUCTS, INC., WAYNE, NJ. FILED 1-22-2003.

MEGABAND

FOR CHIP BASED CIRCUITRY THAT ENHANCES
THE BANDWIDTH OF THE VIDEO SIGNAL TO THE
CRT (U.S. CLS. 21, 23, 26, 36 AND 38).

SN 78-206,600. PLUGZILLA, LLC, LITTLE FERRY, NJ.
FILED 1-23-2003.

HOT KNOBS

NO CLAIM IS MADE TO THE EXCLUSIVE RIGHT TO
USE "KNOBS", APART FROM THE MARK AS SHOWN.

FOR REMOTE CONTROL UNITS FOR AUDIO EF-
FECTS EQUIPMENT AND MUSICAL INSTRUMENTS;
FRONT PANEL CONTROL UNITS FOR AUDIO EF-
FECTS AND MUSICAL INSTRUMENTS (U.S. CLS. 21,
23, 26, 36 AND 38).

SN 78-206,682. GIANTLOOP NETWORK, INC., WALTHAM,
MA. FILED 1-24-2003.

GIANTLOOP

FOR NETWORK MANAGEMENT SOFTWARE TO
ENABLE USERS TO VISUALIZE, MONITOR AND MAN-
AGE APPLICATION DATAPATHS, NAMELY, THE LO-
GICAL CROSS-DOMAIN DATA FLOWS ACROSS
MULTIPLE DATA CENTER AND NETWORK DEVICES
THAT SUPPORT AN APPLICATION. (U.S. CLS. 21, 23, 26,
36 AND 38).

CLASS 9—(Continued).

SN 78-207,024. AUDITSOLUTIONS LLC, SAN JOSE, CA.
FILED 1-24-2003.

AUDITSOLUTIONS

FOR COMPUTER SOFTWARE IN THE FIELD OF
ACCOUNTS PAYABLE AUDITING (U.S. CLS. 21, 23, 26,
36 AND 38).

SN 78-207,055. BIOTAGE, INC., CHARLOTTESVILLE, VA.
FILED 1-24-2003.

SYNTAGE

FOR HIGH PERFORMANCE CHROMATOGRAPHY
SYSTEMS COMPRISING LIQUID CHROMATOGRAPHY
PUMPS, DETECTORS, COLLECTORS, RECORDS, IN-
JECTORS, MASS SPECTROMETERS, DATA PROCES-
SORS AND SOFTWARE, ALL SOLD AS A MODULAR
UNIT, FOR BIOLOGICAL AND CHEMICAL PURIFICA-
TION, SCREENING AND IDENTIFICATION; LABORA-
TORY EQUIPMENT FOR USE IN THE
PHARMACEUTICAL, BIOPHARMACEUTICAL AND
SPECIALTY CHEMICAL INDUSTRIES, NAMELY, PRE-
PACKED CARTRIDGES FOR LOADING SOLUBLE AND
INSOLUBLE SAMPLES OF ORGANIC COMPOUNDS
INTO CHROMATOGRAPHY COLUMNS; COMPUTER
WORKSTATIONS FOR USE IN THE PURIFICATION
OF ORGANIC COMPOUNDS, CONSISTING OF COMPU-
TER HARDWARE, COMPUTER SOFTWARE FOR CON-
TROLLING CHROMATOGRAPHY APPARATUS AND
MANAGING RELATED DATA, AUTOMATED SAMPLE
INJECTORS FOR MAKING SIMULTANEOUS SAMPLE
INJECTIONS INTO MULTIPLE FLOWPATHS, MULTIPLE
FLOWPATH DETECTORS, MULTIPLE PREPACKED
CHROMATOGRAPHY COLUMNS AND MULTIPLE
FRACTION COLLECTORS, AND MANUALS SOLD AS
A UNIT THEREWITH; PREPACKED CHROMATOGRAPHY
AND CHEMISTRY COLUMNS; COMPRESSION
MODULES FOR USE IN CHROMATOGRAPHY; KITS
COMPRISING VARIOUS OF THE FOREGOING GOODS
FOR USE IN CHROMATOGRAPHY (U.S. CLS. 21, 23, 26,
36 AND 38).

SN 78-207,126. TETRIX, INC., THE WOODLANDS, TX.
FILED 1-25-2003.

TETRIX

FOR COMPUTER SOFTWARE FOR THE PROCES-
SING, DISPLAYING, PRINTING AND TRANSMISSION
OF CUSTOMER, VENDOR, PRODUCT AND FINANCIAL
DATA (U.S. CLS. 21, 23, 26, 36 AND 38).

SN 78-207,156. HILLER, CARL C., DAVIS, CA. FILED 1-25-
2003.

WATSMPL

FOR COMPUTER SOFTWARE FOR SIMPLIFIED
WATER HEATING SYSTEM ANALYSIS (U.S. CLS. 21,
23, 26, 36 AND 38).
FIRST USE 12-23-2002; IN COMMERCE 12-23-2002.

CLASS 9—(Continued).

SN 78-207,158. HILLER, CARL C., DAVIS, CA. FILED 1-25-2003.

WATSIM

FOR COMPUTER SOFTWARE FOR DETAILED WATER HEATING SYSTEM ANALYSIS (U.S. CLS. 21, 23, 26, 36 AND 38).
FIRST USE 12-23-2002; IN COMMERCE 12-23-2002.

SN 78-207,495. MATTUS, INC., DBA KEMMA SOFTWARE, SEWICKELY, PA. FILED 1-27-2003.

CI DISCOVERY

FOR COMPUTER SOFTWARE FOR USE BY CORPORATE INFORMATION SYSTEMS DEPARTMENTS NAMELY, SOFTWARE WHICH AUTOMATES THE TRACKING OF COMPUTER HARDWARE AND SOFTWARE CONFIGURATIONS THAT RELATE TO LARGE SCALE COMPUTER EQUIPMENT AND SOFTWARE MODIFICATIONS OR CHANGES WHICH AFFECT COMPUTER USERS. (U.S. CLS. 21, 23, 26, 36 AND 38).

SN 78-207,559. SEA CON/BRANTNER & ASSOCIATES, INC., EL CAJON, CA. FILED 1-27-2003.

MSS-RUFF-NEK

FOR ELECTRICAL CONNECTORS AND OPTICAL CONNECTORS (U.S. CLS. 21, 23, 26, 36 AND 38).

SN 78-207,749. HARMAN INTERNATIONAL INDUSTRIES, INCORPORATED, NORTHRIDGE, CA. FILED 1-28-2003.

CROWN AUDIO

OWNER OF U.S. REG. NOS. 1,137,593, 1,689,943 AND OTHERS.

NO CLAIM IS MADE TO THE EXCLUSIVE RIGHT TO USE "AUDIO", APART FROM THE MARK AS SHOWN.

FOR AUDIO EQUIPMENT, NAMELY, AMPLIFIERS, PROCESSORS, MIXERS, ROUTERS, LOAD MONITORS, CONTROLS, INTERFACES AND SOFTWARE THEREFOR, MICROPHONES, AND POWER SUPPLIES (U.S. CLS. 21, 23, 26, 36 AND 38).

FIRST USE 6-1-2000; IN COMMERCE 6-1-2000.

SN 78-207,776. WMS GAMING INC., WAUKEGAN, IL. FILED 1-28-2003.

TREASURE TALES

FOR CURRENCY AND CREDIT OPERATED SLOT MACHINES AND GAMING DEVICES, NAMELY, GAMING MACHINES FOR USE IN GAMING ESTABLISHMENTS. (U.S. CLS. 21, 23, 26, 36 AND 38).

CLASS 9—(Continued).

SN 78-208,006. VIACOM INTERNATIONAL INC., NEW YORK, NY. FILED 1-28-2003.

TAK AND THE POWER OF JUJU

FOR VIDEO GAME MACHINES FOR USE WITH TELEVISION, AUDIO OUTPUT GAME MACHINES FOR USE WITH TELEVISION, VIDEO GAME CARTRIDGES, VIDEO GAMES RECORDED ON CD-ROM FOR USE IN FREESTANDING VIDEO GAME MACHINES; AND COMPUTER PRODUCTS, NAMELY, GAME CARTRIDGES FOR COMPUTER VIDEO GAMES AND VIDEO OUTPUT GAME MACHINES AND INSTRUCTIONAL MATERIALS SOLD AS A UNIT, COMPUTER GAME CASSETTES, COMPUTER GAME TAPES AND MANUALS SOLD AS A UNIT; THEATRICAL OR MUSICAL SOUND RECORDINGS; THEATRICAL OR MUSICAL VIDEO RECORDINGS, LASER DISCS AND DIGITAL VIDEO DISCS/DIGITAL VERSATILE DISCS ("DVD"); SUNGLASSES (U.S. CLS. 21, 23, 26, 36 AND 38).

SN 78-208,092. VIZX LABS, LLC., SEATTLE, WA. FILED 1-28-2003.

SCIENCE. NOT SOFTWARE.

FOR COMPUTER SOFTWARE USED BY RESEARCH SCIENTISTS TO ACQUIRE, MANAGE AND ANALYZE MOLECULAR BIOLOGY DATA AND GENETIC DATA AND INFORMATION (U.S. CLS. 21, 23, 26, 36 AND 38).

SN 78-208,109. TOSHIBA POWER SYSTEMS RADIATION TECHNO-SERVICE CO., LTD., YOKOHAMA, JAPAN, FILED 1-28-2003.

RANDOM MASTER

FOR COMPUTER HARDWARE; PRINTED CIRCUIT BOARDS; INTEGRATED CIRCUITS; SEMICONDUCTORS (U.S. CLS. 21, 23, 26, 36 AND 38).

SN 78-208,344. SPIELO MANUFACTURING INCORPORATED, MONCTON, NEW BRUNSWICK, CANADA, FILED 1-29-2003.

JACK HAMMER

FOR RECONFIGURABLE CASINO AND LOTTERY GAMING EQUIPMENT, NAMELY, SLOT MACHINES AND OPERATIONAL COMPUTER GAME SOFTWARE THEREFOR. (U.S. CLS. 21, 23, 26, 36 AND 38).

CLASS 9—(Continued).

SN 78-208,359. SPIELO MANUFACTURING INCORPORATED, MONCTON, CANADA, FILED 1-29-2003.

GOIN SQUIRLY

FOR RECONFIGURABLE CASINO AND LOTTERY GAMING EQUIPMENT, NAMELY, SLOT MACHINES AND OPERATIONAL COMPUTER GAME SOFTWARE THEREFOR. (U.S. CLS. 21, 23, 26, 36 AND 38).

SN 78-208,513. PANDUIT CORP., TINLEY PARK, IL. FILED 1-29-2003.

PAN-CAM

FOR COMMUNICATION CABLING DEVICES, NAMELY, FIBER OPTIC CONNECTORS (U.S. CLS. 21, 23, 26, 36 AND 38).

SN 78-208,533. HARRIS CORPORATION, MELBOURNE, FL. FILED 1-29-2003.

ECDI

FOR COMPUTER SOFTWARE FOR MONITORING AND CONTROLLING RADIO AND/OR TELEVISION BROADCASTING TRANSMITTERS, AND MANUALS AND DOCUMENTATION DISTRIBUTED AS A UNIT THEREWITH. (U.S. CLS. 21, 23, 26, 36 AND 38).

SN 78-208,538. PEEBLER, SIMEON, CHICAGO, IL. FILED 1-29-2003.

BLOINK

FOR COMPUTER SOFTWARE FOR A GAME WHICH IS DOWNLOADABLE (U.S. CLS. 21, 23, 26, 36 AND 38).

SN 78-208,546. AVANEX CORPORATION, FREMONT, CA. FILED 1-29-2003.

POWERADAPTER

FOR OPTICAL WAVELENGTH TRANSMITTERS, RECEIVERS, TRANSCEIVERS AND TRANSLATORS (U.S. CLS. 21, 23, 26, 36 AND 38).

CLASS 9—(Continued).

SN 78-208,575. CAPITOL RECORDS, INC., NEW YORK, NY. FILED 1-29-2003.

GOT HITS!

FOR SERIES OF MUSICAL SOUND RECORDINGS (U.S. CLS. 21, 23, 26, 36 AND 38).

SN 78-209,042. PROXYMED, INC., FORT LAUDERDALE, FL. FILED 1-30-2003.

PROXYCLAIM

FOR COMPUTER SOFTWARE FOR USE BY HEALTH CARE SERVICE PROVIDERS FOR SUBMITTING MEDICAL CLAIMS, AND MANUALS AND DOCUMENTATION DISTRIBUTED AS A UNIT THEREWITH. (U.S. CLS. 21, 23, 26, 36 AND 38).

SN 78-209,090. INTERNET BLUEPRINT, INC., IRVINE, CA. FILED 1-30-2003.

BIDMAIL

FOR COMPUTER SOFTWARE FOR MANAGING THE CONSTRUCTION BID PROCESS, INCLUDING FUNCTIONALITY FOR MANAGING AND TRANSMITTING CONSTRUCTION RELATED DOCUMENTS SUCH AS SPECIFICATIONS AND DRAWINGS, AND OTHER RELATED INFORMATION SPECIFIC TO THE CONSTRUCTION INDUSTRY (U.S. CLS. 21, 23, 26, 36 AND 38).
FIRST USE 12-0-1996; IN COMMERCE 3-0-2001.

SN 78-209,092. CONAIR CORPORATION, STAMFORD, CT. FILED 1-30-2003.

SATIN FINISH

FOR ELECTRIC CURLING IRONS, ELECTRIC CURLING BRUSHES, ELECTRIC HEATED ROLLERS, ELECTRIC HAIRSETTERS, ELECTRIC HOT COMBS AND PRESSERS, ELECTRIC HAIR STRAIGHTENING IRONS. (U.S. CLS. 21, 23, 26, 36 AND 38).

SN 78-209,209. MULTILING CORPORATION, PROVO, UT. FILED 1-30-2003.

SEMANTIS

FOR COMPUTER SOFTWARE FOR LANGUAGE TRANSLATION PURPOSES (U.S. CLS. 21, 23, 26, 36 AND 38).

CLASS 9—(Continued).

SN 78-209,223. POWERCHIP GROUP PTY. LTD., SOUTH MELBOURNE, VICTORIA, AUSTRALIA, FILED 1-30-2003.

POWERCHIP

FOR COMPUTER HARDWARE, NAMELY, COMPUTER CHIPS FOR VEHICLE ENGINE COMPUTERS; COMPUTER SOFTWARE FOR USE WITH VEHICLE ENGINE COMPUTER SOFTWARE (U.S. CLS. 21, 23, 26, 36 AND 38).

FIRST USE 1-6-2003; IN COMMERCE 1-6-2003.

SN 78-209,639. PHYTEC AMERICA LLC, BAINBRIDGE ISLAND, WA. FILED 1-31-2003.

STICK IT IN

FOR COMPUTER HARDWARE (U.S. CLS. 21, 23, 26, 36 AND 38).

SN 78-209,640. POTENTIA POWER SYSTEMS, INC., WILMINGTON, DE. FILED 1-31-2003.

POTENTIA

FOR PROGRAMMABLE INTEGRATED CIRCUITS TO CONTROL AND MANAGE ON-BOARD POWER ARCHITECTURES AND DISCRETE POWER SUPPLIES (U.S. CLS. 21, 23, 26, 36 AND 38).

SN 78-209,696. PINTAIL TECHNOLOGIES, INC., PLANO, TX. FILED 1-31-2003.

TESTVISION

FOR COMPUTER SOFTWARE FOR TEST MANAGEMENT, NAMELY TEST ANALYSIS, SIMULATION, SAMPLING, REFINING, OPTIMIZING, MONITORING, STANDARDIZING, INTEGRATING, EXECUTING, AND DEFINITION (U.S. CLS. 21, 23, 26, 36 AND 38).

FIRST USE 10-31-2002; IN COMMERCE 10-31-2002.

SN 78-209,698. SWITCHCORE AB, 22369 LUND, SWEDEN, FILED 1-31-2003.

XPEEDIUM

FOR COMPUTER HARDWARE PRODUCTS, NAMELY DEVICES FOR SWITCHING AND ROUTING ENGINES, FOR USE ON LOCAL AND GLOBAL NETWORKS; SEMICONDUCTORS; MEMORY CHIPS; INTEGRATED CIRCUITS, AND USER MANUALS SOLD TOGETHER THEREWITH (U.S. CLS. 21, 23, 26, 36 AND 38).

CLASS 9—(Continued).

SN 78-209,702. INDIGITA CORPORATION, SANTA ANA, CA. FILED 1-31-2003.



FOR COMPUTER HARDWARE, COMPUTER SOFTWARE FOR USE IN CONNECTION WITH PERSONALIZED, INTERACTIVE TELEVISION PROGRAMMING, COMPUTER PERIPHERALS FOR PERSONALIZED, INTERACTIVE TELEVISION PROGRAMMING, TELEVISIONS, TELEVISION PERIPHERAL REMOTE CONTROLS, AND CONTROLS, NAMELY, VIDEO GAME INTERACTIVE REMOTE CONTROL UNITS AND COMPUTER GAME SOFTWARE FOR USE THEREWITH AND ACCOMPANYING MANUALS SOLD AS A UNIT (U.S. CLS. 21, 23, 26, 36 AND 38).

SN 78-209,756. APTARE, INC., CAMPBELL, CA. FILED 1-31-2003.

APTARE

FOR COMPUTER SOFTWARE ADAPTED FOR USE WITH STORAGE MANAGEMENT AND OPTIMIZATION APPLICATIONS, NAMELY, SOFTWARE FOR PERFORMING DATA STORAGE, DATA BACK-UP, DATA RESTORATION, AND SYSTEM PERFORMANCE OPTIMIZATION FUNCTIONS (U.S. CLS. 21, 23, 26, 36 AND 38).

SN 78-209,870. BRAKE, DAVID, C., HOUSTON, TX. FILED 2-1-2003.

WESTERLAND RECORDS

NO CLAIM IS MADE TO THE EXCLUSIVE RIGHT TO USE "RECORDS", APART FROM THE MARK AS SHOWN. FOR PRERECORDED AUDIO AND VISUAL MUSICAL SOUND RECORDINGS, INCLUDING RECORDS, COMPACT DISCS, DIGITAL VIDEO DISCS, CASSETTES, VIDEOS AND OTHER PRERECORDED TAPES (U.S. CLS. 21, 23, 26, 36 AND 38).

FIRST USE 1-24-2003; IN COMMERCE 1-24-2003.

CLASS 9—(Continued).

SN 78-209,979. ERIE SCIENTIFIC COMPANY, PORTSMOUTH, NH. FILED 2-3-2003.

SUPERFROST PLUS

OWNER OF U.S. REG. NOS. 1,300,389 AND 1,320,442. FOR LABORATORY PRODUCTS, NAMELY MICROSCOPE SLIDES (U.S. CLS. 21, 23, 26, 36 AND 38). FIRST USE 0-0-1990; IN COMMERCE 0-0-1990.

SN 78-212,131. FOLDED THOUGHT, INCORPORATED, HOUSTON, TX. FILED 2-7-2003.

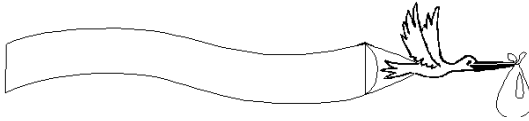

FOR AUDIOVISUAL AND SOUND RECORDINGS FEATURING EDUCATIONAL INFORMATION ON THE SUBJECT OF CHILDBIRTH AND MATERNAL HEALTH AND CHILD HEALTH. (U.S. CLS. 21, 23, 26, 36 AND 38).

SN 78-213,786. FARLEY, SUSAN D., GOLDEN VALLEY, MN. FILED 2-12-2003.

PIXELOOM

FOR COMPUTER SOFTWARE FOR DESIGNING AND ANALYZING WEAVING DRAFTS (U.S. CLS. 21, 23, 26, 36 AND 38).

SN 78-215,863. MARS PRODUCT DESIGN LTD., OTTAWA, ONTARIO, CANADA, FILED 2-18-2003.

STUDIOFILE

FOR WEB-BASED DESIGN MANAGEMENT SOFTWARE TO ALLOW DESIGN MANAGERS TO STORE AND TRACK ASSETS, SCHEDULE RESOURCES AND COLLABORATE ON DESIGN DECISION OVER A REMOTE LINK (U.S. CLS. 21, 23, 26, 36 AND 38).

SN 78-247,768. MIS QUALITY MANAGEMENT CORP., WILMINGTON, DE. FILED 5-9-2003.

MAPRE

FOR COMPUTER SOFTWARE FOR REAL ESTATE CREDIT RISK ANALYSIS. (U.S. CLS. 21, 23, 26, 36 AND 38).

CLASS 9—(Continued).

SN 78-247,786. MIS QUALITY MANAGEMENT CORP, WILMINGTON, DE. FILED 5-9-2003.

MOODY'S MAPRE

OWNER OF U.S. REG. NOS. 871,342 AND 871,497. FOR COMPUTER SOFTWARE FOR REAL ESTATE CREDIT RISK ANALYSIS (U.S. CLS. 21, 23, 26, 36 AND 38).

CLASS 10—MEDICAL APPARATUS

SN 76-088,705. NUVASIVE, INC., SAN DIEGO, CA. FILED 7-10-2000.

VECTOR

FOR CANNULA FOR USE IN TREATMENT OF THE SPINE (U.S. CLS. 26, 39 AND 44).

SN 76-266,497. ADVANCED CARDIOVASCULAR SYSTEMS, INC., SANTA CLARA, CA. FILED 6-5-2001.

HI-TORQUE DELIVERY

OWNER OF U.S. REG. NOS. 1,440,319, 1,879,636 AND OTHERS.

NO CLAIM IS MADE TO THE EXCLUSIVE RIGHT TO USE "DELIVERY", APART FROM THE MARK AS SHOWN. SEC. 2(F) AS TO "HI-TORQUE".

FOR MEDICAL GUIDE WIRES (U.S. CLS. 26, 39 AND 44).

SN 76-344,670. KAWASUMI KAGAKU KOGYO KABUSHIKI-KAISHA, DBA KAWASUMI LABORATORIES, INC., TOKYO, JAPAN, FILED 12-5-2001.



GENETRA
NEXT GENERATION BRACHYTHERAPY

FOR MEDICAL DEVICES FOR PROSTATE BRACHYTHERAPY, NAMELY, COILED WIRE SOURCE, DELIVERY CARTRIDGE, DELIVERY NEEDLE, TEMPLATE, ANTI-STICK NEEDLE DEVICE, TREATMENT PLANNING SOFTWARE (U.S. CLS. 26, 39 AND 44).

CLASS 10—(Continued).

SN 76-353,152. SCIMED LIFE SYSTEMS, INC., MAPLE GROVE, MN. FILED 12-20-2001.

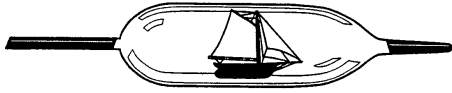
**SHIP IN A BALLOON**

FOR HOUSE MARK FOR MEDICAL AND SURGICAL DEVICES AND APPARATUS IN THE FIELDS OF ELECTROPHYSIOLOGY; VASCULAR SURGERY; ENDOSCOPY; UROLOGY; INTERVENTIONAL RADIOLOGY; AND PERIPHERAL RADIOLOGY, ONCOLOGY AND NEURO/PERIPHERAL INTERVENTIONS, AND PARTS THEREFORE (U.S. CLS. 26, 39 AND 44).

SN 76-371,554. FOURNITURES HOSPITALIERES, HEIMSBRUNN, FRANCE, FILED 2-19-2002.

F.H. ORTHOPEDICS

PRIORITY CLAIMED UNDER SEC. 44(D) ON FRANCE APPLICATION NO. 013132926, FILED 11-22-2001, REG. NO. 013132926, DATED 11-22-2001, EXPIRES 11-22-2011.

NO CLAIM IS MADE TO THE EXCLUSIVE RIGHT TO USE "ORTHOPEDICS", APART FROM THE MARK AS SHOWN.

FOR SURGICAL INSTRUMENTS, NAMELY, ARTICULAR IMPLANTS COMPRISING ARTIFICIAL MATERIAL USED IN CONNECTION WITH THE FOOT, ANKLE, KNEE, HIP, SPINE, HANDS, WRISTS, ELBOW AND SHOULDER; IMPLANTS, COMPRISING ARTIFICIAL MATERIAL; FIXING DEVICES, NAMELY, STAPLES, SCREWS; PROSTHESIS AND SURGICAL FITTING INSTRUMENTS FOR LIGAMENTS, MENISCAL AND TENDINOUS SURGERY; OSTEOSYNTHESIS IMPLANTS COMPRISING ARTIFICIAL MATERIAL, AND FITTING INSTRUMENTS, NAMELY, SURGICAL INSTRUMENTS FOR THE IMPLANTATION OF OSTEOSYNTHESIS IMPLANTS; IMPLANTS COMPRISING ARTIFICIAL MATERIAL; SOLID AND LIQUID BONE SUBSTITUTE NAMELY, ARTIFICIAL SOLID AND LIQUID BONE SUBSTITUTE, FOR COMPENSATING FOR BONE LOSS, FOR REINFORCING CANCELLOUS BONES, CEMENTS, LIGAMENTS AND TENDON REINFORCEMENT (U.S. CLS. 26, 39 AND 44).

CLASS 10—(Continued).

SN 76-386,879. HERAEUS MED GMBH, D-63450 HANAU, FED REP GERMANY, FILED 3-25-2002.

FINA

PRIORITY CLAIMED UNDER SEC. 44(D) ON FED REP GERMANY APPLICATION NO. 30162959.5/1, FILED 11-1-2001, REG. NO. 30162959, DATED 11-1-2001, EXPIRES 11-30-2011.

THE ENGLISH TRANSLATION OF THE WORD "FINA" IN THE MARK IS "FINE", "THIN" OR "SLENDER".

FOR GAS EXTRACTION FITTINGS, SOLD AS INTEGRAL COMPONENTS OF A PNEUMATIC SUCTION APPARATUS FOR THE SUCTION OF PULMONARY SECRETIONS AND OTHER BODY FLUIDS, FOR MEDICAL PURPOSES; VACUUM AND PRESSURE FITTINGS, SOLD AS INTEGRAL COMPONENTS OF A PNEUMATIC SUCTION APPARATUS FOR THE SUCTION OF PULMONARY SECRETIONS AND OTHER BODY FLUIDS, FOR MEDICAL PURPOSES; PNEUMATIC SUCTION APPARATUS FOR THE SUCTION OF PULMONARY SECRETIONS AND OTHER BODY FLUIDS; PARTS AND FITTINGS FOR SUCH APPARATUS (U.S. CLS. 26, 39 AND 44).

SN 76-404,688. SCIMED LIFE SYSTEMS, INC., MAPLE GROVE, MN. FILED 5-7-2002.

TRISPAN

FOR MEDICAL DEVICE, NAMELY, DETACHABLE EMBOLIC COILS (U.S. CLS. 26, 39 AND 44).

SN 76-406,146. MYOCOR, INC., MAPLE GROVE, MN. FILED 5-3-2002.

COAPSYS

FOR MEDICAL INSTRUMENTS AND DEVICES FOR USE IN CARDIOVASCULAR APPLICATIONS, NAMELY, SURGICAL IMPLANTS COMPRISING ARTIFICIAL MATERIAL (U.S. CLS. 26, 39 AND 44).

FIRST USE 4-10-2003; IN COMMERCE 4-10-2003.

SN 76-408,591. MEDICAL SPECIALTIES INCORPORATED, CHARLOTTE, NC. FILED 5-15-2002.

GELFLEX

FOR WRIST BRACES FOR MEDICAL USE (U.S. CLS. 26, 39 AND 44).

FIRST USE 1-25-2002; IN COMMERCE 1-25-2002.

CLASS 10—(Continued).

SN 76-418,570. SROUFE HEATHCARE PRODUCTS, INC., LIGONIER, IN. FILED 6-7-2002.

PNEUGEL

FOR ORTHOPEDIC SOFT BODY SUPPORTS (U.S. CLS. 26, 39 AND 44),
FIRST USE 10-26-2000; IN COMMERCE 10-26-2000.

SN 76-426,855. SIERRA FOOTWORKS LLC, DBA SIERRA MEDICAL SUPPLY, VALDESE, NC. FILED 7-2-2002.

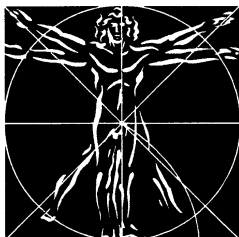
Doctor Specified

THE MARK CONSISTS OF THE TERM "DOCTOR SPECIFIC" OVER A PIE CHART WHICH IS ENCLOSED WITHIN A SQUARE AND SUPERIMPOSED ON THE GRAPHIC REPRESENTATION OF A HUMAN BEING IN MOTION.

FOR MEDICAL HOSIERY, NAMELY, COMPRESSION SOCKS AND HOSE (U.S. CLS. 26, 39 AND 44).
FIRST USE 5-15-2002; IN COMMERCE 5-15-2002.

SN 76-428,803. TREK DIAGNOSTIC SYSTEMS, INC., WESLAKE, OH. FILED 7-1-2002.

VERSATREK

FOR MEDICAL EQUIPMENT, NAMELY, INSTRUMENTATION SYSTEM CONSISTING OF A PLATFORM FOR BOTTLES, BOTTLE AGITATION MECHANISM, AND DATA MANAGEMENT COMPUTER SYSTEM FOR USE IN DETECTING BLOOD, STERILE BODY FLUID, MYCOBACTERIA CULTURE AND M TUBERCULOSIS SUSCEPTIBILITY FOR CLINICAL AND/OR MEDICAL LABORATORY USE (U.S. CLS. 26, 39 AND 44).

FIRST USE 4-0-2002; IN COMMERCE 4-0-2002.

CLASS 10—(Continued).

SN 76-434,727. PENN CENTURY, INC., PHILADELPHIA, PA. FILED 7-26-2002.

MICROSPRAYER

SEC. 2(F).

FOR MEDICAL DEVICES IN THE NATURE OF AN AEROSOLIZER FOR INTRATRACHEAL OR INTRAPULMONARY INSERTION WITHIN A PATIENT TO DELIVER LIQUID PHARMACEUTICALS IN THE FORM OF AN AEROSOL TO A PATIENT'S LUNGS (U.S. CLS. 26, 39 AND 44).

FIRST USE 6-23-1994; IN COMMERCE 6-23-1994.

SN 76-434,988. DYNASPLINT SYSTEMS, INC., SEVERNA PARK, MD. FILED 7-26-2002.

STRETCH BEYOND YOUR EXPECTATIONS

FOR DYNAMIC SPLINT FOR USE WITH THE TOE, FOOT, ANKLE, KNEE, FINGER, HAND, WRIST, ELBOW, FOREARM AND SHOULDER (U.S. CLS. 26, 39 AND 44).

SN 76-435,138. UNILEAD INTERNATIONAL, INC., LAFAYETTE, CA. FILED 7-29-2002.

UNI-LEAD

FOR MEDICAL DEVICES, NAMELY, SENSOR ARRAYS USED WITH ELECTROCARDIOGRAPH EQUIPMENT FOR HEART MONITORING AND/OR DIAGNOSTIC PURPOSES (U.S. CLS. 26, 39 AND 44).

FIRST USE 11-0-2001; IN COMMERCE 11-0-2001.

SN 76-437,059. GEORGETOWN UNIVERSITY, WASHINGTON, DC. FILED 8-1-2002.

COLLIER DU CYCLE

THE ENGLISH TRANSLATION OF "COLLIER DU CYCLE" IS "NECKLACE OF CYCLE".

FOR MNEMONIC DEVICE FOR FAMILY PLANNING, NAMELY, A COLOR-CODED STRING OF BEADS THAT ASSISTS A WOMAN IN TRACKING HER FERTILITY (U.S. CLS. 26, 39 AND 44).

CLASS 10—(Continued).

SN 76-445,915. TYCO HEALTHCARE GROUP LP, NORWALK, CT. FILED 8-29-2002.



FOR MEDICAL APPARATUS, NAMELY, WOUND CLOSURE DEVICES IN THE NATURE OF SUTURES AND SURGICAL NEEDLES (U.S. CLS. 26, 39 AND 44).

SN 76-466,278. ALL PRO EXERCISE PRODUCTS, INC., LONGBOAT KEY, FL. FILED 11-4-2002.

POWER PULLEY

NO CLAIM IS MADE TO THE EXCLUSIVE RIGHT TO USE "PULLEY", APART FROM THE MARK AS SHOWN.

FOR CONVALESCENT DEVICES FOR SHOULDER AND ARM INJURIES, NAMELY A PULLEY (U.S. CLS. 26, 39 AND 44).

SN 76-468,175. HERAEUS MED GMBH, D-63450 HANAU, FED REP GERMANY, FILED 11-13-2002.

VENTA

OWNER OF FED REP GERMANY REG. NO. 30223810, DATED 5-13-2002, EXPIRES 5-31-2012.

FOR SURGICAL SUCTION PUMPS (U.S. CLS. 26, 39 AND 44).

SN 76-479,334. BED-CHECK CORPORATION, TULSA, OK. FILED 12-31-2002.

CLASSIC-CHECK

FOR ELECTRONIC PATIENT MONITORS AND DATA COLLECTORS FOR USE IN MONITORING PATIENT POSITION, PRESENCE/ABSENCE, CONDITION AND THE LIKE (U.S. CLS. 26, 39 AND 44).

SN 76-479,335. BED-CHECK CORPORATION, TULSA, OK. FILED 12-31-2002.

BASIC-CHECK

FOR ELECTRONIC PATIENT MONITORS AND DATA COLLECTORS FOR USE IN MONITORING PATIENT POSITION, PRESENCE/ABSENCE, CONDITION AND THE LIKE (U.S. CLS. 26, 39 AND 44).

CLASS 10—(Continued).

SN 76-480,774. MARS MEDICAL PRODUCT CO., LTD., TAIPEI HSIEN, 241, TAIWAN, FILED 12-31-2002.



FOR SPHYGMOMANOMETER, DIGITAL BLOOD PRESSURE MONITOR, BODY THERMOMETER, STETHOSCOPE, PULSE METER, EAR THERMOMETER, BODY FAT METER, AND ELECTROCARDIOGRAM (U.S. CLS. 26, 39 AND 44).

FIRST USE 12-1-2002; IN COMMERCE 12-1-2002.

SN 78-063,318. HIMENO, KAZUKO, SAPPORO-SHI, HOKKAIDO, JAPAN, FILED 5-14-2001.

HANDYSOFT

FOR APPARATUS AND INSTRUMENTS FOR DENTAL TREATMENT, NAMELY, ULTRASONIC TIPS; INSTRUMENTS FOR DENTAL TREATMENT, NAMELY, NON-ULTRASONIC SCALERS, TIPS AND PROBES, MOUTH GUARDS FOR MEDICAL PURPOSES; APPARATUS AND INSTRUMENTS FOR DENTAL TREATMENT, NAMELY, SPECIAL JIGS, SURGICAL KNIVES AND DENTAL CURETTES FOR USE IN SCRAPING OUT A FOCUS OF PERIODONTAL DISEASE (U.S. CLS. 26, 39 AND 44).

SN 78-071,921. WESSEL, PAUL, DELANO, MN. FILED 7-2-2001.

GLUCOBOY

FOR DIABETES MANAGEMENT CONTROL DEVICE, NAMELY GLUCOMETERS (U.S. CLS. 26, 39 AND 44).

SN 78-099,999. SPECIALIZED HEALTH PRODUCTS, INC., BOUNTIFUL, UT. FILED 12-26-2001.

SLIDELOC

FOR SAFETY NEEDLE DEVICES, NAMELY, MEDICAL NEEDLE GUARDS (U.S. CLS. 26, 39 AND 44).

CLASS 10—(Continued).

SN 78-111,059. ELEKTA AB, STOCKHOLM, SWEDEN, FILED 2-26-2002.

PRECISEBEAM

FOR RADIATION THERAPY DEVICE, NAMELY, A BEAM SHAPING DEVICE FOR USE WITH RADIATION THERAPY SYSTEMS FOR DELIVERY OF CONFORMAL SURGICAL TREATMENT AND RELATED SOFTWARE SOLD AS A UNIT (U.S. CLS. 26, 39 AND 44).

SN 78-137,412. ADVANCED BIO-SURFACES INC., MINNETONKA, MN. FILED 6-20-2002.

INTERCUSHION

FOR ORTHOPEDIC JOINT IMPLANTS (U.S. CLS. 26, 39 AND 44).

SN 78-149,185. GAMBRO LUNDIA AB, LUND, SWEDEN, FILED 7-31-2002.

THE LOOP

FOR MEDICAL DEVICES, NAMELY DIALYZERS FOR EXTRACORPOREAL BLOOD TREATMENT; HEMODIALYSIS MACHINES; HEMOFILTRATION MACHINES; HEMODIAFILTRATION MACHINES FOR THE TREATMENT OF RENAL FAILURE; HEMODIALYSIS APPARATUS; EXTRACORPOREAL CIRCULATION EQUIPMENT, NAMELY, HEMOFILTRATION, HEMODIAFILTRATION EQUIPMENT AND ACCESSORIES, NAMELY TUBING AND TUBING SETS THEREFOR (U.S. CLS. 26, 39 AND 44).

CLASS 10—(Continued).

SN 78-149,225. GAMBRO LUNDIA AB, LUND, SWEDEN, FILED 7-31-2002.

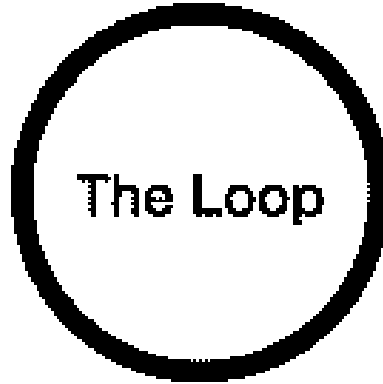

FOR MEDICAL DEVICES, NAMELY DIALYZERS FOR EXTRACORPOREAL BLOOD TREATMENT; HEMODIALYSIS MACHINES; HEMOFILTRATION MACHINES; HEMODIAFILTRATION MACHINES FOR THE TREATMENT OF RENAL FAILURE; HEMODIALYSIS APPARATUS; EXTRACORPOREAL CIRCULATION EQUIPMENT, NAMELY, HEMOFILTRATION, HEMODIAFILTRATION EQUIPMENT AND ACCESSORIES, NAMELY TUBING AND TUBING SETS THEREFOR (U.S. CLS. 26, 39 AND 44).

SN 78-153,619. FILSOUF, EHSAN, MIAMI, FL. FILED 8-13-2002.

MAGIC CONE

NO CLAIM IS MADE TO THE EXCLUSIVE RIGHT TO USE "CONE", APART FROM THE MARK AS SHOWN. FOR MEDICAL APPARATUS, NAMELY, DEVICES THAT ALLOW WOMEN TO URINATE IN A STANDING POSITION FACING THE TOILET. (U.S. CLS. 26, 39 AND 44).

SN 78-159,580. RUBICOR MEDICAL, INC., REDWOOD CITY, CA. FILED 8-30-2002.

J-LOC

FOR SURGICAL INSTRUMENTS, NAMELY MARKERS AND DETECTORS FOR MARKING AND DETECTING MARKED LESION SITES WITHIN TISSUE (U.S. CLS. 26, 39 AND 44).

SN 78-161,735. OTICON A/S, 2900 HELLERUP, DENMARK, FILED 9-7-2002.

SUMO

PRIORITY CLAIMED UNDER SEC. 44(D) ON DENMARK APPLICATION NO. VA200202255, FILED 5-30-2002, REG. NO. VR200202212, DATED 6-21-2002, EXPIRES 6-21-2012. FOR HEARING AIDS AND COMPONENTS THEREOF (U.S. CLS. 26, 39 AND 44).

CLASS 10—(Continued).

SN 78-163,888. VAST RESOURCES, INC., DBA TOPCO SALES, SAN FERNANDO, CA. FILED 9-13-2002.

INFINITY

FOR ADULT SEXUAL AIDS, NAMELY, VIBRATORS AND VIBRATOR SLEEVES, IMITATION SEXUAL ORGANS, NAMELY, PENISES, PENISES AND TESTICLES, VAGINAS, BREASTS AND POSTERIOR ANATOMY, LIFE SIZED ANATOMICALLY CORRECT MANNEQUINS, CONDOMS, AND CONSTRICTOR RINGS FOR USE TO MAINTAIN ERECTIONS; ELECTRIC AND NON-ELECTRIC MASSAGE DEVICES AND ACCESSORIES FOR MASSAGING OR VIBRATING PORTIONS OF THE FACE AND BODY; DEVICES FOR AIDING IN SEXUAL INTERCOURSE AND MASTURBATION, NAMELY, REPRODUCTIONS OF PARTS OF THE MALE AND FEMALE ANATOMY AND VACUUM PUMPS AND PARTS THEREFOR, NAMELY A CYLINDER, SLEEVE, CUSHION INSERTS, CONSTRICTOR RINGS AND CONSTRICTOR RING LOADERS FOR USE IN MAINTAINING PENILE AND VAGINAL RIGIDITY (U.S. CLS. 26, 39 AND 44).

SN 78-169,402. MALIK, ANDREW J., NEW YORK, NY. FILED 9-30-2002.

DOING WELL BY DOING GOOD

FOR DURABLE MEDICAL EQUIPMENT IN THE NATURE OF RAISED TOILET SEATS, SHOWER CHAIRS AND BEDPANS (U.S. CLS. 26, 39 AND 44).

SN 78-180,643. SCIMED LIFE SYSTEMS, INC., MAPLE GROVE, MN. FILED 10-31-2002.

SYNERGO

FOR MICROWAVE ENERGY APPARATUS AND INFUSION SETS FOR CANCER TREATMENT (U.S. CLS. 26, 39 AND 44).

SN 78-188,411. RAZBABY INNOVATIVE BABY PRODUCTS, INC, MIAMI, FL. FILED 11-25-2002.

KEEP IT KLEEN

FOR BABY PACIFIERS (U.S. CLS. 26, 39 AND 44).

CLASS 10—(Continued).

SN 78-188,597. MEDTRONIC, INC., MINNEAPOLIS, MN. FILED 11-25-2002.

ENDOSTARFISH

OWNER OF U.S. REG. NO. 2,701,445.
FOR SURGICAL TOOL USED IN BEATING HEART SURGERY, NAMELY AN ENDOSCOPIC HEART POSITIONER (U.S. CLS. 26, 39 AND 44).

SN 78-194,590. TAKASHIMA, JIRO, HOUSTON, TX. FILED 12-14-2002.

ANEROS

FOR PROSTATE MASSAGERS (U.S. CLS. 26, 39 AND 44).
FIRST USE 1-0-2000; IN COMMERCE 1-0-2000.

SN 78-195,588. NEOTHERMIA CORPORATION, NATICK, MA. FILED 12-18-2002.

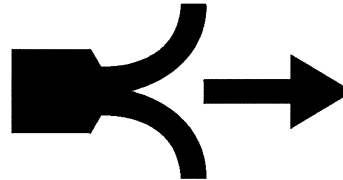

FOR ELECTROSURGICAL CUTTING AND COAGULATION INSTRUMENTS FOR USE IN DIAGNOSTIC BIOPSY PROCEDURES, FEATURING RADIOFREQUENCY GENERATOR AND MOTION CONTROLLER, BIOPSY PROBE FOR PERCUTANEOUSLY EXCISING AND REMOVING TISSUE, AND ELECTRICAL AND MECHANICAL INTERFACE INSTRUMENT FOR USE THEREWITH (U.S. CLS. 26, 39 AND 44).

SN 78-195,589. NEOTHERMIA CORPORATION, NATICK, MA. FILED 12-18-2002.

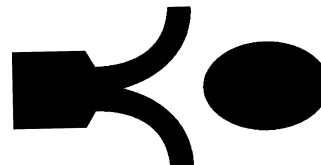

FOR ELECTROSURGICAL CUTTING AND COAGULATION INSTRUMENTS FOR USE IN DIAGNOSTIC BIOPSY PROCEDURES, FEATURING RADIOFREQUENCY GENERATOR AND MOTION CONTROLLER, BIOPSY PROBE FOR PERCUTANEOUSLY EXCISING AND REMOVING TISSUE, AND ELECTRICAL AND MECHANICAL INTERFACE INSTRUMENT FOR USE THEREWITH (U.S. CLS. 26, 39 AND 44).

CLASS 10—(Continued).

SN 78-195,590. NEOTHERMIA CORPORATION, NATICK, MA. FILED 12-18-2002.

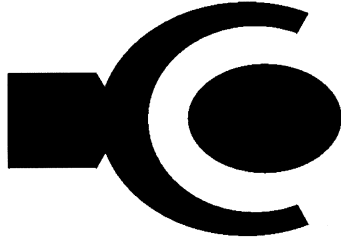

FOR ELECTROSURGICAL CUTTING AND COAGULATION INSTRUMENTS FOR USE IN DIAGNOSTIC BIOPSY PROCEDURES, FEATURING RADIOFREQUENCY GENERATOR AND MOTION CONTROLLER, BIOPSY PROBE FOR PERCUTANEOUSLY EXCISING AND REMOVING TISSUE, AND ELECTRICAL AND MECHANICAL INTERFACE INSTRUMENT FOR USE THEREWITH (U.S. CLS. 26, 39 AND 44).

SN 78-201,738. PHILADELPHIA CERVICAL COLLAR COMPANY, THOROFARE, NJ. FILED 1-9-2003.

C-LOC

FOR ORTHOTIC DEVICES, NAMELY, SPLINTS, BRACES, SUPPORTS AND MEDICAL EQUIPMENT USED FOR SUPPORTING AND IMMOBILIZING AN ENTIRE HUMAN BODY OR PORTION THEREOF SUCH AS HEAD, TORSO, LIMBS, JOINTS, HIP, TIBIA, ANKLE, KNEE, CERVIX, HUMERUS, ELBOW, WRIST, AND HAND (U.S. CLS. 26, 39 AND 44).

SN 78-202,740. IMPLEX CORPORATION, ALLENDALE, NJ. FILED 1-13-2003.

DARWIN

FOR MEDICAL APPARATUS, NAMELY, ORTHOPEDIC JOINT IMPLANTS AND SURGICAL INSTRUMENTS FOR ORTHOPEDIC SURGERY (U.S. CLS. 26, 39 AND 44).

SN 78-206,454. C. R. BARD, INC., MURRAY HILL, NJ. FILED 1-23-2003.

PELVISOFT

FOR MEDICAL DEVICES, NAMELY, MESH TO TREAT URINARY INCONTINENCE (U.S. CLS. 26, 39 AND 44).

CLASS 10—(Continued).

SN 78-206,573. STRATA MEDICAL, INC., CARLSBAD, CA. FILED 1-23-2003.

SENSIGUARD

FOR CONDOMS (U.S. CLS. 26, 39 AND 44).

SN 78-206,605. HONEBEIN ASSOCIATES, INC., RENO, NV. FILED 1-23-2003.



FOR NON-ELECTRIC MASSAGE APPARATUS (U.S. CLS. 26, 39 AND 44). FIRST USE 1-18-2003; IN COMMERCE 1-18-2003.

SN 78-207,951. HOWMEDICA OSTEONICS CORP., ALLENDALE, NJ. FILED 1-28-2003.

NRG

FOR SURGICAL AND MEDICAL GOODS, NAMELY, ORTHOPEDIC IMPLANTS AND INSTRUMENTS FOR IMPLANTING ORTHOPEDIC IMPLANTS. (U.S. CLS. 26, 39 AND 44).

SN 78-208,170. MEDTRONIC, INC., MINNEAPOLIS, MN. FILED 1-29-2003.

EQUATION

FOR SURGICAL IMPLANT SYSTEMS CONSISTING OF PLATES, SCREWS, HOOKS, RINGS, RODS, BOLTS, CONNECTORS, NUTS AND CROSS LINKING MEMBERS, USED IN SPINAL SURGERY (U.S. CLS. 26, 39 AND 44).

CLASS 10—(Continued).

SN 78-208,541. DAVENPORT, RONALD K., TUSTIN, CA.
FILED 1-29-2003.

STAR-TIP - CANE-TIP OF THE NEW MILLENNIUM

NO CLAIM IS MADE TO THE EXCLUSIVE RIGHT TO USE "CANE-TIP", APART FROM THE MARK AS SHOWN, FOR FRICTION TIPS FOR PRODUCTS ADAPTED FOR MEDICAL PATIENTS AND HANDICAPPED PERSONS, NAMELY, WALKING CANES, CRUTCHES, SHOWER CHAIRS, COMMODES AND STOOL LEGS (U.S. CLS. 26, 39 AND 44).

SN 78-208,583. ALTUS MEDICAL, INC., BURLINGAME, CA.
FILED 1-29-2003.

COOLGLIDE XEO

OWNER OF U.S. REG. NOS. 2,462,658 AND 2,515,273.
FOR MEDICAL LASERS. (U.S. CLS. 26, 39 AND 44).

SN 78-208,594. CARDIONICS, INC., WEBSTER, TX. FILED 1-29-2003.

HEARTMAN

FOR STETHOSCOPES AND STETHOPHONES (U.S. CLS. 26, 39 AND 44).
FIRST USE 9-21-1989; IN COMMERCE 9-21-1989.

SN 78-212,740. MEAD JOHNSON & COMPANY, EVANSVILLE, IN. FILED 2-10-2003.

SMART DEVELOPMENT PROGRAM

FOR BABY BOTTLES. (U.S. CLS. 26, 39 AND 44).

SN 78-213,063. MEDTRONIC AVE, INC., SANTA ROSA, CA.
FILED 2-10-2003.

SYMBIANT

FOR MEDICAL DEVICES FOR USE IN VASCULAR AND PERIPHERAL PROCEDURES, NAMELY, STENT DELIVERY SYSTEMS COMPRISED OF STENTS, GUIDE WIRES, BALLOON CATHETERS AND CATHETERS; AND DISTAL PROTECTION DEVICES, NAMELY, OCCLUSION BALLOONS AND FILTERS (U.S. CLS. 26, 39 AND 44).

CLASS 10—(Continued).

SN 78-215,852. MEGADYNE MEDICAL PRODUCTS, INC., DRAPER, UT. FILED 2-18-2003.

SMART CUT

FOR ELECTROSURGICAL EQUIPMENT, NAMELY ELECTROSURGICAL GENERATORS (U.S. CLS. 26, 39 AND 44).

SN 78-215,975. MEDTRONIC MINIMED, INC., NORTH-RIDGE, CA. FILED 2-18-2003.

PARADIGM LINK

OWNER OF U.S. REG. NO. 2,672,616.
FOR TELEMETERED MONITORING DEVICES, NAMELY, GLUCOSE METERS AND MONITORS FOR COMMUNICATION WITH INFUSION DEVICES (U.S. CLS. 26, 39 AND 44).

CLASS 11—ENVIRONMENTAL CONTROL APPARATUS

SN 75-165,756. PYRO INDUSTRIES, INC., BURLINGTON, WA. FILED 9-13-1996.

ADVANTAGE

FOR SERIES OF SOLID FUEL BURNING STOVES AND FIREPLACE INSERTS (U.S. CLS. 13, 21, 23, 31 AND 34).
FIRST USE 5-0-1988; IN COMMERCE 5-0-1988.

SN 75-551,486. KABUSHIKI KAISHA SONY COMPUTER ENTERTAINMENT, TA SONY COMPUTER ENTERTAINMENT, INC., TOKYO, JAPAN, FILED 9-11-1998.

POCKETSTATION

PRIORITY CLAIMED UNDER SEC. 44(D) ON JAPAN APPLICATION NO. 10-52308, FILED 6-19-1998, REG. NO. 4621139, DATED 11-15-2002, EXPIRES 11-15-2012.

FOR APPARATUS FOR LIGHTING, HEATING, STEAM GENERATING, COOKING, REFRIGERATING, DRYING, VENTILATING AND WATER SUPPLY, NAMELY, GAS LAMPS, OIL LAMPS, FURNACE BOILERS, GAS HEATERS, HOT WATER HEATERS, INDUSTRIAL ELECTRIC RICE COOKERS, INDUSTRIAL DISH DRYERS, INDUSTRIAL ELECTRIC OR GAS COOKING RANGES, REFRIGERATORS, AND FREEZERS, WATER HEATERS; BATHTUBS; WATER PURIFICATION UNITS; FLASHLIGHTS, VENTILATING FANS FOR COMMERCIAL USE; WATER COOLERS AND ELECTRIC CHINESE LANTERNS (U.S. CLS. 13, 21, 23, 31 AND 34).

CLASS 11—(Continued).

SN 75-638,413. GENERAL ELECTRIC COMPANY, CLEVELAND, OH. FILED 2-11-1999.

CLASS 11—(Continued).

SN 76-353,378. NORITZ CORPORATION, KOBE 650-0033, JAPAN, FILED 12-31-2001.

OFFICIAL LIGHT BULB OF THE INTERNET

FOR ELECTRIC AND HALOGEN LIGHT BULBS (U.S. CLS. 13, 21, 23, 31 AND 34).



SN 76-168,114. STEIN HEURTEY, 91130 RIS ORANGIS, FRANCE, FILED 11-20-2000.

Digit@I Furnace

PRIORITY CLAIMED UNDER SEC. 44(D) ON FRANCE APPLICATION NO. 003031351, FILED 5-30-2000, REG. NO. 3031351, DATED 5-30-2000, EXPIRES 5-30-2010.

NO CLAIM IS MADE TO THE EXCLUSIVE RIGHT TO USE "DIGITAL FURNACE", APART FROM THE MARK AS SHOWN.

FOR EQUIPMENT FOR USE IN THE HEAVY METALLURGY INDUSTRY, NAMELY, FURNACE FOR THE REHEATING OF PRODUCTS (U.S. CLS. 13, 21, 23, 31 AND 34).

OWNER OF JAPAN REG. NO. 2305073, DATED 4-30-1991, EXPIRES 4-30-2011.

OWNER OF JAPAN REG. NO. 1947560, DATED 4-30-1987, EXPIRES 4-30-2007.

OWNER OF JAPAN REG. NO. 1947559, DATED 4-30-1987, EXPIRES 4-30-2007.

OWNER OF JAPAN REG. NO. 1947558, DATED 4-30-1987, EXPIRES 4-30-2007.

FOR GAS HEATERS FOR WATER; OIL HEATERS FOR WATER FOR DOMESTIC USE; OIL HEATERS FOR WATER FOR INDUSTRIAL USE; SAUNAS FOR INDUSTRIAL USE; INDUSTRIAL BOILERS; HEATING APPARATUS, NAMELY, GAS RANGES, COMMERCIAL AND DOMESTIC COOKING OVENS FOR KITCHEN USE, PORTABLE WOOD BURNING STOVES MADE OF CLAY, OIL STOVES, AND BARBECUE GRILLS; SINKS; DEEP FAT FRYERS AND ELECTRIC DEEP FRYERS FOR INDUSTRIAL AND COMMERCIAL USE; DISH DRYERS FOR INDUSTRIAL USE; RICE COOKERS FOR INDUSTRIAL USE; ELECTRIC ROASTERS FOR COMMERCIAL USE; GAS RANGES FOR INDUSTRIAL AND COMMERCIAL USE; ELECTRIC RANGES FOR INDUSTRIAL AND COMMERCIAL USE; DRYING APPARATUS, NAMELY, HAIR DRYERS, DISH DRYERS, CLOTHES DRYERS, AND INDUSTRIAL ROOM DRYERS FOR HEATING AND DEHUMIDIFYING; DISTILLATE APPARATUS, NAMELY, DISTILLING UNITS, DISTILLING TUBES, DISTILLING TANKS, DISTILLING FLASKS, DISTILLING CONDENSERS, DISTILLATION ANALYZERS, AND DISTILLING COLUMNS; HEAT EXCHANGERS; HEATING AND AIR CONDITIONING EQUIPMENT, NAMELY, WARM HEATERS, AIR HEATING FURNACES, HOT WATER HEATERS, STEAM HEATERS, SINGLE INDUCTION AIR CONDITIONERS, CENTRAL AIR CONDITIONERS, WINDOW AIR CONDITIONERS, RADIATORS, FLOOR WARMERS, AND ROAD SURFACE WARMERS; TOILET CUBICAL UNIT COMPRISING A TOILET, WASHBASIN AND LIGHT FIXTURE ENCLOSED IN A SINGLE UNIT; BATH CUBICLE UNIT COMPRISING A SHOWER, BATHTUB, WASHING FLOOR, VANITY, AND LIGHT FIXTURE ENCLOSED IN A SINGLE UNIT; SAUNAS FOR DOMESTIC USE; BATH GOODS, NAMELY, SHOWERS, BATHTUBS, BATHTUBS WITH WASHING FLOOR, HOT TUBS, BATHTUBS WITH VANITY AND WASHING FLOOR, AND BATH BOILERS; WATER PURIFIERS FOR DOMESTIC USE; LEVEL CONTROLLING VALVES IN TANKS; GARBAGE INCINERATORS FOR DOMESTIC USE; GARBAGE INCINERATORS FOR INDUSTRIAL USE; SOLAR HEATERS FOR WATER; ELECTRIC HEATERS FOR WATER FOR DOMESTIC USE; ELECTRIC HEATING APPLIANCES FOR DOMESTIC USE, NAMELY, AIR CONDITIONERS AND RANGE HOODS; ELECTRIC HEATERS FOR WATER FOR INDUSTRIAL USE; TOILET SEATS WITH HYGIENIC CLEANING FUNCTION; AND TOILET BOWLS (U.S. CLS. 13, 21, 23, 31 AND 34).

SN 76-305,714. DESIGN TECHNOLOGY CORP. OF DELAWARE, SEAFORD, DE. FILED 8-28-2001.



FOR APPARATUS FOR LIGHTING, NAMELY, ELECTRIC LIGHT PROJECTORS AND LUMINAIRES (U.S. CLS. 13, 21, 23, 31 AND 34).
FIRST USE 8-24-1001; IN COMMERCE 8-24-2001.

CLASS 11—(Continued).

SN 76-371,256. P.S. PIBBS, INC., FLUSHING, NY. FILED 2-14-2002.

VIRGO DRYER

NO CLAIM IS MADE TO THE EXCLUSIVE RIGHT TO USE "DRYER", APART FROM THE MARK AS SHOWN.

FOR ELECTRIC HAIR DRYERS, NAMELY, STATIONARY HAIR DRYERS FOR COMMERCIAL USE (U.S. CLS. 13, 21, 23, 31 AND 34).

FIRST USE 12-31-1984; IN COMMERCE 12-31-1984.

SN 76-379,687. TRUCK-LITE CO., INC., FALCONER, NY. FILED 3-7-2002.



OWNER OF U.S. REG. NOS. 235,792, 2,517,771 AND OTHERS.

FOR LIGHT EMITTING DIODE LIGHTING PRODUCTS FOR VEHICLES, NAMELY, HEADLIGHTS; TAIL LIGHTS; MARKER LIGHTS; CLEARANCE LIGHTS; IDENTIFICATION LIGHTS; STOP LIGHTS; TURN LIGHTS; LIGHTING KITS COMPRISED OF LAMPS, GROMMETS, PLUGS, ADAPTERS, AND FLANGES; LICENSE PLATE LIGHTS; BACK-UP LIGHTS; INTERIOR AND UTILITY LIGHTS; SNOW PLOW AND WORK LIGHTS; FOG AND DRIVING LIGHTS; DAYTIME RUNNING LIGHTS; MILITARY LIGHTS; AND FLASHING LIGHTS (U.S. CLS. 13, 21, 23, 31 AND 34).

SN 76-389,137. BALLANTYNE OF OMAHA, INC., OMAHA, NE. FILED 4-1-2002.

OPTIMAX

FOR SEARCHLIGHTS AND SPOTLIGHTS (U.S. CLS. 13, 21, 23, 31 AND 34).

CLASS 11—(Continued).

SN 76-389,913. NORITZ CORPORATION, KOBE 650-0033, JAPAN, FILED 3-29-2002.

NORITZ

FOR GAS HEATERS FOR WATER; OIL HEATERS FOR WATER FOR DOMESTIC USE; OIL HEATERS FOR WATER FOR INDUSTRIAL USE; SAUNAS FOR INDUSTRIAL USE; FURNACE BOILERS; HEATING APPARATUS, NAMELY, GAS RANGES, COOKING OVENS FOR KITCHEN USE, PORTABLE WOOD BURNING STOVES MADE OF CLAY, OIL STOVES, AND BARBECUE GRILLS; SINKS; DEEP FAT FRYERS AND ELECTRIC DEEP FRYERS FOR INDUSTRIAL AND COMMERCIAL USE; DISH DRYERS FOR INDUSTRIAL USE; RICE COOKERS FOR INDUSTRIAL USE; ELECTRIC ROASTERS FOR COMMERCIAL USE; GAS RANGES FOR INDUSTRIAL AND COMMERCIAL USE; ELECTRIC RANGES FOR INDUSTRIAL AND COMMERCIAL USE; DRYING APPARATUS, NAMELY, HAIR DRYERS, DISH DRYERS, CLOTHES DRYERS, AND INDUSTRIAL ROOM DRYERS FOR HEATING AND DEHUMIDIFYING; DISTILLATE APPARATUS, NAMELY, DISTILLING UNITS, DISTILLING TUBES, DISTILLING TANKS, DISTILLING FLASKS, DISTILLING CONDENSERS, DISTILLATION ANALYZERS, AND DISTILLING COLUMNS; HEAT EXCHANGERS; HEATING AND AIR CONDITIONING EQUIPMENT, NAMELY, WARM HEATERS, AIR HEATING FURNACES, HOT WATER HEATERS, STEAM HEATERS, SINGLE INDUCTION AIR CONDITIONERS, CENTRAL AIR CONDITIONERS, WINDOW AIR CONDITIONERS, RADIATORS, FLOOR WARMERS, AND ROAD SURFACE WARMERS; TOILET CUBICAL UNIT COMPRISING A TOILET, WASHBASIN AND LIGHT FIXTURE ENCLOSED IN A SINGLE UNIT; BATH CUBICLE UNIT COMPRISING A SHOWER, BATHTUB, WASHING FLOOR, VANITY, AND LIGHT FIXTURE ENCLOSED IN A SINGLE UNIT; SAUNAS FOR DOMESTIC USE; BATH GOODS, NAMELY, SHOWERS, BATHTUBS, BATHTUBS WITH WASHING FLOOR, HOT TUBS, BATHTUBS WITH VANITY AND WASHING FLOOR, AND BATH BOILERS; WATER PURIFIERS FOR DOMESTIC USE; LEVEL CONTROLLING VALVES IN TANKS; GARBAGE INCINERATORS FOR DOMESTIC USE; GARBAGE INCINERATORS FOR INDUSTRIAL USE; SOLAR HEATERS FOR WATER; ELECTRIC HEATERS FOR WATER FOR DOMESTIC USE; ELECTRIC HEATING APPLIANCES FOR DOMESTIC USE, NAMELY, AIR CONDITIONERS AND RANGE HOODS; ELECTRIC HEATERS FOR WATER FOR INDUSTRIAL USE; TOILET SEATS WITH HYGIENIC CLEANING FUNCTION; AND TOILET BOWLS (U.S. CLS. 13, 21, 23, 31 AND 34).

SN 76-394,726. JETAIR, INC., NEW WINDSOR, NY. FILED 4-11-2002.



THE LINING SHOWN IN THE DRAWING IS A FEATURE OF THE MARK.

FOR ELECTRIC HOT AIR HAND AND HAIR DRYERS (U.S. CLS. 13, 21, 23, 31 AND 34).

FIRST USE 1-0-1987; IN COMMERCE 1-0-1987.

CLASS 11—(Continued).

SN 76-397,020. ELECTRIC POWER RESEARCH INSTITUTE, INC., PALO ALTO, CA. FILED 4-16-2002.

COHPAC

FOR AIR FILTERS FOR INDUSTRIAL USES (U.S. CLS. 13, 21, 23, 31 AND 34).
FIRST USE 1-1-1992; IN COMMERCE 1-1-1998.

SN 76-398,010. FPI FIREPLACE PRODUCTS INTERNATIONAL LTD., BRITISH COLUMBIA, CANADA. BY CHANGE OF NAME FIREPLACE PRODUCTS INTERNATIONAL LTD., DELTA, BRITISH COLUMBIA, CANADA, FILED 4-18-2002.

HAMPTON

FOR WOOD BURNING STOVES AND PARTS, ACCESSORIES AND ATTACHMENTS FOR SUCH STOVES, NAMELY, CAST IRON GAS SURROUND INSERTS, CAST IRON AND CERAMIC PLATES, COVERS, LOUVERS, BRACKETS, BURNERS, ARTIFICIAL FIRE LOGS SOLD AS PARTS OF STOVES (U.S. CLS. 13, 21, 23, 31 AND 34).
FIRST USE 1-2-2002; IN COMMERCE 3-6-2002.

SN 76-405,503. CARAVELL A/S, DK-8831 LOGSTRUP, DENMARK, FILED 4-30-2002.

CARAVELL

OWNER OF U.S. REG. NO. 2,552,484.
FOR REFRIGERATION APPARATUS AND MACHINES, NAMELY REFRIGERATION UNITS, REFRIGERATING CONTAINERS, REFRIGERATION CABINETS, REFRIGERATING CHAMBERS; ICE CREAM CABINETS AND ICE MAKING MACHINES; FREEZERS (U.S. CLS. 13, 21, 23, 31 AND 34).

SN 76-420,304. BOSCH, W. BRUCE, VANCOUVER, WA. AND BOSCH, M. FRAN, VANCOUVER, WA. FILED 6-11-2002.

HYDRO-VAP

FOR WASTEWATER TREATMENT MACHINE USED FOR EVAPORATING WASTEWATER (U.S. CLS. 13, 21, 23, 31 AND 34).
FIRST USE 9-17-1993; IN COMMERCE 9-17-1993.

CLASS 11—(Continued).

SN 76-428,562. P.T. WARISAN EURINDO, 80361, BALI, INDONESIA, FILED 7-8-2002.

WARISAN

THE ENGLISH TRANSLATION OF "WARISAN" IS "HERITAGE".
FOR LAMPS, LAMP SHADES AND ELECTRIC LIGHTING FIXTURES (U.S. CLS. 13, 21, 23, 31 AND 34).
FIRST USE 11-1-1998; IN COMMERCE 11-1-1998.

SN 76-428,801. SILESIA ESPANA, S.A., 08023 BARCELONA, SPAIN, FILED 7-1-2002.

VELOX

FOR ELECTRIC COOKING GRILLS FOR COMMERCIAL USE (U.S. CLS. 13, 21, 23, 31 AND 34).
FIRST USE 7-1-2001; IN COMMERCE 7-0-2001.

SN 76-429,831. REMCRAFT LIGHTING PRODUCTS, MIAMI, FL. FILED 7-10-2002.

BACI

OWNER OF U.S. REG. NO. 2,287,078.
THE ENGLISH TRANSLATION OF "BACI" IS "KISS".
FOR HAND HELD ELECTRIC HAIR DRYERS AND ELECTRIC LIGHTING FIXTURES (U.S. CLS. 13, 21, 23, 31 AND 34).
FIRST USE 1-24-2002; IN COMMERCE 1-24-2002.

SN 76-434,120. REGAL WARE, INC. KEWASKUM, WI. BY ASSIGNMENT PREMARK WB HOLDINGS, INC., WILMINGTON, DE. FILED 7-25-2002.

KITCHEN CRAFT

OWNER OF U.S. REG. NO. 1,660,860.
NO CLAIM IS MADE TO THE EXCLUSIVE RIGHT TO USE "KITCHEN", APART FROM THE MARK AS SHOWN.
FOR ELECTRIC SLOW COOKER; ELECTRIC SKILLET; WATER DISTILLERS FOR DOMESTIC USE (U.S. CLS. 13, 21, 23, 31 AND 34).

CLASS 11—(Continued).

SN 76-434,426. XINGXING GROUP CO., LTD., TAIZHOU, ZHEJIANG, CHINA, FILED 7-24-2002.



FOR BATH TUBS; SHOWERS; TOILET BOWLS, TOILET SEATS; ELECTRIC HOT AIR HAND DRYERS; SOLAR-POWERED WATER HEATERS FOR COMMERCIAL USE (U.S. CLS. 13, 21, 23, 31 AND 34).
FIRST USE 1-8-2002; IN COMMERCE 5-1-2002.

SN 76-436,472. CAM YORK INDUSTRIAL CO., LTD., WU FONG HSIANG, TAICHUNG HSIEN, TAIWAN, FILED 7-29-2002.



THE MARK CONSISTS OF THE LETTER "Y" WITHIN A SILHOUETTE OF A FAN, SURROUNDED BY A BLACK BACKGROUND, THEN BY FAN BLADES.

FOR EVAPORATIVE AIR COOLING UNITS FOR COMMERCIAL, INDUSTRIAL AND DOMESTIC USE; HEAT-EXCHANGE AIR COOLING UNITS FOR COMMERCIAL, INDUSTRIAL AND DOMESTIC USE; VENTILATORS FOR EXHAUSTING AIR FROM BUILDINGS; VENTILATING EXHAUST FANS; STEAM AND ELECTRIC RADIATORS FOR HEATING BUILDINGS; BLAST FANS; BLADES FOR VENTILATORS AND EXHAUST FANS (U.S. CLS. 13, 21, 23, 31 AND 34).
FIRST USE 5-1-1994; IN COMMERCE 7-1-2002.

SN 76-436,684. MESTEK, INC., WESTFIELD, MA. FILED 8-1-2002.

KING

FOR COMMERCIAL AND INDUSTRIAL HEATERS, AIR CONDITIONERS, AND VENTILATORS; AND STRUCTURAL PARTS THEREOF (U.S. CLS. 13, 21, 23, 31 AND 34).

FIRST USE 0-0-1915; IN COMMERCE 0-0-1915.

CLASS 11—(Continued).

SN 76-442,492. CARRIER CORPORATION, SYRACUSE, NY. FILED 8-16-2002.

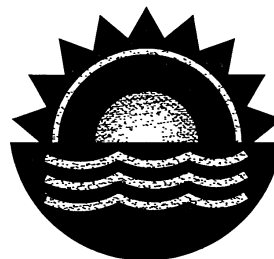

THE STIPPLING IS FOR SHADING PURPOSES ONLY AND DOES NOT INDICATE COLOR.

FOR HEATING, VENTILATING, AND AIR CONDITIONING PRODUCTS, COMPONENTS AND ACCESSORIES, NAMELY, FURNACES, AIR CONDITIONERS, HEAT PUMPS, FAN COILS, AIR HANDLERS AND FANS (U.S. CLS. 13, 21, 23, 31 AND 34).

FIRST USE 5-0-1999; IN COMMERCE 5-0-1999.

SN 76-445,561. INDUSTRIAS HACEB S.A., MEDELLIA, COLOMBIA, FILED 8-30-2002.



Los productos de hoy. La calidad de siempre.

THE ENGLISH TRANSLATION OF THE WORD "LOS PRODUCTOS DE HOY. LA CALIDAD DE SIEMPRE" IN THE MARK IS "THE PRODUCTS OF TODAY. THE QUALITY OF ALWAYS".

FOR ELECTRIC AND GAS OPERATED APPARATUS FOR DOMESTIC AND COMMERCIAL USE, AND PARTS THEREOF, NAMELY, REFRIGERATORS, OVENS, COOKING STOVES, HOT WATER HEATERS, SPACE HEATERS, AIR CONDITIONING UNITS (U.S. CLS. 13, 21, 23, 31 AND 34).

CLASS 11—(Continued).

SN 76-445,875. SHENZHEN NEW ERA DRINKING WATER SCIENCE & TECHNOLOGY CO., LTD., FUTIAN DISTRICT, SHENZHEN, CHINA, FILED 8-28-2002.

Anjier

THE MARK CONSISTS OF "ANJIER".
FOR ACETYLENE BURNERS; GAS BURNERS FOR DOMESTIC USE; MICROWAVE OVENS FOR COOKING; REFRIGERATORS; AIR CONDITIONING UNITS; VENTILATORS FOR DOMESTIC USE; INDUSTRIAL DRYERS FOR HEATING AND DEHUMIDIFYING;- CLOTHES DRYERS; DRYERS FOR THE REMOVAL OF WATER VAPOR FROM COMPRESSED AIR AND GASES; ELECTRIC RADIATORS FOR HEATING BUILDINGS;- ELECTRIC HEATING FANS; PIPES BEING PARTS OF SANITARY FACILITIES; WATER CLOSETS; WATER FILTERS; WATER FILTERING UNITS FOR PRODUCING POTABLE WATER FOR DOMESTIC USE; WATER HEATERS FOR DOMESTIC AND COMMERCIAL USE; ELECTRICAL WATER PUMPS FOR BATHS; WATER PURIFICATION UNITS; WATER SOFTENING UNITS; WATER COOLERS; ELECTRIC SPACE HEATERS FOR COMMERCIAL USE; LAVATORIES; TOILETS; SHOWERS; ELECTRIC BEVERAGE HEATERS; REFRIGERATED BEVERAGE DISPENSING UNITS; ICE MAKING MACHINES; WATER CONDITIONING UNITS (U.S. CLS. 13, 21, 23, 31 AND 34).

SN 76-453,038. CHINA SINGFUN ELECTRIC GROUP CO., LTD., NINGBO, ZHEJIANG, CHINA, FILED 9-17-2002.



THE MARK CONSISTS OF THE WORDING "SINGFUN" AND THREE ARROW DESIGNS POINTED TO THE RIGHT IN AN OVAL ABOVE THE WORDING.
FOR ELECTRIC HEATING APPARATUS, NAMELY, SPACE HEATERS, ROOM HEATERS, ELECTRIC FANS, REFRIGERATED AND HEATED WATER DISPENSERS; MICROWAVE OVENS; AIR CONDITIONERS; HAND HELD ELECTRIC HAIR DRIER FOR DOMESTIC USE; ELECTRIC BREAD TOASTERS; VENTILATOR IN THE NATURE OF A RANGE HOOD; ELECTRICAL WATER KETTLES; HUMIDIFIERS; ELECTRIC DISINFECTANT CUPBOARD FOR DOMESTIC USE FOR STERILIZING DINNER DISHES AND UTENSILS (U.S. CLS. 13, 21, 23, 31 AND 34).

CLASS 11—(Continued).

SN 76-453,702. FX LUMINAIRE, SAN DIEGO, CA. FILED 9-30-2002.

DIAMANTEPICCOLO

THE FOREIGN WORDING IN THE MARK TRANSLATES INTO ENGLISH AS "LITTLE DIAMOND".
FOR ELECTRICAL LIGHTING FIXTURES (U.S. CLS. 13, 21, 23, 31 AND 34).
FIRST USE 2-1-2002; IN COMMERCE 2-1-2002.

SN 76-457,329. DESA INTERNATIONAL INC., BOWLING GREEN, KY. FILED 10-10-2002.



NO CLAIM IS MADE TO THE EXCLUSIVE RIGHT TO USE "TWO YEAR WARRANTY 2", APART FROM THE MARK AS SHOWN.
FOR ELECTRIC LIGHTING FIXTURES (U.S. CLS. 13, 21, 23, 31 AND 34).

SN 76-460,180. NEW WAVE ENVIRO PRODUCTS, INC., DENVER, CO. FILED 10-22-2002.

ENVIRO PRODUCTS

OWNER OF U.S. REG. NO. 2,307,201.
NO CLAIM IS MADE TO THE EXCLUSIVE RIGHT TO USE "PRODUCTS", APART FROM THE MARK AS SHOWN.
FOR WATER FILTER PURIFICATION AND WATER DISPENSING UNITS, AND PARTS THEREFOR FOR USE IN HOMES AND BUSINESSES, AND FOR PERSONAL AND PET USE (U.S. CLS. 13, 21, 23, 31 AND 34).
FIRST USE 7-12-1994; IN COMMERCE 7-12-1994.

CLASS 11—(Continued).

SN 76-464,932. HUGHES SUPPLY IP, INC., WILMINGTON, DE. FILED 10-29-2002.

PROQUALITY

FOR PLUMBING FIXTURES, NAMELY, PIPES, VALVES AND FITTINGS, NAMELY, FAUCETS, BRASS VALVES, STOPS, POP-UP DRAIN ASSEMBLIES, STRAINERS, ESCUTCHEONS, SHOWER ARMS, VACUUM BREAKERS, DISPOSAL CONNECTORS, TUB DIVER-TORS, GRAB BARS, FITTINGS BRUSHES AND TOILET SEATS; WATER PUMPS FOR BATHS AND TOILET TANKS, WATER COOLERS, WATER HEATERS, AND RELATED ACCESSORIES, NAMELY, PRESSURE RELIEF VALVES, SUPPLY LINES, NIPPLES, MALLEABLE FITTINGS, COPPER FITTINGS, PVC VALVES, DRAIN VALVES AND ELEMENTS, FILL VALVES, BALL COCKS, TOILET BOLTS, TRIP LEVERS, BUBBLERS, AND DRAIN ASSEMBLIES; ELECTRIC LIGHTING FIXTURES, FIBER OPTIC LIGHTING FIXTURES, INFRARED LIGHTING FIXTURES, ELECTRIC LIGHTING TRACKS AND RELATED ACCESSORIES, NAMELY, REPLACEMENT GLASS, LIGHT BULBS, BALLASTS, CONDUIT FITTINGS, WIRE TIE WRAPS, OUTLET STRIPS, GFI RECEPTACLES, SWITCH PLATES, RECEPTACLE PLATES, AND WIRING DEVICES (U.S. CLS. 13, 21, 23, 31 AND 34).

SN 76-464,933. HUGHES SUPPLY IP, INC., WILMINGTON, DE. FILED 10-29-2002.

PROVALUE

FOR PLUMBING FIXTURES, NAMELY, PIPES, VALVES AND FITTINGS, NAMELY, FAUCETS, BRASS VALVES, STOPS, POP-UP DRAIN ASSEMBLIES, STRAINERS, ESCUTCHEONS, SHOWER ARMS, VACUUM BREAKERS, DISPOSAL CONNECTORS, TUB DIVER-TORS, GRAB BARS, FITTINGS BRUSHES AND TOILET SEATS; WATER PUMPS FOR BATHS AND TOILET TANKS, WATER COOLERS, WATER HEATERS, AND RELATED ACCESSORIES, NAMELY, PRESSURE RELIEF VALVES, SUPPLY LINES, NIPPLES, MALLEABLE FITTINGS, COPPER FITTINGS, PVC FITTINGS, PVC VALVES, DRAIN VALVES AND ELEMENTS, FILL VALVES BALL COCKS, TOILET BOLTS, TRIP LEVERS, BUBBLERS, AND DRAIN ASSEMBLIES; ELECTRIC LIGHTING FIXTURES, FIBER OPTIC LIGHTING FIXTURES, INFRARED LIGHTING FIXTURES, ELECTRIC LIGHTING TRACKS AND RELATED ACCESSORIES, NAMELY, REPLACEMENT GLASS, LIGHT BULBS, BALLASTS, CONDUIT FITTINGS, WIRE TIE WRAPS, OUTLET STRIPS, GFI RECEPTACLES, SWITCH PLATES, RECEPTACLE PLATES, AND WIRING DEVICES (U.S. CLS. 13, 21, 23, 31 AND 34).

SN 76-467,057. T2T, INC., EVERETT, WA. FILED 11-14-2002.

ASTRO ARM

OWNER OF U.S. REG. NO. 2,691,268.
FOR FLASHLIGHT ACCESSORIES, NAMELY, FLASH-LIGHT HOLDERS (U.S. CLS. 13, 21, 23, 31 AND 34).

CLASS 11—(Continued).

SN 76-468,728. DAGUA INC., ST-NICOLAS, QUEBEC, CA-NADA, FILED 11-7-2002.

DAGUAFLO

FOR PREFABRICATED WATER TREATMENT SYS-TEMS COMPRISED OF A CONTAINER, TREATMENT APPARATUS, DISTRIBUTION APPARATUS, FILTRA-TION AND PURIFICATION DEVICES, DOSING APPA-RATUS, PUMPING STATIONS, OZONE SANITIZERS FOR WATER AND TELEMETRY/REMOTE SURVEIL-LANCE APPARATUS (U.S. CLS. 13, 21, 23, 31 AND 34).

SN 76-470,356. K-RAIN MANUFACTURING CORPORA-TION, RIVIERA BEACH, FL. FILED 11-25-2002.



The logo for K-RAIN features a large, bold, black letter 'K' positioned above the word 'RAIN' in a smaller, bold, black, sans-serif font.

OWNER OF U.S. REG. NO. 2,092,118.
FOR IRRIGATION SPRINKLERS (U.S. CLS. 13, 21, 23, 31 AND 34).
FIRST USE 6-30-1989; IN COMMERCE 1-31-1990.

SN 76-477,964. BB8 TRADING, INC., SAN JOSE, CA. FILED 12-2-2002.



The logo for JBS consists of the letters 'JBS' in a very bold, black, sans-serif font. The 'J' and 'B' are connected, and the 'S' is a simple, thick stroke.

FOR SAUNA (U.S. CLS. 13, 21, 23, 31 AND 34).
FIRST USE 11-15-2002; IN COMMERCE 11-15-2002.

CLASS 11—(Continued).

SN 76-481,290. MUNTERS CORPORATION, FORT MYERS, FL. FILED 1-9-2003.



OWNER OF U.S. REG. NO. 1,985,684.
FOR EVAPORATING PADS FOR WATER COOLING SYSTEMS (U.S. CLS. 13, 21, 23, 31 AND 34).
FIRST USE 6-0-1986; IN COMMERCE 6-0-1986.

SN 76-481,394. MINKA LIGHTING, INC., CORONA, CA. FILED 1-10-2003.

SHANGRI-LA

FOR CEILING FANS AND ELECTRIC LIGHTING FIXTURES (U.S. CLS. 13, 21, 23, 31 AND 34).

SN 76-481,488. HYDRANAUTICS, OCEANSIDE, CA. FILED 1-10-2003.

HYDRASUB

OWNER OF U.S. REG. NOS. 1,458,214, 2,646,065 AND OTHERS.
FOR SUBMERSIBLE MEMBRANE FILTERS FOR USE IN RESIDENTIAL, COMMERCIAL AND INDUSTRIAL WATER FILTRATION (U.S. CLS. 13, 21, 23, 31 AND 34).

SN 76-481,527. WASTE MANAGEMENT, INC., HOUSTON, TX. FILED 1-9-2003.

PORT-O-LET

OWNER OF U.S. REG. NOS. 750,007 AND 950,064.
FOR PORTABLE TOILETS (U.S. CLS. 13, 21, 23, 31 AND 34).
FIRST USE 10-30-1961; IN COMMERCE 10-30-1961.

CLASS 11—(Continued).

SN 76-481,818. ALLEN, DAVID M., DBA LAUGHING RABBIT, INC., BLACHLY, OR. FILED 1-13-2003.

IT'S MAXIMUM POWER IN A PINCH

FOR BATTERY OPERATED FLASHLIGHTS (U.S. CLS. 13, 21, 23, 31 AND 34).
FIRST USE 12-9-2002; IN COMMERCE 12-9-2002.

SN 76-482,157. VECTOR PRODUCTS, INC., FT. LAUDERDALE, FL. FILED 1-14-2003.

E-BRITE

FOR FLASHLIGHTS (U.S. CLS. 13, 21, 23, 31 AND 34).

SN 76-482,158. VECTOR PRODUCTS, INC., FT. LAUDERDALE, FL. FILED 1-14-2003.

E-BRIGHT

FOR FLASHLIGHTS (U.S. CLS. 13, 21, 23, 31 AND 34).

SN 76-482,501. AQUA-AEROBIC SYSTEMS, INC., ROCKFORD, IL. FILED 1-15-2003.

AQUA CB-24

NO CLAIM IS MADE TO THE EXCLUSIVE RIGHT TO USE "AQUA", APART FROM THE MARK AS SHOWN.
FOR COURSE-BUBBLE DIFFUSERS FOR INDUSTRIAL AND MUNICIPAL WATER, WASTEWATER AND PROCESS WATER STREAM TREATMENT (U.S. CLS. 13, 21, 23, 31 AND 34).
FIRST USE 9-21-2001; IN COMMERCE 9-21-2001.

SN 76-483,763. RAIN BIRD CORPORATION, GLENDORA, CA. FILED 1-17-2003.

1800

FOR PLASTIC POP-UP IRRIGATION SPRINKLERS (U.S. CLS. 13, 21, 23, 31 AND 34).
FIRST USE 0-0-1977; IN COMMERCE 0-0-1977.

CLASS 11—(Continued).

SN 76-484,707. HUBBELL INCORPORATED, ORANGE, CT. FILED 1-24-2003.

HERCULES

FOR OUTDOOR ELECTRICAL LIGHTING FIXTURES (U.S. CLS. 13, 21, 23, 31 AND 34).

SN 76-485,683. TRI-COASTAL DESIGN GROUP, INC., BRIDGEWATER, NJ. FILED 1-24-2003.

UMA

FOR LAMPS (U.S. CLS. 13, 21, 23, 31 AND 34).

SN 76-487,450. TEBO, BRADLEY L., TOPSFIELD, MA. FILED 1-23-2003.

BERMUDA TRIANGLE

FOR TANNING BOOTH (U.S. CLS. 13, 21, 23, 31 AND 34).

SN 76-487,537. OSMONICS, INC., MINNETONKA, MN. FILED 2-5-2003.

WELLPRO.Z

FOR DEPTH FILTER CARTRIDGES CONTAINING POLYMER MEDIA FOR USE IN ALL LIQUID FILTRATION (U.S. CLS. 13, 21, 23, 31 AND 34).

SN 76-487,538. OSMONICS, INC., MINNETONKA, MN. FILED 2-5-2003.

ROSAVE.Z

FOR DEPTH FILTER CARTRIDGES CONTAINING POLYMER MEDIA FOR USE IN ALL LIQUID FILTRATION (U.S. CLS. 13, 21, 23, 31 AND 34).

SN 76-487,975. TOM STODDART PTY LTD, SUNNYBANK HILLS, QLD 4109, AUSTRALIA, FILED 2-5-2003.

WINE BY THE GLASS

NO CLAIM IS MADE TO THE EXCLUSIVE RIGHT TO USE "WINE", APART FROM THE MARK AS SHOWN. FOR WINE PRESERVATION, REFRIGERATION AND DISPENSING UNITS (U.S. CLS. 13, 21, 23, 31 AND 34).

CLASS 11—(Continued).

SN 76-494,651. MDW SYSTEMS, LLC., LINCOLN, NE. FILED 2-24-2003.



NO CLAIM IS MADE TO THE EXCLUSIVE RIGHT TO USE "DRINKINGWATER" AND ".COM", APART FROM THE MARK AS SHOWN.

FOR DRINKING WATER PURIFICATION UNIT (U.S. CLS. 13, 21, 23, 31 AND 34). FIRST USE 9-16-2002; IN COMMERCE 9-16-2002.

SN 78-028,887. ALLEN, DAVID, BLACHLY, WA. FILED 10-3-2000.

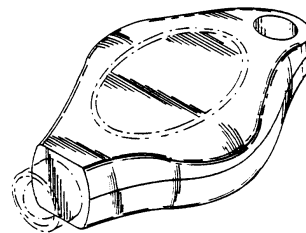

THE LINING IN THE DRAWING IS FOR SHADING PURPOSES ONLY AND IS NOT A PART OF THE MARK.

THE MARK CONSISTS OF THE EXTERNAL APPEARANCE OF A PERSONAL LIGHTING DEVICE HAVING A SUBSTANTIALLY DIAMOND SHAPED MAIN BODY IN TOP PLAN VIEW, CONSISTING OF MAJOR AND MINOR AXES, CONSISTING FURTHER OF WING-SHAPED APPURTENANCES ON EACH LATERAL SIDE OF THE MAJOR AXIS OF THE MAIN BODY CENTERED ABOUT THE MINOR AXIS OF THE MAIN BODY.

FOR BATTERY OPERATED PORTABLE ELECTRIC LIGHTS (U.S. CLS. 13, 21, 23, 31 AND 34). FIRST USE 10-0-1994; IN COMMERCE 10-0-1994.

CLASS 11—(Continued).

SN 78-113,384. PAHWA, DEEPAK, DBA ARCTIC INDIA SALES, DELHI, 110054, INDIA, FILED 6-27-2001.

FOR DEHUMIDIFIERS AND PARTS THEREOF, NAMELY, ROTORS, WHEELS AND CASSETTES; INDUSTRIAL DRYERS FOR DRYING AND DEHUMIDIFYING, NAMELY, AIR DRYERS, PRODUCT DRYERS, COMMERCIAL DRYERS; DESICCANT ROTORS FOR DRYING, CONTROLLING HUMIDITY, TO BE USED IN INDUSTRIES SUCH AS PHARMACEUTICAL INDUSTRIES, SEED INDUSTRY, CHEMICAL INDUSTRIES, ELECTRODE/MICROFILM STORAGE INDUSTRY, ANALYTICAL INSTRUMENTATION AREAS, COMPUTER INSTALLATIONS, PRODUCT DRYING APPLICATIONS, ELECTRICAL INDUSTRIES, FOOD INDUSTRIES, INSTANT COFFEE MANUFACTURING UNITS, BISCUIT INDUSTRY AND OTHERS; AIR CONDITIONING EQUIPMENT AND SYSTEMS, NAMELY, AIR CONDITIONING UNITS FOR DOMESTIC, COMMERCIAL AND INDUSTRIAL USE, PACKAGED AIR CONDITIONING UNITS, DESICCANT BASED COOLING UNITS, FRESH AIR TREATMENT UNITS AND AIR HANDLERS, ROTORS AND CASSETTES FOR MOISTURE/HUMIDITY CONTROL, DEHUMIDIFYING AND DRYING AND DESICCANT ROTORS AND CASSETTES; AIR PURIFYING AND AIR FILTERING EQUIPMENT, NAMELY, AIR PURIFYING AND AIR FILTERING UNITS FOR DOMESTIC, COMMERCIAL AND INDUSTRIAL USE, PACKAGED HEATING UNITS, COOLING UNITS, DRYING UNITS, DEHUMIDIFYING UNITS, HUMIDIFYING UNITS, AND ENERGY RECOVERY UNITS, AND PACKAGED UNITS FOR COMBINATIONS OF HEATING, COOLING, DRYING, DEHUMIDIFYING, HUMIDIFYING, AND ENERGY RECOVERY; DESICCANT BASED COOLING UNITS, FRESH AIR TREATMENT UNITS AND AIR HANDLERS, ALL FOR CLEANING AIR OF OUTDOOR POLLUTANTS SUCH AS DUST, CONTAMINANTS, VIRUSES AND BACTERIA; AIR IONIZERS; AIR STERILIZERS; AIR-HANDLING UNITS, NAMELY, AIR COOLING UNITS AND AIR-DRYING UNITS; AND PARTS AND FITTINGS FOR THE AFOREMENTIONED GOODS (U.S. CLS. 13, 21, 23, 31 AND 34).

FIRST USE 1-0-1997; IN COMMERCE 1-0-1997.

CLASS 11—(Continued).

SN 78-130,509. ROSSTECH SIGNALS, INC., ELLIOT LAKE, ONTARIO, CANADA, FILED 5-22-2002.

ANTHELION

FOR LIGHTING, NAMELY, COLOURED UNDER-WATER LIGHTING UNITS AND FILTERS FOR USE WITH LIGHTING UNITS FOR THE INTERIOR OF HOT TUBS, COLOURED AND WHITE DECORATIVE AND SAFETY LIGHTING FIXTURES FOR EXTERIOR HOT TUB USE; INDOOR AND OUTDOOR LOW VOLTAGE ACCENT LIGHTING UNITS AND FIXTURES FOR DECKS, WALKWAYS, STEPS, SOFFITS, WINDOWS AND WALLS; LIGHTING FIXTURES FOR USE AS FEATURE LIGHTING ACCENTS; ELECTRIC NIGHT-LIGHTS; ELECTRIC LIGHTING FIXTURES AND UNITS FOR ILLUMINATING MARINE INSTRUMENTATION; LOW VOLTAGE ELECTRIC OR BATTERY OPERATED ACCENT LIGHTING FIXTURES FOR USE IN MARINE APPLICATIONS; BATTERY AND ELECTRICALLY OPERATED REMOTE LIGHTING (LED) FLASHLIGHTS, AUTOMOTIVE AND NAUTICAL HEADLAMPS; LIGHTING FIXTURES FOR USE IN SURVEILLANCE USING INFRA-RED AND VISIBLE LIGHT; PHOTO-STUDIO LIGHTING FIXTURES (U.S. CLS. 13, 21, 23, 31 AND 34).

SN 78-137,176. VACUTHERM, INC, WARREN, VT. FILED 6-19-2002.

VACUPRESS

FOR MACHINES USED FOR REMOVING MOISTURE CONTENT FROM LUMBER BY HEATING AN ENCLOSED CHAMBER CONTAINING THE LUMBER AND REDUCING THE VOLUME OF AIR CONTAINED THEREIN (U.S. CLS. 13, 21, 23, 31 AND 34).

FIRST USE 1-1-1986; IN COMMERCE 1-1-1986.

SN 78-146,622. NAILOR INDUSTRIES OF TEXAS, INC., HOUSTON, TX. FILED 7-23-2002.

NAILOR

SEC. 2(F).

FOR A FULL LINE OF AIR DISTRIBUTION AND AIR HANDLING EQUIPMENT; AIR DIFFUSERS FOR VENTILATION SYSTEMS; GRILLES AND REGISTERS FOR USE WITH AIR HANDLING UNITS; AIR TERMINALS, NAMELY FAN POWERED TERMINAL UNITS, AIR FLOW CONTROLLERS, AND STRUCTURAL AND REPLACEMENT PARTS THEREFOR; AIR DISTRIBUTION GOODS, NAMELY DAMPERS, TROFFERS, AND DUCT ACCESS DOORS (U.S. CLS. 13, 21, 23, 31 AND 34).

FIRST USE 0-0-1989; IN COMMERCE 0-0-1989.

CLASS 11—(Continued).

SN 78-146,639. NAILOR INDUSTRIES OF TEXAS, INC., HOUSTON, TX. FILED 7-23-2002.

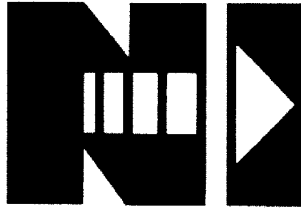

FOR FULL LINE OF AIR DISTRIBUTION AND AIR HANDLING EQUIPMENT; AIR DIFFUSERS FOR VENTILATION SYSTEMS; GRILLES AND REGISTERS FOR USE WITH AIR HANDLING UNITS; AIR TERMINAL UNITS, NAMELY FAN POWERED TERMINAL UNITS, AIR FLOW CONTROLLERS, AND STRUCTURAL AND REPLACEMENT PARTS THEREFOR; DAMPERS AND TROFFERS FOR USE WITH AIR HANDLING UNITS; AIR DUCT ACCESS DOORS (U.S. CLS. 13, 21, 23, 31 AND 34).

FIRST USE 7-0-2002; IN COMMERCE 7-0-2002.

SN 78-148,236. OSRAM SYLVANIA INC., DANVERS, MA. FILED 7-29-2002.

SYLVANIA BRILLIANCE

OWNER OF U.S. REG. NOS. 406,002, 2,281,108 AND OTHERS.

NO CLAIM IS MADE TO THE EXCLUSIVE RIGHT TO USE "BRILLIANCE", APART FROM THE MARK AS SHOWN.

FOR ELECTRIC LAMPS AND LIGHTING FIXTURES (U.S. CLS. 13, 21, 23, 31 AND 34).

SN 78-157,420. ASH MEADOWS LLC, BERLIN, WI. FILED 8-23-2002.

ZEO-PURE

FOR INDUSTRIAL MINERALS FOR USE IN LIQUID MEDIA FILTRATION (U.S. CLS. 13, 21, 23, 31 AND 34).

CLASS 11—(Continued).

SN 78-161,638. SPIN SHADES CORPORATION, VENTURA, CA. FILED 9-6-2002.



NO CLAIM IS MADE TO THE EXCLUSIVE RIGHT TO USE "SHADES", APART FROM THE MARK AS SHOWN.

FOR ROTATING LAMP SHADE MOUNTED ON THE TOP OF A HEAT SOURCE SUCH AS AN ELECTRIC CANDLE LAMP (U.S. CLS. 13, 21, 23, 31 AND 34).

FIRST USE 3-1-1993; IN COMMERCE 6-17-1993.

SN 78-168,305. WEBASTO PRODUCT NORTH AMERICA, INC., BRIGHTON, MI. FILED 9-26-2002.

BLUEHEAT

FOR AFTER-MARKET VEHICLE PREHEATING AND AUXILIARY HEATING SYSTEMS COMPRISED OF ENGINE PREHEATING UNITS FOR VEHICLES AND/OR AUXILIARY HEATING UNITS FOR VEHICLES (U.S. CLS. 13, 21, 23, 31 AND 34).

SN 78-174,988. LUME LIGHTING, INC., ENCINITAS, CA. FILED 10-16-2002.



NO CLAIM IS MADE TO THE EXCLUSIVE RIGHT TO USE "LUME LIGHTING", APART FROM THE MARK AS SHOWN.

THE ENGLISH TRANSLATION OF "LUME" IS "LAMP". FOR FLASHLIGHTS (U.S. CLS. 13, 21, 23, 31 AND 34).

CLASS 11—(Continued).

SN 78-182,712. GRUNDFOS PUMPS CORPORATION, OLATHE, CA. FILED 11-7-2002.

SUPER BRUTE

OWNER OF U.S. REG. NO. 2,132,088.
FOR HYDRONIC HEATING EQUIPMENT, NAMELY, 3-SPEED WET ROTOR CIRCULATING PUMP WITH AN INTEGRATED REMOVABLE CHECK VALVE USED IN HEATING SYSTEMS. (U.S. CLS. 13, 21, 23, 31 AND 34).

SN 78-182,803. EZ TANKS, INC., ORLANDO, FL. FILED 11-7-2002.

EZ TANKS

NO CLAIM IS MADE TO THE EXCLUSIVE RIGHT TO USE "TANKS", APART FROM THE MARK AS SHOWN.

FOR SEPTIC TANKS, WATER STORAGE TANKS, AND GREASE TRAPS; KITS CONSISTING PRIMARILY OF PANELS OF PLASTIC MATERIAL FOR CONSTRUCTING SEPTIC TANKS, WATER STORAGE TANKS, AND GREASE TRAPS (U.S. CLS. 13, 21, 23, 31 AND 34).

SN 78-190,904. VIRCO ASSOCIATES, INC., WALNUT, CA. FILED 12-3-2002.



FOR BARBECUE GRILLS, GAS COOKERS, GAS GRILLS, SMOKER GRILLS, PORTABLE ELECTRIC INDOOR AND OUTDOOR GRILLS, AND PORTABLE CHARCOAL GRILLS (U.S. CLS. 13, 21, 23, 31 AND 34).

SN 78-196,251. PANAMA JACK INTERNATIONAL, INC., ORLANDO, FL. FILED 12-19-2002.

PANAMA JACK

OWNER OF U.S. REG. NOS. 1,325,935, 1,354,252 AND OTHERS.

FOR LAMPS, LAMP SHADES, ELECTRIC LIGHT FIXTURES, CEILING FANS, ELECTRIC FANS, CANDLE LANTERNS, BARBEQUE GRILLS, CHARCOAL GRILLS, HOT TUBS, SAUNAS, REFRIGERATORS AND ELECTRIC ICE CREAM MAKERS (U.S. CLS. 13, 21, 23, 31 AND 34).

CLASS 11—(Continued).

SN 78-198,156. DEALS-NOTHING OVER A DOLLAR, LLC, BRIDGETON, MO. FILED 12-27-2002.

IGNITE 'N LITE

FOR HAND-HELD PROPANE AND BUTANE GAS LIGHTERS PRIMARILY FOR LIGHTING GRILLS, FIREPLACES AND CANDLES (U.S. CLS. 13, 21, 23, 31 AND 34).

SN 78-198,649. GENERAL ELECTRIC COMPANY, SCHE-NECTADY, NY. FILED 12-30-2002.

MOTIFS

FOR ELECTRIC LIGHT BULBS (U.S. CLS. 13, 21, 23, 31 AND 34).

SN 78-202,529. ORANGEWHIP ENTERPRISES, INC., DBA FUNKY JUNK, SMYRNA, GA. FILED 1-13-2003.

JINGLE BELLS SHOTGUN SHELLS

NO CLAIM IS MADE TO THE EXCLUSIVE RIGHT TO USE "SHOTGUN SHELLS", APART FROM THE MARK AS SHOWN.

FOR ELECTRIC LIGHTS FOR CHRISTMAS TREES AND OTHER DECORATIVE PURPOSES, WITH SHOTGUN SHELL BULB COVERS (U.S. CLS. 13, 21, 23, 31 AND 34).

FIRST USE 9-1-2000; IN COMMERCE 9-1-2000.

SN 78-203,509. STAMATAKY, PHILIP, T, CHICAGO, IL. FILED 1-15-2003.

BAA-B-QUE

FOR ROTISSERIES ELECTRICALLY POWERED THAT USE CHARCOAL OR GAS AS THE HEAT SOURCE (U.S. CLS. 13, 21, 23, 31 AND 34).

SN 78-204,160. GLJ, L.L.C., CHICAGO, IL. FILED 1-16-2003.

CIRCULAIR

FOR PORTABLE ELECTRIC FANS, BOTH WITH AND WITHOUT LIQUID ATOMIZERS (U.S. CLS. 13, 21, 23, 31 AND 34).

FIRST USE 3-1-1993; IN COMMERCE 3-1-1993.

CLASS 11—(Continued).

SN 78-205,445. Q-LIGHTING, INC., LEXINGTON, KY. FILED 1-21-2003.

CLAMP LITE- LIGHT YOU NEED; WHERE IT'S NEEDED

NO CLAIM IS MADE TO THE EXCLUSIVE RIGHT TO USE "CLAMP LIGHT", APART FROM THE MARK AS SHOWN.

FOR PORTABLE ELECTRIC LIGHT (U.S. CLS. 13, 21, 23, 31 AND 34).

SN 78-206,889. YANKEE CANDLE COMPANY, INC., THE, SOUTH DEERFIELD, MA. FILED 1-24-2003.

HOUSEWARMER

FOR ELECTRICAL FRAGRANCE DISPENSERS (U.S. CLS. 13, 21, 23, 31 AND 34).

SN 78-208,200. CROWN V CORPORATION, DBA THERMAT-EC, SANTA ROSA, CA. FILED 1-29-2003.

THERMAGRID

OWNER OF U.S. REG. NOS. 1,247,612 AND 1,398,421.
FOR SPLASH BAR FOR GAS-LIQUID HEAT TRANSFER IN COOLING TOWERS (U.S. CLS. 13, 21, 23, 31 AND 34).

SN 78-208,262. WESTINGHOUSE LIGHTING CORPORATION, PHILADELPHIA, PA. FILED 1-29-2003.

ECOMAX

FOR FLUORESCENT LIGHT BULBS (U.S. CLS. 13, 21, 23, 31 AND 34).

SN 78-208,962. EWING IRRIGATION PRODUCTS, INC., PHOENIX, AZ. FILED 1-30-2003.



NO CLAIM IS MADE TO THE EXCLUSIVE RIGHT TO USE "LANDSCAPE LITES" AND "LANDSCAPE PRODUCTS", APART FROM THE MARK AS SHOWN.

FOR ELECTRIC LIGHTING FIXTURES AND ELECTRIC LUMINARIES (U.S. CLS. 13, 21, 23, 31 AND 34).
FIRST USE 1-0-2002; IN COMMERCE 1-0-2002.

CLASS 11—(Continued).

SN 78-209,448. BAKER COMPANY, THE, SANFORD, ME. FILED 1-31-2003.

CHEMOSHIELD

FOR VENTILATING EXHAUST FAN CABINET WITH HEPA FILTERS FOR CLEAN AIRFLOW AND PARTICULATE FILTRATION AND CHEMICAL PROTECTION THROUGHOUT WORK AREAS FOR LABORATORY USE (U.S. CLS. 13, 21, 23, 31 AND 34).

FIRST USE 11-30-2002; IN COMMERCE 11-30-2002.

SN 78-213,147. SOLAROASIS, LLC, OCEANSIDE, CA. FILED 2-10-2003.

SOLAROASIS

FOR ELECTRIC LIGHT BULBS CONTAINING AN ARRAY OF LIGHT EMITTING DIODES. (U.S. CLS. 13, 21, 23, 31 AND 34).

SN 78-219,305. MGV MARKET GROUP VENTURES INC., SHAWNIGAN LAKE, BC, CANADA, FILED 2-26-2003.

SAFE SPECTRUM

FOR ELECTRIC LIGHT BULBS; FIXTURES FOR INCANDESCENT LIGHT BULBS; FLUORESCENT ELECTRIC LIGHT BULBS; HALOGEN LIGHT BULBS; INCANDESCENT LIGHT BULBS; FLUORESCENT LIGHTING TUBES (U.S. CLS. 13, 21, 23, 31 AND 34).

CLASS 12—VEHICLES

SN 75-606,562. ARLINGTON CAPITAL, LLC, FORT WAYNE, IN. BY ASSIGNMENT MANCO PRODUCTS, INC., FORT WAYNE, IN. FILED 12-16-1998.

BAD CAT

FOR MOTORIZED RECREATIONAL VEHICLES, NAMELY, GO CARTS AND ALL TERRAIN VEHICLES (U.S. CLS. 19, 21, 23, 31, 35 AND 44).

FIRST USE 10-1-1998; IN COMMERCE 10-1-1998.

SN 76-087,219. CASIO KEISANKI KABUSHIKI KAISHA, DBA CASIO COMPUTER CO., LTD., SHIBUYA-KU, TOKYO, JAPAN, FILED 7-11-2000.

G-SHOCK

OWNER OF JAPAN REG. NO. 2424099, DATED 8-21-1998, EXPIRES 8-21-2008.

FOR AUTOMOBILES (U.S. CLS. 19, 21, 23, 31, 35 AND 44).

CLASS 12—(Continued).

SN 76-113,455. BCATCO ARL, ST. HELLIER, JERSY JE2 3JW, CHANNEL ISLANDS, FILED 8-21-2000.

CLASS 12—(Continued).

SN 76-229,536. ANDERSON, KENT G., BISMARCH, ND, FILED 8-14-2000.

BEARCAT

FOR INDUSTRIAL TIRES, SOLID TIRES, PRESS ON SOLID TIRES, PNEUMATIC INDUSTRIAL TIRES, PASSENGER TIRES, FARM TIRES, AIRPLANE TIRES (U.S. CLS. 19, 21, 23, 31, 35 AND 44).
FIRST USE 12-8-1996; IN COMMERCE 12-8-1996.

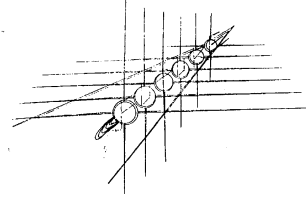

SN 76-169,927. ULTIMA CARS AUSTRALIA PTY. LTD., QUEENSLAND 4051, AUSTRALIA, FILED 11-22-2000.

ULTIMA

FOR AUTOMOBILE STRUCTURAL PARTS, NAMELY, CUSTOM ASSEMBLED CHASSIS AND COMPLETELY OR PARTIALLY CONSTRUCTED BODIES FOR TWO-SEATER, MID-SIZED ENGINE AUTOMOBILES INCLUDING COMPONENTS FOR SAID AUTOMOBILES, NAMELY, POWER TRAIN, DRIVE SHAFTS, ENGINE AND TRANS-AXLE ADAPTOR, CLUTCH, STARTER MOTOR, BRAKES, SEAT BELTS, SUSPENSION, REAR WING, APPROVED ROLL CAGE, AIR CONDITIONING AND HEATER AND STEERING WHEEL, ALL SOLD TOGETHER AS A UNIT (U.S. CLS. 19, 21, 23, 31, 35 AND 44).
FIRST USE 8-27-1999; IN COMMERCE 8-27-1999.

FOR MOTOR VEHICLES, NAMELY, AUTOMOBILES, TRUCKS, VANS, CARS, SPORT UTILITY VEHICLES, AIR CRAFT, PERSONAL WATER CRAFT, NAMELY, BOATS, LAND CRAFT, NAMELY, CARS, AIRPLANES, SEAPLANES, GYRO COPTERS, NAMELY, GYRO PLANES, HELICOPTERS, AMPHIBIOUS AIRPLANES, MILITARY AIR CRAFT, GLIDERS, HYDROPLANES, PERSONAL JET BOATS, WATER SCOOTER, RECREATIONAL JET BOATS, SPACE CRAFT, NAMELY, LUNAR ROVERS, EXPERIMENTAL VEHICLES, NAMELY, CARS, RECREATIONAL VEHICLES, NAMELY, CAMPERS, BOATS, TRAINS, SPEED BOATS, LOCOMOTIVES, BUSES, SHIPS, YACHTS, CRUISE SHIPS, SAIL BOATS, HOVER CRAFT, HELICOPTERS, RECREATIONAL VEHICLES, NAMELY, CAMPERS, MOTORIZED SCOOTERS, ALL TERRAIN VEHICLES, MARINE VEHICLE, NAMELY, BOATS, FERRY BOATS, LUNAR ROVER AND SHUTTLES, TRACTORS, LOCOMOTIVE, SPACECRAFT, NAMELY, ROCKETS, ALL TERRAIN VEHICLES, MOTORCYCLES, BICYCLES, AND STRUCTURAL PARTS THEREFORE (U.S. CLS. 19, 21, 23, 31, 35 AND 44).

SN 76-272,458. BOEING MANAGEMENT COMPANY, SEAL BEACH, CA. FILED 6-18-2001.

SONIC CRUISER

NO CLAIM IS MADE TO THE EXCLUSIVE RIGHT TO USE "SONIC", APART FROM THE MARK AS SHOWN.
FOR AIRCRAFT AND STRUCTURAL PARTS THEREFOR AND MANUALS SOLD THEREWITH AS A UNIT (U.S. CLS. 19, 21, 23, 31, 35 AND 44).

SN 76-223,623. BAYERISCHE MOTOREN WERKE AKTIENGESELLSCHAFT, D-80788 MUENCHEN, FED REP GERMANY, FILED 3-13-2001.

SN 76-334,893. ALLIANCE TIRE COMPANY (1992) LTD., HADERA 38100, ISRAEL, FILED 11-6-2001.

EVEREST

OWNER OF FED REP GERMANY REG. NO. 30020673, DATED 4-13-2000, EXPIRES 3-31-2010.
FOR AUTOMOBILES AND STRUCTURAL PARTS THEREFOR (U.S. CLS. 19, 21, 23, 31, 35 AND 44).

FOR TIRES (U.S. CLS. 19, 21, 23, 31, 35 AND 44).
FIRST USE 4-1-2001; IN COMMERCE 4-1-2001.

CLASS 12—(Continued).

SN 76-338,223. ELDER, GEORGE SCOTT, FT. LAUDERDALE, FL. FILED 11-16-2001.

HITCH HOIST BUDDY

NO CLAIM IS MADE TO THE EXCLUSIVE RIGHT TO USE "HITCH HOIST", APART FROM THE MARK AS SHOWN.

FOR TRAILER HITCH MOUNTED ASSEMBLY COMPRISED OF A HITCH MOUNTED STANCHION, A BOOM, AND A LIFTING DEVICE, FOR SUPPORTING REMOVABLE CARGO IN A VEHICLE (U.S. CLS. 19, 21, 23, 31, 35 AND 44).

SN 76-342,532. KUMHO INDUSTRIAL CO. LTD, KWANGJUSHI, REPUBLIC OF KOREA, FILED 11-27-2001.

SUPERO

FOR BRAKE PADS FOR LAND VEHICLES, BRAKE LININGS FOR LAND VEHICLES, WINDSHIELD WIPERS, AUTOMOBILE TIRES, AND PARTS FOR AUTOMOBILE TIRES, NAMELY—TUBES FOR RESERVE AIR AND FLAPS TO COMBINE THE TUBES TO THE TIRES (U.S. CLS. 19, 21, 23, 31, 35 AND 44).

SN 76-345,530. 921637 ONTARIO LIMITED, TA JUPITER INDUSTRIES, TORONTO, ONTARIO, CANADA, FILED 12-5-2001.

KOMFORT KRUISER

FOR CHILDREN'S CAR SEATS (U.S. CLS. 19, 21, 23, 31, 35 AND 44).
FIRST USE 12-15-2001; IN COMMERCE 12-15-2001.

SN 76-352,937. THOUSAND VALUE LIMITED CORPORATION, DBA PRO-HOPPER INDUSTRIES, VAN NUYS, CA. FILED 12-27-2001.

PRO HOPPER

FOR AUTOMOBILE SUSPENSION SYSTEM COMPONENTS, NAMELY, HYDRAULIC MOTORS, HYDRAULIC CYLINDERS AND HYDRAULIC PUMPS FOR USE IN LOW RIDER VEHICLES; LAND VEHICLES PARTS, NAMELY, WHEELS, BILLET ALUMINUM INTERIOR ACCESSORIES, NAMELY, SWITCH PANELS, DASH PANELS, DOOR-PANEL INSERTS, AIRBAGS FOR VEHICLES (U.S. CLS. 19, 21, 23, 31, 35 AND 44).
FIRST USE 3-1-1994; IN COMMERCE 3-1-1994.

CLASS 12—(Continued).

SN 76-360,221. PIRELLI PNEUMATICI S.P.A., 20126 MILANO, ITALY, FILED 1-18-2002.

PIEZO

FOR TIRES; PNEUMATIC, SEMI-PNEUMATIC AND SOLID TIRES FOR VEHICLE WHEELS; WHEELS FOR VEHICLES, INNER TUBES, WHEEL RIMS, AND REPLACEMENT PARTS FOR ALL THE AFORESAID GOODS (U.S. CLS. 19, 21, 23, 31, 35 AND 44).

SN 76-362,662. TILTON ENGINEERING, INC., BUELLTON, CA. FILED 1-23-2002.

SONIC RACING PRODUCTS

NO CLAIM IS MADE TO THE EXCLUSIVE RIGHT TO USE "RACING PRODUCTS", APART FROM THE MARK AS SHOWN.

FOR RACING CLUTCHES FOR LAND VEHICLES AND COMPONENTS THEREFORE, NAMELY, DISCS USED WITH RACING CLUTCHES, CLUTCH RELEASE BEARING ASSEMBLIES, BELL HOUSINGS, FLY-WHEELS AND FLEXPLATES (U.S. CLS. 19, 21, 23, 31, 35 AND 44).

FIRST USE 8-0-2001; IN COMMERCE 8-0-2001.

SN 76-388,393. MIDWEST MOTORCYCLE SUPPLY DISTRIBUTORS CORP., ARNOLD, MO. FILED 3-27-2002.

THE BULL

FOR MOTORCYCLE FRAMES (U.S. CLS. 19, 21, 23, 31, 35 AND 44).

SN 76-395,974. TEX RACING ENTERPRISES, INC., ETHER, NC. FILED 4-15-2002.



NO CLAIM IS MADE TO THE EXCLUSIVE RIGHT TO USE "RACING DRIVELINE COMPONENTS", APART FROM THE MARK AS SHOWN.

FOR PARTS FOR RACING VEHICLES, NAMELY, TRANSMISSIONS, GEAR SHIFTERS, CLUTCHES, DRIVESHAFTS, AXLES, BRAKE PADS, DRIVE GEARS, GEAR HOUSINGS, BRAKE SPINDLE DUCTS AND HEAT SHIELDS (U.S. CLS. 19, 21, 23, 31, 35 AND 44).

FIRST USE 5-1-1991; IN COMMERCE 5-1-1991.

CLASS 12—(Continued).

SN 76-406,955. NISSAN FORKLIFT CORPORATION, NORTH AMERICA, MARENGO, IL. FILED 5-10-2002.

OPTIVIEW

FOR MASTS FOR FORKLIFT TRUCKS (U.S. CLS. 19, 21, 23, 31, 35 AND 44).
FIRST USE 10-0-1997; IN COMMERCE 10-0-1997.

SN 76-416,204. COMPAGNIE PLASTIC OMNIUM, 69007 LYON, FRANCE, FILED 5-31-2002.



PRIORITY CLAIMED UNDER SEC. 44(D) ON FRANCE APPLICATION NO. 013134834, FILED 12-3-2001, REG. NO. 013134834, DATED 12-3-2001, EXPIRES 12-3-2011.

THE MARK CONSISTS OF THE MARK IS THREE-DIMENSIONAL AND CONSISTS OF A PLURALITY OF HORIZONTAL WAVES ENDING WITH POINTS.

FOR AUTOMOBILE BODIES, BUMPERS, SHIELDS, FENDERS, HOODS, TRUNKS, DOORS; FRONT PANEL FOR AUTOMOBILES; PLASTIC PARTS FOR VEHICLES, NAMELY AUTOMOTIVE EXTERIOR AND INTERIOR DECORATIVE AND PROTECTIVE PLASTIC TRIMS; DECORATIVE OR PROTECTIVE PLASTIC PLATES FOR CARS, NAMELY SHIELDS BODY SIDE MELDING (U.S. CLS. 19, 21, 23, 31, 35 AND 44).

SN 76-419,583. HAMM, DAVID RAY, PHOENIX, AZ. FILED 5-15-2002.

FAIRWAY RAGTOP

NO CLAIM IS MADE TO THE EXCLUSIVE RIGHT TO USE "FAIRWAY", APART FROM THE MARK AS SHOWN. FOR SUN SHADE FOR GOLF CARTS FOR PROVIDING SHADE AND AIR CIRCULATION TO RIDERS (U.S. CLS. 19, 21, 23, 31, 35 AND 44).
FIRST USE 4-28-2002; IN COMMERCE 5-10-2002.

SN 76-422,362. ENGINION AG, 13355 BERLIN, FED REP GERMANY, FILED 6-18-2002.

STEAMCELL

FOR ENGINES FOR USE IN AUTOMOBILES TO SUPPLY MECHANICAL WORK, POWER, HEAT, AND COOLNESS WITH A CALORIC POROUS STRUCTURE CELL (U.S. CLS. 19, 21, 23, 31, 35 AND 44).

CLASS 12—(Continued).

SN 76-422,870. ADAM AIRCRAFT INDUSTRIES, INC., ENGLEWOOD, CO. FILED 6-18-2002.

CARBONAERO

FOR AIRPLANES AND STRUCTURAL PARTS THEREFORE (U.S. CLS. 19, 21, 23, 31, 35 AND 44).

SN 76-422,871. ADAM AIRCRAFT INDUSTRIES, INC., ENGLEWOOD, CO. FILED 6-18-2002.

ADAM AIRCRAFT

NO CLAIM IS MADE TO THE EXCLUSIVE RIGHT TO USE "AIRCRAFT", APART FROM THE MARK AS SHOWN. FOR AIRPLANES AND STRUCTURAL PARTS THEREFORE (U.S. CLS. 19, 21, 23, 31, 35 AND 44).

SN 76-428,753. DAZON INCORPORATED, DOVER, DE. FILED 7-9-2002.



THE STIPPLING SHOWN IN THE DRAWING IS A FEATURE OF THE MARK AND IS NOT INTENDED TO INDICATE COLOR.

THE MARK COMPRISES THE LETTERS "D" AND "Z" IN A RECTANGULAR DESIGN SEPARATED BY A SLIGHTLY S-SHAPED CURVED LINE EXTENDING FROM THE UPPER RIGHT CORNER OF THE RECTANGULAR DESIGN TO THE LOWER LEFT HAND CORNER, IN WHICH THE AREA SURROUNDING THE LETTER "D" IS RED IN COLOR, AND THE AREA SURROUNDING THE LETTER "Z" IS BLUE IN COLOR, AND FURTHER INCLUDING "DAZON" BELOW THE RECTANGULAR DESIGN, AS DEPICTED IN THE ACCOMPANYING DRAWING.

THE ENGLISH TRANSLATION OF THE WORD "DAZON" IN THE MARK IS "MANY THOUSAND OF PEOPLE".

FOR MOTORCYCLES AND MOTOR DRIVEN CYCLES (U.S. CLS. 19, 21, 23, 31, 35 AND 44).

CLASS 12—(Continued).

SN 76-430,616. UNIVERSAL PROPULSION COMPANY, INC., PHOENIX, AZ. FILED 7-11-2002.

TRIBRID

FOR PYROCHEMICAL BASED INFLATORS, WITH SOLID, LIQUID, AND GASSY LOADED COMPONENTS, THAT FUNCTION TO PRODUCE TEMPERATURE COMPENSATED GAS PRESSURE USED TO INFLATE AIRBAGS, AIRCRAFT EMERGENCY SLIDES AND ANY OTHER INFLATABLE OBJECTS REQUIRING INFLATION (U.S. CLS. 19, 21, 23, 31, 35 AND 44).

SN 76-433,983. BOMBARDIER INC., VALCOURT, QUEBEC, CANADA, FILED 7-23-2002.

EVERYBODY'S DOIN' IT

FOR VEHICLES, NAMELY, PERSONAL WATERCRAFT, NAMELY, SINGLE AND MULTIPLE PASSENGER RECREATIONAL JET BOATS, JET BOATS AND STRUCTURAL PARTS THEREFOR; FITTED AND SEMI-FITTED VEHICLE COVERS (U.S. CLS. 19, 21, 23, 31, 35 AND 44).

SN 76-437,086. TRANSDYNAMICS, INC., WINSTON-SALEM, NC. FILED 8-2-2002.



FOR BICYCLE COMPONENTS, NAMELY INFINITELY VARIABLE INTERNAL HUB (U.S. CLS. 19, 21, 23, 31, 35 AND 44).
FIRST USE 12-1-1997; IN COMMERCE 8-1-2002.

SN 76-445,801. C-WORTHY, CORP., POMPANO BEACH, FL. FILED 9-3-2002.

C-CLEAR

FOR FITTED CURTAINS SPECIFICALLY FOR WINDOWS ON BOATS (U.S. CLS. 19, 21, 23, 31, 35 AND 44).

CLASS 12—(Continued).

SN 76-452,369. NATIONAL RV HOLDINGS, INC., PERRIS, CA. FILED 9-24-2002.

NATIONAL RV

OWNER OF U.S. REG. NO. 2,360,065.
NO CLAIM IS MADE TO THE EXCLUSIVE RIGHT TO USE "RV", APART FROM THE MARK AS SHOWN.
FOR RECREATIONAL VEHICLES (U.S. CLS. 19, 21, 23, 31, 35 AND 44).
FIRST USE 4-1-1984; IN COMMERCE 4-1-1984.

SN 76-455,569. SWAY-A-WAY, CHATSWORTH, CA. FILED 10-3-2002.

POWERBARZ

OWNER OF U.S. REG. NO. 2,393,209.
FOR VEHICLE SUSPENSIONS; NAMELY; VEHICLE TORSION BARS, VEHICLE TORSION SPRINGS, VEHICLE TORSIONAL AXLES, VEHICLE INDEPENDENT REAR SUSPENSIONS, SPRING PLATES FOR VEHICLE INDEPENDENT REAR SUSPENSIONS, VEHICLE SHOCK ABSORBERS AND MOUNT SPRING PLATES, VEHICLE LINK PINS, VEHICLE BUSHINGS, TORQUE ADJUSTERS FOR VEHICLE TORSION BARS, LOWERING AND LIFTING BLOCKS, AND VEHICLE TRANSMISSION HOUSINGS, COVERS, SPACER RINGS, AND DRIVE KEYS (U.S. CLS. 19, 21, 23, 31, 35 AND 44).
FIRST USE 5-0-1999; IN COMMERCE 5-0-1999.

SN 76-456,324. KURYAKYN HOLDINGS, INC., STILLWATER, MN. FILED 9-30-2002.

ISO

FOR STRUCTURAL PARTS FOR MOTOR VEHICLES; STRUCTURAL PARTS FOR MOTORCYCLES; AND PARTS OF MOTORCYCLES, NAMELY, FOOT PEGS (U.S. CLS. 19, 21, 23, 31, 35 AND 44).
FIRST USE 2-1-1988; IN COMMERCE 2-1-1988.

SN 76-466,176. CAMPOS, VICTOR, WHITTIER, CA. FILED 10-11-2002.

PRO AUTO SHADE

NO CLAIM IS MADE TO THE EXCLUSIVE RIGHT TO USE "AUTO SHADE", APART FROM THE MARK AS SHOWN.
FOR MOTOR VEHICLE WINDOW SHADES (U.S. CLS. 19, 21, 23, 31, 35 AND 44).

CLASS 12—(Continued).

SN 76-469,578. JETWORLD INC., SOUTH EL MONTE, CA. FILED 11-25-2002.

CARBON IMAGE

FOR VEHICLE PARTS, NAMELY, AIR INTAKE TUBES, BACKVIEW MIRROR SHELLS, BED ASSEMBLIES, CENTER CONSOLES, COWLS, DASHBOARDS, FENDERS, FRONT AIR DAMS, FRONT BUMPERS, FRONT BUMPER LIPS, FRONT BUMPER SIDE SPOILERS, FRONT PANELS, FRONT DOORS, SIDE DOORS, REAR/BACK DOORS, GATE REPAIR PANELS, GATE SHELLS, GRILLES, GAUGE FACES, GAUGE PODS, HOODS, INTERIOR PANELS, LUGGAGE LIDS, PICKUP CAB PANELS, QUARTER PANELS, RADIATOR COOLING PANELS, REAR BUMPERS, REAR BUMPER SIDE SPOILERS, REAR SPOILERS, ROOFS, SHAFT KNOBS, SIDE BODY PANELS, SIDE PANELS, SIDE SKIRTS, SPARK PLUG WIRE COVERS, STRUT BARS, VALVES COVERS, MUD GUARDS, RUNNING BOARDS, SUSPENSION PARTS NAMELY TORSION/SWAY BARS, REARVIEW MIRRORS, CONSTANT VELOCITY JOINTS, SUN VISORS, WINDSHIELD VISORS, WINDSHIELD WIPERS, VEHICLE PROPELLERS, VEHICLE ROLL BARS, VEHICLE SEATS, VEHICLE TOW BARS, AND HOOD SHIELDS (U.S. CLS. 19, 21, 23, 31, 35 AND 44).

SN 76-472,554. WALDEN SPORTS, INC., AYER, MA. FILED 12-4-2002.

WALDEN

OWNER OF U.S. REG. NOS. 2,111,542, 2,466,631 AND OTHERS.

FOR KAYAKS AND KAYAK EQUIPMENT, NAMELY PADDLES, WATER DEFLECTION SKIRTS, COCKPIT RIM COVERS, SEAT PADS AND DECK RIGGING KITS (U.S. CLS. 19, 21, 23, 31, 35 AND 44).

FIRST USE 1-4-1993; IN COMMERCE 1-4-1993.

SN 76-475,982. WALKER EVANS ENTERPRISES INCORPORATED, RIVERSIDE, CA. FILED 12-12-2002.

WALKER EVANS RACING SHOCKS

NO CLAIM IS MADE TO THE EXCLUSIVE RIGHT TO USE "RACING SHOCKS", APART FROM THE MARK AS SHOWN.

THE NAME IN THE MARK IDENTIFIES A LIVING INDIVIDUAL WHO HEREBY GIVES HIS CONSENT TO THE REGISTRATION OF THIS MARK.

FOR SHOCK ABSORBERS FOR VEHICLES (U.S. CLS. 19, 21, 23, 31, 35 AND 44).

FIRST USE 0-0-1994; IN COMMERCE 0-0-1994.

CLASS 12—(Continued).

SN 76-478,194. GREENBALL CORPORATION, LONG BEACH, CA. FILED 12-23-2002.

DIRT TAMER

NO CLAIM IS MADE TO THE EXCLUSIVE RIGHT TO USE "DIRT", APART FROM THE MARK AS SHOWN.

FOR TIRES (U.S. CLS. 19, 21, 23, 31, 35 AND 44).

SN 76-478,477. TECH-DEL LTD., DBA TECH-DEL, WILLITON, TAUNTON TA4 4RF, ENGLAND, FILED 12-26-2002.

MINILITE

FOR WHEELS, WHEEL SPACERS AND HUB CAPS, ALL BEING FOR USE ON LAND VEHICLES (U.S. CLS. 19, 21, 23, 31, 35 AND 44).

FIRST USE 0-0-1964; IN COMMERCE 0-0-1964.

SN 76-481,770. ANTHONY, MICHAEL S., ARDSLEY, PA. FILED 1-7-2003.

PEG BOARDS

FOR MOTORCYCLE FOOTRESTS (U.S. CLS. 19, 21, 23, 31, 35 AND 44).

SN 76-481,816. CARLISLE INTANGIBLE COMPANY, SYRACUSE, NY. FILED 1-13-2003.

QUADCROSS

FOR LAND VEHICLE TIRES, INCLUDING ALL TERRAIN VEHICLE TIRES (U.S. CLS. 19, 21, 23, 31, 35 AND 44).

SN 76-482,078. ABS FRICTION CORP., GUELPH, ONTARIO, N1H 3V4, CANADA, FILED 1-13-2003.

TRUQUIET

FOR BRAKE PAD SHIMS; BRAKE HARDWARE, NAMELY, SHIMS; BRAKE PADS FOR LAND VEHICLES; BRAKE ROTORS FOR LAND VEHICLES; BRAKE SHOES FOR LAND VEHICLES; DISC BRAKE PADS FOR VEHICLES; DISC BRAKES FOR LAND VEHICLES; BRAKE DRUMS FOR LAND VEHICLES; BRAKE BLOCKS FOR LAND VEHICLES; BRAKE CALIPERS FOR LAND VEHICLES; BRAKE HARDWARE FOR LAND VEHICLES; BRAKE LINING FOR LAND VEHICLES; BRAKE LINES FOR VEHICLES (U.S. CLS. 19, 21, 23, 31, 35 AND 44).

CLASS 12—(Continued).

SN 76-484,849. FLEETWOOD ENTERPRISES, INC., RIVERSIDE, CA. FILED 1-27-2003.

PRIDE

FOR TRAVEL TRAILERS (U.S. CLS. 19, 21, 23, 31, 35 AND 44).
FIRST USE 12-0-2001; IN COMMERCE 12-0-2001.

SN 76-484,959. HIGGINBOTHAM, HUGH R. III, WEST PALM BEACH, FL. FILED 1-21-2003.

ADD-A-BIKE

FOR BICYCLE CARRIERS FOR VEHICLES (U.S. CLS. 19, 21, 23, 31, 35 AND 44).
FIRST USE 3-15-2002; IN COMMERCE 3-15-2002.

SN 76-486,422. DEFLECTA-SHIELD CORPORATION, ANOKA, MN. FILED 1-24-2003.

**DEFLECTA-SHIELD
HITCHSTEP**

FOR STEPS FOR ATTACHMENT TO LAND VEHICLES (U.S. CLS. 19, 21, 23, 31, 35 AND 44).

SN 76-486,440. LUND INTERNATIONAL, INC., ANOKA, MN. BY MERGER DEFLECTA-SHIELD CORPORATION, ANOKA, MN. FILED 1-28-2003.

TRAILBACK

OWNER OF U.S. REG. NO. 2,439,023.
FOR BICYCLE CARRIERS, BICYCLE RACKS FOR AUTOMOBILES, ROOFTOP CARGO BASKETS (U.S. CLS. 19, 21, 23, 31, 35 AND 44).

SN 76-487,181. STEPGATE INCORPORATED, SIOUX FALLS, SD. FILED 2-4-2003.

STEP-GATE

FOR VEHICLE PARTS AND ACCESSORIES, NAMELY, TAILGATES FOR PICKUP TRUCKS AND UTILITY VEHICLES (U.S. CLS. 19, 21, 23, 31, 35 AND 44).

CLASS 12—(Continued).

SN 76-488,968. CACO, DENNIS, SAN DIEGO, CA. FILED 2-3-2003.

AUTOCANNON

FOR AUTOMOTIVE WHEELS (U.S. CLS. 19, 21, 23, 31, 35 AND 44).

SN 78-143,389. PULLEN, JEROME A., MINOT, ND. FILED 7-12-2002.

CACOON

FOR FOLDOUT CAMPER SOLD AS A COMPONENT SEPARATE OF A VEHICLE (U.S. CLS. 19, 21, 23, 31, 35 AND 44).
FIRST USE 7-12-2002; IN COMMERCE 7-12-2002.

SN 78-144,026. ANHUI FORKLIFT TRUCK GROUP, ANHUI, CHINA, FILED 7-15-2002.

HELI

OWNER OF U.S. REG. NO. 2,205,416.
FOR FORK LIFT TRUCKS, TRAILERS, NAMELY, CARGO TRAILERS, EQUIPMENT TRAILERS, ELECTRIC VEHICLES, NAMELY, ELECTRICALLY-POWERED GOLF CARTS, ELECTRIC ALL-TERRAIN VEHICLES, STORAGE BATTERY TRUCKS, GEAR BOXES FOR LAND VEHICLES, UNDERCARRIAGE FOR VEHICLES (U.S. CLS. 19, 21, 23, 31, 35 AND 44).
FIRST USE 0-0-1994; IN COMMERCE 7-0-1999.

SN 78-147,674. GATOR CITY RIMS, DETROIT, MI. FILED 7-25-2002.



NO CLAIM IS MADE TO THE EXCLUSIVE RIGHT TO USE "RIMS", APART FROM THE MARK AS SHOWN.
THE STIPPLING IS A FEATURE OF THE MARK.
FOR AUTOMOTIVE CHROME WHEEL RIMS (U.S. CLS. 19, 21, 23, 31, 35 AND 44).

CLASS 12—(Continued).

SN 78-148,685. PACE AMERICAN, INC., MIDDLEBURY, IN. FILED 7-30-2002.

TROOPER

FOR TRAILERS, NAMELY, CARGO TRAILERS (U.S. CLS. 19, 21, 23, 31, 35 AND 44).

SN 78-148,930. CLASS M CORPORATION, SANTO, TX. FILED 7-30-2002.

STEEROIDS

FOR VEHICLE PARTS, NAMELY, STEERING WHEELS, STEERING PARTS, AUTOMOBILE CHASSIS, SUSPENSION STRUTS, AND AUTOMOBILE STRUCTURAL PARTS (U.S. CLS. 19, 21, 23, 31, 35 AND 44). FIRST USE 6-1-1999; IN COMMERCE 10-1-1999.

SN 78-155,600. YAMAHA HATSUDOKI KABUSHIKI KAISHA, SHIZUOKA-KEN, JAPAN, FILED 8-19-2002.

BRUIN

FOR ALL TERRAIN VEHICLES AND STRUCTURAL PARTS THEREFOR (U.S. CLS. 19, 21, 23, 31, 35 AND 44).

SN 78-155,923. DAIMLERCHRYSLER CORPORATION, AUBURN HILLS, MI. FILED 8-20-2002.

JOB-RATED

FOR MOTOR VEHICLES, NAMELY, PICKUP TRUCKS, VANS AND MINIVANS, AND STRUCTURAL PARTS AND ENGINES THEREFOR (U.S. CLS. 19, 21, 23, 31, 35 AND 44).

SN 78-159,280. GENMAR IP LLC, MINNEAPOLIS, MN. FILED 8-28-2002.

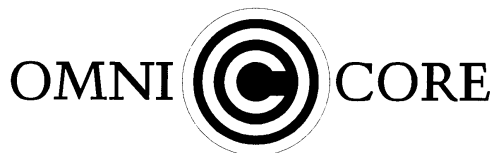

FOR BOATS AND STRUCTURAL PARTS THEREFOR (U.S. CLS. 19, 21, 23, 31, 35 AND 44).

CLASS 12—(Continued).

SN 78-163,152. TRIPP, BERNARD, RICHMOND HILL, GA. FILED 9-11-2002.



FOR NEW, REBUILT AND REFURBISHED AUTOMOTIVE PARTS FOR PERFORMANCE APPLICATIONS, NAMELY TRANSMISSIONS AND STRUCTURAL AND REPLACEMENT PARTS THEREFORE (U.S. CLS. 19, 21, 23, 31, 35 AND 44).

SN 78-166,325. GIRARDIN MINIBUS INC., DRUMMOND-VILLE, QUEBEC, CANADA, FILED 9-20-2002.



FOR MINIBUSES (U.S. CLS. 19, 21, 23, 31, 35 AND 44). FIRST USE 11-17-2000; IN COMMERCE 1-10-2001.

SN 78-169,820. ELEGANT USA, LLC, TOTOWA, NJ. FILED 10-1-2002.

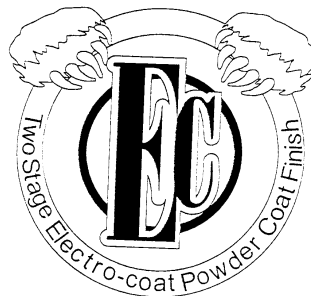

NO CLAIM IS MADE TO THE EXCLUSIVE RIGHT TO USE "TWO STAGE", "ELECTRO COAT", AND "POWDER COAT FINISH", APART FROM THE MARK AS SHOWN. FOR METAL GUARDS MOUNTED TO AUTOMOBILES. (U.S. CLS. 19, 21, 23, 31, 35 AND 44).

CLASS 12—(Continued).

SN 78-182,750. ELEGANT USA, LLC, TOTOWA, NJ. FILED 11-7-2002.

NX RACING

NO CLAIM IS MADE TO THE EXCLUSIVE RIGHT TO USE "RACING", APART FROM THE MARK AS SHOWN.

FOR AUTOMOTIVE ACCESSORIES, NAMELY, SEAT COVERS AND SEAT CUSHIONS FOR AUTOMOBILES, STEERING WHEEL COVERS FOR AUTOMOBILES, METAL GUARDS MOUNTED TO AUTOMOBILES, NAMELY, BRUSH GUARDS, BUMPERS GUARDS, LIGHT GUARDS, AND GRILL GUARDS FOR AUTOMOBILES (U.S. CLS. 19, 21, 23, 31, 35 AND 44).

SN 78-185,057. THYSSENKRUPP BUDD COMPANY, TROY, MI. FILED 11-14-2002.

FLEX-GATE

FOR LAND VEHICLE PARTS, NAMELY, A MOVABLE PANEL THAT PERMITS A USER TO CONFIGURE CARGO AND PASSENGER SPACES IN A VEHICLE (U.S. CLS. 19, 21, 23, 31, 35 AND 44).

SN 78-193,730. AMES TRUE TEMPER PROPERTIES, INC., WILMINGTON, DE. FILED 12-12-2002.

TRUE TEMPER EASY STORE

OWNER OF U.S. REG. NOS. 2,205,580 AND 2,450,140. NO CLAIM IS MADE TO THE EXCLUSIVE RIGHT TO USE "EASY STORE", APART FROM THE MARK AS SHOWN.

FOR WHEELBARROWS (U.S. CLS. 19, 21, 23, 31, 35 AND 44).

SN 78-194,493. SRI USA, INC., AMHERST, NY. FILED 12-13-2002.

SP 382

OWNER OF U.S. REG. NOS. 1,214,772 AND 1,766,661. FOR TIRES (U.S. CLS. 19, 21, 23, 31, 35 AND 44).

SN 78-199,170. TAKEUCHI, TOSHIO, ALHAMBRA, CA. FILED 12-31-2002.

TEE'S BRIDE

FOR CUSTOMIZED VEHICLE SEATS (U.S. CLS. 19, 21, 23, 31, 35 AND 44).

CLASS 12—(Continued).

SN 78-201,435. OCEAN SPIRIT RACING CORPORATION, MIAMI, FL. FILED 1-9-2003.

OCEAN SPIRIT

NO CLAIM IS MADE TO THE EXCLUSIVE RIGHT TO USE "OCEAN", APART FROM THE MARK AS SHOWN. FOR BOATS (U.S. CLS. 19, 21, 23, 31, 35 AND 44).

SN 78-201,903. BRYANT PHARMACY & SUPPLY, ANDERSON, SC. FILED 1-10-2003.



FOR TWO OR THREE WHEEL ELECTRIC SCOOTER (U.S. CLS. 19, 21, 23, 31, 35 AND 44).

SN 78-203,555. MICHELIN NORTH AMERICA, INC., GREENVILLE, SC. FILED 1-15-2003.

HYDROEDGE

FOR PNEUMATIC TIRES AND INNER TUBES FOR VEHICLE WHEELS; TREADS FOR RECAPPING TIRES (U.S. CLS. 19, 21, 23, 31, 35 AND 44).

SN 78-203,624. MICHELIN NORTH AMERICA, INC., GREENVILLE, SC. FILED 1-15-2003.

ANTHEM

FOR PNEUMATIC TIRES AND INNER TUBES FOR VEHICLE WHEELS; TREADS FOR RECAPPING TIRES (U.S. CLS. 19, 21, 23, 31, 35 AND 44).

SN 78-207,027. PEDAL-PADDLE, INC., AMARILLO, TX. FILED 1-24-2003.

PEDAL-PADDLE

FOR VEHICLES FOR LOCOMOTION BY LAND AND WATER, NAMELY, AMPHIBIOUS BICYCLES (U.S. CLS. 19, 21, 23, 31, 35 AND 44).

CLASS 12—(Continued).

SN 78-208,133. NAVATEK LTD., HONOLULU, HI. FILED 1-28-2003.

HDV

FOR DEEP-V HULL VESSEL WITH AN ATTACHED LIFTING BODY, NAMELY SHIPS, INCORPORATING A PROPRIETARY DESIGN (U.S. CLS. 19, 21, 23, 31, 35 AND 44).

FIRST USE 8-1-2002; IN COMMERCE 8-1-2002.

SN 78-208,378. GOODYEAR TIRE & RUBBER COMPANY, THE, AKRON, OH. FILED 1-29-2003.

EAGLE GT

OWNER OF U.S. REG. NOS. 679,617 AND 1,422,760. NO CLAIM IS MADE TO THE EXCLUSIVE RIGHT TO USE "GT", APART FROM THE MARK AS SHOWN, FOR TIRES (U.S. CLS. 19, 21, 23, 31, 35 AND 44).

SN 78-209,496. AMG MEDICAL INC., MONTREAL, QUEBEC, CANADA, FILED 1-31-2003.

I ROK

FOR WHEELCHAIRS (U.S. CLS. 19, 21, 23, 31, 35 AND 44).

SN 78-209,643. AQUA FUN, INC., SCALES MOUND, IL. FILED 1-31-2003.

BODYDOCK

FOR FLOATING RAFT (U.S. CLS. 19, 21, 23, 31, 35 AND 44). FIRST USE 5-3-2001; IN COMMERCE 5-3-2001.

CLASS 12—(Continued).

SN 78-211,290. SCOOTERUPUP LLC, OKEMOS, MI. FILED 2-5-2003.



FOR SELF PROPELLED PERSONAL SCOOTERS (U.S. CLS. 19, 21, 23, 31, 35 AND 44). FIRST USE 8-15-2002; IN COMMERCE 9-1-2002.

CLASS 13—FIREARMS

SN 76-482,033. JAKE'S FIREWORKS, PITTSBURG, KS. FILED 1-13-2003.

ALL - ST★R

FOR FIREWORKS (U.S. CLS. 2 AND 9).

SN 76-490,994. SANDS, JOSEPH E., SPARR, FL. FILED 2-10-2003.

SLINGPOD

FOR FIREARM ACCESSORY, NAMELY A RIFLE SLING (U.S. CLS. 2 AND 9).

SN 78-170,758. ASIA PACIFIC ENTERPRISES CORPORATION, VANCOUVER B.C. CANADA, FILED 10-3-2002.



FOR AIRGUN, ELECTRIC AIRGUNS, AIRGUN PROJECTILES (U.S. CLS. 2 AND 9). FIRST USE 10-27-1996; IN COMMERCE 10-27-1996.

CLASS 13—(Continued).

SN 78-184,127. B.J. ALAN COMPANY, YOUNGSTOWN, OH.
FILED 11-12-2002.

TITAN ROCKET

NO CLAIM IS MADE TO THE EXCLUSIVE RIGHT TO
USE "ROCKET", APART FROM THE MARK AS SHOWN.
FOR FIREWORKS (U.S. CLS. 2 AND 9).

SN 78-198,611. ATES, LEROY, D., JR., SAN ANGELO, TX.
FILED 12-30-2002.

**CONCHO
CARTRIDGE
COMPANY, INC.**

NO CLAIM IS MADE TO THE EXCLUSIVE RIGHT TO
USE "CARTRIDGE COMPANY, INC.", APART FROM THE
MARK AS SHOWN.
FOR SMALL ARMS AMMUNITION (U.S. CLS. 2 AND
9).
FIRST USE 5-26-1988; IN COMMERCE 5-26-1988.

SN 78-201,211. RAYTHEON COMPANY, LEXINGTON, MA.
FILED 1-8-2003.

SEA FURY

FOR GUIDED MISSILES (U.S. CLS. 2 AND 9).

SN 78-208,759. AMERICAN PROMOTIONAL EVENTS, INC.,
FLORENCE, AL. BY ASSIGNMENT NEPTUNE WHOLE-
SALE, DANIA BEACH, FL. FILED 1-30-2003.

MAD DEMON

FOR FIREWORKS (U.S. CLS. 2 AND 9).
FIRST USE 8-15-2002; IN COMMERCE 11-1-2002.

CLASS 14—JEWELRY

SN 75-795,601. TRI-COASTAL DESIGN GROUP, INC.,
BRIDGEWATER, NJ. FILED 9-9-1999.

GROOVY GIRL

FOR IMITATION JEWELRY, NAMELY, NECKLACES,
BRACELETS, WRIST CUFFS, AND RINGS (U.S. CLS. 2,
27, 28 AND 50).

CLASS 14—(Continued).

SN 76-264,492. ORO MEDITERRANEO, S.L., 14011 CORDO-
BA, SPAIN, FILED 5-30-2001.

Med Gold 
by oroMediterráneo s.

PRIORITY CLAIMED UNDER SEC. 44(D) ON SPAIN
APPLICATION NO. 2.398.187, FILED 5-4-2001, REG. NO.
2398187, DATED 11-5-2001, EXPIRES 11-5-2011.

OWNER OF U.S. REG. NO. 2,191,260.
NO CLAIM IS MADE TO THE EXCLUSIVE RIGHT TO
USE "GOLD" OR "ORO OROMEDITERRANEO S.L.",
APART FROM THE MARK AS SHOWN.

THE MARK CONSISTS OF THE WORDS "MED GOLD"
AND "BY OROMEDITERRANEO S.L." WITH A STYLIZED
DRAWING OF SAILING SHIPS.

THE ENGLISH TRANSLATION OF "ORO MEDITERRA-
NEO" IS "MEDITERRANEAN GOLD".

FOR JEWELRY, NAMELY, RINGS, BRACELETS,
EARRINGS, NECKLACES, CUFFLINKS, TIE PINS AND
TACKS AND PENDANTS MADE IN WHOLE OR SUB-
STANTIAL PART OF MEDITERRANEAN GOLD (U.S.
CLS. 2, 27, 28 AND 50).

SN 76-428,844. POTTER, ROBERTA L., AVENTURA, FL.
FILED 7-5-2002.

MESSAGE CONNECTION

NO CLAIM IS MADE TO THE EXCLUSIVE RIGHT TO
USE "MESSAGE", APART FROM THE MARK AS SHOWN.
FOR JEWELRY (U.S. CLS. 2, 27, 28 AND 50).

SN 76-432,000. ETERNAL PROMISE COMPANY, FRONT
ROYAL, VA. FILED 7-15-2002.

**ETERNAL PROMISE
COMPANY**

NO CLAIM IS MADE TO THE EXCLUSIVE RIGHT TO
USE "COMPANY", APART FROM THE MARK AS SHOWN.
FOR JEWELRY (U.S. CLS. 2, 27, 28 AND 50).

SN 76-461,501. STREET HOLES CORP., NEW YORK, NY.
FILED 10-24-2002.

STREET HOLES

FOR BODY JEWELRY (U.S. CLS. 2, 27, 28 AND 50).
FIRST USE 11-1-2000; IN COMMERCE 12-5-2000.

CLASS 14—(Continued).

SN 76-469,817. GHAZAROSSIAN, GHAZAROS, LOS ANGELES, CA. FILED 11-25-2002.

GiantTo

FOR JEWELRY AND WATCHES MADE OF PRECIOUS METALS AND STONES (U.S. CLS. 2, 27, 28 AND 50).
FIRST USE 6-1-1998; IN COMMERCE 6-1-1998.

CLASS 14—(Continued).

SN 76-492,994. LADY LUCK JEWELRY, INC., NIWOT, CO. FILED 1-29-2003.

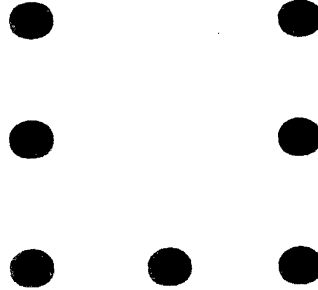

FOR JEWELRY, JEWELRY PINS FOR USE ON HAIR, NECKLACES, BRACELETS, CHARMS (U.S. CLS. 2, 27, 28 AND 50).
FIRST USE 9-0-1999; IN COMMERCE 9-0-1999.

SN 76-487,328. ZODIAC 1882 AG, CH-2500, BIENNE 4, SWITZERLAND, FILED 2-4-2003.

SPACE MAN

FOR WATCHES AND CLOCKS (U.S. CLS. 2, 27, 28 AND 50).

SN 76-501,576. MIDWEST RECOGNITION, LLC, KEARNEY, MO. FILED 3-26-2003.

SN 76-492,322. MCMANUS, JILL, WILLISTON, VT. FILED 2-25-2003.

RUGGED GOOD LOOKS

FOR JEWELRY (U.S. CLS. 2, 27, 28 AND 50).

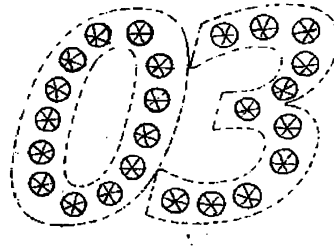

SN 76-492,993. LADY LUCK JEWELRY, INC., NIWOT, CO. FILED 1-29-2003.

LADY LUCK

FOR JEWELRY, JEWELRY PINS FOR USE ON HAIR; NECKLACES, BRACELETS, CHARMS (U.S. CLS. 2, 27, 28 AND 50).
FIRST USE 9-0-1999; IN COMMERCE 9-0-1999.

NO CLAIM IS MADE TO THE EXCLUSIVE RIGHT TO USE "ADJACENT NUMERALS", APART FROM THE MARK AS SHOWN.

THE MARK CONSISTS OF A DECORATIVE AMULET IN THE SHAPE OF A PAIR OF ADJACENT NUMERALS HAVING AN ARRAY OF REFRACTIVE STONES IMBEDDED IN ITS FRONT FACE.

FOR JEWELRY, SPECIFICALLY AN AMULET IN THE FORM OF ADJACENT NUMERALS (U.S. CLS. 2, 27, 28 AND 50).

FIRST USE 8-0-1999; IN COMMERCE 8-0-1999.

CLASS 14—(Continued).

SN 78-140,521. OHANES, RAFI, K., LOS ANGELES, CA. FILED 7-1-2002.

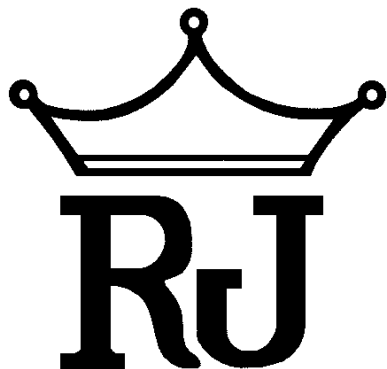

FOR JEWELRY MADE OF PRECIOUS METALS AND THEIR ALLOYS OR COATED THEREWITH (U.S. CLS. 2, 27, 28 AND 50).

SN 78-140,969. IMPERIAL WORLD, INC., WESTMONT, IL. BY ASSIGNMENT ULLENBERG CORPORATION, WESTMONT, IL. FILED 7-3-2002.



OWNER OF U.S. REG. NO. 1,182,860.
FOR JEWELRY FOR PERSONAL WEAR NAMELY NECKLACES, PENDANTS, BRACELETS, RINGS, EARRINGS, BROOCHES, ANKLE BRACELETS, CHARMS, COSTUME JEWELRY, AND NECK CHAINS (U.S. CLS. 2, 27, 28 AND 50).
FIRST USE 5-8-2002; IN COMMERCE 5-8-2002.

SN 78-146,569. RUFF RYDERS ENTERTAINMENT, INC., NEW YORK, NY. FILED 7-23-2002.

RUFF RYDERS

FOR JEWELRY AND KEY CHAINS MADE OF PRECIOUS METAL (U.S. CLS. 2, 27, 28 AND 50).

CLASS 14—(Continued).

SN 78-175,426. DOGGONE JEWELS, EUREKA, CA. FILED 10-17-2002.



NO CLAIM IS MADE TO THE EXCLUSIVE RIGHT TO USE "JEWELS", APART FROM THE MARK AS SHOWN.
FOR BEADED JEWELRY/NECKLACES FOR DOGS (AND THEIR OWNERS) (U.S. CLS. 2, 27, 28 AND 50).
FIRST USE 9-24-2002; IN COMMERCE 9-27-2002.

SN 78-178,851. SANTIAGO, HEIDI, SPOKANE, WA. FILED 10-27-2002.

WEE-MINDER

FOR PENDANTS AND WATCHES IN WHICH A SONG CAN BE SET TO PLAY AT CERTAIN TIMES OF THE DAY TO REMIND TODDLERS TO USE THE BATHROOM (U.S. CLS. 2, 27, 28 AND 50).

SN 78-199,027. DUBUQUE AREA CHAMBER OF COMMERCE, DUBUQUE, IA. FILED 12-31-2002.

AMERICA'S RIVER

FOR LAPEL PINS (U.S. CLS. 2, 27, 28 AND 50).
FIRST USE 4-1-1998; IN COMMERCE 4-1-1998.

SN 78-204,075. AURAFIN-OROAMERICA LLC, TAMARAC, FL. FILED 1-16-2003.

BHG

FOR JEWELRY (U.S. CLS. 2, 27, 28 AND 50).
FIRST USE 12-1-2000; IN COMMERCE 12-1-2000.

CLASS 14—(Continued).

SN 78-208,318. MARC LAZAR INC., NEW YORK, NY. FILED 1-29-2003.

DIAMOND DICE

NO CLAIM IS MADE TO THE EXCLUSIVE RIGHT TO USE "DIAMOND", APART FROM THE MARK AS SHOWN. FOR JEWELRY (U.S. CLS. 2, 27, 28 AND 50).

SN 78-209,143. CUMMINGS, MARGUERITE, ALTADENA, CA. FILED 1-30-2003.



Beauty and the Beads

FOR JEWELRY (U.S. CLS. 2, 27, 28 AND 50).
FIRST USE 1-1-2001; IN COMMERCE 1-1-2001.

SN 78-231,777. FIELD & STREAM LICENSES COMPANY, HOPKINS, MN. FILED 3-31-2003.

FIELD & STREAM

OWNER OF U.S. REG. NO. 1,687,750.
FOR JEWELRY, NAMELY BRACELET, NECKLACE (U.S. CLS. 2, 27, 28 AND 50).
FIRST USE 3-17-2003; IN COMMERCE 3-17-2003.

CLASS 15—MUSICAL INSTRUMENTS

SN 76-479,313. WAGNER, LINDA A., GLENSHAW, PA. FILED 12-31-2002.

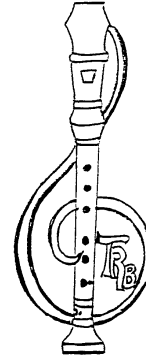

FOR CARRYING CASES FOR A MUSICAL INSTRUMENT, NAMELY A RECORDER (U.S. CLS. 2, 21 AND 36).

SN 76-483,856. YAMAHA CORPORATION, SHIZUOKA, JAPAN, FILED 1-21-2003.

DAXDAD

FOR MUSICAL INSTRUMENTS, NAMELY, DRUMS AND PERCUSSION INSTRUMENTS, PARTS FOR THE AFORESAID GOODS (U.S. CLS. 2, 21 AND 36).

SN 76-484,806. SMITH, ALEXANDER M., BEAVER DAM, WI. FILED 1-27-2003.

AXMAX

FOR TREMOLOS FOR STRING MUSICAL INSTRUMENTS (U.S. CLS. 2, 21 AND 36).
FIRST USE 1-13-2003; IN COMMERCE 1-13-2003.

SN 78-155,945. MARCAT MACHINING CO., LLC, NASHUA, NH. FILED 8-20-2002.



FOR DRUM STICK HOLDER (U.S. CLS. 2, 21 AND 36).
FIRST USE 1-21-2002; IN COMMERCE 1-21-2002.

CLASS 16—PAPER GOODS AND PRINTED MATTER

SN 76-042.175. VBH REALM B.V., 1079 LH AMSTERDAM, NETHERLANDS, FILED 5-5-2000.



PRIORITY CLAIMED UNDER SEC. 44(D) ON BENELUX APPLICATION NO. 949929, FILED 11-10-1999, REG. NO. 661570, DATED 11-10-1999, EXPIRES 11-10-2009.

FOR (BASED ON INTENT TO USE) BULLETIN BOARDS; DECORATIVE PAPER CENTERPIECES; NEWSPAPER AND MAGAZINE COLUMNS DEALING WITH APPAREL, ACCESSORIES, WORKS OF ART, JEWELRY, PERFUME, COSMETICS AND HOUSEHOLD ITEMS; DIRECTORY BOARDS; GENERAL FEATURE MAGAZINES; MAGAZINES DEALING WITH APPAREL, ACCESSORIES, HOUSEHOLD ITEMS, WORKS OF ART, PERFUMES, COSMETICS AND JEWELRY; MOUNTING BOARDS; MURALS; PAPER RACKS; (BASED ON 44(E)) ADDRESS BOOKS; ADDRESS LABELS; ADDRESS PLATES; ADHESIVE TAPE DISPENSERS FOR HOUSEHOLD OR STATIONERY USE; ADHESIVE TAPES FOR STATIONERY OR HOUSEHOLD PURPOSES; AGENDAS; COIN ALBUMS; STAMP ALBUMS; PHOTOGRAPH ALBUMS; ANNIVERSARY BOOKS; ANNOUNCEMENT CARDS; APPLIQUES IN THE FORM OF DECALS; APPOINTMENT BOOKS; ART PADS; ART PAPER; PRINTED ART REPRODUCTIONS; AUTOGRAPH BOOKS; PLASTIC BAGS FOR HOUSEHOLD USE; PAPER BAGS FOR HOUSEHOLD USE; PLASTIC BAGS FOR MERCHANDISE PACKAGING, NAMELY ENVELOPES, POUCHES; PAPER BAGS FOR MERCHANDISE PACKAGING, NAMELY ENVELOPES, POUCHES; PAPER BAGS FOR PACKAGING; BALL-POINT PENS; BINDERS; LOOSE LEAF BINDERS; BLACKBOARDS; BLANK NOTE CARDS; BLOTTERS; BOND PAPER; BOOK COVERS; BOOK HOLDERS; BOOK RESTS; BOOKENDS; BOOKKEEPING BOOKS; BOOKMARKS; BROCHURES ABOUT APPAREL, ACCESSORIES, WORKS OF ART, JEWELRY, PERFUME, COSMETICS AND HOUSEHOLD ITEMS; BUSINESS CARDS; CALENDAR DESK PADS; CALENDAR DESK STANDS; CALENDAR STANDS; CALENDARS; CARDS NOT MAGNETICALLY CODED FOR USE IN BUSINESS TRANSACTIONS; CARDBOARD BOXES; CARD FILES; CARDBOARD CONTAINERS; BLANK CARDS; CARDS BEARING UNIVERSAL GREETINGS; CATALOGS FOR APPAREL, ACCESSORIES, WORKS OF ART, JEWELRY, PERFUME, COSMETICS AND HOUSEHOLD ITEMS; CELESTIAL GLOBES; CHARCOAL PENCILS; CHECKBOOK AND PASSBOOK WALLETS; CHECKBOOK COVERS; CHILDREN'S BOOKS; CHRISTMAS CARDS; CLIP BOARDS; COIN ALBUMS; COIN HOLDERS; COLOR PRINTS; COMPOSITION BOOKS; CONSTRUCTION PAPER; COOK BOOKS; CORRESPONDENCE HOLDERS; CORRESPONDENCE RACKS; COSMETIC PENCIL SHARPENERS; CRAFT PAPER; CRAYONS; CREPE PAPER; DAILY PLANNERS; DATA BOOKS; DATE BOOKS; DATE INDICATORS; DECALS; DESK BASKETS FOR DESK ACCESSORIES; DESK CALENDARS; DESK FILE TRAYS; DESK PADS; DESK SETS; DESK STANDS AND HOLDERS FOR PENS, PENCILS AND INK; DESK TOP DOCUMENT RACKS; DESK TOP DOCUMENT STANDS; DESK TOP ORGANIZERS; DESK TOP PLANNERS; DESK TOP REVOLVING ROTARY CARD FILES; DESK TOP STATIONERY CABINETS; DIARIES; DICTATION BOOKS; DICTIONARIES; DIRECTORIES OF FASHION; DISPENSERS FOR ADHESIVE TAPES FOR STATIONERY OR HOUSEHOLD PURPOSES; AUTOMATIC ADHESIVE DISPENSERS FOR OFFICE USE; DOCUMENT FILE RACKS; DOCUMENT FILE TRAYS; DOCUMENT FILES; DOCUMENT HOLDERS; DOCUMENT STAMP RACKS; DRAWING BOARDS; DRAWING INSTRUMENTS; DRAWING PADS; DRAWING PAPER; DRAWING PENCILS; EASELS; ENGAGEMENT BOOKS; ENGRAVINGS; ENVELOPES; ERASERS; ETCHINGS; FELT PENS; FELT TIP MARKERS; FIBERTIP PENS; FILE BOXES FOR STORAGE OF BUSINESS AND PERSONAL RECORDS; FILE CARDS; FILE FOLDERS; FILE SORTERS; FILE TRAYS; FOLDERS; FOUNTAIN PEN

CLASS 16—(Continued).

INK CARTRIDGES; GIFT CARDS; GIFT WRAPPING PAPER; GLOBES; GRAPHIC ART REPRODUCTIONS; GREETING CARDS; GUEST BOOKS; HANGING FOLDERS; HIGHLIGHTING MARKERS; HIGHLIGHTING PENS; HOLDERS FOR DESK ACCESSORIES; ILLUSTRATION BOARDS; ILLUSTRATIONS; INDEX DIVIDERS; INDIA INK; WRITING INK; INKING PADS; PRINTED INVITATIONS; LAMINATED PAPER; LAP BOARDS FOR READING AND WRITING; LEGAL PADS; LETTER FILES; LETTER OPENERS; LETTER RACKS; LETTER TRAYS; LIQUID PAINT FELT TIP MARKING AND COLORING APPLICATORS; LITHOGRAPHS; LOOSE LEAF BINDERS; LUMINOUS PAPER; MAGAZINE SUPPLEMENTS TO NEWSPAPERS REGARDING APPAREL, ACCESSORIES, HOUSEHOLD ITEMS, WORKS OF ART, PERFUME, COSMETICS AND JEWELRY; MARKERS; MARKING PENS; MECHANICAL PENCILS; MEMO PADS; MEMORANDUM BOARDS; MEMORANDUM BOOKS; PHOTO ALBUMS, NAMELY, MEMORY BOOKS; MERCHANDISE BAGS; MONOGRAPHS; NOTE BOOKS; NOTEBOOK DIVIDERS; NOTEBOOK PAPER; NOTE PADS; NOTE PAPER; PAINT PADDLES; PAINT BRUSHES; PAINTING SETS; PAINTINGS; FIBER PAPER; PAPER BAGS; PAPER BAGS FOR PACKAGING; PAPER BLINDS; PAPER BOXES; PAPER CLIPS; PAPER CLIP HOLDERS; PAPER CONTAINERS; PAPER CUTTERS; PAPER EMBLEMS; PAPER ENVELOPES FOR PACKAGING; PAPER FILE JACKETS; PAPER FOR WRAPPING AND PACKAGING; PAPER GIFT BAGS; PAPER GIFT WRAP BOWS; PAPER GIFT WRAPPING RIBBONS; PAPER HOLE PUNCHES; PAPER PARTY BAGS; PAPER PARTY DECORATIONS; PAPER POUCHES FOR PACKAGING; PAPER TAGS; PAPERBOARD; PAPERWEIGHTS; PARCHMENT PAPER; PASSPORT HOLDERS; CLOTHING DESIGN PATTERNS; PEN AND PENCIL TRAYS; PEN CASES; PEN OR PENCIL HOLDERS; PENCIL CASES; PENCILS; PENCIL OR PEN BOXES; PENS; INK PENS; PHOTOGRAPH ALBUMS; PHOTOGRAPHIC PRINTS; MOUNTED PHOTOGRAPHS; UNMOUNTED PHOTOGRAPHS; PICTURE BOOKS; PICTURES; PLACE CARDS; DAY, MONTH AND YEAR PLANS; PERSONAL PLANNERS; PLAYING CARD CASES; PLAYING CARDS; POCKET CALENDARS; POCKET SECRETARIES; POSTCARDS; POSTERS; PRINTED INVITATIONS; PRINTED MAIL RESPONSE CARDS RELATING TO PERSONAL CORRESPONDENCE; PRINTED PATTERNS; RECIPE BOOKS; RECORD CARDS; RECYCLED PAPER; RUBBER STAMPS; UNGRADUATED RULERS; SCORE CARDS; SCORE PADS; SCRAPBOOK ALBUMS; SCRAPBOOKS; SCRATCH PADS; SEALING WAX; SKETCH BOOKS; SKETCH PADS; SKETCHES; SLATE BOARDS FOR WRITING; SOCIAL NOTE CARDS; SONG BOOKS; STAMP ALBUMS; STAPLE REMOVERS; STATIONERY; STATIONERY BOXES; STATIONERY FOLDERS; STATIONERY TYPE PORTFOLIOS; STATIONERY WRITING PAPER AND ENVELOPES; TELEPHONE NUMBER BOOKS; TERRESTRIAL GLOBES; THREE-RING BINDERS; WALL CALENDARS; WATERCOLOR PICTURES; WEDDING ALBUMS; WIREBOUND BOOKS; WRAPPING PAPER; WRITING INK; WRITING INSTRUMENTS; WRITING PADS; WRITING PAPER; WRITING TABLETS; PASSPORT WALLETS; PASSPORT HOLDERS (U.S. CLS. 2, 5, 22, 23, 29, 37, 38 AND 50).

CLASS 16—(Continued).

SN 76-137,612. STORA ENSO OYJ, 00160 HELSINKI, FINLAND, FILED 9-29-2000.

PERFORMA NATURA

PRIORITY CLAIMED UNDER SEC. 44(D) ON FINLAND APPLICATION NO. T200001105, FILED 3-31-2000, REG. NO. 220728, DATED 4-30-2001, EXPIRES 4-30-2011.

NO CLAIM IS MADE TO THE EXCLUSIVE RIGHT TO USE "NATURA", APART FROM THE MARK AS SHOWN.

THE ENGLISH TRANSLATION OF "NATURA" IS "NATURAL".

FOR CARDBOARD; CORRUGATED PAPER, CORRUGATED CARDBOARD AND GOODS MADE FROM PAPER AND CARDBOARD, NAMELY PAPERBOARD, PACKING CARDBOARD, LIQUID PACKAGING CARDBOARD, PACKAGING PAPER, WRAPPING PAPER, LAMINATED PAPER, PAPER FOR BAGS AND SACKS, KRAFT PAPER, COREBOARD AND CORES, PAPER BOXES, CARDBOARD BOXES AND COMBINATIONS THEREOF AND/OR COMBINED WITH PLASTIC MATERIAL; CONTAINERS, BOXES, BAGS FOR TRANSPORTATION, COLLAPSIBLE CONTAINERS, COLLAPSIBLE BOXES OF PAPER, CORRUGATED CARDBOARD AND/OR COMBINATIONS THEREOF AND/OR COMBINED WITH PLASTIC MATERIAL; COLLAPSIBLE CARDBOARD BOXES, CORRUGATED CARDBOARD COMBINED WITH AN INNER PROTECTIVE PACKAGING OF PLASTIC IN THE FORM OF FOILS AND/OR BUBBLE BACK AND/OR FOAM SHAPED PIECES FOR PACKAGING (U.S. CLS. 2, 5, 22, 23, 29, 37, 38 AND 50).

SN 76-137,613. STORA ENSO OYJ, 00160 HELSINKI, FINLAND, FILED 9-29-2000.

PERFORMA CTMP

PRIORITY CLAIMED UNDER SEC. 44(D) ON FINLAND APPLICATION NO. T200001104, FILED 3-31-2000, REG. NO. 220727, DATED 4-30-2001, EXPIRES 4-30-2011.

NO CLAIM IS MADE TO THE EXCLUSIVE RIGHT TO USE "CTMP", APART FROM THE MARK AS SHOWN.

FOR CARDBOARD: CORRUGATED PAPER, CORRUGATED CARDBOARD AND GOODS MADE FROM PAPER AND CARDBOARD, NAMELY PAPERBOARD, PACKING CARDBOARD, LIQUID PACKAGING CARDBOARD, PACKAGING PAPER, WRAPPING PAPER, LAMINATED PAPER, PAPER FOR BAGS AND SACKS, KRAFT PAPER, COREBOARD AND CORES, PAPER BOXES, CARDBOARD BOXES AND COMBINATIONS THEREOF AND/OR COMBINED WITH PLASTIC MATERIAL; CONTAINERS, BOXES, BAGS FOR TRANSPORTATION, COLLAPSIBLE CONTAINERS, COLLAPSIBLE BOXES OF PAPER, CORRUGATED CARDBOARD AND/OR COMBINATIONS THEREOF AND/OR COMBINED WITH PLASTIC MATERIAL; COLLAPSIBLE CARDBOARD BOXES, CORRUGATED CARDBOARD COMBINED WITH AN INNER PROTECTIVE PACKAGING OF PLASTIC IN THE FORM OF FOILS AND/OR BUBBLE BACK AND/OR FOAM SHAPED PIECES FOR PACKAGING (U.S. CLS. 2, 5, 22, 23, 29, 37, 38 AND 50).

CLASS 16—(Continued).

SN 76-137,614. STORA ENSO OYJ, 00160 HELSINKI, FINLAND, FILED 9-29-2000.

PERFORMA WHITE

PRIORITY CLAIMED UNDER SEC. 44(D) ON FINLAND APPLICATION NO. T200001106, FILED 3-31-2000, REG. NO. 220729, DATED 4-30-2001, EXPIRES 4-30-2011.

NO CLAIM IS MADE TO THE EXCLUSIVE RIGHT TO USE "WHITE", APART FROM THE MARK AS SHOWN.

FOR CARDBOARD: CORRUGATED PAPER, CORRUGATED CARDBOARD AND GOODS MADE FROM PAPER AND CARDBOARD, NAMELY PAPERBOARD, PACKING CARDBOARD, LIQUID PACKAGING CARDBOARD, PACKAGING PAPER, WRAPPING PAPER, LAMINATED PAPER, PAPER FOR BAGS AND SACKS, KRAFT PAPER, COREBOARD AND CORES, PAPER BOXES, CARDBOARD BOXES AND COMBINATIONS THEREOF AND/OR COMBINED WITH PLASTIC MATERIAL; CONTAINERS, BOXES, BAGS FOR TRANSPORTATION, COLLAPSIBLE CONTAINERS, COLLAPSIBLE BOXES OF PAPER, CORRUGATED CARDBOARD AND/OR COMBINATIONS THEREOF AND/OR COMBINED WITH PLASTIC MATERIAL; COLLAPSIBLE CARDBOARD BOXES, CORRUGATED CARDBOARD COMBINED WITH AN INNER PROTECTIVE PACKAGING OF PLASTIC IN THE FORM OF FOILS AND/OR BUBBLE BACK AND/OR FOAM SHAPED PIECES FOR PACKAGING (U.S. CLS. 2, 5, 22, 23, 29, 37, 38 AND 50).

SN 76-195,749. TELEGRAPH GROUP LIMITED, LONDON E14 5DT, UNITED KINGDOM, FILED 1-18-2001.

THE SUNDAY TELEGRAPH

OWNER OF ERPN CMNTY TM OFC REG. NO. 944298, DATED 1-30-2001, EXPIRES 9-30-2008.

NO CLAIM IS MADE TO THE EXCLUSIVE RIGHT TO USE "SUNDAY", APART FROM THE MARK AS SHOWN.

FOR PRINTED MATTER AND PUBLICATIONS, NAMELY, NEWSPAPERS FOR GENERAL CIRCULATION, GENERAL FEATURE MAGAZINES, PERIODICALS IN THE FIELD OF GENERAL INTEREST, NEWS AND POLITICS, SPORTS AND DOMESTIC PURSUITS, NAMELY, INTERIOR DECORATION, COOKING, FURNISHING, HANDICRAFTS, GARDENING, FASHION, ART, AND BOOKS; PRINTED CHARTS; STATIONERY; PRE-PRINTED FORMS AND SCORE SHEETS AND MANUALS IN THE FIELD OF SPORT, ENTERTAINMENT AND COMPETITIONS, NAMELY, CROSSWORDS, ENTERTAINMENT, GAMES AND SPORTS COMPETITIONS, CHESS COMPETITIONS, AND FREE PRIZE DRAWS; FOLDERS; PENS AND PRINTED PLASTIC FILING CARDS (U.S. CLS. 2, 5, 22, 23, 29, 37, 38 AND 50).

CLASS 16—(Continued).

SN 76-237,663. IRENE WOODWARD GOODGAME, CARROLLTON, GA. FILED 4-9-2001.

Deco Folio

NO CLAIM IS MADE TO THE EXCLUSIVE RIGHT TO USE "FOLIO", APART FROM THE MARK AS SHOWN. FOR PORTABLE FILE FOLDER FOR DECORATIVE ELEMENT SAMPLES OF A HOME OR DESIGN PROJECT, NAMELY, PAINT, FABRIC, FLOOR PLANS AND OTHER DECORATIVE SAMPLES (U.S. CLS. 2, 5, 22, 23, 29, 37, 38 AND 50).

SN 76-248,366. PSY-ED CORPORATION, ORADELL, NJ. FILED 4-30-2001.



FOR PRINTED MAGAZINES FOR PARENTS OF CHILDREN WITH DISABILITIES (U.S. CLS. 2, 5, 22, 23, 29, 37, 38 AND 50).
FIRST USE 6-1-1971; IN COMMERCE 6-1-1971.

CLASS 16—(Continued).

SN 76-256,591. UNIVERSITY PRODUCTS, INC., HOLYOKE, MA. FILED 5-14-2001.



NO CLAIM IS MADE TO THE EXCLUSIVE RIGHT TO USE "ARCHIVAL QUALITY", APART FROM THE MARK AS SHOWN.

THE LINING SHOWN IN THE DRAWING IS A FEATURE MARK.

FOR ARCHIVAL SUPPLIES AND MATERIALS, NAMELY, STORAGE BOXES AND CARTONS, UNBUFFERED AND BUFFERED ACID-FREE TISSUE PAPER, ACID-FREE AND LIGNIN-FREE FILE, EXPANSION, AND MANUSCRIPT FOLDERS, DOCUMENT PRESERVATION BINDERS AND FOLDERS, TRANSPARENT ARCHIVAL PLASTIC SHEET PROTECTORS, SLEEVES, ENVELOPES AND FOLDERS, DOUBLE COATED TRANSPARENT TAPE FOR STATIONERY OR HOUSEHOLD PURPOSES, ARCHIVAL PHOTO AND MEMORABILIA ALBUMS AND MOUNTING BOARD AND BUFFERED BOND PAPER; ARCHIVAL BOOK REPAIR AND PROTECTION MATERIALS, NAMELY, ACID-FREE COVERS FOR SHEETS OF PAPER, PAGES OF BOOKS, AND THE LIKE, ARCHIVAL QUALITY REPAIR TAPES FOR STATIONERY OR HOUSEHOLD PURPOSES, MENDING TAPE FOR STATIONERY OR HOUSEHOLD PURPOSES, TAPE DISPENSERS FOR STATIONERY OR HOUSEHOLD PURPOSES, BINDERS, GLUE FOR STATIONERY OR HOUSEHOLD PURPOSES, PASTE FOR STATIONERY OR HOUSEHOLD PURPOSES, EDUCATIONAL BROCHURES IN THE FIELD OF ARCHIVAL BOOK REPAIR; PAPER PRODUCTS AND STATIONERY, NAMELY, GUMMED LINEN TAPE FOR STATIONERY OR HOUSEHOLD PURPOSES, SELF-ADHESIVE LINEN CLOTH TAPE FOR STATIONERY OR HOUSEHOLD PURPOSES, PRESSURE-SENSITIVE FRAME SEALING TAPE FOR STATIONERY OR HOUSEHOLD PURPOSES, GUMMED FRAME AND HINGING SEALING TAPE FOR STATIONERY OR HOUSEHOLD PURPOSES, DOCUMENT REPAIR TAPE FOR STATIONERY OR HOUSEHOLD PURPOSES, PRESSURE SENSITIVE MOUNTING AND HINGING TAPE FOR REINFORCING COVER HINGES, ARCHIVAL MOUNTING CORNERS, ARCHIVAL COLLECTOR'S ALBUMS, ARCHIVAL HEAT SET HINGE AND REPAIR TAPE FOR STATIONERY OR HOUSEHOLD PURPOSES, ARCHIVAL HEAT SET COTTON CLOTH TAPE FOR STATIONERY OR HOUSEHOLD PURPOSES, SEETHROUGH MOUNTING STRIPS FOR HOLDING AND PROTECTING PAGES OF BOOKS, NEUTRAL PH ADHESIVE FOR STATIONERY OR HOUSEHOLD PURPOSES, PURE WHEAT STARCH ADHESIVE FOR STATIONERY OR HOUSEHOLD PURPOSES, PURE RICE STARCH ADHESIVE FOR STATIONERY OR HOUSEHOLD PURPOSES, DESK PADS, PRESENTATION PADS MADE OF ACID-FREE CORRUGATED CARDBOARD, CUT-OUT FRAMING MATS, STORYBOARD LAYOUT MATS MADE OF ACID-FREE CORRUGATED CARDBOARD, TRANSPARENCY MOUNTS FOR HOLDING AND PROTECTING PAGES OF BOOKS, ARTIST PADS AND PAPERS, TYPING, PRINTING AND WRITING PAPERS, AND EASELS (U.S. CLS. 2, 5, 22, 23, 29, 37, 38 AND 50).
FIRST USE 4-0-1989; IN COMMERCE 4-0-1989.

CLASS 16—(Continued).

SN 76-264,399. NBDL ENTERPRISES, LLC, SECAUCUS, NJ.
FILED 5-30-2001.



OWNER OF U.S. REG. NOS. 2,599,556, 2,705,421 AND OTHERS.

NO CLAIM IS MADE TO THE EXCLUSIVE RIGHT TO USE "FAYETTEVILLE", APART FROM THE MARK AS SHOWN.

FOR PUBLICATIONS AND PRINTED MATTER, NAMELY BASKETBALL TRADING CARDS, DANCE TEAM TRADING CARDS, MASCOT TRADING CARDS, ENTERTAINMENT TRADING CARDS, STICKERS, DECALS, COMMEMORATIVE BASKETBALL STAMPS, COLLECTIBLE CARDBOARD TRADING DISCS, MEMO BOARDS, CLIPBOARDS, PAPER COASTERS, POST CARDS, PLACE MATS OF PAPER AND PLASTIC, NOTE CARDS, PLAYING CARDS, MEMO PADS, BALL POINT PENS, PENCILS, PEN AND PAPER HOLDERS, DESKTOP DOCUMENT STANDS, SCRAP BOOKS, RUBBER STAMPS, PAPER BANNERS AND FLAGS, BOOKMARKS, 3-RING BINDERS, STATIONERY FOLDERS, WIREBOUND NOTEBOOKS, PORTFOLIO NOTEBOOKS, UNMOUNTED AND MOUNTED PHOTOGRAPHS, POSTERS, CALENDARS, BUMPER STICKERS, BOOK COVERS, WRAPPING PAPER, CHILDREN'S ACTIVITY BOOKS, STATISTICAL BOOKS, GUIDE BOOKS AND REFERENCE BOOKS FOR BASKETBALL, MAGAZINES IN THE FIELD OF BASKETBALL, COMMEMORATIVE GAME PROGRAMS, PAPER PENNANTS, STATIONERY, STATIONERY-TYPE PORTFOLIOS, AND STATISTICAL SHEETS FOR BASKETBALL TOPICS, NEWSLETTERS AND PAMPHLETS IN THE FIELD OF BASKETBALL, BANK CHECKS, CREDIT CARDS AND TELEPHONE CALLING CARDS NOT MAGNETICALLY ENCODED, ELECTRONIC PUBLICATIONS IN THE NATURE OF MAGAZINES AND NEWSLETTERS IN THE FIELD OF BASKETBALL PROVIDED OVER THE INTERNET; COLORING BOOKS; CATALOGS PROVIDED OVER THE INTERNET FEATURING AUDIO RECORDINGS; VIDEO RECORDINGS; COMPUTER ACCESSORIES; COMPUTER GAMES; COMPUTER SOFTWARE; COMPUTER DATABASES; VIDEO GAMES; TELEPHONES; BINOCULARS; EYEWEAR; MAGNETS; COLLECTIBLE AND NOVELTY ITEMS; COLLECTIBLE COINS; MEDALLIONS; ALBUMS, SCRAPBOOKS; PHOTO FRAMES; SPORTS MEMORABILIA; TIMEPIECES; JEWELRY; JEWELRY BOXES; CREDIT CARDS; CALLING CARDS; PUBLICATIONS; CALENDARS; CATALOGS; ORGANIZERS; DIRECTORIES; STATIONERY; SCHOOL SUPPLIES; GIFTWARE; GIFT SETS; PORTFOLIOS; POSTERS; PHOTOS; TRADING CARDS; BOOKS; CARD HOLDERS; PAMPHLETS; PENNANTS; FLAGS; BANNERS; SOUVENIRS; BANK CHECKS; BAGS; TRAVEL BAGS; TRAVEL CASES; SPORTS BAGS; LUNCH BOXES; WALLETS; UMBRELLAS; CLOTHING; TOYS; GAMES; SPORTING GOODS; CHRISTMAS ORNAMENTS; DECORATIONS; HOUSEWARES; LAMPS; LIGHTNING FIXTURES; BEVERAGE WARE; KITCHENWARE; HOUSEHOLD SUPPLIES; CONTAINERS; BOXES; BED, BATH AND TABLE LINENS; FURNITURE; OFFICE FURNITURE AND ACCESSORIES; LOCKERS AND FOOTLOCKERS (U.S. CLS. 2, 5, 22, 23, 29, 37, 38 AND 50).

CLASS 16—(Continued).

SN 76-298,933. SCHWAN-STABILO SCHWANHAEUSSER GMBH & CO, 90562 HEROLDSBERG, FED REP GERMANY, FILED 8-9-2001.

INK JET GENERATION

PRIORITY CLAIMED UNDER SEC. 44(D) ON FED REP GERMANY APPLICATION NO. 30132063.2/1, FILED 5-22-2001, REG. NO. 30132063, DATED 6-29-2001, EXPIRES 5-31-2011.

NO CLAIM IS MADE TO THE EXCLUSIVE RIGHT TO USE "INK JET", APART FROM THE MARK AS SHOWN.

FOR OFFICE REQUISITES, NAMELY, PENCILS, PENCIL LEADS, PEN INK REFILLS, COLORED OR COPYING PENCILS, REFILLS FOR COLORED OR COPYING PENCILS, RETRACTABLE PENCILS, BALLPOINT PENS, REFILLS FOR BALLPOINT PENS, FELT AND FIBER PENS, REFILLS FOR FIBER PENS, FOUNTAIN PENS, MECHANICAL PENCILS, TEXT MARKERS, AND HIGHLIGHTING MARKERS, RUBBER ERASERS, CORRECTING FLUIDS (U.S. CLS. 2, 5, 22, 23, 29, 37, 38 AND 50).

SN 76-331,563. FOX RACING, INC., MORGAN HILL, CA.
FILED 10-29-2001.

SHIFT RACING

NO CLAIM IS MADE TO THE EXCLUSIVE RIGHT TO USE "RACING", APART FROM THE MARK AS SHOWN.

FOR DECALS, STICKERS, CALENDARS AND CATALOGS RELATING TO MOTOCROSS SPORTS CLOTHING, PROTECTIVE GEAR, CASUAL WEAR AND ACCESSORIES (U.S. CLS. 2, 5, 22, 23, 29, 37, 38 AND 50).

SN 76-356,448. YOO, TAE-WOO, SEOUL, REPUBLIC OF KOREA, FILED 1-8-2002.

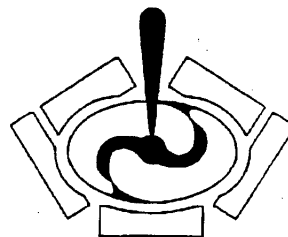

PRIORITY CLAIMED UNDER SEC. 44(D) ON REPUBLIC OF KOREA APPLICATION NO. 2001-53701, FILED 12-4-2001, REG. NO. 0540246, DATED 1-27-2003, EXPIRES 1-27-2013.

FOR BOOKS, HANDBOOKS, NEWSPAPERS, MAGAZINES, PERIODICALS, CATALOGUES AND PAMPHLETS IN THE FIELD OF ACUPUNCTURE; YEARBOOKS, POSTERS AND CALENDARS (U.S. CLS. 2, 5, 22, 23, 29, 37, 38 AND 50).

CLASS 16—(Continued).

SN 76-365,069. NATIONAL FIRE PROTECTION ASSOCIATION, INC., QUINCY, MA. FILED 1-30-2002.

FIREALERT

NO CLAIM IS MADE TO THE EXCLUSIVE RIGHT TO USE "FIRE", APART FROM THE MARK AS SHOWN.
FOR PRINTED PERIODIC PUBLICATION, NAMELY, A CATALOG OF FIRE SERVICE PRODUCTS AND SERVICES (U.S. CLS. 2, 5, 22, 23, 29, 37, 38 AND 50).

SN 76-372,995. BLOCK DISTRIBUTING CO., SCHERTZ, TX. FILED 2-20-2002.

WINE GAZETTE

OWNER OF U.S. REG. NO. 1,910,026.
NO CLAIM IS MADE TO THE EXCLUSIVE RIGHT TO USE "GAZETTE", APART FROM THE MARK AS SHOWN.
SEC. 2(F).
FOR BIMONTHLY PUBLICATION, NAMELY NEWSLETTERS AND MAGAZINES FOR WINE ENTHUSIASTS (U.S. CLS. 2, 5, 22, 23, 29, 37, 38 AND 50).
FIRST USE 5-1-1994; IN COMMERCE 5-1-1994.

SN 76-384,096. MEDIZINE, INC., NEW YORK, NY. FILED 3-11-2002.

DIABETES TODAY

NO CLAIM IS MADE TO THE EXCLUSIVE RIGHT TO USE "DIABETES", APART FROM THE MARK AS SHOWN.
FOR A MAGAZINE CONTAINING INFORMATION OF INTEREST TO DIABETICS (U.S. CLS. 2, 5, 22, 23, 29, 37, 38 AND 50).

SN 76-384,616. TELEFONICA MOVILES, S.A., 24 28001 MADRID, SPAIN, FILED 3-15-2002.

MOVISTAR

OWNER OF SPAIN REG. NO. 2,216,273, DATED 9-6-1999, EXPIRES 9-6-2009.
FOR PRINTED MATTER, NAMELY, VISITOR'S CARDS, LEAFLETS, MAGAZINES, AND CATALOGS RELATING TO THE TELECOMMUNICATION INDUSTRY AND TELECOMMUNICATION PRODUCTS (U.S. CLS. 2, 5, 22, 23, 29, 37, 38 AND 50).

CLASS 16—(Continued).

SN 76-390,848. BENJAMIN MENDLOWITZ, DBA NOAH PUBLICATIONS, BROOKLIN, ME. FILED 4-4-2002.

CALENDAR OF WOODEN BOATS

NO CLAIM IS MADE TO THE EXCLUSIVE RIGHT TO USE "CALENDAR", APART FROM THE MARK AS SHOWN.

SEC. 2(F) AS TO "CALENDARS".
FOR CALENDARS, CARDS, BOOKS ABOUT WOODEN BOATS, AND PAPER BAGS FOR PACKAGING (U.S. CLS. 2, 5, 22, 23, 29, 37, 38 AND 50).
FIRST USE 8-15-1982; IN COMMERCE 8-15-1982.

SN 76-390,907. DELTA UPSILON INTERNATIONAL FRATERNITY, INC., INDIANAPOLIS, IN. FILED 4-1-2002.

DELTA UPSILON QUARTERLY

OWNER OF U.S. REG. NOS. 642,148, 1,270,426 AND OTHERS.
SEC. 2(F).
FOR PERIODICALS, NAMELY, A MAGAZINE PUBLISHED QUARTERLY IN THE FIELD OF EVENTS AND STORIES ABOUT AND OF INTEREST TO MEMBERS OF AN INTERNATIONAL FRATERNAL ORGANIZATION (U.S. CLS. 2, 5, 22, 23, 29, 37, 38 AND 50).
FIRST USE 12-20-1882; IN COMMERCE 12-20-1882.

SN 76-391,487. WIZKIDS, LLC, BELLEVUE, WA. FILED 4-4-2002.

MAGE KNIGHT

FOR BROCHURES AND BOOKLETS RELATING TO GAMES; STRATEGY GUIDE BOOKS AND MAGAZINES RELATING TO GAMES; PRINTED GAME INSTRUCTION SHEETS; PRINTED SCORING SHEETS; POSTERS; COMIC BOOKS AND NOVELS (U.S. CLS. 2, 5, 22, 23, 29, 37, 38 AND 50).

SN 76-407,459. INTERNATIONAL FLAVORS & FRAGRANCES INC., NEW YORK, NY. FILED 5-3-2002.

NATURE UNVEILED

FOR PRINTED INFORMATIONAL REPORTS IN THE FIELDS OF FLAVORS AND FRAGRANCES (U.S. CLS. 2, 5, 22, 23, 29, 37, 38 AND 50).

CLASS 16—(Continued).

SN 76-408,851. BOARDROOM, INC., STAMFORD, CT. FILED 5-16-2002.

BOTTOM LINE SUPER BOOKS

OWNER OF U.S. REG. NOS. 1,240,265, 2,158,698 AND OTHERS.

NO CLAIM IS MADE TO THE EXCLUSIVE RIGHT TO USE "SUPER BOOKS", APART FROM THE MARK AS SHOWN.

FOR PRINTED PUBLICATIONS, NAMELY, A SERIES OF BOOKS DIRECTED TOWARD INFORMATION AND ADVICE ON A WIDE RANGE OF TOPICS INCLUDING HEALTH, NUTRITION, FITNESS, PERSONAL, FINANCIAL AND BUSINESS ISSUES (U.S. CLS. 2, 5, 22, 23, 29, 37, 38 AND 50).

CLASS 16—(Continued).

SN 76-409,775. GEE, CAROL S., PACIFIC PALISADES, CA. FILED 5-17-2002.

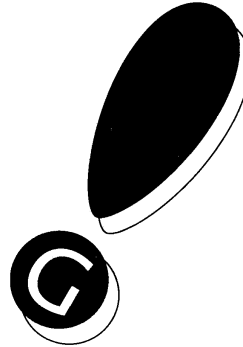

THE MARK CONSISTS OF A SLANTED EXCLAMATION MARK WITH A DROP SHADOW AND THE LETTER "G" IN THE ROUND PORTION OF THE MARK.

FOR PRINTED MATTER, NAMELY, GREETING CARDS (U.S. CLS. 2, 5, 22, 23, 29, 37, 38 AND 50). FIRST USE 11-14-2001; IN COMMERCE 11-14-2001.

SN 76-409,619. GILES, WILLIAM, ORBISONIA, PA. FILED 5-16-2002.



NO CLAIM IS MADE TO THE EXCLUSIVE RIGHT TO USE "PIXELATIONS", APART FROM THE MARK AS SHOWN.

FOR ART PRINTS (U.S. CLS. 2, 5, 22, 23, 29, 37, 38 AND 50).

SN 76-415,967. WEYERHAEUSER COMPANY, FEDERAL WAY, WA. FILED 6-6-2002.

COUGAR

OWNER OF U.S. REG. NO. 1,038,500. FOR PAPER PRODUCTS, NAMELY, ENVELOPES (U.S. CLS. 2, 5, 22, 23, 29, 37, 38 AND 50). FIRST USE 12-31-1987; IN COMMERCE 12-31-1987.

SN 76-416,382. CHECKBOXES DIRECT, INC., MEMPHIS, TN. FILED 6-3-2002.

CHECKBOXES DIRECT

NO CLAIM IS MADE TO THE EXCLUSIVE RIGHT TO USE "DIRECT", APART FROM THE MARK AS SHOWN.

FOR BANK CHECKS, CHECKBOOK REGISTERS, CHECKBOOK COVERS, ADDRESS LABELS, PERSONAL BILL-PAYING ORGANIZERS, MEMO PADS AND OTHER CHECK-RELATED PRODUCTS, NAMELY, PRINTED DEPOSIT TICKETS, DOCUMENT ENDORSEMENT STAMPS AND BANKING DEPOSIT BAGS (U.S. CLS. 2, 5, 22, 23, 29, 37, 38 AND 50). FIRST USE 5-0-2002; IN COMMERCE 5-0-2002.

CLASS 16—(Continued).

SN 76-417,486. CHRIST GOSPEL CHURCHES INTERNATIONAL, INC., JEFFERSONVILLE, IN. FILED 6-3-2002.

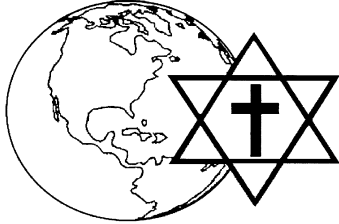

NO CLAIM IS MADE TO THE EXCLUSIVE RIGHT TO USE "THE REPRESENTATION OF THE CROSS AND THE STAR OF DAVID", APART FROM THE MARK AS SHOWN. THE MARK CONSISTS OF A CROSS INSIDE A STAR OF DAVID WHICH IS PARTIALLY LYING ON TOP OF AND TO THE RIGHT OF A PICTURE OF THE EARTH SHOWING THE OUTLINE OF NORTH AND SOUTH AMERICA.

FOR PAMPHLETS AND BOOKLETS FEATURING CHRISTIAN DOCTRINE; RELIGIOUS CIRCULAR LETTERS; RELIGIOUS BOOKS; STATIONERY USED FOR RELIGIOUS COMMUNICATIONS SUCH AS SERMON STUDY NOTES; PRINTED LESSONS ON CHRISTIANITY; PRINTED LECTURES ON CHRISTIANITY; PRINTED INSTRUCTIONAL, EDUCATIONAL, AND TEACHING MATERIALS ON CHRISTIANITY (U.S. CLS. 2, 5, 22, 23, 29, 37, 38 AND 50).

FIRST USE 7-1-1975; IN COMMERCE 7-1-1975.

SN 76-419,178. GONE SCRAPPIN', INC., PARK CITY, UT. FILED 6-6-2002.

GONE SCRAPPIN'

NO CLAIM IS MADE TO THE EXCLUSIVE RIGHT TO USE "SCRAPPIN'", APART FROM THE MARK AS SHOWN.

FOR PAPER PRODUCTS, NAMELY PATTERNED PAPER FOR USE IN SCRAP BOOKING; BORDER PAPER FOR USE IN SCRAP BOOKING; CARDSTOCK; PATTERNED CARDSTOCK; SPECIALTY PAPERS, NAMELY, MULBERRY, VELLUM, EMBOSSED PAPER, HAND-MADE PAPERS, AND GLITTER PAPER; PRE-PRINTED DIE-CUT IMAGES OF PAPER OF VARIOUS PEOPLE, ANIMALS, PHRASES, TITLES, AND OBJECTS; PRE-PRINTED UN-CUT IMAGES ON PAPER, NAMELY, THEMED PAGES PRINTED ON CARDSTOCK WEIGHT MATERIAL; PRE-PRINTED PAPER STICKERS, NAMELY, STICKERS INCLUDING ALPHABET LETTERS, IMAGES, SHAPES, BORDERS, EMBOSSED, AND PHOTOGRAPHIC IMAGES; MAGAZINES AND BROCHURES FEATURING INFORMATION ABOUT SCRAPBOOKING; PAPER PIECING TEMPLATES; DIE-CUT PAPER SHAPES, INCLUDING PHRASES AND LETTERS;

CLASS 16—(Continued).

PAPER PUNCHES; PAPER CUTTERS FOR CUTTING CIRCLES AND OVALS; PAPER TRIMMERS; STENCILS FEATURING ALPHABET LETTERS AND SHAPES; JOURNALING GUIDEBOOKS; GUIDES FOR USE IN CREATING LETTERS, SHAPES AND NUMBERS FOR USE IN JOURNALS; PAPER FASTENERS OF VARIOUS SIZES AND SHAPES; PENS; SPECIALTY PENS, NAMELY, ACID IDENTIFIER, RED-EYE REMOVER, AND WATERCOLOR BLENDER; MARKERS; WATER-COLOR PENCILS; COLOR PENCILS; ADHESIVES FOR HOUSEHOLD PURPOSES INCLUDING SCRAPBOOKING; PHOTO ORGANIZERS; SCRAPBOOKING TOOL AND PRODUCT ORGANIZERS; PHOTO ALBUMS; SCRAPBOOKING ALBUMS; PAGE PROTECTORS INCLUDING FOR USE IN ALBUMS; PHOTO PROTECTORS INCLUDING FOR USE IN ALBUMS; PRE-PRINTED PLASTIC STICKERS, NAMELY, STICKERS INCLUDING ALPHABET LETTERS, IMAGES, SHAPES, BORDERS, EMBOSSED, AND PHOTOGRAPHIC IMAGES; AND, PAPER RIBBONS (U.S. CLS. 2, 5, 22, 23, 29, 37, 38 AND 50).

FIRST USE 6-7-2000; IN COMMERCE 6-7-2000.

SN 76-421,413. R.H. DONNELLEY PUBLISHING & ADVERTISING, INC., PURCHASE, NY. BY CHANGE OF NAME SPRINT PUBLISHING & ADVERTISING, INC., OVERLAND PARK, KS. FILED 6-10-2002.

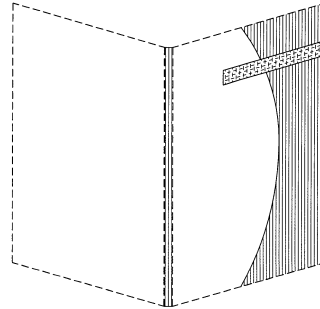

OWNER OF U.S. REG. NOS. 1,832,720 AND 2,334,110. THE MARK CONSISTS OF THE COLOR RED AS APPLIED TO THE FRONT COVER AND THE SPINE OF A TELEPHONE DIRECTORY, AS SHOWN IN THE DRAWING. SEC. 2(F).

FOR TELEPHONE DIRECTORIES (U.S. CLS. 2, 5, 22, 23, 29, 37, 38 AND 50).

FIRST USE 12-28-2001; IN COMMERCE 12-28-2001.

SN 76-422,487. TULLIS RUSSELL COATERS LIMITED, STAFFORDSHIRE, ST1 3QS, UNITED KINGDOM, FILED 6-18-2002.

TEXTITRAN

PRIORITY CLAIMED UNDER SEC. 44(D) ON UNITED KINGDOM APPLICATION NO. 2,298,903, FILED 4-25-2002, REG. NO. 2298903, DATED 10-11-2002, EXPIRES 4-25-2012.

FOR PAPER, NAMELY, HEAT TRANSFER PAPER, COATED PAPER AND DECALCOMANIA PAPER; PAPER PRODUCTS, NAMELY, HEAT TRANSFER PAPER, COATED PAPER AND DECALCOMANIA PAPER, FOR THE TRANSFER OF DESIGNS ONTO TEXTILES; PAPER TRANSFERS (U.S. CLS. 2, 5, 22, 23, 29, 37, 38 AND 50).

CLASS 16—(Continued).

SN 76-426,414. CARUS PUBLISHING COMPANY, PERU, IL. FILED 7-1-2002.

NOODLEBUG USE YOUR NOODLE

FOR EDUCATIONAL MATERIALS IN THE NATURE OF CHILDREN'S BOOKS AND MAGAZINES; PRINTED INSTRUCTION GUIDES AND NEWSLETTERS IN THE FIELDS OF PARENTING ISSUES AND CHILD EDUCATIONAL ISSUES (U.S. CLS. 2, 5, 22, 23, 29, 37, 38 AND 50).

SN 76-429,324. IRELAND, DAWN GREENFIELD, DBA ARTISTIC ORIGINS, WILMINGTON, NC. FILED 7-11-2002.



THE STIPPLING IN THE DRAWING IS FOR SHADING PURPOSES ONLY.

FOR PRINTED MATERIAL, NAMELY, ANNOUNCEMENT CARDS (U.S. CLS. 2, 5, 22, 23, 29, 37, 38 AND 50). FIRST USE 5-13-2001; IN COMMERCE 5-13-2001.

SN 76-429,379. IRELAND, DAWN GREENFIELD, DBA ARTISTIC ORIGINS, WILMINGTON, NC. FILED 7-11-2002.

ARTISTIC ORIGINS

FOR BOOKS, NAMELY BABY BOOKS TO CHART PET'S GROWTH AND PROGRESS; ANNOUNCEMENT CARDS; AND PRINTED CERTIFICATES (U.S. CLS. 2, 5, 22, 23, 29, 37, 38 AND 50).

FIRST USE 11-0-2000; IN COMMERCE 11-0-2000.

SN 76-437,546. VIAD CORP, PHOENIX, AZ. FILED 8-5-2002.

EXHIBITTALK

FOR NEWSLETTER CONCERNING THE EXHIBITION AND TRADE SHOW INDUSTRY (U.S. CLS. 2, 5, 22, 23, 29, 37, 38 AND 50).

CLASS 16—(Continued).

SN 76-440,793. AARON-BARRADA, TAMMIE MARIE, RUFFS DALE, PA. FILED 8-15-2002.

RewardEmStickers

FOR DECORATIVE, THEME-BASED STICKERS FOR USE AS REWARDS FOR INFANTS, TODDLERS, AND CHILDREN IN BEHAVIOR MODIFICATION TRAINING AND BACKGROUND THEME SHEETS ON WHICH TO APPLY THE STICKERS; DECORATIVE, THEME-BASED STICKERS FOR USE AS REWARDS IN TRAINING A TODDLER OR CHILD TO PERFORM DAILY OR WEEKLY TASKS, TO PERFORM SPECIFIC LITTLE SPECIAL JOBS DONE AROUND THE HOUSE TO HELP OUT AND TO PERFORM SPECIFIC POSITIVE BEHAVIORS (U.S. CLS. 2, 5, 22, 23, 29, 37, 38 AND 50).

SN 76-442,266. YOAKAM, DWIGHT, LOS ANGELES, CA. FILED 8-19-2002.

DWIGHT YOAKAM

THE NAME(S), PORTRAIT(S), AND/OR SIGNATURE(S) SHOWN IN THE MARK IDENTIFIES "DWIGHT YOAKAM", WHOSE CONSENT(S) TO REGISTER IS SUBMITTED.

FOR PRINTED MATERIALS, NAMELY POSTERS, SIGNS, STAGE SCENERY, PRESENTATION BOARD (U.S. CLS. 2, 5, 22, 23, 29, 37, 38 AND 50).

FIRST USE 11-0-1984; IN COMMERCE 11-0-1984.

SN 76-442,655. FATHER'S DAY / MOTHER'S DAY COUNCIL, INC., NEW YORK, NY. FILED 8-22-2002.

MY DAD IS MY HERO

FOR PRINTED MATTER, NAMELY, PROMOTIONAL AND ADVERTISING LITERATURE FOR USE IN OPERATIONS OF A COMMUNITY RECOGNITION PROGRAM (U.S. CLS. 2, 5, 22, 23, 29, 37, 38 AND 50).

SN 76-446,830. A. SAMPSON, PAUL, THERMOPOLIS, WY. FILED 9-4-2002.

MISTERLOTTERY

FOR BOOK ABOUT LOTTERIES (U.S. CLS. 2, 5, 22, 23, 29, 37, 38 AND 50).

CLASS 16—(Continued).

SN 76-447,372. LEWIS HYMAN, INC., CARSON, CA. FILED 9-6-2002.



NO CLAIM IS MADE TO THE EXCLUSIVE RIGHT TO USE "HOME MESSAGE CENTER", APART FROM THE MARK AS SHOWN.

FOR BLACK BOARDS, BULLETIN BOARDS, CHALK BOARDS, CORK BOARDS, DRAWING BOARDS, DRY ERASE BOARDS, ILLUSTRATION BOARDS, MAGNETIC BOARDS, MEMORANDUM BOARDS, PRESENTATION BOARDS, WHITE BOARDS, WRITING BOARDS (U.S. CLS. 2, 5, 22, 23, 29, 37, 38 AND 50).

SN 76-449,072. POWERHOUSE CULTURAL ENTERTAINMENT, INC., NEW YORK, NY. FILED 9-10-2002.



NO CLAIM IS MADE TO THE EXCLUSIVE RIGHT TO USE "BOOKS", APART FROM THE MARK AS SHOWN.

FOR HARDCOVER AND SOFTCOVER PHOTOGRAPHY AND ART BOOKS (U.S. CLS. 2, 5, 22, 23, 29, 37, 38 AND 50).

FIRST USE 6-1-1996; IN COMMERCE 6-1-1996.

SN 76-458,888. WALTER & THE CREW, INC., NEW YORK, NY. FILED 10-17-2002.

WALTER'S PET REFERENCE GUIDE A SURVIVAL GUIDE FOR YOU AND YOUR PETS

NO CLAIM IS MADE TO THE EXCLUSIVE RIGHT TO USE "PET REFERENCE GUIDE", APART FROM THE MARK AS SHOWN.

FOR PUBLICATIONS, NAMELY BOOKS, MANUALS, JOURNALS, DIRECTORIES, AND OTHER PUBLICATIONS RELATED TO THE CARE OF ANIMALS (U.S. CLS. 2, 5, 22, 23, 29, 37, 38 AND 50).

FIRST USE 6-12-2002; IN COMMERCE 6-12-2002.

CLASS 16—(Continued).

SN 76-460,053. MEDIA WEST - GSI, INC., RENO, NV. FILED 10-11-2002.

POUGHKEEPSIE JOURNAL

NO CLAIM IS MADE TO THE EXCLUSIVE RIGHT TO USE "JOURNAL", APART FROM THE MARK AS SHOWN. SEC. 2(F).

FOR NEWSPAPERS FOR GENERAL CIRCULATION CONTAINING TOPICS OF GENERAL INTEREST (U.S. CLS. 2, 5, 22, 23, 29, 37, 38 AND 50).

FIRST USE 7-14-1789; IN COMMERCE 7-14-1789.

SN 76-460,054. MEDIA WEST - GSI, INC., RENO, NV. FILED 10-11-2002.

THE BURLINGTON FREE PRESS

NO CLAIM IS MADE TO THE EXCLUSIVE RIGHT TO USE "FREE PRESS", APART FROM THE MARK AS SHOWN.

SEC. 2(F).

FOR NEWSPAPERS FOR GENERAL CIRCULATION CONTAINING TOPICS OF GENERAL INTEREST (U.S. CLS. 2, 5, 22, 23, 29, 37, 38 AND 50).

FIRST USE 6-15-1827; IN COMMERCE 6-15-1827.

SN 76-460,350. MEDIA WEST - UWI, INC., RENO, NV. FILED 10-11-2002.

STAR-GAZETTE

OWNER OF U.S. REG. NO. 2,032,063.

FOR NEWSPAPERS CONTAINING TOPICS OF GENERAL INTEREST (U.S. CLS. 2, 5, 22, 23, 29, 37, 38 AND 50).

FIRST USE 1-23-1967; IN COMMERCE 1-23-1967.

SN 76-461,085. EXPERIENCE MEDIA CORPORATION, BOWLING GREEN, KY. FILED 10-24-2002.

EXPERIENCE OUTDOORS

NO CLAIM IS MADE TO THE EXCLUSIVE RIGHT TO USE "OUTDOORS", APART FROM THE MARK AS SHOWN.

FOR MAGAZINE IN THE FIELD OF TRAVEL, TOURISM, EXERCISE, ACTION, ADVENTURE, OUTDOOR RECREATION (U.S. CLS. 2, 5, 22, 23, 29, 37, 38 AND 50).

FIRST USE 10-2-2002; IN COMMERCE 10-18-2002.

CLASS 16—(Continued).

SN 76-461,706. FESTIVAL ATTRACTIONS, INC., NEW YORK, NY. FILED 10-21-2002.

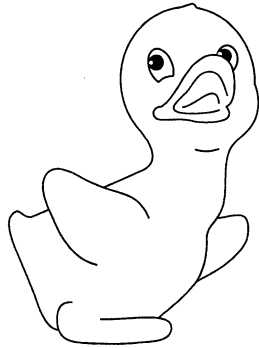

FOR SERIES OF FICTION AND NON-FICTION CHILDREN'S BOOKS; PUBLICATIONS, NAMELY, MAGAZINES AND NEWSLETTERS IN THE FIELD OF CHILDREN'S ENTERTAINMENT AND CHILDREN'S EDUCATION; DECALS; CALENDARS; NOTEPADS; WRITING PAPER; STATIONERY; MEMORANDUM BOOKS; DIARIES; CALENDAR SHEETS; ADDRESS BOOKS; TELEPHONE INDEXES; BLANK PAGE BOOKS; AUTOGRAPH BOOKS; APPOINTMENT AND PLANNING BOOKS; ADHESIVE PADS; CHILDREN'S ACTIVITY BOOKS; PLAYING CARDS; POSTERS; PENS; PENCILS; ART SUPPLIES, NAMELY, ARTISTS' BRUSHES, ARTISTS' PASTELS, AND ARTS AND CRAFT PAINT KITS; CRAYONS; MARKERS; RULERS; PHOTO ALBUMS; GIFT WRAPPING PAPER; PEN AND PENCIL CASES (U.S. CLS. 2, 5, 22, 23, 29, 37, 38 AND 50).

SN 76-462,639. WAGNER SPRAY TECH CORPORATION, PLYMOUTH, MN. FILED 10-30-2002.

TRIM-IT

FOR PAINT APPLICATORS (U.S. CLS. 2, 5, 22, 23, 29, 37, 38 AND 50).

SN 76-463,793. CAMPOS, LORLE, COSTA MESA, CA. FILED 11-4-2002.

**CHANGING THE WORLD
ONE FAMILY AT A TIME**

FOR CONTAINERS FOR COLLECTING AND PRESERVING CHILDHOOD AND FAMILY MEMORABILIA, NAMELY HEIRLOOM-QUALITY PAPER AND CARD-BOARD BOXES, BINDERS, PHOTOGRAPH ALBUMS, SCRAPBOOK ALBUMS, PHOTOGRAPH BOOKS AND BABY BOOKS (U.S. CLS. 2, 5, 22, 23, 29, 37, 38 AND 50).

CLASS 16—(Continued).

SN 76-466,199. TILLMAN ALLEN GREER, LLC, DULUTH, GA. FILED 11-12-2002.

@WORKGWINETT

OWNER OF U.S. REG. NO. 2,394,398.
FOR PRINTED MAGAZINES FEATURING NEWS, INFORMATION AND ARTICLES IN THE FIELD OF EMPLOYMENT AND WORKFORCE ISSUES (U.S. CLS. 2, 5, 22, 23, 29, 37, 38 AND 50).
FIRST USE 2-1-2003; IN COMMERCE 2-1-2003.

SN 76-471,750. SMITH, ROBERT, NEW YORK, NY. FILED 11-6-2002.

**COLLOSSALOTTAPO
TAMOUS**

FOR CHILDREN'S ILLUSTRATED BOOKS (U.S. CLS. 2, 5, 22, 23, 29, 37, 38 AND 50).

SN 76-472,976. CROWN FINANCIAL MINISTRIES, INC., GAINESVILLE, GA. FILED 12-9-2002.

FINANCIAL HOPE

NO CLAIM IS MADE TO THE EXCLUSIVE RIGHT TO USE "FINANCIAL", APART FROM THE MARK AS SHOWN.

FOR PUBLICATIONS AND OTHER PRINTED MATERIALS, NAMELY, WORKBOOKS, STUDY GUIDES, BOOKLETS, PAMPHLETS, LEAFLETS, BROCHURES, BULLETINS, NEWSLETTERS, MAGAZINES, REPORTS, BOOKS, AND PRINTED EDUCATIONAL MATERIALS IN THE FIELDS OF CONSUMER CREDIT, DEBT RECOVERY, MONEY AND DEBT MANAGEMENT, BUDGETING, PERSONAL INVESTING, AND RELIGIOUS AND BIBLICAL MONEY PRINCIPLES, AND COUNSELING AND CONSULTATION THEREOF; POSTCARDS; ADDRESS BOOKS; BOOK COVERS; BOOK ENDS; CALENDARS; DAILY PLANNERS; DECALS; DESK PADS; DESK SETS; DIARIES; FOLDERS; GREETING CARDS; GIFT CARDS; NOTEBOOKS; NOTE PADS; PAPER BANNERS; PAPER BAGS; PRINTED PAPER SIGNS; PAPERWEIGHTS; WRITING PAPER; PENS; PENCILS; PEN OR PENCIL HOLDERS; AND STATIONERY (U.S. CLS. 2, 5, 22, 23, 29, 37, 38 AND 50).

SN 76-477,132. STAMPIN' UP! INC., SANDY, UT. FILED 12-20-2002.

QUICK STRIPS

NO CLAIM IS MADE TO THE EXCLUSIVE RIGHT TO USE "STRIPS", APART FROM THE MARK AS SHOWN.

FOR KIT CONTAINING A COLLECTION OF ARTWORK CONSISTING OF HORIZONTAL AND VERTICAL PAPER STRIPS FOR USE AS DECORATIVE BORDERS, AND PAGE ACCENTS AND ALSO USED FOR DECORATING JOURNALING BOXES, AS WELL AS COORDINATED PAPER FOR SCRAPBOOK PAGES (U.S. CLS. 2, 5, 22, 23, 29, 37, 38 AND 50).
FIRST USE 7-1-2002; IN COMMERCE 7-1-2002.

CLASS 16—(Continued).

SN 76-478,535. MEAD CORPORATION, THE, DAYTON, OH. FILED 12-20-2002.



FOR NOTEBOOKS, BINDERS, ZIPPER POUCHES FOR PENS AND PENCILS, STATIONERY-TYPE PORTFOLIOS (U.S. CLS. 2, 5, 22, 23, 29, 37, 38 AND 50).
FIRST USE 12-6-2002; IN COMMERCE 12-6-2002.

SN 76-478,875. DESTINY IMAGE PUBLISHING, INC., SHIP-PENSBURG, PA. FILED 12-18-2002.

QUIET TALKS

FOR SERIES OF NON-FICTION BOOKS ON SPIRITUAL MATTERS (U.S. CLS. 2, 5, 22, 23, 29, 37, 38 AND 50).

SN 76-479,063. ST MEDIA GROUP INTERNATIONAL, INC., CINCINNATI, OH. FILED 12-30-2002.



OWNER OF U.S. REG. NOS. 1,025,230 AND 2,338,212. NO CLAIM IS MADE TO THE EXCLUSIVE RIGHT TO USE "EN ESPANOL", APART FROM THE MARK AS SHOWN.

THE FOREIGN WORDING IN THE MARK TRANSLATES INTO "IN SPANISH".

SEC. 2(F) AS TO "SCREENPRINTING".
FOR TRADE MAGAZINE CONCERNING THE SIGN AND SCREEN PRINTING INDUSTRIES, PRINTED IN SPANISH (U.S. CLS. 2, 5, 22, 23, 29, 37, 38 AND 50).
FIRST USE 2-1-1997; IN COMMERCE 2-1-1997.

SN 76-481,015. AMERICAN ASSOCIATION FOR THE STUDY OF LIVER DISEASES, ALEXANDRIA, VA. FILED 1-8-2003.

LIVER TRANSPLANTATION

SEC. 2(F).
FOR PUBLICATIONS, NAMELY, NEWSLETTERS, MAGAZINES AND JOURNALS IN THE FIELD OF HEPATOLOGY (U.S. CLS. 2, 5, 22, 23, 29, 37, 38 AND 50).
FIRST USE 0-0-1995; IN COMMERCE 0-0-1995.

CLASS 16—(Continued).

SN 76-481,016. AMERICAN ASSOCIATION FOR THE STUDY OF LIVER DISEASES, ALEXANDRIA, VA. FILED 1-8-2003.

HEPATOLOGY

SEC. 2(F).
FOR PUBLICATIONS, NAMELY, NEWSLETTERS, MAGAZINES AND JOURNALS IN THE FIELD OF HEPATOLOGY (U.S. CLS. 2, 5, 22, 23, 29, 37, 38 AND 50).
FIRST USE 0-0-1982; IN COMMERCE 0-0-1982.

SN 76-481,206. TM ACQUISITION CORP., LAS VEGAS, NV. FILED 1-9-2003.

RCI VENTURES

OWNER OF U.S. REG. NOS. 1,235,234, 2,261,137 AND 2,396,938.

FOR MAGAZINES, NEWSLETTERS, AND DIRECTORIES RELATED TO REAL ESTATE, RESORTS, TRAVEL OR VACATIONS (U.S. CLS. 2, 5, 22, 23, 29, 37, 38 AND 50).

SN 76-482,025. AGC, INC., CLEVELAND, OH. FILED 1-13-2003.

GOLDEN GALLERY

FOR GREETING CARDS (U.S. CLS. 2, 5, 22, 23, 29, 37, 38 AND 50).

SN 76-484,569. E.K. SUCCESS, LTD., CLIFTON, NJ. FILED 1-23-2003.

STUFFED UPS

FOR STICKERS USED WITH SCRAPBOOKS, PHOTO BOOKS, MINI STICKER ENVELOPES (U.S. CLS. 2, 5, 22, 23, 29, 37, 38 AND 50).

SN 76-484,635. HODGES, VANNIE KAY, ANN ARBOR, MI. FILED 1-15-2003.

VIGNETTES

FOR PRINTED INSTRUCTIONAL, EDUCATIONAL, EVALUATIVE, TRAINING, AND TEACHING MATERIALS RELATING TO THE PSYCHOLOGICAL EVALUATION OF CHILDREN AND ADOLESCENTS (U.S. CLS. 2, 5, 22, 23, 29, 37, 38 AND 50).
FIRST USE 8-31-1989; IN COMMERCE 8-31-1989.

CLASS 16—(Continued).

SN 76-484,884. SMITHKLINE BEECHAM CORPORATION, PHILADELPHIA, PA. FILED 1-24-2003.

MANAGING WITH HEART

OWNER OF U.S. REG. NO. 2,392,101.
FOR PRINTED EDUCATIONAL MATERIALS, NAMELY, PAMPHLETS AND GUIDES CONCERNING THE TREATMENTS FOR HEART FAILURE (U.S. CLS. 2, 5, 22, 23, 29, 37, 38 AND 50).
FIRST USE 10-1-2000; IN COMMERCE 10-1-2000.

SN 76-484,946. PENCOA, INC., WESTBURY, NY. FILED 1-24-2003.

CREAMSICLE

FOR WRITING INSTRUMENTS, NAMELY PENS (U.S. CLS. 2, 5, 22, 23, 29, 37, 38 AND 50).

SN 76-485,551. CONNELLY, NANCY V., BARNEGAT LIGHT, NJ. FILED 1-28-2003.

SCIENCE HEROES

NO CLAIM IS MADE TO THE EXCLUSIVE RIGHT TO USE "SCIENCE", APART FROM THE MARK AS SHOWN.
FOR CHILDREN'S BOOKS (U.S. CLS. 2, 5, 22, 23, 29, 37, 38 AND 50).

SN 76-485,561. CMP MEDIA LLC, MANHASSET, NY. FILED 1-28-2003.

INTELLIGENTBPM

FOR PRINT PUBLICATIONS, NAMELY MAGAZINE SUPPLEMENTS RELATING TO THE INFORMATION TECHNOLOGY INDUSTRY (U.S. CLS. 2, 5, 22, 23, 29, 37, 38 AND 50).

SN 76-485,955. SEELEY, NORMA FRANCES, WASHINGTONVILLE, NY. FILED 1-29-2003.

Frances

FOR PAPERWEIGHTS (U.S. CLS. 2, 5, 22, 23, 29, 37, 38 AND 50).

CLASS 16—(Continued).

SN 76-486,036. F & W PUBLICATIONS, INC., IOLA, WI. FILED 1-28-2003.

PRINT

FOR GRAPHIC DESIGN MAGAZINES (U.S. CLS. 2, 5, 22, 23, 29, 37, 38 AND 50).
FIRST USE 5-1-1940; IN COMMERCE 5-1-1940.

SN 76-487,808. AIR WAVES, INC., LEWIS CENTER, OH. FILED 1-27-2003.

AWI

FOR HEAT TRANSFER DECALS FOR CLOTHING (U.S. CLS. 2, 5, 22, 23, 29, 37, 38 AND 50).
FIRST USE 1-1-1999; IN COMMERCE 1-1-1999.

SN 76-488,870. MEADWESTVACO CORPORATION, STAMFORD, CT. FILED 2-6-2003.

ATTRACT

FOR MAGNETICALLY COATED PAPER (U.S. CLS. 2, 5, 22, 23, 29, 37, 38 AND 50).

SN 76-493,093. MOM&I PUBLISHING GROUP INC., ENGLEWOOD CLIFFS, NJ. FILED 2-24-2003.

Mom&i

FOR MAGAZINE PUBLISHED MONTHLY SPECIALIZING IN FAMILY MATTERS DIRECTED TO KOREAN AMERICANS (U.S. CLS. 2, 5, 22, 23, 29, 37, 38 AND 50).
FIRST USE 3-0-2000; IN COMMERCE 3-0-2000.

SN 78-020,995. FRISK, STEVEN JAY, CHICAGO, IL. FILED 8-13-2000.

BRUSH DERBY

NO CLAIM IS MADE TO THE EXCLUSIVE RIGHT TO USE "BRUSH", APART FROM THE MARK AS SHOWN.
FOR PAINT BRUSH HOLDER (U.S. CLS. 2, 5, 22, 23, 29, 37, 38 AND 50).

CLASS 16—(Continued).

SN 78-060,159. DURANKO, MICHAEL , J. SEATTLE, WA.
FILED 4-24-2001.

BOOTIST

FOR BOOKS, CALENDARS, NOTE PADS, WRAPPING PAPER, GREETING CARDS AND PLAYING CARDS REGARDING FOOTCARE OR FOOTWEAR (U.S. CLS. 2, 5, 22, 23, 29, 37, 38 AND 50).

SN 78-094,974. AGUILAR, PABLO, FOREST HILLS, NY.
FILED 11-26-2001.

LATIN CONNOISSEUR

NO CLAIM IS MADE TO THE EXCLUSIVE RIGHT TO USE "LATIN", APART FROM THE MARK AS SHOWN.

FOR PRINTED GUIDE AND MAGAZINES FEATURING FOOD AND WINE (U.S. CLS. 2, 5, 22, 23, 29, 37, 38 AND 50).

FIRST USE 0-0-1998; IN COMMERCE 0-0-1998.

SN 78-097,189. WILLIAMS, NATHANIEL, HOMEWOOD, IL.
FILED 12-7-2001.

INSPIRATIONAL EXPRESSIONS

NO CLAIM IS MADE TO THE EXCLUSIVE RIGHT TO USE "INSPIRATIONAL", APART FROM THE MARK AS SHOWN.

FOR PRINTED MATERIALS, NAMELY, BOOKLETS AND NEWSLETTERS FEATURING ANECDOTES, ESSAYS AND ARTICLES IN THE FIELD OF CHRISTIAN RELIGION AND CHRISTIAN VALUES (U.S. CLS. 2, 5, 22, 23, 29, 37, 38 AND 50).

SN 78-098,482. NORSKE SKOGINDUSTRIER ASA, N-1326
LYSAKER, NORWAY, FILED 12-14-2001.



OWNER OF NORWAY REG. NO. 208761, DATED 5-5-2001,
EXPIRES 5-5-2011.

THE MARK CONSISTS OF STYLIZED TREE BRANCHES. FOR PAPER, NAMELY, PRINTING PAPER AND MAGAZINE PAPER (U.S. CLS. 2, 5, 22, 23, 29, 37, 38 AND 50).

FIRST USE 0-0-1992; IN COMMERCE 0-0-1992.

CLASS 16—(Continued).

SN 78-099,669. ARIZONA DEPARTMENT OF TRANSPORTATION, PHOENIX, AZ. FILED 12-21-2001.

AZURITE

FOR BOOKS IN THE FIELDS OF HISTORY, SOUTHWESTER MISSIONS, TRAVEL AND TOURISM; CALENDARS, NOTE CARDS, AND GREETING CARDS (U.S. CLS. 2, 5, 22, 23, 29, 37, 38 AND 50).

SN 78-108,777. PRECISION DOOR SERVICE, INC., ROCKLEDGE, FL. FILED 2-14-2002.

GARAGE DOOR NEWS

OWNER OF U.S. REG. NO. 2,171,000.
NO CLAIM IS MADE TO THE EXCLUSIVE RIGHT TO USE "NEWS", APART FROM THE MARK AS SHOWN.
SEC. 2(F).

FOR PAPER GOODS AND PRINTED MATTER, NAMELY, PROVIDING UPDATED NEWSLETTERS, PERIODICALS, PUBLICATIONS, MAGAZINES, PAMPHLETS, BOOKS AND PUBLICATIONS COVERING INSTALLATION, MAINTENANCE, REPAIR, ADVERTISEMENTS, WORKSHOPS, SEMINARS, STORES, ARTICLES, MANUFACTURING, DISTRIBUTORS, SELLERS, SERVICE BUSINESSES, FRANCHISES AND FRANCHISEES IN THE FIELD OF THE GARAGE DOOR INDUSTRY (U.S. CLS. 2, 5, 22, 23, 29, 37, 38 AND 50).

FIRST USE 4-0-1998; IN COMMERCE 4-0-1998.

CLASS 16—(Continued).

SN 78-119,631. WORLD WRESTLING FEDERATION ENTERTAINMENT, INC., STAMFORD, CT. FILED 4-4-2002.

WORLD WRESTLING ENTERTAINMENT

OWNER OF U.S. REG. NOS. 1,317,318 AND 1,564,148.

NO CLAIM IS MADE TO THE EXCLUSIVE RIGHT TO USE "ENTERTAINMENT", APART FROM THE MARK AS SHOWN.

SEC. 2(F) AS TO "WORLD WRESTLING".

FOR POSTERS; PHOTOGRAPHS, COLLECTOR ALBUMS FOR PHOTOGRAPHS; TRADING CARDS; LABELS, NAMELY PRINTED LABELS NOT OF TEXTILE; FOLDERS; BROCHURES ABOUT SPORTS ENTERTAINMENT; PACKAGING, NAMELY, PAPER BAGS FOR PACKAGING, PAPER POUCHES FOR PACKAGING, CARDBOARD BOXES FOR PACKAGING, CARDBOARD CONTAINERS FOR PACKAGING; PLASTIC BAGS FOR GENERAL USE; PAPER TABLEWARE, NAMELY, PAPER PLACE MATS, PAPER NAPKINS, PAPER TABLECLOTHS; STICKERS; PENS; PENCILS, PENCIL CASES, PENCIL SHARPENERS; RULERS; ERASERS; BOOK COVERS, NOTEBOOK PAPER, NOTEBOOK DIVIDERS; COLORING BOOKS; CHILDREN'S ACTIVITY BOOKS, COMIC BOOKS, PICTURE BOOKS, APPOINTMENT BOOKS; ADDRESS BOOKS; STICKER ALBUMS; CALENDARS; CHALK; MAGAZINES IN THE FIELD OF SPORTS ENTERTAINMENT; NEWSPAPERS IN THE FIELD OF SPORTS ENTERTAINMENT; POSTCARDS; GREETING CARDS; TEMPORARY TATTOO TRANSFERS; SOUVENIR PROGRAMS CONCERNING SPORTS ENTERTAINMENT; PAPER LUNCH BAGS; MEMO PADS; RUBBER STAMPS; STAMP PADS; COLLECTIBLE PREPAID TELEPHONE CARDS NOT MAGNETICALLY ENCODED; COLLECTIBLE TELEPHONE CALLING CARDS, NOT MAGNETICALLY ENCODED; POSTAGE STAMPS AND COLLECTOR STAMPS, NAMELY, COMMEMORATIVE STAMP SHEETS; CUSTOM PRINTED PERSONAL BANK CHECKS; CHECKBOOK COVERS; RETURN ADDRESS LABELS; BUMPER STICKERS; WINDOW DECALS; LITHOGRAPHS; PAPER PARTY FAVORS, PAPER PARTY HATS; CONFETTI; STENCILS; GIFT WRAPPING PAPER, PLASTIC GIFT WRAP, METALLIC GIFT WRAP; PAPER CAKE DECORATIONS (U.S. CLS. 2, 5, 22, 23, 29, 37, 38 AND 50).

SN 78-123,582. MILLER, JAN R., SALT LAKE CITY, UT. FILED 4-23-2002.



Surrey Hills Collection

NO CLAIM IS MADE TO THE EXCLUSIVE RIGHT TO USE "COLLECTION", APART FROM THE MARK AS SHOWN.

FOR GIFT CARDS, BLANK NOTE CARDS, SOCIAL NOTE CARDS, BOOKMARKS, STICKERS, BABY BOOKS, CHILDREN'S BOOKS, COLORING BOOKS, CALENDARS (U.S. CLS. 2, 5, 22, 23, 29, 37, 38 AND 50).

FIRST USE 9-6-2001; IN COMMERCE 11-1-2001.

CLASS 16—(Continued).

SN 78-125,762. UNITED COMMUNICATIONS CORPORATION, KENOSHA, WI. FILED 5-2-2002.

WATERTOWN NOW

NO CLAIM IS MADE TO THE EXCLUSIVE RIGHT TO USE "WATERTOWN", APART FROM THE MARK AS SHOWN.

FOR BIENNIAL PUBLICATION, NAMELY, MAGAZINE GUIDE TO ARTS, EVENTS, BUSINESSES, RECREATION AND ENTERTAINMENT IN WATERTOWN, SOUTH DAKOTA (U.S. CLS. 2, 5, 22, 23, 29, 37, 38 AND 50).

FIRST USE 11-1-1990; IN COMMERCE 11-1-1990.

SN 78-125,772. UNITED COMMUNICATIONS CORPORATION, KENOSHA, WI. FILED 5-2-2002.

WATERTOWN PUBLIC OPINION

NO CLAIM IS MADE TO THE EXCLUSIVE RIGHT TO USE "WATERTOWN", APART FROM THE MARK AS SHOWN.

FOR DAILY PUBLICATIONS, NAMELY, NEWSPAPERS ADDRESSING MATTERS OF LOCAL, NATIONAL, AND INTERNATIONAL INTEREST (U.S. CLS. 2, 5, 22, 23, 29, 37, 38 AND 50).

FIRST USE 3-25-1887; IN COMMERCE 3-25-1887.

SN 78-127,843. LUPUS ALLIANCE OF AMERICA, BUFFALO, NY. FILED 5-10-2002.

THE LUPUS NEWSLINK

NO CLAIM IS MADE TO THE EXCLUSIVE RIGHT TO USE "LUPUS", APART FROM THE MARK AS SHOWN.

FOR PRINTED MATERIALS, NAMELY NEWSLETTERS, BROCHURES, AND BOOKS ON THE SUBJECT OF LUPUS (U.S. CLS. 2, 5, 22, 23, 29, 37, 38 AND 50).

SN 78-141,313. BIG BUCKS PUBLICATIONS, INC., BLAINE, WA. FILED 7-3-2002.

THE ULTIMATE DICK AND JANE

FOR PRINTED MATERIALS AND PUBLICATIONS, NAMELY A SERIES OF HUMOROUS BOOKS FOR THE ADULT READER (U.S. CLS. 2, 5, 22, 23, 29, 37, 38 AND 50).

FIRST USE 2-1-2002; IN COMMERCE 2-1-2002.

CLASS 16—(Continued).

SN 78-144,321. MAPLE MANUFACTURING PTY LTD, FORESTVILLE, SOUTH AUSTRALIA, AUSTRALIA, FILED 7-16-2002.

AIR-RAP

OWNER OF AUSTRALIA REG. NO. 892780, DATED 10-23-2001, EXPIRES 10-23-2011.

FOR PLASTIC WRAP AND PLASTIC BAGS FOR PACKAGING FOR FOOD (U.S. CLS. 2, 5, 22, 23, 29, 37, 38 AND 50).

SN 78-146,012. WINGER, JODY BETH, MINNEAPOLIS, MN. FILED 7-21-2002.

Sassy Princess



FOR GREETING CARDS, PHOTO ALBUMS, DIARYS, AND SPIRAL NOTEBOOKS (U.S. CLS. 2, 5, 22, 23, 29, 37, 38 AND 50).

FIRST USE 6-1-2001; IN COMMERCE 5-1-2002.

SN 78-148,019. WOODSY KIDS SCHOOL, INC., SCOTTS-DALE, AZ. FILED 7-26-2002.

WOODSY SCHOOL KIDS

NO CLAIM IS MADE TO THE EXCLUSIVE RIGHT TO USE "SCHOOL KIDS", APART FROM THE MARK AS SHOWN.

FOR PRINTED PUBLICATIONS, NAMELY CHILDREN'S BOOKS (U.S. CLS. 2, 5, 22, 23, 29, 37, 38 AND 50).

SN 78-150,370. GAP (APPAREL) INC., SAN FRANCISCO, CA. FILED 8-2-2002.

GAP KIDS

OWNER OF U.S. REG. NOS. 1,416,059, 2,669,157 AND OTHERS.

NO CLAIM IS MADE TO THE EXCLUSIVE RIGHT TO USE "KIDS", APART FROM THE MARK AS SHOWN.

FOR SCHOOL SUPPLIES, NAMELY, PENCILS, PENCIL SHARPENERS, STENCILS, ERASERS, NOTEBOOKS, ADDRESS BOOKS, CALENDARS, STICKERS, MARKERS (U.S. CLS. 2, 5, 22, 23, 29, 37, 38 AND 50).

FIRST USE 7-0-1998; IN COMMERCE 7-0-1998.

CLASS 16—(Continued).

SN 78-152,397. MACOVE, JAMES A., NEW YORK, NY. FILED 8-8-2002.

TOUCH

FOR MAGAZINES, MAGAZINE SUPPLEMENTS TO NEWSPAPERS, SYNDICATED MAGAZINE ARTICLES AND SYNDICATED MAGAZINE COLUMNS ALL IN THE FIELD OF SPIRITUALITY, HOLISTIC LIVING AND RELIGION (U.S. CLS. 2, 5, 22, 23, 29, 37, 38 AND 50).

SN 78-152,661. J AND L MARKETING, INC., LOUISVILLE, KY. FILED 8-9-2002.

CRATE-A-SALE

FOR MARKETING KITS AND MATERIALS FOR USE FOR ADVERTISING AND PROMOTIONAL PURPOSES, COMPRISING PRIMARILY OF PRINTED MATTER, NAMELY, CARDBOARD SIGNS, POSTERS, LABELS, PENNANTS, BALLOONS, PRICE TAGS, BANNERS, SIGNS, FLYERS AND BROCHURES SOLD TOGETHER AS A UNIT (U.S. CLS. 2, 5, 22, 23, 29, 37, 38 AND 50).

SN 78-153,996. J & L MARKETING, INC., LOUISVILLE, KY. FILED 8-14-2002.

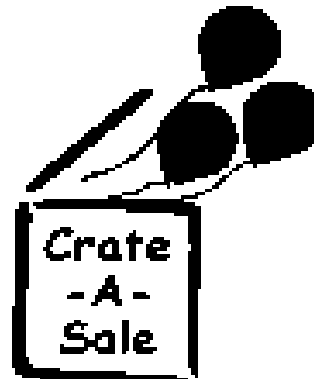

FOR MARKETING KITS AND MATERIALS FOR USE FOR ADVERTISING AND PROMOTIONAL PURPOSES, COMPRISING PRIMARILY OF PRINTED MATTER, NAMELY, CARDBOARD SIGNS, POSTERS, LABELS, PENNANTS, BALLOONS, PRICE TAGS, BANNERS, SIGNS, FLYERS AND BROCHURES SOLD TOGETHER AS A UNIT (U.S. CLS. 2, 5, 22, 23, 29, 37, 38 AND 50).

CLASS 16—(Continued).

SN 78-156,914. NIKIA L. MANIFOLD, BOSTON, MA. AND GINA T. BROOKS, BOSTON, MA. FILED 8-22-2002.



NO CLAIM IS MADE TO THE EXCLUSIVE RIGHT TO USE "MAGAZINE", APART FROM THE MARK AS SHOWN. THE COLORS OF THIS LOGO ARE SHADES OF GRAY GIVING THE LOGO 2 DIMENSIONAL LOOK. IT HAS ROCKY APPEARANCE. THE WORD MAGAZINE IS BLACK WITH A WHITE OUTLINE.

FOR MUSIC, FASHION AND FILM MAGAZINE (U.S. CLS. 2, 5, 22, 23, 29, 37, 38 AND 50).

SN 78-157,477. SHINHAN AMERICAS, HONOLULU, HI. FILED 8-23-2002.

SHINHANONLINE.COM

FOR ARTISTS' PASTELS, BRUSHES, PENCILS, AND PENS AND CANVAS PANELS FOR ARTISTS (U.S. CLS. 2, 5, 22, 23, 29, 37, 38 AND 50).

SN 78-157,917. CAREMARK INTERNATIONAL INC., NORTHBROOK, IL. FILED 8-26-2002.

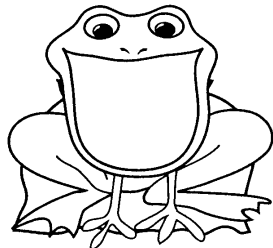

FOR PUBLICATION FOR THE FAMILIES OF CHILDREN USING GROWTH HORMONE THERAPY (U.S. CLS. 2, 5, 22, 23, 29, 37, 38 AND 50). FIRST USE 4-30-2002; IN COMMERCE 4-30-2002.

CLASS 16—(Continued).

SN 78-163,158. THE BERKANA COMPANY LLC, CHANDLER, AZ. FILED 9-11-2002.



THE DESIGN ELEMENT OF THE MARK IS AN ANCIENT "SANSKRIT" SOUND SYMBOL WHICH IS PRONOUNCED "OOOMMM" AND IS OFTEN USED AS A MEDITATIONAL CHANT

FOR ART PRINTS, CALENDARS, GREETING CARDS, NOTECARDS, NOTE PAPER, ADDRESS BOOKS, APPOINTMENT BOOKS, BUMPER STICKERS, DECALS, EMBROIDERY DESIGN PATTERNS, AND WRAPPING PAPER (U.S. CLS. 2, 5, 22, 23, 29, 37, 38 AND 50). FIRST USE 1-1-2001; IN COMMERCE 8-1-2002.

SN 78-165,237. TAYLOR CORPORATION, NORTH MANKATO, MN. FILED 9-18-2002.

BRETT

OWNER OF U.S. REG. NO. 1,220,818. SEC. 2(F). FOR GREETING CARDS; OCCASION CARDS; ENVELOPES; SOCIAL NOTE CARDS; BLANK NOTE CARDS; GIFT CARDS; STATIONERY WRITING PAPER AND ENVELOPES (U.S. CLS. 2, 5, 22, 23, 29, 37, 38 AND 50). FIRST USE 8-15-1956; IN COMMERCE 8-15-1956.

SN 78-165,389. VOSS, ROBERT JAMES, SR., MINNEAPOLIS, MN. FILED 9-18-2002.

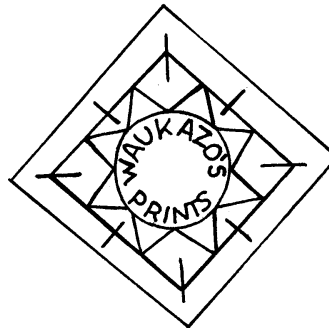

NO CLAIM IS MADE TO THE EXCLUSIVE RIGHT TO USE "PRINTS", APART FROM THE MARK AS SHOWN. FOR PHOTOGRAPHS, PRINTS, GRAPHIC ART REPRODUCTIONS, AND PRINTED ART REPRODUCTIONS (U.S. CLS. 2, 5, 22, 23, 29, 37, 38 AND 50).

CLASS 16—(Continued).

SN 78-166,012. THE TAUNTON PRESS, INC., NEWTOWN, CT. FILED 9-19-2002.

THE TAUNTON PRESS

NO CLAIM IS MADE TO THE EXCLUSIVE RIGHT TO USE "PRESS", APART FROM THE MARK AS SHOWN.

FOR PRINTED PUBLICATIONS, NAMELY MAGAZINES AND BOOKS, IN THE FIELDS OF COOKING, CRAFTS, GARDENING, KNITTING, HOME BUILDING, HOME DESIGN, SEWING AND WOODWORKING (U.S. CLS. 2, 5, 22, 23, 29, 37, 38 AND 50).

FIRST USE 12-31-1975; IN COMMERCE 12-31-1975.

SN 78-166,688. ST. LAURENT, KERRY M., FEEDING HILLS, MA. FILED 9-23-2002.



FOR GREETING CARDS PRINTED FROM HAND-PAINTED DESIGNS (U.S. CLS. 2, 5, 22, 23, 29, 37, 38 AND 50).

FIRST USE 9-30-2000; IN COMMERCE 9-30-2000.

SN 78-171,029. WAVERLY PLASTICS COMPANY, INC., WAVERLY, IA. FILED 10-4-2002.



FOR PLASTIC BAGS, NAMELY GENERAL PURPOSE BAGS, TRASH CAN LINERS, FOOD AND UTILITY BAGS (U.S. CLS. 2, 5, 22, 23, 29, 37, 38 AND 50).

FIRST USE 5-0-1993; IN COMMERCE 5-0-1993.

CLASS 16—(Continued).

SN 78-171,575. GRIMES, GAIL A., ANAHEIM, CA. FILED 10-7-2002.

INTIMACY PAD

NO CLAIM IS MADE TO THE EXCLUSIVE RIGHT TO USE "PAD", APART FROM THE MARK AS SHOWN.

FOR DISPOSABLE COMBINATION PAPER/PLASTIC PAD TO BE USED TO KEEP BEDDING, FURNITURE, RUGS, ETC CLEAN DURING TIMES OF INTIMACY (U.S. CLS. 2, 5, 22, 23, 29, 37, 38 AND 50).

SN 78-177,968. PARAMOUNT PICTURES CORPORATION, LOS ANGELES, CA. FILED 10-24-2002.

FLASHDANCE

OWNER OF U.S. REG. NO. 1,325,693.

FOR PAPER GOODS AND PRINTED MATTER, NAMELY, THEATER PROGRAMS, CALENDARS, GREETING CARDS, POSTERS, POSTCARDS (U.S. CLS. 2, 5, 22, 23, 29, 37, 38 AND 50).

SN 78-178,313. TAUNTON PRESS, INC., THE, NEWTOWN, CT. FILED 10-25-2002.

TAUNTON'S GETTING STARTED IN WOODWORKING

NO CLAIM IS MADE TO THE EXCLUSIVE RIGHT TO USE "GETTING STARTED IN WOODWORKING", APART FROM THE MARK AS SHOWN.

FOR PRINTED PUBLICATIONS, NAMELY, BOOKS AND MAGAZINES ON WOODWORKING (U.S. CLS. 2, 5, 22, 23, 29, 37, 38 AND 50).

SN 78-179,292. SPOKENVIZIONS ENTERTAINMENT GROUP, LLC., FLORISSANT, MO. FILED 10-28-2002.

SPOKENVIZIONS THE MAGAZINE FOR THE CREATIVE SOUL

FOR MAGAZINE HIGHLIGHTING AND PROMOTING THE LIVES AND ACCOMPLISHMENTS OF PRIMARILY POETS AND SPOKEN WORD ARTISTS IN URBAN CULTURE AND ENTERTAINMENT (U.S. CLS. 2, 5, 22, 23, 29, 37, 38 AND 50).

FIRST USE 1-15-2002; IN COMMERCE 1-15-2002.

CLASS 16—(Continued).

SN 78-183,578. DR. GERTRUDE A. BARBER CENTER, ERIE, PA. FILED 11-11-2002.

MAKING DREAMS COME TRUE

FOR PRINTED MARKETING MATERIALS, NAMELY BROCHURES FEATURING INSTRUCTION IN THE FIELD OF MARKETING (U.S. CLS. 2, 5, 22, 23, 29, 37, 38 AND 50).

SN 78-185,228. POYNTER, GRETCHEN, LAURA, TRUCKEE, CA. FILED 11-14-2002.



THE ENGLISH TRANSLATION OF "PIOVANA" IS "RAIN-WATER".

FOR PRINTED PAPER INVITATIONS, GREETING CARDS, PRINTED ANNOUNCEMENTS, STATIONERY, BOXED ALL OCCASION CARDS, BOXED HOLIDAY CARDS, BOXED PRINTED PAPER INVITATIONS AND ANNOUNCEMENT CARDS, GIFT PAPER TAGS, GIFT ENCLOSURE CARDS, SKETCHBOOKS, AND PHOTOGRAPH ALBUMS (U.S. CLS. 2, 5, 22, 23, 29, 37, 38 AND 50).

FIRST USE 8-1-1999; IN COMMERCE 12-1-1999.

SN 78-187,661. MAXWELL-WEISBROD, ANN E., PRINCETON, IL. FILED 11-21-2002.

PICK YOUR NOSE & MAKE A FACE

FOR SCRAPBOOKS, SCRAPBOOK PAGES, CHILDREN'S ACTIVITY BOOKS, REMOVAL WINDOW STICKERS, SCHOOL NOTEBOOKS, TEMPORARY TATTOOS AND GREETING CARDS (U.S. CLS. 2, 5, 22, 23, 29, 37, 38 AND 50).

CLASS 16—(Continued).

SN 78-188,202. VANNATTER, RANDY, A., DELTA, CANADA, FILED 11-22-2002.

CITY PASSPORT

OWNER OF CANADA REG. NO. TMA584721, DATED 7-8-2003, EXPIRES 7-8-2018.

NO CLAIM IS MADE TO THE EXCLUSIVE RIGHT TO USE "CITY", APART FROM THE MARK AS SHOWN.

FOR BOOKLET OF COUPONS OFFERED TO LOCALS AND TOURISTS INBOUND TO EACH CITY PROVIDING A VALUE OR COUPON BY PARTICIPATING VENDORS TO ATTRACT BUSINESS TO THEIR LOCATION (U.S. CLS. 2, 5, 22, 23, 29, 37, 38 AND 50).

SN 78-194,578. FELIX CULPEPPER INTERNATIONAL, INC., TALBOTT, TN. FILED 12-13-2002.

BROWNIE THE LONELY DRAGON

FOR SERIES OF CHILDREN'S BOOKS (U.S. CLS. 2, 5, 22, 23, 29, 37, 38 AND 50).

SN 78-196,667. PHARMACIA & UPJOHN COMPANY, PEAPACK, NJ. FILED 12-20-2002.

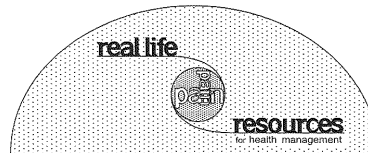

NO CLAIM IS MADE TO THE EXCLUSIVE RIGHT TO USE "RESOURCES FOR HEALTH MANAGEMENT" AND "PAIN", APART FROM THE MARK AS SHOWN.

THE STIPPLING IS FOR SHADING PURPOSES ONLY. FOR PRINTED PUBLICATIONS AND QUESTIONNAIRES RELATING TO PAIN MANAGEMENT (U.S. CLS. 2, 5, 22, 23, 29, 37, 38 AND 50).

SN 78-198,119. SUBLISTATIC INTERNATIONAL, HENIN-BEAUMONT, FRANCE, FILED 12-27-2002.

SUBLICADEAU

PRIORITY CLAIMED UNDER SEC. 44(D) ON FRANCE APPLICATION NO. 023177451, FILED 7-31-2002, REG. NO. 023177451, DATED 7-31-2002, EXPIRES 7-31-2012.

FOR PACKING PAPER, PAPER ARTICLES FOR PACKING; PACKING PAPER, PACKING CARDBOARD, PAPER ARTICLES FOR PACKING, CARDBOARD ARTICLES FOR PACKING; TABLE PAPER NAPKINS; TABLE CLOTHS OF PAPER (U.S. CLS. 2, 5, 22, 23, 29, 37, 38 AND 50).

FIRST USE 0-0-1993; IN COMMERCE 0-0-1993.

CLASS 16—(Continued).

SN 78-199,772. GOD'S HOUSE OF PRAYER, INC., SOUTHLAKE, TX. FILED 1-3-2003.

MAXIMIZED FAMILY

NO CLAIM IS MADE TO THE EXCLUSIVE RIGHT TO USE "FAMILY", APART FROM THE MARK AS SHOWN. FOR RELIGIOUS BOOKS (U.S. CLS. 2, 5, 22, 23, 29, 37, 38 AND 50).

SN 78-199,783. GOD'S HOUSE OF PRAYER, INC., SOUTHLAKE, TX. FILED 1-3-2003.

MAXIMIZED WOMANHOOD

NO CLAIM IS MADE TO THE EXCLUSIVE RIGHT TO USE "WOMANHOOD", APART FROM THE MARK AS SHOWN. FOR RELIGIOUS BOOKS (U.S. CLS. 2, 5, 22, 23, 29, 37, 38 AND 50).

SN 78-199,784. MOTORCYCLE SAFETY FOUNDATION, IRVINE, CA. FILED 1-3-2003.

SAFE CYCLING

OWNER OF U.S. REG. NO. 1,213,677. SEC. 2(F). FOR MAGAZINES RELATING TO MOTORCYCLE SAFETY (U.S. CLS. 2, 5, 22, 23, 29, 37, 38 AND 50). FIRST USE 3-0-1981; IN COMMERCE 3-0-1981.

SN 78-199,787. GOD'S HOUSE OF PRAYER, INC., SOUTHLAKE, TX. FILED 1-3-2003.

MAXIMIZED CHILDREN

NO CLAIM IS MADE TO THE EXCLUSIVE RIGHT TO USE "CHILDREN", APART FROM THE MARK AS SHOWN. FOR RELIGIOUS BOOKS (U.S. CLS. 2, 5, 22, 23, 29, 37, 38 AND 50).

SN 78-199,796. GOD'S HOUSE OF PRAYER, INC., SOUTHLAKE, TX. FILED 1-3-2003.

MAXIMIZED TEENS

NO CLAIM IS MADE TO THE EXCLUSIVE RIGHT TO USE "TEENS", APART FROM THE MARK AS SHOWN. FOR RELIGIOUS BOOKS (U.S. CLS. 2, 5, 22, 23, 29, 37, 38 AND 50).

CLASS 16—(Continued).

SN 78-199,856. GOD'S HOUSE OF PRAYER, INC., SOUTHLAKE, TX. FILED 1-3-2003.

MAXIMIZED MANHOOD

NO CLAIM IS MADE TO THE EXCLUSIVE RIGHT TO USE "MANHOOD", APART FROM THE MARK AS SHOWN. FOR RELIGIOUS BOOKS (U.S. CLS. 2, 5, 22, 23, 29, 37, 38 AND 50).

SN 78-200,580. BROWNSTONE PUBLISHERS, INC., NEW YORK, NY. FILED 1-7-2003.

HIPAA SECURITY COMPLIANCE INSIDER

OWNER OF U.S. REG. NOS. 2,466,687, 2,631,936 AND 2,725,898.

NO CLAIM IS MADE TO THE EXCLUSIVE RIGHT TO USE "HIPAA SECURITY COMPLIANCE", APART FROM THE MARK AS SHOWN.

FOR NEWSLETTER WHICH ASSISTS SECURITY DIRECTORS AT HEALTH CARE ORGANIZATIONS IN ENSURING THE CONFIDENTIALITY AND INTEGRITY OF HEALTH INFORMATION AND THE SECURITY OF HEALTH INFORMATION SYSTEMS IN ACCORDANCE WITH THE SECURITY REGULATIONS ISSUED BY THE DEPARTMENT OF HEALTH AND HUMAN SERVICES, WHICH REGULATIONS ESTABLISH STANDARDS FOR THE SECURITY OF INDIVIDUAL HEALTH INFORMATION MAINTAINED IN ELECTRONIC FORM AND THE USE OF ELECTRONIC SIGNATURES BY HEALTH PLANS, HEALTH CARE CLEARINGHOUSES, AND HEALTH CARE PROVIDERS UNDER THE HEALTH INSURANCE PORTABILITY AND ACCOUNTABILITY ACT OF 1996. (U.S. CLS. 2, 5, 22, 23, 29, 37, 38 AND 50).

SN 78-200,804. GLAXO GROUP LIMITED, GREENFORD, MIDDLESEX, ENGLAND, FILED 1-7-2003.

IF YOU'RE BATTLING WITH CANCER, WE'RE IN THE FIGHT WITH YOU

NO CLAIM IS MADE TO THE EXCLUSIVE RIGHT TO USE "CANCER", APART FROM THE MARK AS SHOWN. FOR PRINTED EDUCATIONAL MATERIALS, NAMELY, POSTERS, PAMPHLETS AND BOOKLETS CONCERNING CANCER, CLINICAL TRIALS FOR CANCER TREATMENTS AND PHARMACEUTICALS TO TREAT CANCER (U.S. CLS. 2, 5, 22, 23, 29, 37, 38 AND 50).

CLASS 16—(Continued).

SN 78-200,807. GLAXO GROUP LIMITED, GREENFORD, MIDDLESEX, UNITED KINGDOM, FILED 1-7-2003.

**THERE'S ONLY ONE THING
MORE RELENTLESS THAN
METASTATIC BREAST
CANCER. YOU**

NO CLAIM IS MADE TO THE EXCLUSIVE RIGHT TO USE "METASTATIC BREAST CANCER", APART FROM THE MARK AS SHOWN.

FOR PRINTED EDUCATIONAL MATERIALS, NAMELY, POSTERS, PAMPHLETS AND BOOKLETS CONCERNING CANCER, CLINICAL TRIALS FOR CANCER TREATMENTS AND PHARMACEUTICALS TO TREAT CANCER (U.S. CLS. 2, 5, 22, 23, 29, 37, 38 AND 50).

SN 78-200,808. GLAXO GROUP LIMITED, GREENFORD, MIDDLESEX, ENGLAND, FILED 1-7-2003.

**THERE'S ONLY ONE THING
MORE RELENTLESS THAN
COLORECTAL CANCER.
YOU**

NO CLAIM IS MADE TO THE EXCLUSIVE RIGHT TO USE "COLORECTAL CANCER", APART FROM THE MARK AS SHOWN.

FOR PRINTED EDUCATIONAL MATERIALS, NAMELY, POSTERS, PAMPHLETS AND BOOKLETS CONCERNING CANCER, CLINICAL TRIALS FOR CANCER TREATMENTS AND PHARMACEUTICALS TO TREAT CANCER (U.S. CLS. 2, 5, 22, 23, 29, 37, 38 AND 50).

SN 78-202,667. DEGNAN, DONALD A., BOULDER, CO. FILED 1-13-2003.

DEEP

FOR MAGAZINE IN THE FIELD OF LIFESTYLES, FASHION, BEAUTY, HEALTH, HOME DECOR, HOME IMPROVEMENT, TRAVEL, ENTERTAINMENT, FOOD, GARDENING, BUSINESS, PERSONAL FINANCE, RELATIONSHIPS, CURRENT EVENTS, LITERATURE, HISTORY, AND FEATURES OF INTEREST FOR PEOPLE LIVING IN THE SOUTH (U.S. CLS. 2, 5, 22, 23, 29, 37, 38 AND 50).

CLASS 16—(Continued).

SN 78-202,752. MCGURK, HAROLD CLAYTON, LAGUNA NIGUEL, CA. AND HENNINGS, IVAR TERRANCE, LAGUNA NIGUEL, CA. FILED 1-13-2003.

TRAVEL-HOLIC

FOR BOOKS, BOOKLETS, BOOKMARKS AND NEWSLETTERS IN THE FIELD OF TRAVEL AND PHOTOGRAPHY, PHOTOGRAPHS, POSTERS, CALENDARS, NOTEPADS, STATIONERY, BUSINESS CARDS, GREETING CARDS AND MAPS (U.S. CLS. 2, 5, 22, 23, 29, 37, 38 AND 50).

SN 78-203,355. INTERNATIONAL PAPER TRADEMARK COMPANY, TUXEDO, NY. FILED 1-15-2003.

CHEMFIBRE

FOR KRAFT LINERBOARD (U.S. CLS. 2, 5, 22, 23, 29, 37, 38 AND 50).
FIRST USE 2-15-1946; IN COMMERCE 2-15-1946.

SN 78-203,419. WILLIAMS, JAY, D., FRANKLIN, TN. FILED 1-15-2003.

FAMILY ON BOARD

FOR BUMPER STICKERS FOR USE ON AUTOMOBILES, HOMES, ETC. (U.S. CLS. 2, 5, 22, 23, 29, 37, 38 AND 50).

SN 78-203,699. LANGENSCHIEDT KOMMANDITGESELLSCHAFT, 10827 BERLIN, FED REP GERMANY, FILED 1-15-2003.

LILLIPUT

FOR MINIATURE-SIZED DICTIONARIES, INCLUDING FOREIGN LANGUAGE DICTIONARIES (U.S. CLS. 2, 5, 22, 23, 29, 37, 38 AND 50).

FIRST USE 0-0-1954, THE MARK WAS FIRST USED ANYWHERE IN A DIFFERENT FORM OTHER THAN THAT SOUGHT TO BE REGISTERED ON 00/00/1909; IN COMMERCE 0-0-1955, THE MARK WAS FIRST USED IN COMMERCE IN A DIFFERENT FORM OTHER THAN THAT SOUGHT TO BE REGISTERED ON 00/00/1928.

CLASS 16—(Continued).

SN 78-203,811. KIMBERLY-CLARK WORLDWIDE, INC., NEENAH, WI. FILED 1-16-2003.



NO CLAIM IS MADE TO THE EXCLUSIVE RIGHT TO USE "EVERYTHING YOU NEED TO MAKE POTTY TRAINING CLICK WWW.COM", APART FROM THE MARK AS SHOWN.

THE MARK CONSISTS OF OVAL, CIRCLE, ARROW AND WORDS.

FOR DISPOSABLE TRAINING PANTS (U.S. CLS. 2, 5, 22, 23, 29, 37, 38 AND 50).

SN 78-204,016. INTERNATIONAL MASTERS PUBLISHERS AB, MALMO, SWEDEN, FILED 1-16-2003.



FOR PRINTED MATERIAL, NAMELY, A SERIES OF CONTINUITY CARDS ON THE SUBJECT OF DESIGNING AND CREATING SCRAPBOOKS, FOR INSERTION INTO A BINDER, AND A BINDER FOR USE IN CONNECTION THEREWITH. (U.S. CLS. 2, 5, 22, 23, 29, 37, 38 AND 50).

SN 78-208,010. SIMON & SCHUSTER, INC., NEW YORK, NY. FILED 1-28-2003.



OWNER OF U.S. REG. NO. 2,270,980.

NO CLAIM IS MADE TO THE EXCLUSIVE RIGHT TO USE "LIBROS PARA NINOS", APART FROM THE MARK AS SHOWN.

FOR FICTION AND NON-FICTION BOOKS FOR CHILDREN (U.S. CLS. 2, 5, 22, 23, 29, 37, 38 AND 50).

CLASS 16—(Continued).

SN 78-208,011. VIACOM INTERNATIONAL INC., NEW YORK, NY. FILED 1-28-2003.

TAK AND THE POWER OF JUJU

FOR PRINTED MATTER, NAMELY, NOTE PAPER AND LOOSE LEAF PAPER, SERIES OF FICTION BOOKS, COMICS, NAMELY, COMIC BOOKS, DECALS, BUMPER STICKERS, TRADING CARDS, NOTE CARDS, POSTERS, FOLDERS, PENCILS, PENS, CALENDARS (U.S. CLS. 2, 5, 22, 23, 29, 37, 38 AND 50).

SN 78-208,014. SIMON & SCHUSTER, INC., NEW YORK, NY. FILED 1-28-2003.



OWNER OF U.S. REG. NO. 2,270,980.
FOR FICTION AND NON-FICTION BOOKS FOR CHILDREN (U.S. CLS. 2, 5, 22, 23, 29, 37, 38 AND 50).

SN 78-208,399. MARVEL CHARACTERS, INC., LOS ANGELES, CA. FILED 1-29-2003.

MARVEL TSUNAMI

OWNER OF U.S. REG. NOS. 870,506, 2,393,629 AND OTHERS.

FOR PUBLICATIONS, NAMELY COMIC BOOKS, COMIC MAGAZINES, STORIES IN ILLUSTRATED FORM, AND BOOKS AND MAGAZINES FEATURING COLLECTIONS OF COMIC FORMAT STORIES (U.S. CLS. 2, 5, 22, 23, 29, 37, 38 AND 50).

SN 78-208,593. BOLAND, DONALD, WINTHROP, MA. FILED 1-29-2003.

BARNARD SHARON CABOT

THE NAME "BERNARD SHARON CABOT" IS AN ALIAS OF "DONALD BOLAND", A LIVING INDIVIDUAL WHOSE CONSENT IS OF RECORD.

FOR PRINTED PUBLICATIONS, NAMELY, BOOKS FEATURING POETRY REGARDING NATURE (U.S. CLS. 2, 5, 22, 23, 29, 37, 38 AND 50).

CLASS 16—(Continued).

SN 78-208,784. THE TAUNTON PRESS, INC., NEWTOWN, CT. FILED 1-30-2003.

AT HOME IN THE GARDEN

FOR PRINTED PUBLICATIONS, NAMELY BOOKS AND MAGAZINES IN THE FIELD OF GARDENING, GARDEN DESIGN, OUTDOOR SPACE DESIGN (U.S. CLS. 2, 5, 22, 23, 29, 37, 38 AND 50).

FIRST USE 12-31-2002; IN COMMERCE 12-31-2002.

SN 78-208,816. TENNIS LIFE MEDIA, INC., TAMPA, FL. FILED 1-30-2003.

TENNIS LIFE MAGAZINE

NO CLAIM IS MADE TO THE EXCLUSIVE RIGHT TO USE "TENNIS" AND "MAGAZINE", APART FROM THE MARK AS SHOWN.

FOR PRINTED MAGAZINES IN THE FIELD OF TENNIS (U.S. CLS. 2, 5, 22, 23, 29, 37, 38 AND 50).

SN 78-208,934. GAINSHARE MEDIA L.L.C., BOSTON, MA. FILED 1-30-2003.

GAINSHARE MEDIA

NO CLAIM IS MADE TO THE EXCLUSIVE RIGHT TO USE "MEDIA", APART FROM THE MARK AS SHOWN.

FOR PUBLICATIONS, NAMELY BOOKS, MAGAZINES, PAMPHLETS, FLIERS, BROCHURES PROMOTING INDUSTRIES, TRADESHOWS, CONFERENCES AND EXHIBITS OF OTHERS (U.S. CLS. 2, 5, 22, 23, 29, 37, 38 AND 50).

SN 78-209,523. SWINGSET PRESS, LLC, VAN NUYS, CA. FILED 1-31-2003.

FRENDZ PAKZ

NO CLAIM IS MADE TO THE EXCLUSIVE RIGHT TO USE "PACKS", APART FROM THE MARK AS SHOWN.

FOR PRINTED CARDS, NOTEBOOKS, STICKERS, STICKER SHEETS, PENS, PENCILS AND MARKERS (U.S. CLS. 2, 5, 22, 23, 29, 37, 38 AND 50).

FIRST USE 1-11-2003; IN COMMERCE 1-11-2003.

SN 78-209,999. THOMAS, BEVERLY D., WINTER GARDEN, FL. FILED 2-3-2003.

**BEVERLY THOMAS
SUCCESS MAGAZINE**

FOR THIS IS A MAGAZINE TO INSPIRE AFRICAN AMERICANS TO USE THEIR GIFT(S)/TALENT(S) AND GO AFTER THEIR DREAMS AND GOALS IN LIFE (U.S. CLS. 2, 5, 22, 23, 29, 37, 38 AND 50).

CLASS 16—(Continued).

SN 78-214,328. MEADWESTVACO CORPORATION, STAMFORD, CT. FILED 2-13-2003.

FAST FLAPS

FOR PERSONAL ORGANIZERS AND PLANNERS, BOTH DATED AND UNDATED (U.S. CLS. 2, 5, 22, 23, 29, 37, 38 AND 50).

SN 78-215,909. METROPOLITAN LIFE INSURANCE COMPANY, NEW YORK, NY. FILED 2-18-2003.

SINCE YOU CARE

FOR PRINTED MATERIALS, NAMELY A SERIES OF BROCHURES, PAMPHLETS, AND NEWSLETTERS ON THE SUBJECT OF INFORMATION FOR CAREGIVERS IN A WIDE VARIETY OF FIELDS TO HELP PEOPLE MANAGE THEIR CAREGIVER RESPONSIBILITIES TO THE ELDERLY, INDIVIDUALS WITH DISABILITIES OR DISEASES, AND TO CHILDREN; SYNDICATED NEWSPAPER COLUMNS FEATURING INFORMATION FOR CAREGIVERS IN A WIDE VARIETY OF FIELDS TO HELP PEOPLE MANAGE THEIR CAREGIVER RESPONSIBILITIES TO THE ELDERLY, INDIVIDUALS WITH DISABILITIES OR DISEASES, AND TO CHILDREN; AND A CATALOG FEATURING HEALTH AND SAFETY EQUIPMENT AND PRODUCTS. (U.S. CLS. 2, 5, 22, 23, 29, 37, 38 AND 50).

SN 78-229,942. FREMANTLEMEDIA NORTH AMERICA, INC., SANTA MONICA, CA. FILED 3-25-2003.

CUPID

FOR POSTERS, CALENDARS, NOTEBOOKS, BINDERS, DAILY ORGANIZERS, MEMO PADS, STICKERS, COMIC BOOKS, WRITING PAPER, ENVELOPES, GREETING CARDS, PAPER COASTERS, PAPER MATS, NEWSPAPERS FOR GENERAL CIRCULATION, BOOKS AND MAGAZINES IN THE FIELD OF REALITY SHOWS, PHOTOGRAPHS, POSTCARDS, TRADING CARDS, CARDBOARD STAND-UP CUTOUTS FEATURING PHOTOGRAPHS OR ARTWORK, PREPAID PHONE DEBIT CARDS WITHOUT MAGNETIC CODING, TRADING CARD MILK BOTTLE CAPS, AND PERSONAL CHECKS (U.S. CLS. 2, 5, 22, 23, 29, 37, 38 AND 50).

SN 78-259,257. VIACOM INTERNATIONAL INC., NEW YORK, NY. FILED 6-6-2003.

MTV SPANKIN NEW STUFF

OWNER OF U.S. REG. NOS. 1,400,277, 2,453,210 AND OTHERS.

FOR CONSUMER MAGAZINE HIGHLIGHTING NEW MUSIC ARTISTS AS WELL AS NEW ALBUMS AND SONGS FROM ESTABLISHED MUSIC ARTISTS (U.S. CLS. 2, 5, 22, 23, 29, 37, 38 AND 50).

CLASS 17—RUBBER GOODS

SN 76-131,821. SHURTAPE TECHNOLOGIES, INC., HICKORY, NC. FILED 9-20-2000.

TR20

FOR ADHESIVE SOLD AS AN INTEGRAL COMPONENT OF PRESSURE SENSITIVE TAPE FOR INDUSTRIAL AND COMMERCIAL USE (U.S. CLS. 1, 5, 12, 13, 35 AND 50).

FIRST USE 4-0-2001; IN COMMERCE 4-0-2001.

SN 76-138,890. WARNING BLINDSPOT, INC., BLOOMINGDALE, IL. FILED 10-2-2000.

WARNING BLINDSPOT INC.

NO CLAIM IS MADE TO THE EXCLUSIVE RIGHT TO USE "BLINDSPOT INC.", APART FROM THE MARK AS SHOWN.

FOR REFLECTIVE TAPE FOR USE ON THE SIDES AND REARS OF LARGE VEHICLES, SIMI-TRUCK TRAILERS AND BUSES TO INFORM THE PUBLIC OF THE LOCATION OF POTENTIALLY DANGEROUS BLINDSPOTS (U.S. CLS. 1, 5, 12, 13, 35 AND 50).

FIRST USE 9-26-2000; IN COMMERCE 6-26-2000.

SN 76-373,209. VALLEY ROLLER COMPANY, INC., MANSFIELD, TX. FILED 2-21-2002.

VALLEY ROLLER COMPANY, INC.

NO CLAIM IS MADE TO THE EXCLUSIVE RIGHT TO USE "ROLLER COMPANY, INC.", APART FROM THE MARK AS SHOWN.

FOR LARGE INDUSTRIAL RUBBER ROLLERS USED IN A WIDE VARIETY OF MANUFACTURING APPLICATIONS (U.S. CLS. 1, 5, 12, 13, 35 AND 50).

FIRST USE 7-11-1984; IN COMMERCE 7-11-1984.

SN 76-388,919. SILVER-LINE PLASTICS CORPORATION, ASHEVILLE, NC. FILED 3-29-2002.

TRACER TUBE

NO CLAIM IS MADE TO THE EXCLUSIVE RIGHT TO USE "TUBE", APART FROM THE MARK AS SHOWN.

FOR PLASTIC TUBES FOR USE IN THE UNDERGROUND TRANSMISSION OF POTABLE WATER, WITH THE TUBES BEING READILY LOCATABLE SO THAT UNDERGROUND WATER LINES CAN BE DETECTED AFTER INSTALLATION (U.S. CLS. 1, 5, 12, 13, 35 AND 50).

CLASS 17—(Continued).

SN 76-392,240. STEGO INDUSTRIES L.L.C., SAN JUAN CAPISTRANO, CA. FILED 4-8-2002.

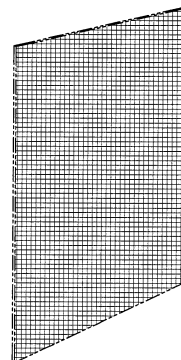

THE MARK CONSISTS OF THE COLOR YELLOW AS APPLIED TO THE ENTIRETY OF THE GOODS. THE BROKEN LINING IS USED ONLY TO SHOW THE POSITION OF THE MARK ON THE GOODS BUT IS NOT A FEATURE OF THE MARK. THE DRAWING IS LINED FOR THE COLOR YELLOW.

FOR PLASTIC SHEETING USED IN THE CONSTRUCTION INDUSTRY AS A VAPOR BARRIER AND AS A VAPOR RETARDER (U.S. CLS. 1, 5, 12, 13, 35 AND 50).

FIRST USE 11-0-1998; IN COMMERCE 11-0-1998.

SN 76-398,642. C&H DISTRIBUTORS, INCORPORATED, MILWAUKEE, WI. FILED 4-22-2002.

ADVANTAGE

FOR ADHESIVE TAPE FOR INDUSTRIAL AND COMMERCIAL USE, NAMELY PRESSURE-SENSITIVE BOX-SEALING ADHESIVE TAPE (U.S. CLS. 1, 5, 12, 13, 35 AND 50).

FIRST USE 0-0-1989; IN COMMERCE 0-0-1989.

SN 76-427,641. PROTECTO WRAP COMPANY, DENVER, CO. FILED 7-5-2002.

PROTECTO BOND

OWNER OF U.S. REG. NOS. 981,491 AND 1,781,548. NO CLAIM IS MADE TO THE EXCLUSIVE RIGHT TO USE "BOND", APART FROM THE MARK AS SHOWN.

FOR PEEL AND STICK WATERPROOFING MEMBRANE FOR ABOVE-GRADE FOUNDATION INSULATION APPLICATIONS (U.S. CLS. 1, 5, 12, 13, 35 AND 50).

CLASS 17—(Continued).

SN 76-433,049. PHYDO, INC., DBA GUTTERSWEEEP,
TAMPA, FL. FILED 7-22-2002.



THE LINING CONTAINED IN THE DRAWING IS FOR SHADING PURPOSES ONLY AND DOES NOT INDICATE COLOR.

THE MARK CONSISTS OF THE STYLIZED WORD "GUTTERSWEEEP" WITH TWO IMAGES OF BROOMS APPEARING SUPERIMPOSED ON BOTH OF THE LETTERS "T" AS THEY APPEAR IN THE WORD "GUTTERSWEEEP" AND THE TERM "THE ONLY SET IT AND FORGET IT SYSTEM" APPEARING DIRECTLY BELOW THEREOF WITH FOUR (4) STYLIZED TREE LEAVES APPEARING TO FALL OUT OF THE BOTTOM OF THE LETTER "P" IN THE WORD "GUTTERSWEEEP".

FOR GUTTER FLUSHING SYSTEM COMPRISED PRINCIPALLY OF PLASTIC PIPES AND FLUID JETS OR NOZZLES THAT UTILIZE PRESSURIZED FLUID PASSING THROUGH PLASTIC PIPES AND FLUID JETS OR NOZZLES ATTACHED THERETO AND WHICH PERIODICALLY CLEANS EAVE TROUGHS OR RAIN GUTTERS (U.S. CLS. 1, 5, 12, 13, 35 AND 50).

FIRST USE 3-1-2002; IN COMMERCE 3-1-2002.

SN 76-434,826. TOYO CHEMICAL CO., LTD., KANAGAWA-KEN, JAPAN, FILED 7-26-2002.

ELEGRIP

FOR PLASTIC PRODUCTS IN SHEET AND STRIP FORM, NAMELY, LAMINATED PLASTIC SHEET, ADHESIVE PLASTIC SHEET FOR FIXING SEMICONDUCTOR WAFER, ADHESIVE PLASTIC SHEET FOR FIXING SUBSTRATE, ADHESIVE PLASTIC TAPE FOR FIXING SEMICONDUCTOR WAFER, ADHESIVE PLASTIC TAPE FOR FIXING SUBSTRATE, ADHESIVE-COATED PLASTIC SHEET FOR USE IN MANUFACTURE, PLASTIC FILM FOR USE IN MANUFACTURE (U.S. CLS. 1, 5, 12, 13, 35 AND 50).

FIRST USE 12-31-1994; IN COMMERCE 12-31-1999.

SN 76-435,677. SHAWCOR PIPE PROTECTION LLC, HOUSTON, TX. BY ASSIGNMENT BREDERO PRICE COMPANY, HOUSTON, TX. FILED 7-30-2002.

NANOTHERM

FOR NANOPOROUS SILICA BASED INSULATING MATERIAL FOR USE IN PIPE-IN-PIPE SYSTEMS (U.S. CLS. 1, 5, 12, 13, 35 AND 50).

CLASS 17—(Continued).

SN 76-444,169. PERMATEX, INC., HARTFORD, CT. FILED 8-23-2002.

POWERBEAD

FOR GASKET MAKING COMPOUNDS, SEALANTS FOR AUTOMOTIVE USE, SEALANTS FOR USE WITH THREADED ASSEMBLIES, GASKETING PREPARATIONS, RUBBER BOTTLE NOZZLES (U.S. CLS. 1, 5, 12, 13, 35 AND 50).

SN 76-448,607. FIRELINE, INC., YOUNGSTOWN, OH. FILED 9-6-2002.

TCON

FOR SOLID CERAMIC METALLIC COMPOSITES OF VARIED COMPOSITION FOR USE IN MANUAL AND ROBOTIC MATERIAL HANDLING COMPONENTS, CRUCIBLES, TUBES INCLUDING COMBUSTION, RADIANT, IMMERSION, AND STALK TUBES, FIXTURES, WEAR PARTS, IMPACT PLATES FOR MOLTEN METALS, PUSHER PLATES FOR FURNACES, PUMPS AND PUMP COMPONENTS (U.S. CLS. 1, 5, 12, 13, 35 AND 50).

SN 76-469,018. SCHNEE-MOREHEAD BUSINESS TRUST, IRVING, TX. FILED 11-21-2002.

RS 200

FOR SEALANTS, NAMELY, SEALANTS IN TAPE FORM FOR USE IN VACUUM BAG MOLDING PROCESSES IN THE MANUFACTURE OF COMPOSITE PARTS FOR THE AEROSPACE INDUSTRY (U.S. CLS. 1, 5, 12, 13, 35 AND 50).

SN 76-472,867. DENKI KAGAKU KOGYO KABUSHIKI KAISHA, TOKYO, JAPAN, FILED 11-27-2002.

DENKA THERMOSHEET EC

NO CLAIM IS MADE TO THE EXCLUSIVE RIGHT TO USE "EC", APART FROM THE MARK AS SHOWN.

FOR PLASTIC SEMI-WORKED PRODUCTS, NAMELY, PLASTIC SHEETS COVERED WITH ELECTRICAL CONDUCTORS, PLASTIC CARRYING TAPES COVERED WITH ELECTRICAL CONDUCTORS (U.S. CLS. 1, 5, 12, 13, 35 AND 50).

FIRST USE 4-1-1982; IN COMMERCE 4-1-1990.

SN 76-484,757. SALZMAN, ALLAN, WALPOLE, MA. FILED 1-24-2003.

SHADE-IT

FOR PLASTIC SHEET FOR BLOCKING SUN (U.S. CLS. 1, 5, 12, 13, 35 AND 50).

FIRST USE 4-22-2002; IN COMMERCE 4-22-2002.

CLASS 17—(Continued).

SN 76-485,360. CAMOWRAPS, L.L.C., SLIDELL, LA. FILED 1-27-2003.

CAMOWRAPS

FOR PLASTIC LAMINATED FILMS, NAMELY CAMOUFLAGE ADHERING FILMS FOR MOTOR VEHICLES, AND HUNTING, CAMPING, AND SPORTING EQUIPMENT (U.S. CLS. 1, 5, 12, 13, 35 AND 50).

FIRST USE 8-17-2002; IN COMMERCE 9-18-2002.

SN 78-185,986. CADIE PRODUCTS CORPORATION, PATERSON, NJ. FILED 11-18-2002.

SPRAY 'N SEAL

SEC. 2(F).
FOR ADHESIVE SEALANT AND CAULKING COMPOUND (U.S. CLS. 1, 5, 12, 13, 35 AND 50).

FIRST USE 1-31-1980; IN COMMERCE 1-31-1980.

SN 78-193,064. MOL BELTING COMPANY, GRAND RAPIDS, MI. FILED 12-10-2002.

TRACKSEAL

FOR FLEXIBLE NON-METAL SEALS FOR USE IN COVERING FLOOR CHANNELS (U.S. CLS. 1, 5, 12, 13, 35 AND 50).

FIRST USE 1-0-1990; IN COMMERCE 1-0-1990.

SN 78-196,532. MCANALLY, BILL, CATOOSA, OK. FILED 12-20-2002.

THERMADRUM

FOR INSULATION COVERS FOR INDUSTRIAL MACHINERY, NAMELY VEHICLE ACCESSORY FOR INSULATING CEMENT MIXTURES (U.S. CLS. 1, 5, 12, 13, 35 AND 50).

SN 78-199,016. AMERICAN PIPE & PLASTICS, INC., BINGHAMTON, NY. FILED 12-31-2002.

AM-DRAIN

FOR LINING SYSTEMS COMPRISED OF PLASTIC TUBING FOR USE IN LATERAL SEWER LINES (U.S. CLS. 1, 5, 12, 13, 35 AND 50).

CLASS 17—(Continued).

SN 78-203,967. KANEKA CORPORATION (KANEGAFUCHI KAGAKU KOGYO KABUSHIKI KAISHA), OSAKA, JAPAN, FILED 1-16-2003.

APICAL
A U D I O I M I D E

OWNER OF U.S. REG. NO. 1,355,351.
FOR POLYIMIDE FILMS FOR USE IN SOUND COMPONENTS (U.S. CLS. 1, 5, 12, 13, 35 AND 50).

FIRST USE 9-5-2002; IN COMMERCE 9-5-2002.

SN 78-206,526. MARMIONS LTD., DUBLIN 15, IRELAND, FILED 1-23-2003.

EASIWRAP

FOR PLASTICS IN THE FORM OF SHEET OR FILM FOR COVERING, WRAPPING OR SHEATHING OF AGRICULTURAL PRODUCTS SUCH AS SILAGE, HAY OR THE LIKE, AND FOR COVERING, WRAPPING OR SHEATHING OF PALLETS OR THE LIKE. (U.S. CLS. 1, 5, 12, 13, 35 AND 50).

SN 78-207,104. ULTRAFAB, INC., FARMINGTON, NY. FILED 1-24-2003.

ULTRA LOC

OWNER OF U.S. REG. NOS. 1,751,296, 2,602,176 AND OTHERS.
FOR WEATHERSTRIPPING FOR USE ON DOORS AND WINDOWS (U.S. CLS. 1, 5, 12, 13, 35 AND 50).

SN 78-207,500. FEDERAL-MOGUL WORLD WIDE, INC., SOUTHFIELD, MI. FILED 1-27-2003.

FLEXTROUGH

FOR SELF-CLOSING SLEEVE FOR SHIELDING AND MAINTAINING WIRE ASSEMBLIES IN MOTOR VEHICLES (U.S. CLS. 1, 5, 12, 13, 35 AND 50).

FIRST USE 11-21-2002; IN COMMERCE 11-21-2002.

SN 78-209,122. KURIYAMA OF AMERICA, ELK GROVE VILLAGE, IL. FILED 1-30-2003.

NEO-DUCT

FOR NEOPRENE FABRIC DUCTING HOSE (U.S. CLS. 1, 5, 12, 13, 35 AND 50).

FIRST USE 11-1-1998; IN COMMERCE 11-1-1998.

CLASS 18—LEATHER GOODS

SN 75-983,291. SRILANKAN AIRLINES LIMITED, COLOMBO 1, SRI LANKA, FILED 11-16-1999.

Srilankan
Airlines

OWNER OF SRI LANKA REG. NO. 92411, DATED 4-9-1999, EXPIRES 4-9-2009.

NO CLAIM IS MADE TO THE EXCLUSIVE RIGHT TO USE "AIRLINES", APART FROM THE MARK AS SHOWN, FOR CANVAS TOTE BAGS, CANVAS SHOPPING BAGS (U.S. CLS. 1, 2, 3, 22 AND 41).

SN 76-136,896. PEPPER'S GHOST PRODUCTIONS LIMITED, SURREY KT2 6NH, ENGLAND, FILED 9-28-2000.

TINY PLANETS

OWNER OF ERPN CMNTY TM OFC REG. NO. 2166833, DATED 3-13-2002, EXPIRES 3-13-2012.

FOR GOODS MADE OF LEATHER AND IMITATIONS OF LEATHER, NAMELY, BAGS, PURSES AND WALLETS, UMBRELLAS AND PARASOLS (U.S. CLS. 1, 2, 3, 22 AND 41).

SN 76-264,546. NBDL ENTERPRISES, LLC, SECAUCUS, NJ, FILED 5-30-2001.

 **FAYETTEVILLE
PATRIOTS**

OWNER OF U.S. REG. NOS. 2,599,556, 2,705,421 AND OTHERS.

NO CLAIM IS MADE TO THE EXCLUSIVE RIGHT TO USE "FAYETTEVILLE", APART FROM THE MARK AS SHOWN.

FOR ATHLETIC BAGS, SHOE BAGS FOR TRAVEL, OVERNIGHT BAGS, UMBRELLAS, BACKPACKS, BABY BACKPACKS, DUFFEL BAGS, TOTE BAGS, LUGGAGE, LUGGAGE TAGS, PATIO UMBRELLAS, VALISES, ATTACHE CASES, BILLFOLDS, WALLETS, BRIEFCASES, CANES, BUSINESS CARD CASES, BOOK BAGS, ALL PURPOSE SPORTS BAGS, GOLF UMBRELLAS, GYM BAGS, PURSES, COIN PURSES, FANNY PACKS, WAIST PACKS, COSMETIC CASES SOLD EMPTY, GARMENT BAGS FOR TRAVEL, HANDBAGS, KEY CASES, KNAPSACKS, SUITCASES, TOILETRY CASES SOLD EMPTY, TRUNKS FOR TRAVELING AND RUCKSACKS (U.S. CLS. 1, 2, 3, 22 AND 41).

CLASS 18—(Continued).

SN 76-398,219. KABUSHIKI KAISHA ONWARD KASHIYAMA, CHUO-KU, TOKYO, JAPAN, FILED 4-19-2002.

mit mitte

PRIORITY CLAIMED UNDER SEC. 44(D) ON JAPAN APPLICATION NO. 2002-008035, FILED 2-5-2002, REG. NO. 4612649, DATED 10-11-2002, EXPIRES 10-11-2012.

THE ENGLISH TRANSLATION OF THE MARK IS "WITH MIDDLE".

FOR HANDBAGS; TRAVELING BAGS; TRUNKS; SUITCASES; BRIEFCASES; ATTACHE CASES; SHOULDER BAGS; LEATHER, MESH OR TEXTILE SHOPPING BAGS; RUCKSACKS; LEATHER BAGS FOR MERCHANDISE PACKAGING; LEATHER POUCHES FOR PACKAGING; PURSES; WALLETS; KEY CASES; CARD CASES FOR CALLING CARDS, CREDIT CARDS, BANK CARDS AND BUSINESS CARDS; TOILETRY CASES SOLD EMPTY; UMBRELLAS; UMBRELLA COVERS; PARASOLS; WALKING STICKS, CANES AND WALKING STICK HANDLES, ALL MADE OF LEATHER; HORSE RIDING EQUIPMENT, NAMELY, BLANKETS FOR HORSES, RIDING SADDLES, SADDLE CLOTHS, WHIPS, SADDLERY, HORSE BRIDLES, HARNESS BLINKERS (U.S. CLS. 1, 2, 3, 22 AND 41).

SN 76-426,494. YOSHIDA & CO., LTD., TOKYO, JAPAN, FILED 7-1-2002.

KURA CHIKA

OWNER OF JAPAN REG. NO. 4437027, DATED 12-1-2000, EXPIRES 12-1-2010.

THE NAME "KURA CHIKA" DOES NOT IDENTIFY A PARTICULAR LIVING INDIVIDUAL.

FOR BAGS, POUCHES AND THE LIKE, NAMELY, PURSES, WALLETS, SHOULDER BAGS, BRIEFCASES, SUITCASES, CARRY-ON BAGS, TOTE BAGS, HAND BAGS, BOSTON BAGS AND BACKPACKS (U.S. CLS. 1, 2, 3, 22 AND 41).

SN 76-464,551. TURNER CLASSIC MOVIES LP, LLLP, ATLANTA, GA. FILED 10-29-2002.

HOLLYWOOD POOLSIDE

FOR BEACH BAGS, BEACH UMBRELLAS, LEATHER GOODS, NAMELY, ATHLETIC BAGS, BRIEF CASES, BUSINESS CARD CASES, DUFFEL CASES, BACKPACKS, LUGGAGE TAGS, TOTE BAGS, UMBRELLAS AND WAIST PACKS (U.S. CLS. 1, 2, 3, 22 AND 41).

CLASS 18—(Continued).

SN 76-487,363. SARNE CORPORATION, EDISON, NJ. FILED 1-30-2003.

DOVER KIDZ

NO CLAIM IS MADE TO THE EXCLUSIVE RIGHT TO USE "KIDZ", APART FROM THE MARK AS SHOWN.

FOR CHILDREN'S BACKPACKS, SCHOOL BAGS, NOVELTY BAGS AND HANDBAGS (U.S. CLS. 1, 2, 3, 22 AND 41).

FIRST USE 9-1-1988; IN COMMERCE 9-1-1988.

SN 78-092,912. SEARS, ROEBUCK AND CO., HOFFMAN ESTATES, IL. FILED 11-13-2001.

COVINGTON

SEC. 2(F).
FOR ACCESSORIES, NAMELY, HANDBAGS, PURSES, AND TOTE BAGS (U.S. CLS. 1, 2, 3, 22 AND 41).
FIRST USE 7-0-2002; IN COMMERCE 7-0-2002.

SN 78-105,977. KABALAB LLC, BROOKLYN, NY. FILED 1-31-2002.



FOR CASES FOR CONTACT LENSES (U.S. CLS. 1, 2, 3, 22 AND 41).
FIRST USE 11-1-2001; IN COMMERCE 3-1-2002.

SN 78-133,401. ANN'S TRADING CO., INC., LOS ANGELES, CA. FILED 6-5-2002.

EL CANTE

THE ENGLISH TRANSLATION OF "EL CANTE" IS "THE SONG".

FOR HANDBAGS, WALLETS, PURSES, SHOULDER BAGS, CLUTCH BAGS, TOTE BAGS, PASSPORT CASES, CREDIT CARD CASES, KEY CASES, DUFFEL BAGS, BACKPACKS, SCHOOL BAGS AND BRIEFCASES (U.S. CLS. 1, 2, 3, 22 AND 41).

FIRST USE 8-1-2001; IN COMMERCE 11-1-2001.

CLASS 18—(Continued).

SN 78-145,608. WELL KNOWN ASSOCIATES LIMITED, ROAD TOWN TORTOLA, BR. VIRGIN ISLANDS, FILED 7-19-2002.

CATINI

THE ENGLISH TRANSLATION OF THE WORD "CATINI" IN THE MARK IS "WASHBOWLS".

FOR BAGS, NAMELY, TOTE BAGS, COSMETIC BAGS SOLD EMPTY, BEACH BAGS, TRAVEL BAGS, HANDBAGS, DUFFEL BAGS, SHOULDER BAGS, VALISES, TRAVELLING BAGS, BRIEFCASES, SUITCASES, WAIST PACKS, BACKPACKS, LUGGAGE, WALLETS AND DIAPER BAGS (U.S. CLS. 1, 2, 3, 22 AND 41).

SN 78-149,245. ALBERS, LISA M., SAN FRANCISCO, CA. FILED 7-31-2002.

KEPT COUTURE

NO CLAIM IS MADE TO THE EXCLUSIVE RIGHT TO USE "COUTURE", APART FROM THE MARK AS SHOWN.

FOR ALL PURPOSE SPORT BAGS, COSMETIC BAGS SOLD EMPTY, COSMETIC CASES SOLD EMPTY, GARMENT BAGS FOR TRAVEL, GYM BAGS, HANDBAGS, LEATHER KEY CHAINS, LEATHER SHOPPING BAGS, OVERNIGHT BAGS, SCHOOL BAGS, SCHOOL BOOK BAGS, SHAVING BAGS SOLD EMPTY, SHOE BAGS FOR TRAVEL, SHOULDER BAGS, SUIT BAGS, TOTE BAGS, TRAVEL BAGS, TRAVELING BAGS (U.S. CLS. 1, 2, 3, 22 AND 41).

FIRST USE 11-1-2001; IN COMMERCE 11-1-2001.

SN 78-162,503. COOGI PARTHERS, LLC, BROOKLYN, NY. BY ASSIGNMENT COOGI NOMINEES PTY LTD (ADMINISTRATORS APPOINTED), VICTORIA, AUSTRALIA, FILED 9-10-2002.

COOGI

FOR PURSES, HANDBAGS, CARRY-ON BAGS, DUFFLE BAGS, TOTE BAGS, LUGGAGE, SUITCASES AND KNAPSACKS (U.S. CLS. 1, 2, 3, 22 AND 41).

SN 78-179,981. LONG, E. HILLARY BUCKMAN, PRINCETON, NJ. FILED 10-30-2002.

BABY POCKETS

NO CLAIM IS MADE TO THE EXCLUSIVE RIGHT TO USE "POCKETS", APART FROM THE MARK AS SHOWN.

FOR HANGING DIAPER BAG AND CHANGING ORGANIZER WITH COMPARTMENTS AND LOOPS FOR ACCESSORIES (U.S. CLS. 1, 2, 3, 22 AND 41).

FIRST USE 10-30-2002; IN COMMERCE 10-30-2002.

CLASS 18—(Continued).

SN 78-187,284. FLEURVILLE, INC., FAIRFAX, CA. FILED 11-20-2002.



FOR DIAPER BAGS FOR THE PURPOSE OF ORGANIZING AND TRANSPORTING ITEMS USED TO CARE FOR SMALL CHILDREN (U.S. CLS. 1, 2, 3, 22 AND 41).
FIRST USE 6-30-2002; IN COMMERCE 7-21-2002.

SN 78-196,464. STORNANT, KRISTINE, MARIE, TARPON SPRINGS, FL. FILED 12-19-2002.

PORTADEN

FOR STACKABLE AND TOTABLE ANIMAL CARRIER WITH A HANDLE AND WHEELS THAT CONTAINS A FEEDER STATION AND A LITTER/POTTY AREA (U.S. CLS. 1, 2, 3, 22 AND 41).

SN 78-199,083. DUBUQUE AREA CHAMBER OF COMMERCE, DUBUQUE, IA. FILED 12-31-2002.

AMERICA'S RIVER

FOR HANDBAGS, BILLFOLDS, COIN PURSES, BRIEF CASES, TOTE BAGS, GYM BAGS, DUFFLE BAGS, UMBRELLAS, BACK PACKS, AND TRAVEL BAGS (U.S. CLS. 1, 2, 3, 22 AND 41).

SN 78-204,243. GAP (APPAREL) INC., SAN FRANCISCO, CA. FILED 1-16-2003.

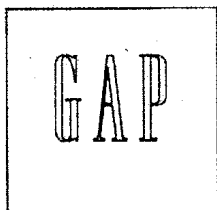

OWNER OF U.S. REG. NOS. 2,431,834, 2,481,997 AND 2,638,121.
FOR BAGS, NAMELY, TOTES, BACKPACKS AND HANDBAGS (U.S. CLS. 1, 2, 3, 22 AND 41).
FIRST USE 8-1-1988; IN COMMERCE 8-1-1988.

CLASS 18—(Continued).

SN 78-207,462. CALEGO INTERNATIONAL, SAINT LAURENT, QUEBEC, CANADA, FILED 1-27-2003.

CALEGO

FOR SUITCASES, LUGGAGE; LUGGAGE TAGS; NON-MOTORIZED, COLLAPSIBLE LUGGAGE CARTS; STRAPS FOR LUGGAGE; LUGGAGE TRUNKS; FANNY PACKS; WAIST PACKS; SHAVING BAGS SOLD EMPTY; ROLL BAGS; WALLETS; BEACH UMBRELLAS; FRAMES FOR UMBRELLAS; GOLF UMBRELLAS; PATIO UMBRELLAS; UMBRELLAS; POCKETBOOKS; CHANGE PURSES; CLUTCH PURSES; COIN PURSES; PURSES; WRIST MOUNTED PURSES; LEATHER KEY CHAINS; ALL PURPOSE SPORT BAGS; ALL-PURPOSE ATHLETIC BAGS; ANIMAL GAME BAGS; ATHLETIC BAGS; BARREL BAGS; BEACH BAGS; BOOK BAGS; BOSTON BAGS; CARRY-ON BAGS; CLUTCH BAGS; COSMETIC BAGS SOLD EMPTY; DIAPER BAGS; DUFFEL BAGS; GARMENT BAGS FOR TRAVEL; GYM BAGS; HUNTERS' GAME BAGS; LEATHER BAGS FOR MERCHANDISE PACKAGING; LEATHER SHOPPING BAGS; MESH SHOPPING BAGS; OVERNIGHT BAGS; SOUVENIR BAGS; SUIT BAGS; TEXTILE SHOPPING BAGS; TOOL BAGS SOLD EMPTY; TOTE BAGS; TRAVEL BAGS; TRAVELING BAGS; WRIST MOUNTED CARRYALL BAGS (U.S. CLS. 1, 2, 3, 22 AND 41).
FIRST USE 6-9-1967; IN COMMERCE 6-9-1967.

SN 78-208,001. AIRWAY INDUSTRIES, INC., ELLWOOD CITY, PA. FILED 1-28-2003.

ATLANTIC EXPRESS

OWNER OF U.S. REG. NOS. 816,805, 2,559,538 AND OTHERS.
FOR LUGGAGE (U.S. CLS. 1, 2, 3, 22 AND 41).

SN 78-212,753. MEAD JOHNSON & COMPANY, EVANSVILLE, IN. FILED 2-10-2003.

SMART DEVELOPMENT PROGRAM

FOR DIAPER BAGS, DIAPER CHANGING PADS. (U.S. CLS. 1, 2, 3, 22 AND 41).

SN 78-213,367. MARIAN, LLC, LAKE FOREST, CA. FILED 2-11-2003.

PURSE-ABILITIES

FOR HANDBAG WITH DETACHABLE FLAP THAT MAY BE EMBROIDERED (U.S. CLS. 1, 2, 3, 22 AND 41).

CLASS 18—(Continued).

SN 78-222,028. VIACOM INTERNATIONAL INC., NEW YORK, NY. FILED 3-5-2003.

EVERVIEW

FOR UMBRELLAS, LUGGAGE, LUGGAGE TAGS, TOTE BAGS, BACKPACKS, FANNY PACKS, MESSENGER BAGS, HANDBAGS, WALLETS AND PURSES, ATHLETIC BAGS, GARMENT BAGS FOR TRAVEL, KNAPSACKS, CHANGE PURSES, DUFFLE BAGS, BEACH BAGS (U.S. CLS. 1, 2, 3, 22 AND 41).

CLASS 19—NON-METALLIC BUILDING MATERIALS

SN 75-686,835. RIDGLASS SHINGLE MANUFACTURING CO, INC., FRESNO, CA. FILED 4-19-1999.

RIDGESCAPE

FOR SKYLIGHTS; SHINGLES COMPOSED OF FIBER-GLASS MAT ASPHALT; ROOF COVERING MATERIAL, NAMELY HIGH PROFILE RIDGE CAPPING AND ROLL ROOFING COMPOSED OF FIBERGLASS MAT ASPHALT; AND NON-METAL GUTTER SUPPORT FRAMES (U.S. CLS. 1, 12, 33 AND 50).

FIRST USE 2-3-1998; IN COMMERCE 2-3-1998.

SN 76-091,742. BAUCO PRODUCTS INCORPORATED, VICTORIA, BRITISH COLUMBIA, CANADA, FILED 7-20-2000.



PRIORITY CLAIMED UNDER SEC. 44(D) ON CANADA APPLICATION NO. 1065968, FILED 7-5-2000, REG. NO. TMA576,874, DATED 3-4-2003, EXPIRES 3-4-2018.

FOR ARCHITECTURAL ACCESS PANELS FOR WALL AND CEILING INSTALLATION (U.S. CLS. 1, 12, 33 AND 50).

SN 76-100,952. CERTAINTED CORPORATION, VALLEY FORGE, PA. FILED 7-31-2000.

THE ULTIMATE DECKING LUMBER

NO CLAIM IS MADE TO THE EXCLUSIVE RIGHT TO USE "DECKING LUMBER", APART FROM THE MARK AS SHOWN.

SEC. 2(F).

FOR COMPOSITE LUMBER (U.S. CLS. 1, 12, 33 AND 50).

FIRST USE 3-1-2000; IN COMMERCE 3-1-2000.

CLASS 19—(Continued).

SN 76-272,888. ROYAL GROUP TECHNOLOGIES LIMITED, VAUGHAN, ONTARIO, CANADA, FILED 6-14-2001.

RBS DIRECT

FOR STRUCTURAL COMPONENTS OF EXTRUDED PLASTIC, NAMELY, WALL FORMING PANELS, BOX CONNECTORS, ROOF PANELS, RIDGE BEAMS, GABLE MEMBERS, LINTELS, AND WALL FORMING PANELS AND BOX CONNECTORS WHICH FORM CONCRETE RECEIVING FORMS (U.S. CLS. 1, 12, 33 AND 50).

FIRST USE 0-0-1998; IN COMMERCE 0-0-1998.

SN 76-362,590. BOISE CASCADE CORPORATION, BOISE, ID. FILED 1-23-2002.

BOISE GLULAM

NO CLAIM IS MADE TO THE EXCLUSIVE RIGHT TO USE "GLULAM", APART FROM THE MARK AS SHOWN.

SEC. 2(F).

FOR LAMINATED WOOD BEAMS (U.S. CLS. 1, 12, 33 AND 50).

SN 76-393,876. ANGERS, MARY, LONG BRANCH, NJ. FILED 4-8-2002.

CIRCULAIR

FOR TRANSPARENT WINDOW SCREEN MADE OF NON-METAL MATERIALS TO ALLOW VISIBILITY TO THE OUTDOORS (U.S. CLS. 1, 12, 33 AND 50).

SN 76-408,692. POOL COVER SPECIALISTS NATIONAL, INC., WEST JORDAN, UT. FILED 5-15-2002.

POOL COVER SPECIALISTS

NO CLAIM IS MADE TO THE EXCLUSIVE RIGHT TO USE "POOL COVER", APART FROM THE MARK AS SHOWN.

FOR MOTORIZED AND MANUALLY-OPERABLE FITTED POOL COVERS, AND FITTED COVERS FOR TANKS CONTAINING LIQUIDS (U.S. CLS. 1, 12, 33 AND 50).

FIRST USE 5-0-1983; IN COMMERCE 5-0-1983.

CLASS 19—(Continued).

SN 76-419,507. RINKER MATERIALS WESTERN, INC., WEST PALM BEACH, FL. BY CHANGE OF NAME KIEWIT MATERIALS COMPANY, OMAHA, NE. FILED 6-11-2002.

ULTRA PERFORMANCE CONCRETE

NO CLAIM IS MADE TO THE EXCLUSIVE RIGHT TO USE "CONCRETE", APART FROM THE MARK AS SHOWN. FOR CONSTRUCTION MATERIALS, NAMELY READY-MIX CONCRETE AND ASPHALT MIXES (U.S. CLS. 1, 12, 33 AND 50).
FIRST USE 5-15-2002; IN COMMERCE 5-15-2002.

SN 76-422,547. HENRY COMPANY, KIMBERTON, PA. FILED 6-17-2002.

KURE-A-LEKE

FOR ASPHALT ROOF COATINGS, ROOF CEMENT, AND ROOFING MEMBRANES (U.S. CLS. 1, 12, 33 AND 50).
FIRST USE 6-1-1960; IN COMMERCE 6-1-1960.

SN 76-426,123. MAROTTE S.A., 93402 SAINT-OUEN, FRANCE, FILED 6-28-2002.



OWNER OF FRANCE REG. NO. 97/697135, DATED 9-30-1997, EXPIRES 9-30-2007.

THE MARK CONSISTS IN PART OF A STYLIZED TREE. "MAROTTE" IS FRENCH FOR "HOBBY" OR "CRAZE".
FOR BUILDING TIMBER; WOOD VENEER; WOOD WORK, NAMELY, VENEERED PANELS, WOVEN PANELS, CARVED PANELS, MOSAIC PANELS, ACOUSTIC PANELS, WOOD CEILINGS AND DOORS, SHAPED PANELS, MARQUETRY, BURL VENEERED PANELS; WOOD PANELING; NON-METAL BUILDING MATERIALS—NAMELY, FASCIA AND SOFFITS, NON-METAL DOORS, NON-METAL RAILINGS FOR FENCES AND BALCONIES, NON-METAL CEILING PANELS, NON-METAL FLOORS, NON-METAL DOOR PANELS; PAVING BLOCKS, WINDOW GLASS FOR BUILDINGS, WOOD MOLDINGS, NON-METAL BUILDING PANELS (U.S. CLS. 1, 12, 33 AND 50).

CLASS 19—(Continued).

SN 76-433,019. GEIGER, PETER, 90113 NEUMARKT/OBERPALZ, FED REP GERMANY, FILED 7-19-2002.

EGRA

FOR PAVING-STONES, PAVING TILES, CERAMIC GARDEN TILES, CURB-STONES, PRECAST CONCRETE STAIRS, CONCRETE STAIR BLOCKS, WALL-STONES, AND CAST CONCRETE STONES FOR USE IN CONSTRUCTION (U.S. CLS. 1, 12, 33 AND 50).

SN 76-436,759. CARLISLE INTANGIBLE COMPANY, SYRACUSE, NY. BY CHANGE OF NAME CARLISLE MANAGEMENT COMPANY, SYRACUSE, NY. FILED 8-2-2002.

FLEECEBACK

FOR POLYMERIC MEMBRANE ROOFING (U.S. CLS. 1, 12, 33 AND 50).
FIRST USE 5-1-1996; IN COMMERCE 5-1-1996.

SN 76-448,649. ABET, INC., ENGLEWOOD, NJ. FILED 9-6-2002.

LAMICOLOR

FOR BUILDING MATERIALS, NAMELY HIGH PRESSURE PLASTIC LAMINATE USED FOR STORE FIXTURES AND COUNTERTOPS (U.S. CLS. 1, 12, 33 AND 50).
FIRST USE 6-1-2002; IN COMMERCE 6-1-2002.

SN 76-448,696. ABET, INC., ENGLEWOOD, NJ. FILED 9-6-2002.

ABET LAMINATI

NO CLAIM IS MADE TO THE EXCLUSIVE RIGHT TO USE "LAMINATI", APART FROM THE MARK AS SHOWN. THE ENGLISH TRANSLATION OF "LAMINATI" IS "LAMINATES".

FOR BUILDING MATERIALS, NAMELY HIGH PRESSURE PLASTIC LAMINATE USED FOR STORE FIXTURES AND COUNTERTOPS (U.S. CLS. 1, 12, 33 AND 50).
FIRST USE 4-1-1990; IN COMMERCE 4-1-1990.

SN 76-448,699. ABET, INC., ENGLEWOOD, NJ. FILED 9-6-2002.

TEFOR

FOR BUILDING MATERIALS, NAMELY HIGH PRESSURE PLASTIC LAMINATE USED FOR RETAIL SHELVING, BACKSPASHES AND VERTICAL CLADDING (U.S. CLS. 1, 12, 33 AND 50).
FIRST USE 1-1-2001; IN COMMERCE 1-1-2001.

CLASS 19—(Continued).

SN 76-456,720. MITTEN VINYL INC., PARIS, ONTARIO, CANADA, FILED 10-3-2002.

COLOR-RICH

PRIORITY CLAIMED UNDER SEC. 44(D) ON CANADA APPLICATION NO. 1153205, FILED 9-18-2002.
FOR VINYL SIDING PROFILES (U.S. CLS. 1, 12, 33 AND 50).

SN 76-456,750. MITTEN VINYL INC., PARIS ONTARIO, CANADA, FILED 10-3-2002.

BRIGADIER

PRIORITY CLAIMED UNDER SEC. 44(D) ON CANADA APPLICATION NO. 1152674, FILED 9-13-2002.
FOR VINYL SIDING PROFILES (U.S. CLS. 1, 12, 33 AND 50).

SN 76-468,318. NAPA VALLEY CAST STONE, NAPA, CA. FILED 11-12-2002.

VENEZIA

THE ENGLISH TRANSLATION OF THE WORD "VENEZIA" IN THE MARK IS "VENICE".
FOR FIREPLACE SURROUNDS (U.S. CLS. 1, 12, 33 AND 50).

SN 76-471,711. WHEATLEY, CHARLES, CINCINNATI, OH. FILED 11-4-2002.

HONEY DECK

NO CLAIM IS MADE TO THE EXCLUSIVE RIGHT TO USE "DECK", APART FROM THE MARK AS SHOWN.
FOR PATIO AND DECK SURFACE FORMING UNITS IN THE NATURE OF RELATIVELY LIGHTWEIGHT, UNITIZED ASSEMBLIES OF PLURAL PIECES OF TREATED LUMBER, ARRANGED IN A DECORATIVE PATTERN (U.S. CLS. 1, 12, 33 AND 50).

SN 76-476,522. ROSBORO LUMBER COMPANY, LLC, SPRINGFIELD, OR. FILED 12-18-2002.

ROSBORO SMARTBEAM

OWNER OF U.S. REG. NOS. 2,624,888 AND 2,711,752.
FOR SUPPORT HEADER, NAMELY, WOOD BEAMS (U.S. CLS. 1, 12, 33 AND 50).
FIRST USE 2-22-2002; IN COMMERCE 2-22-2002.

CLASS 19—(Continued).

SN 76-476,599. MARSHALL INNOVATIVE TECHNOLOGIES, LLC, SOUTHFIELD, MI. FILED 12-18-2002.

STONERIDGE

FOR NATURAL GRANITE OR MARBLE VANITY TOPS (U.S. CLS. 1, 12, 33 AND 50).

SN 76-481,671. PREMARK RWP HOLDINGS, INC., WILMINGTON, DE. FILED 1-13-2003.

PERFECT FIT

FOR LAMINATE FLOORING (U.S. CLS. 1, 12, 33 AND 50).

SN 76-484,775. PARAMOUNT WINDOW MFG. INC., DBA FENTECH WINDOW CORPORATION, BURTON, MI. FILED 1-24-2003.

THE PATRIOT WINDOW

NO CLAIM IS MADE TO THE EXCLUSIVE RIGHT TO USE "WINDOW", APART FROM THE MARK AS SHOWN.
FOR NON-METALLIC WINDOWS (U.S. CLS. 1, 12, 33 AND 50).

SN 76-487,309. MARCHESE, THERESA, MARGATE, FL. FILED 1-31-2003.

CORAL-LIGHT

FOR BUILDING MATERIALS— NAMELY-URETHANE ARCHITECTURAL MOLDINGS (U.S. CLS. 1, 12, 33 AND 50).
FIRST USE 10-1-2001; IN COMMERCE 10-1-2001.

SN 76-492,868. MENARD, INC., EAU CLAIRE, WI. FILED 2-6-2003.

MASTERSHIELD

FOR WOOD WINDOWS AND WOOD AND GLASS PATIO DOORS (U.S. CLS. 1, 12, 33 AND 50).

CLASS 19—(Continued).

SN 78-087,690. GOLDEN TRADE S.R.L., SANTARCANGELO DI ROMAGNA, ITALY, FILED 10-10-2001.

FLORENTIA

THE ENGLISH TRANSLATION OF "FLORENTIA" IS "FLORAL".

FOR BUILDING MATERIALS, NAMELY, NATURAL STONE - NON METAL BUILDING MATERIALS OF NATURAL STONE, NAMELY, SCULPTURES, STATUES, STATUETTES, BUSTS, FIGURES, FIGURINES, MANTELS FOR FIREPLACES, ARCHES, COLUMNS, SILLS, DOOR FRAMES, WINDOW FRAMES, CAPITALS AND BASES (U.S. CLS. 1, 12, 33 AND 50).

FIRST USE 2-3-2000; IN COMMERCE 5-15-2001.

SN 78-099,985. LEE MASONRY PRODUCTS, LLC, BOWLING GREEN, KY. FILED 12-26-2001.

ARMORSTONE

OWNER OF U.S. REG. NOS. 1,352,839, 1,361,927 AND 2,061,003.

FOR REVETMENT SYSTEM COMPRISED OF INTER-LOCKING CONCRETE BLOCKS (U.S. CLS. 1, 12, 33 AND 50).

SN 78-136,567. DAYTON SUPERIOR CORPORATION, DAYTON, OH. FILED 6-18-2002.

AHT MASTER

FOR CEMENT-BASED PATCHING COMPOUND FOR AIRPORT AND HIGHWAY ASPHALT AND CONCRETE PAVEMENT REPAIR (U.S. CLS. 1, 12, 33 AND 50).

SN 78-146,337. SOUTHWEST ENVIROTECH SERVICES, INC., RICHARDSON, TX. FILED 7-22-2002.

ENVIROAD PATCH

FOR MATERIAL FOR PATCHING POT HOLES IN ROADWAYS OR PARKING AREAS, NAMELY, ASPHALT AND LIMESTONE (U.S. CLS. 1, 12, 33 AND 50).

FIRST USE 11-1-2001; IN COMMERCE 12-15-2001.

CLASS 19—(Continued).

SN 78-163,945. SURFACE PROTECTION INDUSTRIES, INC., LOS ANGELES, CA. FILED 9-13-2002.

FAST FIX

FOR BUILDING MATERIALS, NAMELY, VINYL ADHESIVE-BACKED PATCHES WHICH CAN BE USED TO REPAIR DAMAGED WALLS (U.S. CLS. 1, 12, 33 AND 50).

SN 78-191,593. PPG INDUSTRIES OHIO, INC., CLEVELAND, OH. FILED 12-5-2002.

OCEANS OF COLOR

NO CLAIM IS MADE TO THE EXCLUSIVE RIGHT TO USE "COLOR", APART FROM THE MARK AS SHOWN.

FOR COLORED FLAT, FLOAT AND SHEET GLASS ALL FOR BUILDING AND CONSTRUCTION (U.S. CLS. 1, 12, 33 AND 50).

SN 78-201,676. TERRANOVA FOREST PRODUCTS, INC., WANDO, SC. FILED 1-9-2003.

ULTRA PRIME

NO CLAIM IS MADE TO THE EXCLUSIVE RIGHT TO USE "PRIME", APART FROM THE MARK AS SHOWN.

FOR WOOD MOLDINGS (U.S. CLS. 1, 12, 33 AND 50).

SN 78-203,568. NORTH AMERICAN REFRACTORIES CO., MOON TOWNSHIP, PA. FILED 1-15-2003.

LABYRINTH

FOR PERMEABLE REFRACTORY ELEMENTS, NAMELY CONES OR PLUGS FOR USE IN DEVICES FOR STIRRING MOLTEN METAL (U.S. CLS. 1, 12, 33 AND 50).

FIRST USE 1-1-1990; IN COMMERCE 1-1-1990.

SN 78-206,528. M-D BUILDING PRODUCTS, INC., OKLAHOMA CITY, OK. FILED 1-23-2003.

EASY SCREEN

NO CLAIM IS MADE TO THE EXCLUSIVE RIGHT TO USE "SCREEN", APART FROM THE MARK AS SHOWN.

FOR INSECT SCREEN AND INSTALLATION KIT FOR DOORS AND WINDOWS COMPRISING NON-METAL INSECT SCREENING AND ADHESIVE BACKED HOOK-TYPE FASTENERS (U.S. CLS. 1, 12, 33 AND 50).

CLASS 19—(Continued).

SN 78-207,563. VAN'S ENTERPRISES, LTD., MULDELEIN, IL. FILED 1-27-2003.

BATTERS BLOX

FOR UNBAKED CLAY TILES FOR GROUNDS MAINTENANCE ON PLAYING FIELDS AND THE LIKE (U.S. CLS. 1, 12, 33 AND 50).

FIRST USE 3-30-1991; IN COMMERCE 8-31-1991.

SN 78-208,089. TRIO INDUSTRIES HOLDINGS, LLC, DALLAS, TX. FILED 1-28-2003.

NEREWOOD

FOR COMPOSITE BUILDING MATERIALS, COMPOSED OF RESINS, WAX, AND LIGNOCELLULOSIC FIBERS, HAVING THE APPEARANCE AND FEEL OF SURFACED LUMBER FOR USE IN FURTHER MANUFACTURING (U.S. CLS. 1, 12, 33 AND 50).

SN 78-208,407. INTERNATIONAL FOREST PRODUCTS, LLC, OVERLAND PARK, KS. FILED 1-29-2003.

HOBBYLITE

FOR KILN DRIED BALSAM WOOD, SOLD IN DOWELS, STRIPS, VENEERS, SHEETS, PANELS, BLOCKS, PLANKS, IN CUT OR ROUGH FORM. (U.S. CLS. 1, 12, 33 AND 50).

SN 78-209,550. THE WOOD ENERGY GROUP, INC., CHESTERFIELD, MO. FILED 1-31-2003.

DURA-BLEND

FOR BUILDING MATERIAL, NAMELY, BASE MATERIAL COMPRISING ASH, LIMESTONE AND/OR GRANITE SAND FOR USE AS A PAVING, PATIO, AND GROUND SURFACE CONSTRUCTION BASE (U.S. CLS. 1, 12, 33 AND 50).

SN 78-210,132. COVERINGS ETC. INC., NORTH MIAMI, FL. FILED 2-3-2003.

ECO-CEM

FOR CEMENT TILES (U.S. CLS. 1, 12, 33 AND 50).

CLASS 20—FURNITURE AND ARTICLES NOT OTHERWISE CLASSIFIED

CLASS 20—(Continued).

SN 76-126,304. PROTECTIVE PACKAGING, INC., WOODLAND HILLS, CA. FILED 9-11-2000.

E-Z SHIPPER RACKS

NO CLAIM IS MADE TO THE EXCLUSIVE RIGHT TO USE "SHIPPER RACKS", APART FROM THE MARK AS SHOWN.

FOR ALL-PURPOSE, RE-USABLE, RE-ASSEMBLABLE SHELVES (U.S. CLS. 2, 13, 22, 25, 32 AND 50).

FIRST USE 10-1-1998; IN COMMERCE 10-1-1998.

SN 76-306,990. METRO INDUSTRIES, INC., WILKES-BARRE, PA. FILED 8-30-2001.

METRO MEDIA STORAGE

OWNER OF U.S. REG. NOS. 1,483,032, 1,483,039 AND 1,557,853.

NO CLAIM IS MADE TO THE EXCLUSIVE RIGHT TO USE "MEDIA STORAGE", APART FROM THE MARK AS SHOWN.

FOR SHELVING SYSTEMS COMPRISING SHELVES AND ACCESSORIES, NAMELY, SHELF DIVIDERS, DIVIDER KITS, POSTS, ENCLOSURE PANELS, SHELF MARKERS, SHELF INLAYS, LABEL HOLDERS, HOOKS, HOOK CONNECTORS, CLAMPS, FOOT PLATES, LEVELING FEET AND SUPPORTS THEREOF (U.S. CLS. 2, 13, 22, 25, 32 AND 50).

SN 76-341,449. ZORRO PRODUCTIONS, INC., BERKELEY, CA. FILED 11-26-2001.

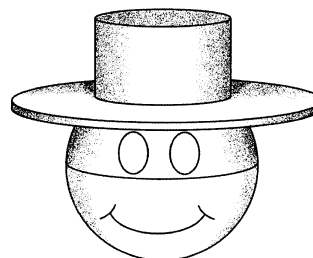

THE SHADED AREAS OF THE HAT AND OF THE SPHERE IN THE DRAWING ARE INTENDED TO ILLUSTRATE THE THREE-DIMENSIONAL CHARACTERISTIC OF THE MARK. THEY ARE NOT INTENDED TO REPRESENT COLOR AND ARE NOT CLAIMED AS FEATURES OF THE MARK.

THE MARK CONSISTS OF A THREE DIMENSIONAL SPHERE WHICH IS A FACE CONSISTING OF A BLACK LINE-MOUTH CURVED UPWARD IN A SMILE, WITH BLACK EYE MASK AND BLACK CORDOBA HAT.

FOR NON-METAL NOVELTY ITEMS IN THE NATURE OF A DECORATIVE BALL FOR PLACEMENT ON THE ANTENNAS OF VEHICLES (U.S. CLS. 2, 13, 22, 25, 32 AND 50).

FIRST USE 3-30-2001; IN COMMERCE 3-30-2001.

CLASS 20—(Continued).

SN 76-353,128. MATTRESS DISCOUNTERS CORPORATION,
UPPER MARLBORO, MD. FILED 12-27-2001.

CLASSIC ELEGANCE

FOR MATTRESSES AND BOX SPRINGS (U.S. CLS. 2,
13, 22, 25, 32 AND 50).
FIRST USE 4-0-1991; IN COMMERCE 4-0-1991.

SN 76-353,137. MATTRESS DISCOUNTERS CORPORATION,
UPPER MARLBORO, MD. FILED 12-27-2001.

CLASSIC ELEGANCE II

FOR MATTRESSES AND BOX SPRINGS (U.S. CLS. 2,
13, 22, 25, 32 AND 50).
FIRST USE 4-0-1991; IN COMMERCE 4-0-1991.

SN 76-380,585. NEWELL WINDOW FURNISHINGS, INC.,
FREEPORT, IL. FILED 3-11-2002.

BACKSTACKER

FOR WINDOW BLINDS; WINDOW TREATMENT
HARDWARE, NAMELY, TRACKS, RAILS, HANDLES,
CORDS, CABLES, SCREWS, PINS, END CAPS, LOCKS,
BRACKETS; AND WINDOW BLINDS AND NON-METAL
VALANCES SOLD TOGETHER AS A SET (U.S. CLS. 2, 13,
22, 25, 32 AND 50).
FIRST USE 12-1-1999; IN COMMERCE 12-1-1999.

SN 76-398,014. HUNTER DOUGLAS INC., UPPER SADDLE
RIVER, NJ. FILED 4-18-2002.

PERMATRAK

FOR HEADRAIL SYSTEM FOR WINDOW BLINDS
AND WINDOW SHADES COMPRISING A HEADRAIL,
CLUTCH, LIFT, MOUNTING BRACKET, SHAFT AND
CONTROL LOOP (U.S. CLS. 2, 13, 22, 25, 32 AND 50).
FIRST USE 7-10-2002; IN COMMERCE 7-10-2002.

SN 76-411,646. BEREAVEMENT BOXES & CHESTS, INC.,
DELTONA, FL. FILED 5-23-2002.

PASSING CHEST

NO CLAIM IS MADE TO THE EXCLUSIVE RIGHT TO
USE "CHEST", APART FROM THE MARK AS SHOWN.
FOR FURNITURE CHESTS, NAMELY, WOOD
CHESTS FOR HOLDING KEEPSAKES AND MEMOR-
ABILIA OF A DECEASED (U.S. CLS. 2, 13, 22, 25, 32 AND
50).

CLASS 20—(Continued).

SN 76-416,170. FOREMOST INTERNATIONAL TRADING,
INC., EAST HANOVER, NJ. FILED 5-31-2002.

TODAY'S OFFICE

NO CLAIM IS MADE TO THE EXCLUSIVE RIGHT TO
USE "OFFICE", APART FROM THE MARK AS SHOWN.
FOR OFFICE FURNITURE (U.S. CLS. 2, 13, 22, 25, 32
AND 50).

SN 76-424,928. BISON DESIGNS, LLC, LONGMONT, CO.
FILED 6-26-2002.

BISON

FOR KEY FOBS NOT MADE OF METAL (U.S. CLS. 2,
13, 22, 25, 32 AND 50).
FIRST USE 8-0-1988; IN COMMERCE 8-0-1988.

SN 76-425,847. DREAMWELL, LTD., LAS VEGAS, NV. FILED
6-26-2002.

**SO YOU CAN SLEEP
THROUGH EVERY TOSS
AND TURN**

FOR MATTRESSES AND BOX SPRINGS (U.S. CLS. 2,
13, 22, 25, 32 AND 50).

SN 76-428,565. P.T. WARISAN EURINDO, 80361, BALI,
INDONESIA, FILED 7-8-2002.

WARISAN

THE ENGLISH TRANSLATION OF "WARISAN" IS "HERI-
TAGE".

FOR FURNITURE, NAMELY, OFFICE FURNITURE,
BEDROOM FURNITURE, HOUSEHOLD FURNITURE,
RESORT FURNITURE, HOTEL FURNITURE, SPA FUR-
NITURE, GARDEN FURNITURE, ORIENTAL FURNI-
TURE, CONTEMPORARY FURNITURE AND WOODEN
FURNITURE (U.S. CLS. 2, 13, 22, 25, 32 AND 50).
FIRST USE 11-1-1998; IN COMMERCE 11-1-1998.

CLASS 20—(Continued).

SN 76-428,834. NATIONAL GEOGRAPHIC SOCIETY, WASHINGTON, DC. FILED 7-5-2002.

BORN TO EXPLORE

OWNER OF U.S. REG. NOS. 1,416,981, 1,994,611 AND OTHERS.

FOR NON-METAL KEY CHAINS AND KEY RINGS; BOXES FOR STORING AND DISPENSING PILLS, SOLD EMPTY; PICTURE FRAMES; COLD CAST RESIN FIGURINES; COLD CAST MUSICAL RESIN FIGURINES; AIR MATTRESSES FOR USE WHEN CAMPING; SLEEPING BAGS; SLEEPING MATS; HAND HELD MIRRORS; HOLIDAY ORNAMENTS MADE OF BONE, PLASTER, PLASTIC, WAX OR WOOD, EXCLUDING CHRISTMAS TREE ORNAMENTS; MINIATURE REPLICAS OF BUILDINGS MADE OF BONE, PLASTER, PLASTIC, WAX OR WOOD; MINIATURE REPLICAS OF VILLAGES MADE OF BONE, PLASTER, PLASTIC, WAX OR WOOD; NON-METAL TIME CAPSULES; PILLOWS; CUSHIONS; FITTED FABRIC FURNITURE COVERS; INDOOR FURNITURE; OUTDOOR FURNITURE; CABINETS BEING FURNITURE; COAT RACKS; SHELVES; NON-METAL HOOKS; MAGAZINE RACKS; MAGAZINE HOLDERS; WINDOW BLINDS; NON-METAL HARDWARE, NAMELY, DRAWER PULLS, DECORATIVE KNOBS, DECORATIVE MOLDINGS, DECORATIVE WINDOW FINIALS AND DRAPERY FINIALS; DECORATIVE WALL MIRRORS; PLAQUES; FIREPLACE SCREENS; PORTABLE PET BEDS; SCENTED CLOTHES HANGERS; NON-METAL KEY RACKS; SELF INFLATING PADS FOR USE WHEN CAMPING; FOAM MATTRESSES FOR USE WHEN CAMPING; SLEEPING BAG LINERS; OVERBAGS FOR SLEEPING BAGS; COTS; BEDS; AND DECORATIVE HOUSEHOLD ACCESSORIES MADE PRIMARILY OF BONE, PLASTER, PLASTIC, WAX OR WOOD, NAMELY, BOXES, JEWELRY BOXES, JEWELRY AND ACCESSORY BOXES, LETTER BOXES, MAIL BOXES, TOY BOXES BEING FURNITURE, FIGURINES, STATUES, WALL SCULPTURES, PLATE RACKS AND FOOT STOOLS (U.S. CLS. 2, 13, 22, 25, 32 AND 50).

SN 76-429,965. WHITE DOVE MATTRESS LTD., CLEVELAND, OH. FILED 7-12-2002.

CAMBRIDGE COLLECTION

NO CLAIM IS MADE TO THE EXCLUSIVE RIGHT TO USE "COLLECTION", APART FROM THE MARK AS SHOWN.

FOR MATTRESSES AND BOX SPRINGS (U.S. CLS. 2, 13, 22, 25, 32 AND 50).

FIRST USE 3-13-1998; IN COMMERCE 3-13-1998.

SN 76-430,694. WESTMINSTER PRODUCTS PTY LTD, SOUTH AUSTRALIA 5160, AUSTRALIA, FILED 7-12-2002.

FROG FARM

OWNER OF AUSTRALIA REG. NO. 839122, DATED 6-19-2000, EXPIRES 6-19-2010.

NO CLAIM IS MADE TO THE EXCLUSIVE RIGHT TO USE "FROG", APART FROM THE MARK AS SHOWN.

FOR ORNAMENTAL PONDS AND POOLS OF PLASTICS; KITS THEREFOR; AND REPLACEMENT PARTS THEREOF (U.S. CLS. 2, 13, 22, 25, 32 AND 50).

CLASS 20—(Continued).

SN 76-435,664. ZRP, LLC, OMAHA, NE. FILED 7-30-2002.

'BOXMATES MAILBOX TOPPERS

NO CLAIM IS MADE TO THE EXCLUSIVE RIGHT TO USE "MAILBOX TOPPERS", APART FROM THE MARK AS SHOWN.

FOR NON-METAL DECORATIVE ACCENT PRODUCTS FOR HOME EXTERIOR AND GARDEN-RELATED USE, NAMELY, NON-METAL DECORATIVE ACCENT PRODUCTS IN THE NATURE OF HOLIDAY ORNAMENTS OF PLASTIC, TO BE USED ON CUSTOMIZED MAILBOXES (U.S. CLS. 2, 13, 22, 25, 32 AND 50).

SN 76-436,072. MAXWELL, BRIAN L., CHARDON, OH. FILED 7-31-2002.

KID TOPPERS

FOR FITTED VINYL COVERS FOR DESKS (U.S. CLS. 2, 13, 22, 25, 32 AND 50).

SN 76-437,054. METRO INDUSTRIES, INC., WILKES BARRE, PA. FILED 8-1-2002.

SITeselect

FOR SHELVES AND SHELVING SYSTEMS COMPRISING SHELF SUPPORTS AND SHELF POSTS (U.S. CLS. 2, 13, 22, 25, 32 AND 50).

SN 76-437,426. CRT ENTERPRISES, INC., OLD TAPPAN, NJ. FILED 8-5-2002.

WALLMRX

FOR PICTURE HANGING KIT FOR MOUNTING FRAMED PICTURES CONSISTING PRIMARILY OF PICTURE HANGER POSITIONING STICKERS AND CORRESPONDING APPLICATOR (U.S. CLS. 2, 13, 22, 25, 32 AND 50).

SN 76-438,565. OPC PACKAGING CORPORATION, WINSTON-SALEM, NC. FILED 8-7-2002.

L.I.T.

FOR THREE-DIMENSIONAL, FLIP LENTICULAR, FLEXOGRAPHIC PRINTED TAGS AND LABELS MADE OF PLASTIC (U.S. CLS. 2, 13, 22, 25, 32 AND 50).

FIRST USE 5-1-2002; IN COMMERCE 5-1-2002.

CLASS 20—(Continued).

SN 76-440,848. K-2 INDUSTRIES, INC., DBA PAVILION GIFT COMPANY, BERGEN, NY. FILED 8-14-2002.

KNEEDED ANGELS

NO CLAIM IS MADE TO THE EXCLUSIVE RIGHT TO USE "ANGELS", APART FROM THE MARK AS SHOWN. FOR FIGURINES AND ORNAMENTS MADE OF RESIN MATERIAL (U.S. CLS. 2, 13, 22, 25, 32 AND 50). FIRST USE 1-2-2002; IN COMMERCE 1-2-2002.

SN 76-473,744. KNEIER, ANDREW W., NEVADA CITY, CA. FILED 12-5-2002.

THE SHOE-EZE CHAIR

NO CLAIM IS MADE TO THE EXCLUSIVE RIGHT TO USE "CHAIR", APART FROM THE MARK AS SHOWN. FOR CHAIR (U.S. CLS. 2, 13, 22, 25, 32 AND 50).

SN 76-480,087. HON TECHNOLOGY INC., MUSCATINE, IA. FILED 1-3-2003.

CADENCE

FOR FREESTANDING OFFICE DESK SYSTEMS, COMPOSED OF WORK SURFACES, STORAGE CABINETS, MODESTY PANELS, END PANELS, SUPPORT LEGS AND BRACKETRY (U.S. CLS. 2, 13, 22, 25, 32 AND 50).

SN 76-482,686. THE JOHN HENRY COMPANY, LANSING, MI. FILED 1-16-2003.

MINI PORTRAIT

OWNER OF U.S. REG. NOS. 2,216,200, 2,486,134 AND 2,605,889.

NO CLAIM IS MADE TO THE EXCLUSIVE RIGHT TO USE "MINI", APART FROM THE MARK AS SHOWN.

FOR PLASTIC PLANT TAGS (U.S. CLS. 2, 13, 22, 25, 32 AND 50).

FIRST USE 12-16-2002; IN COMMERCE 12-16-2002.

SN 76-483,138. "3 IN 1 P.E.T.", LLC, SAN JOSE, CA. FILED 1-17-2003.

"3 IN 1 P.E.T."

NO CLAIM IS MADE TO THE EXCLUSIVE RIGHT TO USE "3 IN 1", APART FROM THE MARK AS SHOWN.

FOR PORTABLE EXTENSION TABLE FOR USE WITH SEWING MACHINES (U.S. CLS. 2, 13, 22, 25, 32 AND 50).

FIRST USE 3-16-2002; IN COMMERCE 3-16-2002.

CLASS 20—(Continued).

SN 76-484,619. EARLE INDUSTRIES, INC., EARLE, AR. FILED 1-27-2003.

POP & FOLD

FOR COLLAPSIBLE HAMPERS (U.S. CLS. 2, 13, 22, 25, 32 AND 50).

SN 76-484,809. HUNTER DOUGLAS INC., UPPER SADDLE RIVER, NJ. FILED 1-27-2003.

PIVOTAL

FOR WINDOW BLINDS AND SHADES AND OPERATING HARDWARE FOR SUCH WINDOW BLINDS AND SHADES SOLD AS A UNIT THEREWITH (U.S. CLS. 2, 13, 22, 25, 32 AND 50).

SN 76-485,125. HON TECHNOLOGY INC., MUSCATINE, IA. FILED 1-27-2003.

MERCATOR

FOR FURNITURE (U.S. CLS. 2, 13, 22, 25, 32 AND 50).

SN 76-485,126. HON TECHNOLOGY INC., MUSCATINE, IA. FILED 1-27-2003.

REPUTATION

FOR FURNITURE (U.S. CLS. 2, 13, 22, 25, 32 AND 50).

SN 76-485,153. FRITZ, WAYNE, OMAHA, NE. FILED 1-27-2003.

KEEP THE CURVE

FOR NON-METAL HAT RACK FOR BASEBALL CAPS (U.S. CLS. 2, 13, 22, 25, 32 AND 50).

FIRST USE 1-20-2003; IN COMMERCE 1-20-2003.

SN 76-486,119. LICARI, YAFFA SHEINA, NEW YORK, NY. FILED 1-30-2003.

SLIM N STRONG

FOR CLOTHING HANGERS (U.S. CLS. 2, 13, 22, 25, 32 AND 50).

CLASS 20—(Continued).

SN 76-487,210. WOLF DESIGNS, INC., MALIBU, CA. FILED 2-3-2003.

DULWICH DESIGNS

OWNER OF U.S. REG. NO. 2,621,186.
NO CLAIM IS MADE TO THE EXCLUSIVE RIGHT TO USE "DESIGNS", APART FROM THE MARK AS SHOWN.
FOR FABRIC, LEATHER AND WOOD JEWELRY BOXES AND UTILITY BOXES (U.S. CLS. 2, 13, 22, 25, 32 AND 50).
FIRST USE 9-11-2002; IN COMMERCE 9-11-2002.

SN 76-487,453. ALL-LUMINUM PRODUCTS, INC., PHILADELPHIA, PA. FILED 1-29-2003.



FOR FOLDING CAMPING EQUIPMENT; NAMELY, FOLDING TABLES, CHAIRS AND STOOLS, HUNTING CHAIRS, FOLDING COTS AND BEDS (U.S. CLS. 2, 13, 22, 25, 32 AND 50).
FIRST USE 6-18-1991; IN COMMERCE 6-18-1991.

SN 76-504,724. DREAMWELL, LTD., LAS VEGAS, NV. FILED 4-4-2003.

BEAUTYREST

OWNER OF U.S. REG. NOS. 207,821, 2,585,251 AND OTHERS.
FOR MATTRESSES AND BOX SPRINGS (U.S. CLS. 2, 13, 22, 25, 32 AND 50).
FIRST USE 6-10-1925; IN COMMERCE 6-10-1925.

SN 76-522,339. MEADWESTVACO CORPORATION, STAMFORD, CT. FILED 6-5-2003.



FOR PICTURE FRAMES (U.S. CLS. 2, 13, 22, 25, 32 AND 50).

CLASS 20—(Continued).

SN 78-034,507. HUNTER PAINE ENTERPRISES, LLC., LA-FAYETTE, CA. FILED 11-9-2000.



NO CLAIM IS MADE TO THE EXCLUSIVE RIGHT TO USE "PALLETS", APART FROM THE MARK AS SHOWN.
THE STIPPLING IS FOR SHADING PURPOSES.
FOR NON-METAL PALLETS (U.S. CLS. 2, 13, 22, 25, 32 AND 50).

SN 78-112,913. CALDER, RODGER, NORTH SALT LAKE, UT. FILED 3-6-2002.

AMPRO

FOR NON-METAL VALVE BOXES, LIDS AND SECURITY LIDS (U.S. CLS. 2, 13, 22, 25, 32 AND 50).
FIRST USE 6-1-1991; IN COMMERCE 8-1-1996.

SN 78-116,674. CLAIRSON, INC., NEWARK, DE. FILED 3-21-2002.

MASTERSUITE

FOR MODULAR STORAGE AND ORGANIZATION PRODUCTS, NAMELY, SHELVES, SHELVING, STORAGE CABINETS, STORAGE RACKS, CLOSET DIVIDERS, DRAWERS, SHOE RACKS, TIE AND BELT RACKS (U.S. CLS. 2, 13, 22, 25, 32 AND 50).

SN 78-126,253. TULEY, GINA, B. FORT MYERS, FL. FILED 5-4-2002.

THE FAKERY

FOR HANDMADE FAKE GOODS AND BEVERAGES INTENDED FOR USE AS THEATRICAL OR MOVIE PROPS AND FOR HOME DECORATING, NAMELY, FAKE CAKES, FAKE ICE CREAM SUNDAES, FAKE COTTON CANDY, FAKE SNOW CONES, FAKE CANDIES, FAKE COOKIES, FAKE PIES, FAKE PASTRIES, FAKE CAVIAR, FAKE WINE, FAKE ORANGE JUICE, FAKE COFFEE AND FAKE HOT COCOA, ALL SUBSTANTIALLY MADE OF PLASTIC (U.S. CLS. 2, 13, 22, 25, 32 AND 50).
FIRST USE 7-2-2001; IN COMMERCE 3-4-2002.

CLASS 20—(Continued).

SN 78-144,151. UNIVERSAL DIGITAL COMMUNICATIONS, INC., MANSFIELD, OH. FILED 7-16-2002.

ILLUMILAMP

FOR PICTURE FRAME, NAMELY, A DECORATIVE TRANSLUCENT PHOTOGRAPHIC DISPLAY FRAME THAT MAY BE USED TO SHOWCASE PERSONAL PHOTOGRAPHS OR POINT OF SALE PRODUCT ADVERTISEMENTS AND PRODUCT DETAILS (U.S. CLS. 2, 13, 22, 25, 32 AND 50).

FIRST USE 4-1-2002; IN COMMERCE 4-1-2002.

SN 78-162,479. ENLEY ENTERPRISES, LLC, ASTORIA, OR. FILED 9-10-2002.

**THE ORIGINAL CHAIR
SAQUE**

NO CLAIM IS MADE TO THE EXCLUSIVE RIGHT TO USE "ORIGINAL CHAIR", APART FROM THE MARK AS SHOWN.

FOR FITTED FABRIC COVERS FOR A MULTIPLE VARIETY OF OFFICE TASK CHAIRS FOR THE PURPOSE OF BEAUTIFYING, ADVERTISING AND/OR EXTENDING THE LIFE OF THE CHAIR (U.S. CLS. 2, 13, 22, 25, 32 AND 50).

FIRST USE 5-1-2001; IN COMMERCE 7-1-2001.

SN 78-190,031. WINDQUEST COMPANIES, INC., HOLLAND, MI. FILED 12-2-2002.

HOMEORG

FOR STORAGE AND ORGANIZATION SYSTEMS COMPRISED OF SHELVES, DRAWERS, CUPBOARDS, AND CLOTHES RODS, SOLD INDIVIDUALLY OR AS A UNIT (U.S. CLS. 2, 13, 22, 25, 32 AND 50).

SN 78-190,032. WINDQUEST COMPANIES, INC., HOLLAND, MI. FILED 12-2-2002.

ORG

FOR STORAGE AND ORGANIZATION SYSTEMS COMPRISED OF SHELVES, DRAWERS, CUPBOARDS, BASKETS AND CLOTHES RODS, SOLD INDIVIDUALLY OR AS A UNIT (U.S. CLS. 2, 13, 22, 25, 32 AND 50).

CLASS 20—(Continued).

SN 78-190,034. WINDQUEST COMPANIES, INC., HOLLAND, MI. FILED 12-2-2002.

CLOSETORG

FOR STORAGE AND ORGANIZATION SYSTEMS COMPRISED OF SHELVES, DRAWERS, CUPBOARDS, AND CLOTHES RODS, SOLD INDIVIDUALLY OR AS A UNIT (U.S. CLS. 2, 13, 22, 25, 32 AND 50).

SN 78-190,038. WINDQUEST COMPANIES, INC., HOLLAND, MI. FILED 12-2-2002.

GARAGEORG

FOR STORAGE AND ORGANIZATION SYSTEMS COMPRISED OF SHELVES, DRAWERS, CUPBOARDS, AND CLOTHES RODS, SOLD INDIVIDUALLY OR AS A UNIT (U.S. CLS. 2, 13, 22, 25, 32 AND 50).

SN 78-193,591. ROSS, BOB, SALT LAKE CITY, UT. FILED 12-11-2002.



NO CLAIM IS MADE TO THE EXCLUSIVE RIGHT TO USE "HAND TURNED SYRACUSE NEW YORK", APART FROM THE MARK AS SHOWN.

THE NAME "JOSEPH G. KREN" DOES NOT IDENTIFY A LIVING INDIVIDUAL.

FOR RACKS FOR STORING AND DISPLAYING BASEBALL BATS (U.S. CLS. 2, 13, 22, 25, 32 AND 50).

SN 78-202,661. ROWLAND, DAVID L., MARION, VA. FILED 1-13-2003.

40/4

FOR FURNITURE FOR SITTING (U.S. CLS. 2, 13, 22, 25, 32 AND 50).

FIRST USE 5-1-1964; IN COMMERCE 5-1-1964.

CLASS 20—(Continued).

SN 78-203,445. JOHNSON OUTDOORS INC., RACINE, WI.
FILED 1-15-2003.

EUREKA!

OWNER OF U.S. REG. NOS. 1,641,312, 2,171,511 AND
OTHERS.

FOR SLEEPING BAGS; SLEEPING MATS AND MATS
FOR CAMPING. (U.S. CLS. 2, 13, 22, 25, 32 AND 50).

SN 78-203,550. DREXEL HERITAGE FURNITURE INDUS-
TRIES, INC., HIGH POINT, NC. FILED 1-15-2003.

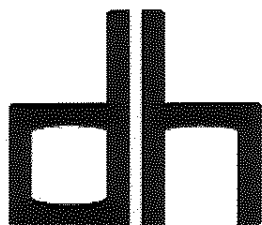

FOR FURNITURE (U.S. CLS. 2, 13, 22, 25, 32 AND 50).

SN 78-204,598. KINGSDOWN, INC., MEBANE, NC. FILED 1-
17-2003.

SLEEP SMART

NO CLAIM IS MADE TO THE EXCLUSIVE RIGHT TO
USE "SLEEP", APART FROM THE MARK AS SHOWN.

FOR MATTRESSES AND BOX SPRINGS (U.S. CLS. 2,
13, 22, 25, 32 AND 50).

SN 78-207,668. BETTER THINGS, LLC, DELRAY BEACH, FL.
FILED 1-27-2003.

MIRACLE MIRROR

NO CLAIM IS MADE TO THE EXCLUSIVE RIGHT TO
USE "MIRROR", APART FROM THE MARK AS SHOWN.

FOR DRESSING MIRROR (U.S. CLS. 2, 13, 22, 25, 32
AND 50).

CLASS 20—(Continued).

SN 78-208,337. VIVIAN OF ST. LOUIS, INC., FENTON, MO.
FILED 1-29-2003.

PLUG & SERVE

FOR MODULAR WORK STATIONS FOR USE IN THE
FOOD-SERVICE INDUSTRY, NAMELY, CONCESSION
STANDS, CONCESSION COUNTERS, DISPLAY COUN-
TERS, DISPLAY CASES, CABINETS, FOOD PREPARA-
TION TABLES AND VENDING BOOTHS (U.S. CLS. 2, 13,
22, 25, 32 AND 50).

SN 78-208,367. LOUISVILLE BEDDING COMPANY, LOUIS-
VILLE, KY. FILED 1-29-2003.

IDEAL COMFORT

FOR PILLOWS (U.S. CLS. 2, 13, 22, 25, 32 AND 50).

SN 78-208,519. NORTHPOLE LIMITED, KOWLOON, HONG
KONG, FILED 1-29-2003.

GUESTS' NEST

FOR AIR MATTRESSES FOR TEMPORARY SLEEP-
ING ACCOMMODATIONS (U.S. CLS. 2, 13, 22, 25, 32
AND 50).

SN 78-208,535. NORTHPOLE LIMITED, KOWLOON, HONG
KONG, FILED 1-29-2003.

PAWZZZ

FOR BEDS FOR PETS (U.S. CLS. 2, 13, 22, 25, 32 AND
50).

SN 78-210,045. DUARTE, DAVID S., BONNERS FERRY, ID.
AND DUARTE, MARIANNE L., BONNERS FERRY, ID.
FILED 2-3-2003.

MISS-L-TOE

FOR HOLIDAY/NOVELTY ORNAMENTS MADE OF
PLASTIC OR WOOD (U.S. CLS. 2, 13, 22, 25, 32 AND 50).

SN 78-215,689. MERILLAT INDUSTRIES, LLC, ADRIAN, MI.
FILED 2-17-2003.

MARIETTA

FOR CABINETRY. (U.S. CLS. 2, 13, 22, 25, 32 AND 50).

CLASS 21—HOUSEWARES AND GLASS

SN 75-893,262. U.S. JESCO INTERNATIONAL, LTD., INC., CARROLLTON, TX. FILED 1-7-2000.



FOR COOKWARE; NAMELY, POTS AND PANS (U.S. CLS. 2, 13, 23, 29, 30, 33, 40 AND 50).
FIRST USE 9-28-1999; IN COMMERCE 9-28-1999.

SN 76-046,959. GURU'S INTERNATIONAL, INC., SALT LAKE CITY, UT. FILED 5-12-2000.

IGNITE THE FIRE WITHIN

FOR DINNERWARE (U.S. CLS. 2, 13, 23, 29, 30, 33, 40 AND 50).

SN 76-286,289. LIGHTHOUSE FOR THE BLIND, INC., THE, SEATTLE, WA. FILED 7-12-2001.

OTM HYDRAPAK

FOR PORTABLE BEVERAGE DISPENSERS AND PORTABLE BEVERAGE DISPENSER KITS (U.S. CLS. 2, 13, 23, 29, 30, 33, 40 AND 50).

SN 76-316,964. PRO LUCRE, INC., RENO, NV. FILED 9-26-2001.

FRUITCASE

FOR REUSABLE CLOTH/FABRIC CARRIERS FOR INDIVIDUAL PIECES OF FRUIT, IN THE FORM OF THE FRUIT (U.S. CLS. 2, 13, 23, 29, 30, 33, 40 AND 50).

SN 76-375,758. COASTAL PET PRODUCTS, INC., ALLIANCE, OH. FILED 2-27-2002.

EVOLUTION

FOR PET COMBS (U.S. CLS. 2, 13, 23, 29, 30, 33, 40 AND 50).
FIRST USE 1-0-2002; IN COMMERCE 1-0-2002.

CLASS 21—(Continued).

SN 76-400,017. STARK, STEVEN, LOS GATOS, CA. FILED 4-25-2002.



NO CLAIM IS MADE TO THE EXCLUSIVE RIGHT TO USE "GRILL", APART FROM THE MARK AS SHOWN.
FOR COOKING UTENSIL, NAMELY, A TILE PLATE THAT FITS INTO AND ON A BARBEQUE; FOR COOKING PIZZA AND FLATBREAD (U.S. CLS. 2, 13, 23, 29, 30, 33, 40 AND 50).

SN 76-404,426. WILTON INDUSTRIES, INC., WOODRIDGE, IL. FILED 5-7-2002.

FOODWRITER

FOR BAKING AND DECORATING SUPPLIES, NAMELY, A DISPENSER FOR ICING OR FOOD COLORING (U.S. CLS. 2, 13, 23, 29, 30, 33, 40 AND 50).
FIRST USE 6-1-2002; IN COMMERCE 6-1-2002.

SN 76-410,323. QDIRECT VENTURES, INC., WEST CHESTER, PA. FILED 5-21-2002.

COOKOLOGY

FOR STAINLESS STEEL NON-STICK COOKWARE, STAINLESS STEEL COOKWARE, ALUMINUM ENAMEL COATED NON-STICK COOKWARE AND ANODIZED ALUMINUM COOKWARE ALL COMPOSED OF POTS, PANS, SAUTE PANS, FRY PANS, STOCK POTS, SAUCE PANS, COLANDERS, NON-ELECTRIC FOOD STEAMERS, STOVE TOP GRILLS AND GRIDDLES, STAINLESS STEEL AND ALUMINUM BAKEWARE; NAMELY, COOKIE SHEETS, CAKE PANS, MUFFIN AND PIE PANS, LOAF PANS, ROAST PANS, PIZZA PANS AND EXPANDABLE CAKE PANS, TEA KETTLES, FRY PANS, INSULATED FOOD CARRIERS, MISTERS, CORK SCREWS, ICE CREAM SCOOPS, GARLIC PRESS, STAINLESS STEEL AND POLURETHANE/PLASTIC KITCHEN UTENSILS NAMELY, SPATULAS, WHISKS, TONGS, LADLES, FOOD DECORATING BAGS, CUTTING BOARDS, DINNERWARE IN GENERAL, GLASS BEVERAGEWARE, COCKTAIL SHAKERS AND ICE BUCKETS (U.S. CLS. 2, 13, 23, 29, 30, 33, 40 AND 50).

CLASS 21—(Continued).

SN 76-430,374. OUTSET, INC., VICTORIA, MN. FILED 7-15-2002.



FOR HOUSEHOLD UTENSILS, NAMELY, SPATULAS, UTENSILS FOR BARBEQUES, NAMELY, TONGS, GRILL BRUSHES, BASTING BRUSHES, NON-ELECTRIC GRILL WOKS, GRILL GRIDS, GRILL BASKETS, GRILL FISH BASKETS, KABOB RACKS, KABOB SKEWERS, CORN COB HOLDERS, BEAN POTS, GRILL CLEANERS, NAMELY, GRILL CLEANING BRUSHES, GRILL COVERS, FLY SWATTERS (U.S. CLS. 2, 13, 23, 29, 30, 33, 40 AND 50).

SN 76-432,247. LOS ANGELES CENTER OF COMMERCE, INC., DBA LACC, VERNON, CA. FILED 1-11-2002.

CLEAN-LITE

FOR KITCHEN, BATHROOM AND HOUSEHOLD ARTICLES MADE OF PLASTIC, NAMELY, DISHES, CUPS, TISSUE DISPENSERS, SHOWER CADDIES, SALT AND PEPPER SHAKERS, BROOMS, MOUNTING CLIPS, SOAP DISHES, CONTAINERS FOR FOOD OR BEVERAGES (U.S. CLS. 2, 13, 23, 29, 30, 33, 40 AND 50).
FIRST USE 9-19-2001; IN COMMERCE 9-19-2001.

SN 76-437,804. CANWORKS, LOS ANGELES, CA. FILED 8-5-2002.

SOFTEYE

OWNER OF U.S. REG. NO. 2,539,802.
FOR TRASH CANS, CLEANING CLOTHS FOR CLEANING TRASH CANS, CHARCOAL PADS FOR ABSORBING ODORS; FOOD CANISTERS, MUGS, THERMOS AND NON-ELECTRIC COFFEE MAKERS (U.S. CLS. 2, 13, 23, 29, 30, 33, 40 AND 50).

SN 76-438,532. METRO/THEBE, INC., RANCHO DOMINGUEZ, CA. FILED 8-5-2002.

KING'S HARVEST

FOR COOKWARE AND ACCESSORIES, NAMELY, PANS, POTS, ROASTING PANS, TEA KETTLES, LASAGNA PANS, CHICKEN FRYER PANS, BUFFET SERVING PANS, COLANDERS AND MIXING BOWLS (U.S. CLS. 2, 13, 23, 29, 30, 33, 40 AND 50).

CLASS 21—(Continued).

SN 76-442,134. WKI HOLDING COMPANY, INC., ELMIRA, NY. FILED 8-16-2002.

CORELLE COORDINATES

NO CLAIM IS MADE TO THE EXCLUSIVE RIGHT TO USE "COORDINATES", APART FROM THE MARK AS SHOWN.

FOR BAKING DISHES, CASSEROLE DISHES, AND SERVING DISHES (U.S. CLS. 2, 13, 23, 29, 30, 33, 40 AND 50).

SN 76-455,612. DJR HOLDINGS, LLC, NEW YORK, NY. FILED 10-1-2002.

DEF JAM WRESTLING

OWNER OF U.S. REG. NOS. 1,790,206, 2,361,626 AND OTHERS.

FOR ALL PURPOSE PORTABLE HOUSEHOLD CONTAINERS; BATH ACCESSORIES, NAMELY, CUP HOLDERS, SOAP BOXES AND HOLDERS, AND TOOTHBRUSH HOLDERS; BOWLS, CEREAL BOWLS, SALAD BOWLS, AND RINSING BOWLS; BOWLS MADE OF EARTHENWARE, GLASS, PORCELAIN, AND PLASTIC; BOTTLES SOLD EMPTY; CAKE MOLDS; BARWARE, NAMELY, HIGH BALL GLASSES, SHOT GLASSES, COCKTAIL SHAKERS, CORK SCREWS, CORK HOLDERS, BOTTLE OPENERS, BEVERAGWARE, NAMELY, TUMBLERS, WINE GOBLETS, CARAFES, DECANTERS, COOLERS FOR WINE, STANDS FOR COOLERS FOR WINE, BEER JUGS; BEVERAGE STIRRERS; BEVERAGWARE MADE OF EARTHENWARE, GLASS, PORCELAIN, AND PLASTIC; BOTTLE SQUEEGEES; BOTTLE STANDS; BUCKETS, CHAMPAGNE BUCKETS, COOLING BUCKETS FOR WINE, ICE BUCKETS, PLASTIC AND WINE BUCKETS; CAKE PANS; CANDY MOLDS; CANDLE HOLDERS NOT OF PRECIOUS METAL; CANDLE SNUFFERS; CANDLESTICKS NOT OF PRECIOUS METAL; CANISTER SETS; CANTEENS; CHILDREN'S DINNERWARE; COASTERS; COMMEMORATIVE PLATES; CONTAINERS FOR FOOD; CONTAINERS FOR HOUSEHOLD OR KITCHEN USE; COOKIE CUTTERS AND STAMPERS; COOKIE JARS; DECORATIVE BASKETS MADE OF STRAW, CLOTH, WICKER, AND WOOD; NONMETAL DECORATIVE BOXES; DECORATIVE PLATES; DINNERWARE; KITCHENWARE, NAMELY, POTS, PANS, CASSEROLE, TEA KETTLES, MIXING BOWLS, SAUCE PANS, DUTCH OVENS, STOCK POTS AND FRY PANS; CANISTER SETS, COOKIE JARS, TOWEL HOLDERS, NAPKIN HOLDERS, TRIVET SPOON RESTS, FLOWER POTS, SALT AND PEPPER SHAKERS, PITCHERS AND WOODEN SERVING SPOONS; GARLIC PRESSES, SCOOPS, SCRUBBING BRUSHES, MIXING SPOONS, SERVING SPOONS, WINE BUCKETS, PITCHERS, CAKE MOLDS, CHOCOLATE MOLDS, COLANDERS, SERVING TONGS, DEWAR BOTTLES AND VESSELS; DISHES, BAKING DISHES, BUTTER DISHES, SERVING DISHES, AND DISH COVERS; DISPENSERS FOR HAIR BRUSHES AND COMBS DRINKING GLASSES; DRINKING CUPS, COFFEE CUPS, ESPRESSO CUPS, PAPER CUPS, PLASTIC CUPS, AND EGG CUPS; DRINK HOLDERS FOR VEHICLES; DRINKING FLASKS; DRINKING STEINS; DRINKING VESSELS AND HEAT-INSULATED VESSELS; ELECTRIC TOOTHBRUSHES; FIGURINES MADE OF CHINA, CRYSTAL, EARTHENWARE, GLASS, PORCELAIN, AND TERRA COTTA; FOAM DRINK HOLDERS; FITTED PICNIC BASKETS; FLASKS, DRINKING FLASKS, INSULATED FLASKS, AND VACUUM FLASKS; FLOWER AND PLANT BASKETS; FLOWER BOWLS; FLOWER POTS; GLASS STORAGE JARS AND INSULATED JARS; GOBLETS; HAIR BRUSHES AND COMBS; ICE CUBE MOLDS; THERMAL INSULATED CONTAINERS FOR FOOD OR BEVERAGES; INSULATING SLEEVE HOLDERS FOR BEVERAGE CANS; JARS SOLD EMPTY; LAP TRAYS;

CLASS 21—(Continued).

LUNCH BOXES; LUNCH PAILS AND INSULATED LUNCH BAGS; MUGS, BEER MUGS, COFFEE MUGS, EARTHENWARE MUGS, GLASS MUGS, PLASTIC MUGS, PORCELAIN MUGS, AND SOUP MUGS; NAPKIN HOLDERS; NAPKIN RINGS NOT OF PRECIOUS METAL; NON-ELECTRIC TOOTHBRUSHES; NON-METAL COIN BANKS; NON-METAL JARS FOR JAMS AND JELLIES MADE OF EARTHENWARE, GLASS, PORCELAIN, AND PLASTIC; NON-METAL PIGGY BANKS; PAPER BOWLS; PAPER PLATES; PET FEEDING DISHES; PLASTIC LUNCH BOXES; PLASTIC DRINKING CUPS FOR INFANTS; PLASTIC PLATES; PORCELAIN STATUETTES; PORTABLE BEVERAGE COOLERS; PORTABLE BEVERAGE DISPENSERS; PORTABLE ICE CHESTS FOR FOOD AND BEVERAGES; SALT AND PEPPER SHAKERS; SAUCERS AND CUP AND SAUCER SETS; SELTZER BOTTLES; SERVIETTE HOLDERS; SERVING PLATTERS; SERVING TRAYS NOT OF PRECIOUS METALS; SOAP DISPENSERS; SOUVENIR PLATES; SPORTS BOTTLES SOLD EMPTY; SQUEEZE BOTTLES SOLD EMPTY; STENCILS FOR APPLYING MAKEUP; TABLE PLACE CARD HOLDERS; THERMAL INSULATED CONTAINERS FOR FOOD AND BEVERAGES; THERMAL INSULATED TOTE BAGS FOR FOOD AND BEVERAGES; THERMAL INSULATED WRAP CANS TO KEEP THE CONTENTS HOT OR COLD; TOOTHBRUSH HOLDERS; TOOTHPICK HOLDERS; TRIVETS; UTENSILS FOR BARBEQUES, NAMELY, FORKS, TONGS, TURNERS, AND DISHES; VACUUM BOTTLES AND SELTZER BOTTLES; VASES; WASTEPAPER BASKETS; WINE BOTTLE CRADLES; WOODEN BASKETS (U.S. CLS. 2, 13, 23, 29, 30, 33, 40 AND 50).

SN 76-455,637. DJR HOLDINGS, LLC, NEW YORK, NY. FILED 10-1-2002.

DEF JAM VENDETTA

OWNER OF U.S. REG. NOS. 1,790,206, 2,361,626 AND OTHERS.

FOR ALL PURPOSE PORTABLE HOUSEHOLD CONTAINERS; BATH ACCESSORIES, NAMELY, CUP HOLDERS, SOAP BOXES AND HOLDERS, AND TOOTHBRUSH HOLDERS; BOWLS, CEREAL BOWLS, SALAD BOWLS, AND RINSING BOWLS; BOWLS MADE OF EARTHENWARE, GLASS, PORCELAIN, AND PLASTIC; BOTTLES SOLD EMPTY; CAKE MOLDS; BARWARE, NAMELY, HIGH BALL GLASSES, SHOT GLASSES, COCKTAIL SHAKERS, CORK SCREWS, CORK HOLDERS, BOTTLE OPENERS, BEVERAGEWARE, NAMELY, TUMBLERS, WINE GOBLETS, CARAFES, DECANTERS, COOLERS FOR WINE, STANDS FOR COOLERS FOR WINE, BEER JUGS; BEVERAGE STIRRERS; BEVERAGEWARE MADE OF EARTHENWARE, GLASS, PORCELAIN, AND PLASTIC; BOTTLE SQUEEGEES; BOTTLE STANDS; BUCKETS, CHAMPAGNE BUCKETS, COOLING BUCKETS FOR WINE, ICE BUCKETS, PLASTIC AND WINE BUCKETS; CAKE PANS; CANDY MOLDS; CANDLE HOLDERS NOT OF PRECIOUS METAL; CANDLE SNUFFERS; CANDLESTICKS NOT OF PRECIOUS METAL; CANISTER SETS; CANTEENS; CHILDREN'S DINNERWARE; COASTERS; COMMEMORATIVE PLATES; CONTAINERS FOR FOOD; CONTAINERS FOR HOUSEHOLD OR KITCHEN USE; COOKIE CUTTERS AND STAMPERS; COOKIE JARS; DECORATIVE BASKETS MADE OF STRAW, CLOTH, WICKER, AND WOOD; NONMETAL DECORATIVE BOXES; DECORATIVE PLATES; DINNERWARE; KITCHENWARE, NAMELY, POTS, PANS, CASSEROLES, TEA KETTLES, MIXING BOWLS, SAUCE PANS, DUTCH OVENS, STOCK POTS AND FRY PANS; CANISTER SETS, COOKIE JARS, TOWEL HOLDERS, NAPKIN HOLDERS, TRIVET SPOON RESTS, FLOWER POTS, SALT AND PEPPER SHAKERS, PITCHERS AND WOODEN SERVING SPOONS; GARLIC PRESSES, SCOOPS, SCRUBBING BRUSHES, MIXING SPOONS, SERVING SPOONS, WINE BUCKETS, PITCHERS, CAKE MOLDS, CHOCOLATE MOLDS, COLANDERS, SERVING TONGS; DEWAR BOTTLES AND VESSELS; DISHES, BAKING DISHES, BUTTER DISHES, SERVING DISHES, AND

CLASS 21—(Continued).

DISH COVERS; DISPENSERS FOR HAIR BRUSHES AND COMBS DRINKING GLASSES; DRINKING CUPS, COFFEE CUPS, ESPRESSO CUPS, PAPER CUPS, PLASTIC CUPS, AND EGG CUPS; DRINK HOLDERS FOR VEHICLES; DRINKING FLASKS; DRINKING STEINS; DRINKING VESSELS AND HEAT-INSULATED VESSELS; ELECTRIC TOOTHBRUSHES; FIGURINES MADE OF CHINA, CRYSTAL, EARTHENWARE, GLASS, PORCELAIN, AND TERRA COTTA; FOAM DRINK HOLDERS; FITTED PICNIC BASKETS; FLASKS, DRINKING FLASKS, INSULATED FLASKS, AND VACUUM FLASKS; FLOWER AND PLANT BASKETS; FLOWER BOWLS; FLOWER POTS; GLASS STORAGE JARS AND INSULATED JARS; GOBLETS; HAIR BRUSHES AND COMBS; ICE CUBE MOLDS; THERMAL INSULATED CONTAINERS FOR FOOD OR BEVERAGES; INSULATING SLEEVE HOLDERS FOR BEVERAGE CANS; JARS SOLD EMPTY; LAP TRAYS; LUNCH BOXES; LUNCH PAILS AND INSULATED LUNCH BAGS; MUGS, BEER MUGS, COFFEE MUGS, EARTHENWARE MUGS, GLASS MUGS, PLASTIC MUGS, PORCELAIN MUGS, AND SOUP MUGS; NAPKIN HOLDERS; NAPKIN RINGS NOT OF PRECIOUS METAL; NON-ELECTRIC TOOTHBRUSHES; NON-METAL COIN BANKS; NON-METAL JARS FOR JAMS AND JELLIES MADE OF EARTHENWARE, GLASS, PORCELAIN, AND PLASTIC; NON-METAL PIGGY BANKS; PAPER BOWLS; PAPER PLATES; PET FEEDING DISHES; PLASTIC LUNCH BOXES; PLASTIC DRINKING CUPS FOR INFANTS; PLASTIC PLATES; PORCELAIN STATUETTES; PORTABLE BEVERAGE COOLERS; PORTABLE BEVERAGE DISPENSERS; PORTABLE ICE CHESTS FOR FOOD AND BEVERAGES; SALT AND PEPPER SHAKERS; SAUCERS AND CUP AND SAUCER SETS; SELTZER BOTTLES; SERVIETTE HOLDERS; SERVING PLATTERS; SERVING TRAYS NOT OF PRECIOUS METALS; SOAP DISPENSERS; SOUVENIR PLATES; SPORTS BOTTLES SOLD EMPTY; SQUEEZE BOTTLES SOLD EMPTY; STENCILS FOR APPLYING MAKEUP; TABLE PLACE CARD HOLDERS; THERMAL INSULATED CONTAINERS FOR FOOD AND BEVERAGES; THERMAL INSULATED TOTE BAGS FOR FOOD AND BEVERAGES; THERMAL INSULATED WRAP CANS TO KEEP THE CONTENTS HOT OR COLD; TOOTHBRUSH HOLDERS; TOOTHPICK HOLDERS; TRIVETS; UTENSILS FOR BARBEQUES, NAMELY, FORKS, TONGS, TURNERS AND DISHES; VACUUM BOTTLES AND SELTZER BOTTLES; VASES; WASTEPAPER BASKETS; WINE BOTTLE CRADLES; WOODEN BASKETS (U.S. CLS. 2, 13, 23, 29, 30, 33, 40 AND 50).

SN 76-458,171. WKI HOLDING COMPANY, INC., RESTON, VA. FILED 10-15-2002.

SUMMER CITRUS

FOR DINNERWARE (U.S. CLS. 2, 13, 23, 29, 30, 33, 40 AND 50).

CLASS 21—(Continued).

SN 76-472,655. HANA COBI CO., LTD., NAMDONG-KU, INCHEON, REPUBLIC OF KOREA, FILED 12-6-2002.



**LOCK &
LOCK**
REVOLVING

NO CLAIM IS MADE TO THE EXCLUSIVE RIGHT TO USE "LOCK", APART FROM THE MARK AS SHOWN.

FOR HOUSEHOLD UTENSILS NOT OF PRECIOUS METAL, NAMELY, SOAP BOXES, TRASH CANS, COOKING POTS AND FRYING PANS, BOWLS, DISHES, PLATES, PLASTIC CUPS, CRUETS, KITCHEN LADLES, NON-ELECTRIC KITCHEN CONTAINERS, SERVING TRAYS, BUCKETS, ICE BUCKETS, BASINS, DRINKING VESSELS, THERMAL INSULATED BOTTLES FOR BEVERAGES AND FOOD, PICNIC CONTAINERS FOR FOODS AND HOUSEHOLD USE (U.S. CLS. 2, 13, 23, 29, 30, 33, 40 AND 50).

SN 76-475,936. NATIONAL RAILROAD PASSENGER CORPORATION, WASHINGTON, DC. FILED 12-17-2002.

ACELA

OWNER OF U.S. REG. NOS. 2,033,491, 2,523,279 AND OTHERS.

FOR PORTABLE BEVERAGE COOLERS; PLASTIC WATER BOTTLES SOLD EMPTY; MUGS; COFFEE MUGS; COFFEE TUMBLERS; COOKIE JARS; PICNIC SETS COMPRISED OF A PICNIC BASKET, PLATES, PLASTIC WARE IN THE NATURE OF EATING UTENSILS, MUGS, WITH NAPKINS AND BLANKETS ALL SOLD TOGETHER IN A WICKER PICNIC BASKET; BEVERAGE GLASSWARE, NAMELY, HIGHBALLS, WINE GLASSES, AND CARAFES; UTENSILS FOR BARBECUE, NAMELY, FORKS, TONGS, TURNERS, AND SPATULAS (U.S. CLS. 2, 13, 23, 29, 30, 33, 40 AND 50).

FIRST USE 11-0-2001; IN COMMERCE 11-0-2001.

SN 76-479,374. CRESCENT TRADING GROUP, LLC, MIAMI, FL. FILED 12-30-2002.

CRESCENT

FOR PLASTIC CONTAINERS FOR GARDEN USE (U.S. CLS. 2, 13, 23, 29, 30, 33, 40 AND 50).

FIRST USE 9-1-1999; IN COMMERCE 1-22-2000.

CLASS 21—(Continued).

SN 76-484,654. HARDWOOD PRODUCTS COMPANY LLC, GUILFORD, ME. FILED 1-27-2003.



trophy

FOR WOODEN COOKING SKEWERS (U.S. CLS. 2, 13, 23, 29, 30, 33, 40 AND 50).
FIRST USE 0-0-1939; IN COMMERCE 0-0-1939.

SN 76-485,119. PACIFIC MARKET, INC., SEATTLE, WA. FILED 1-24-2003.

HEATKEEPER

FOR HOUSEWARES AND GLASS, NAMELY, THERMAL INSULATED, MICROWAVE-ACTIVATED FOOD CONTAINERS (U.S. CLS. 2, 13, 23, 29, 30, 33, 40 AND 50).
FIRST USE 12-0-2000; IN COMMERCE 12-0-2000.

SN 76-485,598. CANNERY CASINO RESORTS, LLC, LAS VEGAS, NV. FILED 1-28-2003.



Cannery

THE STIPLING IN THE DRAWING IS FOR SHADING PURPOSES ONLY AND DOES NOT INDICATE COLOR.

FOR BEVERAGE GLASSWARE: COFFEE CUPS; MUGS (U.S. CLS. 2, 13, 23, 29, 30, 33, 40 AND 50).

FIRST USE 1-3-2003; IN COMMERCE 1-3-2003.

SN 76-486,090. SYRACUSE CHINA COMPANY, TOLEDO, OH. FILED 1-27-2003.

REPETITION

FOR CHINA DINNERWARE (U.S. CLS. 2, 13, 23, 29, 30, 33, 40 AND 50).

CLASS 21—(Continued).

SN 76-486,770. SIEGEL, SHERRY, SANTA FE, NM. FILED 2-3-2003.

GUITAR CHOPS

FOR FOOD CUTTING AND CARVING BOARDS (U.S. CLS. 2, 13, 23, 29, 30, 33, 40 AND 50).
FIRST USE 12-11-2002; IN COMMERCE 12-11-2002.

SN 76-487,665. DAPPEN, DUANE D., ST. HELENA, CA. FILED 2-4-2003.

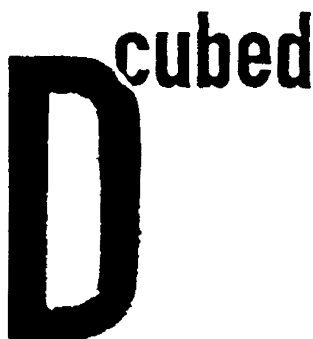

FOR CORKSCREWS (U.S. CLS. 2, 13, 23, 29, 30, 33, 40 AND 50).

SN 78-124,905. C & K MANUFACTURING AND SALES COMPANY, L.L.C., WESTLAKE, OH. FILED 4-29-2002.

C-KURE

OWNER OF U.S. REG. NOS. 2,394,024, 2,411,385 AND 2,480,531.

FOR PAILS, DISPOSABLE PLASTIC GLOVES FOR GENERAL USE (U.S. CLS. 2, 13, 23, 29, 30, 33, 40 AND 50).

SN 78-139,768. ANGELETTA, JOSEPH G., MAMARONECK, NY. FILED 6-28-2002.

BATH BASTER

OWNER OF U.S. REG. NOS. 1,546,470 AND 1,902,828.
NO CLAIM IS MADE TO THE EXCLUSIVE RIGHT TO USE "BATH", APART FROM THE MARK AS SHOWN.

FOR APPLICATORS AND DISPENSERS FOR APPLYING SOAP, LOTION, LIQUID SOAP, LIQUID LOTION, CREAM, BATH AND BODY OIL, OIL, GEL, SUNSCREEN, SUNTAN OIL, SUNBLOCK, SUNSCREEN PREPARATIONS, SUNSCREEN PRODUCTS, SUNTANNING PREPARATIONS (U.S. CLS. 2, 13, 23, 29, 30, 33, 40 AND 50).

CLASS 21—(Continued).

SN 78-139,775. ANGELETTA, JOSEPH G., MAMARONECK, NY. FILED 6-28-2002.

BEACH BASTER

OWNER OF U.S. REG. NOS. 1,546,470 AND 1,902,828.
FOR APPLICATORS AND DISPENSERS FOR APPLYING LIQUID LOTION, BATH AND BODY OIL, OIL, SUNSCREEN, SUNTAN OIL, SUNBLOCK, SUNSCREEN PREPARATIONS, SUNSCREEN PRODUCTS, SUNTANNING PREPARATIONS (U.S. CLS. 2, 13, 23, 29, 30, 33, 40 AND 50).

FIRST USE 4-15-1994; IN COMMERCE 4-15-1994.

SN 78-148,517. MOTTAHEDEH & COMPANY, INC., CRANBURY, NJ. FILED 7-29-2002.

IMARI LEAF

FOR POTTERY, NAMELY PORCELAIN JARS, CACHE POTS, VASES, TRAYS, CANDLESTICKS, GINGER JARS, TUREENS AND BOWLS; GLASS BEVERAGE WARE; NON-METAL DECORATIVE BOXES; CANDLESTICKS NOT OF PRECIOUS METAL; DINNERWARE, NAMELY, PLATES, CUPS, SAUCERS AND BOWLS; DECORATIVE PLATES, BOWLS AND PLATTERS; SOUP TUREENS; SERVING PLATTERS; SERVIETTE RINGS NOT OF PRECIOUS METAL; EARTHENWARE FIGURINES; STONWARE, NAMELY, CASSEROLE DISHES, CACHE POTS AND NAPKIN RINGS. (U.S. CLS. 2, 13, 23, 29, 30, 33, 40 AND 50).

SN 78-187,810. FORT JAMES OPERATING COMPANY, ATLANTA, GA. FILED 11-22-2002.

**MADE TOUGH TO MAKE
LIFE EASIER**

FOR DISPOSABLE PAPER PLATES AND BOWLS. (U.S. CLS. 2, 13, 23, 29, 30, 33, 40 AND 50).

CLASS 21—(Continued).

SN 78-190,898. EWING, JEFF, LOGAN, UT. FILED 12-3-2002.

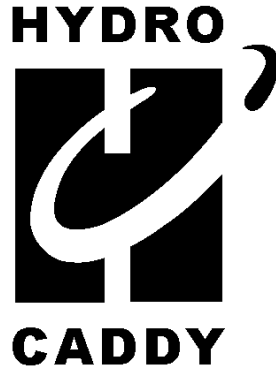

FOR HYDRATION UNIT COMPRISED PRIMARILY OF A PLASTIC WATER BOTTLE SOLD EMPTY AND ALSO CONTAINING TOWELS AND A HOSE, SOLD AS A UNIT FOR ATTACHMENT TO GOLF BAGS, TO ALLOW PLAYERS TO DRINK OR CLEAN THEIR EQUIPMENT (U.S. CLS. 2, 13, 23, 29, 30, 33, 40 AND 50).

SN 78-199,066. MAVERICK VENTURES INC., CHESTERFIELD, MO. FILED 12-31-2002.

COMB-A-COLOR

FOR HAIR COLORING APPLICATOR COMBS (U.S. CLS. 2, 13, 23, 29, 30, 33, 40 AND 50).

SN 78-199,362. CAPITOL INSULATED PRODUCTS, INC., AUBURN, AL. FILED 1-2-2003.

EASY TRAVELER

NO CLAIM IS MADE TO THE EXCLUSIVE RIGHT TO USE "TRAVELER", APART FROM THE MARK AS SHOWN. FOR INSULATED CUPS. (U.S. CLS. 2, 13, 23, 29, 30, 33, 40 AND 50).

SN 78-199,363. CAPITOL INSULATED PRODUCTS, INC., AUBURN, AL. FILED 1-2-2003.

EZ TRAVELER

NO CLAIM IS MADE TO THE EXCLUSIVE RIGHT TO USE "TRAVELER", APART FROM THE MARK AS SHOWN. FOR INSULATED CUPS (U.S. CLS. 2, 13, 23, 29, 30, 33, 40 AND 50).

CLASS 21—(Continued).

SN 78-200,589. MONEY SAVVY GENERATION, LLC, LAKE FOREST, IL. FILED 1-7-2003.

MONEY SAVVY PIG

NO CLAIM IS MADE TO THE EXCLUSIVE RIGHT TO USE "MONEY" AND "PIG", APART FROM THE MARK AS SHOWN.

FOR NON-METAL PIGGY BANKS (U.S. CLS. 2, 13, 23, 29, 30, 33, 40 AND 50).
FIRST USE 5-1-2001; IN COMMERCE 5-1-2001.

SN 78-200,791. RIDGEFIELD PRODUCTS, INC., NAPERVILLE, IL. FILED 1-7-2003.

PLANT BUTLER

NO CLAIM IS MADE TO THE EXCLUSIVE RIGHT TO USE "PLANT", APART FROM THE MARK AS SHOWN.

FOR TRAY FOR HOLDING PLANTS (U.S. CLS. 2, 13, 23, 29, 30, 33, 40 AND 50).

SN 78-202,691. FORT JAMES OPERATING COMPANY, ATLANTA, GA. FILED 1-13-2003.

PERFECTOUCH

OWNER OF U.S. REG. NOS. 2,120,617 AND 2,196,601.
FOR CONTAINERS FOR FOOD OR BEVERAGE (U.S. CLS. 2, 13, 23, 29, 30, 33, 40 AND 50).

SN 78-203,830. FORT JAMES OPERATING COMPANY, ATLANTA, GA. FILED 1-16-2003.

PAW MATES

FOR PET FOOD STORAGE CONTAINERS FOR FOOD OR BEVERAGE (U.S. CLS. 2, 13, 23, 29, 30, 33, 40 AND 50).

SN 78-206,835. KATTKREATIONS, LLC, LITTLETON, CO. FILED 1-24-2003.

KITTYKOTTAGE

FOR COVERED CAT LITTER BOX (U.S. CLS. 2, 13, 23, 29, 30, 33, 40 AND 50).

CLASS 21—(Continued).

SN 78-208,527. POLAR DESIGN, INC., BOISE, ID. FILED 1-29-2003.

GURU GEAR

NO CLAIM IS MADE TO THE EXCLUSIVE RIGHT TO USE "GEAR", APART FROM THE MARK AS SHOWN.

FOR THERMAL INSULATED CONTAINERS FOR BEVERAGES. (U.S. CLS. 2, 13, 23, 29, 30, 33, 40 AND 50).

SN 78-215,645. MILLIKEN & COMPANY, NEW YORK, NY. FILED 2-17-2003.

FLEXSPUN

FOR FABRIC CLEAN ROOM WIPES (U.S. CLS. 2, 13, 23, 29, 30, 33, 40 AND 50).

SN 78-215,664. MILLIKEN & COMPANY, NEW YORK, NY. FILED 2-17-2003.

PREMIRA

OWNER OF U.S. REG. NO. 1,560,994.
FOR FABRIC CLEAN ROOM WIPES (U.S. CLS. 2, 13, 23, 29, 30, 33, 40 AND 50).

CLASS 22—CORDAGE AND FIBERS

SN 76-429,243. ZENTCO PRODUCTS, LTD., GRAND JUNCTION, CO. FILED 7-10-2002.



NO CLAIM IS MADE TO THE EXCLUSIVE RIGHT TO USE "SEAT", APART FROM THE MARK AS SHOWN.

FOR SLING MADE OF WEBBING USED TO WRAP AROUND A TREE OR ROCK, WHICH THEN SUPPORTS SOMEONE'S WEIGHT AS THEY ASSUME A SITTING POSTURE PRIOR TO URINATING OR DEFEACATING IN THE OUT-OF-DOORS (U.S. CLS. 1, 2, 7, 19, 22, 42 AND 50).

CLASS 22—(Continued).

SN 78-184,158. THOMAS & BETTS INTERNATIONAL, INC., SPARKS, NV. FILED 11-12-2002.

SKI-TY

FOR FASTENERS, NAMELY, NON-METAL LOOP-TYPE STRAPS FOR SECURING SEPARATE ITEMS TOGETHER WHETHER TO EACH OTHER OR IN BUNDLES (U.S. CLS. 1, 2, 7, 19, 22, 42 AND 50).

SN 78-213,912. MILKIE, MARY, PHOENIX, AZ. FILED 2-12-2003.

HANG ONTO YOUR STUFF

FOR GADGET AND ITEM HOLDING LANYARDS (U.S. CLS. 1, 2, 7, 19, 22, 42 AND 50).

CLASS 24—FABRICS

SN 76-294,977. ALHAMBRA INTERNACIONAL, S.A., 03114 ALICANTE, SPAIN, FILED 8-3-2001.



Alhambra Internacional

OWNER OF SPAIN REG. NO. 2124842, DATED 3-17-1997, EXPIRES 11-10-2007.

NO CLAIM IS MADE TO THE EXCLUSIVE RIGHT TO USE "INTERNACIONAL", APART FROM THE MARK AS SHOWN.

THE ENGLISH TRANSLATION OF THE SPANISH WORD "INTERNACIONAL" IN THE MARK IS "INTERNATIONAL".

FOR DECORATIVE FABRICS AND TEXTILES FOR THE UPHOLSTERY OF CHAIRS, ARMCHAIRS, SOFAS AND SETTEES; WIDOW CURTAINS; LACE CURTAINS; AND COVERS FOR CUSHIONS (U.S. CLS. 42 AND 50).

SN 76-366,623. SPRINGS LICENSING GROUP, INC., FORT MILL, SC. FILED 2-4-2002.

**WAMSUTTA
QUILTENSEMBLES**

OWNER OF U.S. REG. NOS. 1,233,623, 2,474,109 AND OTHERS.

NO CLAIM IS MADE TO THE EXCLUSIVE RIGHT TO USE "QUILT ENSEMBLES", APART FROM THE MARK AS SHOWN.

FOR SHEETS, PILLOWCASES, PILLOW SHAMS, COMFORTERS, QUILTS, DUST RUFFLES, BEDSPREADS, BLANKETS, WINDOW CURTAINS (U.S. CLS. 42 AND 50).

CLASS 24—(Continued).

SN 76-417,385. TY INC., WESTMONT, IL. FILED 6-4-2002.

TYHAIR

FOR SYNTHETIC FABRIC FOR TEXTILE USE, NAMELY, POLYESTER FABRIC (U.S. CLS. 42 AND 50). FIRST USE 10-3-2001; IN COMMERCE 10-3-2001.

SN 76-437,093. LUNG SHING FIBER CO., LTD., TAIPEI HSIEN, TAIWAN, FILED 8-2-2002.

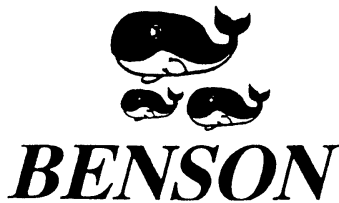

FOR COTTON, SILK, POLYESTER, WOOL, NYLON, RAYON, AND VELVET FABRIC, TEXTILE NAPKINS, TABLE LINEN, TABLE CLOTHS NOT OF PAPER, TOWELS, MOSQUITO NETS, UNFITTED FABRIC FURNITURE COVERS, HANDKERCHIEFS, TEXTILE WALL HANGINGS, FITTED TOILET LID COVERS, COVERS, BLANKETS, COMFORTERS, AND QUILTS; BEDDING AND BED CLOTHES, NAMELY BED LINEN, BED PADS, BED SHEETS, BED BLANKETS, BED SPREADS, MATTRESS COVERS, PILLOW CASES AND PILLOW SHAMS (U.S. CLS. 42 AND 50). FIRST USE 11-1-2000; IN COMMERCE 11-1-2000.

SN 76-462,043. FIELDCREST CANNON LICENSING, INC., KANNAPOLIS, NC. FILED 10-25-2002.

THE CANNON FIT

NO CLAIM IS MADE TO THE EXCLUSIVE RIGHT TO USE "FIT", APART FROM THE MARK AS SHOWN. FOR BEDSHEETS (U.S. CLS. 42 AND 50).

SN 76-474,593. LAMBS & IVY, INC., LOS ANGELES, CA. FILED 12-6-2002.

BATH TO GO

NO CLAIM IS MADE TO THE EXCLUSIVE RIGHT TO USE "BATH", APART FROM THE MARK AS SHOWN.

FOR BATH GIFT SETS FOR INFANTS AND CHILDREN SOLD AS A UNIT, NAMELY, HOODED TOWELS, WASH CLOTHS, WASH MITTS AND BATH TOYS; HOODED TOWELS, WASH CLOTHS AND WASH MITTS (U.S. CLS. 42 AND 50). FIRST USE 12-0-2000; IN COMMERCE 12-0-2000.

CLASS 24—(Continued).

SN 76-480,388. BAILEY, LISA MARGARET, FREMONT, CA. FILED 1-6-2003.

KlassicPferd 

THE ENGLISH TRANSLATION OF "KLASSIC PFERD" IS "CLASSIC HORSE".

FOR QUILTED BED SPREADS, QUILTED BLANKETS, PILLOW CASES, PILLOW SHAMS, BED SHEETS, BED SKIRTS, DECORATIVE THROW PILLOWS, TABLE CLOTHS MADE OF CLOTH OR TEXTILE, TABLE RUNNERS MADE OF CLOTH OR TEXTILE, TABLE PLACEMATS MADE OF CLOTH OR TEXTILE, NAPKINS MADE OF CLOTH OR TEXTILE, KITCHEN TOWELS, BATH TOWELS, WINDOW CURTAINS (U.S. CLS. 42 AND 50). FIRST USE 3-30-2000; IN COMMERCE 4-14-2000.

SN 76-487,324. SAFETY COMPONENTS FABRIC TECHNOLOGIES, INC., GREENVILLE, SC. FILED 1-31-2003.

ULTRAPERM

FOR AIR BAG FABRIC (U.S. CLS. 42 AND 50).

SN 78-145,030. ANDREW LEEDS AND CHERYL PORCARO PARTNERSHIP, THE, CALABASAS, CA. FILED 7-17-2002.

TRAVEL SOFTY

NO CLAIM IS MADE TO THE EXCLUSIVE RIGHT TO USE "TRAVEL", APART FROM THE MARK AS SHOWN.

FOR INFANT AND CHILD SATIN COMFORT BLANKET (U.S. CLS. 42 AND 50).

FIRST USE 7-15-2002; IN COMMERCE 7-15-2002.

SN 78-178,875. BERNE FURNITURE CO., INC., BERNE, IN. FILED 10-28-2002.

ST. JAMES COLLECTION

OWNER OF U.S. REG. NOS. 1,550,184 AND 1,553,760. NO CLAIM IS MADE TO THE EXCLUSIVE RIGHT TO USE "COLLECTION", APART FROM THE MARK AS SHOWN.

FOR FABRICS FOR CURTAINS, UPHOLSTERY AND GENERAL DECORATING USE (U.S. CLS. 42 AND 50).

CLASS 24—(Continued).

SN 78-201,950. BI PROPERTIES I INC., GREENSBORO, NC. FILED 1-10-2003.

BURLINGTON CONTRACT FABRICS

OWNER OF U.S. REG. NOS. 138,483 AND 2,389,944.
NO CLAIM IS MADE TO THE EXCLUSIVE RIGHT TO USE "CONTRACT FABRICS", APART FROM THE MARK AS SHOWN.

FOR FABRICS FOR USE IN THE MANUFACTURE OF FURNISHINGS FOR COMMERCIAL AND INDUSTRIAL USE; UPHOLSTERY FABRICS FOR COMMERCIAL AND INDUSTRIAL USE; TEXTILE FABRICS FOR USE IN THE MANUFACTURE OF WALL COVERINGS, WALL PANELS AND CUBICLES. (U.S. CLS. 42 AND 50).

SN 78-203,487. DAVID NETTO DESIGN, LLC, NEW YORK, NY. FILED 1-15-2003.



THE MARK CONSISTS OF THE WORDING "NETTOCOLLECTION" IN WHITE LETTERING SUPERIMPOSED ON A RED RECTANGLE DISSECTED BY A VERTICAL WHITE LINE.

FOR RECEIVING BLANKETS; BEDDING, NAMELY, COMFORTERS, BED SHEETS FOR CRIBS, PILLOW CASES, BED BLANKETS, DUST RUFFLES; AND NURSERY ACCESSORIES, NAMELY, CRIB BUMPERS, RECEIVING BLANKETS, HOODED TOWELS NOT USED AS CLOTHING, TEXTILE WALL HANGINGS AND PADS USED WHILE CHANGING DIAPERS AND CLOTHING. (U.S. CLS. 42 AND 50).

SN 78-208,802. PERIWINKLE PRODUCTS, INC., BLUE SPRINGS, MO. FILED 1-30-2003.

SLEEP-TIGHT SILKY

NO CLAIM IS MADE TO THE EXCLUSIVE RIGHT TO USE "SILKY", APART FROM THE MARK AS SHOWN.

FOR BEDDING, NAMELY SECURITY BLANKETS AND PILLOWCASES (U.S. CLS. 42 AND 50).

FIRST USE 9-20-2002; IN COMMERCE 9-20-2002.

CLASS 25—CLOTHING

SN 75-213,284. L.L. BEAN, INC., FREEPORT, ME. FILED 12-16-1996.

ALLAGASH

FOR SHIRTS, MOCASSINS, PANTS, AND JACKETS (U.S. CLS. 22 AND 39).

FIRST USE 0-0-1985; IN COMMERCE 0-0-1985.

CLASS 25—(Continued).

SN 75-469,802. GENFOOT INC., MONTREAL, QUEBEC, FILED 4-17-1998.



FOR MEN'S, WOMEN'S AND CHILDREN'S CLOTHING AND APPAREL NAMELY COATS, SPORTCOATS, PARKAS, BLAZERS, JACKETS, SKI SUITS, SKI JACKETS; SKI PANTS, SUITS, PANTS, SHIRTS, DRESSES, SWEATERS, VESTS, HATS, GLOVES, SCARVES, TIES, BELTS, SWIMSUITS, BEACH COVERUPS, SKIRTS, BLOUSES, BLAZERS, SLACKS, SHAWLS, JUMPERS, SUNSUITS, BEACHSUITS, SNOWSUITS, PLAYSUITS, OVERALLS, RAINCOATS, RAINJACKETS, RAIN SUITS, RAINPANTS; BATH ROBES, PYJAMAS, NIGHTGOWNS, DUSTERS, SLEEP SHIRTS, DRESSING-GOWNS; UNDERWEAR, NEGLIGEEES, SLIPS, BRASSIERES; STOCKINGS, LEGGINGS, SOCKS, PANTY-HOSE, KNEE HIGHS, TIGHTS, LEOTARDS, BODY SUITS; JEANS, T-SHIRTS, TANK TOPS, JOGGING SUITS, CAPS, SWEAT SUITS, SWEAT TOPS, SWEAT PANTS, SHORTS (U.S. CLS. 22 AND 39).

SN 76-030,034. EXCELLED SHEEPSKIN & LEATHER COAT CORP., NEW YORK, NY. FILED 4-19-2000.

ROGUE LEATHER BY REILLY OLMES

NO CLAIM IS MADE TO THE EXCLUSIVE RIGHT TO USE "LEATHER", APART FROM THE MARK AS SHOWN.

THE NAME "REILLY OLMES" DOES NOT IDENTIFY A LIVING INDIVIDUAL.

FOR MEN'S, WOMEN'S AND CHILDREN'S CLOTHING MADE IN WHOLE OR IN SUBSTANTIAL PART OF LEATHER, NAMELY, COATS, VESTS, SHIRTS AND PANTS (U.S. CLS. 22 AND 39).

FIRST USE 1-10-2000; IN COMMERCE 1-10-2000.

SN 76-039,850. DYLAN INCORPORATED, DBA CHANNEL MUSIC COMPANY, HENDERSONVILLE, TN. FILED 5-3-2000.

PURPLE PEOPLE EATER

FOR MEN'S, WOMEN'S AND CHILDREN'S CLOTHING NAMELY, T-SHIRTS AND CAPS (U.S. CLS. 22 AND 39).

FIRST USE 0-0-1995; IN COMMERCE 0-0-1995.

CLASS 25—(Continued).

SN 76-088,048. PIZARRO, ALEJANDRO SANCHEZ, 28043 MADRID, SPAIN, FILED 7-13-2000.

ALEJANDRO SANZ

PRIORITY CLAIMED UNDER SEC. 44(D) ON SPAIN APPLICATION NO. 2283237, FILED 1-14-2000, REG. NO. 2283237, DATED 6-5-2000, EXPIRES 6-5-2010.

THE NAME "ALEJANDRO SANZ" IDENTIFIES A LIVING INDIVIDUAL WHOSE CONSENT IS OF RECORD.

FOR CLOTHING, NAMELY SHIRTS, T-SHIRTS, SWEATERS, SWEAT SHIRTS, JACKETS, PANTS, SHORTS, SKIRTS, SCARVES, CAPS, HATS, SHOES AND GLOVES (U.S. CLS. 22 AND 39).

SN 76-151,276. T' S CUSTOM SHOP, CLARKSBURG, WV. FILED 10-23-2000.



FOR CLOTHING, NAMELY, BANDANAS, HEAD BANDS, BASEBALL CAPS, CLOTHING BELTS, UNDERWEAR BRIEFS, CLOTHING CAPS, CHAPS, COVERALLS, FOOTWEAR, GLOVES, GOLF SHIRTS, HALTER TOPS, HATS, HEADBANDS, HEADWEAR, LEATHER JACKETS, WIND RESISTANT JACKETS, JACKETS, JEANS, CLOTHING JERSEYS, JOGGING SUITS, JUMP SUITS, LEG WARMERS, LEGGINGS, LIGHT-REFLECTING COATS, LIGHT-REFLECTING JACKETS, LINGERIE, LOUNGEWEAR, MINISKIRTS, NECKWEAR, NIGHTSHIRTS, PAJAMAS, PANTIES, PANTS, POLO SHIRTS, NIGHT SHIRTS, SPORT SHIRTS, SWEAT SHIRTS, SWEAT SHORTS, SLEEPWEAR, THERMAL SOCKS, SOCKS, SUNVISORS, SUNSUITS, SUSPENDERS, SWEAT BANDS, SWEAT PANTS, SWEAT SUITS, TURTLENECK SWEATERS, VNECK SWEATERS, T-SHIRTS, TANK TOPS, CLOTHING TOPS, VESTS, VISORS, WINDSHIRTS, CLOTHING WRAPS, UNDER CLOTHES, UNDER GARMENTS, UNDER PANTS, UNDER SHIRTS, THERMAL UNDERWEAR (U.S. CLS. 22 AND 39).

SN 76-214,719. PRIMOS, INC., JACKSON, MS. FILED 2-23-2001.

SKULL HUGGER

FOR CLOTHING, NAMELY CAPS (U.S. CLS. 22 AND 39).

SN 76-221,374. RACK ROOM SHOES OF VIRGINIA, LLC, CHARLOTTE, NC. FILED 3-9-2001.

BLACK BOX

FOR FOOTWEAR (U.S. CLS. 22 AND 39).

CLASS 25—(Continued).

SN 76-243,334. DUNTON & DUNTON L.L.P., KINGMAN, AZ. FILED 4-20-2001.

FLICK ETAL

FOR CLOTHING FOR MEN, WOMEN AND CHILDREN, NAMELY, T-SHIRTS, SWEATSHIRTS, TANK TOPS, VESTS, JACKETS, COATS, AND HATS (U.S. CLS. 22 AND 39).

SN 76-264,382. NBDL ENTERPRISES, LLC, SECAUCUS, NJ. FILED 5-30-2001.



OWNER OF U.S. REG. NOS. 2,599,556, 2,705,421 AND OTHERS.

NO CLAIM IS MADE TO THE EXCLUSIVE RIGHT TO USE "FAYETTEVILLE", APART FROM THE MARK AS SHOWN.

FOR CLOTHING, NAMELY HOSIERY, FOOTWEAR, T-SHIRTS, SHIRTS, SWEATSHIRTS, SWEATPANTS, PANTS, TANK TOPS, JERSEYS, SHORTS, PAJAMAS, SPORT SHIRTS, RUGBY SHIRTS, SWEATERS, BELTS, TIES, NIGHTSHIRTS, HATS, WARM-UP SUITS, WARM-UP PANTS, WARM-UP TOPS, JACKETS, PARKAS, COATS, CLOTH BIBS, HEAD BANDS, WRIST BANDS, APRONS, BOXER SHORTS, SLACKS, CAPS, EAR MUFFS, GLOVES, MITTENS, WOVEN AND KNIT SHIRTS (U.S. CLS. 22 AND 39).

SN 76-319,827. YOUNG MARIE, YVONNE, SAN MATEO, CA. FILED 10-1-2001.



FOR T-SHIRTS, SWEAT SHIRTS, SHORTS, JEANS, SWEATERS, CAPS, BATHROBES, SWEATSUITS, LEATHER JACKETS, HATS, BOXERS, UNDERWEAR, PANTIES (U.S. CLS. 22 AND 39).

CLASS 25—(Continued).

SN 76-331,561. FOX RACING, INC., MORGAN HILL, CA. FILED 10-29-2001.

SHIFT RACING

NO CLAIM IS MADE TO THE EXCLUSIVE RIGHT TO USE "RACING", APART FROM THE MARK AS SHOWN.

FOR CLOTHING, NAMELY, JACKETS, RAINCOATS, SWEATSHIRTS, JERSEYS, SHIRTS, BLOUSES, PANTS, UNITARDS, TIGHTS, HATS, CAPS, SWEATBANDS, GLOVES, BELTS, SHOES, SOCKS, APRONS, POLO SHIRTS, OUTRIDER JACKETS (U.S. CLS. 22 AND 39).



SN 76-360,477. GRANGER, JOHNNY, DALLAS, TX. FILED 1-11-2002.

NO HATER WEAR

NO CLAIM IS MADE TO THE EXCLUSIVE RIGHT TO USE "WEAR", APART FROM THE MARK AS SHOWN.

FOR CLOTHING, NAMELY, T-SHIRTS, TANK TOPS, BLUE JEANS, AND JACKETS, ROBES, SWEATSHIRTS, UNDERWEAR, WIND RESISTANT JACKETS, SHIRTS, SOCKS, GLOVES, JOGGING SUITS, SWEATERS, WRIST-BANDS, AND BELTS; HEADWEAR, NAMELY CAPS, HEADBANDS, AND BANDANNAS; FOOTWEAR, NAMELY TENNIS SHOES AND BOOTS (U.S. CLS. 22 AND 39).



SN 76-364,309. COSBY, WILLIAM H. JR., SANTA MONICA, CA. FILED 1-29-2002.



FOR MEN'S, WOMEN'S AND CHILDREN'S SPORTS-WEAR, NAMELY WOVEN AND/OR KNIT SHORTS, SHIRTS, T-SHIRTS, PANTS, JOGGING SUITS, COATS, JACKETS, SWEATERS, SWEATSHIRTS AND JEANS, ALL SOLD AS PART OF A SERIES OF CHARACTER MARKS BASED ON A TELEVISION SHOW (U.S. CLS. 22 AND 39).
FIRST USE 1-15-2000; IN COMMERCE 1-15-2000.

CLASS 25—(Continued).

SN 76-369,901. SIMPATICO, LLC., WHARTON, NJ. FILED 2-10-2002.

SIMPATICO

THE ENGLISH TRANSLATION OF "SIMPATICO" IS "NICE".

FOR CLOTHING, NAMELY, SHIRTS, BLOUSES, SKIRTS, DRESSES, PANTS, SLACKS, TROUSERS, SHORTS, SUITS, SWIMWEAR, BATHING SUITS, COATS, JACKETS, SWEAT SHIRTS, SWEAT PANTS, TANK TOPS, HOSIERY AND LINGERIE (U.S. CLS. 22 AND 39).



SN 76-386,110. INSTITUTE FOR CIVIL SOCIETY, NEWTON CENTRE, MA. FILED 3-22-2002.



FOR CLOTHING, NAMELY HATS, T-SHIRTS AND SHIRTS, AND OUTERWEAR, NAMELY, JACKETS, SWEATERS, SWEATSHIRTS (U.S. CLS. 22 AND 39).



SN 76-399,242. CONSOLIDATED SHOE CO., LYNCHBURG, VA. FILED 4-23-2002.

NOUVELLE

THE ENGLISH TRANSLATION OF THE WORDS "NOUVELLE" IN THE MARK IS "NEW".
FOR WOMEN'S SHOES (U.S. CLS. 22 AND 39).
FIRST USE 2-11-1984; IN COMMERCE 2-11-1984.

CLASS 25—(Continued).

SN 76-403,441. STATE OF OREGON ACTING BY AND THROUGH THE STATE BOARD OF HIGHER EDUCATION ON BEHALF OF THE UNIVERSITY OF OREGON, THE, EUGENE, OR. FILED 5-2-2002.



OWNER OF U.S. REG. NO. 2,127,171.
SEC. 2(F).

FOR CLOTHING, NAMELY, CAPS, SHIRTS, SHORTS, JEANS, SWEATSHIRTS, T-SHIRTS, JACKETS, COATS, BELTS, HATS, BOXER SHORTS, VESTS, SHOES, SHOELACES, SOCKS, SLACKS, COVERALLS, OVERALLS, SUSPENDERS, NECKTIES, SWEATPANTS, APRONS, BANDANAS, SCARVES AND GLOVES (U.S. CLS. 22 AND 39).

FIRST USE 0-0-1991; IN COMMERCE 0-0-1991.

CLASS 25—(Continued).

SN 76-415,510. SAGINAW HOCKEY CLUB, LLC, SAGINAW, MI. FILED 6-5-2002.



NO CLAIM IS MADE TO THE EXCLUSIVE RIGHT TO USE "SAGINAW", APART FROM THE MARK AS SHOWN. THE APPLICANT STATES THE DRAWING IS LINED FOR THE COLORS RED AND BLUE.

FOR CLOTHING; NAMELY, SHIRTS, LONG-SLEEVED SHIRTS, THREE-QUARTER SLEEVED SHIRTS, T-SHIRTS, JERSEYS, SWEATERS, SWEATSHIRTS, JACKETS, PANTS, SWEATPANTS, WARM-UP SUITS, CHILDREN'S SWEATSHIRTS AND T-SHIRTS, WRISTBANDS, HEADBANDS, SHORTS, CAPS, SKI HATS, SCARVES, SOCKS, HATS, TANK TOPS, MITTENS, INFANT WEAR AND CLOTH BABY BIBS (U.S. CLS. 22 AND 39).

SN 76-406,275. JAMES, TEK0 T., DBA GAMETIME HOOPWEAR, OLATHE, KS. FILED 5-9-2002.

Gametime Hoopwear Rep The Game

NO CLAIM IS MADE TO THE EXCLUSIVE RIGHT TO USE "HOOPWEAR", APART FROM THE MARK AS SHOWN.

FOR BASKETBALL APPAREL, NAMELY, SHIRTS, TANK TOPS, HATS AND SWEAT BANDS (U.S. CLS. 22 AND 39).

SN 76-419,059. NOBLE & CO., INC., PHILADELPHIA, PA. FILED 6-10-2002.

RELAXATIONWEAR

FOR SLEEPWEAR AND LOUNGEWEAR (U.S. CLS. 22 AND 39).

SN 76-407,710. UDSEN, NIELS, SAN MIGUEL, CA. AND UDSEN, BERIT, SAN MIGUEL, CA. FILED 5-8-2002.



FOR APPAREL, NAMELY, SHIRTS AND HATS (U.S. CLS. 22 AND 39).
FIRST USE 1-1-1997; IN COMMERCE 1-1-1997.

SN 76-427,469. AMERICAN SPORTS LICENSING, INC., WILMINGTON, DE. FILED 7-5-2002.

PRECISION IN MOTION

FOR GOLF CLOTHING, NAMELY, TOPS, PANTS, RAINWEAR, SOCKS, GLOVES, HEADWEAR, SHOES, AND SHOE SPIKES (U.S. CLS. 22 AND 39).

SN 76-427,501. SOXLAND INTERNATIONAL, INC., JERSEY CITY, NJ. FILED 7-5-2002.

LIL' LADY

FOR HOSEIERY, NAMELY, SOCKS, PANTY HOSE AND TIGHTS NOT SOLD IN BRIDAL SPECIALTY SHOPS OR BOUTIQUES (U.S. CLS. 22 AND 39).

CLASS 25—(Continued).

SN 76-431,064. HUNTER, ILUMINADA PATIO, CHARLESTON, SC. AND HUNTER, RONALD LEWIS, CHARLESTON, SC. FILED 7-16-2002.

A CHARLESTON CHILD

SEC. 2(F).
FOR CLOTHING, NAMELY, COLORED DRESSES, BLOUSES, TOPS, SHIRTS, PANTS, SHORTS, SCARVES, GLOVES, HATS (U.S. CLS. 22 AND 39).
FIRST USE 9-1-1986; IN COMMERCE 9-1-1986.

CLASS 25—(Continued).

SN 76-439,381. DE MA FILLE, INC., DENVER, CO. FILED 8-12-2002.

DE MA FILLE

THE ENGLISH TRANSLATION OF THE FRENCH WORDING "DE MA FILLE" IN THE MARK IS "OF MY DAUGHTER".
FOR WEDDING APPAREL, NAMELY, WEDDING DRESSES, BRIDESMAID DRESSES AND BRIDAL VEILS (U.S. CLS. 22 AND 39).

SN 76-433,194. FISHER, DEREK, SHERMAN OAKS, CA. FILED 7-19-2002.

D FISH

FOR CLOTHING NAMELY T-SHIRTS, SWEATSHIRTS, SWEATPANTS, SHIRTS, PANTS, SHORTS, JACKETS, SOCKS, TOPS AND BOTTOMS; FOOTWEAR, CAPS AND HATS (U.S. CLS. 22 AND 39).

SN 76-435,850. FITZBRADSHAWRACING, L.L.C., WESTLAKE, TX. FILED 7-31-2002.



FOR CLOTHING, NAMELY CAPS, HATS, SHIRTS, T-SHIRTS, POLO SHIRTS, WINDSHIRTS, PULLOVERS AND JACKETS (U.S. CLS. 22 AND 39).
FIRST USE 12-1-2001; IN COMMERCE 12-1-2001.

SN 76-437,567. JERELL, LTD., DALLAS, TX. FILED 8-5-2002.

CREY

FOR WOMEN'S CLOTHING, NAMELY PANTS, SHORTS, SHIRTS, SUITS, JACKETS, DRESSES, SWEATERS, SKIRTS (U.S. CLS. 22 AND 39).

SN 76-439,496. STREET BASKETBALL ASSOCIATION INC., ELIZABETH, NJ. FILED 8-12-2002.



NO CLAIM IS MADE TO THE EXCLUSIVE RIGHT TO USE "BASKETBALL APPAREL", APART FROM THE MARK AS SHOWN.
FOR T-SHIRTS (U.S. CLS. 22 AND 39).

SN 76-446,035. MANLLO KURI, RICARDO JOSE, NUEVO LEON, MEXICO, FILED 8-29-2002.

NICHO HINOJOSA

PRIORITY CLAIMED UNDER SEC. 44(D) ON MEXICO APPLICATION NO. 546425, FILED 4-25-2002, REG. NO. 772175, DATED 11-29-2002, EXPIRES 4-25-2012.
"NICHO HINOJOSA" IS THE STAGE NAME OF A LIVING INDIVIDUAL WHOSE CONSENT IS OF RECORD.
FOR CLOTHING, NAMELY T-SHIRTS, SWEATSHIRTS, HATS, BELTS, TIES AND SHOES (U.S. CLS. 22 AND 39).

CLASS 25—(Continued).

SN 76-448,527. DONNA MALTONY & LORI L. PICKERING, TRYON, NC. FILED 9-11-2002.



NO CLAIM IS MADE TO THE EXCLUSIVE RIGHT TO USE "CLOAKS", APART FROM THE MARK AS SHOWN. FOR EMBROIDERED CLOTHING, NAMELY DRESSES, SHIRTS, BLOUSES, SWEATSHIRTS, HATS, JACKETS, PANTS (U.S. CLS. 22 AND 39). FIRST USE 1-1-1984; IN COMMERCE 1-1-1984.

SN 76-450,712. LAREDO HOCKEY HOLDINGS, L.P., LAREDO, TX. FILED 9-18-2002.



NO CLAIM IS MADE TO THE EXCLUSIVE RIGHT TO USE "LAREDO", APART FROM THE MARK AS SHOWN. FOR CLOTHING, NAMELY, SHIRTS, JERSEYS, SWEATERS, JACKETS, SWEATSHIRTS, T-SHIRTS, SWEATPANTS, WARM-UP SUITS, CAPS, HATS (U.S. CLS. 22 AND 39). FIRST USE 5-10-2002; IN COMMERCE 5-24-2002.

SN 76-451,537. BENMOSHE, OREN, LOS ANGELES, CA. FILED 9-17-2002.

DIVISION E

FOR APPAREL AND ACCESSORIES, NAMELY MEN'S JEANS, TOPS, SHIRTS, PANTS, SHORTS, TEE-SHIRTS, SWEATERS, JACKETS AND UNDERWEAR (U.S. CLS. 22 AND 39). FIRST USE 10-25-2001; IN COMMERCE 10-25-2001.

CLASS 25—(Continued).

SN 76-452,905. KOBE SPORTSWEAR INC., SCARBOROUGH, ONTARIO M1X 1A2, CANADA, FILED 9-19-2002.



FOR OUTERWEAR, NAMELY, JACKETS, COATS, PULLOVERS, VESTS, AND WIND-RESISTANT JACKETS (U.S. CLS. 22 AND 39). FIRST USE 0-0-1995; IN COMMERCE 0-0-1995.

SN 76-452,906. KOBE SPORTSWEAR INC., SCARBOROUGH, ONTARIO M1X 1A2, CANADA, FILED 9-19-2002.

KOBE

FOR OUTERWEAR, NAMELY, JACKETS, COATS, PULLOVERS, VESTS, AND WIND-RESISTANT JACKETS (U.S. CLS. 22 AND 39). FIRST USE 0-0-1995; IN COMMERCE 0-0-1995.

SN 76-463,730. GAKM RESOURCES CORPORATION, NEW YORK, NY. FILED 11-1-2002.

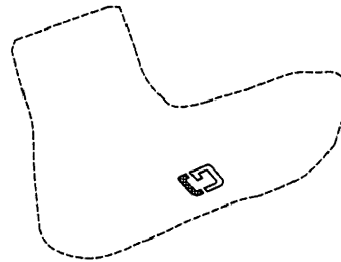

THE MARK COMPRISES THE LETTER "G" POSITIONED ON THE SOLE OF A SOCK. THE DRAWING IS LINED TO INDICATE THE COLOR "GOLD" FOR THE UPPER PORTION OF THE LETTER "G" AND COLOR IS CLAIMED AS A FEATURE OF THE MARK. FOR HOSIERY (U.S. CLS. 22 AND 39). FIRST USE 2-15-2002; IN COMMERCE 2-15-2002.

SN 76-464,144. HIPPILOPPI, INC., FT. LAUDERDALE, FL. FILED 10-28-2002.

GOD MADE MARIJUANA

FOR SHIRTS AND HATS (U.S. CLS. 22 AND 39). FIRST USE 10-0-2002; IN COMMERCE 10-0-2002.

CLASS 25—(Continued).

SN 76-472,515. OIWI OCEAN GEAR, LLC, HONOLULU, HI. FILED 12-5-2002.

GO PADDLE

FOR CLOTHING, NAMELY, T-SHIRTS, FOOTWEAR, HEADWEAR, RASH GUARDS, SHORTS, DRESSES, SWIM WEAR, TANK TOPS, SWEATSHIRTS, SWEAT-PANTS, JERSEYS, SHIRTS, WIND RESISTANT JACKETS AND GLOVES (U.S. CLS. 22 AND 39).

SN 76-472,517. OIWI OCEAN GEAR, LLC, HONOLULU, HI. FILED 12-5-2002.

SIX BODIES ONE MIND ONE SPIRIT

FOR CLOTHING, NAMELY, T-SHIRTS, FOOTWEAR, HEADWEAR, RASH GUARDS, SHORTS, DRESSES, SWIM WEAR, TANK TOPS, SWEATSHIRTS, SWEAT-PANTS, JERSEYS, SHIRTS, WIND RESISTANT JACKETS AND GLOVES (U.S. CLS. 22 AND 39).

SN 76-472,743. GARMENT GROUP, INC., LOS ANGELES, CA. FILED 12-9-2002.

MARATHON CLUB

FOR GARMENTS, NAMELY, MEN'S SOCKS (U.S. CLS. 22 AND 39). FIRST USE 8-6-2002; IN COMMERCE 8-6-2002.

SN 76-475,563. AMERICAN AIRLINES, INC., DFW AIRPORT, TX. FILED 12-16-2002.

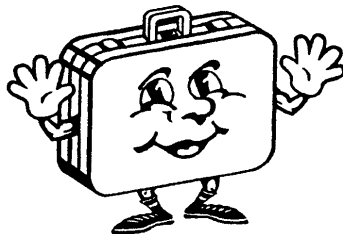

OWNER OF U.S. REG. NO. 2,261,049. FOR SHIRTS (U.S. CLS. 22 AND 39). FIRST USE 12-0-2000; IN COMMERCE 12-0-2000.

CLASS 25—(Continued).

SN 76-475,587. TOMMASO, LEWIS, COOKEVILLE, TN. FILED 12-16-2002.

KNOT MUCH

FOR CLOTHING, NAMELY, BOXER BRIEFS, DENIM JACKETS, JEANS, OVERALLS, SHIRTS, SHOES, SANDALS, BASEBALL CAPS, VISORS AND LADIES HATS (U.S. CLS. 22 AND 39). FIRST USE 3-15-1994; IN COMMERCE 7-1-1994.

SN 76-477,650. COTTA, DANA, MADERA, CA. FILED 12-23-2002.



NO CLAIM IS MADE TO THE EXCLUSIVE RIGHT TO USE "APPAREL", APART FROM THE MARK AS SHOWN. FOR SHIRTS, PANTS AND HATS (U.S. CLS. 22 AND 39).

SN 76-479,293. DOLFIN INTERNATIONAL CORPORATION, SINKING SPRINGS, PA. FILED 12-31-2002.



OWNER OF U.S. REG. NOS. 985,060, 985,126 AND 1,659,816. FOR CLOTHING; NAMELY BATHING SUITS, BATHING TRUNKS, TEE SHIRTS, TANK TOPS, SHORTS, ROBES, SWIMMING CAPS AND WRIST BANDS (U.S. CLS. 22 AND 39). FIRST USE 6-1-1989; IN COMMERCE 6-1-1989.

CLASS 25—(Continued).

SN 76-479,298. 40 THUGS, LLC, SUNNYSIDE, NY. FILED 12-31-2002.



FOR MEN'S, WOMEN'S AND CHILDREN'S APPAREL, NAMELY— SHIRTS, PANTS, HATS, JACKETS, COATS, SOCKS, UNDERWEAR, PAJAMAS/SLEEPWEAR AND SHORTS (U.S. CLS. 22 AND 39).

FIRST USE 6-25-2002; IN COMMERCE 6-25-2002.

SN 76-479,408. SHORTAL, JOE, LOS ANGELES, CA. FILED 12-31-2002.

BLACK JESUS

FOR CLOTHING, NAMELY, SHIRTS, PANTS, T-SHIRTS, FOOTWEAR, HEADWEAR, BASEBALL CAPS, SHORTS, SWIMWEAR, LINGERIE, SWEAT SHIRTS, UNDERWEAR, JACKETS, DRESSES, AND SKIRTS (U.S. CLS. 22 AND 39).

SN 76-479,651. MAROZZI, PETER G., III, WHISPERING PINES, NC. FILED 1-2-2003.



FOR FOOTWEAR (U.S. CLS. 22 AND 39).

SN 76-480,397. MDS IMPORT EXPORT INTERNATIONAL, LLC, LOS ANGELES, CA. FILED 1-6-2003.

THE ROYAL CARDINAL

FOR FOOTWEAR (U.S. CLS. 22 AND 39).

CLASS 25—(Continued).

SN 76-481,145. CANAL GROUP, INC., CHICAGO, IL. FILED 1-9-2003.

MOONBAR

FOR SOUVENIR CLOTHING COMMEMORATING A RESTAURANT AND COCKTAIL LOUNGE OF THE SAME NAME, NAMELY, T-SHIRTS, SWEATSHIRTS, WARM-UP JACKETS, WARM-UP PANTS, BOXER SHORTS, SHORTS, HATS, SUN VISORS, BASEBALL CAPS, POLO SHIRTS, SPORT SHIRTS, BLOUSES, COATS, DRESSES, TANK TOPS, BATHING SUITS, HOSIERY, NECKTIES, UNDERWEAR, LINGERIE AND GLOVES (U.S. CLS. 22 AND 39).

SN 76-482,538. CAMPER, S.L., 07300- BALEARES, SPAIN, FILED 1-15-2003.

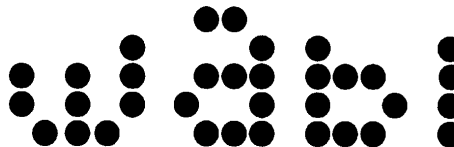

THE MARK CONSISTS OF THE WORD "WABI" IN A STYLIZED DESIGN.

THE ENGLISH TRANSLATION OF "WABI" IS "APOLOGY".

FOR FOOTWEAR, NAMELY, BOOTS, SHOES, SANDALS, CLOGS, SLIPPERS AND INNER SOLES; CLOTHING, NAMELY, SOCKS, JEAN JACKETS, T-SHIRTS AND PANTS; HEAD WEAR, NAMELY, BERETS, BONNETS, CAPS, HATS, HEADBANDS AND SUN VISORS (U.S. CLS. 22 AND 39).

FIRST USE 12-0-2001; IN COMMERCE 12-0-2001.

SN 76-482,551. SOFTSPIKES, INC., GAITHERSBURG, MD. FILED 1-15-2003.

SIMPLEX

FOR CLEATS AND CLEAT INSERTS FOR GOLF, BASEBALL, SOCCER AND FOOTBALL SHOES (U.S. CLS. 22 AND 39).

SN 76-483,005. BENDOCK, RACHEL, SUMMIT, NJ. FILED 1-15-2003.

FLEX POWER

NO CLAIM IS MADE TO THE EXCLUSIVE RIGHT TO USE "FLEX", APART FROM THE MARK AS SHOWN.

FOR CHILDREN'S EXERCISE CLOTHING, NAMELY, SHORTS, PANTS, T-SHIRTS AND SWEAT PANTS (U.S. CLS. 22 AND 39).

CLASS 25—(Continued).

SN 76-486,746. LUCY ACTIVEWEAR, INC., PORTLAND, OR. FILED 2-3-2003.

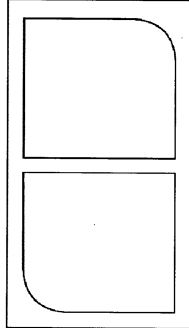

THE MARK CONSIST OF TWO SQUARES EACH WITH ONE ROUNDED CORNER. THE UPPER SQUARE BEING ORANGE AND THE LOWER SQUARE BEING GREEN, CONTAINED WITHIN A WHITE RECTANGLE.

FOR CLOTHING, NAMELY TOPS, TANKS, T-SHIRTS, SHORTS, PANTS, JACKETS, VESTS, WARM-UP SUITS, SKIRTS, DRESSES, SWIMSUITS, SWIMSUIT COVER-UPS, BRAS, UNDERWEAR, HATS, GLOVES, WRISTBANDS, HEADBANDS, AND BODYWEAR, NAMELY LEOTARDS, BODY SUITS, UNITARDS, TIGHTS AND LEGGINGS (U.S. CLS. 22 AND 39).
FIRST USE 12-19-2000; IN COMMERCE 12-19-2000.

SN 76-487,039. SALANT HOLDING CORPORATION, NEW YORK, NY. FILED 2-3-2003.

TRICOLUX

FOR CLOTHING, NAMELY, SWEATERS (U.S. CLS. 22 AND 39).
FIRST USE 8-0-1994; IN COMMERCE 8-0-1994.

SN 76-487,156. KIK-WEAR, INC., LOS ANGELES, CA. FILED 2-3-2003.

PULSION

FOR CLOTHING, NAMELY, PANTS, SHIRTS, SHORTS, T-SHIRTS, TOPS AND HATS (U.S. CLS. 22 AND 39).

SN 76-487,473. MAGO LTD., NEW YORK, NY. FILED 1-29-2003.

MAGO

THE WORD "MAGO" MEANS "WIZARD" OR "MAGICIAN" IN THE ITALIAN LANGUAGE.
FOR WOMEN'S WEARING APPAREL, NAMELY, SWEATERS, JACKETS, PANTS, COATS AND SKIRTS (U.S. CLS. 22 AND 39).

CLASS 25—(Continued).

SN 76-487,577. OLD MISSION BEACH ATHLETIC CLUB, INC., SAN DIEGO, CA. FILED 2-3-2003.

OVER THE LINE

OWNER OF U.S. REG. NOS. 1,562,326 AND 1,748,520. FOR CLOTHING, NAMELY CAPS (U.S. CLS. 22 AND 39).
FIRST USE 7-30-1967; IN COMMERCE 7-30-1967.

SN 76-487,591. SCHLEGEL, PASCALE, DEL MAR, CA. FILED 2-5-2003.

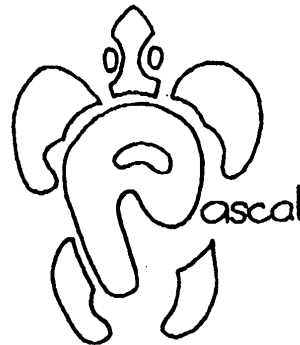

FOR CLOTHING, NAMELY BELTS, SHIRTS, SKIRTS, TOPS, HATS, TEE SHIRTS, SWEATERS, JACKETS, PANTS, AND VESTS (U.S. CLS. 22 AND 39).

SN 76-488,335. ST. EVE INTERNATIONAL, INC., NEW YORK, NY. FILED 2-4-2003.

**LIFE FROM AHHHH TO
ZZZZ**

FOR WOMEN'S AND CHILDREN'S CLOTHING, NAMELY, NIGHTGOWNS; SLEEP SHIRTS; PAJAMAS; ROBES; UNDERGARMENTS; LINGERIE; TEDDIES; CAMISOLES; SLIPS; NEGLIGEEES; FIGURE-ENHANCING AND BODY-SHAPING GARMENTS, NAMELY, GIRDLES, CONTROL PANTIES, BODY SUITS AND BODY SLIPS; SARONGS; MATERNITY SLEEPWEAR; PANTIES; TANK TOPS; BRASSIERES; SPORT BRASSIERES; SWEAT SUITS; SWEAT PANTS; SWEAT PANTS; BOXER SHORTS; SOCKS; T-SHIRTS (U.S. CLS. 22 AND 39).

CLASS 25—(Continued).

SN 76-488,336. ST. EVE INTERNATIONAL, INC., NEW YORK, NY. FILED 2-4-2003.



FOR WOMEN'S AND CHILDREN'S CLOTHING, NAMELY, NIGHTGOWNS; SLEEP SHIRTS; PAJAMAS; ROBES; UNDERGARMENTS; LINGERIE; TEDDIES; CAMISOLES; SLIPS; NEGLIGÉES; FIGURE-ENHANCING AND BODY-SHAPING GARMENTS, NAMELY, GIRDLES, CONTROL PANTIES, BODY SUITS AND BODY SLIPS; SARONGS; MATERNITY SLEEPWEAR; PANTIES; TANK TOPS; BRASSIERES; SPORT BRASSIERES; SWEAT SUITS; SWEAT PANTS; SWEAT PANTS; BOXER SHORTS; SOCKS; T-SHIRTS (U.S. CLS. 22 AND 39).

SN 76-492,103. MOONSTRUCK CHOCOLATE COMPANY, PORTLAND, OR. FILED 2-24-2003.

MERRY CHOCOLATE

FOR CLOTHING, NAMELY, T-SHIRTS (U.S. CLS. 22 AND 39).
FIRST USE 12-0-2002; IN COMMERCE 12-0-2002.

SN 76-493,010. EVIL. PERIOD, INC., JACKSONVILLE, FL. FILED 1-27-2003.

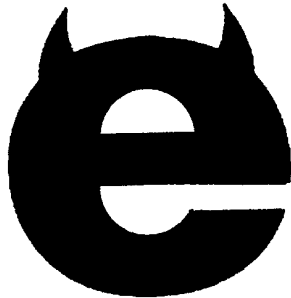

FOR CLOTHING, NAMELY MEN'S, WOMEN'S, CHILDREN'S SHIRTS, TEE SHIRTS, TANK TOPS, PANTS, SHORTS, UNDERWEAR, HATS, CAPS, SOCKS, SWEATERS, AND JACKETS; AND WOMEN'S AND GIRLS DRESSES, SKIRTS AND WRAPS (U.S. CLS. 22 AND 39).

CLASS 25—(Continued).

SN 76-511,318. COOGI PARTNERS, LLC, LAKE SUCCESS, NY. FILED 4-14-2003.

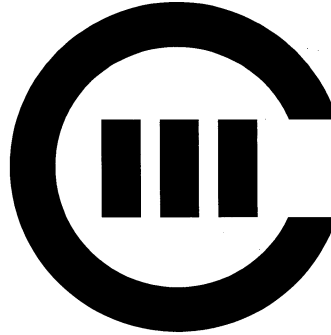

FOR CLOTHING, NAMELY SHIRTS, VESTS, SWEATERS, SHOES, CAPS, BANDANNAS, SHORTS, SWEAT SHIRTS, PANTS, BELTS FOR CLOTHING, SOCKS, SWIMWEAR, JACKETS, RAINWEAR, BLOUSES, DRESSES, FOOTWEAR, HOSIERY, SCARVES, HATS, HEAD BANDS, PAJAMAS AND SLEEPWEAR (U.S. CLS. 22 AND 39).

SN 78-060,574. SAULTERS, DAVID L, NEW YORK, NY. FILED 4-26-2001.



FOR PANTS, JEANS, ROMPERS, JUMPSUITS, SHORTS, SHIRTS, SWEATERS, SWEATSHIRTS, SWEAT SHORTS, VESTS, JACKETS, SPORTCOATS, BLAZERS, HATS, SCARVES, GLOVES, T-SHIRTS, OVERALLS, SWIMSUITS, SOCKS AND UNDERWEAR, ROBES, TROUSERS, SLACKS, BLOUSES, KNIT TOPS, SKIRTS, DRESSES, HOSIERY, PANTY HOSE, TIGHTS, STOCKINGS, LEOTARDS, SLEEPWEAR, UNDERWEAR BRIEFS AND TOPS, STRING BIKINIS, TANK TOPS, BRAS, PANTIES AND FOOTWEAR (U.S. CLS. 22 AND 39).

SN 78-065,694. KRISS AB, SPARSOR, SWEDEN, FILED 5-25-2001.

KRISS

FOR WOMEN'S CLOTHING, NAMELY, SWEATERS, CARDIGANS, TURTLENECKS, DRESS SUITS, SKIRTS, BLAZERS, JACKETS, AND BLOUSES (U.S. CLS. 22 AND 39).
FIRST USE 1-0-1981; IN COMMERCE 5-29-1998.

CLASS 25—(Continued).

SN 78-065,835. LEMO USA INC., BROOKLYN, NY. FILED 5-25-2001.

APOLLO

FOR SWEATERS AND CLOTHING MADE OF DENIM, NAMELY, JEANS, JACKETS, COATS, SHIRTS AND SKIRTS (U.S. CLS. 22 AND 39).



SN 78-089,654. GLOBAL DIRECT SALES LLC, ARLINGTON HEIGHTS, IL. FILED 10-23-2001.

BETWEEN

FOR FOOTWEAR (U.S. CLS. 22 AND 39).



SN 78-091,683. LAUGHING SOUL PRODUCTIONS, LAS VEGAS, NV. FILED 11-5-2001.

SHERO GEAR

NO CLAIM IS MADE TO THE EXCLUSIVE RIGHT TO USE "GEAR", APART FROM THE MARK AS SHOWN.

FOR CLOTHING, NAMELY, MEN'S, WOMEN'S AND CHILDREN'S SHIRTS, SWEAT SHIRTS, JACKETS, BLUE JEANS, PANTS, SHORTS, SKIRTS, DRESSES, T-SHIRTS, BLOUSES, BATHING SUITS, VESTS, SCARVES, GLOVES, BELTS, BELTS NOT MADE OF LEATHER, SWIMWEAR, SOCKS, UNDERGARMENTS, CAPS AND BAGS, MEN'S, WOMEN'S AND CHILDREN'S SHOES, BOOTS AND SLIPPERS. (U.S. CLS. 22 AND 39).



SN 78-095,284. WEAR ME APPAREL, NEW YORK, NY. FILED 11-27-2001.

CONFLICT

FOR CHILDREN'S CLOTHING AND ACCESSORIES, NAMELY, SHIRTS, KNITTED AND WOVEN TOPS, PANTS, SHORTS, DRESSES, SHOES, TIES, HATS, SCARVES, GLOVES, BELTS, OVERALLS, JEANS, SWEATERS, JACKETS, VESTS, SWEATSHIRTS, SWEATPANTS, SUSPENDERS, UNDERWEAR, SLEEPWEAR; WORK-OUT GEAR, NAMELY SWEAT SUITS, SWEATPANTS, SWEATSHIRTS, GYM SHORTS, SNEAKERS, LEG WARMERS, TIGHTS, TRACK SUITS, WRIST BANDS; OUTER WEAR, NAMELY SKIPANTS, COATS, EAR FLAPS, JACKETS, MASKS, VESTS, AND RAINWEAR (U.S. CLS. 22 AND 39).

CLASS 25—(Continued).

SN 78-104,596. BIGELOW MOUNTAIN PARTNERS LLC, BOSTON, MA. FILED 1-24-2002.

WINTERCHICK

FOR CLOTHING, NAMELY JACKETS, HOODED PULLOVERS, SHIRT AND PANT SHELLS, PANTS, SHIRTS, UNDERWEAR, HATS, CAPS, EAR BANDS, HEAD BANDS, GLOVES, BOOTS, SHOES, SKI BOOTS AND SKI GLOVES, HEADWEAR, SNOWBOARD CAPS, NECK WARMERS, MITTENS, VESTS, SWEATERS, T-SHIRTS, SWEATSHIRTS, SWEATPANTS, UNDERGARMENTS, UNDERSHIRTS, UNDER SHORTS, UNDERWEAR, BIB OVERALLS, SKI OVERALLS, SOCKS, FOOTWEAR, STOCKINGS, SOCKS FOR USE IN THE SPORT OF SNOWBOARDING AND SKIING, AND SKI MASKS (U.S. CLS. 22 AND 39).

FIRST USE 1-1-2002; IN COMMERCE 1-22-2002.



SN 78-114,516. LEWIS, JEAN-CLAUDE, MADISON HEIGHTS, MI. FILED 3-13-2002.



beneath the underdog.com

FOR CLOTHING FOR MEN, WOMEN AND CHILDREN, NAMELY, T-SHIRTS, UNDERWEAR, SOCKS, HATS, PANTS, SHOES, BELTS, LONGJOHNS, UNIFORMS AND HEADBANDS (U.S. CLS. 22 AND 39).

CLASS 25—(Continued).

SN 78-126,029. БЕЛОIT PROFESSIONAL BASEBALL ASSO-
CIATION, INC., БЕЛОIT, WI. FILED 5-3-2002.



OWNER OF U.S. REG. NO. 2,081,458.

FOR CLOTHING; NAMELY, SHIRTS, SHORTS, T-
SHIRTS, POLO SHIRTS, GOLF SHIRTS, TANK TOPS,
JOGGING SUITS, SOCKS, UNDERWEAR, JACKETS,
SWEATERS, VESTS, PANTS, PONCHOS, VISORS, RAIN-
COATS, HATS, CAPS, CLOTH BABY BIBS, TIES, PAJA-
MAS, BABY PANTS, BABY BOOTIES AND SHORT SETS,
SWEATSHIRTS, MITTENS, GLOVES, KNITTED HATS,
SCARVES, HOSIERY, WRIST BANDS, HEAD BANDS,
ROBES, APRONS, SHOES, WIND RESISTANT JACKETS,
JUMPSUITS, SWEATPANTS, OVERALLS, BANDANAS,
BEACHWEAR, BATHING SUITS, BELTS, BERMUDA
SHORTS, BLOUSES, COATS, DRESSES, GYM SUITS,
HEAD WEAR, LEATHER JACKETS, JERSEYS, PULL-
OVERS, ROMPERS, RAINWEAR, PARKAS, NIGHT
SHIRTS, NECKWEAR, V-NECK SWEATERS AND KNIT
SHIRTS (U.S. CLS. 22 AND 39).

FIRST USE 4-1-2000; IN COMMERCE 4-1-2000.

SN 78-131,552. SEARLES, ANGELA M., GAITHERSBURG,
MD. FILED 5-28-2002.

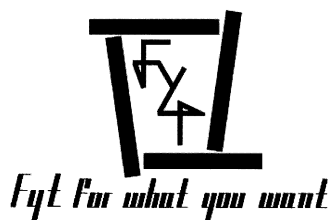

FOR CLOTHING FOR MEN AND WOMEN, NAMELY
SKIRTS, SHIRTS AND PANTS (U.S. CLS. 22 AND 39).
FIRST USE 5-20-2002; IN COMMERCE 5-20-2002.

SN 78-132,581. EIGHT & NINE DESIGNS, NORTH MIAMI
BEACH, FL. FILED 6-1-2002.

NUMERICAL DYNAMICS

FOR MALE AND FEMALE CLOTHING, NAMELY,
SHIRTS, PANTS, SHORTS, AND SWEATSHIRTS (U.S.
CLS. 22 AND 39).

FIRST USE 11-1-2001; IN COMMERCE 4-14-2002.

CLASS 25—(Continued).

SN 78-136,326. PANAMA JACK INTERNATIONAL, INC.,
ORLANDO, FL. FILED 6-17-2002.

**GUIDE AND OUTFITTER
ISSUE**

NO CLAIM IS MADE TO THE EXCLUSIVE RIGHT TO
USE "OUTFITTER", APART FROM THE MARK AS
SHOWN.

FOR CLOTHING, NAMELY, T-SHIRTS, SHIRTS,
PANTS, SHORTS, JACKETS, COATS, CAPS, HATS,
SCARVES, SHOES, BOOTS, SOCKS, SKIRTS, DRESSES,
BLOUSES, VESTS, SWEATERS, SWEAT PANTS AND
SWEATSHIRTS, PAJAMAS, GOWNS, SUN SUITS, SWIM
TRUNKS, SWIM SUITS (U.S. CLS. 22 AND 39).

SN 78-141,337. SIZZLER USA FRANCHISE, INC., SHERMAN
OAKS, CA. FILED 7-3-2002.



NO CLAIM IS MADE TO THE EXCLUSIVE RIGHT TO
USE "AMERICA", APART FROM THE MARK AS SHOWN.

FOR CLOTHING, NAMELY T-SHIRTS AND SHIRTS;
HEADWEAR (U.S. CLS. 22 AND 39).

CLASS 25—(Continued).

SN 78-144,339. LEVI STRAUSS & CO., SAN FRANCISCO, CA. FILED 7-16-2002.

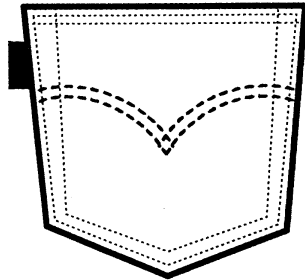

OWNER OF U.S. REG. NOS. 1,041,846, 1,135,196 AND 1,139,254.

THE LINING AND SHADING SHOWN IN THE DRAWING ARE FEATURES OF THE MARK AND NOT INTENDED TO INDICATE COLOR.

THE MARK CONSISTS OF THE COMBINATION OF A DOUBLE ARCUATE AND TAB DESIGN SHOWN ON THE SHAPE OF A POCKET, AS INDICATED BY A SOLID LINE.

FOR PANTS, JEANS, SHORTS, SHIRTS, T-SHIRTS, BLOUSES, SKIRTS AND JACKETS (U.S. CLS. 22 AND 39).

FIRST USE 9-1-1936; IN COMMERCE 9-1-1936.

SN 78-144,380. AGUIRRE, JONATHAN PATRICK, NORTH-RIDGE, CA. FILED 7-16-2002.

VISUAL POLLUTION

FOR CLOTHING, NAMELY, T-SHIRTS, SWEAT SHIRTS, PANTS, SHORTS, JACKETS, AND HEADWEAR (U.S. CLS. 22 AND 39).

SN 78-145,086. BLUE JUICE, HOBE SOUND, FL. FILED 7-18-2002.



FOR T-SHIRTS, SHORTS, PANTS, HEADWEAR, TOPS, BATHING SUITS, CAPS, SKIRTS (U.S. CLS. 22 AND 39).

CLASS 25—(Continued).

SN 78-145,226. ZOO YORK THC LLC, SOUTH RIVER, NJ. FILED 7-18-2002.

UNBREAKABLE

FOR CLOTHING, NAMELY, JEANS, JUMPSUITS, OVERALLS, LINGERIE, GLOVES, PAJAMAS, UNDER-PANTS, UNDERWEAR, SPORTS PANTS, TOPS, JERSEYS, SHIRTS, T-SHIRTS, KNIT SHIRTS, SWEATSHIRTS, TANK-TOPS, VESTS, BLOUSES, COATS, OVERCOATS, TUXEDOS, SUITS, JACKETS, PARKAS, SPORT COATS, SWEATERS, PULLOVERS, JUMPERS, SKIRTS, DRESSES, BODY SUITS, LEOTARDS, LEG-GINGS, PANTS, TROUSERS, SLACKS, SWEATPANTS, CARGO PANTS, SHORTS, SWIMWEAR, SWEATBANDS AND BELTS; HEADWEAR AND FOOTWEAR (U.S. CLS. 22 AND 39).

SN 78-149,019. GREGORY S. SMITH, DBA CARINI SPORT LLC, BOYDS, MD. FILED 7-30-2002.



NO CLAIM IS MADE TO THE EXCLUSIVE RIGHT TO USE "SPORT", APART FROM THE MARK AS SHOWN.

FOR CLOTHING FOR MEN, WOMEN AND YOUTHS, NAMELY, SHIRTS, SHORTS, HATS, PANTS, SOCKS, WARM-UP SUITS, SWEAT PANTS, SWEATSHIRTS, ATHLETIC UNIFORMS, SWIM SUITS, UNDERWEAR AND TIES (U.S. CLS. 22 AND 39).

FIRST USE 7-22-2002; IN COMMERCE 7-22-2002.

SN 78-150,335. BRYLANE, L.P., NEW YORK, NY. FILED 8-2-2002.

EASY OPTIONS

FOR CLOTHING, NAMELY, SWEATERS, VESTS, DUSTERS, SHIRTS, T-SHIRTS, SKIRTS, PANTS, CAPRIS, SHORTS, DRESSES, TUNICS, 2 PIECE SKIRT SETS, PANT SETS, SHORT SETS, CAPRI SETS, 3 PIECE SETS COMPRISED OF JACKET AND PANTS AND SKIRT, AND 3-PIECE SETS COMPRISED OF JACKET AND PANTS AND DRESS (U.S. CLS. 22 AND 39).

CLASS 25—(Continued).

SN 78-150,610. PANOS, MICHAEL P., CHICAGO, IL. FILED 8-4-2002.



FOR SHIRTS, CAPS, HATS, SWEATSHIRTS, SWEAT-PANTS, JACKETS (U.S. CLS. 22 AND 39).

SN 78-159,517. VIACOM INTERNATIONAL INC., NEW YORK, NY. FILED 8-30-2002.

AS TOLD BY GINGER FOUTLEY

OWNER OF U.S. REG. NO. 2,471,945.
THE NAME "GINGER FOUTLEY" DOES NOT IDENTIFY A LIVING INDIVIDUAL.
FOR HATS, SHIRTS, JACKETS, PANTS, SHORTS (U.S. CLS. 22 AND 39).

SN 78-159,983. CALZATURIFICIO MANAS S.P.A., ITALY, FILED 9-1-2002.

ILEA FOSCATI

THE NAMES, PORTRAITS, AND/OR SIGNATURES SHOWN IN THE MARK DOES NOT IDENTIFY A PARTICULAR LIVING INDIVIDUAL.

FOR FOOTWEAR, NAMELY, BOOTS, SANDALS, SHOES AND SLIPPERS (U.S. CLS. 22 AND 39).
FIRST USE 2-0-1997; IN COMMERCE 9-11-2000.

SN 78-163,729. CITI TRENDS, INC., SAVANNAH, GA. FILED 9-13-2002.

CT SPORT

NO CLAIM IS MADE TO THE EXCLUSIVE RIGHT TO USE "SPORT", APART FROM THE MARK AS SHOWN.
FOR CLOTHING AND APPAREL FOR MEN, WOMEN AND CHILDREN, NAMELY SHIRTS, SWEATERS, PANTS AND BLOUSES (U.S. CLS. 22 AND 39).
FIRST USE 8-28-2002; IN COMMERCE 8-28-2002.

CLASS 25—(Continued).

SN 78-163,865. MILLER, CHRISTOPHER, JAMES, SAN DIEGO, CA. FILED 9-13-2002.

calm

FOR SHOES, SHIRTS, PANTS, HATS (U.S. CLS. 22 AND 39).

SN 78-173,676. PINK PIRANHA LIMITED, LONDON, ENGLAND, FILED 10-11-2002.



FOR CLOTHING, FOOTWEAR, HEADWEAR, NAMELY, UNDERWEAR, LINGERIE, CORSETS, NIGHTWEAR NAMELY NIGHT SHIRTS, NIGHT GOWNS, PAJAMAS, NEGLIGEEES, BABY-DOLLS, NIGHTTIES; CLUB WEAR, NAMELY THEATRICAL AND STAGE COSTUMES FOR DANCING AND PERFORMANCES IN NIGHT CLUBS AND LIVE SHOWS; FANCY DRESSES; FANTASY CLOTHING, NAMELY COSTUMES FOR USE IN ROLE-PLAYING GAMES; DRESSING GOWNS; SWIMWEAR, HOSIERY, STOCKINGS, TIGHTS, SUSPENDERS; CLOTHING ACCESSORIES, NAMELY GLOVES, SCARVES, BANDANAS, SHAWLS, SARONGS, VEILS, FEATHER COLLARS AND CUFFS FOR APPLYING TO CLOTHING; AND FANTASY CLOTHING ACCESSORIES, NAMELY GLOVES, SCARVES, BANDANAS, SHAWLS, SARONGS, VEILS, FEATHER AND FUR BOAS, STOLEES, LEG WARMERS, ARM WARMERS, HOODS, EAR MUFFS, FUR AND FEATHER COLLARS AND CUFFS FOR APPLYING TO CLOTHING, ALL FOR USE IN ROLE-PLAYING GAMES (U.S. CLS. 22 AND 39).

SN 78-174,544. BRIDGES, CHRISTOPHER B., CENTREVILLE, VA. FILED 10-15-2002.

LUDACRIS

FOR CLOTHING, NAMELY, BELTS, CAPS, HOODS, JERSEYS, SHORT SETS, TIES, TOPS, WRAPS, ATHLETIC FOOTWEAR, ATHLETIC UNIFORMS, BANDANAS, BATHING SUITS, BATHROBES, BEACHWEAR, BEACH SHOES, BLAZERS, BOOTS, UNDERWEAR, COATS, DRESSES, DUSTERS, FOOTWEAR, GLOVES, GOWNS, HATS, HEADWEAR, HOSIERY, JEANS, KERICHS, JUMPSUITS, LINGERIE, LOUNGEWEAR, PAJAMAS, PANTS, RAIN SUITS, SANDALS, SHIRTS, T-SHIRTS, SOCKS, SWEATSHIRTS (U.S. CLS. 22 AND 39).
FIRST USE 1-0-1994; IN COMMERCE 1-0-1994.

CLASS 25—(Continued).

SN 78-177,281. HACKLE, DOLANDO S., CINCINNATI, OH. FILED 10-23-2002.

D.I.F.F.

FOR BOYS, GIRLS, MEN, AND WOMEN CLOTHING AND ACCESSORIES, NAMELY T-SHIRTS, TANK TOPS, BLOUSES, SHIRTS, SKIRTS, DRESSES, SHORTS, PANTS, OVERALLS, JUMPERS, SWEAT SHIRTS, SWEAT PANTS, SWEATERS, OUTER WEAR NAMELY, VEST, JACKETS AND COATS, LEATHER JACKETS AND COATS, FUR JACKETS AND COATS, SHOES, BOOTS, SWIM WEAR NAMELY SWIM TRUNKS, SWIM SUITS, SWIMMING COVER-UPS, SOCKS, BELTS, HEAD GEAR NAMELY HATS, BANDANNAS, HEAD BANDS, SCARVES, RAIN WEAR, GLOVES, SCARVES (U.S. CLS. 22 AND 39).

SN 78-177,971. PARAMOUNT PICTURES CORPORATION, LOS ANGELES, CA. FILED 10-24-2002.

FLASHDANCE

OWNER OF U.S. REG. NO. 1,325,693. FOR T-SHIRTS, SWEATSHIRTS, HATS, LEG WARMERS, FOOTWEAR (U.S. CLS. 22 AND 39).

SN 78-179,625. HIBALY INC., VERNON, CA. FILED 10-29-2002.



FOR HOSIERY, SOCKS AND UNDERWEAR; PANTY-HOSE (U.S. CLS. 22 AND 39). FIRST USE 10-1-1992; IN COMMERCE 10-1-1992.

CLASS 25—(Continued).

SN 78-180,427. JVB LLC, CASSELBERRY, FL. FILED 10-31-2002.



NO CLAIM IS MADE TO THE EXCLUSIVE RIGHT TO USE "THERAPEUTIC SHOES", APART FROM THE MARK AS SHOWN.

THE NAME J.P. WESLEY DOES NOT IDENTIFY A PARTICULAR LIVING INDIVIDUAL. FOR SHOES (U.S. CLS. 22 AND 39). FIRST USE 7-1-2002; IN COMMERCE 7-1-2002.

SN 78-180,971. DEER STAGS, INC., NEW YORK, NY. FILED 11-1-2002.



FOR FOOTWEAR (U.S. CLS. 22 AND 39).

SN 78-184,135. GREEN MARKET SERVICES COMPANY, INC., BROCKTON, MA. FILED 11-12-2002.



FOR MEN, WOMEN AND CHILDREN'S FOOTWEAR AND SLIPPERS (U.S. CLS. 22 AND 39).

CLASS 25—(Continued).

SN 78-185,270. AMTAI IMPORTS, INC., SANTA CLARA, CA.
FILED 11-14-2002.



FOR SHIRTS, PANTS, SHORTS, SWIMWEAR, COATS,
SOCKS, BOOTS, SHOES AND SANDALS (U.S. CLS. 22
AND 39).

SN 78-185,942. LUBRANO, ALLEGRA B., HANOVER, NH.
FILED 11-17-2002.

VERHAMPSHIRE

FOR SHIRTS AND HATS (U.S. CLS. 22 AND 39).

SN 78-187,919. DIRTY AMERICANS, LLC, SOUTHFIELD,
MI. FILED 11-22-2002.

DIRTY AMERICANS

FOR T-SHIRTS AND TANK TOPS (U.S. CLS. 22 AND
39).
FIRST USE 8-11-2001; IN COMMERCE 8-11-2001.

SN 78-188,982. BRIAN KENDALL, LTD., COLUMBUS, OH.
FILED 11-26-2002.

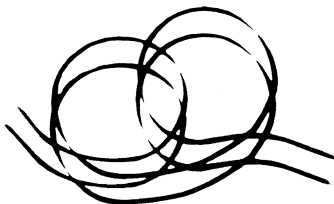

THE MARK CONSISTS OF A REPRESENTATION OF
TIRE SKID MARKS THAT RESULT WHEN A RACECAR
SPINS 360°, WHICH ACTION ALSO RESULTS IN A
"BURNTOUT" FOR HEATING THE TIRES.

FOR CLOTHING, NAMELY, SHIRTS, HATS, JACK-
ETS, AND SWEATSHIRTS (U.S. CLS. 22 AND 39).

CLASS 25—(Continued).

SN 78-191,505. GRIFFIN, ZULEMA, BKLYN, NY. FILED 12-
5-2002.



FOR WOMEN'S AND MEN'S CLOTHING, NAMELY,
BLOUSES, SHIRTS, PANTS, SKIRTS, SHOES, BELTS,
HATS, AND GLOVES (U.S. CLS. 22 AND 39).

SN 78-192,305. SMITH, PAMELA SUE, CENTENNIAL, CO.
FILED 12-8-2002.

LIKE A MOTHER SPORTS

NO CLAIM IS MADE TO THE EXCLUSIVE RIGHT TO
USE "SPORTS", APART FROM THE MARK AS SHOWN.

FOR SPORTS APPAREL FOR MOTHERS, NAMELY,
SPORTS BRAS, SHIRTS, PANTS, BASKETBALL CAPS,
SWEAT SHIRTS, SWEAT PANTS, SWEAT SUITS, AND
GLOVES (U.S. CLS. 22 AND 39).

SN 78-194,132. PHELPS, KENNETH, R., TEMPE, AZ. FILED
12-12-2002.

**UNDRAFTED ATHLETIC
WEAR**

NO CLAIM IS MADE TO THE EXCLUSIVE RIGHT TO
USE "ATHLETIC WEAR", APART FROM THE MARK AS
SHOWN.

FOR CLOTHING; NAMELY, T-SHIRTS, SWEAT-
SHIRTS, SWEATPANTS, SHORTS, SWEATSUITS,
WARM-UP SUITS, PULLOVERS, SOCKS, UNDERWEAR,
WRISTBANDS, GLOVES, JACKETS, JERSEYS, HEAD-
GEAR; NAMELY, CASUAL HATS, VISORS, BASEBALL
CAPS, SKULL CAPS, KNIT CAPS, DU RAGS, BANDAN-
NAS, HEADBANDS, FOOTWEAR; NAMELY CASUAL
SHOES, ATHLETIC SHOES, SHOWER SANDALS. (U.S.
CLS. 22 AND 39).

CLASS 25—(Continued).

SN 78-195,726. OUTSPOKE LLC, NEW YORK, NY. FILED 12-18-2002.

PRINCE OF SOHO

FOR CLOTHING FOR WOMEN, NAMELY, COATS, RAINCOATS, ANORAKS, PARKAS, BLAZERS, JACKETS, CARDIGANS, BOLEROS, CAPES, SPORT COATS, WIND RESISTANT JACKETS, VESTS, TUXEDOS, VESTS, DRESSES, EVENING GOWNS, JUMPERS, SKIRTS, PANTS, SLACKS, TROUSERS, JEANS, DUNGAREES, JUMPSUITS, OVERALLS, COVERALLS, FLIGHT SUITS, GYM SUITS, JOGGING SUITS, SWEAT PANTS, THERMAL UNDERWEAR, SHORTS, SKORTS, ROMPERS, CULOTTES, SHORTALLS, SHIRTS, SWEATERS, JERSEYS, BLOUSES, TUNICS, SWEATSHIRTS, T-SHIRTS, HALTER TOPS, TANK TOPS, BODYSUITS, UNITARDS, CAMISOLES, CHEMISES, UNDERSHIRTS, SLIPS, FOUNDATION GARMENTS, BODYSHAPERS, BRASIERES, BUSTIERS, GARTER BELTS, BRIEFS, BOXER SHORTS, BLOOMERS, UNDERPANTS, PANTIES, LINGERIE, LOUNGEWEAR, NIGHTGOWNS, NIGHT SHIRTS, NEGLIGEEES, ROBES, PAJAMAS, HOSIERY, PANTYHOSE, TIGHTS, KNEE HIGHS, LEG WARMERS, LEGGINGS, SOCKS, HEAD WEAR, HATS, CAPS, HOODS, HEAD BANDS, NECKWEAR, NECKTIES, BOW TIES, ASCOTS, POCKET SQUARES, SCARVES, SHAWLS, NECKERCHIEFS, GLOVES, MITTENS, BELTS, SASHES, CUMMERBUNDS, SHOES, FOOTWEAR, BOOTS, SANDALS, SLIPPERS, SNEAKERS, ATHLETIC SHOES, ATHLETIC FOOTWEAR, GALOSHES, SWIMWEAR, BATHING SUITS, BATHING TRUNKS, BEACHWEAR, BEACH COVERUPS, SARONGS, SKI WEAR, SKI SUITS, SKI PANTS, SKI GLOVES, THERMAL SOCKS, INFANT WEAR, BABY BIBS NOT OF PAPER, BIB OVERALLS, PLASTIC BABY BIBS, SKI BIBS, BOOTIES, BABY BUNTING, PLAYSUITS (U.S. CLS. 22 AND 39).

SN 78-196,323. TACCETTI S.R.L., FIRENZE, ITALY, FILED 12-19-2002.

taccetti

FOR FOOTWEAR (U.S. CLS. 22 AND 39).
FIRST USE 9-14-1999; IN COMMERCE 12-0-1999.

SN 78-198,305. HULLEON RECORDS, INC., FERNDALE, MI. FILED 12-27-2002.

JUSTUS BOYZ

NO CLAIM IS MADE TO THE EXCLUSIVE RIGHT TO USE "BOYZ", APART FROM THE MARK AS SHOWN.
FOR CLOTHING, NAMELY, CAPS, HATS, JACKETS, JERSEYS, SHIRTS, SHORTS, SWEATSHIRTS, AND T-SHIRTS (U.S. CLS. 22 AND 39).

CLASS 25—(Continued).

SN 78-198,385. HOLLANDER, SCOTT E, VENTURA, CA. FILED 12-28-2002.



THE LINING AND STIPPLING ARE A FEATURE OF THE MARK AND NOT INTENDED TO SHOW COLOR.
FOR CLOTHING - VESTS / JACKETS FOR MAKING TRAVELING MORE COMFORTABLE (U.S. CLS. 22 AND 39).

SN 78-199,159. FIERROS, ANDREW, CHULA VISTA, CA. FILED 12-31-2002.



FOR MOTORCYCLE T-SHIRTS. (U.S. CLS. 22 AND 39).

SN 78-200,074. WYNN, GREG A., WILLOW, OK. FILED 1-4-2003.

SMOKLAHOMA

FOR T-SHIRTS (U.S. CLS. 22 AND 39).

SN 78-201,208. OL' NO. 3, INC., HURON, SD. FILED 1-8-2003.

ALLABUNCHA

FOR CLOTHING, NAMELY, T-SHIRTS, SWEAT SHIRTS, CAPS, BANDANAS, NECKTIES, AND SHORTS (U.S. CLS. 22 AND 39).

CLASS 25—(Continued).

SN 78-202,674. TSI BRANDS, INC., WILMINGTON, DE.
FILED 1-13-2003.

UNIVERSAL FIT

FOR CLOTHING, NAMELY PANTS AND SHORTS
(U.S. CLS. 22 AND 39).

SN 78-203,300. SZAFRAN, DAVID M., WOODLAND HILLS,
CA. FILED 1-14-2003.

JACKETOY

FOR WEARING APPAREL, NAMELY, JACKETS,
SWEATERS, AND SHIRTS. (U.S. CLS. 22 AND 39).

SN 78-203,491. VIACOM INTERNATIONAL INC., NEW
YORK, NY. FILED 1-15-2003.

KRABBY PATTIES

FOR BATHING SUITS, BATHROBES, BEACHWEAR,
BELTS, SHORTS, JACKETS, COATS, SOCKS, FOOT-
WEAR, BANDANNAS, SWEATERS, HALLOWEEN COS-
TUMES, DRESSES, GLOVES, EAR MUFFS, NECKWEAR,
PAJAMAS, PANTS, SHIRTS, SKI WEAR, SLACKS, SUN
VISORS, SUSPENDERS, TURTLENECKS, UNDER-
CLOTHES, VESTS, WARM-UP SUITS, HEADWEAR, T-
SHIRTS, SPORTS SHIRTS, SWEAT SHIRTS, HATS (U.S.
CLS. 22 AND 39).

SN 78-203,755. BROOKS BROTHERS, INC., NEW YORK, NY.
FILED 1-15-2003.

1818

FOR CLOTHING, NAMELY, SHIRTS, TOPS, SWEA-
TERS, JACKETS, PANTS, SUITS, BOTTOMS, SOCKS,
HATS, SHOES, SHORTS, COATS, NECKTIES, VESTS,
HOSIERY, SKIRTS, DRESSES, SCARVES, TOPCOATS,
OVERCOATS, RAIN WEAR, TROUSERS, OUTER
COATS, SPORT COATS, POLO AND SPORT SHORTS
(U.S. CLS. 22 AND 39).

CLASS 25—(Continued).

SN 78-203,757. BROOKS BROTHERS, INC., NEW YORK, NY.
FILED 1-15-2003.

1818 SUIT COLLECTION

NO CLAIM IS MADE TO THE EXCLUSIVE RIGHT TO
USE "SUIT COLLECTION", APART FROM THE MARK AS
SHOWN.

FOR CLOTHING, NAMELY, SHIRTS, TOPS, SWEA-
TERS, JACKETS, PANTS, SUITS, BOTTOMS, SOCKS,
HATS, SHOES, SHORTS, COATS, NECKTIES, VESTS,
HOSIERY, SKIRTS, DRESSES, SCARVES, TOPCOATS,
OVERCOATS, RAIN WEAR, TROUSERS, OUTER
COATS, SPORT COATS, POLO AND SPORT SHORTS
(U.S. CLS. 22 AND 39).

SN 78-204,197. GURCHARAN, SINGH, GUTTENBERG, NJ.
FILED 1-16-2003.

KAT KUT

FOR LADIES AND MEN'S GARMENTS, NAMELY
PANTS, SHIRTS, SKIRTS, T-SHIRTS, COATS, BLOUSES,
GOWNS AND SHORTS (U.S. CLS. 22 AND 39).

FIRST USE 1-1-2003; IN COMMERCE 1-1-2003.

SN 78-205,591. FRED MEYER STORES, INC., PORTLAND,
OR. FILED 1-21-2003.

I.C. WINTERS

OWNER OF U.S. REG. NO. 1,665,106.

FOR GLOVES, HATS AND SCARVES (U.S. CLS. 22
AND 39).

SN 78-206,130. BRIDGES, CHRISTOPHER B., CENTRE-
VILLE, VA. FILED 1-22-2003.

DISTURBING THA PEACE

FOR CLOTHING, NAMELY, BELTS, CAPS, HOODS,
JERSEYS, SHORT SETS, TIES, TOPS, WRAPS, ATH-
LETIC FOOTWEAR, ATHLETIC UNIFORMS, BANDA-
NAS, BATHING SUITS, BATHROBES, BEACHWEAR,
BEACH SHOES, BLAZERS, BOOTS, UNDERWEAR,
COATS, DRESSES, DUSTERS, FOOTWEAR, GLOVES,
GOWNS, HATS, HEADWEAR, HOSIERY, JEANS, KER-
CHIEFS, JUMPSUITS, LINGERIE, LOUNGEWEAR, PA-
JAMAS, PANTS, RAIN SUITS, SANDALS, SHIRTS, T-
SHIRTS, SOCKS, SWEATSHIRTS (U.S. CLS. 22 AND 39).
FIRST USE 0-0-1999; IN COMMERCE 0-0-1999.

CLASS 25—(Continued).

SN 78-206,974. VANITY FAIR, INC., WILMINGTON, DE.
FILED 1-24-2003.

SENSUAL & LIVEABLE FOR THE CURVACEOUS WOMAN

FOR LOUNGEWEAR, FOUNDATION GARMENTS, SWIMSUITS, COATS, JACKETS, LEGGINGS, SOCKS, SHORTS, PANTS, JEANS, SKIRTS, SHIRTS, SWEATERS, VESTS, BELTS, DRESSES, LEOTARDS, UNITARDS, JOGGING SUITS, LEG WARMERS, GLOVES, MITTENS, RAINWEAR AND SCARVES (U.S. CLS. 22 AND 39).

SN 78-206,977. VANITY FAIR, INC., WILMINGTON, DE.
FILED 1-24-2003.

SENSUAL & LIVEABLE

FOR LOUNGEWEAR, FOUNDATION GARMENTS, SWIMSUITS, COATS, JACKETS, LEGGINGS, SOCKS, SHORTS, PANTS, JEANS, SKIRTS, SHIRTS, SWEATERS, VESTS, BELTS, DRESSES, LEOTARDS, UNITARDS, JOGGING SUITS, LEG WARMERS, GLOVES, MITTENS, RAINWEAR AND SCARVES (U.S. CLS. 22 AND 39).

SN 78-207,455. PELLA PRODUCTS, INC., PELLA, IA. FILED
1-27-2003.

OUTDOORDRY

FOR CLOTHING, NAMELY PANTS, BIB OVERALLS, JACKETS, PARKAS, GLOVES, MITTENS AND HATS (U.S. CLS. 22 AND 39).
FIRST USE 1-15-2003; IN COMMERCE 1-15-2003.

SN 78-207,479. CALEGO INTERNATIONAL, SAINT LAURENT, QUEBEC, CANADA, FILED 1-27-2003.

CALEGO

FOR SOCKS; CAPS; HATS; EARMUFFS; GLOVES; CLOTHING BELTS; CLOTHING MUFFLERS; RAINCOATS; RAIN JACKETS AND SLICKERS (U.S. CLS. 22 AND 39).
FIRST USE 6-9-1967; IN COMMERCE 9-9-1967.

CLASS 25—(Continued).

SN 78-207,661. FADLE, MAHIR, ANNANDALE, VA. FILED
1-27-2003.

MAZZARI

FOR CLOTHING, NAMELY, BELTS, CAPS, HATS, PANTS, DRESS SHIRTS, FOOTWEAR, GLOVES, HOSIERY, SOCKS, JEANS, KNIT SHIRTS, LOUNGEWEAR, NECKWEAR, SCARVES, SWEATERS, SWIMWEAR, VESTS, T-SHIRTS, JACKETS, PANTS, SHIRTS, COATS, BANDANNAS, SWEATSHIRTS, HEADWEAR AND FASHION ACCESSORIES, NAMELY, BELTS, TIES, GLOVES, SCARVES, SOCKS, HOSIERY, UNDERWEAR, BOXER SHORTS, WOMEN'S LINGERIE AND FOOTWEAR; SPORTSWEAR, NAMELY, SPORTS SHIRTS, SHORTS, JOGGING SUITS, SWEATPANTS, BODY SUITS AND LEGGINGS; OUTERWEAR, NAMELY, COATS, OVERCOATS, RAINCOATS, WAISTCOATS AND JACKETS; AND FORMAL WEAR, NAMELY, SLACKS, FORMAL TROUSERS, FORMAL JACKETS, SUITS, DRESSES, SKIRTS, BLOUSES, TOPS, SHAWLS AND EVENING GOWNS (U.S. CLS. 22 AND 39).

SN 78-207,761. PATRICK, RICHARD, ALLEN, DOVER, DE.
FILED 1-28-2003.

VERSATILE

FOR CLOTHING; NAMELY, SHIRTS, LONG-SLEEVE T-SHIRTS; SHORT-SLEEVE T-SHIRTS; CAPS, HATS, KNIT HATS AND BASEBALL CAPS (U.S. CLS. 22 AND 39).

SN 78-208,037. VIACOM INTERNATIONAL INC., NEW YORK, NY. FILED 1-28-2003.

TAK AND THE POWER OF JUJU

FOR BATHING SUITS, BATHROBES, BEACHWEAR, CLOTHING BELTS, SHORTS, JACKETS, COATS, SOCKS, FOOTWEAR, BANDANNAS, SWEATERS, HALLOWEEN COSTUMES, DRESSES, GLOVES, GYM SHORTS, EAR MUFFS, NECKWEAR, PAJAMAS, PANTS, SHIRTS, SWEAT SHIRTS, SKI WEAR, SLACKS, SUN VISORS, SUSPENDERS, TURTLENECKS, UNDERCLOTHES, VESTS, WARM-UP SUITS, HEADWEAR (U.S. CLS. 22 AND 39).

CLASS 25—(Continued).

SN 78-208,041. FRANCHISE RECORDS, INC., DBA FRANCHISE MARKETING, NEW YORK, NY. FILED 1-28-2003.

FMF1

FOR FOOTWEAR, SNEAKERS, SHOES, BOOTS, GALOSHES, SANDALS, ZORI AND SLIPPERS; CLOTHING, NAMELY, SHIRTS, T-SHIRTS, UNDER SHIRTS, NIGHT SHIRTS, RUGBY SHIRTS, POLO SHIRTS, JERSEYS, UNIFORMS, ATHLETIC UNIFORMS, PANTS, TROUSERS, SLACKS, JEANS, DENIM JEANS, OVERALLS, COVERALLS, JUMPERS, JUMP SUITS, SHORTS, BOXER SHORTS, TOPS, CROP TOPS, TANK TOPS, HALTER TOPS, SWEAT SHIRTS, SWEAT SHORTS, SWEAT PANTS, WRAPS, WARM-UP SUITS, JOGGING SUITS, BLOUSES, SKIRTS, DRESSES, SWEATERS, VESTS, FLEECE VESTS, PULLOVERS, FLEECE PULLOVERS, SNOW SUITS, PARKAS, ANORAKS, PONCHOS, JACKETS, DINNER JACKETS, SPORTS JACKETS, GOLF AND SKI JACKETS, REVERSIBLE JACKETS, COATS, BLAZERS, SUITS, TURTLENECKS, SWIMWEAR, BEACHWEAR, CAPS, BERETS, HATS, HEADBANDS, WRIST BANDS, SWEAT BANDS, HEADWEAR, EAR MUFFS, APRONS, SCARVES, BANDANAS, BELTS, SUSPENDERS, NECKWEAR, NECKTIES, TIES, UNDERWEAR, BRIEFS, TRUNKS, BRAS, SPORTS BRAS, SINGLET, SOCKS, LOUNGEWEAR, ROBES, BATHROBES, UNDERCLOTHES, PAJAMAS, SLEEPWEAR, NIGHT GOWNS, LINGERIE, CAMISOLES, SLIPS, LEG WARMERS, BODYSUITS, LEGGINGS, TIGHTS, LEOTARDS, UNITARDS, GLOVES, MITTENS AND RAINWEAR. (U.S. CLS. 22 AND 39).

SN 78-208,050. CARLETON, WALTER ALEXANDER, CAPE ELIZABETH, ME. FILED 1-28-2003.

ROGUES GALLERY

FOR T-SHIRTS KNIT SHIRTS WOVEN SHIRTS SWEATSHIRTS, JACKETS, JEANS AND WOVEN PANTS (U.S. CLS. 22 AND 39).

SN 78-208,150. FAULKNER, JON, A, BOISE, ID. FILED 1-28-2003.

GET AN AFTERLIFE

FOR T-SHIRTS (U.S. CLS. 22 AND 39).

CLASS 25—(Continued).

SN 78-208,181. KANGOL LIMITED, CLEATOR, UNITED KINGDOM, FILED 1-29-2003.



OWNER OF U.S. REG. NO. 2,136,385.
FOR HEADWEAR, NAMELY, CAPS, HATS AND BERETS (U.S. CLS. 22 AND 39).
FIRST USE 5-0-1982; IN COMMERCE 5-0-1982.

SN 78-208,370. TSI BRANDS, INC., WILMINGTON, DE. FILED 1-29-2003.

MICRO-FLEX

FOR CLOTHING, NAMELY PANTS AND SHORTS (U.S. CLS. 22 AND 39).

SN 78-208,457. DON SHAPIRO INDUSTRIES, INC., EL PASO, TX. FILED 1-29-2003.

ACTION CITY

OWNER OF U.S. REG. NOS. 1,006,638, 1,233,714 AND 1,516,489.
FOR CLOTHING, NAMELY, WOMEN'S SHIRTS, PANTS, JEANS, SHORTS AND SKIRTS; CHILDREN'S SHIRTS, JACKETS, BLAZERS, SLACKS AND JEANS; AND MEN'S SHIRTS, PANTS, JEANS, SHORTS, JACKETS AND BLAZERS. (U.S. CLS. 22 AND 39).

SN 78-208,480. COOLWEAR, INC., LONG ISLAND CITY, NY. FILED 1-29-2003.

CASHMIRACLE

FOR CLOTHING, NAMELY, WOMEN'S SWEATERS AND SWEATER SETS. (U.S. CLS. 22 AND 39).

SN 78-208,616. COOPER, WILLIAM, TEMPE, AZ. FILED 1-29-2003.

IT DIDN'T BEEPPP!

FOR SHIRTS, T-SHIRTS, CAPS AND PANTS (U.S. CLS. 22 AND 39).

CLASS 25—(Continued).

SN 78-208,979. JACQUES MORET, INC., NEW YORK, NY.
FILED 1-30-2003.

ACTIV-8

FOR LEOTARDS, LEGGINGS, TOPS AND TIGHTS
(U.S. CLS. 22 AND 39).

SN 78-209,109. RUI INC., DBA YO RABBIT, JACKSON, WY.
FILED 1-30-2003.

YORABBIT

FOR SHIRTS, PANTS, JACKETS, SWEATERS (U.S.
CLS. 22 AND 39).

SN 78-209,256. AZRIA, SYDNEY CLEMENT, LOS ANGELES,
CA. FILED 1-30-2003.

REBIRTH OF ART

FOR MENS AND WOMENS CLOTHING, NAMELY,
JACKETS, COATS, DRESSES, DRESS SHIRTS, KNIT
SHIRTS, SUITS, BLOUSES, POLO SHIRTS, GOLF
SHORTS, T-SHIRTS, ANORAKS, SKIRTS, SWEATERS,
TURTLENECKS, VESTS, CARDIGANS, PANTS, SLACKS,
TROUSERS, JEANS, OVERALLS, SLEEP WEAR, PAJA-
MAS, GLOVES, SCARVES, TANK TOPS, SHORTS,
SWEATSUITS, SWEATSHIRTS, BELTS, UNDERWEAR,
BOXER SHORTS, BATHING SUITS, BEACHWEAR,
FOOTWEAR, SHOES, BEACH SHOES, SANDALS,
BOOTS, SLIPPERS, HEADBANDS, SWEATBANDS, HATS
AND HEAD WEAR (U.S. CLS. 22 AND 39).

SN 78-209,483. GRIMES, KELLY, KEY WEST, FL. AND
BROCK, ROBERT, KEY WEST, FL. FILED 1-31-2003.

SOUL INFINITE

FOR T-SHIRTS (U.S. CLS. 22 AND 39).

SN 78-210,117. COOPER, WILLIAM, TEMPE, AZ. FILED 2-3-
2003.

IT-DID-N-*EEP!**

FOR SHIRTS, T-SHIRTS, CAPS AND PANTS (U.S. CLS.
22 AND 39).

CLASS 26—FANCY GOODS**CLASS 26—(Continued).**

SN 76-407,848. BOSTON INTERNATIONAL, HOLLISTON,
MA. FILED 5-14-2002.

FRESHLOOK

FOR ARTIFICIAL FLOWER ARRANGEMENTS (U.S.
CLS. 37, 39, 40, 42 AND 50).
FIRST USE 5-7-2002; IN COMMERCE 5-7-2002.

SN 78-162,485. KNITTING & HOWE LLC, NEW YORK, NY.
FILED 9-10-2002.

KNITTING & HOWE

NO CLAIM IS MADE TO THE EXCLUSIVE RIGHT TO
USE "KNITTING", APART FROM THE MARK AS SHOWN.
FOR KNITTING KITS CONTAINING KNITTING NEE-
DLES, WOOL OR COTTON BALLS OF YARN AND
INSTRUCTIONS (U.S. CLS. 37, 39, 40, 42 AND 50).

SN 78-174,349. PROGRESSIVE PRODUCTS INTERNA-
TIONAL, INC., CHESTERFIELD, MO. FILED 10-15-2002.

HAIR WEAR FRIENDS

OWNER OF U.S. REG. NO. 2,687,219.
NO CLAIM IS MADE TO THE EXCLUSIVE RIGHT TO
USE "HAIR WEAR", APART FROM THE MARK AS
SHOWN.
FOR HOLDERS FOR ACCESSORIES FOR HAIR IN
THE FORM OF DOLLS (U.S. CLS. 37, 39, 40, 42 AND 50).

SN 78-176,806. GRANT, ALYSSA N., HUNTINGTON BEACH,
CA. FILED 10-21-2002.

BOBBY BLOOMS

NO CLAIM IS MADE TO THE EXCLUSIVE RIGHT TO
USE "BLOOMS", APART FROM THE MARK AS SHOWN.
FOR HAIR AND FASHION ACCESSORIES MADE
FROM ARTIFICIAL FLOWERS, NAMELY BROOCHES,
BOBBY PINS, ELASTICS AND CLIPS FOR HAIR (U.S.
CLS. 37, 39, 40, 42 AND 50).

SN 78-184,133. PROGRESSIVE PRODUCTS INTERNA-
TIONAL, INC., CHESTERFIELD, MO. FILED 11-12-2002.

HAIR WEAR BEARS

OWNER OF U.S. REG. NO. 2,687,219.
NO CLAIM IS MADE TO THE EXCLUSIVE RIGHT TO
USE "HAIR WEAR", APART FROM THE MARK AS
SHOWN.
FOR HOLDERS FOR HAIR ACCESSORIES IN THE
FORM OF ANIMALS (U.S. CLS. 37, 39, 40, 42 AND 50).

CLASS 26—(Continued).

SN 78-208,193. AMEZQUITA, ALEX, ORLANDO, FL. FILED 1-29-2003.

TOPROCKER

FOR SHOE ORNAMENTS NOT OF PRECIOUS METAL. (U.S. CLS. 37, 39, 40, 42 AND 50).

SN 78-213,374. MARIAN, LLC, LAKE FOREST, CA. FILED 2-11-2003.

THREADTIME STORIES

FOR SEWING, CROSS-STITCH AND NEEDLEPOINT KITS CONSISTING OF FABRIC, THREAD, NEEDLES AND PATTERNS (U.S. CLS. 37, 39, 40, 42 AND 50).

CLASS 27—FLOOR COVERINGS

SN 76-480,742. J & J INDUSTRIES, DALTON, GA. FILED 1-2-2003.

CARPET FOR SPACES THAT WORK

FOR CARPETING (U.S. CLS. 19, 20, 37, 42 AND 50). FIRST USE 1-0-1998; IN COMMERCE 1-0-1998.

SN 76-486,796. MANNINGTON MILLS, INC., SALEM, NJ. FILED 2-3-2003.

COORDINATIONS

FOR NON-METAL LAMINATE FLOOR COVERING (U.S. CLS. 19, 20, 37, 42 AND 50).

SN 76-492,760. MANNINGTON MILLS, INC., SALEM, NJ. FILED 2-26-2003.

MOMENTUM

FOR VINYL FLOOR COVERING (U.S. CLS. 19, 20, 37, 42 AND 50).

CLASS 27—(Continued).

SN 78-149,950. ARDEN ARCHITECTURAL SPECIALITIES, INC., ST. PAUL, MN. FILED 8-1-2002.

DFS

FOR ENTRANCE FLOORING, NAMELY ENTRANCE CARPETING, REPLACEMENT CARPET AND VINYL STRIPS FOR ENTRANCE MATS AND GRATES, AND WALK-OFF MATS, ALL FOR COMMERCIAL BUILDING ENTRANCES (U.S. CLS. 19, 20, 37, 42 AND 50).

SN 78-193,803. SHAW INDUSTRIES GROUP, INC., DALTON, GA. FILED 12-12-2002.



THE MARK CONSISTS OF THE WORD "TEK" FOLLOWED BY A PERIOD, WHICH IS FOLLOWED BY AN "S" SUPERIMPOSED ON A CIRCLE.

FOR CARPETING (U.S. CLS. 19, 20, 37, 42 AND 50). FIRST USE 1-31-2002; IN COMMERCE 1-31-2002.

SN 78-201,212. YATES, CHARLES G., III, INDIALANTIC, FL. FILED 1-8-2003.

SEADEK

FOR EVA CLOSED CELL MARINE TRACTION PADS FOR USE AS NON-SLIP COVERINGS FOR BOAT DECKS (U.S. CLS. 19, 20, 37, 42 AND 50).

SN 78-208,426. PRODUCT CONCEPTS RESIDENTIAL LLC, DALTON, GA. FILED 1-29-2003.

PRECISIONLOC

FOR CARPETS AND BROADLOOM (U.S. CLS. 19, 20, 37, 42 AND 50).

SN 78-209,505. BI PROPERTIES I INC., GREENSBORO, NC. FILED 1-31-2003.

VISIO

FOR TEXTILE FLOOR COVERINGS, NAMELY CARPETS AND CARPET TILES (U.S. CLS. 19, 20, 37, 42 AND 50).

CLASS 28—TOYS AND SPORTING GOODS

CLASS 28—(Continued).

SN 75-415,911. WATERCORE LIMITED, TIA PO, NEW TERRITORIES, HONG KONG, FILED 1-9-1998.



PRIORITY CLAIMED UNDER SEC. 44(D) ON HONG KONG APPLICATION NO. 9716954, FILED 11-29-1997, REG. NO. B12199, DATED 11-29-1997, EXPIRES 11-29-2004.

NO CLAIM IS MADE TO THE EXCLUSIVE RIGHT TO USE "FISHING", APART FROM THE MARK AS SHOWN.

FOR HANDHELD UNIT WITH LIQUID CRYSTAL DISPLAY FOR PLAYING ELECTRONIC AND VIDEO GAMES AND SOFTWARE IN CONNECTION THEREWITH, ALL SOLD AS A UNIT (U.S. CLS. 22, 23, 38 AND 50).

SN 75-808,537. CHAP MEI PLASTIC TOYS MFY. LIMITED, KOWLOON, HONG KONG, FILED 9-24-1999.

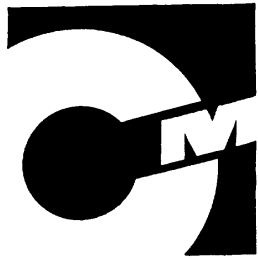

FOR TOY ACTION FIGURES AND ACCESSORIES, NAMELY, TOY WARRIORS, TOY STAR FIGHTERS; TOY WEAPONS, TOY MILITARY EQUIPMENT, TOY GUNS, TOY SWORDS, TOY KNIVES, TOY HAMMERS, TOY ARCHERY, TOY ARROW FETCHING DEVICES, TOY RIBBERS, TOY HOOKS, TOY ARMOR, TOY ARMED, GUARDS, TOY DAGGERS, TOY MILITARY RIFLES; TOY MILITARY VEHICLES, TOY VESSELS, TOY AIRCRAFT, TOY SPACECRAFT, TOY HELICOPTERS, TOY SHIPS AND BOATS, TOY TRUCKS, TOY CARS, TOY MOTORCYCLES, TOY BICYCLES; TOY COMMUNICATION SYSTEMS, NAMELY WALKIE-TALKIES, HEADSETS, HEADPHONES, SIGNAL LIGHTS, WHISTLES, SIGNBOARDS, TOY BINOCULARS, TOY BUILDINGS AND FIXTURES, TOY CASTLES, PLAYSET BUILDINGS; DOLLS, TOY ASTRONAUTS; TOY ACCESSORIES, NAMELY, THOSE FOR USE WITH DOLLS AND TOY ANIMALS; TOY CLOTHING, ACTION FIGURE OR PLAY FIGURE CLOTHING; TOY COSTUME JEWELRY, TOY COSTUME MASKS, TOY MASKS, TOY WATCHES, TOY HAIR ACCESSORIES; TOY ANIMALS, TOY MERMAIDS, TOY LIZARDS; SOCCER GAME SETS COMPRISED OF PLAYING PLATFORMS, SOCCER BALLS, SOCCER GOAL

CLASS 28—(Continued).

NETS AND STANDS, SOCCER KNEE PADS, TOY FIGURES OF SOCCER PLAYERS, FLAGS, AND SIGNS; HOCKEY GAME SETS COMPRISED OF PLAYING PLATFORMS, HOCKEY BALLS, HOCKEY GOAL NETS AND STANDS, HOCKEY GLOVES, HOCKEY GOALIE PADS, TOY HOCKEY HELMETS, HOCKEY STICKS, HOCKEY PUCKS, TOY FIGURES OF HOCKEY PLAYERS, FLAGS, AND SIGNS; BASEBALL GAME SETS COMPRISED OF PLAYING PLATFORMS, BASEBALLS, BASEBALL BASES, BASEBALL BATS, TOY BASEBALL BATTING HELMETS, BASEBALL BATTING TEES, BASEBALL GLOVES, BASEBALL MITTS, TOY FIGURES OF BASEBALL PLAYERS, FLAGS, AND SIGNS; DART SETS COMPRISED OF DARTS, DART BOARD CASES, DART BOARDS, DART CARRYING CASES, DART FLIGHTS, DART POINT SHARPENERS, DART POINTS, DART SHAFTS AND DART STEMS; THREE-DIMENSIONAL PLAY SETS DEPICTING SCENERY; PLAYSETS COMPRISING ONE OR MORE OF THE FOREGOING ITEMS; CASE FOR PLAY ACCESSORIES (U.S. CLS. 22, 23, 38 AND 50).

SN 76-120,045. DYLAN INCORPORATED, DBA CHANNEL MUSIC COMPANY, HENDERSONVILLE, TN. FILED 8-31-2000.

PURPLE PEOPLE EATER

NO CLAIM IS MADE TO THE EXCLUSIVE RIGHT TO USE "PURPLE", APART FROM THE MARK AS SHOWN. FOR PLUSH TOYS (U.S. CLS. 22, 23, 38 AND 50). FIRST USE 6-9-2000; IN COMMERCE 6-9-2000.

SN 76-147,651. FIA A. PAGNELLO CREATIVE CORP., SCARBOROUGH, ONTARIO, CANADA, FILED 10-12-2000.

FRANCAFIA

PRIORITY CLAIMED UNDER SEC. 44(D) ON CANADA APPLICATION NO. 1065444, FILED 7-4-2000, REG. NO. TMA578498, DATED 3-28-2003, EXPIRES 3-28-2018.

FOR FORTUNE TELLING GAME CONSISTING OF A CARDBOARD BOX FILLED WITH A BALL AND CARDS TO BE USED IN CONJUNCTION WITH THEM (U.S. CLS. 22, 23, 38 AND 50).

CLASS 28—(Continued).

SN 76-264,393. NBDL ENTERPRISES, LLC, SECAUCUS, NJ. FILED 5-30-2001.



OWNER OF U.S. REG. NOS. 2,599,556, 2,705,421 AND OTHERS.

NO CLAIM IS MADE TO THE EXCLUSIVE RIGHT TO USE "FAYETTEVILLE", APART FROM THE MARK AS SHOWN.

FOR TOYS, GAMES AND SPORTING GOODS, NAMELY BASKETBALLS; GOLF BALLS; PLAY-GROUND BALLS; SPORTS BALLS; RUBBER ACTION BALLS AND FOAM ACTION BALLS; PLUSH BALLS; BASKETBALL NETS; BASKETBALL BACKBOARDS; PUMPS FOR INFLATING BASKETBALLS, AND NEEDLES THEREFOR; GOLF CLUBS, GOLF BAGS, GOLF PUTTERS, GOLF BALL GIFT SETS WITH DIVOT REPAIR TOOLS, OR TEES OR BALL MARKERS AND GOLF ACCESSORIES, NAMELY GOLF BAG COVERS, CLUB HEAD COVERS, GOLF GLOVES, GOLF BALL SLEEVES; BICYCLE TAGS; ELECTRONIC BASKETBALL TABLE TOP GAMES; BASKETBALL TABLE TOP GAMES; BASKETBALL BOARD GAMES; ELECTRONIC VIDEO ARCADE GAME MACHINES; BASKETBALL KIT COMPRISED OF A BASKETBALL NET AND WHISTLE; DOLLS; TOY ACTION FIGURES; STUFFED TOYS; JIGSAW PUZZLES; CHRISTMAS TREE ORNAMENTS; ACTION SKILL GAMES ARCADE GAMES; ADULT AND CHILDREN'S PARTY GAMES; TRIVIA INFORMATION GAMES (U.S. CLS. 22, 23, 38 AND 50).

SN 76-299,860. ROYLCO INC., ANDERSON, SC. FILED 8-13-2001.



NO CLAIM IS MADE TO THE EXCLUSIVE RIGHT TO USE "CRAFTS", APART FROM THE MARK AS SHOWN.

THE BACKGROUND FOR THE MARK IS DARK BLUE. THE CENTER OF THE LETTER "B" IN THE WORD "BROWN" AND THE LETTER "G" IN THE WORD "BAG" IS RED. THE CENTER OF THE LETTER "O" IN THE WORD "BROWN" IS YELLOW. THE CENTER OF THE LETTER "B" IN THE WORD "BAG" IS LIGHT BLUE.

FOR HOBBY CRAFT SET CONTAINING CHILDREN'S EDUCATIONAL AND CREATIVE PRODUCTS, NAMELY GUMMED PAPER, PAPER NAME TAGS, STICKERS, CRAFT PAPER, YARN, PRE-CUT PAPER SHAPES, FINGER PAINTS, PRE-CUT DECORATIVE SHAPES, FELT CUT-OUTS, PIPE CLEANERS, FEATHERS, FOAM CRAFT SHAPES, BEAD BUDDIES, POM POMS, GLUE, AND ACTIVITY GUIDES (U.S. CLS. 22, 23, 38 AND 50).

CLASS 28—(Continued).

SN 76-299,861. ROYLCO INC., ANDERSON, SC. FILED 8-13-2001.

BROWN BAG CRAFTS

NO CLAIM IS MADE TO THE EXCLUSIVE RIGHT TO USE "CRAFTS", APART FROM THE MARK AS SHOWN.

FOR HOBBY CRAFT SET CONTAINING CHILDREN'S EDUCATIONAL AND CREATIVE PRODUCTS, NAMELY GUMMED PAPER, PAPER NAME TAGS, STICKERS, CRAFT PAPER, YARN, PRE-CUT PAPER SHAPES, FINGER PAINTS, PRE-CUT DECORATIVE SHAPES, FELT CUT-OUTS, PIPE CLEANERS, FEATHERS, FOAM CRAFT SHAPES, BEAD BUDDIES, POM POMS, GLUE, AND ACTIVITY GUIDES (U.S. CLS. 22, 23, 38 AND 50).

SN 76-315,968. SUPERCAR COLLECTIBLES LIMITED, OSSEO, MN. FILED 9-19-2001.

BILLY THE KID

FOR COLLECTIBLE MINIATURE MODEL CARS (U.S. CLS. 22, 23, 38 AND 50).

SN 76-345,177. DISNEY ENTERPRISES, INC., BURBANK, CA. FILED 12-3-2001.

PIXIE DUST COLLECTION

NO CLAIM IS MADE TO THE EXCLUSIVE RIGHT TO USE COLLECTION, APART FROM THE MARK AS SHOWN.

FOR RUBBER BALLS; ACTION FIGURES AND ACCESSORIES; ACTION SKILL GAMES; BEAN BAG DOLLS; PLUSH TOYS; BALLOONS; GOLF BALLS; TENNIS BALLS; BATH TOYS; CHRISTMAS TREE ORNAMENTS; BOARD GAMES; BUILDING BLOCKS; EQUIPMENT SOLD AS A UNIT FOR PLAYING CARD GAMES; DOLLS AND DOLL CLOTHING; DOLL PLAYSETS; CHILDREN'S PLAY COSMETICS; CRIB TOYS; ELECTRIC ACTION TOYS; MANIPULATIVE GAMES; GOLF GLOVES; GOLF BALL MARKERS; JIGSAW PUZZLES; KITES; MOBILES; MUSIC BOX TOYS; PARTY FAVORS IN THE NATURE OF SMALL TOYS; INFLATABLE POOL TOYS; MULTIPLE ACTIVITY TOYS FOR CHILDREN; WIND-UP TOYS; TARGET GAMES; DISC-TYPE TOSS TOYS; BOWS AND ARROWS; TOY VEHICLES; TOY CARS; TOY TRUCKS; TOY BUCKET AND SHOVEL SETS; ROLLER SKATES; TOY MODEL HOBBY-CRAFT KITS; TOY ROCKETS; TOY GUNS; TOY HOLSTERS; MUSICAL TOYS; BADMINTON SETS; BUBBLE MAKING WANDS AND SOLUTION SETS; TOY FIGURINES; TOY BANKS; PUPPETS; YO-YOS; SKATEBOARDS; TOY SCOOTERS; FACE MASKS; HAND-HELD UNIT FOR PLAYING ELECTRONIC GAMES (U.S. CLS. 22, 23, 38 AND 50).

CLASS 28—(Continued).

SN 76-385,052. R & S TRADING COMPANY, INC., IRVINE, CA. FILED 3-20-2002.

SNOW JACK

NO CLAIM IS MADE TO THE EXCLUSIVE RIGHT TO USE "SNOW", APART FROM THE MARK AS SHOWN.

FOR SNOWBOARDS WITH STEERABLE HANDLES; SNOWBOARDS; SNOWBOARD BINDINGS, BINDING PLATES, BINDING BASES, BINDING DISCS, BUCKLES, SLEEVES, STRAPS AND LEASHES; SNOWBOARD WAX; SNOWBOARD CASES AND CARRYING CASES (U.S. CLS. 22, 23, 38 AND 50).

SN 76-407,670. NEW YORK FOOTBALL GIANTS, INC., EAST RUTHERFORD, NJ. FILED 5-14-2002.

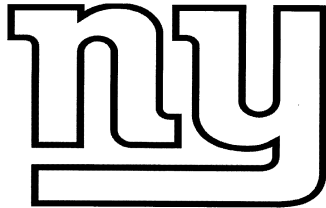

SEC. 2(F).

FOR TOYS AND SPORTING GOODS, NAMELY, PLUSH TOYS, STUFFED ANIMALS, PLAY FIGURES, GOLF BALLS, GOLF BAGS, GOLF CLUBS, GOLF CLUB COVERS, BOWLING BALLS, BOWLING BAGS, FOOTBALLS, DART BOARDS; BOARD GAMES RELATING TO FOOTBALL, CHRISTMAS TREE ORNAMENTS, BALLOONS, JIGSAW PUZZLES, WINDSOCKS FOR TOY AND DECORATIVE PURPOSES, KITES, TOY VEHICLES (U.S. CLS. 22, 23, 38 AND 50).

FIRST USE 5-30-2000; IN COMMERCE 5-30-2000.

SN 76-410,015. ABORIGINAL PRODUCTS, INC., SPRINGFIELD, IL. FILED 5-20-2002.

MAD JACK

FOR GOLF CLUB SWING AIDS, NAMELY MECHANICAL TRAINING APPARATUS (U.S. CLS. 22, 23, 38 AND 50).

SN 76-415,610. THOMAS, LORA LEE, BERRIEN SPRINGS, MI. FILED 6-4-2002.

HUG A TOT

FOR DOLLS, PLAYSETS AND ACCESSORIES THEREFOR (U.S. CLS. 22, 23, 38 AND 50).

CLASS 28—(Continued).

SN 76-428,700. REVELL-MONOGRAM, LLC, MORTON GROVE, IL. BY ASSIGNMENT; BY CHANGE OF NAME REVELL-MONOGRAM, L.L.C., MORTON GROVE, IL. FILED 6-28-2002.

PIE WAGON

NO CLAIM IS MADE TO THE EXCLUSIVE RIGHT TO USE "WAGON", APART FROM THE MARK AS SHOWN.

FOR PLASTIC TOY MODEL CAR KITS; DIE CAST TOY CARS (U.S. CLS. 22, 23, 38 AND 50).

SN 76-428,704. REVELL-MONOGRAM, LLC, MORTON GROVE, IL. BY ASSIGNMENT RM ACQUISITION SUB, LLC, CHICAGO, IL. FILED 6-28-2002.

BEER WAGON

NO CLAIM IS MADE TO THE EXCLUSIVE RIGHT TO USE "WAGON", APART FROM THE MARK AS SHOWN.

FOR PLASTIC TOY MODEL CUSTOM HOT ROD KITS; DIE CAST TOY CUSTOM HOT RODS (U.S. CLS. 22, 23, 38 AND 50).

SN 76-428,846. CHRONO MANUFACTURING LTD., EDMONTON, ALBERTA, CANADA, FILED 7-5-2002.



NO CLAIM IS MADE TO THE EXCLUSIVE RIGHT TO USE "GOOSE CHAIR", APART FROM THE MARK AS SHOWN.

THE MARK CONSISTS OF IN PART, THE STYLIZED REPRESENTATION OF A GOOSE.

FOR HUNTING BLINDS (U.S. CLS. 22, 23, 38 AND 50). FIRST USE 7-0-1996; IN COMMERCE 9-0-1997.

SN 76-432,222. FIVE OF US, INC., THE, SAN FRANCISCO, CA. FILED 7-19-2002.

NONNI'S CIRCUS

FOR PLUSH TOYS; WOOD TOYS IN THE NATURE OF BLOCK PUZZLES; CHILDREN'S TOY BACKPACKS; AND BOARD GAMES (U.S. CLS. 22, 23, 38 AND 50).

CLASS 28—(Continued).

SN 76-438,675. THE OHIO ART COMPANY, BRYAN, OH. FILED 8-8-2002.

A.R.M. 4000 XL

NO CLAIM IS MADE TO THE EXCLUSIVE RIGHT TO USE "XL", APART FROM THE MARK AS SHOWN.
FOR TOY WATER GUNS (U.S. CLS. 22, 23, 38 AND 50).
FIRST USE 11-30-2002; IN COMMERCE 1-16-2003.

SN 76-439,780. THE LOS ANGELES LAKERS, INC., EL SEGUNDO, CA. FILED 8-12-2002.



OWNER OF U.S. REG. NO. 1,809,258 AND OTHERS.
NO CLAIM IS MADE TO THE EXCLUSIVE RIGHT TO USE "MINNEAPOLIS" AND "MPLS", APART FROM THE MARK AS SHOWN.

THE STIPLING IS FOR SHADING PURPOSES ONLY.
FOR TOYS, GAMES AND SPORTING GOODS, NAMELY BASKETBALLS, GOLF BALLS, PLAYGROUND BALLS, SPORTS BALLS, RUBBER ACTION BALLS AND FOAM ACTION BALLS, PLUSH BALLS, BASKETBALL NETS, BASKETBALL BACKBOARDS, PUMPS FOR INFLATING BASKETBALLS, AND NEEDLES THEREFOR, GOLF CLUBS, GOLF BAGS, GOLF PUTTERS, GOLF BALL GIFT SETS WITH DIVOT REPAIR TOOLS, OR TEES OR BALL MARKERS, GOLF ACCESSORIES, NAMELY GOLF BAG COVERS, CLUB HEAD COVERS, GOLF GLOVES, GOLF BALL SLEEVES, ELECTRONIC BASKETBALL TABLE TOP GAMES, BASKETBALL TABLE TOP GAMES, BASKETBALL BOARD GAMES, ACTION SKILL GAMES, ADULT'S AND CHILDREN'S PARTY GAMES, TRIVIA INFORMATION GAMES AND ELECTRONIC VIDEO ARCADE GAME MACHINES, BASKETBALL KIT COMPRISED OF A BASKETBALL NET AND WHISTLE, DOLLS, TOY ACTION FIGURES, BOBBLEHEAD ACTION FIGURES, STUFFED TOYS, JIGSAW PUZZLES AND CHRISTMAS TREE ORNAMENTS (U.S. CLS. 22, 23, 38 AND 50).
FIRST USE 6-0-2000; IN COMMERCE 6-0-2000.

SN 76-445,084. INNER QUESTS, INCORPORATED, GLENWOOD SPRINGS, CO. FILED 7-2-2002.

DragonSport

FOR SPORTING EQUIPMENT, NAMELY, A TRIANGULAR ARENA FOR PRACTICING AND PLAYING MARTIAL ARTS (U.S. CLS. 22, 23, 38 AND 50).
FIRST USE 8-1-1999; IN COMMERCE 1-1-2000.

CLASS 28—(Continued).

SN 76-449,918. HILLWOOD DEVELOPMENT CORPORATION, DALLAS, TX. FILED 9-16-2002.

TEXAS EYE

NO CLAIM IS MADE TO THE EXCLUSIVE RIGHT TO USE "TEXAS", APART FROM THE MARK AS SHOWN.
FOR AMUSEMENT PARK RIDES (U.S. CLS. 22, 23, 38 AND 50).

SN 76-451,096. THE HAMILTON COLLECTION, INC., JACKSONVILLE, FL. FILED 9-13-2002.

HAMILTON AUTHENTICATED

OWNER OF U.S. REG. NOS. 2,256,529, 2,469,237 AND OTHERS.

NO CLAIM IS MADE TO THE EXCLUSIVE RIGHT TO USE "AUTHENTICATED", APART FROM THE MARK AS SHOWN.
FOR TOY MODEL VEHICLES (U.S. CLS. 22, 23, 38 AND 50).
FIRST USE 2-25-2000; IN COMMERCE 2-25-2000.

SN 76-451,389. WIZKIDS, LLC, BELLEVUE, WA. FILED 9-20-2002.



FOR GAME EQUIPMENT, NAMELY, COLLECTIBLE MINIATURE TOY FIGURINES AND ACCESSORIES, AND ROLE PLAYING EQUIPMENT IN THE NATURE OF GAME BOOK MANUALS (U.S. CLS. 22, 23, 38 AND 50).

FIRST USE 12-31-2001; IN COMMERCE 12-31-2001.

SN 76-453,098. SCHOLASTIC INC., NEW YORK, NY. FILED 9-26-2002.

SCHOLASTIC STORYBOOK COLLECTIBLES

OWNER OF U.S. REG. NOS. 2,444,851, 2,687,256 AND OTHERS.

NO CLAIM IS MADE TO THE EXCLUSIVE RIGHT TO USE "STORYBOOK COLLECTIBLES", APART FROM THE MARK AS SHOWN.
FOR PLUSH TOYS, STUFFED TOYS AND DOLLS (U.S. CLS. 22, 23, 38 AND 50).

CLASS 28—(Continued).

SN 76-457,705. NEVADA JACKS, LLC, BALTIMORE, MD.
FILED 10-11-2002.

NEVADA JACKS

FOR GAMING CHIPS (U.S. CLS. 22, 23, 38 AND 50).

SN 76-463,758. PARKER PROPERTIES, L.L.C., KENT, WA.
FILED 11-4-2002.



NO CLAIM IS MADE TO THE EXCLUSIVE RIGHT TO
USE "ULTIMATE" AND "DISC", APART FROM THE MARK
AS SHOWN.
FOR TOY PUZZLE (U.S. CLS. 22, 23, 38 AND 50).

SN 76-465,110. MILLERSPORT, INC., PLAINVIEW, NY.
FILED 10-31-2002.

STIC TAC TOE

FOR DISC TOSS TOY PATTERNED AFTER TIC TAC
TOE (U.S. CLS. 22, 23, 38 AND 50).

SN 76-469,694. ON THE WALL PRODUCTIONS, INC., ST.
LOUIS, MO. FILED 11-12-2002.

BEADBRAIN SKULL SHAKER

NO CLAIM IS MADE TO THE EXCLUSIVE RIGHT TO
USE "SKULL SHAKER", APART FROM THE MARK AS
SHOWN.
FOR TOY PLASTIC SHAKER IN THE SHAPE OF A
SKULL CONTAINING BEADS AND WITH METAL
SPRINGS ATTACHED (U.S. CLS. 22, 23, 38 AND 50).
FIRST USE 11-14-2001; IN COMMERCE 11-14-2001.

CLASS 28—(Continued).

SN 76-471,571. GLASSLINE DISTRIBUTORS PTY LTD, NEW
SOUTH WALES 2481, AUSTRALIA, FILED 11-19-2002.

MADDOG

OWNER OF AUSTRALIA REG. NO. 404000, DATED 2-20-
1984, EXPIRES 2-20-2005.
OWNER OF U.S. REG. NOS. 1,455,547 AND 2,089,465.
FOR SURFBOARDS, SKATEBOARDS, ROLLER-
SKATES, IN-LINE SKATES, ICE SKATES, AND RE-
LATED PARTS AND ACCESSORIES THEREFOR (U.S.
CLS. 22, 23, 38 AND 50).

SN 76-475,160. TOY THINGS, KOWLOON, HONG KONG,
FILED 12-5-2002.

STREET RACERS

NO CLAIM IS MADE TO THE EXCLUSIVE RIGHT TO
USE "RACERS", APART FROM THE MARK AS SHOWN.
FOR REMOTE CONTROL TOY VEHICLES AND AC-
CESSORIES THEREFOR (U.S. CLS. 22, 23, 38 AND 50).

SN 76-475,161. TOY THINGS, KOWLOON, HONG KONG,
FILED 12-5-2002.

BULLET RACERS

NO CLAIM IS MADE TO THE EXCLUSIVE RIGHT TO
USE "RACERS", APART FROM THE MARK AS SHOWN.
FOR TOY VEHICLES AND ACCESSORIES THEREFOR
(U.S. CLS. 22, 23, 38 AND 50).

SN 76-482,602. NRG INTERNATIONAL LIMITED, HONG
KONG, FILED 1-14-2003.



FOR TOYS, NAMELY YO-YOS (U.S. CLS. 22, 23, 38
AND 50).
FIRST USE 11-1-2002; IN COMMERCE 11-1-2002.

CLASS 28—(Continued).

SN 76-483,008. DOWNEY, WILLIAM T., BOSTON, MA. FILED 1-17-2003.

SAFEWEIGHT

FOR EXERCISE, FITNESS, AND SPORTING EQUIPMENT, NAMELY, EXERCISE MACHINES, HAND WEIGHTS, DUMBBELLS, WEIGHT LIFTING MACHINES, FREE WEIGHTS, HANDLE GRIPS FOR WEIGHTS, AND RELATED ACCESSORIES, NAMELY, STRAPS FOR EXERCISE MACHINES (U.S. CLS. 22, 23, 38 AND 50).

FIRST USE 11-28-2002; IN COMMERCE 11-28-2002.

SN 76-483,628. SEIRUS INNOVATIVE ACCESSORIES, INC., POWAY, CA. FILED 1-21-2003.

THE SKI RELAY

NO CLAIM IS MADE TO THE EXCLUSIVE RIGHT TO USE "SKI", APART FROM THE MARK AS SHOWN.

FOR SKI ACCESSORIES, NAMELY SKI AND SKI POLE CARRYING DEVICES (U.S. CLS. 22, 23, 38 AND 50).

FIRST USE 2-0-1990; IN COMMERCE 2-0-1990.

SN 76-484,130. USE YOUR HEAD UNLIMITED, INC., FALLS CHURCH, VA. FILED 1-22-2003.



THE MARK CONSISTS OF THE STYLIZED DEPICTION OF MALE AND FEMALE SOCCER PLAYERS.

FOR THEME-BASED GAMES IN THE NATURE OF STACKING PUZZLES AND MANIPULABLE PUZZLES (U.S. CLS. 22, 23, 38 AND 50).

FIRST USE 12-15-2000; IN COMMERCE 12-15-2000.

SN 76-485,253. HASBRO, INC., PAWTUCKET, RI. FILED 1-24-2003.

ROCKY THE MAGIC TALKIN' SHOVEL

NO CLAIM IS MADE TO THE EXCLUSIVE RIGHT TO USE "TALKIN' SHOVEL", APART FROM THE MARK AS SHOWN.

FOR TOY SHOVEL (U.S. CLS. 22, 23, 38 AND 50).

FIRST USE 4-24-2002; IN COMMERCE 4-24-2002.

CLASS 28—(Continued).

SN 76-485,254. HASBRO, INC., PAWTUCKET, RI. FILED 1-24-2003.

LIT THE MAGIC TALKIN' LANTERN

NO CLAIM IS MADE TO THE EXCLUSIVE RIGHT TO USE "TALKIN' LANTERN", APART FROM THE MARK AS SHOWN.

FOR TOY LANTERN (U.S. CLS. 22, 23, 38 AND 50).

FIRST USE 4-24-2002; IN COMMERCE 4-24-2002.

SN 76-485,413. THE 3DO COMPANY, REDWOOD CITY, CA. FILED 1-27-2003.

THE FOUR HORSEMEN OF THE APOCALYPSE

FOR TOYS, NAMELY, ACTION FIGURES AND ACCESSORIES THEREFORE, CASES FOR ACTION FIGURES, POSITIONAL TOY FIGURES, COLLECTIBLE TOY FIGURES, TOY FIGURES WITH TRANSFORMING PARTS, TOY VEHICLES, TOY VEHICLES WITH TRANSFORMING PARTS, TOY WEAPONS, BOARD GAMES, BOARD GAMES AND ACCESSORIES SOLD AS A UNIT FOR PLAYING BOARD GAMES, CARD GAMES, CARD GAMES AND ACCESSORIES SOLD AS A UNIT FOR PLAYING CARD GAMES, ACTION SKILL GAMES, HANDHELD UNIT, FOR PLAYING ELECTRONIC GAMES, ARCADE GAMES, COIN- OR TOKEN-OPERATED VIDEO GAMES, COIN- OR TOKEN-OPERATED PINBALL MACHINES (U.S. CLS. 22, 23, 38 AND 50).

SN 76-485,569. HSIN LUNG CORP (SHENZHEN) CO., LTD., HU KO HSIANG, HSIN CHU HSIEN, TAIWAN, FILED 1-28-2003.

FLEXY-FOOT

FOR SPORTS EQUIPMENT, NAMELY, STILTS (U.S. CLS. 22, 23, 38 AND 50).

SN 76-485,594. CANNERY CASINO RESORTS, LLC, LAS VEGAS, NV. FILED 1-28-2003.



THE STIPPLING IN THE DRAWING IS FOR SHADING PURPOSES ONLY AND DOES NOT INDICATE COLOR.

FOR GAMING EQUIPMENT, NAMELY, CHIPS AND DICE (U.S. CLS. 22, 23, 38 AND 50).

FIRST USE 1-3-2003; IN COMMERCE 1-3-2003.

CLASS 28—(Continued).

SN 76-485,595. CANNERY CASINO RESORTS, LLC, LAS VEGAS, NV. FILED 1-28-2003.

CANNERY

FOR GAMING EQUIPMENT, NAMELY, CHIPS AND DICE (U.S. CLS. 22, 23, 38 AND 50).
FIRST USE 1-0-2003; IN COMMERCE 1-0-2003.

SN 76-485,679. PLEASANT COMPANY, MIDDLETON, WI. FILED 1-24-2003.

American Girl
TODAY

OWNER OF U.S. REG. NOS. 1,506,148, 2,673,224 AND OTHERS.

FOR DOLLS, DOLL OUTFITS, DOLL SHOES, DOLL ACCESSORIES, DOLL FURNITURE, STUFFED TOY ANIMALS, ACCESSORIES FOR STUFFED TOY ANIMALS, TOY FURNITURE AND TOY DISHES TO ACCOMPANY STUFFED TOY ANIMALS (U.S. CLS. 22, 23, 38 AND 50).

SN 76-485,719. HARO BICYCLE CORPORATION, VISTA, CA. FILED 1-27-2003.

AIRFLOW

FOR BODY ARMOR FOR BICYCLISTS, NAMELY KNEE PADS, ELBOW PADS, SHIN GUARDS AND COMBINATION KNEE-SHIN GUARDS (U.S. CLS. 22, 23, 38 AND 50).
FIRST USE 12-15-2000; IN COMMERCE 12-15-2000.

SN 76-485,781. HOLYBEARS, INC., HOUSTON, TX. FILED 1-29-2003.



FOR PLUSH TOYS (U.S. CLS. 22, 23, 38 AND 50).
FIRST USE 7-6-2000; IN COMMERCE 7-6-2000.

CLASS 28—(Continued).

SN 76-491,919. MERIT INDUSTRIES, INC., BENSALEM, PA. FILED 2-24-2003.

11 BALL

OWNER OF U.S. REG. NO. 2,629,484.
FOR COIN OPERATED VIDEO GAMES (U.S. CLS. 22, 23, 38 AND 50).
FIRST USE 3-6-1998; IN COMMERCE 3-6-1998.

SN 76-495,135. PROTACTIC GOLF ENTERPRISES, INC., CHICAGO, IL. FILED 3-6-2003.

XTECH XPRESS

FOR GOLF CLUBS (U.S. CLS. 22, 23, 38 AND 50).

SN 78-069,704. NBDL ENTERPRISES, LLC, SECAUCUS, NJ. FILED 6-18-2001.

**ROANOKE
DAZZLE**

NO CLAIM IS MADE TO THE EXCLUSIVE RIGHT TO USE "ROANOKE". APART FROM THE MARK AS SHOWN. FOR TOYS, GAMES AND SPORTING GOODS, NAMELY BASKETBALLS, GOLF BALLS, PLAYGROUND BALLS, SPORTS BALLS, RUBBER ACTION BALLS AND FOAM ACTION BALLS, PLUSH BALLS, BASKETBALL NETS, BASKETBALL BACKBOARDS, PUMPS FOR INFLATING BASKETBALLS, AND NEEDLES THEREFOR, GOLF CLUBS, GOLF BAGS, GOLF PUTTERS, GOLF BALL GIFT SETS WITH DIVOT REPAIR TOOLS, OR TEES OR BALL MARKERS, GOLF ACCESSORIES, NAMELY GOLF BAG COVERS, CLUB HEAD COVERS, GOLF GLOVES, GOLF BALL SLEEVES, BICYCLE TAGS, ELECTRONIC BASKETBALL TABLE TOP GAMES, BASKETBALL TABLE TOP GAMES, BASKETBALL BOARD GAMES, ELECTRONIC VIDEO ARCADE GAME MACHINES, BASKETBALL KIT COMPRISED OF A BASKETBALL NET AND WHISTLE, DOLLS, TOY ACTION FIGURES, STUFFED TOYS, JIGSAW PUZZLES AND CHRISTMAS ORNAMENTS; ACTION SKILL GAMES, ARCADE GAMES, ADULT'S AND CHILDREN'S PARTY GAMES, TRIVIA INFORMATION GAMES, AND BOARD GAMES PROVIDED OVER THE INTERNET. (U.S. CLS. 22, 23, 38 AND 50).

CLASS 28—(Continued).

SN 78-096,474. GEN-X SPORTS INC., TORONTO, CANADA, FILED 12-4-2001.

DYNAMIC LOFT TECHNOLOGY

NO CLAIM IS MADE TO THE EXCLUSIVE RIGHT TO USE "TECHNOLOGY", APART FROM THE MARK AS SHOWN.

FOR GOLF CLUBS, GOLF GLOVES, GOLF BAGS, GOLF BAG COVERS, GOLF CLUB HEADS, GOLF CLUB SHAFTS, GRIPS FOR GOLF CLUBS, HEAD COVERS FOR GOLF CLUB, GOLF TEE MARKERS, AND GOLF PUTTERS (U.S. CLS. 22, 23, 38 AND 50).

SN 78-097,385. MAC INVESTORS, LLC, GREELEY, CO. FILED 12-8-2001.

TECH BAIT

NO CLAIM IS MADE TO THE EXCLUSIVE RIGHT TO USE "BAIT", APART FROM THE MARK AS SHOWN.

FOR ELECTRONIC FISHING LURE (U.S. CLS. 22, 23, 38 AND 50).

SN 78-102,832. MATTEL, INC., EL SEGUNDO, CA. FILED 1-15-2002.

N-TEK POLICE RESCUE

OWNER OF U.S. REG. NO. 2,547,876.

NO CLAIM IS MADE TO THE EXCLUSIVE RIGHT TO USE "POLICE", APART FROM THE MARK AS SHOWN.

FOR TOYS, GAMES, AND PLAYTHINGS, NAMELY, TOY ACTION FIGURES AND ACCESSORIES THEREFOR (U.S. CLS. 22, 23, 38 AND 50).

CLASS 28—(Continued).

SN 78-124,724. WORLD WRESTLING FEDERATION ENTERTAINMENT, INC., STAMFORD, CT. FILED 4-29-2002.



FOR PLAYING CARDS; TOY ACTION FIGURES AND ACCESSORIES; CASES FOR ACTION FIGURES; TOY VEHICLES; BOARD GAMES; TOY SPINNING TOPS; STAND ALONE VIDEO OUTPUT GAME MACHINES FEATURING WRESTLING; ARCADE GAMES RELATED TO WRESTLING; PINBALL GAMES RELATED TO WRESTLING; HAND-HELD UNITS FOR PLAYING ELECTRONIC GAMES; TABLETOP ACTION SKILL GAMES RELATED TO WRESTLING; JIGSAW PUZZLES; KITES; TOY WRESTLING RINGS; DOLLS; PUPPETS; STUFFED TOY ANIMALS; CARD GAMES; TOY GUITARS; WATER GUNS; VINYL POOL PRODUCTS FOR PLAYING, NAMELY—PILLOW BACK LOUNGE CHAIR; ONE AND TWO-MAN INFLATABLE BOATS; PERSONAL WATERCRAFTS, NAMELY, SINGLE AND MULTI-PASSENGER JET BOATS; RAFTS; INNER TUBES; AND FOOT PUMPS; CHRISTMAS TREE DECORATIONS; COSTUME MASKS; TOY BELTS, DOLL FURNITURE; PARTY FAVORS IN THE NATURE OF CRACKERS AND NOISEMAKERS; SKATEBOARDS; BOWLING BALLS AND ACCESSORIES, NAMELY, WRISTBANDS, NAMELY, WRIST SUPPORTS FOR BOWLING, BOWLING GLOVES, BALL CLEANING KITS, WRIST SUPPORTS, BOWLING BALL BAGS; WINDUP TOYS; SCOOTERS; BOWLING PINS; KNEE AND ELBOW PADS; YO-YO'S; FACE PAINTING SETS; PLASTIC MODEL KITS; POOL CUES; TOY BANKS MADE OF TIN; TOY GUM MACHINES; TOY CANDY BOWL MECHANICAL DISPENSERS; TOY STICK GUM DISPENSERS; TOY GUM FIGURE MAKERS (U.S. CLS. 22, 23, 38 AND 50).

SN 78-132,265. FAIDLEY, WARREN E., JR., TUCSON, AZ. FILED 5-30-2002.

STORM CHASER

FOR BOARD GAMES, TOY ACTION FIGURES AND ACCESSORIES THEREFOR, TOY VEHICLES, PLASTIC CHARACTER TOYS, MECHANICAL ACTION TOYS, BATTERY OPERATED ACTION TOYS, PUZZLES, NAMELY, JIGSAW PUZZLES, 3-DIMENSIONAL PUZZLES, CARD GAMES, NON-ELECTRONIC HANDHELD SKILL GAMES, TOY WEATHER INSTRUMENTS, WIND-UP TOYS, RIDE-ON TOYS, INFLATABLE TOYS, TALKING TOYS, CHILDREN'S MULTIPLE ACTIVITY TOYS, DOLLS, DOLL CLOTHES AND DOLL ACCESSORIES, BENDABLE TOYS, MUSICAL TOYS, TOY WATCHES, TOY RADIOS, TOY CAMERAS, TOY AIRPLANES, PARTY FAVORS IN THE NATURE OF SMALL TOYS, PLUSH TOYS, SOFT SCULPTURE TOYS, OUTDOOR ACTIVITY GAMES, PLASTIC TOY MODELS, NAMELY TOY MODEL VEHICLES AND RELATED MODEL ACCESSORIES SOLD AS UNITS. (U.S. CLS. 22, 23, 38 AND 50).

CLASS 28—(Continued).

SN 78-134,636. MOORE, BRENDEN, M, BEACON, NY. FILED 6-11-2002.



NO CLAIM IS MADE TO THE EXCLUSIVE RIGHT TO USE DESCRIPTIVE DESIGN OF THE EARTH, APART FROM THE MARK AS SHOWN.

THE STIPPLING IS A FEATURE OF THE MARK. THE MARK CONSISTS OF EVIL EYES, LETTERING, AND THE EARTH. SEC. 2(F). FOR PLASTIC CHARACTER TOYS (U.S. CLS. 22, 23, 38 AND 50).

SN 78-138,890. CLASSIC SPORT COMPANIES, INC., WESTMINSTER, CO. FILED 6-26-2002.

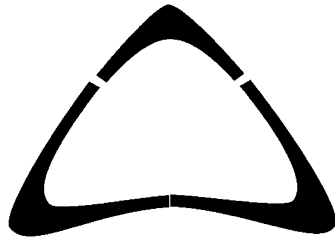

FOR SPORTS BALLS, NAMELY, FOOTBALLS, BASEBALLS, BASKETBALLS, SOCCER BALLS, VOLLEYBALLS, SOFTBALLS, HOCKEY PUCKS, PLAYGROUND BALLS, FOAM SPORTS BALLS, PLASTIC GOLF BALLS; LAWN GAMES, NAMELY, BADMINTON SETS, CROQUET SETS, BOCCIE BALLS, VOLLEYBALL GAME PLAYING EQUIPMENT, LAWN GOLF-TYPE GAMES; SPORTS ACCESSORIES, NAMELY, INFLATION NEEDLES, AIR PUMPS FOR INFLATING BASKETBALLS, VOLLEYBALLS, SOCCER BALLS, PLAYGROUND BALLS AND FOOTBALLS, BASKETBALL NETS, CONES, PLASTIC BATS, SOCCER GOALS, HOCKEY GOALS, PITCHING BACKSTOPS, FIELD MARKER CONES; BEACH PLAYING EQUIPMENT, NAMELY BEACH BALLS AND VOLLEYBALL PLAYING EQUIPMENT, BASEBALL EQUIPMENT, NAMELY, BASEBALL MITTS, BASES; PLASTIC BASEBALL EQUIPMENT, NAMELY, PLASTIC BASEBALL BATS, BASEBALLS, AND BASES; INDOOR ACTIVITY GAMES, NAMELY, TABLE HOCKEY SETS, TABLE SOCCER SETS, FLYING DISCS, MARBLES, JACKS, YO-YOS, BOARD GAMES; MINIATURE SPORTS BALLS NAMELY, FOOTBALLS, BASKETBALLS, SOCCER BALLS AND VOLLEYBALLS; FOAM SPORTS BALLS; PLASTIC SPORTS BALLS NAMELY, BASEBALLS AND GOLF BALLS; MINIATURE SPORTING EQUIPMENT AND ACCESSORIES NAMELY, FOOTBALL FIELD GOAL POSTS, SOCCER GOALS, HOCKEY GOALS, PITCHING BACKSTOPS, BASEBALL BATS, GOLF CLUBS, AND FIELD MARKER CONES (U.S. CLS. 22, 23, 38 AND 50).

CLASS 28—(Continued).

SN 78-145,202. DABBIERO, FRANK A., BERTHOUD, CO. FILED 7-18-2002.

BIG ASS DRIVER

NO CLAIM IS MADE TO THE EXCLUSIVE RIGHT TO USE "DRIVER", APART FROM THE MARK AS SHOWN. FOR GOLF CLUBS (U.S. CLS. 22, 23, 38 AND 50).

SN 78-145,563. BOLLINGER INDUSTRIES, L.P., GRAND PRAIRIE, TX. FILED 7-19-2002.



FOR MANUALLY OPERATED EXERCISE EQUIPMENT AND ACCESSORIES THEREFORE, NAMELY STATIONARY CYCLES, TREADMILLS, STEPPERS, AEROBIC TRAINERS, BENCHES, DIP STANDS, ABDOMINAL MACHINES, RACKS, ROMAN CHAIRS, CONTOUR SHAPERS, WAIST TRIMMERS, THIGH TRIMMERS, DUMBBELLS, BARBELLS, MEDICINE BALLS, WEIGHTED BARS, AEROBIC EXERCISE STEPS, WEIGHTED GLOVES, RINGS, TONE-UP WHEELS, FOREARM DEVELOPERS, PUSHUP BARS AND HANDLES, SPRING BARS, DOORWAY GYM BARS, CHEST PULLS, SIT-UP BARS, MANUALLY OPERATED GRIPS, ANKLE AND WRIST WEIGHTS, WEIGHTED VESTS, WEIGHTED BELTS, WEIGHTED THIGH WRAPS, JUMP ROPES, WEIGHT LIFTING BARS AND HANDLES, WEIGHT LIFTING COLLARS, WEIGHT LIFTING STRAPS, WEIGHT LIFTING GLOVES, WEIGHT LIFTING BELTS, SPEED BAGS, HEAVY BOXING BAGS, BOXING GLOVES, MOUTH GUARDS, HEAD HARNESSSES, SHIN GUARDS, BOXING STANDS AND EXERCISE STRETCHING EQUIPMENT, NAMELY ELASTIC BANDS AND PERSONAL EXERCISE MATS (U.S. CLS. 22, 23, 38 AND 50). FIRST USE 1-1-1991; IN COMMERCE 1-1-1991.

SN 78-147,874. INTERNATIONAL PLAYTHINGS, INC., PARLIPPANY, NJ. FILED 7-26-2002.

IMAGINETICS

FOR TOYS, NAMELY, MAGNETIC PLAYSETS (U.S. CLS. 22, 23, 38 AND 50).

CLASS 28—(Continued).

SN 78-150,333. CHIASSON, JAMES P., BURLINGTON, VT. FILED 8-2-2002.



FOR GOLF EQUIPMENT AND ACCESSORIES, NAMELY, GOLF CLUBS, GOLF CLUB HEADS, GOLF CLUB SHAFTS, GOLF CLUB HEAD COVERS, GOLF BALLS AND GOLF BAGS (U.S. CLS. 22, 23, 38 AND 50).

SN 78-153,123. O-PRO LTD, HATFIELD, UNITED KINGDOM, FILED 8-12-2002.

O.PRO

OWNER OF UNITED KINGDOM REG. NO. 2135919, DATED 2-27-1998, EXPIRES 6-14-2007. FOR ATHLETIC EQUIPMENT, NAMELY, MOUTH-GUARDS (U.S. CLS. 22, 23, 38 AND 50).

SN 78-156,791. PROCAPS ENCAPSULATION INC., ST. LAURENT, QUEBEC, CANADA, FILED 8-22-2002.

ARCTIC

FOR PAINTBALLS; PAINTBALL EQUIPMENT AND ACCESSORIES, NAMELY PAINTBALLS AND PAINTBALL MARKERS; SPORTING EQUIPMENT, NAMELY, PAINTBALL HOPPERS, PAINTBALL LOADING EQUIPMENT, AND HARNESSSES, PAINTBALL BARRELS; SPORTING EQUIPMENT, NAMELY, SKI AND SNOWBOARD PROTECTIVE FACE MASKS AND PADDING; MOTORCYCLE AND MOTOCROSS PROTECTIVE FACE MASKS AND PADDING; APPARATUS FOR USE IN PAINTBALL COMBAT GAMES, NAMELY EQUIPMENT BELTS, PROTECTIVE PADDING, GLOVES; PROTECTIVE FACE MASKS (U.S. CLS. 22, 23, 38 AND 50).

CLASS 28—(Continued).

SN 78-158,256. BANDAI CO., LTD., TOKYO, JAPAN, FILED 8-27-2002.

GASHAPON

OWNER OF JAPAN REG. NO. 4015069, DATED 6-20-1997, EXPIRES 6-20-2007.

FOR STAND ALONE VIDEO GAME MACHINES; LCD GAME MACHINES AND PARTS THEREOF; GAME MACHINES, NAMELY, STAND ALONE VIDEO OUTPUT GAME MACHINES; BALL PITCHING MACHINES AND COIN AND NON-COIN OPERATED PINBALL MACHINES; ARCADE GAMES; CARD GAMES AND PROMOTIONAL GAME CARDS; BOARD GAMES; BALLS FOR GAMES, NAMELY, BASEBALLS, PADDLE BALLS, TENNIS BALLS, BILLIARD BALLS, AND SPORTS BALLS; CHECKER SETS; CHESS SETS; MAGIC TRICKS; DARTS; DICE; DOMINOES; MARBLES FOR GAMES; SQUEEZABLE TOYS; WIND-UP TOYS; BENDABLE TOYS; STUFFED TOYS; TOY FIGURES; TOY ROBOTS; TOY VEHICLES; MUSICAL TOYS; TOY SPINNING TOPS; YO-YOS; KITES; PLASTIC HOBBY CRAFT KITS TO MAKE MINIATURE TRAINS, MINIATURE AIRPLANES AND MINIATURE VEHICLES AND RELATED ACCESSORIES SOLD AS A UNIT THEREWITH; AND CAPSULE TOYS IN THE NATURE OF MINIATURE TOY FIGURES AND ACCESSORIES THEREFOR, MINIATURE TOY VEHICLES AND ACCESSORIES THEREFOR, PLUSH TOYS, TOY WATCHES, AND RUBBER ACTION BALLS, DISTRIBUTED THROUGH COIN-OPERATED VENDING MACHINES (U.S. CLS. 22, 23, 38 AND 50).

SN 78-179,007. SHIMANO INC., OSAKA, JAPAN, FILED 10-28-2002.

**SUPER SLOW OSCILLATION**

NO CLAIM IS MADE TO THE EXCLUSIVE RIGHT TO USE "SUPER SLOW OSCILLATION", APART FROM THE MARK AS SHOWN.

THE LINING IS A FEATURE OF THE MARK AND DOES NOT INDICATE COLOR.

FOR FISHING TACKLE AND EQUIPMENT, NAMELY, REELS, RODS, LINES, LINE GUIDES, HOOKS, LURES, ARTIFICIAL BAITS, CREELS, FLOATS, SINKERS, HAND-HELD LANDING NETS FOR ANGLERS, FISHING GLOVES, FISHING BAGS, ROD CASES AND TACKLE CONTAINERS (U.S. CLS. 22, 23, 38 AND 50).

SN 78-179,012. SHIMANO INC., OSAKA, JAPAN, FILED 10-28-2002.

**EASY MAINTENANCE**

FOR FISHING TACKLE AND EQUIPMENT, NAMELY, REELS, RODS, LINES, LINE GUIDES, HOOKS, LURES, ARTIFICIAL BAITS, CREELS, FLOATS, SINKERS, HAND-HELD LANDING NETS FOR ANGLERS, FISHING GLOVES, FISHING BAGS, ROD CASES AND TACKLE CONTAINERS (U.S. CLS. 22, 23, 38 AND 50).

CLASS 28—(Continued).

SN 78-179,929. NELSON TECHNOLOGIES, INC., KINGSFORD, MI. FILED 10-30-2002.

VIRTUAL BAIT

NO CLAIM IS MADE TO THE EXCLUSIVE RIGHT TO USE "BAIT", APART FROM THE MARK AS SHOWN.

FOR ANIMAL ATTRACTANT SCENTS, NAMELY, A SCENTED LIQUID USED TO MASK HUMAN ODOR AND ATTRACT ANIMALS FOR HUNTING (U.S. CLS. 22, 23, 38 AND 50).

FIRST USE 6-17-2002; IN COMMERCE 8-23-2002.

SN 78-179,931. NELSON TECHNOLOGIES, INC., KINGSFORD, MI. FILED 10-30-2002.

SCENT BURST

NO CLAIM IS MADE TO THE EXCLUSIVE RIGHT TO USE "SCENT", APART FROM THE MARK AS SHOWN.

FOR ANIMAL ATTRACTANT SCENTS, NAMELY, A SCENTED LIQUID USED TO MASK HUMAN ODOR AND ATTRACT ANIMALS FOR HUNTING (U.S. CLS. 22, 23, 38 AND 50).

FIRST USE 6-17-2002; IN COMMERCE 8-23-2002.

SN 78-182,115. STAMINA PRODUCTS, INC., SPRINGFIELD, MO. FILED 11-5-2002.

AEROPILATES

FOR MANUALLY OPERATED EXERCISE EQUIPMENT (U.S. CLS. 22, 23, 38 AND 50).

SN 78-187,071. HOS DEVELOPMENT CORPORATION, LITCHFIELD, IL. FILED 11-20-2002.

CATCHERS-COMFORT

FOR ATHLETIC EQUIPMENT, NAMELY, LEG SUPPORTS, LEG BRACES AND LEG GUARDS (U.S. CLS. 22, 23, 38 AND 50).

SN 78-188,162. NIKE, INC., BEAVERTON, OR. FILED 11-22-2002.

D-TACK

FOR GLOVES FOR THE PRACTICE OF ALL SPORTS, NAMELY, FOOTBALL (U.S. CLS. 22, 23, 38 AND 50).
FIRST USE 6-30-1997; IN COMMERCE 6-30-1997.

CLASS 28—(Continued).

SN 78-188,171. NIKE, INC., BEAVERTON, OR. FILED 11-22-2002.

G-TACK

FOR GLOVES FOR THE PRACTICE OF ALL SPORTS, NAMELY, FOOTBALL (U.S. CLS. 22, 23, 38 AND 50).
FIRST USE 6-30-1997; IN COMMERCE 6-30-1997.

SN 78-192,871. BANDAI AMERICA INCORPORATED, KATELLA, CA. FILED 12-10-2002.

JAGUN FIGHTERS

NO CLAIM IS MADE TO THE EXCLUSIVE RIGHT TO USE "FIGHTERS", APART FROM THE MARK AS SHOWN.

FOR VIDEO GAMES, NAMELY COIN OPERATED AND AUTOMATIC STAND ALONE VIDEO GAME MACHINES IN THE NATURE OF AMUSEMENT PARK MACHINES AND COIN OPERATED VEHICLES FOR USE IN AMUSEMENT PARKS; ELECTRONIC GAME MACHINES, NAMELY STAND ALONE VIDEO AND STAND ALONE OUTPUT GAMES MACHINES; LCD GAME MACHINES; COIN OPERATED PINBALL MACHINES; ARCADE GAMES; BALLS FOR GAMES, NAMELY BASEBALLS, BEACH BALLS, RUBBER BALLS AND SPORTS BALLS; MAGIC TRICKS; DOMINOES; MARBLES FOR GAMES; STUFFED TOYS; TOY VEHICLES; TOY FIGURES; TOY ACTION FIGURES; TOY ROBOTS; TOYS FOR INTELLECTUAL TRAINING, NAMELY ACTIVITY TOYS AND BOARD GAMES; MOVEABLE PIECES FOR USE IN PLAYING A BOARD GAME; TOY SPINNING TOPS; KITES; YO-YO'S; DICE; MANIPULATIVE PUZZLES; CARD GAMES AND PROMOTIONAL CARD GAMES; PLASTIC MODEL KITS, NAMELY TOY MODEL HOBBY CRAFT KITS AND SCALE MODEL VEHICLES; AND PLAYMATS FOR USE WITH ROLE PLAYING GAMES AND CARRYING CASES (U.S. CLS. 22, 23, 38 AND 50).

SN 78-196,763. THIGHMASTER WORLD CORPORATION, CALABASAS, CA. FILED 12-20-2002.



FOR EXERCISE MACHINES (U.S. CLS. 22, 23, 38 AND 50).

CLASS 28—(Continued).

SN 78-196,862. KSERO CORPORATION, INC., RICHMOND, VA. FILED 12-20-2002.

METANON: THE BIOCODE ADVENTURE

THE WORD "METANON" IS A DERIVATIVE OF THE GREEK WORDS FOR "CHANGE" OR "CONVERSION".

FOR GAMES AND PLAYTHINGS, NAMELY ACTION FIGURES, PLUSH DOLLS, PUPPETS, TOY BINOCULARS, HAND-HELD PINBALL GAMES, BOARD GAMES, JIGSAW PUZZLES, TARGET SETS COMPRISED OF TARGETS AND PROJECTILES, TOY BOWLING SETS COMPRISED OF BOWLING PINS AND BOWLING BALLS, BOP BAGS, RING TOSS GAMES, BEAN BAG GAMES, NON-ELECTRONIC HAND-HELD SKILL GAMES, KITES, YO-YOS, TOY BALLOONS, DECORATIVE WIND SOCKS, CARD GAMES, TOY BANKS (U.S. CLS. 22, 23, 38 AND 50).

SN 78-199,014. AMERICAN AUTOMOBILE ASSOCIATION, INC., HEATHROW, FL. FILED 12-31-2002.



NO CLAIM IS MADE TO THE EXCLUSIVE RIGHT TO USE "TRAVEL OUTFITTERS", APART FROM THE MARK AS SHOWN.

FOR STUFFED TOYS (U.S. CLS. 22, 23, 38 AND 50).

SN 78-199,175. CRA SOLUTIONS, INC., CINCINNATI, OH. FILED 12-31-2002.

MY PEOPLE

FOR BOARD GAMES (U.S. CLS. 22, 23, 38 AND 50).

SN 78-201,561. MACK, TAMI, NEW YORK, NY. AND ASTILEAN, AUREL, A, EAST HAMPTON, NY. FILED 1-9-2003.

SPEEDFIT

FOR MANUALLY AND ELECTRONICALLY OPERATED EXERCISE EQUIPMENT; MANUALLY AND ELECTRONICALLY OPERATED EXERCISE MACHINES; EXERCISE BENCHES; PERSONAL EXERCISE MATS; EXERCISE TREADMILLS; EXERCISE WEIGHT CUFFS; AND EXERCISE WEIGHTS. (U.S. CLS. 22, 23, 38 AND 50).

CLASS 28—(Continued).

SN 78-203,525. BRINE, INC., MILFORD, MA. FILED 1-15-2003.

BRINE

OWNER OF U.S. REG. NOS. 1,241,312, 2,474,071 AND OTHERS.

FOR LACROSSE STICKS, LACROSSE STICK HEADS AND PARTS THEREOF, LACROSSE BALLS, LACROSSE GLOVES, LACROSSE ARM PADS, LACROSSE SHOULDER PADS, LACROSSE RIB PADS, LACROSSE CHEST PROTECTORS, LACROSSE GOALS, LACROSSE HELMETS, LACROSSE NETS, LACROSSE NET ACCESSORIES, SOCCER BALLS, SOCCER GOALKEEPER GLOVES, SOCCER SHIN GUARDS, SOCCER GOALS, SOCCER NETS, SOCCER NET ACCESSORIES, FIELD HOCKEY STICKS, FIELD HOCKEY BALLS, FIELD HOCKEY GLOVES, FIELD HOCKEY SHIN GUARDS, FIELD HOCKEY GOALS, FIELD HOCKEY NETS, FIELD HOCKEY NET ACCESSORIES, VOLLEYBALLS, VOLLEYBALL NETS, VOLLEYBALL NET ACCESSORIES (U.S. CLS. 22, 23, 38 AND 50).

FIRST USE 0-0-1923; IN COMMERCE 0-0-1923.

SN 78-203,993. WOOD, HORACE, CARDIFF-BY-THE-SEA, CA. FILED 1-16-2003.

RETROSTIX

FOR SPORTING GOODS; SPECIFICALLY, FUNCTIONAL AND DECORATIVE SURFBOARDS AND SKATEBOARDS OF NOSTALGIC DESIGN (U.S. CLS. 22, 23, 38 AND 50).

FIRST USE 12-15-2001; IN COMMERCE 4-13-2002.

SN 78-205,331. HEDSTROM CORPORATION, ARLINGTON HEIGHTS, IL. FILED 1-21-2003.

HIDE 'N SLEEP

FOR PLAY TENTS WHICH FIT ON TOP OF MATTRESSES (U.S. CLS. 22, 23, 38 AND 50).

SN 78-206,565. TEK NEK TOYS INTERNATIONAL, INC., MOKENA, IL. FILED 1-23-2003.

TEDDY WEARS

FOR TOY FIGURES AND PLUSH ANIMALS (U.S. CLS. 22, 23, 38 AND 50).

CLASS 28—(Continued).

SN 78-206,582. LARSON, STEPHEN P, SPRINGFIELD, OR.
FILED 1-23-2003.

OBFUSCATIONS

FOR EQUIPMENT INCLUDING A PLAYING BOARD, DIE, RULES OF PLAY, QUESTION AND ANSWER CARDS, CARD BOXES, PLAYER TOKENS AND SCORING CARDS SOLD AS A UNIT FOR PLAYING A BOARD OR PARTY GAME (U.S. CLS. 22, 23, 38 AND 50).

SN 78-207,092. MADE IT HAPPEN ENTERTAINMENT,
FOUNTAIN VALLEY, CA. FILED 1-24-2003.

NEVER DOUBT THEM...

FOR PROMOTIONAL SPORTS GAME MATERIALS
(U.S. CLS. 22, 23, 38 AND 50).

SN 78-207,299. PURSUIT MARKETING, INC., DES PLAINES,
IL. FILED 1-27-2003.

RESPIRATOR

FOR PAINTBALL MARKERS AND ACCESSORIES,
NAMELY, REGULATORS FOR USE IN CONNECTION
WITH PAINTBALL MARKERS. (U.S. CLS. 22, 23, 38 AND
50).

SN 78-207,322. PURSUIT MARKETING, INC., DES PLAINES,
IL. FILED 1-27-2003.

STATIC

FOR PAINTBALLS AND PAINTBALL MARKERS.
(U.S. CLS. 22, 23, 38 AND 50).

SN 78-207,330. PURSUIT MARKETING, INC., DES PLAINES,
IL. FILED 1-27-2003.

ULTRA

FOR PAINTBALLS AND PAINTBALL MARKERS.
(U.S. CLS. 22, 23, 38 AND 50).

CLASS 28—(Continued).

SN 78-207,370. IMPACT PROTECTIVE EQUIPMENT, LLC,
MADISON, NJ. FILED 1-27-2003.

PROTECTION REDEFINED

NO CLAIM IS MADE TO THE EXCLUSIVE RIGHT TO
USE "PROTECTION", APART FROM THE MARK AS
SHOWN.

FOR ATHLETIC PROTECTIVE PADS FOR USE IN
FOOTBALL, ICE HOCKEY, BASEBALL, SOFTBALL AND
LACROSSE, NAMELY SHOULDER PADS, ELBOW
PADS, KNEE PADS, BODY PADS, SIDE PADS, HIP
PADS, RIB PADS, NECK ROLLS, AND SHIN PADS,
AND ICE HOCKEY GOALIE PADS (U.S. CLS. 22, 23, 38
AND 50).

SN 78-207,562. SIMPLE WISHES, INC., LA QUINTA, CA.
FILED 1-27-2003.

RICE ROCKETS

FOR TOYS, NAMELY, DIECAST MINIATURE VEHI-
CLES AND ACCESSORIES THEREFOR (U.S. CLS. 22, 23,
38 AND 50).

SN 78-207,648. CAFFREY, MICHAEL S., KIRKLAND, WA.
FILED 1-27-2003.

AQUA ASSASSIN

FOR TOY WATER GUN (U.S. CLS. 22, 23, 38 AND 50).

SN 78-207,797. STUART, WARREN C., LAS VEGAS, NV.
FILED 1-28-2003.

OSTEOVEST

FOR WEIGHTED VEST TO BE USED DURING EX-
ERCISE (U.S. CLS. 22, 23, 38 AND 50).

SN 78-208,328. GLASS, HILARY, R, WALNUT CREEK, CA.
FILED 1-29-2003.

PLAYSPRAY

FOR CHILDREN'S PLAY DETANGLER, CONDI-
TIONER AND STYLE AID FOR DOLL HAIR, PLAY
HORSES' MANES AND TAILS, AND STUFFED ANIMAL
FUR (U.S. CLS. 22, 23, 38 AND 50).

CLASS 28—(Continued).

SN 78-208,468. LANGLEY, SANDRA B., NOBLE, LA. FILED 1-29-2003.

WIGGLE TAIL

FOR ARTIFICIAL FISHING LURES (U.S. CLS. 22, 23, 38 AND 50).

SN 78-209,507. MOOSE MOUNTAIN TOYMAKERS LTD., TSIMSHATSUI EAST KOWLOON, HONG KONG, FILED 1-31-2003.

DISCO MAGIC

FOR TOYS, NAMELY, A MULTIPLE COLOR DISPLAY UNIT FOR DISPLAYING COLORS IN A PREDETERMINED PATTERN AND A FLOOR MAT SOLD THEREWITH AS A UNIT HAVING CORRESPONDING COLORS EACH WITH A SENSOR CONNECTED TO THE DISPLAY UNIT FOR INSTRUCTIONAL GAME PLAY (U.S. CLS. 22, 23, 38 AND 50).

SN 78-209,925. BINARY ARTS CORPORATION, ALEXANDRIA, VA. FILED 2-2-2003.

RIVER CROSSING

FOR GAMES, NAMELY MANIPULATIVE PUZZLES, AND MANIPULATIVE GAMES (U.S. CLS. 22, 23, 38 AND 50).

FIRST USE 1-14-2003; IN COMMERCE 1-14-2003.

CLASS 29—MEATS AND PROCESSED FOODS

SN 76-024,690. BERNER FOODS, INC., ROSCOE, IL. BY CHANGE OF NAME BERNER CHEESE CORPORATION, DAKOTA, IL. FILED 4-13-2000.



NO CLAIM IS MADE TO THE EXCLUSIVE RIGHT TO USE "CHEESE", APART FROM THE MARK AS SHOWN. FOR CHEESE SPREADS IN AN AEROSOL CONTAINER (U.S. CL. 46).
FIRST USE 9-14-1998; IN COMMERCE 9-14-1998.

CLASS 29—(Continued).

SN 76-124,312. CP KELCO U.S., INC., WILMINGTON, DE. FILED 9-8-2000.



OWNER OF U.S. REG. NOS. 277,972, 2,264,747 AND OTHERS.

FOR INGREDIENTS USED IN THE MANUFACTURE OF FOOD, NAMELY, FRUIT PECTIN AND WHEY (U.S. CL. 46).

SN 76-125,056. CP KELCO U.S., INC., WILMINGTON, DE. FILED 9-8-2000.

CP KELCO

OWNER OF U.S. REG. NOS. 277,972, 2,264,747 AND OTHERS.

FOR INGREDIENTS USED IN THE MANUFACTURE OF FOOD, NAMELY, FRUIT PECTIN AND WHEY (U.S. CL. 46).

SN 76-223,466. MOSAIC BRANDS, INC., NEW YORK, NY. FILED 3-13-2001.

MOUNT PELION BLACK OLIVES

NO CLAIM IS MADE TO THE EXCLUSIVE RIGHT TO USE "BLACK OLIVES", APART FROM THE MARK AS SHOWN.

SEC. 2(F).

FOR SUNDRIED TOMATOES, CANNED TOMATOES, TOMATO PASTE, PICKLED VEGETABLES, PICKLED PEPPERS, DRIED MUSHROOM, OLIVES AND EDIBLE OIL (U.S. CL. 46).

FIRST USE 3-26-1998; IN COMMERCE 3-26-1998.

SN 76-223,467. MOSAIC BRANDS, INC., NEW YORK, NY. FILED 3-13-2001.

MT. PELION BLACK OLIVES

NO CLAIM IS MADE TO THE EXCLUSIVE RIGHT TO USE "BLACK OLIVES", APART FROM THE MARK AS SHOWN.

SEC. 2(F).

FOR SUNDRIED TOMATOES, CANNED TOMATOES, TOMATO PASTE, PICKLED VEGETABLES, PICKLED PEPPERS, DRIED MUSHROOM, OLIVES AND EDIBLE OIL (U.S. CL. 46).

FIRST USE 8-28-1996; IN COMMERCE 8-28-1996.

CLASS 29—(Continued).

SN 76-240,389. ALL VEGETARIAN, INC., EL MONTE, CA. FILED 4-13-2001.



NO CLAIM IS MADE TO THE EXCLUSIVE RIGHT TO USE "SOY", APART FROM THE MARK AS SHOWN. FOR PROCESSED SUSHI BAR STYLE SOY BEANS (U.S. CL. 46). FIRST USE 2-8-2001; IN COMMERCE 2-8-2001.

CLASS 29—(Continued).

SN 76-366,072. NGAI TAHU SEAFOOD PRODUCTS LIMITED, CHRISTCHURCH, NEW ZEALAND, BY CHANGE OF NAME NGAI TAHU FISHERIES LIMITED, CHRISTCHURCH, NEW ZEALAND, FILED 1-31-2002.

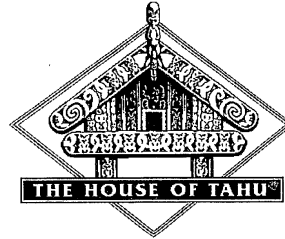

THE MARK CONSISTS OF THE WORDS "THE HOUSE OF TAHU" WITH AN ARBITRARY DESIGN. FOR PRESERVED AND CANNED FISH; SHELLFISH; PREPARED MEALS CONSISTING PRIMARILY OF FISH OR SHELLFISH; PICKLED FISH; FISH SOUFFLES; SOUPS AND PREPARATIONS FOR MAKING SOUPS (U.S. CL. 46). FIRST USE 0-0-1992; IN COMMERCE 0-0-1992.

SN 76-398,558. HEB GROCERY COMPANY, LP, SAN ANTONIO, TX. FILED 4-22-2002.

CREATE A CRACKER

NO CLAIM IS MADE TO THE EXCLUSIVE RIGHT TO USE "CRACKER", APART FROM THE MARK AS SHOWN. FOR PACKAGED COMBINATIONS CONSISTING PRIMARILY OF CHEESE AND CRACKERS (U.S. CL. 46).

SN 76-264,252. CONFEDERATED SWINE PRODUCERS, L.L.C., ELKADER, IA. FILED 5-31-2001.



NO CLAIM IS MADE TO THE EXCLUSIVE RIGHT TO USE "AMERICAN FAMILY FARMS BRANDS FARMER OWNED", APART FROM THE MARK AS SHOWN. THE LINING IS A FEATURE OF THE MARK. FOR MEATS; PACKAGED AND PROCESSED PORK (U.S. CL. 46). FIRST USE 4-10-2001; IN COMMERCE 4-10-2001.

SN 76-423,633. FUJI FOODS CORPORATION, YOKOHAMA, JAPAN, FILED 6-21-2002.



NO CLAIM IS MADE TO THE EXCLUSIVE RIGHT TO USE "HOT, NON-FERMENTED, AND CHILLI PASTE", APART FROM THE MARK AS SHOWN. COLOR IS A FEATURE OF THE MARK. THE VERTICAL BLACK LINES ON WHITE BACKGROUND REPRESENT RED. THE STIPPLING REPRESENTS DARK RED AND DIAGONAL LINES FROM UPPER LEFT TO LOWER RIGHT ON A WHITE BACKGROUND REPRESENT GREEN. FOR RED PEPPER PASTE (U.S. CL. 46).

CLASS 29—(Continued).

SN 76-425,033. SUTAS BURSA VE HAVALISI PASTORIZE SUT VE SUT MAMULLERI GIDA SANAYI VE TICARET ANONIM SIRKETI, BURSA, TURKEY, FILED 6-24-2002.



NO CLAIM IS MADE TO THE EXCLUSIVE RIGHT TO USE "DOGAL LEZZET", APART FROM THE MARK AS SHOWN.

THE FOREIGN WORDING IN THE MARK TRANSLATES INTO ENGLISH AS "NATURAL TASTE".

FOR PROCESSED, CANNED, AND FRESH MEATS, POULTRY AND GAME, NAMELY, BEEF, BOLOGNA, FRANKFURTERS, PORK, CHICKEN, DUCK, TURKEY, LAMB, VENISON; SEAFOOD, NAMELY, FISH, SHRIMP, AND SHELLFISH; MEAT EXTRACTS; PROCESSED FRUITS AND VEGETABLES, NAMELY, PROCESSED BEANS, PROCESSED PEAS, PROCESSED CARROTS, PROCESSED TOMATOES, TOMATO PASTE, TOMATO PUREE, PROCESSED OLIVES, PROCESSED PICKLES, PROCESSED PEPPERS; PROCESSED JELLIES, JAMS; EGGS; PROCESSED AND FRESH DAIRY PRODUCTS, NAMELY, MILK, CHEESE, YOGURT, AND SOUR CREAM; PROCESSED NUTS AND PROCESSED EDIBLE SEEDS; EDIBLE OILS AND FATS, NAMELY, COOKING OIL, LARD, BUTTER AND MARGARINE; SOUPS; PREPARED ENTREES CONSISTING PRIMARILY OF MEAT, POULTRY, FISH OR VEGETABLES (U.S. CL. 46).

SN 76-434,786. CIBAO MEAT PRODUCTS, INC., BRONX, NY, FILED 7-26-2002.



OWNER OF U.S. REG. NO. 1,994,458.
FOR COOKED SAUSAGE (U.S. CL. 46).
FIRST USE 11-5-1987; IN COMMERCE 11-5-1987.

CLASS 29—(Continued).

SN 76-438,510. AMERICAN RICE, INC., HOUSTON, TX, FILED 8-7-2002.

ADOLPHUS

FOR VEGETABLE OIL AND CORN OIL (U.S. CL. 46).

SN 76-440,227. RIENZI, ARMANDO, TRENTON, NJ, FILED 8-12-2002.

D WINGS

NO CLAIM IS MADE TO THE EXCLUSIVE RIGHT TO USE "WINGS", APART FROM THE MARK AS SHOWN.

FOR FULLY COOKED BREADED CHICKEN WING SECTIONS; COOKED CHICKEN PARTS; AND, READY-TO-EAT CHICKEN PIECES (U.S. CL. 46).

FIRST USE 3-12-2002; IN COMMERCE 3-12-2002.

SN 76-442,268. YOAKAM, DWIGHT, LOS ANGELES, CA, FILED 8-19-2002.

DWIGHT YOAKAM

THE NAME(S), PORTRAIT(S), AND/OR SIGNATURE(S) SHOWN IN THE MARK IDENTIFIES "DWIGHT YOAKAM", WHOSE CONSENT(S) TO REGISTER IS SUBMITTED.

FOR FOOD PRODUCTS CONSISTING PRIMARILY OF FROZEN, PREPARED OR PACKAGED MEAT, FISH, POULTRY OR VEGETABLES (U.S. CL. 46).

SN 76-442,720. ROTH KASE U.S.A. LTD., MONROE, WI, FILED 8-19-2002.

BELLEVILLE BLUE

NO CLAIM IS MADE TO THE EXCLUSIVE RIGHT TO USE "BLUE", APART FROM THE MARK AS SHOWN.

FOR CHEESE (U.S. CL. 46).

CLASS 29—(Continued).

SN 76-458,802. DANISH CROWN AMBA, DK-8900 RAN-
DERS, DENMARK, FILED 10-9-2002.



OWNER OF U.S. REG. NOS. 680,865, 1,496,917 AND
OTHERS.

NO CLAIM IS MADE TO THE EXCLUSIVE RIGHT TO
USE "USA", APART FROM THE MARK AS SHOWN.

THE "U" IN "USA" IS THE COLOR RED, THE "S" IN
"USA" IS OUTLINED IN THE COLOR BLUE AND THE "A"
IN "USA" IS THE COLOR BLUE.

FOR MEAT AND MEAT PRODUCTS, NAMELY HAM,
PORK, BEEF, CHICKEN AND TURKEY (U.S. CL. 46).

SN 76-462,648. CORONA, ALFONSO, SANTA ANA, CA. AND
CORONA, ANABELLA, SANTA ANA, CA. FILED 10-30-
2002.



NO CLAIM IS MADE TO THE EXCLUSIVE RIGHT TO
USE "POLLO", APART FROM THE MARK AS SHOWN.

THE FOREIGN WORDING IN THE MARK TRANSLATES
INTO ENGLISH AS "NORTHERN COWBOY CHICKEN".

FOR PREPARED CHICKEN FOR CONSUMPTION ON
OR OFF PREMISES (U.S. CL. 46).

FIRST USE 6-1-1981; IN COMMERCE 6-1-1981.

SN 76-472,918. TRANS FAMILY, INC., SAN GABRIEL, CA.
FILED 12-9-2002.

DOUBLE COW

NO CLAIM IS MADE TO THE EXCLUSIVE RIGHT TO
USE "COW", APART FROM THE MARK AS SHOWN.

FOR CANNED MILK (U.S. CL. 46).

SN 76-476,975. OCHOGAVIA, ANDRES LARROULET, SAN-
TIAGO, CHILE, FILED 12-19-2002.



FOR FROZEN SEAFOOD (U.S. CL. 46).

CLASS 29—(Continued).

SN 76-478,452. THE IRISH DAIRY BOARD CO-OPERATIVE
LIMITED, DUBLIN 2, IRELAND, FILED 12-17-2002.

IRLANA

FOR CHEESE (U.S. CL. 46).

SN 76-479,199. RIZO-LOPEZ FOODS, INC., RIVERBANK, CA.
FILED 12-30-2002.

CHIQUI

THE ENGLISH TRANSLATION OF THE WORD "CHI-
QUI" IS "LITTLE."

FOR DAIRY PRODUCTS EXCLUDING ICE CREAM,
ICE MILK AND FROZEN YOGURT; DRIED BEANS;
MEATS, NAMELY SAUSAGE (U.S. CL. 46).

SN 76-484,936. CENTRAL SOYA COMPANY, INC., FORT
WAYNE, IN. FILED 1-27-2003.

CENTRAGOLD

FOR VEGETABLE OIL (U.S. CL. 46).

SN 76-485,672. INNOTECH PRODUCTS, LTD., RIVERHEAD,
NY. FILED 1-28-2003.

HEATERMEALS

FOR PREPARED, SELF-HEATING ENTREE, CON-
SISTING PRIMARILY OF MEAT, POULTRY OR VEGE-
TABLES (U.S. CL. 46).

FIRST USE 11-15-1994; IN COMMERCE 11-29-1994.

SN 76-486,079. NATIONAL HARVEST, LLC, KANSAS CITY,
MO. FILED 1-27-2003.

WAKE-UP

FOR HAND-HELD PRE-COOKED EGGS (U.S. CL. 46).

SN 76-486,339. ARCHER-DANIELS-MIDLAND COMPANY,
DECATUR, IL. FILED 1-29-2003.

COYOTE

FOR DRIED BEANS (U.S. CL. 46).
FIRST USE 0-0-1997; IN COMMERCE 0-0-1997.

CLASS 29—(Continued).

SN 76-486,466. RECOT, INC., PLEASANTON, CA. FILED 1-27-2003.

RRRUFFLES HAVE RIDGES

OWNER OF U.S. REG. NOS. 582,149, 2,296,648 AND OTHERS.

FOR POTATO-BASED SNACKS, NAMELY, POTATO CHIPS, POTATO CRISPS AND PUFFED POTATO SNACKS (U.S. CL. 46).

CLASS 29—(Continued).

SN 78-141,462. KAO KABUSHIKI KAISHA, TA KAO CORPORATION, CHUO-KU, TOKYO 103-8210, JAPAN, FILED 7-5-2002.

DAG

FOR EDIBLE OILS AND FATS, AND EDIBLE OIL AND FAT REPLACERS (U.S. CL. 46).

SN 76-486,803. PURITY FOODS, INC., CLAYTON, OH. FILED 2-3-2003.

CHIPEEZ

FOR SNACK FOODS, NAMELY, POTATO CHIPS (U.S. CL. 46).

FIRST USE 4-25-2003; IN COMMERCE 4-25-2003.

SN 76-487,251. ARCHER-DANIELS-MIDLAND COMPANY, DECATUR, IL. FILED 1-29-2003.

CHIEF

FOR DRIED BEANS (U.S. CL. 46).
FIRST USE 0-0-1979; IN COMMERCE 0-0-1979.

SN 78-130,398. UIBLE MANAGEMENT, INC., NEW RICHMOND, OH. FILED 5-22-2002.



NO CLAIM IS MADE TO THE EXCLUSIVE RIGHT TO USE "RANCH", APART FROM THE MARK AS SHOWN.
FOR MEAT (U.S. CL. 46).
FIRST USE 8-1-1994; IN COMMERCE 10-1-1999.

SN 78-149,007. MR. MUDBUG, INC., KENNER, LA. FILED 7-30-2002.

KING CREOLE

NO CLAIM IS MADE TO THE EXCLUSIVE RIGHT TO USE "CREOLE", APART FROM THE MARK AS SHOWN.

FOR PROCESSED FOODS, NAMELY, PREPARED SOUPS AND SOUP BASES; PREPARED ENTREES CONSISTING PRIMARILY OF MEAT, FISH, POULTRY OR VEGETABLES; AND SEAFOOD (U.S. CL. 46).
FIRST USE 3-15-2001; IN COMMERCE 3-15-2001.

SN 78-176,048. BEST CHEESE CORP., MT. KISCO, NY. FILED 10-18-2002.

UNIEKAAS AMSTERDAM RESERVE

OWNER OF U.S. REG. NO. 1,958,836.
NO CLAIM IS MADE TO THE EXCLUSIVE RIGHT TO USE "AMSTERDAM RESERVE", APART FROM THE MARK AS SHOWN.
FOR CHEESE (U.S. CL. 46).

SN 78-177,139. ALLIED PACIFIC FOOD (DALIAN) CO., LTD., GARDENA, CA. FILED 10-22-2002.

NOBLE CUISINE

NO CLAIM IS MADE TO THE EXCLUSIVE RIGHT TO USE "CUISINE", APART FROM THE MARK AS SHOWN.
FOR FROZEN SEAFOOD (U.S. CL. 46).

CLASS 29—(Continued).

SN 78-182,445. GARRETT COUNTY FARMS, INC., SWEDESBORO, NJ. FILED 11-6-2002.



NO CLAIM IS MADE TO THE EXCLUSIVE RIGHT TO USE "GC", APART FROM THE MARK AS SHOWN.

THE MARK CONSISTS OF AN OBLONG CIRCLE CONTAINING A DESIGN OF A HORSE DRAWN CARRIAGE WALKING ALONG THE GROUND. APPEARING ABOVE THE CARRIAGE IS A DESIGN OF THE SUN AND APPEARING BENEATH THE CARRIAGE ARE THE LETTERS "GC".

FOR MEATS, NAMELY NATURAL PORK (U.S. CL. 46).

FIRST USE 9-1-2000; IN COMMERCE 9-1-2000.

SN 78-183,684. DANA ALEXANDER, INC., MELVILLE, NY. FILED 11-11-2002.

TERRA YUKON GOLD

NO CLAIM IS MADE TO THE EXCLUSIVE RIGHT TO USE "YUKON GOLD", APART FROM THE MARK AS SHOWN.

FOR VEGETABLE BASED SNACK FOODS, NAMELY, POTATO CHIPS (U.S. CL. 46).

FIRST USE 6-0-1996; IN COMMERCE 6-0-1996.

SN 78-195,764. PACIFIC SOYBEAN & GRAIN, INC, SAN FRANCISCO, CA. FILED 12-18-2002.

FIBERPRO

FOR DRIED SOYBEANS; SOY PROTEIN TO BE USED AS AN EXTENDER OR MEAT SUBSTITUTE; FRUIT AND SOY BASED SNACK FOODS AND MEAT SUBSTITUTES; SOY BASED FOOD BEVERAGE USED AS A MILK SUBSTITUTE; SOY PROTEIN USED AS A FOOD ADDITIVE; PROTEIN BASED, NUTRIENT-DENSE SNACK BARS; SOY CHIPS (U.S. CL. 46).

SN 78-203,446. FRANKLIN FOODS, INC., ENOSBURG FALLS, VT. FILED 1-15-2003.

YO-DIPS

FOR DAIRY PRODUCTS EXCLUDING ICE CREAM, ICE MILK AND FROZEN YOGURT (U.S. CL. 46).

CLASS 29—(Continued).

SN 78-204,345. VISTAR CORPORATION, CENTENNIAL, CO. FILED 1-17-2003.

NORTHLAND STAR

FOR NATURAL AND PROCESSED CHEESE FOR FOODSERVICE DISTRIBUTION (U.S. CL. 46).

SN 78-208,547. RUSSELL MCCALL'S, INC., ATLANTA, GA. FILED 1-29-2003.

BRIATI

FOR CHEESE. (U.S. CL. 46).

SN 78-212,725. SYSCO CORPORATION, HOUSTON, TX. FILED 2-10-2003.

HIDDEN COVE NO COMPROMISES

FOR FRESH, PROCESSED, FROZEN, AND CANNED SEAFOOD (U.S. CL. 46).

CLASS 30—STAPLE FOODS

SN 74-720,016. EINSTEIN AND NOAH CORP., GOLDEN, CO. BY CHANGE OF NAME; BY ASSIGNMENT; BY CHANGE OF NAME PROGRESSIVE BAGEL CONCEPTS, INC., GOLDEN, CO. FILED 8-25-1995.

COOL CAT

FOR CAPPUCCINO, ICED CAPPUCCINO AND SLUSHY CAPPUCCINO (U.S. CL. 46).
FIRST USE 8-29-1995; IN COMMERCE 11-13-1995.

CLASS 30—(Continued).

SN 76-050,913. MARYLAND STYLE INC., TAMPA, FL.
FILED 5-18-2000.

Maryland Style



NO CLAIM IS MADE TO THE EXCLUSIVE RIGHT TO USE "MARYLAND STYLE", APART FROM THE MARK AS SHOWN.

THE MARK IS LINED FOR THE COLORS BLUE AND RED.

FOR SEAFOOD SEASONING, SPICES AND BLENDS OF SPICES FOR WHOLESALE AND RETAIL STORES (U.S. CL. 46).

SN 76-124,313. CP KELCO U.S., INC., WILMINGTON, DE.
FILED 9-8-2000.

CP Kelco

OWNER OF U.S. REG. NOS. 277,972, 2,264,747 AND OTHERS.

FOR FOOD ADDITIVES FOR NON-NUTRITIONAL PURPOSES FOR USE AS INGREDIENTS USED IN THE MANUFACTURE OF FOOD, NAMELY, CARRAGEENAN, GELLAN GUM AND XANTHAN GUM (U.S. CL. 46).

SN 76-125,055. CP KELCO U.S., INC., WILMINGTON, DE.
FILED 9-8-2000.

CP KELCO

FOR FOOD ADDITIVES FOR NON-NUTRITIONAL PURPOSES FOR USE AS INGREDIENTS IN THE MANUFACTURE OF FOOD, NAMELY CARRAGEENAN, GELLAN GUM AND XANTHAN GUM (U.S. CL. 46).

SN 76-158,511. CONAGRA FOODS, INC., OMAHA, NE. BY
MERGER A.M. GILARDI & SONS, INC., TROY, OH.
FILED 11-3-2000.

TOSSED ITALIANO

THE ENGLISH TRANSLATION OF "ITALIANO" IS ITALIAN.
FOR FROZEN PIZZA (U.S. CL. 46).

CLASS 30—(Continued).

SN 76-164,373. FRANKLIN CONNECTIONS, L.P., EL PASO, TX. FILED 11-13-2000.

SUNRISE

FOR CANDY, CHOCOLATE, AND CHOCOLATE-COVERED NUTS (U.S. CL. 46).

SN 76-188,185. FOREIGN CANDY COMPANY, INC., THE,
HULL, IA. FILED 12-29-2000.

SOUR GUMMY FRIES

OWNER OF U.S. REG. NOS. 2,300,727 AND 2,611,598.
NO CLAIM IS MADE TO THE EXCLUSIVE RIGHT TO USE "SOUR GUMMY", APART FROM THE MARK AS SHOWN.

FOR CANDY (U.S. CL. 46).

FIRST USE 12-0-2000; IN COMMERCE 12-0-2000.

SN 76-209,663. LABORATORIO MAVER LTDA., SANTIAGO,
CHILE, FILED 2-14-2001.

ADELGAZUL

OWNER OF CHILE REG. NO. 429,570, DATED 7-29-1994,
EXPIRES 7-29-2004.

FOR TEA USED FOR PEOPLE TO BECOME SLENDER OR THIN (U.S. CL. 46).

CLASS 30—(Continued).

SN 76-271,361. ALSO S.P.A., I-22020 ZELBIO (COMO), ITALY, FILED 6-13-2001.

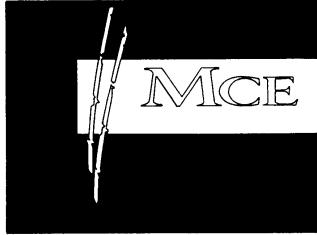

PRIORITY CLAIMED UNDER SEC. 44(D) ON ITALY APPLICATION NO. MI2001C00067, FILED 1-23-2001, REG. NO. 872917, DATED 7-12-2002, EXPIRES 1-23-2011.

FOR COFFEE, TEA, COCOA, SUGAR, RICE, TAPIO-CA, SAGO, ARTIFICIAL COFFEE; FLOUR AND PRE-PARATIONS MADE FROM CEREALS; PASTA, BREAD, BISCUITS, PASTRY AND CANDY, ICE-CREAMS; HON-EY, TREACLE; YEAST, BAKING-POWDER; SALT, MUST-ARD; VINEGAR, SAUCES; SPICES; ICE; DIETETIC AND TONIC FOODSTUFFS NOT FOR MEDICAL USE, NAMELY, EXTRACTS MADE FROM NON-ESSENTIAL OILS AND CONTAINING POLICOSANOLS AND PHY-TOSTEROLS (U.S. CL. 46).

SN 76-330,101. ALDI INC., BATAVIA, IL. FILED 10-26-2001.

B BAR BRAND

OWNER OF U.S. REG. NO. 1,303,974.
NO CLAIM IS MADE TO THE EXCLUSIVE RIGHT TO USE "BRAND", APART FROM THE MARK AS SHOWN.
FOR CORN DOGS (U.S. CL. 46).
FIRST USE 11-28-2000; IN COMMERCE 11-28-2000.

SN 76-334,700. SHARI'S BERRIES INTERNATIONAL, INC., ROSEVILLE, CA. BY CHANGE OF NAME STRAWBERRY ENTERPRISES, INC., SACRAMENTO, CA. FILED 11-6-2001.

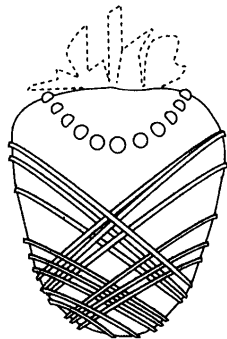

SEC. 2(F).
FOR CHOCOLATE DIPPED STRAWBERRIES (U.S. CL. 46).
FIRST USE 9-0-1989; IN COMMERCE 9-0-1989.

CLASS 30—(Continued).

SN 76-334,828. SHARI'S BERRIES INTERNATIONAL, INC., ROSEVILLE, CA. BY CHANGE OF NAME STRAWBERRY ENTERPRISES, INC., SACRAMENTO, CA. FILED 11-6-2001.



SEC. 2(F).
FOR CHOCOLATE DIPPED STRAWBERRIES (U.S. CL. 46).
FIRST USE 9-0-1989; IN COMMERCE 9-0-1989.

SN 76-340,434. HIGH LINER FOODS (USA) INCORPORATED, FORMERLY NATIONAL SEA PRODUCTS INCORPORATED, PORTSMOUTH, NH. FILED 11-21-2001.



OWNER OF U.S. REG. NOS. 1,665,993, 1,726,717 AND 2,198,508.
NO CLAIM IS MADE TO THE EXCLUSIVE RIGHT TO USE "HOMESTYLE PASTA", APART FROM THE MARK AS SHOWN.

THE LINING IN THE DRAWING IS A FEATURE OF THE MARK AND IS NOT INTENDED TO INDICATE COLOR.
FOR FROZEN STUFFED PASTA AND ITALIAN-STYLE FOOD PRODUCTS, NAMELY RAVIOLI, STUFFED SHELLS, MANICOTTI, CAVATELLI, TOR-TELLINI AND GNOCCHI (U.S. CL. 46).
FIRST USE 2-16-2001; IN COMMERCE 2-16-2001.

CLASS 30—(Continued).

SN 76-356,902. OFF SHORE SUPPLY INC., MIAMI, FL. FILED 1-9-2002.



NO CLAIM IS MADE TO THE EXCLUSIVE RIGHT TO USE "BRAZILIAN ORIGINAL COFFEE", APART FROM THE MARK AS SHOWN.
FOR COFFEE (U.S. CL. 46).

SN 76-356,903. OFF SHORE SUPPLY INC., MIAMI, FL. FILED 1-9-2002.



NO CLAIM IS MADE TO THE EXCLUSIVE RIGHT TO USE "BRAZILIAN" AND "COFFEE", APART FROM THE MARK AS SHOWN.
FOR COFFEE (U.S. CL. 46).

SN 76-366,838. DRAYTON ENTERPRISES, L.L.C., FARGO, ND. FILED 2-4-2002.



NO CLAIM IS MADE TO THE EXCLUSIVE RIGHT TO USE "MICROWAVE BAKING", APART FROM THE MARK AS SHOWN.

THE MARK CONSISTS OF THE WORDS "MICROWAVE BAKING". "MICROWAVE" IS IN LARGE BLOCK LETTERS. LINES VERTICALLY SLANTED TO THE RIGHT ARE UNDERNEATH. "BAKING" WILL BE BOXED ALONG THE BOTTOM.

FOR RAW DOUGH WHICH CAN BE BAKED, RATHER THAN SIMPLY REHEATED, IN A MICROWAVE AND IS USED TO MAKE EDIBLE BAKED GOODS, INCLUDING, BUT NOT LIMITED TO, CINNAMON ROLLS, DINNER ROLLS, CRUSTS, AND BREAD PRODUCTS (U.S. CL. 46).

FIRST USE 12-28-2000; IN COMMERCE 12-28-2000.

CLASS 30—(Continued).

SN 76-369,372. BELLEI LUIGI & FIGLI S.R.L., MODENA, ITALY, FILED 2-11-2002.



"ACETAIA" IS BELIEVED TO BE UNDERSTOOD AS THE PLACE THAT "LODGES" THE TRADITIONAL BALSAMIC VINEGAR'S BARRELS. THE FOREIGN WORDING IN THE MARK TRANSLATES INTO ENGLISH AS THE PORTION "ESPERIENZA" MEANS "EXPERIENCE".

FOR VINEGAR, BALSAMIC VINEGAR (U.S. CL. 46). FIRST USE 10-31-1998; IN COMMERCE 10-31-1999.

SN 76-387,434. MRS. DENSON'S COOKIE COMPANY, INC., UKIAH, CA. FILED 3-26-2002.



NO CLAIM IS MADE TO THE EXCLUSIVE RIGHT TO USE "ORGANIC COFFEE COOKIES", "COOKIE" AND "CUP OF COFFEE", APART FROM THE MARK AS SHOWN.

THE NAME IN THE MARK DOES NOT IDENTIFY A LIVING INDIVIDUAL.

FOR COOKIES, NAMELY, COFFEE FLAVORED COOKIES (U.S. CL. 46).

FIRST USE 12-28-2001; IN COMMERCE 12-28-2001.

SN 76-391,109. CORPORATIVO INTERNACIONAL MEXICANO, S. DE R.L. DE C.V., MEXICO, MEXICO D.F., MEXICO, FILED 4-3-2002.

GAMESA WHIR!S

OWNER OF U.S. REG. NO. 1,157,500 AND OTHERS. FOR COOKIES (U.S. CL. 46).

FIRST USE 1-0-2002; IN COMMERCE 1-0-2002.

CLASS 30—(Continued).

SN 76-402,045. HEB GROCERY COMPANY, LP, SAN ANTONIO, TX. FILED 5-1-2002.

CREATE A PIZZA

NO CLAIM IS MADE TO THE EXCLUSIVE RIGHT TO USE "PIZZA", APART FROM THE MARK AS SHOWN.

FOR PACKAGED COMBINATIONS CONSISTING PRIMARILY OF SNACK-SIZED PIZZA CRUST, MEAT TOPPINGS, CHEESE, AND PIZZA SAUCE (U.S. CL. 46).

CLASS 30—(Continued).

SN 76-411,353. JOE BERTMAN FOODS, INC., CLEVELAND, OH. FILED 5-21-2002.

BERTMAN ORIGINAL BALL PARK

NO CLAIM IS MADE TO THE EXCLUSIVE RIGHT TO USE "ORIGINAL BALL PARK", APART FROM THE MARK AS SHOWN.

FOR MUSTARD, HORSERADISH (U.S. CL. 46).
FIRST USE 4-25-1983; IN COMMERCE 4-25-1983.

SN 76-404,719. LORENZ D'AUSTRIA ESTE, ARCHDUKE, BRUXELLES, BELGIUM, FILED 5-8-2002.

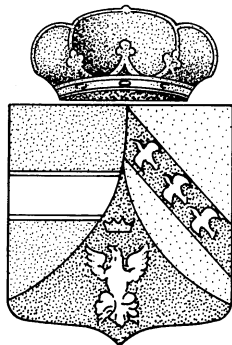

PRIORITY CLAIMED UNDER SEC. 44(D) ON ITALY APPLICATION NO. VE2002C00019, FILED 2-15-2002, REG. NO. 00868061, DATED 3-27-2002, EXPIRES 2-15-2012.

THE STIPPLING IS A FEATURE OF THE MARK.
FOR VINEGAR; SAUCES; SUGAR; SALT; MUSTARD; HONEY; AND TREACLE (U.S. CL. 46).

SN 76-404,720. ARCHDUKE LORENZ D'AUSTRIA ESTE, BRUXELLES, BELGIUM, FILED 5-8-2002.

SOPRAFFINO DEGLI ESTENSI

PRIORITY CLAIMED UNDER SEC. 44(D) ON ITALY APPLICATION NO. 000020, FILED 2-15-2002, REG. NO. 00868062, DATED 5-27-2002, EXPIRES 2-15-2012.

NO CLAIM IS MADE TO THE EXCLUSIVE RIGHT TO USE "SOPRAFFINO", APART FROM THE MARK AS SHOWN.

THE TERM "SOPRAFFINO DEGLI ESTENSI" IS ITALIAN FOR "ESTENSI'S SUPERFINE".

FOR VINEGAR; SAUCES; SUGAR; SALT; MUSTARD, HONEY; AND TREACLE (U.S. CL. 46).

SN 76-411,686. MEDERER GMBH, D-90763 FURTH, FED REP GERMANY, FILED 5-22-2002.

SOUR FRUIT SHAKE

PRIORITY CLAIMED UNDER SEC. 44(D) ON FED REP GERMANY APPLICATION NO. 30221457.7, FILED 5-2-2002, REG. NO. 30221457, DATED 10-18-2002, EXPIRES 5-31-2012.

NO CLAIM IS MADE TO THE EXCLUSIVE RIGHT TO USE "SOUR FRUIT", APART FROM THE MARK AS SHOWN.

FOR CANDY MADE OF OR CONTAINING FRUIT GUM, FOAM SUGAR, JELLY AND/OR LIQUORICE; ALL GOODS NOT FOR MEDICAL USE (U.S. CL. 46).

SN 76-416,800. KENNY B'S COOKIE COMPANY, NEW GERMANY, MN. BY ASSIGNMENT AWARD BAKING INTERNATIONAL, INC., MINNEAPOLIS, MN. FILED 6-4-2002.

ORIGINAL CARLSBAD OBLATEN

NO CLAIM IS MADE TO THE EXCLUSIVE RIGHT TO USE "OBLATEN", APART FROM THE MARK AS SHOWN.

THE ENGLISH TRANSLATION OF "OBLATEN" IN THE MARK IS "HOST".

SEC. 2(F).
FOR DESSERT WAFERS (U.S. CL. 46).
FIRST USE 12-0-1948; IN COMMERCE 12-0-1950.

SN 76-416,821. FARMERS' RICE COOPERATIVE, SACRAMENTO, CA. FILED 6-4-2002.

VILLA RISO

THE ENGLISH TRANSLATION OF "RISO" IS "RICE".
FOR RICE, RISOTTO (U.S. CL. 46).

CLASS 30—(Continued).

SN 76-422,402. BARILLA ALIMENTARE S.P.A., PARMA, ITALY, FILED 6-19-2002.

ITALY'S #1 PASTA

NO CLAIM IS MADE TO THE EXCLUSIVE RIGHT TO USE "PASTA", APART FROM THE MARK AS SHOWN.

SEC. 2(F) AS TO "ITALY'S #1".
FOR PASTA, PASTA PRODUCTS, NAMELY PENNE LISCE, PENNETTE RIGATE, LINGUINE, CAPELLINI, LINGUINE FINI, SPAGHETTI, THIN SPAGHETTI, FARFALLE, ROTINI, RIGATONI, CONCHIGLIE RIGATE, PENNE RIGATE, TORTIGLIONI, GEMELLI, FETTUCCHINE, SAUCES FOR PASTA (U.S. CL. 46).
FIRST USE 0-0-1996; IN COMMERCE 0-0-1996.

CLASS 30—(Continued).

SN 76-433,688. REYNOLDS, JAMIE L., GLENDALE, AZ. FILED 7-22-2002.

LUGNUTS CANDY

NO CLAIM IS MADE TO THE EXCLUSIVE RIGHT TO USE "CANDY", APART FROM THE MARK AS SHOWN.

FOR CANDY, NAMELY, HARD, SOFT, OR GUMMY CANDIES (U.S. CL. 46).

SN 76-424,712. MARS, INCORPORATED, MCLEAN, VA. FILED 6-18-2002.

THE PERFECT LITTLE BASKET TREAT

FOR CONFECTIONERY, NAMELY, CANDY (U.S. CL. 46).

SN 76-427,141. TEE-ZEL COMPANY, INC., THE, BEAUFORT, SC. FILED 7-3-2002.



FOR GOLF TEE-SHAPED BAKERY GOODS, NAMELY, PRETZELS AND CRACKERS (U.S. CL. 46).
FIRST USE 3-15-2002; IN COMMERCE 3-15-2002.

SN 76-427,248. TEE-ZEL COMPANY, INC., THE, BEAUFORT, SC. FILED 7-3-2002.

TEE-ZEL

FOR GOLF TEE-SHAPED BAKERY GOODS, NAMELY PRETZELS AND CRACKERS (U.S. CL. 46).
FIRST USE 12-15-2001; IN COMMERCE 12-15-2001.

SN 76-438,673. WILD, STEPHEN, ST. JAMES, NY. FILED 8-5-2002.

TIC TAC DOUGH

NO CLAIM IS MADE TO THE EXCLUSIVE RIGHT TO USE "DOUGH", APART FROM THE MARK AS SHOWN.

FOR KITS FOR MAKING COOKIES COMPRISED OF COOKIE DOUGH AND ALSO CONTAINING FOOD COLORING MARKERS (U.S. CL. 46).
FIRST USE 5-1-2002; IN COMMERCE 5-1-2002.

SN 76-440,681. HANNA-BARBERA PRODUCTIONS, INC., SHERMAN OAKS, CA. FILED 8-15-2002.

THE MYSTERY MACHINE

FOR BASES FOR MAKING MILKSHAKES, BREAKFAST CEREAL, BUBBLE GUM, CAKE DECORATIONS MADE OF CANDY, CHEWING GUM, FROZEN CONFECTIONS, CRACKERS, FROZEN YOGURT, ICE CREAM, PRETZELS, PEANUT BUTTER CONFECTIONERY CHIPS, MALT FOR FOOD; SOYBEAN MALT; MALT BISCUITS; SUGAR CONFECTIONERY, NAMELY, CANDY, CANDY BARS, CANDY NUTS, CANDY COATED AND CARMEL POPCORN, CANDY DECORATIONS FOR CAKES; EDIBLE DECORATIONS FOR CAKE; RICE CAKES; PASTILLES; PASTRIES; BISCUITS AND BREAD; COFFEE BEVERAGES WITH MILK; COCOA BEVERAGES WITH MILK, CHOCOLATE-BASED BEVERAGES, COFFEE AND COFFEE-BASED BEVERAGES, COCOA AND COCOA-BASED BEVERAGES; TEA, NAMELY, GINSENG TEA, BLACK TEA, OOLONG TEA, BARLEY AND BARLEY-LEAF TEA; MEAT TENDERIZERS FOR HOUSEHOLD PURPOSES; BINDING AGENTS FOR ICE-CREAM (U.S. CL. 46).
FIRST USE 8-0-2000; IN COMMERCE 8-0-2000.

CLASS 30—(Continued).

SN 76-441,003. GENERAL BISCUITS BELGIE, B-2200 HERENTALS, BELGIUM, FILED 8-16-2002.

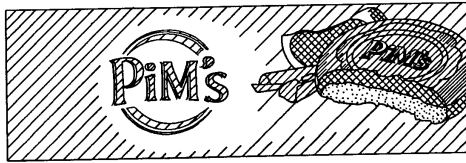

OWNER OF U.S. REG. NO. 1,204,741.
THE STIPLING IS NOT A FEATURE OF THE MARK; IT IS FOR SHADING PURPOSES ONLY.
THE MARK IS LINED FOR THE COLORS BROWN, DARK BROWN AND ORANGE.
FOR BISCUITS, CAKES AND PASTRIES (U.S. CL. 46).

CLASS 30—(Continued).

SN 76-443,984. ESTEBAN DURAN AMAT, S.A., CIUDAD DE PANAMA, PANAMA, FILED 8-26-2002.



OWNER OF PANAMA REG. NO. 31449, DATED 6-17-1983, EXPIRES 6-17-2013.
NO CLAIM IS MADE TO THE EXCLUSIVE RIGHT TO USE "CASA FUNDADA EN 1907", "CAFE", "PURO" AND "HECHO EN PANAMA", APART FROM THE MARK AS SHOWN.
THE ENGLISH TRANSLATION OF "CASA FUNDADA EN 1907" IS "COMPANY (HOUSE) FOUNDED IN 1907". THE ENGLISH TRANSLATION OF "CAFE" IS "COFFEE". THE ENGLISH TRANSLATION OF "PURO" IS "PURE". THE ENGLISH TRANSLATION OF "HECHO EN PANAMA" IS "MADE IN PANAMA."
FOR COFFEE (U.S. CL. 46).

SN 76-441,408. HEB GROCERY COMPANY, LP, SAN ANTONIO, TX. FILED 8-19-2002.



OWNER OF U.S. REG. NOS. 1,886,445, 2,261,631 AND OTHERS.
SEC. 2(F) AS TO "MARKET".
FOR CRACKERS; COOKIES; RICE; PASTA SALADS; SAUCES; PESTO SAUCES; TOMATO-BASED SAUCES; ARTICHOKE SAUCES; VEGETABLE-BASED SAUCES; SPAGHETTI SAUCE; PASTA; PASTA SHELLS; SPAGHETTI; BALSAMIC VINEGAR; MARINADES; CHUTNEY; SALSA; BARBECUE SAUCE; KETCHUP; MUSTARD; SALAD DRESSINGS; HOT SAUCE; STEAK SAUCE; COCKTAIL SAUCE; DESSERT SAUCES, NAMELY, CHOCOLATE SAUCES; SPICES; HONEY; MAPLE SYRUP; COFFEE; COFFEE BEANS; PROCESSED CEREAL; BREADS; PIZZA; FROZEN CONFECTIONS; PIES; CAKES; PASTRIES; TARTS; ICE CREAM; FROZEN HORS D'OEUVRES, NAMELY, FROZEN EMPANADAS (U.S. CL. 46).

SN 76-446,231. TSCHANZ, MARTIN, DBA JOY OF LIFE CHOCOLATE, LLC, WELLINGTON, FL. FILED 8-30-2002.

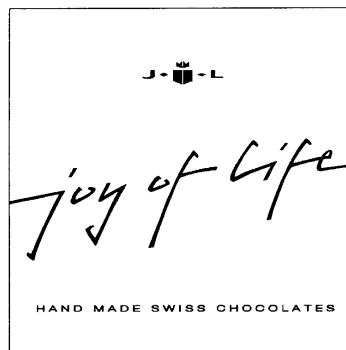

SN 76-442,269. YOAKAM, DWIGHT, LOS ANGELES, CA. FILED 8-19-2002.

DWIGHT YOAKAM

THE NAME(S), PORTRAIT(S), AND/OR SIGNATURE(S) SHOWN IN THE MARK IDENTIFIES "DWIGHT YOAKAM", WHOSE CONSENT(S) TO REGISTER IS SUBMITTED.
FOR BAKERY PRODUCTS, BREAD MIXES, SAUCES, NATURAL SWEETENER, SNACK MIX CONSISTING PRIMARILY OF CRACKERS, PRETZELS, CANDIED NUTS AND/OR POPCORN (U.S. CL. 46).

NO CLAIM IS MADE TO THE EXCLUSIVE RIGHT TO USE "HAND MADE SWISS CHOCOLATES", APART FROM THE MARK AS SHOWN.
FOR CHOCOLATE (U.S. CL. 46).
FIRST USE 1-19-2002; IN COMMERCE 1-19-2002.

CLASS 30—(Continued).

SN 76-446,330. MASTERPIECE COOKIES, INC., PLEASANTON, CA. FILED 9-3-2002.

POP 'N BAKE

NO CLAIM IS MADE TO THE EXCLUSIVE RIGHT TO USE "BAKE", APART FROM THE MARK AS SHOWN. FOR PRE-PORTIONED FROZEN COOKIE DOUGH (U.S. CL. 46).

FIRST USE 8-8-2002; IN COMMERCE 8-8-2002.

SN 76-447,096. TRIMBLE ROAD GARDENS, INC., NASHVILLE, TN. FILED 9-4-2002.



NO CLAIM IS MADE TO THE EXCLUSIVE RIGHT TO USE "RELISH", APART FROM THE MARK AS SHOWN.

THE MARK CONSISTS OF A DOUBLE OVAL CONTAINING THE WORDS "Z-RELISH", SUPERIMPOSED OVER A LARGE LETTER "Z". THE OUTSIDE RING OF THE OVAL IS A GOLDEN YELLOW. THE BACKGROUND OF THE INSIDE OVAL IS A DARK SHADE OF GREEN, AND CONTAINS THE WORDS "Z-RELISH" IN THE SAME GOLDEN YELLOW AS THE OUTER OVAL. THE LARGE LETTER "Z" IN THE BACKGROUND IS A LIGHT SHADE OF GREEN.

FOR ZUCCHINI BASED RELISH (U.S. CL. 46).

FIRST USE 6-15-2001, THE MARK WAS USED ANYWHERE IN A DIFFERENT FORM OTHER THAN THAT SOUGHT TO BE REGISTERED ON 06/15/2001, AND AND IN COMMERCE ON 06/15/2001.; IN COMMERCE 6-15-2001, THE MARK WAS USED ANYWHERE IN A DIFFERENT FORM OTHER THAN THAT SOUGHT TO BE REGISTERED ON 06/15/2001, AND AND IN COMMERCE ON 06/15/2001..

SN 76-451,289. GOLD, SUSAN, NEW YORK, NY. FILED 9-19-2002.

STU'S SCHMUTZ

THE NAME IN THE MARK DOES NOT IDENTIFY A LIVING INDIVIDUAL.

FOR CONDIMENTS, NAMELY, MARINADE (U.S. CL. 46).

SN 76-454,506. TITIS DRINK, LLC, MIAMI, FL. FILED 9-23-2002.

CHICHA CROQUER

THE WORDING "CHICHA" IS AN IDIOMATIC EXPRESSION IN SPANISH AND TRANSLATES ROUGHLY TO "GIRL".

FOR RICE-BASED MILK BEVERAGES (U.S. CL. 46). FIRST USE 12-0-1999; IN COMMERCE 4-0-2002.

CLASS 30—(Continued).

SN 76-455,494. FOOD FOR LIFE BAKING CO., INC., CORONA, CA. FILED 10-3-2002.

EVE'S BREAD

NO CLAIM IS MADE TO THE EXCLUSIVE RIGHT TO USE "BREAD", APART FROM THE MARK AS SHOWN.

FOR BAKED GOODS, NAMELY, BREAD, CAKES, COOKIES, PASTRIES, BISCUITS, CRACKERS, DONUTS, CROUTONS, BAGEL CHIPS, BUNS AND MUFFINS (U.S. CL. 46).

SN 76-458,665. LA CREMAILLIERE, BEDFORD, NY. FILED 10-10-2002.



OWNER OF U.S. REG. NO. 2,549,039.

NO CLAIM IS MADE TO THE EXCLUSIVE RIGHT TO USE "CREME", "FINE FRENCH ICE CREAM", "ALL NATURAL!" AND "WWW.FRENCHICECREAM.COM", APART FROM THE MARK AS SHOWN.

THE ENGLISH TRANSLATION OF THE FOREIGN WORDING IN THE MARK IS "CREAM TRAMMEL".

FOR ICE CREAM (U.S. CL. 46).

FIRST USE 7-14-1999; IN COMMERCE 7-14-1999.

SN 76-463,091. THAI AGRI FOODS PUBLIC COMPANY LIMITED, BANGSAOTHONG, SAMUTPRAKARN 10540, THAILAND, FILED 10-31-2002.



THE TRANSLITERATIONS OF THE FOREIGN CHARACTERS IN THE MARK ARE "PAI JIN" AND "RIEN THONG". THE ENGLISH TRANSLATION OF "PAI JIN" AND "RIEN THONG" IS "GOLDEN MEDAL".

FOR SAUCES, NAMELY FISH SAUCE AND SEASONING SAUCE (U.S. CL. 46).

CLASS 30—(Continued).

SN 76-469,659. THE BEST RAFFAELLO S.R.L., 60035 JESI (ANCONA), ITALY, FILED 11-15-2002.



THE TOP BAND AND THE WORD "VERY" ARE GREEN AND THE BOTTOM BAND AND THE WORD "ITALIANO" ARE RED

THE ENGLISH TRANSLATION OF "ITALIANO" IS "ITALIAN".

FOR FOOD, PRE-COOKED AND FROZEN PRE-COOKED FOOD, NAMELY, PASTA AND RICE, PARTICULARLY HOT AND SPICY PEN-SHAPED PASTA, TOMATO TRICOLOR SEASHELL-SHAPED PASTA, GENOESE PESTO SEASHELL-SHAPED PASTA, 'MACARONI ALLA PUTTANESCA', WHICH IS A MACARONI SERVED WITH TOMATO SAUCE, ANCHOVIES, OLIVES AND CAPERS, SPAGHETTI WITH A SEAFOOD SAUCE, SPIRAL-SHAPED PASTA WITH FRIED BACON AND EGG, 'TORTELLINI' OR RINGLETS OF PASTA FILLED WITH SEASONED MINCED MEAT WITH CREAM, 'RAVIOLI' STUFFED WITH RICOTTA AND SPINACH WITH TOMATO, VEGETARIAN RICE (U.S. CL. 46).

FIRST USE 10-8-2002; IN COMMERCE 10-8-2002.

SN 76-473,337. SAMJIN GLOBALNET CO., LTD., SEOUL, REPUBLIC OF KOREA, FILED 12-10-2002.



THE NON-LATIN CHARACTERS IN THE MARK TRANSLITERATE TO "SURA", AND THIS MEANS "KING'S DINNER" IN ENGLISH.

FOR BARLEY TEA, GINSENG TEA, SOY BEAN FLOUR, RICE FLOUR, BREAD, NOODLES, COOKING SALT, MUSTARD, VINEGAR, SOY SAUCE, MALT EXTRACTS USED AS FLAVORING, AND MALT EXTRACTS FOR FOOD PURPOSES, MINCED AND POWDERED GARLIC USED AS A SPICE IN KOREAN FOODS, POWDERED BLACK PEPPER, FOOD STARCH, PROCESSED CEREALS, TEA, RICE AND PROCESSED BARLEY (U.S. CL. 46).

CLASS 30—(Continued).

SN 76-476,386. NANTUCKET HARVEST CO., INC., FALL RIVER, MA. FILED 12-17-2002.

RIMMER

FOR SEASONINGS AND SPICES, NAMELY, SEASONINGS AND SPICES USED ON DRINKING GLASS RIMS (U.S. CL. 46).

FIRST USE 7-12-2000; IN COMMERCE 7-12-2000.

SN 76-485,104. MAG CORPORATION, MIAMI, FL. FILED 1-24-2003.

KIDS UP

FOR COOKIES (U.S. CL. 46).

SN 76-486,156. OLE MEXICAN FOODS, INC., NORCROSS, GA. FILED 1-30-2003.

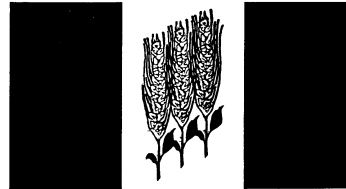

OWNER OF U.S. REG. NO. 2,658,957. FOR TORTILLAS, TORTILLA CHIPS, AND TOSTADAS (U.S. CL. 46).

FIRST USE 0-0-1992; IN COMMERCE 0-0-1992.

SN 76-486,186. OLE MEXICAN FOODS, INC., NORCROSS, GA. FILED 1-30-2003.



OWNER OF U.S. REG. NO. 2,658,957. THE MARK CONSISTS OF A FLAG DESIGN HAVING THREE COLOR SECTIONS GREEN ON THE LEFT, WHITE IN THE CENTER, AND RED ON THE RIGHT, WITH THREE AN EAR OF CORN DISPLAYED IN THE WHITE SECTION. COLOR IS CLAIMED AS A FEATURE OF THE MARK.

FOR TORTILLAS, TORTILLA CHIPS, AND TOSTADAS (U.S. CL. 46).

FIRST USE 10-1-1988; IN COMMERCE 10-1-1988.

CLASS 30—(Continued).

SN 76-486,325. HERITAGE COFFEE CO., LTD., LONDON, ONTARIO, CANADA, FILED 1-29-2003.

SERENGETI

FOR COFFEE (U.S. CL. 46).

SN 76-486,384. H & S BAKERY, INC., BALTIMORE, MD. FILED 1-30-2003.



OWNER OF U.S. REG. NO. 2,014,668. SEC. 2(F). FOR BAKERY PRODUCTS, NAMELY, BREADS AND ROLLS (U.S. CL. 46). FIRST USE 0-0-1955; IN COMMERCE 0-0-1955.

SN 76-486,886. LIMERICK TEA & COFFEE USA, L.P., NEW YORK, NY. FILED 1-30-2003.

HIGGINS & BURKE

FOR BEVERAGES, NAMELY TEA, COFFEE, COCOA AND CAPPUCCINO (U.S. CL. 46). FIRST USE 0-0-1912; IN COMMERCE 0-0-1912.

SN 76-486,887. LIMERICK TEA & COFFEE USA, L.P., NEW YORK, NY. FILED 1-30-2003.

SUVA BAY

FOR BEVERAGES, NAMELY TEA (U.S. CL. 46). FIRST USE 11-1-2002; IN COMMERCE 11-1-2002.

SN 76-489,810. CORPORATIVO INTERNACIONAL MEXICANO, S. DE R.L. DE C.V., COL. LOMAS DE CHAPULTEPEC, MEXICO, FILED 1-3-2003.

MARY BAKER

THE NAME "MARY BAKER" DOES NOT IDENTIFY ANY PARTICULAR LIVING INDIVIDUAL. FOR COOKIES (U.S. CL. 46).

CLASS 30—(Continued).

SN 78-104,894. SOUTHERN SIGNATURE FOODS, BOONE, NC. FILED 1-25-2002.

SOUTHERN SIGNATURE FOODS

NO CLAIM IS MADE TO THE EXCLUSIVE RIGHT TO USE "FOODS", APART FROM THE MARK AS SHOWN. FOR PRETZELS, COOKIES, BROWNIES, SALAD DRESSINGS, FLAVORED SAUCES, GRAVIES, CULINARY GLAZES, FLAVORED MAYONNAISE (U.S. CL. 46). FIRST USE 1-20-2002; IN COMMERCE 1-20-2002.

SN 78-137,132. AMERIKID FOODS, WESTLAKE VILLAGE, CA. FILED 6-19-2002.

STREET SNAX

NO CLAIM IS MADE TO THE EXCLUSIVE RIGHT TO USE "SNACKS", APART FROM THE MARK AS SHOWN. FOR ENERGY ENHANCED BREAKFAST FOODS, NAMELY, PIZZA AND TACO FLAVORED TOASTER PASTRIES, CEREALS, CEREAL BARS, AND READY-TO-EAT WAFFLES (U.S. CL. 46).

SN 78-144,067. SOCIETE DES PRODUITS NESTLE S.A., 1800 VEVEY, SWITZERLAND, FILED 7-15-2002.



NO CLAIM IS MADE TO THE EXCLUSIVE RIGHT TO USE "SINCE 1939", APART FROM THE MARK AS SHOWN. FOR CHOCOLATE, COOKIES, COOKIE DOUGH, BUTTERSCOTCH FLAVORED CHOCOLATE MORSELS FOR EATING AND COOKING PURPOSES, PREPARED EDIBLE CHOCOLATE, COCOA, CHOCOLATE COVERED RAISINS, ICE CREAM SANDWICHES (U.S. CL. 46). FIRST USE 4-1-2001; IN COMMERCE 4-1-2001.

CLASS 30—(Continued).

SN 78-146,116. MANINTVELD, WENDY, LAREN (NH), NETHERLANDS, FILED 7-22-2002.

SONNIGDAL

FOR TEA, COFFEE, COCOA; BEVERAGES WITH TEA, COFFEE, COCOA AND CHOCOLATE BASES, NAMELY, NON-DAIRY, NON-VEGETABLE COCOA AND CHOCOLATE BASED BEVERAGES, COCOA AND CHOCOLATE BASED MILKSHAKES (U.S. CL. 46).

SN 78-150,239. KABUSHIKI KAISHA GANSO TAKOMASA, OSAKA-SHI, OSAKA-FU, JAPAN, FILED 8-2-2002.

SAMURAI BALL

OWNER OF JAPAN REG. NO. 4332191, DATED 11-5-1999, EXPIRES 11-5-2009.

NO CLAIM IS MADE TO THE EXCLUSIVE RIGHT TO USE "BALL", APART FROM THE MARK AS SHOWN.

FOR TAKOYAKI, NAMELY, FRESH OR FROZEN GRILLED BALLS OF MIXED BATTER OF WATER, FLOUR AND EGG WITH A SMALL AMOUNT OF OCTOPUS IN EACH BALL; AKASHIYAKI, NAMELY, FRESH OR FROZEN EGG CUSTARD DUMPLINGS WITH A SMALL PIECE OF OCTOPUS IN EACH DUMPLING (U.S. CL. 46).

SN 78-152,128. CARIBBEAN FOODS WEST, INC., ENCINITAS, CA. FILED 8-8-2002.

**WICKED JAMAICAN
PATTIES**

NO CLAIM IS MADE TO THE EXCLUSIVE RIGHT TO USE "JAMAICAN PATTIES", APART FROM THE MARK AS SHOWN.

FOR EMPANADA-TYPE PASTRIES FILLED WITH COOKED BEEF, CHICKEN, SEAFOOD OR VEGETABLES (U.S. CL. 46).

FIRST USE 8-8-2001; IN COMMERCE 8-8-2001.

CLASS 30—(Continued).

SN 78-152,642. CALLOWAY, CLEOPHUS, JR., SAN LUIS OBISPO, CA. FILED 8-9-2002.

Jake's

Smokehouse Style Bar-B-Que Sauce



NO CLAIM IS MADE TO THE EXCLUSIVE RIGHT TO USE "SMOKEHOUSE STYLE BAR-B-QUE SAUCE", APART FROM THE MARK AS SHOWN.

FOR BARBECUE SAUCE (U.S. CL. 46).
FIRST USE 2-1-2002; IN COMMERCE 5-1-2002.

SN 78-157,314. JONATHAN LORD CORP., BOHEMIA, NY. FILED 8-23-2002.



NO CLAIM IS MADE TO THE EXCLUSIVE RIGHT TO USE "WORLD FAMOUS CHEESECAKES & DESSERTS", APART FROM THE MARK AS SHOWN.

THE NAME "JONATHAN LORD" DOES NOT IDENTIFY A LIVING INDIVIDUAL AND IS A FICTITIOUS NAME.

FOR BAKERY DESSERTS, BAKERY GOODS AND BAKERY PRODUCTS (U.S. CL. 46).

FIRST USE 0-0-1986; IN COMMERCE 0-0-1986.

SN 78-160,341. THE KROGER CO. OF MICHIGAN, LIVONIA, MI. FILED 9-3-2002.



OWNER OF U.S. REG. NOS. 2,613,094, 2,613,100 AND 2,648,648.

FOR PIES (U.S. CL. 46).

FIRST USE 8-18-1999; IN COMMERCE 12-15-1999.

CLASS 30—(Continued).

SN 78-170,768. TURREL, HOWARD, E, GROVE, OK. FILED 10-3-2002.

GERMAN KETTLE POPCORN

NO CLAIM IS MADE TO THE EXCLUSIVE RIGHT TO USE "KETTLE POPCORN", APART FROM THE MARK AS SHOWN.

SEC. 2(F).
FOR SPECIAL 1800'S STYLE POPPED POPCORN (U.S. CL. 46).
FIRST USE 8-28-1995; IN COMMERCE 8-28-1995.

SN 78-171,759. MONKEY MIX, INC., MINNEAPOLIS, MN. FILED 10-7-2002.

MONKEY MIX

NO CLAIM IS MADE TO THE EXCLUSIVE RIGHT TO USE "MIX", APART FROM THE MARK AS SHOWN.
FOR CANDY COATED POPCORN (U.S. CL. 46).

SN 78-172,351. TONE BROTHERS, INC., ANKENY, IA. FILED 10-8-2002.



OWNER OF U.S. REG. NOS. 574,147, 2,255,790 AND OTHERS.

THE LINING IS A FEATURE OF THE MARK AND DOES NOT INDICATE COLOR.

SEC. 2(F).
FOR SPICES, PROCESSED HERBS, SEASONINGS, SAUCES AND MARINADES (U.S. CL. 46).
FIRST USE 5-0-2002; IN COMMERCE 5-0-2002.

CLASS 30—(Continued).

SN 78-187,232. MEL-O-CREAM DONUTS INTERNATIONAL, INC., SPRINGFIELD, IL. FILED 11-20-2002.

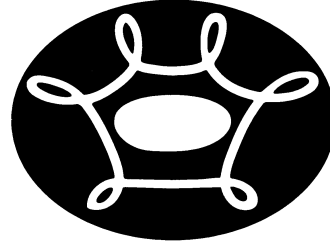

FOR BAKERY GOODS (U.S. CL. 46).
FIRST USE 0-0-1976; IN COMMERCE 0-0-1976.

SN 78-188,178. SANTA CRUZ COFFEE ROASTING COMPANY, THE, WATSONVILLE, CA. FILED 11-22-2002.

BERKELEY

FOR COFFEE BEANS, WHOLE AND GROUND; COFFEE AND COFFEE DRINKS, NAMELY, BLENDED AND UNBLENDED COFFEES, FLAVORED COFFEES, ORGANICALLY GROWN COFFEES AND CAFFEINATED AND DECAFFEINATED COFFEES (U.S. CL. 46).

SN 78-189,472. RECOT, INC., PLEASANTON, CA. FILED 11-27-2002.

SUN CHIPS

OWNER OF U.S. REG. NOS. 986,097, 2,686,169 AND OTHERS.

NO CLAIM IS MADE TO THE EXCLUSIVE RIGHT TO USE "CHIPS", APART FROM THE MARK AS SHOWN.

FOR SNACK MIX COMPRISED OF TORTILLA CHIPS, MULTIGRAIN SNACK CHIPS, CHEESE FLAVORED PUFFED CORN SNACKS, PRETZELS, READY-TO-EAT CEREAL AND/OR CRACKERS (U.S. CL. 46).

SN 78-192,865. GREEN MOUNTAIN COFFEE ROASTERS, INC., WATERBURY, VT. FILED 12-10-2002.

CAFÉ VERDÉ

OWNER OF U.S. REG. NOS. 1,631,794, 1,639,220 AND 2,525,258.

NO CLAIM IS MADE TO THE EXCLUSIVE RIGHT TO USE "CAFE", APART FROM THE MARK AS SHOWN.

THE FOREIGN WORDING IN THE MARK TRANSLATES INTO ENGLISH AS "GREEN".

FOR WHOLE BEAN AND GROUND ROASTED COFFEE (U.S. CL. 46).

CLASS 30—(Continued).

SN 78-194,016. KRAFT FOODS HOLDINGS, INC., NORTH-FIELD, IL. FILED 12-12-2002.

HEALTHY CLASSICS

NO CLAIM IS MADE TO THE EXCLUSIVE RIGHT TO USE "HEALTHY", APART FROM THE MARK AS SHOWN. FOR BREAKFAST CEREAL (U.S. CL. 46).

SN 78-194,024. KRAFT FOODS HOLDINGS, INC., NORTH-FIELD, IL. FILED 12-12-2002.

TASTES SO GREAT YOU FORGET IT'S HEALTHY

FOR BREAKFAST CEREAL (U.S. CL. 46).

SN 78-195,603. LANCE MFG. LLC, CHARLOTTE, NC. FILED 12-18-2002.



OWNER OF U.S. REG. NO. 1,583,825.
NO CLAIM IS MADE TO THE EXCLUSIVE RIGHT TO USE "POPPERS", APART FROM THE MARK AS SHOWN.
FOR FOOD PACKAGE COMBINATIONS CONSISTING PRIMARILY OF CRACKERS AND CRACKER SANDWICHES (U.S. CL. 46).

SN 78-198,193. ROBERTSON, JOHN O., PORTLAND, ME. FILED 12-27-2002.

ELLE ELLE BEAN

FOR COFFEE, TEA, COCOA, CHOCOLATE, FOOD FLAVORINGS BEING NON-ESSENTIAL OILS, FLAVORING ADDITIVES FOR NON-NUTRITIONAL PURPOSES (U.S. CL. 46).

CLASS 30—(Continued).

SN 78-198,195. ROBERTSON, JOHN O., PORTLAND, ME. FILED 12-27-2002.

ELLE ELLE BEAN FRENCH ROAST

NO CLAIM IS MADE TO THE EXCLUSIVE RIGHT TO USE "FRENCH ROAST", APART FROM THE MARK AS SHOWN.

FOR COFFEE BEANS, GROUND COFFEE, COFFEE CONCENTRATES, COFFEE FLAVORING SYRUP, COFFEE-BASED BEVERAGE CONTAINING MILK, COFFEE FLAVORINGS BEING NON-ESSENTIAL OILS, COFFEE FLAVORING ADDITIVES FOR NON-NUTRITIONAL PURPOSES (U.S. CL. 46).

SN 78-201,659. THE PILLSBURY COMPANY, MINNEAPOLIS, MN. FILED 1-9-2003.

MICROWAVE EXPRESS

NO CLAIM IS MADE TO THE EXCLUSIVE RIGHT TO USE "MICROWAVE", APART FROM THE MARK AS SHOWN.
FOR FROZEN BAKERY GOODS (U.S. CL. 46).

SN 78-201,825. KAWASUMI, INC., SPARKS, NV. FILED 1-9-2003.

SUMI

FOR SOY SAUCE (U.S. CL. 46).
FIRST USE 7-1-1988; IN COMMERCE 1-1-1989.

SN 78-202,076. DADDY SAM'S INC., MINNETONKA, MN. FILED 1-10-2003.

JUST SLOP IT ON!

FOR BARBECUE SAUCE (U.S. CL. 46).
FIRST USE 6-6-2002; IN COMMERCE 6-6-2002.

CLASS 30—(Continued).

SN 78-203,497. VIACOM INTERNATIONAL INC., NEW YORK, NY. FILED 1-15-2003.

KRABBY PATTIES

FOR BREAD STICKS, BUBBLE GUM, CANDY CAKE DECORATIONS, EDIBLE CAKE DECORATIONS, CAKE MIXES, CAKES, CAKES AND CHOCOLATE BASED FILLINGS FOR PIES AND CAKES, CANDY, CANDY COATED POPCORN, CARAMEL POPCORN, CARAMELS, CEREAL BASED SNACK FOOD, CHEESE FLAVORED CORN PUFFED SNACKS, CHEWING GUM, CHOCOLATE CHIPS, CORN CHIPS, FLOUR BASED CHIPS, CHOCOLATE, CHOCOLATE COVERED NUTS, CHOCOLATE POWDER, CHOCOLATE SYRUP, CHOCOLATE TOPPING, COCOA MIXES, CONES FOR ICE CREAM, COOKIES, CORN CURLS, CRACKER AND CHEESE COMBINATIONS, CRACKERS, FOOD READY TO EAT CEREAL DERIVED FOOD BARS, FROSTING, FRUIT PIES, FLAVORED AND SWEETENED GELATINS, GRANOLA BASED SNACK BARS, HOT CHOCOLATE, POPPED POPCORN, PRETZELS, PUDDINGS, WAFFLES, ICE CREAM, ICE MILK, FLAVORED ICES, FROZEN CONFECTIONS, FROZEN YOGURT, FROZEN CUSTARD, ALL RELATING TO TELEVISION PROGRAMS (U.S. CL. 46).

SN 78-203,748. TAGHADDOS, SIAMAK, NEWTON, MA. FILED 1-15-2003.

POPRICE

FOR RICE-BASED SNACK FOODS (U.S. CL. 46).

SN 78-204,427. ARCOR S.A.I.C., BUENOS AIRES, ARGENTINA, FILED 1-17-2003.

ARCOR DELI CAKE

OWNER OF U.S. REG. NOS. 904,806, 2,438,978 AND OTHERS.

NO CLAIM IS MADE TO THE EXCLUSIVE RIGHT TO USE "DELI CAKE", APART FROM THE MARK AS SHOWN.

FOR CHOCOLATES, BONBONS, CHOCOLATE COVERED NUTS AND CANDIES, WAFERS, CHOCOLATE COVERED WAFERS, CHOCOLATE COATED SANDWICH COOKIES, TARTS, PIES, SANDWICH BISCUITS, AND CAKES (U.S. CL. 46).

SN 78-207,491. JENNY'S COUNTRY KITCHEN, INC., DOVER, MN. FILED 1-27-2003.

FUNKY MONKEY

FOR INSTANT FLAVORED COFFEE/COCOA BEVERAGE MIX. (U.S. CL. 46).

FIRST USE 1-1-2003; IN COMMERCE 1-1-2003.

CLASS 30—(Continued).

SN 78-207,498. THE COCA-COLA COMPANY, ATLANTA, GA. FILED 1-27-2003.

FAR COAST

FOR COFFEE AND TEA (U.S. CL. 46).

SN 78-207,569. BRIGHAM'S, INC., ARLINGTON, MA. FILED 1-27-2003.

ELAN

FOR FROZEN YOGURT (U.S. CL. 46).
FIRST USE 0-0-1985; IN COMMERCE 0-0-1985.

SN 78-207,617. REVOLUTIONARY SOY, BELMORE NSW 2192, AUSTRALIA, FILED 1-27-2003.

SOYACCINO

FOR COFFEE ALTERNATIVE AND COFFEE SUBSTITUTE FOOD, NAMELY ROASTED SOY BEAN BASED COFFEE BEVERAGE (U.S. CL. 46).

SN 78-208,258. WM. WRIGLEY JR. COMPANY, CHICAGO, IL. FILED 1-29-2003.

EXTRA THIN ICE

OWNER OF U.S. REG. NO. 1,307,342.
FOR CONFECTIONERY, NAMELY, BREATH STRIPS, BREATH MINTS (U.S. CL. 46).

SN 78-208,266. LINDA'S LOLLIES CO., INC., NEW YORK, NY. FILED 1-29-2003.

LINDALICIOUS

OWNER OF U.S. REG. NOS. 1,566,193 AND 1,566,194.
FOR CANDY - LOLLIPOPS - LINDA'S LOLLIES (U.S. CL. 46).

SN 78-208,281. LINDA'S LOLLIES CO., INC., NEW YORK, NY. FILED 1-29-2003.

LOLLIDROPS

FOR CANDY (U.S. CL. 46).

CLASS 30—(Continued).

SN 78-208,540. ARBY'S BRANDS, LLC, FORT LAUDERDALE, FL. FILED 1-29-2003.

ORIGINAPPLE

FOR BAKERY GOODS, NAMELY, CINNAMON ROLLS (U.S. CL. 46).

SN 78-208,554. KENCRAFT, INC., ALPINE, UT. FILED 1-29-2003.

CHOCO CHUMS

FOR CANDY (U.S. CL. 46).

SN 78-209,508. PIZZA HUT, INC., DALLAS, TX. FILED 1-31-2003.

FOUR4ALL

FOR PIZZA; PIZZA PIE CRUSTS; PIZZA SAUCES; PIZZA DOUGH (U.S. CL. 46).

SN 78-209,582. IMAGE BRANDS INC., SAN DIEGO, CA. FILED 1-31-2003.

YUMPUFFS

FOR BAKERY GOODS, BAKERY DESSERTS, BAKERY PRODUCTS, PASTRIES, COOKIES (U.S. CL. 46).

SN 78-210,409. FENG, BI, DIAMOND BAR, CA. FILED 2-4-2003.



FOR PROPOLIS FOR FOOD PURPOSES (U.S. CL. 46). FIRST USE 1-1-2003; IN COMMERCE 1-1-2003.

CLASS 30—(Continued).

SN 78-222,479. THE KAHLUA COMPANY, HEALDSBURG, CA. FILED 3-6-2003.

KAHLUA

OWNER OF U.S. REG. NOS. 752,237, 1,483,994 AND OTHERS. FOR COFFEE BASED DRINKS AND ICED COFFEE BASED DRINKS (U.S. CL. 46).

SN 78-251,390. LEWIS BROTHERS BAKERIES, INCORPORATED, DBA LEWIS BAKERIES, INC., EVANSVILLE, IN. FILED 5-19-2003.

HEALTHY LIFE

OWNER OF U.S. REG. NOS. 1,815,479, 2,043,907 AND 2,402,271. FOR BREAKFAST CEREAL, CEREAL BARS AND GRAIN-BASED BREAKFAST BARS (U.S. CL. 46).

CLASS 31—NATURAL AGRICULTURAL PRODUCTS

SN 76-117,444. VAN STAAVEREN B.V., 1435 EW RIJSENHOUT, NETHERLANDS, FILED 8-25-2000.

MISTY

FOR NATURAL, NON-FOOD BEARING PLANTS EXCLUDING GERANIUMS AND HYBRID TEA ROSE PLANTS (U.S. CLS. 1 AND 46). FIRST USE 1-1-1993; IN COMMERCE 7-1-1993.

SN 76-156,263. KAL KAN FOODS, INC., VERNON, CA. FILED 10-30-2000.



OWNER OF U.S. REG. NOS. 1,829,035 AND 1,896,394. FOR FEED FOR HORSES (U.S. CLS. 1 AND 46). FIRST USE 1-0-2000; IN COMMERCE 1-0-2000.

CLASS 31—(Continued).

SN 76-330,613. COOPERATIE FRUITMASTERS GROEP U.A., 4191 NX GELDERMALSEN, NETHERLANDS, FILED 10-26-2001.



PRIORITY CLAIMED UNDER SEC. 44(D) ON BENELUX APPLICATION NO. 0996256, FILED 8-31-2001, REG. NO. 0694339, DATED 8-31-2001, EXPIRES 8-31-2011.

THE WORD "FRUITMASTERS" IS BLUE, THE HORIZONTAL DESIGN IMMEDIATELY ABOVE "FRUITMASTERS" IS RED, AND THE VERTICAL DESIGN IMMEDIATELY ABOVE THE HORIZONTAL DESIGN IS GREEN.

FOR HORTICULTURAL PRODUCTS, NAMELY, LIVE PLANTS, LIVE FLOWERS, HERBS, NAMELY, FRESH AND RAW HERBS, LIVE FRUIT TREES, GRAINS, NAMELY, AGRICULTURAL GRAINS FOR PLANTING, UNPROCESSED GRAINS FOR HUMAN CONSUMPTION, SEEDS, NAMELY, AGRICULTURAL SEEDS, FLOWER SEEDS, AND PLANT SEEDS, LIVE ANIMALS, FOODSTUFFS FOR ANIMALS, MALT FOR BREWING AND DISTILLING, CORN, NAMELY, FRESH AND RAW CORN, POTATOES, NAMELY, FRESH AND RAW POTATOES, MUSHROOMS, NAMELY, FRESH AND RAW MUSHROOMS, GARLIC, NAMELY, FRESH AND RAW GARLIC, TOMATOES, NAMELY, FRESH AND RAW TOMATOES, NUTS, NAMELY, FRESH AND RAW NUTS, OLIVES, NAMELY, FRESH AND RAW OLIVES, BEANS, NAMELY, FRESH AND RAW BEANS, GINGER, NAMELY, FRESH AND RAW GINGER, CEREALS, NAMELY, UNPROCESSED CEREALS, POPCORN, NAMELY, RAW AND UNPOPPED POPCORN (U.S. CLS. 1 AND 46).

SN 76-408,681. JUNGPFANZEN GRUNEWALD GMBH, D-44534 LUNEN-ALTLUNEN, FED REP GERMANY, FILED 5-15-2002.

DOG'S GONE

FOR LIVE COLEUS PLANTS AND COLEUS PLANT PROPAGATION MATERIALS (U.S. CLS. 1 AND 46).
FIRST USE 7-31-2002; IN COMMERCE 7-31-2002.

SN 76-423,902. GRIMMWAY ENTERPRISES, INC., BAKERSFIELD, CA. FILED 6-21-2002.

CALIFORNIA'S CARROT EXPRESS

NO CLAIM IS MADE TO THE EXCLUSIVE RIGHT TO USE "CALIFORNIA'S CARROT", APART FROM THE MARK AS SHOWN.
FOR FRESH CARROTS (U.S. CLS. 1 AND 46).
FIRST USE 0-0-1998; IN COMMERCE 0-0-1998.

CLASS 31—(Continued).

SN 76-424,445. R. H. DYCK, INC., WINTERS, CA. FILED 6-20-2002.



OWNER OF U.S. REG. NO. 2,009,890.

FOR CONTAINMENT UNITS MADE OF STRAW AND OTHER NATURAL AND RECYCLED MATERIALS AND AMENDMENTS ENCASED IN A BIODEGRADABLE, PHOTODEGRADABLE OR NATURAL MATERIAL NETTING (1) FOR USE IN STREAM BANKS, RIPARIAN AND SEMI-AQUATIC ENVIRONMENTS, (2) FOR USE IN DAIRY, FEED LOT AND ANIMAL WASTE ENVIRONMENTS, (3) FOR USE IN WATER QUALITY FILTRATION, (4) FOR USE IN LAND REHABILITATION, (5) FOR USE IN POND AND LAKE CLARIFICATION, (6) FOR USE IN HOME GARDENING, (7) FOR USE IN SITE REMEDIATION/REVEGETATION, AND (8) FOR USE IN SOIL CONSERVATION APPLICATIONS (U.S. CLS. 1 AND 46).

SN 76-430,559. CAL/WEST SEEDS, WOODLAND, CA. FILED 7-15-2002.

PRODUCER'S CHOICE

FOR AGRICULTURAL SEEDS, NAMELY, SEED OF ALFALFA, SUDANGRASS, CLOVER, SORGHUM, SORGHUM SUDANGRASS, AND CORN (U.S. CLS. 1 AND 46).

FIRST USE 11-15-2001; IN COMMERCE 6-20-2002.

SN 76-435,630. OURPET'S COMPANY, FAIRPORT HARBOR, OH. FILED 7-29-2002.

OURCAT'S CHOICE LITTER

OWNER OF U.S. REG. NOS. 2,048,003 AND 2,577,849.
NO CLAIM IS MADE TO THE EXCLUSIVE RIGHT TO USE "LITTER", APART FROM THE MARK AS SHOWN.
FOR CAT LITTER (U.S. CLS. 1 AND 46).

SN 76-438,752. FERNTRUST, INC., SEVILLE, FL. FILED 8-8-2002.

THE GROWING LEADER

FOR LIVE CUT GREENS AND FOLIAGE (U.S. CLS. 1 AND 46).
FIRST USE 0-0-1992; IN COMMERCE 0-0-1992.

CLASS 31—(Continued).

SN 76-446,544. PACIFIC TOMATO GROWERS, LTD, PALMETTO, FL. FILED 9-3-2002.

NATION FRESH

NO CLAIM IS MADE TO THE EXCLUSIVE RIGHT TO USE "FRESH", APART FROM THE MARK AS SHOWN. FOR FRESH FRUITS AND VEGETABLES, EXCLUDING SWEET CORN (U.S. CLS. 1 AND 46). FIRST USE 1-1-2003; IN COMMERCE 1-1-2003.

SN 76-458,429. KEYSTONE FRUIT MARKETING INC., GREENCASTLE, PA. FILED 10-8-2002.



NO CLAIM IS MADE TO THE EXCLUSIVE RIGHT TO USE "APPLES", APART FROM THE MARK AS SHOWN. FOR FRESH FRUIT, NAMELY, APPLES (U.S. CLS. 1 AND 46). FIRST USE 9-3-2002; IN COMMERCE 9-3-2002.

SN 76-485,105. THIBAUT, KYLE ANN, GOODYEAR, AZ. FILED 1-24-2003.

FOUR LEGS GOURMET BAKERY

NO CLAIM IS MADE TO THE EXCLUSIVE RIGHT TO USE "GOURMET BAKERY", APART FROM THE MARK AS SHOWN. FOR PET FOOD AND EDIBLE PET TREATS (U.S. CLS. 1 AND 46).

SN 76-485,395. CONAGRA GROCERY PRODUCTS COMPANY, IRVINE, CA. FILED 1-28-2003.

AS MUCH FUN TO MAKE AS IT IS TO EAT

FOR UNPOPPED POPCORN (U.S. CLS. 1 AND 46). FIRST USE 1-0-1998; IN COMMERCE 1-0-1998.

SN 76-485,713. FOREST ENERGY CORPORATION, SHOW LOW, AZ. FILED 1-24-2003.

PAWS ONLY

FOR CAT LITTER (U.S. CLS. 1 AND 46).

CLASS 31—(Continued).

SN 76-486,266. EYE DAZZLER ALPACAS, LC, WESTCLIFFE, CO. FILED 1-30-2003.



NO CLAIM IS MADE TO THE EXCLUSIVE RIGHT TO USE "ALPACAS", APART FROM THE MARK AS SHOWN. FOR ALPACA LIVESTOCK (U.S. CLS. 1 AND 46).

SN 76-492,576. MARKON COOPERATIVE, INC., SALINAS, CA. FILED 2-25-2003.

MARKON FIRST CROP FLAVOR PACT

OWNER OF U.S. REG. NOS. 1,410,925, 2,174,822 AND OTHERS. FOR FRESH PRODUCE, NAMELY FRESH FRUITS AND VEGETABLES (U.S. CLS. 1 AND 46).

SN 78-144,609. DUMMEN GMBH, D-47495 RHEINBERG, FED REP GERMANY, FILED 7-17-2002.

QUIX

OWNER OF FED REP GERMANY REG. NO. DD637099, DATED 4-13-1970, EXPIRES 1-31-2010. FOR HORTICULTURAL AND AGRICULTURAL PRODUCTS, NAMELY, LIVE PLANTS, FRESH CUT UNROOTED AND ROOTED PLANT CUTTINGS, YOUNG LIVE PLANTS AND SYSTEMS USED FOR MULTIPLICATION, PROPAGATION AND TRANSPORTATION OF LIVE PLANTS, YOUNG PLANTS, OR CUTTINGS, NAMELY, CULTURE TRAYS, PLANT POTS IN ROWS, PLANT TRAYS AND CARTONS (U.S. CLS. 1 AND 46).

SN 78-156,236. POULSEN ROSER APS, FREDENSBORG, DENMARK, FILED 8-21-2002.

CUYAHOGA

FOR LIVE ROSES (U.S. CLS. 1 AND 46). FIRST USE 6-1-2002; IN COMMERCE 6-1-2002.

CLASS 31—(Continued).

SN 78-179,385. BLUE SEAL FEEDS, INC., LONDONDERRY, NH. FILED 10-29-2002.

SPORT FORMULA

NO CLAIM IS MADE TO THE EXCLUSIVE RIGHT TO USE "FORMULA", APART FROM THE MARK AS SHOWN. FOR FEED FOR HORSES (U.S. CLS. 1 AND 46).

SN 78-193,923. PROMO-FRUIT LTD, CH-8197 RAFZ, SWITZERLAND, FILED 12-12-2002.

TIXIA

FOR AGRICULTURAL SEEDS; SEEDLINGS; LIVING PLANTS; AND PARTS THEREOF; FLOWER BULBS; AND UNPROCESSED FRUITS (U.S. CLS. 1 AND 46).

SN 78-201,261. INTERNATIONAL FLOWER EXCHANGE, INC., MIAMI, FL. FILED 1-8-2003.

WORLD SERIES FLOWERS

NO CLAIM IS MADE TO THE EXCLUSIVE RIGHT TO USE "FLOWERS", APART FROM THE MARK AS SHOWN. FOR FRESH CUT FLOWERS (U.S. CLS. 1 AND 46).

SN 78-203,150. HEB GROCERY COMPANY, LP, SAN ANTONIO, TX. FILED 1-14-2003.

SEASON'S SELECT

NO CLAIM IS MADE TO THE EXCLUSIVE RIGHT TO USE "SELECT", APART FROM THE MARK AS SHOWN. FOR FRESH FRUITS; FRESH VEGETABLES (U.S. CLS. 1 AND 46).

SN 78-209,213. ZAIGER, CHRIS, FLOYD, MODESTO, CA. AND ZAIGER, BETTY, JEAN, MODESTO, CA. FILED 1-30-2003.

PEACOTUM

FOR LIVE COMMERCIAL FRUIT TREES AND FRESH DECIDUOUS FRUIT. (U.S. CLS. 1 AND 46).

CLASS 32—LIGHT BEVERAGES

CLASS 32—(Continued).

SN 75-130,704. BEARDSLEY, WAYNE ROBERT, DURANGO, CO. BY ASSIGNMENT; BY ASSIGNMENT MCCLARAN, STEVEN C., DBA DURANGO BREWING COMPANY, DURANGO, CO. FILED 7-8-1996.



OWNER OF U.S. REG. NO. 2,198,706.
 NO CLAIM IS MADE TO THE EXCLUSIVE RIGHT TO USE "DURANGO COLORADO BREWING COMPANY" OR "TRADITIONALLY BREWED BEER", APART FROM THE MARK AS SHOWN.
 FOR BEER (U.S. CLS. 45, 46 AND 48).
 FIRST USE 9-30-1992; IN COMMERCE 9-30-1992.

SN 75-892,961. URBAN JUICE & SODA COMPANY LTD., VANCOUVER, B.C. V5L 1Y9, CANADA, FILED 1-10-2000.

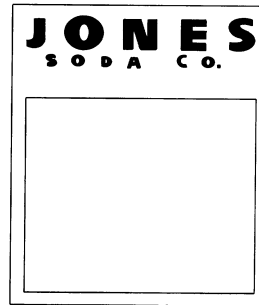

PRIORITY CLAIMED UNDER SEC. 44(D) ON CANADA APPLICATION NO. 1023228, FILED 7-15-1999, REG. NO. TMA573837, DATED 1-16-2003, EXPIRES 1-16-2018.
 OWNER OF U.S. REG. NO. 2,118,528.
 NO CLAIM IS MADE TO THE EXCLUSIVE RIGHT TO USE "SODA CO.", APART FROM THE MARK AS SHOWN.
 FOR NON-ALCOHOLIC CARBONATED AND NON-CARBONATED BEVERAGES, NAMELY, SODA WATER, MINERAL WATER AND SPRING WATER; FRUIT JUICES; SOFT DRINKS (U.S. CLS. 45, 46 AND 48).
 FIRST USE 10-0-1995; IN COMMERCE 10-0-1995.

CLASS 32—(Continued).

SN 76-094,792. ALDO GROUP INC./LE GROUPE ALDO INC., THE, VILLE ST-LAURENT, QUÉBEC, CANADA, FILED 7-24-2000.

ALDO

PRIORITY CLAIMED UNDER SEC. 44(D) ON CANADA APPLICATION NO. 1064536, FILED 6-22-2000, REG. NO. TMA574,248, DATED 1-23-2003, EXPIRES 1-23-2018.

FOR BOTTLED SPRING WATER (U.S. CLS. 45, 46 AND 48).

SN 76-094,793. ALDO GROUP INC./LE GROUPE ALDO INC., THE, VILLE ST-LAURENT, QUÉBEC, CANADA, FILED 7-24-2000.

ALDO

PRIORITY CLAIMED UNDER SEC. 44(D) ON CANADA APPLICATION NO. 1064535, FILED 6-22-2000, REG. NO. TMA574,326, DATED 1-24-2003, EXPIRES 1-24-2018.

FOR BOTTLED SPRING WATER (U.S. CLS. 45, 46 AND 48).

SN 76-125,057. CP KELCO U.S., INC., WILMINGTON, DE. FILED 9-8-2000.

CPKelco

FOR INGREDIENTS USED IN MANUFACTURE OF LIGHT BEVERAGES, NAMELY, CARRAGEENAN, GEL-LAN GUM AND XANTHAN GUM (U.S. CLS. 45, 46 AND 48).

SN 76-178,388. DM ENTERPRISES & DISTRIBUTORS, INC., MIAMI, FL. FILED 12-8-2000.

Cubita

THE LINING SHOWN IN THE DRAWING APPEARS TO BE A FEATURE OF THE MARK AND NOT INTENDED TO INDICATE COLOR.

THE FOREIGN WORDING IN THE MARK TRANSLATES INTO ENGLISH AS "SMALL CUBA".

FOR NON-ALCOHOLIC MALT BEVERAGES (U.S. CLS. 45, 46 AND 48).

CLASS 32—(Continued).

SN 76-287,266. ORTIGOSA, S.A., MADRID, SPAIN, FILED 7-18-2001.

**AGUA
MINERAL NATURAL
BEZOYA**

OWNER OF ERPN CMNTY TM OFC REG. NO. 1773787, DATED 10-5-2001, EXPIRES 7-25-2010.

NO CLAIM IS MADE TO THE EXCLUSIVE RIGHT TO USE "AGUA MINERAL NATURAL", APART FROM THE MARK AS SHOWN.

THE STIPPLING IS A FEATURE OF THE MARK AND IS NOT INTENDED TO INDICATE COLOR.

THE WORD "AGUA" MEANS "WATER".

FOR MINERAL AND AERATED WATERS (U.S. CLS. 45, 46 AND 48).

SN 76-363,237. OLD EUROPEAN BREWERY COMPANY, SAN DIEGO, CA. FILED 1-24-2002.

KARINOV RED ICE

NO CLAIM IS MADE TO THE EXCLUSIVE RIGHT TO USE "RED ICE", APART FROM THE MARK AS SHOWN. FOR BEER (U.S. CLS. 45, 46 AND 48).

SN 76-403,432. CASTLEMAINE PERKINS PTY LIMITED, NEW SOUTH WALES, AUSTRALIA, FILED 5-2-2002.



NO CLAIM IS MADE TO THE EXCLUSIVE RIGHT TO USE "SINCE 1878" AND "PREMIUM LAGER", APART FROM THE MARK AS SHOWN.

FOR BEER, LAGER, ALE, STOUT AND PORTER (U.S. CLS. 45, 46 AND 48).

CLASS 32—(Continued).

SN 76-403,668. WALTON SECHS BEER CO., BYRON CENTER, MI. FILED 5-3-2002.

WALTON SECHS

THE NAME "WALTON SECHS" DOES NOT IDENTIFY A LIVING INDIVIDUAL.
FOR BREWED ALCOHOLIC BEVERAGES, NAMELY BEER AND ALE (U.S. CLS. 45, 46 AND 48).

SN 76-427,233. EARTHSOURCE, INC., GREENVILLE, SC. FILED 7-3-2002.

EARTH SOURCE

FOR BOTTLED DRINKING WATER (U.S. CLS. 45, 46 AND 48).
FIRST USE 4-11-2001; IN COMMERCE 4-11-2001.

SN 76-429,233. BUFFETT, JIMMY, KEY WEST, FL. FILED 7-9-2002.

J.B.'S MARGARITAVILLE

OWNER OF U.S. REG. NOS. 1,641,613, 2,132,559 AND OTHERS.
FOR DRINKING WATER, NON-ALCOHOLIC PUNCHES, NON-ALCOHOLIC MALT BEVERAGES, SOFT DRINKS, FRUIT DRINKS, NON-ALCOHOLIC COCKTAIL MIXES, AND PREPARATIONS FOR MAKING FRUIT DRINKS (U.S. CLS. 45, 46 AND 48).

SN 76-429,298. AIRBOSS FEATURES, LTD., SAN ANTONIO, TX. FILED 7-11-2002.



FOR LIGHT BEVERAGES, NAMELY, CARBONATED AND NON-CARBONATED SOFT DRINKS (U.S. CLS. 45, 46 AND 48).

CLASS 32—(Continued).

SN 76-432,638. CALAHUA S.A. DE C.V., SAN MATEO ATENCO, ESTADO DE MEXICO, MEXICO, FILED 7-22-2002.

FOR MINERAL AND AERATED WATERS, FRUITS DRINKS, FRUIT JUICES, SYRUPS AND PREPARATIONS FOR MAKING FRUIT DRINKS, COCONUT FRUIT DRINKS, FROZEN FRUIT DRINKS FLAVORED WITH COCONUT MILK, FROZEN FRUIT DRINKS; FRUIT DRINK AND FROZEN FRUIT DRINK NON-ALCOHOLIC COCKTAIL MIXES, NON-ALCOHOLIC COCKTAIL CONTAINING STRAINED FRUITS (U.S. CLS. 45, 46 AND 48).

SN 76-433,248. WM. WRIGLEY JR. COMPANY, CHICAGO, IL. FILED 7-23-2002.

WINTERFRESH

OWNER OF U.S. REG. NOS. 1,518,188, 1,918,960 AND 2,056,913.
FOR BEERS; MINERAL AND AERATED WATERS AND SOFT DRINKS; FRUIT DRINKS AND FRUIT JUICES; SYRUPS, POWDERS AND CONCENTRATES FOR USE IN THE PREPARATION OF FRUIT DRINKS, FRUIT JUICES AND SOFT DRINKS (U.S. CLS. 45, 46 AND 48).

SN 76-435,725. MORANDELL, WOLFGANG D., LOS ANGELES, CA. FILED 7-29-2002.



NO CLAIM IS MADE TO THE EXCLUSIVE RIGHT TO USE "LOS ANGELES CA" AND "HARVEST ALE", APART FROM THE MARK AS SHOWN.

THE LINING SHOWN IN THE DRAWING IS A FEATURE OF THE MARK AND NOT INTENDED TO INDICATE COLOR.

FOR ALES, BEERS, MALT LIQUOR IN THE NATURE OF A BEER (U.S. CLS. 45, 46 AND 48).

FIRST USE 9-15-1993; IN COMMERCE 9-15-1993.

CLASS 32—(Continued).

SN 76-441,419. HEB GROCERY COMPANY, LP, SAN ANTONIO, TX. FILED 8-19-2002.

★★★★★
CENTRAL MARKET

OWNER OF U.S. REG. NOS. 1,886,445, 1,887,620 AND 2,261,631.

SEC. 2(F) AS TO "MARKET".
 FOR LEMONADE; SPRING WATER; MINERAL WATER; ORGANIC APPLE JUICE; ORGANIC FRUIT BLEND JUICE (U.S. CLS. 45, 46 AND 48).

SN 76-442,270. YOAKAM, DWIGHT, LOS ANGELES, CA. FILED 8-19-2002.

DWIGHT YOAKAM

THE NAME(S), PORTRAIT(S), AND/OR SIGNATURE(S) SHOWN IN THE MARK IDENTIFIES "DWIGHT YOAKAM", WHOSE CONSENT(S) TO REGISTER IS SUBMITTED.

FOR NONALCOHOLIC BEVERAGES, NAMELY, SOFT DRINKS, FRUIT JUICES AND DRINKS (U.S. CLS. 45, 46 AND 48).

SN 76-447,107. PROMOTORA JUGOS DEL VALLE, S.A. DE C.V., COL. AZCAPOTZALCO, C.P. 02000, MEXICO, FILED 9-3-2002.

**Barrilitos
 Tehuacan**

OWNER OF U.S. REG. NO. 1,110,648.
 NO CLAIM IS MADE TO THE EXCLUSIVE RIGHT TO USE "TEHUACAN", APART FROM THE MARK AS SHOWN.

THE ENGLISH TRANSLATION OF "BARRILITOS" IS "LITTLE BARRELS".

FOR MINERAL AND AERATED WATERS; NONALCOHOLIC MALT COOLERS, NONALCOHOLIC PUNCH; FRUIT FLAVORED SOFT DRINKS; FRUIT FLAVORED DRINKS; SOFT DRINKS; SPORT DRINKS; FRUIT DRINKS AND FRUIT JUICES; CONCENTRATES, SYRUPS AND POWDERS USED IN THE PREPARATION OF SOFT DRINKS (U.S. CLS. 45, 46 AND 48).

CLASS 32—(Continued).

SN 76-454,435. JUGOS DEL VALLE, S.A. DE C.V., MUNICIPIO DE TEPOZOTLAN, EDO. DE MEXICO, MEXICO, FILED 9-23-2002.

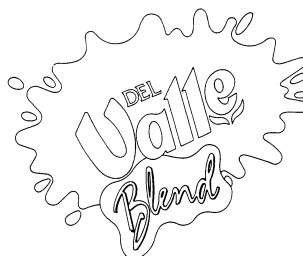

OWNER OF U.S. REG. NOS. 2,406,925, 2,498,599 AND 2,563,277.

NO CLAIM IS MADE TO THE EXCLUSIVE RIGHT TO USE "BLEND", APART FROM THE MARK AS SHOWN.

THE ENGLISH TRANSLATION OF "DEL VALLE" IS "OF THE VALLEY".

FOR MINERAL AND AERATED WATERS NONALCOHOLIC MALT COOLERS, NONALCOHOLIC PUNCH; FRUIT FLAVORED SOFT DRINKS; FRUIT FLAVORED DRINKS— SOFT DRINKS; SPORT DRINKS; FRUIT DRINKS AND FRUIT JUICES; CONCENTRATES, SYRUPS AND POWDERS USED IN THE PREPARATION OF SOFT DRINKS (U.S. CLS. 45, 46 AND 48).

SN 76-470,753. VITALON FOODS CO., LTD., TAICHUNG, TAIWAN, FILED 11-29-2002.



OWNER OF U.S. REG. NO. 1,740,653.

THE CHINESE CHARACTERS IN THE MARK TRANSLITERATE TO "SU PAU" AND THIS MEANS "COMFORTABLE (RELAXED OR LEISURELY) RUNNER".

FOR AERATED WATER; DRINKING WATER; SPORTS DRINKS CONSISTING OF SUGARS, VITAMINS, MINERALS, ACIDS, SALTS AND FRUIT FLAVORS; SOFT DRINK, NAMELY, COLAS; FRUIT DRINKS; FRUIT JUICES; MIXED FRUIT JUICES; FRUIT PUNCH; FRUIT-BASED SOFT DRINKS FLAVORED WITH TEA; TOMATO JUICE; AERATED FRUIT JUICES; VEGETABLE JUICES; FRUIT JUICES IN GENERAL; LEMONADE; MALT WORT; MINERAL WATER; SELTZER WATER; SODA WATER; FRUIT FLAVORED SOFT DRINKS; SYRUPS FOR MAKING SOFT DRINKS; SANSAPARILLA; NON-ALCOHOLIC PUNCHES; AND NON-ALCOHOLIZED WINES (U.S. CLS. 45, 46 AND 48).

FIRST USE 5-0-1995; IN COMMERCE 5-0-1995.

CLASS 32—(Continued).

SN 76-479,802. CITY AND COUNTY OF SAN FRANCISCO, SAN FRANCISCO, CA. FILED 12-24-2002.

HETCH HETCHY MOUNTAIN WATER

OWNER OF U.S. REG. NO. 2,460,751.
NO CLAIM IS MADE TO THE EXCLUSIVE RIGHT TO USE NO CLAIM IS MADE TO THE EXCLUSIVE RIGHT TO USE "MOUNTAIN WATER" APART FROM THE MARK AS SHOWN., APART FROM THE MARK AS SHOWN.
THE ENGLISH TRANSLATION OF THE WORD "HETCH HETCHY" IN THE MARK IS "GRASS WITH EDIBLE SEEDS".
FOR DRINKING WATER (U.S. CLS. 45, 46 AND 48).

SN 76-485,753. ALL-AMERICAN BOTTLING CORPORATION, OKLAHOMA CITY, OK. FILED 1-29-2003.

DIXIE DIAMOND

FOR CARBONATED SOFT DRINKS (U.S. CLS. 45, 46 AND 48).

SN 76-485,755. ALL-AMERICAN BOTTLING CORPORATION, OKLAHOMA CITY, OK. FILED 1-29-2003.

DELTA DIAMOND

FOR CARBONATED SOFT DRINKS (U.S. CLS. 45, 46 AND 48).

SN 76-486,358. CLEMENT PAPPAS AND COMPANY, INC., SEABROOK, NJ. FILED 1-29-2003.

GROWN RIGHT

FOR FRUIT DRINKS AND FRUIT JUICES (U.S. CLS. 45, 46 AND 48).

SN 78-030,397. ERDINGER WEISSBRAU WERNER BROMBACH GMBH, D-85435 ERDING, FED REP GERMANY, FILED 10-12-2000.

ERDINGER
Champ

OWNER OF U.S. REG. NO. 2,085,215.
FOR MALT LIQUOR (U.S. CLS. 45, 46 AND 48).

CLASS 32—(Continued).

SN 78-072,507. INCAUCA ALIMENTOS Y REFRESCOS S.A. - ALIRESA S.A., SANTIAGO DE CALI, COLOMBIA, FILED 7-5-2001.



FOR MINERAL WATERS, SODAS, NON-ALCOHOLIC BEVERAGES, NAMELY, FRUIT-FLAVORED DRINK, FRUIT JUICES, FRUIT BEVERAGES AND PREPARATIONS IN THE NATURE OF POWDER CONCENTRATES FOR MAKING FRUIT DRINKS (U.S. CLS. 45, 46 AND 48).

SN 78-142,581. GIVRAFRUITS, PEYPIN, FRANCE, FILED 7-10-2002.



PRIORITY CLAIMED UNDER SEC. 44(D) ON FRANCE APPLICATION NO. 023142424, FILED 1-18-2002, REG. NO. 023142424, DATED 1-18-2002, EXPIRES 1-18-2012.

FOR SYRUPS FOR MAKING FRUIT BEVERAGES, NAMELY, FRUIT DRINKS, SOFT DRINKS, AND DAIRY-BASED FRUIT BEVERAGES; FRUIT JUICES; FRUIT FLAVORED SOFT DRINKS; FRUIT NECTARS; FRUIT PUNCH; AERATED FRUIT JUICES; SPORTS DRINKS BASED ON FRUITS AND PREPARATIONS FOR MAKING VEGETABLE JUICE BEVERAGES (U.S. CLS. 45, 46 AND 48).

SN 78-161,065. PARTY JUICE, INC., LAYTON, UT. FILED 9-5-2002.

I LOVE YOU

FOR NON-ALCOHOLIC FRUIT JUICE BEVERAGES (U.S. CLS. 45, 46 AND 48).

CLASS 32—(Continued).

SN 78-189,052. JAMBA JUICE COMPANY, SAN FRANCISCO, CA. FILED 11-26-2002.

VERY BERRY BLISS

NO CLAIM IS MADE TO THE EXCLUSIVE RIGHT TO USE "BERRY", APART FROM THE MARK AS SHOWN.
FOR FRUIT AND VEGETABLE JUICES; NUTRITIONALLY FORTIFIED FRUIT AND VEGETABLE DRINKS; AND SMOOTHIES (U.S. CLS. 45, 46 AND 48).

SN 78-195,002. BON LOSEE ENTERPRISES, INC., PROVO, UT. FILED 12-16-2002.

AQUA CIRQUE

NO CLAIM IS MADE TO THE EXCLUSIVE RIGHT TO USE "AQUA", APART FROM THE MARK AS SHOWN.
THE FOREIGN WORDING IN THE MARK TRANSLATES INTO ENGLISH AS (AQUA) WATER + (CIRQUE) A STEEP-WALLED SEMICIRCULAR BASIN IN A MOUNTAIN; MAY CONTAIN A LAKE.
FOR BOTTLED WATER (U.S. CLS. 45, 46 AND 48).

SN 78-200,761. ANHEUSER-BUSCH, INCORPORATED, ST. LOUIS, MO. FILED 1-7-2003.

DOUBLEXPOSURE

FOR BEER (U.S. CLS. 45, 46 AND 48).

SN 78-203,619. MAGIC HAT BREWING COMPANY AND PERFORMING ARTS CENTER, INC., SOUTH BURLINGTON, VT. FILED 1-15-2003.

THUMBSUCKER

FOR BEER AND ALE (U.S. CLS. 45, 46 AND 48).

SN 78-205,890. COORS BREWING COMPANY, GOLDEN, CO. FILED 1-22-2003.

MOUNTAIN JAM

FOR BEER (U.S. CLS. 45, 46 AND 48).

CLASS 32—(Continued).

SN 78-206,971. LIDL STIFTUNG & CO. KG, NECKARSULM, FED REP GERMANY, FILED 1-24-2003.

WARBACHER

OWNER OF FED REP GERMANY REG. NO. 39960671, DATED 11-9-1999, EXPIRES 9-30-2009.
FOR BEERS (U.S. CLS. 45, 46 AND 48).

SN 78-210,023. FOOD COLLAGES, INC., STERLING, VA. FILED 2-3-2003.

DRINK BETTER JUICE

FOR FRUIT JUICE CONCENTRATES, SYRUPS AND POWDERS USED IN THE PREPARATION OF SOFT DRINKS AND SODA WATER, BEVERAGES, NAMELY FRUIT JUICES, FRUIT JUICE DRINKS, CARBONATED AND NON-CARBONATED SOFT DRINKS AND SODA WATER (U.S. CLS. 45, 46 AND 48).

SN 78-240,618. SOUTH BEACH BEVERAGE COMPANY, INC., NORWALK, CT. FILED 4-22-2003.

FUERTE

THE ENGLISH TRANSLATION OF THE SPANISH WORDING "FUERTE" IS "STRONG".
FOR FRUIT DRINKS, JUICE DRINKS, SOFT DRINKS, AND SYRUPS AND CONCENTRATES FOR MAKING THE SAME (U.S. CLS. 45, 46 AND 48).

CLASS 33—WINES AND SPIRITS

SN 76-273,142. GERARDO CESARI S.P.A., BRESCIA, ITALY, FILED 6-18-2001.



PRIORITY CLAIMED UNDER SEC. 44(D) ON ITALY APPLICATION NO. 006142, FILED 5-31-2001, REG. NO. 880288, DATED 12-17-2002, EXPIRES 5-31-2011.
THE LINING IS A FEATURE OF THE MARK AND DOES NOT INDICATE COLOR.
THE WORD "EPICO" MAY BE TRANSLATED AS "EPIC".
FOR WINE, SPARKLING WINE (U.S. CLS. 47 AND 49).

CLASS 33—(Continued).

SN 76-359,117. MAISON A.E. DOR, JARNAC, FRANCE, FILED 1-14-2002.

ALBERT JARRAUD

OWNER OF FRANCE REG. NO. 1241182, DATED 7-19-1983, RENEWED AS REG. NO. 1241182, DATED 2-17-2003, EXPIRES 7-19-2013.

THE NAME IN THE MARK DOES NOT IDENTIFY A LIVING INDIVIDUAL.

FOR LIQUORS, DISTILLED LIQUORS, BRANDIES AND COGNACS (U.S. CLS. 47 AND 49).

SN 76-369,691. ZHEJIANG ZHIZHONGHE WINE INDUSTRY CO., LTD., JIANDE CITY, ZHEJIANG PROVINCE, CHINA, FILED 2-11-2002.



OWNER OF CHINA REG. NO. 1279104, DATED 5-28-1999, EXPIRES 5-27-2009.

THE WORD "ZHIZHONGHE" HAS NO MEANING IN ENGLISH. THE FIRST CHINESE CHARACTER HAS AN ENGLISH TRANSLATION OF "DEVOTION" AND AN ENGLISH TRANSLITERATION OF "ZHI". THE SECOND CHINESE CHARACTER HAS AN ENGLISH TRANSLATION OF "MIDWAY" AND AN ENGLISH TRANSLITERATION OF "ZHONG". THE THIRD CHINESE CHARACTER HAS AN ENGLISH TRANSLATION OF "PEACE" AND AN ENGLISH TRANSLITERATION OF "HE".

FOR ALCOHOLIC BEVERAGES, NAMELY, WINE, ARRACK, RICE WINE, YELLOW WINE, RAKI, RATAFEE, AND HARD CIDER (U.S. CLS. 47 AND 49).

SN 76-389,434. DENNY, WILLIAM M., JR., CHESTER SPRINGS, PA. FILED 4-1-2002.

OLDE MILL RACE

FOR WINES (U.S. CLS. 47 AND 49).

SN 76-405,455. VINTAGE ASSOCIATES, INC., NAPLES, FL. FILED 5-10-2002.

TALLTREE VINEYARDS

NO CLAIM IS MADE TO THE EXCLUSIVE RIGHT TO USE "VINEYARDS", APART FROM THE MARK AS SHOWN.

FOR WINE (U.S. CLS. 47 AND 49).

CLASS 33—(Continued).

SN 76-424,013. P. J. VALCKENBERG GMBH, 67547 WORMS AM RHEIN, FED REP GERMANY, FILED 6-21-2002.

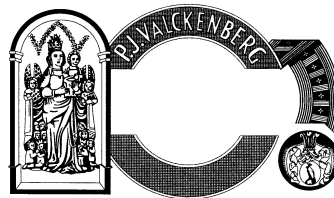

OWNER OF U.S. REG. NO. 1,379,444.

THE LINING AND STIPPLING IN THE DRAWING ARE A FEATURE OF THE MARK AND DO NOT INDICATE COLOR.

THE NAME SHOWN IN THE MARK DOES NOT IDENTIFY A LIVING INDIVIDUAL.

THE MARK IS COMPRISED OF THE NAME "P. J. VALCKENBERG", AND A SHOWING ON THE LEFT SIDE THEREOF OF A STATUE OF A WOMAN HOLDING A BABY AND SURROUNDED BY ANGLES.

FOR WINES (U.S. CLS. 47 AND 49).

FIRST USE 7-1-1994; IN COMMERCE 7-20-1994.

SN 76-425,206. FRANCESCO CINZANO & C.IA S.P.A., 20121 MILANO, ITALY, FILED 6-27-2002.



OWNER OF ITALY REG. NO. 871363, DATED 5-2-2002, EXPIRES 5-2-2012.

THE MARK WORD "CASA FONDATA NEL 1757" IS TRANSLATED IN ENGLISH IS "HOUSE FOUNDED IN 1757".

FOR LIQUEURS, VERMOUTHS, DISTILLED SPIRITS, WINES, SPARKLING WINES, APERITIF WINES, APERITIFS WITH A DISTILLED ALCOHOLIC LIQUOR BASE, AND APERITIFS WITH A WINE BASE (U.S. CLS. 47 AND 49).

SN 76-428,968. WINE GROUP LLC, THE, RIPON, CA. BY ASSIGNMENT VITICOLTORI FRIULANI "LA DELIZIA" SOCIETA' COOPERATIVA A RESPONSABILITA' LIMITATA, CASARSA DELLA DELIZIA (PORDENONE), ITALY, FILED 7-9-2002.

CASARSA

FOR WINES AND SPARKLING WINES (U.S. CLS. 47 AND 49).

FIRST USE 0-0-1975; IN COMMERCE 0-0-1975.

CLASS 33—(Continued).

SN 76-436,927. PENAFLOR S.A., PROVINCIA BUENOS AIRES, ARGENTINA, FILED 8-1-2002.

FINCA LA ESCONDIDA

OWNER OF ARGENTINA REG. NO. 1867373, DATED 4-15-2002, EXPIRES 4-15-2012.

NO CLAIM IS MADE TO THE EXCLUSIVE RIGHT TO USE "FINCA", APART FROM THE MARK AS SHOWN.

THE WORD "FINCA" MAY BE TRANSLATED AS COUNTRY ESTATE OR RANCH. THE WORD "LA ESCONDIDA" MAY BE TRANSLATED AS "THE HIDDEN". "FINCA LA ESCONDIDA" MAY BE TRANSLATED AS "ESTATE THE HIDDEN".

FOR WINES (U.S. CLS. 47 AND 49).

SN 76-447,822. JOHNSON, FRANCIS E., III, NEW YORK, NY, FILED 9-5-2002.

FEJ SELECTIONS

NO CLAIM IS MADE TO THE EXCLUSIVE RIGHT TO USE "SELECTIONS", APART FROM THE MARK AS SHOWN.

FOR WINE (U.S. CLS. 47 AND 49).

FIRST USE 9-1-1998; IN COMMERCE 9-1-1998.

SN 76-457,902. ALSACE WILLM (SA), 67140 BARR, FRANCE, FILED 10-7-2002.



FOR WINES (U.S. CLS. 47 AND 49).
FIRST USE 0-0-1995; IN COMMERCE 0-0-1995.

SN 76-458,551. RENWOOD WINERY, INC., PLYMOUTH, CA, FILED 10-16-2002.

dedicated to the art

FOR WINES (U.S. CLS. 47 AND 49).
FIRST USE 0-0-1994; IN COMMERCE 0-0-1995.

CLASS 33—(Continued).

SN 76-465,881. COOPERATIVA AGRICOLA CONTROL PISQUERO DE ELQUI Y LIMARI LIMITADA, LA SERENA, CHILE, FILED 10-31-2002.

TRES ERRES

OWNER OF CHILE REG. NO. 662467, DATED 4-9-2003, EXPIRES 4-9-2013.

THE ENGLISH TRANSLATION OF "TRES ERRES" IS "THREE R'S".

FOR ALCOHOLIC BEVERAGES, NAMELY WINE (U.S. CLS. 47 AND 49).

SN 76-467,744. JSTAR BRANDS, L.L.C., CHICAGO, IL, FILED 11-18-2002.

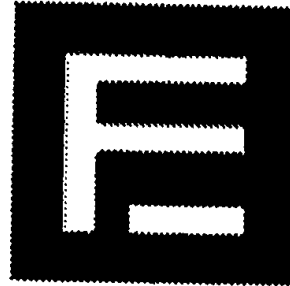

FOR VODKA (U.S. CLS. 47 AND 49).

SN 76-469,921. AUSTIN, ANDRE, PASO ROBLES, CA, FILED 11-25-2002.

ANJELU

FOR WINE (U.S. CLS. 47 AND 49).

SN 76-476,344. ANGOVE'S PROPRIETARY LIMITED, RENMARK, SOUTH AUSTRALIA, 5341, AUSTRALIA, FILED 12-18-2002.

RED BELLY BLACK

PRIORITY CLAIMED UNDER SEC. 44(D) ON AUSTRALIA APPLICATION NO. 924545, FILED 8-23-2002, REG. NO. 924545, DATED 8-23-2002, EXPIRES 8-23-2012.

NO CLAIM IS MADE TO THE EXCLUSIVE RIGHT TO USE "RED" AND "BLACK", APART FROM THE MARK AS SHOWN.

FOR WINES, SPIRITS, AND LIQUEURS (U.S. CLS. 47 AND 49).

CLASS 33—(Continued).

SN 76-478,275. BROWN BROTHERS MILAWA VINEYARD PTY LTD, MILAWA, VICTORIA, AUSTRALIA, FILED 12-26-2002.



OWNER OF AUSTRALIA REG. NO. 848842, DATED 9-4-2000, EXPIRES 9-4-2010.

OWNER OF U.S. REG. NO. 1,427,724.

NO CLAIM IS MADE TO THE EXCLUSIVE RIGHT TO USE "ESTABLISHED 1889" AND "AUSTRALIA", APART FROM THE MARK AS SHOWN.

THE LINING SHOWN IN THE DRAWING IS A FEATURE OF THE MARK.

THE NAME AND PORTRAIT IN THE MARK IS "JOHN F. BROWN" WHO IS NO LONGER LIVING.

FOR WINES, LIQUEURS AND FORTIFIED WINES (U.S. CLS. 47 AND 49).

SN 76-485,096. GLOBAL PERSPECTIVES, INC., FOREST HILLS, QUEENS, NY. FILED 1-27-2003.

INTUITION

FOR LIQUEUR (U.S. CLS. 47 AND 49).

SN 76-485,177. CORDIER ESTATES, INC., FORT STOCKTON, TX. FILED 1-27-2003.

PEREGRINE HILL

FOR WINE (U.S. CLS. 47 AND 49).

SN 76-485,183. DIME GROUP INTERNATIONAL, INC., VERNON HILLS, IL. FILED 1-27-2003.

KRIMSKOYE

FOR CHAMPAGNE (U.S. CLS. 47 AND 49).
FIRST USE 7-0-1999; IN COMMERCE 7-0-1999.

CLASS 33—(Continued).

SN 76-485,186. DIME GROUP INTERNATIONAL, INC., VERNON HILLS, IL. FILED 1-27-2003.

AGUSTOS

THE ENGLISH TRANSLATION OF "AGUSTOS" IS "PLEASURES".

FOR WINE (U.S. CLS. 47 AND 49).

FIRST USE 11-0-2002; IN COMMERCE 11-0-2002.

SN 76-485,621. BERINGER BLASS WINE ESTATES COMPANY, NAPA, CA. FILED 1-28-2003.

VALLEY CREST

FOR WINE (U.S. CLS. 47 AND 49).

SN 76-485,622. BERINGER BLASS WINE ESTATES COMPANY, NAPA, CA. FILED 1-28-2003.

RIVERWALK

FOR WINE (U.S. CLS. 47 AND 49).

SN 76-485,873. BERINGER BLASS WINE ESTATES COMPANY, NAPA, CA. FILED 1-28-2003.

NORTH STATION

FOR WINE (U.S. CLS. 47 AND 49).

SN 76-485,874. BERINGER BLASS WINE ESTATES COMPANY, NAPA, CA. FILED 1-28-2003.

AUTUMN HILLS

FOR WINE (U.S. CLS. 47 AND 49).

CLASS 33—(Continued).

SN 76-486,694. JILL AIGNER, JOY S. SHAFFER, AND I. MILO SHEPARD, ALL AMERICAN CITIZEN, AS TRUSTEES OF THE TRUST CREATED UNDER THE WILL OF IRVING SHEPARD, GLEN ELLEN, CA. FILED 2-3-2003.

Jack London
VINEYARD

NO CLAIM IS MADE TO THE EXCLUSIVE RIGHT TO USE "VINEYARD", APART FROM THE MARK AS SHOWN. THE NAME "JACK LONDON" DOES NOT IDENTIFY ANY PARTICULAR LIVING INDIVIDUAL.
FOR WINE (U.S. CLS. 47 AND 49).
FIRST USE 0-0-1979; IN COMMERCE 0-0-1979.

SN 76-486,958. AZIENDA AGRICOLA PIEROPAN LEONILDO, 37038 SOAVE (VR), ITALY, FILED 1-31-2003.

PIEROPAN

OWNER OF ITALY REG. NO. 831660, DATED 1-16-2001, EXPIRES 11-5-2018.
FOR WINES (U.S. CLS. 47 AND 49).

SN 76-487,843. GREG & GREG, INC., SEBASTOPOL, CA. FILED 1-28-2003.

TANDEM

FOR WINE (U.S. CLS. 47 AND 49).
FIRST USE 8-3-2001; IN COMMERCE 8-3-2001.

SN 78-138,840. DESTILERIA SERRALLES, INC., MERCEDITA, PUERTO RICO, FILED 6-26-2002.

DON Q TROPICAL

OWNER OF U.S. REG. NOS. 341,119 AND 2,104,164.
NO CLAIM IS MADE TO THE EXCLUSIVE RIGHT TO USE "TROPICAL", APART FROM THE MARK AS SHOWN.
FOR RUM (U.S. CLS. 47 AND 49).

CLASS 33—(Continued).

SN 78-142,430. TAITTINGER, REIMS, FRANCE, FILED 7-9-2002.

**LES FOLIES DE LA
MARQUETTERIE**

PRIORITY CLAIMED UNDER SEC. 44(D) ON FRANCE APPLICATION NO. 023141288, FILED 1-14-2002, REG. NO. 23141288, DATED 1-14-2002, EXPIRES 1-14-2012.
THE MARK MAY BE TRANSLATED AS "THE FOLLIES OF LA MARQUETTERIE".
FOR WINES, SPARKLING WINES. (U.S. CLS. 47 AND 49).

SN 78-149,047. MILORAD, KARAKASEVIC, ST. HELENA, CA. FILED 7-30-2002.

CHARBAY

THE MARK CONSISTS OF WORD "CHARBAY".
THE FOREIGN WORDING IN THE MARK TRANSLATES INTO ENGLISH AS COINED WORD FROM TWO ENGLISH WORDS: "CHAR" FROM "CHARDONNAY", A GRAPE VARIETY AND "BAY" FROM "BRANDY".
SEC. 2(F).

FOR ALCOHOLIC APERITIF BITTERS, ALCOHOLIC BEVERAGE PRODUCED FROM A BREWED MALT BASE WITH NATURAL FLAVORS, ALCOHOLIC BITTERS, ALCOHOLIC COFFEE-BASED BEVERAGE, ALCOHOLIC MALT COOLERS, ALCOHOLIC PUNCH, ALCOHOLIC TEA-BASED BEVERAGE, ANISETTE, APERITIF WINES, APERITIFS WITH A DISTILLED ALCOHOLIC LIQUOR BASE, APERITIFS WITH A WINE BASE, BRANDY, BRANDY SPRITS, COOKING WINE, CORDIALS, DISTILLED SPIRITS, DISTILLED SPRITS MADE FROM CORN, WHEAT, BARLEY, MILLET, RYE, FRUITS AND VEGETABLES, EXTRACTS OF SPIRITUOUS LIQUORS, FRUIT WINE, GIN, HARD CIDER, HERB LIQUEURS, LIQUEURS, DISTILLED LIQUOR, MEAD, PORT WINES, PORTABLE SPIRITS, PREPARED ALCOHOLIC COCKTAIL, PREPARED WINE COCKTAILS, RUM, SAKE, SAKI, SANGRIA, SCHNAPPS, SHERRY, TEQUILA, VERMOUTH, VODKA, WHISKEY, WINE, WINE COOLERS DRINKS, WINE PUNCH, WINE PUNCHES (U.S. CLS. 47 AND 49).
FIRST USE 9-29-1987; IN COMMERCE 11-9-1987.

SN 78-151,210. JOSE CUERVO, S.A. DE C.V., MEXICO CITY, MEXICO, FILED 8-6-2002.

TIZOC

FOR LIQUEUR (U.S. CLS. 47 AND 49).

CLASS 33—(Continued).

SN 78-151,545. THE WINE GROUP LLC, RIPON, CA. FILED 8-6-2002.

**EVERYONE FEELS
WELCOME WHEN THE
WINE IS GLEN ELLEN**

OWNER OF U.S. REG. NOS. 1,260,618, 2,623,056 AND OTHERS.
FOR WINE (U.S. CLS. 47 AND 49).

CLASS 33—(Continued).

SN 78-176,755. JASON'S HILL PRIVATE CELLAR (PROPRIETARY) LIMITED, RAWSONVILLE, SOUTH AFRICA, FILED 10-21-2002.



FOR ALCOHOLIC BEVERAGES, NAMELY WINE, PREPARED WINE COCKTAILS; WINE PUNCHES; SPIRITS DISTILLED FROM GRAPES, AND LIQUEURS (U.S. CLS. 47 AND 49).

SN 78-160,308. FUNDACION GALA - SALVADOR DALI, FIGUERES, GIRONA, SPAIN, FILED 9-3-2002.

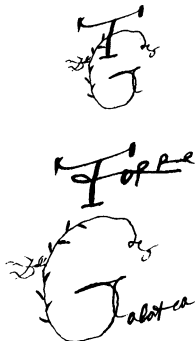

OWNER OF SPAIN REG. NO. 2397775, DATED 4-22-2002, EXPIRES 4-22-2012.

THE MARK CONSISTS OF THE LETTERING AND WORDING "TG TORRE GALATEA".

THE WORD "TORRE" TRANSLATES TO "TOWER" IN ENGLISH.

FOR ALCOHOLIC BEVERAGES, NAMELY, WINE, BRANDY AND SPARKLING WINE (U.S. CLS. 47 AND 49).

SN 78-180,872. VARNA INTERNATIONAL DISTRIBUTORS INC., KELLER, TX. FILED 11-1-2002.



The Pleasure of Kings



SN 78-162,982. BLACK BOX WINES, LLC, WALNUT CREEK, CA. FILED 9-11-2002.

BLACK BOX

FOR WINE AND SPIRIT BEVERAGES (U.S. CLS. 47 AND 49).
FIRST USE 1-20-2003; IN COMMERCE 1-20-2003.

NO CLAIM IS MADE TO THE EXCLUSIVE RIGHT TO USE "VODKA" AND "THE PLEASURE OF KINGS", APART FROM THE MARK AS SHOWN.

THE STIPPLING IS FOR SHADING PURPOSES ONLY. THE MARK CONSISTS OF A KING'S CROWN LOCATED DIRECTLY ABOVE THE WORD "NORDIX" WHICH IS LOCATED AT THE UPPER CENTER OF THE LABEL; THE WORD "VODKA" LOCATED AT THE CENTER OF THE LABEL; THE WORDS "THE PLEASURE OF KINGS" LOCATED AT THE LOWER CENTER OF THE LABEL; AND A DOUBLE HEADED GRIFFIN CENTERED AT THE BOTTOM OF THE LABEL.

FOR VODKA (U.S. CLS. 47 AND 49).
FIRST USE 0-0-1994; IN COMMERCE 10-31-2002.

CLASS 33—(Continued).

SN 78-186,435. LASCELLES MERCHANDISE LIMITED, KINGSTON 10, JAMAICA, FILED 11-19-2002.

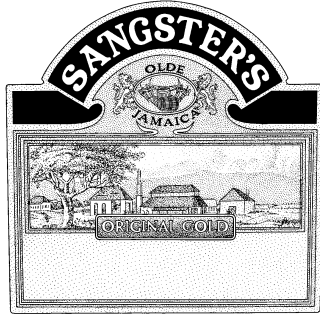

NO CLAIM IS MADE TO THE EXCLUSIVE RIGHT TO USE "OLDE JAMAICA" OR "ORIGINAL GOLD", APART FROM THE MARK AS SHOWN.

THE STIPPLING IS FOR SHADING PURPOSES ONLY AND DOES NOT INDICATE COLOR.

FOR CREAM LIQUEUR (U.S. CLS. 47 AND 49).

SN 78-187,696. WEINER, RUSSEL G., LAS VEGAS, NV, FILED 11-21-2002.

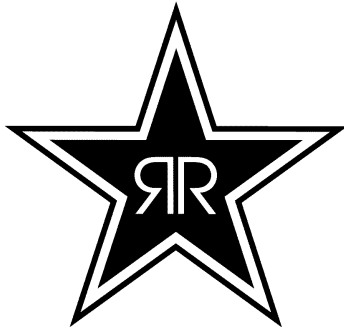

FOR DISTILLED SPIRITS AND ALCOHOLIC BEVERAGE PRODUCED FROM A BREWED MALT BASE WITH NATURAL FLAVORS. (U.S. CLS. 47 AND 49).

SN 78-196,341. VOK BEVERAGES PTY LTD, NORTH PLYMPTON, AUSTRALIA, FILED 12-19-2002.

VOK

OWNER OF AUSTRALIA REG. NO. A80467, DATED 8-27-1943, EXPIRES 8-27-2009.

FOR ALCOHOLIC BEVERAGES, NAMELY FLAVORED LIQUEURS AND POTABLE SPIRITS (U.S. CLS. 47 AND 49).

CLASS 33—(Continued).

SN 78-198,798. TERIIEROOITERAI, GERALD, PAPEETE, FRENCH POLYNESIA, FILED 12-31-2002.

NAPAGNE

FOR CHAMPAGNE (U.S. CLS. 47 AND 49).

SN 78-198,923. BRINTON, WILLIAM W., SAN FRANCISCO, CA, FILED 12-31-2002.

**LA SONRISA DEL
TECOLOTE**

THE ENGLISH TRANSLATION OF THE MARK IS "THE SMILE OF THE OWL" IN SPANISH.

FOR WINE (U.S. CLS. 47 AND 49).

SN 78-199,152. DUBUQUE AREA CHAMBER OF COMMERCE, DUBUQUE, IA, FILED 12-31-2002.

AMERICA'S RIVER

FOR WINE (U.S. CLS. 47 AND 49).

SN 78-205,939. VALENTIN BIANCHI S.A.C.I.F., PROVINCE OF MENDOZA, ARGENTINA, FILED 1-22-2003.

FINCA LAS PAREDES

THE ENGLISH TRANSLATION OF "FINCA" IS "FARM". THE ENGLISH TRANSLATION OF "LAS PAREDES" IS "THE WALLS".

FOR WINES (U.S. CLS. 47 AND 49).

SN 78-205,944. VALENTIN BIANCHI S.A.C.I.F., PROVINCE OF MENDOZA, ARGENTINA, FILED 1-22-2003.

MAINQUE

THE ENGLISH TRANSLATION OF "MAINQUE" IS "CONDOR".

FOR WINES (U.S. CLS. 47 AND 49).

SN 78-206,905. KALARIS, CONSTANTINE, ELLICOTT CITY, MD, FILED 1-24-2003.

WORTHY

FOR WINE (U.S. CLS. 47 AND 49).

CLASS 33—(Continued).

SN 78-208,025. VIA S.A., SAN RAFAEL, TALCA, CHILE,
FILED 1-28-2003.

CASCADA

FOR WINES (U.S. CLS. 47 AND 49).

SN 78-209,048. WALKER, ROBERT W., SAN MATEO, CA.
FILED 1-30-2003.

VITAWINE

FOR WINE WITH VITAMINS, ANTI-OXIDANTS AND
NUTRITIONAL SUPPLEMENTS ADDED (U.S. CLS. 47
AND 49).

SN 78-209,155. HATCHER WINEWORKS, LLC, DUNDEE,
OR. FILED 1-30-2003.

L'OREGON

FOR WINES (U.S. CLS. 47 AND 49).

SN 78-209,298. TWO HANDS WINES PTY. LTD, GREENOCK,
SOUTH AUSTRALIA, AUSTRALIA, FILED 1-31-2003.

TWO HANDS

FOR WINES, SPIRITS, LIQUEURS (U.S. CLS. 47 AND
49).

SN 78-209,726. JACKSON FAMILY FARMS, LLC, SANTA
ROSA, CA. FILED 1-31-2003.

RAY'S STATION

FOR WINES (U.S. CLS. 47 AND 49).

CLASS 34—SMOKERS' ARTICLES

SN 76-234,429. HABANA TOBACCO TRADING COMPANY,
INC., UNION CITY, NJ. FILED 4-2-2001.

THE SOPRANOS CIGARS

NO CLAIM IS MADE TO THE EXCLUSIVE RIGHT TO
USE "CIGARS", APART FROM THE MARK AS SHOWN.
FOR CIGARS AND TOBACCO PRODUCTS, NAMELY
SMOKELESS TOBACCO, TOBACCO (U.S. CLS. 2, 8, 9
AND 17).

CLASS 34—(Continued).

SN 76-394,539. GENERAL CIGAR CO., INC., WINDSOR, CT.
FILED 4-11-2002.

The logo for 'LA RESERVA' features the word 'LA' in a smaller, serif font above the word 'RESERVA' in a larger, bold, serif font. The letters are black and set against a white background.

THE ENGLISH TRANSLATION OF THE WORDS "LA
RESERVA" IN THE MARK IS "THE RESERVE".
SEC. 2(F).
FOR CIGARS (U.S. CLS. 2, 8, 9 AND 17).
FIRST USE 1-0-1989; IN COMMERCE 1-0-1989.

SN 76-443,648. RENEGADE TOBACCO COMPANY, MOCKS-
VILLE, NC. FILED 8-26-2002.

CUT YOUR OWN

FOR CONSUMER CIGARETTE KITS, NAMELY, CI-
GARETTES AND FILTERS (U.S. CLS. 2, 8, 9 AND 17).

SN 76-460,995. GRENON, KEVIN, BURBANK, CA. FILED 10-
21-2002.

GOT-SMOKE?

FOR CIGARS (U.S. CLS. 2, 8, 9 AND 17).

SN 76-467,374. JAPAN TOBACCO INC., TOKYO, JAPAN,
FILED 11-5-2002.

The logo for 'ORIGINAL BLUE' features the word 'ORIGINAL' in a serif font above the word 'BLUE' in a larger, bold, serif font. The letters are black and set against a white background.

OWNER OF SWITZERLAND REG. NO. 503489, DATED 9-
25-2002, EXPIRES 5-7-2012.
FOR CIGARETTES (U.S. CLS. 2, 8, 9 AND 17).

CLASS 34—(Continued).

SN 78-130,782. PINKERTON TOBACCO CO. LP, RICHMOND, VA. FILED 5-23-2002.



OWNER OF U.S. REG. NOS. 683,560 AND 779,753.
NO CLAIM IS MADE TO THE EXCLUSIVE RIGHT TO USE "FLAVORS", APART FROM THE MARK AS SHOWN. THE STIPPLING IS FOR SHADING PURPOSES ONLY. FOR CIGARS (U.S. CLS. 2, 8, 9 AND 17).

SN 78-163,452. WHITE, JULIE, HOGANSBURG, NY. FILED 9-12-2002.

ADIRONDACK

FOR CIGARETTES (U.S. CLS. 2, 8, 9 AND 17).

SN 78-174,521. GMB, INC., KING, NC. FILED 10-15-2002.



NO CLAIM IS MADE TO THE EXCLUSIVE RIGHT TO USE "BERRY", APART FROM THE MARK AS SHOWN. FOR CIGARETTES (U.S. CLS. 2, 8, 9 AND 17).

SN 78-193,124. OBSHCHESTVO S OGRANICHENNOI OT-VETSTVENNOSTIYU "KUB", MOSKOVSKAYA OBLAST, RUSSIAN FEDERATIO, FILED 12-10-2002.

ASTON

FOR RAW AND MANUFACTURED TOBACCO. CIGARETTES, CIGARS, CIGARILLOS, CHEROOTS; MATCHES; ASHTRAYS NOT MADE OF PRECIOUS METALS; AND CIGARETTE LIGHTERS NOT MADE OF PRECIOUS METALS AND PARTS THEREFOR (U.S. CLS. 2, 8, 9 AND 17).

CLASS 34—(Continued).**SERVICE MARKS****CLASS 35—ADVERTISING AND BUSINESS**

SN 75-087,549. CANADIAN PROFESSIONAL LOGISTICS INSTITUTE/INSTITUT CANADIEN PROFESSIONNEL LOGISTIQUE, TORONTO, ONTARIO, M5E 1G4, CANADA, FILED 4-12-1996.

P.LOG.

PRIORITY CLAIMED UNDER SEC. 44(D) ON CANADA APPLICATION NO. 795819, FILED 10-25-1995, REG. NO. TMA530,040, DATED 7-10-2000, EXPIRES 7-10-2015.

FOR PROCUREMENT SERVICES FOR OTHERS, NAMELY, PURCHASING AND INVENTORY CONTROL SERVICES IN THE FIELD OF INDUSTRIAL PARTS AND SUPPLIES AND FINISHED GOODS (U.S. CLS. 100, 101 AND 102).

FIRST USE 4-0-1995; IN COMMERCE 4-0-1995.

SN 75-645,578. LEADERSHIP EDUCATION & DEVELOPMENT, INC., COLUMBIA, TN. FILED 2-19-1999.

LEADERSHOP

PRIORITY CLAIMED UNDER SEC. 44(D) ON CANADA APPLICATION NO. 1001310, FILED 1-6-1999.

FOR RETAIL STORE SERVICES FEATURING GIFTS, AWARDS, PLAQUES, LITHOGRAPHS, PICTURES, CALENDARS, CARDS AND OTHER ITEMS USED IN THE PROCESS OF MAKING PEOPLE MORE EFFECTIVE AND PRODUCTIVE IN THEIR JOBS OR INSPIRING, MOTIVATING, LEADING OR MANAGING PEOPLE; AND ON-LINE COMPUTER SERVICES, NAMELY ON-LINE SHIPPING SERVICES FEATURING GIFTS, AWARDS, PLAQUES, LITHOGRAPHS, PICTURES, CALENDARS, CARDS AND OTHER ITEMS USED IN THE PROCESS OF MAKING PEOPLE MORE EFFECTIVE AND PRODUCTIVE IN THEIR JOBS OR INSPIRING, MOTIVATING, LEADING OR MANAGING PEOPLE (U.S. CLS. 100, 101 AND 102).

FIRST USE 5-22-2003; IN COMMERCE 5-22-2003.

SN 75-666,915. E-POWER MARKETING INC., CHICAGO, IL. FILED 3-24-1999.

E-POWER MARKETING

NO CLAIM IS MADE TO THE EXCLUSIVE RIGHT TO USE "MARKETING", APART FROM THE MARK AS SHOWN.

FOR INCREASING USER VISITS FOR WEBSITES OF OTHERS ON A GLOBAL COMPUTER INFORMATION NETWORK FROM ONLINE SOURCES, NAMELY, SEARCH ENGINES, DIRECTORIES, NEWS GROUPS, WEBSITES AND E-MAIL (U.S. CLS. 100, 101 AND 102).

FIRST USE 7-0-1998; IN COMMERCE 7-0-1998.

CLASS 35—(Continued).

SN 75-841,843. ECANDLE, INC., FAYETTEVILLE, AR.
FILED S.R. 11-5-1999; AM. P.R. 7-17-2003.



OWNER OF U.S. REG. NO. 2,359,750.

NO CLAIM IS MADE TO THE EXCLUSIVE RIGHT TO USE "ECANDLE", APART FROM THE MARK AS SHOWN.

FOR ON-LINE RETAIL STORE SERVICES FEATURING CANDLES, CANDLE ACCESSORIES, BEAUTY AIDS, SOAPS, SHAMPOOS, MASSAGE OILS, SHOWER GELS, BODY LOTION, POTPOURRI, GIFT BASKETS, AND HOME DECORATION PRODUCTS (U.S. CLS. 100, 101 AND 102).

FIRST USE 2-19-1999; IN COMMERCE 2-19-1999.

SN 75-857,204. CALEGO INTERNATIONAL INC., PROVINCE OF QUEBEC, CANADA, FILED 11-24-1999.

BAGPLANET

PRIORITY CLAIMED UNDER SEC. 44(D) ON CANADA APPLICATION NO. 1035736, FILED 11-10-1999, REG. NO. 1035736, DATED 5-12-2003, EXPIRES 5-12-2017.

FOR ON-LINE RETAIL STORE SERVICES FEATURING BAGS (U.S. CLS. 100, 101 AND 102).

CLASS 35—(Continued).

SN 75-894,219. CHUMBO.COM, INC., MINNEAPOLIS, MN. BY CHANGE OF NAME CHUMBO CORPORATION, MINNEAPOLIS, MN. FILED 1-11-2000.

chumbo

OWNER OF U.S. REG. NOS. 2,284,929, 2,293,248 AND 2,323,090.

FOR COMPUTERIZED ON-LINE SEARCH AND ORDERING SERVICES FEATURING COMPUTER SOFTWARE AND MULTIMEDIA PRODUCTS IN THE FORM OF COMPACT DISCS, FLOPPY DISKS AND CD ROMS; DISTRIBUTORSHIPS IN THE FIELD OF COMPUTER SOFTWARE AND MULTIMEDIA PRODUCTS IN THE FORM OF COMPACT DISCS, FLOPPY DISKS AND CD ROMS; ON-LINE RETAIL AND WHOLESALE STORE SERVICES FEATURING COMPUTER SOFTWARE, COMPUTER PERIPHERALS, PRINTERS AND COMPONENTS, COMPUTER AND COMPUTER RELATED BOOKS AND MANUALS, AND MOTION PICTURE FILMS AND DVD ROMS, ALL PROVIDED VIA A GLOBAL COMPUTER NETWORK; RETAIL AND WHOLESALE DISTRIBUTORSHIP SERVICES, PROVIDED BY DIRECT TRANSMISSION VIA A GLOBAL COMPUTER NETWORK, FEATURING COMPUTER SOFTWARE (U.S. CLS. 100, 101 AND 102).

FIRST USE 11-10-1997; IN COMMERCE 11-10-1997.

SN 75-924,063. KNEXA.COM ENTERPRISES INC., VANCOUVER, BRITISH COLUMBIA V6B 1B6, CANADA, BY CHANGE OF NAME DEMAND VENTURES LTD., VANCOUVER, BRITISH COLUMBIA V6B 1B6, CANADA, FILED 2-22-2000.

KNEXA

PRIORITY CLAIMED UNDER SEC. 44(D) ON CANADA APPLICATION NO. 1028467, FILED 9-10-1999, REG. NO. TMA551759, DATED 9-28-2001, EXPIRES 9-28-2016.

FOR PROVIDING ON-LINE AUCTION SERVICES VIA A GLOBAL COMPUTER NETWORK (U.S. CLS. 100, 101 AND 102).

SN 75-938,139. HCTB INCORPORATED, DBA HERE COMES THE BRIDESMAID, INC., NEW YORK, NY. FILED 3-8-2000.

HERE COMES THE BRIDESMAID, INC.

NO CLAIM IS MADE TO THE EXCLUSIVE RIGHT TO USE "INC.", APART FROM THE MARK AS SHOWN.

FOR ON-LINE RETAIL STORE FEATURING BRIDESMAIDS' DRESSES AND ACCESSORIES (U.S. CLS. 100, 101 AND 102).

FIRST USE 11-20-1997; IN COMMERCE 11-20-1997.

CLASS 35—(Continued).

SN 76-007,426. ICOM INFORMATION & COMMUNICATIONS INC., TORONTO, ONTARIO L1R 2T5, CANADA, FILED 3-23-2000.

ICOM

PRIORITY CLAIMED UNDER SEC. 44(D) ON CANADA APPLICATION NO. 1047360, FILED 2-18-2000, REG. NO. TMA558,140, DATED 2-19-2002, EXPIRES 2-19-2017.

FOR INFORMATION AND COMMUNICATION SERVICES USING CONSUMER INFORMATION TO PROVIDE DIRECT MARKETING SERVICES FOR OTHERS, NAMELY, DIRECT MAIL ADVERTISING, MAILING LISTS AND CONSUMER DATA COLLECTION; CONDUCTING BUSINESS RESEARCH AND SURVEYS (U.S. CLS. 100, 101 AND 102).

FIRST USE 12-0-1995; IN COMMERCE 12-0-1995.

SN 76-049,112. GOTCOMPANY.COM INC., CAMPBELL, CA. FILED 5-12-2000.

CAMPAIGNER

PRIORITY CLAIMED UNDER SEC. 44(D) ON CANADA APPLICATION NO. 1048124, FILED 2-23-2000, REG. NO. TMA557311, DATED 2-4-2002, EXPIRES 2-4-2017.

FOR MARKETING AND ADVERTISING SERVICES FOR OTHERS, NAMELY, DIRECT MASS ELECTRONIC-MAILING SERVICES FOR OTHERS (U.S. CLS. 100, 101 AND 102).

SN 76-074,883. THE CUSTOM CLOTHING CONNECTION, L.L.C., COLUMBIA, SC. FILED 6-21-2000.

THE CUSTOM CLOTHING CONNECTION

NO CLAIM IS MADE TO THE EXCLUSIVE RIGHT TO USE "CUSTOM CLOTHING", APART FROM THE MARK AS SHOWN.

FOR PREPARING PROMOTIONAL AND MERCHANDISING MATERIAL FOR OTHERS TO RETAILERS OF CUSTOM COLLECTIONS OF CLOTHING, SHOES AND ACCESSORIES; PROVIDING PRODUCT MERCHANDISING AND DIRECT MARKETING ADVERTISING FOR OTHERS TO RETAILERS OF CUSTOM COLLECTIONS OF CLOTHING, SHOES, AND ACCESSORIES VIA DIRECT MAIL AND ONLINE COMMUNICATIONS NETWORK (U.S. CLS. 100, 101 AND 102).

SN 76-087,746. GREENORDER, INC., NEW YORK, NY. BY CHANGE OF NAME GREENORDER.COM, INC., NEW YORK, NY. FILED 7-12-2000.

GREENORDER

FOR BUSINESS CONSULTATION SERVICES; PROVIDING CONSUMER INFORMATION CONCERNING GOODS AND SERVICES OF OTHERS IN THE FIELD OF ENVIRONMENTALLY SOUND PRODUCTS (U.S. CLS. 100, 101 AND 102).

CLASS 35—(Continued).

SN 76-118,990. TELEFONICA, S.A., 28013 MADRID, SPAIN, FILED 8-25-2000.

TELEFONICA MOVILES

OWNER OF SPAIN REG. NO. 2291406, DATED 2-16-2000, EXPIRES 2-16-2010.

THE ENGLISH TRANSLATION OF THE TERM "TELEFONICA" IS "TELEPHONIC".

FOR ADVERTISING AGENCIES; ADVERTISING SERVICES, NAMELY PROVIDING ADVERTISING SPACE IN A PERIODICAL; ADVERTISING SERVICES, NAMELY, CREATING CORPORATE LOGOS FOR OTHERS; ADVERTISING SLOGAN AND CARTOON CHARACTER LICENSING; AGENCIES FOR ADVERTISING TIME AND SPACE; COOPERATIVE ADVERTISING AND MARKETING; DISSEMINATION OF ADVERTISING FOR OTHERS VIA THE INTERNET; DISSEMINATION OF ADVERTISING MATTER; PREPARING AUDIO-VISUAL PRESENTATIONS FOR USE IN ADVERTISING; PROVIDING TELEVISION ADVERTISING FOR OTHERS; RENTAL OF ADVERTISING SPACE; TELEVISION ADVERTISING AGENCIES (U.S. CLS. 100, 101 AND 102).

SN 76-123,051. REP-PHARM INC., OAKVILLE, ONTARIO, CANADA, FILED 9-6-2000.

VDI/REP-PHARM HEALTHCARE LOGISTICS

PRIORITY CLAIMED UNDER SEC. 44(D) ON CANADA APPLICATION NO. 1,054,968, FILED 4-13-2000, REG. NO. TMA570122, DATED 11-1-2002, EXPIRES 11-1-2017.

NO CLAIM IS MADE TO THE EXCLUSIVE RIGHT TO USE "HEALTHCARE LOGISTICS", APART FROM THE MARK AS SHOWN.

FOR WHOLESALE DISTRIBUTORSHIPS FEATURING PHARMACEUTICALS AND PHARMACEUTICAL PRODUCTS; AND MANAGEMENT OF INVENTORY, AND ACCOUNTS RECEIVABLE SERVICES PROVIDED TO MANUFACTURERS AND IMPORTERS OF PHARMACEUTICALS AND PHARMACEUTICAL PRODUCTS (U.S. CLS. 100, 101 AND 102).

SN 76-161,406. CHIRON CORPORATION, EMERYVILLE, CA. FILED 11-8-2000.

EBLOODBANK

FOR ON-LINE RETAIL STORE SERVICES FEATURING BLOOD SCREENING PRODUCTS (U.S. CLS. 100, 101 AND 102).

CLASS 35—(Continued).

SN 76-202,612. SEARCH AMERICA, INC., MAPLE GROVE, MN. FILED 1-19-2001.

SEARCH AMERICA

FOR COMPUTER SERVICES, NAMELY PROVIDING INFORMATION RELATING TO IDENTIFICATION OF AND INFORMATION ABOUT PERSONS AND BUSINESSES AND FINDING THE LOCATION OF PERSONS AND BUSINESSES VIA A GLOBAL COMPUTER NETWORK (U.S. CLS. 100, 101 AND 102).

FIRST USE 1-1-1996; IN COMMERCE 1-1-1996.

SN 76-204,634. BEARDEN, DENNIS, HOUSTON, TX. FILED 2-5-2001.

THE CENTURY COMPANIES

NO CLAIM IS MADE TO THE EXCLUSIVE RIGHT TO USE "COMPANIES", APART FROM THE MARK AS SHOWN.

FOR WHOLESALE DISTRIBUTORSHIPS FEATURING AIR CONDITIONING SUPPLIES FOR CONTRACTORS AND FOR MULTI-FAMILY HOUSING (U.S. CLS. 100, 101 AND 102).

SN 76-285,789. TRANS HEALTHCARE, INC., CAMP HILL, PA. FILED 7-16-2001.

TRANS HEALTH

OWNER OF U.S. REG. NO. 2,404,043.
FOR MANAGEMENT OF FACILITIES THAT OFFER HEALTH CARE SERVICES FOR OTHERS, NAMELY, OUTPATIENT CARE; EXTENDED CARE, NAMELY, NURSING HOMES, ASSISTED-LIVING FACILITIES, AND CONGREGATE CARE RETIREMENT COMMUNITIES; AND SPECIALTY HOSPITAL CARE, NAMELY, LONG-TERM ACUTE CARE HOSPITALS, REHABILITATION HOSPITALS, SURGICAL HOSPITALS AND ORTHOPEDIC HOSPITALS (U.S. CLS. 100, 101 AND 102).

SN 76-300,254. PLANET EARTH FOUNDATION, SEATTLE, WA. FILED 8-16-2001.

TEACHING SUCCESS

FOR ADVERTISING SERVICES, NAMELY, PROMOTING THE SERVICES OF OTHERS RELATING TO EDUCATION IN THE FIELDS OF VOCATION AND JOB TRAINING THROUGH THE DISTRIBUTION OF PRINTED AND AUDIO PROMOTIONAL MATERIALS (U.S. CLS. 100, 101 AND 102).

FIRST USE 9-0-1998; IN COMMERCE 9-0-1998.

CLASS 35—(Continued).

SN 76-306,165. GO FETCH, INC., NEW YORK, NY. FILED 8-28-2001.



FOR RETAIL STORE SERVICES IN THE NATURE OF A PET BOUTIQUE FEATURING PET GIFTS AND ACCESSORIES; ON-LINE RETAIL STORE SERVICES IN THE NATURE OF A PET BOUTIQUE FEATURING PET GIFTS AND ACCESSORIES (U.S. CLS. 100, 101 AND 102).
FIRST USE 10-0-1998; IN COMMERCE 10-0-1998.

SN 76-342,255. MOTT MEDIA, L.L.C., FENTON, MI. FILED 11-27-2001.

HOMESCHOOLING BOOK CLUB

NO CLAIM IS MADE TO THE EXCLUSIVE RIGHT TO USE "BOOK CLUB", APART FROM THE MARK AS SHOWN.

SEC. 2(F) AS TO "HOMESCHOOLING".
FOR MAIL ORDER BOOK CLUB FEATURING EDUCATIONAL MATERIALS, NAMELY, BOOKS, WORKBOOKS, TAPES, VIDEOS, MANIPULATIVES, CHARTS, AND FLASH CARDS (U.S. CLS. 100, 101 AND 102).

CLASS 35—(Continued).

SN 76-342,350. MACOMB COUNTY, MICHIGAN, MOUNT CLEMENS, MI. FILED 11-28-2001.



NO CLAIM IS MADE TO THE EXCLUSIVE RIGHT TO USE "MACOMB COUNTY, MICHIGAN", "1818" AND "THE REPRESENTATION OF A MAP OF MACOMB COUNTY, MICHIGAN", APART FROM THE MARK AS SHOWN. THE MARK CONSISTS, IN PART OF A REPRESENTATION OF THE MAP OF "MACOMB COUNTY, MICHIGAN". FOR LOCAL GOVERNMENT SERVICES, NAMELY, PROMOTING BUSINESS AND TOURISM IN THE MICHIGAN AREA (U.S. CLS. 100, 101 AND 102).

SN 76-352,319. AMERICAN HEALTHWAYS, INC., NASHVILLE, TN. FILED 12-20-2001.

EMETRIX

FOR HEALTHCARE MANAGEMENT SERVICES, NAMELY, IDENTIFYING HEALTH PLAN MEMBERS WHO ARE AT HIGH RISK FOR PARTICULAR DISEASES AND PROVIDING INFORMATION TO THOSE PEOPLE AND THEIR HEALTH CARE PROFESSIONALS TO IMPROVE TREATMENT OUTCOMES AND REDUCE THE COSTS OF CARE (U.S. CLS. 100, 101 AND 102).

SN 76-352,543. UNI-MARTS, INC., WILMINGTON, DE. FILED 12-26-2001.

CHOICE CIGARETTE DISCOUNT OUTLET

SEC. 2(F). FOR RETAIL CONVENIENCE STORE SERVICES FEATURING TOBACCO PRODUCTS (U.S. CLS. 100, 101 AND 102). FIRST USE 10-0-1996; IN COMMERCE 1-25-1997.

CLASS 35—(Continued).

SN 76-358,819. MAGICAL FARMS, INC., LITCHFIELD, OH. FILED 11-8-2001.



NO CLAIM IS MADE TO THE EXCLUSIVE RIGHT TO USE "2000 BREEDER'S" AND "AUCTION", APART FROM THE MARK AS SHOWN. FOR AUCTIONEERING, NAMELY, ALPACAS (U.S. CLS. 100, 101 AND 102). FIRST USE 12-31-1999; IN COMMERCE 12-31-1999.

SN 76-364,344. TIGER DIRECT, INC., MIAMI, FL. BY ASSIGNMENT SYSTEMAX INC., PORT WASHINGTON, NY. FILED 1-30-2002.

TIGERTV.COM

FOR RETAIL STORE SERVICES AVAILABLE ONLINE AND VIA TELEVISION FEATURING COMPUTERS AND COMPUTER RELATED PRODUCTS (U.S. CLS. 100, 101 AND 102).

SN 76-366,760. GFK AG, MINNEAPOLIS, MN. FILED 2-4-2002.



OWNER OF U.S. REG. NOS. 1,289,312 AND 2,522,589. NO CLAIM IS MADE TO THE EXCLUSIVE RIGHT TO USE "CUSTOM RESEARCH INC.", APART FROM THE MARK AS SHOWN. THE MARK CONSISTS, IN PART, OF THE STYLIZED LETTERS "CRI". FOR DATABASE MARKETING RESEARCH AND CONSULTATION (U.S. CLS. 100, 101 AND 102). FIRST USE 10-0-2001; IN COMMERCE 10-0-2001.

CLASS 35—(Continued).

SN 76-379,616. WEALTH SYSTEMS INTERNATIONAL, LTD., HAMILTON HM 12, BERMUDA, FILED 3-5-2002.

WSI NETWORK

NO CLAIM IS MADE TO THE EXCLUSIVE RIGHT TO USE "NETWORK", APART FROM THE MARK AS SHOWN.

FOR ONLINE BUSINESS ADMINISTRATIVE SUPPORT SERVICES, NAMELY, TRACK CLIENTS AND CLIENT BUSINESS, COMMUNICATION SUPPORT AND FACILITATION, INDIVIDUAL AND GROUP CALENDAR WITH PERSONAL REMINDERS, NOTICE BOARDS WITH AUTOMATIC NOTIFICATIONS FOR ALL ADMINISTRATIVE SUPPORT FEATURES, RECORDS AND INFORMATION MAINTENANCE, CLIENT MEETINGS FACILITATION WITH VOTING AND AUTOMATED PROCESSING OF RESOLUTIONS DIRECTING PEOPLE AND CASH PAYMENTS FOR LICENSEES, MEMBERS, AFFILIATES AND APPROVED VENDORS WHO PROVIDE FINANCIAL ADVICE AND FINANCIAL SERVICES TO HIGH NET-WORTH INDIVIDUALS, THROUGH TRUST DESIGN AND MANAGEMENT, RETIREMENT PLANNING AND COUNSELING, ORGANIZATIONAL MANAGEMENT FOR TRUSTS, COUNSELING REGARDING GENERATION SKIPPING TRANSFERS, ASSET PROTECTION, ESTATE PLANNING AND ADMINISTRATION, TAXATION, INHERITANCE, PHILANTHROPY, CHARITABLE GIVING AND ENDOWMENTS, AND WEALTH MANAGEMENT (U.S. CLS. 100, 101 AND 102).

FIRST USE 8-12-2000; IN COMMERCE 8-12-2000.

SN 76-383,090. CONTEMPORARY STAFFING SOLUTIONS, INC., PLYMOUTH MEETING, PA. FILED 3-18-2002.

CSS PROFESSIONAL SEARCH

NO CLAIM IS MADE TO THE EXCLUSIVE RIGHT TO USE "PROFESSIONAL SEARCH", APART FROM THE MARK AS SHOWN.

FOR TEMPORARY AND PERMANENT PERSONNEL AND PROFESSIONAL PLACEMENT AND RECRUITING SERVICES (U.S. CLS. 100, 101 AND 102).

SN 76-384,921. JAMES BRIANNE & ASSOCIATES, LLC, GLEN ELLYN, IL. FILED 3-18-2002.

JAMES BRIANNE & ASSOCIATES

NO CLAIM IS MADE TO THE EXCLUSIVE RIGHT TO USE "& ASSOCIATES", APART FROM THE MARK AS SHOWN.

THE NAME JAMES BRIANNE IDENTIFIES A LIVING INDIVIDUAL WHOSE CONSENT IS OF RECORD.

FOR TEMPORARY EXECUTIVE PLACEMENT AND TRANSITIONAL STAFFING SERVICES (U.S. CLS. 100, 101 AND 102).

CLASS 35—(Continued).

SN 76-387,404. FVG CALIFORNIA PARTNERSHIP, LOS ANGELES, CA. FILED 3-25-2002.

CONTACTCENTRIC MARKETING

NO CLAIM IS MADE TO THE EXCLUSIVE RIGHT TO USE "MARKETING", APART FROM THE MARK AS SHOWN.

FOR PROFESSIONAL MARKETING SERVICES, NAMELY, ASSISTING COMPANIES AND BUSINESSES IN CONCENTRATING THEIR MARKETING EFFORTS ON GROUPS THAT ARE MOST LIKELY TO REQUIRE THE SERVICES OFFERED BY THAT PARTICULAR COMPANY (U.S. CLS. 100, 101 AND 102).

SN 76-394,597. THOMAS, SHAWN, CONYERS, GA. FILED 4-11-2002.



UKAN

FOR RETAIL STORE SERVICES IN THE FIELD OF CLOTHING AND ACCESSORIES, NAMELY, PANTS, SHOES, CAPS, BANDANNAS, SHORTS, SWEATSHIRTS, SWEATERS, BELTS, BOOK BAGS, SOCKS, SHIRTS, JACKETS, RAIN WEAR, FOOTWEAR, HATS, HEAD BANDS, PAJAMAS AND SLEEP WEAR, BELTS FOR CLOTHING, LEATHER COATS, GLOVES (U.S. CLS. 100, 101 AND 102).

SN 76-398,048. WKI HOLDING COMPANY, INC., ELMIRA, NY. FILED 4-19-2002.

OXO

OWNER OF U.S. REG. NOS. 1,652,173, 2,421,766 AND OTHERS.

FOR RETAIL STORE SERVICES FEATURING GARDEN TOOLS, OFFICE PRODUCTS AND HOUSEWARES, NAMELY, KITCHEN UTENSILS, CLEANING PRODUCTS, STORAGE AND ORGANIZATIONAL PRODUCTS AND BATHROOM UTENSILS (U.S. CLS. 100, 101 AND 102).

CLASS 35—(Continued).

SN 76-403,626. GORACING.COM, INC., PHOENIX, AZ.
FILED 5-3-2002.

GORACING.COM

OWNER OF U.S. REG. NOS. 2,145,010 AND 2,458,888.
FOR CATALOG, ON-LINE, AND TRACKSIDE RETAIL
SERVICES FEATURING MOTORSPORTS SOUVENIRS
AND MEMORABILIA (U.S. CLS. 100, 101 AND 102).
FIRST USE 2-1-1999; IN COMMERCE 2-1-1999.

SN 76-405,668. BLUESTONE CONSULTING, INC., MT.
LAUREL, NJ. FILED 5-10-2002.



NO CLAIM IS MADE TO THE EXCLUSIVE RIGHT TO
USE "BUSINESS PROCESS", APART FROM THE MARK AS
SHOWN.

FOR BUSINESS CONSULTING SERVICES (U.S. CLS.
100, 101 AND 102).
FIRST USE 4-1-2002; IN COMMERCE 4-1-2002.

SN 76-410,956. HARMON STORES, INC., CEDAR GROVE,
NJ. FILED 5-20-2002.

HARMON

OWNER OF U.S. REG. NOS. 1,385,522 AND 1,657,707.
SEC. 2(F).
FOR RETAIL STORE AND ON-LINE SERVICES FEATURING
DRUGS, HEALTH AND BEAUTY AIDS, CLEANING PRODUCTS,
FRAGRANCES, NUTRACEUTICALS, VITAMINS, GREETING CARDS,
COSMETICS, SUNGLASSES, CARRYING CASES MADE OF NYLON,
PAPER PRODUCTS, FURNITURE AND UMBRELLAS
(U.S. CLS. 100, 101 AND 102).
FIRST USE 8-2-1974; IN COMMERCE 8-2-1974.

SN 76-414,083. OMS INVESTMENTS, INC., SANTA MONICA,
CA. FILED 6-3-2002.

LEVINGTON

FOR PROMOTING THE SALE OF GOODS AND
SERVICES OF OTHERS THROUGH THE DISTRIBUTION
OF PRINTED INFORMATIONAL AND ADVISORY
MATERIAL IN THE FIELD OF LAWN AND GARDEN
CARE; PROMOTING PUBLIC AWARENESS OF THE
NEED FOR COMMUNITY GARDENING AND THE
NEED FOR HORTICULTURAL EDUCATION TO
ENCOURAGE AND PROMOTE COMMUNITY PRIDE
THROUGH GARDENING ACTIVITIES; BUSINESS
CONSULTATION PROVIDED TO RETAIL NURSERY
STORES IN THE FIELD OF LAWN AND GARDEN
CARE, AND MAINTENANCE AND DISEASE CONTROL
OF LAWNS AND GARDENS (U.S. CLS. 100, 101 AND
102).

CLASS 35—(Continued).

SN 76-415,745. MORRIS, JEFFREY K., SEA BRIGHT, NJ.
FILED 6-5-2002.

AFRIDESIA

FOR RETAIL STORE SERVICES AND DISTRIBUTOR-
SHIP SERVICES FEATURING UNIQUE ART (U.S. CLS.
100, 101 AND 102).
FIRST USE 2-1-1998; IN COMMERCE 2-1-1998.

SN 76-421,879. VIRTUAL CONNECT TECHNOLOGIES, INC.,
GREER, SC. FILED 6-17-2002.

CLOCKWISE

FOR BUSINESS ADMINISTRATION SERVICES,
NAMELY PROVIDING EMPLOYEE, INDEPENDENT
CONTRACTOR AND VOLUNTEER SCHEDULING; RE-
SOURCE SCHEDULING, NAMELY, SCHEDULING OF
CONFERENCE ROOMS, CLASSROOMS AND AUDIO-
VISUAL EQUIPMENT TO BE USED AS PRESENTATION
AND MEETING SUPPORT; MAINTAINING TIME AND
ATTENDANCE RECORDS, MANAGEMENT OF TIME-
RELATED RECORDS, AND ADMINISTRATION OF
BUSINESS PAYROLL FOR OTHERS VIA A GLOBAL
COMPUTER NETWORK (U.S. CLS. 100, 101 AND 102).

SN 76-425,359. ED BLOCK COURAGE AWARD FOUNDA-
TION, INC., TOWSON, MD. FILED 6-28-2002.

**ED BLOCK COURAGE
AWARD**

OWNER OF U.S. REG. NO. 1,478,985.
NO CLAIM IS MADE TO THE EXCLUSIVE RIGHT TO
USE "COURAGE AWARD", APART FROM THE MARK AS
SHOWN.

THE NAME "ED BLOCK" IS THE NAME OF A DE-
CREASED INDIVIDUAL.

FOR PROMOTING PUBLIC AWARENESS OF THE
NEED FOR SUPPORT OF ABUSED AND NEGLECTED
CHILDREN AND FAMILIES, THROUGH THE MEDIUM
OF AN ANNUAL AWARD GIVEN TO PROFESSIONAL
FOOTBALL PLAYERS SELECTED FOR THEIR COM-
MITMENT TO THE PRINCIPLES OF SPORTSMANSHIP
AND COURAGE (U.S. CLS. 100, 101 AND 102).

FIRST USE 11-1-1984; IN COMMERCE 11-1-1984.

CLASS 35—(Continued).

SN 76-426,521. NATIONAL VETERANS BUSINESS DEVELOPMENT CORPORATION, ALEXANDRIA, VA. FILED 7-1-2002.



NO CLAIM IS MADE TO THE EXCLUSIVE RIGHT TO USE "THE VETERANS CORPORATION", APART FROM THE MARK AS SHOWN.

THE STIPPLING IS FOR SHADING PURPOSES ONLY. FOR BUSINESS DEVELOPMENT SERVICES, NAMELY PROVIDING TECHNICAL ASSISTANCE AND START-UP SUPPORT TO BUSINESSES OF OTHERS (U.S. CLS. 100, 101 AND 102).

FIRST USE 4-5-2002; IN COMMERCE 4-5-2002.

SN 76-427,574. TILE OUTLETS OF AMERICA, INC., NORCROSS, GA. FILED 7-5-2002.



NO CLAIM IS MADE TO THE EXCLUSIVE RIGHT TO USE "TILE OUTLETS OF AMERICA", APART FROM THE MARK AS SHOWN.

THE LINING IS A FEATURE OF THE MARK AND DOES NOT INDICATE COLOR.

THE MARK CONSISTS OF IN PART OF THE STYLIZED REPRESENTATION OF THE LETTERS "T O".

FOR RETAIL STORE SERVICES FEATURING TILE, STONE, AND RELATED FLOORING PRODUCTS AND ACCESSORIES (U.S. CLS. 100, 101 AND 102).

FIRST USE 11-1-2002; IN COMMERCE 11-1-2002.

CLASS 35—(Continued).

SN 76-427,944. CAPT. TONY, LLC, KEY WEST, FL. FILED 7-3-2002.

CAPT. TONY

NO CLAIM IS MADE TO THE EXCLUSIVE RIGHT TO USE "CAPT.", APART FROM THE MARK AS SHOWN.

THE MARK "CAPT. TONY" IDENTIFIES A LIVING INDIVIDUAL WHOSE CONSENT IS OF RECORD.

THE MARK CONSISTS OF THE NAME "CAPT. TONY". FOR LICENSING OTHERS THE RIGHT TO USE AND/OR EXPLOIT, THE NAME AND LIKENESS OF ANTHONY TARRACINO (U.S. CLS. 100, 101 AND 102).

FIRST USE 10-27-2000; IN COMMERCE 10-27-2000.

SN 76-428,075. BILLINGZONE, LP, PITTSBURGH, PA. BY CHANGE OF NAME BILLINGZONE, LLC, PITTSBURGH, PA. FILED 7-8-2002.

ARCONNECT

FOR ACCOUNTS RECEIVABLE SERVICES; BUSINESS INVOICING SERVICES; INTEGRATED TRACKING AND MANAGEMENT OF COMMERCIAL TRANSACTIONS ON A GLOBAL COMPUTER NETWORK (U.S. CLS. 100, 101 AND 102).

FIRST USE 4-1-2002; IN COMMERCE 4-1-2002.

SN 76-428,648. KELLY, JOHN, SAN DIEGO, CA. FILED 7-2-2002.



NO CLAIM IS MADE TO THE EXCLUSIVE RIGHT TO USE "GARDEN", APART FROM THE MARK AS SHOWN.

FOR RETAIL STORE SERVICES FEATURING GARDENING SUPPLIES, INCLUDING CHEMICALS, PHARMACEUTICALS, HAND AND ELECTRIC TOLLS, STATUARY, CONTAINERS, LIVE PLANTS, CLOTHING AND FURNITURE (U.S. CLS. 100, 101 AND 102).

CLASS 35—(Continued).

SN 76-429,380. DIGBY, ROGER B., ALACHUA, FL. FILED 7-11-2002.

TEDDY TOWN CIRCUS

FOR RETAIL STORE SERVICES FOR STUFFED TOYS PROVIDING A UNIQUE EXPERIENCE FOR A PURCHASER NAMELY WHERE A PURCHASER PICKS A PARTICULAR UNSTUFFED TOY, CHOOSES A DESCRIPTION OF A PERSONALITY FOR THE TOY WHICH IS EMBODIED IN A TANGIBLE ITEM, SAID ITEM PLACED INSIDE THE UNSTUFFED TOY, PARTICIPATES IN STUFFING THE TOY, EXPERIENCES A LIGHT SHOW THAT SIMULATES BRINGING THE STUFFED TOY TO LIFE, CHOOSES A NAME FOR THE TOY, AND IS GIVEN A BIRTH CERTIFICATE FOR THE TOY (U.S. CLS. 100, 101 AND 102).

FIRST USE 6-17-2002; IN COMMERCE 6-24-2002.

SN 76-430,536. ALLIANCE MAPS, LLC, SALINE, MI. FILED 7-15-2002.

ALLIANCE MAPS LLC

NO CLAIM IS MADE TO THE EXCLUSIVE RIGHT TO USE "MAPS LLC", APART FROM THE MARK AS SHOWN. FOR BUSINESS CONSULTING SERVICES, NAMELY, CONDUCTING SURVEYS AND PROVIDING ANALYSIS AND CONSULTATION IN THE FIELD OF ORGANIZATIONAL CHANGES, EFFICIENCY, PERFORMANCE, AND PRODUCTIVITY (U.S. CLS. 100, 101 AND 102).

FIRST USE 1-1-2002; IN COMMERCE 1-1-2002.

SN 76-432,095. FLEMING COMPANIES, INC., OKLAHOMA CITY, OK. FILED 7-17-2002.



OWNER OF U.S. REG. NO. 1,563,974 AND OTHERS. NO CLAIM IS MADE TO THE EXCLUSIVE RIGHT TO USE "FOODS", APART FROM THE MARK AS SHOWN. FOR RETAIL SUPERMARKET SERVICES (U.S. CLS. 100, 101 AND 102).

SN 76-432,544. MASTERCARD INTERNATIONAL INCORPORATED, PURCHASE, NY. FILED 7-17-2002.

MASTERCARD ADVISORS

OWNER OF U.S. REG. NOS. 1,186,117, 2,294,060 AND 2,554,524.

NO CLAIM IS MADE TO THE EXCLUSIVE RIGHT TO USE "ADVISORS", APART FROM THE MARK AS SHOWN. FOR BUSINESS MANAGEMENT AND MARKETING SERVICES (U.S. CLS. 100, 101 AND 102).

FIRST USE 6-0-2001; IN COMMERCE 6-0-2001.

CLASS 35—(Continued).

SN 76-433,381. CERAGEM INTERNATIONAL, INC., LOS ANGELES, CA. FILED 7-23-2002.

喜 樂 康

THE NON-LATIN CHINESE CHARACTERS IN THE MARK TRANSLITERATE TO "HUI RAK GANG", AND THIS MEANS "JOYFUL, HAPPINESS AND HEALTH" IN ENGLISH.

FOR RETAIL STORE SERVICES FEATURING THERAPEUTIC MASSAGE BEDS WITH KNEADING APPARATUS, HEATING APPARATUS, ULTRASOUND APPARATUS, ABDOMINAL BELTS AND KNEADERS (U.S. CLS. 100, 101 AND 102).

SN 76-433,801. TY INC., WESTMONT, IL. FILED 7-23-2002.



OWNER OF U.S. REG. NOS. 2,601,538, 2,636,165 AND OTHERS.

NO CLAIM IS MADE TO THE EXCLUSIVE RIGHT TO USE "STORE", APART FROM THE MARK AS SHOWN.

FOR RETAIL STORE AND TRADING SERVICES AVAILABLE THROUGH MULTI-USER GLOBAL INFORMATION NETWORKS FEATURING PLUSH TOYS, MAGAZINES, AND OTHER MERCHANDISE (U.S. CLS. 100, 101 AND 102).

FIRST USE 6-26-2001; IN COMMERCE 10-12-2001.

SN 76-434,271. DRAKE BEAM MORIN, INC., NEW YORK, NY. FILED 7-25-2002.

DBM INTERNET COMPASS

OWNER OF U.S. REG. NOS. 1,896,205, 2,453,469 AND OTHERS.

NO CLAIM IS MADE TO THE EXCLUSIVE RIGHT TO USE "INTERNET", APART FROM THE MARK AS SHOWN.

FOR PROVIDING A WEBSITE FEATURING AN INDEX OF LINKS TO WEBSITES PROVIDING CAREER RELATED CONTENT (U.S. CLS. 100, 101 AND 102).

FIRST USE 7-19-2002; IN COMMERCE 7-19-2002.

CLASS 35—(Continued).

SN 76-434,354. KELLY PROPERTIES, INC., TROY, MI.
FILED 7-25-2002.

KELLY MERCHANDISING RESOURCES

OWNER OF U.S. REG. NOS. 2,090,765, 2,464,209 AND OTHERS.

NO CLAIM IS MADE TO THE EXCLUSIVE RIGHT TO USE "MERCHANDISING RESOURCES", APART FROM THE MARK AS SHOWN.

FOR PERSONNEL PLACEMENT SERVICES; NAMELY, PROVIDING PERSONNEL TO OTHER BUSINESSES TO PERFORM PRODUCT SUPPORT AND MARKETING FUNCTIONS FOR SUCH BUSINESSES IN THE AREAS OF SALES, SERVICE, DELIVERY, BILLING, PRODUCT DEMONSTRATION AND PROMOTION, AND MAINTENANCE OF PRODUCT DISPLAYS (U.S. CLS. 100, 101 AND 102).

FIRST USE 4-30-1998; IN COMMERCE 4-30-1998.

SN 76-434,595. SCIOTTO, SARAH, SANTA MONICA, CA.
FILED 7-26-2002.



NO CLAIM IS MADE TO THE EXCLUSIVE RIGHT TO USE "MUSIC", APART FROM THE MARK AS SHOWN.

FOR PROVIDING DATABASES FEATURING A MUSIC LIBRARY TO FACILITATE THE SELECTION OF MUSIC FOR USE IN ALL FORMS OF ADVERTISING (U.S. CLS. 100, 101 AND 102).

FIRST USE 3-1-2002; IN COMMERCE 3-1-2002.

SN 76-434,651. DIVERS ALERT NETWORK, INC., DURHAM, NC. FILED 7-26-2002.

E-DAN

OWNER OF U.S. REG. NOS. 1,710,576, 2,537,270 AND OTHERS.

FOR ONLINE ASSOCIATION SERVICES, NAMELY, PROMOTING THE INTERESTS OF DIVERS, AND PROVIDING MEMBER SERVICES IN THE NATURE OF NAME AND/OR ADDRESS CHANGES AND MEMBERSHIP RENEWALS (U.S. CLS. 100, 101 AND 102).

CLASS 35—(Continued).

SN 76-435,148. GIGATOY INC, LOS ANGELES, CA. FILED 7-29-2002.



NO CLAIM IS MADE TO THE EXCLUSIVE RIGHT TO USE "GIGA", "TOY", APART FROM THE MARK AS SHOWN.

THE STIPPLING IS FOR SHADING PURPOSES ONLY. THE MARK CONSISTS OF A STYLIZED LETTER "G" WITHIN THE DESIGN WITH THE WORDING "GIGA TOY". FOR WHOLESALE DISTRIBUTORSHIP FEATURING TOYS (U.S. CLS. 100, 101 AND 102).

FIRST USE 1-1-2002; IN COMMERCE 1-1-2002.

SN 76-436,760. MARSH SUPERMARKETS, INC., INDIANAPOLIS, IN. FILED 8-2-2002.

CAPITOL VENDING

NO CLAIM IS MADE TO THE EXCLUSIVE RIGHT TO USE "VENDING", APART FROM THE MARK AS SHOWN.

FOR COFFEE VENDING SERVICES (U.S. CLS. 100, 101 AND 102).

FIRST USE 5-0-1987; IN COMMERCE 5-0-1987.

SN 76-437,904. BOEHNE, EILEEN S., DBA MORE THAN INK, NAPERVILLE, IL. FILED 8-5-2002.

MORE THAN INK

FOR COMPUTERIZED ON-LINE RETAIL STORE SERVICES IN THE FIELD OF SCRAPBOOK AND RUBBER STAMP HOBBY SUPPLIES, NAMELY EMBOSSING TOOLS, PUNCHES, TEMPLATES, CUTTING TOOLS, PHOTO ALBUMS, PAGE REFILLS, PAPER, PENS, RUBBER STAMPS AND ADHESIVES (U.S. CLS. 100, 101 AND 102).

FIRST USE 2-14-2002; IN COMMERCE 2-14-2002.

CLASS 35—(Continued).

SN 76-438,915. BERINGER BLASS WINE ESTATES LIMITED, SOUTHBANK 3006, AUSTRALIA, FILED 8-6-2002.

ANNIE'S LANE

PRIORITY CLAIMED UNDER SEC. 44(D) ON AUSTRALIA APPLICATION NO. 912767, FILED 5-14-2002, REG. NO. 912767, DATED 5-14-2002, EXPIRES 5-14-2012.

OWNER OF U.S. REG. NO. 2,125,230 AND OTHERS.
FOR WHOLESALE AND RETAIL STORE SERVICES FEATURING ALCOHOLIC AND NON-ALCOHOLIC BEVERAGES; WHOLESALE DISTRIBUTORSHIPS FEATURING ALCOHOLIC AND NON-ALCOHOLIC BEVERAGES; DIRECT MARKETING FOR OTHERS OF ALCOHOLIC AND NON-ALCOHOLIC BEVERAGES VIA MAIL, ELECTRONIC MAIL AND BY TELEPHONE; PROMOTING THE GOODS AND SERVICES OF OTHERS BY ARRANGING FOR SPONSORS TO AFFILIATE THEIR GOODS AND SERVICES WITH WINE TASTING (U.S. CLS. 100, 101 AND 102).

SN 76-438,916. BERINGER BLASS WINE ESTATES LIMITED, SOUTHBANK 3006, AUSTRALIA, FILED 8-6-2002.

JAMIESON'S RUN

PRIORITY CLAIMED UNDER SEC. 44(D) ON AUSTRALIA APPLICATION NO. 912765, FILED 5-14-2002, REG. NO. 912765, DATED 5-14-2002, EXPIRES 5-14-2012.

OWNER OF U.S. REG. NO. 2,249,330 AND OTHERS.
FOR WHOLESALE AND RETAIL STORE SERVICES FEATURING ALCOHOLIC AND NON-ALCOHOLIC BEVERAGES; WHOLESALE DISTRIBUTORSHIPS FEATURING ALCOHOLIC AND NON-ALCOHOLIC BEVERAGES; DIRECT MARKETING FOR OTHERS OF ALCOHOLIC AND NON-ALCOHOLIC BEVERAGES VIA MAIL, ELECTRONIC MAIL AND BY TELEPHONE; PROMOTING THE GOODS AND SERVICES OF OTHERS BY ARRANGING FOR SPONSORS TO AFFILIATE THEIR GOODS AND SERVICES WITH WINE TASTING (U.S. CLS. 100, 101 AND 102).

SN 76-440,370. STEVEN, MICHAEL, BARRINGTON, IL. AND STEVEN, SANDY, BARRINGTON, IL. FILED 8-9-2002.

FACILISPACE

FOR MANUFACTURER REPRESENTATIVES IN THE FIELD OF OFFICE FURNITURE (U.S. CLS. 100, 101 AND 102).

FIRST USE 8-2-2002; IN COMMERCE 8-2-2002.

SN 76-440,695. VITA LICENSING, INC., WILMINGTON, DE. FILED 8-15-2002.

ARCHITECTS OF THE NEW BIOMATERIALS AGE

FOR RETAIL AND WHOLESALE DISTRIBUTORSHIPS FEATURING ORTHOPEDIC, DENTAL, AND SURGICAL MATERIALS AND SUPPLIES (U.S. CLS. 100, 101 AND 102).

FIRST USE 3-15-2000; IN COMMERCE 3-15-2000.

CLASS 35—(Continued).

SN 76-440,698. MANAGEMENT ACTION PROGRAMS, INC., SHERMAN OAKS, CA. FILED 8-15-2002.

MANAGEMENT ACTION PROGRAM

OWNER OF U.S. REG. NO. 2,233,052.
NO CLAIM IS MADE TO THE EXCLUSIVE RIGHT TO USE "MANAGEMENT" AND "PROGRAM", APART FROM THE MARK AS SHOWN.

SEC. 2(F).
FOR MANAGEMENT CONSULTING SERVICES (U.S. CLS. 100, 101 AND 102).
FIRST USE 0-0-1970; IN COMMERCE 0-0-1970.

SN 76-441,930. HOUGHTON MIFFLIN COMPANY, BOSTON, MA. FILED 8-16-2002.

KNOWLEDGE BEYOND DOUBT

FOR PROVIDING ON-LINE AND MAIL REGISTRATION SERVICES FOR PROFESSIONAL, OCCUPATIONAL AND VOCATIONAL TESTS; ISSUING AND TRACKING PROFESSIONAL CERTIFICATION AND LICENSES FOR OTHERS; PROMOTING THE GOODS AND SERVICES OF OTHERS, NAMELY, PROVIDING INFORMATION ABOUT EDUCATIONAL ASSESSMENT PROGRAMS AND PRODUCTS OF OTHERS (U.S. CLS. 100, 101 AND 102).

SN 76-444,187. ANSWERS SYSTEMS INC., OLDSMAR, FL. FILED 8-27-2002.

VISITRADE

FOR PROMOTING THE OPERATION OF A FOOD SERVICE BUSINESS, NAMELY, PROMOTING THE GOODS AND SERVICES OF OTHERS THROUGH ON-LINE ADVERTISING INFORMATION ABOUT PRODUCTS, REBATES, PROMOTIONS, AND EQUIPMENT FOR MANUFACTURERS, DISTRIBUTORS, OPERATORS, AND OTHER FOOD SERVICE BUSINESS TO BUSINESS PARTNERS IN THE FOOD INDUSTRY (U.S. CLS. 100, 101 AND 102).

FIRST USE 11-1-1999; IN COMMERCE 4-25-2000.

SN 76-444,351. THE BROOKS PARTNERSHIP LIMITED, RICHMOND, SURREY, TW9 1SE, ENGLAND, FILED 8-28-2002.

INBUCON

FOR BUSINESS MANAGEMENT AND CONSULTATION, HUMAN RESOURCE CONSULTING; JOB PLACEMENT AND RECRUITMENT; MARKET RESEARCH (U.S. CLS. 100, 101 AND 102).

FIRST USE 0-0-1926; IN COMMERCE 2-16-1995.

CLASS 35—(Continued).

SN 76-444,827. ONE WORLD NETWORKS INTEGRATED TECHNOLOGIES, INC., LOS ANGELES, CA. FILED 8-28-2002.

GOD MONEY SEX

FOR DISSEMINATION OF ADVERTISING MATTER ON RADIO, TELEVISION, PRINT AND THE INTERNET FOR INNOVATIVE AND INSPIRATIONAL PRODUCTS (U.S. CLS. 100, 101 AND 102).

SN 76-446,036. MANLLO KURI, RICARDO JOSE, SAN PEDRO GARZA GARCIA, NUEVO LEON, MEXICO, FILED 8-29-2002.

NICHO HINOJOSA

PRIORITY CLAIMED UNDER SEC. 44(D) ON MEXICO APPLICATION NO. 546426, FILED 4-25-2002, REG. NO. 772176, DATED 4-25-2002, EXPIRES 4-25-2012.

THE NAME "NICHO HINOJOSA" IDENTIFIES THE STAGE NAME OF A LIVING INDIVIDUAL WHOSE CONSENT IS OF RECORD.

FOR PUBLICITY AGENTS, PUBLICATION OF PUBLICITY TEXTS, AND BUSINESS MANAGEMENT (U.S. CLS. 100, 101 AND 102).

SN 76-447,815. WOOLF ASSOCIATES, BOSTON, MA. FILED 9-6-2002.

**BRAND ACTION
MARKETING**

NO CLAIM IS MADE TO THE EXCLUSIVE RIGHT TO USE "BRAND" AND "MARKETING", APART FROM THE MARK AS SHOWN.

FOR BUSINESS MARKETING CONSULTING SERVICES, NAMELY, PROVIDING MARKETING AND CONSULTING SERVICES WITHIN THE SPORTS AND ENTERTAINMENT INDUSTRY (U.S. CLS. 100, 101 AND 102).

FIRST USE 7-10-2002; IN COMMERCE 8-7-2002.

SN 76-448,350. GLENWOOD SPRINGS CHAMBER RESORT ASSOCIATION, INC., GLENWOOD SPRINGS, CO. FILED 9-10-2002.

**GLENWOODCHAMBER
R.COM**

FOR CHAMBER OF COMMERCE SERVICES, NAMELY, PROMOTING BUSINESS AND TOURISM IN THE GREATER GLENWOOD SPRINGS, COLORADO AREA; PROVIDING BUSINESS AND PERSONNEL RELOCATION INFORMATION IN THE GREATER GLENWOOD SPRINGS, COLORADO AREA (U.S. CLS. 100, 101 AND 102).

FIRST USE 6-0-1999; IN COMMERCE 6-0-1999.

CLASS 35—(Continued).

SN 76-452,636. TOBIT SEARCH GROUP, INC., CHARLOTTE, NC. FILED 9-23-2002.

TOBIT SEARCH GROUP

NO CLAIM IS MADE TO THE EXCLUSIVE RIGHT TO USE "SEARCH GROUP", APART FROM THE MARK AS SHOWN.

FOR EMPLOYMENT COUNSELING AND RECRUITING (U.S. CLS. 100, 101 AND 102).

SN 76-452,985. ISENMAN, JENNY, NEW YORK, NY. FILED 9-26-2002.

JENNY B. GOOD

FOR RETAIL GIRL'S AND WOMEN'S JEWELRY SHOPS, COMPUTERIZED ON-LINE RETAIL SERVICES IN THE FIELD OF GIRL'S AND WOMEN'S JEWELRY; PROVIDING BUSINESS INFORMATION IN THE FIELD OF JEWELRY VIA AN ON-LINE WEBSITE (U.S. CLS. 100, 101 AND 102).

FIRST USE 6-0-2001; IN COMMERCE 6-0-2001.

SN 76-453,061. AMERICAN HARDWARE MANUFACTURERS ASSOCIATION, SCHAUMBURG, IL. FILED 9-26-2002.

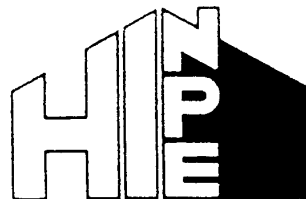

FOR ARRANGING AND CONDUCTING TRADE SHOWS AND EXHIBITIONS IN THE FIELDS OF HARDWARE AND HOME IMPROVEMENT (U.S. CLS. 100, 101 AND 102).

FIRST USE 8-10-1986; IN COMMERCE 8-10-1986.

CLASS 35—(Continued).

SN 76-453,467. DIVERS ALERT NETWORK, INC., DURHAM, NC. FILED 9-27-2002.



OWNER OF U.S. REG. NOS. 1,708,898, 2,636,343 AND OTHERS.

NO CLAIM IS MADE TO THE EXCLUSIVE RIGHT TO USE "BUSINESS MEMBER", APART FROM THE MARK AS SHOWN.

FOR ADMINISTRATION OF A BUSINESS MEMBERSHIP PROGRAM BY WHICH DIVERS CAN OBTAIN DISCOUNTS ON DIVING RELATED GOODS AND SERVICES FROM PARTICIPATING BUSINESS MEMBERS THROUGH THE USE OF A DISCOUNT MEMBERSHIP CARD (U.S. CLS. 100, 101 AND 102).

SN 76-453,992. MMF, INC., CARSON CITY, NV. FILED 9-30-2002.

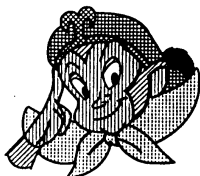

Asian American Association

THE DRAWING IS LINED FOR THE COLORS BEIGE, LIGHT ORANGE, BROWN/DARK BROWN, BURGUNDY AND GOLD.

THE MARK CONSISTS OF THE HEAD OF AND ONE HAND OF A MONKEY WEARING A HAT AND A SCARF.

FOR ADMINISTRATION OF A DISCOUNT PROGRAM FOR ENABLING PARTICIPANTS TO OBTAIN DISCOUNTS ON GOODS AND SERVICES THROUGH USE OF A DISCOUNT MEMBERSHIP CARD (U.S. CLS. 100, 101 AND 102).

FIRST USE 11-6-1992; IN COMMERCE 11-6-1992.

SN 76-454,172. O2 HOLDINGS, LLC, NEW YORK, NY. FILED 10-1-2002.

OH! OXYGEN

OWNER OF U.S. REG. NO. 2,684,295.

FOR CONTEST AND INCENTIVE AWARD PROGRAMS TO PROMOTE THE SALE OF TELEVISION SERVICES, ENTERTAINMENT SERVICES, CABLE NETWORKS AND/OR GOODS AND SERVICES OF OTHERS (U.S. CLS. 100, 101 AND 102).

CLASS 35—(Continued).

SN 76-454,594. TERRAWAVE SOLUTIONS LTD., SAN ANTONIO, TX. FILED 10-1-2002.

TERRAWAVE SOLUTIONS

FOR WHOLESALE DISTRIBUTORSHIPS FEATURING WIRELESS LOCAL AREA NETWORK AND WIRELESS BRIDGING COMPONENTS, NAMELY, AMPLIFIERS, ANTENNAS, ATTENUATORS, CABLES, CONNECTORS, LIGHTNING PROTECTORS, ANALYZERS AND CONVERTERS (U.S. CLS. 100, 101 AND 102).

FIRST USE 11-30-2000; IN COMMERCE 11-30-2000.

SN 76-458,845. MANHATTAN FILM AND TAPE WORKS, INC., HOBOKEN, NJ. FILED 10-15-2002.

The Direct Network

NO CLAIM IS MADE TO THE EXCLUSIVE RIGHT TO USE "NETWORK", APART FROM THE MARK AS SHOWN.

FOR PRODUCTION, PLACING AND CREATION OF TELEVISION COMMERCIALS AND CONSULTATION IN CONNECTION THEREWITH (U.S. CLS. 100, 101 AND 102).

FIRST USE 9-0-1993; IN COMMERCE 9-0-1993.

SN 76-459,295. MEDICUS GROUP INTERNATIONAL, INC., NEW YORK, NY. FILED 10-18-2002.



NO CLAIM IS MADE TO THE EXCLUSIVE RIGHT TO USE "STRATEGY ADVISORS", APART FROM THE MARK AS SHOWN.

THE DRAWING OF THE SUBJECT MARK DOES NOT CLAIM COLORS; THE STIPPLING THEREIN IS FOR SHOWING SHADING.

FOR PROVIDING BUSINESS MARKETING CONSULTING; MARKET RESEARCH; COOPERATIVE ADVERTISING AND MARKETING; DISSEMINATION OF ADVERTISING; DIRECT MARKETING ADVERTISING FOR OTHERS; ARRANGING AND CONDUCTING TRADE SHOW EXHIBITIONS IN THE FIELD OF HEALTHCARE AND PHARMACEUTICALS (U.S. CLS. 100, 101 AND 102).

CLASS 35—(Continued).

SN 76-459,345. THE GOFFIN GROUP, INC., CANTON, MA. FILED 10-18-2002.

GOFFIN

FOR BUSINESS CONSULTING, NAMELY PLANNING AND EVALUATION OF MARKETING EVENTS DIRECTED PRIMARILY TOWARDS CLIENTS, PROSPECTS, AND EMPLOYEES OF THE FINANCIAL SERVICES INDUSTRY (U.S. CLS. 100, 101 AND 102).

FIRST USE 9-24-2002; IN COMMERCE 9-24-2002.

SN 76-461,648. WILLIAM W. ASHBY, LAGUNA HILLS, CA. FILED 10-25-2002.

GENESIS TRIAD

FOR PROVIDING BUSINESS MANAGEMENT SERVICES IN THE FIELD OF SENIOR HEALTH CARE SERVICES, SENIOR COMMUNITY SERVICES, AND TELECOM SERVICES (U.S. CLS. 100, 101 AND 102).

FIRST USE 10-21-2002; IN COMMERCE 10-21-2002.

SN 76-463,331. ER OF MIAMI IMPORT & EXPORT, INC., MIAMI, FL. FILED 10-31-2002.



NO CLAIM IS MADE TO THE EXCLUSIVE RIGHT TO USE "CHURROS USA", APART FROM THE MARK AS SHOWN.

THE DESIGN ELEMENT BELOW THE TERM "USA" IS A REPRESENTATION OF A CHURRO.

FOR DISTRIBUTORSHIP SERVICES IN THE FIELD OF VENDING MACHINES AND FOOD PRODUCTS USED IN CONNECTION THEREWITH (U.S. CLS. 100, 101 AND 102).

FIRST USE 2-28-1998; IN COMMERCE 2-28-1998.

SN 76-463,779. LIPSEY'S, INC., BATON ROUGE, LA. FILED 11-4-2002.

AIM HIGHER

FOR WHOLESALE DISTRIBUTORSHIP IN THE FIELD OF FIREARMS (U.S. CLS. 100, 101 AND 102).

FIRST USE 11-1-2002; IN COMMERCE 11-1-2002.

CLASS 35—(Continued).

SN 76-464,676. THE CANCER INSTITUTE, L.L.C., KANSAS CITY, MO. FILED 11-6-2002.



FOR RETAIL STORE SERVICES FEATURING CLOTHING, COSMETICS, JEWELRY, WIGS, HATS, BRAS, UNDERGARMENTS, BREAST FORMS, HEAD COVERINGS, SKIN PROTECTIVE ITEMS, LYMPHEDEMA THERAPY ITEMS, CANES, EYE PATCHES, OSTOMY CARE ITEMS, PILLOWS, BOOKS, TAPES, THERAPEUTIC PRODUCTS, AND PERSONAL HYGIENE PRODUCTS FOR CANCER PATIENTS AND SURVIVORS (U.S. CLS. 100, 101 AND 102).

SN 76-464,815. NEILL CORPORATION, HAMMOND, LA. FILED 10-29-2002.

ETOPA

OWNER OF U.S. REG. NO. 2,698,223. FOR DISTRIBUTORSHIP SERVICES FEATURING SALON AND SPA EQUIPMENT, FURNITURE AND SUPPLIES (U.S. CLS. 100, 101 AND 102).

FIRST USE 9-1-1999; IN COMMERCE 9-1-1999.

SN 76-465,172. BINH AN TRADING & TOURISM CO., LTD., DISTRICT 1, HCMC, VIETNAM, FILED 11-1-2002.

Dragon Gate



FOR PROVIDING RETAIL STORE SERVICES AND IMPORTATION OF FURNITURE AND HANDICRAFTS, NAMELY, INDO-CHINESE CERAMICS, LAMPS, TEXTILES, LACQUER-WARE, REPRODUCTION FURNITURE, AND CALLIGRAPHY FROM VIETNAM, CAMBODIA AND LAOS (U.S. CLS. 100, 101 AND 102).

FIRST USE 8-20-2002; IN COMMERCE 8-20-2002.

CLASS 35—(Continued).

SN 76-465,262. TRASK, GERALD, JR., NEWARK, CA. FILED 11-7-2002.



NO CLAIM IS MADE TO THE EXCLUSIVE RIGHT TO USE "GOLF", APART FROM THE MARK AS SHOWN.
 FOR ON-LINE RETAIL STORE SERVICES FEATURING GOLFING EQUIPMENT AND APPAREL (U.S. CLS. 100, 101 AND 102).
 FIRST USE 3-20-2002; IN COMMERCE 5-22-2002.

SN 76-467,689. AKALP, PHILIP, AGOURA HILLS, CA. FILED 11-6-2002.

CLICK. YOU'RE INCORPORATED

FOR BUSINESS CONSULTATION; SECRETARIAL AND DOCUMENT FILING SERVICES FOR BUSINESS ENTITIES; BUSINESS RESEARCH SERVICES (U.S. CLS. 100, 101 AND 102).
 FIRST USE 9-12-2002; IN COMMERCE 9-12-2002.

SN 76-470,160. CLEAR THINKING GROUP, INC., HILLSBOROUGH, NJ. FILED 11-18-2002.

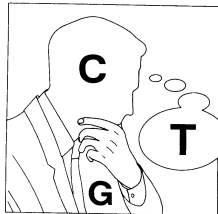

CLEAR THINKING GROUP

NO CLAIM IS MADE TO THE EXCLUSIVE RIGHT TO USE "GROUP", APART FROM THE MARK AS SHOWN.
 FOR BUSINESS CONSULTING SERVICES FOR RETAIL AND CONSUMER PRODUCTS INDUSTRIES (U.S. CLS. 100, 101 AND 102).
 FIRST USE 5-6-2002; IN COMMERCE 5-6-2002.

CLASS 35—(Continued).

SN 76-470,430. STAFFWISE LEGAL, INC., WASHINGTON, DC. FILED 11-25-2002.

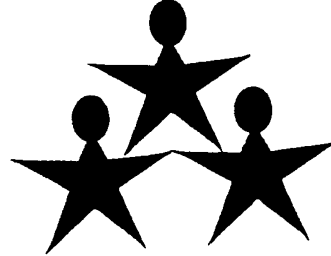

FOR STAFFING SERVICES, NAMELY SUPPLYING TEMPORARY AND PERMANENT PERSONNEL (U.S. CLS. 100, 101 AND 102).
 FIRST USE 2-5-2002; IN COMMERCE 2-5-2002.

SN 76-471,124. NATIONAL CONFERENCE SERVICES, INC., COLUMBIA, MD. FILED 11-19-2002.



FOR ORGANIZING, CONDUCTING, PRODUCING AND PROMOTING TRADE SHOW EXHIBITIONS AND CAREER FAIRS; RENTAL OF ADVERTISING SPACE IN THE NATURE OF EXHIBIT BOOTHS (U.S. CLS. 100, 101 AND 102).
 FIRST USE 1-1-1999; IN COMMERCE 1-1-1999.

SN 76-471,820. SALON STAFFING LLC, PLOVER, WI. FILED 12-3-2002.



...what a beautiful way to do business...

NO CLAIM IS MADE TO THE EXCLUSIVE RIGHT TO USE "SALON STAFFING LLC TEMPORARY SOLUTIONS", APART FROM THE MARK AS SHOWN.
 FOR TEMPORARY EMPLOYMENT AGENCY (U.S. CLS. 100, 101 AND 102).

CLASS 35—(Continued).

SN 76-471,821. SALON STAFFING LLC, PLOVER, WI. FILED 12-3-2002.



NO CLAIM IS MADE TO THE EXCLUSIVE RIGHT TO USE "SALON STAFFING LLC", APART FROM THE MARK AS SHOWN.
FOR TEMPORARY EMPLOYMENT AGENCY (U.S. CLS. 100, 101 AND 102).

SN 76-472,365. CLEVER IDEAS, INC., CHICAGO, IL. FILED 12-5-2002.

LECARD REWARDS

OWNER OF U.S. REG. NO. 1,526,094.
NO CLAIM IS MADE TO THE EXCLUSIVE RIGHT TO USE "REWARDS", APART FROM THE MARK AS SHOWN.
FOR HOSPITALITY INDUSTRY SAVINGS PROGRAM, NAMELY, A RESTAURANT CUSTOMER LOYALTY PROGRAM THAT PROVIDES MEAL DISCOUNTS AND RELATED BENEFITS TO REWARD FIRST TIME AND REPEAT CUSTOMERS (U.S. CLS. 100, 101 AND 102).
FIRST USE 8-1-2002; IN COMMERCE 8-1-2002.

SN 76-472,762. TOURISM LEADERSHIP COUNCIL OF THE GREATER SAVANNAH AREA, INC., SAVANNAH, GA. FILED 12-9-2002.



NO CLAIM IS MADE TO THE EXCLUSIVE RIGHT TO USE "SAVANNAH AREA TOURISM" AND "COUNCIL", APART FROM THE MARK AS SHOWN.
FOR CHAMBER OF COMMERCE SERVICES, NAMELY, PROMOTING BUSINESS AND TOURISM IN THE GREATER SAVANNAH, GEORGIA AREA (U.S. CLS. 100, 101 AND 102).
FIRST USE 9-1-1998; IN COMMERCE 9-1-1998.

CLASS 35—(Continued).

SN 76-472,982. MEDICAL MOBILITY INC., GOODLETTSVILLE, TN. FILED 12-9-2002.

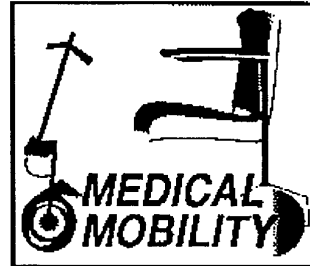

NO CLAIM IS MADE TO THE EXCLUSIVE RIGHT TO USE "MEDICAL MOBILITY", APART FROM THE MARK AS SHOWN.
FOR RETAIL SHOPS FEATURING WHEELCHAIRS, POWER WHEELCHAIRS, SCOOTERS, BATH AND SAFETY SUPPLIES, AMBULATORY AIDS, PRODUCTS FOR ACTIVITIES OF DAILY LIVING AND CUSTOM SEATING SYSTEMS DESIGNED TO ACCOMMODATE AND/OR CORRECT POSTURAL PROBLEMS, DEFORMITIES AND PHYSICAL LIMITATIONS TO ENABLE CLIENTS TO MAINTAIN INDEPENDENCE, AVOID ADDITIONAL PHYSICAL PROBLEMS AND SATISFY PATIENT AND CAREGIVER GOALS FOR FUNCTION AND DAILY LIVING ACTIVITY (U.S. CLS. 100, 101 AND 102).
FIRST USE 2-1-1992; IN COMMERCE 4-1-1992.

SN 76-473,001. MARKETINGNPV, LLC, PRINCETON, NJ. FILED 11-27-2002.

MARKETING[NPV]

FOR BUSINESS-CONSULTING SERVICES IN THE FIELD OF CORPORATE RESOURCE ALLOCATION (U.S. CLS. 100, 101 AND 102).
FIRST USE 11-4-2002; IN COMMERCE 11-4-2002.

SN 76-474,168. ONFONE COMMUNICATIONS, LOOMIS, CA. FILED 12-10-2002.



THE LINING IN THE DRAWING IS TO INDICATE THE COLOR GREY OUTLINING THE COLOR GREEN OUTLINING THE BLACK LETTERS.
FOR OPERATION OF TELEPHONE CALL CENTERS FOR OTHERS IN THE FIELD OF POLITICAL ISSUE POLLING UTILIZING SPEECH RECOGNITION INTERACTIVE SOFTWARE (U.S. CLS. 100, 101 AND 102).

CLASS 35—(Continued).

SN 76-477,415. NATIONAL CONFERENCE SERVICES, INC., COLUMBIA, MD. FILED 12-20-2002.



NO CLAIM IS MADE TO THE EXCLUSIVE RIGHT TO USE "INFORMATION SHARING & HOMELAND SECURITY", "INTELLIGENCE", "LAW ENFORCEMENT", "FEDERAL", "STATE", "LOCAL GOVERNMENTS" AND THE PARTIAL OUTLINE OF THE UNITED STATES, APART FROM THE MARK AS SHOWN.

THE STIPPLING SHOWN IN THE DRAWINGS IS A FEATURE OF THE MARK AND IS NOT INTENDED TO INDICATE COLOR.

FOR ARRANGING AND CONDUCTING BUSINESS CONVENTIONS AND FORUMS FOR FEDERAL, STATE AND LOCAL AGENCIES FOR SHARING AND DISPERSAL OF INFORMATION REGARDING HOMELAND SECURITY (U.S. CLS. 100, 101 AND 102).

FIRST USE 1-30-2002; IN COMMERCE 1-30-2002.

SN 76-477,876. NATIONAL GOLF FOUNDATION, JUPITER, FL. FILED 12-24-2002.

INFORMATION AND INSIGHTS ON THE BUSINESS OF GOLF

NO CLAIM IS MADE TO THE EXCLUSIVE RIGHT TO USE "INFORMATION" AND "BUSINESS OF GOLF", APART FROM THE MARK AS SHOWN.

FOR CONDUCTING BUSINESS RESEARCH AND SURVEYS FOR THE GOLF INDUSTRY; PROVIDING BUSINESS INFORMATION, RESEARCH, AND CONSULTING SERVICES FOR THE GOLF INDUSTRY (U.S. CLS. 100, 101 AND 102).

FIRST USE 3-1-2002; IN COMMERCE 3-1-2002.

SN 76-478,078. CLUB MONACO CORP., TORONTO, ONTARIO M5V 1L5, CANADA, FILED 12-24-2002.

CLUB MONACO OUTLET

OWNER OF U.S. REG. NOS. 2,137,573 AND 2,222,228. NO CLAIM IS MADE TO THE EXCLUSIVE RIGHT TO USE "CLUB" AND "OUTLET", APART FROM THE MARK AS SHOWN.

FOR RETAIL CLOTHING STORE SERVICES (U.S. CLS. 100, 101 AND 102).

FIRST USE 11-20-1995; IN COMMERCE 11-20-1995.

CLASS 35—(Continued).

SN 76-478,242. HOSPITEC, L.L.C., TROY, MI. FILED 12-20-2002.



FOR HOSPITAL INPATIENT UTILIZATION MANAGEMENT SERVICES, NAMELY MONITORING PATIENT ADMITTING AND DISCHARGE INFORMATION AND DIAGNOSES, MONITORING MEDICATION USAGE AND RESULTS, MONITORING PHYSICIAN INPATIENT SERVICES, MANAGING RELATED BILLING INFORMATION, MONITORING AND COMMUNICATING STATISTICAL PATIENT AND PHYSICIAN DATA TO IN SERVICE HOSPITALISTS, OFFICE-BASED PRIMARY CARE PROVIDERS, HOSPITAL STAFF, AND HEALTH PLAN ADMINISTRATORS (U.S. CLS. 100, 101 AND 102).

FIRST USE 10-15-2002; IN COMMERCE 11-26-2002.

SN 76-478,400. CLIFFDWELLER PRODUCTIONS, L.L.C., ALBUQUERQUE, NM. FILED 12-20-2002.

HOMEBUILDERS' GALLERY

NO CLAIM IS MADE TO THE EXCLUSIVE RIGHT TO USE "HOMEBUILDERS'", APART FROM THE MARK AS SHOWN.

FOR PROMOTING THE GOODS AND SERVICES OF OTHERS BY PLACING AND PREPARING ADVERTISEMENTS IN MAGAZINES, MAGAZINE SUPPLEMENTS AND TELEVISION BROADCASTS IN THE FIELD OF RESIDENTIAL BUILDING (U.S. CLS. 100, 101 AND 102).

FIRST USE 10-5-2002; IN COMMERCE 10-5-2002.

SN 76-479,187. KWIK TRIP, INC., LA CROSSE, WI. FILED 12-30-2002.

KWIK BUCKS

FOR RETAIL STORE SERVICES FEATURING CONVENIENCE STORE ITEMS AND GASOLINE, AND FEATURING A PURCHASE POINT AWARDS PROGRAM WITH SUCH POINTS REDEEMABLE FOR MERCHANDISE OR FOOD FOR PROGRAM MEMBERS (U.S. CLS. 100, 101 AND 102).

SN 76-479,473. TECHMAR COMMUNICATIONS, INC., CANTON, MA. FILED 12-20-2002.

KARMA BUSINESS SOLUTIONS

NO CLAIM IS MADE TO THE EXCLUSIVE RIGHT TO USE "BUSINESS SOLUTIONS", APART FROM THE MARK AS SHOWN.

FOR CUSTOMER RELATIONSHIP MANAGEMENT SERVICES (U.S. CLS. 100, 101 AND 102).

CLASS 35—(Continued).

SN 76-479,747. MEDINA, FERNANDO G, STONE PARK, IL. FILED 12-23-2002.

LATINDEAL

FOR BUSINESS ORGANIZATIONAL CONSULTATION (U.S. CLS. 100, 101 AND 102).

SN 76-479,969. ESSENTIAL MEDICAL STAFFING, DBA EMS, JAMAICA, NY. FILED 12-27-2002.

ESSENTIAL MEDICAL STAFFING

NO CLAIM IS MADE TO THE EXCLUSIVE RIGHT TO USE "MEDICAL STAFFING", APART FROM THE MARK AS SHOWN.

FOR EMPLOYMENT HIRING, RECRUITING, PLACEMENT, STAFFING AND CAREER NETWORKING SERVICES IN THE FIELD OF MEDICINE (U.S. CLS. 100, 101 AND 102).

FIRST USE 9-13-2002; IN COMMERCE 11-5-2002.

SN 76-480,329. BREEDER'S DIRECTORY, INC., LAKEPORT, CA. FILED 1-6-2003.

ANYPET.COM

FOR PROMOTING THE GOODS AND SERVICES OF OTHERS BY PROVIDING A WEB SITE AT WHICH USERS CAN LOCATE PET BREEDERS AND PET PRODUCTS (U.S. CLS. 100, 101 AND 102).

FIRST USE 1-1-1998; IN COMMERCE 1-1-1998.

SN 76-481,738. THE CONTAINER STORE, INC., DALLAS, TX. FILED 1-13-2003.

WHO SAYS A TRASH CAN CAN'T MAKE YOU SMILE?

FOR RETAIL STORE SERVICES IN THE AREA OF HOUSEHOLD AND OFFICE ACCESSORIES, STORAGE ITEMS, STORAGE SYSTEMS AND SPACE ORGANIZERS; ON-LINE RETAIL SERVICES IN THE AREA OF HOUSEHOLD AND OFFICE ACCESSORIES, STORAGE ITEMS, STORAGE SYSTEMS AND SPACE ORGANIZERS; MAIL ORDER CATALOG SERVICES IN THE AREA OF HOUSEHOLD AND OFFICE ACCESSORIES, STORAGE ITEMS, STORAGE SYSTEMS AND SPACE ORGANIZERS (U.S. CLS. 100, 101 AND 102).

FIRST USE 9-25-2002; IN COMMERCE 9-25-2002.

CLASS 35—(Continued).

SN 76-481,739. THE CONTAINER STORE, INC., DALLAS, TX. FILED 1-13-2003.

WHO SAYS A STORE CAN'T CHANGE YOUR LIFE?

FOR RETAIL STORE SERVICES IN THE AREA OF HOUSEHOLD AND OFFICE ACCESSORIES, STORAGE ITEMS, STORAGE SYSTEMS AND SPACE ORGANIZERS; ON-LINE RETAIL SERVICES IN THE AREA OF HOUSEHOLD AND OFFICE ACCESSORIES, STORAGE ITEMS, STORAGE SYSTEMS AND SPACE ORGANIZERS; MAIL ORDER CATALOG SERVICES IN THE AREA OF HOUSEHOLD AND OFFICE ACCESSORIES, STORAGE ITEMS, STORAGE SYSTEMS AND SPACE ORGANIZERS (U.S. CLS. 100, 101 AND 102).

FIRST USE 8-13-2002; IN COMMERCE 8-13-2002.

SN 76-483,277. 1 800 FINANCE, INC., NEWPORT BEACH, CA. FILED 1-17-2003.

LOANGENIUS

FOR MARKETING SERVICES, NAMELY, GENERATING AND PROVIDING QUALIFIED SALES LEADS TO FINANCIAL ORGANIZATIONS TO FACILITATE CONSUMER FINANCING (U.S. CLS. 100, 101 AND 102).

SN 76-483,377. MEDISPHERE HEALTH PARTNERS, INC., NASHVILLE, TN. FILED 1-21-2003.

MEDISPHERE

FOR HOSPITAL AND HEALTHCARE FACILITIES MANAGEMENT; CONSULTATION IN THE FIELD OF MANAGING HOSPITAL AND HEALTHCARE FACILITIES (U.S. CLS. 100, 101 AND 102).

FIRST USE 1-0-1994; IN COMMERCE 6-0-1996.

SN 76-483,378. ASSOCIATION OF AMERICAN PUBLISHERS, INC., NEW YORK, NY. FILED 1-21-2003.

¡Ajá, Leyendo!

OWNER OF U.S. REG. NO. 2,390,894. THE ENGLISH TRANSLATION FOR "¡AJA, LEYENDO!" IS "AHA!, READING!"

FOR PROMOTING THE SALE OF BOOKS, MAGAZINES, PERIODICALS, AND OTHER LITERARY WORKS OF OTHERS THROUGH THE DISTRIBUTION OF PRINTED MATERIALS, TELEVISION, RADIO AND GLOBAL COMPUTER NETWORK ADVERTISEMENTS, PUBLIC SERVICE ANNOUNCEMENTS, MAGAZINE AND NEWSPAPER ADVERTISEMENTS AND PUBLICITY CAMPAIGNS (U.S. CLS. 100, 101 AND 102).

CLASS 35—(Continued).

SN 76-483,542. STRYESKI, KATHLEEN, CREAM RIDGE, NJ. FILED 1-16-2003.

STARBARKS

FOR RETAIL STORE FEATURING PET FOODS, PET TREATS, PET TOYS, PET GIFTS AND RELATED SUPPLIES (U.S. CLS. 100, 101 AND 102).

SN 76-484,469. HEALTHCARE RECRUITMENT ON LINE, INC., PEMBROKE PINES, FL. FILED 1-22-2003.

THE ONLY WAY TO RECRUIT!

FOR PROVIDING AN ON-LINE ELECTRONIC DATABASE IN THE FIELD OF EMPLOYMENT AND JOB PLACEMENT SERVICES (U.S. CLS. 100, 101 AND 102). FIRST USE 8-18-2002; IN COMMERCE 8-18-2002.

SN 76-485,026. BORDER FOODS, INC., GOLDEN VALLEY, MN. FILED 1-27-2003.

RSVPIZZA.COM

FOR COMPUTERIZED ON-LINE ORDERING SERVICE FEATURING FOOD FROM RESTAURANTS (U.S. CLS. 100, 101 AND 102).

SN 76-485,428. KOZIOL, DIANNA, NAPA, CA. FILED 1-27-2003.

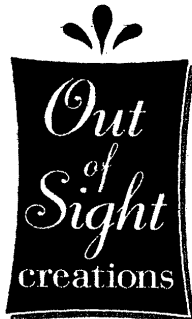

NO CLAIM IS MADE TO THE EXCLUSIVE RIGHT TO USE "CREATIONS", APART FROM THE MARK AS SHOWN.

FOR WHOLESALE DISTRIBUTORSHIP SERVICES FEATURING CLOTHING ACCESSORIES (U.S. CLS. 100, 101 AND 102).

CLASS 35—(Continued).

SN 76-485,829. MARA-MI, INC., MINNEAPOLIS, MN. FILED 1-29-2003.

CARLY'S WISH

FOR MAIL ORDER CATALOG SERVICES, FEATURING GARDEN ACCESSORIES, HOME ACCENTS, FASHION ACCESSORIES AND STATIONERY PRODUCTS (U.S. CLS. 100, 101 AND 102). FIRST USE 1-0-1996; IN COMMERCE 5-0-1996.

SN 76-486,162. MYSTERY WRITERS OF AMERICA, INC., NEW YORK, NY. FILED 1-30-2003.



FOR ASSOCIATION SERVICES, NAMELY, PROMOTING THE INTERESTS OF AUTHORS IN THE MYSTERY AND CRIME GENRES (U.S. CLS. 100, 101 AND 102). FIRST USE 1-1-1990; IN COMMERCE 1-1-1990.

SN 76-486,361. OPTATE, INC., ANN ARBOR, MI. FILED 1-29-2003.

POWER SOURCE FOR CHANGE

FOR BUSINESS CONSULTING SERVICES IN THE FIELD OF EMPLOYEE BENEFIT PLANS (U.S. CLS. 100, 101 AND 102). FIRST USE 8-31-2002; IN COMMERCE 8-31-2002.

SN 76-486,471. VENVEST, INC., ST. LOUIS, MO. FILED 1-28-2003.

SNAP SOLO NAME AWARENESS PERCENTAGE

FOR BUSINESS CONSULTATION AND BUSINESS MARKETING CONSULTATION SERVICES FOR PLUMBING, HEATING, VENTILATION AND AIR CONDITIONING BUSINESSES (U.S. CLS. 100, 101 AND 102).

CLASS 35—(Continued).

SN 76-486,669. TANGERINE PROMOTIONS, LTD., NORTH-BROOK, IL. FILED 2-3-2003.

TANGERINE

FOR SPECIALTY AND PREMIUM ADVERTISING SERVICES, NAMELY, PREPARING ADVERTISING AND PROMOTIONAL PROGRAMS AND EVENTS FOR OTHERS AND ADMINISTRATION OF CORPORATE PROMOTIONAL AND FULFILLMENT PROGRAMS (U.S. CLS. 100, 101 AND 102).

FIRST USE 7-0-2002; IN COMMERCE 7-0-2002.

SN 76-486,670. TANGERINE PROMOTIONS, LTD., NORTH-BROOK, IL. FILED 2-3-2003.



THE MARK CONSISTS OF THE WORD "TANGERINE" IN THE CENTER OF AN ORANGE COLORED CIRCLE. THE COLOR ORANGE IS CLAIMED AS A FEATURE OF THE MARK.

FOR SPECIALTY AND PREMIUM ADVERTISING SERVICES, NAMELY, PREPARING ADVERTISING AND PROMOTIONAL PROGRAMS AND EVENTS FOR OTHERS AND ADMINISTRATION OF CORPORATE PROMOTIONAL AND FULFILLMENT PROGRAMS (U.S. CLS. 100, 101 AND 102).

FIRST USE 7-0-2002; IN COMMERCE 7-0-2002.

SN 76-487,122. TRANSTAR INDUSTRIES, INC., CLEVELAND, OH. FILED 2-3-2003.

NICKELS PERFORMANCE

OWNER OF U.S. REG. NO. 2,410,616.

NO CLAIM IS MADE TO THE EXCLUSIVE RIGHT TO USE "PERFORMANCE", APART FROM THE MARK AS SHOWN.

FOR WHOLESALE DISTRIBUTORSHIP SERVICES IN THE FIELD OF SPECIALTY AUTOMOTIVE PARTS AND ACCESSORIES (U.S. CLS. 100, 101 AND 102).

FIRST USE 12-0-2000; IN COMMERCE 12-0-2000.

CLASS 35—(Continued).

SN 76-487,123. TREMCO INCORPORATED, CLEVELAND, OH. FILED 2-3-2003.

OLI

FOR INVENTORY MANAGEMENT IN THE FIELD OF BUILDING MATERIALS, NAMELY PROVIDING INVENTORY DATA VIA THE GLOBAL COMPUTER NETWORK (U.S. CLS. 100, 101 AND 102).

SN 76-487,820. BEATY, JOHN L., POUND RIDGE, NY. AND BEATY, JOY A., POUND RIDGE, NY. FILED 1-27-2003.

KNIT TOGETHER

FOR RETAIL STORE SERVICES FEATURING NEEDLEARTS, FABRIC ARTS AND NEEDLE CRAFTS; NAMELY, KNITTING, CROCHET, NEEDLEPOINT, CROSS-STITCH, LATCH-HOOK, SPINNING, FABRIC DECORATION, WEAVING, LOOMING AND SEWING YARNS, THREADS, NEEDLES AND RELATED ACCESSORIES, SUPPLIES AND INSTRUCTION (U.S. CLS. 100, 101 AND 102).

SN 76-487,821. BEATY, JOHN L., POUND RIDGE, NY. AND BEATY, JOY A., POUND RIDGE, NY. FILED 1-27-2003.

KTOG

FOR RETAIL STORE SERVICES FEATURING NEEDLE ARTS, FABRIC ARTS AND NEEDLE CRAFTS, NAMELY, KNITTING, CROCHET, NEEDLEPOINT, CROSS-STITCH, LATCH-HOOK, SPINNING, FABRIC DECORATION, WEAVING, LOOMING AND SEWING YARNS, THREADS, NEEDLES AND RELATED ACCESSORIES, AND SUPPLIES (U.S. CLS. 100, 101 AND 102).

SN 76-489,805. MEDRECS COPYING SERVICE, INC., SEATTLE, WA. FILED 12-17-2002.

iRelease

"IRELEASE", WHICH IS IN SMALL CASE LETTERING, EXCEPT FOR THE "R" WHICH IS IN UPPER CASE LETTERING. COLOR IS NOT A FEATURE OF THIS MARK. FOR MEDICAL SUPPORT SERVICES, NAMELY, COPYING AND SCANNING MEDICAL, LEGAL AND EMPLOYMENT RECORDS FOR OTHERS (U.S. CLS. 100, 101 AND 102).

CLASS 35—(Continued).

SN 76-491,192. MAGICAL FARMS, INC., LITCHFIELD, OH. FILED 2-19-2003.



OWNER OF U.S. REG. NO. 2,581,500.
 NO CLAIM IS MADE TO THE EXCLUSIVE RIGHT TO USE "BREEDER'S" AND "AUCTION & FUTURITY", APART FROM THE MARK AS SHOWN.
 FOR AUCTIONEERING OF ALPACAS (U.S. CLS. 100, 101 AND 102).
 FIRST USE 12-31-1999; IN COMMERCE 12-31-1999.

SN 76-491,269. MAGICAL FARMS, INC., LITCHFIELD, OH. FILED 2-19-2003.



OWNER OF U.S. REG. NO. 2,581,500.
 NO CLAIM IS MADE TO THE EXCLUSIVE RIGHT TO USE "BREEDER'S" AND "AUCTION", APART FROM THE MARK AS SHOWN.
 FOR AUCTIONEERING OF ALPACAS (U.S. CLS. 100, 101 AND 102).
 FIRST USE 12-31-1999; IN COMMERCE 12-31-1999.

SN 76-492,575. MONRO MUFFLER BRAKE, INC., ROCHESTER, NY. FILED 2-25-2003.



FOR RETAIL TIRE STORE SERVICES (U.S. CLS. 100, 101 AND 102).
 FIRST USE 7-10-1979; IN COMMERCE 7-10-1979.

CLASS 35—(Continued).

SN 78-065,761. TRIBUNE LICENSE, INC., CHICAGO, IL. FILED 5-25-2001.

THE BALTIMORE SUN'S TRAVEL EXPO

NO CLAIM IS MADE TO THE EXCLUSIVE RIGHT TO USE "BALTIMORE" AND "TRAVEL EXPO", APART FROM THE MARK AS SHOWN.
 FOR ORGANIZING AND CONDUCTING BUSINESS CONFERENCES, NAMELY TRAVEL CONFERENCES, AND PROVIDING THE RENTAL OF EXHIBITION BOOTHS THEREFORE (U.S. CLS. 100, 101 AND 102).
 FIRST USE 6-1-1997; IN COMMERCE 11-11-1997.

SN 78-074,530. BOGGS AVIATION ASSOCIATES, INC., EUGENE, OR. BY ASSIGNMENT SIXEL, BOGGS AND ASSOCIATES, INC., EUGENE, OR. FILED 7-18-2001.

AIRLINE TRAVEL BANK

NO CLAIM IS MADE TO THE EXCLUSIVE RIGHT TO USE "AIRLINE TRAVEL", APART FROM THE MARK AS SHOWN.
 FOR BUSINESS NETWORKING SERVICES, NAMELY ESTABLISHING BUSINESS RELATIONSHIPS BETWEEN COMMERCIAL AIRLINES, AIRPORTS, AND COMMUNITIES SURROUNDING THE AIRPORTS (U.S. CLS. 100, 101 AND 102).

SN 78-078,708. MILL VALLEY RETAIL GROUP, LLC, DBA CANVAS, MILL VALLEY, CA. FILED 8-10-2001.

CANVAS

FOR RETAIL CLOTHING BOUTIQUE FEATURING WOMEN'S AND KID'S CLOTHING, AND CLOTHING ACCESSORIES INCLUDING SHOES, BAGS, BELTS AND HATS (U.S. CLS. 100, 101 AND 102).

SN 78-094,086. ZAPPOS.COM, INC., SAN FRANCISCO, CA. FILED 11-19-2001.

ZAPPOS.COM

FOR ONLINE RETAIL STORE SERVICES FEATURING SHOES, SOCKS, HATS, BELTS, SHOE TREES AND BAGS OF OTHERS THROUGH A WEBSITE (U.S. CLS. 100, 101 AND 102).
 FIRST USE 8-0-1999; IN COMMERCE 8-0-1999.

CLASS 35—(Continued).

SN 78-105,279. FORGET-ME-NOT FACTORY, INC., THE, ELLICOTT CITY, MD. FILED 1-28-2002.

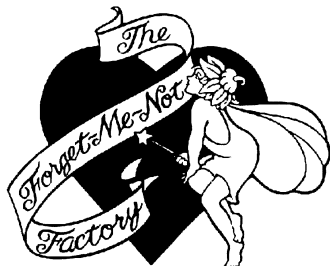

FOR RETAIL STORE AND ON-LINE RETAIL STORE SERVICES FEATURING COSTUMES, FIGURINES, JEWELRY, GIFTS AND COLLECTIBLES DEPICTING FAIRIES, WIZARDS AND OTHER FANTASY THEMES (U.S. CLS. 100, 101 AND 102).

FIRST USE 12-31-1985; IN COMMERCE 12-31-1985.

SN 78-107,916. O'SHEA, DANNY J., BARDONIA, NY. FILED 2-11-2002.

NUTRAZONE

FOR RETAIL STORE AND ONLINE RETAIL STORE SERVICES FEATURING NUTRITIONAL SUPPLEMENTS, VITAMINS, MINERALS AND WEIGHT CONTROL PRODUCTS (U.S. CLS. 100, 101 AND 102).

SN 78-111,385. JUSTAK, CHERYL L., CROWN POINT, IN. FILED 2-27-2002.

GOLF CLUB MASTERS

NO CLAIM IS MADE TO THE EXCLUSIVE RIGHT TO USE "GOLF CLUB", APART FROM THE MARK AS SHOWN.

THE MARK CONSISTS OF TYPED DRAWING CONSISTING OF THREE WORDS."

FOR BUSINESS MANAGEMENT CONSULTATION SERVICES, FEATURING, THE PROVISION OF ON-SITE ASSESSMENT OF CLUBHOUSE OPERATIONS, MEMBERSHIP AND EMPLOYEE SATISFACTION SURVEYS AS WELL AS BUSINESS PLANNING FOR COUNTRY CLUB MEMBERS; AND EXECUTIVE PERSONNEL PLACEMENT AND RECRUITMENT SERVICES FOR GOLF CLUBS (U.S. CLS. 100, 101 AND 102).

CLASS 35—(Continued).

SN 78-112,483. TOTAL RECOGNITION SYSTEMS, LLC, NIWOT, CO. BY ASSIGNMENT PARASCRIPT, LLC, NIWOT, CO. FILED 3-4-2002.

FORMPORT

FOR DATA PROCESSING SERVICES FOR OTHERS IN THE NATURE OF AUTOMATED DATA INPUT SERVICES RENDERED OVER THE INTERNET WHERE DATA MAY ORIGINATE IN CURSIVE, HANDPRINT, MACHINE PRINT, CHECK BOXES, AND BAR CODES (U.S. CLS. 100, 101 AND 102).

SN 78-114,603. ACTIVE DECISIONS, INC., SAN MATEO, CA. BY ASSIGNMENT ACTIVE RESEARCH INC., SAN MATEO, CA. FILED 3-13-2002.

ACTIVE FINANCIAL ASSISTANT

OWNER OF U.S. REG. NOS. 2,259,373 AND 2,427,797. NO CLAIM IS MADE TO THE EXCLUSIVE RIGHT TO USE "FINANCIAL ASSISTANT", APART FROM THE MARK AS SHOWN.

FOR INFORMATION SERVICES UTILIZING A GUIDED SELLING CUSTOMER RELATIONSHIP MANAGEMENT (CRM) PLATFORM, NAMELY PROVIDING PERSONALIZED PRODUCT AND SERVICE BUYING INFORMATION FOR FINANCIAL PRODUCTS AND SERVICES, AND SELLING ASSISTANCE IN THE NATURE OF PROVIDING PURCHASE INFORMATION BASED ON CUSTOMER PREFERENCES IN THE FIELD OF FINANCIAL SERVICES VIA A GLOBAL COMPUTER NETWORK (U.S. CLS. 100, 101 AND 102).

FIRST USE 2-12-2002; IN COMMERCE 2-12-2002.

SN 78-114,615. ACTIVE DECISIONS, INC., SAN MATEO, CA. BY CHANGE OF NAME ACTIVE RESEARCH, INC., SAN MATEO, CA. FILED 3-13-2002.

ACTIVE SALES ASSISTANT

OWNER OF U.S. REG. NOS. 2,259,373 AND 2,427,797. NO CLAIM IS MADE TO THE EXCLUSIVE RIGHT TO USE "SALES ASSISTANT", APART FROM THE MARK AS SHOWN.

FOR INFORMATION SERVICES UTILIZING A GUIDED SELLING CUSTOMER RELATIONSHIP MANAGEMENT (CRM) PLATFORM, NAMELY PROVIDING PERSONALIZED PRODUCT AND SERVICE BUYING INFORMATION AND SELLING ASSISTANCE IN THE NATURE OF PROVIDING PURCHASE INFORMATION BASED ON CUSTOMER PREFERENCES WITH RESPECT TO A VARIETY OF CONSUMER PRODUCTS VIA A GLOBAL COMPUTER NETWORK (U.S. CLS. 100, 101 AND 102).

FIRST USE 12-23-2000; IN COMMERCE 12-23-2000.

CLASS 35—(Continued).

SN 78-119,780. EASTERN SURFING ASSOCIATION, INC., OCEAN CITY, MD. FILED 4-5-2002.

THE EASTERNS

FOR ASSOCIATION SERVICES NAMELY PROMOTING THE INTERESTS AND CONCERNS OF SURFERS ON THE EAST COAST OF THE UNITED STATES OF AMERICA (U.S. CLS. 100, 101 AND 102).
FIRST USE 0-0-1974; IN COMMERCE 0-0-1996.

SN 78-121,638. ROBBINS, GERARD, BELLEVILLE, NJ. FILED 4-15-2002.

**SUPERSOCCERMALL
.COM**

SEC. 2(F).
FOR ON-LINE RETAIL STORE SERVICES FEATURING SOCCER-RELATED SPORTING GOODS; PROMOTING THE GOODS AND SERVICES OF OTHERS BY MEANS OF OPERATING AN ON-LINE SHOPPING MALL WITH LINKS TO THE RETAIL WEBSITES OF OTHERS (U.S. CLS. 100, 101 AND 102).
FIRST USE 6-3-1998; IN COMMERCE 6-3-1998.

SN 78-131,241. PRECISION ENTERTAINMENT, INC., JAMAICA, NY. FILED 5-25-2002.



NO CLAIM IS MADE TO THE EXCLUSIVE RIGHT TO USE "ENTERTAINMENT", APART FROM THE MARK AS SHOWN.

FOR RETAIL STORES FEATURING MUSICAL SOUND RECORDINGS AND AUDIO-VISUAL RECORDINGS, NAMELY, COMPACT DISCS, TAPE CASSETTES, AND RECORDINGS, CD-ROMS, VIDEO TAPES, DVDS, AND LASER DISCS, FILMS AND MANAGEMENT OF PERFORMING ARTISTS (U.S. CLS. 100, 101 AND 102).

CLASS 35—(Continued).

SN 78-137,193. THE HARRISON COMPANY, LLC, AURORA, CO. FILED 6-19-2002.

LOYALTY BANKING

NO CLAIM IS MADE TO THE EXCLUSIVE RIGHT TO USE "BANKING", APART FROM THE MARK AS SHOWN, FOR PROMOTING THE GOODS AND SERVICES OF FINANCIAL INSTITUTIONS BY ARRANGING AND ADMINISTERING A MARKETING PROGRAM THAT PROVIDES PREFERRED RATES ON DEPOSITS, LOANS AND OTHER BANKING SERVICES (U.S. CLS. 100, 101 AND 102).
FIRST USE 3-14-1990; IN COMMERCE 3-14-1990.

SN 78-139,158. MUSIC AND THINGS, MIAMI, FL. FILED 6-26-2002.



NO CLAIM IS MADE TO THE EXCLUSIVE RIGHT TO USE "MUSIC", APART FROM THE MARK AS SHOWN, FOR RETAIL STORE SERVICES AVAILABLE THRU COMPUTER COMMUNICATIONS FEATURING A WIDE VARIETY OF MUSIC RELATED GOODS (U.S. CLS. 100, 101 AND 102).
FIRST USE 10-31-2001; IN COMMERCE 10-31-2001.

SN 78-140,776. LEWIS, BRENTON JAMES, WATERTOWN, NY. FILED 7-2-2002.



NO CLAIM IS MADE TO THE EXCLUSIVE RIGHT TO USE "NATURAL FOOD MARKET", APART FROM THE MARK AS SHOWN.

FOR RETAIL STORES FEATURING NATURAL FOODS, HEALTH SUPPLEMENTS, VITAMINS AND MINERALS, FITNESS PRODUCTS, COSMETICS, BODY CARE PRODUCTS, WEIGHT CONTROL PRODUCTS, AND ORGANIC WINES. (U.S. CLS. 100, 101 AND 102).

SN 78-141,275. GAZETTE COMMUNICATIONS, INC., CEDAR RAPIDS, IA. FILED 7-3-2002.

OURVIRTUALFARM

FOR AGRICULTURAL INFORMATION SERVICES, NAMELY, PROVIDING INFORMATION IN THE FIELD OF FARM MARKET RESEARCH VIA A GLOBAL COMPUTER NETWORK (U.S. CLS. 100, 101 AND 102).

CLASS 35—(Continued).

SN 78-141,336. REPTHENET INTERNATIONAL, INC., FAIRFAX, VA. FILED 7-3-2002.

REPTHENET

FOR BUSINESS MARKETING CONSULTING SERVICES (U.S. CLS. 100, 101 AND 102).
FIRST USE 8-1-1999; IN COMMERCE 8-15-1999.

SN 78-144,012. ALLISON, ERIC, CITRUS HEIGHTS, CA. FILED 7-15-2002.



NO CLAIM IS MADE TO THE EXCLUSIVE RIGHT TO USE "HEALTHCARE STAFFING", APART FROM THE MARK AS SHOWN.

FOR EMPLOYMENT HIRING, RECRUITING, PLACEMENT, STAFFING AND CAREER NETWORKING SERVICES FOR HEALTHCARE PROFESSIONALS (U.S. CLS. 100, 101 AND 102).
FIRST USE 9-1-2001; IN COMMERCE 9-1-2001.

SN 78-147,552. ROBYN FREEDMAN SPIZMAN LITERARY WORKS, L.L.C., ATLANTA, GA. FILED 7-25-2002.

GIFTIONARY

FOR PROVIDING ADVICE ABOUT GIFT GIVING, NAMELY, BUYING GIFTS (U.S. CLS. 100, 101 AND 102).

SN 78-149,910. MASTERCARD INTERNATIONAL INCORPORATED, PURCHASE, NY. FILED 8-1-2002.

MASTERCARD PREFERRED REWARDS

OWNER OF U.S. REG. NOS. 1,186,117, 2,563,830 AND OTHERS.

NO CLAIM IS MADE TO THE EXCLUSIVE RIGHT TO USE "PREFERRED REWARDS", APART FROM THE MARK AS SHOWN.

FOR PROMOTING THE GOODS AND SERVICES OF OTHERS BY MEANS OF COUPONS, DISCOUNTS, ADVERTISEMENTS, AND INCENTIVES GENERATED IN CONNECTION WITH THE USE OF CREDIT AND DEBIT CARDS (U.S. CLS. 100, 101 AND 102).

CLASS 35—(Continued).

SN 78-150,568. PRICE, JULIE K., MONROE, WA. FILED 8-3-2002.

**BONNIE'S GIFT BASKETS
EXPERIENCE THE JOY IN
GIVING A BONNIE BASKET**

NO CLAIM IS MADE TO THE EXCLUSIVE RIGHT TO USE "GIFT BASKETS", APART FROM THE MARK AS SHOWN.

FOR RETAIL STORE SERVICES FEATURING CUSTOMIZED GIFT BASKETS COMPRISED PRIMARILY OF GOURMET BREAD, CAKE, COOKIES, SMOKED SALMON, WINE CHEESE, CRACKERS, PASTA, SPARKLING CIDER, MANICURE SET, TOY BEAR, COFFEE MUG, TOILE TRAY, NOTEPADS AND GOURMET DOG AND CAT TREATS (U.S. CLS. 100, 101 AND 102).

FIRST USE 8-1-2002; IN COMMERCE 9-29-2002.

SN 78-150,978. SCHEELS ALL SPORTS, INC., FARGO, ND. FILED 8-5-2002.



NO CLAIM IS MADE TO THE EXCLUSIVE RIGHT TO USE "SPORTS OUTFITTERS" AND "SINCE 1902", APART FROM THE MARK AS SHOWN.

FOR RETAIL STORE SERVICES FEATURING SPORTING GOODS, CLOTHING, CUTLERY AND OPTICS EQUIPMENT (U.S. CLS. 100, 101 AND 102).

FIRST USE 1-31-1990; IN COMMERCE 1-31-1999.

SN 78-150,989. SCHEELS ALL SPORTS, INC., FARGO, ND. FILED 8-5-2002.

SCHEELS OUTFITTERS

NO CLAIM IS MADE TO THE EXCLUSIVE RIGHT TO USE "OUTFITTERS", APART FROM THE MARK AS SHOWN.

FOR RETAIL STORE SERVICES FEATURING SPORTING GOODS, CLOTHING, CUTLERY AND OPTICS EQUIPMENT (U.S. CLS. 100, 101 AND 102).

FIRST USE 1-31-1990; IN COMMERCE 1-31-1999.

CLASS 35—(Continued).

SN 78-152,702. BAUER, JOHN DAVID, CINCINNATI, OH.
FILED 8-9-2002.



NO CLAIM IS MADE TO THE EXCLUSIVE RIGHT TO USE "PEARL", APART FROM THE MARK AS SHOWN.
FOR RETAIL JEWELRY STORES FEATURING PEARL JEWELRY (U.S. CLS. 100, 101 AND 102).
FIRST USE 8-1-2002; IN COMMERCE 8-1-2002.

SN 78-158,899. PLANSOFT CORPORATION, TWINSBURG, OH. FILED 8-28-2002.

FSS

FOR PROVIDING BUSINESS MANAGEMENT, CONSULTATION AND INFORMATION FOR FACILITATING COMMERCIAL BUSINESS TRANSACTIONS OF OTHERS, NAMELY, REQUESTS FOR PROPOSAL FOR THE PURCHASE AND SELLING OF GOODS AND SERVICES USED FOR PLANNING, MANAGING AND CONDUCTING MEETINGS, CONVENTIONS AND EVENTS; ONLINE BUSINESS DIRECTORIES FEATURING BUSINESSES WHICH PROVIDE FACILITIES FOR BUSINESS MEETINGS, CONVENTIONS, AND EVENTS; INTEGRATED TRACKING AND MANAGEMENT OF COMMERCIAL BUSINESS TRANSACTIONS FOR OTHERS IN THE FIELD OF MEETING, CONVENTION AND EVENT PLANNING ON A GLOBAL COMPUTER NETWORK (U.S. CLS. 100, 101 AND 102).
FIRST USE 12-0-2001; IN COMMERCE 12-0-2001.

SN 78-158,999. GERARD, JOSEPH A, WAUWATOSA, WI. FILED 8-28-2002.

**CUSTOMER FOCUSED
SNAPSHOT**

NO CLAIM IS MADE TO THE EXCLUSIVE RIGHT TO USE "CUSTOMER FOCUSED", APART FROM THE MARK AS SHOWN.

FOR BUSINESS MANAGEMENT CONSULTING SERVICES FOR THE IMPROVEMENT OF CUSTOMER SERVICE, SPECIFICALLY, SERVICES TO ASSESS CURRENT STATES AND PLANNED FUTURE STATES, IDENTIFY GAPS AND PREPARE AN ORGANIZATION TO IMPROVE PERFORMANCE IN THE AREA OF CUSTOMER RELATIONSHIPS (U.S. CLS. 100, 101 AND 102).
FIRST USE 11-15-2001; IN COMMERCE 6-2-2002.

CLASS 35—(Continued).

SN 78-160,673. MESSE FRANKFURT GMBH, FRANKFURT AM MAIN, FED REP GERMANY, FILED 9-4-2002.

AIRCONTEC

FOR COOPERATIVE ADVERTISING AND MARKETING; BUSINESS MANAGEMENT; PERSONNEL MANAGEMENT CONSULTATION; ADMINISTRATION OF BUSINESS PAYROLL FOR OTHERS; OFFICE SERVICES, NAMELY, SECRETARIAL AND CLERICAL SERVICES; RENTAL OF ADVERTISING SPACE; RENTAL OF ADVERTISING DISPLAYS; PREPARING ADVERTISEMENTS FOR OTHERS, NAMELY, PREPARING TRADE SHOW DISPLAYS AND EXHIBITS (U.S. CLS. 100, 101 AND 102).

SN 78-161,072. GREATER HOUSTON PARTNERSHIP, INC., HOUSTON, TX. FILED 9-5-2002.

**HOUSTON ECONOMIC
DEVELOPMENT COUNCIL**

NO CLAIM IS MADE TO THE EXCLUSIVE RIGHT TO USE "ECONOMIC DEVELOPMENT COUNCIL", APART FROM THE MARK AS SHOWN.

SEC. 2(F).
FOR CHAMBER OF COMMERCE SERVICES, NAMELY, PROMOTING TRADE, COMMERCE, INDUSTRY AND ECONOMIC GROWTH RELATING TO THE HOUSTON, TEXAS AREA (U.S. CLS. 100, 101 AND 102).
FIRST USE 6-30-1984; IN COMMERCE 6-30-1984.

SN 78-161,285. CHRISTIAN, NINA, JUDITH, MILSONS POINT, AUSTRALIA, FILED 9-6-2002.

HOMESICK

OWNER OF AUSTRALIA REG. NO. 862697, DATED 1-11-2001, EXPIRES 1-11-2011.

FOR RETAILING AND WHOLESALING SERVICES, NAMELY, RETAIL AND WHOLESALE STORE SERVICES RELATED TO GIFT PACKS, PRINTED MATTER, MUSIC AND ENTERTAINMENT; BUSINESS MANAGEMENT; COMPUTERIZED ON-LINE ORDERING SERVICES FEATURING GENERAL MERCHANDISE AND GENERAL CONSUMER GOODS; PROVIDING AN ON-LINE COMMERCIAL INFORMATION DIRECTORY; DISSEMINATION OF ADVERTISING FOR OTHERS VIA AN ON-LINE ELECTRONIC COMMUNICATIONS NETWORK; PROVIDING A SEARCHABLE ON-LINE ADVERTISING GUIDE FEATURING THE GOODS AND SERVICES OF OTHER ON-LINE VENDORS; COMPUTER SERVICES, NAMELY, PROVIDING DIRECTORIES FOR ALL TYPES OF CONTACT NUMBERS, NAMES AND ADDRESSES; AUCTIONEERING; AUTOMATED AND COMPUTERIZED TRADING OF GOODS AND SER-

CLASS 35—(Continued).

VICES FOR OTHERS PROVIDED OVER A GLOBAL COMMUNICATIONS NETWORK; THE BRINGING TOGETHER, FOR THE BENEFIT OF OTHERS, OF A VARIETY OF GOODS, EXCLUDING THE TRANSPORT THEREOF, ENABLING CUSTOMERS TO CONVENIENTLY VIEW AND PURCHASE GOODS; CLASSIFIED ADVERTISING SERVICES; MAIL ORDER SERVICES, INCLUDING FACSIMILE AND INTERNET-BASED MAIL ORDER SERVICES, FEATURING GIFTS, GIFT PACKS, FOOD, BEVERAGES, PRINTED MATTER, CLOTHING, MUSIC AND ENTERTAINMENT, SOUVENIRS AND LIFESTYLE PRODUCTS; RETAIL ON-LINE DEPARTMENT STORES AND CONVENIENCE STORES; PROVIDING COMMERCIAL INFORMATION REGARDING THE GOODS AND SERVICES OF OTHERS IN THE NATURE OF A BUYERS' GUIDE BY MEANS OF A GLOBAL COMPUTER NETWORK; PUBLICITY AND PUBLIC RELATIONS SERVICES; RENTAL OR LEASING OF OFFICE EQUIPMENT; PROVISION OF OFFICE, CLERICAL AND ADMINISTRATIVE SUPPORT SERVICES (U.S. CLS. 100, 101 AND 102).

SN 78-162,127. WATERFORD WEDGWOOD PLC, WATERFORD, IRELAND, FILED 9-9-2002.

WATERFORD INTERIORS

OWNER OF U.S. REG. NOS. 746,232, 2,393,891 AND OTHERS.

SEC. 2(F) AS TO "WATERFORD".
 FOR RETAIL STORE AND MAIL ORDER CATALOG SERVICES AND ON-LINE RETAIL STORE SERVICES FEATURING HOUSEWARES, CUTLERY, GLASSWARE, CHINA, PORCELAIN, TABLEWARE, FLATWARE, INDOOR AND OUTDOOR FURNITURE, TABLE LINENS, BED LINENS, PICTURE FRAMES, MIRRORS, VASES, WINDOW SHADES, BASKETS, POTHOLDERS, AND BARBEQUE ACCESSORIES (U.S. CLS. 100, 101 AND 102).

SN 78-163,437. FARNAM COMPANIES, INC, PHOENIX, AZ. FILED 9-12-2002.

PET TOGETHERS

FOR RETAIL SHOP-AT-HOME PARTY SERVICES IN THE FIELD OF PET TOYS (U.S. CLS. 100, 101 AND 102).

CLASS 35—(Continued).

SN 78-163,869. NET EXPAT, BRUSSELS, BELGIUM, FILED 9-13-2002.

Net Expat

OWNER OF ERPN CMNTY TM OFC REG. NO. 001026327, DATED 6-23-2000, EXPIRES 12-28-2008.

FOR EMPLOYMENT OUTPLACEMENT SERVICES, EMPLOYEE RELOCATION AND INFORMATION SERVICES, JOB PLACEMENT SERVICES, EXECUTIVE SEARCH AND PLACEMENT SERVICES, CAREER PLACEMENT SERVICES, EMPLOYMENT COUNSELING AND RECRUITING SERVICES, EMPLOYMENT HIRING, RECRUITING, PLACEMENT, STAFFING AND CAREER NETWORKING SERVICES, PERSONNEL PLACEMENT AND RECRUITMENT SERVICES, PSYCHOLOGICAL TESTING FOR THE SELECTION OF PERSONNEL; EMPLOYMENT OUTPLACEMENT SERVICES, EMPLOYEE RELOCATION AND INFORMATION SERVICES, JOB PLACEMENT SERVICES, EXECUTIVE SEARCH AND PLACEMENT SERVICES, CAREER PLACEMENT SERVICES, EMPLOYMENT COUNSELING AND RECRUITING SERVICES, EMPLOYMENT HIRING, RECRUITING, PLACEMENT, STAFFING AND CAREER NETWORKING SERVICES, PERSONNEL PLACEMENT AND RECRUITMENT SERVICES, PSYCHOLOGICAL TESTING FOR THE SELECTION OF PERSONNEL (U.S. CLS. 100, 101 AND 102).

SN 78-164,265. DURAN, ANGELA EDEN, MT HOME, ID. FILED 9-15-2002.



NO CLAIM IS MADE TO THE EXCLUSIVE RIGHT TO USE "SQUADRONEXEC.COM", APART FROM THE MARK AS SHOWN.

FOR PROVIDING ON-LINE DIRECTORY INFORMATION SERVICES ALSO FEATURING HYPERLINKS TO OTHER WEB SITES, AND PROVIDING A WEB SITE WHICH FEATURES ADVERTISEMENTS FOR THE GOODS AND SERVICES OF OTHERS ON A GLOBAL COMPUTER NETWORK (U.S. CLS. 100, 101 AND 102).
 FIRST USE 5-10-2002; IN COMMERCE 5-10-2002.

SN 78-164,455. DIGITAL BRIDGE COMPUTERS, INC., PHOENIX, AZ. FILED 9-16-2002.

BLACK ALLIANCE

NO CLAIM IS MADE TO THE EXCLUSIVE RIGHT TO USE "BLACK", APART FROM THE MARK AS SHOWN.

FOR PROVIDING A COMMUNITY-BASED WEB SITE WHICH FEATURES ADVERTISEMENT AND MARKETING INFORMATION FOR THE GOODS AND SERVICES OF OTHERS ON A GLOBAL COMPUTER NETWORK (U.S. CLS. 100, 101 AND 102).

CLASS 35—(Continued).

SN 78-165,623. ONE DOLLAR CITY, INC., ANAHEIM, CA. FILED 9-19-2002.



NO CLAIM IS MADE TO THE EXCLUSIVE RIGHT TO USE "S1", APART FROM THE MARK AS SHOWN.

THE MARK CONSISTS OF "S1" AND A SOLID CIRCLE FOR THE COLOR(S) GREEN AND BLUE. THE TERM "CITY" IN THE MARK IS REPRESENTED IN THE COLOR MAGENTA.

FOR RETAIL STORE SERVICES WITH RESPECT TO GENERAL MERCHANDISE, PROVIDING ITEMS COSTING \$1 (U.S. CLS. 100, 101 AND 102).

CLASS 35—(Continued).

SN 78-167,237. INTERWEAVE CORPORATION, TAMPA, FL. FILED 9-24-2002.



NO CLAIM IS MADE TO THE EXCLUSIVE RIGHT TO USE "PERFORMANCE MANAGEMENT CYCLE", APART FROM THE MARK AS SHOWN.

FOR PERFORMANCE MANAGEMENT BUSINESS CONSULTING (U.S. CLS. 100, 101 AND 102).

FIRST USE 2-27-2002; IN COMMERCE 8-15-2002.

SN 78-166,201. MORTGAGE BANKERS ASSOCIATION OF AMERICA, WASHINGTON, DC. FILED 9-20-2002.

MFIA

FOR ASSOCIATION SERVICES, NAMELY, PROMOTING THE INTERESTS OF MEMBERS IN THE REAL ESTATE FINANCE FIELD. (U.S. CLS. 100, 101 AND 102).

SN 78-167,313. ROCHESTER POLICE LOCUST CLUB, INC., ROCHESTER, NY. FILED 9-24-2002.



SN 78-166,962. MIDLAND NATIONAL LIFE INSURANCE COMPANY, SIOUX FALLS, SD. FILED 9-23-2002.

BIG ENOUGH TO PLAY, YET SMALL ENOUGH TO CARE

FOR RECRUITMENT OF SALES REPRESENTATIVES TO SELL INSURANCE AND ANNUITIES IN THE LIFE INSURANCE AND ANNUITY UNDERWRITING FIELD (U.S. CLS. 100, 101 AND 102).

FIRST USE 10-26-2001; IN COMMERCE 10-26-2001.

SN 78-167,004. BARRISTERBOOKS, INC., WICHITA, KS. FILED 9-23-2002.

BARRISTER BOOKS

NO CLAIM IS MADE TO THE EXCLUSIVE RIGHT TO USE "BOOKS", APART FROM THE MARK AS SHOWN.

FOR ONLINE RETAIL STORE SERVICES FEATURING LAW BOOKS (U.S. CLS. 100, 101 AND 102).

FIRST USE 1-15-1999; IN COMMERCE 9-15-1999.

NO CLAIM IS MADE TO THE EXCLUSIVE RIGHT TO USE "ROCHESTER POLICE DEPARTMENT ORGANIZED 1904", APART FROM THE MARK AS SHOWN.

THE STIPPLING IS A FEATURE OF THE MARK. FOR LABOR UNION SERVICES NAMELY, GENERAL LABOR UNION ACTIVITIES FOR THE BENEFIT OF ITS MEMBERS (U.S. CLS. 100, 101 AND 102).

FIRST USE 1-4-1904; IN COMMERCE 1-4-1904.

CLASS 35—(Continued).

SN 78-167,495. MARITZ INC., FENTON, MO. FILED 9-24-2002.

SALES REFERRAL MANAGER

NO CLAIM IS MADE TO THE EXCLUSIVE RIGHT TO USE "MANAGER", APART FROM THE MARK AS SHOWN. FOR PROVIDING BUSINESS MANAGEMENT INFORMATION IN THE FIELD OF EMPLOYEE MOTIVATION AND PERFORMANCE IMPROVEMENT PROGRAMS FOR CLIENT COMPANIES; BUSINESS CONSULTATION IN THE FIELD OF MOTIVATION AND PERFORMANCE IMPROVEMENT PROGRAMS FOR CLIENT COMPANY'S EMPLOYEES; AND PROMOTING, CONDUCTING, AND ADMINISTERING MOTIVATION AND PERFORMANCE IMPROVEMENT PROGRAMS, NAMELY, CONDUCTING EMPLOYEE INCENTIVE AWARD PROGRAMS TO PROMOTE PARTICIPATION IN MARKETING DEVELOPMENT EFFORTS (U.S. CLS. 100, 101 AND 102).

SN 78-168,848. AMILLA, LLC, SARASOTA, FL. FILED 9-27-2002.

iTNextGen
IT solutions for tomorrow's market!

NO CLAIM IS MADE TO THE EXCLUSIVE RIGHT TO USE "IT SOLUTIONS", APART FROM THE MARK AS SHOWN.

FOR COMPUTER EMPLOYMENT STAFFING SERVICES FOR INFORMATION TECHNOLOGY BUSINESSES (U.S. CLS. 100, 101 AND 102).

FIRST USE 6-1-2001; IN COMMERCE 10-1-2001.

SN 78-170,830. HUGHES, SHAUN N.G., EVERETT, WA. FILED 10-3-2002.

SOLUTIONS FOR SUN SENSITIVE AND SUN SENSIBLE PEOPLE

SEC. 2(F).
FOR RETAIL STORE AND MAIL ORDER CATALOG SERVICES FEATURING CLOTHING (U.S. CLS. 100, 101 AND 102).

FIRST USE 3-31-1997; IN COMMERCE 3-31-1997.

CLASS 35—(Continued).

SN 78-172,497. SULFUR DIOXIDE MUTUAL ASSISTANCE RESPONSE TEAM, WASHINGTON, DC. FILED 10-9-2002.

SMART-SULFUR DIOXIDE MUTUAL ASSISTANCE RESPONSE TEAM

NO CLAIM IS MADE TO THE EXCLUSIVE RIGHT TO USE "SULFUR DIOXIDE MUTUAL ASSISTANCE RESPONSE TEAM", APART FROM THE MARK AS SHOWN.

FOR ASSOCIATION SERVICES, NAMELY, PROMOTING THE INTERESTS OF THOSE INVOLVED WITH THE HANDLING AND TRANSPORTATION OF SULFUR DIOXIDE AND PROMOTING PUBLIC AWARENESS OF THE NEED FOR SAFE HANDLING AND TRANSPORTATION OF SULFUR DIOXIDE (U.S. CLS. 100, 101 AND 102).

SN 78-175,478. HEART OF WEST MICHIGAN UNITED WAY, GRAND RAPIDS, MI. FILED 10-17-2002.

2-1-1 YOUR WAY TO HELP

NO CLAIM IS MADE TO THE EXCLUSIVE RIGHT TO USE "211", APART FROM THE MARK AS SHOWN.

FOR REFERRALS IN THE FIELD OF SOCIAL SERVICES, COMMUNITY RESOURCES AND VOLUNTEER OPPORTUNITIES (U.S. CLS. 100, 101 AND 102).

SN 78-178,895. JEFFREY BRADSHAW, DBA TOTALVAC.COM, PEABODY, MA. AND LAURIE D. BRADSHAW, DBA TOTALVAC.COM, PEABODY, MA. FILED 10-28-2002.

TOTALVAC.COM

FOR RETAIL SERVICES, NAMELY, COMPUTERIZED ON-LINE RETAIL SERVICES FEATURING SMALL HOUSEHOLD APPLIANCES, COMPONENT AND REPLACEMENT PARTS FOR SMALL HOUSEHOLD APPLIANCES, ACCESSORIES FOR SMALL HOUSEHOLD APPLIANCES; AIR FILTERS FOR AIR CLEANERS, AIR PURIFIERS, HUMIDIFIERS, AND FURNACES, CLEANING SUPPLIES, BARWARE, ORAL, HAIR, AND SKIN CARE ACCESSORIES, AND STORAGE BAGS IN INTERNATIONAL CLASS 35 (U.S. CLS. 100, 101 AND 102).
FIRST USE 1-2-2000; IN COMMERCE 1-2-2000.

SN 78-181,605. AUSTIN, TANYA, M, NEW YORK, NY. FILED 11-5-2002.

GO GLAMM

FOR RETAIL STORE SERVICES FEATURING CLOTHING, ACCESSORIES AND PAPER GOODS (U.S. CLS. 100, 101 AND 102).

CLASS 35—(Continued).

SN 78-181,791. HR OUTSOURCING EVENTS, LLC, FAIRFIELD, NJ. FILED 11-5-2002.

WHERE BUSINESS LEADERS MAKE PROFITABLE DECISIONS

FOR ARRANGING AND CONDUCTING BUSINESS CONFERENCES AND EXPOSITIONS IN THE FIELD OF HUMAN RESOURCES (U.S. CLS. 100, 101 AND 102).
FIRST USE 8-0-2002; IN COMMERCE 8-0-2002.

SN 78-183,586. GRAPHIX HOUSE, INC., DBA BROACH KINLEY, GREENSBORO, NC. FILED 11-11-2002.

FUEL GROWTH

FOR ADVERTISING SERVICES, NAMELY, PREPARING MARKETING PLANS FOR THE PRODUCTS AND SERVICES OF OTHERS (U.S. CLS. 100, 101 AND 102).
FIRST USE 7-18-2002; IN COMMERCE 7-18-2002.

SN 78-184,714. RIENZI & RIENZI COMMUNICATIONS, INC., MONTVILLE, NJ. FILED 11-13-2002.

**(Physician
Assistants')**
Dialogue

FOR PROMOTING AND ADVERTISING THE GOODS AND SERVICES OF CLIENTS IN THE HEALTH CARE INDUSTRY BY DIRECT MAILINGS WHICH COMMUNICATE PRODUCT INFORMATION TO PHYSICIANS ASSISTANTS. (U.S. CLS. 100, 101 AND 102).

SN 78-186,979. EFROGG.COM, LLC, ASHBURN, VA. FILED 11-20-2002.

TADPOLE

FOR COST ACCOUNTING AND BILLING VIA THE INTERNET, INTEGRATED TRACKING AND MANAGEMENT OF COMMERCIAL TRANSACTIONS VIA THE GLOBAL COMPUTER NETWORK; DEVELOPING PROMOTIONAL CAMPAIGNS FOR BUSINESS (U.S. CLS. 100, 101 AND 102).
FIRST USE 2-1-2000; IN COMMERCE 2-1-2000.

CLASS 35—(Continued).

SN 78-187,065. VAGIAS, THEODORE, TOWACO, NJ. FILED 11-20-2002.

HELD HOSTAGE BY IT

NO CLAIM IS MADE TO THE EXCLUSIVE RIGHT TO USE "IT", APART FROM THE MARK AS SHOWN.

FOR BUSINESS MANAGEMENT AND STRATEGIC CONSULTING SERVICES, BUSINESS ORGANIZATIONAL CONSULTATION, BUSINESS PROCESS REENGINEERING SERVICES, BUSINESS CONSULTATION CONCERNING OPERATIONS MANAGEMENT, AND INTERIM EXECUTIVE SERVICES (U.S. CLS. 100, 101 AND 102).
FIRST USE 5-5-1999; IN COMMERCE 5-5-1999.

SN 78-188,269. CHRISTIAN DOLLAR STORE LLC, NORWICH, OH. FILED 11-23-2002.

CHRISTIAN DOLLAR

NO CLAIM IS MADE TO THE EXCLUSIVE RIGHT TO USE "CHRISTIAN", APART FROM THE MARK AS SHOWN. THE STIPPLING IS A FEATURE OF THE MARK.

THE MARK CONSISTS OF THE DRAWING IS LINED FOR THE COLOR BLUE.

FOR RETAIL VARIETY STORES AND ONLINE RETAIL VARIETY STORES FEATURING CHRISTIAN AND CHRISTIAN THEMED PRODUCTS, NAMELY, HOUSEWARES, ARTS AND CRAFTS, CLOTHING AND SHOES, JEWELRY, FURNITURE, BIBLES AND BOOKS (U.S. CLS. 100, 101 AND 102).

FIRST USE 11-22-2002; IN COMMERCE 11-22-2002.

SN 78-188,644. FOODARAMA INCORPORATED, RANDALLSTOWN, MD. FILED 11-25-2002.

METRO

OWNER OF U.S. REG. NO. 1,788,680.
FOR RETAIL GROCERY STORE SERVICES (U.S. CLS. 100, 101 AND 102).
FIRST USE 2-28-2001; IN COMMERCE 2-28-2001.

SN 78-188,746. WATCHMARK CORP., BELLEVUE, WA. FILED 11-25-2002.

WATCHMARK

OWNER OF U.S. REG. NOS. 2,243,488, 2,272,804 AND OTHERS.

FOR COMPILING STATISTICAL REPORTS AND PROVIDING STATISTICAL INFORMATION FOR OTHERS FOR BUSINESS AND COMMERCIAL PURPOSES; COMPUTERIZED DATABASE MANAGEMENT; DATA PROCESSING SERVICES; LICENSING OF COMPUTER SOFTWARE; PREPARING BUSINESS REPORTS FOR OTHERS (U.S. CLS. 100, 101 AND 102).

CLASS 35—(Continued).

SN 78-191,031. LEAD FORWARD, INC., PORTLAND, ME. FILED 12-4-2002.

PIPELINE

FOR BUSINESS CONSULTATION, NAMELY, HELPING OTHERS AGGREGATE AND ORGANIZE THEIR BUSINESS CONTACTS AND PROSPECTIVE CUSTOMERS ON A GLOBAL COMPUTER NETWORK, AND HELPING OTHERS CREATE E-MAIL MARKETING CAMPAIGNS ON A GLOBAL COMPUTER NETWORK (U.S. CLS. 100, 101 AND 102).

SN 78-191,700. MANKATO CHAMBER OF COMMERCE, MANKATO, MN. FILED 12-5-2002.

A LITTLE TWIN CITIES. A LOT MINNESOTA.

NO CLAIM IS MADE TO THE EXCLUSIVE RIGHT TO USE "TWIN CITIES" AND "MINNESOTA", APART FROM THE MARK AS SHOWN.

FOR CHAMBER OF COMMERCE SERVICES, NAMELY, PROMOTING BUSINESS, RESIDENCY, AND TOURISM IN THE GREATER MANKATO, MINNESOTA AREA (U.S. CLS. 100, 101 AND 102).

FIRST USE 11-7-2002; IN COMMERCE 11-7-2002.

SN 78-191,812. SANAKA INVESTMENTS, LLC, SAN JOSE, CA. FILED 12-6-2002.

ALPEN SCHATZ

NO CLAIM IS MADE TO THE EXCLUSIVE RIGHT TO USE "ALPEN", APART FROM THE MARK AS SHOWN.

THE FOREIGN WORDING IN THE MARK TRANSLATES INTO ENGLISH AS "ALPINE TREASURE".

FOR WHOLESALE DISTRIBUTORSHIP FEATURING HANDCRAFTED PRODUCTS MADE IN THE EUROPEAN ALPINE REGION, NAMELY, DOG COLLARS, LEASHES, TABLECLOTH, SCARVES, TRADITIONAL CLOTHING (U.S. CLS. 100, 101 AND 102).

FIRST USE 3-1-2002; IN COMMERCE 3-18-2002.

SN 78-192,200. LUTZMANN INTERNATIONAL CONSULTING, CLEVELAND HEIGHTS, OH. FILED 12-6-2002.

CLEARLY CONTAINERS

NO CLAIM IS MADE TO THE EXCLUSIVE RIGHT TO USE "CONTAINERS", APART FROM THE MARK AS SHOWN.

FOR ON-LINE ORDERING SERVICES FEATURING CONTAINERS (U.S. CLS. 100, 101 AND 102).

FIRST USE 10-18-2001; IN COMMERCE 10-30-2002.

CLASS 35—(Continued).

SN 78-193,405. AMCOR SUNCLIPSE NORTH AMERICA, BUENA PARK, CA. FILED 12-11-2002.

KHL ENGINEERED PACKAGING SOLUTIONS

NO CLAIM IS MADE TO THE EXCLUSIVE RIGHT TO USE "ENGINEERED PACKAGING", APART FROM THE MARK AS SHOWN.

FOR DISTRIBUTORSHIPS IN THE FIELD OF INDUSTRIAL PACKAGING AND EQUIPMENT (U.S. CLS. 100, 101 AND 102).

SN 78-193,491. INTERACTIVE DIRECT IDEAS, INC., TAMPA, FL. FILED 12-11-2002.

PERFECT-TRAK

FOR ADVERTISING SERVICES FOR OTHERS, NAMELY BY THE DISTRIBUTION OF PRINT AND AUDIO PROMOTIONAL MATERIALS (U.S. CLS. 100, 101 AND 102).

SN 78-193,567. CHEVRONTEXACO CORPORATION, SAN FRANCISCO, CA. FILED 12-11-2002.



NO CLAIM IS MADE TO THE EXCLUSIVE RIGHT TO USE "HYDROCARBONS TO LIQUIDS", APART FROM THE MARK AS SHOWN.

FOR LICENSING OF TECHNOLOGY RELATED TO THE MANUFACTURE OF FISCHER-TROPSCH FUELS AND OTHER FISCHER-TROPSCH BASED PRODUCTS, NAMELY HARD WAX, FOOD GRADE WAX, MEDICAL GRADE WAX, SYNTHETIC LUBRICANTS, AND SYNTHETIC DRILLING FLUIDS (U.S. CLS. 100, 101 AND 102).

SN 78-193,729. INTERNATIONAL PAPER TRADEMARK COMPANY, TUXEDO, NY. FILED 12-12-2002.

KIRK XPEDX

OWNER OF U.S. REG. NOS. 2,302,556 AND 2,366,730. FOR DISTRIBUTORSHIP IN THE FIELD OF PAPER, PACKAGING AND GRAPHIC EQUIPMENT (U.S. CLS. 100, 101 AND 102).

FIRST USE 6-22-1998; IN COMMERCE 6-22-1998.

CLASS 35—(Continued).

SN 78-193,898. ALL PET DISCOUNTERS, INC., VIRGINIA BEACH, VA. FILED 12-12-2002.



THE MARK CONSISTS OF FIVE CIRCLES EACH CONTAINING A DIFFERENT DESIGN, THE FIRST A PAW PRINT, THE SECOND A TROPICAL FISH, THE THIRD A PARROT, THE FOURTH A RABBIT, AND THE FIFTH A SNAKE.

FOR RETAIL STORE SERVICES IN THE FIELD OF PETS AND PET SUPPLIES (U.S. CLS. 100, 101 AND 102). FIRST USE 3-0-2001; IN COMMERCE 3-0-2001.

SN 78-194,280. NATIONAL HOUSEWARES MANUFACTURERS ASSOCIATION, ROSEMONT, IL. FILED 12-13-2002.

INTERNATIONAL HOME & HOUSEWARES SHOW

OWNER OF U.S. REG. NOS. 2,303,750, 2,676,457 AND 2,679,795.

NO CLAIM IS MADE TO THE EXCLUSIVE RIGHT TO USE "HOME & HOUSEWARES SHOW", APART FROM THE MARK AS SHOWN.

SEC. 2(F).

FOR ARRANGING AND CONDUCTING TRADE SHOWS IN THE FIELD OF HOUSEWARES AND HOMEWARES MANUFACTURING (U.S. CLS. 100, 101 AND 102).

FIRST USE 3-12-2003; IN COMMERCE 3-12-2003.

SN 78-198,166. ESAVE, INC., WOBURN, MA. FILED 12-27-2002.

CONNECTING BRANDS AND BUYERS

FOR PROVIDING PRODUCT AND RETAIL DISCOUNT AND PROMOTIONAL INFORMATION ABOUT A WIDE RANGE OF CONSUMER PRODUCTS AND SERVICES OF OTHERS BY MEANS OF A GLOBAL COMPUTER NETWORK (U.S. CLS. 100, 101 AND 102).

SN 78-199,068. WORLD INTERNET MARKETING, INC., SUCCASUNNA, NJ. FILED 12-31-2002.

MOVE AHEAD

FOR PROMOTING THE GOODS AND SERVICES OF OTHERS THROUGH THE COPYWRITING AND DISSEMINATION OF PRESS RELEASES AND NEWS RELEASES BY ELECTRONIC MEANS, NAMELY, FAX, SATELLITE, E-MAIL, WIRELESS DEVICES, THE INTERNET AND COMPUTER NETWORKS (U.S. CLS. 100, 101 AND 102).

FIRST USE 9-0-1999; IN COMMERCE 9-0-1999.

CLASS 35—(Continued).

SN 78-199,165. INTERNATIONAL BAR ASSOCIATION, LONDON W1B 2AQ, UNITED KINGDOM. FILED 12-31-2002.

THE GLOBAL VOICE OF THE LEGAL PROFESSION

FOR ASSOCIATION SERVICES, NAMELY PROMOTING THE INTERESTS OF LAWYERS, WITH SPECIAL REGARD TO MATTERS OF INTERNATIONAL AND TRANSNATIONAL LAW (U.S. CLS. 100, 101 AND 102).

FIRST USE 10-28-2001; IN COMMERCE 10-28-2001.

SN 78-199,750. NEW YORK APPLE ASSOCIATION, INC., FISHERS, NY. FILED 1-3-2003.

HOW DO YOU LIKE THEM APPLES

NO CLAIM IS MADE TO THE EXCLUSIVE RIGHT TO USE APPLES, APART FROM THE MARK AS SHOWN.

FOR ASSOCIATION SERVICES, NAMELY PROMOTING THE INTERESTS OF COMMERCIAL APPLE GROWERS IN THE STATE OF NEW YORK (U.S. CLS. 100, 101 AND 102).

FIRST USE 10-21-2002; IN COMMERCE 10-21-2002.

SN 78-200,777. WILLIAM J. CHAPMAN, JR., PLANO, TX. FILED 1-7-2003.

TYROSYS

FOR RETAIL AND ONLINE STORE SERVICES FEATURING TELECOMMUNICATIONS TESTING EQUIPMENT (U.S. CLS. 100, 101 AND 102).

FIRST USE 10-1-2002; IN COMMERCE 10-1-2002.

SN 78-200,925. PTPP SERVICES LLC, SAN FRANCISCO, CA. FILED 1-7-2003.

FLAGSHIP ENERGY

NO CLAIM IS MADE TO THE EXCLUSIVE RIGHT TO USE "ENERGY", APART FROM THE MARK AS SHOWN.

FOR BUSINESS MANAGEMENT SERVICES FOR OTHERS IN THE ENERGY INDUSTRY, NAMELY ARRANGING FOR THE CREATION, CONSTRUCTION, MANAGEMENT, PROVISION, ACQUISITION, OPERATION AND OWNERSHIP OF ENERGY COMMODITIES SUPPLY, GENERATION, TRANSPORTATION, TRANSMISSION AND DISTRIBUTION FACILITIES AND INFRASTRUCTURE (U.S. CLS. 100, 101 AND 102).

CLASS 35—(Continued).

SN 78-201,122. NORTH AMERICAN BRIDAL ASSOCIATION, INC., LAS VEGAS, NV. FILED 1-8-2003.

LAS VEGAS THE MARKET

NO CLAIM IS MADE TO THE EXCLUSIVE RIGHT TO USE "LAS VEGAS", APART FROM THE MARK AS SHOWN. FOR ASSOCIATION SERVICES, NAMELY, PROMOTING THE INTERESTS OF INDEPENDENT BRIDAL SHOPS BY PRODUCING TRADE SHOWS, SEMINARS, AND A SPONSORED WEBSITE (U.S. CLS. 100, 101 AND 102).

FIRST USE 3-31-1994; IN COMMERCE 3-31-1994.

SN 78-201,406. FEINSTEIN, PETER J., FOUNTAIN HILLS, AZ. FILED 1-8-2003.



NO CLAIM IS MADE TO THE EXCLUSIVE RIGHT TO USE "MARKETING", APART FROM THE MARK AS SHOWN.

FOR ADVERTISING AGENCY (U.S. CLS. 100, 101 AND 102).

FIRST USE 1-6-2003; IN COMMERCE 1-6-2003.

SN 78-202,786. PEAKINSIGHT LLC, DURANGO, CO. FILED 1-13-2003.

LEADERSHIP METABOLICS

NO CLAIM IS MADE TO THE EXCLUSIVE RIGHT TO USE "LEADERSHIP", APART FROM THE MARK AS SHOWN.

FOR BUSINESS MANAGEMENT AND HUMAN RESOURCE CONSULTATION; ARRANGING AND CONDUCTING BUSINESS CONFERENCES, OFFERED BOTH LIVE AND VIA THE INTERNET; CONDUCTING BUSINESS AND MARKET RESEARCH SURVEYS. (U.S. CLS. 100, 101 AND 102).

CLASS 35—(Continued).

SN 78-203,083. HR CONSULTANTS, INC., JOHNSTOWN, PA. FILED 1-14-2003.

A MANAGEMENT AND HUMAN RESOURCE CONSULTING FIRM COMMITTED TO MEASURED SUCCESS

NO CLAIM IS MADE TO THE EXCLUSIVE RIGHT TO USE "A MANAGEMENT AND HUMAN RESOURCE CONSULTING FIRM", APART FROM THE MARK AS SHOWN. FOR BUSINESS MANAGEMENT AND HUMAN RESOURCE CONSULTING SERVICES (U.S. CLS. 100, 101 AND 102).

FIRST USE 6-30-1998; IN COMMERCE 6-30-1998.

SN 78-203,800. FIRST TRACKS SOFTWARE, SUPERIOR, CO. FILED 1-15-2003.



Customer Relations on the Web

NO CLAIM IS MADE TO THE EXCLUSIVE RIGHT TO USE "CUSTOMER RELATIONS ON THE WEB", APART FROM THE MARK AS SHOWN.

FOR CUSTOMER SERVICES IN THE FIELD OF CUSTOMER RELATIONSHIP MANAGEMENT OVER THE INTERNET (U.S. CLS. 100, 101 AND 102).

SN 78-203,852. NATIONAL AUTO AUCTION ASSOCIATION, INC., FREDERICK, MD. FILED 1-16-2003.

NATIONAL AUTO AUCTION ASSOCIATION

NO CLAIM IS MADE TO THE EXCLUSIVE RIGHT TO USE "AUTO AUCTION ASSOCIATION", APART FROM THE MARK AS SHOWN.

SEC. 2(F). FOR INTERNATIONAL TRADE ASSOCIATION SERVICES; NAMELY PROMOTING THE INTERESTS OF THE WHOLESALE AUTO AUCTION INDUSTRY (U.S. CLS. 100, 101 AND 102).

FIRST USE 12-19-1954; IN COMMERCE 12-19-1954.

CLASS 35—(Continued).

SN 78-204,191. GAP (APPAREL) INC., SAN FRANCISCO, CA. FILED 1-16-2003.

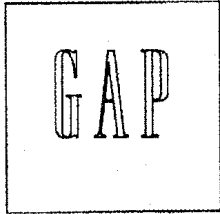

OWNER OF U.S. REG. NOS. 2,431,834, 2,481,997 AND 2,638,121.

FOR RETAIL STORE SERVICES, ONLINE RETAIL STORE SERVICES AND MAIL ORDER CATALOG SERVICES IN THE FIELDS OF CLOTHING, ACCESSORIES, PERSONAL CARE PRODUCTS, SHOES AND SLIPPERS, LEATHER GOODS, BAGS, SOUVENIR ITEMS AND GIFT SETS; PROVIDING GIFT, PRODUCT AND SERVICE INFORMATION TO CUSTOMERS (U.S. CLS. 100, 101 AND 102).

FIRST USE 12-1-1988; IN COMMERCE 12-1-1988.

SN 78-205,871. GHERMEZIAN, MARK, LAS VEGAS, NV. FILED 1-22-2003.



FOR DISSEMINATION OF ADVERTISING MATTER, NAMELY, DISSEMINATION OF INDOOR AND RESTROOM ADVERTISEMENTS; ADVERTISING AGENCIES FOR SPONSORS OF INDOOR AND RESTROOM ADVERTISEMENTS AND CLIENTS; AND AGENCIES FOR INDOOR AND RESTROOM ADVERTISING TIME AND SPACE (U.S. CLS. 100, 101 AND 102).

FIRST USE 1-1-2001; IN COMMERCE 1-1-2001.

SN 78-205,876. GHERMEZIAN, MARK, LAS VEGAS, NV. FILED 1-22-2003.

FLUSH MEDIA

NO CLAIM IS MADE TO THE EXCLUSIVE RIGHT TO USE "MEDIA", APART FROM THE MARK AS SHOWN.

FOR DISSEMINATION OF ADVERTISING MATTER, NAMELY, DISSEMINATION OF INDOOR AND RESTROOM ADVERTISEMENTS; ADVERTISING AGENCIES FOR SPONSORS OF INDOOR AND RESTROOM ADVERTISEMENTS AND CLIENTS; AGENCIES FOR INDOOR AND RESTROOM ADVERTISING TIME AND SPACE (U.S. CLS. 100, 101 AND 102).

FIRST USE 1-1-2001; IN COMMERCE 1-1-2001.

CLASS 35—(Continued).

SN 78-206,595. TILLER, LLC, NEW YORK, NY. FILED 1-23-2003.

TILLER

FOR MARKETING CONSULTING SERVICES, NAMELY PROMOTING THE GOODS AND SERVICES OF OTHERS THROUGH PLANNING, CREATION AND DISTRIBUTION OF SOCIALLY AND ENVIRONMENTALLY CONSCIOUS MARKETING CAMPAIGNS. (U.S. CLS. 100, 101 AND 102).

SN 78-206,602. SCANLON, PATRICK, T. CHATSWORTH, CA. FILED 1-23-2003.



FOR INTERNET WEBSITE THAT FEATURES ADVERTISEMENTS FOR THE GOODS AND SERVICES OF ILLUSTRATORS, PHOTOGRAPHERS, PRINT AND WEB DESIGNERS, AS WELL AS OTHER CREATIVES (U.S. CLS. 100, 101 AND 102).

SN 78-206,963. BINNEY & SMITH PROPERTIES, INC., EASTON, PA. FILED 1-24-2003.

THE CRAYOLA KIDS CLUB AT THE CRAYOLA FACTORY

OWNER OF U.S. REG. NOS. 1,925,419, 1,927,668 AND 2,044,830.

FOR ADMINISTRATION OF A DISCOUNT PROGRAM FOR ENABLING PARTICIPANTS TO OBTAIN DISCOUNTS ON GOODS AND SERVICES THROUGH USE OF A DISCOUNT MEMBERSHIP CARD (U.S. CLS. 100, 101 AND 102).

SN 78-207,020. ARORA, NIGAM, INDIANAPOLIS, IN. FILED 1-24-2003.

REACH THE NEXT LEVEL

FOR BUSINESS MANAGEMENT (U.S. CLS. 100, 101 AND 102).

FIRST USE 4-1-2002; IN COMMERCE 4-1-2002.

CLASS 35—(Continued).

SN 78-207,151. MONKEY'S TRUNK, INC., WEST OCEAN CITY, MD. FILED 1-25-2003.

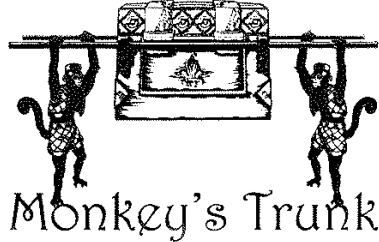

FOR RETAIL GIFT SHOPS (U.S. CLS. 100, 101 AND 102).

SN 78-207,297. HAMMERSTEIN, BRIAN, PALO ALTO, CA. FILED 1-27-2003.

IVCA

FOR PERFORMING BUSINESS RESEARCH, COMPILING STATISTICAL DATA FOR BUSINESS PURPOSES, AND PROVIDING BUSINESS INFORMATION, NAMELY, PROVIDING INFORMATION ABOUT VENTURE CAPITAL SOURCES AND OPPORTUNITIES FOR HIGH TECHNOLOGY COMPANIES AND PRIVATE EQUITY FIRMS (U.S. CLS. 100, 101 AND 102).

SN 78-207,725. GREEN, GEORGE M, ARGYLE, TX. FILED 1-28-2003.



NO CLAIM IS MADE TO THE EXCLUSIVE RIGHT TO USE "HOME IMPROVEMENT COORDINATORS", APART FROM THE MARK AS SHOWN.

FOR REFERRAL SERVICES FOR GENERAL BUILDING CONTRACTORS FOR PURPOSES OF PERFORMING HOME IMPROVEMENTS (U.S. CLS. 100, 101 AND 102).

SN 78-208,115. DIVORCE FINANCIAL CONSULTANTS, LLC, STERLING, VA. FILED 1-28-2003.

NEUTRAL.FACTUAL.ESSENTIAL.

FOR IMPARTIAL, FINANCIAL ANALYSIS SERVICES FOR DIVORCE SETTLEMENTS (U.S. CLS. 100, 101 AND 102).

CLASS 35—(Continued).

SN 78-208,336. CALIFORNIA MILK PROCESSOR BOARD, BERKELEY, CA. FILED 1-29-2003.

STRENGTH COMES FROM WITHIN

FOR ASSOCIATION SERVICES PROVIDED TO MILK PROCESSORS, NAMELY, ADVERTISING AND PROMOTING THE SALE AND USE OF MILK (U.S. CLS. 100, 101 AND 102).

SN 78-208,373. TOPSAIL GROUP, L.L.C., STAMFORD, CT. FILED 1-29-2003.

TOPSAIL

FOR BUSINESS MARKETING CONSULTING SERVICES (U.S. CLS. 100, 101 AND 102).

SN 78-208,383. STANLEY FURNITURE COMPANY, INC., STANLEYTOWN, VA. FILED 1-29-2003.

YOUNG AMERICA SHOPS

NO CLAIM IS MADE TO THE EXCLUSIVE RIGHT TO USE "AMERICA" OR "SHOPS", APART FROM THE MARK AS SHOWN.

FOR RETAIL STORE SERVICES FEATURING BEDROOM FURNITURE FOR CHILDREN (U.S. CLS. 100, 101 AND 102).

SN 78-208,424. THE HOMECARD COMPANY, INC., RO-WAYTON, CT. FILED 1-29-2003.

HOMECARD

OWNER OF U.S. REG. NO. 2,292,969.
FOR PROMOTING THE SALE OF CREDIT CARD ACCOUNTS THROUGH THE ADMINISTRATION OF INCENTIVE AWARD PROGRAMS; PROMOTING THE SALE OF GOODS AND SERVICES OF OTHERS BY AWARDED PURCHASE POINTS FOR CREDIT CARD USE (U.S. CLS. 100, 101 AND 102).

CLASS 35—(Continued).

SN 78-208,564. EURO-RODS, INC., WEST PALM BEACH, FL. FILED 1-29-2003.



FOR DISTRIBUTORSHIPS IN THE FIELD OF MOTOR-CYCLE CONNECTING RODS AND CRANKSHAFT COMPONENTS, NAMELY, CONNECTING RODS, BEARINGS, CRANK PINS, AND THRUST WASHERS (U.S. CLS. 100, 101 AND 102).

FIRST USE 5-1-2000; IN COMMERCE 5-1-2000.

SN 78-208,590. ONE SOURCE INDUSTRIES, LLC, IRVINE, CA. FILED 1-29-2003.

THEFTBUSTER

FOR RETAIL MERCHANDISE PACKAGING SERVICES (U.S. CLS. 100, 101 AND 102).

FIRST USE 8-1-2002; IN COMMERCE 9-12-2002.

SN 78-208,912. GAINSHARE MEDIA L.L.C., BOSTON, MA. FILED 1-30-2003.

PROVIDING RESULTS THROUGH VISIBILITY

FOR ARRANGING AND CONDUCTING TRADE SHOWS, BUSINESS CONFERENCES, AND EXHIBITIONS FOR MANUFACTURERS AND DISTRIBUTORS OF CONSUMER AND INDUSTRIAL PRODUCTS AND SERVICES (U.S. CLS. 100, 101 AND 102).

SN 78-208,922. GAINSHARE MEDIA L.L.C., BOSTON, MA. FILED 1-30-2003.

GAINSHARE MEDIA

NO CLAIM IS MADE TO THE EXCLUSIVE RIGHT TO USE "MEDIA", APART FROM THE MARK AS SHOWN.

FOR ARRANGING AND CONDUCTING BUSINESS TRADESHOWS, CONFERENCES, EXHIBITS FOR MANUFACTURERS AND DISTRIBUTORS OF CONSUMER AND INDUSTRIAL PRODUCTS AND SERVICES (U.S. CLS. 100, 101 AND 102).

CLASS 35—(Continued).

SN 78-209,022. MIRANDA, ROBIN, NEWARK, CA. FILED 1-30-2003.

PROFICIUM

FOR WHOLESALE DISTRIBUTORSHIP SERVICES IN THE FIELD OF STRUCTURED CABLING SYSTEMS PRODUCTS FOR THE TRANSMISSION OF VOICE, VIDEO, DATA, SECURITY, REMOTE AND LOCAL POWER MONITORING APPLICATIONS. (U.S. CLS. 100, 101 AND 102).

SN 78-209,510. THE AMERICAN GEM TRADE ASSOCIATION, INC., DALLAS, TX. FILED 1-31-2003.

AGTA

OWNER OF U.S. REG. NOS. 2,381,326 AND 2,572,618.
FOR TRADE ASSOCIATION SERVICES, NAMELY, PROMOTING THE INTERESTS OF MEMBER WHOLESALE MANUFACTURERS, SUPPLIERS, AND DEALERS OF NATURAL COLORED GEMSTONES, PEARLS, AND CULTURED PEARLS; SPONSORING, PRODUCING, CONDUCTING, PROMOTING, SCHEDULING, MANAGING, COORDINATING AND ARRANGING TRADE SHOWS FOR THE GEM AND JEWELRY INDUSTRY (U.S. CLS. 100, 101 AND 102).

FIRST USE 0-0-1981; IN COMMERCE 0-0-1981.

SN 78-210,346. UNCLE ZACH'S EARTH FRIENDLY, LLC, PORTLAND, OR. FILED 2-3-2003.

UNCLE ZACH'S

"UNCLE ZACH" DOES NOT IDENTIFY A LIVING INDIVIDUAL.

FOR RETAIL STORE SERVICES FEATURING A WIDE VARIETY OF CONSUMER GOODS OF OTHERS; RETAIL STORE SERVICES FEATURING CLOTHING, CLOTHING ACCESSORIES, FOOTWEAR, BAGS AND TOTES, BED, BATH, AND KITCHEN LINENS, BABY CLOTHING AND FOOTWEAR, AND COFFEE; ON-LINE RETAIL STORE SERVICES FEATURING CLOTHING, CLOTHING ACCESSORIES, FOOTWEAR, BAGS AND TOTES, BED, BATH, AND KITCHEN LINENS, BABY CLOTHING, DIAPERS, AND FOOTWEAR, AND COFFEE (U.S. CLS. 100, 101 AND 102).

FIRST USE 12-0-1999; IN COMMERCE 12-0-1999.

SN 78-211,956. M. MITCHENER, INC., PALMDALE, CA. FILED 2-6-2003.

SUNFLORIST

FOR RECEIVING ORDERS FOR FLOWERS AND FLORAL PRODUCTS AND CAUSING THEM TO BE FILLED BY PARTICIPATING FLORISTS IN THE VICINITY OF THE RECIPIENT, RETAIL STORE SERVICES IN THE FIELD OF FLOWERS AND PLANTS (U.S. CLS. 100, 101 AND 102).

CLASS 35—(Continued).

SN 78-212,631. FULLTRONIC, LLC., GERMANTOWN, MD.
FILED 2-9-2003.

TRAVELXIA.COM

FOR BUSINESS CONSULTING AND MANAGEMENT SERVICES IN THE FIELD OF TRAVEL, TRAVEL PLANNING AND THE OPERATION OF TRAVEL RELATED BUSINESS; ON-LINE RETAIL STORE SERVICES FEATURING TRAVEL RELATED GOODS AND SERVICES; RETAIL STORE SERVICES FEATURING TRAVEL RELATED GOODS AND SERVICES. (U.S. CLS. 100, 101 AND 102).

SN 78-213,583. LURIE, STEPHEN M., OLD GREENWICH, CT.
FILED 2-11-2003.

MWB MUSIC AND MEDIA

NO CLAIM IS MADE TO THE EXCLUSIVE RIGHT TO USE "MUSIC AND MEDIA", APART FROM THE MARK AS SHOWN.

FOR RETAIL AND ON-LINE WHOLESALE STORE SERVICES IN THE FIELD OF RECORDS, TAPES, COMPACT DISCS, DIGITAL VERSATILE DISCS, VIDEOS, AND CD-ROMS (U.S. CLS. 100, 101 AND 102).

CLASS 36—INSURANCE AND FINANCIAL

SN 75-769,496. WEBMONEY CORPORATION, SHINAGAWA-KU, 141-0021 TOKYO, JAPAN, BY ASSIGNMENT I 4 CORPORATION, SHINAGAWA-KU, TOKYO 141-8670, JAPAN, FILED 8-6-1999.

WEB MONEY

PRIORITY CLAIMED UNDER SEC. 44(D) ON JAPAN APPLICATION NO. 11-10134, FILED 2-8-1999.

FOR PROVIDING SETTLEMENT SERVICES FOR TRANSACTIONS CONDUCTED ON THE GLOBAL COMPUTER NETWORK; TRANSACTIONS INVOLVING PREPAID CONSUMER MERCHANDISE; FOREIGN EXCHANGES, NAMELY PROVIDING CURRENCY EXCHANGE SERVICES IN CONNECTION WITH INTERNATIONALLY CONDUCTED TRANSACTIONS VIA GLOBAL COMPUTER NETWORKS (U.S. CLS. 100, 101 AND 102).

CLASS 36—(Continued).

SN 75-909,939. UMBRELLABANK FSB, WESTMONT, IL. BY CHANGE OF NAME ARGO FEDERAL SAVINGS BANK, SUMMIT, IL. FILED 2-4-2000.



THE MARK CONSISTS OF THE COLORS YELLOW AND PURPLE FOR THE DESIGN OF THE UMBRELLA AND THE COLOR PURPLE FOR THE WORD "UMBRELLABANK". FOR FINANCIAL SERVICES, NAMELY, BANKING, PERSONAL AND COMMERCIAL LENDING, FINANCIAL PLANNING, FINANCIAL MANAGEMENT, BILL PAYMENT, AUTOMATIC TELLER MACHINES, MORTGAGE BROKERAGE, MORTGAGE LENDING, CREDIT CARD SERVICES, INSURANCE BROKERAGE SERVICES, AND INVESTMENT ADVISORY AND BROKERAGE SERVICES OFFERED AND RENDERED THROUGH GLOBAL COMMUNICATIONS NETWORKS (U.S. CLS. 100, 101 AND 102).

SN 76-031,557. FOUNDERS BANK, WORTH, IL. FILED 4-21-2000.



OWNER OF U.S. REG. NOS. 2,392,568, 2,392,569 AND 2,394,830.

NO CLAIM IS MADE TO THE EXCLUSIVE RIGHT TO USE "BANK", APART FROM THE MARK AS SHOWN.

FOR BANKING SERVICES; AND FINANCIAL SERVICES, NAMELY ESTATE TRUST MANAGEMENT AND TRUST INVESTMENT AND TRUST COMPANY SERVICES (U.S. CLS. 100, 101 AND 102).

FIRST USE 4-0-1998; IN COMMERCE 4-0-1998.

SN 76-126,629. LARRY KINLIN & ASSOCIATES INC., LONDON, ONTARIO N6J 2N6, CANADA, FILED 9-8-2000.

KINSURE

PRIORITY CLAIMED UNDER SEC. 44(D) ON CANADA APPLICATION NO. 1,049,708, FILED 3-8-2000, REG. NO. TMA580,296, DATED 4-30-2003, EXPIRES 4-20-2018.

FOR INSURANCE ADMINISTRATION AND INSURANCE BROKERAGE (U.S. CLS. 100, 101 AND 102).

CLASS 36—(Continued).

SN 76-152,169. EASYTEL, WOODLAND HILLS, CA. FILED 10-23-2000.

NO DRAWING-SENSORY MARK

THE MARK CONSISTS OF A FEMININE VOICE SAYING THE WORDS, "YOU'VE GOT CASH."

FOR NOTIFICATION SERVICE THAT FUNDS HAVE BEEN DEPOSITED INTO RECIPIENT'S ACCOUNT, NAMELY A BANK ACCOUNT, CHECKING ACCOUNT, ELECTRONIC COMMERCE ACCOUNT, CREDIT/DEBIT CARD ACCOUNT, SAID NOTIFICATION BEING TELEPHONIC OR THROUGH A WORLD WIDE COMPUTER NETWORK (U.S. CLS. 100, 101 AND 102).

FIRST USE 9-1-1999; IN COMMERCE 9-1-1999.

CLASS 36—(Continued).

SN 76-205,908. NEW FRONTIER BANCSHARES, INC., ST. CHARLES, MO. FILED 2-6-2001.



OWNER OF U.S. REG. NO. 2,493,354.

NO CLAIM IS MADE TO THE EXCLUSIVE RIGHT TO USE "BANK" AND "ST. CHARLES COUNTY", APART FROM THE MARK AS SHOWN.

THE DRAWING IS LINED FOR THE COLOR(S) ORANGE, PINK, BLUE AND GREEN.

FOR BANKING SERVICES (U.S. CLS. 100, 101 AND 102).

FIRST USE 9-1-2000; IN COMMERCE 9-1-2000.

SN 76-182,637. FIRST NATIONAL BANK OF OMAHA, OMAHA, NE. FILED 12-18-2000.

FIRST NATIONAL MERCHANT SOLUTIONS

NO CLAIM IS MADE TO THE EXCLUSIVE RIGHT TO USE "MERCHANT SOLUTIONS", APART FROM THE MARK AS SHOWN.

SEC. 2(F) AS TO "FIRST NATIONAL".

FOR CREDIT CARD TRANSACTION PROCESSING SERVICES (U.S. CLS. 100, 101 AND 102).

FIRST USE 4-15-2002; IN COMMERCE 4-15-2002.

SN 76-213,514. LUCKY COMMUNICATIONS INC, SAN FRANCISCO, CA. FILED 2-22-2001.



NO CLAIM IS MADE TO THE EXCLUSIVE RIGHT TO USE "COMM", APART FROM THE MARK AS SHOWN.

THE MARK CONSISTS OF BRIGHT RED LETTERS UNDERLINED WITH A BLUE LINE ENDING IN A BLUE DOT.

FOR DOMESTIC AND INTERNATIONAL LONG DISTANCE TELEPHONE CALLING CARD SERVICES (U.S. CLS. 100, 101 AND 102).

FIRST USE 7-0-2000; IN COMMERCE 7-0-2000.

SN 76-197,677. ICAFS, INC., RICHMOND, VA. FILED 1-22-2001.



FOR PROVIDING INFORMATION TO OTHERS REGARDING THE AVAILABILITY OF APARTMENT UNITS, NAMELY, THE LEASING AND MANAGEMENT THEREOF (U.S. CLS. 100, 101 AND 102).

FIRST USE 1-0-2000; IN COMMERCE 1-0-2000.

SN 76-234,786. ONEPOINTCITY, L.L.C., NORWALK, OH. FILED 4-3-2001.



FOR PROVIDING A REAL ESTATE TRANSACTION MANAGEMENT WEBSITE ON THE GLOBAL INFORMATION NETWORK FOR CONNECTING USERS WITH THEIR SPECIFIED REAL ESTATE CLIENTS, VENDORS, AGENCIES AND BUSINESS PARTNERS IN ORDER TO PROVIDE REAL ESTATE INFORMATION, ENABLING PARTICIPANTS TO PLACE, TRACK AND ARCHIVE ORDERS FOR CONSUMER AND BUSINESS FINANCIAL CREDIT REPORTS, REAL ESTATE APPRAISALS, FINANCIAL VALUATION OF PERSONAL PROPERTY AND REAL ESTATE PROPERTY, REAL ESTATE CLOSING REPORTS, REAL ESTATE TITLE REPORTS, REAL ESTATE ESCROW DOCUMENTS, REAL ESTATE CERTIFICATION OF FLOOD ZONE LOCATION (U.S. CLS. 100, 101 AND 102).

FIRST USE 6-1-2001; IN COMMERCE 6-1-2001.

CLASS 36—(Continued).

SN 76-245,817. ERIE INSURANCE EXCHANGE, ERIE, PA. FILED 4-25-2001.

ERIEXPRESSPAY

OWNER OF U.S. REG. NOS. 1,335,915 AND 1,335,916. FOR ELECTRONIC FUND TRANSFER SERVICES FOR PAYMENT OF INSURANCE PREMIUMS (U.S. CLS. 100, 101 AND 102).
FIRST USE 7-1-2001; IN COMMERCE 7-1-2001.

SN 76-315,582. KEYCORP, CLEVELAND, OH. FILED 9-21-2001.

KEY EXPRESS CHECKING

OWNER OF U.S. REG. NOS. 1,495,327, 1,946,742 AND OTHERS.

NO CLAIM IS MADE TO THE EXCLUSIVE RIGHT TO USE "EXPRESS CHECKING", APART FROM THE MARK AS SHOWN.

FOR FINANCIAL SERVICES, NAMELY, CHECKING ACCOUNT SERVICES (U.S. CLS. 100, 101 AND 102).

SN 76-315,584. KEYCORP, CLEVELAND, OH. FILED 9-21-2001.

KEY CLASSIC CHECKING

OWNER OF U.S. REG. NOS. 1,495,327, 1,722,378 AND OTHERS.

NO CLAIM IS MADE TO THE EXCLUSIVE RIGHT TO USE "CLASSIC CHECKING", APART FROM THE MARK AS SHOWN.

FOR FINANCIAL SERVICES, NAMELY, CHECKING ACCOUNT SERVICES (U.S. CLS. 100, 101 AND 102).

SN 76-316,254. FORTIS N.V., ARCHIMEDESLAAN 6, NETHERLANDS, AND FORTIS SA/NV, BRUSSELS, BELGIUM, BY MERGER FORTIS (NL) N.V., UTRECHT3584 BA, NETHERLANDS, AND FORTIS (B), 100 BRUSSELS, BELGIUM, FILED 9-24-2001.

**FORTIS BENEFITS
ESSENTIAL INCOME
SOLUTIONS/PLANS**

NO CLAIM IS MADE TO THE EXCLUSIVE RIGHT TO USE "BENEFITS" OR "INCOME", APART FROM THE MARK AS SHOWN.

FOR INSURANCE SERVICES, NAMELY, UNDERWRITING, ADMINISTRATION AND CLAIMS PROCESSING, ALL IN CONNECTION WITH GROUP LONG-TERM DISABILITY INSURANCE (U.S. CLS. 100, 101 AND 102).

CLASS 36—(Continued).

SN 76-320,739. BSM FINANCIAL, LP, ADDISON, TX. FILED 10-4-2001.

BANKSOURCE MORTGAGE

NO CLAIM IS MADE TO THE EXCLUSIVE RIGHT TO USE "MORTGAGE", APART FROM THE MARK AS SHOWN.

FOR LOAN FINANCING, NAMELY, FINANCING HOME LOANS FOR NEW HOME PURCHASES USING BANKS TO SERVICE THE TRANSACTION; HOME MORTGAGE FINANCING AND REFINANCING; FINANCIAL SERVICES, NAMELY, HOME EQUITY LENDING (U.S. CLS. 100, 101 AND 102).

FIRST USE 2-1-2000; IN COMMERCE 2-1-2000.

SN 76-322,681. ORION PARTNERS, INC., SAN ANTONIO, TX. FILED 10-9-2001.

ORION

OWNER OF U.S. REG. NO. 1,974,896. FOR REAL ESTATE MANAGEMENT (U.S. CLS. 100, 101 AND 102).

FIRST USE 8-1-1989; IN COMMERCE 8-1-1989.

SN 76-322,682. ORION PARTNERS, INC., SAN ANTONIO, TX. FILED 10-9-2001.



OWNER OF U.S. REG. NO. 1,974,896. FOR COMMERCIAL AND RESIDENTIAL REAL ESTATE BROKERAGE; REAL ESTATE MANAGEMENT (U.S. CLS. 100, 101 AND 102).

FIRST USE 0-0-1989; IN COMMERCE 0-0-1989.

SN 76-333,335. AMERICAN INTERNATIONAL GROUP, INC., NEW YORK, NY. FILED 11-1-2001.

WEBMERCHANTGUARD

FOR INSURANCE UNDERWRITING SERVICES, NAMELY TO PROTECT INTERNET MERCHANTS AGAINST CREDIT CARD FRAUD (U.S. CLS. 100, 101 AND 102).

FIRST USE 10-8-2001; IN COMMERCE 10-8-2001.

CLASS 36—(Continued).

SN 76-334,787. INSTINET TECHNOLOGIES LIMITED PARTNERSHIP, BILLERICA, MA. BY MERGER B.D. OF NEVADA, RENO, NV. FILED 11-5-2001.

XQ TRACKER

FOR FINANCIAL SERVICES, NAMELY, FINANCIAL PLANNING, FINANCIAL MANAGEMENT, FINANCIAL ANALYSIS AND CONSULTATION, INVESTMENT AND TRADING ADVICE, INVESTMENT AND TRADING CONSULTATION, PROVIDING INFORMATION ABOUT FINANCIAL INVESTMENTS VIA AN ON-LINE GLOBAL COMMUNICATIONS NETWORK; DISTRIBUTING MANUALS AND FINANCIAL REPORTS IN CONNECTION THEREWITH (U.S. CLS. 100, 101 AND 102).

SN 76-341,892. MUTUAL OF OMAHA INSURANCE COMPANY, OMAHA, NE. FILED 11-27-2001.

EASY MIND

OWNER OF U.S. REG. NO. 1,279,218.
FOR UNDERWRITING ACCIDENTAL DEATH AND DISMEMBERMENT INSURANCE SERVICES (U.S. CLS. 100, 101 AND 102).
FIRST USE 8-27-1982; IN COMMERCE 8-27-1982.

SN 76-347,553. OTC OREGON TELCO COMMUNITY CREDIT UNION, PORTLAND, OR. FILED 12-10-2001.



FOR CREDIT UNION SERVICES FOR CREDIT UNION MEMBERS; NAMELY SAVINGS, CHECKING, RETIREMENT ACCOUNT SERVICES, PERSONAL PROPERTY, REAL PROPERTY, AND UNSECURED LOAN SERVICES, AND CREDIT CARD SERVICES (U.S. CLS. 100, 101 AND 102).
FIRST USE 4-6-2001; IN COMMERCE 4-6-2001.

CLASS 36—(Continued).

SN 76-369,990. LA FRANCAISE DES PLACEMENTS, 75016 PARIS, FRANCE, FILED 2-12-2002.

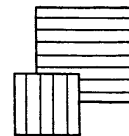

ASYMMETRICAL
Asset Management
ASYMMETRIC
Investment

PRIORITY CLAIMED UNDER SEC. 44(D) ON FRANCE APPLICATION NO. 013129985, FILED 11-7-2001, REG. NO. 013129985, DATED 11-7-2001, EXPIRES 11-7-2011.

NO CLAIM IS MADE TO THE EXCLUSIVE RIGHT TO USE "ASSET MANAGEMENT" AND "INVESTMENT", APART FROM THE MARK AS SHOWN.

THE DRAWING IS LINED FOR THE COLORS RED AND BLUE.

FOR FINANCIAL SERVICES, NAMELY FINANCIAL ANALYSIS, FINANCIAL INVESTMENTS IN THE FIELD OF REAL-ESTATE, SECURITIES, INNOVATION FINANCING, AND FINANCIAL INVESTMENT CONSULTATION; MONETARY SERVICES, NAMELY MONETARY EXCHANGE; REAL-ESTATE SERVICES, NAMELY REAL-ESTATE MANAGEMENT; BANKING; FINANCIAL INVESTMENT SERVICES; FINANCIAL SPONSORING AND PATRONAGE IN THE FIELD OF SPORTS AND LEISURE ACTIVITIES; STOCK BROKERAGE FEATURING STOCK AND SHARE MANAGEMENT (U.S. CLS. 100, 101 AND 102).

SN 76-374,196. SECURITY FINANCIAL LIFE INSURANCE COMPANY, LINCOLN, NE. FILED 2-25-2002.

ASCENTIAL LIFE

NO CLAIM IS MADE TO THE EXCLUSIVE RIGHT TO USE "LIFE", APART FROM THE MARK AS SHOWN.

FOR LIFE INSURANCE UNDERWRITING SERVICES (U.S. CLS. 100, 101 AND 102).

SN 76-376,024. MONEYTREE, INC., SEATTLE, WA. BY ASSIGNMENT MONEYTREE LENDING, INC., MODESTO, CA. FILED 3-1-2002.

MONEYTREE LENDING

NO CLAIM IS MADE TO THE EXCLUSIVE RIGHT TO USE "LENDING", APART FROM THE MARK AS SHOWN.

FOR MORTGAGE LENDING SERVICES (U.S. CLS. 100, 101 AND 102).

FIRST USE 5-0-2000; IN COMMERCE 5-0-2000.

CLASS 36—(Continued).

SN 76-386,591. ACE LIMITED, HAMILTON HM 08, BERMUDA, FILED 3-25-2002.

ARM

FOR PROPERTY AND CASUALTY INSURANCE UNDERWRITING (U.S. CLS. 100, 101 AND 102).

SN 76-386,783. REALTY SYSTEMS, INC., CHICAGO, IL. FILED 3-25-2002.



NO CLAIM IS MADE TO THE EXCLUSIVE RIGHT TO USE "REALTY SYSTEMS INC", APART FROM THE MARK AS SHOWN.

FOR LEASING OF MOBILE HOMES AND MANUFACTURED HOMES; BROKERAGE OF MOBILE HOMES AND MANUFACTURED HOMES (U.S. CLS. 100, 101 AND 102).

FIRST USE 12-0-1980; IN COMMERCE 12-0-1980.

SN 76-403,333. VITAL PROCESSING SERVICES, LLC, TEMPE, AZ. FILED 5-3-2002.

SARATOGA

FOR ELECTRONIC FINANCIAL PROCESSING SERVICES RENDERED TO MERCHANTS AND BANKS, NAMELY, CREDIT CARD TRANSACTION PROCESSING SERVICES; DEBIT CARD TRANSACTION PROCESSING SERVICES; CREDIT AND DEBIT CARD AUTHORIZATION SERVICES; ELECTRONIC PAYMENT, NAMELY, ELECTRONIC PROCESSING AND TRANSMISSION OF PAYMENT DATA; ELECTRONIC FUNDS TRANSFER SERVICES; AND INFORMATION SERVICES, NAMELY, FINANCIAL INFORMATION PROVIDED BY ELECTRONIC MEANS IN THE FIELD OF PAYMENT TRANSACTION PROCESSING (U.S. CLS. 100, 101 AND 102).

FIRST USE 10-0-2001; IN COMMERCE 10-0-2001.

CLASS 36—(Continued).

SN 76-411,569. AMERICAN INTERNATIONAL GROUP, INC., NEW YORK, NY. FILED 5-23-2002.

PATROL

FOR INSURANCE UNDERWRITING SERVICES IN THE FIELD OF GLOBAL CRISIS MANAGEMENT, PROVIDED VIA THE INTERNET (U.S. CLS. 100, 101 AND 102).

FIRST USE 4-14-2002; IN COMMERCE 4-14-2002.

SN 76-417,776. ABN AMRO NORTH AMERICA, INC., CHICAGO, IL. FILED 6-5-2002.

PORTAL FUNDS

NO CLAIM IS MADE TO THE EXCLUSIVE RIGHT TO USE "FUNDS", APART FROM THE MARK AS SHOWN.

FOR FINANCIAL SERVICES, NAMELY, OPERATING AND MANAGING FUNDS FOR OTHERS COMPRISED OF DIVERSIFIED POOLS OF PORTFOLIO FUNDS (U.S. CLS. 100, 101 AND 102).

FIRST USE 2-11-2002; IN COMMERCE 2-11-2002.

SN 76-417,781. ABN AMRO NORTH AMERICA, INC., CHICAGO, IL. FILED 6-5-2002.

PORTAL ARBITRAGE OPPORTUNITIES FUNDS

NO CLAIM IS MADE TO THE EXCLUSIVE RIGHT TO USE "ARBITRAGE OPPORTUNITIES FUNDS", APART FROM THE MARK AS SHOWN.

FOR FINANCIAL SERVICES, NAMELY, OPERATING AND MANAGING FUNDS FOR OTHERS COMPRISED OF DIVERSIFIED POOLS OF PORTFOLIO FUNDS (U.S. CLS. 100, 101 AND 102).

FIRST USE 12-31-2001; IN COMMERCE 12-31-2001.

SN 76-417,787. ABN AMRO NORTH AMERICA, INC., CHICAGO, IL. FILED 6-5-2002.

PORTAL MARKET DECISIONS FUNDS

NO CLAIM IS MADE TO THE EXCLUSIVE RIGHT TO USE "FUNDS", APART FROM THE MARK AS SHOWN.

FOR FINANCIAL SERVICES, NAMELY, OPERATING AND MANAGING FUNDS FOR OTHERS COMPRISED OF DIVERSIFIED POOLS OF PORTFOLIO FUNDS (U.S. CLS. 100, 101 AND 102).

FIRST USE 12-31-2001; IN COMMERCE 12-31-2001.

CLASS 36—(Continued).

SN 76-418,155. AGSTAR FINANCIAL SERVICES, ACA, MANKATO, MN. FILED 6-10-2002.

AGRI-ACCESS

OWNER OF U.S. REG. NO. 2,407,099.
FOR BANKING AND FINANCIAL SERVICES OFFERED TO CORRESPONDENT BANKS AND OTHER FINANCIAL INSTITUTIONS BY A GLOBAL COMPUTER NETWORK, NAMELY PROVIDING AGRICULTURAL LOANS AND LEASES, AGRICULTURAL LOAN FINANCING, AND AGRICULTURAL AND RESIDENTIAL MORTGAGE LENDING (U.S. CLS. 100, 101 AND 102).

SN 76-423,059. THE GLOBAL FUND FOR WOMEN, SAN FRANCISCO, CA. FILED 6-20-2002.



GLOBAL FUND
FOR WOMEN

OWNER OF U.S. REG. NOS. 1,942,123, 2,174,624 AND 2,174,625.

NO CLAIM IS MADE TO THE EXCLUSIVE RIGHT TO USE "FUND FOR WOMEN", APART FROM THE MARK AS SHOWN.

FOR ELEEMOSYNARY SERVICES IN THE FIELD OF MONETARY DONATIONS FOR ORGANIZATIONS WHICH PROMOTE THE WELL-BEING OF WOMEN (U.S. CLS. 100, 101 AND 102).

FIRST USE 1-0-2001; IN COMMERCE 1-0-2001.

SN 76-424,132. LIBERTY PROPERTY LIMITED PARTNERSHIP, MALVERN, PA. FILED 6-24-2002.

LIBERTY PROPERTY TRUST

NO CLAIM IS MADE TO THE EXCLUSIVE RIGHT TO USE "PROPERTY TRUST", APART FROM THE MARK AS SHOWN.

FOR REAL ESTATE SERVICES, NAMELY, THE MANAGEMENT, ACQUISITION, DEVELOPMENT AND LEASING OF COMMERCIAL REAL ESTATE (U.S. CLS. 100, 101 AND 102).

FIRST USE 6-1-1994; IN COMMERCE 6-1-1994.

CLASS 36—(Continued).

SN 76-426,232. JULIUS BAR HOLDING AG, 8001 ZURICH, SWITZERLAND, FILED 6-13-2002.

JULIUS BÄR

OWNER OF SWITZERLAND REG. NO. 478,291, DATED 5-10-2000, EXPIRES 5-10-2010.

OWNER OF U.S. REG. NO. 1,967,924.
THE NAME IN THE MARK "JULIUS BAR" DOES NOT IDENTIFY A LIVING INDIVIDUAL.

FOR BANKING AND FINANCIAL SERVICES, NAMELY, PORTFOLIO MANAGEMENT, INVESTMENT ADVICE SERVICES, COMMODITY TRADING FOR OTHERS, FOREIGN EXCHANGE SERVICES, BROKERAGE IN THE FIELDS OF ART, INSURANCE, STOCKS, BONDS, AND COMMODITIES; INVESTMENT FUND SERVICES; INVESTMENTS MANAGEMENT; MERGER LOAN FINANCING; MORTGAGE BANKING SERVICES, FINANCIAL INVESTMENT IN THE FIELD OF STOCKS, BONDS, INTERNATIONAL SHORT TERM MONEY, MARKET FUNDS, AND PRECIOUS METALS; FINANCIAL CONSULTING; FINANCIAL ANALYSIS; FINANCIAL INFORMATION PROVIDED BY ELECTRONIC MEANS; PROVIDING PRINTED FINANCIAL MATERIALS AND PERSONAL FINANCIAL CONSULTATION; SAFE DEPOSIT BOX SERVICES; FIDUCIARY REPRESENTATIVES; AND REAL ESTATE BROKERAGE (U.S. CLS. 100, 101 AND 102).

FIRST USE 9-2-1996; IN COMMERCE 9-2-1996.

SN 76-427,953. TOSH, INC., PROVO, UT. FILED 7-8-2002.

CHECK CITY

NO CLAIM IS MADE TO THE EXCLUSIVE RIGHT TO USE "CHECK", APART FROM THE MARK AS SHOWN.

FOR FINANCIAL SERVICES, NAMELY ELECTRONIC FUNDS TRANSFER, MONEY ORDERS, LENDING OF MONEY, CHECK CASHING SERVICES AND PAYDAY LOAN ADVANCE SERVICES (U.S. CLS. 100, 101 AND 102).

FIRST USE 5-0-1994; IN COMMERCE 5-0-1994.

SN 76-429,128. BIG D APARTMENTS, DALLAS, TX. FILED 7-11-2002.

BIG D APARTMENTS

NO CLAIM IS MADE TO THE EXCLUSIVE RIGHT TO USE "APARTMENTS", APART FROM THE MARK AS SHOWN.

FOR APARTMENT LOCATING SERVICES FOR OTHERS (U.S. CLS. 100, 101 AND 102).

FIRST USE 4-0-2002; IN COMMERCE 5-0-2002.

CLASS 36—(Continued).

SN 76-432,859. TIME4 MEDIA, INC., NEW YORK, NY. FILED 7-22-2002.

POPULAR SCIENCE

OWNER OF U.S. REG. NOS. 636,827, 2,366,226 AND OTHERS.

SEC. 2(F).
FOR FINANCIAL SPONSORSHIP OF COMPETITIONS IN THE FIELD OF SCIENCE, TECHNOLOGY, ARTS, CULTURE AND SPORTS (U.S. CLS. 100, 101 AND 102).

SN 76-433,007. ING USA HOLDING CORPORATION, WILMINGTON, DE. FILED 7-19-2002.

SAVE@WORK

FOR FINANCIAL SERVICES NAMELY FINANCIAL CONSULTATION, FINANCIAL MANAGEMENT, FINANCIAL PLANNING, FINANCIAL INFORMATION PROVIDED BY ELECTRONIC MEANS, ELECTRONIC PROCESSING AND TRANSMISSION OF BILL PAYMENT DATA, FINANCIAL INFORMATION IN THE NATURE OF RATES OF EXCHANGE, CREDIT, DEBIT AND STORED VALUE CARD AND ELECTRONIC TRANSACTION SERVICES, LOAN FINANCING SERVICES; BANKING SERVICES; BANKING SERVICES OFFERED OVER A GLOBAL COMPUTER NETWORK; MUTUAL FUND SERVICES; MORTGAGE LENDING AND BROKERAGE SERVICES; MORTGAGE BANKING; MORTGAGE LOANS, HOME EQUITY LOANS; AUTO LOANS; SAVINGS ACCOUNT SERVICES; SECURITIES BROKERAGE SERVICES (U.S. CLS. 100, 101 AND 102).

SN 76-433,452. HOME SAVINGS MORTGAGE, OXNARD, CA. FILED 7-22-2002.



NO CLAIM IS MADE TO THE EXCLUSIVE RIGHT TO USE "HOME SAVINGS MORTGAGE", APART FROM THE MARK AS SHOWN.

THE STIPPLING IS FOR SHADING PURPOSES ONLY.
THE MARK CONSISTS OF THE WORDS "HOME SAVINGS" IN NAVY BLUE AND THE WORD "MORTGAGE" IN GOLD. THE WORD "MORTGAGE" SITS BELOW THE WORD "SAVINGS" AND IS APPROXIMATELY ONE-HALF THE SIZE OF THE WORDS "HOME SAVINGS". THE WORD "HOME" IS PARTIALLY ENCLOSED WITHIN A GRAPHICAL REPRESENTATION OF A HOME WHICH ALSO WRAPS AROUND AND UNDERSCORES THE WORD "HOME" AND A PORTION OF THE WORD "SAVINGS". THE GRAPHICAL REPRESENTATION OF THE HOME BLEEDS FROM NAVY BLUE TO GOLD AS IT APPROACHES AND INTERSECTS WITH THE WORD "MORTGAGE". THE GRAPHICAL REPRESENTATION OF THE HOME IS TOPPED BY A GOLD SUNBURST.

FOR MORTGAGE LENDING (U.S. CLS. 100, 101 AND 102).

FIRST USE 4-3-2002; IN COMMERCE 4-3-2002.

CLASS 36—(Continued).

SN 76-436,365. STRATEGIES FOR PHILANTHROPY LLC, MILWAUKEE, WI. FILED 7-30-2002.

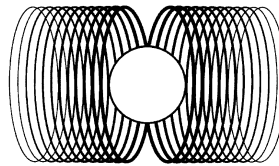

**STRATEGIES FOR
PHILANTHROPY**
VISION • FOCUS • ACTION

NO CLAIM IS MADE TO THE EXCLUSIVE RIGHT TO USE "STRATEGIES FOR PHILANTHROPY", APART FROM THE MARK AS SHOWN.

THE SPIRAL DESIGNS, THE OUTLINE OF THE SPHERE IN THE CENTER OF THE DESIGN, AND THE WORDS "STRATEGIES FOR PHILANTHROPY" ARE PURPLE, PANTONE MATCHING SYSTEM NUMBER 249CVU; THE INTERIOR OF CIRCLE IN MIDDLE OF THE DESIGN IS A CENTERED RADIAL GRADIENT IN SHADES OF BLUE TO WHITE, PANTONE MATCHING SYSTEM NUMBERS 249 AND 299. THE WORDS "VISION", "FOCUS" AND "ACTION" ARE ALSO BLUE, PANTONE MATCHING SYSTEM NUMBER 299CVU.

FOR CHARITABLE FUND RAISING CONSULTATION SERVICES TO INDIVIDUALS AND FOUNDATIONS REGARDING PHILANTHROPIC GIFTS; AND CHARITABLE FUND RAISING CONSULTATION SERVICES TO NONPROFIT CORPORATIONS REGARDING STRATEGIC PLANNING FOR INCREASING REVENUES (U.S. CLS. 100, 101 AND 102).

SN 76-444,129. CCCS OF FORSYTH COUNTY, INC., WINSTON-SALEM, NC. FILED 8-22-2002.

SFC

FOR FINANCIAL MANAGEMENT SERVICES, NAMELY, MANAGEMENT OF MONTHLY EXPENSES FOR OTHERS; BILL PAYMENT SERVICES; DEBT COUNSELING SERVICES; CREDIT COUNSELING SERVICES; AND CONSULTATION SERVICES RELATED TO HEALTH INSURANCE (U.S. CLS. 100, 101 AND 102).

FIRST USE 1-0-1996; IN COMMERCE 1-0-1996.

SN 76-446,074. SOVEREIGN MILITARY HOSPITALLER ORDER OF SAINT JOHN OF JERUSALEM OF RHODES AND OF MALTA, ROME, ITALY, FILED 9-3-2002.

**SOVEREIGN ORDER OF
MALTA**

NO CLAIM IS MADE TO THE EXCLUSIVE RIGHT TO USE "ORDER", APART FROM THE MARK AS SHOWN.

FOR CHARITABLE SERVICES, NAMELY, FUND RAISING FOR AND PROVIDING GRANTS TO DOMESTIC AND INTERNATIONAL HUMANITARIAN, HOSPITALLER, MEDICAL, RELIGIOUS, AND DIPLOMATIC CAUSES (U.S. CLS. 100, 101 AND 102).

FIRST USE 1-1-1700; IN COMMERCE 12-31-1926.

CLASS 36—(Continued).

SN 76-447,213. GARELL, JEFFREY, IRVINE, CA. FILED 9-6-2002.

SILVERSAGE ADVISORS

NO CLAIM IS MADE TO THE EXCLUSIVE RIGHT TO USE "ADVISORS", APART FROM THE MARK AS SHOWN. FOR FINANCIAL PLANNING SERVICES (U.S. CLS. 100, 101 AND 102).

SN 76-448,675. IN TOUCH MINISTRIES, INC., ATLANTA, GA. FILED 9-11-2002.

THE ACTS CHALLENGE

FOR CHARITABLE FUND RAISING (U.S. CLS. 100, 101 AND 102).
FIRST USE 8-27-2001; IN COMMERCE 8-27-2001.

SN 76-449,360. EMPIRE GENERAL LIFE ASSURANCE CORPORATION, OVERLAND PARK, KS. FILED 9-13-2002.

IQI INTERNET QUICK ISSUE

NO CLAIM IS MADE TO THE EXCLUSIVE RIGHT TO USE "INTERNET QUICK ISSUE", APART FROM THE MARK AS SHOWN. FOR UNDERWRITING LIFE INSURANCE (U.S. CLS. 100, 101 AND 102).
FIRST USE 9-3-2002; IN COMMERCE 9-3-2002.

SN 76-449,906. LOUISIANA MEDICAL MUTUAL INSURANCE COMPANY, METAIRIE, LA. FILED 9-16-2002.

LAMMICO

FOR INSURANCE ADMINISTRATION IN THE FIELD OF PROFESSIONAL LIABILITY AND MEDICAL MALPRACTICE (U.S. CLS. 100, 101 AND 102).

SN 76-450,474. LOUISIANA MEDICAL MUTUAL INSURANCE COMPANY, METAIRIE, LA. FILED 9-16-2002.

LAMMICO

FOR INSURANCE ADMINISTRATION IN THE FIELD OF PROFESSIONAL LIABILITY AND MEDICAL MALPRACTICE (U.S. CLS. 100, 101 AND 102).
FIRST USE 8-16-1981; IN COMMERCE 8-16-1981.

CLASS 36—(Continued).

SN 76-450,901. GUGGENHEIM BROTHERS, NEW YORK, NY. FILED 9-13-2002.

GUGGENHEIM BROTHERS

NO CLAIM IS MADE TO THE EXCLUSIVE RIGHT TO USE "BROTHERS", APART FROM THE MARK AS SHOWN. SEC. 2(F).

FOR PROVIDING INFORMATION AND ADVICE IN THE FIELDS OF FINANCE, ASSET MANAGEMENT AND INVESTMENT; FINANCIAL INVESTMENT IN THE FIELDS OF SECURITIES, REAL ESTATE AND VENTURE CAPITAL BUSINESSES; INVESTMENT MANAGEMENT AND ASSET MANAGEMENT SERVICES; AND INVESTMENT OF FUNDS FOR OTHERS (U.S. CLS. 100, 101 AND 102).
FIRST USE 0-0-1951; IN COMMERCE 0-0-1951.

SN 76-450,922. THE PET SAVERS FOUNDATION, INC., STATEN ISLAND, NY. FILED 9-16-2002.

POWERPET

FOR CHARITABLE FUND RAISING SERVICES IN THE NATURE OF SWEEPSTAKES, DIRECT MAIL SOLICITATIONS, AND CONTESTS (U.S. CLS. 100, 101 AND 102).

SN 76-451,268. CALDWELL & ORKIN, INC., NORCROSS, GA. FILED 9-19-2002.

CALDWELL & ORKIN

FOR INVESTMENT MANAGEMENT, INVESTMENT ADVICE, MUTUAL FUND INVESTMENT, FINANCIAL PLANNING AND INVESTMENT MANAGEMENT AND CONSULTATION (U.S. CLS. 100, 101 AND 102).
FIRST USE 6-28-1982; IN COMMERCE 6-28-1982.

SN 76-451,785. GMAC COMMERCIAL MORTGAGE CORPORATION, HORSHAM, PA. FILED 9-18-2002.

INVESTOR QUERY

NO CLAIM IS MADE TO THE EXCLUSIVE RIGHT TO USE "INVESTOR", APART FROM THE MARK AS SHOWN. SEC. 2(F).

FOR FINANCIAL SERVICES, NAMELY, PROVIDING INFORMATION ABOUT LOANS FOR INVESTORS, POSSIBLE INVESTORS AND TRUSTEES (U.S. CLS. 100, 101 AND 102).

FIRST USE 1-0-1998; IN COMMERCE 1-0-1998.

CLASS 36—(Continued).

SN 76-457,221. BANK ONE CORPORATION, CHICAGO, IL. FILED 10-9-2002.

BANK ONE PRIME PLATINUM

OWNER OF U.S. REG. NOS. 2,457, 1,812,388 AND OTHERS.

NO CLAIM IS MADE TO THE EXCLUSIVE RIGHT TO USE "BANK" AND "PRIME PLATINUM", APART FROM THE MARK AS SHOWN.

FOR BANKING AND BANK RELATED FINANCIAL SERVICES (U.S. CLS. 100, 101 AND 102).

SN 76-458,673. THE MILLS LIMITED PARTNERSHIP, ARLINGTON, VA. FILED 10-10-2002.

THERE'S JUST MORE AT THE MILLS

FOR SHOPPING CENTER SERVICES AND LEASING OF SHOPPING MALL SPACE (U.S. CLS. 100, 101 AND 102).

SN 76-458,995. RESMARK EQUITY PARTNERS, LLC, LOS ANGELES, CA. BY CHANGE OF NAME OLYMPIC REALTY ADVISORS II, LLC, LOS ANGELES, CA. FILED 10-17-2002.

INVESTING IN BUILDING RELATIONSHIPS

FOR REAL ESTATE AND FINANCIAL SERVICES, NAMELY, PROVIDING INVESTMENT AND FINANCIAL SERVICES RELATED TO REAL ESTATE DEVELOPMENT (U.S. CLS. 100, 101 AND 102).

FIRST USE 11-11-2002; IN COMMERCE 11-11-2002.

SN 76-459,116. D. E. SHAW & CO., L.P., NEW YORK, NY. FILED 10-9-2002.

RAZOR

FOR INVESTMENT ADVICE; INVESTMENT MANAGEMENT (U.S. CLS. 100, 101 AND 102).

FIRST USE 9-0-2000; IN COMMERCE 9-0-2000.

CLASS 36—(Continued).

SN 76-461,759. TRANSPLATINUM SERVICE CORP., NASHVILLE, TN. FILED 10-25-2002.

OUR WAY IS THE HIGHWAY

FOR FINANCIAL SERVICES FOR THE TRANSPORTATION INDUSTRY, NAMELY PROVIDING CREDIT CARD SERVICES (U.S. CLS. 100, 101 AND 102).

FIRST USE 4-1-2002; IN COMMERCE 4-1-2002.

SN 76-464,155. TERRABELLA REALTY, LLC, NORTH MIAMI BEACH, FL. FILED 11-5-2002.

TERRABELLA REALTY

NO CLAIM IS MADE TO THE EXCLUSIVE RIGHT TO USE "REALTY", APART FROM THE MARK AS SHOWN.

FOR REAL ESTATE BROKERAGE SERVICES (U.S. CLS. 100, 101 AND 102).

FIRST USE 6-0-2002; IN COMMERCE 6-0-2002.

SN 76-465,636. BB&T CORPORATION, WINSTON-SALEM, NC. FILED 11-8-2002.

EL BANCO QUE NOS APOYA

THE MARK "EL BANCO QUE NOS APOYA" IS IN THE SPANISH LANGUAGE, AND THE ENGLISH TRANSLATION OF THE MARK IS "THE BANK THAT SUPPORTS US".

FOR BANKING AND RELATED FINANCIAL SERVICES (U.S. CLS. 100, 101 AND 102).

FIRST USE 9-5-2002; IN COMMERCE 9-5-2002.

SN 76-467,089. REALTY INCOME CORPORATION, ESCONDIDO, CA. FILED 11-6-2002.

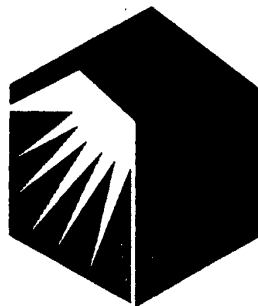

THE MARK CONSISTS OF A DRAWING OF A BUILDING WITH A SUN DESIGN. THE SUN IS WHITE, THE SIDE OF THE BUILDING WITH THE SUN DESIGN IS YELLOW, AND THE ROOF AND REMAINING PORTIONS OF THE BUILDING ARE RED.

FOR INVESTING THE FUNDS OF OTHERS IN REAL ESTATE AND MANAGING REAL ESTATE PORTFOLIOS (U.S. CLS. 100, 101 AND 102).

FIRST USE 8-15-1994; IN COMMERCE 8-15-1994.

CLASS 36—(Continued).

SN 76-468,283. PACIFIC MARINE CREDIT UNION, CAMP PENDLETON, CA. FILED 11-12-2002.

PACIFIC MARINE CREDIT UNION

NO CLAIM IS MADE TO THE EXCLUSIVE RIGHT TO USE "CREDIT UNION", APART FROM THE MARK AS SHOWN.

FOR CREDIT UNION SERVICES, CONSUMER AND COMMERCIAL LENDING SERVICES (U.S. CLS. 100, 101 AND 102).

FIRST USE 2-1-2002; IN COMMERCE 2-1-2002.

SN 76-472,977. CROWN FINANCIAL MINISTRIES, INC., GAINESVILLE, GA. FILED 12-9-2002.

FINANCIAL HOPE

NO CLAIM IS MADE TO THE EXCLUSIVE RIGHT TO USE "FINANCIAL", APART FROM THE MARK AS SHOWN.

FOR COUNSELING AND CONSULTATION IN THE FIELDS OF CONSUMER CREDIT, DEBT RECOVERY, MONEY AND DEBT MANAGEMENT, BUDGETING, PERSONAL INVESTING, AND RELIGIOUS AND BIBLICAL MONEY PRINCIPLES; DEBT REDUCTION AND CONSOLIDATION SERVICES (U.S. CLS. 100, 101 AND 102).

SN 76-475,842. STRATIS FINANCIAL CORP., HUNTINGTON BEACH, CA. FILED 12-17-2002.

SERIOUS ABOUT SERVICE

FOR MORTGAGE BROKERAGE AND FINANCIAL SERVICES IN THE FIELD OF MONEY LENDING (U.S. CLS. 100, 101 AND 102).

FIRST USE 2-10-2002; IN COMMERCE 2-10-2002.

CLASS 36—(Continued).

SN 76-476,601. COASTAL BANKING COMPANY, INC., BEAUFORT, SC. FILED 12-18-2002.



FOR BANKING AND FINANCIAL SERVICES, NAMELY MORTGAGE LENDING, COMMERCIAL LOANS, MORTGAGE REFINANCING, CONSUMER LENDING INTERNET BANKING; SMALL BUSINESS (SBA) LOANS, CONSTRUCTION LOANS, CONSUMER CHECKING, COMMERCIAL CHECKING, CONSUMER AND COMMERCIAL SAVINGS, CERTIFICATES OF DEPOSIT AND IRAS (U.S. CLS. 100, 101 AND 102).

FIRST USE 5-10-2000; IN COMMERCE 5-10-2000.

SN 76-478,667. GELB, JAY W., ROCHESTER, NY. FILED 12-27-2002.

DOLLARS & SENSE MORTGAGE INC.

NO CLAIM IS MADE TO THE EXCLUSIVE RIGHT TO USE "MORTGAGE INC.", APART FROM THE MARK AS SHOWN.

FOR MORTGAGE BANKING (U.S. CLS. 100, 101 AND 102).

FIRST USE 10-3-1994; IN COMMERCE 11-0-1994.

SN 76-481,407. THE BEAR STEARNS COMPANIES INC., NEW YORK, NY. FILED 1-10-2003.

PACRE

FOR FINANCIAL SERVICES, NAMELY, ANALYSIS AND EVALUATION OF HIGH YIELD COLLATERALIZED DEBT OBLIGATIONS (U.S. CLS. 100, 101 AND 102).

FIRST USE 9-19-2002; IN COMMERCE 9-19-2002.

SN 76-482,983. NARRAGANSETT FINANCIAL CORP., FALL RIVER, MA. FILED 1-17-2003.

FEEL THE FREEDOM

FOR FINANCIAL SERVICES, NAMELY, COMMERCIAL AND RETAIL BANKING SERVICES, TRUST SERVICES, NAMELY, INVESTMENT MANAGEMENT SERVICES, INSURANCE AGENCY SERVICES AND SECURITIES BROKERAGE SERVICES (U.S. CLS. 100, 101 AND 102).

CLASS 36—(Continued).

SN 76-483,006. THE COLBURN CORPORATION, TROY, MI. FILED 1-13-2003.

YOUR WORKERS' COMPENSATION WATCHDOG

NO CLAIM IS MADE TO THE EXCLUSIVE RIGHT TO USE "WORKERS' COMPENSATION", APART FROM THE MARK AS SHOWN.

FOR RISK MANAGEMENT CONSULTING SERVICES, PARTICULARLY, THE EVALUATION OF WORKERS' COMPENSATION PROGRAM COMPONENTS, THE EVALUATION AND AUDITING/MONITORING OF WORKERS' COMPENSATION CLAIMS (U.S. CLS. 100, 101 AND 102).

FIRST USE 5-2-2000; IN COMMERCE 5-2-2000.

SN 76-484,579. LYRICAL HOLDINGS LLC, NEW YORK, NY. FILED 1-23-2003.

LYRICAL

FOR INVESTMENT AND FINANCIAL MANAGEMENT AND ADVISORY SERVICES (U.S. CLS. 100, 101 AND 102).

SN 76-484,719. SKYLIGHT FINANCIAL, INC., ATLANTA, GA. FILED 1-24-2003.

BANK ACCOUNT IN A CARD

FOR DEBIT CARD SERVICES (U.S. CLS. 100, 101 AND 102).

SN 76-484,741. FITCH RISK MANAGEMENT, INC., NEW YORK, NY. FILED 1-24-2003.

THERE'S NOTHING LIKE EXPERIENCE

FOR RISK MANAGEMENT AND FINANCIAL CONSULTING SERVICES (U.S. CLS. 100, 101 AND 102).
FIRST USE 9-0-1998; IN COMMERCE 9-0-1998.

SN 76-485,308. FRIEDBERG PROPERTIES & ASSOCIATES, INC., TENAFLY, NJ. FILED 1-27-2003.

FRIEDBERG

SEC. 2(F).
FOR REAL ESTATE BROKERAGE SERVICES AND REAL ESTATE AGENCIES (U.S. CLS. 100, 101 AND 102).
FIRST USE 9-0-1994; IN COMMERCE 9-0-1994.

CLASS 36—(Continued).

SN 76-485,460. FORTIS, INC., NEW YORK, NY. FILED 1-28-2003.

ASSUREADVANTAGE!

FOR INSURANCE SERVICES, NAMELY, UNDERWRITING EXTENDED SERVICE CONTRACTS CONCERNING THE THEFT, BURGLARY, OR PERILS TO COMPUTERS, APPLIANCES, CONSUMER ELECTRONICS, JEWELRY, AND LAWN AND GARDEN EQUIPMENT (U.S. CLS. 100, 101 AND 102).

SN 76-485,461. MBNA AMERICA BANK, NATIONAL ASSOCIATION, WILMINGTON, DE. FILED 1-28-2003.

THE MOST REWARDING CARD OF ALL

NO CLAIM IS MADE TO THE EXCLUSIVE RIGHT TO USE "CARD", APART FROM THE MARK AS SHOWN.

FOR BANKING AND CREDIT CARD SERVICES (U.S. CLS. 100, 101 AND 102).

FIRST USE 9-0-2002; IN COMMERCE 9-0-2002.

SN 76-486,000. FEDERAL HOME LOAN MORTGAGE CORPORATION, MCLEAN, VA. FILED 1-30-2003.

YOUR HOME FOR MORE LOANS

FOR FINANCIAL SERVICES IN THE FIELD OF MORTGAGE LOANS AND MORTGAGE-BACKED OR MORTGAGE RELATED SECURITIES (U.S. CLS. 100, 101 AND 102).

FIRST USE 12-8-2002; IN COMMERCE 12-8-2002.

SN 76-486,144. FIRST RELIANCE BANK, FLORENCE, SC. FILED 1-30-2003.



OWNER OF U.S. REG. NO. 2,445,659.
NO CLAIM IS MADE TO THE EXCLUSIVE RIGHT TO USE "FIRST" AND "BANK", APART FROM THE MARK AS SHOWN.

FOR BANKING SERVICES (U.S. CLS. 100, 101 AND 102).

FIRST USE 1-16-2003; IN COMMERCE 1-16-2003.

CLASS 36—(Continued).

SN 76-486,703. LIFESTAR FINANCIAL NETWORK, INC., SALT LAKE CITY, UT. FILED 2-3-2003.

YOU'RE INDEPENDENT BUT NOT ALONE

FOR INSURANCE AGENCIES (U.S. CLS. 100, 101 AND 102).

SN 76-486,885. GARCIA FAMILY BAIL BONDS, INC., MODESTO, CA. FILED 1-30-2003.

BAIL BOND GIRL

NO CLAIM IS MADE TO THE EXCLUSIVE RIGHT TO USE "BAIL BOND", APART FROM THE MARK AS SHOWN. FOR BAIL BONDING SERVICES (U.S. CLS. 100, 101 AND 102). FIRST USE 3-0-1998; IN COMMERCE 3-0-1998.

SN 76-487,248. QUINN, JAMES BERNARD, ARCADIA, CA. FILED 2-4-2003.

BEAT THE FAVORITE!

FOR PARI-MUTUEL BETTING SERVICES (U.S. CLS. 100, 101 AND 102).

SN 76-487,294. BENSOFIT INC., SAN DIEGO, CA. FILED 1-31-2003.

REPAYME

FOR ADMINISTRATION OF EMPLOYEE BENEFIT PLANS (U.S. CLS. 100, 101 AND 102). FIRST USE 6-1-2000; IN COMMERCE 6-1-2000.

CLASS 36—(Continued).

SN 76-492,365. SWINERTON INCORPORATED, SAN FRANCISCO, CA. FILED 2-3-2003.



OWNER OF U.S. REG. NO. 2,292,209. FIGURES IN HARD HATS WITH PLANS FOR REAL ESTATE LEASING, MANAGING, AND ACQUISITION SERVICES PROVIDED TO OTHERS (U.S. CLS. 100, 101 AND 102). FIRST USE 2-10-1988; IN COMMERCE 2-10-1988.

SN 76-492,582. MCPHERSON ENTERPRISES LIMITED, TOWSON, MD. FILED 2-25-2003.

MCPHERSON

OWNER OF U.S. REG. NO. 1,341,782. SEC. 2(F). FOR CONSULTING SERVICES IN THE FIELD OF FINANCIAL PLANNING AND INVESTMENTS (U.S. CLS. 100, 101 AND 102). FIRST USE 10-0-1983; IN COMMERCE 3-14-1984.

SN 76-493,365. MERRILL LYNCH & CO., INC., NEW YORK, NY. FILED 2-27-2003.

CAPES

FOR FINANCIAL SERVICES IN THE NATURE OF DEBT SECURITIES (U.S. CLS. 100, 101 AND 102).

SN 78-079,267. ENCORE BANK, HOUSTON, TX. BY CHANGE OF NAME; BY CHANGE OF NAME GUARDIAN SAVINGS & LOAN ASSOCIATION, HOUSTON, TX. FILED 8-15-2001.

ENCORE BANK

FOR BANKING SERVICES (U.S. CLS. 100, 101 AND 102).

CLASS 36—(Continued).

SN 78-094,146. WEB PAGE CONDOMINIUM NEWS (WPCN) INC., POINT ROBERTS, WA. FILED 11-19-2001.

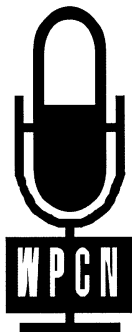

FOR PROVIDING REAL ESTATE INFORMATION, NAMELY; PROVIDING INFORMATION CONCERNING CONDOMINIUM LISTINGS, ASSOCIATIONS AND INFORMATION DEALING WITH THE OPERATION, MANAGEMENT, BUILDING AND SALES AND RENTALS OF CONDOMINIUMS FOR THE BENEFIT OF CONDOMINIUM OWNERS, CONDOMINIUM ASSOCIATIONS, PROPERTY MANAGERS, CONDOMINIUM MANAGERS, ASSOCIATION MANAGERS, REAL ESTATE AGENTS, ELECTED OFFICIALS, REGULATORY AGENCIES, GOVERNMENT DEPARTMENTS, DEVELOPERS, REAL ESTATE AGENTS, RESEARCHERS, AND THE GENERAL PUBLIC (U.S. CLS. 100, 101 AND 102).

FIRST USE 2-22-2001; IN COMMERCE 2-22-2001.

SN 78-128,083. PARADIGM GROUP, LLC, NASHVILLE, TN. FILED 5-12-2002.



NO CLAIM IS MADE TO THE EXCLUSIVE RIGHT TO USE "GROUP", APART FROM THE MARK AS SHOWN.

FOR CONSULTATION IN THE FIELD OF EMPLOYEE BENEFIT PLANS, NAMELY, ASSISTING THIRD PARTY EMPLOYERS DESIGN, DEVELOP, NEGOTIATE, IMPLEMENT AND MANAGE THEIR EMPLOYEE BENEFIT PLANS (U.S. CLS. 100, 101 AND 102).

FIRST USE 4-26-1996; IN COMMERCE 4-26-1996.

SN 78-137,708. CHARLES W. WARNER COMPANY, GLASTONBURY, CT. FILED 6-21-2002.

LIFETREE

FOR INSURANCE BROKERAGE SERVICES; INSURANCE CONSULTATION SERVICES; INSURANCE ADVISORY SERVICES; INSURANCE RETENTION SERVICES (U.S. CLS. 100, 101 AND 102).

CLASS 36—(Continued).

SN 78-140,330. MICHIGAN STATE UNIVERSITY FEDERAL CREDIT UNION, EAST LANSING, MI. FILED 7-1-2002.



FOR FINANCIAL SERVICES, NAMELY PROVIDING FOR MEMBERS AGGREGATED PERSONAL AND FINANCIAL ACCOUNT INFORMATION IN AN ELECTRONIC ENVIRONMENT (U.S. CLS. 100, 101 AND 102). FIRST USE 9-1-2002; IN COMMERCE 9-1-2002.

SN 78-143,168. PRAIRIE CAPITAL MEZZANINE FUND, L.P., CHICAGO, IL. FILED 7-11-2002.

THE PRAIRIE GROUP

NO CLAIM IS MADE TO THE EXCLUSIVE RIGHT TO USE "GROUP", APART FROM THE MARK AS SHOWN.

FOR INVESTMENT MANAGEMENT SERVICES (U.S. CLS. 100, 101 AND 102).

SN 78-143,175. PRAIRIE CAPITAL MEZZANINE FUND, L.P., CHICAGO, IL. FILED 7-11-2002.

PRAIRIE EQUITY CAPITAL

NO CLAIM IS MADE TO THE EXCLUSIVE RIGHT TO USE "EQUITY CAPITAL", APART FROM THE MARK AS SHOWN.

FOR INVESTMENT MANAGEMENT SERVICES (U.S. CLS. 100, 101 AND 102).

SN 78-143,178. PRAIRIE CAPITAL MEZZANINE FUND, L.P., CHICAGO, IL. FILED 7-11-2002.

PRAIRIE PRIVATE EQUITY

NO CLAIM IS MADE TO THE EXCLUSIVE RIGHT TO USE "PRIVATE EQUITY", APART FROM THE MARK AS SHOWN.

FOR INVESTMENT MANAGEMENT SERVICES (U.S. CLS. 100, 101 AND 102).

CLASS 36—(Continued).

SN 78-144,174. NORTHPOINT MORTGAGE CORP., EL-MONT, NY. FILED 7-16-2002.



Northpoint

FOR MORTGAGE BROKERAGE SERVICES (U.S. CLS. 100, 101 AND 102).
FIRST USE 12-0-2001; IN COMMERCE 12-0-2001.

SN 78-144,637. COMPUCREDIT CORPORATION, ATLANTA, GA. FILED 7-17-2002.

ASPIRE

OWNER OF U.S. REG. NOS. 2,126,948, 2,305,816 AND 2,506,815.

FOR FINANCIAL INVESTMENT SERVICES IN THE FIELD OF MUTUAL FUNDS, IRAS, SELF-EMPLOYED PENSIONS, INDIVIDUAL PENSION FUNDS, ANNUITIES, CERTIFICATES OF DEPOSIT, SAVINGS ACCOUNTS AND EDUCATION SAVINGS PLANS (U.S. CLS. 100, 101 AND 102).

SN 78-144,699. CAMPUS DINING NETWORK, INC., KING OF PRUSSIA, PA. FILED 7-17-2002.



FOR DEBIT CARD SERVICES (U.S. CLS. 100, 101 AND 102).

SN 78-144,769. WACHOVIA CORPORATION, CHARLOTTE, NC. FILED 7-17-2002.

**CAPITAL RESOURCE
MEDALLION ACCOUNT**

NO CLAIM IS MADE TO THE EXCLUSIVE RIGHT TO USE "CAPITAL" OR "ACCOUNT", APART FROM THE MARK AS SHOWN.

FOR FINANCIAL INVESTMENT SERVICES IN THE FIELD OF SECURITIES, CASH, AND ASSET MANAGEMENT (U.S. CLS. 100, 101 AND 102).

FIRST USE 1-0-2002; IN COMMERCE 1-0-2002.

CLASS 36—(Continued).

SN 78-148,119. F.N.B. CORPORATION, HERMITAGE, PA. FILED 7-26-2002.



**First National Bank
of Florida**

OWNER OF U.S. REG. NOS. 1,828,543, 2,367,700 AND OTHERS.

NO CLAIM IS MADE TO THE EXCLUSIVE RIGHT TO USE "NATIONAL BANK", APART FROM THE MARK AS SHOWN.

SEC. 2(F) AS TO "FIRST NATIONAL BANK OF FLORIDA".

FOR BANKING SERVICES; FINANCIAL SERVICES IN THE NATURE OF AN INVESTMENT SECURITY; FINANCIAL INFORMATION IN THE NATURE OF RATES OF EXCHANGE, FINANCIAL EXCHANGE, FINANCIAL FORECASTING AND FINANCIAL GUARANTEE AND SURETY; FINANCIAL INFORMATION PROVIDED BY ELECTRONIC MEANS; FINANCIAL MANAGEMENT; FINANCIAL PLANNING; FINANCIAL PORTFOLIO MANAGEMENT; FINANCIAL RESEARCH; FINANCIAL VALUATION OF PERSONAL PROPERTY AND REAL ESTATE; LOAN FINANCING; LEASE-PURCHASE FINANCING; FINANCING SERVICES; INVESTMENT SERVICES, NAMELY INVESTMENT BROKERAGE; CAPITAL INVESTMENT CONSULTATION; COMMODITY INVESTMENT ADVICE; FUND INVESTMENT CONSULTATION; INVESTMENT CONSULTATION; FINANCIAL INVESTMENT IN THE FIELD OF SECURITIES; FUNDS INVESTMENT; MUTUAL FUNDS INVESTMENT; REAL ESTATE INVESTMENT; COMMODITY INVESTMENT ADVICE; INVESTMENT ADVICE; INVESTMENT BROKERAGE; INVESTMENT CLUBS; CAPITAL INVESTMENT CONSULTATION; INVESTMENT MANAGEMENT; MAINTAINING ESCROW ACCOUNTS FOR INVESTMENTS; INVESTMENT OF FUNDS FOR OTHERS; INSURANCE SERVICES, NAMELY INSURANCE UNDERWRITING, BROKERAGE AND EXTENDED WARRANTY CONTRACTS IN THE FIELDS OF LIFE, HEALTH, ACCIDENT, FIRE, MARINE, MEDICAL AND PRE-PAID HEALTH CARE AND LEGAL SERVICES; INSURANCE ADMINISTRATION IN THE FIELD OF LIFE, HEALTH, ACCIDENT, FIRE, MARINE, MEDICAL AND PRE-PAID HEALTH CARE AND LEGAL SERVICES; INSURANCE AGENCIES IN THE FIELDS OF LIFE, HEALTH, ACCIDENT, FIRE, MARINE, MEDICAL AND PRE-PAID HEALTH CARE AND LEGAL SERVICES; APPRAISALS FOR INSURANCE CLAIMS OF PERSONAL PROPERTY AND REAL ESTATE; INSURANCE BROKERAGE, CONSULTATION, SUBROGATION AND ACTUARIAL SERVICES IN THE FIELDS OF LIFE, HEALTH, ACCIDENT, FIRE, MARINE, MEDICAL AND PRE-PAID HEALTH CARE AND LEGAL SERVICES; DEBIT CARD SERVICES; CREDIT CARD SERVICES; ELECTRONIC INTERACTIVE BANKING SERVICES; INTERNET BANKING SERVICES; SAFETY DEPOSIT BOX SERVICES; AND INFORMATION SERVICES FOR ALL FOR THE FOREGOING PROVIDED VIA A GLOBAL COMPUTER NETWORK (U.S. CLS. 100, 101 AND 102).

FIRST USE 6-24-2002; IN COMMERCE 6-24-2002.

CLASS 36—(Continued).

SN 78-148,320. DESADERAL, INC., DBA CHARITYATM, TORONTO, ONTARIO, CANADA, FILED 7-29-2002.

CHARITYATM

FOR AUTOMATED TELLER MACHINE SERVICES; CHARITABLE FUND RAISING SERVICES, NAMELY, SHARING PROFITS FROM ATM SERVICES FEES (U.S. CLS. 100, 101 AND 102).
FIRST USE 10-30-2001; IN COMMERCE 10-30-2001.

SN 78-149,164. BROWN & BROWN, INC., TAMPA, FL. FILED 7-31-2002.

SOUTHWEST ASSURANCE CORPORATION OF FLORIDA

NO CLAIM IS MADE TO THE EXCLUSIVE RIGHT TO USE "ASSURANCE CORPORATION OF FLORIDA", APART FROM THE MARK AS SHOWN.
FOR INSURANCE BROKERAGE AND ADMINISTRATION SERVICES (U.S. CLS. 100, 101 AND 102).
FIRST USE 4-0-1998; IN COMMERCE 4-0-1998.

SN 78-150,770. 14 COMMERCE INC., TIMONIUM, MD. FILED 8-5-2002.

MY WAY TO PAY

FOR CREDIT SERVICES, NAMELY, PROVIDING REVOLVING CREDIT ACCOUNT SERVICES VIA THE INTERNET (U.S. CLS. 100, 101 AND 102).

SN 78-158,343. ENCORE BANK, HOUSTON, TX. FILED 8-27-2002.

ENCORE MORTGAGE COMPANY

NO CLAIM IS MADE TO THE EXCLUSIVE RIGHT TO USE "MORTGAGE COMPANY", APART FROM THE MARK AS SHOWN.
FOR BANKING SERVICES AND FINANCIAL SERVICES, NAMELY MORTGAGE SERVICES. (U.S. CLS. 100, 101 AND 102).

CLASS 36—(Continued).

SN 78-160,191. SIB MORTGAGE CORPORATION D/B/A IVY MORTGAGE, BRANCHBURG, NJ. FILED 9-3-2002.



NO CLAIM IS MADE TO THE EXCLUSIVE RIGHT TO USE "MORTGAGE MAKER", APART FROM THE MARK AS SHOWN.
THE MARK CONSISTS OF A CAPITAL LETTER "M" ABOVE THE WORDS "MORTGAGE MAKER". THE LETTER "M" IS WHITE ON A HALF GREEN HALF BLUE BACKGROUND AND THE WORDS "MORTGAGE MAKER" ARE GREEN ON A WHITE BACKGROUND.
FOR MORTGAGE LENDING TO BORROWERS NOT SUITED TO OR ELIGIBLE FOR CONVENTIONAL MORTGAGES (U.S. CLS. 100, 101 AND 102).
FIRST USE 3-1-2002; IN COMMERCE 3-1-2002.

SN 78-161,268. UNITEDNATIONAL MORTGAGE CORPORATION, BERNARDSVILLE, NJ. FILED 9-6-2002.

CITIZEN FIRST MORTGAGE

NO CLAIM IS MADE TO THE EXCLUSIVE RIGHT TO USE "MORTGAGE", APART FROM THE MARK AS SHOWN.
FOR HOME EQUITY LOANS AND MORTGAGE LENDING SERVICES (U.S. CLS. 100, 101 AND 102).
FIRST USE 8-14-2002; IN COMMERCE 8-14-2002.

SN 78-162,583. GIFT PUZZLE, INC., LOS GATOS, CA. FILED 9-10-2002.

GIFT PUZZLE

NO CLAIM IS MADE TO THE EXCLUSIVE RIGHT TO USE "GIFT", APART FROM THE MARK AS SHOWN.
FOR FINANCIAL MANAGEMENT SERVICES, NAMELY, ONLINE FINANCIAL GIFT CONSOLIDATION SERVICES (U.S. CLS. 100, 101 AND 102).
FIRST USE 6-15-2002; IN COMMERCE 8-15-2002.

CLASS 36—(Continued).

SN 78-171,034. LOUISVILLE COMMUNITY DEVELOPMENT BANK, LOUISVILLE, KY. FILED 10-4-2002.



NO CLAIM IS MADE TO THE EXCLUSIVE RIGHT TO USE "COMMUNITY DEVELOPMENT BANK", APART FROM THE MARK AS SHOWN.
SEC. 2(F) AS TO "LOUISVILLE".
FOR BANKING SERVICES (U.S. CLS. 100, 101 AND 102).
FIRST USE 7-19-1996; IN COMMERCE 8-8-1996.

SN 78-171,265. LIBERTY LIFE INSURANCE COMPANY, GREENVILLE, SC. FILED 10-4-2002.

RBC DIRECTTERM

FOR LIFE INSURANCE UNDERWRITING SERVICES (U.S. CLS. 100, 101 AND 102).
FIRST USE 6-0-2003; IN COMMERCE 6-0-2003.

SN 78-175,015. GOODENOUGH, ALEXANDER W., KESWICK, VA. FILED 10-16-2002.

LANDAHOME.COM

FOR ON-LINE REAL ESTATE LISTING SERVICES ADVERTISING REAL ESTATE FOR SALE (U.S. CLS. 100, 101 AND 102).
FIRST USE 8-31-1999; IN COMMERCE 8-31-1999.

SN 78-177,562. T3 REALTY ADVISORS, LLC, WALTHAM, MA. FILED 10-23-2002.



FOR REAL ESTATE BROKERAGE, LEASING AND ADVISORY SERVICES FOR TECHNOLOGY COMPANIES (U.S. CLS. 100, 101 AND 102).
FIRST USE 8-27-2001; IN COMMERCE 8-27-2001.

CLASS 36—(Continued).

SN 78-186,425. NORTH AMERICAN COMPANY FOR LIFE AND HEALTH INSURANCE, CHICAGO, IL. FILED 11-19-2002.

NORTH AMERICAN HERITAGE

OWNER OF U.S. REG. NOS. 789,153, 2,584,727 AND 2,584,728.
SEC. 2(F) AS TO "NORTH AMERICAN".
FOR LIFE INSURANCE AND ANNUITY UNDERWRITING SERVICES (U.S. CLS. 100, 101 AND 102).

SN 78-186,436. NORTH AMERICAN COMPANY FOR LIFE AND HEALTH INSURANCE, CHICAGO, IL. FILED 11-19-2002.

NORTH AMERICAN HERITAGE BONUS 10

OWNER OF U.S. REG. NOS. 789,153, 2,584,727 AND 2,584,728.
SEC. 2(F) AS TO "NORTH AMERICAN".
FOR LIFE INSURANCE AND ANNUITY UNDERWRITING SERVICES (U.S. CLS. 100, 101 AND 102).

SN 78-187,852. LIBERTY BANKERS LIFE INSURANCE COMPANY, WEST DES MOINES, IA. FILED 11-22-2002.

LIBERTY BANKERS LIFE INSURANCE COMPANY

NO CLAIM IS MADE TO THE EXCLUSIVE RIGHT TO USE "BANKERS LIFE INSURANCE COMPANY", APART FROM THE MARK AS SHOWN.
FOR LIFE INSURANCE AGENCY SERVICES (U.S. CLS. 100, 101 AND 102).

SN 78-189,188. REGULATORY RESEARCH CORPORATION, WABAN, MA. FILED 11-26-2002.

AGENTGAUGE

FOR FINANCIAL FRAUD PREVENTION SERVICES IN THE NATURE OF USING NON-LINEAR STATISTICAL ANALYSIS TO MEASURE THE FINANCIAL RISK POSED TO INSURERS BY THE ACTIONS OF THEIR INSURANCE AGENTS (U.S. CLS. 100, 101 AND 102).
FIRST USE 11-19-2001; IN COMMERCE 11-19-2001.

CLASS 36—(Continued).

SN 78-191,461. AMERICAN PENSION SERVICES, INC., TAMPA, FL. FILED 12-5-2002.

APS PATHWAYS 401K PROGRAM

NO CLAIM IS MADE TO THE EXCLUSIVE RIGHT TO USE "401K PROGRAM", APART FROM THE MARK AS SHOWN.

FOR FINANCIAL PLANNING MANAGEMENT AND ADMINISTRATION IN THE FIELD OF 401K RETIREMENT PROGRAMS FOR OTHERS (U.S. CLS. 100, 101 AND 102).

FIRST USE 10-1-2002; IN COMMERCE 10-1-2002.

SN 78-194,538. JEFFERSON CAPITAL SYSTEMS, LLC, ATLANTA, GA. FILED 12-13-2002.

JEFFERSON CAPITAL SYSTEMS

NO CLAIM IS MADE TO THE EXCLUSIVE RIGHT TO USE "CAPITAL SYSTEMS", APART FROM THE MARK AS SHOWN.

FOR DEBT RECOVERY AND COLLECTION SERVICES (U.S. CLS. 100, 101 AND 102).

SN 78-194,680. BENCHMARK SOURCE, LLC, CORNELIUS, NC. FILED 12-16-2002.



NO CLAIM IS MADE TO THE EXCLUSIVE RIGHT TO USE "BENCHMARK", APART FROM THE MARK AS SHOWN.

FOR PROVIDING AN ONLINE DATABASE OF BENCHMARK DATA IN THE FIELD OF EMPLOYEE BENEFITS, RETIREMENT PLANS AND PROPERTY AND CASUALTY INSURANCE COVERAGES, THAT ALLOWS EMPLOYERS TO CREATE CUSTOM BENCHMARK DATA REPORTS (U.S. CLS. 100, 101 AND 102).

FIRST USE 6-30-2002; IN COMMERCE 11-30-2002.

CLASS 36—(Continued).

SN 78-195,468. AMERICAN INTERNATIONAL GROUP, INC., NEW YORK, NY. FILED 12-17-2002.

AIG WARRANTY

OWNER OF U.S. REG. NOS. 1,151,229, 1,272,845 AND OTHERS.

NO CLAIM IS MADE TO THE EXCLUSIVE RIGHT TO USE "WARRANTY", APART FROM THE MARK AS SHOWN.

FOR INSURANCE UNDERWRITING SERVICES IN THE FIELD OF WARRANTIES AND SERVICE CONTRACTS FOR COMPUTERS, APPLIANCES AND ELECTRONIC PRODUCTS (U.S. CLS. 100, 101 AND 102).

FIRST USE 2-1-2002; IN COMMERCE 2-1-2002.

SN 78-196,355. MIDLAND NATIONAL LIFE INSURANCE COMPANY, SIOUX FALLS, SD. FILED 12-19-2002.

MIDLAND NATIONAL LEGACY

OWNER OF U.S. REG. NOS. 1,487,093, 2,589,561 AND OTHERS.

NO CLAIM IS MADE TO THE EXCLUSIVE RIGHT TO USE "NATIONAL", APART FROM THE MARK AS SHOWN.

FOR LIFE INSURANCE AND ANNUITY UNDERWRITING SERVICES (U.S. CLS. 100, 101 AND 102).

SN 78-196,643. CIRCLE K STORES INC., TEMPE, AZ. FILED 12-20-2002.

CIRCLE K

FOR PREPAID/PRESTORED POINT OF SALE PURCHASE CARD SERVICES, CREDIT CARD AND DEBIT CARD SERVICES, AND TELEPHONE CALLING CARD SERVICES (U.S. CLS. 100, 101 AND 102).

SN 78-197,399. COMMUNITY MANAGEMENT CORPORATION, CINCINNATI, OH. FILED 12-23-2002.



NO CLAIM IS MADE TO THE EXCLUSIVE RIGHT TO USE "PROPERTIES", APART FROM THE MARK AS SHOWN.

FOR REAL ESTATE LEASING SERVICES (U.S. CLS. 100, 101 AND 102).

FIRST USE 4-0-1998; IN COMMERCE 4-0-1998.

CLASS 36—(Continued).

SN 78-199,551. MEDSOLUTIONS, INC., TEMPE, AZ. FILED 1-2-2003.

HEALTH EDUCATION SOLUTIONS

NO CLAIM IS MADE TO THE EXCLUSIVE RIGHT TO USE "HEALTH EDUCATION", APART FROM THE MARK AS SHOWN.

FOR FINANCIAL SERVICES IN THE FIELD OF MONEY LENDING, NAMELY LOANS TO STUDENTS IN THE MEDICAL PROFESSIONS TO FINANCE THE COST OF EDUCATION. (U.S. CLS. 100, 101 AND 102).

SN 78-199,763. FRANKLIN RESOURCES, INC., SAN MATEO, CA. FILED 1-3-2003.

FRANKLIN TEMPLETON

OWNER OF U.S. REG. NOS. 1,067,629, 2,161,656 AND OTHERS.

FOR FINANCIAL SERVICES, NAMELY, MUTUAL FUNDS INVESTMENT SERVICES; ADVISORY, DISTRIBUTION, UNDERWRITING AND ADMINISTRATION OF MUTUAL FUNDS AND LIMITED PARTNERSHIP INVESTMENT VEHICLES; FINANCIAL AND INVESTMENT MANAGEMENT, ADVISORY, ANALYSIS, CONSULTATION, RECORD KEEPING AND INFORMATION SERVICES; FINANCIAL ANALYSIS; FORMATION, OFFERING AND MANAGEMENT OF LIMITED PARTNERSHIPS; SECURITIES BROKERAGE; INVESTMENT BROKERAGE AND MANAGEMENT; TRANSFER AGENT SERVICES; BANKING; LENDING SERVICES, CREDIT CARD SERVICES, AUTOMOBILE LOAN FINANCING SERVICES; INVESTMENT TRUST SERVICES; REAL ESTATE MANAGEMENT SERVICES; AND INSURANCE SERVICES, NAMELY, ISSUANCE AND ADMINISTRATION OF LIFE INSURANCE AND ANNUITY CONTRACTS, REINSURANCE OF LIFE INSURANCE AND ANNUITY CONTRACTS OF OTHER LICENSED INSURERS, AND ADMINISTRATION OF INVESTMENT ACCOUNTS WHICH FUND THE BENEFITS UNDERLYING LIFE INSURANCE AND ANNUITY CONTRACTS (U.S. CLS. 100, 101 AND 102).

FIRST USE 3-0-1993; IN COMMERCE 3-0-1993.

SN 78-200,519. HAVANA BAY COMPANY, INC., NORTH PLATTE, NE. FILED 1-6-2003.

MACEO MARTI ASSET ADVISORS

NO CLAIM IS MADE TO THE EXCLUSIVE RIGHT TO USE "ASSET ADVISORS", APART FROM THE MARK AS SHOWN.

"MACEO MARTI ASSET ADVISORS" DOES NOT IDENTIFY A PARTICULAR LIVING INDIVIDUAL.

FOR FINANCIAL SERVICES IN THE FIELD OF INVESTMENT MANAGEMENT FOR OTHERS (U.S. CLS. 100, 101 AND 102).

FIRST USE 12-31-2002; IN COMMERCE 12-31-2002.

CLASS 36—(Continued).

SN 78-200,856. GLOBEX FINANIAL GROUP, INC., CORAL GABLES, FL. FILED 1-7-2003.

MARKET AWARENESS

NO CLAIM IS MADE TO THE EXCLUSIVE RIGHT TO USE "MARKET", APART FROM THE MARK AS SHOWN. FOR FINANCIAL INVESTMENT CONSULTATION SERVICES (U.S. CLS. 100, 101 AND 102).

SN 78-201,907. FAIRFIELD RESORTS, INC., ORLANDO, FL. FILED 1-10-2003.

SHARE TIME NOW

FOR REAL ESTATE TIME-SHARING SERVICES (U.S. CLS. 100, 101 AND 102).

SN 78-203,387. FMR CORP., BOSTON, MA. FILED 1-15-2003.

EXCELLENCE CREATES OPPORTUNITY

FOR FINANCIAL SERVICES, NAMELY, RETIREMENT FUND INVESTMENT SERVICES; PROVIDING FINANCIAL INFORMATION IN THE FIELD OF RETIREMENT PLANNING; RETIREMENT PLAN ADMINISTRATION SERVICES; INVESTMENT MANAGEMENT SERVICES; SECURITIES BROKERAGE SERVICES (U.S. CLS. 100, 101 AND 102).

SN 78-203,527. HARTFORD FIRE INSURANCE COMPANY, HARTFORD, CT. FILED 1-15-2003.

HARTFORD 401 KEY

OWNER OF U.S. REG. NOS. 1,155,051, 2,571,007 AND OTHERS.

NO CLAIM IS MADE TO THE EXCLUSIVE RIGHT TO USE "401", APART FROM THE MARK AS SHOWN.

SEC. 2(F) AS TO "HARTFORD".

FOR MUTUAL FUND INVESTMENT AND INVESTMENT MANAGEMENT OF VARIABLE ANNUITIES FOR DEFINED BENEFIT AND RETIREMENT PLANS (U.S. CLS. 100, 101 AND 102).

FIRST USE 1-15-2003; IN COMMERCE 1-15-2003.

CLASS 36—(Continued).

SN 78-204,374. HARTFORD FIRE INSURANCE COMPANY, HARTFORD, CT. FILED 1-17-2003.

THE HARTFORD FINANCIAL SERVICES GROUP

OWNER OF U.S. REG. NOS. 2,374,660 AND 2,376,997.

NO CLAIM IS MADE TO THE EXCLUSIVE RIGHT TO USE "FINANCIAL SERVICES GROUP", APART FROM THE MARK AS SHOWN.

SEC. 2(F) AS TO "HARTFORD".

FOR INSURANCE UNDERWRITING SERVICES FOR ALL TYPES OF INSURANCE; INSURANCE ADMINISTRATION SERVICES; INVESTMENT SERVICES; NAMELY, INVESTMENT MANAGEMENT AND INVESTMENT OF FUNDS FOR OTHERS; MUTUAL FUNDS SERVICES, NAMELY, MUTUAL FUND DISTRIBUTION AND MUTUAL FUND INVESTMENT; FINANCIAL ADVISORY SERVICES; ASSET MANAGEMENT SERVICES; NAMELY, FINANCIAL MANAGEMENT, FINANCIAL PORTFOLIO MANAGEMENT AND INVESTMENT MANAGEMENT (U.S. CLS. 100, 101 AND 102).

SN 78-207,289. HAMMERSTEIN, BRIAN, PALO ALTO, CA. FILED 1-27-2003.

IVCA

FOR FINANCIAL INFORMATION PROVIDED BY ELECTRONIC MEANS IN RELATING TO HIGH TECHNOLOGY COMPANIES AND PUBLIC EQUITY FIRMS (U.S. CLS. 100, 101 AND 102).

SN 78-207,439. MHB LLC, GETTYSBURG, PA. FILED 1-27-2003.

K4K RENTBYKREDIT

FOR CREDIT CARD SERVICES; BANKING AND FINANCIAL SERVICES, NAMELY, ELECTRONIC PAYMENT SERVICES IN THE NATURE OF ELECTRONIC PROCESSING AND TRANSMISSION OF BILL PAYMENT DATA; BILL PAYMENT SERVICES IN THE NATURE OF PROVIDING BILLING AND PAYMENT INFORMATION; PROCESSING, CLEARING AND RECONCILING FINANCIAL TRANSACTIONS, NAMELY, CREDIT CARD TRANSACTION PROCESSING SERVICES, ELECTRONIC CASH TRANSACTIONS, AND ELECTRONIC DEBIT TRANSACTIONS (U.S. CLS. 100, 101 AND 102).

SN 78-207,460. AQUARION WATER COMPANY, BRIDGEPORT, CT. FILED 1-27-2003.

AQUARIONLINE

FOR ELECTRONIC PAYMENT SERVICES, NAMELY, ELECTRONIC TRANSMISSION AND PROCESSING OF BILL PAYMENT DATA IN THE FIELD OF WATER UTILITIES (U.S. CLS. 100, 101 AND 102).

CLASS 36—(Continued).

SN 78-207,478. MHB LLC, GETTYSBURG, PA. FILED 1-27-2003.

K4K NO4KLOSE

FOR CREDIT CARD SERVICES; BANKING AND FINANCIAL SERVICES, NAMELY, ELECTRONIC PAYMENT SERVICES IN THE NATURE OF ELECTRONIC PROCESSING AND TRANSMISSION OF BILL PAYMENT DATA; BILL PAYMENT SERVICES IN THE NATURE OF PROVIDING BILLING AND PAYMENT INFORMATION; PROCESSING, CLEARING AND RECONCILING FINANCIAL TRANSACTIONS, NAMELY, CREDIT CARD TRANSACTION PROCESSING SERVICES, ELECTRONIC CASH TRANSACTIONS, AND ELECTRONIC DEBIT TRANSACTIONS (U.S. CLS. 100, 101 AND 102).

SN 78-207,538. AMERICAN INTERNATIONAL GROUP, INC., NEW YORK, NY. FILED 1-27-2003.

AIGTG DATADIRECT

OWNER OF U.S. REG. NOS. 1,151,229, 2,337,215 AND OTHERS.

FOR FINANCIAL SERVICES, NAMELY FOREIGN EXCHANGE TRADING (U.S. CLS. 100, 101 AND 102). FIRST USE 11-1-2002; IN COMMERCE 11-1-2002.

SN 78-207,548. INCAPITAL HOLDINGS, LLC, CHICAGO, IL. FILED 1-27-2003.

BONDS FOR TODAY'S INVESTOR

NO CLAIM IS MADE TO THE EXCLUSIVE RIGHT TO USE "BONDS", APART FROM THE MARK AS SHOWN.

FOR FINANCIAL BROKERAGE SERVICES IN THE FIELD OF BOND NOTES (U.S. CLS. 100, 101 AND 102). FIRST USE 11-1-2002; IN COMMERCE 11-1-2002.

SN 78-208,080. BRAZEN GROUP REAL ESTATE COMPANY, INC., BELLEVUE, WA. FILED 1-28-2003.

ULTIMATE REAL ESTATE EXPERIENCE

NO CLAIM IS MADE TO THE EXCLUSIVE RIGHT TO USE "REAL ESTATE", APART FROM THE MARK AS SHOWN.

FOR BROKERAGE OF REAL ESTATE PROPERTIES, REAL ESTATE LISTING, AND LEASING OF REAL ESTATE (U.S. CLS. 100, 101 AND 102).

FIRST USE 1-15-2003; IN COMMERCE 1-15-2003.

CLASS 36—(Continued).

SN 78-208,098. TODD HARRISON CAPITAL PARTNERS LLC, NEW YORK, NY. FILED 1-28-2003.

TODD HARRISON CAPITAL PARTNERS

NO CLAIM IS MADE TO THE EXCLUSIVE RIGHT TO USE "CAPITAL PARTNERS", APART FROM THE MARK AS SHOWN.

THE NAME "TODD HARRISON" IDENTIFIES A LIVING INDIVIDUAL WHOSE CONSENT IS OF RECORD.

FOR FINANCIAL SERVICES IN THE NATURE OF INVESTMENT FUND MANAGEMENT (U.S. CLS. 100, 101 AND 102).

SN 78-208,121. CONCA, DAVID, C., SAN JOSE, CA. AND CONCA, JOANNE, C., SAN JOSE, CA. FILED 1-28-2003.

BEYOND HOMES

NO CLAIM IS MADE TO THE EXCLUSIVE RIGHT TO USE "HOMES", APART FROM THE MARK AS SHOWN.

FOR REAL PROPERTY BROKERAGE AND PROPERTY MANAGEMENT SERVICES, AND MORTGAGE LOAN ORIGATION AND MORTGAGE LENDING SERVICES. (U.S. CLS. 100, 101 AND 102).

FIRST USE 8-2-2001; IN COMMERCE 8-2-2001.

SN 78-208,128. ALLIANZ LIFE INSURANCE COMPANY OF NORTH AMERICA, MINNEAPOLIS, MN. FILED 1-28-2003.

POWERDEX

FOR INSURANCE SERVICES, NAMELY, UNDERWRITING, CLAIMS PROCESSING, CLAIMS ADMINISTRATION, CONSULTATION AND BROKERAGE IN THE FIELDS OF LIFE INSURANCE AND ANNUITIES (U.S. CLS. 100, 101 AND 102).

FIRST USE 1-2-2003; IN COMMERCE 1-2-2003.

SN 78-208,374. GRINNELL MUTUAL REINSURANCE COMPANY, GRINNELL, IA. FILED 1-29-2003.

FARMUTUAL

OWNER OF U.S. REG. NOS. 763,273 AND 1,761,668. FOR UNDERWRITING FARM PROPERTY REINSURANCE AND DIRECT INSURANCE; AND PROPERTY AND CASUALTY INSURANCE AND REINSURANCE AGENCY AND UNDERWRITING SERVICES (U.S. CLS. 100, 101 AND 102).

FIRST USE 12-0-1961; IN COMMERCE 2-0-1962.

CLASS 36—(Continued).

SN 78-209,003. MORTGAGE LENDERS NETWORK USA, INC., MIDDLETOWN, CT. FILED 1-30-2003.

IN EVERYONE'S BEST INTEREST

FOR MORTGAGE LENDING SERVICES (U.S. CLS. 100, 101 AND 102).

SN 78-209,116. BRAZOS HIGHER EDUCATION SERVICE CORP., AUSTIN, TX. FILED 1-30-2003.



FOR EDUCATIONAL LOANS SERVICES. (U.S. CLS. 100, 101 AND 102).

SN 78-209,619. RASTI, MEHRAN, R., BATON ROUGE, LA. FILED 1-31-2003.

VARICARD

FOR CREDIT CARD TRANSACTION PROCESSING SERVICES (U.S. CLS. 100, 101 AND 102).

SN 78-213,830. MORGAN STANLEY, NEW YORK, NY. FILED 2-12-2003.

MPN

FOR FINANCIAL SERVICES IN THE NATURE OF AN INVESTMENT SECURITY (U.S. CLS. 100, 101 AND 102).

SN 78-214,330. METROPOLITAN LIFE INSURANCE COMPANY, NEW YORK, NY. FILED 2-13-2003.

METSELECT

OWNER OF U.S. REG. NO. 2,212,076. FOR INVESTMENT MANAGEMENT; PENSIONS, NAMELY THE UNDERWRITING AND ADMINISTRATION OF DEFINED CONTRIBUTION PLANS; MUTUAL FUND INVESTMENT SERVICES; INVESTMENT INFORMATION AND GUIDANCE. (U.S. CLS. 100, 101 AND 102).

CLASS 36—(Continued).

SN 78-214,557. GANCAYCO, GABRIEL, SAN JOSE, CA. FILED 2-13-2003.

BAY ELITE REALTY

NO CLAIM IS MADE TO THE EXCLUSIVE RIGHT TO USE "ELITE REALTY", APART FROM THE MARK AS SHOWN.

FOR REAL ESTATE BROKERAGE SERVICES (U.S. CLS. 100, 101 AND 102).

SN 78-236,243. ALLIANZ LIFE INSURANCE COMPANY OF NORTH AMERICA, MINNEAPOLIS, MN. FILED 4-10-2003.

POWERDEX ELITE

FOR INSURANCE SERVICES, NAMELY, UNDERWRITING, CLAIMS PROCESSING, CLAIMS ADMINISTRATION, CONSULTATION AND BROKERAGE, IN THE FIELDS OF LIFE INSURANCE AND ANNUITIES. (U.S. CLS. 100, 101 AND 102).

SN 78-247,774. MIS QUALITY MANAGEMENT CORP., WILMINGTON, DE. FILED 5-9-2003.

MAPRE

FOR CREDIT RISK ANALYSIS FOR REAL ESTATE. (U.S. CLS. 100, 101 AND 102).

SN 78-247,793. MIS QUALITY MANAGEMENT CORP., WILMINGTON, DE. FILED 5-9-2003.

MOODY'S MAPRE

OWNER OF U.S. REG. NOS. 871,342 AND 871,497. FOR CREDIT RISK ANALYSIS FOR REAL ESTATE (U.S. CLS. 100, 101 AND 102).

CLASS 37—CONSTRUCTION AND REPAIR

SN 75-240,347. RITM, INC., WILMINGTON, DE. FILED 2-12-1997.



OWNER OF U.S. REG. NO. 1,703,729. NO CLAIM IS MADE TO THE EXCLUSIVE RIGHT TO USE "INDUSTRIES", APART FROM THE MARK AS SHOWN.

THE MARK IS LINED FOR RED. FOR WASTE COLLECTION AND DISPOSAL SERVICES FOR OTHERS (U.S. CLS. 100, 103 AND 106). FIRST USE 11-28-1995; IN COMMERCE 11-28-1995.

SN 75-839,948. ICYNENE INC, MISSISSAUGA, ONTARIO, CANADA, FILED 11-5-1999.

**HEALTHIER. QUIETER.
MORE ENERGY EFFICIENT**

OWNER OF CANADA REG. NO. 580369, DATED 5-1-2003, EXPIRES 5-1-2018.

FOR INSTALLATION OF INDUSTRIAL, COMMERCIAL AND RESIDENTIAL BUILDING INSULATION (U.S. CLS. 100, 103 AND 106). FIRST USE 9-1-1996; IN COMMERCE 10-1-1996.

SN 76-191,387. INNCOM INTERNATIONAL, INC., OLD LYME, CT. FILED 1-9-2001.

INNCOM

FOR INSTALLATION, REPAIR, AND MAINTENANCE OF SYSTEMS AND DEVICES THAT USE INFRARED, RADIO FREQUENCY OR LOW VOLTAGE WIRE TECHNOLOGY AND COMPUTER HARDWARE AND SOFTWARE AND SYSTEMS TO COORDINATE, CONTROL, ENHANCE, STREAMLINE AND REPORT STATUS OF THE OPERATION OF TELEVISION, CATV, AUDIO/VIDEO, LIGHTS, TEMPERATURE, HEATING, VENTILATION AND AIR CONDITIONING EQUIPMENT, ELECTRONIC LOCK, SMOKE AND FIRE DETECTORS, MINI-BAR, ACCESS DOORS, DOORBELL, MOTORIZED DRAPES, INTERNET ACCESS DEVICES AND OTHER MECHANICAL AND ELECTRICAL OR ELECTRONIC SYSTEMS AND SERVICES IN COMMERCIAL AND RESIDENTIAL BUILDINGS AND THE HOSPITALITY, HEALTH CARE AND EDUCATIONAL INDUSTRIES (U.S. CLS. 100, 103 AND 106).

FIRST USE 4-18-1986; IN COMMERCE 4-18-1986.

CLASS 37—(Continued).

SN 76-212,535. PETER SNELTEN & SONS, INC., WAUCONDA, IL. FILED 2-20-2001.



NO CLAIM IS MADE TO THE EXCLUSIVE RIGHT TO USE "& SONS, INC.", APART FROM THE MARK AS SHOWN.

THE MARK IS LINED FOR THE COLORS YELLOW AND RED.

THE NAME IN THE MARK IDENTIFIES A LIVING INDIVIDUAL WHOSE CONSENT IS OF RECORD.

FOR WATER WELL CONSTRUCTION AND REPAIR SERVICES, INCLUDING, WELL PUMP INSTALLATION AND REPAIR, WELL DRILLING, WATER STORAGE TANK INSTALLATION, WELL ABANDONMENT AND CHLORINATION SERVICES (U.S. CLS. 100, 103 AND 106).

FIRST USE 1-1-1958; IN COMMERCE 1-15-2001.

CLASS 37—(Continued).

SN 76-386,607. HYDREX PEST CONTROL CO., INC., LOS ANGELES, CA. FILED 3-25-2002.



OWNER OF U.S. REG. NO. 1,010,053.

NO CLAIM IS MADE TO THE EXCLUSIVE RIGHT TO USE "PEST CONTROL CO.", APART FROM THE MARK AS SHOWN.

THE MARK CONSISTS OF THE WORDING "HYDREX PEST CONTROL CO." WITH SPIDER AND FRAMEWORK DESIGN.

FOR NON-AGRICULTURAL INSECT AND PEST EXTERMINATION SERVICES WITH RELATED INSPECTIONS (U.S. CLS. 100, 103 AND 106).

FIRST USE 3-12-1957; IN COMMERCE 3-12-1957.

SN 76-322,679. ORION PARTNERS, INC., SAN ANTONIO, TX. FILED 10-9-2001.



OWNER OF U.S. REG. NO. 1,974,896.
FOR COMMERCIAL AND RESIDENTIAL REAL ESTATE DEVELOPMENT; RESIDENTIAL AND COMMERCIAL BUILDING INSTALLATION AND RENOVATION (U.S. CLS. 100, 103 AND 106).
FIRST USE 0-0-1989; IN COMMERCE 0-0-1989.

SN 76-396,087. JOHNSON, HOWARD R., EL SEGUNDO, CA. FILED 4-16-2002.

NEW HORIZONS

FOR REPAIR SERVICES FOR AIRCRAFT IGNITION PARTS AND SYSTEMS (U.S. CLS. 100, 103 AND 106).
FIRST USE 4-0-1987; IN COMMERCE 4-0-1987.

SN 76-322,680. ORION PARTNERS, INC., SAN ANTONIO, TX. FILED 10-9-2001.

ORION

OWNER OF U.S. REG. NO. 1,974,896.
FOR RESIDENTIAL AND COMMERCIAL BUILDING CONSTRUCTION AND RENOVATION (U.S. CLS. 100, 103 AND 106).
FIRST USE 8-1-1989; IN COMMERCE 8-1-1989.

SN 76-396,503. RACO CAR WASH SYSTEMS, INC., JOPLIN, MO. FILED 4-16-2002.

KLEEN WASH

OWNER OF U.S. REG. NOS. 1,546,979, 2,161,168 AND OTHERS.
NO CLAIM IS MADE TO THE EXCLUSIVE RIGHT TO USE "WASH", APART FROM THE MARK AS SHOWN.
FOR CAR WASH SERVICES (U.S. CLS. 100, 103 AND 106).
FIRST USE 7-15-2002; IN COMMERCE 7-15-2002.

CLASS 37—(Continued).

SN 76-427,997. SUBURBAN HENNEPIN REGIONAL PARK DISTRICT, PLYMOUTH, MN. FILED 7-8-2002.



NO CLAIM IS MADE TO THE EXCLUSIVE RIGHT TO USE PARK DISTRICT, APART FROM THE MARK AS SHOWN.

FOR LAND DEVELOPMENT AND MAINTENANCE SERVICES FOR LARGE PARKS, WILDLIFE SANCTUARIES, RESERVATIONS, TRAILS, HISTORIC SITES AND ACCESS TO NATURAL PHENOMENA PURPOSES (U.S. CLS. 100, 103 AND 106).
FIRST USE 12-20-2001; IN COMMERCE 12-20-2001.

CLASS 37—(Continued).

SN 76-444,559. MASTER CHURCH BUILDERS, LLC, GROVE CITY, OH. FILED 8-28-2002.



NO CLAIM IS MADE TO THE EXCLUSIVE RIGHT TO USE "CHURCH BUILDERS", APART FROM THE MARK AS SHOWN.

FOR CHURCH BUILDING CONSTRUCTION AND REPAIR AND INSTALLATION OF APPLIANCES (U.S. CLS. 100, 103 AND 106).
FIRST USE 8-12-1997; IN COMMERCE 8-12-1997.

SN 76-428,128. SOLAR DEVELOPMENT LLC, NEW YORK, NY. FILED 7-3-2002.

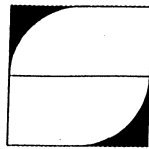

SOLAR DEVELOPMENT LLC

NO CLAIM IS MADE TO THE EXCLUSIVE RIGHT TO USE "DEVELOPMENT LLC", APART FROM THE MARK AS SHOWN.

FOR REAL ESTATE DEVELOPMENT AND REAL ESTATE SITE SELECTION (U.S. CLS. 100, 103 AND 106).

SN 76-449,933. NEWFIELD CONSTRUCTION, INC., HARTFORD, CT. FILED 9-16-2002.



Newfield
CONSTRUCTION
EXPERIENCE. WE BUILD ON IT.

NO CLAIM IS MADE TO THE EXCLUSIVE RIGHT TO USE "CONSTRUCTION", APART FROM THE MARK AS SHOWN.

FOR CONSTRUCTION SERVICES, NAMELY, CONSTRUCTION MANAGEMENT, GENERAL CONTRACTING FOR COMMERCIAL, INDUSTRIAL, RETAIL BUILDING CONSTRUCTION (U.S. CLS. 100, 103 AND 106).
FIRST USE 9-11-2002; IN COMMERCE 9-11-2002.

SN 76-441,943. CITIZENS COMMUNICATIONS COMPANY, STAMFORD, CT. FILED 8-16-2002.

FRONTIER WIRE CARE

OWNER OF U.S. REG. NOS. 1,936,139, 2,619,191 AND OTHERS.

NO CLAIM IS MADE TO THE EXCLUSIVE RIGHT TO USE "WIRE CARE", APART FROM THE MARK AS SHOWN.

FOR INSTALLATION, MAINTENANCE, AND REPAIR OF COMMERCIAL AND RESIDENTIAL CABLING AND WIRING, DATA CABLING AND WIRING, AND TELECOMMUNICATIONS CABLING AND WIRING (U.S. CLS. 100, 103 AND 106).

SN 76-454,604. VENVEST, INC., ST. LOUIS, MO. FILED 10-2-2002.

**FIXED TODAY OR YOU
DON'T PAY**

FOR REPAIR, MAINTENANCE AND INSTALLATION SERVICES IN THE FIELD OF PLUMBING, HEATING, VENTILATION AND AIR CONDITIONING (U.S. CLS. 100, 103 AND 106).

CLASS 37—(Continued).

SN 76-457,640. MR. CARPET COMPANY, CHICAGO, IL. FILED 10-11-2002.



NO CLAIM IS MADE TO THE EXCLUSIVE RIGHT TO USE "CARPET" AND "SHOP AT HOME", APART FROM THE MARK AS SHOWN.

FOR CARPET INSTALLATION SERVICES (U.S. CLS. 100, 103 AND 106).
FIRST USE 1-0-2001; IN COMMERCE 1-0-2001.

SN 76-469,206. NATIONAL LEAK DETECTION INC., REDONDO BEACH, CA. FILED 9-9-2002.



NO CLAIM IS MADE TO THE EXCLUSIVE RIGHT TO USE "LEAK DETECTION", APART FROM THE MARK AS SHOWN.

SEC. 2(F).
FOR REPAIR AND MAINTENANCE SERVICES FOR SWIMMING POOLS (U.S. CLS. 100, 103 AND 106).
FIRST USE 3-1-1989; IN COMMERCE 3-1-1989.

SN 76-473,710. PERMA BUILT INC., TULSA, OK. FILED 12-11-2002.

PERMA LIFT SYSTEM

NO CLAIM IS MADE TO THE EXCLUSIVE RIGHT TO USE "SYSTEM", APART FROM THE MARK AS SHOWN.

FOR BUILDING FOUNDATION REPAIR AND STABILIZATION SERVICES, CONCRETE FOUNDATION REPAIR SERVICES AND FOUNDATION CONTRACTOR SERVICES (U.S. CLS. 100, 103 AND 106).

SN 76-479,165. KORMAN, JODY FINE, VIRGINIA BEACH, VA. FILED 12-30-2002.

THE WINDSHIELD DOCTOR

NO CLAIM IS MADE TO THE EXCLUSIVE RIGHT TO USE "WINDSHIELD", APART FROM THE MARK AS SHOWN.

FOR REPAIR SERVICES, NAMELY VEHICLE WINDSHIELD REPAIRS FOR CRACKS, CHIPS AND STARS IN WINDSHIELDS (U.S. CLS. 100, 103 AND 106).
FIRST USE 8-1-1987; IN COMMERCE 8-1-1987.

CLASS 37—(Continued).

SN 76-479,653. ALLEN, JOHN J., JR., PHOENIXVILLE, PA. AND JONES, JOHN A, POTTSTOWN, PA. FILED 1-2-2003.

FGS

FOR CONCRETE FINISHING AND RESTORATION SERVICES (U.S. CLS. 100, 103 AND 106).
FIRST USE 2-0-2001; IN COMMERCE 2-0-2001.

SN 78-147,167. PRIETO CONSTRUCTION CO., INC., IRVINE, CA. FILED 7-24-2002.

PRIETO CONSTRUCTION COMPANY

NO CLAIM IS MADE TO THE EXCLUSIVE RIGHT TO USE "CONSTRUCTION COMPANY", APART FROM THE MARK AS SHOWN.

SEC. 2(F).
FOR RESIDENTIAL AND COMMERCIAL BUILDING CONSTRUCTION (U.S. CLS. 100, 103 AND 106).
FIRST USE 1-1-1981; IN COMMERCE 1-1-1981.

SN 78-153,407. APPLERA CORPORATION, FOSTER CITY, CA. FILED 8-12-2002.

BIOASSURANCE

FOR INSTALLATION, MAINTENANCE, AND REPAIR OF LABORATORY MACHINERY AND EQUIPMENT; COMPUTER INSTALLATION AND REPAIR; MAINTENANCE AND REPAIR OF COMPUTER HARDWARE (U.S. CLS. 100, 103 AND 106).

SN 78-184,284. COLLEY, WILLIAM, R, ATLANTA, GA. FILED 11-12-2002.

IN-TOWN DEVELOPMENT GROUP

NO CLAIM IS MADE TO THE EXCLUSIVE RIGHT TO USE "DEVELOPMENT GROUP", APART FROM THE MARK AS SHOWN.

FOR CUSTOM CONSTRUCTION AND RENOVATION OF HOMES (U.S. CLS. 100, 103 AND 106).
FIRST USE 6-1-1999; IN COMMERCE 6-1-1999.

CLASS 37—(Continued).

SN 78-188,695. CUSTOM PAINTING & REMODELING, INC., WHEAT RIDGE, CO. FILED 11-25-2002.

does your house/office need



Custom Painting & Remodeling

NO CLAIM IS MADE TO THE EXCLUSIVE RIGHT TO USE "CUSTOM PAINTING & REMODELING", APART FROM THE MARK AS SHOWN.

THE LINING SHOWN IN THE DRAWING IS A FEATURE OF THE MARK.

FOR RESIDENTIAL AND COMMERCIAL REMODELING/PAINTING (U.S. CLS. 100, 103 AND 106).

FIRST USE 5-1-1997; IN COMMERCE 5-1-1997.

SN 78-198,568. WOOLLEY, BENJAMIN, P., GRAND RAPIDS, MI. FILED 12-30-2002.

NERDS ON WHEELS

FOR COMPUTER INSTALLATION AND REPAIR SERVICES; MAINTENANCE OF COMPUTER HARDWARE (U.S. CLS. 100, 103 AND 106).

SN 78-199,121. TAKEUCHI, TOSHIO, ALHAMBRA, CA. FILED 12-31-2002.

REP-SEE

FOR AUTOMOTIVE WHEEL REPAIR SERVICE (U.S. CLS. 100, 103 AND 106).

SN 78-199,855. OKOLONA PEST CONTROL, INC., LOUISVILLE, KY. FILED 1-3-2003.

THE BUG THUGS

NO CLAIM IS MADE TO THE EXCLUSIVE RIGHT TO USE "BUG", APART FROM THE MARK AS SHOWN.

FOR PEST CONTROL SERVICES (U.S. CLS. 100, 103 AND 106).

FIRST USE 1-21-1982; IN COMMERCE 1-21-1982.

CLASS 37—(Continued).

SN 78-201,433. OCEAN SPIRIT RACING CORPORATION, CORAL GABLES, FL. FILED 1-9-2003.

OCEAN SPIRIT RACING

NO CLAIM IS MADE TO THE EXCLUSIVE RIGHT TO USE "OCEAN" AND "RACING", APART FROM THE MARK AS SHOWN.

FOR MAINTENANCE AND/OR REPAIR OF BOATS; INSTALLATION OF BOAT PRODUCTS ON BOATS (U.S. CLS. 100, 103 AND 106).

FIRST USE 4-0-1999; IN COMMERCE 4-0-1999.

SN 78-203,290. SP EVENTURES, INC, ARROYO GRANDE, CA. FILED 1-14-2003.

BECAUSE YOUR TIME IS PRECIOUS

FOR CONVENIENCE BASED VEHICLE REPAIR, LUBRICATION AND SERVICE DESIGNED TO SAVE THE CONSUMER HIS/HER PRECIOUS TIME (U.S. CLS. 100, 103 AND 106).

SN 78-206,405. GAMBLIN, KRISTINA L., BRIGHTON, IL. FILED 1-23-2003.

TIGER PLUMBING SERVICES

NO CLAIM IS MADE TO THE EXCLUSIVE RIGHT TO USE "PLUMBING SERVICES", APART FROM THE MARK AS SHOWN.

FOR PLUMBING SERVICES (U.S. CLS. 100, 103 AND 106).

SN 78-206,481. INSTRUMENT DOCTORS, LLC, ALBANY, NY. FILED 1-23-2003.



NO CLAIM IS MADE TO THE EXCLUSIVE RIGHT TO USE "LLC", APART FROM THE MARK AS SHOWN.

THE MARK CONSISTS OF BLUE LETTERS FOR THE WORD "INSTRUMENT" AND RED LETTERS FOR THE WORD "DOCTORS". THE "I" AND THE "D" ARE BOTH BLACK.

FOR MEDICAL EQUIPMENT REPAIR SERVICES (U.S. CLS. 100, 103 AND 106).

CLASS 37—(Continued).

SN 78-207,512. THE BONITA BAY GROUP, BONITA SPRINGS, FL. FILED 1-27-2003.

LIFE IN BALANCE

FOR REAL ESTATE DEVELOPMENT (U.S. CLS. 100, 103 AND 106).



CLASS 38—COMMUNICATION

SN 75-447,779. CINCINNATI BELL TELEPHONE COMPANY, CINCINNATI, OH. FILED 3-10-1998.

ONE REACH

FOR TELECOMMUNICATION SERVICES, NAMELY A SPECIAL RING FEATURE THAT ALLOWS INCOMING TELEPHONE CALLS TO RING AT MORE THAN ONE LOCATION (U.S. CLS. 100, 101 AND 104).



SN 75-447,781. CINCINNATI BELL TELEPHONE COMPANY, CINCINNATI, OH. FILED 3-10-1998.

ONE REACH PLUS

FOR TELECOMMUNICATION SERVICES, NAMELY, PROVIDING A SPECIAL RING FEATURE THAT ALLOWS INCOMING TELEPHONE CALLS TO RING AT MORE THAN ONE LOCATION (U.S. CLS. 100, 101 AND 104).



SN 75-607,284. TUTTLE, ROBERT J., ORMOND BEACH, FL. FILED 12-17-1998.



THE LINING IS A FEATURE OF THE MARK AND IS NOT MEANT TO INDICATE COLOR.

FOR ELECTRONIC VOICE MESSAGING BY TELEPHONE, NAMELY, THE RECORDING, STORAGE AND SUBSEQUENT TRANSMISSION OF VOICE MESSAGES BY TELEPHONE (U.S. CLS. 100, 101 AND 104).

FIRST USE 4-1-1997; IN COMMERCE 4-1-1997.

CLASS 38—(Continued).

SN 76-025,441. WEE, PATRICK TER, WERVERSHOOF, NETHERLANDS, FILED 4-14-2000.

THE HUN'S

FOR PROVIDING ON-LINE CHAT ROOMS FOR TRANSMISSION OF MESSAGES AMONG COMPUTER USERS CONCERNING ADULT TOPICS; PROVIDING ON-LINE ELECTRONIC BULLETIN BOARDS FOR TRANSMISSION OF MESSAGES AMONG COMPUTER USERS IN THE NATURE OF NEWSPAPER AND MAGAZINE PERSONALS ADVERTISEMENTS (U.S. CLS. 100, 101 AND 104).

FIRST USE 5-0-1995; IN COMMERCE 5-0-1995.



SN 76-025,443. WEE, PATRICK TER, WERVERSHOOF, NETHERLANDS, FILED 4-14-2000.

HUN

FOR PROVIDING ON-LINE CHAT ROOMS FOR TRANSMISSION OF MESSAGES AMONG COMPUTER USERS CONCERNING ADULT TOPICS; PROVIDING ON-LINE ELECTRONIC BULLETIN BOARDS FOR TRANSMISSION OF MESSAGES AMONG COMPUTER USERS IN THE NATURE OF NEWSPAPER AND MAGAZINE PERSONALS ADVERTISEMENTS (U.S. CLS. 100, 101 AND 104).



SN 76-049,463. PRIMERA RED INTERACTIVA DE MEDIOS ARGENTINOS (PRIMA) S.A., BUENOS AIRES, ARGENTINA, FILED 5-16-2000.

FULLZERO

PRIORITY CLAIMED UNDER SEC. 44(D) ON ARGENTINA APPLICATION NO. 2.265.172, FILED 1-31-2000, REG. NO. 2265172, DATED 1-31-2000, EXPIRES 1-31-2010.

FOR PROVIDING MULTIPLE-USER ACCESS TO A GLOBAL COMPUTER INFORMATION NETWORK (U.S. CLS. 100, 101 AND 104).



SN 76-191,320. GETWIRELESS INC., STATE COLLEGE, PA. FILED 1-6-2001.

GETWIRELESS

FOR PROVIDING MULTIPLE-USER ACCESS TO A WIRELESS GLOBAL COMPUTER INFORMATION NETWORK (U.S. CLS. 100, 101 AND 104).

FIRST USE 9-30-1998; IN COMMERCE 1-30-1999.

CLASS 38—(Continued).

SN 76-203,543. ZTANGO, INC., HERNDON, VA. FILED 2-1-2001.

ZTANGO

FOR TELECOMMUNICATION SERVICES, NAMELY, THE DELIVERY AND RECEIPT OF MESSAGES, DATA, MUSIC, GAMES AND GRAPHICAL IMAGES VIA ELECTRONIC TRANSMISSIONS; PROVIDING MULTIPLE-USER ACCESS TO GLOBAL COMPUTER INFORMATION NETWORK; WIRELESS DIGITAL MESSAGING SERVICES (U.S. CLS. 100, 101 AND 104).

FIRST USE 12-15-1999; IN COMMERCE 12-15-1999.

SN 76-336,114. USA NETWORKS, INC., NEW YORK, NY. FILED 11-9-2001.

USA TRAVEL NETWORK

OWNER OF U.S. REG. NOS. 1,773,817, 2,455,726 AND OTHERS.

NO CLAIM IS MADE TO THE EXCLUSIVE RIGHT TO USE TRAVEL NETWORK, APART FROM THE MARK AS SHOWN.

SEC. 2(F).

FOR TELEVISION BROADCASTING SERVICES (U.S. CLS. 100, 101 AND 104).

SN 76-350,965. LONDON STOCK EXCHANGE PLC, LONDON EC2N 1HP, ENGLAND, FILED 12-20-2001.

TECHMARK MEDISCIENCE

PRIORITY CLAIMED UNDER SEC. 44(D) ON UNITED KINGDOM APPLICATION NO. 2273164, FILED 6-20-2001, REG. NO. 2273164, DATED 6-20-2001, EXPIRES 6-20-2011.

FOR TELECOMMUNICATIONS SERVICES, NAMELY, THE TRANSMISSION OF DATA VIA TELEPHONE, CABLE, SATELLITE TRANSMISSION, INTERNET PROTOCOL; TRANSMISSION OF DATA, MESSAGES AND INFORMATION BY COMPUTER, ELECTRONIC MAIL, TELEPRINTER, TELELETTER, AND DIGITAL TRANSMISSION; ELECTRONIC MAIL SERVICES; COMPUTER COMMUNICATION SERVICES, NAMELY, ELECTRONIC TRANSMISSION OF DATA AND DOCUMENTS VIA MODEM AND ELECTRONIC MAIL SERVICES; PROVIDING CONNECTIONS TO HIGH BANDWIDTH RESTRICTED COMPUTERS; TELECOMMUNICATION OF INFORMATION, NAMELY, TRANSMISSION OF WEB PAGES, COMPUTER PROGRAMS AND DATA BY MEANS OF TELEPHONE, CABLE, SATELLITE TRANSMISSION; TELECOMMUNICATIONS GATEWAY SERVICES, NAMELY, PROVISION OF TELECOMMUNICATIONS ACCESS LINKS TO COMPUTER DATABASES AND THE INTERNET FOR THE PROVISION OF FINANCIAL DATA AND DOCUMENTS; ALL RELATING TO, OR CONNECTED WITH, THE TRADING OF FINANCIAL INSTRUMENTS, SECURI-

CLASS 38—(Continued).

TIES, SHARES, OPTIONS AND OTHER DERIVATIVE PRODUCTS; MESSAGE SENDING AND RECEIVING SERVICES; NAMELY, E-MAIL AND TEXT MESSAGES, ALL RELATING TO STOCK EXCHANGE QUOTATIONS, TO STATISTICAL INFORMATION, TO BUSINESS OPPORTUNITIES APPRAISALS, TO FINANCIAL BUSINESS APPRAISALS AND TO INVESTMENTS, STOCKS AND SHARES; TRANSMISSION AND BROADCASTING OF SOUND, IMAGES, DATA AND INFORMATION BY MEANS OF DIGITAL, SATELLITE, CABLE AND TELEPHONE TRANSMISSION AND BROADCASTING OF SOUND, IMAGES AND INFORMATION BY MEANS OF SATELLITE AND TERRESTRIAL TELEVISION, THE INTERNET AND BY MEANS OF COMPUTERS; TRANSMISSION AND BROADCASTING OF SOUND, IMAGES AND INFORMATION BY MEANS OF COMPUTERS; TRANSMISSION AND BROADCASTING OF SOUND, IMAGES AND INFORMATION BY MEANS OF WEBSITES; DIGITAL TELEVISION, CABLE TELEVISION, SATELLITE TELEVISION, RADIO AND WEB BROADCASTS (U.S. CLS. 100, 101 AND 104).

SN 76-396,920. GUARANTY BROADCASTING COMPANY OF BATON ROUGE, L.L.C., BATON ROUGE, LA. FILED 4-17-2002.



OWNER OF U.S. REG. NOS. 2,335,368 AND 2,434,029. NO CLAIM IS MADE TO THE EXCLUSIVE RIGHT TO USE "100.7", APART FROM THE MARK AS SHOWN. FOR RADIO BROADCASTING SERVICES (U.S. CLS. 100, 101 AND 104). FIRST USE 10-18-2001; IN COMMERCE 10-18-2001.

SN 76-411,527. INTEGRATED BUSINESS COMMUNICATIONS, INC., INDIANAPOLIS, IN. FILED 5-23-2002.



FOR TELECOMMUNICATIONS IN THE NATURE OF LOCAL EXCHANGE BUSINESS TELEPHONE LINES AND SERVICES TO OWNERS AND TENANTS OF COMMERCIAL OFFICE LOCATIONS (U.S. CLS. 100, 101 AND 104).

FIRST USE 6-1-2001; IN COMMERCE 6-1-2001.

CLASS 38—(Continued).

SN 76-420,644. LEADER TECHNOLOGIES, LLC, WESTERVILLE, OH. FILED 6-13-2002.

LEADERSHIP SMART CAMERA

NO CLAIM IS MADE TO THE EXCLUSIVE RIGHT TO USE "SMART CAMERA", APART FROM THE MARK AS SHOWN.

FOR TELECOMMUNICATIONS SERVICES, NAMELY ELECTRONIC TRANSMISSION OF VOICE, DATA, INFORMATION AND IMAGES (U.S. CLS. 100, 101 AND 104).

SN 76-423,101. LEADER TECHNOLOGIES, LLC, WESTERVILLE, OH. FILED 6-14-2002.

LEADER CUBE

NO CLAIM IS MADE TO THE EXCLUSIVE RIGHT TO USE "CUBE", APART FROM THE MARK AS SHOWN.

FOR TELECOMMUNICATIONS SERVICES, NAMELY ELECTRONIC TRANSMISSION OF VOICE, DATA, INFORMATION AND IMAGES (U.S. CLS. 100, 101 AND 104).

SN 76-423,453. TENGO INTERNET, INC., AUSTIN, TX. FILED 6-20-2002.

TENGO

THE ENGLISH TRANSLATION OF "TENGO" IS "I HAVE".

FOR TELECOMMUNICATIONS SERVICES, NAMELY, PROVIDING FOR TRANSMISSION OF DATA, VOICE, VIDEO AND AUDIO VIA A GLOBAL COMPUTER INFORMATION NETWORK; TELECOMMUNICATIONS SERVICES, NAMELY, PROVIDING MULTIPLE-USER ACCESS TO A GLOBAL COMPUTER INFORMATION NETWORK; TELECOMMUNICATIONS SERVICES, NAMELY, PROVIDING WIRELESS SINGLE OR MULTIPLE-USER ACCESS TO THE INTERNET OR INTRANETS; TELECOMMUNICATIONS SERVICES, NAMELY, REMOTE LOCAL AREA NETWORK (LAN) ACCESS SERVICES (U.S. CLS. 100, 101 AND 104).

FIRST USE 12-11-2001; IN COMMERCE 3-6-2002.

CLASS 38—(Continued).

SN 76-429,335. KDDI AMERICA, INC., NEW YORK, NY. FILED 7-10-2002.

ICHIBANKAIGI 1番会議

NO CLAIM IS MADE TO THE EXCLUSIVE RIGHT TO USE "THE JAPANESE CHARACTER MEANING CONFERENCE", APART FROM THE MARK AS SHOWN.

"ICHIBAN" MEANS, "NUMBER 1, COMES IN FIRST, AND TOP CLASS". "KAIGI" MEANS, "CONFERENCE, IN ANY FORM, SUCH AS FACE-TO-FACE, OVER THE TELEPHONE AND/OR WEB". THE ENGLISH TRANSLITERATION OF THE FOREIGN JAPANESE CHARACTERS IS: "ICHIBANKAIGI".

FOR TELECOMMUNICATION SERVICES, NAMELY AUDIO AND VIDEO TELECONFERENCING, COMPUTER NETWORK CONFERENCING, AND ELECTRONIC TRANSMISSION OF DATA VOICE (U.S. CLS. 100, 101 AND 104).

FIRST USE 3-1-2002; IN COMMERCE 3-1-2002.

SN 76-435,437. SPRINT COMMUNICATIONS COMPANY L.P., OVERLAND PARK, KS. FILED 7-29-2002.

SPRINT BROADBAND DIRECT

NO CLAIM IS MADE TO THE EXCLUSIVE RIGHT TO USE "BROADBAND DIRECT", APART FROM THE MARK AS SHOWN.

FOR ELECTRONIC TRANSMISSION OF DATA AND DOCUMENTS VIA COMPUTER TERMINALS; PROVIDING MULTIPLE-USER ACCESS TO A GLOBAL COMPUTER INFORMATION NETWORK; PROVIDING TELECOMMUNICATIONS CONNECTIONS TO A GLOBAL COMPUTER NETWORK WHICH IS USED TO FACILITATE HIGH SPEED, WIRELESS TRANSMISSION OF VIDEO, VOICE AND DATA (U.S. CLS. 100, 101 AND 104).

FIRST USE 6-29-2000; IN COMMERCE 6-29-2000.

SN 76-444,829. ONE WORLD NETWORKS INTEGRATED TECHNOLOGIES, INC., LOS ANGELES, CA. FILED 8-28-2002.

GOD MONEY SEX

FOR STREAMING OF PERSONAL GROWTH AUDIO AND VISUAL MATERIAL ON THE INTERNET; PROVIDING ON-LINE ELECTRONIC BULLETIN BOARDS FOR TRANSMISSION OF MESSAGES AMONG COMPUTER USERS CONCERNING PERSONAL GROWTH (U.S. CLS. 100, 101 AND 104).

CLASS 38—(Continued).

SN 76-446,322. CHARTER COMMUNICATIONS HOLDING COMPANY, LLC, ST. LOUIS, MO. FILED 9-3-2002.

ALL TOGETHER NOW

FOR TELECOMMUNICATIONS SERVICES, NAMELY BROADBAND TELECOMMUNICATIONS SERVICES, NAMELY, LOCAL AND LONG DISTANCE TELEPHONE COMMUNICATION SERVICES, CABLE TELEVISION BROADCASTING, DIGITAL CABLE TELEVISION BROADCASTING, VIDEO-ON-DEMAND BROADCASTING, INTERACTIVE TELEVISION BROADCASTING, DIGITAL TRANSMISSION OF VOICE, DATA, IMAGES, SIGNALS AND MESSAGES DELIVERED IN HIGH DEFINITION FORMAT AND HIGH SPEED DATA AND LOCAL TELEPHONE SERVICES (U.S. CLS. 100, 101 AND 104).

FIRST USE 3-31-2003; IN COMMERCE 3-31-2003.

SN 76-454,171. O2 HOLDINGS, LLC, NEW YORK, NY. FILED 10-1-2002.

OH! OXYGEN

OWNER OF U.S. REG. NO. 2,684,295.
FOR TELEVISION BROADCASTING VIA CABLE, SATELLITE AND BROADCAST TRANSMISSIONS; AND PROVIDING ON-LINE CHAT ROOMS AND ELECTRONIC BULLETIN BOARDS FOR TRANSMISSION OF MESSAGES AMONG COMPUTER USERS CONCERNING CURRENT EVENTS, ATTITUDES, PROFILES AND LIFESTYLE ISSUES INCLUDING HEALTH, FITNESS, MEDICINE, BEAUTY, FAMILY, BUSINESS MEDIA AND POLITICS (U.S. CLS. 100, 101 AND 104).

SN 76-459,399. NEUSTAR, INC., STERLING, VA. FILED 10-15-2002.

LSREXPRESS

FOR TELECOMMUNICATIONS OPERATIONS SUPPORT SERVICES, NAMELY PROVIDING LOCAL TELEPHONE SERVICE REQUEST MANAGED AUTOMATED INTERCONNECTION CLEARINGHOUSE SERVICES TO TELECOMMUNICATIONS SERVICE AND NETWORK PROVIDERS (U.S. CLS. 100, 101 AND 104).

FIRST USE 9-23-2002; IN COMMERCE 9-23-2002.

SN 76-462,049. MEDIA DISTRIBUTION SYSTEMS, LLC, SUNRIVER, OR. FILED 10-25-2002.

VIEWNOW

FOR TELECOMMUNICATIONS SERVICES FOR DELIVERING INFORMATION IN THE FORM OF VIDEO, GRAPHICS AND TEXTUAL INFORMATION VIA A VARIETY OF DELIVERY MEANS, NAMELY, CABLE LINES, DIGITAL SUBSCRIBER LINES, FIBER OPTIC CHANNELS, WIRELESS AND SATELLITE LINKS; VIDEO ON DEMAND TRANSMISSION SERVICES (U.S. CLS. 100, 101 AND 104).

CLASS 38—(Continued).

SN 76-468,603. COMPUNETIX, INC., MONROEVILLE, PA. FILED 11-12-2002.

AUDIOCENTREX

FOR MULTIPOINT AUDIO CONFERENCING SERVICES (U.S. CLS. 100, 101 AND 104).

SN 76-478,947. THE NATIONAL COLLEGIATE ATHLETIC ASSOCIATION, INDIANAPOLIS, IN. FILED 12-30-2002.

NCAA INTERNATIONAL

NO CLAIM IS MADE TO THE EXCLUSIVE RIGHT TO USE "INTERNATIONAL", APART FROM THE MARK AS SHOWN.

FOR BROADCASTING SERVICES VIA TELEVISION, RADIO AND THE GLOBAL COMPUTER NETWORK (U.S. CLS. 100, 101 AND 104).

SN 76-483,584. MICROSENTRY, LLC, FORT LAUDERDALE, FL. FILED 1-21-2003.

MICROSENTRY

FOR ELECTRONIC MAIL SERVICES, NAMELY PROVIDING SECURE ELECTRONIC MESSAGES BETWEEN SENDER(S) AND RECIPIENTS(S) (U.S. CLS. 100, 101 AND 104).

SN 76-486,462. BETHANY WORLD PRAYER CENTER, BAKER, LA. FILED 1-27-2003.

ONE STATION UNDER GOD

FOR CHRISTIAN RADIO BROADCASTING (U.S. CLS. 100, 101 AND 104).
FIRST USE 8-5-2002; IN COMMERCE 8-5-2002.

SN 78-077,052. TELEVISION FOOD NETWORK, G.P., NEW YORK, NY. FILED 8-2-2001.

FOOD NETWORK

OWNER OF U.S. REG. NOS. 2,090,091 AND 2,230,206.
NO CLAIM IS MADE TO THE EXCLUSIVE RIGHT TO USE "NETWORK", APART FROM THE MARK AS SHOWN. SEC. 2(F).

FOR CABLE TELEVISION BROADCASTING SERVICES (U.S. CLS. 100, 101 AND 104).
FIRST USE 4-0-1996; IN COMMERCE 4-0-1996.

CLASS 38—(Continued).

SN 78-121,006. VOICETREE, INC., MCLEAN, VA. FILED 4-11-2002.

VOICETREE

FOR ELECTRONIC VOICE MESSAGING, NAMELY, THE RECORDING AND SUBSEQUENT TRANSMISSION OF VOICE MESSAGES BY TELEPHONE (U.S. CLS. 100, 101 AND 104).

CLASS 38—(Continued).

SN 78-150,865. ZONE BROADCASTING (MAXIMUM REALITY) LIMITED, LONDON, ENGLAND, UNITED KINGDOM, FILED 8-5-2002.

MAXIMUM REALITY

PRIORITY CLAIMED UNDER SEC. 44(D) ON UNITED KINGDOM APPLICATION NO. 2292055, FILED 2-6-2002, REG. NO. 2292055, DATED 2-6-2002, EXPIRES 2-6-2012.

NO CLAIM IS MADE TO THE EXCLUSIVE RIGHT TO USE "REALITY", APART FROM THE MARK AS SHOWN.

FOR TELEVISION BROADCASTING, TELEVISION TRANSMISSION SERVICES, RADIO BROADCASTING AND COMMUNICATION SERVICES, BROADCASTING PROGRAMS VIA A GLOBAL COMPUTER NETWORK, CABLE TELEVISION BROADCASTING, CABLE RADIO BROADCASTING, CABLE TELEVISION TRANSMISSION SERVICES, CABLE RADIO TRANSMISSION SERVICES (U.S. CLS. 100, 101 AND 104).

SN 78-132,303. PARAMA NETWORKS, INC., SAN JOSE, CA. FILED 5-31-2002.

PARAMESH

FOR TELECOMMUNICATIONS AND DATA NETWORKING SERVICES, NAMELY, AUDIO AND VIDEO BROADCASTING AND ELECTRONIC TRANSMISSION OF DATA (U.S. CLS. 100, 101 AND 104).

SN 78-146,683. GOL TV, INC., KEY BISCAVNE, FL. FILED 7-23-2002.

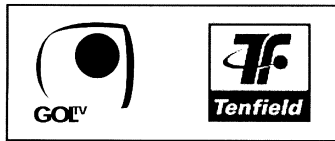

NO CLAIM IS MADE TO THE EXCLUSIVE RIGHT TO USE "TV", APART FROM THE MARK AS SHOWN.

THE MARK CONSISTS OF THE STYLIZED LETTERS "TF" ABOVE THE WORD "TENFIELD".

FOR TELEVISION BROADCASTING OF SPORTS (U.S. CLS. 100, 101 AND 104).

SN 78-153,502. AT&T WIRELESS SERVICES, INC., REDMOND, WA. FILED 8-12-2002.

ROAD TRIP MINUTES

NO CLAIM IS MADE TO THE EXCLUSIVE RIGHT TO USE "MINUTES", APART FROM THE MARK AS SHOWN.

FOR TELECOMMUNICATIONS SERVICES, NAMELY WIRELESS TRANSMISSION, UPLOADING AND DOWNLOADING OF VOICE, DATA, IMAGES, AUDIO, VIDEO, SIGNALS, SOFTWARE, INFORMATION, GAMES, RING TONES, AND MESSAGES; WIRELESS TELEPHONE SERVICES; PROVIDING WIRELESS CALLING PLANS; WIRELESS VOICE MESSAGING SERVICES, NAMELY, WIRELESS DIGITAL AND ANALOG VOICE MESSAGING SERVICES, CALL FORWARDING SERVICES; WIRELESS TEXT AND NUMERIC DIGITAL MESSAGING SERVICES; ELECTRONIC MAIL SERVICES; PAGING SERVICES; FACSIMILE TRANSMISSION SERVICES; INTERNET SERVICE PROVIDER AND ONLINE SERVICE PROVIDER SERVICES, NAMELY, PROVIDING MULTIPLE USER ACCESS TO A GLOBAL COMPUTER INFORMATION NETWORK, THE INTERNET, WIDE AREA NETWORKS, LOCAL AREA NETWORKS, AND PRIVATE COMPUTER INFORMATION NETWORKS; TELECOMMUNICATIONS SERVICES THAT ALLOW USERS TO PERFORM ELECTRONIC BUSINESS TRANSACTIONS VIA WIRELESS TELEPHONES, PERSONAL DIGITAL ASSISTANTS, HANDHELD COMPUTERS, AND MOBILE DATA RECEIVERS AND THROUGH A GLOBAL COMPUTER INFORMATION NETWORK, THE INTERNET, WIDE AREA NETWORKS, LOCAL AREA NETWORKS AND PRIVATE COMPUTER INFORMATION NETWORKS; WIRELESS ROAMING SERVICES; TELECOMMUNICATIONS CONSULTING; TELEMATICS SERVICES; TELEMETRY SERVICES; TELECOMMUNICATIONS GATEWAY SERVICES (U.S. CLS. 100, 101 AND 104).

SN 78-146,701. GOL TV, INC., KEY BISCAVNE, FL. FILED 7-23-2002.



NO CLAIM IS MADE TO THE EXCLUSIVE RIGHT TO USE "TV", APART FROM THE MARK AS SHOWN.

FOR TELEVISION BROADCASTING OF SPORTS (U.S. CLS. 100, 101 AND 104).

CLASS 38—(Continued).

SN 78-163,986. MCBLUE TELECOM, INC., WESTLAKE VILLAGE, CA. FILED 9-13-2002.

BRASTEL

FOR TELECOMMUNICATION SERVICES, NAMELY, LOCAL AND LONG-DISTANCE TRANSMISSION OF VOICE, DATA, AND GRAPHICS BY MEANS OF TELEPHONE, TELEGRAPHIC, CABLE, AND SATELLITE TRANSMISSIONS; AND TELECOMMUNICATION RESSELLER SERVICES, NAMELY, PROVIDING LONG-DISTANCE TELECOMMUNICATION SERVICES (U.S. CLS. 100, 101 AND 104).

FIRST USE 12-2-1996; IN COMMERCE 4-23-1999.

SN 78-163,991. MCBLUE TELECOM, INC., WESTLAKE VILLAGE, CA. FILED 9-13-2002.

MCBLUE

FOR TELECOMMUNICATION SERVICES, NAMELY, LOCAL AND LONG-DISTANCE TRANSMISSION OF VOICE, DATA, AND GRAPHICS BY MEANS OF TELEPHONE, TELEGRAPHIC, CABLE, AND SATELLITE TRANSMISSIONS; AND TELECOMMUNICATION RESSELLER SERVICES, NAMELY, PROVIDING LONG-DISTANCE TELECOMMUNICATION SERVICES (U.S. CLS. 100, 101 AND 104).

FIRST USE 3-1-1996; IN COMMERCE 10-1-1996.

SN 78-188,488. SUMMIT AMERICA TELEVISION, INC., NAPLES, FL. FILED 11-25-2002.

**SUMMIT AMERICA
TELEVISION**

NO CLAIM IS MADE TO THE EXCLUSIVE RIGHT TO USE "AMERICAN TELEVISION", APART FROM THE MARK AS SHOWN.

FOR PROVIDING BROADCASTING SERVICES, NAMELY, TELEVISION BROADCASTING SERVICES; TELECOMMUNICATIONS SERVICES, NAMELY, PROVIDING WIRELESS ELECTRONIC VOICE AND DATA TRANSMISSION SERVICES VIA COMPUTER TERMINALS; WIRELESS CELLULAR TELEPHONE SERVICES; WIRELESS INTERNET TELEPHONE SERVICES; WIRELESS TELEPHONE COMMUNICATION SERVICES; PROVIDING MULTIPLE USER DIAL-UP AND DEDICATED WIRELESS ACCESS TO THE INTERNET BY MEANS OF RADIO FREQUENCY TRANSMISSION (U.S. CLS. 100, 101 AND 104).

SN 78-200,806. CORR WIRELESS COMMUNICATIONS, LLC, ONEONTA, AL. FILED 1-7-2003.

**WHAT A WIRELESS WORLD
IT COULD BE**

FOR TELEPHONE SERVICES; NAMELY, WIRELESS TELEPHONE AND PERSONAL COMMUNICATION SERVICES (U.S. CLS. 100, 101 AND 104).

CLASS 38—(Continued).

SN 78-200,935. EACCELERATION CORP., POULSBO, WA. FILED 1-7-2003.

KON-X

FOR PROVIDING TELECOMMUNICATIONS CONNECTIONS TO A GLOBAL COMPUTER NETWORK (U.S. CLS. 100, 101 AND 104).

FIRST USE 12-16-2002; IN COMMERCE 12-17-2002.

SN 78-201,783. AZADI TELEVISION, INC., CHATSWORTH, CA. FILED 1-9-2003.

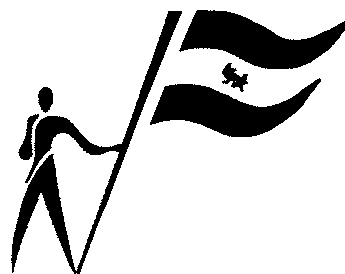

THE MARK CONSISTS OF A HUMAN FIGURE HOLDING A FLAG CONSISTING OF THREE HORIZONTAL SECTIONS, TOP AND BOTTOM PORTIONS BEING SUBSTANTIALLY THE SAME WITH A MIDDLE PORTION CONTAINING A DRAWING OF A LION. THE FLAG WAS FORMERLY THE FLAG OF IRAN BUT IS NOT NOW THE FLAG OF ANY NATION OR SOVEREIGN GOVERNMENT.

FOR TELEVISION BROADCASTING SERVICES; WEBCASTING SERVICES, NAMELY BROADCASTING TELEVISION PROGRAMS VIA A GLOBAL COMPUTER NETWORK (U.S. CLS. 100, 101 AND 104).

FIRST USE 9-1-2002; IN COMMERCE 9-12-2002.

SN 78-202,527. MCCURDY, EVERETT M., DBA INDIAN CREEK INTERNET SERVICES, BANDERA, TX. FILED 1-13-2003.

**GET OFF THE PHONE AND
GET ON THE AIR**

FOR PROVIDING HIGH-SPEED WIRELESS ACCESS TO THE INTERNET (U.S. CLS. 100, 101 AND 104).

FIRST USE 0-0-2001; IN COMMERCE 12-0-2002.

CLASS 38—(Continued).

SN 78-204,617. WNBA ENTERPRISES, LLC, SECAUCUS, NJ.
FILED 1-17-2003.

CONNECTICUT SUN

NO CLAIM IS MADE TO THE EXCLUSIVE RIGHT TO USE "CONNECTICUT", APART FROM THE MARK AS SHOWN.

FOR AUDIO BROADCASTING; CABLE TELEVISION BROADCASTING; RADIO BROADCASTING; SUBSCRIPTION TELEVISION BROADCASTING; TELEVISION BROADCASTING; VIDEO BROADCASTING; WEBCASTING SERVICES IN THE NATURE OF PROVIDING ON-LINE CHAT ROOMS AND ON-LINE INTERACTIVE CHAT ROOMS WITH GUESTS FOR TRANSMISSION OF MESSAGES AMONG COMPUTER USERS CONCERNING THE FIELD OF BASKETBALL; BROADCASTING PROGRAMS OVER THE INTERNET; PROVIDING ON-LINE ELECTRONIC BULLETIN BOARDS FOR TRANSMISSION OF MESSAGES AMONG COMPUTER USERS CONCERNING THE FIELD OF BASKETBALL; AND PROVIDING MULTIPLE-USER ACCESS TO A GLOBAL COMPUTER INFORMATION NETWORK FOR THE PURPOSE OF PARTICIPATING IN INTERACTIVE POLLING IN THE FIELD OF BASKETBALL (U.S. CLS. 100, 101 AND 104).

SN 78-208,748. SILER, TODD, ENGLEWOOD, CO. FILED 1-30-2003.

CREATIVE OPERATING SYSTEM

NO CLAIM IS MADE TO THE EXCLUSIVE RIGHT TO USE "OPERATING SYSTEM", APART FROM THE MARK AS SHOWN.

FOR PROVIDING MULTIPLE-USER ACCESS TO A GLOBAL COMPUTER INFORMATION NETWORK; PROVIDING ON-LINE CHAT ROOMS FOR TRANSMISSION OF MESSAGES AMONG COMPUTER USERS CONCERNING CREATIVITY, INNOVATIVE LEARNING, CREATIVE THINKING, AND MULTIMEDIA LEARNING. (U.S. CLS. 100, 101 AND 104).

SN 78-208,941. FIBERSAT GLOBAL SERVICES, LLC, CHATSWORTH, CA. FILED 1-30-2003.



NO CLAIM IS MADE TO THE EXCLUSIVE RIGHT TO USE "GLOBAL SERVICES", APART FROM THE MARK AS SHOWN.

FOR TRANSMISSION OF VIDEO AND DATA VIA SATELLITE AND FIBER OPTIC NETWORKS (U.S. CLS. 100, 101 AND 104).

FIRST USE 10-0-2002; IN COMMERCE 10-0-2002.

CLASS 39—TRANSPORTATION AND STORAGE

SN 75-483,361. BOSTON DUCK TOURS, BOSTON, MA.
FILED 5-7-1998.

conDUCKtor

FOR SIGHTSEEING TOUR SERVICES, NAMELY, PROVIDING SIGHTSEEING TOURS FOR OTHERS (U.S. CLS. 100 AND 105).

SN 75-703,971. TNT HOLDINGS BV, 2132 JA HOOFDDORP, NETHERLANDS, FILED 5-12-1999.



OWNER OF BENELUX REG. NO. 0640896, DATED 1-25-1999, EXPIRES 1-25-2009.

THE DRAWING IS LINED FOR THE COLOR ORANGE.
FOR EXPRESS DELIVERY SERVICES, NAMELY, DELIVERY OF FREIGHT, PACKAGES, DOCUMENTS AND THE LIKE VIA MEANS OF TRANSPORTATION INCLUDING, TRUCK, SHIP, TRAIN OR AIRPLANE; WAREHOUSE STORAGE; PASSENGER TRANSPORTATION VIA BUS, PLANE, SHIP, TAXICAB, LIMOUSINE, TRAIN; MOVING VAN TRANSPORT AND TRANSPORTATION; STORAGE AND DELIVERY OF DOCUMENTS, PACKAGES AND FREIGHT BY LAND AND AIR (U.S. CLS. 100 AND 105).

SN 76-055,038. EXELON CORPORATION, PHILADELPHIA, PA. FILED 5-23-2000.

Exelon

OWNER OF U.S. REG. NOS. 2,153,101, 2,339,885 AND OTHERS.

FOR UTILITY AND PUBLIC UTILITY SERVICES IN THE NATURE OF TRANSMISSION AND DISTRIBUTION OF ELECTRICITY AND NATURAL GAS; INFORMATION SERVICES REGARDING ELECTRICITY AND GAS UTILITY AND PUBLIC UTILITY SERVICES PROVIDED THROUGH WEBSITE AND HOME PAGES AND DISTRIBUTED VIA GLOBAL COMPUTER NETWORKS; UTILITY AND PUBLIC UTILITY SERVICES IN THE NATURE OF DISTRIBUTING ELECTRICAL POWER AND STEAM HEAT (U.S. CLS. 100 AND 105).

CLASS 39—(Continued).

SN 76-070,996. AIR CANADA, SAINT-LAURENT, PROVINCE OF QUEBEC, CANADA, FILED 6-15-2000.



OWNER OF CANADA REG. NO. TMA564325, DATED 7-4-2002, EXPIRES 7-4-2017.

OWNER OF U.S. REG. NOS. 1,874,245, 1,986,490 AND OTHERS.

FOR AIR TRANSPORTATION SERVICES OF PASSENGERS AND FREIGHT (U.S. CLS. 100 AND 105).

SN 76-216,346. 3034998 NOVA SCOTIA COMPANY, CHURCHILL, MANITOBA R0B 0E0, CANADA, FILED 2-26-2001.

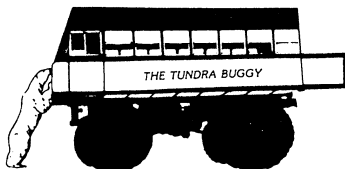

SEC. 2(F).
FOR ARRANGING AND OPERATING TRAVEL TOURS (U.S. CLS. 100 AND 105).
FIRST USE 7-7-1980; IN COMMERCE 7-7-1980.

SN 76-356,111. LAS VEGAS MONORAIL COMPANY, LAS VEGAS, NV. BY ASSIGNMENT B. KIMMEL, JEFFREY, LAS VEGAS, NV. AND BADEAU, FRANCOIS, LAS VEGAS, NV. FILED 1-8-2002.

LAS VEGAS MONORAIL TEAM

NO CLAIM IS MADE TO THE EXCLUSIVE RIGHT TO USE "MONORAIL", APART FROM THE MARK AS SHOWN. SEC. 2(F) AS TO "LAS VEGAS".
FOR TRANSPORTATION OF PASSENGERS AND/OR GOODS BY AN URBAN TRANSIT GRADE MONORAIL SYSTEM (U.S. CLS. 100 AND 105).
FIRST USE 6-21-1996; IN COMMERCE 6-21-1996.

CLASS 39—(Continued).

SN 76-356,112. LAS VEGAS MONORAIL COMPANY, LAS VEGAS, NV. BY ASSIGNMENT B. KIMMEL, JEFFREY, LAS VEGAS, NV. AND BADEAU, FRANCOIS, LAS VEGAS, NV. FILED 1-8-2002.

LAS VEGAS MONORAIL

NO CLAIM IS MADE TO THE EXCLUSIVE RIGHT TO USE "MONORAIL", APART FROM THE MARK AS SHOWN. SEC. 2(F) AS TO "LAS VEGAS".

FOR TRANSPORTATION OF PASSENGERS AND/OR GOODS BY AN URBAN TRANSIT GRADE MONORAIL SYSTEM (U.S. CLS. 100 AND 105).

FIRST USE 6-21-1996; IN COMMERCE 6-21-1996.

SN 76-363,044. NISSAN NORTH AMERICA, INC., GARDENA, CA. FILED 1-24-2002.

SNUG KIDS

FOR PROVIDING SAFETY INFORMATION IN THE INSTALLATION AND USE OF CHILDREN'S CAR SEATS (U.S. CLS. 100 AND 105).

FIRST USE 1-8-2002; IN COMMERCE 1-8-2002.

SN 76-432,669. NORTH AMERICAN NUTRITION COMPANIES, INC., LEWISBURG, OH. FILED 7-22-2002.

NTS

FOR TRANSPORTATION OF ANIMAL, LIVESTOCK, AND POULTRY FEED (U.S. CLS. 100 AND 105).

FIRST USE 1-1-2002; IN COMMERCE 1-1-2002.

SN 76-439,315. AIR CANADA, ST. LAURENT, QUEBEC, CANADA, FILED 8-8-2002.

ZIP

FOR AIR TRANSPORTATION SERVICES FOR PASSENGERS (U.S. CLS. 100 AND 105).

SN 76-439,665. AIR CANADA, ST. LAURENT, QUEBEC H4Y 1JK, CANADA, FILED 8-8-2002.

ZIP AIR

NO CLAIM IS MADE TO THE EXCLUSIVE RIGHT TO USE "AIR", APART FROM THE MARK AS SHOWN.
FOR AIR TRANSPORTATION SERVICES FOR PASSENGERS (U.S. CLS. 100 AND 105).

CLASS 39—(Continued).

SN 76-465,822. TEXAS EASTERN PRODUCTS PIPELINE COMPANY, HOUSTON, TX. FILED 11-8-2002.



OWNER OF U.S. REG. NO. 1,611,577.
 THE LINING IN THE DRAWING IS A FEATURE OF THE MARK, AND DOES NOT INDICATE ANY PARTICULAR COLOR.
 SEC. 2(F).
 FOR TRANSPORTATION OF PETROLEUM PRODUCTS BY PIPELINE; STORAGE OF PETROLEUM PRODUCTS; AND LOADING AND TRANSLOADING OF PETROLEUM PRODUCTS IN SHIPS AND BARGES, AND LOADING OF PETROLEUM PRODUCTS IN RAILROAD TANKCARS AND TANK TRUCKS (U.S. CLS. 100 AND 105).
 FIRST USE 4-30-1987; IN COMMERCE 4-30-1987.

SN 76-469,606. CUNARD LINE LIMITED, MIAMI, FL. FILED 11-22-2002.



OWNER OF U.S. REG. NOS. 1,435,958, 1,996,709 AND OTHERS.
 FOR PASSENGER CRUISE SHIP SERVICES; TRAVEL AND TOUR ARRANGEMENT SERVICES; MAKING RESERVATIONS AND BOOKINGS FOR TRANSPORTATION BY AIR, LAND AND SEA (U.S. CLS. 100 AND 105).

SN 76-486,403. ARKANSAS CHILDREN'S HOSPITAL, LITTLE ROCK, AR. FILED 1-27-2003.

ANGEL ONE TRANSPORT

NO CLAIM IS MADE TO THE EXCLUSIVE RIGHT TO USE "TRANSPORT", APART FROM THE MARK AS SHOWN.
 FOR TRANSPORTATION OF HUMAN PATIENTS AND ORGANS BY GROUND AND BY AIR (U.S. CLS. 100 AND 105).

CLASS 39—(Continued).

SN 76-486,722. BIOGEN, INC., CAMBRIDGE, MA. FILED 2-3-2003.

BIOGENDIRECT

OWNER OF U.S. REG. NOS. 1,275,543, 2,063,817 AND OTHERS.
 FOR DELIVERY SERVICES, NAMELY, ARRANGING FOR THE TRANSPORTATION OF PHARMACEUTICAL PRODUCTS FROM ONE LOCATION TO ANOTHER BY COURIER, BY AIR, BY TRUCK AND BY RAIL (U.S. CLS. 100 AND 105).

SN 78-136,713. EAGLE VAN LINES, INC., TEMPLE HILLS, MD. FILED 6-18-2002.



NO CLAIM IS MADE TO THE EXCLUSIVE RIGHT TO USE "VAN LINES", APART FROM THE MARK AS SHOWN.
 FOR PACKAGING ARTICLES FOR TRANSPORTATION, AND FREIGHT TRANSPORTATION BY TRUCKS AND AIRPLANES WITHIN THE UNITED STATES AND WORLDWIDE (U.S. CLS. 100 AND 105).
 FIRST USE 1-1-1986; IN COMMERCE 1-1-1986.

SN 78-143,993. GAYJET, LLC, SAN FRANCISCO, CA. FILED 7-15-2002.

GIRLJET

FOR TRAVEL AGENCY SERVICES, NAMELY, MAKING RESERVATIONS AND BOOKINGS FOR TRANSPORTATION FOR OTHERS; TRAVEL INFORMATION SERVICES, NAMELY, DESTINATION INFORMATION, CAR RENTAL RATES, AIRLINE INFORMATION AND CRUISE SCHEDULES (U.S. CLS. 100 AND 105).
 FIRST USE 7-14-2002; IN COMMERCE 7-14-2002.

SN 78-144,967. JETBLUE AIRWAYS CORPORATION, KEW GARDENS, NY. FILED 7-17-2002.

GRATITUDE ADJUSTMENT

FOR AIR TRANSPORTATION SERVICES FEATURING A FREQUENT FLYER AWARD PROGRAM; PROVIDING DESIGNATED HANDLING, CHECK-IN, SEATING AND RESERVATION SERVICES FOR AIR TRAVELERS; PROVIDING AUTOMATED CHECK-IN AND TICKETING SERVICES FOR AIR TRAVELERS; AND PROVIDING INFORMATION ABOUT AIR TRANSPORTATION VIA COMPUTER NETWORK (U.S. CLS. 100 AND 105).
 FIRST USE 6-13-2002; IN COMMERCE 6-13-2002.

CLASS 39—(Continued).

SN 78-168,310. GREAT LAKES GAS TRANSMISSION LIMITED PARTNERSHIP, TROY, MI. FILED 9-26-2002.

GREAT LAKES GAS TRANSMISSION COMPANY

NO CLAIM IS MADE TO THE EXCLUSIVE RIGHT TO USE "GAS TRANSMISSION COMPANY", APART FROM THE MARK AS SHOWN.

SEC. 2(F).
FOR TRANSMISSION OF NATURAL AND SYNTHETIC GAS THROUGH PIPELINES (U.S. CLS. 100 AND 105).

FIRST USE 9-24-1965; IN COMMERCE 9-24-1965.

SN 78-168,690. AMERICAN EXPRESS COMPANY, NEW YORK, NY. FILED 9-27-2002.

SMART ALERT

FOR TRAVEL INFORMATION SERVICES, NAMELY, AIRLINE TICKET STATUS NOTIFICATION SERVICE (U.S. CLS. 100 AND 105).

SN 78-200,918. PTP SERVICES LLC, SAN FRANCISCO, CA. FILED 1-7-2003.

FLAGSHIP ENERGY

NO CLAIM IS MADE TO THE EXCLUSIVE RIGHT TO USE "ENERGY", APART FROM THE MARK AS SHOWN.

FOR UTILITY SERVICES, NAMELY TRANSMISSION, TRANSPORTATION, DISTRIBUTION AND STORAGE OF ELECTRICITY, NATURAL GAS, CRUDE OIL, FUEL OIL, COAL AND LIQUID FUELS; PROVIDING ON-LINE INFORMATION ON A GLOBAL COMPUTER NETWORK IN THE FIELD OF ENERGY; CONSULTING SERVICES IN THE FIELD OF TRANSMISSION, TRANSPORTATION, DISTRIBUTION AND STORAGE OF ELECTRICITY, NATURAL GAS, CRUDE OIL, FUEL OIL, COAL AND LIQUID FUELS. (U.S. CLS. 100 AND 105).

CLASS 39—(Continued).

SN 78-201,495. SCHWARTZ, SAMUEL I., NEW YORK, NY. FILED 1-9-2003.

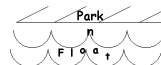

NO CLAIM IS MADE TO THE EXCLUSIVE RIGHT TO USE "PARK", APART FROM THE MARK AS SHOWN.

THE MARK CONSISTS OF THE WORDS "PARK N FLOAT" AND THE DESIGN OF A PARKING LOT DEPICTED BY THE LINE STRIPING USED TO DENOTE SEPARATE PARKING SPACES ABOVE WAVES DENOTING WATER.

FOR WATERBORNE PARKING LOT SERVICES AND TRANSPORTATION BY FERRY AND WATER TAXIS (U.S. CLS. 100 AND 105).

SN 78-203,343. YOUR CRUISE CONCIERGE, BETHESDA, MD. FILED 1-15-2003.

YOUR CRUISE CONCIERGE

NO CLAIM IS MADE TO THE EXCLUSIVE RIGHT TO USE "CRUISE CONCIERGE", APART FROM THE MARK AS SHOWN.

FOR TRAVEL AGENCY SERVICES, NAMELY MAKING RESERVATIONS AND BOOKINGS FOR CRUISES (U.S. CLS. 100 AND 105).

SN 78-207,094. STRATOSPHERE, INC., SANTA MONICA, CA. FILED 1-24-2003.

SKYONE

FOR TRANSPORTATION OF PASSENGERS BY AIR ON A SCHEDULED AND CHARTER BASIS (U.S. CLS. 100 AND 105).

SN 78-208,173. PET-ARK, INC., BREMERTON, WA. FILED 1-29-2003.

A HOME FOR EVERY PET

FOR SERVICES IN THE FIELD OF PET ADOPTION, NAMELY, PET RESCUE SERVICES (U.S. CLS. 100 AND 105).

FIRST USE 1-7-2003; IN COMMERCE 1-12-2003.

CLASS 39—(Continued).

SN 78-208,445. CAESH PROPERTIES, LLC, BLOOMINGDALE, IL. FILED 1-29-2003.

HOME TOWN STORAGE

NO CLAIM IS MADE TO THE EXCLUSIVE RIGHT TO USE "STORAGE", APART FROM THE MARK AS SHOWN. FOR SELF STORAGE FACILITY SERVICES. (U.S. CLS. 100 AND 105).

SN 78-218,675. MOBILITY TECHNOLOGIES, INC., WAYNE, PA. FILED 2-25-2003.

TANGO

FOR TRAFFIC INFORMATION SERVICES (U.S. CLS. 100 AND 105).

SN 78-218,702. MOBILITY TECHNOLOGIES, INC., WAYNE, PA. FILED 2-25-2003.

TANGO TIME

FOR TRAFFIC INFORMATION SERVICES (U.S. CLS. 100 AND 105).

SN 78-218,734. MOBILITY TECHNOLOGIES, INC., WAYNE, PA. FILED 2-25-2003.

IT'S TIME TO TANGO

FOR TRAFFIC INFORMATION SERVICES (U.S. CLS. 100 AND 105).

CLASS 40—MATERIAL TREATMENT

SN 76-165,503. MODERN PLATING CORP., FREEPORT, IL. FILED 11-13-2000.

T-WAX

FOR ELECTROPLATING OF A VARIETY OF METALS UTILIZING PROPRIETARY TOPCOATS AND FINISHES (U.S. CLS. 100, 103 AND 106).
FIRST USE 6-0-2000; IN COMMERCE 6-0-2000.

CLASS 40—(Continued).

SN 76-383,008. REYNOLDS METALS COMPANY, RICHMOND, VA. FILED 3-18-2002.

SOUTHERN GRAPHIC SYSTEMS

NO CLAIM IS MADE TO THE EXCLUSIVE RIGHT TO USE "GRAPHIC SYSTEMS", APART FROM THE MARK AS SHOWN.

FOR PREPRESS SERVICES FOR THE GRAVURE, FLEXOGRAPHIC OFFSET PRINTING AND METAL DECORATION INDUSTRIES, NAMELY, IMAGE CAPTURE, IMAGE MANIPULATION, IMAGE LAYOUT, ASSEMBLY, PROOFING AND OUTPUT (U.S. CLS. 100, 103 AND 106).

FIRST USE 9-0-1991; IN COMMERCE 9-0-1991.

SN 76-390,381. PHOTOLAB IMAGING CORP., GOLDEN VALLEY, MN. FILED 4-3-2002.

FOR MANUFACTURE OF CUSTOM DIGITAL DISPLAY GRAPHICS FOR COMMERCIAL USE; NAMELY, TRADE SHOW DISPLAYS, POINT OF PURCHASE DISPLAYS, VEHICLE GRAPHICS, INDOOR AND OUTDOOR SIGNAGE AND BANNERS (U.S. CLS. 100, 103 AND 106).

SN 76-421,032. GREAT WESTERN INDUSTRIES, INC., DALLAS, TX. FILED 6-13-2002.

LIQUID JEWELS

NO CLAIM IS MADE TO THE EXCLUSIVE RIGHT TO USE "LIQUID", APART FROM THE MARK AS SHOWN.

FOR PRINTING SERVICES, NAMELY, PROVIDING PROPRIETARY PRINTING OR DECORATION TECHNIQUES FOR OTHERS ON PRINTABLE MATERIAL (U.S. CLS. 100, 103 AND 106).

SN 76-422,002. THE CARLTON WINEMAKERS' STUDIO, LLC, CARLTON, OR. FILED 6-17-2002.

THE STUDIO

FOR PRODUCTION OF WINE FOR OTHERS; RENTING OR LEASING USE OF WINEMAKING FACILITIES OR EQUIPMENT (U.S. CLS. 100, 103 AND 106).

CLASS 40—(Continued).

SN 76-432,352. INTERNATIONAL CONSORTIUM, INC.,
HENDERSONVILLE, TN. FILED 7-19-2002.



NO CLAIM IS MADE TO THE EXCLUSIVE RIGHT TO
USE "INTERNATIONAL CONSORTIUM", APART FROM
THE MARK AS SHOWN.

FOR CONTRACT MANUFACTURING AND ASSEM-
BLY OF PRODUCTS FOR OTHERS (U.S. CLS. 100, 103
AND 106).

FIRST USE 7-28-1981; IN COMMERCE 7-28-1981.

SN 76-460,884. SPHINX SOFTWARE, INC., PRINCETON
JUNCTION, NJ. FILED 10-24-2002.

E-NREPORT

NO CLAIM IS MADE TO THE EXCLUSIVE RIGHT TO
USE "REPORT", APART FROM THE MARK AS SHOWN.

FOR DOCUMENT DATA TRANSFER AND PHYSICAL
CONVERSION SERVICES FROM ONE MEDIA TO AN-
OTHER, NAMELY, CONVERTING FINANCIAL RE-
PORTS FOR OTHERS (U.S. CLS. 100, 103 AND 106).

SN 76-460,885. SPHINX SOFTWARE, INC., PRINCETON
JUNCTION, NJ. FILED 10-24-2002.

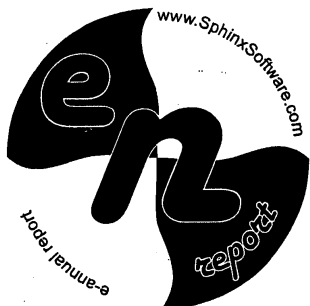

NO CLAIM IS MADE TO THE EXCLUSIVE RIGHT TO
USE "WWW.", "SOFTWARE.COM", "E-ANNUAL REPORT"
AND "REPORT", APART FROM THE MARK AS SHOWN.

FOR DOCUMENT DATA TRANSFER AND PHYSICAL
CONVERSION SERVICES FROM ONE MEDIA TO AN-
OTHER, NAMELY, CONVERTING FINANCIAL RE-
PORTS FOR OTHERS (U.S. CLS. 100, 103 AND 106).

CLASS 40—(Continued).

SN 76-462,334. BRAUN, DANIEL R., DBA BRAUN FURNI-
TURE, MCHENRY, IL. FILED S.R. 10-25-2002; AM. P.R. 4-
21-2003.



NO CLAIM IS MADE TO THE EXCLUSIVE RIGHT TO
USE "FURNITURE", APART FROM THE MARK AS
SHOWN.

THE STIPPLING SHOWN IN THE DRAWING IS A
FEATURE OF THE MARK AND IS NOT INTENDED TO
INDICATE COLOR.

SEC. 2(F).

FOR CUSTOM MANUFACTURE OF WOOD FURNI-
TURE FOR OTHERS (U.S. CLS. 100, 103 AND 106).

FIRST USE 0-0-1998; IN COMMERCE 0-0-1998.

SN 76-472,337. BOBAROSA'S GOURMET, INC., CLEAR-
WATER, FL. FILED 12-4-2002.

BOBAROSA'S GOURMET

NO CLAIM IS MADE TO THE EXCLUSIVE RIGHT TO
USE "GOURMET", APART FROM THE MARK AS SHOWN.
FOR CUSTOM FLAVORING OF SAUCES AND DRY
SEASONINGS (U.S. CLS. 100, 103 AND 106).

FIRST USE 6-0-2001; IN COMMERCE 6-0-2001.

SN 76-477,367. BARTLETT, WILLIAM A., ATLANTA, GA.
FILED 12-23-2002.

WINGNUT RACING

NO CLAIM IS MADE TO THE EXCLUSIVE RIGHT TO
USE "RACING", APART FROM THE MARK AS SHOWN.

FOR CUSTOM FABRICATION AND FINISHING OF
RACING CARS (U.S. CLS. 100, 103 AND 106).

FIRST USE 9-14-2001; IN COMMERCE 9-14-2001.

CLASS 40—(Continued).

SN 76-478,871. VALENTINE ENTERPRISES, INC., LAWRENCEVILLE, GA. FILED 12-26-2002.



NO CLAIM IS MADE TO THE EXCLUSIVE RIGHT TO USE "ENTERPRISES, INC.", APART FROM THE MARK AS SHOWN.

FOR CONTRACT FORMULATION AND MANUFACTURING IN THE FIELD OF POWDERED FOOD PRODUCTS AND COMPRESSED TABLETS FOR OTHERS (U.S. CLS. 100, 103 AND 106).
FIRST USE 0-0-1989; IN COMMERCE 0-0-1989.

SN 76-479,340. PREVOST CAR INC., STE CLAIRE, QUEBEC, CANADA, FILED 12-31-2002.



OWNER OF U.S. REG. NOS. 2,621,160, 2,718,699 AND OTHERS.
FOR MANUFACTURE OF GENERAL PRODUCT LINES IN THE FIELD OF AUTOMOBILES, NAMELY BUSES, TO THE ORDER AND SPECIFICATION OF OTHERS (U.S. CLS. 100, 103 AND 106).
FIRST USE 9-23-2002; IN COMMERCE 9-23-2002.

SN 76-484,291. LETTEROR VOF, 2513 BJ THE HAGUE, NETHERLANDS, FILED 1-22-2003.

LETTERSETTER

FOR REMOTE TYPESETTING SERVICES, NAMELY, PROVIDING FOR THE ON-LINE PRE VIEWING AND SELECTION OF TYPE FACE FONTS VIA THE USER'S REMOTE INPUT OF USER SELECTED TEXT AND PROVIDING FOR THE RETURN OF A REMOTE USER'S TYPE SET TEXT VIA A GLOBAL COMPUTER INFORMATION NETWORK (U.S. CLS. 100, 103 AND 106).
FIRST USE 1-8-2002; IN COMMERCE 1-8-2002.

SN 76-484,805. VISUAL SYSTEMS, INC., MILWAUKEE, WI. FILED 1-27-2003.

VARICHROME

FOR PRINTING SERVICES, NAMELY, PRINTING TEXTBOOKS AND BOOK JACKETS (U.S. CLS. 100, 103 AND 106).

CLASS 40—(Continued).

SN 78-067,380. RICHLAND LAUNDRY & DRY CLEANERS, DBA U.S. LINEN & UNIFORM, RICHLAND, WA. FILED 6-5-2001.

“SERVICE WHEN YOU NEED IT!”

FOR RENTAL OF LINENS AND LAUNDRY (U.S. CLS. 100, 103 AND 106).
FIRST USE 1-1-2001; IN COMMERCE 1-1-2001.

SN 78-100,702. GRIEBAHN, LYNN, DBA THE BALLOON HOUSE, IOWA CITY, IA. FILED 1-3-2002.

OVERNIGHT LINE

SEC. 2(F).
FOR CUSTOMIZED PRINTING OF NAMES, LOGOS, WORDS AND GRAPHICS ON BALLOONS FOR PROMOTIONAL, ENTERTAINMENT OR ADVERTISING PURPOSES OF OTHERS (U.S. CLS. 100, 103 AND 106).
FIRST USE 0-0-1995; IN COMMERCE 0-0-1995.

SN 78-140,917. SB OPERATINGCO, LLC, SAN DIEGO, CA. BY CHANGE OF NAME SB OPERATINGCO, INC., SAN DIEGO, CA. FILED 7-2-2002.

ENJOY WITH CONFIDENCE

FOR TREATMENT OF FOOD BY IRRADIATION (U.S. CLS. 100, 103 AND 106).
FIRST USE 4-0-2002; IN COMMERCE 4-0-2002.

SN 78-157,980. PANNONIA GROUP, INC., CULVER CITY, CA. FILED 8-26-2002.

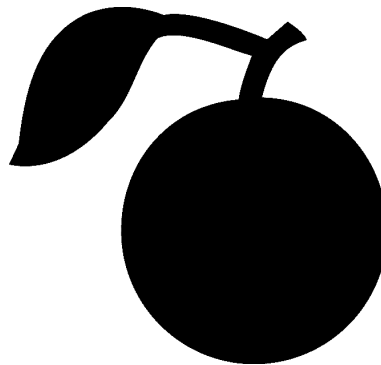

FOR CUSTOM MANUFACTURING OF RETAIL STORE SIGNAGE, FABRIC AND VINYL BANNERS, POSTERS, WALL MURALS AND BARRICADES, WINDOW CLINGS, INTERIOR HARDWARE AND STORE FIXTURES, TRADE SHOW GRAPHICS AND BOOTHS, POP DISPLAYS, EVENT GRAPHICS, MUSEUM DISPLAYS, VEHICLE GRAPHICS, TRUCKSIDE ADVERTISING, FLEET GRAPHICS, LIGHT BOXES AND BACKLIT GRAPHICS (U.S. CLS. 100, 103 AND 106).

CLASS 40—(Continued).

SN 78-166,796. SERFOSS, JACQUELINE, LAS VEGAS, NV. FILED 9-23-2002.

PEDALKINZ

FOR CUSTOM PRINTING OF INFANT BIRTH STATISTICS AND FOOT PRINTS ON STATIONERY, CERTIFICATES, CANDY WRAPPERS, T-SHIRTS, PILLOWS, BLANKETS, MUGS, PLATES, PLAQUES, FRAMES SUITABLE FOR BIRTH ANNOUNCEMENTS. (U.S. CLS. 100, 103 AND 106).

FIRST USE 9-20-2002; IN COMMERCE 9-20-2002.

SN 78-193,570. CHEVRONTEXACO CORPORATION, SAN FRANCISCO, CA. FILED 12-11-2002.



NO CLAIM IS MADE TO THE EXCLUSIVE RIGHT TO USE "HYDROCARBONS TO LIQUIDS", APART FROM THE MARK AS SHOWN.

FOR CONVERSION OF LOW VALUE HYDROCARBONS TO FISCHER-TROPSCH FUELS AND OTHER FISCHER-TROPSCH BASED PRODUCTS (U.S. CLS. 100, 103 AND 106).

SN 78-204,126. QUAD/GRAPHICS, INC., SUSSEX, WI. FILED 1-16-2003.

SMARTCREATE

FOR DIGITAL IMAGING SERVICES IN THE FIELD OF PRINTING AND PRINT PRODUCTION (U.S. CLS. 100, 103 AND 106).

FIRST USE 4-1-2002; IN COMMERCE 4-1-2002.

SN 78-206,064. TUGBOAT, INC., NAPA, CA. FILED 1-22-2003.

TUGBOAT

FOR CUSTOMIZED PRINTING OF COMPANY NAMES AND LOGOS FOR PROMOTIONAL AND ADVERTISING PURPOSES; CUSTOM EMBROIDERY OF CORPORATE NAMES AND LOGOS FOR OTHERS (U.S. CLS. 100, 103 AND 106).

SN 78-206,575. RABBANI, HAMI, NORTHRIDGE, CA. FILED 1-23-2003.

PRINTRUNNER

FOR PRINTING BROCHURES, CATALOGS, BUSINESS CARDS AND POSTERS (U.S. CLS. 100, 103 AND 106).

CLASS 40—(Continued).

SN 78-208,038. NUCON STEEL CORPORATION, WILMINGTON, DE. FILED 1-28-2003.

NUSHELTER

FOR MANUFACTURE OF GENERAL PRODUCT LINES IN THE FIELD OF STEEL FRAMED HOUSING TO THE ORDER OF OTHERS (U.S. CLS. 100, 103 AND 106).

SN 78-211,291. KATAYAMA AMERICAN COMPANY, INCORPORATED, SHELBYVILLE, KY. FILED 2-5-2003.

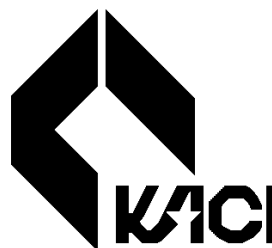

FOR CUSTOM MANUFACTURE OF AUTOMOTIVE PARTS FOR OTHERS; MANUFACTURE OF GENERAL PRODUCT LINES IN THE FIELD OF AUTOMOTIVE PARTS TO THE ORDER AND SPECIFICATION OF OTHERS (U.S. CLS. 100, 103 AND 106).

FIRST USE 8-31-1989; IN COMMERCE 8-31-1989.

SN 78-215,592. MAZAMA INCORPORATED, BLUE SPRINGS, MO. FILED 2-17-2003.

MAZAMA

FOR EMBROIDERY SERVICES, NAMELY, ELECTRONIC SCANNING, DIGITIZING AND EDITING OF PHOTOGRAPHIC IMAGES AND ARTWORK USED BY SOFTWARE TO GUIDE EMBROIDERING MACHINES (U.S. CLS. 100, 103 AND 106).

FIRST USE 9-30-1994; IN COMMERCE 12-31-1995.

CLASS 41—EDUCATION AND ENTERTAINMENT

CLASS 41—(Continued).

SN 75-587,358. SENIOR CONSULTING GROUP, L.L.C., NORTH BRUNSWICK, NJ. FILED S.R. 11-12-1998; AM. P.R. 12-6-2000.



THE LINING SHOWN IN THE DRAWING IS A FEATURE OF THE MARK AND IS NOT INTENDED TO INDICATE COLOR. THE STIPPLING IN THE DRAWING IS INTENDED FOR SHADING PURPOSES ONLY.
 FOR CONDUCTING SEMINARS FOR SENIOR PERSONS RELATING TO FINANCIAL AND ESTATE MATTERS (U.S. CLS. 100, 101 AND 107).
 FIRST USE 11-30-1998; IN COMMERCE 11-30-1998.

SN 75-655,284. BLOMELEY COMMUNICATIONS INC., NEPEAN, ONTARIO, K2H 8R2, CANADA, FILED 3-8-1999.

KARDIO KNOCKOUT

PRIORITY CLAIMED UNDER SEC. 44(D) ON CANADA APPLICATION NO. 889,712, FILED 9-9-1998, REG. NO. 539,225, DATED 9-9-1998, EXPIRES 9-9-2013.
 NO CLAIM IS MADE TO THE EXCLUSIVE RIGHT TO USE "KARDIO", APART FROM THE MARK AS SHOWN.
 FOR TELEVISION SHOWS AND PROGRAMS IN THE FIELD OF PHYSICAL FITNESS; AND LIVE PERFORMANCES FEATURING PHYSICAL FITNESS DEMONSTRATIONS AT FITNESS EXPOS AND FITNESS WORKSHOPS (U.S. CLS. 100, 101 AND 107).

SN 75-826,123. THE ASHTON-DRAKE GALLERIES, LTD., NILES, IL. FILED 10-18-1999.

THE OFFICIAL GENE FAN CLUB

NO CLAIM IS MADE TO THE EXCLUSIVE RIGHT TO USE "OFFICIAL" AND "FAN CLUB", APART FROM THE MARK AS SHOWN.
 FOR FAN CLUB SERVICES RELATED TO COLLECTIBLE DOLLS (U.S. CLS. 100, 101 AND 107).

CLASS 41—(Continued).

SN 75-840,776. SIGMUND, BENJAMIN, WASHBURN, IA. FILED 11-5-1999.

A.K.A. DESIGN

FOR CATALOG PUBLISHING SERVICES (U.S. CLS. 100, 101 AND 107).

SN 76-015,840. RONALD, FENLEY, REDONDO BEACH, CA. FILED 4-3-2000.



NO CLAIM IS MADE TO THE EXCLUSIVE RIGHT TO USE "TURNKEY MULTIMEDIA", APART FROM THE MARK AS SHOWN.
 THE NAME "RON FENLEY" IDENTIFIES A LIVING INDIVIDUAL WHOSE CONSENT IS OF RECORD.
 FOR (BASED ON USE IN COMMERCE) VIDEOTAPE PRODUCTION SERVICES; (BASED ON INTENT TO USE) VIDEO PRODUCTION, NAMELY, CD-ROM PRODUCTION SERVICES FOR BUSINESSES SEEKING PROMOTIONAL, SALES AND MARKETING VIDEO AND CD-ROM PRODUCTS (U.S. CLS. 100, 101 AND 107).
 FIRST USE 4-2-1991; IN COMMERCE 4-2-1991.

CLASS 41—(Continued).

SN 76-264,389. NBDL ENTERPRISES, LLC, SECAUCUS, NJ. FILED 5-30-2001.



OWNER OF U.S. REG. NOS. 2,599,556, 2,705,421 AND OTHERS.

NO CLAIM IS MADE TO THE EXCLUSIVE RIGHT TO USE "FAYETTEVILLE", APART FROM THE MARK AS SHOWN.

FOR ENTERTAINMENT AND EDUCATIONAL SERVICES IN THE NATURE OF ONGOING TELEVISION AND RADIO PROGRAMS IN THE FIELD OF BASKETBALL AND RENDERING LIVE BASKETBALL GAMES AND BASKETBALL EXHIBITIONS; THE PRODUCTION AND DISTRIBUTION OF RADIO AND TELEVISION BROADCASTS OF BASKETBALL GAMES, BASKETBALL EVENTS AND PROGRAMS IN THE FIELD OF BASKETBALL; CONDUCTING AND ARRANGING BASKETBALL CLINICS AND COACHES CLINICS AND BASKETBALL EVENTS; ENTERTAINMENT SERVICES, NAMELY PROVIDING A WEBSITE FEATURING TELEVISION HIGHLIGHTS, VIDEO RECORDINGS, RADIO PROGRAMS, RADIO HIGHLIGHTS, AND AUDIO RECORDINGS IN THE FIELD OF BASKETBALL; ENTERTAINMENT SERVICES, NAMELY PROVIDING A WEBSITE FEATURING SPORTS INFORMATION, NAMELY BASKETBALL NEWS, STATISTICAL INFORMATION, POLLING INFORMATION, AND INTERACTIVE POLLING IN THE FIELD OF BASKETBALL; ENTERTAINMENT SERVICES, NAMELY PROVIDING A WEBSITE FEATURING ON-LINE COMPUTER GAMES, COMPUTER BOARD GAMES AND VIDEO GAMES (U.S. CLS. 100, 101 AND 107).

SN 76-288,262. TECHNOLOTREE, INC., NEW YORK, NY. FILED 7-23-2001.

TECHNOLOTREE

FOR ENTERTAINMENT IN THE NATURE OF PROVIDING HUMOROUS MOTIVATIONAL EMAIL MESSAGES REGARDING DIET, HEALTH, LIFESTYLE AND PERSONAL HEALTH GOALS (U.S. CLS. 100, 101 AND 107).

SN 76-293,789. BARABINO, BARBARA, LOS ANGELES, CA. FILED 8-3-2001.

REGGAE OLD SCHOOL JAM

NO CLAIM IS MADE TO THE EXCLUSIVE RIGHT TO USE "REGGAE", APART FROM THE MARK AS SHOWN. SEC. 2(F).

FOR ENTERTAINMENT IN THE NATURE OF AN ETHNIC FESTIVAL FEATURING LIVE MUSICAL GROUPS (U.S. CLS. 100, 101 AND 107).

FIRST USE 6-15-1997; IN COMMERCE 6-15-1997.

CLASS 41—(Continued).

SN 76-310,932. MAGNOLIA PICTURES, LLC, AUSTIN, TX. FILED 9-10-2001.

MAGNOLIA PICTURES

NO CLAIM IS MADE TO THE EXCLUSIVE RIGHT TO USE "PICTURES", APART FROM THE MARK AS SHOWN.

FOR CONDUCTING ENTERTAINMENT EXHIBITIONS IN THE NATURE OF INDEPENDENT AND FOREIGN FILMS; DISTRIBUTION OF INDEPENDENT AND FOREIGN FILMS (U.S. CLS. 100, 101 AND 107).

SN 76-312,654. MAGNOLIA PICTURES, LLC, AUSTIN, TX. FILED 9-12-2001.

THE MAGNOLIA

FOR CONDUCTING ENTERTAINMENT EXHIBITIONS IN THE NATURE OF INDEPENDENT AND FOREIGN FILMS; DISTRIBUTION OF INDEPENDENT AND FOREIGN FILMS (U.S. CLS. 100, 101 AND 107).

SN 76-340,938. NATIONAL CONFERENCE ON PUBLIC EMPLOYEE RETIREMENT SYSTEMS, WASHINGTON, DC. FILED 11-23-2001.

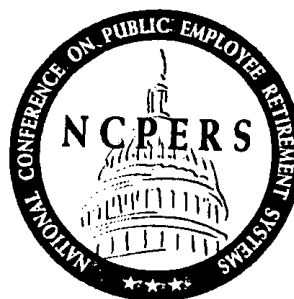

NO CLAIM IS MADE TO THE EXCLUSIVE RIGHT TO USE "CONFERENCE", APART FROM THE MARK AS SHOWN.

THE STIPLING SHOWN IN THE DRAWING IS A FEATURE OF THE MARK AND IS NOT INTENDED TO INDICATE COLOR.

SEC. 2(F) AS TO "NATIONAL CONFERENCE ON PUBLIC EMPLOYEE RETIREMENT SYSTEMS".

FOR EDUCATIONAL SERVICES, NAMELY, ARRANGING AND CONDUCTING CONFERENCES IN THE FIELD OF PUBLIC EMPLOYEE RETIREMENT SYSTEMS (U.S. CLS. 100, 101 AND 107).

FIRST USE 6-25-2001; IN COMMERCE 6-25-2001.

CLASS 41—(Continued).

SN 76-349,744. AMERICAN COLLEGE, THE, BRYN MAWR, PA. FILED 12-18-2001.

REGISTERED HEALTH UNDERWRITER

NO CLAIM IS MADE TO THE EXCLUSIVE RIGHT TO USE HEALTH UNDERWRITER, APART FROM THE MARK AS SHOWN.

SEC. 2(F) AS TO "REGISTERED".

FOR EDUCATIONAL SERVICES, NAMELY, CONDUCTING CLASSES AND SEMINARS IN THE FIELDS OF DISABILITY INCOME AND HEALTH INSURANCE BY MEANS OF VIDEO TAPE, CD-ROM, AND VIDEO TELECONFERENCE PRESENTATIONS (U.S. CLS. 100, 101 AND 107).

FIRST USE 0-0-1979; IN COMMERCE 0-0-1979.

SN 76-360,853. DISNEY ENTERPRISES, INC., BURBANK, CA. FILED 1-17-2002.

DISNEY'S RETURN TO NEVERLAND

FOR LIVE STAGE SHOWS; PRESENTATION OF LIVE PERFORMANCES, NAMELY, LIVE MUSICAL PERFORMANCES AND STREET PERFORMANCES; THEATER PRODUCTIONS; AMUSEMENT PARK AND THEME PARK SERVICES; ENTERTAINER SERVICES, NAMELY, LIVE PERFORMANCES BY COSTUMED ENTERTAINERS; ENTERTAINMENT SERVICES RENDERED IN A THEME PARK, NAMELY, AMUSEMENT PARK RIDES AND ATTRACTIONS; LIVE SHOWS FEATURING LIGHTS, MUSIC AND FIREWORKS, AND AMUSEMENT ARCADES; PROVIDING ENTERTAINMENT INFORMATION OVER THE INTERNET; A CONTINUING CHILDREN'S TELEVISION SERIES (U.S. CLS. 100, 101 AND 107).

SN 76-367,558. YAN, XIN, NEW YORK, NY. FILED 2-6-2002.

NINE-STEP QIGONG

NO CLAIM IS MADE TO THE EXCLUSIVE RIGHT TO USE "QIGONG", APART FROM THE MARK AS SHOWN.

THE ENGLISH TRANSLATION OF "QIGONG" IN THE MARK IS "WORKING WITH ENERGY".

SEC. 2(F).

FOR QIGONG INSTRUCTION; EDUCATION SERVICES, NAMELY, CLASSES, SEMINARS, CONFERENCES, WORKSHOPS AND MEETINGS IN THE FIELD OF QIGONG (U.S. CLS. 100, 101 AND 107).

FIRST USE 1-1-1992; IN COMMERCE 1-1-1992.

CLASS 41—(Continued).

SN 76-367,951. SHARP LABORATORIES OF AMERICA, INC., CAMAS, WA. FILED 2-6-2002.

HIGH-IMPACT SPORTS!

NO CLAIM IS MADE TO THE EXCLUSIVE RIGHT TO USE "SPORTS", APART FROM THE MARK AS SHOWN.

FOR ENTERTAINMENT SERVICES, NAMELY, PROVIDING SPORTS GAME VIDEO SUMMARIES OF FOOTBALL, SOCCER, SUMO WRESTLING AND BASEBALL (U.S. CLS. 100, 101 AND 107).

SN 76-368,088. MINYANVILLE PUBLISHING AND MULTIMEDIA, INC., NEW YORK, NY. BY ASSIGNMENT TODD HARRISON & ASSOCIATES, INC., NEW YORK, NY. FILED 2-8-2002.

SNAPPER THE TURTLE

FOR PROVIDING ON-LINE COMIC STRIPS AND FINANCIAL CARTOONS IN THE FIELDS OF THE STOCK MARKET, STOCK MARKET MOVEMENT AND INVESTMENT ADVICE (U.S. CLS. 100, 101 AND 107).

FIRST USE 12-3-2002; IN COMMERCE 12-3-2002.

SN 76-368,089. MINYANVILLE PUBLISHING AND MULTIMEDIA, INC., NEW YORK, NY. BY ASSIGNMENT TODD HARRISON & ASSOCIATES, INC., NEW YORK, NY. FILED 2-8-2002.

DAISY THE COW

FOR PROVIDING ON-LINE COMIC STRIPS AND FINANCIAL CARTOONS IN THE FIELDS OF THE STOCK MARKET, STOCK MARKET MOVEMENT AND INVESTMENT ADVICE (U.S. CLS. 100, 101 AND 107).

FIRST USE 12-3-2002; IN COMMERCE 12-3-2002.

SN 76-368,090. MINYANVILLE PUBLISHING AND MULTIMEDIA, INC., NEW YORK, NY. BY ASSIGNMENT TODD HARRISON & ASSOCIATES, INC., NEW YORK, NY. FILED 2-8-2002.

SAMMY THE SNAKE

FOR PROVIDING ON-LINE COMIC STRIPS AND FINANCIAL CARTOONS IN THE FIELDS OF THE STOCK MARKET, STOCK MARKET MOVEMENT AND INVESTMENT ADVICE (U.S. CLS. 100, 101 AND 107).

FIRST USE 12-3-2002; IN COMMERCE 12-3-2002.

CLASS 41—(Continued).

SN 76-369,001. ASSOCIATION OF LEGAL ADMINISTRATORS, VERNON HILLS, IL. FILED 2-7-2002.

ALA

OWNER OF U.S. REG. NOS. 1,562,146, 1,792,093 AND 1,792,379.

FOR EDUCATIONAL SERVICES TO ENHANCE THE COMPETENCE AND PROFESSIONALISM OF LEGAL ADMINISTRATORS AND OTHER MEMBERS OF MANAGEMENT IN LEGAL SERVICE ORGANIZATIONS, NAMELY, CONDUCTING CLASSES, SEMINARS, CONFERENCES AND WORKSHOPS IN THE FIELD OF LEGAL SERVICES ADMINISTRATION (U.S. CLS. 100, 101 AND 107).

FIRST USE 11-0-1987; IN COMMERCE 11-0-1987.

SN 76-386,219. INTELLIGENT HEALTH, LTD., CAREFREE, AZ. FILED 3-20-2002.

EMBARC

FOR PROVIDING FITNESS AND EXERCISE FACILITIES FOR OTHERS; HEALTH CLUB SERVICES, NAMELY, PROVIDING EQUIPMENT IN THE FIELD OF PHYSICAL EXERCISE; PROVIDING PHYSICAL FITNESS INSTRUCTION AND CONSULTATION FOR OTHERS; EDUCATIONAL SERVICES, NAMELY, CONDUCTING CLASSES, SEMINARS, CONFERENCES AND WORKSHOPS IN THE FIELD OF PHYSICAL EXERCISE; SPORTING AND CULTURAL ACTIVITIES, NAMELY, ORGANIZING COMMUNITY SPORTING AND FITNESS EVENTS AND COMPETITIONS; ENTERTAINMENT SERVICES, NAMELY, RENTAL OF COMPUTER AND VIDEO GAMES FOR USE BY OTHERS WHILE EXERCISING; PROVIDING AN ON-LINE COMPUTER GAME FOR OTHERS; RENTAL OF COMPUTER GAME PROGRAMS; AND AMUSEMENT CENTERS (U.S. CLS. 100, 101 AND 107).

SN 76-392,796. BRICKYARD TRADEMARKS, INC., HENDERSON, NV. FILED 4-9-2002.



NO CLAIM IS MADE TO THE EXCLUSIVE RIGHT TO USE "PRO SERIES", APART FROM THE MARK AS SHOWN. FOR ORGANIZING AND CONDUCTING AN AUTOMOBILE RACING SERIES (U.S. CLS. 100, 101 AND 107). FIRST USE 7-7-2002; IN COMMERCE 7-7-2002.

CLASS 41—(Continued).

SN 76-393,631. LISTER, ETHEL A., TUCKER, GA. FILED 4-8-2002.

THE STATESMEN QUARTET

NO CLAIM IS MADE TO THE EXCLUSIVE RIGHT TO USE "QUARTET", APART FROM THE MARK AS SHOWN.

FOR ENTERTAINMENT SERVICES IN THE NATURE OF LIVE PERFORMANCES BY A MUSICAL GROUP (U.S. CLS. 100, 101 AND 107).

FIRST USE 10-0-1948; IN COMMERCE 10-0-1948.

SN 76-395,898. FENLON, CYNDEE G, SAN DIEGO, CA. FILED 4-15-2002.



FOR EDUCATIONAL SERVICES, NAMELY, CONDUCTING CLASSES, SEMINARS AND WORKSHOPS IN THE FIELD OF HEALTH AND HYGIENE (U.S. CLS. 100, 101 AND 107).

FIRST USE 11-0-2000; IN COMMERCE 11-0-2001.

SN 76-397,376. GRIMARD WILSON CONSULTING, INC., CHICAGO, IL. FILED 4-18-2002.

Resources for the Human Side of Work

FOR CAREER COUNSELING, CAREER TRANSITION COUNSELING, EMPLOYEE OUTPLACEMENT SERVICES; EDUCATIONAL SERVICES, NAMELY, CONDUCTING CLASSES, SEMINARS, CONFERENCES AND WORKSHOPS IN THE FIELD OF LEADERSHIP DEVELOPMENT, STRESS MANAGEMENT TECHNIQUES, COACHING COMMUNICATION SKILLS TRAINING, TEAM BUILDING TRAINING, NEGOTIATION SKILLS TRAINING, AND ORGANIZATIONAL DEVELOPMENT TRAINING (U.S. CLS. 100, 101 AND 107).

FIRST USE 8-1-2001; IN COMMERCE 8-1-2001.

CLASS 41—(Continued).

SN 76-397,604. BOURQUE, ASHLEY, GOTH, FL. FILED 4-18-2002.

ROCKING CHAIR PRODUCTIONS

NO CLAIM IS MADE TO THE EXCLUSIVE RIGHT TO USE "PRODUCTION", APART FROM THE MARK AS SHOWN.

FOR ENTERTAINMENT, NAMELY, MUSIC PUBLISHING; PRODUCTION OF LIVE VARIETY SHOWS, RECORDS, COMPACT DISCS AND AUDIO TAPE PRODUCTION; MOTION PICTURE FILM PRODUCTION; PRODUCTION OF VIDEO CASSETTES; PRODUCTION OF LIVE MUSICAL CONCERTS; COMPOSITION OF MUSIC FOR OTHERS, NAMELY, WRITING AND SCORING OF MUSICAL COMPOSITION (U.S. CLS. 100, 101 AND 107).

SN 76-401,088. JUKO-KAI INTERNATIONAL, INC., RICHARDSON, TX. FILED 4-26-2002.

COMBAT-KI

FOR EDUCATIONAL SERVICES, NAMELY, TRAINING IN A JAPANESE-DERIVED FORM OF INTERNAL ENERGY; TRAINING IN THE MARTIAL ARTS (U.S. CLS. 100, 101 AND 107).

SN 76-407,494. INTV, INC., NEW YORK, NY. FILED 5-14-2002.

PSEUDO

FOR DISTRIBUTION OF TELEVISION PROGRAMS FOR OTHERS AND DISTRIBUTION OF TELEVISION PROGRAMMING TO CABLE TELEVISION SYSTEMS (U.S. CLS. 100, 101 AND 107).

FIRST USE 1-0-1995; IN COMMERCE 1-0-1995.

CLASS 41—(Continued).

SN 76-407,669. NEW YORK FOOTBALL GIANTS, INC., EAST RUTHERFORD, NJ. FILED 5-14-2002.

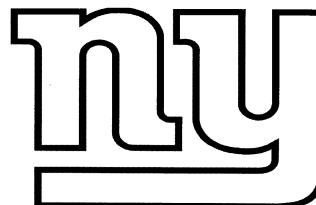

SEC. 2(F).

FOR EDUCATION AND ENTERTAINMENT SERVICES IN THE NATURE OF PROFESSIONAL FOOTBALL GAMES AND EXHIBITIONS; PROVIDING SPORTS AND ENTERTAINMENT INFORMATION VIA A GLOBAL COMPUTER NETWORK OR A COMMERCIAL ON-LINE SERVICE; ORGANIZATION OF SPORTS EVENTS; FAN CLUB SERVICES; EDUCATIONAL SERVICES, NAMELY, PHYSICAL EDUCATION PROGRAMS; ENTERTAINMENT SERVICES, NAMELY, MUSICAL AND DANCE PERFORMANCES PROVIDED DURING INTERVALS AT SPORTS EVENTS; PRODUCTION OF RADIO AND TELEVISION PROGRAMS. LIVE SHOWS FEATURING FOOTBALL GAMES, EXHIBITIONS, COMPETITIONS AND MUSICAL, COMEDY AND DANCE PERFORMANCES (U.S. CLS. 100, 101 AND 107).

FIRST USE 8-30-2000; IN COMMERCE 8-30-2000.

SN 76-410,668. THE INNIS COMPANY, DALLAS, TX. FILED 5-22-2002.

SMART, BUT

OWNER OF U.S. REG. NO. 2,615,944.
FOR CAREER COUNSELING (U.S. CLS. 100, 101 AND 107).

FIRST USE 1-15-2000; IN COMMERCE 1-15-2000.

SN 76-412,920. FAR WEST EDGE, INC., MEDFORD, OR. FILED 5-28-2002.

SENIOR PROJECT

NO CLAIM IS MADE TO THE EXCLUSIVE RIGHT TO USE "PROJECT", APART FROM THE MARK AS SHOWN.
SEC. 2(F).

FOR EDUCATIONAL SERVICES, NAMELY, CONDUCTING SEMINARS, CONFERENCES AND WORKSHOPS IN THE FIELD OF EDUCATION CURRICULUM PLANNING, APPLICATION AND IMPLEMENTATION (U.S. CLS. 100, 101 AND 107).

FIRST USE 0-0-1987; IN COMMERCE 0-0-1988.

CLASS 41—(Continued).

SN 76-415,192. CAST GROUP OF COMPANIES INC., TORONTO ONTARIO, CANADA, BY CHANGE OF NAME COMPUTER ANIMATED STAGE AND TELEVISION LIGHTING LIMITED, TORONTO, ONTARIO, M6S 3P2, CANADA, FILED 5-30-2002.

CAST LIGHTING

NO CLAIM IS MADE TO THE EXCLUSIVE RIGHT TO USE "LIGHTING", APART FROM THE MARK AS SHOWN, FOR DESIGN FOR OTHERS AND CONSULTATION FOR THE ENTERTAINMENT LIGHTING INDUSTRY (U.S. CLS. 100, 101 AND 107).

FIRST USE 9-0-2001; IN COMMERCE 9-0-2001.

SN 76-415,232. NOCERA & ASSOCIATES, LLC, NUTLEY, NJ. FILED 6-6-2002.

PROJECT IMAGINE!

FOR EDUCATIONAL SERVICES IN THE NATURE OF A PROGRAM FOR GUIDING CHILDREN THROUGH CAREER CHOICES (U.S. CLS. 100, 101 AND 107).

FIRST USE 9-15-2000; IN COMMERCE 9-15-2000.

SN 76-420,462. BRAD LACHMAN PRODUCTIONS, INC., BURBANK, CA. FILED 6-19-2002.

LIFE'S FUNNIEST MOMENTS

OWNER OF U.S. REG. NOS. 1,673,697, 2,397,199 AND OTHERS.

FOR ENTERTAINMENT IN THE NATURE OF ONGOING TELEVISION PROGRAMS IN THE FIELD OF COMEDY (U.S. CLS. 100, 101 AND 107).

SN 76-420,624. FIRST DRAFT, INC., SUMMERVILLE, SC. FILED 6-13-2002.

FERN MICHAELS

THE NAME IN THE MARK IDENTIFIES A LIVING INDIVIDUAL WHOSE CONSENT IS OF RECORD.

FOR PROVIDING INFORMATION ABOUT AUTHORS AND NEW BOOK RELEASES OF OTHERS BY MEANS OF THE INTERNET; PROVIDING AN ON-LINE NEWS COLUMN IN THE FIELD OF ROMANCE LITERATURE, FAN CLUB, PROVIDING A WEB SITE FEATURING ENTERTAINMENT INFORMATION IN THE FIELD OF ROMANCE LITERATURE AND FEATURING AN ON-LINE GUEST BOOK AND SUGGESTION BOX; PROVIDING LINKS TO WEB SITES OF OTHERS FEATURING ROMANCE LITERATURE (U.S. CLS. 100, 101 AND 107).

FIRST USE 5-0-1996; IN COMMERCE 5-0-1996.

CLASS 41—(Continued).

SN 76-424,010. BUZZTIME ENTERTAINMENT, INC., CARLSBAD, CA. FILED 6-21-2002.

MY TV ASKS ME QUESTIONS

FOR ENTERTAINMENT SERVICES, NAMELY CABLE TELEVISION AND NETWORK TELEVISION PROGRAMS FEATURING INTERACTIVE GAMES, DISTRIBUTION OF TELEVISION PROGRAMMING FEATURING INTERACTIVE GAMES TO CABLE TELEVISION SYSTEMS, PROVISION OF ON-LINE INTERACTIVE GAMES AND PROVISION OF INTERACTIVE GAMES VIA TELEPHONE AND OTHER ELECTRONIC MEDIA ENVIRONMENTS, NAMELY WIRELESS WEB AND SATELLITE, GLOBAL AND LOCAL TRANSMISSION NETWORKS SERVICING WIRELESS DEVICES, NAMELY CELL PHONES AND PDAS (U.S. CLS. 100, 101 AND 107).

SN 76-424,159. KIRSCHNER, JACALYN, TAMPA, FL. FILED 6-21-2002.



NO CLAIM IS MADE TO THE EXCLUSIVE RIGHT TO USE "CHEER CHAMPS", APART FROM THE MARK AS SHOWN.

FOR PROVIDING CHEERLEADING AND DANCING TRAINING AND COMPETITION (U.S. CLS. 100, 101 AND 107).

SN 76-427,445. DERWENT INFORMATION LIMITED, LONDON WC2B 5DF, ENGLAND, FILED 7-3-2002.

IP MATTERS

NO CLAIM IS MADE TO THE EXCLUSIVE RIGHT TO USE "IP", APART FROM THE MARK AS SHOWN.

FOR PROVIDING NON-DOWNLOADABLE ON-LINE ELECTRONIC NEWSLETTERS IN THE FIELD OF INTELLECTUAL PROPERTY (U.S. CLS. 100, 101 AND 107).

FIRST USE 3-15-2000; IN COMMERCE 3-15-2000.

CLASS 41—(Continued).

SN 76-427,461. NEW YORK ISLANDERS HOCKEY CLUB, L.P., PLAINVIEW, NY. FILED 7-5-2002.

ISLES

FOR ENTERTAINMENT SERVICES IN THE NATURE OF PROFESSIONAL ICE HOCKEY EXHIBITIONS (U.S. CLS. 100, 101 AND 107).

FIRST USE 6-0-1972; IN COMMERCE 6-0-1972.

SN 76-429,149. BROWN & WILLIAMSON TOBACCO CORPORATION, LOUISVILLE, KY. FILED 7-11-2002.

PLAY ON THE HOUSE

NO CLAIM IS MADE TO THE EXCLUSIVE RIGHT TO USE "PLAY", APART FROM THE MARK AS SHOWN.

FOR ENTERTAINMENT IN THE NATURE OF PLAYING CARD TOURNAMENTS (U.S. CLS. 100, 101 AND 107).

SN 76-430,652. GLOBAL INFORMATION LICENSING CORPORATION, CLAYMONT, DE. FILED 7-12-2002.

NATIONAL INITIATIVE FOR RHEUMATOID ARTHRITIS

NO CLAIM IS MADE TO THE EXCLUSIVE RIGHT TO USE "NATIONAL" AND "RHEUMATOID ARTHRITIS", APART FROM THE MARK AS SHOWN.

FOR PROVIDING SEMINARS ON THE TOPIC OF RHEUMATOID ARTHRITIS TO THE MEDICAL PROFESSION, AS WELL AS, COURSE MATERIALS DISTRIBUTED THEREWITH (U.S. CLS. 100, 101 AND 107).

SN 76-430,662. KUSHNER, ANDREW, SILVER SPRING, MD. FILED 7-12-2002.

PCG RECORDS

NO CLAIM IS MADE TO THE EXCLUSIVE RIGHT TO USE "RECORDS", APART FROM THE MARK AS SHOWN.

FOR RECORD COMPANY SERVICES, NAMELY, MUSIC RECORDING PRODUCTION AND MUSIC PUBLISHING SERVICES (U.S. CLS. 100, 101 AND 107).

CLASS 41—(Continued).

SN 76-430,706. NEW JERSEY VETERINARY MEDICAL ASSOCIATION, SPRINGFIELD, NJ. FILED 7-11-2002.

ATLANTIC COAST VETERINARY CONFERENCE

NO CLAIM IS MADE TO THE EXCLUSIVE RIGHT TO USE "VETERINARY CONFERENCE", APART FROM THE MARK AS SHOWN.

SEC. 2(F).

FOR EDUCATIONAL SERVICES, NAMELY, PROVIDING ON-SITE COURSES OF INSTRUCTION IN THE FIELD OF CONTINUING VETERINARY MEDICINE AND THE DISTRIBUTION OF COURSE MATERIALS THEREWITH (U.S. CLS. 100, 101 AND 107).

FIRST USE 5-1-1988; IN COMMERCE 5-1-1988.

SN 76-432,349. FILMTHEORY, LLC, LOS ANGELES, CA. FILED 7-19-2002.

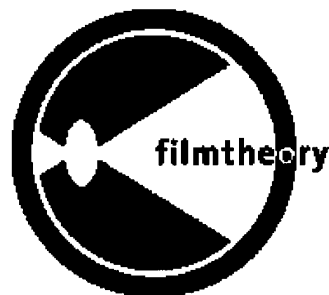

THE MARK CONSISTS OF A GREEN LOGO CIRCLE WITH "FILMTHEORY" TYPED IN THE MIDDLE OF THE LOGO IN A BLOOD ORANGE COLOR.

FOR MOTION PICTURE FILM PRODUCTION (U.S. CLS. 100, 101 AND 107).

FIRST USE 5-5-2002; IN COMMERCE 5-5-2002.

SN 76-432,688. NYS OFFICE OF PARKS, REC., AND HISTORIC PRESERVATION, ALBANY, NY. FILED 7-22-2002.

BETHPAGE BLACK

NO CLAIM IS MADE TO THE EXCLUSIVE RIGHT TO USE "BETHPAGE", APART FROM THE MARK AS SHOWN.

FOR GOLF COURSE AND GOLF CLUB SERVICES, PROVIDING RECREATIONAL PROGRAMS, FACILITIES AND SERVICES IN THE NATURE OF GOLF (U.S. CLS. 100, 101 AND 107).

FIRST USE 6-12-1996; IN COMMERCE 6-10-2002.

CLASS 41—(Continued).

SN 76-432,910. TANNING RESEARCH LABORATORIES, INC., ORMOND BEACH, FL. FILED 7-2-2002.

MISS HAWAIIAN TROPIC INTERNATIONAL

OWNER OF U.S. REG. NOS. 1,083,788, 2,311,448 AND OTHERS.

NO CLAIM IS MADE TO THE EXCLUSIVE RIGHT TO USE "INTERNATIONAL", APART FROM THE MARK AS SHOWN.

FOR ENTERTAINMENT IN THE NATURE OF BEAUTY PAGEANTS (U.S. CLS. 100, 101 AND 107).

FIRST USE 5-0-1983; IN COMMERCE 5-0-1983.

SN 76-433,193. PAULIST NATIONAL CATHOLIC EVANGELIZATION ASSOCIATION, WASHINGTON, DC. FILED 7-19-2002.

PLANNING OUR PARISH FUTURE

FOR EDUCATIONAL SERVICES, NAMELY WORKSHOPS AND SEMINARS IN THE FIELD OF RELIGION (U.S. CLS. 100, 101 AND 107).

FIRST USE 3-11-2002; IN COMMERCE 3-11-2002.

SN 76-435,097. DEGNAN, THERESA, MILTON, MA. AND LYDON, JESSICA, NORWELL, MA. FILED 7-23-2002.

EMPOWER YOURSELF

FOR HEALTH CLUB (U.S. CLS. 100, 101 AND 107).

SN 76-435,247. AMERICAN FOUNDATION FOR SURGERY OF THE HAND, ROSEMONT, IL. FILED 7-26-2002.



NO CLAIM IS MADE TO THE EXCLUSIVE RIGHT TO USE "AMERICAN FOUNDATION FOR SURGERY OF THE HAND", APART FROM THE MARK AS SHOWN.

FOR EDUCATIONAL SERVICES; NAMELY, CONDUCTING CLASSES AND SEMINARS DEALING WITH HAND SURGERY (U.S. CLS. 100, 101 AND 107).

FIRST USE 11-0-2001; IN COMMERCE 11-0-2001.

CLASS 41—(Continued).

SN 76-435,840. FITZBRADSHAWRACING, L.L.C., WESTLAKE, TX. FILED 7-31-2002.



FOR ENTERTAINMENT SERVICES IN THE NATURE OF CONDUCTING AND SPONSORING PROFESSIONAL AUTOMOBILE RACES; ENTERTAINMENT SERVICES IN THE NATURE OF PARTICIPATING IN PROFESSIONAL AUTOMOBILE RACES AND RELATED EXHIBITIONS (U.S. CLS. 100, 101 AND 107).

FIRST USE 12-1-2001; IN COMMERCE 12-1-2001.

SN 76-435,964. RESLIFE.NET, LTD., YARDLEY, PA. FILED 7-31-2002.



THE MARK CONSISTS OF THE TERM "RESLIFE.NET" WITH "R" FORMED BY A REPRESENTATION OF A MORTARBOARD AND TASSEL.

FOR ON-LINE TRAINING SERVICES IN THE FIELD OF STUDENT AFFAIRS FOR COLLEGE AND UNIVERSITY HOUSING OPERATIONS (U.S. CLS. 100, 101 AND 107).

FIRST USE 4-0-2000; IN COMMERCE 4-0-2000.

SN 76-440,515. REYNOLDS, DAVID K., COOS BAY, OR. FILED 8-14-2002.

CONSTRUCTIVE LIVING

FOR EDUCATIONAL SERVICES; NAMELY, PROVIDING LECTURES, SEMINARS AND INSTRUCTION IN THE FIELD OF MENTAL HEALTH AND HEALING (U.S. CLS. 100, 101 AND 107).

FIRST USE 1-10-1984; IN COMMERCE 1-10-1984.

CLASS 41—(Continued).

SN 76-440,656. GARRISON, MARTIN ANDREW, ALBUQUERQUE, NM. FILED 8-15-2002.

K O CARTEL

FOR CONSULTATION, COUNSELING, AND TRAINING SERVICES FOR ATHLETES IN THE FIELDS OF OPTIMIZING ATHLETIC PERFORMANCE AND ENHANCING SPORTS-RELATED MENTAL SKILLS (U.S. CLS. 100, 101 AND 107).

SN 76-441,246. THE UNIVERSITY OF SYDNEY, THE UNIVERSITY OF SYDNEY NSW 2006, AUSTRALIA, FILED 8-13-2002.

TIMEMAP

OWNER OF AUSTRALIA REG. NO. 778,672, DATED 11-18-1998, EXPIRES 11-18-2008.

FOR EDUCATIONAL SERVICES, NAMELY, CONDUCTING CLASSES, WORKSHOPS, PUBLIC EXHIBITIONS, EDUCATIONAL EXHIBITIONS, EDUCATIONAL LECTURES AND PRESENTATIONS ABOUT HISTORY UTILIZING COMPUTER-GENERATED IMAGES AND DISPLAYS; EDUCATION SERVICES IN THE NATURE OF COURSES AT THE UNIVERSITY LEVEL; EDUCATIONAL SERVICES, NAMELY, CONDUCTING CLASSES, WORKSHOPS, PUBLIC EXHIBITIONS, EDUCATIONAL EXHIBITIONS IN THE FIELDS OF EDUCATIONAL SOFTWARE AND HISTORY (U.S. CLS. 100, 101 AND 107).

SN 76-444,828. ONE WORLD NETWORKS INTEGRATED TECHNOLOGIES, INC., LOS ANGELES, CA. FILED 8-28-2002.

GOD MONEY SEX

FOR ENTERTAINMENT SERVICES IN THE NATURE OF ON-GOING RADIO AND TELEVISION PROGRAMS FEATURING ADVICE AND INNOVATIVE INSTRUCTION ON PERSONAL GROWTH; AND EDUCATIONAL SERVICES, NAMELY, CONDUCTING SEMINARS AND CONFERENCES IN THE FIELD OF INSTRUCTION ON PERSONAL GROWTH (U.S. CLS. 100, 101 AND 107).

SN 76-446,037. MANLLO KURI, RICARDO JOSE, SAN PEDRO GARZA GARCIA, NUEVO LEON, MEXICO, FILED 8-29-2002.

NICHO HINOJOSA

OWNER OF MEXICO REG. NO. 753500, DATED 9-18-2002, EXPIRES 9-18-2012.

"NICHO HINOJOSA" IS THE STAGE NAME OF A LIVING INDIVIDUAL WHOSE CONSENT IS OF RECORD.

FOR ENTERTAINMENT, NAMELY, LIVE MUSICAL PERFORMANCES; ORGANIZING EXHIBITIONS FOR MUSICAL PERFORMANCES (U.S. CLS. 100, 101 AND 107).

CLASS 41—(Continued).

SN 76-446,925. GILLEY, KAY, DBA INTENTIONAL LEADERSHIP SYSTEMS, DURHAM, NC. FILED 9-5-2002.

DEEP INTEGRITY

NO CLAIM IS MADE TO THE EXCLUSIVE RIGHT TO USE "INTEGRITY", APART FROM THE MARK AS SHOWN. FOR PERSONAL COACHING SERVICES IN THE PURSUIT OF INTEGRITY ON A SPIRITUAL AND RELATIONAL BASIS (U.S. CLS. 100, 101 AND 107).

SN 76-447,732. TROTT, JEFF, CLEVELAND, OH. FILED 9-9-2002.

BLACK APPLE

FOR AUDIO RECORDING AND PRODUCTION; RECORDING STUDIO; PROVIDING ENTERTAINMENT INFORMATION ABOUT PERFORMANCES, SOUND RECORDINGS, MUSICAL ARTIST APPEARANCES, MUSICAL ARTIST BIOGRAPHIES AND OTHER ENTERTAINMENT INFORMATION ABOUT MUSICAL ARTISTS VIA WEBSITES ON A GLOBAL COMPUTER NETWORK; PROVIDING NON-DOWNLOADABLE MUSIC BY MEANS OF A GLOBAL COMPUTER NETWORK (U.S. CLS. 100, 101 AND 107).

FIRST USE 10-1-2001; IN COMMERCE 12-1-2001.

SN 76-448,539. WORLD MUSIC, INC., CAMBRIDGE, MA. FILED 9-11-2002.

CRASHARTS

NO CLAIM IS MADE TO THE EXCLUSIVE RIGHT TO USE "ARTS", APART FROM THE MARK AS SHOWN.

FOR PERFORMING ARTS CONCERTS, NAMELY, PERFORMANCES OF LIVE MUSIC, DANCE, SPOKEN WORD, THEATER AND EXHIBITIONS IN THE NATURE OF FILM PRESENTATIONS (U.S. CLS. 100, 101 AND 107).

FIRST USE 9-6-2001; IN COMMERCE 9-6-2001.

CLASS 41—(Continued).

SN 76-453,434. TIMES PUBLISHING COMPANY, ST. PETERSBURG, FL. FILED 9-27-2002.

**TAMPABAY.COM A SERVICE
OF THE ST. PETERSBURG
TIMES**

OWNER OF U.S. REG. NOS. 1,587,715, 1,617,625 AND OTHERS.

FOR ELECTRONIC AND ON-LINE SERVICES, NAMELY, PROVIDING ELECTRONIC AND ON-LINE SPORTS, ENTERTAINMENT, DINING, CULTURAL, ARTS AND RECREATIONAL NEWSPAPERS; EDUCATION SERVICES, NAMELY CONDUCTING ON-LINE EXHIBITIONS AND DISPLAYS AND INTERACTIVE EXHIBITS IN THE FIELD OF NEWSPAPERS; ELECTRONIC PUBLISHING SERVICES, NAMELY, ON-LINE PUBLICATION OF TEXT AND GRAPHIC WORKS OF OTHERS IN THE FIELDS OF SPORTS; ENTERTAINMENT, DINING CULTURE, ARTS, AND RECREATION; ENTERTAINMENT SERVICES, NAMELY PROVIDING ON-LINE REPORTING AND REVIEWS IN THE FIELDS OF SPORTS AND ENTERTAINMENT DINING, CULTURE, ARTS AND RECREATION FROM INFORMATION PROVIDED IN NEWSPAPERS (U.S. CLS. 100, 101 AND 107).

FIRST USE 3-1-1999; IN COMMERCE 3-1-1999.

SN 76-454,173. O2 HOLDINGS, LLC, NEW YORK, NY. FILED 10-1-2002.

OH! OXYGEN

OWNER OF U.S. REG. NO. 2,684,295.

FOR PRODUCTION OF TELEVISION PROGRAMS IN THE NATURE OF COMEDY, DRAMA, ANIMATED PROGRAMMING, TALK SHOWS, MUSICAL PERFORMANCES, NEWS AND INFORMATION ON TOPICS OF INTEREST TO WOMEN; EDUCATIONAL AND ENTERTAINMENT SERVICES, NAMELY, TELEVISION PROGRAMMING IN THE NATURE OF COMEDY, DRAMA, ANIMATED PROGRAMMING, TALK SHOWS, MUSICAL PERFORMANCES, NEWS AND INFORMATION ON TOPICS OF INTEREST TO WOMEN PROVIDED BY MEANS OF THE INTERNET, CABLE, BROADCAST AND SATELLITE TELEVISION AND AUDIO AND VISUAL MEDIA (U.S. CLS. 100, 101 AND 107).

CLASS 41—(Continued).

SN 76-458,891. NEW YORK STATE HISTORICAL ASSOCIATION, COOPERSTOWN, NY. FILED 10-17-2002.



FOR LIBRARY SERVICES, NAMELY LIBRARY SERVICES WHICH FEATURE NEWSPAPERS, MAGAZINES, PHOTOGRAPHS AND PICTURES IN THE FIELD OF HISTORY OF THE STATE OF NEW YORK; EDUCATIONAL SERVICES, NAMELY, CONDUCTING PROGRAMS IN THE FIELD OF THE HISTORY OF THE STATE OF NEW YORK; EDUCATIONAL SERVICES, NAMELY, CONDUCTING CLASSES, SEMINARS, CONFERENCES AND WORKSHOPS IN THE FIELD OF THE HISTORY OF THE STATE OF NEW YORK AND DISTRIBUTING COURSE MATERIAL IN CONNECTION THEREWITH (U.S. CLS. 100, 101 AND 107).

FIRST USE 0-0-1998; IN COMMERCE 0-0-1998.

SN 76-460,378. SYLVESTER, R. TODD, SANDY, UT. FILED 10-22-2002.

**SLY DOG DRUG FREE
THAT'S ME**

FOR EDUCATIONAL SERVICES, NAMELY, CONDUCTING SEMINARS AND ASSEMBLY PRESENTATIONS TO PUBLIC AND PRIVATE SCHOOLS CONCERNING DRUG EDUCATION, AWARENESS AND ABUSE PREVENTION (U.S. CLS. 100, 101 AND 107).

FIRST USE 1-1-1989; IN COMMERCE 1-1-1990.

CLASS 41—(Continued).

SN 76-461,593. BELLARMINE UNIVERSITY, LOUISVILLE, KY. FILED 10-18-2002.

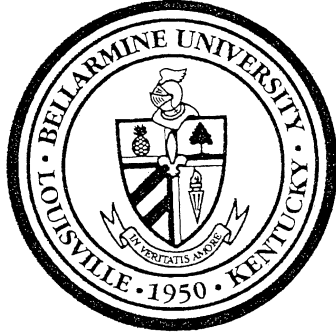

OWNER OF U.S. REG. NOS. 2,184,102, 2,184,103 AND 2,184,105.

NO CLAIM IS MADE TO THE EXCLUSIVE RIGHT TO USE "UNIVERSITY", "LOUISVILLE", "KENTUCKY" OR "1950", APART FROM THE MARK AS SHOWN.

FOR EDUCATIONAL SERVICES, NAMELY, OFFERING COURSES OF INSTRUCTION AT THE COLLEGE UNDERGRADUATE AND GRADUATE LEVEL (U.S. CLS. 100, 101 AND 107).

FIRST USE 9-12-2000; IN COMMERCE 9-12-2000.

SN 76-461,594. BELLARMINE UNIVERSITY, LOUISVILLE, KY. FILED 10-18-2002.

**BELLARMINE
UNIVERSITY**

OWNER OF U.S. REG. NOS. 2,184,103 AND 2,184,105.
NO CLAIM IS MADE TO THE EXCLUSIVE RIGHT TO USE "UNIVERSITY", APART FROM THE MARK AS SHOWN.

FOR EDUCATIONAL SERVICES, NAMELY, OFFERING COURSES OF INSTRUCTION AT THE COLLEGE, UNDERGRADUATE AND GRADUATE LEVEL (U.S. CLS. 100, 101 AND 107).

FIRST USE 9-12-2000; IN COMMERCE 9-12-2000.

SN 76-462,105. UNIVERSITY OF CHICAGO, CHICAGO, IL. FILED 10-28-2002.

**WHERE IDEAS COMPETE
AND PEOPLE
COLLABORATE**

FOR EDUCATION COURSES AND SEMINARS IN THE FIELD OF BUSINESS (U.S. CLS. 100, 101 AND 107).

FIRST USE 10-0-2002; IN COMMERCE 10-0-2002.

CLASS 41—(Continued).

SN 76-464,739. FLORIDA GULF COAST UNIVERSITY BOARD OF TRUSTEES, FORT MYERS, FL. FILED 11-6-2002.



NO CLAIM IS MADE TO THE EXCLUSIVE RIGHT TO USE "UNIVERSITY", APART FROM THE MARK AS SHOWN.

THE STIPPLING IS FOR SHADING PURPOSES ONLY.
SEC. 2(F) AS TO "FLORIDA GULF COAST".

FOR EDUCATIONAL AND ENTERTAINMENT SERVICES, NAMELY, CONDUCTING COLLEGE LEVEL COURSES, CONDUCTING COLLEGE SPORTS COMPETITIONS, EXHIBITIONS, LECTURES, CONCERT AND THEATER PROGRAMS (U.S. CLS. 100, 101 AND 107).

FIRST USE 3-1-1996; IN COMMERCE 3-1-1996.

SN 76-466,118. OPEN THEATER, INC., TUCSON, AZ. FILED 11-12-2002.

OPEN THEATER

NO CLAIM IS MADE TO THE EXCLUSIVE RIGHT TO USE "THEATER", APART FROM THE MARK AS SHOWN.
FOR THEATER PRODUCTIONS (U.S. CLS. 100, 101 AND 107).

FIRST USE 9-1-2002; IN COMMERCE 9-1-2002.

SN 76-466,679. ENDEMOL USA, INC., BEVERLY HILLS, CA. FILED 11-4-2002.

EXHAUSTED

FOR ENTERTAINMENT IN THE NATURE OF ONGOING TELEVISION PROGRAMS IN THE NATURE OF A REALITY TELEVISION SERIES (U.S. CLS. 100, 101 AND 107).

CLASS 41—(Continued).

SN 76-467,031. AMERICA ONLINE, INC., DULLES, VA.
FILED 11-5-2002.

MAKE IT YOUR TOWN

FOR PROVIDING NEWS IN THE NATURE OF CURRENT EVENTS REPORTING; NEWS REPORTING SERVICES; PROVIDING INFORMATION IN THE FIELDS OF MUSIC, ARTS, CULTURAL EVENTS, SPORTS AND SHOPPING VIA COMPUTER NETWORKS (U.S. CLS. 100, 101 AND 107).

SN 76-467,467. AF2 ENTERPRISES, LLC, CHICAGO, IL.
FILED 11-14-2002.

CINCINNATI SWARM

NO CLAIM IS MADE TO THE EXCLUSIVE RIGHT TO USE "CINCINNATI", APART FROM THE MARK AS SHOWN.

FOR ENTERTAINMENT SERVICES, NAMELY ORGANIZING AND PRESENTING FOOTBALL GAMES BEFORE LIVE AUDIENCES AND ON TELEVISION, RADIO, FOR GLOBAL COMPUTER NETWORK DISPLAY AND OTHER MEDIA (U.S. CLS. 100, 101 AND 107).

SN 76-469,286. NBI, INC., ALTOONA, WI. FILED 11-22-2002.

NBI

FOR EDUCATIONAL SERVICES, NAMELY CONDUCTING SEMINARS, CONFERENCES, WORKSHOPS OR CONTINUING EDUCATION CLASSES IN THE FIELDS OF LEGAL SEMINARS, ACCOUNTING, AND BUSINESS (U.S. CLS. 100, 101 AND 107).

FIRST USE 9-21-1981; IN COMMERCE 9-21-1981.

SN 76-469,287. NBI, INC., ALTOONA, WI. FILED 11-22-2002.

IPE

FOR EDUCATIONAL SERVICES, NAMELY CONDUCTING SEMINARS, CONFERENCES, WORKSHOPS OR CONTINUING EDUCATION CLASSES IN THE FIELD OF PARALEGAL EDUCATION (U.S. CLS. 100, 101 AND 107).

FIRST USE 6-23-1995; IN COMMERCE 6-23-1995.

CLASS 41—(Continued).

SN 76-469,288. NBI, INC., ALTOONA, WI. FILED 11-22-2002.

OTTER CREEK INSTITUTE

NO CLAIM IS MADE TO THE EXCLUSIVE RIGHT TO USE "INSTITUTE", APART FROM THE MARK AS SHOWN. FOR EDUCATIONAL SERVICES, NAMELY CONDUCTING SEMINARS, CONFERENCES, WORKSHOPS OR CONTINUING EDUCATION CLASSES IN THE FIELD OF EDUCATION FOR EDUCATORS AND SCHOOL ADMINISTRATORS (U.S. CLS. 100, 101 AND 107).

FIRST USE 9-15-1999; IN COMMERCE 9-15-1999.

SN 76-469,289. NBI, INC., ALTOONA, WI. FILED 11-22-2002.

**INSTITUTE FOR
PARALEGAL EDUCATION**

NO CLAIM IS MADE TO THE EXCLUSIVE RIGHT TO USE "INSTITUTE", APART FROM THE MARK AS SHOWN. SEC. 2(F).

FOR EDUCATIONAL SERVICES, NAMELY CONDUCTING SEMINARS, CONFERENCES, WORKSHOPS OR CONTINUING EDUCATION CLASSES IN THE FIELD OF PARALEGAL EDUCATION (U.S. CLS. 100, 101 AND 107).

FIRST USE 6-23-1995; IN COMMERCE 6-23-1995.

SN 76-469,291. NBI, INC., ALTOONA, WI. FILED 11-22-2002.

**NATIONAL BUSINESS
INSTITUTE**

NO CLAIM IS MADE TO THE EXCLUSIVE RIGHT TO USE "BUSINESS INSTITUTE", APART FROM THE MARK AS SHOWN. SEC. 2(F).

FOR EDUCATIONAL SERVICES, NAMELY CONDUCTING SEMINARS, CONFERENCES, WORKSHOPS OR CONTINUING EDUCATION CLASSES IN THE FIELDS OF LEGAL SEMINARS, ACCOUNTING, AND BUSINESS (U.S. CLS. 100, 101 AND 107).

FIRST USE 9-21-1981; IN COMMERCE 9-21-1981.

SN 76-469,938. FAUX EFFECTS INC., VERO BEACH, FL.
FILED 11-25-2002.

**AQUA FINISHING
SOLUTIONS**

NO CLAIM IS MADE TO THE EXCLUSIVE RIGHT TO USE "FINISHING SOLUTIONS", APART FROM THE MARK AS SHOWN.

FOR EDUCATION AND INSTRUCTIONAL SERVICES IN THE NATURE OF COURSES AND WORKSHOPS IN THE FIELD OF DECORATION AND APPLYING DECORATE FINISHES (U.S. CLS. 100, 101 AND 107).

FIRST USE 0-0-1993; IN COMMERCE 0-0-1993.

CLASS 41—(Continued).

SN 76-472,759. BROWNSTONE PUBLISHING, LLC, DBA ANGIE'S LIST, INDIANAPOLIS, IN. FILED 12-9-2002.



OWNER OF U.S. REG. NO. 2,083,451.
NO CLAIM IS MADE TO THE EXCLUSIVE RIGHT TO USE "SUPER SERVICE AWARD", APART FROM THE MARK AS SHOWN.

FOR PROVIDING RECOGNITION AND INCENTIVES BY WAY OF AWARDS TO PROMOTE EXCELLENCE IN THE FIELD OF CONSUMER-ORIENTED PRODUCTS AND SERVICES (U.S. CLS. 100, 101 AND 107).
FIRST USE 1-0-2000; IN COMMERCE 1-0-2000.

SN 76-472,791. POKORNY, LAUREN, SCOTTSDALE, AZ. FILED 12-9-2002.

PORSCHE LYNN

THE NAME "PORSCHE LYNN" DOES NOT IDENTIFY A LIVING INDIVIDUAL.

FOR ENTERTAINMENT SERVICES, NAMELY APPEARANCES BY A MOVIE/VIDEO STAR (U.S. CLS. 100, 101 AND 107).

SN 76-474,320. INNOVATIVE MARBLE & TILE, INC., HAUPPAUGE, NY. FILED 11-29-2002.

INNOVATIVE SURFACES

OWNER OF U.S. REG. NO. 1,469,403.
NO CLAIM IS MADE TO THE EXCLUSIVE RIGHT TO USE "SURFACES", APART FROM THE MARK AS SHOWN.
FOR EDUCATIONAL SERVICES, NAMELY, PROVIDING CLASSES OF INSTRUCTION TO INDIVIDUALS IN THE USE OF GRANITE, MARBLE, AND OTHER CONSTRUCTION MATERIALS FOR WALLS, FLOORS AND CABINET TOPS (U.S. CLS. 100, 101 AND 107).

CLASS 41—(Continued).

SN 76-475,772. GIRLS PREPARATORY SCHOOL, CHATTANOOGA, TN. FILED 12-17-2002.

**GIRLS PREPARATORY
SCHOOL**

NO CLAIM IS MADE TO THE EXCLUSIVE RIGHT TO USE "PREPARATORY SCHOOL", APART FROM THE MARK AS SHOWN.

SEC. 2(F).
FOR EDUCATIONAL SERVICES, NAMELY, PROVIDING COURSES OF INSTRUCTION AT THE MIDDLE SCHOOL, HIGH SCHOOL AND COLLEGE PREPARATORY LEVELS AND DISTRIBUTING COURSE MATERIALS IN CONJUNCTION THEREWITH; RECREATION, SPORT AND SUMMER CAMPS; ENTERTAINMENT SERVICES, NAMELY, PROVIDING LIVE MUSICAL AND THEATRICAL PERFORMANCES, AND ARRANGING AND CONDUCTING ATHLETIC COMPETITIONS; AND INFORMATION SERVICES FOR ALL OF THE FOREGOING PROVIDED BY A GLOBAL COMPUTER NETWORK (U.S. CLS. 100, 101 AND 107).

FIRST USE 0-0-1906; IN COMMERCE 0-0-1906.

SN 76-476,302. GARFINKEL, ERIC, GREAT FALLS, VA. FILED 12-19-2002.

LIQUIDREASON

FOR EDUCATIONAL SERVICES, NAMELY, CONDUCTING INTERACTIVE ONLINE EXERCISES AND WORKSHOPS SPECIFICALLY TO TEACH TEENS ABOUT CAUSE MARKETING, AND HOW THEY CAN MAKE A POSITIVE DIFFERENCE IN THE WORLD BY PURCHASING PRODUCTS WHICH SUPPORT CAUSES IMPORTANT TO THEM, SUCH AS, THE ENVIRONMENT, POVERTY, ETC AND HOW TO DESIGN AND MARKET A PRODUCT, NAMELY, A HYPOTHETICAL SOFT DRINK THAT SUPPORTS A CAUSE (U.S. CLS. 100, 101 AND 107).

FIRST USE 12-10-2002; IN COMMERCE 12-10-2002.

SN 76-478,380. CONNECTIONS ACADEMY, INC., BALTIMORE, MD. FILED 12-24-2002.

**MOVING AT THE SPEED OF
LEARNING**

FOR CHARTER SCHOOL SERVICES; EDUCATIONAL SERVICES, NAMELY PROVIDING COURSES OF INSTRUCTION AT THE K-12 LEVELS; EDUCATIONAL SERVICES, NAMELY PROVIDING INTERNET AND PRINT-BASED COURSES OF INSTRUCTION AT THE K-12 LEVELS; EDUCATIONAL SERVICES, NAMELY PROVIDING TEACHING, LEARNING MANAGEMENT, TECHNOLOGY, REPORTING AND ALL OTHER ASPECTS OF OPERATING A CHARTER SCHOOL; EDUCATIONAL SERVICES, NAMELY PROVIDING CONSULTING SERVICES IN THE FIELD OF ESTABLISHING AND OPERATING CHARTER SCHOOLS (U.S. CLS. 100, 101 AND 107).

FIRST USE 12-19-2002; IN COMMERCE 12-19-2002.

CLASS 41—(Continued).

SN 76-478,429. VALESKI, VICTOR, CAMDEN, DE. FILED 12-26-2002.

SPINES

FOR EDUCATIONAL SERVICES, NAMELY, CONDUCTING CLASSES, SEMINARS, CONFERENCES, AND WORKSHOPS, FOR EDUCATIONAL INSTITUTIONS, SCHOOL ARCHITECTS AND DESIGNERS, EDUCATING INDIVIDUALS IN THE FIELDS OF SPACE REQUIREMENTS, PLACEMENT OF EQUIPMENT AND FURNITURE, INTEGRATION OF TECHNOLOGY, NOISE AND ACOUSTICAL CONTROLS, ENVIRONMENT AND SECURITY IN EDUCATIONAL AND TRAINING FACILITIES (U.S. CLS. 100, 101 AND 107).

SN 76-478,541. MORE THAN MANAGEMENT, INC., NAUET, NY. FILED 12-20-2002.

COWBOY JANE

FOR RECORD PRODUCTION; MUSIC PRODUCTION; AUDIO RECORDING AND PRODUCTION; VIDEOTAPE PRODUCTION; MOTION PICTURE SONG PRODUCTION; PRODUCTION OF VIDEO DISCS FOR OTHERS; RECORDING STUDIOS; ENTERTAINMENT SERVICES, NAMELY, PRODUCING MUSICAL AUDIO AND VIDEO RECORDINGS; MUSIC COMPOSITION AND TRANSCRIPTION FOR OTHERS; SONG WRITING SERVICES; MUSIC PUBLISHING SERVICES; ENTERTAINMENT IN THE NATURE OF A LIVE MUSICAL PERFORMER AND MUSICAL BAND; ENTERTAINMENT IN THE NATURE OF LIVE PERFORMANCES BY A MUSICAL ARTIST AND MUSICAL BAND; ENTERTAINMENT IN THE NATURE OF VISUAL AND AUDIO PERFORMANCES BY A MUSICAL ARTIST AND MUSICAL BAND; ENTERTAINMENT, NAMELY, LIVE MUSIC CONCERTS; ENTERTAINMENT, NAMELY, PERSONAL APPEARANCES BY A MUSICIAN AND MUSICAL BAND; ENTERTAINMENT SERVICES, NAMELY, PROVIDING A WEB SITE FEATURING MUSICAL PERFORMANCES, MUSICAL VIDEOS, RELATED FILM CLIPS, PHOTOGRAPHS, AND OTHER MULTIMEDIA MATERIALS; ENTERTAINMENT SERVICES, NAMELY, PROVIDING PRERECORDED MUSIC, INFORMATION IN THE FIELD OF MUSIC, COMMENTARY AND ARTICLES ABOUT MUSIC, ALL ONLINE VIA A GLOBAL COMPUTER NETWORK; TELEVISION AND RADIO PRODUCTION; DISTRIBUTION OF TELEVISION PROGRAMS FOR OTHERS; ENTERTAINMENT IN THE NATURE OF ON-GOING TELEVISION AND RADIO PROGRAMS FEATURING MUSICAL PERFORMANCES, DRAMATIC AND COMEDIC ACTS, PERSONAL INTERVIEWS AND MOTION PICTURE FILMS; ENTERTAINMENT SERVICES, NAMELY, PROVIDING TELEVISION AND RADIO PROGRAMS FEATURING MUSICAL PERFORMANCES, DRAMATIC AND COMEDIC ACTS, PERSONAL INTERVIEWS AND MOTION PICTURE FILMS VIA A GLOBAL COMPUTER NETWORK; PRODUCTION OF CABLE TELEVISION PROGRAMS; ENTERTAINMENT IN THE NATURE OF THEATER PRODUCTIONS; ENTERTAINMENT, NAMELY, PRODUCTION OF PLAYS; ENTERTAINMENT SERVICES, NAMELY, PERSONAL APPEARANCES BY A MUSICIAN, MUSICAL BAND AND CELEBRITY; ENTERTAINMENT IN THE NATURE OF VISUAL AND AUDIO PERFORMANCES, AND MUSICAL, VARIETY, NEWS AND COMEDY SHOWS; ENTERTAINMENT, NAMELY, A CONTINUING VARIETY SHOW DISTRIBUTED OVER TELEVISION, SATELLITE, AUDIO AND VIDEO MEDIA; PRODUCTION AND DISTRIBUTION OF MOTION PICTURES; FILM EDITING; SPECIAL EFFECTS ANIMATION SERVICES FOR FILM AND VIDEO; AND PROVIDING ON-LINE PUBLICATIONS IN THE NATURE OF MAGAZINES, BOOKS, JOURNALS, LEAFLETS, NEWSLETTERS AND BROCHURES IN THE FIELD OF MUSIC, FILM AND ENTERTAINMENT (U.S. CLS. 100, 101 AND 107).

CLASS 41—(Continued).

SN 76-480,888. TUFTS UNIVERSITY, MEDFORD, MA. FILED 1-8-2003.

STRONG LIVING PROGRAM

NO CLAIM IS MADE TO THE EXCLUSIVE RIGHT TO USE "PROGRAM", APART FROM THE MARK AS SHOWN. FOR STRENGTH TRAINING PROGRAMS FOR ADULTS OVER 50 TO IMPROVE STRENGTH, BALANCE, FLEXIBILITY, ENDURANCE, AND NUTRITION, AND TO TRAIN AND CERTIFY INSTRUCTORS OF SUCH PROGRAMS (U.S. CLS. 100, 101 AND 107).

FIRST USE 10-23-1998; IN COMMERCE 10-23-1998.

SN 76-483,292. RCN ENTERTAINMENT, INC., PRINCETON, NJ. FILED 1-21-2003.

WHAT'S GOING ON?

FOR DOCUMENTARY TELEVISION SERIES FOR FAMILIES FOCUSING ON AREAS OF CRISIS AROUND THE WORLD (U.S. CLS. 100, 101 AND 107).

FIRST USE 11-21-2002; IN COMMERCE 1-19-2003.

SN 76-484,519. TRANSITIONS: MEN OF TOMORROW, INC., MILWAUKEE, WI. FILED 1-23-2003.

TRANSITIONS: MEN OF TOMORROW, INC.

NO CLAIM IS MADE TO THE EXCLUSIVE RIGHT TO USE "INC.", APART FROM THE MARK AS SHOWN.

FOR EDUCATIONAL SERVICES, NAMELY, ONE-ON-ONE MENTORING OF AFRICAN-AMERICAN AND OTHER MINORITY MALES IN THE FIELD OF LIFE SKILLS, NAMELY, ACCOUNTABILITY, RESPONSIBILITY, CULTURAL PRIDE, INCREASED SELF-ESTEEM, AND RESPECT TOWARD GOD, SELF, AND COMMUNITY (U.S. CLS. 100, 101 AND 107).

SN 76-484,581. NATIONAL INSTITUTE FOR LEARNING DISABILITIES, NORFOLK, VA. FILED 1-23-2003.

DP

FOR EDUCATIONAL SERVICES, NAMELY CONDUCTING SEMINARS, CLASSES, CONFERENCES AND WORKSHOPS FOR EDUCATIONAL THERAPISTS, TEACHERS, SCHOOLS, AND ORGANIZATIONS IN THE FIELD OF SPECIAL EDUCATION; PROVIDING SPECIALTY EDUCATIONAL PROGRAMS OF INSTRUCTION FOR INDIVIDUALS WITH LEARNING DISABILITIES; AND PROVIDING A WEBSITE ON GLOBAL COMPUTER NETWORKS FEATURING INFORMATION IN THE FIELD OF LEARNING DISABILITIES AND TEACHING METHODS FOR CHILDREN WITH SPECIAL NEEDS (U.S. CLS. 100, 101 AND 107).

FIRST USE 6-10-2002; IN COMMERCE 6-10-2002.

CLASS 41—(Continued).

SN 76-484,634. HODGES, VANNIE KAY, ANN ARBOR, MI. FILED 1-15-2003.

CAFAS CERTIFIED

OWNER OF U.S. REG. NO. 2,071,566.
NO CLAIM IS MADE TO THE EXCLUSIVE RIGHT TO USE "CERTIFIED", APART FROM THE MARK AS SHOWN.
FOR EDUCATIONAL SERVICES, NAMELY, CONDUCTING COURSES OF INSTRUCTION AND TRAINING ON PSYCHOLOGICAL ASSESSMENT AND EVALUATION ASSESSMENT INSTRUMENTS AND TESTS FOR THE PURPOSE OF TRAINING QUALIFIED PERSONS TO CONDUCT INTERRATER RELIABILITY TRAINING ON THE INSTRUMENT, INCLUDING ADMINISTRATION, SCORING, VALIDITY RESEARCH EVIDENCE, TESTING FOR INTERRATER RELIABILITY, PROCEDURES ON HOW TO TRAIN OTHERS TO BE RELIABLE, POLICIES AND PROCEDURES TO FOLLOW TO TRACK TRAINING ACTIVITIES OF THE AGENCY, POLICIES AND PROCEDURES REGARDING BOOSTER RELIABILITY TRAINING, USE OF THE INSTRUMENT FOR CLINICAL TREATMENT PLANNING AND MONITORING, AND USE OF THE INSTRUMENT FOR TREATMENT OUTCOME EVALUATION (U.S. CLS. 100, 101 AND 107).

SN 76-484,832. THE FUND FOR AMERICAN STUDIES, WASHINGTON, DC. FILED 1-27-2003.



FOR EDUCATIONAL SERVICES, NAMELY, PROVIDING COURSES OF INSTRUCTION AT THE UNIVERSITY LEVEL (U.S. CLS. 100, 101 AND 107).
FIRST USE 7-1-2002; IN COMMERCE 7-1-2002.

SN 76-484,948. FOSSIL CONNOISSEUR, INC., FORT LEE, NJ. FILED 1-24-2003.

DINOSAURS ROCK

NO CLAIM IS MADE TO THE EXCLUSIVE RIGHT TO USE "DINOSAURS", APART FROM THE MARK AS SHOWN.
FOR EDUCATIONAL SERVICES, NAMELY, CONDUCTING WORKSHOPS AND SEMINARS AT SCHOOLS, PARTIES, CAMPS AND SPECIAL EVENTS FOR OTHERS REGARDING FOSSILS, DINOSAURS AND MINERALS (U.S. CLS. 100, 101 AND 107).
FIRST USE 1-12-2003; IN COMMERCE 1-12-2003.

CLASS 41—(Continued).

SN 76-485,213. BURRUS, SWAN, IV, BRENTWOOD, TN. FILED 1-27-2003.

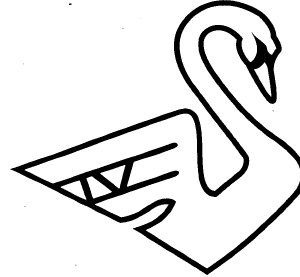

FOR ENTERTAINMENT SERVICES IN THE NATURE OF LIVE MUSICAL PERFORMANCES (U.S. CLS. 100, 101 AND 107).

SN 76-485,216. BURRUS, SWAN, IV, BRENTWOOD, TN. FILED 1-27-2003.

SWAN

FOR ENTERTAINMENT SERVICES IN THE NATURE OF LIVE MUSICAL PERFORMANCES (U.S. CLS. 100, 101 AND 107).

SN 76-485,339. FANTASIA OCCASIONS ENTERPRISES, INC., ST. THOMAS, US VIRGIN ISLANDS, FILED 1-27-2003.



NO CLAIM IS MADE TO THE EXCLUSIVE RIGHT TO USE "WEDDINGS & HONEYMOONS", APART FROM THE MARK AS SHOWN.
FOR WEDDING PLANNING AND COORDINATING SERVICES (U.S. CLS. 100, 101 AND 107).
FIRST USE 2-1-1990; IN COMMERCE 2-1-1990.

CLASS 41—(Continued).

SN 76-485,682. HOLLYWOOD FAMILIES, INC., GLEN ELYN, IL. FILED 1-24-2003.

HOLLYWOOD FAMILIES

FOR ENTERTAINMENT SERVICES, NAMELY A SERIES OF RADIO AND TELEVISION PROGRAMS CONCERNING THE PRIVATE LIVES OF MEDIA CELEBRITIES AND THEIR CHILDREN, AND PROVIDING INFORMATION IN THE FIELD OF ENTERTAINMENT VIA THE INTERNET (U.S. CLS. 100, 101 AND 107).

SN 76-485,743. MICHAELS, DAVID, LAS VEGAS, NV. FILED 1-27-2003.

POP

FOR PROVIDING CASINO FACILITIES AND NIGHT CLUB SERVICES (U.S. CLS. 100, 101 AND 107).

SN 76-485,768. MISCH, CARL E., ORCHARD LAKE, MI. FILED 1-22-2003.

**MISCH INTERNATIONAL
IMPLANT INSTITUTE**

OWNER OF U.S. REG. NO. 2,306,973.
NO CLAIM IS MADE TO THE EXCLUSIVE RIGHT TO USE "INTERNATIONAL IMPLANT INSTITUTE", APART FROM THE MARK AS SHOWN.

FOR EDUCATIONAL SERVICES, NAMELY, CONDUCTING COURSES AND SEMINARS IN THE FIELD OF IMPLANT DENTISTRY (U.S. CLS. 100, 101 AND 107).
FIRST USE 0-0-2000; IN COMMERCE 0-0-2000.

SN 76-486,055. BEHAVIORAL SCIENCE TECHNOLOGY, INC., OJAI, CA. FILED 1-30-2003.

LEADING WITH SAFETY

FOR EDUCATIONAL SERVICES, NAMELY CONDUCTING EDUCATIONAL SEMINARS, TRAINING COURSES, CONFERENCES AND WORKSHOPS ON APPLYING BEHAVIORAL SCIENCE METHODS TO PERFORMANCE IMPROVEMENT IN VARIOUS ASPECTS OF A BUSINESS (U.S. CLS. 100, 101 AND 107).
FIRST USE 6-0-2002; IN COMMERCE 6-0-2002.

CLASS 41—(Continued).

SN 76-486,159. MYSTERY WRITERS OF AMERICA, INC., NEW YORK, NY. FILED 1-30-2003.

EDGAR

FOR EDUCATIONAL AND ENTERTAINMENT SERVICES, NAMELY, AN ANNUAL AWARD PROGRAM FOR PRESENTATION OF AWARDS IN RECOGNITION OF DISTINGUISHED ACHIEVEMENT BY AUTHORS IN THE MYSTERY AND CRIME GENRES (U.S. CLS. 100, 101 AND 107).

FIRST USE 4-1-1947; IN COMMERCE 4-1-1947.

SN 76-486,201. AUDITORY-VERBAL INTERNATIONAL, INC., ALEXANDRIA, VA. FILED 1-30-2003.

AUDITORY-VERBAL

OWNER OF U.S. REG. NOS. 2,017,678, 2,527,081 AND 2,572,999.

SEC. 2(F).

FOR EDUCATIONAL SERVICES, NAMELY, DEVELOPING COMMUNICATION AND SOCIALIZATION SKILLS FOR CHILDREN WITH HEARING IMPAIRMENTS; CONDUCTING WORKSHOPS AND CONFERENCES IN THE FIELD OF DEVELOPING COMMUNICATION AND SOCIALIZATION SKILLS FOR CHILDREN WITH HEARING IMPAIRMENTS (U.S. CLS. 100, 101 AND 107).

FIRST USE 0-0-1988; IN COMMERCE 0-0-1988.

SN 76-486,298. INTERSTATE INDUSTRIES, INC., LOVINGSTON, VA. FILED 1-31-2003.

GATEWAY VOYAGE

FOR EDUCATIONAL SERVICES, NAMELY, CONDUCTING CLASSES, WORKSHOPS, AND RETREATS IN THE FIELD OF EXPANDED AWARENESS AND SELF-DISCOVERY, STRESS MANAGEMENT, FEAR CONTROL, POSITIVE THINKING, COMMUNICATION WITH OTHERS, IMPROVING PERFORMANCE, PROFOUND RELAXATION, AND DISTRIBUTING COURSE MATERIALS IN CONNECTION THEREWITH (U.S. CLS. 100, 101 AND 107).

FIRST USE 7-15-1981; IN COMMERCE 7-15-1981.

SN 76-486,428. BEARFOOT, INC., WESTVILLE, IN. FILED 1-28-2003.

Captain
U.S.A.

NO CLAIM IS MADE TO THE EXCLUSIVE RIGHT TO USE "U.S.A.", APART FROM THE MARK AS SHOWN.

FOR ENTERTAINMENT SERVICES IN THE NATURE OF CUSTOMIZED TRUCK STUNT SHOWS (U.S. CLS. 100, 101 AND 107).

CLASS 41—(Continued).

SN 76-486,468. ADVENTURE LANDING, LLC, JACKSONVILLE, FL. FILED 1-28-2003.

EYE OF THE STORM

FOR ENTERTAINMENT IN THE NATURE OF AMUSEMENT PARK RIDES (U.S. CLS. 100, 101 AND 107).

SN 76-486,789. THE ARABY PARTNERSHIP, BOSTON, MA. FILED 2-3-2003.

ARABY

FOR ENTERTAINMENT SERVICES - NAMELY LIVE PERFORMANCES BY A MUSICAL GROUP (U.S. CLS. 100, 101 AND 107).
FIRST USE 9-18-2001; IN COMMERCE 9-18-2001.

SN 76-486,790. THE SAND MACHINE PARTNERSHIP, QUINCY, MA. FILED 2-3-2003.

SAND MACHINE

FOR ENTERTAINMENT SERVICES - NAMELY LIVE PERFORMANCES BY A MUSICAL GROUP (U.S. CLS. 100, 101 AND 107).
FIRST USE 6-26-1999; IN COMMERCE 6-26-1999.

SN 76-486,976. MAJOR LEAGUE LACROSSE, LLC, SECAUCUS, NJ. FILED 1-31-2003.

MLL

FOR ENTERTAINMENT IN THE NATURE OF LACROSSE GAMES, COMPETITIONS AND TOURNAMENTS; ENTERTAINMENT, NAMELY, PARTICIPATION IN LACROSSE GAMES AND COMPETITIONS; CONDUCTING ENTERTAINMENT EXHIBITIONS IN THE NATURE OF LACROSSE GAMES AND COMPETITIONS; ORGANIZING EXHIBITIONS FOR THE SPORT OF LACROSSE; PROVIDING FACILITIES FOR LACROSSE TOURNAMENTS; ARRANGING AND CONDUCTING ATHLETIC COMPETITIONS; ENTERTAINMENT IN THE NATURE ON-GOING TELEVISION PROGRAMS IN THE FIELD OF SPORTING EVENTS; ENTERTAINMENT, NAMELY, A CONTINUING SPORTS EVENT SHOW DISTRIBUTED OVER TELEVISION, SATELLITE, AUDIO AND VIDEO MEDIA; ENTERTAINMENT SERVICES, NAMELY, PROVIDING A TELEVISION PROGRAM FEATURING SPORTING EVENTS VIA A GLOBAL COMPUTER NETWORK; PROVIDING AN ON-LINE COMPUTER DATABASE IN THE FIELD OF LACROSSE; ENTERTAINMENT SERVICES, NAMELY, PROVIDING A WEB SITE FEATURING INFORMATION PERTAINING TO LACROSSE GOODS AND SERVICES (U.S. CLS. 100, 101 AND 107).
FIRST USE 6-1-2000; IN COMMERCE 6-1-2000.

CLASS 41—(Continued).

SN 76-487,244. INSCAPE PUBLISHING, INC., MINNEAPOLIS, MN. FILED 2-4-2003.

INDRA

FOR SELF-DIRECTED TRAINING PROGRAMS IN THE FIELDS OF BEHAVIOR EVALUATION, COUNSELING, PERSONAL DEVELOPMENT, YOUTH DEVELOPMENT, PARENTAL TRAINING, BUSINESS MANAGEMENT AND EMPLOYEE TRAINING; EDUCATIONAL SERVICES, NAMELY, CONDUCTING CLASSES AND SEMINARS IN THE FIELDS OF BEHAVIOR EVALUATION, COUNSELING, PERSONAL DEVELOPMENT, YOUTH DEVELOPMENT, PARENTAL TRAINING, BUSINESS MANAGEMENT AND EMPLOYEE TRAINING (U.S. CLS. 100, 101 AND 107).

SN 76-487,390. MICHAELS, DAVID, LAS VEGAS, NV. FILED 1-30-2003.

CYBERSCENE

FOR NIGHT CLUB SERVICES (U.S. CLS. 100, 101 AND 107).

SN 76-487,838. BOWLAY-WILLIAMS, IRIS E., ALISO VIEJO, CA. FILED 1-28-2003.

LEGENDARY TALES

FOR SCRIPT WRITING SERVICES, ENTERTAINMENT SERVICES, NAMELY WRITING TELEVISION SHOWS (U.S. CLS. 100, 101 AND 107).

SN 76-492,626. MICHAELS, DAVID, LAS VEGAS, NV. FILED 2-19-2003.

DROPSHOT

FOR ENTERTAINMENT IN THE NATURE OF AN AMUSEMENT PARK RIDE (U.S. CLS. 100, 101 AND 107).

SN 76-975,683. SFX MOTOR SPORTS, INC., HOUSTON, TX. FILED 12-7-2001.

HIGH ROLLER

FOR ENTERTAINMENT SERVICES IN THE NATURE OF PARTICIPATING IN COMPETITIONS AND EXHIBITIONS IN THE FIELD OF MOTOR SPORTS (U.S. CLS. 100, 101 AND 107).
FIRST USE 12-1-2001; IN COMMERCE 12-1-2001.

CLASS 41—(Continued).

SN 78-017,937. GREENE, HILLIARD DWANE, GEORGETOWN, SC. FILED 7-22-2000.

THE JAZZ EXPRESSIONS

NO CLAIM IS MADE TO THE EXCLUSIVE RIGHT TO USE "JAZZ", APART FROM THE MARK AS SHOWN.

FOR ENTERTAINMENT SERVICES, NAMELY, PERFORMANCES BY A MUSICAL GROUP (U.S. CLS. 100, 101 AND 107).

FIRST USE 11-1-1988; IN COMMERCE 2-26-1999.

SN 78-054,829. MARLIN, MICHAEL F., MADISON, WI. FILED 3-24-2001.

LUMA

FOR ENTERTAINMENT SERVICES, NAMELY, THE PRODUCTION OF DANCE PERFORMANCES, THEATRICAL PERFORMANCES, LIGHT SHOWS, MAGIC SHOWS, OPERAS, TELEVISION SHOWS, PLAYS AND LASER SHOWS INVOLVING SPECIAL EFFECTS AND THE HUMAN/MECHANICAL MANIPULATION OF TECHNOLOGY, NAMELY, ILLUMINATED OBJECTS AND REMOTELY CONTROLLED VISUAL, AUDIO AND PHYSICAL MOTION DEVICES (U.S. CLS. 100, 101 AND 107).

FIRST USE 1-1-1975; IN COMMERCE 3-1-1990.

SN 78-087,436. CUEVAS, HATTI A JR., LAKE RONKONKOMA, NY. AND SCHAEFER, DONALD E., LAKE RONKONKOMA, NY. AND FAULKNER, RANDALL, FARMINGVILLE, NY. FILED 10-8-2001.

SUB-URBAN

FOR ENTERTAINMENT SERVICES, NAMELY, LIVE PERFORMANCES BY A MUSICAL BAND IN THE RAP/HIP-HOP GENRE (U.S. CLS. 100, 101 AND 107).

SN 78-104,880. JULIE ANN TURNER & COMPANY, PLANO, TX. FILED 1-25-2002.

**COMMUNITY
RENAISSANCE**

FOR EDUCATIONAL SERVICES, NAMELY WORKSHOPS, COURSES, SEMINARS, COLLABORATIVE SESSIONS, FACILITATIONS AND PRESENTATIONS IN THE FIELD OF INDIVIDUAL AND BUSINESS POTENTIAL, INNOVATION AND CREATIVITY, PLANNING AND ORGANIZATIONAL DEVELOPMENT/MANAGEMENT, AND DISTRIBUTING EDUCATIONAL AND COURSE MATERIALS IN CONNECTION THEREWITH (U.S. CLS. 100, 101 AND 107).

FIRST USE 2-16-1999; IN COMMERCE 2-16-1999.

CLASS 41—(Continued).

SN 78-116,289. USA DEAF SPORTS FEDERATION, SIOUX FALLS, SD. FILED 3-20-2002.



NO CLAIM IS MADE TO THE EXCLUSIVE RIGHT TO USE "USA DEAF SPORTS FEDERATION", APART FROM THE MARK AS SHOWN.

FOR ENTERTAINMENT SERVICES, NAMELY, PARTICIPATION IN SPORTS COMPETITION WORLDWIDE FOR DEAF AND HARD OF HEARING ATHLETES (U.S. CLS. 100, 101 AND 107).

SN 78-116,480. TEXAS LOTTERY COMMISSION, AUSTIN, TX. FILED 3-21-2002.



OWNER OF U.S. REG. NOS. 1,757,208 AND 2,391,987.
NO CLAIM IS MADE TO THE EXCLUSIVE RIGHT TO USE "PICK 3" AND "LOTTERY", APART FROM THE MARK AS SHOWN.

THE MARK CONSISTS OF THE WORDING "PICK 3 TEXAS LOTTERY" WITH THE DEPICTION OF A HAND THROWING A COWBOY HAT INTO THE AIR.

SEC. 2(F) AS TO "TEXAS".

FOR ENTERTAINMENT AND LOTTERY SERVICES, NAMELY, CONDUCTING AND ADMINISTERING PERIODIC DRAWINGS AND GAMES OF CHANCE FOR AWARDING MONETARY AND OTHER PRIZES (U.S. CLS. 100, 101 AND 107).

FIRST USE 10-23-1993; IN COMMERCE 10-23-1993.

CLASS 41—(Continued).

SN 78-119,523. LONG NOW FOUNDATION, THE, PRESIDIO OF SAN FRANCISCO, CA. FILED 4-4-2002.

THE LONG NOW FOUNDATION

NO CLAIM IS MADE TO THE EXCLUSIVE RIGHT TO USE "FOUNDATION", APART FROM THE MARK AS SHOWN.

FOR EDUCATIONAL RESEARCH TO ASSIST IN ESTABLISHING AN ELECTRONIC LIBRARY FOR CRITICAL INFORMATION IN VARIOUS DISCIPLINES TO PERMIT EXPLORATIONS OF THE DEEP FUTURE; ON-LINE LIBRARY SERVICES NAMELY PROVIDING ELECTRONIC LIBRARY SERVICES WHICH FEATURE BOOKS, PHOTOGRAPHS, PICTURES AND INFORMATION REGARDING WORKS OF ART, ARCHITECTURE, EVENTS AND SCHOLARLY CONFERENCES ORGANIZED OR SPONSORED BY THE FOUNDATION VIA AN ON-LINE COMPUTER NETWORK (U.S. CLS. 100, 101 AND 107).

FIRST USE 12-31-1996; IN COMMERCE 12-31-1996.

SN 78-121,549. PLAYSTUFF, INC., BELMONT, CA. FILED 4-13-2002.



FOR CINEMA STUDIOS; MOVIE STUDIOS; MOTION PICTURE FILM PRODUCTION; PRODUCTION AND DISTRIBUTION OF MOTION PICTURES; PRODUCTION OF CABLE TELEVISION PROGRAMS; VIDEO PRODUCTION, EDITING AND POST-PRODUCTION; SPECIAL EFFECTS ANIMATION SERVICES FOR FILM AND VIDEO; CLASSICAL ANIMATION (2D) AND COMPUTER ANIMATION (3D) PRODUCTION FOR VIDEO AND MOTION PICTURES; FILM DIRECTING; PHOTOGRAPHY SERVICES (U.S. CLS. 100, 101 AND 107).

SN 78-125,715. MCCAULEY MARK DOUGLAS, HOLLISTER, MO. FILED 5-2-2002.

SON SONG RECORDS

NO CLAIM IS MADE TO THE EXCLUSIVE RIGHT TO USE "RECORDS", APART FROM THE MARK AS SHOWN.

FOR RECORD PRODUCTION SERVICES (U.S. CLS. 100, 101 AND 107).

FIRST USE 5-1-2002; IN COMMERCE 5-1-2002.

CLASS 41—(Continued).

SN 78-125,752. WORLD WRESTLING FEDERATION ENTERTAINMENT, INC., STAMFORD, CT. FILED 5-2-2002.



FOR ENTERTAINMENT SERVICES, NAMELY, THE PRODUCTION AND EXHIBITION OF PROFESSIONAL WRESTLING EVENTS RENDERED LIVE AND THROUGH THE MEDIA OF TELEVISION; PROVIDING WRESTLING NEWS AND INFORMATION VIA A GLOBAL COMPUTER NETWORK. (U.S. CLS. 100, 101 AND 107).

SN 78-126,531. DEBBIE COHEN, TAMPA, FL. FILED 5-6-2002.

I AM FORMULA

FOR OFFERING CLASSES AND SEMINARS IN THE FIELD OF SELF-MOTIVATION AND SELF-IMPROVEMENT; EDUCATIONAL AND ENTERTAINMENT SERVICES, NAMELY PROVIDING MOTIVATIONAL SPEAKERS (U.S. CLS. 100, 101 AND 107).

FIRST USE 1-1-2000; IN COMMERCE 1-31-2000.

SN 78-128,132. VIACOM INTERNATIONAL INC., NEW YORK, NY. FILED 5-13-2002.

DORA THE EXPLORER

OWNER OF U.S. REG. NOS. 2,493,373 AND 2,526,038.

FOR PROVIDING INFORMATION IN THE FIELD OF ENTERTAINMENT, FEATURING ANIMATION RENDERED BY MEANS OF A GLOBAL COMPUTER NETWORK (U.S. CLS. 100, 101 AND 107).

FIRST USE 7-17-2000; IN COMMERCE 7-17-2000.

SN 78-129,616. SIWEK, JAMES J., DES PLAINES, IL. FILED 5-17-2002.

OUTERDRIVE

FOR LIVE MUSICAL PERFORMANCES (U.S. CLS. 100, 101 AND 107).

CLASS 41—(Continued).

SN 78-131,702. BLACK HEART, INC., MINNEAPOLIS, MN. FILED 5-29-2002.

BLACK HEART PUBLISHING

NO CLAIM IS MADE TO THE EXCLUSIVE RIGHT TO USE "PUBLISHING", APART FROM THE MARK AS SHOWN.

FOR PUBLISHING SERVICES IN PRINT AND ELECTRONIC FORM OF GENERAL INTEREST AND FOR THE AFRICAN-AMERICAN COMMUNITY (U.S. CLS. 100, 101 AND 107).

SN 78-133,892. GREENKY, SETH, R., DBA GREEN KEY MANAGEMENT, NEW YORK, NY. FILED 6-7-2002.

GOING P.O.S.T.A.L. GOING POSTAL!

FOR ENTERTAINMENT SERVICES, NAMELY, AN ON-GOING TELEVISION SERIES AND FEATURE FILM FEATURING A COMEDY/MYSTERY TAKING PLACE IN THE BUSINESS-AS-USUAL WORLD OF CIVIL SERVICE AT GENERAL POST OFFICE IN NEW YORK CITY FEATURING AN ASSORTMENT OF QUIRKY CHARACTERS INCLUDING EMPLOYEES, CUSTOMERS AND A HIDDEN, UNDERGROUND LAIR WITH ITS OWN ASSORTMENT OF CHARACTERS FEATURING ITS OWN, SECRET AND SPECIAL AGENDA (U.S. CLS. 100, 101 AND 107).

SN 78-135,097. REICH, GREGG, BENJAMIN, CAPE MAY, NJ. FILED 6-12-2002.

SURFTRADER

FOR PROVIDING INFORMATION IN THE FIELD OF THE SPORT OF SURFING (U.S. CLS. 100, 101 AND 107). FIRST USE 1-1-1995; IN COMMERCE 1-1-1996.

SN 78-137,353. LEE, ROBERT, MAXWELL, JR., MARTINEZ, CA. FILED 6-20-2002.



NO CLAIM IS MADE TO THE EXCLUSIVE RIGHT TO USE "PRODUCTIONS", APART FROM THE MARK AS SHOWN.

FOR PRODUCTION OF MOTION PICTURES (U.S. CLS. 100, 101 AND 107).

FIRST USE 0-0-2001; IN COMMERCE 0-0-2001.

CLASS 41—(Continued).

SN 78-140,767. FOX BROADCASTING COMPANY, LOS ANGELES, CA. FILED 7-2-2002.

ISLA DE LA TENTACION

OWNER OF U.S. REG. NO. 2,571,569.

NO CLAIM IS MADE TO THE EXCLUSIVE RIGHT TO USE "ISLA", APART FROM THE MARK AS SHOWN.

THE ENGLISH TRANSLATION OF "ISLA DE LA TENTACION" IS "TEMPTATION ISLAND".

FOR ENTERTAINMENT SERVICES IN THE NATURE OF A TELEVISION SERIES IN THE REALITY GENRE (U.S. CLS. 100, 101 AND 107).

SN 78-142,969. AUDIO VISUAL SERVICES CORPORATION, LONG BEACH, CA. FILED 7-11-2002.

AVHQ SHOW SOLUTIONS

OWNER OF U.S. REG. NO. 1,811,189.

NO CLAIM IS MADE TO THE EXCLUSIVE RIGHT TO USE "SHOW SOLUTIONS", APART FROM THE MARK AS SHOWN.

FOR RENTAL OF AUDIOVISUAL EQUIPMENT; STAGING SERVICES, NAMELY, AUDIO, VIDEO, AND LIGHTING PRODUCTION AND PROJECTION SERVICES FOR LIVE EVENTS (U.S. CLS. 100, 101 AND 107).

SN 78-143,439. MOVIE MANUFACTURING LEASING COMPANY, INC., SAN DIEGO, CA. FILED 7-12-2002.

STRATEGIC OPERATIONS

FOR EDUCATIONAL SERVICES NAMELY, PROVIDING TRAINING SEMINARS TO LAW ENFORCEMENT, SECURITY, MILITARY AND FIRST RESPONDERS IN THE FIELD OF HOW TO RESPOND TO DANGEROUS SITUATIONS AND EMERGENCY SCENARIOS (U.S. CLS. 100, 101 AND 107).

SN 78-143,480. AUDIO VISUAL SERVICES CORPORATION, LONG BEACH, CA. FILED 7-12-2002.

OWNER OF U.S. REG. NO. 1,811,189.

NO CLAIM IS MADE TO THE EXCLUSIVE RIGHT TO USE "MEETING SERVICES", APART FROM THE MARK AS SHOWN.

FOR RENTAL OF AUDIOVISUAL EQUIPMENT; STAGING SERVICES, NAMELY, AUDIO, VIDEO, AND LIGHTING PRODUCTION AND PROJECTION SERVICES FOR LIVE EVENTS (U.S. CLS. 100, 101 AND 107).

CLASS 41—(Continued).

SN 78-143,482. AUDIO VISUAL SERVICES CORPORATION, LONG BEACH, CA. FILED 7-12-2002.



OWNER OF U.S. REG. NO. 1,811,189.
NO CLAIM IS MADE TO THE EXCLUSIVE RIGHT TO USE "SHOW SOLUTIONS", APART FROM THE MARK AS SHOWN.
FOR RENTAL OF AUDIOVISUAL EQUIPMENT; STAGING SERVICES, NAMELY, AUDIO, VIDEO, AND LIGHTING PRODUCTION AND PROJECTION SERVICES FOR LIVE EVENTS (U.S. CLS. 100, 101 AND 107).

SN 78-143,484. AUDIO VISUAL SERVICES CORPORATION, LONG BEACH, CA. FILED 7-12-2002.



OWNER OF U.S. REG. NO. 1,811,189.
NO CLAIM IS MADE TO THE EXCLUSIVE RIGHT TO USE "RENTAL SERVICES", APART FROM THE MARK AS SHOWN.
FOR RENTAL OF AUDIOVISUAL EQUIPMENT; STAGING SERVICES, NAMELY, AUDIO, VIDEO, AND LIGHTING PRODUCTION AND PROJECTION SERVICES FOR LIVE EVENTS (U.S. CLS. 100, 101 AND 107).

CLASS 41—(Continued).

SN 78-148,216. MEYERSON, SHANA JILL, LOS ANGELES, CA. FILED 7-28-2002.



NO CLAIM IS MADE TO THE EXCLUSIVE RIGHT TO USE "YOGIS", APART FROM THE MARK AS SHOWN.
FOR EDUCATIONAL SERVICES, NAMELY, CONDUCTING YOGA CLASSES FOR CHILDREN AGES INFANT TO 18 (U.S. CLS. 100, 101 AND 107).
FIRST USE 3-19-2002; IN COMMERCE 3-19-2002.

SN 78-148,398. SOUTH CAROLINA EDUCATION LOTTERY COMMISSION, COLUMBIA, SC. FILED 7-29-2002.



NO CLAIM IS MADE TO THE EXCLUSIVE RIGHT TO USE "SOUTH CAROLINA EDUCATION LOTTERY", APART FROM THE MARK AS SHOWN.
FOR LOTTERY SERVICES (U.S. CLS. 100, 101 AND 107).
FIRST USE 6-1-2002; IN COMMERCE 6-1-2002.

SN 78-148,542. WARP & WOOF, LTD., NEW BRUNSWICK, NJ. FILED 7-29-2002.



NO CLAIM IS MADE TO THE EXCLUSIVE RIGHT TO USE "PLAYERS", APART FROM THE MARK AS SHOWN.
FOR ENTERTAINMENT IN THE NATURE OF THEATER PRODUCTIONS (U.S. CLS. 100, 101 AND 107).
FIRST USE 9-0-1993, 09/00/1972; IN COMMERCE 9-0-1993, 09/00/1980.

CLASS 41—(Continued).

SN 78-149,933. BROKERS' CHOICE OF AMERICA, INC., GLENDALE, CO. FILED 8-1-2002.

LONG TERM CARE UNIVERSITY

NO CLAIM IS MADE TO THE EXCLUSIVE RIGHT TO USE "LONG TERM CARE", APART FROM THE MARK AS SHOWN.

FOR EDUCATIONAL SERVICES, NAMELY, CONDUCTING CLASSES FOR FINANCIAL ADVISORS ON LONG TERM CARE NEEDS OF SENIOR CITIZENS AND THE FINANCIAL PRODUCTS AVAILABLE TO ASSIST SENIORS IN FUNDING THE COSTS APPLICABLE TO SUCH NEEDS (U.S. CLS. 100, 101 AND 107).

SN 78-152,001. LUTTERMOSER, KURT, HUNTSVILLE, AL. FILED 8-7-2002.

A GAMES

NO CLAIM IS MADE TO THE EXCLUSIVE RIGHT TO USE "GAMES", APART FROM THE MARK AS SHOWN.

FOR ENTERTAINMENT SERVICES IN THE NATURE OF A LIVE SPORTING EVENT FEATURING AGGRESSIVE IN-LINE SKATING, SKATEBOARDING, SKY-DIVING, MOTOR CROSS RACING, BAREFOOT WATER SKIING, WAKE BOARDING, WAVE RUNNER RACING AND MOUNTAIN BIKING (U.S. CLS. 100, 101 AND 107).

SN 78-152,170. REIMAN MEDIA GROUP, INC., GREENDALE, WI. FILED 8-8-2002.

TASTE OF HOME MINUTE

OWNER OF U.S. REG. NOS. 2,002,133, 2,431,989 AND OTHERS.

FOR ENTERTAINMENT SERVICES IN THE NATURE OF AN ON-GOING TELEVISION PROGRAM IN THE FIELD OF COOKING (U.S. CLS. 100, 101 AND 107).
FIRST USE 8-6-2002; IN COMMERCE 10-15-2002.

SN 78-152,552. APPLIED TALENT, INC., LA JOLLA, CA. FILED 8-8-2002.

PHOTOGRAPHS BY ROBIN NATIONS

NO CLAIM IS MADE TO THE EXCLUSIVE RIGHT TO USE "PHOTOGRAPHS", APART FROM THE MARK AS SHOWN.

FOR WEDDING PHOTOGRAPHY, FAMILY PORTRAITURE (U.S. CLS. 100, 101 AND 107).
FIRST USE 5-1-2002; IN COMMERCE 5-1-2002.

CLASS 41—(Continued).

SN 78-155,672. G4 MEDIA, LLC, LOS ANGELES, CA. FILED 8-19-2002.

ICONS

FOR ENTERTAINMENT SERVICES IN THE NATURE OF AN ONGOING TELEVISION PROGRAM IN THE FIELD OF VIDEO, COMPUTER, ONLINE AND WIRELESS GAMES (U.S. CLS. 100, 101 AND 107).
FIRST USE 5-1-2002; IN COMMERCE 5-1-2002.

SN 78-155,742. KATHY HESSLER-RINGWOOD AND CHET RINGWOOD JOINT VENTURE, THE, HUNTINGTON BEACH, CA. FILED 8-19-2002.

CHESTERMOLESTHER

FOR ENTERTAINMENT SERVICES, NAMELY, PROVIDING A WEB SITE FEATURING PROVOCATIVE ADULT SUBJECT MATTER (U.S. CLS. 100, 101 AND 107).
FIRST USE 12-15-2000; IN COMMERCE 12-15-2000.

SN 78-157,162. CRUZ, CAMILO, F, PLANTATION, FL. FILED 8-23-2002.

ACTIONEERING

FOR EDUCATIONAL AND TRAINING SERVICES, NAMELY LIVE, TELECONFERENCING AND INTERNET SEMINARS AND LECTURES, TO ASSIST INDIVIDUALS AND ORGANIZATIONS TO ACTIVELY PURSUE THEIR GOALS AND ACHIEVE SPECIFIC RESULTS; A SERIES OF RADIO BROADCASTS AND TELEVISION SHOWS ON THE SUBJECT OF PERSONAL AND PROFESSIONAL DEVELOPMENT AND ACHIEVING SUCCESS (U.S. CLS. 100, 101 AND 107).

SN 78-157,982. UNITED STATES AUTOSOUND COMPETITION, INC., BRANDON, MS. FILED 8-26-2002.

SPL SHOOTOUT

NO CLAIM IS MADE TO THE EXCLUSIVE RIGHT TO USE "SPL", APART FROM THE MARK AS SHOWN.

FOR ENTERTAINMENT IN THE NATURE OF COMPETITIONS IN THE FIELD OF AUTOMOBILE AUDIO SOUND (U.S. CLS. 100, 101 AND 107).
FIRST USE 7-0-1984; IN COMMERCE 7-0-1984.

CLASS 41—(Continued).

SN 78-157,983. UNITED STATES AUTOSOUND COMPETITION, INC., BRANDON, MS. FILED 8-26-2002.

OUTLAW SPL

NO CLAIM IS MADE TO THE EXCLUSIVE RIGHT TO USE "SPL", APART FROM THE MARK AS SHOWN.

FOR ENTERTAINMENT IN THE NATURE OF COMPETITIONS IN THE FIELD OF AUTOMOBILE AUDIO SOUND (U.S. CLS. 100, 101 AND 107).

FIRST USE 0-0-1989; IN COMMERCE 0-0-1989.

SN 78-157,985. UNITED STATES AUTOSOUND COMPETITION, INC., BRANDON, MS. FILED 8-26-2002.

OUTLAW SPL SHOOTOUT

NO CLAIM IS MADE TO THE EXCLUSIVE RIGHT TO USE "SPL", APART FROM THE MARK AS SHOWN.

FOR ENTERTAINMENT IN THE NATURE OF COMPETITIONS IN THE FIELD OF AUTOMOBILE AUDIO SOUND (U.S. CLS. 100, 101 AND 107).

FIRST USE 0-0-1989; IN COMMERCE 0-0-1989.

SN 78-158,753. POMPA, ANTHONY MICHAEL, ENGLEWOOD, NJ. FILED 8-28-2002.

AVID

FOR RECORD LABEL SERVICES, NAMELY, AUDIO RECORDING AND PRODUCTION (U.S. CLS. 100, 101 AND 107).

FIRST USE 11-23-1995; IN COMMERCE 11-23-1995.

SN 78-158,931. WOODARD III, OTIS, JACK, PARK CITY, UT. FILED 8-28-2002.

A PATH WITH HEART

FOR CONDUCTING SEMINARS, WORKSHOPS, LECTURES, AND CLASSES IN THE FIELDS OF PERSONAL AWARENESS, PERSONAL DEVELOPMENT, LEADERSHIP, MANAGEMENT, AND COMPUTER SKILLS; EDUCATIONAL SERVICES, NAMELY, PROVIDING COURSES OF INSTRUCTION FOR SECONDARY AND COLLEGE LEVELS IN THE FIELDS OF PERSONAL AWARENESS AND PERSONAL DEVELOPMENT; ONLINE PUBLICATION OF SUMMARIES OF PUBLISHED BOOKS IN THE FIELDS OF PERSONAL AWARENESS, PERSONAL DEVELOPMENT, LEADERSHIP, AND MANAGEMENT; PERSONAL COACHING SERVICES IN THE FIELDS OF PERSONAL AWARENESS, PERSONAL DEVELOPMENT, LEADERSHIP, MANAGEMENT AND COMPUTER SKILLS; PUBLICATION OF BOOKS, MANUALS, AND TEXTBOOKS IN THE AREAS OF PERSONAL AWARENESS, PERSONAL DEVELOPMENT, LEADERSHIP AND MANAGEMENT (U.S. CLS. 100, 101 AND 107).

CLASS 41—(Continued).

SN 78-161,150. BASS BENEFIT CONSULTANTS, MIAMI SHORES, FL. FILED 9-5-2002.

PRIORITY LIVING SYSTEMS

NO CLAIM IS MADE TO THE EXCLUSIVE RIGHT TO USE "SYSTEMS", APART FROM THE MARK AS SHOWN.

FOR EDUCATIONAL SERVICES NAMELY CONDUCTING PROGRAMS IN THE FIELD OF BUSINESS DEVELOPMENT AND PERSONAL GROWTH PROGRAMS, NAMELY, BUSINESS PLANNING, SALES, MARKETING, AND TIME MANAGEMENT; STRESS CONTROL AND THE DEVELOPMENT OF MENTAL, PHYSICAL AND EMOTIONAL FACULTIES (U.S. CLS. 100, 101 AND 107).

FIRST USE 9-1-1998; IN COMMERCE 9-1-1998.

SN 78-163,593. UNITED STATES OLYMPIC COMMITTEE, COLORADO SPRINGS, CO. FILED 9-12-2002.

ROAD TO TORINO

NO CLAIM IS MADE TO THE EXCLUSIVE RIGHT TO USE "TORINO", APART FROM THE MARK AS SHOWN.

FOR ENTERTAINMENT SERVICES, NAMELY, ORGANIZING AND CONDUCTING ATHLETIC COMPETITIONS AND DEMONSTRATIONS; A SERIES OF TELEVISION SHOWS FEATURING SPORTS AND ATHLETIC EVENTS. (U.S. CLS. 100, 101 AND 107).

SN 78-163,621. YWCA OF GREATER LOS ANGELES, LOS ANGELES, CA. FILED 9-12-2002.

*SOCIETY of
Benefactrix*

FOR AWARD PROGRAMS FOR MAJOR CORPORATIONS AND INDIVIDUALS WHO HAVE MADE SIGNIFICANT CHARITABLE CONTRIBUTIONS (U.S. CLS. 100, 101 AND 107).

FIRST USE 10-1-2000; IN COMMERCE 10-1-2000.

SN 78-164,921. NELSON, GUNNAR, CLEVELAND, OH. FILED 9-17-2002.

IT'S ALL ABOUT YOU

FOR ENTERTAINMENT SERVICES, NAMELY, ONGOING TELEVISION VARIETY SERIES, DISTRIBUTED OVER TELEVISION, SATELLITE, WIRELESS AUDIO AND VIDEO MEDIA, FIBER OPTICS, CABLE AND A GLOBAL COMPUTER NETWORK (U.S. CLS. 100, 101 AND 107).

CLASS 41—(Continued).

SN 78-165,530. COAST HOTELS LIMITED, VANCOUVER, BRITISH COLUMBIA, FILED 9-18-2002.

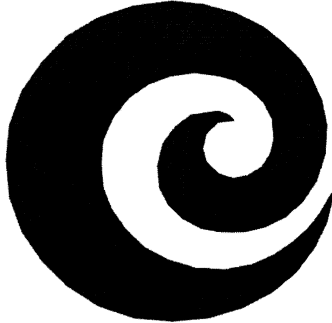

FOR GOLF COURSE SERVICES (U.S. CLS. 100, 101 AND 107).

SN 78-166,569. VILLALOBOS, CARLOS, BEVERLY HILLS, CA. FILED 9-20-2002.

ANGRY CHIWAHAH

FOR MUSICAL ENTERTAINMENT SERVICES IN THE NATURE OF LIVE PERFORMANCES BY A MUSICAL BAND (U.S. CLS. 100, 101 AND 107).

SN 78-171,416. STROUD-LEE, DIERDRA, G, ATHENS, GA. FILED 10-5-2002.

GETAN RECORDS

NO CLAIM IS MADE TO THE EXCLUSIVE RIGHT TO USE "RECORDS", APART FROM THE MARK AS SHOWN. FOR MUSIC PRODUCTION (U.S. CLS. 100, 101 AND 107).

SN 78-174,406. SAN DIEGO SUNFIRE, SAN DIEGO, CA. FILED 10-15-2002.



NO CLAIM IS MADE TO THE EXCLUSIVE RIGHT TO USE "SAN DIEGO", APART FROM THE MARK AS SHOWN. FOR ENTERTAINMENT SERVICES IN THE NATURE OF PROFESSIONAL FOOTBALL GAMES AND EXHIBITIONS (U.S. CLS. 100, 101 AND 107). FIRST USE 11-1-2001; IN COMMERCE 11-1-2001.

CLASS 41—(Continued).

SN 78-175,052. ABB INC., NEW BERLIN, WI. FILED 10-16-2002.

EVIEWER

FOR PERIODIC ELECTRONIC PUBLICATIONS IN THE NATURE OF A NEWSLETTER SENT VIA EMAIL IN THE FIELD OF POWER TECHNOLOGY (U.S. CLS. 100, 101 AND 107).

FIRST USE 9-20-2002; IN COMMERCE 9-20-2002.

SN 78-175,996. BURNS, SHELLEY SPIRA, SAN FRANCISCO, CA. FILED 10-18-2002.

DATING FITNESS

NO CLAIM IS MADE TO THE EXCLUSIVE RIGHT TO USE "DATING", APART FROM THE MARK AS SHOWN.

FOR EDUCATIONAL SERVICES AND ONLINE EDUCATIONAL SERVICES, NAMELY CONDUCTING GROUP WORKSHOPS AND CLASSES IN THE FIELDS OF DATING, COMPATIBILITY, AND SOCIAL RELATIONSHIPS AND PROVIDING COURSE MATERIALS IN CONNECTION THEREWITH; PERSONAL COACHING SERVICES IN THE FIELDS OF DATING, COMPATIBILITY, AND SOCIAL RELATIONSHIPS; PROVIDING ONLINE NON-DOWNLOADABLE PUBLICATIONS, NAMELY BOOKS AND MAGAZINES IN THE FIELDS OF DATING, COMPATIBILITY, AND SOCIAL RELATIONSHIPS (U.S. CLS. 100, 101 AND 107).

SN 78-176,594. LALLY, DANIEL J., LOUISVILLE, KY. FILED 10-21-2002.



NO CLAIM IS MADE TO THE EXCLUSIVE RIGHT TO USE "CHI", APART FROM THE MARK AS SHOWN.

THE MARK CONSISTS OF THE WORDS "WAY CHI", WRITTEN IN Papyrus FONT IN ORDER TO CONVEY AN ANCIENT QUALITY, AND A VERTICAL YIN YANG SYMBOL IN BETWEEN WITH A BLACK SILHOUETTE IN THE WHITE SECTION AND A WHITE SILHOUETTE IN THE BLACK SECTION. BOTH SILHOUETTES ARE FACING EACHOTHER, CONVEYING TWO "WAY CHI" MOVEMENTS, THE WAY OF THE WARRIOR, AND THE WAY OF THE PEACEMAKER.

FOR EDUCATIONAL SERVICES, NAMELY, CLASSES AND WORKSHOPS PROVIDING SERIES OF BODY MOVEMENTS FOR THE BODY, MIND AND SPIRIT THAT PROVIDE A FELT-SENSE OF RELIGIOUS SCRIPTURES (U.S. CLS. 100, 101 AND 107).

FIRST USE 3-14-2002; IN COMMERCE 3-14-2002.

CLASS 41—(Continued).

SN 78-185,252. BIG DAWG MONSTER TRUCK RACING L.L.C., UNION, MO. FILED 11-14-2002.

BIG DAWG

FOR ENTERTAINMENT SERVICES, NAMELY, PERFORMING AND COMPETING IN MOTOR SPORTS EVENTS (U.S. CLS. 100, 101 AND 107).
FIRST USE 1-0-1994; IN COMMERCE 1-0-1994.

SN 78-185,800. HILLENBRAND, SARAH H., CHICAGO, IL. FILED 11-15-2002.

EQUIPHILIA

FOR HORSE TRAINING AND RIDING INSTRUCTION (U.S. CLS. 100, 101 AND 107).
FIRST USE 1-1-1997; IN COMMERCE 1-1-1997.

SN 78-187,351. CENTER FOR VITAL THOUGHT, LLC, CINCINNATI, OH. FILED 11-21-2002.

CENTER FOR VITAL THOUGHT

NO CLAIM IS MADE TO THE EXCLUSIVE RIGHT TO USE "CENTER", APART FROM THE MARK AS SHOWN.
FOR EDUCATIONAL SERVICES, NAMELY, CONDUCTING PROGRAMS, TRAINING SERVICES AND CONSULTATIONS IN THE FIELD OF COGNITIVE AND INTERPERSONAL COMMUNICATION SKILLS (U.S. CLS. 100, 101 AND 107).
FIRST USE 10-28-2002; IN COMMERCE 11-8-2002.

SN 78-187,828. RUMBLEFISH, LOS ANGELES, CA. FILED 11-22-2002.

RUMBLEFISH

OWNER OF U.S. REG. NO. 2,233,968.
FOR ENTERTAINMENT SERVICES, NAMELY LIVE PERFORMANCES BY A MUSICAL GROUP (U.S. CLS. 100, 101 AND 107).
FIRST USE 10-30-1997; IN COMMERCE 10-30-1997.

CLASS 41—(Continued).

SN 78-187,832. THE TRUSTEES OF DAVIDSON COLLEGE, DAVIDSON, NC. FILED 11-22-2002.

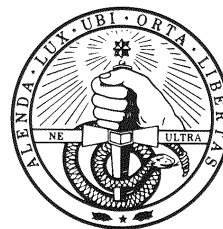

THE LINING IS A FEATURE OF THE MARK AND IS NOT INTENDED TO INDICATE COLOR.

THE ENGLISH TRANSLATION OF THE FOREIGN WORDING "ALENDA LUX UBI ORTA LIBERTAS" AND "NE ULTRA" IS "LET LEARNING BE CHERISHED WHERE LIBERTY HAS ARISEN" AND "NONE HIGHER".

FOR EDUCATIONAL SERVICES, NAMELY, CONDUCTING CLASSES, SEMINARS, AND CONFERENCES IN THE FIELDS OF ANTHROPOLOGY, ASIAN STUDIES, BIOLOGY, CHEMISTRY, CLASSICS, COMPOSITION, COMPUTER SCIENCE, ECONOMICS, EDUCATION, ENGLISH, ETHNIC STUDIES, FINE ARTS, FOREIGN LANGUAGES, GENDER STUDIES, HISTORY, HUMANITIES, INTERNATIONAL STUDIES, LITERATURE, MATHEMATICS, MEDICAL HUMANITIES, MILITARY STUDIES, MUSIC, PHILOSOPHY, NEUROSCIENCE, PHYSICS, PHYSICAL EDUCATION, POLITICAL SCIENCE, PSYCHOLOGY, PRE-LAW, PRE-MEDICINE, PRE-MINISTERIAL, RELIGION, ROTC, SOCIOLOGY, SOUTH ASIAN STUDIES, SOUTHERN UNITED STATES STUDIES, AND THEATRE, AND DISTRIBUTING COURSE MATERIALS IN CONJUNCTION THEREWITH; ENTERTAINMENT IN THE NATURE OF COMPETITIONS IN THE FIELD OF ATHLETICS, ENTERTAINMENT IN THE NATURE OF DANCE PERFORMANCES, ENTERTAINMENT IN THE NATURE OF LECTURES, ENTERTAINMENT IN THE NATURE OF LIVE MUSIC CONCERTS, ENTERTAINMENT IN THE NATURE OF RADIO ENTERTAINMENT PRODUCTION, ENTERTAINMENT IN THE NATURE OF THEATRE PERFORMANCES, ENTERTAINMENT IN THE NATURE OF VISUAL ARTS EXHIBITIONS (U.S. CLS. 100, 101 AND 107).

FIRST USE 8-31-1840; IN COMMERCE 8-31-1840.

SN 78-188,707. MCCLOSKEY, PATRICK L., LONG BEACH, NY, AND RUBINOWITZ, BEN B., ROSLYN HEIGHTS, NY. FILED 11-25-2002.

THE CENTER FOR WINNING ADVOCACY

NO CLAIM IS MADE TO THE EXCLUSIVE RIGHT TO USE "CENTER" AND "ADVOCACY", APART FROM THE MARK AS SHOWN.

FOR PROVIDING CONTINUING LEGAL EDUCATION COURSES; PROVIDING LEGAL EDUCATION WORKSHOPS AND LECTURES TO LAW FIRMS AND LAWYERS (U.S. CLS. 100, 101 AND 107).

FIRST USE 10-22-2002; IN COMMERCE 10-22-2002.

CLASS 41—(Continued).

SN 78-193,477. AFSABI, VIC, FARAMARZ, ANAHEIM HILLS, CA. FILED 12-11-2002.



FOR ENTERTAINMENT SERVICES, NAMELY, PROVIDING ON-LINE REVIEWS OF RESTAURANTS; ENTERTAINMENT SERVICES, NAMELY, PROVIDING A WEBSITE FEATURING ORIGINAL ARTWORK AND ORIGINAL PHOTOGRAPHS AND SHORT FILMS (U.S. CLS. 100, 101 AND 107).

SN 78-193,715. THE SPACE DAY FOUNDATION, INC., WASHINGTON, DC. FILED 12-12-2002.

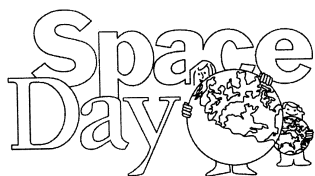

SEC. 2(F) AS TO "SPACE DAY".
FOR EDUCATIONAL SERVICES, NAMELY, CONDUCTING PROGRAMS, ONLINE EXHIBITIONS AND DISPLAYS AND INTERACTIVE EXHIBITS, AND WORKSHOPS AND SEMINARS IN THE FIELD OF SPACE, TECHNOLOGY, SCIENCE AND AERONAUTICS, AND DISTRIBUTION OF COURSE MATERIALS IN CONNECTION THEREWITH (U.S. CLS. 100, 101 AND 107).

FIRST USE 4-30-1997; IN COMMERCE 4-30-1997.

SN 78-194,522. BASEBALL CLUB OF SEATTLE LP, SEATTLE, WA. FILED 12-13-2002.

FIELD OF LIGHTS

FOR ENTERTAINMENT SERVICES, NAMELY, CONDUCTING ENTERTAINMENT EXHIBITIONS OF HOLIDAY DECORATIONS AND CONDUCTING HOLIDAY FAIRS; ENTERTAINMENT IN THE NATURE OF LIVE MUSICAL PERFORMANCES; ENTERTAINMENT IN THE NATURE OF BASEBALL GAMES AND BASEBALL GAMES AND BASEBALL EXHIBITIONS; PROVIDING FACILITIES FOR ENTERTAINMENT, SPORTS AND RECREATIONAL ACTIVITIES; AND CHARITABLE SERVICES, NAMELY PROVIDING ENTERTAINMENT IN THE NATURE OF BASEBALL GAMES AND EXHIBITIONS AND LIVE MUSICAL PERFORMANCES TO THOSE SERVICED BY CHARITABLE ORGANIZATIONS (U.S. CLS. 100, 101 AND 107).

CLASS 41—(Continued).

SN 78-194,525. BASEBALL CLUB OF SEATTLE LP, SEATTLE, WA. FILED 12-13-2002.



FOR ENTERTAINMENT SERVICES, NAMELY, CONDUCTING ENTERTAINMENT EXHIBITIONS OF HOLIDAY DECORATIONS AND CONDUCTING HOLIDAY FAIRS; ENTERTAINMENT IN THE NATURE OF LIVE MUSICAL PERFORMANCES; ENTERTAINMENT IN THE NATURE OF BASEBALL GAMES AND BASEBALL GAMES AND BASEBALL EXHIBITIONS; PROVIDING FACILITIES FOR ENTERTAINMENT, SPORTS AND RECREATIONAL ACTIVITIES; AND CHARITABLE SERVICES, NAMELY PROVIDING ENTERTAINMENT IN THE NATURE OF BASEBALL GAMES AND EXHIBITIONS AND LIVE MUSICAL PERFORMANCES TO THOSE SERVICED BY CHARITABLE ORGANIZATIONS (U.S. CLS. 100, 101 AND 107).

SN 78-194,683. CHARLES, DAWN-MARIE M, HYDE PARK, MA. FILED 12-16-2002.

VYSTARR

FOR ENTERTAINMENT SERVICES IN THE NATURE OF A WEBSITE FEATURING WORLD NEWS, HAPPENINGS IN THE ENTERTAINMENT INDUSTRY, VARIOUS CELEBRITY INFORMATION, CONCERT TOURS, CELEBRITY INTERVIEWS, SPORTS COVERAGE AND BOOK REVIEWS (U.S. CLS. 100, 101 AND 107).

SN 78-197,235. CHAPMAN, NATHAN, MADISON, TN. AND CHAPMAN, STEPHANIE, MADISON, TN. FILED 12-23-2002.

BRISTOL CROSSING

FOR ENTERTAINMENT SERVICES IN THE NATURE OF A LIVE MUSICAL GROUP (U.S. CLS. 100, 101 AND 107).

SN 78-198,171. SEGEBRECHT, LINDA, OVERLAND PARK, KS. AND BECICKA, CHRIS, OVERLAND PARK, KS. FILED 12-27-2002.

SIGNATURE EXPERIENCE

NO CLAIM IS MADE TO THE EXCLUSIVE RIGHT TO USE "EXPERIENCE", APART FROM THE MARK AS SHOWN.

FOR EDUCATIONAL SERVICES, NAMELY, CONDUCTING SEMINARS IN ART, SCIENCE AND HISTORY AT MUSEUMS, LIBRARIES AND ZOOS (U.S. CLS. 100, 101 AND 107).

CLASS 41—(Continued).

SN 78-198,306. HULLEON RECORDS, INC., FERNDALE, MI. FILED 12-27-2002.

JUSTUS BOYZ

NO CLAIM IS MADE TO THE EXCLUSIVE RIGHT TO USE "BOYZ", APART FROM THE MARK AS SHOWN.

FOR RECORD PRODUCTION SERVICES; ENTERTAINMENT SERVICES, NAMELY, LIVE PERFORMANCES BY A MUSICAL GROUP (U.S. CLS. 100, 101 AND 107).

SN 78-199,756. HARRAH'S BOSSIER CITY INVESTMENT COMPANY, LLC, LAS VEGAS, NV. FILED 1-3-2003.



FOR ENTERTAINMENT SERVICES, NAMELY, ORGANIZING AND CONDUCTING LIVE HORSE RACES; PROVIDING FACILITIES WHERE SIMULCAST BROADCASTS OF HORSE RACES ARE SHOWN; AND PROVIDING SPORTS FACILITIES IN THE NATURE OF HORSE TRACKS (U.S. CLS. 100, 101 AND 107).

FIRST USE 12-31-1986; IN COMMERCE 12-31-1986.

SN 78-199,849. GOD'S HOUSE OF PRAYER, INC., SOUTHLAKE, TX. FILED 1-3-2003.

MAXIMIZED FAMILY

NO CLAIM IS MADE TO THE EXCLUSIVE RIGHT TO USE "FAMILY", APART FROM THE MARK AS SHOWN.

FOR RELIGIOUS INSTRUCTION (U.S. CLS. 100, 101 AND 107).

SN 78-201,648. GUTIN, LINDA, LOS ANGELES, CA. FILED 1-9-2003.

LAUGHTER BAITING

FOR PRODUCTION OF TELEVISION PROGRAMS (U.S. CLS. 100, 101 AND 107).

CLASS 41—(Continued).

SN 78-201,755. THE CARTOON NETWORK LP, LLLP, ATLANTA, GA. FILED 1-9-2003.

CARTOON NETWORK HOOP HOP

OWNER OF U.S. REG. NOS. 1,798,899, 2,581,434 AND OTHERS.

FOR ENTERTAINMENT SERVICES, NAMELY EXHIBITIONS COMPOSED OF INTERACTIVE GAME DISPLAYS, CELEBRITY APPEARANCES, PARTICIPATORY ACTIVITIES, CONTESTS AND COMPETITIONS CENTERED AROUND SPORTING AND ENTERTAINMENT EVENTS. (U.S. CLS. 100, 101 AND 107).

SN 78-202,679. FREMANTLE MEDIA NORTH AMERICA, INC., SANTA MONICA, CA. FILED 1-13-2003.

CUPID

FOR ENTERTAINMENT SERVICES IN THE NATURE OF A CONTINUING TELEVISION REALITY PROGRAM (U.S. CLS. 100, 101 AND 107).

SN 78-202,787. HESS, GARY S., NEW YORK, NY. FILED 1-13-2003.

YOUR ONE-STOP SOURCE FOR PRECISION TECHNICAL TRANSLATIONS

FOR LANGUAGE TRANSLATION SERVICES OF TECHNICAL MATERIAL (U.S. CLS. 100, 101 AND 107).

FIRST USE 6-20-2002; IN COMMERCE 6-20-2002.

SN 78-203,384. FLORES, IAN, J, AUSTIN, TX. FILED 1-15-2003.

TWENTY AFTER

FOR ENTERTAINMENT IN THE NATURE OF VISUAL AND AUDIO PERFORMANCES, NAMELY, MUSICAL BAND, ROCK GROUP, GYMNASTIC, DANCE, AND BALLET PERFORMANCES (U.S. CLS. 100, 101 AND 107).

SN 78-203,500. JCW ENTERPRISES, INC., NEW YORK, NY. FILED 1-15-2003.

JCW

FOR PUBLICATION OF CHILDREN'S BOOKS (U.S. CLS. 100, 101 AND 107).

FIRST USE 0-0-2002; IN COMMERCE 0-0-2002.

CLASS 41—(Continued).

SN 78-203,670. PLANET3 WIRELESS, INC., BREMEN, GA. FILED 1-15-2003.

WI-SCHOOL

FOR COMPUTER EDUCATION TRAINING SERVICES, NAMELY TRAINING IN THE FIELD OF WIRELESS COMPUTER HARDWARE AND SOFTWARE NETWORKING SYSTEMS (U.S. CLS. 100, 101 AND 107). FIRST USE 7-15-2002; IN COMMERCE 1-6-2003.

CLASS 41—(Continued).

SN 78-204,846. QUILES, MICHELLE D., JERSEY CITY, NJ. FILED 1-18-2003.



SN 78-203,974. VEHICLE INFORMATION SERVICES, INC., BATH, OH. FILED 1-16-2003.

DVA

FOR INSTRUCTION IN THE FIELD OF AUTOMOBILE VALUE ASSESSMENT (U.S. CLS. 100, 101 AND 107).

FOR EDUCATIONAL AND ENTERTAINMENT SERVICES, NAMELY, PROVIDING MOTIVATIONAL AND EDUCATIONAL SPEAKERS (U.S. CLS. 100, 101 AND 107).

SN 78-205,143. MCCLURE, BRUCE P., SAN DIEGO, CA. FILED 1-20-2003.

MCTUTOR

SN 78-204,168. CINCINNATI REDS, LLC, THE, CINCINNATI, OH. FILED 1-16-2003.

GAPPER

FOR ENTERTAINMENT SERVICES IN THE NATURE OF PERSONAL AND PUBLIC APPEARANCES BY A COSTUMED CHARACTER BASEBALL TEAM MASCOT AT BASEBALL GAMES AND EXHIBITIONS, CLINICS, PROMOTIONS, AND OTHER BASEBALL RELATED EVENTS, BOTH LIVE AND VIA BROADCAST OVER TELEVISION, CABLE, SATELLITE AND/OR THE INTERNET (U.S. CLS. 100, 101 AND 107).

FOR EDUCATION SERVICES, NAMELY PROVIDING TUTORING IN THE FIELD OF GENERAL EDUCATION SUBJECTS, NAMELY MATHEMATICS, PHYSICS, ENGLISH, FOREIGN LANGUAGES, AND TEST PREPARATION (U.S. CLS. 100, 101 AND 107). FIRST USE 12-15-2000; IN COMMERCE 12-15-2000.

SN 78-205,385. ROCK HARD PRODUCTIONS, INC., BOSTON, MA. FILED 1-21-2003.

TRAIN YOUR HEAD TO THINK ON ITS FEET

SN 78-204,500. LEXCAR, LLC, NEW YORK, NY. FILED 1-17-2003.

WESTCHESTER WILDFIRE

NO CLAIM IS MADE TO THE EXCLUSIVE RIGHT TO USE "WESTCHESTER", APART FROM THE MARK AS SHOWN.

FOR ENTERTAINMENT AND EDUCATIONAL SERVICES IN THE NATURE OF ONGOING TELEVISION AND RADIO PROGRAMS IN THE FIELD OF BASKETBALL, AND RENDERING LIVE BASKETBALL GAMES AND BASKETBALL EXHIBITIONS; THE PRODUCTION AND DISTRIBUTION OF RADIO AND TELEVISION BROADCASTS OF BASKETBALL GAMES, BASKETBALL EVENTS AND PROGRAMS IN THE FIELD OF BASKETBALL; CONDUCTING AND ARRANGING BASKETBALL CLINICS AND COACHES CLINICS AND BASKETBALL EVENTS (U.S. CLS. 100, 101 AND 107).

SN 78-205,564. ARTISTDIRECT RECORDS, LLC., LOS ANGELES, CA. FILED 1-21-2003.

URBAN ETHOS

FOR ENTERTAINMENT SERVICES, NAMELY, MUSICAL SOUND RECORDING PRODUCTION AND AUDIOVISUAL RECORDING PRODUCTION; PROVIDING A WEB SITE FEATURING PRERECORDED MUSIC, MUSICAL PERFORMANCES AND VIDEO CLIPS, PHOTOGRAPHS, NEWS, REVIEWS AND OTHER MULTIMEDIA ARTICLES IN CONNECTION WITH A RECORD LABEL, MUSICAL GROUPS AND SOLO RECORDINGS ARTISTS (U.S. CLS. 100, 101 AND 107).

CLASS 41—(Continued).

SN 78-206,611. BOEING MANAGEMENT COMPANY, SEAL BEACH, CA. FILED 1-23-2003.

AVISTEL

FOR TRAINING AND EDUCATION SERVICES IN THE FIELD OF AVIATION, NAMELY, FLIGHT AND GROUND CREW TRAINING AND TECHNICAL TRAINING, INCLUDING FLIGHT SIMULATION TRAINING (U.S. CLS. 100, 101 AND 107).

SN 78-206,612. BOEING MANAGEMENT COMPANY, SEAL BEACH, CA. FILED 1-23-2003.

AVI-STEL

FOR TRAINING AND EDUCATION SERVICES IN THE FIELD OF AVIATION, NAMELY, FLIGHT AND GROUND CREW TRAINING AND TECHNICAL TRAINING, INCLUDING FLIGHT SIMULATION TRAINING (U.S. CLS. 100, 101 AND 107).

SN 78-206,907. LATHAM, DAN, DOWNEY, CA. FILED 1-24-2003.

CYBEROBICS

FOR FITNESS PROGRAM IN THE NATURE OF PHYSICAL EDUCATION SERVICES, PHYSICAL FITNESS INSTRUCTION, TRAINING IN THE USE AND OPERATION OF EXERCISE EQUIPMENT AND TEACHING IN THE FIELD OF PHYSICAL FITNESS (U.S. CLS. 100, 101 AND 107).

FIRST USE 1-1-1992; IN COMMERCE 1-1-2002.

SN 78-207,105. JACOBSON, RALPH DAVID, GOLDEN VALLEY, MN. FILED 1-25-2003.

THE LEADER'S TOOLBOX

NO CLAIM IS MADE TO THE EXCLUSIVE RIGHT TO USE "LEADER'S", APART FROM THE MARK AS SHOWN. FOR SEMINARS AND PERSONAL COACHING TO IMPROVE LEADERS' ABILITIES TO LEAD ORGANIZATIONS (U.S. CLS. 100, 101 AND 107).

SN 78-207,583. RADIOACTIVE BROADCASTING, LLC, EDMONDS, WA. FILED 1-27-2003.

THE VOCAL MINORITY

FOR ENTERTAINMENT IN THE NATURE OF A CONTINUING RADIO TALK PROGRAM (U.S. CLS. 100, 101 AND 107).

CLASS 41—(Continued).

SN 78-207,625. HARMONY KNIGHT PRODUCTIONS LLC, ENCINITAS, CA. FILED 1-27-2003.

AUTUMN KNIGHT

FOR ENTERTAINMENT SERVICES IN THE NATURE OF LIVE MUSICAL PERFORMANCES; ENTERTAINMENT SERVICES IN THE NATURE OF LIVE MUSICAL PERFORMANCES PROVIDED BY MEANS OF A GLOBAL COMPUTER NETWORK; PROVIDING INFORMATION ON A MUSICAL ARTIST AND SUCH ARTIST'S MUSIC, SOUND AND VIDEO RECORDINGS, PICTURES, NEWS, SPECIALS PROJECT TOURS, PERSONAL APPEARANCES AND BIOGRAPHY VIA A WEBSITE ON A GLOBAL COMPUTER NETWORK (U.S. CLS. 100, 101 AND 107).

FIRST USE 2-6-2002; IN COMMERCE 2-6-2002.

SN 78-207,643. FOX TELEVISION STUDIOS, INC., LOS ANGELES, CA. FILED 1-27-2003.

WALKING WITH DOGS

FOR ENTERTAINMENT SERVICES IN THE NATURE OF A TELEVISION SERIES FEATURING DOMESTICATED ANIMALS AND THEIR RELATIONSHIP WITH HUMANS. (U.S. CLS. 100, 101 AND 107).

SN 78-208,847. GROENING, MATT, LOS ANGELES, CA. FILED 1-30-2003.

PLANET EXPRESS

FOR ENTERTAINMENT SERVICES, NAMELY, PRODUCTION AND DISTRIBUTION OF MOTION PICTURES, FILMS, TELEVISION PROGRAMS, RADIO PROGRAMS, INTERACTIVE TELEVISION PROGRAMS, IN THE FIELDS OF ANIMATED AND LIVE-ACTION ENTERTAINMENT, SCIENCE FICTION, COMEDY, DRAMA, MYSTERY, PSYCHIC PHENOMENA, SPORTS, NEWS, TALK SHOWS, VARIETY, TRAVEL, DOCUMENTARIES, MOVIE REVIEWS, PSYCHOLOGY, EDUCATION, RECREATION, LIVE PERFORMANCES, INDIVIDUAL ENTERTAINERS, CULTURES AND CULTURAL EVENTS, AND MUSIC; AUDIO RECORDING AND PRODUCTION OF ANIMATED AND LIVE ACTION ENTERTAINMENT, SCIENCE FICTION, COMEDY, DRAMA, MYSTERY, PSYCHIC PHENOMENA, SPORTS, NEWS, TALK SHOWS, VARIETY, TRAVEL, DOCUMENTARIES, MOVIE REVIEWS, PSYCHOLOGY, EDUCATION, RECREATION, LIVE PERFORMANCES, INDIVIDUAL ENTERTAINERS, CULTURES AND CULTURAL EVENTS, AND MUSIC; ENTERTAINMENT IN THE NATURE OF THEATER PRODUCTIONS IN THE FIELDS OF ANIMATED AND LIVE-ACTION ENTERTAINMENT, SCIENCE FICTION, COMEDY, DRAMA, MYSTERY, PSYCHIC PHENOMENA, SPORTS, NEWS, TALK SHOWS, VARIETY, TRAVEL, DOCUMENTARIES, MOVIE REVIEWS, PSYCHOLOGY, EDUCATION, RECREATION, LIVE PERFORMANCES, INDIVIDUAL ENTERTAINERS, CULTURES AND CULTURAL EVENTS, AND MUSIC; PUBLICATION OF BOOKS, MAGAZINES, CARTOONS, COMIC STRIPS AND COMIC BOOKS; FAN CLUB SERVICES (U.S. CLS. 100, 101 AND 107).

CLASS 41—(Continued).

SN 78-209,008. IMPERIAL CIRCUS CORPORATION, ORADELL, NJ. FILED 1-30-2003.

IMPERIAL CIRCUS

NO CLAIM IS MADE TO THE EXCLUSIVE RIGHT TO USE "CIRCUS", APART FROM THE MARK AS SHOWN. FOR ENTERTAINMENT IN THE NATURE OF CIRCUSES (U.S. CLS. 100, 101 AND 107).

FIRST USE 1-0-1997; IN COMMERCE 1-0-1997.

SN 78-209,158. DANCE SANCTUARY, EL CERRITO, CA. FILED 1-30-2003.

DANCE SANCTUARY

NO CLAIM IS MADE TO THE EXCLUSIVE RIGHT TO USE "DANCE", APART FROM THE MARK AS SHOWN.

FOR DANCE CLASSES AND WORKSHOPS (U.S. CLS. 100, 101 AND 107).

SN 78-209,287. TAKE BACK THE MEDIA, CARPINTERIA, CA. FILED 1-31-2003.

TAKE BACK THE MEDIA

FOR PROVIDING A WEBSITE FEATURING TEXT, GRAPHIC AND INTERACTIVE COMMENTARY ON POLITICS, THE MEDIA AND SOCIAL ISSUES (U.S. CLS. 100, 101 AND 107).

SN 78-209,310. MINNESOTA PUBLIC RADIO, ST. PAUL, MN. FILED 1-31-2003.

WEEKNIGHT KITCHEN

FOR PROVIDING ELECTRONIC PUBLICATIONS, NAMELY, NEWSLETTERS FEATURING RECIPES, SUPERMARKET TIPS, INFORMATION ON FOODS AND NUTRITION, SERVING SUGGESTIONS, AND INFORMATION ON FOOD-RELATED RADIO PROGRAMS MADE AVAILABLE ON-LINE THROUGH A GLOBAL COMPUTER NETWORK (U.S. CLS. 100, 101 AND 107).

FIRST USE 12-1-2002; IN COMMERCE 12-1-2002.

SN 78-209,486. MERCATOR SOFTWARE, INC., WILTON, CT. FILED 1-31-2003.

**THE ADVANTAGE INSIDE
INTEGRATION**

FOR EDUCATIONAL SERVICES, NAMELY, CONDUCTING TRAINING PROGRAMS IN INSTALLATION INTEGRATION AND USE OF COMPUTER SOFTWARE (U.S. CLS. 100, 101 AND 107).

CLASS 41—(Continued).

SN 78-209,563. HANKINS, ELIZABETH A., LAKEWOOD, OH. FILED 1-31-2003.

THE LAKEWOOD PROJECT

NO CLAIM IS MADE TO THE EXCLUSIVE RIGHT TO USE "LAKEWOOD", APART FROM THE MARK AS SHOWN.

FOR ENTERTAINMENT, NAMELY, LIVE MUSICAL PERFORMANCES; EDUCATIONAL SERVICES, NAMELY, CONDUCTING CLASSES AND CLINICS IN THE FIELD OF MUSIC (U.S. CLS. 100, 101 AND 107).

FIRST USE 9-1-2002; IN COMMERCE 1-24-2003.

SN 78-209,653. RED SUN, INC., FT. LAUDERDALE, FL. FILED 1-31-2003.

JOURNALUTION

FOR SELF HELP SEMINARS AND WORKSHOPS (U.S. CLS. 100, 101 AND 107).

SN 78-209,976. WORLD WRESTLING ENTERTAINMENT, INC., STAMFORD, CT. FILED 2-3-2003.

EVOLUTION

FOR ENTERTAINMENT SERVICES, NAMELY WRESTLING EXHIBITIONS AND PERFORMANCES BY A PROFESSIONAL WRESTLER AND ENTERTAINER; PROVIDING WRESTLING NEWS AND INFORMATION VIA A GLOBAL COMPUTER NETWORK. (U.S. CLS. 100, 101 AND 107).

SN 78-210,509. BIG CREEK GOLF LLC, WHEELING, IL. FILED 2-4-2003.

CANYATA

FOR GOLF COURSES, GOLF CLUB SERVICES, ENTERTAINMENT IN THE NATURE OF GOLF TOURNAMENTS AND COUNTRY CLUBS (U.S. CLS. 100, 101 AND 107).

CLASS 41—(Continued).

SN 78-214,848. GFR, LTD., WILLIAMSBURG, MI. FILED 2-14-2003.



SEC. 2(F) AS TO "THE AMERICAN BAND".
FOR ENTERTAINMENT SERVICES IN THE FORM OF
PERFORMANCES BY A VOCAL AND INSTRUMENTAL
GROUP (U.S. CLS. 100, 101 AND 107).
FIRST USE 5-0-1996; IN COMMERCE 5-0-1996.

CLASS 41—(Continued).

SN 78-215,672. MADDOX, JAMES L, AUSTIN, TX. FILED 2-17-2003.

**AMERICAN GHOST HUNTS
101**

NO CLAIM IS MADE TO THE EXCLUSIVE RIGHT TO
USE "AMERICAN GHOST HUNTS", APART FROM THE
MARK AS SHOWN.
FOR ENTERTAINMENT IN THE NATURE OF ON-
GOING TELEVISION PROGRAMS IN THE FIELD OF
GHOST HUNTING (U.S. CLS. 100, 101 AND 107).

SN 78-219,468. WEINER, RUSSELL G., LAS VEGAS, NV.
FILED 2-26-2003.

ROCKSTAR

FOR ENTERTAINMENT IN THE NATURE OF ON-
GOING TELEVISION PROGRAMS RELATING TO MU-
SIC, COMEDY, VARIETY, AND TALK SHOWS; AND
PROVIDING INTERACTIVE TELEVISION PROGRAMS
VIA A GLOBAL COMPUTER NETWORK RELATING TO
MUSIC, COMEDY, VARIETY, AND TALK SHOWS;
RADIO AND TELEVISION PROGRAMMING RELATING
TO MUSIC, COMEDY, VARIETY, AND TALK SHOWS
(U.S. CLS. 100, 101 AND 107).

SN 78-215,003. MRAZ, DENISE, BRECKSVILLE, OH. FILED
2-14-2003.

POLYMER VALLEY, USA

FOR SPONSORING AND CONDUCTING SYMPOSIA
ON ADVANCED POLYMER MATERIALS. (U.S. CLS. 100,
101 AND 107).

SN 78-259,232. VIACOM INTERNATIONAL INC., NEW
YORK, NY. FILED 6-6-2003.

MTV CROWD CONTROL

SN 78-215,605. BIG CREEK GOLF LLC, WHEELING, IL.
FILED 2-17-2003.



FOR GOLF COURSES, GOLF CLUB SERVICES, EN-
TERTAINMENT IN THE NATURE OF GOLF TOURNA-
MENTS AND COUNTRY CLUBS (U.S. CLS. 100, 101 AND
107).

OWNER OF U.S. REG. NOS. 1,580,650, 2,540,212 AND
OTHERS.
NO CLAIM IS MADE TO THE EXCLUSIVE RIGHT TO
USE "CROWD CONTROL", APART FROM THE MARK AS
SHOWN.
FOR ENTERTAINMENT SERVICES IN THE NATURE
OF AN ONGOING TELEVISION PROGRAM FEATUR-
ING CONCERT SECURITY GUARDS; PROVIDING IN-
FORMATION IN THE FIELD OF ENTERTAINMENT IN
THE NATURE OF A TELEVISION PROGRAM FEATUR-
ING CONCERT SECURITY GUARDS RENDERED VIA
COMPUTER BY MEANS OF A GLOBAL COMPUTER
NETWORK (U.S. CLS. 100, 101 AND 107).

CLASS 42—SCIENTIFIC, COMPUTER AND LEGAL SERVICES

SN 75-316,853. IX DEVELOPMENT LABORATORIES, INC., SANTA ROSA, CA. FILED 6-30-1997.

INTELLIX

FOR COMPUTER SERVICES, NAMELY, FACILITATING THE IDENTIFICATION AND CREATION OF ON-LINE BUSINESS PROCESSES OVER NETWORKS AND THE INTERNET THAT SUPPORT AND AMPLIFY CLIENT-BASED BUSINESS OBJECTIVES (U.S. CLS. 100 AND 101).

FIRST USE 6-0-1997; IN COMMERCE 6-0-1997.

SN 75-557,438. BUFFETT, JIMMY, KEY WEST, FL. FILED 9-23-1998.

CHEESEBURGER IN PARADISE

OWNER OF U.S. REG. NO. 1,765,057. FOR RESTAURANT, BAR AND NIGHTCLUB SERVICES (U.S. CLS. 100 AND 101).

FIRST USE 8-22-2002; IN COMMERCE 8-22-2002.

SN 75-731,086. QUOTE.COM, INC., MOUNTAIN VIEW, CA. BY MERGER WHOWHERE, INC., MOUNTAIN VIEW, CA. FILED 6-17-1999.

ANGELFIRE

FOR COMPUTER SERVICES, NAMELY, CREATING AND MAINTAINING WEB SITES OF OTHERS ON A GLOBAL COMPUTER NETWORK (U.S. CLS. 100 AND 101).

FIRST USE 6-1-1995; IN COMMERCE 6-1-1995.

SN 75-770,470. LAWSON, JANET B., SAN FRANCISCO, CA. FILED 9-2-1999.

CITYSPA

FOR BEAUTY SALON AND SPA SERVICES, NAMELY HYDROTHERAPY, BODY WRAPS, AROMATHERAPY, MASSAGE, SKIN CARE, FACIALS, WAXING, MAKEUP, NAIL CARE, MANICURES, PEDICURES, AND NAIL ENHANCEMENTS (U.S. CLS. 100 AND 101).

CLASS 42—(Continued).

SN 75-824,301. OUTCOME SCIENCES, INC., CAMBRIDGE, MA. FILED 10-18-1999.

POINT SYSTEM

NO CLAIM IS MADE TO THE EXCLUSIVE RIGHT TO USE "SYSTEM", APART FROM THE MARK AS SHOWN.

FOR PROVIDING TEMPORARY USE OF ON-LINE NON-DOWNLOADABLE COMPUTER SOFTWARE USED FOR COLLECTING AND REPORTING MEDICAL DATA RELATING TO PATIENT MEDICAL CONDITIONS IN THE AREA OF CLINICAL TRIALS AND OUTCOMES RESEARCH (U.S. CLS. 100 AND 101).

FIRST USE 12-15-1997; IN COMMERCE 12-15-1997.

SN 75-838,545. COM-GUARD.COM, INC., CARLSBAD, CA. FILED 11-4-1999.

WEB-GUARD

FOR COMPUTER NETWORK SECURITY MANAGEMENT SERVICES (U.S. CLS. 100 AND 101).

SN 75-866,406. 1-800-HOSTING.COM, INC, DALLAS, TX. FILED 12-6-1999.



NO CLAIM IS MADE TO THE EXCLUSIVE RIGHT TO USE "HOSTING", APART FROM THE MARK AS SHOWN.

FOR COMPUTER SERVICES, NAMELY, DESIGNING, CREATING, IMPLEMENTING AND MAINTAINING NETWORK WEB PAGES AND WEB SITES FOR OTHERS; HOSTING WEB SITES OF OTHERS ON A COMPUTER SERVER FOR A GLOBAL COMPUTER NETWORK (U.S. CLS. 100 AND 101).

FIRST USE 10-1-1999; IN COMMERCE 10-1-1999.

SN 75-923,453. PEERVIEW, INC., YARDLEY, PA. FILED 2-19-2000.

PEERVIEW

FOR PROVIDING AN ON-LINE COMPUTER DATABASE OF INFORMATION VIA THE INTERNET IN THE FIELD OF MEDICINE RELEVANT TO THE PHARMACEUTICAL INDUSTRY (U.S. CLS. 100 AND 101).

CLASS 42—(Continued).

SN 76-018,909. XACTA CORPORATION, ASHBURN, VA. FILED 4-6-2000.



FOR COMPUTER SOFTWARE DESIGN FOR OTHERS, NAMELY, COMPUTER SYSTEM AND NETWORK SECURITY SERVICES FOR OTHERS ENGAGED IN E-COMMERCE, NAMELY, SECURITY CERTIFICATION AND ACCREDITATION SUPPORT, SECURITY POLICY AND OPERATIONAL PROCEDURE DEVELOPMENT, SECURITY ARCHITECTURE DESIGN AND IMPLEMENTATION, NETWORK SECURITY TESTING AND EVALUATION, VULNERABILITY ANALYSIS AND RECTIFICATION, MALICIOUS CODE ANALYSIS, SECURITY RISK ASSESSMENT (U.S. CLS. 100 AND 101).
FIRST USE 2-0-2000; IN COMMERCE 2-0-2000.

SN 76-029,577. LEWIS, LONGMAN & WALKER, P.A., WEST PALM BEACH, FL. FILED 4-20-2000.

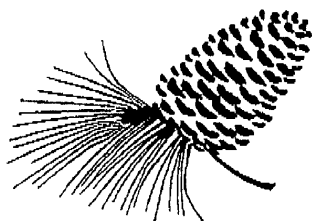

FOR LEGAL SERVICES (U.S. CLS. 100 AND 101).
FIRST USE 9-30-1999; IN COMMERCE 9-30-1999.

SN 76-070,895. TUV RHEINLAND OF NORTH AMERICA, INC., NEWTOWN, CT. FILED 6-15-2000.

E-PORT

FOR TECHNICAL CONSULTATION, TESTING AND PROVIDING ON-LINE TEST REPORTS IN THE FIELDS OF CONSTRUCTION, ENGINEERING, COMMUNICATIONS, POWER TECHNIQUES, POWER TRANSMISSION, ENVIRONMENTAL PROTECTION, INDUSTRIAL SAFETY, PRODUCT SAFETY, POWER STATION SAFETY, AND CONSTRUCTION SAFETY; INSPECTIONS IN THE FIELDS OF CONSTRUCTION, ENGINEERING, COMMUNICATIONS, POWER TECHNIQUES, POWER TRANSMISSION, ENVIRONMENTAL PROTECTION, INDUSTRIAL SAFETY, PRODUCT SAFETY, POWER STATION SAFETY, AND CONSTRUCTION SAFETY; TESTING, ANALYSIS AND EVALUATION OF THE GOODS AND SERVICES OF OTHERS FOR THE PURPOSE OF CERTIFICATION; ENGINEERING SERVICES; MATERIAL TESTING SERVICES; AND MEDICAL LABORATORY SERVICES (U.S. CLS. 100 AND 101).
FIRST USE 4-1-2000; IN COMMERCE 4-1-2000.

CLASS 42—(Continued).

SN 76-072,105. 566382 ONTARIO LIMITED, TA USHER'S WHOLESALE GROCERS AND/OR UWG, MISSISSAUGA, ONTARIO, CANADA, FILED 6-16-2000.

GENTLE CARE

OWNER OF CANADA REG. NO. TMA521791, DATED 1-19-2000, EXPIRES 1-19-2015.
FOR LIQUID FABRIC SOFTENER; FABRIC SOFTENER SHEETS; LAUNDRY DETERGENT, NAMELY, FABRIC WASH(BASED ON 44(E)) (U.S. CLS. 100 AND 101).

SN 76-091,019. INFORMATION MANAGEMENT CONSULTANTS, INC., MCLEAN, VA. FILED 7-19-2000.



FOR INFORMATION TECHNOLOGY CONSULTING SERVICES (U.S. CLS. 100 AND 101).
FIRST USE 1-6-2000; IN COMMERCE 1-6-2000.

SN 76-102,115. CONCEPTIS TECHNOLOGIES INC., MONTREAL, QUEBEC, CANADA, FILED 8-2-2000.



NO CLAIM IS MADE TO THE EXCLUSIVE RIGHT TO USE "CLINICAL TRIAL", APART FROM THE MARK AS SHOWN.

FOR ONLINE INFORMATION SERVICES, NAMELY PROVIDING DATABASES AND WEBSITE LINKS TO OTHER CONTENT PROVIDERS IN THE FIELD OF PHARMACEUTICALS AND MEDICAL DEVICES; PROVIDING INFORMATION AND NEWS IN THE FIELD OF PHARMACEUTICALS AND MEDICAL DEVICES (U.S. CLS. 100 AND 101).
FIRST USE 6-15-2000; IN COMMERCE 6-15-2000.

SN 76-118,769. HEALTHEXCHANGE, INC., STAMFORD, CT. FILED 8-29-2000.

THEHEALTHEXCHANGE.ORG

FOR CLINICAL TRIAL SERVICES, NAMELY, OFFERING CLINICAL TRIALS TO PATIENTS VIA THE INTERNET ON BEHALF OF THE PHARMACOLOGY INDUSTRY (U.S. CLS. 100 AND 101).
FIRST USE 2-10-2000; IN COMMERCE 2-10-2000.

CLASS 42—(Continued).

SN 76-125,396. SOLWORKS, INC., CARLSBAD, CA. BY CHANGE OF NAME BROADBOOKS CORPORATION, CARLSBAD, CA. FILED 9-8-2000.

SOLWORKS

FOR CONSULTING SERVICES IN THE FIELD OF COMPUTER PROGRAMMING; COMPUTER SOFTWARE DEVELOPMENT FOR OTHERS; COMPUTER SOFTWARE DESIGN FOR OTHERS; AND COMPUTER SOFTWARE PROGRAMMING FOR OTHERS, ALL IN THE FIELD OF VIDEO GAMES AND ENTERTAINMENT (U.S. CLS. 100 AND 101).

FIRST USE 1-1-1999; IN COMMERCE 1-1-1999.

SN 76-169,651. AVIT SERVICES, LLC, ATLANTA, GA. BY ASSIGNMENT KEY TECHNOLOGIES, LLC, ATLANTA, GA. FILED 11-21-2000.



NO CLAIM IS MADE TO THE EXCLUSIVE RIGHT TO USE "SERVICES", APART FROM THE MARK AS SHOWN. THE DRAWING IS LINED RED.

FOR CUSTOM DESIGN OF COMPUTER NETWORKS AND COMPUTER HARDWARE AND SOFTWARE SYSTEMS; INTEGRATION OF COMPUTER SYSTEMS AND NETWORKS; COMPUTER SOFTWARE DEVELOPMENT; COMPUTER SOFTWARE DESIGN FOR OTHERS; INSTALLATION AND MAINTENANCE OF COMPUTER SOFTWARE FOR OTHERS; TELEPHONY DESIGN SERVICES FOR OTHERS; DATA ENCRYPTION OF COMPUTER NETWORKS FOR OTHERS (U.S. CLS. 100 AND 101).

SN 76-199,503. FHR REAL ESTATE CORPORATION, TORONTO, ONTARIO, CANADA. BY CHANGE OF NAME CANADIAN PACIFIC HOTEL REAL ESTATE CORPORATION, TORONTO, ONTARIO M5K 1B7, CANADA, FILED 1-25-2001.

LE CHATEAU MONTEBELLO

PRIORITY CLAIMED UNDER SEC. 44(D) ON CANADA APPLICATION NO. 1,068,271, FILED 7-26-2000, REG. NO. TMA576702, DATED 2-28-2003, EXPIRES 2-28-2018.

NO CLAIM IS MADE TO THE EXCLUSIVE RIGHT TO USE "CHATEAU", APART FROM THE MARK AS SHOWN. SEC. 2(F).

FOR TRAVEL AND ACCOMMODATION SERVICES NAMELY, MAKING AND TAKING HOTEL RESERVATIONS FOR OTHERS (U.S. CLS. 100 AND 101).

CLASS 42—(Continued).

SN 76-214,568. MICRO INDUSTRIES CORPORATION, WESTERVILLE, OH. FILED 2-26-2001.

**virtual
SYSTEM DESIGNER**

NO CLAIM IS MADE TO THE EXCLUSIVE RIGHT TO USE "VIRTUAL SYSTEM DESIGNER", APART FROM THE MARK AS SHOWN.

THE MARK CONSISTS OF, IN PART, A DESIGN OF A CHECK MARK WHICH CONNECTS TO THE TOP PART OF THE CHECK MARK OF THE LETTER "V" TO THE LETTER "I" IN THE WORD "VIRTUAL".

FOR COMPUTER SERVICES, NAMELY, PROVIDING AN ON-LINE WEBSITE FOR DESIGN OF COMPUTERS AND COMPUTER HARDWARE COMPONENTS (U.S. CLS. 100 AND 101).

SN 76-234,994. AKAEZUWA, EMEKA, RANDOLPH, NJ. FILED 4-3-2001.

**GAVIRI TECHNOLOGIES
THE E-DATA COMPANY**

NO CLAIM IS MADE TO THE EXCLUSIVE RIGHT TO USE "TECHNOLOGIES" AND "THE E-DATA COMPANY", APART FROM THE MARK AS SHOWN.

FOR COMPUTER SERVICES, NAMELY CONSULTING, DESIGN OF COMPUTER SYSTEMS FOR OTHERS, AND COMPUTER SOFTWARE DESIGN (U.S. CLS. 100 AND 101).

SN 76-243,592. U.S. SECURITY ASSOCIATES, INC., ROSWELL, GA. FILED 4-19-2001.

U.S. SECURITY ASSOCIATES

NO CLAIM IS MADE TO THE EXCLUSIVE RIGHT TO USE "SECURITY ASSOCIATES", APART FROM THE MARK AS SHOWN.

THE MARK IS USED BY PLACING IT ON ADVERTISING AND PROMOTIONAL MATERIALS FOR THE SERVICES, AND OTHER WAYS CUSTOMARY IN THE TRADE.

SEC. 2(F).

FOR MONITORING OF RESIDENTIAL AND COMMERCIAL SECURITY SYSTEMS; SECURITY SYSTEM CONSULTATION SERVICES; AND SECURITY GUARD SERVICES (U.S. CLS. 100 AND 101).

FIRST USE 11-30-1993; IN COMMERCE 11-30-1993.

CLASS 42—(Continued).

SN 76-261,910. WELLS FARGO & COMPANY, MINNEAPOLIS, MN. FILED 5-24-2001.

WELLS FARGO ONLINE ROLLOVER WIZARD

OWNER OF U.S. REG. NOS. 779,187, 838,059 AND 2,433,473.

NO CLAIM IS MADE TO THE EXCLUSIVE RIGHT TO USE "ONLINE ROLLOVER WIZARD", APART FROM THE MARK AS SHOWN.

FOR COMPUTER SERVICES, NAMELY, PROVIDING NON-DOWNLOADABLE ON-LINE APPLICATION FORMS FOR THE TRANSFER OF RETIREMENT ASSETS VIA THE INTERNET (U.S. CLS. 100 AND 101).

SN 76-270,525. PHOENIX INTANGIBLES HOLDING COMPANY, WILMINGTON, DE. FILED 6-12-2001.



OWNER OF U.S. REG. NOS. 1,298,171, 2,362,391 AND OTHERS.

NO CLAIM IS MADE TO THE EXCLUSIVE RIGHT TO USE "SOUP AND SALAD", APART FROM THE MARK AS SHOWN.

FOR SOUP AND SALAD BARS FOR CONSUMPTION ON OR OFF THE PREMISES OF A SUPERMARKET (U.S. CLS. 100 AND 101).

FIRST USE 11-20-2000; IN COMMERCE 11-20-2000.

SN 76-270,526. PHOENIX INTANGIBLES HOLDING COMPANY, WILMINGTON, DE. FILED 6-12-2001.

LEAF & LADLE

FOR SOUP AND SALAD BARS FOR CONSUMPTION ON OR OFF THE PREMISES OF A SUPERMARKET (U.S. CLS. 100 AND 101).

FIRST USE 6-0-1995; IN COMMERCE 6-0-1995.

CLASS 42—(Continued).

SN 76-276,013. OHIO-KENTUCKY-INDIANA REGIONAL COUNCIL OF GOVERNMENTS, CINCINNATI, OH. FILED 6-25-2001.



NO CLAIM IS MADE TO THE EXCLUSIVE RIGHT TO USE "OHIO", "KENTUCKY", "INDIANA" AND "REGIONAL COUNCIL OF GOVERNMENTS", APART FROM THE MARK AS SHOWN.

FOR URBAN PLANNING IN THE NATURE OF PROVIDING RESEARCH AND PLANNING SERVICES AS DELEGATED BY ITS MEMBER GOVERNMENTS, TO FACILITATE COLLABORATION BETWEEN THOSE MEMBER GOVERNMENTS TO IMPROVE THE QUALITY OF LIFE AND ECONOMIC DEVELOPMENT POTENTIAL OF THE REGION AT THE INTERSECTION OF THE STATES OF OHIO, KENTUCKY AND INDIANA (U.S. CLS. 100 AND 101).

FIRST USE 4-30-2001; IN COMMERCE 4-30-2001.

SN 76-285,788. TRANS HEALTHCARE, INC., CAMP HILL, PA. FILED 7-16-2001.

TRANS HEALTH

OWNER OF U.S. REG. NO. 2,404,043.

FOR HEALTH CARE SERVICES, NAMELY, OUTPATIENT CARE FACILITIES; EXTENDED CARE, NAMELY, NURSING HOMES, ASSISTED-LIVING FACILITIES, AND CONGREGATE CARE RETIREMENT COMMUNITIES; AND SPECIALTY HOSPITAL CARE, NAMELY, LONG-TERM ACUTE HOSPITALS, REHABILITATION HOSPITALS, SURGICAL HOSPITALS AND ORTHOPEDIC HOSPITALS (U.S. CLS. 100 AND 101).

SN 76-297,439. RAINDANCE COMMUNICATIONS, INC., LOUISVILLE, CO. FILED 8-9-2001.

RAINDANCE COMMUNICATIONS

NO CLAIM IS MADE TO THE EXCLUSIVE RIGHT TO USE "COMMUNICATIONS", APART FROM THE MARK AS SHOWN.

FOR APPLICATION SERVICE PROVIDER, NAMELY, HOSTING INTERNET BASED COMPUTER APPLICATIONS TO FACILITATE THE ONLINE INTERACTION OF MULTIPLE USERS AND SHARING OF COMPUTER APPLICATIONS, INFORMATION AND WEB-BROWSING (U.S. CLS. 100 AND 101).

FIRST USE 5-15-2001; IN COMMERCE 7-9-2001.

CLASS 42—(Continued).

SN 76-298,193. NSITE SOFTWARE, INC., SAN RAMON, CA. FILED 8-10-2001.

WORKMAIL

FOR CONSULTING SERVICES IN THE FIELD OF DESIGNING, CUSTOMIZING AND IMPLEMENTING SOFTWARE FOR USE IN BUSINESS ENTERPRISE SOLUTIONS (U.S. CLS. 100 AND 101).

FIRST USE 8-8-2001; IN COMMERCE 8-8-2001.

SN 76-317,902. HIGH DESERT RIDERS, ROCK SPRINGS, WY. FILED 9-28-2001.



NO CLAIM IS MADE TO THE EXCLUSIVE RIGHT TO USE "RIDERS", APART FROM THE MARK AS SHOWN.

FOR ASSOCIATION SERVICES, NAMELY, A SOCIAL CLUB FOR EDUCATING AND ADVANCING THE RIGHTS OF MOTORCYCLE ENTHUSIASTS (U.S. CLS. 100 AND 101).

FIRST USE 1-0-1992; IN COMMERCE 1-0-1992.

SN 76-334,000. ENGLISH, TODD, CHARLESTOWN, MA. FILED 11-5-2001.



THE NAME IN THE MARK IDENTIFIES A LIVING INDIVIDUAL WHOSE CONSENT IS OF RECORD.

FOR RESTAURANT AND BAR SERVICES (U.S. CLS. 100 AND 101).

FIRST USE 6-0-2000; IN COMMERCE 6-0-2000.

CLASS 42—(Continued).

SN 76-338,698. NETBYTEL, INC., BOCA RATON, FL. FILED 11-13-2001.

NO DRAWING-SENSORY MARK

THE MARK CONSISTS OF A XYLOPHONE TONE, PLAYING A DESCENDING SERIES OF 16TH NOTES ENDING AT "C": GEDC.

FOR COMPUTER SOFTWARE DESIGN FOR OTHERS, NAMELY, THE DESIGN OF VOICE-ENABLED COMPUTER PROGRAMS FOR USE IN OPERATING TELEPHONE ACCESSED, SELF-SERVICE SITES (U.S. CLS. 100 AND 101).

SN 76-340,939. NATIONAL CONFERENCE ON PUBLIC EMPLOYEE RETIREMENT SYSTEMS, WASHINGTON, DC. FILED 11-23-2001.



NO CLAIM IS MADE TO THE EXCLUSIVE RIGHT TO USE "CONFERENCE", APART FROM THE MARK AS SHOWN.

THE STIPLING SHOWN IN THE DRAWING IS A FEATURE OF THE MARK AND IS NOT INTENDED TO INDICATE COLOR.

SEC. 2(F) AS TO "NATIONAL CONFERENCE ON PUBLIC EMPLOYEE RETIREMENT SYSTEMS".

FOR ASSOCIATION SERVICES, NAMELY, PROMOTING THE INTEREST OF PUBLIC SECTOR EMPLOYEES (U.S. CLS. 100 AND 101).

FIRST USE 6-25-2001; IN COMMERCE 6-25-2001.

SN 76-383,009. REYNOLDS METALS COMPANY, RICHMOND, VA. FILED 3-18-2002.

SOUTHERN GRAPHIC SYSTEMS

NO CLAIM IS MADE TO THE EXCLUSIVE RIGHT TO USE "GRAPHIC SYSTEMS", APART FROM THE MARK AS SHOWN.

FOR GRAPHIC DESIGN SERVICES, NAMELY, PREPARING FILMS, DIGITAL FILES, ARTWORK AND GRAPHIC DESIGNS FOR OTHERS (U.S. CLS. 100 AND 101).

FIRST USE 9-0-1991; IN COMMERCE 9-0-1991.

CLASS 42—(Continued).

SN 76-387,681. BIOTROVE, INC., CAMBRIDGE, MA. FILED 3-27-2002.

GET YOUR ASSAY MOVING

NO CLAIM IS MADE TO THE EXCLUSIVE RIGHT TO USE "ASSAY", APART FROM THE MARK AS SHOWN.

FOR SCIENTIFIC AND TECHNOLOGICAL SERVICES, NAMELY, DEVELOPMENT, TESTING, INSPECTION AND RESEARCH IN THE FIELD OF BIOLOGY, ENZYMOLOGY, TOXICOLOGY, ANALYTICAL CHEMISTRY, MATERIALS SCIENCE AND SURFACE SCIENCE; DESIGN OF DEVELOPMENT, TESTING, INSPECTION AND RESEARCH PROGRAMS FOR OTHERS IN THE FIELD OF BIOLOGY, ENZYMOLOGY, TOXICOLOGY, ANALYTICAL CHEMISTRY, MATERIALS SCIENCE AND SURFACE SCIENCE (U.S. CLS. 100 AND 101).

SN 76-390,263. INTERNATIONAL CODE COUNCIL, INC., WHITTIER, CA. FILED 4-1-2002.

C.B.O.

SEC. 2(F).
FOR TESTING, ANALYSIS AND EVALUATION OF THE GOODS AND SERVICES OF OTHERS FOR THE PURPOSE OF CERTIFICATION (U.S. CLS. 100 AND 101).
FIRST USE 0-0-1980; IN COMMERCE 0-0-1980.

SN 76-390,348. INTERNATIONAL CODE COUNCIL, INC., WHITTIER, CA. FILED 4-1-2002.

CBO

SEC. 2(F).
FOR TESTING, ANALYSIS AND EVALUATION OF THE GOODS AND SERVICES OF OTHERS FOR THE PURPOSE OF CERTIFICATION (U.S. CLS. 100 AND 101).
FIRST USE 0-0-1980; IN COMMERCE 0-0-1980.

CLASS 42—(Continued).

SN 76-405,662. BLUESTONE CONSULTING, INC., MT. LAUREL, NJ. FILED 5-10-2002.

STREAMLINING BUSINESS PROCESS THROUGH THE USE OF TECHNOLOGY

FOR COMPUTER CONSULTING SERVICES AND TECHNICAL CONSULTATION IN THE FIELD OF COMPUTERS AND ELECTRONIC COMMERCE, NAMELY, COMPUTER PROGRAMMING FOR OTHERS, DESIGNING COMPUTER NETWORKS AND SOFTWARE FOR OTHERS, UPDATING COMPUTER SOFTWARE, PROVIDING TECHNICAL ASSISTANCE AND RESEARCH IN THE FIELD OF COMPUTER SOFTWARE APPLICATION DEVELOPMENT, PROVIDING A TECHNICAL SUPPORT DATABASE VIA A GLOBAL COMPUTER NETWORK, TECHNICAL SUPPORT, NAMELY, MONITORING NETWORK SYSTEMS BY PROVIDING COMPUTER NETWORK AND SYSTEMS ADMINISTRATION AND PLANNING AND PROVIDING ENTERPRISE APPLICATION INTEGRATION SERVICES, AND COMPUTER DISASTER RECOVERY PLANNING BY PROVIDING NETWORK SECURITY AND DISASTER RECOVERY AUDITS (U.S. CLS. 100 AND 101).

FIRST USE 4-1-2002; IN COMMERCE 4-1-2002.

SN 76-405,673. BLUESTONE CONSULTING, INC., MT. LAUREL, NJ. FILED 5-10-2002.



NO CLAIM IS MADE TO THE EXCLUSIVE RIGHT TO USE "BUSINESS PROCESS", APART FROM THE MARK AS SHOWN.

FOR COMPUTER CONSULTING SERVICES AND TECHNICAL CONSULTATION IN THE FIELD OF COMPUTERS AND ELECTRONIC COMMERCE, NAMELY, COMPUTER PROGRAMMING FOR OTHERS, DESIGNING COMPUTER NETWORKS AND SOFTWARE FOR OTHERS, UPDATING COMPUTER SOFTWARE, PROVIDING TECHNICAL ASSISTANCE AND RESEARCH IN THE FIELD OF COMPUTER SOFTWARE APPLICATION DEVELOPMENT, PROVIDING A TECHNICAL SUPPORT DATABASE VIA A GLOBAL COMPUTER NETWORK, TECHNICAL SUPPORT, NAMELY, MONITORING NETWORK SYSTEMS BY PROVIDING COMPUTER NETWORK AND SYSTEMS ADMINISTRATION AND PLANNING AND PROVIDING ENTERPRISE APPLICATION INTEGRATION SERVICES, AND COMPUTER DISASTER RECOVERY PLANNING BY PROVIDING NETWORK SECURITY AND DISASTER RECOVERY AUDITS (U.S. CLS. 100 AND 101).

FIRST USE 4-1-2002; IN COMMERCE 4-1-2002.

CLASS 42—(Continued).

SN 76-406,409. TRANSTECH PHARMA, INC., HIGH POINT, NC. FILED 5-13-2002.

TTPOSTGENE

FOR PHARMACEUTICAL RESEARCH SERVICES, NAMELY, THE DESIGN AND USAGE OF ENABLING SOFTWARE TOOLS FOR PROTEIN STRUCTURE DETERMINATION AND DERIVATION FROM PRIMARY SEQUENCE; AND CONSULTATION SERVICES RELATED THERETO (U.S. CLS. 100 AND 101).

FIRST USE 1-0-2001; IN COMMERCE 6-0-2001.

SN 76-414,744. ASM INTERNATIONAL N.V., 3723 BC BILTHOVEN, NETHERLANDS, FILED 5-17-2002.

CARBONSPEED

OWNER OF BENELUX REG. NO. 0703681, DATED 2-28-2002, EXPIRES 2-28-2012.

FOR DESIGN FOR OTHERS OF PRODUCTION PROCESSES FOR THE MANUFACTURE OF SEMICONDUCTORS (U.S. CLS. 100 AND 101).

SN 76-426,118. BASF CORPORATION, MOUNT OLIVE, NJ. FILED 6-28-2002.



THE STIPPLING IN THE DRAWING IS A FEATURE OF THE MARK.

THE MARK CONSISTS OF THE LETTERS "ECO" AND THE NUMBER "2" TOGETHER PLACED ON A WATER DROPLET DESIGN WITHIN A BACKGROUND CIRCLE.

FOR PRODUCT DEVELOPMENT CONSULTATION SERVICES AND TECHNICAL CONSULTATION SERVICES IN THE FIELD OF PAINTS AND COATINGS FOR USE IN THE AUTOMOTIVE INDUSTRY (U.S. CLS. 100 AND 101).

FIRST USE 4-0-2000; IN COMMERCE 4-0-2000.

CLASS 42—(Continued).

SN 76-429,322. GLOBAL INFORMATION LICENSING CORPORATION, CLAYMONT, DE. FILED 7-11-2002.

NAAAC

FOR PROVIDING INFORMATION ON ATTENTION DEFICIT HYPERACTIVITY DISORDER TO PHYSICIANS AND CONSUMERS (U.S. CLS. 100 AND 101).

SN 76-429,574. TOSHIBA TEC KABUSHIKI KAISHA, TOKYO, JAPAN, FILED 7-10-2002.



THE MARK CONSISTS OF THE WORD "PRINTSPOT" WITH THE FIRST TWO LETTERS WITHIN A CIRCULAR DESIGN AND THE BOTTOM OF THE THIRD LETTER WITHIN THE SAME DESIGN.

FOR COMPUTER SERVICES, NAMELY, PROVIDING INFORMATION VIA A GLOBAL COMPUTER NETWORK IN THE FIELDS OF STORING, ACCESSING, MANAGING, PRINTING AND TRANSMITTING DOCUMENTS, COLOR AND IMAGE PROCESSING, NETWORKING, IMAGE EDITING, GRAPHICS AND PRINTING SYSTEMS; COMPUTER CONSULTATION SERVICES IN THE FIELDS OF DIGITAL PRINTING, PUBLISHING AND DOCUMENT DELIVERY (U.S. CLS. 100 AND 101).

SN 76-431,023. AMERICAN WOODMARK CORPORATION, WINCHESTER, VA. FILED 7-15-2002.



NO CLAIM IS MADE TO THE EXCLUSIVE RIGHT TO USE "CABINETTRACKER.COM", APART FROM THE MARK AS SHOWN.

FOR PROVIDING TEMPORARY USE OF ON-LINE NON-DOWNLOADABLE COMMUNICATIONS SOFTWARE TO ALLOW CUSTOMERS TO AUTOMATE TRACKING PROCESSES FOR KITCHEN AND BATHROOM CABINET PRODUCTS VIA THE GLOBAL COMPUTER NETWORK (U.S. CLS. 100 AND 101).

FIRST USE 2-1-2001; IN COMMERCE 3-1-2001.

CLASS 42—(Continued).

SN 76-432,462. ELDER LAW CENTERS, P.C., BOSTON, MA. FILED 7-19-2002.

ELDER LAW CENTER, BECAUSE WE CARE

NO CLAIM IS MADE TO THE EXCLUSIVE RIGHT TO USE "ELDER LAW CENTER", APART FROM THE MARK AS SHOWN.

FOR LEGAL SERVICES (U.S. CLS. 100 AND 101).

CLASS 42—(Continued).

SN 76-443,823. AMERICAN INSTITUTE OF CHEMICAL ENGINEERS, NEW YORK, NY. FILED 8-26-2002.

PSID

FOR PROVIDING AN ON-LINE COMPUTER DATABASE IN THE FIELD OF CHEMICAL PROCESS INCIDENTS FOR THE PURPOSE OF PROMOTING CHEMICAL PROCESS SAFETY (U.S. CLS. 100 AND 101). FIRST USE 0-0-1995; IN COMMERCE 0-0-1995.

SN 76-436,764. PORT-TO-PORT COMMUNICATIONS CORPORATION, INDIANAPOLIS, IN. FILED 8-2-2002.

PERTINGO

FOR COMPUTER CONSULTING SERVICES; TECHNICAL SUPPORT, NAMELY, TROUBLESHOOTING COMPUTER HARDWARE AND SOFTWARE PROBLEMS; MAINTENANCE OF COMPUTER SOFTWARE; DESIGN AND DEVELOPMENT OF COMPUTER SOFTWARE AND COMPUTER NETWORKS (U.S. CLS. 100 AND 101).

SN 76-440,521. OASIS BIOSCIENCES INCORPORATED, SAN DIEGO, CA. FILED 8-14-2002.

COMBISENSE

FOR PROVIDING TECHNICAL CONSULTATION IN THE FIELDS OF PHARMACEUTICAL AND MEDICAL TESTING, SCIENTIFIC RESEARCH, MEDICAL DIAGNOSTIC SERVICES, REAGENT DEVELOPMENT ALL FOR OTHERS UTILIZING PROPRIETARY AND PATENTED TECHNOLOGY (U.S. CLS. 100 AND 101).

SN 76-444,983. GEOINFORMATION RESEARCH CENTRE SA, 1207 GENEVA, SWITZERLAND, FILED 8-15-2002.

SPUTNIK PROSPECTING

SN 76-443,822. AMERICAN INSTITUTE OF CHEMICAL ENGINEERS, NEW YORK, NY. FILED 8-26-2002.



NO CLAIM IS MADE TO THE EXCLUSIVE RIGHT TO USE "PROCESS SAFETY INCIDENT DATABASE", APART FROM THE MARK AS SHOWN.

THE MARK IS LINED FOR THE COLOR(S) RED AND BLUE.

FOR PROVIDING AN ON-LINE COMPUTER DATABASE IN THE FIELD OF CHEMICAL PROCESS INCIDENTS FOR THE PURPOSE OF PROMOTING CHEMICAL PROCESS SAFETY (U.S. CLS. 100 AND 101). FIRST USE 3-13-2002; IN COMMERCE 3-13-2002.

OWNER OF SWITZERLAND REG. NO. 501304, DATED 6-21-2002, EXPIRES 6-21-2012.

NO CLAIM IS MADE TO THE EXCLUSIVE RIGHT TO USE "PROSPECTING", APART FROM THE MARK AS SHOWN.

FOR ANALYSIS FOR OIL-FIELD EXPLOITATION, CHEMICAL ANALYSIS, CHEMICAL RESEARCH CHEMISTRY SERVICES, CONSULTATION IN ENVIRONMENT PROTECTION, ENGINEERING, UNDERWATER EXPLORATION, WEATHER FORECASTING, GEOLOGICAL PROSPECTING GEOLOGICAL RESEARCH, GEOLOGICAL SURVEYS, LAND SURVEYING, MATERIAL TESTING, MECHANICAL RESEARCH, METEOROLOGICAL INFORMATION, OIL PROSPECTING, OIL-FIELD SURVEYS, OIL-WELL TESTING, RESEARCH PHYSICS, TECHNICAL PROJECT STUDIES, SURVEYING, LAND SURVEYS (U.S. CLS. 100 AND 101).

CLASS 42—(Continued).

SN 76-449,665. GENENCOR INTERNATIONAL, INC., PALO ALTO, CA. FILED 9-11-2002.



Genencor International

OWNER OF U.S. REG. NOS. 1,669,970, 2,087,501 AND OTHERS.

NO CLAIM IS MADE TO THE EXCLUSIVE RIGHT TO USE "INTERNATIONAL", APART FROM THE MARK AS SHOWN.

FOR TECHNICAL CONSULTATION, RESEARCH AND DEVELOPMENT IN THE FIELDS OF GENE DISCOVERY, FUNCTIONAL GENOMICS, PROTEIN AND ENZYME PRODUCTION AND RECOVERY SYSTEMS, MOLECULAR EVOLUTION AND DESIGN, HUMAN IMMUNOLOGY, METABOLIC PATHWAY ENGINEERING, AND FORMULATION DELIVERY SYSTEMS, NAMELY FOR THE HEALTH CARE, AGRICULTURE, INDUSTRIAL CHEMICALS, CLEANING PRODUCTS, TEXTILE PROCESSING, GRAIN PROCESSING, FOOD, FEED, PERSONAL CARE, AND PHARMACEUTICAL INDUSTRIES; GENETIC AND PROTEIN ENGINEERING SERVICES; SCIENTIFIC RESEARCH SERVICES, DESIGN AND TESTING OF NEW BIOTECHNOLOGY, HEALTH CARE, AGRICULTURE AND INDUSTRIAL CHEMICAL PRODUCTS FOR OTHERS; IMMUNOBIOLOGICAL RESEARCH AND TESTING (U.S. CLS. 100 AND 101).

FIRST USE 9-1-1999; IN COMMERCE 9-1-1999.

SN 76-459,927. CLOSING SPECIALISTS LP, THE, LIGONIER, PA. FILED 10-7-2002.



NO CLAIM IS MADE TO THE EXCLUSIVE RIGHT TO USE "CLOSING SPECIALISTS", APART FROM THE MARK AS SHOWN.

THE STIPPLING SHOWN IN THE DRAWING IS INTENDED TO INDICATE SHADING AND IS NOT A FEATURE OF THE MARK.

FOR REAL ESTATE CLOSING SERVICES (U.S. CLS. 100 AND 101).

FIRST USE 6-0-2002; IN COMMERCE 6-0-2002.

CLASS 42—(Continued).

SN 76-464,761. TORCH CONCEPTS, INC., HUNTSVILLE, AL. FILED 11-6-2002.

TORCH TECHNOLOGIES

OWNER OF U.S. REG. NOS. 2,573,639 AND 2,673,099.

NO CLAIM IS MADE TO THE EXCLUSIVE RIGHT TO USE "TECHNOLOGIES", APART FROM THE MARK AS SHOWN.

FOR ENGINEERING SERVICES AND TECHNICAL CONSULTATION IN THE FIELD OF WEAPON SYSTEM PERFORMANCE ANALYSIS OF SENSORS/SEEKERS, AERODYNAMICS, GUIDANCE AND CONTROL, TARGET DISCRIMINATION, ENDGAME PERFORMANCE, AND COMMAND AND CONTROL; TECHNICAL TESTING FOR OTHERS, NAMELY, MODELING AND SIMULATION WITH EMPHASIS PRIMARILY ON ENGINEERING LEVEL SIMULATIONS INCLUDING ALL DIGITAL SIMULATIONS, SYSTEM SOFTWARE IN THE LOOP SIMULATIONS, AND HARDWARE IN THE LOOP SIMULATIONS; TECHNICAL CONSULTING IN THE FIELD OF INFORMATION SYSTEMS TECHNOLOGIES, NAMELY, DISTRIBUTED SIMULATIONS/DATA MANAGEMENT SYSTEMS, VISUALIZATION TECHNIQUES, HIGH PERFORMANCE COMPUTER SYSTEMS, AND NETWORK INTEGRATION; AND DATA MINING AND PATTERN RECOGNITION APPLICATIONS SERVICES, NAMELY, TECHNICAL ANALYSIS OF RADAR SIGNATURES FROM WEAPON SYSTEM TESTS (U.S. CLS. 100 AND 101).

FIRST USE 10-4-2002; IN COMMERCE 10-4-2002.

SN 76-480,413. BABCOCK, JOHN A. LEAGUE CITY, TX. FILED 1-6-2003.

SAGD-PLUS

FOR CONSULTING SERVICE FOR OTHERS IN THE FIELD OF DESIGN, IDENTIFICATION, DEVELOPMENT AND PRODUCTION OF HEAVY OIL FIELDS, CONVENTIONAL OIL AND GAS FIELDS, TAR SANDS AND THE COGENERATION OF POWER (U.S. CLS. 100 AND 101).

FIRST USE 9-24-2001; IN COMMERCE 9-24-2001.

SN 76-481,781. SECURITY INNOVATION, LLC, MELBOURNE, FL. FILED 1-7-2003.

SECURITY INNOVATION

NO CLAIM IS MADE TO THE EXCLUSIVE RIGHT TO USE "SECURITY", APART FROM THE MARK AS SHOWN.

FOR PROVIDING NEWS AND INFORMATION IN THE FIELD OF INFORMATION SECURITY (U.S. CLS. 100 AND 101).

SN 76-492,580. MCNAMARA, THOMAS E., TA HARD FACTS, FREEHOLD, NJ. FILED 2-25-2003.

HARD FACTS

FOR INVESTIGATIVE AND FORENSIC ENGINEERING (U.S. CLS. 100 AND 101).

FIRST USE 10-1-1990; IN COMMERCE 10-1-1990.

CLASS 42—(Continued).

SN 78-090,052. SAFEHARBOR TECHNOLOGY CORPORATION, SATSOP, WA. FILED 10-24-2001.

CASE CRAWLER

NO CLAIM IS MADE TO THE EXCLUSIVE RIGHT TO USE "CRAWLER", APART FROM THE MARK AS SHOWN. FOR TECHNICAL AND CUSTOMER SUPPORT SERVICES, NAMELY, TROUBLESHOOTING OF COMPUTER HARDWARE AND SOFTWARE PROBLEMS VIA THE INTERNET AND BY TELEPHONE; COMPUTER SERVICES, NAMELY, DATABASE SEARCH AND RETRIEVAL SERVICES IN THE NATURE OF SEARCH ENGINES FOR OBTAINING DATA FROM INTRANETS AND GLOBAL COMPUTER NETWORKS (U.S. CLS. 100 AND 101).

SN 78-091,461. NORTHEASTERN ASSOCIATION OF THE BLIND AT ALBANY, INC., ALBANY, NY. FILED 11-2-2001.

KIDSIGHT

FOR CHILDREN'S VISION SCREENING (U.S. CLS. 100 AND 101).

SN 78-097,088. TEN REN TEA CO., LTD., TAIPEI, TAIWAN, FILED 12-6-2001.

天仁茶坊**Ten Ren's Tea Time**

NO CLAIM IS MADE TO THE EXCLUSIVE RIGHT TO USE "TEA", APART FROM THE MARK AS SHOWN. THE NAME "TEN REN" DOES NOT IDENTIFY A LIVING INDIVIDUAL.

THE NON-LATIN CHARACTERS IN THE MARK TRANSLITERATE TO "TEIN REN CHA FENG" AND THIS MEANS "TEN REN'S TEA COMMUNITY". THE WORD "TEN" MEANS "SKY" AND THE WORD "REN" MEANS "HUMANITY" IN ENGLISH.

FOR CAFETERIAS, CAFES, CATERING, HOTELS, RESTAURANTS, SELF-SERVICE RESTAURANTS, AND SNACK-BARS (U.S. CLS. 100 AND 101).

FIRST USE 9-0-2000; IN COMMERCE 12-0-2000.

SN 78-097,413. LINDA, LEIBL L., SCOTTSDALE, AZ. FILED 12-9-2001.

MICRO-DERMABRASION PLUS

NO CLAIM IS MADE TO THE EXCLUSIVE RIGHT TO USE "MICRODERMABRASION", APART FROM THE MARK AS SHOWN.

FOR BEAUTY CARE (U.S. CLS. 100 AND 101).

CLASS 42—(Continued).

SN 78-097,699. SAHU, MANORANJAN, HOUSTON, TX. FILED 12-11-2001.

€log

FOR PROVIDING AN ONLINE COMPUTER DATABASE FEATURING REAL TIME DATA ACQUISITION, MONITORING, PROCESSING, AND INTERPRETATION OF DATA IN THE FIELD OF OIL AND GAS DRILLING (U.S. CLS. 100 AND 101).

SN 78-101,834. PETER H. MATTSON & CO., INC., FOSTER CITY, CA. FILED 1-10-2002.



NO CLAIM IS MADE TO THE EXCLUSIVE RIGHT TO USE "A SERVICE OF" AND "& COMPANY", APART FROM THE MARK AS SHOWN.

FOR PRODUCT DEVELOPMENT CONSULTATION (U.S. CLS. 100 AND 101).

FIRST USE 1-1-1999; IN COMMERCE 1-1-1999.

SN 78-105,020. LEGALGRIND, INC., SANTA MONICA, CA. FILED 1-25-2002.

HELP YOURSELF TO JUSTICE

NO CLAIM IS MADE TO THE EXCLUSIVE RIGHT TO USE "JUSTICE", APART FROM THE MARK AS SHOWN.

FOR LEGAL SERVICES, PROVIDING LEGAL REPRESENTATION TO OTHERS, DOCUMENT PREPARATION, AND PROVIDING INFORMATION IN THE FIELD OF LEGAL SERVICES (U.S. CLS. 100 AND 101).

FIRST USE 2-6-1996; IN COMMERCE 2-6-1996.

CLASS 42—(Continued).

SN 78-107,485. PLACE ARCHITECTS, PLLC, SEATTLE, WA. FILED 2-7-2002.

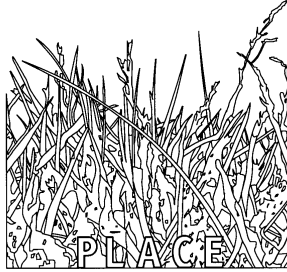

FOR ARCHITECTURE DESIGN SERVICES FOR OTHERS (U.S. CLS. 100 AND 101). FIRST USE 7-1-1999; IN COMMERCE 7-1-1999.

SN 78-122,357. NORTH CENTRAL INTERNET SERVICES, INC., RED BOILING SPRINGS, TN. FILED 4-17-2002.

NORTH CENTRAL INTERNET SERVICES, INC.

NO CLAIM IS MADE TO THE EXCLUSIVE RIGHT TO USE "INTERNET SERVICES, INC.", APART FROM THE MARK AS SHOWN.

FOR HOSTING THE WEB SITES OF OTHERS ON A COMPUTER SERVER FOR A GLOBAL COMPUTER NETWORK (U.S. CLS. 100 AND 101).

SN 78-128,852. BINDKEY TECHNOLOGIES, SANTA CLARA, CA. FILED 5-15-2002.

BINDKEY

FOR COMPUTER SOFTWARE DESIGN FOR OTHERS IN THE FIELD OF ELECTRONIC DESIGN AUTOMATION (U.S. CLS. 100 AND 101).

CLASS 42—(Continued).

SN 78-129,495. KASIULIS, ERICK, M, BELLEVUE, WA. FILED 5-17-2002.

TURNING DATA INTO ADVANTAGE

FOR COMPUTER SOFTWARE CONSULTATION, CONSULTING SERVICES IN THE FIELD OF DESIGN, SELECTION, IMPLEMENTATION AND USE OF COMPUTER SOFTWARE SYSTEMS FOR OTHERS, INSTALLATION OF COMPUTER SOFTWARE, MAINTENANCE OF COMPUTER SOFTWARE, TECHNICAL SUPPORT SERVICES, NAMELY, TROUBLESHOOTING OF COMPUTER SOFTWARE PROBLEMS, UPDATING OF COMPUTER SOFTWARE FOR OTHERS, CONSULTING SERVICES IN THE FIELD OF DESIGN, SELECTION, IMPLEMENTATION AND USE OF COMPUTER SOFTWARE SYSTEMS FOR OTHERS, CUSTOMIZATION OF COMPUTER SOFTWARE (U.S. CLS. 100 AND 101). FIRST USE 7-1-2001; IN COMMERCE 7-1-2001.

SN 78-129,713. MORPHIS, INC., DALLAS, TX. FILED 5-17-2002.

MORPHIS

FOR COMPUTER SOFTWARE CONSULTING FOR MANAGING FINANCIAL INVENTORY OF ATM'S AND ARMORED CARS INCLUDING CUSTOM DESIGN OF THIS COMPUTER SOFTWARE FOR OTHERS, AND MAINTENANCE OF THE COMPUTER SOFTWARE (U.S. CLS. 100 AND 101). FIRST USE 10-10-2000; IN COMMERCE 10-10-2000.

SN 78-131,300. WILSON, JEFFREY C., CHICAGO, IL. FILED 5-27-2002.

COPLAW

FOR LEGAL SERVICES (U.S. CLS. 100 AND 101).

SN 78-133,641. HEIM, WAYNE E, CHESTERLAND, OH. FILED 6-6-2002.



FOR DESIGNING AND MAINTAINING A WEB SITE FOR OTHERS IN THE ART FIELD (U.S. CLS. 100 AND 101). FIRST USE 6-19-1999; IN COMMERCE 6-19-1999.

CLASS 42—(Continued).

SN 78-143,974. ICON INTERNATIONAL IMAGES INC., DBA 3DMIRAGE, NEW YORK, NY. FILED 7-15-2002.

THINK 3D

NO CLAIM IS MADE TO THE EXCLUSIVE RIGHT TO USE "3D", APART FROM THE MARK AS SHOWN.

FOR COMPUTER ANIMATION AND COMPUTER AIDED DESIGN, GRAPHIC ILLUSTRATION, GRAPHIC DESIGN, MECHANICAL DESIGN AND MULTIMEDIA DESIGN FOR OTHERS; CONSULTING IN THE FIELDS OF COMPUTER ANIMATION DESIGN AND MULTIMEDIA DESIGN (U.S. CLS. 100 AND 101).

FIRST USE 7-31-2000; IN COMMERCE 7-31-2000.

SN 78-144,267. CASTROL LIMITED, SWINDON, UNITED KINGDOM, FILED 7-16-2002.

CE²

FOR MONITORING OF, AND ADVISING ON, REGULATIONS AND LEGISLATION RELATING TO LUBRICANTS, LUBRICATION, HEALTH, SAFETY AND THE ENVIRONMENT, AND THE OIL INDUSTRY; PRODUCT DEVELOPMENT FOR OTHERS IN THE LUBRICANTS INDUSTRY (U.S. CLS. 100 AND 101).

SN 78-144,628. LSC CORPORATION, JACKSON, TN. FILED 7-17-2002.

L S C

FOR ENGINEERING, NAMELY, SYSTEM INTEGRATION SERVICES IN THE FIELD OF AUTOMATION SYSTEMS (U.S. CLS. 100 AND 101).

FIRST USE 12-30-1996; IN COMMERCE 12-30-1996.

CLASS 42—(Continued).

SN 78-145,472. HYDROSERVE TECHNOLOGIES, INC., LAWRENCEVILLE, GA. FILED 7-18-2002.

HYDROSERVE
TECHNOLOGIES, INC.
EVOLVING TECHNOLOGIES FOR A BETTER TOMORROW

OWNER OF U.S. REG. NO. 2,544,044.

NO CLAIM IS MADE TO THE EXCLUSIVE RIGHT TO USE "TECHNOLOGIES, INC.", APART FROM THE MARK AS SHOWN.

FOR CONSULTATION SERVICES RELATING TO COOLING TOWER SYSTEM, BOILER SYSTEMS AND EVAPORATIVE CONDENSERS (U.S. CLS. 100 AND 101).

SN 78-148,589. CONETH SOLUTIONS, INC, MANTECA, CA. FILED 7-29-2002.

coneth
solutions

NO CLAIM IS MADE TO THE EXCLUSIVE RIGHT TO USE "SOLUTIONS", APART FROM THE MARK AS SHOWN.

THE MARK CONSISTS OF THREE SQUARE BLOCKS OF EQUAL SIZE PLACED TOGETHER FORMING A TRIANGULAR PATTERN. THERE IS A TOP SQUARE, A LEFT SQUARE AND A RIGHT SQUARE. THE TOP SQUARE APPEARS IN THE FOREGROUND OF THE MARK WITH THE LEFT AND RIGHT SQUARES IN THE BACKGROUND. WHEN FACING THE MARK THE BOTTOM LEFT CORNER OF THE TOP SQUARE OVERLAPS THE TOP RIGHT CORNER OF THE LEFT SQUARE. WHEN FACING THE MARK THE BOTTOM RIGHT CORNER OF THE TOP SQUARE OVERLAPS THE TOP LEFT CORNER OF THE RIGHT SQUARE. THE TOP SQUARE IS SLIGHTLY OFF CENTER TO THE LEFT OF THE LEFT AND RIGHT SQUARES WHEN FACING THE MARK WHICH LEAVES LESS OF THE LEFT SQUARE VISIBLE THAN THE RIGHT SQUARE. THE OVERLAP OF THE TOP SQUARE ON THE LEFT AND RIGHT SQUARES IS LESS THAN TWENTY FIVE PERCENT OF THE SIZE OF THE LEFT AND RIGHT SQUARES. THERE IS A VISIBLE SPACE BETWEEN THE LEFT AND RIGHT SQUARE. THE LEFT SQUARE IS BLUE. THE TOP SQUARE IS RED AND THE RIGHT SQUARE IS GREEN. THE COLORS OF THE SQUARES MAY VARY SLIGHTLY DEPENDING ON THE MEDIA IN WHICH THE MARK APPEARS. THE SQUARES MAY HAVE VISIBLE EFFECTS SUCH AS DROP SHADOWS, EMBOSING AND OTHER LIGHTING EFFECTS DEPENDING ON THE MEDIA IN WHICH THE MARK IS USED. THE WORD "CONETH" APPEARS TO THE LEFT OF THE SQUARE BLOCKS BUT NOT TOUCHING THE SQUARE BLOCKS. THE HEIGHT OF THE WORD "CONETH" IS EQUAL TO THE HEIGHT OF THE SQUARE BLOCKS. THERE IS LINE SLIGHTLY BENEATH THE SQUARE BLOCKS BUT NOT TOUCHING THE WORD "CONETH" OR THE SQUARE BLOCKS. THE LINE IS SLIGHTLY LONGER - BUT VISIBLY NOTICEABLE - THEN THE LENGTH OF THE WORD "CONETH" AND THE SQUARE BLOCKS COMBINED. THE WORD "SOLUTIONS" APPEARS SLIGHTLY BELOW THE LINE BUT NOT

CLASS 42—(Continued).

TOUCHING THE LINE. THE RIGHT EDGE OF THE WORD "SOLUTIONS" IS EVEN WITH THE END OF THE LINE ABOVE THE WORD "SOLUTIONS". THE LEFT EDGE OF THE WORD SOLUTIONS IS VERTICALLY ALIGNED WITH THE MIDDLE OF THE LETTER "E" IN THE WORD "CONETH". THE WORD "SOLUTIONS" APPEARS IN A SMALLER FONT THAN THE WORD "CONETH" WHICH MAKES THE WORD "SOLUTIONS" APPEAR IN HALF THE FONT SIZE OF THE WORD "CONETH". BOTH THE WORDS "CONETH" AND "SOLUTIONS" APPEAR IN BOLD TYPE.

FOR CONSULTING, DEVELOPMENT, IMPLEMENTATION AND SUPPORT SERVICES FOR COMPUTER HARDWARE AND SOFTWARE USED IN BUSINESS COMPUTING ENVIRONMENTS; TECHNICAL SUPPORT SERVICES, NAMELY, TROUBLESHOOTING OF COMPUTER HARDWARE AND SOFTWARE PROBLEMS (U.S. CLS. 100 AND 101).

FIRST USE 1-2-2002; IN COMMERCE 1-2-2002.

SN 78-151,406. SAFECO FINANCIAL INSTITUTIONS SOLUTIONS, INC., SEATTLE, WA. FILED 8-6-2002.

AGILSERVE

FOR PROVIDING TEMPORARY USE OF ON-LINE NON-DOWNLOADABLE COMPUTER SOFTWARE FOR PROCESSING LENDER PLACED HAZARD INSURANCE (U.S. CLS. 100 AND 101).

SN 78-152,508. GARVEY, SCHUBERT & BARER, A PARTNERSHIP OF PROFESSIONAL CORPORATIONS, SEATTLE, WA. FILED 8-8-2002.

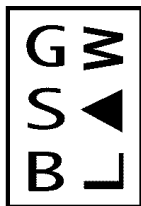

THE MARK CONSISTS OF IN PART A REPRESENTATION OF THE LETTER A IN THE FORM OF A TRIANGLE. FOR LEGAL SERVICES (U.S. CLS. 100 AND 101).

SN 78-156,054. SAFECO FINANCIAL INSTITUTIONS SOLUTIONS, INC., SEATTLE, WA. FILED 8-20-2002.

AGILSTREAM

FOR PROVIDING TEMPORARY USE OF ON-LINE, NON-DOWNLOADABLE COMPUTER SOFTWARE FOR PROCESSING LENDER PLACED HAZARD INSURANCE (U.S. CLS. 100 AND 101).

CLASS 42—(Continued).

SN 78-156,383. SEEKAMERICA NETWORKS INC., KELOWNA, BRITISH COLUMBIA, CANADA, FILED 8-21-2002.

PRIVATE LABEL RESELLER PLANS

NO CLAIM IS MADE TO THE EXCLUSIVE RIGHT TO USE "RESELLER PLANS", APART FROM THE MARK AS SHOWN.

FOR HOSTING THE WEB SITES OF OTHERS ON COMPUTER SERVERS FOR A GLOBAL COMPUTER NETWORK (U.S. CLS. 100 AND 101).

FIRST USE 5-20-2001; IN COMMERCE 5-20-2001.

SN 78-160,326. YOTTAYOTTA, INC., EDMONTON, CANADA, FILED 9-3-2002.



FOR COMPUTER CONSULTING SERVICES IN THE FIELD OF DESIGN, SELECTION, IMPLEMENTATION AND USE OF MASS DATA STORAGE COMPUTER HARDWARE AND SOFTWARE FOR OTHERS (U.S. CLS. 100 AND 101).

FIRST USE 3-27-2003; IN COMMERCE 3-27-2003.

SN 78-161,245. MARSH, STEVEN JOHN, GLOUCESTER, UNITED KINGDOM, FILED 9-6-2002.

BABBOO

FOR COMPUTER PROGRAMMING FOR OTHERS; COMPUTER CONSULTATION; COMPUTER SUPPORT, NAMELY, TROUBLESHOOTING OF COMPUTER HARDWARE AND SOFTWARE PROBLEMS; COMPUTER SOFTWARE DESIGN (U.S. CLS. 100 AND 101).

SN 78-163,951. ALPHA FREIGHT SYSTEMS, INC., STOW, OH. FILED 9-13-2002.



OWNER OF U.S. REG. NOS. 2,538,841 AND 2,545,621. FOR CONSULTING SERVICES IN THE FIELD OF DESIGN, SELECTION, IMPLEMENTATION AND USE OF COMPUTER HARDWARE AND SOFTWARE SYSTEMS FOR OTHERS (U.S. CLS. 100 AND 101).

CLASS 42—(Continued).

SN 78-179,358. CONSUMERS UNION OF UNITED STATES, INC., YONKERS, NY. FILED 10-29-2002.



OWNER OF U.S. REG. NOS. 2,258,693, 2,572,299 AND 2,604,145.
FOR PROVIDING INFORMATION TO THE PUBLIC IN THE FIELDS OF CONSUMER PRODUCT AND SERVICE TESTING AND EVALUATION VIA THE INTERNET (U.S. CLS. 100 AND 101).
FIRST USE 11-12-2002; IN COMMERCE 11-12-2002.

SN 78-183,779. BOWNE OF LOS ANGELES, INC., DOMINGUEZ HILLS, CA. BY ASSIGNMENT BOWNE BUSINESS SOLUTIONS, INC., CHICAGO, IL. FILED 11-11-2002.

DIGITAL LITIGATION SOLUTIONS

NO CLAIM IS MADE TO THE EXCLUSIVE RIGHT TO USE "DIGITAL LITIGATION", APART FROM THE MARK AS SHOWN.
FOR PROVIDING LITIGATION SUPPORT SERVICES, NAMELY IMAGING AND CODING DOCUMENTS, MAINTAINING A WEB BASED DOCUMENT REPOSITORY, ELECTRONIC RETRIEVAL OF DATA AND DOCUMENTS AND PROVIDING COPIES OF THE DOCUMENTS FROM THE DOCUMENT DEPOSITORY (U.S. CLS. 100 AND 101).
FIRST USE 9-3-2002; IN COMMERCE 9-3-2002.

SN 78-188,954. ROBERT LIPKA ARCHITECT P.C., ROMEO, MI. FILED 11-26-2002.

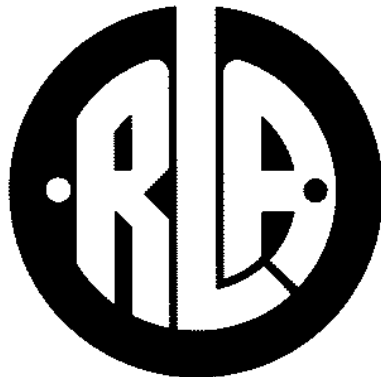

FOR ARCHITECTURAL DESIGN (U.S. CLS. 100 AND 101).
FIRST USE 1-2-2001; IN COMMERCE 1-2-2001.

CLASS 42—(Continued).

SN 78-192,199. ROCKETRAINER LLC, CARLSBAD, CA. FILED 12-6-2002.



FOR APPLICATION SERVICE PROVIDER [ASP] FEATURING SOFTWARE FOR USE BY ATHLETIC COACHES AND FOR PERSONAL DEVELOPMENT AND GOAL SETTING (U.S. CLS. 100 AND 101).
FIRST USE 12-0-2001; IN COMMERCE 8-0-2002.

SN 78-192,231. ENVIRONMENTAL HEALTH AND SAFETY COMPLIANCE CORPORATION, SAN JOSE, CA. FILED 12-7-2002.

EHSCC

FOR DOCUMENTS, PERMITS, PROJECTS AND SPECIFICATIONS RELATED TO THE ENVIRONMENT, HEALTH, SAFETY OR ANY OTHER WORK, NAMELY, REVIEWING STANDARDS AND PRACTICES TO ASSURE COMPLIANCE WITH ENVIRONMENTAL, HEALTH AND SAFETY LAWS AND REGULATIONS (U.S. CLS. 100 AND 101).

SN 78-198,281. WHITE, CAROLYN, AURORA, WV. FILED 12-27-2002.

BOOKMAKERS INK

NO CLAIM IS MADE TO THE EXCLUSIVE RIGHT TO USE "BOOKMAKERS", APART FROM THE MARK AS SHOWN.
FOR GRAPHIC ART DESIGN FEATURING BOOK COVERS (U.S. CLS. 100 AND 101).

SN 78-199,039. ALWAYSSTOCK, LLC, LONGMEADOW, MA. FILED 12-31-2002.



FOR STOCK PHOTOGRAPHY SERVICES, NAMELY, LEASING REPRODUCTION RIGHTS TO OTHERS OF PHOTOGRAPHS, ANIMATION, ILLUSTRATIONS, AND COLLECTIONS THEREOF (U.S. CLS. 100 AND 101).
FIRST USE 12-1-2001; IN COMMERCE 12-1-2001.

CLASS 42—(Continued).

SN 78-199,062. APPLIED PREDICTIVE TECHNOLOGIES, INC., ARLINGTON, VA. FILED 12-31-2002.

APTRETAILER

OWNER OF U.S. REG. NO. 2,653,367.
FOR PROVIDING USE OF ON-LINE NON-DOWNLOADABLE SOFTWARE THAT USES PREDICTIVE MODELING TO RECOMMEND MORE PROFITABLE CAPITAL, OPERATING, MARKETING, MERCHANDISING, AND PRICING DECISIONS TO RETAILERS (U.S. CLS. 100 AND 101).

FIRST USE 6-1-2001; IN COMMERCE 6-1-2001.

SN 78-201,236. DISABLED WORKERS FOUNDATION OF CANADA, PORT ALBERNI, BRITISH COLUMBIA, FILED 1-8-2003.

IDMSC

FOR TESTING, ANALYSIS AND EVALUATION OF THE SERVICES OF OTHERS FOR THE PURPOSE OF CERTIFICATION (U.S. CLS. 100 AND 101).

SN 78-201,300. SCULPTURA CONSULTING, INC., CHICAGO, IL. FILED 1-8-2003.

STRATEGYSPIHERE SYSTEM

NO CLAIM IS MADE TO THE EXCLUSIVE RIGHT TO USE "SYSTEM", APART FROM THE MARK AS SHOWN.
FOR PROVIDING TEMPORARY USE OF ONLINE NON-DOWNLOADABLE SOFTWARE FOR BUSINESS STRATEGY PLANNING (U.S. CLS. 100 AND 101).

FIRST USE 12-3-2002; IN COMMERCE 12-3-2002.

SN 78-201,581. MARKS, JAMES A., SAINT PAUL, MN. FILED 1-9-2003.

WILLCRAFT

FOR LEGAL SERVICES (U.S. CLS. 100 AND 101).
FIRST USE 12-12-2002; IN COMMERCE 12-12-2002.

SN 78-203,732. INPUT, RESTON, VA. FILED 1-15-2003.

MYINPUT

OWNER OF U.S. REG. NOS. 1,179,113, 1,224,189 AND 1,572,344.

FOR APPLICATION SERVICE PROVIDER SERVICES, NAMELY, HOSTING A NON-DOWNLOADABLE SOFTWARE TOOL FOR TEMPORARY USE AND PERSONALIZATION OF AN ON-LINE COMPUTER DATABASE FEATURING PUBLIC SECTOR BUSINESS AND MARKET INFORMATION AND ANALYSIS (U.S. CLS. 100 AND 101).

FIRST USE 10-15-2000; IN COMMERCE 10-15-2000.

CLASS 42—(Continued).

SN 78-206,940. SUNESIS PHARMACEUTICALS INCORPORATED, SOUTH SAN FRANCISCO, CA. FILED 1-24-2003.

SUNESIS

FOR PHARMACEUTICAL RESEARCH AND DEVELOPMENT SERVICES FOR OTHERS (U.S. CLS. 100 AND 101).

FIRST USE 5-25-1998; IN COMMERCE 5-25-1998.

SN 78-207,458. SNELL & WILMER L.L.P., PHOENIX, AZ. FILED 1-27-2003.

CHARACTER COMES THROUGH

FOR LEGAL SERVICES (U.S. CLS. 100 AND 101).
FIRST USE 11-1-2002; IN COMMERCE 11-1-2002.

SN 78-207,504. CARR LAW FIRM LLP, DALLAS, TX. FILED 1-27-2003.

INNOVATE

FOR LEGAL SERVICES (U.S. CLS. 100 AND 101).

SN 78-207,567. RIBOZYME PHARMACEUTICALS INCORPORATED, BOULDER, CO. FILED 1-27-2003.

HEPTAZYME

FOR MEDICINAL AND BIOLOGICAL PRODUCT RESEARCH, DEVELOPMENT AND TESTING. (U.S. CLS. 100 AND 101).

SN 78-207,590. JONES, JEFF A., WEST BARNSTABLE, MA. FILED 1-27-2003.

WEBEXPOSER

FOR COMPUTER SERVICES, NAMELY PROVIDING SEARCH ENGINES FOR OBTAINING DATA ON A GLOBAL COMPUTER NETWORK. (U.S. CLS. 100 AND 101).

CLASS 42—(Continued).

SN 78-207,616. ROSENBAUM & ASSOCIATES, P.C., CHICAGO, IL. FILED 1-27-2003.

BRINGING LIFE TO YOUR IDEAS

FOR LEGAL SERVICES (U.S. CLS. 100 AND 101).

SN 78-208,377. MCCARTER & ENGLISH, LLP, NEWARK, NJ. FILED 1-29-2003.



OWNER OF U.S. REG. NO. 2,401,912.
FOR LEGAL SERVICES (U.S. CLS. 100 AND 101).
FIRST USE 12-31-2002; IN COMMERCE 12-31-2002.

SN 78-208,580. DIRE, NICK, HOLLYWOOD, CA. FILED 1-29-2003.



THE MARK CONSISTS OF A BACKWARD "C" INSIDE A CIRCLE.
FOR COMPUTER SERVICES, NAMELY, DESIGNING AND IMPLEMENTING WEB SITES FOR OTHERS AND CONSULTING SERVICES RENDERED IN CONNECTION THEREWITH (U.S. CLS. 100 AND 101).
FIRST USE 11-1-2002; IN COMMERCE 12-1-2002.

SN 78-209,757. APTARE, INC., CAMPBELL, CA. FILED 1-31-2003.

APTARE

FOR COMPUTER SYSTEMS INTEGRATION; PROVIDING VENDOR-INDEPENDENT COMPUTER SOFTWARE CONSULTING; CUSTOM SOFTWARE PROGRAMMING AND DEVELOPMENT FOR OTHERS (U.S. CLS. 100 AND 101).
FIRST USE 3-31-1996; IN COMMERCE 3-31-1996.

CLASS 42—(Continued).

SN 78-213,742. SMOLENYAK, MEGAN, WILLIAMSBURG, VA. FILED 2-12-2003.

HONORING OUR ANCESTORS

FOR GENEALOGICAL RESEARCH (U.S. CLS. 100 AND 101).

SN 78-975,030. BOOM LLC, NEW YORK, NY. FILED 5-8-2002.

BOOM!

FOR PRODUCT DEVELOPMENT FOR OTHERS; PACKAGING DESIGN FOR OTHERS; PRODUCT DEVELOPMENT CONSULTATION (U.S. CLS. 100 AND 101).
FIRST USE 2-0-2001; IN COMMERCE 2-0-2001.

CLASS 43—HOTEL AND RESTAURANT SERVICES

SN 75-539,277. LHO WASHINGTON HOTEL ONE, LLC, BETHESDA, MD. BY ASSIGNMENT KIMPTON HOTEL & RESTAURANT GROUP, INC., SAN FRANCISCO, CA. FILED 8-19-1998.

HOTEL TOPAZ

NO CLAIM IS MADE TO THE EXCLUSIVE RIGHT TO USE "HOTEL", APART FROM THE MARK AS SHOWN.
FOR HOTEL SERVICES (U.S. CLS. 100 AND 101).
FIRST USE 10-1-2001; IN COMMERCE 10-1-2001.

SN 76-411,751. SPEEDIE PIZZA, INC., SURFSIDE BEACH, SC. FILED 5-24-2002.



NO CLAIM IS MADE TO THE EXCLUSIVE RIGHT TO USE "SICILIAN STYLE PIZZA", APART FROM THE MARK AS SHOWN.
FOR DINE IN AND TAKE OUT RESTAURANT SERVICES (U.S. CLS. 100 AND 101).
FIRST USE 2-18-2001; IN COMMERCE 2-18-2001.

CLASS 43—(Continued).

SN 76-427,835. SOUTHERN EQUITY PTY. LTD., MELBOURNE, VICTORIA, 3004, AUSTRALIA, FILED 6-28-2002.

ETTAMOGAH PUB

OWNER OF AUSTRALIA REG. NO. 454,043, DATED 10-21-1986, EXPIRES 10-21-2007.

NO CLAIM IS MADE TO THE EXCLUSIVE RIGHT TO USE "PUB", APART FROM THE MARK AS SHOWN.

THE ENGLISH TRANSLATION OF THE WORD "ETTAMOGAH" IN THE MARK IS "LET'S HAVE A DRINK".

FOR RESTAURANT SERVICES, NAMELY, SELF SERVICE RESTAURANTS, SNACK BARS, CAFES, AND CAFETERIAS AND CANTEEN SERVICES; CATERING SERVICES, HOTEL SERVICES, NAMELY, HOTELS AND MAKING HOTEL RESERVATIONS FOR OTHERS; PROVIDING TEMPORARY HOUSING ACCOMMODATION FOR TRAVELLERS (U.S. CLS. 100 AND 101).

SN 76-433,856. BELL, MARSHALL, GERMANTOWN, MD. FILED 7-23-2002.



NO CLAIM IS MADE TO THE EXCLUSIVE RIGHT TO USE "GRILL & TAVERN" AND "GOURMET WINGS" AND "RIBS" AND "BEER", APART FROM THE MARK AS SHOWN.

THE DRAWING CONTAINS STIPPLING IN THE MARK WHICH REPRESENTS SHADING IN THE FORM OF A SUNBURST PATTERN INSIDE THE CIRCULAR BACKGROUND IN THE MARK.

FOR RESTAURANT AND BAR SERVICES SPECIALIZING IN PROVIDING AMERICAN STYLE FOOD AND ALCOHOLIC AND NON-ALCOHOLIC BEVERAGES (U.S. CLS. 100 AND 101).

SN 76-435,354. KNOWL-WOOD ENTERPRISES, INC., FOUNTAIN VALLEY, CA. FILED 7-29-2002.

**HOME OF THE WORLD'S
BEST HAMBURGER**

SEC. 2(F).
FOR RESTAURANT SERVICES (U.S. CLS. 100 AND 101).

FIRST USE 7-29-1969; IN COMMERCE 7-29-1969.

CLASS 43—(Continued).

SN 76-435,609. LO, CHI-CHUAN, TAIPEI, TAIWAN, FILED 7-29-2002.

ICE MÖNSTER 冰館

NO CLAIM IS MADE TO THE EXCLUSIVE RIGHT TO USE "ICE", APART FROM THE MARK AS SHOWN.

A TRANSLITERATION OF NON-LATIN CHARACTERS IN THE MARK IS "BING GUAN". A TRANSLATION OF THE NON-ENGLISH WORDING IN THE MARK IS "ICED HOUSE". THE CHINESE CHARACTERS ARE A CREATED TERM, NOT AN IDIOM.

FOR RESTAURANTS, COFFEE SHOPS, COCKTAIL LOUNGES, SNACK BARS, TAKE-OUT FOOD SERVICES AND CAFETERIAS (U.S. CLS. 100 AND 101).

SN 76-436,024. HI LIMITED PARTNERSHIP, CLEARWATER, FL. FILED 7-31-2002.

MORE THAN A MOUTHFUL

FOR RESTAURANT SERVICES (U.S. CLS. 100 AND 101).

SN 76-436,272. SMACNALLY'S, INC., OCRACOKE, NC. FILED 7-30-2002.



NO CLAIM IS MADE TO THE EXCLUSIVE RIGHT TO USE "RAW BAR AND GRILL" AND "OCRACOKE ISLAND, N.C.", APART FROM THE MARK AS SHOWN.

FOR RESTAURANT SERVICES (U.S. CLS. 100 AND 101).

FIRST USE 4-7-2001; IN COMMERCE 4-7-2001.

CLASS 43—(Continued).

SN 76-436,336. CHANG, TOM, SOUTH PASADENA, CA. FILED 7-31-2002.



NO CLAIM IS MADE TO THE EXCLUSIVE RIGHT TO USE "ESTABLISHED 1965", APART FROM THE MARK AS SHOWN.

THE MARK CONSISTS OF THE WORDS "PHOENIX ESTABLISHED 1965" WITH A BIRD DESIGN RISING OUT OF THE LETTER "O".

FOR RESTAURANT SERVICES OF PROVIDING SPECIALIZED CHINESE SNACKS, DELICATESSEN, FOOD AND DESSERTS (U.S. CLS. 100 AND 101).

FIRST USE 11-28-2000; IN COMMERCE 11-28-2000.

CLASS 43—(Continued).

SN 76-459,134. GOURMET GUYZ, LLC., STROUDSBURG, PA. FILED 10-18-2002.

GOURMET GUYZ

NO CLAIM IS MADE TO THE EXCLUSIVE RIGHT TO USE "GOURMET", APART FROM THE MARK AS SHOWN. FOR RESTAURANT AND DELICATESSEN SERVICES; CATERING SERVICES (U.S. CLS. 100 AND 101).

SN 76-472,613. OTG MANAGEMENT, INC., PHILADELPHIA, PA. FILED 12-4-2002.



NO CLAIM IS MADE TO THE EXCLUSIVE RIGHT TO USE "CIBO BISTRO & WINE BAR", APART FROM THE MARK AS SHOWN.

THE ENGLISH TRANSLATION OF "CIBO" IS "FOOD". FOR FULL SERVICE RESTAURANT AND BAR SERVICES (U.S. CLS. 100 AND 101).

FIRST USE 3-0-2000; IN COMMERCE 3-0-2000.

SN 76-440,010. INVERSIONES SIN LIMITES 7.000 C.A., CARACAS, VENEZUELA, FILED 8-12-2002.



FOR RESTAURANT SERVICES (U.S. CLS. 100 AND 101).

SN 76-475,194. BALLARD, PAUL, COVINGTON, LA. FILED 12-11-2002.

WINGERY

FOR RESTAURANT SERVICES (U.S. CLS. 100 AND 101).

SN 76-446,557. NEW YORK MILKSHAKE COMPANY, INC., NEW YORK, NY. FILED 9-3-2002.



SN 76-476,451. HI LIMITED PARTNERSHIP, CLEARWATER, FL. FILED 12-18-2002.

BAYOU GUMBO

NO CLAIM IS MADE TO THE EXCLUSIVE RIGHT TO USE "THE ORIGINAL NEW YORK MILKSHAKE COMPANY", APART FROM THE MARK AS SHOWN.

FOR RESTAURANT SERVICES (U.S. CLS. 100 AND 101).

NO CLAIM IS MADE TO THE EXCLUSIVE RIGHT TO USE "GUMBO", APART FROM THE MARK AS SHOWN.

FOR RESTAURANT SERVICES (U.S. CLS. 100 AND 101).

CLASS 43—(Continued).

SN 76-477,889. MANESS, ANTHONY KEITH, LAWNSDALE, NC. FILED 12-24-2002.

THE PEPPERONI EXPRESS PIZZA CO.

NO CLAIM IS MADE TO THE EXCLUSIVE RIGHT TO USE "PEPPERONI" AND "PIZZA CO.", APART FROM THE MARK AS SHOWN.

FOR RESTAURANT SERVICES (U.S. CLS. 100 AND 101).

FIRST USE 12-2-2002; IN COMMERCE 12-2-2002.

SN 76-478,020. MOONFISH RESTAURANTS, INC., ORLANDO, FL. FILED 12-23-2002.

THE FRESHEST SEAFOOD FROM THE OCEANS OF PLANET EARTH!

NO CLAIM IS MADE TO THE EXCLUSIVE RIGHT TO USE "FRESHEST SEAFOOD", APART FROM THE MARK AS SHOWN.

FOR RESTAURANT SERVICES (U.S. CLS. 100 AND 101).

FIRST USE 10-15-2002; IN COMMERCE 10-15-2002.

SN 76-484,750. BURGER KING BRANDS, INC., MIAMI, FL. FILED 1-24-2003.

BK

FOR RESTAURANT SERVICES (U.S. CLS. 100 AND 101).

FIRST USE 7-31-2000; IN COMMERCE 7-31-2000.

SN 76-485,188. BAILEY, AMY, AUGUSTA, GA. FILED 1-27-2003.

BEYOND CASUAL

OWNER OF U.S. REG. NOS. 2,069,947 AND 2,336,416. FOR RESTAURANT SERVICES (U.S. CLS. 100 AND 101).

FIRST USE 7-7-1987; IN COMMERCE 7-7-1987.

SN 76-485,441. MY @ LLC, DENVER, CO. FILED 1-27-2003.

MY@

FOR RESTAURANT SERVICES (U.S. CLS. 100 AND 101).

CLASS 43—(Continued).

SN 76-485,442. EAST @ LLC, DENVER, CO. FILED 1-27-2003.

EAST @

FOR RESTAURANT SERVICES (U.S. CLS. 100 AND 101).

SN 76-485,742. MICHAELS, DAVID, LAS VEGAS, NV. FILED 1-27-2003.

THE CANNING PLANT

FOR RESTAURANT AND BAR SERVICES (U.S. CLS. 100 AND 101).

SN 76-485,938. THE BUONA COMPANIES, L.L.C., BERWYN, IL. FILED 1-29-2003.

BUONA CATERING

OWNER OF U.S. REG. NOS. 1,554,944 AND 1,573,667. NO CLAIM IS MADE TO THE EXCLUSIVE RIGHT TO USE "CATERING", APART FROM THE MARK AS SHOWN. THE ENGLISH TRANSLATION OF "BUONA" IS "GOOD". FOR CATERING SERVICES (U.S. CLS. 100 AND 101). FIRST USE 6-1-1996; IN COMMERCE 6-1-1996.

SN 76-486,013. BAKED & WIRED, INC., WASHINGTON, DC. FILED 1-30-2003.

BAKED & WIRED

FOR COFFEE BAR, CATERING AND RESTAURANT SERVICES (U.S. CLS. 100 AND 101). FIRST USE 5-28-2001; IN COMMERCE 5-28-2001.

CLASS 43—(Continued).

SN 76-487,481. GORDON BIRSCH BREWERY RESTAURANT GROUP, INC., DBA BIG RIVER BREWERIES, INC., BIG RIVER GRILLE & BREWING WORKS, ROCK BOTTOM RESTAURANT AND BREWERY, RAGTIME TAVERN SEAFOOD & GRILL, A1A ALE WORKS AND SEVEN BRIDGES GRILL & BREWERY, CHATTANOOGA, TN. FILED 2-4-2003.



FOR RESTAURANT AND CATERING SERVICES, EXCLUDING CONCESSION SERVICES (U.S. CLS. 100 AND 101).
FIRST USE 9-30-1997; IN COMMERCE 9-30-1997.

SN 76-487,657. VRL INTERNATIONAL LIMITED, GEORGETOWN, GRAND CAYMAN, CAYMAN ISLANDS, FILED 2-4-2003.

MUNASAN

FOR RESTAURANT SERVICES (U.S. CLS. 100 AND 101).

SN 76-492,625. MICHAELS, DAVID, LAS VEGAS, NV. FILED 2-19-2003.

THE FREEZER

FOR RESTAURANT AND BAR SERVICES (U.S. CLS. 100 AND 101).

SN 78-052,910. K & S ENTERPRISES, SALEM, NH. FILED 3-13-2001.

TASTE THE GOOD LIFE

OWNER OF U.S. REG. NO. 2,315,380.
FOR RESTAURANT SERVICES (U.S. CLS. 100 AND 101).
FIRST USE 3-1-2001; IN COMMERCE 11-1-2001.

CLASS 43—(Continued).

SN 78-101,263. AMATO'S SANDWICH SHOPS, INC., PORTLAND, ME. FILED 1-7-2002.

AMATO'S

SUBJECT TO CONCURRENT USE PROCEEDING WITH KENNETH J. AMATO. APPLICANT CLAIMS EXCLUSIVE RIGHT TO USE THE MARK IN THE AREA COMPRISING THE ENTIRE UNITED STATES, EXCEPT ETNA PENNSYLVANIA.

OWNER OF U.S. REG. NOS. 2,221,295 AND 2,221,297.
FOR RESTAURANT SERVICES (U.S. CLS. 100 AND 101).
FIRST USE 1-1-1903; IN COMMERCE 1-1-1923.

SN 78-119,910. EMPRESA NACIONAL DE POLLOS ASADOS, S.A. DE C.V., GUANAJUATO LEON, MEXICO, FILED 4-5-2002.



OWNER OF MEXICO REG. NO. 427832, DATED 12-16-1992, RENEWED AS REG. NO. 13877, DATED 10-15-2002, EXPIRES 10-15-2012.

NO CLAIM IS MADE TO THE EXCLUSIVE RIGHT TO USE "POLLO", APART FROM THE MARK AS SHOWN.

THE ENGLISH TRANSLATION OF "POLLO FELIZ NO HAY OTRO MEJOR" IS "HAPPY CHICKEN THERE IS NONE OTHER BETTER".

FOR RESTAURANT SERVICES (U.S. CLS. 100 AND 101).

SN 78-122,986. CHALET NAVY PROPERTIES, L.P., WILTON, NH. FILED 4-19-2002.



NO CLAIM IS MADE TO THE EXCLUSIVE RIGHT TO USE "GROTON CHALET", APART FROM THE MARK AS SHOWN.

FOR HOTEL SERVICES (U.S. CLS. 100 AND 101).
FIRST USE 7-15-2001; IN COMMERCE 7-15-2001.

CLASS 43—(Continued).

SN 78-122,989. CHALET NAVY PROPERTIES, L.P., WILTON, NH. FILED 4-19-2002.

**Newport
Chalet** 

NO CLAIM IS MADE TO THE EXCLUSIVE RIGHT TO USE "NEWPORT CHALET", APART FROM THE MARK AS SHOWN.

FOR HOTEL SERVICES (U.S. CLS. 100 AND 101).
FIRST USE 7-15-2001; IN COMMERCE 7-15-2001.

SN 78-141,031. FAIRMONT HOTELS & RESORTS (U.S.) INC., TORONTO, CANADA, FILED 7-3-2002.

**FAIRMONT LIFESTYLE
CUISINE**

NO CLAIM IS MADE TO THE EXCLUSIVE RIGHT TO USE "CUISINE", APART FROM THE MARK AS SHOWN.

FOR RESTAURANT SERVICES AND PROVIDING ROOM SERVICES FOR FOOD, DRINKS AND SNACKS (U.S. CLS. 100 AND 101).

SN 78-146,763. ALMOST LIKE HOME, INC., BALTIMORE, MD. FILED 7-23-2002.

ALMOST LIKE HOME, INC.

NO CLAIM IS MADE TO THE EXCLUSIVE RIGHT TO USE "INC.", APART FROM THE MARK AS SHOWN.

FOR PROVIDING ASSISTED LIVING FACILITIES (U.S. CLS. 100 AND 101).

FIRST USE 4-7-1997; IN COMMERCE 10-1-1997.

SN 78-151,562. WASHINGTON STATE PUBLIC STADIUM AUTHORITY, SEATTLE, WA. FILED 8-6-2002.



THE MARK CONSISTS OF A STYLIZED RENDITION OF A STADIUM ROOF. THE MARK IS RENDERED IN BRUSH STROKES WHICH TRAIL OFF IN INTENSITY AND CONSISTENCY.

FOR ARENA SERVICES, NAMELY, PROVIDING FACILITIES FOR SPORTING EVENTS, ENTERTAINMENT EVENTS AND EXHIBITIONS IN THE NATURE OF CONSUMER SHOWS AND TRADE SHOWS (U.S. CLS. 100 AND 101).

FIRST USE 10-31-1999; IN COMMERCE 10-31-1999.

CLASS 43—(Continued).

SN 78-157,184. PASTA HOUSE COMPANY, THE, ST. LOUIS, MO. FILED 8-23-2002.



OWNER OF U.S. REG. NOS. 1,269,396, 2,242,435 AND OTHERS.

NO CLAIM IS MADE TO THE EXCLUSIVE RIGHT TO USE "CO.", APART FROM THE MARK AS SHOWN.

SEC. 2(F) AS TO "THE PASTA HOUSE CO."

FOR RESTAURANT AND COCKTAIL LOUNGE SERVICES (U.S. CLS. 100 AND 101).

FIRST USE 6-1-2001; IN COMMERCE 6-1-2001.

SN 78-182,512. K & M RELOCATION NETWORK, INC., CAMPBELL, CA. FILED 11-6-2002.



NO CLAIM IS MADE TO THE EXCLUSIVE RIGHT TO USE "CORPORATE HOUSING", APART FROM THE MARK AS SHOWN.

FOR CORPORATE HOUSING AND RELOCATION SERVICES, NAMELY, ARRANGING TEMPORARY HOUSING ACCOMMODATIONS FOR RELOCATING EMPLOYEES OR EMPLOYEES ON EXTENDED STAY BUSINESS TRAVEL (U.S. CLS. 100 AND 101).

FIRST USE 1-0-1990; IN COMMERCE 1-0-1990.

SN 78-192,982. OMNI HOTELS MANAGEMENT CORPORATION, IRVING, TX. FILED 12-10-2002.

E-VENTS REZ 24/7

NO CLAIM IS MADE TO THE EXCLUSIVE RIGHT TO USE "EVENTS RES 24/7", APART FROM THE MARK AS SHOWN.

FOR PROVIDING AN ONLINE RESERVATIONS AND BOOKINGS DATABASE FOR MAKING BUSINESS MEETING RESERVATIONS HELD IN HOTELS (U.S. CLS. 100 AND 101).

CLASS 43—(Continued).

SN 78-203,526. SODEXHO OPERATIONS, LLC, GAITHERSBURG, MD. FILED 1-15-2003.

THINK CLIENTS FIRST

FOR CONTRACT FOOD SERVICES; PREPARING AND SERVING FOODS IN INSTITUTIONAL DINING FACILITIES; CATERING (U.S. CLS. 100 AND 101).
FIRST USE 1-1-2000; IN COMMERCE 1-1-2000.

SN 78-205,112. ATIYEH, ABRAHAM R., WHITEHALL, PA. FILED 1-20-2003.

ALLENTOWN MANOR

NO CLAIM IS MADE TO THE EXCLUSIVE RIGHT TO USE "ALLENTOWN", APART FROM THE MARK AS SHOWN.

FOR PROVIDING AN ASSISTED LIVING RESIDENCE FOR SENIOR CITIZENS (U.S. CLS. 100 AND 101).
FIRST USE 9-1-2001; IN COMMERCE 9-1-2001.

SN 78-205,128. ATIYEH, ABRAHAM, R., WHITEHALL, PA. FILED 1-20-2003.

SAUCON VALLEY MANOR

NO CLAIM IS MADE TO THE EXCLUSIVE RIGHT TO USE "SAUCON VALLEY", APART FROM THE MARK AS SHOWN.

FOR PROVIDING AN ASSISTED LIVING RESIDENCE FOR SENIOR CITIZENS (U.S. CLS. 100 AND 101).
FIRST USE 9-1-2000; IN COMMERCE 9-1-2000.

SN 78-205,477. MODULAR RESTAURANT FRANCHISE, INC., FT. LAUDERDALE, FL. FILED 1-21-2003.

STARLITE DINER

NO CLAIM IS MADE TO THE EXCLUSIVE RIGHT TO USE "DINER", APART FROM THE MARK AS SHOWN.

FOR RESTAURANT SERVICES (U.S. CLS. 100 AND 101).
FIRST USE 12-1-1997; IN COMMERCE 12-1-1997.

SN 78-206,620. SOURGOSE, SHEREE, MARIE, FONTANA, CA. FILED 1-23-2003.

SPAGHETS

FOR FAST FOOD ITALIAN RESTAURANT (U.S. CLS. 100 AND 101).

CLASS 43—(Continued).

SN 78-207,780. BRINKER RESTAURANT CORPORATION, DALLAS, TX. FILED 1-28-2003.

MAKING LIFE DELICIOUS

FOR RESTAURANT AND BAR SERVICES (U.S. CLS. 100 AND 101).
FIRST USE 11-11-2002; IN COMMERCE 11-11-2002.

SN 78-207,785. GREEN ELEPHANT, INC., CHAPEL HILL, NC. FILED 1-28-2003.

GREEN TANGO

FOR RESTAURANT SERVICES, TAKE-OUT RESTAURANT SERVICES, CATERING (U.S. CLS. 100 AND 101).

SN 78-208,495. TUSCAN OVEN INC., THE, TAMPA, FL. FILED 1-29-2003.



NO CLAIM IS MADE TO THE EXCLUSIVE RIGHT TO USE "SPORTS PUB SOHO, TAMPA BAY", APART FROM THE MARK AS SHOWN.

THE OUTER CIRCLE AROUND THE WORD "MAC'S" IS RED, BUT COLOR IS NOT CLAIMED AS A FEATURE OF THE MARK.

FOR RESTAURANT AND BAR SERVICES (U.S. CLS. 100 AND 101).
FIRST USE 6-26-2002; IN COMMERCE 6-26-2002.

CLASS 43—(Continued).

SN 78-208,518. KONISAN, INC., CHICAGO, IL. FILED 1-29-2003.



OWNER OF U.S. REG. NO. 1,858,261.
THE FOREIGN WORDING IN THE MARK TRANSLATES INTO ENGLISH AS "8 TURTLES".
FOR RESTAURANT SERVICES; TAKE-OUT RESTAURANT SERVICES; CATERING (U.S. CLS. 100 AND 101).
FIRST USE 2-22-1994; IN COMMERCE 2-22-1994.

SN 78-208,532. KONISAN, INC., CHICAGO, IL. FILED 1-29-2003.

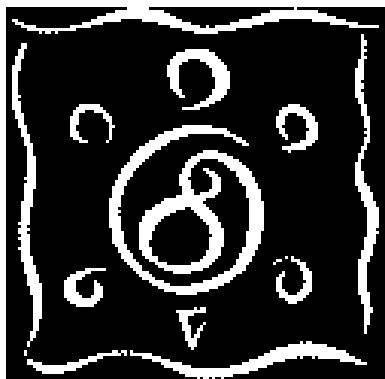

THE MARK CONSISTS OF A STYLIZED DRAWING OF A TURTLE.
FOR RESTAURANT SERVICES; TAKE-OUT RESTAURANT SERVICES; CATERING (U.S. CLS. 100 AND 101).
FIRST USE 2-22-1994; IN COMMERCE 2-22-1994.

SN 78-208,543. PRETZELMAKER, INC., SALT LAKE CITY, UT. FILED 1-29-2003.

SERVING THE WORLD A PRETZEL AND A SMILE

FOR RESTAURANT SERVICES (U.S. CLS. 100 AND 101).

CLASS 43—(Continued).

SN 78-209,025. INTERNATIONAL RESTAURANT GROUP, L.L.C., DALLAS, TX. FILED 1-30-2003.

SLO POKE'S

FOR RESTAURANT SERVICES (U.S. CLS. 100 AND 101).

SN 78-209,292. ATOI-USA, LLC, LAS VEGAS, NV. FILED 1-31-2003.



NO CLAIM IS MADE TO THE EXCLUSIVE RIGHT TO USE "INDONESIA", APART FROM THE MARK AS SHOWN.
FOR RESTAURANT SERVICES (U.S. CLS. 100 AND 101).

SN 78-214,613. MORRISON HOLDING COMPANY, NAPERVILLE, IL. FILED 2-13-2003.

CATERING TO YOU

NO CLAIM IS MADE TO THE EXCLUSIVE RIGHT TO USE "CATERING", APART FROM THE MARK AS SHOWN.
FOR FOOD SERVICES FOR OTHERS, NAMELY, PREPARING AND SERVING FOOD AND DRINKS (U.S. CLS. 100 AND 101).
FIRST USE 9-0-2000; IN COMMERCE 12-0-2000.

CLASS 44—MEDICAL, BEAUTY AND AGRICULTURAL SERVICES

SN 76-350,086. THE AGRICULTURAL GAS COMPANY, HUDSON, WI. FILED 12-18-2001.

ATMOGATION

FOR SPREADING OF FERTILIZERS AND OTHER AGRICULTURAL CHEMICALS BY AERIAL OR SURFACE MEANS TO ENHANCE AND DEFEND CROPS FOR AGRICULTURAL GROWERS OF ROW CROPS, VINEYARDS, ORCHARDS AND PLANTATIONS (U.S. CLS. 100 AND 101).

CLASS 44—(Continued).

SN 76-388,024. TYBAR RANCH COMPANY, CARBONDALE, CO. FILED 3-26-2002.

ALTITUDE PROOF GENES

NO CLAIM IS MADE TO THE EXCLUSIVE RIGHT TO USE "GENES", APART FROM THE MARK AS SHOWN.

FOR BREEDING AND ARTIFICIAL INSEMINATION SERVICES IN THE AGRICULTURAL, CATTLE AND LIVESTOCK BUSINESS (U.S. CLS. 100 AND 101).

FIRST USE 8-1-1999; IN COMMERCE 8-1-1999.

SN 76-402,536. MODULAR PROPERTIES, LTD., ALTA-MONTE SPRINGS, FL. FILED 5-1-2002.

THE BOSTON METHOD

NO CLAIM IS MADE TO THE EXCLUSIVE RIGHT TO USE "METHOD", APART FROM THE MARK AS SHOWN.

FOR MEDICAL SERVICES FOR SEXUAL FUNCTION, NAMELY, MEDICAL TREATMENTS RELATED TO SEXUAL PROBLEMS, CONSULTATION AND EVALUATION OF SEXUALLY RELATED PROBLEMS, AND PROVIDING CUSTOMIZED FORMULATIONS FOR SEXUAL PERFORMANCE (U.S. CLS. 100 AND 101).

FIRST USE 7-0-1998; IN COMMERCE 7-0-1998.

SN 76-403,302. QMED, INC., LAURENCE HARBOR, NJ. FILED 5-2-2002.

Q-VANTAGE

FOR MEDICAL DIAGNOSTIC SERVICES, NAMELY, PROVIDING A COMPUTER-GENERATED DIAGNOSTIC AND THERAPEUTIC DISEASE MANAGEMENT REPORT FROM A CENTRAL LOCATION TO A PHYSICIAN TREATING A PATIENT AT A REMOTE LOCATION BASED ON THE ANALYSIS OF KNOWN RISK FACTORS OF THE PATIENT, AND GENERATING ANALYTIC RISK REPORTS FOR DISEASE MANAGEMENT BASED ON EMPIRICAL DATA COLLECTED AND INTERPRETED BY A COMPUTER AT A CENTRAL LOCATION (U.S. CLS. 100 AND 101).

SN 76-403,800. CLEARPULSE CORP., RICHMOND HILL, ONTARIO, CANADA, FILED 5-6-2002.

CLEARPULSE

FOR REMOTE MEDICAL EVALUATION SERVICES, NAMELY, FUNCTIONAL ASSESSMENT PROGRAM FOR PATIENTS RECEIVING MEDICAL REHABILITATION SERVICES FOR PURPOSES OF GUIDING TREATMENT OF MEDICAL CONDITIONS AND DISEASES AND ASSESSING PROGRAM EFFECTIVENESS VIA A GLOBAL COMPUTER NETWORK (U.S. CLS. 100 AND 101).

CLASS 44—(Continued).

SN 76-410,822. ST. MARY'S HEALTH CARE SYSTEM, INC., ATHENS, GA. FILED 5-15-2002.

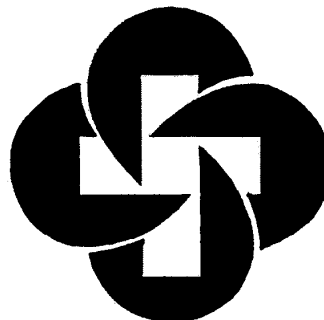

OWNER OF U.S. REG. NOS. 1,880,182, 2,485,445 AND OTHERS.

THE VERTICAL PORTION OF THE DESIGN FEATURE SURROUNDING THE CROSS IS DARK BLUE. THE HORIZONTAL PORTION OF THE DESIGN FEATURE SURROUNDING THE CROSS IS LIGHT BLUE

FOR HEALTH CARE SERVICES, INCLUDING HOSPITAL SERVICES, LONG-TERM CARE FACILITY SERVICES, HOSPICE SERVICES, HOME HEALTH CARE SERVICES, PERSONAL CARE HOMES, AND URGENT CARE CENTERS (U.S. CLS. 100 AND 101).

SN 76-410,851. ST. MARY'S HEALTH CARE SYSTEM, INC., ATHENS, GA. FILED 5-15-2002.



ST. MARY'S
HEALTH CARE SYSTEM
It feels better here.

OWNER OF U.S. REG. NOS. 1,880,182, 2,485,445 AND OTHERS.

NO CLAIM IS MADE TO THE EXCLUSIVE RIGHT TO USE "HEALTH CARE SYSTEM", APART FROM THE MARK AS SHOWN.

FOR HEALTH CARE SERVICES, INCLUDING HOSPITAL SERVICES, LONG-TERM CARE FACILITY SERVICES, HOSPICE SERVICES, HOME HEALTH CARE SERVICES, PERSONAL CARE HOMES, AND URGENT CARE CENTERS (U.S. CLS. 100 AND 101).

CLASS 44—(Continued).

SN 76-410,852. ST. MARY'S HEALTH CARE SYSTEM, INC., ATHENS, GA. FILED 5-15-2002.



OWNER OF U.S. REG. NOS. 1,880,182, 2,485,445 AND OTHERS.

NO CLAIM IS MADE TO THE EXCLUSIVE RIGHT TO USE "HEALTH CARE SYSTEM", APART FROM THE MARK AS SHOWN.

FOR HEALTH CARE SERVICES, INCLUDING HOSPITAL SERVICES, LONG-TERM CARE FACILITY SERVICES, HOSPICE SERVICES, HOME HEALTH CARE SERVICES, PERSONAL CARE HOMES, AND URGENT CARE CENTERS (U.S. CLS. 100 AND 101).

SN 76-410,856. ST. MARY'S HEALTH CARE SYSTEM, INC., ATHENS, GA. FILED 5-15-2002.



OWNER OF U.S. REG. NOS. 1,880,182, 2,485,445 AND OTHERS.

NO CLAIM IS MADE TO THE EXCLUSIVE RIGHT TO USE "HEALTH CARE SYSTEM", APART FROM THE MARK AS SHOWN.

THE LETTERING FOR THE WORDS "ST. MARY'S HEALTH CARE SYSTEM" ARE DARK BLUE. THE LETTERING FOR THE WORDS "IT FEELS BETTER HERE" ARE LIGHT BLUE. THE VERTICAL PORTION OF THE DESIGN FEATURE SURROUNDING THE CROSS IS DARK BLUE. THE HORIZONTAL PORTION OF THE DESIGN FEATURE SURROUNDING THE CROSS IS LIGHT BLUE. APPLICANT CLAIMS COLOR AS AN INTEGRAL PART OF THE MARK.

FOR HEALTH CARE SERVICES, INCLUDING HOSPITAL SERVICES, LONG-TERM CARE FACILITY SERVICES, HOSPICE SERVICES, HOME HEALTH CARE SERVICES, PERSONAL CARE HOMES, AND URGENT CARE CENTERS (U.S. CLS. 100 AND 101).

CLASS 44—(Continued).

SN 76-424,005. LEFKOWITZ, HARVEY, FERNDALE, MI. FILED 6-21-2002.



NO CLAIM IS MADE TO THE EXCLUSIVE RIGHT TO USE "MICHIGAN FOOT AND ANKLE", APART FROM THE MARK AS SHOWN.

THE STIPPLING IN THE DRAWING APPEARS TO BE FOR SHADING PURPOSES ONLY.

FOR MEDICAL SERVICES IN THE NATURE OF TREATMENT AND CARE OF THE FOOT AND THE ANKLE (U.S. CLS. 100 AND 101).

FIRST USE 4-19-2002; IN COMMERCE 4-19-2002.

SN 76-428,946. HOSPICE & PALLIATIVE CARE OF CAPE COD, INC., HYANNIS, MA. FILED 7-10-2002.

LIVING WELL WITH SERIOUS ILLNESS

FOR HOSPICES AND CONSULTING SERVICES THEREFORE (U.S. CLS. 100 AND 101).

FIRST USE 11-0-2000; IN COMMERCE 11-0-2000.

SN 76-430,180. BLUE CROSS AND BLUE SHIELD OF SOUTH CAROLINA, COLUMBIA, SC. FILED 7-12-2002.



FOR PROVIDING HEALTH BENEFITS CLAIM PROCESSING, HEALTH BENEFITS CLAIM REIMBURSEMENT AND HEALTH BENEFITS CLAIM INFORMATION BY MEANS OF A MULTIPLE USER COMPUTER NETWORK (U.S. CLS. 100 AND 101).

FIRST USE 6-21-2002; IN COMMERCE 6-21-2002.

CLASS 44—(Continued).

SN 76-432,381. BRAIN BOLUS MEDICAL EDUCATION FOUNDATION, ARLINGTON, TX. FILED 7-17-2002.

CANCER TOGETHER

NO CLAIM IS MADE TO THE EXCLUSIVE RIGHT TO USE "CANCER", APART FROM THE MARK AS SHOWN.

FOR PROVIDING MEDICAL INFORMATION, NAMELY CANCER AND CANCER TREATMENT INFORMATION VIA A GLOBAL COMPUTER NETWORK BY MEANS OF STREAMING VIDEO PROGRAMS, MULTIMEDIA PRESENTATIONS, DOWNLOADS FILES, AND CHAT ROOM SUPPORT GROUPS AND BULLETIN BOARDS FOR CANCER PATIENTS AND FAMILY MEMBERS (U.S. CLS. 100 AND 101).

FIRST USE 4-5-2002; IN COMMERCE 4-5-2002.

SN 76-448,829. THE EQUINE TOUCH FOUNDATION, INC., OXFORD, PA. FILED 9-12-2002.



The Equine Touch

NO CLAIM IS MADE TO THE EXCLUSIVE RIGHT TO USE "EQUINE", APART FROM THE MARK AS SHOWN.

THE MARK CONSISTS OF THE STYLIZED HEADS OF TWO HORSES WITH INTERTWINING NECKS.

FOR PROVIDING MUSCULAR REHABILITATIVE SERVICES TO HUMANS AND HORSES (U.S. CLS. 100 AND 101).

FIRST USE 1-1-2002; IN COMMERCE 3-27-2002.

SN 76-469,595. NORTH AMERICAN MEDICAL CORPORATION, ATLANTA, GA. FILED 11-25-2002.

ACCUTOX THERAPY

NO CLAIM IS MADE TO THE EXCLUSIVE RIGHT TO USE "THERAPY", APART FROM THE MARK AS SHOWN.

FOR MEDICAL TREATMENT SERVICES TO RELIEVE BACK PAIN WITHOUT SURGICAL INTERVENTION (U.S. CLS. 100 AND 101).

CLASS 44—(Continued).

SN 76-470,400. BANOWETZ, DEAN F., VALLEY VILLAGE, CA. FILED 11-25-2002.

CHANGING LIVES ONE HEAD AT A TIME

NO CLAIM IS MADE TO THE EXCLUSIVE RIGHT TO USE "HEAD", APART FROM THE MARK AS SHOWN.

FOR BEAUTY SALON SERVICES; PROVIDING INFORMATION ABOUT BEAUTY AND HYGIENE (U.S. CLS. 100 AND 101).

FIRST USE 2-0-2002; IN COMMERCE 2-0-2002.

SN 76-471,935. VAIL CLINIC, INC., VAIL, CO. FILED 11-26-2002.

HOWARD HEAD SPORTS MEDICINE CENTER

NO CLAIM IS MADE TO THE EXCLUSIVE RIGHT TO USE "SPORTS MEDICINE CENTER", APART FROM THE MARK AS SHOWN.

THE NAME HOWARD HEAD DOES NOT IDENTIFY A LIVING INDIVIDUAL.

FOR PROFESSIONAL SPORTS MEDICINE SERVICES AND REHABILITATION SERVICES (U.S. CLS. 100 AND 101).

FIRST USE 0-0-1986; IN COMMERCE 0-0-1986.

SN 76-473,130. JOAN M. CABLE'S LA FEMMINA BEAUTY SALONS, INC., LEVITTOWN, NY. FILED 12-6-2002.

Lemon Tree

OWNER OF U.S. REG. NO. 1,204,072.

FOR BEAUTY SALON AND BARBERSHOP SERVICES (U.S. CLS. 100 AND 101).

FIRST USE 8-1-2001; IN COMMERCE 8-1-2001.

SN 76-477,338. CONSUMER'S MEDICAL RESOURCE, DUXBURY, MA. FILED 12-20-2002.

CONSUMER'S MEDICAL RESOURCE

SEC. 2(F).

FOR PROVIDING MEDICAL INFORMATION (U.S. CLS. 100 AND 101).

FIRST USE 4-1-1996; IN COMMERCE 12-31-1996.

CLASS 44—(Continued).

SN 76-477,598. EVERGREEN SURGICAL WEIGHT CONTROL SPECIALISTS, S.C., EVERGREEN PARK, IL. FILED 12-23-2002.

**EVERGREEN SURGICAL
WEIGHT CONTROL
SPECIALISTS**

NO CLAIM IS MADE TO THE EXCLUSIVE RIGHT TO USE "SURGICAL WEIGHT CONTROL SPECIALISTS", APART FROM THE MARK AS SHOWN.

FOR SURGERY, NAMELY, SURGICAL WEIGHT MANAGEMENT SERVICES AND RELATED MEDICAL SERVICES (U.S. CLS. 100 AND 101).

CLASS 44—(Continued).

SN 76-491,194. MAGICAL FARMS, INC., LITCHFIELD, OH. FILED 2-19-2003.



NO CLAIM IS MADE TO THE EXCLUSIVE RIGHT TO USE "FARMS INC.", APART FROM THE MARK AS SHOWN.

FOR BREEDING SERVICES OF ALPACAS, FOR OTHERS (U.S. CLS. 100 AND 101).

FIRST USE 2-15-1999; IN COMMERCE 2-15-1999.

SN 76-479,382. GARY M. KAWESCH, MD, INC., SAN JOSE, CA. FILED 12-30-2002.

PERSONALASIK

FOR MEDICAL SERVICES, SPECIFICALLY, LASER VISION CORRECTION (U.S. CLS. 100 AND 101). FIRST USE 1-4-2003; IN COMMERCE 1-4-2003.

SN 76-497,142. MAGICAL FARMS, INC., LITCHFIELD, OH. FILED 3-13-2003.



FOR BREEDING SERVICES OF ALPACAS, FOR OTHERS (U.S. CLS. 100 AND 101).

FIRST USE 2-15-1999; IN COMMERCE 2-15-1999.

SN 76-484,456. ALITUS, LLC, VERNON HILLS, IL. FILED 1-22-2003.



NO CLAIM IS MADE TO THE EXCLUSIVE RIGHT TO USE "INTEGRATIVE HEALTH & WELLNESS", APART FROM THE MARK AS SHOWN.

FOR MEDICAL SERVICES (U.S. CLS. 100 AND 101). FIRST USE 6-1-2002; IN COMMERCE 6-1-2002.

SN 78-136,348. COMMUNITY HOSPITAL OF THE MONTEREY PENINSULA, MONTEREY, CA. FILED 6-17-2002.



SN 76-487,822. NORTHWEST CANCER SPECIALISTS, PC, PORTLAND, OR. FILED 1-27-2003.

**WE KNOW CANCER. WE'RE
SPECIALISTS.**

NO CLAIM IS MADE TO THE EXCLUSIVE RIGHT TO USE "CANCER", APART FROM THE MARK AS SHOWN.

FOR MEDICAL SERVICES FOR THE TREATMENT OF CANCER (U.S. CLS. 100 AND 101). FIRST USE 2-1-2002; IN COMMERCE 2-1-2002.

OWNER OF U.S. REG. NOS. 2,460,966, 2,470,977 AND 2,629,683.

NO CLAIM IS MADE TO THE EXCLUSIVE RIGHT TO USE "BREAST CARE CENTER" AND "COMMUNITY HOSPITAL", APART FROM THE MARK AS SHOWN.

SEC. 2(F) AS TO "COMMUNITY HOSPITAL OF THE MONTEREY PENINSULA".

FOR MEDICAL SERVICES (U.S. CLS. 100 AND 101). FIRST USE 2-21-2002; IN COMMERCE 2-21-2002.

CLASS 44—(Continued).

SN 78-146,004. FOSTER, HELEN KAY, SAN LORENZO, CA. FILED 7-21-2002.

PETS 'N PLANTS PET & HOUSESITTING



NO CLAIM IS MADE TO THE EXCLUSIVE RIGHT TO USE "PETS AND PLANTS PET & HOUSESETTING", APART FROM THE MARK AS SHOWN.
 THE LINING IS A FEATURE OF THE MARK AND DOES NOT INDICATE COLOR.
 FOR PET SITTING (U.S. CLS. 100 AND 101).
 FIRST USE 11-17-1982; IN COMMERCE 11-17-1982.

SN 78-152,182. FACIAL PLASTIC SURGERY SPECIALISTS - EDINA, EDINA, MN. FILED 8-8-2002.

INDIGO

FOR MEDICAL SERVICES, NAMELY PLASTIC SURGERY AND YOUTHFUL AGING TREATMENTS (U.S. CLS. 100 AND 101).

SN 78-155,076. WITHERELL, JOHN, C., GLEN MILLS, PA. FILED 8-16-2002.

WIZARD OF EYES

NO CLAIM IS MADE TO THE EXCLUSIVE RIGHT TO USE "EYES", APART FROM THE MARK AS SHOWN.
 FOR PROVIDING INFORMATION IN THE FIELD OF EYE HEALTH VIA THE INTERNET (U.S. CLS. 100 AND 101).

SN 78-159,351. COLIN CORPORATION, AICHI-KEN, JAPAN, FILED 8-29-2002.

HEALTHTAINMENT

OWNER OF JAPAN REG. NO. 4663818, DATED 4-18-2003, EXPIRES 4-18-2013.
 FOR PROVIDING MEDICAL INFORMATION; AND RENTAL OF MEDICAL EQUIPMENT (U.S. CLS. 100 AND 101).

CLASS 44—(Continued).

SN 78-188,983. DAYTON AREA HEALTH PLAN, DAYTON, OH. FILED 11-26-2002.

CARESOURCE 24

FOR TELEPHONE HOTLINE COUNSELING NAMELY, OFFERING MEDICAL AND HEALTHCARE ADVICE; AND TELEPHONE INFORMATION SERVICE FEATURING INFORMATION IN THE FIELD OF MEDICAL AND HEALTHCARE ADVICE (U.S. CLS. 100 AND 101).

SN 78-197,371. ROMA, PATRICIA A., HUNTINGTON, WV. AND BUELL, MEGAN R., HUNTINGTON, WV. AND HOSPICE OF HUNTINGTON, INC., HUNTINGTON, WV. FILED 12-23-2002.

HOSPICE, WE LIGHT THE WAY HOME

NO CLAIM IS MADE TO THE EXCLUSIVE RIGHT TO USE "HOSPICE", APART FROM THE MARK AS SHOWN.
 FOR HOSPICE CARE FOR THE TERMINALLY ILL (U.S. CLS. 100 AND 101).
 FIRST USE 2-1-2002; IN COMMERCE 2-1-2002.

SN 78-199,953. MEDICORPS, HONOLULU, HI. FILED 1-3-2003.

MEDICORPS

FOR CHARITABLE SERVICES, NAMELY, PROVIDING MEDICAL SERVICES TO LESS PRIVILEGED COUNTRIES THROUGH THE USE OF TECHNOLOGY AND ADVANCED SKILLS (U.S. CLS. 100 AND 101).

SN 78-200,945. WILLIAMS, KENNETH V., OWEGO, NY. FILED 1-7-2003.

"OUR COMMITMENT TO SERVICE IS WELL ROOTED"

FOR LANDSCAPING AND TREE NURSERY (U.S. CLS. 100 AND 101).

SN 78-208,813. HEALTHY LIFE PUBLICATIONS INC, BEVERLY HILLS, CA. FILED 1-30-2003.

HORMONE DIVA

NO CLAIM IS MADE TO THE EXCLUSIVE RIGHT TO USE "HORMONE", APART FROM THE MARK AS SHOWN.
 FOR MEDICAL COUNSELING SERVICES, NAMELY PROVIDING ADVICE ON MEN'S AND WOMEN'S HEALTH ISSUES (U.S. CLS. 100 AND 101).

CLASS 44—(Continued).

SN 78-210,106. AUSTIN, MARGI, UPLAND, CA. FILED 2-3-2003.

LIVE WELL AT HOME

FOR HOME/COMPANION CARE, PRIMARILY FOR, BUT NOT LIMITED TO THE ELDERLY (U.S. CLS. 100 AND 101).

SN 78-213,507. SMITHKLINE BEECHAM CORPORATION, PHILADELPHIA, PA. FILED 2-11-2003.

CONNECTING WITH US HAS NEVER BEEN EASIER

FOR INFORMATION SERVICES, NAMELY A PASSWORD PROTECTED WEBSITE DIRECTED TOWARD PHYSICIANS AND OTHER HEALTHCARE PROFESSIONALS PROVIDING HEALTHCARE INFORMATION. (U.S. CLS. 100 AND 101).

CLASS 45—PERSONAL SERVICES

SN 76-438,486. NATIONAL EQUIPMENT REGISTER, NEW YORK, NY. FILED 8-7-2002.



NO CLAIM IS MADE TO THE EXCLUSIVE RIGHT TO USE "HEAVY EQUIPMENT LOSS PREVENTION TECHNOLOGY", APART FROM THE MARK AS SHOWN.

FOR SEARCHABLE DATABASE ACCESSIBLE VIA A GLOBAL COMMUNICATION NETWORK THAT CONTAINS A DESCRIPTION OF EQUIPMENT TO ASSIST OWNERS AND LAW ENFORCEMENT, IN THE CASE OF THEFT, TO HASTEN THE POSSIBILITY OF RECOVERY (U.S. CLS. 100 AND 101).

FIRST USE 2-1-2002; IN COMMERCE 2-8-2002.

SN 76-460,656. CHRISTIAN COUNSELING CONCEPTS INCORPORATED, ROANOKE, VA. FILED 10-15-2002.

CHRISTIAN COUNSELING CONCEPTS

NO CLAIM IS MADE TO THE EXCLUSIVE RIGHT TO USE "CHRISTIAN COUNSELING", APART FROM THE MARK AS SHOWN.

FOR COUNSELING SERVICES IN THE FIELD OF CHRISTIAN CONDUCT IN PERSONAL RELATIONSHIPS (U.S. CLS. 100 AND 101).

FIRST USE 3-15-2002; IN COMMERCE 3-15-2002.

CLASS 45—(Continued).

SN 76-471,020. JOHNSON, JOHNNY, TUSTIN, CA. FILED 11-18-2002.



THE STIPPLING IS FOR SHADING PURPOSES ONLY AND DOES NOT INDICATE COLOR.

FOR PROVIDING INFORMATION TO THE PUBLIC REGARDING POOL SAFETY AND DROWNING PREVENTION (U.S. CLS. 100 AND 101).

FIRST USE 10-23-2002; IN COMMERCE 10-23-2002.

SN 76-478,104. EVESTIGATIONS INC., WEST CHESTER, PA. FILED 12-23-2002.

EVESTIGATIONS

FOR PROFESSIONAL THIRD PARTY INVESTIGATIVE SERVICES, NAMELY, INVESTIGATION SERVICES RELATED TO INSURANCE CLAIMS, DETECTIVE INVESTIGATIONS; AND FORENSIC SERVICES (U.S. CLS. 100 AND 101).

FIRST USE 6-15-2000; IN COMMERCE 6-15-2000.

SN 76-487,441. ZANKER, BILL, MILLWOOD, NY. FILED 2-5-2003.

ANNEXMATE

OWNER OF U.S. REG. NO. 1,233,095.
FOR DATING SERVICES (U.S. CLS. 100 AND 101).

SN 78-144,274. VISA U.S.A. INC., FOSTER CITY, CA. FILED 7-16-2002.

E-CRYPTMATICS

FOR FRAUD DETECTION AND PROTECTION SERVICES IN THE FIELD OF ELECTRONIC PAYMENT PROCESSING (U.S. CLS. 100 AND 101).

CLASS 45—(Continued).

SN 78-145,852. COOLSAINTS.COM, L.L.C., OREM, UT. FILED 7-19-2002.

FRIENDLY WITNESS

FOR ONLINE AND COMPUTER DATING SERVICES (U.S. CLS. 100 AND 101).

SN 78-147,155. DJAY SOUND AND LIGHT SHOWS, INC., HASTINGS, MN. FILED 7-24-2002.

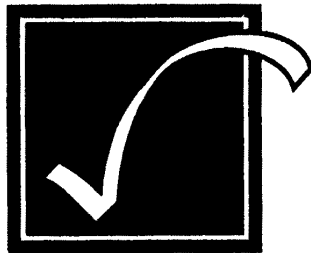

FOR RESERVATION SERVICES, NAMELY, TAKING BUSINESS AND SOCIAL FUNCTION GUEST LIST CONFIRMATION FOR OTHERS (U.S. CLS. 100 AND 101). FIRST USE 6-6-1997; IN COMMERCE 6-6-1997.

SN 78-148,080. COOLSAINTS.COM, L.L.C., OREM, UT. FILED 7-26-2002.

SHARED BLOCK

NO CLAIM IS MADE TO THE EXCLUSIVE RIGHT TO USE "BLOCK", APART FROM THE MARK AS SHOWN.

FOR ONLINE COMPUTER DATING SERVICES, INCLUDING SERVICES THAT PROVIDE USERS WITHIN AN ONLINE DATING COMMUNITY THE ABILITY TO UNILATERALLY AND SELECTIVELY INITIATE A PROHIBITION THAT PREVENTS ANY OTHER USER FROM VIEWING INFORMATION ABOUT OR CONCERNING THE INITIATING USER, AS WELL AS TO ALLOW THE INITIATING USER TO SELECTIVELY DISSEMINATE NOTICE OF THE PROHIBITION TO OTHER USERS FOR COMMUNITY AWARENESS AND SAFETY PURPOSES (U.S. CLS. 100 AND 101).

SN 78-171,589. ROSENTHAL, BENJAMIN, T, SAN FRANCISCO, CA. FILED 10-7-2002.

NICE JEWISH SINGLES

NO CLAIM IS MADE TO THE EXCLUSIVE RIGHT TO USE "JEWISH SINGLES", APART FROM THE MARK AS SHOWN.

FOR DATING SERVICE AND PERSONALS WEB SITE FOR JEWISH INDIVIDUALS (U.S. CLS. 100 AND 101). FIRST USE 0-0-1997; IN COMMERCE 0-0-1997.

CLASS 45—(Continued).

SN 78-203,158. STOCO, REGINA M., ROYAL OAK, MI. FILED 1-14-2003.

4MEN.4WOMEN.FOR DINNER

FOR SOCIAL INTRODUCTION AGENCY SERVICES (U.S. CLS. 100 AND 101). FIRST USE 8-1-2001; IN COMMERCE 8-1-2001.

SN 78-209,689. RECRUITCHECK INCORPORATED, OWENS CROSSROADS, AL. FILED 1-31-2003.



THE MARK CONSISTS OF THE WORDING "RECRUITCHECK" IN BLUE OVER A GRAY CHECKMARK. FOR PRE-EMPLOYMENT BACKGROUND SCREENING SERVICES (U.S. CLS. 100 AND 101). FIRST USE 1-11-2003; IN COMMERCE 1-21-2003.

SN 78-210,123. VIRTUAL SECURITY CORPORATION, WEST PALM BEACH, FL. FILED 2-3-2003.

VIRTUGUARD

FOR PROVIDING GATE AND PREMISE SECURITY MONITORING (U.S. CLS. 100 AND 101).

SN 78-210,133. VIRTUAL SECURITY CORPORATION, WEST PALM BEACH, FL. FILED 2-3-2003.

VIRTUGATE

FOR PROVIDING GATE AND PREMISE SECURITY MONITORING (U.S. CLS. 100 AND 101).

SN 78-218,963. MATCHNET PLC, BEVERLY HILLS, CA. FILED 2-26-2003.

GLIMPSE

FOR DATING AGENCY SERVICES; DATING AGENCY SERVICES PROVIDED VIA AN INTERNET WEB SITE; AND CONSULTATION IN THE FIELD OF DATING SERVICES (U.S. CLS. 100 AND 101).

CLASS 45—(Continued).

SN 78-218,985. MATCHNET PLC, BEVERLY HILLS, CA.
FILED 2-26-2003.

GLIMPSE.COM

FOR DATING AGENCY SERVICES; DATING
AGENCY SERVICES PROVIDED VIA AN INTERNET
WEB SITE; AND CONSULTATION IN THE FIELD OF
DATING SERVICES (U.S. CLS. 100 AND 101).

* * * * *

SECTION 4.—PRIOR UNITED STATES CLASSIFICATION

APPLICATION IN ONE CLASS

COLLECTIVE MEMBERSHIP MARKS

CLASS 200—COLLECTIVE MEMBERSHIP

SN 76-400,227. CHRISTIAN DEER HUNTERS ASSOCIATION, SILVER LAKE, MN. FILED 4-23-2002.

**CHRISTIAN DEER HUNTERS
ASSOCIATION**

NO CLAIM IS MADE TO THE EXCLUSIVE RIGHT TO USE "DEER HUNTERS ASSOCIATION", APART FROM THE MARK AS SHOWN.

SEC. 2(F).

FOR INDICATE MEMBERSHIP IN A RELIGIOUS AND EDUCATION ASSOCIATION OF HUNTERS AND OTHERS SUPPORTIVE OF THE RELIGIOUS EDUCATION OF HUNTERS.

FIRST USE 3-11-1994; IN COMMERCE 3-15-1994.

SN 76-473,879. PIRATES OF THE RUBICON, ORANGEVALE, CA. FILED 12-11-2002.



FOR INDICATE MEMBERSHIP IN A SOCIAL CLUB FOR OFF-ROAD VEHICLES.
FIRST USE 1-1-1995; IN COMMERCE 1-1-1995.

CERTIFICATION MARKS

CLASS A—GOODS

SN 76-278,845. LA FEDERATION DES PRODUCTEURS DE BOVINS DU QUEBEC, LONGUEUIL, QUEBEC, CANADA, FILED 6-28-2001.



Quebec Certified
Grain-fed Veal

PRIORITY CLAIMED UNDER SEC. 44(D) ON CANADA APPLICATION NO. 1,092,851, FILED 2-14-2001, REG. NO. 579529, DATED 4-14-2003, EXPIRES 4-14-2018.

NO CLAIM IS MADE TO THE EXCLUSIVE RIGHT TO USE "QUEBEC CERTIFIED GRAIN-FED VEAL", APART FROM THE MARK AS SHOWN.

THE CERTIFICATION MARK, AS IT IS INTENDED TO BE USED BY PERSONS AUTHORIZED BY THE CERTIFIER, WILL CERTIFY THAT THE QUALITY OF THE GOODS CONFORMS TO THE STANDARDS APPROVED BY THE CERTIFIER AS THE COLOUR OF THE MEAT AND MEETS GRADE A1 OR A2 AS SPECIFIED IN CANADA GRADING REGULATIONS AND THAT THE VEAL COMES FROM CATTLE THAT HAVE BEEN FED GRAIN.
FOR VEAL.

SN 76-471,327. SLEEPKO, INC., LAS VEGAS, NV. FILED 12-2-2002.



NO CLAIM IS MADE TO THE EXCLUSIVE RIGHT TO USE "ORIGINAL" AND "FORMULATED TO HELP YOU SLEEP", APART FROM THE MARK AS SHOWN.

STYLIZED WHITE LETTERS ON A MEDIUM-BLUE FIELD

THE MARK CONSISTS OF STYLIZED WHITE LETTERING ON A MEDIUM-BLUE OF THE LETTERING "THE ORIGINAL SLEEP COOKIES".

THE CERTIFICATION MARK, INTENDED TO BE USED BY AUTHORIZED PERSONS, IS INTENDED TO CERTIFY THAT "THE ORIGINAL SLEEP COOKIES" IS APPLICANT'S BAKED COOKIES MADE WITH INGREDIENTS TO HELP PEOPLE SLEEP.
 FOR BAKED COOKIES MADE WITH INGREDIENTS THAT HELP PEOPLE SLEEP.
 FIRST USE 11-4-2002; IN COMMERCE 11-4-2002.

SN 76-467,313. PHYSICIANS COMMITTEE FOR RESPONSIBLE MEDICINE, INC., WASHINGTON, DC. FILED 11-15-2002.

SN 76-485,459. FEDERATION DES PRODUCTEURS ACERICOLES DU QUEBEC, LONGUEUIL (QUEBEC), CANADA, FILED 1-28-2003.



SIROPRO

THE CERTIFICATION MARK, AS INTENDED TO BE USED BY AUTHORIZED PERSONS, IS INTENDED TO CERTIFY THAT THE GOODS HAVE BEEN CLASSIFIED AND INSPECTED BY THE CLASSIFYING AGENT RECOMMENDED BY FEDERATION DES PRODUCTEURS ACERICOLES DU QUEBEC OR ANY SUCCESSOR IN TITLE THERETO; THAT GOODS CONFORM WITH LAWS AND REGULATIONS SPECIFICALLY REGULATING THEM; AND THAT THE CLARITY, PURITY, COLOUR, DENSITY, CONDUCTIVITY AND FLAVOUR OF THE GOODS, THE PRESENCE OR ABSENCE OF ADDED SUGAR, IODINE, SODIUM, LEAD, ANTIMOLD AGENTS, PROCESSING ADITIVES, CONTAMINANTS, FERMENTATION OR PARAFORMALDEHYDE THEREIN, THE QUALITY OF WATER USED IN MANUFACTURING THE GOODS, AND THE PACKAGING, LABELLING, MANUFACTURING AND PRODUCTION OF THE GOODS ALL CONFORM WITH THE STANDARDS, NORMS AND INSTRUCTIONS SPECIFIED BY FEDERATION DES PRODUCTEURS ACERICOLES DU QUEBEC OR ANY SUCCESSOR IN TITLE THERETO.
 FOR MAPLE SYRUP.

NO CLAIM IS MADE TO THE EXCLUSIVE RIGHT TO USE "HUMANE CHARITY", APART FROM THE MARK AS SHOWN.
 THE CERTIFIED CHARITIES DO NOT FUND OR CONDUCT ANIMAL EXPERIMENTS
 FOR CERTIFYING HEALTH CHARITIES THAT FUND OR CONDUCT MEDICAL AND SCIENTIFIC RESEARCH, OR PROVIDE SERVICES, WITHOUT THE USE OF ANIMALS.
 FIRST USE 10-0-2001; IN COMMERCE 10-0-2001.

SN 76-475,571. SGS SOCIETE GENERALE DE SURVEILLANCE S.A., CH-1201 GENEVE, SWITZERLAND, FILED 12-16-2002.

CLASS B—SERVICES

SN 76-407,553. INTERNATIONAL COMMISSION FOR THE ACCREDITATION OF PROFESSIONAL GENEALOGISTS, DBA ICAPGEN, OREM, UT. FILED 5-14-2002.

AG



APPLICANT'S CERTIFICATION MARK "AG" AS USED BY AUTHORIZED PERSONS, CERTIFIES THAT THE PERSON DISPLAYING SAID MARK HAS COMPLETED TESTS ADMINISTERED BY THE APPLICANT IN A SATISFACTORY MANNER AND IS COMPETENT IN THE FIELDS OF GENEALOGY AND HISTORY RESEARCH
 FOR CERTIFICATION MARK FOR GENEALOGISTS AND HISTORICAL RESEARCHERS.
 FIRST USE 10-0-1966; IN COMMERCE 6-0-1969.

PRIORITY CLAIMED UNDER SEC. 44(D) ON SWITZERLAND APPLICATION NO. 06995/2002, FILED 8-12-2002.
 OWNER OF U.S. REG. NOS. 1,237,780, 2,494,417 AND OTHERS.

THE CERTIFICATION MARK, INTENDED TO BE USED BY AUTHORIZED PERSONS, IS INTENDED TO CERTIFY - THAT THE SERVICES CONFORM WITH THE REQUIREMENTS OF THE INTERNATIONAL STANDARDS ORGANIZATION OR WITH OTHER STANDARDS OR SPECIFICATIONS ISSUED BY PRIVATE AND/OR GOVERNMENTAL ENTITIES.

SN 76-475,878. THE AMERICAN BOARD OF ORTHODONTICS, ST. LOUIS, MO. FILED 12-17-2002.

FOR ADVERTISING, BUSINESS MANAGEMENT, ADVISORY SERVICES FOR BUSINESS MANAGEMENT; BUSINESS ADMINISTRATION; PUBLIC RELATIONS; BUSINESS EXPERTISE, PERSONNEL RECRUITMENT; PERSONNEL RECRUITMENT CONSULTANCY; PROCUREMENT SERVICES OF PRODUCTS AND SERVICES FOR OTHERS (PURCHASING GOODS AND SERVICES FOR OTHERS); OFFICE FUNCTIONS; EMPLOYMENT AGENCIES; FINANCIAL AFFAIRS, INSURANCE; INSURANCE BROKERAGE; REAL ESTATE AFFAIRS; REAL ESTATE AGENCIES; REAL EXPERTISE; APARTMENT HOUSE MANAGEMENT; BUILDING CONSTRUCTION; INSTALLATION, REPAIR AND MAINTENANCE SERVICES; VULCANIZATION SERVICES; DRY CLEANING SERVICES; VEHICLE SERVICE STATIONS; TELECOMMUNICATIONS; COMMUNICATIONS SERVICES BY COMPUTER TERMINALS; TELEPHONE SERVICES; TRANSPORT, DELIVERY OF GOODS DELIVERED OR NON DELIVERED BY MAIL; PARCEL, MAIL DELIVERY SERVICES; PACKAGING AND STORAGE OF GOODS; TRAVEL ARRANGEMENT; TREATMENT OF MATERIALS SERVICES; ORGANIZATION OF COLLECTION OF GOODS; RECYCLING AND DEMOLITION OF GOODS; EDUCATION, ENTERTAINMENT; PROVIDING OF TRAINING; TRANSLATION SERVICES; DRIVING SCHOOLS; SPORTING AND CULTURAL ACTIVITIES; SCHOOLS, NURSERIES; CONTROL OF THE CONFORMITY OF SERVICES AND PRODUCTS PROVIDERS, LEGAL SERVICES; SCIENTIFIC AND INDUSTRIAL RESEARCH; TEMPORARY ACCOMMODATION SERVICES; PROVIDING OF FOOD AND DRINK; RETIREMENT AND CONVALESCENT HOMES; MEDICAL SERVICES; HOSPITAL; THALASSOTHERAPY SERVICES; LANDSCAPE GARDENING SERVICES; AGRICULTURAL, HORTICULTURE AND SYLVICULTURE SERVICES; AERIAL AND SURFACE SPREADING OF FERTILIZERS AND OTHER AGRICULTURAL CHEMICALS; BEAUTY AND HAIRDRESSING SALONS; MANICURING; REST HOMES; MEDICAL, DENTISTRY AND VETERINARY ASSISTANT AND CARE; PERSONAL AND SOCIAL SERVICES SUCH AS CHAPERONING SERVICES AND MIDWIFE SERVICES; MARRIAGE AGENCIES; UNDERTAKING; BODY GUARDS; SECURITY SERVICES.



THE CERTIFICATION MARK, AS USED BY AUTHORIZED PERSONS, CERTIFIES THAT THE MEMBER OF THE CERTIFIER HAS PASSED WRITTEN AND ORAL EXAMINATIONS THAT DEMONSTRATE MASTERY OF ADVANCED LEVELS OF KNOWLEDGE AND SKILL IN THE FIELD OF ORTHODONTICS.

FOR ORTHODONTIC SERVICES.
FIRST USE 12-1-1986; IN COMMERCE 12-1-1986.

* * * * *

TRADEMARK REGISTRATIONS ISSUED

PRINCIPAL REGISTER

SECTION 1.— INTERNATIONAL CLASSIFICATION

The short titles associated below with the international class numbers are terms designed merely for quick identification and are not an official part of the international classification. The full names of international classes are given in section 6.1 of the trademark rules of practice.

The designation "U.S. Cl." appearing in this section refers to the U.S. class in effect prior to Sep. 1, 1973 rather than the international class which applies to applications filed on or after that date. For adoption of international classification see notice in the OFFICIAL GAZETTE of Jun. 26, 1973 (911 O.G. TM 210).

CLASS 1—CHEMICALS

- 2,763,056. **MISCELLANEOUS DESIGN.** BELZONA POLYMERICS LIMITED, MULTIPLE CLASS, (INT. CLS. 1 AND 2), (U.S. CLS. 1, 5, 6, 10, 11, 16, 26 AND 46). SN 75-510,174. PUB. 3-7-2000. FILED 6-29-1998.
- 2,763,066. **ACTIZYME.** ACTIVE ORGANICS, INC., (U.S. CLS. 1, 5, 6, 10, 26 AND 46). SN 75-619,784. PUB. 11-23-1999. FILED 1-11-1999.
- 2,763,131. **AQUAFIL.** AQUAFIL S.P.A., MULTIPLE CLASS, (INT. CLS. 1, 17, 22 AND 23), (U.S. CLS. 1, 2, 5, 6, 7, 10, 12, 13, 19, 22, 26, 35, 42, 43, 46 AND 50). SN 76-011,121. PUB. 6-24-2003. FILED 3-28-2000.
- 2,763,146. **CHROMAX.** CHEMTECH FINISHING SYSTEMS, INC., (U.S. CLS. 1, 5, 6, 10, 26 AND 46). SN 76-046,644. PUB. 7-23-2002. FILED 5-11-2000.
- 2,763,174. **SUPERIOR GRAPHITE CO..** SUPERIOR GRAPHITE COMPANY, MULTIPLE CLASS, (INT. CLS. 1 AND 4), (U.S. CLS. 1, 5, 6, 10, 15, 26 AND 46). SN 76-112,871. PUB. 6-11-2002. FILED 8-21-2000.
- 2,763,193. **75 SENTINEL (STYLIZED).** AEA TECHNOLOGY PLC, (U.S. CLS. 1, 5, 6, 10, 26 AND 46). SN 76-143,273. PUB. 6-24-2003. FILED 10-10-2000.
- 2,763,290. **POTENT-SEA (STYLIZED).** EARTHWORKS NATURAL ORGANIC PRODUCTS, (U.S. CLS. 1, 5, 6, 10, 26 AND 46). SN 76-248,229. PUB. 6-24-2003. FILED 4-26-2001.
- 2,763,317. **OSMOSE.** OSMOSE, INC., MULTIPLE CLASS, (INT. CLS. 1, 2, 3, 5, 6, 9, 17, 19, 35, 37, 40 AND 42), (U.S. CLS. 1, 2, 4, 5, 6, 10, 11, 12, 13, 14, 16, 18, 21, 23, 25, 26, 33, 35, 36, 38, 44, 46, 50, 51, 52, 100, 101, 102, 103 AND 106). SN 76-281,401. PUB. 6-24-2003. FILED 7-6-2001.
- 2,763,330. **SIACE-RNAL.** DHARMACON RESEARCH, INC., (U.S. CLS. 1, 5, 6, 10, 26 AND 46). SN 76-293,048. PUB. 6-24-2003. FILED 7-31-2001.
- 2,763,347. **PATTEX REPAIR EXPRESS AND DESIGN.** HENKEL KGAA, (U.S. CLS. 1, 5, 6, 10, 26 AND 46). SN 76-307,664. PUB. 6-24-2003. FILED 8-30-2001.
- 2,763,348. **PATTEX REPAIR EXTREME AND DESIGN.** HENKEL KGAA, (U.S. CLS. 1, 5, 6, 10, 26 AND 46). SN 76-307,666. PUB. 6-24-2003. FILED 8-30-2001.
- 2,763,379. **MISCELLANEOUS DESIGN.** DRAGOCO GERBERDING & CO. AG, MULTIPLE CLASS, (INT. CLS. 1, 2, 3, 29 AND 30), (U.S. CLS. 1, 4, 5, 6, 10, 11, 16, 26, 46, 50, 51 AND 52). SN 76-326,537. PUB. 6-24-2003. FILED 10-16-2001.
- 2,763,395. **FAIGLE.** FAIGLE KUNSTSTOFFE GESELLSCHAFT M.B.H., MULTIPLE CLASS, (INT. CLS. 1, 7 AND 17), (U.S. CLS. 1, 5, 6, 10, 12, 13, 19, 21, 23, 26, 31, 34, 35, 46 AND 50). SN 76-334,718. PUB. 6-24-2003. FILED 11-6-2001.
- 2,763,398. **ELAMATES.** ELAM-T LIMITED, MULTIPLE CLASS, (INT. CLS. 1, 9 AND 11), (U.S. CLS. 1, 5, 6, 10, 13, 21, 23, 26, 31, 34, 36, 38 AND 46). SN 76-336,020. PUB. 2-18-2003. FILED 11-9-2001.
- 2,763,405. **VINNACOAT.** WACKER POLYMER SYSTEMS GMBH & CO. KG, MULTIPLE CLASS, (INT. CLS. 1, 2, 16 AND 17), (U.S. CLS. 1, 2, 5, 6, 10, 11, 12, 13, 16, 22, 23, 26, 29, 35, 37, 38, 46 AND 50). SN 76-339,688. PUB. 6-24-2003. FILED 11-13-2001.
- 2,763,407. **VIAMERINE.** ALDIVIA S.A., MULTIPLE CLASS, (INT. CLS. 1, 3 AND 5), (U.S. CLS. 1, 4, 5, 6, 10, 18, 26, 44, 46, 50, 51 AND 52). SN 76-341,264. PUB. 6-24-2003. FILED 11-26-2001.
- 2,763,425. **DEPCO INCORPORATED.** DEPCO, INCORPORATED, (U.S. CLS. 1, 5, 6, 10, 26 AND 46). SN 76-345,598. PUB. 6-24-2003. FILED 12-6-2001.
- 2,763,432. **ECOPREP.** ECOTECH, INC., MULTIPLE CLASS, (INT. CLS. 1 AND 4), (U.S. CLS. 1, 5, 6, 10, 15, 26 AND 46). SN 76-347,298. PUB. 10-15-2002. FILED 12-7-2001.
- 2,763,499. **TACKY SPOTS AND DESIGN.** CHICAGO GLUE MACHINE & SUPPLY CO., INC., (U.S. CLS. 1, 5, 6, 10, 26 AND 46). SN 76-376,620. PUB. 6-24-2003. FILED 2-27-2002.
- 2,763,596. **SI 266 (STYLIZED).** DEGUSSA AG, (U.S. CLS. 1, 5, 6, 10, 26 AND 46). SN 76-401,655. PUB. 6-24-2003. FILED 4-29-2002.
- 2,763,597. **X 266-S.** DEGUSSA AG, (U.S. CLS. 1, 5, 6, 10, 26 AND 46). SN 76-401,657. PUB. 6-24-2003. FILED 4-29-2002.
- 2,763,612. **NURTURING FOR LIFE AND DESIGN.** AKZO NOBEL CHEMICALS B.V., (U.S. CLS. 1, 5, 6, 10, 26 AND 46). SN 76-404,539. PUB. 6-24-2003. FILED 4-19-2002.
- 2,763,652. **DONE DEAL ADHESIVES LAB AND DESIGN.** DONE DEAL ADHESIVES LAB., INC., MULTIPLE CLASS, (INT. CLS. 1 AND 17), (U.S. CLS. 1, 5, 6, 10, 12, 13, 26, 35, 46 AND 50). SN 76-409,614. PUB. 6-24-2003. FILED 5-16-2002.
- 2,763,750. **ENGAGE.** DUPONT DOW ELASTOMERS LLC, (U.S. CLS. 1, 5, 6, 10, 26 AND 46). SN 76-425,476. PUB. 6-24-2003. FILED 6-25-2002.
- 2,763,816. **EMERALD.** FUJI HUNT PHOTOGRAPHIC CHEMICALS, INC., (U.S. CLS. 1, 5, 6, 10, 26 AND 46). SN 76-436,467. PUB. 6-24-2003. FILED 7-30-2002.
- 2,763,857. **MAJESTIC.** DAVISON OIL COMPANY, INC., MULTIPLE CLASS, (INT. CLS. 1 AND 4), (U.S. CLS. 1, 5, 6, 10, 15, 26 AND 46). SN 76-444,311. PUB. 6-24-2003. FILED 8-23-2002.
- 2,763,938. **USC (STYLIZED).** MAKINO INC., (U.S. CLS. 1, 5, 6, 10, 26 AND 46). SN 76-457,643. PUB. 6-24-2003. FILED 10-11-2002.
- 2,763,970. **PALMER.** PALMER INTERNATIONAL, INC. (U.S. CLS. 1, 5, 6, 10, 26 AND 46). SN 76-461,686. PUB. 6-24-2003. FILED 10-25-2002.
- 2,764,057. **NAXALLOY.** POLYMERIC RESOURCES CORPORATION, (U.S. CLS. 1, 5, 6, 10, 26 AND 46). SN 76-472,927. PUB. 6-24-2003. FILED 11-25-2002.
- 2,764,093. **HILLEX.** SOLOHILL ENGINEERING, INC., (U.S. CLS. 1, 5, 6, 10, 26 AND 46). SN 76-484,426. PUB. 6-24-2003. FILED 1-21-2003.
- 2,764,096. **JUNGLE AND DESIGN.** JUNGLE LABORATORIES CORPORATION, (U.S. CLS. 1, 5, 6, 10, 26 AND 46). SN 76-485,676. PUB. 6-24-2003. FILED 1-24-2003.
- 2,764,100. **SPLASH.** B. BROS. PACKAGING, INC., (U.S. CLS. 1, 5, 6, 10, 26 AND 46). SN 76-486,133. PUB. 6-24-2003. FILED 1-27-2003.
- 2,764,101. **SPLASH AND DESIGN.** B. BROS. PACKAGING, INC., (U.S. CLS. 1, 5, 6, 10, 26 AND 46). SN 76-486,134. PUB. 6-24-2003. FILED 1-27-2003.
- 2,764,102. **BEIJING 2008.** COMITE INTERNATIONAL OLYMPIQUE, MULTIPLE CLASS, (INT. CLS. 1, 3, 4, 5, 6, 9, 12, 14, 16, 18, 20, 21, 25, 26, 28, 29, 30, 32, 35, 36, 38, 39 AND 42), (U.S. CLS. 1, 2, 3, 4, 5, 6, 10, 12, 13, 14, 15, 18, 19, 21, 22, 23, 25, 26, 27, 28, 29, 30, 31, 32, 33, 35, 36, 37, 38, 39, 40, 41, 42, 44, 45, 46, 48, 50, 51, 52, 100, 101, 102, 104 AND 105). SN 76-975,105.

PUB. 6-24-2003. FILED 9-19-2000.
 2,764,138. **LURGI EUROFUEL**. LURGI AG, MULTIPLE CLASS, (INT. CLS. 1, 4, 11, 37 AND 42), (U.S. CLS. 1, 5, 6, 10, 13, 15, 21, 23, 26, 31, 34, 46, 100, 101, 103 AND 106). SN 78-081,160. PUB. 6-24-2003. FILED 8-26-2001.
 2,764,266. **MOISTURE MIZER AND DESIGN**. CRUMLEY, JONATHAN, (U.S. CLS. 1, 5, 6, 10, 26 AND 46). SN 78-146,835. PUB. 6-24-2003. FILED 7-23-2002.
 2,764,287. **PROVEN WINNERS PW**. PROVEN WINNERS NORTH AMERICA, L.L.C., (U.S. CLS. 1, 5, 6, 10, 26 AND 46). SN 78-155,699. PUB. 6-24-2003. FILED 8-19-2002.
 2,764,436. **AQUASOMES**. INTERNATIONAL FLORA TECHNOLOGIES, LTD., (U.S. CLS. 1, 5, 6, 10, 26 AND 46). SN 78-185,832. PUB. 6-24-2003. FILED 11-16-2002.

CLASS 2—PAINTS

2,763,056 (*See Class 1 for this trademark*).
 2,763,276. **MIKE AND DESIGN**. MICHELANGELO POMPEY PTY LIMITED, (U.S. CLS. 6, 11 AND 16). SN 76-228,444. PUB. 6-24-2003. FILED 3-21-2001.
 2,763,317 (*See Class 1 for this trademark*).
 2,763,379 (*See Class 1 for this trademark*).
 2,763,405 (*See Class 1 for this trademark*).
 2,763,530. **EZ-PRIME**. DUNN-EDWARDS CORPORATION, (U.S. CLS. 6, 11 AND 16). SN 76-387,958. PUB. 6-24-2003. FILED 3-28-2002.
 2,763,643. **OAM ORIGINAL AFTERMARKET MANUFACTURER AND DESIGN**. E. ALKO INC., (U.S. CLS. 6, 11 AND 16). SN 76-408,477. PUB. 6-24-2003. FILED 5-15-2002.
 2,763,733. **HEALTHY MILK PAINT**. ANTIQUE DRAPERY ROD COMPANY, (U.S. CLS. 6, 11 AND 16). SN 76-421,944. PUB. 6-24-2003. FILED 6-17-2002.
 2,763,810. **GAS-GUARD UHB TR-53**. AMERICAN POLYMERS INC., (U.S. CLS. 6, 11 AND 16). SN 76-435,040. PUB. 6-24-2003. FILED 7-29-2002.
 2,763,819. **STYROTHANE**. FUTURA COATINGS, INC., (U.S. CLS. 6, 11 AND 16). SN 76-438,054. PUB. 6-24-2003. FILED 8-5-2002.
 2,763,878. **LEX ADVANCED PAINT SEALANT PRODUCTS AND DESIGN**. LEX INTERNATIONAL, INC., (U.S. CLS. 6, 11 AND 16). SN 76-449,934. PUB. 6-24-2003. FILED 9-16-2002.
 2,763,977. **RAPID**. C.P. PAINTS, INC., (U.S. CLS. 6, 11 AND 16). SN 76-463,233. PUB. 6-24-2003. FILED 10-31-2002.
 2,764,006. **INTERNATIONAL PRODUCTS**. INTERNATIONAL CHEMICAL COMPANY, MULTIPLE CLASS, (INT. CLS. 2, 3 AND 4), (U.S. CLS. 1, 4, 6, 11, 15, 16, 50, 51 AND 52). SN 76-467,392. PUB. 6-24-2003. FILED 11-15-2002.
 2,764,106. **MONOPUR**. RPM/BELGIUM, NAAMLOZE VENNOOTSCHAP, MULTIPLE CLASS, (INT. CLS. 2, 19 AND 27), (U.S. CLS. 1, 6, 11, 12, 16, 19, 20, 33, 37, 42 AND 50). SN 76-975,835. PUB. 10-22-2002. FILED 5-22-2000.

CLASS 3—COSMETICS AND CLEANING PREPARATIONS

2,763,043. **SPA THERAPIES**. COSMYL, INC., (U.S. CLS. 1, 4, 6, 50, 51 AND 52). SN 75-400,049. PUB. 6-24-2003. FILED 12-4-1997.
 2,763,044. **ORICA**. ORICA AUSTRALIA PTY LTD, BY CHANGE OF NAME ICI AUSTRALIA OPERATIONS PROPRIETARY LIMITED, (U.S. CLS. 1, 4, 6, 50, 51 AND 52). SN 75-423,218. PUB. 10-2-2001. FILED 1-23-1998.
 2,763,054. **ORICA AND DESIGN**. ORICA AUSTRALIA PTY LTD, (U.S. CLS. 1, 4, 6, 50, 51 AND 52). SN 75-505,628. PUB. 9-4-2001. FILED 6-19-1998.
 2,763,064. **FISHBONE AND DESIGN**. NEW YORKER S.H.K. JEANS, GMBH, MULTIPLE CLASS, (INT. CLS. 3, 9, 14, 18, 25, 28 AND 32), (U.S. CLS. 1, 2, 3, 4, 6, 21, 22, 23, 26, 27, 28, 36, 38, 39, 41, 45, 46, 48, 50, 51 AND 52). SN 75-585,380. PUB. 6-24-2003. FILED 11-9-1998.
 2,763,123. **ANCIENT FUTURE**. ALCYONE LIMITED, MULTIPLE CLASS, (INT. CLS. 3, 5, 9, 16 AND 42), (U.S. CLS. 1, 2, 4,

5, 6, 18, 21, 22, 23, 26, 29, 36, 37, 38, 44, 46, 50, 51, 52, 100 AND 101). SN 75-981,724. PUB. 6-24-2003. FILED 5-25-1999.
 2,763,126. **PINGU. JOKER, INC., BY ASSIGNMENT EDITOY AG**, MULTIPLE CLASS, (INT. CLS. 3, 4, 5, 6, 8, 9, 11, 12, 14, 15, 16, 20, 21, 22, 24, 26, 27, 29, 30, 31, 32, 35, 36, 38, 39, 41 AND 42), (U.S. CLS. 1, 2, 4, 5, 6, 7, 12, 13, 14, 15, 18, 19, 20, 21, 22, 23, 25, 26, 27, 28, 29, 30, 31, 32, 33, 34, 35, 36, 37, 38, 39, 40, 42, 44, 45, 46, 48, 50, 51, 52, 100, 101, 102, 104, 105 AND 107). SN 75-983,115. PUB. 12-26-1995. FILED 9-13-1993.
 2,763,158. **THE TOOLS AND DESIGN**. BOGARD, (U.S. CLS. 1, 4, 6, 50, 51 AND 52). SN 76-075,959. PUB. 6-24-2003. FILED 6-23-2000.
 2,763,163. **ADONIS SIMPLY THE BEST FOR MEN AND DESIGN**. JACKSON INTERNATIONAL TRADING COMPANY KURT D. BRUHL GESELLSCHAFT MBH & CO., MULTIPLE CLASS, (INT. CLS. 3, 18 AND 25), (U.S. CLS. 1, 2, 3, 4, 6, 22, 39, 41, 50, 51 AND 52). SN 76-087,439. PUB. 6-24-2003. FILED 7-12-2000.
 2,763,200. **M' LIS**. M' LIS COMPANY, INC., THE, MULTIPLE CLASS, (INT. CLS. 3 AND 5), (U.S. CLS. 1, 4, 6, 18, 44, 46, 50, 51 AND 52). SN 76-157,144. PUB. 6-24-2003. FILED 10-31-2000.
 2,763,204. **BRISK**. STEARNS PACKAGING CORPORATION, (U.S. CLS. 1, 4, 6, 50, 51 AND 52). SN 76-161,667. PUB. 6-24-2003. FILED 11-8-2000.
 2,763,224. **M'LIS (STYLIZED)**. M'LIS COMPANY, INC., THE, MULTIPLE CLASS, (INT. CLS. 3 AND 5), (U.S. CLS. 1, 4, 6, 18, 44, 46, 50, 51 AND 52). SN 76-180,419. PUB. 6-24-2003. FILED 12-13-2000.
 2,763,232. **MISCELLANEOUS DESIGN**. NEW YORKER KERESKEDELMI KFT., MULTIPLE CLASS, (INT. CLS. 3, 9, 14, 16, 18, 25, 28, 32, 33 AND 42), (U.S. CLS. 1, 2, 3, 4, 5, 6, 21, 22, 23, 26, 27, 28, 29, 36, 37, 38, 39, 41, 45, 46, 47, 48, 49, 50, 51, 52, 100 AND 101). SN 76-184,996. PUB. 5-7-2002. FILED 12-21-2000.
 2,763,243. **DESIGNS FOR THE FACE**. GA MODEFINE S.A., (U.S. CLS. 1, 4, 6, 50, 51 AND 52). SN 76-195,120. PUB. 6-11-2002. FILED 1-16-2001.
 2,763,247. **VENICE BEACH AND DESIGN**. HALEKO HANSEATISCHES LEBENSMITTELKONTOR GMBH, MULTIPLE CLASS, (INT. CLS. 3, 14, 18, 24, 25 AND 28), (U.S. CLS. 1, 2, 3, 4, 6, 22, 23, 27, 28, 38, 39, 41, 42, 50, 51 AND 52). SN 76-202,276. PUB. 2-11-2003. FILED 1-30-2001.
 2,763,282. **CUSTO**. ANGEL-CUSTODIO DALMAU SALMONS, (U.S. CLS. 1, 4, 6, 50, 51 AND 52). SN 76-237,371. PUB. 7-30-2002. FILED 4-9-2001.
 2,763,287. **BAD HAIR DAY**. JUDY WELLS INC., (U.S. CLS. 1, 4, 6, 50, 51 AND 52). SN 76-244,214. PUB. 2-11-2003. FILED 4-23-2001.
 2,763,317 (*See Class 1 for this trademark*).
 2,763,329. **ART A FACE**. ART A FACE COSMETICS LIMITED, (U.S. CLS. 1, 4, 6, 50, 51 AND 52). SN 76-290,161. PUB. 6-24-2003. FILED 7-25-2001.
 2,763,345. **STARRY NIGHT**. KONINKLIJKE SANDERS B.V., (U.S. CLS. 1, 4, 6, 50, 51 AND 52). SN 76-307,125. PUB. 6-24-2003. FILED 8-29-2001.
 2,763,379 (*See Class 1 for this trademark*).
 2,763,407 (*See Class 1 for this trademark*).
 2,763,459. **SANI-SHINE**. CELESTE INDUSTRIES CORP., (U.S. CLS. 1, 4, 6, 50, 51 AND 52). SN 76-357,262. PUB. 6-24-2003. FILED 1-10-2002.
 2,763,477. **MINTPERFEKT**. ZIAJA LTD. ZAKLAD PRODUKCJI LEKOW SPOLKA Z O.O., MULTIPLE CLASS, (INT. CLS. 3 AND 5), (U.S. CLS. 1, 4, 6, 18, 44, 46, 50, 51 AND 52). SN 76-365,604. PUB. 6-24-2003. FILED 2-1-2002.
 2,763,487. **MISCELLANEOUS DESIGN**. LENTHERIC LIMITED, (U.S. CLS. 1, 4, 6, 50, 51 AND 52). SN 76-372,086. PUB. 11-19-2002. FILED 2-19-2002.
 2,763,497. **VOLUM FITNESS**. L'OREAL, (U.S. CLS. 1, 4, 6, 50, 51 AND 52). SN 76-376,473. PUB. 6-24-2003. FILED 2-28-2002.
 2,763,502. **MISCELLANEOUS DESIGN**. BROUGHTON FARM SUPPLY, INC., (U.S. CLS. 1, 4, 6, 50, 51 AND 52). SN 76-378,691. PUB. 6-24-2003. FILED 3-7-2002.
 2,763,527. **BRING IT UP**. BRING IT UP, INC., (U.S. CLS. 1, 4, 6, 50, 51 AND 52). SN 76-387,072. PUB. 6-24-2003. FILED 3-26-2002.
 2,763,529. **ANNAYAKE NATSUMI AND DESIGN**. ANNAYAKE, (U.S. CLS. 1, 4, 6, 50, 51 AND 52). SN 76-

387,838. PUB. 6-24-2003. FILED 3-25-2002.

2,763,547. **MISCELLANEOUS DESIGN**. EB5 CORPORATION, (U.S. CLS. 1, 4, 6, 50, 51 AND 52). SN 76-391,612. PUB. 6-24-2003. FILED 4-4-2002.

2,763,571. **HOME PEEL**. LA ROCHE-POSAY LABORATOIRE PHARMACEUTIQUE, MULTIPLE CLASS, (INT. CLS. 3 AND 5), (U.S. CLS. 1, 4, 6, 18, 44, 46, 50, 51 AND 52). SN 76-397,245. PUB. 6-24-2003. FILED 4-18-2002.

2,763,586. **STAIN REMOVER AND DESIGN**. TECH ENTERPRISES INC., (U.S. CLS. 1, 4, 6, 50, 51 AND 52). SN 76-399,603. PUB. 6-24-2003. FILED 4-22-2002.

2,763,593. **URBAN BOTANICA**. URBAN BOTANICA, INC., (U.S. CLS. 1, 4, 6, 50, 51 AND 52). SN 76-401,123. PUB. 6-24-2003. FILED 5-1-2002.

2,763,604. **THE BIZ 4 FRIZZ**. GUM HAIR COMPANY LIMITED, (U.S. CLS. 1, 4, 6, 50, 51 AND 52). SN 76-402,971. PUB. 6-24-2003. FILED 5-2-2002.

2,763,654. **SKIN AN APOTHECARY AND DESIGN**. SKIN AN APOTHECARY, INC., MULTIPLE CLASS, (INT. CLS. 3 AND 35), (U.S. CLS. 1, 4, 6, 50, 51, 52, 100, 101 AND 102). SN 76-409,656. PUB. 6-24-2003. FILED 5-17-2002.

2,763,658. **CELUTONE (STYLIZED)**. TROPICAL FOREST COSMETICS, (U.S. CLS. 1, 4, 6, 50, 51 AND 52). SN 76-409,776. PUB. 6-24-2003. FILED 5-17-2002.

2,763,688. **SPUN GOLD**. KAO KABUSHIKI KAISHA, TA KAO CORPORATION, BY ASSIGNMENT JOHN FRIEDA PROFESSIONAL HAIR CARE, INC., (U.S. CLS. 1, 4, 6, 50, 51 AND 52). SN 76-415,826. PUB. 6-24-2003. FILED 6-4-2002.

2,763,697. **CUBBIE CARE AND DESIGN**. LEMAX, (U.S. CLS. 1, 4, 6, 50, 51 AND 52). SN 76-417,379. PUB. 6-24-2003. FILED 6-3-2002.

2,763,765. **PHYTOBAUME**. CASTER, (U.S. CLS. 1, 4, 6, 50, 51 AND 52). SN 76-428,389. PUB. 6-24-2003. FILED 7-9-2002.

2,763,766. **PHYTOSesame**. CASTER, (U.S. CLS. 1, 4, 6, 50, 51 AND 52). SN 76-428,390. PUB. 6-24-2003. FILED 7-9-2002.

2,763,800. **MENBOOST**. LABORATOIRE GARNIER & CIE, (U.S. CLS. 1, 4, 6, 50, 51 AND 52). SN 76-433,799. PUB. 6-24-2003. FILED 7-24-2002.

2,763,848. **MENCOCOON**. LABORATOIRE GARNIER & CIE, (U.S. CLS. 1, 4, 6, 50, 51 AND 52). SN 76-443,157. PUB. 6-24-2003. FILED 8-23-2002.

2,763,875. **INSTA-LIFT MASQUE**. LANCOME PARFUMS ET BEAUTE & CIE, (U.S. CLS. 1, 4, 6, 50, 51 AND 52). SN 76-448,821. PUB. 6-24-2003. FILED 9-12-2002.

2,763,936. **LIGAID**. HERBACEUTICALS, INC., (U.S. CLS. 1, 4, 6, 50, 51 AND 52). SN 76-457,254. PUB. 6-24-2003. FILED 10-10-2002.

2,764,006 (*See Class 2 for this trademark*).

2,764,013. **SHAMPOO ONE**. JOHN PAUL MITCHELL SYSTEMS, (U.S. CLS. 1, 4, 6, 50, 51 AND 52). SN 76-468,014. PUB. 6-24-2003. FILED 11-12-2002.

2,764,043. **PROLIFERA**. THE F.A.C.E. COMPANY, L.L.C., (U.S. CLS. 1, 4, 6, 50, 51 AND 52). SN 76-471,944. PUB. 6-24-2003. FILED 11-26-2002.

2,764,102 (*See Class 1 for this trademark*).

2,764,175. **JET-DRY**. RECKITT BENCKISER N.V., (U.S. CLS. 1, 4, 6, 50, 51 AND 52). SN 78-105,145. PUB. 6-24-2003. FILED 1-28-2002.

2,764,208. **PRO 2000**. VAN CAO, (U.S. CLS. 1, 4, 6, 50, 51 AND 52). SN 78-123,162. PUB. 6-24-2003. FILED 4-22-2002.

2,764,244. **DIMEOLA**. DIMEOLA & COMPANY, INC., (U.S. CLS. 1, 4, 6, 50, 51 AND 52). SN 78-136,585. PUB. 6-24-2003. FILED 6-18-2002.

2,764,261. **SUNGLASSES FOR THE SKIN**. MERCK KGAA, (U.S. CLS. 1, 4, 6, 50, 51 AND 52). SN 78-143,998. PUB. 6-24-2003. FILED 7-15-2002.

2,764,275. **TAUNT**. GADZOOKS, INC., (U.S. CLS. 1, 4, 6, 50, 51 AND 52). SN 78-151,774. PUB. 6-24-2003. FILED 8-7-2002.

2,764,395. **COVER ALL**. SUPERIOR PRODUCTS CO., INC., (U.S. CLS. 1, 4, 6, 50, 51 AND 52). SN 78-180,705. PUB. 6-24-2003. FILED 10-31-2002.

2,764,415. **SMART WHITE**. HUNTZINGER, THOMAS E., (U.S. CLS. 1, 4, 6, 50, 51 AND 52). SN 78-184,394. PUB. 6-24-2003. FILED 11-12-2002.

2,764,427. **MICRIN SMOKE-OUT**. GARCEAU, ARTHUR H., (U.S. CLS. 1, 4, 6, 50, 51 AND 52). SN 78-185,359. PUB. 6-24-2003. FILED 11-15-2002.

2,764,429. **FORCEOUT**. ADVENTUS PRODUCT MARKET-

ING, LLC, (U.S. CLS. 1, 4, 6, 50, 51 AND 52). SN 78-185,610. PUB. 6-24-2003. FILED 11-15-2002.

CLASS 4—LUBRICANTS AND FUELS

2,763,073. **BERNARDAUD**. BERNARDAUD PORCELAINES DE LIMOGES, S.A., MULTIPLE CLASS, (INT. CLS. 4 AND 21), (U.S. CLS. 1, 2, 6, 13, 15, 23, 29, 30, 33, 40 AND 50). SN 75-701,762. PUB. 6-24-2003. FILED 5-10-1999.

2,763,122. **WHOLE FOODS AND DESIGN AND DESIGN**. WHOLE FOODS MARKET IP, INC., BY ASSIGNMENT WHOLE FOODS MARKET SERVICES, INC., (U.S. CLS. 1, 6 AND 15). SN 75-981,702. PUB. 6-24-2003. FILED 1-8-1999.

2,763,126 (*See Class 3 for this trademark*).

2,763,139. **CDX**. CASTROL LIMITED, (U.S. CLS. 1, 6 AND 15). SN 76-036,931. PUB. 6-24-2003. FILED 4-28-2000.

2,763,174 (*See Class 1 for this trademark*).

2,763,401. **NYCOLUBE**. NYCO SA, (U.S. CLS. 1, 6 AND 15). SN 76-337,026. PUB. 6-24-2003. FILED 11-13-2001.

2,763,432 (*See Class 1 for this trademark*).

2,763,514. **JAX DRY-GLIDE**. PRESSURE-LUBE, INC., (U.S. CLS. 1, 6 AND 15). SN 76-382,304. PUB. 6-24-2003. FILED 3-12-2002.

2,763,857 (*See Class 1 for this trademark*).

2,764,006 (*See Class 2 for this trademark*).

2,764,008. **DEVON (STYLIZED)**. DEVON ENERGY CORPORATION, (U.S. CLS. 1, 6 AND 15). SN 76-467,530. PUB. 6-24-2003. FILED 11-18-2002.

2,764,014. **MISTRAL**. MISTRAL LLC, (U.S. CLS. 1, 6 AND 15). SN 76-468,281. PUB. 6-24-2003. FILED 11-12-2002.

2,764,077. **LIBERTY STAR CANDLES**. BRIAR PATCH PRIMITIVES, INC., (U.S. CLS. 1, 6 AND 15). SN 76-474,472. PUB. 6-24-2003. FILED 12-6-2002.

2,764,088. **NUT SAUCE**. BIG BENDS, LLC, (U.S. CLS. 1, 6 AND 15). SN 76-478,749. PUB. 6-24-2003. FILED 12-24-2002.

2,764,102 (*See Class 1 for this trademark*).

2,764,138 (*See Class 1 for this trademark*).

2,764,298. **LUBRITECH**. FUCHS LUBRITECH GMBH, (U.S. CLS. 1, 6 AND 15). SN 78-158,708. PUB. 6-24-2003. FILED 8-28-2002.

CLASS 5—PHARMACEUTICALS

2,763,047. **NACALIN**. AVENTIS PHARMA HOLDING GMBH, BY CHANGE OF NAME; BY CHANGE OF NAME HOECHST MARION ROUSSEL AG, (U.S. CLS. 6, 18, 44, 46, 51 AND 52). SN 75-448,015. PUB. 6-24-2003. FILED 3-11-1998.

2,763,052. **MICRO-GARD (STYLIZED)**. FUEL QUALITY SERVICES, INC., (U.S. CLS. 6, 18, 44, 46, 51 AND 52). SN 75-494,472. PUB. 6-24-2003. FILED 6-1-1998.

2,763,079. **ACTIVATE**. MARKET ONE, INC., (U.S. CLS. 6, 18, 44, 46, 51 AND 52). SN 75-756,158. PUB. 6-24-2003. FILED 7-22-1999.

2,763,100. **CERVITAL**. GRAMINEX L.L.C., BY ASSIGNMENT AB CERNELLE COMPANY, (U.S. CLS. 6, 18, 44, 46, 51 AND 52). SN 75-857,801. PUB. 6-24-2003. FILED 11-26-1999.

2,763,123 (*See Class 3 for this trademark*).

2,763,126 (*See Class 3 for this trademark*).

2,763,129. **PATISSERIE PRESTIGE AND DESIGN**. TEEUWEN, GERARDUS LEONARDUS MATHIEU, MULTIPLE CLASS, (INT. CLS. 5, 29 AND 30), (U.S. CLS. 6, 18, 44, 46, 51 AND 52). SN 76-009,723. PUB. 8-27-2002. FILED 3-27-2000.

2,763,159. **ICE MINT**. VI-JON LABORATORIES, INC., DBA VI-JON, INC., (U.S. CLS. 6, 18, 44, 46, 51 AND 52). SN 76-077,641. PUB. 6-24-2003. FILED 6-22-2000.

2,763,200 (*See Class 3 for this trademark*).

2,763,206. **LARY PHARY**. PANZER, DANIEL, (U.S. CLS. 6, 18, 44, 46, 51 AND 52). SN 76-165,359. PUB. 12-10-2002. FILED 11-14-2000.

2,763,219. **HEAL WITH NATURE**. HEAL WITH NATURE, INC., (U.S. CLS. 6, 18, 44, 46, 51 AND 52). SN 76-178,226. PUB. 6-24-2003. FILED 12-11-2000.

- 2,763,224 (*See Class 3 for this trademark*).
- 2,763,241. **PERIOSCREEN**. ESPE DENTAL AG, MULTIPLE CLASS, (INT. CLS. 5 AND 10), (U.S. CLS. 6, 18, 26, 39, 44, 46, 51 AND 52). SN 76-194,901. PUB. 6-3-2003. FILED 1-16-2001.
- 2,763,277. **BETA AND DESIGN**. BETA PHARMA, INC., (U.S. CLS. 6, 18, 44, 46, 51 AND 52). SN 76-228,863. PUB. 6-24-2003. FILED 3-22-2001.
- 2,763,278. **HANDIHALER**. BOEHRINGER INGELHEIM PHARMA KG, MULTIPLE CLASS, (INT. CLS. 5 AND 10), (U.S. CLS. 6, 18, 26, 39, 44, 46, 51 AND 52). SN 76-231,932. PUB. 6-24-2003. FILED 3-28-2001.
- 2,763,317 (*See Class 1 for this trademark*).
- 2,763,339. **BIO PROGESTRONE CREAM AND DESIGN**. CHUNG, YUN SOO, (U.S. CLS. 6, 18, 44, 46, 51 AND 52). SN 76-301,513. PUB. 6-24-2003. FILED 8-20-2001.
- 2,763,407 (*See Class 1 for this trademark*).
- 2,763,421. **ALTA NATURAL**. ALTA NATURAL HERBS & SUPPLEMENTS LTD., (U.S. CLS. 6, 18, 44, 46, 51 AND 52). SN 76-344,976. PUB. 6-24-2003. FILED 12-5-2001.
- 2,763,443. **TILLOTT'S**. TILLOTT'S PHARMA AG, MULTIPLE CLASS, (INT. CLS. 5 AND 42), (U.S. CLS. 6, 18, 44, 46, 51, 52, 100 AND 101). SN 76-351,904. PUB. 6-24-2003. FILED 12-21-2001.
- 2,763,448. **CERIMA**. ASTRAZENECA AB, (U.S. CLS. 6, 18, 44, 46, 51 AND 52). SN 76-353,169. PUB. 1-21-2003. FILED 12-21-2001.
- 2,763,473. **DIATECT**. DIATECT INTERNATIONAL CORPORATION, (U.S. CLS. 6, 18, 44, 46, 51 AND 52). SN 76-363,469. PUB. 6-24-2003. FILED 1-11-2002.
- 2,763,477 (*See Class 3 for this trademark*).
- 2,763,478. **DOCTOR'S CORNER**. SMITH, JOSEPH, (U.S. CLS. 6, 18, 44, 46, 51 AND 52). SN 76-366,118. PUB. 6-24-2003. FILED 2-4-2002.
- 2,763,480. **WAI YUEN TONG**. WAI YUEN TONG MEDICINE COMPANY LIMITED, (U.S. CLS. 6, 18, 44, 46, 51 AND 52). SN 76-366,519. PUB. 6-24-2003. FILED 2-5-2002.
- 2,763,512. **BIOPLEX**. ALLTECH, INC., MULTIPLE CLASS, (INT. CLS. 5 AND 31), (U.S. CLS. 1, 6, 18, 44, 46, 51 AND 52). SN 76-381,236. PUB. 11-5-2002. FILED 3-12-2002.
- 2,763,522. **DR. RATH'S SPORT FORMULA**. RATH, MATTHIAS, MULTIPLE CLASS, (INT. CLS. 5, 30 AND 32), (U.S. CLS. 6, 18, 44, 45, 46, 48, 51 AND 52). SN 76-384,756. PUB. 6-24-2003. FILED 3-20-2002.
- 2,763,571 (*See Class 3 for this trademark*).
- 2,763,577. **MISCELLANEOUS DESIGN**. SHEFRIN, DAVID K., (U.S. CLS. 6, 18, 44, 46, 51 AND 52). SN 76-398,794. PUB. 6-24-2003. FILED 4-19-2002.
- 2,763,616. **CHRYSMORI**. HERBA ENTERPRISE, INC., MULTIPLE CLASS, (INT. CLS. 5 AND 30), (U.S. CLS. 6, 18, 44, 46, 51 AND 52). SN 76-405,067. PUB. 6-24-2003. FILED 5-8-2002.
- 2,763,682. **ALLO SOURCE AND DESIGN**. ALLOSOURCE, (U.S. CLS. 6, 18, 44, 46, 51 AND 52). SN 76-414,438. PUB. 6-24-2003. FILED 5-28-2002.
- 2,763,725. **THERION BIOLOGICS**. THERION BIOLOGICS CORPORATION, MULTIPLE CLASS, (INT. CLS. 5 AND 42), (U.S. CLS. 6, 18, 44, 46, 51, 52, 100 AND 101). SN 76-420,341. PUB. 6-24-2003. FILED 6-7-2002.
- 2,763,729. **R AND DESIGN**. THE NUTRACEUTICAL MEDICINE COMPANY INC., (U.S. CLS. 6, 18, 44, 46, 51 AND 52). SN 76-420,769. PUB. 6-24-2003. FILED 6-13-2002.
- 2,763,763. **DBM100**. GENSCI ORTHOBIOLOGICS, INC., MULTIPLE CLASS, (INT. CLS. 5 AND 10), (U.S. CLS. 6, 18, 26, 39, 44, 46, 51 AND 52). SN 76-427,765. PUB. 6-24-2003. FILED 7-5-2002.
- 2,763,764. **M AND DESIGN**. MERRICK'S, INC., (U.S. CLS. 6, 18, 44, 46, 51 AND 52). SN 76-428,228. PUB. 6-24-2003. FILED 7-5-2002.
- 2,763,794. **NATURE'S PROTECTION**. RICOLA AG, MULTIPLE CLASS, (INT. CLS. 5 AND 30), (U.S. CLS. 6, 18, 44, 46, 51 AND 52). SN 76-432,915. PUB. 6-24-2003. FILED 7-2-2002.
- 2,763,796. **FRONTLINE PLUS**. MERIAL, (U.S. CLS. 6, 18, 44, 46, 51 AND 52). SN 76-433,119. PUB. 6-24-2003. FILED 7-19-2002.
- 2,763,833. **MOIST**. PIPE DREAM PRODUCTS, INC., (U.S. CLS. 6, 18, 44, 46, 51 AND 52). SN 76-439,933. PUB. 6-24-2003. FILED 8-12-2002.
- 2,763,844. **OCUFRESH**. OPTICS LABORATORY, INC., (U.S. CLS. 6, 18, 44, 46, 51 AND 52). SN 76-441,789. PUB. 6-24-2003. FILED 8-12-2002.
- 2,763,849. **BOBSON (STYLIZED)**. E. JAANG CORPORATION, (U.S. CLS. 6, 18, 44, 46, 51 AND 52). SN 76-443,200. PUB. 6-24-2003. FILED 8-23-2002.
- 2,763,908. **NOVODOR**. NOVOZYMES A/S, (U.S. CLS. 6, 18, 44, 46, 51 AND 52). SN 76-454,462. PUB. 6-24-2003. FILED 9-25-2002.
- 2,763,912. **PULZIUM**. SOLVAY PHARMACEUTICALS B.V., (U.S. CLS. 6, 18, 44, 46, 51 AND 52). SN 76-455,214. PUB. 6-24-2003. FILED 9-30-2002.
- 2,763,913. **EQUASIS**. SOLVAY PHARMACEUTICALS B.V., (U.S. CLS. 6, 18, 44, 46, 51 AND 52). SN 76-455,215. PUB. 6-24-2003. FILED 9-30-2002.
- 2,763,915. **FILIANCE**. SOLVAY PHARMACEUTICALS B.V., (U.S. CLS. 6, 18, 44, 46, 51 AND 52). SN 76-455,330. PUB. 6-24-2003. FILED 9-30-2002.
- 2,763,916. **FILIANZE**. SOLVAY PHARMACEUTICALS B.V., (U.S. CLS. 6, 18, 44, 46, 51 AND 52). SN 76-455,331. PUB. 6-24-2003. FILED 9-30-2002.
- 2,764,002. **KICKSTART AND DESIGN**. KENPAL FARM PRODUCTS INC., (U.S. CLS. 6, 18, 44, 46, 51 AND 52). SN 76-467,186. PUB. 6-24-2003. FILED 11-8-2002.
- 2,764,079. **ALPHA PROGRAM**. SASSOVER, NATHAN, (U.S. CLS. 6, 18, 44, 46, 51 AND 52). SN 76-476,956. PUB. 6-24-2003. FILED 12-19-2002.
- 2,764,080. **INTRATHERAPIES ALPHA PROGRAM**. SASSOVER, NATHAN, (U.S. CLS. 6, 18, 44, 46, 51 AND 52). SN 76-476,987. PUB. 6-24-2003. FILED 12-19-2002.
- 2,764,081. **INTRATHERAPIES**. SASSOVER, NATHAN, (U.S. CLS. 6, 18, 44, 46, 51 AND 52). SN 76-476,988. PUB. 6-24-2003. FILED 12-19-2002.
- 2,764,082. **NURENEX**. SASSOVER, NATHAN, (U.S. CLS. 6, 18, 44, 46, 51 AND 52). SN 76-476,989. PUB. 6-24-2003. FILED 12-19-2002.
- 2,764,097. **LITTLE ADVENTURES (STYLIZED)**. CIRCLE OF FRIENDS PRODUCTS, LLC, (U.S. CLS. 6, 18, 44, 46, 51 AND 52). SN 76-485,947. PUB. 6-24-2003. FILED 1-29-2003.
- 2,764,102 (*See Class 1 for this trademark*).
- 2,764,110. **MAGISTO**. SMITHKLINE BEECHAM BIOLOGICALS MANUFACTURING S.A., (U.S. CLS. 6, 18, 44, 46, 51 AND 52). SN 78-028,232. PUB. 6-24-2003. FILED 9-29-2000.
- 2,764,144. **AGMIR**. NOVARTIS AG, (U.S. CLS. 6, 18, 44, 46, 51 AND 52). SN 78-089,445. PUB. 6-24-2003. FILED 10-22-2001.
- 2,764,145. **CERGOLYA**. NOVARTIS AG, (U.S. CLS. 6, 18, 44, 46, 51 AND 52). SN 78-089,457. PUB. 6-24-2003. FILED 10-22-2001.
- 2,764,146. **EXFORGE**. NOVARTIS AG, (U.S. CLS. 6, 18, 44, 46, 51 AND 52). SN 78-089,458. PUB. 6-24-2003. FILED 10-22-2001.
- 2,764,160. **VISUAL EYES**. VITA CUBE SYSTEMS, INC., (U.S. CLS. 6, 18, 44, 46, 51 AND 52). SN 78-100,924. PUB. 6-24-2003. FILED 1-4-2002.
- 2,764,183. **WOUNDEL**. GDT GARABET DERMA TECHNOLOGY GMBH, MULTIPLE CLASS, (INT. CLS. 5 AND 10), (U.S. CLS. 6, 18, 26, 39, 44, 46, 51 AND 52). SN 78-108,022. PUB. 6-24-2003. FILED 2-11-2002.
- 2,764,197. **LUCELBA**. NOVARTIS AG, (U.S. CLS. 6, 18, 44, 46, 51 AND 52). SN 78-115,786. PUB. 6-24-2003. FILED 3-19-2002.
- 2,764,238. **SPOT THERAPY**. HISAMITSU PHARMACEUTICAL CO., INC., (U.S. CLS. 6, 18, 44, 46, 51 AND 52). SN 78-134,198. PUB. 6-24-2003. FILED 6-8-2002.
- 2,764,239. **GANIREST**. N.V. ORGANON, (U.S. CLS. 6, 18, 44, 46, 51 AND 52). SN 78-135,072. PUB. 6-24-2003. FILED 6-12-2002.
- 2,764,240. **SRP**. EPITOPIX, LLC, (U.S. CLS. 6, 18, 44, 46, 51 AND 52). SN 78-135,637. PUB. 6-24-2003. FILED 6-13-2002.
- 2,764,251. **SHORANT**. AVENTIS PHARMA S.A., (U.S. CLS. 6, 18, 44, 46, 51 AND 52). SN 78-139,550. PUB. 6-24-2003. FILED 6-27-2002.
- 2,764,276. **RHINOMIST**. LABORATOIRES GOEMAR, (U.S. CLS. 6, 18, 44, 46, 51 AND 52). SN 78-152,441. PUB. 6-24-2003. FILED 8-8-2002.
- 2,764,299. **PROMANAL**. W. NEUDORFF GMBH KG, (U.S. CLS. 6, 18, 44, 46, 51 AND 52). SN 78-159,142. PUB. 6-24-2003. FILED 8-29-2002.
- 2,764,357. **BROVEX (STYLIZED)**. ATHLON PHARMACEUTICALS, INC., (U.S. CLS. 6, 18, 44, 46, 51 AND 52). SN 78-176,952. PUB. 6-24-2003. FILED 10-22-2002.

CLASS 6—METAL GOODS

- 2,763,036. **F AND DESIGN**. FEDERAL SCREW WORKS, (U.S. CLS. 2, 12, 13, 14, 23, 25 AND 50). SN 75-270,160. PUB. 6-24-2003. FILED 4-7-1997.
- 2,763,126 (*See Class 3 for this trademark*).
- 2,763,134. **MONKEY WORLD APE RESCUE CENTRE AND DESIGN**. MONKEY WORLD LIMITED, MULTIPLE CLASS, (INT. CLS. 6, 9, 16, 20, 21, 24, 25, 26, 28, 38 AND 41), (U.S. CLS. 2, 5, 12, 13, 14, 21, 22, 23, 25, 26, 29, 30, 32, 33, 36, 37, 38, 39, 40, 42, 50, 100, 101, 104 AND 107). SN 76-026,953. PUB. 6-24-2003. FILED 4-17-2000.
- 2,763,245. **DURA-FLEX (STYLIZED)**. ELECTRON BEAM TECHNOLOGIES, INC., (U.S. CLS. 2, 12, 13, 14, 23, 25 AND 50). SN 76-200,197. PUB. 7-24-2001. FILED 1-25-2001.
- 2,763,268. **PURE COMPETITION**. INTERNATIONAL AMATEUR ATHLETIC FEDERATION, MULTIPLE CLASS, (INT. CLS. 6, 9, 12, 14, 16, 18, 25, 28, 32, 35, 36, 38, 41 AND 42), (U.S. CLS. 1, 2, 3, 5, 12, 13, 14, 19, 21, 22, 23, 25, 26, 27, 28, 29, 31, 35, 36, 37, 38, 39, 41, 44, 45, 46, 48, 50, 100, 101, 102, 104 AND 107). SN 76-213,287. PUB. 6-24-2003. FILED 2-21-2001.
- 2,763,292. **PROCEDES CHENEL (STYLIZED)**. PROCEDES CHENEL INTERNATIONAL, MULTIPLE CLASS, (INT. CLS. 6, 16, 19, 20 AND 24), (U.S. CLS. 1, 2, 5, 12, 13, 14, 22, 23, 25, 29, 32, 33, 37, 38, 42 AND 50). SN 76-250,628. PUB. 6-24-2003. FILED 5-3-2001.
- 2,763,317 (*See Class 1 for this trademark*).
- 2,763,408. **HERMLE AND DESIGN**. MASCHINENFABRIK BERTHOLD HERMLE AG, MULTIPLE CLASS, (INT. CLS. 6, 7, 9 AND 20), (U.S. CLS. 2, 12, 13, 14, 19, 21, 22, 23, 25, 26, 31, 32, 34, 35, 36, 38 AND 50). SN 76-342,129. PUB. 6-24-2003. FILED 11-28-2001.
- 2,763,409. **HERMLE**. MASCHINENFABRIK BERTHOLD HERMLE AG, MULTIPLE CLASS, (INT. CLS. 6, 7, 9 AND 20), (U.S. CLS. 2, 12, 13, 14, 19, 21, 22, 23, 25, 26, 31, 32, 34, 35, 36, 38 AND 50). SN 76-342,130. PUB. 6-24-2003. FILED 11-28-2001.
- 2,763,513. **SAFESEC**. SAFESEC CORPORATION, FORMERLY REVOLVING DOOR CONTROL, INC., MULTIPLE CLASS, (INT. CLS. 6, 7, 9 AND 19), (U.S. CLS. 1, 2, 12, 13, 14, 19, 21, 23, 25, 26, 31, 33, 34, 35, 36, 38 AND 50). SN 76-381,735. PUB. 6-24-2003. FILED 3-12-2002.
- 2,763,587. **H&K (STYLIZED)**. HARRINGTON & KING PERFORATING CO., INC., THE, MULTIPLE CLASS, (INT. CLS. 6 AND 40), (U.S. CLS. 2, 12, 13, 14, 23, 25, 50, 100, 103 AND 106). SN 76-399,657. PUB. 6-24-2003. FILED 4-23-2002.
- 2,763,601. **KRAUSE HANDLER**. SX BUROWAREN PRODUKTIONS UND HANDELS GMBH, MULTIPLE CLASS, (INT. CLS. 6, 7 AND 16), (U.S. CLS. 2, 5, 12, 13, 14, 19, 21, 22, 23, 25, 29, 31, 34, 35, 37, 38 AND 50). SN 76-402,716. PUB. 6-24-2003. FILED 5-1-2002.
- 2,763,602. **KOLOMAN HANDLER**. SX BUROWAREN PRODUKTIONS UND HANDELS GMBH, MULTIPLE CLASS, (INT. CLS. 6, 7 AND 16), (U.S. CLS. 2, 5, 12, 13, 14, 19, 21, 22, 23, 25, 29, 31, 34, 35, 37, 38 AND 50). SN 76-402,718. PUB. 6-24-2003. FILED 5-1-2002.
- 2,763,660. **CONTINENTAL**. MUSTAD INTERNATIONAL GROUP B.V., MULTIPLE CLASS, (INT. CLS. 6 AND 17), (U.S. CLS. 1, 2, 5, 12, 13, 14, 23, 25, 35 AND 50). SN 76-411,116. PUB. 6-24-2003. FILED 5-23-2002.
- 2,763,840. **EAGLE COUPLINGS AND DESIGN**. MURPHY, JOHN P., (U.S. CLS. 2, 12, 13, 14, 23, 25 AND 50). SN 76-441,092. PUB. 6-24-2003. FILED 8-16-2002.
- 2,763,971. **U.S. GRANULES**. U.S. GRANULES CORPORATION, (U.S. CLS. 2, 12, 13, 14, 23, 25 AND 50). SN 76-461,758. PUB. 6-24-2003. FILED 10-25-2002.
- 2,764,102 (*See Class 1 for this trademark*).
- 2,764,212. **HOT METAL MAMA AND DESIGN**. THOMPSON, TERESA L., (U.S. CLS. 2, 12, 13, 14, 23, 25 AND 50). SN 78-124,674. PUB. 6-24-2003. FILED 4-28-2002.
- 2,764,281. **US STRUT**. UNITRON PRODUCTS, INC., (U.S. CLS. 2, 12, 13, 14, 23, 25 AND 50). SN 78-155,441. PUB. 6-24-2003. FILED 8-19-2002.
- 2,764,363. **AEGIS**. AMERISTAR FENCE PRODUCTS, INC., (U.S. CLS. 2, 12, 13, 14, 23, 25 AND 50). SN 78-178,078. PUB. 6-24-2003. FILED 10-24-2002.

CLASS 7—MACHINERY

- 2,763,039. **OPTICON**. HECKETT MULTISERV INTERNATIONAL N.V., (U.S. CLS. 13, 19, 21, 23, 31, 34 AND 35). SN 75-296,773. PUB. 12-25-2001. FILED 5-22-1997.
- 2,763,101. **PROSPER**. DAIMLERCHRYSLER AG, MULTIPLE CLASS, (INT. CLS. 7, 9, 12, 35, 37, 39 AND 42), (U.S. CLS. 13, 19, 21, 23, 26, 31, 34, 35, 36, 38, 44, 100, 101, 102, 103, 105 AND 106). SN 75-860,832. PUB. 6-24-2003. FILED 11-30-1999.
- 2,763,105. **PRODECANTER**. FLOTTWEG GMBH, (U.S. CLS. 13, 19, 21, 23, 31, 34 AND 35). SN 75-873,549. PUB. 4-23-2002. FILED 12-16-1999.
- 2,763,133. **TOLERANS**. TOLERANS INGOL, INC., (U.S. CLS. 13, 19, 21, 23, 31, 34 AND 35). SN 76-018,135. PUB. 6-24-2003. FILED 4-5-2000.
- 2,763,141. **LPD (STYLIZED)**. LONG MANUFACTURING LTD., (U.S. CLS. 13, 19, 21, 23, 31, 34 AND 35). SN 76-037,593. PUB. 6-24-2003. FILED 5-1-2000.
- 2,763,222. **AEM**. ADVANCED ENGINE MANAGEMENT, INC., MULTIPLE CLASS, (INT. CLS. 7 AND 12), (U.S. CLS. 13, 19, 21, 23, 31, 34, 35 AND 44). SN 76-180,290. PUB. 6-24-2003. FILED 12-13-2000.
- 2,763,305. **ELENESSA**. MITSUBISHI ELECTRIC CORPORATION, (U.S. CLS. 13, 19, 21, 23, 31, 34 AND 35). SN 76-271,906. PUB. 6-24-2003. FILED 6-15-2001.
- 2,763,306. **DI DETROIT INDUSTRIAL TOOL AND DESIGN**. MARED INDUSTRIES, INCORPORATED, (U.S. CLS. 13, 19, 21, 23, 31, 34 AND 35). SN 76-272,668. PUB. 6-24-2003. FILED 6-19-2001.
- 2,763,307. **STAB ITALY AND DESIGN**. STAB S.R.L., (U.S. CLS. 13, 19, 21, 23, 31, 34 AND 35). SN 76-275,291. PUB. 6-24-2003. FILED 6-21-2001.
- 2,763,341. **ADVANTEK**. ADVANTEK, INC., MULTIPLE CLASS, (INT. CLS. 7, 9, 16, 17, 37, 40 AND 42), (U.S. CLS. 1, 2, 5, 12, 13, 19, 21, 22, 23, 26, 29, 31, 34, 35, 36, 37, 38, 50, 100, 101, 103 AND 106). SN 76-302,640. PUB. 6-24-2003. FILED 8-21-2001.
- 2,763,395 (*See Class 1 for this trademark*).
- 2,763,408 (*See Class 6 for this trademark*).
- 2,763,409 (*See Class 6 for this trademark*).
- 2,763,413. **SURE CLEAN**. CAE RANSOHOFF, INC., (U.S. CLS. 13, 19, 21, 23, 31, 34 AND 35). SN 76-342,391. PUB. 6-24-2003. FILED 11-21-2001.
- 2,763,416. **MINI MAG**. BOAT LIFTS UNLIMITED, (U.S. CLS. 13, 19, 21, 23, 31, 34 AND 35). SN 76-343,142. PUB. 8-13-2002. FILED 11-30-2001.
- 2,763,442. **CLEAIRE ADVANCED EMISSION CONTROLS AND DESIGN**. CUMMINS WEST, INC., MULTIPLE CLASS, (INT. CLS. 7 AND 9), (U.S. CLS. 13, 19, 21, 23, 26, 31, 34, 35, 36 AND 38). SN 76-351,633. PUB. 6-24-2003. FILED 12-21-2001.
- 2,763,445. **CLEAIRE ADVANCED EMISSION CONTROLS (STYLIZED)**. CUMMINS WEST, INC., MULTIPLE CLASS, (INT. CLS. 7 AND 9), (U.S. CLS. 13, 19, 21, 23, 26, 31, 34, 35, 36 AND 38). SN 76-352,519. PUB. 6-24-2003. FILED 12-21-2001.
- 2,763,513 (*See Class 6 for this trademark*).
- 2,763,589. **SMART-LOC**. JRB COMPANY, INC., (U.S. CLS. 13, 19, 21, 23, 31, 34 AND 35). SN 76-400,026. PUB. 6-24-2003. FILED 4-23-2002.
- 2,763,601 (*See Class 6 for this trademark*).
- 2,763,602 (*See Class 6 for this trademark*).
- 2,763,630. **DRAGON**. ASM INTERNATIONAL N.V., (U.S. CLS. 13, 19, 21, 23, 31, 34 AND 35). SN 76-406,820. PUB. 6-24-2003. FILED 5-2-2002.
- 2,763,646. **TRUE BILLET**. GCA INDUSTRIES, (U.S. CLS. 13, 19, 21, 23, 31, 34 AND 35). SN 76-409,321. PUB. 6-24-2003. FILED 5-20-2002.
- 2,763,670. **YINLUN AND DESIGN**. ZHEJIANG YINLUN MACHINERY CO., LTD., (U.S. CLS. 13, 19, 21, 23, 31, 34 AND 35). SN 76-412,442. PUB. 6-24-2003. FILED 5-24-2002.
- 2,763,702. **SYSTEGRA (STYLIZED)**. SIG TECHNOLOGY AG (SIG TECHNOLOGY LTD.), MULTIPLE CLASS, (INT. CLS. 7, 35 AND 42), (U.S. CLS. 13, 19, 21, 23, 31, 34, 35, 100, 101 AND 102). SN 76-418,092. PUB. 6-24-2003. FILED 6-14-2002.
- 2,763,706. **DRIVECON**. DRIVECON, INC., MULTIPLE CLASS, (INT. CLS. 7 AND 9), (U.S. CLS. 13, 19, 21, 23, 26, 31, 34, 35, 36 AND 38). SN 76-418,753. PUB. 6-24-2003. FILED

- 6-7-2002.
- 2,763,717. **REVOLUTION**. IWATA-MEDEA, INCORPORATED, (U.S. CLS. 13, 19, 21, 23, 31, 34 AND 35). SN 76-419,817. PUB. 6-24-2003. FILED 6-12-2002.
- 2,763,743. **M/C**. ARN, RUSS, (U.S. CLS. 13, 19, 21, 23, 31, 34 AND 35). SN 76-424,551. PUB. 6-24-2003. FILED 2-19-2002.
- 2,763,805. **ACCUMAVEYOR**. FMC TECHNOLOGIES, INC., (U.S. CLS. 13, 19, 21, 23, 31, 34 AND 35). SN 76-434,183. PUB. 6-24-2003. FILED 7-25-2002.
- 2,763,813. **DURALAST GOLD**. AUTOZONE, INC., MULTIPLE CLASS, (INT. CLS. 7 AND 9), (U.S. CLS. 13, 19, 21, 23, 26, 31, 34, 35, 36 AND 38). SN 76-435,454. PUB. 6-24-2003. FILED 7-25-2002.
- 2,763,814. **WE SET THE WHEELS IN MOTION**. HYDROGEAR LIMITED PARTNERSHIP, MULTIPLE CLASS, (INT. CLS. 7, 12, 41 AND 42), (U.S. CLS. 13, 19, 21, 23, 31, 34, 35, 44, 100, 101 AND 107). SN 76-435,806. PUB. 6-24-2003. FILED 7-30-2002.
- 2,763,818. **SUPERIOR BROOM AND DESIGN**. SB MANUFACTURING INC., (U.S. CLS. 13, 19, 21, 23, 31, 34 AND 35). SN 76-437,374. PUB. 6-24-2003. FILED 8-5-2002.
- 2,763,876. **QUICK VAC**. HAND TOOL DESIGN CORPORATION, (U.S. CLS. 13, 19, 21, 23, 31, 34 AND 35). SN 76-449,304. PUB. 6-24-2003. FILED 9-9-2002.
- 2,763,982. **EMPRESS**. AXIA INCORPORATED, (U.S. CLS. 13, 19, 21, 23, 31, 34 AND 35). SN 76-463,977. PUB. 6-24-2003. FILED 11-4-2002.
- 2,763,985. **MURRAY**. MURRAY, INC., (U.S. CLS. 13, 19, 21, 23, 31, 34 AND 35). SN 76-464,333. PUB. 6-24-2003. FILED 10-28-2002.
- 2,764,049. **TEKMAX**. TEKMAX, INC., (U.S. CLS. 13, 19, 21, 23, 31, 34 AND 35). SN 76-472,224. PUB. 6-24-2003. FILED 12-5-2002.
- 2,764,120. **POWERED BY GE ECM TECHNOLOGY AND DESIGN**. GENERAL ELECTRIC COMPANY, MULTIPLE CLASS, (INT. CLS. 7 AND 42), (U.S. CLS. 13, 19, 21, 23, 31, 34, 35, 100 AND 101). SN 78-045,712. PUB. 6-24-2003. FILED 1-30-2001.
- 2,764,182. **TUMBLEMASTER**. HESS MASCHINENFABRIK GMBH & CO. KG, (U.S. CLS. 13, 19, 21, 23, 31, 34 AND 35). SN 78-107,236. PUB. 6-24-2003. FILED 2-6-2002.
- 2,764,292. **MBO**. MBO BINDER & CO. OF AMERICA, MULTIPLE CLASS, (INT. CLS. 7 AND 9), (U.S. CLS. 13, 19, 21, 23, 26, 31, 34, 35, 36 AND 38). SN 78-157,287. PUB. 6-24-2003. FILED 8-23-2002.
- 2,764,310. **TUSA**. SANDAR INDUSTRIES, INC., (U.S. CLS. 13, 19, 21, 23, 31, 34 AND 35). SN 78-163,263. PUB. 6-3-2003. FILED 9-12-2002.
- 2,764,320. **MIX 'N GO (STYLIZED)**. NEOPOST S.A., MULTIPLE CLASS, (INT. CLS. 7 AND 9), (U.S. CLS. 13, 19, 21, 23, 26, 31, 34, 35, 36 AND 38). SN 78-165,782. PUB. 6-24-2003. FILED 9-19-2002.
- 2,764,327. **ACERTA**. MILLIPORE CORPORATION, (U.S. CLS. 13, 19, 21, 23, 31, 34 AND 35). SN 78-169,576. PUB. 6-24-2003. FILED 10-1-2002.
- 2,764,329. **BL INFINITY SOLUTIONS BY BRI-LIN AND DESIGN**. BRI-LIN, INCORPORATED, (U.S. CLS. 13, 19, 21, 23, 31, 34 AND 35). SN 78-171,108. PUB. 6-24-2003. FILED 10-4-2002.
- 2,764,375. **JACK AND DESIGN**. JACK SEWING MACHINE CO., LTD. OF ZHEJIANG, (U.S. CLS. 13, 19, 21, 23, 31, 34 AND 35). SN 78-179,406. PUB. 6-24-2003. FILED 10-29-2002.
- 2,764,441. **MINI-ARBORIST**. SKYLIFT, INC., (U.S. CLS. 13, 19, 21, 23, 31, 34 AND 35). SN 78-186,427. PUB. 6-24-2003. FILED 11-19-2002.
2003. FILED 12-29-2000.
- 2,763,303. **CLOVER CLOVER MFG. CO., LTD. JAPAN AND DESIGN**. CLOVER MFG. CO., LTD., MULTIPLE CLASS, (INT. CLS. 8, 16 AND 26), (U.S. CLS. 2, 5, 22, 23, 28, 29, 37, 38, 39, 40, 42, 44 AND 50). SN 76-269,651. PUB. 6-24-2003. FILED 6-11-2001.
- 2,763,328. **LCN AND DESIGN**. WILDE COSMETICS GMBH, MULTIPLE CLASS, (INT. CLS. 8, 11 AND 21), (U.S. CLS. 2, 13, 21, 23, 28, 29, 30, 31, 33, 34, 40, 44 AND 50). SN 76-290,102. PUB. 12-3-2002. FILED 7-25-2001.
- 2,763,366. **URREA AND DESIGN**. ASESORIA Y DESARROLLOS URREA, S.A. DE C.V., (U.S. CLS. 23, 28 AND 44). SN 76-320,846. PUB. 6-24-2003. FILED 10-2-2001.
- 2,763,628. **ROUGH CUT**. CAMILLUS CUTLERY CO., (U.S. CLS. 23, 28 AND 44). SN 76-406,430. PUB. 6-24-2003. FILED 5-13-2002.
- 2,763,680. **MICRO+**. KONINKLIJKE PHILIPS ELECTRONICS N.V., (U.S. CLS. 23, 28 AND 44). SN 76-413,992. PUB. 6-24-2003. FILED 5-24-2002.
- 2,763,749. **SUPER NGHIA AND DESIGN**. CONG TY TRACH NHIEM HUU HAN SAN XUAT CO KHI KEM NGHIA, AKA NGHIA NIPPERS PRODUCTION MECHANICAL ENGINEERING CO., LTD., (U.S. CLS. 23, 28 AND 44). SN 76-425,458. PUB. 6-24-2003. FILED 6-24-2002.
- 2,763,836. **CANOPOWER**. GLAZE, INC., (U.S. CLS. 23, 28 AND 44). SN 76-440,389. PUB. 6-24-2003. FILED 8-8-2002.
- 2,763,839. **PROGRESSIVE SUSPENSION**. PROGRESSIVE SUSPENSION INC., MULTIPLE CLASS, (INT. CLS. 8 AND 12), (U.S. CLS. 19, 21, 23, 28, 31, 35 AND 44). SN 76-440,998. PUB. 6-24-2003. FILED 8-16-2002.
- 2,764,456. **LONGABERGER**. LONGABERGER COMPANY, THE, (U.S. CLS. 23, 28 AND 44). SN 78-191,128. PUB. 6-24-2003. FILED 12-4-2002.

CLASS 9—ELECTRICAL AND SCIENTIFIC APPARATUS

- 2,763,024. **ORION AND DESIGN**. DIRECTED AUDIO, INC., BY ASSIGNMENT ORION INDUSTRIES, INC., (U.S. CLS. 21, 23, 26, 36 AND 38). SN 74-260,632. PUB. 6-24-2003. FILED 3-30-1992.
- 2,763,033. **LABTRAK**. ROSEN, DAVID B., DBA SOFTWARE INNOVATIONS, (U.S. CLS. 21, 23, 26, 36 AND 38). SN 75-192,710. PUB. 6-24-2003. FILED 11-4-1996.
- 2,763,035. **ALLEGRO AND DESIGN**. ALLEGRO SOFTWARE DEVELOPMENT CORPORATION, (U.S. CLS. 21, 23, 26, 36 AND 38). SN 75-265,792. PUB. 6-24-2003. FILED 3-28-1997.
- 2,763,050. **INNOVACAPTURE**. INNOVASYS INC., (U.S. CLS. 21, 23, 26, 36 AND 38). SN 75-488,180. PUB. 2-11-2003. FILED 5-20-1998.
- 2,763,055. **JFLOW**. THE WORKFLOW AUTOMATION CORPORATION, (U.S. CLS. 21, 23, 26, 36 AND 38). SN 75-507,302. PUB. 6-24-2003. FILED 6-23-1998.
- 2,763,057. **THE SSI GROUP, INC. AND DESIGN**. THE SSI GROUP, INC., MULTIPLE CLASS, (INT. CLS. 9 AND 42), (U.S. CLS. 21, 23, 26, 36, 38, 100 AND 101). SN 75-525,991. PUB. 6-24-2003. FILED 7-27-1998.
- 2,763,060. **MICROSAFE**. CONTROL MICROSYSTEMS INC./MICROSYSTEMES DE CONTROLE INC., (U.S. CLS. 21, 23, 26, 36 AND 38). SN 75-564,063. PUB. 6-6-2000. FILED 10-2-1998.
- 2,763,064 (*See Class 3 for this trademark*).
- 2,763,068. **WE'VE GOT THE WHOLE WORLD LISTENING**. DOLBY LABORATORIES LICENSING CORPORATION, (U.S. CLS. 21, 23, 26, 36 AND 38). SN 75-627,626. PUB. 6-24-2003. FILED 1-26-1999.
- 2,763,072. **MAJOR POWER**. MAJORPOWER.COM CANADA CORPORATION, BY CHANGE OF NAME ZZZAP POWER LTD., (U.S. CLS. 21, 23, 26, 36 AND 38). SN 75-691,541. PUB. 2-19-2002. FILED 4-26-1999.
- 2,763,082. **CRYSTAL VISION**. CRYSTAL VISION, LTD., (U.S. CLS. 21, 23, 26, 36 AND 38). SN 75-766,702. PUB. 6-24-2003. FILED 8-3-1999.
- 2,763,085. **D'MUSIC**. SAMTACK COMPUTER INC., (U.S. CLS. 21, 23, 26, 36 AND 38). SN 75-780,748. PUB. 6-24-2003. FILED 8-20-1999.

CLASS 8—HAND TOOLS

- 2,763,126 (*See Class 3 for this trademark*).
- 2,763,128. **CG TIPS**. 1361382 ONTARIO INC., DBA CG TIPS, (U.S. CLS. 23, 28 AND 44). SN 76-007,657. PUB. 6-24-2003. FILED 3-23-2000.
- 2,763,236. **MAGIC YEARS AND DESIGN**. H. J. RASHTI & COMPANY, INC., MULTIPLE CLASS, (INT. CLS. 8, 10, 14, 16, 20, 24, 25 AND 28), (U.S. CLS. 2, 5, 13, 22, 23, 25, 26, 27, 28, 29, 32, 37, 38, 39, 42, 44 AND 50). SN 76-187,677. PUB. 6-24-

- 2,763,088. **TELIA SITECONNECT**. TELIA AB (PUBL), MULTIPLE CLASS, (INT. CLS. 9, 37, 38, 41 AND 42), (U.S. CLS. 21, 23, 26, 36, 38, 100, 101, 103, 104, 106 AND 107). SN 75-794,139. PUB. 2-19-2002. FILED 9-9-1999.
- 2,763,089. **CARLIN**. CARLIN COMBUSTION TECHNOLOGY, INC., MULTIPLE CLASS, (INT. CLS. 9 AND 11), (U.S. CLS. 13, 21, 23, 26, 31, 34, 36 AND 38). SN 75-805,944. PUB. 4-30-2002. FILED 9-22-1999.
- 2,763,096. **THE STANDARD IN PROJECT MANAGEMENT**. INTEGRAL VISION, (U.S. CLS. 21, 23, 26, 36 AND 38). SN 75-840,056. PUB. 6-24-2003. FILED 11-19-1999.
- 2,763,097. **MOBO AND DESIGN**. MOBO HOLDINGS (UK) LIMITED, MULTIPLE CLASS, (INT. CLS. 9, 16, 25, 35, 38, 41 AND 42), (U.S. CLS. 2, 5, 21, 22, 23, 26, 29, 36, 37, 38, 39, 50, 100, 101, 102, 104 AND 107). SN 75-842,350. PUB. 6-24-2003. FILED 11-8-1999.
- 2,763,101 (*See Class 7 for this trademark*).
- 2,763,111. **TIGER**. POWERTREND CORPORATION, (U.S. CLS. 21, 23, 26, 36 AND 38). SN 75-893,198. PUB. 6-24-2003. FILED 1-10-2000.
- 2,763,123 (*See Class 3 for this trademark*).
- 2,763,124. **SHAN**. LES COLLECTIONS SHAN INC., MULTIPLE CLASS, (INT. CLS. 9, 21, 24 AND 25), (U.S. CLS. 2, 13, 21, 22, 23, 26, 29, 30, 33, 36, 38, 39, 40, 42 AND 50). SN 75-982,312. PUB. 9-3-2002. FILED 3-14-2000.
- 2,763,126 (*See Class 3 for this trademark*).
- 2,763,134 (*See Class 6 for this trademark*).
- 2,763,140. **2020DOC**. REED, DANIEL M., (U.S. CLS. 21, 23, 26, 36 AND 38). SN 76-036,977. PUB. 1-15-2002. FILED 4-27-2000.
- 2,763,145. **ACE RECORDS AND DESIGN**. A.C.E. RECORDS, INC., (U.S. CLS. 21, 23, 26, 36 AND 38). SN 76-046,419. PUB. 6-24-2003. FILED 5-12-2000.
- 2,763,155. **IMAC**. APPLE COMPUTER, INC., (U.S. CLS. 21, 23, 26, 36 AND 38). SN 76-070,198. PUB. 8-14-2001. FILED 6-15-2000.
- 2,763,156. **NOVO MIND (STYLIZED)**. NOVOMIND AG, MULTIPLE CLASS, (INT. CLS. 9, 38 AND 42), (U.S. CLS. 21, 23, 26, 36, 38, 100, 101 AND 104). SN 76-071,739. PUB. 6-24-2003. FILED 6-15-2000.
- 2,763,162. **TESYS (STYLIZED)**. SCHNEIDER ELECTRIC INDUSTRIES SA, (U.S. CLS. 21, 23, 26, 36 AND 38). SN 76-085,680. PUB. 1-28-2003. FILED 7-7-2000.
- 2,763,166. **MINIMECH (STYLIZED)**. DE LA RUE INTERNATIONAL LIMITED, (U.S. CLS. 21, 23, 26, 36 AND 38). SN 76-099,308. PUB. 7-30-2002. FILED 7-28-2000.
- 2,763,167. **MISCELLANEOUS DESIGN**. RINGTAIL SOLUTIONS PTY LIMITED, MULTIPLE CLASS, (INT. CLS. 9, 35, 38 AND 42), (U.S. CLS. 21, 23, 26, 36, 38, 100, 101, 102 AND 104). SN 76-099,338. PUB. 5-21-2002. FILED 7-28-2000.
- 2,763,168. **RINGTAIL**. RINGTAIL SOLUTIONS PTY LIMITED, MULTIPLE CLASS, (INT. CLS. 9, 35, 38 AND 42), (U.S. CLS. 21, 23, 26, 36, 38, 100, 101, 102 AND 104). SN 76-099,339. PUB. 5-21-2002. FILED 7-28-2000.
- 2,763,169. **FUNPL@YCE (STYLIZED)**. DOLPHIN CAPITAL AG, BY ASSIGNMENT; BY ASSIGNMENT FUNWORLD AG, MULTIPLE CLASS, (INT. CLS. 9, 35 AND 41), (U.S. CLS. 21, 23, 26, 36, 38, 100, 101, 102 AND 107). SN 76-099,712. PUB. 6-24-2003. FILED 7-31-2000.
- 2,763,170. **ORCA VISION**. ORCA VISION, INC., MULTIPLE CLASS, (INT. CLS. 9, 35, 36, 38, 39 AND 41), (U.S. CLS. 21, 23, 26, 36, 38, 100, 101, 102, 104, 105 AND 107). SN 76-107,532. PUB. 6-24-2003. FILED 8-10-2000.
- 2,763,171. **TRUE READ**. RADIOPATH, LLC, (U.S. CLS. 21, 23, 26, 36 AND 38). SN 76-108,163. PUB. 6-24-2003. FILED 8-14-2000.
- 2,763,172. **MBYN AND DESIGN**. MBYN INC., (U.S. CLS. 21, 23, 26, 36 AND 38). SN 76-108,460. PUB. 6-24-2003. FILED 8-14-2000.
- 2,763,177. **LOGIPHONE**. SIC GMBH, MULTIPLE CLASS, (INT. CLS. 9, 35, 38, 41 AND 42), (U.S. CLS. 21, 23, 26, 36, 38, 100, 101, 102, 104 AND 107). SN 76-114,410. PUB. 11-12-2002. FILED 8-23-2000.
- 2,763,182. **SPECTRASHIELD**. GPT GLENDALE, INC., (U.S. CLS. 21, 23, 26, 36 AND 38). SN 76-124,216. PUB. 6-24-2003. FILED 9-6-2000.
- 2,763,183. **HIGHTOWER**. HIGH TOWER SOFTWARE, INC., (U.S. CLS. 21, 23, 26, 36 AND 38). SN 76-125,316. PUB. 6-24-2003. FILED 9-7-2000.
- 2,763,191. **OAKSTONE**. OAKSTONE PUBLISHING LLC, MULTIPLE CLASS, (INT. CLS. 9, 16 AND 35), (U.S. CLS. 2, 5, 21, 22, 23, 26, 29, 36, 37, 38, 50, 100, 101 AND 102). SN 76-137,618. PUB. 6-24-2003. FILED 9-29-2000.
- 2,763,196. **S-COP AND DESIGN**. SOFTPROTEC CO., (U.S. CLS. 21, 23, 26, 36 AND 38). SN 76-144,545. PUB. 2-4-2003. FILED 10-11-2000.
- 2,763,203. **MISCELLANEOUS DESIGN**. SOMA NETWORKS, INC., (U.S. CLS. 21, 23, 26, 36 AND 38). SN 76-160,287. PUB. 6-24-2003. FILED 11-3-2000.
- 2,763,209. **PAXTER AND DESIGN**. PAXTER AB, BY CHANGE OF NAME HAGANDER-OHLSSON AB, MULTIPLE CLASS, (INT. CLS. 9 AND 42), (U.S. CLS. 21, 23, 26, 36, 38, 100 AND 101). SN 76-169,314. PUB. 8-20-2002. FILED 11-21-2000.
- 2,763,223. **SOLUTION VISION AND DESIGN**. FUJITSU LIMITED, MULTIPLE CLASS, (INT. CLS. 9, 35, 36, 37, 38, 39, 41 AND 42), (U.S. CLS. 21, 23, 26, 36, 38, 100, 101, 102, 103, 104, 105, 106 AND 107). SN 76-180,294. PUB. 6-24-2003. FILED 12-13-2000.
- 2,763,225. **NOMINET UK**. NOMINET UK, MULTIPLE CLASS, (INT. CLS. 9, 16, 35, 38, 41 AND 42), (U.S. CLS. 2, 5, 21, 22, 23, 26, 29, 36, 37, 38, 50, 100, 101, 102, 104 AND 107). SN 76-180,828. PUB. 6-24-2003. FILED 12-14-2000.
- 2,763,232 (*See Class 3 for this trademark*).
- 2,763,237. **GEOSURF**. BEICIP-FRANLAB, MULTIPLE CLASS, (INT. CLS. 9, 35 AND 42), (U.S. CLS. 21, 23, 26, 36, 38, 100, 101 AND 102). SN 76-188,536. PUB. 6-24-2003. FILED 12-29-2000.
- 2,763,238. **TOUCHTRAK**. TOUCHTRAK SYSTEMS, INC., (U.S. CLS. 21, 23, 26, 36 AND 38). SN 76-190,326. PUB. 6-24-2003. FILED 1-4-2001.
- 2,763,239. **VAMEDIS**. PAUL HARTMANN AG, MULTIPLE CLASS, (INT. CLS. 9, 35, 36, 38, 39, 41 AND 42), (U.S. CLS. 21, 23, 26, 36, 38, 100, 101, 102, 104, 105 AND 107). SN 76-192,201. PUB. 6-24-2003. FILED 1-10-2001.
- 2,763,240. **ENTERTRAINER**. INTERTRAIN PRODUCTIONS PTY LTD, (U.S. CLS. 21, 23, 26, 36 AND 38). SN 76-192,313. PUB. 10-1-2002. FILED 1-10-2001.
- 2,763,248. **VERSATA AND DESIGN**. VERSATA, INC., MULTIPLE CLASS, (INT. CLS. 9 AND 42), (U.S. CLS. 21, 23, 26, 36, 38, 100 AND 101). SN 76-202,813. PUB. 6-24-2003. FILED 1-31-2001.
- 2,763,249. **SMARTPUMP (STYLIZED)**. ING. ERICH PFEIFER GMBFH, MULTIPLE CLASS, (INT. CLS. 9, 10 AND 21), (U.S. CLS. 2, 13, 21, 23, 26, 29, 30, 33, 36, 38, 39, 40, 44 AND 50). SN 76-203,798. PUB. 6-24-2003. FILED 2-2-2001.
- 2,763,254. **HANDS ON**. GEMINI INDUSTRIES, INC., (U.S. CLS. 21, 23, 26, 36 AND 38). SN 76-205,574. PUB. 6-24-2003. FILED 2-5-2001.
- 2,763,256. **SCRIPTURIT**. OON, YEONG KUANG, (U.S. CLS. 21, 23, 26, 36 AND 38). SN 76-207,726. PUB. 6-24-2003. FILED 2-7-2001.
- 2,763,263. **GELPAD BY DINICTA**. DINICTA S.R.L., MULTIPLE CLASS, (INT. CLS. 9, 10 AND 20), (U.S. CLS. 2, 13, 21, 22, 23, 25, 26, 32, 36, 38, 39, 44 AND 50). SN 76-210,985. PUB. 6-24-2003. FILED 2-16-2001.
- 2,763,268 (*See Class 6 for this trademark*).
- 2,763,269. **ZN-SMARTEYE**. ZN VISION TECHNOLOGIES AG, MULTIPLE CLASS, (INT. CLS. 9, 38, 39 AND 42), (U.S. CLS. 21, 23, 26, 36, 38, 100, 101, 104 AND 105). SN 76-217,488. PUB. 2-25-2003. FILED 2-28-2001.
- 2,763,270. **NORTH AMERICAN CABLE COMPANY, INC.**. NORTH AMERICAN CABLE COMPANY, INC., (U.S. CLS. 21, 23, 26, 36 AND 38). SN 76-218,413. PUB. 6-24-2003. FILED 3-5-2001.
- 2,763,271. **THE FIRST FOOT OF THE FIRST MILE**. WAY2-CALL COMMUNICATIONS LTD., (U.S. CLS. 21, 23, 26, 36 AND 38). SN 76-221,109. PUB. 6-24-2003. FILED 3-7-2001.
- 2,763,274. **BIOTONIX**. BIOTONIX INC., MULTIPLE CLASS, (INT. CLS. 9 AND 42), (U.S. CLS. 21, 23, 26, 36, 38, 100 AND 101). SN 76-224,745. PUB. 6-24-2003. FILED 3-15-2001.
- 2,763,284. **SYNPAQ**. SYNERGY SYSTEMS, LLC, (U.S. CLS. 21, 23, 26, 36 AND 38). SN 76-240,536. PUB. 10-9-2001. FILED 4-10-2001.
- 2,763,295. **EASE-E AND DESIGN**. TETRADATA CORPORATION, (U.S. CLS. 21, 23, 26, 36 AND 38). SN 76-254,134. PUB. 6-24-2003. FILED 5-8-2001.

- 2,763,308. **STAB - USALS AND DESIGN**. STAB S.R.L., (U.S. CLS. 21, 23, 26, 36 AND 38). SN 76-275,292. PUB. 6-24-2003. FILED 6-21-2001.
- 2,763,309. **9-6. SAAB AUTOMOBILE AB, MULTIPLE CLASS**, (INT. CLS. 9, 12 AND 37), (U.S. CLS. 19, 21, 23, 26, 31, 35, 36, 38, 44, 100, 103 AND 106). SN 76-275,627. PUB. 6-24-2003. FILED 6-21-2001.
- 2,763,310. **9-5. SAAB AUTOMOBILE AB, MULTIPLE CLASS**, (INT. CLS. 9, 12 AND 37), (U.S. CLS. 19, 21, 23, 26, 31, 35, 36, 38, 44, 100, 103 AND 106). SN 76-275,707. PUB. 6-24-2003. FILED 6-21-2001.
- 2,763,317 (*See Class 1 for this trademark*).
- 2,763,318. **NE NEW ENERGY OPPORTUNITIES AND DESIGN**. NEW ENERGY OPPORTUNITIES, INC., (U.S. CLS. 21, 23, 26, 36 AND 38). SN 76-281,748. PUB. 6-24-2003. FILED 7-10-2001.
- 2,763,321. **IATIA**. IATIA LIMITED, BY CHANGE OF NAME IATIA PTY LTD, (U.S. CLS. 21, 23, 26, 36 AND 38). SN 76-285,751. PUB. 6-24-2003. FILED 7-16-2001.
- 2,763,324. **GRACIDA AND DESIGN**. GRACIDA EQUIPOS MAGNETICOS, S.A. DE C.V., (U.S. CLS. 21, 23, 26, 36 AND 38). SN 76-288,159. PUB. 6-24-2003. FILED 7-20-2001.
- 2,763,333. **AGILE**. AGILE SOFTWARE CORPORATION, (U.S. CLS. 21, 23, 26, 36 AND 38). SN 76-295,621. PUB. 6-24-2003. FILED 8-3-2001.
- 2,763,340. **THE CASH FLOW CHRONICLES**. KAUFMAN-PETERS LLC, MULTIPLE CLASS, (INT. CLS. 9 AND 16), (U.S. CLS. 2, 5, 21, 22, 23, 26, 29, 36, 37, 38 AND 50). SN 76-301,820. PUB. 5-28-2002. FILED 8-20-2001.
- 2,763,341 (*See Class 7 for this trademark*).
- 2,763,344. **HYPERLINK**. ARISTOCRAT TECHNOLOGIES AUSTRALIA PTY LTD., (U.S. CLS. 21, 23, 26, 36 AND 38). SN 76-306,393. PUB. 6-24-2003. FILED 8-29-2001.
- 2,763,351. **SIMMENTOR**. SIMSURGERY AS, MULTIPLE CLASS, (INT. CLS. 9, 10, 41 AND 42), (U.S. CLS. 21, 23, 26, 36, 38, 39, 44, 100, 101 AND 107). SN 76-310,007. PUB. 6-24-2003. FILED 9-7-2001.
- 2,763,354. **C AND DESIGN**. J.S.C. SVETLANA, (U.S. CLS. 21, 23, 26, 36 AND 38). SN 76-312,946. PUB. 1-29-2002. FILED 9-18-2001.
- 2,763,359. **BBS-TEK (STYLIZED)**. BRIGADE ELECTRONICS PLC, (U.S. CLS. 21, 23, 26, 36 AND 38). SN 76-314,240. PUB. 6-24-2003. FILED 9-18-2001.
- 2,763,360. **MKS INTEGRITY MANAGER**. MKS INC., BY CHANGE OF NAME MORTICE KERN SYSTEMS INC., (U.S. CLS. 21, 23, 26, 36 AND 38). SN 76-314,757. PUB. 6-24-2003. FILED 9-20-2001.
- 2,763,361. **METADIMENSION**. HEIDELBERGER DRUCKMASCHINEN AKTIENGESELLSCHAFT, (U.S. CLS. 21, 23, 26, 36 AND 38). SN 76-316,301. PUB. 6-24-2003. FILED 9-24-2001.
- 2,763,363. **GINFAX AND DESIGN**. GINFAX DEVELOPMENT LIMITED, (U.S. CLS. 21, 23, 26, 36 AND 38). SN 76-317,723. PUB. 3-4-2003. FILED 9-26-2001.
- 2,763,364. **MOST WANTED**. KONAMI GAMING, INC., (U.S. CLS. 21, 23, 26, 36 AND 38). SN 76-319,722. PUB. 5-14-2002. FILED 9-28-2001.
- 2,763,372. **FELLOWS (STYLIZED)**. BOURN & KOCH, INC., BY ASSIGNMENT; BY ASSIGNMENT FELLOWS CORPORATION, (U.S. CLS. 21, 23, 26, 36 AND 38). SN 76-323,611. PUB. 6-24-2003. FILED 10-10-2001.
- 2,763,375. **BLUE NICKEL**. TELECT, INC., (U.S. CLS. 21, 23, 26, 36 AND 38). SN 76-324,325. PUB. 6-24-2003. FILED 10-11-2001.
- 2,763,376. **SOLARISM**. WANG, ROBERT, (U.S. CLS. 21, 23, 26, 36 AND 38). SN 76-324,976. PUB. 8-13-2002. FILED 10-12-2001.
- 2,763,397. **GOVISUAL (STYLIZED)**. STIFTUNG CAESAR, MULTIPLE CLASS, (INT. CLS. 9, 16 AND 42), (U.S. CLS. 2, 5, 21, 22, 23, 26, 29, 36, 37, 38, 50, 100 AND 101). SN 76-335,416. PUB. 6-24-2003. FILED 11-7-2001.
- 2,763,398 (*See Class 1 for this trademark*).
- 2,763,399. **SILICON KEY VAULT**. SECURE SYSTEMS LIMITED, (U.S. CLS. 21, 23, 26, 36 AND 38). SN 76-336,272. PUB. 6-24-2003. FILED 11-9-2001.
- 2,763,403. **DELPRO**. ILLINOIS TOOL WORKS INC., MULTIPLE CLASS, (INT. CLS. 9, 11, 12 AND 20), (U.S. CLS. 2, 13, 19, 21, 22, 23, 25, 26, 31, 32, 34, 35, 36, 38, 44 AND 50). SN 76-337,325. PUB. 6-24-2003. FILED 11-14-2001.
- 2,763,404. **RELIEF FACTOR MANAGEMENT SYSTEMS RFMS**. HATRAK, ROBERT STEPHEN, MULTIPLE CLASS, (INT. CLS. 9 AND 35), (U.S. CLS. 21, 23, 26, 36, 38, 100, 101 AND 102). SN 76-339,628. PUB. 6-24-2003. FILED 11-19-2001.
- 2,763,408 (*See Class 6 for this trademark*).
- 2,763,409 (*See Class 6 for this trademark*).
- 2,763,410. **PREMET**. LEHMANN & MICHELS GMBH & CO. KG, (U.S. CLS. 21, 23, 26, 36 AND 38). SN 76-342,144. PUB. 6-24-2003. FILED 11-28-2001.
- 2,763,414. **PROTEINEER (STYLIZED)**. BRUKER DALTONIK GMBH, (U.S. CLS. 21, 23, 26, 36 AND 38). SN 76-342,610. PUB. 6-24-2003. FILED 11-28-2001.
- 2,763,418. **RELATIONVIEWER**. FABASOFT AG, MULTIPLE CLASS, (INT. CLS. 9, 41 AND 42), (U.S. CLS. 21, 23, 26, 36, 38, 100, 101 AND 107). SN 76-343,374. PUB. 6-24-2003. FILED 11-29-2001.
- 2,763,430. **LIVING TECHNOLOGY**. KONINKLIJKE PHILIPS ELECTRONICS N.V., (U.S. CLS. 21, 23, 26, 36 AND 38). SN 76-347,194. PUB. 6-24-2003. FILED 12-10-2001.
- 2,763,433. **HIGHTOWER SOFTWARE**. HIGH TOWER SOFTWARE, INC., (U.S. CLS. 21, 23, 26, 36 AND 38). SN 76-347,747. PUB. 6-24-2003. FILED 12-10-2001.
- 2,763,441. **ZAPF ESSENTIALS**. HEIDELBERGER DRUCKMASCHINEN AG, MULTIPLE CLASS, (INT. CLS. 9 AND 16), (U.S. CLS. 2, 5, 21, 22, 23, 26, 29, 36, 37, 38 AND 50). SN 76-350,945. PUB. 6-24-2003. FILED 12-19-2001.
- 2,763,442 (*See Class 7 for this trademark*).
- 2,763,445 (*See Class 7 for this trademark*).
- 2,763,471. **THE MAZE OF THE KINGS**. KABUSHIKI KAISHA SEGA, DBA SEGA CORPORATION, AND KABUSHIKI KAISHA HITMAKER, DBA HITMAKER CO., LTD., MULTIPLE CLASS, (INT. CLS. 9, 28 AND 41), (U.S. CLS. 21, 22, 23, 26, 36, 38, 50, 100, 101 AND 107). SN 76-362,876. PUB. 6-24-2003. FILED 1-25-2002.
- 2,763,481. **TRUE AGE**. MARK BRITTINGHAM ASSOCIATES, LLC, (U.S. CLS. 21, 23, 26, 36 AND 38). SN 76-366,890. PUB. 6-24-2003. FILED 2-5-2002.
- 2,763,482. **MOTIVATION**. BRITTINGHAM SOFTWARE DESIGN, INC., (U.S. CLS. 21, 23, 26, 36 AND 38). SN 76-366,891. PUB. 6-24-2003. FILED 2-5-2002.
- 2,763,484. **FLEXCARD**. FSV PAYMENT SYSTEMS LTD., BY ASSIGNMENT ATM BENEFITS AND SERVICES LLC, (U.S. CLS. 21, 23, 26, 36 AND 38). SN 76-369,921. PUB. 6-24-2003. FILED 2-11-2002.
- 2,763,486. **QSOLVE**. AGATE SOFTWARE, INC., (U.S. CLS. 21, 23, 26, 36 AND 38). SN 76-371,257. PUB. 6-24-2003. FILED 2-14-2002.
- 2,763,495. **ESSIENT**. ESSIENT PHOTONICS, INC., (U.S. CLS. 21, 23, 26, 36 AND 38). SN 76-375,718. PUB. 6-24-2003. FILED 2-25-2002.
- 2,763,500. **MAGICASE**. NAN JIN RONG BAO XIANG BAO, LIMITED, (U.S. CLS. 21, 23, 26, 36 AND 38). SN 76-376,677. PUB. 6-24-2003. FILED 3-1-2002.
- 2,763,508. **MYMAIL**. FRANCO TYP-POSTALIA AG & CO., MULTIPLE CLASS, (INT. CLS. 9 AND 16), (U.S. CLS. 2, 5, 21, 22, 23, 26, 29, 36, 37, 38 AND 50). SN 76-380,628. PUB. 6-24-2003. FILED 3-11-2002.
- 2,763,513 (*See Class 6 for this trademark*).
- 2,763,516. **WWW.HEIGHTMATTERS.COM**. NOVO NORDISK A/S, MULTIPLE CLASS, (INT. CLS. 9, 42 AND 44), (U.S. CLS. 21, 23, 26, 36, 38, 100 AND 101). SN 76-382,776. PUB. 6-24-2003. FILED 3-13-2002.
- 2,763,517. **RESULTS 6**. LPG SYSTEMS, (U.S. CLS. 21, 23, 26, 36 AND 38). SN 76-382,783. PUB. 6-24-2003. FILED 3-13-2002.
- 2,763,521. **THE SEAL OF THE CHURCH OF GOD IN CHRIST, INC. ORGANIZED 1907 MEMPHIS, TENNESSEE AND DESIGN**. CHURCH OF GOD IN CHRIST, INC., MULTIPLE CLASS, (INT. CLS. 9, 16, 41 AND 45), (U.S. CLS. 2, 5, 21, 22, 23, 26, 29, 36, 37, 38, 50, 100, 101 AND 107). SN 76-384,593. PUB. 6-24-2003. FILED 3-20-2002.
- 2,763,523. **VIRGINIA HOSPITAL CENTER - ARLINGTON**. VIRGINIA HOSPITAL CENTER ARLINGTON HEALTH SYSTEM, MULTIPLE CLASS, (INT. CLS. 9, 16 AND 44), (U.S. CLS. 2, 5, 21, 22, 23, 26, 29, 36, 37, 38, 50, 100 AND 101). SN 76-385,310. PUB. 6-24-2003. FILED 3-18-2002.
- 2,763,524. **MISCELLANEOUS DESIGN**. VIRGINIA HOSPITAL CENTER ARLINGTON HEALTH SYSTEM, MULTI-

- PLE CLASS, (INT. CLS. 9, 16 AND 44), (U.S. CLS. 2, 5, 21, 22, 23, 26, 29, 36, 37, 38, 50, 100 AND 101). SN 76-385,311. PUB. 6-24-2003. FILED 3-18-2002.
- 2,763,541. **ACCUBANKER USA AND DESIGN**. HILTON TRADING CORPORATION, (U.S. CLS. 21, 23, 26, 36 AND 38). SN 76-390,640. PUB. 6-24-2003. FILED 4-2-2002.
- 2,763,546. **PIMSLEUR INSTANT CONVERSATION**. SIMON & SCHUSTER, INC., (U.S. CLS. 21, 23, 26, 36 AND 38). SN 76-391,500. PUB. 6-24-2003. FILED 4-4-2002.
- 2,763,553. **HYDROFOAM**. CELLULAR EXPORT INTERNATIONAL, INC., (U.S. CLS. 21, 23, 26, 36 AND 38). SN 76-392,646. PUB. 6-24-2003. FILED 4-8-2002.
- 2,763,560. **HIERAPIPE (STYLIZED)**. GAZ DE FRANCE, SERVICE NATIONAL, MULTIPLE CLASS, (INT. CLS. 9, 16, 35, 38 AND 42), (U.S. CLS. 2, 5, 21, 22, 23, 26, 29, 36, 37, 38, 50, 100, 101, 102 AND 104). SN 76-393,769. PUB. 6-24-2003. FILED 4-11-2002.
- 2,763,564. **NOWDOCS**. TAYLOR CORPORATION, BY ASSIGNMENT NOWDOCS, INC., MULTIPLE CLASS, (INT. CLS. 9 AND 42), (U.S. CLS. 21, 23, 26, 36, 38, 100 AND 101). SN 76-394,168. PUB. 6-24-2003. FILED 4-10-2002.
- 2,763,565. **NEWTON THEATER**. CREATIVE TECHNOLOGY LTD., (U.S. CLS. 21, 23, 26, 36 AND 38). SN 76-394,591. PUB. 6-24-2003. FILED 4-11-2002.
- 2,763,566. **HPL AND DESIGN**. HPL TECHNOLOGIES, INC., MULTIPLE CLASS, (INT. CLS. 9, 41 AND 42), (U.S. CLS. 21, 23, 26, 36, 38, 100, 101 AND 107). SN 76-394,593. PUB. 6-24-2003. FILED 4-11-2002.
- 2,763,567. **ENCORUS TECHNOLOGIES AND DESIGN**. ENCORUS HOLDINGS LIMITED, MULTIPLE CLASS, (INT. CLS. 9, 35, 36, 37, 41 AND 42), (U.S. CLS. 21, 23, 26, 36, 38, 100, 101, 102, 103, 106 AND 107). SN 76-395,427. PUB. 6-24-2003. FILED 4-15-2002.
- 2,763,572. **GEMPSY AND DESIGN**. GEMPSY FRANCE SA, (U.S. CLS. 21, 23, 26, 36 AND 38). SN 76-397,372. PUB. 6-24-2003. FILED 4-17-2002.
- 2,763,575. **Q PLUS AND DESIGN**. ELECTRONICS AND TELECOMMUNICATIONS RESEARCH INSTITUTE, (U.S. CLS. 21, 23, 26, 36 AND 38). SN 76-398,340. PUB. 6-24-2003. FILED 4-19-2002.
- 2,763,579. **ROCKMAN**. ENHA GMBH, (U.S. CLS. 21, 23, 26, 36 AND 38). SN 76-398,842. PUB. 6-24-2003. FILED 4-22-2002.
- 2,763,603. **JEWELRING**. HELMUT FISCHER GMBH & CO. INSTITUT FUR ELEKTRONIK UND MESSTECHNIK, (U.S. CLS. 21, 23, 26, 36 AND 38). SN 76-402,726. PUB. 6-24-2003. FILED 4-30-2002.
- 2,763,607. **ULTRABASS**. RED CHIP COMPANY LTD., (U.S. CLS. 21, 23, 26, 36 AND 38). SN 76-403,616. PUB. 6-24-2003. FILED 5-3-2002.
- 2,763,609. **WELLSOURCE**. WELLSOURCE, INC., MULTIPLE CLASS, (INT. CLS. 9, 16, 35, 41, 42 AND 44), (U.S. CLS. 2, 5, 21, 22, 23, 26, 29, 36, 37, 38, 50, 100, 101, 102 AND 107). SN 76-404,213. PUB. 6-24-2003. FILED 4-30-2002.
- 2,763,618. **DYNABLACK**. SONY ELECTRONICS INC., (U.S. CLS. 21, 23, 26, 36 AND 38). SN 76-405,233. PUB. 6-24-2003. FILED 5-8-2002.
- 2,763,621. **CATA**. CARMICHAEL HOLDINGS, LLC, (U.S. CLS. 21, 23, 26, 36 AND 38). SN 76-405,630. PUB. 6-24-2003. FILED 5-10-2002.
- 2,763,625. **VINCENT ASSOCIATES**. VA, INC., (U.S. CLS. 21, 23, 26, 36 AND 38). SN 76-405,983. PUB. 6-24-2003. FILED 5-10-2002.
- 2,763,627. **RAIDMAX**. RAIDTRONICS, INC., (U.S. CLS. 21, 23, 26, 36 AND 38). SN 76-406,425. PUB. 6-24-2003. FILED 5-13-2002.
- 2,763,631. **EVERYTHING FROM A TO V**. OMNIMOUNT SYSTEMS, INC., MULTIPLE CLASS, (INT. CLS. 9 AND 20), (U.S. CLS. 2, 13, 21, 22, 23, 25, 26, 32, 36, 38 AND 50). SN 76-406,931. PUB. 6-24-2003. FILED 5-9-2002.
- 2,763,641. **MGA DUPLICA**. NEW AGE CONSULTANTS PTY LIMITED, (U.S. CLS. 21, 23, 26, 36 AND 38). SN 76-408,308. PUB. 6-24-2003. FILED 5-13-2002.
- 2,763,647. **HELIX BY ALORICA**. ALORICA INC., MULTIPLE CLASS, (INT. CLS. 9, 35 AND 42), (U.S. CLS. 21, 23, 26, 36, 38, 100, 101 AND 102). SN 76-409,362. PUB. 6-24-2003. FILED 5-20-2002.
- 2,763,655. **AIRE SERV**. AIRE SERV HEATING & AIR CONDITIONING, INC., MULTIPLE CLASS, (INT. CLS. 9, 11 AND 37), (U.S. CLS. 13, 21, 23, 26, 31, 34, 36, 38, 100, 103 AND 106). SN 76-409,673. PUB. 6-24-2003. FILED 5-17-2002.
- 2,763,656. **MISCELLANEOUS DESIGN**. AIRE SERV HEATING & AIR CONDITIONING, INC., MULTIPLE CLASS, (INT. CLS. 9, 11 AND 37), (U.S. CLS. 13, 21, 23, 26, 31, 34, 36, 38, 100, 103 AND 106). SN 76-409,674. PUB. 6-24-2003. FILED 5-17-2002.
- 2,763,657. **HELIX BY ALORICA AND DESIGN**. ALORICA INC., MULTIPLE CLASS, (INT. CLS. 9, 35 AND 42), (U.S. CLS. 21, 23, 26, 36, 38, 100, 101 AND 102). SN 76-409,743. PUB. 6-24-2003. FILED 5-20-2002.
- 2,763,687. **WOMEN, MEANING & MONEY**. BRADLEY, SUSAN K., MULTIPLE CLASS, (INT. CLS. 9 AND 41), (U.S. CLS. 21, 23, 26, 36, 38, 100, 101 AND 107). SN 76-415,743. PUB. 6-24-2003. FILED 6-5-2002.
- 2,763,693. **TVLOK NOW YOU HOLD THE KEY AND DESIGN**. HALVORSON, GREGORY LYNN, AND HALVORSON, MARLYS ELAINE, (U.S. CLS. 21, 23, 26, 36 AND 38). SN 76-416,462. PUB. 6-24-2003. FILED 5-31-2002.
- 2,763,695. **SAKAR**. SAKAR INTERNATIONAL INC., MULTIPLE CLASS, (INT. CLS. 9 AND 28), (U.S. CLS. 21, 22, 23, 26, 36, 38 AND 50). SN 76-416,562. PUB. 6-24-2003. FILED 5-23-2002.
- 2,763,699. **MELLIBASE**. ROCHE DIAGNOSTICS GMBH, MULTIPLE CLASS, (INT. CLS. 9, 36, 41 AND 44), (U.S. CLS. 21, 23, 26, 36, 38, 100, 101, 102 AND 107). SN 76-417,590. PUB. 6-24-2003. FILED 6-5-2002.
- 2,763,706 (*See Class 7 for this trademark*).
- 2,763,727. **MISCELLANEOUS DESIGN**. CEREBIS, L.P., (U.S. CLS. 21, 23, 26, 36 AND 38). SN 76-420,478. PUB. 6-24-2003. FILED 5-14-2002.
- 2,763,731. **KESTREL TRACKER**. NIELSEN-KELLERMAN CO., INC., (U.S. CLS. 21, 23, 26, 36 AND 38). SN 76-421,535. PUB. 6-24-2003. FILED 6-14-2002.
- 2,763,746. **CP 1512**. SIEMENS AKTIENGESSELLSCHAFT, (U.S. CLS. 21, 23, 26, 36 AND 38). SN 76-424,949. PUB. 6-24-2003. FILED 6-18-2002.
- 2,763,753. **SCALEXTRIC**. HORNBY HOBBIES LIMITED, (U.S. CLS. 21, 23, 26, 36 AND 38). SN 76-426,119. PUB. 6-24-2003. FILED 6-28-2002.
- 2,763,770. **CORAL RIDGE MINISTRIES**. CORAL RIDGE MINISTRIES MEDIA, INC., (U.S. CLS. 21, 23, 26, 36 AND 38). SN 76-428,961. PUB. 6-24-2003. FILED 7-9-2002.
- 2,763,772. **CORAL RIDGE MINISTRIES AND DESIGN**. CORAL RIDGE MINISTRIES MEDIA, INC., (U.S. CLS. 21, 23, 26, 36 AND 38). SN 76-428,965. PUB. 6-24-2003. FILED 7-9-2002.
- 2,763,786. **GRANDTEC USA**. DOBBS STANFORD CORPORATION, (U.S. CLS. 21, 23, 26, 36 AND 38). SN 76-430,788. PUB. 6-24-2003. FILED 7-15-2002.
- 2,763,791. **AMINOSCREEN**. DEGUSSA AG, MULTIPLE CLASS, (INT. CLS. 9, 41 AND 42), (U.S. CLS. 21, 23, 26, 36, 38, 100, 101 AND 107). SN 76-431,543. PUB. 6-24-2003. FILED 7-11-2002.
- 2,763,799. **CEA (STYLIZED)**. COMPUTER EMPLOYMENT APPLICATIONS, INC., MULTIPLE CLASS, (INT. CLS. 9, 35 AND 45), (U.S. CLS. 21, 23, 26, 36, 38, 100, 101 AND 102). SN 76-433,394. PUB. 6-24-2003. FILED 7-23-2002.
- 2,763,803. **DL (STYLIZED)**. TBAC INVESTMENT TRUST, AND SUPERBA, INC., MULTIPLE CLASS, (INT. CLS. 9, 16, 18, 20 AND 25), (U.S. CLS. 1, 2, 3, 5, 13, 21, 22, 23, 25, 26, 29, 32, 36, 37, 38, 39, 41 AND 50). SN 76-433,943. PUB. 6-24-2003. FILED 7-24-2002.
- 2,763,804. **MISCELLANEOUS DESIGN**. SCIENTIFIC INSTRUMENT SERVICES, INC., (U.S. CLS. 21, 23, 26, 36 AND 38). SN 76-434,067. PUB. 6-24-2003. FILED 7-25-2002.
- 2,763,813 (*See Class 7 for this trademark*).
- 2,763,855. **S AND DESIGN**. SENSITECH, INC., MULTIPLE CLASS, (INT. CLS. 9 AND 42), (U.S. CLS. 21, 23, 26, 36, 38, 100 AND 101). SN 76-444,250. PUB. 6-24-2003. FILED 3-25-2002.
- 2,763,864. **THE PRIME GUIDE.COM AND DESIGN**. PRIME COMMUNITY PUBLICATIONS, INC., (U.S. CLS. 21, 23, 26, 36 AND 38). SN 76-447,635. PUB. 6-24-2003. FILED 9-6-2002.
- 2,763,924. **POLYGRADIENT**. BNL EUROLENS, (U.S. CLS. 21, 23, 26, 36 AND 38). SN 76-456,346. PUB. 6-24-2003. FILED 9-30-2002.
- 2,763,930. **U-WATCH RECORDS**. U-WATCH RECORD, LLC,

- BY ASSIGNMENT WHOLE OATS ENTERPRISES, (U.S. CLS. 21, 23, 26, 36 AND 38). SN 76-457,060. PUB. 6-24-2003. FILED 10-7-2002.
- 2,763,955. **MARSALIS MUSIC**. MARSALIS MUSIC LLC, (U.S. CLS. 21, 23, 26, 36 AND 38). SN 76-460,108. PUB. 6-24-2003. FILED 10-17-2002.
- 2,763,960. **REMOTEWATCH XPERIENCE**. ALPHA SYSTEMS LAB, INC., (U.S. CLS. 21, 23, 26, 36 AND 38). SN 76-460,558. PUB. 6-24-2003. FILED 10-18-2002.
- 2,763,972. **ENGLISH ON A ROLL**. KORAN, LINDA H., MULTIPLE CLASS, (INT. CLS. 9, 16 AND 41), (U.S. CLS. 2, 5, 21, 22, 23, 26, 29, 36, 37, 38, 50, 100, 101 AND 107). SN 76-461,825. PUB. 6-24-2003. FILED 10-28-2002.
- 2,763,990. **DISAMBIGUATOR**. VISUAL ANALYTICS, INCORPORATED, (U.S. CLS. 21, 23, 26, 36 AND 38). SN 76-465,519. PUB. 6-24-2003. FILED 10-30-2002.
- 2,764,020. **ECAR**. EDUCAUSE CORPORATION, (U.S. CLS. 21, 23, 26, 36 AND 38). SN 76-468,731. PUB. 6-24-2003. FILED 11-7-2002.
- 2,764,028. **HONDEX**. HONDA ELECTRONICS CO., LTD., (U.S. CLS. 21, 23, 26, 36 AND 38). SN 76-469,789. PUB. 6-24-2003. FILED 11-26-2002.
- 2,764,034. **POWERED BY [TOPCODER]**. TOPCODER, INC., (U.S. CLS. 21, 23, 26, 36 AND 38). SN 76-470,771. PUB. 6-24-2003. FILED 11-29-2002.
- 2,764,036. **E-Z (STYLIZED)**. ENEFCO INTERNATIONAL LTD., (U.S. CLS. 21, 23, 26, 36 AND 38). SN 76-470,911. PUB. 6-24-2003. FILED 11-25-2002.
- 2,764,102 (*See Class 1 for this trademark*).
- 2,764,111. **NOTESMD NOTESMD.COM NOTES.MD NOTESMD.NET NOTESMD.ORG NOTESMD.EDU**. KARLSBERG, RONALD P., (U.S. CLS. 21, 23, 26, 36 AND 38). SN 78-029,638. PUB. 6-24-2003. FILED 10-8-2000.
- 2,764,115. **DOCUBLASTER**. PACIFIC DATAVISION, INC., (U.S. CLS. 21, 23, 26, 36 AND 38). SN 78-036,359. PUB. 6-24-2003. FILED 11-22-2000.
- 2,764,119. **20/20 HINDSIGHT AND DESIGN**. MONITORING TECHNOLOGY CORPORATION, (U.S. CLS. 21, 23, 26, 36 AND 38). SN 78-043,160. PUB. 6-24-2003. FILED 1-15-2001.
- 2,764,128. **OSISWITCH**. SCHNEIDER ELECTRIC INDUSTRIES SA, MULTIPLE CLASS, (INT. CLS. 9 AND 16), (U.S. CLS. 2, 5, 21, 22, 23, 26, 29, 36, 37, 38 AND 50). SN 78-067,929. PUB. 1-28-2003. FILED 6-7-2001.
- 2,764,129. **QUICKSTORE POINT-OF-SALE**. DIAMOND DATA SYSTEMS, INC., (U.S. CLS. 21, 23, 26, 36 AND 38). SN 78-067,983. PUB. 6-24-2003. FILED 6-7-2001.
- 2,764,130. **SAFETYDX**. SAFETY VISION, L.P., (U.S. CLS. 21, 23, 26, 36 AND 38). SN 78-070,175. PUB. 6-24-2003. FILED 6-20-2001.
- 2,764,134. **SHAREDBASE**. SHAREDBASE LIMITED, MULTIPLE CLASS, (INT. CLS. 9, 38 AND 42), (U.S. CLS. 21, 23, 26, 36, 38, 100, 101 AND 104). SN 78-072,312. PUB. 6-24-2003. FILED 7-4-2001.
- 2,764,137. **ACCESS POINT**. FREELAND SYSTEMS, L.L.C., (U.S. CLS. 21, 23, 26, 36 AND 38). SN 78-077,244. PUB. 7-30-2002. FILED 8-2-2001.
- 2,764,140. **DREAMTIME MEDITATION SYSTEMS AND DESIGN**. ANCIENT DRUM ENTERPRISES, LLC, (U.S. CLS. 21, 23, 26, 36 AND 38). SN 78-085,956. PUB. 6-24-2003. FILED 9-27-2001.
- 2,764,147. **DURHAM GEO SLOPE INDICATOR AND DESIGN**. DURHAM GEO-ENTERPRISES, INC., (U.S. CLS. 21, 23, 26, 36 AND 38). SN 78-090,819. PUB. 6-24-2003. FILED 10-30-2001.
- 2,764,151. **HYMITE**. HYMITE APS, MULTIPLE CLASS, (INT. CLS. 9 AND 40), (U.S. CLS. 21, 23, 26, 36, 38, 100, 103 AND 106). SN 78-096,883. PUB. 6-24-2003. FILED 12-6-2001.
- 2,764,152. **PICPRODIGY**. ATLANTEK MICROSYSTEMS PTY. LTD., (U.S. CLS. 21, 23, 26, 36 AND 38). SN 78-097,259. PUB. 6-24-2003. FILED 12-7-2001.
- 2,764,153. **IM AND DESIGN**. JORDAN, PAUL, D, (U.S. CLS. 21, 23, 26, 36 AND 38). SN 78-097,778. PUB. 6-24-2003. FILED 12-11-2001.
- 2,764,154. **THE PER ANNUM GREATER BOSTON CITY DIRECTORY**. PER ANNUM, INC., (U.S. CLS. 21, 23, 26, 36 AND 38). SN 78-098,732. PUB. 6-24-2003. FILED 12-17-2001.
- 2,764,155. **THE PER ANNUM METROPOLITAN CITY DIRECTORY**. PER ANNUM, INC., (U.S. CLS. 21, 23, 26, 36 AND 38). SN 78-098,965. PUB. 6-24-2003. FILED 12-18-2001.
- 2,764,164. **ISA (STYLIZED)**. I.S. ASSOCIATES, INC., MULTIPLE CLASS, (INT. CLS. 9 AND 42), (U.S. CLS. 21, 23, 26, 36, 38, 100 AND 101). SN 78-102,507. PUB. 6-24-2003. FILED 1-14-2002.
- 2,764,170. **ASSISTWARE**. BAYDON SOLUTIONS LTD, (U.S. CLS. 21, 23, 26, 36 AND 38). SN 78-104,276. PUB. 6-24-2003. FILED 1-23-2002.
- 2,764,171. **GROUP 6 AND DESIGN**. INTELLECT CORP., (U.S. CLS. 21, 23, 26, 36 AND 38). SN 78-104,291. PUB. 4-8-2003. FILED 1-23-2002.
- 2,764,176. **XPEDIATOR COMPLIANCE PORTAL (STYLIZED)**. XPEDIATE CONSULTING, LLC, (U.S. CLS. 21, 23, 26, 36 AND 38). SN 78-105,197. PUB. 6-24-2003. FILED 1-28-2002.
- 2,764,184. **GUAPA RECORDS AND DESIGN**. NORWOOD, NELSON BEDELL, (U.S. CLS. 21, 23, 26, 36 AND 38). SN 78-108,068. PUB. 6-24-2003. FILED 2-11-2002.
- 2,764,195. **WEBEXIT**. NOBSCOT CORPORATION, (U.S. CLS. 21, 23, 26, 36 AND 38). SN 78-114,556. PUB. 6-24-2003. FILED 3-13-2002.
- 2,764,211. **X-COLORS**. NOVARTIS AG, (U.S. CLS. 21, 23, 26, 36 AND 38). SN 78-124,159. PUB. 6-24-2003. FILED 4-25-2002.
- 2,764,216. **FOCAL ONE**. NOVARTIS AG, (U.S. CLS. 21, 23, 26, 36 AND 38). SN 78-127,571. PUB. 6-24-2003. FILED 5-9-2002.
- 2,764,269. **FLASHTAX AND DESIGN**. PARROTT, JAMES R., (U.S. CLS. 21, 23, 26, 36 AND 38). SN 78-148,828. PUB. 6-24-2003. FILED 7-30-2002.
- 2,764,279. **HIGH HAVEN MUSIC AND DESIGN**. BARCHAS, SARAH, DBA HIGH HAVEN MUSIC, (U.S. CLS. 21, 23, 26, 36 AND 38). SN 78-154,118. PUB. 6-24-2003. FILED 8-14-2002.
- 2,764,280. **M:PRINT**. PEARSON MEDICAL TECHNOLOGIES, LLC, (U.S. CLS. 21, 23, 26, 36 AND 38). SN 78-154,229. PUB. 6-24-2003. FILED 8-14-2002.
- 2,764,290. **COMPLIANCE NAVIGATOR**. PITTENGER, ROBERT, (U.S. CLS. 21, 23, 26, 36 AND 38). SN 78-156,691. PUB. 6-24-2003. FILED 8-22-2002.
- 2,764,292 (*See Class 7 for this trademark*).
- 2,764,297. **GASHAPON**. BANDAI CO., LTD., (U.S. CLS. 21, 23, 26, 36 AND 38). SN 78-158,206. PUB. 6-24-2003. FILED 8-27-2002.
- 2,764,301. **VALSIZ**. CONTROL COMPONENTS, INC., (U.S. CLS. 21, 23, 26, 36 AND 38). SN 78-159,680. PUB. 6-24-2003. FILED 8-30-2002.
- 2,764,316. **# AND DESIGN**. INTERGGS, INC., DBA VERSADIAL SOLUTIONS, (U.S. CLS. 21, 23, 26, 36 AND 38). SN 78-163,981. PUB. 6-24-2003. FILED 9-13-2002.
- 2,764,320 (*See Class 7 for this trademark*).
- 2,764,324. **MEDILINKS**. MEDISERVE INFORMATION SYSTEMS, INC., (U.S. CLS. 21, 23, 26, 36 AND 38). SN 78-168,695. PUB. 6-24-2003. FILED 9-27-2002.
- 2,764,335. **EXPOCHARGER**. EXPOCHARGER INTERNATIONAL, INC., (U.S. CLS. 21, 23, 26, 36 AND 38). SN 78-172,518. PUB. 6-24-2003. FILED 10-9-2002.
- 2,764,351. **PLANNED PERFORMANCE**. MAUCH, LARRY, A., (U.S. CLS. 21, 23, 26, 36 AND 38). SN 78-176,259. PUB. 6-24-2003. FILED 10-19-2002.
- 2,764,355. **THELONIOUS MONK**. THELONIOUS MUSIC CORP, (U.S. CLS. 21, 23, 26, 36 AND 38). SN 78-176,512. PUB. 6-24-2003. FILED 10-21-2002.
- 2,764,356. **THELONIOUS RECORDS**. THELONIOUS MUSIC CORP, (U.S. CLS. 21, 23, 26, 36 AND 38). SN 78-176,522. PUB. 6-24-2003. FILED 10-21-2002.
- 2,764,366. **SOLARMETER**. SOLARTECH INC, (U.S. CLS. 21, 23, 26, 36 AND 38). SN 78-178,830. PUB. 6-24-2003. FILED 10-27-2002.
- 2,764,368. **USER-ACCESS**. NETWORK EXECUTIVE SOFTWARE, INC., (U.S. CLS. 21, 23, 26, 36 AND 38). SN 78-178,944. PUB. 6-24-2003. FILED 10-28-2002.
- 2,764,369. **HYPERCHANNEL**. NETWORK EXECUTIVE SOFTWARE, INC., (U.S. CLS. 21, 23, 26, 36 AND 38). SN 78-178,948. PUB. 6-24-2003. FILED 10-28-2002.
- 2,764,402. **JUTX**. AMERICAN ADVANCED POWER INC., (U.S. CLS. 21, 23, 26, 36 AND 38). SN 78-182,959. PUB. 6-24-2003. FILED 11-7-2002.
- 2,764,406. **USBEE LX**. HARVEY, TIMOTHY, JOHN, (U.S. CLS. 21, 23, 26, 36 AND 38). SN 78-183,385. PUB. 6-24-2003. FILED

- 11-8-2002.
 2,764,413. **AZEOTECH**. AZEOTECH, INC., (U.S. CLS. 21, 23, 26, 36 AND 38). SN 78-184,017. PUB. 6-24-2003. FILED 11-12-2002.
 2,764,416. **INSIDER**. ABB WATER METERS INC., (U.S. CLS. 21, 23, 26, 36 AND 38). SN 78-184,493. PUB. 6-24-2003. FILED 11-13-2002.
 2,764,453. **MISCELLANEOUS DESIGN**. VISIONARY COMMUNICATIONS, INC., MULTIPLE CLASS, (INT. CLS. 9 AND 42), (U.S. CLS. 21, 23, 26, 36, 38, 100 AND 101). SN 78-190,660. PUB. 6-24-2003. FILED 12-3-2002.
 2,764,455. **QUICKBOOKS**. INTUIT INC., (U.S. CLS. 21, 23, 26, 36 AND 38). SN 78-191,813. PUB. 6-24-2003. FILED 12-3-2002.
 2,764,459. **NIAGARA SCX**. VIEWCAST.COM, INC., DBA VIEWCAST CORPORATION, (U.S. CLS. 21, 23, 26, 36 AND 38). SN 78-191,440. PUB. 6-24-2003. FILED 12-5-2002.
 2,764,468. **EXCELLIS**. ISLAND AUTOMATED MEDICAL SERVICES, INC., (U.S. CLS. 21, 23, 26, 36 AND 38). SN 78-193,799. PUB. 6-24-2003. FILED 12-12-2002.

CLASS 10—MEDICAL APPARATUS

- 2,763,065. **E-SCAN AND DESIGN**. ESAOTE S.P.A., (U.S. CLS. 26, 39 AND 44). SN 75-618,296. PUB. 4-15-2003. FILED 1-7-1999.
 2,763,130. **BED SENTRY**. UNIVERSAL MEDICAL PRODUCTS, INC., (U.S. CLS. 26, 39 AND 44). SN 76-010,895. PUB. 6-24-2003. FILED 3-28-2000.
 2,763,208. **RAMBLER**. 1029894 ONTARIO INC., (U.S. CLS. 26, 39 AND 44). SN 76-166,777. PUB. 6-24-2003. FILED 11-16-2000.
 2,763,231. **AOA**. ALLESEE ORTHODONTIC APPLIANCES, INC., (U.S. CLS. 26, 39 AND 44). SN 76-184,628. PUB. 6-24-2003. FILED 12-22-2000.
 2,763,236 (*See Class 8 for this trademark*).
 2,763,241 (*See Class 5 for this trademark*).
 2,763,249 (*See Class 9 for this trademark*).
 2,763,263 (*See Class 9 for this trademark*).
 2,763,278 (*See Class 5 for this trademark*).
 2,763,297. **MEDICAL ADVANCES THROUGH TECHNOLOGY**. VSM MEDTECH LTD., (U.S. CLS. 26, 39 AND 44). SN 76-254,787. PUB. 6-24-2003. FILED 5-8-2001.
 2,763,351 (*See Class 9 for this trademark*).
 2,763,518. **VYGON AND DESIGN**. VYGON, (U.S. CLS. 26, 39 AND 44). SN 76-383,231. PUB. 6-24-2003. FILED 3-12-2002.
 2,763,534. **CHAROPS**. MIRAE OPTICS CO., LTD., (U.S. CLS. 26, 39 AND 44). SN 76-389,015. PUB. 6-24-2003. FILED 4-1-2002.
 2,763,674. **LIGASURE VESSEL SEALING SYSTEM AND DESIGN**. SHERWOOD SERVICES AG, (U.S. CLS. 26, 39 AND 44). SN 76-413,160. PUB. 6-24-2003. FILED 5-29-2002.
 2,763,683. **KION-I (STYLIZED)**. SIEMENS AKTIENGESELLSCHAFT, (U.S. CLS. 26, 39 AND 44). SN 76-414,734. PUB. 6-24-2003. FILED 5-31-2002.
 2,763,719. **TENO FIX**. ORTHEON MEDICAL, (U.S. CLS. 26, 39 AND 44). SN 76-419,907. PUB. 6-24-2003. FILED 6-13-2002.
 2,763,740. **ENDO ITR**. ASEPTICO, INC., (U.S. CLS. 26, 39 AND 44). SN 76-423,974. PUB. 6-24-2003. FILED 6-19-2002.
 2,763,763 (*See Class 5 for this trademark*).
 2,763,776. **SELESORB**. KANEKA CORPORATION, (U.S. CLS. 26, 39 AND 44). SN 76-429,734. PUB. 6-24-2003. FILED 7-8-2002.
 2,763,787. **VENTLAB**. VENTLAB CORPORATION, (U.S. CLS. 26, 39 AND 44). SN 76-431,033. PUB. 6-24-2003. FILED 7-12-2002.
 2,763,838. **COMFORTFLEX (STYLIZED)**. HANGER ORTHOPEDIC GROUP, INC., (U.S. CLS. 26, 39 AND 44). SN 76-440,976. PUB. 6-24-2003. FILED 8-16-2002.
 2,763,892. **CARE TENS**. CARE REHAB & ORTHOPAEDIC PRODUCTS, INC., (U.S. CLS. 26, 39 AND 44). SN 76-452,169. PUB. 6-24-2003. FILED 9-18-2002.
 2,763,921. **ACUITY DIGITAL AND DESIGN**. STARKEY LABORATORIES, INC., (U.S. CLS. 26, 39 AND 44). SN 76-456,074. PUB. 6-24-2003. FILED 10-4-2002.
 2,764,067. **TOMMY GUN**. RINGWALT, TOMMY, (U.S. CLS. 26, 39 AND 44). SN 76-473,898. PUB. 6-24-2003. FILED 12-11-

2002.
 2,764,116. **ULTRAPURE 6900**. SOCIETE DE TRANSFORMATION DES ELASTOMERES A USAGES MEDICAUX ET INDUSTRIELS, MULTIPLE CLASS, (INT. CLS. 10 AND 17), (U.S. CLS. 1, 5, 12, 13, 26, 35, 39, 44 AND 50). SN 78-036,382. PUB. 4-30-2002. FILED 11-22-2000.
 2,764,156. **HOYA AF-1 (UV)**. HOYA CORPORATION, (U.S. CLS. 26, 39 AND 44). SN 78-099,498. PUB. 6-24-2003. FILED 12-20-2001.
 2,764,166. **SPINE-FLEX (STYLIZED)**. YK AMERICA INTERNATIONAL, INC., MULTIPLE CLASS, (INT. CLS. 10 AND 28), (U.S. CLS. 22, 23, 26, 38, 39, 44 AND 50). SN 78-103,008. PUB. 6-24-2003. FILED 1-16-2002.
 2,764,183 (*See Class 5 for this trademark*).
 2,764,217. **TRUFOLD**. NOVARTIS AG, (U.S. CLS. 26, 39 AND 44). SN 78-127,575. PUB. 6-24-2003. FILED 5-9-2002.
 2,764,226. **SEGWAY**. BIOSPHERE MEDICAL INC., (U.S. CLS. 26, 39 AND 44). SN 78-130,719. PUB. 6-24-2003. FILED 5-23-2002.
 2,764,277. **COMFO-EZE WALKER**. DERROYAL INDUSTRIES, INC., (U.S. CLS. 26, 39 AND 44). SN 78-152,660. PUB. 6-24-2003. FILED 8-9-2002.
 2,764,288. **HIGH PERFORMANCE DETACH AND DESIGN**. WILLIAM COOK EUROPE APS, (U.S. CLS. 26, 39 AND 44). SN 78-155,971. PUB. 6-24-2003. FILED 8-20-2002.
 2,764,303. **FLYSAFE**. HJ SOCK GROUP LTD., (U.S. CLS. 26, 39 AND 44). SN 78-160,214. PUB. 6-24-2003. FILED 9-3-2002.
 2,764,376. **NUMED, INC. AND DESIGN**. NUMED, INC., (U.S. CLS. 26, 39 AND 44). SN 78-179,493. PUB. 6-24-2003. FILED 10-29-2002.
 2,764,458. **HBS**. MILLENNIUM MEDICAL TECHNOLOGIES, INC., (U.S. CLS. 26, 39 AND 44). SN 78-191,241. PUB. 6-24-2003. FILED 12-4-2002.

CLASS 11—ENVIRONMENTAL CONTROL APPARATUS

- 2,763,048. **TAPMASTER**. INTEGRA DYNAMICS INC., (U.S. CLS. 13, 21, 23, 31 AND 34). SN 75-450,890. PUB. 6-24-2003. FILED 3-16-1998.
 2,763,081. **MEXICAN DINNER AND DESIGN**. SEB S.A., BY ASSIGNMENT MOULINEX S.A., MULTIPLE CLASS, (INT. CLS. 11 AND 21), (U.S. CLS. 2, 13, 21, 23, 29, 30, 31, 33, 34, 40 AND 50). SN 75-766,459. PUB. 6-24-2003. FILED 8-2-1999.
 2,763,083. **LIGHTWAVE**. HIGH END SYSTEMS, INC., (U.S. CLS. 13, 21, 23, 31 AND 34). SN 75-775,738. PUB. 6-24-2003. FILED 8-10-1999.
 2,763,089 (*See Class 9 for this trademark*).
 2,763,107. **GROW WELL AND DESIGN**. DIORIO, JAMES J., (U.S. CLS. 13, 21, 23, 31 AND 34). SN 75-884,752. PUB. 11-7-2000. FILED 1-3-2000.
 2,763,126 (*See Class 3 for this trademark*).
 2,763,189. **HAIR ESSENTIALS**. NEILL CORPORATION, MULTIPLE CLASS, (INT. CLS. 11 AND 21), (U.S. CLS. 2, 13, 21, 23, 29, 30, 31, 33, 34, 40 AND 50). SN 76-135,524. PUB. 6-24-2003. FILED 9-26-2000.
 2,763,285. **PUSHON**. ACCOR TECHNOLOGY, INC., (U.S. CLS. 13, 21, 23, 31 AND 34). SN 76-243,267. PUB. 6-24-2003. FILED 4-18-2001.
 2,763,328 (*See Class 8 for this trademark*).
 2,763,367. **CF CALIFORNIA FAUCETS (STYLIZED)**. CALIFORNIA FAUCETS, MULTIPLE CLASS, (INT. CLS. 11 AND 21), (U.S. CLS. 2, 13, 21, 23, 29, 30, 31, 33, 34, 40 AND 50). SN 76-321,375. PUB. 6-24-2003. FILED 10-2-2001.
 2,763,398 (*See Class 1 for this trademark*).
 2,763,403 (*See Class 9 for this trademark*).
 2,763,412. **ARTLUNA**. YOSHIKAWA, KAZUhide, (U.S. CLS. 13, 21, 23, 31 AND 34). SN 76-342,292. PUB. 6-24-2003. FILED 11-28-2001.
 2,763,538. **FLEX-LINE**. BRUCK LIGHTING SYSTEMS, INC., (U.S. CLS. 13, 21, 23, 31 AND 34). SN 76-390,137. PUB. 6-24-2003. FILED 4-2-2002.
 2,763,556. **CLASSIC CATERER AND DESIGN**. PICK-UP-PAN, INC., MULTIPLE CLASS, (INT. CLS. 11 AND 21), (U.S. CLS. 2, 13, 21, 23, 29, 30, 31, 33, 34, 40 AND 50). SN 76-392,857.

- PUB. 6-24-2003. FILED 4-5-2002.
 2,763,655 (*See Class 9 for this trademark*).
 2,763,656 (*See Class 9 for this trademark*).
 2,763,691. **BOAO AND DESIGN**. SICHUAN CHANGHONG ELECTRONICS GROUP CORPORATION, (U.S. CLS. 13, 21, 23, 31 AND 34). SN 76-416,265. PUB. 6-24-2003. FILED 6-3-2002.
 2,763,754. **PG2000**. PENTAIR POOL PRODUCTS, INC., (U.S. CLS. 13, 21, 23, 31 AND 34). SN 76-426,136. PUB. 6-24-2003. FILED 6-28-2002.
 2,763,835. **EXCELUME**. LEGION LIGHTING COMPANY, INC., (U.S. CLS. 13, 21, 23, 31 AND 34). SN 76-440,211. PUB. 6-24-2003. FILED 8-12-2002.
 2,763,858. **RAPIDFIRE**. RAPIDFIRE, (U.S. CLS. 13, 21, 23, 31 AND 34). SN 76-444,389. PUB. 6-24-2003. FILED 8-26-2002.
 2,763,869. **60 SERIES**. AMERICAN METER COMPANY, (U.S. CLS. 13, 21, 23, 31 AND 34). SN 76-448,226. PUB. 6-24-2003. FILED 9-4-2002.
 2,763,871. **EVERSOFT AND DESIGN**. EVERSOFT, INC., MULTIPLE CLASS, (INT. CLS. 11 AND 37), (U.S. CLS. 13, 21, 23, 31, 34, 100, 103 AND 106). SN 76-448,384. PUB. 6-24-2003. FILED 9-10-2002.
 2,763,877. **ADVANCAIR**. CLEANROOM SYSTEMS, INC., (U.S. CLS. 13, 21, 23, 31 AND 34). SN 76-449,900. PUB. 6-24-2003. FILED 9-16-2002.
 2,763,914. **DOMO WINE**. THERMOWINE, INC., (U.S. CLS. 13, 21, 23, 31 AND 34). SN 76-455,288. PUB. 6-24-2003. FILED 10-3-2002.
 2,763,981. **AQUATICONCEPTS AND DESIGN**. STRONG INDUSTRIES INC., (U.S. CLS. 13, 21, 23, 31 AND 34). SN 76-463,962. PUB. 6-24-2003. FILED 9-19-2002.
 2,763,988. **PROLITE**. O.C. WHITE CO., (U.S. CLS. 13, 21, 23, 31 AND 34). SN 76-464,909. PUB. 6-24-2003. FILED 11-6-2002.
 2,764,112. **CHEMPEX**. NUPI S.P.A., MULTIPLE CLASS, (INT. CLS. 11, 17 AND 19), (U.S. CLS. 1, 5, 12, 13, 21, 23, 31, 33, 34, 35 AND 50). SN 78-030,006. PUB. 6-24-2003. FILED 10-10-2000.
 2,764,138 (*See Class 1 for this trademark*).
 2,764,180. **GLENWOOD DESIGNS (STYLIZED)**. GLENWOOD DESIGNS, MULTIPLE CLASS, (INT. CLS. 11 AND 21), (U.S. CLS. 2, 13, 21, 23, 29, 30, 31, 33, 34, 40 AND 50). SN 78-106,468. PUB. 6-24-2003. FILED 2-4-2002.
 2,764,205. **GRANADA**. KING OF FANS, INC., (U.S. CLS. 13, 21, 23, 31 AND 34). SN 78-121,339. PUB. 6-24-2003. FILED 4-12-2002.
 2,764,387. **EASY-FIRE**. L&L KILN MFG., INC., (U.S. CLS. 13, 21, 23, 31 AND 34). SN 78-180,485. PUB. 6-24-2003. FILED 10-31-2002.
 2,764,417. **DIXIE BELLE**. DAN'S FAN CITY, INC., (U.S. CLS. 13, 21, 23, 31 AND 34). SN 78-184,498. PUB. 6-24-2003. FILED 11-13-2002.
 2,764,470. **JETSTREAM**. WATKINS MANUFACTURING CORPORATION, (U.S. CLS. 13, 21, 23, 31 AND 34). SN 78-195,812. PUB. 6-24-2003. FILED 12-18-2002.
 31, 35, 39 AND 44). SN 76-134,863. PUB. 6-24-2003. FILED 9-25-2000.
 2,763,222 (*See Class 7 for this trademark*).
 2,763,268 (*See Class 6 for this trademark*).
 2,763,309 (*See Class 9 for this trademark*).
 2,763,310 (*See Class 9 for this trademark*).
 2,763,326. **BH. BICICLETAS DE ALAVA, S.A.**, (U.S. CLS. 19, 21, 23, 31, 35 AND 44). SN 76-289,246. PUB. 6-24-2003. FILED 7-20-2001.
 2,763,355. **MAZDA 9 (STYLIZED)**. MAZDA MOTOR CORPORATION, (U.S. CLS. 19, 21, 23, 31, 35 AND 44). SN 76-313,328. PUB. 6-24-2003. FILED 9-12-2001.
 2,763,356. **MAZDA 5 (STYLIZED)**. MAZDA MOTOR CORPORATION, (U.S. CLS. 19, 21, 23, 31, 35 AND 44). SN 76-313,444. PUB. 6-24-2003. FILED 9-12-2001.
 2,763,357. **MAZDA 8 (STYLIZED)**. MAZDA MOTOR CORPORATION, (U.S. CLS. 19, 21, 23, 31, 35 AND 44). SN 76-313,447. PUB. 6-24-2003. FILED 9-12-2001.
 2,763,403 (*See Class 9 for this trademark*).
 2,763,454. **DVS ROAD WHEELS**. ATLANTIC WHOLESALERS INC., (U.S. CLS. 19, 21, 23, 31, 35 AND 44). SN 76-355,185. PUB. 6-24-2003. FILED 1-4-2002.
 2,763,464. **SLK 350**. DAIMLERCHRYSLER AG, MULTIPLE CLASS, (INT. CLS. 12, 28 AND 37), (U.S. CLS. 19, 21, 22, 23, 31, 35, 38, 44, 50, 100, 103 AND 106). SN 76-359,645. PUB. 6-24-2003. FILED 1-16-2002.
 2,763,638. **JMASON AND DESIGN**. MTS PRODUCTS, MULTIPLE CLASS, (INT. CLS. 12, 18, 20 AND 28), (U.S. CLS. 1, 2, 3, 13, 19, 21, 22, 23, 25, 31, 32, 35, 38, 41, 44 AND 50). SN 76-407,919. PUB. 6-24-2003. FILED 5-14-2002.
 2,763,666. **VARIOWING**. OFNER, ANTON GERALD, (U.S. CLS. 19, 21, 23, 31, 35 AND 44). SN 76-412,102. PUB. 6-24-2003. FILED 5-17-2002.
 2,763,684. **REV**. BOMBARDIER INC., (U.S. CLS. 19, 21, 23, 31, 35 AND 44). SN 76-414,851. PUB. 6-24-2003. FILED 5-30-2002.
 2,763,685. **R.A.S.**. BOMBARDIER INC., (U.S. CLS. 19, 21, 23, 31, 35 AND 44). SN 76-414,854. PUB. 6-24-2003. FILED 5-30-2002.
 2,763,811. **TRIPLEEDGE**. DTR ASSOCIATES LIMITED PARTNERSHIP, (U.S. CLS. 19, 21, 23, 31, 35 AND 44). SN 76-435,400. PUB. 6-24-2003. FILED 7-25-2002.
 2,763,814 (*See Class 7 for this trademark*).
 2,763,815. **RLX**. DAIMLERCHRYSLER AG, (U.S. CLS. 19, 21, 23, 31, 35 AND 44). SN 76-436,301. PUB. 6-24-2003. FILED 7-31-2002.
 2,763,839 (*See Class 8 for this trademark*).
 2,764,102 (*See Class 1 for this trademark*).
 2,764,181. **SAVOY**. ROYCE UNION BICYCLE COMPANY, (U.S. CLS. 19, 21, 23, 31, 35 AND 44). SN 78-106,527. PUB. 6-24-2003. FILED 2-4-2002.
 2,764,249. **MISCELLANEOUS DESIGN**. DAIMLERCHRYSLER CORPORATION, (U.S. CLS. 19, 21, 23, 31, 35 AND 44). SN 78-138,435. PUB. 6-24-2003. FILED 6-25-2002.
 2,764,438. **AVPRO**. A.E.R.O. AVIATION, INC., (U.S. CLS. 19, 21, 23, 31, 35 AND 44). SN 78-185,946. PUB. 6-24-2003. FILED 11-18-2002.

CLASS 12—VEHICLES

- 2,763,087. **BABYTOO (STYLIZED)**. GROUPE BERCHET, BY MERGER ETS MAURICE CHARTON, (U.S. CLS. 19, 21, 23, 31, 35 AND 44). SN 75-785,657. PUB. 7-3-2001. FILED 8-26-1999.
 2,763,101 (*See Class 7 for this trademark*).
 2,763,126 (*See Class 3 for this trademark*).
 2,763,154. **KONIG MAGIC AND DESIGN**. KONIG S.P.A., (U.S. CLS. 19, 21, 23, 31, 35 AND 44). SN 76-069,389. PUB. 4-30-2002. FILED 6-13-2000.
 2,763,178. **MISCELLANEOUS DESIGN**. DELAWARE CAPITAL FORMATION, INC., BY ASSIGNMENT KALYN/SIEBERT, L.P., (U.S. CLS. 19, 21, 23, 31, 35 AND 44). SN 76-115,065. PUB. 6-24-2003. FILED 8-23-2000.
 2,763,181. **DT COMPETITION AND DESIGN**. DT SWISS AG, MULTIPLE CLASS, (INT. CLS. 12 AND 25), (U.S. CLS. 19, 21, 22, 23, 31, 35, 39 AND 44). SN 76-122,397. PUB. 6-24-2003. FILED 9-5-2000.
 2,763,188. **DT TENSIO AND DESIGN**. DT SWISS AG, MULTIPLE CLASS, (INT. CLS. 12 AND 25), (U.S. CLS. 19, 21, 22, 23,

CLASS 13—FIREARMS

- 2,763,226. **DEPTH CHARGE**. AMERICAN PROMOTIONAL EVENTS, INC., (U.S. CLS. 2 AND 9). SN 76-181,402. PUB. 6-24-2003. FILED 12-18-2000.

CLASS 14—JEWELRY

- 2,763,027. **REGGAE SUNSPLASH AND DESIGN**. REGGAE SUNSPLASH, INC., MULTIPLE CLASS, (INT. CLS. 14, 25 AND 41), (U.S. CLS. 22, 28, 39 AND 107). SN 74-366,575. PUB. 11-16-1993. FILED 3-10-1993.
 2,763,064 (*See Class 3 for this trademark*).
 2,763,126 (*See Class 3 for this trademark*).
 2,763,232 (*See Class 3 for this trademark*).
 2,763,236 (*See Class 8 for this trademark*).

- 2,763,244. **THE DIVA**. TXDC., L.P., BY ASSIGNMENT ZALE DELAWARE, INC., (U.S. CLS. 2, 27, 28 AND 50). SN 76-199,046. PUB. 6-24-2003. FILED 1-24-2001.
- 2,763,247 (*See Class 3 for this trademark*).
- 2,763,268 (*See Class 6 for this trademark*).
- 2,763,377. **ASHWORTH**. ASHWORTH, INC., (U.S. CLS. 2, 27, 28 AND 50). SN 76-324,994. PUB. 6-24-2003. FILED 10-12-2001.
- 2,763,384. **IABUNDANCE AND DESIGN**. ABUNDANCE RESOURCE NETWORK, INC., (U.S. CLS. 2, 27, 28 AND 50). SN 76-329,851. PUB. 6-24-2003. FILED 10-23-2001.
- 2,763,424. **WALDMANN**. WALDMANN KG, (U.S. CLS. 2, 27, 28 AND 50). SN 76-345,347. PUB. 6-24-2003. FILED 12-5-2001.
- 2,763,498. **PENNDOT AND DESIGN**. COMMONWEALTH OF PENNSYLVANIA, ACTING THROUGH THE PENNSYLVANIA DEPARTMENT OF TRANSPORTATION, MULTIPLE CLASS, (INT. CLS. 14, 16, 18, 20, 25, 26 AND 28), (U.S. CLS. 1, 2, 3, 5, 13, 22, 23, 25, 27, 28, 29, 32, 37, 38, 39, 40, 41, 42 AND 50). SN 76-376,618. PUB. 6-24-2003. FILED 2-27-2002.
- 2,763,554. **PLUMES**. CHAUMET INTERNATIONAL S.A., (U.S. CLS. 2, 27, 28 AND 50). SN 76-392,760. PUB. 6-24-2003. FILED 4-5-2002.
- 2,763,637. **RK ORIGINALS**. KELLY, RONDA HAESSIG, (U.S. CLS. 2, 27, 28 AND 50). SN 76-407,688. PUB. 6-24-2003. FILED 5-13-2002.
- 2,763,689. **COPPER GOES GLAMOROUS**. SHAPIRO, LINDA S., (U.S. CLS. 2, 27, 28 AND 50). SN 76-415,987. PUB. 6-24-2003. FILED 6-5-2002.
- 2,763,828. **G AND DESIGN**. GARRARD HOLDINGS LIMITED, (U.S. CLS. 2, 27, 28 AND 50). SN 76-439,109. PUB. 6-24-2003. FILED 8-9-2002.
- 2,764,102 (*See Class 1 for this trademark*).
- 2,764,105. **DIVERSITY LEADERSHIP ACADEMY**. AMERICAN INSTITUTE FOR MANAGING DIVERSITY, INC., MULTIPLE CLASS, (INT. CLS. 14, 16 AND 18), (U.S. CLS. 1, 2, 3, 5, 22, 23, 27, 28, 29, 37, 38, 41 AND 50). SN 76-975,408. PUB. 6-24-2003. FILED 7-1-2002.
- 2,764,127. **CANERA**. CAN, VIKTOR, (U.S. CLS. 2, 27, 28 AND 50). SN 78-064,831. PUB. 10-9-2001. FILED 5-21-2001.
- 2,764,229. **COQUETTE**. TEMPUS INTERNATIONAL CORPORATION, (U.S. CLS. 2, 27, 28 AND 50). SN 78-131,171. PUB. 6-24-2003. FILED 5-24-2002.
- 2,764,262. **MOVE 1**. FRED JOAILLIER, (U.S. CLS. 2, 27, 28 AND 50). SN 78-144,100. PUB. 6-24-2003. FILED 7-15-2002.
- 2,764,282. **LIGHTHOUSE BELL**. FORTESCUE, JAMES M., (U.S. CLS. 2, 27, 28 AND 50). SN 78-155,601. PUB. 6-24-2003. FILED 8-19-2002.
- 2,764,462. **LOCKHEED MARTIN**. LOCKHEED MARTIN CORPORATION, (U.S. CLS. 2, 27, 28 AND 50). SN 78-193,417. PUB. 6-24-2003. FILED 12-11-2002.
- (INT. CLS. 16 AND 42), (U.S. CLS. 2, 5, 22, 23, 29, 37, 38, 50, 100 AND 101). SN 75-899,094. PUB. 8-13-2002. FILED 1-19-2000.
- 2,763,123 (*See Class 3 for this trademark*).
- 2,763,126 (*See Class 3 for this trademark*).
- 2,763,134 (*See Class 6 for this trademark*).
- 2,763,151. **PEBBLE BOOKS**. CAPSTONE PRESS, INC., (U.S. CLS. 2, 5, 22, 23, 29, 37, 38 AND 50). SN 76-059,825. PUB. 6-24-2003. FILED 5-31-2000.
- 2,763,160. **FLAGSHIP FABRIC**. PM COMPANY, (U.S. CLS. 2, 5, 22, 23, 29, 37, 38 AND 50). SN 76-083,217. PUB. 6-24-2003. FILED 7-5-2000.
- 2,763,191 (*See Class 9 for this trademark*).
- 2,763,212. **DIVA GIRL**. EK SUCCESS, LTD., (U.S. CLS. 2, 5, 22, 23, 29, 37, 38 AND 50). SN 76-172,581. PUB. 6-24-2003. FILED 11-29-2000.
- 2,763,218. **CASHMONEY AND DESIGN**. CASH MONEY CHEQUE CASHING INC., MULTIPLE CLASS, (INT. CLS. 16, 36, 38 AND 39), (U.S. CLS. 2, 5, 22, 23, 29, 37, 38, 50, 100, 101, 102, 104 AND 105). SN 76-178,038. PUB. 6-24-2003. FILED 12-8-2000.
- 2,763,225 (*See Class 9 for this trademark*).
- 2,763,232 (*See Class 3 for this trademark*).
- 2,763,236 (*See Class 8 for this trademark*).
- 2,763,257. **PERFORMANCE TRACKER**. UP-STATISTICS CORPORATION, (U.S. CLS. 2, 5, 22, 23, 29, 37, 38 AND 50). SN 76-208,212. PUB. 3-19-2002. FILED 2-12-2001.
- 2,763,264. **HYDRO-STICK**. QST INDUSTRIES, INC., BY ASSIGNMENT JOHN SOLOMON, INC., (U.S. CLS. 2, 5, 22, 23, 29, 37, 38 AND 50). SN 76-211,284. PUB. 6-24-2003. FILED 2-16-2001.
- 2,763,265. **GESNER**. WEISS & WINTER GMBH, (U.S. CLS. 2, 5, 22, 23, 29, 37, 38 AND 50). SN 76-211,781. PUB. 6-24-2003. FILED 2-16-2001.
- 2,763,267. **VALUECARDS**. MOSSOP, CORNELISSEN CONSULTANTS INC., (U.S. CLS. 2, 5, 22, 23, 29, 37, 38 AND 50). SN 76-212,148. PUB. 6-24-2003. FILED 2-20-2001.
- 2,763,268 (*See Class 6 for this trademark*).
- 2,763,273. **(A) ANYTHING BUT ORDINARY**. CORPORATE CREATIVE, INC., (U.S. CLS. 2, 5, 22, 23, 29, 37, 38 AND 50). SN 76-224,625. PUB. 6-24-2003. FILED 3-15-2001.
- 2,763,275. **FREE TIMES**. CLEVELAND FREE TIMES MEDIA, INC., MULTIPLE CLASS, (INT. CLS. 16 AND 42), (U.S. CLS. 2, 5, 22, 23, 29, 37, 38, 50, 100 AND 101). SN 76-225,941. PUB. 6-24-2003. FILED 3-16-2001.
- 2,763,292 (*See Class 6 for this trademark*).
- 2,763,299. **MISCELLANEOUS DESIGN**. LEE, JOON HEE, (U.S. CLS. 2, 5, 22, 23, 29, 37, 38 AND 50). SN 76-256,258. PUB. 6-24-2003. FILED 5-14-2001.
- 2,763,303 (*See Class 8 for this trademark*).
- 2,763,304. **EASY FIT**. DAVIS GROUP OF COMPANIES CORP., (U.S. CLS. 2, 5, 22, 23, 29, 37, 38 AND 50). SN 76-271,802. PUB. 7-16-2002. FILED 6-15-2001.
- 2,763,322. **ZANER-BLOSER**. ZANER-BLOSER, INC., MULTIPLE CLASS, (INT. CLS. 16 AND 41), (U.S. CLS. 2, 5, 22, 23, 29, 37, 38, 50, 100, 101 AND 107). SN 76-285,894. PUB. 6-24-2003. FILED 7-16-2001.
- 2,763,340 (*See Class 9 for this trademark*).
- 2,763,341 (*See Class 7 for this trademark*).
- 2,763,353. **ECO-FLEX**. ECOLOGICAL FIBERS, INC., (U.S. CLS. 2, 5, 22, 23, 29, 37, 38 AND 50). SN 76-311,941. PUB. 8-27-2002. FILED 9-14-2001.
- 2,763,369. **HUGS & KISSES**. ONTARIO PAINT & WALL-PAPER LIMITED, MULTIPLE CLASS, (INT. CLS. 16 AND 27), (U.S. CLS. 2, 5, 19, 20, 22, 23, 29, 37, 38, 42 AND 50). SN 76-322,646. PUB. 6-24-2003. FILED 10-9-2001.
- 2,763,381. **MR. EXERCISE**. CHELO PUBLISHING, INC., MULTIPLE CLASS, (INT. CLS. 16 AND 41), (U.S. CLS. 2, 5, 22, 23, 29, 37, 38, 50, 100, 101 AND 107). SN 76-328,407. PUB. 6-24-2003. FILED 10-23-2001.
- 2,763,385. **QUICK-MATH**. CURRICULUM ASSOCIATES, INC., (U.S. CLS. 2, 5, 22, 23, 29, 37, 38 AND 50). SN 76-329,984. PUB. 6-24-2003. FILED 10-23-2001.
- 2,763,397 (*See Class 9 for this trademark*).
- 2,763,405 (*See Class 1 for this trademark*).
- 2,763,423. **THE WIRELESS AUTHORITY**. REED ELSEVIER INC., (U.S. CLS. 2, 5, 22, 23, 29, 37, 38 AND 50). SN 76-345,325. PUB. 6-24-2003. FILED 12-6-2001.

CLASS 15—MUSICAL INSTRUMENTS

- 2,763,126 (*See Class 3 for this trademark*).
- 2,763,192. **EVAH PIRAZZI (STYLIZED)**. GUSTAV PIRAZZI & COMP. KG, (U.S. CLS. 2, 21 AND 36). SN 76-140,133. PUB. 6-24-2003. FILED 10-3-2000.

CLASS 16—PAPER GOODS AND PRINTED MATTER

- 2,763,028. **SMART PRACTICE**. FEARON, HEPNER & RHODES, INC., (U.S. CLS. 2, 5, 22, 23, 29, 37, 38 AND 50). SN 75-011,698. PUB. 9-17-1996. FILED 10-30-1995.
- 2,763,097 (*See Class 9 for this trademark*).
- 2,763,104. **MEDIORAMA**. LILIENBERG UNTERNEHMER-FORUM, MULTIPLE CLASS, (INT. CLS. 16, 41 AND 42), (U.S. CLS. 2, 5, 22, 23, 29, 37, 38, 50, 100, 101 AND 107). SN 75-865,521. PUB. 5-8-2001. FILED 12-20-1999.
- 2,763,113. **HITIS HOSPITALITY INDUSTRY TECHNOLOGY INTEGRATION STANDARDS AND DESIGN**. AMERICAN HOTEL & MOTEL ASSOCIATION, AND AMERICAN HOTEL & LODGING ASSOCIATION, MULTIPLE CLASS,

- 2,763,440. **TECHNO-CULINARY NEWS**. FOOD INGREDIENTS SPECIALITIES S.A., (U.S. CLS. 2, 5, 22, 23, 29, 37, 38 AND 50). SN 76-350,865. PUB. 6-24-2003. FILED 12-20-2001. 2,763,441 (*See Class 9 for this trademark*).
- 2,763,451. **SUPER TIP**. ROSE ART INDUSTRIES, INC., (U.S. CLS. 2, 5, 22, 23, 29, 37, 38 AND 50). SN 76-353,742. PUB. 9-3-2002. FILED 12-31-2001.
- 2,763,457. **MISCELLANEOUS DESIGN**. PEOPLES PUBLISHING GROUP, INC., THE, (U.S. CLS. 2, 5, 22, 23, 29, 37, 38 AND 50). SN 76-356,502. PUB. 6-24-2003. FILED 1-8-2002.
- 2,763,491. **ELSMERE PRESS**. BUBAR, DAVID N., (U.S. CLS. 2, 5, 22, 23, 29, 37, 38 AND 50). SN 76-373,191. PUB. 6-24-2003. FILED 2-6-2002.
- 2,763,498 (*See Class 14 for this trademark*).
- 2,763,506. **N (STYLIZED)**. NAFCU SERVICE CORPORATION, MULTIPLE CLASS, (INT. CLS. 16 AND 36), (U.S. CLS. 2, 5, 22, 23, 29, 37, 38, 50, 100, 101 AND 102). SN 76-380,476. PUB. 6-24-2003. FILED 3-12-2002.
- 2,763,508 (*See Class 9 for this trademark*).
- 2,763,521 (*See Class 9 for this trademark*).
- 2,763,523 (*See Class 9 for this trademark*).
- 2,763,524 (*See Class 9 for this trademark*).
- 2,763,533. **KIDS VOTING USA AND DESIGN**. KIDS VOTING USA, INC., MULTIPLE CLASS, (INT. CLS. 16 AND 35), (U.S. CLS. 2, 5, 22, 23, 29, 37, 38, 50, 100, 101 AND 102). SN 76-388,885. PUB. 6-24-2003. FILED 3-28-2002.
- 2,763,555. **VALLEY PACKAGING**. VALLEY PACKAGING CORP., MULTIPLE CLASS, (INT. CLS. 16 AND 20), (U.S. CLS. 2, 5, 13, 22, 23, 25, 29, 32, 37, 38 AND 50). SN 76-392,763. PUB. 6-24-2003. FILED 4-5-2002.
- 2,763,560 (*See Class 9 for this trademark*).
- 2,763,562. **ESSENTIAL PAPERS FOR ARTFUL LIVING**. SCRIPTURA, INC., (U.S. CLS. 2, 5, 22, 23, 29, 37, 38 AND 50). SN 76-393,965. PUB. 6-24-2003. FILED 4-11-2002.
- 2,763,591. **AAO AMERICAN ACADEMY OF OPHTHALMOLOGY (THE EYE M.D. ASSOCIATION (STYLIZED))**. AMERICAN ACADEMY OF OPHTHALMOLOGY, INC., (U.S. CLS. 2, 5, 22, 23, 29, 37, 38 AND 50). SN 76-400,771. PUB. 6-24-2003. FILED 4-24-2002.
- 2,763,601 (*See Class 6 for this trademark*).
- 2,763,602 (*See Class 6 for this trademark*).
- 2,763,609 (*See Class 9 for this trademark*).
- 2,763,642. **FOOD RETAILING TODAY**. LEBHAR FRIEDMAN, INC., (U.S. CLS. 2, 5, 22, 23, 29, 37, 38 AND 50). SN 76-408,362. PUB. 6-24-2003. FILED 5-15-2002.
- 2,763,663. **BERT DOHMEN'S SMARTE TRADER**. DOHMEN CAPITAL HOLDINGS, INC., (U.S. CLS. 2, 5, 22, 23, 29, 37, 38 AND 50). SN 76-411,570. PUB. 6-24-2003. FILED 5-23-2002.
- 2,763,715. **THE BEST RED YELLOW PAGES**. SPRINT PUBLISHING & ADVERTISING, INC., (U.S. CLS. 2, 5, 22, 23, 29, 37, 38 AND 50). SN 76-419,642. PUB. 6-24-2003. FILED 6-10-2002.
- 2,763,761. **DR AND DESIGN**. SCHLUSSEL, JOSEPH, (U.S. CLS. 2, 5, 22, 23, 29, 37, 38 AND 50). SN 76-427,324. PUB. 6-24-2003. FILED 7-5-2002.
- 2,763,768. **BIBLE BLAST**. MITCHELL, JANE A., (U.S. CLS. 2, 5, 22, 23, 29, 37, 38 AND 50). SN 76-428,606. PUB. 6-24-2003. FILED 7-9-2002.
- 2,763,775. **CAROLINA COUNTRY**. NORTH CAROLINA ASSOCIATION OF ELECTRIC COOPERATIVES, INC., (U.S. CLS. 2, 5, 22, 23, 29, 37, 38 AND 50). SN 76-429,536. PUB. 6-24-2003. FILED 7-11-2002.
- 2,763,782. **SUNWEST SCREEN GRAPHICS**. SUNWEST SCREEN GRAPHICS LTD., MULTIPLE CLASS, (INT. CLS. 16 AND 40), (U.S. CLS. 2, 5, 22, 23, 29, 37, 38, 50, 100, 103 AND 106). SN 76-430,393. PUB. 6-24-2003. FILED 7-15-2002.
- 2,763,798. **PLANET CURVE AND DESIGN**. PLANET CURVE, INC., (U.S. CLS. 2, 5, 22, 23, 29, 37, 38 AND 50). SN 76-433,331. PUB. 6-24-2003. FILED 7-22-2002.
- 2,763,801. **HAWAII THE BIG ISLAND REVEALED THE ULTIMATE GUIDEBOOK**. WIZARD PUBLICATIONS, INC., (U.S. CLS. 2, 5, 22, 23, 29, 37, 38 AND 50). SN 76-433,831. PUB. 6-24-2003. FILED 7-22-2002.
- 2,763,802. **MAUI REVEALED THE ULTIMATE GUIDEBOOK**. WIZARD PUBLICATIONS, INC., (U.S. CLS. 2, 5, 22, 23, 29, 37, 38 AND 50). SN 76-433,832. PUB. 6-24-2003. FILED 7-22-2002.
- 2,763,803 (*See Class 9 for this trademark*).
- 2,763,820. **ALL AROUND THE WEB**. MEREDITH CORPORATION, MULTIPLE CLASS, (INT. CLS. 16 AND 44), (U.S. CLS. 2, 5, 22, 23, 29, 37, 38, 50, 100 AND 101). SN 76-438,117. PUB. 6-24-2003. FILED 8-5-2002.
- 2,763,825. **THE SIGNPOST**. SYSCO CORPORATION, (U.S. CLS. 2, 5, 22, 23, 29, 37, 38 AND 50). SN 76-438,733. PUB. 6-24-2003. FILED 8-8-2002.
- 2,763,843. **EXCELSORB**. WHITESTONE ACQUISITION CORP., (U.S. CLS. 2, 5, 22, 23, 29, 37, 38 AND 50). SN 76-441,697. PUB. 6-24-2003. FILED 8-20-2002.
- 2,763,852. **AG SOURCE MAGAZINE**. AG SOURCE MAGAZINE, (U.S. CLS. 2, 5, 22, 23, 29, 37, 38 AND 50). SN 76-443,684. PUB. 6-24-2003. FILED 8-22-2002.
- 2,763,854. **PIN PLUS 45 (STYLIZED)**. AGRIL LABORATORIES, LTD., MULTIPLE CLASS, (INT. CLS. 16 AND 44), (U.S. CLS. 2, 5, 22, 23, 29, 37, 38, 50, 100 AND 101). SN 76-444,049. PUB. 6-24-2003. FILED 8-23-2002.
- 2,763,862. **EVERYDAY MEMORIES**. DECAL SPECIALTIES, INC., (U.S. CLS. 2, 5, 22, 23, 29, 37, 38 AND 50). SN 76-447,423. PUB. 6-24-2003. FILED 9-6-2002.
- 2,763,884. **MOBILIZING GEORGIA, IMMOBILIZING CANCER**. GEORGIA CANCER COALITION, MULTIPLE CLASS, (INT. CLS. 16, 35, 36 AND 41), (U.S. CLS. 2, 5, 22, 23, 29, 37, 38, 50, 100, 101, 102 AND 107). SN 76-451,337. PUB. 6-24-2003. FILED 9-13-2002.
- 2,763,890. **HOUSEWARES MARKETWATCH AND DESIGN**. NATIONAL HOUSEWARES MANUFACTURERS ASSOCIATION, (U.S. CLS. 2, 5, 22, 23, 29, 37, 38 AND 50). SN 76-451,925. PUB. 6-24-2003. FILED 9-24-2002.
- 2,763,898. **GCC GEORGIA CANCER COALITION AND DESIGN**. GEORGIA CANCER COALITION, MULTIPLE CLASS, (INT. CLS. 16, 35, 36 AND 41), (U.S. CLS. 2, 5, 22, 23, 29, 37, 38, 50, 100, 101, 102 AND 107). SN 76-452,911. PUB. 6-24-2003. FILED 9-19-2002.
- 2,763,910. **IDENTI-STRIPS**. LEWIN, THOMAS M., (U.S. CLS. 2, 5, 22, 23, 29, 37, 38 AND 50). SN 76-454,659. PUB. 6-24-2003. FILED 9-26-2002.
- 2,763,917. **CAMBRIDGE HOME AND DESIGN**. THE MEAD CORPORATION, (U.S. CLS. 2, 5, 22, 23, 29, 37, 38 AND 50). SN 76-455,407. PUB. 6-24-2003. FILED 9-26-2002.
- 2,763,918. **CAMBRIDGE HOME**. THE MEAD CORPORATION, (U.S. CLS. 2, 5, 22, 23, 29, 37, 38 AND 50). SN 76-455,408. PUB. 6-24-2003. FILED 9-26-2002.
- 2,763,972 (*See Class 9 for this trademark*).
- 2,763,974. **MISCELLANEOUS DESIGN**. AMERICA ONLINE, INC., (U.S. CLS. 2, 5, 22, 23, 29, 37, 38 AND 50). SN 76-462,507. PUB. 6-24-2003. FILED 10-22-2002.
- 2,763,987. **CHECKS IN THE MAIL**. CHECKS IN THE MAIL, INC., (U.S. CLS. 2, 5, 22, 23, 29, 37, 38 AND 50). SN 76-464,879. PUB. 6-24-2003. FILED 10-31-2002.
- 2,764,004. **THE CANCER PROJECT AND DESIGN**. PHYSICIANS COMMITTEE FOR RESPONSIBLE MEDICINE, INC., MULTIPLE CLASS, (INT. CLS. 16, 35, 41 AND 42), (U.S. CLS. 2, 5, 22, 23, 29, 37, 38, 50, 100, 101, 102 AND 107). SN 76-467,312. PUB. 6-24-2003. FILED 11-15-2002.
- 2,764,005. **PCRM**. PHYSICIANS COMMITTEE FOR RESPONSIBLE MEDICINE, INC., MULTIPLE CLASS, (INT. CLS. 16, 35 AND 42), (U.S. CLS. 2, 5, 22, 23, 29, 37, 38, 50, 100, 101 AND 102). SN 76-467,315. PUB. 6-24-2003. FILED 11-15-2002.
- 2,764,016. **SAN MATEO COUNTY TIMES**. CALIFORNIA NEWSPAPERS PARTNERSHIP, (U.S. CLS. 2, 5, 22, 23, 29, 37, 38 AND 50). SN 76-468,490. PUB. 6-24-2003. FILED 11-20-2002.
- 2,764,019. **ECAR**. EDUCAUSE CORPORATION, (U.S. CLS. 2, 5, 22, 23, 29, 37, 38 AND 50). SN 76-468,724. PUB. 6-24-2003. FILED 11-7-2002.
- 2,764,025. **FREEDOM FROM ABUSE (STYLIZED)**. MIRSKY-MACNAMARA, ARLENE C., DBA ABUSE PREVENTION SPECIALISTS, (U.S. CLS. 2, 5, 22, 23, 29, 37, 38 AND 50). SN 76-469,591. PUB. 6-24-2003. FILED 11-25-2002.
- 2,764,032. **TRENDWATCH**. PHYSICIANS INSURANCE COMPANY OF WISCONSIN, (U.S. CLS. 2, 5, 22, 23, 29, 37, 38 AND 50). SN 76-470,575. PUB. 6-24-2003. FILED 11-27-2002.
- 2,764,047. **OSAAT**. PEP PRODUCTIONS, L.L.C., MULTIPLE CLASS, (INT. CLS. 16 AND 41), (U.S. CLS. 2, 5, 22, 23, 29, 37, 38, 50, 100, 101 AND 107). SN 76-472,171. PUB. 6-24-2003. FILED 12-3-2002.

- 2,764,061. **POLY PORTBOOK**. MEAD CORPORATION, THE, (U.S. CLS. 2, 5, 22, 23, 29, 37, 38 AND 50). SN 76-473,540. PUB. 6-24-2003. FILED 12-5-2002.
- 2,764,070. **POLY PORTBOOK (STYLIZED)**. MEAD CORPORATION, THE, (U.S. CLS. 2, 5, 22, 23, 29, 37, 38 AND 50). SN 76-474,116. PUB. 6-24-2003. FILED 12-5-2002.
- 2,764,071. **SPACE KEEPER AND DESIGN**. MEAD CORPORATION, THE, (U.S. CLS. 2, 5, 22, 23, 29, 37, 38 AND 50). SN 76-474,117. PUB. 6-24-2003. FILED 12-5-2002.
- 2,764,072. **SPACE KEEPER**. MEAD CORPORATION, THE, (U.S. CLS. 2, 5, 22, 23, 29, 37, 38 AND 50). SN 76-474,127. PUB. 6-24-2003. FILED 12-5-2002.
- 2,764,074. **PEARLS BEFORE SWINE**. PASTIS, STEPHAN, (U.S. CLS. 2, 5, 22, 23, 29, 37, 38 AND 50). SN 76-474,225. PUB. 6-24-2003. FILED 12-12-2002.
- 2,764,083. **VITAMIN RETAILER**. VITAMIN RETAILER MAGAZINE, INC., (U.S. CLS. 2, 5, 22, 23, 29, 37, 38 AND 50). SN 76-477,384. PUB. 6-24-2003. FILED 12-23-2002.
- 2,764,086. **PTI AND DESIGN**. POST-TENSIONING INSTITUTE, MULTIPLE CLASS, (INT. CLS. 16 AND 35), (U.S. CLS. 2, 5, 22, 23, 29, 37, 38, 50, 100, 101 AND 102). SN 76-477,798. PUB. 6-24-2003. FILED 12-24-2002.
- 2,764,102 (*See Class 1 for this trademark*).
- 2,764,105 (*See Class 14 for this trademark*).
- 2,764,121. **PLAYSMART**. INTERNATIONAL DATA GROUP, INC., MULTIPLE CLASS, (INT. CLS. 16 AND 42), (U.S. CLS. 2, 5, 22, 23, 29, 37, 38, 50, 100 AND 101). SN 78-049,641. PUB. 6-24-2003. FILED 2-22-2001.
- 2,764,128 (*See Class 9 for this trademark*).
- 2,764,136. **GROOVE INC. TOTAL ENTERTAINMENT (STYLIZED)**. FLYNN, JOSEPH ROBERT, AND GRAY, COLLEEN ANN, (U.S. CLS. 2, 5, 22, 23, 29, 37, 38 AND 50). SN 78-075,771. PUB. 6-24-2003. FILED 7-26-2001.
- 2,764,157. **EDIBA**. EDIBA, INC., MULTIPLE CLASS, (INT. CLS. 16 AND 41), (U.S. CLS. 2, 5, 22, 23, 29, 37, 38, 50, 100, 101 AND 107). SN 78-100,283. PUB. 6-24-2003. FILED 12-28-2001.
- 2,764,173. **O HOLLAR AND DESIGN**. SMITH, EASTERN A., BY ASSIGNMENT SMITH, EASTERN A., (U.S. CLS. 2, 5, 22, 23, 29, 37, 38 AND 50). SN 78-105,140. PUB. 6-24-2003. FILED 1-28-2002.
- 2,764,186. **COMICS BUYER'S GUIDE AND DESIGN**. KRAUSE PUBLICATIONS, INC., (U.S. CLS. 2, 5, 22, 23, 29, 37, 38 AND 50). SN 78-108,865. PUB. 6-24-2003. FILED 2-14-2002.
- 2,764,194. **WORKING SOLO**. WORKING SOLO, INC., MULTIPLE CLASS, (INT. CLS. 16 AND 35), (U.S. CLS. 2, 5, 22, 23, 29, 37, 38, 50, 100, 101 AND 102). SN 78-114,088. PUB. 6-24-2003. FILED 3-11-2002.
- 2,764,219. **ATLANTA MAGAZINE HOME**. EMMIS PUBLISHING, L.P., (U.S. CLS. 2, 5, 22, 23, 29, 37, 38 AND 50). SN 78-128,129. PUB. 3-4-2003. FILED 5-13-2002.
- 2,764,227. **KNIGHT & HALE ULTIMATE TEAM HUNTING (STYLIZED)**. EBSCO INDUSTRIES, INC., (U.S. CLS. 2, 5, 22, 23, 29, 37, 38 AND 50). SN 78-131,005. PUB. 6-24-2003. FILED 5-24-2002.
- 2,764,233. **AREA WEDDINGS**. NEVA, BETH A., (U.S. CLS. 2, 5, 22, 23, 29, 37, 38 AND 50). SN 78-131,856. PUB. 6-24-2003. FILED 5-29-2002.
- 2,764,245. **REGENCY**. GENERAL BINDING CORPORATION, (U.S. CLS. 2, 5, 22, 23, 29, 37, 38 AND 50). SN 78-136,680. PUB. 6-24-2003. FILED 6-18-2002.
- 2,764,270. **JOHN LUND ANIMALANTICS AND DESIGN**. JOHN M. LUND PHOTOGRAPHY, (U.S. CLS. 2, 5, 22, 23, 29, 37, 38 AND 50). SN 78-148,899. PUB. 6-24-2003. FILED 7-30-2002.
- 2,764,274. **FISH WHISPERER**. HAXTON, CHRISTOPHER W, MULTIPLE CLASS, (INT. CLS. 16, 18 AND 25), (U.S. CLS. 1, 2, 3, 5, 22, 23, 29, 37, 38, 39, 41 AND 50). SN 78-151,530. PUB. 6-24-2003. FILED 8-6-2002.
- 2,764,304. **ALEXANDER'S**. STANLEY G. ALEXANDER, INC., DBA ALEXANDER'S MOVING AND STORAGE, INC., MULTIPLE CLASS, (INT. CLS. 16, 35, 36 AND 39), (U.S. CLS. 2, 5, 22, 23, 29, 37, 38, 50, 100, 101, 102 AND 105). SN 78-160,245. PUB. 6-24-2003. FILED 9-3-2002.
- 2,764,342. **CHOICE MARKETING SPORTSCARDS AND DESIGN**. CHOICE MARKETING INC., (U.S. CLS. 2, 5, 22, 23, 29, 37, 38 AND 50). SN 78-173,414. PUB. 6-24-2003. FILED 10-11-2002.
- 2,764,344. **COFFEE STAIN CARDS**. KEENE, CRAIG, (U.S. CLS. 2, 5, 22, 23, 29, 37, 38 AND 50). SN 78-175,120. PUB. 6-24-2003. FILED 10-16-2002.
- 2,764,367. **FITGREETINGS**. PROGRAM FIT, INCORPORATED, (U.S. CLS. 2, 5, 22, 23, 29, 37, 38 AND 50). SN 78-178,837. PUB. 6-24-2003. FILED 10-27-2002.
- 2,764,397. **STATIONMASTERS**. BOWRING, LARRY A., (U.S. CLS. 2, 5, 22, 23, 29, 37, 38 AND 50). SN 78-181,420. PUB. 6-24-2003. FILED 11-4-2002.
- 2,764,412. **CRY FOR DAWN**. LINSNER, JOSEPH, MICHAEL, MULTIPLE CLASS, (INT. CLS. 16 AND 25), (U.S. CLS. 2, 5, 22, 23, 29, 37, 38, 39 AND 50). SN 78-184,012. PUB. 6-24-2003. FILED 11-12-2002.
- 2,764,439. **STACKED AND PACKED**. JONES, JEFFREY A., (U.S. CLS. 2, 5, 22, 23, 29, 37, 38 AND 50). SN 78-186,087. PUB. 6-24-2003. FILED 11-18-2002.
- 2,764,443. **READRX**. LEARNINGRX, INC., (U.S. CLS. 2, 5, 22, 23, 29, 37, 38 AND 50). SN 78-190,588. PUB. 6-24-2003. FILED 12-3-2002.
- 2,764,444. **PROCESSRX**. LEARNINGRX, INC., (U.S. CLS. 2, 5, 22, 23, 29, 37, 38 AND 50). SN 78-190,596. PUB. 6-24-2003. FILED 12-3-2002.
- 2,764,445. **SPELLRX**. LEARNINGRX, INC., (U.S. CLS. 2, 5, 22, 23, 29, 37, 38 AND 50). SN 78-190,599. PUB. 6-24-2003. FILED 12-3-2002.
- 2,764,446. **THINKRX**. LEARNINGRX, INC., (U.S. CLS. 2, 5, 22, 23, 29, 37, 38 AND 50). SN 78-190,620. PUB. 6-24-2003. FILED 12-3-2002.
- 2,764,447. **ATTENDRX**. LEARNINGRX, INC., (U.S. CLS. 2, 5, 22, 23, 29, 37, 38 AND 50). SN 78-190,627. PUB. 6-24-2003. FILED 12-3-2002.
- 2,764,448. **COMPREHENDRX**. LEARNINGRX, INC., (U.S. CLS. 2, 5, 22, 23, 29, 37, 38 AND 50). SN 78-190,636. PUB. 6-24-2003. FILED 12-3-2002.
- 2,764,449. **WRITERX**. LEARNINGRX, INC., (U.S. CLS. 2, 5, 22, 23, 29, 37, 38 AND 50). SN 78-190,639. PUB. 6-24-2003. FILED 12-3-2002.
- 2,764,450. **STUDYRX**. LEARNINGRX, INC., (U.S. CLS. 2, 5, 22, 23, 29, 37, 38 AND 50). SN 78-190,643. PUB. 6-24-2003. FILED 12-3-2002.
- 2,764,451. **BRAINRX**. LEARNINGRX, INC., (U.S. CLS. 2, 5, 22, 23, 29, 37, 38 AND 50). SN 78-190,646. PUB. 6-24-2003. FILED 12-3-2002.
- 2,764,452. **MEMORYRX**. LEARNINGRX, INC., (U.S. CLS. 2, 5, 22, 23, 29, 37, 38 AND 50). SN 78-190,648. PUB. 6-24-2003. FILED 12-3-2002.

CLASS 17—RUBBER GOODS

- 2,763,131 (*See Class 1 for this trademark*).
- 2,763,190. **INVISION**. A. SCHULMAN, INC., (U.S. CLS. 1, 5, 12, 13, 35 AND 50). SN 76-137,363. PUB. 6-24-2003. FILED 9-28-2000.
- 2,763,252. **FLEXEEL AND DESIGN**. COILHOSE PNEUMATICS, (U.S. CLS. 1, 5, 12, 13, 35 AND 50). SN 76-204,642. PUB. 6-24-2003. FILED 2-5-2001.
- 2,763,259. **SNAP-LOC SYSTEMS**. CEDARBERG INDUSTRIES, INC., (U.S. CLS. 1, 5, 12, 13, 35 AND 50). SN 76-210,068. PUB. 6-24-2003. FILED 2-15-2001.
- 2,763,289. **TUFFCARD**. PLASTAG CORPORATION, (U.S. CLS. 1, 5, 12, 13, 35 AND 50). SN 76-248,055. PUB. 6-24-2003. FILED 4-30-2001.
- 2,763,317 (*See Class 1 for this trademark*).
- 2,763,338. **ECOSYAR**. TOYO BOSEKI KABUSHIKI KAISHA (TOYOBO CO., LTD.), (U.S. CLS. 1, 5, 12, 13, 35 AND 50). SN 76-300,320. PUB. 6-24-2003. FILED 8-16-2001.
- 2,763,341 (*See Class 7 for this trademark*).
- 2,763,395 (*See Class 1 for this trademark*).
- 2,763,405 (*See Class 1 for this trademark*).
- 2,763,550. **SUDDEN SHADE**. DEWITT COMPANY, (U.S. CLS. 1, 5, 12, 13, 35 AND 50). SN 76-392,303. PUB. 6-24-2003. FILED 4-8-2002.
- 2,763,551. **PRO 5 WEED BARRIER**. DEWITT COMPANY, (U.S. CLS. 1, 5, 12, 13, 35 AND 50). SN 76-392,304. PUB. 6-24-2003. FILED 4-8-2002.
- 2,763,552. **PLANT GUARD**. DEWITT COMPANY, (U.S. CLS. 1, 5, 12, 13, 35 AND 50). SN 76-392,305. PUB. 6-24-2003. FILED

4-8-2002.
 2,763,561. **PETAN**. SCANCOM INTERNATIONAL A/S, MULTIPLE CLASS, (INT. CLS. 17 AND 20), (U.S. CLS. 1, 2, 5, 12, 13, 22, 25, 32, 35 AND 50). SN 76-393,781. PUB. 6-24-2003. FILED 4-11-2002.
 2,763,626. **FIBRECRETE**. APPLIED POLYMERICS, INC., (U.S. CLS. 1, 5, 12, 13, 35 AND 50). SN 76-406,312. PUB. 6-24-2003. FILED 5-13-2002.
 2,763,652 (*See Class 1 for this trademark*).
 2,763,660 (*See Class 6 for this trademark*).
 2,763,721. **GILMORE**. GILMORE ENTERPRISES WINDOW COVERINGS, INC., MULTIPLE CLASS, (INT. CLS. 17, 20 AND 24), (U.S. CLS. 1, 2, 5, 12, 13, 22, 25, 32, 35, 42 AND 50). SN 76-420,088. PUB. 6-24-2003. FILED 5-31-2002.
 2,763,792. **MISCELLANEOUS DESIGN**. ENVIRONMENTAL SEALS LTD., (U.S. CLS. 1, 5, 12, 13, 35 AND 50). SN 76-431,922. PUB. 6-24-2003. FILED 7-16-2002.
 2,763,793. **321**. ENVIRONMENTAL SEALS LTD., (U.S. CLS. 1, 5, 12, 13, 35 AND 50). SN 76-431,923. PUB. 6-24-2003. FILED 7-16-2002.
 2,763,842. **NOXUDOL**. AUSON AB, (U.S. CLS. 1, 5, 12, 13, 35 AND 50). SN 76-441,583. PUB. 6-24-2003. FILED 8-14-2002.
 2,763,872. **HILITE**. N.V. BEKAERT S.A., (U.S. CLS. 1, 5, 12, 13, 35 AND 50). SN 76-448,483. PUB. 6-24-2003. FILED 9-11-2002.
 2,763,980. **AMBERLITH**. KIWO HOLDINGS, INC., (U.S. CLS. 1, 5, 12, 13, 35 AND 50). SN 76-463,707. PUB. 6-24-2003. FILED 10-28-2002.
 2,764,107. **VIPER TAPE AND DESIGN**. NEWAY PACKAGING CORP, (U.S. CLS. 1, 5, 12, 13, 35 AND 50). SN 78-004,292. PUB. 3-26-2002. FILED 4-14-2000.
 2,764,112 (*See Class 11 for this trademark*).
 2,764,116 (*See Class 10 for this trademark*).
 2,764,223. **REPELGRO**. GREGORY S. WHIPPO, (U.S. CLS. 1, 5, 12, 13, 35 AND 50). SN 78-129,888. PUB. 6-24-2003. FILED 5-20-2002.

CLASS 18—LEATHER GOODS

2,763,064 (*See Class 3 for this trademark*).
 2,763,163 (*See Class 3 for this trademark*).
 2,763,187. **MISCELLANEOUS DESIGN**. AIRWALK INTERNATIONAL, LLC, (U.S. CLS. 1, 2, 3, 22 AND 41). SN 76-132,791. PUB. 6-24-2003. FILED 9-21-2000.
 2,763,232 (*See Class 3 for this trademark*).
 2,763,247 (*See Class 3 for this trademark*).
 2,763,268 (*See Class 6 for this trademark*).
 2,763,337. **ORRICK AND DESIGN**. ORRICK, HERRINGTON & SUTCLIFFE LLP, (U.S. CLS. 1, 2, 3, 22 AND 41). SN 76-299,355. PUB. 6-24-2003. FILED 8-13-2001.
 2,763,388. **MISCELLANEOUS DESIGN**. CHATEAU INTERNATIONAL INC., (U.S. CLS. 1, 2, 3, 22 AND 41). SN 76-330,998. PUB. 6-24-2003. FILED 10-29-2001.
 2,763,439. **TIRER**. TAKATA KABUSHIKI KAISHA, TA TAKATA CORPORATION, MULTIPLE CLASS, (INT. CLS. 18 AND 25), (U.S. CLS. 1, 2, 3, 22, 39 AND 41). SN 76-350,455. PUB. 6-24-2003. FILED 12-20-2001.
 2,763,498 (*See Class 14 for this trademark*).
 2,763,535. **VAGABOND**. VAGABOND SKOR VARBERG AB, (U.S. CLS. 1, 2, 3, 22 AND 41). SN 76-389,128. PUB. 6-24-2003. FILED 4-1-2002.
 2,763,638 (*See Class 12 for this trademark*).
 2,763,661. **KRISTYN CHAMBERS AUSTIN**. CHAMBERS, KRISTYN, MULTIPLE CLASS, (INT. CLS. 18 AND 25), (U.S. CLS. 1, 2, 3, 22, 39 AND 41). SN 76-411,490. PUB. 6-24-2003. FILED 5-20-2002.
 2,763,690. **FRIDGE PAK**. A.D. SUTTON & SONS, INC., MULTIPLE CLASS, (INT. CLS. 18 AND 21), (U.S. CLS. 1, 2, 3, 13, 22, 23, 29, 30, 33, 40, 41 AND 50). SN 76-416,092. PUB. 6-24-2003. FILED 6-6-2002.
 2,763,771. **CORAL RIDGE MINISTRIES**. CORAL RIDGE MINISTRIES MEDIA, INC., (U.S. CLS. 1, 2, 3, 22 AND 41). SN 76-428,962. PUB. 6-24-2003. FILED 7-9-2002.
 2,763,803 (*See Class 9 for this trademark*).
 2,763,859. **FOP AND DESIGN**. FRATERNAL ORDER OF POLICE, MULTIPLE CLASS, (INT. CLS. 18 AND 25), (U.S. CLS. 1, 2, 3, 22, 39 AND 41). SN 76-445,910. PUB. 6-

24-2003. FILED 8-29-2002.
 2,764,102 (*See Class 1 for this trademark*).
 2,764,105 (*See Class 14 for this trademark*).
 2,764,274 (*See Class 16 for this trademark*).
 2,764,291. **MISCELLANEOUS DESIGN**. MCL CREATION FACTORY, LTD., MULTIPLE CLASS, (INT. CLS. 18 AND 25), (U.S. CLS. 1, 2, 3, 22, 39 AND 41). SN 78-157,026. PUB. 6-24-2003. FILED 8-22-2002.
 2,764,372. **TAMARA EVENING**. SAYTR, (U.S. CLS. 1, 2, 3, 22 AND 41). SN 78-178,953. PUB. 6-24-2003. FILED 10-28-2002.

CLASS 19—NON-METALLIC BUILDING MATERIALS

2,763,041. **KARNDAN DA VINCI**. KARNDAN INTERNATIONAL LIMITED, (U.S. CLS. 1, 12, 33 AND 50). SN 75-388,363. PUB. 6-24-2003. FILED 11-12-1997.
 2,763,199. **ALTITUDE**. THERMOPLAST INC., (U.S. CLS. 1, 12, 33 AND 50). SN 76-147,009. PUB. 6-24-2003. FILED 10-16-2000.
 2,763,234. **EZI FIX AND DESIGN**. EZIFIX FASTENING SYSTEMS AUSTRALIA PTY LTD, (U.S. CLS. 1, 12, 33 AND 50). SN 76-186,745. PUB. 6-24-2003. FILED 12-27-2000.
 2,763,242. **NIAGARA**. EMCO BUILDING PRODUCTS LTD., BY ASSIGNMENT EMCO LIMITED, (U.S. CLS. 1, 12, 33 AND 50). SN 76-195,116. PUB. 6-24-2003. FILED 1-16-2001.
 2,763,292 (*See Class 6 for this trademark*).
 2,763,317 (*See Class 1 for this trademark*).
 2,763,462. **AIR FORCE USA UNIQUE INFLATABLE TECHNOLOGIES AND DESIGN**. INFLATABLE IMAGE TECHNOLOGIES, PTY. LIMITED, MULTIPLE CLASS, (INT. CLS. 19, 20 AND 22), (U.S. CLS. 1, 2, 7, 12, 13, 19, 22, 25, 32, 33, 42 AND 50). SN 76-358,345. PUB. 6-24-2003. FILED 1-15-2002.
 2,763,504. **SALONI (STYLIZED)**. SALONI PORTUGAL-MATERIAIS DE CONSTRUCAO LDA., MULTIPLE CLASS, (INT. CLS. 19 AND 35), (U.S. CLS. 1, 12, 33, 50, 100, 101 AND 102). SN 76-379,200. PUB. 6-24-2003. FILED 3-5-2002.
 2,763,513 (*See Class 6 for this trademark*).
 2,763,542. **DOVAE (STYLIZED)**. CHEMCORE INDUSTRIES, INC., (U.S. CLS. 1, 12, 33 AND 50). SN 76-390,940. PUB. 6-24-2003. FILED 4-4-2002.
 2,763,595. **IRIS CERAMICA FABBRICA MARMI E GRANITI TECHNOLOGICAL STONES AND DESIGN**. IRIS CERAMICA - SOCIETA' PER AZIONI, (U.S. CLS. 1, 12, 33 AND 50). SN 76-401,500. PUB. 6-24-2003. FILED 4-29-2002.
 2,763,698. **ULEX AND DESIGN**. GIN YOUNG ENTERPRISE CO., LTD., (U.S. CLS. 1, 12, 33 AND 50). SN 76-417,405. PUB. 6-24-2003. FILED 6-5-2002.
 2,763,736. **BR 111 EXOTIC HARDWOOD FLOORING AND DESIGN**. BR 111 IMPORTS & EXPORTS, INC., MULTIPLE CLASS, (INT. CLS. 19 AND 35), (U.S. CLS. 1, 12, 33, 50, 100, 101 AND 102). SN 76-423,277. PUB. 6-24-2003. FILED 6-20-2002.
 2,763,807. **SQUARE-FLEX**. SKYLIGHTS UNLIMITED, (U.S. CLS. 1, 12, 33 AND 50). SN 76-434,522. PUB. 6-24-2003. FILED 7-26-2002.
 2,763,902. **CARMELLE**. CRAFTMASTER MANUFACTURING, INC., (U.S. CLS. 1, 12, 33 AND 50). SN 76-453,771. PUB. 6-24-2003. FILED 9-30-2002.
 2,763,903. **WEATHER BEST COMPOSITE DECKING AND DESIGN**. LOUISIANA-PACIFIC CORPORATION, (U.S. CLS. 1, 12, 33 AND 50). SN 76-453,834. PUB. 6-24-2003. FILED 9-30-2002.
 2,764,106 (*See Class 2 for this trademark*).
 2,764,112 (*See Class 11 for this trademark*).
 2,764,124. **DUSTLOC AND DESIGN**. ENVIRONMENTALIST, INC., (U.S. CLS. 1, 12, 33 AND 50). SN 78-054,189. PUB. 10-1-2002. FILED 3-21-2001.
 2,764,189. **LAMCAR**. CARTER, RICKY S., (U.S. CLS. 1, 12, 33 AND 50). SN 78-110,059. PUB. 6-24-2003. FILED 2-20-2002.
 2,764,215. **CHARTER OAK**. ASSOCIATED MATERIALS, INCORPORATED D/B/A ALSIDE, (U.S. CLS. 1, 12, 33 AND 50). SN 78-127,536. PUB. 6-24-2003. FILED 5-9-2002.
 2,764,321. **STUDIO CERAMICA**. SUPERIOR PRODUCTS, INC., (U.S. CLS. 1, 12, 33 AND 50). SN 78-167,290. PUB. 6-

24-2003. FILED 9-24-2002.

CLASS 20—FURNITURE AND ARTICLES NOT OTHERWISE CLASSIFIED

2,763,126 (*See Class 3 for this trademark*).
 2,763,134 (*See Class 6 for this trademark*).
 2,763,184. **COMFORT LIFE**. SEALY TECHNOLOGY LLC, (U.S. CLS. 2, 13, 22, 25, 32 AND 50). SN 76-125,955. PUB. 6-24-2003. FILED 9-11-2000.
 2,763,236 (*See Class 8 for this trademark*).
 2,763,263 (*See Class 9 for this trademark*).
 2,763,292 (*See Class 6 for this trademark*).
 2,763,352. **BEVGUARD**. CROWN CORK & SEAL TECHNOLOGIES CORPORATION, (U.S. CLS. 2, 13, 22, 25, 32 AND 50). SN 76-310,495. PUB. 6-24-2003. FILED 9-6-2001.
 2,763,403 (*See Class 9 for this trademark*).
 2,763,408 (*See Class 6 for this trademark*).
 2,763,409 (*See Class 6 for this trademark*).
 2,763,462 (*See Class 19 for this trademark*).
 2,763,498 (*See Class 14 for this trademark*).
 2,763,555 (*See Class 16 for this trademark*).
 2,763,561 (*See Class 17 for this trademark*).
 2,763,631 (*See Class 9 for this trademark*).
 2,763,638 (*See Class 12 for this trademark*).
 2,763,718. **PERFECT DOWN**. CARPENTER CO., (U.S. CLS. 2, 13, 22, 25, 32 AND 50). SN 76-419,882. PUB. 6-24-2003. FILED 6-4-2002.
 2,763,721 (*See Class 17 for this trademark*).
 2,763,803 (*See Class 9 for this trademark*).
 2,763,867. **THE AMERICAN GIRLS COLLECTION AND DESIGN**. PLEASANT COMPANY, (U.S. CLS. 2, 13, 22, 25, 32 AND 50). SN 76-447,744. PUB. 6-24-2003. FILED 9-9-2002.
 2,763,899. **JOYN**. VITRA PATENTE AG, (U.S. CLS. 2, 13, 22, 25, 32 AND 50). SN 76-452,965. PUB. 6-24-2003. FILED 9-20-2002.
 2,764,102 (*See Class 1 for this trademark*).
 2,764,168. **OPEN UP**. SEDUS STOLL AG, (U.S. CLS. 2, 13, 22, 25, 32 AND 50). SN 78-104,168. PUB. 2-4-2003. FILED 1-22-2002.
 2,764,337. **SLIM-PACK**. ILLINOIS TOOL WORKS INC., (U.S. CLS. 2, 13, 22, 25, 32 AND 50). SN 78-172,888. PUB. 6-24-2003. FILED 10-10-2002.
 2,764,361. **JETREST**. JAMES, DAVID, F, (U.S. CLS. 2, 13, 22, 25, 32 AND 50). SN 78-177,781. PUB. 6-24-2003. FILED 10-24-2002.
 2,764,404. **NURSE EZ**. BASIC COMFORT, INC., (U.S. CLS. 2, 13, 22, 25, 32 AND 50). SN 78-183,326. PUB. 6-24-2003. FILED 11-8-2002.
 2,764,411. **OFF MAIN**. OFF MAIN FURNITURE, MULTIPLE CLASS, (INT. CLS. 20, 24 AND 35), (U.S. CLS. 2, 13, 22, 25, 32, 42, 50, 100, 101 AND 102). SN 78-183,978. PUB. 6-24-2003. FILED 11-12-2002.
 2,764,420. **REST EZ**. BASIC COMFORT, INC., (U.S. CLS. 2, 13, 22, 25, 32 AND 50). SN 78-185,282. PUB. 6-24-2003. FILED 11-14-2002.

CLASS 21—HOUSEWARES AND GLASS

2,763,073 (*See Class 4 for this trademark*).
 2,763,081 (*See Class 11 for this trademark*).
 2,763,098. **PAINTBOX AND DESIGN**. MILTON, DAVID, (U.S. CLS. 2, 13, 23, 29, 30, 33, 40 AND 50). SN 75-846,325. PUB. 6-24-2003. FILED 11-11-1999.
 2,763,124 (*See Class 9 for this trademark*).
 2,763,126 (*See Class 3 for this trademark*).
 2,763,134 (*See Class 6 for this trademark*).
 2,763,189 (*See Class 11 for this trademark*).
 2,763,249 (*See Class 9 for this trademark*).
 2,763,328 (*See Class 8 for this trademark*).
 2,763,367 (*See Class 11 for this trademark*).
 2,763,392. **BUBBLE HEAD**. BUBBLE HEAD, INC., (U.S. CLS. 2, 13, 23, 29, 30, 33, 40 AND 50). SN 76-332,681. PUB. 6-24-

2003. FILED 11-1-2001.
 2,763,406. **THE ICE TUBES TRAY**. ICE TUBES, INC., (U.S. CLS. 2, 13, 23, 29, 30, 33, 40 AND 50). SN 76-339,861. PUB. 6-24-2003. FILED S.R. 11-20-2001; AM. P.R. 4-25-2003.
 2,763,507. **RA TREASURES BY RACHEL ASHWELL AND DESIGN**. SHABBY CHIC, INC., MULTIPLE CLASS, (INT. CLS. 21 AND 24), (U.S. CLS. 2, 13, 23, 29, 30, 33, 40, 42 AND 50). SN 76-380,520. PUB. 6-24-2003. FILED 3-11-2002.
 2,763,556 (*See Class 11 for this trademark*).
 2,763,690 (*See Class 18 for this trademark*).
 2,763,709. **FOG-FIXER**. ENCON SAFETY PRODUCTS, INC., (U.S. CLS. 2, 13, 23, 29, 30, 33, 40 AND 50). SN 76-419,118. PUB. 6-24-2003. FILED 6-10-2002.
 2,763,885. **MAGICAL MUG**. SHIFTING FREQUENCIES, L.L.C., (U.S. CLS. 2, 13, 23, 29, 30, 33, 40 AND 50). SN 76-451,457. PUB. 6-24-2003. FILED 9-16-2002.
 2,763,952. **COWBOY PETE'S**. ANDE ROONEY INC., (U.S. CLS. 2, 13, 23, 29, 30, 33, 40 AND 50). SN 76-459,710. PUB. 6-24-2003. FILED 10-16-2002.
 2,763,995. **VINO**. TABLETOPS UNLIMITED, INC., (U.S. CLS. 2, 13, 23, 29, 30, 33, 40 AND 50). SN 76-466,143. PUB. 6-24-2003. FILED 11-12-2002.
 2,763,996. **CARNIVAL**. TABLETOPS UNLIMITED, INC., (U.S. CLS. 2, 13, 23, 29, 30, 33, 40 AND 50). SN 76-466,144. PUB. 6-24-2003. FILED 11-12-2002.
 2,763,997. **CABERNET**. TABLETOPS UNLIMITED, INC., (U.S. CLS. 2, 13, 23, 29, 30, 33, 40 AND 50). SN 76-466,145. PUB. 6-24-2003. FILED 11-12-2002.
 2,763,998. **ESPANA (STYLIZED)**. TABLETOPS UNLIMITED, INC., (U.S. CLS. 2, 13, 23, 29, 30, 33, 40 AND 50). SN 76-466,146. PUB. 6-24-2003. FILED 11-12-2002.
 2,764,031. **MISCELLANEOUS DESIGN**. SPACE NEEDLE CORPORATION, (U.S. CLS. 2, 13, 23, 29, 30, 33, 40 AND 50). SN 76-470,558. PUB. 6-24-2003. FILED 11-27-2002.
 2,764,059. **AMPLIFIER**. RWD DISTRIBUTORS, INC., DBA RAVENSCROFT, (U.S. CLS. 2, 13, 23, 29, 30, 33, 40 AND 50). SN 76-473,274. PUB. 6-24-2003. FILED 11-26-2002.
 2,764,102 (*See Class 1 for this trademark*).
 2,764,169. **TEA SOCK**. THOMAS, ROBERT G., (U.S. CLS. 2, 13, 23, 29, 30, 33, 40 AND 50). SN 78-104,208. PUB. 6-24-2003. FILED 1-23-2002.
 2,764,180 (*See Class 11 for this trademark*).

CLASS 22—CORDAGE AND FIBERS

2,763,126 (*See Class 3 for this trademark*).
 2,763,131 (*See Class 1 for this trademark*).
 2,763,462 (*See Class 19 for this trademark*).
 2,763,492. **RATCH-A-STRAP**. KVAERNER OILFIELD PRODUCTS, INC., (U.S. CLS. 1, 2, 7, 19, 22, 42 AND 50). SN 76-373,675. PUB. 6-24-2003. FILED 2-25-2002.

CLASS 23—YARNS AND THREADS

2,763,131 (*See Class 1 for this trademark*).
 2,763,251. **ZERBION**. SINTERAMA S.P.A., MULTIPLE CLASS, (INT. CLS. 23 AND 24), (U.S. CLS. 42, 43 AND 50). SN 76-204,433. PUB. 6-24-2003. FILED 2-2-2001.

CLASS 24—FABRICS

2,763,051. **ALLNIGHTER**. ABSORB-PLUS INC./ABSORBE-PLUS INC., BY CHANGE OF NAME ABSORB-PLUS TEXTILES INC., (U.S. CLS. 42 AND 50). SN 75-492,219. PUB. 5-7-2002. FILED 5-28-1998.
 2,763,070. **ACORN**. KEY CORPORATE CAPITAL INC., BY ASSIGNMENT ACORN PRODUCTS CO., INC., MULTIPLE CLASS, (INT. CLS. 24 AND 25), (U.S. CLS. 22, 39, 42 AND 50). SN 75-672,879. PUB. 6-24-2003. FILED 4-1-1999.
 2,763,071. **ACORN AND DESIGN**. KEY CORPORATE CAPITAL INC., BY ASSIGNMENT ACORN PRODUCTS CO.,

- INC., MULTIPLE CLASS, (INT. CLS. 24 AND 25), (U.S. CLS. 22, 39, 42 AND 50). SN 75-672,880. PUB. 6-24-2003. FILED 4-1-1999.
- 2,763,124 (*See Class 9 for this trademark*).
- 2,763,126 (*See Class 3 for this trademark*).
- 2,763,134 (*See Class 6 for this trademark*).
- 2,763,144. **ZIRO-TEC**. YASHA FABRIC, INC., (U.S. CLS. 42 AND 50). SN 76-043,902. PUB. 6-24-2003. FILED 5-8-2000.
- 2,763,236 (*See Class 8 for this trademark*).
- 2,763,247 (*See Class 3 for this trademark*).
- 2,763,251 (*See Class 23 for this trademark*).
- 2,763,292 (*See Class 6 for this trademark*).
- 2,763,467. **TREASURES BY RACHEL ASHWELL**. SHABBY CHIC, INC., (U.S. CLS. 42 AND 50). SN 76-360,731. PUB. 6-24-2003. FILED 1-22-2002.
- 2,763,507 (*See Class 21 for this trademark*).
- 2,763,563. **BABY-BE-SAFE AND DESIGN**. TRIMBLE, LYNN, (U.S. CLS. 42 AND 50). SN 76-394,145. PUB. 6-24-2003. FILED 4-11-2002.
- 2,763,614. **BIO-SILVER**. PERFORMANCE APPAREL CORP., (U.S. CLS. 42 AND 50). SN 76-404,571. PUB. 6-24-2003. FILED 5-7-2002.
- 2,763,678. **GNAWTY DOG**. ANY DESIGN MONOGRAM EMBROIDERY, INC., MULTIPLE CLASS, (INT. CLS. 24 AND 25), (U.S. CLS. 22, 39, 42 AND 50). SN 76-413,761. PUB. 6-24-2003. FILED 5-30-2002.
- 2,763,721 (*See Class 17 for this trademark*).
- 2,763,808. **BUSATTI AND DESIGN**. GLES BUSATTI DI SASSOLINI GIOVANNI & C. S.N.C., (U.S. CLS. 42 AND 50). SN 76-434,550. PUB. 6-24-2003. FILED 7-25-2002.
- 2,763,929. **BIANCA EXCLUSIVE**. BIANCA USA INC., (U.S. CLS. 42 AND 50). SN 76-456,957. PUB. 6-24-2003. FILED 10-7-2002.
- 2,764,411 (*See Class 20 for this trademark*).
- 2,764,422. **HANDY'S PLUS**. BASIC COMFORT, INC., (U.S. CLS. 42 AND 50). SN 78-185,301. PUB. 6-24-2003. FILED 11-14-2002.
-
- CLASS 25—CLOTHING**
- 2,763,025. **NO SHOE AND DESIGN**. CONCHI, INC., (U.S. CL. 39). SN 74-261,808. PUB. 9-8-1992. FILED 4-2-1992.
- 2,763,027 (*See Class 14 for this trademark*).
- 2,763,029. **DICK'S CLOTHING & SPORTING GOODS AND DESIGN**. GENERAL ELECTRIC CAPITAL CORPORATION, ASSIGNEE OF DICK'S CLOTHING & SPORTING GOODS, INC., (U.S. CLS. 22 AND 39). SN 75-055,490. PUB. 7-7-1998. FILED 2-9-1996.
- 2,763,034. **BRIOSO**. J.A. BESNER & SONS (CANADA) LTD., BY ASSIGNMENT LA STRADA FASHIONS, INC., (U.S. CLS. 22 AND 39). SN 75-258,602. PUB. 6-24-2003. FILED 3-17-1997.
- 2,763,038. **ALMOST PERFECT**. STONE INTERNATIONAL, LLC, BY ASSIGNMENT; BY ASSIGNMENT UMBRO INTERNATIONAL, INC., (U.S. CLS. 22 AND 39). SN 75-289,457. PUB. 6-24-2003. FILED 5-9-1997.
- 2,763,045. **ZEELANDER AND DESIGN**. ZEELANDER, INC., (U.S. CLS. 22 AND 39). SN 75-434,428. PUB. 6-24-2003. FILED 2-13-1998.
- 2,763,049. **HARLEM HIGH**. HARLEM HIGH INC., (U.S. CLS. 22 AND 39). SN 75-473,084. PUB. 6-24-2003. FILED 4-23-1998.
- 2,763,064 (*See Class 3 for this trademark*).
- 2,763,070 (*See Class 24 for this trademark*).
- 2,763,071 (*See Class 24 for this trademark*).
- 2,763,078. **PELLA PRODUCTS RUGGED OUTDOOR CLOTHING MAKERS OF QUALITY APPAREL SINCE 1907**. PELLA, IOWA USA AND DESIGN. PELLA PRODUCTS, INC., (U.S. CLS. 22 AND 39). SN 75-744,803. PUB. 4-25-2000. FILED 7-7-1999.
- 2,763,091. **INTECH**. KING PAR CORPORATION, (U.S. CLS. 22 AND 39). SN 75-823,436. PUB. 6-24-2003. FILED 10-15-1999.
- 2,763,097 (*See Class 9 for this trademark*).
- 2,763,124 (*See Class 9 for this trademark*).
- 2,763,134 (*See Class 6 for this trademark*).
- 2,763,163 (*See Class 3 for this trademark*).
- 2,763,181 (*See Class 12 for this trademark*).
- 2,763,188 (*See Class 12 for this trademark*).
- 2,763,197. **SOUTHWEST RESEARCH INSTITUTE**. SOUTHWEST RESEARCH INSTITUTE, (U.S. CLS. 22 AND 39). SN 76-144,964. PUB. 3-11-2003. FILED 10-11-2000.
- 2,763,210. **MISCELLANEOUS DESIGN**. THE SIMON PARTNERSHIP, (U.S. CLS. 22 AND 39). SN 76-170,451. PUB. 6-24-2003. FILED 11-24-2000.
- 2,763,232 (*See Class 3 for this trademark*).
- 2,763,236 (*See Class 8 for this trademark*).
- 2,763,247 (*See Class 3 for this trademark*).
- 2,763,250. **PEGASUS CREEK**. PEGASUS CREEK, INC., MULTIPLE CLASS, (INT. CLS. 25 AND 41), (U.S. CLS. 22, 39, 100, 101 AND 107). SN 76-204,343. PUB. 5-28-2002. FILED 2-5-2001.
- 2,763,268 (*See Class 6 for this trademark*).
- 2,763,293. **N AND DESIGN**. AMERICAN SPORTING GOODS CORPORATION, (U.S. CLS. 22 AND 39). SN 76-251,056. PUB. 6-24-2003. FILED 5-7-2001.
- 2,763,300. **NEOPETS**. NEOPETS, INC., BY CHANGE OF NAME NEOPETS.COM, INC., (U.S. CLS. 22 AND 39). SN 76-257,900. PUB. 6-24-2003. FILED 5-11-2001.
- 2,763,331. **GRAND**. HARTZ HOTEL SERVICES, INC., DBA GRAND HOSPITALITY, (U.S. CLS. 22 AND 39). SN 76-294,303. PUB. 6-11-2002. FILED 8-6-2001.
- 2,763,332. **THE HIP SITE AND DESIGN**. BENETTON GROUP S.P.A., (U.S. CLS. 22 AND 39). SN 76-295,560. PUB. 6-24-2003. FILED 8-6-2001.
- 2,763,382. **THE CHAPIN COMPANY**. CHAPIN COMPANY, THE, (U.S. CLS. 22 AND 39). SN 76-329,531. PUB. 6-4-2002. FILED 10-22-2001.
- 2,763,439 (*See Class 18 for this trademark*).
- 2,763,456. **WORST GIRL AND DESIGN**. LARSEN, ARIC P., (U.S. CLS. 22 AND 39). SN 76-355,615. PUB. 6-24-2003. FILED 1-7-2002.
- 2,763,460. **CHAUDRY**. KVM INTERNATIONAL FASHIONS LTD., (U.S. CLS. 22 AND 39). SN 76-357,273. PUB. 6-24-2003. FILED 1-14-2002.
- 2,763,498 (*See Class 14 for this trademark*).
- 2,763,599. **MISCELLANEOUS DESIGN**. PHILLIPS CHEVROLET, INC., MULTIPLE CLASS, (INT. CLS. 25, 35, 37 AND 39), (U.S. CLS. 22, 39, 100, 101, 102, 103, 105 AND 106). SN 76-402,032. PUB. 6-24-2003. FILED 5-1-2002.
- 2,763,608. **FIRSTLOVE**. JACK WHITE PRODUCTIONS USA INC, (U.S. CLS. 22 AND 39). SN 76-404,207. PUB. 6-24-2003. FILED 4-30-2002.
- 2,763,644. **J.G. HOOK AND DESIGN**. J.G. HOOK GROUP, LLC, (U.S. CLS. 22 AND 39). SN 76-408,894. PUB. 6-24-2003. FILED 5-16-2002.
- 2,763,661 (*See Class 18 for this trademark*).
- 2,763,676. **THURSDAY**. THURSDAY LLC, (U.S. CLS. 22 AND 39). SN 76-413,624. PUB. 6-24-2003. FILED 5-29-2002.
- 2,763,678 (*See Class 24 for this trademark*).
- 2,763,696. **GLOVE FIT**. DILLARD'S INC., (U.S. CLS. 22 AND 39). SN 76-417,353. PUB. 6-24-2003. FILED 5-31-2002.
- 2,763,744. **LOVE POTION AND DESIGN**. MS. BUBBLES, INC., (U.S. CLS. 22 AND 39). SN 76-424,612. PUB. 1-7-2003. FILED 6-24-2002.
- 2,763,751. **PLEASANT DREAMERS**. PLEASANT DREAMERS, INC., (U.S. CLS. 22 AND 39). SN 76-425,901. PUB. 6-24-2003. FILED 6-27-2002.
- 2,763,795. **K AND DESIGN**. J H CALIFORNIA TRADING CO, (U.S. CLS. 22 AND 39). SN 76-433,090. PUB. 6-24-2003. FILED 7-22-2002.
- 2,763,803 (*See Class 9 for this trademark*).
- 2,763,851. **MISCELLANEOUS DESIGN**. THE TJX COMPANIES, INC., (U.S. CLS. 22 AND 39). SN 76-443,670. PUB. 6-24-2003. FILED 8-26-2002.
- 2,763,859 (*See Class 18 for this trademark*).
- 2,763,860. **CAPUCINE & CAPUCIN**. CAPUCINE & CAPUCIN, INC., (U.S. CLS. 22 AND 39). SN 76-446,183. PUB. 6-24-2003. FILED 8-30-2002.
- 2,763,865. **SYBER**. WIN WIN EXPORT/IMPORT, INC., (U.S. CLS. 22 AND 39). SN 76-447,691. PUB. 6-24-2003. FILED 9-6-2002.
- 2,763,866. **C AND DESIGN**. CONAL INT'L TRADING CO., (U.S. CLS. 22 AND 39). SN 76-447,692. PUB. 6-24-2003. FILED 9-6-2002.

- 2,763,870. **THE VIRGINIAN**. PILGRIM PARTNERS, INC., DBA THE VIRGINIAN RESTAURANT, MULTIPLE CLASS, (INT. CLS. 25 AND 43), (U.S. CLS. 22, 39, 100 AND 101). SN 76-448,358. PUB. 6-24-2003. FILED 9-6-2002.
- 2,763,923. **ALFRED DUNNER**. ALFRED DUNNER, INC., (U.S. CLS. 22 AND 39). SN 76-456,328. PUB. 6-24-2003. FILED 9-27-2002.
- 2,763,949. **NOM NAISSANCE ON MELROSE**. THE NOONAN GROUP, INC., (U.S. CLS. 22 AND 39). SN 76-459,402. PUB. 6-24-2003. FILED 10-15-2002.
- 2,763,950. **HIRA**. HIRA COLLECTION INC., (U.S. CLS. 22 AND 39). SN 76-459,673. PUB. 6-24-2003. FILED 10-21-2002.
- 2,763,951. **BRIDAL HOME**. HIRA COLLECTION INC., MULTIPLE CLASS, (INT. CLS. 25 AND 35), (U.S. CLS. 22, 39, 100, 101 AND 102). SN 76-459,674. PUB. 6-24-2003. FILED 10-21-2002.
- 2,763,953. **BETTY BELTS**. MARLOW, NICK, DBA BETTY BELTS, (U.S. CLS. 22 AND 39). SN 76-459,866. PUB. 6-24-2003. FILED 10-11-2002.
- 2,763,956. **DON JONATHAN (STYLIZED)**. DON JONATHAN CRAVATS, INC., (U.S. CLS. 22 AND 39). SN 76-460,186. PUB. 6-24-2003. FILED 10-22-2002.
- 2,763,959. **INTERNATIONAL AID**. INTERNATIONAL AID INC., (U.S. CLS. 22 AND 39). SN 76-460,447. PUB. 6-24-2003. FILED 10-22-2002.
- 2,763,961. **COASTAL EDGE**. NACHNANI, GOBIND H., MULTIPLE CLASS, (INT. CLS. 25 AND 35), (U.S. CLS. 22, 39, 100, 101 AND 102). SN 76-460,729. PUB. 6-24-2003. FILED 10-23-2002.
- 2,763,965. **GRIPION**. GUMBERT, JERRY F., (U.S. CLS. 22 AND 39). SN 76-460,924. PUB. 6-24-2003. FILED 10-18-2002.
- 2,763,966. **NATURAL HIGH**. ANGIULI, FRANK, (U.S. CLS. 22 AND 39). SN 76-461,046. PUB. 6-24-2003. FILED 10-24-2002.
- 2,764,102 (*See Class 1 for this trademark*).
- 2,764,103. **COLLECTION AND DESIGN**. ASHLEY NETTIE, INC., (U.S. CLS. 22 AND 39). SN 76-975,354. PUB. 6-24-2003. FILED 7-19-2002.
- 2,764,108. **LOCAL SURF**. D.P. THAI TEES, INC., (U.S. CLS. 22 AND 39). SN 78-010,719. PUB. 6-24-2003. FILED 6-1-2000.
- 2,764,123. **S 3 AND DESIGN**. DRIFT SURF, LLC, (U.S. CLS. 22 AND 39). SN 78-051,918. PUB. 6-24-2003. FILED 3-7-2001.
- 2,764,141. **SMOOTH TONERS**. SARA LEE CORPORATION, BY ASSIGNMENT SARAMAR, L.L.C., (U.S. CLS. 22 AND 39). SN 78-086,661. PUB. 6-24-2003. FILED 10-3-2001.
- 2,764,174. **GOTTA PLAY!**. BROWNE, ALAN J., AND BROWNE, DOREEN M., (U.S. CLS. 22 AND 39). SN 78-105,143. PUB. 6-24-2003. FILED 1-28-2002.
- 2,764,192. **SUGAR SWEET**. WEAR ME APPAREL, (U.S. CLS. 22 AND 39). SN 78-111,358. PUB. 6-24-2003. FILED 2-27-2002.
- 2,764,193. **COLOSSEUM AND DESIGN**. COLOSSEUM ATHLETICS CORPORATION, (U.S. CLS. 22 AND 39). SN 78-113,166. PUB. 6-24-2003. FILED 3-7-2002.
- 2,764,225. **MISCELLANEOUS DESIGN**. PACIFIC SUNWEAR OF CALIFORNIA, (U.S. CLS. 22 AND 39). SN 78-130,704. PUB. 6-24-2003. FILED 5-23-2002.
- 2,764,259. **GLHEART**. KABUSHIKI KAISHA BIG JOHN, TA BIG JOHN CORPORATION, (U.S. CLS. 22 AND 39). SN 78-143,076. PUB. 6-24-2003. FILED 7-11-2002.
- 2,764,274 (*See Class 16 for this trademark*).
- 2,764,291 (*See Class 18 for this trademark*).
- 2,764,305. **AUTHENTIC CHINO CASUALS**. TSI BRANDS, INC., (U.S. CLS. 22 AND 39). SN 78-161,575. PUB. 6-24-2003. FILED 9-6-2002.
- 2,764,401. **ZIZI AND DESIGN**. R.G. BARRY (TEXAS) L.P., (U.S. CLS. 22 AND 39). SN 78-182,788. PUB. 6-24-2003. FILED 11-7-2002.
- 2,764,412 (*See Class 16 for this trademark*).
- 2,764,414. **POLLI SAYS....** FARSHOUKH, SIRA, (U.S. CLS. 22 AND 39). SN 78-184,360. PUB. 6-24-2003. FILED 11-12-2002.
- 2,764,428. **OUTDOOR COUNTRY AUTHENTIC OUTDOOR SOCKS AND DESIGN**. FOX RIVER MILLS, INC., (U.S. CLS. 22 AND 39). SN 78-185,411. PUB. 6-24-2003. FILED 11-15-2002.
- 2,764,466. **DOUBLE DRY**. SARA LEE GLOBAL FINANCE, L.L.C., (U.S. CLS. 22 AND 39). SN 78-193,699. PUB. 6-24-2003. FILED 12-12-2002.
- 2,764,471. **DOUBLEDRIVE**. DOUBLEDRIIVE, LLC, (U.S. CLS. 22 AND 39). SN 78-213,876. PUB. 6-24-2003. FILED 2-12-2003.

CLASS 26—FANCY GOODS

- 2,763,126 (*See Class 3 for this trademark*).
- 2,763,134 (*See Class 6 for this trademark*).
- 2,763,303 (*See Class 8 for this trademark*).
- 2,763,498 (*See Class 14 for this trademark*).
- 2,763,525. **SILKIES**. SILKIES, INC., (U.S. CLS. 37, 39, 40, 42 AND 50). SN 76-385,484. PUB. 6-24-2003. FILED 3-18-2002.
- 2,763,778. **TOP SECRET HAIRCESSORY AND DESIGN**. ROSSOUW, DENISE, (U.S. CLS. 37, 39, 40, 42 AND 50). SN 76-429,805. PUB. 6-24-2003. FILED 7-12-2002.
- 2,764,102 (*See Class 1 for this trademark*).
- 2,764,252. **LITE SEAMS MAGIC AND DESIGN**. CHUMBLEY, JAMES F., (U.S. CLS. 37, 39, 40, 42 AND 50). SN 78-140,593. PUB. 6-24-2003. FILED 7-2-2002.
- 2,764,381. **ABBY**. SC LICENSING, (U.S. CLS. 37, 39, 40, 42 AND 50). SN 78-179,907. PUB. 6-24-2003. FILED 10-30-2002.
- 2,764,382. **BRUSSELS**. SC LICENSING CORP., (U.S. CLS. 37, 39, 40, 42 AND 50). SN 78-179,945. PUB. 6-24-2003. FILED 10-30-2002.
- 2,764,383. **COLLEEN**. SC LICENSING CORP., (U.S. CLS. 37, 39, 40, 42 AND 50). SN 78-179,948. PUB. 6-24-2003. FILED 10-30-2002.
- 2,764,384. **GENTRY II**. SC LICENSING CORP., (U.S. CLS. 37, 39, 40, 42 AND 50). SN 78-179,961. PUB. 6-24-2003. FILED 10-30-2002.
- 2,764,394. **ROSE**. SC LICENSING CORP., (U.S. CLS. 37, 39, 40, 42 AND 50). SN 78-180,659. PUB. 6-24-2003. FILED 10-31-2002.

CLASS 27—FLOOR COVERINGS

- 2,763,095. **CORAL**. BONAR FLOORS LIMITED, (U.S. CLS. 19, 20, 37, 42 AND 50). SN 75-839,414. PUB. 6-24-2003. FILED 11-2-1999.
- 2,763,126 (*See Class 3 for this trademark*).
- 2,763,127. **TEXTRA**. JOHNS MANVILLE INTERNATIONAL, INC., (U.S. CLS. 19, 20, 37, 42 AND 50). SN 76-001,050. PUB. 12-31-2002. FILED 3-14-2000.
- 2,763,229. **YOGA-FLEX**. LUDLOW COMPOSITES CORPORATION, (U.S. CLS. 19, 20, 37, 42 AND 50). SN 76-184,576. PUB. 6-24-2003. FILED 12-21-2000.
- 2,763,369 (*See Class 16 for this trademark*).
- 2,763,580. **MISCELLANEOUS DESIGN**. JOHNS MANVILLE AB, (U.S. CLS. 19, 20, 37, 42 AND 50). SN 76-399,136. PUB. 6-24-2003. FILED 4-23-2002.
- 2,763,581. **TASSOGLAS**. JOHNS MANVILLE AB, (U.S. CLS. 19, 20, 37, 42 AND 50). SN 76-399,137. PUB. 6-24-2003. FILED 4-23-2002.
- 2,763,904. **PERMASTONE**. DOMCO TARKETT INC., (U.S. CLS. 19, 20, 37, 42 AND 50). SN 76-453,906. PUB. 6-24-2003. FILED 9-30-2002.
- 2,764,106 (*See Class 2 for this trademark*).

CLASS 28—TOYS AND SPORTING GOODS

- 2,763,053. **QUIK BLADE AND DESIGN**. QUIKBLADE INC., BY ASSIGNMENT MULTIMATIC INC., (U.S. CLS. 22, 23, 38 AND 50). SN 75-496,844. PUB. 1-15-2002. FILED 6-5-1998.
- 2,763,063. **BLACK WIDOW**. SOFTSPIKES, INC., (U.S. CLS. 22, 23, 38 AND 50). SN 75-571,529. PUB. 6-24-2003. FILED 10-16-1998.
- 2,763,064 (*See Class 3 for this trademark*).
- 2,763,134 (*See Class 6 for this trademark*).
- 2,763,232 (*See Class 3 for this trademark*).
- 2,763,236 (*See Class 8 for this trademark*).
- 2,763,247 (*See Class 3 for this trademark*).
- 2,763,268 (*See Class 6 for this trademark*).
- 2,763,464 (*See Class 12 for this trademark*).
- 2,763,471 (*See Class 9 for this trademark*).
- 2,763,498 (*See Class 14 for this trademark*).
- 2,763,531. **ZODIAK**. PARADIGM LEARNING, INC., (U.S. CLS. 22, 23, 38 AND 50). SN 76-388,471. PUB. 6-24-2003. FILED 3-28-2002.

- 2,763,545. **THINK*OF-IT!**. THINK OF IT!, INC., (U.S. CLS. 22, 23, 38 AND 50). SN 76-391,397. PUB. 6-24-2003. FILED 4-4-2002.
- 2,763,584. **STUFFY BEAR FACTORY**. STUFFY BEAR FACTORY, MULTIPLE CLASS, (INT. CLS. 28 AND 35), (U.S. CLS. 22, 23, 38, 50, 100, 101 AND 102). SN 76-399,569. PUB. 6-24-2003. FILED 4-24-2002.
- 2,763,585. **SUNA TAROT AND DESIGN**. MIDAX, MULTIPLE CLASS, (INT. CLS. 28 AND 43), (U.S. CLS. 22, 23, 38, 50, 100 AND 101). SN 76-399,591. PUB. 6-24-2003. FILED 4-25-2002.
- 2,763,588. **BLUE WATER CANDY AND DESIGN**. GAY, JODIE, AND GAY, TERRY, (U.S. CLS. 22, 23, 38 AND 50). SN 76-400,007. PUB. 6-24-2003. FILED 4-25-2002.
- 2,763,629. **THE SHABBAT BOX OF QUESTIONS**. CECE & HEIDI LLC, (U.S. CLS. 22, 23, 38 AND 50). SN 76-406,600. PUB. 6-24-2003. FILED 5-15-2002.
- 2,763,638 (*See Class 12 for this trademark*).
- 2,763,645. **ADORA BELLE AND DESIGN**. MARIE, INC., (U.S. CLS. 22, 23, 38 AND 50). SN 76-409,276. PUB. 6-24-2003. FILED 5-20-2002.
- 2,763,695 (*See Class 9 for this trademark*).
- 2,763,703. **FAN FACE**. FRANKLIN SPORTS, INC., (U.S. CLS. 22, 23, 38 AND 50). SN 76-418,139. PUB. 6-24-2003. FILED 6-10-2002.
- 2,763,759. **REFLEX AND DESIGN**. PACIFIC PAINTBALL SUPPLY, INC., (U.S. CLS. 22, 23, 38 AND 50). SN 76-426,770. PUB. 6-24-2003. FILED 7-1-2002.
- 2,763,773. **LICENSE JAN CALIFORNIA 1914 AND DESIGN**. PHILCOX, SYDNEY, AND PHILCOX, ELIZABETH, (U.S. CLS. 22, 23, 38 AND 50). SN 76-428,995. PUB. 6-24-2003. FILED 7-9-2002.
- 2,763,850. **REDMAN**. MACHO PRODUCTS, INC., (U.S. CLS. 22, 23, 38 AND 50). SN 76-443,520. PUB. 6-24-2003. FILED 8-26-2002.
- 2,763,883. **ANIMOEES**. PIERNAS, ONDRE L., (U.S. CLS. 22, 23, 38 AND 50). SN 76-451,239. PUB. 6-24-2003. FILED 6-26-2002.
- 2,763,896. **SELF-CORRECTING LEARNING WRAP-UPS AND DESIGN**. LEARNING WRAP-UPS, INC., (U.S. CLS. 22, 23, 38 AND 50). SN 76-452,520. PUB. 6-24-2003. FILED 9-25-2002.
- 2,763,900. **CARL & RAY**. BLOCKBUSTER INC., (U.S. CLS. 22, 23, 38 AND 50). SN 76-453,139. PUB. 6-24-2003. FILED 9-26-2002.
- 2,763,943. **AQUA TOSS**. MEESE, INC., (U.S. CLS. 22, 23, 38 AND 50). SN 76-458,593. PUB. 6-24-2003. FILED 10-16-2002.
- 2,764,003. **PUTTER POOL**. SUNSET GOLF, INC., (U.S. CLS. 22, 23, 38 AND 50). SN 76-467,278. PUB. 6-24-2003. FILED 11-15-2002.
- 2,764,007. **ULTIMATE CLASSIC**. RINGSIDE, INC., (U.S. CLS. 22, 23, 38 AND 50). SN 76-467,477. PUB. 6-24-2003. FILED 11-15-2002.
- 2,764,052. **THIS LITTLE PIGGY....** MILTON SALES, INC., (U.S. CLS. 22, 23, 38 AND 50). SN 76-472,578. PUB. 6-24-2003. FILED 11-27-2002.
- 2,764,102 (*See Class 1 for this trademark*).
- 2,764,113. **DOG SOLDIERS AND DESIGN**. GAULDIN, MICHAEL G., (U.S. CLS. 22, 23, 38 AND 50). SN 78-030,640. PUB. 6-24-2003. FILED 10-14-2000.
- 2,764,132. **MYSTIC (STYLIZED)**. COUSIN CORPORATION OF AMERICA, (U.S. CLS. 22, 23, 38 AND 50). SN 78-071,309. PUB. 6-24-2003. FILED 6-27-2001.
- 2,764,166 (*See Class 10 for this trademark*).
- 2,764,213. **FLASH TARGET**. COHEN, LAWRENCE M., (U.S. CLS. 22, 23, 38 AND 50). SN 78-124,883. PUB. 6-24-2003. FILED 4-29-2002.
- 2,764,256. **JUSTIN TIME PRODUCTIONS**. COHEN, JUSTIN, HOWARD, (U.S. CLS. 22, 23, 38 AND 50). SN 78-141,377. PUB. 6-24-2003. FILED 7-4-2002.
- 2,764,296. **SPONGEBOB SQUAREPANTS**. VIACOM INTERNATIONAL INC., (U.S. CLS. 22, 23, 38 AND 50). SN 78-157,828. PUB. 6-24-2003. FILED 8-26-2002.
- 2,764,325. **ARMOTECH**. LIN, TING-SHENG, (U.S. CLS. 22, 23, 38 AND 50). SN 78-168,953. PUB. 6-24-2003. FILED 9-28-2002.
- 2,764,338. **COMBAT WING**. ZELLMER, WESTON, LANE, (U.S. CLS. 22, 23, 38 AND 50). SN 78-173,006. PUB. 6-24-2003. FILED 10-10-2002.
- 2,764,350. **FASHION ROYALTY**. INTEGRITY TOYS, INC., (U.S. CLS. 22, 23, 38 AND 50). SN 78-175,846. PUB. 6-24-2003. FILED 10-18-2002.
- 2,764,359. **MISCELLANEOUS DESIGN**. RIDERWARE CO INC, (U.S. CLS. 22, 23, 38 AND 50). SN 78-177,689. PUB. 6-24-2003. FILED 10-23-2002.
- 2,764,392. **HOOKER CHEMICAL**. RUOCCHIO, ALBERT C., (U.S. CLS. 22, 23, 38 AND 50). SN 78-180,640. PUB. 6-24-2003. FILED 10-31-2002.
- 2,764,419. **CRANKY**. KIKKERLAND DESIGN, INC., AND DOMINGUES, FRANCISCO BICALHO, (U.S. CLS. 22, 23, 38 AND 50). SN 78-185,279. PUB. 6-24-2003. FILED 11-14-2002.
- 2,764,423. **CRITTER**. KIKKERLAND DESIGNS, INC., (U.S. CLS. 22, 23, 38 AND 50). SN 78-185,302. PUB. 6-24-2003. FILED 11-14-2002.
- 2,764,424. **KATITA**. KIKKERLAND DESIGNS, INC., (U.S. CLS. 22, 23, 38 AND 50). SN 78-185,309. PUB. 6-24-2003. FILED 11-14-2002.
- 2,764,425. **SPARKLZ**. KIKKERLAND DESIGNS, INC., AND DONMIGUES, FRANCISCO BICALHO, (U.S. CLS. 22, 23, 38 AND 50). SN 78-185,326. PUB. 6-24-2003. FILED 11-14-2002.
- 2,764,431. **CREATE-A-STORY**. CREATE! PRESS, INC., (U.S. CLS. 22, 23, 38 AND 50). SN 78-185,755. PUB. 6-24-2003. FILED 11-15-2002.

CLASS 29—MEATS AND PROCESSED FOODS

- 2,763,032. **CLOVER AND DESIGN**. DAIRY CREST LIMITED, (U.S. CL. 46). SN 75-183,039. PUB. 6-24-2003. FILED 10-17-1996.
- 2,763,040. **TASTE THE PRIDE INSIDE..** FOREMOST FARMS USA, COOPERATIVE, MULTIPLE CLASS, (INT. CLS. 29, 30 AND 32), (U.S. CLS. 45, 46 AND 48). SN 75-388,333. PUB. 6-24-2003. FILED 11-12-1997.
- 2,763,061. **GRANDE PREMIER AND DESIGN**. SUPREME OIL COMPANY, MULTIPLE CLASS, (INT. CLS. 29, 30 AND 33), (U.S. CLS. 46, 47 AND 49). SN 75-564,374. PUB. 6-8-1999. FILED 10-5-1998.
- 2,763,080. **RANI BRAND AUTHENTIC INDIAN PRODUCTS AND DESIGN**. KUNDAN FOODS, INC., MULTIPLE CLASS, (INT. CLS. 29 AND 30), (U.S. CL. 46). SN 75-760,070. PUB. 6-24-2003. FILED 8-17-1999.
- 2,763,126 (*See Class 3 for this trademark*).
- 2,763,129 (*See Class 5 for this trademark*).
- 2,763,157. **SQM**. SWEDISH MEATS, EK. FOR, (U.S. CL. 46). SN 76-073,982. PUB. 6-24-2003. FILED 6-21-2000.
- 2,763,211. **DIP INDULGENCE**. WILLIAM POLL, INC., (U.S. CL. 46). SN 76-172,357. PUB. 6-24-2003. FILED 11-28-2000.
- 2,763,283. **GOLDEN SUN**. LIDL STIFTUNG & CO. KG, MULTIPLE CLASS, (INT. CLS. 29, 30 AND 33), (U.S. CLS. 46, 47 AND 49). SN 76-238,997. PUB. 2-11-2003. FILED 3-19-2001.
- 2,763,315. **SIRIUS**. LIDL STIFTUNG & CO. KG, (U.S. CL. 46). SN 76-280,323. PUB. 6-24-2003. FILED 7-3-2001.
- 2,763,336. **YONSON**. DEAN INTELLECTUAL PROPERTY SERVICES, L.P., BY ASSIGNMENT; BY ASSIGNMENT SUIZA DAIRY GROUP, L.P., (U.S. CL. 46). SN 76-298,209. PUB. 6-24-2003. FILED 8-9-2001.
- 2,763,379 (*See Class 1 for this trademark*).
- 2,763,452. **JELLY JOY AND DESIGN**. TASTYFOOD INDUSTRIES (S) PTE LTD, (U.S. CL. 46). SN 76-354,324. PUB. 6-24-2003. FILED 1-3-2002.
- 2,763,511. **OK FOODS FLAVOR SEALED QUALITY GUARDED AND DESIGN**. OK FOODS, INC., (U.S. CL. 46). SN 76-381,128. PUB. 6-24-2003. FILED 3-12-2002.
- 2,763,558. **PARMA CUBES BERTOZZI PARMA AND DESIGN**. ABELE BERTOZZI S.P.A., (U.S. CL. 46). SN 76-393,446. PUB. 6-24-2003. FILED 4-8-2002.
- 2,763,559. **PARMA FLAKES BERTOZZI PARMA AND DESIGN**. ABELE BERTOZZI S.P.A., (U.S. CL. 46). SN 76-393,447. PUB. 6-24-2003. FILED 4-8-2002.
- 2,763,649. **GRANDPA'S**. GARDEN-FRESH FOODS, INC., MULTIPLE CLASS, (INT. CLS. 29 AND 30), (U.S. CL. 46). SN 76-409,409. PUB. 6-24-2003. FILED 5-16-2002.
- 2,763,707. **POLISH PRINCESS POLSKA KROLEWNA AND DESIGN**. KOLYNICZ, MARK, MULTIPLE CLASS, (INT. CLS. 29 AND 30), (U.S. CL. 46). SN 76-418,809. PUB. 6-24-

2003. FILED 6-7-2002.
- 2,763,711. **MISCELLANEOUS DESIGN. INCREDIBLY EDIBLE DELITES, INC.**, (U.S. CL. 46). SN 76-419,410. PUB. 6-24-2003. FILED 6-11-2002.
- 2,763,737. **CALLISTO FRANCESCONI. SOCIETA PER AZIONI LUCCHESI OLII E VINI**, (U.S. CL. 46). SN 76-423,282. PUB. 6-24-2003. FILED 6-25-2002.
- 2,763,760. **BLACK-ANGUS GOLD BEEF DAF AND DESIGN. FREI, DANIEL**, (U.S. CL. 46). SN 76-427,279. PUB. 6-24-2003. FILED 12-18-2002.
- 2,763,784. **MISCELLANEOUS DESIGN. THE J. M. SMUCKER COMPANY, MULTIPLE CLASS**, (INT. CLS. 29 AND 30), (U.S. CL. 46). SN 76-430,411. PUB. 6-24-2003. FILED 7-15-2002.
- 2,763,861. **NATIONAL DELI AND DESIGN. NATIONAL PROVISIONS, INC.**, (U.S. CL. 46). SN 76-446,798. PUB. 6-24-2003. FILED 9-3-2002.
- 2,763,868. **THE JELLY MAKER'S DAUGHTER. LAKIN, GAY**, MULTIPLE CLASS, (INT. CLS. 29 AND 30), (U.S. CL. 46). SN 76-448,094. PUB. 6-24-2003. FILED 9-9-2002.
- 2,763,893. **FOUR STAR BEEF. SWIFT BRANDS COMPANY**, (U.S. CL. 46). SN 76-452,315. PUB. 6-24-2003. FILED 9-23-2002.
- 2,764,102 (*See Class 1 for this trademark*).
- 2,764,109. **MOO CHEW. BARTLETT, GREG, A**, (U.S. CL. 46). SN 78-024,732. PUB. 6-24-2003. FILED 9-7-2000.
- 2,764,179. **HEARTLAND PREMIUM BEEF, INC. AND DESIGN. HEARTLAND PREMIUM BEEF, INC.**, MULTIPLE CLASS, (INT. CLS. 29, 31, 35 AND 44), (U.S. CLS. 1, 46, 100, 101 AND 102). SN 78-106,102. PUB. 6-24-2003. FILED 1-31-2002.
- 2,764,185. **HARVEST CUTS (STYLIZED). SUN ORCHARD FRUIT COMPANY, INC., DBA SUN ORCHARD BRAND**, (U.S. CL. 46). SN 78-108,130. PUB. 6-24-2003. FILED 2-11-2002.
- 2,764,248. **GOODAY. ASSISTANCE FOOD AMERICA INC**, (U.S. CL. 46). SN 78-138,367. PUB. 6-24-2003. FILED 6-24-2002.
- 2,764,430. **HARVEST OF THE SEA. ORE-CAL CORPORATION**, (U.S. CL. 46). SN 78-185,754. PUB. 6-24-2003. FILED 11-15-2002.
- 2,764,432. **HARVEST OF THE SEA AND DESIGN. ORE-CAL CORPORATION**, (U.S. CL. 46). SN 78-185,758. PUB. 6-24-2003. FILED 11-15-2002.
- 2,764,433. **FISHERMAN'S OUTLET. ORE-CAL CORPORATION**, (U.S. CL. 46). SN 78-185,766. PUB. 6-24-2003. FILED 11-15-2002.
- 2,764,469. **TASTE O' THE WEST. SIGNATURE FRUIT COMPANY LLC**, (U.S. CL. 46). SN 78-193,835. PUB. 6-24-2003. FILED 12-12-2002.
- 2,763,379 (*See Class 1 for this trademark*).
- 2,763,396. **WILD-X AND DESIGN. PRODUCTOS INDUSTRIALIZADOS DE SALTILLO, S. DE R.L. DE C.V.**, (U.S. CL. 46). SN 76-335,304. PUB. 6-24-2003. FILED 11-7-2001.
- 2,763,420. **MARY JANE. FLOWERS BAKERIES BRANDS, INC.**, (U.S. CL. 46). SN 76-343,689. PUB. 6-24-2003. FILED 11-29-2001.
- 2,763,438. **XTRACHENE. CHENE DEVELOPPEMENT, MULTIPLE CLASS**, (INT. CLS. 30 AND 31), (U.S. CLS. 1 AND 46). SN 76-349,738. PUB. 6-24-2003. FILED 12-18-2001.
- 2,763,522 (*See Class 5 for this trademark*).
- 2,763,532. **AMAZON FRUTTI AND DESIGN. LACO OVERSEAS, INC.**, (U.S. CL. 46). SN 76-388,688. PUB. 6-24-2003. FILED 3-26-2002.
- 2,763,544. **ALFREDO'S GALLERY ALLA SCROFA ROMA AND DESIGN. MOZZETTI, MARIO**, (U.S. CL. 46). SN 76-391,360. PUB. 6-24-2003. FILED 4-5-2002.
- 2,763,573. **TULSY QUALITY FOODS AND DESIGN. MAHA-BAZAAR.COM, INC.**, (U.S. CL. 46). SN 76-398,071. PUB. 6-24-2003. FILED 4-19-2002.
- 2,763,616 (*See Class 5 for this trademark*).
- 2,763,649 (*See Class 29 for this trademark*).
- 2,763,662. **MISCELLANEOUS DESIGN. SHUNFAR INTERNATIONAL, INC.**, (U.S. CL. 46). SN 76-411,548. PUB. 6-24-2003. FILED 5-23-2002.
- 2,763,679. **DELTOPICO GOURMET AND DESIGN. SOUTH FLORIDA BAKERY, INC.**, (U.S. CL. 46). SN 76-413,877. PUB. 6-24-2003. FILED 5-30-2002.
- 2,763,700. **SOFRITO LA SOLUCION EH. E.H. SOLUTION SEASONING INC**, (U.S. CL. 46). SN 76-417,620. PUB. 6-24-2003. FILED 6-10-2002.
- 2,763,707 (*See Class 29 for this trademark*).
- 2,763,716. **DANNY'S BAR-B-QUE "LEAN MEAT, GREAT SAUCE" AND DESIGN. DANNY'S BAR-B-QUE, INC.**, MULTIPLE CLASS, (INT. CLS. 30 AND 43), (U.S. CLS. 46, 100 AND 101). SN 76-419,792. PUB. 6-24-2003. FILED 6-12-2002.
- 2,763,735. **GEGE AND DESIGN. AGRITECH S.P.A.**, (U.S. CL. 46). SN 76-423,116. PUB. 6-24-2003. FILED 6-13-2002.
- 2,763,784 (*See Class 29 for this trademark*).
- 2,763,794 (*See Class 5 for this trademark*).
- 2,763,822. **APIS ONE (STYLIZED). ARGUS CAPITAL LLC**, (U.S. CL. 46). SN 76-438,345. PUB. 6-24-2003. FILED 8-7-2002.
- 2,763,868 (*See Class 29 for this trademark*).
- 2,763,931. **RICHARD'S GOURMET AND DESIGN. RICHARD'S OF CHESTNUT HILL, INC.**, (U.S. CL. 46). SN 76-457,075. PUB. 6-24-2003. FILED 10-8-2002.
- 2,763,945. **RENEE'S GOURMET AND DESIGN. INTERCORP EXCELLE INC.**, (U.S. CL. 46). SN 76-459,105. PUB. 6-24-2003. FILED 10-9-2002.
- 2,763,986. **JEL SHOOTERS AND DESIGN. JEL SHOOTERS, INC.**, (U.S. CL. 46). SN 76-464,786. PUB. 6-24-2003. FILED 11-6-2002.
- 2,763,989. **FLORENCE'S. MOM'S KANDY KITCHEN, INC.**, (U.S. CL. 46). SN 76-465,221. PUB. 6-24-2003. FILED 11-7-2002.
- 2,763,991. **RIP ROLLS. THE FOREIGN CANDY COMPANY, INC.**, (U.S. CL. 46). SN 76-465,617. PUB. 6-24-2003. FILED 11-8-2002.
- 2,764,045. **IVY COTTAGE. CAFFE D'AMORE, INC.**, (U.S. CL. 46). SN 76-472,042. PUB. 6-24-2003. FILED 11-25-2002.
- 2,764,055. **SEAPORT AND DESIGN. TEXAS COFFEE COMPANY, INC.**, (U.S. CL. 46). SN 76-472,890. PUB. 6-24-2003. FILED 12-9-2002.
- 2,764,064. **DOC LEE'S. DOC LEE'S PEPPER COMPANY, INC.**, (U.S. CL. 46). SN 76-473,865. PUB. 6-24-2003. FILED 12-11-2002.
- 2,764,076. **ARBOR DAY. THE NATIONAL ARBOR DAY FOUNDATION, INC.**, (U.S. CL. 46). SN 76-474,412. PUB. 6-24-2003. FILED 12-12-2002.
- 2,764,102 (*See Class 1 for this trademark*).
- 2,764,163. **BLACK TIE COFFEE. COFFEE TRADE SERVICES, INC.**, (U.S. CL. 46). SN 78-102,295. PUB. 6-24-2003. FILED 1-11-2002.
- 2,764,177. **ENLIGHTENMINTS. SHAW, STEPHAN**, (U.S. CL. 46). SN 78-105,550. PUB. 6-24-2003. FILED 1-29-2002.
- 2,764,241. **LATTEA. TAPIOCA EXPRESS, INC.**, (U.S. CL. 46). SN 78-135,873. PUB. 6-24-2003. FILED 6-14-2002.

CLASS 30—STAPLE FOODS

- 2,763,040 (*See Class 29 for this trademark*).
- 2,763,061 (*See Class 29 for this trademark*).
- 2,763,080 (*See Class 29 for this trademark*).
- 2,763,126 (*See Class 3 for this trademark*).
- 2,763,129 (*See Class 5 for this trademark*).
- 2,763,180. **TURIN AND DESIGN. CHOCOLATES TURIN, S.A. DE C.V.**, (U.S. CL. 46). SN 76-121,147. PUB. 6-24-2003. FILED S.R. 9-1-2000; AM. P.R. 5-31-2002.
- 2,763,216. **PAPA POINTS AND DESIGN. NAPCO, INC.**, MULTIPLE CLASS, (INT. CLS. 30 AND 35), (U.S. CLS. 46, 100, 101 AND 102). SN 76-176,741. PUB. 6-24-2003. FILED 12-6-2000.
- 2,763,233. **CHOCO-CIRCUS. LIDL STIFTUNG & CO. KG**, (U.S. CL. 46). SN 76-185,863. PUB. 6-18-2002. FILED 12-22-2000.
- 2,763,272. **BELLA CREMA. COFFEE MASTERS, INC.**, (U.S. CL. 46). SN 76-222,983. PUB. 6-24-2003. FILED 3-12-2001.
- 2,763,279. **ECORINO. LIDL STIFTUNG & CO. KG**, (U.S. CL. 46). SN 76-232,812. PUB. 6-24-2003. FILED 3-29-2001.
- 2,763,283 (*See Class 29 for this trademark*).
- 2,763,342. **SOCCER GOALS. MRS. SMITH'S BRANDS, INC.**, (U.S. CL. 46). SN 76-303,100. PUB. 6-24-2003. FILED 8-22-2001.

2,764,263. **DIVERSITEA AND DESIGN**. DAVIS, JANINE, LYNNE, (U.S. CL. 46). SN 78-144,936. PUB. 6-24-2003. FILED 7-17-2002.

2,764,319. **CHAUDOC**. ANHING CORPORATION, MULTIPLE CLASS, (INT. CLS. 30 AND 32), (U.S. CLS. 45, 46 AND 48). SN 78-165,599. PUB. 6-24-2003. FILED 9-18-2002.

2,764,379. **RED BERET ROASTERS**. TRI STAR MARKETING, INC., (U.S. CL. 46). SN 78-179,635. PUB. 6-24-2003. FILED 10-29-2002.

2,764,390. **STARKISS**. AMERICAN DAIRY QUEEN CORPORATION, (U.S. CL. 46). SN 78-180,610. PUB. 6-24-2003. FILED 10-31-2002.

2,764,461. **THE DANGEROUS STUFF**. ROSS, LAURA K., DBA THE TOFFEE HOUSE, (U.S. CL. 46). SN 78-191,699. PUB. 6-24-2003. FILED 12-5-2002.

CLASS 31—NATURAL AGRICULTURAL PRODUCTS

2,763,126 (*See Class 3 for this trademark*).

2,763,186. **CINNA-BONE**. HARRINGTON-MCGILL, SISSY, (U.S. CLS. 1 AND 46). SN 76-132,638. PUB. 6-24-2003. FILED 9-22-2000.

2,763,296. **ATLAS BRAND AND DESIGN**. MERTEC LLC, (U.S. CLS. 1 AND 46). SN 76-254,287. PUB. 6-24-2003. FILED 5-9-2001.

2,763,438 (*See Class 30 for this trademark*).

2,763,512 (*See Class 5 for this trademark*).

2,763,919. **DEBONAIR**. EARL CULLY HERITAGE TREES, INC., (U.S. CLS. 1 AND 46). SN 76-455,545. PUB. 6-24-2003. FILED 9-30-2002.

2,763,928. **TIETJEN VINEYARD**. RUTHERFORD GROUP, (U.S. CLS. 1 AND 46). SN 76-456,592. PUB. 6-24-2003. FILED 10-8-2002.

2,763,978. **MISCELLANEOUS DESIGN**. RIVER RANCH FRESH FOODS, LLC, (U.S. CLS. 1 AND 46). SN 76-463,603. PUB. 6-24-2003. FILED 11-4-2002.

2,763,984. **RICHARD L. BLAIR VINEYARDS**. BLAIR, RICHARD L., (U.S. CLS. 1 AND 46). SN 76-464,203. PUB. 6-24-2003. FILED 11-5-2002.

2,764,060. **EASY-BAKER AND DESIGN**. WADA FARMS POTATOES, INC., (U.S. CLS. 1 AND 46). SN 76-473,419. PUB. 6-24-2003. FILED 12-4-2002.

2,764,179 (*See Class 29 for this trademark*).

2,764,221. **BOLERO**. LIDL STIFTUNG & CO. KG, (U.S. CLS. 1 AND 46). SN 78-129,465. PUB. 6-24-2003. FILED 5-17-2002.

2,764,278. **SABZI AND DESIGN**. PAN AMERICAN AGRICULTURE CORPORATION, (U.S. CLS. 1 AND 46). SN 78-153,829. PUB. 6-24-2003. FILED 8-13-2002.

2,764,360. **INTIMIDATOR**. HI-TEK RATIONS, INC, (U.S. CLS. 1 AND 46). SN 78-177,695. PUB. 6-24-2003. FILED 10-23-2002.

2,764,378. **MISCELLANEOUS DESIGN**. VALLEYBROOK INTERNATIONAL VENTURES, INC., (U.S. CLS. 1 AND 46). SN 78-179,532. PUB. 6-24-2003. FILED 10-29-2002.

2,764,389. **TRIFORMANCE**. MCCAULEY BROTHERS, INC., (U.S. CLS. 1 AND 46). SN 78-180,498. PUB. 6-24-2003. FILED 10-31-2002.

CLASS 32—LIGHT BEVERAGES

2,763,040 (*See Class 29 for this trademark*).

2,763,064 (*See Class 3 for this trademark*).

2,763,094. **STELLA ARTOIS PREMIUM LAGER BEER BELGIUM 'S ORIGINAL BEER ANNO 1366 LEUVEN AND DESIGN**. INTERBREW, S.A., (U.S. CLS. 45, 46 AND 48). SN 75-838,717. PUB. 6-24-2003. FILED 11-1-1999.

2,763,126 (*See Class 3 for this trademark*).

2,763,214. **WATER +**. GLOBAL BRANDS, INC., BY ASSIGNMENT ENERGY BRANDS, INC., (U.S. CLS. 45, 46 AND 48). SN 76-174,463. PUB. 6-24-2003. FILED 12-2-2000.

2,763,232 (*See Class 3 for this trademark*).

2,763,268 (*See Class 6 for this trademark*).

2,763,371. **LE BLEU FRUTE NON-CARBONATED**. LE BLEU

CORPORATION, (U.S. CLS. 45, 46 AND 48). SN 76-323,483. PUB. 6-24-2003. FILED 10-11-2001.

2,763,402. **BIO DELICE AND DESIGN**. VITAMONT (SOCIETE ANONYME), (U.S. CLS. 45, 46 AND 48). SN 76-337,241. PUB. 6-24-2003. FILED 11-13-2001.

2,763,522 (*See Class 5 for this trademark*).

2,763,789. **HITACHINO NEST**. KIUCHI BREWERY GOSHI-KAISHA, (U.S. CLS. 45, 46 AND 48). SN 76-431,212. PUB. 6-24-2003. FILED 7-15-2002.

2,763,941. **CANITA (STYLIZED)**. EAT, INC., (U.S. CLS. 45, 46 AND 48). SN 76-457,992. PUB. 6-24-2003. FILED S.R. 10-11-2002; AM. P.R. 5-1-2003.

2,764,063. **ORCHARD SPLASH**. WM. H. LEAHY ASSOCIATES, INC., (U.S. CLS. 45, 46 AND 48). SN 76-473,775. PUB. 6-24-2003. FILED 12-5-2002.

2,764,102 (*See Class 1 for this trademark*).

2,764,188. **CAPITAL IMPORTS**. CAPITAL BREWERY CO., INC., (U.S. CLS. 45, 46 AND 48). SN 78-110,021. PUB. 6-24-2003. FILED 2-20-2002.

2,764,319 (*See Class 30 for this trademark*).

2,764,386. **NALECZOWIANKA (STYLIZED)**. NALECZOWIANKA SP. Z O.O., (U.S. CLS. 45, 46 AND 48). SN 78-180,435. PUB. 6-24-2003. FILED 10-31-2002.

CLASS 33—WINES AND SPIRITS

2,763,061 (*See Class 29 for this trademark*).

2,763,232 (*See Class 3 for this trademark*).

2,763,235. **MISCELLANEOUS DESIGN**. LUZHOU LAOJIAO STOCK CORPORATION, LIMITED, (U.S. CLS. 47 AND 49). SN 76-187,034. PUB. 3-18-2003. FILED 12-26-2000.

2,763,283 (*See Class 29 for this trademark*).

2,763,390. **CB AUSTRALIAN WINES OF DISTINCTION AND DESIGN**. CHEVIOT BRIDGE PTY LTD, (U.S. CLS. 47 AND 49). SN 76-331,298. PUB. 6-24-2003. FILED 10-29-2001.

2,763,634. **XF. CALVET**, (U.S. CLS. 47 AND 49). SN 76-407,260. PUB. 6-24-2003. FILED 5-9-2002.

2,763,708. **CASTELLO DEL POGGIO**. A.C.T.A. S.P.A., (U.S. CLS. 47 AND 49). SN 76-419,097. PUB. 6-24-2003. FILED 6-10-2002.

2,763,712. **DELLA CASA**. WENTE BROS., (U.S. CLS. 47 AND 49). SN 76-419,432. PUB. 6-24-2003. FILED 6-11-2002.

2,764,000. **TRES ERRES RRR**. COOPERATIVA AGRICOLA CONTROL PISQUERO DE ELQUI Y LIMARI LIMITADA, (U.S. CLS. 47 AND 49). SN 76-467,032. PUB. 6-24-2003. FILED 11-5-2002.

2,764,054. **PAGE NORD VINEYARD**. NORD ESTATE WINES, LLC, (U.S. CLS. 47 AND 49). SN 76-472,827. PUB. 6-24-2003. FILED 12-6-2002.

2,764,056. **CHARLES SHAW**. BRONCO WINE COMPANY, (U.S. CLS. 47 AND 49). SN 76-472,906. PUB. 6-24-2003. FILED 12-9-2002.

2,764,122. **LADY BAY**. LADY BAY VINEYARD PTY LTD., (U.S. CLS. 47 AND 49). SN 78-051,848. PUB. 6-24-2003. FILED 3-7-2001.

2,764,142. **CRACK ICE**. ARTHUR CRACK LIMITED, (U.S. CLS. 47 AND 49). SN 78-087,601. PUB. 6-24-2003. FILED 10-9-2001.

2,764,322. **THOMAS HYLAND**. SOUTHCOPT WINES PTY LIMITED, (U.S. CLS. 47 AND 49). SN 78-168,430. PUB. 6-24-2003. FILED 9-26-2002.

2,764,405. **EASY TOTE**. EARLY TIMES DISTILLERS COMPANY, (U.S. CLS. 47 AND 49). SN 78-183,362. PUB. 6-24-2003. FILED 11-8-2002.

2,764,418. **CRANE FAMILY VINEYARDS**. CHIARELLA, PETER, (U.S. CLS. 47 AND 49). SN 78-185,048. PUB. 6-24-2003. FILED 11-14-2002.

2,764,464. **FLYING PIG**. CAYUSE VINEYARDS, L.L.C., (U.S. CLS. 47 AND 49). SN 78-193,572. PUB. 6-24-2003. FILED 12-11-2002.

CLASS 34—SMOKERS' ARTICLES

2,763,474. **SAFESMOKER (STYLIZED)**. EAGLE MANUFACTURING COMPANY, (U.S. CLS. 2, 8, 9 AND 17). SN 76-363,579. PUB. 6-24-2003. FILED 1-29-2002.

SERVICE MARKS**CLASS 35—ADVERTISING AND BUSINESS**

2,763,030. **PHARMALYTICS INC. AND DESIGN**. PHARMALYTICS, INC., MULTIPLE CLASS, (INT. CLS. 35 AND 42), (U.S. CLS. 100, 101 AND 102). SN 75-146,147. PUB. 6-24-2003. FILED 7-26-1996.

2,763,058. **INTEROPNET**. KEY3MEDIA EVENTS, INC., BY CHANGE OF NAME ZD EVENTS INC., (U.S. CLS. 100, 101 AND 102). SN 75-531,302. PUB. 8-29-2000. FILED 8-5-1998.

2,763,059. **MTC EXPRESS**. MTC LEASING INC., MULTIPLE CLASS, (INT. CLS. 35 AND 37), (U.S. CLS. 100, 101, 102, 103 AND 106). SN 75-554,872. PUB. 1-23-2001. FILED 9-17-1998.

2,763,067. **CHANNEL CAT AND DESIGN**. PETERSON MANUFACTURING COMPANY, (U.S. CLS. 100, 101 AND 102). SN 75-625,785. PUB. 6-24-2003. FILED 1-20-1999.

2,763,076. **PAIN NET**. PAIN NET, INC., MULTIPLE CLASS, (INT. CLS. 35, 41 AND 42), (U.S. CLS. 100, 101, 102 AND 107). SN 75-735,561. PUB. 6-24-2003. FILED 7-21-1999.

2,763,086. **CDC JBCM FLOW AUDIT**. J. B. COMPUTER MANAGEMENT (JBCM), (U.S. CLS. 100, 101 AND 102). SN 75-785,536. PUB. 6-24-2003. FILED 9-23-1999.

2,763,090. **WEDDINGCHANNEL.COM (STYLIZED)**. WEDDINGCHANNEL.COM, INC., BY CHANGE OF NAME WEDCOM INC., MULTIPLE CLASS, (INT. CLS. 35 AND 39), (U.S. CLS. 100, 101, 102 AND 105). SN 75-806,968. PUB. 6-24-2003. FILED 9-23-1999.

2,763,097 (*See Class 9 for this trademark*).

2,763,101 (*See Class 7 for this trademark*).

2,763,102. **TEC AND DESIGN**. ARLINGTON SOFTWARE CORPORATION, (U.S. CLS. 100, 101 AND 102). SN 75-862,639. PUB. 6-24-2003. FILED 12-2-1999.

2,763,103. **THE KITCHEN AT GENUARDI'S AND DESIGN**. GENUARDI'S FAMILY MARKETS, L.P., (U.S. CLS. 100, 101 AND 102). SN 75-863,321. PUB. 3-19-2002. FILED 12-3-1999.

2,763,114. **VICTORY**. BEAUTY HOLDING COMPANY, INC., BY CHANGE OF NAME SALLY BEAUTY HOLDINGS, INC., (U.S. CLS. 100, 101 AND 102). SN 75-899,310. PUB. 6-24-2003. FILED 1-19-2000.

2,763,115. **MISCELLANEOUS DESIGN**. SFCC, INC., MULTIPLE CLASS, (INT. CLS. 35 AND 42), (U.S. CLS. 100, 101 AND 102). SN 75-907,822. PUB. 6-24-2003. FILED 2-2-2000.

2,763,116. **SHASA**. DOLLERO FIGUEROA, ARMANDO ERNESTO, AND DOLLERO FIGUEROA, CARLO, (U.S. CLS. 100, 101 AND 102). SN 75-912,158. PUB. 6-24-2003. FILED 2-7-2000.

2,763,117. **IPO ROW**. HOTJOBS.COM, LTD., (U.S. CLS. 100, 101 AND 102). SN 75-924,123. PUB. 2-20-2001. FILED 2-22-2000.

2,763,119. **MAGELLAN'S AND DESIGN**. MAGELLAN'S INTERNATIONAL TRAVEL CORPORATION, DBA MAGELLAN'S, (U.S. CLS. 100, 101 AND 102). SN 75-932,255. PUB. 1-16-2001. FILED 3-1-2000.

2,763,125. **ISITES@PNCBANK**. PNC FINANCIAL SERVICES GROUP, INC., THE, FORMERLY PNC BANK CORP., MULTIPLE CLASS, (INT. CLS. 35 AND 36), (U.S. CLS. 100, 101 AND 102). SN 75-982,950. PUB. 6-24-2003. FILED 7-26-1999.

2,763,126 (*See Class 3 for this trademark*).

2,763,136. **REDEFINING THE FRANCHISE MARKETPLACE**. FRANCHISE OPPORTUNITIES.COM, LLC, MULTIPLE CLASS, (INT. CLS. 35 AND 42), (U.S. CLS. 100, 101 AND 102). SN 76-031,845. PUB. 6-24-2003. FILED 4-20-2000.

2,763,137. **ES-Q-LAB (STYLIZED)**. SIMON, UDO, MULTIPLE CLASS, (INT. CLS. 35, 38, 41 AND 42), (U.S. CLS. 100, 101, 102, 104 AND 107). SN 76-034,082. PUB. 6-24-2003. FILED 4-25-2000.

2,763,147. **911 SKIN CARE**. 911 SKINCARE.COM, LLC, (U.S. CLS. 100, 101 AND 102). SN 76-047,044. PUB. 7-9-2002. FILED 5-15-2000.

2,763,149. **FLOWERS YOUR WAY**. FLOWERS YOUR WAY (INTERNATIONAL & WORLDWIDE DELIVERY) ALL MAJOR CREDIT CARDS ACCEPTED CORPORATION, (U.S. CLS. 100, 101 AND 102). SN 76-056,925. PUB. 6-24-2003. FILED 5-26-2000.

2,763,150. **LOVE LIKE YOU'VE NEVER BEEN HURT DANCE LIKE NOBODY'S WATCHING WORK LIKE YOU OWN THE COMPANY AND SEND FLOWERS YOUR WAY**. FLOWERS YOUR WAY (INTERNATIONAL & WORLDWIDE DELIVERY) ALL MAJOR CREDIT CARDS ACCEPTED CORPORATION, (U.S. CLS. 100, 101 AND 102). SN 76-056,926. PUB. 6-24-2003. FILED 5-26-2000.

2,763,152. **SOLUTIONS PHARMACY**. SOLUTIONS PHARMACY, INC., MULTIPLE CLASS, (INT. CLS. 35 AND 39), (U.S. CLS. 100, 101, 102 AND 105). SN 76-063,640. PUB. 6-24-2003. FILED 6-5-2000.

2,763,153. **GGINVENT**. GRAJ & GUSTAVSEN, INC., (U.S. CLS. 100, 101 AND 102). SN 76-066,800. PUB. 6-24-2003. FILED 6-9-2000.

2,763,164. **WHERE E-BUSINESS MEETS E-AGRICULTURE**. AVENTIS CROPS SCIENCE S.A. (SOCIETE ANONYME), MULTIPLE CLASS, (INT. CLS. 35 AND 38), (U.S. CLS. 100, 101, 102 AND 104). SN 76-091,893. PUB. 2-4-2003. FILED 7-15-2000.

2,763,167 (*See Class 9 for this trademark*).

2,763,168 (*See Class 9 for this trademark*).

2,763,169 (*See Class 9 for this trademark*).

2,763,170 (*See Class 9 for this trademark*).

2,763,175. **IEC THE GLOBAL LOGISTICS COMPANY AND DESIGN**. IEC LOGISTICS, INC., MULTIPLE CLASS, (INT. CLS. 35 AND 39), (U.S. CLS. 100, 101, 102 AND 105). SN 76-114,023. PUB. 6-24-2003. FILED 8-22-2000.

2,763,176. **IWFRAMEWORK**. INFRASTRUCTUREWORLD.COM, (U.S. CLS. 100, 101 AND 102). SN 76-114,161. PUB. 6-11-2002. FILED 8-21-2000.

2,763,177 (*See Class 9 for this trademark*).

2,763,191 (*See Class 9 for this trademark*).

2,763,195. **AHA!WORKS**. AHA!WORKS, INCORPORATED, (U.S. CLS. 100, 101 AND 102). SN 76-144,239. PUB. 6-24-2003. FILED 10-10-2000.

2,763,198. **BOSTONWORKS AND DESIGN**. THE TRUSTEE OF NYT MANAGEMENT SERVICES, A MASSACHUSETTS BUSINESS TRUST, THE TRUSTEE COMPRISING NYT GROUP SERVICES LLC, A DELAWARE LIMITED LIABILITY COMPANY, (U.S. CLS. 100, 101 AND 102). SN 76-145,382. PUB. 6-24-2003. FILED 10-13-2000.

2,763,205. **GROUPE TFN SERVICE GLOBAL AND DESIGN**. RJMF, BY CHANGE OF NAME LA TECHNIQUE FRANCAISE DU NETTOYAGE, MULTIPLE CLASS, (INT. CLS. 35, 36, 37, 38, 39, 40 AND 42), (U.S. CLS. 100, 101, 102, 103, 104, 105 AND 106). SN 76-162,662. PUB. 6-24-2003. FILED 11-10-2000.

2,763,215. **NEXT ECONOMY INDEX**. AEX- INDICES B.V., MULTIPLE CLASS, (INT. CLS. 35, 36 AND 41), (U.S. CLS. 100, 101, 102 AND 107). SN 76-176,205. PUB. 6-24-2003. FILED 12-5-2000.

2,763,216 (*See Class 30 for this trademark*).

2,763,220. **VISIONSITE AND DESIGN**. VISIONSITE CORPORATION, MULTIPLE CLASS, (INT. CLS. 35 AND 42), (U.S. CLS. 100, 101 AND 102). SN 76-179,028. PUB. 1-29-2002. FILED 12-11-2000.

2,763,223 (*See Class 9 for this trademark*).

2,763,225 (*See Class 9 for this trademark*).

2,763,227. **WEI**. COVANSYS CORPORATION, BY CHANGE OF NAME COMPLETE BUSINESS SOLUTIONS, INC., MULTIPLE CLASS, (INT. CLS. 35 AND 42), (U.S. CLS. 100, 101 AND 102). SN 76-182,406. PUB. 6-24-2003. FILED 12-18-2000.

2,763,230. **IQ SOLUTIONS**. IQSOLUTIONS, INC., (U.S. CLS. 100, 101 AND 102). SN 76-184,596. PUB. 6-24-2003. FILED 12-21-2000.

2,763,237 (*See Class 9 for this trademark*).

2,763,239 (*See Class 9 for this trademark*).

2,763,260. **MISCELLANEOUS DESIGN**. WACKENHUT RESOURCES, (U.S. CLS. 100, 101 AND 102). SN 76-210,451.

- PUB. 6-24-2003. FILED 2-15-2001.
2,763,268 (*See Class 6 for this trademark*).
2,763,298. **BIDZ.COM AND DESIGN**. BIDZ.COM, INC., (U.S. CLS. 100, 101 AND 102). SN 76-255,992. PUB. 6-24-2003. FILED 5-11-2001.
2,763,313. **VERBAL FLAGGING**. METH COMMUNICATIONS GROUP LLC, (U.S. CLS. 100, 101 AND 102). SN 76-278,278. PUB. 6-24-2003. FILED 7-2-2001.
2,763,317 (*See Class 1 for this trademark*).
2,763,334. **CONSTRUMEX AND DESIGN**. CONSTRUTODO, INC., MULTIPLE CLASS, (INT. CLS. 35, 36 AND 37), (U.S. CLS. 100, 101, 102, 103 AND 106). SN 76-295,811. PUB. 6-24-2003. FILED 8-6-2001.
2,763,335. **FISH MART**. FISH MART, INC., (U.S. CLS. 100, 101 AND 102). SN 76-295,988. PUB. 6-24-2003. FILED 8-8-2001.
2,763,343. **FLYTHROUGH**. BRITISH AIRWAYS PLC., MULTIPLE CLASS, (INT. CLS. 35 AND 39), (U.S. CLS. 100, 101, 102 AND 105). SN 76-305,104. PUB. 6-24-2003. FILED 8-24-2001.
2,763,346. **PARTYSPACE**. JEFFREY MILLER CATERING CO., MULTIPLE CLASS, (INT. CLS. 35 AND 41), (U.S. CLS. 100, 101, 102 AND 107). SN 76-307,453. PUB. 6-24-2003. FILED 8-30-2001.
2,763,349. **VALUE PLUS**. HOME INTERIORS & GIFTS, INC., (U.S. CLS. 100, 101 AND 102). SN 76-308,437. PUB. 6-24-2003. FILED 8-31-2001.
2,763,362. **WAV**. WAV, INC., (U.S. CLS. 100, 101 AND 102). SN 76-317,499. PUB. 6-24-2003. FILED 9-26-2001.
2,763,368. **SPECK INDUSTRIAL CONTROLS, INC. REPAIR & SUPPLY "YOUR ONE SOURCE" AND DESIGN**. SPECK INDUSTRIAL CONTROLS, INC., MULTIPLE CLASS, (INT. CLS. 35 AND 37), (U.S. CLS. 100, 101, 102, 103 AND 106). SN 76-322,434. PUB. 6-24-2003. FILED 10-9-2001.
2,763,378. **TOY OF THE YEAR T.O.Y. AWARDS AND DESIGN**. DISNEY ENTERPRISES, INC., (U.S. CLS. 100, 101 AND 102). SN 76-325,720. PUB. 6-24-2003. FILED 10-16-2001.
2,763,394. **AQ**. PEAK LEARNING, INC., MULTIPLE CLASS, (INT. CLS. 35 AND 41), (U.S. CLS. 100, 101, 102 AND 107). SN 76-334,683. PUB. 6-24-2003. FILED 11-6-2001.
2,763,404 (*See Class 9 for this trademark*).
2,763,415. **IGAMING EXCHANGE**. RIVER CITY GROUP, LLC, THE, (U.S. CLS. 100, 101 AND 102). SN 76-342,701. PUB. 6-24-2003. FILED 11-29-2001.
2,763,417. **RESULTS FIRST SUITE**. BRAVANTA, INC., (U.S. CLS. 100, 101 AND 102). SN 76-343,372. PUB. 6-24-2003. FILED 11-29-2001.
2,763,419. **MCKESSON EMPOWERING HEALTHCARE**. MCKESSON CORPORATION, MULTIPLE CLASS, (INT. CLS. 35 AND 42), (U.S. CLS. 100, 101 AND 102). SN 76-343,503. PUB. 6-24-2003. FILED 11-28-2001.
2,763,450. **UNITED STATES POSTAL INSPECTION SERVICE AND DESIGN**. UNITED STATES POSTAL SERVICE, MULTIPLE CLASS, (INT. CLS. 35 AND 42), (U.S. CLS. 100, 101 AND 102). SN 76-353,549. PUB. 6-24-2003. FILED 12-26-2001.
2,763,455. **INSULATING CONCRETE HOMES AND DESIGN**. GARRETT BUILDING MATERIALS, L.L.C., (U.S. CLS. 100, 101 AND 102). SN 76-355,297. PUB. 6-24-2003. FILED 1-7-2002.
2,763,465. **PULL-A-PART AND DESIGN**. PULL-A-PART, INC., MULTIPLE CLASS, (INT. CLS. 35 AND 39), (U.S. CLS. 100, 101, 102 AND 105). SN 76-359,971. PUB. 6-24-2003. FILED 1-9-2002.
2,763,472. **THE GREEN BANANA PAPERS**. COLEMAN, CHRISTINE Y., (U.S. CLS. 100, 101 AND 102). SN 76-362,973. PUB. 6-24-2003. FILED 1-25-2002.
2,763,493. **NFIB WELLPASS**. NATIONAL FEDERATION OF INDEPENDENT BUSINESS, (U.S. CLS. 100, 101 AND 102). SN 76-374,801. PUB. 6-24-2003. FILED 2-25-2002.
2,763,504 (*See Class 19 for this trademark*).
2,763,519. **TOTAL PLANT RELIABILITY**. HSB RELIABILITY TECHNOLOGIES LLC, (U.S. CLS. 100, 101 AND 102). SN 76-383,841. PUB. 6-24-2003. FILED 3-15-2002.
2,763,533 (*See Class 16 for this trademark*).
2,763,537. **CENTER IN THE SQUARE**. WESTERN VIRGINIA FOUNDATION FOR THE ARTS AND SCIENCES, (U.S. CLS. 100, 101 AND 102). SN 76-389,497. PUB. 6-24-2003. FILED 3-28-2002.
2,763,539. **ADVANCING CANCER CARE IN AMERICA**. US ONCOLOGY, INC., (U.S. CLS. 100, 101 AND 102). SN 76-390,380. PUB. 6-24-2003. FILED 4-3-2002.
2,763,560 (*See Class 9 for this trademark*).
2,763,567 (*See Class 9 for this trademark*).
2,763,568. **MISCELLANEOUS DESIGN**. S.S. SARNA INC., (U.S. CLS. 100, 101 AND 102). SN 76-395,750. PUB. 6-24-2003. FILED 4-15-2002.
2,763,569. **WE SOURCE THE WORLD FOR YOU**. WESSCO INTERNATIONAL, (U.S. CLS. 100, 101 AND 102). SN 76-396,252. PUB. 6-24-2003. FILED 4-16-2002.
2,763,570. **PALMETTO INSTITUTE**. PALMETTO INSTITUTE, (U.S. CLS. 100, 101 AND 102). SN 76-397,061. PUB. 6-24-2003. FILED 4-17-2002.
2,763,582. **THE RGH GROUP PERSONNEL TESTING EXECUTIVE SEARCH MANAGEMENT DEVELOPMENT AND DESIGN**. HAMBY, ROSCOE J. JR., (U.S. CLS. 100, 101 AND 102). SN 76-399,266. PUB. 6-24-2003. FILED 4-23-2002.
2,763,583. **TEN 10 THE EMPLOYMENT NETWORK 10 TEMPORARY AND PERMANENT STAFFING SOLUTIONS AND DESIGN**. HAMBY, ROSCOE J. JR., (U.S. CLS. 100, 101 AND 102). SN 76-399,330. PUB. 6-24-2003. FILED 4-22-2002.
2,763,584 (*See Class 28 for this trademark*).
2,763,599 (*See Class 25 for this trademark*).
2,763,600. **PHARMAPLAN**. PHARMAPLAN INTERNATIONAL GMBH, MULTIPLE CLASS, (INT. CLS. 35, 36, 37 AND 42), (U.S. CLS. 100, 101, 102, 103 AND 106). SN 76-402,375. PUB. 6-24-2003. FILED 4-29-2002.
2,763,605. **ATLANTA SPRING GIFT, ACCESSORIES & HOLIDAY MARKET**. AMC, INC., (U.S. CLS. 100, 101 AND 102). SN 76-403,197. PUB. 6-24-2003. FILED 5-1-2002.
2,763,606. **ALMA INTERNATIONAL**. AMERICAN LOUD-SPEAKER MANUFACTURERS ASSOCIATION, INC., (U.S. CLS. 100, 101 AND 102). SN 76-403,203. PUB. 6-24-2003. FILED 5-2-2002.
2,763,609 (*See Class 9 for this trademark*).
2,763,613. **INVERCAP AND DESIGN**. INVERCAP, S.A. DE C. V., MULTIPLE CLASS, (INT. CLS. 35 AND 36), (U.S. CLS. 100, 101 AND 102). SN 76-404,558. PUB. 6-24-2003. FILED 5-7-2002.
2,763,622. **HELPING YOU CONNECT**. HEALY & CO, MULTIPLE CLASS, (INT. CLS. 35 AND 42), (U.S. CLS. 100, 101 AND 102). SN 76-405,792. PUB. 6-24-2003. FILED 4-4-2002.
2,763,624. **PREMIUMS, PROMOTIONS, PARTNERSHIPS**. JAC INVESTMENTS INC., MULTIPLE CLASS, (INT. CLS. 35, 40 AND 42), (U.S. CLS. 100, 101, 102, 103 AND 106). SN 76-405,952. PUB. 6-24-2003. FILED 5-10-2002.
2,763,632. **SAVVIER DIRECT**. SAVVIER, INC., (U.S. CLS. 100, 101 AND 102). SN 76-407,124. PUB. 6-24-2003. FILED 5-13-2002.
2,763,635. **FOODTOPIA**. FOODTOPIA, INC., (U.S. CLS. 100, 101 AND 102). SN 76-407,293. PUB. 6-24-2003. FILED 5-3-2002.
2,763,639. **ORYGEN**. HORIZON AG, LLC, (U.S. CLS. 100, 101 AND 102). SN 76-408,284. PUB. 6-24-2003. FILED 5-13-2002.
2,763,647 (*See Class 9 for this trademark*).
2,763,654 (*See Class 3 for this trademark*).
2,763,657 (*See Class 9 for this trademark*).
2,763,671. **FAST FORWARD SKATE SHOP SHOES APPAREL AND DESIGN**. ACTION CONCEPTS, INC., (U.S. CLS. 100, 101 AND 102). SN 76-412,501. PUB. 6-24-2003. FILED 5-28-2002.
2,763,672. **NETWORK AND DESIGN**. ABN AMRO LEASE HOLDING N.V., MULTIPLE CLASS, (INT. CLS. 35, 36 AND 39), (U.S. CLS. 100, 101, 102 AND 105). SN 76-412,623. PUB. 6-24-2003. FILED 5-21-2002.
2,763,673. **LAVAGGI ARTIST OF HOPE**. LAVAGGI, STEVEN, (U.S. CLS. 100, 101 AND 102). SN 76-412,911. PUB. 6-24-2003. FILED 5-28-2002.
2,763,702 (*See Class 7 for this trademark*).
2,763,710. **INSPIRING BEAUTIFUL HOMES**. STROUDS ACQUISITION CORPORATION, (U.S. CLS. 100, 101 AND 102). SN 76-419,377. PUB. 6-24-2003. FILED 6-11-2002.
2,763,726. **EXECUTIVE RELOCATION**. ABN AMRO NORTH AMERICA, INC., (U.S. CLS. 100, 101 AND 102). SN 76-420,442. PUB. 6-24-2003. FILED 6-11-2002.

- 2,763,732. **IMAGEMAKER 360**. ACCESS TECHNOLOGY SERVICES, INC., (U.S. CLS. 100, 101 AND 102). SN 76-421,834. PUB. 6-24-2003. FILED 6-17-2002.
- 2,763,736 (*See Class 19 for this trademark*).
- 2,763,742. **COKEM INTERNATIONAL**. COKEM INTERNATIONAL, LTD., (U.S. CLS. 100, 101 AND 102). SN 76-424,407. PUB. 6-24-2003. FILED 6-24-2002.
- 2,763,748. **HOITY TOITY**. LULY, ANN BOOTH, (U.S. CLS. 100, 101 AND 102). SN 76-425,376. PUB. 6-24-2003. FILED 6-24-2002.
- 2,763,752. **BREAD & CIE**. BREAD & CIE, INC., MULTIPLE CLASS, (INT. CLS. 35 AND 43), (U.S. CLS. 100, 101 AND 102). SN 76-425,947. PUB. 6-24-2003. FILED 6-27-2002.
- 2,763,762. **PROJECT PRESERVE**. SECOND HARVEST FOOD BANK OF MIDDLE TENNESSEE, INC., (U.S. CLS. 100, 101 AND 102). SN 76-427,643. PUB. 6-24-2003. FILED 7-5-2002.
- 2,763,767. **MISCELLANEOUS DESIGN**. MZM, INC., MULTIPLE CLASS, (INT. CLS. 35, 39 AND 42), (U.S. CLS. 100, 101, 102 AND 105). SN 76-428,507. PUB. 6-24-2003. FILED 7-8-2002.
- 2,763,774. **HOOUP WIRELESS AND DESIGN**. MATTHEW CHOI ENTERPRISE, DBA -HOOUP WIRELESS, (U.S. CLS. 100, 101 AND 102). SN 76-429,121. PUB. 6-24-2003. FILED 7-9-2002.
- 2,763,783. **TALENT TRAK**. WESTAFF SUPPORT, INC., (U.S. CLS. 100, 101 AND 102). SN 76-430,396. PUB. 6-24-2003. FILED 7-15-2002.
- 2,763,790. **GOODIES FROM GOODMAN AND DESIGN**. GOODIES FROM GOODMAN, INC., (U.S. CLS. 100, 101 AND 102). SN 76-431,299. PUB. 6-24-2003. FILED 7-15-2002.
- 2,763,797. **SM AND DESIGN**. SUPPLYMAN, INC., (U.S. CLS. 100, 101 AND 102). SN 76-433,202. PUB. 6-24-2003. FILED 7-23-2002.
- 2,763,799 (*See Class 9 for this trademark*).
- 2,763,821. **OSO.COM**. CIMCITIES, LLC, MULTIPLE CLASS, (INT. CLS. 35, 41, 42 AND 43), (U.S. CLS. 100, 101, 102 AND 107). SN 76-438,285. PUB. 6-24-2003. FILED 8-6-2002.
- 2,763,823. **PHYSICIANWORK.COM**. STAFFMD, INC., (U.S. CLS. 100, 101 AND 102). SN 76-438,399. PUB. 6-24-2003. FILED 8-7-2002.
- 2,763,837. **MEGA CAR SALE AND DESIGN**. CLEAR CHANNEL INTANGIBLES, INC., (U.S. CLS. 100, 101 AND 102). SN 76-440,476. PUB. 6-24-2003. FILED 8-14-2002.
- 2,763,841. **MIDWEST COMPUTER GROUP**. MIDWEST COMPUTER, INC., (U.S. CLS. 100, 101 AND 102). SN 76-441,506. PUB. 6-24-2003. FILED 8-19-2002.
- 2,763,845. **CURAGEAR**. CURAGEN CORPORATION, (U.S. CLS. 100, 101 AND 102). SN 76-441,991. PUB. 6-24-2003. FILED 8-15-2002.
- 2,763,847. **1 SUPER ONE FOODS AND DESIGN**. PIGGLY WIGGLY COMPANY, (U.S. CLS. 100, 101 AND 102). SN 76-442,338. PUB. 6-24-2003. FILED 8-19-2002.
- 2,763,863. **LOVE HONOR REMEMBER AND DESIGN**. NATIONAL FOUNDATION FOR CANCER RESEARCH, INC., MULTIPLE CLASS, (INT. CLS. 35 AND 36), (U.S. CLS. 100, 101 AND 102). SN 76-447,479. PUB. 6-24-2003. FILED 8-8-2002.
- 2,763,880. **FILM SAN ANTONIO AND DESIGN**. CITY OF SAN ANTONIO, (U.S. CLS. 100, 101 AND 102). SN 76-450,279. PUB. 6-24-2003. FILED 9-17-2002.
- 2,763,884 (*See Class 16 for this trademark*).
- 2,763,898 (*See Class 16 for this trademark*).
- 2,763,901. **COMMUNITY RESPONSE AND DESIGN**. SCREENING FOR MENTAL HEALTH, INC., (U.S. CLS. 100, 101 AND 102). SN 76-453,315. PUB. 6-24-2003. FILED 9-26-2002.
- 2,763,907. **TOBLER'S**. TOBLER'S FLOWERS, INCORPORATED, (U.S. CLS. 100, 101 AND 102). SN 76-454,409. PUB. 6-24-2003. FILED 9-23-2002.
- 2,763,909. **NSC (STYLIZED)**. NATIONAL SALES COMPANY, (U.S. CLS. 100, 101 AND 102). SN 76-454,603. PUB. 6-24-2003. FILED 10-2-2002.
- 2,763,911. **DAISY SEED COMMUNICATIONS, INC. AND DESIGN**. DAISYSEED, INC., (U.S. CLS. 100, 101 AND 102). SN 76-454,805. PUB. 6-24-2003. FILED 10-2-2002.
- 2,763,922. **YOUR LOCAL FOOD!**. BODDICKER, PAUL, (U.S. CLS. 100, 101 AND 102). SN 76-456,130. PUB. 6-24-2003. FILED 10-1-2002.
- 2,763,927. **MOTO XTREME**. MOTO XTREME, INC., (U.S. CLS. 100, 101 AND 102). SN 76-456,523. PUB. 6-24-2003. FILED 10-8-2002.
- 2,763,932. **INDEX-D**. INDEX-D, LLC, (U.S. CLS. 100, 101 AND 102). SN 76-457,133. PUB. 6-24-2003. FILED 10-9-2002.
- 2,763,935. **WICKERSHAM COMPANY**. WICKERSHAM JEWELERS, INC., (U.S. CLS. 100, 101 AND 102). SN 76-457,234. PUB. 6-24-2003. FILED 10-9-2002.
- 2,763,939. **MISMO**. MORTGAGE BANKERS ASSOCIATION OF AMERICA, (U.S. CLS. 100, 101 AND 102). SN 76-457,786. PUB. 6-24-2003. FILED 10-11-2002.
- 2,763,940. **NBHA**. MCC EVENTS, LLC, MULTIPLE CLASS, (INT. CLS. 35 AND 41), (U.S. CLS. 100, 101, 102 AND 107). SN 76-457,807. PUB. 6-24-2003. FILED 10-11-2002.
- 2,763,951 (*See Class 25 for this trademark*).
- 2,763,961 (*See Class 25 for this trademark*).
- 2,763,962. **CORAM HEALTHCARE**. CORAM, INC., MULTIPLE CLASS, (INT. CLS. 35, 40 AND 44), (U.S. CLS. 100, 101, 102, 103 AND 106). SN 76-460,769. PUB. 6-24-2003. FILED 10-16-2002.
- 2,763,963. **CORAM**. CORAM, INC., MULTIPLE CLASS, (INT. CLS. 35, 40 AND 44), (U.S. CLS. 100, 101, 102, 103 AND 106). SN 76-460,770. PUB. 6-24-2003. FILED 10-16-2002.
- 2,763,976. **THE INTERVIEW EXCHANGE**. ADAMSHAND INC, DBA THE INTERVIEW EXCHANGE, (U.S. CLS. 100, 101 AND 102). SN 76-462,538. PUB. 6-24-2003. FILED 10-29-2002.
- 2,763,983. **MISCELLANEOUS DESIGN**. WILLIAM M. BIRD AND COMPANY, INC., (U.S. CLS. 100, 101 AND 102). SN 76-464,064. PUB. 6-24-2003. FILED 11-4-2002.
- 2,763,992. **SAVINNET**. SAVIN CORPORATION, (U.S. CLS. 100, 101 AND 102). SN 76-465,672. PUB. 6-24-2003. FILED 11-12-2002.
- 2,763,999. **CREDITBACK AND DESIGN**. CREDITBACK, INC., (U.S. CLS. 100, 101 AND 102). SN 76-466,436. PUB. 6-24-2003. FILED 11-13-2002.
- 2,764,004 (*See Class 16 for this trademark*).
- 2,764,005 (*See Class 16 for this trademark*).
- 2,764,009. **SIMPLY THE SMARTEST WAY TO INCORPORATE ONLINE**. AKALP, PHILIP, (U.S. CLS. 100, 101 AND 102). SN 76-467,692. PUB. 6-24-2003. FILED 11-6-2002.
- 2,764,010. **CLICK. YOU'RE A LIMITED LIABILITY COMPANY**. AKALP, PHILIP, (U.S. CLS. 100, 101 AND 102). SN 76-467,695. PUB. 6-24-2003. FILED 11-6-2002.
- 2,764,011. **CLICK. YOU'RE A CORPORATION**. AKALP, PHILIP, (U.S. CLS. 100, 101 AND 102). SN 76-467,698. PUB. 6-24-2003. FILED 11-6-2002.
- 2,764,017. **YOU CAN TRUST YOUR VISION TO YOUR DOCTOR OF OPTOMETRY AND DESIGN**. EYE CARE COUNCIL, INC., (U.S. CLS. 100, 101 AND 102). SN 76-468,586. PUB. 6-24-2003. FILED 11-7-2002.
- 2,764,021. **NYC ICY**. NEW YORK CITY ICY COMPANY, (U.S. CLS. 100, 101 AND 102). SN 76-468,855. PUB. 6-24-2003. FILED 11-21-2002.
- 2,764,029. **CARVE-OUT ACCELERATOR (STYLIZED)**. EYGN LIMITED, (U.S. CLS. 100, 101 AND 102). SN 76-470,028. PUB. 6-24-2003. FILED 11-25-2002.
- 2,764,037. **INTERNATIONAL WINDOW FILM ASSOCIATION**. INTERNATIONAL WINDOW FILM ASSOCIATION, (U.S. CLS. 100, 101 AND 102). SN 76-471,184. PUB. 6-24-2003. FILED 11-29-2002.
- 2,764,062. **OBERWEIS DAIRY**. OBERWEIS DAIRY, INC., (U.S. CLS. 100, 101 AND 102). SN 76-473,577. PUB. 6-24-2003. FILED 11-29-2002.
- 2,764,065. **VELOCITY 3PL AND DESIGN**. VELOCITY 3PL, INC., (U.S. CLS. 100, 101 AND 102). SN 76-473,891. PUB. 6-24-2003. FILED 12-11-2002.
- 2,764,068. **VEXURE AND DESIGN**. VEXURE, INC, (U.S. CLS. 100, 101 AND 102). SN 76-473,956. PUB. 6-24-2003. FILED 12-11-2002.
- 2,764,075. **NJEA AND DESIGN**. NEW JERSEY EDUCATION ASSOCIATION, (U.S. CLS. 100, 101 AND 102). SN 76-474,236. PUB. 6-24-2003. FILED 12-12-2002.
- 2,764,078. **COGNITIO AND DESIGN**. COGNITIO, LLC, (U.S. CLS. 100, 101 AND 102). SN 76-475,771. PUB. 6-24-2003. FILED 12-13-2002.
- 2,764,086 (*See Class 16 for this trademark*).
- 2,764,089. **INTERNET ASSIGNED NUMBERS AUTHORITY**.

- INTERNET CORPORATION FOR ASSIGNED NAMES AND NUMBERS, MULTIPLE CLASS, (INT. CLS. 35 AND 42), (U.S. CLS. 100, 101 AND 102). SN 76-481,499. PUB. 6-24-2003. FILED 1-10-2003.
- 2,764,099. **THE NAME WITH THE FLAME**. COBURN SUPPLY COMPANY, INC., (U.S. CLS. 100, 101 AND 102). SN 76-486,048. PUB. 6-24-2003. FILED 1-30-2003.
- 2,764,102 (*See Class 1 for this trademark*).
- 2,764,117. **MISSION:ACCOMPLISHED AND DESIGN**. INTELWORKS, INC., (U.S. CLS. 100, 101 AND 102). SN 78-040,903. PUB. 6-24-2003. FILED 12-28-2000.
- 2,764,125. **THE RESOURCE CONNECTION (STYLIZED)**. POLAND, LEILANI MAY, (U.S. CLS. 100, 101 AND 102). SN 78-060,252. PUB. 6-24-2003. FILED 4-25-2001.
- 2,764,126. **BOOK CORNER**. HUDSON NEWS COMPANY, (U.S. CLS. 100, 101 AND 102). SN 78-062,988. PUB. 6-24-2003. FILED 5-10-2001.
- 2,764,131. **INCHORD AND DESIGN**. GERBIG, SNELL/WEISHEIMER & ASSOCIATES, INC., MULTIPLE CLASS, (INT. CLS. 35, 41 AND 42), (U.S. CLS. 100, 101, 102 AND 107). SN 78-070,549. PUB. 9-24-2002. FILED 6-22-2001.
- 2,764,139. **IMAGISTICS**. IMAGISTICS INTERNATIONAL INC., BY CHANGE OF NAME PITNEY BOWES OFFICE SYSTEMS, INC., MULTIPLE CLASS, (INT. CLS. 35 AND 37), (U.S. CLS. 100, 101, 102, 103 AND 106). SN 78-085,198. PUB. 11-19-2002. FILED 9-24-2001.
- 2,764,150. **NAFTADVANTAGE AND DESIGN**. LIVINGSTON INTERNATIONAL INC., (U.S. CLS. 100, 101 AND 102). SN 78-094,709. PUB. 6-24-2003. FILED 11-21-2001.
- 2,764,159. **SOURCECHECK**. SOURCECHECK, LLC., MULTIPLE CLASS, (INT. CLS. 35, 42 AND 45), (U.S. CLS. 100, 101 AND 102). SN 78-100,728. PUB. 6-24-2003. FILED 1-3-2002.
- 2,764,161. **INTERLOG USA, INC.**. INTERLOG USA, INC., MULTIPLE CLASS, (INT. CLS. 35 AND 39), (U.S. CLS. 100, 101, 102 AND 105). SN 78-101,532. PUB. 6-24-2003. FILED 1-8-2002.
- 2,764,165. **TEXAS MEDICAL FOUNDATION**. TEXAS MEDICAL FOUNDATION, MULTIPLE CLASS, (INT. CLS. 35 AND 44), (U.S. CLS. 100, 101 AND 102). SN 78-102,543. PUB. 6-24-2003. FILED 1-14-2002.
- 2,764,179 (*See Class 29 for this trademark*).
- 2,764,187. **AERIE ART GALLERY AND STUDIO P.O. BOX 612 CANON CITY, CO 81215-0612 DRAGONAERIE@HOT-MAIL.COM AND DESIGN**. BLACKETER, LOUANN, (U.S. CLS. 100, 101 AND 102). SN 78-109,561. PUB. 6-24-2003. FILED 2-18-2002.
- 2,764,194 (*See Class 16 for this trademark*).
- 2,764,200. **GREAT PEOPLE GREAT CLIENTS**. WINDHAM BRANNON, P.C., MULTIPLE CLASS, (INT. CLS. 35, 36 AND 42), (U.S. CLS. 100, 101 AND 102). SN 78-119,658. PUB. 6-24-2003. FILED 4-4-2002.
- 2,764,201. **EZEVENTS**. HYDER, TRACIE, D., MULTIPLE CLASS, (INT. CLS. 35 AND 41), (U.S. CLS. 100, 101, 102 AND 107). SN 78-119,922. PUB. 6-24-2003. FILED 4-5-2002.
- 2,764,202. **MID PENINSULA ACTION FOR TOMORROW MPACT (STYLIZED)**. MID PENINSULA ACTION FOR TOMORROW, (U.S. CLS. 100, 101 AND 102). SN 78-120,214. PUB. 6-24-2003. FILED 4-8-2002.
- 2,764,209. **F&F FINE WINES INTERNATIONAL, INC.**. F & F FINE WINES INTERNATIONAL INC., (U.S. CLS. 100, 101 AND 102). SN 78-123,614. PUB. 6-24-2003. FILED 4-23-2002.
- 2,764,222. **HOMEDAD**. HOMEDAD SERVICES INCORPORATED, (U.S. CLS. 100, 101 AND 102). SN 78-129,862. PUB. 6-24-2003. FILED 5-20-2002.
- 2,764,230. **BILLY MARTIN'S USA AND DESIGN**. BILLY MARTIN'S WESTERN WEAR LA, INC., (U.S. CLS. 100, 101 AND 102). SN 78-131,331. PUB. 6-24-2003. FILED 5-27-2002.
- 2,764,231. **WISCONSIN LAWYERS EXPERT ADVISERS. SERVING YOU.**. STATE BAR OF WISCONSIN, MULTIPLE CLASS, (INT. CLS. 35 AND 41), (U.S. CLS. 100, 101, 102 AND 107). SN 78-131,723. PUB. 6-24-2003. FILED 5-29-2002.
- 2,764,234. **THE QUEEN OF COLD CALLING**. WEISS, WENDY, MULTIPLE CLASS, (INT. CLS. 35 AND 41), (U.S. CLS. 100, 101, 102 AND 107). SN 78-132,459. PUB. 6-24-2003. FILED 5-31-2002.
- 2,764,242. **WHAT HAVE YOU GOT TO LOSE BUT THE PAIN?**. LAURENCE ALTSHULER, M.D., P.C., MULTIPLE CLASS, (INT. CLS. 35 AND 44), (U.S. CLS. 100, 101 AND 102). SN 78-136,300. PUB. 6-24-2003. FILED 6-17-2002.
- 2,764,246. **PEOPLE AND PROCESS BALANCED FOR SUCCESS SYMMETRY CONSULTING, INC AND DESIGN**. SYMMETRY CONSULTING, INC., (U.S. CLS. 100, 101 AND 102). SN 78-137,289. PUB. 6-24-2003. FILED 6-20-2002.
- 2,764,257. **LAVA GROUP**. LAVA GROUP, INC., (U.S. CLS. 100, 101 AND 102). SN 78-142,010. PUB. 6-24-2003. FILED 7-8-2002.
- 2,764,258. **PART'COM**. PART'COM MANAGEMENT, MULTIPLE CLASS, (INT. CLS. 35 AND 36), (U.S. CLS. 100, 101 AND 102). SN 78-142,403. PUB. 6-24-2003. FILED 7-9-2002.
- 2,764,268. **SONS OF CONFEDERATE VETERANS 1896 AND DESIGN**. SONS OF CONFEDERATE VETERANS, INC., (U.S. CLS. 100, 101 AND 102). SN 78-148,736. PUB. 6-24-2003. FILED 7-30-2002.
- 2,764,273. **LEADERSHIP DEVELOPMENT GROUP, INC AND DESIGN**. LEADERSHIP DEVELOPMENT GROUP, INC., (U.S. CLS. 100, 101 AND 102). SN 78-150,912. PUB. 6-24-2003. FILED 8-5-2002.
- 2,764,289. **CHRISTIAN MUSIC NETWORK THE POWER OF MUSIC AND DESIGN**. REAL LIFE MARKETING, LLC, MULTIPLE CLASS, (INT. CLS. 35 AND 41), (U.S. CLS. 100, 101, 102 AND 107). SN 78-156,574. PUB. 6-24-2003. FILED 8-21-2002.
- 2,764,300. **AFFORDABLE CLASSICS**. POLAN, NEAL, S., MULTIPLE CLASS, (INT. CLS. 35 AND 37), (U.S. CLS. 100, 101, 102, 103 AND 106). SN 78-159,420. PUB. 6-24-2003. FILED 8-29-2002.
- 2,764,304 (*See Class 16 for this trademark*).
- 2,764,312. **TOUGHER THAN SCHOOL**. L. L. BEAN, INC., (U.S. CLS. 100, 101 AND 102). SN 78-163,483. PUB. 6-24-2003. FILED 9-12-2002.
- 2,764,313. **CHEVRON FOOD MART 24HRS AND DESIGN**. CHEVRONTEXACO CORPORATION, MULTIPLE CLASS, (INT. CLS. 35 AND 37), (U.S. CLS. 100, 101, 102, 103 AND 106). SN 78-163,820. PUB. 6-24-2003. FILED 9-13-2002.
- 2,764,326. **SPECTRAL WEB**. SPECTRAL WEB, INC., (U.S. CLS. 100, 101 AND 102). SN 78-169,519. PUB. 6-24-2003. FILED 9-30-2002.
- 2,764,328. **NATIONAL MOTORISTS ASSOCIATION**. NATIONAL MOTORISTS ASSOCIATION, INC, (U.S. CLS. 100, 101 AND 102). SN 78-170,778. PUB. 6-24-2003. FILED 10-3-2002.
- 2,764,333. **IT'S ABOUT GENUINE DESIGN**. M2L, INC., (U.S. CLS. 100, 101 AND 102). SN 78-172,128. PUB. 6-24-2003. FILED 10-8-2002.
- 2,764,336. **NAVIGATOR ELECTRONICS AND DESIGN**. NAVIGATOR ELECTRONICS, INC., (U.S. CLS. 100, 101 AND 102). SN 78-172,838. PUB. 6-24-2003. FILED 10-10-2002.
- 2,764,341. **SJ AND DESIGN**. ST. JOHN KNITS, INC., (U.S. CLS. 100, 101 AND 102). SN 78-173,288. PUB. 6-24-2003. FILED 10-10-2002.
- 2,764,343. **STAND**. OHIO TOBACCO USE PREVENTION & CONTROL FOUNDATION, (U.S. CLS. 100, 101 AND 102). SN 78-174,922. PUB. 6-24-2003. FILED 10-16-2002.
- 2,764,345. **STRATEGYHEAD**. MURDICO, VINCENT A., (U.S. CLS. 100, 101 AND 102). SN 78-175,149. PUB. 6-24-2003. FILED 10-16-2002.
- 2,764,353. **TALENTCITY**. ROBERT ABBOTT HOLDING, INC., (U.S. CLS. 100, 101 AND 102). SN 78-176,362. PUB. 6-24-2003. FILED 10-20-2002.
- 2,764,354. **SHER-LINK**. THE SHERWIN-WILLIAMS COMPANY, (U.S. CLS. 100, 101 AND 102). SN 78-176,415. PUB. 6-24-2003. FILED 10-21-2002.
- 2,764,358. **REDDY SQUIRREL**. FOREST SERVICE EMPLOYEES FOR ENVIRONMENTAL ETHICS, INC., (U.S. CLS. 100, 101 AND 102). SN 78-177,684. PUB. 6-24-2003. FILED 10-23-2002.
- 2,764,362. **SENDTEC**. SENDTEC, INC., MULTIPLE CLASS, (INT. CLS. 35 AND 42), (U.S. CLS. 100, 101 AND 102). SN 78-178,039. PUB. 6-24-2003. FILED 10-24-2002.
- 2,764,365. **S THE SERENITY SOURCE YOUR SOURCE FOR A HEALTHIER, STRESS-FREE LIFE AND DESIGN**. CONWAY, DAVID, (U.S. CLS. 100, 101 AND 102). SN 78-178,653. PUB. 6-24-2003. FILED 10-25-2002.
- 2,764,371. **MOTOR MODELS**. HANKINS, STEVEN, (U.S. CLS. 100, 101 AND 102). SN 78-178,952. PUB. 6-24-2003. FILED 10-

- 28-2002.
- 2,764,373. **THE CUSTOMER CONNECTION**. THE CUSTOMER CONNECTION, INC., (U.S. CLS. 100, 101 AND 102). SN 78-178,984. PUB. 6-24-2003. FILED 10-28-2002.
- 2,764,374. **NETWORK OF RELATIONSHIPS**. STRATEGIC COMMUNICATIONS GROUP, INC., (U.S. CLS. 100, 101 AND 102). SN 78-179,209. PUB. 6-24-2003. FILED 10-28-2002.
- 2,764,377. **MISCELLANEOUS DESIGN**. THE OHIO MANUFACTURERS' ASSOCIATION, (U.S. CLS. 100, 101 AND 102). SN 78-179,529. PUB. 6-24-2003. FILED 10-29-2002.
- 2,764,391. **NTRC**. NATIONAL TAX REFUND CENTER, INC., (U.S. CLS. 100, 101 AND 102). SN 78-180,612. PUB. 6-24-2003. FILED 10-31-2002.
- 2,764,399. **OMNICOMPETENT OPERATIONS**. STEVENS, THOMAS HAROLD, DBA T. H. STEVENS ASSOCIATES, (U.S. CLS. 100, 101 AND 102). SN 78-182,555. PUB. 6-24-2003. FILED 11-6-2002.
- 2,764,408. **TEE TIME AND DESIGN**. TEE TIME ENTERPRISES, INC., (U.S. CLS. 100, 101 AND 102). SN 78-183,735. PUB. 6-24-2003. FILED 11-11-2002.
- 2,764,410. **RECRUITMINDS**. RECRUITMINDS, LLC, (U.S. CLS. 100, 101 AND 102). SN 78-183,768. PUB. 6-24-2003. FILED 11-11-2002.
- 2,764,411 (*See Class 20 for this trademark*).
- 2,764,434. **TCTA AND DESIGN**. TEXAS CLASSROOM TEACHERS ASSOCIATION, (U.S. CLS. 100, 101 AND 102). SN 78-185,822. PUB. 6-24-2003. FILED 11-16-2002.
- 2,764,442. **SEARS**. SEARS, ROEBUCK AND CO., (U.S. CLS. 100, 101 AND 102). SN 78-190,585. PUB. 6-24-2003. FILED 12-3-2002.
- 2,764,460. **ALIXPARTNERS**. ALIXPARTNERS, LLC, MULTIPLE CLASS, (INT. CLS. 35, 36 AND 42), (U.S. CLS. 100, 101 AND 102). SN 78-191,508. PUB. 6-24-2003. FILED 12-5-2002.
-
- CLASS 36—INSURANCE AND FINANCIAL**
- 2,763,042. **ENTERPRISE OIL AND DESIGN**. ENTERPRISE OIL PLC, (U.S. CLS. 100, 101 AND 102). SN 75-392,512. PUB. 6-24-2003. FILED 11-19-1997.
- 2,763,069. **ARCSTAR AND DESIGN**. NTT COMMUNICATIONS KABUSHIKI KAISHA, DBA NTT COMMUNICATIONS CORPORATION, BY ASSIGNMENT NIPPON DENSHIN DENWA KABUSHIKI KAISHA, DBA NIPPON TELEGRAPH AND TELEPHONE CORPORATION, MULTIPLE CLASS, (INT. CLS. 36, 37, 38, 39, 41 AND 42), (U.S. CLS. 100, 101, 102, 103, 104, 105, 106 AND 107). SN 75-671,708. PUB. 11-12-2002. FILED 3-31-1999.
- 2,763,077. **BLUE RIDGE CAPITAL**. BLUE RIDGE CAPITAL, L.L.C., (U.S. CLS. 100, 101 AND 102). SN 75-739,843. PUB. 7-23-2002. FILED 6-30-1999.
- 2,763,125 (*See Class 35 for this trademark*).
- 2,763,126 (*See Class 3 for this trademark*).
- 2,763,132. **ASSOCIATED CONSULTING SERVICES**. LIFE INSURANCE MARKETING CO., INC., THE, BY ASSIGNMENT EXECUTIVE INSURANCE AGENCY, INC., (U.S. CLS. 100, 101 AND 102). SN 76-013,898. PUB. 6-24-2003. FILED 3-30-2000.
- 2,763,138. **SAVE YOUR MONEY**. ING BANK OF CANADA, (U.S. CLS. 100, 101 AND 102). SN 76-036,369. PUB. 6-24-2003. FILED 4-27-2000.
- 2,763,143. **THE SMARTEST PLACE TO INVEST ONLINE**. MERRILL LYNCH & CO., INC., (U.S. CLS. 100, 101 AND 102). SN 76-039,799. PUB. 6-24-2003. FILED 5-2-2000.
- 2,763,170 (*See Class 9 for this trademark*).
- 2,763,179. **BROKER INSIGHT**. WEDBUSH MORGAN SECURITIES, INC., (U.S. CLS. 100, 101 AND 102). SN 76-120,417. PUB. 11-12-2002. FILED 8-31-2000.
- 2,763,205 (*See Class 35 for this trademark*).
- 2,763,215 (*See Class 35 for this trademark*).
- 2,763,218 (*See Class 16 for this trademark*).
- 2,763,223 (*See Class 9 for this trademark*).
- 2,763,239 (*See Class 9 for this trademark*).
- 2,763,253. **PHOENIX INCOME CHOICE**. PHOENIX HOME LIFE MUTUAL INSURANCE COMPANY, (U.S. CLS. 100, 101 AND 102). SN 76-205,527. PUB. 6-24-2003. FILED 2-6-2001.
- 2,763,255. **E D T S EDERIVATIVE TRADING SYSTEM (STYLIZED)**. EDERIVATIVE.COM, INC., (U.S. CLS. 100, 101 AND 102). SN 76-207,600. PUB. 3-11-2003. FILED 2-8-2001.
- 2,763,268 (*See Class 6 for this trademark*).
- 2,763,302. **RODEO REALTY INC. FINE ESTATES AND DESIGN**. RODEO REALTY, INC., (U.S. CLS. 100, 101 AND 102). SN 76-268,434. PUB. 6-24-2003. FILED 6-6-2001.
- 2,763,334 (*See Class 35 for this trademark*).
- 2,763,365. **LP CLASSIC**. FEDERAL HOME LOAN MORTGAGE CORPORATION, (U.S. CLS. 100, 101 AND 102). SN 76-320,573. PUB. 6-24-2003. FILED 10-4-2001.
- 2,763,373. **SANDY SPRING BANK**. SANDY SPRING BANK, (U.S. CLS. 100, 101 AND 102). SN 76-324,002. PUB. 6-24-2003. FILED 10-11-2001.
- 2,763,374. **SANDY SPRING BANK B AND DESIGN**. SANDY SPRING BANK, (U.S. CLS. 100, 101 AND 102). SN 76-324,006. PUB. 6-24-2003. FILED 10-11-2001.
- 2,763,387. **FTJ FUNDCHOICE**. FTJ FUNDCHOICE, L.L.C., (U.S. CLS. 100, 101 AND 102). SN 76-330,686. PUB. 4-9-2002. FILED 10-26-2001.
- 2,763,400. **YALE SCHOOL OF MANAGEMENT STOCK MARKET CONFIDENCE INDEXES**. YALE UNIVERSITY, (U.S. CLS. 100, 101 AND 102). SN 76-336,485. PUB. 6-24-2003. FILED 11-13-2001.
- 2,763,426. **VANCOUVERCENTER AND DESIGN**. VANDEVCO LIMITED, (U.S. CLS. 100, 101 AND 102). SN 76-346,239. PUB. 6-24-2003. FILED 12-10-2001.
- 2,763,447. **CONSOLIDATED FINANCIAL CORPORATION BETTER CHOICES. BETTER PLANNING. BETTER FUTURE. AND DESIGN**. CONSOLIDATED FINANCIAL CORPORATION, (U.S. CLS. 100, 101 AND 102). SN 76-352,802. PUB. 6-24-2003. FILED 12-27-2001.
- 2,763,463. **TRI-GUARD SAFETY TEMPLATES**. PRAESIDIUM, INC., (U.S. CLS. 100, 101 AND 102). SN 76-358,361. PUB. 6-24-2003. FILED 1-14-2002.
- 2,763,466. **RHONE GROUP LLC (STYLIZED)**. RHONE GROUP LLC, (U.S. CLS. 100, 101 AND 102). SN 76-360,187. PUB. 6-24-2003. FILED 1-17-2002.
- 2,763,476. **ANALYSIS, SOLUTIONS, RESULTS FOR THE NON-PROFIT COMMUNITY**. CONWAY COMPANY, LLC, (U.S. CLS. 100, 101 AND 102). SN 76-364,997. PUB. 6-24-2003. FILED 1-31-2002.
- 2,763,485. **WALKER MACRAE**. WALKER MACRAE INC., (U.S. CLS. 100, 101 AND 102). SN 76-370,277. PUB. 6-24-2003. FILED 2-13-2002.
- 2,763,489. **PUBLIC DATA CORPORATION**. PUBLIC DATA CORPORATION, (U.S. CLS. 100, 101 AND 102). SN 76-372,347. PUB. 6-24-2003. FILED 2-19-2002.
- 2,763,505. **TIERONE CORPORATION**. TIERONE BANK, (U.S. CLS. 100, 101 AND 102). SN 76-379,958. PUB. 6-24-2003. FILED 3-8-2002.
- 2,763,506 (*See Class 16 for this trademark*).
- 2,763,520. **E-VANTAGE INTERNATIONAL**. E-VANTAGE INTERNATIONAL, INC., (U.S. CLS. 100, 101 AND 102). SN 76-383,897. PUB. 6-24-2003. FILED 3-19-2002.
- 2,763,567 (*See Class 9 for this trademark*).
- 2,763,590. **AUTOONE**. CALIFORNIA FEDERAL BANK, (U.S. CLS. 100, 101 AND 102). SN 76-400,708. PUB. 6-24-2003. FILED 4-25-2002.
- 2,763,600 (*See Class 35 for this trademark*).
- 2,763,610. **RELIANCE HOUSING FOUNDATION AND DESIGN**. RELIANCE HOUSING FOUNDATION, INC., (U.S. CLS. 100, 101 AND 102). SN 76-404,256. PUB. 6-24-2003. FILED 5-7-2002.
- 2,763,613 (*See Class 35 for this trademark*).
- 2,763,615. **RELIANCE**. RELIANCE HOUSING FOUNDATION, INC., (U.S. CLS. 100, 101 AND 102). SN 76-404,677. PUB. 6-24-2003. FILED 5-7-2002.
- 2,763,653. **THRIFTY TAX AND DESIGN**. INTERSTATE BUSINESS MANAGEMENT, INC., (U.S. CLS. 100, 101 AND 102). SN 76-409,648. PUB. 6-24-2003. FILED 5-17-2002.
- 2,763,664. **THE FRIENDS OF BENJAMIN FRANKLIN HOUSE**. FRIENDS OF BENJAMIN FRANKLIN HOUSE, US, THE, (U.S. CLS. 100, 101 AND 102). SN 76-411,925. PUB. 6-24-2003. FILED 5-17-2002.
- 2,763,672 (*See Class 35 for this trademark*).
- 2,763,699 (*See Class 9 for this trademark*).

- 2,763,701. **CYBERX2**. CYBERCORP HOLDINGS, INC., (U.S. CLS. 100, 101 AND 102). SN 76-418,088. PUB. 6-24-2003. FILED 6-7-2002.
- 2,763,728. **EXPENSE REDUCTION ANALYSTS AND DESIGN**. DORGAN INVESTMENTS LIMITED, (U.S. CLS. 100, 101 AND 102). SN 76-420,545. PUB. 6-24-2003. FILED 6-13-2002.
- 2,763,755. **SPACE IS MONEY**. BAYERISCHE HYPO- UND VEREINSBANK AG, (U.S. CLS. 100, 101 AND 102). SN 76-426,287. PUB. 6-24-2003. FILED 6-28-2002.
- 2,763,779. **LOCK & LOCATE**. INDYMAC BANK, F.S.B., (U.S. CLS. 100, 101 AND 102). SN 76-429,986. PUB. 6-24-2003. FILED 7-8-2002.
- 2,763,826. **EPARTNER NETWORK (STYLIZED)**. ONYX ACCEPTANCE CORPORATION, (U.S. CLS. 100, 101 AND 102). SN 76-439,062. PUB. 6-24-2003. FILED 8-8-2002.
- 2,763,827. **EPARTNER NETWORK SUCCESS IN TEAMWORK AND DESIGN**. ONYX ACCEPTANCE CORPORATION, (U.S. CLS. 100, 101 AND 102). SN 76-439,064. PUB. 6-24-2003. FILED 8-8-2002.
- 2,763,829. **MATTERHORN**. MATTERHORN FINANCIAL SERVICES, INC., (U.S. CLS. 100, 101 AND 102). SN 76-439,438. PUB. 6-24-2003. FILED 8-12-2002.
- 2,763,830. **MATTERHORN (STYLIZED)**. MATTERHORN FINANCIAL SERVICES, INC., (U.S. CLS. 100, 101 AND 102). SN 76-439,440. PUB. 6-24-2003. FILED 8-12-2002.
- 2,763,831. **MISCELLANEOUS DESIGN**. VISTA HEALTH PLAN, INC., (U.S. CLS. 100, 101 AND 102). SN 76-439,476. PUB. 6-24-2003. FILED 8-12-2002.
- 2,763,863 (*See Class 35 for this trademark*).
- 2,763,884 (*See Class 16 for this trademark*).
- 2,763,888. **METROREPORT**. MRB, INC., (U.S. CLS. 100, 101 AND 102). SN 76-451,582. PUB. 6-24-2003. FILED 9-23-2002.
- 2,763,891. **SCOTT HAZELCORN MEMORIAL CHILDREN'S FOUNDATION**. SCOTT HAZELCORN MEMORIAL CHILDREN'S FOUNDATION, MULTIPLE CLASS, (INT. CLS. 36 AND 41), (U.S. CLS. 100, 101, 102 AND 107). SN 76-452,105. PUB. 6-24-2003. FILED 9-24-2002.
- 2,763,898 (*See Class 16 for this trademark*).
- 2,763,948. **SUPER VALUE TUESDAY**. MIDFIRST BANK, (U.S. CLS. 100, 101 AND 102). SN 76-459,381. PUB. 6-24-2003. FILED 10-15-2002.
- 2,763,964. **PTC AND DESIGN**. DLJ LONG TERM INVESTMENT CORPORATION, (U.S. CLS. 100, 101 AND 102). SN 76-460,918. PUB. 6-24-2003. FILED 10-22-2002.
- 2,763,979. **HNI RISK SERVICES (STYLIZED)**. HNI RISK SERVICES, INC., (U.S. CLS. 100, 101 AND 102). SN 76-463,634. PUB. 6-24-2003. FILED 11-1-2002.
- 2,764,001. **MISCELLANEOUS DESIGN**. NATIONAL ACADEMY OF RECORDING ARTS & SCIENCES, INC., MULTIPLE CLASS, (INT. CLS. 36 AND 44), (U.S. CLS. 100, 101 AND 102). SN 76-467,033. PUB. 6-24-2003. FILED 11-5-2002.
- 2,764,012. **SNB SECOND NATIONAL BANK AND DESIGN**. SECOND NATIONAL BANK OF WARREN, (U.S. CLS. 100, 101 AND 102). SN 76-467,897. PUB. 6-24-2003. FILED 11-18-2002.
- 2,764,027. **THE GOURMET COLLECTION BY ABUNDANT FUNDS (STYLIZED)**. ROBERTS ENTERPRISES, INC., (U.S. CLS. 100, 101 AND 102). SN 76-469,672. PUB. 6-24-2003. FILED 11-13-2002.
- 2,764,038. **NYSE SPECIALIST PORTFOLIO**. NEW YORK STOCK EXCHANGE, INC., (U.S. CLS. 100, 101 AND 102). SN 76-471,257. PUB. 6-24-2003. FILED 11-18-2002.
- 2,764,039. **THERE'S A CERTAIN SPIRIT HERE**. HARVARD INVESTMENTS, INC., MULTIPLE CLASS, (INT. CLS. 36 AND 37), (U.S. CLS. 100, 101, 102, 103 AND 106). SN 76-471,399. PUB. 6-24-2003. FILED 11-18-2002.
- 2,764,044. **LHO**. HORWITZ, LEWIS P., (U.S. CLS. 100, 101 AND 102). SN 76-472,038. PUB. 6-24-2003. FILED 11-25-2002.
- 2,764,051. **SPIRITS**. UBS AG, (U.S. CLS. 100, 101 AND 102). SN 76-472,560. PUB. 6-24-2003. FILED 12-4-2002.
- 2,764,053. **TALKING ROCK**. HARVARD INVESTMENTS, INC., MULTIPLE CLASS, (INT. CLS. 36 AND 37), (U.S. CLS. 100, 101, 102, 103 AND 106). SN 76-472,735. PUB. 6-24-2003. FILED 12-9-2002.
- 2,764,084. **ONE UP**. UPUB, INC., (U.S. CLS. 100, 101 AND 102). SN 76-477,444. PUB. 6-24-2003. FILED 12-20-2002.
- 2,764,090. **CAMBRIDGE CAPITAL ADVISORY SERVICE**. CAMBRIDGE ASSOCIATES LLC, (U.S. CLS. 100, 101 AND 102). SN 76-482,525. PUB. 6-24-2003. FILED 1-15-2003. 2,764,102 (*See Class 1 for this trademark*).
- 2,764,172. **GLOBIS**. DEUTSCHE BANK AG, MULTIPLE CLASS, (INT. CLS. 36 AND 42), (U.S. CLS. 100, 101 AND 102). SN 78-104,834. PUB. 6-24-2003. FILED 1-25-2002.
- 2,764,196. **ABE**. LINCOLN NATIONAL LIFE INSURANCE COMPANY, THE, (U.S. CLS. 100, 101 AND 102). SN 78-114,565. PUB. 6-24-2003. FILED 3-13-2002.
- 2,764,200 (*See Class 35 for this trademark*).
- 2,764,207. **FREEDOM ADVISOR**. LANGVA, MARC D., (U.S. CLS. 100, 101 AND 102). SN 78-122,637. PUB. 6-24-2003. FILED 4-18-2002.
- 2,764,247. **SINCLAIR HEALTH SERVICES**. SINCLAIR OIL CORPORATION, (U.S. CLS. 100, 101 AND 102). SN 78-138,327. PUB. 6-24-2003. FILED 6-24-2002.
- 2,764,253. **KEY EQUIPMENT FINANCE**. KEYCORP, (U.S. CLS. 100, 101 AND 102). SN 78-140,738. PUB. 6-24-2003. FILED 7-2-2002.
- 2,764,258 (*See Class 35 for this trademark*).
- 2,764,271. **MORTGAGE911**. FERRAZZA, MICHAEL J., (U.S. CLS. 100, 101 AND 102). SN 78-149,679. PUB. 6-24-2003. FILED 8-1-2002.
- 2,764,294. **CROSSING PLACE**. MEYER RESIDENTIAL LLC, (U.S. CLS. 100, 101 AND 102). SN 78-157,790. PUB. 6-24-2003. FILED 8-26-2002.
- 2,764,304 (*See Class 16 for this trademark*).
- 2,764,317. **INTERO REAL ESTATE SERVICES**. INTERO REAL ESTATE SERVICES, INC., MULTIPLE CLASS, (INT. CLS. 36 AND 42), (U.S. CLS. 100, 101 AND 102). SN 78-164,053. PUB. 6-24-2003. FILED 9-13-2002.
- 2,764,318. **SMARTCONNECT**. LEHMAN BROTHERS INC., (U.S. CLS. 100, 101 AND 102). SN 78-164,820. PUB. 6-24-2003. FILED 9-17-2002.
- 2,764,332. **XCU MANAGED PROGRAM**. XCU CAPITAL CORPORATION, INC., (U.S. CLS. 100, 101 AND 102). SN 78-172,089. PUB. 6-24-2003. FILED 10-8-2002.
- 2,764,334. **ENJOY LIFE. PLAN WISELY.**. FRANKLIN, JOYCE, (U.S. CLS. 100, 101 AND 102). SN 78-172,503. PUB. 6-24-2003. FILED 10-9-2002.
- 2,764,340. **LE'S INTERCONTINENTAL MONEY TRANSFER, INC. GOI TIEN LE AND DESIGN**. LE'S INTERCONTINENTAL MONEY TRANSFER, INC., (U.S. CLS. 100, 101 AND 102). SN 78-173,249. PUB. 6-24-2003. FILED 10-10-2002.
- 2,764,347. **WE SEE NEIGHBORS WHERE OTHERS SEE NUMBERS**. GENOA SAVINGS AND LOAN COMPANY, THE, (U.S. CLS. 100, 101 AND 102). SN 78-175,351. PUB. 6-24-2003. FILED 10-17-2002.
- 2,764,370. **CLASSIC HARTFORD LEADERS OUTLOOK**. HARTFORD FIRE INSURANCE COMPANY, (U.S. CLS. 100, 101 AND 102). SN 78-178,949. PUB. 6-24-2003. FILED 10-28-2002.
- 2,764,398. **TODAY'S CAPITAL FOR TOMORROW'S CURES**. OXFORD FINANCE CORPORATION, (U.S. CLS. 100, 101 AND 102). SN 78-182,068. PUB. 6-24-2003. FILED 11-5-2002.
- 2,764,409. **LAND/WATER/SKY AND DESIGN**. LAND/WATER/SKY, L.L.C., (U.S. CLS. 100, 101 AND 102). SN 78-183,763. PUB. 6-24-2003. FILED 11-11-2002.
- 2,764,435. **WHOSHOME**. WHOSHOME, INC., (U.S. CLS. 100, 101 AND 102). SN 78-185,827. PUB. 6-24-2003. FILED 11-16-2002.
- 2,764,437. **REAL ESTATE. REAL VALUE.**. WHOSHOME, INC., (U.S. CLS. 100, 101 AND 102). SN 78-185,833. PUB. 6-24-2003. FILED 11-16-2002.
- 2,764,460 (*See Class 35 for this trademark*).

CLASS 37—CONSTRUCTION AND REPAIR

- 2,763,059 (*See Class 35 for this trademark*).
- 2,763,069 (*See Class 36 for this trademark*).
- 2,763,088 (*See Class 9 for this trademark*).
- 2,763,101 (*See Class 7 for this trademark*).
- 2,763,112. **SEEDTECH**. THE NATIONAL URBAN TECHNOLOGY CENTER, INC., MULTIPLE CLASS, (INT. CLS. 37 AND 42), (U.S. CLS. 100, 101, 103 AND 106). SN 75-897,863. PUB. 6-24-2003. FILED 1-18-2000.
- 2,763,135. **LOCUSCARE**. LOCUS DIALOGUE INC., MULTI-

- PLE CLASS, (INT. CLS. 37 AND 42), (U.S. CLS. 100, 101, 103 AND 106). SN 76-027,428. PUB. 6-24-2003. FILED 4-17-2000.
- 2,763,194. **AMERICAN WEST HOMES**. RISI, JOSEPH S., (U.S. CLS. 100, 103 AND 106). SN 76-144,191. PUB. 6-24-2003. FILED 10-11-2000.
- 2,763,201. **MISCELLANEOUS DESIGN**. SOMA NETWORKS, INC., (U.S. CLS. 100, 103 AND 106). SN 76-160,281. PUB. 6-24-2003. FILED 11-3-2000.
- 2,763,205 (*See Class 35 for this trademark*).
- 2,763,223 (*See Class 9 for this trademark*).
- 2,763,258. **RESTRUCTION**. RESTRUCTION CORPORATION, (U.S. CLS. 100, 103 AND 106). SN 76-209,466. PUB. 6-24-2003. FILED 2-14-2001.
- 2,763,309 (*See Class 9 for this trademark*).
- 2,763,310 (*See Class 9 for this trademark*).
- 2,763,311. **CTS**. MAPAL FABRIK FUR PRAZISIONSWERKZEUGE DR. KRESS KG, MULTIPLE CLASS, (INT. CLS. 37, 38, 39 AND 42), (U.S. CLS. 100, 101, 103, 104, 105 AND 106). SN 76-276,498. PUB. 6-24-2003. FILED 6-26-2001.
- 2,763,317 (*See Class 1 for this trademark*).
- 2,763,319. **CAIN INTEGRATED SYSTEMS AND DESIGN**. CAIN SECURITY SYSTEMS, INC., DBA CAIN INTEGRATED SYSTEMS, MULTIPLE CLASS, (INT. CLS. 37 AND 42), (U.S. CLS. 100, 101, 103 AND 106). SN 76-283,861. PUB. 6-24-2003. FILED 7-10-2001.
- 2,763,320. **CAIN SECURITY SYSTEMS, INC.**, CAIN SECURITY SYSTEMS, INC., MULTIPLE CLASS, (INT. CLS. 37 AND 42), (U.S. CLS. 100, 101, 103 AND 106). SN 76-283,862. PUB. 6-24-2003. FILED 7-10-2001.
- 2,763,327. **ONE SOURCE FOR WORLDWIDE INFRASTRUCTURE SERVICES**. BB TECHNOLOGIES, INC., MULTIPLE CLASS, (INT. CLS. 37 AND 42), (U.S. CLS. 100, 101, 103 AND 106). SN 76-289,987. PUB. 6-24-2003. FILED 7-25-2001.
- 2,763,334 (*See Class 35 for this trademark*).
- 2,763,341 (*See Class 7 for this trademark*).
- 2,763,368 (*See Class 35 for this trademark*).
- 2,763,429. **CHEMDRY AND DESIGN**. HARRIS RESEARCH, INC., (U.S. CLS. 100, 103 AND 106). SN 76-347,033. PUB. 6-24-2003. FILED 12-10-2001.
- 2,763,431. **CHEMDRY AND DESIGN**. HARRIS RESEARCH, INC., (U.S. CLS. 100, 103 AND 106). SN 76-347,296. PUB. 6-24-2003. FILED 12-10-2001.
- 2,763,464 (*See Class 12 for this trademark*).
- 2,763,567 (*See Class 9 for this trademark*).
- 2,763,599 (*See Class 25 for this trademark*).
- 2,763,600 (*See Class 35 for this trademark*).
- 2,763,655 (*See Class 9 for this trademark*).
- 2,763,656 (*See Class 9 for this trademark*).
- 2,763,738. **REDI-HOMES**. BIELINSKI BROS. BUILDERS, INC., (U.S. CLS. 100, 103 AND 106). SN 76-423,341. PUB. 6-24-2003. FILED 6-19-2002.
- 2,763,780. **CORE TECHNICAL SERVICES AND DESIGN**. CORE TECHNICAL SERVICES LTD., (U.S. CLS. 100, 103 AND 106). SN 76-430,060. PUB. 6-24-2003. FILED 7-12-2002.
- 2,763,781. **CORE TECHNICAL SERVICES**. CORE TECHNICAL SERVICES LTD., (U.S. CLS. 100, 103 AND 106). SN 76-430,061. PUB. 6-24-2003. FILED 7-12-2002.
- 2,763,846. **CARSMETICS MINOR ACCIDENT EXPERTS AND DESIGN**. CARSMETICS, INC., (U.S. CLS. 100, 103 AND 106). SN 76-442,023. PUB. 6-24-2003. FILED 8-21-2002.
- 2,763,871 (*See Class 11 for this trademark*).
- 2,763,906. **DRACOOLOF LYKENS**. DRACOOLOF LYKENS, INC., (U.S. CLS. 100, 103 AND 106). SN 76-454,103. PUB. 6-24-2003. FILED 10-1-2002.
- 2,763,925. **NANIQ**. TIKIGAQ CORPORATION, MULTIPLE CLASS, (INT. CLS. 37 AND 42), (U.S. CLS. 100, 101, 103 AND 106). SN 76-456,355. PUB. 6-24-2003. FILED 9-30-2002.
- 2,763,947. **W.O. HARPER PLUMBING 410 WEST 18TH ST. 476-2657 "SINCE 1921" AND DESIGN**. W.O. HARPER PLUMBING CO., (U.S. CLS. 100, 103 AND 106). SN 76-459,334. PUB. 6-24-2003. FILED 10-18-2002.
- 2,764,022. **MISCELLANEOUS DESIGN**. EAGLE RESEARCH CORPORATION, MULTIPLE CLASS, (INT. CLS. 37 AND 42), (U.S. CLS. 100, 101, 103 AND 106). SN 76-468,893. PUB. 6-24-2003. FILED 11-21-2002.
- 2,764,030. **BUILT ON TRUST**. ANTHONY HOME IMPROVEMENTS, INC., (U.S. CLS. 100, 103 AND 106). SN 76-470,346. PUB. 6-24-2003. FILED 11-22-2002.
- 2,764,039 (*See Class 36 for this trademark*).
- 2,764,053 (*See Class 36 for this trademark*).
- 2,764,085. **BUFF CAR WASH AND DESIGN**. CCMKS, L.L.C., (U.S. CLS. 100, 103 AND 106). SN 76-477,628. PUB. 6-24-2003. FILED 12-20-2002.
- 2,764,104. **GLOBAL REACH WITH LOCAL SERVICE**. RICHARDSON ELECTRONICS, LTD., (U.S. CLS. 100, 103 AND 106). SN 76-975,358. PUB. 6-24-2003. FILED 2-19-2002.
- 2,764,138 (*See Class 1 for this trademark*).
- 2,764,139 (*See Class 35 for this trademark*).
- 2,764,210. **LAWGISTICS**. LAWDEV, INC., MULTIPLE CLASS, (INT. CLS. 37, 41 AND 42), (U.S. CLS. 100, 101, 103, 106 AND 107). SN 78-123,753. PUB. 6-24-2003. FILED 4-24-2002.
- 2,764,264. **HOK AND DESIGN**. HOK GROUP, INC., MULTIPLE CLASS, (INT. CLS. 37 AND 42), (U.S. CLS. 100, 101, 103 AND 106). SN 78-145,142. PUB. 6-24-2003. FILED 7-18-2002.
- 2,764,300 (*See Class 35 for this trademark*).
- 2,764,313 (*See Class 35 for this trademark*).
- 2,764,426. **FLETCHER PIANO SERVICE**. FLETCHER, JAMES E., (U.S. CLS. 100, 103 AND 106). SN 78-185,356. PUB. 6-24-2003. FILED 11-14-2002.
- 2,764,457. **N NOBILITY CREST AND DESIGN**. JERALD DEVELOPMENT GROUP, INC., THE, (U.S. CLS. 100, 103 AND 106). SN 78-191,138. PUB. 6-24-2003. FILED 12-4-2002.
- 2,764,463. **JSSI AND DESIGN**. JET SUPPORT SERVICES, INC., (U.S. CLS. 100, 103 AND 106). SN 78-193,538. PUB. 6-24-2003. FILED 12-11-2002.

CLASS 38—COMMUNICATION

- 2,763,069 (*See Class 36 for this trademark*).
- 2,763,088 (*See Class 9 for this trademark*).
- 2,763,097 (*See Class 9 for this trademark*).
- 2,763,126 (*See Class 3 for this trademark*).
- 2,763,134 (*See Class 6 for this trademark*).
- 2,763,137 (*See Class 35 for this trademark*).
- 2,763,156 (*See Class 9 for this trademark*).
- 2,763,164 (*See Class 35 for this trademark*).
- 2,763,167 (*See Class 9 for this trademark*).
- 2,763,168 (*See Class 9 for this trademark*).
- 2,763,170 (*See Class 9 for this trademark*).
- 2,763,177 (*See Class 9 for this trademark*).
- 2,763,205 (*See Class 35 for this trademark*).
- 2,763,217. **ABCTEACH**. KEMSLEY, SANDRA G., MULTIPLE CLASS, (INT. CLS. 38 AND 41), (U.S. CLS. 100, 101, 104 AND 107). SN 76-177,641. PUB. 6-24-2003. FILED 12-8-2000.
- 2,763,218 (*See Class 16 for this trademark*).
- 2,763,223 (*See Class 9 for this trademark*).
- 2,763,225 (*See Class 9 for this trademark*).
- 2,763,239 (*See Class 9 for this trademark*).
- 2,763,268 (*See Class 6 for this trademark*).
- 2,763,269 (*See Class 9 for this trademark*).
- 2,763,311 (*See Class 37 for this trademark*).
- 2,763,380. **GROOVENATION**. GROOVE NATION, INC., (U.S. CLS. 100, 101 AND 104). SN 76-327,507. PUB. 6-24-2003. FILED 10-19-2001.
- 2,763,411. **OFF THE RECORD**. THE SPORTS NETWORK INC., MULTIPLE CLASS, (INT. CLS. 38 AND 41), (U.S. CLS. 100, 101, 104 AND 107). SN 76-342,176. PUB. 6-24-2003. FILED 11-28-2001.
- 2,763,475. **ACTIVATE**. PASS & SEYMOUR/LEGRAND, (U.S. CLS. 100, 101 AND 104). SN 76-363,616. PUB. 6-24-2003. FILED 1-28-2002.
- 2,763,560 (*See Class 9 for this trademark*).
- 2,763,617. **WINGSPAN**. WESTERN PACIFIC TELECOMMUNICATIONS, (U.S. CLS. 100, 101 AND 104). SN 76-405,152. PUB. 6-24-2003. FILED 5-9-2002.
- 2,763,713. **BEYONDVOICE II**. CBEYOND COMMUNICATIONS, LLC, (U.S. CLS. 100, 101 AND 104). SN 76-419,470. PUB. 6-24-2003. FILED 6-11-2002.
- 2,763,714. **BEYONDVOICE I**. CBEYOND COMMUNICATIONS, LLC, (U.S. CLS. 100, 101 AND 104). SN 76-419,471. PUB. 6-24-2003. FILED 6-11-2002.
- 2,763,730. **WALSH MEDIA, INC.**, WALSH MEDIA INC., (U.S. CLS. 100, 101 AND 104). SN 76-421,201. PUB. 6-24-2003. FILED 6-12-2002.

- 2,763,757. **AIM-HIGH**. INNOVATIVE ANSWERS, INC., (U.S. CLS. 100, 101 AND 104). SN 76-426,356. PUB. 6-24-2003. FILED 7-1-2002.
- 2,763,785. **INPHOMATCH**. INPHOMATCH, INC., MULTIPLE CLASS, (INT. CLS. 38 AND 42), (U.S. CLS. 100, 101 AND 104). SN 76-430,614. PUB. 6-24-2003. FILED 7-11-2002.
- 2,763,882. **MOBILE CENTREX AND DESIGN**. MOBILE CENTREX, INC., MULTIPLE CLASS, (INT. CLS. 38 AND 42), (U.S. CLS. 100, 101 AND 104). SN 76-450,349. PUB. 6-24-2003. FILED 9-17-2002.
- 2,763,886. **STREEM CENTER**. STREEM COMMUNICATIONS, LLC, (U.S. CLS. 100, 101 AND 104). SN 76-451,576. PUB. 6-24-2003. FILED 9-23-2002.
- 2,763,887. **STREEM**. STREEM COMMUNICATIONS, LLC, (U.S. CLS. 100, 101 AND 104). SN 76-451,577. PUB. 6-24-2003. FILED 9-23-2002.
- 2,763,889. **STREEM AND DESIGN**. STREEM COMMUNICATIONS, LLC, (U.S. CLS. 100, 101 AND 104). SN 76-451,633. PUB. 6-24-2003. FILED 9-23-2002.
- 2,764,018. **HOLLA GRAM**. BET INTERACTIVE, L.L.C., (U.S. CLS. 100, 101 AND 104). SN 76-468,665. PUB. 6-24-2003. FILED 11-8-2002.
- 2,764,024. **YOUR PROVEN PARTNER IN COMMUNICATIONS SOLUTIONS**. ROCKEFELLER GROUP, INC., (U.S. CLS. 100, 101 AND 104). SN 76-469,416. PUB. 6-24-2003. FILED 11-13-2002.
- 2,764,058. **900EMAIL**. 900EMAIL, (U.S. CLS. 100, 101 AND 104). SN 76-473,049. PUB. 6-24-2003. FILED 12-6-2002.
- 2,764,087. **NBA INSIDE TICKET**. NBA PROPERTIES, INC., (U.S. CLS. 100, 101 AND 104). SN 76-478,252. PUB. 6-24-2003. FILED 12-23-2002.
- 2,764,102 (*See Class 1 for this trademark*).
- 2,764,134 (*See Class 9 for this trademark*).
- 2,764,148. **THE NEW MOBILE EXPERIENCE (STYLIZED)**. I3 MOBILE, INC., MULTIPLE CLASS, (INT. CLS. 38, 41 AND 42), (U.S. CLS. 100, 101, 104 AND 107). SN 78-091,074. PUB. 6-24-2003. FILED 10-31-2001.
- 2,764,228. **STORKPICS**. DUENSING, ROBERT, DBA BEST REGARDS, AND DUENSING, CHERRIE, DBA BEST REGARDS, (U.S. CLS. 100, 101 AND 104). SN 78-131,025. PUB. 6-24-2003. FILED 5-24-2002.
- 2,764,235. **COMLINK WIRELESS**. COMLINK WIRELESS, INC., (U.S. CLS. 100, 101 AND 104). SN 78-132,762. PUB. 6-24-2003. FILED 6-3-2002.
- 2,764,236. **COMLINK WIRELESS DISPATCH AND DATA SOLUTIONS AND DESIGN**. COMLINK WIRELESS, INC., (U.S. CLS. 100, 101 AND 104). SN 78-132,769. PUB. 6-24-2003. FILED 6-3-2002.
- 2,764,237. **INTERMOUNTAIN GIGAPOP AND DESIGN**. JAHSMAN, WILLIAM E., (U.S. CLS. 100, 101 AND 104). SN 78-132,945. PUB. 6-24-2003. FILED 6-3-2002.
- 2,764,352. **1-800-AS-SEEN-ON-TV**. DELOR, THOMAS, (U.S. CLS. 100, 101 AND 104). SN 78-176,289. PUB. 6-24-2003. FILED 10-19-2002.
- 2,764,364. **WINNERCOMM**. WINNERCOMM, INC., MULTIPLE CLASS, (INT. CLS. 38 AND 41), (U.S. CLS. 100, 101, 104 AND 107). SN 78-178,132. PUB. 6-24-2003. FILED 10-24-2002.
- 2,764,388. **GO COACH!**. FMR CORP., (U.S. CLS. 100, 101 AND 104). SN 78-180,495. PUB. 6-24-2003. FILED 10-31-2002.
- 2,763,175 (*See Class 35 for this trademark*).
- 2,763,205 (*See Class 35 for this trademark*).
- 2,763,218 (*See Class 16 for this trademark*).
- 2,763,223 (*See Class 9 for this trademark*).
- 2,763,239 (*See Class 9 for this trademark*).
- 2,763,246. **WILDFUN**. WILDFUN XTREME SPORTS, MULTIPLE CLASS, (INT. CLS. 39, 41 AND 42), (U.S. CLS. 100, 101, 105 AND 107). SN 76-200,786. PUB. 6-24-2003. FILED 1-29-2001.
- 2,763,269 (*See Class 9 for this trademark*).
- 2,763,311 (*See Class 37 for this trademark*).
- 2,763,343 (*See Class 35 for this trademark*).
- 2,763,386. **PAYFAST EDISON PARK FAST AND DESIGN**. EDISON PROPERTIES, LLC, BY ASSIGNMENT EDISON PARKING CORPORATION, (U.S. CLS. 100 AND 105). SN 76-330,027. PUB. 6-24-2003. FILED 10-26-2001.
- 2,763,428. **LAN PAX**. LAN CHILE S.A., (U.S. CLS. 100 AND 105). SN 76-347,009. PUB. 1-28-2003. FILED 12-7-2001.
- 2,763,465 (*See Class 35 for this trademark*).
- 2,763,479. **SMALL PAWS RESCUE TULSA OKLAHOMA AND DESIGN**. SMALL PAWS RESCUE, INC., (U.S. CLS. 100 AND 105). SN 76-366,462. PUB. 6-24-2003. FILED 2-5-2002.
- 2,763,599 (*See Class 25 for this trademark*).
- 2,763,672 (*See Class 35 for this trademark*).
- 2,763,694. **MIRAGE**. MIRAGE LIMOUSINE SERVICE, INC., (U.S. CLS. 100 AND 105). SN 76-416,525. PUB. 12-3-2002. FILED 5-31-2002.
- 2,763,767 (*See Class 35 for this trademark*).
- 2,763,937. **YOUR ISLAND IN THE SKY**. AIR PACIFIC LIMITED, (U.S. CLS. 100 AND 105). SN 76-457,379. PUB. 6-24-2003. FILED 10-4-2002.
- 2,764,042. **PLANTATION CELLARS WINE STORAGE AND DESIGN**. SOUTHEAST STORAGE & DEVELOPMENT COMPANY, LLC, (U.S. CLS. 100 AND 105). SN 76-471,858. PUB. 6-24-2003. FILED 11-15-2002.
- 2,764,066. **STONIER AND DESIGN**. STONIER TRANSPORTATION GROUP, INC., (U.S. CLS. 100 AND 105). SN 76-473,893. PUB. 6-24-2003. FILED 12-11-2002.
- 2,764,102 (*See Class 1 for this trademark*).
- 2,764,161 (*See Class 35 for this trademark*).
- 2,764,167. **EITINERARY AND DESIGN**. TRAVEL INCORPORATED, (U.S. CLS. 100 AND 105). SN 78-103,307. PUB. 6-24-2003. FILED 1-17-2002.
- 2,764,206. **AMERICAN VALET**. AMERICAN VALET & LIMOUSINE, INCORPORATED, (U.S. CLS. 100 AND 105). SN 78-122,431. PUB. 6-24-2003. FILED 4-17-2002.
- 2,764,254. **LIL HAULER**. LILLEY, JOHN K., AND LILLEY, ANGELA C., (U.S. CLS. 100 AND 105). SN 78-141,008. PUB. 6-24-2003. FILED 7-3-2002.
- 2,764,302. **JOURNEYS OF DISCOVERY**. SIEMER & HAND TRAVEL, INC., (U.S. CLS. 100 AND 105). SN 78-159,712. PUB. 6-24-2003. FILED 8-30-2002.
- 2,764,304 (*See Class 16 for this trademark*).
- 2,764,306. **TRAVEL HARMONY AND DESIGN**. TRAVEL HARMONY, (U.S. CLS. 100 AND 105). SN 78-161,721. PUB. 6-24-2003. FILED 9-7-2002.
- 2,764,349. **SKYBRATIONS LUGGAGE SHIPPERS MAKING TRAVEL LIGHTER AND DESIGN**. SKYBRATIONS, LLC, (U.S. CLS. 100 AND 105). SN 78-175,693. PUB. 6-24-2003. FILED 10-17-2002.

CLASS 39—TRANSPORTATION AND STORAGE

- 2,763,031. **SKYWAY**. YX PROPERTIES, LLC, BY ASSIGNMENT MIDWEST EXPRESS AIRLINES, INC., (U.S. CLS. 100 AND 105). SN 75-151,926. PUB. 6-24-1997. FILED 8-19-1996.
- 2,763,069 (*See Class 36 for this trademark*).
- 2,763,090 (*See Class 35 for this trademark*).
- 2,763,099. **CLASSICAL CRUISES**. CLASSICAL CRUISES, INC., (U.S. CLS. 100 AND 105). SN 75-856,179. PUB. 6-24-2003. FILED 11-23-1999.
- 2,763,101 (*See Class 7 for this trademark*).
- 2,763,126 (*See Class 3 for this trademark*).
- 2,763,152 (*See Class 35 for this trademark*).
- 2,763,170 (*See Class 9 for this trademark*).

CLASS 40—MATERIAL TREATMENT

- 2,763,118. **SAI STERLING AUTOMATION INC. AND DESIGN**. STERLING AUTOMATION, INC., (U.S. CLS. 100, 103 AND 106). SN 75-926,828. PUB. 6-24-2003. FILED 2-23-2000.
- 2,763,205 (*See Class 35 for this trademark*).
- 2,763,317 (*See Class 1 for this trademark*).
- 2,763,341 (*See Class 7 for this trademark*).
- 2,763,536. **PROMO DEPOT AND DESIGN**. PROMO DEPOT, INC., (U.S. CLS. 100, 103 AND 106). SN 76-389,179. PUB. 11-12-2002. FILED 4-1-2002.
- 2,763,587 (*See Class 6 for this trademark*).
- 2,763,624 (*See Class 35 for this trademark*).
- 2,763,659. **M-PACT**. HERITAGE PRESERVATION CORPORATION, (U.S. CLS. 100, 103 AND 106). SN 76-409,916.

PUB. 6-24-2003. FILED 5-20-2002.
 2,763,782 (*See Class 16 for this trademark*).
 2,763,897. **SYPRIS**. SYPRIS SOLUTIONS, INC, MULTIPLE CLASS, (INT. CLS. 40 AND 42), (U.S. CLS. 100, 101, 103 AND 106). SN 76-452,772. PUB. 6-24-2003. FILED 9-23-2002.
 2,763,962 (*See Class 35 for this trademark*).
 2,763,963 (*See Class 35 for this trademark*).
 2,763,973. **INTUIT**. INTUIT INC., (U.S. CLS. 100, 103 AND 106). SN 76-462,269. PUB. 6-24-2003. FILED 10-29-2002.
 2,764,023. **MDI PRODUCTS**. MDI PRODUCTS, LLC, (U.S. CLS. 100, 103 AND 106). SN 76-469,123. PUB. 6-24-2003. FILED 11-21-2002.
 2,764,046. **SMILE AFTER SMILE**. ECKERD CORPORATION, (U.S. CLS. 100, 103 AND 106). SN 76-472,112. PUB. 6-24-2003. FILED 12-5-2002.
 2,764,114. **R - PAC AND DESIGN**. TEITELBAUM, MICHAEL L., (U.S. CLS. 100, 103 AND 106). SN 78-033,524. PUB. 6-24-2003. FILED 11-2-2000.
 2,764,151 (*See Class 9 for this trademark*).
 2,764,243. **LOUD INK**. SCHIMELFENIG, JAY D., (U.S. CLS. 100, 103 AND 106). SN 78-136,352. PUB. 6-24-2003. FILED 6-17-2002.
 2,764,348. **BY REQUEST**. TAYLOR CORPORATION, (U.S. CLS. 100, 103 AND 106). SN 78-175,392. PUB. 6-24-2003. FILED 10-17-2002.
 2,764,421. **FINAL FINISH**. IMMERSION GRAPHICS CORPORATION, (U.S. CLS. 100, 103 AND 106). SN 78-185,291. PUB. 6-24-2003. FILED 11-14-2002.

CLASS 41—EDUCATION AND ENTERTAINMENT

2,763,027 (*See Class 14 for this trademark*).
 2,763,037. **QUANTUM CREATIVITY**. MEYER CREATIVITY ASSOCIATES, INC., (U.S. CLS. 100, 101 AND 107). SN 75-277,062. PUB. 5-21-2002. FILED 4-18-1997.
 2,763,046. **WILD THINGS**. PARAMOUNT PICTURES CORPORATION, (U.S. CLS. 100, 101 AND 107). SN 75-446,864. PUB. 6-24-2003. FILED 3-9-1998.
 2,763,069 (*See Class 36 for this trademark*).
 2,763,074. **STERNBERG MUSEUM OF NATURAL HISTORY**. FORT HAYS STATE UNIVERSITY, (U.S. CLS. 100, 101 AND 107). SN 75-705,535. PUB. 6-24-2003. FILED 6-10-1999.
 2,763,076 (*See Class 35 for this trademark*).
 2,763,088 (*See Class 9 for this trademark*).
 2,763,092. **FITNESS INNOVATIONS BY JEFF RILEY**. FITNESS INNOVATIONS INCORPORATED, (U.S. CLS. 100, 101 AND 107). SN 75-827,349. PUB. 6-24-2003. FILED 10-20-1999.
 2,763,097 (*See Class 9 for this trademark*).
 2,763,104 (*See Class 16 for this trademark*).
 2,763,110. **NOVATEC**. NOVATEC SA, (U.S. CLS. 100, 101 AND 107). SN 75-889,303. PUB. 10-15-2002. FILED 1-6-2000.
 2,763,121. **PRECISION DYNAMICS**. PRECISION DYNAMICS, INC., (U.S. CLS. 100, 101 AND 107). SN 75-978,136. PUB. 6-24-2003. FILED 11-21-1997.
 2,763,126 (*See Class 3 for this trademark*).
 2,763,134 (*See Class 6 for this trademark*).
 2,763,137 (*See Class 35 for this trademark*).
 2,763,142. **TV YELLOW**. PERHOLTZ, JEFFREY, AND SCOTT, SHAWN, AND PHILLIPS, ANDREW, AND PHILLIPS, ADAM, (U.S. CLS. 100, 101 AND 107). SN 76-037,841. PUB. 7-30-2002. FILED 5-1-2000.
 2,763,148. **VECTOR**. VECTOR, INC., MULTIPLE CLASS, (INT. CLS. 41 AND 42), (U.S. CLS. 100, 101 AND 107). SN 76-054,833. PUB. 6-24-2003. FILED 5-22-2000.
 2,763,169 (*See Class 9 for this trademark*).
 2,763,170 (*See Class 9 for this trademark*).
 2,763,177 (*See Class 9 for this trademark*).
 2,763,213. **SPORTS FANS CHOICE AWARDS**. PROFILE NETWORK INC., DBA SPORTS PROFILES, (U.S. CLS. 100, 101 AND 107). SN 76-173,504. PUB. 6-24-2003. FILED 11-30-2000.
 2,763,215 (*See Class 35 for this trademark*).
 2,763,217 (*See Class 38 for this trademark*).
 2,763,223 (*See Class 9 for this trademark*).
 2,763,225 (*See Class 9 for this trademark*).

2,763,228. **WILD JUNGLE (STYLIZED)**. KABUSHIKI KAISHA SEGA, DBA SEGA CORPORATION, (U.S. CLS. 100, 101 AND 107). SN 76-183,670. PUB. 6-24-2003. FILED 12-20-2000.
 2,763,239 (*See Class 9 for this trademark*).
 2,763,246 (*See Class 39 for this trademark*).
 2,763,250 (*See Class 25 for this trademark*).
 2,763,266. **IF YOU ONLY SEE ONE SHOW**. GILMORE ENTERTAINMENT GROUP LLC, (U.S. CLS. 100, 101 AND 107). SN 76-211,791. PUB. 3-26-2002. FILED 2-20-2001.
 2,763,268 (*See Class 6 for this trademark*).
 2,763,281. **NORTH 40 AND DESIGN**. NORTH-40.COM LLC, (U.S. CLS. 100, 101 AND 107). SN 76-236,288. PUB. 6-24-2003. FILED 4-6-2001.
 2,763,288. **SONGSEARCH**. SONGSEARCH, LLC, (U.S. CLS. 100, 101 AND 107). SN 76-246,750. PUB. 6-24-2003. FILED 4-24-2001.
 2,763,291. **BIRD3 (STYLIZED)**. BIRD3, (U.S. CLS. 100, 101 AND 107). SN 76-250,424. PUB. 6-24-2003. FILED 5-1-2001.
 2,763,322 (*See Class 16 for this trademark*).
 2,763,323. **THE FLETCHER SCHOOL**. TUFTS UNIVERSITY, (U.S. CLS. 100, 101 AND 107). SN 76-286,940. PUB. 6-24-2003. FILED 7-18-2001.
 2,763,346 (*See Class 35 for this trademark*).
 2,763,351 (*See Class 9 for this trademark*).
 2,763,358. **ELECTRONICS TECHNICIANS ASSOCIATION, INTERNATIONAL**. ELECTRONICS TECHNICIANS ASSOCIATION INTERNATIONAL INC., THE, MULTIPLE CLASS, (INT. CLS. 41 AND 42), (U.S. CLS. 100, 101 AND 107). SN 76-314,046. PUB. 6-24-2003. FILED 9-18-2001.
 2,763,381 (*See Class 16 for this trademark*).
 2,763,383. **A LIFE OF FAITH**. MISSION CITY PRESS, INC., (U.S. CLS. 100, 101 AND 107). SN 76-329,626. PUB. 6-24-2003. FILED 10-24-2001.
 2,763,391. **ENTERPRISE SERVICES PARTNER**. VECTOR ESP, INC., MULTIPLE CLASS, (INT. CLS. 41 AND 42), (U.S. CLS. 100, 101 AND 107). SN 76-331,387. PUB. 6-24-2003. FILED 10-30-2001.
 2,763,394 (*See Class 35 for this trademark*).
 2,763,411 (*See Class 38 for this trademark*).
 2,763,418 (*See Class 9 for this trademark*).
 2,763,422. **BLACK STARZ! AND DESIGN**. STARZ ENCORE GROUP LLC, (U.S. CLS. 100, 101 AND 107). SN 76-345,110. PUB. 6-24-2003. FILED 12-5-2001.
 2,763,437. **BEYOND TUTORING**. OXFORD LEARNING CENTRES, INC., (U.S. CLS. 100, 101 AND 107). SN 76-349,651. PUB. 6-24-2003. FILED 12-18-2001.
 2,763,446. **AFFORDABLE ISO**. EAGLE REGISTRATIONS INC., (U.S. CLS. 100, 101 AND 107). SN 76-352,634. PUB. 6-24-2003. FILED 12-21-2001.
 2,763,453. **PARALLEL CALIFORNIA**. DEMETRIOS, EAMES, (U.S. CLS. 100, 101 AND 107). SN 76-354,493. PUB. 6-24-2003. FILED 1-2-2002.
 2,763,468. **BONANZA CASINO**. LITTLE BONANZA, INC., (U.S. CLS. 100, 101 AND 107). SN 76-360,904. PUB. 6-24-2003. FILED 1-22-2002.
 2,763,471 (*See Class 9 for this trademark*).
 2,763,490. **MO NUNN RACING**. NUNN RACING LLC, (U.S. CLS. 100, 101 AND 107). SN 76-373,046. PUB. 6-24-2003. FILED 2-20-2002.
 2,763,515. **ROCKY MOUNTAIN NATIONAL RENDEZVOUS**. ROCKY MOUNTAIN NATIONAL RENDEZVOUS, (U.S. CLS. 100, 101 AND 107). SN 76-382,383. PUB. 6-24-2003. FILED 3-14-2002.
 2,763,521 (*See Class 9 for this trademark*).
 2,763,528. **DYNAMICS OF MEDITATION**. HIMALAYAN INTERNATIONAL INSTITUTE OF YOGA SCIENCE AND PHILOSOPHY OF THE USA, (U.S. CLS. 100, 101 AND 107). SN 76-387,768. PUB. 6-24-2003. FILED 3-26-2002.
 2,763,549. **I MADE THE RIGHT CALL**. NATIONAL EMERGENCY NUMBER ASSOCIATION, INC., (U.S. CLS. 100, 101 AND 107). SN 76-392,032. PUB. 6-24-2003. FILED 4-6-2002.
 2,763,566 (*See Class 9 for this trademark*).
 2,763,567 (*See Class 9 for this trademark*).
 2,763,574. **MISCELLANEOUS DESIGN**. CRICKET PRODUCTIONS, INC., (U.S. CLS. 100, 101 AND 107). SN 76-398,279. PUB. 6-24-2003. FILED 4-22-2002.

- 2,763,576. **SONI D'S OLD SKOOL MEGA MIX.** SHERIDAN BROADCASTING CORPORATION, (U.S. CLS. 100, 101 AND 107). SN 76-398,571. PUB. 6-24-2003. FILED 4-22-2002.
- 2,763,592. **SMOKE ON THE WATER CHILI COOK OFF.** SMOKE ON THE WATER CHILI COOK OFF, (U.S. CLS. 100, 101 AND 107). SN 76-401,034. PUB. 6-24-2003. FILED 4-26-2002.
- 2,763,594. **TAI-KI.** JUKO-KAI INTERNATIONAL, INC., (U.S. CLS. 100, 101 AND 107). SN 76-401,372. PUB. 6-24-2003. FILED 4-26-2002.
- 2,763,598. **PROTECH!** HOLT TEXAS LTD, DBA HOLT COMPANY OF TEXAS, (U.S. CLS. 100, 101 AND 107). SN 76-402,011. PUB. 6-24-2003. FILED 5-1-2002.
- 2,763,609 (*See Class 9 for this trademark*).
- 2,763,611. **L2 FOUNDATION (STYLIZED).** CHOU FAMILY FOUNDATION, (U.S. CLS. 100, 101 AND 107). SN 76-404,535. PUB. 6-24-2003. FILED 5-2-2002.
- 2,763,619. **R AND DESIGN.** EFFECTIVENESS ENHANCEMENT, INC., (U.S. CLS. 100, 101 AND 107). SN 76-405,587. PUB. 6-24-2003. FILED 4-30-2002.
- 2,763,620. **EXPLORING YOU.** EFFECTIVENESS ENHANCEMENT, INC., (U.S. CLS. 100, 101 AND 107). SN 76-405,588. PUB. 6-24-2003. FILED 4-30-2002.
- 2,763,623. **LEADERSHIP ON THE LINE A CORE SERVICE OF BRUCE MAST & ASSOCIATES, INC. PROFESSIONALS IN LEADERSHIP AND ORGANIZATIONAL DEVELOPMENT AND DESIGN.** BRUCE MAST & ASSOCIATES, INC., (U.S. CLS. 100, 101 AND 107). SN 76-405,863. PUB. 6-24-2003. FILED 5-3-2002.
- 2,763,636. **FAMILY VALUES.** FAMILY VALUES TOUR LLC, (U.S. CLS. 100, 101 AND 107). SN 76-407,478. PUB. 6-24-2003. FILED 5-14-2002.
- 2,763,665. **COLLEGE FOOTBALL'S BIGGEST PARTY.** THE ARIZONA SPORTS FOUNDATION, (U.S. CLS. 100, 101 AND 107). SN 76-411,963. PUB. 6-24-2003. FILED 5-23-2002.
- 2,763,667. **THE COUNTRY CHORALE.** BABCOCK, JOSEPH T., (U.S. CLS. 100, 101 AND 107). SN 76-412,187. PUB. 6-24-2003. FILED 5-22-2002.
- 2,763,669. **HORSICRY.** M'CLOUD, CALLOWAY GRETCHEN MARI, (U.S. CLS. 100, 101 AND 107). SN 76-412,400. PUB. 6-24-2003. FILED 5-24-2002.
- 2,763,675. **YAC YOUTH ADVISORY COUNCIL AN ARKANSAS COMMUNITY FOUNDATION INITIATIVE AND DESIGN.** ARKANSAS COMMUNITY FOUNDATION, INC., (U.S. CLS. 100, 101 AND 107). SN 76-413,218. PUB. 6-24-2003. FILED 5-28-2002.
- 2,763,681. **DAUGHTERS OF HEAVEN.** DAUGHTERS OF HEAVEN MINISTRIES, INC., MULTIPLE CLASS, (INT. CLS. 41 AND 45), (U.S. CLS. 100, 101 AND 107). SN 76-414,195. PUB. 6-24-2003. FILED 6-5-2002.
- 2,763,687 (*See Class 9 for this trademark*).
- 2,763,692. **PALOMAR COLLEGE.** PALOMAR COMMUNITY COLLEGE DISTRICT, (U.S. CLS. 100, 101 AND 107). SN 76-416,334. PUB. 6-24-2003. FILED 6-3-2002.
- 2,763,699 (*See Class 9 for this trademark*).
- 2,763,720. **HISPANOS UNIDOS.** SPANISH BROADCASTING SYSTEM, INC., (U.S. CLS. 100, 101 AND 107). SN 76-420,063. PUB. 6-24-2003. FILED 6-13-2002.
- 2,763,723. **DREAM EVENTS, INC.** DREAM EVENTS, INC., (U.S. CLS. 100, 101 AND 107). SN 76-420,103. PUB. 6-24-2003. FILED 5-16-2002.
- 2,763,724. **SUNDAY RIVER.** SUNDAY RIVER SKIWAY CORPORATION, MULTIPLE CLASS, (INT. CLS. 41 AND 43), (U.S. CLS. 100, 101 AND 107). SN 76-420,244. PUB. 6-24-2003. FILED 6-3-2002.
- 2,763,734. **ADVENTURES IN MEDIA WE'RE CHARTING NEW TERRITORY IN PUBLISHING & PUBLICITY AND DESIGN.** STEBBEN, GREGG, (U.S. CLS. 100, 101 AND 107). SN 76-422,908. PUB. 6-24-2003. FILED 6-19-2002.
- 2,763,745. **TOKI TOKI BOOM.** YAHOO! INC., (U.S. CLS. 100, 101 AND 107). SN 76-424,625. PUB. 6-24-2003. FILED 6-21-2002.
- 2,763,747. **SILVER SADDLE RANCH & SPA AND DESIGN.** SILVER SADDLE RANCH & CLUB, INC., MULTIPLE CLASS, (INT. CLS. 41 AND 44), (U.S. CLS. 100, 101 AND 107). SN 76-425,002. PUB. 6-24-2003. FILED 6-24-2002.
- 2,763,758. **KARATE FOR KIDS AND DESIGN.** CLARK, WILLIAM, (U.S. CLS. 100, 101 AND 107). SN 76-426,769. PUB. 6-24-2003. FILED 7-1-2002.
- 2,763,791 (*See Class 9 for this trademark*).
- 2,763,806. **NEW YORK EXPERIENCE ENTERTAINMENT.** NYX ENTERTAINMENT INC., (U.S. CLS. 100, 101 AND 107). SN 76-434,487. PUB. 6-24-2003. FILED 7-24-2002.
- 2,763,812. **SLAMSON.** SACRAMENTO KINGS LIMITED PARTNERSHIP, L.P., (U.S. CLS. 100, 101 AND 107). SN 76-435,433. PUB. 6-24-2003. FILED 7-29-2002.
- 2,763,814 (*See Class 7 for this trademark*).
- 2,763,817. **TUPAC AMARU SHAKUR FOUNDATION.** TUPAC AMARU SHAKUR FOUNDATION, (U.S. CLS. 100, 101 AND 107). SN 76-437,220. PUB. 6-24-2003. FILED 8-5-2002.
- 2,763,821 (*See Class 35 for this trademark*).
- 2,763,834. **BABY BOOT CAMP.** HORLER, KRISTEN M., (U.S. CLS. 100, 101 AND 107). SN 76-439,997. PUB. 6-24-2003. FILED 8-9-2002.
- 2,763,853. **PRECIOUS MINDS, NEW CONNECTIONS.** KRON-KOSKY CHARITABLE FOUNDATION, (U.S. CLS. 100, 101 AND 107). SN 76-444,001. PUB. 6-24-2003. FILED 8-27-2002.
- 2,763,873. **DRUGFREE PENNSYLVANIA MAKING TOMORROW WORK BETTER AND DESIGN.** DRUG FREE PENNSYLVANIA, INC., (U.S. CLS. 100, 101 AND 107). SN 76-448,748. PUB. 6-24-2003. FILED 9-12-2002.
- 2,763,879. **OUTIE.** ETHAN INTERACTIVE, INC., (U.S. CLS. 100, 101 AND 107). SN 76-450,243. PUB. 6-24-2003. FILED 9-17-2002.
- 2,763,884 (*See Class 16 for this trademark*).
- 2,763,891 (*See Class 36 for this trademark*).
- 2,763,895. **IBE INSTITUTE OF BIBLICAL EDUCATION AND DESIGN.** BOB JONES UNIVERSITY, INC., (U.S. CLS. 100, 101 AND 107). SN 76-452,474. PUB. 6-24-2003. FILED 9-25-2002.
- 2,763,898 (*See Class 16 for this trademark*).
- 2,763,920. **TUNXIS PLANTATION AND DESIGN.** TOMASSO BROTHERS, INC., MULTIPLE CLASS, (INT. CLS. 41 AND 43), (U.S. CLS. 100, 101 AND 107). SN 76-455,962. PUB. 6-24-2003. FILED 10-7-2002.
- 2,763,933. **LADYBUG.** VELASQUEZ, TANIA D., (U.S. CLS. 100, 101 AND 107). SN 76-457,176. PUB. 6-24-2003. FILED 10-9-2002.
- 2,763,934. **THE NO SHOW.** WNYC RADIO, (U.S. CLS. 100, 101 AND 107). SN 76-457,198. PUB. 6-24-2003. FILED 10-9-2002.
- 2,763,940 (*See Class 35 for this trademark*).
- 2,763,944. **JOE VERDE GROUP.** JOE VERDE GROUP, (U.S. CLS. 100, 101 AND 107). SN 76-458,768. PUB. 6-24-2003. FILED 10-17-2002.
- 2,763,954. **IMN.** INFORMATION MANAGEMENT NETWORK, INC., (U.S. CLS. 100, 101 AND 107). SN 76-460,079. PUB. 6-24-2003. FILED 10-15-2002.
- 2,763,967. **MOVIE FREEDOM PASS.** BLOCKBUSTER INC., (U.S. CLS. 100, 101 AND 107). SN 76-461,476. PUB. 6-24-2003. FILED 10-24-2002.
- 2,763,968. **DVD FREEDOM PASS.** BLOCKBUSTER INC., (U.S. CLS. 100, 101 AND 107). SN 76-461,477. PUB. 6-24-2003. FILED 10-24-2002.
- 2,763,969. **GAMES FREEDOM PASS.** BLOCKBUSTER INC., (U.S. CLS. 100, 101 AND 107). SN 76-461,478. PUB. 6-24-2003. FILED 10-24-2002.
- 2,763,972 (*See Class 9 for this trademark*).
- 2,763,993. **LEED.** U.S. GREEN BUILDING COUNCIL, MULTIPLE CLASS, (INT. CLS. 41 AND 42), (U.S. CLS. 100, 101 AND 107). SN 76-465,708. PUB. 6-24-2003. FILED 11-12-2002.
- 2,763,994. **USGBC.** U.S. GREEN BUILDING COUNCIL, MULTIPLE CLASS, (INT. CLS. 41 AND 42), (U.S. CLS. 100, 101 AND 107). SN 76-465,715. PUB. 6-24-2003. FILED 11-12-2002.
- 2,764,004 (*See Class 16 for this trademark*).
- 2,764,015. **WHERE WIT LIVES.** SWEET FANCY MOSES, INC., (U.S. CLS. 100, 101 AND 107). SN 76-468,294. PUB. 6-24-2003. FILED 11-12-2002.
- 2,764,035. **POWERED BY [TOPCODER].** TOPCODER, INC., (U.S. CLS. 100, 101 AND 107). SN 76-470,773. PUB. 6-24-2003. FILED 11-29-2002.
- 2,764,040. **MYRTLEWOOD GOLF CLUB.** BURROUGHS AND CHAPIN COMPANY, INC., (U.S. CLS. 100, 101 AND 107). SN 76-471,560. PUB. 6-24-2003. FILED 11-19-2002.
- 2,764,047 (*See Class 16 for this trademark*).
- 2,764,069. **MISCELLANEOUS DESIGN.** MAACO ENTER-

- PRIZES, INC., (U.S. CLS. 100, 101 AND 107). SN 76-474,059. PUB. 6-24-2003. FILED 12-12-2002.
- 2,764,073. **MOUNTAIN BRANCH.** 1492 HOSPITALITY GROUP, INC., (U.S. CLS. 100, 101 AND 107). SN 76-474,172. PUB. 6-24-2003. FILED 12-10-2002.
- 2,764,098. **MISCELLANEOUS DESIGN.** CENTEX BUSINESS CONSULTANTS, L.C., (U.S. CLS. 100, 101 AND 107). SN 76-485,967. PUB. 6-24-2003. FILED 1-29-2003.
- 2,764,118. **SPEAKEASY FILMS.** SPEAKEASY FILMS, INC., (U.S. CLS. 100, 101 AND 107). SN 78-041,256. PUB. 6-24-2003. FILED 1-1-2001.
- 2,764,131 (*See Class 35 for this trademark.*).
- 2,764,135. **WARREN MILLER'S GLOBAL ADVENTURE.** WARREN MILLER ENTERTAINMENT, INC., BY ASSIGNMENT INTERNATIONAL ENTERTAINMENT GROUP, INC., (U.S. CLS. 100, 101 AND 107). SN 78-074,288. PUB. 6-24-2003. FILED 7-17-2001.
- 2,764,143. **DELICIOUS KARMA.** DELICIOUS KARMA LLC, (U.S. CLS. 100, 101 AND 107). SN 78-087,641. PUB. 6-24-2003. FILED 10-10-2001.
- 2,764,148 (*See Class 38 for this trademark.*).
- 2,764,157 (*See Class 16 for this trademark.*).
- 2,764,162. **MICHAEL GRECCO PHOTOGRAPHY.** GRECCO, MICHAEL, (U.S. CLS. 100, 101 AND 107). SN 78-101,739. PUB. 6-24-2003. FILED 1-9-2002.
- 2,764,178. **SACRED DYING.** ANDERSON, MEGORY, (U.S. CLS. 100, 101 AND 107). SN 78-106,062. PUB. 6-24-2003. FILED 1-31-2002.
- 2,764,190. **GREAT EXPECTATIONS.** GREAT EXPECTATIONS, INC., (U.S. CLS. 100, 101 AND 107). SN 78-110,899. PUB. 3-18-2003. FILED 2-25-2002.
- 2,764,198. **INNER EXPANSION WORKSHOPS FOR THE SOUL AND DESIGN.** INNER EXPANSION WORKSHOPS, INC., (U.S. CLS. 100, 101 AND 107). SN 78-116,411. PUB. 6-24-2003. FILED 3-20-2002.
- 2,764,199. **STADIUM OF FIRE.** LAZY RIVER PRODUCTIONS, INC., (U.S. CLS. 100, 101 AND 107). SN 78-117,008. PUB. 6-24-2003. FILED 3-22-2002.
- 2,764,201 (*See Class 35 for this trademark.*).
- 2,764,203. **BLAGUE COMMUNICATIONS AND DESIGN.** KISIC, BLAS A., (U.S. CLS. 100, 101 AND 107). SN 78-120,515. PUB. 6-24-2003. FILED 4-9-2002.
- 2,764,204. **NIGHT OF THE SINGING DEAD.** GREFENSTETTE, CARL M., DBA WORLDWIDE FILMWORKS, (U.S. CLS. 100, 101 AND 107). SN 78-121,044. PUB. 6-24-2003. FILED 4-11-2002.
- 2,764,210 (*See Class 37 for this trademark.*).
- 2,764,220. **HISTORIC TOWN OF NEW PHILADELPHIA.** WALKER, JULIET E.K., (U.S. CLS. 100, 101 AND 107). SN 78-129,284. PUB. 6-24-2003. FILED 5-16-2002.
- 2,764,231 (*See Class 35 for this trademark.*).
- 2,764,232. **3RD STOREE.** 3RD STOREE MUSIC, LLC., (U.S. CLS. 100, 101 AND 107). SN 78-131,855. PUB. 6-24-2003. FILED 5-29-2002.
- 2,764,234 (*See Class 35 for this trademark.*).
- 2,764,255. **OPEN HOUSE TELEVISION SHOW AND DESIGN.** SILVERWINGS PRODUCTIONS, INCORPORATED, (U.S. CLS. 100, 101 AND 107). SN 78-141,025. PUB. 6-24-2003. FILED 7-3-2002.
- 2,764,260. **BUILDING A NATION OF READERS, ARTISTS AND DREAMERS.** BAYLOR UNIVERSITY, (U.S. CLS. 100, 101 AND 107). SN 78-143,560. PUB. 6-24-2003. FILED 7-12-2002.
- 2,764,265. **BE YOURSELF MARKETING.** SUMMERHAWK, KENDALL, (U.S. CLS. 100, 101 AND 107). SN 78-145,205. PUB. 6-24-2003. FILED 7-18-2002.
- 2,764,272. **TESTOUT CHALLENGE.** TESTOUT CORPORATION, (U.S. CLS. 100, 101 AND 107). SN 78-149,961. PUB. 6-24-2003. FILED 8-1-2002.
- 2,764,283. **BLISTER.** G4 MEDIA, LLC, (U.S. CLS. 100, 101 AND 107). SN 78-155,663. PUB. 6-24-2003. FILED 8-19-2002.
- 2,764,284. **CHEAT!** G4 MEDIA, LLC, (U.S. CLS. 100, 101 AND 107). SN 78-155,665. PUB. 6-24-2003. FILED 8-19-2002.
- 2,764,285. **CINEMATECH.** G4 MEDIA, LLC, (U.S. CLS. 100, 101 AND 107). SN 78-155,667. PUB. 6-24-2003. FILED 8-19-2002.
- 2,764,286. **SWEAT.** G4 MEDIA, LLC, (U.S. CLS. 100, 101 AND 107). SN 78-155,680. PUB. 6-24-2003. FILED 8-19-2002.
- 2,764,289 (*See Class 35 for this trademark.*).
- 2,764,307. **CLEAR YOUR DESK... CLEAR YOUR MIND... ORGANIZE IT.** KYRIAZIS, CYNTHIA, (U.S. CLS. 100, 101 AND 107). SN 78-161,846. PUB. 6-24-2003. FILED 9-9-2002.
- 2,764,309. **EYEKON.** COOLEY, ROBERT WILLIAM, (U.S. CLS. 100, 101 AND 107). SN 78-162,930. PUB. 6-24-2003. FILED 9-11-2002.
- 2,764,311. **DR CUE AND DESIGN.** ROSSMAN, THOMAS, (U.S. CLS. 100, 101 AND 107). SN 78-163,367. PUB. 6-24-2003. FILED 9-12-2002.
- 2,764,346. **MISCELLANEOUS DESIGN.** ARIZONA SCIENCE CENTER, (U.S. CLS. 100, 101 AND 107). SN 78-175,150. PUB. 6-24-2003. FILED 10-16-2002.
- 2,764,364 (*See Class 38 for this trademark.*).
- 2,764,385. **WORLDSAFE.** SAFE AMERICA FOUNDATION, INC., (U.S. CLS. 100, 101 AND 107). SN 78-180,430. PUB. 6-24-2003. FILED 10-31-2002.
- 2,764,393. **BIX PIX.** BIX PIX ENTERTAINMENT, INC., (U.S. CLS. 100, 101 AND 107). SN 78-180,648. PUB. 6-24-2003. FILED 10-31-2002.
- 2,764,407. **AUTO DETAILING SOLUTIONS.** AUTO DETAILING SOLUTIONS, (U.S. CLS. 100, 101 AND 107). SN 78-183,444. PUB. 6-24-2003. FILED 11-9-2002.
- 2,764,440. **EARTHWORM PRODUCTIONS.** EARTHWORM PRODUCTIONS, LLC, (U.S. CLS. 100, 101 AND 107). SN 78-186,409. PUB. 6-24-2003. FILED 11-19-2002.
- 2,764,465. **STEPXTRA.** 24 HOUR FITNESS USA, INC., (U.S. CLS. 100, 101 AND 107). SN 78-193,624. PUB. 6-24-2003. FILED 12-11-2002.

CLASS 42—SCIENTIFIC, COMPUTER AND LEGAL SERVICES

- 2,763,026. **FOX COMPUTER RENTALS AND DESIGN.** A PC COMPUTER RENTAL CO., INC., (U.S. CLS. 100 AND 101). SN 74-324,771. PUB. 6-24-2003. FILED 10-23-1992.
- 2,763,030 (*See Class 35 for this trademark.*).
- 2,763,057 (*See Class 9 for this trademark.*).
- 2,763,062. **EXTRACARE HEALTH SERVICES.** EXTRACARE HEALTH SERVICES, (U.S. CLS. 100 AND 101). SN 75-567,849. PUB. 6-24-2003. FILED 10-13-1998.
- 2,763,069 (*See Class 36 for this trademark.*).
- 2,763,075. **ABOOKMARK.COM AND DESIGN.** AUSTIN QUANTUM SYSTEMS, INC., (U.S. CLS. 100 AND 101). SN 75-725,496. PUB. 6-24-2003. FILED 7-7-1999.
- 2,763,076 (*See Class 35 for this trademark.*).
- 2,763,084. **MICROBURST TECHNOLOGIES, INC. AND DESIGN.** MICROBURST TECHNOLOGIES, INC., (U.S. CLS. 100 AND 101). SN 75-780,693. PUB. 7-3-2001. FILED 8-18-1999.
- 2,763,088 (*See Class 9 for this trademark.*).
- 2,763,093. **AMERICAN AND DESIGN.** AMERICAN BUSINESS FORMS, INC., (U.S. CLS. 100 AND 101). SN 75-837,425. PUB. 11-28-2000. FILED 11-1-1999.
- 2,763,097 (*See Class 9 for this trademark.*).
- 2,763,101 (*See Class 7 for this trademark.*).
- 2,763,104 (*See Class 16 for this trademark.*).
- 2,763,106. **DIOGENE TECHNOLOGY.** SOCIETE DELPHES INC., (U.S. CLS. 100 AND 101). SN 75-878,482. PUB. 6-24-2003. FILED 12-22-1999.
- 2,763,108. **NET ONE STOP AND DESIGN.** PRACTICAL SOLUTIONS, INC., (U.S. CLS. 100 AND 101). SN 75-884,757. PUB. 6-24-2003. FILED 1-3-2000.
- 2,763,109. **GOOD DOG.** GOOD DOG! INC., (U.S. CLS. 100 AND 101). SN 75-885,526. PUB. 6-24-2003. FILED 1-7-2000.
- 2,763,112 (*See Class 37 for this trademark.*).
- 2,763,113 (*See Class 16 for this trademark.*).
- 2,763,115 (*See Class 35 for this trademark.*).
- 2,763,120. **GOLF MAGAZINE PICTURE COLLECTION.** TIME4 MEDIA, INC., BY CHANGE OF NAME TIMES MIRROR MAGAZINES, INC., (U.S. CLS. 100 AND 101). SN 75-950,346. PUB. 6-24-2003. FILED 2-29-2000.
- 2,763,123 (*See Class 3 for this trademark.*).
- 2,763,126 (*See Class 3 for this trademark.*).
- 2,763,135 (*See Class 37 for this trademark.*).
- 2,763,136 (*See Class 35 for this trademark.*).

- 2,763,137 (*See Class 35 for this trademark*).
 2,763,148 (*See Class 41 for this trademark*).
 2,763,156 (*See Class 9 for this trademark*).
 2,763,161. **EL MIRASOL**. CALVILLO, JESUS E., (U.S. CLS. 100 AND 101). SN 76-085,285. PUB. 6-24-2003. FILED 7-10-2000.
 2,763,165. **ARRAY BIOPHARMA THE DISCOVERY RESEARCH COMPANY**. ARRAY BIOPHARMA INC., (U.S. CLS. 100 AND 101). SN 76-098,989. PUB. 6-24-2003. FILED 7-28-2000.
 2,763,167 (*See Class 9 for this trademark*).
 2,763,168 (*See Class 9 for this trademark*).
 2,763,173. **RAPTORBYTES**. RAPTORBYTES INC., (U.S. CLS. 100 AND 101). SN 76-109,121. PUB. 6-24-2003. FILED 8-14-2000.
 2,763,177 (*See Class 9 for this trademark*).
 2,763,185. **AERONET**. BELL/AGUSTA AEROSPACE COMPANY LLC, (U.S. CLS. 100 AND 101). SN 76-127,114. PUB. 6-11-2002. FILED 9-13-2000.
 2,763,202. **MISCELLANEOUS DESIGN**. SOMA NETWORKS, INC., (U.S. CLS. 100 AND 101). SN 76-160,284. PUB. 6-24-2003. FILED 11-3-2000.
 2,763,205 (*See Class 35 for this trademark*).
 2,763,207. **THE SMILE SPA**. NIX, DAVID D., (U.S. CLS. 100 AND 101). SN 76-165,636. PUB. 6-24-2003. FILED 11-15-2000.
 2,763,209 (*See Class 9 for this trademark*).
 2,763,220 (*See Class 35 for this trademark*).
 2,763,221. **PACKNOLOGY**. REIS, MARY ELLEN, (U.S. CLS. 100 AND 101). SN 76-179,705. PUB. 6-24-2003. FILED 12-4-2000.
 2,763,223 (*See Class 9 for this trademark*).
 2,763,225 (*See Class 9 for this trademark*).
 2,763,227 (*See Class 35 for this trademark*).
 2,763,232 (*See Class 3 for this trademark*).
 2,763,237 (*See Class 9 for this trademark*).
 2,763,239 (*See Class 9 for this trademark*).
 2,763,246 (*See Class 39 for this trademark*).
 2,763,248 (*See Class 9 for this trademark*).
 2,763,261. **ASPIRINCHECK AND DESIGN**. ESOTERIX INC., (U.S. CLS. 100 AND 101). SN 76-210,491. PUB. 4-15-2003. FILED 2-13-2001.
 2,763,262. **INSURING THE CHILDREN (STYLIZED)**. INSURING THE CHILDREN OF SOUTHERN OHIO, (U.S. CLS. 100 AND 101). SN 76-210,540. PUB. 6-24-2003. FILED 2-14-2001.
 2,763,268 (*See Class 6 for this trademark*).
 2,763,269 (*See Class 9 for this trademark*).
 2,763,274 (*See Class 9 for this trademark*).
 2,763,275 (*See Class 16 for this trademark*).
 2,763,280. **PHOENIX MERCURY AND DESIGN**. WNBA ENTERPRISES, LLC, (U.S. CLS. 100 AND 101). SN 76-236,064. PUB. 6-24-2003. FILED 4-5-2001.
 2,763,286. **GO NATIONAL RESTAURANT ASSOCIATION GRASSROOTS OPPORTUNITIES NETWORK AND DESIGN**. NATIONAL RESTAURANT ASSOCIATION, (U.S. CLS. 100 AND 101). SN 76-243,365. PUB. 6-24-2003. FILED 4-19-2001.
 2,763,294. **EDDIE MERLOT'S**. HUMPHRIES, WILLIAM C., (U.S. CLS. 100 AND 101). SN 76-254,070. PUB. 6-24-2003. FILED 5-8-2001.
 2,763,301. **E EDDIE MERLOT'S AND DESIGN**. HUMPHRIES, WILLIAM C., (U.S. CLS. 100 AND 101). SN 76-258,600. PUB. 6-24-2003. FILED 5-17-2001.
 2,763,311 (*See Class 37 for this trademark*).
 2,763,312. **SUPERH RISC ENGINE (STYLIZED)**. KABUSHIKI KAISHA HITACHI SEISAKUSHO, DBA HITACHI, LTD., (U.S. CLS. 100 AND 101). SN 76-277,729. PUB. 6-24-2003. FILED 6-28-2001.
 2,763,314. **RESCULPTING BODY TREATMENT BY TRACIE MARTYN**. TRACIE MARTYN, INC., (U.S. CLS. 100 AND 101). SN 76-280,211. PUB. 6-24-2003. FILED 6-26-2001.
 2,763,316. **NOWCASTING AND DESIGN**. NOWCASTING INTERNATIONAL LIMITED, (U.S. CLS. 100 AND 101). SN 76-280,428. PUB. 6-24-2003. FILED 7-5-2001.
 2,763,317 (*See Class 1 for this trademark*).
 2,763,319 (*See Class 37 for this trademark*).
 2,763,320 (*See Class 37 for this trademark*).
 2,763,325. **PAICE**. PAICE CORPORATION, (U.S. CLS. 100 AND 101). SN 76-288,534. PUB. 6-24-2003. FILED 7-20-2001.
 2,763,327 (*See Class 37 for this trademark*).
 2,763,341 (*See Class 7 for this trademark*).
 2,763,350. **WORLD WATERPARK ASSOCIATION**. WORLD WATERPARK ASSOCIATION, (U.S. CLS. 100 AND 101). SN 76-309,815. PUB. 6-24-2003. FILED 9-6-2001.
 2,763,351 (*See Class 9 for this trademark*).
 2,763,358 (*See Class 41 for this trademark*).
 2,763,370. **CHINALAWONE AND DESIGN**. HO, HELEN K., (U.S. CLS. 100 AND 101). SN 76-323,301. PUB. 6-24-2003. FILED 10-11-2001.
 2,763,389. **THE BELLMOOR**. COASTAL PROPERTIES I, L.L.C., (U.S. CLS. 100 AND 101). SN 76-331,227. PUB. 6-24-2003. FILED 10-29-2001.
 2,763,391 (*See Class 41 for this trademark*).
 2,763,393. **JESUS IF AMERICA WOULD ONLY FOCUS (STYLIZED)**. IF AMERICA WOULD ONLY FOCUS, INC., (U.S. CLS. 100 AND 101). SN 76-333,614. PUB. 6-24-2003. FILED 11-2-2001.
 2,763,397 (*See Class 9 for this trademark*).
 2,763,418 (*See Class 9 for this trademark*).
 2,763,419 (*See Class 35 for this trademark*).
 2,763,427. **IPS INTEGRATED PRINT SOLUTIONS AND DESIGN**. INTEGRATED PRINT SOLUTIONS, INC., (U.S. CLS. 100 AND 101). SN 76-346,480. PUB. 10-1-2002. FILED 12-10-2001.
 2,763,434. **FINASTERIDE MAINTENANCE**. ROBERT LEROY LEIBOWITZ, M.D., (U.S. CLS. 100 AND 101). SN 76-349,437. PUB. 6-24-2003. FILED 12-14-2001.
 2,763,435. **TRIPLE HORMONE BLOCKADE**. ROBERT LEROY LEIBOWITZ, M.D., (U.S. CLS. 100 AND 101). SN 76-349,438. PUB. 6-24-2003. FILED 12-14-2001.
 2,763,436. **TRIPLE ANDROGEN BLOCKADE**. ROBERT LEROY LEIBOWITZ, M.D., (U.S. CLS. 100 AND 101). SN 76-349,439. PUB. 6-24-2003. FILED 12-14-2001.
 2,763,443 (*See Class 5 for this trademark*).
 2,763,444. **CHEBA HUT AND DESIGN**. CHEBA HUT FRANCHISING, INC., BY ASSIGNMENT NICE DREAMS, INC., (U.S. CLS. 100 AND 101). SN 76-352,507. PUB. 6-24-2003. FILED 12-26-2001.
 2,763,449. **STS CONSTRUCTION AND DESIGN**. COUNCIL ON CERTIFICATION OF HEALTH, ENVIRONMENTAL AND SAFETY TECHNOLOGISTS, (U.S. CLS. 100 AND 101). SN 76-353,480. PUB. 6-24-2003. FILED 12-31-2001.
 2,763,450 (*See Class 35 for this trademark*).
 2,763,488. **DOCUFLEX**. DOCUCORP INTERNATIONAL, INC., (U.S. CLS. 100 AND 101). SN 76-372,124. PUB. 6-24-2003. FILED 2-19-2002.
 2,763,494. **CREATIVE PRESENTATION RESOURCES**. CREATIVE PRESENTATION RESOURCES LLC, (U.S. CLS. 100 AND 101). SN 76-375,189. PUB. 6-24-2003. FILED 2-26-2002.
 2,763,503. **GOLDSTAR AND DESIGN**. IT SOLUTIONS CONSULTING, INC., (U.S. CLS. 100 AND 101). SN 76-379,193. PUB. 6-24-2003. FILED 3-8-2002.
 2,763,516 (*See Class 9 for this trademark*).
 2,763,548. **LOJX**. JKG GROUP, INC., (U.S. CLS. 100 AND 101). SN 76-391,816. PUB. 6-24-2003. FILED 4-3-2002.
 2,763,557. **POINT & CLICK SOFTWARE INC. AND DESIGN**. POINT & CLICK SOFTWARE, INC., (U.S. CLS. 100 AND 101). SN 76-393,100. PUB. 6-24-2003. FILED 3-4-2002.
 2,763,560 (*See Class 9 for this trademark*).
 2,763,564 (*See Class 9 for this trademark*).
 2,763,566 (*See Class 9 for this trademark*).
 2,763,567 (*See Class 9 for this trademark*).
 2,763,600 (*See Class 35 for this trademark*).
 2,763,609 (*See Class 9 for this trademark*).
 2,763,622 (*See Class 35 for this trademark*).
 2,763,624 (*See Class 35 for this trademark*).
 2,763,633. **HODGSON RUSS ATTORNEYS LLP AND DESIGN**. HODGSON RUSS LLP, (U.S. CLS. 100 AND 101). SN 76-407,155. PUB. 6-24-2003. FILED 5-10-2002.
 2,763,640. **T AND DESIGN**. THOMAS PUBLISHING COMPANY, (U.S. CLS. 100 AND 101). SN 76-408,301. PUB. 6-24-2003. FILED 5-13-2002.
 2,763,647 (*See Class 9 for this trademark*).
 2,763,648. **EXPERIENCE MAPPING**. THIRD PERSON, INC., (U.S. CLS. 100 AND 101). SN 76-409,368. PUB. 6-24-2003. FILED 5-20-2002.
 2,763,657 (*See Class 9 for this trademark*).

- 2,763,686. **MERGE2MEDIA AND DESIGN**. MERGE 2 MEDIA LLC, (U.S. CLS. 100 AND 101). SN 76-415,251. PUB. 6-24-2003. FILED 6-5-2002.
- 2,763,702 (*See Class 7 for this trademark*).
- 2,763,704. **MISCELLANEOUS DESIGN**. TRACTMANAGER, LLC, (U.S. CLS. 100 AND 101). SN 76-418,476. PUB. 6-24-2003. FILED 6-6-2002.
- 2,763,705. **TRACTMANAGER**. TRACTMANAGER, LLC, (U.S. CLS. 100 AND 101). SN 76-418,477. PUB. 6-24-2003. FILED 6-6-2002.
- 2,763,725 (*See Class 5 for this trademark*).
- 2,763,739. **RWK DESIGN**. RWK DESIGN, INC., (U.S. CLS. 100 AND 101). SN 76-423,799. PUB. 6-24-2003. FILED 6-21-2002.
- 2,763,756. **CLUSTERCARE**. CHAMPION SOLUTIONS GROUP, INC., (U.S. CLS. 100 AND 101). SN 76-426,327. PUB. 6-24-2003. FILED 6-28-2002.
- 2,763,767 (*See Class 35 for this trademark*).
- 2,763,785 (*See Class 38 for this trademark*).
- 2,763,791 (*See Class 9 for this trademark*).
- 2,763,809. **U AND DESIGN**. UNICENTRIC, INC., (U.S. CLS. 100 AND 101). SN 76-434,734. PUB. 6-24-2003. FILED 7-26-2002.
- 2,763,814 (*See Class 7 for this trademark*).
- 2,763,821 (*See Class 35 for this trademark*).
- 2,763,824. **ENTRAC**. ENTRAC TECHNOLOGIES INC., (U.S. CLS. 100 AND 101). SN 76-438,518. PUB. 6-24-2003. FILED 8-7-2002.
- 2,763,832. **SIGNATURE RESEARCH**. SIGNATURE RESEARCH, INC., (U.S. CLS. 100 AND 101). SN 76-439,732. PUB. 6-24-2003. FILED 8-13-2002.
- 2,763,855 (*See Class 9 for this trademark*).
- 2,763,856. **AMICUS LAW GROUP, PC**. AMICUS LAW GROUP, PC, (U.S. CLS. 100 AND 101). SN 76-444,277. PUB. 6-24-2003. FILED 8-28-2002.
- 2,763,874. **SMARTSAFE**. WAVE SYSTEMS CORP., (U.S. CLS. 100 AND 101). SN 76-448,814. PUB. 6-24-2003. FILED 9-12-2002.
- 2,763,882 (*See Class 38 for this trademark*).
- 2,763,897 (*See Class 40 for this trademark*).
- 2,763,925 (*See Class 37 for this trademark*).
- 2,763,942. **CSCI**. CRAWFORD SOFTWARE CONSULTING, INC., (U.S. CLS. 100 AND 101). SN 76-458,552. PUB. 6-24-2003. FILED 10-16-2002.
- 2,763,957. **SUNCHEMICALINK.COM**. SUN CHEMICAL CORPORATION, (U.S. CLS. 100 AND 101). SN 76-460,236. PUB. 6-24-2003. FILED 10-16-2002.
- 2,763,993 (*See Class 41 for this trademark*).
- 2,763,994 (*See Class 41 for this trademark*).
- 2,764,004 (*See Class 16 for this trademark*).
- 2,764,005 (*See Class 16 for this trademark*).
- 2,764,022 (*See Class 37 for this trademark*).
- 2,764,026. **TECHRANGERS**. UNIVERSITY OF CENTRAL FLORIDA, (U.S. CLS. 100 AND 101). SN 76-469,648. PUB. 6-24-2003. FILED 11-25-2002.
- 2,764,033. **ENTRIX**. ESOTERIX, INC., (U.S. CLS. 100 AND 101). SN 76-470,645. PUB. 6-24-2003. FILED 11-29-2002.
- 2,764,048. **ELTSIGNS.COM**. ELECTRONIC LABEL TECHNOLOGY, INC., (U.S. CLS. 100 AND 101). SN 76-472,197. PUB. 6-24-2003. FILED 12-3-2002.
- 2,764,050. **REGLERA**. REGLERA, LLC, (U.S. CLS. 100 AND 101). SN 76-472,248. PUB. 6-24-2003. FILED 12-5-2002.
- 2,764,089 (*See Class 35 for this trademark*).
- 2,764,102 (*See Class 1 for this trademark*).
- 2,764,120 (*See Class 7 for this trademark*).
- 2,764,121 (*See Class 16 for this trademark*).
- 2,764,131 (*See Class 35 for this trademark*).
- 2,764,134 (*See Class 9 for this trademark*).
- 2,764,138 (*See Class 1 for this trademark*).
- 2,764,148 (*See Class 38 for this trademark*).
- 2,764,149. **ENSO DESIGN**. ENSO DESIGN, (U.S. CLS. 100 AND 101). SN 78-091,637. PUB. 6-24-2003. FILED 11-5-2001.
- 2,764,158. **INFOPACK CONSULTING, INC. AND DESIGN**. INFOPACK CONSULTING, INC., (U.S. CLS. 100 AND 101). SN 78-100,675. PUB. 6-24-2003. FILED 1-3-2002.
- 2,764,159 (*See Class 35 for this trademark*).
- 2,764,164 (*See Class 9 for this trademark*).
- 2,764,172 (*See Class 36 for this trademark*).
- 2,764,191. **CAMION TECHNOLOGIES**. CAMION TECHNOLOGIES, LLC, (U.S. CLS. 100 AND 101). SN 78-111,005. PUB. 6-24-2003. FILED 2-26-2002.
- 2,764,200 (*See Class 35 for this trademark*).
- 2,764,210 (*See Class 37 for this trademark*).
- 2,764,218. **FAST TRACK AND DESIGN**. DUPONT PHOTO-MASKS, INC., (U.S. CLS. 100 AND 101). SN 78-127,586. PUB. 6-24-2003. FILED 5-9-2002.
- 2,764,264 (*See Class 37 for this trademark*).
- 2,764,267. **"NETWORK SECURITY IS OUR BUSINESS, BUILDING IT IS OUR PASSION"**. HEXIMER COMMUNICATIONS, INC., (U.S. CLS. 100 AND 101). SN 78-147,312. PUB. 6-24-2003. FILED 7-25-2002.
- 2,764,293. **TYPE A**. TYPE A MULTIMEDIA NETWORK, (U.S. CLS. 100 AND 101). SN 78-157,713. PUB. 6-24-2003. FILED 8-26-2002.
- 2,764,295. **IM IDENTITY MINE AND DESIGN**. IDENTITY-MINE, INCORPORATED, (U.S. CLS. 100 AND 101). SN 78-157,824. PUB. 6-24-2003. FILED 8-26-2002.
- 2,764,308. **DIGITAL DEFENSE**. DIGITAL DEFENSE INCORPORATED, (U.S. CLS. 100 AND 101). SN 78-162,921. PUB. 6-24-2003. FILED 9-11-2002.
- 2,764,315. **SUITESPOT**. SUITESPEED, INC., (U.S. CLS. 100 AND 101). SN 78-163,879. PUB. 6-24-2003. FILED 9-13-2002.
- 2,764,317 (*See Class 36 for this trademark*).
- 2,764,323. **IPEOPLE**. INTERFACE PEOPLE, LLC, (U.S. CLS. 100 AND 101). SN 78-168,432. PUB. 6-24-2003. FILED 9-26-2002.
- 2,764,330. **MOORECREATIVE**. MOORE, MICHAEL, (U.S. CLS. 100 AND 101). SN 78-171,968. PUB. 6-24-2003. FILED 10-8-2002.
- 2,764,339. **SPROUT STUDIOS AND DESIGN**. NOLLMAN, JORDAN, (U.S. CLS. 100 AND 101). SN 78-173,182. PUB. 6-24-2003. FILED 10-10-2002.
- 2,764,362 (*See Class 35 for this trademark*).
- 2,764,380. **CRADLE TO LIQUIDITY**. SHEPPARD MULLIN RICHTER & HAMPTON LLP, (U.S. CLS. 100 AND 101). SN 78-179,690. PUB. 6-24-2003. FILED 10-29-2002.
- 2,764,396. **FOTKI (STYLIZED)**. DMITRI, DON, (U.S. CLS. 100 AND 101). SN 78-181,149. PUB. 6-24-2003. FILED 11-2-2002.
- 2,764,400. **RDRAM**. RAMBUS INC., (U.S. CLS. 100 AND 101). SN 78-182,726. PUB. 6-24-2003. FILED 11-7-2002.
- 2,764,453 (*See Class 9 for this trademark*).
- 2,764,460 (*See Class 35 for this trademark*).
- 2,764,467. **MISCELLANEOUS DESIGN**. WOODARD, EM-HARDT, NAUGHTON, MORIARTY & MCNETT LLP, (U.S. CLS. 100 AND 101). SN 78-193,710. PUB. 6-24-2003. FILED 12-12-2002.

CLASS 43—HOTEL AND RESTAURANT SERVICES

- 2,763,461. **WINGS OF LIFE**. JORDAN, JULIE, (U.S. CLS. 100 AND 101). SN 76-358,241. PUB. 7-16-2002. FILED 1-14-2002.
- 2,763,470. **COCOA SUITES**. MSH SOUTH INC., (U.S. CLS. 100 AND 101). SN 76-362,473. PUB. 6-24-2003. FILED 1-25-2002.
- 2,763,483. **CAFE X-PRESS DELI CAFE AND DESIGN**. AMERICAN FOOD AND GUEST SERVICES, INC., (U.S. CLS. 100 AND 101). SN 76-366,966. PUB. 6-24-2003. FILED 2-6-2002.
- 2,763,496. **COUNTRY FAIR**. ROCKY MOUNTAIN ADVENTURES, LLC, (U.S. CLS. 100 AND 101). SN 76-376,391. PUB. 2-11-2003. FILED 2-28-2002.
- 2,763,509. **GRAND CENTRAL DINING CONCOURSE**. METROPOLITAN TRANSPORTATION AUTHORITY, (U.S. CLS. 100 AND 101). SN 76-380,850. PUB. 6-24-2003. FILED 3-12-2002.
- 2,763,510. **GCT GRAND CENTRAL DINING CONCOURSE AND DESIGN**. METROPOLITAN TRANSPORTATION AUTHORITY, (U.S. CLS. 100 AND 101). SN 76-380,851. PUB. 6-24-2003. FILED 3-12-2002.
- 2,763,526. **PERSONAL SHELTER PROJECT**. PERSONAL SHELTER PROJECT, INC., (U.S. CLS. 100 AND 101). SN 76-386,854. PUB. 6-24-2003. FILED 3-22-2002.
- 2,763,578. **JAPON2GO (STYLIZED)**. HASHIMOTO'S, LLC, (U.S. CLS. 100 AND 101). SN 76-398,809. PUB. 6-24-2003. FILED 4-22-2002.
- 2,763,585 (*See Class 28 for this trademark*).

2,763,716 (*See Class 30 for this trademark.*)
 2,763,722. **TROPICAL SMOOTHIE CAFE AND DESIGN.** TROPICAL SMOOTHIE FRANCHISE DEVELOPMENT CORPORATION, (U.S. CLS. 100 AND 101). SN 76-420,094. PUB. 6-24-2003. FILED 6-13-2002.
 2,763,724 (*See Class 41 for this trademark.*)
 2,763,752 (*See Class 35 for this trademark.*)
 2,763,821 (*See Class 35 for this trademark.*)
 2,763,870 (*See Class 25 for this trademark.*)
 2,763,920 (*See Class 41 for this trademark.*)
 2,763,946. **SONIO'S CAFE ROTISSERIE.** SOTERA'S, INC., (U.S. CLS. 100 AND 101). SN 76-459,201. PUB. 6-24-2003. FILED 10-11-2002.
 2,763,958. **LA FONTANA (STYLIZED).** SEGALL, E.M., (U.S. CLS. 100 AND 101). SN 76-460,380. PUB. 6-24-2003. FILED 10-22-2002.
 2,764,091. **FATZ.** CAFE ENTERPRISES, INC., (U.S. CLS. 100 AND 101). SN 76-484,281. PUB. 6-24-2003. FILED 1-22-2003.
 2,764,092. **FATZ CAFE.** CAFE ENTERPRISES, INC., (U.S. CLS. 100 AND 101). SN 76-484,283. PUB. 6-24-2003. FILED 1-22-2003.
 2,764,094. **CANNERY ROW.** CANNERY CASINO RESORTS, LLC, (U.S. CLS. 100 AND 101). SN 76-485,576. PUB. 6-24-2003. FILED 1-28-2003.
 2,764,095. **CANNERY ROW BUFFET AND DESIGN.** CANNERY CASINO RESORTS, LLC, (U.S. CLS. 100 AND 101). SN 76-485,577. PUB. 6-24-2003. FILED 1-28-2003.
 2,764,224. **EVENTSTYLE.** EVENTSTYLE, INC., (U.S. CLS. 100 AND 101). SN 78-130,139. PUB. 6-24-2003. FILED 5-21-2002.
 2,764,314. **LA BODEGUITA DEL MEDIO AND DESIGN.** EKWALL, MICHAEL ANDREW, (U.S. CLS. 100 AND 101). SN 78-163,843. PUB. 6-24-2003. FILED 9-13-2002.

CLASS 44—MEDICAL, BEAUTY AND AGRICULTURAL SERVICES

2,763,458. **A FILES AND DESIGN.** SCHERING CORPORATION, (U.S. CLS. 100 AND 101). SN 76-357,261. PUB. 7-9-2002. FILED 1-9-2002.
 2,763,501. **CARITA.** CARITA, (U.S. CLS. 100 AND 101). SN 76-378,550. PUB. 6-24-2003. FILED 3-4-2002.
 2,763,516 (*See Class 9 for this trademark.*)
 2,763,523 (*See Class 9 for this trademark.*)
 2,763,524 (*See Class 9 for this trademark.*)
 2,763,540. **PRO-SCREENER.** PISCOTTANO, MAURICE, (U.S. CLS. 100 AND 101). SN 76-390,581. PUB. 6-24-2003. FILED 4-1-2002.
 2,763,543. **WEBHHLA.** HOME HEALTHCARE LABORATORY OF AMERICA, INC., (U.S. CLS. 100 AND 101). SN 76-391,184. PUB. 6-24-2003. FILED 4-3-2002.
 2,763,609 (*See Class 9 for this trademark.*)
 2,763,677. **ERGOSCIENCE.** ERGOSCIENCE, INC., (U.S. CLS. 100 AND 101). SN 76-413,677. PUB. 6-24-2003. FILED 5-29-2002.
 2,763,699 (*See Class 9 for this trademark.*)
 2,763,747 (*See Class 41 for this trademark.*)
 2,763,788. **MGGOBARDVM AND DESIGN.** GOBAR, GLENNA M., (U.S. CLS. 100 AND 101). SN 76-431,181. PUB. 6-24-2003. FILED 7-16-2002.
 2,763,820 (*See Class 16 for this trademark.*)
 2,763,854 (*See Class 16 for this trademark.*)
 2,763,894. **DICOA.** MANSUETO, ROBERT F., (U.S. CLS. 100 AND 101). SN 76-452,317. PUB. 6-24-2003. FILED 9-23-2002.
 2,763,962 (*See Class 35 for this trademark.*)
 2,763,963 (*See Class 35 for this trademark.*)
 2,764,001 (*See Class 36 for this trademark.*)
 2,764,041. **OUR WORK IS TREE-MENDOUS.** HANSEN'S TREE, LAWN & LANDSCAPING SERVICES, INC., (U.S. CLS. 100 AND 101). SN 76-471,588. PUB. 6-24-2003. FILED 12-2-2002.
 2,764,133. **AMERICHOICE PERSONAL CARE MODEL AND DESIGN.** AMERICHOICE CORPORATION, BY ASSIGNMENT AMERICHOICE HEALTH SERVICES, INC., (U.S. CLS. 100 AND 101). SN 78-072,040. PUB. 6-24-2003. FILED 7-2-2001.
 2,764,165 (*See Class 35 for this trademark.*)

2,764,179 (*See Class 29 for this trademark.*)
 2,764,242 (*See Class 35 for this trademark.*)
 2,764,250. **MOTIONWISE.** MOTIONWISE, LLC, (U.S. CLS. 100 AND 101). SN 78-139,309. PUB. 6-24-2003. FILED 6-27-2002.
 2,764,403. **GET YOUR SCREEN TEST.** AMERICAN CANCER SOCIETY, INC., (U.S. CLS. 100 AND 101). SN 78-183,087. PUB. 6-24-2003. FILED 11-8-2002.
 2,764,454. **MULCHAPPLIER.** CEDAR HILL LANDSCAPING, (U.S. CLS. 100 AND 101). SN 78-190,665. PUB. 6-24-2003. FILED 12-3-2002.

CLASS 45—PERSONAL SERVICES

2,763,521 (*See Class 9 for this trademark.*)
 2,763,681 (*See Class 41 for this trademark.*)
 2,763,741. **CLICKDATE.** CLICKDATE, INC., (U.S. CLS. 100 AND 101). SN 76-424,367. PUB. 6-24-2003. FILED 6-21-2002.
 2,763,769. **CORAL RIDGE MINISTRIES.** CORAL RIDGE MINISTRIES MEDIA, INC., (U.S. CLS. 100 AND 101). SN 76-428,950. PUB. 6-24-2003. FILED 7-9-2002.
 2,763,777. **STILLSECURE.** LATIS NETWORKS, INC., (U.S. CLS. 100 AND 101). SN 76-429,758. PUB. 6-24-2003. FILED 7-9-2002.
 2,763,799 (*See Class 9 for this trademark.*)
 2,763,881. **VERISPEC.** PIC USA, INC., (U.S. CLS. 100 AND 101). SN 76-450,290. PUB. 6-24-2003. FILED 9-17-2002.
 2,763,905. **XPRESSGUARD.** CIA SECURITY SERVICES INC., (U.S. CLS. 100 AND 101). SN 76-453,988. PUB. 6-24-2003. FILED 9-30-2002.
 2,763,926. **S.T.A.N.D.U.P..** S.T.A.N.D.U.P., INC., (U.S. CLS. 100 AND 101). SN 76-456,422. PUB. 6-24-2003. FILED 10-7-2002.
 2,763,975. **ASURETEE AND DESIGN.** FIRST DATA CORPORATION, (U.S. CLS. 100 AND 101). SN 76-462,512. PUB. 6-24-2003. FILED 10-22-2002.
 2,764,159 (*See Class 35 for this trademark.*)
 2,764,331. **ROOM TO HOME.** CREATIVE PET PRODUCTS, INC., (U.S. CLS. 100 AND 101). SN 78-172,023. PUB. 6-24-2003. FILED 10-8-2002.

* * * * *

SECTION 2.—PRIOR UNITED STATES CLASSIFICATION

COLLECTIVE MEMBERSHIP MARKS

CLASS 200—COLLECTIVE MEMBERSHIP

2,763,650. **BUSINESS MASTERS AND DESIGN.** THE NATIONAL EXCHANGE CLUB, SN 76-409,573. PUB. 6-24-2003. FILED 5-16-2002.

2,763,651. **BUSINESS MASTERS.** THE NATIONAL EXCHANGE CLUB, SN 76-409,574. PUB. 6-24-2003. FILED 5-16-2002.

CERTIFICATION MARKS

CLASS A—GOODS

2,764,214. **VERMONT ORGANIC CERTIFIED VERMONT ORGANIC FARMERS P.O. BOX 697 RICHMOND, VT 05477 434-4122 AND DESIGN.** VERMONT ORGANIC FARMERS, LLC, SN 78-127,440. PUB. 6-24-2003. FILED 5-9-2002.

CLASS B—SERVICES

2,763,668. **A+.** THE COMPUTING TECHNOLOGY INDUSTRY ASSOCIATION, INC., SN 76-412,368. PUB. 6-24-2003. FILED 5-14-2002.

* * * * *

TRADEMARK REGISTRATIONS ISSUED UNDER SECTION 1(d)

The following marks have registered on the Principal Register pursuant to the intent-to-use provisions of Section 1(d) of the Trademark Act of 1946, as amended.

SECTION 1.— INTERNATIONAL CLASSIFICATION

The short titles associated below with the international class numbers are terms designed merely for quick identification and are not an official part of the international classification. The full names of international classes are given in section 6.1 of the trademark rules of practice.

The designation "U.S. Cl." appearing in this section refers to the U.S. class in effect prior to Sep. 1, 1973 rather than the international class which applies to applications filed on or after that date. For adoption of international classification see notice in the OFFICIAL GAZETTE of Jun. 26, 1973 (911 O.G. TM 210).

Application in more than one class

2,764,474. VERITEL TECHNOLOGIES INC., NEW YORK, NY. SN 75-056,709. PUB. 2-10-1998, FILED 2-12-1996.

VERITELNET

CLASS 35—ADVERTISING AND BUSINESS

FOR ADVERTISING SERVICES, NAMELY, CREATING AND DISPLAYING BUSINESS INFORMATION, ADVERTISING AND DESCRIPTIONS OF PRODUCTS OF OTHERS VIA TELEPHONE, MAIL, FACSIMILE TRANSMISSION, AND AN INTERACTIVE COMPUTER COMMUNICATIONS NETWORK; PROVIDING MARKETING AND BUSINESS DEVELOPMENT CONSULTATION, NAMELY, ASSISTING AND ADVISING OTHERS IN THE DISPLAY OF BUSINESS INFORMATION, ADVERTISING AND DESCRIPTIONS OF PRODUCTS VIA TELEPHONE, MAIL FACSIMILE TRANSMISSION, AND AN INTERACTIVE COMPUTER COMMUNICATIONS NETWORK; MANAGEMENT CONSULTING SERVICES, NAMELY, ADVISING OTHERS IN THE PLANNING, IMPLEMENTING, OPERATING, MANAGING AND STAFFING OF TELECOMMUNICATIONS AND COMPUTER NETWORKS (U.S. CLS. 100, 101 AND 102).

FIRST USE 1-0-2000; IN COMMERCE 1-0-2000.

CLASS 38—COMMUNICATION

FOR TELECOMMUNICATIONS SERVICES, NAMELY, ELECTRONIC TRANSMISSION OF VOICE, FACSIMILE, VIDEO, DATA, IMAGES, COMPUTER SOFTWARE AND DOCUMENTS VIA COMPUTER TERMINALS, TELEPHONES, SATELLITES AND GLOBAL AND WIDE-AREA COMPUTER AND TELECOMMUNICATIONS NETWORKS; ELECTRONIC MAIL SERVICES (U.S. CLS. 100, 101 AND 104).

FIRST USE 1-0-2000; IN COMMERCE 1-0-2000.

CLASS 42—SCIENTIFIC, COMPUTER AND LEGAL SERVICES

FOR COMPUTER AND DATA NETWORK SERVICES, NAMELY, PROVIDING ACCESS TO AND LEASING ACCESS TIME TO A GLOBAL AND WIDE-AREA COMPUTER INFORMATION NETWORK AND TO COMPUTER DATABASES AND COMPUTER INFORMATION SERVICES IN THE NATURE OF COMPUTER BULLETIN BOARDS AND COMPUTER NETWORKS, RESEARCH AND REFERENCE MATERIALS IN THE FIELDS OF NEWS, BUSINESS, FINANCE, INVESTMENTS, ENTERTAINMENT, COMPUTING, COMPUTER SOFTWARE, WEATHER, TRAVEL, EDUCATION AND TOPICS OF GENERAL INTEREST AND FOR ONLINE PERSONAL AND BUSINESS COMMUNICATION; COMPUTER SER-

VICES, NAMELY, PROVIDING ACCESS TO ONLINE COMPUTER SERVICES, COMPUTER CONSULTATION, RESEARCH, PROGRAMMING AND SOFTWARE DESIGN SERVICES FOR OTHERS; OUTSOURCED ELECTRONIC STORAGE AND RETRIEVAL SERVICES, NAMELY, THE MAINTENANCE FOR OTHERS OF DATABASES CONTAINING VOICE, DATA, INFORMATION, COMPUTER SOFTWARE, IMAGES AND DOCUMENTS, WHICH DATABASES MAY BE ACCESSED AND MODIFIED VIA COMPUTER TERMINALS, TELEPHONES, SATELLITES AND GLOBAL AND WIDE-AREA COMPUTER TELECOMMUNICATIONS NETWORKS AND THEN RE-STORED FOR SUBSEQUENT FURTHER ACCESS, USE AND MODIFICATION; REMOTE BACKUP SERVICES; RETAIL AND WHOLESALE SERVICES VIA TELEPHONE, MAIL, COURIER, FACSIMILE TRANSMISSION AND AN INTERACTIVE COMPUTER NETWORK IN THE FIELDS OF ACCOUNTING, SPORTSWEAR, LINGERIE, HOISERY, ADHESIVES, AEROBICS, AFGHANS, ARTS AND CRAFTS, AIR FILTER AND PURIFICATION SYSTEMS, WATER FILTERS AND WATER PURIFICATION SYSTEMS, AIRCRAFT SUPPLIES AND EQUIPMENT, ANIMATION, ANTIQUES AND REPRODUCTIONS, SILVERWARE RESTORATION, APPLIANCES, AROMATHERAPY, ART SUPPLIES AND EQUIPMENT, NECKTIES, CLOTHING, ORIGINAL ART, ARTIFICIAL FLOWERS AND PLANTS, ARTWORK POSTERS, PAINTINGS AND PRINTS, AUDIO BOOKS, SELF-HELP AUDIO TAPES, AUDIO CASSETTES, RECORDS AND COMPACT DISCS, HIGH-END AND LOW-END AUDIO ACCESSORIES, BOOKS AND PERIODICALS, AUTOMOBILE BUYING SERVICE, AUTOMOBILE CLEANING ACCESSORIES, AUTOMOTIVE PARTS, SUPPLIES AND ACCESSORIES, AUTOMOTIVE ENGINE PARTS AND SUPPLIES, AUTOMOBILE STEREO EQUIPMENT, HOME STEREO EQUIPMENT, TRUCK PARTS AND SUPPLIES, AUTOMOBILE, VAN, SPORTS UTILITY VEHICLE AND TRUCK AFTERMARKET ACCESSORIES, MOTORCYCLE PARTS AND ACCESSORIES, AUTOGRAPHS, VINYL DECALS, AWARDS AND TROPHIES, BATHROOM FIXTURES AND ACCESSORIES, BICYCLES AND ACCESSORIES, BICYCLE TOURS, SCIENTIFIC RESEARCH EQUIPMENT AND SUPPLIERS, BIRD FEEDERS AND HOUSES, BLANKETS, BOAT BUILDING KITS, BOATING SUPPLIES, ACCESSORIES AND EQUIPMENT, PROPELLERS, CANOES AND KAYAKS, YACHTS, BOWLING EQUIPMENT, BUSINESS AND COMPUTER SKILLS, CALENDARS, CALLIGRAPHY, CAMCORDERS AND CAMCORDER ACCESSORIES, CAMPING AND BACKPACKING, CAMPING AND BACKPACKING SUPPLIES AND EQUIPMENT, CANDLES AND CANDLEMAKING, CARPETING, COMPACT DISCS AND PHONOGRAPH RECORDS, CD-ROM SERVICES, CD-ROMS, CATALOGS, CELLULAR PHONES AND PAGERS AND ACCESSORIES, CERAMIC DECORATIVE ITEMS, CHILDCARE, PARENTING AND PREGNANCY, CHINA, POTTERY AND STONWARE, CHRISTMAS COLLECTIBLES, CHRISTMAS DECORATIONS AND ORNAMENTS, CIGARS AND TOBACCO,

CLEANING PRODUCTS, CLOCKS, MUSIC BOXES, COLOGNES AND PERFUMES, COLLECTIBLES, COMMUNICATIONS, COMPUTER FURNITURE, COMPUTER HARDWARE AND SOFTWARE, COMPUTER PERIPHERALS, SUPPLIES AND ACCESSORIES, COMPUTER MEDIA, VIDEOS, CD-ROM STORAGE, LAPTOP COMPUTER CARRYING CASES, COMPUTER MEMORY, CONTACT LENSES, COOKING SUPPLIES AND RECIPES, COPIER AND FAX SUPPLIES, COPIERS AND FAX MACHINES, COSMETICS AND SKIN CARE, CRAFT KITS, CRAFT SUPPLIES, CRYSTAL AND GLASSWARE, CURTAINS, DRAPES AND BLINDS, CUSTOM EMBROIDERY, CUSTOM-IMPRINTED MUGS, GLASSWARE AND CHINA, DANCEWEAR, DECORATIVE ALUMINUM MAILBOXES, DECORATIVE OUTDOOR LIGHTING, DECORATIVE PAINT AND CERAMIC PAINT BRUSHES, DIABETIC SUPPLIES, DIABETIC FOOD, DISPLAY FIXTURES AND PORTABLE EXHIBITS, DOLLHOUSES AND MINIATURES, DOLLS, DOWN COMFORTERS, PILLOWS, FEATHERBEDS AND ACCESSORIES, EDUCATIONAL IMPRINTED SUPPLIES AND GRADUATION APPAREL, EDUCATIONAL TEAM UNIFORMS, SPORT EQUIPMENT, EDUCATION MATERIALS, EDUCATIONAL TOYS AND GAMES, EDUCATIONAL VIDEOS AND CD-ROMS, ELECTRONIC TUBES, ELECTRONICS EQUIPMENT AND COMPONENTS, TOOLS AND ACCESSORIES FOR ELECTRONIC EQUIPMENT, RADIOS AND ACCESSORIES, ENVIRONMENTAL PRODUCTS, EXERCISE EQUIPMENT, FABRICS AND TRIM, WATCHES, FASHION ACCESSORIES, HANDBAGS, WRITING INSTRUMENTS AND REFILLS, FISHING EQUIPMENT, FLAGS AND FLAG POLES, FLOWERS AND PLANTS, ARTIFICIAL FLOWERS AND PLANTS, DRIED FLOWERS, FLY TYING AND FLY FISHING, FOOD DEHYDRATORS, DRIED FRUITS AND NUTS, CAKES AND COOKIES, FRUITS AND VEGETABLES, FOOD, CANDY, FOOD GIFT ASSORTMENTS, GOURMET COFFEE, GOURMET SAUCES, GOURMET TEAS, HEALTH AND NATURAL FOOD, HERBS AND SPICES, FRUITCAKES, ORGANIC FOOD, PRESERVES, JELLIES AND HONEY, SEASONINGS AND CONDIMENTS, SUGAR-FREE AND DIETETIC FOOD, GLUTEN-FREE FOODS, COCOA, SPECIALTY AND GOURMET FOODS, FOOTWEAR, FULL-SIZE WOODEN CAROUSELS, FURNITURE REPRODUCTIONS, BEDS, FURNITURE, HOME FURNISHINGS, OFFICE FURNITURE, OUTDOOR FURNITURE, RESTORATION OF ANTIQUE TRUNKS, WICKER AND RATTAN FURNITURE, GARDENING EQUIPMENT AND SUPPLIES, GREENHOUSES, SEEDLINGS AND TRANSPLANTS, EXOTIC SEEDS, FLOWERS, BULBS AND PERENNIALS, GIFTS, BONSAI PLANTS, HANDCRAFTED GIFTS, RELIGIOUS GIFTS, ROMANCE GIFTS, SPORTS GIFTS, GOLF EQUIPMENT AND ACCESSORIES, GOLF CART PARTS AND ACCESSORIES, GOLF CLOTHING, GOLF CLUBS, GOLF COLLECTIBLES, GRAIN AND CORN MILLS, GREETING CARDS, AIR GUNS AND SUPPLIES, GUNS AND AMMUNITION, GUNSMITHING VIDEOS, TOOLS AND ACCESSORIES, HAIRGOODS, HANDWRITING ANALYSIS, HATS, HEALTH AND NUTRITION, HEALTH AIDS, HEALTH AND FITNESS, MEDICINE, SELF HELP, HEALTH CARE SUPPLIES AND AIDS FOR THE DISABLED, HEARTBURN, HOME CLEANING PRODUCTS, HEARING AND COMMUNICATION AIDS, HERBAL MEDICINE AND OTHER HERBAL PRODUCTS, DRIED HERBS AND PLANTS, HOBBIES AND GAMES, HOME AUTOMATION, HOME BUILDING AND IMPROVEMENTS, STAIRWAYS, HOME BUSINESS OPPORTUNITIES, HOME DECORATIONS AND ACCESSORIES, LOG HOMES, HORSE AND STABLE SUPPLIES AND EQUIPMENT, HORSE DRAWN VEHICLES, HOT TUBS AND SAUNAS, HOUSEWARES, HUNTING ACCESSORIES, HUNTING CLOTHING AND EQUIPMENT, HYDROPONICS, HYPNOSIS, INCENSE AND ACCESSORIES, INDUSTRIAL GOODS, EQUIPMENT AND SUPPLIES, INDUSTRIAL RUBBER PRODUCTS, SWEATERS, JAPANESE BOOKS AND VIDEOS, JAPANESE SOFTWARE, JAPANESE SPECIALTY ITEMS, JET SKIS, JEWELRY, BEADS, DIAMONDS, SIMULATED DIAMONDS, JUDAICA, KALEIDOSCOPIES, POSTCARDS, KITCHEN UTENSILS AND COOKWARE, KNIVES AND KNIFE-MAKING, LADDERS, SLEEPWEAR, LAMPS AND LIGHTING, LASER VIDEO DISCS AND PLAYERS, LEARNING ELECTRONICS, AGRICULTURAL AND GREENHOUSE LIGHTING, LINENS AND DOMESTICS, LONG DISTANCE TELEPHONE SERVICE, LUGGAGE AND BRIEFCASES, MAGIC TRICKS AND VENTRILOQUISM, MARRIAGE, RELATIONSHIP AND PERSONAL

GROWTH, MARTIAL ARTS, MASSAGE THERAPY, MEDICAL ALERT INFORMATION PRODUCTS, INCONTINENCE PRODUCTS, MOVIES AND TELEVISION MEMORABILIA, MILITARY MEMORABILIA, PICTURE AND INTERIOR DESIGN MOULDINGS AND FRAMES, MOVIE AND TELEVISION SCRIPTS, SHEET MUSIC, MOVIE POSTERS, FILMS, MULTI-MEDIA STORAGE CABINETS, MUSIC, MUSICAL INSTRUMENTS, MUSICAL KEYBOARD ACCESSORIES, NATURAL HEALTH, NUTRITIONAL SUPPLEMENTS, OFFICE AND BUSINESS SUPPLIES, OPERA VIDEOS, PAPER-CRAFT SUPPLIES, PERFUME, PEST CONTROL DEVICES, PET FOOD AND SUPPLEMENTS, PET SUPPLIES, BIRD SUPPLIES, DOG AND CAT SUPPLIES, KENNELS AND ENCLOSURES, PET DOORS, PHOTOGRAPHY BAGS AND CAMERA CASES, NEW AND USED CAMERAS, PHOTOGRAPHY DEVELOPING KITS AND ACCESSORIES, PHOTOGRAPHIC FILM, OUTDOOR PHOTOGRAPHY EQUIPMENT, PHOTO PROCESSING, PHOTOGRAPHY STORAGE AND FILING SYSTEMS, LIGHTING AND DARKROOM EQUIPMENT, DIGITIZED PHOTOGRAPHS, DIGITIZATION OF PHOTOGRAPHS, PRODUCTS FOR THE PHYSICALLY HANDICAPPED, PICTURE FRAMING AND SUPPLIES, PLAYER PIANO ROLLS, POLITICAL MEMORABILIA, POTPOURRI, PREPAID PHONE CARDS, PRINTER RIBBONS, PROMOTIONAL ITEMS, PUZZLES, QUILTING, RADIO CONTROL MODEL AIRPLANES, AMATEUR RADIO EQUIPMENT, RAFTING AND WHITEWATER RAFTING EQUIPMENT, RECIPES, RUBBER STAMPS, RUGS, SATELLITE TELEVISION EQUIPMENT AND ACCESSORIES, SAUNA STOVES, SCIENCE FICTION COLLECTIBLES, SCIENTIFIC RESEARCH EXPEDITIONS, HOME AND BUSINESS SECURITY, SEWING, SHOES AND BOOTS, SHOWER FILTERS, SHUTTERS AND SHUTTER HARDWARE, SIGN AND SIGN-MAKING, DECALS AND BUMPER STICKERS, SILK-SCREENING, SILVER AND FLATWARE, SKATEBOARDING CLOTHING AND EQUIPMENT, SKATEBOARDS, SKIING CLOTHING AND EQUIPMENT, SKIN CARE, SKULL CAPS AND YARMULKAS, SLIDES AND PRESENTATION MATERIALS, SMOKING ACCESSORIES, SOUVENIRS, SPORTING EQUIPMENT, SPY EQUIPMENT, STAMPS AND COINS, STATIONERY, STEREOS AND COMPACT DISC PLAYERS, STRESS REDUCTION, SUNGLASSES AND EYEWEAR, HOME, LAPTOP, INDUSTRIAL AND COMMERCIAL SURGE PROTECTORS, SURPLUS AND LIQUIDATION MERCHANDISE, TATTOO EQUIPMENT AND SUPPLIES, TELEPHONES AND ANSWERING MACHINES, TENNIS CLOTHING, EQUIPMENT AND ACCESSORIES, TAPESTRY PRODUCTS, HAND AND POWER TOOLS, TOYS, TRAVEL, TRAVEL GEAR, INTERNATIONAL ADVENTURE TRAVEL, OUTDOOR ADVENTURE TRAVEL, LIFT TRUCKS AND PARTS, TELEVISION, TELESCOPES, BINOCULARS AND OPTICAL EQUIPMENT AND ACCESSORIES, VIDEO CASSETTE RECORDER (VCR) AND CABLE TELEVISION EQUIPMENT, SUPPLIES AND ACCESSORIES, VACUUM CLEANERS, VIDEO EQUIPMENT, PRODUCTS FOR THE VISUALLY CHALLENGED AND THE BLIND, VITAMINS AND MINERALS, WALLETS AND PURSES, WATER SKIING CLOTHING AND EQUIPMENT, WEATHER INSTRUMENTS, WEDDING FAVORS, INVITATIONS AND ACCESSORIES, WEIGHT LOSS, WIGS AND HAIRPIECES, WINE, BREWING AND BEER MAKING, WINE CELLARS AND RACKS, WINE ACCESSORIES, SUN VISORS, WOODCRAFTING EQUIPMENT, PARTS AND SUPPLIES AND WROUGHT IRON ART, YARN, FABRIC AND TEXTILES; LOGISTICAL SERVICES, NAMELY, SALES AND PAYMENT PROCESSING, SALES FULFILLMENT, BILLING, AGENCY, REPRESENTATION AND DISTRIBUTION SERVICES AND OTHERWISE EFFECTING TRANSACTIONS (AS AN AGENT OR AS A PRINCIPAL) FOR GOODS IN THE FIELDS OF ACCOUNTING, SPORTSWEAR, LINGERIE, HOISERY, ADHESIVES, AEROBICS, AFGHANS, ARTS AND CRAFTS, AIR FILTERS AND PURIFICATION SYSTEMS, WATER FILTERS AND WATER PURIFICATION SYSTEMS, AIRCRAFT SUPPLIES AND EQUIPMENT, ANIMATION, ANTIQUES AND REPRODUCTIONS, SILVERWARE RESTORATION, APPLIANCES, AROMATHERAPY, ART SUPPLIES AND EQUIPMENT, NECKTIES, CLOTHING, ORIGINAL ART, ARTIFICIAL FLOWERS AND PLANTS, ARTWORK POSTERS, PAINTINGS AND PRINTS, AUDIO BOOKS, SELF-HELP AUDIO TAPES, AUDIO CASSETTES, RECORDS AND COMPACT DISCS, HIGH-END AND LOW-END AUDIO ACCESSORIES, BOOKS AND PERIODICALS, AUTOMOBILE BUYING SERVICE,

AUTOMOBILE CLEANING ACCESSORIES, AUTOMOTIVE PARTS, SUPPLIES AND ACCESSORIES, AUTOMOTIVE ENGINE PARTS AND SUPPLIES, AUTOMOBILE STEREO EQUIPMENT, HOME STEREO EQUIPMENT, TRUCK PARTS AND SUPPLIES, AUTOMOBILE, VAN, SPORTS UTILITY VEHICLE AND TRUCK AFTERMARKET ACCESSORIES, MOTORCYCLE PARTS AND ACCESSORIES, AUTOGRAPHS, VINYL DECALS, AWARDS AND TROPHIES, BATHROOM FIXTURES AND ACCESSORIES, BICYCLES AND ACCESSORIES, BICYCLE TOURS, SCIENTIFIC RESEARCH EQUIPMENT AND SUPPLIES, BIRD FEEDERS AND HOUSES, BLANKETS, BOAT BUILDING KITS, BOATING SUPPLIES, ACCESSORIES AND EQUIPMENT, PROPELLERS, CANOES AND KAYAKS, YACHTS, BOWLING EQUIPMENT, BUSINESS AND COMPUTER SKILLS, CALENDARS, CALLIGRAPHY, CAMCORDERS AND CAMCORDER ACCESSORIES, CAMPING AND BACKPACKING, CAMPING AND BACKPACKING SUPPLIES AND EQUIPMENT, CANDLES AND CANDLEMAKING, CARPETING, COMPACT DISCS AND PHONOGRAPH RECORDS, CD-ROM SERVICES, CD-ROMS, CATALOGS, CELLULAR PHONES AND PAGERS AND ACCESSORIES, CERAMIC DECORATIVE ITEMS, CHILDCARE, PARENTING AND PREGNANCY, CHINA, POTTERY AND STONWARE, CHRISTMAS COLLECTIBLES, CHRISTMAS DECORATIONS AND ORNAMENTS, CIGARS AND TOBACCO, CLEANING PRODUCTS, CLOCKS, MUSIC BOXES, COLOGNES AND PERFUMES, COLLECTIBLES, COMMUNICATIONS, COMPUTER ACCESSORIES, COMPUTER FURNITURE, COMPUTER HARDWARE AND SOFTWARE, COMPUTER PERIPHERALS, SUPPLIES AND ACCESSORIES, COMPUTER MEDIA, VIDEOS, CD-ROM STORAGE, LAPTOP COMPUTER CARRYING CASES, COMPUTER MEMORY, CONTACT LENSES, COOKING SUPPLIES AND RECIPES, COPIER AND FAX SUPPLIES, COPIERS AND FAX MACHINES, COSMETICS AND SKIN CARE, CRAFT KITS, CRAFT SUPPLIES, CRYSTAL AND GLASSWARE, CURTAINS, DRAPES AND BLINDS, CUSTOM EMBROIDERY, CUSTOM-IMPRINTED MUGS, GLASSWARE AND CHINA, DANCEWEAR, DECORATIVE ALUMINUM MAILBOXES, DECORATIVE OUTDOOR LIGHTING, DECORATIVE PAINT AND CERAMIC PAINT BRUSHES, DIABETIC SUPPLIES, DIABETIC FOOD, DISPLAY FIXTURES AND PORTABLE EXHIBITS, DOLLHOUSES AND MINIATURES, DOLLS, DOWN COMFORTERS, PILLOWS, FEATHERBEDS AND ACCESSORIES, EDUCATIONAL IMPRINTED SUPPLIES AND GRADUATION APPAREL, EDUCATIONAL TEAM UNIFORMS, SPORT EQUIPMENT, EDUCATIONAL MATERIALS, EDUCATIONAL TOYS AND GAMES, EDUCATIONAL VIDEOS AND CD-ROMS, ELECTRONIC TUBES, ELECTRONICS EQUIPMENT AND COMPONENTS, TOOLS AND ACCESSORIES FOR ELECTRONIC EQUIPMENT, RADIOS AND ACCESSORIES, ENVIRONMENTAL PRODUCTS, EXERCISE EQUIPMENT, FABRICS AND TRIM, WATCHES, FASHION ACCESSORIES, HANDBAGS, WRITING INSTRUMENTS AND REFILLS, FISHING EQUIPMENT, FLAGS AND FLAG POLES, FLOWERS AND PLANTS, ARTIFICIAL FLOWERS AND PLANTS, DRIED FLOWERS, FLY TYING AND FLY FISHING, FOOD DEHYDRATORS, DRIED FRUITS AND NUTS, CAKES AND COOKIES, FRUITS AND VEGETABLES, FOOD, CANDY, FOOD GIFT ASSORTMENTS, GOURMET COFFEE, GOURMET SAUCES, GOURMET TEAS, HEALTH AND NATURAL FOOD, HERBS AND SPICES, FRUITCAKES, ORGANIC FOOD, PRESERVES, JELLIES AND HONEY, SEASONINGS AND CONDIMENTS, SUGAR-FREE AND DIETETIC FOOD, GLUTEN-FREE FOODS, COCOA, SPECIALTY AND GOURMET FOODS, FOOTWEAR, FULL-SIZE WOODEN CAROUSELS, FURNITURE REPRODUCTIONS, BEDS, FURNITURE, HOME FURNISHINGS, OFFICE FURNITURE, OUTDOOR FURNITURE, RESTORATION OR ANTIQUE TRUNKS, WICKER AND RATTAN FURNITURE, GARDENING EQUIPMENT AND SUPPLIES, GREENHOUSES, SEEDLINGS AND TRANSPLANTS, EXOTIC SEEDS, FLOWERS, BULBS AND PERENNIALS, GIFTS, BONSAI PLANTS, HANDCRAFTED GIFTS, RELIGIOUS GIFTS, ROMANCE GIFTS, SPORTS GIFTS, GOLF EQUIPMENT AND ACCESSORIES, GOLF CART PARTS AND ACCESSORIES, GOLF CLOTHING, GOLF CLUBS, GOLF COLLECTIBLES, GRAIN AND CORN MILLS, GREETING CARDS, AIR GUNS AND SUPPLIES, GUNS AND AMMUNITION, GUNSMITHING VIDEOS, TOOLS AND ACCESSORIES, HAIRGOODS, HANDWRITING ANALYSIS, HATS, HEALTH AND NUTRITION,

HEALTH AIDS, HEALTH AND FITNESS, MEDICINE, SELF HELP, HEALTH CARE SUPPLIES AND AIDS FOR THE DISABLED, HEARTBURN, HOME CLEANING PRODUCTS, HEARING AND COMMUNICATION AIDS, HERBAL MEDICINE AND OTHER HERBAL PRODUCTS, DRIED HERBS AND PLANTS, HOBBIES AND GAMES, HOME AUTOMATION, HOME BUILDING AND IMPROVEMENTS, STAIRWAYS, HOME BUSINESS OPPORTUNITIES, HOME DECORATIONS AND ACCESSORIES, LOG HOMES, HORSE AND STABLE SUPPLIES AND EQUIPMENT, HORSE DRAWN VEHICLES, HOT TUBS AND SAUNAS, HOUSEWARES, HUNTING ACCESSORIES, HUNTING CLOTHING AND EQUIPMENT, HYDROPONICS, HYPNOSIS, INCENSE AND ACCESSORIES, INDUSTRIAL GOODS, EQUIPMENT AND SUPPLIES, INDUSTRIAL RUBBER PRODUCTS, SWEATERS, JAPANESE BOOKS AND VIDEOS, JAPANESE SOFTWARE, JAPANESE SPECIALTY ITEMS, JET SKIS, JEWELRY, BEADS, DIAMONDS, SIMULATED DIAMONDS, JUDAICA, KALEIDOSCOPIES, POSTCARDS, KITCHEN UTENSILS AND COOKWARE, KNIVES AND KNIFE-MAKING, LADDERS, SLEEPWEAR, LAMPS AND LIGHTING, LASER VIDEO DISCS AND PLAYERS, LEARNING ELECTRONICS, AGRICULTURAL AND GREENHOUSE LIGHTING, LINENS AND DOMESTICS, LONG DISTANCE TELEPHONE SERVICE, LUGGAGE AND BRIEFCASES, MAGIC TRICKS AND VENTRILOQUISM, MARRIAGE, RELATIONSHIP AND PERSONAL GROWTH, MARTIAL ARTS, MASSAGE THERAPY, MEDICAL ALERT INFORMATION PRODUCTS, INCONTINENCE PRODUCTS, MOVIES AND TELEVISION MEMORABILIA, MILITARY MEMORABILIA, PICTURE AND INTERIOR DESIGN MOULDINGS AND FRAMES, MOVIE AND TELEVISION SCRIPTS, SHEET MUSIC, MOVIE POSTERS, FILMS, MULTI-MEDIA STORAGE CABINETS, MUSIC, MUSICAL INSTRUMENTS, MUSICAL KEYBOARD ACCESSORIES, NATURAL HEALTH, NUTRITIONAL SUPPLEMENTS, OFFICE AND BUSINESS SUPPLIES, OPERA VIDEOS, PAPERCRAFT SUPPLIES, PERFUME, PEST CONTROL DEVICES, PET FOOD AND SUPPLEMENTS, PET SUPPLIES, BIRD SUPPLIES, DOG AND CAT SUPPLIES, KENNELS AND ENCLOSURES, PET DOORS, PHOTOGRAPHY BAGS AND CAMERA CASES, NEW AND USED CAMERAS, PHOTOGRAPHY DEVELOPING KITS AND ACCESSORIES, PHOTOGRAPHIC FILM, OUTDOOR PHOTOGRAPHY EQUIPMENT, PHOTO PROCESSING, PHOTOGRAPHY STORAGE AND FILING SYSTEMS, LIGHTING AND DARKROOM EQUIPMENT, DIGITIZED PHOTOGRAPHS, DIGITIZATION OF PHOTOGRAPHS, PRODUCTS FOR THE PHYSICALLY HANDICAPPED, PICTURE FRAMING AND SUPPLIES, PLAYER PIANO ROLLS, POLITICAL MEMORABILIA, POTPOURRI, PREPAID PHONE CARDS, PRINTER RIBBONS, PROMOTIONAL ITEMS, PUZZLES, QUILTING, RADIO CONTROL MODEL AIRPLANES, AMATEUR RADIO EQUIPMENT, RAFTING AND WHITEWATER RAFTING EQUIPMENT, RECIPES, RUBBER STAMPS, RUGS, SATELLITE TELEVISION EQUIPMENT AND ACCESSORIES, SAUNA STOVES, SCIENCE FICTION COLLECTIBLES, SCIENTIFIC RESEARCH EXPEDITIONS, HOME AND BUSINESS SECURITY, SEWING, SHOES AND BOOTS, SHOWER FILTERS, SHUTTERS AND SHUTTER HARDWARE, SIGNS AND SIGN-MAKING, DECALS AND BUMPER STICKERS, SILK-SCREENING, SILVER AND FLATWARE, SKATEBOARDING CLOTHING AND EQUIPMENT, SKATEBOARDS, SKIING CLOTHING AND EQUIPMENT, SKIN CARE, SKULL CAPS AND YARMULKAS, SLIDES AND PRESENTATION MATERIALS, SMOKING ACCESSORIES, SOUVENIRS, SPORTING EQUIPMENT, SPY EQUIPMENT, STAMPS AND COINS, STATIONERY, STEREOS AND COMPACT DISC PLAYERS, STRESS REDUCTION, SUNGLASSES AND EYEWEAR, HOME, LAPTOP, INDUSTRIAL AND COMMERCIAL SURGE PROTECTORS, SURPLUS AND LIQUIDATION MERCHANDISE, TATTOO EQUIPMENT AND SUPPLIES, TELEPHONES AND ANSWERING MACHINES, TENNIS CLOTHING, EQUIPMENT AND ACCESSORIES, TAPETRY PRODUCTS, HAND AND POWER TOOLS, TOYS, TRAVEL, TRAVEL GEAR, INTERNATIONAL ADVENTURE TRAVEL, OUTDOOR ADVENTURE TRAVEL, LIFT TRUCKS AND PARTS, TELEVISION, TELESCOPES, BINOCULARS AND OTHER OPTICAL EQUIPMENT AND ACCESSORIES, VIDEO CASSETTE RECORDER (VCR) AND CABLE TELEVISION EQUIPMENT, SUPPLIES AND ACCESSORIES, VACUUM

CLEANERS, VIDEO EQUIPMENT, PRODUCTS FOR THE VISUALLY CHALLENGED AND THE BLIND, VITAMINS AND MINERALS, WALLETS AND PURSES, WATER SKIING CLOTHING AND EQUIPMENT, WEATHER INSTRUMENTS, WEDDING FAVORS, INVITATIONS AND ACCESSORIES, WEIGHT LOSS, WIGS AND HAIRPIECES, WINE, BREWING AND BEER MAKING, WINE CELLARS AND RACKS, WINE ACCESSORIES, SUN VISORS, WOODCRAFTING EQUIPMENT, PARTS AND SUPPLIES AND WROUGHT IRON ART, YARN, FABRIC AND TEXTILES (U.S. CLS. 100 AND 101).

FIRST USE 1-0-2000; IN COMMERCE 1-0-2000.

2,764,481. ENZO BIOCHEM, INC., NEW YORK, NY. SN 75-403,225. PUB. 1-18-2000, FILED 12-10-1997.

HUGGIE MOLECULE

CLASS 1—CHEMICALS

FOR CHEMICAL REAGENTS FOR DIAGNOSTIC SCIENTIFIC OR RESEARCH USE, NAMELY, VECTORS, PLASMIDS, AND OTHER BIOLOGICAL MATERIALS USED IN THE DELIVERY OF GENETIC MATTER OR NUCLEIC ACIDS FOR DIAGNOSTIC AND RESEARCH PURPOSES (U.S. CLS. 1, 5, 6, 10, 26 AND 46).

FIRST USE 4-9-2003; IN COMMERCE 4-9-2003.

CLASS 5—PHARMACEUTICALS

FOR CHEMICAL REAGENTS FOR CLINICAL OR MEDICAL LABORATORY USE, NAMELY, VECTORS, PLASMIDS, AND OTHER BIOLOGICAL MATERIALS USED IN THE DELIVERY OF GENETIC MATTER AND NUCLEIC ACIDS FOR THERAPEUTIC AND DIAGNOSTIC PURPOSES, INCLUDING GENE THERAPY SYSTEMS (U.S. CLS. 6, 18, 44, 46, 51 AND 52).

FIRST USE 4-9-2003; IN COMMERCE 4-9-2003.

2,764,490. ANDIN INTERNATIONAL INC., NEW YORK, NY. SN 75-483,927. PUB. 9-14-1999, FILED 5-12-1998.



OWNER OF U.S. REG. NO. 2,411,465.

NO CLAIM IS MADE TO THE EXCLUSIVE RIGHT TO USE "HEART", APART FROM THE MARK AS SHOWN.

THE STIPPLING IS FOR SHADING ONLY.

THE MARK CONSISTS OF THE WORDS "THE MILLENNIUM HEART" AND TWO NUMERAL "2000"'S IN MIRROR IMAGE RELATIONSHIP TO EACH OTHER SO THAT THE TWO "2"'S OF "2000" FORM THE DESIGN OF A HEART.

SEC. 2(F).

CLASS 20—FURNITURE AND ARTICLES NOT OTHERWISE CLASSIFIED

FOR JEWELRY BOXES NOT OF METAL (U.S. CLS. 2, 13, 22, 25, 32 AND 50).

FIRST USE 8-12-1998; IN COMMERCE 8-12-1998.

CLASS 25—CLOTHING

FOR SHIRTS, AND HEADWEAR (U.S. CLS. 22 AND 39).

FIRST USE 8-12-1998; IN COMMERCE 8-12-1998.

2,764,494. BROADWAY FEAST CORPORATION, NEW YORK, NY. SN 75-507,285. PUB. 5-2-2000, FILED 6-23-1998.



THE MARK IS LINED FOR THE COLOR RED, AND COLOR IS CLAIMED AS A FEATURE OF THE MARK.

CLASS 21—HOUSEWARES AND GLASS

FOR BEVERAGE GLASSWARE (U.S. CLS. 2, 13, 23, 29, 30, 33, 40 AND 50).

FIRST USE 0-0-1992; IN COMMERCE 0-0-1992.

CLASS 25—CLOTHING

FOR CLOTHING, NAMELY, FT-SHIRTS, HATS (U.S. CLS. 22 AND 39).

FIRST USE 0-0-1992; IN COMMERCE 0-0-1992.

2,764,501. RURAL CELLULAR CORPORATION, ALEXANDRIA, MN. SN 75-542,270. PUB. 3-21-2000, FILED 8-25-1998.

UNICEL

OWNER OF U.S. REG. NO. 1,551,307.

CLASS 35—ADVERTISING AND BUSINESS

FOR RETAIL OUTLETS FEATURING TELECOMMUNICATION EQUIPMENT AND ACCESSORIES THEREFOR; TELEPHONE DIRECTORY INFORMATION (U.S. CLS. 100, 101 AND 102).

FIRST USE 3-0-1998; IN COMMERCE 3-0-1998.

CLASS 36—INSURANCE AND FINANCIAL

FOR TELEPHONE CALLING CARD SERVICES (U.S. CLS. 100, 101 AND 102).

FIRST USE 10-0-1990; IN COMMERCE 10-0-1990.

CLASS 38—COMMUNICATION

FOR TELEPHONE COMMUNICATION SERVICES; TELEPHONE VOICE MESSAGING SERVICES; VOICE-ACTIVATED DIALING SERVICES; NETWORK CONFERENCING SERVICES; PROVIDING TELECOMMUNICATIONS CONNECTIONS TO A GLOBAL COMPUTER NETWORK (U.S. CLS. 100, 101 AND 104).

FIRST USE 10-0-1987; IN COMMERCE 10-0-1987.

2,764,512. PLASTIPAK PACKAGING, INC., PLYMOUTH, MI. SN 75-587,064. PUB. 1-25-2000, FILED 11-12-1998.

2,764,519. SUPINO, WENDY, LAKE FOREST, FL. SN 75-623,087. PUB. 3-14-2000, FILED 1-19-1999.

AQUAPET

CLASS 20—FURNITURE AND ARTICLES NOT OTHERWISE CLASSIFIED

FOR UNFILLED INJECTION-MOLDED AND BLOW-MOLDED PLASTIC CONTAINERS (U.S. CLS. 2, 13, 22, 25, 32 AND 50).

FIRST USE 4-2-2003; IN COMMERCE 4-2-2003.

CLASS 21—HOUSEWARES AND GLASS

FOR PLASTIC BOTTLES FOR WATER AND OTHER BEVERAGES, SOLD EMPTY (U.S. CLS. 2, 13, 23, 29, 30, 33, 40 AND 50).

FIRST USE 4-2-2003; IN COMMERCE 4-2-2003.

2,764,518. INSYSTEMS TECHNOLOGIES INC., MARKHAM, ONTARIO, L3R 9X1, CANADA. SN 75-621,555. PUB. 7-16-2002, FILED 1-15-1999.

CALLIGO

PRIORITY CLAIMED UNDER SEC. 44(D) ON CANADA APPLICATION NO. 896,045, FILED 11-12-1998, REG. NO. TMA554495, DATED 11-27-2001, EXPIRES 11-27-2016.

CLASS 9—ELECTRICAL AND SCIENTIFIC APPARATUS

FOR COMPUTER SOFTWARE USED TO AUTHOR, ASSEMBLE AND GENERATE DOCUMENTS, AND TO PULL AND COMPILE CONTENT FROM VARIOUS SOURCES TO ALLOW BUSINESS USERS TO CREATE AND MODIFY DOCUMENTS, AND THAT PROVIDES A WEB-BASED REPOSITORY FOR STORAGE AND MANAGEMENT OF DOCUMENTS AND WHICH HAS SEARCH CAPABILITIES, VERSION CONTROL AND SECURITY ACCESS, PERMITTING USERS TO CONTROL BUSINESS PROCESSES TO MANAGE TASKS AND PROJECTS CROSS-FUNCTIONALLY THROUGHOUT AN ENTERPRISE (U.S. CLS. 21, 23, 26, 36 AND 38).

FIRST USE 6-0-1998; IN COMMERCE 6-0-1998.

CLASS 41—EDUCATION AND ENTERTAINMENT

FOR COMPUTER EDUCATION TRAINING SERVICES (U.S. CLS. 100, 101 AND 107).

FIRST USE 11-0-1998; IN COMMERCE 1-0-1999.

CLASS 42—SCIENTIFIC, COMPUTER AND LEGAL SERVICES

FOR INSTALLATION AND UPDATING OF COMPUTER SOFTWARE; COMPUTER SOFTWARE DESIGN FOR OTHERS (U.S. CLS. 100 AND 101).

FIRST USE 6-0-1998; IN COMMERCE 6-0-1998.

EDOGZ

CLASS 18—LEATHER GOODS

FOR PET CLOTHING, DOG COLLARS, DOG LEASHES (U.S. CLS. 1, 2, 3, 22 AND 41).

FIRST USE 5-21-2003; IN COMMERCE 5-25-2003.

CLASS 21—HOUSEWARES AND GLASS

FOR PET FEEDING DISHES, DOG BRUSHES (U.S. CLS. 2, 13, 23, 29, 30, 33, 40 AND 50).

FIRST USE 4-28-2003; IN COMMERCE 5-25-2003.

2,764,530. TWO'S COMPANY, INC., MOUNT VERNON, NY. SN 75-659,774. PUB. 9-10-2002, FILED 3-12-1999.

TOZAI

CLASS 8—HAND TOOLS

FOR TABLEWARE; NAMELY, FORKS, KNIVES, SPOONS (U.S. CLS. 23, 28 AND 44).

FIRST USE 11-2-1998; IN COMMERCE 11-2-1998.

CLASS 16—PAPER GOODS AND PRINTED MATTER

FOR ADDRESS BOOKS, NOTEBOOKS, PENCILS, PENCIL HOLDERS, PAPER BOXES FOR STORING HATS, PAPERWEIGHTS, CLIPBOARDS AND ART OBJECTS, NAMELY PRINTED ART AND ETCHINGS (U.S. CLS. 2, 5, 22, 23, 29, 37, 38 AND 50).

FIRST USE 11-2-1998; IN COMMERCE 11-2-1998.

CLASS 20—FURNITURE AND ARTICLES NOT OTHERWISE CLASSIFIED

FOR MIRRORS; PICTURE FRAMES, FURNITURE, NAMELY, INDOOR AND OUTDOOR CHAIRS, TABLES, SOFAS, AND DESKS; NON METAL JEWELRY BOXES; FIGURINES, AND SCULPTURES MADE OF BONE, IVORY, PLASTER, PLASTIC, WAX AND WOOD; PILLOWS AND NON-METAL JEWELRY BOXES (U.S. CLS. 2, 13, 22, 25, 32 AND 50).

FIRST USE 11-2-1998; IN COMMERCE 11-2-1998.

CLASS 21—HOUSEWARES AND GLASS

FOR HOUSEWARES AND GLASS, NAMELY, BEVERAGE GLASSWARE, EARTHENWARE, NAMELY, MUGS, DISHES, AND FIGURINES AND SCULPTURES; VASES, FLOWERS POTS AND FLOWER POT HOLDERS, CANDLE HOLDERS NOT OF PRECIOUS METAL; HAND EMBROIDERED AND NEEDLEPOINTED FABRIC HOUSEHOLD BOXES FOR HOLDING TISSUES AND STORING HATS (U.S. CLS. 2, 13, 23, 29, 30, 33, 40 AND 50).

FIRST USE 11-2-1998; IN COMMERCE 11-2-1998.

2,764,534. XO COMMUNICATION, INC., RESTON, VA, BY MERGER: BY CHANGE OF NAME CONCENTRIC NETWORK CORPORATION, SAN JOSE, CA. SN 75-668,273. PUB. 11-27-2001, FILED 3-26-1999.

CONCENTRIC

OWNER OF U.S. REG. NOS. 2,096,863 AND 2,098,881.

CLASS 38—COMMUNICATION

FOR PROVIDING MULTIPLE-USER ACCESS TO A GLOBAL COMPUTER INFORMATION NETWORK (U.S. CLS. 100, 101 AND 104).

FIRST USE 9-1-1995; IN COMMERCE 9-1-1995.

CLASS 42—SCIENTIFIC, COMPUTER AND LEGAL SERVICES

FOR COMPUTER SERVICES, NAMELY HOSTING THE WEB SITES OF OTHERS ON A COMPUTER SERVER FOR A GLOBAL COMPUTER NETWORK; COMPUTER SERVICES, NAMELY ESTABLISHING VIRTUAL PRIVATE NETWORKS FOR OTHERS (U.S. CLS. 100 AND 101).

FIRST USE 9-1-1995; IN COMMERCE 9-1-1995.

2,764,539. PETER LETTERESE & ASSOCIATES, INC., FORT LAUDERDALE, FL. SN 75-676,864. PUB. 12-14-1999, FILED 4-7-1999.

WITHOUT INTIMIDATION

CLASS 9—ELECTRICAL AND SCIENTIFIC APPARATUS

FOR PRE-RECORDED AUDIO TAPES, PRE-RECORDED COMPACT DISCS, PRE-RECORDED CD-ROMS, COMPUTER SOFTWARE, AND PRE-RECORDED VIDEOTAPES, ALL FEATURING A SERIES OF INSTRUCTIONAL GUIDES FOR PURCHASING AND SALES TECHNIQUES (U.S. CLS. 21, 23, 26, 36 AND 38).

FIRST USE 6-13-2001; IN COMMERCE 7-21-2001.

CLASS 16—PAPER GOODS AND PRINTED MATTER

FOR SERIES OF NON-FICTION BOOKS FEATURING INSTRUCTION IN PURCHASING AND SALES TECHNIQUES (U.S. CLS. 2, 5, 22, 23, 29, 37, 38 AND 50).

FIRST USE 6-13-2001; IN COMMERCE 7-21-2001.

CLASS 38—COMMUNICATION

FOR COMPUTER SERVICES, NAMELY, AN ON-LINE COMPUTER BULLETIN BOARD FEATURING PURCHASING AND SALES TECHNIQUES (U.S. CLS. 100, 101 AND 104).

FIRST USE 6-13-2001; IN COMMERCE 7-21-2001.

CLASS 41—EDUCATION AND ENTERTAINMENT

FOR PROVIDING A SERIES OF COURSES, LECTURES AND INSTRUCTION IN PURCHASING AND SALES TECHNIQUES (U.S. CLS. 100, 101 AND 107).

FIRST USE 6-13-2001; IN COMMERCE 7-21-2001.

2,764,543. GFTA ANALYTICS INSTITUT GMBH, 40699 ERKRATH, FED REP GERMANY. SN 75-689,308. PUB. 9-19-2000, FILED 4-23-1999.

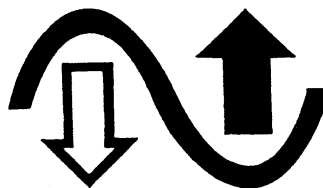

PRIORITY CLAIMED UNDER SEC. 44(D) ON FED REP GERMANY APPLICATION NO. 39863695.8, FILED 11-5-1998, REG. NO. 39863695, DATED 11-26-1998, EXPIRES 11-30-2008.

CLASS 35—ADVERTISING AND BUSINESS

FOR LICENSING OF COMPUTER SOFTWARE FOR THE ANALYSIS OF PRICES AND TRENDS IN THE FINANCE MARKETS; DATA PROCESSING SERVICES (U.S. CLS. 100, 101 AND 102).

FIRST USE 0-0-1978; IN COMMERCE 0-0-1978.

CLASS 36—INSURANCE AND FINANCIAL

FOR FINANCIAL ANALYSIS AND CONSULTATION IN THE FIELD OF PRICES AND TRENDS IN THE FINANCE MARKETS; PROVIDING FINANCIAL INFORMATION, NAMELY, INFORMATION ABOUT EXCHANGE RATES, BUSINESS INVESTMENT, FUND INVESTMENT AND ASSET MANAGEMENT; CUSTOMER SERVICE FOR OTHERS IN FINANCIAL AND CURRENCY EXCHANGE MATTERS, NAMELY, CURRENCY EXCHANGE AND ADVICE (U.S. CLS. 100, 101 AND 102).

FIRST USE 0-0-1978; IN COMMERCE 0-0-1978.

CLASS 42—SCIENTIFIC, COMPUTER AND LEGAL SERVICES

FOR DESIGN OF COMPUTER SOFTWARE FOR OTHERS; COMPUTER PROGRAMMING FOR OTHERS (U.S. CLS. 100 AND 101).

FIRST USE 0-0-1978; IN COMMERCE 0-0-1978.

2,764,544. METAL MAMMOTH, INC., NORTHAMPTON, MA. SN 75-689,961. PUB. 9-3-2002, FILED 4-23-1999.



CLASS 6—METAL GOODS

FOR METAL GOODS NAMELY, SIGNS, BASKETS, KEY CHAINS, PENHOLDERS, AND LUNCH BOXES (U.S. CLS. 2, 12, 13, 14, 23, 25 AND 50).

FIRST USE 4-1-1999; IN COMMERCE 4-1-1999.

CLASS 14—JEWELRY

FOR LIGHTERS OF PRECIOUS METAL AND JEWELRY (U.S. CLS. 2, 27, 28 AND 50).

FIRST USE 4-1-1999; IN COMMERCE 4-1-1999.

CLASS 28—TOYS AND SPORTING GOODS

FOR MINI SKATEBOARDS, SKATEBOARDS, RESIN MODEL KITS, TOY ACTION FIGURES, POOL CUES AND TOY SWORDS AND KNIVES (U.S. CLS. 22, 23, 38 AND 50).

FIRST USE 4-1-1999; IN COMMERCE 4-1-1999.

CLASS 42—SCIENTIFIC, COMPUTER AND LEGAL SERVICES

FOR DESIGN SERVICES FOR OTHERS IN THE FIELD OF INTEGRATED CIRCUIT DESIGN AND INTEGRATED CIRCUIT ENGINEERING; CONSULTING SERVICES IN THE FIELD OF HARDWARE AND SOFTWARE DATA NETWORKING, TELECOMMUNICATIONS AND SEMI-CONDUCTOR MEMORY APPLICATIONS (U.S. CLS. 100 AND 101).

FIRST USE 9-27-1999; IN COMMERCE 9-27-1999.

2,764,553. WALKINE, KATHY, BROOKLYN, NY. SN 75-704,286. PUB. 1-25-2000, FILED 5-12-1999.

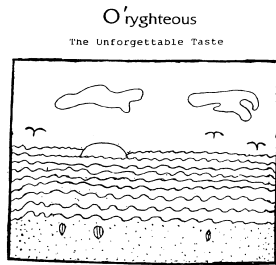

THE LINING AND STIPPLING IS A FEATURE OF THE MARK AND DOES NOT INDICATE COLOR.

CLASS 29—MEATS AND PROCESSED FOODS

FOR JAM-VARIETY FLAVORS; SWEET POTATO CHIPS, SANDWICH SPREAD, FRUIT-BASED-SPREAD, VEGETABLE BASED SPREAD, CHEESE SPREAD AND DAIRY-BASED DIPS (U.S. CL. 46).

FIRST USE 3-29-2003; IN COMMERCE 3-29-2003.

CLASS 30—STAPLE FOODS

FOR HOT PEPPER SAUCES-VARIETY FLAVORS; BBQ SAUCES-VARIETY FLAVORS; PRETZEL-VARIETY FLAVORS; MINI BAGELS-VARIETY FLAVORS, CHOCOLATE COOKIES, AND COOKIES (U.S. CL. 46).

FIRST USE 3-29-2003; IN COMMERCE 3-29-2003.

2,764,564. MIPS TECHNOLOGIES, INC., MOUNTAIN VIEW, CA. SN 75-737,587. PUB. 3-12-2002, FILED 6-25-1999.

MIPS64

CLASS 9—ELECTRICAL AND SCIENTIFIC APPARATUS

FOR COMPUTER SOFTWARE FOR USE IN, AND FOR USE IN THE DESIGN, DESCRIPTION AND TESTING OF COMPUTING DEVICES, COMPUTER HARDWARE AND CODE; COMPUTER SOFTWARE FOR DESCRIBING, DESIGNING, TESTING, MODELING, SIMULATING, DEBUGGING, DEVELOPING, VERIFYING COMPUTING DEVICES, COMPUTER HARDWARE AND CODE; COMPUTING DEVICES, NAMELY, PRINTED CIRCUIT BOARDS, SEMICONDUCTORS, SEMICONDUCTOR DEVICES, INTEGRATED CIRCUITS, CIRCUIT CHIPS, MICROPROCESSORS; MICROPROCESSOR CORES AND INSTRUCTION SET ARCHITECTURES AND PROCESSOR ARCHITECTURES FOR INTEGRATED CIRCUITS, NAMELY, MICROPROCESSORS (U.S. CLS. 21, 23, 26, 36 AND 38).

FIRST USE 7-3-2002; IN COMMERCE 7-3-2002.

CLASS 16—PAPER GOODS AND PRINTED MATTER

FOR LITERATURE, NAMELY, PAMPHLETS, RELATING TO COMPUTER TECHNOLOGY, HARDWARE AND SOFTWARE (U.S. CLS. 2, 5, 22, 23, 29, 37, 38 AND 50).

FIRST USE 2-23-2000; IN COMMERCE 2-23-2000.

CLASS 41—EDUCATION AND ENTERTAINMENT

FOR EDUCATIONAL SERVICES, NAMELY CONDUCTING SEMINARS, IN THE FIELD OF EMBEDDED COMPUTER SYSTEMS AND IN THE USE AND OPERATION OF COMPUTER TECHNOLOGY, INCLUDING COMPUTER HARDWARE AND SOFTWARE (U.S. CLS. 100, 101 AND 107).

FIRST USE 1-26-2002; IN COMMERCE 1-26-2002.

CLASS 42—SCIENTIFIC, COMPUTER AND LEGAL SERVICES

FOR LICENSING OF INTELLECTUAL PROPERTY; PROVIDING INFORMATION RELATING TO COMPUTER TECHNOLOGY, HARDWARE AND COMPUTER CODE, INCLUDING, INSTRUCTION SET ARCHITECTURES, PROCESSOR ARCHITECTURES, MICROPROCESSOR CORES (U.S. CLS. 100 AND 101).

FIRST USE 4-7-2003; IN COMMERCE 4-7-2003.

2,764,563. MOSAID TECHNOLOGIES INCORPORATED, KANATA, ONTARIO, CANADA. SN 75-736,540. PUB. 9-5-2000, FILED 6-24-1999.

MOSAID CLASS-IC

OWNER OF U.S. REG. NO. 1,965,347.

CLASS 9—ELECTRICAL AND SCIENTIFIC APPARATUS

FOR COMPUTERS; COMPUTER HARDWARE; COMPUTER SOFTWARE, NAMELY, APPLICATIONS FOR HARDWARE AND SOFTWARE DATA NETWORKING, APPLICATIONS FOR TELECOMMUNICATIONS, AND SEMI-CONDUCTOR MEMORY APPLICATIONS; PERIPHERALS AND SEMI-CONDUCTORS (U.S. CLS. 21, 23, 26, 36 AND 38).

FIRST USE 9-27-1999; IN COMMERCE 9-27-1999.

2,764,565. VARIAN MEDICAL SYSTEMS, INC., PALO ALTO, CA. SN 75-737,949. PUB. 7-18-2000, FILED 6-24-1999.

2,764,569. ALLIANCE ENTERPRISES, INC., OLYMPIA, WA. SN 75-742,401. PUB. 10-2-2001, FILED 7-2-1999.



CLASS 9—ELECTRICAL AND SCIENTIFIC APPARATUS

FOR COMPUTER SOFTWARE FOR USE IN FORMING MEDICAL DIAGNOSES, DEVELOPING TREATMENT PLANS, MONITORING, CONTROLLING AND SIMULATING PATIENT TREATMENT, MANAGING AND TRANSMITTING PATIENT DATA, INFORMATION AND RADIOGRAPHIC IMAGES, X-RAY IMAGING, AND CONTROLLING MEDICAL APPARATUS; COMPUTER PROGRAMS ON COMPUTER-READABLE MEDIA FOR USE IN FORMING MEDICAL DIAGNOSES, DEVELOPING TREATMENT PLANS, MONITORING, CONTROLLING AND SIMULATING PATIENT TREATMENT, MANAGING AND TRANSMITTING PATIENT DATA, INFORMATION AND RADIOGRAPHIC IMAGES, X-RAY IMAGING, AND CONTROLLING MEDICAL APPARATUS (U.S. CLS. 21, 23, 26, 36 AND 38).

FIRST USE 3-13-2003; IN COMMERCE 3-13-2003.

CLASS 10—MEDICAL APPARATUS

FOR MEDICAL APPARATUS AND SYSTEMS, USED FOR DIAGNOSTIC, THERAPEUTIC AND RADIOGRAPHIC PURPOSES, CONSISTING OF X-RAY TUBES AND HOUSINGS THEREFOR; MEDICAL CHARGED PARTICLE ACCELERATORS USED IN RADIOTHERAPY AND COMPUTER SOFTWARE EMBEDDED THEREIN FOR USE IN THE FIELD OF RADIOTHERAPY, SOLD AS A UNIT; INDUSTRIAL LINEAR ACCELERATORS USED IN INDUSTRIAL IMAGING; MEDICAL LINEAR ACCELERATORS USED IN RADIOTHERAPY AND COMPUTER SOFTWARE EMBEDDED THEREIN FOR USE IN THE FIELD OF RADIOTHERAPY, SOLD AS A UNIT; PATIENT POSITIONING TOOLS; RADIATION BEAM COLLIMATION APPARATUS FOR CONFORMAL BEAM RADIOTHERAPY; IMAGING AND TREATMENT SIMULATION APPARATUS FOR TREATMENT PLANNING AND SIMULATION; X-RAY RADIOGRAPHIC AND FLUOROSCOPIC IMAGING SYSTEMS COMPRISED OF A RECEIVER AND TRANSMITTER PANEL AND A DISPLAY; X-RAY IMAGING SYSTEMS THAT CONVERT RADIATION INTO DIGITAL SIGNALS COMPRISED OF RECEIVER/TRANSMITTER PANELS, USER INTERFACE COMPUTERS, DISPLAYS, AND EMBEDDED SOFTWARE FOR USE IN THE FIELD OF X-RAY IMAGING, SOLD AS A UNIT; AND MEDICAL DEVICES FOR DELIVERY OF RADIATION FROM WITHIN THE PATIENT, NAMELY, REMOTE AFTERLOADERS FOR BRACHYTHERAPY AND BRACHYTHERAPY WIRE AND NEEDLE POSITIONING APPARATUS AND COMPUTER SOFTWARE EMBEDDED THEREIN, SOLD AS A UNIT, FOR USE THEREWITH (U.S. CLS. 26, 39 AND 44).

FIRST USE 3-13-2003; IN COMMERCE 3-13-2003.

AWARE

CLASS 9—ELECTRICAL AND SCIENTIFIC APPARATUS

FOR COMPUTER SOFTWARE FOR USE IN TRACKING, MAINTAINING, ORGANIZING, COMMUNICATING, AND INDEXING A WIDE RANGE OF INFORMATION RELATED TO FINANCIAL ACCOUNTABILITY, EMPLOYMENT, CASE OUTCOMES, CASE ACTIVITIES, EDUCATIONAL COURSES, TRAINING, PERFORMANCE ACCOUNTABILITY, AND CASE STATUS, IN THE FIELDS OF VOCATIONAL REHABILITATION CASE MANAGEMENT, SOCIAL SERVICE CASE MANAGEMENT, AND INDEPENDENT LIVING CASE MANAGEMENT; COMPUTER SOFTWARE FOR MANAGING CASES, CONTRACTS, AND PROJECTS IN CONNECTION WITH WORKFORCE INVESTMENT SYSTEMS SUCH AS UNDER THE WORKFORCE INVESTMENT ACT; AND COMPUTER SOFTWARE FOR USE IN MANAGING DATABASES (U.S. CLS. 21, 23, 26, 36 AND 38).

FIRST USE 5-0-1998; IN COMMERCE 7-0-1998.

CLASS 42—SCIENTIFIC, COMPUTER AND LEGAL SERVICES

FOR PROVIDING TEMPORARY USE OF ONLINE NON-DOWNLOADABLE COMPUTER SOFTWARE FOR USE IN TRACKING, MAINTAINING, ORGANIZING, COMMUNICATING, AND INDEXING A WIDE RANGE OF INFORMATION RELATED TO FINANCIAL ACCOUNTABILITY, EMPLOYMENT, CASE OUTCOMES, CASE ACTIVITIES, EDUCATIONAL COURSES, TRAINING, PERFORMANCE ACCOUNTABILITY, AND CASE STATUS, IN THE FIELDS OF VOCATIONAL REHABILITATION CASE MANAGEMENT, SOCIAL SERVICE CASE MANAGEMENT, AND INDEPENDENT LIVING CASE MANAGEMENT; PROVIDING TEMPORARY USE OF ONLINE NON-DOWNLOADABLE COMPUTER SOFTWARE FOR MANAGING CASES, CONTRACTS, AND PROJECTS IN CONNECTION WITH WORKFORCE INVESTMENT SYSTEMS SUCH AS UNDER THE WORKFORCE INVESTMENT ACT; AND PROVIDING TEMPORARY USE OF ONLINE NON-DOWNLOADABLE COMPUTER SOFTWARE FOR USE IN MANAGING DATABASES (U.S. CLS. 100 AND 101).

FIRST USE 4-30-2001; IN COMMERCE 9-15-2001.

2,764,577. BATESVILLE SERVICES, INC., BATESVILLE, IN. SN 75-766,254. PUB. 5-1-2001, FILED 8-2-1999.

BATESVILLE

OWNER OF U.S. REG. NOS. 1,259,466 AND 1,347,930. SEC. 2(F).

CLASS 9—ELECTRICAL AND SCIENTIFIC APPARATUS

FOR PRE-RECORDED VIDEO TAPES FEATURING INFORMATION ABOUT FUNERAL PLANNING (U.S. CLS. 21, 23, 26, 36 AND 38).

FIRST USE 0-0-1998; IN COMMERCE 0-0-1998.

CLASS 16—PAPER GOODS AND PRINTED MATTER

FOR PRINTED PUBLICATIONS, NAMELY, FLYERS, BROCHURES, PAMPHLETS, BOOKLETS AND POSTERS, FEATURING INFORMATION ABOUT FUNERAL PLANNING (U.S. CLS. 2, 5, 22, 23, 29, 37, 38 AND 50).

FIRST USE 0-0-1991; IN COMMERCE 0-0-1991.

CLASS 20—FURNITURE AND ARTICLES NOT OTHERWISE CLASSIFIED

FOR MEMORIALIZATION PRODUCTS FOR DECEASED PERSONS, NAMELY CONTAINERS FOR HOLDING MEMORABILIA OF DECEASED PERSONS; POINT-OF-PURCHASE DISPLAYS, NAMELY, STAND-UP SALES DISPLAYS FEATURING INFORMATION ABOUT FUNERAL PLANNING (U.S. CLS. 2, 13, 22, 25, 32 AND 50).

FIRST USE 0-0-1992; IN COMMERCE 0-0-1992.

CLASS 35—ADVERTISING AND BUSINESS

FOR BUSINESS MARKETING CONSULTATION SERVICES, NAMELY, CONSULTING WITH FUNERAL HOMES REGARDING THE MARKETING OF FUNERAL PRODUCTS AND SERVICES (U.S. CLS. 100, 101 AND 102).

FIRST USE 0-0-1975; IN COMMERCE 0-0-1975.

CLASS 41—EDUCATION AND ENTERTAINMENT

FOR EDUCATIONAL SERVICES, NAMELY, CONDUCTING SEMINARS IN THE FIELD OF FUNERAL PRODUCTS AND SERVICES (U.S. CLS. 100, 101 AND 107).

FIRST USE 7-0-1997; IN COMMERCE 7-0-1997.

CLASS 42—SCIENTIFIC, COMPUTER AND LEGAL SERVICES

FOR ARRANGING FOR PLANTING OF TREES IN MEMORY OF DECEASED PERSONS; FUNERAL PLANNING SERVICES; CUSTOMIZATION SERVICES FOR BURIAL CASKETS, NAMELY, OFFERING CUSTOMERS CUSTOM DESIGN ENHANCEMENTS FOR BURIAL CASKETS (U.S. CLS. 100 AND 101).

FIRST USE 0-0-1976; IN COMMERCE 0-0-1976.

2,764,579. GLOBAL RELAY COMMUNICATIONS INC., VANCOUVER, BRITISH COLUMBIA V6J 2H4, CANADA. SN 75-769,700. PUB. 8-28-2001, FILED 8-6-1999.

GLOBAL RELAY**CLASS 35—ADVERTISING AND BUSINESS**

FOR PROJECT DATA MANAGEMENT AND COLLABORATION SERVICES IN THE FIELD OF BUSINESS COMMUNICATIONS BY MEANS OF A GLOBAL COMPUTER NETWORK; ONLINE RETAIL AND PERSONAL RETAIL SERVICES FEATURING COMPUTER SOFTWARE AND COMPUTER HARDWARE; COMPUTER DATA MANAGEMENT SERVICES (U.S. CLS. 100, 101 AND 102).

FIRST USE 11-18-2002; IN COMMERCE 11-18-2002.

CLASS 38—COMMUNICATION

FOR TELECOMMUNICATIONS SERVICES, NAMELY, GLOBAL COMPUTER NETWORK COMMUNICATIONS SERVICES; FACSIMILE TRANSMISSION; ELECTRONIC MAIL AND VOICE MAIL SERVICES (U.S. CLS. 100, 101 AND 104).

FIRST USE 11-18-2002; IN COMMERCE 11-18-2002.

CLASS 42—SCIENTIFIC, COMPUTER AND LEGAL SERVICES

FOR HOSTING THE WEB SITES OF OTHERS ON A COMPUTER SERVER FOR A GLOBAL COMPUTER NETWORK; COMPUTER CONSULTATION SERVICES; COMPUTER SYSTEMS ANALYSIS AND PLANNING AND COMPUTER NETWORK DESIGN SERVICES; COMPUTER SOFTWARE DEVELOPMENT SERVICES; LANGUAGE TRANSLATION SERVICES; FILE TRANSFER PROTOCOL GLOBAL COMPUTER NETWORK COMMUNICATION SERVICES (U.S. CLS. 100 AND 101).

FIRST USE 11-18-2002; IN COMMERCE 11-18-2002.

2,764,584. VOXCOM INCORPORATED, EDMONTON T6E 5V7, ALBERTA, CANADA. SN 75-786,582. PUB. 3-26-2002, FILED 10-30-1999.

VOXCOM**CLASS 37—CONSTRUCTION AND REPAIR**

FOR INSTALLATION OF SECURITY ALARM SYSTEMS (U.S. CLS. 100, 103 AND 106).

FIRST USE 3-16-2003; IN COMMERCE 3-16-2003.

CLASS 42—SCIENTIFIC, COMPUTER AND LEGAL SERVICES

FOR MONITORING SECURITY ALARMS (U.S. CLS. 100 AND 101).

FIRST USE 3-16-2003; IN COMMERCE 3-16-2003.

2,764,593. MINERAL DENT, INC., DETROIT, MI. SN 75-808,272. PUB. 10-10-2000, FILED 9-21-1999.

MINERALDENT**CLASS 3—COSMETICS AND CLEANING PREPARATIONS**

FOR DENTAL CARE PREPARATIONS, NAMELY, A MINERAL-BASED DENTIFRICE WITH FLUORIDE AND OTHER MINERALS (U.S. CLS. 1, 4, 6, 50, 51 AND 52).

FIRST USE 6-18-2002; IN COMMERCE 6-18-2002.

CLASS 5—PHARMACEUTICALS

FOR DENTAL CARE PREPARATIONS, NAMELY, A MINERAL-BASED DENTIFRICE WITH FLUORIDE AND OTHER MINERALS TO PREVENT TOOTH DECAY AND TREAT GUMS (U.S. CLS. 6, 18, 44, 46, 51 AND 52).

FIRST USE 6-18-2002; IN COMMERCE 6-18-2002.

2,764,595. CLEVELAND, DIANNA L., MISSION VIEJO, CA. AND NAMISNIAK, LEE A., MISSION VIEJO, CA. SN 75-810,366. PUB. 3-26-2002, FILED 10-20-1999.

PLAYBOOK

CLASS 16—PAPER GOODS AND PRINTED MATTER

FOR PRINTED MATTER, NAMELY, BOOKS AND PERIODICALS ADAPTED TO A ROLE-PLAY READING FORMAT IN THE FIELD OF CHILDREN'S LITERATURE (U.S. CLS. 2, 5, 22, 23, 29, 37, 38 AND 50).

FIRST USE 2-20-2000; IN COMMERCE 2-9-2001.

CLASS 41—EDUCATION AND ENTERTAINMENT

FOR PUBLICATION OF BOOKS AND MAGAZINES RELATED TO ROLE-PLAY READING MATERIALS FOR CHILDREN (U.S. CLS. 100, 101 AND 107).

FIRST USE 2-20-2000; IN COMMERCE 2-9-2001.

2,764,596. CLEVELAND, DIANNA L., MISSION VIEJO, CA. AND NAMISNIAK, LEE A., MISSION VIEJO, CA. SN 75-810,372. PUB. 3-26-2002, FILED 10-20-1999.

EPLAYBOOK

CLASS 16—PAPER GOODS AND PRINTED MATTER

FOR PRINTED MATTER, NAMELY, BOOKS AND PERIODICALS ADAPTED TO A ROLE-PLAY READING FORMAT IN THE FIELD OF CHILDREN'S LITERATURE (U.S. CLS. 2, 5, 22, 23, 29, 37, 38 AND 50).

FIRST USE 2-9-2001; IN COMMERCE 2-9-2001.

CLASS 41—EDUCATION AND ENTERTAINMENT

FOR PUBLICATION OF BOOKS AND MAGAZINES RELATED TO ROLE-PLAY READING MATERIALS FOR CHILDREN (U.S. CLS. 100, 101 AND 107).

FIRST USE 2-9-2001; IN COMMERCE 2-9-2001.

2,764,597. MID ATLANTIC MEDICAL SERVICES, INC., ROCKVILLE, MD. SN 75-812,866. PUB. 5-23-2000, FILED 10-1-1999.

YOUR LIFE. OUR MISSION.

CLASS 36—INSURANCE AND FINANCIAL

FOR INSURANCE UNDERWRITING IN THE FIELDS OF LIFE, HEALTH, DENTAL, ACCIDENT, AND DISABILITY; AND UNDERWRITING AND ADMINISTRATION OF PREPAID HEALTH CARE PLANS (U.S. CLS. 100, 101 AND 102).

FIRST USE 5-1-2000; IN COMMERCE 5-1-2000.

CLASS 42—SCIENTIFIC, COMPUTER AND LEGAL SERVICES

FOR MANAGED HEALTH CARE SERVICES; MENTAL HEALTH AND PSYCHIATRIC SERVICES (U.S. CLS. 100 AND 101).

FIRST USE 5-1-2000; IN COMMERCE 5-1-2000.

2,764,598. METABOLIFE INTERNATIONAL, INC., SAN DIEGO, CA. SN 75-813,737. PUB. 1-30-2001, FILED 10-4-1999.

Metabolife

OWNER OF U.S. REG. NOS. 1,827,188, 2,282,986, AND OTHERS.

CLASS 5—PHARMACEUTICALS

FOR HERBAL DIETARY SUPPLEMENTS; VITAMIN AND MINERAL SUPPLEMENTS; HERBAL DIETARY SUPPLEMENTS FOR USE AS SLEEPING AIDS; DIETARY SUPPLEMENTS CONSISTING OF MULTIPLE MINERAL CAPLETS; DIETARY SUPPLEMENTS CONSISTING OF MULTIPLE VITAMIN CAPLETS; DIETARY SUPPLEMENTS; NUTRITIONAL SUPPLEMENTS; NON-PRESCRIPTION ANTACIDS; NON-PRESCRIPTION PHARMACEUTICAL PREPARATIONS FOR THE TREATMENT OF HEADACHES, ARTHRITIS, COLDS, FLU AND PREMENSTRUAL SYNDROMES (U.S. CLS. 6, 18, 44, 46, 51 AND 52).

FIRST USE 1-14-2000; IN COMMERCE 1-27-2000.

CLASS 25—CLOTHING

FOR CLOTHING, NAMELY, T-SHIRTS, POLO SHIRTS, JACKETS, BASEBALL CAPS, AND SWEATSHIRTS (U.S. CLS. 22 AND 39).

FIRST USE 1-31-2000; IN COMMERCE 1-31-2000.

2,764,600. MEDIA DESIGN GESELLSCHAFT FUR MULTIMEDIA UND ONLINE-PUBLISHING MBH, D-07549 GERA, FED REP GERMANY. SN 75-814,445. PUB. 2-20-2001, FILED 10-4-1999.

SPEEDMAP

PRIORITY CLAIMED UNDER SEC. 44(D) ON ERPN CMNTY TM OFC APPLICATION NO. 001224930, FILED 6-30-1999, REG. NO. 39760433, DATED 2-4-1998, EXPIRES 12-31-2007.

CLASS 38—COMMUNICATION

FOR ELECTRONIC TRANSMISSION OF IMAGES AND DATA (U.S. CLS. 100, 101 AND 104).

FIRST USE 4-18-1998; IN COMMERCE 10-10-1999.

CLASS 42—SCIENTIFIC, COMPUTER AND LEGAL SERVICES

FOR PROVIDING AN ON-LINE DATABASE FEATURING GEOGRAPHIC MAPS AND CITY MAPS; COMPUTER SOFTWARE DEVELOPMENT FOR OTHERS; INNOVATIVE PRODUCT DEVELOPMENT FOR THIRD PARTIES; AND LEASING OF COMPUTERS (U.S. CLS. 100 AND 101).

FIRST USE 4-18-1998; IN COMMERCE 10-10-1999.

2,764,603. MULTIFOODS DISTRIBUTION GROUP, INC., ENGLEWOOD, CO. SN 75-821,759. PUB. 11-14-2000, FILED 10-13-1999.

MULTI-CHOICE

CLASS 8—HAND TOOLS

FOR CUTLERY, NAMELY, PIZZA CUTTERS (U.S. CLS. 23, 28 AND 44).
FIRST USE 3-7-2003; IN COMMERCE 3-7-2003.

CLASS 16—PAPER GOODS AND PRINTED MATTER

FOR PLASTIC FILM FOR COMMERCIAL FOOD AND PACKAGE WRAPPING (U.S. CLS. 2, 5, 22, 23, 29, 37, 38 AND 50).
FIRST USE 3-7-2003; IN COMMERCE 3-7-2003.

2,764,604. BROOKNAM ENTERTAINMENT, INC., BROOKLYN, NY. SN 75-822,298. PUB. 5-2-2000, FILED 10-13-1999.

BROOKNAM

CLASS 25—CLOTHING

FOR CLOTHING; NAMELY; T-SHIRTS, PANTS, SHORTS, JACKETS, SWEATSHIRTS, SWEATPANTS, SHIRTS, BELTS, VEST, HATS, CAPS AND SHOES (U.S. CLS. 22 AND 39).
FIRST USE 2-19-1998; IN COMMERCE 2-19-1998.

CLASS 41—EDUCATION AND ENTERTAINMENT

FOR MUSIC PUBLISHING SERVICES; VIDEOTAPE, CD, MOTION PICTURE FILM, AUDIO TAPE AND RECORD PRODUCTION; LIVE MUSICAL PERFORMANCES BY A MUSICAL GROUP (U.S. CLS. 100, 101 AND 107).
FIRST USE 2-19-1998; IN COMMERCE 2-19-1998.

2,764,610. MACROFIRM CORPORATION, WAKEFIELD, MA. SN 75-840,991. PUB. 3-19-2002, FILED 11-4-1999.

REVISION

OWNER OF U.S. REG. NO. 2,304,389.

CLASS 9—ELECTRICAL AND SCIENTIFIC APPARATUS

FOR DOWNLOADABLE COMPUTER SOFTWARE, NAMELY, A COMPREHENSIVE SUITE OF COMMERCIAL REAL ESTATE AND ASSET MANAGEMENT SOFTWARE FOR PROPERTY LEASING AND VALUATION, REAL ESTATE ACCOUNTING, ASSET MANAGEMENT, OPERATIONS MANAGEMENT, AND PROJECT MANAGEMENT; AND DOWNLOADABLE SOFTWARE FOR USE AS AN INTERNET BROWSER (U.S. CLS. 21, 23, 26, 36 AND 38).
FIRST USE 1-1-1996; IN COMMERCE 1-1-2000.

CLASS 36—INSURANCE AND FINANCIAL

FOR FINANCIAL ANALYSIS AND VALUATION OF REAL PROPERTY (U.S. CLS. 100, 101 AND 102).
FIRST USE 1-1-1996; IN COMMERCE 1-1-2000.

CLASS 37—CONSTRUCTION AND REPAIR

FOR INSTALLATION AND IMPLEMENTATION OF COMPUTER HARDWARE, NETWORKS AND SYSTEMS (U.S. CLS. 100, 103 AND 106).
FIRST USE 1-1-1996; IN COMMERCE 1-1-2000.

CLASS 42—SCIENTIFIC, COMPUTER AND LEGAL SERVICES

FOR HOSTING THE WEBSITES OF OTHERS ON A COMPUTER SERVER FOR A GLOBAL COMPUTER NETWORK; SERVICE IN CONNECTION WITH COMPUTER SOFTWARE, NAMELY, INSTALLATION, MAINTENANCE AND UPDATING OF COMPUTER SOFTWARE; SOFTWARE DESIGN AND DEVELOPMENT FOR OTHERS; PROVIDING TEMPORARY USE OF ON-LINE NON-DOWNLOADABLE SOFTWARE CONSISTING OF A COMPREHENSIVE SUITE OF COMMERCIAL REAL ESTATE AND ASSET MANAGEMENT SOFTWARE FOR PROPERTY LEASING AND VALUATION, REAL ESTATE ACCOUNTING, ASSET MANAGEMENT, OPERATIONS MANAGEMENT, AND PROJECT MANAGEMENT; CONSULTATION IN THE FIELD OF COMPUTER SOFTWARE; AND TECHNICAL SUPPORT SERVICES, NAMELY, TROUBLE SHOOTING OF COMPUTER HARDWARE AND SOFTWARE PROBLEMS VIA TELEPHONE, E-MAIL AND IN PERSON; APPLICATION SERVICE PROVIDER FEATURING A COMPREHENSIVE SUITE OF COMMERCIAL REAL ESTATE AND ASSET MANAGEMENT SOFTWARE FOR PROPERTY LEASING AND VALUATION, REAL ESTATE ACCOUNTING, ASSET MANAGEMENT, OPERATIONS MANAGEMENT, AND PROJECT MANAGEMENT (U.S. CLS. 100 AND 101).
FIRST USE 1-1-1996; IN COMMERCE 1-1-2000.

2,764,612. TELEMAC CORPORATION, LOS ANGELES, CA. SN 75-845,631. PUB. 1-1-2002, FILED 11-10-1999.

TELEMAC-ENABLED

CLASS 9—ELECTRICAL AND SCIENTIFIC APPARATUS

FOR COMPUTER SOFTWARE FOR USE IN ACCOUNTING FOR PREPAID AND POSTPAID WIRELESS COMMUNICATION SERVICES, PROVIDING BILLING INFORMATION FOR WIRELESS COMMUNICATION SERVICES, MONITORING USAGE OF WIRELESS COMMUNICATION SERVICES, ESTABLISHING USAGE LIMITS FOR WIRELESS COMMUNICATION SERVICES, PERFORMING ELECTRONIC COMMERCE AND MOBILE ELECTRONIC COMMERCE TRANSACTIONS VIA A GLOBAL COMPUTER NETWORK, PERFORMING CREDIT CARD PAYMENTS OVER A WIRELESS COMMUNICATIONS NETWORK, PERFORMING CALLING CARD PAYMENTS OVER A WIRELESS COMMUNICATIONS NETWORK, PREVENTING FRAUD IN WIRELESS COMMUNICATION SERVICES, PROVIDING BILLING INFORMATION FOR RENTAL OF WIRELESS COMMUNICATION SERVICES, ACTIVATING A WIRELESS COMMUNICATION DEVICE AT VARIOUS POINTS IN THE SUPPLY CHAIN, TRACKING USAGE OF A WIRELESS COMMUNICATION DEVICE, AND ENCRYPTION AND DECRYPTION OF DATA; CELLULAR COMMUNICATIONS EQUIPMENT, NAMELY, CELLULAR TELEPHONES, CELLULAR PAGERS, AND CELLULAR COMMUNICATIONS SYSTEMS COMPRISED OF COMPUTERS, COMPUTER COMMUNICATIONS SOFTWARE TO ENABLE CELLULAR TELEPHONE COMMUNICATION, COMPUTER FILE COMMUNICATION SERVERS, CELLULAR TELEPHONES AND CELLULAR PAGERS (U.S. CLS. 21, 23, 26, 36 AND 38).

FIRST USE 4-27-1999; IN COMMERCE 11-21-2002.

CLASS 42—SCIENTIFIC, COMPUTER AND LEGAL SERVICES

FOR COMPUTER PROGRAMMING FOR OTHERS IN THE FIELD OF COMPUTERS AND COMPUTER SOFTWARE FOR USE IN CELLULAR COMMUNICATIONS EQUIPMENT (U.S. CLS. 100 AND 101).

FIRST USE 5-28-2002; IN COMMERCE 5-28-2002.

2,764,613. BIANCO, MONICA, ITALY. SN 75-845,935. PUB. 9-3-2002, FILED 11-10-1999.

MONICA BIANCO

CLASS 18—LEATHER GOODS

FOR COSMETIC BAGS SOLD EMPTY, TOTE BAGS, GYM BAGS AND ALL PURPOSE ATHLETIC BAGS (U.S. CLS. 1, 2, 3, 22 AND 41).

FIRST USE 6-0-1994; IN COMMERCE 6-0-1994.

CLASS 24—FABRICS

FOR TEXTILES FOR USE IN THE MANUFACTURE OF CLOTHING; TEXTILE PLACE MATS; TEXTILE NAPKINS; HOUSEHOLD LINEN; BED BLANKETS; DOWN COVERLETS; PILLOW COVERS" (U.S. CLS. 42 AND 50).

FIRST USE 6-0-1994; IN COMMERCE 6-0-1994.

CLASS 25—CLOTHING

FOR MEN', WOMEN'S AND CHILDREN'S CLOTHING, NAMELY, SUITS MADE OF LEATHER, SHIRTS, BLOUSES, SKIRTS, TAILLEURS, JACKETS, TROUSERS, SHORTS, VESTS, JERSEYS, PAJAMAS, STOCKINGS, SINGLETS, CORSET, GARTERS, PANTS, BRAS, PETTICOATS, HATS, FOULARDS, NECKTIES, RAINCOATS, OVERCOATS, GREATCOATS, BATHING SUITS, SPORTS OVERALLS, WIND RESISTANT JACKETS, SKI PANTS, BELTS, FUR COATS, FUR JACKETS, FUR STOLE, SCARVES, GLOVES, DRESSING GOWNS, AND SHOEWEAR, NAMELY, SLIPPERS, SHOES, SPORT SHOES, BOOTS AND SANDALS (U.S. CLS. 22 AND 39).

FIRST USE 6-0-1994; IN COMMERCE 6-0-1994.

2,764,616. SMITHKLINE BEECHAM CORPORATION, PHILADELPHIA, PA. SN 75-853,363. PUB. 5-22-2001, FILED 11-18-1999.

I WILL BE WELL

CLASS 3—COSMETICS AND CLEANING PREPARATIONS

FOR TOOTHPASTE (U.S. CLS. 1, 4, 6, 50, 51 AND 52).
FIRST USE 3-1-2002; IN COMMERCE 3-1-2002.

CLASS 5—PHARMACEUTICALS

FOR PHARMACEUTICAL PREPARATIONS, NAMELY, ANALGESICS, GASTROINTESTINAL PREPARATIONS, SMOKING CESSATION PREPARATIONS AND SUPPLEMENTS (U.S. CLS. 6, 18, 44, 46, 51 AND 52).
FIRST USE 3-1-2002; IN COMMERCE 3-1-2002.

CLASS 21—HOUSEWARES AND GLASS

FOR TOOTHBRUSHES (U.S. CLS. 2, 13, 23, 29, 30, 33, 40 AND 50).

FIRST USE 3-1-2002; IN COMMERCE 3-1-2002.

2,764,625. ASYST TECHNOLOGIES, INC., FREMONT, CA. SN 75-867,342. PUB. 3-6-2001, FILED 12-8-1999.

VERSAPORT

CLASS 7—MACHINERY

FOR MATERIAL HANDLING MACHINES FOR LOADING AND UNLOADING STANDARD MECHANICAL INTERFACE CONTAINERS DURING THE MANUFACTURE OF SEMICONDUCTOR WAFERS, FLAT PANEL DISPLAYS, MAGNETIC MEDIA, AND RETICLES; FACTORY AUTOMATION MACHINES FOR LOADING AND UNLOADING STANDARD MECHANICAL INTERFACE CONTAINERS DURING THE MANUFACTURE OF SEMICONDUCTOR WAFERS, FLAT PANEL DISPLAYS, MAGNETIC MEDIA, AND RETICLES (U.S. CLS. 13, 19, 21, 23, 31, 34 AND 35).

FIRST USE 8-25-1999; IN COMMERCE 8-25-1999.

CLASS 9—ELECTRICAL AND SCIENTIFIC APPARATUS

FOR COMPUTER HARDWARE AND RELATED COMPUTER SOFTWARE FOR CONTROLLING MATERIAL HANDLING MACHINES AND FACTORY AUTOMATION EQUIPMENT (U.S. CLS. 21, 23, 26, 36 AND 38).

FIRST USE 8-25-1999; IN COMMERCE 8-25-1999.

2,764,633. A PERFECT CIRCLE, LOS ANGELES, CA. SN 75-887,436. PUB. 1-29-2002, FILED 1-5-2000.

2,764,638. DENTSPLY INTERNATIONAL INC., YORK, PA. SN 75-894,323. PUB. 10-17-2000, FILED 1-12-2000.

A PERFECT CIRCLE

CLASS 9—ELECTRICAL AND SCIENTIFIC APPARATUS

FOR SERIES OF MUSICAL SOUND RECORDINGS (U.S. CLS. 21, 23, 26, 36 AND 38).
FIRST USE 8-10-1999; IN COMMERCE 10-14-1999.

CLASS 25—CLOTHING

FOR SHIRTS AND TANKTOPS (U.S. CLS. 22 AND 39).
FIRST USE 8-10-1999; IN COMMERCE 8-10-1999.

CLASS 41—EDUCATION AND ENTERTAINMENT

FOR ENTERTAINMENT SERVICES, NAMELY, LIVE MUSICAL PERFORMANCES; PROVIDING INFORMATION ABOUT PERFORMANCES, RECORDINGS, APPEARANCES, THE BIOGRAPHY AND OTHER INFORMATION ABOUT A MUSIC GROUP VIA WEBSITES ON A GLOBAL COMPUTER NETWORK; PROVIDING MUSIC SELECTABLE BY INDIVIDUAL USERS BY MEANS OF A GLOBAL COMPUTER NETWORK (U.S. CLS. 100, 101 AND 107).
FIRST USE 8-10-1999; IN COMMERCE 8-10-1999.

2,764,637. TRAVELBEE, PAULA M., DBA SPIRIT TO SPIRIT, SYLVANIA, OH. SN 75-893,632. PUB. 1-30-2001, FILED 1-10-2000.

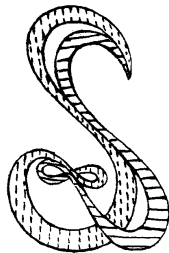

THE DRAWING IS LINED FOR THE COLORS BLUE AND PURPLE, BUT COLOR IS NOT A FEATURE OF THE MARK. THE MARK CONSISTS OF A DOUBLE "S" CONNECTED BY AN INFINITY SIGN.

CLASS 16—PAPER GOODS AND PRINTED MATTER

FOR GREETING CARDS AND NOTE CARDS, NAMELY, THOSE WITH INSPIRATIONAL MESSAGES (U.S. CLS. 2, 5, 22, 23, 29, 37, 38 AND 50).
FIRST USE 8-1-2001; IN COMMERCE 10-3-2001.

CLASS 25—CLOTHING

FOR TSHIRTS AND SWEATSHIRTS, NAMELY, THOSE WITH INSPIRATIONAL MESSAGES (U.S. CLS. 22 AND 39).
FIRST USE 8-1-2001; IN COMMERCE 10-3-2001.

TRUMATCH

CLASS 5—PHARMACEUTICALS

FOR SHADE MATCHING SYSTEM COMPRISED PRIMARILY OF DENTAL RESTORATIVE COMPOUNDS (U.S. CLS. 6, 18, 44, 46, 51 AND 52).
FIRST USE 7-9-2002; IN COMMERCE 7-9-2002.

CLASS 10—MEDICAL APPARATUS

FOR SHADE MATCHING SYSTEM COMPRISED PRIMARILY OF COLOR DISCRIMINATION GUIDES FOR USE IN DENTISTRY (U.S. CLS. 26, 39 AND 44).
FIRST USE 7-9-2002; IN COMMERCE 7-9-2002.

2,764,639. ZEKS AIR DRIER CORPORATION, WEST CHESTER, PA. SN 75-899,830. PUB. 9-3-2002, FILED 1-20-2000.

COMPRESSED AIR SOLUTIONS

NO CLAIM IS MADE TO THE EXCLUSIVE RIGHT TO USE "COMPRESSED AIR", APART FROM THE MARK AS SHOWN.

CLASS 7—MACHINERY

FOR COMPRESSED AIR SYSTEM MACHINE PARTS, NAMELY, COMPRESSED AIR BALL VALVE DRAINS (U.S. CLS. 13, 19, 21, 23, 31, 34 AND 35).
FIRST USE 6-1-2000; IN COMMERCE 6-1-2000.

CLASS 9—ELECTRICAL AND SCIENTIFIC APPARATUS

FOR COMPRESSED AIR ELECTRONIC DRAINS, COMPRESSED AIR SOLENOID DRAINS, COMPRESSED AIR FLOW DEMAND CONTROLLER, AIR COMPRESSOR CONTROL SYSTEM CONSISTING OF A PROGRAMMABLE LOGIC CONTROL THAT CONTROLS AND MONITORS THE OPERATION OF MULTIPLE AIR COMPRESSORS (U.S. CLS. 21, 23, 26, 36 AND 38).
FIRST USE 6-1-2000; IN COMMERCE 6-1-2000.

CLASS 11—ENVIRONMENTAL CONTROL APPARATUS

FOR GENERAL HEAT EXCHANGERS; COMPRESSED AIR REFRIGERATED CYCLING DRYERS; COMPRESSED AIR REFRIGERATED NON-CYCLING DRYERS; COMPRESSED AIR HIGH TEMPERATURE REFRIGERATED DRYERS; COMPRESSED AIR HIGH PRESSURE REFRIGERATED CYCLING DRYERS; COMPRESSED AIR STAINLESS STEEL REFRIGERATED DRYERS; COMPRESSED AIR HEATLESS DESICCANT DRYERS; COMPRESSED AIR HEAT REACTIVATED DESICCANT DRYERS; COMPRESSED AIR HEAT REACTIVATED BLOWER PURGE DESICCANT DRYERS; COMPRESSED AIR AFTER-COOLERS FOR USE IN HEAT EXCHANGERS; COMPRESSED AIR PARTICULATE FILTERS DOWN TO ONE MICRON FOR INDUSTRIAL AND COMMERCIAL USE; COMPRESSED AIR COALESCING FILTERS DOWN TO 01 MICRON FOR INDUSTRIAL AND COMMERCIAL USE; COMPRESSED AIR ACTIVATED CARBON FILTERS FOR INDUSTRIAL AND COMMERCIAL USE; COMPRESSED AIR PARTICULATE/COALESCING FILTERS FOR INDUSTRIAL AND COMMERCIAL USE; COMPRESSED AIR HIGH PRESSURE FILTERS FOR INDUSTRIAL AND COMMERCIAL USE; COMPRESSED AIR HIGH TEMPERATURE FILTERS FOR INDUSTRIAL AND COMMERCIAL USE; COMPRESSED AIR MIST ELIMINATORS IN THE NATURE OF HEAVY DUTY, SELF CLEANING COALESCING FILTERS DESIGNED TO REMOVE OIL AND WATER AEROSOLS FROM COMPRESSED AIR SYSTEMS WITH MINIMUM PRESSURE DROP; COMPRESSED AIR COLOR CHANGE FILTERS TO INDICATE TIME FOR REPLACEMENT, FOR INDUSTRIAL AND COMMERCIAL USE; COMPRESSED AIR CENTRIFUGAL SEPARATORS FOR THE CLEANING OF AIR BY REMOVING WATER; COMPRESSED AIR BREATHING AIR PURIFIERS FOR INDUSTRIAL AND COMMERCIAL USE; COMPRESSED AIR HEALTHCARE PURIFIERS FOR USE IN NURSING HOMES AND HOSPITALS; COMPRESSED AIR PORTABLE BREATHING AIR PURIFIERS FOR INDUSTRIAL AND COMMERCIAL USE; AIR DRIERS AND SEPARATORS; COMPRESSED AIR PURIFICATION UNITS; COMPRESSED AIR FILTERS; COMPRESSED AIR DRIERS AND SEPARATORS; COMPRESSED AIR AFTER-COOLERS AND AFTER-COOLER PREHEATERS (U.S. CLS. 13, 21, 23, 31 AND 34).
FIRST USE 5-15-2000; IN COMMERCE 5-15-2000.

2,764,643. NEWSCALE, INC., OAKLAND, CA, BY CHANGE OF NAME CELOSIS, INC., ALAMEDA, CA. SN 75-909,747. PUB. 6-11-2002, FILED 2-4-2000.

REQUESTCENTER**CLASS 9—ELECTRICAL AND SCIENTIFIC APPARATUS**

FOR SOFTWARE FOR USE IN CATALOGING, MERCHANDISING, MANAGING, MONITORING, AND COORDINATING THE DELIVERY OF GOODS AND SERVICES IN THE FIELD OF BUSINESS OPERATING SERVICES MANAGEMENT, AND FOR SUPPORTING THE PLACEMENT AND PROCESSING OF ORDERS FOR THESE GOODS AND SERVICES (U.S. CLS. 21, 23, 26, 36 AND 38).
FIRST USE 7-0-2000; IN COMMERCE 11-0-2000.

CLASS 35—ADVERTISING AND BUSINESS

FOR PROVIDING A WEBSITE FOR ON-LINE CATALOGING AND MERCHANDISING OF OFFICE EQUIPMENT AND SUPPLIES AND FOR ORDERING BUSINESS-RELATED SERVICES IN THE FIELDS OF INFORMATION TECHNOLOGY, TELECOMMUNICATIONS, HUMAN RESOURCES, AND FACILITIES MANAGEMENT; PROCESSING OF ORDERS FOR OFFICE EQUIPMENT AND SUPPLIES AND FOR BUSINESS-RELATED SERVICES IN THE FIELDS OF INFORMATION TECHNOLOGY (U.S. CLS. 100, 101 AND 102).
FIRST USE 7-0-2000; IN COMMERCE 11-0-2000.

2,764,649. CELLULAR PROCESS CHEMISTRY, INC., KENNEWICK, WA. SN 75-919,088. PUB. 4-23-2002, FILED 2-14-2000.

CPC-CELLULAR PROCESS CHEMISTRY

NO CLAIM IS MADE TO THE EXCLUSIVE RIGHT TO USE "PROCESS CHEMISTRY", APART FROM THE MARK AS SHOWN.

CLASS 9—ELECTRICAL AND SCIENTIFIC APPARATUS

FOR LABORATORY EQUIPMENT, NAMELY, MICROREACTOR-BASED CHEMICAL REACTION MODULES IN WHICH CHEMICAL REACTIONS ARE CARRIED OUT IN MICROSCALE FOR USE IN RESEARCH AND PHARMACEUTICAL INDUSTRIES (U.S. CLS. 21, 23, 26, 36 AND 38).
FIRST USE 12-20-2000; IN COMMERCE 12-20-2000.

CLASS 42—SCIENTIFIC, COMPUTER AND LEGAL SERVICES

FOR CHEMICAL RESEARCH RELATING TO THE USE AND DESIGN OF SUCH MICROREACTOR-BASED CHEMICAL REACTION MODULES; MICROSCALE SYNTHESIS OF CHEMICAL PRODUCTS FOR RESEARCH AND PHARMACEUTICAL INDUSTRIES BY EMPLOYING SUCH MICROREACTOR-BASED CHEMICAL REACTION MODULES; AND OPTIMIZING MICROSCALE PRODUCTION OF CHEMICAL PRODUCTS PRODUCED BY SUCH MICROREACTOR-BASED CHEMICAL REACTION MODULES FOR RESEARCH AND PHARMACEUTICAL INDUSTRIES (U.S. CLS. 100 AND 101).
FIRST USE 12-20-2000; IN COMMERCE 12-20-2000.

2,764,650. INTERNATIONAL DATA GROUP, INC., FRAMINGHAM, MA. SN 75-920,140. PUB. 12-11-2001, FILED 2-4-2000.

BUSINESS EVOLVING IN THE INFORMATION AGE**CLASS 16—PAPER GOODS AND PRINTED MATTER**

FOR PRINT PUBLICATIONS, NAMELY, MAGAZINES, MAGAZINE SUPPLEMENTS, NEWSLETTERS, JOURNALS AND NEWSPAPERS IN THE FIELDS OF COMPUTERS, COMPUTER SOFTWARE, ONLINE SERVICES, HIGH TECHNOLOGY, COMMUNICATIONS, INFORMATION TECHNOLOGY AND INFORMATION SERVICES (U.S. CLS. 2, 5, 22, 23, 29, 37, 38 AND 50).
FIRST USE 6-0-2000; IN COMMERCE 6-0-2000.

CLASS 42—SCIENTIFIC, COMPUTER AND LEGAL SERVICES

FOR ONLINE PUBLICATIONS, NAMELY, MAGAZINES, MAGAZINE SUPPLEMENTS, NEWSLETTERS, JOURNALS AND NEWSPAPER IN THE FIELDS OF COMPUTERS, COMPUTER SOFTWARE, ONLINE SERVICES, HIGH TECHNOLOGY, COMMUNICATIONS, INFORMATION TECHNOLOGY AND INFORMATION SERVICES; ONLINE INFORMATION SERVICES IN THE NATURE OF A NEWSLETTER IN THE FIELDS OF COMPUTERS, COMPUTER SOFTWARE, ONLINE SERVICES, HIGH TECHNOLOGY, COMMUNICATIONS, INFORMATION TECHNOLOGY AND INFORMATION SERVICES DELIVERED VIA E-MAIL; PROVIDING A WEBSITE IN THE FIELDS OF COMPUTERS, COMPUTER SOFTWARE, ONLINE SERVICES, HIGH TECHNOLOGY, COMMUNICATIONS, INFORMATION TECHNOLOGY AND INFORMATION SERVICES (U.S. CLS. 100 AND 101).

FIRST USE 6-0-2000; IN COMMERCE 6-0-2000.

2,764,666. EURPSVILLE USA, INC., MANHASSET, NY. SN 75-982,569. PUB. 6-6-2000, FILED 3-4-1999.

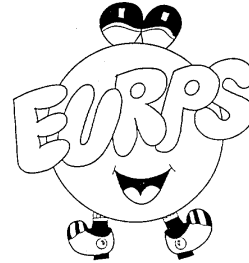

2,764,651. AYOMA INC., SAN FRANCISCO, CA, BY ASSIGNMENT SHERIDAN INTERNATIONAL LTD., TOKYO, JAPAN. SN 75-922,540. PUB. 9-18-2001, FILED 2-18-2000.

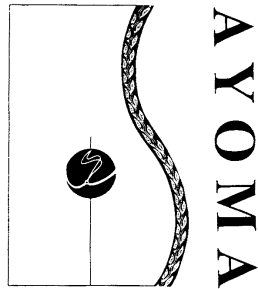

THE MARK CONSISTS IN PART, OF THE DESIGN OF THE ROUND LOGO WITH THE "S" FLAME, AND THE WAVE BRAID.

CLASS 3—COSMETICS AND CLEANING PREPARATIONS

FOR COSMETICS, NAMELY, SOAPS, ESSENTIAL OILS FOR PERSONAL USE, HAIR LOTIONS AND DENTRIFICES (U.S. CLS. 1, 4, 6, 50, 51 AND 52).
FIRST USE 1-1-1999; IN COMMERCE 1-1-1999.

CLASS 41—EDUCATION AND ENTERTAINMENT

FOR EDUCATIONAL SERVICES, NAMELY, PROVIDING TRAINING, SEMINARS, AND WORKSHOPS IN THE FIELD OF HERBAL, HEALTH AND BEAUTY CARE PRODUCTS (U.S. CLS. 100, 101 AND 107).
FIRST USE 1-1-1999; IN COMMERCE 1-1-1999.

CLASS 9—ELECTRICAL AND SCIENTIFIC APPARATUS

FOR PRE-RECORDED CD'S, AUDIO AND VIDEO CASSETTE TAPES FEATURING MUSICAL SOUND RECORDINGS AND CHILDREN'S STORIES; PRE-RECORDED CD-ROMS AND COMPUTER DISKS CONTAINING COMPUTER SOFTWARE USED TO EDUCATE AND ENTERTAIN CHILDREN IN THE FIELD OF CHILDREN'S STORIES, ACTIVITIES, GAMES AND MUSIC; COMPUTER GAMES SOFTWARE; AND PRE-RECORDED CARTRIDGES CONTAINING ELECTRONIC GAME SOFTWARE (U.S. CLS. 21, 23, 26, 36 AND 38).
FIRST USE 6-0-1998; IN COMMERCE 6-0-1998.

CLASS 16—PAPER GOODS AND PRINTED MATTER

FOR BOOKMARKS; STICKERS; AND CHILDREN'S BOOKS OR COMIC BOOKS FEATURING ANIMATED CHARACTERS (U.S. CLS. 2, 5, 22, 23, 29, 37, 38 AND 50).
FIRST USE 2-0-1998; IN COMMERCE 2-0-1998.

CLASS 28—TOYS AND SPORTING GOODS

FOR PLUSH TOYS; GAMES IN THE NATURE OF ACTION SKILL GAMES, ACTION TYPE TARGET GAMES, BOARD GAMES, CARD GAMES, MANIPULATIVE GAMES, PARLOR GAMES AND ROLE PLAYING GAMES; PUZZLES IN THE NATURE OF JIGSAW PUZZLES, MANIPULATIVE PUZZLES, STICKER PUZZLES AND CUBE PUZZLES (U.S. CLS. 22, 23, 38 AND 50).
FIRST USE 2-0-2000; IN COMMERCE 2-0-2000.

2,764,672. ERIN ENGINEERING AND RESEARCH, INC., WALNUT CREEK, CA. SN 75-983,308. PUB. 10-23-2001, FILED 3-14-2000.

IERIN

OWNER OF U.S. REG. NOS. 1,421,521 AND 2,369,762.

CLASS 9—ELECTRICAL AND SCIENTIFIC APPARATUS

FOR COMPUTER PROGRAMS FOR USE IN DATABASE MANAGEMENT, FOR USE IN DOCUMENT PREPARATION AND CONTROL, FOR USE IN EMBEDDING LOGIC INTO DOCUMENTS, FOR USE IN CREATING SPREAD SHEETS, FOR USE IN CREATING DATABASES AND LARGER COMPUTER PROGRAMS, FOR USE IN REPORT GENERATION, E-MAIL DISTRIBUTION, AND FOR EVALUATING, ANALYZING AND TRACKING CONDITION, STATUS, MAINTENANCE, SAFETY, RELIABILITY AND PERFORMANCE OF EQUIPMENT AND FACILITIES AND PROCESSES FOR A WIDE RANGE OF INDUSTRIES AND FACILITIES, SUCH AS ELECTRIC POWER, PETROCHEMICAL, PHARMACEUTICAL, AND MANUFACTURING INDUSTRIES, AND MANAGEMENT OF MEDICAL, EDUCATIONAL AND GOVERNMENT FACILITIES (U.S. CLS. 21, 23, 26, 36 AND 38).

FIRST USE 9-0-2000; IN COMMERCE 11-19-2002.

CLASS 42—SCIENTIFIC, COMPUTER AND LEGAL SERVICES

FOR COMPUTER CONSULTATION AND TECHNICAL SERVICES IN THE DEVELOPMENT USE AND IMPLEMENTATION OF COMPUTER SOFTWARE FOR THE ANALYSIS, DATABASE MANAGEMENT AND EVALUATION OF INFORMATION RELATING TO THE MAINTENANCE, AVAILABILITY, RELIABILITY, SAFETY AND PERFORMANCE OF EQUIPMENT AND FACILITIES AND PROCESSES IN A WIDE RANGE OF INDUSTRIES AND FACILITIES (U.S. CLS. 100 AND 101).

FIRST USE 9-0-2000; IN COMMERCE 12-3-2002.

2,764,683. INDEX NEWSPAPERS LLC, SEATTLE, WA, BY ASSIGNMENT LOADED-FOR-BEAR PUBLISHING CO., SEATTLE, WA. SN 76-019,456. PUB. 4-24-2001, FILED 4-6-2000.

THE PORTLAND MERCURY

NO CLAIM IS MADE TO THE EXCLUSIVE RIGHT TO USE "THE PORTLAND", APART FROM THE MARK AS SHOWN.

CLASS 35—ADVERTISING AND BUSINESS

FOR RENTAL OF ADVERTISING SPACE (U.S. CLS. 100, 101 AND 102).

FIRST USE 2-11-2003; IN COMMERCE 2-11-2003.

CLASS 42—SCIENTIFIC, COMPUTER AND LEGAL SERVICES

FOR COMPUTER SERVICES, NAMELY, PROVIDING AN ON-LINE NEWSPAPER IN THE FIELD OF COMMENTARY, HUMOR, NEWS AND ENTERTAINMENT (U.S. CLS. 100 AND 101).

FIRST USE 2-11-2003; IN COMMERCE 2-11-2003.

2,764,674. PHOTOWORKS, INC., SEATTLE, WA. SN 76-003,332. PUB. 10-1-2002, FILED 3-17-2000.

PHOTOWORKS

OWNER OF U.S. REG. NOS. 1,593,459, 2,018,625, AND 2,137,592.

CLASS 35—ADVERTISING AND BUSINESS

FOR ON-LINE ORDERING SERVICES IN THE FIELD OF PHOTOGRAPHIC IMAGES (U.S. CLS. 100, 101 AND 102).

FIRST USE 4-30-1999; IN COMMERCE 4-30-1999.

CLASS 38—COMMUNICATION

FOR PROVIDING AN ON-LINE COMPUTER WEB SITE WHERE USERS CAN ELECTRONICALLY TRANSMIT PHOTOGRAPHIC IMAGES (U.S. CLS. 100, 101 AND 104).

FIRST USE 4-30-1999; IN COMMERCE 4-30-1999.

CLASS 39—TRANSPORTATION AND STORAGE

FOR PROVIDING AN ON-LINE COMPUTER WEB SITE WHERE USERS CAN ELECTRONICALLY STORE PHOTOGRAPHIC IMAGES (U.S. CLS. 100 AND 105).

FIRST USE 4-30-1999; IN COMMERCE 4-30-1999.

2,764,685. CONFLUENT SURGICAL, INC., WALTHAM, MA. SN 76-021,483. PUB. 12-3-2002, FILED 4-10-2000.

MATERIALIZING SOLUTIONS**CLASS 5—PHARMACEUTICALS**

FOR IN SITU POLYMERIZING HYDROGEL-BASED MEDICAL DEVICES, NAMELY, SEALANT PREPARATIONS FOR TISSUE SEALING AND LOCAL DRUG DELIVERY; PREFORMED PATCHES AND SHEETS SOLD WITH MEDICATION FOR DELIVERY OF POLYMER PRECURSORS FOR MEDICAL USE IN THE TREATMENT OF ANEURISMS (U.S. CLS. 6, 18, 44, 46, 51 AND 52).

FIRST USE 11-0-1999; IN COMMERCE 11-0-1999.

CLASS 10—MEDICAL APPARATUS

FOR IN SITU POLYMERIZING HYDROGEL-BASED DRUG DELIVERY SYSTEMS COMPRISED OF SYNTHETIC POLYMERS FOR TISSUE SEALING AND LOCAL DRUG DELIVERY; SYNTHETIC, BIOCOMPATIBLE, HYDROGEL PRECURSORS, BIOCOMPATIBLE CROSSLINKED POLYMERS, RESORBABLE PROTECTORS AND SEALING AND SPACE FILLING DRUG DELIVERY SYSTEMS COMPRISED OF SYNTHETIC POLYMERS AND DELIVERY CATHETERS FOR TISSUE SEALING AND LOCAL DRUG DELIVERY; DRUG DELIVERY SYSTEMS, NAMELY, MULTI-LUMEN CATHETERS AND SINGLE LUMEN CATHETERS; PREFORMED PATCHES AND SHEETS SOLD WITHOUT MEDICATION FOR DELIVERY OF POLYMER PRECURSORS FOR MEDICAL USE (U.S. CLS. 26, 39 AND 44).

FIRST USE 11-0-1999; IN COMMERCE 11-0-1999.

2,764,690. CNET NETWORKS, INC., SAN FRANCISCO, CA.
SN 76-027,242. PUB. 8-6-2002, FILED 4-14-2000.

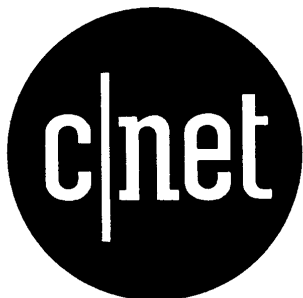

OWNER OF U.S. REG. NOS. 1,888,794, 2,254,659, AND OTHERS.

CLASS 9—ELECTRICAL AND SCIENTIFIC APPARATUS

FOR COMPUTER HARDWARE; COMPUTER SOFTWARE, AND MANUALS SOLD AS A UNIT, FOR FACILITATING ELECTRONIC SHOPPING OR PURCHASING BY MEANS OF ELECTRONIC COMMUNICATIONS NETWORKS; COMPUTER SOFTWARE PROVIDING DATABASES OF PRODUCT OR SERVICE INFORMATION IN THE FIELDS OF COMPUTERS, COMPUTING, COMPUTER SOFTWARE, ELECTRONIC GAMING, WEBSITE DESIGN AND HOSTING, SOFTWARE APPLICATION HOSTING, HIGH TECHNOLOGY, ELECTRONIC COMMUNICATIONS, ELECTRONIC COMMERCE, CONSUMER ELECTRONICS, FINANCE OR DIGITAL TECHNOLOGIES; COMPUTER SOFTWARE FOR FACILITATING THE TRANSMISSION OF TEXT, AUDIO, VIDEO, IMAGES, COMPUTER SOFTWARE OR MULTIMEDIA DATA OVER ELECTRONIC COMMUNICATIONS NETWORKS; COMPUTER SOFTWARE FOR DESIGNING AND MANAGING COMMUNICATIONS NETWORKS (U.S. CLS. 21, 23, 26, 36 AND 38).

FIRST USE 11-24-1997; IN COMMERCE 11-24-1997.

CLASS 35—ADVERTISING AND BUSINESS

FOR BUSINESS SERVICES, NAMELY, THE PROVISION OF ONLINE TRADING, AUCTIONS, AND RETAIL AND COMPARISON SHOPPING SERVICES IN THE FIELDS OF COMPUTERS, COMPUTING, COMPUTER SOFTWARE, ELECTRONIC GAMING, HIGH TECHNOLOGY, ELECTRONIC COMMUNICATIONS, ELECTRONIC COMMERCE, CONSUMER ELECTRONICS, OR DIGITAL TECHNOLOGIES, ALL BY MEANS OF ELECTRONIC COMMUNICATIONS NETWORKS; PROVIDING CONSUMER PRODUCT AND CONSUMER SERVICE INFORMATION FOR BUSINESSES AND FOR INDIVIDUALS IN THE FIELDS OF COMPUTERS, COMPUTING, COMPUTER SOFTWARE, ELECTRONIC GAMING, WEBSITE DESIGN AND HOSTING, SOFTWARE APPLICATION HOSTING, HIGH TECHNOLOGY, CONSUMER ELECTRONICS, ELECTRONIC COMMERCE, ELECTRONIC COMMUNICATIONS OR DIGITAL TECHNOLOGIES, ALL BY MEANS OF ELECTRONIC COMMUNICATIONS NETWORKS; BUSINESS INFORMATION SERVICES IN THE FIELD OF RECENT BUSINESS DEVELOPMENTS IN MARKETING, INFORMATION TECHNOLOGY, OFFICE EQUIPMENT, CONSUMER ELECTRONICS PRODUCTS, COMPUTING, AND CORPORATE ORGANIZATION, MANAGEMENT, MERGERS AND ACQUISITIONS (U.S. CLS. 100, 101 AND 102).

FIRST USE 11-24-1997; IN COMMERCE 11-24-1997.

CLASS 36—INSURANCE AND FINANCIAL

FOR FINANCIAL INFORMATION AND RELATED SERVICES, NAMELY, PROVISION OF STOCK QUOTES, FINANCIAL ANALYSIS, FINANCIAL NEWS, FINANCIAL RESEARCH, FINANCIAL COMMENTARY, AND INTERACTIVE MESSAGE SERVICES, ALL IN THE FIELD OF FINANCE AND VIA ELECTRONIC COMMUNICATIONS NETWORKS (U.S. CLS. 100, 101 AND 102).

FIRST USE 8-2-1999; IN COMMERCE 8-2-1999.

CLASS 38—COMMUNICATION

FOR TELECOMMUNICATIONS SERVICES, NAMELY, ELECTRONIC TRANSMISSION OF TEXT, AUDIO, VIDEO, IMAGES, COMPUTER SOFTWARE AND MULTIMEDIA DATA VIA ELECTRONIC COMMUNICATIONS NETWORKS; CHAT ROOM SERVICES IN THE FIELDS OF COMPUTERS, COMPUTING, COMPUTER SOFTWARE, ELECTRONIC GAMING, WEBSITE DESIGN AND HOSTING, SOFTWARE APPLICATION HOSTING, HIGH TECHNOLOGY, ELECTRONIC COMMUNICATIONS, ELECTRONIC COMMERCE, CONSUMER ELECTRONICS, FINANCE OR DIGITAL TECHNOLOGIES (U.S. CLS. 100, 101 AND 104).

FIRST USE 6-24-1995; IN COMMERCE 6-24-1995.

CLASS 41—EDUCATION AND ENTERTAINMENT

FOR EDUCATIONAL AND ENTERTAINMENT SERVICES, NAMELY, PROVIDING RADIO AND TELEVISION PROGRAMMING, AND PROGRAMMING DELIVERED VIA ELECTRONIC COMMUNICATIONS NETWORKS, ALL IN THE FIELDS OF COMPUTERS, COMPUTING, COMPUTER SOFTWARE, ELECTRONIC GAMING, WEBSITE DESIGN AND HOSTING, SOFTWARE APPLICATION HOSTING, HIGH TECHNOLOGY, ELECTRONIC COMMUNICATIONS, ELECTRONIC COMMERCE, CONSUMER ELECTRONICS, FINANCE OR DIGITAL TECHNOLOGIES (U.S. CLS. 100, 101 AND 107).

FIRST USE 4-1-1995; IN COMMERCE 4-1-1995.

CLASS 42—SCIENTIFIC, COMPUTER AND LEGAL SERVICES

FOR PROVIDING A WIDE RANGE OF NEWS, INFORMATION, REVIEWS, COMMENTARY, COMMUNICATIONS, ENTERTAINMENT AND EDUCATIONAL CONTENT IN THE FIELDS OF COMPUTERS, COMPUTING, COMPUTER SOFTWARE, ELECTRONIC GAMING, WEBSITE DESIGN AND HOSTING, SOFTWARE APPLICATION HOSTING, HIGH TECHNOLOGY, ELECTRONIC COMMUNICATIONS, ELECTRONIC COMMERCE, CONSUMER ELECTRONICS, OR DIGITAL TECHNOLOGIES, ALL VIA ELECTRONIC COMMUNICATIONS NETWORKS; COMPUTER SERVICES, NAMELY, MAINTAINING A WEBSITE FOR THE DISSEMINATION OF DOWNLOADABLE SOFTWARE OF OTHERS IN A WIDE VARIETY OF FIELDS; COMPUTER SERVICES NAMELY PROVIDING A SEARCH ENGINE FOR USE ON ELECTRONIC COMMUNICATIONS NETWORKS (U.S. CLS. 100 AND 101).

FIRST USE 6-24-1995; IN COMMERCE 6-24-1995.

2,764,692. GUST, DAVID, CHICAGO, IL. SN 76-030,537. PUB. 4-3-2001, FILED 4-20-2000.

GLOVE PLANET

NO CLAIM IS MADE TO THE EXCLUSIVE RIGHT TO USE "GLOVE", APART FROM THE MARK AS SHOWN.

CLASS 10—MEDICAL APPARATUS

FOR DISPOSABLE GLOVES FOR MEDICAL AND LABORATORY USE (U.S. CLS. 26, 39 AND 44). FIRST USE 7-0-2001; IN COMMERCE 7-0-2001.

CLASS 21—HOUSEWARES AND GLASS

FOR DISPOSABLE GLOVES FOR INDUSTRIAL AND FOOD SERVICE USE (U.S. CLS. 2, 13, 23, 29, 30, 33, 40 AND 50). FIRST USE 7-0-2001; IN COMMERCE 7-0-2001.

2,764,694. CONSOLIDATED PROPERTY HOLDINGS, INC., LAS VEGAS, NV. SN 76-033,255. PUB. 12-25-2001, FILED 4-20-2000.

SHOP SOURCE

NO CLAIM IS MADE TO THE EXCLUSIVE RIGHT TO USE "SHOP", APART FROM THE MARK AS SHOWN.

CLASS 9—ELECTRICAL AND SCIENTIFIC APPARATUS

FOR SAFETY PRODUCTS, NAMELY, GOGGLES, GLASSES, DUST MASKS, PROTECTIVE MASKS, HEARING PROTECTORS; BATTERIES; INDIVIDUAL USE GLOVES; CONTOUR GAUGES; CARPENTERS, SURVEYORS AND PLUMB LEVELS, YARDSTICKS, GRADUATED AND TAPE RULERS, CALIPERS FOR MEASURING AND MAGNIFIERS (U.S. CLS. 21, 23, 26, 36 AND 38). FIRST USE 8-0-2002; IN COMMERCE 8-0-2002.

CLASS 11—ENVIRONMENTAL CONTROL APPARATUS

FOR FLASHLIGHTS (U.S. CLS. 13, 21, 23, 31 AND 34). FIRST USE 10-0-2002; IN COMMERCE 10-0-2002.

CLASS 12—VEHICLES

FOR HAND TRUCKS AND SHOP CARTS (U.S. CLS. 19, 21, 23, 31, 35 AND 44). FIRST USE 9-0-2002; IN COMMERCE 9-0-2002.

CLASS 20—FURNITURE AND ARTICLES NOT OTHERWISE CLASSIFIED

FOR NON-METAL TOOL CHESTS AND WORKBENCHES (U.S. CLS. 2, 13, 22, 25, 32 AND 50). FIRST USE 9-0-2002; IN COMMERCE 9-0-2002.

CLASS 21—HOUSEWARES AND GLASS

FOR GLOVES FOR GENERAL USE (U.S. CLS. 2, 13, 23, 29, 30, 33, 40 AND 50). FIRST USE 7-0-2002; IN COMMERCE 7-0-2002.

2,764,696. GRANT DESIGN COLLABORATIVE, INC., CANTON, GA. SN 76-036,445. PUB. 8-20-2002, FILED 4-27-2000.

GRANT DESIGN COLLABORATIVE

NO CLAIM IS MADE TO THE EXCLUSIVE RIGHT TO

USE "DESIGN COLLABORATIVE", APART FROM THE MARK AS SHOWN.

THE NAME "GRANT" IDENTIFIES A LIVING INDIVIDUAL WHOSE CONSENT IS OF RECORD.

CLASS 35—ADVERTISING AND BUSINESS

FOR CREATING, PREPARING AND PLACING ADVERTISEMENTS FOR OTHERS (U.S. CLS. 100, 101 AND 102). FIRST USE 6-1-2000; IN COMMERCE 6-1-2000.

CLASS 42—SCIENTIFIC, COMPUTER AND LEGAL SERVICES

FOR GRAPHIC ART DESIGN; GRAPHIC ART DESIGN FOR PUBLICATIONS; INTERIOR DESIGN (U.S. CLS. 100 AND 101). FIRST USE 6-1-2000; IN COMMERCE 6-1-2000.

2,764,699. CONFLUENT SURGICAL, INC., BOSTON, MA. SN 76-041,227. PUB. 11-6-2001, FILED 5-4-2000.

**CLASS 5—PHARMACEUTICALS**

FOR IN SITU POLYMERIZING HYDROGEL-BASED MEDICAL DEVICES, NAMELY, POST SURGICAL ADHESION PREVENTION BARRIERS AND SEALANT PREPARATIONS FOR TISSUE SEALING AND SPACE FILLING; IN SITU POLYMERIZING HYDROGEL-BASED MEDICAL SERVICES USED IN THE TREATMENT OF ANEURISMS; LIQUID EMBOLICS FOR USE IN ENDOVASCULAR SURGICAL PROCEDURES; PREFORMED PATCHES AND SHEETS SOLD WITH MEDICATION FOR MEDICAL USE (U.S. CLS. 6, 18, 44, 46, 51 AND 52). FIRST USE 11-0-1999; IN COMMERCE 11-0-1999.

CLASS 10—MEDICAL APPARATUS

FOR IN SITU POLYMERIZING HYDROGEL-BASED DRUG DELIVERY SYSTEMS COMPRISED OF SYNTHETIC POLYMERS FOR TISSUE SEALING AND LOCAL DRUG DELIVERY; COMPOSITIONS FOR MEDICAL USE, NAMELY, SYNTHETIC, BIOCOMPATIBLE, HYDROGEL PRECURSORS, BIOCOMPATIBLE CROSSLINKED POLYMERS FOR USE IN SURGICAL PROCEDURES; RESORBABLE AND NONRESORBABLE PROTECTORS FOR USE IN SURGICAL PROCEDURES; SEALING AND SPACE FILLING DRUG DELIVERY SYSTEMS COMPRISED OF SYNTHETIC POLYMERS AND DELIVERY CATHETERS FOR TISSUE SEALING AND LOCAL DRUG DELIVERY; DRUG DELIVERY SYSTEMS, NAMELY, AIR ASSISTED SPRAYERS AND NON-AIR ASSISTED SPRAYERS, MULTI-LUMEN CATHETERS AND SINGLE LUMEN CATHETERS AND REFORMED PATCHES AND SHEETS SOLD WITHOUT MEDICATION FOR MEDICAL USE (U.S. CLS. 26, 39 AND 44). FIRST USE 11-0-1999; IN COMMERCE 11-0-1999.

2,764,705. EHARMONY.COM, INC., PASADENA, CA. SN 76-047,490. PUB. 4-30-2002, FILED 5-12-2000.

EHARMONY

CLASS 9—ELECTRICAL AND SCIENTIFIC APPARATUS

FOR AUDIO TAPES AND VIDEO TAPES, NAMELY, PRE-RECORDED AUDIO TAPES AND PRE-RECORDED VIDEO TAPES FEATURING SELF-HELP, RELATIONSHIP COUNSELING AND ANGER MANAGEMENT (U.S. CLS. 21, 23, 26, 36 AND 38).

FIRST USE 7-8-2000; IN COMMERCE 8-22-2000.

CLASS 42—SCIENTIFIC, COMPUTER AND LEGAL SERVICES

FOR DATING SERVICES, MARRIAGE COUNSELING, COUNSELING, NAMELY, OFFERING ADVICE REGARDING PERSONAL RELATIONSHIPS AND PERSONAL WELL BEING VIA A GLOBAL COMPUTER NETWORK (U.S. CLS. 100 AND 101).

FIRST USE 1-0-1999; IN COMMERCE 8-22-2000.

CLASS 42—SCIENTIFIC, COMPUTER AND LEGAL SERVICES

FOR COMPUTER MANAGEMENT SERVICES, NAMELY, SOFTWARE APPLICATION MANAGEMENT; HOSTING THE WEB SITES OF OTHERS ON A COMPUTER SERVER FOR A GLOBAL COMPUTER NETWORK; MONITORING AND MANAGING THE COMPUTER SYSTEMS OF OTHERS AND PROVIDING BACK-UP COMPUTER PROGRAMS IN THE NATURE OF DATA RECOVERY SERVICES AND DISASTER RECOVERY SYSTEMS; LEASING COMPUTER FACILITIES; LEASING COMPUTER NETWORKS AND SYSTEMS FOR USE AS BACK-UP SYSTEMS, AND PROVIDING TECHNICAL CONSULTATION IN THE AREA OF COMPUTERIZED DISASTER RECOVERY; MAINTENANCE OF COMPUTER NETWORKS IN THE NATURE OF UPDATING COMPUTER SOFTWARE FOR OTHERS; COMPUTER CONSULTING SERVICES, NAMELY, HELP DESK SERVICES RELATED TO COMPUTER HARDWARE AND SOFTWARE; COMPUTER SYSTEMS ANALYSIS; COMPUTER SOFTWARE DESIGN; COMPUTER DATABASE DESIGN AND IMPLEMENTATION; AND INTEGRATION OF COMPUTER SYSTEMS AND NETWORKS; DESIGN, DEVELOPMENT, PROGRAMMING, IMPLEMENTATION, AND MANAGEMENT OF COMPUTER SYSTEMS THAT CONNECT TO A GLOBAL COMPUTER NETWORK AND OTHER COMPUTER AND COMMUNICATIONS NETWORKS (U.S. CLS. 100 AND 101).

FIRST USE 11-0-2000; IN COMMERCE 11-0-2000.

2,764,717. MITSUBISHI HEAVY INDUSTRIES, LTD., TOKYO, JAPAN. SN 76-061,680. PUB. 8-20-2002, FILED 6-2-2000.

2,764,713. (I)STRUCTURE, INC., OMAHA, NE. SN 76-056,530. PUB. 11-6-2001, FILED 5-25-2000.



CLASS 35—ADVERTISING AND BUSINESS

FOR DATABASE MANAGEMENT (U.S. CLS. 100, 101 AND 102).

FIRST USE 11-0-2000; IN COMMERCE 11-0-2000.

DIASYS Netmation

CLASS 9—ELECTRICAL AND SCIENTIFIC APPARATUS

FOR CONTROL SYSTEM HARDWARE AND CONTROL SYSTEM SOFTWARE USED FOR LOCAL OR REMOTE CONTROL, OPERATION, MONITORING, DIAGNOSIS, ADJUSTMENT, OPTIMIZING, DATA RECORDING, MAINTENANCE AND TESTING OF INDUSTRIAL MANUFACTURING PLANTS AND PUBLIC UTILITY PLANTS (U.S. CLS. 21, 23, 26, 36 AND 38).

FIRST USE 4-30-2001; IN COMMERCE 5-31-2001.

CLASS 37—CONSTRUCTION AND REPAIR

FOR MAINTENANCE SERVICES IN THE NATURE OF ADJUSTMENT AND REPAIR OF CONTROL AND MONITORING SYSTEMS FOR INDUSTRIAL MANUFACTURING PLANTS AND PUBLIC UTILITY PLANTS (U.S. CLS. 100, 103 AND 106).

FIRST USE 4-30-2003; IN COMMERCE 5-31-2001.

CLASS 42—SCIENTIFIC, COMPUTER AND LEGAL SERVICES

FOR MONITORING THE COMPUTER CONTROL SYSTEMS OF OTHERS FOR INDUSTRIAL PLANTS AND PUBLIC UTILITY PLANTS; DESIGN PLANNING FOR CONTROL AND MONITORING SYSTEMS FOR INDUSTRIAL PLANTS AND PUBLIC UTILITY PLANTS (U.S. CLS. 100 AND 101).

FIRST USE 4-30-2001; IN COMMERCE 5-31-2001.

2,764,725. AUTONATION HOLDING CORP., FORT LAUDERDALE, FL. SN 76-071,821. PUB. 3-5-2002, FILED 6-16-2000.

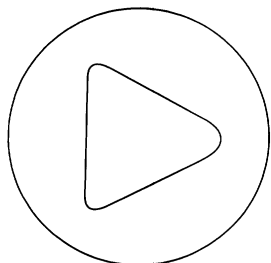

CLASS 36—INSURANCE AND FINANCIAL

FOR FINANCIAL SERVICES, NAMELY, PROVIDING FINANCING FOR THE PURCHASE OF NEW AND USED VEHICLES (U.S. CLS. 100, 101 AND 102).

FIRST USE 7-0-2000; IN COMMERCE 7-0-2000.

CLASS 39—TRANSPORTATION AND STORAGE

FOR LEASING OF NEW AND USED MOTOR VEHICLES (U.S. CLS. 100 AND 105).

FIRST USE 7-0-2000; IN COMMERCE 7-0-2000.

2,764,730. ASAHI MEDICAL CO., LTD., CHIYODA-KU, TOKYO, JAPAN. SN 76-074,413. PUB. 3-13-2001, FILED 6-21-2000.

SEPACELL FLEX

OWNER OF U.S. REG. NO. 1,293,940.

CLASS 9—ELECTRICAL AND SCIENTIFIC APPARATUS

FOR FILTRATION LEUKOPHORESIS APPARATUS FOR SCIENTIFIC USE AND PARTS THEREOF (U.S. CLS. 21, 23, 26, 36 AND 38).

FIRST USE 1-0-2003; IN COMMERCE 1-0-2003.

CLASS 10—MEDICAL APPARATUS

FOR FILTRATION LEUKOPHORESIS APPARATUS FOR SURGICAL AND MEDICAL USE, AND PARTS THEREOF (U.S. CLS. 26, 39 AND 44).

FIRST USE 1-0-2003; IN COMMERCE 1-0-2003.

2,764,755. CADUCIAN, INC., AUSTIN, TX. SN 76-092,079. PUB. 10-2-2001, FILED 7-19-2000.



THE MARK CONSISTS OF A DESIGN IN THE FORM OF THE HEAD OF MERCURY, A GREEK GOD ASSOCIATED WITH THE MEDICAL ARTS, AND THE WORD "CADUCIAN" BELOW THE DESIGN.

CLASS 9—ELECTRICAL AND SCIENTIFIC APPARATUS

FOR COMPUTER SOFTWARE THAT COMPRESSES LARGE DATA FILES OF PATIENT INFORMATION AND FACILITATES THE ANALYSIS OF PATIENT DATA FOR USE WITH THE DELIVERY OF MEDICAL PATIENT INFORMATION VIA A COMPUTER INFORMATION SYSTEM NETWORK; AND COMPUTER MONITORS (U.S. CLS. 21, 23, 26, 36 AND 38).

FIRST USE 6-0-2002; IN COMMERCE 6-0-2002.

CLASS 42—SCIENTIFIC, COMPUTER AND LEGAL SERVICES

FOR COMPUTER SOFTWARE AND HARDWARE DESIGNED FOR OTHERS, NAMELY, DESIGNING SOFTWARE FOR USE IN THE DELIVERY OF MEDICAL PATIENT INFORMATION VIA A WIRELESS COMMUNICATIONS SYSTEM OR COMPUTER INFORMATION SYSTEM NETWORK (U.S. CLS. 100 AND 101).

FIRST USE 4-0-2001; IN COMMERCE 4-0-2001.

2,764,756. MPORTAL, INC., MCLEAN, VA, BY CHANGE OF NAME MPORTAL.COM, INC., MCLEAN, VA. SN 76-092,380. PUB. 8-20-2002, FILED 7-20-2000.

MOBILIZING BUSINESS

CLASS 9—ELECTRICAL AND SCIENTIFIC APPARATUS

FOR COMPUTER SOFTWARE FOR PROVIDING ACCESS TO A GLOBAL COMPUTER NETWORK AND PRIVATE COMPUTER NETWORKS VIA MOBILE WIRELESS COMMUNICATIONS DEVICES (U.S. CLS. 21, 23, 26, 36 AND 38).

FIRST USE 8-24-2000; IN COMMERCE 8-24-2000.

CLASS 42—SCIENTIFIC, COMPUTER AND LEGAL SERVICES

FOR COMPUTER SOFTWARE DESIGN AND CONSULTING SERVICES FOR PROVIDING ACCESS TO A GLOBAL COMPUTER NETWORK AND PRIVATE COMPUTER NETWORKS VIA MOBILE WIRELESS COMMUNICATIONS DEVICES (U.S. CLS. 100 AND 101).

FIRST USE 8-21-2000; IN COMMERCE 8-21-2000.

2,764,758. BARNES, JOHN WILLIAM, NASHVILLE, TN. SN 76-092,534. PUB. 4-23-2002, FILED 7-20-2000.

THE GARDEN CLUB

CLASS 16—PAPER GOODS AND PRINTED MATTER

FOR PAPER GOODS AND PRINTED MATTER, NAMELY, JOURNALS, PLANNERS, CALENDARS, FRAMEABLE PRINTS, NOTE CARDS, STATIONERY, GREETING CARDS, NOTE PAPER, DATE BOOKS, DIARIES, POSTERS, STICKERS, WRAPPING PAPER, BOOK MARKS, POSTCARDS, PHOTO ALBUMS, SCRAPBOOKS, GUEST CARDS, RECIPE BOOKS AND RECIPE CARDS, COUPON BOOKS, OCCASION CARDS, PRINTED INVITATIONS, PAPER TABLE NAPKINS, PAPER AND PLASTIC PLACE MATS, PAPER TABLE RUNNERS, PLAYING CARDS AND PAPER BAGS FOR PACKAGING (U.S. CLS. 2, 5, 22, 23, 29, 37, 38 AND 50).
FIRST USE 5-8-2003; IN COMMERCE 5-8-2003.

CLASS 25—CLOTHING

FOR CLOTHING, NAMELY HATS, CAPS, APRONS, SMOCKS, SHIRTS, SWEATSHIRTS, JACKETS, SHOES, SUN VISORS AND SWEAT BANDS (U.S. CLS. 22 AND 39).
FIRST USE 6-11-2003; IN COMMERCE 6-11-2003.

2,764,778. WALL STREET RADIO.NET, BOULDER, CO. SN 76-110,940. PUB. 6-18-2002, FILED 8-16-2000.

WINNING ON WALL STREET

CLASS 9—ELECTRICAL AND SCIENTIFIC APPARATUS

FOR PRERECORDED CD'S AND AUDIOTAPES IN THE FIELD OF FINANCE (U.S. CLS. 21, 23, 26, 36 AND 38).
FIRST USE 8-0-1999; IN COMMERCE 11-1-1998.

CLASS 16—PAPER GOODS AND PRINTED MATTER

FOR BOOKS AND NEWSLETTERS ABOUT FINANCIAL MATTERS (U.S. CLS. 2, 5, 22, 23, 29, 37, 38 AND 50).
FIRST USE 8-0-1999; IN COMMERCE 11-1-1998.

CLASS 36—INSURANCE AND FINANCIAL

FOR PROVIDING AN ON-LINE COMPUTER DATABASE IN THE FIELD OF FINANCE AND ADVICE (U.S. CLS. 100, 101 AND 102).
FIRST USE 8-0-1999; IN COMMERCE 11-1-1998.

CLASS 41—EDUCATION AND ENTERTAINMENT

FOR RADIO PROGRAMS FEATURING INFORMATION AND ADVICE (U.S. CLS. 100, 101 AND 107).
FIRST USE 8-0-1999; IN COMMERCE 11-1-1998.

2,764,763. GENPASS INC., FORT WASHINGTON, PA. SN 76-099,326. PUB. 6-12-2001, FILED 7-28-2000.

GENPASS TECHNOLOGIES

NO CLAIM IS MADE TO THE EXCLUSIVE RIGHT TO USE "TECHNOLOGIES", APART FROM THE MARK AS SHOWN.

CLASS 36—INSURANCE AND FINANCIAL

FOR FINANCIAL AND BANKING SERVICES, NAMELY, ELECTRONIC BANKING SERVICES; ELECTRONIC PROCESSING AND TRANSMISSION OF POINT OF SALE PURCHASE PAYMENTS; BANK CARD SERVICES; BANKING SERVICES PROVIDED VIA A GLOBAL COMPUTER NETWORK; AND PROCESSING SERVICES RELATING TO SELF-SERVICE ELECTRONIC FUNDS TRANSFER (U.S. CLS. 100, 101 AND 102).
FIRST USE 1-0-2002; IN COMMERCE 1-0-2002.

CLASS 37—CONSTRUCTION AND REPAIR

FOR PROVIDING MAINTENANCE SERVICES RELATING TO SELF-SERVICE ELECTRONIC FUNDS TRANSFER DEVICES (U.S. CLS. 100, 103 AND 106).
FIRST USE 1-0-2002; IN COMMERCE 1-0-2002.

2,764,798. TVC ADVANCED LEARNING LIMITED, BALLYBRIT, CO. GALWAY, IRELAND, BY CHANGE OF NAME TVC MEDIA LIMITED, BALLYBRIT, CO. GALWAY, IRELAND. SN 76-134,959. PUB. 5-7-2002, FILED 9-25-2000.



NO CLAIM IS MADE TO THE EXCLUSIVE RIGHT TO USE "LEARNING", APART FROM THE MARK AS SHOWN.

CLASS 9—ELECTRICAL AND SCIENTIFIC APPARATUS

FOR COMPUTERS, COMPUTER MONITORS, KEYBOARDS, AND MODEMS; COMPACT DISCS FEATURING INFORMATION TECHNOLOGY LITERACY TRAINING SOFTWARE; BLANK COMPUTER DISCS; AUDIO AND VIDEO TAPES, CASSETTES, AND DISCS FEATURING INFORMATION TECHNOLOGY LITERACY TRAINING PROGRAMS; PRE-RECORDED COMPUTER SOFTWARE USED FOR TRAINING, EDUCATIONAL AND REFERENCE PURPOSES IN THE FIELD OF INFORMATION TECHNOLOGY LITERACY (U.S. CLS. 21, 23, 26, 36 AND 38).
FIRST USE 3-31-2001; IN COMMERCE 9-30-2001.

CLASS 16—PAPER GOODS AND PRINTED MATTER

FOR COMPUTER MANUALS FOR SUPPORTING COMPUTER SOFTWARE USED FOR TRAINING, EDUCATIONAL AND REFERENCE PURPOSES IN THE FIELD OF INFORMATION TECHNOLOGY; BOOKS, BOOKLETS, AND NEWSLETTERS FOR TRAINING, EDUCATIONAL, AND REFERENCE PURPOSES IN THE FIELD OF INFORMATION TECHNOLOGY (U.S. CLS. 2, 5, 22, 23, 29, 37, 38 AND 50).

FIRST USE 3-31-2001; IN COMMERCE 9-30-2001.

CLASS 41—EDUCATION AND ENTERTAINMENT

FOR EDUCATIONAL SERVICES, NAMELY, CONDUCTING CLASSES AND SEMINARS IN THE FIELD OF INFORMATION TECHNOLOGY LITERACY; AUDIO RECORDING AND PRODUCTION; VIDEOTAPE PRODUCTION; PUBLICATION OF TEXT BOOKS AND COMPUTER SOFTWARE MANUALS; PROVIDING EDUCATIONAL AND TRAINING COURSES IN THE FIELD OF INFORMATION TECHNOLOGY VIA A LOCAL, WIDE AREA, OR GLOBAL COMPUTER NETWORK (U.S. CLS. 100, 101 AND 107).

FIRST USE 3-31-2001; IN COMMERCE 9-30-2001.

2,764,800. PROBUBUSINESS SERVICES, INC., PLEASANTON, CA. SN 76-135,415. PUB. 4-23-2002, FILED 9-25-2000.

GOLDEN GATE**CLASS 9—ELECTRICAL AND SCIENTIFIC APPARATUS**

FOR COMPUTER SOFTWARE AND MANUALS SOLD AS A UNIT FOR HUMAN RESOURCE APPLICATIONS, PAYROLL SERVICE APPLICATIONS, ADMINISTRATION OF AN INTEGRATED PAYROLL SYSTEM, AND ADMINISTRATION OF EMPLOYEE BENEFITS (U.S. CLS. 21, 23, 26, 36 AND 38).

FIRST USE 2-1-2003; IN COMMERCE 2-1-2003.

CLASS 16—PAPER GOODS AND PRINTED MATTER

FOR PUBLICATIONS, NAMELY, NEWSLETTERS AND INFORMATION BULLETINS IN THE FIELDS OF HUMAN RESOURCES, EMPLOYEE INFORMATION MANAGEMENT, EMPLOYEE BENEFITS, AND PAYROLL MANAGEMENT (U.S. CLS. 2, 5, 22, 23, 29, 37, 38 AND 50).

FIRST USE 2-1-2003; IN COMMERCE 2-1-2003.

CLASS 35—ADVERTISING AND BUSINESS

FOR PAYROLL PREPARATION, AND PROVIDING INFORMATION IN THE FIELD OF PAYROLL PREPARATION (U.S. CLS. 100, 101 AND 102).

FIRST USE 2-1-2003; IN COMMERCE 2-1-2003.

CLASS 36—INSURANCE AND FINANCIAL

FOR ADMINISTRATION OF EMPLOYEE BENEFIT PLANS, PROVIDING ENROLLMENT REGISTRATION SERVICES FOR EMPLOYEE BENEFIT AND INSURANCE PLANS, AND TAX PAYMENT PROCESSING SERVICES; AND PROVIDING INFORMATION IN THE FIELD OF ADMINISTRATION OF EMPLOYEE BENEFITS AND INSURANCE PLANS, ENROLLMENT REGISTRATION SERVICES FOR EMPLOYEE BENEFIT AND INSURANCE PLANS, AND TAX PAYMENT PROCESSING SERVICES BY MEANS OF A GLOBAL COMPUTER NETWORK (U.S. CLS. 100, 101 AND 102).

FIRST USE 2-1-2003; IN COMMERCE 2-1-2003.

CLASS 41—EDUCATION AND ENTERTAINMENT

FOR TRAINING IN THE USE AND OPERATION OF SOFTWARE FOR HUMAN RESOURCES, HUMAN RESOURCE APPLICATIONS, PAYROLL SERVICE APPLICATIONS, ADMINISTRATION OF AN INTEGRATED PAYROLL SYSTEM, TAX PROCESSING AND MANAGEMENT, MANAGEMENT OF EMPLOYEE INFORMATION, ADMINISTRATION OF EMPLOYEE BENEFITS, AND ADMINISTRATION OF EMPLOYEE INSURANCE (U.S. CLS. 100, 101 AND 107).

FIRST USE 2-1-2003; IN COMMERCE 2-1-2003.

2,764,801. SPORTS AUTHORITY MICHIGAN, INC., THE, FORT LAUDERDALE, FL. SN 76-135,840. PUB. 4-30-2002, FILED 9-26-2000.



OWNER OF U.S. REG. NO. 1,245,417.
NO CLAIM IS MADE TO THE EXCLUSIVE RIGHT TO USE "FITNESS", APART FROM THE MARK AS SHOWN.

CLASS 25—CLOTHING

FOR SHIRTS, SHORTS, PANTS, JACKETS, HATS, VISORS AND CAPS (U.S. CLS. 22 AND 39).

FIRST USE 1-0-2001; IN COMMERCE 1-0-2001.

CLASS 41—EDUCATION AND ENTERTAINMENT

FOR PHYSICAL FITNESS, CONDITIONING AND EXERCISE INSTRUCTION SERVICES; EDUCATION SERVICES, NAMELY, ORGANIZING PERSONAL PHYSICAL FITNESS AND HEALTH PROGRAMS (U.S. CLS. 100, 101 AND 107).

FIRST USE 6-0-2000; IN COMMERCE 6-0-2000.

CLASS 42—SCIENTIFIC, COMPUTER AND LEGAL SERVICES

FOR PROMOTING PUBLIC AWARENESS OF THE NEED FOR PHYSICAL FITNESS AND HEALTH PROGRAMS (U.S. CLS. 100 AND 101).

FIRST USE 12-0-1999; IN COMMERCE 12-0-1999.

2,764,802. SPORTS AUTHORITY MICHIGAN, INC., THE, FORT LAUDERDALE, FL. SN 76-135,841. PUB. 4-9-2002, FILED 9-26-2000.

FITNESS AUTHORITY

OWNER OF U.S. REG. NO. 1,245,417.
NO CLAIM IS MADE TO THE EXCLUSIVE RIGHT TO USE "FITNESS", APART FROM THE MARK AS SHOWN.

CLASS 25—CLOTHING

FOR SHIRTS, SHORTS, PANTS, JACKETS, HATS, VISORS AND CAPS (U.S. CLS. 22 AND 39).
FIRST USE 1-0-2001; IN COMMERCE 1-0-2001.

CLASS 41—EDUCATION AND ENTERTAINMENT

FOR PHYSICAL FITNESS, CONDITIONING AND EXERCISE INSTRUCTION SERVICES; EDUCATION SERVICES, NAMELY, ORGANIZING PERSONAL PHYSICAL FITNESS AND HEALTH PROGRAMS (U.S. CLS. 100, 101 AND 107).
FIRST USE 6-0-2000; IN COMMERCE 6-0-2000.

CLASS 42—SCIENTIFIC, COMPUTER AND LEGAL SERVICES

FOR PROMOTING PUBLIC AWARENESS OF THE NEED FOR PHYSICAL FITNESS AND HEALTH PROGRAMS (U.S. CLS. 100 AND 101).
FIRST USE 12-0-1999; IN COMMERCE 12-0-1999.

2,764,815. HATCHER, VIRGIL A., NEW YORK, NY. SN 76-141,038. PUB. 4-9-2002, FILED 10-4-2000.

DERMALESSENCE**CLASS 3—COSMETICS AND CLEANING PREPARATIONS**

FOR BODY AND SKINCARE PRODUCTS, NAMELY, SKIN CLEANSERS, TONERS, SKIN MOISTURIZERS, SKIN MASKS, NON-MEDICATED OINTMENTS FOR THE PREVENTION AND TREATMENT OF SUNBURN, BATH GELS, SHAMPOOS, HAIR CONDITIONERS, SKIN BLEACHING CREAMS AND LOTIONS, SUNSCREENS, SELF-TANNING LOTIONS, NON-MEDICATED SKIN SERUMS, FOUNDATIONS, CONCEALERS, LIP PENCILS, LIPSTICKS, BLUSHES, EYE PENCILS, EYE SHADOW (U.S. CLS. 1, 4, 6, 50, 51 AND 52).
FIRST USE 12-16-2002; IN COMMERCE 12-16-2002.

CLASS 5—PHARMACEUTICALS

FOR MEDICATED SKINCARE AND HYGIENE PRODUCTS, NAMELY, MEDICATED TONERS, MEDICATED SKIN MOISTURIZERS, ANTI-ITCH OINTMENTS AND GELS (U.S. CLS. 6, 18, 44, 46, 51 AND 52).
FIRST USE 12-16-2002; IN COMMERCE 12-16-2002.

CLASS 21—HOUSEWARES AND GLASS

FOR GROOMING GOODS, NAMELY, FACE AND BODY SPONGES, FACIAL SPONGES FOR APPLYING MAKE-UP, MAKE-UP BRUSHES, SHIMMIES USED FOR APPLYING MAKE-UP (U.S. CLS. 2, 13, 23, 29, 30, 33, 40 AND 50).
FIRST USE 12-16-2002; IN COMMERCE 12-16-2002.

2,764,818. AERO PRODUCTS INTERNATIONAL, INC., WAUCONDA, IL. SN 76-143,508. PUB. 7-16-2002, FILED 10-10-2000.

BED BASICS

NO CLAIM IS MADE TO THE EXCLUSIVE RIGHT TO USE "BED", APART FROM THE MARK AS SHOWN.

CLASS 20—FURNITURE AND ARTICLES NOT OTHERWISE CLASSIFIED

FOR INFLATABLE MATTRESSES FOR INDOOR AND OUTDOOR USE; BED FRAMES (U.S. CLS. 2, 13, 22, 25, 32 AND 50).
FIRST USE 4-11-2001; IN COMMERCE 4-11-2001.

CLASS 24—FABRICS

FOR BED BLANKETS, BED SPREADS, BED LINENS, BED COVERS MADE OF CLOTH, BED SHEETS AND DUST RUFFLES (U.S. CLS. 42 AND 50).
FIRST USE 4-11-2001; IN COMMERCE 4-11-2001.

2,764,838. LETRO PRODUCTS, INC., REDDING, CA. SN 76-159,035. PUB. 4-9-2002, FILED 11-3-2000.

**CLASS 7—MACHINERY**

FOR AUTOMATIC CLEANER FOR SWIMMING POOLS AND SPAS IN THE NATURE OF A VACUUM TYPE UNIT (U.S. CLS. 13, 19, 21, 23, 31, 34 AND 35).
FIRST USE 6-6-2001; IN COMMERCE 6-6-2001.

CLASS 11—ENVIRONMENTAL CONTROL APPARATUS

FOR AUTOMATIC CLEANER FOR SWIMMING POOLS AND SPAS IN THE NATURE OF A WATER CLEANING AND FILTERING UNIT (U.S. CLS. 13, 21, 23, 31 AND 34).
FIRST USE 6-6-2001; IN COMMERCE 6-6-2001.

2,764,839. HEALTHMEDIA, INC., ANN ARBOR, MI. SN 76-159,203. PUB. 9-24-2002, FILED 11-6-2000.

 **HealthMedia**
nourish

OWNER OF U.S. REG. NOS. 2,276,506, 2,324,542, AND 2,577,770.

CLASS 16—PAPER GOODS AND PRINTED MATTER

FOR PUBLICATIONS, NAMELY, PRINTED MATERIALS IN THE FIELDS OF WELLNESS, HEALTH PROMOTION, PREVENTATIVE HEALTH CARE, DISEASE MANAGEMENT, BEHAVIOR CHANGE, AND HEALTH RISK ASSESSMENT (U.S. CLS. 2, 5, 22, 23, 29, 37, 38 AND 50).
FIRST USE 2-21-2001; IN COMMERCE 2-21-2001.

CLASS 42—SCIENTIFIC, COMPUTER AND LEGAL SERVICES

FOR COLLECTION AND ANALYSIS OF HEALTH, LIFESTYLE, AND PERSONAL INFORMATION AND CREATION OF PERSONAL GUIDES FOR USE BY INDIVIDUALS IN CONNECTION WITH THEIR OWN WELLNESS, PREVENTATIVE HEALTH CARE, DISEASE MANAGEMENT AND BEHAVIOR CHANGE, VIA THE GLOBAL COMPUTER NETWORK; AND COMPUTER SERVICES, NAMELY, PROVIDING ONLINE QUESTIONNAIRES, GUIDEBOOKS, SUPPLEMENTAL GUIDES, TAILORED FOLLOW-UP MATERIALS, AND NEWSLETTERS, ALL IN THE FIELDS OF WELLNESS, HEALTH PROMOTION, PREVENTATIVE HEALTH CARE, DISEASE MANAGEMENT, BEHAVIOR CHANGE, AND HEALTH RISK ASSESSMENT (U.S. CLS. 100 AND 101).
FIRST USE 2-21-2001; IN COMMERCE 2-21-2001.

2,764,840. SPICE ENTERTAINMENT, INC., CHICAGO, IL. SN 76-159,915. PUB. 3-5-2002, FILED 11-6-2000.

SUGAR-N-SPICE**CLASS 5—PHARMACEUTICALS**

FOR LUBRICANTS, NAMELY OILS AND GELS FOR PERSONAL USE (U.S. CLS. 6, 18, 44, 46, 51 AND 52).
FIRST USE 11-15-2000; IN COMMERCE 11-15-2000.

CLASS 10—MEDICAL APPARATUS

FOR PROSTHETIC BREAST, VAGINAS AND PENIS DEVICES; IMITATION SEXUAL ORGANS; ELECTRIC AND NON-ELECTRIC MASSAGE DEVICES; HAND-HELD VIBRATORS; SEXUAL AIDS, NAMELY VACUUM THERAPY DEVICES AND PENIS PUMPS; SEXUAL STIMULATORS NAMELY, DILDOS AND DONGS; CONDOMS (U.S. CLS. 26, 39 AND 44).
FIRST USE 11-8-2000; IN COMMERCE 11-8-2000.

2,764,844. SPOT WALL, INC., ENCINO, CA. SN 76-161,476. PUB. 6-19-2001, FILED 11-7-2000.

SPOT WALL

NO CLAIM IS MADE TO THE EXCLUSIVE RIGHT TO USE "WALL", APART FROM THE MARK AS SHOWN.

CLASS 19—NON-METALLIC BUILDING MATERIALS

FOR NON-METALLIC WALL, FLOOR AND ROOF TRUSSES, PANELS AND READY TO ASSEMBLE KITS COMPRISED OF WALL, FLOOR, AND ROOF TRUSSES FOR BUILDING CONSTRUCTION (U.S. CLS. 1, 12, 33 AND 50).
FIRST USE 3-1-2001; IN COMMERCE 3-1-2001.

CLASS 37—CONSTRUCTION AND REPAIR

FOR INSTALLATION OF METALLIC AND NON-METALLIC WALL, FLOOR AND ROOF SYSTEMS, PANELS AND READY TO ASSEMBLE KITS FOR BUILDING CONSTRUCTION AND PROVIDING TECHNICAL INFORMATION RELATING THERETO (U.S. CLS. 100, 103 AND 106).
FIRST USE 3-1-2001; IN COMMERCE 3-1-2001.

2,764,851. AERO PRODUCTS INTERNATIONAL, INC., WAUCONDA, IL. SN 76-164,967. PUB. 4-30-2002, FILED 11-14-2000.

QUADRA COIL

NO CLAIM IS MADE TO THE EXCLUSIVE RIGHT TO USE "COIL", APART FROM THE MARK AS SHOWN.

THE LATIN WORD "QUADRA" MEANS "FOUR" OR "SQUARE".

CLASS 20—FURNITURE AND ARTICLES NOT OTHERWISE CLASSIFIED

FOR FEATURE OF INFLATABLE MATTRESSES FOR INDOOR AND OUTDOOR USE, NAMELY, SUPPORT STRUCTURES (U.S. CLS. 2, 13, 22, 25, 32 AND 50).
FIRST USE 5-1-2002; IN COMMERCE 5-1-2002.

CLASS 28—TOYS AND SPORTING GOODS

FOR FEATURE OF INFLATABLE MATTRESSES FOR RECREATIONAL USE, NAMELY, SUPPORT STRUCTURES (U.S. CLS. 22, 23, 38 AND 50).
FIRST USE 5-1-2002; IN COMMERCE 5-1-2002.

2,764,853. DPT LABORATORIES, LTD., SAN ANTONIO, TX. SN 76-166,093. PUB. 2-12-2002, FILED 11-15-2000.

READY TO MARKET**CLASS 40—MATERIAL TREATMENT**

FOR CUSTOM MANUFACTURE OF CONSUMER HEALTHCARE PRODUCTS FOR OTHERS (U.S. CLS. 100, 103 AND 106).
FIRST USE 1-30-2002; IN COMMERCE 1-30-2002.

CLASS 42—SCIENTIFIC, COMPUTER AND LEGAL SERVICES

FOR RESEARCH AND DEVELOPMENT OF NEW CONSUMER HEALTHCARE PRODUCTS (U.S. CLS. 100 AND 101).
FIRST USE 1-30-2002; IN COMMERCE 1-30-2002.

2,764,857. EPIX HOLDINGS CORPORATION, TAMPA, FL. SN 76-168,012. PUB. 5-14-2002, FILED 11-17-2000.

EPIXCENTER**CLASS 35—ADVERTISING AND BUSINESS**

FOR PROVIDING PROFESSIONAL EMPLOYER ORGANIZATION SERVICES, NAMELY, ADMINISTRATION OF BUSINESS PAYROLL FOR OTHERS; PAYROLL PREPARATION SERVICES, INCLUDING WAGE GARNISHMENT SERVICES; PERSONNEL MANAGEMENT; EMPLOYEE LEASING SERVICES; BUSINESS MANAGEMENT SERVICES FOR OTHERS; DATA PROCESSING SERVICES FOR SMALL AND MEDIUM SIZED COMPANIES; COMPUTER SERVICES, NAMELY, PROVIDING INFORMATION IN THE FIELD OF PAYROLL DATA AND PERSONNEL DATA VIA THE INTERNET (U.S. CLS. 100, 101 AND 102).
FIRST USE 8-22-2000; IN COMMERCE 8-15-2001.

CLASS 36—INSURANCE AND FINANCIAL

FOR PAYROLL TAX DEBITING SERVICES; EMPLOYEE BENEFIT SERVICES, NAMELY, ADMINISTRATION OF EMPLOYEE BENEFIT PLANS AND ADMINISTRATION OF UNEMPLOYMENT COMPENSATION PROGRAMS; WORKERS COMPENSATION RISK MANAGEMENT, NAMELY, ADMINISTRATION OF WORKERS COMPENSATION PROGRAMS; COMPUTER SERVICES, NAMELY, PROVIDING INFORMATION IN THE FIELD OF EMPLOYEE BENEFITS VIA THE INTERNET (U.S. CLS. 100, 101 AND 102).

FIRST USE 8-22-2000; IN COMMERCE 8-15-2001.

CLASS 42—SCIENTIFIC, COMPUTER AND LEGAL SERVICES

FOR REGULATORY COMPLIANCE CONSULTATION IN THE FIELD OF HUMAN RESOURCES AND FEDERAL EMPLOYMENT REGULATION AND LABOR LAWS; REVIEWING STANDARDS AND PRACTICES TO ASSURE COMPLIANCE WITH GOVERNMENTAL EMPLOYMENT REGULATIONS; COMPUTER SERVICES, NAMELY, PROVIDING INFORMATION FEATURING STANDARDS AND PRACTICES FOR ASSURING COMPLIANCE WITH GOVERNMENTAL EMPLOYMENT REGULATIONS (U.S. CLS. 100 AND 101).

FIRST USE 8-22-2000; IN COMMERCE 8-15-2001.

CLASS 16—PAPER GOODS AND PRINTED MATTER

FOR PUBLICATIONS, NAMELY, PRINTED MATERIALS IN THE FIELDS OF WELLNESS, HEALTH PROMOTION, PREVENTATIVE HEALTH CARE, DISEASE MANAGEMENT, BEHAVIOR CHANGE, AND HEALTH RISK ASSESSMENT (U.S. CLS. 2, 5, 22, 23, 29, 37, 38 AND 50).

FIRST USE 2-21-2001; IN COMMERCE 2-21-2001.

CLASS 42—SCIENTIFIC, COMPUTER AND LEGAL SERVICES

FOR COLLECTION AND ANALYSIS OF HEALTH, LIFESTYLE, AND PERSONAL INFORMATION AND CREATION OF PERSONAL GUIDES FOR USE BY INDIVIDUALS IN CONNECTION WITH THEIR OWN WELLNESS, PREVENTATIVE HEALTH CARE, DISEASE MANAGEMENT AND BEHAVIOR CHANGE, VIA THE GLOBAL COMPUTER NETWORK; AND COMPUTER SERVICES, NAMELY, PROVIDING ONLINE QUESTIONNAIRES, GUIDEBOOKS, SUPPLEMENTAL GUIDES, TAILORED FOLLOW-UP MATERIALS, AND NEWSLETTERS, ALL IN THE FIELDS OF WELLNESS, HEALTH PROMOTION, PREVENTATIVE HEALTH CARE, DISEASE MANAGEMENT, BEHAVIOR CHANGE, AND HEALTH RISK ASSESSMENT (U.S. CLS. 100 AND 101).

FIRST USE 2-21-2001; IN COMMERCE 2-21-2001.

2,764,859. MONEYFITNESS.COM, INC., PLYMOUTH, MA. SN 76-168,844. PUB. 10-29-2002, FILED 11-21-2000.

MONEYFITNESS CENTER

NO CLAIM IS MADE TO THE EXCLUSIVE RIGHT TO USE "CENTER", APART FROM THE MARK AS SHOWN.

CLASS 36—INSURANCE AND FINANCIAL

FOR FINANCIAL SERVICES, NAMELY, PROVIDING INFORMATION AND GUIDANCE REGARDING EVERYDAY FINANCIAL MATTERS VIA A GLOBAL COMPUTER NETWORK (U.S. CLS. 100, 101 AND 102).

FIRST USE 3-15-2001; IN COMMERCE 3-15-2001.

CLASS 41—EDUCATION AND ENTERTAINMENT

FOR EDUCATIONAL SERVICES, NAMELY, PROVIDING EDUCATIONAL INFORMATION AND GUIDANCE REGARDING EVERYDAY FINANCIAL MATTERS VIA A GLOBAL COMPUTER NETWORK (U.S. CLS. 100, 101 AND 107).

FIRST USE 3-15-2001; IN COMMERCE 3-15-2001.

2,764,865. HEALTHMEDIA, INC., ANN ARBOR, MI. SN 76-175,466. PUB. 9-3-2002, FILED 12-4-2000.



OWNER OF U.S. REG. NOS. 2,276,506, 2,324,542, AND 2,577,770.

2,764,868. BOSCOMBE ENTERTAINMENT CORPORATION LIMITED, DORSET, UNITED KINGDOM. SN 76-176,912. PUB. 9-3-2002, FILED 12-5-2000.



PRIORITY CLAIMED UNDER SEC. 44(D) ON UNITED KINGDOM APPLICATION NO. 2251574, FILED 11-6-2000.

CLASS 9—ELECTRICAL AND SCIENTIFIC APPARATUS

FOR PHONOGRAPH RECORDS, AUDIO DISCS AND AUDIO DIGITAL DISCS FEATURING LIVE AND PRE-RECORDED MUSICAL RECORDINGS; VIDEO DISCS FEATURING LIVE AND PRE-RECORDED FOOTAGE AT MUSICAL AND/OR DANCING EVENTS, DISCOS, RAVES AND NIGHTCLUBS (U.S. CLS. 21, 23, 26, 36 AND 38).

FIRST USE 9-0-2000; IN COMMERCE 9-0-2000.

CLASS 41—EDUCATION AND ENTERTAINMENT

FOR ENTERTAINMENT SERVICES, NAMELY, ORGANIZATION AND STAGING OF MUSICAL AND DANCING EVENTS, DISCOS AND RAVES, AND DISC JOCKEYS SERVICES; DISCOTHEQUE SERVICES; MUSICAL ENTERTAINMENT SERVICES FEATURING LIVE PERFORMANCES BY MUSICAL BANDS AND LIVE PERFORMANCES BY DISC JOCKEYS PLAYING PRE-RECORDED MUSIC; ENTERTAINMENT SERVICES, NAMELY, ORGANIZING, PRODUCING AND CONDUCTING OF DANCING EXHIBITIONS AND COMPETITIONS, AND PROVIDING DANCING FACILITIES (U.S. CLS. 100, 101 AND 107).

FIRST USE 11-23-2000; IN COMMERCE 11-23-2000.

CLASS 42—SCIENTIFIC, COMPUTER AND LEGAL SERVICES

FOR NIGHT CLUB SERVICES (U.S. CLS. 100 AND 101).
FIRST USE 11-23-2000; IN COMMERCE 11-23-2000.

2,764,873. CENDANT MEMBERSHIP SERVICES HOLDINGS
SUBSIDIARY, INC., NORWALK, CT. SN 76-180,212.
PUB. 10-8-2002, FILED 12-13-2000.

TRILEGIANT

2,764,869. IDEAL CONCRETE BLOCK CO, WESTFORD, MA.
SN 76-177,388. PUB. 6-19-2001, FILED 12-7-2000.

COLORS WITH STYLE**CLASS 19—NON-METALLIC BUILDING MATERIALS**

FOR CONSTRUCTION MATERIALS, NAMELY, CONCRETE PAVING BLOCKS AND LANDSCAPE BLOCKS (U.S. CLS. 1, 12, 33 AND 50).
FIRST USE 3-7-2003; IN COMMERCE 3-7-2003.

CLASS 42—SCIENTIFIC, COMPUTER AND LEGAL SERVICES

FOR DESIGN CONSULTATION, SPECIFICATION CONSULTATION, AND QUALITY INSPECTION SERVICES, ALL IN THE FIELD OF CONCRETE PAVING BLOCKS AND LANDSCAPE BLOCKS AND WALLS (U.S. CLS. 100 AND 101).

FIRST USE 0-0-1998; IN COMMERCE 0-0-1998.

CLASS 35—ADVERTISING AND BUSINESS

FOR DIRECT MAIL ADVERTISING SERVICES; PROMOTING THE SALE OF CREDIT CARD ACCOUNTS THROUGH THE ADMINISTRATION OF INCENTIVE AWARD PROGRAMS; PROMOTING THE SALE OF GOODS AND SERVICES OF OTHERS THROUGH PROMOTIONAL CONTESTS ON BEHALF OF CREDIT AND DEBIT CARD ISSUERS, FINANCIAL INSTITUTIONS, TELECOMMUNICATION COMPANIES, AIRLINES, OIL AND GAS COMPANIES, RETAILERS, AND OTHER INDUSTRIES; PROMOTING THE GOODS AND SERVICES OF OTHERS THROUGH THE DISTRIBUTION OF DISCOUNT CARDS WHICH PROVIDE DISCOUNTS ON TRAVEL, DINING, LEISURE ACTIVITIES, HEALTH CARE PRODUCTS AND SERVICES, AUTOMOTIVE VEHICLES AND OTHER AUTOMOTIVE PRODUCTS AND SERVICES, HOME IMPROVEMENT PRODUCTS AND SERVICES, AND OTHER CONSUMER MERCHANDISE; PROVIDING HOME SHOPPING SERVICES IN THE FIELDS OF HOME IMPROVEMENT PRODUCTS, CONSUMER ELECTRONICS, COMPUTERS AND SOFTWARE, AND OTHER CONSUMER MERCHANDISE BY MEANS OF THE TELEPHONE AND INTERNET; ADMINISTERING EMPLOYEE INCENTIVE AWARD PROGRAMS FOR OTHERS THAT ALLOWS EMPLOYEES TO ACCUMULATE POINTS BASED ON PERFORMANCE AND OTHER FACTORS AND REDEEM THOSE POINTS FOR MERCHANDISE AND TRAVEL-RELATED BENEFITS; ADMINISTERING CONSUMER PROGRAMS THAT PROVIDE CREDIT CARD REGISTRATION (U.S. CLS. 100, 101 AND 102).

FIRST USE 7-2-2001; IN COMMERCE 7-2-2001.

2,764,870. IDEAL CONCRETE BLOCK CO, WESTFORD, MA.
SN 76-177,391. PUB. 6-26-2001, FILED 12-7-2000.

WALLS WITH STYLE**CLASS 19—NON-METALLIC BUILDING MATERIALS**

FOR CONSTRUCTION MATERIALS, NAMELY, CONCRETE PAVING BLOCKS AND LANDSCAPE BLOCKS (U.S. CLS. 1, 12, 33 AND 50).

FIRST USE 3-7-2003; IN COMMERCE 3-7-2003.

CLASS 42—SCIENTIFIC, COMPUTER AND LEGAL SERVICES

FOR DESIGN CONSULTATION, SPECIFICATION CONSULTATION, AND QUALITY INSPECTION SERVICES, ALL IN THE FIELD OF CONCRETE PAVING BLOCKS AND LANDSCAPE BLOCKS AND WALLS (U.S. CLS. 100 AND 101).

FIRST USE 0-0-1996; IN COMMERCE 0-0-1996.

CLASS 36—INSURANCE AND FINANCIAL

FOR ADMINISTERING CONSUMER BENEFIT PROGRAMS THAT PROVIDE CREDIT CARD PROTECTION AND VERIFICATION; CREDIT INQUIRY AND CONSULTATION SERVICES IN THE NATURE OF PROVIDING MEMBERS WITH INFORMATION REGARDING AND ACCESS TO CREDIT REPORTS AND FINANCIAL RECORDS OF THEMSELVES AND THEIR FAMILIES; ADMINISTERING CONSUMER PROGRAMS THAT PROVIDE MEMBERS WITH EXTENDED WARRANTIES, FULL AND PARTIAL PRICE REIMBURSEMENT, REIMBURSEMENT FOR POST-PURCHASE PRICE REDUCTIONS, AND REIMBURSEMENT FOR PRODUCT REPAIR AND REPLACEMENT, IN CONNECTION WITH THEIR PURCHASE OF A WIDE RANGE OF CONSUMER MERCHANDISE (U.S. CLS. 100, 101 AND 102).

FIRST USE 7-2-2001; IN COMMERCE 7-2-2001.

CLASS 42—SCIENTIFIC, COMPUTER AND LEGAL SERVICES

FOR COMPUTER SERVICES, NAMELY, PROVIDING A WEBSITE WHEREBY MEMBERS CAN ACCESS A DATABASE WITH INFORMATION REGARDING SOCIAL SECURITY RECORDS, MEDICAL RECORDS AND DRIVING RECORDS OF THEMSELVES AND THEIR FAMILIES (U.S. CLS. 100 AND 101).

FIRST USE 7-2-2001; IN COMMERCE 7-2-2001.

2,764,875. INTERVOICE LIMITED PARTNERSHIP, RENO, NV. SN 76-181,325. PUB. 8-13-2002, FILED 12-15-2000.

OMVIA

CLASS 9—ELECTRICAL AND SCIENTIFIC APPARATUS

FOR INTERACTIVE TELECOMMUNICATIONS SYSTEMS COMPRISED OF COMPUTER HARDWARE AND SOFTWARE FOR PROCESSING TELEPHONE CALLS AND DATA TELECOMMUNICATIONS ACROSS A COMMUNICATIONS NETWORK, INTERACTIVE VOICE RESPONSE COMMUNICATIONS, GRAPHICAL TELEPHONY APPLICATION DEVELOPMENT, INBOUND/OUTBOUND CALL DISTRIBUTION AND ENHANCED TELEPHONY SERVICES (U.S. CLS. 21, 23, 26, 36 AND 38).

FIRST USE 9-4-2002; IN COMMERCE 9-4-2002.

CLASS 35—ADVERTISING AND BUSINESS

FOR BUSINESS INFORMATION SERVICES FOR THE INTERACTIVE TELECOMMUNICATIONS AND INFORMATION SYSTEMS OF OTHERS (U.S. CLS. 100, 101 AND 102).

FIRST USE 10-26-2001; IN COMMERCE 10-26-2001.

CLASS 38—COMMUNICATION

FOR TELECOMMUNICATIONS SERVICES, NAMELY, PERSONAL COMMUNICATIONS SERVICES OF PROCESSING TELEPHONE CALLS AND DATA TELECOMMUNICATIONS ACROSS A COMMUNICATIONS NETWORK, AND INTERACTIVE VOICE RESPONSE COMMUNICATIONS (U.S. CLS. 100, 101 AND 104).

FIRST USE 10-26-2001; IN COMMERCE 10-26-2001.

CLASS 42—SCIENTIFIC, COMPUTER AND LEGAL SERVICES

FOR COMPUTER SYSTEMS MANAGEMENT AND SUPPORT SERVICES FOR INTERACTIVE TELECOMMUNICATIONS AND INFORMATION SYSTEMS FOR OTHERS, NAMELY, PROVIDING MANAGEMENT AND SUPPORT FROM AN ON-SITE OR OFF-SITE LOCATION FOR PROCESSING TELEPHONE CALLS AND DATA TELECOMMUNICATIONS ACROSS A COMMUNICATIONS NETWORK, INTERACTIVE VOICE RESPONSE COMMUNICATIONS, GRAPHICAL TELEPHONY APPLICATION DEVELOPMENT, INBOUND OR OUTBOUND CALL DISTRIBUTION AND ENHANCED TELEPHONY SERVICES (U.S. CLS. 100 AND 101).

FIRST USE 10-26-2001; IN COMMERCE 10-26-2001.

2,764,876. LAWRENCE TECHNOLOGIES, LLC, DALLAS, TX. SN 76-182,850. PUB. 7-17-2001, FILED 12-13-2000.

SYNGENCE

CLASS 9—ELECTRICAL AND SCIENTIFIC APPARATUS

FOR COMPUTER SOFTWARE FOR DEFINING, MANIPULATING, AND OTHERWISE UTILIZING CORRELITHM OBJECTS FOR USE IN THE FIELDS OF COMPUTER PROGRAMMING, DATA STRUCTURES, DATA REPRESENTATIONS, ARTIFICIAL INTELLIGENCE, PATTERN RECOGNITION, ROBOTICS AND SYNTHETIC ORGANISMS (U.S. CLS. 21, 23, 26, 36 AND 38).

FIRST USE 3-1-2001; IN COMMERCE 6-1-2001.

CLASS 42—SCIENTIFIC, COMPUTER AND LEGAL SERVICES

FOR CONSULTING AND CUSTOM DESIGN OF COMPUTER SOFTWARE FOR OTHERS FOR DEFINING, MANIPULATING, AND OTHERWISE UTILIZING CORRELITHM OBJECTS FOR USE IN THE FIELDS OF COMPUTER PROGRAMMING, DATA STRUCTURES, DATA REPRESENTATIONS, ARTIFICIAL INTELLIGENCE, PATTERN RECOGNITION, ROBOTICS AND SYNTHETIC ORGANISMS (U.S. CLS. 100 AND 101).

FIRST USE 3-1-2001; IN COMMERCE 6-1-2001.

2,764,878. VECTOR SCM, LLC, NOVI, MI, BY ASSIGNMENT CNF TRANSPORTATION INC., PALO ALTO, CA. SN 76-184,079. PUB. 1-1-2002, FILED 12-19-2000.

VECTOR SCM



NO CLAIM IS MADE TO THE EXCLUSIVE RIGHT TO USE "SCM", APART FROM THE MARK AS SHOWN.

CLASS 9—ELECTRICAL AND SCIENTIFIC APPARATUS

FOR INFORMATION MANAGEMENT SYSTEMS, NAMELY, COMPUTER SOFTWARE FOR SHIPMENT PROCESSING, PREPARING SHIPPING DOCUMENTS AND INVOICES, AND TRACKING DOCUMENTS, PACKAGES AND FREIGHT OVER COMPUTER NETWORKS, INTRANETS, AND THE INTERNET (U.S. CLS. 21, 23, 26, 36 AND 38).

FIRST USE 12-0-2000; IN COMMERCE 12-0-2000.

CLASS 35—ADVERTISING AND BUSINESS

FOR SUPPLY CHAIN, LOGISTICS, AND REVERSE LOGISTICS SERVICES, NAMELY, COMPUTERIZED TRACKING OF DOCUMENTS, PACKAGES, > RAW MATERIALS, AND OTHER FREIGHT FOR OTHERS; WAREHOUSING SERVICES, NAMELY, KITTING, SUB-ASSEMBLY, RETURNS PROCESSING, AND LABELING OF DOCUMENTS, PACKAGES, RAW MATERIALS, AND OTHER FREIGHT FOR OTHERS; INFORMATION MANAGEMENT SERVICES, NAMELY, SHIPMENT PROCESSING, PREPARING SHIPPING DOCUMENTS AND INVOICES, TRACKING DOCUMENTS, PACKAGES, AND FREIGHT, OVER COMPUTER NETWORKS, INTRANETS, AND THE INTERNET; BUSINESS MANAGEMENT SERVICES, NAMELY MANAGING LOGISTICS, REVERSE LOGISTICS, SUPPLY CHAIN SERVICES, SUPPLY CHAIN VISIBILITY AND SYNCHRONIZATION, SUPPLY AND DEMAND FORECASTING AND PRODUCT DISTRIBUTION PROCESSES FOR OTHERS; AND BUSINESS CONSULTING SERVICES RELATING TO PRODUCT DISTRIBUTION, OPERATIONS MANAGEMENT SERVICES, LOGISTICS, REVERSE LOGISTICS, SUPPLY CHAIN, AND PRODUCTION SYSTEMS AND DISTRIBUTION SOLUTIONS (U.S. CLS. 100, 101 AND 102).

FIRST USE 12-0-2000; IN COMMERCE 12-0-2000.

CLASS 36—INSURANCE AND FINANCIAL

FOR CUSTOMS BROKERAGE SERVICES FOR OTHERS (U.S. CLS. 100, 101 AND 102).

FIRST USE 12-0-2000; IN COMMERCE 12-0-2000.

CLASS 39—TRANSPORTATION AND STORAGE

FOR SUPPLY CHAIN, LOGISTICS, AND REVERSE LOGISTICS SERVICES, NAMELY, PICK-UP, STORAGE, TRANSPORTATION, AND DELIVERY OF DOCUMENTS, PACKAGES, RAW MATERIALS, AND OTHER FREIGHT FOR OTHERS BY AIR, RAIL, SHIP OR TRUCK; WAREHOUSING SERVICES, NAMELY, STORAGE, DISTRIBUTION, PICK-UP, AND PACKING FOR SHIPMENT OF DOCUMENTS, PACKAGES, RAW MATERIALS, AND OTHER FREIGHT FOR OTHERS; FREIGHT FORWARDING SERVICES; AND TRANSPORTATION OF THE GOODS OF OTHERS BY AIR, RAIL, SHIP OR TRUCK (U.S. CLS. 100 AND 105).
FIRST USE 12-0-2000; IN COMMERCE 12-0-2000.

2,764,887. RLX TECHNOLOGIES, INC., THE WOODLANDS, TX, BY CHANGE OF NAME ROCKETLOGIX, INC., PLANO, TX. SN 76-191,360. PUB. 3-5-2002, FILED 1-8-2001.

RLX

CLASS 9—ELECTRICAL AND SCIENTIFIC APPARATUS

FOR COMPUTER HARDWARE, NAMELY, COMPUTER SERVERS FOR A GLOBAL COMPUTER NETWORK AND CHASSIS, CABLING AND SUPPORT SYSTEMS FOR ATTACHING AND INTEGRATING MULTIPLE COMPUTER SERVERS; COMPUTER SOFTWARE FOR MONITORING, MANAGING, MAINTAINING AND PREVENTING AND REACTING TO FAILURE OF COMPUTER SERVERS; COMPUTER SOFTWARE FOR PROVIDING AND MANAGING ACCESS TO COMPUTER SOFTWARE AND DATABASES ON OTHER SERVERS AMONG MULTIPLE COMPUTER SERVERS (U.S. CLS. 21, 23, 26, 36 AND 38).
FIRST USE 5-8-2001; IN COMMERCE 5-8-2001.

CLASS 37—CONSTRUCTION AND REPAIR

FOR INSTALLATION OF COMPUTER HARDWARE (U.S. CLS. 100, 103 AND 106).
FIRST USE 5-8-2001; IN COMMERCE 5-8-2001.

CLASS 42—SCIENTIFIC, COMPUTER AND LEGAL SERVICES

FOR INSTALLATION OF COMPUTER SOFTWARE FOR OTHERS; MONITORING, MANAGING, AND PREVENTING AND REACTING TO FAILURE OF COMPUTER SERVERS FOR OTHERS (U.S. CLS. 100 AND 101).
FIRST USE 5-8-2001; IN COMMERCE 5-8-2001.

2,764,883. FMC TECHNOLOGIES, INC., CHICAGO, IL. SN 76-189,198. PUB. 5-28-2002, FILED 1-3-2001.

FMC TECHNOLOGIES

NO CLAIM IS MADE TO THE EXCLUSIVE RIGHT TO USE "TECHNOLOGIES", APART FROM THE MARK AS SHOWN.

CLASS 35—ADVERTISING AND BUSINESS

FOR CONSULTING SERVICES, NAMELY, BUSINESS CONSULTING SERVICES FOR CANNING, COAL HANDLING, STORAGE, FOOD PROCESSING, MATERIAL HANDLING AND WAREHOUSING INDUSTRIES (U.S. CLS. 100, 101 AND 102).
FIRST USE 6-1-2000; IN COMMERCE 6-1-2000.

2,764,891. N-ABLE TECHNOLOGIES INTERNATIONAL, INC., DOVER, DE. SN 76-196,210. PUB. 4-16-2002, FILED 1-19-2001.

CLASS 40—MATERIAL TREATMENT

FOR MANUFACTURE OF OIL AND GAS WELLHEAD, FLUID CONTROL AND METERING SYSTEMS TO ORDER AND/OR SPECIFICATION OF OTHERS (U.S. CLS. 100, 103 AND 106).
FIRST USE 6-1-2000; IN COMMERCE 6-1-2000.

CLASS 42—SCIENTIFIC, COMPUTER AND LEGAL SERVICES

FOR CONSULTING SERVICES, NAMELY, TECHNICAL CONSULTING SERVICES FOR CANNING, COAL HANDLING, STORAGE, FOOD PROCESSING, MATERIAL HANDLING AND WAREHOUSING INDUSTRIES; ENGINEERING SERVICES FOR BULK MATERIAL HANDLING, COAL HANDLING, AND PETROLEUM METERING SYSTEMS; SUB SEA ENGINEERING; OIL FIELD SERVICES, NAMELY, ENGINEERING, AND SERVICING OF WELLHEAD, FLUID CONTROL AND METERING SYSTEMS FOR LAND AND SUB SEA OIL AND GAS DRILLING, PRODUCTION, REFINING AND TRANSPORTATION (U.S. CLS. 100 AND 101).
FIRST USE 6-1-2000; IN COMMERCE 6-1-2000.

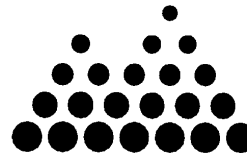

CLASS 9—ELECTRICAL AND SCIENTIFIC APPARATUS

FOR COMPUTER SOFTWARE FOR NETWORK ADMINISTRATION (U.S. CLS. 21, 23, 26, 36 AND 38).
FIRST USE 9-1-2000; IN COMMERCE 9-1-2000.

CLASS 42—SCIENTIFIC, COMPUTER AND LEGAL SERVICES

FOR CUSTOM COMPUTER SOFTWARE PROGRAMMING FOR OTHERS; COMPUTER SOFTWARE DESIGN FOR OTHERS; COMPUTER CONSULTATION; INTEGRATION AND AUDITING OF COMPUTER SYSTEMS AND NETWORKS; APPLICATION SERVICE PROVIDER FEATURING SOFTWARE IN THE FIELD OF IT INFRASTRUCTURE AND MONITORING OF SERVERS AND SOFTWARE OVER THE INTERNET FROM OFF-SITE LOCATIONS; TECHNICAL SUPPORT SERVICES, NAMELY, TROUBLESHOOTING OF COMPUTER HARDWARE AND SOFTWARE PROBLEMS VIA TELEPHONE, FAX, MAIL, E-MAIL AND IN PERSON; REMOTE MONITORING OF COMPUTER SYSTEMS OF OTHERS AND PROVIDING BACK-UP COMPUTER PROGRAMS AND FACILITIES (U.S. CLS. 100 AND 101).

FIRST USE 9-1-2000; IN COMMERCE 9-1-2000.

2,764,896. FRANKLIN, IAN, BRACKLEY, NORTHANTS NN13 6DQ, GREAT BRITAIN. SN 76-201,182. PUB. 12-3-2002, FILED 1-29-2001.

SPEECHMARK**CLASS 9—ELECTRICAL AND SCIENTIFIC APPARATUS**

FOR ELECTRONIC PUBLICATIONS, NAMELY BOOKS AND MANUALS RELATING TO SPEECH AND LANGUAGE THERAPY, SPECIAL NEEDS EDUCATION AND THERAPY, PSYCHOLOGY, MENTAL HEALTH AND SOCIAL CARE EDUCATION AND THERAPY, ALL RECORDED ON OPTICAL DISKS; COMPUTER SOFTWARE, NAMELY EDUCATIONAL AND INSTRUCTIONAL PROGRAMS FOR USE IN SPEECH AND LANGUAGE THERAPY, SPECIAL NEEDS EDUCATION AND THERAPY, PSYCHOLOGY, MENTAL HEALTH AND SOCIAL CARE EDUCATION AND THERAPY; COMPUTER MEDIA CONTAINING ELECTRONICALLY REPRODUCED PICTURE CARDS FOR USE IN INSTRUCTION AND TEACHING SPEECH AND LANGUAGE THERAPY, EDUCATION, SPECIAL NEEDS EDUCATION AND THERAPY, PSYCHOLOGY, MENTAL HEALTH AND SOCIAL CARE EDUCATION AND THERAPY (U.S. CLS. 21, 23, 26, 36 AND 38).

FIRST USE 1-1-2001; IN COMMERCE 1-1-2001.

2,764,895. CHANNING BETE COMPNAY, INC., SOUTH DEERFIELD, MA, BY CHANGE OF NAME CHANNING L. BETE CO., INC., SOUTH DEERFIELD, MA. SN 76-199,743. PUB. 12-10-2002, FILED 1-24-2001.

PRESENT & PREVENT!**CLASS 9—ELECTRICAL AND SCIENTIFIC APPARATUS**

FOR COMPUTER SOFTWARE, NAMELY SOFTWARE PROVIDING INFORMATION IN THE FIELDS OF HEALTH AND WELLNESS, PARENTING, YOUTH DEVELOPMENT, EDUCATION, SOCIAL ISSUES, STAFF TRAINING, BEHAVIORAL CHANGE, ELDER ISSUES, EDUCATION, EDUCATIONAL CURRICULUM, SAFETY, ELECTRICITY, ENERGY AND CONSERVATION, EMERGENCY PREPAREDNESS, RECREATION AND LEISURE, ANIMAL WELFARE, RELIGION, INDUSTRY, AND GOVERNMENT AND BUSINESS; PHOTOGRAPHIC SLIDE TRANSPARENCIES (U.S. CLS. 21, 23, 26, 36 AND 38).

FIRST USE 8-7-2001; IN COMMERCE 8-7-2001.

CLASS 16—PAPER GOODS AND PRINTED MATTER

FOR PRINTED MATTER, NAMELY PRINTED PRESENTATION MATERIALS IN THE AREAS OF HEALTH AND WELLNESS, PARENTING, YOUTH DEVELOPMENT, EDUCATION, SOCIAL ISSUES, STAFF TRAINING, BEHAVIORAL CHANGE, ELDER ISSUES, EDUCATIONAL CURRICULUM, SAFETY, ELECTRICITY, ENERGY AND CONSERVATION, EMERGENCY PREPAREDNESS, RECREATIONAL AND LEISURE, ANIMAL WELFARE, RELIGION, INDUSTRY, GOVERNMENT AND BUSINESS, AND EDUCATION AND EDUCATIONAL CURRICULUM IN THE FORM OF PAPER COPIES OF PRESENTATION SLIDES; BINDERS CONTAINING PRINTED PRESENTATION MATERIALS; PRINTED EDUCATIONAL, INSTRUCTIONAL, EVALUATION AND REFERENCE BOOKS, FORMS, HAND-OUTS, AND PAMPHLETS IN THE AREAS OF HEALTH AND WELLNESS, PARENTING, YOUTH DEVELOPMENT, EDUCATION, SOCIAL ISSUES, STAFF TRAINING, BEHAVIORAL CHANGE, ELDER ISSUES, EDUCATIONAL CURRICULUM, SAFETY, ELECTRICITY, ENERGY AND CONSERVATION, EMERGENCY PREPAREDNESS, RECREATIONAL AND LEISURE, ANIMAL WELFARE, RELIGION, INDUSTRY, GOVERNMENT AND BUSINESS, AND EDUCATION AND EDUCATIONAL CURRICULUM (U.S. CLS. 2, 5, 22, 23, 29, 37, 38 AND 50).

FIRST USE 8-7-2001; IN COMMERCE 8-7-2001.

CLASS 16—PAPER GOODS AND PRINTED MATTER

FOR PRINTED INSTRUCTIONAL, EDUCATIONAL AND TEACHING MATERIALS FOR USE IN SPEECH AND LANGUAGE THERAPY, SPECIAL NEEDS EDUCATION AND THERAPY, PSYCHOLOGY, MENTAL HEALTH AND SOCIAL CARE EDUCATION AND THERAPY; INSTRUCTIONAL AND TEACHING MATERIALS IN THE FORM OF PICTURE CARDS; BOXES FOR DISPLAY, INDEXING AND STORAGE OF THE AFORESAID GOODS (U.S. CLS. 2, 5, 22, 23, 29, 37, 38 AND 50).

FIRST USE 1-1-2001; IN COMMERCE 1-1-2001.

2,764,902. INTERPUBLIC GROUP OF COMPANIES, INC., THE, NEW YORK, NY, BY ASSIGNMENT TRUE NORTH COMMUNICATIONS INC., CHICAGO, IL. SN 76-204,209. PUB. 7-16-2002, FILED 2-2-2001.

PICTURETRAX**CLASS 35—ADVERTISING AND BUSINESS**

FOR BUSINESS SERVICES, NAMELY, COMPUTERIZED DATABASE MANAGEMENT IN THE NATURE OF DIGITAL ASSET MANAGEMENT SERVICES FOR OTHERS, ENABLING USERS TO STORE, EDIT, DISTRIBUTE AND SHARE PHOTOGRAPHS, TEXT, SOUND AND OTHER DIGITIZED ADVERTISING AND MARKETING MATERIALS VIA THE INTERNET (U.S. CLS. 100, 101 AND 102).

FIRST USE 4-30-2002; IN COMMERCE 4-30-2002.

CLASS 39—TRANSPORTATION AND STORAGE

FOR ELECTRONIC STORAGE OF DIGITAL PHOTOGRAPHS AND IMAGES FOR OTHERS (U.S. CLS. 100 AND 105).

FIRST USE 4-30-2002; IN COMMERCE 4-30-2002.

2,764,904. HALFORD COMPANY, NASHVILLE, TN. SN 76-206,490. PUB. 5-21-2002, FILED 2-7-2001.

2,764,921. GOODRICH CORPORATION, CHARLOTTE, NC, BY CHANGE OF NAME B.F.GOODRICH COMPANY, THE, CHARLOTTE, NC. SN 76-218,199. PUB. 5-21-2002, FILED 3-2-2001.

CD GUYS

NO CLAIM IS MADE TO THE EXCLUSIVE RIGHT TO USE "CD", APART FROM THE MARK AS SHOWN.

CLASS 9—ELECTRICAL AND SCIENTIFIC APPARATUS

FOR PRE-RECORDED PROMOTIONAL AUDIO PRODUCTS, NAMELY, COMPACT DISCS (U.S. CLS. 21, 23, 26, 36 AND 38).

FIRST USE 6-29-2001; IN COMMERCE 6-29-2001.

CLASS 35—ADVERTISING AND BUSINESS

FOR PROMOTING THE GOODS AND SERVICES OF OTHERS THROUGH DISTRIBUTION OF PROMOTIONAL PRE-RECORDED AUDIO PRODUCTS, NAMELY, COMPACT DISCS (U.S. CLS. 100, 101 AND 102).

FIRST USE 6-29-2001; IN COMMERCE 6-29-2001.

2,764,912. LOGILENT LEARNING SYSTEMS, INC., LAFAYETTE, CA, BY CHANGE OF NAME CYBERSTATEU.-COM, LAFAYETTE, CA. SN 76-213,317. PUB. 2-12-2002, FILED 2-16-2001.

LOGILENT

CLASS 41—EDUCATION AND ENTERTAINMENT

FOR EDUCATIONAL SERVICES, NAMELY, CONDUCTING CLASSES, SEMINARS, AND WORKSHOPS IN THE FIELDS OF COMPUTER HARDWARE, COMPUTER SOFTWARE, COMPUTER SYSTEMS NETWORKING, TELECOMMUNICATIONS, AND INFORMATION PROCESSING (U.S. CLS. 100, 101 AND 107).

FIRST USE 4-0-2001; IN COMMERCE 4-0-2001.

CLASS 42—SCIENTIFIC, COMPUTER AND LEGAL SERVICES

FOR PREPARING, ADMINISTERING, AND SCORING STANDARDIZED TESTS FOR INDIVIDUALS AND COMPANIES IN THE FIELDS OF COMPUTER HARDWARE, COMPUTER SOFTWARE, COMPUTER SYSTEMS NETWORKING, TELECOMMUNICATIONS, AND INFORMATION PROCESSING (U.S. CLS. 100 AND 101).

FIRST USE 4-0-2001; IN COMMERCE 4-0-2001.



OWNER OF U.S. REG. NOS. 64,996, 1,423,775, AND OTHERS.

CLASS 8—HAND TOOLS

FOR MULTIPLE FUNCTION FOLDING POCKET TOOLS; POCKETKNIVES; MULTIPLE FUNCTION POCKET SIZE INSTRUMENTS CONSISTING OF VARIOUS IMPLEMENTS, NAMELY, NAIL FILE WITH SCREWDRIVER TIP, TOOTHPICK, STRAIGHT PIN, TWEEZERS, PEN, RULER, KNIFE BLADE AND SCISSORS (U.S. CLS. 23, 28 AND 44).

FIRST USE 6-1-2001; IN COMMERCE 6-1-2001.

CLASS 14—JEWELRY

FOR CLOCKS; WATCHES (U.S. CLS. 2, 27, 28 AND 50).

FIRST USE 6-1-2001; IN COMMERCE 6-1-2001.

CLASS 16—PAPER GOODS AND PRINTED MATTER

FOR PENS; HIGHLIGHTING PENS; NOTE PADS; MEMO BOOKS; WRITING SETS CONSISTING PRIMARILY OF PENCILS, PENCIL SHARPENER, ERASER, AND DRAWING RULER; STATIONERY PORTFOLIOS; DOCUMENT HOLDERS; LUNCH BAGS (U.S. CLS. 2, 5, 22, 23, 29, 37, 38 AND 50).

FIRST USE 6-1-2001; IN COMMERCE 6-1-2001.

CLASS 18—LEATHER GOODS

FOR BUSINESS CARD CASES; UMBRELLAS; PLASTIC TRADE SHOW TOTE BAGS; SUITCASES; DUFFEL BAGS; GARMENT BAGS FOR TRAVEL; LUGGAGE TAGS; WALLETS; ALL-PURPOSE ATHLETIC BAGS (U.S. CLS. 1, 2, 3, 22 AND 41).

FIRST USE 6-1-2001; IN COMMERCE 6-1-2001.

CLASS 21—HOUSEWARES AND GLASS

FOR PORTABLE BEVERAGE COOLERS; PORTABLE COOLERS; MUGS; SPORTS BOTTLES SOLD EMPTY; VACUUM BOTTLES; INSULATING SLEEVE HOLDERS FOR BEVERAGE CANS (U.S. CLS. 2, 13, 23, 29, 30, 33, 40 AND 50).

FIRST USE 6-1-2001; IN COMMERCE 6-1-2001.

CLASS 24—FABRICS

FOR TOWELS; FABRIC FLAGS AND BANNERS (U.S. CLS. 42 AND 50).

FIRST USE 6-1-2001; IN COMMERCE 6-1-2001.

CLASS 25—CLOTHING

FOR CLOTHING, NAMELY, CAPS, SHIRTS, JACKETS (U.S. CLS. 22 AND 39).

FIRST USE 6-1-2001; IN COMMERCE 6-1-2001.

CLASS 28—TOYS AND SPORTING GOODS

FOR SPORTING GOODS, NAMELY, GOLF BALLS, GOLF TEES, AND DIVOT FIXERS (U.S. CLS. 22, 23, 38 AND 50).

FIRST USE 6-1-2001; IN COMMERCE 6-1-2001.

2,764,940. CENTIV, INC., VERNON HILLS, IL, BY CHANGE OF NAME; BY MERGER TEKGRAF, INC., VERNON HILLS, IL. SN 76-230,106. PUB. 6-11-2002, FILED 3-26-2001.

INSTANT IMPACT**CLASS 35—ADVERTISING AND BUSINESS**

FOR ONLINE RETAIL SERVICES IN THE FIELD OF GRAPHIC DESIGN PRODUCTS AND DISTRIBUTORSHIP IN THE FIELD OF COMPUTER GRAPHICS TECHNOLOGIES (U.S. CLS. 100, 101 AND 102).

FIRST USE 4-1-2001; IN COMMERCE 4-1-2001.

2,764,927. MASONIC HOME, INC., THE, CHARLTON, MA. SN 76-221,206. PUB. 2-19-2002, FILED 3-7-2001.

OVERLOOK COMMUNITIES

NO CLAIM IS MADE TO THE EXCLUSIVE RIGHT TO USE "COMMUNITIES", APART FROM THE MARK AS SHOWN.

CLASS 42—SCIENTIFIC, COMPUTER AND LEGAL SERVICES

FOR GRAPHIC ART DESIGN (U.S. CLS. 100 AND 101).
FIRST USE 4-1-2001; IN COMMERCE 4-1-2001.

CLASS 35—ADVERTISING AND BUSINESS

FOR PROVIDING MANAGEMENT OF HEALTH CARE FACILITIES, NAMELY, NURSING HOME FACILITIES, RETIREMENT HOME FACILITIES, AND RESIDENTIAL LONG TERM HEALTH CARE FACILITIES (U.S. CLS. 100, 101 AND 102).

FIRST USE 2-1-2001; IN COMMERCE 2-15-2001.

2,764,946. MEDICAL MUTUAL INSURANCE COMPANY OF NORTH CAROLINA, RALEIGH, NC. SN 76-234,906. PUB. 8-20-2002, FILED 3-27-2001.

CANOPY DM**CLASS 36—INSURANCE AND FINANCIAL**

FOR PROVIDING ADMINISTRATION SERVICES FOR PRE-PAID HEALTH CARE PLANS (U.S. CLS. 100, 101 AND 102).

FIRST USE 2-1-2001; IN COMMERCE 2-15-2001.

OWNER OF U.S. REG. NOS. 2,427,133 AND 2,427,134.
NO CLAIM IS MADE TO THE EXCLUSIVE RIGHT TO USE "DM", APART FROM THE MARK AS SHOWN.

CLASS 42—SCIENTIFIC, COMPUTER AND LEGAL SERVICES

FOR PROVIDING HOUSING AND ACCOMMODATION SERVICES, NAMELY, RETIREMENT AND NURSING HOME SERVICES, HEALTH CARE SERVICES, AND ON-PREMISES ASSISTED LIVING AND SKILLED NURSING CARE SERVICES (U.S. CLS. 100 AND 101).

FIRST USE 2-1-2001; IN COMMERCE 2-15-2001.

CLASS 35—ADVERTISING AND BUSINESS

FOR BUSINESS SERVICES, NAMELY, PROVIDING ONLINE CASE MANAGEMENT SERVICES FOR USE IN THE HEALTHCARE AND INSURANCE FIELDS FOR TARGETING, ASSESSING AND MANAGING TARGETED PATIENTS WITH SPECIFIC DISEASE AND CHRONIC ILLNESSES USING EVIDENCE-BASED GUIDELINES AND EDUCATION TOOLS (U.S. CLS. 100, 101 AND 102).

FIRST USE 11-0-2000; IN COMMERCE 11-0-2000.

CLASS 42—SCIENTIFIC, COMPUTER AND LEGAL SERVICES

FOR MEDICAL SERVICES, NAMELY, PROVIDING DISEASE MANAGEMENT SERVICES TO HEALTHCARE PROVIDERS, CASE MANAGERS, PAYORS AND ANCILLARY SERVICE PROVIDERS FOR USE IN THE HEALTHCARE AND INSURANCE FIELDS FOR PATIENTS WITH SPECIFIC DISEASE AND CHRONIC ILLNESSES (U.S. CLS. 100 AND 101).

FIRST USE 11-0-2000; IN COMMERCE 11-0-2000.

2,764,929. FIRST TANK CORPORATION, INC., FAIRFIELD, CA. SN 76-221,800. PUB. 9-17-2002, FILED 3-7-2001.

QUAD LOGISTICS

NO CLAIM IS MADE TO THE EXCLUSIVE RIGHT TO USE "LOGISTICS", APART FROM THE MARK AS SHOWN.

CLASS 37—CONSTRUCTION AND REPAIR

FOR MAINTENANCE AND REPAIR OF LARGE PLASTIC CONTAINERS USED FOR STORAGE AND TRANSPORTATION OF GOODS (U.S. CLS. 100, 103 AND 106).

FIRST USE 4-30-2001; IN COMMERCE 4-30-2001.

2,764,949. GLOBAL CASH ACCESS, LLC, SUNNYVALE, CA. SN 76-236,726. PUB. 9-17-2002, FILED 4-4-2001.

QUIKPLAY**CLASS 39—TRANSPORTATION AND STORAGE**

FOR RENTAL OF LARGE PLASTIC CONTAINERS USED FOR STORAGE AND TRANSPORTATION OF GOODS (U.S. CLS. 100 AND 105).

FIRST USE 4-30-2001; IN COMMERCE 4-30-2001.

CLASS 9—ELECTRICAL AND SCIENTIFIC APPARATUS

FOR COMPUTER SOFTWARE, ATM DEBIT CARD KEYPADS AND CARD READERS USED IN CASINOS FOR ELECTRONIC MONEY TRANSFERS BY CONSUMERS (U.S. CLS. 21, 23, 26, 36 AND 38).

FIRST USE 9-15-2001; IN COMMERCE 9-15-2001.

CLASS 36—INSURANCE AND FINANCIAL

FOR ELECTRONIC FUNDS TRANSFER SERVICES, NAMELY TRANSACTION TRACKING, WITHDRAWAL LIMITATIONS AND FUNDS TRANSFER (U.S. CLS. 100, 101 AND 102).

FIRST USE 9-15-2001; IN COMMERCE 9-15-2001.

2,764,967. MUREX S.A., PARIS 75116, FRANCE. SN 76-241,922. PUB. 5-14-2002, FILED 4-17-2001.



2,764,951. VIDEO MONITORING SERVICES OF AMERICA, L.P., NEW YORK, NY. SN 76-237,581. PUB. 12-31-2002, FILED 4-4-2001.

INSIGHT BEGINS WITH KNOWLEDGE

CLASS 35—ADVERTISING AND BUSINESS

FOR PROVIDING BUSINESS RESEARCH, MARKET ANALYSIS AND ADVERTISING SERVICES, NAMELY FACILITATING ADVERTISING CLIPPING, REGARDING NEWS AND ADVERTISING IN THE BROADCAST, PRINT AND INTERNET MEDIA FOR THE PURPOSES OF REPORTING, REFERENCING AND ANALYZING NEWS AND ADVERTISING WHICH MATCHES A CLIENT'S PROFILE OF INTEREST (U.S. CLS. 100, 101 AND 102).

FIRST USE 10-0-2001; IN COMMERCE 10-0-2001.

OWNER OF U.S. REG. NO. 1,898,616.
THE TERM "MUREX" IS "THE FRENCH NAME OF A GENUS OF MARINE MOLLUSKS".

CLASS 9—ELECTRICAL AND SCIENTIFIC APPARATUS

FOR COMPUTER SOFTWARE USED FOR VALUATION, MANAGEMENT, AND PROCESSING OF FINANCIAL TRANSACTIONS IN THE FIELDS OF CAPITAL MARKETS, BUSINESS AND FINANCE (U.S. CLS. 21, 23, 26, 36 AND 38).

FIRST USE 11-0-2000; IN COMMERCE 11-0-2000.

CLASS 42—SCIENTIFIC, COMPUTER AND LEGAL SERVICES

FOR NEWS ANALYSIS AND NEWS CLIPPING FROM THE BROADCAST, PRINT AND INTERNET MEDIA FOR THE PURPOSES OF REPORTING, REFERENCING AND ANALYZING NEWS AND ADVERTISING WHICH MATCHES A CLIENT'S PROFILE OF INTEREST (U.S. CLS. 100 AND 101).

FIRST USE 10-0-2001; IN COMMERCE 10-0-2001.

CLASS 42—SCIENTIFIC, COMPUTER AND LEGAL SERVICES

FOR COMPUTER PROGRAMMING FOR OTHERS, COMPUTER SOFTWARE DESIGN AND UPDATING COMPUTER SOFTWARE, AND CONSULTATION SERVICES RELATING TO COMPUTER PROGRAMS (U.S. CLS. 100 AND 101).

FIRST USE 11-0-2000; IN COMMERCE 11-0-2000.

2,764,965. BLUEARC CORPORATION, MOUNTAIN VIEW, CA. SN 76-240,833. PUB. 9-17-2002, FILED 4-13-2001.

BLUEARC

CLASS 9—ELECTRICAL AND SCIENTIFIC APPARATUS

FOR COMPUTER HARDWARE, COMPUTER NETWORKING HARDWARE, COMPUTER SERVERS AND NETWORK-ATTACHED STORAGE SYSTEMS, NAMELY, AN OPERATING SYSTEM AND NETWORK OF STORAGE DISCS AND SERVERS FOR DATA STORAGE AND RETRIEVAL (U.S. CLS. 21, 23, 26, 36 AND 38).

FIRST USE 8-0-2001; IN COMMERCE 8-0-2001.

CLASS 16—PAPER GOODS AND PRINTED MATTER

FOR PRINTED PUBLICATIONS, COMPUTER MANUALS, DATA SHEETS, INFORMATIONAL LEAFLETS, INFORMATIONAL PAMPHLETS, AND INFORMATIONAL BROCHURES AND REPORTS, ALL FEATURING INFORMATION REGARDING DATA STORAGE (U.S. CLS. 2, 5, 22, 23, 29, 37, 38 AND 50).

FIRST USE 8-0-2001; IN COMMERCE 8-0-2001.

2,764,973. FORNI & FATTORIE S.P.A., 70022 ALTAMURA (BA), ITALY. SN 76-247,375. PUB. 6-25-2002, FILED 4-30-2001.



COLOR IS CLAIMED AS A FEATURE OF THE MARK, WITH THE INTERIOR OF THE WHEEL BEING THE COLOR BLUE, THE OUTLINE OF THE CHICKEN, THE FEATHERS AND THE CART, IS THE COLOR GREEN, THE HAY UNDER THE CHICKEN IS THE COLOR YELLOW, AND THE SIDES OF THE CART AND CHICKEN ITSELF ARE THE COLOR ORANGE.

THE MARK CONSISTS OF THE WORDS "FORNI & FATTORIE" UNDER A FANCIFUL DESIGN OF A CHICKEN SITTING ON A CART FULL OF HAY WITH FEATHERS FLYING OUT THE BACK OF THE CART.

THE ENGLISH TRANSLATION OF "FORNI & FATTORIE" IS "OVENS AND FARMS".

CLASS 29—MEATS AND PROCESSED FOODS

FOR PRESERVED, DRIED AND COOKED FRUITS AND VEGETABLES, JELLIES, JAMS, FRUIT SAUCES, EDIBLE OILS AND FATS (U.S. CL. 46).

FIRST USE 6-0-2002; IN COMMERCE 6-0-2002.

CLASS 30—STAPLE FOODS

FOR COFFEE, TEA, COCOA, SUGAR, RICE, TAPIOCA, SAGO, COFFEE SUBSTITUTES; FLOUR, PROCESSED CEREAL AND PREPARATIONS MADE FROM CEREALS, NAMELY, BREAKFAST CEREALS; BREAD, BISCUITS, CAKES, PASTRY AND CONFECTIONERY, NAMELY, CANDY; FLAVORED ICES; PROCESSED POPCORN; HONEY, TREACLE; YEAST, BAKING POWDER; SALT, PEPPER; KETCHUP, MUSTARD, MAYONNAISE; VINEGAR, SAUCES, FLAVORING SYRUP, SPICES; SALAD DRESSINGS; ICE (U.S. CL. 46).

FIRST USE 6-0-2002; IN COMMERCE 6-0-2002.

CLASS 32—LIGHT BEVERAGES

FOR BEER, MINERAL AND AERATED WATER, SOFT DRINKS, FRUIT DRINKS; FRUIT JUICES; SYRUPS FOR MAKING SOFT DRINKS AND FRUIT DRINKS (U.S. CLS. 45, 46 AND 48).

FIRST USE 6-0-2002; IN COMMERCE 6-0-2002.

CLASS 33—WINES AND SPIRITS

FOR ALCOHOLIC BEVERAGES, NAMELY, WHISKEY, VODKA, GIN, TEQUILA, RUM, BRANDY, COGNAC; WINE, WINE COOLERS; CHAMPAGNE AND SPARKLING WINE (U.S. CLS. 47 AND 49).

FIRST USE 6-0-2002; IN COMMERCE 6-0-2002.

2,764,976. NATIONAL INSTITUTE FOR HEALTHCARE RESEARCH, ROCKVILLE, MD. SN 76-249,749. PUB. 2-11-2003, FILED 5-2-2001.



NO CLAIM IS MADE TO THE EXCLUSIVE RIGHT TO USE "INTERNATIONAL CENTER FOR THE INTEGRATION OF HEALTH & SPIRITUALITY", APART FROM THE MARK AS SHOWN.

CLASS 16—PAPER GOODS AND PRINTED MATTER

FOR BOOKS, BROCHURES, LEAFLETS AND PAMPHLETS RELATING TO EDUCATION AND RESEARCH REGARDING THE RELATIONSHIP OF SPIRITUALITY AND HEALTH (U.S. CLS. 2, 5, 22, 23, 29, 37, 38 AND 50).

FIRST USE 8-15-2001; IN COMMERCE 8-15-2001.

CLASS 41—EDUCATION AND ENTERTAINMENT

FOR EDUCATIONAL SERVICES, NAMELY, PROVIDING SEMINARS, RESEARCH CONFERENCES, AND WORKSHOPS RELATING TO THE RELATIONSHIPS OF SPIRITUALITY AND HEALTH, AND DISTRIBUTING COURSE MATERIAL IN CONNECTION THEREWITH, NAMELY, WRITTEN MATERIALS, NEWSLETTERS AND PUBLICATION; AND ONLINE INFORMATION RELATING TO EDUCATIONAL SERVICES, NAMELY, SEMINARS, RESEARCH CONFERENCES, AND WORKSHOPS RELATING TO THE RELATIONSHIP OF SPIRITUALITY AND HEALTH (U.S. CLS. 100, 101 AND 107).

FIRST USE 8-15-2001; IN COMMERCE 8-15-2001.

CLASS 42—SCIENTIFIC, COMPUTER AND LEGAL SERVICES

FOR HEALTHCARE SERVICES AND SCIENTIFIC RESEARCH SERVICES; AND ONLINE DISSEMINATION OF INFORMATION RELATING TO HEALTHCARE AND SCIENTIFIC RESEARCH SERVICES (U.S. CLS. 100 AND 101).

FIRST USE 8-15-2001; IN COMMERCE 8-15-2001.

2,764,979. SKATENATION PLUS, LLC, GLEN ALLEN, VA. SN 76-252,361. PUB. 9-10-2002, FILED 5-4-2001.



OWNER OF U.S. REG. NOS. 2,164,757, 2,392,375, AND OTHERS.

NO CLAIM IS MADE TO THE EXCLUSIVE RIGHT TO USE "SKATING", APART FROM THE MARK AS SHOWN.

CLASS 25—CLOTHING

FOR HATS, SHIRTS, AND SWEATSHIRTS (U.S. CLS. 22 AND 39).

FIRST USE 6-1-2001; IN COMMERCE 6-1-2001.

CLASS 41—EDUCATION AND ENTERTAINMENT

FOR ICE SKATING INSTRUCTIONAL CLASSES AND PROVIDING THE FACILITIES OF ICE SKATING RINKS (U.S. CLS. 100, 101 AND 107).

FIRST USE 6-1-2001; IN COMMERCE 6-1-2001.

2,764,980. ATOFINA, 92800 PUTEAUX, FRANCE. SN 76-254,510. PUB. 8-27-2002, FILED 5-9-2001.

PEROXAL

CLASS 1—CHEMICALS

FOR ORGANIC AND INORGANIC CHEMICALS FOR USE IN THE MANUFACTURE OF INDUSTRY, NAMELY, PULP AND PAPER INDUSTRY, TEXTILE EFFLUENT TREATMENT INDUSTRY, DETERGENCE INDUSTRY, CLEANING PRODUCTS INDUSTRY, FOOD INDUSTRY, METALLURGY INDUSTRY, ELECTRONIC INDUSTRY; HYDROGEN PEROXIDE USED FOR OXIDATION PROCESS AND ASEPTIC PACKAGING FOR USE IN THE MANUFACTURE OF INDUSTRY, NAMELY PULP AND PAPER INDUSTRY, FOOD INDUSTRY, TEXTILE INDUSTRY, EFFLUENT TREATMENT INDUSTRY, DETERGENCE INDUSTRY, METALLURGY INDUSTRY, ELECTRONIC INDUSTRY (U.S. CLS. 1, 5, 6, 10, 26 AND 46).

FIRST USE 10-16-1989; IN COMMERCE 3-28-2003.

CLASS 3—COSMETICS AND CLEANING PREPARATIONS

FOR HYDROGEN PEROXIDE USED FOR COSMETIC PURPOSES, NAMELY HAIR BLEACHING (U.S. CLS. 1, 4, 6, 50, 51 AND 52).

FIRST USE 10-16-1989; IN COMMERCE 3-28-2003.

CLASS 5—PHARMACEUTICALS

FOR HYDROGEN PEROXIDE USED FOR MEDICAL PURPOSES, NAMELY, SKIN DISINFECTION AND CONTACT LENSES (U.S. CLS. 6, 18, 44, 46, 51 AND 52).

FIRST USE 10-16-1989; IN COMMERCE 3-28-2003.

CLASS 35—ADVERTISING AND BUSINESS

FOR BUYER'S AGENT REPRESENTATION IN THE FIELD OF ART; EXCHANGE SERVICES, NAMELY, BARTERING AND EXCHANGING OF ART FOR OTHERS; RETAIL CONSIGNMENT SERVICES IN THE FIELD OF ART; COMMISSIONING THE CREATION OF ART FOR OTHERS; EVALUATION AND COST/PRICE ANALYSIS IN THE FIELD OF ART; AUCTION SERVICES IN THE FIELD OF ART; LICENSING OF ART; ADVERTISING SERVICES, NAMELY, PREPARING AND PLACING ADVERTISEMENTS FOR OTHERS IN THE FIELD OF ART; PROVIDING ON-LINE ORDERING AND RETAIL STORE SERVICES FEATURING ART AND ART-RELATED MERCHANDISE VIA A GLOBAL COMPUTER NETWORK; PROVIDING ON-LINE MARKETING OF ART AND ART-RELATED MERCHANDISE FOR OTHERS VIA A GLOBAL COMPUTER NETWORK; ART GALLERY SERVICES; BUSINESS CONSULTING AND BUSINESS ADVISORY SERVICES; WHOLESALE DISTRIBUTORSHIP AND DISTRIBUTORSHIP SERVICES FEATURING ART AND ART REPRODUCTIONS; IMPORTING AND EXPORTING OF ART; BUYING AND SELLING OF ART FOR OTHERS; PROMOTION AND SALE OF ART FOR OTHERS BY OPERATING AN ON-LINE MARKETPLACE FOR SELLERS AND PURCHASERS OF ART; CONSULTATION IN THE FIELD OF ART DISTRIBUTION (U.S. CLS. 100, 101 AND 102).

FIRST USE 1-0-2000; IN COMMERCE 1-0-2000.

CLASS 36—INSURANCE AND FINANCIAL

FOR ART BROKERAGE SERVICES; APPRAISAL AND VALUATION OF ARTWORK; APPRAISALS FOR INSURANCE CLAIMS OF PERSONAL PROPERTY; FINANCIAL VALUATION OF PERSONAL PROPERTY; INSURANCE UNDERWRITING IN THE FIELD OF ART; INSURANCE BROKERAGE; INSURANCE CONSULTATION; PROVIDING INSURANCE INFORMATION IN THE FIELD OF ART; FINANCING OF ART FOR OTHERS; FINANCIAL CLEARING HOUSE FOR THE FINANCING OF ART; CONSULTING IN THE FIELDS OF BROKERAGE OF ART, VALUATION OF ART, INSURING ART, ART APPRAISALS, AND FINANCING OF ART (U.S. CLS. 100, 101 AND 102).

FIRST USE 1-0-2000; IN COMMERCE 1-0-2000.

CLASS 42—SCIENTIFIC, COMPUTER AND LEGAL SERVICES

FOR ART LEASING SERVICES; RESEARCH, ADVICE AND AUTHENTICATION SERVICES RELATING TO THE AGE, PROVENANCE, AND HISTORY OF WORKS OF ART; ART INVENTORYING, NAMELY, INVENTORYING OF ART FOR SECURITY, CURATING AND INSURANCE PURPOSES; CONSULTATION SERVICES IN THE FIELD OF ART; COMPUTER SERVICES, NAMELY, PROVIDING A DATABASE AND RELATED SEARCH ENGINE FOR OBTAINING DATA ON THE GLOBAL COMPUTER NETWORK PERTAINING TO THE FIELD OF ART; CONSULTATION SERVICES IN THE FIELD OF ART RESTORATION; CONSULTATION SERVICES IN THE FIELD OF CUSTOM ART FRAMING (U.S. CLS. 100 AND 101).

FIRST USE 1-0-2000; IN COMMERCE 1-0-2000.

2,764,987. TRANSACT ART, INC., SAN DIEGO, CA. SN 76-259,073. PUB. 2-19-2002, FILED 5-16-2001.

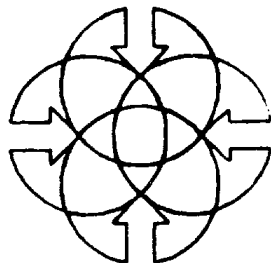

2,764,993. SNIDERMAN, ANDREA, CALABASAS, CA. SN 76-262,644. PUB. 9-3-2002, FILED 5-29-2001.

BABY FOOTNOTES

THE LINING OF THE MARK IS A FEATURE OF THE MARK, AND NOT INTENDED TO INDICATE COLOR.

NO CLAIM IS MADE TO THE EXCLUSIVE RIGHT TO USE "BABY", APART FROM THE MARK AS SHOWN.

CLASS 16—PAPER GOODS AND PRINTED MATTER

FOR PERSONAL NOTE PADS; PERSONAL LEATHER, IMITATION LEATHER, VINYL AND FABRIC ORGANIZERS; PHOTO ALBUMS; PERSONAL CARDBOARD BOXES, TO RECORD BABY'S DAILY ACTIVITIES AND ACCOMPLISHMENTS, AS WELL AS PERSONAL AND EMERGENCY INFORMATION (U.S. CLS. 2, 5, 22, 23, 29, 37, 38 AND 50).

FIRST USE 4-1-2002; IN COMMERCE 4-1-2002.

CLASS 20—FURNITURE AND ARTICLES NOT OTHERWISE CLASSIFIED

FOR WOOD, NON-METAL ACRYLIC, AND PLASTIC BOXES TO RECORD BABY'S DAILY ACTIVITIES AND ACCOMPLISHMENTS, AS WELL AS PERSONAL AND EMERGENCY INFORMATION (U.S. CLS. 2, 13, 22, 25, 32 AND 50).

FIRST USE 4-1-2002; IN COMMERCE 4-1-2002.

2,764,997. PRIMAL ELEMENTS, INC., GARDEN GROVE, CA. SN 76-263,881. PUB. 12-17-2002, FILED 5-29-2001.

PRIMAL DEFENSE

CLASS 3—COSMETICS AND CLEANING PREPARATIONS

FOR NON-MEDICATED BATH SOAPS AND TOILET SOAPS; NON-MEDICATED SKIN CREAMS AND LOTIONS; PERFUME AND PERFUME OILS (U.S. CLS. 1, 4, 6, 50, 51 AND 52).

FIRST USE 9-0-1996; IN COMMERCE 9-0-1996.

CLASS 4—LUBRICANTS AND FUELS

FOR CANDLES (U.S. CLS. 1, 6 AND 15).
FIRST USE 11-29-2001; IN COMMERCE 11-29-2001.

2,765,004. LEARNING INTERNET, INC., THE, PORTLAND, OR. SN 76-265,033. PUB. 6-25-2002, FILED 5-30-2001.



THE MARK CONSISTS OF THE STYLIZED WORDS "ET EASYTECH" WHERE THE "T" APPEARS AS STYLIZED PLUS SIGNS.

CLASS 41—EDUCATION AND ENTERTAINMENT

FOR EDUCATIONAL SERVICES, NAMELY, CONDUCTING INTERACTIVE LESSONS AND STUDENT ACTIVITIES VIA THE INTERNET FOR GRADES K-12; EDUCATIONAL TESTING IN THE NATURE OF TRACKING AND ASSESSING STUDENT PROGRESS OF INTERACTIVE LESSONS VIA THE INTERNET (U.S. CLS. 100, 101 AND 107).

FIRST USE 3-15-2002; IN COMMERCE 4-8-2002.

CLASS 42—SCIENTIFIC, COMPUTER AND LEGAL SERVICES

FOR COMPUTER SERVICES, NAMELY, APPLICATION SERVICE PROVIDER SERVICES IN THE NATURE OF HOSTING THE SOFTWARE APPLICATIONS OF OTHERS; MONITORING THE SOFTWARE APPLICATIONS OF OTHERS; INSTALLATION AND MAINTENANCE OF COMPUTER SOFTWARE FOR OTHERS (U.S. CLS. 100 AND 101).

FIRST USE 3-15-2002; IN COMMERCE 4-5-2002.

2,765,006. SHONAN HALLOWS K.K. (JAPAN), FUJISAWA, KANAGAWA, JAPAN. SN 76-265,246. PUB. 7-23-2002, FILED 5-31-2001.

THE HALLOW'S

CLASS 3—COSMETICS AND CLEANING PREPARATIONS

FOR HAIR SHAMPOO, SKIN LOTION, SKIN CREAM (U.S. CLS. 1, 4, 6, 50, 51 AND 52).

FIRST USE 5-1-1997; IN COMMERCE 5-1-1997.

CLASS 42—SCIENTIFIC, COMPUTER AND LEGAL SERVICES

FOR HAIRDRESSING SALONS (U.S. CLS. 100 AND 101).

FIRST USE 9-5-1984; IN COMMERCE 9-5-1984.

2,765,015. MANTAS, INC., FAIRFAX, VA. SN 76-266,895. PUB. 6-4-2002, FILED 6-5-2001.



OWNER OF U.S. REG. NO. 2,488,253.

CLASS 9—ELECTRICAL AND SCIENTIFIC APPARATUS

FOR COMPUTER SOFTWARE FOR USE IN THE FINANCIAL SERVICES INDUSTRY, NAMELY FOR MARKET, TRADE AND SECURITIES ANALYSES (U.S. CLS. 21, 23, 26, 36 AND 38).

FIRST USE 6-0-2001; IN COMMERCE 6-0-2001.

CLASS 42—SCIENTIFIC, COMPUTER AND LEGAL SERVICES

FOR INFORMATION TECHNOLOGY CONSULTING SERVICES, NAMELY, DEVELOPING SOFTWARE FOR MARKET, TRADE, AND SECURITIES ANALYSES IN THE FINANCIAL SERVICES INDUSTRY (U.S. CLS. 100 AND 101).

FIRST USE 6-0-2001; IN COMMERCE 6-0-2001.

2,765,016. BLUESOCKET, INC., BURLINGTON, MA. SN 76-267,908. PUB. 8-13-2002, FILED 6-6-2001.



CLASS 9—ELECTRICAL AND SCIENTIFIC APPARATUS

FOR COMPUTER HARDWARE AND SOFTWARE PRODUCTS FOR USE IN WIRELESS LOCAL AREA NETWORKS, NAMELY NETWORK MANAGEMENT COMPUTERS AND NETWORK BRIDGERS, ROUTERS, AND GATEWAYS, AND NETWORK INTERFACING AND NETWORK MANAGEMENT SOFTWARE; COMPUTER HARDWARE AND SOFTWARE PRODUCTS FOR USE IN PICO-CELLULAR NETWORKS, NAMELY, NETWORK MANAGEMENT COMPUTERS AND NETWORK BRIDGES, ROUTERS AND GATEWAYS, AND NETWORK INTERFACING AND NETWORK MANAGEMENT SOFTWARE; WIRELESS CONNECTIVITY PRODUCTS, NAMELY, ADAPTERS TO ENABLE LAPTOP COMPUTERS AND PDA'S TO CONNECT TO EITHER HARDWARE OR SOFTWARE PRODUCTS (U.S. CLS. 21, 23, 26, 36 AND 38).

FIRST USE 9-28-2001; IN COMMERCE 9-28-2001.

CLASS 37—CONSTRUCTION AND REPAIR

FOR MAINTENANCE AND REPAIR OF COMPUTER HARDWARE (U.S. CLS. 100, 103 AND 106).

FIRST USE 9-28-2001; IN COMMERCE 9-28-2001.

CLASS 42—SCIENTIFIC, COMPUTER AND LEGAL SERVICES

FOR COMPUTER CONSULTATION SERVICES; TECHNICAL SUPPORT SERVICES; NAMELY, TROUBLESHOOTING OF COMPUTER HARDWARE AND SOFTWARE PROBLEMS, AND PROVIDING BACKUP COMPUTER PROGRAMS; MAINTENANCE AND REPAIR OF COMPUTER HARDWARE (U.S. CLS. 100 AND 101).

FIRST USE 9-28-2001; IN COMMERCE 9-28-2001.

2,765,022. IOWA STUDENT LOAN LIQUIDITY CORPORATION, DES MOINES, IA. SN 76-268,497. PUB. 11-19-2002, FILED 6-7-2001.

ILINK

CLASS 9—ELECTRICAL AND SCIENTIFIC APPARATUS

FOR COMPUTER SOFTWARE FOR USE BY EDUCATIONAL INSTITUTIONS TO ACCESS STUDENT LOAN INFORMATION (U.S. CLS. 21, 23, 26, 36 AND 38).

FIRST USE 3-19-2001; IN COMMERCE 3-19-2001.

CLASS 36—INSURANCE AND FINANCIAL

FOR (BASED ON USE IN COMMERCE) PROVIDING ELECTRONIC STUDENT LOAN INFORMATION HANDLING SERVICES TO EDUCATIONAL INSTITUTIONS (U.S. CLS. 100, 101 AND 102).

FIRST USE 3-19-2001; IN COMMERCE 3-19-2001.

2,765,031. GEM STORES, INC., JAMAICA, NY. SN 76-271,980. PUB. 9-17-2002, FILED 6-11-2001.

CLEAN-RITE

CLASS 3—COSMETICS AND CLEANING PREPARATIONS

FOR TOOTHPASTE (U.S. CLS. 1, 4, 6, 50, 51 AND 52).
FIRST USE 6-0-2002; IN COMMERCE 6-0-2002.

CLASS 21—HOUSEWARES AND GLASS

FOR NON-ELECTRIC TOOTHBRUSHES (U.S. CLS. 2, 13, 23, 29, 30, 33, 40 AND 50).
FIRST USE 6-0-2002; IN COMMERCE 6-0-2002.

2,765,033. GODINGER SILVER ART CO., LTD., NEW YORK, NY. SN 76-273,148. PUB. 3-26-2002, FILED 6-18-2001.

RECOLLECTIONS

CLASS 8—HAND TOOLS

FOR STERLING SILVER AND SILVERPLATE FLATWARE (U.S. CLS. 23, 28 AND 44).

FIRST USE 10-31-2002; IN COMMERCE 10-31-2002.

CLASS 14—JEWELRY

FOR STERLING SILVER AND SILVERPLATE SERVEWARE, NAMELY, LASAGNA SERVERS, SALAD TONGS, PIE SERVERS, CAKE SERVERS, SERVING LADLES, BOWLS AND PITCHERS; STERLING SILVER AND SILVERPLATE GIFTWARE, NAMELY, VASES, CANDLESTICKS, VANITY TRAYS AND DECORATIVE BOXES (U.S. CLS. 2, 27, 28 AND 50).

FIRST USE 9-30-2002; IN COMMERCE 9-30-2002.

2,765,043. STERLING PRODUCTS, INC., WOOD DALE, IL. SN 76-277,172. PUB. 10-15-2002, FILED 6-27-2001.

ACS

CLASS 35—ADVERTISING AND BUSINESS

FOR MANUFACTURERS' REPRESENTATIVE SERVICES FOR OTHERS, OF PLASTICS CONVEYING, MANUFACTURING AND PROCESSING EQUIPMENT (U.S. CLS. 100, 101 AND 102).

FIRST USE 3-1-2002; IN COMMERCE 3-1-2002.

CLASS 37—CONSTRUCTION AND REPAIR

FOR CUSTOM INSTALLATION, REPAIR AND MAINTENANCE SERVICES FOR OTHERS, OF PLASTICS CONVEYING, MANUFACTURING, AND PROCESSING EQUIPMENT; INSTALLATION, REPAIR AND MAINTENANCE SERVICES FOR OTHERS IN THE FIELDS OF WATER COOLING, WATER CHILLING, PROCESS WATER RECOVERY APPARATUS, AND AIR CONDITIONING APPARATUS (U.S. CLS. 100, 103 AND 106).

FIRST USE 3-1-2002; IN COMMERCE 3-1-2002.

CLASS 40—MATERIAL TREATMENT

FOR CUSTOM ASSEMBLY OF PLASTICS CONVEYING, MANUFACTURING, AND PROCESSING EQUIPMENT (U.S. CLS. 100, 103 AND 106).

FIRST USE 3-1-2002; IN COMMERCE 3-1-2002.

CLASS 42—SCIENTIFIC, COMPUTER AND LEGAL SERVICES

FOR CUSTOM DESIGN AND ENGINEERING SERVICES FOR OTHERS, OF PLASTICS CONVEYING, MANUFACTURING AND PROCESSING EQUIPMENT (U.S. CLS. 100 AND 101).

FIRST USE 3-1-2002; IN COMMERCE 3-1-2002.

2,765,046. MARTY'S FOOD & WINE, INC., DALLAS, TX. SN 76-277,930. PUB. 1-21-2003, FILED 6-28-2001.

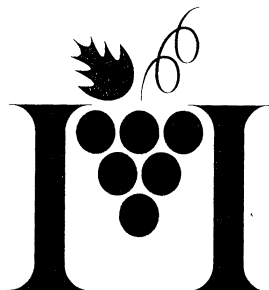
**CLASS 29—MEATS AND PROCESSED FOODS**

FOR PREPARED MEAT, FISH, POULTRY, DRIED AND COOKED FRUITS, COOKED VEGETABLES, CHEESES, FRUIT PRESERVES, JAMS, JELLIES, PICKLES AND GIFT BASKETS CONTAINING SAME (U.S. CL. 46).

FIRST USE 1-1-2003; IN COMMERCE 1-1-2003.

CLASS 30—STAPLE FOODS

FOR RELISHES, SANDWICHES, COFFEES, CANDIES AND GIFT BASKETS CONTAINING SAME (U.S. CL. 46).

FIRST USE 1-1-2003; IN COMMERCE 1-1-2003.

CLASS 31—NATURAL AGRICULTURAL PRODUCTS

FOR FRESH FRUITS AND VEGETABLES AND GIFT BASKETS CONTAINING SAME (U.S. CLS. 1 AND 46).

FIRST USE 1-1-2003; IN COMMERCE 1-1-2003.

CLASS 33—WINES AND SPIRITS

FOR WINES AND GIFT BASKETS CONTAINING SAME (U.S. CLS. 47 AND 49).

FIRST USE 1-1-2003; IN COMMERCE 1-1-2003.

CLASS 35—ADVERTISING AND BUSINESS

FOR RETAIL GROCERY AND RETAIL DELICATESSEN SERVICES (U.S. CLS. 100, 101 AND 102).

FIRST USE 1-1-2003; IN COMMERCE 1-1-2003.

CLASS 42—SCIENTIFIC, COMPUTER AND LEGAL SERVICES

FOR RESTAURANT, TAKE-OUT FOOD AND CATERING SERVICES (U.S. CLS. 100 AND 101).

FIRST USE 1-1-2003; IN COMMERCE 1-1-2003.

2,765,047. E-NETPIC.COM, INC., WEST PALM BEACH, FL. SN 76-278,760. PUB. 8-6-2002, FILED 6-29-2001.

PARTSVISION**CLASS 9—ELECTRICAL AND SCIENTIFIC APPARATUS**

FOR ELECTRONIC DATA TRANSMISSION INTERFACE UNIT BETWEEN A DIGITAL CAMERA AND AN INTERNET WEBSITE, FOR WIRELESS TRANSMISSION OF DIGITAL IMAGES TO THE INTERNET WEBSITE (U.S. CLS. 21, 23, 26, 36 AND 38).

FIRST USE 11-18-2002; IN COMMERCE 1-31-2002.

CLASS 42—SCIENTIFIC, COMPUTER AND LEGAL SERVICES

FOR PROVIDING AN INTERNET SITE COMPRISING A PLURALITY OF SEPARATELY ACCESSIBLE DIGITAL IMAGE VIEWING SITES FOR SERVICE SUBSCRIBERS FOR VIEWING DIGITAL IMAGES TRANSMITTED TO THE SITE FROM REMOTE DIGITAL CAMERAS VIA A CELLULAR CONNECTION; PROVIDING AN INTERNET SITE FOR USE BY PLUMBING CONTRACTORS FOR RECEIVING DIGITAL IMAGES TRANSMITTED BY TECHNICIANS IN THE FIELD AND DISPLAYING SAME FOR VIEWING BY ADVISORY PERSONNEL OF A PLUMBING WHOLESALE (U.S. CLS. 100 AND 101).

FIRST USE 1-31-2002; IN COMMERCE 11-18-2002.

2,765,052. NEXTEL COMMUNICATIONS, INC., RESTON, VA. SN 76-280,540. PUB. 2-19-2002, FILED 7-5-2001.

**NEXTEL DIRECT CONNECT.
GET RIGHT THROUGH**

OWNER OF U.S. REG. NOS. 1,637,139, 2,435,925, AND OTHERS.

NO CLAIM IS MADE TO THE EXCLUSIVE RIGHT TO USE "DIRECT CONNECT", APART FROM THE MARK AS SHOWN.

CLASS 9—ELECTRICAL AND SCIENTIFIC APPARATUS

FOR EQUIPMENT USED IN PROVIDING TELECOMMUNICATIONS SERVICES, NAMELY MOBILE RADIOS, TWO-WAY RADIOS, CELLULAR TELEPHONES, DIGITAL CELLULAR TELEPHONES, MOBILE TELEPHONES, DISPATCH RADIOS, PAGERS AND MOBILE DISPATCH RADIOS, PAGERS AND MOBILE DISPATCH RADIOS, PAGERS AND MOBILE DATA RECEIVERS (U.S. CLS. 21, 23, 26, 36 AND 38).

FIRST USE 6-0-2001; IN COMMERCE 11-0-2001.

CLASS 38—COMMUNICATION

FOR TELECOMMUNICATIONS SERVICES, NAMELY TWO-WAY RADIO DISPATCHING SERVICES, ELECTRONIC TRANSMISSION OF VOICE, TEXT, IMAGES DATA AND INFORMATION BY MEANS OF TWO-WAY RADIOS, MOBILE RADIOS, CELLULAR TELEPHONES, DIGITAL CELLULAR TELEPHONES, MOBILE TELEPHONES, DISPATCH RADIOS, PAGERS; PAGING SERVICES; MOBILE TELEPHONE COMMUNICATION SERVICES; WIRELESS INTERNET ACCESS SERVICES; AND WIRELESS DATA SERVICES FOR MOBILE DEVICES VIA A WIRELESS NETWORK FOR THE PURPOSE OF SENDING AND RECEIVING ELECTRONIC MAIL, FACSIMILES, DATA, IMAGES, INFORMATION, TEXT, NUMERIC MESSAGING AND TEXT MESSAGING AND FOR ACCESSING A GLOBAL COMMUNICATIONS NETWORK (U.S. CLS. 100, 101 AND 104).

FIRST USE 6-0-2001; IN COMMERCE 11-0-2001.

CLASS 3—COSMETICS AND CLEANING PREPARATIONS

FOR LAUNDRY BLEACH AND DETERGENT; INDUSTRIAL CLEANING, POLISHING, SCOURING AND ABRASIVE PREPARATIONS IN SOLID, GEL AND LIQUID FORM, CLEANING PREPARATIONS WITH PROTECTIVE COMPONENT FOR INDUSTRIAL USE; LIQUID PAINT REMOVERS AND PAINT STRIPPERS; STRIPPING, CLEANING AND FINISHING PREPARATIONS FOR FLOORS; ACRYLIC COATINGS FOR FLOORING (U.S. CLS. 1, 4, 6, 50, 51 AND 52).

FIRST USE 7-9-2001; IN COMMERCE 7-9-2001.

CLASS 17—RUBBER GOODS

FOR INSULATING PAINT, VARNISHES AND LACQUERS FOR PROTECTION OF STEEL AND WOOD FROM TEMPERATURE, LIQUID, ELECTRICITY AND CORROSION (U.S. CLS. 1, 5, 12, 13, 35 AND 50).

FIRST USE 7-9-2001; IN COMMERCE 7-9-2001.

2,765,056. GUNDERSON, MARY L., YANKTON, SD. SN 76-282,696. PUB. 8-20-2002, FILED 7-9-2001.

PALEOCUISINEOLOGY**CLASS 16—PAPER GOODS AND PRINTED MATTER**

FOR BOOKS IN FIELDS OF FOODS, COOKING AND HISTORY (U.S. CLS. 2, 5, 22, 23, 29, 37, 38 AND 50).

FIRST USE 4-14-2003; IN COMMERCE 4-15-2003.

CLASS 41—EDUCATION AND ENTERTAINMENT

FOR PROVIDING LECTURES, SEMINARS, CLASSES, COURSES, PRESENTATIONS, TEACHER TRAINING, AND INDIVIDUAL INSTRUCTION IN THE FIELD OF HISTORY, FOODS AND COOKING AND DISTRIBUTING COURSE MATERIALS IN CONNECTION THEREWITH (U.S. CLS. 100, 101 AND 107).

FIRST USE 4-14-2003; IN COMMERCE 4-15-2003.

2,765,058. EURONAVY-TINTAS MARITIMAS E INDUSTRIAIS, SA, SETUBAL, PORTUGAL. SN 76-284,083. PUB. 10-1-2002, FILED 7-13-2001.

EURONAVY**CLASS 1—CHEMICALS**

FOR INDUSTRIAL CHEMICALS, NAMELY, EPOXY, URETHANE, POLYURETHANE, POLYSULFIED, ACRYLIC, POLYESTER, AND SILICONES FOR GENERAL SEALING, BONDING, REPAIR, AND PROTECTIVE PURPOSES (U.S. CLS. 1, 5, 6, 10, 26 AND 46).

FIRST USE 7-9-2001; IN COMMERCE 7-9-2001.

CLASS 2—PAINTS

FOR PAINTS FOR INTERIOR AND EXTERIOR USE, NAMELY, WATER BASED ACRYLIC PAINT, TEXTURED VINYL COPOLIMER EMULSION PAINT, OIL BASED PAINTS (U.S. CLS. 6, 11 AND 16).

FIRST USE 7-9-2001; IN COMMERCE 7-9-2001.

2,765,062. BBA HOLDINGS, INC., WILMINGTON, DE. SN 76-288,358. PUB. 8-6-2002, FILED 7-20-2001.



OWNER OF U.S. REG. NOS. 1,238,386, 2,286,557, AND OTHERS.

NO CLAIM IS MADE TO THE EXCLUSIVE RIGHT TO USE "KIDS", APART FROM THE MARK AS SHOWN.

CLASS 20—FURNITURE AND ARTICLES NOT OTHERWISE CLASSIFIED

FOR FURNITURE, INCLUDING CHAIRS, LOVE SEATS, SOFAS, ROCKERS, BEDS, OTTOMANS, HEADBOARDS, ARMOIRES, TABLES, BEDSIDE TABLES, DESKS, STOOLS, DRESSERS, ROCKING CHAIRS, CANOPY BEDS, PEDESTALS, STORAGE PEDESTALS, BOOKCASES, CHESTS, DESKS, COMPUTER DESKS, HUTCHES, AND DRAWER CHESTS; HOME ACCESSORIES, NAMELY DECORATIVE MOBILES, LOCKERS, NON METAL NAMEPLATES, JEWELRY BOXES NOT MADE OF METAL; MIRRORS, SEATING CUBES, PICTURE FRAMES, WALL STORAGE UNITS AND WALL SHELF LEDGES, PLASTIC DOG DOOR STOPPERS, MAGAZINE RACKS, PILLOW NECK ROLLS, PILLOWS, FLOOR PILLOWS, AND APPLIQUE PILLOWS (U.S. CLS. 2, 13, 22, 25, 32 AND 50).

FIRST USE 8-7-2001; IN COMMERCE 8-7-2001.

CLASS 24—FABRICS

FOR BEDDING, NAMELY BLANKETS, QUILTS, COVERLETS, BLANKET THROWS, BED SKIRTS, BED CURTAINS, DUST RUFFLES, PILLOW SHAMS, PILLOWCASES, SHEET AND SHEET SETS, DUVETS, COMFORTER AND BLANKET COVERS, AND BED CANOPIES; WINDOW TREATMENTS, NAMELY FABRIC VALENCES, CURTAINS, DRAPERIES, PANELS, SWAGS AND TIE-BACKS (U.S. CLS. 42 AND 50).

FIRST USE 8-7-2001; IN COMMERCE 8-7-2001.

CLASS 35—ADVERTISING AND BUSINESS

FOR MAIL ORDER AND ELECTRONIC CATALOG SERVICES FEATURING FURNITURE, HOME ACCESSORIES AND GIFTS; ON-LINE RETAIL SERVICES IN THE FIELD OF FURNITURE, HOME ACCESSORIES AND GIFTS (U.S. CLS. 100, 101 AND 102).

FIRST USE 8-7-2001; IN COMMERCE 8-7-2001.

2,765,082. WESTON MEDICAL TRAINING SYSTEMS, INC., FORT COLLINS, CO. SN 76-297,085. PUB. 10-22-2002, FILED 8-10-2001.

WESTON MEDICAL TRAINING SYSTEMS

NO CLAIM IS MADE TO THE EXCLUSIVE RIGHT TO USE "MEDICAL TRAINING SYSTEMS", APART FROM THE MARK AS SHOWN.

CLASS 9—ELECTRICAL AND SCIENTIFIC APPARATUS

FOR ELECTRONICALLY RECORDED STUDY MATERIALS, NAMELY, AUDIO AND VIDEO TAPES, CD'S, DVD'S DESIGNED TO ASSIST IN THE TRAINING OF MEDICAL CARE FACILITY PERSONNEL IN BILLING, CODING AND TRANSCRIPTION FUNCTIONS (U.S. CLS. 21, 23, 26, 36 AND 38).

FIRST USE 1-4-2002; IN COMMERCE 1-4-2002.

CLASS 16—PAPER GOODS AND PRINTED MATTER

FOR BOOKS, BROCHURES, MANUALS, PAMPHLETS AND TEXTS DESIGNED TO ASSIST IN THE TRAINING OF MEDICAL CARE FACILITY PERSONNEL IN BILLING, CODING AND TRANSCRIPTION FUNCTIONS (U.S. CLS. 2, 5, 22, 23, 29, 37, 38 AND 50).

FIRST USE 1-4-2002; IN COMMERCE 1-4-2002.

2,765,067. BOATS N SUCH SUPERSTORES, INC., ORLANDO, FL. SN 76-290,153. PUB. 6-18-2002, FILED 7-25-2001.

BOATS N SUCH

NO CLAIM IS MADE TO THE EXCLUSIVE RIGHT TO USE "BOATS", APART FROM THE MARK AS SHOWN.

CLASS 35—ADVERTISING AND BUSINESS

FOR RETAIL STORE SERVICES FEATURING BOATS AND BOAT ACCESSORIES (U.S. CLS. 100, 101 AND 102).

FIRST USE 9-0-2001; IN COMMERCE 9-0-2001.

CLASS 37—CONSTRUCTION AND REPAIR

FOR MAINTENANCE AND REPAIR OF BOATS (U.S. CLS. 100, 103 AND 106).

FIRST USE 9-0-2001; IN COMMERCE 9-0-2001.

2,765,088. FIRST ILR, LLC, BLOOMINGDALE, IL. SN 76-299,097. PUB. 10-15-2002, FILED 8-13-2001.

2,765,078. PASQUALI, PAOLO, 50039, VICCHIO DI MUGELLO, (FIRENZE), ITALY. SN 76-295,652. PUB. 9-17-2002, FILED 8-6-2001.

OLEOTECA

CLASS 29—MEATS AND PROCESSED FOODS

FOR OLIVE OIL (U.S. CL. 46).
FIRST USE 5-2-2002; IN COMMERCE 5-2-2003.

CLASS 41—EDUCATION AND ENTERTAINMENT

FOR EDUCATIONAL SERVICES, NAMELY, PROVIDING COURSES OF INSTRUCTION, NAMELY CLASSES, SEMINARS, CONFERENCES, WORKSHOPS IN THE FIELD OF NOURISHMENT AND EDIBLE OILS AND FATS, DISTRIBUTING COURSE MATERIAL IN CONNECTION THEREWITH (U.S. CLS. 100, 101 AND 107).

FIRST USE 5-2-2002; IN COMMERCE 5-2-2003.

CLASS 42—SCIENTIFIC, COMPUTER AND LEGAL SERVICES

FOR HOTEL, RESTAURANT AND BAR SERVICES, NUTRITION COUNSELING (U.S. CLS. 100 AND 101).

FIRST USE 5-2-2002; IN COMMERCE 5-2-2003.

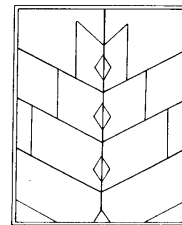

INDIAN LAKES
R E S O R T

OWNER OF U.S. REG. NO. 1,156,769.
NO CLAIM IS MADE TO THE EXCLUSIVE RIGHT TO USE "RESORT", APART FROM THE MARK AS SHOWN.

CLASS 35—ADVERTISING AND BUSINESS

FOR CONFERENCE SERVICES, NAMELY ARRANGING AND CONDUCTING BUSINESS CONFERENCES AND PROVIDING FACILITIES FOR BUSINESS CONFERENCES AND MEETINGS (U.S. CLS. 100, 101 AND 102).

FIRST USE 5-31-2001; IN COMMERCE 5-31-2001.

CLASS 41—EDUCATION AND ENTERTAINMENT

FOR GOLF CLUB SERVICES AND CONFERENCE SERVICES, NAMELY ARRANGING AND CONDUCTING EDUCATIONAL CONFERENCES AND PROVIDING FACILITIES FOR EDUCATIONAL CONFERENCES AND MEETINGS (U.S. CLS. 100, 101 AND 107).

FIRST USE 5-31-2001; IN COMMERCE 5-31-2001.

CLASS 42—SCIENTIFIC, COMPUTER AND LEGAL SERVICES

FOR RESTAURANT, RESORT HOTEL, HOTEL AND HEALTH SPA SERVICES (U.S. CLS. 100 AND 101).

FIRST USE 5-31-2001; IN COMMERCE 5-31-2001.

2,765,092. UNITED LIFE AGENCY SERVICES, L.L.C., GARDEN CITY, NY. SN 76-299,349. PUB. 1-22-2002, FILED 8-15-2001.

PREMIUM SOLUTIONS

NO CLAIM IS MADE TO THE EXCLUSIVE RIGHT TO USE "PREMIUM", APART FROM THE MARK AS SHOWN.

CLASS 9—ELECTRICAL AND SCIENTIFIC APPARATUS

FOR COMPUTER SOFTWARE FOR USE IN VARIOUS ADMINISTRATIVE SERVICES FOR BILLING, COLLECTING, RECONCILIATION, AND PROCESSING OF INSURANCE SERVICES THAT UTILIZES DATABASE MANAGEMENT THAT MAY BE DOWNLOADED FROM A GLOBAL COMPUTER NETWORK (U.S. CLS. 21, 23, 26, 36 AND 38).

FIRST USE 10-0-2001; IN COMMERCE 10-0-2001.

CLASS 36—INSURANCE AND FINANCIAL

FOR FINANCIAL SERVICES, NAMELY, THE COLLECTION, RECONCILIATION, AND REMITTANCE OF EMPLOYEE PREMIUMS, FEES, AND DUES (U.S. CLS. 100, 101 AND 102).

FIRST USE 10-0-2001; IN COMMERCE 10-0-2001.

2,765,105. MARK TRAVEL CORPORATION, THE, MILWAUKEE, WI. SN 76-304,853. PUB. 1-14-2003, FILED 8-24-2001.

VACATION TOGETHER

NO CLAIM IS MADE TO THE EXCLUSIVE RIGHT TO USE "VACATION", APART FROM THE MARK AS SHOWN.

CLASS 39—TRANSPORTATION AND STORAGE

FOR TRAVEL SERVICES, NAMELY, MAKING RESERVATIONS AND BOOKINGS FOR TRANSPORTATION (U.S. CLS. 100 AND 105).

FIRST USE 10-1-2000; IN COMMERCE 10-1-2000.

CLASS 42—SCIENTIFIC, COMPUTER AND LEGAL SERVICES

FOR TRAVEL SERVICES, NAMELY, MAKING RESERVATIONS AND BOOKINGS FOR LODGING (U.S. CLS. 100 AND 101).

FIRST USE 10-1-2000; IN COMMERCE 10-1-2000.

2,765,108. UNION INDUSTRIAL GAS & SUPPLY, INC., IRVING, TX. SN 76-305,831. PUB. 8-20-2002, FILED 8-28-2001.

LIQUILUX/TEXGAS**CLASS 37—CONSTRUCTION AND REPAIR**

FOR EXCHANGING AND REFURBISHING PROPANE GAS CYLINDERS (U.S. CLS. 100, 103 AND 106).

FIRST USE 3-1-2000; IN COMMERCE 3-1-2000.

CLASS 39—TRANSPORTATION AND STORAGE

FOR UTILITY SERVICES IN THE NATURE OF PROPANE GAS DISTRIBUTION (U.S. CLS. 100 AND 105).

FIRST USE 3-1-2000; IN COMMERCE 3-1-2000.

CLASS 40—MATERIAL TREATMENT

FOR PROPANE GAS PRODUCTION SERVICES (U.S. CLS. 100, 103 AND 106).

FIRST USE 3-1-2000; IN COMMERCE 3-1-2000.

2,765,111. ROSETTA INPHARMATICS LLC, KIRKLAND, WA, BY ASSIGNMENT ROSETTA INPHARMATICS, INC., KIRKLAND, WA. SN 76-306,945. PUB. 9-3-2002, FILED 8-30-2001.

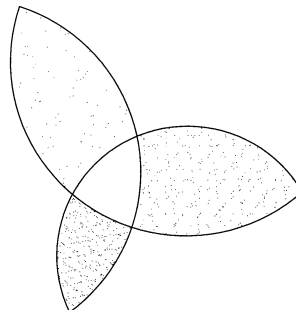

THE STIPPLING ON THE MARK IS FOR SHADING PURPOSES ONLY AND DOES NOT INDICATE COLOR.

CLASS 9—ELECTRICAL AND SCIENTIFIC APPARATUS

FOR COMPUTER SOFTWARE CONTAINING AN ARCHITECTURE TO ACCESS A DATABASE FOR USE IN RESEARCH AND DRUG DISCOVERY; COMPUTER SOFTWARE FOR STORING, RETRIEVING, AND ANALYZING GENE EXPRESSION DATA FOR USE IN RESEARCH AND DRUG DISCOVERY (U.S. CLS. 21, 23, 26, 36 AND 38).

FIRST USE 9-20-2001; IN COMMERCE 9-20-2001.

CLASS 16—PAPER GOODS AND PRINTED MATTER

FOR MANUALS FOR USE WITH RESEARCH, DATABASE, AND DRUG DISCOVERY SOFTWARE (U.S. CLS. 2, 5, 22, 23, 29, 37, 38 AND 50).
FIRST USE 9-20-2001; IN COMMERCE 9-20-2001.

CLASS 42—SCIENTIFIC, COMPUTER AND LEGAL SERVICES

FOR RESEARCH AND SCIENTIFIC ANALYSIS RELATING TO DRUG DISCOVERY AND DEVELOPMENT FOR OTHERS (U.S. CLS. 100 AND 101).
FIRST USE 9-20-2001; IN COMMERCE 9-20-2001.

2,765,114. KOLPIN OUTDOORS, INC., FOX LAKE, WI. SN 76-307,209. PUB. 10-29-2002, FILED 8-30-2001.

RHINO HIDE**CLASS 13—FIREARMS**

FOR POLYESTER MATERIAL COATED WITH PVC USED AS A COMPONENT OF GUN CASES (U.S. CLS. 2 AND 9).
FIRST USE 11-0-2001; IN COMMERCE 11-0-2001.

CLASS 18—LEATHER GOODS

FOR POLYESTER MATERIAL COATED WITH PVC USED AS A COMPONENT OF LUGGAGE AND BAGS, NAMELY, ALL-TERRAIN VEHICLE BAGS AND SPORTS BAGS USED FOR HUNTING AND OUTDOOR USE (U.S. CLS. 1, 2, 3, 22 AND 41).
FIRST USE 11-0-2001; IN COMMERCE 11-0-2001.

2,765,117. WALTON, EDWARD W., SARASOTA, FL. SN 76-307,973. PUB. 6-11-2002, FILED 9-4-2001.

FANDAGES**CLASS 5—PHARMACEUTICALS**

FOR ADHESIVE BANDAGES FEATURING SPORTS TEAM NAMES AND/OR LOGOS AND/OR SPONSORS PRINTED ON THE BACKING SIDE OF THE BANDAGES (U.S. CLS. 6, 18, 44, 46, 51 AND 52).
FIRST USE 11-28-2002; IN COMMERCE 12-13-2002.

CLASS 10—MEDICAL APPARATUS

FOR ELASTIC BANDAGES FEATURING SPORTS TEAM NAMES AND/OR LOGOS AND/OR SPONSORS PRINTED ON THE BACKING SIDE OF THE BANDAGES (U.S. CLS. 26, 39 AND 44).
FIRST USE 11-28-2002; IN COMMERCE 12-13-2002.

2,765,121. INTERNATIONAL REMOTE IMAGING SYSTEMS, INC., CHATSWORTH, CA. SN 76-308,911. PUB. 1-14-2003, FILED 9-4-2001.

IQ**CLASS 5—PHARMACEUTICALS**

FOR MEDICAL DIAGNOSTIC CONSUMABLE PREPARATIONS, NAMELY, SHEATH FLUIDS IN THE NATURE OF PRESERVED, STABILIZED SALT SOLUTIONS USED TO SURROUND A SAMPLE IN A READING CHAMBER, STAIN SOLUTIONS OF DYES IN WATER AND ALCOHOL USED TO COLOR CELLS AND OTHER PARTICLES IN URINE, CONTROL MATERIALS OF A KNOWN CONCENTRATION OF RED CELLS IN A SALT SOLUTION USED TO VERIFY PERFORMANCE OF THE URINE SEDIMENT COUNTING ANALYZER, AND CALIBRATOR MATERIALS OF A KNOWN CONCENTRATION OF RED CELLS IN SALT SOLUTION USED TO ADJUST THE COUNTING ACCURACY OF THE URINE ANALYZER, ALL FOR USE WITH A URINE SEDIMENT DETECTION AND COUNTING ANALYZER (U.S. CLS. 6, 18, 44, 46, 51 AND 52).
FIRST USE 1-0-2002; IN COMMERCE 1-0-2003.

CLASS 10—MEDICAL APPARATUS

FOR MEDICAL DIAGNOSTIC EQUIPMENT, NAMELY A URINE SEDIMENT DETECTION AND COUNTING ANALYZER (U.S. CLS. 26, 39 AND 44).
FIRST USE 1-0-2002; IN COMMERCE 1-0-2003.

2,765,130. CREASOURCE LTD., LONDON WIT 2PH, UNITED KINGDOM. SN 76-311,588. PUB. 9-24-2002, FILED 9-12-2001.

CREASOURCE**CLASS 16—PAPER GOODS AND PRINTED MATTER**

FOR PRINTED MATTER, NAMELY PICTURE CATALOGUES (U.S. CLS. 2, 5, 22, 23, 29, 37, 38 AND 50).
FIRST USE 11-1-2001; IN COMMERCE 1-1-2002.

CLASS 35—ADVERTISING AND BUSINESS

FOR COPYRIGHT MANAGEMENT SERVICES, NAMELY, EXPLOITATION OF PHOTOGRAPHS, PHOTOGRAPHIC WORKS, FILMS, VIDEOS AND IMAGE AND SOUND SEQUENCES ON IMAGE AND SOUND RECORDING CARRIERS OF ALL TYPES (U.S. CLS. 100, 101 AND 102).
FIRST USE 11-1-2001; IN COMMERCE 1-1-2002.

CLASS 41—EDUCATION AND ENTERTAINMENT

FOR PRODUCTION OF PHOTOGRAPHS AND PHOTOGRAPHIC WORKS, FILMS, VIDEOS AND IMAGE AND SOUND SEQUENCES ON IMAGE AND SOUND RECORDING CARRIERS OF ALL TYPES, NAMELY, FILM, VIDEOTAPE, VIDEO CASSETTES, VIDEO DISCS; PUBLICATION OF PICTURE CATALOGUES (U.S. CLS. 100, 101 AND 107).
FIRST USE 11-1-2001; IN COMMERCE 1-1-2002.

CLASS 42—SCIENTIFIC, COMPUTER AND LEGAL SERVICES

FOR STOCK PHOTOGRAPHY SERVICES, NAMELY, LEASING REPRODUCTION RIGHTS OF PHOTOGRAPHS AND PHOTOGRAPHIC WORKS (U.S. CLS. 100 AND 101).

FIRST USE 11-1-2001; IN COMMERCE 1-1-2002.

2,765,132. SAX, EDWARD, LOXAHATCHEE, FL. SN 76-312,049. PUB. 7-16-2002, FILED 9-13-2001.

WONDERTEC**CLASS 1—CHEMICALS**

FOR CHEMICAL ADDITIVES FOR STUCCO; AND CONCRETE ADDITIVES (U.S. CLS. 1, 5, 6, 10, 26 AND 46).

FIRST USE 12-15-2001; IN COMMERCE 12-15-2001.

CLASS 19—NON-METALLIC BUILDING MATERIALS

FOR NON-METAL WALL BOARDS; FENCE PANELS; STUCCO TILES; AND ROOFING TILES (U.S. CLS. 1, 12, 33 AND 50).

FIRST USE 3-1-2003; IN COMMERCE 3-1-2003.

CLASS 37—CONSTRUCTION AND REPAIR

FOR CONSTRUCTION SERVICES FOR INSTALLING WALLS, FENCES AND ROOFS (U.S. CLS. 100, 103 AND 106).

FIRST USE 3-1-2003; IN COMMERCE 3-1-2003.

2,765,134. FRUITS ET LEGUMES ERIC FRECHETTE INC., LEVIS, PROVINCE OF QUEBEC, CANADA. SN 76-313,093. PUB. 10-1-2002, FILED 9-17-2001.

**CLASS 31—NATURAL AGRICULTURAL PRODUCTS**

FOR FRESH AND UNPROCESSED FRUITS AND VEGETABLES (U.S. CLS. 1 AND 46).

FIRST USE 3-18-2002; IN COMMERCE 3-18-2002.

CLASS 35—ADVERTISING AND BUSINESS

FOR WHOLESALE DISTRIBUTORSHIPS AND WHOLESALE STORES FEATURING FRESH AND UNPROCESSED FRUITS AND VEGETABLES (U.S. CLS. 100, 101 AND 102).

FIRST USE 3-18-2002; IN COMMERCE 3-18-2002.

2,765,146. RUSHTON, THOMAS L., WILMINGTON, NC. AND RUSHTON, KIMBERLY L., WILMINGTON, NC. SN 76-317,071. PUB. 4-16-2002, FILED 9-24-2001.



NO CLAIM IS MADE TO THE EXCLUSIVE RIGHT TO USE "EQUESTRIAN", APART FROM THE MARK AS SHOWN.

CLASS 16—PAPER GOODS AND PRINTED MATTER

FOR DECALS AND STICKERS (U.S. CLS. 2, 5, 22, 23, 29, 37, 38 AND 50).

FIRST USE 8-0-2002; IN COMMERCE 8-0-2002.

CLASS 25—CLOTHING

FOR CLOTHING, NAMELY, QUILTED VESTS, SCARF, OVER COATS, SPORT COATS, RAIN COATS, GLOVES, SUN VISORS, SOCKS, NECKTIES, SPORT SHIRTS, HATS, BOXER SHORTS, NIGHT SHIRTS, SWEAT SHIRTS, SWEATERS, T-SHIRTS, TANK TOPS, BLOUSES, CAPS, KNIT SHIRTS, TURTLE NECKS, BELTS, SWEAT PANTS, VESTS, VISORS, POLO SHIRTS, WIND RESISTANT JACKETS, HEAD WEAR, JACKETS, CLOTH BIBS, GOLF SHIRTS, APRONS, SHIRTS, GLOVES, MITTENS, CHAPS, JODHPURS, BANDANNAS, AND UNDERWEAR (U.S. CLS. 22 AND 39).

FIRST USE 8-0-2002; IN COMMERCE 8-0-2002.

2,765,153. PC SPECIALISTS, INC., SAN DIEGO, CA. SN 76-319,602. PUB. 9-24-2002, FILED 10-1-2001.

INNOVATIVE CORPORATE ENVIRONMENTS

NO CLAIM IS MADE TO THE EXCLUSIVE RIGHT TO USE "CORPORATE ENVIRONMENTS", APART FROM THE MARK AS SHOWN.

CLASS 35—ADVERTISING AND BUSINESS

FOR RETAIL FURNITURE STORES (U.S. CLS. 100, 101 AND 102).

FIRST USE 5-15-2001; IN COMMERCE 5-15-2001.

CLASS 37—CONSTRUCTION AND REPAIR

FOR INSTALLATION OF FURNITURE (U.S. CLS. 100, 103 AND 106).

FIRST USE 5-15-2001; IN COMMERCE 5-15-2001.

CLASS 42—SCIENTIFIC, COMPUTER AND LEGAL SERVICES

FOR INTERIOR DESIGN (U.S. CLS. 100 AND 101).

FIRST USE 5-15-2001; IN COMMERCE 5-15-2001.

2,765,155. APOLLO PRODUCTS, INC., KANSAS CITY, MO.
SN 76-319,934. PUB. 6-25-2002, FILED 10-1-2001.

ULTRA ESSENTIALS

CLASS 3—COSMETICS AND CLEANING PREPARATIONS

FOR HAIR CARE PREPARATIONS, NAMELY HAIR CLEANER, HAIR CONDITIONER, HAIR SPRAY, HAIR STYLING MOUSSE, HAIRPIECE CLEANER, HAIRPIECE REMOVER AND HAIR PIECE ADHESIVE REMOVER; SKIN LOTION; AND COLOGNE (U.S. CLS. 1, 4, 6, 50, 51 AND 52).

FIRST USE 11-12-2002; IN COMMERCE 11-12-2002.

CLASS 5—PHARMACEUTICALS

FOR VITAMINS, MINERALS AND DIETARY SUPPLEMENTS (U.S. CLS. 6, 18, 44, 46, 51 AND 52).

FIRST USE 11-12-2002; IN COMMERCE 11-12-2002.

CLASS 26—FANCY GOODS

FOR HAIRPIECES AND HAIRPIECE TAPE (U.S. CLS. 37, 39, 40, 42 AND 50).

FIRST USE 11-12-2002; IN COMMERCE 11-12-2002.

CLASS 35—ADVERTISING AND BUSINESS

FOR RETAIL STORE SERVICES IN THE FIELD OF HAIR CARE PREPARATIONS, SKIN LOTIONS, COLOGNES, WIGS, TOUPEES, AND OTHER TYPES OF HAIRPIECES (U.S. CLS. 100, 101 AND 102).

FIRST USE 11-12-2002; IN COMMERCE 11-12-2002.

CLASS 42—SCIENTIFIC, COMPUTER AND LEGAL SERVICES

FOR CUSTOM DESIGN AND FITTING OF ARTIFICIAL AND NATURAL HAIRPIECES TO THE SCALP TO CORRECT BALDNESS; HAIR STYLING SALON SERVICES; HAIR REPLACEMENT SERVICES (U.S. CLS. 100 AND 101).

FIRST USE 11-12-2002; IN COMMERCE 11-12-2002.

2,765,169. WATTS RADIANT, INC., SPRINGFIELD, MO. SN
76-323,506. PUB. 8-27-2002, FILED 10-11-2001.

THE FUTURE LOOKS RADIANT

CLASS 6—METAL GOODS

FOR COPPER PLUMBING PIPES (U.S. CLS. 2, 12, 13, 14, 23, 25 AND 50).

FIRST USE 5-15-2003; IN COMMERCE 5-15-2003.

CLASS 11—ENVIRONMENTAL CONTROL APPARATUS

FOR PLUMBING FITTINGS - NAMELY, VALVES AND MECHANICAL PANELS USED TO HOUSE PLUMBING HOSE, PIPES AND VALVES FOR USE IN ELECTRO-MECHANICALLY OPERATED RADIANT HEATING SYSTEMS FOR FLOORS AND ROADWAYS (U.S. CLS. 13, 21, 23, 31 AND 34).

FIRST USE 5-15-2003; IN COMMERCE 5-15-2003.

CLASS 17—RUBBER GOODS

FOR PLASTIC PLUMBING HOSE (U.S. CLS. 1, 5, 12, 13, 35 AND 50).

FIRST USE 5-15-2003; IN COMMERCE 5-15-2003.

2,765,176. MUNCHKIN, INC., VAN NUYS, CA. SN 76-325,636.
PUB. 12-17-2002, FILED 10-15-2001.

TWISTY

CLASS 10—MEDICAL APPARATUS

FOR TEETHING RINGS (U.S. CLS. 26, 39 AND 44).

FIRST USE 3-31-2002; IN COMMERCE 3-31-2002.

CLASS 28—TOYS AND SPORTING GOODS

FOR INFANT TOYS (U.S. CLS. 22, 23, 38 AND 50).

FIRST USE 3-31-2002; IN COMMERCE 3-31-2002.

2,765,177. CREATIVE FORECASTING, INC., COLORADO
SPRINGS, CO. SN 76-325,849. PUB. 9-3-2002, FILED 10-17-
2001.

CREATIVE FORECASTING

OWNER OF U.S. REG. NO. 1,966,680.

CLASS 9—ELECTRICAL AND SCIENTIFIC APPARATUS

FOR COMPUTER SOFTWARE FOR USE IN THE DEVELOPMENT, SCHEDULING, ORGANIZING, CONDUCTING AND EVALUATING OF PROJECTS AND ACTIVITIES IN THE FIELDS OF ACTIVITY AND RECREATIONAL PROGRAMMING AND RECREATIONAL THERAPY (U.S. CLS. 21, 23, 26, 36 AND 38).

FIRST USE 10-1-2001; IN COMMERCE 10-1-2001.

CLASS 16—PAPER GOODS AND PRINTED MATTER

FOR PRINTED MATERIALS AND PUBLICATIONS, NAMELY, BOOKS, MAGAZINES, PERIODICALS, JOURNALS, MANUALS, NEWSLETTERS, INFORMATION SHEETS, PAMPHLETS, BROCHURES, CALENDARS, WORKBOOKS, AND WORKSHEETS ON THE SUBJECT OF OR FOR USE IN THE FIELDS OF ACTIVITY AND RECREATIONAL PROGRAMMING AND RECREATIONAL THERAPY (U.S. CLS. 2, 5, 22, 23, 29, 37, 38 AND 50).

FIRST USE 10-31-1988; IN COMMERCE 10-31-1988.

2,765,178. ARNALDO CAPRAI GRUPPO TESSILE S.P.A.,
06037-FOLOGNO (PG), ITALY. SN 76-325,989. PUB. 10-1-
2002, FILED 10-16-2001.

Gioielli ad Ago

THE MARK "GIOIELLI AD AGO" MEANS "NEEDLE-

MADE JEWELS" IN ENGLISH.

CLASS 24—FABRICS

FOR BED BLANKETS, PILLOW CASES, TABLE MATS NOT OF PAPER, TEXTILE BATH MATS AND TOWELS, SHEETS, CURTAINS, HANDKERCHIEFS (U.S. CLS. 42 AND 50).

FIRST USE 3-28-2003; IN COMMERCE 3-28-2003.

CLASS 25—CLOTHING

FOR PAJAMAS, DRESSING GOWNS, VESTS, BATH-ROBES, COLLARS, SCARVES, NECK TIES, STOLES, BELTS (U.S. CLS. 22 AND 39).

FIRST USE 3-28-2003; IN COMMERCE 3-28-2003.

2,765,179. CONAGRA FOODS, INC., OMAHA, NE. SN 76-326,210. PUB. 10-1-2002, FILED 10-17-2001.

ONE-DISH CLASSICS

NO CLAIM IS MADE TO THE EXCLUSIVE RIGHT TO USE "ONE-DISH", APART FROM THE MARK AS SHOWN.

CLASS 29—MEATS AND PROCESSED FOODS

FOR DINNERS AND ENTREES CONSISTING PRIMARILY OF BEEF, POULTRY, SEAFOOD, VEGETABLES, CHILI OR STEW (U.S. CL. 46).

FIRST USE 5-15-2003; IN COMMERCE 5-15-2003.

CLASS 30—STAPLE FOODS

FOR DINNERS AND ENTREES CONSISTING PRIMARILY OF PASTA OR RICE (U.S. CL. 46).

FIRST USE 5-15-2003; IN COMMERCE 5-15-2003.

2,765,192. ANTON HUMMEL VERWALTUNGS GMBH, 79183 WALDKIRCH, FED REP GERMANY. SN 76-329,743. PUB. 10-1-2002, FILED 10-25-2001.

EURO-LOCK-SYSTEM

PRIORITY CLAIMED UNDER SEC. 44(D) ON FED REP GERMANY APPLICATION NO. 30128768.6, FILED 5-7-2001.

CLASS 9—ELECTRICAL AND SCIENTIFIC APPARATUS

FOR ELECTRICAL PLUGS AND TIP JACKS; ELECTRICAL CONTACTS, ESPECIALLY CONTACT JACKS AND CONTACT PINS FOR CONNECTORS; ELECTRICAL FASTENERS CONSISTING OF LOCKING RINGS AND LOCKING SLIDES FOR FASTENING ELECTRICAL CONTACTS IN CONNECTORS (U.S. CLS. 21, 23, 26, 36 AND 38).

FIRST USE 2-28-2001; IN COMMERCE 2-28-2001.

CLASS 17—RUBBER GOODS

FOR INSULATION, NAMELY, MATERIALS FOR ELECTRICAL INSTALLATION, NAMELY, SHEATHS OR CORRUGATED SHEATHS TO PROTECT ELECTRICAL CABLE, CABLES AND SHEATH CONNECTIONS, AND PLUGS, BALL AND SOCKET JOINTS, REDUCING FITTINGS AND EXTENSIONS FOR ELECTRICAL LINES, INSPECTION PLUGS FOR ELECTRICAL MACHINES, FOR DEVICES AND/OR FOR SWITCH CABINETS (U.S. CLS. 1, 5, 12, 13, 35 AND 50).

FIRST USE 2-28-2001; IN COMMERCE 2-28-2001.

2,765,197. PARK LI GROUP, LTD., NEW YORK, NY. SN 76-331,674. PUB. 12-10-2002, FILED 10-25-2001.

BRIDGING CULTURES

NO CLAIM IS MADE TO THE EXCLUSIVE RIGHT TO USE "CULTURES", APART FROM THE MARK AS SHOWN.

CLASS 9—ELECTRICAL AND SCIENTIFIC APPARATUS

FOR COMPUTER SOFTWARE ON DISC FOR USE IN RAISING AWARENESS OF AND INSTRUCTION ABOUT CROSS-CULTURAL ISSUES AND THE IMPACT OF CROSS-CULTURAL DIFFERENCES ON BUSINESS AND PERSONAL LIFE IN FOREIGN CULTURES, AND WORK BOOK FOR USE IN CONNECTION THEREWITH, SOLD TOGETHER AS A UNIT (U.S. CLS. 21, 23, 26, 36 AND 38).

FIRST USE 10-21-1998; IN COMMERCE 10-21-1998.

CLASS 42—SCIENTIFIC, COMPUTER AND LEGAL SERVICES

FOR PROVIDING TEMPORARY USE OF NON-DOWNLOADABLE COMPUTER SOFTWARE FOR USE IN RAISING AWARENESS OF AND INSTRUCTION ABOUT CROSS-CULTURAL ISSUES AND THE IMPACT OF CROSS-CULTURAL DIFFERENCES ON BUSINESS AND PERSONAL LIFE IN FOREIGN CULTURES (U.S. CLS. 100 AND 101).

FIRST USE 5-3-2002; IN COMMERCE 5-3-2002.

2,765,203. PREMIER SYSTEM INTEGRATORS, INC., SMYRNA, TN. SN 76-332,281. PUB. 12-3-2002, FILED 10-30-2001.

APTITEK

CLASS 35—ADVERTISING AND BUSINESS

FOR EMPLOYMENT RECRUITING AND STAFFING SERVICES (U.S. CLS. 100, 101 AND 102).

FIRST USE 1-31-2002; IN COMMERCE 1-31-2002.

CLASS 40—MATERIAL TREATMENT

FOR CONSULTING SERVICES IN THE FIELD OF MANUFACTURING (U.S. CLS. 100, 103 AND 106).

FIRST USE 1-31-2002; IN COMMERCE 1-31-2002.

2,765,208. FAIRFIELD UNIVERSITY, FAIRFIELD, CT. SN 76-335,487. PUB. 4-30-2002, FILED 11-7-2001.



OWNER OF U.S. REG. NOS. 2,380,616 AND 2,426,138.
THE STIPPLING SHOWN IN THE MARK ON THE DRAWING INDICATES DIFFERENCES IN COLOR BUT DOES NOT INDICATE COLOR.

CLASS 25—CLOTHING

FOR SHIRTS (U.S. CLS. 22 AND 39).
FIRST USE 10-18-2001; IN COMMERCE 10-18-2001.

CLASS 41—EDUCATION AND ENTERTAINMENT

FOR ENTERTAINMENT SERVICES, NAMELY ARRANGING AND CONDUCTING ATHLETIC EVENTS (U.S. CLS. 100, 101 AND 107).
FIRST USE 10-18-2001; IN COMMERCE 10-18-2001.

2,765,212. EVERBRITE, INC., GREENFIELD, WI. SN 76-337,485. PUB. 10-15-2002, FILED 11-13-2001.

LUMI DIGIT

CLASS 9—ELECTRICAL AND SCIENTIFIC APPARATUS

FOR ELECTRIC SIGNS; LUMINOUS SIGNS; ELECTRIC LUMINESCENT DISPLAY PANELS AND ILLUMINATED LETTERING FOR INFORMATIVE AND ADVERTISING SIGNS AND DISPLAYS (U.S. CLS. 21, 23, 26, 36 AND 38).
FIRST USE 9-1-2001; IN COMMERCE 9-1-2001.

CLASS 11—ENVIRONMENTAL CONTROL APPARATUS

FOR LIGHTING DEVICES; NAMELY, ELECTRIC LIGHTING FIXTURES, DECORATIVE LIGHT STRINGS, ACCENT LIGHTING UNITS AND ELECTRIC STRIP LIGHTING (U.S. CLS. 13, 21, 23, 31 AND 34).
FIRST USE 9-1-2001; IN COMMERCE 9-1-2001.

2,765,219. VELOCITY EXPRESS CORPORATION, BLOOMINGTON, MN, BY CHANGE OF NAME UNITED SHIPPING & TECHNOLOGY, INC., BLOOMINGTON, MN. SN 76-339,091. PUB. 11-5-2002, FILED 11-16-2001.

RELENTLESS RELIABILITY

CLASS 35—ADVERTISING AND BUSINESS

FOR TRACKING OF PACKAGE SHIPMENTS AND LOGISTICS MANAGEMENT IN THE FIELD OF PARCEL DELIVERY (U.S. CLS. 100, 101 AND 102).
FIRST USE 6-0-2001; IN COMMERCE 6-0-2001.

CLASS 39—TRANSPORTATION AND STORAGE

FOR COURIER SERVICES, DOCUMENT DELIVERY SERVICES AND DELIVERY OF PARCELS (U.S. CLS. 100 AND 105).
FIRST USE 6-0-2001; IN COMMERCE 6-0-2001.

2,765,220. H.S. HOSPITAL SERVICE S.P.A., 00040 POMEZIA (RM), ITALY. SN 76-339,635. PUB. 11-26-2002, FILED 11-19-2001.



COLOR IS CLAIMED AS A FEATURE OF THE MARK, WITH THE LETTERS "HS" BEING THE COLOR GREY, AND THE LINES BEING THE COLOR GREEN.

THE MARK CONSISTS OF THE STYLIZED LETTERS "HS" HAVING A SOLID THICK LINE CENTERED BEHIND AND FIVE THIN LINES BEHIND AND BELOW.

CLASS 5—PHARMACEUTICALS

FOR PHARMACEUTICAL PREPARATIONS IN LIQUID, CAPSULE, AND PILL FORM, NAMELY, ANTI-BIOTICS, ANTICOAGULANTS, ANTIDEPRESSANTS, ANALGESICS, LAXATIVES, ANTIDIARRHEALS, BLOOD PRESSURE REGULATORS, COMPOUNDS FOR TREATING HAIR LOSS, COMPOUNDS FOR TREATING ERECTILE DYSFUNCTION; SANITARY PREPARATIONS, NAMELY, SANITARY NAPKINS, TAMPONS, PADS, FEMININE HYGIENE CLEANSING TOWELLETTES AND PRE-MOISTENED MEDICATED WIPES, MEDICAL PLASTERS, WOUND, BURN AND SURGICAL DRESSINGS; MATERIAL FOR STOPPING TEETH, DENTAL WAX; ALL PURPOSE DISINFECTANTS FOR DOMESTIC USE, ALL PURPOSE ANTIBACTERIAL PREPARATIONS FOR DOMESTIC USE; PREPARATIONS FOR DESTROYING VERMIN; FUNGICIDES AND HERBICIDES FOR DOMESTIC USES (U.S. CLS. 6, 18, 44, 46, 51 AND 52).
FIRST USE 0-0-2001; IN COMMERCE 0-0-2001.

CLASS 10—MEDICAL APPARATUS

FOR MEDICAL AND SURGICAL INSTRUMENTS AND APPARATUS, NAMELY, CATHETERS, NEEDLES, BIOPSY NEEDLES, EPIDURAL INJECTION KITS COMPRISED OF MEDICAL SYRINGE, NEEDLES, AND TUBING; SPINAL ANAESTHESIA NEEDLES, DIAGNOSTIC LUMBAR NEEDLES; ENDOSCOPIC INSTRUMENTS, NAMELY, GRASPERS, SCISSORS, RETRACTORS, FORCEPS, AND NEEDLE TROCARS, ENDOSCOPIC MOUTHGUARDS, ENDOSCOPES, ENDOSCOPE PROTECTOR HOODS, ENDOSCOPIC PROBES, ENDOSCOPIC LIGHT SOURCES, ENDOSCOPIC CLEANING BRUSHES AND SPONGES; ORAL ASPIRATORS; SOFT TISSUE BIOPSY KITS CONTAINING ASSORTED SYRINGES AND NEEDLES, PERCUTANEOUS DRAINAGE LINES, SURGERY DRAINAGE LINES, BIOPSY FORCEPS, FOREIGN BODY REMOVAL FORCEPS, ORAL ANESTHETIC DISPENSERS; ENDOTRACHEAL AND TRACHEOTOMY TUBES; ETHANOL INJECTION SET FOR LIVER AND THYROID NODULES TREATMENT COMPRISED OF MEDICAL SYRINGE, NEEDLES, AND TUBING; LAPAROSCOPIC SURGICAL INSTRUMENTS, NAMELY BIOPSY PUNCHES, DISSECTORS, FORCEPS, NEEDLE HOLDERS, SCISSORS, AND ACCESSORIES THEREFOR; SURGICAL INSTRUMENT TRAYS (U.S. CLS. 26, 39 AND 44).

FIRST USE 0-0-2001; IN COMMERCE 0-0-2001.

2,765,233. WITHROW PHARMACEUTICAL, PICO RIVERA, CA. SN 76-342,791. PUB. 9-10-2002, FILED 11-29-2001.

INVISIBLE SHIELD**CLASS 3—COSMETICS AND CLEANING PREPARATIONS**

FOR MOISTURIZING SKIN CREAM FOR THE HANDS AND FACE AND BODY FEATURING AN ANTISEPTIC (U.S. CLS. 1, 4, 6, 50, 51 AND 52).

FIRST USE 3-9-2002; IN COMMERCE 3-9-2002.

CLASS 5—PHARMACEUTICALS

FOR ANTISEPTIC SKIN PROTECTANT CREAM WITH MOISTURIZER FOR THE HANDS FACE AND BODY (U.S. CLS. 6, 18, 44, 46, 51 AND 52).

FIRST USE 3-9-2002; IN COMMERCE 3-9-2002.

2,765,239. HEALTH NET, INC., WOODLAND HILLS, CA. SN 76-344,419. PUB. 7-9-2002, FILED 12-3-2001.

PREGNANCY MATTERS

NO CLAIM IS MADE TO THE EXCLUSIVE RIGHT TO USE "PREGNANCY", APART FROM THE MARK AS SHOWN.

CLASS 16—PAPER GOODS AND PRINTED MATTER

FOR NEWSLETTERS RELATED TO HEALTH CARE FOR MOTHER AND CHILD IN CONNECTION WITH PREGNANCY (U.S. CLS. 2, 5, 22, 23, 29, 37, 38 AND 50).

FIRST USE 2-0-2002; IN COMMERCE 2-0-2002.

CLASS 41—EDUCATION AND ENTERTAINMENT

FOR EDUCATIONAL SERVICES, NAMELY PROGRAMS AIMED AT PROVIDING INFORMATION FOR BOTH MOTHER AND CHILD ON PREGNANCY (U.S. CLS. 100, 101 AND 107).

FIRST USE 2-0-2002; IN COMMERCE 2-0-2002.

2,765,244. JOHN HENRY COMPANY, THE, LANSING, MI. SN 76-346,440. PUB. 1-14-2003, FILED 12-7-2001.

JOHN HENRY

OWNER OF U.S. REG. NO. 1,168,908.

THE NAME "JOHN HENRY" DOES NOT IDENTIFY A LIVING INDIVIDUAL.

CLASS 1—CHEMICALS

FOR FLOWER PRESERVATIVES (U.S. CLS. 1, 5, 6, 10, 26 AND 46).

FIRST USE 0-0-1941; IN COMMERCE 0-0-1941.

CLASS 8—HAND TOOLS

FOR HAND TOOLS, NAMELY, FLOWER AND PLANT STEM CUTTERS (U.S. CLS. 23, 28 AND 44).

FIRST USE 0-0-1941; IN COMMERCE 0-0-1941.

CLASS 16—PAPER GOODS AND PRINTED MATTER

FOR BAGS MADE OF PAPER; PLASTIC BAGS, NAMELY, PLASTIC FLOWER BAGS; BOOKS ON CARE AND DESIGN OF FLOWERS AND PLANTS; BOWS, NAMELY, RIBBON BOWS FOR GIFT WRAP AND FLOWER POTS AND VASES; BROCHURES ABOUT PLANTS AND PLANT LIFE, GROWING FLOWERS, CARING FOR PLANTS AND FLOWERS; BUSINESS AND ORDER FORMS; CATALOGS REGARDING FLORISTS, GROWERS, AND GARDEN CENTERS; CIRCULARS IN THE NATURE OF PLANT AND FLOWER CARE; DECO KITS CONSISTING PRIMARILY OF DECORATIVE BOWS, FLOWER POT LINERS AND COVERS FOR USE WITH FLOWERS AND PLANTS; LABELS, NAMELY, PARTIALLY PRINTED LABELS NOT OF TEXTILES; PRINTED MATERIALS, NAMELY, LETTERHEAD; LETTERHEAD STATIONERY; PAPER GIFT WRAP; WRAPPING PAPER; PLANT LABELS AND SIGNS MADE OF PAPER; POSTCARDS; PAPER FLOWER POT COVERS; PRICING PRODUCTS IN THE NATURE OF PRICE TAGS; PRINTED CHARTS; BLANK CARDS; BLANK NOTE CARDS; FILING CARDS; STATIONERY; AND TISSUE PAPER GIFT WRAP (U.S. CLS. 2, 5, 22, 23, 29, 37, 38 AND 50).

FIRST USE 0-0-1941; IN COMMERCE 0-0-1941.

CLASS 20—FURNITURE AND ARTICLES NOT OTHERWISE CLASSIFIED

FOR ACCENT PICKS FOR FLORAL ARRANGEMENTS MADE OF PLASTIC AND WOOD; PLANT LABELS AND SIGNS MADE OF WOOD AND PLASTIC; DELIVERY TRAYS OF FOAM AND PLASTIC FOR FLORAL ARRANGEMENTS; LABELS, NAMELY, PLASTIC LABELS; DISPLAY RACKS; DRIED AND SILK FOAM SUPPORTS FOR FLORAL ARRANGEMENTS (U.S. CLS. 2, 13, 22, 25, 32 AND 50).

FIRST USE 0-0-1941; IN COMMERCE 0-0-1941.

CLASS 21—HOUSEWARES AND GLASS

FOR PLASTIC FLOWER POT BASES FOR FLORAL ARRANGEMENTS; PLASTIC FLOWER POT COVERS; BASKETS OF WICKER, STRAW, WOOD, OR CLOTH; CERAMIC CONTAINERS FOR FLOWERS AND PLANTS; COFFEE MUGS; AND BEVERAGE GLASSWARE (U.S. CLS. 2, 13, 23, 29, 30, 33, 40 AND 50).

FIRST USE 0-0-1941; IN COMMERCE 0-0-1941.

CLASS 26—FANCY GOODS

FOR BOWS, NAMELY, ORNAMENTAL BOWS OF TEXTILE FOR DECORATION, BOWS FOR GIFT WRAPPING AND BOWS FOR WRAPPING (U.S. CLS. 37, 39, 40, 42 AND 50).

FIRST USE 0-0-1941; IN COMMERCE 0-0-1941.

2,765,284. BANGKOK MARKET, INC., MAYWOOD, CA. SN 76-357,586. PUB. 9-17-2002, FILED 1-9-2002.

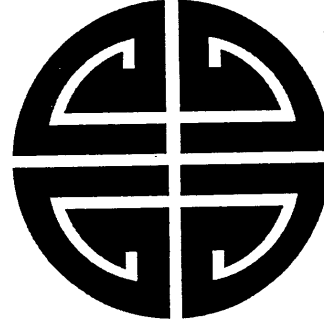

THE MARK CONSISTS OF A CHINESE SYMBOL FOR THE WORDS "LONG LIFE".

2,765,246. SHINKO CORPORATION, BUCHEON-CITY, KYUNGKI-DO, REPUBLIC OF KOREA. SN 76-346,554. PUB. 10-1-2002, FILED 12-7-2001.

VIBRACELL**CLASS 9—ELECTRICAL AND SCIENTIFIC APPARATUS**

FOR AMPLIFIER FOR GUITAR (U.S. CLS. 21, 23, 26, 36 AND 38).

FIRST USE 1-0-2002; IN COMMERCE 1-0-2002.

CLASS 15—MUSICAL INSTRUMENTS

FOR GUITAR, ELECTRONIC GUITAR (U.S. CLS. 2, 21 AND 36).

FIRST USE 1-0-2002; IN COMMERCE 1-0-2002.

CLASS 29—MEATS AND PROCESSED FOODS

FOR PROCESSED CANNED VEGETABLES, CANNED SOUPS (U.S. CL. 46).

FIRST USE 1-1-2003; IN COMMERCE 1-1-2003.

CLASS 30—STAPLE FOODS

FOR CANNED SAUCES, BOTTLED SAUCES, RICE, CURRY PASTE AND SPICES (U.S. CL. 46).

FIRST USE 4-1-2003; IN COMMERCE 4-1-2003.

CLASS 31—NATURAL AGRICULTURAL PRODUCTS

FOR FRESH PRODUCE, NAMELY, VEGETABLES (U.S. CLS. 1 AND 46).

FIRST USE 6-10-2003; IN COMMERCE 6-10-2003.

2,765,265. INNODESK, INC., CLEVELAND, OH. SN 76-352,181. PUB. 6-18-2002, FILED 12-21-2001.

INNODESK**CLASS 7—MACHINERY**

FOR PORTABLE BATTERY OPERATED BLOWER FOR USE IN CLEANING DUST, LINT AND DEBRIS OFF KEYBOARDS, PRINTERS, FAX MACHINES, PHOTOGRAPHIC EQUIPMENT AND OTHER HIGH TECH EQUIPMENT (U.S. CLS. 13, 19, 21, 23, 31, 34 AND 35).

FIRST USE 10-22-2002; IN COMMERCE 10-22-2002.

CLASS 16—PAPER GOODS AND PRINTED MATTER

FOR OFFICE PRODUCTS, NAMELY CAPLESS MARKERS AND HIGHLIGHTING MARKERS; AND PORTABLE BATTERY OPERATED SHREDDERS, PORTABLE BATTERY OPERATED PENCIL SHARPENERS, PORTABLE BATTERY OPERATED LETTER OPENERS, AND PORTABLE LAMINATORS (U.S. CLS. 2, 5, 22, 23, 29, 37, 38 AND 50).

FIRST USE 10-22-2002; IN COMMERCE 10-22-2002.

2,765,288. GAYLORD ENTERTAINMENT COMPANY, NASHVILLE, TN. SN 76-358,156. PUB. 6-25-2002, FILED 1-11-2002.



THE MARK CONSISTS OF A STYLIZED REPRESENTATION OF A PARTIAL SUN WITH THE LETTER "G" IN THE MIDDLE, THE RIGHT SIDE OF THE SUN DESIGN BEING OPEN.

CLASS 35—ADVERTISING AND BUSINESS

FOR PROVIDING FACILITIES FOR BUSINESS MEETINGS; RETAIL STORE SERVICES, NAMELY RETAIL SHOPS FEATURING CANDY, SNACKS, MAGAZINES, BOOKS, FLOWERS, JEWELRY, GOLF EQUIPMENT, GOLF APPAREL, AND GOLF ACCESSORIES (U.S. CLS. 100, 101 AND 102).

FIRST USE 1-0-2002; IN COMMERCE 1-0-2002.

CLASS 41—EDUCATION AND ENTERTAINMENT

FOR ENTERTAINMENT SERVICES IN THE NATURE OF GOLF TOURNAMENTS AND GOLF RELATED EVENTS, NAMELY, BANQUETS, AWARD CEREMONIES AND EXHIBITIONS; PROVIDING FITNESS FACILITIES; GOLF COURSES; COUNTRY CLUBS; ENTERTAINMENT SERVICES, NAMELY, LIVE MUSICAL PERFORMANCES, DRAMATICO-MUSICAL PROGRAMS AND/OR MUSICAL PROGRAMS; PROVIDING FACILITIES FOR EDUCATIONAL CONVENTIONS (U.S. CLS. 100, 101 AND 107).

FIRST USE 1-0-2002; IN COMMERCE 1-0-2002.

CLASS 43—HOTEL AND RESTAURANT SERVICES

FOR HOTEL SERVICES; RESORT LODGING SERVICES; PROVIDING GENERAL PURPOSE CONVENTION FACILITIES; ARENA SERVICES, NAMELY PROVIDING FACILITIES FOR CONVENTIONS AND EXHIBITIONS; PROVIDING BANQUET AND SOCIAL FUNCTION FACILITIES FOR SPECIAL OCCASIONS; RESTAURANT SERVICES; FOOD CATERING SERVICES; BAR SERVICES; NIGHT CLUB AND COCKTAIL LOUNGE SERVICES (U.S. CLS. 100 AND 101).

FIRST USE 6-0-2002; IN COMMERCE 6-0-2002.

CLASS 44—MEDICAL, BEAUTY AND AGRICULTURAL SERVICES

FOR BARBER SHOP AND BEAUTY SALON SERVICES; HEALTH SPA SERVICES, NAMELY, COSMETIC BODY CARE SERVICES (U.S. CLS. 100 AND 101).

FIRST USE 1-0-2002; IN COMMERCE 1-0-2002.

2,765,292. NSA INTERNATIONAL, INC., MEMPHIS, TN. SN 76-359,070. PUB. 11-19-2002, FILED 1-15-2002.

JUICE PLUS+
*Children's Research
Foundation*



OWNER OF U.S. REG. NOS. 1,854,442, 2,474,348, AND OTHERS.

NO CLAIM IS MADE TO THE EXCLUSIVE RIGHT TO USE "JUICE" AND "CHILDREN RESEARCH FOUNDATION", APART FROM THE MARK AS SHOWN.

CLASS 35—ADVERTISING AND BUSINESS

FOR PROMOTING PUBLIC AWARENESS OF THE NEED FOR HEALTHY EATING HABITS FOR CHILDREN (U.S. CLS. 100, 101 AND 102).

FIRST USE 10-31-1999; IN COMMERCE 10-31-1999.

CLASS 42—SCIENTIFIC, COMPUTER AND LEGAL SERVICES

FOR CONDUCTING RESEARCH REGARDING CHILDREN'S HEALTH (U.S. CLS. 100 AND 101).

FIRST USE 10-31-1999; IN COMMERCE 10-31-1999.

2,765,294. NORMAN INTERNATIONAL, INC., SANTA FE SPRINGS, CA. SN 76-359,650. PUB. 9-3-2002, FILED 1-16-2002.

NIC**CLASS 6—METAL GOODS**

FOR METAL WINDOW SHUTTERS (U.S. CLS. 2, 12, 13, 14, 23, 25 AND 50).

FIRST USE 5-6-2003; IN COMMERCE 5-6-2003.

CLASS 19—NON-METALLIC BUILDING MATERIALS

FOR NON-METAL EXTERIOR WINDOW SHUTTERS, AND COMPONENT PARTS THEREFOR; EXTERIOR WINDOW SHUTTERS MADE OF WOOD OR PLASTIC (U.S. CLS. 1, 12, 33 AND 50).

FIRST USE 5-6-2003; IN COMMERCE 5-6-2003.

CLASS 20—FURNITURE AND ARTICLES NOT OTHERWISE CLASSIFIED

FOR INTERIOR WINDOW SHUTTERS; INTERIOR WINDOW SHUTTERS MADE OF WOOD OR PLASTIC; WINDOW COVERINGS, NAMELY, WINDOW BLINDS AND WINDOW SHADES, NAMELY, VENETIAN BLINDS, MINI BLINDS, TWO-INCH BLINDS, MICRO BLINDS, INDOOR SLATTED BLINDS, VERTICAL BLINDS, PLEATED SHADES, ROLLER SHADES (U.S. CLS. 2, 13, 22, 25, 32 AND 50).

FIRST USE 5-6-2003; IN COMMERCE 5-6-2003.

2,765,327. DUN & BRADSTREET, INC., MURRAY HILL, NJ. SN 76-369,282. PUB. 2-25-2003, FILED 2-11-2002.

SMALL BUSINESS RISK INSIGHT

NO CLAIM IS MADE TO THE EXCLUSIVE RIGHT TO USE "SMALL BUSINESS RISK", APART FROM THE MARK AS SHOWN.

CLASS 35—ADVERTISING AND BUSINESS

FOR PROVIDING BUSINESS INFORMATION IN THE NATURE OF MARKETING BUSINESS INFORMATION (U.S. CLS. 100, 101 AND 102).

FIRST USE 2-25-2002; IN COMMERCE 7-2-2002.

CLASS 36—INSURANCE AND FINANCIAL

FOR PROVIDING INFORMATION IN THE FIELD OF SMALL BUSINESS RISK MANAGEMENT AND FINANCIAL CREDIT INFORMATION ON SMALL BUSINESSES (U.S. CLS. 100, 101 AND 102).

FIRST USE 2-25-2002; IN COMMERCE 7-2-2002.

2,765,373. MIDWESTERN PET FOODS, INC., EVANSVILLE, IN. SN 76-379,631. PUB. 10-29-2002, FILED 3-7-2002.

EPAWS**CLASS 35—ADVERTISING AND BUSINESS**

FOR PROMOTING THE GOODS AND SERVICES RELATED TO PET CARE BY PROVIDING A WEB SITE AT WHICH USERS CAN LINK TO AND INPUT PET PROFILE INFORMATION AND RECEIVE COUPONS (U.S. CLS. 100, 101 AND 102).

FIRST USE 5-1-2002; IN COMMERCE 5-1-2002.

CLASS 45—PERSONAL SERVICES

FOR REMINDER SERVICES IN THE AREA OF UPCOMING IMPORTANT DATES AND EVENTS FOR PET CARE (U.S. CLS. 100 AND 101).

FIRST USE 5-1-2002; IN COMMERCE 5-1-2002.

2,765,338. GREATER CINCINNATI CHAMBER OF COMMERCE, CINCINNATI, OH. SN 76-372,855. PUB. 12-10-2002, FILED 2-20-2002.

TASTE OF CINCINNATI

OWNER OF U.S. REG. NO. 1,668,847.

NO CLAIM IS MADE TO THE EXCLUSIVE RIGHT TO USE "CINCINNATI", APART FROM THE MARK AS SHOWN.

CLASS 21—HOUSEWARES AND GLASS

FOR THERMAL INSULATED BEVERAGE CONTAINERS; BEER MUGS; BEVERAGE GLASSWARE, BEVERAGEWARE; CUPS; DRINKING GLASSES AND MUGS (U.S. CLS. 2, 13, 23, 29, 30, 33, 40 AND 50).

FIRST USE 3-1-1980; IN COMMERCE 5-25-1980.

CLASS 25—CLOTHING

FOR T-SHIRTS; GOLF SHIRTS; BOXER SHORTS; CAPS; HATS; APRONS; BANDANNAS; CLOTH BIBS; GYM SHORTS; JACKETS; SWEAT SHIRTS; TANK TOPS AND VISORS (U.S. CLS. 22 AND 39).

FIRST USE 3-1-1980; IN COMMERCE 5-25-1980.

2,765,376. MCNEILUS TRUCK AND MANUFACTURING, INC., DODGE CENTER, MN. SN 76-380,594. PUB. 8-20-2002, FILED 3-11-2002.



THE DRAWING IS LINED FOR THE OVAL/V IS MARKED FOR BLUE

CLASS 7—MACHINERY

FOR MIXING DRUMS FOR TRANSIT CONCRETE MIXING VEHICLES (U.S. CLS. 13, 19, 21, 23, 31, 34 AND 35).

FIRST USE 2-0-2002; IN COMMERCE 2-0-2002.

CLASS 12—VEHICLES

FOR TRANSIT CONCRETE MIXING VEHICLES (U.S. CLS. 19, 21, 23, 31, 35 AND 44).

FIRST USE 2-0-2002; IN COMMERCE 2-0-2002.

2,765,341. LAYTON PRODUCTIONS, INC., OREM, UT. SN 76-373,144. PUB. 10-8-2002, FILED 2-21-2002.

EXCELLING AND SURPASSING ALL ELSE**CLASS 35—ADVERTISING AND BUSINESS**

FOR PROMOTING THE GOODS AND SERVICES OF OTHERS BY CONDUCTING SPECIAL EVENTS IN THE FIELDS OF ARTS, TECHNOLOGIES, ACADEMIA, TRADE, AND INDUSTRY (U.S. CLS. 100, 101 AND 102).

FIRST USE 8-6-2002; IN COMMERCE 8-6-2002.

2,765,417. MENTOR TALK, INC., NEW YORK, NY. SN 76-394,561. PUB. 11-26-2002, FILED 4-12-2002.

A CATALYST FOR BUILDING YOUR CAREER**CLASS 41—EDUCATION AND ENTERTAINMENT**

FOR PROVIDING RECOGNITION THROUGH SPECIAL EVENTS AND AWARDS TO DEMONSTRATE EXCELLENCE IN THE FIELDS OF ARTS, TECHNOLOGIES, ACADEMIA, TRADE, AND INDUSTRY (U.S. CLS. 100, 101 AND 107).

FIRST USE 8-6-2002; IN COMMERCE 8-6-2002.

CLASS 35—ADVERTISING AND BUSINESS

FOR CAREER SERVICES, NAMELY CAREER-NETWORKING SERVICES, CAREER PLACEMENT SERVICES AND RESUME PREPARATION ASSISTANCE AND SERVICES (U.S. CLS. 100, 101 AND 102).

FIRST USE 7-1-2002; IN COMMERCE 7-1-2002.

CLASS 41—EDUCATION AND ENTERTAINMENT

FOR EDUCATIONAL SERVICES, NAMELY, CONDUCTING WORKSHOPS, SEMINARS AND CLASSES IN THE FIELD OF CAREER MANAGEMENT AND PEER REVIEW, CAREER MENTORING, CAREER COUNSELING AND ADVICE IN THE FIELD OF EDUCATION AND CAREER COACHING (U.S. CLS. 100, 101 AND 107).
FIRST USE 7-1-2002; IN COMMERCE 7-1-2002.

CLASS 42—SCIENTIFIC, COMPUTER AND LEGAL SERVICES

FOR ENVIRONMENTAL ENGINEERING AND RELATED CONSULTATION SERVICES, NAMELY CONCEPT ENGINEERING, ENGINEERING DESIGN, URBAN AND REGIONAL PLANNING, GEOLOGICAL AND HYDROLOGICAL RESEARCH STUDIES, ANALYTICAL TESTING AND LABORATORY SERVICES IN THE FIELD OF ENVIRONMENTAL PROTECTION (U.S. CLS. 100 AND 101).
FIRST USE 7-1-2002; IN COMMERCE 7-1-2002.

2,765,418. MENTOR TALK, INC., NEW YORK, NY. SN 76-394,568. PUB. 12-17-2002, FILED 4-12-2002.

MENTOR TALK, INC.

NO CLAIM IS MADE TO THE EXCLUSIVE RIGHT TO USE "INC.", APART FROM THE MARK AS SHOWN.

CLASS 35—ADVERTISING AND BUSINESS

FOR CAREER SERVICES, NAMELY, CAREER-NETWORKING SERVICES, CAREER PLACEMENT SERVICES AND RESUME PREPARATION ASSISTANCE SERVICES (U.S. CLS. 100, 101 AND 102).
FIRST USE 7-1-2002; IN COMMERCE 7-1-2002.

CLASS 41—EDUCATION AND ENTERTAINMENT

FOR EDUCATIONAL SERVICES, NAMELY, CONDUCTING WORKSHOPS, SEMINARS AND CLASSES IN THE FIELDS OF CAREER MANAGEMENT AND PEER REVIEW, CAREER MENTORING, CAREER COUNSELING AND ADVICE IN THE FIELDS OF EDUCATION AND CAREER COACHING (U.S. CLS. 100, 101 AND 107).
FIRST USE 7-1-2002; IN COMMERCE 7-1-2002.

2,765,466. SCHOTTENSTEIN STORES CORPORATION, DBA VALUE CITY FURNITURE, COLUMBUS, OH. SN 76-413,256. PUB. 3-18-2003, FILED 5-23-2002.

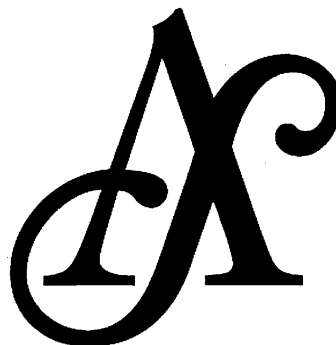
**CLASS 11—ENVIRONMENTAL CONTROL APPARATUS**

FOR LAMPS (U.S. CLS. 13, 21, 23, 31 AND 34).
FIRST USE 6-12-2002; IN COMMERCE 6-12-2002.

CLASS 14—JEWELRY

FOR CLOCKS (U.S. CLS. 2, 27, 28 AND 50).
FIRST USE 6-12-2002; IN COMMERCE 6-12-2002.

CLASS 20—FURNITURE AND ARTICLES NOT OTHERWISE CLASSIFIED

FOR HOME AND OFFICE FURNISHINGS AND DECORATIVE ACCESSORIES; NAMELY, FURNITURE, PILLOWS, MATTRESSES AND BOX SPRINGS, FURNITURE MIRRORS, FILING CABINETS, FREE-STANDING SHELVES, WALL-MOUNTED SHELVES, FREE-STANDING GUN RACKS, WALL-MOUNTED GUN RACKS, FREE-STANDING HAT RACKS, WALL-MOUNTED HAT RACKS, MAGAZINE RACKS, STORAGE RACKS, PICTURE FRAMES, PLASTIC AND WOOD FIGURINES, COMPUTER FURNITURE, FREE-STANDING KITCHEN STORAGE RACKS, WALL-MOUNTED KITCHEN STORAGE RACKS, MULTI-FUNCTION FREE-STANDING KITCHEN WORK CENTERS CONTAINING STORAGE, WRITING SURFACE TABLE AND/OR DESK, AND FURNITURE PARTS, NAMELY, COUNTERTOPS (U.S. CLS. 2, 13, 22, 25, 32 AND 50).
FIRST USE 6-12-2002; IN COMMERCE 6-12-2002.

CLASS 21—HOUSEWARES AND GLASS

FOR FIGURINES OF GLASS, CRYSTAL, PORCELAIN, AND CHINA; WINE RACKS, SPICE RACKS (U.S. CLS. 2, 13, 23, 29, 30, 33, 40 AND 50).
FIRST USE 6-12-2002; IN COMMERCE 6-12-2002.

2,765,434. ROY F. WESTON, INC., WEST CHESTER, PA. SN 76-403,874. PUB. 11-26-2002, FILED 5-6-2002.

WESTON SOLUTIONS

OWNER OF U.S. REG. NOS. 1,419,415, 1,563,676, AND 1,576,714.

CLASS 35—ADVERTISING AND BUSINESS

FOR MANAGEMENT ASSISTANCE SERVICES (U.S. CLS. 100, 101 AND 102).
FIRST USE 6-19-2002; IN COMMERCE 6-19-2002.

CLASS 37—CONSTRUCTION AND REPAIR

FOR CONSTRUCTION MANAGEMENT SUPERVISORY SERVICES AND CONSTRUCTION SERVICES, NAMELY PLANNING, LAYING OUT AND CUSTOM CONSTRUCTION OF COMMERCIAL PROPERTIES (U.S. CLS. 100, 103 AND 106).
FIRST USE 7-1-2002; IN COMMERCE 7-1-2002.

CLASS 24—FABRICS

FOR BED AND TABLE LINENS, BED BLANKETS, SHAMS, DUVET COVERS, BEDSPREADS, TEXTILE WALL HANGINGS, CURTAINS, DRAPERIES, UNFITTED FURNITURE COVERS, QUILTS, AND DUST RUFFLES (U.S. CLS. 42 AND 50).

FIRST USE 6-12-2002; IN COMMERCE 6-12-2002.

2,765,510. ZEEKS, INC., WASHINGTON, DC. SN 76-975,315. PUB. 5-14-2002, FILED 4-19-2000.

2,765,487. BREVARD WORKFORCE DEVELOPMENT BOARD, INC., ROCKLEDGE, FL. SN 76-424,449. PUB. 2-25-2003, FILED 6-24-2002.

DYNAMIC WORKS INSTITUTE

NO CLAIM IS MADE TO THE EXCLUSIVE RIGHT TO USE "INSTITUTE", APART FROM THE MARK AS SHOWN.

CLASS 41—EDUCATION AND ENTERTAINMENT

FOR EDUCATIONAL SERVICES, NAMELY, SPONSORING SEMINARS AND WORKSHOPS AND PROVIDING COURSES OF INSTRUCTION, ALL IN THE FIELD OF WORKER TRAINING AND RE-TRAINING (U.S. CLS. 100, 101 AND 107).

FIRST USE 7-29-2002; IN COMMERCE 7-29-2002.

CLASS 42—SCIENTIFIC, COMPUTER AND LEGAL SERVICES

FOR PROVIDING TEMPORARY ACCESS TO NON-DOWNLOADABLE EDUCATIONAL SOFTWARE IN THE FIELD OF WORKER TRAINING AND RE-TRAINING (U.S. CLS. 100 AND 101).

FIRST USE 7-29-2002; IN COMMERCE 7-29-2002.

2,765,509. ATLANTIC STATION, L.L.C., ATLANTA, GA. BY CHANGE OF NAME ATLANTIC REDEVELOPMENT, L.L.C., ATLANTA, GA. SN 76-975,198. PUB. 4-24-2001, FILED 8-4-2000.

ATLANTIC STATION

CLASS 36—INSURANCE AND FINANCIAL

FOR REAL ESTATE SERVICES, NAMELY REAL ESTATE SYNDICATION, TIME-SHARING, TRUSTEE SERVICES, INVESTMENT, LISTING, MANAGEMENT, INSURANCE CLAIMS PROCESSING, LEASING, MANAGEMENT, AGENCIES, EQUITY SHARING, NAMELY MANAGING AND ARRANGING FOR CO-OWNERSHIP, ESCROW SERVICES, FINANCIAL INVESTMENT IN THE FIELD OF REAL ESTATE, FINANCIAL VALUATION OF REAL ESTATE, BROKERAGE SERVICES (U.S. CLS. 100, 101 AND 102).

FIRST USE 4-18-2000; IN COMMERCE 4-18-2000.

CLASS 37—CONSTRUCTION AND REPAIR

FOR REAL ESTATE DEVELOPMENT, SITE SELECTION (U.S. CLS. 100, 103 AND 106).

FIRST USE 2-17-2000; IN COMMERCE 2-17-2000.

NSYNC

CLASS 9—ELECTRICAL AND SCIENTIFIC APPARATUS

FOR MUSICAL SOUND RECORDINGS; PRERECORDED RECORDS, AUDIO CASSETTES, COMPACT DISCS AND CD-ROMS FEATURING MUSIC AND LYRICS; PRERECORDED VIDEO TAPES FEATURING MUSICAL ENTERTAINMENT; LASER DISCS FEATURING MUSICAL ENTERTAINMENT; VIDEO DISCS FEATURING MUSICAL ENTERTAINMENT; MULTIMEDIA SOFTWARE RECORDED ON CD-ROM FEATURING MUSICAL ENTERTAINMENT (U.S. CLS. 21, 23, 26, 36 AND 38).

FIRST USE 10-0-1995; IN COMMERCE 3-24-1998.

CLASS 35—ADVERTISING AND BUSINESS

FOR MAIL ORDER SERVICES AND COMPUTERIZED ON-LINE ORDERING SERVICES FEATURING MUSICAL SOUND RECORDINGS, PRERECORDED RECORDS, AUDIO CASSETTES, COMPACT DISCS AND CD-ROMS FEATURING MUSIC AND LYRICS; PRERECORDED VIDEO TAPES FEATURING MUSICAL ENTERTAINMENT; LASER DISCS FEATURING MUSICAL ENTERTAINMENT; VIDEO DISCS FEATURING MUSICAL ENTERTAINMENT; MULTIMEDIA SOFTWARE RECORDED ON CD-ROM FEATURING MUSICAL ENTERTAINMENT; JEWELRY; EARRINGS AND EAR CLIPS; CLOCKS AND WATCHES; ORNAMENTAL PINS; CHAINS; BRACELETS; MEDALS; RINGS; NECKLACES; CIGARETTE LIGHTERS AND CIGARETTE CASES; CUFF LINKS; PENDANTS; BELT BUCKLES; CHARMS; BOOKS, NEWSLETTERS, PAMPHLETS, MAGAZINES, MAGAZINE SUPPLEMENTS ALL IN THE FIELD OF ENTERTAINMENT AND MUSIC; SHEET MUSIC; POSTERS; STICKERS; DECALS; NOTE CARDS, STATIONERY, CALENDARS; TRADING CARDS; MOUNTED AND UNMOUNTED PHOTOGRAPHS TEMPORARY TATTOOS; CLOTHING NAMELY, HATS, CAPS, VISORS, HEADBANDS, HOODS, SCARVES, NECKTIES, MUFFLERS, SHIRTS, T-SHIRTS, BLOUSES, PULLOVERS, TOPS, JACKETS, PARKAS, COATS, SWEATERS, VESTS, SWEAT SHIRTS, PANTS, SWEAT PANTS, SHORTS, BOTTOMS, SKIRTS, DRESSES; UNDERWEAR, NAMELY, BOXER SHORTS, UNDERSHORTS, UNDERPANTS, BRAS; SOCKS, HOSIERY; FOOTWEAR, NAMELY, SHOES AND BOOTS; GLOVES, MITTENS; SWIMWEAR, BEACHWEAR; LEOTARDS, LEGGINGS, TIGHTS; PAJAMAS, ROBES, LOUNGEWEAR; AND BELTS (U.S. CLS. 100, 101 AND 102).

FIRST USE 3-0-2000; IN COMMERCE 3-0-2000.

OWNER OF U.S. REG. NO. 1,843,498.

CLASS 41—EDUCATION AND ENTERTAINMENT

FOR PROVIDING AN ON-LINE COMPUTER DATABASE VIA A GLOBAL COMPUTER NETWORK FEATURING INFORMATION, GRAPHICS AND DATA ABOUT A MUSICAL GROUP FEATURING NEWS, INTERVIEWS, SCHEDULES OF RELEASES OF SOUND RECORDINGS, SCHEDULES OF RELEASES OF VIDEO RECORDINGS, SCHEDULES OF RELEASES OF LASER AND DIGITAL RECORDINGS, SCHEDULES OF RELEASES OF MULTI-MEDIA SOFTWARE, SCHEDULES OF RELEASES OF COLLECTIBLE, FASHION, APPAREL, JEWELRY AND PRINTED MATTER MERCHANDISE, SCHEDULES OF TOURS, SCHEDULES OF TRAVEL, SCHEDULES OF LIVE AND PRERECORDED MUSICAL PERFORMANCES, SCHEDULES OF LIVE AND PERSONAL APPEARANCES; PROVIDING AN ON-LINE COMPUTER DATABASE VIA A GLOBAL COMPUTER NETWORK FEATURING MUSIC, MUSIC CONCERTS, MUSIC VIDEOS AND MUSIC VIDEO CLIPS OF A MUSICAL GROUP; ENTERTAINMENT IN THE NATURE OF LIVE PERFORMANCES BY A MUSICAL GROUP (U.S. CLS. 100, 101 AND 107).

FIRST USE 10-0-1995; IN COMMERCE 3-0-1998.

2,765,513. SAUL ZAENTZ COMPANY, THE, DBA TOLKIEN ENTERPRISES, BERKELEY, CA. SN 76-975,415. PUB. 9-24-2002, FILED 10-29-2001.

**THE
LORD
OF THE
RINGS**

OWNER OF U.S. REG. NO. 1,553,027.

CLASS 16—PAPER GOODS AND PRINTED MATTER

FOR PRINTED MATTER NAMELY, POSTERS; WALL CHARTS; STATIONERY; CALENDARS; PLAYING CARDS; TRADING CARDS; BOOKMARKS; STICKERS; WRITING PAPER; NOTE BOOKS; NOTE PADS; FOLDERS; SERIES OF FANTASY BOOKS AND MAGAZINES; PENCILS, PENS, AND ERASERS (U.S. CLS. 2, 5, 22, 23, 29, 37, 38 AND 50).

FIRST USE 9-25-2002; IN COMMERCE 9-25-2002.

2,765,511. ATLANTIC STATION LLC, ATLANTA, GA, BY CHANGE OF NAME ATLANTIC REDEVELOPMENT, L.L.C., ATLANTA, GA. SN 76-975,327. PUB. 5-1-2001, FILED 8-4-2000.

CLASS 25—CLOTHING

FOR CLOTHING, NAMELY T-SHIRTS, COSTUMES AND HEADWEAR (U.S. CLS. 22 AND 39).

FIRST USE 8-26-2002; IN COMMERCE 8-26-2002.

CLASS 28—TOYS AND SPORTING GOODS

FOR TOY ACTION FIGURES AND ACCESSORIES THEREFOR; TOY FIGURES; CARD GAMES; EQUIPMENT SOLD AS A UNIT FOR PLAYING CARD GAMES; PUZZLES, EXCEPT CROSSWORD PUZZLES; CHESS SETS; ROLE-PLAYING GAMES AND ACCESSORIES; COLLECTIBLE TOY FIGURES; TOY BOXES; COSTUME MASKS; TOY SWORDS, TOY DAGGERS, TOY BOWS AND ARROWS; FANTASY CHARACTER TOYS AND CHRISTMAS TREE ORNAMENTS (U.S. CLS. 22, 23, 38 AND 50).

FIRST USE 8-27-2002; IN COMMERCE 8-27-2002.



2,765,514. EUREKA HELLAS S.A., INDUSTRIAL AREA, GREECE. SN 76-975,537. PUB. 6-11-2002, FILED 10-23-2001.

CHIRTON

CLASS 36—INSURANCE AND FINANCIAL

FOR REAL ESTATE SERVICES, NAMELY REAL ESTATE SYNDICATION, TIME-SHARING, TRUSTEE SERVICES, INVESTMENT, LISTING, MANAGEMENT, INSURANCE CLAIMS PROCESSING, LEASING, MANAGEMENT, AGENCIES, EQUITY SHARING, NAMELY MANAGING AND ARRANGING FOR CO-OWNERSHIP, ESCROW SERVICES, FINANCIAL INVESTMENT IN THE FIELD OF REAL ESTATE, FINANCIAL VALUATION OF REAL ESTATE, BROKERAGE SERVICES (U.S. CLS. 100, 101 AND 102).

FIRST USE 1-0-2002; IN COMMERCE 1-0-2002.

CLASS 3—COSMETICS AND CLEANING PREPARATIONS

FOR FURNITURE POLISH (U.S. CLS. 1, 4, 6, 50, 51 AND 52).

FIRST USE 10-0-2000; IN COMMERCE 12-0-2001.

CLASS 37—CONSTRUCTION AND REPAIR

FOR REAL ESTATE DEVELOPMENT, SITE SELECTION (U.S. CLS. 100, 103 AND 106).

FIRST USE 1-0-2002; IN COMMERCE 1-0-2002.

CLASS 5—PHARMACEUTICALS

FOR AIR FRESHENERS (U.S. CLS. 6, 18, 44, 46, 51 AND 52).

FIRST USE 10-0-2000; IN COMMERCE 12-0-2001.

2,765,515. DELONGHI AMERICA, INC., SADDLE BROOK, NJ. SN 76-975,564. PUB. 7-2-2002, FILED 3-9-2001.



Living innovation.

OWNER OF U.S. REG. NOS. 1,200,965, 2,417,071, AND OTHERS.

CLASS 7—MACHINERY

FOR HOUSE MARK FOR A FULL LINE OF HOUSEHOLD ELECTRIC APPLIANCES, NAMELY, FOOD PROCESSORS, JUICE EXTRACTORS, HAND-HELD MIXERS, BLENDERS, MINCING MACHINES AND REPLACEMENT PARTS THEREFOR; AND FLOOR CARE APPLIANCES, NAMELY, ELECTRIC SWEEPERS, EXTRACTOR CLEANERS, VACUUM CLEANERS, AND HAND HELD STEAM CLEANERS, AND REPLACEMENT PARTS THEREFOR (U.S. CLS. 13, 19, 21, 23, 31, 34 AND 35).
FIRST USE 3-1-2000; IN COMMERCE 3-1-2000.

CLASS 11—ENVIRONMENTAL CONTROL APPARATUS

FOR HOUSE MARK FOR A FULL LINE OF DOMESTIC HEATING APPLIANCES, NAMELY, FAN HEATERS, CONVECTORS, OIL FILLED ELECTRIC RADIATORS, WOOD AND COAL BURNING STOVES, KEROSENE HEATERS, CATALYTIC GAS HEATERS, NATURAL GAS HEATERS, INFRA-RED GAS HEATERS, AND INFRA-RED QUARTZ HEATERS, ELECTRIC CONTACT GRILLS, ELECTRIC BARBECUES, ELECTRIC DEEP FRYERS, ELECTRIC OVENS, MICROWAVE OVENS FOR COOKING, ELECTRIC TOASTER OVENS, ESPRESSO, CAPPUCCINO AND FILTER COFFEE MACHINES, ELECTRIC PERCOLATORS, ELECTRIC TOASTERS, HAND HELD ELECTRIC HAIR DRYERS, AND REPLACEMENT PARTS THEREFOR; ELECTRIC ICE CREAM MAKERS AND REPLACEMENT PARTS THEREFOR AND AIR TREATMENT APPLIANCES, NAMELY, HUMIDIFIERS, DEHUMIDIFIERS, AIR PURIFIERS, ELECTRIC FANS, AND AIR CONDITIONERS, AND REPLACEMENT PARTS THEREOF (U.S. CLS. 13, 21, 23, 31 AND 34).
FIRST USE 3-1-2000; IN COMMERCE 3-1-2000.

2,765,519. HODGES, ROBERT, ARTESIA, NM. SN 76-975,621. PUB. 8-20-2002, FILED 10-11-2001.



CLASS 30—STAPLE FOODS

FOR SALSA (U.S. CL. 46).
FIRST USE 4-15-2003; IN COMMERCE 4-15-2003.

CLASS 35—ADVERTISING AND BUSINESS

FOR PROMOTING THE GOODS AND SERVICES OF OTHERS BY PROVIDING LINKS TO THE WEB SITES OF OTHERS (U.S. CLS. 100, 101 AND 102).
FIRST USE 8-28-2001; IN COMMERCE 8-28-2001.

2,765,520. DNA WEAR, INC., RICHMOND, CA. SN 76-975,623. PUB. 7-23-2002, FILED 1-16-2001.

REDEFINING APPAREL

NO CLAIM IS MADE TO THE EXCLUSIVE RIGHT TO USE "APPAREL", APART FROM THE MARK AS SHOWN.

CLASS 40—MATERIAL TREATMENT

FOR CUSTOM MANUFACTURING OF CLOTHING (U.S. CLS. 100, 103 AND 106).
FIRST USE 10-31-2001; IN COMMERCE 10-31-2001.

CLASS 42—SCIENTIFIC, COMPUTER AND LEGAL SERVICES

FOR DESIGN FOR OTHERS IN THE FIELD OF CLOTHING (U.S. CLS. 100 AND 101).
FIRST USE 10-31-2001; IN COMMERCE 10-31-2001.

2,765,525. INVENTURE PLACE, INC., AKRON, OH. SN 76-975,666. PUB. 2-19-2002, FILED 6-18-2001.

INVENT NOW

NO CLAIM IS MADE TO THE EXCLUSIVE RIGHT TO USE "INVENT", APART FROM THE MARK AS SHOWN.

CLASS 16—PAPER GOODS AND PRINTED MATTER

FOR PRINTED INSTRUCTIONAL, EDUCATIONAL AND TEACHING MATERIALS RELATED TO INVENTION AND CREATIVITY; ACTIVITY BOOKS; BALL POINT PENS; FELT PENS; FIBERTIP PENS; ROLLER BALL PENS AND PENCILS (U.S. CLS. 2, 5, 22, 23, 29, 37, 38 AND 50).
FIRST USE 4-20-2001; IN COMMERCE 9-30-2001.

CLASS 25—CLOTHING

FOR SHIRTS AND HATS (U.S. CLS. 22 AND 39).
FIRST USE 4-20-2001; IN COMMERCE 5-9-2003.

CLASS 41—EDUCATION AND ENTERTAINMENT

FOR EDUCATIONAL SERVICES, NAMELY, CONDUCTING PROGRAMS IN THE FIELD OF PROMOTING AND COMMEMORATING CREATIVITY AND INVENTIVENESS (U.S. CLS. 100, 101 AND 107).
FIRST USE 4-20-2001; IN COMMERCE 12-30-2001.

2,765,529. VITASOY INTERNATIONAL HOLDINGS LIMITED, NEW TERRITORIES, HONG KONG. SN 76-975,715. PUB. 6-18-2002, FILED 2-23-2001.

VITASOY

OWNER OF U.S. REG. NOS. 1,833,973, 1,868,942, AND 1,893,224.

CLASS 29—MEATS AND PROCESSED FOODS

FOR FRESH TOFU; SOY BEVERAGES, NAMELY, SOY BASED BEVERAGE USED AS A MILK SUBSTITUTE (U.S. CL. 46).

FIRST USE 5-0-1987; IN COMMERCE 5-0-1987.

CLASS 30—STAPLE FOODS

FOR TOFU DESSERTS, NAMELY, TOFU BASED PUDDINGS AND CUSTARDS MADE WITH SOY; SOY BEVERAGES, NAMELY, TEAS MADE WITH SOY (U.S. CL. 46).

FIRST USE 8-0-1995; IN COMMERCE 8-0-1995.

2,765,539. MATTEL, INC., EL SEGUNDO, CA. SN 78-011,538. PUB. 4-2-2002, FILED 6-6-2000.

KOZMIC KIDDLES

CLASS 6—METAL GOODS

FOR METAL KEY CHAINS, METAL KEY RINGS AND METAL KEY HOLDERS (U.S. CLS. 2, 12, 13, 14, 23, 25 AND 50).

FIRST USE 7-0-2001; IN COMMERCE 7-0-2001.

CLASS 20—FURNITURE AND ARTICLES NOT OTHERWISE CLASSIFIED

FOR NON-METAL KEY CHAINS, NON-METAL KEY RINGS AND NON-METAL KEY HOLDERS (U.S. CLS. 2, 13, 22, 25, 32 AND 50).

FIRST USE 7-0-2001; IN COMMERCE 7-0-2001.

CLASS 28—TOYS AND SPORTING GOODS

FOR TOY ACTION FIGURES SOLD IN A COMPACT PLAY ENVIRONMENT KEYCHAIN (U.S. CLS. 22, 23, 38 AND 50).

FIRST USE 7-0-2001; IN COMMERCE 7-0-2001.

2,765,547. SAFETY TODAY, INC., GAHANNA, OH. SN 78-019,302. PUB. 9-10-2002, FILED 8-2-2000.

DISPENSE SAFE

CLASS 10—MEDICAL APPARATUS

FOR GLOVE DISPENSERS FOR MEDICAL USE (U.S. CLS. 26, 39 AND 44).

FIRST USE 12-23-2002; IN COMMERCE 1-19-2003.

CLASS 20—FURNITURE AND ARTICLES NOT OTHERWISE CLASSIFIED

FOR METAL AND NON-METAL GLOVE DISPENSERS FOR NON-MEDICAL USE (U.S. CLS. 2, 13, 22, 25, 32 AND 50).

FIRST USE 12-23-2002; IN COMMERCE 1-19-2003.

2,765,549. BRADY, CHRISTOPHER J., GRAND BLANC, MI. AND WOODWARD, ORRIN A., GRAND BLANC, MI. SN 78-025,894. PUB. 1-1-2002, FILED 9-14-2000.

TEAM OF DESTINY

CLASS 35—ADVERTISING AND BUSINESS

FOR CONSULTATION SERVICES IN THE FIELD OF BUSINESS FOR A GROUP OF AFFILIATED INDEPENDENT BUSINESS OWNERS WHO ARE INDIVIDUALLY INVOLVED IN ELECTRONIC COMMERCE DEVELOPMENT (U.S. CLS. 100, 101 AND 102).

FIRST USE 4-1-1999; IN COMMERCE 5-1-1999.

CLASS 41—EDUCATION AND ENTERTAINMENT

FOR CONDUCTING WORKSHOPS AND SEMINARS IN PERSONAL AWARENESS AND MOTIVATION FOR A GROUP OF AFFILIATED INDEPENDENT BUSINESS OWNERS WHO ARE INDIVIDUALLY INVOLVED IN ELECTRONIC COMMERCE DEVELOPMENT (U.S. CLS. 100, 101 AND 107).

FIRST USE 4-1-1999; IN COMMERCE 5-1-1999.

2,765,559. INTERNATIONAL DATA GROUP, INC., FRAMINGHAM, MA. SN 78-034,522. PUB. 9-3-2002, FILED 11-9-2000.

CHANGING THE WAY YOU VIEW IT

CLASS 35—ADVERTISING AND BUSINESS

FOR ARRANGING AND CONDUCTING TRADE SHOWS, EXPOSITIONS, EXHIBITIONS, BUSINESS SEMINARS AND BUSINESS CONFERENCES RELATING TO COMPUTERS, COMPUTER SOFTWARE, ONLINE SERVICES, HIGH TECHNOLOGY, COMMUNICATIONS, INFORMATION TECHNOLOGY AND INFORMATION SERVICES; PROVIDING INTEGRATED ADVERTISING SERVICES, NAMELY, PREPARING AND PLACING ADVERTISEMENTS FOR THE GOODS AND SERVICES OF OTHERS (U.S. CLS. 100, 101 AND 102).

FIRST USE 9-0-2001; IN COMMERCE 9-0-2001.

CLASS 42—SCIENTIFIC, COMPUTER AND LEGAL SERVICES

FOR PROVIDING ONLINE INFORMATION IN THE FIELDS OF COMPUTERS, COMPUTER SOFTWARE, ONLINE SERVICES, HIGH TECHNOLOGY, COMMUNICATIONS, INFORMATION TECHNOLOGY AND INFORMATION SERVICES VIA A COMPUTER NETWORK; RESEARCH AND CONSULTING SERVICES IN THE FIELDS OF COMPUTERS, COMPUTER SOFTWARE, ONLINE SERVICES, HIGH TECHNOLOGY, COMPUTER COMMUNICATIONS, INFORMATION TECHNOLOGY AND COMPUTER INFORMATION SERVICES; COMPUTER SERVICES, NAMELY, PROVIDING AN ON-LINE NEWSLETTER IN THE FIELDS OF COMPUTERS, COMPUTER SOFTWARE, ONLINE SERVICES, HIGH TECHNOLOGY COMMUNICATIONS, INFORMATION SERVICES; PROVISION OF ONLINE SERVICES AND DATABASES, NAMELY, ONLINE MAGAZINES, NEWSLETTERS, JOURNALS, NEWSPAPERS AND BOOKS RELATING TO COMPUTERS, COMPUTER SOFTWARE, ONLINE SERVICES, HIGH TECHNOLOGY, COMMUNICATIONS, INFORMATION TECHNOLOGY AND INFORMATION SERVICES (U.S. CLS. 100 AND 101).

FIRST USE 9-0-2001; IN COMMERCE 9-0-2001.

2,765,574. BEATNIK, INC., SAN MATEO, CA. SN 78-044,071. PUB. 3-12-2002, FILED 1-19-2001.

**CLASS 9—ELECTRICAL AND SCIENTIFIC APPARATUS**

FOR COMPUTER SOFTWARE FOR EDITING, IMPORTING AND COMPRESSING AUDIO COMPUTER FILES, AND FOR SYNTHESIZING AUDIO COMPUTER PROGRAMS AND SEQUENCING NOTES FOR AUDIO COMPUTER FILES (U.S. CLS. 21, 23, 26, 36 AND 38).

FIRST USE 9-0-2001; IN COMMERCE 9-0-2001.

CLASS 16—PAPER GOODS AND PRINTED MATTER

FOR PRINTED MATTER, NAMELY, BOOKS, INSTRUCTION MANUALS, REFERENCE BOOKS IN THE FIELD OF COMPUTERS, COMPUTER SOFTWARE, EDITING COMPUTER AUDIO FILES, AND MUSICAL AUDIO EFFECTS AND ENHANCEMENT, AND PRINTED TEACHING MATERIALS IN THE FIELD OF COMPUTERS, COMPUTER SOFTWARE AND AUDIO AND VISUAL EFFECTS (U.S. CLS. 2, 5, 22, 23, 29, 37, 38 AND 50).

FIRST USE 11-0-2001; IN COMMERCE 11-0-2001.

CLASS 42—SCIENTIFIC, COMPUTER AND LEGAL SERVICES

FOR COMPUTER SERVICES, NAMELY, PROVIDING EDITING SERVICES FOR COMPUTER AUDIO FILES (U.S. CLS. 100 AND 101).

FIRST USE 12-0-2001; IN COMMERCE 12-0-2001.

2,765,560. DEFINITY HEALTH CORPORATION, MINNEAPOLIS, MN. SN 78-034,666. PUB. 9-17-2002, FILED 11-10-2000.



definity health

NO CLAIM IS MADE TO THE EXCLUSIVE RIGHT TO USE "HEALTH", APART FROM THE MARK AS SHOWN.

CLASS 35—ADVERTISING AND BUSINESS

FOR ON-LINE RETAIL SERVICES FEATURING HEALTH, WELLNESS AND MEDICAL PRODUCTS (U.S. CLS. 100, 101 AND 102).

FIRST USE 10-13-2000; IN COMMERCE 10-13-2000.

CLASS 42—SCIENTIFIC, COMPUTER AND LEGAL SERVICES

FOR PROVIDING INFORMATION VIA THE INTERNET IN THE FIELD OF HEALTH CARE, NAMELY, DESCRIPTION OF HEALTH CARE PLANS AND BENEFITS, COMMUNITY SPECIFIC PROVIDER EVALUATION, ANSWERS TO CONSUMERS HEALTH CARE NEEDS, AND CONTROL AND ACCESS TO PERSONAL HEALTH INFORMATION AND BENEFITS ACCOUNTS; ON-LINE SCHEDULING OF PROVIDER APPOINTMENTS (U.S. CLS. 100 AND 101).

FIRST USE 10-13-2000; IN COMMERCE 10-13-2000.

2,765,582. MILE HI CHURCH OF RELIGIOUS SCIENCE, LAKEWOOD, CO. SN 78-053,247. PUB. 1-14-2003, FILED 3-15-2001.

PRACTICAL SPIRITUALITY NETWORK

NO CLAIM IS MADE TO THE EXCLUSIVE RIGHT TO USE "SPIRITUALITY NETWORK", APART FROM THE MARK AS SHOWN.

CLASS 9—ELECTRICAL AND SCIENTIFIC APPARATUS

FOR DOWNLOADABLE ELECTRONIC PUBLICATIONS IN THE NATURE OF ARTICLES AND NEWSLETTERS IN THE FIELD OF SPIRITUALITY; PRE-RECORDED AUDIO CASSETTES, COMPACT DISCS AND VIDEOS FEATURING SPIRITUALITY (U.S. CLS. 21, 23, 26, 36 AND 38).

FIRST USE 5-28-2003; IN COMMERCE 5-28-2003.

CLASS 41—EDUCATION AND ENTERTAINMENT

FOR EDUCATIONAL SERVICES, NAMELY, CONDUCTING CLASSES AND ONLINE CLASSES IN THE FIELD OF SPIRITUALITY (U.S. CLS. 100, 101 AND 107).

FIRST USE 5-28-2003; IN COMMERCE 5-28-2003.

CLASS 42—SCIENTIFIC, COMPUTER AND LEGAL SERVICES

FOR COMPUTER SERVICES, NAMELY, PROVIDING ON-LINE PUBLICATIONS, NAMELY, ARTICLES AND NEWSLETTERS IN THE FIELD OF SPIRITUALITY (U.S. CLS. 100 AND 101).

FIRST USE 5-28-2003; IN COMMERCE 5-28-2003.

CLASS 41—EDUCATION AND ENTERTAINMENT

FOR ENTERTAINMENT SERVICES, NAMELY PROVIDING CASINO AND GAMING INFORMATION AND SERVICES VIA A GLOBAL COMPUTER NETWORK AND VIA TELEVISION (U.S. CLS. 100, 101 AND 107).

FIRST USE 8-7-2001; IN COMMERCE 8-7-2001.

2,765,589. IDG WORLD EXPO CORP., INC., FRAMINGHAM, MA. SN 78-058,780. PUB. 12-31-2002, FILED 4-17-2001.

BIOITWORLD CONFERENCE AND EXPO

NO CLAIM IS MADE TO THE EXCLUSIVE RIGHT TO USE "CONFERENCE AND EXPO", APART FROM THE MARK AS SHOWN.

CLASS 35—ADVERTISING AND BUSINESS

FOR ARRANGING AND CONDUCTING TRADE SHOWS, EXPOSITIONS AND EXHIBITIONS IN THE FIELDS OF COMPUTERS, COMPUTER SOFTWARE, ONLINE SERVICES, HIGH TECHNOLOGY, COMMUNICATIONS, INFORMATION TECHNOLOGY AND INFORMATION SERVICES (U.S. CLS. 100, 101 AND 102).

FIRST USE 8-31-2001; IN COMMERCE 8-31-2001.

CLASS 41—EDUCATION AND ENTERTAINMENT

FOR ARRANGING AND CONDUCTING SEMINARS, CONFERENCES, SYMPOSIUMS, COLLOQUIUMS AND DISCUSSION GROUPS IN THE FIELDS OF COMPUTERS, COMPUTER SOFTWARE, ONLINE SERVICES, HIGH TECHNOLOGY, COMMUNICATIONS, INFORMATION TECHNOLOGY AND INFORMATION SERVICES (U.S. CLS. 100, 101 AND 107).

FIRST USE 8-31-2001; IN COMMERCE 8-31-2001.

CLASS 42—SCIENTIFIC, COMPUTER AND LEGAL SERVICES

FOR PROVIDING A WEBSITE OF INFORMATION IN THE FIELDS OF COMPUTERS, COMPUTER SOFTWARE, ONLINE SERVICES, COMMUNICATIONS, INFORMATION TECHNOLOGY AND INFORMATION SERVICES (U.S. CLS. 100 AND 101).

FIRST USE 11-30-2001; IN COMMERCE 11-30-2001.

2,765,596. PLAYBOY ENTERPRISES INTERNATIONAL, INC., CHICAGO, IL. SN 78-061,267. PUB. 11-13-2001, FILED 5-1-2001.

PLAYBOYRACINGUSA

OWNER OF U.S. REG. NOS. 769,702, 2,482,255, AND OTHERS.

CLASS 36—INSURANCE AND FINANCIAL

FOR PROVIDING BETTING AND WAGING INFORMATION AND SERVICES VIA A GLOBAL COMPUTER NETWORK AND VIA TELEVISION (U.S. CLS. 100, 101 AND 102).

FIRST USE 8-7-2001; IN COMMERCE 8-7-2001.

2,765,598. NATIONAL HEALTH ADMINISTRATORS, INC., PEEKSKILL, NY. SN 78-062,714. PUB. 9-17-2002, FILED 5-9-2001.

PLANNING TODAY TO INSURE YOUR FUTURE TOMORROWS**CLASS 35—ADVERTISING AND BUSINESS**

FOR MANAGING PREFERRED PROVIDER HEALTHCARE ORGANIZATIONS AND HEALTH MAINTENANCE ORGANIZATIONS AND OTHER ALTERNATIVE HEALTH CARE DELIVERY SYSTEMS FOR INSURERS AND PROVIDERS OF MEDICAL SERVICES (U.S. CLS. 100, 101 AND 102).

FIRST USE 1-1-1974; IN COMMERCE 1-1-1974.

CLASS 36—INSURANCE AND FINANCIAL

FOR ORGANIZING PREFERRED PROVIDER HEALTHCARE ORGANIZATIONS AND HEALTH MAINTENANCE ORGANIZATIONS AND OTHER ALTERNATIVE HEALTH CARE DELIVERY SYSTEMS FOR INSURERS AND PROVIDERS OF MEDICAL SERVICES (U.S. CLS. 100, 101 AND 102).

FIRST USE 1-1-1974; IN COMMERCE 1-1-1974.

2,765,605. ST. JUDE MEDICAL, INC., ST. PAUL, MN. SN 78-065,359. PUB. 8-6-2002, FILED 5-23-2001.

ONE VALVE FOR LIFE**CLASS 41—EDUCATION AND ENTERTAINMENT**

FOR EDUCATIONAL SERVICES, NAMELY, PROVIDING LECTURES, SEMINARS AND SYMPOSIA REGARDING THE SELECTION AND PURCHASE OF CARDIOVASCULAR PRODUCTS (U.S. CLS. 100, 101 AND 107).

FIRST USE 4-15-2001; IN COMMERCE 4-15-2001.

CLASS 42—SCIENTIFIC, COMPUTER AND LEGAL SERVICES

FOR PROVIDING HEALTH AND MEDICAL INFORMATION REGARDING CARDIOVASCULAR GOODS AND SERVICES (U.S. CLS. 100 AND 101).

FIRST USE 4-15-2001; IN COMMERCE 4-15-2001.

2,765,606. DIEBOLD, INCORPORATED, NORTH CANTON, OH. SN 78-066,056. PUB. 7-9-2002, FILED 5-28-2001.

DIEBOLD ATM CASH MANAGEMENT

OWNER OF U.S. REG. NOS. 682,872, 2,225,504, AND OTHERS.

NO CLAIM IS MADE TO THE EXCLUSIVE RIGHT TO USE "ATM CASH MANAGEMENT", APART FROM THE MARK AS SHOWN.

CLASS 37—CONSTRUCTION AND REPAIR

FOR COMPUTER DISPATCHED MAINTENANCE AND REPAIR OF AUTOMATED TELLER MACHINES (U.S. CLS. 100, 103 AND 106).

FIRST USE 9-30-2001; IN COMMERCE 9-30-2001.

CLASS 42—SCIENTIFIC, COMPUTER AND LEGAL SERVICES

FOR REMOTE MONITORING OF AUTOMATED TELLER MACHINES (U.S. CLS. 100 AND 101).

FIRST USE 9-30-2001; IN COMMERCE 9-30-2001.

2,765,619. BANK OF AMERICA CORPORATION, CHARLOTTE, NC. SN 78-071,542. PUB. 2-26-2002, FILED 6-28-2001.

SAFESEND

CLASS 9—ELECTRICAL AND SCIENTIFIC APPARATUS

FOR MAGNETICALLY ENCODED STORED VALUE CARDS (U.S. CLS. 21, 23, 26, 36 AND 38).

FIRST USE 5-1-2002; IN COMMERCE 5-1-2002.

CLASS 36—INSURANCE AND FINANCIAL

FOR BANKING AND RELATED FINANCIAL SERVICES; MONEY TRANSFER AND INTERNATIONAL REMITTANCE (U.S. CLS. 100, 101 AND 102).

FIRST USE 5-1-2002; IN COMMERCE 5-1-2002.

2,765,628. TRAMUTOLA, LLC, OAKLAND, CA. SN 78-075,891. PUB. 1-21-2003, FILED 7-26-2001.

SIDEWALK STRATEGIES

NO CLAIM IS MADE TO THE EXCLUSIVE RIGHT TO USE "STRATEGIES", APART FROM THE MARK AS SHOWN.

CLASS 35—ADVERTISING AND BUSINESS

FOR BUSINESS MARKETING CONSULTING, NAMELY, DESIGNING, DEVELOPING, ORGANIZING, MANAGING AND IMPLEMENTING STRATEGIES AND BUDGETS THAT PROMOTE THE PUBLIC AWARENESS OF THE NEED FOR ENHANCING AN EDUCATIONAL INSTITUTION'S PROGRAMS AND FACILITIES (U.S. CLS. 100, 101 AND 102).

FIRST USE 1-0-2002; IN COMMERCE 3-0-2003.

CLASS 41—EDUCATION AND ENTERTAINMENT

FOR EDUCATIONAL SERVICES, NAMELY, CONDUCTING SEMINARS, WORKSHOPS, AND CLASSES ON DESIGNING, DEVELOPING, ORGANIZING, MANAGING, AND IMPLEMENTING STRATEGIES, PLANS, AND BUDGETS TO ASSIST EDUCATIONAL INSTITUTION WITH BUILDING PUBLIC AWARENESS AND UNDERSTANDING OF ITS PROGRAMS AND FACILITY NEEDS (U.S. CLS. 100, 101 AND 107).

FIRST USE 12-0-2000; IN COMMERCE 12-0-2000.

2,765,640. EXOPACK, L.L.C., SPARTANBURG, SC. SN 78-079,895. PUB. 9-17-2002, FILED 8-17-2001.

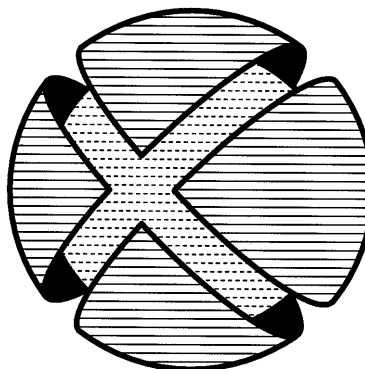

THE DRAWING IS LINED FOR THE COLOR(S) BLUE AND GREY.

THE MARK CONSISTS OF A GRAY BALL WITH A BLUE SPLIT COVER, THE OVERALL SHAPE OF WHICH IS REMINISCENT OF THE LETTERS "X" AS WELL AS "O".

CLASS 16—PAPER GOODS AND PRINTED MATTER

FOR FLEXIBLE PACKAGING MATERIALS OF PAPER FOR INDUSTRIAL AND COMMERCIAL PACKAGING AND WRAPPING (U.S. CLS. 2, 5, 22, 23, 29, 37, 38 AND 50).

FIRST USE 6-0-2002; IN COMMERCE 6-0-2002.

CLASS 17—RUBBER GOODS

FOR FLEXIBLE PACKAGING MATERIALS OF PLASTIC, NAMELY, FILM OF PLASTIC FOR INDUSTRIAL AND COMMERCIAL PACKAGING AND WRAPPING (U.S. CLS. 1, 5, 12, 13, 35 AND 50).

FIRST USE 6-0-2002; IN COMMERCE 6-0-2002.

CLASS 35—ADVERTISING AND BUSINESS

FOR PACKAGING ARTICLES TO THE ORDER AND SPECIFICATION OF OTHERS (U.S. CLS. 100, 101 AND 102).

FIRST USE 6-0-2002; IN COMMERCE 6-0-2002.

2,765,641. EXOPACK, LLC, SPARTANBURG, SC, BY CHANGE OF NAME EXO-TECH PACKAGING, L.L.C., SPARTANBURG, SC. SN 78-079,904. PUB. 9-17-2002, FILED 8-17-2001.

EXOPACK

CLASS 16—PAPER GOODS AND PRINTED MATTER

FOR FLEXIBLE PACKAGING MATERIALS OF PAPER FOR INDUSTRIAL AND COMMERCIAL PACKAGING AND WRAPPING (U.S. CLS. 2, 5, 22, 23, 29, 37, 38 AND 50).

FIRST USE 6-0-2002; IN COMMERCE 6-0-2002.

CLASS 17—RUBBER GOODS

FOR FLEXIBLE PACKAGING MATERIALS OF PLASTIC, NAMELY, FILM OF PLASTIC FOR INDUSTRIAL AND COMMERCIAL PACKAGING AND WRAPPING (U.S. CLS. 1, 5, 12, 13, 35 AND 50).

FIRST USE 3-0-2003; IN COMMERCE 3-0-2003.

CLASS 35—ADVERTISING AND BUSINESS

FOR PACKAGING ARTICLES TO THE ORDER AND SPECIFICATION OF OTHERS (U.S. CLS. 100, 101 AND 102).

FIRST USE 6-0-2002; IN COMMERCE 6-0-2002.

2,765,642. MIDDENDORF, DWIGHT R., FEDERAL WAY, WA. SN 78-080,178. PUB. 11-27-2001, FILED 8-20-2001.

TOYHOYST.COM

CLASS 7—MACHINERY

FOR HOIST FOR RAISING RECREATIONAL VEHICLES ABOVE GROUND LEVEL TO ALLOW ANOTHER VEHICLE TO BE PARTIALLY PARKED THERE UNDER (U.S. CLS. 13, 19, 21, 23, 31, 34 AND 35).

FIRST USE 10-24-2001; IN COMMERCE 10-24-2001.

CLASS 12—VEHICLES

FOR FLAT BED TRAILERS WITH HYDRAULIC OR MANUAL HOIST (U.S. CLS. 19, 21, 23, 31, 35 AND 44).

FIRST USE 10-24-2001; IN COMMERCE 10-24-2001.

2,765,648. GOLDWELL GMBH, DARMSTADT, FED REP GERMANY. SN 78-081,369. PUB. 4-16-2002, FILED 8-28-2001.

SALON ALLIANCE

NO CLAIM IS MADE TO THE EXCLUSIVE RIGHT TO USE "SALON", APART FROM THE MARK AS SHOWN.

CLASS 35—ADVERTISING AND BUSINESS

FOR RETAIL STORE SERVICES AND WHOLESALE DISTRIBUTORSHIPS IN THE FIELD OF BEAUTY CARE PRODUCTS, NAMELY HAIR CARE PRODUCTS AND SHOWER AND BATH PRODUCTS (U.S. CLS. 100, 101 AND 102).

FIRST USE 6-0-2001; IN COMMERCE 6-0-2001.

CLASS 41—EDUCATION AND ENTERTAINMENT

FOR EDUCATIONAL SERVICES, NAMELY PROVIDING CLASSES AND SEMINARS, IN THE FIELD OF HAIRDRESSING, HAIR STYLING, PERMING AND DYEING (U.S. CLS. 100, 101 AND 107).

FIRST USE 6-0-2001; IN COMMERCE 6-0-2001.

CLASS 42—SCIENTIFIC, COMPUTER AND LEGAL SERVICES

FOR BEAUTY AND HAIR DRESSING SALON SERVICES (U.S. CLS. 100 AND 101).

FIRST USE 6-0-2001; IN COMMERCE 6-0-2001.

2,765,651. LANGUAGESPEED, INC., SANTA BARBARA, CA. SN 78-083,193. PUB. 6-25-2002, FILED 9-8-2001.

ENLEXICA

CLASS 9—ELECTRICAL AND SCIENTIFIC APPARATUS

FOR COMPUTER SOFTWARE FOR ACCESSING INFORMATION IN CONNECTION WITH DICTIONARIES, LANGUAGE TRANSLATION DICTIONARIES AND THESAURI (U.S. CLS. 21, 23, 26, 36 AND 38).

FIRST USE 12-1-2002; IN COMMERCE 5-22-2003.

CLASS 16—PAPER GOODS AND PRINTED MATTER

FOR REFERENCE BOOKS, NAMELY, DICTIONARIES, LANGUAGE TRANSLATION DICTIONARIES, AND THESAURI (U.S. CLS. 2, 5, 22, 23, 29, 37, 38 AND 50).

FIRST USE 12-1-2002; IN COMMERCE 5-5-2003.

CLASS 42—SCIENTIFIC, COMPUTER AND LEGAL SERVICES

FOR COMPUTER SERVICES, NAMELY, PROVIDING ON-LINE PUBLICATIONS IN THE NATURE OF DICTIONARIES, LANGUAGE TRANSLATION DICTIONARIES AND THESAURI (U.S. CLS. 100 AND 101).

FIRST USE 10-1-2002; IN COMMERCE 10-1-2002.

2,765,655. TICKETMASTER CORPORATION, LOS ANGELES, CA. SN 78-084,824. PUB. 10-15-2002, FILED 9-20-2001.

TICKETFAST

CLASS 16—PAPER GOODS AND PRINTED MATTER

FOR TICKETS FOR SPORTING EVENTS, MUSICAL CONCERTS AND OTHER ENTERTAINMENT EVENTS AND CULTURAL VENUES (U.S. CLS. 2, 5, 22, 23, 29, 37, 38 AND 50).

FIRST USE 7-15-2001; IN COMMERCE 7-15-2001.

CLASS 35—ADVERTISING AND BUSINESS

FOR TICKET AGENCY SERVICES FOR SPORTING EVENTS, MUSICAL CONCERTS AND OTHER ENTERTAINMENT EVENTS AND CULTURAL VENUES, WITH TICKETS DELIVERED ONLINE VIA THE INTERNET OR BY EMAIL TO BE PRINTED OUT DIRECTLY BY THE CUSTOMER; ADVERTISING THE GOODS AND SERVICES OF OTHERS ON EVENT ADMISSION TICKETS (U.S. CLS. 100, 101 AND 102).

FIRST USE 7-15-2001; IN COMMERCE 7-15-2001.

2,765,656. ROLAND, INC., IDAHO FALLS, ID. SN 78-085,320.
PUB. 10-1-2002, FILED 9-24-2001.

SCOTTY'S SNACKS

NO CLAIM IS MADE TO THE EXCLUSIVE RIGHT TO USE "SNACKS", APART FROM THE MARK AS SHOWN.

CLASS 29—MEATS AND PROCESSED FOODS

FOR SHELF STABLE, NON-PERISHABLE NUTS AND MEAT SNACKS, NAMELY, BEEF JERKY; SMOKED SAUSAGES; SNACK MIX CONSISTING PRIMARILY OF PROCESSED FRUITS, PROCESSED NUTS AND/OR RAISINS; ROASTED CASHEW NUTS, SALTED AND LOW-SALT; ROASTED PEANUTS, SALTED AND LOW-SALT; PROCESSED BUTTER TOFFEE ALMONDS; ROASTED ALMONDS, SALTED, LOW-SALT, AND SMOKED; AND SUNFLOWER SEEDS (U.S. CL. 46).

FIRST USE 5-30-2003; IN COMMERCE 5-30-2003.

CLASS 30—STAPLE FOODS

FOR VARIOUS SNACK MIXES CONSISTING PRIMARILY OF CRACKERS, NUTS, RAISINS, CHOCOLATE PIECES, AND CHOCOLATE COVERED NUTS/RAISINS; RED AND BLACK LICORICE; SOFT GELATIN CANDIES IN THE SHAPE OF BEARS, APPLE RINGS, PEACH RINGS, WORMS, JELLY FISH, AND ORANGE SLICES; HARD CANDIES IN VARIOUS FLAVORS, NAMELY LEMON AND PEPPERMINT; AND YOGURT-COVERED PRETZELS (U.S. CL. 46).

FIRST USE 5-30-2003; IN COMMERCE 5-30-2003.

2,765,687. GIANCARLO PAOLI S.P.A., PORTO SANTELPIDIO, ITALY, BY CHANGE OF NAME GIANCARLO PAOLI S.R.L., PORTO SANTELPIDIO, ITALY. SN 78-098,408. PUB. 9-24-2002, FILED 12-14-2001.

GIANCARLO PAOLI

THE NAME "GIANCARLO PAOLI" IDENTIFIES A LIVING INDIVIDUAL WHOSE CONSENT IS OF RECORD.

CLASS 18—LEATHER GOODS

FOR BAGS, NAMELY, BEACH BAGS, CARRY-ON BAGS, LEATHER SHOPPING BAGS, SHOE BAGS, TOTE BAGS, TRAVEL BAGS, AND HANDBAGS; PURSES, WALLETS, SUITCASES, TRUNKS, BEAUTY-CASES SOLD EMPTY, DOCUMENT CASES (U.S. CLS. 1, 2, 3, 22 AND 41).

FIRST USE 10-5-2000; IN COMMERCE 10-5-2000.

CLASS 25—CLOTHING

FOR SHOES; FOOTWEAR; BELTS FOR CLOTHING, BOOTS, SANDALS, CLOGS AND SLIPPERS (U.S. CLS. 22 AND 39).

FIRST USE 4-27-1993; IN COMMERCE 4-27-1993.

2,765,694. LINDEN CORPORATION, WILMINGTON, DE.
SN 78-100,932. PUB. 7-16-2002, FILED 1-4-2002.

LYSOL ONE STEP

OWNER OF U.S. REG. NOS. 53,937, 225,545, AND OTHERS.

CLASS 3—COSMETICS AND CLEANING PREPARATIONS

FOR PREPARATION FOR CLEANING FLOORS (U.S. CLS. 1, 4, 6, 50, 51 AND 52).

FIRST USE 7-5-2002; IN COMMERCE 7-5-2002.

CLASS 5—PHARMACEUTICALS

FOR PREPARATION FOR DISINFECTING FLOORS (U.S. CLS. 6, 18, 44, 46, 51 AND 52).

FIRST USE 7-5-2002; IN COMMERCE 7-5-2002.

2,765,743. SILVER SPRING GARDENS, INC., EAU CLAIRE, WI. SN 78-116,938. PUB. 12-10-2002, FILED 3-22-2002.

OLD ORIGINAL BOOKBINDER'S

OWNER OF U.S. REG. NOS. 1,524,711 AND 2,121,060.
NO CLAIM IS MADE TO THE EXCLUSIVE RIGHT TO USE "ORIGINAL", APART FROM THE MARK AS SHOWN.

CLASS 29—MEATS AND PROCESSED FOODS

FOR FROZEN AND FRESH SEAFOOD; PACKAGED AND CANNED/JARRED SOUPS, CHOWDERS, BISQUES AND STEWS; FROZEN SOUPS, CHOWDERS, BISQUES AND STEWS; CLAM JUICE (U.S. CL. 46).

FIRST USE 1-0-1938; IN COMMERCE 1-0-1938.

CLASS 30—STAPLE FOODS

FOR SAUCES; HORSERADISH SAUCE; COCKTAIL SAUCE; SEAFOOD SAUCE; TARTAR SAUCE; CLAM SAUCE; MUSTARD; HORSERADISH; SEASONINGS; AND BREAD CRUMBS (U.S. CL. 46).

FIRST USE 1-0-1938; IN COMMERCE 1-0-1938.

2,765,759. NAUGHTON, DANIEL P., SAN DIEGO, CA. SN 78-121,434. PUB. 10-22-2002, FILED 4-12-2002.

ULTIMATE COMPETITION

CLASS 9—ELECTRICAL AND SCIENTIFIC APPARATUS

FOR INTERACTIVE VIDEO GAME PROGRAM, VIDEO GAME DISCS, AND VIDEO GAME SOFTWARE (U.S. CLS. 21, 23, 26, 36 AND 38).

FIRST USE 6-6-2003; IN COMMERCE 6-6-2003.

CLASS 28—TOYS AND SPORTING GOODS

FOR PROMOTIONAL GAME CARDS, PROMOTIONAL GAME MATERIALS; TOYS, NAMELY, BATTERY-POWERED COMPUTER GAME WITH LCD SCREEN WHICH FEATURES ANIMATION AND SOUND EFFECTS; COLLECTIBLE TOY FIGURES; TOY ACTION FIGURES AND ACCESSORIES THEREFOR; TRANSFORMING ROBOTIC TOY VEHICLES; ATHLETIC EQUIPMENT, NAMELY, MOUTH GUARDS, FOOTBALL PADS, STRIKING BAGS, AND HAND RAPS; VOLLEY BALL GAME PLAY EQUIPMENT; FOOTBALLS; BASKETBALLS; SOCCER BALLS; AND RACKET BALLS; AND EXERCISE EQUIPMENT, NAMELY MANUALLY OPERATED JOGGING MACHINES, ROWING MACHINES, STAIR-STEPPING MACHINES, STATIONARY CYCLES, ABDOMINAL BOARDS, CHEST EXPANDERS, CHEST PULLS, WEIGHT-LIFTING MACHINES, AND WEIGHT-LIFTING BARS AND WEIGHTS (U.S. CLS. 22, 23, 38 AND 50).

FIRST USE 6-6-2003; IN COMMERCE 6-6-2003.

2,765,764. MYTHIC ENTERTAINMENT, INC., FAIRFAX, VA. SN 78-124,911. PUB. 11-19-2002, FILED 4-29-2002.

SHROUDED ISLES

CLASS 9—ELECTRICAL AND SCIENTIFIC APPARATUS

FOR COMPUTER GAME SOFTWARE (U.S. CLS. 21, 23, 26, 36 AND 38).

FIRST USE 5-15-2002; IN COMMERCE 12-3-2002.

CLASS 41—EDUCATION AND ENTERTAINMENT

FOR ENTERTAINMENT SERVICES, NAMELY, PROVIDING A REAL TIME, ROLE PLAYING GAME FOR OTHERS VIA GLOBAL COMPUTER NETWORKS (U.S. CLS. 100, 101 AND 107).

FIRST USE 5-15-2002; IN COMMERCE 12-3-2002.

2,765,768. WALTER HEIMLER INC., NEW YORK, NY. SN 78-126,487. PUB. 12-31-2002, FILED 5-6-2002.

COOL STUFF

OWNER OF U.S. REG. NOS. 2,087,817 AND 2,480,242.

CLASS 6—METAL GOODS

FOR METAL KEY RINGS AND KEY CHAINS (U.S. CLS. 2, 12, 13, 14, 23, 25 AND 50).

FIRST USE 10-24-1996; IN COMMERCE 10-24-1996.

CLASS 18—LEATHER GOODS

FOR VANITY CASES SOLD EMPTY, BACKPACKS (U.S. CLS. 1, 2, 3, 22 AND 41).

FIRST USE 5-6-2002; IN COMMERCE 5-6-2002.

2,765,786. FEDERAL EXPRESS CORPORATION, MEMPHIS, TN. SN 78-134,143. PUB. 12-10-2002, FILED 6-7-2002.

THE MOST RELIABLE PLAYER IN THE GAME

CLASS 35—ADVERTISING AND BUSINESS

FOR PROMOTING SPORTS COMPETITION OF OTHERS IN THE NATURE OF PROFESSIONAL GOLF TOURNAMENTS (U.S. CLS. 100, 101 AND 102).

FIRST USE 6-26-2002; IN COMMERCE 6-26-2002.

CLASS 39—TRANSPORTATION AND STORAGE

FOR PICK-UP, STORAGE, TRANSPORTATION AND DELIVERY OF DOCUMENTS, PACKAGES AND FREIGHT VIA LAND AND AIR (U.S. CLS. 100 AND 105).

FIRST USE 6-26-2002; IN COMMERCE 6-26-2002.

2,765,792. METROPOLITAN LIFE INSURANCE COMPANY, NEW YORK, NY. SN 78-135,752. PUB. 1-7-2003, FILED 6-14-2002.

METLAW

CLASS 36—INSURANCE AND FINANCIAL

FOR ADMINISTRATION OF LEGAL SERVICES INSURANCE PLANS AND UNDERWRITING INSURANCE FOR PREPAID LEGAL SERVICES AS AN EMPLOYEE BENEFIT (U.S. CLS. 100, 101 AND 102).

FIRST USE 6-1-2002; IN COMMERCE 6-1-2002.

CLASS 42—SCIENTIFIC, COMPUTER AND LEGAL SERVICES

FOR LEGAL SERVICES (U.S. CLS. 100 AND 101).

FIRST USE 6-1-2002; IN COMMERCE 6-1-2002.

2,765,796. ACCUSOFT CORPORATION, NORTHBOROUGH, MA. SN 78-137,591. PUB. 1-7-2003, FILED 6-21-2002.

REVIEWNOW

CLASS 9—ELECTRICAL AND SCIENTIFIC APPARATUS

FOR COMPUTER SOFTWARE FOR USE IN THE FIELD OF MANAGING ANNOTATIONS AND COMMENTS IN DOCUMENTS AND WEB PAGES (U.S. CLS. 21, 23, 26, 36 AND 38).

FIRST USE 5-31-2002; IN COMMERCE 6-14-2002.

CLASS 42—SCIENTIFIC, COMPUTER AND LEGAL SERVICES

FOR COMPUTER SOFTWARE CONSULTATION (U.S. CLS. 100 AND 101).
FIRST USE 5-31-2002; IN COMMERCE 8-23-2002.

2,765,821. HOLLAND, PAMELA, NORTHPORT, NY. SN 78-146,443. PUB. 3-25-2003, FILED 7-23-2002.

2,765,814. RANBAXY LABORATORIES LIMITED, NEW DELHI, DELHI, INDIA. SN 78-143,952. PUB. 2-11-2003, FILED 7-15-2002.

I.M.P.A.R.T.

CLASS 16—PAPER GOODS AND PRINTED MATTER

FOR PRINTED INSTRUCTIONAL AND EDUCATIONAL MATERIALS USED FOR COUNSELING DOCTORS TO PROVIDE PATIENTS WITH INFORMATION ON THE IMPORTANCE OF PREGNANCY PREVENTION WHILE UNDERGOING TREATMENT WITH A PHARMACEUTICAL PREPARATION ASSOCIATED WITH FETAL ABNORMALITIES (U.S. CLS. 2, 5, 22, 23, 29, 37, 38 AND 50).
FIRST USE 2-13-2003; IN COMMERCE 2-13-2003.

CLASS 44—MEDICAL, BEAUTY AND AGRICULTURAL SERVICES

FOR MEDICAL COUNSELING TO DOCTORS TO PROVIDE PATIENTS WITH INFORMATION ON THE IMPORTANCE OF PREGNANCY PREVENTION WHILE UNDERGOING TREATMENT WITH A PHARMACEUTICAL PREPARATION ASSOCIATED WITH FETAL ABNORMALITIES (U.S. CLS. 100 AND 101).
FIRST USE 2-13-2003; IN COMMERCE 2-13-2003.

MAZEL NOSH

NO CLAIM IS MADE TO THE EXCLUSIVE RIGHT TO USE "NOSH", APART FROM THE MARK AS SHOWN.

CLASS 29—MEATS AND PROCESSED FOODS

FOR SNACK FOODS, NAMELY, FRUIT BASED SNACK FOODS INCLUDING DRIED FRUITS, RAISINS AND FRUIT CHIPS; POTATO BASED SNACK FOODS, NAMELY, POTATO CHIPS; VEGETABLE BASED SNACK CHIPS; SNACK MIX CONSISTING PRIMARILY OF FRUIT BASED SNACKS AND PROCESSED NUTS; NUTS (U.S. CL. 46).
FIRST USE 7-11-2002; IN COMMERCE 7-11-2002.

CLASS 30—STAPLE FOODS

FOR SNACK FOODS, NAMELY, CEREAL BASED SNACK FOODS, RICE BASED SNACK FOODS, GRANOLA BASED SNACK FOODS; COOKIES; CRACKERS; BREAD; BAKERY GOODS; CORN CHIPS; GRAIN-BASED CHIPS; TORTILLA CHIPS; CHOCOLATE; CHOCOLATE COVERED SNACK FOODS; PRETZELS; POPCORN, NAMELY, CANDY COATED POPCORN, CARAMEL COATED POPCORN, GLAZED POPCORN, MICROWAVE POPCORN; SNACK MIX CONSISTING PRIMARILY OF THE AFOREMENTIONED SNACK FOODS (U.S. CL. 46).
FIRST USE 7-11-2002; IN COMMERCE 7-11-2002.

* * * * *

SECTION 2.— INTERNATIONAL CLASSIFICATION

The short titles associated below with the international class numbers are terms designed merely for quick identification and are not an official part of the international classification. The full names of international classes are given in section 6.1 of the trademark rules of practice.

The designation "U.S. Cl." appearing in this section refers to the U.S. class in effect prior to Sep. 1, 1973 rather than the international class which applies to applications filed on or after that date. For adoption of international classification see notice in the OFFICIAL GAZETTE of Jun. 26, 1973 (911 O.G. TM 210).

Application in one class

CLASS 1—CHEMICALS

2,764,500. KIKKOMAN CORPORATION, CHIBA, JAPAN. SN 75-535,428. PUB. 6-4-2002, FILED 8-11-1998.

CHECKLITE

FOR CHEMICAL ASSAY KITS COMPRISED OF CHEMICAL REAGENTS FOR BIOLUMINESCENT MEASUREMENT OF CLEANLINESS IN KITCHENS, LABORATORIES, HOSPITALS AND CLINICS (U.S. CLS. 1, 5, 6, 10, 26 AND 46).

FIRST USE 12-25-2000; IN COMMERCE 12-25-2000.

2,764,521. M-I HOLDINGS L.L.C., HOUSTON, TX, BY CHANGE OF NAME, BY ASSIGNMENT M-I L.L.C., HOUSTON, TX. SN 75-633,984. PUB. 11-16-1999, FILED 2-5-1999.

VERSAPAC

FOR PETROLEUM INDUSTRY CHEMICALS, NAMELY A DRILLING FLUID ADDITIVE FOR USE IN THE OIL AND GAS WELL DRILLING INDUSTRY (U.S. CLS. 1, 5, 6, 10, 26 AND 46).

FIRST USE 2-21-2002; IN COMMERCE 2-21-2002.

CLASS 1—(Continued).

2,764,533. CATALER CORPORATION, OGASA-GUN, SHIZUOKA-KEN, 437-1492, JAPAN. SN 75-666,778. PUB. 8-22-2000, FILED 3-23-1999.



FOR CATALYSTS FOR PURIFYING EXHAUST GASES FOR AUTOMOBILES FOR USE IN THE AUTOMOBILE INDUSTRY; CATALYSTS FOR DEODORIZATION FOR USE IN THE MANUFACTURE OF AUTOMOBILES, AIR PURIFIERS; ACTIVATED CARBON FOR COAL FOR USE IN THE MANUFACTURE OF BREATHING AIR RESPIRATORS, WATER PURIFIERS; CHEMICALS, NAMELY, ACTIVATED ALUMINA FOR USE IN THE MANUFACTURE OF AUTOMOBILES, CATALYST SUBSTRATES; CATALYSTS FOR DISSOLVING OZONE FOR USE IN THE AUTOMOBILE INDUSTRY (U.S. CLS. 1, 5, 6, 10, 26 AND 46).

FIRST USE 9-1-1998; IN COMMERCE 2-1-2003.

2,764,557. GENESOFT PHARMACEUTICALS, INC., SOUTH SAN FRANCISCO, CA, BY CHANGE OF NAME GENESOFT, INC., SAN FRANCISCO, CA. SN 75-713,228. PUB. 9-17-2002, FILED 5-24-1999.

GENESOFT

FOR HIGH TECHNOLOGY CHEMICAL PREPARATIONS FOR USE IN THE MANUFACTURE OF HUMAN PHARMACEUTICALS AND FOR USE IN AGRICULTURAL, SCIENTIFIC AND MEDICAL LABORATORY RESEARCH (U.S. CLS. 1, 5, 6, 10, 26 AND 46).

FIRST USE 0-0-1998; IN COMMERCE 0-0-1998.

CLASS 1—(Continued).

2,764,624. BASF AKTIENGESELLSCHAFT, LUDWIGSHAFEN AM RHEIN, FED REP GERMANY. SN 75-866,455. PUB. 8-22-2000, FILED 12-7-1999.

STYROFLEX

FOR UNPROCESSED PLASTICS IN THE FORM OF POWDERS, LIQUIDS, GRANULES OR PASTES FOR USE IN THE PRODUCTION OF FOILS FOR WRAPPING FOODSTUFF (U.S. CLS. 1, 5, 6, 10, 26 AND 46).
FIRST USE 8-16-2002; IN COMMERCE 8-16-2002.

2,764,810. SHIRE LABORATORIES, INC., ROCKVILLE, MD. SN 76-138,865. PUB. 6-12-2001, FILED 9-29-2000.

LIQUIBEAD

FOR CHEMICAL ADDITIVES FOR USE IN THE MANUFACTURE OF PHARMACEUTICALS, NAMELY, ADDITIVES WHICH PERMIT ORAL DELIVERY FOR INCREASED DRUG LOADING, ENHANCED SOLUBILITY OR ENHANCED ABSORPTION OF PHARMACEUTICAL PRODUCTS (U.S. CLS. 1, 5, 6, 10, 26 AND 46).
FIRST USE 2-26-2003; IN COMMERCE 2-26-2003.

2,764,947. ROGUE VALLEY NATURAL SPRINGS, INC., GRANTS PASS, OR. SN 76-235,184. PUB. 4-16-2002, FILED 4-3-2001.

BIO-LOGIC AQUA

NO CLAIM IS MADE TO THE EXCLUSIVE RIGHT TO USE "AQUA", APART FROM THE MARK AS SHOWN.
FOR PURIFIED LIQUIDS, NAMELY HIGHLY PURIFIED WATER FOR USE IN SCIENTIFIC RESEARCH AND LABORATORY RESEARCH (U.S. CLS. 1, 5, 6, 10, 26 AND 46).
FIRST USE 3-31-2003; IN COMMERCE 3-31-2003.

2,765,050. HONEYWELL INTERNATIONAL INC., MORRISTOWN, NJ. SN 76-279,257. PUB. 12-24-2002, FILED 7-2-2001.

ENOVATE

FOR FOAM BLOWING AGENTS FOR USE IN INSULATION, FURNITURE, FOOTWEAR, TOYS, RECREATIONAL EQUIPMENT, AND COMMERCIAL AND RESIDENTIAL APPLIANCES, AS WELL AS FOR USE IN THE AEROSPACE, CONSTRUCTION AND BUILDINGS, TRANSPORTATION, MARINE AND AUTOMOTIVE INDUSTRIES; REFRIGERANTS FOR USE IN COMMERCIAL AND RESIDENTIAL REFRIGERATION APPLICATIONS AND COMMERCIAL AND RESIDENTIAL HEATING, VENTILATION AND AIR CONDITIONING SYSTEMS; FLUORINATED SOLVENTS AND SOLVENTS FOR AEROSOLS FOR USE IN INDUSTRIAL CLEANING APPLICATIONS AND AS DEPOSITION AND PROPELLANTS (U.S. CLS. 1, 5, 6, 10, 26 AND 46).
FIRST USE 7-18-2001; IN COMMERCE 6-1-2002.

CLASS 1—(Continued).

2,765,061. BAIT CARE COMPANY, THE, CHALFON, PA. SN 76-287,433. PUB. 10-23-2001, FILED 7-19-2001.

PROTECTOR

FOR CHEMICAL PREPARATIONS FOR THE MAINTENANCE OF FISH AND OTHER AQUATIC ANIMALS USED AS FISHING BAIT (U.S. CLS. 1, 5, 6, 10, 26 AND 46).
FIRST USE 6-27-2002; IN COMMERCE 6-27-2002.

2,765,168. POLYMER GROUP, INC., NORTH CHARLESTON, SC. SN 76-323,227. PUB. 2-26-2002, FILED 10-9-2001.

FIBERSOURCE

FOR CONCRETE ADDITIVES, NAMELY, CONCRETE REINFORCING FIBERS (U.S. CLS. 1, 5, 6, 10, 26 AND 46).
FIRST USE 9-1-2001; IN COMMERCE 9-1-2001.

2,765,286. SANITARY BOARD OF THE WESTERN LAKE SUPERIOR SANITARY DISTRICT, DULUTH, MN. SN 76-357,760. PUB. 8-6-2002, FILED 1-10-2002.



FOR FERTILIZERS FOR AGRICULTURE USE (U.S. CLS. 1, 5, 6, 10, 26 AND 46).
FIRST USE 5-15-2002; IN COMMERCE 10-15-2002.

2,765,321. INTERNATIONAL FLAVORS & FRAGRANCES INC., NEW YORK, NY. SN 76-365,366. PUB. 2-25-2003, FILED 2-1-2002.

WE MAKE SENSE

FOR CHEMICALS AND FRAGRANCES FOR THE MANUFACTURE OF— COLOGNES, COSMETICS, NAMELY, LIPSTICKS, LIP OIL, FACE POWDER, CAKE ROUGE, LIQUID ROUGE, MASCARA, CAKE MAKE-UP, EYEBROW PENCILS, EYE SHADOW AND NAIL CARE PRODUCTS; SKIN CARE PRODUCTS, NAMELY LOTIONS, GELS, OILS, MOUSSES, SCENTED BODY SPRAYS, BATH FOAMS, MOISTURIZERS, CREAMS AND FACIAL MASQUES, SKIN TANNING PRODUCTS, NAMELY, LOTIONS, SUNSCREENS, GELS, OILS, MOUSSES, SPRAYS, FOAMS AND CREAMS; HAIR CARE PRODUCTS, NAMELY SHAMPOOS, RINSES, GELS, FOAMS, CONDITIONERS AND SPRAYS, DETERGENTS, FABRIC SOFTENERS, ODORANTS, DEODORANTS, BLEACHES, BRIGHTENERS AND AIR FRESHENERS (U.S. CLS. 1, 5, 6, 10, 26 AND 46).
FIRST USE 11-5-2002; IN COMMERCE 11-5-2002.

CLASS 1—(Continued).

2,765,412. W. R. GRACE & CO.-CONN., COLUMBIA, MD. SN 76-393,543. PUB. 11-5-2002, FILED 4-10-2002.

SATURN

FOR CHEMICALS, NAMELY, FLUID CRACKING CATALYSTS AND ADDITIVES USED IN THE PETROLEUM REFINING INDUSTRY (U.S. CLS. 1, 5, 6, 10, 26 AND 46).

FIRST USE 5-17-2002; IN COMMERCE 5-17-2002.

2,765,555. MORPHOTEK INC, PHILADELPHIA, PA. SN 78-031,102. PUB. 9-18-2001, FILED 10-18-2000.

MORPHODOMA

FOR GENETICALLY ALTERED CELLS FOR THE MANUFACTURE OF PHARMACEUTICAL, DIAGNOSTIC AND RESEARCH PRODUCTS (U.S. CLS. 1, 5, 6, 10, 26 AND 46).

FIRST USE 6-10-2003; IN COMMERCE 6-10-2003.

2,765,622. BAYER POLYMERS LLC, PITTSBURGH, PA, BY ASSIGNMENT BAYER CORPORATION, PITTSBURGH, PA. SN 78-073,751. PUB. 3-5-2002, FILED 7-13-2001.

FANTASIA

FOR SYNTHETIC PLASTIC RESINS FOR THE MANUFACTURE OF PLASTICS, PLASTIC PELLETS, PLASTIC BARS, PLASTIC BLOCKS, PLASTIC RODS, PLASTIC SHEETS AND PLASTIC TUBES, ALL FOR FURTHER MANUFACTURE (U.S. CLS. 1, 5, 6, 10, 26 AND 46).

FIRST USE 2-28-2003; IN COMMERCE 2-28-2003.

2,765,637. ARCH CHEMICALS, INC., NORWALK, CT. SN 78-079,283. PUB. 2-12-2002, FILED 8-15-2001.

PACE PLUS

OWNER OF U.S. REG. NO. 963,329.
FOR CHEMICALS USED TO SANITIZE AND TO TREAT WATER, SWIMMING POOLS, SPAS AND HOT TUBS (U.S. CLS. 1, 5, 6, 10, 26 AND 46).

FIRST USE 12-31-2001; IN COMMERCE 12-31-2001.

CLASS 1—(Continued).

2,765,658. MONSANTO TECHNOLOGY LLC, ST. LOUIS, MO. SN 78-086,368. PUB. 10-22-2002, FILED 10-1-2001.



OWNER OF U.S. REG. NOS. 2,095,766, 2,103,941, AND 2,257,441.

NO CLAIM IS MADE TO THE EXCLUSIVE RIGHT TO USE "ROOTWORM", APART FROM THE MARK AS SHOWN.

THE MARK CONSISTS OF A SEMI-CIRCULAR SHAPE CONTAINING A STYLIZED DEPICTION OF A CORN KERNEL ABOVE THE WORD "YIELDGARD", UNDERNEATH THE WORD "YIELDGARD", DIVIDED BY A LINE WITHIN THE SEMI-CIRCLE, IS THE WORD "ROOTWORM".

FOR INSECT-TOLERANT GENES FOR USE IN THE PRODUCTION OF AGRICULTURAL SEED (U.S. CLS. 1, 5, 6, 10, 26 AND 46).

FIRST USE 2-26-2003; IN COMMERCE 2-26-2003.

2,765,685. BIOSAFE SYSTEMS LLC, GLASTONBURY, CT. SN 78-096,850. PUB. 9-17-2002, FILED 12-5-2001.

OXYGROW

FOR CHEMICAL COMPOSITIONS FOR TREATING SOIL TO ENHANCE GROWTH OF AGRICULTURAL AND HORTICULTURAL PRODUCTS (U.S. CLS. 1, 5, 6, 10, 26 AND 46).

FIRST USE 6-15-2001; IN COMMERCE 6-15-2001.

2,765,750. INDOPCO, INC., DBA NATIONAL STARCH & CHEMICAL COMPANY, BRIDGEWATER, NJ. SN 78-118,864. PUB. 10-29-2002, FILED 4-2-2002.

DYNAMX

FOR POLYMER FOR USE IN HAIR STYLING PRODUCTS (U.S. CLS. 1, 5, 6, 10, 26 AND 46).

FIRST USE 7-1-2002; IN COMMERCE 7-1-2002.

CLASS 2—PAINTS

CLASS 2—(Continued).

2,764,499. SHERWIN-WILLIAMS COMPANY, THE, CLEVELAND, OH. SN 75-535,394. PUB. 7-6-1999, FILED 8-12-1998.

DIAMOND-CLAD

FOR CLEAR AND PIGMENTED COATINGS USED IN THE NATURE OF PAINTS, STAINS AND VARNISHES (U.S. CLS. 6, 11 AND 16).

FIRST USE 1-25-1999; IN COMMERCE 1-25-1999.

2,764,757. SATIN FINISH HARDWOOD FLOORING LIMITED, WESTON, ONTARIO M9N 1R8, CANADA. SN 76-092,510. PUB. 9-24-2002, FILED 7-20-2000.



NO CLAIM IS MADE TO THE EXCLUSIVE RIGHT TO USE "THE ULTIMATE FLOOR-FINISH", APART FROM THE MARK AS SHOWN.

FOR CLEAR COAT HIGH WEAR FINISH FOR HARDWOOD FLOORING (U.S. CLS. 6, 11 AND 16).

FIRST USE 1-1-2000; IN COMMERCE 1-1-2000.

2,765,021. ECKART GMBH & CO. KG, GA, BY CHANGE OF NAME ECKART-WERKE STANDARD-BRONZEPULVERWERKE CARL ECKART GMBH & CO., FED REP GERMANY. SN 76-268,321. PUB. 10-2-2001, FILED 6-7-2001.



FOR PEARLESCENT PIGMENTS FOR COSMETIC PRODUCTS (U.S. CLS. 6, 11 AND 16).

FIRST USE 5-30-2001; IN COMMERCE 8-0-2002.

CLASS 2—(Continued).

2,765,065. N.V. BALTA INDUSTRIES, SINT-BAAFS-VIJVE, BELGIUM, BY MERGER N.V. ITC, IMPERIAL TUFTING COMPANY (DIVISION IVC), TIELT, BELGIUM. SN 76-289,839. PUB. 10-15-2002, FILED 7-25-2001.

PROTECTONITE

FOR CHEMICALS AND SEALER COATINGS USED AS PROTECTIVE COATINGS AND SERVING AS TOP LAYERS WITH HIGH RESISTANCE TO WEAR, NAMELY, LIQUIDS TO BE APPLIED TO PVC FLOOR COVERINGS SERVING AS EXTRA TOP LAYER WITH HIGH RESISTANCE TO WEAR (U.S. CLS. 6, 11 AND 16).

FIRST USE 9-0-2002; IN COMMERCE 9-0-2002.

2,765,183. PPG INDUSTRIES OHIO, INC., CLEVELAND, OH. SN 76-327,942. PUB. 12-17-2002, FILED 10-19-2001.



FOR VEHICLE FINISHING PAINTS AND COATINGS (U.S. CLS. 6, 11 AND 16).

FIRST USE 11-4-2002; IN COMMERCE 11-4-2002.

2,765,267. HEALTHY HOME CENTER, INC., ST. PETERSBURG, FL, BY CHANGE OF NAME HEALTHY HOME CENTER, INC., SAINT PETERSBURG, FL. SN 76-353,008. PUB. 7-23-2002, FILED 12-26-2001.

HEALTHY HUES

FOR HOUSE PAINT AND HOUSE STAIN (U.S. CLS. 6, 11 AND 16).

FIRST USE 4-0-2002; IN COMMERCE 4-0-2002.

CLASS 2—(Continued).

2,765,630. CORONADO PAINT COMPANY, INC., EDGEWATER, FL. SN 78-077,056. PUB. 9-10-2002, FILED 8-2-2001.



NO CLAIM IS MADE TO THE EXCLUSIVE RIGHT TO USE "PAINT", APART FROM THE MARK AS SHOWN.

THE STIPPLING SHOWN IN THE DRAWING IS A FEATURE OF THE MARK AND IS NOT INTENDED TO INDICATE COLOR.

THE MARK CONSISTS OF WORDS "CORONADO PAINT", ALONG WITH A COIN BEARING THE BUST OF A MAN WEARING A METAL CHEST PLATE AND HELMET, WITH THE WORDS "CORONADO PAINT" IN A CURVED PATTERN AT THE BOTTOM OF THE COIN.

FOR EXTERIOR AND INTERIOR PAINT (U.S. CLS. 6, 11 AND 16).

FIRST USE 12-31-1957; IN COMMERCE 12-31-1957.

CLASS 3—COSMETICS AND CLEANING PREPARATIONS

2,764,571. GREATENS, AMANDA, CINCINNATI, OH. SN 75-743,226. PUB. 2-1-2000, FILED 7-6-1999.

ELEMENTS. THE BUILDING BLOCKS THAT MATTER.

FOR COSMETICS, NAMELY, FOUNDATION, CONCEALER, ROUGE, SHADOW LINER, LIPSTICK, AND MASCARA (U.S. CLS. 1, 4, 6, 50, 51 AND 52).

FIRST USE 7-16-1999; IN COMMERCE 5-20-2000.

2,764,657. GREAT BAY SOAP COMPANY, RYE BEACH, NH. SN 75-934,174. PUB. 9-25-2001, FILED 2-22-2000.

GREAT BAY SOAP

NO CLAIM IS MADE TO THE EXCLUSIVE RIGHT TO USE "SOAP", APART FROM THE MARK AS SHOWN.

FOR NATURAL SOAP SEAWEED AND MILK (U.S. CLS. 1, 4, 6, 50, 51 AND 52).

FIRST USE 11-15-1998; IN COMMERCE 11-15-1998.

2,764,675. COOPERLABS LIMITED, CARPINTERIA, CA, BY CHANGE OF NAME DIFA COOPER S.P.A., CARONNO PERTUSELLA, 21042, ITALY. SN 76-007,284. PUB. 8-7-2001, FILED 3-22-2000.

SPA MAGISTRALI**CLASS 3—(Continued).**

THE WORD "MAGISTRALI" MEANS "MASTERLY AND SKILLFUL".

FOR SKIN CARE PRODUCTS, NAMELY, SKIN CREAMS, SKIN LOTIONS, SKIN CLEANSERS, SKIN TONERS, FACIAL MASKS, SKIN MOISTURIZERS (U.S. CLS. 1, 4, 6, 50, 51 AND 52).

FIRST USE 2-1-2003; IN COMMERCE 2-1-2003.

2,764,677. LUSTER PRODUCTS, INC., CHICAGO, IL. SN 76-010,274. PUB. 9-3-2002, FILED 3-27-2000.

Pink
Smooth
Touch

OWNER OF U.S. REG. NOS. 1,223,860, 2,209,243, AND OTHERS.

SEC. 2(F) AS TO "PINK".

FOR HAIR CARE PREPARATIONS, NAMELY, HAIR RELAXERS (U.S. CLS. 1, 4, 6, 50, 51 AND 52).

FIRST USE 12-31-2001; IN COMMERCE 12-31-2001.

2,764,807. CHESEBROUGH-POND'S INC., WILMINGTON, DE. SN 76-138,047. PUB. 6-5-2001, FILED 9-29-2000.

DOVE

OWNER OF U.S. REG. NOS. 205,770, 1,699,679, AND OTHERS.

FOR NON-MEDICATED TOWELETTES IMPREGNATED WITH SKIN CLEANSERS (U.S. CLS. 1, 4, 6, 50, 51 AND 52).

FIRST USE 2-4-2001; IN COMMERCE 2-4-2001.

CLASS 3—(Continued).

2,764,856. LAVETT&CHIN, INC., BROOKLYN, NY. SN 76-166,642. PUB. 8-14-2001, FILED 11-16-2000.

AGUA DE LA FLOR

THE ENGLISH TRANSLATION OF "AGUA DE LA FLOR" IS "WATER OF THE FLOWER".

FOR HAIR CARE PRODUCTS, NAMELY SHAMPOOS, CONDITIONERS, PASTES, BALMS, OILS, TONERS, MISTS AND SPRAYS, GROOMING PREPARATIONS, ELIXIRS, CREAMS, TONICS, GLOSSES AND WAXES; SKIN CARE PRODUCTS, NAMELY MOISTURIZERS, TONERS, CLEANSERS, CONDITIONERS, LOTIONS, OILS, BALMS, SCRUBS, SALVES, SUNSCREENS, MASQUES, ASTRINGENT, SHAVING CREAMS AND LOTIONS, BATH OILS, SHOWER GELS, SKIN SOAPS AND POWDERS; FRAGRANCES, NAMELY PERFUMES, OILS, ESSENCES, COLOGNES AND BALMS; COSMETICS, NAMELY, LIPSTICK, LIP BALM, EYE SHADOW, FOUNDATIONS, BLUSHES, FACE POWDER, EYE PENCILS, LIP PENCILS, MASCARA AND MAKEUP REMOVER (U.S. CLS. 1, 4, 6, 50, 51 AND 52).

FIRST USE 2-9-2003; IN COMMERCE 3-14-2003.

2,764,930. BLISS WORLD LLC, BROOKLYN, NY. SN 76-222,224. PUB. 9-18-2001, FILED 3-9-2001.

FABULIPS

FOR LIPSTICK, LIP GLOSS, LIP CREAM, LIP LINER, NON-MEDICATED LIP BALM, LIP PENCILS (U.S. CLS. 1, 4, 6, 50, 51 AND 52).

FIRST USE 1-1-2002; IN COMMERCE 1-1-2002.

2,764,970. PACIFIC CORPORATION, YONGSAN-KU, SEOUL, REPUBLIC OF KOREA. SN 76-244,632. PUB. 8-27-2002, FILED 4-23-2001.

SULWHA-SOO

OWNER OF U.S. REG. NO. 1,514,230.
THE PHRASE "SULWHA-SOO" MEANS "SNOW FLOWER EXCELLENCE".

FOR SKIN MILK LOTIONS, SKIN FRESHENERS, PERFUMES, NOURISHING CREAMS, MAKE-UP BASE, LIQUID FOUNDATION, CREAM FOUNDATION, SKIN CLEANSING CREAMS, MASSAGE CREAMS, EYE SHADOWS, LIPSTICKS, COSMETIC SOAPS, BODY CLEANSERS, COMPACT POWDERS, MASCARAS, FACIAL MASKS, SKIN NOURISHING SERUM, SHAMPOOS, AND POWDER FOUNDATION (U.S. CLS. 1, 4, 6, 50, 51 AND 52).

FIRST USE 10-0-1998; IN COMMERCE 10-1-1998.

CLASS 3—(Continued).

2,764,991. DONNOVIN HOLDINGS, INC., LOOKOUT MOUNTAIN, TN. SN 76-262,077. PUB. 9-10-2002, FILED 5-24-2001.

PRETTYBOY

FOR BEAUTY AND PERSONAL CARE PRODUCTS NAMELY MAKEUP, COSMETICS, LIPSTICK, LIP PENCILS, LIP LINERS, LIP GLOSSES, LIP SALVES, BODY GLOSSES, BODY SALVES, FACES GLOSSES, FACE SALVES, EYE PENCILS, EYE LINERS, EYE SHADOWS, EYE BROWN GELS AND PENCILS, BLUSH, MASCARA, NAIL POLISH, LIP TREATMENTS, FACE AND BODY POWDERS, MAKEUP FOUNDATIONS, FACE AND BODY CLEANSERS, FACE AND BODY CREAMS, FACE AND BODY LOTIONS, AND FACE AND BODY WASHES (U.S. CLS. 1, 4, 6, 50, 51 AND 52).

FIRST USE 5-29-2003; IN COMMERCE 5-29-2003.

2,765,027. CHURCH & DWIGHT COMPANY, GREEN RIVER, WY. SN 76-270,533. PUB. 3-19-2002, FILED 6-13-2001.



COMPLETE CARE

THE STIPLING IS A FEATURE OF THE MARK AND DOES NOT INDICATE COLOR.

FOR TOOTHPASTE, TOOTH GEL AND MOUTHWASH (U.S. CLS. 1, 4, 6, 50, 51 AND 52).

FIRST USE 8-6-2002; IN COMMERCE 12-31-2002.

2,765,074. VI-JON LABORATORIES, INC., DBA VI-JON, INC., ST. LOUIS, MO. SN 76-292,809. PUB. 7-23-2002, FILED 7-31-2001.

POLISH OFF

FOR NAIL POLISH REMOVER; ARTIFICIAL FINGER-NAIL REMOVER KITS COMPRISED OF A CONTAINER CONTAINING REMOVING COMPOUND AND A SPONGE WITH OPENINGS TO ADMIT THE NAIL OF THE USER (U.S. CLS. 1, 4, 6, 50, 51 AND 52).

FIRST USE 4-15-2003; IN COMMERCE 4-15-2003.

2,765,109. ORIGINS NATURAL RESOURCES INC., NEW YORK, NY. SN 76-306,019. PUB. 8-27-2002, FILED 8-27-2001.

NUDE AND IMPROVED

FOR COSMETICS (U.S. CLS. 1, 4, 6, 50, 51 AND 52).
FIRST USE 3-1-2002; IN COMMERCE 3-1-2002.

CLASS 3—(Continued).

2,765,158. CHESEBROUGH-POND'S INC., WILMINGTON, DE. SN 76-320,915. PUB. 11-12-2002, FILED 10-3-2001.

DOVE

OWNER OF U.S. REG. NOS. 746,360, 2,453,222, AND OTHERS.

FOR HAIR SHAMPOO AND HAIR CONDITIONER (U.S. CLS. 1, 4, 6, 50, 51 AND 52).

FIRST USE 1-13-2003; IN COMMERCE 1-13-2003.

2,765,206. TISHCON CORP., WESTBURY, NY. SN 76-335,419. PUB. 6-18-2002, FILED 11-7-2001.

HAIR! HAIR!

FOR NON-MEDICATED TOPICAL LOTIONS, CREAMS AND GELS FOR USE ON THE HEAD (U.S. CLS. 1, 4, 6, 50, 51 AND 52).

FIRST USE 5-22-2003; IN COMMERCE 5-22-2003.

2,765,207. TISHCON CORP., WESTBURY, NY. SN 76-335,420. PUB. 6-18-2002, FILED 11-7-2001.

HAIR IT IS

FOR NON-MEDICATED TOPICAL LOTIONS, CREAMS AND GELS FOR USE ON THE HEAD (U.S. CLS. 1, 4, 6, 50, 51 AND 52).

FIRST USE 5-22-2003; IN COMMERCE 5-22-2003.

2,765,243. PERRICONE, NICHOLAS V., GUILFORD, CT. SN 76-345,862. PUB. 12-10-2002, FILED 12-6-2001.

OUTPATIENT THERAPY

FOR SKIN CARE PRODUCTS, NAMELY SKIN CLEANSERS, CREAMS AND LOTIONS (U.S. CLS. 1, 4, 6, 50, 51 AND 52).

FIRST USE 6-1-2002; IN COMMERCE 8-1-2002.

2,765,302. CASE MEDICAL, INC., RIDGEFIELD, NJ. SN 76-361,401. PUB. 9-24-2002, FILED 1-22-2002.

CASE SOLUTIONS

OWNER OF U.S. REG. NO. 2,054,547.

NO CLAIM IS MADE TO THE EXCLUSIVE RIGHT TO USE "SOLUTIONS", APART FROM THE MARK AS SHOWN.

FOR ENZYMATIC CLEANING AND DECONTAMINATION PREPARATIONS FOR THE STERILIZATION OF MEDICAL INSTRUMENTS (U.S. CLS. 1, 4, 6, 50, 51 AND 52).

FIRST USE 2-1-2002; IN COMMERCE 2-1-2002.

CLASS 3—(Continued).

2,765,310. SEL-LEB MARKETING, INC., PATERSON, NJ. SN 76-363,595. PUB. 9-3-2002, FILED 1-29-2002.

COLEBROOK & POTTER

FOR BATH AND SPA PREPARATIONS, NAMELY, BATH OIL, SOAP, POWDER, MASSAGE OIL AND CREME, SKIN LOTION, BODY OIL AND SKIN CREME; COSMETIC PREPARATIONS, NAMELY, LIP GLOSS, LIP STICK, LIP BALM, LIP PENCIL, CONCEAL CREME, PRESSED POWDER, EYE PENCILS, BLUSH, MASCARA, FOUNDATIONS, EYE SHADOW, FINGERNAIL POLISH; HAIR CARE PREPARATIONS, NAMELY, SHAMPOO, HAIR CONDITIONER, HAIR MOUSSE AND STYLING GEL; AND, MEN'S AND WOMEN'S FRAGRANCES, MEN'S COLOGNES, AND MEN'S AFTER SHAVE (U.S. CLS. 1, 4, 6, 50, 51 AND 52).

FIRST USE 4-1-2002; IN COMMERCE 4-1-2002.

2,765,313. SHISEIDO COMPANY, LTD., TOKYO 104-8010, JAPAN. SN 76-363,782. PUB. 11-19-2002, FILED 1-28-2002.

10CT EYE SHADOW

NO CLAIM IS MADE TO THE EXCLUSIVE RIGHT TO USE "EYE SHADOW", APART FROM THE MARK AS SHOWN.

FOR SOAPS, PERFUMERIES AND COSMETICS, NAMELY, NON-MEDICATED SKIN CARE PREPARATIONS, NON-MEDICATED HAIR CARE PREPARATIONS, BODY CREAM, BODY SPRAY, BODY LOTION, AND MAKE-UP (U.S. CLS. 1, 4, 6, 50, 51 AND 52).

FIRST USE 10-1-2002; IN COMMERCE 10-1-2002.

2,765,329. GEL CONCEPTS LLC, WHIPPANY, NJ. SN 76-369,687. PUB. 10-8-2002, FILED 2-11-2002.

NATRAGEL

FOR WATER BASED POLYMER GELS FOR COSMETIC PURPOSES IN THE NATURE OF FACIAL, MANDIBLE AND OCULAR MASKS, PADS, DISCS AND PATCHES, ELASTIC WRAPS, ANATOMICALLY CONTOURED PADS AND SHEETS (U.S. CLS. 1, 4, 6, 50, 51 AND 52).

FIRST USE 8-0-2001; IN COMMERCE 8-0-2001.

2,765,336. CHESEBROUGH-PONDS, INC., WILMINGTON, DE. SN 76-372,163. PUB. 10-1-2002, FILED 2-15-2002.

ALL OXI-ACTIVE

OWNER OF U.S. REG. NOS. 1,781,008 AND 2,345,628.

FOR MULTI-PURPOSE STAIN REMOVER FOR LAUNDRY AND GENERAL HOUSEHOLD USE (U.S. CLS. 1, 4, 6, 50, 51 AND 52).

FIRST USE 4-1-2002; IN COMMERCE 4-1-2002.

CLASS 3—(Continued).

2,765,345. GREENWAY RESEARCH LABS, INC., BURNSVILLE, MN. SN 76-373,980. PUB. 9-24-2002, FILED 2-21-2002.

(H2T)

FOR HAIR CARE PRODUCTS, NAMELY, SHAMPOO, CONDITIONER, GEL, MOUSSE, GLAZE, FIXATIVE, MOISTURIZER, HAIRSPRAY, NON-MEDICATED SCALP TREATMENTS, AND HAIR STYLING PREPARATIONS; AND, COSMETICS AND SKIN CARE PREPARATIONS, NAMELY, BATH AND SHOWER GELS, BATH FOAMS, BATH SALTS, BATH OILS, SKIN EXFOLIANTS, FACIAL AND BODY MASKS, FACIAL AND BODY SCRUBS AND CLEANSERS, FACE, HAND, AND BODY LOTIONS, CREAMS, OILS, AND GELS, SUN SCREEN AND SUN TAN LOTIONS, OILS, AND GELS, AND TONERS (U.S. CLS. 1, 4, 6, 50, 51 AND 52).
FIRST USE 3-29-2001; IN COMMERCE 5-7-2001.

2,765,349. AMERIPLUS, INC., OLDSMAR, FL. SN 76-375,087. PUB. 1-14-2003, FILED 2-26-2002.

Orange Shine

NO CLAIM IS MADE TO THE EXCLUSIVE RIGHT TO USE "ORANGE", APART FROM THE MARK AS SHOWN.
FOR GENERAL PURPOSE CLEANING PREPARATION (U.S. CLS. 1, 4, 6, 50, 51 AND 52).
FIRST USE 1-29-2003; IN COMMERCE 1-29-2003.

2,765,359. ROSENHAUS, STEVEN S., NEW YORK, NY. SN 76-377,082. PUB. 11-26-2002, FILED 3-1-2002.

BREATHLESS

FOR DENTIFRICES, NAMELY, MOUTHWASH (U.S. CLS. 1, 4, 6, 50, 51 AND 52).
FIRST USE 4-28-2003; IN COMMERCE 4-28-2003.

2,765,462. S. C. JOHNSON & SON, INC., RACINE, WI. SN 76-412,389. PUB. 1-7-2003, FILED 5-22-2002.

GLADE

FOR TOILET BOWL CLEANER (U.S. CLS. 1, 4, 6, 50, 51 AND 52).
FIRST USE 12-2-2002; IN COMMERCE 12-2-2002.

CLASS 3—(Continued).

2,765,580. PROCTER & GAMBLE COMPANY, THE, CINCINNATI, OH. SN 78-050,690. PUB. 1-14-2003, FILED 2-28-2001.

CASCADE POWER TABS

OWNER OF U.S. REG. NOS. 500,212, 2,445,228, AND OTHERS.

NO CLAIM IS MADE TO THE EXCLUSIVE RIGHT TO USE "TABS", APART FROM THE MARK AS SHOWN.
FOR AUTOMATIC DISHWASHING DETERGENT (U.S. CLS. 1, 4, 6, 50, 51 AND 52).

FIRST USE 7-31-2001; IN COMMERCE 7-31-2001.

2,765,581. AVON PRODUCTS, INC., NEW YORK, NY. SN 78-052,571. PUB. 9-24-2002, FILED 3-12-2001.

AUTO FOCUS

FOR COSMETICS, NAMELY - FACIAL FOUNDATION (U.S. CLS. 1, 4, 6, 50, 51 AND 52).
FIRST USE 3-14-2002; IN COMMERCE 3-14-2002.

2,765,590. AVON PRODUCTS, INC., NEW YORK, NY. SN 78-059,210. PUB. 9-11-2001, FILED 4-19-2001.

SHEER NOURISHMENT

FOR SKIN CARE PRODUCTS, NAMELY, FACIAL MOISTURIZER (U.S. CLS. 1, 4, 6, 50, 51 AND 52).
FIRST USE 4-0-2003; IN COMMERCE 4-0-2003.

2,765,609. CYPHER, JOHN ALFRED, HOUSTON, TX. SN 78-069,002. PUB. 10-23-2001, FILED 6-13-2001.

BULLIE

FOR COSMETICS (U.S. CLS. 1, 4, 6, 50, 51 AND 52).
FIRST USE 2-12-2002; IN COMMERCE 4-2-2002.

2,765,631. BEAUTY HOLDING COMPANY, INC., HAMILTON HM12, BERMUDA. BY CHANGE OF NAME SALLY BEAUTY HOLDINGS, INC., HAMILTON, BERMUDA. SN 78-078,093. PUB. 3-26-2002, FILED 8-8-2001.

AIR WAX

NO CLAIM IS MADE TO THE EXCLUSIVE RIGHT TO USE "WAX", APART FROM THE MARK AS SHOWN.
FOR HAIR CARE PREPARATIONS (U.S. CLS. 1, 4, 6, 50, 51 AND 52).
FIRST USE 10-31-2001; IN COMMERCE 10-31-2001.

CLASS 3—(Continued).

2,765,649. PROSTRONG, INC., OAKVILLE, CT. SN 78-082,577. PUB. 3-12-2002, FILED 9-5-2001.

PROSHIELD

FOR NAIL CARE PREPARATIONS, NAMELY, NAIL POLISH TOP COATS AND NAIL STRENGTHENERS (U.S. CLS. 1, 4, 6, 50, 51 AND 52).
FIRST USE 9-26-2001; IN COMMERCE 9-26-2001.

2,765,664. BEAUTY HOLDING COMPANY, INC., HAMILTON HM12, BERMUDA, BY CHANGE OF NAME SALLY BEAUTY HOLDINGS, INC., HAMILTON, BERMUDA. SN 78-089,193. PUB. 3-19-2002, FILED 10-19-2001.

LAST CALL

FOR HAIR CARE PREPARATIONS (U.S. CLS. 1, 4, 6, 50, 51 AND 52).
FIRST USE 5-31-2002; IN COMMERCE 5-31-2002.

2,765,665. BEAUTY HOLDING COMPANY, INC., HAMILTON HM12, BERMUDA, BY CHANGE OF NAME SALLY BEAUTY HOLDINGS, INC., HAMILTON, BERMUDA. SN 78-089,194. PUB. 3-19-2002, FILED 10-19-2001.

NOODLE HEAD

FOR HAIR CARE PREPARATIONS (U.S. CLS. 1, 4, 6, 50, 51 AND 52).
FIRST USE 5-31-2002; IN COMMERCE 5-31-2002.

2,765,725. COLGATE-PALMOLIVE COMPANY, NEW YORK, NY. SN 78-113,083. PUB. 10-8-2002, FILED 3-7-2002.

REFRESCATE

THE FOREIGN WORDING IN THE MARK TRANSLATES INTO ENGLISH AS "REFRESH YOURSELF".
FOR TOOTHPASTE (U.S. CLS. 1, 4, 6, 50, 51 AND 52).
FIRST USE 3-31-2002; IN COMMERCE 3-31-2002.

2,765,731. CONAIR CIP, INC., STAMFORD, CT. SN 78-114,158. PUB. 9-24-2002, FILED 3-12-2002.

AQUATEX

FOR HAIR CARE PRODUCTS, NAMELY, SHAMPOOS, CONDITIONERS, STYLING GELS, LUSTERIZERS, MOUSSE AND HAIRSPRAYS (U.S. CLS. 1, 4, 6, 50, 51 AND 52).
FIRST USE 6-1-2002; IN COMMERCE 6-1-2002.

CLASS 3—(Continued).

2,765,734. IVREA, INC., QUINCY, MA. SN 78-114,769. PUB. 10-29-2002, FILED 3-14-2002.

CIAO BELLA

THE ENGLISH TRANSLATION OF "CIAO BELLA" IS "HELLO BEAUTIFUL".
FOR COSMETICS, NAMELY NON-MEDICATED SKIN CREAMS, GELS AND LOTIONS (U.S. CLS. 1, 4, 6, 50, 51 AND 52).
FIRST USE 8-1-2002; IN COMMERCE 8-1-2002.

2,765,748. REVLON CONSUMER PRODUCTS CORPORATION, NEW YORK, NY. SN 78-118,782. PUB. 10-22-2002, FILED 4-1-2002.

MOISTUROUS

FOR COSMETICS AND MAKEUP (U.S. CLS. 1, 4, 6, 50, 51 AND 52).
FIRST USE 12-31-2002; IN COMMERCE 12-31-2002.

2,765,761. RIVER WEST BRANDS, LLC, CHICAGO, IL. SN 78-122,121. PUB. 2-18-2003, FILED 4-16-2002.

HALO

FOR HAIR SHAMPOO AND HAIR CONDITIONER (U.S. CLS. 1, 4, 6, 50, 51 AND 52).
FIRST USE 2-20-2003; IN COMMERCE 2-20-2003.

2,765,781. MATTHEW C. WINN, WESTVILLE, NJ. SN 78-131,051. PUB. 12-17-2002, FILED 5-24-2002.

EVELA SPAS

NO CLAIM IS MADE TO THE EXCLUSIVE RIGHT TO USE "SPAS", APART FROM THE MARK AS SHOWN.
FOR COSMETICS, SKIN SOAP, BUBBLING BATHS, ESSENTIAL FRAGRANCES FOR PERSONAL USE, AROMATHERAPY, SKIN CREAMS, LOTIONS, OILS (U.S. CLS. 1, 4, 6, 50, 51 AND 52).
FIRST USE 8-5-2002; IN COMMERCE 11-21-2002.

2,765,802. THE PROCTER & GAMBLE COMPANY, CINCINNATI, OH. SN 78-139,833. PUB. 1-14-2003, FILED 6-28-2002.

DAWN POWER DISSOLVER

OWNER OF U.S. REG. NOS. 562,962, 2,541,805, AND OTHERS.
NO CLAIM IS MADE TO THE EXCLUSIVE RIGHT TO USE "DISSOLVER", APART FROM THE MARK AS SHOWN.
FOR CLEANING SPRAY FOR USE IN DEGREASING POTS, PANS, DISHES, COUNTERTOPS AND RELATED KITCHEN SURFACES (U.S. CLS. 1, 4, 6, 50, 51 AND 52).
FIRST USE 2-2-2003; IN COMMERCE 2-2-2003.

CLASS 3—(Continued).

2,765,809. NICHOLS, DAVID, PALMER, MA. SN 78-140,650.
PUB. 3-25-2003, FILED 7-2-2002.

SIMPLE SCENTS AUSTRALIA

NO CLAIM IS MADE TO THE EXCLUSIVE RIGHT TO USE "SCENTS AUSTRALIA ", APART FROM THE MARK AS SHOWN.

FOR SKIN SOAP AND HAIR SHAMPOO (U.S. CLS. 1, 4, 6, 50, 51 AND 52).
FIRST USE 3-9-2002; IN COMMERCE 1-7-2003.

CLASS 4—LUBRICANTS AND FUELS

2,765,059. AOS THERMAL COMPOUNDS, LLC, EATON-TOWN, NJ. SN 76-285,477. PUB. 8-13-2002, FILED 7-16-2001.

POWER-FORM

FOR THERMAL HEAT SINK COMPOUNDS, NAMELY, THERMAL GREASE FOR USE IN MOUNTING TRANSISTORS, DIODES, RECTIFIER, RESISTORS, POWER SUPPLIES AND POWER CONVERTERS AND FOR USE IN A THERMAL JOINT FOR ANY ELECTRONIC APPARATUS WHERE EFFICIENT COOLING IS DESIRED (U.S. CLS. 1, 6 AND 15).

FIRST USE 8-10-2002; IN COMMERCE 8-10-2002.

2,765,695. AVON PRODUCTS, INC., NEW YORK, NY. SN 78-101,650. PUB. 8-13-2002, FILED 1-9-2002.

LUMINOUS TREASURES

OWNER OF U.S. REG. NO. 2,276,599.
NO CLAIM IS MADE TO THE EXCLUSIVE RIGHT TO USE "LUMINOUS", APART FROM THE MARK AS SHOWN.
FOR CANDLES (U.S. CLS. 1, 6 AND 15).
FIRST USE 3-0-2003; IN COMMERCE 3-0-2003.

2,765,799. DIAL BRANDS, INC., SCOTTSDALE, AZ. SN 78-139,394. PUB. 1-7-2003, FILED 6-27-2002.

PERFECT HARMONY

FOR CANDLES (U.S. CLS. 1, 6 AND 15).
FIRST USE 12-6-2002; IN COMMERCE 12-6-2002.

CLASS 5—PHARMACEUTICALS**CLASS 5—(Continued).**

2,764,520. TISHCON CORP., WESTBURY, NY. SN 75-624,036.
PUB. 8-20-2002, FILED 1-21-1999.

HERBAL REMEDIES FOR THE NEW MILLENNIUM

FOR NUTRITIONAL SUPPLEMENTS (U.S. CLS. 6, 18, 44, 46, 51 AND 52).
FIRST USE 12-13-2002; IN COMMERCE 12-13-2002.

2,764,572. CROSSCARE LIMLTD, TALLAGHT, DUBLIN 24, IRELAND. SN 75-753,019. PUB. 1-18-2000, FILED 7-14-1999.

COLIEF

FOR PREPARATIONS FOR REDUCING LACTOSE INTOLERANCE IN INFANTS (U.S. CLS. 6, 18, 44, 46, 51 AND 52).

FIRST USE 12-0-1995; IN COMMERCE 9-0-2001.

2,764,611. HOFFMANN GROUP L.L.C., WICHITA, KS, BY ASSIGNMENT GREENACRE.COM, L.L.C., WICHITA, KS. SN 75-843,886. PUB. 6-19-2001, FILED 11-8-1999.

GREENACRE

FOR HERBS AND SPICES FOR MEDICINAL AND NUTRITIONAL PURPOSES; HERBAL SUPPLEMENTS; NUTRITIONAL SUPPLEMENTS; VITAMINS; NUTRACEUTICALS FOR USE AS A DIETARY SUPPLEMENT; PHYTOCHEMICAL DIETARY SUPPLEMENTS (U.S. CLS. 6, 18, 44, 46, 51 AND 52).

FIRST USE 1-13-2000; IN COMMERCE 1-13-2000.

2,764,641. RX/IBR CORPORATION, HOUSTON, TX. SN 75-901,179. PUB. 9-17-2002, FILED 1-21-2000.

HEALTH ARISING

FOR PHARMACEUTICAL PREPARATIONS OF BIOLOGICAL OR BOTANICAL ORIGIN FOR USE IN TARGETED BIOLOGIC THERAPY, TO PROVIDE ACTIVATION OF SPECIFIC RECEPTORS AND/OR CELLULAR MECHANISMS IN THE TREATMENT OF OBESITY, NEUROPATHY, VIRAL INFECTIONS, HEADACHES, JET LAG, INJURIES, AGE-RELATED DEGENERATION, STRESS, FATIGUE AND INFECTIOUS DISEASES, AND INCREASE HEALTH AND WELLNESS (U.S. CLS. 6, 18, 44, 46, 51 AND 52).

FIRST USE 5-0-2000; IN COMMERCE 5-0-2000.

CLASS 5—(Continued).

2,764,646. RECAPS, LLC, BELLEVUE, WA. SN 75-916,662. PUB. 10-24-2000, FILED 2-10-2000.

REFRESH

FOR DIETARY SUPPLEMENTS, NAMELY A SLEEP SUPPORT FORMULA, EXCLUDING SUPPLEMENTS FOR EYE CARE (U.S. CLS. 6, 18, 44, 46, 51 AND 52).
FIRST USE 8-0-2000; IN COMMERCE 8-0-2000.

2,764,698. TIMAC, 35400 SAINT-MALO, FRANCE. SN 76-039,929. PUB. 3-26-2002, FILED 5-3-2000.

EXTRAFORM

FOR FEED SUPPLEMENTS FOR LIVESTOCK (U.S. CLS. 6, 18, 44, 46, 51 AND 52).
FIRST USE 1-31-2001; IN COMMERCE 1-31-2001.

2,764,710. ORCAS INTERNATIONAL, INC., HACKETTS-TOWN, NJ. SN 76-052,952. PUB. 4-17-2001, FILED 5-22-2000.

P-ZYME

FOR NUTRITIONAL SUPPLEMENT FOR HUMAN USE ONLY IN THE NATURE OF A RAW MATERIAL IN POWDERED FORM PACKED IN DRUMS (U.S. CLS. 6, 18, 44, 46, 51 AND 52).
FIRST USE 5-8-2000; IN COMMERCE 5-8-2000.

2,764,728. ORIGIN GROUP INC., THE, MARIETTA, GA. SN 76-073,012. PUB. 4-17-2001, FILED 6-19-2000.

MICRO-FLEX

FOR DIETARY AND NUTRITIONAL SUPPLEMENTS (U.S. CLS. 6, 18, 44, 46, 51 AND 52).
FIRST USE 9-1-2000; IN COMMERCE 9-1-2000.

2,764,738. PML MICROBIOLOGICALS, INC., WILSONVILLE, OR. SN 76-079,955. PUB. 10-30-2001, FILED 6-28-2000.

FOAM

FOR MEDIA FOR CULTIVATION OF ANTIBIOTIC MICROORGANISMS HAVING SPECIAL METABOLIC REQUIREMENTS (U.S. CLS. 6, 18, 44, 46, 51 AND 52).
FIRST USE 4-23-2003; IN COMMERCE 4-23-2003.

CLASS 5—(Continued).

2,764,784. ANDRX PHARMACEUTICALS, INC., FT. LAUDERDALE, FL. SN 76-117,581. PUB. 5-28-2002, FILED 8-29-2000.

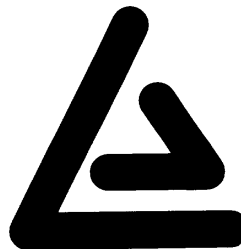

THE MARK CONSISTS OF A STYLIZED REPRESENTATION OF THE LETTER "A".

FOR PHARMACEUTICAL PREPARATIONS IN TABLET FORM FOR USE IN PREVENTING AND TREATING CONDITIONS, DISEASES, AND DISORDERS OF THE CARDIOVASCULAR, CENTRAL NERVOUS, DERMATOLOGIC, ENDOCRINE, GASTRIC, GASTROENTERIC, HEMATOLOGIC, IMMUNOLOGIC, INFLAMMATORY, OSTEOLOGIC AND RESPIRATORY SYSTEMS; PREVENTION AND TREATMENT OF ALLERGIES AND ALLERGIC RESPONSES, METABOLIC DISORDERS, PSYCHIATRIC AND EMOTIONAL DISORDERS, INFECTION, INFECTIOUS DISEASES AND PAIN (U.S. CLS. 6, 18, 44, 46, 51 AND 52).

FIRST USE 7-8-2002; IN COMMERCE 7-8-2002.

2,764,813. NUTRITION & FITNESS, INC., FAYETTEVILLE, NC, BY CHANGE OF NAME NUTRITION & FITNESS, IMG, INC., FAYETTEVILLE, NC. SN 76-140,182. PUB. 6-19-2001, FILED 10-4-2000.

BURN&BOOST

FOR DIETARY SUPPLEMENTS (U.S. CLS. 6, 18, 44, 46, 51 AND 52).

FIRST USE 8-6-2001; IN COMMERCE 8-15-2001.

2,764,837. TEGAN, CHARLES G., NORTON, MA. SN 76-158,735. PUB. 8-28-2001, FILED 11-2-2000.

HEART MATE

NO CLAIM IS MADE TO THE EXCLUSIVE RIGHT TO USE "HEART", APART FROM THE MARK AS SHOWN.

FOR ENTERIC COATED ASPIRIN IN LOW DOSAGES SUITABLE FOR PREVENTATIVE CARDIAC REGIMEN (U.S. CLS. 6, 18, 44, 46, 51 AND 52).

FIRST USE 8-0-2001; IN COMMERCE 3-7-2003.

CLASS 5—(Continued).

2,764,846. WATSON PHARMACEUTICALS, INC., CORONA, CA. SN 76-162,253. PUB. 6-26-2001, FILED 11-8-2000.

OXYTROL

FOR MEDICAL TRANSDERMAL PATCHES FOR THE DELIVERY OF ANTICHOLINERGIC AGENTS (U.S. CLS. 6, 18, 44, 46, 51 AND 52).
FIRST USE 4-5-2003; IN COMMERCE 4-8-2003.

2,764,881. INTERNATIONAL LABORATORY TECHNOLOGY CORP., HOLLYWOOD, FL. SN 76-186,344. PUB. 8-27-2002, FILED 12-26-2000.

PURE GUARD

NO CLAIM IS MADE TO THE EXCLUSIVE RIGHT TO USE "PURE", APART FROM THE MARK AS SHOWN.
FOR ANTIBACTERIAL HAND LOTION (U.S. CLS. 6, 18, 44, 46, 51 AND 52).
FIRST USE 2-1-2001; IN COMMERCE 2-1-2001.

2,764,953. INFINITY2, INC., SCOTTSDALE, AZ. SN 76-237,807. PUB. 4-2-2002, FILED 4-9-2001.



OWNER OF U.S. REG. NOS. 2,339,228 AND 2,339,237.
NO CLAIM IS MADE TO THE EXCLUSIVE RIGHT TO USE "GUARANTEED NUTRIENT DELIVERY", APART FROM THE MARK AS SHOWN.
FOR NUTRITIONAL AND DIETARY SUPPLEMENTS (U.S. CLS. 6, 18, 44, 46, 51 AND 52).
FIRST USE 6-0-1998; IN COMMERCE 7-0-1998.

2,764,974. WATSON, DANIEL L. JR., LAMPE, MO. SN 76-248,803. PUB. 9-11-2001, FILED 4-27-2001.

EUKY BEAR

FOR TOPICAL ANALGESIC PREPARATION (U.S. CLS. 6, 18, 44, 46, 51 AND 52).
FIRST USE 5-3-2003; IN COMMERCE 5-3-2003.

CLASS 5—(Continued).

2,764,983. LIN, SHI-LUNG, ALHAMBRA, CA. SN 76-256,396. PUB. 3-26-2002, FILED 5-14-2001.

TCR

FOR CHEMICAL DIAGNOSTIC REAGENTS FOR USE IN BIOCHEMICAL RESEARCH, AGRICULTURAL RESEARCH, BIOMEDICAL RESEARCH, LABORATORY ANALYSIS, CLINICAL DIAGNOSIS, DRUG PRODUCTION AND PHARMACEUTICAL THERAPY FOR CONDUCTING NUCLEIC ACID AMPLIFICATION IN VIVO OR IN VITRO, ALL FOR CLINICAL OR MEDICAL LABORATORY USE (U.S. CLS. 6, 18, 44, 46, 51 AND 52).
FIRST USE 10-10-2002; IN COMMERCE 10-10-2002.

2,765,023. SWEAZY, JILL A., ORANGEBURG, SC. SN 76-268,847. PUB. 8-20-2002, FILED 6-8-2001.

GEN-SELECT

FOR KIT COMPRISED OF A SET OF INSTRUCTIONS, A TEMPERATURE MEASURING DEVICE, A PLURALITY OF CAPSULES CONTAINING SELECTED NUTRIENTALS; AND A DOUCHE FOR USE IN INCREASING THE CHANCES OF CONCEIVING A CHILD OF A DESIRED GENDER (U.S. CLS. 6, 18, 44, 46, 51 AND 52).
FIRST USE 6-0-2001; IN COMMERCE 11-0-2001.

2,765,028. TAIKO PHARMACEUTICAL CO., LTD., OSAKA, 564-0032, JAPAN. SN 76-270,736. PUB. 10-22-2002, FILED 6-14-2001.

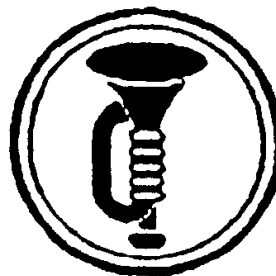

OWNER OF U.S. REG. NO. 1,154,467.
FOR PHARMACEUTICAL PREPARATIONS FOR THE TREATMENT OF STOMACHACHES, INDIGESTION, DIARRHEA, CONSTIPATION, AND FOOD POISONING; GASTROINTESTINAL TREATMENT PREPARATIONS; DIARRHEA MEDICATIONS; ANTACIDS; ANTI-EMETICS; CASTOR OIL FOR THE TREATMENT OF CONSTIPATION (U.S. CLS. 6, 18, 44, 46, 51 AND 52).
FIRST USE 7-0-1972; IN COMMERCE 8-7-2002.

CLASS 5—(Continued).

2,765,049. WENG SENG HENG MEDICAL HALL SDN BHD, 10300 PENANG, MALAYSIA. SN 76-279,145. PUB. 8-13-2002, FILED 7-2-2001.



NO CLAIM IS MADE TO THE EXCLUSIVE RIGHT TO USE "LIME BRAND", APART FROM THE MARK AS SHOWN.

THE CHINESE CHARACTERS IN THE MARK TRANSLITERATE TO "JI XIANG", AND THIS MEANS "LIME LUCKY DETAILED MINUTE" IN ENGLISH.

FOR MEDICATED SKIN CARE PREPARATIONS, NAMELY, OILS, BALMS AND OINTMENTS; MEDICINAL HERBAL SUPPLEMENTS (U.S. CLS. 6, 18, 44, 46, 51 AND 52).

FIRST USE 10-0-1963; IN COMMERCE 1-0-2003.

2,765,051. GOODMAN, GERALD I., MIAMI, FL. SN 76-279,815. PUB. 8-6-2002, FILED 7-5-2001.

**UNCLE ALBERT'S SUPER
SMART ANT BAIT**

NO CLAIM IS MADE TO THE EXCLUSIVE RIGHT TO USE "ANT BAIT", APART FROM THE MARK AS SHOWN. FOR INSECTICIDE, NAMELY, ANT BAIT FOR DOMESTIC AND COMMERCIAL USE (U.S. CLS. 6, 18, 44, 46, 51 AND 52).

FIRST USE 3-1-2001; IN COMMERCE 3-3-2001.

CLASS 5—(Continued).

2,765,057. PLAYBOY ENTERPRISES INTERNATIONAL, INC., CHICAGO, IL. SN 76-283,213. PUB. 10-22-2002, FILED 7-3-2001.

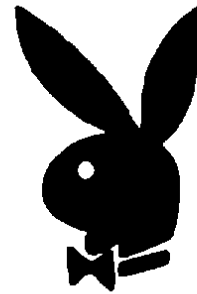

OWNER OF U.S. REG. NOS. 643,926, 2,483,351, AND OTHERS.

FOR VITAMINS, VITAMIN AND MINERAL SUPPLEMENTS, NUTRITIONAL SUPPLEMENTS AND DIETARY SUPPLEMENTS (U.S. CLS. 6, 18, 44, 46, 51 AND 52). FIRST USE 5-1-2003; IN COMMERCE 5-1-2003.

2,765,141. FMC CORPORATION, PHILADELPHIA, PA. SN 76-314,903. PUB. 7-30-2002, FILED 9-19-2001.

HFT

FOR PREPARATIONS FOR THE DESTRUCTION OF VERMIN AND WEEDS; PESTICIDES FOR AGRICULTURAL USE (U.S. CLS. 6, 18, 44, 46, 51 AND 52). FIRST USE 9-28-2001; IN COMMERCE 9-28-2001.

2,765,184. SUNSET HEALTH PRODUCTS, INC., LOS ANGELES, CA. SN 76-328,257. PUB. 6-11-2002, FILED 10-23-2001.

10•48

FOR DIETARY SUPPLEMENTS (U.S. CLS. 6, 18, 44, 46, 51 AND 52). FIRST USE 6-1-2002; IN COMMERCE 6-1-2002.

CLASS 5—(Continued).

2,765,248. MAITAKE PRODUCTS, INC., RIDGEFIELD PARK, NJ. SN 76-346,691. PUB. 5-14-2002, FILED 12-6-2001.

SX-FRACTION

FOR PHARMACEUTICAL PREPARATIONS MADE FROM MUSHROOMS AND HERBS FOR THE TREATMENT OF HYPERTENSION, OBESITY, DIABETES, HYPERLINK, AUTO IMMUNE DISEASES, THYROID, TOPIC HYPERSENSITIVITY, ASTHMA, BRONCHITIS, ECZEMA, HAY FEVER, COLLAGENS, ULCERS, INFLAMMATORY DISEASES, CANCER AND HIV POSITIVE/AIDS IN THE FORM OF TABLETS, CAPSULES, SUPPOSITORIES AND AMPLE FOR INJECTION; AND DIETARY, NUTRITIONAL AND FOOD SUPPLEMENTS MADE FROM MUSHROOMS AND HERBS IN THE FORM OF TABLETS, CAPSULES, TINCTURE, EXTRACTS, POWDER AND TEA (U.S. CLS. 6, 18, 44, 46, 51 AND 52).

FIRST USE 1-14-2003; IN COMMERCE 1-21-2003.

2,765,281. ASPEN BENEFITS GROUP, INC., COEUR D'ALENE, ID. SN 76-356,466. PUB. 6-18-2002, FILED 1-8-2002.

TOCOBLEND

FOR DIETARY, HERBAL, MINERAL, NUTRITIONAL AND VITAMIN SUPPLEMENTS (U.S. CLS. 6, 18, 44, 46, 51 AND 52).

FIRST USE 2-12-2002; IN COMMERCE 2-12-2002.

2,765,285. NICHINO AMERICA, INC., WILMINGTON, DE. SN 76-357,629. PUB. 12-3-2002, FILED 1-11-2002.

ARTISAN

FOR FUNGICIDES FOR AGRICULTURAL AND DOMESTIC USE (U.S. CLS. 6, 18, 44, 46, 51 AND 52).

FIRST USE 6-6-2002; IN COMMERCE 6-13-2002.

2,765,312. MINITUBE OF AMERICA, INC., VERONA, WI. SN 76-363,722. PUB. 7-23-2002, FILED 1-28-2002.

CRYOGUARD

FOR CULTURE AND DILUTION MEDIUM AS USED IN ARTIFICIAL INSEMINATION AND EMBRYO TRANSFER OF MAMMALS (U.S. CLS. 6, 18, 44, 46, 51 AND 52).

FIRST USE 10-1-2002; IN COMMERCE 10-1-2002.

CLASS 5—(Continued).

2,765,316. MERZ, INCORPORATED, GREENSBORO, NC. SN 76-364,611. PUB. 1-14-2003, FILED 1-30-2002.

APPEAREX

FOR PHARMACEUTICAL PREPARATION, NAMELY A NUTRITIONAL SUPPLEMENT (U.S. CLS. 6, 18, 44, 46, 51 AND 52).

FIRST USE 4-2-2002; IN COMMERCE 4-2-2002.

2,765,369. INGENIOUS DESIGNS LLC, ST. PETERSBURG, FL. SN 76-378,429. PUB. 12-17-2002, FILED 3-4-2002.

MIRACLE BREEZE

FOR HOUSEHOLD AND LAUNDRY DEODORIZER (U.S. CLS. 6, 18, 44, 46, 51 AND 52).

FIRST USE 4-8-2002; IN COMMERCE 4-8-2002.

2,765,408. XANODYNE PHARMACAL, INC., FLORENCE, KY. SN 76-392,112. PUB. 10-22-2002, FILED 4-8-2002.

LUCIDEX

FOR CAFFEINE SUPPLEMENT (U.S. CLS. 6, 18, 44, 46, 51 AND 52).

FIRST USE 6-1-2002; IN COMMERCE 9-27-2002.

2,765,416. GENI, INC., CARMEL, IN. SN 76-394,416. PUB. 10-22-2002, FILED 4-11-2002.

WOKVEL

FOR DIETARY SUPPLEMENT (U.S. CLS. 6, 18, 44, 46, 51 AND 52).

FIRST USE 10-25-2002; IN COMMERCE 10-25-2002.

2,765,424. PHARMAVITE LLC, NORTHRIDGE, CA. SN 76-398,524. PUB. 11-5-2002, FILED 4-22-2002.

MOOD PLUS

FOR DIETARY AND NUTRITIONAL SUPPLEMENTS (U.S. CLS. 6, 18, 44, 46, 51 AND 52).

FIRST USE 10-17-2002; IN COMMERCE 10-17-2002.

CLASS 5—(Continued).

2,765,433. VISIONTEL COMMUNICATIONS, LLC, ELIOT, ME. SN 76-403,675. PUB. 12-10-2002, FILED 5-3-2002.

PROCYLON

FOR DIETARY SUPPLEMENTS (U.S. CLS. 6, 18, 44, 46, 51 AND 52).
FIRST USE 7-2-2002; IN COMMERCE 7-2-2002.

2,765,465. WRIGHT MEDICAL TECHNOLOGY, INC., ARLINGTON, TN. SN 76-412,634. PUB. 11-26-2002, FILED 5-22-2002.

GRAFTJACKET

FOR BIOLOGICAL TISSUE FOR HUMAN IMPLANTATION, NAMELY, HUMAN DERMA IN THE NATURE OF ACELLULAR PERIOSTEUM REPLACEMENT SCAFFOLD FOR HUMAN IMPLANTATION (U.S. CLS. 6, 18, 44, 46, 51 AND 52).
FIRST USE 9-30-2002; IN COMMERCE 9-30-2002.

2,765,469. RIDLEY BLOCK OPERATIONS, INC., MANKATO, MN. SN 76-414,496. PUB. 12-31-2002, FILED 6-3-2002.

ARE YOU TIRED?

FOR CATTLE FEED SUPPLEMENTS (U.S. CLS. 6, 18, 44, 46, 51 AND 52).
FIRST USE 4-19-2002; IN COMMERCE 4-19-2002.

2,765,475. NATURAL ORGANICS INC., MELVILLE, NY. SN 76-416,412. PUB. 12-10-2002, FILED 6-3-2002.

ULTRA LUTEIN

NO CLAIM IS MADE TO THE EXCLUSIVE RIGHT TO USE "LUTEIN", APART FROM THE MARK AS SHOWN.
FOR VITAMIN SUPPLEMENTS CONTAINING LUTEIN (U.S. CLS. 6, 18, 44, 46, 51 AND 52).
FIRST USE 7-1-2002; IN COMMERCE 7-15-2002.

2,765,483. GLACIER NUTRIENTS, LLC, RED LODGE, MT. SN 76-420,087. PUB. 12-10-2002, FILED 6-13-2002.

GLACIER NUTRIENTS

NO CLAIM IS MADE TO THE EXCLUSIVE RIGHT TO USE "NUTRIENTS", APART FROM THE MARK AS SHOWN.
FOR VITAMINS; NUTRITIONAL AND FOOD SUPPLEMENTS; DIETARY SUPPLEMENTS (U.S. CLS. 6, 18, 44, 46, 51 AND 52).
FIRST USE 4-23-2003; IN COMMERCE 4-23-2003.

CLASS 5—(Continued).

2,765,492. CHIC ACCESSORIES, LLC, SCOTTSDALE, AZ. SN 76-427,579. PUB. 12-10-2002, FILED 7-3-2002.

BUZZ BUGS

FOR AUTOMOTIVE AIR FRESHENERS (U.S. CLS. 6, 18, 44, 46, 51 AND 52).
FIRST USE 7-0-2002; IN COMMERCE 7-0-2002.

2,765,512. SPA DE SOLEIL, INC., SUN VALLEY, CA. SN 76-975,364. PUB. 6-18-2002, FILED 12-6-2001.

**SKINFORCE
DERMAJUVENATE**

FOR MEDICATED SKIN CARE PRODUCTS AND FACIAL AND BODY TREATMENTS, NAMELY, SKIN CREAMS, FACIAL CREAMS, FACIAL LOTIONS, FACIAL CLEANERS, FACIAL MASKS, BODY CREAMS, BODY LOTIONS, BODY CLEANSERS, AND BODY MASKS (U.S. CLS. 6, 18, 44, 46, 51 AND 52).
FIRST USE 9-25-2002; IN COMMERCE 9-25-2002.

2,765,591. NASH, ALAN E., CANTON, MA. SN 78-059,360. PUB. 9-24-2002, FILED 4-19-2001.

SCIVOLUTIONS

FOR ADHESIVE BANDAGES FOR USE ON SKIN FOR NATURAL HEALING OF SKIN WOUNDS; TRANSDERMAL PATCHES FOR USE WITH SEMI-SOLID ANTIBIOTIC MEDICATION FOR HEALING SKIN WOUNDS; SURGICAL BANDAGES (U.S. CLS. 6, 18, 44, 46, 51 AND 52).
FIRST USE 9-1-2001; IN COMMERCE 9-1-2001.

2,765,646. WEST ALTERNATIVE MEDICINE, INC., HIALEAH, FL. SN 78-081,249. PUB. 3-26-2002, FILED 8-27-2001.



FOR DIETARY SUPPLEMENTS (U.S. CLS. 6, 18, 44, 46, 51 AND 52).
FIRST USE 2-5-2001; IN COMMERCE 5-15-2003.

CLASS 5—(Continued).

2,765,811. WESTERN HOLDINGS, L.L.C., CASPER, WY. SN 78-142,391. PUB. 1-7-2003, FILED 7-9-2002.

KYNOVAR

FOR DIETARY SUPPLEMENT MAINLY USED FOR FAT REDUCTION, WEIGHT CONTROL, AND SPORTS NUTRITION (U.S. CLS. 6, 18, 44, 46, 51 AND 52).
FIRST USE 10-2-2002; IN COMMERCE 10-2-2002.

2,765,815. DROGUERIA SARRA S.A., INC., CORAL GABLES, FL. SN 78-144,275. PUB. 1-28-2003, FILED 7-16-2002.

LYCORICH

FOR DIETARY SUPPLEMENT (U.S. CLS. 6, 18, 44, 46, 51 AND 52).
FIRST USE 4-1-2003; IN COMMERCE 4-1-2003.

2,765,817. MHB FEEDS, LLC, DBA MILLBROOK FEEDS, LLC, MITCHELL, SD. SN 78-144,668. PUB. 1-21-2003, FILED 7-17-2002.

DAKOTA LYK'S

FOR FEED SUPPLEMENT FOR LIVESTOCK ANIMALS (U.S. CLS. 6, 18, 44, 46, 51 AND 52).
FIRST USE 11-26-2002; IN COMMERCE 11-26-2002.

2,765,820. TERLITZKY, STEPHEN FENNING, NYC, NY. SN 78-145,951. PUB. 2-11-2003, FILED 7-20-2002.

**TRAVEL DROPS FOR A
RELAXED JOURNEY**

FOR HOMEOPATHIC FLOWER ESSENCE PREPARATION FOR RELIEVING STRESS AND ANXIETY (U.S. CLS. 6, 18, 44, 46, 51 AND 52).
FIRST USE 1-1-2002; IN COMMERCE 1-1-2002.

CLASS 6—METAL GOODS**CLASS 6—(Continued).**

2,764,502. POLAR FOCUS, INC., HADLEY, MA. SN 75-546,689. PUB. 12-14-1999, FILED 9-2-1998.

DIVIDER

FOR SUPPORTING DEVICE FOR SUSPENDING AND DIRECTIONALLY FOCUSING LOADS, NAMELY, A ROTARY SPREADER BEAM SYSTEM CONSISTING OF A PAIR OF METAL BEAMS HAVING A COMMON AXLE FOR ADJUSTMENT OF AZIMUTH TO DIRECTIONALLY FOCUS LOADS SUCH AS LOUDSPEAKER SYSTEMS INSTALLED PERMANENTLY OR TEMPORARILY IN AUDITORIUMS, CONCERT HALLS AND CIVIC CENTERS (U.S. CLS. 2, 12, 13, 14, 23, 25 AND 50).

FIRST USE 2-12-2003; IN COMMERCE 2-12-2003.

2,764,642. WHIRLWIND STEEL BUILDINGS, INC., HOUSTON, TX. SN 75-904,489. PUB. 1-29-2002, FILED 1-28-2000.

LOW RIB

NO CLAIM IS MADE TO THE EXCLUSIVE RIGHT TO USE "RIB", APART FROM THE MARK AS SHOWN.

FOR STEEL ROOFING AND SIDING PANELS FOR INSTALLATION ON COMMERCIAL AND INDUSTRIAL STEEL BUILDINGS (U.S. CLS. 2, 12, 13, 14, 23, 25 AND 50).

FIRST USE 1-1-2000; IN COMMERCE 1-1-2000.

2,764,915. TIMELY INDUSTRIES, A DIVISION OF S.D.S. INDUSTRIES, INC., PACOIMA, CA. SN 76-214,515. PUB. 9-24-2002, FILED 2-23-2001.



NO CLAIM IS MADE TO THE EXCLUSIVE RIGHT TO USE "MITER", APART FROM THE MARK AS SHOWN.

FOR METAL DOOR FRAMES (U.S. CLS. 2, 12, 13, 14, 23, 25 AND 50).

FIRST USE 9-23-2002; IN COMMERCE 9-23-2002.

CLASS 6—(Continued).

2,765,038. DONGBU STEEL CO., LTD., SEO-KU, INCHON, REPUBLIC OF KOREA. SN 76-276,060. PUB. 7-9-2002, FILED 6-25-2001.



DONGBU

THE WORD "DONGBU" IS AN ENGLISH TRANSLITERATION OF A KOREAN WORD WHICH MEANS "THE EASTERN PART OF A GENERAL GEOGRAPHICAL DESIGNATION".

FOR STEEL WIRE AND STEEL BARS (U.S. CLS. 2, 12, 13, 14, 23, 25 AND 50).

FIRST USE 1-29-2003; IN COMMERCE 1-29-2003.

CLASS 6—(Continued).

2,765,234. SPS TECHNOLOGIES, INC., JENKINTOWN, PA. SN 76-343,289. PUB. 11-19-2002, FILED 12-3-2001.

MP98T

OWNER OF U.S. REG. NOS. 994,982, 1,183,450, AND 2,324,541.

FOR METAL ALLOY IN BAR, ROD, BILLET, TUBE, WIRE, SHEET, STRIP AND PLATE FORM FOR USE IN FURTHER MANUFACTURING (U.S. CLS. 2, 12, 13, 14, 23, 25 AND 50).

FIRST USE 3-8-2002; IN COMMERCE 3-8-2002.

2,765,151. TRUTH HARDWARE CORPORATION, OWATONNA, MN. SN 76-318,967. PUB. 8-13-2002, FILED 9-27-2001.

WRIGHT IMPRESSIONS

FOR METAL DOOR HANDLES, LATCHES AND LOCKS (U.S. CLS. 2, 12, 13, 14, 23, 25 AND 50).

FIRST USE 6-1-2002; IN COMMERCE 6-1-2002.

2,765,383. JENNMAR CORPORATION, PITTSBURGH, PA. SN 76-383,455. PUB. 3-4-2003, FILED 3-15-2002.

LITTLE JOHN

FOR METAL TUBULAR SUPPORTS FOR USE IN MINE ROOF CONTROL (U.S. CLS. 2, 12, 13, 14, 23, 25 AND 50).

FIRST USE 11-7-2002; IN COMMERCE 11-7-2002.

2,765,162. DUVAL S.A., 95360 MONTMAGNY, FRANCE. SN 76-322,489. PUB. 10-1-2002, FILED 10-8-2001.

LEON BERNARD

THE NAME "LEON BERNARD" IN THE MARK DOES NOT IDENTIFY A LIVING INDIVIDUAL.

FOR IRONMONGERY, NAMELY, BOLTS; DOOR CASES OF METAL; METAL DOORS AND WINDOWS; DOOR STOPS OF METAL; PULL-RINGS AND HANGING RINGS OF METAL FOR DOORS AND WINDOWS; KNOBS OF METAL; WINDOW FRAMES OF METAL; HINGES OF METAL; CORNICES OF METAL; METAL HOOKS; HOOKS OF METAL FOR CLOTHES RAILS; METAL DOOR AND WINDOW FITTINGS, NAMELY ESPAGNOLETTES; IRONWORK FOR DOORS AND WINDOWS; DOOR HANDLES OF METAL; METAL NON-ELECTRIC DOOR OPENERS; DOOR PANELS OF METAL; DOOR BOLTS; NON-ELECTRIC LOCKS OF METAL; METAL DOOR AND WINDOW FASTENERS, NAMELY BOLTS (U.S. CLS. 2, 12, 13, 14, 23, 25 AND 50).

FIRST USE 10-10-2001; IN COMMERCE 10-10-2001.

2,765,495. SILK, MARGO, MOORESTOWN, NJ. AND GIOR-DANO, GLORIA, CHERRY HILL, NJ. SN 76-428,860. PUB. 2-25-2003, FILED 7-5-2002.

PURSAFE

FOR METAL HOOKS USED TO CONNECT PURSES TO TABLES FOR SECURITY (U.S. CLS. 2, 12, 13, 14, 23, 25 AND 50).

FIRST USE 9-21-2002; IN COMMERCE 9-21-2002.

CLASS 6—(Continued).

2,765,603. NEWFREY LLC, NEWARK, DE, BY CHANGE OF NAME EMHART INC., NEWARK, DE. SN 78-064,914. PUB. 9-17-2002, FILED 5-22-2001.



NO CLAIM IS MADE TO THE EXCLUSIVE RIGHT TO USE "LIMITED" AND "LIFETIME WARRANTY", APART FROM THE MARK AS SHOWN.

FOR METAL DOOR HARDWARE, NAMELY, KNOBS, LEVERS, LEVER SETS, HANDLES, HANDLE SETS, DEAD BOLTS, KEYS AND KEY BLANKS (U.S. CLS. 2, 12, 13, 14, 23, 25 AND 50).

FIRST USE 8-31-2001; IN COMMERCE 8-31-2001.

2,765,683. BURROWS, SIBYL, W., NORTH RICHLAND HILLS, TX. SN 78-094,795. PUB. 8-20-2002, FILED 11-23-2001.

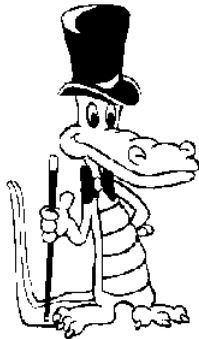

FOR CONTAINMENT BOX FOR STORAGE OF MISCELLANEOUS ITEMS TRANSPORTED IN THE CARGO AREA OF VEHICLES MADE PRIMARILY MADE OF METAL (U.S. CLS. 2, 12, 13, 14, 23, 25 AND 50).
FIRST USE 11-20-2002; IN COMMERCE 11-20-2002.

CLASS 6—(Continued).

2,765,784. BOWERS, NED C., LEESBURG, FL. SN 78-133,501. PUB. 12-17-2002, FILED 6-5-2002.

CLOC ALOC ZLOC SKYLOC

FOR METAL THREADED FASTENERS, NAMELY, ONE FOURTH TURN PANEL FASTENERS (U.S. CLS. 2, 12, 13, 14, 23, 25 AND 50).
FIRST USE 3-1-1998; IN COMMERCE 11-27-2002.

CLASS 7—MACHINERY

2,764,492. TECHNIFOR, 01700 MIRIBEL, FRANCE. SN 75-504,253. PUB. 8-13-2002, FILED 6-18-1998.

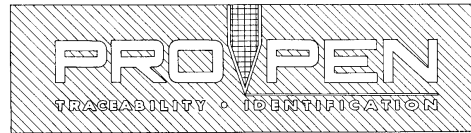

PRIORITY CLAIMED UNDER SEC. 44(D) ON FRANCE APPLICATION NO. 97/710646, FILED 12-18-1997, REG. NO. 97710646, DATED 12-18-1997, EXPIRES 12-18-2007.

NO CLAIM IS MADE TO THE EXCLUSIVE RIGHT TO USE "PEN", "TRACEABILITY" OR "IDENTIFICATION", APART FROM THE MARK AS SHOWN.

THE DRAWING IS LINED FOR THE COLOR(S) GREEN AND YELLOW.

FOR MARKING MACHINES AND PARTS THEREFORE; ENGRAVING MACHINES; PRESSING MACHINES (U.S. CLS. 13, 19, 21, 23, 31, 34 AND 35).

FIRST USE 2-28-1998; IN COMMERCE 6-19-1998.

2,764,493. GOSS INTERNATIONAL CORPORATION, WESTMONT, IL, BY ASSIGNMENT GOSS GRAPHIC SYSTEMS, INC., WESTMONT, IL. SN 75-505,185. PUB. 6-22-1999, FILED 6-19-1998.

UNILINER

FOR PRINTING PRESSES (U.S. CLS. 13, 19, 21, 23, 31, 34 AND 35).
FIRST USE 6-10-2002; IN COMMERCE 6-10-2002.

CLASS 7—(Continued).

2,764,523. PERMA-TEC GMBH & CO., KG, D-97717 EUR-DORF, FED REP GERMANY. SN 75-640,546. PUB. 8-7-2001, FILED 2-12-1999.

PRIORITY CLAIMED UNDER SEC. 44(D) ON ERPN CMNTY TM OFC APPLICATION NO. 914176, FILED 8-24-1998, REG. NO. 914176, DATED 12-15-1999, EXPIRES 8-24-2008.

THE DRAWING OF THE MARK IS LINED FOR THE COLOR RED. COLOR IS NOT CLAIMED AS A FEATURE OF THE MARK.

FOR OIL AND GREASE PUMPS FOR LUBRICATING INDUSTRIAL MACHINERY; ELECTROCHEMICALLY ACTUATED LUBRICATORS FOR THE GAS-CONTROLLED LUBRICATION OF INDUSTRIAL MACHINERY (U.S. CLS. 13, 19, 21, 23, 31, 34 AND 35).

FIRST USE 2-28-2003; IN COMMERCE 2-28-2003.

2,764,524. GRUNDFOS PUMPS CORPORATION, FRESNO, CA. SN 75-642,840. PUB. 2-13-2001, FILED 2-17-1999.

COOL TOP

NO CLAIM IS MADE TO THE EXCLUSIVE RIGHT TO USE "COOL", APART FROM THE MARK AS SHOWN.

FOR COMPONENT OF CENTRIFUGAL PUMPS, NAMELY A CHAMBER THAT USES AIR TO REDUCE THE TEMPERATURE OF THE PUMPED LIQUID (U.S. CLS. 13, 19, 21, 23, 31, 34 AND 35).

FIRST USE 3-5-1999; IN COMMERCE 3-13-2000.

2,764,562. MADISON FILTER 981 LIMITED, LANCASHIRE, UNITED KINGDOM. SN 75-728,416. PUB. 8-15-2000, FILED 6-14-1999.

PRIMAPOR

FOR PARTS FOR PAPERMAKING OR FILTRATION MACHINES, AND MACHINE ENGINES, NAMELY, FILTRATION AND DRAINAGE FELTS AND FABRICS; AND FILTERS AND FILTER CLOTHS (U.S. CLS. 13, 19, 21, 23, 31, 34 AND 35).

FIRST USE 9-13-1994; IN COMMERCE 9-13-1994.

2,764,621. NIPPON SEIKO KABUSHIKI KAISHA, DBA NSK LTD., TOKYO, JAPAN. SN 75-859,061. PUB. 9-25-2001, FILED 11-29-1999.

WATER-TF WATER-TOUGH

FOR BEARINGS, BALL BEARINGS, ROLLER BEARINGS, ALL BEING PARTS OF MACHINES (U.S. CLS. 13, 19, 21, 23, 31, 34 AND 35).

FIRST USE 3-0-2001; IN COMMERCE 9-0-2001.

CLASS 7—(Continued).

2,764,636. WHIRLPOOL PROPERTIES, INC., ST. JOSEPH, MI. SN 75-893,357. PUB. 10-31-2000, FILED 1-7-2000.

CUSTOM METALLIC

NO CLAIM IS MADE TO THE EXCLUSIVE RIGHT TO USE "METALLIC", APART FROM THE MARK AS SHOWN.

FOR ELECTRIC BEATING AND MIXING MACHINES AND ATTACHMENTS FOR SUCH MACHINES (U.S. CLS. 13, 19, 21, 23, 31, 34 AND 35).

FIRST USE 2-15-2003; IN COMMERCE 2-15-2003.

2,764,653. HERBERT KANNEGIESSER GMBH & CO., 32602 VLOTHO, FED REP GERMANY. SN 75-929,068. PUB. 7-17-2001, FILED 2-28-2000.

KANNEGIESSER

FOR IRONING MACHINES, WASHING MACHINES, FEEDING MACHINES, SEPARATING MACHINES (U.S. CLS. 13, 19, 21, 23, 31, 34 AND 35).

FIRST USE 8-30-2000; IN COMMERCE 8-30-2000.

2,764,701. TROMLEY INDUSTRIAL HOLDINGS, INC., DBA REDFORD-CARVER FOUNDRY PRODUCTS COMPANY, TUALATIN, OR. SN 76-043,238. PUB. 2-27-2001, FILED 5-4-2000.

CORECOMMAND

FOR MACHINES FOR MAKING FOUNDRY MOLDS (U.S. CLS. 13, 19, 21, 23, 31, 34 AND 35).

FIRST USE 5-10-2002; IN COMMERCE 5-10-2002.

2,764,799. SCHUNK GMBH & CO. KG, D-74348 LAUFFEN/NECKAR, FED REP GERMANY. SN 76-135,306. PUB. 9-24-2002, FILED 9-26-2000.

TB-LH

FOR MACHINES FOR METALWORKING, WOODWORKING, AND PLASTICS PROCESSING INDUSTRIES, NAMELY, CLAMPING CHUCKS, MANDRELS, CLAMPING CHUCKS OF METAL FOR WORK PIECES, GRIPPING CHUCKS, ELECTRICALLY, HYDRAULICALLY OR PNEUMATICALLY DRIVEN TRANSLATING, SWIVELING AND LIFTING CHUCKS, ROTATING CHUCKS, METAL CLAMPING DRILL CHUCKS FOR POWER DRILLS, POWERED EXPANSION CHUCKS, POWERED SHRINKAGE CHUCKS, BACK STAY FOR LATHES, CLAMPING CYLINDERS FOR POWER CLAMPING CHUCKS, POWERED EXTENSION CHUCKS, AND PARTS THEREOF (U.S. CLS. 13, 19, 21, 23, 31, 34 AND 35).

FIRST USE 1-0-2001; IN COMMERCE 1-0-2001.

CLASS 7—(Continued).

2,764,910. NATIONAL INSTRUMENT COMPANY, INCORPORATED, BALTIMORE, MD. SN 76-210,531. PUB. 5-28-2002, FILED 2-14-2001.

DIGIFIL

FOR MACHINES, NAMELY, LIQUID FILLING SYSTEMS COMPRISING DIGITAL CONTROL SYSTEMS FOR THE ADJUSTMENT OF OPERATING PARAMETERS (U.S. CLS. 13, 19, 21, 23, 31, 34 AND 35).
FIRST USE 11-0-2002; IN COMMERCE 11-0-2002.

2,764,918. HENSCHEL INDUSTRIE-TECHNIK GMBH, 34127 KASSEL, FED REP GERMANY, BY CHANGE OF NAME THYSSEN HENSCHEL INDUSTRIE-TECHNIK GMBH, KASSEL, FED REP GERMANY. SN 76-216,207. PUB. 7-2-2002, FILED 2-26-2001.

T2MAX

PRIORITY CLAIMED UNDER SEC. 44(D) ON FED REP GERMANY APPLICATION NO. 30080291, FILED 10-31-2000, REG. NO. 30080291, DATED 3-5-2001, EXPIRES 10-31-2010.
FOR GEAR, NAMELY, GEAR BOX WITH POWER DISTRIBUTION ONTO TWO OUTPUTS SHAFTS, FOR DOUBLE SCREW EXTRUDER (U.S. CLS. 13, 19, 21, 23, 31, 34 AND 35).
FIRST USE 6-19-2000; IN COMMERCE 0-0-2002.

2,764,952. HARRY MAJOR MACHINE, CLINTON TWP., MI. SN 76-237,618. PUB. 9-25-2001, FILED 4-6-2001.

**AUTOMATING YOUR
WORLD**

FOR INDUSTRIAL CONVEYORS, NAMELY, WALKING BEAM CONVEYORS, OVER AND UNDER CONVEYORS, ELECTRIC ROLLER CONVEYORS, ACCUMULATING ROLLER CONVEYORS, HEAVY TRANSFER AUTOMATION CONVEYORS; SMALL PARTS HANDLING MACHINERY, AND INDUSTRIAL PARTS WASHERS (U.S. CLS. 13, 19, 21, 23, 31, 34 AND 35).
FIRST USE 10-31-2002; IN COMMERCE 10-31-2002.

2,765,003. LITE-PREP SURFACE PREPARATION LLC, TALLMADGE, OH, BY ASSIGNMENT LITE-PREP COMPANY, L.L.C., TALLMADGE, OH. SN 76-264,892. PUB. 9-18-2001, FILED 6-1-2001.

SPIROSANDER

FOR POWER OPERATED MACHINES FOR SANDING AND FINISHING FLOORS AND WALLS; SANDING AND FINISHING DISKS FOR USE WITH MACHINES FOR SANDING AND FINISHING FLOORS AND WALLS (U.S. CLS. 13, 19, 21, 23, 31, 34 AND 35).
FIRST USE 4-8-2003; IN COMMERCE 4-8-2003.

CLASS 7—(Continued).

2,765,053. HAEGER, INCORPORATED, OAKDALE, CA. SN 76-281,178. PUB. 3-12-2002, FILED 7-6-2001.

SUREFIRE

FOR MACHINE PARTS, NAMELY, PARTS OF FASTENER INSERTING SYSTEMS FOR SINGULATING, ORIENTING, FEEDING AND INSERTING FASTENERS (U.S. CLS. 13, 19, 21, 23, 31, 34 AND 35).
FIRST USE 6-1-2001; IN COMMERCE 8-1-2001.

2,765,119. REIFENHAUSER GMBH & CO MASCHINENFABRIK, D-53839 TROISDORF, FED REP GERMANY. SN 76-308,405. PUB. 9-17-2002, FILED 9-4-2001.

FILMTEC

PRIORITY CLAIMED UNDER SEC. 44(D) ON FED REP GERMANY APPLICATION NO. 30133809.4, FILED 6-1-2001, REG. NO. 30133809, DATED 9-13-2001, EXPIRES 6-30-2011.
FOR MACHINES FOR PRODUCTION OF BLOWN PLASTIC FILMS BY EXTRUSION AND BLOWING (U.S. CLS. 13, 19, 21, 23, 31, 34 AND 35).
FIRST USE 6-30-2001; IN COMMERCE 6-30-2001.

2,765,311. TUBI STYLE S.R.L., UBERSETTO DI FIORANO (MODENA), ITALY. SN 76-363,604. PUB. 9-24-2002, FILED 1-28-2002.

TUBI STYLE

OWNER OF U.S. REG. NO. 2,270,973.
NO CLAIM IS MADE TO THE EXCLUSIVE RIGHT TO USE "STYLE", APART FROM THE MARK AS SHOWN.
THE ENGLISH TRANSLATION OF "TUBI" IS "TUBES".
FOR EXHAUST PIPES, MUFFLERS, AND EXHAUST MANIFOLDS FOR LAND VEHICLES (U.S. CLS. 13, 19, 21, 23, 31, 34 AND 35).
FIRST USE 7-13-1987; IN COMMERCE 4-14-1992.

2,765,323. GENERAC PORTABLE PRODUCTS, INC., JEFFERSON, WI. SN 76-366,345. PUB. 10-8-2002, FILED 2-4-2002.

SUREGRIP

FOR MULTI-PURPOSE HIGH PRESSURE WASHERS AND PARTS THEREOF (U.S. CLS. 13, 19, 21, 23, 31, 34 AND 35).
FIRST USE 12-27-2002; IN COMMERCE 12-27-2002.

CLASS 7—(Continued).

2,765,362. PRECISION RUBBER PLATE CO., INC., INDIANAPOLIS, IN. SN 76-377,303. PUB. 8-6-2002, FILED 3-1-2002.

EXSPECT

FOR PRINTING PLATES (U.S. CLS. 13, 19, 21, 23, 31, 34 AND 35).

FIRST USE 1-15-2003; IN COMMERCE 1-15-2003.

2,765,367. STERLING PRODUCTS, INC., WOOD DALE, IL. SN 76-377,945. PUB. 12-3-2002, FILED 3-4-2002.

ECONOGRIND

FOR POWER OPERATED GRINDERS FOR USE IN THE MANUFACTURING, HANDLING OR PROCESSING OF PLASTIC MATERIALS AND DRY BULK MATERIALS (U.S. CLS. 13, 19, 21, 23, 31, 34 AND 35).

FIRST USE 8-0-2002; IN COMMERCE 8-0-2002.

2,765,522. DELTAHAWK, INC., FRANKLIN, WI. SN 76-975,643. PUB. 2-6-2001, FILED 3-27-2000.

DELTAHAWK

FOR DIESEL ENGINES FOR RECREATIONAL VEHICLES (U.S. CLS. 13, 19, 21, 23, 31, 34 AND 35).

FIRST USE 4-10-2003; IN COMMERCE 4-10-2003.

2,765,689. THOMSON, HOWARD M., OAKFIELD, TN. SN 78-098,478. PUB. 9-10-2002, FILED 12-14-2001.



THE MARK CONSISTS OF THE WORDING "THE GOLDEN GOAT" IN STYLIZED FORM, WITH A STYLIZED REPRESENTATION OF AN ALUMINUM CAN FORMING THE O IN GOAT. ALL OF THIS ENCLOSED WITHIN A RECTANGULAR DESIGN.

FOR ALUMINUM CAN COMPACTING MACHINES (U.S. CLS. 13, 19, 21, 23, 31, 34 AND 35).

FIRST USE 5-24-2002; IN COMMERCE 5-24-2002.

CLASS 7—(Continued).

2,765,712. CALIFORNIA INSTRUMENTS CORPORATION, SAN DIEGO, CA. SN 78-108,094. PUB. 10-8-2002, FILED 2-11-2002.

ARGANTIX

FOR HIGH FREQUENCY MOTOR SPINDLES WITH HIGH FREQUENCY ELECTRIC CONVERTERS AND POWER SUPPLY UNITS (U.S. CLS. 13, 19, 21, 23, 31, 34 AND 35).

FIRST USE 1-1-2003; IN COMMERCE 1-1-2003.

CLASS 8—HAND TOOLS

2,765,010. PACIFIC HANDY CUTTER, INC., COSTA MESA, CA. SN 76-266,246. PUB. 9-24-2002, FILED 6-4-2001.

RAZE

FOR MANUALLY HELD TOOLS AND IMPLEMENTS, NAMELY, UTILITY KNIVES, SNAP KNIVES, HOBBY KNIVES, MINI KNIVES, BOX CUTTERS, SAFETY CUTTERS, BLADES FOR UTILITY KNIVES, SNAP KNIVES, HOBBY KNIVES, MINI KNIVES, BOX CUTTERS AND SAFETY CUTTERS, AND SPECIALTY HOLSTERS FOR CARRYING KNIVES, CUTTERS AND BLADES (U.S. CLS. 23, 28 AND 44).

FIRST USE 5-1-2001; IN COMMERCE 2-28-2002.

2,765,068. RONSON CORPORATION, WOODBRIDGE, NJ. SN 76-290,176. PUB. 11-12-2002, FILED 7-25-2001.

TECH TORCH

FOR MINIATURE, NON-WELDING, BUTANE TORCHES FOR GENERAL HEATING APPLICATIONS (U.S. CLS. 23, 28 AND 44).

FIRST USE 7-31-2002; IN COMMERCE 7-31-2002.

2,765,097. HAND TOOL DESIGN CORPORATION, WILMINGTON, DE. SN 76-300,547. PUB. 1-21-2003, FILED 8-16-2001.



OWNER OF U.S. REG. NO. 2,129,955.
NO CLAIM IS MADE TO THE EXCLUSIVE RIGHT TO USE "GEAR RATCHET", APART FROM THE MARK AS SHOWN.

THE MARK CONSISTS, IN PART, OF A STYLIZED DEPICTION OF A DRIVE TOOL HEAD.

FOR HAND-OPERATED TOOLS, NAMELY, RATCHET AND SOCKET SET COMBINED (U.S. CLS. 23, 28 AND 44).

FIRST USE 8-20-2002; IN COMMERCE 8-20-2002.

CLASS 9—ELECTRICAL AND SCIENTIFIC APPARATUS

2,764,475. LIGHTYEAR TECHNOLOGIES (USA), INC., NORTH VANCOUVER, BRITISH COLUMBIA, CANADA, BY ASSIGNMENT; BY CHANGE OF NAME REND TECHNOLOGIES LTD., NORTH VANCOUVER, B.C., CANADA. SN 75-277,648. PUB. 3-7-2000, FILED 4-21-1997.

LIGHTYEAR

PRIORITY CLAIMED UNDER SEC. 44(D) ON CANADA APPLICATION NO. 832392, FILED 12-20-1996.

FOR BATTERY ANODE AND CATHODE MATERIALS COMPRISED OF EXFOLIATED TRANSITION METAL DICHALCOGENIDE COATED METALS, EXFOLIATED TRANSITION METAL DICHALCOGENIDE COATED METAL ALLOYS, EXFOLIATED TRANSITION METAL DICHALCOGENIDE METAL MATRIX COMPOSITES, AND MIXTURES OF EXFOLIATED TRANSITION METAL DICHALCOGENIDE AND POLYMERS EMPLOYED AS SEPARATORS, AND ELECTROLYTE MATERIALS COMPRISED OF EXFOLIATED TRANSITION METAL DICHALCOGENIDES DISPERSED IN ACIDS, ALKALINE, SOLUBLE HYDRIDES, SALTS, ORGANIC MATERIAL, OR CONDUCTION POLYMERS FOR USE AS COMPONENTS FOR MAKING BATTERIES OR ELECTROCHEMICAL CELLS (U.S. CLS. 21, 23, 26, 36 AND 38). FIRST USE 1-20-1998; IN COMMERCE 2-0-2001.

2,764,477. LETZER, SALLY, CALABASAS, CA. SN 75-288,328. PUB. 12-7-1999, FILED 5-8-1997.

THOUGHT TRANSFERENCE THOROUGHFARE

NO CLAIM IS MADE TO THE EXCLUSIVE RIGHT TO USE "THOUGHT TRANSFERENCE", APART FROM THE MARK AS SHOWN.

FOR PRE-RECORDED VIDEO CASSETTES, PRE-RECORDED AUDIO TAPES, PRE-RECORDED COMPACT DISCS AND PRE-RECORDED DVDS FEATURING INFORMATION FOR ASSISTING AN INDIVIDUAL IN GAINING AWARENESS OF AND ANALYZING WHERE THOUGHTS COME FROM, THE PROCESS OF HOW THOUGHTS ARE GENERATED AND MATERIALIZED AND ARE THEN TRANSFERRED AND RELAYED THROUGHOUT THEIR PSYCHE AS WELL AS OUTSIDE OF THEMSELVES (U.S. CLS. 21, 23, 26, 36 AND 38).

FIRST USE 5-3-1997; IN COMMERCE 8-8-2002.

CLASS 9—(Continued).

2,764,478. SPES EDITORIAL, S.L., BARCELONA, SPAIN, BY CHANGE OF NAME BIBLOGRAF, S.A., 08015 BARCELONA, SPAIN. SN 75-322,118. PUB. 10-5-1999, FILED 7-10-1997.

VOX

THE MARK CONSISTS OF THE WORD "VOX" IN A THREE DIMENSIONAL STYLED LETTERING. FOR CD ROMS FEATURING DICTIONARIES (U.S. CLS. 21, 23, 26, 36 AND 38).

FIRST USE 9-0-2002; IN COMMERCE 9-0-2002.

2,764,479. RED CHIP COMPANY LTD., TORTOLA, BR. VIRGIN ISLANDS, BY ASSIGNMENT; BY ASSIGNMENT HARRIS CORPORATION, MELBOURNE, FL. SN 75-384,433. PUB. 2-8-2000, FILED 11-4-1997.

COOLAUDIO

FOR APPARATUS FOR USE IN CONNECTION WITH THE PROCESSING, RECORDING, REPRODUCTION, TRANSMISSION AND RECEPTION OF ELECTRONIC SIGNALS, NAMELY, SIGNAL PROCESSORS, SOUND PROCESSORS, AND CIRCUIT BOARDS; SEMICONDUCTORS AND ELECTRONIC CIRCUITS FOR USE IN AUDIO, VIDEO, DIGITAL AND ANALOG DEVICES; ALL OF THE AFORESAID APPARATUS, SEMICONDUCTORS, AND ELECTRONIC CIRCUITS FOR USE IN PORTABLE, NONPORTABLE AND/OR IN VEHICLE VIDEO TELECONFERENCING EQUIPMENT, RECEIVERS AND TRANSMITTERS FOR DIGITALLY-ENCODED AUDIO AND DATA SIGNALS, SOUND PROCESSORS, AUDIO AND VIDEO AMPLIFIERS AND RECEIVERS, STEREO AUDIO RECEIVERS, RECORD PLAYERS, COMPACT DISCS PLAYERS, LOUDSPEAKERS, RADIOS, TELEVISION RECEIVERS, VIDEO MONITORS, VIDEO TUNERS, AUDIO AND VIDEO RECORDERS, AUDIO AND VIDEO TAPE AND DISC PLAYERS, AUDIO AND VIDEO TAPE AND DISC DUBBING DECKS, CABLE TELEVISION RECEIVERS AND DECODERS, REMOTE CONTROL UNITS FOR THOSE GOODS, COMPUTERS, CD-ROM PLAYERS AND RECORDERS, COMPUTER PROGRAMS FOR USE IN GENERATING SOUND, ELECTRONIC SIGNAL PROCESSORS AND ELECTRONIC SATELLITE SIGNAL PROCESSORS; ALIGNMENT AND TEST EQUIPMENT FOR ELECTRONIC APPARATUS FOR USE IN CONNECTION WITH THE PROCESSING, RECORDING, REPRODUCTION, AND TRANSMISSION AND RECEPTION OF ELECTRONIC SIGNALS, NAMELY, AMMETERS, VOLT METERS, MULTIMETERS, OSCILLOSCOPES, AND CONTINUITY TESTERS (U.S. CLS. 21, 23, 26, 36 AND 38). FIRST USE 11-5-2002; IN COMMERCE 11-5-2002.

CLASS 9—(Continued).

2,764,480. MOTOROLA, INC., SCHAUMBURG, IL. SN 75-386,329. PUB. 7-4-2000, FILED 11-7-1997.

DIGITAL DNA

OWNER OF U.S. REG. NO. 2,178,802.
NO CLAIM IS MADE TO THE EXCLUSIVE RIGHT TO USE "DIGITAL", APART FROM THE MARK AS SHOWN.
FOR TELEPHONES, CELLULAR TELEPHONES, RADIO PAGERS, MOBILE AND PORTABLE TWO-WAY RADIOS, RADIO BASE STATIONS, ELECTRONIC TELECOMMUNICATIONS SWITCHES FOR CELLULAR TELEPHONE AND PAGING SYSTEMS, BLANK SMARTCARDS, ENCODED SMARTCARDS CONTAINING PROGRAMMING FOR VERIFYING USER IDENTIFICATION AND FOR ACCESS CONTROL, SMARTCARD READERS, RADIO FREQUENCY IDENTIFICATION TAGS, NAMELY, RADIO FREQUENCY RECEIVERS, TRANSMITTERS AND READERS, ELECTRONIC HANDHELD DATA TERMINALS, COMPUTER SOFTWARE FOR OPERATING AND PROGRAMMING THE FOREGOING GOODS, REPLACEMENT PARTS FOR THE FOREGOING GOODS AND INSTRUCTIONAL MANUALS DISTRIBUTED WITH THE FOREGOING GOODS (U.S. CLS. 21, 23, 26, 36 AND 38).
FIRST USE 2-28-1998; IN COMMERCE 2-28-1998.

2,764,482. CREATIVE TECHNOLOGY LTD., CREATIVE RESOURCE, SINGAPORE. SN 75-416,995. PUB. 9-24-2002, FILED 1-12-1998.

ENVIRONMENTAL AUDIO

NO CLAIM IS MADE TO THE EXCLUSIVE RIGHT TO USE "AUDIO", APART FROM THE MARK AS SHOWN.
FOR COMPUTER HARDWARE, COMPUTER PERIPHERALS, AND COMPUTER SOFTWARE TO ENHANCE THE AUDIO CAPABILITIES OF INTERACTIVE GAME APPLICATIONS FOR USE ON A PERSONAL COMPUTER (U.S. CLS. 21, 23, 26, 36 AND 38).
FIRST USE 8-6-1998; IN COMMERCE 8-6-1998.

2,764,484. DASSAULT SYSTEMES, S.A., 92156 SURESNES, CEDEX, FRANCE. SN 75-438,763. PUB. 5-29-2001, FILED 2-23-1998.

ENOVIA

FOR COMPUTER SOFTWARE FOR PROJECT MANAGEMENT; INFRASTRUCTURE AND APPLICATION SOFTWARE TO MANAGE, ADMINISTER, MODEL AND SHARE INDUSTRIAL DATA, BUSINESS DATA, AND CORPORATE PROCESSES; COMPUTER SOFTWARE USED TO DEFINE, CONTROL AND MONITOR DATA THROUGH PRODUCT/SERVICE LIFE CYCLE FROM CONCEPT TO DESIGN, MANUFACTURE, MAINTENANCE, AND MARKETING, ALL AFORESAID GOODS ARE NOT TO BE USED IN CONNECTION WITH TRANSPORTATION BY LAND (U.S. CLS. 21, 23, 26, 36 AND 38).
FIRST USE 4-1-1998; IN COMMERCE 4-1-1998.

CLASS 9—(Continued).

2,764,486. CREO INC., BURNABY, B.C. V5G 4M1, CANADA, BY CHANGE OF NAME CREO PRODUCTS INC., BURNABY, B.C. V5G 4M1, CANADA. SN 75-450,134. PUB. 2-29-2000, FILED 3-13-1998.

PROOFSETTER SPECTRUM

NO CLAIM IS MADE TO THE EXCLUSIVE RIGHT TO USE "PROOFSETTER", APART FROM THE MARK AS SHOWN.
FOR COMPUTER HARDWARE, NAMELY, DIGITAL HALFTONE PROOFERS (U.S. CLS. 21, 23, 26, 36 AND 38).
FIRST USE 2-2-1998; IN COMMERCE 2-2-1998.

2,764,488. FIELDCENTRIX, INC., NEWPORT BEACH, CA. SN 75-469,196. PUB. 3-9-1999, FILED 4-16-1998.

INFORMATION ON A TOOL BELT

FOR COMPUTER SOFTWARE THAT ENABLES FIELD SERVICE TECHNICIANS TO COMMUNICATE FROM A REMOTE LOCATION WITH A FIELD SERVICE COMPANY, SUPPLIERS, AND CUSTOMERS IN NEED OF REPAIR SERVICES (U.S. CLS. 21, 23, 26, 36 AND 38).
FIRST USE 10-30-2001; IN COMMERCE 10-30-2001.

2,764,496. AMERICA ONLINE, INC., DULLES, VA. SN 75-512,113. PUB. 4-11-2000, FILED 6-26-1998.

YOU'VE GOT AOL

FOR PRE-RECORDED AUDIO AND VIDEO CASSETTES AND COMPACT DISCS FEATURING MOVIES, MUSIC, INTERVIEWS, DISPLAYS OF TALENT, AND GRAPHICS; COMPUTER PROGRAMS FEATURING COMPUTER INSTRUCTION, APPLICATIONS AND NETWORK OPERATING PROCEDURES; COMPUTER GAME PROGRAMS AND COMPUTER GAME SOFTWARE AND COMPUTER PERIPHERALS (U.S. CLS. 21, 23, 26, 36 AND 38).
FIRST USE 9-0-2002; IN COMMERCE 9-0-2002.

2,764,506. LECROY CORPORATION, CHESTNUT RIDGE, NY. SN 75-567,027. PUB. 3-14-2000, FILED 10-7-1998.

JITTERTRACK

FOR COMPUTER SOFTWARE FOR USE WITH OR IN OSCILLOSCOPES FOR ANALYZING, PROCESSING AND DISPLAYING ELECTRONIC VOLTAGE SIGNALS IN THE FIELD OF SCIENTIFIC ANALYSIS; AND USER MANUALS SOLD AS A UNIT (U.S. CLS. 21, 23, 26, 36 AND 38).
FIRST USE 4-0-1998; IN COMMERCE 5-0-1998.

CLASS 9—(Continued).

2,764,507. CLEAR AS CRYSTAL PRODUCTIONS, INC., MELBOURNE, FL. SN 75-568,417. PUB. 4-4-2000, FILED 10-20-1998.

CLEAR AS CRYSTAL PRODUCTIONS

NO CLAIM IS MADE TO THE EXCLUSIVE RIGHT TO USE "PRODUCTIONS", APART FROM THE MARK AS SHOWN.

FOR PRE-RECORDED VIDEO TAPES FEATURING EDUCATION IN THE FIELD OF HOBBIES AND CAREERS (U.S. CLS. 21, 23, 26, 36 AND 38).

FIRST USE 5-1-2003; IN COMMERCE 5-1-2003.

2,764,509. AMKOR TECHNOLOGY, INC., WEST CHESTER, PA. SN 75-577,326. PUB. 9-11-2001, FILED 10-27-1998.

MicroLeadFrame

FOR SEMICONDUCTOR PACKAGING (U.S. CLS. 21, 23, 26, 36 AND 38).

FIRST USE 11-0-1999; IN COMMERCE 11-0-1999.

2,764,513. A-1 COMPONENTS CORPORATION, HIALEAH, FL. SN 75-589,900. PUB. 10-8-2002, FILED 11-17-1998.

LINEBACKER

FOR ELECTRONIC PROTECTION CIRCUITRY IN THE NATURE OF SURGE PROTECTORS AND TIMERS ALL FOR USE WITH ELECTRIC MOTORS USED IN CONNECTION WITH REFRIGERATING, HEATING, VENTILATING, AND AIR CONDITIONING APPLIANCES, NAMELY, REFRIGERATORS, AIR CONDITIONERS, HEAT PUMPS AND FURNACES (U.S. CLS. 21, 23, 26, 36 AND 38).

FIRST USE 1-1-1978; IN COMMERCE 1-1-1978.

2,764,516. BS & B SAFETY SYSTEMS, INC., TULSA, OK. SN 75-609,460. PUB. 2-12-2002, FILED 8-4-1998.

SMARTDISK

FOR ELECTRONIC SENSORS AND RELATED COMPUTER HARDWARE AND SOFTWARE, ALL FOR DETECTING, MONITORING, AND ANALYZING THE CONDITION OF PRESSURE RELIEF EQUIPMENT USED IN CONNECTION WITH PIPES, VESSELS, VALVES, AND TANKS FOR USE IN INDUSTRIES UTILIZING PRESSURE RELIEF EQUIPMENT (U.S. CLS. 21, 23, 26, 36 AND 38).

FIRST USE 9-11-2001; IN COMMERCE 9-11-2001.

CLASS 9—(Continued).

2,764,526. ATMEL CORPORATION, SAN JOSE, CA. SN 75-645,651. PUB. 4-9-2002, FILED 2-22-1999.



FOR INTEGRATED CIRCUIT DEVICES NAMELY MICROCONTROLLERS, MICROPROCESSORS, DIGITAL SIGNAL PROCESSORS (DSP) AND APPLICATION SPECIFIC INTEGRATED CIRCUITS (ASIC) (U.S. CLS. 21, 23, 26, 36 AND 38).

FIRST USE 8-31-2000; IN COMMERCE 10-2-2000.

2,764,531. INTERNATIONAL TIME RECORDER LIMITED, TORONTO, ONTARIO M8Y 1E5, CANADA. SN 75-661,623. PUB. 9-12-2000, FILED 3-16-1999.



NO CLAIM IS MADE TO THE EXCLUSIVE RIGHT TO USE "A TIME AND ATTENDANCE LABOUR TRACKING SOLUTION", APART FROM THE MARK AS SHOWN.

FOR LABOR TRACKING SOFTWARE, NAMELY SOFTWARE THAT TRACKS THE HOURS AND ATTENDANCE OF PERSONNEL (U.S. CLS. 21, 23, 26, 36 AND 38).

FIRST USE 1-0-2000; IN COMMERCE 6-2-2002.

2,764,537. FOTONATION, INC., MILLBRAE, CA. SN 75-673,093. PUB. 12-28-1999, FILED 3-26-1999.

FOTOKIOSK

FOR COMPUTER HARDWARE APPLIANCE IN THE NATURE OF A DEVICE FOR CONVERTING AND FORMATTING IMAGES FROM A DIGITAL CAMERA TO A PRINTING DEVICE; COMPUTER SOFTWARE FOR CONVERTING AND FORMATTING IMAGES FROM A DIGITAL CAMERA TO A PRINTING DEVICE (U.S. CLS. 21, 23, 26, 36 AND 38).

FIRST USE 3-26-1999; IN COMMERCE 2-23-2003.

CLASS 9—(Continued).

2,764,540. VMWARE, INC., PALO ALTO, CA. SN 75-677,921.
PUB. 3-26-2002, FILED 4-7-1999.

VMWARE

SEC. 2(F).
FOR COMPUTER SOFTWARE FOR MANAGING,
TESTING, AND USING MULTIPLE OPERATING SYS-
TEMS, AND INSTRUCTIONAL MANUALS THEREFOR
SOLD AS A UNIT (U.S. CLS. 21, 23, 26, 36 AND 38).
FIRST USE 5-15-1999; IN COMMERCE 5-15-1999.

2,764,567. ADVANCED MICRO DEVICES, INC., SUNNY-
VALE, CA. SN 75-739,656. PUB. 2-29-2000, FILED 6-23-1999.



OWNER OF U.S. REG. NOS. 1,449,383 AND 2,250,375.
NO CLAIM IS MADE TO THE EXCLUSIVE RIGHT TO
USE "PROCESSOR", APART FROM THE MARK AS
SHOWN.

FOR COMPUTER HARDWARE, SEMICONDUCTOR
DEVICES; MICROPROCESSOR MODULES; COMPUTER
HARDWARE SUBSYSTEMS; AND COMPUTER SOFT-
WARE, NAMELY, OPERATING SYSTEM SOFTWARE,
GAMING SOFTWARE AND 3D GRAPHICS SOFTWARE
(U.S. CLS. 21, 23, 26, 36 AND 38).

FIRST USE 6-23-1999; IN COMMERCE 6-23-1999.

2,764,585. EMWARE, INC., SALT LAKE CITY, UT. SN 75-
788,941. PUB. 3-20-2001, FILED 8-31-1999.

EMCHIP

FOR FIRMWARE AND/OR COMPUTER SOFTWARE
TO CONTROL AND/OR ACQUIRE DATA FOR CONSU-
MER AND/OR INDUSTRIAL APPLICATIONS FROM
ELECTRONIC EQUIPMENT THROUGH LOCAL AND/
OR GLOBAL COMPUTER NETWORKS AND INSTRUC-
TION MANUAL SOLD AS A UNIT THEREWITH (U.S.
CLS. 21, 23, 26, 36 AND 38).

FIRST USE 9-22-1999; IN COMMERCE 9-22-1999.

CLASS 9—(Continued).

2,764,594. TRABELCO, N.V., WILLEMSTAD, CURACAO,
NETHERLD ANTILLES. SN 75-809,960. PUB. 8-22-2000,
FILED 9-28-1999.

BLUE ICE

FOR AUDIO TAPE RECORDERS AND REWINDERS
(U.S. CLS. 21, 23, 26, 36 AND 38).
FIRST USE 5-14-2003; IN COMMERCE 5-14-2003.

2,764,599. TERRY SAVAGE PRODUCTIONS, LTD., CHICA-
GO, IL. SN 75-814,431. PUB. 5-23-2000, FILED 10-4-1999.

THE SAVAGE TRUTH

FOR PRE-RECORDED AUDIO AND VIDEO CAS-
SETTE TAPES ON THE SUBJECT OF FINANCE (U.S.
CLS. 21, 23, 26, 36 AND 38).
FIRST USE 10-13-1999; IN COMMERCE 10-13-1999.

2,764,601. GLUON NETWORKS, INC., COTATI, CA. SN 75-
814,452. PUB. 6-11-2002, FILED 10-4-1999.

GLUON

FOR TELECOMMUNICATIONS GATEWAY,
NAMELY, VOICE, CELL AND PACKET SWITCHES
THAT FACILITATE LOCAL ACCESS, MULTIPLEXING,
SWITCHING AND TRANSPORT OF VOICE AND DATA
SERVICES (U.S. CLS. 21, 23, 26, 36 AND 38).
FIRST USE 11-8-2002; IN COMMERCE 11-8-2002.

2,764,626. YIANILOS, PETER N., PRINCETON, NJ. SN 75-
870,690. PUB. 3-20-2001, FILED 12-14-1999.

INTERMEMORY

FOR COMPUTER PROGRAMS FOR DIGITAL STO-
RAGE, RETRIEVAL AND BACKUP; COMPUTER SOFT-
WARE FOR ARCHIVING, STORING, MANAGING AND
MANIPULATING INFORMATION AND DIGITAL DATA
OVER COMPUTER NETWORKS (U.S. CLS. 21, 23, 26, 36
AND 38).

FIRST USE 6-1-1998; IN COMMERCE 1-1-2002.

CLASS 9—(Continued).

2,764,631. LEADER DRILLING, L.L.C., HOUSTON, TX. SN 75-886,637. PUB. 9-11-2001, FILED 1-4-2000.

THE MARK CONSISTS IN PART OF THE WORD "DRILL-RIGHT" WITH THE WORD "RIGHT" SHIFTED SLIGHTLY UP WITH RESPECT TO THE WORD "DRILL" AND THE LAST LETTER "L" IN THE WORD "DRILL" EXTENDING UNDER THE WORD "RIGHT" AND TERMINATING IN A HAND HOLDING A DRILL BIT.

FOR COMPUTER SOFTWARE FOR THE MANIPULATION AND VISUALIZATION OF DRILLING AND GEOLOGICAL INFORMATION AND DATA FOR USE IN THE PETROLEUM INDUSTRY (U.S. CLS. 21, 23, 26, 36 AND 38).

FIRST USE 10-31-2000; IN COMMERCE 1-31-2003.

2,764,634. NEW LIFE CHART, LLC, BELLEVUE, WA, BY ASSIGNMENT LIFECHART.COM, INC., MOUNTAIN VIEW, CA. SN 75-888,630. PUB. 11-7-2000, FILED 1-6-2000.

LIFECHART

OWNER OF U.S. REG. NO. 1,918,983.

FOR COMPUTER SOFTWARE, COMPUTER HARDWARE, COMPUTER PERIPHERALS AND MODEMS FOR RETRIEVING, ANALYZING AND TRANSMITTING DATA IN THE MEDICAL, FITNESS AND WEIGHT MANAGEMENT FIELD (U.S. CLS. 21, 23, 26, 36 AND 38).

FIRST USE 7-31-1999; IN COMMERCE 7-31-1999.

2,764,652. IMAGINATION TECHNOLOGIES LTD., HERTFORDSHIRE WD4 8LZ, UNITED KINGDOM. SN 75-924,270. PUB. 6-12-2001, FILED 2-22-2000.

SIROCCO

FOR AUDIO EQUIPMENT FOR PERSONAL COMPUTERS, NAMELY, AUDIO SPEAKERS; HI-FI EQUIPMENT, NAMELY, AUDIO SPEAKERS (U.S. CLS. 21, 23, 26, 36 AND 38).

FIRST USE 11-30-1998; IN COMMERCE 6-20-2000.

2,764,654. AVIONICS SPECIALTIES, INC., EARLYSVILLE, VA. SN 75-933,194. PUB. 1-15-2002, FILED 3-2-2000.

IMFP

FOR MULTIFUNCTION AIRCRAFT PROBE WITH INTEGRAL AIR DATA SENSORS, MOUNTED ON AIRCRAFT FUSELAGE FOR DETERMINING LOCAL AIR FLOW ANGLE RELATIVE TO THE AIRCRAFT, STATIC PRESSURE, TOTAL PRESSURE AND TOTAL TEMPERATURE (U.S. CLS. 21, 23, 26, 36 AND 38).

FIRST USE 3-28-2003; IN COMMERCE 3-28-2003.

CLASS 9—(Continued).

2,764,659. HILL, MARIANNE, LAS VEGAS, NV. AND ALLEN, MICHAEL D., LAS VEGAS, NV. SN 75-936,965. PUB. 10-8-2002, FILED 3-6-2000.

*A Mental Strategy to Maximize Your...
For Men and For Women*

NO CLAIM IS MADE TO THE EXCLUSIVE RIGHT TO USE "MENTAL STRATEGY" AND "FOR MEN AND FOR WOMEN", APART FROM THE MARK AS SHOWN.

FOR PRERECORDED AUDIO CASSETTES AND COMPACT DISCS FEATURING HYPNOTIC SESSIONS, VISUALIZATIONS, AND GUIDED MEDITATIONS, TO ENHANCE YOUR SPORTS ABILITY, SELF-ESTEEM, MOTIVATION, PRODUCTIVITY, PERFORMANCE, CONFIDENCE, SELF-IMAGE AND OVERCOMING STRESS, WEIGHT AND SMOKING ISSUES, PERSONAL LIMITATIONS, HABITS, FEARS, ANXIETY AND PAIN (U.S. CLS. 21, 23, 26, 36 AND 38).

FIRST USE 11-30-1999; IN COMMERCE 11-30-1999.

2,764,678. SANNAEDLE INSU CO., LTD., SEOUL, REPUBLIC OF KOREA. SN 76-011,052. PUB. 10-2-2001, FILED 3-24-2000.

CECROP

FOR ELECTRIC LOCK, AUTOMATED TELLER MACHINE, ELECTRONIC TIME CLOCK, CREDIT CARD PAYMENT AND PROCESSING TERMINAL, ELECTRONIC DOOR OPENER, ELECTRONIC DOOR CLOSER, COMPUTERS, COMPUTER MOUSE, AND COMPUTER KEYBOARDS (U.S. CLS. 21, 23, 26, 36 AND 38).

FIRST USE 6-0-2001; IN COMMERCE 4-18-2002.

2,764,681. COLEMAN CABLE SYSTEMS, INC., WAUKEGAN, IL. SN 76-017,601. PUB. 10-30-2001, FILED 3-29-2000.

SLENDER PLUG

NO CLAIM IS MADE TO THE EXCLUSIVE RIGHT TO USE "PLUG", APART FROM THE MARK AS SHOWN.

FOR ELECTRICAL EXTENSION CORDS (U.S. CLS. 21, 23, 26, 36 AND 38).

FIRST USE 6-0-2002; IN COMMERCE 7-0-2002.

CLASS 9—(Continued).

2,764,682. VIEWSONIC CORPORATION, WALNUT, CA. SN 76-018,598. PUB. 8-13-2002, FILED 4-5-2000.

NEXTVISION

FOR COMPUTER MONITORS; FLAT DISPLAY SCREENS FOR USE WITH COMPUTERS, NAMELY LCD/LIQUID CRYSTAL DISPLAY PANELS AND PLASMA DISPLAY PANELS; HIGH DEFINITION TELEVISION SET/DIGITAL TELEVISION SET; LCD/LIQUID CRYSTAL OR LCOS DISPLAY PROJECTORS THAT PROJECT IMAGES OF DATA OR VIDEO GENERATED FROM A COMPUTER OR A VIDEO SOURCE (U.S. CLS. 21, 23, 26, 36 AND 38).

FIRST USE 1-24-2003; IN COMMERCE 1-24-2003.

2,764,684. PYXIS CORPORATION, SAN DIEGO, CA. SN 76-020,635. PUB. 1-15-2002, FILED 4-7-2000.

OPTIVATION

FOR AUTOMATED POINT-OF-USE DISPENSING MACHINES AND MOBILE DISPENSING MACHINES FOR DISPENSING PARTS, COMPONENTS, TOOLS, SUPPLIES, MATERIALS AND OTHER MAINTENANCE, REPAIR AND OPERATING ITEMS USED IN ANY MANUFACTURING OR ASSEMBLY ENVIRONMENT; COMPUTER SOFTWARE FOR OPERATING SUCH DISPENSING MACHINES, TRACKING INVENTORY LEVELS OF ITEMS DISPENSED BY SUCH DISPENSING MACHINES AND ELECTRONIC INVENTORY REORDERING (U.S. CLS. 21, 23, 26, 36 AND 38).

FIRST USE 7-29-2002; IN COMMERCE 7-29-2002.

2,764,687. CAR ELECTRONICS APS, COPENHAGEN, DENMARK. SN 76-026,446. PUB. 9-17-2002, FILED 4-12-2000.

BLINDER

FOR LASER DETECTORS FOR DETECTING VEHICLE SPEED LASER GUNS; DEVICES FOR DETECTING AND ANALYZING VEHICLE SPEED LASER SIGNALS AND EMITTING OUTGOING JAMMING PULSES; AND COMPUTERS (U.S. CLS. 21, 23, 26, 36 AND 38).

FIRST USE 12-31-1997; IN COMMERCE 12-31-1997.

2,764,691. DATADIRECT NETWORKS, INC., CHATSWORTH, CA. SN 76-027,993. PUB. 2-13-2001, FILED 4-18-2000.

GALEFORCE

FOR APPLICATION SPECIFIC INTEGRATED CIRCUITS (U.S. CLS. 21, 23, 26, 36 AND 38).

FIRST USE 6-23-2000; IN COMMERCE 6-23-2000.

CLASS 9—(Continued).

2,764,702. BLUE CROSS AND BLUE SHIELD OF NEBRASKA, OMAHA, NE. SN 76-044,570. PUB. 10-16-2001, FILED 5-9-2000.

ECHO HEALTH

NO CLAIM IS MADE TO THE EXCLUSIVE RIGHT TO USE "HEALTH", APART FROM THE MARK AS SHOWN.

FOR COMPUTER SOFTWARE FOR USE TO ORGANIZE, VALIDATE AND TRANSFER DATA RELATING TO HEALTH INSURANCE COVERAGE, HEALTH INSURANCE TRANSACTIONS AND TO ASSIST OTHERS IN MAKING ON-LINE HEALTH INSURANCE CLAIMS (U.S. CLS. 21, 23, 26, 36 AND 38).

FIRST USE 8-0-2002; IN COMMERCE 8-0-2002.

2,764,709. EFPAC LIMITED, SWANSEA, WALES, UNITED KINGDOM, BY ASSIGNMENT IMAGITECH LIMITED, SWANSEA SA2 8PP, UNITED KINGDOM. SN 76-052,196. PUB. 1-8-2002, FILED 5-19-2000.

EFPAC

FOR COMPUTER SOFTWARE FOR THE PLANNING AND COSTING OF AIRCRAFT ENGINE MAINTENANCE (U.S. CLS. 21, 23, 26, 36 AND 38).

FIRST USE 8-0-2000; IN COMMERCE 5-0-2001.

2,764,711. CENIXDIGICOM CO., LTD., KYUNGGI-DO 440-290, REPUBLIC OF KOREA. SN 76-055,749. PUB. 9-10-2002, FILED 5-24-2000.

CENIX

FOR TELEPHONES, VIDEO PHONES, DIGITAL VOICE RECORDERS, PHOTO VOICE RECORDERS, MP3 PLAYERS, RADIO PAGERS, ELECTRONIC COMPUTERS, ELECTRONIC DICTIONARIES, DIGITAL CAMERAS, SOUND RECORDING AND PLAYING MACHINES, PDAS-PERSONAL DIGITAL ASSISTANTS AND CDPS-COMPACT DISC PLAYERS (U.S. CLS. 21, 23, 26, 36 AND 38).

FIRST USE 2-10-1998; IN COMMERCE 1-16-2002.

CLASS 9—(Continued).

2,764,712. GENKI CO., LTD., TOKYO 2-4-12, JAPAN, BY ASSIGNMENT; CRAVE ENTERTAINMENT, INC., RANCHO DOMINGUEZ, CA. SN 76-056,448. PUB. 2-26-2002, FILED 5-25-2000.

KENGO MASTER OF BUSHIDO

"KENGO" MEANS "SWORDMASTER" IN JAPANESE. "BUSHIDO" IS A JAPANESE WORD MEANING "A WAY OF LIFE BASED ON THE PRINCIPLES OF A JAPANESE LEADER AND SWORD FIGHTER".

FOR COMPUTER GAME PROGRAMS; COMPUTER GAME SOFTWARE; COMPUTER GAME CARTRIDGES; COMPUTER GAME DISCS; VIDEO GAME PROGRAMS; VIDEO GAME SOFTWARE; VIDEO GAME CARTRIDGES; AND VIDEO GAME DISCS (U.S. CLS. 21, 23, 26, 36 AND 38).

FIRST USE 12-14-2000; IN COMMERCE 1-4-2001.

CLASS 9—(Continued).

2,764,719. GEORGIA PUBLIC TELECOMMUNICATIONS COMMISSION, ATLANTA, GA. SN 76-063,195. PUB. 4-17-2001, FILED 6-5-2000.

i irasshai

THE ENGLISH TRANSLATION OF "IRASSHAI" IS "WELCOME".

FOR CD-ROM SOLD AS A COMPONENT OF A MULTIMEDIA, DISTANCE LEARNING CULTURE AND LANGUAGE EDUCATION PROGRAM (U.S. CLS. 21, 23, 26, 36 AND 38).

FIRST USE 8-26-2002; IN COMMERCE 8-26-2002.

2,764,714. ARTHUR COURT DESIGNS, INC., BRISBANE, CA. SN 76-058,426. PUB. 12-18-2001, FILED 5-30-2000.

ARTHUR COURT KITCHEN

OWNER OF U.S. REG. NO. 1,731,161.

NO CLAIM IS MADE TO THE EXCLUSIVE RIGHT TO USE "KITCHEN", APART FROM THE MARK AS SHOWN.

THE NAME "ARTHUR COURT" IDENTIFIES A LIVING INDIVIDUAL WHOSE CONSENT IS OF RECORD.

FOR KITCHEN TOOLS, NAMELY MEASURING CUPS AND MEASURING SPOONS (U.S. CLS. 21, 23, 26, 36 AND 38).

FIRST USE 12-9-2002; IN COMMERCE 12-9-0202.

2,764,726. ARTISTDIRECT, INC., LOS ANGELES, CA. SN 76-072,567. PUB. 3-27-2001, FILED 6-19-2000.



FOR COMPACT DISCS, PRE-RECORDED AUDIO TAPES, PRE-RECORDED DIGITAL AUDIO TAPES, AND PHONOGRAPH RECORDS FEATURING MUSICAL SOUND RECORDINGS AND OTHER RECORDINGS IN THE FIELDS OF MUSIC AND ENTERTAINMENT; PRE-RECORDED VIDEO TAPES, VIDEO RECORDINGS, VIDEO DISCS, DVDS, AND DOWNLOADABLE VIDEO RECORDINGS FEATURING MUSICAL AUDIOVISUAL PROGRAMS AND OTHER AUDIOVISUAL PROGRAMS IN THE FIELDS OF MUSIC AND ENTERTAINMENT (U.S. CLS. 21, 23, 26, 36 AND 38).

FIRST USE 3-0-2000; IN COMMERCE 3-0-2000.

2,764,716. THOMSON MULTIMEDIA INC., INDIANAPOLIS, IN, BY CHANGE OF NAME; BY CHANGE OF NAME THOMSON CONSUMER ELECTRONICS, INC., INDIANAPOLIS, IN. SN 76-061,072. PUB. 5-21-2002, FILED 6-1-2000.

SCENIUM

FOR TELEVISION SETS; VIDEO CASSETTE RECORDERS; DIGITAL VIDEO DISC PLAYERS; RADIOS; DISPLAY DEVICES, NAMELY, READERS FOR RECEIVING AND DISPLAYS ELECTRONICALLY PUBLISHED WORKS; DIGITAL MUSIC PLAYERS; DIGITAL STILL CAMERAS; CABLE TELEVISION RECEIVERS; DIGITAL AUDIO AND VIDEO RECEIVERS; COMPUTERS; COMPUTER HARDWARE FOR ACCESSING A GLOBAL COMPUTER NETWORK; CABLE MODEMS (U.S. CLS. 21, 23, 26, 36 AND 38).

FIRST USE 7-31-2001; IN COMMERCE 9-28-2002.

2,764,746. CREATIVE PHARMACY SOLUTIONS, INC., GRAPEVINE, TX. SN 76-083,054. PUB. 3-13-2001, FILED 7-5-2000.

AUTOPHARM

FOR SOFTWARE FOR PHARMACEUTICAL INVENTORY MANAGEMENT (U.S. CLS. 21, 23, 26, 36 AND 38).

FIRST USE 10-8-2002; IN COMMERCE 5-22-2003.

CLASS 9—(Continued).

2,764,748. DIGIGRAM, 38330 MONTBONNOT, FRANCE. SN 76-086,958. PUB. 11-19-2002, FILED 7-12-2000.

 The logo for miXart features the word "miXart" in a bold, lowercase, sans-serif font. A diagonal slash is drawn through the letter 'i', extending from the top right to the bottom left.

FOR APPARATUS FOR RECORDING, TRANSMISSION, REPRODUCTION, AND MIXING OF DIGITAL SOUND, NAMELY MICROPHONES, AUDIO SPEAKERS, COMPUTER HARDWARE AND SOFTWARE FOR MANIPULATING, EDITING, RECORDING, MIXING, STORING, PLAYING AND CREATING DIGITAL AUDIO DATA AND FOR FILE MANAGEMENT, COMPUTER AUDIO BOARDS, DIGITAL AND ANALOG AUDIO CABLES; APPARATUS AND INSTRUMENTS FOR TELECOMMUNICATIONS, NAMELY TELECOMMUNICATIONS TERMINALS, TELEPHONE AND RADIO TELEPHONE RECEIVERS AND TRANSMITTERS, AND NETWORK CONNECTION SOCKETS (U.S. CLS. 21, 23, 26, 36 AND 38).

FIRST USE 7-12-2001; IN COMMERCE 7-12-2001.

2,764,749. HASCO I.A. LIMITED, EARTH CITY, MO. SN 76-088,367. PUB. 6-11-2002, FILED 7-12-2000.

WEBNURSERY

OWNER OF U.S. REG. NOS. 2,369,918 AND 2,396,821. FOR NAMELY, COMPUTERS AND COMPUTER SOFTWARE FOR IMAGE PROCESSING AND DATABASE MANAGEMENT, COMPACT DISCS FOR STORAGE OF DIGITAL IMAGES (U.S. CLS. 21, 23, 26, 36 AND 38).

FIRST USE 6-30-2000; IN COMMERCE 6-30-2000.

2,764,751. QUEST SOFTWARE, INC., IRVINE, CA, BY CHANGE OF NAME; BY ASSIGNMENT; BY ASSIGNMENT SITRAKA INC., TORONTO ONTARIO, CANADA. SN 76-089,046. PUB. 9-24-2002, FILED 7-17-2000.

DEPLOYDIRECTOR

PRIORITY CLAIMED UNDER SEC. 44(D) ON CANADA APPLICATION NO. 1053047, FILED 3-30-2000, REG. NO. TMA560197, DATED 4-15-2002, EXPIRES 4-15-2017.

FOR COMPUTER SOFTWARE UTILITY DEVELOPMENT PROGRAMS WHICH ASSIST OR SUPPORT OTHER SOFTWARE PRODUCTS (U.S. CLS. 21, 23, 26, 36 AND 38).

FIRST USE 1-31-1999; IN COMMERCE 3-31-2000.

CLASS 9—(Continued).

2,764,754. MISSLER, CHUCK, COEUR D'ALENE, ID. SN 76-090,154. PUB. 5-22-2001, FILED 7-17-2000.

LEARN THE BIBLE IN 24 HOURS

FOR PRE-RECORDED CASSETTE TAPES AND COMPACT DISCS ON THE TOPIC OF RELIGION, NAMELY INTERPRETATION OF THE BIBLE (U.S. CLS. 21, 23, 26, 36 AND 38).

FIRST USE 8-9-2000; IN COMMERCE 8-9-2000.

2,764,770. EXTREMIS AUDIO, LLC, SEATTLE, WA. SN 76-104,686. PUB. 1-8-2002, FILED 8-7-2000.

ADIRE AUDIO

NO CLAIM IS MADE TO THE EXCLUSIVE RIGHT TO USE "AUDIO", APART FROM THE MARK AS SHOWN.

THE ENGLISH TRANSLATION OF "ADIRE" IS "ADVANCE OR APPROACH".

FOR AUDIO LOUDSPEAKERS (U.S. CLS. 21, 23, 26, 36 AND 38).

FIRST USE 10-1-2000; IN COMMERCE 10-1-2000.

2,764,775. CREATIVE COMPUTER APPLICATIONS, INC., CALABASAS, CA. SN 76-110,418. PUB. 5-28-2002, FILED 8-17-2000.

CyberPATH

FOR COMPUTER SOFTWARE FOR REPORTING ANATOMICAL PATHOLOGY AND CYTOLOGY PROCEDURES (U.S. CLS. 21, 23, 26, 36 AND 38).

FIRST USE 1-8-2000; IN COMMERCE 1-8-2000.

2,764,776. GENERAL CABLE TECHNOLOGIES CORPORATION, HIGHLAND HEIGHTS, KY. SN 76-110,438. PUB. 1-15-2002, FILED 8-16-2000.

POWRSERV

FOR ELECTRICAL POWER CABLES (U.S. CLS. 21, 23, 26, 36 AND 38).

FIRST USE 10-0-2001; IN COMMERCE 10-0-2001.

CLASS 9—(Continued).

2,764,780. MULTIMEDIA GAMES, INC., AUSTIN, TX. SN 76-111,152. PUB. 2-12-2002, FILED 8-11-2000.

WILD SPINNER

NO CLAIM IS MADE TO THE EXCLUSIVE RIGHT TO USE "SPINNER", APART FROM THE MARK AS SHOWN. FOR GAMING MACHINES, NAMELY, SLOT MACHINES WITH OR WITHOUT VIDEO DISPLAY (U.S. CLS. 21, 23, 26, 36 AND 38).

FIRST USE 3-29-2001; IN COMMERCE 3-29-2001.

2,764,781. ROWE INTERNATIONAL, INC., GRAND RAPIDS, MI. SN 76-116,321. PUB. 3-19-2002, FILED 8-24-2000.

STUDIO SOUND

NO CLAIM IS MADE TO THE EXCLUSIVE RIGHT TO USE "SOUND", APART FROM THE MARK AS SHOWN.

FOR MUSICAL JUKEBOXES; MUSICAL JUKEBOX SYSTEMS COMPRISED OF JUKEBOXES, SPEAKERS, AND INTERFACE SOFTWARE AND BOARDS USED TO CONNECT TO KARAOKE EQUIPMENT AND OTHER EXTERNAL SOURCE (U.S. CLS. 21, 23, 26, 36 AND 38).

FIRST USE 9-0-2000; IN COMMERCE 9-0-2000.

2,764,782. TATUNG SCIENCE & TECHNOLOGY, INC., FREMONT, CA. SN 76-116,517. PUB. 12-18-2001, FILED 8-25-2000.

TSTI

FOR COMPUTER HARDWARE AND SOFTWARE, NAMELY WORKSTATIONS, SERVERS, MICROPROCESSORS, DISK ARRAY STORAGE DEVICES, CENTRAL PROCESSING UNITS, CIRCUIT BOARDS, INTEGRATED CIRCUITS, COMPUTER PROGRAMS FOR OPERATING SYSTEMS AND USER MANUALS SOLD THEREWITH (U.S. CLS. 21, 23, 26, 36 AND 38).

FIRST USE 8-25-2000; IN COMMERCE 8-25-2000.

CLASS 9—(Continued).

2,764,783. CONVEDIA CORPORATION, VANCOUVER, BC, CANADA. SN 76-116,613. PUB. 3-26-2002, FILED 8-25-2000.

CONVEDIA

FOR COMPUTER HARDWARE, FIRMWARE, AND SOFTWARE PRODUCTS THAT ENABLE MULTIMEDIA SERVICES AND APPLICATIONS NAMELY SWITCHES, SERVERS, MULTIMEDIA DATA PROCESSORS AND MULTIMEDIA MICROPROCESSORS FOR USE WITH TELECOMMUNICATIONS NETWORKS FOR THE PURPOSE OF CONFERENCING, MESSAGE STORAGE, AND VOICE RECOGNITION; MULTIMEDIA DATA PROCESSORS AND MULTIMEDIA MICROPROCESSORS IMPLEMENTED WITH DIGITAL SIGNAL PROCESSORS, VERY LARGE SCALE INTEGRATED CIRCUITS, AND FIELD PROGRAMMABLE GATE ARRAYS; SOFTWARE FOR THE OPERATION AND CONTROL OF SWITCHES, SERVERS, MULTIMEDIA DATA PROCESSORS AND MULTIMEDIA MICROPROCESSORS; AND INSTRUCTIONAL DOCUMENTATION SOLD AS A UNIT WITH COMPUTER SOFTWARE AND HARDWARE (U.S. CLS. 21, 23, 26, 36 AND 38).

FIRST USE 3-30-2001; IN COMMERCE 3-30-2001.

2,764,794. ECTEL LTD., PETACH-TIKVA 49517, ISRAEL. SN 76-131,811. PUB. 6-25-2002, FILED 9-20-2000.

X-PERTVIEW

FOR TELECOMMUNICATION EQUIPMENT, NAMELY COMPUTER SOFTWARE AND HARDWARE AND PERIPHERAL EQUIPMENT FOR PERFORMING SYSTEM ANALYSIS, NAMELY PRODUCING DECISIONS, CALCULATIONS, EXCEPTIONS AND RECOMMENDATIONS ON DATA MEASURES FOR, BUT NOT LIMITED TO, QUALITY AND MONITORING FRAUD DETECTION (U.S. CLS. 21, 23, 26, 36 AND 38).

FIRST USE 11-30-2001; IN COMMERCE 11-30-2001.

2,764,796. LIFESTREAM TECHNOLOGIES, INC., POST FALLS, ID. SN 76-133,808. PUB. 9-17-2002, FILED 9-22-2000.

PERSONAL HEALTH CARD

NO CLAIM IS MADE TO THE EXCLUSIVE RIGHT TO USE "CARD", APART FROM THE MARK AS SHOWN.

FOR WALLET-SIZED CARDS CONTAINING A COMPUTER-READABLE MEMORY UNIT FOR STORING PERSONAL, MEDICAL AND FINANCIAL DATA AND ASSOCIATED SECURITY DATA AND SOFTWARE (U.S. CLS. 21, 23, 26, 36 AND 38).

FIRST USE 11-1-2000; IN COMMERCE 11-1-2000.

CLASS 9—(Continued).

2,764,797. GULFSTREAM AEROSPACE CORPORATION, SAVANNAH, GA. SN 76-133,988. PUB. 1-15-2002, FILED 9-21-2000.

PLANEVIEW

FOR AIRCRAFT AVIONICS SYSTEMS CONSISTING OF COMPUTER HARDWARE AND COMPUTER SOFTWARE FOR AIRPLANE COMMUNICATION, AIRPLANE NAVIGATION AND IMPROVED SITUATIONAL AWARENESS OF AIRPORTS, WEATHER, AIR TRAFFIC AND TERRAIN; INTEGRATED PILOTS' PRIMARY FLIGHT DISPLAYS AND MULTIFUNCTION DISPLAYS, ALL SOLD AS A COMPONENT OF AN AIRPLANE (U.S. CLS. 21, 23, 26, 36 AND 38).

FIRST USE 10-9-2000; IN COMMERCE 10-9-2000.

2,764,804. COBRA ELECTRONICS CORPORATION, CHICAGO, IL. SN 76-136,738. PUB. 7-2-2002, FILED 9-27-2000.

SNAP

FOR RADIO COMPONENTS, NAMELY, REMOVABLE RADIO COVERS (U.S. CLS. 21, 23, 26, 36 AND 38).

FIRST USE 12-0-2002; IN COMMERCE 3-0-2001.

2,764,806. AQS, INC., HARTLAND, WI. SN 76-137,209. PUB. 9-10-2002, FILED 9-28-2000.

GALILEO

FOR COMPUTER SOFTWARE FOR USE IN PROCESSING, RATING AND CODING INSURANCE POLICIES IN THE FIELD OF COMMERCIAL INSURANCE (U.S. CLS. 21, 23, 26, 36 AND 38).

FIRST USE 9-0-2000; IN COMMERCE 10-0-2001.

CLASS 9—(Continued).

2,764,808. RUEDA, DANIEL, 75016 PARIS, FRANCE. SN 76-138,380. PUB. 6-11-2002, FILED 9-29-2000.

OPENPRICER

FOR COMPUTER SOFTWARE THAT CALCULATES OPTIMAL PRICES FOR GOODS AND SERVICES AND PROVIDES DECISION SUPPORT TO ENTERPRISES IN THE PRICING AREA BASED ON COSTS, CONSUMER WILLINGNESS TO PAY, COMPETITIVE OFFERINGS, MARKETING STRATEGIES, MORE SPECIFICALLY SOFTWARE THAT CALCULATES THE PRICE OF AN ORDER BASED ON PRICING RULES INVOLVING PRODUCT FEATURES, TIME, TYPE OF CUSTOMER, MARKET SEGMENT AND CHANNEL OF DISTRIBUTION, STATISTICAL MODELING OF CUSTOMER RESPONSE FOR THE GLOBAL MARKET OF THE FIRM; FOR A SPECIFIC MARKET SEGMENT OR FOR A PARTICULAR CUSTOMER AS A FUNCTION OF PRICE, PROMOTIONS OR ADVERTISING, CALCULATION OF THE OPTIMAL ALLOCATION OF PRODUCTION OR OPERATING RESOURCES IN FUNCTION OF A DEMAND FORECAST BY PRODUCT OR MARKET SEGMENT, CALCULATION OF THE MARGINAL AND OPPORTUNITY COSTS OF THE PRODUCTS AND THE RESOURCES BASED ON THIS ALLOCATION, CALCULATION OF THE OPTIMAL PRICE FOR A GIVEN PRODUCT, FOR A SET OF PRODUCTS OR FOR AN OPEN OR GLOBAL CONTRACT BASED ON AT LEAST ONE OF THE FOLLOWING ELEMENTS; STATISTICAL MODELING OF CUSTOMER RESPONSE, BUYING PROFILE OF THE CUSTOMER, COST STRUCTURE, COMPETITIVE OFFERINGS, PRICING STRATEGIES BY PRODUCT, MARKET SEGMENT OR CUSTOMERS (U.S. CLS. 21, 23, 26, 36 AND 38).

FIRST USE 2-0-2002; IN COMMERCE 2-0-2002.

2,764,809. PACKETLIGHT NETWORKS, LTD., KFAR SABA, ISRAEL. SN 76-138,576. PUB. 9-3-2002, FILED 9-29-2000.

CENTRALIGHT

FOR TELECOMMUNICATIONS NETWORKING HARDWARE THAT ENABLES THE AGGREGATION OF NETWORK SERVICES, SUCH AS VOICE, DATA, AND VIDEO, FROM MULTIPLE OPTICAL NETWORKS AND THE CONNECTION THEREOF TO TELEPHONE, CABLE, INTERNET, AND PRIVATE LINE SERVICE PROVIDER NETWORKS (U.S. CLS. 21, 23, 26, 36 AND 38).

FIRST USE 1-1-2001; IN COMMERCE 1-1-2001.

CLASS 9—(Continued).

2,764,812. F.J. TIEMAN B. V., 3235 XK ROCKANJE, NETHERLANDS. SN 76-139,906. PUB. 8-27-2002, FILED 10-2-2000.

 **Braille Voyager:**

PRIORITY CLAIMED UNDER SEC. 44(D) ON BENELUX APPLICATION NO. 967,943, FILED 6-29-2000, REG. NO. 0669168, DATED 6-29-2000, EXPIRES 6-29-2010.

NO CLAIM IS MADE TO THE EXCLUSIVE RIGHT TO USE "BRAILLE", APART FROM THE MARK AS SHOWN. THE MARK CONSISTS OF A DESIGN OF A SOLID CURVE WITH A SOLID OVAL RESTING ON THE INSIDE OF THE CURVE FOLLOWED BY THE WORDS "BRAILLE VOYAGER" AND A COLON.

FOR BRAILLE READING APPARATUS; BRAILLE READING APPARATUS IN THE SHAPE OF A KEYBOARD (U.S. CLS. 21, 23, 26, 36 AND 38).

FIRST USE 1-0-2002; IN COMMERCE 1-0-2002.



2,764,819. FRANK RUSSELL COMPANY, TACOMA, WA. SN 76-143,571. PUB. 6-25-2002, FILED 10-5-2000.

R U S S E L L
EMPulse

OWNER OF U.S. REG. NOS. 1,576,348, 1,945,514, AND OTHERS.

FOR ELECTRONIC PUBLICATIONS, NAMELY, FINANCIAL AND INVESTMENT REPORTS RECORDED ON COMPUTER READABLE MEDIA (U.S. CLS. 21, 23, 26, 36 AND 38).

FIRST USE 10-18-2002; IN COMMERCE 10-18-2002.



2,764,822. SMEAD MANUFACTURING COMPANY, HASTINGS, MN. SN 76-148,476. PUB. 9-17-2002, FILED 10-17-2000.

COLORBAR CLICKFILE

OWNER OF U.S. REG. NO. 2,016,335.

FOR COMPUTER PRINTING SOFTWARE; COMPUTER SOFTWARE FOR PRINTING LABELS ON FOLDERS AND FILE FOLDERS (U.S. CLS. 21, 23, 26, 36 AND 38).

FIRST USE 11-0-2000; IN COMMERCE 11-0-2000.

CLASS 9—(Continued).

2,764,824. SEMROCK, INC., ANNAPOLIS, MD. SN 76-149,659. PUB. 10-8-2002, FILED 10-18-2000.

SEMROCK

FOR OPTICAL AND FIBEROPTIC COMPONENTS FOR TELECOMMUNICATIONS AND DATA COMMUNICATIONS INDUSTRIES, NAMELY, OPTICAL FILTERS, OPTICAL SWITCHES, OPTICAL COLLIMATORS, VARIABLE OPTICAL ATTENUATORS, OPTICAL FIBER, OPTICAL AMPLIFIERS AND OPTICAL MODULES; OPTICAL COMPONENT SYSTEMS COMPRISED OF OPTICAL CROSS CONNECTS AND RESTORATION SWITCHES (U.S. CLS. 21, 23, 26, 36 AND 38).

FIRST USE 4-0-2003; IN COMMERCE 4-0-2003.



2,764,828. WANDERING RECORDS, INC., PORTLAND, OR. SN 76-152,691. PUB. 7-2-2002, FILED 10-23-2000.

WANDERING RECORDS

NO CLAIM IS MADE TO THE EXCLUSIVE RIGHT TO USE "RECORDS", APART FROM THE MARK AS SHOWN.

FOR PHONOGRAPH RECORDS FEATURING MUSIC, VIDEO RECORDINGS FEATURING MUSIC, PRE-RECORDED COMPACT DISCS AND PRE-RECORDED CASSETTE TAPES FEATURING MUSIC, DOWNLOADABLE MUSICAL SOUND RECORDINGS, DOWNLOADABLE VIDEO RECORDINGS FEATURING PRE-RECORDED MUSICAL PERFORMANCES (U.S. CLS. 21, 23, 26, 36 AND 38).

FIRST USE 2-14-2003; IN COMMERCE 3-9-2003.



2,764,836. TRANSFORMATION SOFTWARE, INC., GUELPH, ONTARIO N1G 3M5, CANADA. SN 76-158,620. PUB. 9-24-2002, FILED 11-2-2000.



NO CLAIM IS MADE TO THE EXCLUSIVE RIGHT TO USE "SOFTWARE", APART FROM THE MARK AS SHOWN.

FOR COMPUTER SOFTWARE, NAMELY ENGINEERING APPLICATIONS SOFTWARE FOR USE IN AUTOMOTIVE PARTS MANUFACTURING INDUSTRY, AND PRINTED MATERIALS, NAMELY INSTRUCTION MANUALS AND USER MANUALS FOR COMPUTER SOFTWARE PROGRAM DISTRIBUTED THEREWITH (U.S. CLS. 21, 23, 26, 36 AND 38).

FIRST USE 1-20-2000; IN COMMERCE 11-17-2000.

CLASS 9—(Continued).

2,764,843. SIMPLETECH, INC., SANTA ANA, CA. SN 76-161,386. PUB. 6-25-2002, FILED 11-7-2000.

DRIVELINK

FOR COMPUTER HARDWARE, NAMELY, A DATA TRANSFER KIT COMPRISED OF A PC CARD (PCMCIA) INTERFACE AND DATA TRANSFER SOFTWARE FOR NOTEBOOK HARD DRIVES (U.S. CLS. 21, 23, 26, 36 AND 38).

FIRST USE 1-0-2001; IN COMMERCE 1-0-2001.

2,764,849. KEYBOWL, INC., WINTER PARK, FL. SN 76-163,241. PUB. 4-2-2002, FILED 11-10-2000.



NO CLAIM IS MADE TO THE EXCLUSIVE RIGHT TO USE "KEYLESS KEYBOARD", APART FROM THE MARK AS SHOWN.

FOR COMBINATION COMPUTER KEYBOARD AND COMPUTER MOUSE (U.S. CLS. 21, 23, 26, 36 AND 38).
FIRST USE 1-31-2003; IN COMMERCE 1-31-2003.

2,764,850. SOS COMPUTER SYSTEMS, INC., OREM, UT. SN 76-164,488. PUB. 2-4-2003, FILED 11-9-2000.



FOR COMPUTER SOFTWARE FOR USE IN CREDIT UNION DATA BASE MANAGEMENT; COMPUTER OPERATING SYSTEMS FOR USE BY CREDIT UNIONS (U.S. CLS. 21, 23, 26, 36 AND 38).

FIRST USE 11-0-1998; IN COMMERCE 11-0-1998.

CLASS 9—(Continued).

2,764,852. INTERNATIONAL BUSINESS MACHINES CORPORATION, ARMONK, NY, BY ASSIGNMENT LOTUS DEVELOPMENT CORPORATION, CAMBRIDGE, MA. SN 76-165,051. PUB. 4-30-2002, FILED 11-14-2000.

LOTUS DISCOVERY SERVER

NO CLAIM IS MADE TO THE EXCLUSIVE RIGHT TO USE "SERVER", APART FROM THE MARK AS SHOWN.

FOR COMPUTER SOFTWARE, NAMELY, SOFTWARE FOR USE IN ORGANIZING, EXTRACTING, SEARCHING AND STORING DATA; AND FOR ORGANIZATION OF INFORMATION SUCH AS SPREADSHEETS, E-MAIL, AND DATABASES; CREATING CONTENT CATEGORIES, AND HIERARCHICAL MAPPING, ACROSS A GLOBAL COMPUTER INFORMATION NETWORK OR CORPORATE INTRANET AND OTHER KNOWLEDGE MANAGEMENT APPLICATIONS (U.S. CLS. 21, 23, 26, 36 AND 38).

FIRST USE 4-0-2000; IN COMMERCE 4-0-2000.

2,764,854. CMC MAGNETICS CORPORATION, TAIPEI, 104, TAIWAN. SN 76-166,120. PUB. 10-23-2001, FILED 11-15-2000.

POCKET ENTERTAINMENT

FOR PERSONAL DIGITAL ASSISTANTS (PDA); ELECTRONIC PERSONAL ORGANIZERS; HANDHELD COMPUTERS (U.S. CLS. 21, 23, 26, 36 AND 38).

FIRST USE 11-22-2002; IN COMMERCE 11-22-2002.

2,764,858. PHARMETRICS, INC., WATERTOWN, MA. SN 76-168,223. PUB. 7-23-2002, FILED 11-20-2000.

PHARMETRICS

FOR ELECTRONIC DATABASES AND RELATED ANALYSES REGARDING CLINICAL AND PHARMACEUTICAL PRODUCTS AND SERVICES TO PAYERS, PROVIDERS, PHARMACEUTICAL COMPANIES AND MANAGED CARE ORGANIZATIONS RECORDED ON COMPUTER STORAGE MEDIA; COMPUTER PROGRAMS FOR USE IN ACCESSING AND USING SUCH DATABASES AND ANALYSES (U.S. CLS. 21, 23, 26, 36 AND 38).

FIRST USE 10-0-2000; IN COMMERCE 10-0-2000.

CLASS 9—(Continued).

2,764,860. INTERNET ACCESS TECHNOLOGIES, INC., HOUSTON, TX. SN 76-170,172. PUB. 6-11-2002, FILED 11-22-2000.

IAT

FOR COMMUNICATIONS SOFTWARE FOR CONNECTING COMPUTER USERS TO A GLOBAL COMPUTER NETWORK AND FOR ALLOWING COMPUTER USERS TO ACCESS ON-LINE SOFTWARE APPLICATIONS, NAMELY, WORD PROCESSING, SPREADSHEET, DATABASE, PERSONAL INFORMATION MANAGEMENT, FILE MANAGEMENT, AND EMAIL APPLICATIONS, AND APPLICATIONS THAT PROVIDE A USER WITH THE ABILITY TO DESIGN AND CREATE DATA ARCHIVING SYSTEMS, TO SEND PRINTING INSTRUCTIONS VIA A GLOBAL COMPUTER NETWORK TO A REMOTE PRINTER, AND TO DEVELOP MULTIMEDIA PRESENTATIONS BY INTEGRATING TEXT, AUDIO, GRAPHICS, STILL IMAGES AND/OR MOVING PICTURES (U.S. CLS. 21, 23, 26, 36 AND 38).
FIRST USE 8-20-2001; IN COMMERCE 8-20-2001.

2,764,923. STANER ELETRONICA LTDA., SN-KM 68 PRESIDENTE PRUDENTE - SP, BRAZIL. SN 76-218,445. PUB. 5-21-2002, FILED 3-1-2001.



FOR COMMUNICATION EQUIPMENT AND COMPONENTS, NAMELY, TELEPHONES AND CELLULAR PHONES, COMPUTERS, HUBS, SERVERS AND COMMUNICATIONS SOFTWARE FOR CONNECTING COMPUTER NETWORK USERS AND GLOBAL COMPUTER NETWORKS; AUDIO ENCLOSURES; AUDIO MIXERS; AUDIO EQUALIZERS; POWER AMPLIFIERS; SOUND AND DATA PROCESSING EQUIPMENT, NAMELY, COMPUTERS AND DATA PROCESSORS; AND APPARATUS FOR RECORDING, TRANSMISSION OR REPRODUCTION OF SOUND OR IMAGES, NAMELY, PLAYERS AND RECORDERS FOR MAGNETIC TAPES, CDS, CD-ROMS, CD-RS, CD-RWS, DVDS, DVD-RS, DVD-RAMS, FLOPPY DISCS AND HARD DISCS, VIDEO CAMERAS, TELEVISIONS, AUDIO SPEAKERS, VIDEO MONITORS, FILM PROJECTORS AND SLIDE PROJECTORS (U.S. CLS. 21, 23, 26, 36 AND 38).
FIRST USE 9-4-2001; IN COMMERCE 9-4-2001.

CLASS 9—(Continued).

2,764,924. TED PELLA INC., REDDING, CA. SN 76-218,684. PUB. 1-1-2002, FILED 3-5-2001.

PELCO TissueVac

FOR LABORATORY EQUIPMENT, NAMELY, A SYSTEM CONSISTING OF A VACUUM CHAMBER, TEMPERATURE PROBE, CASSETTE HOLDER, INTERCHANGEABLE TRAYS, AND GRANITE STONE FOR MICROWAVE OVEN USE IN HISTOLOGY AND PATHOLOGY LABORATORIES (U.S. CLS. 21, 23, 26, 36 AND 38).
FIRST USE 5-30-2002; IN COMMERCE 5-30-2002.

2,764,925. ALIEN TECHNOLOGY CORPORATION, HAYWARD, CA. SN 76-219,592. PUB. 7-30-2002, FILED 3-6-2001.



FOR ELECTRONIC AND FLAT PANEL DISPLAYS FOR USE IN ELECTRONIC SIGNS, CELLULAR TELEPHONES, PERSONAL DIGITAL ASSISTANTS, PAGERS, CALCULATORS, HANDHELD GAMES, WATCHES, SMART CARDS, AUDIO AND VIDEO EQUIPMENT, AND AUTOMOBILES; MICRO-ELECTRO-MECHANICAL MACHINES, NAMELY, ACCELEROMETERS, ACTUATORS, SENSORS, AND MECHANICAL SWITCHES; PHOTONIC DEVICES, NAMELY, LASERS FOR NON-MEDICAL USE, LIGHT WAVEGUIDES, LIGHT FILTERS AND MODULATORS; ELECTRO-OPTICAL FILMS AND SUBSTRATES FOR USE IN FORMING LIGHT-HANDLING DEVICES; OPTO-ELECTRONIC INTEGRATED CIRCUITS, PHOTONIC INTEGRATED CIRCUITS, MULTIPLEXERS, LIGHT AMPLIFIERS, OPTICAL AMPLIFIERS, FIBER OPTIC AMPLIFIERS, PARAMETRIC OPTICAL AMPLIFIERS, SPATIAL LIGHT MODULATORS, OPTICAL SENSORS AND MICROWAVE SENSORS; PHOTONIC AND OPTICAL COMPONENTS, NAMELY, LENSES, MIRRORS, ENCODERS, SOLAR CELLS, SCALES, OPTICAL LENSES AND MIRRORS FEATURING THIN-FILM CHEMICAL COATINGS; IDENTIFICATION AND INVENTORY TAGS AND LABELS WHICH USE RADIO FREQUENCY TO COMMUNICATE INFORMATION TO COMPUTERS; ELECTRONIC AND RADIO FREQUENCY TRANSMITTERS, RECEIVERS AND PROCESSORS (U.S. CLS. 21, 23, 26, 36 AND 38).
FIRST USE 2-18-2002; IN COMMERCE 2-18-2002.

CLASS 9—(Continued).

2,764,931. SYNAPSE, INC., HUNTSVILLE, AL. SN 76-222,275. PUB. 5-14-2002, FILED 3-9-2001.

SYNAPSE

FOR EMBEDDED COMPUTER HARDWARE AND SOFTWARE FOR USE IN SMART DEVICES NAMELY SINKS, TOILETS, AND OTHER WATER FLOW CONTROL DEVICES USED IN RESIDENTIAL AND INDUSTRIAL ENVIRONMENTS TO PERFORM THE FOLLOWING FUNCTIONS - COLLECTION AND MONITORING OF INFORMATION RELATED TO THE SMART DEVICES, NAMELY, POWER SUPPLY, POWER OUTPUT, ACTIVATION, DEACTIVATION, FLOW, AND MOTION SENSORS; AND CALIBRATION AND ALTERATION OF THE SMART DEVICE SETTINGS RELATED TO POWER SUPPLY, POWER OUTPUT, ACTIVATION, DEACTIVATION, FLOW, AND MOTION SENSORS (U.S. CLS. 21, 23, 26, 36 AND 38).
FIRST USE 2-21-2001; IN COMMERCE 3-30-2001.

2,764,934. CONWEST RESOURCES INC., SAN FRANCISCO, CA. SN 76-223,374. PUB. 12-18-2001, FILED 3-12-2001.

HOT HAND PRODUCTIONS

NO CLAIM IS MADE TO THE EXCLUSIVE RIGHT TO USE "PRODUCTIONS", APART FROM THE MARK AS SHOWN.
FOR PRERECORDED VIDEOTAPES AND DIGITAL VIDEO DISCS FEATURING ADULT ENTERTAINMENT (U.S. CLS. 21, 23, 26, 36 AND 38).
FIRST USE 12-12-2000; IN COMMERCE 4-24-2001.

2,764,936. BUREAU OF THE PUBLIC DEBT, WASHINGTON, DC. SN 76-224,125. PUB. 7-9-2002, FILED 3-14-2001.

SAVINGS BOND PRO

OWNER OF U.S. REG. NO. 2,350,301.
NO CLAIM IS MADE TO THE EXCLUSIVE RIGHT TO USE "SAVINGS BOND", APART FROM THE MARK AS SHOWN.
FOR COMPUTER SOFTWARE THAT COMPUTES THE VALUE OF US SAVINGS BONDS FOR BOND PAYING AGENTS (U.S. CLS. 21, 23, 26, 36 AND 38).
FIRST USE 11-1-2002, 08/15/1997; IN COMMERCE 11-1-2002, 08/15/1997.

2,764,938. PARAGON VISION SCIENCES, INC., MESA, AZ. SN 76-224,809. PUB. 8-28-2001, FILED 3-13-2001.

SLEEP YOUR WAY TO GREAT VISION

FOR CONTACT LENSES (U.S. CLS. 21, 23, 26, 36 AND 38).
FIRST USE 7-1-2002; IN COMMERCE 4-1-2003.

CLASS 9—(Continued).

2,764,943. OCCUNOMIX INTERNATIONAL LLC, NEW YORK, NY, BY ASSIGNMENT OCCUNOMIX INTERNATIONAL INC., PORT JEFFERSON STATION, NY. SN 76-232,664. PUB. 12-18-2001, FILED 3-29-2001.

GULFPORT

FOR PROTECTIVE CLOTHING FOR INDUSTRIAL USE, NAMELY, JACKETS, PANTS, APRONS, SLEEVES, SHIRTS, COATS AND FLAME-RESISTANT PROTECTIVE OVERALLS (U.S. CLS. 21, 23, 26, 36 AND 38).
FIRST USE 8-1-2001; IN COMMERCE 8-1-2001.

2,764,995. RELIANT RESOURCES, INC., HOUSTON, TX, BY ASSIGNMENT RELIANT ENERGY, INCORPORATED, HOUSTON, TX. SN 76-263,578. PUB. 7-2-2002, FILED 5-25-2001.

ENERGY COMMANDER

NO CLAIM IS MADE TO THE EXCLUSIVE RIGHT TO USE "ENERGY", APART FROM THE MARK AS SHOWN.
FOR SYSTEMS COMPRISED OF COMPUTER HARDWARE AND INTEGRATED COMPUTER SOFTWARE FOR COMMUNICATIONS, AND FOR MONITORING, CONTROLLING, AND MANAGING ENVIRONMENTAL CONDITIONS AND ENERGY USAGE (U.S. CLS. 21, 23, 26, 36 AND 38).
FIRST USE 5-0-2001; IN COMMERCE 5-0-2001.

2,764,996. HARRIS CORPORATION, MELBOURNE, FL. SN 76-263,723. PUB. 9-18-2001, FILED 5-29-2001.

EVERYTHING YOUR NETWORK NEEDS

FOR COMPUTER SOFTWARE AND MANUALS AND DOCUMENTATION DISTRIBUTED AS A UNIT THEREWITH FOR NETWORK MANAGEMENT (U.S. CLS. 21, 23, 26, 36 AND 38).
FIRST USE 5-19-2003; IN COMMERCE 5-19-2003.

2,764,999. APPLIED SIGNAL TECHNOLOGY, INC., SUNNYVALE, CA, BY ASSIGNMENT TRANSCENDENT TECHNOLOGIES, INC., SUNNYVALE, CA. SN 76-264,613. PUB. 5-7-2002, FILED 5-30-2001.

DOUBLETALK

FOR COMPUTER HARDWARE FOR DIGITAL SATELLITE SIGNAL PROCESSING (U.S. CLS. 21, 23, 26, 36 AND 38).
FIRST USE 9-0-2000; IN COMMERCE 9-0-2000.

CLASS 9—(Continued).

2,765,000. SNOWSHORE NETWORKS, INC., CHELMSFORD, MA. SN 76-264,679. PUB. 12-4-2001, FILED 5-30-2001.

SNOWSHORE

FOR COMPUTER HARDWARE, NAMELY, MEDIA SERVERS USED FOR MEDIA PROCESSING ON IP NETWORKS TO DELIVER ENHANCED SERVICES (U.S. CLS. 21, 23, 26, 36 AND 38).

FIRST USE 6-4-2002; IN COMMERCE 8-18-2002.

2,765,005. THOMAS & BETTS INTERNATIONAL, INC., SPARKS, NV. SN 76-265,052. PUB. 12-25-2001, FILED 5-31-2001.

CABLE RANGER

NO CLAIM IS MADE TO THE EXCLUSIVE RIGHT TO USE "CABLE", APART FROM THE MARK AS SHOWN.

FOR ELECTRICAL TERMINATORS FOR POWER DISTRIBUTION CABLE SYSTEMS (U.S. CLS. 21, 23, 26, 36 AND 38).

FIRST USE 2-1-2002; IN COMMERCE 2-1-2002.

2,765,007. CONCENTRIC SYSTEMS, INC., ALPHARETTA, GA. SN 76-265,435. PUB. 5-21-2002, FILED 6-1-2001.



OWNER OF U.S. REG. NO. 2,284,586.
FOR COMPUTERS, NAMELY, COMPUTER HARDWARE, TERMINALS AND MONITORS (U.S. CLS. 21, 23, 26, 36 AND 38).

FIRST USE 6-0-2001; IN COMMERCE 6-0-2001.

2,765,013. MICREL, INCORPORATED, SAN JOSE, CA. SN 76-266,697. PUB. 10-15-2002, FILED 6-4-2001.

QWIKRADIO

FOR SEMICONDUCTOR DEVICES AND INTEGRATED CIRCUITS (U.S. CLS. 21, 23, 26, 36 AND 38).

FIRST USE 3-20-2003; IN COMMERCE 3-20-2003.

CLASS 9—(Continued).

2,765,014. MICREL, INCORPORATED, SAN JOSE, CA. SN 76-266,699. PUB. 10-15-2002, FILED 6-4-2001.

SUPERLITE

FOR SEMICONDUCTOR DEVICES AND INTEGRATED CIRCUITS (U.S. CLS. 21, 23, 26, 36 AND 38).

FIRST USE 3-20-2003; IN COMMERCE 3-20-2003.

2,765,025. YAMAMOTO ENTERPRISES, LLC, TEMPE, AZ. SN 76-269,578. PUB. 3-19-2002, FILED 6-11-2001.



FOR LIFE JACKETS, LIFE NETS, LIFE PRESERVERS, LIFE BUOYS, LIFE SAVING RAFTS, SUNGLASSES, EYEGLOSS STRAPS AND CHAINS, BINOCULARS, SAFETY GOGGLES, AND THERMOMETERS USED FOR FISHING (U.S. CLS. 21, 23, 26, 36 AND 38).

FIRST USE 3-1-2003; IN COMMERCE 3-1-2003.

2,765,042. SIGE SEMICONDUCTOR INC., OTTAWA, ONTARIO, CANADA. SN 76-276,665. PUB. 9-17-2002, FILED 6-26-2001.

STREAMCHARGER

PRIORITY CLAIMED UNDER SEC. 44(D) ON CANADA APPLICATION NO. 1,101,447, FILED 5-2-2001.

FOR INTEGRATED CIRCUITS, MULTI-CHIP MODULES, AND INTEGRATED CIRCUITS WITH PASSIVE COMPONENT MODULES (U.S. CLS. 21, 23, 26, 36 AND 38).

FIRST USE 4-0-2002; IN COMMERCE 4-0-2002.

CLASS 9—(Continued).

2,765,055. SMART PRODUCTS, INC., TEMPE, AZ. SN 76-282,308. PUB. 3-5-2002, FILED 7-9-2001.



FOR ELECTRICAL RECEPTACLES FOR WALL OUTLETS (U.S. CLS. 21, 23, 26, 36 AND 38).

FIRST USE 5-23-2003; IN COMMERCE 5-23-2003.

2,765,063. LEAD DATA USA, CERRITOS, CA. SN 76-288,440. PUB. 1-21-2003, FILED 7-18-2001.

LEAD DATA

NO CLAIM IS MADE TO THE EXCLUSIVE RIGHT TO USE "DATA", APART FROM THE MARK AS SHOWN.

FOR COMPUTER PRODUCTS, NAMELY, BLANK OPTICAL MEDIA UPON WHICH IS RECORDED DIGITAL AND COMPUTER DATA, NAMELY, COMPACT DISCS, AUDIO CASSETTES, VIDEO CASSETTES, DIGITAL CAMERAS, PERSONAL DIGITAL ASSISTANTS, MEMORY CARDS, UNIVERSAL SERIAL BUS AND FIRE WIRE-BASED MEMORY CARD READERS, HUBS, COMPUTER ADAPTERS, NAMELY, CABLE ADAPTERS, CIRCUIT BOARD ADAPTERS, AND ADAPTERS FOR PLUGGING INTO A GROUND CONTACT SOCKET OUTLET FOR EQUIPMENT PROTECTION (U.S. CLS. 21, 23, 26, 36 AND 38).

FIRST USE 1-8-2001; IN COMMERCE 1-8-2001.

2,765,070. MEYERS, ROBERT, MIAMI, FL. SN 76-290,736. PUB. 2-12-2002, FILED 7-25-2001.

PULPCHAT

FOR SOFTWARE FOR ACCESSING, AND OPERATING A CHAT ROOM ACCESSIBLE THROUGH A GLOBAL COMPUTER NETWORK (U.S. CLS. 21, 23, 26, 36 AND 38).

FIRST USE 6-22-2002; IN COMMERCE 6-22-2002.

CLASS 9—(Continued).

2,765,072. WHEELER, JOHN, NASHVILLE, TN. SN 76-292,190. PUB. 9-3-2002, FILED 7-30-2001.

HAYSEED DIXIE

FOR SERIES OF PRE-RECORDED AUDIO TAPES, CASSETTES, COMPACT DISCS, DIGITAL AUDIO DISCS AND RECORDS FEATURING MUSIC; A SERIES OF PRE-RECORDED VIDEO TAPES AND DIGITAL VIDEO DISCS FEATURING MUSIC; DOWNLOADABLE MUSICAL SOUND RECORDINGS; AND DOWNLOADABLE MUSICAL VIDEO RECORDINGS (U.S. CLS. 21, 23, 26, 36 AND 38).

FIRST USE 4-17-2001; IN COMMERCE 5-21-2002.

2,765,086. SPEECHWORKS INTERNATIONAL, INC., BOSTON, MA. SN 76-298,196. PUB. 12-18-2001, FILED 8-10-2001.

SPEECH2GO

FOR SPEECH RECOGNITION SOFTWARE (U.S. CLS. 21, 23, 26, 36 AND 38).

FIRST USE 5-3-2002; IN COMMERCE 3-10-2003.

2,765,093. SHERRY, MARK, GRANADA HILLS, CA. SN 76-299,531. PUB. 3-19-2002, FILED 8-15-2001.

SHERRY JAM RECORDS

NO CLAIM IS MADE TO THE EXCLUSIVE RIGHT TO USE "RECORDS", APART FROM THE MARK AS SHOWN.

FOR SERIES OF PRERECORDED COMPACT DISCS, AUDIOCASSETTES AND PHONOGRAPH RECORDS FEATURING MUSICAL SOUND RECORDINGS (U.S. CLS. 21, 23, 26, 36 AND 38).

FIRST USE 1-1-1998; IN COMMERCE 10-1-2002.

2,765,095. WESTCO SCIENTIFIC INSTRUMENTS, INC., DANBURY, CT. SN 76-299,950. PUB. 6-11-2002, FILED 8-15-2001.

SMARTCHEM

FOR ELECTRONIC EQUIPMENT IN THE NATURE OF SPECTROMETERS, PHOTOMETERS, AUTOMATED ANALYZERS, AND WATER TEST KITS COMPRISED OF SAMPLE CONTAINERS, REAGENTS AND COLOR TEST STANDARDS, FOR THE PREPARATION AND TESTING OF WATER SAMPLES FOR A VARIETY OF NUTRIENTS (U.S. CLS. 21, 23, 26, 36 AND 38).

FIRST USE 8-1-2001; IN COMMERCE 12-1-2001.

CLASS 9—(Continued).

2,765,102. QUANTUM CORPORATION, MILPITAS, CA. SN 76-303,944. PUB. 9-24-2002, FILED 8-24-2001.

RADICAL SIMPLICITY

FOR RECORDING AND MEMORY DEVICES, NAMELY, AUTOLOADERS (U.S. CLS. 21, 23, 26, 36 AND 38).

FIRST USE 4-9-2002; IN COMMERCE 4-9-2002.

2,765,103. TELMEMOR-E, INC., NEW YORK, NY. SN 76-304,540. PUB. 9-10-2002, FILED 8-24-2001.

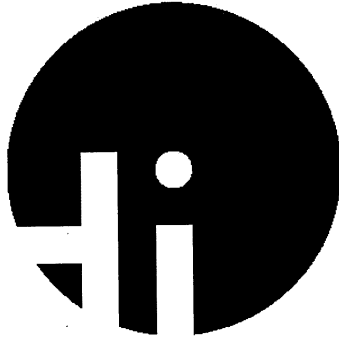

FOR WIRELESS INFRARED TRANSMITTERS AND RADIO FREQUENCY TRANSMITTERS FOR USE IN DIGITALLY TRANSMITTING POINT-OF-SALE INFORMATION (U.S. CLS. 21, 23, 26, 36 AND 38).

FIRST USE 9-0-2001; IN COMMERCE 9-0-2001.

2,765,104. SILVA, ROBERT, BROOKLYN, NY. SN 76-304,560. PUB. 11-19-2002, FILED 8-27-2001.

SILVA LINE RECORDS

NO CLAIM IS MADE TO THE EXCLUSIVE RIGHT TO USE "RECORDS", APART FROM THE MARK AS SHOWN.

FOR PRERECORDED AUDIO TAPES, PHONOGRAPH RECORDS AND COMPACT DISCS, FEATURING MUSICAL ENTERTAINMENT (U.S. CLS. 21, 23, 26, 36 AND 38).

FIRST USE 3-1-2003; IN COMMERCE 3-1-2003.

2,765,106. SHARP KABUSHIKI KAISHA A/T/A SHARP CORPORATION, OSAKA 545-8522, JAPAN. SN 76-305,241. PUB. 8-6-2002, FILED 8-24-2001.

SHARP

OWNER OF U.S. REG. NOS. 842,768, 1,985,630, AND OTHERS.

FOR COMPUTER SOFTWARE FOR MANAGING DOCUMENTS (U.S. CLS. 21, 23, 26, 36 AND 38).

FIRST USE 4-0-2000; IN COMMERCE 4-0-2000.

CLASS 9—(Continued).

2,765,110. RODGERS INSTRUMENTS LLC, HILLSBORO, OR. SN 76-306,772. PUB. 9-3-2002, FILED 8-29-2001.

RODGERS SMARTCARD MEMORY SYSTEM

OWNER OF U.S. REG. NOS. 1,623,559 AND 1,624,562. NO CLAIM IS MADE TO THE EXCLUSIVE RIGHT TO USE "SMARTCARD MEMORY SYSTEM", APART FROM THE MARK AS SHOWN.

SEC. 2(F).

FOR COMPUTER HARDWARE AND SOFTWARE USED FOR STORING, CUSTOMIZING, AND ACCESSING SETTINGS AND DATA FOR ELECTRONIC ORGANS (U.S. CLS. 21, 23, 26, 36 AND 38).

FIRST USE 5-8-2003; IN COMMERCE 5-8-2003.

2,765,112. EAGLE ROCK ENTERTAINMENT LIMITED, LONDON SW181EZ, UNITED KINGDOM, BY CHANGE OF NAME EAGLE ROCK ENTERTAINMENT, PLC, WANDSWORTH LONDON, ENGLAND. SN 76-306,969. PUB. 7-30-2002, FILED 8-24-2001.

EAGLE EYE MEDIA

NO CLAIM IS MADE TO THE EXCLUSIVE RIGHT TO USE "MEDIA", APART FROM THE MARK AS SHOWN.

FOR DVDS FEATURING MUSIC CONCERTS AND MUSIC DOCUMENTARIES (U.S. CLS. 21, 23, 26, 36 AND 38).

FIRST USE 11-6-2001; IN COMMERCE 11-6-2001.

2,765,122. LABORSAGE INCORPORATED, CAMAS, WA, BY CHANGE OF NAME EVENTSAGE INCORPORATED, CAMAS, WA. SN 76-309,040. PUB. 9-10-2002, FILED 9-4-2001.

EVENTSAGE

FOR COMPUTER SOFTWARE FOR USE TO ALLOCATE HUMAN AND PHYSICAL RESOURCES IN THE FIELD OF EVENT PLANNING (U.S. CLS. 21, 23, 26, 36 AND 38).

FIRST USE 11-10-2002; IN COMMERCE 11-10-2002.

2,765,124. DIGI INTERNATIONAL INC., MINNETONKA, MN. SN 76-310,132. PUB. 5-28-2002, FILED 9-7-2001.

DIGI ONE

OWNER OF U.S. REG. NOS. 1,666,495, 2,369,665, AND OTHERS.

FOR COMPUTER NETWORK CONNECTIVITY HARDWARE, NAMELY, EXTERNAL AND EMBEDDED COMPUTER HARDWARE USED TO NETWORK ENABLE SERIAL COMPONENTS (U.S. CLS. 21, 23, 26, 36 AND 38).

FIRST USE 7-0-2001; IN COMMERCE 9-0-2001.

CLASS 9—(Continued).

2,765,142. KLA-TENCOR TECHNOLOGIES CORPORATION, MILPITAS, CA. BY ASSIGNMENT KLA-TENCOR CORPORATION, SAN JOSE, CA. SN 76-315,081. PUB. 9-24-2002, FILED 9-19-2001.

ED0

FOR COMPUTER HARDWARE, SOFTWARE AND USER MANUALS SOLD AS A UNIT, AND EQUIPMENT, NAMELY INSPECTION, METROLOGY AND TESTING HARDWARE, ALL FOR INSPECTING AND MEASURING SEMICONDUCTORS DURING MANUFACTURING AND PROCESSING (U.S. CLS. 21, 23, 26, 36 AND 38).
FIRST USE 1-1-2002; IN COMMERCE 1-1-2002.

2,765,145. CYBER VILLAGE ACADEMY, INC., ST. PAUL, MN. SN 76-316,998. PUB. 9-17-2002, FILED 9-24-2001.

STAR INTERACTION

FOR COMPUTER SOFTWARE IN THE FIELD OF EDUCATION, NAMELY, SOFTWARE USED BY TEACHERS TO CREATE TESTS, PRESENTATIONS, GAMES AND SIMULATIONS FOR A VARIETY OF CONTENT (U.S. CLS. 21, 23, 26, 36 AND 38).
FIRST USE 10-9-2001; IN COMMERCE 10-9-2001.

2,765,156. MAXON CORPORATION, MUNCIE, IN. SN 76-320,534. PUB. 9-10-2002, FILED 10-3-2001.

SMARTLINK

FOR ELECTRIC VALVE ACTUATORS (U.S. CLS. 21, 23, 26, 36 AND 38).
FIRST USE 1-0-2001; IN COMMERCE 1-0-2001.

2,765,166. WESTGARD QC, INC., MADISON, WI. SN 76-322,810. PUB. 11-12-2002, FILED 10-10-2001.

EZ RUNS

NO CLAIM IS MADE TO THE EXCLUSIVE RIGHT TO USE "EZ", APART FROM THE MARK AS SHOWN.
FOR STATISTICAL PROCESS CONTROL SOFTWARE FOR QUALITY CONTROL OF ANALYTICAL TEST METHODS IN CLINICAL LABORATORIES (U.S. CLS. 21, 23, 26, 36 AND 38).
FIRST USE 6-30-2002; IN COMMERCE 6-30-2002.

CLASS 9—(Continued).

2,765,186. JOHNSON, DOUGLAS M., SEATTLE, WA. SN 76-328,519. PUB. 10-15-2002, FILED 10-22-2001.

CAMBRIA

FOR ELECTRONIC AND ELECTRICAL SENSORS, NAMELY, PROXIMITY SENSORS, POSITION SENSORS, DISTANCE SENSORS, ENVIRONMENTAL SENSORS, AND TRANSPONDERS; AUTOMATED CONTROL SYSTEMS AND REMOTE MONITORING SYSTEMS COMPRISED OF PROXIMITY SENSORS, POSITION SENSORS, DISTANCE SENSORS, ENVIRONMENTAL SENSORS, AND TRANSPONDERS; ALARM NOTIFICATION SYSTEMS COMPRISED OF PROXIMITY SENSORS, POSITION SENSORS, DISTANCE SENSORS, ENVIRONMENTAL SENSORS, AND TRANSPONDERS (U.S. CLS. 21, 23, 26, 36 AND 38).
FIRST USE 0-0-1991; IN COMMERCE 0-0-1991.

2,765,215. ALEXANIAN, GEORGE, FRESNO, CA. SN 76-338,290. PUB. 9-10-2002, FILED 11-15-2001.

THE SMART ONE

NO CLAIM IS MADE TO THE EXCLUSIVE RIGHT TO USE "SMART", APART FROM THE MARK AS SHOWN.
FOR IRRIGATION AND INDUSTRIAL CONTROL SYSTEMS AND APPARATUS FOR USE IN LANDSCAPING AND TURF APPLICATIONS, NAMELY, IRRIGATION VALVE CONTROLLERS, BATTERY OPERATED IRRIGATION VALVE CONTROLLERS, SOLENOID ACTUATORS, RELAY ACTUATORS, AND MICROPROCESSORS AND CIRCUITS (U.S. CLS. 21, 23, 26, 36 AND 38).
FIRST USE 10-31-2002; IN COMMERCE 10-31-2002.

2,765,217. IKANOS COMMUNICATIONS, FREMONT, CA. SN 76-338,765. PUB. 4-30-2002, FILED 11-16-2001.

SMARTLEAP

FOR COMPUTER HARDWARE; SEMICONDUCTORS; SEMICONDUCTORS FOR DATA, AUDIO, AND VIDEO COMMUNICATION (U.S. CLS. 21, 23, 26, 36 AND 38).
FIRST USE 1-28-2002; IN COMMERCE 1-28-2002.

2,765,247. SILICON LABORATORIES, INC., AUSTIN, TX. SN 76-346,639. PUB. 12-17-2002, FILED 12-6-2001.

ISOMODEM

FOR INTEGRATED CIRCUITS FOR COMMUNICATIONS SYSTEMS (U.S. CLS. 21, 23, 26, 36 AND 38).
FIRST USE 7-0-1999; IN COMMERCE 7-0-1999.

CLASS 9—(Continued).

2,765,263. YOTTAYOTTA, INC., EDMONTON, ALBERTA T6H 5S4, CANADA. SN 76-351,954. PUB. 9-3-2002, FILED 12-20-2001.

UNITY PILOT

FOR DATA STORAGE SYSTEMS, COMPRISED OF COMPUTER HARDWARE AND SOFTWARE FOR COMPUTER DATA STORAGE MANAGEMENT AND USER MANUALS SOLD TOGETHER AS A UNIT (U.S. CLS. 21, 23, 26, 36 AND 38).

FIRST USE 1-11-2003; IN COMMERCE 1-11-2003.

CLASS 9—(Continued).

2,765,296. AGORICS, INC., LOS ALTOS, CA. SN 76-360,113. PUB. 9-24-2002, FILED 1-16-2002.

GUARDPOSTE

FOR E-MAIL SECURITY SOFTWARE (U.S. CLS. 21, 23, 26, 36 AND 38).

FIRST USE 4-17-2002; IN COMMERCE 4-17-2002.

2,765,266. HUNTER ENGINEERING COMPANY, BRIDGE-TON, MO. SN 76-352,662. PUB. 8-13-2002, FILED 12-21-2001.

ROAD FORCE

OWNER OF U.S. REG. NO. 2,440,138.
FOR WHEEL BALANCING EQUIPMENT NAMELY, VIBRATION DETECTION MACHINE HAVING A ROLLER FOR APPLYING FORCE AGAINST A TIRE TO DETECT NON-BALANCE RELATED VIBRATION SOLD AS AN INTEGRAL COMPONENT OF WHEEL BALANCING MACHINES FOR LAND VEHICLES (U.S. CLS. 21, 23, 26, 36 AND 38).

FIRST USE 10-1-1997; IN COMMERCE 10-1-1997.

2,765,298. MYRIAGON CORPORATION, DALLAS, TX. SN 76-360,360. PUB. 12-10-2002, FILED 1-18-2002.

WELL INFORMED

FOR COMPUTER SOFTWARE FOR DATABASE MANAGEMENT, INFORMATION MANAGEMENT, SCHEDULING JOBS, TRACKING RESOURCES, WORKERS, AND EVENTS, AND ASSISTING IN THE MANAGEMENT OF BUSINESS OPERATIONS BY MAKING INFORMATION RELATED TO THE BUSINESS OPERATIONS ORGANIZED AND ACCESSIBLE FROM A MYRIAD OF ELECTRONIC DEVICES AND LOCATIONS (U.S. CLS. 21, 23, 26, 36 AND 38).

FIRST USE 9-10-2002; IN COMMERCE 9-10-2002.

2,765,273. IGT, RENO, NV. SN 76-354,503. PUB. 12-24-2002, FILED 12-27-2001.

SIZZLING 7 TIMES PAY

OWNER OF U.S. REG. NOS. 2,050,175, 2,340,380, AND OTHERS.

NO CLAIM IS MADE TO THE EXCLUSIVE RIGHT TO USE "7 TIMES PAY", APART FROM THE MARK AS SHOWN.

FOR GAMING MACHINES, NAMELY, SLOT MACHINES WITH OR WITHOUT A VIDEO OUTPUT (U.S. CLS. 21, 23, 26, 36 AND 38).

FIRST USE 1-0-2002; IN COMMERCE 1-0-2002.

2,765,304. H & H INDUSTRIES, INC., ELMWOOD, IL. SN 76-362,056. PUB. 9-3-2002, FILED 1-22-2002.

POWERMASTER

FOR FLUORESCENT LIGHT BALLASTS (U.S. CLS. 21, 23, 26, 36 AND 38).

FIRST USE 1-17-2000; IN COMMERCE 1-17-2000.

2,765,289. MIAMI TRIBE OF OKLAHOMA BUSINESS DEVELOPMENT AUTHORITY, MIAMI, OK. SN 76-358,324. PUB. 9-17-2002, FILED 1-7-2002.

BUFFALO BUCKS

FOR GAMING MACHINES AND OPERATING SOFTWARE THAT RUNS THEREON (U.S. CLS. 21, 23, 26, 36 AND 38).

FIRST USE 5-22-2002; IN COMMERCE 5-22-2002.

2,765,306. SELMOSOFT INC., PACIFICA, CA. SN 76-362,564. PUB. 8-6-2002, FILED 1-25-2002.

THEY CAME FROM HOLLYWOOD

FOR COMPUTER SOFTWARE GAMES AND COMPUTER SOFTWARE GAME PROGRAMS FOR ENTERTAINMENT USES (U.S. CLS. 21, 23, 26, 36 AND 38).

FIRST USE 4-21-2003; IN COMMERCE 4-21-2003.

CLASS 9—(Continued).

2,765,320. CORRELOGIC SYSTEMS, INC., BETHESDA, MD. SN 76-365,249. PUB. 9-10-2002, FILED 1-30-2002.

PROTEOME QUEST

NO CLAIM IS MADE TO THE EXCLUSIVE RIGHT TO USE "PROTEOME", APART FROM THE MARK AS SHOWN, FOR COMPUTER SOFTWARE, NAMELY, PATTERN RECOGNITION AND PATTERN DISCOVERY, COMPUTER PROGRAMS FOR ANALYZING BIOLOGICAL DATA, INCLUDING BUT NOT LIMITED TO, PROTEIN EXPRESSIONS, FOR EARLY DISEASE DETECTION AND DIAGNOSIS, TOXICITY ASSESSMENT AND DIAGNOSIS, AND THERAPEUTIC EFFICACY (U.S. CLS. 21, 23, 26, 36 AND 38).

FIRST USE 4-5-2002; IN COMMERCE 4-5-2002.

2,765,352. ARISTAR, INC., AKRON, OH. SN 76-376,196. PUB. 10-1-2002, FILED 2-28-2002.

ORTHOEMR

FOR SOFTWARE FOR PROCESSING MEDICAL RECORDS (U.S. CLS. 21, 23, 26, 36 AND 38).

FIRST USE 3-11-2002; IN COMMERCE 3-11-2002.

2,765,356. VERPLEX SYSTEMS, INC., MILPITAS, CA. SN 76-376,811. PUB. 9-3-2002, FILED 2-27-2002.

DESIGN IT GOLDEN AND KEEP IT GOLDEN

FOR COMPUTER SOFTWARE FOR ELECTRONIC DESIGN AUTOMATION FOR INTEGRATED CIRCUIT DESIGN (U.S. CLS. 21, 23, 26, 36 AND 38).

FIRST USE 3-31-2002; IN COMMERCE 3-31-2002.

2,765,360. INTELLITECH CORPORATION, DURHAM, NH. SN 76-377,267. PUB. 11-26-2002, FILED 3-1-2002.

ULTRATAP

FOR ELECTRONIC TEST EQUIPMENT FOR TESTING ELECTRONIC DEVICES, NAMELY, INTEGRATED CIRCUITS, PRINTED CIRCUIT BOARDS AND SYSTEMS COMPRISING INTEGRATED CIRCUITS AND PRINTED CIRCUIT BOARDS (U.S. CLS. 21, 23, 26, 36 AND 38).

FIRST USE 3-27-2002; IN COMMERCE 3-27-2002.

CLASS 9—(Continued).

2,765,363. EISENWORLD, INC., SUNRISE, FL. SN 76-377,341. PUB. 10-22-2002, FILED 3-2-2002.

THE DIGITAL MOVING COMPANY

FOR COMPUTER SOFTWARE FOR MIGRATING, TRANSFERRING OR REPLICATING ALL OR PART OF THE ASSETS OF ONE COMPUTER OR COMPUTER SYSTEM TO ONE OR MORE OTHER COMPUTERS OR COMPUTER SYSTEMS (U.S. CLS. 21, 23, 26, 36 AND 38).

FIRST USE 4-0-2002; IN COMMERCE 9-1-2001.

2,765,379. YOTTAYOTTA, INC., EDMONTON, ALBERTA T6H 5S4, CANADA. SN 76-381,645. PUB. 10-29-2002, FILED 3-12-2002.



FOR DATA STORAGE SYSTEMS, COMPRISED OF COMPUTER HARDWARE AND SOFTWARE FOR COMPUTER DATA STORAGE MANAGEMENT AND USER MANUALS SOLD TOGETHER AS A UNIT (U.S. CLS. 21, 23, 26, 36 AND 38).

FIRST USE 1-11-2003; IN COMMERCE 1-11-2003.

2,765,407. KABUSHIKIGAISSYA GOTO KOQAKU KENKYU-JYO, TOKYO, 183-830, JAPAN. SN 76-391,676. PUB. 10-29-2002, FILED 4-4-2002.

CHRONOS

FOR PLANETARIUM SYSTEMS COMPRISED OF PHOTOGRAPHIC PROJECTORS FOR PROJECTING STARS, COMPUTER HARDWARE AND OPERATING SOFTWARE, CONTROL CONSOLE AND DOME SCREENS ALL SOLD AS A UNIT (U.S. CLS. 21, 23, 26, 36 AND 38).

FIRST USE 4-30-2002; IN COMMERCE 4-30-2002.

CLASS 9—(Continued).

2,765,410. HUBBELL INCORPORATED, ORANGE, CT. SN 76-392,841. PUB. 10-15-2002, FILED 4-9-2002.

SIGNAL-QUICK

FOR MOUNTING BRACKETS AND PROTECTIVE COVERS FOR USE WITH SENSORS (U.S. CLS. 21, 23, 26, 36 AND 38).

FIRST USE 7-31-2002; IN COMMERCE 7-31-2002.

2,765,411. NEW YORK AIR BRAKE CORPORATION, WATERDOWN, NY. SN 76-393,403. PUB. 12-10-2002, FILED 4-10-2002.

WIREDP

FOR COMPUTER SOFTWARE FOR CONTROLLING PROPULSION AND BRAKE SYSTEMS ON REMOTELY LOCATED LOCOMOTIVES WITHIN A TRAIN (U.S. CLS. 21, 23, 26, 36 AND 38).

FIRST USE 1-28-2001; IN COMMERCE 1-28-2001.

2,765,419. COMPASS AI, INC., EL DORADO HILLS, CA. SN 76-395,079. PUB. 11-12-2002, FILED 4-12-2002.

COMPASS A.I.

NO CLAIM IS MADE TO THE EXCLUSIVE RIGHT TO USE "A.I.", APART FROM THE MARK AS SHOWN.

FOR COMPUTER SOFTWARE, NAMELY SOFTWARE TO PERFORM AUTOMATED APPLICATION INTEGRATION (U.S. CLS. 21, 23, 26, 36 AND 38).

FIRST USE 1-17-2002; IN COMMERCE 2-2-2002.

2,765,431. HARRIS CORPORATION, MELBOURNE, FL. SN 76-403,187. PUB. 10-29-2002, FILED 5-2-2002.

HARBORVIEW

FOR COMPUTER PROGRAMS FOR CONVERTING TWO-DIMENSIONAL IMAGES INTO THREE-DIMENSIONAL MODELS AND MANUALS DISTRIBUTED AS A UNIT THEREWITH (U.S. CLS. 21, 23, 26, 36 AND 38).

FIRST USE 7-31-2002; IN COMMERCE 7-31-2002.

2,765,446. USA AIRMOBILE, INC., FT. LAUDERDALE, FL. SN 76-408,396. PUB. 11-12-2002, FILED 5-14-2002.

S.E.R.T.S.

FOR FALL PROTECTION EQUIPMENT FOR FALL RESTRAINT, FALL ARREST, AND EMERGENCY RELEASE, NAMELY, HARNESES, LANYARDS, LINES, LADDER HOOKS, AND CARABINERS (U.S. CLS. 21, 23, 26, 36 AND 38).

FIRST USE 9-30-2002; IN COMMERCE 9-30-2002.

CLASS 9—(Continued).

2,765,448. INFOGRAMES, INC., NEW YORK, NY. SN 76-408,873. PUB. 12-3-2002, FILED 5-16-2002.

MOONBASE COMMANDER

FOR INTERACTIVE MULTIMEDIA VIDEO GAME SOFTWARE FOR USE ON PERSONAL COMPUTERS AND ELECTRONIC GAME-PLAYING UNITS (U.S. CLS. 21, 23, 26, 36 AND 38).

FIRST USE 8-13-2002; IN COMMERCE 8-13-2002.

2,765,451. FOUNDATION SOFTWARE, INC., BRUNSWICK, OH. SN 76-411,753. PUB. 12-10-2002, FILED 5-24-2002.

CONVERSIONQUICK SERVICE

NO CLAIM IS MADE TO THE EXCLUSIVE RIGHT TO USE "SERVICE", APART FROM THE MARK AS SHOWN.

FOR CONSTRUCTION ACCOUNTING COMPUTER SOFTWARE FOR CONSTRUCTION COMPANIES (U.S. CLS. 21, 23, 26, 36 AND 38).

FIRST USE 5-1-2002; IN COMMERCE 5-1-2002.

2,765,470. CRP ENTERPRISES, INC., SAN LUIS OBISPO, CA. SN 76-414,576. PUB. 12-10-2002, FILED 5-31-2002.

AUDIO LAUNCHER

NO CLAIM IS MADE TO THE EXCLUSIVE RIGHT TO USE "AUDIO", APART FROM THE MARK AS SHOWN.

FOR LOUDSPEAKERS FOR USE IN A MARINE ENVIRONMENT (U.S. CLS. 21, 23, 26, 36 AND 38).

FIRST USE 12-0-2002; IN COMMERCE 12-0-2002.

2,765,476. CYSIVE, INC., RESTON, VA. SN 76-417,071. PUB. 12-3-2002, FILED 6-6-2002.

CYMBIO MULTICHANNEL DESIGNER

NO CLAIM IS MADE TO THE EXCLUSIVE RIGHT TO USE "MULTICHANNEL DESIGNER", APART FROM THE MARK AS SHOWN.

FOR UNIVERSAL SESSION MANAGEMENT SOFTWARE IN THE FIELD OF ELECTRONIC BUSINESS, NAMELY SOFTWARE THAT MANAGES THE FLOW OF TRANSACTION DATA AND PERMITS SINGLE TRANSACTIONS TO BE ACCOMPLISHED OVER MULTIPLE DEVICES, NAMELY COMPUTERS, PDAS AND MOBILE TELEPHONES, AND THROUGH MULTIPLE CHANNELS, NAMELY WEB, WIRELESS, MOBILE, WEB SERVICES AND VOICE CHANNELS, WITHOUT THE LOSS OF DATA AND WITHOUT THE LOSS OF STAGE WITHIN THE TRANSACTION (U.S. CLS. 21, 23, 26, 36 AND 38).

FIRST USE 2-1-2002; IN COMMERCE 2-1-2002.

CLASS 9—(Continued).

2,765,498. YOKELS SOFTWARE, INC., LAS VEGAS, NV. SN 76-431,793. PUB. 2-18-2003, FILED 7-18-2002.

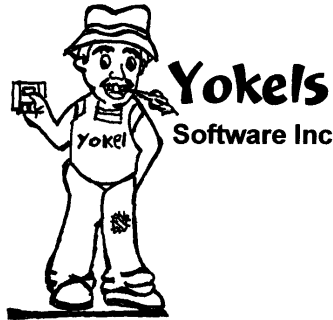

NO CLAIM IS MADE TO THE EXCLUSIVE RIGHT TO USE "SOFTWARE, INC.", APART FROM THE MARK AS SHOWN.

FOR COMPUTER SOFTWARE FOR ACCOUNTING PURPOSES (U.S. CLS. 21, 23, 26, 36 AND 38). FIRST USE 7-4-2002; IN COMMERCE 12-1-2002.

2,765,502. GARDNER, MERLE F., GERMANTOWN, TN. SN 76-435,154. PUB. 2-11-2003, FILED 7-29-2002.

BUCK BRUSH

FOR DUCK CALL (U.S. CLS. 21, 23, 26, 36 AND 38). FIRST USE 7-9-2002; IN COMMERCE 8-13-2002.

2,765,528. CHELTON FIGHT SYSTEMS INC., BOISE, ID, BY CHANGE OF NAME SIERRA FLIGHT SYSTEMS INC., BOISE, ID. SN 76-975,704. PUB. 3-5-2002, FILED 9-12-2001.

FLIGHTLOGIC

FOR ELECTRONIC FLIGHT INSTRUMENT SYSTEMS COMPRISED OF DISPLAY SCREENS AND CENTRAL PROCESSING UNITS IN COMMUNICATION WITH A VARIETY OF AIRFRAME MOUNTED SENSORS FOR DISPLAYING SENSOR INFORMATION TO AIRCREW MEMBERS; ENGINE MONITORING SYSTEMS COMPRISED OF A DISPLAY SCREEN, CENTRAL PROCESSING UNIT AND A VARIETY OF ENGINE SENSORS FOR DISPLAYING SENSOR INFORMATION TO AIRCREW MEMBERS AND TRANSMITTING SENSOR INFORMATION TO AN ELECTRONIC FLIGHT INSTRUMENT SYSTEM; AIR DATA COMPUTERS; AND AVIONICS SOFTWARE FOR ACQUIRING DATA FROM SENSORS, STORING THE DATA ON ELECTRONIC MEDIA, AND PRESENTING THE DATA ON AIRCREW MEMBER DISPLAY SCREENS IN A VARIETY OF FORMATS (U.S. CLS. 21, 23, 26, 36 AND 38). FIRST USE 1-20-2003; IN COMMERCE 1-20-2003.

CLASS 9—(Continued).

2,765,533. SIDERA, INC., SANTA CRUZ, CA. SN 78-000,308. PUB. 9-11-2001, FILED 3-21-2000.

LOUPE-LITE

FOR OPTICAL MAGNIFYING APPARATUS, NAMELY EYE LOUPES (U.S. CLS. 21, 23, 26, 36 AND 38). FIRST USE 12-1-1997; IN COMMERCE 1-1-1999.

2,765,535. EDELSTEIN, SCOTT, W, ALAMEDA, CA. AND BENJAMIN, MAIRA, M, ALAMEDA, CA. SN 78-003,671. PUB. 1-9-2001, FILED 4-11-2000.



FOR BUSINESS MANAGEMENT SOFTWARE TO DOCUMENT, AUTOMATE AND CONTROL OPERATIONS THROUGH PROCESS ENGINEERING AND INTEGRATION OF ADVANCED INFORMATION TECHNOLOGIES; FOR GENERAL BUSINESS AND INDUSTRY-SPECIFIC USE (U.S. CLS. 21, 23, 26, 36 AND 38).

FIRST USE 8-1-2001; IN COMMERCE 8-1-2001.

2,765,546. KIDVID, INC., ALPHARETTA, GA. SN 78-017,767. PUB. 7-24-2001, FILED 7-21-2000.

JINGLE- BELL BABY

NO CLAIM IS MADE TO THE EXCLUSIVE RIGHT TO USE "BABY", APART FROM THE MARK AS SHOWN.

FOR PRE-RECORDED VIDEO TAPES, AUDIO CASSETTES, DIGITAL VIDEO DISCS, AND COMPACT DISCS CONTAINING SOUND AND IMAGES PRIMARILY RELATED TO WINTER AND CHRISTMAS THEMES INTENDED TO DEVELOP AND IMPROVE THE CREATIVE AND INTELLECTUAL FACULTIES OF INFANTS AND CHILDREN (U.S. CLS. 21, 23, 26, 36 AND 38). FIRST USE 3-1-2001; IN COMMERCE 3-1-2001.

2,765,556. DATA TRANSMISSION NETWORK, OMAHA, DE. SN 78-032,175. PUB. 9-11-2001, FILED 10-24-2000.

ROVER

FOR SOFTWARE APPLICATION FOR AGRICULTURE INFORMATION DELIVERY VIA PERSONAL DIGITAL ASSISTANT (U.S. CLS. 21, 23, 26, 36 AND 38). FIRST USE 2-1-2000; IN COMMERCE 2-1-2000.

CLASS 9—(Continued).

2,765,557. MACH 5 ENTERPRISES, LLC, CHATTANOOGA, TN. SN 78-033,513. PUB. 3-5-2002, FILED 11-2-2000.

M5

FOR COMPUTER SOFTWARE FOR ELECTRONIC MAIL CUSTOMIZATION AND DELIVERY APPLICATIONS; ELECTRONIC MAIL AND DATABASE MERGING APPLICATIONS; OFFICE MANAGEMENT APPLICATIONS; DATA ENCRYPTION; AND INTERNET WEB SITE APPLICATIONS, NAMELY, CREATING, MAINTAINING, AND ANALYZING INTERNET WEBSITES (U.S. CLS. 21, 23, 26, 36 AND 38).
FIRST USE 2-1-2001; IN COMMERCE 2-1-2001.

CLASS 9—(Continued).

2,765,583. VIEW ENGINEERING, INC., SIMI VALLEY, CA. SN 78-053,445. PUB. 12-10-2002, FILED 3-16-2001.

VIEW SUMMIT

NO CLAIM IS MADE TO THE EXCLUSIVE RIGHT TO USE "VIEW", APART FROM THE MARK AS SHOWN. FOR NON-CONTACT, THREE-AXIS VISION MACHINE (U.S. CLS. 21, 23, 26, 36 AND 38).
FIRST USE 2-12-2001; IN COMMERCE 2-12-2001.

2,765,564. NETWORK EQUIPMENT TECHNOLOGIES, INC., FREMONT, CA. SN 78-039,320. PUB. 10-16-2001, FILED 12-14-2000.

**SERVICE CREATION
MANAGER**

FOR COMPUTER NETWORKING PRODUCTS, NAMELY, NETWORK INTERFACE CARDS, COMPUTER NETWORK MANAGEMENT HARDWARE, COMPUTER NETWORK MANAGEMENT SOFTWARE (U.S. CLS. 21, 23, 26, 36 AND 38).
FIRST USE 10-0-2000; IN COMMERCE 10-0-2000.

2,765,607. MICROSOFT CORPORATION, REDMOND, WA. SN 78-066,457. PUB. 10-8-2002, FILED 5-30-2001.

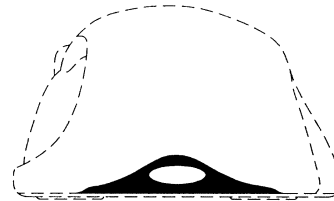

THE MARK CONSISTS OF AN OVAL AND SURROUNDING SWOOSH SHAPE POSITIONED ON ONE END OF A COMPUTER MOUSE. THE OVAL IS SILVER AND THE SWOOSH SHAPE IS RED. COLOR IS CLAIMED AS PART OF THE MARK.
FOR COMPUTER MICE (U.S. CLS. 21, 23, 26, 36 AND 38).
FIRST USE 8-1-1999; IN COMMERCE 8-1-1999.

2,765,577. ELECTRO-MECHANICAL CORP., BRISTOL, VA. SN 78-047,840. PUB. 2-19-2002, FILED 2-12-2001.



THE LINING IS A FEATURE OF THE MARK AND NOT INTENDED TO INDICATE COLOR.
THE MARK CONSISTS OF A MAN HOLDING LIGHTNING BOLTS IN HIS LEFT ARM AND WIELDING A LIGHTNING BOLT IN HIS RIGHT ARM, INDICATING A THROWING POSITION.
FOR PRODUCTS FOR POWER DISTRIBUTION AND CONTROL, NAMELY, ELECTRICAL TRANSFORMERS, SWITCHBOXES FOR SWITCHING OFF POWER, AND ELECTROMECHANICAL CONTROLS FOR USE IN MINING (U.S. CLS. 21, 23, 26, 36 AND 38).
FIRST USE 1-1-2001; IN COMMERCE 1-1-2001.

2,765,608. ERB INDUSTRIES, INC., WOODSTOCK, GA. SN 78-068,924. PUB. 6-18-2002, FILED 6-13-2001.

SURVIVORS

FOR INDUSTRIAL SAFETY EYEWEAR, NAMELY, SAFETY GLASSES AND SAFETY GOGGLES (U.S. CLS. 21, 23, 26, 36 AND 38).
FIRST USE 5-1-2002; IN COMMERCE 5-1-2002.

CLASS 9—(Continued).

2,765,612. XOBJEX CORPORATION, CHICAGO, IL. SN 78-069,826. PUB. 7-2-2002, FILED 6-19-2001.

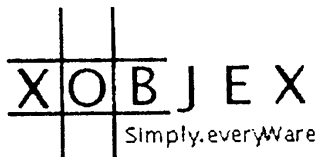

FOR COMPUTER SOFTWARE THAT ENABLES COMMUNICATION, COLLABORATION AND EXECUTION OF WEB SERVICES FOR AND BETWEEN INTERNET (NETWORK) DEVICES SUCH AS PERSONAL COMPUTERS, PDA'S, AND CELLULAR PHONES (U.S. CLS. 21, 23, 26, 36 AND 38).

FIRST USE 2-1-2001; IN COMMERCE 4-1-2001.

2,765,613. DESTINY NETWORKS, MORGAN HILL, CA. SN 78-070,089. PUB. 6-25-2002, FILED 6-20-2001.

HOME POSITIONING

FOR OCCUPANCY DETECTION SYSTEM COMPRISING ROOM OCCUPANCY SENSORS SUCH AS MOTION, ENTRY/EXIT AND SPOT SENSORS TOGETHER WITH A CENTRAL CONTROLLER, FOR AUTOMATED CONTROL OF ELECTRONIC SERVICES SUCH AS LIGHTING, HEATING AND APPLIANCES (U.S. CLS. 21, 23, 26, 36 AND 38).

FIRST USE 6-0-2002; IN COMMERCE 6-0-2002.

2,765,617. CASE LOGIC, INC., LONGMONT, CO. SN 78-070,620. PUB. 10-29-2002, FILED 6-22-2001.

CREATIVE WIRELESS

NO CLAIM IS MADE TO THE EXCLUSIVE RIGHT TO USE "WIRELESS", APART FROM THE MARK AS SHOWN.

FOR ACCESSORIES FOR PORTABLE ELECTRONIC WIRELESS COMMUNICATION DEVICES, NAMELY, CELLULAR PHONES AND PERSONAL DIGITAL ASSISTANTS, NAMELY, DESKTOP HOLDERS, BATTERY CHARGERS, FITTED HOLDERS FOR AUTOMOBILES, CASES MADE OF A FLEXIBLE MATERIAL, BELT CLIPS, HANDS-FREE TELEPHONE HEADSETS, AND TELEPHONE SPEAKERPHONES (U.S. CLS. 21, 23, 26, 36 AND 38).

FIRST USE 12-12-2001; IN COMMERCE 12-12-2001.

CLASS 9—(Continued).

2,765,629. TEMIS FRANCE, PARIS, FRANCE. SN 78-076,555. PUB. 4-23-2002, FILED 7-31-2001.

SKILL CARTRIDGE

FOR CD DRIVES FOR COMPUTERS; COMPUTERS AND INSTRUCTIONAL MANUALS SOLD AS A UNIT; FLOPPY DISCS FOR COMPUTERS; HARD DISCS FOR COMPUTERS; HARD DRIVES FOR COMPUTERS; COMPUTER SOFTWARE FOR TEXT MINING, ANALYZING AND STRUCTURING DOCUMENTS BY USING STATISTICS OR COMPUTATIONAL LINGUISTIC TECHNOLOGY; COMPUTER SOFTWARE DEVELOPMENT TOOLS; COMPUTER SOFTWARE FOR APPLICATION AND DATABASE INTEGRATION; TRAINING SOFTWARE FEATURING INSTRUCTION IN ANALYZING AND STRUCTURING DOCUMENTS BY USING STATISTICS OR COMPUTATIONAL LINGUISTIC TECHNOLOGY; TRANSLATION SOFTWARE; AUDIO-VIDEO COMPACT DISCS; READ-ONLY MEMORY COMPACT DISCS; COMPUTER INTERFACE BOARDS (U.S. CLS. 21, 23, 26, 36 AND 38).

FIRST USE 8-10-2001; IN COMMERCE 3-1-2002.

2,765,643. COMPRESSOR CONTROLS CORPORATION, DES MOINES, IA. SN 78-080,874. PUB. 11-5-2002, FILED 8-23-2001.

VANTAGE

FOR CONTROLLERS FOR TURBINES AND COMPRESSORS, NAMELY, A RACK OR PANEL-MOUNTED CONTROLLER HAVING A SINGLE, INTEGRATED, LOCAL INPUT/OUTPUT (I/O) SYSTEM IN A SIMPLEX CONFIGURATION (U.S. CLS. 21, 23, 26, 36 AND 38).

FIRST USE 8-23-2001; IN COMMERCE 6-28-2002.

2,765,652. BAUSCH & LOMB INCORPORATED, ROCHESTER, NY. SN 78-083,278. PUB. 1-15-2002, FILED 9-10-2001.

CYBERCASES

FOR CONTACT LENS CASES (U.S. CLS. 21, 23, 26, 36 AND 38).

FIRST USE 5-1-2002; IN COMMERCE 5-1-2002.

2,765,653. ALEXANDER, KAREN R., COLUMBIA, SC. AND COUNTS, BYRON D., COLUMBIA, SC. SN 78-083,932. PUB. 2-19-2002, FILED 9-14-2001.

AUNTIE KAREN

FOR EDUCATIONAL PRE-RECORDED AUDIO CASSETTE TAPES, COMPACT DISCS, AND VIDEOS FOR ELEMENTARY EDUCATION ON VARIOUS SUBJECTS (U.S. CLS. 21, 23, 26, 36 AND 38).

FIRST USE 3-1-2001; IN COMMERCE 3-1-2002.

CLASS 9—(Continued).

2,765,660. ASSOCIATES OF CAPE COD, INCORPORATED, FALMOUTH, MA. SN 78-086,943. PUB. 4-16-2002, FILED 10-4-2001.

BACTIFLUOR

FOR FLUORESCENT TEST FOR LIVE BACTERIA USING FLUORESCENCE (U.S. CLS. 21, 23, 26, 36 AND 38).

FIRST USE 6-18-2001; IN COMMERCE 9-10-2002.

2,765,721. MICROSOFT CORPORATION, REDMOND, WA. SN 78-110,604. PUB. 10-8-2002, FILED 2-22-2002.

RISE OF NATIONS

FOR COMPUTER PROGRAMS, NAMELY, GAME SOFTWARE FOR USE ON COMPUTERS AND VIDEO GAME PLAYERS (U.S. CLS. 21, 23, 26, 36 AND 38).

FIRST USE 5-20-2003; IN COMMERCE 5-20-2003.

2,765,726. PERFORMANCE SOLUTIONS INTERNATIONAL, LLC, RANDOLPH, NJ. SN 78-113,123. PUB. 10-8-2002, FILED 3-7-2002.

INSIDE FINANCIAL SERVICES

NO CLAIM IS MADE TO THE EXCLUSIVE RIGHT TO USE "FINANCIAL SERVICES", APART FROM THE MARK AS SHOWN.

FOR COMPUTER SOFTWARE FOR EDUCATION AND TRAINING IN THE FIELD OF FINANCIAL SERVICES (U.S. CLS. 21, 23, 26, 36 AND 38).

FIRST USE 10-1-2001; IN COMMERCE 11-1-2001.

2,765,727. M2 COMMUNICATIONS, INC., JERSEY CITY, NJ. SN 78-113,157. PUB. 9-24-2002, FILED 3-7-2002.

PEER POINTS

FOR CUSTOMIZED INTERACTIVE MULTIMEDIA CD-ROMS CONTAINING PROMOTIONAL, DESCRIPTIVE, AND EDUCATIONAL MATERIALS REGARDING THE PHARMACEUTICAL AND/OR MEDICAL PRODUCTS, TREATMENTS AND STRATEGIES OF OTHERS (U.S. CLS. 21, 23, 26, 36 AND 38).

FIRST USE 6-0-2002; IN COMMERCE 6-0-2002.

CLASS 9—(Continued).

2,765,728. OAKLEY, INC., FOOTHILL RANCH, CA. SN 78-113,235. PUB. 9-24-2002, FILED 3-7-2002.

SINE

FOR PROTECTIVE EYEWEAR, NAMELY SPECTACLES, PRESCRIPTION EYEWEAR, ANTI-GLARE GLASSES AND SUNGLASSES AND THEIR PARTS AND ACCESSORIES, NAMELY REPLACEMENT LENSES, FRAMES, EARSTEMS, AND NOSE PIECES; CASES SPECIALLY ADAPTED FOR SPECTACLES AND SUNGLASSES AND THEIR PARTS AND ACCESSORIES (U.S. CLS. 21, 23, 26, 36 AND 38).

FIRST USE 2-25-2002; IN COMMERCE 2-25-2002.

2,765,749. CORNERSTONE CONSULTING, INC., BARTLETT, TN. SN 78-118,813. PUB. 12-31-2002, FILED 4-1-2002.

QSTATIM

FOR COMPUTER SOFTWARE FOR MULTI PLATFORM INCIDENT REPORTING (U.S. CLS. 21, 23, 26, 36 AND 38).

FIRST USE 6-1-2002; IN COMMERCE 7-1-2002.

2,765,758. LAMBDA PHYSIK AG, GOTTINGEN, FED REP GERMANY. SN 78-121,292. PUB. 12-31-2002, FILED 4-12-2002.

NOVAGASPURIFIER

FOR LASERS NOT FOR MEDICAL USE (U.S. CLS. 21, 23, 26, 36 AND 38).

FIRST USE 5-0-2002; IN COMMERCE 7-28-2002.

2,765,771. SWANSON, MICKEY, HOUSTON, MS. SN 78-127,993. PUB. 12-31-2002, FILED 5-10-2002.

DAYLILY PRO

NO CLAIM IS MADE TO THE EXCLUSIVE RIGHT TO USE "DAYLILY", APART FROM THE MARK AS SHOWN.

FOR COMPUTER SOFTWARE FOR CATALOGING THE HEMEROCALLIS FLOWER, COMMONLY KNOWN AS THE DAYLILY (U.S. CLS. 21, 23, 26, 36 AND 38).

FIRST USE 1-20-2003; IN COMMERCE 1-20-2003.

CLASS 9—(Continued).

2,765,775. SPIELO MANUFACTURING INCORPORATED, MONCTON, NEW BRUNSWICK, CANADA. SN 78-128,480. PUB. 11-26-2002, FILED 5-14-2002.

BULLFROGGIN'

FOR RECONFIGURABLE CASINO AND LOTTERY GAMING EQUIPMENT, NAMELY, SLOT MACHINES AND OPERATIONAL COMPUTER GAME SOFTWARE THEREFOR (U.S. CLS. 21, 23, 26, 36 AND 38).
FIRST USE 3-3-2002; IN COMMERCE 3-3-2002.

2,765,783. REFLECT SYSTEMS, INC., DALLAS, TX, BY CHANGE OF NAME REFLECTION SYSTEMS, INC., DALLAS, TX. SN 78-133,016. PUB. 12-17-2002, FILED 6-4-2002.

REFLECTNET

FOR COMPUTER HARDWARE AND SOFTWARE FOR CONTENT AND DATA CREATION, DISTRIBUTION AND STORAGE (U.S. CLS. 21, 23, 26, 36 AND 38).
FIRST USE 12-2-2002; IN COMMERCE 12-2-2002.

2,765,789. COORDINATED COMPUTING TECHNOLOGIES, WINCHESTER, MA. SN 78-135,665. PUB. 1-14-2003, FILED 6-13-2002.

FORETELL-DSS

FOR COMPUTER SOFTWARE FOR MODELING, SIMULATION, RISK AND REWARD MANAGEMENT, STRATEGIC DECISION-MAKING, AND DATA ANALYSIS, AND PRINTED INSTRUCTIONAL MATERIALS SOLD THEREWITH (U.S. CLS. 21, 23, 26, 36 AND 38).
FIRST USE 7-5-2002; IN COMMERCE 7-5-2002.

CLASS 9—(Continued).

2,765,795. DOOMZDAY ENTERTAINMENT, INC., BROOKLYN, NY. SN 78-136,620. PUB. 1-21-2003, FILED 6-18-2002.



NO CLAIM IS MADE TO THE EXCLUSIVE RIGHT TO USE "ENTERTAINMENT INC", APART FROM THE MARK AS SHOWN.

FOR AUDIO RECORDING OF MUSIC AND MUSICAL COMPOSITIONS IN THE FORM OF AUDIO AND VIDEO CASSETTE RECORDINGS, PHONOGRAPH RECORDS AND COMPACT DISCS (U.S. CLS. 21, 23, 26, 36 AND 38).
FIRST USE 10-15-2002; IN COMMERCE 10-15-2002.

2,765,819. DISTRIBUTOR SOFTWARE SOLUTIONS, INC., BLUE BELL, PA. SN 78-145,180. PUB. 2-11-2003, FILED 7-18-2002.

MINIVAN

FOR COMPUTER SOFTWARE FOR DELIVERING AND RECEIVING SECURE DATA (U.S. CLS. 21, 23, 26, 36 AND 38).
FIRST USE 7-18-2002; IN COMMERCE 7-18-2002.

2,765,822. D. MICHAEL CORPORATION, INDIANAPOLIS, IN. SN 78-146,595. PUB. 3-11-2003, FILED 7-23-2002.

PAYMINDER

FOR SOFTWARE FOR MANAGING PAYMENT FOR LEASED AND FINANCED EQUIPMENT (U.S. CLS. 21, 23, 26, 36 AND 38).
FIRST USE 12-18-2002; IN COMMERCE 12-18-2002.

CLASS 10—MEDICAL APPARATUS

2,764,535. NEWDEAL, VIENNE, FRANCE. SN 75-671,950. PUB. 9-4-2001, FILED 3-30-1999.

SPIN

FOR SHAP-OFF-SCREWS, SELF-DRILLING AND SELF-TAPPING SCREWS FOR BONE IMPLANTS AND FOR ORTHOPEDIC JOINT IMPLANTS (U.S. CLS. 26, 39 AND 44).
FIRST USE 5-9-1997; IN COMMERCE 4-20-2000.

CLASS 10—(Continued).

2,764,586. IMZ FERTIGUNGS-UND VERTRIEBSEGESELLSCHAFT FUR DENTALE TECHNOLOGIE MBH, 70794 FILDERSTADT, FED REP GERMANY. SN 75-791,852. PUB. 7-18-2000, FILED 9-3-1999.

ALTATEC CAMLOG

OWNER OF U.S. REG. NO. 2,275,217.
FOR DENTAL BONE IMPLANTS AND PARTS THEREOF (U.S. CLS. 26, 39 AND 44).
FIRST USE 11-5-1999; IN COMMERCE 3-21-2001.

2,764,623. PHOENIX SCIENTIFIC, INC., ST. JOSEPH, MO. SN 75-863,182. PUB. 9-19-2000, FILED 12-3-1999.

RIGICARE

FOR MEDICAL APPARATUS; NAMELY, PLASTIC CONTAINERS FOR VETERINARY FLUIDS (U.S. CLS. 26, 39 AND 44).
FIRST USE 5-30-2003; IN COMMERCE 5-30-2003.

2,764,635. TRUDELL MEDICAL INTERNATIONAL, LONDON, ONTARIO, CANADA. SN 75-889,552. PUB. 5-21-2002, FILED 1-7-2000.



FOR MEDICAL APPARATUS, NAMELY, HOLDING CHAMBERS USED IN CONJUNCTION WITH AEROSOL DISPENSING DEVICES (U.S. CLS. 26, 39 AND 44).
FIRST USE 8-23-2000; IN COMMERCE 8-23-2000.

2,764,732. COMPUMEDICS LIMITED, ABBOTSFORD, VICTORIA, AUSTRALIA, BY ASSIGNMENT NEUROSOFT, INC., STERLING, VA. SN 76-076,852. PUB. 3-26-2002, FILED 6-26-2000.

COMPERIO

FOR ELECTROMYOGRAPHY MACHINES (U.S. CLS. 26, 39 AND 44).
FIRST USE 8-0-2000; IN COMMERCE 8-0-2000.

CLASS 10—(Continued).

2,764,777. MEDIVANCE, INC., LOUISVILLE, CO. SN 76-110,697. PUB. 8-27-2002, FILED 8-16-2000.

ARCTIC SUN

FOR ELECTROMECHANICAL DEVICES THAT TREAT NEUROVASCULAR DISORDERS THROUGH THE REGULATION OF PATIENT BODY TEMPERATURE (U.S. CLS. 26, 39 AND 44).
FIRST USE 2-8-2001; IN COMMERCE 2-8-2001.

2,764,789. DELTEC, INC., ST. PAUL, MN, BY CHANGE OF NAME SIMS DELTEC, INC., ST. PAUL, MN. SN 76-125,031. PUB. 6-19-2001, FILED 9-8-2000.

TRUFLOW

FOR HEMODIALYSIS CATHETERS (U.S. CLS. 26, 39 AND 44).
FIRST USE 4-29-2003; IN COMMERCE 4-29-2003.

2,764,826. NUVASIVE, INC., SAN DIEGO, CA. SN 76-152,041. PUB. 6-18-2002, FILED 10-23-2000.

INS-1

FOR MEDICAL DEVICES FOR NERVE SURVEILLANCE AND MONITORING (U.S. CLS. 26, 39 AND 44).
FIRST USE 1-11-2001; IN COMMERCE 1-11-2001.

2,764,841. SPICE ENTERTAINMENT, INC., CHICAGO, IL. SN 76-160,028. PUB. 3-5-2002, FILED 11-6-2000.

SENSUAL SWIRL

FOR PROSTHETIC BREAST, VAGINAS AND PENIS DEVICES; IMITATION SEXUAL ORGANS; ELECTRIC AND NON-ELECTRIC MASSAGE DEVICES; HAND-HELD VIBRATORS; SEXUAL AIDS, NAMELY VACUUM THERAPY DEVICES AND PENIS PUMPS; SEXUAL STIMULATORS NAMELY, DILDOS AND DONGS; CONDOMS (U.S. CLS. 26, 39 AND 44).
FIRST USE 10-21-2000; IN COMMERCE 10-21-2000.

2,764,871. WEST PHARMACEUTICAL SERVICES, INC., LIONVILLE, PA. SN 76-179,501. PUB. 6-25-2002, FILED 12-12-2000.

ATOMIST

FOR DRUG DELIVERY DEVICES USED FOR NASAL AND OPHTHALMIC ADMINISTRATION OF MEDICATION, NAMELY SPRAYERS, ATOMIZERS, AND NEBULIZERS, SOLD EMPTY (U.S. CLS. 26, 39 AND 44).
FIRST USE 10-30-2000; IN COMMERCE 1-17-2001.

CLASS 10—(Continued).

2,764,885. OPUS MEDICAL, SAN JUAN CAPISTRANO, CA. SN 76-190,844. PUB. 10-15-2002, FILED 1-3-2001.

SMART STITCH

NO CLAIM IS MADE TO THE EXCLUSIVE RIGHT TO USE "STITCH", APART FROM THE MARK AS SHOWN.

FOR SURGICAL DEVICES, NAMELY SUTURING INSTRUMENTS USED IN ORTHOPEDIC PROCEDURES AND ACCESSORIES THEREFOR (U.S. CLS. 26, 39 AND 44).

FIRST USE 7-31-2002; IN COMMERCE 7-31-2002.

2,764,986. ALL BETTER PRODUCTS, L.L.C., STUDIO CITY, CA. SN 76-258,142. PUB. 8-13-2002, FILED 5-16-2001.

THIS AND A KISS ARE ALL YOU NEED

FOR REUSABLE COLD PACK FOR BRUISES (U.S. CLS. 26, 39 AND 44).
FIRST USE 11-19-2001; IN COMMERCE 11-19-2001.

2,765,017. F-SQUARED DENTAL, INC., WINFIELD, IL. SN 76-267,925. PUB. 12-18-2001, FILED 6-5-2001.



FOR HOLDER FOR HOLDING DENTAL X-RAY FILM TO IMPRINT RADIO-OPAQUE DATA ONTO X-RAYS (U.S. CLS. 26, 39 AND 44).

FIRST USE 10-19-2002; IN COMMERCE 10-19-2002.

2,765,036. JOHNSON & JOHNSON, NEW BRUNSWICK, NJ. SN 76-274,492. PUB. 8-27-2002, FILED 6-21-2001.

ENDOPOUCH RETRIEVER

OWNER OF U.S. REG. NO. 1,984,905.
FOR SPECIMEN RETRIEVAL BAG FOR ENDO-MORPHIC SURGERY (U.S. CLS. 26, 39 AND 44).
FIRST USE 3-6-2003; IN COMMERCE 3-6-2003.

CLASS 10—(Continued).

2,765,073. EDWARDS LIFESCIENCES CORPORATION, IRVINE, CA. SN 76-292,515. PUB. 3-5-2002, FILED 7-31-2001.

S.A.V.

FOR MEDICAL DEVICES; NAMELY HEART VALVES (U.S. CLS. 26, 39 AND 44).

FIRST USE 8-13-2002; IN COMMERCE 8-13-2002.

2,765,172. MOSS, GERALD, WEST SAND LAKE, NY. SN 76-325,031. PUB. 4-9-2002, FILED 10-12-2001.

MARK Y2K2

FOR FEEDING/DECOMPRESSION TUBES (U.S. CLS. 26, 39 AND 44).

FIRST USE 10-31-2002; IN COMMERCE 10-31-2002.

2,765,332. LINVATEC CORPORATION, LARGO, FL. SN 76-370,095. PUB. 9-10-2002, FILED 2-12-2002.

LIGHTNING

FOR SURGICAL INSTRUMENTS, NAMELY, ENDO-MORPHIC SHAVER BLADES AND BURS, AND ACCESSORIES THEREFOR (U.S. CLS. 26, 39 AND 44).
FIRST USE 5-15-2002; IN COMMERCE 5-15-2002.

2,765,354. FOSSA MEDICAL INC., BOSTON, MA, BY CHANGE OF NAME FOSSA INDUSTRIES, INC., BOSTON, MA. SN 76-376,513. PUB. 10-8-2002, FILED 3-1-2002.

STONE SWEEPER

NO CLAIM IS MADE TO THE EXCLUSIVE RIGHT TO USE "STONE", APART FROM THE MARK AS SHOWN.

FOR MEDICAL DEVICE DESIGNED TO WITHDRAW KIDNEY STONES (U.S. CLS. 26, 39 AND 44).

FIRST USE 9-27-2002; IN COMMERCE 9-27-2002.

2,765,393. STRYKER CORPORATION, KALAMAZOO, MI. SN 76-387,649. PUB. 12-10-2002, FILED 3-27-2002.

EXFEN

FOR MEDICAL DEVICE, NAMELY, CATHETERS (U.S. CLS. 26, 39 AND 44).

FIRST USE 3-12-2002; IN COMMERCE 3-12-2002.

CLASS 10—(Continued).

2,765,401. MENTOR CORPORATION, SANTA BARBARA, CA. SN 76-389,396. PUB. 10-22-2002, FILED 3-28-2002.

FAS-TAP

FOR MEDICAL PRODUCTS NAMELY DRAINAGE VALVES AND CHECK VALVES FOR USE WITH URINARY LEG BAGS (U.S. CLS. 26, 39 AND 44).
FIRST USE 2-28-2003; IN COMMERCE 2-28-2003.

2,765,430. DELTEC, INC., ST. PAUL, MN. SN 76-402,942. PUB. 12-10-2002, FILED 5-2-2002.

**DELTEC COZMO
ESSENTIAL**

OWNER OF U.S. REG. NOS. 1,351,529 AND 1,393,140.
FOR MEDICAL APPARATUS, NAMELY, INFUSION ADMINISTRATION SETS COMPRISED OF CATHETERS, FILTERS, LUERS, VALVES, AND CLAMPS; MEDICATION RESERVOIRS, CARTRIDGES AND SYRINGES (U.S. CLS. 26, 39 AND 44).
FIRST USE 8-0-2002; IN COMMERCE 12-0-2002.

2,765,484. ANGIOLINK CORPORATION, TAUNTON, MA. SN 76-421,363. PUB. 12-10-2002, FILED 6-12-2002.



THE MARK CONSISTS OF THE LETTERS "EVS" ENCLOSED WITHIN A STYLIZED DESIGN OF A VASCULAR CLOSURE.
FOR SURGICAL APPARATUS, NAMELY, VASCULAR CLOSURES (U.S. CLS. 26, 39 AND 44).
FIRST USE 3-17-2003; IN COMMERCE 3-17-2003.

2,765,690. STARKEY LABORATORIES, INC., EDEN PRAIRIE, MN. SN 78-099,424. PUB. 9-17-2002, FILED 12-20-2001.

WAXCEPTOR

FOR EAR WAX REMOVAL INSTRUMENT (U.S. CLS. 26, 39 AND 44).
FIRST USE 4-1-2002; IN COMMERCE 4-1-2002.

CLASS 10—(Continued).

2,765,737. DAVID, MURRAY JAMES, DELAND, FL. SN 78-115,703. PUB. 1-14-2003, FILED 3-18-2002.

SURGICAL DIRECT

NO CLAIM IS MADE TO THE EXCLUSIVE RIGHT TO USE "SURGICAL", APART FROM THE MARK AS SHOWN.
FOR SURGICAL INSTRUMENTS, NAMELY SCALPES, BLADES, FORCEPS, LAPAROSCOPIC FORCEPS, LAPAROSCOPES, FIBER LIGHT CABLES, TROCARS, CANNULAS, SCISSORS, DISPOSABLE VERRES NEEDLES, DISPOSABLE INSUFFLATION TUBING, DISPOSABLE ANTIFOG (U.S. CLS. 26, 39 AND 44).
FIRST USE 4-1-2002; IN COMMERCE 6-1-2002.

2,765,826. TACTILE SYSTEMS TECHNOLOGY, INC., EAST BETHEL, MN. SN 78-156,230. PUB. 3-4-2003, FILED 8-21-2002.

FLEXITOUCH

FOR LYMPHEDEMA TREATMENT APPARATUS (U.S. CLS. 26, 39 AND 44).
FIRST USE 3-0-2003; IN COMMERCE 3-0-2003.

CLASS 11—ENVIRONMENTAL CONTROL APPARATUS

2,764,522. ELKAY MANUFACTURING COMPANY, OAK BROOK, IL. SN 75-635,295. PUB. 12-31-2002, FILED 2-5-1999.

ELITE GOURMET

OWNER OF U.S. REG. NO. 1,551,804.
FOR SINKS AND FAUCETS (U.S. CLS. 13, 21, 23, 31 AND 34).
FIRST USE 4-1-1999; IN COMMERCE 4-1-1999.

2,764,648. UNCLE BEN'S, INC., HOUSTON, TX. SN 75-918,613. PUB. 2-26-2002, FILED 2-15-2000.

EXPRESS CAFÉ

FOR FREEZER EQUIPMENT, NAMELY, FREEZER RACKS; FREEZERS (U.S. CLS. 13, 21, 23, 31 AND 34).
FIRST USE 7-0-2000; IN COMMERCE 7-0-2000.

CLASS 11—(Continued).

2,764,767. ENCON ELECTRIC, L.P., PHILADELPHIA, PA. SN 76-102,059. PUB. 5-15-2001, FILED 8-2-2000.

BIG SUR

FOR CEILING FANS (U.S. CLS. 13, 21, 23, 31 AND 34).
FIRST USE 7-7-2000; IN COMMERCE 7-7-2000.

2,764,803. GARRITY INDUSTRIES, INC., MADISON, CT. SN 76-136,188. PUB. 9-11-2001, FILED 9-27-2000.

GLO LITE

NO CLAIM IS MADE TO THE EXCLUSIVE RIGHT TO USE "LIGHT", APART FROM THE MARK AS SHOWN.
FOR FLASHLIGHTS (U.S. CLS. 13, 21, 23, 31 AND 34).
FIRST USE 9-0-2001; IN COMMERCE 9-0-2001.

2,764,832. FALCON WATERFREE TECHNOLOGIES, LLC, LOS ANGELES, CA. SN 76-155,285. PUB. 10-29-2002, FILED 10-30-2000.

FALCON WATERFREE

FOR URINALS, URINAL TRAPS AND STRUCTURAL AND REPLACEMENT PARTS THEREFORE (U.S. CLS. 13, 21, 23, 31 AND 34).
FIRST USE 3-0-2001; IN COMMERCE 3-0-2001.

2,764,834. GARLAND COMMERCIAL RANGES LIMITED, MISSISSAUGA, ONTARIO L4W 1X4, CANADA. SN 76-158,390. PUB. 4-23-2002, FILED 11-2-2000.

REACTOCELL

FOR VENTILATED CEILING SYSTEM COMPRISED OF BLOWER MOTORS WITH INTERLOCKING COMPONENTS FOR GREASE EXTRACTION, VAPOR EXTRACTION, MAKE-UP AIR, LIGHTING AND/OR SURFACE FIRE SUPPRESSION DESIGNED FOR COMMERCIAL COOKING ENVIRONMENTS AND ASSOCIATED AREAS (U.S. CLS. 13, 21, 23, 31 AND 34).
FIRST USE 2-10-2003; IN COMMERCE 2-10-2003.

CLASS 11—(Continued).

2,764,914. FRESH AKTIEBOLAG, 360 32 GEMLA, SWEDEN. SN 76-214,450. PUB. 11-13-2001, FILED 2-23-2001.



PRIORITY CLAIMED UNDER SEC. 44(D) ON SWEDEN APPLICATION NO. 00-09421, FILED 12-13-2000.

NO CLAIM IS MADE TO THE EXCLUSIVE RIGHT TO USE "VENTILATION", APART FROM THE MARK AS SHOWN.

THE STIPPLING SHOWN IN THE DRAWING IS A FEATURE OF THE MARK AND NOT INTENDED TO INDICATE COLOR.

FOR VENTILATION APPARATUS, NAMELY, VENTILATION PERIMETERS, VENTILATING CHILLED BEAMS AND DIFFUSERS; AIR VENTILATORS AND AIR CONDITIONERS FEATURING COMPONENT PARTS AND FITTINGS THEREFOR, NAMELY, FANS, HUMIDITY CONTROLLERS, TEMPERATURE CONTROLLERS, TIMERS, FILTERS, STORM SHIELDS, AIR DEFLECTORS, DAMPERS, COVER PLATES AND COLD AIR SHIELDS SOLD AS A UNIT, AND REPLACEMENT PARTS THEREFOR (U.S. CLS. 13, 21, 23, 31 AND 34).
FIRST USE 6-30-2001; IN COMMERCE 6-30-2001.

2,764,961. SOUTHERN COMFORT PROPERTIES, INC., SAN RAFAEL, CA. SN 76-237,946. PUB. 10-16-2001, FILED 4-9-2001.



OWNER OF U.S. REG. NOS. 317,529, 1,522,030, AND OTHERS.

NO CLAIM IS MADE TO THE EXCLUSIVE RIGHT TO USE "ESTABLISH 1847", APART FROM THE MARK AS SHOWN.

THE LINING AND STIPPLING SHOWN IN THE DRAWING ARE FEATURES OF THE MARK AND NOT INTENDED TO INDICATE COLOR.

FOR LAMPS, CEILING FANS, ELECTRIC FANS, ELECTRIC LIGHTING FIXTURES, ELECTRIC NIGHT LIGHTS, BARBECUE GRILLS, FLASH LIGHTS, PEN LIGHTS, ELECTRIC LIGHTS FOR CHRISTMAS TREES (U.S. CLS. 13, 21, 23, 31 AND 34).

FIRST USE 6-30-2002; IN COMMERCE 6-30-2002.

CLASS 11—(Continued).

2,765,066. EVO, INC., BEAVERTON, OR. SN 76-290,080. PUB. 8-6-2002, FILED 7-24-2001.

for the way you cook

FOR BARBECUE GRILLS, OUTDOOR COOKING GAS GRILLS AND DOMESTIC COOKING OVENS (U.S. CLS. 13, 21, 23, 31 AND 34).
FIRST USE 10-27-2000; IN COMMERCE 10-27-2000.

2,765,071. THERMO FORMA INC., MARIETTA, OH. SN 76-291,556. PUB. 6-25-2002, FILED 7-27-2001.

HEPA²

NO CLAIM IS MADE TO THE EXCLUSIVE RIGHT TO USE "HEPA", APART FROM THE MARK AS SHOWN.
FOR AIR FILTERS FOR INDUSTRIAL INSTALLATIONS FOR SCIENTIFIC AND LABORATORY EQUIPMENT (U.S. CLS. 13, 21, 23, 31 AND 34).
FIRST USE 10-1-2001; IN COMMERCE 10-1-2001.

2,765,077. HARDSCAPE MATERIALS, INC., BIXBY, OK. SN 76-294,902. PUB. 10-8-2002, FILED 8-3-2001.

PONDECO

FOR ORNAMENTAL POND KITS COMPRISED PRIMARILY OF ELECTRICAL WATER PUMPS, FITTED LINERS, WATER FILTERS, SKIMMER FILTERS, AND OTHER COMPONENTS OF THE SAME TYPE ALL SOLD AS A UNIT (U.S. CLS. 13, 21, 23, 31 AND 34).
FIRST USE 8-12-2000; IN COMMERCE 8-12-2000.

CLASS 11—(Continued).

2,765,133. APCOM, INC., FRANKLIN, TN. SN 76-312,206. PUB. 9-24-2002, FILED 9-14-2001.



NO CLAIM IS MADE TO THE EXCLUSIVE RIGHT TO USE "ELEMENT", APART FROM THE MARK AS SHOWN.
FOR WATER HEATER PARTS, NAMELY ELECTRICAL HEATING ELEMENT FOR WATER HEATERS (U.S. CLS. 13, 21, 23, 31 AND 34).
FIRST USE 1-0-1977; IN COMMERCE 1-0-1977.

2,765,138. CALLIDUS TECHNOLOGIES, L.L.C., TYLER, TX. SN 76-314,344. PUB. 9-3-2002, FILED 9-19-2001.

CUB

FOR INDUSTRIAL BURNERS DESIGNED TO COMBUST VOLATILE GASES IN THE PRESENCE OF OXYGEN TO GENERATE HEAT WITHIN INDUSTRIAL FURNACES (U.S. CLS. 13, 21, 23, 31 AND 34).
FIRST USE 2-0-2000; IN COMMERCE 2-0-2000.

2,765,164. SULZER METCO (US) INC., WESTBURY, NY. SN 76-322,700. PUB. 10-8-2002, FILED 10-9-2001.

CLIMET-HE

FOR THERMAL SPRAY APPARATUS, NAMELY, HEAT EXCHANGER FOR USE IN COOLING THERMAL SPRAY DEVICES (U.S. CLS. 13, 21, 23, 31 AND 34).
FIRST USE 10-0-2001; IN COMMERCE 10-0-2001.

2,765,165. SULZER METCO (US) INC., WESTBURY, NY. SN 76-322,701. PUB. 9-10-2002, FILED 10-9-2001.

CLIMET-RC

FOR THERMAL SPRAY APPARATUS, NAMELY, REFRIGERATOR CHILLING UNITS USED IN COOLING THERMAL SPRAY MACHINES (U.S. CLS. 13, 21, 23, 31 AND 34).
FIRST USE 10-0-2001; IN COMMERCE 10-0-2001.

CLASS 11—(Continued).

2,765,167. DIMPLEX NORTH AMERICA LIMITED, CAMBRIDGE, ONTARIO, CANADA. SN 76-323,110. PUB. 10-1-2002, FILED 10-10-2001.

milano^{ef}

PRIORITY CLAIMED UNDER SEC. 44(D) ON CANADA APPLICATION NO. 1116675, FILED 9-25-2001.

THE ENGLISH TRANSLATION OF "MILANO" IS "MILAN".

FOR ELECTRIC SIMULATED WOODSTOVES (U.S. CLS. 13, 21, 23, 31 AND 34).

FIRST USE 11-0-2001; IN COMMERCE 11-0-2001.

2,765,357. HANS GROHE, INC., ALPHARETTA, GA. SN 76-376,827. PUB. 9-3-2002, FILED 2-26-2002.

PROAKTIV

FOR KITCHEN FAUCET, BATH FAUCET, TUB FILTERS, SHOWER PANELS, SHOWER HEADS AND HAND SHOWERS (U.S. CLS. 13, 21, 23, 31 AND 34).

FIRST USE 7-1-2002; IN COMMERCE 7-1-2002.

2,765,414. BURCH CORPORATION, BIRMINGHAM, AL. SN 76-394,042. PUB. 10-8-2002, FILED 4-10-2002.

COLDGUARD

FOR COMMERCIAL AND INDUSTRIAL COOLER AND FREEZER DOORS (U.S. CLS. 13, 21, 23, 31 AND 34).

FIRST USE 4-24-2002; IN COMMERCE 4-24-2002.

2,765,415. LITEGLOW INDUSTRIES, INC., POMPANO BEACH, FL. SN 76-394,369. PUB. 9-24-2002, FILED 4-10-2002.

STREET BURNER

FOR AUTOMOTIVE LIGHTING ACCESSORIES, NAMELY, ILLUMINATED TIPS FOR AUTOMOBILE EXHAUST PIPES (U.S. CLS. 13, 21, 23, 31 AND 34).

FIRST USE 10-0-2002; IN COMMERCE 10-0-2002.

CLASS 11—(Continued).

2,765,422. ALOHA HOUSEWARES, INC., MANSFIELD, TX. SN 76-398,412. PUB. 10-29-2002, FILED 4-22-2002.

ALOHA BREEZE

FOR ELECTRIC FANS (U.S. CLS. 13, 21, 23, 31 AND 34).

FIRST USE 12-0-2002; IN COMMERCE 12-0-2002.

2,765,423. LAARS, INC., NEWPORT BEACH, CA. SN 76-398,423. PUB. 1-28-2003, FILED 4-22-2002.

PENNANT

FOR BOILERS AND WATER HEATERS FOR COMMERCIAL USE (U.S. CLS. 13, 21, 23, 31 AND 34).

FIRST USE 2-11-2003; IN COMMERCE 2-11-2003.

2,765,587. NOVATION ENVIRONMENTAL TECHNOLOGIES, INC., RENO, NV. SN 78-055,396. PUB. 9-11-2001, FILED 3-27-2001.

NOVATION

FOR WATER FILTRATION AND PURIFICATION UNITS FOR PRODUCING POTABLE WATER FOR DOMESTIC AND COMMERCIAL USE (U.S. CLS. 13, 21, 23, 31 AND 34).

FIRST USE 5-15-2003; IN COMMERCE 5-15-2003.

2,765,686. KOHLER CO., KOHLER, WI. SN 78-097,898. PUB. 7-23-2002, FILED 12-12-2001.

REVIVAL

FOR PLUMBING PRODUCTS AND FIXTURES, NAMELY, BATHS, BATHTUBS, WHIRLPOOL BATHS; SHOWER AND SHOWER AND BATH CUBICLES; BIDETS; LAVATORIES WITH TOILETS; TOILETS; TOILET SEATS; WATER CLOSETS; SINKS; TAPS; FAUCETS; BATH SPOUTS, BATHROOM FITTINGS, NAMELY, VALVES; SAUNAS; SANITARY APPARATUS IN THE NATURE OF URINALS, SANITARY WARE, NAMELY, LAVATORY SINKS AND WASH BASINS (U.S. CLS. 13, 21, 23, 31 AND 34).

FIRST USE 1-0-1993; IN COMMERCE 1-0-1993.

CLASS 11—(Continued).

2,765,708. ROBINSON, MICHAEL D., ANGELFIRE, NM. SN 78-106,780. PUB. 7-30-2002, FILED 2-4-2002.

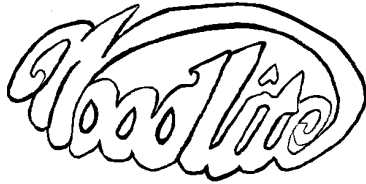

FOR AUTOMOTIVE VEHICLE PARTS, NAMELY HEADLAMPS (U.S. CLS. 13, 21, 23, 31 AND 34). FIRST USE 9-1-2002; IN COMMERCE 9-1-2002.

CLASS 12—VEHICLES

2,764,491. TITANIC LLC, CHICAGO, IL. SN 75-486,142. PUB. 10-5-1999, FILED 5-15-1998.

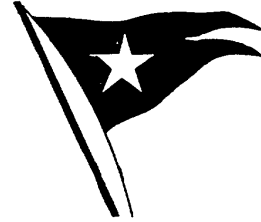

2,765,755. CATMULL, DALE ALBERT, IDAHO FALLS, ID. SN 78-120,870. PUB. 1-28-2003, FILED 4-10-2002.



NO CLAIM IS MADE TO THE EXCLUSIVE RIGHT TO USE "GEAR", APART FROM THE MARK AS SHOWN. FOR BATTERY OPERATED PORTABLE ELECTRIC LIGHTS, NAMELY, FLASHLIGHTS AND HEAD LAMPS (U.S. CLS. 13, 21, 23, 31 AND 34). FIRST USE 6-4-2002; IN COMMERCE 3-15-2003.

FOR BOATS, SINGLE RECREATIONAL JET BOATS, MULTIPLE RIDER RECREATIONAL JET BOATS, CANOES, FERRY BOATS, KAYAKS, RAFTS, SAILBOATS, SHIPS, YACHTS, CANOE PADDLES, KAYAK EQUIPMENT, NAMELY, PADDLES, REINFORCING STRUTS AND WATER DEFLECTING SKIRTS (U.S. CLS. 19, 21, 23, 31, 35 AND 44). FIRST USE 12-12-2002; IN COMMERCE 12-12-2002.

2,765,776. CONAIRCIP, INC., STAMFORD, CT. SN 78-128,746. PUB. 11-5-2002, FILED 5-15-2002.

CUISINART

FOR ELECTRIC PIZZELLE PRESS AND ELECTRIC SANDWICH GRILL (U.S. CLS. 13, 21, 23, 31 AND 34). FIRST USE 8-0-2002; IN COMMERCE 8-0-2002.

2,764,503. ROUTE 66, L.P., NEW YORK, NY. SN 75-551,981. PUB. 10-19-1999, FILED 9-11-1998.

ROUTE 66

FOR BICYCLES (U.S. CLS. 19, 21, 23, 31, 35 AND 44). FIRST USE 3-30-2003; IN COMMERCE 3-0-2003.

2,765,828. MOEN INCORPORATED, NORTH OLMSTED, OH. SN 78-975,098. PUB. 11-26-2002, FILED 7-13-2000.

CORNERSTONE

FOR FAUCETS FOR USE IN KITCHENS, LAVATORIES, AND ROMAN TUBS; TUB SPOUTS; SHOWER AND TUB CONTROL VALVES; TUB WASTES AND OVERFLOWS; BIDETS; SHOWER HEADS; HAND-HELD SHOWERS AND SLIDE BARS THEREFOR; SHOWER GRAB BARS; SHOWER ACCESSORY HOLDERS; AND STAINLESS STEEL SINKS (U.S. CLS. 13, 21, 23, 31 AND 34). FIRST USE 11-0-2000; IN COMMERCE 1-0-2001.

2,764,558. FREIGHTLINER LLC, PORTLAND, OR. SN 75-713,438. PUB. 11-19-2002, FILED 5-25-1999.

COLUMBIA

FOR HEAVY DUTY TRUCKS (U.S. CLS. 19, 21, 23, 31, 35 AND 44). FIRST USE 3-0-2000; IN COMMERCE 3-0-2000.

CLASS 12—(Continued).

2,764,825. STONE WELL BODIES & EQUIPMENT, INC., GENOA, NY. SN 76-151,544. PUB. 10-8-2002, FILED 10-23-2000.

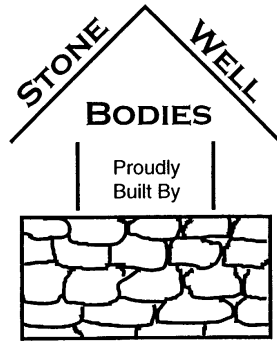

NO CLAIM IS MADE TO THE EXCLUSIVE RIGHT TO USE "PROUDLY BUILT BY" AND "BODIES", APART FROM THE MARK AS SHOWN. FOR TRUCK BODIES (U.S. CLS. 19, 21, 23, 31, 35 AND 44). FIRST USE 11-19-2001; IN COMMERCE 11-19-2001.

2,764,866. PRINCETON DELIVERY SYSTEMS, INC., CANAL WINCHESTER, OH. SN 76-176,365. PUB. 10-1-2002, FILED 12-5-2000.



OWNER OF U.S. REG. NO. 1,502,109. FOR FORK LIFT TRUCKS (U.S. CLS. 19, 21, 23, 31, 35 AND 44). FIRST USE 3-0-2001; IN COMMERCE 3-0-2001.

CLASS 12—(Continued).

2,764,884. PEP BOYS MANNY, MOE & JACK OF CALIFORNIA, THE, PHILADELPHIA, PA. SN 76-189,675. PUB. 12-4-2001, FILED 1-4-2001.

PROLINE

OWNER OF U.S. REG. NOS. 1,725,416, 2,179,083, AND 2,356,875. FOR AUTOMOTIVE PARTS, NAMELY, WHEELS (U.S. CLS. 19, 21, 23, 31, 35 AND 44). FIRST USE 2-17-2003; IN COMMERCE 2-17-2003.

2,764,889. UTILITY TRAILER MANUFACTURING CO., CITY OF INDUSTRY, CA. SN 76-194,807. PUB. 3-19-2002, FILED 1-16-2001.

3000D

OWNER OF U.S. REG. NO. 2,419,837. FOR TRUCK TRAILER BODIES (U.S. CLS. 19, 21, 23, 31, 35 AND 44). FIRST USE 7-1-2002; IN COMMERCE 7-1-2002.

2,764,890. UTILITY TRAILER MANUFACTURING CO., CITY OF INDUSTRY, CA. SN 76-194,809. PUB. 3-26-2002, FILED 1-16-2001.

3000D-X

OWNER OF U.S. REG. NO. 2,419,837. FOR TRUCK TRAILER BODIES (U.S. CLS. 19, 21, 23, 31, 35 AND 44). FIRST USE 1-1-2003; IN COMMERCE 1-1-2003.

2,765,039. MICHELIN NORTH AMERICA, INC., GREENVILLE, SC. SN 76-276,193. PUB. 1-15-2002, FILED 6-25-2001.

X-HAUL

FOR PNEUMATIC TIRES AND INNER TUBES FOR EARTHMOVER VEHICLES; TREADS FOR RECAPPING PNEUMATIC TIRES FOR EARTHMOVER VEHICLES; TRACKS FOR EARTHMOVER VEHICLES (U.S. CLS. 19, 21, 23, 31, 35 AND 44). FIRST USE 4-0-2002; IN COMMERCE 4-0-2002.

2,765,081. PACE AMERICAN, INC., MIDDLEBURY, IN. SN 76-296,784. PUB. 2-11-2003, FILED 8-7-2001.

SUMMIT

FOR ENCLOSED TRAILERS, NAMELY CARGO TRAILERS AND TRAILERS FOR HAULING LANDSCAPE PRODUCTS AND EQUIPMENT (U.S. CLS. 19, 21, 23, 31, 35 AND 44). FIRST USE 1-28-2002; IN COMMERCE 1-28-2002.

CLASS 12—(Continued).

2,765,091. FULTON PERFORMANCE PRODUCTS, INC., MOSINEE, WI. SN 76-299,232. PUB. 8-27-2002, FILED 8-15-2001.

FULTON

SEC. 2(F).

FOR LAND VEHICLE ACCESSORIES, NAMELY, TRAILER COUPLERS AND HITCHES, BEARING PROTECTORS, HITCH BALLS, HITCH BLOCKS, JACKS, WINCHES, TRAILER STANDS, BOAT GUIDES, BOAT MOTOR SUPPORT BRACKETS, BOAT MOTOR LOCKS, JACK CASTERS, JACK COUPLERS, PROTECTORS IN THE NATURE OF CAPS WHICH COVER THE HUBS OF VEHICLE WHEELS, ANTI-THEFT BLOCKS FOR USE ON VEHICLE TIRE WHEELS, BOAT MOTOR SUPPORT BRACKETS, AND ELECTRICALLY ACTUATED BRAKES (U.S. CLS. 19, 21, 23, 31, 35 AND 44).

FIRST USE 0-0-1941; IN COMMERCE 0-0-1941.

2,765,126. MITSUBISHI MOTORS NORTH AMERICA, INC., CYPRESS, CA. BY CHANGE OF NAME MITSUBISHI MOTOR SALES OF AMERICA, INC., CYPRESS, CA. SN 76-310,412. PUB. 3-26-2002, FILED 9-7-2001.

LANCER EVOLUTION

FOR MOTOR VEHICLES, NAMELY, AUTOMOBILES, SPORT UTILITY VEHICLES, AND STRUCTURAL PARTS THEREOF (U.S. CLS. 19, 21, 23, 31, 35 AND 44).

FIRST USE 3-20-2003; IN COMMERCE 3-20-2003.

2,765,150. FLEETWOOD ENTERPRISES, INC., RIVERSIDE, CA. SN 76-318,909. PUB. 9-24-2002, FILED 9-28-2001.

YUMA

FOR FOLDING CAMPING TRAILERS (U.S. CLS. 19, 21, 23, 31, 35 AND 44).

FIRST USE 11-0-2001; IN COMMERCE 11-0-2001.

2,765,224. KOMATSU FORKLIFT U.S.A., INC., COVINGTON, GA. SN 76-340,367. PUB. 5-14-2002, FILED 11-19-2001.

 The logo for 'EZview' features the letters 'EZ' in a large, bold, stylized font. The 'E' and 'Z' are connected at the top. To the right of 'EZ', the word 'view' is written in a smaller, lowercase, sans-serif font.

FOR FORKLIFT MASTS (U.S. CLS. 19, 21, 23, 31, 35 AND 44).

FIRST USE 7-0-2001; IN COMMERCE 7-0-2001.

CLASS 12—(Continued).

2,765,254. VOLKSWAGEN OF AMERICA, INC., AUBURN HILLS, MI. SN 76-348,888. PUB. 11-26-2002, FILED 12-17-2001.

TURBO S

NO CLAIM IS MADE TO THE EXCLUSIVE RIGHT TO USE "TURBO", APART FROM THE MARK AS SHOWN.

FOR AUTOMOBILES AND STRUCTURAL PARTS THEREFOR, AND ENGINES FOR AUTOMOBILES AND STRUCTURAL PARTS THEREFOR (U.S. CLS. 19, 21, 23, 31, 35 AND 44).

FIRST USE 1-0-2002; IN COMMERCE 1-0-2002.

2,765,307. R.A. PHILLIPS INDUSTRIES, INC., SANTA FE SPRINGS, CA. SN 76-362,640. PUB. 11-5-2002, FILED 1-24-2002.

POLARAIR

FOR AIR BRAKE HOSES FOR CONNECTION BETWEEN TOWING AND TOWED VEHICLES, EG, BETWEEN TRUCK TRACTORS AND TRAILERS AND BETWEEN TRAILERS (U.S. CLS. 19, 21, 23, 31, 35 AND 44).

FIRST USE 2-21-2002; IN COMMERCE 2-21-2002.

2,765,328. EXPLORER COMPETITION PRODUCTS, INC., CHULA VISTA, CA. SN 76-369,473. PUB. 2-4-2003, FILED 2-12-2002.

MX6

FOR VEHICLE PARTS, NAMELY, SHOCK ABSORBERS (U.S. CLS. 19, 21, 23, 31, 35 AND 44).

FIRST USE 11-0-2001; IN COMMERCE 11-0-2001.

2,765,382. INTELLIGENT DESIGNS 2000 CORPORATION, DENVER, CO. SN 76-382,932. PUB. 12-24-2002, FILED 3-12-2002.

GOBI

FOR ROOF RACK STORAGE CONTAINERS FOR LAND VEHICLES; ROOF RACKS FOR VEHICLES FOR USE IN CARRYING CARGO, BICYCLES, WHEELS, SKIS, SNOWBOARDS, SAILBOARDS, SURFBOARDS, KAYAKS, LUGGAGE AND SPORTS EQUIPMENT; LAND VEHICLE ACCESSORIES, NAMELY, GRILL GUARDS (U.S. CLS. 19, 21, 23, 31, 35 AND 44).

FIRST USE 1-6-2003; IN COMMERCE 1-6-2003.

CLASS 12—(Continued).

2,765,385. HONDA GIKEN KOGYO KABUSHIKI KAISHA (HONDA MOTOR CO., LTD.), MINATO-KU, TOKYO 107, JAPAN. SN 76-385,442. PUB. 9-10-2002, FILED 3-19-2002.

ELEMENT

FOR LAND MOTOR VEHICLES, NAMELY TRUCKS, SUVs, AND STRUCTURAL PARTS THEREOF (U.S. CLS. 19, 21, 23, 31, 35 AND 44).
FIRST USE 3-27-2002; IN COMMERCE 3-27-2002.

2,765,394. THOR TECH, INC., IMLAY CITY, MI. SN 76-387,691. PUB. 10-15-2002, FILED 3-27-2002.

COLORADO

FOR RECREATIONAL VEHICLES NAMELY, TRAVEL TRAILERS AND FIFTH WHEEL TRAILERS (U.S. CLS. 19, 21, 23, 31, 35 AND 44).
FIRST USE 8-0-2002; IN COMMERCE 8-0-2002.

2,765,406. KENT INTERNATIONAL INC., PARSIPPANY, NJ. SN 76-391,441. PUB. 12-17-2002, FILED 4-4-2002.

WEERIDE

FOR BICYCLES; BICYCLE ACCESSORIES AND PARTS THEREOF, NAMELY, SADDLES AND SADDLE COVERS, TIRES AND INNER TUBES, CHAIN STAYS, HANDLEBARS, FORKS, AND SUSPENSIONS; WATER BOTTLE RACKS WHICH ATTACH TO BICYCLES, AIR PUMPS, BICYCLE RACKS FOR VEHICLES, AND CYCLING BAGS ADAPTED FOR BICYCLES; CHILD CARRIERS FOR BICYCLES IN THE NATURE OF CHILD SEATS THAT MOUNT ONTO THE FRONT AND/OR THE REAR OF A BICYCLE (U.S. CLS. 19, 21, 23, 31, 35 AND 44).
FIRST USE 5-2-2003; IN COMMERCE 5-2-2003.

2,765,439. HONDA GIKEN KOGYO KABUSHIKI KAISHA (HONDA MOTOR CO., LTD.), TOKYO 107, JAPAN. SN 76-406,701. PUB. 11-5-2002, FILED 5-1-2002.

TSX

FOR LAND MOTOR VEHICLES, NAMELY, AUTOMOBILES AND STRUCTURAL PARTS THEREOF (U.S. CLS. 19, 21, 23, 31, 35 AND 44).
FIRST USE 4-0-2003; IN COMMERCE 4-0-2003.

CLASS 12—(Continued).

2,765,496. DENSO SALES CALIFORNIA, INC., LONG BEACH, CA. SN 76-430,603. PUB. 2-11-2003, FILED 7-11-2002.

ENDUROVISION

FOR WINDSHIELD WIPER BLADES (U.S. CLS. 19, 21, 23, 31, 35 AND 44).
FIRST USE 11-4-2002; IN COMMERCE 11-4-2002.

2,765,723. GENERAL MOTORS CORPORATION, DETROIT, MI. SN 78-112,407. PUB. 3-25-2003, FILED 3-4-2002.

PATHWAY

FOR ELECTRICALLY POWERED LAND VEHICLES, NAMELY, AUTOMOBILES (U.S. CLS. 19, 21, 23, 31, 35 AND 44).
FIRST USE 4-20-2002; IN COMMERCE 4-20-2002.

CLASS 13—FIREARMS

2,764,605. HUNTER PACIFIC LIMITED, TORTOLA, BR. VIRGIN ISLANDS. SN 75-832,112. PUB. 12-5-2000, FILED 10-27-1999.

POWER PACK

FOR FIREWORKS (U.S. CLS. 2 AND 9).
FIRST USE 6-0-2001; IN COMMERCE 6-0-2001.

2,765,218. INGRAM ENTERPRISES, INC., SPRINGFIELD, MO. SN 76-338,920. PUB. 7-16-2002, FILED 11-16-2001.

SEVENTH HEAVEN

FOR FIREWORKS (U.S. CLS. 2 AND 9).
FIRST USE 4-15-2003; IN COMMERCE 4-15-2003.

CLASS 14—JEWELRY

2,764,527. TIFFANY AND COMPANY, NEW YORK, NY, BY ASSIGNMENT; BY ASSIGNMENT CELLINI NYC, NEW YORK, NY. SN 75-646,781. PUB. 12-14-1999, FILED 2-23-1999.

DIAMONDS BY THE YEAR

NO CLAIM IS MADE TO THE EXCLUSIVE RIGHT TO USE "DIAMONDS", APART FROM THE MARK AS SHOWN. FOR DIAMOND JEWELRY (U.S. CLS. 2, 27, 28 AND 50).
FIRST USE 4-18-1999; IN COMMERCE 4-18-1999.

CLASS 14—(Continued).

2,764,669. INSCRIPT, LLC, CAMBRIDGE, MA. SN 75-983,242.
PUB. 7-3-2001, FILED 1-21-2000.

INSCRIPT

FOR JEWELRY THAT INCLUDES A STORAGE MEDIUM FOR IMAGES, TEXT AND DATA, NAMELY PHOTOLITHOGRAPHICALLY DEPOSITED IMAGES, TEXT AND DATA UPON A SUBSTRATE (U.S. CLS. 2, 27, 28 AND 50).
FIRST USE 11-25-2002; IN COMMERCE 11-25-2002.

2,764,671. AYRTON SENNA PROMOCOES E EMPREEDIMENTOS S/C LTDA., 02037-000 SAO PAULO, SP, BRAZIL.
SN 75-983,302. PUB. 2-22-2000, FILED 3-24-1998.

THE NAME DOES NOT IDENTIFY A LIVING INDIVIDUAL.
FOR WRISTWATCHES (U.S. CLS. 2, 27, 28 AND 50).
FIRST USE 10-0-2001; IN COMMERCE 10-0-2001.

2,765,075. APEX JEWELRY INC., NEW YORK, NY. SN 76-293,394. PUB. 3-19-2002, FILED 8-1-2001.

FOR JEWELRY (U.S. CLS. 2, 27, 28 AND 50).
FIRST USE 9-0-2002; IN COMMERCE 9-0-2002.

2,765,140. POMMES DE CLAIRE ORCHARDS, INC., HIGHLAND, NY. SN 76-314,559. PUB. 9-3-2002, FILED 9-19-2001.

P DE C

FOR JEWELRY (U.S. CLS. 2, 27, 28 AND 50).
FIRST USE 4-15-2002; IN COMMERCE 4-15-2002.

CLASS 14—(Continued).

2,765,200. KOBOLD, MICHAEL, PITTSBURGH, PA. SN 76-331,970. PUB. 9-3-2002, FILED 10-31-2001.

SPIRIT OF AMERICA

NO CLAIM IS MADE TO THE EXCLUSIVE RIGHT TO USE "AMERICA", APART FROM THE MARK AS SHOWN.
FOR WATCHES (U.S. CLS. 2, 27, 28 AND 50).
FIRST USE 11-1-2002; IN COMMERCE 11-1-2002.

2,765,308. ED LEVIN, INC., CAMBRIDGE, NY. SN 76-362,802.
PUB. 9-24-2002, FILED 1-28-2002.

**SHAPING AMERICAN
DESIGN SINCE 1950**

NO CLAIM IS MADE TO THE EXCLUSIVE RIGHT TO USE "SINCE 1950", APART FROM THE MARK AS SHOWN.
FOR JEWELRY (U.S. CLS. 2, 27, 28 AND 50).
FIRST USE 1-0-1998; IN COMMERCE 1-0-1998.

2,765,340. DIAMINTANGIBLES INTERNATIONAL, LTD., NASSAU, BAHAMAS. SN 76-373,126. PUB. 12-24-2002, FILED 2-21-2002.

SIMPLY 3 STONE

NO CLAIM IS MADE TO THE EXCLUSIVE RIGHT TO USE "3 STONE", APART FROM THE MARK AS SHOWN.
FOR JEWELRY (U.S. CLS. 2, 27, 28 AND 50).
FIRST USE 6-3-2003; IN COMMERCE 6-3-2003.

2,765,371. POMMES DE CLAIRE, INC., NEW YORK, NY. SN 76-379,009. PUB. 9-24-2002, FILED 3-6-2002.

LOVEWORDS

FOR JEWELRY (U.S. CLS. 2, 27, 28 AND 50).
FIRST USE 4-15-2002; IN COMMERCE 4-15-2002.

2,765,403. ROBERT TALBOTT, INC., CARMEL VALLEY, CA. SN 76-391,205. PUB. 10-22-2002, FILED 4-3-2002.

AUDREY TALBOTT

OWNER OF U.S. REG. NO. 1,318,228.
THE NAME "AUDREY TALBOTT" IS THE NAME OF A LIVING INDIVIDUAL WHOSE CONSENT IS OF RECORD.
FOR CUFFLINKS (U.S. CLS. 2, 27, 28 AND 50).
FIRST USE 1-0-2002; IN COMMERCE 1-0-2002.

CLASS 14—(Continued).

2,765,482. DIAMINTANGIBLES INTERNATIONAL, LTD., NASSAU, BAHAMAS. SN 76-420,056. PUB. 12-31-2002, FILED 6-13-2002.

LOVE'S CHOICE

FOR DIAMONDS AND FINE JEWELRY (U.S. CLS. 2, 27, 28 AND 50).
FIRST USE 1-14-2003; IN COMMERCE 1-14-2003.

2,765,536. KNECHTEL, CHARLES DOBSON, NAPA, CA. SN 78-005,919. PUB. 10-29-2002, FILED 4-27-2000.

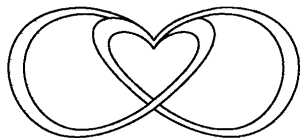

FOR JEWELRY MADE OF PRECIOUS AND SEMI-PRECIOUS MATERIALS, NAMELY, RINGS, EARRINGS, PENDANTS, CUFF-LINKS, LAPEL PINS, BRACELETS, NECKLACES AND BROOCHES (U.S. CLS. 2, 27, 28 AND 50).
FIRST USE 1-1-1999; IN COMMERCE 1-1-1999.

2,765,579. YONI DIAMONDS, INC., NEW YORK, NY. SN 78-049,765. PUB. 10-22-2002, FILED 2-22-2001.

EVOLUTION

FOR JEWELRY, NAMELY, DIAMOND AND GEMSTONE ANNIVERSARY BANDS AND RINGS (U.S. CLS. 2, 27, 28 AND 50).
FIRST USE 7-14-2001; IN COMMERCE 7-14-2001.

2,765,744. KOVAL, DANIEL, PAUL, STOCKBRIDGE, MA. SN 78-117,259. PUB. 10-29-2002, FILED 3-25-2002.

EWECOO

FOR BATTERY OPERATED CLOCK USING A SHEEP CHARACTER TO REPLACE CUCKOO CLOCK SOUND (U.S. CLS. 2, 27, 28 AND 50).
FIRST USE 7-15-2001; IN COMMERCE 1-22-2002.

CLASS 14—(Continued).

2,765,745. KOVAL, DANIEL, PAUL, STOCKBRIDGE, MA. SN 78-117,261. PUB. 12-17-2002, FILED 3-25-2002.

CLUCKCOO

FOR BATTERY OPERATED CLOCK FROM WHICH A CHICKEN CHARACTER AUTOMATICALLY EMERGES AND EMITS A CHICKEN SOUND ON THE HOUR (U.S. CLS. 2, 27, 28 AND 50).
FIRST USE 7-15-2001; IN COMMERCE 1-22-2002.

2,765,778. PANAMA JACK INTERNATIONAL, INC., ORLANDO, FL. SN 78-129,295. PUB. 11-26-2002, FILED 5-16-2002.

PANAMA JACK EXTREME

OWNER OF U.S. REG. NOS. 1,690,257, 1,776,347, AND OTHERS.
FOR JEWELRY (U.S. CLS. 2, 27, 28 AND 50).
FIRST USE 5-16-2002; IN COMMERCE 7-1-2002.

2,765,808. THEURER, HAROLD JR., BROOKLYN, NY. SN 78-140,566. PUB. 3-18-2003, FILED 7-2-2002.

**THE OFFICIAL ACTOR'S
GOOD LUCK CHARM**

NO CLAIM IS MADE TO THE EXCLUSIVE RIGHT TO USE "CHARM", APART FROM THE MARK AS SHOWN.
FOR JEWELRY; CHARMS FOR NECKLACES, PINS OR CHAINS MADE IN GOLD, SILVER, PEWTER (U.S. CLS. 2, 27, 28 AND 50).
FIRST USE 7-6-2002; IN COMMERCE 3-23-2003.

CLASS 15—MUSICAL INSTRUMENTS

2,764,792. COMPOSITE ACOUSTICS DEVELOPMENT AND LICENSING, L.L.C, LAFAYETTE, LA. SN 76-128,140. PUB. 4-16-2002, FILED 9-13-2000.

CA

FOR STRINGED INSTRUMENTS (U.S. CLS. 2, 21 AND 36).
FIRST USE 10-11-2001; IN COMMERCE 10-11-2001.

CLASS 15—(Continued).

2,764,793. COMPOSITE ACOUSTICS DEVELOPMENT AND LICENSING, L.L.C., LAFAYETTE, LA. SN 76-131,417. PUB. 7-23-2002, FILED 9-19-2000.



THE MARK CONSISTS OF THE LETTERS "C" AND "A" IN STYLIZED FORM. FOR STRINGED INSTRUMENTS (U.S. CLS. 2, 21 AND 36). FIRST USE 10-11-2001; IN COMMERCE 10-11-2001.

2,765,157. DRUM DOCTORS LLC, NORTH HOLLYWOOD, CA. SN 76-320,574. PUB. 10-1-2002, FILED 10-4-2001.



NO CLAIM IS MADE TO THE EXCLUSIVE RIGHT TO USE "DRUM", APART FROM THE MARK AS SHOWN. FOR CARRYING CASES, USED FOR PERCUSSION INSTRUMENTS AND PERCUSSION INSTRUMENT ACCESSORIES (U.S. CLS. 2, 21 AND 36). FIRST USE 1-15-2002; IN COMMERCE 1-15-2002.

CLASS 16—PAPER GOODS AND PRINTED MATTER

2,764,510. BIOMET, INC., WARSAW, IN. SN 75-585,030. PUB. 5-29-2001, FILED 11-9-1998.

VACPAC

FOR PLASTIC FLEXIBLE FILM BAG FEATURING A RIGID PLASTIC VACUUM COMPARTMENT FOR PACKAGING BONE CEMENT (U.S. CLS. 2, 5, 22, 23, 29, 37, 38 AND 50). FIRST USE 10-23-2002; IN COMMERCE 10-23-2002.

CLASS 16—(Continued).

2,764,561. FITZGERALD, JUNE, WINCHESTER, MA. SN 75-728,100. PUB. 3-14-2000, FILED 6-14-1999.

LUGGAGE LOOKOUT

NO CLAIM IS MADE TO THE EXCLUSIVE RIGHT TO USE "LUGGAGE", APART FROM THE MARK AS SHOWN. FOR PRINTED MATERIALS, NAMELY, STICKERS AND LABELS TO BE PLACED ON LUGGAGE FOR IDENTIFICATION (U.S. CLS. 2, 5, 22, 23, 29, 37, 38 AND 50). FIRST USE 5-15-2003; IN COMMERCE 5-19-2003.

2,764,580. ELLIS, KAREN, NEW YORK, NY. SN 75-773,195. PUB. 6-19-2001, FILED 8-11-1999.

CHAKRA

THE ENGLISH TRANSLATION OF THE WORD "CHAKRA" IN THE MARK IS "ENERGY CENTER". FOR PAPER GOODS, NAMELY, NOTE CARDS, ENVELOPES, STATIONERY, GREETING CARDS, PAPER POUCHES FOR PACKAGING, PAPER BAGS FOR PACKAGING, PAPER ENVELOPES FOR PACKAGING, PAPER FOR WRAPPING AND PACKAGING, BOOKMARKS, BOOK COVERS, CALENDARS, NOTEBOOKS, PERSONAL JOURNALS, DATE BOOKS, DIARIES, SKETCH PADS, PAINT BRUSHES, ARTS AND CRAFTS PAINT KITS (U.S. CLS. 2, 5, 22, 23, 29, 37, 38 AND 50). FIRST USE 1-6-2003; IN COMMERCE 1-6-2003.

2,764,590. C4CAST.COM, INC., PASADENA, CA. SN 75-801,699. PUB. 4-3-2001, FILED 9-17-1999.

C4CAST

FOR PRINTED MAGAZINES, NEWSLETTERS, BOOKS AND PAMPHLETS IN THE FIELD OF BUSINESS, FINANCIAL AND ECONOMIC FORECASTING, CONSULTATION, RESEARCH, ANALYSIS, INFORMATION AND ENTERTAINMENT; PRINTED AWARD CERTIFICATES (U.S. CLS. 2, 5, 22, 23, 29, 37, 38 AND 50). FIRST USE 7-1-2001; IN COMMERCE 7-1-2001.

CLASS 16—(Continued).

2,764,630. HERB STIRLING BRIDGMAN, CHERRY VALLEY, CA. SN 75-886,129. PUB. 9-19-2000, FILED 1-4-2000.



THE STIPPLING IS FOR SHADING PURPOSES ONLY AND DOES NOT INCLUDE COLOR.

THE MARK CONSISTS IN PART OF THE WORDING "BANDIMALS".

FOR CHILDREN'S BOOKS (U.S. CLS. 2, 5, 22, 23, 29, 37, 38 AND 50).

FIRST USE 0-0-1999; IN COMMERCE 3-23-2003.

2,764,644. PROCTER & GAMBLE COMPANY, THE, CINCINNATI, OH. SN 75-910,128. PUB. 10-24-2000, FILED 1-26-2000.

EASY-UPS

OWNER OF U.S. REG. NO. 1,762,957 AND OTHERS. FOR DISPOSABLE DIAPERS (U.S. CLS. 2, 5, 22, 23, 29, 37, 38 AND 50).

FIRST USE 2-11-2002; IN COMMERCE 2-11-2002.

2,764,667. INFLUENCE AT WORK, TEMPE, AZ. SN 75-982,988. PUB. 9-18-2001, FILED 10-13-1999.

INFLUENCE AT WORK

FOR PRINTED MATERIALS, NAMELY, LOOSE-LEAF BINDERS, WORKBOOKS, TRAINING GUIDES, PAMPHLETS AND BOOKS IN THE FIELD OF PERSUASION TECHNIQUES (U.S. CLS. 2, 5, 22, 23, 29, 37, 38 AND 50).

FIRST USE 5-5-2000; IN COMMERCE 5-5-2000.

2,764,744. GRUPPO CORDENONS S.P.A., MILAN, ITALY, BY CHANGE OF NAME CARTIERE DI CORDENONS S.P.A., 20145 MILAN, ITALY. SN 76-080,635. PUB. 2-5-2002, FILED 6-30-2000.

STARDREAM

FOR WRITING PAPER; ART MOUNTS; ART SKETCHING BOARDS; PICTURE FRAMING MAT BOARDS; WATERCOLOR BOARDS; POSTERBOARDS; FOLDERS; PHOTO ALBUM COVERS; CALENDARS; GREETING CARDS; BUSINESS CARDS; PRINTED MENUS; LUXURY PACKAGING MATERIALS, NAMELY, PAPER GIFT BOXES AND GIFT WRAPPING PAPER; PAPER TAGS FOR CLOTHES; CARDBOARD DISPLAY BOXES; BOOK COVERS; STATIONERY (U.S. CLS. 2, 5, 22, 23, 29, 37, 38 AND 50).

FIRST USE 8-0-2000; IN COMMERCE 8-0-2000.

CLASS 16—(Continued).

2,764,861. HARBOR PACKAGING, INC., POWAY, CA. SN 76-170,607. PUB. 3-19-2002, FILED 11-24-2000.



NO CLAIM IS MADE TO THE EXCLUSIVE RIGHT TO USE "PACKAGING INC.", APART FROM THE MARK AS SHOWN.

FOR BOXES, NAMELY, CUSTOM CORRUGATED AND CARDBOARD (U.S. CLS. 2, 5, 22, 23, 29, 37, 38 AND 50).

FIRST USE 1-15-2003; IN COMMERCE 1-15-2003.

2,764,867. CHANDARIA, SACHEN, NAIROBI, KENYA. SN 76-176,645. PUB. 3-19-2002, FILED 12-7-2000.

I-NOTE

FOR MEMO PADS WITH A SELF-ADHESIVE BACKING THEREON (U.S. CLS. 2, 5, 22, 23, 29, 37, 38 AND 50).

FIRST USE 6-11-2002; IN COMMERCE 6-11-2002.

2,764,928. CDK ASSOCIATES & CONSULTANTS, INC., BOSTON, MA. SN 76-221,579. PUB. 11-27-2001, FILED 3-8-2001.

LEARNING CHALLENGE

NO CLAIM IS MADE TO THE EXCLUSIVE RIGHT TO USE "LEARNING", APART FROM THE MARK AS SHOWN.

FOR FICTION BOOKS AND NON-FICTION BOOKS IN THE FIELD OF HISTORY, BIOGRAPHIES, NATURE AND CLASSICS AND WHICH CONTAIN QUESTIONS AND ANSWERS ON THE BOOK TOPIC (U.S. CLS. 2, 5, 22, 23, 29, 37, 38 AND 50).

FIRST USE 3-8-2001; IN COMMERCE 3-25-2003.

2,764,942. IT'S ACADEMIC OF ILLINOIS, INC., NORTHBROOK, IL. SN 76-232,177. PUB. 7-9-2002, FILED 3-28-2001.

PRISMIX

FOR STATIONERY TYPE BINDERS; STATIONERY TYPE EXPANDING FILES; STATIONERY TYPE PORTFOLIOS; PENCIL POUCHES (U.S. CLS. 2, 5, 22, 23, 29, 37, 38 AND 50).

FIRST USE 3-0-2001; IN COMMERCE 3-0-2001.

CLASS 16—(Continued).

2,764,990. NATIONAL HOCKEY LEAGUE, NEW YORK, NY.
SN 76-261,783. PUB. 1-29-2002, FILED 5-23-2001.

NHL HOCKEY RULES

FOR INSTRUCTIONAL BOOKS AND BOOKLETS RELATING TO HOCKEY, EXCLUDING BOOKS AND BOOKLETS RELATING TO THE RULES OF HOCKEY; POSTERS, MOUNTED PHOTOGRAPHS, UNMOUNTED PHOTOGRAPHS, PRINTED PAPER SIGNS, STICKER PACKS AND ALBUMS, TRADING CARDS AND ALBUMS, BOOK COVERS, DECALS, BUMPER STICKERS AND PAPER DOOR KNOB HANGER SIGNS (U.S. CLS. 2, 5, 22, 23, 29, 37, 38 AND 50).

FIRST USE 9-0-2001; IN COMMERCE 9-0-2001.

2,765,001. INSTITUTE OF ELECTRICAL AND ELECTRONICS ENGINEERS, INC. DBA IEEE, PISCATAWAY, NJ.
SN 76-264,780. PUB. 12-18-2001, FILED 5-31-2001.

WIRELESSMAN

FOR PUBLICATION, NAMELY A PAMPHLET FOR A STANDARD FOR WIRELESS METROPOLITAN AREA NETWORKS (U.S. CLS. 2, 5, 22, 23, 29, 37, 38 AND 50).

FIRST USE 10-12-2001; IN COMMERCE 10-12-2001.

2,765,041. STAMM, JILL, PHOENIX, AZ. SN 76-276,535. PUB.
8-6-2002, FILED 6-25-2001.

BRAIN BOX

FOR EDUCATIONAL MATERIALS, NAMELY, KITS COMPOSED PRIMARILY OF PRINTED CARDS, CHILDRENS BOOKS, PRINTED INSTRUCTIONAL, EDUCATIONAL AND TEACHING MATERIALS, PLUSH TOYS, MANIPULATIVE PUZZLES, MANIPULATIVE GAMES FOR USE IN INTERACTIVE ACTIVITIES FOR THE STIMULATION AND DEVELOPMENT OF A CHILD'S LEARNING POTENTIAL (U.S. CLS. 2, 5, 22, 23, 29, 37, 38 AND 50).

FIRST USE 1-0-2000; IN COMMERCE 3-6-2002.

CLASS 16—(Continued).

2,765,044. STUDIOCANAL IMAGE S.A., BOULOGNE-BILLANCOURT, FRANCE, BY MERGER CANAL + D.A., 92100 BOULOGNE-BILLANCOURT, FRANCE. SN 76-277,833. PUB. 8-6-2002, FILED 6-28-2001.



OWNER OF U.S. REG. NO. 1,753,212.
THE MARK CONSISTS OF THE HEAD OF AN ENDOSKELETON SURROUNDED BY FLAMES.

FOR MEMO PADS AND PENS (U.S. CLS. 2, 5, 22, 23, 29, 37, 38 AND 50).

FIRST USE 3-0-2003; IN COMMERCE 3-0-2003.

2,765,089. AMBASSADORS FOR CHRIST INTERNATIONAL - USA, INC., MARIETTA, GA. SN 76-299,120. PUB. 9-17-2002, FILED 8-15-2001.

LIFEWORKS

FOR BOOKS, BOOKLETS, AND PRINTED MATERIALS, NAMELY, STUDY OUTLINES, LESSON PLANS, AND PAMPHLETS, ALL FEATURING CHRISTIANITY AND EVANGELISM FOR USE IN THE CONVERSION OF PEOPLE TO CHRISTIANITY, TO BE MARKETED ONLY IN DIRECT CHANNELS OF TRADE TARGETED AT CHURCHES (U.S. CLS. 2, 5, 22, 23, 29, 37, 38 AND 50).

FIRST USE 9-0-2001; IN COMMERCE 9-0-2001.

2,765,135. NICE DE MEXICO, S.A. DE.C. V., GUADALAJARA JALISCO, MEXICO. SN 76-313,778. PUB. 9-17-2002, FILED 9-19-2001.

NICEWORLD

FOR BROCHURES, MAGAZINES, CATALOGS, NEWSLETTERS AND NEWSPAPERS FEATURING JEWELRY, PERFUMES, SOAPS, COSMETICS, CLOTHING AND MULTI-LEVEL MARKETING SERVICES INFORMATION (U.S. CLS. 2, 5, 22, 23, 29, 37, 38 AND 50).

FIRST USE 4-1-2003; IN COMMERCE 4-1-2003.

CLASS 16—(Continued).

2,765,137. PRO-TEL PRODUCTS, INC., BEVERLY HILLS, CA. SN 76-314,169. PUB. 9-3-2002, FILED 9-17-2001.

BONDINI THE MAGIC GLUE

NO CLAIM IS MADE TO THE EXCLUSIVE RIGHT TO USE "GLUE", APART FROM THE MARK AS SHOWN.

FOR ADHESIVE GLUE FOR STATIONERY AND HOUSEHOLD USE (U.S. CLS. 2, 5, 22, 23, 29, 37, 38 AND 50).

FIRST USE 2-1-2002; IN COMMERCE 2-1-2002.

2,765,223. MATTOS, LESLEY J., MOUNTAIN VIEW, CA. SN 76-340,204. PUB. 12-10-2002, FILED 11-20-2001.

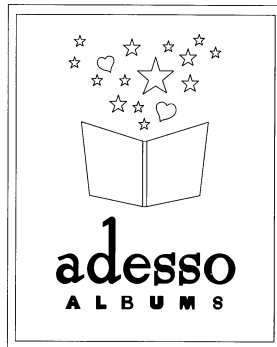

NO CLAIM IS MADE TO THE EXCLUSIVE RIGHT TO USE "ALBUMS", APART FROM THE MARK AS SHOWN.

THE ENGLISH TRANSLATION OF THE WORD "ADESSO" IS "NOW".

FOR PHOTOGRAPHIC ALBUMS (U.S. CLS. 2, 5, 22, 23, 29, 37, 38 AND 50).

FIRST USE 12-3-2001; IN COMMERCE 12-3-2001.

2,765,262. COMPASSLEARNING, INC., SAN DIEGO, CA. SN 76-351,666. PUB. 7-9-2002, FILED 12-21-2001.

**COMPASSLEARNING
EXPLORER**

FOR EDUCATIONAL BOOKS, BOOKLETS, BROCHURES, LEAFLETS, GUIDES, MANUALS AND OTHER PRINTED EDUCATIONAL MATERIALS FOR USE IN ASSESSING STUDENT ABILITY AND PERFORMANCE AT THE ELEMENTARY, SECONDARY AND COLLEGE LEVELS (U.S. CLS. 2, 5, 22, 23, 29, 37, 38 AND 50).

FIRST USE 1-15-2002; IN COMMERCE 1-15-2002.

CLASS 16—(Continued).

2,765,271. BLANCHARD TRAINING AND DEVELOPMENT, INC., ESCONDIDO, CA. SN 76-353,337. PUB. 9-17-2002, FILED 12-31-2001.

WHALE DONE!

FOR PRINTED MATERIALS, NAMELY EDUCATIONAL MATERIALS FOR USE IN BUSINESS MANAGEMENT TRAINING (U.S. CLS. 2, 5, 22, 23, 29, 37, 38 AND 50).

FIRST USE 4-19-2002; IN COMMERCE 12-1-2002.

2,765,428. THINKING CAP, INC., GREER, SC. SN 76-401,017. PUB. 12-24-2002, FILED 4-26-2002.

52 CARD PICK UP

FOR PRINTED CARDS BEARING MESSAGES AND GREETINGS FOR SOCIAL PURPOSES (U.S. CLS. 2, 5, 22, 23, 29, 37, 38 AND 50).

FIRST USE 2-14-2003; IN COMMERCE 2-25-2003.

2,765,523. WORLDWIDE RESTAURANT CONCEPTS, INC., SHERMAN OAKS, CA, BY CHANGE OF NAME SIZZLER INTERNATIONAL, INC., CULVER CITY, CA. SN 76-975,654. PUB. 7-16-2002, FILED 8-15-2001.

**WORLDWIDE
RESTAURANT CONCEPTS**

NO CLAIM IS MADE TO THE EXCLUSIVE RIGHT TO USE "RESTAURANT", APART FROM THE MARK AS SHOWN.

FOR PAPER GOODS, NAMELY STATIONERY, WRITING PAPER, PAPER NAPKINS (U.S. CLS. 2, 5, 22, 23, 29, 37, 38 AND 50).

FIRST USE 9-0-2001; IN COMMERCE 9-0-2001.

2,765,541. BOWIT, LLC, COLUMBUS, OH. SN 78-014,711. PUB. 9-11-2001, FILED 6-28-2000.

SIGNATUREWRAP

FOR BOOKS AND NEWSLETTERS ON THE SUBJECT OF GIFT-WRAPPING IDEALS (U.S. CLS. 2, 5, 22, 23, 29, 37, 38 AND 50).

FIRST USE 5-0-2003; IN COMMERCE 5-0-2003.

CLASS 16—(Continued).

2,765,634. INTEGRIX VENTURES LLC, TOLEDO, OH. SN 78-079,054. PUB. 11-27-2001, FILED 8-14-2001.

HOMEPRIDE

FOR NEWSLETTER IN THE FIELD OF RESIDENTIAL INSPECTION, MAINTENANCE, AND REPAIR (U.S. CLS. 2, 5, 22, 23, 29, 37, 38 AND 50).
FIRST USE 4-21-2003; IN COMMERCE 4-21-2003.

2,765,638. MICHIGAN SPEECH COACHES, INC., TROY, MI. SN 78-079,288. PUB. 7-23-2002, FILED 8-15-2001.

EKOTA

THE ENGLISH TRANSLATION OF "EKOTA" IS "LISTEN UP".
FOR PROFESSIONAL SPEECH JOURNAL (U.S. CLS. 2, 5, 22, 23, 29, 37, 38 AND 50).
FIRST USE 5-18-1999; IN COMMERCE 5-18-1999.

2,765,684. TUFF TURTLE PUBLISHING, LLC, CROFTON, MD. SN 78-096,446. PUB. 1-21-2003, FILED 12-4-2001.



NO CLAIM IS MADE TO THE EXCLUSIVE RIGHT TO USE "PUBLISHING", APART FROM THE MARK AS SHOWN.

FOR FOOTBALL TRIVIA BOOK, QUIZ BOOKS, BOOKS FEATURING TOPICS RELATING TO DIVORCE, MARKETING FOR SPAS AND HOTELS, AND RECIPES (U.S. CLS. 2, 5, 22, 23, 29, 37, 38 AND 50).
FIRST USE 9-1-1996; IN COMMERCE 9-1-1996.

CLASS 16—(Continued).

2,765,692. CLARKE AMERICAN HOLDINGS, INC., WILMINGTON, DE. SN 78-100,092. PUB. 9-10-2002, FILED 12-27-2001.

SIGNATURE

FOR BANK CHECKS AND RELATED ACCESSORIES, NAMELY, CHECKBOOKS, ADDRESS LABELS, CHECK BOOK COVERS AND CHECKBOOK WALLETS, SELF-INKING STAMPS, CHECK STORAGE BOXES, BINDERS, BANKING DEPOSIT BAGS, ENVELOPES, STATIONERY-TYPE PORTFOLIO CASES AND DESK TOP BUSINESS CARD HOLDERS (U.S. CLS. 2, 5, 22, 23, 29, 37, 38 AND 50).
FIRST USE 4-1-2002; IN COMMERCE 4-1-2002.

2,765,698. TAYLOR CORPORATION, NORTH MANKATO, MN. SN 78-103,099. PUB. 9-10-2002, FILED 1-16-2002.

GUIDE-WRITE

FOR WRITING PAPER FEATURING THERMOGRAPHICALLY RAISED LINES FOR USE IN DEVELOPING MOTOR SKILLS AND MANUAL DEXTERITY (U.S. CLS. 2, 5, 22, 23, 29, 37, 38 AND 50).
FIRST USE 5-9-2002; IN COMMERCE 5-9-2002.

2,765,713. LONGEVITY MAGAZINE INC., LARGO, FL. SN 78-108,242. PUB. 12-10-2002, FILED 2-12-2002.

LONGEVITY LIFESTYLES

NO CLAIM IS MADE TO THE EXCLUSIVE RIGHT TO USE "LONGEVITY", APART FROM THE MARK AS SHOWN.

FOR PRINTED PUBLICATIONS, NAMELY, MAGAZINES IN THE FIELD OF AGING, HEALTH, NUTRITION, FITNESS AND LIFESTYLE (U.S. CLS. 2, 5, 22, 23, 29, 37, 38 AND 50).
FIRST USE 6-30-2002; IN COMMERCE 10-11-2002.

2,765,715. FORD MOTOR COMPANY, DEARBORN, MI. SN 78-108,942. PUB. 2-25-2003, FILED 2-15-2002.

FORD FIELD

FOR PRINTED MATERIALS, NAMELY, BOOKS, BROCHURES, PROGRAMS, AND MAGAZINES RELATING TO ENTERTAINMENT OR SPORTING EVENTS; STATIONERY, POSTERS, CALENDARS, AND TRADING CARDS (U.S. CLS. 2, 5, 22, 23, 29, 37, 38 AND 50).
FIRST USE 9-22-2002; IN COMMERCE 9-22-2002.

CLASS 16—(Continued).

2,765,738. BIC CORPORATION, MILFORD, CT. SN 78-115,759. PUB. 10-8-2002, FILED 3-19-2002.

FLIP YOUR BIC

FOR WRITING INSTRUMENTS, NAMELY PENS (U.S. CLS. 2, 5, 22, 23, 29, 37, 38 AND 50).
FIRST USE 12-7-2002; IN COMMERCE 12-7-2002.

2,765,767. THE ADMINISTRATORS OF THE TULANE EDUCATIONAL FUND, NEW ORLEANS, LA. SN 78-126,464. PUB. 1-21-2003, FILED 5-6-2002.

BURKENROAD REPORTS

NO CLAIM IS MADE TO THE EXCLUSIVE RIGHT TO USE "REPORTS", APART FROM THE MARK AS SHOWN, FOR PUBLICATIONS, NAMELY, INVESTMENT RESEARCH REPORTS (U.S. CLS. 2, 5, 22, 23, 29, 37, 38 AND 50).
FIRST USE 12-1-1997; IN COMMERCE 12-1-1997.

2,765,801. MANGAN COMMUNICATIONS, INC., DAVENPORT, IA. SN 78-139,802. PUB. 1-7-2003, FILED 6-28-2002.

REGLOGIC

FOR BOOKS, NAMELY EDUCATIONAL BOOKS, GOVERNMENT REGULATIONS (U.S. CLS. 2, 5, 22, 23, 29, 37, 38 AND 50).
FIRST USE 12-15-2002; IN COMMERCE 1-2-2003.

CLASS 17—RUBBER GOODS

2,764,658. AMCOR SUNCLIPSE NORTH AMERICA, BUENA PARK, CA. SN 75-936,686. PUB. 9-11-2001, FILED 3-4-2000.

MAJESTIK

FOR ADHESIVE TAPE FOR SEALING CARTONS FOR INDUSTRIAL AND COMMERCIAL USE (U.S. CLS. 1, 5, 12, 13, 35 AND 50).
FIRST USE 4-4-2001; IN COMMERCE 4-4-2001.

CLASS 17—(Continued).

2,764,773. ADVANCED FLEXIBLE COMPOSITES, INC., LAKE IN THE HILLS, IL. SN 76-107,520. PUB. 3-5-2002, FILED 8-10-2000.

DURALAM

FOR LAMINATED FLUOROPOLYMER COMPOSITE FABRICS MANUFACTURED FOR USE IN INDUSTRIAL, CONSUMER AND MILITARY APPLICATIONS, NAMELY, RELEASE FABRICS, CONVEYOR BELTS, GASKETS, FILTERS, CURTAINS, CLOTHING, PROTECTIVE COVERS AND RELEASE LINERS (U.S. CLS. 1, 5, 12, 13, 35 AND 50).
FIRST USE 4-30-2001; IN COMMERCE 4-30-2001.

2,764,774. ADVANCED FLEXIBLE COMPOSITES, INC., LAKE IN THE HILLS, IL. SN 76-107,523. PUB. 3-5-2002, FILED 8-10-2000.

DURASTICK

FOR PRESSURE SENSITIVE INDUSTRIAL TAPES WITH SILICONE AND ACRYLIC ADHESIVE SYSTEMS FOR USE IN INDUSTRIAL, CONSUMER, AND MILITARY APPLICATIONS, NAMELY, RELEASE MATERIALS, COVERING OF HEAT SEALING, INSULATION, PADDING AND ROLL COVERINGS (U.S. CLS. 1, 5, 12, 13, 35 AND 50).
FIRST USE 4-30-2001; IN COMMERCE 4-30-2001.

2,764,882. ARISTECH ACRYLICS LLC, FLORENCE, KY. SN 76-188,662. PUB. 8-13-2002, FILED 1-2-2001.

QUARITE SELECT PLUS

OWNER OF U.S. REG. NOS. 1,844,448 AND 1,868,285.
NO CLAIM IS MADE TO THE EXCLUSIVE RIGHT TO USE "SELECT", APART FROM THE MARK AS SHOWN.
FOR THERMOFORMABLE GRANITE-SURFACED ACRYLIC SHEETS, HAVING A REINFORCING LAYER LAMINATED TO A DECORATIVE LAYER, FOR ARCHITECTURE USE IN THE MANUFACTURE OF FORMED SURFACES, NAMELY HOT TUBS, SHOWER PANELS, BATHTUBS, SINKS AND TRASH RECEPTACLES (U.S. CLS. 1, 5, 12, 13, 35 AND 50).
FIRST USE 6-1-2003; IN COMMERCE 6-1-2003.

2,765,076. ACOUSTICS FIRST CORPORATION, RICHMOND, VA. SN 76-293,826. PUB. 7-16-2002, FILED 8-2-2001.

BERMUDA TRIANGLE TRAP

FOR ARCHITECTURAL ACOUSTICAL PRODUCTS, NAMELY, SOUND ABSORBERS AND DIFFUSORS (U.S. CLS. 1, 5, 12, 13, 35 AND 50).
FIRST USE 4-4-2003; IN COMMERCE 4-4-2003.

CLASS 17—(Continued).

2,765,148. JAKQUMAR AG, 6300 ZUG, SWITZERLAND. SN 76-317,651. PUB. 12-17-2002, FILED 9-25-2001.

MAX COPPER

NO CLAIM IS MADE TO THE EXCLUSIVE RIGHT TO USE "COPPER", APART FROM THE MARK AS SHOWN.
FOR CAULKING, CAULKING COMPOUNDS, ADHESIVE SEALANTS FOR GENERAL USE AND FOR AUTOMOTIVE AND MARINE USE, AND GENERAL PURPOSE SILICONE RUBBER SEALANTS (U.S. CLS. 1, 5, 12, 13, 35 AND 50).

FIRST USE 3-31-2003; IN COMMERCE 3-31-2003.

2,765,274. KAMA OF ILLINOIS, INC., LINCOLNSHIRE, IL. SN 76-354,524. PUB. 9-17-2002, FILED 1-2-2002.

SEALPET

FOR POLYESTER PLASTIC FILM USED AS AN INDUSTRIAL OR COMMERCIAL PACKING FOR HIGH VISIBILITY DISPLAY PACKAGES; PACKING MATERIAL COMPOSED OF POLYESTER PLASTIC SHEET MATERIAL FOR FORMING SEALS FOR HIGH VISIBILITY DISPLAY PACKAGES; AND PLASTIC PACKING FOR SHIPPING CONTAINERS FOR HIGH VISIBILITY DISPLAY PACKAGES (U.S. CLS. 1, 5, 12, 13, 35 AND 50).

FIRST USE 10-1-2001; IN COMMERCE 10-1-2001.

2,765,305. WYKO INDUSTRIAL SERVICES LIMITED, WEST MIDLANDS, B62 8WG, ENGLAND. SN 76-362,304. PUB. 1-14-2003, FILED 1-24-2002.



FOR NON-METAL SEALS, GASKETS AND O-RINGS FOR USE IN ENGINES, MOTORS AND MACHINES (U.S. CLS. 1, 5, 12, 13, 35 AND 50).

FIRST USE 1-31-2002; IN COMMERCE 1-31-2002.

2,765,370. LANGER, INC., DEER PARK, NY. SN 76-378,684. PUB. 10-22-2002, FILED 3-7-2002.

LangerZorb

FOR FOAM USED IN THE MANUFACTURE OF FOOT ORTHOSES (U.S. CLS. 1, 5, 12, 13, 35 AND 50).

FIRST USE 2-1-2002; IN COMMERCE 2-1-2002.

CLASS 17—(Continued).

2,765,413. SOLUTIA INC., ST. LOUIS, MO. SN 76-393,546. PUB. 11-12-2002, FILED 4-10-2002.



FOR PLASTIC INTERLAYER FOR USE IN THE ARCHITECTURAL, AUTOMOTIVE AND RESIDENTIAL LAMINATED GLASS INDUSTRIES; PLASTIC INTERLAYER FOR SAFETY GLASS; PLASTIC INTERLAYER FOR USE IN LAMINATING SAFETY GLASS; SYNTHETIC RESIN SHEETING FOR USE IN THE MANUFACTURE OF LAMINATED GLASS; POLYVINYL BUTYRAL FILM FOR USE IN GLASS LAMINATIONS; TINTED, COLORED, PATTERNED, METALLIC, IMAGED, LAMINATED, SOUND INSULATING, IMPACT RESISTANT, SOLAR PROTECTIVE, SOLAR ABSORBING AND REFLECTIVE PLASTIC FILMS AND INTERLAYERS FOR USE IN HOME, ARCHITECTURAL OR VEHICLE GLASS AND WINDOWS (U.S. CLS. 1, 5, 12, 13, 35 AND 50).

FIRST USE 10-0-2001; IN COMMERCE 10-0-2001.

2,765,586. INTERNATIONAL PAPER COMPANY, TUXEDO, NY. SN 78-054,992. PUB. 9-18-2001, FILED 3-26-2001.

CHEMARMOR

FOR HIGH PRESSURE PLASTIC LAMINATES USED IN THE MANUFACTURE OF COUNTERTOPS (U.S. CLS. 1, 5, 12, 13, 35 AND 50).

FIRST USE 5-0-1998; IN COMMERCE 9-0-1999.

CLASS 18—LEATHER GOODS

2,764,549. GMR FASHION INC., NEW YORK, NY. SN 75-698,015. PUB. 12-28-1999, FILED 5-5-1999.



FOR HANDBAGS (U.S. CLS. 1, 2, 3, 22 AND 41).

FIRST USE 5-1-2002; IN COMMERCE 5-1-2002.

CLASS 18—(Continued).

2,764,664. DJF ENTERPRISES, CULVER CITY, CA. SN 75-976,134. PUB. 10-13-1998, FILED 8-16-1995.

SMASH BOX

FOR FELT POUCHES, DRAWSTRING POUCHES AND TOTE BAGS (U.S. CLS. 1, 2, 3, 22 AND 41).
FIRST USE 10-31-2000; IN COMMERCE 10-31-2000.

2,764,805. ACTION COPY CO. CORP., EDMONTON, ALBERTA. SN 76-136,931. PUB. 10-29-2002, FILED 9-25-2000.



NO CLAIM IS MADE TO THE EXCLUSIVE RIGHT TO USE "CALF", APART FROM THE MARK AS SHOWN.
FOR BLANKETS AND EARMUFFS FOR NEWBORN CALVES (U.S. CLS. 1, 2, 3, 22 AND 41).
FIRST USE 11-4-2000; IN COMMERCE 11-4-2000.

2,765,030. LASERLINE COMPANY, THE, STAMFORD, CT, BY ASSIGNMENT MEAD CORPORATION, THE, DAYTON, OH. SN 76-271,475. PUB. 10-2-2001, FILED 6-14-2001.



FOR ACCESSORY BAGS, NAMELY BAGS FOR CELL PHONES, SUNGLASSES, PDAS, CD PLAYERS, MP3 PLAYERS AND DVD PLAYERS (U.S. CLS. 1, 2, 3, 22 AND 41).
FIRST USE 1-8-2002; IN COMMERCE 1-8-2002.

CLASS 18—(Continued).

2,765,343. BLUEDESERT, LTD., KFAR MONASH, ISRAEL, BY ASSIGNMENT BLUEDESERT LTD., KFAR MONASH, ISRAEL. SN 76-373,376. PUB. 9-10-2002, FILED 2-20-2002.

BLUEDESERT

FOR BACKPACKS, LUGGAGE, AND TRAVEL BAGS (U.S. CLS. 1, 2, 3, 22 AND 41).
FIRST USE 5-0-2001; IN COMMERCE 5-0-2001.

2,765,632. LEE STEVENS INDUSTRIES, INC., BARTLETT, IL. SN 78-078,183. PUB. 12-3-2002, FILED 8-8-2001.

TRAY MAGNIFIQUE

NO CLAIM IS MADE TO THE EXCLUSIVE RIGHT TO USE "TRAY", APART FROM THE MARK AS SHOWN.
THE ENGLISH TRANSLATION OF THE WORD MAGNIFIQUE IN THE MARK IS MAGNIFICENT.
FOR COSMETIC CASES SOLD EMPTY (U.S. CLS. 1, 2, 3, 22 AND 41).
FIRST USE 9-1-2001; IN COMMERCE 5-11-2001.

2,765,669. QUIKSILVER, INC., HUNTINGTON BEACH, CA. SN 78-090,919. PUB. 9-17-2002, FILED 10-30-2001.



OWNER OF U.S. REG. NO. 1,454,255.
FOR ATHLETIC BAGS, BACKPACKS, BEACH BAGS, GENERAL PURPOSE BAGS BEING DUFFEL BAGS AND ALL-PURPOSE SPORT BAGS AND ATHLETIC BAGS, TOTE BAGS, TRAVELING BAGS, FANNY PACKS, PURSES, WALLETS AND UMBRELLAS (U.S. CLS. 1, 2, 3, 22 AND 41).
FIRST USE 1-31-1994; IN COMMERCE 1-31-1994.

2,765,707. COASTAL PET PRODUCTS, INC., ALLIANCE, OH. SN 78-106,588. PUB. 12-17-2002, FILED 2-4-2002.

ACCENT

FOR EQUINE, BOVINE AND OTHER ANIMAL RESTRAINTS, NAMELY, HALTERS, LEADS, COLLARS AND RESTRAINTS IN THE NATURE OF STRAPS TO IMMOBILIZE ANIMALS DURING TRANSPORT AND GROOMING (U.S. CLS. 1, 2, 3, 22 AND 41).
FIRST USE 6-7-2002; IN COMMERCE 6-7-2002.

CLASS 18—(Continued).

2,765,716. AS WE GROW LLC, SEATTLE, WA. SN 78-109,278. PUB. 10-8-2002, FILED 2-17-2002.

RED E BAG

NO CLAIM IS MADE TO THE EXCLUSIVE RIGHT TO USE "BAG", APART FROM THE MARK AS SHOWN.
 FOR BAGS, NAMELY, FABRIC HANDBAGS FOR USE IN CARRYING DISPOSABLE LINER BAGS (U.S. CLS. 1, 2, 3, 22 AND 41).
 FIRST USE 8-24-2002; IN COMMERCE 12-2-2002.

CLASS 19—(Continued).

2,764,723. CASCADE POLE AND LUMBER COMPANY, TACOMA, WA. SN 76-066,889. PUB. 3-20-2001, FILED 6-9-2000.

E DECK

NO CLAIM IS MADE TO THE EXCLUSIVE RIGHT TO USE "DECK", APART FROM THE MARK AS SHOWN.
 FOR PLASTIC EXTRUSIONS, NAMELY DECKING (U.S. CLS. 1, 12, 33 AND 50).
 FIRST USE 6-10-2002; IN COMMERCE 7-14-2002.

2,765,780. EJAY INTERNATIONAL, INC., GLENDORA, CA. SN 78-131,028. PUB. 11-19-2002, FILED 5-24-2002.

SAF-T-CLEAR

FOR ELIZABETHAN COLLAR FOR ANIMALS (U.S. CLS. 1, 2, 3, 22 AND 41).
 FIRST USE 9-26-2002; IN COMMERCE 9-26-2002.

2,764,768. FLOORCO INTERNATIONAL (NORTH AMERICA) INC., DALLAS, TX. SN 76-102,437. PUB. 11-27-2001, FILED 8-2-2000.

CENTERRA

FOR WOOD FLOORING, NAMELY, PARQUET, PLANK, STRIP, WOOD FIBER LAMINATE WITH HARD SURFACE AND RANDOM WIDTH PLANK FLOORING OF MULTI-PLY CONSTRUCTION (U.S. CLS. 1, 12, 33 AND 50).
 FIRST USE 2-0-2001; IN COMMERCE 2-0-2001.

CLASS 19—NON-METALLIC BUILDING MATERIALS

2,764,508. LOUISIANA-PACIFIC CORPORATION, PORTLAND, OR. SN 75-570,490. PUB. 5-2-2000, FILED 10-15-1998.

SMARTGUARD

FOR NON-METALLIC BUILDING MATERIALS, NAMELY, SIDING, WALL AND ROOF SHEATHING, FLOORING PANELS, SOFFITS, FASCIA, AND TRIM MADE PRIMARILY OF WOOD, LUMBER, AND PLYWOOD, TREATED WITH CHEMICALS THAT RESIST INSECTS AND ROT (U.S. CLS. 1, 12, 33 AND 50).
 FIRST USE 4-0-2000; IN COMMERCE 4-0-2000.

2,764,892. MARGARITELLI ITALIA S.P.A., SAN VENANZO (TR), ITALY. SN 76-198,396. PUB. 10-1-2002, FILED 1-23-2001.



2,764,542. DUTCH HOUSING, INC., WHITE PIGEON, MI. SN 75-686,558. PUB. 12-19-2000, FILED 4-19-1999.

COMMANDER

FOR MANUFACTURED HOUSING IN THE NATURE OF MOBILE HOMES, PREFABRICATED HOMES AND MODULAR HOMES (U.S. CLS. 1, 12, 33 AND 50).
 FIRST USE 6-30-2002; IN COMMERCE 6-30-2002.

NO CLAIM IS MADE TO THE EXCLUSIVE RIGHT TO USE "PARQUET", APART FROM THE MARK AS SHOWN.
 FOR PARQUET WOOD FLOORING (U.S. CLS. 1, 12, 33 AND 50).
 FIRST USE 9-0-2002; IN COMMERCE 9-0-2002.

CLASS 19—(Continued).

2,765,139. RICHMOND PLYWOOD CORPORATION LIMITED, VANCOUVER, BC V6C 1S4, CANADA. SN 76-314,545. PUB. 3-5-2002, FILED 9-18-2001.

COASTFORM

FOR PLYWOOD CONSTRUCTION PRODUCTS, NAMELY PLYWOOD FORMS FOR POURED CONCRETE (U.S. CLS. 1, 12, 33 AND 50).
FIRST USE 5-0-2001; IN COMMERCE 10-23-2001.

2,765,258. MENARD, INC., EAU CLAIRE, WI. SN 76-349,976. PUB. 12-31-2002, FILED 12-19-2001.

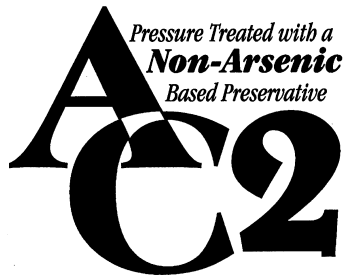

NO CLAIM IS MADE TO THE EXCLUSIVE RIGHT TO USE "PRESSURE TREATED WITH A NON-ARSENIC BASED PRESERVATIVE", APART FROM THE MARK AS SHOWN.

THE "AC" OF THE MARK IS GREEN AND THE "2" IS LIGHT BROWN.

FOR NON-METAL BUILDING MATERIALS, NAMELY, LUMBER (U.S. CLS. 1, 12, 33 AND 50).
FIRST USE 12-13-2001; IN COMMERCE 2-1-2002.

2,765,259. MENARD, INC., EAU CLAIRE, WI. SN 76-349,977. PUB. 12-17-2002, FILED 12-19-2001.

AC2

FOR NON-METAL BUILDING MATERIALS, NAMELY, LUMBER (U.S. CLS. 1, 12, 33 AND 50).
FIRST USE 12-31-2001; IN COMMERCE 2-1-2002.

2,765,368. NICHIIHA CORPORATION, MINATO-KU, NAGOYA 455-8550, JAPAN. SN 76-378,133. PUB. 10-22-2002, FILED 3-1-2002.

NEWPORT BRICK

NO CLAIM IS MADE TO THE EXCLUSIVE RIGHT TO USE "BRICK", APART FROM THE MARK AS SHOWN.

FOR CEMENT EXTERIOR WALLS (U.S. CLS. 1, 12, 33 AND 50).
FIRST USE 8-1-2002; IN COMMERCE 8-1-2002.

CLASS 19—(Continued).

2,765,397. VARIFORM, INC., KEARNEY, MO. SN 76-388,342. PUB. 10-8-2002, FILED 3-25-2002.

CHATEAU MYSTIQUE

FOR VINYL SIDING PANELS FOR EXTERIOR SURFACES OF MOBILE HOMES AND RESIDENTIAL AND COMMERCIAL BUILDINGS (U.S. CLS. 1, 12, 33 AND 50).
FIRST USE 2-25-2003; IN COMMERCE 2-25-2003.

2,765,627. EBERT COMPOSITES CORPORATION, CHULA VISTA, CA. SN 78-075,680. PUB. 7-16-2002, FILED 7-25-2001.

TRANSONITE

FOR COMPOSITE STRUCTURES AND SANDWICH PANELS HAVING OUTSIDE SKINS AND A CORE MATERIAL THAT ARE REINFORCED WITH 3-DIMENSIONAL COMPOSITE FIBERS TO TIE SKINS AND CORES WITH TRANS-LAMINAR REINFORCEMENT AND FOR USE IN INDUSTRIAL, RECREATIONAL, CONSTRUCTION AND TRANSPORTATION SYSTEMS, INCLUDING RAIL, LAND-BASED VEHICLES, MARINE AND AEROSPACE (U.S. CLS. 1, 12, 33 AND 50).
FIRST USE 8-28-2002; IN COMMERCE 8-28-2002.

2,765,650. AACER FLOORING, LLC, PESHTIGO, WI. SN 78-082,719. PUB. 6-18-2002, FILED 9-5-2001.

POWERPLAY

FOR WOOD FLOORING AND FLOORING UNDERLAYMENT (U.S. CLS. 1, 12, 33 AND 50).
FIRST USE 7-27-2001; IN COMMERCE 9-12-2001.

2,765,677. HOLNAM INC., DUNDEE, MI. SN 78-093,717. PUB. 8-6-2002, FILED 11-16-2001.

RAINBOW CUSTOM COLOR MASONRY CEMENT

OWNER OF U.S. REG. NO. 1,518,013.
NO CLAIM IS MADE TO THE EXCLUSIVE RIGHT TO USE "CUSTOM COLOR MASONRY CEMENT", APART FROM THE MARK AS SHOWN.
FOR MASONRY CEMENT (U.S. CLS. 1, 12, 33 AND 50).
FIRST USE 12-12-2001; IN COMMERCE 12-12-2001.

CLASS 19—(Continued).

2,765,733. ADAMS, JAMES, ADRIAN, LOS OSOS, CA. SN 78-114,223. PUB. 10-8-2002, FILED 3-12-2002.

I-WALL

FOR SHEAR WALL COMPOSED PRIMARILY OF WOOD USED IN WOOD AND LIGHT GAGE METAL FRAMED CONSTRUCTION TO RESIST WIND AND EARTHQUAKES (U.S. CLS. 1, 12, 33 AND 50).
FIRST USE 12-3-2002; IN COMMERCE 12-3-2002.

2,765,747. FITZPATRICK, ANNE MARIE, DBA NATURE'S TRAIL, JIM THORPE, PA. SN 78-117,986. PUB. 12-10-2002, FILED 3-27-2002.

DO-LITTLE AQUARIUM

NO CLAIM IS MADE TO THE EXCLUSIVE RIGHT TO USE "AQUARIUM", APART FROM THE MARK AS SHOWN.

FOR KITS CONSISTING PRIMARILY OF BIOSAND BEADS, A NATURAL PRODUCT MADE UP MOSTLY OF SILICA DIOXIDE SAND AND BIOSAND LIQUID MINERAL ENRICHED WATER, USED TO ASSEMBLE AQUARIUMS (U.S. CLS. 1, 12, 33 AND 50).
FIRST USE 3-1-2003; IN COMMERCE 3-1-2003.

2,765,803. AMERICAN POLYSTEEL, LLC, ALBUQUERQUE, NM. SN 78-139,991. PUB. 1-21-2003, FILED 6-28-2002.



OWNER OF U.S. REG. NO. 1,980,199.
THE MARK CONSISTS OF AN OUTLINE OF RESIDENTIAL HOUSING UNITS, A STYLIZED TREE, AND A 5-POINT STAR WITH THE PRINTED WORDS "POLYSTEEL"; "WE'RE BUILDING A BETTER WORLD".
FOR INSULATED CONCRETE FORMS (U.S. CLS. 1, 12, 33 AND 50).
FIRST USE 11-1-2001; IN COMMERCE 11-1-2001.

CLASS 20—FURNITURE AND ARTICLES NOT OTHERWISE CLASSIFIED

CLASS 20—(Continued).

2,764,660. HORIZON DESIGNS LTD., 50 TOWN RANGE, GIBRALTAR. SN 75-938,768. PUB. 8-14-2001, FILED 3-7-2000.

HORIZON DESIGNS

NO CLAIM IS MADE TO THE EXCLUSIVE RIGHT TO USE "DESIGNS", APART FROM THE MARK AS SHOWN.
FOR PICTURE FRAMES (U.S. CLS. 2, 13, 22, 25, 32 AND 50).
FIRST USE 2-28-1999; IN COMMERCE 5-18-2000.

2,764,740. AGAM GROUP, LTD., THE, ELKRIDGE, MD. SN 76-080,245. PUB. 10-9-2001, FILED 6-28-2000.

AGAMDISPLAY

OWNER OF U.S. REG. NO. 2,134,191.
FOR FURNITURE, NAMELY, DISPLAY BOOTHS, DESKS, CHAIRS, TABLES, DISPLAY UNITS AND SHELVING UNITS (U.S. CLS. 2, 13, 22, 25, 32 AND 50).
FIRST USE 0-0-2001; IN COMMERCE 0-0-2001.

2,764,743. JUDGMENT STONE, INC., TRAFFORD, AL. SN 76-080,454. PUB. 2-19-2002, FILED 6-29-2000.

JUDGMENT STONES

NO CLAIM IS MADE TO THE EXCLUSIVE RIGHT TO USE "STONES", APART FROM THE MARK AS SHOWN.
FOR NOVELTY GIFT ITEMS, NAMELY, A STONE WITH A MESSAGE THEREON (U.S. CLS. 2, 13, 22, 25, 32 AND 50).
FIRST USE 6-0-2001; IN COMMERCE 6-0-2001.

2,765,011. MECHOSHADE SYSTEMS, INC., LONG ISLAND CITY, NY. SN 76-266,407. PUB. 7-23-2002, FILED 6-4-2001.

DOUBLESHADE

FOR MOTORIZED WINDOW SHADES AND WINDOW SHADE COMPONENTS MADE OF METAL, NAMELY BRACKETS, CEILING POCKETS, FASCIA, SIDE AND SILL CHANNELS AND GUIDE TRACKS (U.S. CLS. 2, 13, 22, 25, 32 AND 50).
FIRST USE 1-0-1998; IN COMMERCE 1-0-1998.

2,765,034. SINT, INC., WILMINGTON, DE. SN 76-274,196. PUB. 10-9-2001, FILED 6-21-2001.

PLATINUM CREST

FOR MATTRESSES AND BOX SPRINGS (U.S. CLS. 2, 13, 22, 25, 32 AND 50).
FIRST USE 11-0-2002; IN COMMERCE 11-0-2002.

CLASS 20—(Continued).

2,765,301. NEMSCHOFF CHAIRS, INC., SHEBOYGAN, WI. SN 76-360,732. PUB. 9-10-2002, FILED 1-22-2002.

FOXXMAN

FOR FURNITURE, NAMELY, FURNITURE FOR CLINICS AND MEDICAL OFFICES (U.S. CLS. 2, 13, 22, 25, 32 AND 50).
FIRST USE 4-25-2003; IN COMMERCE 4-25-2003.

2,765,400. HARRIS CORPORATION, MELBOURNE, FL. SN 76-388,852. PUB. 10-15-2002, FILED 3-29-2002.

SMOOTHLINE

FOR BROADCAST STUDIO FURNITURE (U.S. CLS. 2, 13, 22, 25, 32 AND 50).
FIRST USE 6-9-2003; IN COMMERCE 6-9-2003.

2,765,426. HON TECHNOLOGY INC., MUSCATINE, IA. SN 76-399,632. PUB. 10-29-2002, FILED 4-24-2002.

VENTECH

FOR FABRIC WITH A HEAT DISSIPATING WEAVE, SOLD AS AN INTEGRAL COMPONENT OF CHAIRS (U.S. CLS. 2, 13, 22, 25, 32 AND 50).
FIRST USE 3-0-2002; IN COMMERCE 5-0-2002.

2,765,445. KIMBALL INTERNATIONAL, INC., JASPER, IN. SN 76-408,338. PUB. 11-12-2002, FILED 5-16-2002.

XSITE

FOR FURNITURE; MOVEABLE OFFICE PARTITIONS AND PANELS AND COMPONENT PARTS THEREOF (U.S. CLS. 2, 13, 22, 25, 32 AND 50).
FIRST USE 1-3-2003; IN COMMERCE 1-3-2003.

2,765,467. SCHER, ROBERT, RANCHO PALOS VERDES, CA. SN 76-413,531. PUB. 12-3-2002, FILED 5-28-2002.

NAP-STRAP

FOR HARNESS FOR HOLDING A PERSON'S HEAD STRAIGHT IN A CHAIR (U.S. CLS. 2, 13, 22, 25, 32 AND 50).
FIRST USE 11-10-2002; IN COMMERCE 11-10-2002.

CLASS 20—(Continued).

2,765,468. SCHOTTENSTEIN STORES CORPORATION, DBA VALUE CITY FURNITURE, COLUMBUS, OH. SN 76-413,685. PUB. 11-26-2002, FILED 5-29-2002.

FOREVER ROSES

FOR FURNITURE (U.S. CLS. 2, 13, 22, 25, 32 AND 50).
FIRST USE 6-0-2002; IN COMMERCE 6-0-2002.

2,765,473. GELCO PRODUCTS, INC., ALISO VIEJO, CA. SN 76-416,192. PUB. 1-7-2003, FILED 5-31-2002.



THE MARK CONSISTS, IN PART, OF A STYLIZED LETTER "G".
FOR CUSHIONS (U.S. CLS. 2, 13, 22, 25, 32 AND 50).
FIRST USE 5-0-2003; IN COMMERCE 5-0-2003.

2,765,553. GARDNER, MICHAEL STUART, REMUERA, NEW ZEALAND. SN 78-028,728. PUB. 9-10-2002, FILED 10-3-2000.

ZEE TAG

NO CLAIM IS MADE TO THE EXCLUSIVE RIGHT TO USE "TAG", APART FROM THE MARK AS SHOWN.
FOR NON-METALLIC AND NON PAPER IDENTIFICATION BRACELETS, IDENTITY PLATES AND TAGS FOR ANIMALS AND PARTS AND ACCESSORIES THEREFOR (U.S. CLS. 2, 13, 22, 25, 32 AND 50).
FIRST USE 12-31-1999; IN COMMERCE 12-31-1999.

2,765,570. SLEEPER CONCEPTS, INC., MONETT, MO. SN 78-041,611. PUB. 9-11-2001, FILED 1-3-2001.

SLEEPER CONCEPTS

NO CLAIM IS MADE TO THE EXCLUSIVE RIGHT TO USE "SLEEPER", APART FROM THE MARK AS SHOWN.
FOR ADJUSTABLE BEDS FOR SEMI-TRACTOR SLEEPING COMPARTMENTS (U.S. CLS. 2, 13, 22, 25, 32 AND 50).
FIRST USE 4-0-2002; IN COMMERCE 4-0-2002.

CLASS 20—(Continued).

2,765,769. GIFTABLES, INC., CUPERTINO, CA. SN 78-126,726. PUB. 1-7-2003, FILED 5-7-2002.

SENTIMENTS JUST FOR YOU

FOR PLAQUES, PICTURE FRAMES (U.S. CLS. 2, 13, 22, 25, 32 AND 50).
FIRST USE 7-1-2002; IN COMMERCE 7-7-2002.

2,765,788. VARASTEH, VAHDAT, SAN DIEGO, CA. SN 78-135,326. PUB. 12-31-2002, FILED 6-13-2002.

SIGN-CADDY

FOR FRAME FOR DISPLAYING SIGNAGE (U.S. CLS. 2, 13, 22, 25, 32 AND 50).
FIRST USE 6-12-2002; IN COMMERCE 12-1-2002.

CLASS 21—HOUSEWARES AND GLASS

2,764,547. BALLARINI, PAOLO & FIGLI SPA, 46017 RIVAROLO MANTOVANO (MN), ITALY. SN 75-696,684. PUB. 12-19-2000, FILED 5-3-1999.



FOR CASSEROLE DISHES; COLANDERS FOR HOUSEHOLD USE; DUTCH OVENS; METAL PANS; BROILING PANS; FRYING PANS; COATED FRYING PANS; NON-STICK FRYING PANS; ROASTING PANS; NON-ELECTRIC GRIDDLES; COOKING UTENSILS, NAMELY GRILLS; SOUP KETTLES; POTS; STEW POTS; LIDS FOR POTS; NON-ELECTRIC PRESSURE COOKERS; SAUCEPANS; AND WOKS (U.S. CLS. 2, 13, 23, 29, 30, 33, 40 AND 50).

FIRST USE 7-0-1999; IN COMMERCE 7-0-1999.

2,764,560. LIBBEY GLASS INC., TOLEDO, OH. SN 75-723,944. PUB. 10-10-2000, FILED 6-8-1999.

RESTAURANT BASICS

NO CLAIM IS MADE TO THE EXCLUSIVE RIGHT TO USE "RESTAURANT", APART FROM THE MARK AS SHOWN.

FOR BEVERAGE GLASSWARE (U.S. CLS. 2, 13, 23, 29, 30, 33, 40 AND 50).
FIRST USE 9-0-2002; IN COMMERCE 9-0-2002.

CLASS 21—(Continued).

2,764,785. D & E INTERNATIONAL INC., TORTOLA, BR. VIRGIN ISLANDS. SN 76-118,041. PUB. 3-5-2002, FILED 8-28-2000.



PRIORITY CLAIMED UNDER SEC. 44(D) ON HONG KONG APPLICATION NO. 200004026, FILED 2-29-2000.

FOR HOUSEHOLD UTENSILS, NAMELY, STAINLESS OR PLASTIC SIEVES, SPATULAS, STRAINERS, TURNERS, GRATERS, POT AND PAN SCRAPERS, ROLLING PINS, LADLES, AND WHISKS (U.S. CLS. 2, 13, 23, 29, 30, 33, 40 AND 50).

FIRST USE 8-0-2000; IN COMMERCE 8-0-2000.

2,764,845. ZAVORAL, ERNEST, CANFIELD, OH. AND SLATER, JANE, BUTLER, PA. SN 76-161,758. PUB. 9-17-2002, FILED 11-8-2000.

TURKEY SADDLE

NO CLAIM IS MADE TO THE EXCLUSIVE RIGHT TO USE "TURKEY", APART FROM THE MARK AS SHOWN.

FOR HOT FOOD HANDLING DEVICE; NAMELY, A NET-LIKE ASSEMBLY HAVING HANDLES AND USED TO SUPPORT OR CARRY FOOD SUCH AS POULTRY, ROASTS, HAM, CORN-ON-THE-COB, AND POTATOES (U.S. CLS. 2, 13, 23, 29, 30, 33, 40 AND 50).

FIRST USE 10-0-2000; IN COMMERCE 10-0-2000.

2,765,040. CIOLINO, WAYNE V., LONG BEACH, NY. SN 76-276,470. PUB. 2-26-2002, FILED 6-26-2001.

SMARTSPOUT

FOR POURING SPOUTS FOR FLUIDS, SPOUTS FOR POURING LIQUIDS, SPOUTS FOR POURING PAINT, SPOUT ADAPTERS FOR LIQUID CONTAINERS, AND DETACHABLE SPOUTS FOR PAINT CANISTERS (U.S. CLS. 2, 13, 23, 29, 30, 33, 40 AND 50).

FIRST USE 4-1-2002; IN COMMERCE 4-1-2002.

2,765,113. SAINT-GOBAIN CALMAR INC., CITY OF INDUSTRY, CA. SN 76-306,981. PUB. 5-21-2002, FILED 8-30-2001.

SD

FOR MANUALLY ACTUATED PUMP DISPENSERS FOR ATTACHMENT TO CONTAINERS FOR USE IN DISPENSING LIQUIDS (U.S. CLS. 2, 13, 23, 29, 30, 33, 40 AND 50).

FIRST USE 1-4-2002; IN COMMERCE 1-4-2002.

CLASS 21—(Continued).

2,765,161. STEPA A/S, 8900 RANDERS, DENMARK. SN 76-322,089. PUB. 10-1-2002, FILED 10-4-2001.

SCANCOOK

FOR HOUSEHOLD, KITCHEN, AND COOKING UTENSILS, NAMELY STEW PANS, STEW POTS, GRILL PANS, FRYING PANS, COOKING POTS, BAKING PANS, FISH BOILERS, SAUCEPANS, AND CASSEROLES (U.S. CLS. 2, 13, 23, 29, 30, 33, 40 AND 50).

FIRST USE 3-10-1995; IN COMMERCE 3-27-2002.

2,765,204. NATURAL SCIENCE INDUSTRIES, LTD., WEST HEMPSTEAD, NY. SN 76-333,449. PUB. 7-2-2002, FILED 11-2-2001.

BEAUTIFILLS

FOR CLEAR PLASTIC CONTAINERS FOR HOUSEHOLD USE WITH HOLLOW WALLS, WHICH CAN BE FILLED WITH DECORATIVE MATERIALS (U.S. CLS. 2, 13, 23, 29, 30, 33, 40 AND 50).

FIRST USE 2-28-2002; IN COMMERCE 2-28-2002.

2,765,225. HOUSEWARES AMERICA, INC., NEW YORK, NY. SN 76-340,495. PUB. 12-24-2002, FILED 11-20-2001.

KAKE-SAV'R

FOR FOOD SERVER AND STORAGE DEVICE, NAMELY, A CAKE SERVER (U.S. CLS. 2, 13, 23, 29, 30, 33, 40 AND 50).

FIRST USE 4-2-2002; IN COMMERCE 4-2-2002.

2,765,421. HARPER CORPORATION, DBA TEXAS FEATHERS, INC., FAIRFIELD, IA. SN 76-397,330. PUB. 10-22-2002, FILED 4-17-2002.

BIO FRESH

FOR SCRUBBING CLOTHS; CLEANING CLOTHS; POLISHING CLOTHS; WASHING CLOTHS; WIPING CLOTHS; MOPS; CLEANING SPONGES; SCOURING SPONGES; SCRUB SPONGES; SPONGES FOR HOUSEHOLD PURPOSES; DISHWASHING BRUSHES; FLOOR BRUSHES; POT CLEANING BRUSHES; SCRUBBING BRUSHES; TOILET BRUSHES (U.S. CLS. 2, 13, 23, 29, 30, 33, 40 AND 50).

FIRST USE 5-15-2003; IN COMMERCE 5-15-2003.

CLASS 21—(Continued).

2,765,481. RANIR/DCP CORPORATION, WEST ORANGE, NJ. SN 76-419,788. PUB. 1-7-2003, FILED 6-12-2002.

SURF

FOR MANUAL TOOTHBRUSHES (U.S. CLS. 2, 13, 23, 29, 30, 33, 40 AND 50).

FIRST USE 11-15-2002; IN COMMERCE 11-15-2002.

2,765,709. KRAFT FOODS HOLDINGS, INC., NORTHFIELD, IL. SN 78-107,083. PUB. 9-17-2002, FILED 2-6-2002.

GO-TUBES

OWNER OF U.S. REG. NO. 1,805,252.
FOR PLASTIC CONTAINERS FOR SNACK FOODS (U.S. CLS. 2, 13, 23, 29, 30, 33, 40 AND 50).

FIRST USE 1-2-2003; IN COMMERCE 1-0-2003.

2,765,736. LITTLE FRENCH BAKERY L.L.C., THE NORTH FREEDOM, WI. SN 78-115,693. PUB. 10-22-2002, FILED 3-18-2002.

Croûteur

FOR BAKING PANS FOR BAKING BREAD (U.S. CLS. 2, 13, 23, 29, 30, 33, 40 AND 50).

FIRST USE 6-6-2002; IN COMMERCE 7-21-2002.

2,765,791. BEAUTY HOLDING COMPANY, INC., HAMILTON, BERMUDA. SN 78-135,730. PUB. 12-31-2002, FILED 6-14-2002.

SALON CARE

OWNER OF U.S. REG. NOS. 2,083,563, 2,301,571, AND 2,540,686.

NO CLAIM IS MADE TO THE EXCLUSIVE RIGHT TO USE "SALON", APART FROM THE MARK AS SHOWN.

FOR PROTECTIVE GLOVES FOR COSMETIC USE (U.S. CLS. 2, 13, 23, 29, 30, 33, 40 AND 50).

FIRST USE 12-30-2002; IN COMMERCE 12-30-2002.

2,765,816. WHITNEY DESIGN, INC., ST. LOUIS, MO. SN 78-144,619. PUB. 1-28-2003, FILED 7-17-2002.

FIBERTECH

FOR IRONING BOARD COVERS (U.S. CLS. 2, 13, 23, 29, 30, 33, 40 AND 50).

FIRST USE 10-11-2002; IN COMMERCE 10-11-2002.

CLASS 22—CORDAGE AND FIBERS

2,765,377. ELEGANT USA, LLC, TOTOWA, NJ. SN 76-380,715.
PUB. 10-22-2002, FILED 3-8-2002.



OWNER OF U.S. REG. NOS. 2,212,229, 2,238,832, AND 2,343,714.

NO CLAIM IS MADE TO THE EXCLUSIVE RIGHT TO USE "CANOPY", APART FROM THE MARK AS SHOWN.

THE STIPPLING IN THE DRAWING APPEARS FOR SHADING PURPOSES ONLY.

FOR STAND ALONE CANOPY FOR SHELTERING AUTOMOBILES (U.S. CLS. 1, 2, 7, 19, 22, 42 AND 50).

FIRST USE 6-30-2002; IN COMMERCE 6-30-2002.

CLASS 23—YARNS AND THREADS

2,765,342. COATS & CLARK INC., CHARLOTTE, NC. SN 76-373,252. PUB. 11-12-2002, FILED 2-20-2002.

RED HEART TWEED

OWNER OF U.S. REG. NOS. 540,531, 2,392,284, AND OTHERS.

NO CLAIM IS MADE TO THE EXCLUSIVE RIGHT TO USE "TWEED", APART FROM THE MARK AS SHOWN.

FOR HANDKNITTING YARNS (U.S. CL. 43).

FIRST USE 4-4-2002; IN COMMERCE 4-4-2002.

CLASS 24—FABRICS

2,764,581. ELLIS, KAREN, NEW YORK, NY. SN 75-773,198.
PUB. 6-19-2001, FILED 8-11-1999.

CHAKRA

THE ENGLISH TRANSLATION OF THE WORD "CHAKRA" IN THE MARK IS "ENERGY CENTER".

FOR TEXTILE GOODS, NAMELY, BED SHEETS, PILLOW CASES, PILLOW SHAMS, DUVETS, BLANKETS, TROWS, TOWELS, CLOTH PLACEMATS, CLOTH NAPKINS, TABLE COVERS, BED LINENS (U.S. CLS. 42 AND 50).

FIRST USE 1-23-2003; IN COMMERCE 1-23-2003.

CLASS 24—(Continued).

2,764,727. PACIFIC COAST FEATHER COMPANY, SEATTLE, WA. SN 76-072,592. PUB. 3-5-2002, FILED 6-19-2000.

EUROCLOSE

FOR PILLOW CASES (U.S. CLS. 42 AND 50).
FIRST USE 3-5-2003; IN COMMERCE 3-29-2003.

2,764,731. HEXCEL CORPORATION, PLEASANTON, CA. SN 76-074,505. PUB. 4-9-2002, FILED 6-21-2000.

XL

FOR FABRICS FOR WINDOW SHADES AND BLINDS (U.S. CLS. 42 AND 50).

FIRST USE 12-11-2002; IN COMMERCE 12-11-2002.

2,764,734. MUNSON, LOUANN ELIZABETH STONE, SPRINGFIELD, VA. SN 76-077,859. PUB. 9-17-2002, FILED 6-28-2000.

BED SASH

NO CLAIM IS MADE TO THE EXCLUSIVE RIGHT TO USE "BED", APART FROM THE MARK AS SHOWN.

FOR ACCESSORY FOR BED COVERINGS, SPECIFICALLY DECORATIVE AND FUNCTIONAL PIECE OR PIECES OF FABRIC OR FLEXIBLE MATERIAL THAT IS EITHER DETACHABLE OR PERMANENTLY ATTACHED TO A COMFORTER, COVERLET, DUVET AND THE LIKE (U.S. CLS. 42 AND 50).

FIRST USE 0-0-1996; IN COMMERCE 1-1-1999.

2,764,764. EX-CELL HOME FASHIONS, INC., NEW YORK, NY. SN 76-099,551. PUB. 10-22-2002, FILED 7-31-2000.

WATERGARD

FOR SHOWER CURTAINS AND SHOWER CURTAIN LINERS (U.S. CLS. 42 AND 50).

FIRST USE 1-30-2002; IN COMMERCE 1-30-2002.

2,764,933. ABSECON MILLS, INC., COLONGE, NJ. SN 76-222,589. PUB. 9-25-2001, FILED 3-12-2001.

Utility*Chic

FOR UPHOLSTERY FABRIC FOR COMMERCIAL APPLICATIONS (U.S. CLS. 42 AND 50).

FIRST USE 10-0-2001; IN COMMERCE 10-0-2001.

CLASS 24—(Continued).

2,765,201. LINNEVAVERIET I HORRED AB, SWEDEN. SN 76-332,047. PUB. 11-5-2002, FILED 10-29-2001.



MASTER WEAVERS SINCE 1692

NO CLAIM IS MADE TO THE EXCLUSIVE RIGHT TO USE "MASTER WEAVERS", APART FROM THE MARK AS SHOWN.

FOR TEXTILES AND TEXTILE GOODS, NAMELY, FABRIC TABLE RUNNERS, NAPKINS, CLOTH BANNERS, HAND TOWELS AND BATH TOWELS, CURTAINS, TABLE MATS, PILLOW SHAMS, BEDSPREADS, DRAPES, UPHOLSTERY FABRICS, BLANKETS, TABLE CLOTHS NOT MADE OF PAPER (U.S. CLS. 42 AND 50). FIRST USE 1-1-2000; IN COMMERCE 1-1-2000.

2,765,240. SPORTS AUTHORITY MICHIGAN, INC., THE, FORT LAUDERDALE, FL. SN 76-344,926. PUB. 7-2-2002, FILED 12-4-2001.

HYDROMATIC

FOR MOISTURE WICKING FABRIC FOR USE IN ATHLETIC AND LEISURE APPAREL (U.S. CLS. 42 AND 50).

FIRST USE 2-0-2002; IN COMMERCE 2-0-2002.

2,765,255. REVERE MILLS, INC., NILES, IL. SN 76-349,046. PUB. 2-11-2003, FILED 12-17-2001.

KITCHEN SOLUTIONS

NO CLAIM IS MADE TO THE EXCLUSIVE RIGHT TO USE "KITCHEN", APART FROM THE MARK AS SHOWN.

FOR TOWELS, DISH CLOTHS, OVEN MITTS, POT HOLDERS AND WASH CLOTHS (U.S. CLS. 42 AND 50). FIRST USE 6-30-2001; IN COMMERCE 6-30-2001.

2,765,770. BOOTH ARLEN LEROY, HENRY, IL. SN 78-127,456. PUB. 2-4-2003, FILED 5-9-2002.

TRAVELER'S COZY

NO CLAIM IS MADE TO THE EXCLUSIVE RIGHT TO USE "TRAVELER'S", APART FROM THE MARK AS SHOWN.

FOR BLANKET COAT (U.S. CLS. 42 AND 50). FIRST USE 4-1-2002; IN COMMERCE 9-1-2002.

CLASS 24—(Continued).

2,765,787. ASTRUP COMPANY, CLEVELAND, OH. SN 78-135,087. PUB. 12-17-2002, FILED 6-12-2002.

NORTHSTAR

FOR FABRICS FOR USE IN THE MANUFACTURE OF BACKLIT SIGNS AND AWNINGS (U.S. CLS. 42 AND 50). FIRST USE 7-28-2002; IN COMMERCE 7-28-2002.

CLASS 25—CLOTHING

2,764,472. MALAMA PONO, LTD., OXNARD, CA, BY ASSIGNMENT OUTRIGGER DUKE KAHANAMOKU FOUNDATION, HONOLULU, HI. SN 74-659,857. PUB. 5-15-2001, FILED 4-6-1995.

DUKE KAHANAMOKU

OWNER OF U.S. REG. NO. 1,019,452. THE NAME IN THE MARK DOES NOT IDENTIFY A LIVING INDIVIDUAL.

FOR MEN'S TEE SHIRTS, SHORTS AND BATHING SUITS (U.S. CLS. 22 AND 39). FIRST USE 12-1-1999; IN COMMERCE 12-1-1999.

2,764,487. RAINFOREST CAFE, INC., HOPKINS, MN. SN 75-453,080. PUB. 5-4-1999, FILED 3-19-1998.

WILD BUNCH

OWNER OF U.S. REG. NOS. 2,457,656, 2,643,642, AND OTHERS.

FOR CLOTHING, NAMELY, MEN'S, WOMEN'S AND CHILDREN'S CLOTHING, NAMELY, SWEATSHIRTS, SWEATPANTS, SHIRTS, T-SHIRTS, POLO SHIRTS, SHORTS, BOXER SHORTS, VESTS, COORDINATED GROUPS, NAMELY, TWO OR MORE OF THE FOREGOING CLOTHING ITEMS DESIGNED TO BE WORN TOGETHER, BATHROBES, BATHING SUITS, OUTERWEAR, NAMELY, JACKETS, LEATHER JACKETS, JEAN JACKETS, RAINWEAR, TIES, BOLO TIES, SCARVES, HATS, SUN VISORS, SUSPENDERS, BELTS, HEADBANDS, AND WRISTBANDS, SOLD IN THE RETAIL SECTION OF APPLICANT'S RESTAURANT (U.S. CLS. 22 AND 39).

FIRST USE 3-0-1998; IN COMMERCE 3-0-1998.

2,764,505. RUTGERS, THE STATE UNIVERSITY OF NEW JERSEY, NEW BRUNSWICK, NJ. SN 75-563,706. PUB. 3-28-2000, FILED 10-5-1998.

UNIVERSITY OF NEW JERSEY

NO CLAIM IS MADE TO THE EXCLUSIVE RIGHT TO USE "NEW JERSEY", APART FROM THE MARK AS SHOWN.

FOR APPAREL, NAMELY, SWEATPANTS, SHIRTS, SWEATSHIRTS, TEE-SHIRTS, SHORTS, SOCKS, HATS AND SWEATERS (U.S. CLS. 22 AND 39).

FIRST USE 4-22-2003; IN COMMERCE 4-28-2003.

CLASS 25—(Continued).

2,764,517. S.A.S. ORNAMENTAL INC., DBA THE 807 CO., EL PASO, TX. SN 75-610,692. PUB. 1-4-2000, FILED 12-21-1998.

JUNK JEANS

NO CLAIM IS MADE TO THE EXCLUSIVE RIGHT TO USE "JEANS", APART FROM THE MARK AS SHOWN. FOR CLOTHING, NAMELY JEANS, JEAN JACKET, SHORTS, PANTS AND SHIRTS (U.S. CLS. 22 AND 39). FIRST USE 11-6-2002; IN COMMERCE 11-6-2002.

2,764,528. TIMBERLAND COMPANY, THE, STRATHAM, NH. SN 75-651,639. PUB. 1-11-2000, FILED 3-2-1999.

TIMBERLAND PRO

OWNER OF U.S. REG. NOS. 1,300,704, 1,355,531, AND 1,523,598. FOR FOOTWEAR; CLOTHING, NAMELY JACKETS, PANTS, SHIRTS, T-SHIRTS SOCKS, HATS AND SWEAT-SHIRTS (U.S. CLS. 22 AND 39). FIRST USE 8-0-1999; IN COMMERCE 8-0-1999.

2,764,555. WNBA ENTERPRISES, LLC, SECAUCUS, NJ. SN 75-709,569. PUB. 10-10-2000, FILED 5-19-1999.



OWNER OF U.S. REG. NOS. 2,109,892, 2,231,147, AND OTHERS. FOR CLOTHING, NAMELY, HOSIERY, FOOTWEAR, T-SHIRTS, SWEATSHIRTS, SWEATPANTS, PANTS, TANK TOPS, JERSEYS, SHORTS, PAJAMAS, SPORT SHIRTS, RUGBY SHIRTS, SWEATERS, BELTS, TIES, NIGHTSHIRTS, HATS, WARM-UP SUITS, JACKETS, PARKAS, COATS, CLOTH BIBS, HEAD BANDS, WRIST BANDS, APRONS, BOXER SHORTS, SLACKS, CAPS, EAR MUFFS AND GLOVES (U.S. CLS. 22 AND 39). FIRST USE 8-24-1999; IN COMMERCE 8-24-1999.

CLASS 25—(Continued).

2,764,587. NATIONAL ASSOCIATION FOR STOCK CAR AUTO RACING, INC., DAYTONA BEACH, FL. SN 75-794,674. PUB. 7-30-2002, FILED 9-8-1999.



OWNER OF U.S. REG. NOS. 990,987, 1,850,527, AND OTHERS.

FOR CLOTHING, NAMELY, WARM UP SUITS; JOGGING SUITS; SWEAT SUITS, SWEAT PANTS AND SWEAT SHIRTS; BODY SUITS, LEOTARDS, TIGHTS, LEG WARMERS, LEGGINGS, ROMPERS, SING LETS, WET SUITS, SKI SUITS, SKI PANTS, SKI BIBS, SKI JACKETS, SWIM WEAR, BATHING SUITS, BEACH AND BATHING COVER -UPS, SUITS, SLACKS, TROUSERS, PANTS, JEANS, SHORTS, SWEAT SHORTS, GYM SHORTS, TOPS, COATS, SPORT COATS, SHIRTS, SPORT SHIRTS, T-SHIRTS, KNIT SHIRTS, POLO SHIRTS, PULLOVERS, SWEATERS, VESTS, TANK TOPS, BLAZERS, JUMP SUITS, PLAY SUITS, JACKETS, OVERCOATS, PARKAS, WIND RESISTANT JACKETS, LEATHER JACKETS, SKIRTS, DRESSES, FOOTWEAR, SHOES, BOOTS, SLIPPERS, ATHLETIC FOOTWEAR, BASKETBALL SHOES, CASUAL FOOTWEAR, SANDALS, HEAD WEAR, HATS, CAPS, VISORS, HOODS, BERETS, HEAD BANDS, SWEAT BANDS, WRIST BANDS, EAR MUFFS, NECKWEAR, NECKTIES, NECKERCHIEFS, SCARVES, BANDANNAS, SLEEP WEAR, ROBES, PAJAMAS, NIGHTSHIRTS, RAINWEAR, GLOVES, MITTENS, GALOSHES, LOUNGE WEAR, UNDERWEAR, BRIEFS, UNDERPANTS, BOXER SHORTS, CLOTH DIAPERS, UNDERSHIRTS, SUSPENDERS, HOSIERY, SOCKS, BELTS, MASQUERADE AND HALLOWEEN COSTUMES AND APRONS (U.S. CLS. 22 AND 39). FIRST USE 2-1-2000; IN COMMERCE 2-1-2000.

2,764,632. PHOENIX SUNS LIMITED PARTNERSHIP, PHOENIX, AZ. SN 75-887,011. PUB. 2-20-2001, FILED 1-4-2000.



OWNER OF U.S. REG. NOS. 1,850,765, 2,299,905, AND OTHERS.

THE MARK IS COMPOSED OF A DESIGN OF BASKETBALL SUPERIMPOSED ONTO A STREAKING SUN. FOR CLOTHING, NAMELY, HOSIERY, FOOTWEAR, T-SHIRTS, SWEATSHIRTS, SWEATPANTS, PANTS, TANK TOPS, JERSEYS, SHORTS, PAJAMAS, SPORT SHIRTS, RUGBY SHIRTS, SWEATERS, BELTS, TIES, NIGHTSHIRTS, HATS, WARM-UP SUITS, JACKETS, PARKAS, COATS, CLOTH BIBS, HEAD BANDS, WRIST BANDS, APRONS, BOXER SHORTS, SLACKS, CAPS, EAR MUFFS, GLOVES, WOVEN AND KNIT SHIRTS (U.S. CLS. 22 AND 39). FIRST USE 11-1-2000; IN COMMERCE 11-1-2000.

CLASS 25—(Continued).

2,764,640. AGHAMOHAMMAD, SHAHIN, NORTH HILLS, CA. SN 75-899,996. PUB. 5-15-2001, FILED 1-21-2000.

FRANK WHITE

THE MARK IS FICTITIOUS AND DOES NOT REFER TO ANY DECEASED OR LIVING PERSON

FOR MEN'S, WOMEN'S, AND CHILDREN'S CLOTHING, NAMELY T-SHIRTS, BEANIES, HATS, JACKETS, SWEATERS, JERSEYS, JUMPSUITS, SHORTS, UNDERWEAR, SHOES, SOCKS, TANK TOPS, DRESS SHIRTS, COATS, LINGERIE, NECKERCHIEFS, TIES, BANDANAS, TURBANS, SWEAT BANDS, SUSPENDERS, AND BELTS (U.S. CLS. 22 AND 39).

FIRST USE 3-4-2003; IN COMMERCE 3-4-2003.

2,764,662. A DEWEY DOES CORPORATION, S.I, NY, BY CHANGE OF NAME BRYSON, LNC., STATEN ISLAND, NY. SN 75-939,041. PUB. 2-5-2002, FILED 3-9-2000.

DEWEY DOES

FOR FOOTWEAR, TEE SHIRTS, HEAD GEAR, NAMELY, BASEBALL CAPS, SOCKS, SWEAT SHIRTS, SWEAT SUITS, UNDERWEAR, PULLOVERS, BASEBALL SHIRTS (U.S. CLS. 22 AND 39).

FIRST USE 5-10-1998; IN COMMERCE 4-21-1999.

2,764,668. POTOMAC ELECTRIC POWER COMPANY, WASHINGTON, DC. SN 75-983,225. PUB. 2-27-2001, FILED 1-14-1999.



OWNER OF U.S. REG. NOS. 934,606, 1,844,972, AND OTHERS.

THE WORDS PEPCO AND POWER, THE OVAL AROUND THE WORD REAL AND THE OUTLINING AROUND THE WORDS THE AND IN WASHINGTON ARE IN THE COLOR BLUE; THE WORDS THE REAL AND IN WASHINGTON, AND THE OUTLINING AROUND THE OVAL AND THE WORD POWER ARE IN THE COLOR YELLOW.

FOR SHIRTS, T-SHIRTS AND HATS (U.S. CLS. 22 AND 39).

FIRST USE 8-0-2001; IN COMMERCE 8-0-2001.

CLASS 25—(Continued).

2,764,703. ALUMNI ASSOCIATION OF THE UNIVERSITY OF KANSAS, THE, LAWRENCE, KS. SN 76-045,620. PUB. 5-29-2001, FILED 5-11-2000.

KANSAS ALUMNI ASSOCIATION

OWNER OF U.S. REG. NO. 2,482,020.
NO CLAIM IS MADE TO THE EXCLUSIVE RIGHT TO USE "KANSAS" AND "ASSOCIATION", APART FROM THE MARK AS SHOWN.

FOR APPAREL, NAMELY, SHIRTS AND CAPS (U.S. CLS. 22 AND 39).

FIRST USE 5-0-2000; IN COMMERCE 5-0-2000.

2,764,729. BERNARD ET CIE - LES SUCESSEURS DE PREGERMAN, 86310 SAINT SAVIN, FRANCE. SN 76-074,346. PUB. 11-5-2002, FILED 6-20-2000.



OWNER OF FRANCE REG. NO. 93/497323, DATED 12-20-1993, EXPIRES 12-20-2003.

NO CLAIM IS MADE TO THE EXCLUSIVE RIGHT TO USE "LADIES UNDERWEAR" OR "LINGERIE DE FEMME" OR "DAMEN DESSOUS", APART FROM THE MARK AS SHOWN.

THE MARK CONSISTS OF THE OUTLINE OF A WOMAN'S FIGURE COMPRISED OF THE REPEATED WORDS "LINGERIE DE FEMME LADIES UNDERWEAR DAMEN DESSOUS".

FOR CLOTHING, NAMELY UNDERWEAR, LINGERIE, HOSIERY AND SWIMSUITS (U.S. CLS. 22 AND 39).

FIRST USE 12-0-1993; IN COMMERCE 2-0-2000.

CLASS 25—(Continued).

2,764,745. LORMAR S.R.L., 41012 CARPI (MO), ITALY. SN 76-082,195. PUB. 12-25-2001, FILED 7-3-2000.

LORMAR

FOR CLOTHING, NAMELY, PANTS, SHIRTS, T-SHIRTS, SWEATSHIRTS, SHORTS AND SWIMSUITS; BOOTS, SHOES AND SLIPPERS; AND ARTICLES OF CORSETRY, NAMELY, FOUNDATION GARMENTS (U.S. CLS. 22 AND 39).

FIRST USE 0-0-1971; IN COMMERCE 2-0-2003.

2,764,750. ZEITOUN, M. FRANCK SALOMON, L'PLESSIS TREVISE, FRANCE. SN 76-089,005. PUB. 10-1-2002, FILED 7-14-2000.



FOR CLOTHING, NAMELY COATS, PARKAS, JACKETS, CAPES, SWEATERS, VEST, PULLOVERS, CARDIGANS, SHIRTS, T-SHIRTS, SWEATSHIRTS, PANTS, SHORTS, BELTS, SHOES, BOOTS, HATS, GLOVES, AND SCARVES; HEADWEAR (U.S. CLS. 22 AND 39).

FIRST USE 8-22-2002; IN COMMERCE 8-22-2002.

2,764,762. MISSIONSIX LLC., MAMMOTH LAKES, CA. SN 76-099,121. PUB. 5-7-2002, FILED 7-28-2000.

MISSIONSIX

FOR BANDANNAS, SWEATBANDS, CLOTHING BELTS, COATS, FOUL WEATHER GEAR, SHIRTS, SKIRTS, SWEATPANTS, SWEATSHIRTS, SWEATERS, FT-SHIRTS, TANK TOPS, JACKETS, SKI PANTS, SKI BIBS, SKI JACKETS, VESTS, SNOW BOARD JACKETS, SNOW BOARD PANTS (U.S. CLS. 22 AND 39).

FIRST USE 9-0-1994; IN COMMERCE 9-0-1994.

CLASS 25—(Continued).

2,764,847. FAIR GROUNDS CORPORATION, NEW ORLEANS, LA. SN 76-162,540. PUB. 5-7-2002, FILED 11-9-2000.



OWNER OF U.S. REG. NOS. 2,717,830, 2,719,779, AND OTHERS.

THE MARK CONSISTS OF A STYLIZED HORSE HEAD WITH A MANE FLOWING BEHIND THE HEAD IN A WINDSWEEP FASHION. THE MANE IS REPRESENTED BY FOUR FLOWING RIBBONS, EACH OF A DIFFERENT COLOR. COLOR IS NOT CLAIMED AS A FEATURE OF THE MARK IN THIS REGISTRATION. ALL COMMON LAW RIGHTS TO COLOR ARE RESERVED.

SEC. 2(F).

FOR CLOTHING, NAMELY, T-SHIRTS, GOLF SHIRTS, SWEAT SHIRTS, SPORT SHIRTS, CAPS, BATH ROBES, RAIN PONCHOS, JACKETS, SCARVES, CAPS, HATS, AND VESTS (U.S. CLS. 22 AND 39).

FIRST USE 12-1-1991; IN COMMERCE 12-1-1991.

2,764,855. SPOT INTERNATIONAL, INC., SANTA ANA, CA. SN 76-166,561. PUB. 7-16-2002, FILED 11-16-2000.

EXOTHERMIC

FOR CLOTHING, NAMELY, CASUAL, LEISURE, SPORTS AND BEACH CLOTHING, NAMELY, SHIRTS, T-SHIRTS, SWEATSHIRTS, JACKETS, PANTS, SHORTS, BELTS, HATS, CAPS, SWIMWEAR AND FOOTWEAR (U.S. CLS. 22 AND 39).

FIRST USE 8-0-2002; IN COMMERCE 8-0-2002.

2,764,919. MILLIGAN, TIM, BOYNTON BEACH, FL. SN 76-216,647. PUB. 8-28-2001, FILED 2-26-2001.

THIS GAME'S EASY

FOR CLOTHING, NAMELY SHIRTS, SWEATSHIRTS, HATS, AND SHORTS (U.S. CLS. 22 AND 39).

FIRST USE 2-15-2001; IN COMMERCE 1-15-2003.

CLASS 25—(Continued).

2,764,926. MEGASCENE AB, 435 33 MOLNLYCKE, SWEDEN.
SN 76-220,162. PUB. 7-9-2002, FILED 3-1-2001.



FOR CLOTHING, NAMELY, WET SUITS, SHIRTS,
PANTS, JACKETS, SWEATERS, HATS AND FOOTWEAR
(U.S. CLS. 22 AND 39).
FIRST USE 0-0-2001; IN COMMERCE 0-0-2001.

2,764,935. IMAGEWEAR APPAREL CORP., WILMINGTON,
DE, BY MERGER RED KAP APPAREL CORP., WILMING-
TON, DE. SN 76-224,075. PUB. 10-15-2002, FILED 3-12-2001.

HORIZON TECHNOLOGIES BY VF WORKWEAR

OWNER OF U.S. REG. NO. 1,697,117.
NO CLAIM IS MADE TO THE EXCLUSIVE RIGHT TO
USE "WORKWEAR" OR "TECHNOLOGIES", APART FROM
THE MARK AS SHOWN.

FOR UNIFORMS, SHIRTS, PANTS, LAB COATS, CHEF
COATS, BUTCHER COATS, COOK SHIRTS AND PANTS
(U.S. CLS. 22 AND 39).

FIRST USE 1-0-2003; IN COMMERCE 1-0-2003.

2,764,954. MAJOR LEAGUE LACROSSE LLC, SECAUCUS,
NJ. SN 76-237,832. PUB. 2-5-2002, FILED 4-4-2001.



NO CLAIM IS MADE TO THE EXCLUSIVE RIGHT TO
USE "LACROSSE", APART FROM THE MARK AS SHOWN.
THE MARK CONSISTS OF THE WORDS "LIZARDS
LACROSSE" AND TWO STYLIZED LIZARDS.

FOR CLOTHING, NAMELY, T-SHIRTS, TANK-TOPS,
SWEATSHIRTS, SWEATPANTS, PULLOVERS, SHIRTS,
JACKETS, EXERCISE PANTS, ATHLETIC UNIFORMS,
JERSEYS, BOXER SHORTS, SHORT PANTS, GYM
SHORTS, HEADGEAR, NAMELY, CAPS, HATS (U.S.
CLS. 22 AND 39).

FIRST USE 6-0-2000; IN COMMERCE 6-0-2000.

CLASS 25—(Continued).

2,764,958. MAJOR LEAGUE LACROSSE LLC, SECAUCUS,
NJ. SN 76-237,844. PUB. 12-18-2001, FILED 4-4-2001.

BALTIMORE BAYHAWKS

NO CLAIM IS MADE TO THE EXCLUSIVE RIGHT TO
USE "BALTIMORE", APART FROM THE MARK AS
SHOWN.

FOR CLOTHING, NAMELY, T-SHIRTS, TANK-TOPS,
SWEATSHIRTS, SWEATPANTS, PULLOVERS, SHIRTS,
JACKETS, EXERCISE PANTS, ATHLETIC UNIFORMS,
JERSEYS, BOXER SHORTS, SHORT PANTS, GYM
SHORTS, HEADGEAR, NAMELY, CAPS AND HATS
(U.S. CLS. 22 AND 39).

FIRST USE 6-0-2000; IN COMMERCE 6-0-2000.

2,764,959. MAJOR LEAGUE LACROSSE LLC, SECAUCUS,
NJ. SN 76-237,845. PUB. 12-18-2001, FILED 4-4-2001.

ROCHESTER RATTLERS

NO CLAIM IS MADE TO THE EXCLUSIVE RIGHT TO
USE "ROCHESTER", APART FROM THE MARK AS
SHOWN.

FOR CLOTHING, NAMELY, T-SHIRTS, TANK-TOPS,
SWEATSHIRTS, SWEATPANTS, PULLOVERS, SHIRTS,
JACKETS, EXERCISE PANTS, ATHLETIC UNIFORMS,
JERSEYS, BOXER SHORTS, SHORT PANTS, GYM
SHORTS, HEADGEAR, NAMELY, CAPS, HATS (U.S.
CLS. 22 AND 39).

FIRST USE 6-0-2000; IN COMMERCE 6-0-2000.

2,764,960. MAJOR LEAGUE LACROSSE LLC, SECAUCUS,
NJ. SN 76-237,846. PUB. 12-18-2001, FILED 4-4-2001.

NEW JERSEY PRIDE

NO CLAIM IS MADE TO THE EXCLUSIVE RIGHT TO
USE "NEW JERSEY", APART FROM THE MARK AS
SHOWN.

FOR CLOTHING, NAMELY, T-SHIRTS, TANK-TOPS,
SWEATSHIRTS, SWEATPANTS, PULLOVERS, SHIRTS,
JACKETS, EXERCISE PANTS, ATHLETIC UNIFORMS,
JERSEYS, BOXER SHORTS, SHORT PANTS, GYM
SHORTS, HEADGEAR, NAMELY, CAPS AND HATS
(U.S. CLS. 22 AND 39).

FIRST USE 6-0-2000; IN COMMERCE 6-0-2000.

CLASS 25—(Continued).

2,764,963. HURRICANES HOCKEY LIMITED PARTNER-
SHIP, RALEIGH, NC. SN 76-238,420. PUB. 9-18-2001, FILED
4-10-2001.



FOR CLOTHING, NAMELY T-SHIRTS AND HATS
FOR USE WITH PROMOTIONAL ACTIVITIES IN CON-
NECTION WITH ENTERTAINMENT IN THE NATURE
OF PROFESSIONAL HOCKEY GAMES (U.S. CLS. 22
AND 39).
FIRST USE 9-0-2001; IN COMMERCE 9-0-2001.

2,764,969. MPOWER ENTERTAINMENT, LLC, WOODLAND
HILLS, CA. SN 76-242,610. PUB. 10-2-2001, FILED 4-18-2001.

NWM ENTERTAINMENT

FOR MEN'S AND WOMEN'S CLOTHING, NAMELY,
HATS, CAPS, T-SHIRTS, SHIRTS, TROUSERS, JACKETS,
COATS AND SOCKS (U.S. CLS. 22 AND 39).
FIRST USE 1-1-2002; IN COMMERCE 2-6-2002.

2,764,972. DEWKS, LLC, NEWBURYPORT, MA. SN 76-
245,123. PUB. 8-28-2001, FILED 4-23-2001.

**SKEWD COMFORT WITH A
SLANT**

FOR FOOTWEAR (U.S. CLS. 22 AND 39).
FIRST USE 2-0-2001; IN COMMERCE 2-0-2001.

CLASS 25—(Continued).

2,764,981. AWAKE, INC., SAN FERNANDO, CA. SN 76-
255,028. PUB. 12-10-2002, FILED 5-11-2001.



NO CLAIM IS MADE TO THE EXCLUSIVE RIGHT TO
USE "INCORPORATED", APART FROM THE MARK AS
SHOWN.
THE MARK CONSISTS OF THE WORDING "AWAKE
BY O.S. INCORPORATED" AND A STYLIZED DESIGN RE-
SEMBLING A LOWER CASE LETTER "A".
FOR NOVELTY KNITS, NAMELY, PANTS, SHIRTS, S-
KIRTS AND SWEATERS (U.S. CLS. 22 AND 39).
FIRST USE 1-0-2001; IN COMMERCE 1-0-2001.

2,765,024. RYCAM, INC., CARTER LAKE, IA. SN 76-269,184.
PUB. 2-19-2002, FILED 6-11-2001.

CITY COLLEGE USA

NO CLAIM IS MADE TO THE EXCLUSIVE RIGHT TO
USE "USA", APART FROM THE MARK AS SHOWN.
FOR SHIRTS, SHORTS, PANTS AND JACKETS (U.S.
CLS. 22 AND 39).
FIRST USE 1-0-2003; IN COMMERCE 1-0-2003.

2,765,064. CAPON, MICHAEL, KALISPELL, MT. SN 76-
288,594. PUB. 8-27-2002, FILED 7-23-2001.

WHITEFISH UNIVERSITY

FOR T-SHIRTS, SWEATSHIRTS AND HATS (U.S. CLS.
22 AND 39).
FIRST USE 6-1-2001; IN COMMERCE 4-1-2003.

CLASS 25—(Continued).

2,765,099. MERELINDA FARM LLC, DBA ALPACA.COM LLC, WHITMORE LAKE, MI. SN 76-302,897. PUB. 9-3-2002, FILED 8-22-2001.



NO CLAIM IS MADE TO THE EXCLUSIVE RIGHT TO USE "ALPACA" AND "WEAR", APART FROM THE MARK AS SHOWN.

FOR CLOTHING MADE IN WHOLE OR SUBSTANTIALLY OF ALPACA WOOL, NAMELY SWEATERS, COATS, CAPES, JACKETS, SHIRTS, TOPS, DRESSES, SUITS, BELTS, PANTS, SCARVES, STOLE, CAPELETS, HATS, MITTENS, GLOVES, SOCKS, UNDERWEAR, PAJAMAS, SWEATPANTS, SWEATSHIRTS, SHORTS, SLEEPERS, T-SHIRTS, TANK TOPS, VESTS, NECKTIES, ROBES, NIGHTSHIRTS, NIGHTGOWNS, LEG WARMERS, STOCKINGS, SLIPPERS, AND RAINWEAR (U.S. CLS. 22 AND 39).

FIRST USE 9-1-2001; IN COMMERCE 9-1-2001.

2,765,118. EASY SWEATERS LLC, NEW YORK, NY. SN 76-308,398. PUB. 1-1-2002, FILED 9-1-2001.

ERIC SCOT

THE NAME "ERIC SCOT" IDENTIFIES A PARTICULAR LIVING INDIVIDUAL WHOSE CONSENT IS OF RECORD.

FOR CLOTHING, NAMELY, JEANS, DENIM JEANS, TROUSERS, SLACKS, PANTS, SHORTS, SHIRTS, T-SHIRTS, JERSEYS, POLO SHIRTS, TOPS, CROP TOPS, TANK TOPS, HALTER TOPS, SWEAT SHIRTS, SWEAT SHORTS, SWEAT PANTS, BLOUSES, SKIRTS, DRESSES, SWEATERS, VESTS, TURTLENECKS (U.S. CLS. 22 AND 39).

FIRST USE 1-30-2002; IN COMMERCE 1-30-2002.

CLASS 25—(Continued).

2,765,128. CHILDRESS, RONALD JR., HUNTSVILLE, AL. SN 76-310,764. PUB. 4-9-2002, FILED 9-10-2001.

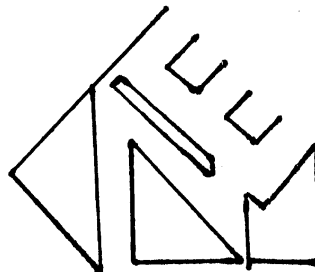

THE MARK CONSISTS OF GEOMETRIC FIGURES REPRESENTING THE LETTERS "NE".

FOR T-SHIRTS, SOCKS, POLO SHIRTS, SHOES, UNDERWEAR, COATS, SWEATERS, SWEATSHIRTS, HEADWEAR, BELTS, NECKTIES, BLAZERS, SLACKS, JEANS, BUTTON DOWN SHIRTS, DRESSES, BLOUSES AND SKIRTS (U.S. CLS. 22 AND 39).

FIRST USE 9-1-2001; IN COMMERCE 1-23-2002.

2,765,174. LOS ANGELES GAY AND LESBIAN COMMUNITY SERVICES CENTER, THE, LOS ANGELES, CA. AND SAN FRANCISCO AIDS FOUNDATION, THE, SAN FRANCISCO, CA. SN 76-325,553. PUB. 6-18-2002, FILED 10-15-2001.

AIDS/LIFECYCLE

FOR CLOTHING; NAMELY, T-SHIRTS, JERSEYS, SWEATSHIRTS, TANK TOPS, POLO SHIRTS, SHORTS, BANDANNAS, HATS, VISORS, AND JACKETS (U.S. CLS. 22 AND 39).

FIRST USE 10-22-2001; IN COMMERCE 10-22-2001.

2,765,180. MILLER, SCOTT, VALPARAISO, IN. AND RICHARDSON, ROBERT, LOCKPORT, IL. SN 76-326,320. PUB. 9-24-2002, FILED 10-17-2001.

UFFIZI

FOR WOMEN'S SHOES (U.S. CLS. 22 AND 39).
FIRST USE 4-1-2002; IN COMMERCE 4-1-2002.

CLASS 25—(Continued).

2,765,230. LAMEY-WELLEHAN, LEWISTON, ME. SN 76-341,443. PUB. 12-10-2002, FILED 11-16-2001.

KŪL

FOR MEN'S AND WOMEN'S FOOTWEAR; CLOTHING, NAMELY, T-SHIRTS, JEANS, GYM SHORTS, COATS, HATS, HEADBANDS, EARBANDS, SWEATBANDS, BASEBALL-STYLE CAPS, NECK WARMERS, MITTENS, SCARVES, GLOVES, JACKETS, PULLOVERS, SHELLS, VESTS, SWEATERS, SHIRTS, TURTLENECKS, CLOTHING TOPS, SWEATSHIRTS, SWEATPANTS, PANTS, UNDERGARMENTS, UNDERSHIRTS, UNDERSHORTS, BERMUDA SHORTS, SOCKS, BELTS, BALACLAVAS (U.S. CLS. 22 AND 39).

FIRST USE 10-9-2001; IN COMMERCE 10-9-2001.

2,765,245. TUZLACI, OMAR, MONTECILLOS, ALAJUELA, COSTA RICA. SN 76-346,508. PUB. 8-13-2002, FILED 12-10-2001.

SOX CONNECTION

NO CLAIM IS MADE TO THE EXCLUSIVE RIGHT TO USE "SOCKS", APART FROM THE MARK AS SHOWN.

FOR SPORT SOCKS, MEN'S SOCKS, WOMEN'S SOCKS AND KIDS SOCKS (U.S. CLS. 22 AND 39).

FIRST USE 7-31-1997; IN COMMERCE 7-31-1997.

2,765,257. L.C. LICENSING, INC., NEW YORK, NY. SN 76-349,950. PUB. 9-24-2002, FILED 12-19-2001.

CLAIBORNE COMPONENTS

OWNER OF U.S. REG. NOS. 1,454,345, 2,545,212, AND OTHERS.

NO CLAIM IS MADE TO THE EXCLUSIVE RIGHT TO USE "COMPONENTS", APART FROM THE MARK AS SHOWN.

SEC. 2(F).

FOR PANTS, SHIRTS, VESTS, SUIT JACKETS AND SWEATERS (U.S. CLS. 22 AND 39).

FIRST USE 8-1-2002; IN COMMERCE 8-1-2002.

CLASS 25—(Continued).

2,765,272. LACKAWANNA CHAPTER, RAILWAY & LOCOMOTIVE HISTORICAL SOCIETY, INC., MOUNTAIN-HOME, PA. SN 76-353,743. PUB. 11-5-2002, FILED 12-31-2001.

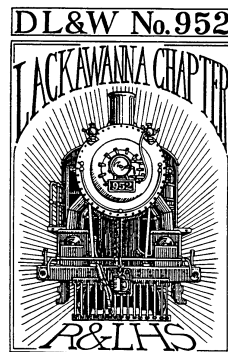

NO CLAIM IS MADE TO THE EXCLUSIVE RIGHT TO USE "LACKAWANNA CHAPTER", APART FROM THE MARK AS SHOWN.

FOR CLOTHING, NAMELY, JACKETS, T-SHIRTS AND CAPS (U.S. CLS. 22 AND 39).

FIRST USE 7-13-2002; IN COMMERCE 7-13-2002.

2,765,280. WINNER SHOES CO., LTD., TAICHUNG HSIEN, TAIWAN. SN 76-356,194. PUB. 10-8-2002, FILED 1-7-2002.

VARY

FOR SHOES, BASKETBALL SHOES, LOUNGE SHOES, SPORTS SHOES, SKI BOOTS, INNER SOLES FOR SHOES, INSOLES FOR SHOES, OVERSHOES (U.S. CLS. 22 AND 39).

FIRST USE 1-12-2003; IN COMMERCE 1-12-2003.

2,765,346. BECHTOLD, JOSEPH A., CLEVELAND, OH. SN 76-374,451. PUB. 9-10-2002, FILED 2-21-2002.

NOTHING MATTERS WHEN I'M IN MY SPATTERS

FOR WEARING APPAREL FOR ADULTS AND CHILDREN, NAMELY OVERALLS, PANTS, SKIRTS, SHIRTS, SHORTS, APRONS AND INFANT WEAR (U.S. CLS. 22 AND 39).

FIRST USE 5-9-2003; IN COMMERCE 5-9-2003.

CLASS 25—(Continued).

2,765,347. BECHTOLD, JOSEPH A., CLEVELAND, OH. SN 76-374,452. PUB. 9-17-2002, FILED 2-21-2002.

SPATTERS N SPLATTERS

FOR WEARING APPAREL FOR ADULTS AND CHILDREN, NAMELY OVERALLS, PANTS, SKIRTS, SHIRTS, SHORTS, APRONS AND INFANT WEAR (U.S. CLS. 22 AND 39).

FIRST USE 5-9-2003; IN COMMERCE 5-9-2003.

2,765,348. BECHTOLD, JOSEPH A., CLEVELAND, OH. SN 76-374,453. PUB. 9-17-2002, FILED 2-21-2002.

SPATTERS

FOR WEARING APPAREL FOR ADULTS AND CHILDREN, NAMELY OVERALLS, PANTS, SKIRTS, SHIRTS, SHORTS, APRONS AND INFANT WEAR (U.S. CLS. 22 AND 39).

FIRST USE 5-8-2003; IN COMMERCE 5-8-2003.

2,765,375. PYUNG AN TEXTILE CO., LTD., SEOUL, REPUBLIC OF KOREA. SN 76-380,160. PUB. 9-24-2002, FILED 3-11-2002.



THE MARK CONSISTS OF A FANCIFUL DEPICTION OF AN OWL.

FOR CLOTHING, NAMELY, SHORTS, SHIRTS, T-SHIRTS, SWIMSUITS, BLOUSES, SKIRTS, SCARVES, GLOVES, PANTS, SWEATERS, JERSEYS, SOCKS, JACKETS, SUITS, TRAINING SUITS, VESTS, NECKTIES, BELTS, SUSPENDERS, DRESSES, COATS, RAINCOATS, OVERCOATS, SMOCKS, UNDERWEAR, PAJAMAS, BRASSIERES, CORSETS, SLIPS, LINGERIE; HEADWEAR, NAMELY, HATS, CAPS AND BERETS; FOOTWEAR, NAMELY, BOOTS, SANDALS, SHOES AND SLIPPERS (U.S. CLS. 22 AND 39).

FIRST USE 6-0-2002; IN COMMERCE 6-0-2002.

CLASS 25—(Continued).

2,765,425. REID, WILLIAM BURCH, FLORENCE, AL. SN 76-399,523. PUB. 12-17-2002, FILED 4-23-2002.

SOUTHERN LABORATORY

FOR T-SHIRTS, SWEATERS, PANTS, COATS, JACKETS, SHIRTS, DRESSES, SHOES, HATS, JEANS, SCARFS, SWEATSHIRTS, BLOUSES, TANK TOPS (U.S. CLS. 22 AND 39).

FIRST USE 4-1-2002; IN COMMERCE 5-1-2003.

2,765,441. MARTIN ROSS AND ROBBIE STANFORD PARTNERSHIP, THE, LOS ANGELES, CA. SN 76-406,954. PUB. 12-31-2002, FILED 5-10-2002.



FOR MEN'S AND BOY'S WEARING APPAREL, NAMELY, T-SHIRTS, SWEATSHIRTS, TANK TOPS, WOVEN SHIRTS, SWEATERS, CARDIGANS, VESTS, JACKETS, PANTS, SWEATPANTS, JEANS, SHORTS, HATS, CAPS, COATS, PAJAMAS, SOCKS, SHOES, UNDERWEAR, SWIMWEAR, TRUNKS, SCARVES, HATS, TIES, PAJAMAS, WRIST BANDS AND HEAD BANDS; AND INFANT AND CHILDREN'S GARMENTS, NAMELY, T-SHIRTS, PULLOVERS, SHIRTS, LEGGINGS, CAPS, AND UNDERWEAR; AND WOMEN'S AND GIRL'S WEARING APPAREL, NAMELY, T-SHIRTS, SWEATSHIRTS, TANK TOPS, WOVEN SHIRTS, SWEATERS, CARDIGANS, VESTS, JACKETS, PANTS, SWEATPANTS, JEANS, SHORTS, HATS, CAPS, COATS, PAJAMAS, SOCKS, UNDERWEAR, PANTYHOSE, TEDDIES, BRAS, SKIRTS, DRESSES, BLOUSES, SWIMWEAR, BIKINIS, SCARVES, HATS, TIES, PAJAMAS, WRIST BANDS, AND HEAD BANDS; AND INFANT AND CHILDREN'S GARMENTS, NAMELY, T-SHIRTS, PULLOVERS, SHIRTS, LEGGINGS, CAPS, AND UNDERWEAR (U.S. CLS. 22 AND 39).

FIRST USE 7-31-2002; IN COMMERCE 7-31-2002.

2,765,444. GREEN, WILHELMINA B., MONCKS CORNER, SC. SN 76-407,745. PUB. 12-31-2002, FILED 5-14-2002.

EL-ELYON

THE ENGLISH TRANSLATION OF "EL-ELYON" IS "THE MOST HIGH GOD."

FOR CLOTHING, NAMELY, SHIRTS, T-SHIRTS, PANTS, JEANS, SHORTS, SHOES, SANDALS, HATS, CAPS, GLOVES, BELTS, SOCKS, NECKTIES, DRESSES, SKIRTS, COATS, SWEATERS, SWEATSHIRTS, SWEATPANTS, JACKETS, SCARVES (U.S. CLS. 22 AND 39).

FIRST USE 1-4-2003; IN COMMERCE 1-4-2003.

CLASS 25—(Continued).

2,765,464. LIN, LUCY, MANHATTAN BEACH, CA. AND BRAGADO, DANALEE, MANHATTAN BEACH, CA. SN 76-412,480. PUB. 12-3-2002, FILED 5-24-2002.

VOLLYDOLLY

FOR CLOTHING, NAMELY TOPS AND BOTTOMS, TANK TOPS, T-SHIRTS, SWEATSHIRTS, SWEAT PANTS, SWEAT SUITS, ATHLETIC UNIFORMS, JACKETS, SHORTS, SHIRTS, BATHING SUITS, SWIMWEAR, BRAS, UNDERWEAR, SOCKS, BANDANNAS AND HEADBANDS; HEADWEAR AND FOOTWEAR (U.S. CLS. 22 AND 39).

FIRST USE 2-25-2003; IN COMMERCE 3-20-2003.

2,765,491. GILMORE, MATTHEW A., NEW YORK, NY. SN 76-427,514. PUB. 1-7-2003, FILED 7-5-2002.

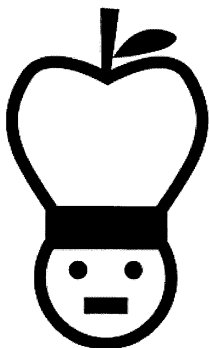

FOR CLOTHING, NAMELY, HATS, T-SHIRTS AND SWEATSHIRTS (U.S. CLS. 22 AND 39).

FIRST USE 3-31-2003; IN COMMERCE 3-31-2003.

2,765,503. AT WORK SALES CORPORATION, ORANGE BEACH, AL. SN 76-438,440. PUB. 3-4-2003, FILED 8-7-2002.

WARDROBE'S CHOICE

FOR CLOTHING, NAMELY SHIRTS AND PANTS; CLOTHING, NAMELY COVERALLS, JACKETS, COATS, SMOCKS, APRONS, SHOES, BOOTS, SOCKS, BELTS, TIES, HATS, CAPS, GLOVES, AND RAINWEAR (U.S. CLS. 22 AND 39).

FIRST USE 7-29-2002; IN COMMERCE 7-29-2002.

CLASS 25—(Continued).

2,765,526. MOUNT CASHMERE INC., WHISTLER, BRITISH COLUMBIA, CANADA. SN 76-975,698. PUB. 9-3-2002, FILED 1-11-2001.



FOR CLOTHES, NAMELY CARDIGAN, SWEATER, PULLOVER, SKIRT, PANTS, SCARF, SHAWL, GLOVES, HATS, SLIPPERS (U.S. CLS. 22 AND 39).

FIRST USE 11-0-1999; IN COMMERCE 12-0-1999.

2,765,530. L.C. LICENSING, INC., NEW YORK, NY. SN 76-975,739. PUB. 9-17-2002, FILED 12-17-2001.

LIZ & CO.

OWNER OF U.S. REG. NO. 1,602,413.
NO CLAIM IS MADE TO THE EXCLUSIVE RIGHT TO USE "CO.", APART FROM THE MARK AS SHOWN.

FOR CLOTHING, NAMELY, SKIRTS, SHIRTS, BLOUSES, PANTS, JACKETS, VESTS, SWEATERS, DRESSES, JUMPSUITS, SHORTS, JEANS, JERSEYS, CULOTTES, SCARVES, TUNICS, BLAZERS, NECKWEAR, BELTS, COATS, HATS, CAPS, HOODS, GLOVES AND MITTENS; PANTYHOSE, DRESS HOSIERY, SPORT HOSIERY AND SOCKS (U.S. CLS. 22 AND 39).

FIRST USE 2-2-1989; IN COMMERCE 2-2-1989.

2,765,531. WALTERS SCOTTY JOE, RAGLAND, AL. SN 78-000,002. PUB. 7-30-2002, FILED 3-20-2000.

GALAVANTING

FOR SHIRTS, PANTS, AND HEADGEAR, NAMELY, CAPS AND HATS (U.S. CLS. 22 AND 39).

FIRST USE 3-18-2000; IN COMMERCE 3-18-2000.

CLASS 25—(Continued).

2,765,572. BROOKS BROTHERS, INC., NEW YORK, NY. SN 78-042,659. PUB. 6-18-2002, FILED 1-10-2001.

BROOKS BOYS

FOR CLOTHING, NAMELY, SHIRTS, TOPS, SWEATERS, JACKETS, PANTS, SUITS, BOTTOMS, SOCKS, HATS AND CAPS; SHOES; SHORTS, COATS, NECKTIES, UNDERWEAR, VESTS, ROBES, HOSIERY, SKIRTS, DRESSES, LOUNGEWEAR, SCARVES, RAINWEAR, TROUSERS, ASCOTS, TIES, OUTER SHIRTS INCLUDING EVENING, DRESS, POLO, AND SPORTS SHIRTS, COLLARS, PAJAMAS, ROBES, SMOKING JACKETS, DRESSING GOWNS, MUFFLERS, GLOVES, HOSE, BELTS, SUSPENDERS, GARTERS, BOOTS, SLIPPERS, SHOES, OVERSHOES, BEACH WEAR, SWIMWEAR, FORMAL WEAR, NAMELY JACKETS, PANTS, SUITS, SHIRTS, SHOES, CUMMERBUNDS, TIES, SUSPENDERS AND GOWNS (U.S. CLS. 22 AND 39).

FIRST USE 9-30-2002; IN COMMERCE 9-30-2002.

2,765,573. MICROSOFT CORPORATION, REDMOND, WA. SN 78-043,745. PUB. 8-14-2001, FILED 1-18-2001.

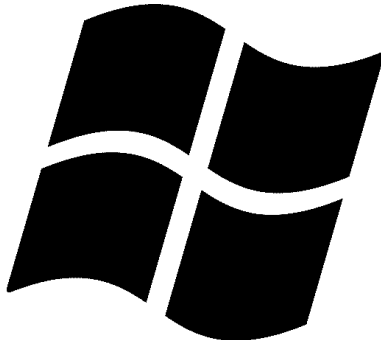

OWNER OF U.S. REG. NOS. 1,815,350, 1,816,354, AND OTHERS.

THE MARK CONSISTS OF A FLAG DESIGN. COLOR IS NOT CLAIMED AS PART OF THE MARK.

FOR SHIRTS, VESTS, SWEATSHIRTS, SWEATERS, SWEATPANTS, SHORTS, JACKETS, CAPS, COATS, SCARVES, GLOVES, MITTENS, SOCKS, TIES, VISORS AND WRIST BANDS (U.S. CLS. 22 AND 39).

FIRST USE 7-2-2001; IN COMMERCE 7-2-2001.

2,765,575. BMG IMPORT-EXPORT, INC., NEW YORK, NY. SN 78-045,386. PUB. 8-21-2001, FILED 1-29-2001.

FABRIANO

FOR CLOTHING, NAMELY, MEN'S SUITS, TROUSERS, VESTS, OVERCOATS, AND JACKETS (U.S. CLS. 22 AND 39).

FIRST USE 4-1-2003; IN COMMERCE 4-1-2003.

CLASS 25—(Continued).

2,765,578. MARBLE SPORTSWEAR, INC., BEVERLY HILLS, CA. SN 78-048,063. PUB. 9-24-2002, FILED 2-13-2001.

CAMP GM

FOR BATHING SUITS, BLAZERS, BLOUSES, BOOTS, BRAS, UNDERWEAR BRIEFS, CAMISOLES, CAPS, COATS, DRESSES, GLOVES, HATS, JACKETS, JEANS, JUMPSUITS, LEOTARDS, NECKTIES, NIGHTGOWNS, OVERALLS, PAJAMAS, PANTS, PANTYHOSE, RAINCOATS, ROBES, SANDALS, SHIRTS, SHOES, SHORTS, SKIRTS, SLIPPERS, SLIPS, SOCKS, STOCKINGS, SUITS, SWEATERS, SWEATPANTS, SWEATSHIRTS, T-SHIRTS, TIGHTS, TUXEDOS, VESTS, WARM-UP SUITS (U.S. CLS. 22 AND 39).

FIRST USE 5-1-2002; IN COMMERCE 5-1-2002.

2,765,592. CALLAWAY GOLF COMPANY, CARLSBAD, CA. SN 78-060,152. PUB. 9-25-2001, FILED 4-24-2001.

VFT

FOR CLOTHING AND HEADGEAR, NAMELY, BELTS, BLAZERS, BLOUSES, BODYSUITS, CAMISOLES, CAPS, COATS, DICKIES, DRESSES, HATS, HOSIERY, JACKETS, JUMP SUITS, KNIT SHIRTS, OUTER WEAR, PANTS, PULL-OVERS, SCARVES, SHIRTS, SHORTS, SKIRTS, SKORTS, SLACKS, SOCKS, SPORTCOATS, SWEAT PANTS, SWEATSHIRTS, SWEATERS, SWIMWEAR, T-SHIRTS, TANK TOPS, TIGHTS, TOPS, UNDERWEAR, VESTS, VISORS, WARM-UPS AND WIND SHIRTS (U.S. CLS. 22 AND 39).

FIRST USE 10-26-2000; IN COMMERCE 10-26-2000.

2,765,593. MARBLE SPORTSWEAR, INC., BEVERLY HILLS, CA. SN 78-060,546. PUB. 10-8-2002, FILED 4-26-2001.

CLEVERLY

FOR BATHING SUITS, BLAZERS, BLOUSES, BOOTS, BRAS, BRIEFS, CAMISOLES, CAPS, COATS, DRESSES, GLOVES, HATS, JACKETS, JEANS, JUMPSUITS, LEOTARDS, NECKTIES, NIGHTGOWNS, OVERALLS, PAJAMAS, PANTS, PANTYHOSE, RAINCOATS, ROBES, SANDALS, SHIRTS, SHOES, SHORTS, SKIRTS, SLIPPERS, SLIPS, SOCKS, STOCKINGS, SUITS, SWEATERS, SWEATPANTS, SWEATSHIRTS, T-SHIRTS, TIGHTS, TUXEDOS, VESTS, WARM-UP SUITS (U.S. CLS. 22 AND 39).

FIRST USE 6-1-2001; IN COMMERCE 6-1-2001.

2,765,604. GILLETT, DENNIS, S, ENCINITAS, CA. SN 78-065,102. PUB. 10-2-2001, FILED 5-22-2001.

EXPENDABLE YOUTH

FOR TEE-SHIRTS, SWEAT SHIRTS, HATS, PANTS (U.S. CLS. 22 AND 39).

FIRST USE 3-19-2002; IN COMMERCE 5-1-2002.

CLASS 25—(Continued).

2,765,639. STEIN, ALEX, HUDSON, OH. SN 78-079,858. PUB. 9-24-2002, FILED 8-17-2001.

ASHLEY WHIPPET

OWNER OF U.S. REG. NO. 1,263,828.
THE NAME "ASHLEY WHIPPET" DOES NOT IDENTIFY A LIVING INDIVIDUAL.

FOR T-SHIRTS (U.S. CLS. 22 AND 39),
FIRST USE 2-21-2003; IN COMMERCE 2-21-2003.

CLASS 25—(Continued).

2,765,705. LILOEBE LLC, TRAVERSE CITY, MI. SN 78-105,750. PUB. 7-23-2002, FILED 1-30-2002.



FOR ONE PIECE INFANT OUTFITS DESIGNED TO APPEAR AS SEPARATE LAYERS OF CLOTHING (U.S. CLS. 22 AND 39).

FIRST USE 2-12-2002; IN COMMERCE 2-12-2002.

2,765,670. NINE WEST DEVELOPMENT CORPORATION, WILMINGTON, DE. SN 78-091,017. PUB. 2-11-2003, FILED 10-31-2001.

NINE & COMPANY

NO CLAIM IS MADE TO THE EXCLUSIVE RIGHT TO USE "& COMPANY", APART FROM THE MARK AS SHOWN.

FOR CLOTHING, NAMELY, BELTS; LEG WEAR, NAMELY HOSIERY, TIGHTS AND SOCKS; GLOVES, MITTENS, SCARVES AND HATS (U.S. CLS. 22 AND 39).
FIRST USE 12-31-2001; IN COMMERCE 12-31-2001.

2,765,706. LEVI STRAUSS & CO., SAN FRANCISCO, CA. SN 78-106,175. PUB. 7-23-2002, FILED 2-1-2002.

GO KHAKI

NO CLAIM IS MADE TO THE EXCLUSIVE RIGHT TO USE "KHAKI", APART FROM THE MARK AS SHOWN.
FOR CLOTHING, NAMELY PANTS (U.S. CLS. 22 AND 39).

FIRST USE 5-2-2002; IN COMMERCE 5-2-2002.

2,765,720. B2 HOLDINGS, LLC, AMHERST, MA. SN 78-110,008. PUB. 9-24-2002, FILED 2-20-2002.

NOR'EASTER

FOR FOOTWEAR; BOOTS (U.S. CLS. 22 AND 39).
FIRST USE 12-0-2002; IN COMMERCE 12-0-2002.

2,765,681. SCREEN IRRIX, NEW ROCHELLE, NY. SN 78-094,457. PUB. 9-24-2002, FILED 11-20-2001.



D.U.O.

DA UNDERGROUND ORGANIZATION

FOR CLOTHING AND APPAREL, NAMELY T-SHIRTS, HATS, SWEATSHIRTS, SHORTS, CAPS, PANTS, AND JACKETS (U.S. CLS. 22 AND 39).
FIRST USE 8-15-2001; IN COMMERCE 4-7-2002.

2,765,740. MCRAE'S, INC., BIRMINGHAM, AL. SN 78-116,121. PUB. 11-26-2002, FILED 3-20-2002.

(RELATIVITY) DESIGN LAB

OWNER OF U.S. REG. NO. 2,384,258.

NO CLAIM IS MADE TO THE EXCLUSIVE RIGHT TO USE "DESIGN", APART FROM THE MARK AS SHOWN.

FOR CLOTHING, NAMELY, CLOTHING BELTS, BRAS, CARDIGANS, CHEMISES, COATS, LEATHER COATS, COVERUPS, DRESSES, DUNGAREES, GLOVES, HATS, HOSIERY, JACKETS, JEANS, JUMPERS, MITTENS, CLOTHING MUFFLERS, NECKWEAR, PANTS, PULLOVERS, SCARVES, SHORTS, SKIRTS, SLACKS, SOCKS, BATHING SUITS, SWEAT PANTS, SWEAT SHIRTS, T-SHIRTS, TANK TOPS, HALTER TOPS, TUNICS, SWEATERS, TURTLENECKS, VESTS, FOUL WEATHER GEAR, RAINWEAR, BLOUSES, CAMISOLES, KNIT SHIRTS, LINGERIE, LOUNGEWEAR, NIGHT GOWNS, PAJAMAS, PULLOVERS, ROBES, SLEEPWEAR, SLIPS, SUITS, UNDERWEAR, AND TIGHTS (U.S. CLS. 22 AND 39).

FIRST USE 7-0-2002; IN COMMERCE 7-0-2002.

CLASS 25—(Continued).

2,765,752. RECREATIONAL EQUIPMENT, INC., SUMNER, WA. SN 78-120,271. PUB. 11-5-2002, FILED 4-8-2002.

REI ONE

OWNER OF U.S. REG. NOS. 1,163,815, 2,470,584, AND OTHERS.

FOR JACKETS, PANTS, GLOVES, HEAD WEAR (U.S. CLS. 22 AND 39).

FIRST USE 8-10-2002; IN COMMERCE 8-10-2002.

2,765,753. CALLAWAY GOLF COMPANY, CARLSBAD, CA. SN 78-120,617. PUB. 1-21-2003, FILED 4-9-2002.

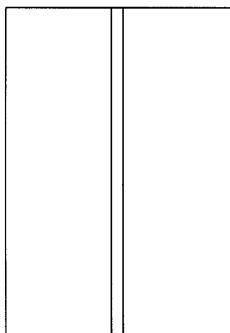

THE MARK CONSISTS OF TWO RECTANGLES NEXT TO EACH OTHER, DIVIDED BY A SINGLE LINE. THE LEFT RECTANGLE IS TAUPE IN COLOR, THE OPPOSING RECTANGLE IS LIGHT GRAY IN COLOR AND THE SINGLE LINE IN THE CENTER IS GOLD IN COLOR.

FOR CLOTHING FOR GOLF, NAMELY— KNIT SHIRTS, COTTON SHIRTS, T-SHIRTS, WIND RESISTANT JACKETS, BELTS, PULL-OVERS, TANK TOPS, SHORTS, SLACKS, SOCKS, SWEATERS, HATS, VISORS, JEANS, SKIRTS, SWEAT SHIRTS AND SWEAT PANTS (U.S. CLS. 22 AND 39).

FIRST USE 5-1-2002; IN COMMERCE 5-1-2002.

2,765,807. WELGEMOED, MORGAN SHAUN, LOS ANGELES, CA. SN 78-140,015. PUB. 1-28-2003, FILED 6-28-2002.

SEETHER

FOR ARTICLES OF CLOTHING, FOR MEN, WOMEN AND CHILDREN, NAMELY, T-SHIRTS, SWEATSHIRTS, TANK TOPS, JACKETS, KNITTED HEADWEAR, HATS, CAPS AND VISORS, PAJAMAS, NIGHTSHIRTS, ROBES, JOGGING SUITS, SWEATSUITS, JERSEYS, COLLAR-SHIRTS, BLOUSES, SHORTS, PANTS, JUMPERS, OVERALLS, DRESSES, SKIRTS, SHORT SETS COMPRISED OF SHORTS AND TOPS, SWEATERS, COATS, RAINCOATS, SCARVES, BANDANNAS, UNDERWEAR, VESTS, TIES, BELTS AND SUSPENDERS, SOCKS, GLOVES, MITTENS, APRONS, SWIMSUITS, FOOTWEAR AND MASQUERADE COSTUMES (U.S. CLS. 22 AND 39).

FIRST USE 8-1-2002; IN COMMERCE 8-1-2002.

CLASS 26—FANCY GOODS

2,765,350. BOY SCOUTS OF AMERICA, IRVING, TX. SN 76-375,391. PUB. 3-18-2003, FILED 2-26-2002.



FOR CLOTH PATCHES FOR CLOTHING (U.S. CLS. 37, 39, 40, 42 AND 50).

FIRST USE 4-30-2002; IN COMMERCE 4-30-2002.

CLASS 27—FLOOR COVERINGS

2,764,735. HOME DYNAMICS, LLC, S. HACKENSACK, NJ. SN 76-078,293. PUB. 3-13-2001, FILED 6-28-2000.

MONACO

FOR CARPETS (U.S. CLS. 19, 20, 37, 42 AND 50).
FIRST USE 1-0-2001; IN COMMERCE 1-0-2001.

2,765,147. SUPERIOR MANUFACTURING GROUP, INC., CHICAGO, IL. SN 76-317,647. PUB. 6-18-2002, FILED 9-26-2001.

TUFF TWIST

FOR FLOOR MATS FOR COMMERCIAL USE (U.S. CLS. 19, 20, 37, 42 AND 50).

FIRST USE 6-1-2001; IN COMMERCE 6-1-2001.

2,765,461. SUPERIOR MANUFACTURING GROUP, INC., CHICAGO, IL. SN 76-412,379. PUB. 11-19-2002, FILED 5-22-2002.

BLADE RUNNER

FOR ANTI-FATIGUE FLOOR MATS FOR COMMERCIAL AND INDUSTRIAL USE (U.S. CLS. 19, 20, 37, 42 AND 50).

FIRST USE 11-1-2002; IN COMMERCE 11-1-2002.

CLASS 28—TOYS AND SPORTING GOODS

CLASS 28—(Continued).

2,764,515. KWIK TEK INC., DENVER, CO. SN 75-602,693.
PUB. 1-18-2000, FILED 12-10-1998.

AIRHEAD

FOR INFLATABLE FLOATS FOR RECREATIONAL
USE IN WATER WHICH ARE TOWED BEHIND POWER
CRAFT (U.S. CLS. 22, 23, 38 AND 50).
FIRST USE 7-23-1998; IN COMMERCE 12-6-1999.

2,764,546. MIDWAY HOME ENTERTAINMENT INC., CHI-
CAGO, IL. SN 75-693,428. PUB. 12-28-1999, FILED 4-29-1999.

KEMO CLAW

FOR COIN-OPERATED ARCADE AND VIDEO
GAMES; HAND-HELD UNITS FOR PLAYING VIDEO
GAMES; TOY ACTION FIGURES AND ACTION FIGURE
ACCESSORIES (U.S. CLS. 22, 23, 38 AND 50).
FIRST USE 12-7-1999; IN COMMERCE 12-7-1999.

2,764,568. LANDSCAPE STRUCTURES, INC., DELANO, MN.
SN 75-741,682. PUB. 2-20-2001, FILED 6-25-1999.

PLAYODYSSEY

FOR PLAYGROUND EQUIPMENT, NAMELY, CLIMB-
ING STRUCTURE WITH TUNNEL SLIDE (U.S. CLS. 22,
23, 38 AND 50).
FIRST USE 5-1-2003; IN COMMERCE 5-1-2003.

2,764,607. DELOS SANTOS, JAMES R., DBA JRDS ENTER-
PRISES, PORT ANGELES, WA. SN 75-837,208. PUB. 9-25-
2001, FILED 11-1-1999.

GOLF-A-ROUND

FOR GOLF PRACTICE AIDS, NAMELY, OVERLAY
SIMULATED GOLF HOLE FOR PRACTICING GOLFING
(U.S. CLS. 22, 23, 38 AND 50).
FIRST USE 5-0-2003; IN COMMERCE 5-0-2003.

CLASS 28—(Continued).

2,764,609. BASS BARBARIANS, INC., HAYWARD, CA. SN 75-
840,914. PUB. 8-20-2002, FILED 11-4-1999.



NO CLAIM IS MADE TO THE EXCLUSIVE RIGHT TO
USE "BASS" AND "INC.", APART FROM THE MARK AS
SHOWN.

FOR FISHING EQUIPMENT, NAMELY, FISHING
NETS, REELS, TACKLE, SNAPS, SWIVELS, SNAP SWI-
VELS, CONNECTING LINKS, LURES, ARTIFICIAL
FISHING BAIT, PACKAGED FREEZE DRIED FISHING
BAIT, FLY RODS, SPINNING RODS, CASTING RODS,
ROD HOLDERS, ROD KITS COMPRISING FISHING
RODS AND REELS, BLANK, FLIES, JIGS, RIGS,
GLOATS, PLANER RIGGERS, DOWNRIGGERS, BUZ-
ZERS, HOOKS, HOOK REMOVERS, AND CARRYING
CASES AND BOXES THEREFORE (U.S. CLS. 22, 23, 38
AND 50).

FIRST USE 6-0-2002; IN COMMERCE 7-0-2002.

2,764,772. CURIOSITY KITS, INC., HUNT VALLEY, MD. SN
76-107,029. PUB. 8-27-2002, FILED 8-10-2000.

CURIOUS GIRL

NO CLAIM IS MADE TO THE EXCLUSIVE RIGHT TO
USE "GIRL", APART FROM THE MARK AS SHOWN.

FOR HOBBY CRAFT KITS FOR CHILDREN FEATUR-
ING MATERIALS AND INSTRUCTIONS FOR MAKING,
DESIGNING AND DECORATING ADDRESS BOOKS,
BLANK DIARIES, BLANK JOURNALS, STATIONERY,
CLOTHING, CLOTHING ACCESSORIES, HAIR CARE
PRODUCTS, HAIR ACCESSORIES, AND MAKE-UP
(U.S. CLS. 22, 23, 38 AND 50).

FIRST USE 10-18-2000; IN COMMERCE 10-18-2000.

2,764,787. SPIN MASTER LTD., TORONTO ONTARIO,
CANADA. BY ASSIGNMENT SPIN MASTER TOYS,
LTD., TORONTO, M5A 192, ONTARIO. SN 76-121,960.
PUB. 4-16-2002, FILED 9-5-2000.

HYDRONAUT

FOR PNEUMATICALLY POWERED TOY WATER
VEHICLES (U.S. CLS. 22, 23, 38 AND 50).
FIRST USE 1-23-2001; IN COMMERCE 3-13-2001.

CLASS 28—(Continued).

2,764,831. TOCCI, JEFFREY W., WELLESLEY, MA. SN 76-154,827. PUB. 10-22-2002, FILED 10-26-2000.

PUT YOUR HANDS ON A BETTER GAME

FOR SPORTING GOODS, NAMELY, FISHING EQUIPMENT, NAMELY, FISHING POLES, GOLF CLUBS, HOCKEY EQUIPMENT, NAMELY HOCKEY STICKS, SKI POLES, TENNIS RACKETS, RACQUETBALL RACKETS, AND SQUASH RACKETS (U.S. CLS. 22, 23, 38 AND 50).

FIRST USE 4-0-2002; IN COMMERCE 4-0-2002.

2,764,886. FRANKLY CONSULTING LLC., CHESTER, NJ. SN 76-191,353. PUB. 11-12-2002, FILED 1-8-2001.

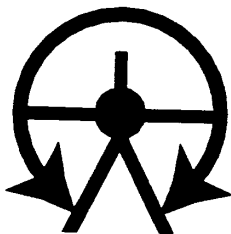

FOR SPORTING ARTICLES, NAMELY, GOLF CLUBS, GOLF BALLS, GOLF TEES, GOLF HAND GRIPS, BAGS, NAMELY GOLF BAGS, SHOE BAGS AND TOTE BAGS, STRAPS FOR GOLF BAGS, AND GOLF HEAD COVERS (U.S. CLS. 22, 23, 38 AND 50).

FIRST USE 10-28-2002; IN COMMERCE 10-28-2002.

2,764,908. THOSE CHARACTERS FROM CLEVELAND, INC., CLEVELAND, OH. SN 76-209,018. PUB. 12-18-2001, FILED 2-13-2001.

BLUEBERRY-PIE POPPLE

OWNER OF U.S. REG. NOS. 1,386,032, 1,430,199, AND 1,440,047.

FOR TOY FIGURES (U.S. CLS. 22, 23, 38 AND 50).
FIRST USE 6-0-2001; IN COMMERCE 6-0-2001.

CLASS 28—(Continued).

2,764,916. CENTURY INCORPORATED, MIDWEST CITY, OK. SN 76-214,539. PUB. 4-16-2002, FILED 2-22-2001.

BODY REFLECTIONS

FOR EXERCISE EQUIPMENT, NAMELY, PERSONAL EXERCISE MATS, O-RING WEIGHTS, WRIST WEIGHTS, ANKLE WEIGHTS, DUMBBELLS, WEIGHT BARS, HAND EXERCISERS, GRIP BALLS, JUMP ROPES, WEIGHTED GLOVES, WEIGHTED BELTS, WEIGHTED VESTS, WEIGHTED SHORTS, PUSH-UP BARS, ABDOMEN TONING WHEELS, MEDICINE BALLS, EXERCISE BALLS, AND MANUALLY OPERATED THIGH EXERCISERS AND WAIST EXERCISERS (U.S. CLS. 22, 23, 38 AND 50).

FIRST USE 1-15-2000; IN COMMERCE 1-15-2000.

2,764,944. ROAD CHAMPS, INC., MALIBU, CA. SN 76-233,417. PUB. 1-15-2002, FILED 4-2-2001.

SPINBOTS ACTION ARENA

NO CLAIM IS MADE TO THE EXCLUSIVE RIGHT TO USE "ACTION ARENA", APART FROM THE MARK AS SHOWN.

FOR TOYS, NAMELY TOY ROBOTS AND PLAYSETS FOR USE THEREWITH (U.S. CLS. 22, 23, 38 AND 50).
FIRST USE 5-24-2001; IN COMMERCE 5-24-2001.

2,764,988. CARTOON NETWORK LP, LLLP, THE, ATLANTA, GA. SN 76-261,114. PUB. 1-15-2002, FILED 5-23-2001.



SAMURAI
JACK

FOR TOYS AND SPORTING GOODS, NAMELY, PLUSH DOLLS, VINYL DOLLS, RAG DOLLS, ACTION FIGURES AND ACCESSORIES THEREFOR, PLAY KITCHEN AND COOKWARE, WIND-UP, PULL BACK AND FRICTION POWERED TOYS, PVC FIGURINES, PLASTIC TOY VEHICLES, KITES, PLAYGROUND AND SPORTS BALLS, BASEBALL BATS, GOLF CLUBS, FISHING RODS AND REELS, SANDBOX TOY PAILS, RING TOSS GAMES, HORSE SHOES FOR RECREATIONAL PURPOSES, PADDLE BALL, BADMINTON SETS, PLAY BOWLING SETS, RIDE-ON TOYS, PEDAL CARS, SWIM RINGS, INFLATABLE AND PLAY SWIMMING POOLS FOR RECREATIONAL USE, SURF BOARDS, PLAY HOUSES, PLASTIC INFLATED BOP BAGS, BOARD GAMES, SKIN DIVING MASKS AND SWIM FINS, FLOATING ACTION SKILL GAMES FOR USE IN WATER, FLOATING ACTION TARGET GAMES FOR USE IN WATER, JIGSAW PUZZLES, CHESS SETS, HAND-HELD ELECTRONIC GAMES, THROW TARGET GAMES, CHILDREN'S THREE-DIMENSIONAL VIEWERS AND PROJECTORS AND CHRISTMAS TREE ORNAMENTS (U.S. CLS. 22, 23, 38 AND 50).

FIRST USE 4-7-2003; IN COMMERCE 4-7-2003.

CLASS 28—(Continued).

2,765,032. ORVIS COMPANY, INC., THE, MANCHESTER, VT. SN 76-272,039. PUB. 12-10-2002, FILED 6-18-2001.

ORVIS T3

OWNER OF U.S. REG. NOS. 580,991 AND 1,023,585.
FOR FLY FISHING RODS (U.S. CLS. 22, 23, 38 AND 50).
FIRST USE 9-0-2001; IN COMMERCE 1-0-2002.

2,765,037. RICE, MARC, DAVIE, FL. SN 76-274,823. PUB. 6-25-2002, FILED 6-22-2001.

SQUIRT BAIT

NO CLAIM IS MADE TO THE EXCLUSIVE RIGHT TO USE "BAIT", APART FROM THE MARK AS SHOWN.
FOR FISHING LURES (U.S. CLS. 22, 23, 38 AND 50).
FIRST USE 3-12-2003; IN COMMERCE 3-12-2003.

2,765,069. PLACO CORPORATION LIMITED, KOWLOON, HONG KONG. SN 76-290,575. PUB. 9-24-2002, FILED 7-27-2001.

TURBO BUBBLES 500

OWNER OF U.S. REG. NOS. 2,211,837, 2,264,806, AND 2,428,297.

NO CLAIM IS MADE TO THE EXCLUSIVE RIGHT TO USE "BUBBLES", APART FROM THE MARK AS SHOWN.
FOR BATTERY OPERATED, HAND-HELD BUBBLE TOYS, NAMELY BUBBLE GUNS, BUBBLE MACHINES, BUBBLE WANDS, AND BUBBLE SOLUTION CONTAINERS; AND NON-BATTERY OPERATED, HAND-HELD BUBBLE TOYS, NAMELY BUBBLE GUNS, BUBBLE MACHINES, BUBBLE WANDS, AND BUBBLE SOLUTION CONTAINERS (U.S. CLS. 22, 23, 38 AND 50).
FIRST USE 8-10-2002; IN COMMERCE 8-10-2002.

2,765,083. PLACO CORPORATION LIMITED, KOWLOON, HONG KONG. SN 76-297,765. PUB. 9-24-2002, FILED 8-13-2001.

TURBO BUBBLES TECHNOLOGY

OWNER OF U.S. REG. NOS. 2,211,837, 2,264,806, AND 2,428,297.

NO CLAIM IS MADE TO THE EXCLUSIVE RIGHT TO USE "BUBBLES", APART FROM THE MARK AS SHOWN.
FOR BATTERY OPERATED, HAND-HELD BUBBLE TOYS, NAMELY BUBBLE GUNS, BUBBLE MACHINES, BUBBLE WANDS, AND BUBBLE SOLUTION CONTAINERS; AND NON-BATTERY OPERATED, HAND-HELD BUBBLE TOYS, NAMELY BUBBLE GUNS, BUBBLE MACHINES, BUBBLE WANDS, AND BUBBLE SOLUTION CONTAINERS (U.S. CLS. 22, 23, 38 AND 50).
FIRST USE 8-10-2002; IN COMMERCE 8-10-2002.

CLASS 28—(Continued).

2,765,101. INGE-GLAS GMBH & CO. KG, 96465 NEUSTADT B. COBURG, FED REP GERMANY. SN 76-303,560. PUB. 10-15-2002, FILED 8-23-2001.

STAR CROWN

NO CLAIM IS MADE TO THE EXCLUSIVE RIGHT TO USE "STAR", APART FROM THE MARK AS SHOWN.
FOR CHRISTMAS TREE DECORATIONS AND ORNAMENTS, EXCLUDING CONFECTIONERY OR ILLUMINATING ARTICLES (U.S. CLS. 22, 23, 38 AND 50).
FIRST USE 3-1-2001; IN COMMERCE 3-1-2001.

2,765,116. TURBO TEC COMPANY LIMITED, KOWLOON, HONG KONG. SN 76-307,923. PUB. 3-19-2002, FILED 8-31-2001.



FOR TOYS, NAMELY, WOODEN PLAYSETS CONSISTING OF WOODEN TRAIN SETS AND WOODEN BLOCKS OF ALPHABETICAL LETTERS; SOFT TOYS; RADIO AND INFRA-RED CONTROLLED TOYS, NAMELY, TOY FIGURES, ROBOTS, AND TOY VEHICLES; BATTERY-OPERATED TOYS AND TOY VEHICLES; FRICTION-POWERED TOYS AND TOY VEHICLES; MANUALLY-OPERATED TOYS AND TOY VEHICLES; TOY PIANOS; MUSICAL TOYS; TOY VEHICLES; AND TOY WALKIE TALKIES (U.S. CLS. 22, 23, 38 AND 50).

FIRST USE 7-1-2002; IN COMMERCE 7-1-2002.

2,765,181. X-LARGE LICENSING, LLC, LOS ANGELES, CA. SN 76-326,965. PUB. 8-27-2002, FILED 10-19-2001.

XLA

FOR SKATEBOARDS AND SKATEBOARD ACCESSORIES, NAMELY, SKATEBOARD WHEELS, SKATEBOARD TRUCKS, SKATEBOARD RAILS, SKATEBOARD DECKS, BALL BEARINGS FOR SKATEBOARDS, SKATEBOARD GRIP TAPE, SKATEBOARD HARDWARE, AND PADDING AND GUARDS FOR SKATEBOARDING, NAMELY, ELBOW PADS, KNEE PADS AND WRIST GUARDS (U.S. CLS. 22, 23, 38 AND 50).

FIRST USE 9-0-2001; IN COMMERCE 9-0-2001.

CLASS 28—(Continued).

2,765,198. CHRISTIAN TEACHER'S AID, FENTON, MO. SN 76-331,807. PUB. 9-17-2002, FILED 10-30-2001.



THE STIPPLING IS A FEATURE OF THE MARK. FOR CHRISTMAS TREE DECORATIONS AND CHRISTMAS TREE ORNAMENTS HAVING RELIGIOUS THEMES (U.S. CLS. 22, 23, 38 AND 50).
FIRST USE 11-1-2002; IN COMMERCE 11-1-2002.

2,765,221. GUND, INC., EDISON, NJ. SN 76-340,069. PUB. 5-14-2002, FILED 11-19-2001.

KLUMBSY'S

FOR PLUSH TOYS (U.S. CLS. 22, 23, 38 AND 50).
FIRST USE 6-0-2002; IN COMMERCE 6-0-2002.

2,765,256. HASBRO, INC., PAWTUCKET, RI. SN 76-349,418. PUB. 12-24-2002, FILED 12-17-2001.

BOBBLE BOYS

FOR TOY VEHICLES (U.S. CLS. 22, 23, 38 AND 50).
FIRST USE 8-5-2002; IN COMMERCE 8-5-2002.

2,765,268. QUICKSWING, INC., WOODBURY, MN. SN 76-353,067. PUB. 9-3-2002, FILED 12-27-2001.

QUICKSWING

FOR SPORTING GOODS, NAMELY, A BATTING AID (U.S. CLS. 22, 23, 38 AND 50).
FIRST USE 6-26-2002; IN COMMERCE 6-26-2002.

2,765,269. QUICKSWING, INC., WOODBURY, MN. SN 76-353,144. PUB. 9-3-2002, FILED 12-27-2001.

MAUER'S QUICKSWING

FOR SPORTING GOODS, NAMELY, A BATTING AID (U.S. CLS. 22, 23, 38 AND 50).
FIRST USE 6-26-2002; IN COMMERCE 6-26-2002.

CLASS 28—(Continued).

2,765,275. UNIMAX GIFTWARE LIMITED, TSIM SHA TSUI, KOWLOON, HONG KONG. SN 76-354,682. PUB. 9-3-2002, FILED 1-3-2002.

PANACHE PLACE

FOR TOYS, NAMELY, STUFFED TOYS; PLUSH TOYS; ACTION FIGURES; SOFT SCULPTURE; VINYL CHILDREN'S SOFT SCULPTURE SQUEEZABLE SQUEAKER TOYS; MECHANICAL OR ELECTRICAL ACTIVITY TOYS WITH OR WITHOUT ELECTRONIC SOUNDS; MECHANICALLY, ELECTRICALLY OR BATTERY-OPERATED LIGHT, SOUND AND/OR ACTION TOYS, NAMELY, CARS MOTORCYCLES, TRAINS, LOCOMOTIVES, AIRPLANES, HELICOPTERS, BOATS, AND OTHER VEHICLES; MUSICAL TOYS; ELECTRONIC ACTION TOYS; DOLLS; FASHION DOLLS AND ACCESSORIES; MOBILES; CHILDREN'S TOY FIGURES AND PLAY SETS THEREFOR; TOY MODEL VEHICLES AND RELATED ACCESSORIES SOLD AS A UNIT; RADIO CONTROL AND REMOTE CONTROL CARS (U.S. CLS. 22, 23, 38 AND 50).
FIRST USE 6-7-2002; IN COMMERCE 6-7-2002.

2,765,282. PLAYMATES TOYS INC., COSTA MESA, CA. SN 76-356,904. PUB. 8-27-2002, FILED 1-10-2002.

MAGIC TALK

NO CLAIM IS MADE TO THE EXCLUSIVE RIGHT TO USE "TALK", APART FROM THE MARK AS SHOWN. FOR TALKING DOLLS AND RELATED DOLL ACCESSORIES (U.S. CLS. 22, 23, 38 AND 50).
FIRST USE 7-0-2002; IN COMMERCE 7-0-2002.

2,765,283. MEGA BLOKS INC., MONTREAL, QUEBEC, CANADA. SN 76-357,114. PUB. 10-29-2002, FILED 1-10-2002.

SING ALONG JUKEBLOCKS

NO CLAIM IS MADE TO THE EXCLUSIVE RIGHT TO USE "SING ALONG", APART FROM THE MARK AS SHOWN. FOR CONSTRUCTION TOYS (U.S. CLS. 22, 23, 38 AND 50).
FIRST USE 6-10-2002; IN COMMERCE 6-10-2002.

2,765,325. PENN RACQUET SPORTS, INC., PHOENIX, AZ. SN 76-368,134. PUB. 9-17-2002, FILED 2-8-2002.

PRO PENN MARATHON

OWNER OF U.S. REG. NOS. 972,793, 1,129,344, AND OTHERS. FOR TENNIS BALLS (U.S. CLS. 22, 23, 38 AND 50).
FIRST USE 7-19-2002; IN COMMERCE 7-19-2002.

CLASS 28—(Continued).

2,765,330. FITNESS CARE, INC., YORBA LINDA, CA. SN 76-369,919. PUB. 10-8-2002, FILED 2-13-2002.

OPTI-TACK

FOR CHEMICAL COMPOUNDS IN THE NATURE OF MATERIAL INGREDIENTS WITH TACKY, STICKY CHARACTERISTICS TO ENHANCE THE TACKINESS AND GRIPABILITY OF SPORT PRODUCTS SOLD AS AN INTEGRAL COMPONENT OF SPORTING EQUIPMENT, NAMELY, SPORT BALLS (U.S. CLS. 22, 23, 38 AND 50).

FIRST USE 12-1-2001; IN COMMERCE 12-1-2002.

2,765,335. WALSH, STEPHEN, SILVER LAKE, NH. SN 76-371,931. PUB. 9-3-2002, FILED 2-19-2002.



NO CLAIM IS MADE TO THE EXCLUSIVE RIGHT TO USE "CARD" AND "WORD", APART FROM THE MARK AS SHOWN.

FOR CARD GAME (U.S. CLS. 22, 23, 38 AND 50).
FIRST USE 7-15-2002; IN COMMERCE 7-15-2002.

2,765,395. SCOTT, RAY, PINTLALA, AL. SN 76-387,836. PUB. 10-29-2002, FILED 3-25-2002.

SPORTACKLE

FOR FISHING EQUIPMENT, NAMELY FISHING RODS, FISHING REELS, FISHING TACKLE AND FISHING LURES (U.S. CLS. 22, 23, 38 AND 50).

FIRST USE 5-21-2002; IN COMMERCE 5-21-2002.

2,765,396. SCOTT, RAY, PINTLALA, AL. SN 76-387,837. PUB. 10-29-2002, FILED 3-25-2002.

RAY SCOTT'S SPORTACKLE

THE NAME "RAY SCOTT" IDENTIFIES A LIVING INDIVIDUAL WHOSE CONSENT IS OF RECORD.

FOR FISHING EQUIPMENT, NAMELY FISHING RODS, FISHING REELS, FISHING TACKLE AND FISHING LURES (U.S. CLS. 22, 23, 38 AND 50).

FIRST USE 5-21-2002; IN COMMERCE 5-21-2002.

CLASS 28—(Continued).

2,765,398. RAPID DISPLAYS, INC., CHICAGO, IL. SN 76-388,449. PUB. 11-12-2002, FILED 3-28-2002.

CADACO'S STATIONERY MAKER

OWNER OF U.S. REG. NO. 2,406,847.

NO CLAIM IS MADE TO THE EXCLUSIVE RIGHT TO USE "STATIONERY", APART FROM THE MARK AS SHOWN.

FOR CHILDREN'S HOBBY CRAFT SET CONSISTING OF EMBOSSING PEN, PAPER AND ENVELOPES, STENCILS, COLORED PENCILS, AND AN EMBOSSING LIGHT BOX TO ALLOW THE USER TO DESIGN, TRACK AND EMBOSS STATIONERY (U.S. CLS. 22, 23, 38 AND 50).

FIRST USE 2-21-2002; IN COMMERCE 2-21-2002.

2,765,435. X CONCEPTS, LLC, ESCONDIDO, CA. SN 76-404,311. PUB. 1-14-2003, FILED 5-6-2002.

QUIKCLIP

FOR TOYS, NAMELY KITES AND ACCESSORIES FOR KITES, NAMELY KITE HANDLES, KITE LINES, KITE REELS, KITE STRING AND KITE TAILS (U.S. CLS. 22, 23, 38 AND 50).

FIRST USE 2-10-2002; IN COMMERCE 3-1-2002.

2,765,437. LITTLE KIDS, INC., PROVIDENCE, RI. SN 76-405,976. PUB. 1-28-2003, FILED 5-13-2002.

DIP 'N FLIP BUBBLE TOTE

NO CLAIM IS MADE TO THE EXCLUSIVE RIGHT TO USE "BUBBLE TOTE", APART FROM THE MARK AS SHOWN.

FOR BUBBLE BLOWING CONTAINER AND WAND SETS, AND BUBBLE BLOWING CONTAINER, WAND AND SOLUTION SETS (U.S. CLS. 22, 23, 38 AND 50).

FIRST USE 12-18-2002; IN COMMERCE 12-18-2002.

2,765,450. BURG AND ASSOCIATES, PLANO, TX. SN 76-410,315. PUB. 2-18-2003, FILED 5-21-2002.

FIZ

FOR SPORTING GOODS, NAMELY, ARTIFICIAL FISHING BAIT, FISHING LURES, AND FISHING SPINNERS (U.S. CLS. 22, 23, 38 AND 50).

FIRST USE 1-0-2003; IN COMMERCE 1-0-2003.

CLASS 28—(Continued).

2,765,452. SHOGAKUKAN PRODUCTION CO., LTD., TOKYO, 101-8415, JAPAN. SN 76-411,995. PUB. 3-18-2003, FILED 5-24-2002.

CLASS 28—(Continued).

2,765,453. SHOGAKUKAN PRODUCTION CO., LTD., TOKYO, 101-8415, JAPAN. SN 76-411,996. PUB. 3-18-2003, FILED 5-24-2002.

PASHMINA HAM-HAM

FOR TOYS, GAMES AND PLAYTHINGS, NAMELY, PLUSH TOYS; DOLLS; ACTION SKILL GAMES; BOARD GAMES; CARD GAMES; MANIPULATIVE PUZZLES; TOY ACTION FIGURES AND ACCESSORIES THEREFORE; MANIPULATIVE GAMES; HAND HELD UNITS FOR PLAYING ELECTRONIC GAMES; SQUEEZE TOYS; TOY FIGURES AND ACCESSORIES THEREFORE; PLAY SETS FOR ACTION FIGURES AND MASQUERADE GAMES AND COSTUMES; ROLE-PLAYING GAME SETS; BATH TOYS; BEACH TOYS; MULTIPLE ACTIVITY BABY TOYS; PUPPETS; TOY FILM CARTRIDGES AND VIEWERS; BEAN BAGS; PULL TOYS; BABY RATTLES; RIDE-ON TOYS; ELECTRONIC LEARNING TOYS; CHRISTMAS TREE DECORATIONS AND TREE ORNAMENTS; AIR MATTRESSES FOR RECREATIONAL USE; TOY VEHICLES; TOY SCOOTERS; ICE SKATES; ROLLER SKATES; SPORTS BALLS; BEACH BALLS; PLAYGROUND BALLS; FLYING DISCS; INFLATABLE SWIM FLOATS FOR RECREATIONAL USE; JUMP ROPES; KITES; INFLATABLE SWIMMING POOLS; PLAYGROUND SAND BOXES; SNOW SLEDS FOR RECREATIONAL USE; SNOW BOARDS; TENNIS RACKET TAPE GRIP COVERS; WIND UP TOYS; BALLOONS; TOY BUILDING BLOCKS; CONSTRUCTION TOYS; TOY BANKS; TOY SHOVELS; STATUETTES AND FIGURINES MADE OF MOLDED PLASTIC; CASES FOR PLAY ACCESSORIES, TOY STRUCTURES, AND ACTION FIGURES; DOLL CLOTHING AND COSTUMES; DOLL ACCESSORIES; YO-YOS; HOBBY CRAFT KITS FOR CHILDREN; TOY FOAM BALLS; HOBBY CRAFT KITS FOR CHILDREN FOR MAKING AND DECORATING FINGERNAILS AND TOENAILS, HOBBY CRAFT KITS FOR DECORATING HAIR, HOBBY CRAFT KITS FOR MAKING CANDY, HOBBY CRAFT KITS FOR MAKING SOAP, HOBBY CRAFT KITS FOR MAKING PERFUME, HOBBY CRAFT KITS FOR MAKING CRYSTALS, HOBBY CRAFT KITS FOR MOLDING CHOCOLATE, HOBBY CRAFT KITS FOR MAKING CLAY POTTERY, HOBBY CRAFT KITS FOR MAKING HAND-PAINTED, TRANSLUCENT WINDOW DECORATIONS, HOBBY CRAFT SETS AND PLAY KITS CONSISTING OF PLAY COSMETICS, HOBBY CRAFT KITS FOR MAKING BEADS AND TOY JEWELRY, HOBBY CRAFT SETS FOR DECORATING PICTURE FRAMES, HOBBY CRAFT KITS FOR MAKING SAND ART, HOBBY CRAFT KITS FOR MAKING AND DESIGNING GREETING CARDS CONSISTING OF GLITTER AND GLUE, HOBBY CRAFT KITS FOR MAKING DECORATIVE OBJECTS WITH MAGNETS (U.S. CLS. 22, 23, 38 AND 50).

FIRST USE 8-20-2002; IN COMMERCE 8-20-2002.

DEXTER HAM-HAM

FOR TOYS, GAMES AND PLAYTHINGS, NAMELY, PLUSH TOYS; DOLLS; ACTION SKILL GAMES; BOARD GAMES; CARD GAMES; MANIPULATIVE PUZZLES; TOY ACTION FIGURES AND ACCESSORIES THEREFORE; MANIPULATIVE GAMES; HAND HELD UNITS FOR PLAYING ELECTRONIC GAMES; SQUEEZE TOYS; TOY FIGURES AND ACCESSORIES THEREFORE; PLAY SETS FOR ACTION FIGURES AND MASQUERADE GAMES AND COSTUMES; ROLE-PLAYING GAME SETS; BATH TOYS; BEACH TOYS; MULTIPLE ACTIVITY BABY TOYS; PUPPETS; TOY FILM CARTRIDGES AND VIEWERS; BEAN BAGS; PULL TOYS; BABY RATTLES; RIDE-ON TOYS; ELECTRONIC LEARNING TOYS; CHRISTMAS TREE DECORATIONS AND TREE ORNAMENTS; AIR MATTRESSES FOR RECREATIONAL USE; TOY VEHICLES; TOY SCOOTERS; ICE SKATES; ROLLER SKATES; SPORTS BALLS; BEACH BALLS; PLAYGROUND BALLS; FLYING DISCS; INFLATABLE SWIM FLOATS FOR RECREATIONAL USE; JUMP ROPES; KITES; INFLATABLE SWIMMING POOLS; PLAYGROUND SAND BOXES; SNOW SLEDS FOR RECREATIONAL USE; SNOW BOARDS; TENNIS RACKET TAPE GRIP COVERS; WIND UP TOYS; BALLOONS; TOY BUILDING BLOCKS; CONSTRUCTION TOYS; TOY BANKS; TOY SHOVELS; STATUETTES AND FIGURINES MADE OF MOLDED PLASTIC; CASES FOR PLAY ACCESSORIES, TOY STRUCTURES, AND ACTION FIGURES; DOLL CLOTHING AND COSTUMES; DOLL ACCESSORIES; YO-YOS; HOBBY CRAFT KITS FOR CHILDREN; TOY FOAM BALLS; HOBBY CRAFT KITS FOR CHILDREN FOR MAKING AND DECORATING FINGERNAILS AND TOENAILS, HOBBY CRAFT KITS FOR DECORATING HAIR, HOBBY CRAFT KITS FOR MAKING CANDY, HOBBY CRAFT KITS FOR MAKING SOAP, HOBBY CRAFT KITS FOR MAKING PERFUME, HOBBY CRAFT KITS FOR MAKING CRYSTALS, HOBBY CRAFT KITS FOR MOLDING CHOCOLATE, HOBBY CRAFT KITS FOR MAKING CLAY POTTERY, HOBBY CRAFT KITS FOR MAKING HAND-PAINTED, TRANSLUCENT WINDOW DECORATIONS, HOBBY CRAFT SETS AND PLAY KITS CONSISTING OF PLAY COSMETICS, HOBBY CRAFT KITS FOR MAKING BEADS AND TOY JEWELRY, HOBBY CRAFT SETS FOR DECORATING PICTURE FRAMES, HOBBY CRAFT KITS FOR MAKING SAND ART, HOBBY CRAFT KITS FOR MAKING AND DESIGNING GREETING CARDS CONSISTING OF GLITTER AND GLUE, HOBBY CRAFT KITS FOR MAKING DECORATIVE OBJECTS WITH MAGNETS (U.S. CLS. 22, 23, 38 AND 50).

FIRST USE 8-20-2002; IN COMMERCE 8-20-2002.

CLASS 28—(Continued).

2,765,454. SHOGAKUKAN PRODUCTION CO., LTD., TOKYO, 101-8415, JAPAN. SN 76-411,997. PUB. 3-18-2003, FILED 5-24-2002.

CLASS 28—(Continued).

2,765,455. SHOGAKUKAN PRODUCTION CO., LTD., TOKYO, 101-8415, JAPAN. SN 76-411,999. PUB. 3-18-2003, FILED 5-24-2002.

MAXWELL HAM-HAM**OXNARD HAM-HAM**

FOR TOYS, GAMES AND PLAYTHINGS, NAMELY, PLUSH TOYS; DOLLS; ACTION SKILL GAMES; BOARD GAMES; CARD GAMES; MANIPULATIVE PUZZLES; TOY ACTION FIGURES AND ACCESSORIES THEREFORE; MANIPULATIVE GAMES; HAND HELD UNITS FOR PLAYING ELECTRONIC GAMES; SQUEEZE TOYS; TOY FIGURES AND ACCESSORIES THEREFORE; PLAY SETS FOR ACTION FIGURES AND MASQUERADE GAMES AND COSTUMES; ROLE-PLAYING GAME SETS; BATH TOYS; BEACH TOYS; MULTIPLE ACTIVITY BABY TOYS; PUPPETS; TOY FILM CARTRIDGES AND VIEWERS; BEAN BAGS; PULL TOYS; BABY RATTLES; RIDE-ON TOYS; ELECTRONIC LEARNING TOYS; CHRISTMAS TREE DECORATIONS AND TREE ORNAMENTS; AIR MATTRESSES FOR RECREATIONAL USE; TOY VEHICLES; TOY SCOOTERS; ICE SKATES; ROLLER SKATES; SPORTS BALLS; BEACH BALLS; PLAYGROUND BALLS; FLYING DISCS; INFLATABLE SWIM FLOATS FOR RECREATIONAL USE; JUMP ROPES; KITES; INFLATABLE SWIMMING POOLS; PLAYGROUND SAND BOXES; SNOW SLEDS FOR RECREATIONAL USE; SNOW BOARDS; TENNIS RACKET TAPE GRIP COVERS; WIND UP TOYS; BALLOONS; TOY BUILDING BLOCKS; CONSTRUCTION TOYS; TOY BANKS; TOY SHOVELS; STATUETTES AND FIGURINES MADE OF MOLDED PLASTIC; CASES FOR PLAY ACCESSORIES, TOY STRUCTURES, AND ACTION FIGURES; DOLL CLOTHING AND COSTUMES; DOLL ACCESSORIES; YO-YOS; HOBBY CRAFT KITS FOR CHILDREN; TOY FOAM BALLS; HOBBY CRAFT KITS FOR CHILDREN FOR MAKING AND DECORATING FINGERNAILS AND TOENAILS, HOBBY CRAFT KITS FOR DECORATING HAIR, HOBBY CRAFT KITS FOR MAKING CANDY, HOBBY CRAFT KITS FOR MAKING SOAP, HOBBY CRAFT KITS FOR MAKING PERFUME, HOBBY CRAFT KITS FOR MAKING CRYSTALS, HOBBY CRAFT KITS FOR MOLDING CHOCOLATE, HOBBY CRAFT KITS FOR MAKING CLAY POTTERY, HOBBY CRAFT KITS FOR MAKING HAND-PAINTED, TRANSLUCENT WINDOW DECORATIONS, HOBBY CRAFT SETS AND PLAY KITS CONSISTING OF PLAY COSMETICS, HOBBY CRAFT KITS FOR MAKING BEADS AND TOY JEWELRY, HOBBY CRAFT SETS FOR DECORATING PICTURE FRAMES, HOBBY CRAFT KITS FOR MAKING SAND ART, HOBBY CRAFT KITS FOR MAKING AND DESIGNING GREETING CARDS CONSISTING OF GLITTER AND GLUE, HOBBY CRAFT KITS FOR MAKING DECORATIVE OBJECTS WITH MAGNETS (U.S. CLS. 22, 23, 38 AND 50).

FIRST USE 8-20-2002; IN COMMERCE 8-20-2002.

FOR TOYS, GAMES AND PLAYTHINGS, NAMELY, PLUSH TOYS; DOLLS; ACTION SKILL GAMES; BOARD GAMES; CARD GAMES; MANIPULATIVE PUZZLES; TOY ACTION FIGURES AND ACCESSORIES THEREFORE; MANIPULATIVE GAMES; HAND HELD UNITS FOR PLAYING ELECTRONIC GAMES; SQUEEZE TOYS; TOY FIGURES AND ACCESSORIES THEREFORE; PLAY SETS FOR ACTION FIGURES AND MASQUERADE GAMES AND COSTUMES; ROLE-PLAYING GAME SETS; BATH TOYS; BEACH TOYS; MULTIPLE ACTIVITY BABY TOYS; PUPPETS; TOY FILM CARTRIDGES AND VIEWERS; BEAN BAGS; PULL TOYS; BABY RATTLES; RIDE-ON TOYS; ELECTRONIC LEARNING TOYS; CHRISTMAS TREE DECORATIONS AND TREE ORNAMENTS; AIR MATTRESSES FOR RECREATIONAL USE; TOY VEHICLES; TOY SCOOTERS; ICE SKATES; ROLLER SKATES; SPORTS BALLS; BEACH BALLS; PLAYGROUND BALLS; FLYING DISCS; INFLATABLE SWIM FLOATS FOR RECREATIONAL USE; JUMP ROPES; KITES; INFLATABLE SWIMMING POOLS; PLAYGROUND SAND BOXES; SNOW SLEDS FOR RECREATIONAL USE; SNOW BOARDS; TENNIS RACKET TAPE GRIP COVERS; WIND UP TOYS; BALLOONS; TOY BUILDING BLOCKS; CONSTRUCTION TOYS; TOY BANKS; TOY SHOVELS; STATUETTES AND FIGURINES MADE OF MOLDED PLASTIC; CASES FOR PLAY ACCESSORIES, TOY STRUCTURES, AND ACTION FIGURES; DOLL CLOTHING AND COSTUMES; DOLL ACCESSORIES; YO-YOS; HOBBY CRAFT KITS FOR CHILDREN; TOY FOAM BALLS; HOBBY CRAFT KITS FOR CHILDREN FOR MAKING AND DECORATING FINGERNAILS AND TOENAILS, HOBBY CRAFT KITS FOR DECORATING HAIR, HOBBY CRAFT KITS FOR MAKING CANDY, HOBBY CRAFT KITS FOR MAKING SOAP, HOBBY CRAFT KITS FOR MAKING PERFUME, HOBBY CRAFT KITS FOR MAKING CRYSTALS, HOBBY CRAFT KITS FOR MOLDING CHOCOLATE, HOBBY CRAFT KITS FOR MAKING CLAY POTTERY, HOBBY CRAFT KITS FOR MAKING HAND-PAINTED, TRANSLUCENT WINDOW DECORATIONS, HOBBY CRAFT SETS AND PLAY KITS CONSISTING OF PLAY COSMETICS, HOBBY CRAFT KITS FOR MAKING BEADS AND TOY JEWELRY, HOBBY CRAFT SETS FOR DECORATING PICTURE FRAMES, HOBBY CRAFT KITS FOR MAKING SAND ART, HOBBY CRAFT KITS FOR MAKING AND DESIGNING GREETING CARDS CONSISTING OF GLITTER AND GLUE, HOBBY CRAFT KITS FOR MAKING DECORATIVE OBJECTS WITH MAGNETS (U.S. CLS. 22, 23, 38 AND 50).

FIRST USE 8-20-2002; IN COMMERCE 8-20-2002.

CLASS 28—(Continued).

2,765,456. SHOGAKUKAN PRODUCTION CO., LTD., TOKYO, 101-8415, JAPAN. SN 76-412,000. PUB. 3-18-2003, FILED 5-24-2002.

CLASS 28—(Continued).

2,765,457. SHOGAKUKAN PRODUCTION CO., LTD., TOKYO, 101-8415, JAPAN. SN 76-412,001. PUB. 3-18-2003, FILED 5-24-2002.

SANDY HAM-HAM

FOR TOYS, GAMES AND PLAYTHINGS, NAMELY, PLUSH TOYS; DOLLS; ACTION SKILL GAMES; BOARD GAMES; CARD GAMES; MANIPULATIVE PUZZLES; TOY ACTION FIGURES AND ACCESSORIES THEREFORE; MANIPULATIVE GAMES; HAND HELD UNITS FOR PLAYING ELECTRONIC GAMES; SQUEEZE TOYS; TOY FIGURES AND ACCESSORIES THEREFORE; PLAY SETS FOR ACTION FIGURES AND MASQUERADE GAMES AND COSTUMES; ROLE-PLAYING GAME SETS; BATH TOYS; BEACH TOYS; MULTIPLE ACTIVITY BABY TOYS; PUPPETS; TOY FILM CARTRIDGES AND VIEWERS; BEAN BAGS; PULL TOYS; BABY RATTLES; RIDE-ON TOYS; ELECTRONIC LEARNING TOYS; CHRISTMAS TREE DECORATIONS AND TREE ORNAMENTS; AIR MATTRESSES FOR RECREATIONAL USE; TOY VEHICLES; TOY SCOOTERS; ICE SKATES; ROLLER SKATES; SPORTS BALLS; BEACH BALLS; PLAYGROUND BALLS; FLYING DISCS; INFLATABLE SWIM FLOATS FOR RECREATIONAL USE; JUMP ROPES; KITES; INFLATABLE SWIMMING POOLS; PLAYGROUND SAND BOXES; SNOW SLEDS FOR RECREATIONAL USE; SNOW BOARDS; TENNIS RACKET TAPE GRIP COVERS; WIND UP TOYS; BALLOONS; TOY BUILDING BLOCKS; CONSTRUCTION TOYS; TOY BANKS; TOY SHOVELS; STATUETTES AND FIGURINES MADE OF MOLDED PLASTIC; CASES FOR PLAY ACCESSORIES, TOY STRUCTURES, AND ACTION FIGURES; DOLL CLOTHING AND COSTUMES; DOLL ACCESSORIES; YO-YOS; HOBBY CRAFT KITS FOR CHILDREN; TOY FOAM BALLS; HOBBY CRAFT KITS FOR CHILDREN FOR MAKING AND DECORATING FINGERNAILS AND TOENAILS, HOBBY CRAFT KITS FOR DECORATING HAIR, HOBBY CRAFT KITS FOR MAKING CANDY, HOBBY CRAFT KITS FOR MAKING SOAP, HOBBY CRAFT KITS FOR MAKING PERFUME, HOBBY CRAFT KITS FOR MAKING CRYSTALS, HOBBY CRAFT KITS FOR MOLDING CHOCOLATE, HOBBY CRAFT KITS FOR MAKING CLAY POTTERY, HOBBY CRAFT KITS FOR MAKING HAND-PAINTED, TRANSLUCENT WINDOW DECORATIONS, HOBBY CRAFT SETS AND PLAY KITS CONSISTING OF PLAY COSMETICS, HOBBY CRAFT KITS FOR MAKING BEADS AND TOY JEWELRY, HOBBY CRAFT SETS FOR DECORATING PICTURE FRAMES, HOBBY CRAFT KITS FOR MAKING SAND ART, HOBBY CRAFT KITS FOR MAKING AND DESIGNING GREETING CARDS CONSISTING OF GLITTER AND GLUE, HOBBY CRAFT KITS FOR MAKING DECORATIVE OBJECTS WITH MAGNETS (U.S. CLS. 22, 23, 38 AND 50).

FIRST USE 8-20-2002; IN COMMERCE 8-20-2002.

SNOOZER HAM-HAM

FOR TOYS, GAMES AND PLAYTHINGS, NAMELY, PLUSH TOYS; DOLLS; ACTION SKILL GAMES; BOARD GAMES; CARD GAMES; MANIPULATIVE PUZZLES; TOY ACTION FIGURES AND ACCESSORIES THEREFORE; MANIPULATIVE GAMES; HAND HELD UNITS FOR PLAYING ELECTRONIC GAMES; SQUEEZE TOYS; TOY FIGURES AND ACCESSORIES THEREFORE; PLAY SETS FOR ACTION FIGURES AND MASQUERADE GAMES AND COSTUMES; ROLE-PLAYING GAME SETS; BATH TOYS; BEACH TOYS; MULTIPLE ACTIVITY BABY TOYS; PUPPETS; TOY FILM CARTRIDGES AND VIEWERS; BEAN BAGS; PULL TOYS; BABY RATTLES; RIDE-ON TOYS; ELECTRONIC LEARNING TOYS; CHRISTMAS TREE DECORATIONS AND TREE ORNAMENTS; AIR MATTRESSES FOR RECREATIONAL USE; TOY VEHICLES; TOY SCOOTERS; ICE SKATES; ROLLER SKATES; SPORTS BALLS; BEACH BALLS; PLAYGROUND BALLS; FLYING DISCS; INFLATABLE SWIM FLOATS FOR RECREATIONAL USE; JUMP ROPES; KITES; INFLATABLE SWIMMING POOLS; PLAYGROUND SAND BOXES; SNOW SLEDS FOR RECREATIONAL USE; SNOW BOARDS; TENNIS RACKET TAPE GRIP COVERS; WIND UP TOYS; BALLOONS; TOY BUILDING BLOCKS; CONSTRUCTION TOYS; TOY BANKS; TOY SHOVELS; STATUETTES AND FIGURINES MADE OF MOLDED PLASTIC; CASES FOR PLAY ACCESSORIES, TOY STRUCTURES, AND ACTION FIGURES; DOLL CLOTHING AND COSTUMES; DOLL ACCESSORIES; YO-YOS; HOBBY CRAFT KITS FOR CHILDREN; TOY FOAM BALLS; HOBBY CRAFT KITS FOR CHILDREN FOR MAKING AND DECORATING FINGERNAILS AND TOENAILS, HOBBY CRAFT KITS FOR DECORATING HAIR, HOBBY CRAFT KITS FOR MAKING CANDY, HOBBY CRAFT KITS FOR MAKING SOAP, HOBBY CRAFT KITS FOR MAKING PERFUME, HOBBY CRAFT KITS FOR MAKING CRYSTALS, HOBBY CRAFT KITS FOR MOLDING CHOCOLATE, HOBBY CRAFT KITS FOR MAKING CLAY POTTERY, HOBBY CRAFT KITS FOR MAKING HAND-PAINTED, TRANSLUCENT WINDOW DECORATIONS, HOBBY CRAFT SETS AND PLAY KITS CONSISTING OF PLAY COSMETICS, HOBBY CRAFT KITS FOR MAKING BEADS AND TOY JEWELRY, HOBBY CRAFT SETS FOR DECORATING PICTURE FRAMES, HOBBY CRAFT KITS FOR MAKING SAND ART, HOBBY CRAFT KITS FOR MAKING AND DESIGNING GREETING CARDS CONSISTING OF GLITTER AND GLUE, HOBBY CRAFT KITS FOR MAKING DECORATIVE OBJECTS WITH MAGNETS (U.S. CLS. 22, 23, 38 AND 50).

FIRST USE 8-20-2002; IN COMMERCE 8-20-2002.

CLASS 28—(Continued).

2,765,458. SHOGAKUKAN PRODUCTION CO., LTD., TOKYO, 101-8415, JAPAN. SN 76-412,003. PUB. 3-18-2003, FILED 5-24-2002.

CLASS 28—(Continued).

2,765,459. SHOGAKUKAN PRODUCTION CO., LTD., TOKYO, 101-8415, JAPAN. SN 76-412,004. PUB. 3-18-2003, FILED 5-24-2002.

PENELOPE HAM-HAM**HOWDY HAM-HAM**

FOR TOYS, GAMES AND PLAYTHINGS, NAMELY, PLUSH TOYS; DOLLS; ACTION SKILL GAMES; BOARD GAMES; CARD GAMES; MANIPULATIVE PUZZLES; TOY ACTION FIGURES AND ACCESSORIES THEREFORE; MANIPULATIVE GAMES; HAND HELD UNITS FOR PLAYING ELECTRONIC GAMES; SQUEEZE TOYS; TOY FIGURES AND ACCESSORIES THEREFORE; PLAY SETS FOR ACTION FIGURES AND MASQUERADE GAMES AND COSTUMES; ROLE-PLAYING GAME SETS; BATH TOYS; BEACH TOYS; MULTIPLE ACTIVITY BABY TOYS; PUPPETS; TOY FILM CARTRIDGES AND VIEWERS; BEAN BAGS; PULL TOYS; BABY RATTLES; RIDE-ON TOYS; ELECTRONIC LEARNING TOYS; CHRISTMAS TREE DECORATIONS AND TREE ORNAMENTS; AIR MATTRESSES FOR RECREATIONAL USE; TOY VEHICLES; TOY SCOOTERS; ICE SKATES; ROLLER SKATES; SPORTS BALLS; BEACH BALLS; PLAYGROUND BALLS; FLYING DISCS; INFLATABLE SWIM FLOATS FOR RECREATIONAL USE; JUMP ROPES; KITES; INFLATABLE SWIMMING POOLS; PLAYGROUND SAND BOXES; SNOW SLEDS FOR RECREATIONAL USE; SNOW BOARDS; TENNIS RACKET TAPE GRIP COVERS; WIND UP TOYS; BALLOONS; TOY BUILDING BLOCKS; CONSTRUCTION TOYS; TOY BANKS; TOY SHOVELS; STATUETTES AND FIGURINES MADE OF MOLDED PLASTIC; CASES FOR PLAY ACCESSORIES, TOY STRUCTURES, AND ACTION FIGURES; DOLL CLOTHING AND COSTUMES; DOLL ACCESSORIES; YO-YOS; HOBBY CRAFT KITS FOR CHILDREN; TOY FOAM BALLS; HOBBY CRAFT KITS FOR CHILDREN FOR MAKING AND DECORATING FINGERNAILS AND TOENAILS, HOBBY CRAFT KITS FOR DECORATING HAIR, HOBBY CRAFT KITS FOR MAKING CANDY, HOBBY CRAFT KITS FOR MAKING SOAP, HOBBY CRAFT KITS FOR MAKING PERFUME, HOBBY CRAFT KITS FOR MAKING CRYSTALS, HOBBY CRAFT KITS FOR MOLDING CHOCOLATE, HOBBY CRAFT KITS FOR MAKING CLAY POTTERY, HOBBY CRAFT KITS FOR MAKING HAND-PAINTED, TRANSLUCENT WINDOW DECORATIONS, HOBBY CRAFT SETS AND PLAY KITS CONSISTING OF PLAY COSMETICS, HOBBY CRAFT KITS FOR MAKING BEADS AND TOY JEWELRY, HOBBY CRAFT SETS FOR DECORATING PICTURE FRAMES, HOBBY CRAFT KITS FOR MAKING SAND ART, HOBBY CRAFT KITS FOR MAKING AND DESIGNING GREETING CARDS CONSISTING OF GLITTER AND GLUE, HOBBY CRAFT KITS FOR MAKING DECORATIVE OBJECTS WITH MAGNETS (U.S. CLS. 22, 23, 38 AND 50).

FIRST USE 8-20-2002; IN COMMERCE 8-20-2002.

FOR TOYS, GAMES AND PLAYTHINGS, NAMELY, PLUSH TOYS; DOLLS; ACTION SKILL GAMES; BOARD GAMES; CARD GAMES; MANIPULATIVE PUZZLES; TOY ACTION FIGURES AND ACCESSORIES THEREFORE; MANIPULATIVE GAMES; HAND HELD UNITS FOR PLAYING ELECTRONIC GAMES; SQUEEZE TOYS; TOY FIGURES AND ACCESSORIES THEREFORE; PLAY SETS FOR ACTION FIGURES AND MASQUERADE GAMES AND COSTUMES; ROLE-PLAYING GAME SETS; BATH TOYS; BEACH TOYS; MULTIPLE ACTIVITY BABY TOYS; PUPPETS; TOY FILM CARTRIDGES AND VIEWERS; BEAN BAGS; PULL TOYS; BABY RATTLES; RIDE-ON TOYS; ELECTRONIC LEARNING TOYS; CHRISTMAS TREE DECORATIONS AND TREE ORNAMENTS; AIR MATTRESSES FOR RECREATIONAL USE; TOY VEHICLES; TOY SCOOTERS; ICE SKATES; ROLLER SKATES; SPORTS BALLS; BEACH BALLS; PLAYGROUND BALLS; FLYING DISCS; INFLATABLE SWIM FLOATS FOR RECREATIONAL USE; JUMP ROPES; KITES; INFLATABLE SWIMMING POOLS; PLAYGROUND SAND BOXES; SNOW SLEDS FOR RECREATIONAL USE; SNOW BOARDS; TENNIS RACKET TAPE GRIP COVERS; WIND UP TOYS; BALLOONS; TOY BUILDING BLOCKS; CONSTRUCTION TOYS; TOY BANKS; TOY SHOVELS; STATUETTES AND FIGURINES MADE OF MOLDED PLASTIC; CASES FOR PLAY ACCESSORIES, TOY STRUCTURES, AND ACTION FIGURES; DOLL CLOTHING AND COSTUMES; DOLL ACCESSORIES; YO-YOS; HOBBY CRAFT KITS FOR CHILDREN; TOY FOAM BALLS; HOBBY CRAFT KITS FOR CHILDREN FOR MAKING AND DECORATING FINGERNAILS AND TOENAILS, HOBBY CRAFT KITS FOR DECORATING HAIR, HOBBY CRAFT KITS FOR MAKING CANDY, HOBBY CRAFT KITS FOR MAKING SOAP, HOBBY CRAFT KITS FOR MAKING PERFUME, HOBBY CRAFT KITS FOR MAKING CRYSTALS, HOBBY CRAFT KITS FOR MOLDING CHOCOLATE, HOBBY CRAFT KITS FOR MAKING CLAY POTTERY, HOBBY CRAFT KITS FOR MAKING HAND-PAINTED, TRANSLUCENT WINDOW DECORATIONS, HOBBY CRAFT SETS AND PLAY KITS CONSISTING OF PLAY COSMETICS, HOBBY CRAFT KITS FOR MAKING BEADS AND TOY JEWELRY, HOBBY CRAFT SETS FOR DECORATING PICTURE FRAMES, HOBBY CRAFT KITS FOR MAKING SAND ART, HOBBY CRAFT KITS FOR MAKING AND DESIGNING GREETING CARDS CONSISTING OF GLITTER AND GLUE, HOBBY CRAFT KITS FOR MAKING DECORATIVE OBJECTS WITH MAGNETS (U.S. CLS. 22, 23, 38 AND 50).

FIRST USE 8-20-2002; IN COMMERCE 8-20-2002.

CLASS 28—(Continued).

2,765,460. SHOGAKUKAN PRODUCTION CO., LTD., TOKYO, 101-8415, JAPAN. SN 76-412,005. PUB. 3-18-2003, FILED 5-24-2002.

CAPPY HAM-HAM

FOR TOYS, GAMES AND PLAYTHINGS, NAMELY, PLUSH TOYS; DOLLS; ACTION SKILL GAMES; BOARD GAMES; CARD GAMES; MANIPULATIVE PUZZLES; TOY ACTION FIGURES AND ACCESSORIES THEREFORE; MANIPULATIVE GAMES; HAND HELD UNITS FOR PLAYING ELECTRONIC GAMES; SQUEEZE TOYS; TOY FIGURES AND ACCESSORIES THEREFORE; PLAY SETS FOR ACTION FIGURES AND MASQUERADE GAMES AND COSTUMES; ROLE-PLAYING GAME SETS; BATH TOYS; BEACH TOYS; MULTIPLE ACTIVITY BABY TOYS; PUPPETS; TOY FILM CARTRIDGES AND VIEWERS; BEAN BAGS; PULL TOYS; BABY RATTLES; RIDE-ON TOYS; ELECTRONIC LEARNING TOYS; CHRISTMAS TREE DECORATIONS AND TREE ORNAMENTS; AIR MATTRESSES FOR RECREATIONAL USE; TOY VEHICLES; TOY SCOOTERS; ICE SKATES; ROLLER SKATES; SPORTS BALLS; BEACH BALLS; PLAYGROUND BALLS; FLYING DISCS; INFLATABLE SWIM FLOATS FOR RECREATIONAL USE; JUMP ROPES; KITES; INFLATABLE SWIMMING POOLS; PLAYGROUND SAND BOXES; SNOW SLEDS FOR RECREATIONAL USE; SNOW BOARDS; TENNIS RACKET TAPE GRIP COVERS; WIND UP TOYS; BALLOONS; TOY BUILDING BLOCKS; CONSTRUCTION TOYS; TOY BANKS; TOY SHOVELS; STATUETTES AND FIGURINES MADE OF MOLDED PLASTIC; CASES FOR PLAY ACCESSORIES, TOY STRUCTURES, AND ACTION FIGURES; DOLL CLOTHING AND COSTUMES; DOLL ACCESSORIES; YO-YOS; HOBBY CRAFT KITS FOR CHILDREN; TOY FOAM BALLS; HOBBY CRAFT KITS FOR CHILDREN FOR MAKING AND DECORATING FINGERNAILS AND TOENAILS, HOBBY CRAFT KITS FOR DECORATING HAIR, HOBBY CRAFT KITS FOR MAKING CANDY, HOBBY CRAFT KITS FOR MAKING SOAP, HOBBY CRAFT KITS FOR MAKING PERFUME, HOBBY CRAFT KITS FOR MAKING CRYSTALS, HOBBY CRAFT KITS FOR MOLDING CHOCOLATE, HOBBY CRAFT KITS FOR MAKING CLAY POTTERY, HOBBY CRAFT KITS FOR MAKING HAND-PAINTED, TRANSLUCENT WINDOW DECORATIONS, HOBBY CRAFT SETS AND PLAY KITS CONSISTING OF PLAY COSMETICS, HOBBY CRAFT KITS FOR MAKING BEADS AND TOY JEWELRY, HOBBY CRAFT SETS FOR DECORATING PICTURE FRAMES, HOBBY CRAFT KITS FOR MAKING SAND ART, HOBBY CRAFT KITS FOR MAKING AND DESIGNING GREETING CARDS CONSISTING OF GLITTER AND GLUE, HOBBY CRAFT KITS FOR MAKING DECORATIVE OBJECTS WITH MAGNETS (U.S. CLS. 22, 23, 38 AND 50).

FIRST USE 8-20-2002; IN COMMERCE 8-20-2002.

2,765,516. CHEROKEE INC., VAN NUYS, CA. SN 76-975,569. PUB. 6-18-2002, FILED 5-5-2000.



OWNER OF U.S. REG. NOS. 2,061,660, 2,394,028, AND OTHERS.

FOR NON-MOTORIZED SCOOTERS AND VOLLEYBALL NETS (U.S. CLS. 22, 23, 38 AND 50).
FIRST USE 0-0-2000; IN COMMERCE 0-0-2000.

CLASS 28—(Continued).

2,765,551. CALLAWAY GOLF COMPANY, CARLSBAD, CA. SN 78-028,166. PUB. 5-29-2001, FILED 9-28-2000.

X-16

FOR GOLF CLUBS, GOLF CLUB HEAD COVERS, GOLF BAGS AND GOLF BALLS (U.S. CLS. 22, 23, 38 AND 50).

FIRST USE 9-13-2002; IN COMMERCE 9-13-2002.

2,765,585. MATTEL, INC., EL SEGUNDO, CA. SN 78-054,475. PUB. 7-16-2002, FILED 3-22-2001.

SLINGSHOTZ

FOR TOY VEHICLES AND AIRPLANES, AND ACCESSORIES THEREFOR (U.S. CLS. 22, 23, 38 AND 50).

FIRST USE 10-0-2001; IN COMMERCE 10-0-2001.

2,765,600. TY INC., WESTMONT, IL. SN 78-064,239. PUB. 7-30-2002, FILED 5-17-2001.

BEANIE BOPPERS

OWNER OF U.S. REG. NOS. 2,049,196, 2,521,191, AND OTHERS.

FOR PLUSH TOYS; DOLLS; DOLL ACCESSORIES (U.S. CLS. 22, 23, 38 AND 50).

FIRST USE 7-3-2001; IN COMMERCE 7-3-2001.

2,765,602. SABAN ENTERTAINMENT, INC., LOS ANGELES, CA. SN 78-064,828. PUB. 11-13-2001, FILED 5-21-2001.

POWER RANGERS: WILD FORCE

OWNER OF U.S. REG. NOS. 1,893,768, 1,933,464, AND 2,288,081.

FOR TOYS, GAMES, PLAYTHINGS, AND SPORTING GOODS, NAMELY, BASKETBALL BACKBOARDS; TOY AND NON-MOTORIZED SCOOTERS; SKATEBOARDS AND SKATEBOARD BAGS; BENDABLE PLAY FIGURES; TOY ACTION FIGURES AND ACCESSORIES THEREFOR; SPORTS BOARD GAMES; BALLS, NAMELY, BASKETBALLS, PLAYGROUND BALLS, SPORT BALLS, FOAM ACTION BALLS AND TOY HOOP SETS; TOY BANKS; TOY WATCHES; BATH TUB TOYS; CHILDREN'S MULTIPLE ACTIVITY TOYS; TOY MAGIC TRICKS; WATER SQUIRTING TOYS; WIND-UP TOYS; JUMP ROPES; SLING SHOTS; AUDIO AND VISUAL TOYS, NAMELY, TOY WALKIE-TALKIES, ACTION GAMES, TALKING DOLLS, TOY 3-D VIEWERS AND REELS; ACTION SKILL GAMES; BOARD GAMES; CARD GAMES; HAND HELD UNITS FOR PLAYING ELECTRONIC GAMES; STAND ALONE VIDEO GAME MACHINES AND PROGRAMS THEREFOR SOLD AS A UNIT; ELECTRONIC GAME EQUIPMENT WITH A WATCH FUNCTION; HAND HELD LCD GAME MACHINES; COIN AND NON-COIN OPERATED GAME TABLES; PINBALL MACHINES AND PINBALL-TYPE GAMES; JIGSAW PUZZLES; MANIPULATIVE PUZZLES; MECHANICAL ACTION TOYS; BATTERY-OPERATED ACTION TOYS; BATTERY-OPERATED ACTION TOYS

CLASS 28—(Continued).

FEATURING LIGHTS AND SOUNDS; DOLLS; PUPPETS; PLAYSETS FOR DOLLS; DOLL CLOTHING AND COSTUMES; CHILDREN'S PLAY COSMETICS; ROLE PLAYING GAMES; ACTION-TYPE TARGET SHOOTING GAME SETS COMPRISING TOY GUN, TOY SUCTION DARTS AND TARGET; TOY WEAPONS; SQUIRT GUNS; KITES; PAPER AND PLASTIC PARTY FAVORS IN THE NATURE OF SMALL TOYS AND NOISEMAKERS; BALLOONS; STUFFED AND PLUSH TOYS; LATEX SQUEEZE TOY FIGURES; MUSICAL TOYS; INFLATABLE BATH TOYS; SWIMMING AND RIDE-ON TOYS; TOY VEHICLES; TRANSFORMING ROBOTIC TOY VEHICLES; RIDE-IN TOYS; INFLATABLE PLAY SWIMMING POOLS; TOY PLAY HOUSES AND TOY PLAY TENTS; SURF BOARDS, KICK BOARD FLOATATION DEVICES, NAMELY, BODY BOARDS AND LEASHES THEREFOR FOR RECREATIONAL USE; TOY SAND BOXES AND SAND TOYS; SNOW SLEDS, TOBOGGANS, SNOW SAUCERS AND SNOW BOARDS FOR RECREATIONAL USE; TOY BUILDING BLOCKS; MOBILES FOR CHILDREN; CHRISTMAS TREE ORNAMENTS; TOY CRAFT KITS COMPRISING MOLDS AND MOLDING COMPOUND FOR MAKING TOY FIGURES; PLASTIC ACTION FIGURE MODELS; FLYING DISCS; PET TOYS; MARBLES AND YO-YOS, BATTERY-OPERATED REMOTE-CONTROLLED TOYS, NAMELY, TOY ACTION FIGURES, TOY VEHICLES, AND TRANSFORMING ROBOTIC TOY VEHICLES (U.S. CLS. 22, 23, 38 AND 50).
FIRST USE 12-0-2001; IN COMMERCE 12-0-2001.

2,765,615. PACHECO CREATIVE ENTERPRISES, INC., MIAMI, FL. SN 78-070,507. PUB. 1-8-2002, FILED 6-22-2001.

TROLLEY KAT

NO CLAIM IS MADE TO THE EXCLUSIVE RIGHT TO USE "TROLLEY", APART FROM THE MARK AS SHOWN.
FOR PLUSH TOYS (U.S. CLS. 22, 23, 38 AND 50).
FIRST USE 8-15-2002; IN COMMERCE 8-15-2002.

2,765,623. MATTEL, INC., EL SEGUNDO, CA. SN 78-074,470. PUB. 7-16-2002, FILED 7-18-2001.

N7:FORMULA FIGHTER

NO CLAIM IS MADE TO THE EXCLUSIVE RIGHT TO USE "FIGHTER", APART FROM THE MARK AS SHOWN.
FOR TOYS, GAMES, AND PLAYTHINGS, NAMELY TOY VEHICLES THAT TRANSFORM INTO TOY ROBOTS AND ACCESSORIES THEREFOR (U.S. CLS. 22, 23, 38 AND 50).
FIRST USE 9-0-2001; IN COMMERCE 9-0-2001.

CLASS 28—(Continued).

2,765,666. VAL SKINNER FOUNDATION, BAY HEAD, NJ. SN 78-089,300. PUB. 7-23-2002, FILED 10-19-2001.

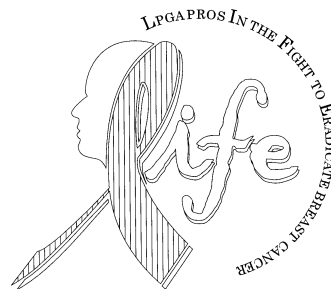

NO CLAIM IS MADE TO THE EXCLUSIVE RIGHT TO USE "LPGA PROS IN THE FIGHT TO ERADICATE BREAST CANCER", APART FROM THE MARK AS SHOWN.
THE LINING IN THE MARK IS USED TO INDICATE THE COLOR PINK IN THE RIBBON DESIGN.
FOR PLUSH TOYS (U.S. CLS. 22, 23, 38 AND 50).
FIRST USE 7-1-2002; IN COMMERCE 7-1-2002.

2,765,676. HUANG, YA-CHIN, TAINAN HSIEN, TAIWAN. SN 78-093,318. PUB. 9-24-2002, FILED 11-14-2001.



NO CLAIM IS MADE TO THE EXCLUSIVE RIGHT TO USE "FITNESS" OR "EST. 1921", APART FROM THE MARK AS SHOWN.
FOR SHIN GUARDS, LEG GUARDS, WRIST PADS, CHEST PROTECTORS, FACE MASKS, AND KNEE PADS, ALL FOR ATHLETIC USE; EXERCISE MACHINES, NAMELY, CHEST PULL, SIT-UP MACHINE, SIT-UP CHAIR, ROWING MACHINE, UNIVERSAL GYM, MANUALLY OPERATED JOGGING MACHINE, ABDOMINAL AND ARM MACHINE, WEIGHT MACHINE, STATIONARY EXERCISE BICYCLE (U.S. CLS. 22, 23, 38 AND 50).
FIRST USE 1-3-2001; IN COMMERCE 1-3-2001.

CLASS 28—(Continued).

2,765,682. DIMENSION ONE SPAS, INC., VISTA, CA. SN 78-094,649. PUB. 1-14-2003, FILED 11-21-2001.

CLASS 28—(Continued).

2,765,711. DC COMICS, NEW YORK, NY. SN 78-107,430. PUB. 7-23-2002, FILED 2-7-2002.

OptiMount

FOR WATERTIGHT FLEXIBLE CONNECTING DEVICE THAT ALLOWS EXERCISE EQUIPMENT TO BE CONNECTED, EITHER HORIZONTALLY OR VERTICALLY, TO A VARIETY OF SURFACES ON A SPA, HEATED POOL, WHIRLPOOL, BATHTUB, HOT TUBE, WHIRLPOOL BATH, OR RECREATION POOL (U.S. CLS. 22, 23, 38 AND 50).

FIRST USE 10-1-2002; IN COMMERCE 10-1-2002.

2,765,691. AXELROD, STEVE, W., FLINT, TX. SN 78-100,018. PUB. 7-2-2002, FILED 12-26-2001.

PUTT N' CAST

FOR FUNCTIONAL GOLF PUTTER THAT CONVERTS INTO A FUNCTIONAL FISHING POLE WITH ATTACHABLE FISHING REEL (U.S. CLS. 22, 23, 38 AND 50).

FIRST USE 10-24-2001; IN COMMERCE 8-1-2002.

2,765,702. BUILD-A-BEAR WORKSHOP, INC., ST. LOUIS, MO. SN 78-104,489. PUB. 7-23-2002, FILED 1-24-2002.

PAW-CYCLE

FOR TOY BICYCLES (U.S. CLS. 22, 23, 38 AND 50).
FIRST USE 2-1-2002; IN COMMERCE 2-1-2002.

SMALLVILLE

FOR TOYS AND SPORTING GOODS, INCLUDING GAMES AND PLAYTHINGS - NAMELY, ACTION FIGURES AND ACCESSORIES THEREFOR; PLUSH TOYS; BALLOONS; BATHTUB TOYS; RIDE-ON TOYS; EQUIPMENT SOLD AS A UNIT FOR PLAYING CARD GAMES; TOY VEHICLES; DOLLS; FLYING DISCS; ELECTRONIC HAND-HELD GAME UNIT; GAME EQUIPMENT SOLD AS A UNIT FOR PLAYING A BOARD GAME, A CARD GAME, A MANIPULATIVE GAME, A PARLOR GAME AND AN ACTION TYPE TARGET GAME; STAND ALONE VIDEO OUTPUT GAME MACHINES; JIGSAW AND MANIPULATIVE PUZZLES; PAPER FACE MASKS; SKATEBOARDS; ICE SKATES; WATER SQUIRTING TOYS; BALLS - NAMELY, PLAYGROUND BALLS, SOCCER BALLS, BASEBALLS, BASKETBALLS; BASEBALL GLOVES; SWIMMING FLOATS FOR RECREATIONAL USE; KICKBOARD FLOTATION DEVICES FOR RECREATIONAL USE; SURFBOARDS; SWIM BOARDS FOR RECREATIONAL USE; SWIM FINS; TOY BAKEWARE AND TOY COOKWARE; TOY BANKS; TOY SNOW GLOBES; AND CHRISTMAS TREE ORNAMENTS (U.S. CLS. 22, 23, 38 AND 50).

FIRST USE 10-16-2002; IN COMMERCE 10-16-2002.

2,765,735. COUSIN CORPORATION OF AMERICA, LARGO, FL. SN 78-115,101. PUB. 11-12-2002, FILED 3-15-2002.

PRECIOUS ACCENTS

NO CLAIM IS MADE TO THE EXCLUSIVE RIGHT TO USE "ACCENTS", APART FROM THE MARK AS SHOWN. FOR HOBBYCRAFT KITS COMPRISING BEADS AND FINDINGS (U.S. CLS. 22, 23, 38 AND 50).
FIRST USE 4-1-2003; IN COMMERCE 4-1-2003.

CLASS 28—(Continued).

2,765,751. WORLD WRESTLING FEDERATION ENTERTAINMENT, INC., STAMFORD, CT. SN 78-119,563. PUB. 2-4-2003, FILED 4-4-2002.



FOR TOY ACTION FIGURES AND ACCESSORIES; CASES FOR ACTION FIGURES; TOY VEHICLES; BOARD GAMES; TOY SPINNING TOPS; STAND ALONE VIDEO OUTPUT GAME MACHINES FEATURING WRESTLING; ARCADE GAMES RELATED TO WRESTLING; PINBALL GAMES RELATED TO WRESTLING; HAND-HELD UNITS FOR PLAYING VIDEO GAMES FEATURING WRESTLING; TABLETOP ACTION SKILL GAMES RELATED TO WRESTLING; JIGSAW PUZZLES; KITES; TOY WRESTLING RINGS; DOLLS; PUPPETS; STUFFED TOY ANIMALS; CARD GAMES; TOY GUITARS; WATER GUNS; FLOATING RECREATIONAL LOUNGE CHAIRS; INFLATABLE TOY BOATS; CHRISTMAS TREE DECORATIONS; COSTUME MASKS; TOY BELTS; DOLL FURNITURE; PARTY FAVORS IN THE NATURE OF CRACKERS AND NOISEMAKERS; SKATEBOARDS; BOWLING BALLS AND ACCESSORIES, NAMELY, BOWLING GLOVES, WRIST SUPPORTS, BOWLING BALL BAGS, BOWLING PINS; WINDUP TOYS; TOY SCOOTERS; KNEE AND ELBOW PADS; YO-YO'S; CHILDREN'S PLAY COSMETIC PAINTS; TOY MODEL HOBBYCRAFT KITS; POOL CUES; TOY TIN MONEY BANKS; TOY GUM FIGURE MAKERS (U.S. CLS. 22, 23, 38 AND 50).

FIRST USE 5-28-2002; IN COMMERCE 5-28-2002.

2,765,804. AERO PRODUCTS INTERNATIONAL, INC., WAUCONDA, IL. SN 78-139,994. PUB. 2-11-2003, FILED 6-28-2002.

YELLOW JACKET

FOR INFLATABLE WATER SKI TOWABLES (U.S. CLS. 22, 23, 38 AND 50).

FIRST USE 1-23-2003; IN COMMERCE 1-23-2003.

2,765,805. AERO PRODUCTS INTERNATIONAL, INC., WAUCONDA, IL. SN 78-139,996. PUB. 2-11-2003, FILED 6-28-2002.

SCORCHER

FOR INFLATABLE WATER SKI TOWABLES (U.S. CLS. 22, 23, 38 AND 50).

FIRST USE 1-21-2003; IN COMMERCE 1-21-2003.

CLASS 28—(Continued).

2,765,806. AERO PRODUCTS INTERNATIONAL, INC., WAUCONDA, IL. SN 78-139,998. PUB. 2-11-2003, FILED 6-28-2002.

SCORPION

FOR INFLATABLE WATER SKI TOWABLES (U.S. CLS. 22, 23, 38 AND 50).

FIRST USE 1-31-2003; IN COMMERCE 1-31-2003.

CLASS 29—MEATS AND PROCESSED FOODS

2,764,656. LES FROMAGES SAPUTO LIMITEE / SAPUTO CHEESE LIMITED, ST-LEONARD, PROVINCE OF QUEBEC, CANADA. SN 75-933,915. PUB. 11-28-2000, FILED 3-3-2000.

THE ART OF CHEESEMAKING

FOR CHEESE (U.S. CL. 46).

FIRST USE 11-0-2002; IN COMMERCE 11-0-2002.

2,764,752. FRESHLAND PRODUCE LLC, YAKIMA, WA. SN 76-089,267. PUB. 9-25-2001, FILED 7-14-2000.

FRESHLAND

FOR FRESH SLICED FRUITS AND VEGETABLES TREATED WITH ANTIMICROBIAL OR ANTIOXIDANT COMPOUNDS TO MAINTAIN FRESHNESS (U.S. CL. 46).

FIRST USE 9-0-2002; IN COMMERCE 9-0-2002.

2,764,903. EAGLE FAMILY FOODS, INC., TARRYTOWN, NY. SN 76-206,403. PUB. 9-17-2002, FILED 1-30-2001.

EAGLE

OWNER OF U.S. REG. NOS. 137,954 AND 2,356,145. FOR SWEETENED CONDENSED MILK; EVAPORATED MILK (U.S. CL. 46).

FIRST USE 1-1-1865; IN COMMERCE 1-1-1865.

2,764,917. VEGE CHIP CO. PTY LTD, THE, QUEENSLAND, AUSTRALIA. SN 76-215,736. PUB. 9-17-2002, FILED 2-26-2001.

AJITA'S

FOR SNACK FOODS, NAMELY, VEGETABLE CHIPS, AND VEGETABLE BASED SNACK FOOD (U.S. CL. 46).

FIRST USE 4-0-1999; IN COMMERCE 12-0-2002.

CLASS 29—(Continued).

2,764,971. PERDUE HOLDINGS, INC., WILMINGTON, DE. SN 76-244,687. PUB. 1-14-2003, FILED 4-23-2001.

CHIK-TAC-TOE

FOR POULTRY (U.S. CL. 46).
FIRST USE 6-15-1994; IN COMMERCE 6-15-1994.

2,764,977. HICKORY FARMS, INC., MAUMEE, OH. SN 76-250,013. PUB. 10-22-2002, FILED 5-2-2001.

HoneyGold

FOR HAM AND POULTRY (U.S. CL. 46).
FIRST USE 1-0-2001; IN COMMERCE 8-0-2002.

2,765,182. TREE OF LIFE, INC., SAINT AUGUSTINE, FL. SN 76-327,010. PUB. 3-12-2002, FILED 10-18-2001.

GREAT EXPECTATIONS

FOR FRUIT TOPPINGS, FRUIT SAUCES, FRUIT-BASED FILLINGS FOR CAKES AND PIES (U.S. CL. 46).
FIRST USE 8-0-2002; IN COMMERCE 8-0-2002.

2,765,187. NEW CHOICE FOOD, INC., IRWINDALE, CA. SN 76-328,728. PUB. 10-8-2002, FILED 10-24-2001.

FRU GURT

FOR YOGURT CONSISTING OF FRUIT AND LESS THAN 1% FERMENTED MILK (U.S. CL. 46).
FIRST USE 6-1-2002; IN COMMERCE 6-1-2002.

2,765,199. HORMEL FOODS, LLC, AUSTIN, MN. SN 76-331,840. PUB. 6-4-2002, FILED 10-31-2001.

RIO BLANCO

THE ENGLISH TRANSLATION OF "RIO BLANCO" IS "WHITE RIVER".
FOR CHILI WITH OR WITHOUT BEANS (U.S. CL. 46).
FIRST USE 10-23-2001; IN COMMERCE 10-23-2001.

CLASS 29—(Continued).

2,765,222. LAMB-WESTON, INC., KENNEWICK, WA. SN 76-340,128. PUB. 10-22-2002, FILED 11-20-2001.



NO CLAIM IS MADE TO THE EXCLUSIVE RIGHT TO USE "FRIES", APART FROM THE MARK AS SHOWN.
FOR FROZEN PROCESSED POTATOES, NAMELY FRENCH FRIES (U.S. CL. 46).
FIRST USE 10-28-2002; IN COMMERCE 10-28-2002.

2,765,295. WAKEFERN FOOD CORP., ELIZABETH, NJ. SN 76-359,871. PUB. 8-6-2002, FILED 1-18-2002.

CRÈME DE VEAU

OWNER OF U.S. REG. NOS. 1,189,507 AND 1,191,273.
NO CLAIM IS MADE TO THE EXCLUSIVE RIGHT TO USE "VEAU", APART FROM THE MARK AS SHOWN.
THE ENGLISH TRANSLATION OF "CREME DE VEAU" IS "CREAM OF VEAL".
FOR VEAL (U.S. CL. 46).
FIRST USE 4-7-2003; IN COMMERCE 4-7-2003.

2,765,355. MEATS PLUS, INC., LODA, IL. SN 76-376,662. PUB. 10-8-2002, FILED 2-28-2002.

AMISH COUNTRY KITCHENS

OWNER OF U.S. REG. NO. 2,382,117.
NO CLAIM IS MADE TO THE EXCLUSIVE RIGHT TO USE "AMISH", APART FROM THE MARK AS SHOWN.
FOR MEAT AND MEAT BYPRODUCTS, NAMELY, POULTRY (U.S. CL. 46).
FIRST USE 0-0-1999; IN COMMERCE 0-0-2002.

2,765,611. DEWAR, SAM D., FT. LAUDERDALE, FL. SN 78-069,584. PUB. 6-25-2002, FILED 6-18-2001.

SOYLEAN

FOR FRESH AND PROCESSED GROUND MEAT FOOD PRODUCT, WITH VEGETABLE PROTEINS, NAMELY PREPACKAGED FRESH UNCOOKED, FRESH COOKED, AND FROZEN COOKED GROUND MEAT FOOD PRODUCT WITH SOY PROTEIN (U.S. CL. 46).
FIRST USE 9-17-2002; IN COMMERCE 1-15-2003.

CLASS 29—(Continued).

2,765,697. NUTRAPAK INC., YORBA LINDA, CA. SN 78-102,362. PUB. 8-20-2002, FILED 1-12-2002.

AULIO

FOR HAZELNUT PRODUCTS, NAMELY, REFINED AND RAW COOKING OIL, COOKING OIL PAN SPRAY; HAZELNUT AND VEGETABLE COOKING OIL BLENDS (U.S. CL. 46).

FIRST USE 3-31-2002; IN COMMERCE 4-9-2002.

2,765,704. GENERAL MILLS, INC., MINNEAPOLIS, MN. SN 78-104,808. PUB. 9-17-2002, FILED 1-25-2002.

CHERRY RAGE

NO CLAIM IS MADE TO THE EXCLUSIVE RIGHT TO USE "CHERRY", APART FROM THE MARK AS SHOWN. FOR FRUIT BASED SNACK FOODS (U.S. CL. 46).

FIRST USE 8-26-2002; IN COMMERCE 8-26-2002.

2,765,810. FUERTE, FERNANDO, TUCSON, AZ. SN 78-141,437. PUB. 1-21-2003, FILED 7-5-2002.

CARNAZOS

FOR MEAT, BEEF JERKY, MEAT EXTRACTS, PRE-SERVED MEATS, POULTRY, JAMS (U.S. CL. 46).

FIRST USE 5-12-2003; IN COMMERCE 5-12-2003.

CLASS 30—STAPLE FOODS

2,764,497. PLANTAIN PRODUCTS COMPANY, INC., TAMPA, FL. SN 75-514,719. PUB. 8-3-1999, FILED 6-25-1998.

NEW WORLD SNACKS

NO CLAIM IS MADE TO THE EXCLUSIVE RIGHT TO USE "SNACKS", APART FROM THE MARK AS SHOWN. FOR PLANTAIN AND CASSAVA CHIPS (U.S. CL. 46).

FIRST USE 12-26-2001; IN COMMERCE 12-26-2001.

2,764,538. PILLSBURY COMPANY, THE, MINNEAPOLIS, MN. SN 75-675,312. PUB. 10-23-2001, FILED 4-26-1999.

DOUGHBOY

OWNER OF U.S. REG. NO. 2,091,501. FOR REFRIGERATED DOUGH (U.S. CL. 46).

FIRST USE 2-28-2000; IN COMMERCE 2-28-2000.

CLASS 30—(Continued).

2,764,541. TUMARO'S INC., LOS ANGELES, CA. SN 75-683,942. PUB. 5-9-2000, FILED 4-16-1999.

TUMARO'S THE ORIGINAL GOURMET WRAPS

OWNER OF U.S. REG. NO. 1,893,236. NO CLAIM IS MADE TO THE EXCLUSIVE RIGHT TO USE "THE ORIGINAL GOURMET WRAPS", APART FROM THE MARK AS SHOWN.

FOR TORTILLAS AND CREPES (U.S. CL. 46).

FIRST USE 4-26-2002; IN COMMERCE 4-26-2002.

2,764,582. MATTEL, INC., EL SEGUNDO, CA. SN 75-780,474. PUB. 5-2-2000, FILED 9-16-1999.

BARBIE AVENUE

FOR CANDY (U.S. CL. 46).

FIRST USE 4-11-2003; IN COMMERCE 4-11-2003.

2,764,673. XTZ INDUSTRIES, INC., EDMONDS, WA. SN 75-983,327. PUB. 4-18-2000, FILED 12-23-1998.

ZENERGY

FOR NON-ALCOHOLIC BREWED TEA BEVERAGES (U.S. CL. 46).

FIRST USE 12-31-2002; IN COMMERCE 12-31-2002.

2,764,688. LOTTE CO., LTD., TOKYO, JAPAN. SN 76-027,169. PUB. 11-6-2001, FILED 4-17-2000.

KOALA'S MARCH

FOR PASTRIES INCLUDING BISCUIT (U.S. CL. 46).

FIRST USE 5-0-1990; IN COMMERCE 5-0-1990.

CLASS 30—(Continued).

2,764,689. LOTTE CO., LTD., TOKYO, JAPAN. SN 76-027,170. PUB. 11-6-2001, FILED 4-17-2000.

コアラのマーチ

THE NON-LATIN CHARACTERS IN THE MARK TRANSLITERATE TO "KOALA NO MARCH" AND THIS MEANS "KOALA'S MARCH" IN ENGLISH.
FOR PASTRIES INCLUDING BISCUIT (U.S. CL. 46).
FIRST USE 3-0-1986; IN COMMERCE 5-0-1990.

2,764,693. FARAGHER FAMILY FARM, LLC, DBA OUR FAMILY FARM, NEWPORT, KY. SN 76-031,085. PUB. 9-11-2001, FILED 4-14-2000.

ARCTIC BEAR

FOR BAKED SNACK GOODS, NAMELY CRACKERS AND COOKIES (U.S. CL. 46).
FIRST USE 10-3-2002; IN COMMERCE 10-3-2002.

2,764,695. SOS CUETARA, S.A., MADRID, SPAIN, BY MERGER, BY CHANGE OF NAME CUETARA, S.A., 28599 VILLAREJO DE SALVANES (MADRID), SPAIN. SN 76-035,324. PUB. 11-6-2001, FILED 4-26-2000.

F PLUS

FOR PASTRIES, BISCUITS, COOKIES, CRACKERS (U.S. CL. 46).
FIRST USE 8-0-2000; IN COMMERCE 8-0-2000.

2,764,747. ALPINE USA LTD., BROOKLYN, NY. SN 76-085,865. PUB. 8-20-2002, FILED 7-10-2000.

GUMMI WORLD

NO CLAIM IS MADE TO THE EXCLUSIVE RIGHT TO USE "GUMMI", APART FROM THE MARK AS SHOWN.
FOR GUMMI CANDIES (U.S. CL. 46).
FIRST USE 1-0-2002; IN COMMERCE 1-0-2002.

CLASS 30—(Continued).

2,764,898. ASOCIACION NACIONAL DEL CAFE, GUATEMALA CITY, GUATEMALA. SN 76-202,190. PUB. 2-18-2003, FILED 1-31-2001.



OWNER OF GUATEMALA REG. NO. 1998-05550, DATED 9-20-1999, EXPIRES 9-20-2009.

NO CLAIM IS MADE TO THE EXCLUSIVE RIGHT TO USE "GUATEMALAN COFFEES", APART FROM THE MARK AS SHOWN.

THE MARK CONSISTS OF THE WORDING "GUATEMALAN COFFEES" WITH A DESIGN FEATURING A RECTANGULAR SHAPED BORDER CONTAINING MOUNTAIN SCENERY BACKGROUND WITH FIVE PEOPLE HARVESTING COFFEE BEANS. THE MARK CONTAINS THE COLORS PURPLE, RED, ORANGE, GREEN AND YELLOW.

FOR COFFEE BEANS AND ROASTED AND GROUND COFFEE (U.S. CL. 46).

FIRST USE 1-30-2003; IN COMMERCE 1-30-2003.

2,764,922. SANTALUCIA ALIMENTOS LTDA., PORTO ALEGRE (RS), BRAZIL. SN 76-218,297. PUB. 3-5-2002, FILED 3-1-2001.



THE BLACK LINING IS CLEAR.

FOR RICE (U.S. CL. 46).

FIRST USE 5-15-2003; IN COMMERCE 5-15-2003.

2,764,939. SHERWOOD BRANDS, LLC, ROCKVILLE, MD. SN 76-228,311. PUB. 11-20-2001, FILED 3-21-2001.

EGG-STREME

FOR BUBBLE GUM (U.S. CL. 46).

FIRST USE 5-30-2001; IN COMMERCE 5-30-2001.

CLASS 30—(Continued).

2,765,060. VAN LAW FOOD PRODUCTS, INC., FULLERTON, CA. SN 76-286,277. PUB. 3-26-2002, FILED 7-12-2001.

PORTO FINO

THE ENGLISH TRANSLATION OF "PORTO FINO" IS "FINE PORT".
FOR SYRUPS, COFFEE SYRUPS (U.S. CL. 46).
FIRST USE 11-0-2002; IN COMMERCE 11-0-2002.

2,765,107. VASOS IMPORT, INC., LANSING, MI. SN 76-305,708. PUB. 9-3-2002, FILED 8-28-2001.

VASOS

THE ENGLISH TRANSLATION OF "VASOS" IS "GLASSES" FOR DRINKING OR HOLDING LIQUIDS.
FOR SALAD DRESSING (U.S. CL. 46).
FIRST USE 9-28-2001; IN COMMERCE 9-28-2001.

2,765,154. RICH PRODUCTS CORPORATION, BUFFALO, NY. SN 76-319,898. PUB. 5-14-2002, FILED 10-1-2001.



NO CLAIM IS MADE TO THE EXCLUSIVE RIGHT TO USE "BAKERY", APART FROM THE MARK AS SHOWN.
FOR BAKED GOODS, NAMELY BREADS, ROLLS, PIZZAS, COOKIES, DANISH PASTRIES, BREADSTICKS, DONUTS, CAKES, MUFFINS, PIES, ECLAIRS, BAGELS, CROISSANTS, BISCUITS, PRETZELS, PUFF PASTRIES, SCONES, AND BROWNIES (U.S. CL. 46).
FIRST USE 12-0-2001; IN COMMERCE 12-0-2001.

2,765,191. ALLIED INTERNATIONAL INC., ASHBURN, VA. SN 76-329,584. PUB. 5-28-2002, FILED 10-25-2001.

CREAM SATIONS

NO CLAIM IS MADE TO THE EXCLUSIVE RIGHT TO USE "CREAM", APART FROM THE MARK AS SHOWN.
FOR HARD CANDIES (U.S. CL. 46).
FIRST USE 4-1-2003; IN COMMERCE 4-1-2003.

CLASS 30—(Continued).

2,765,309. PREMIUM ESPRESSO, LLC, ARLINGTON HEIGHTS, IL. SN 76-363,494. PUB. 10-8-2002, FILED 1-28-2002.

ORANGE MOCHA MIO

NO CLAIM IS MADE TO THE EXCLUSIVE RIGHT TO USE "ORANGE MOCHA", APART FROM THE MARK AS SHOWN.
THE TRANSLATION OF "MIO" IN APPLICANT'S MARK IS "MY".
FOR COFFEE AND ESPRESSO BEVERAGES (U.S. CL. 46).
FIRST USE 5-10-2002; IN COMMERCE 5-10-2002.

2,765,380. RICH-SEAPAK CORPORATION, ST. SIMONS ISLAND, GA. SN 76-381,968. PUB. 9-24-2002, FILED 3-13-2002.

PIZZATAS

FOR LAYERED FROZEN PIZZA SNACK FOOD (U.S. CL. 46).
FIRST USE 6-10-2002; IN COMMERCE 6-10-2002.

2,765,384. DREYER'S GRAND ICE CREAM, INC., OAKLAND, CA. SN 76-383,868. PUB. 12-31-2002, FILED 3-14-2002.

WHAT FLAVOR DO YOU DREAM IN

FOR ICE CREAM, REDUCED FAT, LOW FAT AND FAT FREE ICE CREAM; ICE CREAM CONFECTIONS; FROZEN DAIRY AND NON-DAIRY CONFECTIONS; FROZEN DAIRY AND NON-DAIRY DESSERTS; FROZEN REDUCED FAT, LOW FAT AND FAT FREE DAIRY AND NON-DAIRY CONFECTIONS; ICE MILK; SORBETS; SHERBETS; SHAVED ICE; FROZEN FRUIT JUICE BARS; FROZEN FRUIT JUICE FLAVORED BARS; FAT FREE FROZEN YOGURT (U.S. CL. 46).
FIRST USE 4-1-2003; IN COMMERCE 4-1-2003.

CLASS 30—(Continued).

2,765,436. TAWA SUPERMARKET, INC., BUENA PARK, CA.
SN 76-405,069. PUB. 11-26-2002, FILED 5-8-2002.



THE ENGLISH TRANSLATION OF "DESIR" IS "DESIRE".
FOR BAKERY GOODS, BREADS, CAKES, PIES,
COOKIES, PUDDINGS, TARTS, FLAVORED AND
SWEETENED GELATINS AND GELATIN DESERTS,
PASTRIES, MOUSSES AND DOUGH (U.S. CL. 46).
FIRST USE 8-2-2002; IN COMMERCE 8-2-2002.

2,765,447. CANDYBEARS LLC, LYNTHURST, NJ. SN 76-
408,849. PUB. 11-26-2002, FILED 5-8-2002.

BEARBERRIES

FOR HARD CANDIES IN ASSORTED FLAVORS IN-
CLUDING STRAWBERRY, LEMON, AND CHERRY (U.S.
CL. 46).
FIRST USE 8-1-2002; IN COMMERCE 8-1-2002.

2,765,463. FLICHIA, GUS J., COLUMBUS, OH. SN 76-412,451.
PUB. 12-31-2002, FILED 5-24-2002.

MONTEVALLO COFFEE

NO CLAIM IS MADE TO THE EXCLUSIVE RIGHT TO
USE "COFFEE", APART FROM THE MARK AS SHOWN.
FOR COFFEE (U.S. CL. 46).
FIRST USE 11-12-2002; IN COMMERCE 11-12-2002.

2,765,488. YOSHA! ENTERPRISES, INC., WESTFIELD, NJ.
SN 76-424,843. PUB. 12-31-2002, FILED 6-18-2002.

MOMINTS

FOR CANDY AND GUM (U.S. CL. 46).
FIRST USE 2-25-2003; IN COMMERCE 2-25-2003.

CLASS 30—(Continued).

2,765,497. AMERICAN LICORICE CO., BEND, OR. SN 76-
431,440. PUB. 3-4-2003, FILED 7-17-2002.

NEON PUNCH

OWNER OF U.S. REG. NOS. 1,904,559, 2,469,518, AND
OTHERS.

NO CLAIM IS MADE TO THE EXCLUSIVE RIGHT TO
USE "NEON", APART FROM THE MARK AS SHOWN.
FOR CANDY (U.S. CL. 46).
FIRST USE 1-24-2003; IN COMMERCE 2-6-2003.

2,765,505. SWEET LADY JANE, INC., LOS ANGELES, CA. SN
76-442,474. PUB. 2-25-2003, FILED 8-16-2002.

SWEET LADY JANE

FOR BAKERY GOODS, NAMELY CAKES, COOKIES,
PIES, BROWNIES, MUFFINS, SCONES, AND PASTRIES
(U.S. CL. 46).
FIRST USE 8-21-2002; IN COMMERCE 8-21-2002.

2,765,524. CONAGRA FOODS, INC., OMAHA, NE. SN 76-
975,665. PUB. 11-19-2002, FILED 5-21-2002.

MAXSNAX

FOR APPETIZERS AND SNACKS CONSISTING OF
BREADSTICKS AND BAGELS FILLED OR TOPPED
WITH ONE OR MORE OF PORK, POULTRY, OR
CHEESE (U.S. CL. 46).
FIRST USE 1-10-2003; IN COMMERCE 1-10-2003.

2,765,714. BABE FARMS, INC., SANTA MARIA, CA. SN 78-
108,276. PUB. 3-4-2003, FILED 2-12-2002.

**BABE FARMS FINAL TOUCH
SALAD DRESSING &
MARINADE**

OWNER OF U.S. REG. NO. 2,131,798.
NO CLAIM IS MADE TO THE EXCLUSIVE RIGHT TO
USE "SALAD DRESSING & MARINADE", APART FROM
THE MARK AS SHOWN.
FOR FOOD PRODUCTS, NAMELY, SALAD DRES-
SINGS, MARINADES, AND SAUCES (U.S. CL. 46).
FIRST USE 5-1-2002; IN COMMERCE 5-1-2002.

CLASS 30—(Continued).

2,765,756. SHERWOOD BRANDS, LLC, ROCKVILLE, MD.
SN 78-121,083. PUB. 11-5-2002, FILED 4-11-2002.

GUMMY WORKSHOP

NO CLAIM IS MADE TO THE EXCLUSIVE RIGHT TO
USE "GUMMY", APART FROM THE MARK AS SHOWN.
FOR CANDY (U.S. CL. 46).
FIRST USE 3-31-2002; IN COMMERCE 3-31-2002.

2,765,757. SHERWOOD BRANDS, LLC, ROCKVILLE, MD.
SN 78-121,085. PUB. 11-5-2002, FILED 4-11-2002.

JELLY MUMMY MIX

NO CLAIM IS MADE TO THE EXCLUSIVE RIGHT TO
USE "JELLY" AND "MIX", APART FROM THE MARK AS
SHOWN.
FOR CANDY (U.S. CL. 46).
FIRST USE 12-31-2002; IN COMMERCE 12-31-2002.

2,765,790. GENERAL MILLS IP HOLDINGS I, LLC, MIN-
NEAPOLIS, MN. SN 78-135,707. PUB. 1-21-2003, FILED 6-14-
2002.

BERRY BURST CHEERIOS

OWNER OF U.S. REG. NOS. 414,338, 2,150,560, AND
OTHERS.
NO CLAIM IS MADE TO THE EXCLUSIVE RIGHT TO
USE "BERRY", APART FROM THE MARK AS SHOWN.
FOR PROCESSED CEREAL-DERIVED FOOD PRO-
DUCTS TO BE USED AS A BREAKFAST CEREAL,
SNACK FOOD, OR INGREDIENT FOR MAKING FOOD
(U.S. CL. 46).
FIRST USE 12-30-2002; IN COMMERCE 12-30-2002.

2,765,797. LEE, JIN, W, CEDAR HILL, TX. SN 78-137,909.
PUB. 12-31-2002, FILED 6-21-2002.

COOLENJOYS

FOR PURE FRUIT ICE CREAM (U.S. CL. 46).
FIRST USE 3-15-2003; IN COMMERCE 4-2-2003.

2,765,813. PARTNERS, A TASTEFUL CHOICE CO, SEATTLE,
WA. SN 78-143,589. PUB. 1-28-2003, FILED 7-12-2002.

BLUE STAR FARMS

FOR CRACKERS (U.S. CL. 46).
FIRST USE 7-5-2002; IN COMMERCE 9-15-2002.

CLASS 30—(Continued).

2,765,824. AMERICAN POP CORN COMPANY, SIOUX CITY,
IA. SN 78-148,299. PUB. 2-11-2003, FILED 7-29-2002.

THE BIG CHEEZ

FOR UNPOPPED MICROWAVE POPCORN (U.S. CL.
46).
FIRST USE 2-25-2003; IN COMMERCE 2-25-2003.

**CLASS 31—NATURAL AGRICULTURAL PRO-
DUCTS**

2,764,514. NATIONAL BOTANICAL INSTITUTE, WESTERN
CAPE, SOUTH AFRICA. SN 75-594,143. PUB. 4-3-2001,
FILED 11-20-1998.

KIRSTENBOSCH

FOR FLOWER SEEDS, PLANT SEEDS, DRIED FLOW-
ERS, MALT FOR BREWING AND DISTILLING PUR-
POSES, AND TISSUE CULTURE PLANTLETS FOR THE
PROPAGATION OF PLANTS (U.S. CLS. 1 AND 46).
FIRST USE 1-1-2003; IN COMMERCE 1-1-2003.

2,764,629. INDUSTRIES MAIBEC INC./MAIBEC INDUS-
TRIES INC., SAINTE-FOY, QUEBEC, CANADA. SN 75-
881,022. PUB. 10-16-2001, FILED 12-27-1999.

AGROFIBRE

FOR COMPOST AND MULCH (U.S. CLS. 1 AND 46).
FIRST USE 10-25-2001; IN COMMERCE 10-25-2001.

CLASS 31—(Continued).

2,764,842. FLOWER VILLAGE CIA. LTDA., QUITO, ECUADOR. SN 76-161,147. PUB. 6-18-2002, FILED 11-7-2000.



NO CLAIM IS MADE TO THE EXCLUSIVE RIGHT TO USE "FLOWERS", APART FROM THE MARK AS SHOWN. THE STIPPLING IN THE DRAWING IS FOR SHADING PURPOSES ONLY.

FOR FLOWER SEEDS, LIVE PLANTS AND NATURAL FLOWERS (U.S. CLS. 1 AND 46).

FIRST USE 6-15-2002; IN COMMERCE 6-27-2002.

2,764,848. MORENO, KAREN K., HAYWARD, WI. SN 76-162,781. PUB. 8-20-2002, FILED 11-9-2000.

BONE APPÉTREATS

NO CLAIM IS MADE TO THE EXCLUSIVE RIGHT TO USE "BONE", APART FROM THE MARK AS SHOWN.

FOR PET FOOD, NAMELY, EDIBLE DOG TREATS (U.S. CLS. 1 AND 46).

FIRST USE 8-21-2000; IN COMMERCE 8-22-2002.

2,764,906. FABIAN, PATRICK, TA FABIAN SEED FARMS, TILLEY, AB T0J 3K0, CANADA. SN 76-208,833. PUB. 2-19-2002, FILED 2-13-2001.

PLANTING THE SEEDS OF SUCCESS

FOR AGRICULTURAL SEEDS, NAMELY, SPECIALTY PEDIGREE CEREAL SEEDS AND CUSTOM BLENDS OF SPECIALTY PEDIGREE CEREAL SEEDS (U.S. CLS. 1 AND 46).

FIRST USE 6-28-1996; IN COMMERCE 11-0-2001.

CLASS 31—(Continued).

2,764,989. DAVE WILSON NURSERY, INC, HICKMAN, CA. SN 76-261,451. PUB. 4-9-2002, FILED 5-21-2001.

SWEET BAGEL

FOR LIVE FRUIT TREES AND FRESH DECIDUOUS FRUIT, NAMELY PEENTO TYPE PEACHES AND NECTARINES (U.S. CLS. 1 AND 46).

FIRST USE 12-15-2002; IN COMMERCE 12-15-2002.

2,764,992. WRIGHT, EULA H., DBA HILL HIGH FARM, WINCHESTER, VA. SN 76-262,275. PUB. 10-1-2002, FILED 5-25-2001.



NO CLAIM IS MADE TO THE EXCLUSIVE RIGHT TO USE "FARM" AND "PUMPKIN PATCH", APART FROM THE MARK AS SHOWN.

THE STIPPLING IS FOR SHADING PURPOSES ONLY AND DOES NOT INDICATE COLOR.

FOR FRESH PUMPKINS FOR VISITING GROUPS TO THE FARM (U.S. CLS. 1 AND 46).

FIRST USE 5-1-2001; IN COMMERCE 5-1-2001.

2,765,048. ROD MCLELLAN CO., SAN MATEO, CA. SN 76-278,922. PUB. 7-2-2002, FILED 7-2-2001.

TURF-FIT

NO CLAIM IS MADE TO THE EXCLUSIVE RIGHT TO USE "TURF", APART FROM THE MARK AS SHOWN.

FOR MULCHES FOR GARDEN USE (U.S. CLS. 1 AND 46).

FIRST USE 4-18-2002; IN COMMERCE 4-18-2002.

CLASS 31—(Continued).

2,765,096. FRANK'S NURSERY & CRAFTS, INC., TROY, MI, BY ASSIGNMENT FRANK'S NURSERY AND CRAFTS, INC., TROY, MI. SN 76-300,123. PUB. 8-20-2002, FILED 8-16-2001.



NO CLAIM IS MADE TO THE EXCLUSIVE RIGHT TO USE "EXCLUSIVE" AND "COLLECTION", APART FROM THE MARK AS SHOWN.

THE STIPPLING IN THE DRAWING IS FOR SHADING PURPOSES ONLY.

THE MARK INCLUDES THE WORDING "JACK FROST COLLECTION".

FOR SEEDS, NAMELY FLOWER SEEDS; LIVING PLANTS; LIVE FLOWERS (U.S. CLS. 1 AND 46).

FIRST USE 9-7-2001; IN COMMERCE 9-7-2001.

2,765,386. MEREDITH CORPORATION, DES MOINES, IA. SN 76-385,614. PUB. 10-15-2002, FILED 3-21-2002.

HOME AND FAMILY

FOR LIVE PLANTS (U.S. CLS. 1 AND 46).
FIRST USE 8-1-2002; IN COMMERCE 1-1-2003.

2,765,387. PHOENIX INTANGIBLES HOLDING COMPANY, GREENVILLE, DE. SN 76-386,422. PUB. 10-15-2002, FILED 3-25-2002.

ACTIVE CHOICE

FOR PET FOOD (U.S. CLS. 1 AND 46).
FIRST USE 8-23-2002; IN COMMERCE 8-23-2002.

CLASS 31—(Continued).

2,765,388. PHOENIX INTANGIBLES HOLDING COMPANY, GREENVILLE, DE. SN 76-386,550. PUB. 3-4-2003, FILED 3-25-2002.

DAILY CHOICE

NO CLAIM IS MADE TO THE EXCLUSIVE RIGHT TO USE "DAILY", APART FROM THE MARK AS SHOWN.

FOR PET FOOD (U.S. CLS. 1 AND 46).

FIRST USE 8-23-2002; IN COMMERCE 8-23-2002.

2,765,402. PHOENIX INTANGIBLES HOLDING COMPANY, GREENVILLE, DE. SN 76-390,951. PUB. 1-7-2003, FILED 4-3-2002.

PUPPY SOURCE

NO CLAIM IS MADE TO THE EXCLUSIVE RIGHT TO USE "PUPPY", APART FROM THE MARK AS SHOWN.

FOR DOG FOOD (U.S. CLS. 1 AND 46).

FIRST USE 5-10-2002; IN COMMERCE 5-10-2002.

2,765,420. FREEDOM FEEDS, INC., URBANA, OH. SN 76-395,568. PUB. 10-29-2002, FILED 4-15-2002.

VEGIPRO

FOR AQUACULTURE DIET FOR USE IN FEEDING FARM RAISED FISH AND CRUSTACEANS, NAMELY, FISH AND CRUSTACEAN FOOD (U.S. CLS. 1 AND 46).
FIRST USE 1-0-2001; IN COMMERCE 1-0-2001.

2,765,485. SIEGERS SEED COMPANY, HOLLAND, MI. SN 76-422,153. PUB. 2-4-2003, FILED 6-17-2002.



FOR PLANT SEEDS, FRESH FRUITS AND VEGETABLES (U.S. CLS. 1 AND 46).
FIRST USE 6-30-2002; IN COMMERCE 6-30-2002.

2,765,565. CHU FARMS, INC., WIMAUMA, FL. SN 78-039,442. PUB. 6-4-2002, FILED 12-15-2000.

SUGAR DROPS

FOR FRESH VEGETABLES, NAMELY, FRESH TOMATOES (U.S. CLS. 1 AND 46).
FIRST USE 8-6-2002; IN COMMERCE 2-6-2003.

CLASS 31—(Continued).

2,765,595. ST. CLAIRE, LISETTE, M., HOLLYWOOD, CA. SN 78-061,015. PUB. 8-27-2002, FILED 4-29-2001.

BARKFEST

FOR FOODSTUFFS FOR ANIMALS, NAMELY, DOG TREATS, DOG BISCUITS, DOG COOKIES, AND BREAKFAST BARS FOR DOGS (U.S. CLS. 1 AND 46).
FIRST USE 11-0-1999; IN COMMERCE 11-0-1999.

2,765,659. MONSANTO TECHNOLOGY LLC, ST. LOUIS, MO. SN 78-086,370. PUB. 9-3-2002, FILED 10-1-2001.



OWNER OF U.S. REG. NOS. 2,095,766, 2,103,941, AND 2,257,441.

NO CLAIM IS MADE TO THE EXCLUSIVE RIGHT TO USE "ROOTWORM", APART FROM THE MARK AS SHOWN.

THE MARK CONSISTS OF A SEMI-CIRCULAR SHAPE CONTAINING A STYLIZED DEPICTION OF A CORN KERNEL ABOVE THE WORD "YIELDGARD". UNDERNEATH THE WORD "YIELDGARD", DIVIDED BY A LINE WITHIN THE SEMI-CIRCLE, IS THE WORD "ROOTWORM".

FOR AGRICULTURAL SEEDS CONTAINING INSECT-TOLERANT GENES (U.S. CLS. 1 AND 46).
FIRST USE 2-26-2003; IN COMMERCE 2-26-2003.

2,765,678. PHILLIPS, JOSH, J. SONOMA, CA. SN 78-093,723. PUB. 5-28-2002, FILED 11-16-2001.

WOLF RUN

FOR FRESH FRUITS; UNPROCESSED WINE GRAPES (U.S. CLS. 1 AND 46).
FIRST USE 11-15-2002; IN COMMERCE 11-15-2002.

CLASS 31—(Continued).

2,765,773. GREAT AMERICAN BOUQUET, LLC, MIAMI, FL. SN 78-128,257. PUB. 11-5-2002, FILED 5-13-2002.

GREAT AMERICAN BOUQUET

NO CLAIM IS MADE TO THE EXCLUSIVE RIGHT TO USE "BOUQUET", APART FROM THE MARK AS SHOWN. FOR FRESH CUT FLOWERS (U.S. CLS. 1 AND 46).
FIRST USE 5-1-2002; IN COMMERCE 5-21-2002.

CLASS 32—LIGHT BEVERAGES

2,764,707. 7-ELEVEN, INC., DALLAS, TX. SN 76-048,737. PUB. 3-13-2001, FILED 5-15-2000.

TRIPLE SPLITZ-O

OWNER OF U.S. REG. NO. 2,236,874.
FOR SOFT DRINKS FOR CONSUMPTION ON OR OFF THE PREMISES (U.S. CLS. 45, 46 AND 48).
FIRST USE 7-31-2000; IN COMMERCE 7-31-2000.

2,765,079. KOMPANIA PIWOWARSKA S.A., 61-285 POZNAN, POLAND. SN 76-296,351. PUB. 7-2-2002, FILED 8-8-2001.

TYSKIE

FOR BEER, ALE AND PORTER (U.S. CLS. 45, 46 AND 48).
FIRST USE 0-0-1993; IN COMMERCE 2-8-2002.

2,765,080. HODGES, ROBERT, ARTESIA, NM. SN 76-296,731. PUB. 7-9-2002, FILED 8-9-2001.



OWNER OF U.S. REG. NO. 2,164,154.
NO CLAIM IS MADE TO THE EXCLUSIVE RIGHT TO USE "H2O", APART FROM THE MARK AS SHOWN. FOR DRINKING WATER (U.S. CLS. 45, 46 AND 48).
FIRST USE 4-8-2003; IN COMMERCE 4-8-2003.

CLASS 32—(Continued).

2,765,229. XO ENERGY BEVERAGE CORP., NEW YORK, NY, BY CHANGE OF NAME NATU CORP., NEW YORK, NY. SN 76-340,909. PUB. 1-28-2003, FILED 11-23-2001.

XO2

FOR ENERGY SPORTS DRINK (U.S. CLS. 45, 46 AND 48).
FIRST USE 4-1-2002; IN COMMERCE 4-1-2002.

2,765,250. XO ENERGY BEVERAGE CORP., NEW YORK, NY, BY CHANGE OF NAME NATU CORP., NEW YORK, NY. SN 76-346,762. PUB. 1-28-2003, FILED 12-10-2001.

XO6

FOR ENERGY SPORTS DRINK (U.S. CLS. 45, 46 AND 48).
FIRST USE 4-1-2002; IN COMMERCE 4-1-2002.

2,765,251. XO ENERGY BEVERAGE CORP., NEW YORK, NY, BY CHANGE OF NAME NATU CORP., NEW YORK, NY. SN 76-346,764. PUB. 1-28-2003, FILED 12-10-2001.

XO3

FOR ENERGY SPORTS DRINK (U.S. CLS. 45, 46 AND 48).
FIRST USE 4-1-2002; IN COMMERCE 4-1-2002.

2,765,253. IDEAS & INNOVATIONS, INC., LAKE LAND, FL. SN 76-347,208. PUB. 5-14-2002, FILED 12-10-2001.



NO CLAIM IS MADE TO THE EXCLUSIVE RIGHT TO USE "MIXER", APART FROM THE MARK AS SHOWN.
FOR CONCENTRATED AND DEHYDRATED FRUIT AND VEGETABLE JUICE POWDERS AND NON-ALCOHOLIC COCKTAIL MIXES (U.S. CLS. 45, 46 AND 48).
FIRST USE 10-8-2001; IN COMMERCE 4-24-2003.

CLASS 32—(Continued).

2,765,344. WESTERN PENNSYLVANIA CONSERVANCY, PITTSBURGH, PA. SN 76-373,834. PUB. 9-10-2002, FILED 2-22-2002.

FALLINGWATER

FOR BOTTLED SPRING WATER (U.S. CLS. 45, 46 AND 48).
FIRST USE 4-0-2002; IN COMMERCE 12-0-2002.

2,765,372. COORS BREWING COMPANY, GOLDEN, CO. SN 76-379,580. PUB. 1-7-2003, FILED 3-6-2002.

COLD DOWN EASY

NO CLAIM IS MADE TO THE EXCLUSIVE RIGHT TO USE "COLD", APART FROM THE MARK AS SHOWN.
FOR BEER (U.S. CLS. 45, 46 AND 48).
FIRST USE 2-28-2003; IN COMMERCE 2-28-2003.

2,765,472. JARRITOS, INC., EL PASO, TX. SN 76-415,652. PUB. 12-3-2002, FILED 5-31-2002.

AGUAS FRESCAS DE MI TIERRA

NO CLAIM IS MADE TO THE EXCLUSIVE RIGHT TO USE "AGUAS FRESCAS", APART FROM THE MARK AS SHOWN.

THE ENGLISH TRANSLATION OF "AGUAS FRESCAS DE MI TIERRA" IS "FRESH WATERS FROM MY LAND".

FOR NON-CARBONATED, NON-ALCOHOLIC TROPICAL BEVERAGE MADE WITH NATURAL FLAVORS FROM FRUITS, GRAINS, SPICES, HERBS AND BOTANICALS (U.S. CLS. 45, 46 AND 48).

FIRST USE 2-28-2003; IN COMMERCE 2-28-2003.

2,765,499. KALIL BOTTLING COMPANY, TUCSON, AZ. SN 76-432,898. PUB. 2-4-2003, FILED 7-19-2002.

Dr. Good Guy

OWNER OF U.S. REG. NOS. 1,841,069 AND 1,977,019.
NO CLAIM IS MADE TO THE EXCLUSIVE RIGHT TO USE "DR.", APART FROM THE MARK AS SHOWN.

FOR BEVERAGES, NAMELY CARBONATED AND NON-CARBONATED FLAVORED SODAS AND WATER (U.S. CLS. 45, 46 AND 48).

FIRST USE 8-15-2002; IN COMMERCE 8-15-2002.

CLASS 32—(Continued).

2,765,647. PEPSICO, INC., PURCHASE, NY. SN 78-081,306.
PUB. 1-1-2002, FILED 8-27-2001.

PEPSI CHART

OWNER OF U.S. REG. NOS. 111,508, 2,427,616, AND OTHERS.
FOR SOFT DRINKS (U.S. CLS. 45, 46 AND 48).
FIRST USE 7-0-2002; IN COMMERCE 7-0-2002.

2,765,763. PEPSICO, INC., PURCHASE, NY. SN 78-124,173.
PUB. 11-19-2002, FILED 4-25-2002.

PEPSI BLUE

OWNER OF U.S. REG. NOS. 1,237,565, 2,104,304, AND OTHERS.
NO CLAIM IS MADE TO THE EXCLUSIVE RIGHT TO USE "BLUE", APART FROM THE MARK AS SHOWN.
FOR SOFT DRINKS (U.S. CLS. 45, 46 AND 48).
FIRST USE 8-0-2002; IN COMMERCE 8-0-2002.

2,765,798. PEPSICO, INC., PURCHASE, NY. SN 78-139,159.
PUB. 1-14-2003, FILED 6-26-2002.

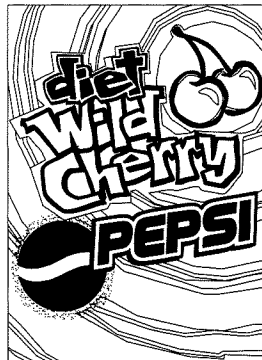

OWNER OF U.S. REG. NOS. 156,658, 2,162,149, AND OTHERS.
NO CLAIM IS MADE TO THE EXCLUSIVE RIGHT TO USE "DIET WILD CHERRY", APART FROM THE MARK AS SHOWN.
THE STIPPLING IS A FEATURE OF THE MARK.
FOR SOFT DRINKS, AND SYRUPS AND CONCENTRATES FOR MAKING THE SAME (U.S. CLS. 45, 46 AND 48).
FIRST USE 8-0-2002; IN COMMERCE 8-0-2002.

CLASS 33—WINES AND SPIRITS**CLASS 33—(Continued).**

2,764,551. ARBOR HILL ASSOCIATES, INCORPORATED, NAPLES, NY. SN 75-698,922. PUB. 11-30-1999, FILED 5-6-1999.

ARBOR FROST

FOR WINES (U.S. CLS. 47 AND 49).
FIRST USE 6-20-2003; IN COMMERCE 6-20-2003.

2,764,614. RIEBEEK KELDER BEPERK, WESTERN CAPE, SOUTH AFRICA. SN 75-850,772. PUB. 8-1-2000, FILED 11-16-1999.

A FEW GOOD MEN

FOR WINE (U.S. CLS. 47 AND 49).
FIRST USE 11-10-1999; IN COMMERCE 4-1-2003.

2,764,622. BRASSFIELD, JERRY, LOS GATOS, CA. SN 75-861,655. PUB. 8-15-2000, FILED 11-30-1999.

HIGH VALLEY

FOR WINE (U.S. CLS. 47 AND 49).
FIRST USE 3-21-2003; IN COMMERCE 3-21-2003.

2,764,655. BFC TEQUILA LIMITED, DUBLIN 22, IRELAND.
SN 75-933,382. PUB. 2-27-2001, FILED 3-2-2000.

ALMENDRADO ORENDAIN

OWNER OF U.S. REG. NOS. 1,554,972 AND 2,063,773.
THE WORDING IN THE MARK "ALMENDRADO ORENDAIN" IS NOT THE NAME OF A LIVING PERSON.
FOR ALCOHOLIC BEVERAGES, NAMELY, DISTILLED SPIRITS (U.S. CLS. 47 AND 49).
FIRST USE 11-30-1997; IN COMMERCE 11-30-1997.

2,764,766. HOURGLASS WINE COMPANY, INC., ST. HELENA, CA, BY CHANGE OF NAME SMITH, JEFFREY ROBERT, DBA SWAN SPIRITS INTERNATIONAL, ST. HELENA, CA. SN 76-101,246. PUB. 8-28-2001, FILED 8-2-2000.

HOURGLASS

FOR WINE (U.S. CLS. 47 AND 49).
FIRST USE 6-5-2001; IN COMMERCE 10-0-2001.

CLASS 33—(Continued).

2,764,823. BENZIGER FAMILY WINERY LLC, GLEN ELLEN, CA. SN 76-149,369. PUB. 12-18-2001, FILED 10-17-2000.

WILDWATER CREEK

FOR WINE (U.S. CLS. 47 AND 49).
FIRST USE 11-8-2000; IN COMMERCE 11-8-2000.

2,764,827. ALIVE ENTERPRISES, INC., KIHEI, MAUI, HI. SN 76-152,136. PUB. 8-28-2001, FILED 10-23-2000.

OLD WHISKEY RIVER

NO CLAIM IS MADE TO THE EXCLUSIVE RIGHT TO USE "WHISKEY", APART FROM THE MARK AS SHOWN. FOR WHISKEY (U.S. CLS. 47 AND 49).
FIRST USE 8-0-2001; IN COMMERCE 8-0-2001.

2,764,863. DE WET EXCELSIOR FARMS (PROPRIETARY) LIMITED, ASHTON, 6715, SOUTH AFRICA. SN 76-172,326. PUB. 9-17-2002, FILED 11-28-2000.

STONEHURST

FOR ALCOHOLIC BEVERAGES, NAMELY WINE (U.S. CLS. 47 AND 49).
FIRST USE 2-14-2001; IN COMMERCE 2-14-2001.

2,764,877. LINDEMANS WINES PTY LTD., ADELAIDE SA 5000, AUSTRALIA. SN 76-183,768. PUB. 11-19-2002, FILED 12-19-2000.



OWNER OF U.S. REG. NOS. 896,229 AND 1,091,531. NO CLAIM IS MADE TO THE EXCLUSIVE RIGHT TO USE "1843", APART FROM THE MARK AS SHOWN. THE SHADING IN THE DRAWING IS A FEATURE OF THE MARK AND DOES NOT REPRESENT COLOR. FOR WINES (U.S. CLS. 47 AND 49).
FIRST USE 9-0-2001; IN COMMERCE 9-0-2001.

CLASS 33—(Continued).

2,765,098. JACK DANIEL'S PROPERTIES, INC., SAN RAFAEL, CA. SN 76-301,935. PUB. 11-12-2002, FILED 8-17-2001.



OWNER OF U.S. REG. NOS. 394,017, 1,942,451, AND OTHERS.

NO CLAIM IS MADE TO THE EXCLUSIVE RIGHT TO USE "TENNESSEE WHISKEY"; "BRAND"; "QUALITY TENNESSEE SOUR MASH WHISKEY"; AND "BOTTLED AT THE DISTILLERY", APART FROM THE MARK AS SHOWN.

THE LINING AND STIPPLING SHOWN IN THE DRAWING OF THE MARK IS FOR SHADING PURPOSES ONLY AND NOT INTENDED TO INDICATE COLOR.

THE NAME "JACK DANIEL" IN THE MARK IS NOT THE NAME OF A LIVING INDIVIDUAL.

THE MARK CONSISTS OF THE CONFIGURATION OF THE BOTTLE CONTAINER FOR THE GOODS, HAVING AN EMBOSSED RIDGE OR SCALLOPED DESIGN ON THE NECK PORTION OF THE BOTTLE, AND AN EMBOSSED SIGNATURE DESIGN COMPRISED OF THE WORDS "JACK DANIEL". THE MARK ALSO CONTAINS A NECK LABEL BEARING THE WORDS "JACK DANIEL'S OLD NO. 7 TENNESSEE WHISKEY" AND A BOTTLE LABEL CONTAINING A FILLAGREE DESIGN BORDER, OVAL AND MULTI-LOOP CARTOUCHE DESIGN, AND THE WORDS "JACK DANIEL'S"; "OLD TIME"; "OLD NO. 7 BRAND"; "QUALITY TENNESSEE SOUR MASH WHISKEY"; AND "BOTTLED AT THE DISTILLERY". THE DOTTED OR BROKEN LINES IN THE DRAWING ARE INTENDED TO SHOW THE POSITION OF THE DISTINCTIVE ELEMENTS OF THE MARK.

FOR ALCOHOLIC BEVERAGES, NAMELY, TENNESSEE SOUR MASH WHISKEY (U.S. CLS. 47 AND 49).
FIRST USE 8-15-2001; IN COMMERCE 8-15-2001.

2,765,123. MCWILLIAM'S WINES PTY LIMITED, CHULLORA, NEW SOUTH WALES, 2190, AUSTRALIA. SN 76-309,995. PUB. 8-6-2002, FILED 9-7-2001.

MCWILLIAM'S HANWOOD ESTATE

NO CLAIM IS MADE TO THE EXCLUSIVE RIGHT TO USE "ESTATE", APART FROM THE MARK AS SHOWN. FOR WINES (U.S. CLS. 47 AND 49).
FIRST USE 6-1-2002; IN COMMERCE 6-1-2002.

CLASS 33—(Continued).

2,765,144. MIRANDA WINES PTY LTD, GRIFFITH, NSW 2680, AUSTRALIA. SN 76-315,800. PUB. 10-8-2002, FILED 9-21-2001.

HIGH COUNTRY

FOR TABLE WINES MADE FROM GRAPES AND LABELLED WITH THE GRAPE VARIETY OR VARIETIES FROM WHICH THE WINES ARE MADE, SUCH TABLE WINES BEING PACKAGED EXCLUSIVELY IN GLASS BOTTLES (U.S. CLS. 47 AND 49).
FIRST USE 5-31-1995; IN COMMERCE 5-27-1998.

2,765,202. DAVIES & GAMBLE, LLC, ST. HELENA, CA. SN 76-332,124. PUB. 3-12-2002, FILED 10-30-2001.

DAVIES & GAMBLE

FOR WINE (U.S. CLS. 47 AND 49).
FIRST USE 5-28-2003; IN COMMERCE 5-28-2003.

2,765,252. DISTILLERIE BUSNEL, CORMEILLES, FRANCE, BY CHANGE OF NAME; CIDRERIES ET SOPAGLY REUNIES, LA COURNEUVE, FRANCE. SN 76-347,061. PUB. 8-20-2002, FILED 12-7-2001.

BUSNEL

FOR ALCOHOLIC BEVERAGES, NAMELY, CIDERS, CALVADOS AND POMMEAU (U.S. CLS. 47 AND 49).
FIRST USE 0-0-1968; IN COMMERCE 0-0-1995.

2,765,276. SAZERAC COMPANY, INC., NEW ORLEANS, LA. SN 76-354,856. PUB. 10-8-2002, FILED 1-3-2002.

GEORGE T. STAGG

"GEORGE T. STAGG" DOES NOT IDENTIFY A LIVING INDIVIDUAL.
FOR ALCOHOLIC BEVERAGES, NAMELY, WHISKEY (U.S. CLS. 47 AND 49).
FIRST USE 11-0-2002; IN COMMERCE 11-0-2002.

2,765,278. MAURITSON, THOMAS, HEALDSBURG, CA. SN 76-355,709. PUB. 9-17-2002, FILED 1-8-2002.

**ROCK PILE RIDGE
VINEYARDS & WINERY**

NO CLAIM IS MADE TO THE EXCLUSIVE RIGHT TO USE "VINEYARDS & WINERY", APART FROM THE MARK AS SHOWN.
FOR WINE (U.S. CLS. 47 AND 49).
FIRST USE 5-1-2003; IN COMMERCE 5-1-2003.

CLASS 33—(Continued).

2,765,381. MENDOCINO CELLARS LLC, HOPLAND, CA. SN 76-382,564. PUB. 11-19-2002, FILED 3-14-2002.

WILLIAM ROAN

THE NAME "WILLIAM ROAN" DOES NOT IDENTIFY A LIVING INDIVIDUAL.
FOR WINE AND DISTILLED SPIRITS (U.S. CLS. 47 AND 49).
FIRST USE 10-15-2002; IN COMMERCE 10-15-2002.

2,765,399. EMPSON (U.S.A.) INC., ALEXANDRIA, VA. SN 76-388,719. PUB. 10-1-2002, FILED 3-29-2002.

SHEEP'S BACK

FOR WINE (U.S. CLS. 47 AND 49).
FIRST USE 9-27-2002; IN COMMERCE 9-27-2002.

2,765,479. HOLDENER, TIM R., LOCKEFORD, CA. SN 76-419,563. PUB. 12-3-2002, FILED 6-11-2002.

MACCHIA

THE ENGLISH TRANSLATION OF "MACCHIA" IS "SPOT".
FOR WINE (U.S. CLS. 47 AND 49).
FIRST USE 8-1-2002; IN COMMERCE 8-1-2002.

2,765,507. BRONCO WINE COMPANY, CERES, CA. SN 76-448,842. PUB. 1-21-2003, FILED 9-12-2002.



OWNER OF U.S. REG. NOS. 2,198,682 AND 2,254,439.
FOR WINES (U.S. CLS. 47 AND 49).
FIRST USE 11-11-2002; IN COMMERCE 4-29-2003.

2,765,561. E. & J. GALLO WINERY, MODESTO, CA. SN 78-035,167. PUB. 12-24-2002, FILED 11-14-2000.

REDWOOD CREEK

FOR WINES (U.S. CLS. 47 AND 49).
FIRST USE 2-1-2001; IN COMMERCE 2-1-2001.

CLASS 33—(Continued).

2,765,782. IAN MACLEOD & CO. LTD., BROXBURN, UNITED KINGDOM. SN 78-131,701. PUB. 12-17-2002, FILED 5-29-2002.

MARSHAL

FOR SCOTCH WHISKY, WHISKY, WHISKY-BASED LIQUEURS (U.S. CLS. 47 AND 49).
FIRST USE 1-16-2003; IN COMMERCE 1-16-2003.

2,765,785. JACK DANIEL'S PROPERTIES, INC., SAN RAFAEL, CA. SN 78-133,504. PUB. 12-10-2002, FILED 6-5-2002.

COME AS YOU ARE

FOR ALCOHOLIC BEVERAGE PRODUCED FROM A BREWED MALT BASE WITH NATURAL FLAVORS (U.S. CLS. 47 AND 49).
FIRST USE 7-1-2002; IN COMMERCE 7-1-2002.

CLASS 34—SMOKERS' ARTICLES

2,765,489. C.A.O. INTERNATIONAL, INC., NASHVILLE, TN. SN 76-425,513. PUB. 12-31-2002, FILED 6-25-2002.

PAMPA

THE ENGLISH TRANSLATION OF "PAMPA" IS "WIDE, TREELESS PLAIN".
FOR SMOKERS' ARTICLES, NAMELY, CIGARS (U.S. CLS. 2, 8, 9 AND 17).
FIRST USE 7-21-2002; IN COMMERCE 7-21-2002.

2,765,490. C.A.O. INTERNATIONAL, INC., NASHVILLE, TN. SN 76-425,518. PUB. 12-10-2002, FILED 6-25-2002.

CONQUISTADOR

FOR SMOKERS' ARTICLES, NAMELY, CIGARS (U.S. CLS. 2, 8, 9 AND 17).
FIRST USE 7-21-2002; IN COMMERCE 7-21-2002.

2,765,618. XCALIBER INTERNATIONAL LTD., L.L.C., PRYOR, OK. SN 78-070,778. PUB. 11-6-2001, FILED 6-25-2001.

EXETER

FOR CIGARETTES, CIGARS (U.S. CLS. 2, 8, 9 AND 17).
FIRST USE 1-9-2000; IN COMMERCE 2-1-2001.

CLASS 35—(Continued).**SERVICE MARKS****CLASS 35—ADVERTISING AND BUSINESS**

2,764,498. AMERICAN SPORTS LICENSING, INC., WILMINGTON, DE. BY ASSIGNMENT; BY ASSIGNMENT DICK'S CLOTHING & SPORTING GOODS, INC., CORAOPOLIS, PA. SN 75-520,819. PUB. 10-8-2002, FILED 7-17-1998.



FOR PROMOTING THE RETAIL SALE OF GOODS THROUGH THE ADMINISTRATION OF A BACK-TO-SCHOOL CAMPAIGN WHEREIN MONIES ARE DONATED TO ORGANIZATIONS INVOLVED IN OR WITH SCHOLASTIC EXCELLENCE, SCHOOL FUNCTIONS, TEAM SPORTS, SCHOOL CLUBS AND/OR DRUG-FREE INVOLVEMENT, BASED ON CONSUMER PURCHASES OF SAID GOODS (U.S. CLS. 100, 101 AND 102).
FIRST USE 8-1-1998; IN COMMERCE 8-1-1998.

2,764,511. VITAMINS 4 LESS INC., NORTH HAMPTON, NH. SN 75-586,659. PUB. 1-25-2000, FILED 11-9-1998.

CLICK AND SAVE

FOR ELECTRONIC RETAILING SERVICES VIA COMPUTER FEATURING NUTRITIONAL AND DIETARY SUPPLEMENTS AND HEALTH RELATED PRODUCTS (U.S. CLS. 100, 101 AND 102).
FIRST USE 8-10-2001; IN COMMERCE 8-10-2001.

2,764,529. LIMCO, INC., WILMINGTON, DE. SN 75-652,664. PUB. 12-28-1999, FILED 3-3-1999.

THE LIMITED

OWNER OF U.S. REG. NOS. 1,020,794, 2,243,565, AND OTHERS.
FOR MAIL ORDER CATALOG SERVICES FEATURING CLOTHING (U.S. CLS. 100, 101 AND 102).
FIRST USE 7-0-2001; IN COMMERCE 7-0-2001.

CLASS 35—(Continued).

2,764,559. MITCHELL INTERNATIONAL, INC., SAN DIEGO, CA. BY ASSIGNMENT THOMSON FINANCE S.A., CH 6300 ZUG, SWITZERLAND. SN 75-719,718. PUB. 11-6-2001, FILED 6-2-1999.

INTOTAL

FOR PROVIDING REGULARLY UPDATED COMPARABLE VEHICLE INFORMATION IN ORDER TO ACCURATELY SETTLE A TOTAL LOSS CLAIM TO THE AUTOMOTIVE PHYSICAL DAMAGE MARKET VIA A WEBSITE ON GLOBAL COMPUTER NETWORKS (U.S. CLS. 100, 101 AND 102).

FIRST USE 4-23-1999; IN COMMERCE 4-23-1999.

2,764,570. NATIONAL ASPHALT PAVEMENT ASSOCIATION, LANHAM, MD. SN 75-742,721. PUB. 12-28-1999, FILED 7-1-1999.

WORLD OF ASPHALT

NO CLAIM IS MADE TO THE EXCLUSIVE RIGHT TO USE "ASPHALT", APART FROM THE MARK AS SHOWN.

FOR PROMOTING AND CONDUCTING TRADE SHOWS FOR OTHERS TO EXHIBIT AND PROMOTE GOODS AND SERVICES IN THE FIELD OF ASPHALT AND ASPHALT PAVING (U.S. CLS. 100, 101 AND 102).

FIRST USE 2-6-1999; IN COMMERCE 2-6-1999.

2,764,589. FORD MOTOR COMPANY, DEARBORN, MI. SN 75-799,969. PUB. 1-8-2002, FILED 9-15-1999.

FORD SUPPLIER NETWORK

OWNER OF U.S. REG. NOS. 74,530, 2,087,916, AND OTHERS.

NO CLAIM IS MADE TO THE EXCLUSIVE RIGHT TO USE "NETWORK", APART FROM THE MARK AS SHOWN.

FOR PROCUREMENT SERVICES OF MATERIALS, COMPONENTS, AND SERVICES USED IN THE MANUFACTURE OF MOTOR VEHICLES (U.S. CLS. 100, 101 AND 102).

FIRST USE 12-31-1997; IN COMMERCE 12-31-1997.

2,764,606. FAMILY OF FAITH MINISTRIES, MODESTO, CA. SN 75-835,900. PUB. 12-26-2000, FILED 10-29-1999.

CHRISTIANYELLOW PAGES.COM

OWNER OF U.S. REG. NO. 2,266,313. SEC. 2(F).

FOR ONLINE ADVERTISING OF CHRISTIAN BUSINESSES, MERCHANDISE AND SERVICES OF OTHERS THROUGH AN INTERACTIVE DIRECTORY ON A GLOBAL COMPUTER NETWORK (U.S. CLS. 100, 101 AND 102).

FIRST USE 10-1-2002; IN COMMERCE 10-1-2002.

CLASS 35—(Continued).

2,764,618. GATEWAY, INC., SAN DIEGO, CA. SN 75-855,495. PUB. 6-4-2002, FILED 12-10-1999.

Gateway@Work

OWNER OF U.S. REG. NOS. 1,624,580, 2,177,114, AND OTHERS.

FOR RETAIL STORE SERVICES AND RETAIL SERVICES BY DIRECT SOLICITATION BY SALES AGENTS, TO INDIVIDUALS, AS WELL AS CORPORATE AND GOVERNMENT ENTITIES, IN THE FIELD OF COMPUTERS, COMPUTER PERIPHERALS AND COMPUTER ACCESSORIES (U.S. CLS. 100, 101 AND 102).

FIRST USE 12-1-1999; IN COMMERCE 12-1-1999.

2,764,620. 1010DATA, INC., NEW YORK, NY, BY ASSIGNMENT KZS GROUP, LLC, THE, NEW YORK, NY. SN 75-859,014. PUB. 12-26-2000, FILED 11-29-1999.

1010data

FOR LICENSING OF COMPUTER SOFTWARE; COMPUTERIZED DATABASE MANAGEMENT; AND COMPUTERIZED DATABASE MANAGEMENT APPLICATION SERVICE OFFERED OVER A GLOBAL COMPUTER NETWORK (U.S. CLS. 100, 101 AND 102).

FIRST USE 1-21-2000; IN COMMERCE 1-21-2000.

2,764,628. IRONWORKS EXECUTIVE PARTNERS, INC., NEWFIELDS, NH. SN 75-875,236. PUB. 10-8-2002, FILED 12-29-1999.

IRONWORKS

FOR CONSULTING SERVICES, NAMELY, IN THE AREA OF HUMAN RESOURCES IN THE FIELD OF PERSONNEL RECRUITMENT (U.S. CLS. 100, 101 AND 102).

FIRST USE 10-13-1998; IN COMMERCE 10-13-1998.

CLASS 35—(Continued).

2,764,661. P.T. ON CALL, P.S., VANCOUVER, WA. SN 75-938,830. PUB. 6-18-2002, FILED 3-8-2000.



NO CLAIM IS MADE TO THE EXCLUSIVE RIGHT TO USE "RX ON CALL", APART FROM THE MARK AS SHOWN.

THE LINING IS A FEATURE OF THE MARK AND DOES NOT INDICATE COLOR.

FOR PHARMACY TEMPORARY STAFFING SERVICES (U.S. CLS. 100, 101 AND 102).

FIRST USE 9-27-2002; IN COMMERCE 9-27-2002.

2,764,665. LINGUISTIQUE ET INTELLIGENCE ARTIFICIELLE, DBA LIDIA S.A. 45000 ORLEANS, FRANCE. SN 75-980,776. PUB. 6-6-2000, FILED 12-29-1998.

LIDIA RETRIEVER

FOR BUSINESS CONSULTATION DIRECTED TO THE RESEARCH AND SCIENTIFIC ANALYSIS OF THE SYNTAX OF WRITTEN AND VERBAL COMMUNICATIONS, WITH PARTICULAR REGARD TO DISCERNING THE MAIN IDEAS OF SUCH COMMUNICATIONS AND THEIR ASSOCIATED IDEAS, ESPECIALLY TO ENABLE INTELLIGENT INDEXING OF SUCH COMMUNICATIONS (U.S. CLS. 100, 101 AND 102).

FIRST USE 2-28-1997; IN COMMERCE 2-28-1997.

2,764,670. TELIGENT, INC., HERNDON, VA. SN 75-983,298. PUB. 5-8-2001, FILED 12-6-1999.

E-MAGINE

FOR ELECTRONIC BILLING; BUSINESS MANAGEMENT, NAMELY, PROVIDING ACCOUNT MANAGEMENT, TROUBLE-SHOOTING AND OTHER CUSTOMER SUPPORT SERVICES VIA THE INTERNET (U.S. CLS. 100, 101 AND 102).

FIRST USE 4-1-2003; IN COMMERCE 4-1-2003.

2,764,676. U.S. HEALTH CLUB, INC., HASTINGS-ON-HUDSON, NY. SN 76-010,181. PUB. 7-17-2001, FILED 3-27-2000.

USHC

FOR ONLINE CATALOG SERVICES IN THE FIELD OF NUTRITIONAL SUPPLEMENTS AND HEALTHCARE PRODUCTS, EXCLUDING INSURANCE PRODUCTS (U.S. CLS. 100, 101 AND 102).

FIRST USE 6-3-2003; IN COMMERCE 6-3-2003.

CLASS 35—(Continued).

2,764,706. INSPIRATIONAL NETWORK, INC., THE, CHARLOTTE, NC. SN 76-048,503. PUB. 9-10-2002, FILED 5-15-2000.

INSPIRATIONAL MALL

NO CLAIM IS MADE TO THE EXCLUSIVE RIGHT TO USE "MALL", APART FROM THE MARK AS SHOWN.

FOR RETAIL STORE SERVICES, FEATURING GOODS OF A RELIGIOUS OR SPIRITUAL NATURE, NAMELY, BOOKS, BIBLES, PRE-RECORDED AUDIO CASSETTES, PRE-RECORDED VIDEO TAPES, CDS, ART PRINTS, PICTURE FRAMES, AND DRINKING MUGS, VIA A GLOBAL COMPUTER NETWORK (U.S. CLS. 100, 101 AND 102).

FIRST USE 9-30-1999; IN COMMERCE 9-30-1999.

2,764,715. ANCHOR PHARMACIES, INC., HAMPSTEAD, MD. SN 76-060,645. PUB. 1-15-2002, FILED 5-31-2000.

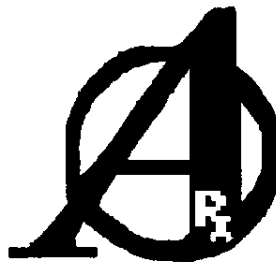

NO CLAIM IS MADE TO THE EXCLUSIVE RIGHT TO USE "RX", APART FROM THE MARK AS SHOWN.

FOR RETAIL PHARMACY STORE SERVICES (U.S. CLS. 100, 101 AND 102).

FIRST USE 8-0-2001; IN COMMERCE 8-0-2001.

2,764,718. AD*ITIVE, LLC, THE, NEW YORK, NY, BY ASSIGNMENT ARNOLD COMMUNICATIONS, INC., BOSTON, MA. SN 76-062,797. PUB. 10-15-2002, FILED 6-5-2000.

Ad•itive

FOR ADVERTISING SERVICES, NAMELY, CREATIVE PLANNING IN THE NATURE OF DEVELOPING COMMERCIAL BRANDS (U.S. CLS. 100, 101 AND 102).

FIRST USE 7-18-2000; IN COMMERCE 7-18-2000.

CLASS 35—(Continued).

2,764,721. BUCKMAN LABORATORIES INTERNATIONAL, INC., MEMPHIS, TN. SN 76-065,658. PUB. 3-19-2002, FILED 6-7-2000.

K'NEXIONS

FOR E-COMMERCE SERVICES, NAMELY, PROVIDING ONLINE ORDERING SERVICES IN THE FIELD OF CHEMICALS (U.S. CLS. 100, 101 AND 102).
FIRST USE 10-0-2000; IN COMMERCE 10-0-2000.

2,764,724. FOSTER, KAY S., NEW YORK, NY. SN 76-067,672. PUB. 4-9-2002, FILED 6-8-2000.

FOSTER MARINE ART

NO CLAIM IS MADE TO THE EXCLUSIVE RIGHT TO USE "MARINE ART", APART FROM THE MARK AS SHOWN.
FOR ART GALLERIES (U.S. CLS. 100, 101 AND 102).
FIRST USE 5-17-2003; IN COMMERCE 5-17-2003.

2,764,761. TRUCKLOAD USA, INC., DALLAS, TX, BY MERGER TRUCKLOAD USA, INC., DALLAS, TX. SN 76-097,527. PUB. 6-4-2002, FILED 7-26-2000.

TRUCKLOAD

FOR RETAIL STORES, DIRECT SALES REPRESENTATIVES AND ONLINE RETAIL STORE SERVICES FEATURING COMMERCIAL AND RESIDENTIAL BUILDING AND CONSTRUCTION MATERIALS, EQUIPMENT, SUPPLIES AND TOOLS (U.S. CLS. 100, 101 AND 102).
FIRST USE 9-0-2000; IN COMMERCE 9-0-2000.

2,764,820. LEO BURNETT WORLDWIDE, INC., CHICAGO, IL. SN 76-144,857. PUB. 9-25-2001, FILED 10-10-2000.

BRANDSTRETCH

FOR ADVERTISING AGENCY SERVICES (U.S. CLS. 100, 101 AND 102).
FIRST USE 8-0-2002; IN COMMERCE 11-0-2002.

CLASS 35—(Continued).

2,764,830. ALPHADIRECTIONS, INC., PORTSMOUTH, NH. SN 76-154,787. PUB. 1-8-2002, FILED 10-27-2000.

A SWIRL WITH AN ARROW SUPERIMPOSED OVER WORD MARK.
FOR BUSINESS CONSULTATION SERVICES, NAMELY, DEVELOPING HUMAN RESOURCE MANAGEMENT OPERATIONS FOR BUSINESSES BY EVALUATING AND ANALYZING THE BUSINESS' HUMAN RESOURCE STRATEGIES AND DESIGNING APPROPRIATE PROCESSES AND SYSTEMS AND IMPLEMENTING THE DESIGNED PROCESSES AND SYSTEMS (U.S. CLS. 100, 101 AND 102).
FIRST USE 12-13-2001; IN COMMERCE 12-13-2001.

2,764,872. CD PEO PLUS LLC, ST. PETE BEACH, FL. SN 76-179,733. PUB. 8-28-2001, FILED 12-12-2000.

PEOPLE PREMIER

FOR EMPLOYEE LEASING (U.S. CLS. 100, 101 AND 102).
FIRST USE 1-1-2001; IN COMMERCE 1-1-2001.

2,764,880. SCHNEIDER, LONE, SAN FRANCISCO, CA. AND SCHNEIDER, CHRISTIAN, SAN FRANCISCO, CA. DBA IDEAGARDEN, SN 76-186,074. PUB. 7-17-2001, FILED 12-26-2000.

IDEAGARDEN

FOR ADVERTISING SERVICES, NAMELY, CONSULTING REGARDING STRATEGIES AND CONCEPT DEVELOPMENT FOR ADVERTISING AND PROMOTION AND THE USE OF VIDEO AND PORTRAITURE IN ADVERTISING AND PROMOTION (U.S. CLS. 100, 101 AND 102).
FIRST USE 8-30-1999; IN COMMERCE 8-30-1999.

2,764,899. SYSTEMS RESEARCH & DEVELOPMENT, LAS VEGAS, NV. SN 76-203,034. PUB. 10-30-2001, FILED 1-31-2001.

NORA

FOR BUSINESS CONSULTATION SERVICES IN THE NATURE OF INFORMATION RETENTION, INFORMATION PROCESSING, INFORMATION EVALUATION, INFORMATION UTILIZATION AND INFORMATION MANAGEMENT (U.S. CLS. 100, 101 AND 102).
FIRST USE 11-2-2001; IN COMMERCE 11-2-2001.

CLASS 35—(Continued).

2,764,907. PUBLIC INTEREST DATA, INC., ALEXANDRIA, VA. SN 76-208,926. PUB. 12-11-2001, FILED 2-12-2001.

SERVING NONPROFITS WITH LEADING-EDGE DATABASE SOLUTIONS

FOR COMPUTERIZED DATABASE MANAGEMENT FOR NON-PROFIT ORGANIZATIONS (U.S. CLS. 100, 101 AND 102).
FIRST USE 3-0-2001; IN COMMERCE 3-0-2001.

2,764,945. 3W GMBH, 81379 MUNCHEN, FED REP GERMANY. SN 76-234,825. PUB. 8-27-2002, FILED 4-2-2001.

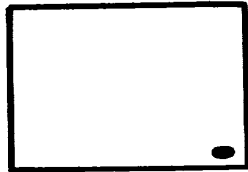

PRIORITY CLAIMED UNDER SEC. 44(D) ON FED REP GERMANY APPLICATION NO. 30073411.5, FILED 10-2-2000, REG. NO. 30073411, DATED 9-18-2001, EXPIRES 10-31-2010.

FOR PROVIDING A WEBSITE FEATURING INFORMATION IN THE FIELD OF BUSINESS MANAGEMENT, MARKETING AND ADVERTISING, COMPLETION OF CONTRACTS FOR THE SALE OF GOODS AND SERVICES ON THE INTERNET, NAMELY, RETAIL AND WHOLESALE SERVICES PROVIDED OVER THE INTERNET, PROCUREMENT SERVICES, ON-LINE ORDERING SERVICES FEATURING FRAMED AND UNFRAMED PRINTS, GRAPHICS, POSTERS, CARDS, CALENDARS, ART SUPPLIES, GIFT ITEMS, CD-ROMS; PROVIDING DATABASES FEATURING DIRECTORIES OF RETAILERS AND WHOLESALE; MARKETING SERVICES NAMELY PROMOTING THE GOODS AND SERVICES OF OTHERS THROUGH THE DISTRIBUTION OF PROMOTIONAL MATERIALS AND COUPONS; MARKETING CONSULTATION; MARKET RESEARCH; MARKET ANALYSIS; PUBLIC OPINION POLLING FOR BUSINESS OR ADVERTISING PURPOSES; PROMOTING THE SALE OF GOODS AND SERVICES OF OTHERS THROUGH THE DISTRIBUTION OF PRINTED MATERIAL AND PROMOTIONAL CONTESTS; BUSINESS CONSULTING; ORGANIZATION CONSULTING, NAMELY PERSONAL MANAGEMENT CONSULTATION, BUSINESS MANAGEMENT CONSULTATION; INFORMATION SERVICES, NAMELY, COMPILATION, PREPARATION, ACCUMULATION, AND DISTRIBUTION OF BUSINESS AND COMPANY INFORMATION IN THE NATURE OF PROVIDING BUSINESS FINANCIAL AND DEMOGRAPHIC DATA (U.S. CLS. 100, 101 AND 102).
FIRST USE 5-1-2000; IN COMMERCE 5-1-2000.

CLASS 35—(Continued).

2,764,948. HUNES HOME FURNISHINGS, INC., WILMINGTON, DE. SN 76-235,225. PUB. 11-19-2002, FILED 4-4-2001.

MULTIVIEW

FOR INFORMATION SERVICES, NAMELY, PROVIDING DIGITAL IMAGES OF TEXTILE GOODS OF OTHERS VIA THE INTERNET (U.S. CLS. 100, 101 AND 102).

FIRST USE 4-24-2001; IN COMMERCE 4-24-2001.

2,764,975. SINGAPORE EXCHANGE LIMITED, #19-00 SGX CENTRE 1, SINGAPORE. SN 76-249,312. PUB. 7-30-2002, FILED 5-1-2001.

SGX

FOR BUSINESS INFORMATION MANAGEMENT RELATING TO SECURITIES, DERIVATIVES AND COMMODITIES EXCHANGE QUOTATIONS, NAMELY, SERVICES CONSISTING OF COMPUTATION, COMPILATION, ECONOMIC ANALYSIS, MAINTENANCE AND ADMINISTRATION OF DATA RELATING TO SECURITIES, DERIVATIVES AND COMMODITIES EXCHANGE PRICES; BUSINESS AND COMMERCIAL INFORMATION SERVICES IN THE FIELD OF SECURITIES, DERIVATIVES AND COMMODITIES EXCHANGE INFORMATION, CORPORATE FINANCIAL STATEMENTS, CORPORATE EARNINGS ESTIMATES, MARKET RESEARCH; PROVIDING STATISTICAL INFORMATION; PROVISION OF FOREIGN TRADE INFORMATION, NAMELY, FOREIGN TRADE STATISTICS, SECURITIES, DERIVATIVES AND COMMODITIES, AND BONDS EXCHANGE INFORMATION; SHAREHOLDER RECORD KEEPING SERVICES, NAMELY, SHARE REGISTRATION AND NOMINEE SERVICES; SHAREHOLDER RECORD KEEPING SERVICES PROVIDED ONLINE FROM A COMPUTER DATABASE OR VIA THE INTERNET OR EXTRANETS OR BY MEANS OF GLOBAL COMPUTER COMMUNICATIONS NETWORKS (U.S. CLS. 100, 101 AND 102).
FIRST USE 8-1-2000; IN COMMERCE 8-1-2000.

2,764,984. CRN INTERNATIONAL, INC., HAMDEN, CT. SN 76-256,666. PUB. 7-16-2002, FILED 5-14-2001.

RACEPASS

FOR MARKETING SERVICES, NAMELY, DEVELOPING RADIO PROGRAMS, PROMOTIONS, CONTESTS, AND EVENTS FOR OTHERS TO MEET THEIR SPECIFIC CONSUMER AND TRADE MARKETING OBJECTIVES (U.S. CLS. 100, 101 AND 102).
FIRST USE 2-0-2001; IN COMMERCE 2-0-2001.

CLASS 35—(Continued).

2,765,002. COLUMBIA FOREST PRODUCTS, INC., PORTLAND, OR. SN 76-264,852. PUB. 3-19-2002, FILED 5-30-2001.

CFP REWARDS

NO CLAIM IS MADE TO THE EXCLUSIVE RIGHT TO USE "REWARDS", APART FROM THE MARK AS SHOWN. FOR AWARD PROGRAM, NAMELY PROMOTING THE SALE OF PRODUCTS THROUGH THE ADMINISTRATION OF AN INCENTIVE PROGRAM (U.S. CLS. 100, 101 AND 102).
FIRST USE 1-1-2000; IN COMMERCE 1-1-2000.

2,765,019. SINGAPORE EXCHANGE LIMITED, #19-00 SGX CENTRE 1, SINGAPORE. SN 76-268,297. PUB. 10-15-2002, FILED 6-6-2001.



FOR BUSINESS INFORMATION MANAGEMENT RELATING TO SECURITIES, DERIVATIVES AND COMMODITIES EXCHANGE QUOTATIONS, NAMELY, SERVICES CONSISTING OF COMPUTATION, COMPILATION, ECONOMIC ANALYSIS, MAINTENANCE AND ADMINISTRATION OF DATA RELATING TO SECURITIES, DERIVATIVES AND COMMODITIES EXCHANGE PRICES; BUSINESS AND COMMERCIAL INFORMATION SERVICES IN THE FIELD OF SECURITIES, DERIVATIVES AND COMMODITIES EXCHANGE INFORMATION, CORPORATE FINANCIAL STATEMENTS, CORPORATE EARNINGS ESTIMATES, MARKET RESEARCH; PROVIDING STATISTICAL INFORMATION; PROVISION OF FOREIGN TRADE INFORMATION, NAMELY, FOREIGN TRADE STATISTICS, SECURITIES, DERIVATIVES AND COMMODITIES, AND BONDS EXCHANGE INFORMATION; SHAREHOLDER RECORD KEEPING SERVICES, NAMELY, SHARE REGISTRATION AND NOMINEE SERVICES; SHAREHOLDER RECORD KEEPING SERVICES PROVIDED ONLINE FROM A COMPUTER DATABASE OR VIA THE INTERNET OR EXTRANETS OR BY MEANS OF GLOBAL COMPUTER COMMUNICATIONS NETWORKS (U.S. CLS. 100, 101 AND 102).
FIRST USE 8-1-2000; IN COMMERCE 8-1-2000.

CLASS 35—(Continued).

2,765,026. PEOPLECLICK, INC., RALEIGH, NC. SN 76-269,632. PUB. 8-20-2002, FILED 6-11-2001.



THE MARK IS LINED FOR THE COLORS RED, GREEN AND BLUE.
FOR EMPLOYEE RECRUITMENT AND HUMAN RESOURCE MANAGEMENT SERVICES RENDERED OVER A GLOBAL COMPUTER NETWORK; EMPLOYEE RECRUITMENT AND HUMAN RESOURCE MANAGEMENT CONSULTATION SERVICES (U.S. CLS. 100, 101 AND 102).
FIRST USE 8-0-2001; IN COMMERCE 8-0-2001.

2,765,094. WORK AT HOME AND LOVE IT, CORP., DELRAY BEACH, FL. SN 76-299,948. PUB. 4-2-2002, FILED 8-14-2001.



NO CLAIM IS MADE TO THE EXCLUSIVE RIGHT TO USE "WORK AT HOME", APART FROM THE MARK AS SHOWN.
THE MARK CONSISTS OF THE DESIGN OF A HOUSE AND THE SETTING SUN PLUS THE WORDS "WORK AT HOME AND LOVE IT".
FOR BUSINESS MANAGEMENT, BUSINESS CONSULTATION AND NETWORKING, NAMELY PROVIDING INFORMATION RELATING TO MULTI-LEVEL MARKETING BUSINESS SERVICES (U.S. CLS. 100, 101 AND 102).
FIRST USE 9-30-2001; IN COMMERCE 9-30-2001.

2,765,120. MOTIVATION EXCELLENCE, INC., SCHAMBURG, IL. SN 76-308,635. PUB. 2-19-2002, FILED 8-27-2001.

POWERBUILDER

FOR INCENTIVE AWARD AND CUSTOMER LOYALTY PROGRAMS TO PROMOTE THE SALE OF PRODUCTS AND SERVICES OF OTHERS (U.S. CLS. 100, 101 AND 102).
FIRST USE 12-0-2002; IN COMMERCE 12-0-2002.

CLASS 35—(Continued).

2,765,131. GREATER GREENVILLE CHAMBER OF COMMERCE, GREENVILLE, SC. SN 76-311,652. PUB. 4-9-2002, FILED 9-12-2001.



FOR CHAMBER OF COMMERCE SERVICES, NAMELY, PROMOTING BUSINESS AND TOURISM IN THE UPSTATE AREA OF SOUTH CAROLINA (U.S. CLS. 100, 101 AND 102).
FIRST USE 7-17-2002; IN COMMERCE 8-3-2002.

2,765,152. VERIDIAN CORPORATION, ARLINGTON, VA. SN 76-319,564. PUB. 10-1-2002, FILED 10-1-2001.

VERITRACKS

FOR TRACKING, MONITORING AND LOCATING PERSONS VIA A PORTABLE ELECTRONIC DEVICE WHICH RECEIVES AND TRANSMITS LOCATION DATA FROM A GPS SYSTEM OR RADIO FREQUENCY SYSTEM (U.S. CLS. 100, 101 AND 102).
FIRST USE 4-0-2001; IN COMMERCE 4-0-2001.

2,765,163. MOTIVATION EXCELLENCE, INC., SCHAUMBURG, IL. SN 76-322,514. PUB. 11-12-2002, FILED 10-5-2001.

THE HOSPITALITY CLUB

NO CLAIM IS MADE TO THE EXCLUSIVE RIGHT TO USE "CLUB", APART FROM THE MARK AS SHOWN.
FOR BUSINESS-TO-BUSINESS INCENTIVE AWARD AND CUSTOMER LOYALTY PROGRAMS TO PROMOTE THE SALE OF PRODUCTS AND SERVICES OF OTHERS, EXCLUDING TRANSPORTATION SERVICES, NAMELY AN AWARD PROGRAM WITHIN A FREQUENT TRAVELER PROGRAM (U.S. CLS. 100, 101 AND 102).
FIRST USE 8-0-2002; IN COMMERCE 8-0-2002.

CLASS 35—(Continued).

2,765,194. SPECTRUM MANAGEMENT, L.L.C., CARROLLTON, TX. SN 76-329,869. PUB. 8-27-2002, FILED 10-23-2001.



NO CLAIM IS MADE TO THE EXCLUSIVE RIGHT TO USE "MANAGEMENT", APART FROM THE MARK AS SHOWN.

FOR DISTRIBUTORSHIPS OF ELECTRONIC TRACKING DEVICES TO BE USED IN CONNECTION WITH LAW ENFORCEMENT (U.S. CLS. 100, 101 AND 102).
FIRST USE 3-1-2000; IN COMMERCE 3-1-2000.

2,765,196. PR NEWswire ASSOCIATION, INC., NEW YORK, NY. SN 76-330,720. PUB. 12-31-2002, FILED 10-25-2001.

RELEASEWATCH

FOR ELECTRONIC MONITORING SERVICES VIA THE INTERNET, NAMELY THE MONITORING OF PRESS RELEASES IN THE FIELDS OF CORPORATE BUSINESS DATA AND BUSINESS NEWS POSTINGS AND ISSUING REPORTS IN CONNECTION THEREWITH (U.S. CLS. 100, 101 AND 102).
FIRST USE 12-4-2001; IN COMMERCE 12-4-2001.

2,765,205. GADGET SHOP LIMITED, THE, GLASGOW, SCOTLAND. SN 76-334,599. PUB. 7-16-2002, FILED 11-5-2001.

GADGETSHOP

FOR RETAIL STORE SERVICES, PROVIDING HOME SHOPPING SERVICES BY MEANS OF TELEVISION, MAIL ORDER CATALOG SERVICES, AND ON-LINE RETAIL STORE SERVICES, ALL FEATURING A WIDE VARIETY OF CONSUMER GOODS OF OTHERS (U.S. CLS. 100, 101 AND 102).
FIRST USE 3-0-1991; IN COMMERCE 10-13-1999.

CLASS 35—(Continued).

2,765,210. JACKSON ORGANIZATION, INC., THE, COLUMBIA, MD. SN 76-336,608. PUB. 1-28-2003, FILED 11-13-2001.

TQA - TOTAL QUALITY ASSESSMENT

NO CLAIM IS MADE TO THE EXCLUSIVE RIGHT TO USE "QUALITY ASSESSMENT", APART FROM THE MARK AS SHOWN.

FOR BUSINESS CONSULTATION SERVICES; MARKET AND BUSINESS RESEARCH SERVICES; CONDUCTING BUSINESS AND MARKET RESEARCH SURVEYS (U.S. CLS. 100, 101 AND 102).

FIRST USE 4-0-2003; IN COMMERCE 4-28-2003.

2,765,214. THE JACKSON ORGANIZATION, INC., COLUMBIA, MD. SN 76-337,834. PUB. 5-14-2002, FILED 11-15-2001.

OCA

FOR BUSINESS CONSULTATION SERVICES; MARKET AND BUSINESS RESEARCH SERVICES; CONDUCTING BUSINESS AND MARKET RESEARCH SURVEYS, ALL OF THE FOREGOING SERVICES BEING PROVIDED TO BUSINESSES (U.S. CLS. 100, 101 AND 102).

FIRST USE 10-0-2001; IN COMMERCE 10-0-2001.

2,765,227. NEW YORK STATE DEPARTMENT OF ECONOMIC DEVELOPMENT, ALBANY, NY. SN 76-340,790. PUB. 9-3-2002, FILED 11-21-2001.



NO CLAIM IS MADE TO THE EXCLUSIVE RIGHT TO USE "NY", APART FROM THE MARK AS SHOWN.

THE MARK CONSISTS OF A HEART'S UPPER LEFT QUADRANT OF A BLUE BACKGROUND WITH WHITE STARS. THE REMAINING PORTIONS OF THE HEART CONSIST OF HORIZONTAL STRIPES OF EQUAL THICKNESS. THE STRIPES ALTERNATE IN COLOR. BEGINNING FROM THE TOP AND EVERY OTHER STRIPE MOVING DOWN TO THE BOTTOM IS RED. THE SECOND STRIPE AND EVERY OTHER STRIPE THEREAFTER IS WHITE. THUS, THE LETTERING IS BLACK AND THE HEART CONSISTS OF A RED, WHITE AND BLUE DESIGN.

FOR PROMOTING THE ECONOMIC DEVELOPMENT OF NEW YORK STATE (U.S. CLS. 100, 101 AND 102).

FIRST USE 0-0-2002; IN COMMERCE 0-0-2002.

CLASS 35—(Continued).

2,765,228. NEW YORK STATE DEPARTMENT OF ECONOMIC DEVELOPMENT, ALBANY, NY. SN 76-340,791. PUB. 9-10-2002, FILED 11-21-2001.



NO CLAIM IS MADE TO THE EXCLUSIVE RIGHT TO USE "NY", APART FROM THE MARK AS SHOWN.

THE MARK CONSISTS OF A HEART'S UPPER LEFT QUADRANT OF A BLUE BACKGROUND WITH WHITE STARS. THE REMAINING PORTIONS OF THE HEART CONSIST OF HORIZONTAL STRIPES OF EQUAL THICKNESS. THE STRIPES ALTERNATE IN COLOR. BEGINNING FROM THE TOP AND EVERY OTHER STRIPE MOVING DOWN TO THE BOTTOM IS RED. THE SECOND STRIPE AND EVERY OTHER STRIPE THEREAFTER IS WHITE. THUS, THE LETTERING IS BLACK AND THE HEART CONSISTS OF A RED, WHITE AND BLUE DESIGN.

FOR PROMOTING THE ECONOMIC DEVELOPMENT OF NEW YORK STATE (U.S. CLS. 100, 101 AND 102).

FIRST USE 0-0-2002; IN COMMERCE 0-0-2002.

2,765,236. PHOENIX INTANGIBLES HOLDING COMPANY, WILMINGTON, DE. SN 76-343,807. PUB. 10-22-2002, FILED 11-30-2001.

GIANT EAGLE WIRELESS

OWNER OF U.S. REG. NOS. 1,287,433, 2,521,719, AND OTHERS.

NO CLAIM IS MADE TO THE EXCLUSIVE RIGHT TO USE "WIRELESS", APART FROM THE MARK AS SHOWN.

FOR RETAIL STORE SERVICES, NAMELY, A DEPARTMENT IN A SUPERMARKET, FEATURING PAGERS, CELLULAR TELEPHONES AND PAGER AND CELLULAR TELEPHONE SERVICE PLANS OF OTHERS TELEPHONE CARDS, PERSONAL DIGITAL ASSISTANTS AND INTERNET ACCESS SERVICES OF OTHERS (U.S. CLS. 100, 101 AND 102).

FIRST USE 6-0-2002; IN COMMERCE 6-0-2002.

CLASS 35—(Continued).

2,765,249. THORNTON OIL CORPORATION, LOUISVILLE, KY. SN 76-346,712. PUB. 7-9-2002, FILED 12-10-2001.

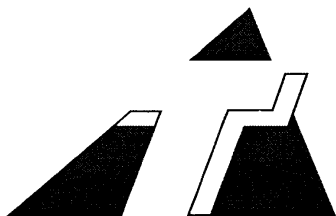

FOR RETAIL STORE SERVICES FEATURING CONVENIENCE STORE ITEMS AND GASOLINE (U.S. CLS. 100, 101 AND 102).
FIRST USE 1-1-2002; IN COMMERCE 1-1-2002.

2,765,261. FRESH BRANDS, INC., SHEBOYGAN, WI. SN 76-350,302. PUB. 8-20-2002, FILED 12-19-2001.

MARKETCIRCLE

FOR RETAIL SUPERMARKETS AND RETAIL GROCERY STORE SERVICES; DISTRIBUTORSHIP SERVICES IN THE FIELD OF RETAIL SUPERMARKETS AND RETAIL GROCERY STORES (U.S. CLS. 100, 101 AND 102).
FIRST USE 12-15-2002; IN COMMERCE 12-15-2002.

2,765,277. HOK GROUP, INC., ST. LOUIS, MO. SN 76-355,023. PUB. 1-28-2003, FILED 1-3-2002.

ADVANCE STRATEGIES

NO CLAIM IS MADE TO THE EXCLUSIVE RIGHT TO USE "STRATEGIES", APART FROM THE MARK AS SHOWN.

FOR WORKPLACE FACILITIES CONSULTATION IN THE FIELD OF WORKPLACE BUILDINGS FACILITY PLANNING AND MANAGEMENT, EXCLUDING GENERAL BUSINESS MANAGEMENT AND CONSULTING SERVICES (U.S. CLS. 100, 101 AND 102).
FIRST USE 3-26-2003; IN COMMERCE 3-26-2003.

2,765,279. GLUCHANICZ, PAUL, WAYNE, PA. SN 76-355,791. PUB. 7-30-2002, FILED 1-3-2002.

LOTTOMATIC

FOR RETAIL SALE SERVICES FEATURING LOTTERY TICKETS ON A SUBSCRIPTION BASIS (U.S. CLS. 100, 101 AND 102).
FIRST USE 3-7-2003; IN COMMERCE 3-7-2003.

CLASS 35—(Continued).

2,765,293. AL HENDRICKSON TOYOTA, INC., COCONUT CREEK, FL. SN 76-359,332. PUB. 8-13-2002, FILED 1-17-2002.

IT'S ALL ABOUT YOU

FOR AUTOMOBILE DEALERSHIP SERVICES (U.S. CLS. 100, 101 AND 102).
FIRST USE 5-1-2002; IN COMMERCE 5-1-2002.

2,765,318. BJC HEALTH SYSTEM, ST. LOUIS, MO. SN 76-364,958. PUB. 8-20-2002, FILED 1-30-2002.

PhyFocu\$

FOR BILLING SERVICES FOR PHYSICIANS (U.S. CLS. 100, 101 AND 102).
FIRST USE 11-18-2001; IN COMMERCE 11-18-2001.

2,765,319. ASPENWOOD ADVERTISING, INC., MINERAL WELLS, WV. SN 76-365,189. PUB. 8-27-2002, FILED 1-30-2002.

ASPENWOOD ADVERTISING

NO CLAIM IS MADE TO THE EXCLUSIVE RIGHT TO USE "ADVERTISING", APART FROM THE MARK AS SHOWN.

FOR ADVERTISING SERVICES, NAMELY, PROMOTING THE GOODS AND SERVICES OF OTHERS (U.S. CLS. 100, 101 AND 102).
FIRST USE 5-27-2003; IN COMMERCE 5-27-2003.

2,765,326. NETTIE'S FLOWER GARDEN, INC., ST. LOUIS, MO. SN 76-368,619. PUB. 9-10-2002, FILED 2-9-2002.

**FLOWERS
WITHIN HOURS**

FOR RETAIL FLORAL SHOP SERVICES (U.S. CLS. 100, 101 AND 102).
FIRST USE 5-12-2003; IN COMMERCE 5-12-2003.

CLASS 35—(Continued).

2,765,339. CAPSICUM GROUP, L.L.C., BERWYN, PA, BY ASSIGNMENT CAPSICUM GROUP, INC., BERWYN, PA. SN 76-372,857. PUB. 9-17-2002, FILED 2-20-2002.

CAPSICUM

FOR BUSINESS AND MANAGEMENT CONSULTATION SERVICES RELATING TO BUSINESS ORGANIZATION, BUSINESS MANAGEMENT AND PLANNING, BUSINESS DEVELOPMENT SERVICES, BUSINESS MARKETING SERVICES, BUSINESS ADMINISTRATION AND BUSINESS PROCESS REENGINEERING, CONTRACT NEGOTIATION, BUSINESS OUTSOURCING, BUSINESS IMPLEMENTATION, BUSINESS INFRASTRUCTURE DEVELOPMENT AND MANAGEMENT, COST PRICE ANALYSIS, AND STRATEGIC PLANNING IN THE TECHNOLOGY INDUSTRY (U.S. CLS. 100, 101 AND 102).

FIRST USE 3-1-2002; IN COMMERCE 3-1-2002.

2,765,353. BEACHWOOD PACKAGING CORPORATION, BEACHWOOD, OH. SN 76-376,203. PUB. 1-14-2003, FILED 2-28-2002.

SWEET PACKAGING

NO CLAIM IS MADE TO THE EXCLUSIVE RIGHT TO USE "PACKAGING", APART FROM THE MARK AS SHOWN.

FOR WHOLESALE DISTRIBUTORSHIP FEATURING PACKAGING PRODUCTS, NAMELY SPECIALLY DESIGNED BOXES (U.S. CLS. 100, 101 AND 102).

FIRST USE 4-1-2002; IN COMMERCE 4-1-2002.

2,765,358. GRAY, MICHAEL C., SAN JOSE, CA. SN 76-377,009. PUB. 10-22-2002, FILED 3-1-2002.

TAXTRIMMERS

FOR BUSINESS MANAGEMENT; BUSINESS MANAGEMENT, NAMELY BUSINESS ADMINISTRATION; ACCOUNTING SERVICES; BUSINESS MANAGEMENT AND ACCOUNTING CONSULTING SERVICES (U.S. CLS. 100, 101 AND 102).

FIRST USE 5-1-2003; IN COMMERCE 5-1-2003.

2,765,364. AMC, INC., ATLANTA, GA. SN 76-377,408. PUB. 11-26-2002, FILED 3-1-2002.

AMERICASMART PREMIERE

OWNER OF U.S. REG. NOS. 2,076,918 AND 2,312,742. FOR ARRANGING AND CONDUCTING TRADE SHOWS FEATURING UPSCALE APPAREL AND FASHION ACCESSORIES (U.S. CLS. 100, 101 AND 102).

FIRST USE 4-0-2002; IN COMMERCE 4-0-2002.

CLASS 35—(Continued).

2,765,378. MICHAELS MANAGEMENT SERVICES, LP, IRVING, TX. SN 76-381,085. PUB. 9-17-2002, FILED 3-8-2002.

VILLAGE CRAFTS BY MICHAELS

OWNER OF U.S. REG. NOS. 1,222,952, 2,486,259, AND OTHERS.

NO CLAIM IS MADE TO THE EXCLUSIVE RIGHT TO USE "VILLAGE CRAFTS", APART FROM THE MARK AS SHOWN.

FOR RETAIL STORE SERVICES FOR THE SALE OF PICTURE FRAMING MATERIALS, SILK AND DRIED FLOWERS, HOBBY AND ART SUPPLIES, CREATIVE CRAFTS, HOME DECOR ITEMS, AND PARTY, SEASONAL AND HOLIDAY MERCHANDISE (U.S. CLS. 100, 101 AND 102).

FIRST USE 4-15-2003; IN COMMERCE 4-15-2003.

2,765,405. INSTITUTE FOR INTERNATIONAL RESEARCH, NEW YORK, NY. SN 76-391,406. PUB. 11-5-2002, FILED 4-4-2002.



NO CLAIM IS MADE TO THE EXCLUSIVE RIGHT TO USE "PREPAID" AND "EXPO", APART FROM THE MARK AS SHOWN.

FOR ARRANGING AND CONDUCTING CONFERENCES, TRAINING COURSES, WORKSHOPS, SEMINARS AND EXPOSITIONS IN THE FIELD OF PREPAID TELECOMMUNICATIONS (U.S. CLS. 100, 101 AND 102).

FIRST USE 3-1-2002; IN COMMERCE 3-1-2002.

2,765,427. MILTON'S DISTRIBUTING CO., INC., NORWOOD, MA. SN 76-400,425. PUB. 12-24-2002, FILED 4-27-2002.

SIGNATURE IMPORTS

NO CLAIM IS MADE TO THE EXCLUSIVE RIGHT TO USE "IMPORTS", APART FROM THE MARK AS SHOWN.

FOR IMPORT AGENCIES IN THE FIELD OF WINE, BEER AND ALCOHOL; BUSINESS MARKETING CONSULTING SERVICES FOR OTHERS IN THE FIELD OF WINE, BEER AND ALCOHOL; AND DISTRIBUTORSHIPS IN THE FIELD OF WINE, BEER AND ALCOHOL (U.S. CLS. 100, 101 AND 102).

FIRST USE 7-29-2002; IN COMMERCE 7-29-2002.

CLASS 35—(Continued).

2,765,442. MAIN ST. SUPPLY CO., LLC, MONROE, NC. SN 76-407,722. PUB. 11-12-2002, FILED 5-8-2002.

...THE GENERAL STORE FOR THE NEXT GENERATION.

FOR ON-LINE RETAIL STORE SERVICES FEATURING HOUSEWARE AND HARDWARE PRODUCTS (U.S. CLS. 100, 101 AND 102).
FIRST USE 4-22-2002; IN COMMERCE 5-10-2002.



2,765,443. MAIN ST. SUPPLY CO., LLC, MONROE, NC. SN 76-407,723. PUB. 11-12-2002, FILED 5-8-2002.



NO CLAIM IS MADE TO THE EXCLUSIVE RIGHT TO USE "SUPPLY", APART FROM THE MARK AS SHOWN.
FOR ON-LINE RETAIL STORE SERVICES FEATURING HOUSEWARE AND HARDWARE PRODUCTS (U.S. CLS. 100, 101 AND 102).
FIRST USE 2-4-2002; IN COMMERCE 5-10-2002.



2,765,449. SEQUENT, INC., COLUMBUS, OH, BY CHANGE OF NAME ALLIED EMPLOYER RESOURCES, INC., COLUMBUS, OH. SN 76-409,131. PUB. 12-10-2002, FILED 5-16-2002.

SEQUENT

FOR PROVIDING HUMAN RESOURCES SERVICES TO OTHERS (U.S. CLS. 100, 101 AND 102).
FIRST USE 10-1-2002; IN COMMERCE 10-1-2002.



2,765,474. KOHL'S ILLINOIS, INC., AURORA, IL. SN 76-416,307. PUB. 12-10-2002, FILED 6-3-2002.

KOHL'S BRIDAL AISLE

NO CLAIM IS MADE TO THE EXCLUSIVE RIGHT TO USE "BRIDAL", APART FROM THE MARK AS SHOWN.
FOR BRIDAL GIFT REGISTRY SERVICES, NAMELY, A RETAIL DEPARTMENT STORE BRIDAL GIFT REGISTRY (U.S. CLS. 100, 101 AND 102).
FIRST USE 9-0-2002; IN COMMERCE 9-0-2002.

CLASS 35—(Continued).

2,765,518. HODGES, ROBERT, ARTESIA, NM. SN 76-975,620. PUB. 8-20-2002, FILED 10-11-2001.

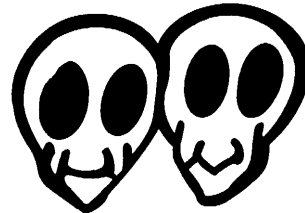

A couple of Joe's.

FOR PROMOTING THE GOODS AND SERVICES OF OTHERS BY PROVIDING LINKS TO THE WEB SITES OF OTHERS (U.S. CLS. 100, 101 AND 102).
FIRST USE 8-28-2001; IN COMMERCE 8-28-2001.



2,765,521. SCHOTTENSTEIN STORES CORPORATION, DBA VALUE CITY FURNITURE, COLUMBUS, OH. SN 76-975,632. PUB. 12-10-2002, FILED 5-23-2002.

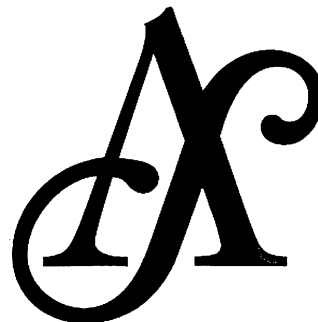

FOR RETAIL STORE SERVICES IN THE FIELD OF FURNITURE, HOME AND OFFICE FURNITURE, AND DECORATIVE ACCESSORIES (U.S. CLS. 100, 101 AND 102).
FIRST USE 6-12-2002; IN COMMERCE 6-12-2002.

CLASS 35—(Continued).

2,765,545. VALENTE, JOHN, SAN DIEGO, CA. SN 78-016,822.
PUB. 6-5-2001, FILED 7-14-2000.

FANTASTIC FELINES

NO CLAIM IS MADE TO THE EXCLUSIVE RIGHT TO USE "FELINES", APART FROM THE MARK AS SHOWN.

FOR RETAIL STORE SERVICES AND COMPUTERIZED ON-LINE RETAIL STORE SERVICES FEATURING CAT THEMED HOME DECOR AND GIFT ITEMS NAMELY, JEWELRY, TOTE BAGS, CERAMIC TABLE WARE, STATIONERY, CLOTHING, PENS, SCARVES, WOOD AND RESIN SCULPTURES (U.S. CLS. 100, 101 AND 102).

FIRST USE 2-1-1999; IN COMMERCE 2-1-1999.

2,765,552. LAWSON, CHRISTINA MARIE, LAS VEGAS, NV.
SN 78-028,502. PUB. 9-4-2001, FILED 10-1-2000.

MAD MUSCLE

FOR RETAIL STORES FEATURING SUPPLEMENTS USED FOR WEIGHT MANAGEMENT AND BODY BUILDING (U.S. CLS. 100, 101 AND 102).

FIRST USE 8-1-2002; IN COMMERCE 8-1-2002.

2,765,566. IC COMM LLC, NEW YORK, NY. SN 78-039,576.
PUB. 10-2-2001, FILED 12-16-2000.



FOR PROMOTING AND ADVERTISING THE GOODS AND SERVICES OF OTHERS, NAMELY DESIGNING PROMOTIONAL CAMPAIGNS FOR DISTRIBUTION IN PRINT, TELEVISION AND RADIO MEDIA, AND PRODUCT MARKETING SERVICES (U.S. CLS. 100, 101 AND 102).

FIRST USE 6-1-2001; IN COMMERCE 6-1-2001.

CLASS 35—(Continued).

2,765,567. IC COMM LLC, NEW YORK, NY. SN 78-039,577.
PUB. 8-28-2001, FILED 12-16-2000.

SUPERVISION

FOR PROMOTING AND ADVERTISING THE GOODS AND SERVICES OF OTHERS, NAMELY DESIGNING PROMOTIONAL CAMPAIGNS FOR DISTRIBUTION IN PRINT, TELEVISION AND RADIO MEDIA, AND PRODUCT MARKETING SERVICES (U.S. CLS. 100, 101 AND 102).

FIRST USE 6-1-2001; IN COMMERCE 6-1-2001.

2,765,568. IC COMM LLC, NEW YORK, NY. SN 78-039,579.
PUB. 8-28-2001, FILED 12-16-2000.

THINKVAULT

FOR PROMOTING AND ADVERTISING THE GOODS AND SERVICES OF OTHERS, NAMELY DESIGNING PROMOTIONAL CAMPAIGNS FOR DISTRIBUTION IN PRINT, TELEVISION AND RADIO MEDIA, AND PRODUCT MARKETING SERVICES (U.S. CLS. 100, 101 AND 102).

FIRST USE 6-1-2001; IN COMMERCE 6-1-2001.

2,765,569. MACPRICE, CYNTHIA M, OKLAHOMA CITY, OK. SN 78-041,421. PUB. 3-26-2002, FILED 1-2-2001.

SUPERIOR STAFFING, INC.

NO CLAIM IS MADE TO THE EXCLUSIVE RIGHT TO USE "STAFFING, INC.", APART FROM THE MARK AS SHOWN.

FOR EMPLOYMENT AGENCY SERVICES, NAMELY, TEMPORARY TO PERMANENT EMPLOYMENT SERVICES (U.S. CLS. 100, 101 AND 102).

FIRST USE 12-15-1999; IN COMMERCE 1-1-2001.

2,765,571. NAPIER, MICK, J, CHICAGO, IL. SN 78-041,904.
PUB. 9-25-2001, FILED 1-5-2001.

QUIBIT

FOR DISSEMINATION OF ADVERTISING VIA THE INTERNET (U.S. CLS. 100, 101 AND 102).

FIRST USE 7-1-2001; IN COMMERCE 7-27-2001.

CLASS 35—(Continued).

2,765,576. MILANIAN, CYRUS, POMPANO BEACH, FL. SN 78-046,460. PUB. 10-9-2001, FILED 2-4-2001.

THE BIG BEN

FOR BUSINESS MANAGEMENT OF RESORT HOTELS, CASINOS AND THEME PARKS FOR OTHERS AND PRODUCTS MERCHANDISING SERVICES (U.S. CLS. 100, 101 AND 102).

FIRST USE 5-0-2000; IN COMMERCE 5-0-2000.

2,765,584. LAKE & AIR, INC., SOUTH ST. PAUL, MN. SN 78-053,600. PUB. 9-17-2002, FILED 3-16-2001.



NO CLAIM IS MADE TO THE EXCLUSIVE RIGHT TO USE "SEAPLANE GEAR", APART FROM THE MARK AS SHOWN.

THE MARK CONSISTS OF A STYLIZED DEPICTION OF A PLANE TAKING OFF FROM A LAKE.

FOR RETAIL OUTLETS FEATURING SEAPLANES, AIRPLANES, AIRCRAFT, AND RELATED ACCESSORIES, PARTS, AND EQUIPMENT, AND BOAT AND MARINE RELATED ACCESSORIES, PARTS, AND EQUIPMENT, ALL FOR THE USE, MAINTENANCE, CARE, CLEANING, OPERATION, AND SAFETY AND SAFE OPERATION OF SEAPLANES, AIRPLANES, AIRCRAFT, AND BOATS; RETAIL OUTLETS FEATURING LUGGAGE, CLOTHING, NAMELY JACKETS, T-SHIRTS, SWEATSHIRTS, HATS, FLOATING DOCKS, KEY CHAINS, PORTABLE ARM CHAIRS, KNIVES, POCKET-KNIVES, PORTABLE HEATERS, SEAT CUSHIONS, EMERGENCY POSITION INDICATING RADIO BEACONS (EPIRBs), SURVIVAL KITS, BOOKS, PINS, MODELS, MAGNIFYING GLASSES, OIL PAINTINGS, PRINTS, POSTERS, UTILITY BOXES, TOOLS, BATTERIES, BATTERY CHARGERS, CARBON MONOXIDE DETECTORS, SOFTWARE FOR SCREEN SAVERS, MOUSE PADS, AND FIRE EXTINGUISHERS (U.S. CLS. 100, 101 AND 102).

FIRST USE 1-25-2001; IN COMMERCE 1-25-2001.

2,765,616. WORLD FUEL SERVICES, INC., MIAMI SPRINGS, FL. SN 78-070,599. PUB. 10-1-2002, FILED 6-22-2001.

WORLD FUEL MANAGEMENT

OWNER OF U.S. REG. NO. 2,180,935.

NO CLAIM IS MADE TO THE EXCLUSIVE RIGHT TO USE "FUEL MANAGEMENT", APART FROM THE MARK AS SHOWN.

SEC. 2(F).

FOR SUPPLYING FUEL AND FUEL PRODUCTS TO OTHERS (U.S. CLS. 100, 101 AND 102).

FIRST USE 3-1-2003; IN COMMERCE 3-1-2003.

CLASS 35—(Continued).

2,765,620. SICO COMPANY, THE, MOUNT JOY, PA. SN 78-071,937. PUB. 9-17-2002, FILED 7-2-2001.

COUNTRY MILE MARKET

NO CLAIM IS MADE TO THE EXCLUSIVE RIGHT TO USE "MARKET", APART FROM THE MARK AS SHOWN.

FOR RETAIL CONVENIENCE STORE SERVICES PROVIDED AT GASOLINE STATIONS (U.S. CLS. 100, 101 AND 102).

FIRST USE 12-31-2002; IN COMMERCE 12-31-2002.

2,765,624. SWISS CHALET FINE FOODS, INC., MIAMI, FL. SN 78-074,954. PUB. 4-16-2002, FILED 7-20-2001.



FOR IMPORT AGENCY SERVICES IN THE FIELD OF CONSUMER GOODS, NAMELY, SPECIAL PASTRY TOOLS, NAMELY MOLDS, BOARDS, MATS, CUTTERS, PLATES AND BAGS, CHEF'S JACKETS, SOUPS, CON-SOMMES, POTATO CROQUETTES, PORTION JAMS, BAKERY JAMS, BAKERY GLAZES, FRUIT PUREES AND COMPOUNDS, FRUIT TOPPING, FRUIT PEELS AND ZESTS, FRUIT FILLINGS, PATE, GOOSE LIVERS, OLIVE OIL, CAVIAR, SMOKED SALMON, ESCARGOTS, CANNED AND DRY MUSHROOMS, SAUERKRAUT, SAUCES, BASES FOR MAKING SOUPS, PASTES, BROTHS, SAUCES, AND MARINADES, SPECIALTY DECORATIVE ITEMS, NAMELY CANDY DECORATION FOR CAKE AND PASTRY, PORTION HONEY, COVERTURES SUCH AS SUGAR COATINGS, CHOCOLATE COATINGS, CUSTARD, CAKE DECORATIONS, AL-MOND AND MARZIPAN PASTE, CHOCOLATE SHELLS, PRE-BAKED PASTRY SHELLS, DESSERT MOUSSES, ICING, TRUFFLES, VINEGAR, PASTAS, MUESLI CER-EALS, CAPERS, BREAD IMPROVERS, NAMELY, SPICES, CAKE MIXES, VANILLA BEANS, VANILLA EXTRACT, GELATIN LEAVES, CHOCOLATE TRUF-FLES, CHOCOLATE LABELS, LEMON WRAPS, COOK-ING WINES AND DISTILLED SPIRITS; DISTRIBUTORSHIP, NAMELY, FOOD AND FOOD PRO-DUCTS (U.S. CLS. 100, 101 AND 102).

FIRST USE 2-0-2001; IN COMMERCE 2-0-2001.

2,765,626. BENOW, INC., BEVERLY, MA. BY ASSIGNMENT; BY CHANGE OF NAME BENOW, INC., WAKEFIELD, MA. SN 78-075,565. PUB. 1-29-2002, FILED 7-25-2001.

FASTTRACK

FOR MARKETING STUDIES UTILIZING A HOSTED COMPUTER DATABASE OF CUSTOMER INFORMATION (U.S. CLS. 100, 101 AND 102).

FIRST USE 10-23-2001; IN COMMERCE 10-23-2001.

CLASS 35—(Continued).

2,765,668. A2D LP, HUMBLE, TX. SN 78-090,088. PUB. 12-10-2002, FILED 10-25-2001.

LOG-LINE PLUS!

OWNER OF U.S. REG. NO. 2,445,431.
FOR DATA MANAGEMENT SERVICES, NAMELY, MANAGEMENT OF PROPRIETARY OIL AND GAS WELL LOG DATA FOR OTHERS (U.S. CLS. 100, 101 AND 102).

FIRST USE 6-1-2001; IN COMMERCE 6-4-2001.

2,765,673. INDOPCO, INC., DBA NATIONAL STARCH & CHEMICAL COMPANY, BRIDGEWATER, NJ. SN 78-092,712. PUB. 12-17-2002, FILED 11-12-2001.

YOUR PERSONAL CARE CONNECTION... WWW.PERSONALCAREPOLYMERS.COM

FOR PROVIDING CONSUMER PRODUCT INFORMATION TO MANUFACTURERS VIA THE INTERNET IN THE FIELD OF PERSONAL AND BEAUTY CARE PRODUCTS; OPERATING ON-LINE MARKETPLACES FOR SELLERS OF GOODS IN THE FIELD OF PERSONAL AND BEAUTY CARE PRODUCTS (U.S. CLS. 100, 101 AND 102).

FIRST USE 12-1-2001; IN COMMERCE 12-1-2001.

2,765,696. CHAMBERS, ANITA M., GOLETA, CA. SN 78-102,332. PUB. 9-24-2002, FILED 1-12-2002.

RAZZO

THE ENGLISH TRANSLATION OF THE WORD "RAZZO" IN THE MARK IS "ROCKET".

FOR COOPERATIVE ADVERTISING AND MARKETING SERVICES, PUBLIC RELATIONS, AND ADVERTISING AGENCIES, ALL RELATED TO THE LAUNCH AND PROMOTION OF NEW PRODUCTS OF OTHERS (U.S. CLS. 100, 101 AND 102).

FIRST USE 9-1-2001; IN COMMERCE 1-2-2001.

2,765,718. CAM COMMERCE SOLUTIONS, INC., FOUNTAIN VALLEY, CA. SN 78-109,852. PUB. 8-27-2002, FILED 2-19-2002.

A-TRADE

FOR ON-LINE AUCTION SERVICES (U.S. CLS. 100, 101 AND 102).

FIRST USE 4-30-2003; IN COMMERCE 4-30-2003.

CLASS 35—(Continued).

2,765,719. WISNIEWSKI, DAVID A., DBA TAXIWAY MEDIA, FAIR OAKS, CA. SN 78-109,970. PUB. 9-3-2002, FILED 2-20-2002.

VIRTUALCASH

FOR PROVIDING CLASSIFIED ADVERTISEMENTS FOR OTHERS VIA A GLOBAL COMPUTER NETWORK (U.S. CLS. 100, 101 AND 102).

FIRST USE 2-28-2003; IN COMMERCE 2-28-2003.

2,765,746. WILLIAMS, DALE J., OMAHA, NE. SN 78-117,790. PUB. 2-11-2003, FILED 3-27-2002.

TAKING CARE OF YOU SO YOU CAN TAKE CARE OF OTHERS

FOR HEALTHCARE RECRUITING AND STAFFING SERVICE (U.S. CLS. 100, 101 AND 102).

FIRST USE 11-22-2001; IN COMMERCE 11-22-2001.

2,765,760. KAUFMAN, GARY G, GALLATIN, TN. SN 78-121,740. PUB. 12-17-2002, FILED 4-15-2002.



NO CLAIM IS MADE TO THE EXCLUSIVE RIGHT TO USE "YOUR HRLINK.NET", APART FROM THE MARK AS SHOWN.

FOR HUMAN RESOURCES ASSISTANCE AND ADVICE, NAMELY, EMPLOYEE RECRUITING AND SELECTION (U.S. CLS. 100, 101 AND 102).

FIRST USE 8-9-2002; IN COMMERCE 8-9-2002.

2,765,777. FRANKEL, ROBERT S., ENCINO, CA. SN 78-129,054. PUB. 3-18-2003, FILED 5-15-2002.

BRANDED COMMUNITY

FOR ADVERTISING SERVICES, NAMELY, DISSEMINATING AND ENHANCING CORPORATE AND BRAND VALUE FOR OTHERS (U.S. CLS. 100, 101 AND 102).

FIRST USE 3-1-1998; IN COMMERCE 3-1-1998.

CLASS 35—(Continued).

2,765,779. LANDSCAPE LOCATORS, LLC, WALNUT CREEK, CA. SN 78-130,434. PUB. 12-17-2002, FILED 5-22-2002.



NO CLAIM IS MADE TO THE EXCLUSIVE RIGHT TO USE "LANDSCAPE", APART FROM THE MARK AS SHOWN.

FOR LANDSCAPE REFERRAL SERVICE PROVIDING HOMEOWNERS WITH ASSISTANCE IN RECEIVING BIDS FROM PROFESSIONAL LANDSCAPE CONTRACTORS (U.S. CLS. 100, 101 AND 102).

FIRST USE 9-1-2001; IN COMMERCE 9-1-2001.

2,765,825. BT HUMAN RESOURCES CONSULTING, LLC, INDIANAPOLIS, IN. SN 78-150,950. PUB. 2-18-2003, FILED 8-5-2002.

FLASHPOINT

FOR BUSINESS CONSULTING SERVICES IN THE FIELD OF HUMAN RESOURCES (U.S. CLS. 100, 101 AND 102).

FIRST USE 8-0-2002; IN COMMERCE 8-0-2002.

CLASS 36—INSURANCE AND FINANCIAL

2,764,532. HOMESITE GROUP INCORPORATED, BOSTON, MA, BY CHANGE OF NAME HOMEOWNERS DIRECT CORPORATION, BOSTON, MA. SN 75-663,297. PUB. 12-28-1999, FILED 3-18-1999.

24DIRECT

FOR INSURANCE SERVICES IN THE FIELD OF PERSONAL LINES OF PROPERTY, CASUALTY, AND HOMEOWNERS' INSURANCE, NAMELY CLAIMS ADMINISTRATION AND CLAIMS PROCESSING SERVICES (U.S. CLS. 100, 101 AND 102).

FIRST USE 2-0-2000; IN COMMERCE 2-0-2000.

CLASS 36—(Continued).

2,764,552. SIRIOS CAPITAL MANAGEMENT, L.P., BOSTON, MA. SN 75-701,468. PUB. 10-24-2000, FILED 5-10-1999.

SIRIOS CAPITAL MANAGEMENT

NO CLAIM IS MADE TO THE EXCLUSIVE RIGHT TO USE "CAPITAL MANAGEMENT", APART FROM THE MARK AS SHOWN.

FOR FINANCIAL SERVICES; NAMELY, INVESTMENT ADVISORY SERVICES; INVESTMENT MANAGEMENT SERVICES; AND ASSET MANAGEMENT SERVICES, ALL IN THE NATURE OF MANAGING AND INVESTING THE FUNDS OF OTHERS IN PRIVATE EQUITY AND HIGH NET WORTH INVESTMENT VEHICLES, HEDGE FUNDS, STOCKS AND MUTUAL FUNDS (U.S. CLS. 100, 101 AND 102).

FIRST USE 4-0-1999; IN COMMERCE 4-0-1999.

2,764,566. GREAT AMERICAN INSURANCE COMPANY, CINCINNATI, OH. SN 75-738,942. PUB. 4-11-2000, FILED 6-29-1999.

HIGH SEAS INSURANCE AGENCY

NO CLAIM IS MADE TO THE EXCLUSIVE RIGHT TO USE "INSURANCE AGENCY", APART FROM THE MARK AS SHOWN.

FOR INSURANCE AGENCY SERVICES IN THE FIELD OF MARINE INSURANCE (U.S. CLS. 100, 101 AND 102).

FIRST USE 4-0-2000; IN COMMERCE 4-0-2000.

2,764,575. COMPUCREDIT CORPORATION, ATLANTA, GA. SN 75-758,042. PUB. 1-11-2000, FILED 7-22-1999.

ASPIRECARD

OWNER OF U.S. REG. NO. 2,126,948. FOR CREDIT CARD SERVICES (U.S. CLS. 100, 101 AND 102).

FIRST USE 8-31-1999; IN COMMERCE 8-31-1999.

2,764,591. EBERHARDT, ROBERT M., WHEATON, IL. SN 75-804,598. PUB. 7-30-2002, FILED 9-21-1999.

CERTAIN

FOR FINANCIAL SERVICES, NAMELY, FINANCIAL PLANNING, FINANCIAL PORTFOLIO MANAGEMENT, STOCK AND BOND BROKERAGE SERVICES; INSURANCE BROKERAGE SERVICES IN THE FIELDS OF LIFE, HEALTH, LONG-TERM CARE POLICIES AND ANNUITIES (U.S. CLS. 100, 101 AND 102).

FIRST USE 2-0-2002; IN COMMERCE 2-0-2002.

CLASS 36—(Continued).

2,764,619. FEDERAL NATIONAL MORTGAGE ASSOCIATION, DBA FANNIE MAE, WASHINGTON, DC. SN 75-856,791. PUB. 8-28-2001, FILED 11-23-1999.

FANNIE 3/2

OWNER OF U.S. REG. NOS. 1,682,215, 2,347,143, AND OTHERS.

NO CLAIM IS MADE TO THE EXCLUSIVE RIGHT TO USE "3/2", APART FROM THE MARK AS SHOWN.

FOR MORTGAGE LENDING AND FINANCING SERVICES (U.S. CLS. 100, 101 AND 102).

FIRST USE 12-14-1999; IN COMMERCE 12-14-1999.

2,764,647. GUARDIAN LIFE INSURANCE COMPANY OF AMERICA, THE, NEW YORK, NY. SN 75-916,682. PUB. 9-24-2002, FILED 2-11-2000.

INVESTOR'S BLUEPRINT

NO CLAIM IS MADE TO THE EXCLUSIVE RIGHT TO USE "INVESTOR'S", APART FROM THE MARK AS SHOWN.

FOR MUTUAL FUND PORTFOLIO INVESTMENT ADVISORY SERVICES (U.S. CLS. 100, 101 AND 102).

FIRST USE 1-0-2000; IN COMMERCE 7-0-2000.

2,764,704. COLONIAL REALTY LIMITED PARTNERSHIP, BIRMINGHAM, AL. SN 76-047,185. PUB. 9-4-2001, FILED 5-15-2000.

COLONIAL PROMENADE

OWNER OF U.S. REG. NOS. 2,113,049 AND 2,113,050.
NO CLAIM IS MADE TO THE EXCLUSIVE RIGHT TO USE "PROMENADE", APART FROM THE MARK AS SHOWN.

FOR REAL ESTATE LEASING SERVICES, NAMELY, THE LEASING OF COMMERCIAL, RESIDENTIAL, RETAIL AND OFFICE SPACE (U.S. CLS. 100, 101 AND 102).
FIRST USE 4-0-1997; IN COMMERCE 4-0-1997.

2,764,741. FORD MOTOR COMPANY, DEARBORN, MI. SN 76-080,314. PUB. 11-27-2001, FILED 6-29-2000.

KIDS REVVIN' WITH FORD

OWNER OF U.S. REG. NOS. 74,530, 1,874,207, AND OTHERS.

FOR ELEEMOSYNARY SERVICES IN THE AREA OF DONATIONS OF MONEY (U.S. CLS. 100, 101 AND 102).
FIRST USE 7-0-2000; IN COMMERCE 7-0-2000.

CLASS 36—(Continued).

2,764,753. KSIXTEEN LLC, NEW YORK, NY. SN 76-089,575. PUB. 3-26-2002, FILED 7-13-2000.

K16

FOR FINANCIAL ANALYSIS AND CONSULTATION, NAMELY, FINANCIAL AND BUDGETARY PLANNING (U.S. CLS. 100, 101 AND 102).

FIRST USE 5-15-2000; IN COMMERCE 5-15-2000.

2,764,765. SHAMBLLEN, JEANETTE, FISHERS, IN. SN 76-099,806. PUB. 2-11-2003, FILED 7-31-2000.

CREATING HOPE

FOR CHARITABLE FUND RAISING SERVICES FOR FIGHTING CANCER AND PROVIDING SUPPORT FOR CANCER SURVIVORS AND OTHERS WHOSE LIVES HAVE BEEN TOUCHED BY CANCER (U.S. CLS. 100, 101 AND 102).

FIRST USE 1-26-2001; IN COMMERCE 1-26-2001.

2,764,769. STATE EMPLOYEES FEDERAL CREDIT UNION, ALBANY, NY. SN 76-104,684. PUB. 5-21-2002, FILED 8-7-2000.

SEFCU *iPay*

NO CLAIM IS MADE TO THE EXCLUSIVE RIGHT TO USE "IPAY", APART FROM THE MARK AS SHOWN.

FOR PROVIDING ELECTRONIC BILL PAYMENT SERVICES FOR OTHERS VIA THE INTERNET (U.S. CLS. 100, 101 AND 102).

FIRST USE 8-1-1999; IN COMMERCE 8-1-1999.

2,764,791. I-DEAL LLC, NEW YORK, NY, BY ASSIGNMENT MERRILL LYNCH & CO., INC., NEW YORK, NY. SN 76-128,050. PUB. 8-28-2001, FILED 9-14-2000.



FOR FINANCIAL SERVICES, NAMELY THE OFFERING OF TRADING SERVICES, RESEARCH AND ANALYST REPORTS AND OTHER INFORMATION RELATED TO THE OFFERING OF SECURITIES VIA AN ELECTRONIC NETWORK (U.S. CLS. 100, 101 AND 102).

FIRST USE 1-1-2001; IN COMMERCE 1-1-2001.

CLASS 36—(Continued).

2,764,814. MORTGAGE PARTNERSHIP OF AMERICA, L.L.C., ST. LOUIS, MO. SN 76-140,406. PUB. 11-26-2002, FILED 10-3-2000.

LENDERS ONE

NO CLAIM IS MADE TO THE EXCLUSIVE RIGHT TO USE "LENDERS", APART FROM THE MARK AS SHOWN. FOR COOPERATIVE MORTGAGE LENDING SERVICES (U.S. CLS. 100, 101 AND 102).
FIRST USE 2-0-2002; IN COMMERCE 2-0-2002.

2,764,833. RAYNOR CANADA INC., DBA RICHARDS-WILCOX CANADA, MISSISSAUGA, ONTARIO, CANADA. SN 76-156,506. PUB. 8-6-2002, FILED 10-31-2000.

LIFETIMER GOLD

FOR UNDERWRITING LIFETIME WARRANTY PROGRAMS IN THE FIELD OF GARAGE DOORS; PROVIDING A LIFETIME WARRANTY ON GARAGE DOOR MATERIALS TO THE ORIGINAL PURCHASER (U.S. CLS. 100, 101 AND 102).
FIRST USE 10-31-2000; IN COMMERCE 10-31-2000.

2,764,835. EMIGRANT MORTGAGE COMPANY, INC., NEW YORK, NY. SN 76-158,504. PUB. 7-17-2001, FILED 11-1-2000.

STARFLEX

FOR MORTGAGE LENDING SERVICES (U.S. CLS. 100, 101 AND 102).
FIRST USE 11-0-1999; IN COMMERCE 11-0-1999.

2,764,893. RESTREPO, MONICA ESTRADA, BOGOTA, D.C., COLOMBIA. SN 76-198,779. PUB. 9-10-2002, FILED 1-23-2001.

COUNT-PROPERTY

FOR INSURANCE BROKERAGE; INSURANCE CLAIMS ADMINISTRATION; INSURANCE ADMINISTRATION IN THE FIELD OF REAL ESTATE; APPRAISAL FOR INSURANCE CLAIMS OF REAL ESTATE; REAL ESTATE BROKERAGE; ESTATE PLANNING; ESTATE TRUST MANAGEMENT; PROVIDING EXTENDED WARRANTY CONTRACTS FOR REAL ESTATE; FINANCING SERVICES; FINANCIAL ANALYSIS AND CONSULTATION; FINANCIAL MANAGEMENT; FINANCIAL PLANNING (U.S. CLS. 100, 101 AND 102).
FIRST USE 4-1-2003; IN COMMERCE 4-1-2003.

CLASS 36—(Continued).

2,764,900. BEAR STEARNS COMPANIES INC., THE, NEW YORK, NY, BY CHANGE OF NAME BEAR STEARNS COMPANIES INC., THE, NEW YORK, NY. SN 76-204,090. PUB. 1-15-2002, FILED 2-2-2001.

MY BEAR

OWNER OF U.S. REG. NOS. 1,603,999, 1,712,161, AND 2,331,703.
FOR FINANCIAL SERVICES, NAMELY, PROVIDING AUTOMATED SECURITIES BROKERAGE SERVICES WHICH ARE DELIVERED VIA A GLOBAL COMPUTER NETWORK (U.S. CLS. 100, 101 AND 102).
FIRST USE 8-22-2002; IN COMMERCE 8-22-2002.

2,764,905. TETON CAPITAL ADVISERS, JACKSON, WY. SN 76-207,112. PUB. 10-8-2002, FILED 2-5-2001.

TETON CAPITAL ADVISERS

NO CLAIM IS MADE TO THE EXCLUSIVE RIGHT TO USE "CAPITAL ADVISERS", APART FROM THE MARK AS SHOWN.
FOR INVESTMENT ADVISORY SERVICES, HEDGE FUND MANAGEMENT AND MONEY MANAGEMENT SERVICES (U.S. CLS. 100, 101 AND 102).
FIRST USE 1-17-2001; IN COMMERCE 1-17-2001.

2,764,911. NEW YORK STOCK EXCHANGE, INC., NEW YORK, NY. SN 76-210,803. PUB. 1-15-2002, FILED 2-15-2001.

NYSE ORDERTRAC

FOR PROVIDING FINANCIAL AND SECURITIES INFORMATION, NAMELY, ORDER DATA, TO OTHERS BY GLOBAL COMPUTER NETWORKS AND OTHER ELECTRONIC MEANS (U.S. CLS. 100, 101 AND 102).
FIRST USE 6-27-2002; IN COMMERCE 6-27-2002.

2,764,941. FEDERAL HOME LOAN MORTGAGE CORPORATION, MCLEAN, VA. SN 76-231,642. PUB. 2-4-2003, FILED 3-28-2001.

HOME VALUE EXPLORER

NO CLAIM IS MADE TO THE EXCLUSIVE RIGHT TO USE "HOME VALUE", APART FROM THE MARK AS SHOWN.
FOR FINANCIAL SERVICES IN THE FIELD OF MORTGAGE LOANS AND MORTGAGE-BACKED OR MORTGAGE RELATED SECURITIES, NAMELY PROVIDING MODEL-DRIVEN ESTIMATES OF THE VALUE OF RESIDENTIAL REAL PROPERTY (U.S. CLS. 100, 101 AND 102).
FIRST USE 4-12-2001; IN COMMERCE 4-12-2001.

CLASS 36—(Continued).

2,764,978. TITAN INTERCONTINENTAL, S.A., CALI, COLOMBIA. SN 76-250,491. PUB. 3-19-2002, FILED 5-2-2001.

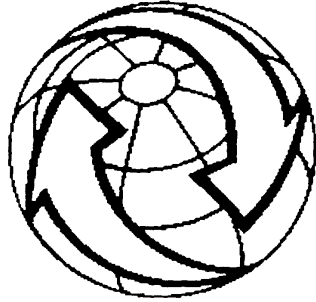

FOR FINANCIAL SERVICES, NAMELY, MONEY TRANSFER SERVICES, PROCESSING AND TRANSMISSION OF MONEY TRANSFERS FOR LICENSED MONEY TRANSMITTERS, ELECTRONIC FUNDS TRANSFERS, MONEY ORDER SERVICES, MONETARY EXCHANGE, CURRENCY EXCHANGE, AND CHECK CASHING (U.S. CLS. 100, 101 AND 102).

FIRST USE 1-1-1994; IN COMMERCE 1-1-1994.

2,765,008. FAIR GROUNDS CORPORATION, NEW ORLEANS, LA. SN 76-265,476. PUB. 12-17-2002, FILED 6-1-2001.

FAIR GROUNDS NET BET

NO CLAIM IS MADE TO THE EXCLUSIVE RIGHT TO USE "NET BET", APART FROM THE MARK AS SHOWN.

FOR WAGERING SERVICES PROVIDED VIA A GLOBAL OR OTHER WIDE AREA NETWORK FOR HORSE RACES HELD AT FACILITIES PRIMARILY DEDICATED TO HORSE RACING AND DELIVERED TO PATRONS LOCATED IN NONCOMMERCIAL FACILITIES, TO PATRONS LOCATED AT OFF-TRACK BETTING PARLORS AND TO PATRONS LOCATED AT FACILITIES PRIMARILY DEDICATED TO HORSE RACING (U.S. CLS. 100, 101 AND 102).

FIRST USE 4-1-2001; IN COMMERCE 4-1-2001.

CLASS 36—(Continued).

2,765,020. SINGAPORE EXCHANGE LIMITED, #19-00 SGX CENTRE 1, SINGAPORE. SN 76-268,299. PUB. 7-30-2002, FILED 6-6-2001.



FOR SECURITIES, DERIVATIVES AND COMMODITIES EXCHANGE SERVICES, NAMELY, PROVIDING MARKETS FOR THE TRADING, CLEARING AND SETTLEMENT OF SECURITIES, DERIVATIVES AND COMMODITIES TRANSACTIONS; PROVIDING FINANCIAL CLEARING HOUSE AND SETTLEMENT SERVICES FOR SECURITIES, DERIVATIVES AND COMMODITIES TRANSACTIONS; PROVISION OF INFORMATION IN RELATION TO SECURITIES, DERIVATIVES AND COMMODITIES TRANSACTIONS; FINANCIAL SERVICES RENDERED BY SECURITIES, DERIVATIVES AND COMMODITIES EXCHANGES IN RELATION TO FINANCIAL, MONETARY AND REGULATORY AFFAIRS, NAMELY, FINANCIAL INFORMATION PROCESSING, FINANCIAL FORECASTING, SECURITIES AND COMMODITIES BROKERAGE; COMMODITY INVESTMENT SERVICES, NAMELY, COMMODITY TRADING FOR OTHERS, COMMODITY INVESTMENT ADVICE, COMMODITY EXCHANGE, COMMODITY BROKERAGE; PROVIDING FINANCIAL INFORMATION IN THE NATURE OF RATES OF EXCHANGE, SECURITIES, DERIVATIVES AND COMMODITIES EXCHANGE QUOTATIONS, SECURITIES, DERIVATIVES AND COMMODITIES MARKET INFORMATION AND NEWS, SECURITIES, DERIVATIVES AND COMMODITIES MARKET INDICES, SECURITIES, DERIVATIVES AND COMMODITIES PRICES, BOND MARKET INFORMATION AND NEWS, BOND MARKET INDICES, BOND PRICES, INTEREST RATE INFORMATION, CORPORATE PROFILES, CORPORATE RATES AND CORPORATE FINANCIAL STATEMENTS; OPERATION OF SECURITIES, DERIVATIVES AND COMMODITIES EXCHANGES; EXCHANGE AND BROKERAGE SERVICES RELATING TO COMMODITY FUTURES CONTRACTS; SECURITIES, DERIVATIVES AND COMMODITIES EXCHANGE SERVICES; FINANCIAL ANALYSIS AND REPORTING OF INFORMATION REGARDING SECURITIES, DERIVATIVES AND COMMODITIES EXCHANGE PRICES; FINANCIAL CONSULTANCY; FINANCIAL MANAGEMENT; PROVISION OF FINANCIAL SECURITIES IN THE NATURE OF AN INVESTMENT SECURITY, SECURITIES BROKERAGE; PROVIDING COMPUTERIZED INFORMATION RELATING TO FINANCIAL BUSINESS APPRAISALS AND TO INVESTMENTS, SECURITIES, DERIVATIVES AND COMMODITIES; FINANCIAL INFORMATION PROCESSING SERVICES RELATING TO RECORDING, CONFIRMING AND CONTROLLING INTER PARTES TRANSACTIONS IN RESPECT OF SECURITIES, DERIVATIVES AND COMMODITIES AND FINANCIAL AND INVESTMENT MATTERS; SECURITIES DERIVATIVES AND COMMODITIES EXCHANGE SERVICES; PROVIDING FINANCIAL INFORMATION, NAMELY, COMPILING AND DISSEMINATING SECURITY AND COMMODITY TRADE AND QUOTE, INDEX VALUE AND MARKET INFORMATION; SECURITIES, DERIVATIVES AND COMMODITIES BROKERAGE; STOCKS, DERIVATIVES AND BONDS BROKERAGE; INVESTMENT MANAGEMENT SERVICES; SECURITIES, DERIVATIVES AND COMMODITIES TRADING SERVICES

CLASS 36—(Continued).

FOR OTHERS; PROVISION OF FINANCIAL AND MONETARY INFORMATION AND ADVICE; FINANCIAL RISK MANAGEMENT; FINANCIAL DEALING IN DERIVATIVES, NAMELY, DERIVATIVES EXCHANGE SERVICES, FINANCIAL RESEARCH AND FORECASTING SERVICES; PROVISION OF FINANCIAL SERVICES IN THE NATURE OF FUTURES, DERIVATIVES, OPTIONS, SWOPTIONS AND SWAPS; TRADING IN FUTURES, DERIVATIVES, OPTIONS, SWOPTIONS AND SWAPS FOR OTHERS; PERSONAL PROPERTY AND REAL ESTATE VALUATION, APPRAISAL, EVALUATIONS AND BROKERAGE; REAL PROPERTY INVESTMENT AND FINANCE SERVICES; DEPOSITORY AND CUSTODIAN SERVICES FOR SECURITIES; PROVIDING AN ON-LINE COMPUTER DATABASE IN THE FIELD OF SECURITIES, DERIVATIVES AND COMMODITIES EXCHANGE QUOTATIONS AND SERVICES, STATISTICAL INFORMATION, BUSINESS OPPORTUNITIES APPRAISALS, FINANCIAL BUSINESS APPRAISALS AND TO INVESTMENTS, SECURITIES, DERIVATIVES AND COMMODITIES (U.S. CLS. 100, 101 AND 102).
FIRST USE 8-1-2000; IN COMMERCE 8-1-2000.

2,765,045. AMERIQUEST MORTGAGE COMPANY, ORANGE, CA. SN 76-277,892. PUB. 9-10-2002, FILED 6-25-2001.

ARGENT MORTGAGE COMPANY

NO CLAIM IS MADE TO THE EXCLUSIVE RIGHT TO USE "MORTGAGE COMPANY", APART FROM THE MARK AS SHOWN.

FOR MORTGAGE LENDING; MORTGAGE BANKING; BROKER SERVICES, NAMELY, MORTGAGE BROKERAGE; MORTGAGE LENDING AND FINANCIAL SERVICES, NAMELY, LOAN PROCESSING, LOAN COLLECTIONS, AND MORTGAGE BROKERAGE; AND WHOLESALE AND RETAIL MORTGAGE SERVICES, NAMELY PURCHASING MORTGAGE LOANS FROM REAL ESTATE AND MORTGAGE BROKERS AND CORRESPONDENT LENDERS FOR OTHERS, BROKERING THE SALE AND SERVICING OF MORTGAGE LOANS TO SECONDARY MORTGAGE LENDERS, MAINTENANCE OF MORTGAGE ESCROW ACCOUNTS, AND PURCHASING MORTGAGE LOANS FROM REAL ESTATE AND MORTGAGE BROKERS AND CORRESPONDENT LENDERS FOR OTHERS OVER THE GLOBAL COMPUTER NETWORK (U.S. CLS. 100, 101 AND 102).

FIRST USE 5-1-2002; IN COMMERCE 5-1-2002.

2,765,054. CANADA LIFE ASSURANCE COMPANY, THE, ATLANTA, GA. SN 76-281,381. PUB. 11-19-2002, FILED 7-6-2001.

CANADA LIFE'S ADVANTAGE SERIES

OWNER OF U.S. REG. NOS. 2,259,803 AND 2,439,622.
NO CLAIM IS MADE TO THE EXCLUSIVE RIGHT TO USE "SERIES", APART FROM THE MARK AS SHOWN.
SEC. 2(F) AS TO "CANADA LIFE".

FOR INSURANCE SERVICES, NAMELY UNDERWRITING IN THE FIELD OF FIXED ANNUITIES (U.S. CLS. 100, 101 AND 102).
FIRST USE 8-0-2000; IN COMMERCE 8-0-2000.

CLASS 36—(Continued).

2,765,087. GMG CAPITAL INVESTMENTS, LLC, NEW YORK, NY. SN 76-298,865. PUB. 7-23-2002, FILED 8-10-2001.

GMG CAPITAL PARTNERS

NO CLAIM IS MADE TO THE EXCLUSIVE RIGHT TO USE "CAPITAL PARTNERS", APART FROM THE MARK AS SHOWN.

FOR FINANCIAL SERVICES, NAMELY VENTURE CAPITAL FUNDING AND OTHER INVESTMENT FUNDING (U.S. CLS. 100, 101 AND 102).

FIRST USE 8-0-2001; IN COMMERCE 8-0-2001.

2,765,129. RP FINANCIAL, LC, ARLINGTON, VA. SN 76-310,941. PUB. 9-17-2002, FILED 9-10-2001.

RP

FOR BUSINESS MANAGEMENT CONSULTING, MERGER AND ACQUISITION ADVISORY SERVICES, BUSINESS VALUATION SERVICES, PRIMARILY TO THE FINANCIAL SERVICES INDUSTRY (U.S. CLS. 100, 101 AND 102).

FIRST USE 11-1-1988; IN COMMERCE 11-1-1988.

2,765,171. UNITED STATES STEEL CORPORATION, PITTSBURGH, PA. SN 76-324,201. PUB. 9-10-2002, FILED 10-11-2001.

STRAIGHTQUOTE

FOR PROVIDING CUSTOMERS AND POTENTIAL CUSTOMERS WITH PRICE QUOTATIONS FOR STEEL FOR USE IN CONNECTION WITH MAKING A COMMITMENT TO A CUSTOMER, SHOPPING A QUOTE, OR MAKING A QUOTE FOR THE PURCHASE OF STEEL (U.S. CLS. 100, 101 AND 102).

FIRST USE 10-0-2001; IN COMMERCE 10-0-2001.

2,765,185. AEGON DIRECT MARKETING SERVICES, INC., BALTIMORE, MD. SN 76-328,515. PUB. 12-10-2002, FILED 10-22-2001.

RECOVERY ADVANTAGE PLAN

NO CLAIM IS MADE TO THE EXCLUSIVE RIGHT TO USE "PLAN", APART FROM THE MARK AS SHOWN.

FOR CRITICAL ILLNESS INSURANCE SERVICES, NAMELY UNDERWRITING AND ADMINISTRATION OF LIFE-THREATENING CANCER INSURANCE, HEART ATTACK INSURANCE, STROKE INSURANCE, KIDNEY FAILURE INSURANCE, MAJOR ORGAN TRANSPLANT INSURANCE, MULTIPLE SCLEROSIS INSURANCE, PARALYSIS INSURANCE, LOSS OF HEARING INSURANCE, LOSS OF SIGHT INSURANCE, LOSS OF SPEECH INSURANCE, ALZHEIMER'S DISEASE INSURANCE, PARKINSON'S DISEASE INSURANCE, SEVERE BURN INSURANCE, AND SEVERE COMA INSURANCE (U.S. CLS. 100, 101 AND 102).

FIRST USE 10-7-2002; IN COMMERCE 10-7-2002.

CLASS 36—(Continued).

2,765,188. XL CAPITAL LTD, HAMILTON, HM 11, BERMUDA. SN 76-329,033. PUB. 9-17-2002, FILED 10-23-2001.

XL PROFESSIONAL

OWNER OF U.S. REG. NOS. 2,167,223 AND 2,167,224.
NO CLAIM IS MADE TO THE EXCLUSIVE RIGHT TO USE "PROFESSIONAL", APART FROM THE MARK AS SHOWN.

FOR INSURANCE UNDERWRITING IN THE FIELD OF PROFESSIONAL LIABILITY (U.S. CLS. 100, 101 AND 102).

FIRST USE 8-31-2001; IN COMMERCE 11-1-2001.

2,765,189. PAYMENTECH, L.P., DALLAS, TX, BY CHANGE OF NAME; PAYMENTECH, L.L.C., DALLAS, TX. SN 76-329,175. PUB. 1-7-2003, FILED 10-24-2001.

ORBITAL

FOR ONLINE CREDIT AND DEBIT TRANSACTION PROCESSING SERVICES (U.S. CLS. 100, 101 AND 102).
FIRST USE 1-29-2002; IN COMMERCE 1-29-2002.

2,765,190. PROBUSINESS SERVICES, INC., PLEASANTON, CA. SN 76-329,484. PUB. 4-9-2002, FILED 10-25-2001.



FOR ADMINISTRATION OF EMPLOYEE BENEFIT PLANS, PROVIDING ENROLLMENT REGISTRATION SERVICES FOR EMPLOYEE BENEFIT AND INSURANCE PLANS, AND TAX PAYMENT PROCESSING SERVICES; AND PROVIDING INFORMATION IN THE FIELD OF ADMINISTRATION OF EMPLOYEE BENEFITS AND INSURANCE PLANS, ENROLLMENT REGISTRATION SERVICES FOR EMPLOYEE BENEFIT AND INSURANCE PLANS, AND TAX PAYMENT PROCESSING SERVICES BY MEANS OF A GLOBAL COMPUTER NETWORK (U.S. CLS. 100, 101 AND 102).

FIRST USE 2-1-2003; IN COMMERCE 2-1-2003.

CLASS 36—(Continued).

2,765,213. UNB CORP., CANTON, OH. SN 76-337,487. PUB. 8-20-2002, FILED 11-13-2001.

UNIZAN

FOR BANKING SERVICES, TRUST SERVICES, NAMELY, INVESTMENT AND TRUST COMPANY SERVICES, ASSET MANAGEMENT SERVICES, FINANCIAL PLANNING SERVICES, INSURANCE SERVICES, NAMELY, INSURANCE BROKERAGE SERVICES IN THE FIELD OF LIFE INSURANCE, SECURITIES BROKERAGE SERVICES, AND CONSUMER LENDING SERVICES (U.S. CLS. 100, 101 AND 102).

FIRST USE 3-7-2002; IN COMMERCE 3-7-2002.

2,765,232. MELLEOS CAPITAL MANAGEMENT LLC, NEW YORK, NY. SN 76-342,756. PUB. 9-24-2002, FILED 11-29-2001.

MELLEOS

FOR FINANCIAL SERVICES, NAMELY, FINANCIAL ANALYSIS AND CONSULTATION, FORECASTING AND RESEARCH; FINANCIAL INVESTMENTS IN THE FIELD OF MUTUAL FUNDS, HEDGE FUNDS AND PRIVATE EQUITY INVESTMENTS; OPTIONS TRADING FOR OTHERS; INVESTMENT BROKERAGE SERVICES (U.S. CLS. 100, 101 AND 102).

FIRST USE 12-1-2002; IN COMMERCE 12-1-2002.

2,765,237. CAMPISI FINANCIAL NETWORK, LLC, FAIRVIEW VILLAGE, PA. SN 76-343,996. PUB. 1-7-2003, FILED 11-30-2001.



FOR FINANCIAL SERVICES, NAMELY, INVESTMENT CONSULTATION, INVESTMENT MANAGEMENT, ASSET MANAGEMENT, TAX ADVISORY SERVICES AND INSURANCE SERVICES, NAMELY, INSURANCE BROKERAGE SERVICES, INSURANCE UNDERWRITING SERVICES FOR ALL TYPES OF INSURANCE SERVICES, INSURANCE CONSULTATION, INSURANCE ADMINISTRATION AND APPRAISALS FOR INSURANCE CLAIMS FOR REAL ESTATE AND PERSONAL PROPERTY (U.S. CLS. 100, 101 AND 102).

FIRST USE 11-7-2002; IN COMMERCE 11-7-2002.

CLASS 36—(Continued).

2,765,238. OAKLEAF PLANTATION, L.L.C., JACKSONVILLE, FL. SN 76-344,329. PUB. 9-24-2002, FILED 12-3-2001.

OAKLEAF PLANTATION

FOR REAL ESTATE PROPERTY MANAGEMENT SERVICES, NAMELY, THE OPERATION OF A PLANNED COMMUNITY, UTILITIES, PARKS, CIVIC, RECREATIONAL AND ATHLETIC FACILITIES (U.S. CLS. 100, 101 AND 102).

FIRST USE 5-26-2003; IN COMMERCE 5-26-2003.

2,765,260. LINCOLN UNDERWRITERS, INC., DEERFIELD BEACH, FL. SN 76-350,059. PUB. 7-16-2002, FILED 12-19-2001.

THE INNOVATIVE WEALTH MANAGEMENT SYSTEM

NO CLAIM IS MADE TO THE EXCLUSIVE RIGHT TO USE "WEALTH MANAGEMENT SYSTEM", APART FROM THE MARK AS SHOWN.

FOR FINANCIAL PLANNING SERVICES; ESTATE PLANNING SERVICES; TAX PLANNING SERVICES (U.S. CLS. 100, 101 AND 102).

FIRST USE 3-1-2003; IN COMMERCE 3-1-2003.

2,765,300. QUIXOTE PARTNERS LLC, GREENWOOD VILLAGE, CO. SN 76-360,516. PUB. 12-17-2002, FILED 1-18-2002.

QUIXOTE CAPITAL

NO CLAIM IS MADE TO THE EXCLUSIVE RIGHT TO USE CAPITAL, APART FROM THE MARK AS SHOWN.

FOR ASSET MANAGEMENT (U.S. CLS. 100, 101 AND 102).

FIRST USE 12-19-2001, THE MARK WAS FIRST USED ANYWHERE IN A DIFFERENT FORM OTHER THAN THAT SOUGHT TO BE REGISTERED ON 01/31/2000; IN COMMERCE 4-3-2002, THE MARK WAS FIRST USED IN COMMERCE IN A DIFFERENT FORM OTHER THAN THAT SOUGHT TO BE REGISTERED ON 02/01/2000.

CLASS 36—(Continued).

2,765,315. ALLIANZ LIFE INSURANCE COMPANY OF NORTH AMERICA, MINNEAPOLIS, MN. SN 76-364,297. PUB. 10-29-2002, FILED 1-29-2002.

TURN UNCERTAINTY INTO OPPORTUNITY

FOR FINANCIAL AND INSURANCE SERVICES, NAMELY INSURANCE ADMINISTRATION, INSURANCE AND FINANCIAL CONSULTATION, INSURANCE AGENCIES IN THE FIELDS OF LIFE INSURANCE, ANNUITY UNDERWRITING, MUTUAL FUND BROKERAGE, INSURANCE CLAIMS PROCESSING AND ADJUSTMENT, PROVIDING INSURANCE AND FINANCIAL INFORMATION VIA GLOBAL COMPUTER INFORMATION NETWORKS, INVESTMENT CONSULTATION, FINANCIAL PLANNING AND RESEARCH, INSURANCE AGENCIES IN THE FIELD OF LIFE INSURANCE, VARIABLE ANNUITIES UNDERWRITING, MUTUAL FUND DISTRIBUTION, AND FINANCIAL SERVICES, NAMELY INSURANCE CONSULTATION, INVESTMENT SERVICES, NAMELY FUNDS INVESTMENT MANAGEMENT, AND ESTATE PLANNING SERVICES RELATED TO THE FOREGOING (U.S. CLS. 100, 101 AND 102).

FIRST USE 1-0-2002; IN COMMERCE 1-0-2002.

2,765,322. ELECTRIC INSURANCE COMPANY, BEVERLY, MA. SN 76-366,257. PUB. 3-4-2003, FILED 1-31-2002.

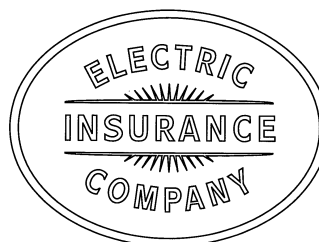

OWNER OF U.S. REG. NOS. 2,366,310 AND 2,366,311. NO CLAIM IS MADE TO THE EXCLUSIVE RIGHT TO USE "INSURANCE COMPANY", APART FROM THE MARK AS SHOWN.

FOR PROPERTY AND CASUALTY INSURANCE UNDERWRITING; INSURANCE INFORMATION SERVICES, NAMELY, PROVIDING GENERAL INSURANCE INFORMATION, PRICING QUOTATIONS, COVERAGE INFORMATION, AND CLAIMS PROCESSING VIA THE INTERNET, LOCAL, WIDE AREA, AND GLOBAL COMPUTER INFORMATION NETWORKS (U.S. CLS. 100, 101 AND 102).

FIRST USE 1-23-2002; IN COMMERCE 2-6-2002.

CLASS 36—(Continued).

2,765,324. MISSIONARY ASSOCIATION OF MARY IMMACULATE, BELLEVILLE, IL. SN 76-367,919. PUB. 9-24-2002, FILED 2-7-2002.

ANGEL OF HEALING AND HOPE

FOR CHARITABLE FUND-RAISING SERVICES (U.S. CLS. 100, 101 AND 102).
FIRST USE 2-28-2003; IN COMMERCE 2-28-2003.

2,765,331. STAFFORD INSURANCE COMPANY, BOSTON, MA. SN 76-370,007. PUB. 11-5-2002, FILED 2-12-2002.

STAFFORD

FOR INSURANCE SERVICES, NAMELY, CLAIMS ADJUSTMENT SERVICES IN THE FIELD OF INSURANCE; PROCESSING OF INSURANCE CLAIMS AND PAYMENT DATA; INSURANCE ACTUARIAL SERVICES; INSURANCE ADMINISTRATION; LIFE INSURANCE UNDERWRITING; TRACKING AND MONITORING INSURANCE COMPLIANCE (U.S. CLS. 100, 101 AND 102).
FIRST USE 3-1-2002; IN COMMERCE 3-1-2002.

2,765,351. WACHOVIA CORPORATION, CHARLOTTE, NC. SN 76-375,903. PUB. 10-15-2002, FILED 2-27-2002.

FERNHILL FINANCIAL ADVISORS

NO CLAIM IS MADE TO THE EXCLUSIVE RIGHT TO USE "FINANCIAL ADVISORS", APART FROM THE MARK AS SHOWN.

FOR FINANCIAL SERVICES, NAMELY, FINANCIAL ANALYSIS AND CONSULTATION, INVESTMENT BROKERAGE SERVICES, AND SECURITIES BROKERAGE SERVICES (U.S. CLS. 100, 101 AND 102).
FIRST USE 6-30-2000; IN COMMERCE 6-30-2003.

2,765,365. CITIZENS FINANCIAL GROUP, INC., PROVIDENCE, RI. SN 76-377,702. PUB. 10-15-2002, FILED 3-4-2002.

CITIZENSSELECT

OWNER OF U.S. REG. NOS. 2,177,462 AND 2,226,579.
FOR FINANCIAL SERVICES, NAMELY INVESTMENT MANAGEMENT AND ADVISORY SERVICES (U.S. CLS. 100, 101 AND 102).
FIRST USE 5-1-2002; IN COMMERCE 5-1-2002.

CLASS 36—(Continued).

2,765,429. EMPIRE GENERAL LIFE ASSURANCE CORPORATION, OVERLAND PARK, KS. SN 76-402,358. PUB. 12-10-2002, FILED 4-29-2002.

RAPIDTERM

FOR LIFE INSURANCE UNDERWRITING SERVICES (U.S. CLS. 100, 101 AND 102).
FIRST USE 7-0-2002; IN COMMERCE 7-0-2002.

2,765,478. FORTIS, INC., NEW YORK, NY. SN 76-418,961. PUB. 12-10-2002, FILED 6-7-2002.

SYSTEMSURE

FOR INSURANCE SERVICES, NAMELY, UNDERWRITING INSURANCE FOR COMPUTERS AND COMPUTER ACCESSORIES (U.S. CLS. 100, 101 AND 102).
FIRST USE 7-0-1993; IN COMMERCE 0-0-1994.

2,765,480. KEYCORP, CLEVELAND, OH. SN 76-419,592. PUB. 1-21-2003, FILED 6-12-2002.

KEY BUSINESS EQUITY LINE

OWNER OF U.S. REG. NOS. 1,495,327, 2,566,844, AND OTHERS.

NO CLAIM IS MADE TO THE EXCLUSIVE RIGHT TO USE "BUSINESS EQUITY LINE", APART FROM THE MARK AS SHOWN.

FOR FINANCIAL SERVICES, NAMELY, LOAN FINANCING SERVICES (U.S. CLS. 100, 101 AND 102).
FIRST USE 9-27-2002; IN COMMERCE 9-27-2002.

CLASS 36—(Continued).

2,765,493. WOORI BANK, SEOUL 100-792, REPUBLIC OF KOREA. SN 76-427,988. PUB. 1-14-2003, FILED 7-8-2002.

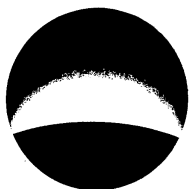
**WOORI BANK**

NO CLAIM IS MADE TO THE EXCLUSIVE RIGHT TO USE "BANK", APART FROM THE MARK AS SHOWN.

THE MARK CONSISTS OF A CIRCULAR DESIGN IN THE COLORS "BLUE" AND "WHITE". STARTING FROM THE TOP AND PROGRESSING TO THE BOTTOM OF THE DESIGN, THE UPPER CRESCENT-SHAPED SEGMENT IS DARK "BLUE"; THE COLOR CHANGES TO PROGRESSIVELY LIGHTER GRADATIONS OF "BLUE" UNTIL REACHING THE CRESCENT-SHAPED MIDSECTION WHICH IS "WHITE"; THE LOWER CRESCENT-SHAPED SEGMENT IS A UNIFORM SHADE OF DARK "BLUE". COLOR IS CLAIMED AS A FEATURE OF THE MARK EXCEPT AS FOR THE WORDING "WOORI BANK" APPEARING BELOW THE DESIGN.

THE TERM "WOORI" WHEN TRANSLATED TO ENGLISH MEANS "US" OR "WE".

FOR BANKING SERVICES, MONETARY EXCHANGE SERVICES, SECURITIES BROKERAGE SERVICES AND INVESTMENT TRUST SERVICES (U.S. CLS. 100, 101 AND 102).

FIRST USE 8-14-2002; IN COMMERCE 8-14-2002.

2,765,494. ATLANTIC STATES BANK, FORT MYERS, FL. SN 76-428,366. PUB. 1-28-2003, FILED 7-9-2002.

IRONSTONE BANK

NO CLAIM IS MADE TO THE EXCLUSIVE RIGHT TO USE "BANK", APART FROM THE MARK AS SHOWN.

FOR BANKING SERVICES (U.S. CLS. 100, 101 AND 102).

FIRST USE 6-17-2002; IN COMMERCE 9-23-2002.

2,765,501. CRUSADER CAPITAL MANAGEMENT, LLC, ORLANDO, FL. SN 76-434,366. PUB. 12-31-2002, FILED 7-23-2002.

**CRUSADER CAPITAL
MANAGEMENT**

NO CLAIM IS MADE TO THE EXCLUSIVE RIGHT TO USE "CAPITAL MANAGEMENT", APART FROM THE MARK AS SHOWN.

FOR INVESTMENT MANAGEMENT SERVICES, NAMELY MANAGEMENT OF INVESTMENT FUNDS (U.S. CLS. 100, 101 AND 102).

FIRST USE 4-1-2003; IN COMMERCE 4-1-2003.

CLASS 36—(Continued).

2,765,504. LOS ANGELES GAY AND LESBIAN COMMUNITY SERVICES CENTER, THE, LOS ANGELES, CA. AND SAN FRANCISCO AIDS FOUNDATION, THE, SAN FRANCISCO, CA. SN 76-439,280. PUB. 12-17-2002, FILED 10-15-2001.

AIDS/LIFECYCLE

FOR CHARITABLE FUND RAISING EVENTS (U.S. CLS. 100, 101 AND 102).

FIRST USE 10-22-2001; IN COMMERCE 10-22-2001.

2,765,532. TEAM DUNN INC, COPPELL, TX. SN 78-000,054. PUB. 1-21-2003, FILED 3-20-2000.

**BUY LOCALLY, SELL
GLOBALLY!!!**

FOR REAL ESTATE BROKERAGE AND LISTINGS (U.S. CLS. 100, 101 AND 102).

FIRST USE 9-21-2000; IN COMMERCE 9-21-2000.

2,765,542. INTERCONTINENTALEXCHANGE, INC., ATLANTA, GA, BY MERGER INTERCONTINENTALEXCHANGE, L.L.C., ATLANTA, GA. SN 78-016,604. PUB. 9-17-2002, FILED 7-13-2000.

**INTERCONTINENTAL
EXCHANGE**

FOR PROVIDING AN ONLINE EXCHANGE SERVICE FOR PURCHASING AND/OR SELLING COMMODITIES AND COMMODITY DERIVATIVES, PROVIDING ONLINE COMMODITIES AND COMMODITY DERIVATIVES PRICING AND RELATED INFORMATION (U.S. CLS. 100, 101 AND 102).

FIRST USE 8-0-2000; IN COMMERCE 8-0-2000.

2,765,544. INTERCONTINENTALEXCHANGE, INC., ATLANTA, GA, BY MERGER INTERCONTINENTALEXCHANGE, L.L.C., ATLANTA, GA. SN 78-016,607. PUB. 9-17-2002, FILED 7-13-2000.



IntercontinentalExchange

FOR PROVIDING AN ONLINE EXCHANGE SERVICE FOR PURCHASING AND/OR SELLING COMMODITIES AND COMMODITY DERIVATIVES, PROVIDING ONLINE COMMODITIES AND COMMODITY DERIVATIVES PRICING AND RELATED INFORMATION (U.S. CLS. 100, 101 AND 102).

FIRST USE 8-0-2000; IN COMMERCE 8-0-2000.

CLASS 36—(Continued).

2,765,594. ALLABOUTLONGTERMCARE.COM, INC., DALLAS, TX. SN 78-060,849. PUB. 10-8-2002, FILED 4-27-2001.

ALL ABOUT LONG TERM CARE

FOR INSURANCE AGENCY IN THE FIELD OF LONG TERM CARE INSURANCE (U.S. CLS. 100, 101 AND 102). FIRST USE 4-1-2001; IN COMMERCE 4-1-2001.

2,765,645. AETNA INC., BLUE BELL, PA. SN 78-081,246. PUB. 6-11-2002, FILED 8-27-2001.

AETNA HEALTHFUND

OWNER OF U.S. REG. NOS. 822,577, 2,167,068, AND OTHERS.

NO CLAIM IS MADE TO THE EXCLUSIVE RIGHT TO USE "HEALTHFUND", APART FROM THE MARK AS SHOWN.

FOR ADMINISTRATION AND UNDERWRITING SERVICES IN THE FIELD OF HEALTH CARE INSURANCE (U.S. CLS. 100, 101 AND 102).

FIRST USE 1-1-2002; IN COMMERCE 1-1-2002.

2,765,661. BANKNORTH GROUP, INC., PORTLAND, ME. SN 78-088,384. PUB. 4-9-2002, FILED 10-15-2001.

IT'S NICE KNOWING

FOR BANKING SERVICES (U.S. CLS. 100, 101 AND 102).

FIRST USE 1-1-2002; IN COMMERCE 1-1-2002.

2,765,662. THE PENNY PROJECT, INC., NEW YORK, NY. SN 78-088,682. PUB. 6-25-2002, FILED 10-16-2001.

**THE PENNY PROJECT
"SMALL CHANGE, BIG
DIFFERENCE"**

FOR NON-PROFIT ORGANIZATION/STUDENT-PROPELLED SCHOLARSHIP FUND PROVIDING BOTH FINANCIAL AID AND MERIT BASED SCHOLARSHIPS FOR YOUNG PEOPLE TOWARDS THE OBTAINMENT OF HIGHER EDUCATION, INTERNATIONAL, CROSS-CULTURAL AND SOCIO-EDUCATIONAL EXPERIENCES (U.S. CLS. 100, 101 AND 102).

FIRST USE 10-28-2002; IN COMMERCE 10-28-2002.

CLASS 36—(Continued).

2,765,700. ADVANCED SETTLEMENTS, ORLANDO, FL. SN 78-103,486. PUB. 10-8-2002, FILED 1-18-2002.

ADVANCED SETTLEMENTS

NO CLAIM IS MADE TO THE EXCLUSIVE RIGHT TO USE "SETTLEMENTS", APART FROM THE MARK AS SHOWN.

FOR VIATICAL SETTLEMENT AND LIFE SETTLEMENT SERVICES (U.S. CLS. 100, 101 AND 102).

FIRST USE 6-24-2002; IN COMMERCE 6-24-2002.

2,765,703. NATIONAL CITY CORPORATION, CLEVELAND, OH. SN 78-104,526. PUB. 9-24-2002, FILED 1-24-2002.

**THE LAST LOAN YOU'LL
EVER NEED**

FOR BANKING SERVICES (U.S. CLS. 100, 101 AND 102).

FIRST USE 4-1-2002; IN COMMERCE 4-1-2002.

2,765,710. SCUDDER TRUST COMPANY, SALEM, NH. SN 78-107,091. PUB. 9-17-2002, FILED 2-6-2002.

PERSONAL (K)

NO CLAIM IS MADE TO THE EXCLUSIVE RIGHT TO USE "PERSONAL", APART FROM THE MARK AS SHOWN.

FOR RETIREMENT PLAN ADMINISTRATION SERVICES (U.S. CLS. 100, 101 AND 102).

FIRST USE 4-0-2002; IN COMMERCE 4-0-2002.

2,765,729. WAYNE HUMMER INVESTMENTS, L.L.C., CHICAGO, IL. SN 78-113,572. PUB. 11-26-2002, FILED 3-8-2002.

**WAYNE HUMMER TRUST
COMPANY**

OWNER OF U.S. REG. NOS. 2,049,248 AND 2,537,069.

NO CLAIM IS MADE TO THE EXCLUSIVE RIGHT TO USE "TRUST COMPANY", APART FROM THE MARK AS SHOWN.

THE NAME IN THE MARK DOES NOT IDENTIFY A LIVING INDIVIDUAL.

FOR FINANCIAL MANAGEMENT SERVICES, NAMELY, CREATING, MANAGING AND ADMINISTERING TRUSTS AND PROVIDING CUSTODIAL SERVICES THERETO, NAMELY, OPERATING THE GENERAL BUSINESS OF A TRUST COMPANY (U.S. CLS. 100, 101 AND 102).

FIRST USE 5-0-2003; IN COMMERCE 5-0-2003.

CLASS 36—(Continued).

2,765,741. GLOBAL SERVICE SOLUTIONS, INC, ATLANTA, GA. SN 78-116,187. PUB. 11-26-2002, FILED 3-20-2002.

GOT PREPAID?

NO CLAIM IS MADE TO THE EXCLUSIVE RIGHT TO USE "PREPAID", APART FROM THE MARK AS SHOWN.

FOR PRE-PAID PURCHASE CARD SERVICES NAMELY, PROCESSING ELECTRONIC PAYMENTS MADE THROUGH PREPAID CARDS FEATURING PINS; TELEPHONE CALLING CARD SERVICES FEATURING PREPAID ACCOUNTS AND PINS (U.S. CLS. 100, 101 AND 102).

FIRST USE 10-15-2002; IN COMMERCE 10-15-2002.

2,765,742. FMR CORP., BOSTON, MA. SN 78-116,196. PUB. 10-8-2002, FILED 3-20-2002.

FUND PICKS FROM FIDELITY

OWNER OF U.S. REG. NOS. 1,277,373, 1,481,037, AND OTHERS.

NO CLAIM IS MADE TO THE EXCLUSIVE RIGHT TO USE FUND PICKS, APART FROM THE MARK AS SHOWN.

FOR PROVIDING INFORMATION IN THE FIELD OF MUTUAL FUNDS BY MEANS OF THE INTERNET; FINANCIAL INFORMATION PROVIDED BY ELECTRONIC MEANS (U.S. CLS. 100, 101 AND 102).

FIRST USE 5-0-2002; IN COMMERCE 5-0-2002.

2,765,754. INTERMART CORP., THOUSAND OAKS, CA. SN 78-120,658. PUB. 11-5-2002, FILED 4-10-2002.

CARD2CARD

FOR FINANCIAL SERVICES; NAMELY, PROVIDING CREDIT CARDS, DEBIT CARDS, CHARGE CARDS, STORED VALUE CARDS, SMART CARDS, TRAVELERS CARDS, CASH DISBURSEMENTS, AND TRANSACTION AUTHORIZATION, TRANSFER SETTLEMENT SERVICES (U.S. CLS. 100, 101 AND 102).

FIRST USE 3-23-2002; IN COMMERCE 3-23-2002.

2,765,762. OWENS-CORNING FIBERGLAS TECHNOLOGY INC., SUMMIT, IL. SN 78-122,242. PUB. 10-22-2002, FILED 4-17-2002.

TRU PROTECTION PLUS

FOR PROVIDING EXTENDED WARRANTY SERVICES ON BUILDING CONSTRUCTION MATERIALS (U.S. CLS. 100, 101 AND 102).

FIRST USE 7-31-2002; IN COMMERCE 7-31-2002.

CLASS 36—(Continued).

2,765,818. METROPOLITAN LIFE INSURANCE COMPANY, NEW YORK, NY. SN 78-144,893. PUB. 2-4-2003, FILED 7-17-2002.

MFFS

FOR FINANCIAL SERVICES, NAMELY, FINANCIAL PLANNING FOR RETIREMENT AND FINANCIAL CONSULTATION FOR EMPLOYEES OF EDUCATION, HEALTHCARE, AND NOT-FOR-PROFIT ORGANIZATIONS; INVESTMENT MANAGEMENT AND DISTRIBUTION OF VARIABLE ANNUITIES; MUTUAL FUND INVESTMENT FOR RETIREMENT PROGRAMS; PROVIDING FINANCIAL INFORMATION VIA THE INTERNET IN THE FIELD OF RETIREMENT PROGRAMS (U.S. CLS. 100, 101 AND 102).

FIRST USE 5-1-2002; IN COMMERCE 5-1-2002.

2,765,827. CITICORP, NEW YORK, NY. SN 78-975,080. PUB. 10-16-2001, FILED 10-13-2000.



FOR FINANCIAL SERVICES, NAMELY, PERFORM PERSONAL BANKING, BILL PRESENTMENT AND PAYMENT SERVICES, COMPRISED OF CREDIT AND DEBIT CARD SERVICES, ON-LINE BANK ACCOUNTS AND WEB-BASED MONEY TRANSFERS, AND FINANCIAL AND ACCOUNT INFORMATION AGGREGATION SERVICES OVER A GLOBAL COMPUTER NETWORK (U.S. CLS. 100, 101 AND 102).

FIRST USE 7-15-2000; IN COMMERCE 10-23-2000.

CLASS 37—CONSTRUCTION AND REPAIR

2,764,525. HOLZER, ROBERT W., MAPLE GROVE, MN. SN 75-642,937. PUB. 10-26-1999, FILED 2-16-1999.

TIDY TIM

FOR WASTE COLLECTION AND DISPOSAL FOR OTHERS (U.S. CLS. 100, 103 AND 106).

FIRST USE 12-1-2002; IN COMMERCE 12-1-2002.

CLASS 37—(Continued).

2,764,554. KEFORD COLLISION SERVICE, INC., NOVI, MI.
SN 75-704,981. PUB. 7-24-2001, FILED 5-13-1999.

MASTER CLASS COLLISION CENTER

NO CLAIM IS MADE TO THE EXCLUSIVE RIGHT TO USE "COLLISION CENTER", APART FROM THE MARK AS SHOWN.

FOR AUTOMOTIVE REPAIR SERVICES (U.S. CLS. 100, 103 AND 106).
FIRST USE 4-22-2003; IN COMMERCE 4-22-2003.

2,764,556. KEFORD COLLISION SERVICE, INC., NOVI, MI.
SN 75-710,931. PUB. 4-16-2002, FILED 5-20-1999.



NO CLAIM IS MADE TO THE EXCLUSIVE RIGHT TO USE "COLLISION CENTER", APART FROM THE MARK AS SHOWN.

THE MARK IS NOT LINED FOR COLOR.
FOR AUTOMOTIVE REPAIR SERVICES (U.S. CLS. 100, 103 AND 106).
FIRST USE 4-22-2003; IN COMMERCE 4-22-2003.

2,764,578. CASTROL LIMITED, SWINDON, WILTSHIRE SN3
1RE, ENGLAND. SN 75-766,858. PUB. 3-7-2000, FILED 8-3-
1999.

CASTROL

FOR LUBRICATION, MAINTENANCE AND REPAIR
SERVICES FOR MOTOR VEHICLES (U.S. CLS. 100, 103
AND 106).
FIRST USE 7-12-1999; IN COMMERCE 7-12-1999.

2,764,679. BOOKER, BRIAN C., CASTROVILLE, TX. SN 76-
015,543. PUB. 1-2-2001, FILED 4-3-2000.



NO CLAIM IS MADE TO THE EXCLUSIVE RIGHT TO USE "USA", APART FROM THE MARK AS SHOWN.
FOR REPAIR AND MAINTENANCE OF RECREA-
TIONAL VEHICLES (U.S. CLS. 100, 103 AND 106).
FIRST USE 8-1-2000; IN COMMERCE 8-1-2000.

CLASS 37—(Continued).

2,764,788. XO COMMUNICATIONS, INC., RESTON, VA. SN
76-124,996. PUB. 4-16-2002, FILED 9-8-2000.

XO

PRIORITY CLAIMED UNDER SEC. 44(D) ON ERPN
CMNTY TM OFC APPLICATION NO. 1789494, FILED 8-2-
2000.

FOR CONSTRUCTION, INSTALLATION, AND MAIN-
TENANCE OF TELECOMMUNICATIONS SYSTEMS,
NAMESLY CELLULAR TELEPHONE SYSTEMS, VOICE,
DATA, FACSIMILE, AND VIDEO COMMUNICATIONS
SYSTEMS, AND INTERNET CONNECTIONS; INSTAL-
LATION, MAINTENANCE, AND REPAIR OF COMPU-
TERS, COMPUTER RELATED HARDWARE, AND
COMPUTER NETWORKS (U.S. CLS. 100, 103 AND 106).
FIRST USE 9-25-2000; IN COMMERCE 9-25-2000.

2,764,874. SER SOLUTIONS, INC., DULLES, VA, BY MER-
GER PORTAL CONNECT, INC., HERNDON, VA. SN 76-
181,113. PUB. 8-13-2002, FILED 12-14-2000.

SER SOLUTIONS

OWNER OF U.S. REG. NO. 2,428,042.
NO CLAIM IS MADE TO THE EXCLUSIVE RIGHT TO
USE "SOLUTIONS", APART FROM THE MARK AS
SHOWN.

FOR INSTALLATION OF COMPUTER HARDWARE;
MAINTENANCE OF COMPUTER HARDWARE (U.S.
CLS. 100, 103 AND 106).
FIRST USE 1-1-2001; IN COMMERCE 1-1-2001.

2,765,035. TFH-EB, INC., DBA THE WATERWORKS, CO-
LUMBUS, OH. SN 76-274,388. PUB. 8-6-2002, FILED 6-19-
2001.

UNIVERSAL PROTECTION PLAN

NO CLAIM IS MADE TO THE EXCLUSIVE RIGHT TO
USE "PROTECTION PLAN", APART FROM THE MARK AS
SHOWN.

FOR PLUMBING SERVICES, NAMESLY, INSTALLA-
TION, REPAIR AND MAINTENANCE OF PLUMBING
SYSTEM AND FIXTURES AT A VALUE RATE PRICE
(U.S. CLS. 100, 103 AND 106).
FIRST USE 11-1-2000; IN COMMERCE 11-1-2000.

CLASS 37—(Continued).

2,765,193. SPECTRUM MANAGEMENT, L.L.C., CARROLLTON, TX. SN 76-329,868. PUB. 9-17-2002, FILED 10-23-2001.



NO CLAIM IS MADE TO THE EXCLUSIVE RIGHT TO USE "MANAGEMENT", APART FROM THE MARK AS SHOWN.

FOR MAINTENANCE OF ELECTRONIC TRACKING DEVICES TO BE USED IN CONNECTION WITH LAW ENFORCEMENT (U.S. CLS. 100, 103 AND 106).
FIRST USE 1-0-2000; IN COMMERCE 1-0-2000.

2,765,297. ASBURY AUTOMOTIVE GROUP L.L.C., STAMFORD, CT. SN 76-360,286. PUB. 7-30-2002, FILED 1-18-2002.



NO CLAIM IS MADE TO THE EXCLUSIVE RIGHT TO USE "EXPRESS SERVICE", APART FROM THE MARK AS SHOWN.

FOR AUTOMOBILE MAINTENANCE AND REPAIR SERVICES (U.S. CLS. 100, 103 AND 106).
FIRST USE 5-0-2002; IN COMMERCE 5-0-2002.

2,765,337. WASTE MANAGEMENT, INC., HOUSTON, TX. SN 76-372,685. PUB. 9-24-2002, FILED 2-14-2002.

THE SERVICE MACHINE

FOR SOLID WASTE LANDFILL SERVICES (U.S. CLS. 100, 103 AND 106).
FIRST USE 4-22-2003; IN COMMERCE 4-22-2003.

2,765,374. RECEIL IT INTERNATIONAL, INC., COPIAGUE, NY. SN 76-379,860. PUB. 10-8-2002, FILED 3-7-2002.

WE GIVE CEILINGS A SECOND CHANCE

FOR CEILING RESTORATION SERVICES (U.S. CLS. 100, 103 AND 106).
FIRST USE 11-13-2002; IN COMMERCE 11-13-2002.

CLASS 37—(Continued).

2,765,392. ASSOCIATION OF WEDDING GOWN SPECIALISTS, ORANGE, CT. SN 76-387,599. PUB. 10-8-2002, FILED 3-25-2002.

MUSEUMCARE

FOR CLEANING AND PRESERVATIONS OF GOWNS AND SPECIALTY CLOTHING (U.S. CLS. 100, 103 AND 106).

FIRST USE 2-1-2002; IN COMMERCE 2-11-2002.

2,765,404. PATZWALD, DAVID, DALLAS, TX. SN 76-391,283. PUB. 10-29-2002, FILED 4-3-2002.



FOR MAINTENANCE OF COMPUTER HARDWARE; INSTALLATION AND REPAIR OF COMPUTERS AND COMPUTER NETWORKS (U.S. CLS. 100, 103 AND 106).
FIRST USE 2-1-2003; IN COMMERCE 2-1-2003.

2,765,409. ENVIRONMENTAL SYSTEMS CORPORATION, KNOXVILLE, TN. SN 76-392,379. PUB. 1-21-2003, FILED 4-5-2002.

ECO Monitoring

NO CLAIM IS MADE TO THE EXCLUSIVE RIGHT TO USE "ECO MONITORING", APART FROM THE MARK AS SHOWN.

FOR INSTALLATION AND MAINTENANCE OF ENVIRONMENTAL MONITORING EQUIPMENT (U.S. CLS. 100, 103 AND 106).
FIRST USE 8-1-2002; IN COMMERCE 8-1-2002.

2,765,537. DIRTBANC, LLC, WEBSTER GROVES, MO. SN 78-006,085. PUB. 9-25-2001, FILED 4-28-2000.

DIRTBANC

FOR PROVIDING INFORMATION REGARDING LAND DEVELOPMENT SERVICES; NAMELY, DATA RELATED TO THE ACQUISITION, REMOVAL OR RECLAMATION OF DIRT, EARTH OR SOIL PROVIDED VIA A GLOBAL COMPUTER NETWORK (U.S. CLS. 100, 103 AND 106).

FIRST USE 2-1-2001; IN COMMERCE 2-1-2001.

CLASS 37—(Continued).

2,765,667. CONNECTICUT TICK CONTROL LLC, NORWALK, CT. SN 78-089,973. PUB. 6-4-2002, FILED 10-24-2001.

CLASS 37—(Continued).

2,765,793. CLARK'S QUALITY ROOFING INCORPORATION, MURRAY, UT. SN 78-136,307. PUB. 1-7-2003, FILED 6-17-2002.

TICK PRO

NO CLAIM IS MADE TO THE EXCLUSIVE RIGHT TO USE "TICK", APART FROM THE MARK AS SHOWN.
FOR TICK EXTERMINATION OTHER THAN FOR AGRICULTURE (U.S. CLS. 100, 103 AND 106).
FIRST USE 3-21-2002; IN COMMERCE 3-21-2002.



2,765,699. SOLOMON, DANE, SANTA MONICA, CA. AND TURPIN, TOM, SANTA MONICA, CA. SN 78-103,298. PUB. 12-10-2002, FILED 1-17-2002.

SPRUCE CLEANERS

NO CLAIM IS MADE TO THE EXCLUSIVE RIGHT TO USE "CLEANERS", APART FROM THE MARK AS SHOWN.
FOR PROVIDING SERVICES FOR OTHERS, NAMELY CLOTH IRONING, CLOTH LAUNDERING, CLOTH LAUNDRY, CLOTH PRESSING, CLOTHING IRONING, CLOTHING LAUNDRY, CLOTHING PRESSING, CLOTHING REPAIR, CLOTHING WASHING, DIAPER CLEANING, DRY CLEANING, PRESSING OF FABRIC, WASHING OF FABRIC, FABRIC IRONING, FABRIC LAUNDERING, PROVIDING WASHING AND DRYING LAUNDRY FACILITIES, HAT REPAIR, HAT RESTORATION, SELF-SERVICE LAUNDRY, LAUNDRY SERVICES FOR SPECIFIC GOODS, NAMELY CLOTH, CLOTHING, FABRIC, LINEN, TEXTILES; LEATHER CLEANING AND REPAIR, PRESSING OF GOODS, NAMELY CLOTH, CLOTHING, FABRIC, TEXTILES; WASHING OF CLOTH, CLOTHING, FABRIC, LINEN AND TEXTILES (U.S. CLS. 100, 103 AND 106).
FIRST USE 2-15-2002; IN COMMERCE 2-15-2002.

NO CLAIM IS MADE TO THE EXCLUSIVE RIGHT TO USE "INDUSTRIAL" AND "COMMERCIAL" AND "QUALITY ROOFING" AND "INC." AND "PRACTICAL ROOF", APART FROM THE MARK AS SHOWN.
FOR ROOFING INSTALLATION AND REPAIR; ROOFING CONTRACTING (U.S. CLS. 100, 103 AND 106).
FIRST USE 12-1-2002; IN COMMERCE 12-1-2002.

CLASS 38—COMMUNICATION

2,764,617. NEXTEL COMMUNICATIONS, INC., RESTON, VA. SN 75-854,539. PUB. 8-1-2000, FILED 11-22-1999.

2,765,732. O & S HOLDINGS, LLC, LOS ANGELES, CA. SN 78-114,202. PUB. 10-15-2002, FILED 3-12-2002.

NEXTEL HOW BUSINESS GETS DONE INSTANTLY**BUILDING TOMORROW'S FUTURE, TODAY!**

FOR REAL ESTATE DEVELOPMENT (U.S. CLS. 100, 103 AND 106).
FIRST USE 1-15-2002; IN COMMERCE 5-10-2002.

FOR TELECOMMUNICATIONS SERVICES, NAMELY TWO-WAY RADIO DISPATCHING SERVICES, ELECTRONIC TRANSMISSION OF VOICE, DATA AND INFORMATION BY MEANS OF TWO-WAY RADIOS, PAGING SERVICES AND MOBILE TELEPHONE COMMUNICATION SERVICES (U.S. CLS. 100, 101 AND 104).
FIRST USE 3-0-2002; IN COMMERCE 3-0-2002.

CLASS 38—(Continued).

2,764,790. XO COMMUNICATIONS, INC., RESTON, VA. SN 76-126,777. PUB. 5-21-2002, FILED 9-8-2000.



THE MARK CONSISTS OF THE LETTERS "XO" IN STYLIZED FORM IMMEDIATELY ABOVE THE PHRASE "NOT JUST TALK".
 FOR WIRELESS DIGITAL MESSAGING SERVICES; LOCATION INDEPENDENT PERSONAL COMMUNICATIONS SERVICES COMPRISING MOBILE VOICE, DATA, AND FACSIMILE SERVICES; PROVIDING ONLINE FACILITIES FOR OTHERS FOR REAL-TIME INTERACTION WITH OTHER COMPUTER USERS, NAMELY, INSTANT MESSAGING; VIDEO TELECONFERENCING SERVICES; TELEMISSION OF VOICE, TEXT FACSIMILE, VIDEO AND DATA VIA SATELLITE AND UNDERSEA TELECOMMUNICATIONS LINKS (U.S. CLS. 100, 101 AND 104).
 FIRST USE 9-25-2000; IN COMMERCE 9-25-2000.

2,764,864. THE TRUSTEES OF THE UNIVERSITY OF PENNSYLVANIA, PHILADELPHIA, PA. SN 76-172,515. PUB. 12-25-2001, FILED 11-29-2000.

MAGPI

FOR PROVIDING MULTIPLE-USER ACCESS TO A GLOBAL COMPUTER INFORMATION NETWORK (U.S. CLS. 100, 101 AND 104).
 FIRST USE 1-0-1997; IN COMMERCE 1-0-1997.

2,765,115. FLAMENCO NETWORKS, INC., ALPHARETTA, GA, BY CHANGE OF NAME FLAMENCO CORPORATION, DBA FLAMENCO NETWORKS, ALPHARETTA, GA. SN 76-307,785. PUB. 6-11-2002, FILED 8-31-2001.



NO CLAIM IS MADE TO THE EXCLUSIVE RIGHT TO USE "NETWORKS", APART FROM THE MARK AS SHOWN.
 FOR ELECTRONIC COMMERCE DISTRIBUTED VIA EXTENSIBLE MARKUP LANGUAGE (XML) NETWORKING SERVICES, NAMELY, PROVIDING MULTIPLE USER ACCESS TO A GLOBAL COMPUTER NETWORK (U.S. CLS. 100, 101 AND 104).
 FIRST USE 8-1-2001; IN COMMERCE 8-31-2001.

CLASS 38—(Continued).

2,765,136. EPIK COMMUNICATIONS INCORPORATED, ORLANDO, FL. SN 76-313,889. PUB. 8-20-2002, FILED 9-19-2001.

ENLIGHTENED OPTICAL

NO CLAIM IS MADE TO THE EXCLUSIVE RIGHT TO USE "OPTICAL", APART FROM THE MARK AS SHOWN.
 FOR TELECOMMUNICATION SERVICES, NAMELY, OPTICAL NETWORK SERVICES FOR VOICE AND DATA TRANSMISSION, NAMELY, TRADITIONAL OC-N CAPACITY, MANAGED WAVELENGTH SERVICES; TELECOMMUNICATION SERVICES INVOLVING WAVELENGTH SERVICES, NAMELY, LONG-HAUL AND METRO HIGH CAPACITY WAVES DELIVERED AT 25 AND 10 GIGABITS PER SECOND AND UTILIZING DENSE WAVE DIVISION MULTIPLEXING TECHNOLOGY; TELECOMMUNICATION CONNECTIVITY SERVICES PROVIDED TO LONG DISTANCE, INTERNATIONAL, AND WIRELESS CARRIERS, INTERNET SERVICE PROVIDERS, AND COMPETITIVE LOCAL EXCHANGE CARRIERS; TELECOMMUNICATION SERVICES, NAMELY, PROVIDING OF PROTOCOL-INDEPENDENT CONNECTIVITY WITH HAND-OFF TO CUSTOMERS USING INDUSTRY STANDARD OPTICAL INTERFACES (U.S. CLS. 100, 101 AND 104).
 FIRST USE 10-17-2001; IN COMMERCE 10-17-2001.

2,765,334. US CONVERGION, LLC, NORCROSS, GA. SN 76-371,567. PUB. 9-10-2002, FILED 2-15-2002.

COMMUNICATING AT THE SPEED OF BUSINESS

FOR TELECOMMUNICATION SERVICES, NAMELY, INTEGRATED ELECTRONIC TRANSMISSION OF VOICE, VIDEO, AND DATA (U.S. CLS. 100, 101 AND 104).
 FIRST USE 2-14-2002; IN COMMERCE 2-20-2002.

2,765,508. ROAD RUNNER HOLDCO LLC, HERNDON, VA. SN 76-449,529. PUB. 2-25-2003, FILED 9-13-2002.

YOUR WORLD IS ALWAYS ON

FOR BROADBAND INTERNET ACCESS SERVICES (U.S. CLS. 100, 101 AND 104).
 FIRST USE 9-0-2002; IN COMMERCE 9-0-2002.

CLASS 38—(Continued).

2,765,534. BELLSOUTH INTELLECTUAL PROPERTY CORPORATION, WILMINGTON, DE. SN 78-002,429. PUB. 9-18-2001, FILED 4-4-2000.

>>> CONÉCTATE >> Y CREA MARAVILLAS

THE ENGLISH TRANSLATION OF ">>> CONECTATE >> Y CREA MARVILLAS" IS ">>> CONNECT >> AND CREATE SOMETHING".

FOR TELECOMMUNICATIONS SERVICES, NAMELY, PROVIDING TRANSMISSION OF VOICE, DATA, FACSIMILE AND VIDEO VIA COMPUTER, TELEVISION AND TELECOMMUNICATIONS NETWORKS; WIRELINE AND WIRELESS COMMUNICATION TRANSMISSION SERVICES; CUSTOM CALLING SERVICES FOR CONSUMERS AND BUSINESS; VOICE AND DATA MESSAGING STORE AND FORWARD SERVICES; VOICE AND VIDEO CONFERENCING SERVICES; TELECOMMUNICATIONS GATEWAY SERVICES FOR PROVIDING ACCESS TO GLOBAL COMPUTER COMMUNICATIONS NETWORKS, ELECTRONIC TRANSMISSION OF DATA, SOUND, TEXT AND IMAGE MESSAGES, AND VIDEO TRANSMISSION SERVICES; CELLULAR TELEPHONE SERVICES; PAGING SERVICES, TELEPHONE COMMUNICATION SERVICES; ANALOG AND DIGITAL TELEVISION TRANSMISSION SERVICES, TELEVISION BROADCASTING SERVICES; PROVIDING NON-INTERACTIVE AND INTERACTIVE ONLINE MULTIPLE USER ACCESS TO GLOBAL COMPUTER INFORMATION NETWORKS FOR THE TRANSFER AND DISSEMINATION OF INFORMATION ON A WIDE RANGE OF TOPICS (U.S. CLS. 100, 101 AND 104).
FIRST USE 7-1-2000; IN COMMERCE 7-1-2000.

CLASS 39—TRANSPORTATION AND STORAGE

2,764,485. AIRPORT SATELLITE PARKING LLC, NEWARK, NJ. SN 75-449,390. PUB. 5-7-2002, FILED 3-10-1998.



NO CLAIM IS MADE TO THE EXCLUSIVE RIGHT TO USE "AIRPORT VALET PARKING", APART FROM THE MARK AS SHOWN.

THE LINING SHOWN IN THE DRAWING IS A FEATURE OF THE MARK AND IS NOT INTENDED TO INDICATE COLOR

FOR PARKING LOT SERVICES AND GROUND TRANSPORTATION OF PASSENGERS TO AND FROM AN AIRPORT AND A PARKING LOT (U.S. CLS. 100 AND 105).

FIRST USE 11-30-1997; IN COMMERCE 11-30-1997.

CLASS 39—(Continued).

2,764,545. TRAVELONLINE.COM LLC, SPRINGFIELD, NJ. SN 75-691,544. PUB. 8-27-2002, FILED 4-26-1999.



NO CLAIM IS MADE TO THE EXCLUSIVE RIGHT TO USE "TRAVEL ONLINE", APART FROM THE MARK AS SHOWN.

FOR PROVIDING INFORMATION AND RESERVATION SERVICES IN THE FIELD OF TRAVEL ARRANGEMENTS AND TRANSPORT BY MEANS OF A GLOBAL COMPUTER NETWORK (U.S. CLS. 100 AND 105).

FIRST USE 6-4-1999; IN COMMERCE 6-4-1999.

2,764,608. FEDERAL EXPRESS CORPORATION, MEMPHIS, TN. SN 75-838,829. PUB. 7-2-2002, FILED 11-3-1999.

FEDEX CUSTOM CRITICAL

OWNER OF U.S. REG. NOS. 1,311,503, 1,741,751, AND OTHERS.

FOR PICK-UP TRANSPORTATION, STORAGE, TRACKING AND DELIVERY OF DOCUMENTS, PACKAGES AND FREIGHT BY LAND AND AIR (U.S. CLS. 100 AND 105).

FIRST USE 1-19-2000; IN COMMERCE 1-19-2000.

2,764,627. YIANILOS, PETER N., PRINCETON, NJ. SN 75-870,691. PUB. 3-20-2001, FILED 12-14-1999.

INTERMEMORY

FOR COMPUTER SERVICES BY MEANS OF A GLOBAL COMPUTER NETWORK TO PROVIDE ELECTRONIC STORAGE OF DATA (U.S. CLS. 100 AND 105).

FIRST USE 6-1-1998; IN COMMERCE 1-1-2002.

2,764,733. BARRERA, ALBERTO ANCHUSTEGUI, 54840 ESTADO DE MEXICO, MEXICO. SN 76-077,048. PUB. 9-18-2001, FILED 6-23-2000.

EASO

THE WORD "EASO" MEANS "PLACE NEAR THE SEA" OR "CLOSE TO THE WATERS".

FOR PUBLIC AND PRIVATE FREIGHT TRANSPORTATION BY TRUCKS (U.S. CLS. 100 AND 105).

FIRST USE 12-6-2002; IN COMMERCE 12-6-2002.

CLASS 39—(Continued).

2,764,737. MN AIRLINES, LLC, MENDOTA, MN, BY CHANGE OF NAME SUN COUNTRY AIRLINES, INC., MENDOTA HEIGHTS, MN. SN 76-079,553. PUB. 2-12-2002, FILED 6-28-2000.

AGENT ACCESS

NO CLAIM IS MADE TO THE EXCLUSIVE RIGHT TO USE "AGENT", APART FROM THE MARK AS SHOWN. FOR AIRLINE TRAVEL RESERVATION SERVICES PROVIDED VIA A GLOBAL COMPUTER NETWORK (U.S. CLS. 100 AND 105).

FIRST USE 5-1-2003; IN COMMERCE 5-1-2003.

2,764,816. HOBIN, WILLIAM W, SANTA MONICA, CA. SN 76-142,229. PUB. 6-26-2001, FILED 10-10-2000.

STORQUEST

FOR STORAGE SERVICES TO THE PUBLIC IN CONNECTION WITH SELF-STORAGE WAREHOUSE FACILITIES (U.S. CLS. 100 AND 105).

FIRST USE 1-1-2001; IN COMMERCE 1-1-2001.

2,765,125. DIVERSIFIED DATA PROCESSING & CONSULTING, INC., FERNDALE, MI. SN 76-310,338. PUB. 9-3-2002, FILED 9-7-2001.

DIVERSECURE

FOR ELECTRONIC STORAGE AND ARCHIVING OF DATA AND DOCUMENTS FOR OTHERS; AND STORAGE SERVICES FOR ARCHIVING DATABASES, IMAGES AND OTHER ELECTRONIC DATA (U.S. CLS. 100 AND 105).

FIRST USE 3-0-2001; IN COMMERCE 3-0-2001.

2,765,440. NORFOLK SOUTHERN CORPORATION, NORFOLK, VA. SN 76-406,849. PUB. 12-17-2002, FILED 5-8-2002.



THE MARK CONSISTS OF HORSE HEAD AND "NS" DESIGN.

FOR FREIGHT TRANSPORTATION BY RAIL (U.S. CLS. 100 AND 105).

FIRST USE 6-12-2002; IN COMMERCE 6-12-2002.

CLASS 39—(Continued).

2,765,558. MARINER INTERNATIONAL TRAVEL, INC., CLEARWATER, FL. SN 78-033,775. PUB. 10-29-2002, FILED 11-3-2000.

FIVE STAR SAILING

NO CLAIM IS MADE TO THE EXCLUSIVE RIGHT TO USE "SAILING", APART FROM THE MARK AS SHOWN. FOR YACHT CHARTERING (U.S. CLS. 100 AND 105).

FIRST USE 9-11-2000; IN COMMERCE 9-11-2000.

2,765,663. IRONLINK INC., CALGARY, ALBERTA T2W 3X6, CANADA. SN 78-088,828. PUB. 10-1-2002, FILED 10-17-2001.

IRONLINK

FOR LOGISTICS SERVICES, NAMELY, FREIGHT FORWARDING SERVICES AND LOGISTICS BROKERAGE SERVICES IN THE NATURE OF TRANSPORT BROKERAGE (U.S. CLS. 100 AND 105).

FIRST USE 12-12-2001; IN COMMERCE 12-12-2001.

2,765,671. NOVARTIS AG, BASEL, SWITZERLAND. SN 78-091,649. PUB. 6-4-2002, FILED 11-5-2001.

NUTRITION TO YOUR DOOR

FOR DELIVERY OF GROCERIES, NUTRITIONAL SUPPLEMENTS, VITAMINS, AND SUNDRIES TO HOMES, ASSISTED CARE FACILITIES, AND NURSING HOMES (U.S. CLS. 100 AND 105).

FIRST USE 10-1-2001; IN COMMERCE 10-1-2001.

2,765,688. WHERE'S WINE LLC, SAN FRANCISCO, CA. SN 78-098,425. PUB. 8-6-2002, FILED 12-14-2001.

WHICH WINERY

NO CLAIM IS MADE TO THE EXCLUSIVE RIGHT TO USE "WINERY", APART FROM THE MARK AS SHOWN.

FOR PROVIDING INFORMATION IN THE FIELD OF TRAVEL BY MEANS OF A GLOBAL COMPUTER NETWORK (U.S. CLS. 100 AND 105).

FIRST USE 1-25-2003; IN COMMERCE 1-25-2003.

CLASS 40—MATERIAL TREATMENT

CLASS 40—(Continued).

2,764,663. XPORTATION SAFETY CONCEPTS, INC. (XSCI), COLORADO SPRINGS, CO. SN 75-950,342. PUB. 12-26-2000, FILED 2-29-2000.

PIONEERED

FOR CUSTOM MANUFACTURE OF AUTOMOTIVE SAFETY DEVICES TO THE ORDER AND SPECIFICATION OF OTHERS (U.S. CLS. 100, 103 AND 106).
FIRST USE 2-0-2002; IN COMMERCE 2-0-2002.

2,765,170. PINNACLE WEST ENERGY CORPORATION, PHOENIX, AZ. SN 76-324,195. PUB. 6-25-2002, FILED 10-10-2001.

**REDHAWK**

THE MARK CONSISTS OF A HAWK'S HEAD COLORED IN RED WITH A CREAM COLORED BEAK. THE HAWK'S HEAD IS SURROUNDED BY AN ORANGE COLORED FLAME DESIGN WHICH CONTAINS CREAM COLORED DOTS WITHIN A RED CIRCLE LOCATED ABOVE THE WORD RED HAWK, ALSO COLORED IN RED.

FOR ENERGY GENERATION SERVICES (U.S. CLS. 100, 103 AND 106).
FIRST USE 5-13-2003; IN COMMERCE 5-13-2003.

2,765,361. TECHMETALS, INC., DAYTON, OH. SN 76-377,301. PUB. 7-23-2002, FILED 3-1-2002.

E-KROME

FOR METAL TREATMENT SERVICES (U.S. CLS. 100, 103 AND 106).
FIRST USE 4-7-2003; IN COMMERCE 4-7-2003.

CLASS 40—(Continued).

2,765,601. CRIDER AMERICAS, LLC, IRWINDALE, CA. SN 78-064,292. PUB. 4-2-2002, FILED 5-18-2001.



FOR CUSTOM GREENHOUSE MANUFACTURING (U.S. CLS. 100, 103 AND 106).
FIRST USE 4-10-2001; IN COMMERCE 4-10-2001.

2,765,672. NOLTE PRECISE MANUFACTURING, INC., CINCINNATI, OH. SN 78-091,925. PUB. 10-15-2002, FILED 11-6-2001.

**NOLTE PRECISE
MANUFACTURING**

NO CLAIM IS MADE TO THE EXCLUSIVE RIGHT TO USE "PRECISE MANUFACTURING", APART FROM THE MARK AS SHOWN.

FOR CUSTOM MANUFACTURE OF COMPONENT PARTS FROM STEEL, STAINLESS STEEL, ALUMINUM AND PLASTIC FOR OTHERS; CUSTOM MANUFACTURE OF FORGING, CASTINGS, AND ROUGH MACHINED PARTS FOR OTHERS (U.S. CLS. 100, 103 AND 106).

FIRST USE 2-1-2002; IN COMMERCE 2-1-2002.

2,765,829. PLURI-CAPITAL (PCI) INC, JONQUIERE, PROVINCE OF QUEBEC, CANADA. SN 78-975,099. PUB. 8-6-2002, FILED 10-22-2001.

PERDURE

FOR HIGH TEMPERATURE WOOD TREATMENT WHICH RESULTS IN THE ELIMINATION OF ROTTING AND WARPING, AN INCREASE IN WOOD HARDNESS AND STABILITY, A DECREASE IN MOISTURE LEVEL AND THOROUGH CROSS-SELECTION EL COLORING (U.S. CLS. 100, 103 AND 106).

FIRST USE 7-15-2002; IN COMMERCE 7-15-2002.

CLASS 41—EDUCATION AND ENTERTAINMENT

CLASS 41—(Continued).

2,764,489. TWENTIETH CENTURY FOX FILM CORPORATION, LOS ANGELES, CA. SN 75-472,548. PUB. 11-26-2002, FILED 4-22-1998.

FUTURAMA

FOR ENTERTAINMENT SERVICES IN THE NATURE OF AN ON-GOING ANIMATED TELEVISION SERIES FEATURING COMEDY (U.S. CLS. 100, 101 AND 107).
FIRST USE 3-28-1999; IN COMMERCE 3-28-1999.

2,764,536. LES SYSTEMES DE FORMATION ET DE GESTION PERFORM INC., MONTREAL, PROVINCE OF QUEBEC, CANADA. SN 75-672,726. PUB. 9-10-2002, FILED 4-1-1999.

PERFORM

PRIORITY CLAIMED UNDER SEC. 44(D) ON CANADA APPLICATION NO. 693206, FILED 11-8-1991, REG. NO. TMA419,766, DATED 11-19-1993, EXPIRES 11-19-2008.

OWNER OF U.S. REG. NOS. 1,233,540 AND 2,301,217.
FOR ARRANGING AND CONDUCTING EDUCATIONAL CONFERENCES IN THE FIELD OF BUSINESS MANAGEMENT; EDUCATIONAL SERVICES, NAMELY, CONDUCTING SEMINARS, CONFERENCES AND COURSES IN THE FIELDS OF BUSINESS MANAGEMENT, SALES AND COMMUNICATION; DEVELOPMENT AND DISSEMINATION OF EDUCATIONAL MATERIALS OF OTHERS FOR STAFF TRAINING PROGRAMS AND FOR COURSES IN BUSINESS MANAGEMENT, SALES AND COMMUNICATION (U.S. CLS. 100, 101 AND 107).

FIRST USE 3-0-1980; IN COMMERCE 9-0-2002.

2,764,583. READING VENTURE ONE L. L. C., BIRMINGHAM, MI. SN 75-783,504. PUB. 4-18-2000, FILED 8-24-1999.

PHONICSNOW

FOR EDUCATIONAL SERVICES, NAMELY, PROVIDING INSTRUCTION AND TRAINING IN THE FIELD OF BASIC CURRICULUM, NAMELY, LANGUAGE ARTS AND READING (U.S. CLS. 100, 101 AND 107).
FIRST USE 5-0-2000; IN COMMERCE 5-0-2000.

CLASS 41—(Continued).

2,764,592. INDIANAPOLIS ICE L.L.C., INDIANAPOLIS, IN. SN 75-807,262. PUB. 2-12-2002, FILED 9-23-1999.



OWNER OF U.S. REG. NOS. 1,999,301, 2,229,783, AND OTHERS.

NO CLAIM IS MADE TO THE EXCLUSIVE RIGHT TO USE "INDIANAPOLIS", APART FROM THE MARK AS SHOWN.

FOR ENTERTAINMENT SERVICES IN THE NATURE OF PROFESSIONAL HOCKEY COMPETITIONS (U.S. CLS. 100, 101 AND 107).

FIRST USE 9-0-1999; IN COMMERCE 9-0-1999.

2,764,602. ROCK MOUNTAIN CORP. LTD., NOOSA HEADS Q1D, AUSTRALIA. SN 75-817,389. PUB. 12-26-2000, FILED 10-7-1999.



THE LOGO CONSISTS OF THE WORDS ROCK MOUNTAIN WITH AN OUTLINE OF A MOUNTAIN HAVING TWO PEAKS OVER THE LETTER R WITH A MUSICAL NOTE BETWEEN THE PEAKS.

FOR ENTERTAINMENT AND EDUCATIONAL SERVICES, NAMELY, MUSIC THEME PARKS AND ENTERTAINMENT IN THE NATURE OF THEATRE PRODUCTIONS BROADCAST THROUGH MULTIMEDIA SOURCES (U.S. CLS. 100, 101 AND 107).

FIRST USE 9-10-2002; IN COMMERCE 9-10-2002.

2,764,686. STEPPENWOLF THEATRE COMPANY, THE, CHICAGO, IL. SN 76-026,256. PUB. 9-24-2002, FILED 4-13-2000.

STEPPENWOLF

FOR MOTION PICTURE FILM PRODUCTION; PRODUCTION OF TELEVISION SHOWS (U.S. CLS. 100, 101 AND 107).

FIRST USE 9-0-2000; IN COMMERCE 9-0-2000.

CLASS 41—(Continued).

2,764,697. MULTIMEDIA CHANNEL (HK) LIMITED, KOWLOON, HONG KONG. SN 76-039,041. PUB. 8-13-2002, FILED 5-2-2000.



FOR AMUSEMENT CENTERS; EDUCATION INFORMATION IN RELATION TO AMUSEMENT; ENTERTAINMENT INFORMATION IN RELATION TO COMPUTER PROGRAMMING; PUBLICATION OF TEXTS OTHER THAN PUBLICITY TEXTS; INSTRUCTION IN THE FIELD OF ENTERTAINMENT PROGRAMMES; DISTRIBUTION OF CINE-FILMS; CINEMA STUDIOS, MOVIE STUDIOS; ORGANIZATIONS OF EXHIBITIONS FOR CULTURAL AND EDUCATIONAL PURPOSES; PRODUCTION OF RADIO AND TELEVISION PROGRAMMES; RECORDING STUDIOS; PRACTICAL TRAINING IN RELATION TO COMPUTER PROGRAMMING; VIDEOTAPE FILM PRODUCTION (U.S. CLS. 100, 101 AND 107).

FIRST USE 3-1-2000; IN COMMERCE 6-1-2002.

2,764,736. TWENTIETH CENTURY FOX FILM CORPORATION, LOS ANGELES, CA. SN 76-079,498. PUB. 1-29-2002, FILED 6-27-2000.

FOX SPORTS RADIO NETWORK

NO CLAIM IS MADE TO THE EXCLUSIVE RIGHT TO USE "SPORTS RADIO NETWORK", APART FROM THE MARK AS SHOWN.

FOR PRODUCTION OF RADIO PROGRAMMING; DISTRIBUTION OF RADIO PROGRAMMING FOR OTHERS (U.S. CLS. 100, 101 AND 107).

FIRST USE 8-28-2000; IN COMMERCE 8-28-2000.

CLASS 41—(Continued).

2,764,739. USA TRACK & FIELD, INC., INDIANAPOLIS, IN. SN 76-080,234. PUB. 4-10-2001, FILED 6-29-2000.



OWNER OF U.S. REG. NOS. 1,833,872, 1,960,613, AND OTHERS.

NO CLAIM IS MADE TO THE EXCLUSIVE RIGHT TO USE "USA" AND "TRACK AND FIELD", APART FROM THE MARK AS SHOWN.

FOR ENTERTAINMENT SERVICES, NAMELY, TRACK AND FIELD, RUNNING AND RACEWALKING COMPETITIONS AND EVENTS (U.S. CLS. 100, 101 AND 107).

FIRST USE 1-27-2002; IN COMMERCE 1-27-2002.

2,764,759. O2 HOLDINGS, LLC, NEW YORK, NY. SN 76-095,781. PUB. 6-4-2002, FILED 7-25-2000.

OXYGEN SPORTS

NO CLAIM IS MADE TO THE EXCLUSIVE RIGHT TO USE "SPORTS", APART FROM THE MARK AS SHOWN.

FOR EDUCATIONAL AND ENTERTAINMENT SERVICES, NAMELY PROVIDING AUDIO AND VISUAL PROGRAMMING IN THE NATURE OF COMPETITION IN THE FIELD OF ATHLETICS VIA A GLOBAL COMPUTER NETWORK, BROADCAST, CABLE AND SATELLITE TELEVISION (U.S. CLS. 100, 101 AND 107).

FIRST USE 6-15-2002; IN COMMERCE 6-15-2002.

2,764,760. KC MOVIES LLC, INDEPENDENCE, MO. SN 76-096,050. PUB. 9-17-2002, FILED 7-25-2000.

GLOBE CINEMAS

NO CLAIM IS MADE TO THE EXCLUSIVE RIGHT TO USE "CINEMAS", APART FROM THE MARK AS SHOWN.

FOR MOTION PICTURE EXHIBITION SERVICES (U.S. CLS. 100, 101 AND 107).

FIRST USE 11-1-2002; IN COMMERCE 11-1-2002.

CLASS 41—(Continued).

2,764,817. FRANK RUSSELL COMPANY, TACOMA, WA. SN 76-143,147. PUB. 4-9-2002, FILED 10-5-2000.

R U S S E L L
EMPulse

OWNER OF U.S. REG. NOS. 1,576,348, 1,945,514, AND OTHERS.

FOR EDUCATIONAL SERVICES, NAMELY, CONDUCTING CLASSES, CONFERENCES, SEMINARS, WORKSHOPS IN THE FINANCIAL AND INVESTMENT FIELDS (U.S. CLS. 100, 101 AND 107).

FIRST USE 9-8-1999; IN COMMERCE 9-8-1999.

2,764,821. UNIVERSITY OF AKRON, THE, AKRON, OH. SN 76-147,194. PUB. 6-26-2001, FILED 10-13-2000.

AKRON ADVANTAGE

NO CLAIM IS MADE TO THE EXCLUSIVE RIGHT TO USE "AKRON", APART FROM THE MARK AS SHOWN.

FOR EDUCATIONAL SERVICES, NAMELY, PROVIDING EDUCATIONAL INSTRUCTION, COURSES, SEMINARS, LECTURES, PRESENTATIONS, AND EDUCATION AT THE UNIVERSITY LEVEL (U.S. CLS. 100, 101 AND 107).

FIRST USE 6-0-2001; IN COMMERCE 6-0-2001.

2,764,829. B.F.C. INTERNATIONAL, INC., EL PASO, TX. SN 76-153,042. PUB. 1-29-2002, FILED 10-24-2000.

**PEOPLE FACTOR
TECHNOLOGY**

NO CLAIM IS MADE TO THE EXCLUSIVE RIGHT TO USE "PEOPLE" AND "TECHNOLOGY", APART FROM THE MARK AS SHOWN.

FOR EDUCATIONAL SERVICES, NAMELY, PROVIDING SEMINARS, LECTURES, AND CONFERENCES IN THE FIELD OF LEADERSHIP TRAINING (U.S. CLS. 100, 101 AND 107).

FIRST USE 9-1-2000; IN COMMERCE 9-1-2000.

2,764,862. LEAN CONCEPTS, LLC, GRAND RAPIDS, MI. SN 76-171,336. PUB. 5-14-2002, FILED 11-28-2000.

OFFICE LEAN

NO CLAIM IS MADE TO THE EXCLUSIVE RIGHT TO USE "OFFICE", APART FROM THE MARK AS SHOWN.

FOR EDUCATIONAL TRAINING SERVICES, NAMELY, CONDUCTING COURSES AND WORKSHOPS IN THE FIELD OF BUSINESS MANAGEMENT PRACTICES (U.S. CLS. 100, 101 AND 107).

FIRST USE 10-0-1998; IN COMMERCE 11-0-1998.

CLASS 41—(Continued).

2,764,888. COURTROOM TELEVISION NETWORK LLC, NEW YORK, NY. SN 76-191,561. PUB. 7-2-2002, FILED 1-9-2001.

LEGAL FLASHBACK

NO CLAIM IS MADE TO THE EXCLUSIVE RIGHT TO USE "LEGAL", APART FROM THE MARK AS SHOWN.

FOR EDUCATIONAL AND ENTERTAINMENT SERVICES, NAMELY ONGOING CABLE TELEVISION PROGRAMS ABOUT CRIMINALS, CRIMINAL EVENTS, LAW ENFORCEMENT AND COURTROOM TRIALS (U.S. CLS. 100, 101 AND 107).

FIRST USE 3-1-2001; IN COMMERCE 3-1-2001.

2,764,894. DISCOVERY COMMUNICATIONS, INC., BETHESDA, MD. SN 76-198,951. PUB. 8-20-2002, FILED 1-24-2001.

BODY CHALLENGE

NO CLAIM IS MADE TO THE EXCLUSIVE RIGHT TO USE "BODY", APART FROM THE MARK AS SHOWN.

FOR ENTERTAINMENT SERVICES IN THE NATURE OF A TELEVISION SERIES ON THE SUBJECT OF HEALTH, NUTRITION AND PHYSICAL FITNESS (U.S. CLS. 100, 101 AND 107).

FIRST USE 1-10-2002; IN COMMERCE 1-10-2002.

2,764,897. WORLD BIRDING CENTER, INC., MISSION, TX. SN 76-201,709. PUB. 6-25-2002, FILED 1-29-2001.

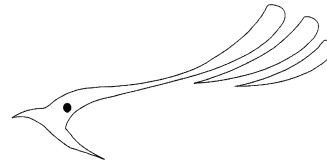

FOR EDUCATION SERVICES, NAMELY, SEMINARS, CONFERENCES AND CLASSES IN THE FIELD OF WILDLIFE AND ENVIRONMENTAL CONSERVATION; ENTERTAINMENT SERVICES, NAMELY, TOURS AND EXHIBITIONS FOR THE VIEWING AND IDENTIFICATION OF PLANTS AND WILDLIFE (U.S. CLS. 100, 101 AND 107).

FIRST USE 9-14-2002; IN COMMERCE 9-14-2002.

CLASS 41—(Continued).

2,764,920. LINCOLN TECHNICAL INSTITUTE, INC., WEST ORANGE, NJ. SN 76-217,098. PUB. 9-25-2001, FILED 2-23-2001.

LINCOLN EDUCATIONAL SERVICES

OWNER OF U.S. REG. NOS. 2,222,267 AND 2,440,890. NO CLAIM IS MADE TO THE EXCLUSIVE RIGHT TO USE "EDUCATIONAL SERVICES", APART FROM THE MARK AS SHOWN.

FOR VOCATIONAL EDUCATIONAL AND TRAINING SERVICES, NAMELY, CONDUCTING CLASSES IN THE FIELDS OF COMPUTERS; ELECTRONICS; COURT REPORTING; AUTOMOTIVE TECHNOLOGY AND REPAIR; DIESEL-ENGINE TECHNOLOGY AND REPAIR; DRAFTING; MAINTENANCE, INSTALLATION AND REPAIR OF HEATING AND AIR CONDITIONING SYSTEMS (U.S. CLS. 100, 101 AND 107).

FIRST USE 11-1-2000; IN COMMERCE 1-1-2001.

2,764,932. CAREY, MARK D., PUYALLUP, WA. SN 76-222,554. PUB. 9-17-2002, FILED 3-12-2001.

MY SOFTWARE HELPER

NO CLAIM IS MADE TO THE EXCLUSIVE RIGHT TO USE "SOFTWARE", APART FROM THE MARK AS SHOWN. FOR TRAINING IN THE USE OF COMPUTER SOFTWARE (U.S. CLS. 100, 101 AND 107).

FIRST USE 5-8-2001; IN COMMERCE 5-8-2001.

2,764,950. LEAPFROG ENTERPRISES, INC., EMERYVILLE, CA. SN 76-237,156. PUB. 7-23-2002, FILED 4-9-2001.



OWNER OF U.S. REG. NOS. 2,169,827 AND 2,284,485. FOR EDUCATIONAL INFORMATION SERVICES FOR PARENTS AND CHILDREN, NAMELY, PROVIDING INFORMATION ON SUBJECTS OF INTEREST TO CHILDREN IN THE NATURE OF TRIVIA GAME-TYPE QUESTIONS, AND IN ACADEMIC SUBJECTS IN THE FIELDS OF HISTORY, MATH, SCIENCE, SPELLING AND GRAMMAR, READING SKILLS, ENGLISH, AND SOCIAL SCIENCES (U.S. CLS. 100, 101 AND 107).

FIRST USE 2-0-2001; IN COMMERCE 6-0-2001.

2,764,955. MAJOR LEAGUE LACROSSE LLC, SECAUCUS, NJ. SN 76-237,840. PUB. 1-1-2002, FILED 4-4-2001.

BRIDGEPORT BARRAGE

NO CLAIM IS MADE TO THE EXCLUSIVE RIGHT TO

CLASS 41—(Continued).

USE "BRIDGEPORT", APART FROM THE MARK AS SHOWN.

FOR ENTERTAINMENT SERVICES, NAMELY, PROFESSIONAL LACROSSE GAMES, COMPETITIONS AND EXHIBITIONS (U.S. CLS. 100, 101 AND 107).

FIRST USE 6-0-2000; IN COMMERCE 6-0-2000.

2,764,956. MAJOR LEAGUE LACROSSE LLC, SECAUCUS, NJ. SN 76-237,841. PUB. 1-1-2002, FILED 4-4-2001.

BOSTON CANNONS

NO CLAIM IS MADE TO THE EXCLUSIVE RIGHT TO USE "BOSTON", APART FROM THE MARK AS SHOWN.

FOR ENTERTAINMENT SERVICES, NAMELY, PROFESSIONAL LACROSSE GAMES, COMPETITIONS AND EXHIBITIONS (U.S. CLS. 100, 101 AND 107).

FIRST USE 6-0-2000; IN COMMERCE 6-0-2000.

2,764,957. MAJOR LEAGUE LACROSSE LLC, SECAUCUS, NJ. SN 76-237,842. PUB. 1-1-2002, FILED 4-4-2001.

BALTIMORE BAYHAWKS

NO CLAIM IS MADE TO THE EXCLUSIVE RIGHT TO USE "BALTIMORE", APART FROM THE MARK AS SHOWN.

FOR ENTERTAINMENT SERVICES, NAMELY, PROFESSIONAL LACROSSE GAMES, COMPETITIONS AND EXHIBITIONS (U.S. CLS. 100, 101 AND 107).

FIRST USE 6-0-2000; IN COMMERCE 6-0-2000.

2,764,964. SIX FLAGS THEME PARKS, INC., OKLAHOMA CITY, OK. SN 76-238,760. PUB. 9-18-2001, FILED 4-6-2001.

TROPICAL TREASURES

FOR ENTERTAINMENT SERVICES, NAMELY AMUSEMENT AND THEME PARK SERVICES (U.S. CLS. 100, 101 AND 107).

FIRST USE 8-10-2002; IN COMMERCE 8-10-2002.

2,764,968. MUSEUM OF MUSICAL INSTRUMENTS, THE, SANTA CRUZ, CA. SN 76-242,066. PUB. 8-28-2001, FILED 4-16-2001.

MOMI

FOR MUSEUM SERVICES, NAMELY, HOUSING THE WORLD'S FINEST MUSICAL INSTRUMENT COLLECTIONS, ARCHIVING PRINTED AND RECORDED MUSICAL MATERIALS, AND PROVIDING EXHIBITIONS AND ACTIVITIES THAT FOSTER A BETTER APPRECIATION OF THE HISTORY AND DEVELOPMENT OF MUSIC (U.S. CLS. 100, 101 AND 107).

FIRST USE 5-16-2003; IN COMMERCE 5-16-2003.

CLASS 41—(Continued).

2,764,985. GLASTON HOLDINGS LLP, NEW YORK, NY. SN 76-258,049. PUB. 9-10-2002, FILED 5-16-2001.

AMERICANA RANCH

NO CLAIM IS MADE TO THE EXCLUSIVE RIGHT TO USE RANCH, APART FROM THE MARK AS SHOWN.

FOR RECREATIONAL SERVICES IN THE NATURE OF PROVIDING HORSEBACK RIDING FACILITIES ON A WESTERN STYLE RANCH (U.S. CLS. 100, 101 AND 107).

FIRST USE 4-16-2001; IN COMMERCE 3-11-2003.

CLASS 41—(Continued).

2,765,084. PROFESSIONAL TRAINING SERVICES, INC., PALATINE, IL. SN 76-297,917. PUB. 11-20-2001, FILED 8-8-2001.

SUCCESSTRAK

FOR EDUCATIONAL SERVICES, NAMELY, CONDUCTING SEMINARS IN THE FIELD OF PREPARING PROFESSIONALS FOR CERTIFICATION EXAMINATIONS AS WELL AS DISTRIBUTING COURSE MATERIALS IN CONNECTION THEREWITH (U.S. CLS. 100, 101 AND 107).

FIRST USE 1-1-2002; IN COMMERCE 1-1-2002.

2,765,012. CINEBRIDGE VENTURES, INC., DEDHAM, MA. SN 76-266,644. PUB. 10-1-2002, FILED 6-4-2001.

thebridge
:: CINEMA DE LUX ::

NO CLAIM IS MADE TO THE EXCLUSIVE RIGHT TO USE "CINEMA DE LUXE", APART FROM THE MARK AS SHOWN.

THE DRAWING IS LINED FOR THE COLORS ORANGE AND BLUE, AND COLOR IS CLAIMED AS A FEATURE OF THE MARK.

THE MARK CONSISTS OF THE WORDS "THEBRIDGE" IN STYLIZED LOWER CASE LETTERS WITH "THE" IN LIGHT BLUE AND "BRIDGE" IN RED/ORANGE. CENTERED UNDER "THEBRIDGE" IN DARK BLUE UPPER CASE LETTERS APPEARS THE WORDS AND SYMBOLS "CINEMA DE LUX ::".

FOR MOVIE THEATRES; PROVIDING FACILITIES FOR LIVE ENTERTAINMENT (U.S. CLS. 100, 101 AND 107).

FIRST USE 9-0-2001; IN COMMERCE 9-0-2001.

2,765,090. AMBASSADORS FOR CHRIST INTERNATIONAL - USA, INC., MARIETTA, GA. SN 76-299,121. PUB. 9-10-2002, FILED 8-15-2001.

LIFEWORKS

FOR EDUCATIONAL SERVICES, NAMELY, PROVIDING CLASSES, WORKSHOPS, SEMINARS, IN THE FIELD OF CHRISTIANITY AND EVANGELISM FOR USE IN THE CONVERSION OF PEOPLE TO CHRISTIANITY TO BE MARKETED ONLY IN DIRECT CHANNELS OF TRADE TARGETED AT CHURCHES (U.S. CLS. 100, 101 AND 107).

FIRST USE 9-0-2001; IN COMMERCE 9-0-2001.

2,765,100. INTERMOUNTAIN HEALTH CARE, INC., SALT LAKE CITY, UT. SN 76-303,322. PUB. 9-10-2002, FILED 8-22-2001.

INTERMOUNTAIN MEDICAL CENTER

OWNER OF U.S. REG. NO. 1,913,834.

NO CLAIM IS MADE TO THE EXCLUSIVE RIGHT TO USE "MEDICAL CENTER", APART FROM THE MARK AS SHOWN.

SEC. 2(F) AS TO "INTERMOUNTAIN".

FOR EDUCATIONAL SERVICES, NAMELY, CONDUCTING CLASSES, SEMINARS, CONFERENCES AND WORKSHOPS IN THE FIELD OF HEALTH CARE; ENTERTAINMENT SERVICES, NAMELY EDUCATIONAL ON-GOING TELEVISION SPOTS AND PROGRAMS IN THE FIELD OF HEALTH CARE (U.S. CLS. 100, 101 AND 107).

FIRST USE 12-11-2000; IN COMMERCE 12-11-2000.

2,765,029. HARMONY OF THE SPHERES, INC., BUFFALO, NY. SN 76-271,385. PUB. 2-12-2002, FILED 6-14-2001.

MUSIC NIAGARA
INTERNATIONAL FESTIVAL OF

NO CLAIM IS MADE TO THE EXCLUSIVE RIGHT TO USE "INTERNATIONAL FESTIVAL OF MUSIC NIAGARA", APART FROM THE MARK AS SHOWN.

THE STIPPLING IS A FEATURE OF THE MARK AND DOES NOT INDICATE COLOR.

FOR MUSIC FESTIVALS (U.S. CLS. 100, 101 AND 107).
FIRST USE 5-30-2001; IN COMMERCE 5-30-2001.

2,765,159. HOUGHTON MIFFLIN COMPANY, BOSTON, MA. SN 76-321,339. PUB. 9-10-2002, FILED 10-4-2001.

HM MATHSPACE

FOR EDUCATIONAL SERVICES, NAMELY, PROVIDING ON-LINE INTERACTIVE TUTORIALS, TESTS AND TEXTBOOK EXCERPTS IN THE FIELD OF MATHEMATICS (U.S. CLS. 100, 101 AND 107).

FIRST USE 1-1-2003; IN COMMERCE 1-1-2003.

CLASS 41—(Continued).

2,765,160. PARADIGM GROUP, LC, DBA THE PARADIGM GROUP, LC, HOLLADAY, UT. SN 76-321,821. PUB. 10-8-2002, FILED 10-5-2001.



THE MARK CONSISTS OF COLORS, AND THE COLORS ARE BEING CLAIMED AS A FEATURE OF THE MARK. SPECIFICALLY, THE LAND MASSES ON THE GLOBE HAVE DIFFERENT COLORS AS FOLLOWS. NORTH AMERICA IS RED. SOUTH AMERICA IS ORANGE. THE AFRICAN CONTINENT IS GREEN. GREAT BRITAIN, THE ISLANDS IN THE MEDITERRANEAN, THE TIP OF NORTH AMERICA THAT IS ON THE RIGHT SIDE OF THE GLOBE, AND ICELAND ARE ALSO GREEN. EUROPE AND THE MIDDLE EAST ARE LIGHT BLUE. THE WATER ON THE RIGHT SIDE OF THE GLOBE IS DARK BLUE. THE WATER ON THE LEFT SIDE OF THE GLOBE IS YELLOW. THE DARK AREA BENEATH THE GLOBE REPRESENTS SHADING.

FOR ENTERTAINMENT SERVICES, NAMELY, PRODUCTION OF TELEVISION SHOWS AND DIRECTING TELEVISION SHOWS (U.S. CLS. 100, 101 AND 107).

FIRST USE 5-12-2003; IN COMMERCE 5-12-2003.

2,765,211. GOMBAR, RICK, LOS ANGELES, CA. SN 76-336,717. PUB. 7-16-2002, FILED 11-13-2001.

NATIONAL SAFE AT HOME PROGRAM

NO CLAIM IS MADE TO THE EXCLUSIVE RIGHT TO USE "NATIONAL" AND "PROGRAM", APART FROM THE MARK AS SHOWN.

FOR EDUCATIONAL SERVICES, NAMELY, CONDUCTING SAFETY PROGRAMS DESIGNED TO ALERT THE GENERAL PUBLIC TO EVERYDAY HAZARDS, AND DISTRIBUTION OF PROGRAM MATERIAL IN CONNECTION THEREWITH (U.S. CLS. 100, 101 AND 107).

FIRST USE 3-5-2003; IN COMMERCE 3-5-2003.

CLASS 41—(Continued).

2,765,216. SP MINISTRIES, GLEN ELLYN, IL. SN 76-338,744. PUB. 10-29-2002, FILED 11-19-2001.

KIDBUILDERS

FOR EDUCATIONAL PRODUCTS AND SERVICES FOR CHILDREN AND THEIR LEADERS, NAMELY, CONDUCTING CONFERENCES, SEMINARS, COURSES AND PROGRAMS AND PROVIDING WRITTEN COURSE MATERIALS FEATURING CHARACTER DEVELOPMENT AND LEADERSHIP THROUGH A GLOBAL INFORMATION COMPUTER NETWORK (U.S. CLS. 100, 101 AND 107).

FIRST USE 1-31-2002; IN COMMERCE 1-31-2002.

2,765,264. SUPERSTATION, INC., ATLANTA, GA. SN 76-352,127. PUB. 6-25-2002, FILED 12-21-2001.

TEARJERKER

FOR EDUCATION AND ENTERTAINMENT SERVICES, NAMELY, A CONTINUING TELEVISION PROGRAM SERIES FEATURING MOTION PICTURE FILMS PROVIDED THROUGH CABLE AND BROADCAST TELEVISION, RADIO AND THE GLOBAL INFORMATION SERVICES NETWORK (U.S. CLS. 100, 101 AND 107).

FIRST USE 11-14-2002; IN COMMERCE 11-14-2002.

2,765,270. APEX FITNESS, INC., PLEASANTON, CA. SN 76-353,290. PUB. 2-4-2003, FILED 12-28-2001.

ACCIDENTAL EXERCISER

FOR PHYSICAL FITNESS INSTRUCTION; EDUCATIONAL SERVICES, NAMELY, CONDUCTING PROGRAMS IN THE FIELD OF FITNESS AND HEALTH DISTRIBUTING COURSE MATERIALS IN CONNECTION THEREWITH (U.S. CLS. 100, 101 AND 107).

FIRST USE 12-20-2002; IN COMMERCE 12-20-2002.

CLASS 41—(Continued).

2,765,299. VERSATILE ENTERTAINMENT INC., NEW YORK, NY. SN 76-360,515. PUB. 9-17-2002, FILED 1-18-2002.



*Versatile
Entertainment*

NO CLAIM IS MADE TO THE EXCLUSIVE RIGHT TO USE "ENTERTAINMENT", APART FROM THE MARK AS SHOWN.

THE STIPPLING SHOWN IN THE DRAWING REPRESENTS A CONTRASTING COLOR, HOWEVER NO CLAIM IS MADE TO COLOR IN THIS REGISTRATION.

FOR MUSIC PRODUCTION SERVICES, NAMELY, PRE-RECORDING FOR COMMERCIAL MUSIC, FILM AND STAGE, FEATURING MUSIC AND ENTERTAINMENT (U.S. CLS. 100, 101 AND 107).

FIRST USE 3-1-2002; IN COMMERCE 3-1-2002.

2,765,317. CITY OF GOLDEN, GOLDEN, CO. SN 76-364,649. PUB. 8-20-2002, FILED 1-29-2002.

FOSSIL TRACE GOLF CLUB

NO CLAIM IS MADE TO THE EXCLUSIVE RIGHT TO USE "GOLF CLUB", APART FROM THE MARK AS SHOWN.

FOR GOLF CLUB SERVICES; GOLF COURSES; ENTERTAINMENT IN THE NATURE OF GOLF TOURNAMENTS (U.S. CLS. 100, 101 AND 107).

FIRST USE 1-1-2003; IN COMMERCE 1-1-2003.

2,765,391. CAMELBACK SKI CORPORATION, TANNERSVILLE, PA. SN 76-386,972. PUB. 1-14-2003, FILED 3-25-2002.

SPIN CYCLE

FOR AMUSEMENT PARK RIDE SERVICES (U.S. CLS. 100, 101 AND 107).

FIRST USE 3-1-2002; IN COMMERCE 6-1-2002.

CLASS 41—(Continued).

2,765,477. ARTWORKS PARTNERS, LLC, CINCINNATI, OH. SN 76-417,532. PUB. 2-18-2003, FILED 6-3-2002.



FOR ENTERTAINMENT SERVICES IN THE NATURE OF PRODUCTION AND DISTRIBUTION OF MOTION PICTURE FILMS; PRODUCTION OF PRE-RECORDED AUDIO AND VIDEO TAPES, PRE-RECORDED AUDIO AND VIDEO CASSETTES, PRE-RECORDED AUDIO AND VIDEO DISCS AND PRE-RECORDED VCD'S AND DVD'S (U.S. CLS. 100, 101 AND 107).

FIRST USE 6-30-2002; IN COMMERCE 6-30-2002.

2,765,506. IMPACT COMMUNICATIONS, INC., NEW YORK, NY. SN 76-442,897. PUB. 1-21-2003, FILED 8-22-2002.

EDUCATION EXCHANGE

NO CLAIM IS MADE TO THE EXCLUSIVE RIGHT TO USE "EDUCATION", APART FROM THE MARK AS SHOWN.

FOR PROVIDING THE TRAINING OF PHYSICIAN AND OTHER HEALTH CARE PROFESSIONAL SPEAKERS TO SPEAK TO PHYSICIANS AND OTHER HEALTH CARE PROFESSIONALS AT HOSPITALS ABOUT CURRENT ISSUES IN THE MEDICAL FIELD (U.S. CLS. 100, 101 AND 107).

FIRST USE 9-15-2002; IN COMMERCE 9-15-2002.

2,765,527. A&E TELEVISION NETWORKS, NEW YORK, NY. SN 76-975,702. PUB. 8-20-2002, FILED 9-20-2001.

MAIL CALL

FOR ENTERTAINMENT IN THE NATURE OF ONGOING CABLE TELEVISION PROGRAMS FEATURING THE TECHNOLOGY OF WAR (U.S. CLS. 100, 101 AND 107).

FIRST USE 8-0-2002; IN COMMERCE 8-0-2002.

2,765,538. BACKSLAP ENTERTAINMENT INC., NEW YORK, NY. SN 78-006,622. PUB. 8-28-2001, FILED 5-3-2000.

BACKSLAP

FOR MEDIA AND ENTERTAINMENT SERVICES, NAMELY, INTERNET SERVICES CONSISTING OF PROVIDING AN INTERACTIVE WEBSITE FEATURING COMEDY AND COMEDY MATERIAL (U.S. CLS. 100, 101 AND 107).

FIRST USE 3-1-2003; IN COMMERCE 3-1-2003.

CLASS 41—(Continued).

2,765,548. FLORIDA SAFETY ASSOCIATION, INC., ORLANDO, FL. SN 78-024,161. PUB. 11-5-2002, FILED 9-1-2000.



NO CLAIM IS MADE TO THE EXCLUSIVE RIGHT TO USE "FLORIDA SAFETY ASSOCIATION", APART FROM THE MARK AS SHOWN.

FOR EDUCATIONAL SERVICE, NAMELY, CONDUCTING CLASSES, SEMINARS, AND WORKSHOPS IN THE FIELD OF OCCUPATIONAL SAFETY, MOTOR VEHICLE SAFETY, AND HEALTHCARE, SAFETY, TOGETHER WITH THE DISTRIBUTION OF COURSE MATERIALS IN CONNECTION THEREWITH (U.S. CLS. 100, 101 AND 107).
FIRST USE 10-19-1999; IN COMMERCE 10-19-1999.

CLASS 41—(Continued).

2,765,563. FLORIDA ASSOCIATION OF SAFETY COUNCILS, INC., ORLANDO, FL. SN 78-038,425. PUB. 11-5-2002, FILED 12-8-2000.



NO CLAIM IS MADE TO THE EXCLUSIVE RIGHT TO USE "PRINCIPLES OF SAFETY MANAGEMENT" AND "A FLORIDA ASSOCIATION OF SAFETY COUNCILS' PROGRAM", APART FROM THE MARK AS SHOWN.

FOR EDUCATIONAL SERVICES, NAMELY, PROVIDING SEMINARS AND WORKSHOPS IN LOSS CONTROL AND RISK MANAGEMENT IN THE WORKPLACE FOR BUSINESS AND INDUSTRY (U.S. CLS. 100, 101 AND 107).
FIRST USE 6-16-1998; IN COMMERCE 6-16-1998.

2,765,562. FLORIDA ASSOCIATION OF SAFETY COUNCILS, INC., ORLANDO, FL. SN 78-038,419. PUB. 10-1-2002, FILED 12-8-2000.

2,765,588. WILLIAMS, JASON COCHISE, NORCROSS, GA. SN 78-057,856. PUB. 1-8-2002, FILED 4-11-2001.

NOTHING SIMPLE

FOR ENTERTAINMENT, NAMELY, LIVE PERFORMANCES BY A MUSICAL BAND (U.S. CLS. 100, 101 AND 107).

FIRST USE 9-1-2000; IN COMMERCE 9-1-2000.



2,765,610. WHITE HAT VENTURES, LLC, AKRON, OH. SN 78-069,298. PUB. 3-12-2002, FILED 6-15-2001.

OHDELA

FOR EDUCATIONAL SERVICES, NAMELY, PROVIDING COURSES OF STUDY FOR SAFELY PROFESSIONALS TO OBTAIN CERTIFICATION IN ADVANCED SAFETY MANAGEMENT FOR BUSINESS AND INDUSTRY (U.S. CLS. 100, 101 AND 107).
FIRST USE 5-22-1999; IN COMMERCE 5-22-1999.

FOR EDUCATIONAL SERVICES, NAMELY, CONDUCTING AND PROVIDING ELEMENTARY, JUNIOR HIGH, AND HIGH SCHOOL CLASSES AND EDUCATION COURSES THROUGH MEANS OF TELECOMMUNICATIONS AND COMPUTER NETWORKS (U.S. CLS. 100, 101 AND 107).
FIRST USE 11-1-2001; IN COMMERCE 11-1-2001.

CLASS 41—(Continued).

2,765,621. UNIVERSITY OF NEW HAMPSHIRE, DURHAM, NH. SN 78-072,683. PUB. 5-14-2002, FILED 7-6-2001.

FLEETLINK

FOR EDUCATIONAL SERVICES, NAMELY CONDUCTING COURSES AND SEMINARS IN THE FIELD OF RESEARCHING, COLLECTING AND ASSIMILATING OCEANOGRAPHIC AND METEOROLOGICAL DATA; EDUCATIONAL RESEARCH IN THE FIELD OF DEVELOPING METHODS OF DATA COLLECTION (U.S. CLS. 100, 101 AND 107).

FIRST USE 5-8-2000; IN COMMERCE 5-8-2000.

2,765,635. RITZ-CARLTON HOTEL COMPANY, L.L.C., THE, BETHESDA, MD. SN 78-079,192. PUB. 1-29-2002, FILED 8-14-2001.

THE RITZ-CARLTON SPA

OWNER OF U.S. REG. NOS. 1,094,823, 2,386,118, AND OTHERS.

NO CLAIM IS MADE TO THE EXCLUSIVE RIGHT TO USE "SPA", APART FROM THE MARK AS SHOWN.

FOR PHYSICAL FITNESS INSTRUCTION SERVICES; HEALTH CLUB SERVICES (U.S. CLS. 100, 101 AND 107).
FIRST USE 12-17-1997; IN COMMERCE 12-17-1997.

2,765,644. TRIFUS N.A., LLC, CHICAGO, IL. SN 78-080,892. PUB. 10-8-2002, FILED 8-23-2001.

DELIVERING THE PROMISE OF E-LEARNING

FOR EDUCATIONAL SERVICES, NAMELY CONDUCTING CLASSES, COURSES, SEMINARS, AND WORKSHOPS LIVE AND OR BY MEANS OF ELECTRONIC COMMUNICATIONS NETWORKS, DEVELOPMENT OF EDUCATIONAL MATERIALS FOR OTHERS, ALL IN THE FIELDS OF BUSINESS MANAGEMENT, ORGANIZATIONAL MANAGEMENT, LEADERSHIP, BUSINESS OPERATIONS, BUSINESS SKILLS, MANUFACTURING, PRODUCTIVITY, EFFICIENCY, NEGOTIATION, SALES, MARKETING, HUMAN RESOURCES, ACCOUNTING, FINANCE, COMPUTERS, COMPUTING OR HIGH TECHNOLOGY, AND EVALUATION OF THE PROCESS OF PARTICIPANTS IN THE FOREGOING ACTIVITIES (U.S. CLS. 100, 101 AND 107).

FIRST USE 7-0-2001; IN COMMERCE 7-0-2001.

CLASS 41—(Continued).

2,765,679. DAUPHANT-SENEAULT, MUSA, 97223 LE DIAMANTE, MARTINIQUE. SN 78-093,798. PUB. 8-20-2002, FILED 11-16-2001.

LE TAROT DE MUSA

NO CLAIM IS MADE TO THE EXCLUSIVE RIGHT TO USE "LE TAROT", APART FROM THE MARK AS SHOWN. THE ENGLISH TRANSLATION OF THE WORD "LE TAROT DE MUSA" IN THE MARK IS "THE TAROT OF MUSA".

FOR ONLINE ENTERTAINMENT SERVICES IN THE NATURE OF TAROT CARD GAMES, FORTUNE TELLING, LIFE ADVICE, DECISION-MAKING, PROGNOSTICATIONS AND ACTS OF CLAIRVOYANCE FOR OTHERS (U.S. CLS. 100, 101 AND 107).

FIRST USE 2-6-2002; IN COMMERCE 2-6-2002.

2,765,680. PARRISH, JANET H., CEDAR FALLS, IA. SN 78-093,918. PUB. 7-30-2002, FILED 11-17-2001.

BIGFISH JAZZ

NO CLAIM IS MADE TO THE EXCLUSIVE RIGHT TO USE "JAZZ", APART FROM THE MARK AS SHOWN.

FOR PROFESSIONAL PERFORMING MUSICAL JAZZ ENSEMBLE FOR ENTERTAINMENT AND EDUCATIONAL PURPOSES (U.S. CLS. 100, 101 AND 107).

FIRST USE 11-4-2000; IN COMMERCE 3-22-2003.

2,765,739. MINDGIFTS, LLC, CHICAGO, IL. SN 78-115,968. PUB. 10-15-2002, FILED 3-19-2002.

MINDGIFTS

FOR EDUCATIONAL SERVICES, NAMELY, CONDUCTING RETREATS IN THE FIELD OF SENIOR EXECUTIVE DEVELOPMENT, INCLUDING DISTRIBUTION OF COURSE MATERIALS IN CONNECTION THEREWITH (U.S. CLS. 100, 101 AND 107).

FIRST USE 3-6-2002; IN COMMERCE 3-6-2002.

2,765,765. SLAUGHTER WILLIAM R., FORSYTH, GA. AND SLAUGHTER CONNIE D., FORSYTH, GA. SN 78-125,892. PUB. 12-24-2002, FILED 5-2-2002.

FAITH WALKERS

FOR ENTERTAINMENT SERVICES, NAMELY LIVE MUSICAL PERFORMANCES BY GOSPEL SINGERS (U.S. CLS. 100, 101 AND 107).

FIRST USE 10-1-1994; IN COMMERCE 8-10-2001.

CLASS 41—(Continued).

2,765,800. YBOR HOLDINGS, LLC, TAMPA, FL. SN 78-139,396. PUB. 1-7-2003, FILED 6-27-2002.

SECRETS

FOR ENTERTAINMENT SERVICES, NAMELY, LIVE PERFORMANCES BY EXOTIC DANCERS (U.S. CLS. 100, 101 AND 107).

FIRST USE 7-8-2002; IN COMMERCE 7-8-2002.

2,765,812. ADKINS, MICHAEL, INDIANAPOLIS, IN. SN 78-142,950. PUB. 1-7-2003, FILED 7-11-2002.

THE UGLY MONKEY

FOR NIGHT CLUB SERVICES (U.S. CLS. 100, 101 AND 107).

FIRST USE 8-29-2002; IN COMMERCE 8-29-2002.

2,765,823. DISCOVERY COMMUNICATIONS, INC., SILVER SPRING, MD. SN 78-147,441. PUB. 2-4-2003, FILED 7-25-2002.

UNSOLVED HISTORY

FOR ENTERTAINMENT SERVICES IN THE NATURE OF TELEVISION PROGRAMMING ON THE SUBJECT OF FORENSIC SCIENCE (U.S. CLS. 100, 101 AND 107).

FIRST USE 10-9-2002; IN COMMERCE 10-9-2002.

CLASS 42—SCIENTIFIC, COMPUTER AND LEGAL SERVICES

2,764,473. NEW PARADIGMS, INC., DBA NEW PARADIGMS, MARYLAND HEIGHTS, MO. SN 74-692,050. PUB. 8-17-1999, FILED 6-22-1995.

NEW PARADIGMS

FOR DESIGN AND TESTING FOR NEW PRODUCT DEVELOPMENT (U.S. CLS. 100 AND 101).

FIRST USE 10-0-2002; IN COMMERCE 10-0-2002.

CLASS 42—(Continued).

2,764,476. AMERICA ONLINE, INC., DULLES, VA. SN 75-280,610. PUB. 3-7-2000, FILED 4-24-1997.

VIRTUAL KEY

FOR COMPUTER SERVICES, NAMELY, COMPUTER PROGRAMMING FOR ON-LINE INFORMATION SERVICES AND GLOBAL COMPUTER INFORMATION NETWORK COMMUNICATIONS; COMPUTER CONSULTATION SERVICES FOR ON-LINE INFORMATION SERVICES AND GLOBAL COMPUTER INFORMATION NETWORK COMMUNICATIONS; DESIGNING AND UPDATING COMPUTER SECURITY SOFTWARE FOR ON-LINE AND GLOBAL COMPUTER INFORMATION NETWORK COMMUNICATIONS; MONITORING SECURITY SYSTEMS FOR ON-LINE INFORMATION SERVICES AND GLOBAL COMPUTER INFORMATION NETWORK COMMUNICATIONS (U.S. CLS. 100 AND 101).

FIRST USE 4-1-2003; IN COMMERCE 4-1-2003.

2,764,483. SANTA MONICA BAYKEEPER, MARINA DEL REY, CA. SN 75-426,285. PUB. 12-5-2000, FILED 1-30-1998.

COASTKEEPER

FOR ASSOCIATION SERVICES, NAMELY, PROMOTING THE INTERESTS OF COASTAL ENVIRONMENTALISTS WITHIN THE STATE OF CALIFORNIA (U.S. CLS. 100 AND 101).

FIRST USE 0-0-1998; IN COMMERCE 0-0-1998.

2,764,495. XO COMMUNICATION, INC., RESTON, VA. BY MERGER; BY CHANGE OF NAME CONCENTRIC NETWORK CORPORATION, SAN JOSE, CA. SN 75-509,883. PUB. 12-28-1999, FILED 6-29-1998.

REMOTEHANDS

FOR PROVIDING MULTIPLE USER ACCESS TO A COMPUTER INFORMATION NETWORK FOR THE TRANSFER AND DISSEMINATION OF A WIDE RANGE OF INFORMATION; COMPUTER SERVICES, NAMELY, CONFIGURATION, TESTING, DIAGNOSIS, AND CUSTOM PROGRAMMING FOR OTHERS OF COMPUTER NETWORKS, REPAIR OF COMPUTER SOFTWARE (U.S. CLS. 100 AND 101).

FIRST USE 7-26-1999; IN COMMERCE 7-26-1999.

2,764,504. ALADDIN GAMING, LLC, LAS VEGAS, NV. SN 75-563,195. PUB. 8-10-1999, FILED 10-2-1998.

WHERE WISHES COME TRUE!

FOR HOTEL, RESTAURANT, BAR, COCKTAIL LOUNGE, BEAUTY SALON AND HEALTH SPA SERVICES (U.S. CLS. 100 AND 101).

FIRST USE 10-15-1998; IN COMMERCE 10-15-1998.

CLASS 42—(Continued).

2,764,548. GENEROSO, GIUSEPPE, STATEN ISLAND, NY.
SN 75-697,828. PUB. 3-28-2000, FILED 5-3-1999.

JOE SPAGHETTI

NO CLAIM IS MADE TO THE EXCLUSIVE RIGHT TO USE "SPAGHETTI", APART FROM THE MARK AS SHOWN. FOR RESTAURANTS AND CAFES (U.S. CLS. 100 AND 101).
FIRST USE 3-0-2002; IN COMMERCE 3-0-2002.

2,764,550. SIX CONTINENTS HOTELS, INC., ATLANTA, GA, BY CHANGE OF NAME BASS HOTELS & RESORTS, INC., ATLANTA, GA. SN 75-698,215. PUB. 4-18-2000, FILED 5-5-1999.



NO CLAIM IS MADE TO THE EXCLUSIVE RIGHT TO USE "2 BEDROOM SUITES", APART FROM THE MARK AS SHOWN.
FOR HOTEL SERVICES (U.S. CLS. 100 AND 101).
FIRST USE 5-7-1999; IN COMMERCE 7-1-1999.

2,764,573. MANAGED HEALTH NETWORK, INC., SAN RAFAEL, CA. SN 75-755,826. PUB. 11-12-2002, FILED 7-20-1999.

GLOBALINC

FOR EMPLOYEE ASSISTANCE PROGRAMS IN THE FIELD OF MENTAL HEALTH; MENTAL HEALTH CONSULTATION SERVICES FOR EMPLOYEES; PROVIDING MENTAL HEALTH INFORMATION TO EMPLOYEES; AND PROVIDING MENTAL HEALTH SERVICES TO EMPLOYEES (U.S. CLS. 100 AND 101).
FIRST USE 2-0-1999; IN COMMERCE 2-0-1999.

CLASS 42—(Continued).

2,764,576. INTEGRITS CORPORATION, SAN DIEGO, CA. SN 75-764,936. PUB. 12-5-2000, FILED 8-2-1999.



NO CLAIM IS MADE TO THE EXCLUSIVE RIGHT TO USE "INTEGRATED INFORMATION TECHNOLOGY SOLUTIONS", APART FROM THE MARK AS SHOWN. FOR INTEGRATION OF COMPUTER SYSTEMS AND NETWORKS (U.S. CLS. 100 AND 101).
FIRST USE 1-1-2000; IN COMMERCE 1-1-2000.

2,764,588. DATASTREAM SYSTEMS INCORPORATED, GREENVILLE, SC. SN 75-796,578. PUB. 7-16-2002, FILED 9-10-1999.

MP5i

OWNER OF U.S. REG. NO. 1,656,143.
FOR PROVIDING TEMPORARY USE OF ON-LINE NON-DOWNLOADABLE SOFTWARE IN THE FIELD OF MAINTENANCE MANAGEMENT, NAMELY MANAGING DATA ASSOCIATED WITH FACILITY MANAGEMENT INCLUDING PROVIDING CUSTOMIZED INDUSTRY-SPECIFIC WORK PROCESSES, SCREENS, MENUS AND REPORTS FOR ENTERPRISE ORIENTED ASSET MANAGEMENT ESPECIALLY APPLICABLE FOR LARGE, ASSET-INTENSIVE CORPORATIONS, CONCERNING EQUIPMENT, WORK ORDERS, INVENTORY, TASKS, PREVENTIVE AND PREDICTIVE MAINTENANCE OPERATIONS, PURCHASING, PLANNING, SCHEDULING, AND REPORTING, AND PROVIDING WORKFLOW/BUSINESS PROCESS TEMPLATES FOR DATA INPUT/RETRIEVAL BY ESTABLISHING SET PROTOCOLS AND SCREEN ACCESSIBILITY BASED ON EITHER JOB TITLE OR TASK, PROVIDING REAL-TIME TRACKING OF MOBILE ASSETS AND ROTABLE SPARES VIA BARCODING OR HAND-HELD COMPUTER, AND PROVIDING PACKAGED REPORTS FOR AUTOMATIC CAPTURE OF ALL INFORMATION RELATING TO ISO 9000 OR OTHER INDUSTRY CERTIFICATIONS FOR MEETING COMPLIANCE REQUIREMENTS (U.S. CLS. 100 AND 101).
FIRST USE 8-0-2000; IN COMMERCE 8-0-2000.

CLASS 42—(Continued).

2,764,615. SHERWOOD PARTNERS, INC., LOS ANGELES, CA, BY ASSIGNMENT; BY ASSIGNMENT ISCRIBE, INC., SAN MATEO, CA. SN 75-851,543. PUB. 8-28-2001, FILED 11-15-1999.



FOR COMPUTER SERVICES, NAMELY PROVIDING INFORMATION IN THE FIELDS OF HEALTH AND MEDICINE VIA A WEBSITE ON GLOBAL COMPUTER NETWORKS; PROVIDING AN ONLINE ELECTRONIC DATABASE ON GLOBAL COMPUTER NETWORKS IN THE FIELDS OF HEALTH, PHARMACEUTICALS, MEDICINES, AND MEDICAL DEVICES; AND MAINTAINING RECORDS FOR OTHERS CONCERNING THE PURCHASE OF PHARMACEUTICALS, MEDICINES AND MEDICAL DEVICES (U.S. CLS. 100 AND 101).
FIRST USE 2-20-2000; IN COMMERCE 2-20-2000.

2,764,645. DESIGN HOTELS, INC., SAUSALITO, CA. SN 75-910,514. PUB. 5-21-2002, FILED 1-28-2000.

DESIGN HOTELS

NO CLAIM IS MADE TO THE EXCLUSIVE RIGHT TO USE "HOTELS", APART FROM THE MARK AS SHOWN.
FOR HOTELS, MOTELS, RESORT INNS, AND RESTAURANT SERVICES (U.S. CLS. 100 AND 101).
FIRST USE 0-0-1993; IN COMMERCE 0-0-1993.

2,764,680. VANMOOR, ARTHUR, BOCA RATON, FL. SN 76-017,121. PUB. 6-12-2001, FILED 4-4-2000.

PLAYFUL

FOR ESCORT SERVICES PROVIDED FOR SOCIAL, RECREATIONAL, COURTESY, GUIDANCE, AND BUSINESS PURPOSES (U.S. CLS. 100 AND 101).
FIRST USE 9-1-2002; IN COMMERCE 9-1-2002.

CLASS 42—(Continued).

2,764,700. K.B.E., LONG BRANCH, NJ. SN 76-041,821. PUB. 7-2-2002, FILED 4-26-2000.

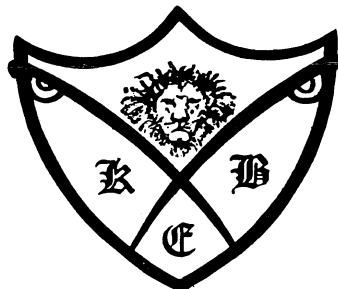

FOR COMPUTER CONSULTATION (U.S. CLS. 100 AND 101).
FIRST USE 7-1-2000; IN COMMERCE 7-1-2000.

2,764,708. BENJI'S BED AND BREAKFAST, NORTON, MA. SN 76-049,893. PUB. 10-8-2002, FILED 5-11-2000.

BENJI 'S BED & BREAKFAST

NO CLAIM IS MADE TO THE EXCLUSIVE RIGHT TO USE "BED & BREAKFAST", APART FROM THE MARK AS SHOWN.

FOR DOG KENNEL SERVICE FEATURING OVERNIGHT BOARDING, DAY TIME CARE, WASHING AND GROOMING (U.S. CLS. 100 AND 101).
FIRST USE 5-11-2000; IN COMMERCE 5-11-2000.

2,764,720. IDYON, LLC, GREENSBORO, NC. SN 76-064,887. PUB. 4-3-2001, FILED 6-6-2000.

IDYON

FOR PROVIDING AN ON-LINE DATABASE FOR IDENTIFICATION OF LOST PERSONS AND THINGS BY PRE-AUTHORIZED USERS (U.S. CLS. 100 AND 101).
FIRST USE 12-15-2002; IN COMMERCE 12-15-2002.

CLASS 42—(Continued).

2,764,722. SHOTT, GEORGE C. JR., FT. HOOD, TX. SN 76-065,683. PUB. 12-4-2001, FILED 6-7-2000.



NO CLAIM IS MADE TO THE EXCLUSIVE RIGHT TO USE "IRISH", "1854", AND "PUB", APART FROM THE MARK AS SHOWN.

THE LINING IN THE DRAWING IS A FEATURE OF THE MARK AND IS NOT INTENDED TO INDICATE COLOR.

AN 1854 IRISH DRAGOON SERGEANT IN SCARLET TUNIC & BLACK TROUSERS, KNEE-HIGH BLACK BOOTS STANDING AT EASE IN A WHITE RECTANGLE. TROOPER'S HELMET IS GOLD, CHEVRONS YELLOW, COLLAR & CUFFS BLACK W/YELLOW TRIM, BELT WHITE W/YELLOW BUCKLE AND A YELLOW STRIPE DOWN THE RIGHT LEG. HOLDING & WEARING WHITE GLOVES. ACROSS THE TUNIC IS A WHITE CROSS BELT. SWORD IS SILVER. TO THE CENTER LEFT IS THE NUMBER "18" & TO THE CENTER RIGHT, THE NUMBER "54". BOTH SETS OF NUMBERS IN GREEN. BELOW THE WHITE RECTANGLE IS THE WORD "PUB" IN GREEN AND ABOVE THE WHITE RECTANGLE ARE THE WORDS: "THE IRISH DRAGOON" ALSO IN GREEN. THE WORDS ARE OUTLINED IN BLACK LINE. THE BACKGROUND OF THE ENTIRE LOGO BROWN WOOD-GRAIN.

FOR IRISH-STYLE RESTAURANT AND PUB SERVICES (U.S. CLS. 100 AND 101).

FIRST USE 6-1-2001; IN COMMERCE 9-23-2002.

2,764,742. FORD MOTOR COMPANY, DEARBORN, MI. SN 76-080,315. PUB. 1-29-2002, FILED 6-29-2000.

KIDS REVVIN' WITH FORD

OWNER OF U.S. REG. NOS. 74,530, 1,874,207, AND OTHERS.

FOR ELEEMOSYNARY SERVICES IN THE AREA OF DONATIONS OF FOOD, CLOTHING, OR MEDICINE (U.S. CLS. 100 AND 101).

FIRST USE 7-0-2000; IN COMMERCE 7-0-2000.

2,764,771. AMERICAN ARBITRATION ASSOCIATION, NEW YORK, NY. SN 76-106,534. PUB. 1-8-2002, FILED 8-9-2000.

AAA PARTNERING

NO CLAIM IS MADE TO THE EXCLUSIVE RIGHT TO USE "PARTNERING", APART FROM THE MARK AS SHOWN.

FOR ADMINISTRATION OF ALTERNATIVE DISPUTE RESOLUTION PROCEEDINGS FOR OTHERS (U.S. CLS. 100 AND 101).

FIRST USE 5-0-2001; IN COMMERCE 5-0-2001.

CLASS 42—(Continued).

2,764,779. ECOS TECHNOLOGIES, NEW YORK, NY. SN 76-110,973. PUB. 8-13-2002, FILED 8-16-2000.

ECOS TECHNOLOGIES

NO CLAIM IS MADE TO THE EXCLUSIVE RIGHT TO USE "TECHNOLOGIES", APART FROM THE MARK AS SHOWN.

FOR PROVIDING AN ONLINE COMPUTER DATABASE TO AGGREGATE, ORGANIZE AND DELIVER MULTIPLE SOURCES OF ECOLOGICAL AND ENVIRONMENTAL INFORMATION VIA A GLOBAL COMPUTER NETWORK (U.S. CLS. 100 AND 101).

FIRST USE 7-0-2000; IN COMMERCE 9-0-2001.

2,764,786. PROJECT CONSULTING SERVICES, INC., METAIRIE, LA. SN 76-120,667. PUB. 7-9-2002, FILED 8-31-2000.

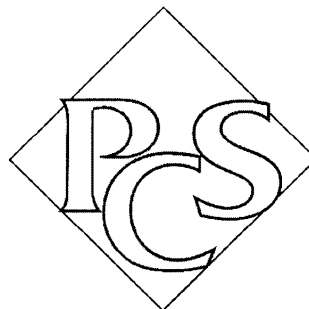

THE MARK CONSISTS OF THE LETTERS PCS ENCLOSED IN A DIAMOND.

FOR DESIGN FOR OTHERS IN THE FIELD OF ENGINEERING FOR BOTH ONSHORE AND OFFSHORE PROJECTS IN THE OIL AND GAS INDUSTRY; PROJECT ENGINEERING IN THE FIELD OF BOTH ONSHORE AND OFFSHORE PROJECTS IN THE OIL AND GAS INDUSTRY; AND, INSPECTION IN THE FIELD OF BOTH ONSHORE AND OFFSHORE PROJECTS IN THE OIL AND GAS INDUSTRY (U.S. CLS. 100 AND 101).

FIRST USE 3-31-1998; IN COMMERCE 3-31-1998.

2,764,795. G.X. CLARKE & CO., JERSEY CITY, NJ. SN 76-131,976. PUB. 12-17-2002, FILED 9-20-2000.

GXCALC

FOR PROVIDING TEMPORARY USE OF ON-LINE, NON-DOWNLOADABLE SOFTWARE THAT ENABLES CUSTOMERS TO ENTER ORDERS FOR, AND RETRIEVE INFORMATION ABOUT, US GOVERNMENT AND FEDERAL AGENCY SECURITIES (U.S. CLS. 100 AND 101).

FIRST USE 6-21-2000; IN COMMERCE 6-21-2000.

CLASS 42—(Continued).

2,764,811. MERCK & CO., INC., WHITEHOUSE STATION, NJ. SN 76-139,380. PUB. 8-28-2001, FILED 9-28-2000.

JOINTWATCH

FOR PROMOTING THE AWARENESS OF OSTEOARTHRITIS AND THE AWARENESS OF THE RISK OF SUFFERING OSTEOARTHRITIS BY DISTRIBUTING QUESTIONNAIRES, EDUCATIONAL BROCHURES AND COMPUTER SOFTWARE FEATURING INFORMATION ABOUT OSTEOARTHRITIS AND OSTEOARTHRITIS RISK (U.S. CLS. 100 AND 101).

FIRST USE 2-3-2003; IN COMMERCE 2-3-2003.

CLASS 42—(Continued).

2,764,909. HORWICH, DAVID, WAYNE, PA. SN 76-209,876. PUB. 8-21-2001, FILED 2-8-2001.

OVERHEALTH.COM

FOR HEALTH CARE SERVICES (U.S. CLS. 100 AND 101).

FIRST USE 5-7-2003; IN COMMERCE 5-7-2003.

2,764,879. SPRATLEY, DWIGHT C., SUFFOLK, VA. SN 76-184,630. PUB. 10-29-2002, FILED 12-22-2000.

**LION AND LAMB
MINISTRIES**

NO CLAIM IS MADE TO THE EXCLUSIVE RIGHT TO USE "MINISTRIES", APART FROM THE MARK AS SHOWN.

FOR PROVIDING CHURCH SERVICES, EVANGELISTIC AND OUTREACH MINISTERIAL SERVICES (U.S. CLS. 100 AND 101).

FIRST USE 1-6-2002; IN COMMERCE 1-6-2002.

2,764,901. FIRE CONCEPTS, INC., CRYSTAL LAKE, IL. SN 76-204,165. PUB. 1-1-2002, FILED 2-2-2001.



THE DRAWING IS LINED FOR THE COLOR(S) RED AND BLUE.

FOR FIRE PREVENTION CONSULTATION SERVICES (U.S. CLS. 100 AND 101).

FIRST USE 10-31-2000; IN COMMERCE 2-2-2001.

2,764,913. CALLISON ARCHITECTURE, INC., SEATTLE, WA. SN 76-213,879. PUB. 2-19-2002, FILED 2-20-2001.

INSIGHT ALLIANCE

FOR ARCHITECTURAL DESIGN; INTERIOR DECORATING; CONSULTATION IN THE FIELDS OF PROJECT SCHEDULING, PROJECT IMPLEMENTATION, REAL ESTATE DEVELOPMENT, REAL ESTATE MANAGEMENT, INTERIOR DECORATION, ERGONOMICS AND WORKPLACE DESIGN; COMMERCIAL AND GRAPHIC ART DESIGN; CONDUCTING FEASIBILITY AND DESIGN STUDIES; REVIEWING STANDARDS AND PRACTICES FOR DEVELOPMENT AND CONSTRUCTION PROJECTS TO ASSURE COMPLIANCE WITH LAWS AND REGULATIONS; URBAN PLANNING (U.S. CLS. 100 AND 101).

FIRST USE 0-0-2001; IN COMMERCE 0-0-2001.

2,764,937. HALLIBURTON ENERGY SERVICES, INC., CARROLLTON, TX. SN 76-224,182. PUB. 10-9-2001, FILED 3-12-2001.

FLOIMAGER

FOR MEASUREMENT EVALUATIONS, NAMELY, PROVIDING WATER HOLDUP AND FLUID DATA MEASUREMENT SERVICES FOR BOREHOLE DRILLING IN THE OIL AND GAS INDUSTRY (U.S. CLS. 100 AND 101).

FIRST USE 9-29-2002; IN COMMERCE 9-29-2002.

CLASS 42—(Continued).

2,764,962. COLLINS & AIKMAN FLOORCOVERINGS, INC., DALTON, GA. SN 76-238,170. PUB. 9-25-2001, FILED 4-10-2001.

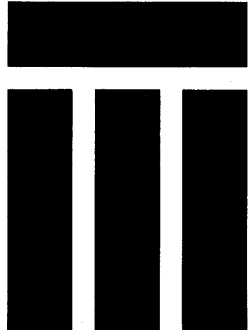

THE MARK IS A DESIGN COMPRISED OF ONE HORIZONTAL AND THREE VERTICAL BARS.
FOR DESIGN OF FLOOR COVERINGS AND CARPETS FOR OTHERS (U.S. CLS. 100 AND 101).
FIRST USE 6-0-2001; IN COMMERCE 6-0-2001.

CLASS 42—(Continued).

2,764,982. BEYOND SECURITY LTD., KFAR SABA, ISRAEL. SN 76-256,312. PUB. 8-20-2002, FILED 5-9-2001.



NO CLAIM IS MADE TO THE EXCLUSIVE RIGHT TO USE "SECURITY", APART FROM THE MARK AS SHOWN. FOR COMPUTER SERVICES, NAMELY, DIAGNOSTIC SERVICES IN THE NATURE OF SCANNING COMPUTER NETWORKS TO DETECT VULNERABILITIES SUCH AS VIRUSES, BUGS AND THE LIKE, IN THE FIELD OF GLOBAL COMPUTER AREA NETWORK SECURITY (U.S. CLS. 100 AND 101).
FIRST USE 10-27-1999; IN COMMERCE 10-27-1999.

2,764,994. MATCHNET PLC, BEVERLY HILLS, CA, BY ASSIGNMENT FACELINK.COM, SAN JOSE, CA. SN 76-262,840. PUB. 7-2-2002, FILED 5-25-2001.

FACEPAGE

FOR COMPUTER SERVICES, NAMELY, CREATING AND MAINTAINING WEB PAGES FOR OTHERS CONTAINING PRE-RECORDED VISUAL IMAGES (U.S. CLS. 100 AND 101).
FIRST USE 5-25-2001; IN COMMERCE 5-25-2001.

2,764,966. TOPIC RADIO, INC., RESEARCH TRIANGLE PARK, NC. SN 76-241,865. PUB. 6-4-2002, FILED 4-17-2001.

MICROBROADCASTING

FOR CUSTOMIZED INFORMATION SERVICES, NAMELY, PROVIDING TEMPORARY USE OF ON-LINE, NON-DOWNLOADABLE SOFTWARE FOR SEARCHING AND OBTAINING DATA ON GLOBAL AND PRIVATE COMPUTER NETWORKS SO THAT AN INDIVIDUAL OR GROUP CAN ACCESS SEARCH RESULTS IN AN USER-DEFINED FORMAT, NAMELY, TEXT, GRAPHICS, AUDIO, OR VIDEO VIA A COMPUTER, MOBILE TELEPHONE, OR PERSONAL DIGITAL ASSISTANT (U.S. CLS. 100 AND 101).
FIRST USE 5-31-2001; IN COMMERCE 5-31-2001.

2,764,998. CHRISTUS ST. PATRICK HOSPITAL, LAKE CHARLES, LA. SN 76-263,899. PUB. 9-3-2002, FILED 5-29-2001.



FOR PROMOTING PUBLIC AWARENESS OF HEALTH PROGRAMS AND HEALTH CARE ISSUES IN THE FIELD OF WELLNESS AND DISEASE PREVENTION (U.S. CLS. 100 AND 101).
FIRST USE 7-1-2001; IN COMMERCE 7-1-2001.

CLASS 42—(Continued).

2,765,009. INNOVATIVE CEREAL SYSTEMS, LLC, WILSONVILLE, OR. SN 76-265,751. PUB. 9-25-2001, FILED 5-31-2001.

BRINGING YOU TOMORROW'S TECHNOLOGY TODAY

FOR TECHNICAL SUPERVISION AND CONSULTATION IN THE FIELD OF BAKERY PROCESS AND BAKERY PRODUCT QUALITY CONTROL (U.S. CLS. 100 AND 101).

FIRST USE 1-31-2002; IN COMMERCE 1-31-2002.

2,765,018. ABSOLUTE SOFTWARE CORP., VANCOUVER, BRITISH COLUMBIA, CANADA. SN 76-268,099. PUB. 12-18-2001, FILED 6-7-2001.

ABSOLUTE

FOR COMPUTER SERVICES, NAMELY, MONITORING AND TRACKING OF LOCATION OF PERSONAL COMPUTERS; MONITORING AND TRACKING OF INFORMATION, DATA AND STATUS OF SOFTWARE AND OTHER PROGRAMS ON PERSONAL COMPUTERS; VALIDATION OF IDENTITY OF END USERS OF PERSONAL COMPUTERS; AUTOMATIC DELETION OF FILES ON PERSONAL COMPUTERS AND NOTIFICATION OF LAW ENFORCEMENT IF PERSONAL COMPUTERS ARE LOST OR STOLEN; AUTOMATIC BACK-UP OF INFORMATION ON PERSONAL COMPUTERS; INSTALLATION, REMOVAL, AND UPDATING OF COMPUTER SOFTWARE ON A PERSONAL COMPUTER (U.S. CLS. 100 AND 101).

FIRST USE 0-0-1998; IN COMMERCE 0-0-1998.

2,765,085. OLGA'S KITCHEN, INC., TROY, MI. SN 76-298,180. PUB. 12-10-2002, FILED 8-10-2001.

SUNCOAST

FOR RESTAURANT AND CARRY OUT RESTAURANT SERVICES FEATURING PRIMARILY BEVERAGES (U.S. CLS. 100 AND 101).

FIRST USE 10-0-2001; IN COMMERCE 10-0-2001.

CLASS 42—(Continued).

2,765,127. TODAY COMMUNICATIONS, INC., OVERLAND PARK, KS. SN 76-310,619. PUB. 8-27-2002, FILED 9-10-2001.

VITALSEEK

FOR COMPUTER SERVICES, NAMELY, PROVIDING A SEARCH ENGINE FOR OBTAINING DATA ON A GLOBAL COMPUTER NETWORK; COMPUTER SERVICES, NAMELY SEARCH AND RETRIEVAL OF INFORMATION AND DATA IN THE FIELDS OF USER'S CHOICE VIA A GLOBAL COMPUTER NETWORK; COMPUTER SERVICES, NAMELY CREATING INDEXES OF INFORMATION, INDEXES OF WEB SITES AND OTHER INFORMATION SOURCES VIA A GLOBAL COMPUTER NETWORK; PROVIDING SPECIFIC INFORMATION AS REQUESTED BY CUSTOMERS VIA THE INTERNET (U.S. CLS. 100 AND 101).

FIRST USE 11-15-2001; IN COMMERCE 11-15-2001.

2,765,143. THE QUIZNO'S MASTER LLC, DENVER, CO. BY ASSIGNMENT QUIZNO'S CORPORATION, THE, DENVER, CO. SN 76-315,477. PUB. 1-22-2002, FILED 9-20-2001.

QUIZ KIDZ

FOR RESTAURANT SERVICES (U.S. CLS. 100 AND 101).

FIRST USE 9-0-2001; IN COMMERCE 9-0-2001.

2,765,173. GEISINGER MEDICAL CENTER, DANVILLE, PA. SN 76-325,218. PUB. 3-12-2002, FILED 10-10-2001.

GMLLINK

FOR MEDICAL LAB SERVICES, NAMELY, COLLECTING DATA FOR MEDICAL LAB TESTS FROM AUTHORIZED USERS VIA A GLOBAL COMPUTER NETWORK, CONDUCTING LAB TESTS AND REPORTING LAB TEST RESULTS AND PROVIDING MEDICAL INFORMATION TO AUTHORIZED USERS VIA A GLOBAL COMPUTER NETWORK (U.S. CLS. 100 AND 101).

FIRST USE 12-15-2002; IN COMMERCE 12-15-2002.

2,765,175. LISTEN.COM, INC., SAN FRANCISCO, CA. SN 76-325,558. PUB. 7-16-2002, FILED 10-15-2001.

RHAPSODY

FOR APPLICATION SERVICE PROVIDER (ASP) FEATURING SOFTWARE THAT ENABLES USERS TO PLAY AND PROGRAM ENTERTAINMENT-RELATED VIDEO, TEXT AND MULTIMEDIA CONTENT, AND SOFTWARE FEATURING ENTERTAINMENT-RELATED VIDEO, TEXT AND MULTIMEDIA CONTENT; PROVIDING ON-LINE FACILITIES, VIA GLOBAL COMPUTER NETWORK, TO ENABLE USERS TO PROGRAM VIDEO, TEXT AND OTHER MULTIMEDIA CONTENT, INCLUDING VIDEOS, TELEVISION, NEWS, SPORTS, GAMES, CULTURAL EVENTS, AND ENTERTAINMENT-RELATED PROGRAMS (U.S. CLS. 100 AND 101).

FIRST USE 12-3-2001; IN COMMERCE 12-3-2001.

CLASS 42—(Continued).

2,765,195. SPECTRUM MANAGEMENT, L.L.C., CARROLLTON, TX. SN 76-329,870. PUB. 8-27-2002, FILED 10-23-2001.



NO CLAIM IS MADE TO THE EXCLUSIVE RIGHT TO USE "INTERNATIONAL", "SECURITY SERVICES" AND "MANAGEMENT COMPANY", APART FROM THE MARK AS SHOWN.

FOR LEASING, TECHNICAL SUPPORT SERVICES AND MONITORING OF SECURITY PRODUCTS AND SERVICES USED IN CONNECTION WITH CORPORATE AND PRIVATE SECURITY FUNCTIONS AND LAW ENFORCEMENT (U.S. CLS. 100 AND 101).
FIRST USE 9-1-2001; IN COMMERCE 9-1-2001.

CLASS 42—(Continued).

2,765,226. RAILINC CORP., CARY, NC. SN 76-340,723. PUB. 9-17-2002, FILED 11-21-2001.

RAILSYNC

OWNER OF U.S. REG. NO. 1,447,211.
FOR APPLICATION SERVICE PROVIDER (ASP) FEATURING SOFTWARE FOR SHORT-LINE RAILROADS IN THE FIELD OF BILLING AND ACCOUNTING OF EQUIPMENT OWNED OR IN SERVICE, RECONCILE REVENUE ACCOUNTING BETWEEN MULTIPLE RAILROADS, AND PROCESS AND REPORT ON DAY-TO-DAY BUSINESS FUNCTIONS (U.S. CLS. 100 AND 101).
FIRST USE 12-0-2001; IN COMMERCE 12-0-2001.

2,765,231. BOARD OF TRUSTEES OF THE ILLINOIS MATHEMATICS AND SCIENCE ACADEMY, AURORA, IL. SN 76-342,644. PUB. 9-17-2002, FILED 11-28-2001.

IMSA INTERNET SEARCH WIZARD

NO CLAIM IS MADE TO THE EXCLUSIVE RIGHT TO USE "INTERNET SEARCH", APART FROM THE MARK AS SHOWN.

FOR COMPUTER SERVICES, NAMELY, PROVIDING SEARCH ENGINES FOR OBTAINING DATA ON A GLOBAL COMPUTER NETWORK; PROVIDING CUSTOMIZED ONLINE WEB PAGES FEATURING USER-DEFINED INFORMATION, WHICH INCLUDES SEARCH ENGINES AND ONLINE WEB LINKS; TWO OTHER WEB SITES (U.S. CLS. 100 AND 101).
FIRST USE 6-2-2003; IN COMMERCE 6-2-2003.

2,765,209. LOS ANGELES ONCOLOGY MEDICAL GROUP, LOS ANGELES, CA. SN 76-335,605. PUB. 7-16-2002, FILED 11-7-2001.



THE MARK CONSISTS OF A STYLIZED DEPICTION OF A CRAB AND A CELL.

FOR MEDICAL SERVICES, NAMELY, EVALUATION, TESTING AND TREATMENT OF ONCOLOGY PATIENTS (U.S. CLS. 100 AND 101).
FIRST USE 7-0-2001; IN COMMERCE 7-0-2001.

2,765,235. MARKET MEASURES/ COZINT L.P., EAST HANOVER, NJ, BY CHANGE OF NAME COZINT INTERACTIVE, INC., ANDOVER, MA. SN 76-343,549. PUB. 7-9-2002, FILED 12-3-2001.

INFAC T

FOR PROVIDING INTERACTIVE DRUG PRESCRIPTION INFORMATION SYSTEMS ONLINE (U.S. CLS. 100 AND 101).
FIRST USE 6-0-2000; IN COMMERCE 6-0-2000.

CLASS 42—(Continued).

2,765,241. FLORIDA PROSTATE INSTITUTE, DAVENPORT, FL. SN 76-345,505. PUB. 9-10-2002, FILED 11-29-2001.



NO CLAIM IS MADE TO THE EXCLUSIVE RIGHT TO USE "FLORIDA PROSTATE INSTITUTE", APART FROM THE MARK AS SHOWN.

THE STIPPLING IN THE DRAWING IS FOR SHADING PURPOSES ONLY.

FOR DIAGNOSIS AND SCREENING FOR PROSTATE CANCER AND MANAGEMENT OF PROSTATE HEALTH (U.S. CLS. 100 AND 101).

FIRST USE 9-20-2002; IN COMMERCE 9-20-2002.

2,765,242. LARGE BINOCULAR TELESCOPE CORPORATION, TUCSON, AZ. SN 76-345,796. PUB. 10-29-2002, FILED 12-7-2001.



NO CLAIM IS MADE TO THE EXCLUSIVE RIGHT TO USE "LARGE BINOCULAR TELESCOPE", APART FROM THE MARK AS SHOWN.

FOR SCIENTIFIC RESEARCH IN THE FIELD OF ASTRONOMY (U.S. CLS. 100 AND 101).

FIRST USE 6-10-2003; IN COMMERCE 6-10-2003.

2,765,290. ALONSO, JORGE, ENCINO, CA. SN 76-358,364. PUB. 9-10-2002, FILED 1-14-2002.

NEWBASE

FOR GRAPHIC ART DESIGN FOR ADVERTISING IN PRINT, BROADCAST, OUTDOOR, DIRECTMAIL, PROMOTIONAL, LITERATURE, MULTIMEDIA, ELECTRONIC MEDIA, FILM AND VIDEO, DESIGNING AND CREATING WEBSITES FOR OTHERS (U.S. CLS. 100 AND 101).

FIRST USE 5-5-2003; IN COMMERCE 5-5-2003.

CLASS 42—(Continued).

2,765,303. OPGEN, INC., MILWAUKEE, WI. SN 76-361,549. PUB. 2-11-2003, FILED 1-22-2002.

OPGEN

FOR SCIENTIFIC ANALYSIS OF GENE SEQUENCES (U.S. CLS. 100 AND 101).

FIRST USE 2-5-2003; IN COMMERCE 2-5-2003.

2,765,314. EDEAGROUP.COM, INC., DALLAS, TX. SN 76-363,932. PUB. 8-27-2002, FILED 1-29-2002.

ITguaranteed

FOR COMPUTER CONSULTING SERVICES, NAMELY, CONSULTING IN THE AREA OF THE DEVELOPMENT, DESIGN AND IMPLEMENTATION OF SOFTWARE AND WEBSITES FOR OTHERS; PROVIDING WEB-BASED AND SOFTWARE CONSULTING SERVICES, NAMELY, EVALUATION OF CLIENT SOFTWARE AND WEBSITES AND RECOMMENDATION OF SPECIFIC MODIFICATIONS; INTEGRATION OF COMPUTER SYSTEMS, NETWORKS AND SOFTWARE; SOFTWARE DEVELOPMENT SERVICES; TECHNICAL SUPPORT SERVICES, NAMELY, TROUBLESHOOTING OF COMPUTER HARDWARE, SOFTWARE AND NETWORK PROBLEMS VIA ON-SITE VISITS, TELEPHONE AND VIA GLOBAL COMPUTER NETWORK; INSTALLATION OF BUSINESS APPLICATION SOFTWARE IN THE FIELDS OF ELECTRONIC COMMERCE, FINANCE AND ACCOUNTING, HUMAN RESOURCES, MANUFACTURING AND DISTRIBUTION, ADVANCED BUSINESS PLANNING, CUSTOMER CARE, SUPPLY-CHAIN, SALES FORCE, AND FINANCIAL AUTOMATION (U.S. CLS. 100 AND 101).

FIRST USE 1-21-2002; IN COMMERCE 1-21-2002.

2,765,333. PENWEST PHARMACEUTICALS CO., PATTERSON, NY. SN 76-370,134. PUB. 12-17-2002, FILED 2-12-2002.

EXCIPIO ECONOMICS

FOR DRUG DEVELOPMENT SERVICES FOR OTHERS (U.S. CLS. 100 AND 101).

FIRST USE 11-9-2002; IN COMMERCE 11-9-2002.

2,765,471. LEAGRE CHANDLER & MILLARD LLP, INDIANAPOLIS, IN. SN 76-414,877. PUB. 11-12-2002, FILED 5-30-2002.

FULL SERVICE AT FULL SPEED

FOR LEGAL SERVICES (U.S. CLS. 100 AND 101).

FIRST USE 8-29-2002; IN COMMERCE 8-29-2002.

CLASS 42—(Continued).

2,765,517. VERIO INC., ENGLEWOOD, CO. SN 76-975,572. PUB. 7-23-2002, FILED 6-20-2001.



FOR HOSTING THE WEBSITES OF OTHERS ON A COMPUTER SERVER FOR A GLOBAL COMPUTER NETWORK; HOSTING OF INTRANETS ON A COMPUTER SERVER FOR OTHERS; PROVIDING SECURITY SERVICES FOR OTHERS OF GLOBAL COMPUTER NETWORKS AND ELECTRONIC COMMERCE; PROVIDING TEMPORARY USE OF ON-LINE NON-DOWNLOADABLE SOFTWARE, THE SOFTWARE BEING DEVELOPED BY OTHERS FOR A VARIETY OF APPLICATIONS; DOMAIN NAME REGISTRATION SERVICES; PROVISION OF INTERNET ADDRESSES; ELECTRONIC BACK UP AND RECOVERY OF COMPUTER DATA; MONITORING OF COMPUTER SYSTEMS; PROVISION OF SUPPORT AND MAINTENANCE OF INTERNET APPLICATIONS FOR OTHERS; COMPUTER CONSULTATION IN THE FIELD OF COMPUTER NETWORKS, COMPUTER SECURITY AND ELECTRONIC COMMERCE AND TELECOMMUNICATIONS CONSULTATION (U.S. CLS. 100 AND 101).

FIRST USE 2-5-2001; IN COMMERCE 2-5-2001.

2,765,540. BUDGETINNS.COM, INC, DENHAM SPRINGS, LA. SN 78-013,416. PUB. 1-8-2002, FILED 6-19-2000.



NO CLAIM IS MADE TO THE EXCLUSIVE RIGHT TO USE "HIGHLAND INN", APART FROM THE MARK AS SHOWN.

THE MARK CONSISTS OF A STYLIZED UPPER CASE "H" IN THE CIRCLE.

FOR HOTEL AND MOTEL SERVICES (U.S. CLS. 100 AND 101).

FIRST USE 12-10-2000; IN COMMERCE 4-12-2001.

CLASS 42—(Continued).

2,765,543. COPHAROS, INC., PONTE VEDRA BEACH, FL. SN 78-016,605. PUB. 9-17-2002, FILED 7-13-2000.

COPHAROS

FOR RESEARCH, DESIGN AND DEVELOPMENT OF PHARMACEUTICAL PRODUCTS (U.S. CLS. 100 AND 101).

FIRST USE 6-1-2001; IN COMMERCE 6-1-2001.

2,765,550. MOORE NORTH AMERICA, INC., STAMFORD, CT. SN 78-026,362. PUB. 6-12-2001, FILED 9-18-2000.

DIRECTORY123

FOR PRINTING SERVICES PROVIDED OVER A GLOBAL COMMUNICATION NETWORK (U.S. CLS. 100 AND 101).

FIRST USE 8-0-2001; IN COMMERCE 8-0-2001.

2,765,554. CHEMICAL SPECIALTIES MANUFACTURERS ASSOCIATION, INC. (CSMA), WASHINGTON, DC. SN 78-030,116. PUB. 10-29-2002, FILED 10-11-2000.



NO CLAIM IS MADE TO THE EXCLUSIVE RIGHT TO USE "CONSUMER SPECIALTY PRODUCTS ASSOCIATION", APART FROM THE MARK AS SHOWN.

FOR ASSOCIATION SERVICES, NAMELY, PROMOTING THE INTERESTS OF BUSINESSES ENGAGED IN, OR ALLIED WITH, THE PRODUCTION OR MARKETING OF CONSUMER SPECIALTY PRODUCTS (U.S. CLS. 100 AND 101).

FIRST USE 12-7-2000; IN COMMERCE 1-5-2001.

CLASS 42—(Continued).

2,765,597. SOLAR RETREAT, HOUSTON, TX. SN 78-062,146. PUB. 10-8-2002, FILED 5-4-2001.

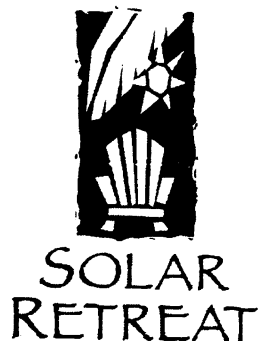

FOR TANNING SALONS (U.S. CLS. 100 AND 101).
FIRST USE 3-1-2003; IN COMMERCE 3-1-2003.

2,765,599. TRUSTEES OF AMERICA'S DRIVE-IN TRUST, A PENNSYLVANIA BUSINESS TRUST, COMPRISING KENNETH L. KEYMER, RONALD L. MATLOCK AND JANICE C. GEORGE, ALL UNITED STATES CITIZENS, THE, RENO, NV. SN 78-063,601. PUB. 9-10-2002, FILED 5-15-2001.

EAT DESSERT FIRST

FOR RESTAURANT SERVICES (U.S. CLS. 100 AND 101).
FIRST USE 8-1-2001; IN COMMERCE 8-1-2001.

2,765,614. SOFTPROS CONSULTING, INC., OCEANPORT, NJ. SN 78-070,132. PUB. 8-13-2002, FILED 6-20-2001.



FOR CONSULTATION SERVICES IN THE FIELD OF INFORMATION TECHNOLOGY; DEVELOPMENT OF COMPUTER SOFTWARE; INTEGRATION OF COMPUTER SYSTEMS (U.S. CLS. 100 AND 101).
FIRST USE 0-0-1998; IN COMMERCE 0-0-1998.

2,765,625. PACIFIC TRANSDUCER CORP., LOS ANGELES, CA. SN 78-075,390. PUB. 3-26-2002, FILED 7-24-2001.

PTC METROLOGY**CLASS 42—(Continued).**

NO CLAIM IS MADE TO THE EXCLUSIVE RIGHT TO USE "METROLOGY", APART FROM THE MARK AS SHOWN.
FOR CALIBRATION SERVICES (U.S. CLS. 100 AND 101).
FIRST USE 1-1-1999; IN COMMERCE 1-1-1999.

2,765,633. MARATHON ENGINEERS/ARCHITECTS/PLANNERS, LLC, APPLETON, WI. SN 78-078,974. PUB. 8-27-2002, FILED 8-13-2001.

LOC@L SERVICE

NO CLAIM IS MADE TO THE EXCLUSIVE RIGHT TO USE "SERVICE", APART FROM THE MARK AS SHOWN.
FOR ENGINEERING SAFETY CONSULTING AND ENGINEERING CONSULTING SERVICES (U.S. CLS. 100 AND 101).
FIRST USE 5-12-2001; IN COMMERCE 4-4-2003.

2,765,636. RITZ-CARLTON HOTEL COMPANY, L.L.C., THE, BETHESDA, MD. SN 78-079,193. PUB. 4-23-2002, FILED 8-14-2001.

THE RITZ-CARLTON SPA

OWNER OF U.S. REG. NOS. 1,094,823, 2,386,118, AND OTHERS.
NO CLAIM IS MADE TO THE EXCLUSIVE RIGHT TO USE "SPA", APART FROM THE MARK AS SHOWN.
FOR RESORT AND LODGING SERVICES; RESTAURANT, BAR AND LOUNGE SERVICES; HEALTH SPA SERVICES; PHYSICAL FITNESS CONSULTATION SERVICES; MASSAGE SERVICES; BEAUTY SALON SERVICES (U.S. CLS. 100 AND 101).
FIRST USE 12-17-1997; IN COMMERCE 12-17-1997.

2,765,654. SMALL WORLD NETWORKS, INC., BOZEMAN, MT, BY CHANGE OF NAME BAYLESS & ASSOCIATES, INC., BOZEMAN, MT. SN 78-084,423. PUB. 2-26-2002, FILED 9-18-2001.

PIONEER ENTREPRENEURS

NO CLAIM IS MADE TO THE EXCLUSIVE RIGHT TO USE "ENTREPRENEURS", APART FROM THE MARK AS SHOWN.
FOR SOCIAL NETWORKING SERVICES FOR ENTREPRENEURS IN EMERGING MARKETS (U.S. CLS. 100 AND 101).
FIRST USE 1-1-2002; IN COMMERCE 1-1-2002.

CLASS 42—(Continued).

2,765,657. NATIONAL LEGAL CENTER FOR THE MEDICALLY DEPENDENT & DISABLED, INC., TERRE HAUTE, IN. SN 78-085,515. PUB. 9-3-2002, FILED 9-25-2001.

CLASS 42—(Continued).

2,765,701. KOSMAN, GARY LEE, GRANADA HILLS, CA. SN 78-104,468. PUB. 1-7-2003, FILED 1-24-2002.

NIGHTINGALE ALLIANCE

NO CLAIM IS MADE TO THE EXCLUSIVE RIGHT TO USE "ALLIANCE", APART FROM THE MARK AS SHOWN. FOR ASSOCIATION SERVICES, NAMELY PROMOTING THE INTERESTS OF AND PROVIDING SUPPORT SERVICES TO PERSONS HAVING FEARS ASSOCIATED WITH DYING; PROVIDING INFORMATION, NEWS, AND COMMENTARY REGARDING PHYSICIAN-ASSISTED SUICIDE AND EUTHANASIA TO POLITICAL LEADERS, EDUCATORS, AND MEDICAL PROFESSIONALS (U.S. CLS. 100 AND 101).

FIRST USE 1-27-2003; IN COMMERCE 1-27-2003.

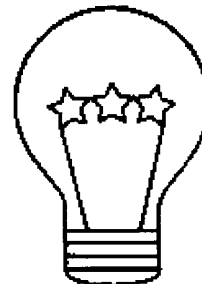

2,765,674. LOCKHEED MARTIN CORPORATION, BETHESDA, MD. SN 78-093,042. PUB. 12-3-2002, FILED 11-13-2001.

JSF

FOR TECHNICAL AND ENGINEERING CONSULTING SERVICES IN THE FIELD OF AERONAUTICS AND AVIATION, COMPUTER SOFTWARE DEVELOPMENT FOR OTHERS, UPDATING OF COMPUTER SOFTWARE FOR OTHERS, TECHNICAL SUPPORT SERVICES, NAMELY, TROUBLESHOOTING OF COMPUTER HARDWARE AND SOFTWARE PROBLEMS, PROMOTING THE INTEREST OF THE PUBLIC IN THE FIELD OF AERONAUTICS AND AVIATION (U.S. CLS. 100 AND 101).

FIRST USE 10-29-2001; IN COMMERCE 10-29-2001.

2,765,675. AVENUE A, INC., SEATTLE, WA. SN 78-093,047. PUB. 8-6-2002, FILED 11-13-2001.

ATLAS DMT

FOR PROVIDING TEMPORARY USE OF ON-LINE NON-DOWNLOADABLE SOFTWARE FOR MANAGING, TRACKING AND EVALUATING MEDIA PLANNING, MEDIA BUYING AND THE SUCCESS OF MARKETING EFFORTS OF OTHERS (U.S. CLS. 100 AND 101).

FIRST USE 8-31-2001; IN COMMERCE 8-31-2001.

FOR APPLICATION SERVICE PROVIDER (ASP) FEATURING SOFTWARE USE TO EVALUATE, MONITOR, AND SUPPORT STAFF, VOLUNTEERS, AND CLIENTS OF NONPROFIT AND FOR PROFIT ORGANIZATIONS; PROVIDING TEMPORARY USE OF ON-LINE NON-DOWNLOADABLE SOFTWARE FOR EVALUATING, MONITORING, AND SUPPORT STAFF, VOLUNTEERS, AND CLIENTS OF NONPROFIT AND FOR PROFIT ORGANIZATIONS (U.S. CLS. 100 AND 101).

FIRST USE 11-1-2000; IN COMMERCE 10-1-2001.

2,765,722. CAMPMINDER, LLC, NEW YORK, NY. SN 78-112,319. PUB. 9-24-2002, FILED 3-4-2002.

CAMP MINDER

FOR APPLICATION SERVICE PROVIDER SERVICES, NAMELY, COMPUTER APPLICATION SOFTWARE USED ON A COMPUTER SERVER THAT IS NETWORKED VIA A GLOBAL COMPUTER NETWORK AND IS RELATED TO THE CHILD CARE INDUSTRY, FEATURING- DATABASE MANAGEMENT AND BILLING; STAFF RECRUITMENT AND TIME MANAGEMENT; MARKETING MANAGEMENT; SCHEDULING MANAGEMENT; ACTIVITY MANAGEMENT; ENROLLMENT TRACKING; AND PERSONAL HISTORY MANAGEMENT OF STAFF AND CHILDREN (U.S. CLS. 100 AND 101).

FIRST USE 8-1-2002; IN COMMERCE 8-1-2002.

2,765,766. WRIGHT, DWAYNE V, DECATUR, GA. SN 78-125,895. PUB. 11-5-2002, FILED 5-2-2002.

DUBELYOO

FOR GRAPHIC ART DESIGN; GRAPHIC ILLUSTRATION SERVICES FOR OTHERS (U.S. CLS. 100 AND 101).

FIRST USE 9-1-2000; IN COMMERCE 9-1-2000.

CLASS 42—(Continued).

2,765,794. BALL, TROY, E, TARPON SPRINGS, FL. SN 78-136,473. PUB. 3-18-2003, FILED 6-18-2002.

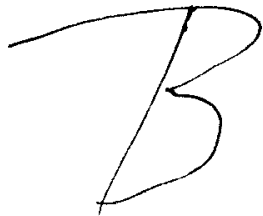

FOR CUSTOM JEWELRY DESIGN SERVICES FOR OTHERS (U.S. CLS. 100 AND 101).
FIRST USE 1-1-2003; IN COMMERCE 1-1-2003.

CLASS 43—HOTEL AND RESTAURANT SERVICES

2,765,366. DAVID A. KOMATZ AND ASSOCIATES, INC., KALAMAZOO, MI. SN 76-377,727. PUB. 10-22-2002, FILED 3-5-2002.

FOOD YOU CAN WALK WITH

FOR RESTAURANTS (U.S. CLS. 100 AND 101).
FIRST USE 5-1-2002; IN COMMERCE 5-1-2002.

2,765,438. LEISURE STATION CO., LTD., TAICHUNG, TAIWAN, TAIWAN. SN 76-406,138. PUB. 11-12-2002, FILED 5-3-2002.

Easy Together 休閒小聚

THE NON-LATIN CHARACTERS IN THE MARK TRANSLITERATE TO "HSIU HSIEN HSIU JIUH". THIS TRANSLATES TO "LEISURE", "SMALL" AND "TO COME OR PUT TOGETHER OR ASSEMBLE" IN ENGLISH.

FOR BAR SERVICES, SNACK BARS, CARRY-OUT RESTAURANTS, COCKTAIL LOUNGES, COCKTAIL LOUNGE BUFFETS, OFFICE COFFEE SUPPLY SERVICES, RENTAL OF FOOD SERVICE EQUIPMENT, RESTAURANTS, SELF-SERVICE RESTAURANTS, RESTAURANTS FEATURING HOME DELIVERY, SALAD BARS, CANTEEN SERVICES, CAFES AND CAFETERIAS (U.S. CLS. 100 AND 101).

FIRST USE 12-30-2002; IN COMMERCE 12-30-2002.

CLASS 43—(Continued).

2,765,500. MG-AH OPERATING, INC., DENVER, CO. SN 76-434,322. PUB. 2-11-2003, FILED 7-22-2002.

ALGONQUIN HOTEL

OWNER OF U.S. REG. NO. 935,506.
NO CLAIM IS MADE TO THE EXCLUSIVE RIGHT TO USE "HOTEL", APART FROM THE MARK AS SHOWN.
FOR HOTEL SERVICES, RESTAURANT, CATERING, BAR AND LOUNGE SERVICES; PROVISION OF FACILITIES FOR CONFERENCES, MEETINGS AND EXHIBITIONS; RESERVATION SERVICES FOR HOTEL ACCOMMODATIONS FOR OTHERS (U.S. CLS. 100 AND 101).

FIRST USE 9-1-2002; IN COMMERCE 9-1-2002.

2,765,717. RADISSON HOTELS INTERNATIONAL, INC., MINNEAPOLIS, MN. SN 78-109,769. PUB. 9-17-2002, FILED 2-19-2002.

FLEXNIGHTS

FOR HOTEL SERVICES, NAMELY A FREQUENT CUSTOMER LOYALTY/PROMOTION PROGRAM (U.S. CLS. 100 AND 101).

FIRST USE 5-0-2002; IN COMMERCE 5-0-2002.

2,765,730. KELLEY, SEAN, GRAY, ME. SN 78-114,157. PUB. 10-15-2002, FILED 3-12-2002.

DOGGIE COTTAGE

NO CLAIM IS MADE TO THE EXCLUSIVE RIGHT TO USE "DOGGIE", APART FROM THE MARK AS SHOWN.
FOR KENNEL SERVICES (U.S. CLS. 100 AND 101).

FIRST USE 11-3-2000; IN COMMERCE 4-30-2001.

2,765,772. LOG CABIN BBQ, FAIRFIELD GLADE, TN. SN 78-128,225. PUB. 12-24-2002, FILED 5-13-2002.

LOG CABIN BBQ

NO CLAIM IS MADE TO THE EXCLUSIVE RIGHT TO USE "BBQ", APART FROM THE MARK AS SHOWN.

FOR TAKE-OUT LUNCH AND DINNER RESTAURANT SERVICES FEATURING DRIVE-THRU AND CARRY-OUT SERVICES FEATURING BARBECUED MEATS AND EXCLUDING BREAKFAST FOODS AND MAPLE SYRUPS (U.S. CLS. 100 AND 101).

FIRST USE 5-26-2003; IN COMMERCE 5-26-2003.

CLASS 45—(Continued).

2,765,774. LHO WASHINGTON HOTEL TWO, LLC, BETHESDA, MD. SN 78-128,356. PUB. 1-14-2003, FILED 5-13-2002.

HOTEL MADERA

NO CLAIM IS MADE TO THE EXCLUSIVE RIGHT TO USE "HOTEL", APART FROM THE MARK AS SHOWN. THE ENGLISH TRANSLATION OF THE WORD "MADERA" IN THE MARK IS "WOOD".
FOR HOTEL SERVICES (U.S. CLS. 100 AND 101).
FIRST USE 9-23-2002; IN COMMERCE 9-23-2002.

CLASS 44—(Continued).

2,765,486. COGNICHECK, INC., LYNCHBURG, VA. SN 76-423,869. PUB. 12-10-2002, FILED 6-24-2002.

CREWS TEST

NO CLAIM IS MADE TO THE EXCLUSIVE RIGHT TO USE "TEST", APART FROM THE MARK AS SHOWN. FOR PSYCHOLOGICAL TESTING (U.S. CLS. 100 AND 101).
FIRST USE 11-1-2002; IN COMMERCE 11-1-2002.

CLASS 44—MEDICAL, BEAUTY AND AGRICULTURAL SERVICES

2,765,291. BOSTWICK LABORATORIES OF AMERICA, LLC, RICHMOND, VA. SN 76-358,801. PUB. 9-17-2002, FILED 1-15-2002.

FOR ABSOLUTE CONFIDENCE

FOR PATHOLOGY SERVICES, NAMELY, THE TESTING OF BIOPSIES IN THE AREAS OF UROLOGY AND PROSTATE CANCER (U.S. CLS. 100 AND 101).
FIRST USE 1-1-2001; IN COMMERCE 1-1-2001.

CLASS 45—PERSONAL SERVICES

2,765,287. DREAM IN COLOR, LLC, NEW YORK, NY. SN 76-358,100. PUB. 2-4-2003, FILED 1-11-2002.



NO CLAIM IS MADE TO THE EXCLUSIVE RIGHT TO USE "BACHELOR & BACHELORETTE", APART FROM THE MARK AS SHOWN. FOR DATING SERVICES PROVIDED ON-LINE OVER A GLOBAL COMPUTER INFORMATION NETWORK (U.S. CLS. 100 AND 101).
FIRST USE 10-15-2002; IN COMMERCE 10-15-2002.

2,765,432. LANE, JUVES, V, HICKSVILLE, NY. SN 76-403,289. PUB. 11-19-2002, FILED 5-2-2002.

TEETH BRITE

NO CLAIM IS MADE TO THE EXCLUSIVE RIGHT TO USE "TEETH", APART FROM THE MARK AS SHOWN. FOR TEETH BLEACHING SERVICE (U.S. CLS. 100 AND 101).
FIRST USE 4-1-2002; IN COMMERCE 4-1-2002.

2,765,693. PEARCE, KENNETH, B., SAN DIMAS, CA. SN 78-100,837. PUB. 6-25-2002, FILED 1-4-2002.

CUSTER CHRISTIANSEN

THE NAME "CUSTER CHRISTIANSEN" DOES NOT IDENTIFY A LIVING INDIVIDUAL. FOR MORTUARY AND FUNERAL SERVICES (U.S. CLS. 100 AND 101).
FIRST USE 1-25-2003; IN COMMERCE 1-25-2003.

* * * * *

PRIOR UNITED STATES CLASSIFICATION

APPLICATION IN ONE CLASS

COLLECTIVE MEMBERSHIP MARKS

CLASS 200—COLLECTIVE MEMBERSHIP

2,764,574. HOME BUILDERS ASSOCIATION OF METROPOLITAN DENVER, DENVER, CO, BY ASSIGNMENT KUROWSKI, JOHN, LITTLETON, CO. SN 75-757,611. PUB. 4-23-2002, FILED 7-22-1999.

BUILT GREEN

NO CLAIM IS MADE TO THE EXCLUSIVE RIGHT TO USE "GREEN", APART FROM THE MARK AS SHOWN.
FOR INDICATING MEMBERSHIP IN AN ASSOCIATION OF DEVELOPERS, CONTRACTORS, BUILDERS, AND MANUFACTURERS IN THE CONSTRUCTION INDUSTRY WHO ARE ENVIRONMENTALLY FRIENDLY (U.S. CL. 200).
FIRST USE 6-1-1997; IN COMMERCE 6-1-1997.

2,765,389. COLSON ASSOCIATES, INC., CHICAGO, IL. SN 76-386,707. PUB. 10-15-2002, FILED 3-25-2002.



FOR INDICATING MEMBERSHIP IN AN ORGANIZATION COMPOSED OF MANUFACTURERS AND ALL TYPES OF SERVICE COMPANIES (U.S. CL. 200).
FIRST USE 6-0-2002; IN COMMERCE 6-0-2002.

2,765,390. COLSON ASSOCIATES, INC., CHICAGO, IL. SN 76-386,708. PUB. 10-1-2002, FILED 3-25-2002.

COLSON ASSOCIATE

FOR INDICATING MEMBERSHIP IN AN ORGANIZATION COMPOSED OF MANUFACTURERS AND ALL TYPES OF SERVICE COMPANIES (U.S. CL. 200).
FIRST USE 6-0-2002; IN COMMERCE 6-0-2002.

CERTIFICATION MARKS

CLASS A—GOODS

2,765,149. CALIFORNIA MILK PRODUCERS ADVISORY BOARD, SOUTH SAN FRANCISCO, CA. SN 76-318,515. PUB. 9-17-2002, FILED 10-1-2001.



NO CLAIM IS MADE TO THE EXCLUSIVE RIGHT TO USE "BUTTER", APART FROM THE MARK AS SHOWN.
THE STIPPLING AND LINING ON THE MAP OF CALIFORNIA IS A DESIGN FEATURE AND DOES NOT INDICATE COLOR.
THAT THE BUTTER ON WHICH THE MARK IS USED WAS MADE IN THE STATE OF CALIFORNIA.
FOR BUTTER (U.S. CL. A).
FIRST USE 3-4-2002; IN COMMERCE 3-4-2002.

* * * * *

SUPPLEMENTAL REGISTER

These registrations are not subject to opposition.

SECTION 1.— INTERNATIONAL CLASSIFICATION

The short titles associated below with the international class numbers are terms designed merely for quick identification and are not an official part of the international classification. The full names of international classes are given in section 6.1 of the trademark rules of practice.

The designation "U.S. Cl." appearing in this section refers to the U.S. class in effect prior to Sep. 1, 1973 rather than the international class which applies to applications filed on or after that date. For adoption of international classification see notice in the OFFICIAL GAZETTE of Jun. 26, 1973 (911 O.G. TM 210).

Application in more than one class

2,765,831. VOLKSWAGEN AKTIENGESELLSCHAFT, D-38436, WOLFSBURG, FED REP GERMANY. SN 75-575,157. FILED P.R. 10-22-1998; AM. S.R. 2-23-2001.

W 10

OWNER OF FED REP GERMANY REG. NO. 39749684, DATED 1-26-1998, EXPIRES 10-31-2007.

NO CLAIM IS MADE TO THE EXCLUSIVE RIGHT TO USE "10", APART FROM THE MARK AS SHOWN.

CLASS 7—MACHINERY

FOR ENGINES NOT FOR LAND VEHICLES (U.S. CLS. 13, 19, 21, 23, 31, 34 AND 35).

CLASS 12—VEHICLES

FOR AUTOMOBILES AND STRUCTURAL PARTS THEREFOR AND MOTORS FOR AUTOMOBILES (U.S. CLS. 19, 21, 23, 31, 35 AND 44).

CLASS 28—TOYS AND SPORTING GOODS

FOR TOY AUTOMOBILES VEHICLES AND SCALE MODEL TOY VEHICLES (U.S. CLS. 22, 23, 38 AND 50).

2,765,832. VOLKSWAGEN AKTIENGESELLSCHAFT, D-38436, WOLFSBURG, FED REP GERMANY. SN 75-575,158. FILED P.R. 10-22-1998; AM. S.R. 2-23-2001.

W 12

OWNER OF FED REP GERMANY REG. NO. 39749685, DATED 12-16-1997, EXPIRES 10-31-2007.

NO CLAIM IS MADE TO THE EXCLUSIVE RIGHT TO USE "12", APART FROM THE MARK AS SHOWN.

CLASS 7—MACHINERY

FOR ENGINES NOT FOR LAND VEHICLES (U.S. CLS. 13, 19, 21, 23, 31, 34 AND 35).

CLASS 12—VEHICLES

FOR AUTOMOBILES AND STRUCTURAL PARTS THEREFOR AND MOTORS FOR AUTOMOBILES (U.S. CLS. 19, 21, 23, 31, 35 AND 44).

CLASS 28—TOYS AND SPORTING GOODS

FOR TOY AUTOMOBILES VEHICLES AND SCALE MODEL TOY VEHICLES (U.S. CLS. 22, 23, 38 AND 50).

2,765,836. HENKEL CONSUMER ADHESIVES, INC., AVON, OH, BY CHANGE OF NAME MANCO, INC., AVON, OH. SN 75-842,390. FILED P.R. 11-4-1999; AM. S.R. 5-23-2003.

REPAIR METAL FOR GOOD

NO CLAIM IS MADE TO THE EXCLUSIVE RIGHT TO USE "REPAIR METAL", APART FROM THE MARK AS SHOWN.

CLASS 1—CHEMICALS

FOR ADHESIVES FOR USE IN HOME AND BUILDING CONSTRUCTION, RENOVATION, MAINTENANCE AND REPAIR (U.S. CLS. 1, 5, 6, 10, 26 AND 46).
FIRST USE 12-31-1999; IN COMMERCE 12-31-1999.

CLASS 2—PAINTS

FOR METAL FILLER COMPOUNDS, NAMELY, RESIN-BASED FILLER AND HARDENER, FOR USE IN HOME AND BUILDING CONSTRUCTION, RENOVATION, MAINTENANCE, AND REPAIR (U.S. CLS. 6, 11 AND 16).
FIRST USE 12-31-1999; IN COMMERCE 12-31-1999.

2,765,837. HENKEL CONSUMER ADHESIVES, INC., AVON, OH, BY CHANGE OF NAME MANCO, INC., AVON, OH. SN 75-842,393. FILED P.R. 11-4-1999; AM. S.R. 5-23-2003.

REPAIR WOOD FOR GOOD

NO CLAIM IS MADE TO THE EXCLUSIVE RIGHT TO USE "REPAIR WOOD", APART FROM THE MARK AS SHOWN.

CLASS 1—CHEMICALS

FOR ADHESIVES FOR USE IN HOME AND BUILDING CONSTRUCTION, RENOVATION, MAINTENANCE AND REPAIR (U.S. CLS. 1, 5, 6, 10, 26 AND 46).

FIRST USE 12-31-1999; IN COMMERCE 12-31-1999.

CLASS 2—PAINTS

FOR WOOD FILLER COMPOUNDS, NAMELY, RESIN-BASED FILLER AND HARDENER, FOR USE IN HOME AND BUILDING CONSTRUCTION, RENOVATION, MAINTENANCE AND REPAIR (U.S. CLS. 6, 11 AND 16).

FIRST USE 12-31-1999; IN COMMERCE 12-31-1999.

2,765,839. HONDA GIKEN KOGYO KABUSHIKI KAISHA (HONDA MOTOR CO., LTD.), MINATO-KU, TOKYO 107, JAPAN. SN 75-982,297. FILED P.R. 3-27-2001; AM. S.R. 12-26-2001.

Owner Link

CLASS 37—CONSTRUCTION AND REPAIR

FOR PROVIDING ON-LINE AUTOMOBILE MAINTENANCE INFORMATION (U.S. CLS. 100, 103 AND 106).

FIRST USE 10-0-2001; IN COMMERCE 10-0-2001.

CLASS 38—COMMUNICATION

FOR PROVIDING MULTIPLE USER ACCESS TO COMPUTER NETWORKS; PROVIDING ON-LINE ELECTRONIC BULLETIN BOARDS FOR TRANSMISSION OF MESSAGES AMONG COMPUTER USERS CONCERNING A WIDE VARIETY OF TOPICS; TELECOMMUNICATIONS SERVICES, NAMELY ELECTRONIC TRANSMISSION OF DATA, IMAGES AND DOCUMENTS VIA COMPUTER TERMINALS; ELECTRONIC STORE-AND-FORWARD MESSAGING; ELECTRONIC MAIL SERVICES, AND FACSIMILE TRANSMISSIONS (U.S. CLS. 100, 101 AND 104).

FIRST USE 10-0-2001; IN COMMERCE 10-0-2001.

2,765,844. JEFFERY GROUP LTD., THE, TORONTO, ONTARIO, CANADA. SN 76-083,995. FILED P.R. 7-6-2000; AM. S.R. 7-10-2003.

E-MENTORING

PRIORITY CLAIMED UNDER SEC. 44(D) ON CANADA APPLICATION NO. 1046800, FILED 2-16-2000, REG. NO. TMA559391, DATED 3-18-2002, EXPIRES 3-18-2017.

CLASS 35—ADVERTISING AND BUSINESS

FOR BUSINESS NETWORKING AND BUSINESS CONSULTATION SERVICES (U.S. CLS. 100, 101 AND 102).

CLASS 41—EDUCATION AND ENTERTAINMENT

FOR EDUCATIONAL AND ENTERTAINMENT SERVICES, NAMELY, PROVIDING MOTIVATIONAL AND EDUCATIONAL SPEAKERS (U.S. CLS. 100, 101 AND 107).

2,765,850. FOCUS ON THE FAMILY, COLORADO SPRINGS, CO. SN 76-160,202. FILED P.R. 11-6-2000; AM. S.R. 1-27-2003.

PHYSICIAN

CLASS 35—ADVERTISING AND BUSINESS

FOR PROVIDING AN ONLINE MAGAZINE FEATURING INFORMATION OF INTEREST TO PHYSICIANS IN THE FIELD OF BUSINESS PRACTICES IN MEDICAL OFFICES (U.S. CLS. 100, 101 AND 102).

FIRST USE 4-6-2000; IN COMMERCE 4-6-2000.

CLASS 45—PERSONAL SERVICES

FOR PROVIDING AN ONLINE MAGAZINE FEATURING INFORMATION OF INTEREST TO PHYSICIANS IN THE FIELDS OF RELIGION, SOCIAL ISSUES AND PERSONAL ISSUES RELATED TO CAREER AND WORKING LIFE (U.S. CLS. 100 AND 101).

FIRST USE 4-6-2000; IN COMMERCE 4-6-2000.

2,765,852. HERITAGE MINISTRIES, WACO, TX. SN 76-188,054. FILED P.R. 1-2-2001; AM. S.R. 1-9-2002.

CENTER FOR ESSENTIAL EDUCATION

NO CLAIM IS MADE TO THE EXCLUSIVE RIGHT TO USE "EDUCATION", APART FROM THE MARK AS SHOWN.

CLASS 16—PAPER GOODS AND PRINTED MATTER

FOR PRINTED EDUCATIONAL PUBLICATIONS, NAMELY, BOOKS, CURRICULUM MATERIALS, STUDENT WORKBOOKS, TEACHER'S MANUALS, SEMINAR AND WORKSHOP HANDOUTS, PRINTED CHARTS, PLASTIC OVERHEAD TRANSPARENCIES, AND BOOK COVERS, ALL IN THE AREAS OF ACADEMIC, RELIGIOUS, AND CRAFT SUBJECTS FROM ELEMENTARY THROUGH COLLEGE LEVELS (U.S. CLS. 2, 5, 22, 23, 29, 37, 38 AND 50).

FIRST USE 10-23-2000; IN COMMERCE 10-23-2000.

CLASS 41—EDUCATION AND ENTERTAINMENT

FOR EDUCATIONAL SERVICES, NAMELY, LECTURES, SEMINARS, WORKSHOPS, FESTIVALS, CRAFT FAIRS, PANEL DISCUSSIONS, VIDEO PRESENTATIONS, SLIDE PRESENTATIONS, FILMS, OVERHEAD PROJECTIONS, GUIDED TOURS, SELF-GUIDED TOURS, MEDIA PRESENTATIONS AND MULTI-MEDIA PRESENTATIONS, ALL IN THE FIELDS OF ACADEMIC, RELIGIOUS, AND CRAFT SUBJECT FROM ELEMENTARY THROUGH COLLEGE LEVELS (U.S. CLS. 100, 101 AND 107).

FIRST USE 10-22-1999; IN COMMERCE 10-22-1999.

2,765,855. PATSYSTEMS (UK) LTD., LONDON, UNITED KINGDOM. SN 76-228,258. FILED P.R. 3-21-2001; AM. S.R. 8-19-2002.

PROFESSIONAL AUTOMATED TRADING SYSTEMS

NO CLAIM IS MADE TO THE EXCLUSIVE RIGHT TO USE "AUTOMATED TRADING SYSTEMS", APART FROM THE MARK AS SHOWN.

CLASS 9—ELECTRICAL AND SCIENTIFIC APPARATUS

FOR COMPUTER SOFTWARE TO PERMIT DIRECT MARKET ACCESS WITH STREAMING DATA, REAL TIME SECURITIES PRICES AND ADVANCED TRADING FUNCTIONALITY; COMPUTER SOFTWARE FOR TRADING FINANCIAL SECURITIES USING COMPLEX MATHEMATICAL ANALYSIS AND ALLOWING FOR THE SPECULATION OF VOLATILITY LEVELS AND PRICES; COMPUTER SOFTWARE ENABLING THE EXECUTION OF TRADES, IN THE FIELD OF SECURITIES TRADING; COMPUTER SOFTWARE THAT PROVIDES FINANCIAL INSTITUTIONS THE ABILITY TO OFFER AND DISTRIBUTE TRADING ACCESS TO PRODUCTS CLEARED AND TRADED BY SECURITIES EXCHANGES, TO OTHER FINANCIAL INSTITUTIONS, DATA PROCESSORS AND COMPUTERS; COMPUTER SOFTWARE FOR ADMINISTERING THE RISK ASSOCIATED WITH SECURITIES TRADING AND FOR THE SETTING OF SECURITIES TRADING RISK (U.S. CLS. 21, 23, 26, 36 AND 38).

FIRST USE 5-0-2000; IN COMMERCE 5-0-2000.

CLASS 35—ADVERTISING AND BUSINESS

FOR BUSINESS CONSULTATION, NAMELY, PROVIDING FINANCIAL INSTITUTIONS AN ALTERNATIVE METHOD OF COMMUNICATION WITH SECURITIES EXCHANGES (U.S. CLS. 100, 101 AND 102).

FIRST USE 5-0-2000; IN COMMERCE 5-0-2000.

2,765,884. ASSETHOUSE TECHNOLOGY LIMITED, GUILDFORD, SURREY, GU2 7RF, UNITED KINGDOM. SN 76-354,258. FILED P.R. 1-2-2002; AM. S.R. 11-4-2002.

CONTENT OBJECT ARCHITECTURE

PRIORITY CLAIMED UNDER SEC. 44(D) ON ERP/CMNTY TM OFC APPLICATION NO. 2281541, FILED 7-2-2001, REG. NO. 002281541, DATED 2-13-2003, EXPIRES 7-2-2011.

CLASS 9—ELECTRICAL AND SCIENTIFIC APPARATUS

FOR COMPUTER SOFTWARE FOR USE IN DATABASE MANAGEMENT IN THE FIELD OF APPLICATION INFRASTRUCTURE; APPLICATION SOFTWARE, NAMELY, COMPUTER SOFTWARE FOR APPLICATION AND DATABASE INTEGRATION; COMPUTER SOFTWARE ADAPTED FOR USE IN THE OPERATION OF COMPUTERS, NAMELY, COMPUTER UTILITY PROGRAMS; COMPUTER SOFTWARE FOR COMMUNICATION PURPOSES OVER AN INTERNAL AND EXTERNAL NETWORK BETWEEN DIGITAL DEVICES AND MAINFRAME COMPUTERS, MOBILE TELEPHONES, INTERACTIVE TELEVISIONS AND COMPUTER KIOSKS; NETWORK MANAGEMENT COMPUTER SOFTWARE (U.S. CLS. 21, 23, 26, 36 AND 38).

CLASS 35—ADVERTISING AND BUSINESS

FOR LICENSING OF COMPUTER SOFTWARE (U.S. CLS. 100, 101 AND 102).

CLASS 38—COMMUNICATION

FOR INTERNET SERVICES PROVISIONS, NAMELY, PROVIDING MULTIPLE USER DIAL-UP AND DEDICATED ACCESS TO THE INTERNET; DELIVERY AND MANAGEMENT OF APPLICATIONS FROM REMOTE DATA CENTERS TO MULTIPLE USERS VIA THE INTERNET OR A PRIVATE NETWORK (U.S. CLS. 100, 101 AND 104).

CLASS 42—SCIENTIFIC, COMPUTER AND LEGAL SERVICES

FOR APPLICATION SERVICE PROVISION, NAMELY, HOSTING SOFTWARE APPLICATIONS FOR OTHERS; MAINTENANCE OF COMPUTER SOFTWARE VIA THE INTERNET OR PRIVATE NETWORK; PROVIDING TEMPORARY USE OF ON-LINE NON-DOWNLOADABLE SOFTWARE FOR USE IN DATABASE MANAGEMENT VIA THE INTERNET OR A PRIVATE NETWORK; HOSTING OF DIGITAL CONTENT ON THE INTERNET; INTERNET DEVELOPMENT SERVICES IN THE NATURE OF COMPUTER SERVICES, NAMELY CREATING, MAINTAINING AND DESIGNING WEB SITES FOR OTHERS (U.S. CLS. 100 AND 101).

2,765,887. RECKITT BENCKISER N.V., 2132 NZ HOOFDORP, NETHERLANDS. SN 76-364,754. FILED P.R. 1-30-2002; AM. S.R. 10-25-2002.

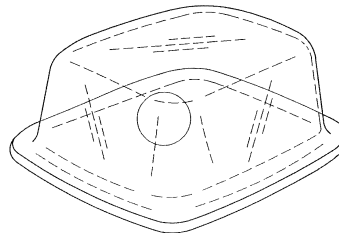

PRIORITY CLAIMED UNDER SEC. 44(D) ON BENELUX APPLICATION NO. 0994524, FILED 7-31-2001, REG. NO. 0692672, DATED 7-31-2001, EXPIRES 7-31-2011.

THE MARK CONSISTS OF A RECTANGULAR SHAPED TABLET WITH BEVELED SIDEWALLS, HAVING A SPHERICAL COMPONENT VISIBLE INSIDE OF THE TABLET.

CLASS 1—CHEMICALS

FOR CHEMICALS FOR USE IN THE MANUFACTURE OF DETERGENTS IN THE INDUSTRIAL AND CONSUMER CLEANING INDUSTRY; DESCALING AGENTS, NAMELY, DETERGENTS IN THE INDUSTRIAL AND CONSUMER CLEANING PRODUCTS INDUSTRY; WATER SOFTENER SALT, PROTECTIVE PREPARATIONS FOR GLASSWARE, PORCELAIN AND EARTHENWARE, CROCKERY AND OTHER KITCHENWARE, ALL AFOREMENTIONED GOODS WITH OR WITHOUT A DISINFECTIVE COMPONENT (U.S. CLS. 1, 5, 6, 10, 26 AND 46).

CLASS 3—COSMETICS AND CLEANING PREPARATIONS

FOR LAUNDRY BLEACH, LAUNDRY WHITENER, LAUNDRY NEUTRALIZING DETERGENTS, LAUNDRY CONDITIONING DETERGENTS, LAUNDRY DE-STAINING AND STAIN REMOVING PREPARATIONS, LAUNDRY RUST REMOVERS AND LAUNDRY RINSE AGENTS; LAUNDRY PREPARATIONS FOR DRY CLEANING; GENERAL PURPOSE HOUSEHOLD CLEANING, POLISHING, SCOURING AND ABRASIVE PREPARATIONS AND CARPET CLEANERS; LAUNDRY DETERGENTS, DISH DETERGENTS, AND DISHWASHER DETERGENTS; CHEMICAL DECALCIFYING AND DESCALING PREPARATIONS FOR CLEANING GLASSWARE, PORCELAIN, EARTHENWARE, CROCKERY AND OTHER KITCHENWARE; FABRIC SOFTENERS AND ANTI-STATIC LAUNDRY PREPARATIONS (U.S. CLS. 1, 4, 6, 50, 51 AND 52).

2,765,894. TRANSACTION CONSULTANTS, INC., LIGHTHOUSE POINT, FL. SN 76-400,645. FILED P.R. 4-25-2002; AM. S.R. 5-9-2003.

TRANSACTION CONSULTANTS

CLASS 35—ADVERTISING AND BUSINESS

FOR BUSINESS SERVICES IN THE NATURE OF PROCURING QUALIFIED AND CREDENTIALLED THIRD-PARTY EXPERTS, PROFESSIONALS AND OTHER QUALIFIED PERSONNEL, AND DOCUMENTATION AND INFORMATION, ALL ON BEHALF OF OTHERS (U.S. CLS. 100, 101 AND 102).

FIRST USE 7-18-1991; IN COMMERCE 7-18-1991.

CLASS 36—INSURANCE AND FINANCIAL

FOR REAL ESTATE BROKERAGE SERVICES; REAL ESTATE SERVICES, NAMELY TENANT REPRESENTATION; FINANCIAL ANALYSES, MODELING AND VALUATION OF REAL ESTATE; EQUITY AND DEBT ANALYSES, UNDERWRITING AND LOAN REQUIREMENT FULFILLMENT SERVICES; FEASIBILITY ANALYSES (U.S. CLS. 100, 101 AND 102).

FIRST USE 7-18-1991; IN COMMERCE 7-18-1991.

2,765,905. CMP MEDIA LLC, MANHASSET, NY. SN 76-424,525. FILED P.R. 6-20-2002; AM. S.R. 4-25-2003.

SUPPLY NETWORK CONFERENCE

NO CLAIM IS MADE TO THE EXCLUSIVE RIGHT TO USE "CONFERENCE", APART FROM THE MARK AS SHOWN.

CLASS 35—ADVERTISING AND BUSINESS

FOR ARRANGING AND CONDUCTING BUSINESS CONFERENCES, TRADE SHOWS AND EXPOSITIONS IN THE FIELD OF ELECTRONICS (U.S. CLS. 100, 101 AND 102).

FIRST USE 9-17-2002; IN COMMERCE 9-17-2002.

CLASS 41—EDUCATION AND ENTERTAINMENT

FOR EDUCATIONAL SERVICES, NAMELY, CONDUCTING SEMINARS IN THE FIELDS OF ELECTRONICS (U.S. CLS. 100, 101 AND 107).

FIRST USE 9-17-2002; IN COMMERCE 9-17-2002.

2,765,910. INFORMATION SYSTEMS AUDIT AND CONTROL ASSOCIATION, ROLLING MEADOWS, IL. SN 76-429,160. FILED P.R. 7-10-2002; AM. S.R. 4-18-2003.

INFORMATION SYSTEMS CONTROL JOURNAL

OWNER OF U.S. REG. NOS. 2,497,927 AND 2,572,797.
NO CLAIM IS MADE TO THE EXCLUSIVE RIGHT TO USE "JOURNAL", APART FROM THE MARK AS SHOWN.

CLASS 9—ELECTRICAL AND SCIENTIFIC APPARATUS

FOR DOWNLOADABLE ELECTRONIC PUBLICATION IN THE NATURE OF A JOURNAL IN THE FIELD OF INFORMATION TECHNOLOGY FOR BUSINESS MANAGEMENT, CONSULTATION AND AUDITING OF INFORMATION SYSTEMS (U.S. CLS. 21, 23, 26, 36 AND 38).

FIRST USE 1-0-2000; IN COMMERCE 1-0-2000.

CLASS 16—PAPER GOODS AND PRINTED MATTER

FOR PRINTED JOURNAL IN THE FIELD OF INFORMATION TECHNOLOGY FOR BUSINESS MANAGEMENT, CONSULTATION, AND AUDITING OF INFORMATION SYSTEMS (U.S. CLS. 2, 5, 22, 23, 29, 37, 38 AND 50).

FIRST USE 1-0-2000; IN COMMERCE 1-0-2000.

2,765,918. KNOLL PRINTING AND PACKAGING, INC., ROSLYN HEIGHTS, NY. SN 76-442,961. FILED P.R. 8-19-2002; AM. S.R. 6-20-2003.

SNAP HANDLE BOX

NO CLAIM IS MADE TO THE EXCLUSIVE RIGHT TO USE "BOX", APART FROM THE MARK AS SHOWN.

CLASS 16—PAPER GOODS AND PRINTED MATTER

FOR PAPER GIFT BOXES SOLD EMPTY TO SELLERS, MARKETERS AND DISTRIBUTORS OF FRAGRANCES, COSMETICS AND OTHER ITEMS (U.S. CLS. 2, 5, 22, 23, 29, 37, 38 AND 50).

FIRST USE 6-0-2001; IN COMMERCE 6-0-2001.

CLASS 21—HOUSEWARES AND GLASS

FOR NON-METAL DECORATIVE GIFT BOXES SOLD EMPTY TO SELLERS, MARKETERS AND DISTRIBUTORS OF FRAGRANCES, COSMETICS AND OTHER ITEMS (U.S. CLS. 2, 13, 23, 29, 30, 33, 40 AND 50).
FIRST USE 6-0-2001; IN COMMERCE 6-0-2001.

CLASS 20—FURNITURE AND ARTICLES NOT OTHERWISE CLASSIFIED

FOR FURNITURE; BATHROOM VANITIES; CONSOLE TABLES; TABLES; TABLE TOPS; WOODEN AND PLASTIC STORAGE CASES FOR HOUSEHOLD USE; WOODEN AND PLASTIC STORAGE DRAWERS FOR HOUSEHOLD USE (U.S. CLS. 2, 13, 22, 25, 32 AND 50).
FIRST USE 4-0-2000; IN COMMERCE 4-0-2000.



2,765,940. CREDITVIEW AS, OSLO, NORWAY. SN 78-105,590.
FILED P.R. 1-29-2002; AM. S.R. 5-12-2003.

2,765,939. KOHLER CO., KOHLER, WI. SN 78-098,630. FILED
P.R. 12-17-2001; AM. S.R. 8-5-2002.

FINANCIAL-CRM

IRON WORKS

CLASS 35—ADVERTISING AND BUSINESS

FOR BUSINESS CONSULTATION; PROVIDING BUSINESS MARKETING INFORMATION; BUSINESS SERVICES, NAMELY PROVIDING COMPUTER DATABASES REGARDING THE PURCHASE AND SALE OF A WIDE VARIETY OF PRODUCTS AND SERVICES OF OTHERS; DISSEMINATION OF ADVERTISING FOR OTHERS VIA THE INTERNET; AUTOMATED ACCOUNTING SERVICES (U.S. CLS. 100, 101 AND 102).
FIRST USE 11-0-2000; IN COMMERCE 12-4-2000.

CLASS 11—ENVIRONMENTAL CONTROL APPARATUS

FOR PLUMBING PRODUCTS AND FIXTURES NAMELY, BATHTUBS, WHIRLPOOL BATHS, SHOWERS AND SHOWER INSTALLATIONS, NAMELY, SHOWER HEADS AND SHOWER RECEPTORS, SHOWER CUBICLES; BIDETS; LAVATORIES; TOILETS; TOILET SEATS; WATER CLOSETS; SINKS; TAPS; FAUCETS; FIXED SPOUTS DIRECTLY ON BATHS, BATHROOM FITTINGS, NAMELY VALVES; SANITARY APPARATUS AND INSTALLATIONS NAMELY URINALS; SANITARY WARE, NAMELY LAVATORY SINKS (U.S. CLS. 13, 21, 23, 31 AND 34).
FIRST USE 4-0-2000; IN COMMERCE 4-0-2000.

CLASS 36—INSURANCE AND FINANCIAL

FOR FINANCIAL SERVICES, NAMELY, CREDIT AND RISK MANAGEMENT SERVICES; FINANCIAL INFORMATION PROCESSING; FINANCIAL INFORMATION PROVIDED BY ELECTRONIC MEANS; FINANCIAL CONSULTING SERVICES (U.S. CLS. 100, 101 AND 102).
FIRST USE 11-0-2000; IN COMMERCE 12-4-2000.

* * * * *

SECTION 2.— INTERNATIONAL CLASSIFICATION

The short titles associated below with the international class numbers are terms designed merely for quick identification and are not an official part of the international classification. The full names of international classes are given in section 6.1 of the trademark rules of practice.

The designation "U.S. Cl." appearing in this section refers to the U.S. class in effect prior to Sep. 1, 1973 rather than the international class which applies to applications filed on or after that date. For adoption of international classification see notice in the OFFICIAL GAZETTE of Jun. 26, 1973 (911 O.G. TM 210).

Application in one class

CLASS 1—CHEMICALS

2,765,935. GENEDETECT.COM LIMITED, AUCKLAND, NEW ZEALAND. SN 78-056,122. FILED P.R. 3-31-2001; AM. S.R. 6-25-2003.

GENEDETECT

FOR REAGENTS FOR SCIENTIFIC OR RESEARCH USE, NAMELY REAGENTS FOR USE IN DETECTING, MEASURING, CHARACTERIZING, INHIBITING OR STIMULATING GENE EXPRESSION, COMPRISING OF GENE PROBES, TRANSCRIPTION FACTOR DECOYS, DNA CONSENSUS SEQUENCES, IN-SITU DNA CONSENSUS SEQUENCES, IN-SITU DNA BINDING KITS CONSISTING PRIMARILY OF RADIOACTIVE OR NON-RADIOACTIVE LABELED DNA CONSENSUS SEQUENCES, DNA ARRAYS (U.S. CLS. 1, 5, 6, 10, 26 AND 46).

FIRST USE 8-1-2000; IN COMMERCE 8-1-2000.

CLASS 2—PAINTS

2,765,877. SEI CHEMICAL INC., LAS VEGAS, NV. SN 76-341,766. FILED P.R. 11-27-2001; AM. S.R. 5-19-2003.

GRAFFITI PROOFER

FOR CHEMICALS NAMELY; A PROTECTIVE COATING IN THE NATURE OF CLEAR ACRYLIC APPLIED TO FLOORS, WALLS, DOORS, CEILINGS AND WALKWAYS TO PROTECT TREATED SURFACES FROM BEING DAMAGED BY VANDALS (U.S. CLS. 6, 11 AND 16).

FIRST USE 9-1-2001; IN COMMERCE 9-1-2001.

CLASS 3—COSMETICS AND CLEANING PREPARATIONS

2,765,859. OLD WORLD INDUSTRIES, INC., NORTHBROOK, IL. SN 76-256,523. FILED P.R. 5-14-2001; AM. S.R. 1-21-2003.

ALL WEATHER

OWNER OF U.S. REG. NOS. 1,700,058 AND 1,700,059. FOR AUTOMOTIVE WINDSHIELD CLEANING FLUIDS (U.S. CLS. 1, 4, 6, 50, 51 AND 52). FIRST USE 8-0-2001; IN COMMERCE 8-0-2001.

CLASS 3—(Continued).

2,765,922. 4LIFE RESEARCH, L.C., SANDY, UT. SN 76-447,921. FILED P.R. 9-9-2002; AM. S.R. 6-23-2003.

TF

OWNER OF U.S. REG. NO. 2,665,085. FOR NON-MEDICATED SKIN CARE PREPARATIONS, NAMELY, SKIN CLEANSERS, BODY LOTIONS, CREAMS AND GELS (U.S. CLS. 1, 4, 6, 50, 51 AND 52). FIRST USE 9-0-2001; IN COMMERCE 9-0-2001.

CLASS 4—LUBRICANTS AND FUELS

2,765,872. NORTH AMERICAN LUBRICANTS, PLEASANTON, CA. SN 76-321,049. FILED P.R. 10-4-2001; AM. S.R. 6-12-2002.

NORTH AMERICAN LUBRICANTS, CO.

NO CLAIM IS MADE TO THE EXCLUSIVE RIGHT TO USE "LUBRICANTS", APART FROM THE MARK AS SHOWN.

FOR PASSENGER CAR MOTOR OIL (U.S. CLS. 1, 6 AND 15).

FIRST USE 8-15-2001; IN COMMERCE 8-15-2001.

2,765,917. J & S CHEMICAL CORPORATION, CANTON, GA. SN 76-442,938. FILED P.R. 8-22-2002; AM. S.R. 5-15-2003.

DRYSPRAY

FOR LUBRICANTS FOR INDUSTRIAL MACHINERY (U.S. CLS. 1, 6 AND 15).

FIRST USE 11-18-1998; IN COMMERCE 11-18-1998.

CLASS 5—PHARMACEUTICALS

CLASS 5—(Continued).

2,765,833. G.D. SEARLE & CO., SKOKIE, IL. SN 75-724,356. FILED P.R. 6-8-1999; AM. S.R. 12-19-2002.

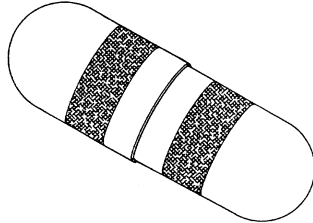

NO CLAIM IS MADE TO THE EXCLUSIVE RIGHT TO USE THE REPRESENTATION OF A CAPSULE, APART FROM THE MARK AS SHOWN.

THE MARK CONSISTS OF TWO YELLOW BANDS AS APPLIED TO THE CIRCUMFERENCE OF THE GOODS. THE DOTTED OUTLINE OF THE GOODS IS INTENDED TO SHOW THE POSITION OF THE MARK AND IS NOT A PART OF THE MARK.

FOR PHARMACEUTICAL PRODUCTS IN THE NATURE OF ANTI-INFLAMMATORY ANALGESICS (U.S. CLS. 6, 18, 44, 46, 51 AND 52).
FIRST USE 2-6-1999; IN COMMERCE 2-6-1999.

2,765,853. FIDIA FARMACEUTICI SPA, I-350131 ABANO TERME, ITALY, BY CHANGE OF NAME FIDIA S.P.A., I-35031 ABANO TERME, ITALY. SN 76-219,010. FILED P.R. 3-2-2001; AM. S.R. 4-9-2003.

WET

OWNER OF ITALY REG. NO. 869064, DATED 12-17-2002, EXPIRES 6-10-2022.

FOR RHINOLOGICAL PREPARATIONS; NASAL SPRAYS, GELS AND SOLUTIONS (U.S. CLS. 6, 18, 44, 46, 51 AND 52).

2,765,874. ANABOLIC LABORATORIES, INC., LAKE FOREST, CA. SN 76-323,961. FILED P.R. 10-10-2001; AM. S.R. 5-23-2003.

**DUAL ACTION
ACIDOPHILUS & BIFIDUS**

NO CLAIM IS MADE TO THE EXCLUSIVE RIGHT TO USE "ACIDOPHILUS & BIFIDUS", APART FROM THE MARK AS SHOWN.

FOR VITAMINS AND NUTRITIONAL SUPPLEMENTS (U.S. CLS. 6, 18, 44, 46, 51 AND 52).
FIRST USE 11-13-2001; IN COMMERCE 11-13-2001.

CLASS 5—(Continued).

2,765,885. QUALITY OF LIFE LABS, INC., PURCHASE, NY. SN 76-359,710. FILED P.R. 1-17-2002; AM. S.R. 4-25-2003.

KINOKO

FOR DIETARY SUPPLEMENTS CONTAINING KINOKO MUSHROOMS (U.S. CLS. 6, 18, 44, 46, 51 AND 52).
FIRST USE 10-0-2002; IN COMMERCE 10-0-2002.

CLASS 6—METAL GOODS

2,765,860. ALU-REX INC., ST-JEAN-CHRYSOSTOME (QUEBEC), CANADA. SN 76-282,618. FILED P.R. 7-3-2001; AM. S.R. 11-6-2001.

GUTTER CLEAN SYSTEM

PRIORITY CLAIMED UNDER SEC. 44(D) ON CANADA APPLICATION NO. 1092988, FILED 2-16-2001, REG. NO. TMA576359, DATED 2-25-2003, EXPIRES 2-25-2018.

FOR METAL GUTTER PROTECTORS FOR AVOIDING THE ACCUMULATION OF LEAVES AND BRANCHES AND THE ACCUMULATION OF SNOW AND ICE (U.S. CLS. 2, 12, 13, 14, 23, 25 AND 50).

2,765,866. LAXON CORPORATION, TORRANCE, CA. SN 76-305,554. FILED P.R. 8-28-2001; AM. S.R. 4-11-2003.

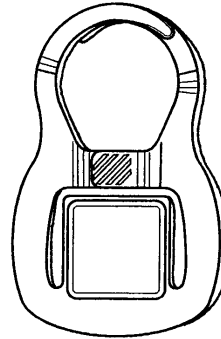

THE MARK CONSISTS OF A CONFIGURATION OF A KEY RING.

FOR METAL KEY RINGS (U.S. CLS. 2, 12, 13, 14, 23, 25 AND 50).
FIRST USE 2-0-2001; IN COMMERCE 2-0-2001.

CLASS 7—MACHINERY

CLASS 7—(Continued).

2,765,848. AMERICAN TRUCKSOURCE, INC., IRVING, TX. SN 76-146,493. FILED P.R. 10-13-2000; AM. S.R. 5-15-2003.

AMERICAN PARTSSOURCE

OWNER OF U.S. REG. NOS. 2,375,928, 2,375,931, AND OTHERS.

FOR PARTS FOR MOTORS, NAMELY—CONNECTING HOSES FOR RADIATORS; GASKETS FOR COMBUSTION ENGINES; AIR FILTERS AND OIL PUMPS AND FUEL PUMPS FOR LAND MOTORS AND ENGINES; OIL, FUEL, AND AIR FILTERS FOR USE IN DIESEL ENGINES AND AUTOMOTIVE PARTS; IGNITION COMPONENTS, NAMELY, ALTERNATORS AND STARTERS; WATER PUMPS, CAM SHAFTS, CRANKSHAFTS FOR USE IN DIESEL ENGINES, AIR COMPRESSORS, TURBOCHARGERS FOR USE IN DIESEL ENGINES, ENGINE OR MOTOR MUFFLERS, EXHAUST COMPONENTS, NAMELY EXHAUST HEADERS, PIPING, AND MUFFLERS, PARTS FOR LAND MOTORS AND ENGINES, NAMELY, CHROME EXHAUST STACKS (U.S. CLS. 13, 19, 21, 23, 31, 34 AND 35).

FIRST USE 9-27-2002; IN COMMERCE 9-27-2002.

2,765,863. KABUSHIKI KAISHA KOMATSU SEISAKUSHO, TOKYO, JAPAN. SN 76-293,743. FILED P.R. 8-2-2001; AM. S.R. 6-10-2003.

E - PROBE

PRIORITY CLAIMED UNDER SEC. 44(D) ON JAPAN APPLICATION NO. 2001-009511, FILED 2-7-2001, REG. NO. 4574530, DATED 6-7-2002, EXPIRES 6-7-2012.

FOR PIPE LINE BURYING MACHINES AND TOOLS, EXCLUDING EXCAVATION SYSTEMS, NAMELY, HORIZONTAL DIRECTIONAL DRILLS; CONSTRUCTION MACHINES AND POWER TOOLS, NAMELY, TRUCK CRANES, POWER SHOVELS, ROOTERS, EARTH AUGERS, PILE DRIVERS, PILE EXTRACTORS, GROUTING PUMPS, GRADERS, SCRAPERS, TAMPERS, BULLDOZERS, RAMMERS, ROLLERS, CONCRETE PLACING MACHINES, CONCRETE VIBRATORS, CONCRETE PAVING MACHINES, CONCRETE MIXERS, BATCHING PLANTS, ASPHALT DISTRIBUTORS, ASPHALT FINISHERS, ASPHALT PLANTS, ASPHALT MIXERS, DREDGING MACHINES, LOADER BUCKETS, AND BUCKET EXCAVATORS; CARGO HANDLING MACHINES AND APPARATUS, NAMELY, CABLE CRANES, SELF-TRAVELLING CRANES, JIB CRANES, DERRICKS, OVERHEAD TRAVELLING CRANES, TOWER CRANES, BRIDGE CRANES, FLOATING CRANES, UNLOADERS, LOCOMOTIVE CRANES, PNEUMATIC CONVEYORS, HYDRAULIC CONVEYORS, SCREW CONVEYORS, CHAIN CONVEYORS, BUCKET ELEVATORS, BELT CONVEYORS, ROLLER CONVEYORS, WINCHES, WINDLASSES, CAPSTANS, CHAIN BLOCKS, HOISTS, AND UNLOADING HOPPERS; AND MINING MACHINES AND TOOLS, NAMELY, CUTTER LOADERS, COAL CUTTERS, OIL WELL PUMPING MACHINES, ROCK DRILLS, WELL DRILLING MACHINES, SHARPENERS, DRILLING AND BORING MACHINES, LOADERS, AND TRUCK MILLS (U.S. CLS. 13, 19, 21, 23, 31, 34 AND 35).

2,765,865. BRADLEY, BURCE J., JEROME, ID. SN 76-301,131. FILED P.R. 8-20-2001; AM. S.R. 2-11-2003.

MICROBIAL- VAC SYSTEMS**CLASS 7—(Continued).**

NO CLAIM IS MADE TO THE EXCLUSIVE RIGHT TO USE "SYSTEMS", APART FROM THE MARK AS SHOWN.

FOR VACUUM COLLECTION, FILTRATION AND CONCENTRATION EQUIPMENT NAMELY VACUUM SAMPLING HEADS, FILTER HOLDING DEVICES, LIQUID CANISTERS, VACUUM PUMPS, PRESSURE PUMPS, HOSES, TUBING, FILTER MEDIA, FOR SAMPLE ACQUISITION AND ANALYSIS OF SURFACE OF AIR PARTICULATES INCLUDING MICROBES AND OTHER ORGANIC OR INORGANIC PARTICLES (U.S. CLS. 13, 19, 21, 23, 31, 34 AND 35).

FIRST USE 3-5-2002; IN COMMERCE 3-5-2002.

2,765,897. SATAKE USA, INC., HOUSTON, TX. SN 76-411,212. FILED P.R. 5-20-2002; AM. S.R. 12-12-2002.

PELLETSCAN

FOR SORTING MACHINES EMPLOYING OPTO-ELECTRONIC SENSORS FOR USE IN SORTING PLASTIC PELLETS AND PLASTIC FLAKES (U.S. CLS. 13, 19, 21, 23, 31, 34 AND 35).

FIRST USE 6-4-2002; IN COMMERCE 6-4-2002.

CLASS 8—HAND TOOLS

2,765,952. STEWART-WARNER ALEMITE LICENSCO, INC., WILMINGTON, DE. SN 78-169,855. FILED P.R. 10-1-2002; AM. S.R. 5-28-2003.

PUSH 'N LUBE

FOR MANUALLY-OPERATED GREASE GUNS (U.S. CLS. 23, 28 AND 44).

FIRST USE 11-30-2002; IN COMMERCE 11-30-2002.

CLASS 9—ELECTRICAL AND SCIENTIFIC APPARATUS

2,765,830. RG DELAWARE, INC., WILMINGTON, DE. SN 75-525,634. FILED P.R. 7-27-1998; AM. S.R. 9-7-2000.

DYNAMIC PROBE

NO CLAIM IS MADE TO THE EXCLUSIVE RIGHT TO USE "PROBE", APART FROM THE MARK AS SHOWN.

FOR PRESSURE MONITOR WITH PRESSURE SENSORS FOR USE IN CONNECTION WITH FILTRATION BEDS (U.S. CLS. 21, 23, 26, 36 AND 38).

FIRST USE 8-1-1998; IN COMMERCE 8-1-1998.

CLASS 9—(Continued).

2,765,834. JUNOT SYSTEMS, INC., HOUSTON, TX. SN 75-776,405. FILED P.R. 8-16-1999; AM. S.R. 1-29-2003.

EXTENDERS

FOR COMPUTER SOFTWARE FOR INTEGRATING DIFFERENT SOFTWARE APPLICATIONS, NAMELY PROPRIETARY OR IN-HOUSE DEVELOPED SOFTWARE APPLICATIONS, INTERFACES, OR DATABASES; AND AUTOMATED DATA COLLECTION SOFTWARE FOR USE IN THE FIELD OF E-COMMERCE, BUSINESS-TO-BUSINESS, INTERNET, AND ENTERPRISE APPLICATION INTEGRATION (U.S. CLS. 21, 23, 26, 36 AND 38).

FIRST USE 5-6-1999; IN COMMERCE 5-6-1999.

2,765,835. INVISIBLE FENCE, INC, GARRETT, IN, BY ASSIGNMENT; BY ASSIGNMENT; BY CHANGE OF NAME IFCO ENTERPRISES, INC., MALVERN, PA. SN 75-828,570. FILED P.R. 10-21-1999; AM. S.R. 6-21-2001.

YOUR CAT SAFE @ HOME

FOR ELECTRICAL PET CONTAINMENT SYSTEM, COMPRISING ELECTRICAL TRANSMITTER AND RECEIVER (U.S. CLS. 21, 23, 26, 36 AND 38).

FIRST USE 5-0-2001; IN COMMERCE 5-0-2001.

2,765,841. STOCK OPTION ANALYZER.COM, INC., MABLETON, GA. SN 76-056,444. FILED P.R. 5-25-2000; AM. S.R. 4-15-2002.

STOCK OPTION ANALYZER

FOR SOFTWARE USED TO ASSIST EMPLOYEE STOCK OPTION HOLDERS AND THOSE WHO ASSIST THEM WITH FINANCIAL PLANNING AND TAX PLANNING TO ESTABLISH A STRATEGY FOR EXERCISING STOCK OPTIONS WHEREBY THE ALTERNATIVE MINIMUM TAX IS MINIMIZED (U.S. CLS. 21, 23, 26, 36 AND 38).

FIRST USE 4-10-2002; IN COMMERCE 4-10-2002.

2,765,849. WINGRA TECHNOLOGIES, LLC, MADISON, WI. SN 76-146,673. FILED P.R. 10-16-2000; AM. S.R. 5-5-2003.

STANDARDS MIGRATOR

FOR COMPUTER SOFTWARE FOR MOVING MESSAGE STORES FROM ONE INTERNET STANDARDS-BASED SYSTEM (POP OR IMAP) TO ANOTHER STANDARDS-BASED SYSTEM (U.S. CLS. 21, 23, 26, 36 AND 38).

FIRST USE 1-15-2002; IN COMMERCE 1-15-2002.

CLASS 9—(Continued).

2,765,871. MEDIA SYNDICATION GLOBAL, INC., NEW YORK, NY. SN 76-320,005. FILED P.R. 10-2-2001; AM. S.R. 6-16-2003.

SWITCHBOARD

FOR COMMUNICATIONS EQUIPMENT, NAMELY AN INTERNET PHONE LINE SHARING DEVICE COMPRISING A MULTIPLE INPUT/OUTPUT UNIT FOR ALLOWING INTERNET USERS TO RECEIVE CALLS FROM A SINGLE TELECOMMUNICATIONS LINE (U.S. CLS. 21, 23, 26, 36 AND 38).

FIRST USE 12-1-2001; IN COMMERCE 12-1-2001.

2,765,875. KAUFMAN, HALL & ASSOCIATES, INC., DBA KAUFMAN, HALL & ASSOCIATES, NORTHFIELD, IL. SN 76-335,312. FILED P.R. 11-7-2001; AM. S.R. 3-6-2003.

PHYSICIAN ADVISOR

FOR FINANCIAL PLANNING SOFTWARE FOR USE IN THE HEALTH CARE INDUSTRY, NAMELY, COMPUTER PROGRAMS FOR USE IN DATABASE MANAGEMENT AND FOR USE AS A SPREADSHEET AND MANUALS SOLD THEREWITH AS A UNIT (U.S. CLS. 21, 23, 26, 36 AND 38).

FIRST USE 8-0-1999; IN COMMERCE 12-0-1999.

2,765,892. LITERA CORP., MCLEANSVILLE, NC. SN 76-392,148. FILED P.R. 4-8-2002; AM. S.R. 5-14-2003.

INTELLIGENT DOCUMENT SYSTEMS

NO CLAIM IS MADE TO THE EXCLUSIVE RIGHT TO USE "SYSTEMS", APART FROM THE MARK AS SHOWN.

FOR COMPUTER SOFTWARE WHICH ALLOWS MULTIPLE USERS TO COLLABORATE ON A SINGLE DOCUMENT, WHICH INSERTS DIGITAL SIGNATURES AND WHICH ARCHIVES AND RETRIEVES DATA ACCORDING TO SPECIAL SEARCH CRITERIA DEFINED BY THE USER (U.S. CLS. 21, 23, 26, 36 AND 38).

FIRST USE 2-10-2003; IN COMMERCE 2-10-2003.

2,765,893. PROVATION MEDICAL, INC., MINNEAPOLIS, MN. SN 76-392,799. FILED P.R. 4-8-2002; AM. S.R. 6-30-2003.

SMARTMENU

FOR SOFTWARE FOR MEDICAL SPECIALTIES PROCEDURE DOCUMENTATION, NAMELY, SOFTWARE WHICH ENABLES PHYSICIANS AND MEDICAL PERSONNEL TO CREATE A CLINICAL RECORD DIRECTLY FROM THEIR PROCEDURES BY INTEGRATING IMAGE CAPTURE AND ADVANCED GRAPHICS WITH PROCEDURE-SENSITIVE MEDICAL KNOWLEDGE; SOFTWARE FOR DATABASE MANAGEMENT INCLUDING THE MANAGEMENT OF DATA AND IMAGES, SOFTWARE FOR CREATING MEDICAL REPORTS, IN THE FIELD OF MEDICAL CARE (U.S. CLS. 21, 23, 26, 36 AND 38).

FIRST USE 4-2-2002; IN COMMERCE 4-2-2002.

CLASS 9—(Continued).

2,765,900. APTE, INC., EVANSTON, IL. SN 76-419,232. FILED P.R. 6-11-2002; AM. S.R. 4-28-2003.

DIGITAL CAMERA STUDIO

NO CLAIM IS MADE TO THE EXCLUSIVE RIGHT TO USE "DIGITAL CAMERA", APART FROM THE MARK AS SHOWN.

FOR DIGITAL PHOTOGRAPHIC ACTIVITY KIT COMPRISING A DIGITAL PHOTOGRAPHIC CAMERA AND A SOFTWARE COMPONENT FOR USE WITH THE CAMERA (U.S. CLS. 21, 23, 26, 36 AND 38).

FIRST USE 5-14-2002; IN COMMERCE 8-28-2002.

2,765,902. TELEMAGEMENT FORUM, MORRISTOWN, NJ. SN 76-419,925. FILED P.R. 6-13-2002; AM. S.R. 6-2-2003.

ENHANCED TELECOM OPERATIONS MAP

FOR COMPUTER SOFTWARE FOR USE BY TELECOMMUNICATIONS SERVICE PROVIDERS IN SYSTEMS DESIGN, PROCESS MANAGEMENT AND PROCESS DEFINITION AND FOR USE BY SUPPLIERS TO THE TELECOMMUNICATIONS INDUSTRY IN DEFINING THE BOUNDARIES AND INTERFACES FOR THEIR PRODUCTS (U.S. CLS. 21, 23, 26, 36 AND 38).

FIRST USE 5-29-2002; IN COMMERCE 5-29-2002.

2,765,912. THE CLARK FOUNDATION, NEW YORK, NY. SN 76-435,922. FILED P.R. 7-31-2002; AM. S.R. 6-13-2003.

HORTICULTURE OF COOPERSTOWN

NO CLAIM IS MADE TO THE EXCLUSIVE RIGHT TO USE "HORTICULTURE", APART FROM THE MARK AS SHOWN.

FOR VIDEOS, NAMELY INSTRUCTIONAL GUIDES ON THE GROWING, ARRANGING, DESIGNING AND DISPLAYING OF FLOWERS, ORNAMENTAL PLANTS, SHRUBS, AND GARDENS (U.S. CLS. 21, 23, 26, 36 AND 38).

FIRST USE 11-0-2001; IN COMMERCE 11-0-2001.

2,765,921. Z-WORLD, INC., DAVIS, CA. SN 76-447,739. FILED P.R. 9-9-2002; AM. S.R. 6-26-2003.

EDISPLAY

FOR SINGLE BOARD COMPUTERS AND OPERATOR INTERFACES INCLUDING DISPLAY SCREENS AND HUMAN MACHINE INTERFACES (U.S. CLS. 21, 23, 26, 36 AND 38).

FIRST USE 10-10-2002; IN COMMERCE 10-10-2002.

CLASS 9—(Continued).

2,765,932. ESE, INCORPORATED, MARSHFIELD, WI. SN 78-035,702. FILED P.R. 11-17-2000; AM. S.R. 7-13-2003.

FOOD QUANTIFIER

FOR LABORATORY INSTRUMENT FOR USE IN ANALYZING AND AT-LINE PROCESS APPLICATIONS, NAMELY, TO ANALYZE AND QUANTIFY MULTIPLE CONSTITUENTS WITHIN FOODSTUFFS AND PHARMACEUTICALS FOR USE WITHIN THE FIELDS OF AGRICULTURE, BEVERAGES, DAIRY, MEAT, AND PHARMACEUTICALS; LABORATORY APPARATUS FOR USE IN ANALYZING AND QUANTIFYING MULTIPLE CONSTITUENTS WITHIN FOOD STUFF AND PHARMACEUTICALS WHICH FEATURE SOFTWARE THAT INTEGRATED AND EXPORTS CONSTITUENT DATA WITHIN FOODSTUFFS AND PHARMACEUTICALS FOR USE WITHIN THE FIELDS OF AGRICULTURE, BEVERAGES, DAIRY, FOOD, MEAT, AND PHARMACEUTICALS (U.S. CLS. 21, 23, 26, 36 AND 38).

FIRST USE 6-1-1998; IN COMMERCE 7-1-2000.

2,765,938. NATIONAL ELECTRICAL CONTRACTORS ASSOCIATION, BETHESDA, MD. SN 78-093,322. FILED P.R. 11-14-2001; AM. S.R. 5-27-2003.

NATIONAL ELECTRICAL INSTALLATION STANDARDS

NO CLAIM IS MADE TO THE EXCLUSIVE RIGHT TO USE "STANDARDS", APART FROM THE MARK AS SHOWN.

FOR PRE-RECORDED SOFTWARE ON CD-ROM FEATURING INFORMATION RELATING TO STANDARDS AND PRACTICES IN THE FIELD OF ELECTRICAL CONTRACTING AND INSTALLATION (U.S. CLS. 21, 23, 26, 36 AND 38).

FIRST USE 5-15-2003; IN COMMERCE 5-15-2003.

2,765,942. INTRINSITY, INC., AUSTIN, TX. SN 78-119,352. FILED P.R. 4-3-2002; AM. S.R. 4-8-2003.

ION RING

FOR SEMICONDUCTOR INTERFACES AND SEMICONDUCTOR DATA NETWORKS (U.S. CLS. 21, 23, 26, 36 AND 38).

FIRST USE 12-23-2002; IN COMMERCE 12-23-2002.

2,765,945. WRIGHT, JESSE M., CENTENNIAL, CO. SN 78-137,451. FILED P.R. 6-20-2002; AM. S.R. 5-20-2003.

LOCKPROBE

FOR ELECTRONIC INSTRUMENT THAT DIGITALLY PROBES AUTOMOTIVE LOCKS TO DETECT KEY CUTS (U.S. CLS. 21, 23, 26, 36 AND 38).

FIRST USE 3-0-1998; IN COMMERCE 11-15-2001.

CLASS 9—(Continued).

2,765,946. VOYANT TECHNOLOGIES, INC., WESTMINSTER, CO. SN 78-142,150. FILED P.R. 7-9-2002; AM. S.R. 12-18-2002.

MOBILEMEETING

FOR COMPUTER HARDWARE AND SOFTWARE FOR ENABLING CONFERENCING VIA WIRELESS COMMUNICATION DEVICES; ELECTRIC TELEPHONE SWITCHES; TELECOMMUNICATION APPARATUS, NAMELY, BRIDGES; COMPUTER INTERFACE BOARDS; ISDN INTEGRATED CIRCUITS; ETHERNET INTERFACE CARDS; ELECTRICAL POWER SUPPLIES; COMPUTER NETWORK ROUTERS; COMPUTER CONTROLS; TELECOMMUNICATION OPERATOR UNITS (U.S. CLS. 21, 23, 26, 36 AND 38).

FIRST USE 5-13-2002; IN COMMERCE 5-20-2002.

2,765,958. PHOENIX WIRELESS, INC., HATFIELD, PA. SN 78-199,018. FILED P.R. 12-31-2002; AM. S.R. 6-27-2003.

RUGGED

OWNER OF U.S. REG. NO. 2,670,595.
FOR CARRYING CASE FOR CELLULAR TELEPHONES (U.S. CLS. 21, 23, 26, 36 AND 38).
FIRST USE 9-10-2001; IN COMMERCE 9-10-2001.

CLASS 10—MEDICAL APPARATUS

2,765,928. BEDFORD INDUSTRIES, INC., WORTHINGTON, MN. SN 76-467,912. FILED P.R. 11-19-2002; AM. S.R. 5-27-2003.

BENDABLE COMPONENTS

OWNER OF U.S. REG. NO. 1,696,204 AND OTHERS.
NO CLAIM IS MADE TO THE EXCLUSIVE RIGHT TO USE "COMPONENTS", APART FROM THE MARK AS SHOWN.

FOR ADHESIVELY BACKED AND NON-ADHESIVELY BACKED FLEXIBLE SHAPE-RETAINING DEADFOLD RIBBONS FOR CONTOURING THE SHAPE OF MEDICAL AND HEALTH CARE PRODUCTS SUCH AS SURGICAL DRAPES AND LINENS, WASTE AND STORAGE BAGS, OSTOMIC BAGS, BODY FLUID COLLECTION BAGS, VOMIT-CONFINING BAGS, AND AIR-FILTERING FACE MASKS (U.S. CLS. 26, 39 AND 44).

FIRST USE 8-23-2002; IN COMMERCE 8-23-2002.

CLASS 11—ENVIRONMENTAL CONTROL APPARATUS**CLASS 11—(Continued).**

2,765,896. DELL ROMAINE COMPANIES, INC., NEWBURGH, IN. SN 76-409,525. FILED P.R. 5-8-2002; AM. S.R. 3-10-2003.

SHOWER DELICER

NO CLAIM IS MADE TO THE EXCLUSIVE RIGHT TO USE "SHOWER", APART FROM THE MARK AS SHOWN.

FOR SHAMPOO DELIVERY UNIT BEING PART OF A SHOWER SYSTEM FOR DELOUSING INDIVIDUALS (U.S. CLS. 13, 21, 23, 31 AND 34).

FIRST USE 3-1-2002; IN COMMERCE 3-1-2002.

2,765,943. KEURIG, INCORPORATED, WAKEFIELD, MA. SN 78-123,288. FILED P.R. 4-22-2002; AM. S.R. 5-22-2003.

CUSTOM BREW

FOR ELECTRIC COFFEE AND TEA BREWING MACHINES FOR DOMESTIC AND COMMERCIAL USE (U.S. CLS. 13, 21, 23, 31 AND 34).

FIRST USE 3-24-2003; IN COMMERCE 3-24-2003.

CLASS 12—VEHICLES

2,765,847. AMERICAN TRUCKSOURCE, INC., IRVING, TX. SN 76-146,492. FILED P.R. 10-13-2000; AM. S.R. 5-15-2003.

AMERICAN PARTSSOURCE

OWNER OF U.S. REG. NOS. 2,375,928, 2,375,931, AND OTHERS.

FOR MOTOR VEHICLES, NAMELY, AUTOMOBILES AND TRUCKS; PARTS FOR AUTOMOBILES AND TRUCKS, NAMELY, AUTOMOTIVE VEHICLE DRIVE LINE COMPONENTS, NAMELY, ENGINE TRANSMISSIONS AND DRIVE SHAFTS FOR AUTOMOTIVE VEHICLES, DIESEL ENGINE ASSEMBLIES AND PARTS, NAMELY, CYLINDER HEADS, CYLINDER KITS, V-BELTS, CLUTCH ASSEMBLIES AND BRAKE SHOES, CHAMBERS AND RELATED VALVES FOR AIR BRAKES; BODY PARTS FOR AUTOMOBILES AND TRUCKS, NAMELY, CAB AND SLEEPER PANELS, INNER STRUCTURE, NAMELY, RAILS AND CORE SUPPORT, FENDERS, HOODS AND HOOD COMPONENTS, NAMELY, HOOD LATCH, HOOD LATCH MOUNTING BRACKET, HOOD BRACE, HOOD HINGE, HOOD HINGE SUPPORT BAR, HOOD LATCH LOOP, HOOD RELEASE CABLE, DOORS, ALUMINUM AND STEEL WHEELS, TIRES, SHOCK ABSORBERS, AIR SUSPENSION PARTS, NAMELY, SHOCK ABSORBERS, SHOCK BRACKETS, AIR SPRINGS, TRAILER PARTS, NAMELY, HITCHES, BALLS, BALL MOUNTS, HITCH COVERS, CARGO CARRIERS, TOW BARS, AND WHEEL BEARINGS, CARGO EQUIPMENT, NAMELY, CARGO BARS, WINDSHIELDS, WINDSHIELD WIPERS, BRAKE CHAMBERS, MUD FLAPS, AIR HORNS, SEATS, STEERING WHEELS, STEERING GEARS, POWER STEERING PUMPS, TRANSMISSION ASSEMBLIES AND COMPONENTS, NAMELY, GEARS, BEARINGS, MOTORS, REDUCERS, CLUTCHES, BRAKES, BUMPER, CHROME ACCESSORIES, NAMELY, BUMPER, FENDER GUIDES, MUD FLAP WEIGHTS, HORN COVERS, HUB CAPS, LUG NUT COVERS, DASHBOARD ACCESSORIES CONSISTING OF INSTRUMENT PANELS, GAUGES AND KNOBS, SUN VISORS, BRAKE DRUMS, AND BRAKE SHOES AND BRAKE HARDWARE (U.S. CLS. 19, 21, 23, 31, 35 AND 44).

FIRST USE 9-27-2002; IN COMMERCE 9-27-2002.

CLASS 14—JEWELRY

2,765,947. ALLIED MARKETING GROUP, INC., DALLAS, TX. SN 78-142,552. FILED P.R. 7-10-2002; AM. S.R. 5-5-2003.

HAMMOND

FOR GRANDFATHER CLOCKS AND WALL CLOCKS (U.S. CLS. 2, 27, 28 AND 50).
FIRST USE 9-19-2002; IN COMMERCE 9-19-2002.

CLASS 15—(Continued).

2,765,898. SAMICK MUSIC CORPORATION, CITY OF INDUSTRY, CA. SN 76-417,154. FILED P.R. 6-6-2002; AM. S.R. 4-11-2003.

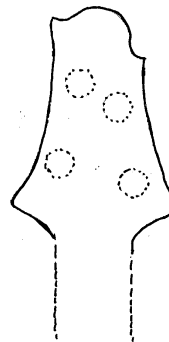

FOR MUSICAL INSTRUMENTS, NAMELY, ELECTRIC GUITARS, ACOUSTIC GUITARS AND BASS GUITARS (U.S. CLS. 2, 21 AND 36).
FIRST USE 1-2-2000; IN COMMERCE 1-2-2000.

CLASS 15—MUSICAL INSTRUMENTS

2,765,861. PAUL REED SMITH GUITARS, STEVENSVILLE, MD. SN 76-284,146. FILED P.R. 7-13-2001; AM. S.R. 5-23-2003.

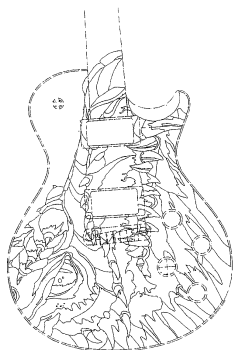

OWNER OF U.S. REG. NOS. 1,732,217, 1,975,653, AND OTHERS.

THE MARK CONSISTS OF A FANCIFUL REPRESENTATION OF A DRAGON ON THE BODY AND NECK OF AN ELECTRIC GUITAR. THE GUITAR IS DEPICTED IN DOTTED LINES SO THAT THE POSITION OF THE MARK IN RELATION THERETO IS CLEAR.

FOR ELECTRIC GUITARS (U.S. CLS. 2, 21 AND 36).
FIRST USE 1-0-2002; IN COMMERCE 1-0-2002.

CLASS 16—PAPER GOODS AND PRINTED MATTER

2,765,840. CMP MEDIA LLC, MANHASSET, NY, BY CHANGE OF NAME CMP MEDIA INC., MANHASSET, NY. SN 76-006,406. FILED P.R. 3-21-2000; AM. S.R. 11-12-2002.

REDEFINING BUSINESS

FOR PUBLICATIONS, NAMELY, A SECTION OF A MAGAZINE FEATURING INFORMATION IN THE FIELD OF HIGH TECHNOLOGY (U.S. CLS. 2, 5, 22, 23, 29, 37, 38 AND 50).
FIRST USE 4-3-2000; IN COMMERCE 4-3-2000.

2,765,842. FOGARASSY, GUSZTAV UJFALUSI, MARSHALL, MN. SN 76-058,791. FILED P.R. 5-27-2000; AM. S.R. 4-29-2003.

FUSION DANCE

OWNER OF U.S. REG. NO. 1,724,364.

FOR PRINTED MATTER, NAMELY, RESEARCH-BASED NEWSLETTER ON A DANCER'S SPECTRUM OF CULTURE; PRINTED INSTRUCTIONAL, EDUCATIONAL AND TEACHING MATERIALS ON ARTISTIC HUMAN MOVEMENT AND EXERCISE, INCLUDING PRINTED RESEARCH STUDIES; SHEET MUSIC AND NOTATION OF CHOREOGRAPHY; AND BROCHURES AND INFORMATIONAL FLYERS ABOUT DANCE (U.S. CLS. 2, 5, 22, 23, 29, 37, 38 AND 50).

FIRST USE 11-3-1980; IN COMMERCE 11-3-1980.

CLASS 16—(Continued).

2,765,862. MINORITY CORPORATE COUNSEL ASSOCIATION, WASHINGTON, DC. SN 76-284,467. FILED P.R. 7-3-2001; AM. S.R. 5-19-2003.

MINORITY CORPORATE COUNSEL ASSOCIATION

NO CLAIM IS MADE TO THE EXCLUSIVE RIGHT TO USE "ASSOCIATION", APART FROM THE MARK AS SHOWN.

FOR PUBLICATIONS, NAMELY, NEWSLETTERS, PAMPHLETS, MAGAZINES, BOOKLETS AND MANUALS FOR PROMOTING AND FOSTERING DIVERSITY IN THE WORKPLACE (U.S. CLS. 2, 5, 22, 23, 29, 37, 38 AND 50).

FIRST USE 2-1-1999; IN COMMERCE 2-1-1999.

2,765,901. TELEMAGEMENT FORUM, MORRISTOWN, NJ. SN 76-419,924. FILED P.R. 6-13-2002; AM. S.R. 6-2-2003.

ENHANCED TELECOM OPERATIONS MAP

FOR PRINTED REPORTS AND MANUALS (U.S. CLS. 2, 5, 22, 23, 29, 37, 38 AND 50).

FIRST USE 5-15-2002; IN COMMERCE 5-15-2002.

2,765,931. AMERICAN DIABETES ASSOCIATION, INC., ALEXANDRIA, VA. SN 76-477,999. FILED P.R. 12-23-2002; AM. S.R. 6-30-2003.

Month of Meals

FOR BOOK SERIES OF PRESET BREAKFAST, LUNCH AND DINNER MENU PLANNING FOR PEOPLE WITH DIABETES THAT INCLUDES A COMPLETE NUTRITION ANALYSIS AND RECIPES (U.S. CLS. 2, 5, 22, 23, 29, 37, 38 AND 50).

FIRST USE 6-0-1998; IN COMMERCE 6-0-1998.

CLASS 16—(Continued).

2,765,933. JENKINS, LAWRENCE E., ARLINGTON, TX. SN 78-043,050. FILED P.R. 1-13-2001; AM. S.R. 6-10-2003.

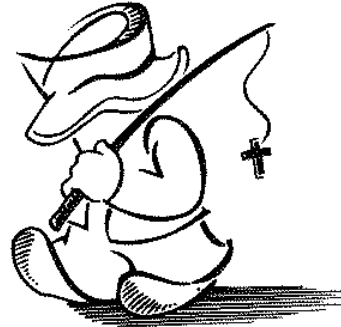

FOR DECALS (U.S. CLS. 2, 5, 22, 23, 29, 37, 38 AND 50).
FIRST USE 7-1-2001; IN COMMERCE 4-1-2002.

2,765,934. CENTER FOR DOCUMENTARY STUDIES, DURHAM, NC. SN 78-044,719. FILED P.R. 1-24-2001; AM. S.R. 4-28-2003.

DOCUMENT

FOR NEWSLETTER PUBLICATIONS FOR DISTRIBUTION TO THE PUBLIC ON THE SUBJECTS OF DOCUMENTARY STUDIES, FILM, PHOTOGRAPHY, AND LITERATURE, NAMELY THE USE OF AND PRESENTATION OF THE RESULTS OF USING DOCUMENTARY TOOLS AND METHODOLOGIES, INCLUDING PHOTOGRAPHY, ORAL HISTORY, FILMMAKING, WRITING, RADIO, AND FOLKLORE, TO EXAMINE SOCIETY (U.S. CLS. 2, 5, 22, 23, 29, 37, 38 AND 50).

FIRST USE 3-24-2000; IN COMMERCE 3-24-2000.

2,765,944. TYWIN COMMUNICATIONS LLC, RARITAN, NJ. SN 78-135,108. FILED P.R. 6-12-2002; AM. S.R. 1-27-2003.

THE AMERICAN JOURNAL OF UROLOGY REVIEW

NO CLAIM IS MADE TO THE EXCLUSIVE RIGHT TO USE "JOURNAL" AND "REVIEW", APART FROM THE MARK AS SHOWN.

FOR JOURNALS ON THE SUBJECT OF UROLOGY (U.S. CLS. 2, 5, 22, 23, 29, 37, 38 AND 50).

FIRST USE 1-21-2003; IN COMMERCE 1-21-2003.

CLASS 16—(Continued).

2,765,949. NATIONAL FIRE PROTECTION ASSOCIATION, INC., QUINCY, MA. SN 78-145,688. FILED P.R. 7-19-2002; AM. S.R. 3-6-2003.

COMPREHENSIVE CONSENSUS CODES

OWNER OF U.S. REG. NOS. 1,094,460, 2,427,178, AND OTHERS.

FOR PERIODICAL PUBLICATIONS, NAMELY, BOOKS IN THE FIELDS OF SAFETY, ELECTRICAL STANDARDS AND BUILDING CONSTRUCTION STANDARDS (U.S. CLS. 2, 5, 22, 23, 29, 37, 38 AND 50).

FIRST USE 10-4-2002; IN COMMERCE 10-4-2002.

2,765,951. THE CHRISTIAN FAMILY PUBLICATION, INC., PELHAM, AL. SN 78-154,749. FILED P.R. 8-15-2002; AM. S.R. 6-3-2003.

TUSCALOOSA CHRISTIAN FAMILY

OWNER OF U.S. REG. NOS. 2,533,181, 2,687,670, AND 2,716,813.

FOR PUBLICATIONS, NAMELY, MAGAZINES IN THE FIELD OF CHRISTIAN VALUES, FAMILY ISSUES AND RELIGION (U.S. CLS. 2, 5, 22, 23, 29, 37, 38 AND 50).

FIRST USE 12-2-2002; IN COMMERCE 12-2-2002.

2,765,953. HEDSTROM CORPORATION, ARLINGTON HEIGHTS, IL. SN 78-172,988. FILED P.R. 10-10-2002; AM. S.R. 4-14-2003.

MOVIE STICK-UPS

OWNER OF U.S. REG. NOS. 1,634,015, 2,572,415, AND OTHERS.

FOR ADHESIVE DECALS (U.S. CLS. 2, 5, 22, 23, 29, 37, 38 AND 50).

FIRST USE 10-21-2002; IN COMMERCE 10-21-2002.

2,765,954. RODALE INC., EMMAUS, PA. SN 78-189,608. FILED P.R. 11-27-2002; AM. S.R. 7-20-2003.

ONE-WORD ANSWERS

FOR PRINTED PUBLICATIONS, NAMELY, A COLUMN, FEATURE OR SECTION IN A MAGAZINE FEATURING INFORMATION IN THE FIELD OF HEALTH, FITNESS, DIET, EXERCISE AND LIFESTYLE (U.S. CLS. 2, 5, 22, 23, 29, 37, 38 AND 50).

FIRST USE 10-0-2002; IN COMMERCE 10-0-2002.

CLASS 17—RUBBER GOODS

CLASS 17—(Continued).

2,765,879. HANCOR, INC., FINDLAY, OH. SN 76-344,975. FILED P.R. 11-28-2001; AM. S.R. 12-30-2002.



THE DRAWING IS LINED FOR THE COLOR(S) GREEN. THE MARK CONSISTS OF THE COLOR GREEN AS APPLIED TO THE ENDS OF THE GOODS AS A BAND RUNNING AROUND THE CIRCUMFERENCE OF THE GOODS. THE BROKEN LINES ARE USED TO SHOW THE POSITION OF THE MARK ON THE GOODS BUT ARE NOT A FEATURE OF THE MARK.

FOR POLYETHYLENE PIPE (U.S. CLS. 1, 5, 12, 13, 35 AND 50).

FIRST USE 10-24-2001; IN COMMERCE 10-24-2001.

2,765,880. HANCOR, INC., FINDLAY, OH. SN 76-344,985. FILED P.R. 11-28-2001; AM. S.R. 12-30-2002.

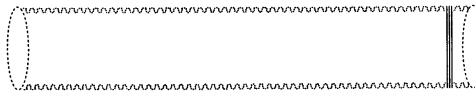

THE MARK CONSISTS OF THE COLOR BLUE AS APPLIED TO THE ENDS OF THE GOODS AS A BAND RUNNING AROUND THE CIRCUMFERENCE OF THE GOODS. THE BROKEN LINES ARE USED TO SHOW THE POSITION OF THE MARK ON THE GOODS BUT ARE NOT A FEATURE OF THE MARK. THE MARK IS LINED FOR THE COLOR BLUE.

FOR POLYETHYLENE DRAINAGE AND IRRIGATION PIPE (U.S. CLS. 1, 5, 12, 13, 35 AND 50).

FIRST USE 3-19-2001; IN COMMERCE 3-19-2001.

CLASS 19—NON-METALLIC BUILDING MATERIALS

2,765,864. O'KEEFFE'S INC., SAN FRANCISCO, CA. SN 76-294,038. FILED P.R. 8-2-2001; AM. S.R. 12-18-2002.

SAFTI

FOR FIRE AND SAFETY RATED GLASS (U.S. CLS. 1, 12, 33 AND 50).

FIRST USE 3-21-1997; IN COMMERCE 3-21-1997.

CLASS 20—FURNITURE AND ARTICLES NOT OTHERWISE CLASSIFIED

CLASS 20—(Continued).

2,765,857. MEIER, RUDOLF, HARPSTEDT, FED REP GERMANY. SN 76-238,095. FILED P.R. 4-10-2001; AM. S.R. 6-10-2003.

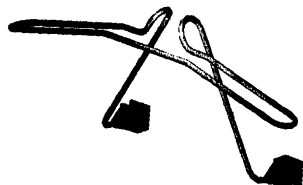

PRIORITY CLAIMED UNDER SEC. 44(D) ON FED REP GERMANY APPLICATION NO. 30075260.1/2, FILED 10-11-2000, REG. NO. 30075260, DATED 1-22-2001, EXPIRES 10-31-2010.

THE MARK CONSISTS OF A UNIQUE 3-DIMENSIONAL DESIGN FOR THE GOODS

FOR COAT HANGERS, ESPECIALLY FOR ATTACHMENT TO HEAD-RESTS OF VEHICLE SEATS (U.S. CLS. 2, 13, 22, 25, 32 AND 50).

2,765,876. AMERICAN FOAM TECHNOLOGIES, INC., NEWPORT, RI. SN 76-335,410. FILED P.R. 11-7-2001; AM. S.R. 5-8-2003.

KOLORKUBES

FOR FOAM SUPPORTS FOR FLORAL ARRANGEMENTS (U.S. CLS. 2, 13, 22, 25, 32 AND 50).
FIRST USE 2-13-2002; IN COMMERCE 2-13-2002.

2,765,913. THE VINUM CORPORATION, BARRINGTON HILLS, IL. SN 76-436,479. FILED P.R. 7-31-2002; AM. S.R. 6-16-2003.

VINUM CORKER

NO CLAIM IS MADE TO THE EXCLUSIVE RIGHT TO USE "CORKER", APART FROM THE MARK AS SHOWN.
THE ENGLISH TRANSLATION OF "VINUM" IS "WINE".
FOR NON-METAL BOTTLE STOPPERS (U.S. CLS. 2, 13, 22, 25, 32 AND 50).
FIRST USE 5-31-2002; IN COMMERCE 5-31-2002.

CLASS 21—HOUSEWARES AND GLASS**CLASS 21—(Continued).**

2,765,854. CANTERBURY ENTERPRISES, INC., CORONA, CA. SN 76-224,623. FILED P.R. 3-14-2001; AM. S.R. 11-22-2002.

BAR-B-Q BUCKET

NO CLAIM IS MADE TO THE EXCLUSIVE RIGHT TO USE "BUCKET", APART FROM THE MARK AS SHOWN.

FOR PLASTIC COMPARTMENTALIZED CONTAINER USED FOR SORTING A VARIETY OF BARBEQUE CONDIMENTS AND ACCESSORIES THEREIN (U.S. CLS. 2, 13, 23, 29, 30, 33, 40 AND 50).

FIRST USE 6-1-2001; IN COMMERCE 6-1-2001.

2,765,858. VIOLET POT, LLC, THE, CHERRY HILL, NJ. SN 76-248,057. FILED P.R. 4-30-2001; AM. S.R. 5-8-2003.

THE VIOLET POT

NO CLAIM IS MADE TO THE EXCLUSIVE RIGHT TO USE "POT", APART FROM THE MARK AS SHOWN.

FOR SELF-WATERING FLOWER POT (U.S. CLS. 2, 13, 23, 29, 30, 33, 40 AND 50).

FIRST USE 9-0-1996; IN COMMERCE 9-0-1996.

2,765,867. HANA COBI CO., LTD., INCHEON, REPUBLIC OF KOREA. SN 76-306,833. FILED P.R. 8-30-2001; AM. S.R. 1-29-2003.

AIR LOCK

FOR PORTABLE CRUETS, NOT OF PRECIOUS METAL; KITCHEN CONTAINERS, NOT OF PRECIOUS METAL FOR HOUSEHOLD OR KITCHEN USE; HOUSEHOLD KITCHEN UTENSILS, NOT OF PRECIOUS METAL, NAMELY, POT AND PAN SCRAPERS, ROLLING PINS, SPATULAS, TURNERS, AND WHISKS (U.S. CLS. 2, 13, 23, 29, 30, 33, 40 AND 50).

FIRST USE 11-0-2001; IN COMMERCE 11-0-2001.

2,765,908. PURICLE INC., IRVINE, CA. SN 76-428,910. FILED P.R. 7-8-2002; AM. S.R. 5-20-2003.

NEVER SCRUB

FOR TOILET BOWL DISPENSERS FOR MOUNTING IN A TOILET TANK FOR DISPENSING CLEANER FOR THE TANK BOWL AND OTHER COMPONENTS OF A TOILET (U.S. CLS. 2, 13, 23, 29, 30, 33, 40 AND 50).

FIRST USE 12-0-1999; IN COMMERCE 6-0-2000.

CLASS 24—FABRICS

CLASS 24—(Continued).

2,765,845. CON-WAL, INC., DBA SOUTHWESTERN SALES COMPANY, ROGERS, AR. SN 76-111,008. FILED P.R. 8-16-2000; AM. S.R. 12-12-2002.

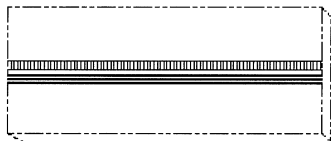

OWNER OF U.S. REG. NO. 1,369,072.
THE MARK CONSISTS OF THE COLORS RED AND BLUE AS APPLIED IN HORIZONTAL STRIPES ACROSS THE GOODS. THE COLOR RED IS CLAIMED AS A FEATURE FOR THE UPPER STRIPE AND THE COLOR BLUE IS CLAIMED AS A FEATURE OF THE LOWER STRIPE. THE BROKEN LINES ARE USED TO SHOW THE POSITION OF THE MARK ON THE GOODS BUT ARE NOT A FEATURE OF THE MARK.

FOR WOVEN POLYETHYLENE FABRIC PRIMARILY USED FOR POULTRY HOUSE CURTAINS (U.S. CLS. 42 AND 50).

FIRST USE 1-1-1995; IN COMMERCE 1-1-1995.

CLASS 25—CLOTHING

2,765,878. DUNGAREES U.S.A., INC., MONTREAL, QUEBEC, CANADA. SN 76-343,288. FILED P.R. 11-29-2001; AM. S.R. 7-3-2003.

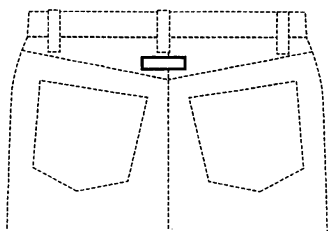

OWNER OF U.S. REG. NO. 2,147,027.
FOR MEN'S AND WOMEN'S CLOTHING, NAMELY, PANTS, SHORTS, SKIRTS, AND OVERALLS (U.S. CLS. 22 AND 39).

FIRST USE 9-1-1992; IN COMMERCE 9-1-1992.

2,765,886. SALAS, ROBERT, DONNA, TX. SN 76-362,488. FILED P.R. 1-25-2002; AM. S.R. 6-18-2003.

GOODTIMESHUFFLE

FOR SHIRTS, T-SHIRTS, HATS, PANTS, SHORTS (U.S. CLS. 22 AND 39).

FIRST USE 4-9-2003; IN COMMERCE 4-9-2003.

CLASS 28—TOYS AND SPORTING GOODS**CLASS 28—(Continued).**

2,765,920. GUND, INC., EDISON, NJ. SN 76-447,589. FILED P.R. 9-5-2002; AM. S.R. 6-23-2003.

DREYFUS

FOR PLUSH TOYS (U.S. CLS. 22, 23, 38 AND 50).
FIRST USE 6-0-2002; IN COMMERCE 6-0-2002.

2,765,925. HAAR, KENNETH W., LINCOLN, NE. SN 76-454,717. FILED P.R. 10-2-2002; AM. S.R. 6-5-2003.

BEARHOOKS

FOR SPORTING ARTICLES, NAMELY, STAINLESS STEEL HOOKS AND ROPES DESIGNED TO PROTECT CAMPERS' FOOD BY RAISING IT OFF THE GROUND AND AWAY FROM WILD ANIMALS, SPECIFICALLY BEARS (U.S. CLS. 22, 23, 38 AND 50).

FIRST USE 6-15-2002; IN COMMERCE 6-15-2002.

2,765,926. OSMENT MODELS, INC., LINN CREEK, MO. SN 76-457,401. FILED P.R. 10-10-2002; AM. S.R. 5-15-2003.

Scenic Accents

FOR SCALE-MODEL, MINIATURES OF HUMAN/ANIMAL FIGURES, TRAINS, AUTOMOBILES AND ACCESSORIES FOR MINIATURE STRUCTURES UTILIZED IN DIORAMAS (U.S. CLS. 22, 23, 38 AND 50).

FIRST USE 10-1-2002; IN COMMERCE 10-1-2002.

CLASS 30—STAPLE FOODS

2,765,914. LETTIERI'S, INC., BURNSVILLE, MN. SN 76-439,041. FILED P.R. 8-9-2002; AM. S.R. 7-2-2003.

STUFFED BAGUETTE

NO CLAIM IS MADE TO THE EXCLUSIVE RIGHT TO USE "BAGUETTE", APART FROM THE MARK AS SHOWN.

FOR FOOD ITEM CONSISTING OF BREAD WITH A FILLING CONSISTING PRIMARILY OF ONE OR MORE OF MEATS, CHEESES, SAUCES, VEGETABLES, CONDIMENTS, GRAINS, DAIRY PRODUCTS AND FLAVORINGS (U.S. CL. 46).

FIRST USE 7-0-1999; IN COMMERCE 10-0-2000.

CLASS 30—(Continued).

2,765,915. JERSEY MARY BARBEQUE, INC., CHICAGO, IL.
SN 76-440,298. FILED P.R. 8-13-2002; AM. S.R. 6-16-2003.

AMERICA'S SWEET TART

FOR SAUCES FOR FLAVORING FOODS (U.S. CL. 46).
FIRST USE 12-6-2002; IN COMMERCE 12-6-2002.

2,765,929. BOBAROSA'S GOURMET, INC., CLEARWATER,
FL. SN 76-472,617. FILED P.R. 12-4-2002; AM. S.R. 6-5-2003.



FOR SAUCES, NAMELY GRILLING SAUCES FOR
MEATS, POULTRY AND FISH (U.S. CL. 46).
FIRST USE 6-0-2002; IN COMMERCE 6-0-2002.

CLASS 33—WINES AND SPIRITS

2,765,891. MEX LATIN IMPORTS, LTD., AUSTIN, TX. SN 76-
377,568. FILED P.R. 3-4-2002; AM. S.R. 12-11-2002.

CAVA ANTONELLI

NO CLAIM IS MADE TO THE EXCLUSIVE RIGHT TO
USE "CAVA", APART FROM THE MARK AS SHOWN.
THE ENGLISH TRANSLATION OF THE FOREIGN
WORDS IS "ANTONELLI WINE CELLAR".
FOR LIQUOR, SPECIFICALLY A SHERRY (U.S. CLS.
47 AND 49).
FIRST USE 10-20-1999; IN COMMERCE 10-20-1999.

2,765,923. ROYAL WINE CORPORATION, BAYONNE, NJ.
SN 76-453,320. FILED P.R. 9-26-2002; AM. S.R. 6-2-2003.

VALERO ESPECIAL

THE ENGLISH TRANSLATION OF "VALERO ESPECIAL"
IS "SPECIAL VALUE".
FOR WINE (U.S. CLS. 47 AND 49).
FIRST USE 1-0-2003; IN COMMERCE 1-0-2003.

CLASS 35—(Continued).**SERVICE MARKS****CLASS 35—ADVERTISING AND BUSINESS**

2,765,838. DAVID GREEN & ASSOCIATES, INC., TUCSON,
AZ. SN 75-909,114. FILED P.R. 2-4-2000; AM. S.R. 7-7-2003.

SURPLUS.COM

FOR DISSEMINATION OF ADVERTISING OF
OTHERS VIA AN ONLINE ELECTRONIC COMMUNICA-
TIONS NETWORK, NAMELY, ADVERTISING AND
PROMOTING THE SURPLUS GOODS OF OTHERS (U.S.
CLS. 100, 101 AND 102).
FIRST USE 5-3-1995; IN COMMERCE 8-25-1999.

2,765,846. AMERICAN TRUCKSOURCE, INC., IRVING, TX.
SN 76-134,012. FILED P.R. 9-22-2000; AM. S.R. 4-22-2003.

AMERICAN PARTSSOURCE

OWNER OF U.S. REG. NOS. 2,375,928, 2,375,929, AND
2,375,930.
FOR RETAIL SERVICES FEATURING AUTOMOTIVE
PARTS AND EQUIPMENT, CAR CARE PRODUCTS,
AND TOOLS FOR SERVICING AND REPAIRING VEHI-
CLES AND AUTOMOTIVE EQUIPMENT (U.S. CLS. 100,
101 AND 102).
FIRST USE 6-25-2002; IN COMMERCE 6-25-2002.

2,765,851. BROADBAND SERVICES, INC., HIGHLANDS
RANCH, CO. SN 76-178,312. FILED P.R. 12-8-2000; AM.
S.R. 6-26-2003.

VIRTUAL WAREHOUSE

FOR ONLINE INVENTORY CONTROL AND MONI-
TORING SERVICE THAT ASSISTS IN IDENTIFYING
THE LOCATION AND THE STATUS OF THE CLIENT'S
INVENTORY AND EQUIPMENT AT ANY POINT BE-
TWEEN THE POINT OF MANUFACTURE AND THE
DELIVERY TO THE END-USER (U.S. CLS. 100, 101 AND
102).
FIRST USE 9-0-2000; IN COMMERCE 9-0-2000.

2,765,856. MARINEBIDEXCHANGE.COM, INC., DANIA, FL.
SN 76-237,971. FILED P.R. 4-9-2001; AM. S.R. 9-13-2002.

**MARINEBIDEXCHAN
G E . C O M**

FOR ON-LINE TRADING SERVICES IN WHICH SELL-
ER POSTS PRODUCTS AND SERVICES TO BE AUC-
TIONED AND BIDDING IS DONE VIA THE INTERNET
FOR USE BY INDIVIDUALS, INSURANCE COMPANIES,
PRIVATE REQUESTORS, LAW ENFORCEMENT AGEN-
CIES, SALVAGE BUYERS, REPAIR VENDORS AND
BOAT BUILDERS IN THE FIELD OF MARINE SAL-
VAGE VESSELS AND RESTORATION AND REPAIR OF
SALVAGE VESSELS (U.S. CLS. 100, 101 AND 102).
FIRST USE 4-10-2001; IN COMMERCE 4-10-2001.

CLASS 35—(Continued).

2,765,883. GALLAGHER, MICHAEL, NAPA, CA. SN 76-350,806. FILED P.R. 12-13-2001; AM. S.R. 7-1-2003.

AMERICA'S GREATEST CITIES

NO CLAIM IS MADE TO THE EXCLUSIVE RIGHT TO USE "CITIES", APART FROM THE MARK AS SHOWN. FOR COOPERATIVE ADVERTISING AND MARKETING SERVICES WHEREIN SELECTED CITIES, THROUGH THEIR VISITORS' BUREAUS, MAY PROMOTE AND CROSS-PROMOTE TOURISM AMONG THE SELECTED CITIES (U.S. CLS. 100, 101 AND 102). FIRST USE 2-0-2003; IN COMMERCE 2-0-2003.

2,765,890. MIDWEST DIAGNOSTIC MANAGEMENT, LLC, MOKENA, IL. SN 76-369,377. FILED P.R. 2-11-2002; AM. S.R. 2-3-2003.

MIDWEST DIAGNOSTIC MANAGEMENT

NO CLAIM IS MADE TO THE EXCLUSIVE RIGHT TO USE "MANAGEMENT", APART FROM THE MARK AS SHOWN. FOR MANAGEMENT ARRANGEMENT FOR MEDICAL SERVICES, NAMELY, MAGNETIC RESONANCE IMAGING (MRI) AND COMPUTERIZED TOMOGRAPHY (CT) SERVICES (U.S. CLS. 100, 101 AND 102). FIRST USE 2-0-2001; IN COMMERCE 2-0-2001.

2,765,906. NATIONAL VETERANS BUSINESS DEVELOPMENT CORPORATION, ALEXANDRIA, VA. SN 76-426,508. FILED P.R. 7-1-2002; AM. S.R. 6-26-2003.

NATIONAL VETERANS BUSINESS DEVELOPMENT CORPORATION

FOR BUSINESS DEVELOPMENT SERVICES, NAMELY PROVIDING TECHNICAL ASSISTANCE AND START-UP SUPPORT TO BUSINESSES OF OTHERS (U.S. CLS. 100, 101 AND 102). FIRST USE 4-5-2002; IN COMMERCE 4-5-2002.

2,765,911. MERCER HUMAN RESOURCE CONSULTING, INC., NEW YORK, NY, BY CHANGE OF NAME WILLIAM M. MERCER, INCORPORATED, NEW YORK, NY. SN 76-431,991. FILED P.R. 7-16-2002; AM. S.R. 6-13-2003.

HUMAN CAPITAL SCAN

FOR BUSINESS MANAGEMENT CONSULTING SERVICES; HUMAN RESOURCE CONSULTING SERVICES; AND BUSINESS CONSULTING ON ANALYZING THE IMPACT OF HUMAN CAPITAL PRACTICES ON BUSINESS PERFORMANCE (U.S. CLS. 100, 101 AND 102). FIRST USE 10-0-2001; IN COMMERCE 10-0-2001.

CLASS 35—(Continued).

2,765,919. CAR WASH SUPERSTORE, LLC, COLLIERSVILLE, TN. SN 76-446,094. FILED P.R. 8-29-2002; AM. S.R. 5-20-2003.

CAR WASH SUPERSTORE

FOR RETAIL STORE SERVICES FEATURING CAR WASH SUPPLIES AND ACCESSORIES (U.S. CLS. 100, 101 AND 102). FIRST USE 1-31-2003; IN COMMERCE 1-31-2003.

2,765,936. BOCH, MICHAEL, S, RALEIGH, NC. SN 78-076,784. FILED P.R. 8-1-2001; AM. S.R. 4-18-2002.

THE BUSINESS CLINIC

NO CLAIM IS MADE TO THE EXCLUSIVE RIGHT TO USE "BUSINESS", APART FROM THE MARK AS SHOWN. FOR WEB-BASED, REAL-TIME BUSINESS CONSULTING SERVICES FOR SMALL AND MID-SIZE COMPANIES (U.S. CLS. 100, 101 AND 102). FIRST USE 12-1-2001; IN COMMERCE 12-1-2001.

2,765,941. FETISH FACTORY, INC., FORT LAUDERDALE, FL. SN 78-117,850. FILED P.R. 3-27-2002; AM. S.R. 5-19-2003.

AUTO EROTIC BOUTIQUE

FOR MAIL ORDER CATALOG SERVICES FEATURING ADULT SEX TOYS PROVIDED VIA A GLOBAL COMPUTER NETWORK (U.S. CLS. 100, 101 AND 102). FIRST USE 5-1-2003; IN COMMERCE 5-1-2003.

2,765,955. MCARTHUR PROFESSIONAL, INCORPORATED, ABBEVILLE, SC. SN 78-191,648. FILED P.R. 12-5-2002; AM. S.R. 5-19-2003.

THE BAG FACTORY

FOR DISTRIBUTORSHIPS IN THE FIELD OF SPECIALTY AND CORPORATE PROMOTIONAL ITEMS PRODUCED BY OTHERS, NAMELY, TOTE BAGS, GYM BAGS, TRAVELING BAGS, GARMENT BAGS FOR TRAVELING, BRIEFCASE-TYPE PORTFOLIOS, ATTACHE CASES, LUGGAGE, TRAVELING BAGS, BRIEFCASES, PURSES AND SUITCASES (U.S. CLS. 100, 101 AND 102). FIRST USE 1-1-2003; IN COMMERCE 1-1-2003.

CLASS 36—INSURANCE AND FINANCIAL

CLASS 36—(Continued).

2,765,870. WELLS FARGO HOME MORTGAGE, INC., DES MOINES, IA. SN 76-315,410. FILED P.R. 9-20-2001; AM. S.R. 5-19-2003.

FIRST HOME

FOR MORTGAGE LENDING SERVICES (U.S. CLS. 100, 101 AND 102).
FIRST USE 1-30-2001; IN COMMERCE 1-30-2001.

2,765,948. ROYAL MORTGAGE CORP., PRINCETON, NJ. SN 78-144,678. FILED P.R. 7-17-2002; AM. S.R. 5-19-2003.

**THE GREAT RATE
COMPANY**

NO CLAIM IS MADE TO THE EXCLUSIVE RIGHT TO USE "COMPANY", APART FROM THE MARK AS SHOWN.
FOR MORTGAGE LENDING, MORTGAGE BANKING, MORTGAGE BROKERAGE, CONSUMER LENDING, FINANCING SERVICES, NAMELY, LOAN AND ASSET SECURITIZATION, COMMERCIAL LENDING SERVICES, NAMELY, CORRESPONDENT LENDING, WHOLESALE LENDING, RETAIL LENDING (U.S. CLS. 100, 101 AND 102).
FIRST USE 1-1-1990; IN COMMERCE 1-1-1990.

2,765,956. KAMADIA, RAHIM, HOUSTON, TX. SN 78-195,104. FILED P.R. 12-17-2002; AM. S.R. 7-1-2003.

2 PERCENT BACK

FOR REAL ESTATE PROCUREMENT FOR OTHERS; REAL ESTATE BROKERAGE (U.S. CLS. 100, 101 AND 102).
FIRST USE 12-28-1999; IN COMMERCE 12-28-1999.

2,765,957. FLORIDA LAWYERS MUTUAL INSURANCE COMPANY, ORLANDO, FL. SN 78-198,196. FILED 12-27-2002.

**FLORIDA LAWYERS
INSURANCE AGENCY, INC.**

NO CLAIM IS MADE TO THE EXCLUSIVE RIGHT TO USE "INSURANCE AGENCY, INC.", APART FROM THE MARK AS SHOWN.
FOR INSURANCE AGENCY SERVICES FEATURING INSURANCE PRODUCTS, PROFESSIONAL LIABILITY INSURANCE, COURT BONDS, FIDUCIARY BONDS, LICENSE AND PERMIT BONDS, LOST INSTRUMENT BONDS, PUBLIC OFFICIAL BONDS (U.S. CLS. 100, 101 AND 102).
FIRST USE 6-15-2002; IN COMMERCE 6-15-2002.

CLASS 37—CONSTRUCTION AND REPAIR**CLASS 37—(Continued).**

2,765,881. ROBERT FORBIS, INC., NAPLES, FL. SN 76-346,243. FILED P.R. 12-7-2001; AM. S.R. 5-5-2003.

**THE RESIDENTIAL WIRING
SPECIALISTS**

NO CLAIM IS MADE TO THE EXCLUSIVE RIGHT TO USE "RESIDENTIAL WIRING", APART FROM THE MARK AS SHOWN.

FOR RESIDENTIAL ELECTRICAL AND LOW-VOLTAGE CONTRACTOR SERVICES, NAMELY, POWER WIRING, LOW VOLTAGE WIRING, CUSTOM WIRING FOR ELECTRONICS, WIRING FOR STEREO'S AND HOME THEATERS, WIRING FOR ELECTRIC FLOOR WARMING SYSTEMS AND EQUIPMENT, WIRING FOR HOME AUTOMATION PRODUCTS, WIRING FOR POWER GENERATING SYSTEMS, WIRING FOR EQUIPMENT INTENDED FOR USE WITH ALTERNATIVE FUEL SOURCES, WIRING FOR FIRE ALARM AND SECURITY SYSTEMS, WIRING FOR LIGHTING, ELECTRIC WIRING AND INSTALLATION FOR NEW AND EXISTING HOMES, AND CONDOMINIUMS (U.S. CLS. 100, 103 AND 106).
FIRST USE 4-23-2003; IN COMMERCE 4-23-2003.

CLASS 38—COMMUNICATION

2,765,907. ULTIMATE MEDIUM, INDIANAPOLIS, IN. SN 76-428,532. FILED P.R. 7-9-2002; AM. S.R. 6-3-2003.

ULTIMATE MEDIUM

FOR TELECOMMUNICATIONS SERVICES, NAMELY, PROVIDING HIGH SPEED ACCESS TO AREA NETWORKS AND A GLOBAL COMPUTER INFORMATION NETWORK; LOCAL AND LONG DISTANCE TRANSMISSION OF VOICE BY MEANS OF TELEPHONE AND GLOBAL COMPUTER NETWORK; MESSAGE TRANSMISSION SERVICES; ELECTRONIC MAIL SERVICES; CONNECTING TELEPHONE AND GLOBAL COMPUTER NETWORK CONFERENCE CALLS FOR OTHERS; VOICE MAIL SERVICES; PROVIDING TELECOMMUNICATIONS CONNECTIONS TO A GLOBAL COMPUTER NETWORK; ELECTRONIC TRANSMISSION OF DATA (U.S. CLS. 100, 101 AND 104).
FIRST USE 9-10-2001; IN COMMERCE 9-10-2001.

CLASS 41—EDUCATION AND ENTERTAINMENT

CLASS 41—(Continued).

2,765,882. REGIONAL PERFORMING ARTS CENTER, INC., PHILADELPHIA, PA. SN 76-349,100. FILED P.R. 12-14-2001; AM. S.R. 6-10-2003.

THE KIMMEL CENTER FOR THE PERFORMING ARTS

FOR ENTERTAINMENT SERVICES, NAMELY PRESENTING WORKS OF THE PERFORMING ARTS SUCH AS OPERA, BALLET, THEATER, DANCE, AND MUSIC; PRESENTING LIVE PERFORMANCES OR MUSICAL, DRAMATICO-MUSICAL, CHOREOGRAPHIC, AND OTHER ARTISTIC WORKS, TO THE PUBLIC THROUGH THE MEDIA OF RADIO AND TELEVISION BROADCASTS; ORCHESTRAL PERFORMANCES; ORGANIZING AND CONDUCTING MUSICAL CONCERTS, ORCHESTRAL CONCERTS AND DANCE PERFORMANCES (U.S. CLS. 100, 101 AND 107).

FIRST USE 4-1-2001; IN COMMERCE 4-1-2001.

CLASS 41—(Continued).

2,765,916. CLEVELAND CENTER FOR INFORMATION & TECHNOLOGY, INC., CLEVELAND, OH. SN 76-442,231. FILED P.R. 8-21-2002; AM. S.R. 5-16-2003.

CLEVELAND CENTER FOR INFORMATION & TECHNOLOGY

FOR LIBRARIES; ON-LINE LIBRARY SERVICES, NAMELY, PROVIDING ELECTRONIC LIBRARY SERVICES WHICH FEATURE NEWSPAPERS, MAGAZINES PHOTOGRAPHS AND PICTURES VIA AN ON-LINE COMPUTER NETWORK; EDUCATIONAL RESEARCH; EDUCATIONAL AND ENTERTAINMENT SERVICES, NAMELY, PROVIDING MOTIVATIONAL AND EDUCATIONAL SPEAKERS (U.S. CLS. 100, 101 AND 107).

FIRST USE 10-26-2000; IN COMMERCE 10-26-2000.

2,765,895. BGR INFOTECH, INC., COLUMBIA, MD. SN 76-402,874. FILED P.R. 5-1-2002; AM. S.R. 3-31-2003.

INTERNATIONAL CENTER FOR ENVIRONMENT, SAFETY, AND HEALTH

FOR PROVIDING ON-LINE ELECTRONIC PUBLICATIONS, NAMELY, BOOKS, MAGAZINES, NEWSLETTERS, NEWSPAPERS, JOURNALS, CATALOGS, MANUALS, PAMPHLETS, LEAFLETS, POSTERS, AND INSTRUCTIONAL AND TEACHING MATERIALS IN THE FIELD OF ENVIRONMENTAL REGULATION, ENVIRONMENTAL HEALTH, ENVIRONMENTAL SAFETY, AND ENVIRONMENTAL EDUCATION (U.S. CLS. 100, 101 AND 107).

FIRST USE 3-2-2000; IN COMMERCE 3-26-2001.

2,765,924. BRICKYARD TRADEMARKS, INC., HENDERSON, NV. SN 76-453,596. FILED P.R. 9-19-2002; AM. S.R. 7-11-2003.

500 FESTIVAL

NO CLAIM IS MADE TO THE EXCLUSIVE RIGHT TO USE "500", APART FROM THE MARK AS SHOWN.

FOR ENTERTAINMENT IN THE FORM OF AUTOMOBILE RACING SERVICES, NAMELY CONDUCTING PRE-RACE EVENTS IN CONJUNCTION WITH AN ANNUAL AUTOMOBILE RACE (U.S. CLS. 100, 101 AND 107).

FIRST USE 5-0-1957; IN COMMERCE 5-0-1957.

2,765,903. CRAFT, LOGAN, SANTA FE, NM. AND CRAFT, BARBRA, SANTA FE, NM. SN 76-420,486. FILED P.R. 5-13-2002; AM. S.R. 6-10-2003.

CHURCH AND STATE

FOR ENTERTAINMENT AND EDUCATIONAL SERVICES IN THE NATURE OF ON-GOING TELEVISION PROGRAMS FEATURING GUEST INTERVIEWS CONCERNING CURRENT EVENTS, PUBLIC AFFAIRS, GOVERNMENT POLICY, LAW AND JUDICIAL DECISIONS, POLITICS, EDUCATION, MORAL AND ETHICAL CONCERNS, RELIGION, AND LOCAL, STATE AND INTERNATIONAL ISSUES (U.S. CLS. 100, 101 AND 107).

FIRST USE 10-0-2001; IN COMMERCE 10-0-2001.

2,765,927. GILMORE ENTERTAINMENT GROUP LLC, MYRTLE BEACH, SC. SN 76-464,540. FILED P.R. 10-28-2002; AM. S.R. 5-27-2003.

THE CHARLESTON CHRISTMAS SHOW

OWNER OF U.S. REG. NOS. 1,993,965 AND 2,042,456.

NO CLAIM IS MADE TO THE EXCLUSIVE RIGHT TO USE "CHARLESTON" AND "SHOW", APART FROM THE MARK AS SHOWN.

FOR ENTERTAINMENT SERVICES IN THE NATURE OF MUSIC AND VARIETY SHOWS (U.S. CLS. 100, 101 AND 107).

FIRST USE 11-29-2002; IN COMMERCE 11-29-2002.

CLASS 41—(Continued).

2,765,950. THE FOREIGN LANGUAGE SOCIETY LLC, MALIBU, CA. SN 78-146,022. FILED P.R. 7-22-2002; AM. S.R. 6-23-2003.

THE FOREIGN LANGUAGE SOCIETY

NO CLAIM IS MADE TO THE EXCLUSIVE RIGHT TO USE "FOREIGN LANGUAGE", APART FROM THE MARK AS SHOWN.

FOR EDUCATION SERVICES, NAMELY, PROVIDING COURSES, SEMINARS AND WORKSHOPS IN THE FIELD OF FOREIGN LANGUAGE AND DISTRIBUTION OF COURSE MATERIALS RELATED THERETO; AND ORGANIZING CULTURAL EXHIBITIONS AND CULTURAL EVENTS (U.S. CLS. 100, 101 AND 107).

FIRST USE 7-7-2002; IN COMMERCE 7-7-2002.

CLASS 42—SCIENTIFIC, COMPUTER AND LEGAL SERVICES

2,765,843. NEW LEVEL SADKHIN GROUP, INC., BROOKLYN, NY. SN 76-061,125. FILED P.R. 6-1-2000; AM. S.R. 1-22-2002.

SADKHIN METHOD

OWNER OF U.S. REG. NOS. 2,147,426 AND 2,147,427.
NO CLAIM IS MADE TO THE EXCLUSIVE RIGHT TO USE "METHOD", APART FROM THE MARK AS SHOWN.

FOR PROMOTING PUBLIC AWARENESS OF THE NEED FOR HEALTH FITNESS; ALTERNATIVE MEDICAL SERVICES IN THE AREA OF DIAGNOSTIC PROCEDURES AND TREATMENTS; WEIGHT REDUCTION DIET PLANNING AND SUPERVISION; ALTERNATIVE MEDICAL SERVICES IN THE AREA OF SKIN TREATMENT, STRESS REDUCTION, TREATMENT WITH HERBS, AND TREATMENT WITH VITAMINS; HOLISTIC WEIGHT REDUCTION DIET PLANNING AND SUPERVISION; HOLISTIC HEALTH THERAPY SERVICES, NAMELY, ACUPRESSURE (U.S. CLS. 100 AND 101).

FIRST USE 1-0-2000; IN COMMERCE 7-0-2000.

2,765,868. CAYS, JOHN, NUTLEY, NJ. SN 76-306,879. FILED P.R. 8-30-2001; AM. S.R. 5-8-2002.

GRADE

FOR ARCHITECTURAL, INTERIOR AND FURNITURE DESIGN SERVICES FOR RESIDENTIAL AND COMMERCIAL CLIENTELE (U.S. CLS. 100 AND 101).

FIRST USE 5-1-2001; IN COMMERCE 5-1-2001.

CLASS 42—(Continued).

2,765,869. INCELLICO, INC., DURHAM, NC. SN 76-307,623. FILED P.R. 8-31-2001; AM. S.R. 5-22-2003.

CELL

FOR PROVIDING TEMPORARY USE OF ON-LINE NON-DOWNLOADABLE COMPUTER SOFTWARE FOR USE IN GENOMIC AND BIOINFORMATIC ANALYSIS VIA A GLOBAL COMPUTER NETWORK (U.S. CLS. 100 AND 101).

FIRST USE 6-0-2002; IN COMMERCE 6-0-2002.

2,765,873. GRAFIX -N- TOONS STUDIOS, INC., WAPPINGER FALLS, NY. SN 76-322,672. FILED P.R. 10-9-2001; AM. S.R. 1-27-2003.

GRAFIX -N- TOONS STUDIOS

NO CLAIM IS MADE TO THE EXCLUSIVE RIGHT TO USE "STUDIOS", APART FROM THE MARK AS SHOWN.

FOR GRAPHIC ART DESIGN SERVICES FOR OTHERS, NAMELY HUMOROUS ILLUSTRATION SERVICES, CARTOON DESIGN SERVICES, AND CARTOON CHARACTER DESIGN SERVICES (U.S. CLS. 100 AND 101).

FIRST USE 6-0-1994; IN COMMERCE 6-0-1994.

2,765,888. INGENEUS CORPORATION, BRIDGETOWN, BARBADOS. SN 76-368,972. FILED P.R. 2-8-2002; AM. S.R. 2-20-2003.

TRIPLEX ASSAY

NO CLAIM IS MADE TO THE EXCLUSIVE RIGHT TO USE "ASSAY", APART FROM THE MARK AS SHOWN.

FOR SCIENTIFIC RESEARCH SERVICES IN THE FIELD OF BIOTECHNOLOGY (U.S. CLS. 100 AND 101).

FIRST USE 7-0-2002; IN COMMERCE 7-0-2002.

2,765,889. INGENEUS CORPORATION, BRIDGETOWN, BARBADOS. SN 76-369,141. FILED P.R. 2-8-2002; AM. S.R. 6-18-2003.

TRIPLEX ARRAY

NO CLAIM IS MADE TO THE EXCLUSIVE RIGHT TO USE "ARRAY", APART FROM THE MARK AS SHOWN.

FOR SCIENTIFIC RESEARCH SERVICES IN THE FIELD OF BIOTECHNOLOGY (U.S. CLS. 100 AND 101).

FIRST USE 3-26-2003; IN COMMERCE 3-26-2003.

CLASS 45—(Continued).

2,765,904. NEW ORLEANS CENTER FOR CLINICAL RESEARCH, INC., NEW ORLEANS, LA. AND ORLANDO CLINICAL RESEARCH CENTER, INC., ORLANDO, FL. AND TOTAL RENAL RESEARCH, INC., MINNEAPOLIS, MN. SN 76-421,297. FILED P.R. 6-13-2002; AM. S.R. 7-1-2003.

US RENAL NETWORK

NO CLAIM IS MADE TO THE EXCLUSIVE RIGHT TO USE "RENAL", APART FROM THE MARK AS SHOWN. FOR MEDICAL RESEARCH AND SERVICES, NAMELY, CONDUCTING CLINICAL TRIALS FOR PHARMACEUTICAL FIRMS CONCERNING RENAL DISEASE, PRE-END STAGE RENAL DISEASE, AND END-STAGE RENAL DISEASE (U.S. CLS. 100 AND 101). FIRST USE 6-10-2000; IN COMMERCE 6-10-2000.

2,765,937. MILLIKEN, TULSI, CARLSBAD, CA. SN 78-077,465. FILED P.R. 8-3-2001; AM. S.R. 1-10-2003.

REGRESSION RELEASE THERAPY

NO CLAIM IS MADE TO THE EXCLUSIVE RIGHT TO USE "THERAPY", APART FROM THE MARK AS SHOWN. FOR PSYCHOLOGICAL COUNSELING (U.S. CLS. 100 AND 101). FIRST USE 0-0-1990; IN COMMERCE 3-1-1996.

CLASS 43—HOTEL AND RESTAURANT SERVICES

2,765,930. E. A. ISSA & BROS. LTD., KINGSTON 4, JAMAICA. SN 76-475,719. FILED P.R. 12-12-2002; AM. S.R. 5-27-2003.

COUPLES RESORTS

CLASS 43—(Continued).

OWNER OF U.S. REG. NO. 1,220,353. FOR RESORT HOTEL, RESTAURANT AND TRAVEL RESERVATION SERVICES, NAMELY MAKING RESERVATIONS AND BOOKINGS FOR TEMPORARY LODGING (U.S. CLS. 100 AND 101). FIRST USE 8-0-2001; IN COMMERCE 8-0-2001.

CLASS 44—MEDICAL, BEAUTY AND AGRICULTURAL SERVICES

2,765,899. LDT SYSTEMS, INC., CINCINNATI, OH. SN 76-417,573. FILED P.R. 6-6-2002; AM. S.R. 5-8-2003.

ORGAN TRANSPLANT RESPONSE SYSTEM

FOR PROVIDING INFORMATION TO THE ORGAN TRANSPLANT INDUSTRY REGARDING THE PLACEMENT AND TRANSPORTATION OF HUMAN BIOLOGICAL ORGANS FOR TRANSPLANT (U.S. CLS. 100 AND 101). FIRST USE 1-6-2003; IN COMMERCE 1-6-2003.

CLASS 45—PERSONAL SERVICES

2,765,909. TEEN MANIA MINISTRIES, INC., GARDEN VALLEY, TX. SN 76-429,124. FILED P.R. 7-9-2002; AM. S.R. 5-27-2003.

GLOBAL EXPEDITIONS

FOR EVANGELISTIC AND MINISTERIAL SERVICES (U.S. CLS. 100 AND 101). FIRST USE 1-1-2000; IN COMMERCE 1-1-2000.

* * * * *

TRADEMARK REGISTRATIONS RENEWED

The designation "U.S. Cl." appearing in this section refers to the U.S. class in effect prior to Sep. 1, 1973 rather than the international class which applies to applications filed on or after that date. For adoption of international classification see notice in the OFFICIAL GAZETTE of Jun. 26, 1973 (911 O.G. TM 210).

23,089.	SEEMAN BROS. FAMOUS WHITE ROSE PEARS (STYLIZED). U.S. CL. 46. (INT. CLS. 1, 5, 29, 30, 31 AND 32). REG. 5-23-1893.	751,518.	MASTER PLUMBER. U.S. CL. 13. (INT. CL. 11). REG. 6-25-1963.
91,444.	VACHERON & CONSTANTIN AND DESIGN. U.S. CL. 27. (INT. CL. 14). REG. 5-6-1913.	752,055.	ESPO. U.S. CL. 28. (INT. CL. 14). REG. 7-2-1963.
91,860.	JOHN DEERE. U.S. CL. 23. (INT. CL. 7). REG. 6-3-1913.	757,015.	GOVERNOR'S CLUB. U.S. CL. 49. (INT. CL. 9). REG. 9-17-1963.
95,099.	RED H (STYLIZED). U.S. CL. 9. (INT. CL. 13). REG. 2-3-1914.	757,855.	PLEASONING. U.S. CL. 46. (INT. CL. 30). REG. 10-1-1963.
152,263.	ORCO AND DESIGN.	758,969.	AMODEX. U.S. CL. 52. (INT. CL. 3). REG. 10-22-1963.
168,186.	ESQUIRE (STYLIZED). U.S. CL. 39. (INT. CL. 25). REG. 5-15-1923.	762,962.	OSV. U.S. CL. 13. (INT. CL. 6). REG. 1-14-1964.
308,200.	INCONEL. U.S. CL. 14. (INT. CL. 6). REG. 11-21-1933.	764,209.	ALDORIL. U.S. CL. 18. (INT. CL. 5). REG. 2-4-1964.
398,909.	CASTLEFILM. U.S. CL. 26. (INT. CL. 9). REG. 12-1-1942.	768,642.	CITATION. U.S. CL. 17. (INT. CL. 34). REG. 4-28-1964.
401,593.	NICOTAP (STYLIZED). U.S. CL. 21. (INT. CL. 9). REG. 5-25-1943.	770,092.	MIKROKLENE. U.S. CL. 52. (INT. CL. 3). REG. 5-19-1964.
568,406.	ORKIN AND DESIGN. U.S. CL. 103. (INT. CL. 37). REG. 12-23-1952.	926,737.	AUGAT. U.S. CL. 21. (INT. CL. 9). REG. 1-11-1972.
571,270.	CARPENTER HIGH PERMEABILITY "49" (STYLIZED). U.S. CL. 14. (INT. CL. 6). REG. 3-3-1953.	937,600.	BRIGHT OF AMERICA. U.S. CL. 42 ONLY. (INT. CL. 24). REG. 7-11-1972.
571,271.	CARPENTER INVAR "36" (STYLIZED). U.S. CL. 14. (INT. CL. 6). REG. 3-3-1953.	941,838.	TUL-KUT. U.S. CL. 15. (INT. CL. 4). REG. 8-29-1972.
571,272.	CARPENTER LOW EXPANSION "42" (STYLIZED). U.S. CL. 14. (INT. CL. 6). REG. 3-3-1953.	946,964.	BLAST. U.S. CL. 52. (INT. CL. 3). REG. 11-7-1972.
571,273.	CARPENTER TEMPERATURE COMPENSATOR "30" (STYLIZED). U.S. CL. 14. (INT. CL. 6). REG. 3-3-1953.	947,567.	C.A.V. (STYLIZED). U.S. CL. 23. (INT. CL. 7). REG. 11-21-1972.
573,997.	VISCARIN (STYLIZED). U.S. CL. 6. (INT. CL. 1). REG. 5-5-1953.	947,584.	SHUR-LINE AND DESIGN. U.S. CL. 29. (INT. CL. 16). REG. 11-21-1972.
574,495.	SKY MASTER (STYLIZED). U.S. CL. 46. (INT. CL. 31). REG. 5-19-1953.	947,709.	MARRIOTT (STYLIZED). U.S. CL. 100. (INT. CL. 42). REG. 11-21-1972.
580,682.	SAANDAM. U.S. CL. 46. (INT. CL. 30). REG. 10-6-1953.	947,825.	CLTC. U.S. CL. 18. (INT. CL. 5). REG. 11-28-1972.
581,325.	SERATURE (STYLIZED). U.S. CL. 44. (INT. CL. 10). REG. 10-20-1953.	947,852.	SUPER SLICKS. U.S. CL. 22. (INT. CL. 28). REG. 11-28-1972.
581,897.	PERFECT SLEEPER (STYLIZED). U.S. CL. 32. (INT. CL. 20). REG. 11-3-1953.	948,642.	COLOMBO (STYLIZED). U.S. CL. 46. (INT. CLS. 1, 5, 29, 30, 31 AND 32). REG. 12-12-1972.
582,463.	SERTA (STYLIZED). U.S. CL. 32. (INT. CL. 20). REG. 11-17-1953.	952,291.	HR (STYLIZED). U.S. CL. 51. (INT. CLS. 3 AND 5). REG. 1-30-1973.
582,464.	SERTA AND DESIGN. U.S. CL. 32. (INT. CL. 20). REG. 11-17-1953.	952,834.	WHITE WITCH. U.S. CL. 51. (INT. CL. 3). REG. 2-6-1973.
583,712.	ARO AND DESIGN. U.S. CL. 13. (INT. CL. 7). REG. 12-15-1953.	953,195.	AMSTER. U.S. CL. 46. (INT. CLS. 29 AND 30). REG. 2-13-1973.
732,138.	POLACOLOR. U.S. CL. 26. (INT. CLS. 1, 9 AND 10). REG. 5-29-1962.	955,872.	LA SIERRA. U.S. CL. 46. (INT. CLS. 1, 5, 29, 30, 31 AND 32). REG. 3-20-1973.
733,853.	LIQUIMIX. U.S. CL. 46. (INT. CL. 29). REG. 7-3-1962.	956,179.	PEPSI-COLA AND DESIGN. U.S. CL. 45. (INT. CL. 32). REG. 3-27-1973.
735,744.	GOLDEN HEARTH. U.S. CL. 46. (INT. CL. 30). REG. 8-7-1962.	956,212.	HEISSNER. U.S. CL. 50. (INT. CL. 21). REG. 3-27-1973.
747,580.	MISCELLANEOUS DESIGN. U.S. CL. 26. (INT. CL. 9). REG. 4-2-1963.	958,889.	FLEXWELL. U.S. CL. 21. (INT. CL. 9). REG. 5-15-1973.
749,522.	MISCELLANEOUS DESIGN. U.S. CL. 51. (INT. CL. 3). REG. 5-14-1963.	958,956.	GEYSER. U.S. CL. 23. (INT. CL. 7). REG. 5-15-1973.
749,615.	METYLAN. U.S. CL. 5. (INT. CL. 16). REG. 5-21-1963.	958,988.	CHOCOLATE SOUP. U.S. CL. 39. (INT. CL. 25). REG. 5-15-1973.
749,671.	PALINEY. U.S. CL. 14. (INT. CL. 6). REG. 5-21-1963.	959,183.	HYDROFAST. U.S. CL. 11. (INT. CL. 2). REG. 5-22-1973.
749,723.	EXER-GENIE. U.S. CL. 22. (INT. CL. 28). REG. 5-21-1963.	959,352.	HEIRLOOM. U.S. CL. 28. (INT. CL. 14). REG. 5-22-1973.
749,809.	HANRO. U.S. CL. 39. (INT. CL. 25). REG. 5-21-1963.	959,392.	ROMOR. U.S. CL. 35. (INT. CL. 17). REG. 5-22-1973.
749,834.	KEX WALK OFF. U.S. CL. 42. (INT. CL. 24). REG. 5-21-1963.	959,447.	ROSSETTI. U.S. CL. 39. (INT. CL. 25). REG. 5-22-1973.
750,066.	POWERFLOOD. U.S. CL. 21. (INT. CL. 9). REG. 5-28-1963.	959,534.	TOPOL. U.S. CL. 51. (INT. CL. 3). REG. 5-22-1973.
750,900.	FOOD ENGINEERING. U.S. CL. 38. (INT. CL. 16). REG. 6-11-1963.	959,761.	NIKKISO NON-SEAL (STYLIZED). U.S. CL. 23. (INT. CL. 7). REG. 5-29-1973.
		960,137.	CEAC. U.S. CL. 107. (INT. CL. 41). REG. 5-29-1973.
		960,141.	PSI UPSILON. U.S. CL. 200. REG. 5-29-1973.
		960,248.	EASY WAY. U.S. CLS. 15, 16 AND 52 ONLY. (INT. CLS. 2, 3 AND 4). REG. 6-5-1973.
		960,282.	VOLTAREN. U.S. CL. 18. (INT. CL. 5). REG. 6-5-1973.
		960,516.	PEPSI-COLA AND DESIGN. U.S. CL. 45. (INT. CL. 32). REG. 6-5-1973.

- 960,663. SEE-THRU. U.S. CL. 44. (INT. CL. 10). REG. 6-5-1973.
- 960,811. NK AND DESIGN. U.S. CL. 23. (INT. CL. 7). REG. 6-12-1973.
- 961,825. SPROUT-STOP. U.S. CL. 6. (INT. CL. 1). REG. 6-26-1973.
- 961,949. BERT. U.S. CL. 22. (INT. CL. 28). REG. 6-26-1973.
- 961,950. ERNIE. U.S. CL. 22. (INT. CL. 28). REG. 6-26-1973.
- 962,203. PIRATES GOLD FOR MEN AND DESIGN. U.S. CL. 51. (INT. CL. 3). REG. 6-26-1973.
- 963,130. SNOWY-COAT. U.S. CL. 52. (INT. CL. 3). REG. 7-3-1973.
- 963,131. 10 FOR 1. U.S. CL. 52. (INT. CL. 3). REG. 7-3-1973.
- 964,047. HARKEN. U.S. CL. 19. (INT. CL. 12). REG. 7-17-1973.
- 968,148. POLYFACE. U.S. CL. 34. (INT. CL. 9). REG. 9-11-1973.
- 968,885. MID-TOWN TENNIS CLUB AND DESIGN. U.S. CL. 101. (INT. CLS. 35 AND 42). REG. 9-18-1973.
- 974,472. A HELPFUL SMILE IN EVERY AISLE. U.S. CL. 101. (INT. CL. 42). REG. 12-4-1973.
- 975,242. BORONOMETER. U.S. CL. 26. (INT. CL. 9). REG. 12-18-1973.
- 977,144. BLOCADREN. U.S. CL. 18. (INT. CL. 5). REG. 1-22-1974.
- 979,811. SINEMET. U.S. CL. 18. (INT. CL. 5). REG. 3-5-1974.
- 982,728. COLUMBAC. INT. CL. 1. (U.S. CL. 1). REG. 4-30-1974.
- 1,195,429. THE GREAT LAKES SHIPPING CO.. INT. CL. 42. (U.S. CL. 100). REG. 5-11-1982.
- 1,197,582. ALUMA BLACK. INT. CL. 2. (U.S. CL. 16). REG. 6-15-1982.
- 1,198,347. MANAGING HUMAN PERFORMANCE (STYLIZED). INT. CLS. 16 AND 41. (U.S. CLS. 2, 21, 32, 38 AND 107). REG. 6-15-1982.
- 1,198,507. MAGNATEST. INT. CL. 9. (U.S. CLS. 21 AND 26). REG. 6-22-1982.
- 1,198,971. FREEWAY. INT. CL. 28. (U.S. CL. 22). REG. 6-22-1982.
- 1,201,689. PATENT 289. INT. CL. 3. (U.S. CL. 51). REG. 7-20-1982.
- 1,207,903. ZIPPO AND DESIGN. INT. CLS. 8 AND 28. (U.S. CLS. 22 AND 23). REG. 9-14-1982.
- 1,215,831. WEATHER-LOK. INT. CL. 17. (U.S. CLS. 5 AND 12). REG. 11-9-1982.
- 1,215,968. TARAFLEX. INT. CL. 27. (U.S. CLS. 20 AND 42). REG. 11-9-1982.
- 1,216,765. MULTISAC AND DESIGN. INT. CL. 22. (U.S. CL. 2). REG. 11-16-1982.
- 1,217,168. CHARM TEST. INT. CL. 1. (U.S. CL. 6). REG. 11-23-1982.
- 1,217,659. VELDURA. INT. CL. 27. (U.S. CLS. 20 AND 42). REG. 11-23-1982.
- 1,218,925. TATTLETALE. INT. CL. 9. (U.S. CLS. 21 AND 26). REG. 12-7-1982.
- 1,220,228. BANG! AND DESIGN. INT. CL. 32. (U.S. CL. 45). REG. 12-14-1982.
- 1,220,637. PHOTOVAC. INT. CL. 9. (U.S. CL. 26). REG. 12-21-1982.
- 1,222,299. BIRAL AND DESIGN. INT. CL. 4. (U.S. CL. 15). REG. 1-4-1983.
- 1,222,541. TAB. INT. CL. 16. (U.S. CL. 37). REG. 1-4-1983.
- 1,223,619. BANG! (STYLIZED). INT. CL. 32. (U.S. CL. 45). REG. 1-11-1983.
- 1,227,639. FOREMOST. INT. CL. 27. (U.S. CLS. 20 AND 37). REG. 2-15-1983.
- 1,228,251. AIWA (STYLIZED). INT. CL. 9. (U.S. CLS. 21, 23, 26, 36 AND 38). REG. 2-22-1983.
- 1,230,597. PEOPLE FOR THE AMERICAN WAY AND DESIGN. INT. CL. 42. (U.S. CL. 100). REG. 3-8-1983.
- 1,231,322. NIC AND DESIGN. INT. CL. 35. (U.S. CL. 101). REG. 3-15-1983.
- 1,233,533. EVERYWOMAN'S. INT. CL. 16. (U.S. CL. 38). REG. 4-5-1983.
- 1,235,559. LYTOR. INT. CL. 1. (U.S. CL. 6). REG. 4-26-1983.
- 1,237,218. MATTHEW NORMAN AND DESIGN. INT. CL. 14. (U.S. CL. 27). REG. 5-10-1983.
- 1,237,899. TERRA GLAZE. INT. CL. 2. (U.S. CL. 6). REG. 5-17-1983.
- 1,238,026. KATO. INT. CLS. 7 AND 9. (U.S. CLS. 21 AND 26). REG. 5-17-1983.
- 1,238,082. SELECTRONIC. INT. CL. 9. (U.S. CL. 21). REG. 5-17-1983.
- 1,238,093. CYBEREX. INT. CL. 9. (U.S. CL. 21). REG. 5-17-1983.
- 1,238,220. UNIVERSITY OF NOTRE DAME AND DESIGN. INT. CLS. 14, 16, 20, 21, 24 AND 25 ONLY. (U.S. CLS. 2, 28, 30, 32, 33, 37, 38, 39, 42 AND 50). REG. 5-17-1983.
- 1,238,509. KINDERCARE AND DESIGN. INT. CLS. 25 AND 28. (U.S. CLS. 22 AND 39). REG. 5-17-1983.
- 1,238,690. PINEAU FRANCOIS LER (STYLIZED). INT. CL. 33. (U.S. CL. 47). REG. 5-17-1983.
- 1,238,780. BIB. INT. CL. 38. (U.S. CL. 104). REG. 5-17-1983.
- 1,238,866. TOPPS. INT. CL. 42. (U.S. CL. 101). REG. 5-17-1983.
- 1,238,926. H.E.R.E. AND DESIGN. U.S. CL. 200. REG. 5-17-1983.
- 1,238,929. SUPER-SKIM. INT. CLS. 9 AND 11. (U.S. CLS. 13, 21 AND 31). REG. 5-17-1983.
- 1,239,105. MISCELLANEOUS DESIGN. INT. CL. 3. (U.S. CLS. 51 AND 52). REG. 5-24-1983.
- 1,239,151. BABYLAX. INT. CL. 5. (U.S. CL. 18). REG. 5-24-1983.
- 1,239,159. SOONER. INT. CLS. 6, 7 AND 8. (U.S. CLS. 13 AND 23). REG. 5-24-1983.
- 1,239,216. MK (STYLIZED). INT. CL. 9. (U.S. CLS. 21 AND 36). REG. 5-24-1983.
- 1,239,269. CLINITRON. INT. CL. 10. (U.S. CL. 44). REG. 5-24-1983.
- 1,239,453. REFRA. INT. CL. 19. (U.S. CL. 12). REG. 5-24-1983.
- 1,239,514. GINTY. INT. CLS. 25 AND 28. (U.S. CLS. 22 AND 39). REG. 5-24-1983.
- 1,239,600. BARNEY'S. INT. CL. 29. (U.S. CL. 46). REG. 5-24-1983.
- 1,239,601. BARNEY'S THE HORS D'OEUVRE PEOPLE. INT. CL. 29. (U.S. CL. 46). REG. 5-24-1983.
- 1,239,603. MILANI 1890. INT. CL. 29. (U.S. CL. 46). REG. 5-24-1983.
- 1,239,630. CHERRY STIX. INT. CL. 30. (U.S. CL. 46). REG. 5-24-1983.
- 1,239,720. NIC. INT. CL. 35. (U.S. CL. 101). REG. 5-24-1983.
- 1,239,769. FREEDOM RENT-A-CAR AND DESIGN. INT. CL. 39. (U.S. CL. 105). REG. 5-24-1983.
- 1,239,790. NIC. INT. CL. 41. (U.S. CLS. 100 AND 107). REG. 5-24-1983.
- 1,239,791. NIC AND DESIGN. INT. CL. 41. (U.S. CLS. 100 AND 107). REG. 5-24-1983.
- 1,239,829. GRECIAN GOURMET AND DESIGN. INT. CL. 42. (U.S. CL. 100). REG. 5-24-1983.
- 1,239,984. YAM AND DESIGN. INT. CLS. 7 AND 12. (U.S. CLS. 19 AND 23). REG. 5-31-1983.
- 1,240,247. MISCELLANEOUS DESIGN. INT. CL. 16. (U.S. CL. 37). REG. 5-31-1983.
- 1,240,368. PLUS + GRID. INT. CL. 20. (U.S. CL. 2). REG. 5-31-1983.
- 1,241,277. PAJAR. INT. CL. 25. (U.S. CL. 39). REG. 6-7-1983.
- 1,242,038. GLUCOGRAF (STYLIZED). INT. CL. 16. (U.S. CL. 38). REG. 6-14-1983.
- 1,242,210. KISSES. INT. CL. 28. (U.S. CL. 22). REG. 6-14-1983.
- 1,242,580. TEXEL. INT. CL. 7. (U.S. CL. 23). REG. 6-21-1983.
- 1,242,673. ALCAN AND DESIGN. INT. CL. 9. (U.S. CL. 21). REG. 6-21-1983.
- 1,244,081. KLORANE. INT. CL. 3. (U.S. CL. 51). REG. 7-5-1983.
- 1,244,398. PEARL BY PEARL (STYLIZED). INT. CL. 14. (U.S. CL. 28). REG. 7-5-1983.
- 1,244,869. NIC. INT. CL. 42. (U.S. CL. 100). REG. 7-5-1983.
- 1,244,903. TUFEL. INT. CL. 1. (U.S. CLS. 1 AND 6). REG. 7-12-1983.
- 1,245,735. TALON. INT. CL. 5. (U.S. CL. 6). REG. 7-19-1983.
- 1,246,780. AUBELIA. INT. CL. 3. (U.S. CL. 51). REG. 8-2-1983.
- 1,247,369. SOUPER SALADS AND DESIGN. INT. CL. 42. (U.S. CL. 100). REG. 8-2-1983.
- 1,248,739. HAY DAY. INT. CL. 42. (U.S. CL. 101). REG. 8-16-1983.
- 1,249,575. MILLER AND DESIGN. INT. CL. 6. (U.S. CLS. 2, 12, 13, 14, 23, 25 AND 50). REG. 8-30-1983.
- 1,251,443. CASCOWAX. INT. CL. 4. (U.S. CL. 15). REG. 9-20-1983.
- 1,251,873. SMILEMAKER (STYLIZED). INT. CL. 40. (U.S. CL. 106). REG. 9-20-1983.
- 1,252,932. JETWRAP. INT. CL. 16. (U.S. CLS. 2 AND 37). REG. 10-4-1983.
- 1,253,338. PROFESSIONAL'S CARE. INT. CL. 5. (U.S. CL. 51). REG. 10-4-1983.
- 1,253,838. EASTLAND NWS AND DESIGN. INT. CL. 25. (U.S. CL. 39). REG. 10-11-1983.

- 1,254,979. K-CRYL. INT. CL. 1. (U.S. CL. 6). REG. 10-25-1983.
- 1,255,028. DR. SCHOLL'S. INT. CLS. 3, 5, 10 AND 25. (U.S. CLS. 18, 22, 26, 39, 44 AND 51). REG. 10-25-1983.
- 1,256,305. DILETTANTE CHOCOLATES (STYLIZED). INT. CL. 30. (U.S. CL. 46). REG. 11-1-1983.
- 1,256,591. POLYSONIC. INT. CL. 5. (U.S. CL. 18). REG. 11-8-1983.
- 1,256,722. 20TH CENTURY FOX AND DESIGN. INT. CLS. 9 AND 41. (U.S. CLS. 21, 38 AND 107). REG. 11-8-1983.
- 1,257,588. LADY AMERICANA. INT. CL. 20. (U.S. CL. 32). REG. 11-15-1983.
- 1,257,652. COTTON LITES. INT. CL. 25. (U.S. CL. 39). REG. 11-15-1983.
- 1,257,719. EVANS (STYLIZED). INT. CLS. 29 AND 30. (U.S. CL. 46). REG. 11-15-1983.
- 1,258,372. BATTERY SENTINEL. INT. CL. 9. (U.S. CL. 26). REG. 11-22-1983.
- 1,258,861. HH AND DESIGN. INT. CL. 37. (U.S. CL. 103). REG. 11-22-1983.
- 1,259,073. DORYX. INT. CL. 5. (U.S. CL. 18). REG. 11-29-1983.
- 1,261,271. HAY DAY THE COUNTRY FARM MARKET AND DESIGN. INT. CL. 42. (U.S. CL. 101). REG. 12-13-1983.
- 1,262,471. U OF W. INT. CL. 25. (U.S. CL. 39). REG. 12-27-1983.
- 1,262,552. MISCELLANEOUS DESIGN. INT. CLS. 29 AND 30. (U.S. CL. 46). REG. 12-27-1983.
- 1,262,553. KANEKU (STYLIZED). INT. CLS. 29 AND 30. (U.S. CL. 46). REG. 12-27-1983.
- 1,271,008. CENTURY. INT. CL. 34. (U.S. CL. 17). REG. 3-20-1984.
- 1,273,745. SINGLETREE FARMS AND DESIGN. INT. CL. 29. (U.S. CL. 46). REG. 4-10-1984.
- 1,275,986. PEDILAN. INT. CL. 10. (U.S. CL. 44). REG. 5-1-1984.
- 1,590,289. SIAM. INT. CL. 42. (U.S. CL. 100). REG. 4-3-1990.
- 1,703,263. TOTAL QUALITY TRANSFORMATION. INT. CL. 16. (U.S. CL. 38). REG. 7-28-1992.
- 1,703,721. BRING US YOUR DREAMS. INT. CL. 36. (U.S. CL. 102). REG. 7-28-1992.
- 1,705,253. MARISCAL. INT. CL. 30. (U.S. CL. 46). REG. 8-4-1992.
- 1,707,068. EDUARDO'S. INT. CL. 42 ONLY. (U.S. CLS. 100 AND 105). REG. 8-11-1992.
- 1,720,735. 1-800-VISA-TOW. INT. CLS. 37 AND 38. (U.S. CLS. 103 AND 104). REG. 9-29-1992.
- 1,721,012. SEAL OF ACCEPTANCE ALLIANCE OF CHILDREN'S HOSPITALS, INC. AND DESIGN. U.S. CL. A. REG. 9-29-1992.
- 1,730,502. BERKEBILE 2+2 AND DESIGN. INT. CLS. 1, 2 AND 3. (U.S. CLS. 4, 6, 16 AND 52). REG. 11-10-1992.
- 1,731,134. THE SIAM CEMENT CO., LTD. AND DESIGN. INT. CL. 19. (U.S. CL. 12). REG. 11-10-1992.
- 1,732,446. LIL' SPORTS BALL. INT. CL. 6. (U.S. CLS. 2, 12, 13, 14, 23, 25 AND 50). REG. 11-17-1992.
- 1,733,079. SPACEMAKER 2000. INT. CL. 20. (U.S. CL. 32). REG. 11-17-1992.
- 1,734,032. FIREBALL. INT. CL. 16. (U.S. CL. 38). REG. 11-17-1992.
- 1,734,253. CARAPACE. INT. CL. 2. (U.S. CL. 11). REG. 11-24-1992.
- 1,734,518. RTX. INT. CL. 9. (U.S. CL. 26). REG. 11-24-1992.
- 1,735,369. THE POWER TO INFLUENCE. INT. CL. 41. (U.S. CL. 107). REG. 11-24-1992.
- 1,735,449. REED SMITH AND DESIGN. INT. CL. 42. (U.S. CLS. 100 AND 101). REG. 11-24-1992.
- 1,736,563. SPECIALTY TAPES AND DESIGN. INT. CL. 17. (U.S. CL. 5). REG. 12-1-1992.
- 1,737,643. FLEXIS. INT. CL. 20. (U.S. CL. 32). REG. 12-1-1992.
- 1,737,948. ENZY-CLEAN. INT. CL. 5. (U.S. CLS. 6 AND 18). REG. 12-8-1992.
- 1,738,574. CRA AND DESIGN. INT. CLS. 35 AND 36. (U.S. CLS. 101 AND 102). REG. 12-8-1992.
- 1,738,742. THE CHURCH OF JESUS CHRIST OF LATTER-DAY SAINTS (STYLIZED). INT. CL. 42. (U.S. CL. 100). REG. 12-8-1992.
- 1,739,986. AMERICAN AND DESIGN. INT. CL. 28. (U.S. CL. 22). REG. 12-15-1992.
- 1,741,379. TRE MODE (STYLIZED). INT. CL. 24. (U.S. CL. 42). REG. 12-22-1992.
- 1,743,433. FLORES CONDOR AND DESIGN. INT. CL. 31. (U.S. CL. 1). REG. 12-29-1992.
- 1,743,934. DECORELLE. INT. CL. 19. (U.S. CLS. 12 AND 33). REG. 12-29-1992.
- 1,744,270. U.S. POWER. INT. CL. 7. (U.S. CLS. 23 AND 31). REG. 1-5-1993.
- 1,745,687. METAL-BAG. INT. CL. 11. (U.S. CLS. 31 AND 34). REG. 1-12-1993.
- 1,746,076. KABA. INT. CLS. 37 AND 42. (U.S. CLS. 100, 101 AND 103). REG. 1-12-1993.
- 1,749,745. FUTURE FOODS. INT. CL. 3. (U.S. CL. 18). REG. 2-2-1993.
- 1,750,024. SENTINEL. INT. CL. 11. (U.S. CLS. 2 AND 31). REG. 2-2-1993.
- 1,750,421. AMERICAN HOUSEKEEPING AND DESIGN. INT. CL. 37. (U.S. CL. 103). REG. 2-2-1993.
- 1,751,435. HEARTY KITCHEN. INT. CL. 29. (U.S. CL. 46). REG. 2-9-1993.
- 1,751,873. GREENMARK. INT. CL. 16. (U.S. CLS. 2, 5 AND 37). REG. 2-9-1993.
- 1,752,240. LIFTING TECHNOLOGIES. INT. CL. 7. (U.S. CL. 23). REG. 2-16-1993.
- 1,753,587. STEELMASTER AND DESIGN. INT. CL. 6. (U.S. CL. 12). REG. 2-23-1993.
- 1,753,628. RISKMASTER. INT. CL. 9. (U.S. CL. 38). REG. 2-23-1993.
- 1,755,676. BUYERS RESOURCE AND DESIGN. INT. CL. 36. (U.S. CLS. 101 AND 102). REG. 3-2-1993.
- 1,759,138. VIREX. INT. CL. 11. (U.S. CLS. 31 AND 34). REG. 3-16-1993.
- 1,762,080. FREE SLIDE. INT. CL. 20. (U.S. CL. 32). REG. 3-30-1993.
- 1,762,681. SUN OVEN. INT. CL. 11. (U.S. CL. 34). REG. 4-6-1993.
- 1,763,650. SOLO-TRAK. INT. CL. 10. (U.S. CL. 44). REG. 4-6-1993.
- 1,763,727. MARIGO (STYLIZED). INT. CL. 25. (U.S. CL. 39). REG. 4-6-1993.
- 1,763,853. CHIA HERB GARDEN. INT. CL. 20. (U.S. CLS. 2 AND 50). REG. 4-6-1993.
- 1,764,141. PS/NVISION. INT. CL. 9. (U.S. CL. 38). REG. 4-13-1993.
- 1,764,998. SLIDER AND DESIGN. INT. CL. 41. (U.S. CL. 107). REG. 4-13-1993.
- 1,765,095. VIKING OFFICE PRODUCTS (STYLIZED). INT. CL. 42. (U.S. CL. 101). REG. 4-13-1993.
- 1,766,432. AMERICA'S LEADING JEWELER. INT. CL. 42. (U.S. CL. 101). REG. 4-20-1993.
- 1,767,365. H HELLENBRAND WATER CONDITIONERS, INC. (STYLIZED). INT. CL. 11. (U.S. CLS. 31 AND 34). REG. 4-27-1993.
- 1,767,746. ECCO-LA. INT. CL. 42. (U.S. CL. 100). REG. 4-27-1993.
- 1,767,767. MISCELLANEOUS DESIGN. INT. CL. 42. (U.S. CL. 100). REG. 4-27-1993.
- 1,768,352. REL VIRON. INT. CL. 2. (U.S. CL. 16). REG. 5-4-1993.
- 1,768,794. MY FATHER'S BEST AND DESIGN. INT. CLS. 29 AND 30. (U.S. CL. 46). REG. 5-4-1993.
- 1,770,080. MISCELLANEOUS DESIGN. INT. CL. 20. (U.S. CL. 2). REG. 5-11-1993.
- 1,770,386. BLADE AGENCY. INT. CL. 35. (U.S. CLS. 101 AND 107). REG. 5-11-1993.
- 1,770,607. LA-Z-BOY BUSINESS FURNITURE GALLERY. INT. CL. 42. (U.S. CL. 100). REG. 5-11-1993.
- 1,770,644. ABRATECH. INT. CL. 42. (U.S. CL. 100). REG. 5-11-1993.
- 1,770,889. INCITE. INT. CL. 42. (U.S. CL. 100). REG. 5-11-1993.
- 1,770,917. PURITY. INT. CL. 1. (U.S. CL. 6). REG. 5-18-1993.
- 1,770,934. HYPERFILM. INT. CL. 1. (U.S. CLS. 6 AND 26). REG. 5-18-1993.
- 1,771,001. WHITE RAIN. INT. CL. 3. (U.S. CL. 51). REG. 5-18-1993.
- 1,771,037. VETOQUINOL. INT. CL. 5. (U.S. CLS. 6, 18, 44, 46, 51 AND 52). REG. 5-18-1993.
- 1,771,043. SOLUGEL. INT. CLS. 5 AND 29. (U.S. CLS. 18 AND 46). REG. 5-18-1993.
- 1,771,085. ALON. INT. CLS. 6 AND 40. (U.S. CLS. 14 AND 106). REG. 5-18-1993.
- 1,771,093. DB AND DESIGN. INT. CL. 7 ONLY. (U.S. CL. 23). REG. 5-18-1993.
- 1,771,098. ROTOPRESS. INT. CL. 7. (U.S. CL. 23). REG. 5-18-1993.
- 1,771,106. CAVOTEC. INT. CL. 7. (U.S. CL. 23). REG. 5-18-1993.

- 1,771,212. BUDDAH. INT. CL. 9. (U.S. CL. 36). REG. 5-18-1993.
- 1,771,266. POLNET. INT. CL. 9. (U.S. CLS. 21 AND 26). REG. 5-18-1993.
- 1,771,276. OXISENSOR. INT. CL. 10. (U.S. CL. 44). REG. 5-18-1993.
- 1,771,357. MISCELLANEOUS DESIGN. INT. CLS. 14, 18, 25 AND 28. (U.S. CLS. 3, 22, 28 AND 39). REG. 5-18-1993.
- 1,771,374. AS THEY GROW. INT. CL. 16. (U.S. CL. 38). REG. 5-18-1993.
- 1,771,375. M COLORADO SCHOOL OF MINES 1874 AND DESIGN. INT. CLS. 16 AND 25. (U.S. CLS. 38, 39 AND 50). REG. 5-18-1993.
- 1,771,392. PENNSYLVANIA CONNECTION. INT. CL. 16. (U.S. CL. 38). REG. 5-18-1993.
- 1,771,393. OHIO CONNECTION. INT. CL. 16. (U.S. CL. 38). REG. 5-18-1993.
- 1,771,394. INDIANA-ILLINOIS CONNECTION. INT. CL. 16. (U.S. CL. 38). REG. 5-18-1993.
- 1,771,395. MICHIGAN CONNECTION. INT. CL. 16. (U.S. CL. 38). REG. 5-18-1993.
- 1,771,442. LITTLE HOUSE. INT. CL. 16. (U.S. CL. 38). REG. 5-18-1993.
- 1,771,471. KARONA (STYLIZED). INT. CL. 19. (U.S. CLS. 13, 33 AND 50). REG. 5-18-1993.
- 1,771,505. GARDEN GOURMET. INT. CL. 21. (U.S. CL. 2). REG. 5-18-1993.
- 1,771,690. BROOKS BROTHERS. INT. CL. 30. (U.S. CL. 46). REG. 5-18-1993.
- 1,771,726. NUTRI-AN. INT. CL. 31. (U.S. CL. 46). REG. 5-18-1993.
- 1,771,771. MARKET DATA RETRIEVAL. INT. CL. 35. (U.S. CL. 101). REG. 5-18-1993.
- 1,772,104. PUBLIX. INT. CL. 42. (U.S. CLS. 100 AND 101). REG. 5-18-1993.
- 1,772,125. THE PRAXIS SERIES: PROFESSIONAL ASSESSMENTS FOR BEGINNING TEACHERS. INT. CLS. 9, 16 AND 42. (U.S. CLS. 38, 100 AND 101). REG. 5-18-1993.
- 1,772,128. THE PRAXIS SERIES PROFESSIONAL ASSESSMENTS FOR BEGINNING TEACHERS AND DESIGN. INT. CLS. 9, 16 AND 42. (U.S. CLS. 38 AND 100). REG. 5-18-1993.
- 1,772,243. ULTRAFLEX (STYLIZED). INT. CL. 9. (U.S. CL. 21). REG. 5-18-1993.
- 1,772,336. QUILT-RAP. INT. CL. 16. (U.S. CL. 38). REG. 5-18-1993.
- 1,772,373. CAROUSEL. INT. CL. 20. (U.S. CL. 13). REG. 5-18-1993.
- 1,772,457. HAWAIIAN BUFFALO. INT. CL. 25. (U.S. CL. 39). REG. 5-18-1993.
- 1,772,587. R&O (STYLIZED). INT. CL. 39. (U.S. CL. 105). REG. 5-18-1993.
- 1,772,736. JUMBOMATIC AND DESIGN. INT. CLS. 16 AND 21 ONLY. (U.S. CLS. 2 AND 37). REG. 5-25-1993.
- 1,772,871. POLYVEND AND DESIGN. INT. CL. 9. (U.S. CLS. 21 AND 23). REG. 5-25-1993.
- 1,772,950. BOOK WINDOW. INT. CL. 16. (U.S. CLS. 37 AND 38). REG. 5-25-1993.
- 1,773,012. MISCELLANEOUS DESIGN. INT. CL. 21. (U.S. CL. 29). REG. 5-25-1993.
- 1,773,050. VERTICAL CLUB AND DESIGN. INT. CL. 25. (U.S. CL. 39). REG. 5-25-1993.
- 1,773,088. COASTER. INT. CL. 28. (U.S. CL. 22). REG. 5-25-1993.
- 1,773,112. ENERGIZE YOUR DAY!. INT. CL. 30. (U.S. CL. 46). REG. 5-25-1993.
- 1,773,248. AV AVFUEL AVNET AND DESIGN. INT. CL. 42. (U.S. CL. 101). REG. 5-25-1993.
- 1,773,249. AQUAHEALTH. INT. CL. 42. (U.S. CL. 100). REG. 5-25-1993.
- 1,773,260. RIZZO'S MALABAR INN. INT. CL. 42. (U.S. CL. 100). REG. 5-25-1993.
- 1,773,326. PROBIMAGE. INT. CL. 1. (U.S. CLS. 1 AND 6). REG. 5-25-1993.
- 1,773,337. PHOTOPIA. INT. CL. 2. (U.S. CLS. 6 AND 16). REG. 5-25-1993.
- 1,773,351. RAPTURE. INT. CL. 3. (U.S. CLS. 1, 4, 6, 50, 51 AND 52). REG. 5-25-1993.
- 1,773,384. ODOR GUN. INT. CL. 5. (U.S. CL. 6). REG. 5-25-1993.
- 1,773,392. RIPPED FUEL. INT. CL. 5. (U.S. CL. 18). REG. 5-25-1993.
- 1,773,397. LEVEL-MASTER. INT. CL. 6. (U.S. CL. 13). REG. 5-25-1993.
- 1,773,470. AUDIO NET. INT. CL. 9. (U.S. CL. 38). REG. 5-25-1993.
- 1,773,471. AUDIO NET AND DESIGN. INT. CL. 9. (U.S. CLS. 26 AND 38). REG. 5-25-1993.
- 1,773,586. SIMPLICITY SERIES. INT. CL. 16. (U.S. CL. 37). REG. 5-25-1993.
- 1,773,616. FAS-N-FREE. INT. CL. 19. (U.S. CL. 22). REG. 5-25-1993.
- 1,773,632. PARLIAMENT COLLECTION (STYLIZED). INT. CL. 20. (U.S. CL. 32). REG. 5-25-1993.
- 1,773,774. ALP AND DELL. INT. CL. 29. (U.S. CL. 46). REG. 5-25-1993.
- 1,773,798. AMERICAN MASTERPIECE. INT. CL. 31. (U.S. CL. 1). REG. 5-25-1993.
- 1,773,810. STAG. INT. CL. 34. (U.S. CL. 17). REG. 5-25-1993.
- 1,773,840. SUNLINE EXPRESS. INT. CL. 39. (U.S. CL. 105). REG. 5-25-1993.
- 1,773,853. CRESCENT MOON STUDIOS AND DESIGN. INT. CL. 41. (U.S. CL. 107). REG. 5-25-1993.
- 1,773,885. KIDS' KINGDOM. INT. CL. 42. (U.S. CL. 101). REG. 5-25-1993.
- 1,773,904. MISCELLANEOUS DESIGN. INT. CL. 7. (U.S. CLS. 21 AND 23). REG. 5-25-1993.
- 1,773,956. SILPLUS. INT. CL. 1. (U.S. CL. 6). REG. 6-1-1993.
- 1,774,053. PACALOY. INT. CL. 6. (U.S. CL. 13). REG. 6-1-1993.
- 1,774,210. LAMINATED LABELS AND DESIGN. INT. CL. 16. (U.S. CL. 23). REG. 6-1-1993.
- 1,774,360. GOLDEN MAGIC (STYLIZED). INT. CL. 30. (U.S. CL. 46). REG. 6-1-1993.
- 1,774,450. PATHFINDER TRUCKING. INT. CL. 39. (U.S. CL. 105). REG. 6-1-1993.
- 1,774,728. HARVEST CHEDDAR. INT. CL. 30. (U.S. CL. 46). REG. 6-1-1993.
- 1,774,954. VERSAFOIL. INT. CL. 7. (U.S. CL. 23). REG. 6-8-1993.
- 1,774,963. BARCO (STYLIZED). INT. CL. 8. (U.S. CL. 23). REG. 6-8-1993.
- 1,775,007. FARO. INT. CLS. 9 AND 10. (U.S. CLS. 26, 39 AND 44). REG. 6-8-1993.
- 1,775,026. ENCOMPASS. INT. CL. 9. (U.S. CL. 38). REG. 6-8-1993.
- 1,775,125. DYNASHIFT. INT. CL. 12. (U.S. CLS. 19 AND 23). REG. 6-8-1993.
- 1,775,404. TREASURE SHIP. INT. CL. 31. (U.S. CL. 1). REG. 6-8-1993.
- 1,775,520. MISCELLANEOUS DESIGN. INT. CL. 41. (U.S. CLS. 101 AND 107). REG. 6-8-1993.
- 1,775,586. SOITENLY STOOGES (STYLIZED). INT. CL. 42. (U.S. CL. 101). REG. 6-8-1993.
- 1,775,589. BRINGING COMPASSION AND EXPERT CARE TOGETHER. INT. CL. 42. (U.S. CL. 100). REG. 6-8-1993.
- 1,775,617. NCI CCC A COMPREHENSIVE CANCER CENTER DESIGNATED BY THE NATIONAL CANCER INSTITUTE AND DESIGN. U.S. CL. B. REG. 6-8-1993.
- 1,775,676. BODY-HEAT ACTIVATED DEGREE. INT. CL. 3. (U.S. CL. 51). REG. 6-8-1993.
- 1,775,696. WL WAMPOLE LABORATORIES (STYLIZED). INT. CL. 5. (U.S. CLS. 6 AND 18). REG. 6-8-1993.
- 1,775,712. ARLINGTON. INT. CL. 6. (U.S. CL. 13). REG. 6-8-1993.
- 1,775,819. LANDIA AND DESIGN. INT. CL. 11. (U.S. CL. 21). REG. 6-8-1993.
- 1,775,938. FLYMASTERS AND DESIGN. INT. CL. 28. (U.S. CLS. 22, 23, 38 AND 50). REG. 6-8-1993.
- 1,775,944. SKILCRAFT AND DESIGN. INT. CL. 28. (U.S. CL. 22). REG. 6-8-1993.
- 1,776,041. COMERICA AND DESIGN. INT. CL. 36. (U.S. CL. 102). REG. 6-8-1993.
- 1,776,286. KOCOM (STYLIZED). INT. CL. 9. (U.S. CLS. 21, 26 AND 36). REG. 6-15-1993.
- 1,776,635. DETERMINED PRODUCTIONS, INC.. INT. CL. 28. (U.S. CL. 22). REG. 6-15-1993.
- 1,776,722. DETERMINED PRODUCTIONS, INC.. INT. CL. 35. (U.S. CL. 101). REG. 6-15-1993.
- 1,776,874. THE REMINGTON SPORTSMEN'S LIBRARY. INT. CL. 42. (U.S. CL. 101). REG. 6-15-1993.
- 1,777,009. UNIPORT 10K. INT. CL. 6. (U.S. CL. 13). REG. 6-15-1993.
- 1,777,043. PAN PI AND DESIGN. INT. CL. 9. (U.S. CLS. 21 AND 26). REG. 6-15-1993.

- 1,777,049. CLINICAL LINK. INT. CL. 9. (U.S. CLS. 26 AND 38). REG. 6-15-1993.
- 1,777,273. EVOLUTION. INT. CL. 27. (U.S. CLS. 20 AND 50). REG. 6-15-1993.
- 1,777,370. PARADE. INT. CL. 31. (U.S. CL. 1). REG. 6-15-1993.
- 1,777,563. QUIKHYB. INT. CL. 1. (U.S. CLS. 1, 5, 6, 10, 26 AND 46). REG. 6-22-1993.
- 1,778,040. MARIAH. INT. CL. 33. (U.S. CL. 47). REG. 6-22-1993.
- 1,778,203. SAM & LIBBY. INT. CL. 42. (U.S. CL. 101). REG. 6-22-1993.
- 1,778,446. KOOKY FRUITS. INT. CL. 30. (U.S. CL. 46). REG. 6-22-1993.
- 1,778,994. JEANNE PIERRE. INT. CL. 25. (U.S. CL. 39). REG. 6-29-1993.
- 1,779,055. TANGLE. INT. CL. 28. (U.S. CLS. 22 AND 50). REG. 6-29-1993.
- 1,779,123. FRANGO. INT. CL. 30. (U.S. CL. 46). REG. 6-29-1993.
- 1,779,212. NORTHLAND. INT. CLS. 36 AND 37. (U.S. CLS. 102 AND 103). REG. 6-29-1993.
- 1,780,286. AIRDEC. INT. CL. 17. (U.S. CL. 1). REG. 7-6-1993.
- 1,780,288. QUIET CORE AND DESIGN. INT. CL. 17. (U.S. CL. 12). REG. 7-6-1993.
- 1,780,305. PLAS-T-LATH. INT. CL. 19. (U.S. CL. 12). REG. 7-6-1993.
- 1,780,311. VERSAL. INT. CL. 20. (U.S. CL. 32). REG. 7-6-1993.
- 1,780,656. NORTHERN EXPOSURE AND DESIGN. INT. CL. 41. (U.S. CL. 107). REG. 7-6-1993.
- 1,780,735. VOTER ROLL-CALL. INT. CL. 42. (U.S. CLS. 100 AND 101). REG. 7-6-1993.
- 1,780,842. HELLO AGAIN. INT. CL. 16. (U.S. CLS. 2 AND 37). REG. 7-6-1993.
- 1,780,967. MISCELLANEOUS DESIGN. INT. CL. 2. (U.S. CL. 16). REG. 7-13-1993.
- 1,781,004. STELLA NOVA. INT. CLS. 3 AND 42. (U.S. CLS. 51, 52 AND 101). REG. 7-13-1993.
- 1,781,505. AVIARA AND DESIGN. INT. CL. 25. (U.S. CL. 39). REG. 7-13-1993.
- 1,781,634. LOADING ZONE. INT. CL. 30. (U.S. CL. 46). REG. 7-13-1993.
- 1,781,933. WHERE SAN FRANCISCO BEGINS. INT. CL. 42. (U.S. CLS. 100 AND 101). REG. 7-13-1993.
- 1,782,398. DOUBLE C. INT. CL. 6. (U.S. CLS. 13 AND 14). REG. 7-20-1993.
- 1,782,421. EXPLORER. INT. CL. 8. (U.S. CL. 23). REG. 7-20-1993.
- 1,782,527. EASY MEDICAL. INT. CL. 9. (U.S. CL. 38). REG. 7-20-1993.
- 1,782,740. KOOLVEST. INT. CL. 25. (U.S. CL. 39). REG. 7-20-1993.
- 1,782,899. TRANS PACIFIC INSURANCE COMPANY. INT. CL. 36. (U.S. CL. 102). REG. 7-20-1993.
- 1,783,257. INDIGO. INT. CL. 9. (U.S. CLS. 21 AND 26). REG. 7-20-1993.
- 1,783,375. UTILITY POSTOP. INT. CL. 11. (U.S. CL. 21). REG. 7-20-1993.
- 1,783,609. SMOKE AND DESIGN. INT. CL. 34. (U.S. CL. 17). REG. 7-20-1993.
- 1,783,749. MONOMULS. INT. CL. 1. (U.S. CL. 6). REG. 7-27-1993.
- 1,783,984. FIBERCAM. INT. CL. 9. (U.S. CL. 26). REG. 7-27-1993.
- 1,784,099. WOOD BROTHERS 21 (STYLIZED). INT. CLS. 16, 25 AND 28. (U.S. CLS. 22, 37, 38, 39 AND 50). REG. 7-27-1993.
- 1,784,168. HAVE YOUR ICE AND HEAT IT TOO. INT. CL. 21. (U.S. CL. 2). REG. 7-27-1993.
- 1,784,359. AMERICAN VETERINARY MEDICAL ASSOCIATION. INT. CL. 35. (U.S. CLS. 100 AND 101). REG. 7-27-1993.
- 1,784,614. COMPUCOM. INT. CL. 42. (U.S. CL. 101). REG. 7-27-1993.
- 1,785,811. YOU'RE #1 AND DESIGN. INT. CL. 36. (U.S. CLS. 101 AND 102). REG. 8-3-1993.
- 1,786,290. LEAD COVER. INT. CL. 2. (U.S. CL. 16). REG. 8-3-1993.
- 1,786,562. GLOBAL SYNTHESIS. INT. CL. 9. (U.S. CL. 38). REG. 8-10-1993.
- 1,786,679. VIPER. INT. CL. 13. (U.S. CLS. 2 AND 9). REG. 8-10-1993.
- 1,786,888. WILD THING. INT. CL. 28. (U.S. CLS. 22 AND 38). REG. 8-10-1993.
- 1,787,200. NATION PIZZA PRODUCTS AND DESIGN. INT. CL. 42. (U.S. CLS. 100 AND 101). REG. 8-10-1993.
- 1,788,720. TIMESAVER. INT. CL. 1. (U.S. CL. 6). REG. 8-17-1993.
- 1,788,858. CEZANNE. INT. CL. 14. (U.S. CL. 28). REG. 8-17-1993.
- 1,788,967. RELOACTION. INT. CL. 39. (U.S. CLS. 100 AND 105). REG. 8-17-1993.
- 1,789,229. WETBOSS. INT. CL. 9. (U.S. CL. 26). REG. 8-24-1993.
- 1,789,831. TURF-GARD. INT. CL. 4. (U.S. CL. 15). REG. 8-24-1993.
- 1,790,144. KOVAX AND DESIGN. INT. CL. 7. (U.S. CL. 23). REG. 8-31-1993.
- 1,790,320. COCOA 'N CREME. INT. CL. 16. (U.S. CL. 38). REG. 8-31-1993.
- 1,790,425. MECALUX. INT. CL. 20. (U.S. CL. 32). REG. 8-31-1993.
- 1,791,305. TAURUS SURVIVOR. INT. CL. 8. (U.S. CL. 23). REG. 9-7-1993.
- 1,791,969. KINGSMILL. INT. CL. 41. (U.S. CLS. 100, 101 AND 107). REG. 9-7-1993.
- 1,792,488. CO-LIFTER. INT. CL. 10. (U.S. CL. 44). REG. 9-14-1993.
- 1,792,559. MISCELLANEOUS DESIGN. INT. CLS. 16 AND 18. (U.S. CLS. 2, 3 AND 37). REG. 9-14-1993.
- 1,793,462. POSTALSOFT. INT. CLS. 9, 37 AND 41. (U.S. CLS. 21, 23, 26, 36, 38, 100, 101, 103, 106 AND 107). REG. 9-21-1993.
- 1,793,712. INSTA-HUT. INT. CL. 22. (U.S. CL. 22). REG. 9-21-1993.
- 1,794,226. VAPURE. INT. CL. 11. (U.S. CLS. 31 AND 34). REG. 9-21-1993.
- 1,794,422. INTEGRAND. INT. CL. 36. (U.S. CLS. 101 AND 102). REG. 9-21-1993.
- 1,794,425. INTEGRAND AND DESIGN. INT. CL. 36. (U.S. CLS. 101 AND 102). REG. 9-21-1993.
- 1,794,854. CIRCLEDOME. INT. CL. 11. (U.S. CLS. 21 AND 34). REG. 9-28-1993.
- 1,795,331. VENTURES IN EDUCATION. INT. CL. 41. (U.S. CL. 107). REG. 9-28-1993.
- 1,795,524. RESTOR PLUS. INT. CL. 3. (U.S. CLS. 51 AND 52). REG. 9-28-1993.
- 1,796,199. MILLS MAGIC ROSE MIX. INT. CL. 1. (U.S. CL. 10). REG. 10-5-1993.
- 1,796,784. PEBBLES. INT. CL. 8. (U.S. CL. 23). REG. 10-5-1993.
- 1,797,036. GROOMER'S TOUCH. INT. CL. 21. (U.S. CLS. 3 AND 29). REG. 10-5-1993.
- 1,798,187. WHITE GLOVE SERVICE. INT. CL. 37. (U.S. CL. 103). REG. 10-12-1993.
- 1,798,883. INTEGRAND ASSURANCE COMPANY. INT. CL. 36. (U.S. CLS. 101 AND 102). REG. 10-12-1993.
- 1,799,836. DSTI. INT. CL. 42. (U.S. CLS. 100 AND 101). REG. 10-19-1993.
- 1,799,925. WILD EMOTIONS. INT. CL. 3. (U.S. CL. 51). REG. 10-19-1993.
- 1,799,957. SEA SHELL. INT. CL. 8. (U.S. CL. 23). REG. 10-19-1993.
- 1,800,255. AEROGROUND. INT. CL. 39. (U.S. CL. 105). REG. 10-19-1993.
- 1,800,285. SOLMET TECHNOLOGIES. INT. CL. 42. (U.S. CLS. 103 AND 106). REG. 10-19-1993.
- 1,800,456. DO HWI IT AND DESIGN. INT. CL. 7. (U.S. CL. 23). REG. 10-26-1993.
- 1,800,806. PREMIER NORTHERN. INT. CL. 22. (U.S. CL. 1). REG. 10-26-1993.
- 1,800,968. MISCELLANEOUS DESIGN. INT. CL. 30. (U.S. CL. 46). REG. 10-26-1993.
- 1,801,491. OMNI-LAPOTRACT. INT. CL. 10. (U.S. CL. 44). REG. 10-26-1993.
- 1,801,664. BLACK EAGLE. INT. CL. 33. (U.S. CL. 49). REG. 10-26-1993.
- 1,802,012. RENE (STYLIZED). INT. CL. 12. (U.S. CL. 19). REG. 11-2-1993.
- 1,802,534. MISCELLANEOUS DESIGN. INT. CL. 3. (U.S. CL. 51). REG. 11-2-1993.
- 1,802,889. TASTE OF AMERICA. INT. CL. 34. (U.S. CL. 17). REG. 11-2-1993.
- 1,802,939. WOMEN'S INTUITIVE TRAINING. INT. CL. 41. (U.S. CL. 107). REG. 11-2-1993.
- 1,803,157. ROBO PLAY. INT. CL. 9. (U.S. CL. 21). REG. 11-9-1993.
- 1,804,692. MISCELLANEOUS DESIGN. INT. CL. 34. (U.S. CL. 17). REG. 11-16-1993.

- 1,804,846. COPS. INT. CL. 41. (U.S. CL. 107). REG. 11-16-1993.
1,806,290. FRISK AND DESIGN. INT. CL. 30. (U.S. CL. 46).
REG. 11-23-1993.
1,806,547. 500 CLUB. INT. CL. 42. (U.S. CLS. 100 AND 107).
REG. 11-23-1993.
1,808,089. PURPLE POTAMUS VIDEO AND DESIGN. INT.
CL. 41. (U.S. CLS. 100 AND 107). REG. 11-30-
1993.
1,808,189. IDENTO. INT. CL. 42. (U.S. CLS. 100 AND 101).
REG. 11-30-1993.
1,809,485. CREDO. INT. CL. 34. (U.S. CL. 17). REG. 12-7-1993.
1,809,630. AMERICAN DANCE THERAPY ASSOCIATION.
INT. CLS. 41 AND 42. (U.S. CLS. 101 AND 107).
REG. 12-7-1993.
1,809,632. ADTA AMERICAN DANCE THERAPY ASSO-
CIATION AND DESIGN. INT. CLS. 41 AND
42. (U.S. CLS. 100 AND 107). REG. 12-7-1993.
1,809,769. VISUAL PREFERENCE SURVEY. INT. CL. 42.
(U.S. CLS. 100 AND 103). REG. 12-7-1993.
1,810,621. USHOW. INT. CL. 9. (U.S. CL. 38). REG. 12-14-
1993.
1,810,813. BRUSH BLANKET. INT. CL. 22. (U.S. CL. 12).
REG. 12-14-1993.
1,811,049. EXPRESSIONS OF FAITH. INT. CL. 35. (U.S. CL.
101). REG. 12-14-1993.
1,811,508. GS300. INT. CL. 12. (U.S. CL. 19). REG. 12-14-1993.
1,816,049. MISCELLANEOUS DESIGN. INT. CL. 30. (U.S.
CL. 46). REG. 1-11-1994.
1,816,620. WOODDEX. INT. CL. 6. (U.S. CLS. 13 AND 23).
REG. 1-18-1994.
1,816,635. STEAM JENNY. INT. CL. 7. (U.S. CL. 23). REG. 1-
18-1994.
1,817,724. JENNY. INT. CL. 7. (U.S. CLS. 23 AND 34). REG. 1-
25-1994.
1,818,742. HYPRESSURE JENNY. INT. CL. 7. (U.S. CL. 23).
REG. 2-1-1994.
1,820,938. EAGLE OTTAWA. INT. CL. 3. (U.S. CL. 52). REG.
2-15-1994.
1,821,581. TWIGS. INT. CL. 31. (U.S. CLS. 1 AND 50). REG. 2-
15-1994.
1,821,600. MISCELLANEOUS DESIGN. INT. CL. 34. (U.S.
CL. 17). REG. 2-15-1994.
1,823,664. RADIOMARK. INT. CL. 10. (U.S. CL. 44). REG. 2-
22-1994.
1,823,830. PTO. INT. CL. 28. (U.S. CLS. 22 AND 38). REG. 2-
22-1994.
1,825,187. LENS CATCHER. INT. CL. 21. (U.S. CLS. 2 AND
13). REG. 3-8-1994.
1,825,540. ICLE AND DESIGN. INT. CL. 41. (U.S. CL. 107).
REG. 3-8-1994.
1,825,722. BLACK OPAL. INT. CL. 3. (U.S. CLS. 51 AND 52).
REG. 3-8-1994.
1,825,742. MISCELLANEOUS DESIGN. INT. CL. 6. (U.S. CL.
13). REG. 3-8-1994.
1,827,271. ICLE AND DESIGN. INT. CL. 9. (U.S. CLS. 21
AND 36). REG. 3-22-1994.
1,828,418. IL FORNAIO (STYLIZED). INT. CLS. 29, 30 AND
33. (U.S. CLS. 46 AND 47). REG. 3-29-1994.
1,828,739. FORTRESS. INT. CL. 3. (U.S. CL. 52). REG. 3-29-
1994.
1,829,144. EAGLE OTTAWA AND DESIGN. INT. CL. 3. (U.S.
CL. 52). REG. 4-5-1994.
1,829,368. WORLDSCAN. INT. CL. 16. (U.S. CL. 38). REG. 4-
5-1994.
1,829,484. M AND DESIGN. INT. CL. 26. (U.S. CLS. 40 AND
42). REG. 4-5-1994.
1,830,363. BULLSHOOTER. INT. CL. 16. (U.S. CL. 38). REG.
4-12-1994.
1,831,368. MODUCLASSIX. INT. CL. 20. (U.S. CL. 32). REG.
4-19-1994.
1,831,530. PACIFIC COAST OIL SHOW & CONFERENCE.
INT. CL. 35. (U.S. CL. 101). REG. 4-19-1994.
1,831,626. CENTURY THEATRES. INT. CL. 41. (U.S. CL.
107). REG. 4-19-1994.
1,832,761. SMARTSASH. INT. CL. 19. (U.S. CL. 12). REG. 4-
26-1994.
1,832,967. MISCELLANEOUS DESIGN. INT. CL. 42. (U.S.
CL. 101). REG. 4-26-1994.
1,833,405. PACIFIC THEATER OF OPERATIONS. INT. CL.
28. (U.S. CLS. 22 AND 38). REG. 4-26-1994.
1,834,010. MISCELLANEOUS DESIGN. INT. CLS. 35 AND
39. (U.S. CLS. 101 AND 105). REG. 5-3-1994.
1,834,569. SNAP DRAGONS. INT. CL. 13. (U.S. CL. 9). REG.
5-3-1994.
1,835,100. DURABIDE. INT. CL. 2. (U.S. CL. 16). REG. 5-10-
1994.

* * * * *

TRADEMARK REGISTRATIONS CANCELED

The designation "U.S. Cl." appearing in this section refers to the U.S. class in effect prior to Sep. 1, 1973 rather than the international class which applies to applications filed on or after that date. For adoption of international classification see notice in the OFFICIAL GAZETTE of Jun. 26, 1973 (911 O.G. TM 210).

SECTION 7(D)

1,386,932.	GRANDE PARMESAN (STYLIZED). INT. CL. 29. REG. 3-18-1986.	739,942.	TELE-STRIPS AND DESIGN. U.S. CL. 21. REG. 10-30-1962.
1,808,286.	F1. INT. CL. 1. REG. 11-30-1993.	739,964.	SILENCE IS GOLDEN. U.S. CL. 23. REG. 10-30-1962.
2,055,372.	ERNST & YOUNG'S EXPRESS. INT. CL. 35. REG. 4-22-1997.	739,966.	TRANCO (STYLIZED). U.S. CL. 23. REG. 10-30-1962.
2,072,738.	RAPID REPLY. INT. CL. 36. REG. 6-17-1997.	739,975.	SONAIRE (STYLIZED). U.S. CL. 23. REG. 10-30-1962.
2,186,678.	FOOTPRINTS, INT'L. INT. CLS. 36 AND 42. REG. 9-1-1998.	739,987.	DURALOCK. U.S. CL. 25. REG. 10-30-1962.

SECTION 8

21,900.	ALCOOL DE MENTHE DE RICQLES AND DESIGN. U.S. CL. 51. REG. 11-1-1892.	740,040.	TIMBERLINE. U.S. CL. 37. REG. 10-30-1962.
87,919.	PENFLEX (STYLIZED). U.S. CL. 35. REG. 8-13-1912.	740,041.	ETUDE (STYLIZED). U.S. CL. 37. REG. 10-30-1962.
152,263.	ORCO AND DESIGN. U.S. CL. 46. REG. 2-21-1922.	740,046.	TRENDLEY. U.S. CL. 39. REG. 10-30-1962.
160,827.	DARLING (STYLIZED). U.S. CL. 6. REG. 10-31-1922.	740,051.	THE IMPERIAL LADY (STYLIZED). U.S. CL. 39. REG. 10-30-1962.
160,861.	FIAT. U.S. CL. 21. REG. 10-31-1922.	740,055.	GINO PAOLI. U.S. CL. 39. REG. 10-30-1962.
160,890.	RED CROSS SALT AND DESIGN. U.S. CL. 6. REG. 10-31-1922.	740,056.	GINO PAOLI AND DESIGN. U.S. CL. 39. REG. 10-30-1962.
160,910.	FORT SUTTER AND DESIGN. U.S. CL. 46. REG. 10-31-1922.	740,061.	SHIR-O-SHAKKAR KING OF WASHABLE NECKWEAR. U.S. CL. 39. REG. 10-30-1962.
160,916.	MARK (STYLIZED). U.S. CL. 35. REG. 10-31-1922.	740,066.	GASLIGHT. U.S. CL. 39. REG. 10-30-1962.
395,298.	COCK 'N BULL AND DESIGN. U.S. CL. 45. REG. 5-19-1942.	740,076.	NUFASHOND AND DESIGN. U.S. CL. 40. REG. 10-30-1962.
398,413.	DURA AND DESIGN. U.S. CL. 19. REG. 10-27-1942.	740,083.	COBOND. U.S. CL. 42. REG. 10-30-1962.
398,421.	= AIROLITE = AND DESIGN. U.S. CL. 34. REG. 10-27-1942.	740,086.	WELDEX. U.S. CL. 42. REG. 10-30-1962.
398,428.	MISCELLANEOUS DESIGN. U.S. CL. 46. REG. 10-27-1942.	740,097.	BERNAT. U.S. CL. 43. REG. 10-30-1962.
398,431.	HAMILTON. U.S. CL. 32. REG. 10-27-1942.	740,100.	AMERICAN (STYLIZED). U.S. CL. 44. REG. 10-30-1962.
398,438.	MISCELLANEOUS DESIGN. U.S. CL. 46. REG. 10-27-1942.	740,105.	SUE CORY. U.S. CL. 44. REG. 10-30-1962.
398,439.	RED CROSS. U.S. CL. 46. REG. 10-27-1942.	740,119.	ARCTIC C. U.S. CL. 46. REG. 10-30-1962.
566,424.	MELBA ROUNDS (STYLIZED). U.S. CL. 46. REG. 11-4-1952.	740,127.	WAYNE-MIX. U.S. CL. 46. REG. 10-30-1962.
728,415.	SET. U.S. CL. 12. REG. 3-13-1962.	740,130.	BUITONI (STYLIZED). U.S. CL. 46. REG. 10-30-1962.
739,861.	CUTLER. U.S. CL. 2. REG. 10-30-1962.	740,133.	JOSE PEMARTIN (STYLIZED). U.S. CL. 47. REG. 10-30-1962.
739,863.	BUR LENE (STYLIZED). U.S. CL. 2. REG. 10-30-1962.	740,135.	KG. U.S. CL. 49. REG. 10-30-1962.
739,872.	DUETTE. U.S. CL. 3. REG. 10-30-1962.	740,140.	SURFATROPE. U.S. CL. 52. REG. 10-30-1962.
739,877.	N-K. U.S. CL. 6. REG. 10-30-1962.	740,150.	HT AND DESIGN. U.S. CL. 103. REG. 10-30-1962.
739,899.	CONFLEX (STYLIZED). U.S. CL. 13. REG. 10-30-1962.	937,600.	BRIGHT OF AMERICA. U.S. CL. 38. ONLY. REG. 7-11-1972.
739,902.	CHEMTITE. U.S. CL. 13. REG. 10-30-1962.	938,168.	DE JEAN'S. U.S. CL. 46. REG. 7-18-1972.
739,908.	DURALOCK. U.S. CL. 13. REG. 10-30-1962.	1,175,096.	BIENFANG. INT. CLS. 16 AND 17. REG. 10-27-1981.
739,911.	SHIELDOR (STYLIZED). U.S. CL. 13. REG. 10-30-1962.	1,198,289.	CAREINSTITUTE. INT. CL. 41. REG. 6-15-1982.
739,923.	TOLINASE. U.S. CL. 18. REG. 10-30-1962.	1,210,213.	CONTROL. INT. CL. 5. REG. 9-28-1982.
739,932.	MAOLATE. U.S. CL. 18. REG. 10-30-1962.	1,213,703.	NEGALITH. INT. CLS. 1 AND 7. REG. 10-26-1982.
739,934.	TUSSTROL. U.S. CL. 18. REG. 10-30-1962.	1,213,706.	GENOVESE. INT. CL. 1. REG. 10-26-1982.
739,936.	AEROBUS (STYLIZED). U.S. CL. 19. REG. 10-30-1962.	1,213,707.	MISCELLANEOUS DESIGN. INT. CL. 1. REG. 10-26-1982.
		1,213,725.	EMERY (STYLIZED). INT. CL. 1. REG. 10-26-1982.
		1,213,727.	HOUSE SAVER AND DESIGN. INT. CL. 2. REG. 10-26-1982.
		1,213,729.	POLY-TONE. INT. CL. 2. REG. 10-26-1982.
		1,213,740.	NEW-MATIZING. INT. CLS. 3 AND 37. REG. 10-26-1982.

- 1,213,743. MIRROR. INT. CL. 3. REG. 10-26-1982.
 1,213,745. PREM. INT. CL. 3. REG. 10-26-1982.
 1,213,746. NU-TROX. INT. CL. 3. REG. 10-26-1982.
 1,213,756. CASTROL MIRACOL. INT. CL. 4. REG. 10-26-1982.
 1,213,758. NOPALCOL. INT. CL. 4. REG. 10-26-1982.
 1,213,759. MELGRIND. INT. CL. 4. REG. 10-26-1982.
 1,213,760. MELCOMOLY. INT. CL. 4. REG. 10-26-1982.
 1,213,764. DELTIC. INT. CL. 5. REG. 10-26-1982.
 1,213,766. CEFOMONIL. INT. CL. 5. REG. 10-26-1982.
 1,213,775. GUSTAVSBERG AND DESIGN. INT. CLS. 6, 7, 11, 19, 20 AND 21. REG. 10-26-1982.
 1,213,776. B AND DESIGN. INT. CLS. 6 AND 19. REG. 10-26-1982.
 1,213,779. DAVIS BELL-STOP. INT. CL. 6. REG. 10-26-1982.
 1,213,781. VMC. INT. CL. 6. REG. 10-26-1982.
 1,213,786. CORROFLO. INT. CL. 6. REG. 10-26-1982.
 1,213,790. SKF. INT. CL. 6. REG. 10-26-1982.
 1,213,792. PYPLOK AND DESIGN. INT. CL. 6. REG. 10-26-1982.
 1,213,793. GC GATE CITY STEEL THE GOOD SERVICE PEOPLE (STYLIZED). INT. CL. 6. REG. 10-26-1982.
 1,213,795. ULTRACOAT. INT. CL. 6. REG. 10-26-1982.
 1,213,803. F. AND DESIGN. INT. CLS. 7, 12 AND 17. REG. 10-26-1982.
 1,213,809. CYBOTECH. INT. CL. 7. REG. 10-26-1982.
 1,213,811. TAYLOR MAID. INT. CLS. 8 AND 21. REG. 10-26-1982.
 1,213,812. KIENZLE. INT. CLS. 9 AND 16. REG. 10-26-1982.
 1,213,813. ARC. INT. CL. 9. REG. 10-26-1982.
 1,213,814. QUICK-WRAP. INT. CL. 9. REG. 10-26-1982.
 1,213,818. CANSTAR. INT. CLS. 9, 37, 38 AND 42. REG. 10-26-1982.
 1,213,830. NEWSTRACK. INT. CL. 9. REG. 10-26-1982.
 1,213,835. NUK (STYLIZED). INT. CLS. 10 AND 21. REG. 10-26-1982.
 1,213,849. QUALIFIER. INT. CL. 13. REG. 10-26-1982.
 1,213,854. GUILLAUME. INT. CL. 14. REG. 10-26-1982.
 1,213,862. LEATHER LOCK. INT. CL. 14. REG. 10-26-1982.
 1,213,869. PER SPOOK. (STYLIZED). INT. CLS. 14, 18, 25 AND 42. REG. 10-26-1982.
 1,213,871. ARC. INT. CL. 16. REG. 10-26-1982.
 1,213,872. EASTERN'S BUSINESSWOMAN. INT. CL. 16. REG. 10-26-1982.
 1,213,873. SHAZBOT. INT. CL. 16. REG. 10-26-1982.
 1,213,874. MORK FROM ORK AND DESIGN. INT. CL. 16. REG. 10-26-1982.
 1,213,876. COSMIC AND DESIGN. INT. CLS. 16 AND 42. REG. 10-26-1982.
 1,213,879. ASPEN INSTITUTE. INT. CL. 16. REG. 10-26-1982.
 1,213,881. GLOBAL BALL. INT. CLS. 16 AND 28. REG. 10-26-1982.
 1,213,884. SCHOLASTIC BOOK SERVICES. INT. CLS. 16 AND 41. REG. 10-26-1982.
 1,213,885. THE DOOBIE DB BROTHERS AND DESIGN. INT. CLS. 16 AND 41. REG. 10-26-1982.
 1,213,887. REDJACK. INT. CL. 16. REG. 10-26-1982.
 1,213,889. EHRET LITERATURE PUBLISHING CO.. INT. CL. 16. REG. 10-26-1982.
 1,213,890. MISCELLANEOUS DESIGN. INT. CL. 16. REG. 10-26-1982.
 1,213,892. COACH & ATHLETE. INT. CL. 16. REG. 10-26-1982.
 1,213,895. SUPER SIMPLE. INT. CL. 16. REG. 10-26-1982.
 1,213,898. FORMRUN. INT. CL. 16. REG. 10-26-1982.
 1,213,903. WDX. INT. CL. 16. REG. 10-26-1982.
 1,213,907. SHEFFIELD LEGAL PARCHMENT. INT. CL. 16. REG. 10-26-1982.
 1,213,908. COMMODITY YEAR BOOK STATISTICAL ABSTRACT SERVICE. INT. CL. 16. REG. 10-26-1982.
 1,213,910. CUDDLE BUNNIES. INT. CL. 16. REG. 10-26-1982.
 1,213,912. WINTERTHUR (STYLIZED). INT. CL. 16. REG. 10-26-1982.
 1,213,916. H HILL AND DESIGN. INT. CLS. 16 AND 41. REG. 10-26-1982.
 1,213,917. HARLEQUIN BOOKS (STYLIZED). INT. CL. 16. REG. 10-26-1982.
 1,213,922. RH AND DESIGN. INT. CL. 16. REG. 10-26-1982.
 1,213,926. CRAYOLA.ROLA. INT. CL. 16. REG. 10-26-1982.
 1,213,927. AG PERSPECTIVES. INT. CL. 16. REG. 10-26-1982.
 1,213,935. FOLDCOTE. INT. CL. 16. REG. 10-26-1982.
 1,213,936. KIDDIE GRAM. INT. CL. 16. REG. 10-26-1982.
 1,213,937. PATRIOT. INT. CL. 16. REG. 10-26-1982.
 1,213,938. MILLER COMPREHENSIVE GAAP GUIDE AND DESIGN. INT. CL. 16. REG. 10-26-1982.
 1,213,939. PRESTAX. INT. CL. 16. REG. 10-26-1982.
 1,213,940. PEERLESS PROXY MAILER. INT. CL. 16. REG. 10-26-1982.
 1,213,944. THE FINE PAPER HOUSE. INT. CL. 16. REG. 10-26-1982.
 1,213,947. BASIC (STYLIZED). INT. CL. 16. REG. 10-26-1982.
 1,213,950. LINGUITRONICS. INT. CLS. 16 AND 41. REG. 10-26-1982.
 1,213,964. HOGAN. INT. CLS. 18, 25 AND 28. REG. 10-26-1982.
 1,213,967. ROGER & GALLET. INT. CLS. 18 AND 25. REG. 10-26-1982.
 1,213,972. SOPRASOLIN. INT. CL. 19. REG. 10-26-1982.
 1,213,977. CEDAR MARK HOMES (STYLIZED). INT. CL. 19. REG. 10-26-1982.
 1,213,980. CORK-TEX. INT. CL. 19. REG. 10-26-1982.
 1,213,986. L-P-WAFERWOOD. INT. CL. 19. REG. 10-26-1982.
 1,213,987. TEMPA FORM. INT. CL. 19. REG. 10-26-1982.
 1,213,989. SUN VALLEY WATERBEDS. INT. CL. 20. REG. 10-26-1982.
 1,213,994. THE UPPER CRUST. INT. CL. 20. REG. 10-26-1982.
 1,213,997. LY-PAK. INT. CL. 20. REG. 10-26-1982.
 1,213,998. WINTERTHUR (STYLIZED). INT. CL. 20. REG. 10-26-1982.
 1,214,000. RADIO CITY MUSIC HALL. INT. CL. 20. REG. 10-26-1982.
 1,214,001. FLIP LOK. INT. CL. 20. REG. 10-26-1982.
 1,214,010. LILIEEN PORZELLAN. INT. CL. 21. REG. 10-26-1982.
 1,214,011. LILIEEN PORZELLAN AUSTRIA AND DESIGN. INT. CL. 21. REG. 10-26-1982.
 1,214,012. HEXI-SPACESAVER. INT. CL. 21. REG. 10-26-1982.
 1,214,013. PLAYMATE PLUS. INT. CL. 21. REG. 10-26-1982.
 1,214,016. ENTRAY. INT. CL. 21. REG. 10-26-1982.
 1,214,025. THE TOY WORKS AND DESIGN. INT. CLS. 24 AND 28. REG. 10-26-1982.
 1,214,027. HILAIRE COLCOMBET-BUCOL (STYLIZED). INT. CLS. 24 AND 25. REG. 10-26-1982.
 1,214,028. CLOTHWORKS. INT. CLS. 24, 28 AND 42. REG. 10-26-1982.
 1,214,031. LYCLAD. INT. CL. 24. REG. 10-26-1982.
 1,214,035. TERRI-E (STYLIZED). INT. CL. 24. REG. 10-26-1982.
 1,214,041. B.P. BRITCHES AND DESIGN. INT. CL. 25. REG. 10-26-1982.
 1,214,043. "SISTINE SATIN". INT. CL. 25. REG. 10-26-1982.
 1,214,048. HANSEN. INT. CL. 25. REG. 10-26-1982.
 1,214,049. GUARDIAN ANGELS SAFETY PATROL AND DESIGN. INT. CLS. 25 AND 42. REG. 10-26-1982.
 1,214,053. REYNOLDS. INT. CL. 25. REG. 10-26-1982.
 1,214,057. SUHANA. INT. CL. 25. REG. 10-26-1982.
 1,214,058. AIMEE JULIEN AND DESIGN. INT. CL. 25. REG. 10-26-1982.
 1,214,059. OFF SHORE. INT. CL. 25. REG. 10-26-1982.
 1,214,061. SILVERWOODS. INT. CL. 25. REG. 10-26-1982.
 1,214,069. LAURA DARE. INT. CL. 25. REG. 10-26-1982.
 1,214,080. GRATEFUL DEAD AND DESIGN. INT. CL. 25. REG. 10-26-1982.
 1,214,089. AMORELLA. INT. CL. 25. REG. 10-26-1982.
 1,214,091. RAG DOLL (STYLIZED). INT. CL. 25. REG. 10-26-1982.
 1,214,095. ROBINIT (STYLIZED). INT. CL. 25. REG. 10-26-1982.
 1,214,102. AHC (STYLIZED). INT. CL. 25. REG. 10-26-1982.
 1,214,103. WESTERNER. INT. CL. 25. REG. 10-26-1982.
 1,214,112. ESPA-STRETCH. INT. CL. 25. REG. 10-26-1982.

- 1,214,113. LARRY MAHAN. INT. CL. 25. REG. 10-26-1982.
1,214,127. TAHITI. INT. CL. 27. REG. 10-26-1982.
1,214,129. ROBERTEX ROBERTEX AMERICA'S WOOL CARPET COMPANY (STYLIZED). INT. CL. 27. REG. 10-26-1982.
1,214,132. CUSTOMAX. INT. CL. 27. REG. 10-26-1982.
1,214,138. DISET AND DESIGN. INT. CL. 28. REG. 10-26-1982.
1,214,139. RIVIERA (STYLIZED). INT. CL. 28. REG. 10-26-1982.
1,214,142. MISCELLANEOUS DESIGN. INT. CL. 28. REG. 10-26-1982.
1,214,147. MONEYPOWER. INT. CL. 28. REG. 10-26-1982.
1,214,151. "LITTLE-JOHN". INT. CL. 28. REG. 10-26-1982.
1,214,154. THERMO-SKI. INT. CL. 28. REG. 10-26-1982.
1,214,159. SKIMEE (STYLIZED). INT. CL. 28. REG. 10-26-1982.
1,214,161. RAIL BARON. INT. CL. 28. REG. 10-26-1982.
1,214,166. BOLIGOMA. INT. CL. 28. REG. 10-26-1982.
1,214,167. SPALDING (STYLIZED). INT. CL. 28. REG. 10-26-1982.
1,214,171. P.TEE. INT. CL. 28. REG. 10-26-1982.
1,214,179. GRAPHITE CBK. INT. CL. 28. REG. 10-26-1982.
1,214,181. DUPLO AND DESIGN. INT. CL. 28. REG. 10-26-1982.
1,214,184. BIRDY. INT. CL. 28. REG. 10-26-1982.
1,214,202. FW1. INT. CL. 28. REG. 10-26-1982.
1,214,204. CUSTOM CLASSIC. INT. CL. 28. REG. 10-26-1982.
1,214,218. VANESSA. INT. CL. 28. REG. 10-26-1982.
1,214,220. KANDOS AND DESIGN. INT. CLS. 29 AND 30. REG. 10-26-1982.
1,214,226. THE CANNERY. INT. CL. 29. REG. 10-26-1982.
1,214,228. EMBASA EMBASA AND DESIGN. INT. CL. 29. REG. 10-26-1982.
1,214,235. DELTA PLANTATION. INT. CL. 29. REG. 10-26-1982.
1,214,236. DIXIE-NUGGETS. INT. CL. 29. REG. 10-26-1982.
1,214,238. NOBILITO. INT. CL. 29. REG. 10-26-1982.
1,214,240. STARBAR AND DESIGN. INT. CL. 30. REG. 10-26-1982.
1,214,241. CHOCADO POPS (STYLIZED). INT. CL. 30. REG. 10-26-1982.
1,214,243. HAMFULL. INT. CL. 30. REG. 10-26-1982.
1,214,244. MISCELLANEOUS DESIGN. INT. CL. 30. REG. 10-26-1982.
1,214,245. HB AND DESIGN. INT. CL. 30. REG. 10-26-1982.
1,214,249. KITTY POO. INT. CL. 31. REG. 10-26-1982.
1,214,250. CALIFORNIA BIG TOP CELERY AND DESIGN. INT. CL. 31. REG. 10-26-1982.
1,214,258. MISCELLANEOUS DESIGN. INT. CL. 32. REG. 10-26-1982.
1,214,263. DOMAINES R AND DESIGN. INT. CL. 33. REG. 10-26-1982.
1,214,266. H AND DESIGN. INT. CL. 35. REG. 10-26-1982.
1,214,267. WACKENHUT SECURITY SYSTEMS AND SERVICES THROUGHOUT THE WORLD (STYLIZED). INT. CLS. 35 AND 42. REG. 10-26-1982.
1,214,274. TIME TEMPORARIES (STYLIZED). INT. CL. 35. REG. 10-26-1982.
1,214,277. THE FIRST NAME IN FINE REAL ESTATE. INT. CL. 35. REG. 10-26-1982.
1,214,285. PCS/CTAMS. INT. CL. 35. REG. 10-26-1982.
1,214,288. TV AUCTION. INT. CL. 35. REG. 10-26-1982.
1,214,289. MISCELLANEOUS DESIGN. INT. CL. 35. REG. 10-26-1982.
1,214,291. MISCELLANEOUS DESIGN. INT. CL. 35. REG. 10-26-1982.
1,214,292. GOTMO. INT. CL. 35. REG. 10-26-1982.
1,214,293. SCAN AND DESIGN. INT. CL. 35. REG. 10-26-1982.
1,214,294. ERA EXTRA RISK ASSOCIATES (STYLIZED). INT. CL. 36. REG. 10-26-1982.
1,214,312. MARKETPAC. INT. CL. 36. REG. 10-26-1982.
1,214,315. GALIC (STYLIZED). INT. CL. 36. REG. 10-26-1982.
1,214,318. TIP AND DESIGN. INT. CL. 36. REG. 10-26-1982.
1,214,321. IRA/UNIVERSAL. INT. CL. 36. REG. 10-26-1982.
1,214,324. SRC AND DESIGN. INT. CL. 36. REG. 10-26-1982.
1,214,332. THE AERO INC. AND DESIGN. INT. CL. 37. REG. 10-26-1982.
1,214,337. B BONRAY AND DESIGN. INT. CL. 37. REG. 10-26-1982.
1,214,341. SPIRIT OF ALASKA. INT. CL. 38. REG. 10-26-1982.
1,214,348. AIR PACIFIC YOUR ISLAND IN THE SKY AND DESIGN. INT. CL. 39. REG. 10-26-1982.
1,214,352. ANR AND DESIGN. INT. CL. 39. REG. 10-26-1982.
1,214,354. MISCELLANEOUS DESIGN. INT. CL. 39. REG. 10-26-1982.
1,214,356. THE GRAY LINE AND DESIGN. INT. CL. 39. REG. 10-26-1982.
1,214,362. AC ALLOY CLADDING AND DESIGN. INT. CL. 40. REG. 10-26-1982.
1,214,367. MISCELLANEOUS DESIGN. INT. CL. 41. REG. 10-26-1982.
1,214,368. AMERICA GO FORTH AND FIX. INT. CL. 41. REG. 10-26-1982.
1,214,372. DINGBATS AND DESIGN. INT. CL. 41. REG. 10-26-1982.
1,214,373. REACHING THE WORLD IN THIS GENERATION THROUGH TRAINED CHRISTIAN LEADERS AND DESIGN. INT. CL. 41. REG. 10-26-1982.
1,214,379. SESAME STREET LIVE. INT. CL. 41. REG. 10-26-1982.
1,214,380. THE FLYING DUTCHMAN. INT. CL. 41. REG. 10-26-1982.
1,214,389. INDIANAPOLIS 500 THE SIXTY-SIXTH.MAY 30, 1982 AND DESIGN. INT. CL. 41. REG. 10-26-1982.
1,214,392. WINTERTHUR. INT. CL. 41. REG. 10-26-1982.
1,214,395. CINEMASLIDE (STYLIZED). INT. CL. 41. REG. 10-26-1982.
1,214,400. AMA AND DESIGN. INT. CL. 41. REG. 10-26-1982.
1,214,408. CRAZY JOE'S. INT. CL. 42. REG. 10-26-1982.
1,214,413. CAFE A'LEX AND DESIGN. INT. CL. 42. REG. 10-26-1982.
1,214,414. MISCELLANEOUS DESIGN. INT. CL. 42. REG. 10-26-1982.
1,214,416. CT AND DESIGN. INT. CL. 42. REG. 10-26-1982.
1,214,422. DD AND DESIGN. INT. CL. 42. REG. 10-26-1982.
1,214,424. DUNFEY HOTELS AND DESIGN. INT. CL. 42. REG. 10-26-1982.
1,214,437. 1 FOOD CHIEF AND DESIGN. INT. CL. 42. REG. 10-26-1982.
1,214,439. LA RUE DES REVES (STYLIZED). INT. CL. 42. REG. 10-26-1982.
1,214,443. KEY BUY (STYLIZED). INT. CL. 42. REG. 10-26-1982.
1,214,444. SAE THE ENGINEERING RESOURCE FOR ADVANCING MOBILITY (STYLIZED). INT. CL. 42. REG. 10-26-1982.
1,214,450. FIRST-START. INT. CL. 42. REG. 10-26-1982.
1,214,456. THE HIGH Q. INT. CL. 42. REG. 10-26-1982.
1,214,460. ABODIO AND DESIGN. INT. CL. 42. REG. 10-26-1982.
1,214,464. WOODEN DOOR. INT. CL. 42. REG. 10-26-1982.
1,214,466. GREENMAN'S DELI - THE HOME OF THE REAL HOAGIE. INT. CL. 42. REG. 10-26-1982.
1,214,467. BUMBLE + BUMBLE. INT. CL. 42. REG. 10-26-1982.
1,214,471. MISCELLANEOUS DESIGN. INT. CL. 42. REG. 10-26-1982.
1,214,477. CHRIST'S SANCTIFIED HOLY CHURCH. U.S. CL. 200. REG. 10-26-1982.
1,214,478. MISCELLANEOUS DESIGN. U.S. CL. A. REG. 10-26-1982.
1,214,480. NUCLEIC PLUS (STYLIZED). INT. CL. 3. REG. 10-26-1982.
1,214,486. WHISTLE HELP. INT. CL. 9. REG. 10-26-1982.
1,214,491. OFFICE EQUIPMENT & METHODS. INT. CL. 16. REG. 10-26-1982.
1,214,492. ATLANTIC CITY MAGAZINE (STYLIZED). INT. CL. 16. REG. 10-26-1982.
1,214,499. BOXETTE. INT. CL. 21. REG. 10-26-1982.

- 1,214,508. BRING 'EM BACK CASH 'EM IN. INT. CL. 37. REG. 10-26-1982.
- 1,238,220. UNIVERSITY OF NOTRE DAME AND DESIGN. INT. CL. 26 ONLY. REG. 5-17-1983.
- 1,674,248. MCMILLEN COLLECTION. INT. CL. 20. REG. 2-4-1992.
- 1,689,131. SNO-FLAKE. INT. CL. 25. REG. 5-26-1992.
- 1,695,305. THE DESIGN CONNECTION. INT. CL. 14. REG. 6-16-1992.
- 1,700,656. MANNINGTON GOLD SERIES. INT. CL. 27. REG. 7-14-1992.
- 1,700,932. BACK TO THE BEACH. INT. CL. 41. REG. 7-14-1992.
- 1,703,849. DESIGNS FOR LEARNING. INT. CL. 41. REG. 7-28-1992.
- 1,704,227. CONTENT WORLD. INT. CL. 16. REG. 7-28-1992.
- 1,707,068. EDWARD'S. INT. CL. 30 ONLY. REG. 8-11-1992.
- 1,708,290. MISCELLANEOUS DESIGN. INT. CL. 25. REG. 8-18-1992.
- 1,710,128. GOLDEN TIGER AND DESIGN. INT. CL. 25. REG. 8-25-1992.
- 1,710,148. TG (STYLIZED). INT. CL. 25. REG. 8-25-1992.
- 1,713,539. THE SHY LITTLE KITTEN. INT. CL. 16. REG. 9-8-1992.
- 1,715,502. EXEL (STYLIZED). INT. CL. 13. REG. 9-15-1992.
- 1,715,920. L.B. EVANS SINCE 1804. INT. CL. 25. REG. 9-15-1992.
- 1,718,142. DB (STYLIZED). INT. CLS. 18 AND 25. REG. 9-22-1992.
- 1,725,467. T&C. INT. CL. 14. REG. 10-20-1992.
- 1,726,800. DERMATEIN. INT. CL. 1. REG. 10-27-1992.
- 1,726,801. ELASTEIN 5000. INT. CL. 1. REG. 10-27-1992.
- 1,726,805. RIBOSEP. INT. CL. 1. REG. 10-27-1992.
- 1,726,807. CARBOMANT. INT. CL. 1. REG. 10-27-1992.
- 1,726,811. ROT-GARD (STYLIZED). INT. CL. 1. REG. 10-27-1992.
- 1,726,812. RED613. INT. CL. 1. REG. 10-27-1992.
- 1,726,815. ALOECORP AND DESIGN. INT. CL. 1. REG. 10-27-1992.
- 1,726,819. PASCOFIX. INT. CL. 1. REG. 10-27-1992.
- 1,726,821. RIOCIDE. INT. CLS. 1 AND 5. REG. 10-27-1992.
- 1,726,825. THERMO-STRIPS. INT. CL. 1. REG. 10-27-1992.
- 1,726,828. ISAPLAST. INT. CL. 1. REG. 10-27-1992.
- 1,726,832. ACT. INT. CL. 1. REG. 10-27-1992.
- 1,726,836. V TECH (STYLIZED). INT. CLS. 1 AND 6. REG. 10-27-1992.
- 1,726,839. NAZDASOL RAPID. INT. CL. 1. REG. 10-27-1992.
- 1,726,841. NAZDASOL X-TRA. INT. CL. 1. REG. 10-27-1992.
- 1,726,842. ALLSTATES COATINGS COMPANY. INT. CL. 1. REG. 10-27-1992.
- 1,726,845. CLONEAMP. INT. CL. 1. REG. 10-27-1992.
- 1,726,855. TYBAR. INT. CL. 1. REG. 10-27-1992.
- 1,726,859. UV GUARD. INT. CL. 1. REG. 10-27-1992.
- 1,726,870. THICK'N QUICK. INT. CL. 2. REG. 10-27-1992.
- 1,726,872. SPORTSMAN. INT. CL. 2. REG. 10-27-1992.
- 1,726,879. BIOPTRON. INT. CLS. 3, 5 AND 32. REG. 10-27-1992.
- 1,726,884. RAINFOREST. INT. CL. 3. REG. 10-27-1992.
- 1,726,895. ONE STEP. INT. CL. 3. REG. 10-27-1992.
- 1,726,904. BREATH O' PINE AND DESIGN. INT. CL. 3. REG. 10-27-1992.
- 1,726,907. TOPIFRAM UNDER-EYE TREATMENT AND DESIGN. INT. CLS. 3 AND 5. REG. 10-27-1992.
- 1,726,921. DREXOFF. INT. CL. 3. REG. 10-27-1992.
- 1,726,940. PROCOR TECHNOLOGIES. INT. CL. 5. REG. 10-27-1992.
- 1,726,951. ULTRA DIET PLAN. INT. CL. 5. REG. 10-27-1992.
- 1,726,952. B AND DESIGN. INT. CL. 5. REG. 10-27-1992.
- 1,726,954. PRO-BAC. INT. CL. 5. REG. 10-27-1992.
- 1,726,958. AXON. INT. CL. 5. REG. 10-27-1992.
- 1,726,969. BIONEED. INT. CL. 5. REG. 10-27-1992.
- 1,726,992. EPP. INT. CL. 6. REG. 10-27-1992.
- 1,727,002. MISCELLANEOUS DESIGN. INT. CL. 6. REG. 10-27-1992.
- 1,727,005. RESPENSER. INT. CL. 6. REG. 10-27-1992.
- 1,727,008. SAF-T-ISOLATOR. INT. CL. 6. REG. 10-27-1992.
- 1,727,010. BOSS AND DESIGN. INT. CL. 6. REG. 10-27-1992.
- 1,727,018. PECO AND DESIGN. INT. CL. 7. REG. 10-27-1992.
- 1,727,020. SERVOCONE (STYLIZED). INT. CL. 7. REG. 10-27-1992.
- 1,727,023. MITY MITE. INT. CL. 7. REG. 10-27-1992.
- 1,727,024. HAHN INDUSTRIES AND DESIGN. INT. CL. 7. REG. 10-27-1992.
- 1,727,026. GLASSALOY. INT. CL. 7. REG. 10-27-1992.
- 1,727,027. SUPER-MOD. INT. CL. 7. REG. 10-27-1992.
- 1,727,031. LEUCO DIA AND DESIGN. INT. CL. 7. REG. 10-27-1992.
- 1,727,035. LEGRAND. INT. CL. 7. REG. 10-27-1992.
- 1,727,060. "PERFORMANCE UNDER PRESSURE" AND DESIGN. INT. CL. 7. REG. 10-27-1992.
- 1,727,067. QC SYSTEM AND DESIGN. INT. CL. 7. REG. 10-27-1992.
- 1,727,075. SENSEI SHEAR SYSTEMS AND DESIGN. INT. CL. 8. REG. 10-27-1992.
- 1,727,076. CABLE QUICK. INT. CL. 8. REG. 10-27-1992.
- 1,727,082. STINGER AND DESIGN. INT. CL. 8. REG. 10-27-1992.
- 1,727,097. SATTTOP. INT. CL. 9. REG. 10-27-1992.
- 1,727,106. TERRA VAC. INT. CLS. 9 AND 37. REG. 10-27-1992.
- 1,727,109. DIALOGIC. INT. CL. 9. REG. 10-27-1992.
- 1,727,133. BIG CLEANING POWER IN A COMPACT PACKAGE. INT. CL. 9. REG. 10-27-1992.
- 1,727,138. IDEAL INTERACTIVE TRAINING AND DESIGN. INT. CL. 9. REG. 10-27-1992.
- 1,727,148. DURAN. INT. CL. 9. REG. 10-27-1992.
- 1,727,154. ELITEGROUP. INT. CL. 9. REG. 10-27-1992.
- 1,727,155. ECS ELITEGROUP AND DESIGN. INT. CL. 9. REG. 10-27-1992.
- 1,727,159. THE SWORD OF THE LORD MESSIANIC MINISTRY THE SWORD OF THE SPIRIT IS THE WORD OF AND DESIGN. INT. CLS. 9 AND 16. REG. 10-27-1992.
- 1,727,175. PRO-FIT. INT. CL. 9. REG. 10-27-1992.
- 1,727,190. ASCEND. INT. CL. 9. REG. 10-27-1992.
- 1,727,198. INFORM. INT. CLS. 9 AND 36. REG. 10-27-1992.
- 1,727,199. DDDD AND DESIGN. INT. CLS. 9 AND 11. REG. 10-27-1992.
- 1,727,205. ANYKEY. INT. CL. 9. REG. 10-27-1992.
- 1,727,206. ZTEK VP REMOTE. INT. CL. 9. REG. 10-27-1992.
- 1,727,207. SPEEDY (STYLIZED). INT. CLS. 9 AND 16. REG. 10-27-1992.
- 1,727,211. DIESEL ONLY. INT. CL. 9. REG. 10-27-1992.
- 1,727,219. STAR SWITCH AND DESIGN. INT. CL. 9. REG. 10-27-1992.
- 1,727,258. SOLUTION IV ACCOUNTING AND DESIGN. INT. CL. 9. REG. 10-27-1992.
- 1,727,259. OPENT1. INT. CL. 9. REG. 10-27-1992.
- 1,727,260. CD CLIF DESIGNS AND DESIGN. INT. CL. 9. REG. 10-27-1992.
- 1,727,262. DATA RACE AND DESIGN. INT. CL. 9. REG. 10-27-1992.
- 1,727,265. NSM LOUDSPEAKERS. INT. CL. 9. REG. 10-27-1992.
- 1,727,268. BLUE KNIGHT AND DESIGN. INT. CL. 9. REG. 10-27-1992.
- 1,727,277. FUNDBALANCE PLUS AND DESIGN. INT. CL. 9. REG. 10-27-1992.
- 1,727,282. ONE FOR ALL. INT. CL. 9. REG. 10-27-1992.
- 1,727,283. MERONA. INT. CL. 9. REG. 10-27-1992.
- 1,727,286. MISCELLANEOUS DESIGN. INT. CL. 9. REG. 10-27-1992.
- 1,727,287. LESN. INT. CL. 9. REG. 10-27-1992.
- 1,727,299. TIXON. INT. CL. 9. REG. 10-27-1992.
- 1,727,303. COMPEST FRANKLIN OFFSET CATALOG (STYLIZED). INT. CL. 9. REG. 10-27-1992.
- 1,727,305. RFM (STYLIZED). INT. CL. 9. REG. 10-27-1992.
- 1,727,306. HYDROPHONICS. INT. CL. 9. REG. 10-27-1992.
- 1,727,311. LOGIST. INT. CLS. 9 AND 16. REG. 10-27-1992.
- 1,727,314. FOR THE BUSINESS OF BEING CREATIVE (STYLIZED). INT. CL. 9. REG. 10-27-1992.
- 1,727,315. SUPERFONE AND DESIGN. INT. CL. 9. REG. 10-27-1992.
- 1,727,317. POWerview. INT. CL. 9. REG. 10-27-1992.
- 1,727,325. ISOFLEX. INT. CL. 10. REG. 10-27-1992.
- 1,727,328. BICORD. INT. CL. 10. REG. 10-27-1992.

- 1,727,335. MICROHOLSTER. INT. CL. 10. REG. 10-27-1992.
1,727,345. DOLOMAT. INT. CL. 10. REG. 10-27-1992.
1,727,348. FLAT-BACK. INT. CL. 10. REG. 10-27-1992.
1,727,354. FARMONT. INT. CLS. 11 AND 12. REG. 10-27-1992.
1,727,361. LF-16. INT. CL. 11. REG. 10-27-1992.
1,727,362. GEMINI. INT. CL. 11. REG. 10-27-1992.
1,727,363. NAPLES. INT. CL. 11. REG. 10-27-1992.
1,727,365. MTS. INT. CL. 11. REG. 10-27-1992.
1,727,368. BIOHOCH. INT. CL. 11. REG. 10-27-1992.
1,727,371. MISCELLANEOUS DESIGN. INT. CLS. 11 AND 17. REG. 10-27-1992.
1,727,374. MISCELLANEOUS DESIGN. INT. CL. 11. REG. 10-27-1992.
1,727,375. RAZZA. INT. CL. 11. REG. 10-27-1992.
1,727,380. PERFECT COMPANION. INT. CL. 11. REG. 10-27-1992.
1,727,381. SPIRAL3. INT. CL. 11. REG. 10-27-1992.
1,727,382. WATER STAR AND DESIGN. INT. CL. 11. REG. 10-27-1992.
1,727,383. TANK BANK. INT. CL. 11. REG. 10-27-1992.
1,727,387. ADMIRAL. INT. CL. 11. REG. 10-27-1992.
1,727,388. RADINOX. INT. CL. 11. REG. 10-27-1992.
1,727,389. ELECTROFLOC. INT. CL. 11. REG. 10-27-1992.
1,727,392. PRESSALITE (STYLIZED). INT. CL. 11. REG. 10-27-1992.
1,727,398. PROLIGHT AND DESIGN. INT. CL. 11. REG. 10-27-1992.
1,727,406. RACK MASTER. INT. CL. 12. REG. 10-27-1992.
1,727,408. STRIPSCREEN (STYLIZED). INT. CL. 12. REG. 10-27-1992.
1,727,414. BULKRAILER. INT. CL. 12. REG. 10-27-1992.
1,727,423. NOVA. INT. CL. 12. REG. 10-27-1992.
1,727,433. HYPO SENSE. INT. CL. 14. REG. 10-27-1992.
1,727,434. CADILLAC. INT. CL. 14. REG. 10-27-1992.
1,727,435. B (STYLIZED). INT. CL. 14. REG. 10-27-1992.
1,727,437. L (STYLIZED). INT. CL. 14. REG. 10-27-1992.
1,727,454. TG (STYLIZED). INT. CL. 15. REG. 10-27-1992.
1,727,456. THE TALKING PHONEBOOK. INT. CL. 16. REG. 10-27-1992.
1,727,466. MISCELLANEOUS DESIGN. INT. CLS. 16, 35 AND 36. REG. 10-27-1992.
1,727,469. LEADERSHIP. INT. CL. 16. REG. 10-27-1992.
1,727,471. CHEAP CALORIE SERIES. INT. CL. 16. REG. 10-27-1992.
1,727,475. LYNTON. INT. CL. 16. REG. 10-27-1992.
1,727,478. ROLF LINES. INT. CL. 16. REG. 10-27-1992.
1,727,487. ADIS INTERNATIONAL AND DESIGN. INT. CL. 16. REG. 10-27-1992.
1,727,493. THE TRUCK BLUE BOOK RESIDUAL VALUES. INT. CL. 16. REG. 10-27-1992.
1,727,496. VENTURA COUNTY LIFE. INT. CL. 16. REG. 10-27-1992.
1,727,500. ESPECIALLY FOR YOU. INT. CL. 16. REG. 10-27-1992.
1,727,505. ACCU-CRISP. INT. CL. 16. REG. 10-27-1992.
1,727,507. ZIP-LIP. INT. CL. 16. REG. 10-27-1992.
1,727,527. MISCELLANEOUS DESIGN. INT. CL. 16. REG. 10-27-1992.
1,727,528. AVANTIS. INT. CL. 16. REG. 10-27-1992.
1,727,542. MISCELLANEOUS DESIGN. INT. CL. 16. REG. 10-27-1992.
1,727,567. MISCELLANEOUS DESIGN. INT. CL. 16. REG. 10-27-1992.
1,727,570. ENVIROSTAND. INT. CL. 16. REG. 10-27-1992.
1,727,577. TIE TITE. INT. CL. 16. REG. 10-27-1992.
1,727,578. IGLINE (STYLIZED). INT. CL. 16. REG. 10-27-1992.
1,727,596. FAB-WRAP. INT. CL. 17. REG. 10-27-1992.
1,727,597. INSUL-VEST AND DESIGN. INT. CL. 17. REG. 10-27-1992.
1,727,599. PLASTAIR. INT. CL. 17. REG. 10-27-1992.
1,727,604. LLAMA. INT. CL. 18. REG. 10-27-1992.
1,727,610. SAT SAC SAVE A TREE ENVIRONMENTAL SYSTEMS AND DESIGN. INT. CL. 18. REG. 10-27-1992.
1,727,616. FLOOR GRES CERAMICHE AND DESIGN. INT. CL. 19. REG. 10-27-1992.
1,727,631. SUPER FLEX. INT. CL. 19. REG. 10-27-1992.
1,727,633. ORGANIC SEAL-DOWN 25. INT. CL. 19. REG. 10-27-1992.
1,727,643. FORMULA. INT. CL. 20. REG. 10-27-1992.
1,727,648. CASA LUCENTE. INT. CLS. 20 AND 25. REG. 10-27-1992.
1,727,653. PANEL CONCEPTS. INT. CL. 20. REG. 10-27-1992.
1,727,663. WAYSIDE OF MILFORD. INT. CL. 20. REG. 10-27-1992.
1,727,665. JAN-MAR CABINETS AND DESIGN. INT. CL. 20. REG. 10-27-1992.
1,727,680. SDD. INT. CL. 21. REG. 10-27-1992.
1,727,682. COLOR CONNECTION. INT. CL. 21. REG. 10-27-1992.
1,727,690. DURAGLOW (STYLIZED). INT. CL. 22. REG. 10-27-1992.
1,727,698. SURALINE. INT. CL. 24. REG. 10-27-1992.
1,727,702. DEWEY TRADING COMPANY. INT. CL. 24. REG. 10-27-1992.
1,727,715. CHIHUAHUA. INT. CL. 25. REG. 10-27-1992.
1,727,726. BRITISH KHAKI. INT. CL. 25. REG. 10-27-1992.
1,727,727. RENA ROWAN FOR SAVILLE. INT. CL. 25. REG. 10-27-1992.
1,727,739. CRISDEN (STYLIZED). INT. CL. 25. REG. 10-27-1992.
1,727,743. COSABELLA. INT. CL. 25. REG. 10-27-1992.
1,727,745. RAGHEDD SKULLWEAR AND DESIGN. INT. CL. 25. REG. 10-27-1992.
1,727,750. CHARTERHOUSE. INT. CL. 25. REG. 10-27-1992.
1,727,755. LD (STYLIZED). INT. CL. 25. REG. 10-27-1992.
1,727,763. MISCELLANEOUS DESIGN. INT. CL. 25. REG. 10-27-1992.
1,727,764. DARTMOUTH AUTHENTICS. INT. CL. 25. REG. 10-27-1992.
1,727,768. LARGELY LITERARY. INT. CL. 25. REG. 10-27-1992.
1,727,770. COOL BREEZE (STYLIZED). INT. CL. 25. REG. 10-27-1992.
1,727,777. HYP. INT. CL. 25. REG. 10-27-1992.
1,727,778. S (STYLIZED). INT. CL. 25. REG. 10-27-1992.
1,727,781. CASCAIS AND DESIGN. INT. CL. 25. REG. 10-27-1992.
1,727,783. NOBS. INT. CLS. 25 AND 28. REG. 10-27-1992.
1,727,796. J.W. FIT TECHNOLOGY. INT. CL. 25. REG. 10-27-1992.
1,727,806. GYDZIT AND DESIGN. INT. CL. 26. REG. 10-27-1992.
1,727,807. BIRGE VICTORIAN SMALL PRINTS. INT. CL. 27. REG. 10-27-1992.
1,727,811. LIL' MVP. INT. CL. 28. REG. 10-27-1992.
1,727,812. APOLLO PLATINUM (STYLIZED). INT. CL. 28. REG. 10-27-1992.
1,727,816. METACARBO. INT. CL. 28. REG. 10-27-1992.
1,727,817. MISCELLANEOUS DESIGN. INT. CL. 28. REG. 10-27-1992.
1,727,820. DOMINATOR. INT. CL. 28. REG. 10-27-1992.
1,727,823. INVISIBLIND. INT. CL. 28. REG. 10-27-1992.
1,727,829. MISCELLANEOUS DESIGN. INT. CL. 28. REG. 10-27-1992.
1,727,834. SPIRAL WHISTLER BALL. INT. CL. 28. REG. 10-27-1992.
1,727,841. STRONGPUT AND DESIGN. INT. CL. 28. REG. 10-27-1992.
1,727,846. ACCUSMART. INT. CL. 28. REG. 10-27-1992.
1,727,847. SURE-GRIP. INT. CL. 28. REG. 10-27-1992.
1,727,849. 422 TRI-DIMPLE. INT. CL. 28. REG. 10-27-1992.
1,727,853. DINOSAURS & THINGS. INT. CL. 29. REG. 10-27-1992.
1,727,854. AWARE. INT. CL. 29. REG. 10-27-1992.
1,727,875. ODYSSEY ODYSSEY ENTERPRISES, INC. AND DESIGN. INT. CL. 29. REG. 10-27-1992.
1,727,889. SUNNY SOUTH. INT. CL. 29. REG. 10-27-1992.
1,727,890. MISCELLANEOUS DESIGN. INT. CL. 29. REG. 10-27-1992.
1,727,893. JEPPI. INT. CL. 29. REG. 10-27-1992.
1,727,895. UNCLE ERNIE'S GOURMET COOKIES AND DESIGN. INT. CL. 30. REG. 10-27-1992.

- 1,727,898. STRAWBERRY CREAM BONBONS AND DESIGN. INT. CL. 30. REG. 10-27-1992.
- 1,727,925. ALMOST BREAD (STYLIZED). INT. CL. 30. REG. 10-27-1992.
- 1,727,926. HERBAL EXCELLENTS. INT. CL. 30. REG. 10-27-1992.
- 1,727,930. SWOOPEE. INT. CL. 30. REG. 10-27-1992.
- 1,727,931. MY HONEY CO.. INT. CL. 30. REG. 10-27-1992.
- 1,727,933. FRUITAGE (STYLIZED). INT. CL. 30. REG. 10-27-1992.
- 1,727,934. HOOTERS AND DESIGN. INT. CL. 30. REG. 10-27-1992.
- 1,727,935. SORCERER-OF-SAUCE AND DESIGN. INT. CL. 30. REG. 10-27-1992.
- 1,727,939. HELL HOT. INT. CL. 30. REG. 10-27-1992.
- 1,727,948. ITO (STYLIZED). INT. CL. 31. REG. 10-27-1992.
- 1,727,952. GROWING COLORS AND DESIGN. INT. CL. 31. REG. 10-27-1992.
- 1,727,955. EXCLUSIVELY ROSES. INT. CL. 31. REG. 10-27-1992.
- 1,727,960. NATURE'S BLOOMS. INT. CL. 31. REG. 10-27-1992.
- 1,727,969. CORONA LIGHT AND DESIGN. INT. CL. 32. REG. 10-27-1992.
- 1,727,978. ALMDUDLER. INT. CL. 32. REG. 10-27-1992.
- 1,727,984. EMPERORS GOLD. INT. CL. 32. REG. 10-27-1992.
- 1,727,996. MISCELLANEOUS DESIGN. INT. CL. 33. REG. 10-27-1992.
- 1,727,999. BRAULIO AMARO ALPINO AND DESIGN. INT. CL. 33. REG. 10-27-1992.
- 1,728,002. TULEO. INT. CL. 33. REG. 10-27-1992.
- 1,728,011. CONSUMERS DIGEST BEST BUY AND DESIGN. INT. CL. 35. REG. 10-27-1992.
- 1,728,021. HOMEOWNERS GOLD. INT. CL. 35. REG. 10-27-1992.
- 1,728,023. WRIGHT HEALTH ASSOCIATES INC AND DESIGN. INT. CLS. 35 AND 42. REG. 10-27-1992.
- 1,728,024. PATTERNS OF TREATMENT. INT. CL. 35. REG. 10-27-1992.
- 1,728,030. SYNCHRONOUS STATISTICS. INT. CL. 35. REG. 10-27-1992.
- 1,728,032. ENTERTAINMENT COMMUNITY ALLIANCE. INT. CLS. 35 AND 36. REG. 10-27-1992.
- 1,728,041. WATERCRAFT WORLD. INT. CL. 35. REG. 10-27-1992.
- 1,728,052. WORDMASON. INT. CLS. 35 AND 42. REG. 10-27-1992.
- 1,728,056. O-TEAM. INT. CL. 35. REG. 10-27-1992.
- 1,728,057. OETTING'S DETASSELING INC. AND DESIGN. INT. CL. 35. REG. 10-27-1992.
- 1,728,060. WELCOME HOME. INT. CL. 35. REG. 10-27-1992.
- 1,728,061. SERVICE SIGNAL. INT. CL. 35. REG. 10-27-1992.
- 1,728,063. RESPONSE BUILDERS. INT. CLS. 35, 40 AND 42. REG. 10-27-1992.
- 1,728,069. LR AND DESIGN. INT. CL. 35. REG. 10-27-1992.
- 1,728,070. DREAMWERKS. INT. CL. 35. REG. 10-27-1992.
- 1,728,076. MISCELLANEOUS DESIGN. INT. CLS. 36 AND 42. REG. 10-27-1992.
- 1,728,079. SWETT INSURANCE MANAGERS. INT. CL. 36. REG. 10-27-1992.
- 1,728,087. ROSENBERG. INT. CL. 36. REG. 10-27-1992.
- 1,728,104. MORGAN STANLEY VENTURE CAPITAL. INT. CL. 36. REG. 10-27-1992.
- 1,728,107. MASTERCHECKING. INT. CL. 36. REG. 10-27-1992.
- 1,728,109. SCHRODER CAPITAL MANAGEMENT INTERNATIONAL. INT. CL. 36. REG. 10-27-1992.
- 1,728,123. VARIABLE TRUST. INT. CL. 36. REG. 10-27-1992.
- 1,728,130. LOANGUARD. INT. CL. 36. REG. 10-27-1992.
- 1,728,132. MMI (STYLIZED). INT. CL. 36. REG. 10-27-1992.
- 1,728,135. SMARTEL AND DESIGN. INT. CL. 36. REG. 10-27-1992.
- 1,728,137. DART. INT. CL. 36. REG. 10-27-1992.
- 1,728,141. STRUT. INT. CL. 36. REG. 10-27-1992.
- 1,728,144. WHEN IT MATTERS MOST, THE COUNTRY'S BEHIND YOU. (STYLIZED). INT. CL. 36. REG. 10-27-1992.
- 1,728,147. TOWER INSURANCE COMPANY, INC.. INT. CL. 36. REG. 10-27-1992.
- 1,728,148. ONE WORLD. ONE CARD.. INT. CL. 36. REG. 10-27-1992.
- 1,728,150. MILLAR ELEVATOR INDUSTRIES, INC.. INT. CLS. 37 AND 42. REG. 10-27-1992.
- 1,728,162. COASTALDRIL. INT. CL. 37. REG. 10-27-1992.
- 1,728,167. "BENDER-MENDER". INT. CLS. 37 AND 42. REG. 10-27-1992.
- 1,728,168. THE MIRADA RANCHO MIRAGE CALIFORNIA AND DESIGN. INT. CL. 37. REG. 10-27-1992.
- 1,728,175. NEW YORK-LINK. INT. CL. 38. REG. 10-27-1992.
- 1,728,181. CITY-FM AND DESIGN. INT. CLS. 38 AND 41. REG. 10-27-1992.
- 1,728,185. 8 KFMB TV AND DESIGN. INT. CL. 38. REG. 10-27-1992.
- 1,728,189. ALLSTAR (STYLIZED). INT. CL. 39. REG. 10-27-1992.
- 1,728,190. PREFERRED RENTER. INT. CL. 39. REG. 10-27-1992.
- 1,728,198. TOPS AND DESIGN. INT. CL. 39. REG. 10-27-1992.
- 1,728,199. TRADESOURCE. INT. CL. 39. REG. 10-27-1992.
- 1,728,201. LUXOTTICA AIR NEXT DAY...EVERY DAY! AND DESIGN. INT. CL. 39. REG. 10-27-1992.
- 1,728,208. TODO ES ESPECIAL. INT. CL. 39. REG. 10-27-1992.
- 1,728,211. PRELUDE. INT. CL. 39. REG. 10-27-1992.
- 1,728,218. E AND E DISPLAY GROUP (STYLIZED). INT. CL. 40. REG. 10-27-1992.
- 1,728,220. FORMING THE FUTURE. INT. CL. 40. REG. 10-27-1992.
- 1,728,223. NSI AND DESIGN. INT. CL. 40. REG. 10-27-1992.
- 1,728,252. WINGS WITNESS IN GOD'S SERVICE AND DESIGN. INT. CL. 41. REG. 10-27-1992.
- 1,728,255. MISCELLANEOUS DESIGN. INT. CL. 41. REG. 10-27-1992.
- 1,728,258. INTERSCOPE RECORDS. INT. CL. 41. REG. 10-27-1992.
- 1,728,259. I AND DESIGN. INT. CL. 41. REG. 10-27-1992.
- 1,728,261. KIDS F.A.C.E.. INT. CL. 41. REG. 10-27-1992.
- 1,728,263. THE WRITING ROAD TO READING. INT. CL. 41. REG. 10-27-1992.
- 1,728,264. COUNCIL OF CHILDBIRTH EDUCATION SPECIALISTS. INT. CL. 41. REG. 10-27-1992.
- 1,728,266. FORMULA SUPER VEE. INT. CL. 41. REG. 10-27-1992.
- 1,728,270. SUCCESS STRATEGIES. INT. CL. 41. REG. 10-27-1992.
- 1,728,271. YOUTH-PRIDE OF THE PRESENT, HOPE OF THE FUTURE. INT. CL. 41. REG. 10-27-1992.
- 1,728,278. MYSTERY EXPRESS. INT. CL. 41. REG. 10-27-1992.
- 1,728,304. THE PRODUCTION GARDEN. INT. CL. 41. REG. 10-27-1992.
- 1,728,324. ENTERTAINMENT THIS WEEK AND DESIGN. INT. CL. 41. REG. 10-27-1992.
- 1,728,325. CLANG. INT. CL. 41. REG. 10-27-1992.
- 1,728,327. MISCELLANEOUS DESIGN. INT. CL. 41. REG. 10-27-1992.
- 1,728,337. GIFTS IN KIND AMERICA AND DESIGN. INT. CL. 42. REG. 10-27-1992.
- 1,728,340. BIOPTRON HEALTH CENTER. INT. CL. 42. REG. 10-27-1992.
- 1,728,341. BAMBO. INT. CL. 42. REG. 10-27-1992.
- 1,728,347. DEAN AND DESIGN. INT. CL. 42. REG. 10-27-1992.
- 1,728,353. MISCELLANEOUS DESIGN. INT. CL. 42. REG. 10-27-1992.
- 1,728,355. DORN. INT. CL. 42. REG. 10-27-1992.
- 1,728,370. MISCELLANEOUS DESIGN. INT. CL. 42. REG. 10-27-1992.
- 1,728,382. WEE CARE FOR KIDS. INT. CL. 42. REG. 10-27-1992.
- 1,728,386. BACKINTYME CAFE AND DESIGN. INT. CL. 42. REG. 10-27-1992.
- 1,728,414. LINCOLN PARK COLUMBUS DENTAL ASSOCIATES AND DESIGN. INT. CL. 42. REG. 10-27-1992.

- 1,728,418. KATMANDU. INT. CL. 42. REG. 10-27-1992.
 1,728,419. GREEN LIGHTS. INT. CL. 42. REG. 10-27-1992.
 1,728,420. DUSINA'S PIZZA. INT. CL. 42. REG. 10-27-1992.
 1,728,422. BREAKTHROUGH TOUCHING GOD ON BEHALF OF OTHERS AND DESIGN. INT. CL. 42. REG. 10-27-1992.
 1,728,424. IMMLAW. INT. CL. 42. REG. 10-27-1992.
 1,728,427. SUPERSOLUTIONS CORPORATION AND DESIGN. INT. CL. 42. REG. 10-27-1992.
 1,728,428. BETTER IMAGE. INT. CL. 42. REG. 10-27-1992.
 1,728,429. IT'S A BIG COUNTRY. SOMEONE'S GOT TO FURNISH IT.. INT. CL. 42. REG. 10-27-1992.
 1,728,438. THE RICE ROAD AND DESIGN. INT. CL. 42. REG. 10-27-1992.
 1,728,450. CO-OP CROP SERVICES YOUR PROFESSIONAL CROPPING PARTNERS AND DESIGN. INT. CL. 42. REG. 10-27-1992.
 1,728,451. OPTIONCARE AND DESIGN. INT. CL. 42. REG. 10-27-1992.
 1,728,459. AUTO JAVA. INT. CL. 42. REG. 10-27-1992.
 1,728,476. STRUT. INT. CL. 42. REG. 10-27-1992.
 1,728,478. THE FAMILY CHANNEL. INT. CL. 42. REG. 10-27-1992.
 1,728,479. THE FAMILY CHANNEL AND DESIGN. INT. CL. 42. REG. 10-27-1992.
 1,728,483. A CHILD'S HAVEN AND DESIGN. INT. CL. 42. REG. 10-27-1992.
 1,728,498. HDL AND DESIGN. U.S. CL. 200. REG. 10-27-1992.
 1,728,499. HPDL AND DESIGN. U.S. CL. 200. REG. 10-27-1992.
 1,728,500. NOT TESTED ON ANIMALS AND DESIGN. U.S. CL. A. REG. 10-27-1992.
 1,728,509. NOXTECH. INT. CLS. 7 AND 37. REG. 10-27-1992.
 1,728,511. ULTRAFINO. INT. CL. 1. REG. 10-27-1992.
 1,728,516. ULTRA-CLEAN. INT. CL. 1. REG. 10-27-1992.
 1,728,526. VERNAJET. INT. CL. 7. REG. 10-27-1992.
 1,728,536. BI-STRETCH. INT. CL. 7. REG. 10-27-1992.
 1,728,540. DSTL. INT. CL. 9. REG. 10-27-1992.
 1,728,546. SOLUTION VIEW. INT. CL. 9. REG. 10-27-1992.
 1,728,554. FASTERM. INT. CL. 9. REG. 10-27-1992.
 1,728,560. LOVO/LITE. INT. CL. 11. REG. 10-27-1992.
 1,728,572. PASEO. INT. CL. 12. REG. 10-27-1992.
 1,728,576. TROUGH TRAIN. INT. CL. 12. REG. 10-27-1992.
 1,728,577. APORA. INT. CL. 12. REG. 10-27-1992.
 1,728,578. GLARESTOPPER. INT. CL. 12. REG. 10-27-1992.
 1,728,587. BANDSHIRE, RINGS OF ENGLAND. INT. CL. 14. REG. 10-27-1992.
 1,728,590. TECH GEAR. INT. CL. 14. REG. 10-27-1992.
 1,728,595. PACER. INT. CL. 16. REG. 10-27-1992.
 1,728,603. HAZ-MAT SAF-T-STOR. INT. CL. 19. REG. 10-27-1992.
 1,728,607. REMARO. INT. CL. 19. REG. 10-27-1992.
 1,728,613. HOME TIME. INT. CL. 20. REG. 10-27-1992.
 1,728,619. FLYING DOWN TO RIO. INT. CL. 25. REG. 10-27-1992.
 1,728,629. COMFORT CONTROL. INT. CL. 25. REG. 10-27-1992.
 1,728,638. DOCKERS SINCE 1850 LEVI'S AND DESIGN. INT. CL. 25. REG. 10-27-1992.
 1,728,641. ATTREZZI. INT. CL. 25. REG. 10-27-1992.
 1,728,647. WESTERN CHALLENGE. INT. CL. 25. REG. 10-27-1992.
 1,728,661. WAVERLY DESIGNER SERIES. INT. CL. 27. REG. 10-27-1992.
 1,728,669. STROKES OF GENIUS. INT. CL. 28. REG. 10-27-1992.
 1,728,673. MISCELLANEOUS DESIGN. INT. CL. 30. REG. 10-27-1992.
 1,728,675. SNACKWELL'S. INT. CL. 30. REG. 10-27-1992.
 1,728,678. SINCERELY YOURS. INT. CL. 34. REG. 10-27-1992.
 1,728,688. VERMONT PREMIER. INT. CL. 36. REG. 10-27-1992.
 1,728,690. SOURCE ONE. INT. CL. 36. REG. 10-27-1992.
 1,728,704. FRUGAL FLOWERS. INT. CL. 42. REG. 10-27-1992.
 1,728,707. DR. FRUHBECK CONSULTANTS. INT. CLS. 35, 36 AND 42. REG. 10-27-1992.
 1,728,708. DR. FRUHBECK ABOGADOS Y ECONOMISTAS. INT. CLS. 35, 36 AND 42. REG. 10-27-1992.
 1,728,724. DELICIOUS, NUTRITIOUS & LITE. INT. CL. 29. REG. 10-27-1992.
 1,728,725. BERSTED. INT. CL. 29. REG. 10-27-1992.
 1,728,730. INTERNATIONAL COLLECTIBLE EXPOSITION. INT. CL. 35. REG. 10-27-1992.
 1,728,731. SERVICE MONITOR. INT. CL. 35. REG. 10-27-1992.
 1,728,734. FINANCIAL TEMPS (STYLIZED). INT. CL. 35. REG. 10-27-1992.
 1,771,093. DB AND DESIGN. INT. CL. 12 ONLY. REG. 5-18-1993.
 1,860,188. THE BLADE EXCHANGE AND DESIGN. INT. CLS. 7 AND 37. REG. 10-25-1994.
 1,937,449. THE SOURCE OF PURE WATER. INT. CL. 39. REG. 11-21-1995.
 1,974,521. FREEDOM COMMUNICATIONS. INT. CL. 16. REG. 5-21-1996.
 1,975,383. HURRICANE REEF. INT. CL. 32. REG. 5-21-1996.
 1,983,091. TRC AND DESIGN. INT. CL. 42. REG. 6-25-1996.
 1,985,183. CTC THE CROSSTRaining CLUB (STYLIZED). INT. CL. 41. REG. 7-9-1996.
 1,989,418. MISCELLANEOUS DESIGN. INT. CL. 42. REG. 7-30-1996.
 1,998,147. OTC. INT. CL. 35. REG. 9-3-1996.
 1,998,188. CRIADA. INT. CL. 30. REG. 9-3-1996.
 2,008,485. SHOCK THERAPY. INT. CL. 12. REG. 10-15-1996.
 2,011,263. COLOREXPert (STYLIZED). INT. CLS. 9 AND 41. REG. 10-29-1996.
 2,011,265. GULA GULA. INT. CL. 42. REG. 10-29-1996.
 2,011,266. REFLECTIVE MEMORY. INT. CL. 9. REG. 10-29-1996.
 2,011,267. ALLPRO. INT. CL. 20. REG. 10-29-1996.
 2,011,271. MIDWEST TRADERS. INT. CL. 25. REG. 10-29-1996.
 2,011,272. KANSEI AND DESIGN. INT. CLS. 9, 11 AND 12. REG. 10-29-1996.
 2,011,273. WATER QUALITY INTERNATIONAL. INT. CLS. 16, 41 AND 42. REG. 10-29-1996.
 2,011,275. OMNI SUPERSTORE. INT. CL. 42. REG. 10-29-1996.
 2,011,277. BOOSTER. INT. CL. 12. REG. 10-29-1996.
 2,011,283. BRANDT. INT. CL. 42. REG. 10-29-1996.
 2,011,284. MINUTEMAN. INT. CL. 6. REG. 10-29-1996.
 2,011,285. FRANK & BRYAN'S. INT. CL. 30. REG. 10-29-1996.
 2,011,286. PUTTING QUALITY IN MOTION. INT. CL. 39. REG. 10-29-1996.
 2,011,290. DIOPTEARS. INT. CL. 5. REG. 10-29-1996.
 2,011,291. POWER BUILT (STYLIZED). INT. CL. 7. REG. 10-29-1996.
 2,011,292. WILD SOUR BERRIES (STYLIZED). INT. CL. 30. REG. 10-29-1996.
 2,011,295. KIDS AND DESIGN. INT. CLS. 16, 25 AND 28. REG. 10-29-1996.
 2,011,300. THE NEIGHBORHOOD CLEANERS AND DESIGN. INT. CL. 37. REG. 10-29-1996.
 2,011,301. BIG BRUCE'S GUNPOWDER CHILI. INT. CL. 30. REG. 10-29-1996.
 2,011,305. METAVERSE. INT. CL. 38. REG. 10-29-1996.
 2,011,307. KOKOMO'S PIZZA AND DESIGN. INT. CL. 42. REG. 10-29-1996.
 2,011,309. WE'RE NOT #1, YOU ARE. INT. CL. 38. REG. 10-29-1996.
 2,011,310. BINAR GRAPHICS. INT. CLS. 9 AND 42. REG. 10-29-1996.
 2,011,311. SCULPTURA. INT. CL. 8. REG. 10-29-1996.
 2,011,312. MINUTE MENUS AND DESIGN. INT. CL. 16. REG. 10-29-1996.
 2,011,315. CULINARY CLASSICS. INT. CL. 25. REG. 10-29-1996.
 2,011,316. THE GREEN FRAMER DECORATIVE FINE ART ACCESSORIES AND DESIGN. INT. CL. 16. REG. 10-29-1996.
 2,011,317. OST. INT. CL. 16. REG. 10-29-1996.
 2,011,318. MAR'S 15TH ANNUAL CONFERENCE. INT. CL. 41. REG. 10-29-1996.

- 2,011,320. CABMAN. INT. CL. 9. REG. 10-29-1996.
 2,011,321. ROYAL SILK AND DESIGN. INT. CL. 26. REG. 10-29-1996.
 2,011,322. VALUE PLUS. INT. CL. 39. REG. 10-29-1996.
 2,011,323. GREAT CANADIAN OUTBACK. INT. CL. 25. REG. 10-29-1996.
 2,011,331. CAPRO (STYLIZED). INT. CL. 9. REG. 10-29-1996.
 2,011,332. THE QUIET DRIVE. INT. CL. 12. REG. 10-29-1996.
 2,011,334. THREE I (STYLIZED). INT. CL. 9. REG. 10-29-1996.
 2,011,335. MISCELLANEOUS DESIGN. INT. CLS. 1, 4, 6, 7, 11, 19, 37, 39 AND 42. REG. 10-29-1996.
 2,011,338. MISCELLANEOUS DESIGN. INT. CL. 25. REG. 10-29-1996.
 2,011,340. EVERLINK (STYLIZED). INT. CL. 9. REG. 10-29-1996.
 2,011,342. SIGNA-SURE AND DESIGN. INT. CL. 36. REG. 10-29-1996.
 2,011,343. THE SOFTEE. INT. CL. 25. REG. 10-29-1996.
 2,011,346. SNS (STYLIZED). INT. CL. 11. REG. 10-29-1996.
 2,011,347. ROUNDSTER. INT. CL. 12. REG. 10-29-1996.
 2,011,348. DEFINITION. INT. CL. 12. REG. 10-29-1996.
 2,011,349. NUANCE. INT. CL. 12. REG. 10-29-1996.
 2,011,350. INTUITION. INT. CL. 12. REG. 10-29-1996.
 2,011,351. MISS BRITT. INT. CL. 25. REG. 10-29-1996.
 2,011,353. PERFECT FOR PERMS. INT. CL. 3. REG. 10-29-1996.
 2,011,357. FRUCTOSE FREEZER (STYLIZED). INT. CL. 29. REG. 10-29-1996.
 2,011,358. NEUTRA FRESH. INT. CL. 5. REG. 10-29-1996.
 2,011,362. NEUBERGER BERMAN PARTNERS TRUST. INT. CL. 36. REG. 10-29-1996.
 2,011,363. THE COUNTERPART. INT. CL. 38. REG. 10-29-1996.
 2,011,364. NO GUTS NO GALAXY. INT. CL. 41. REG. 10-29-1996.
 2,011,365. JUST RACING AND DESIGN. INT. CLS. 18, 20, 21 AND 25. REG. 10-29-1996.
 2,011,366. SNACKWELL'S. INT. CL. 30. REG. 10-29-1996.
 2,011,367. CYBERPAGES (STYLIZED). INT. CL. 35. REG. 10-29-1996.
 2,011,369. NORTHERN ELEMENTS. INT. CL. 42. REG. 10-29-1996.
 2,011,370. PURE WATER CORPORATION OUR SEAL IS YOUR ASSURANCE OF QUALITY SINCE 1970 AND DESIGN. INT. CL. 32. REG. 10-29-1996.
 2,011,371. LA BUONA NATURA AND DESIGN. INT. CLS. 29, 30 AND 32. REG. 10-29-1996.
 2,011,372. SOLID BACKING. INT. CLS. 35 AND 36. REG. 10-29-1996.
 2,011,376. GDE SYSTEMS, INC.. INT. CLS. 9 AND 42. REG. 10-29-1996.
 2,011,377. NATURE'S CHOICE ORIGINAL RECIPE BREADS AND DESIGN. INT. CL. 30. REG. 10-29-1996.
 2,011,378. NATURE'S CHOICE ORIGINAL RECIPE BREADS. INT. CL. 30. REG. 10-29-1996.
 2,011,382. DYNATEST. INT. CL. 9. REG. 10-29-1996.
 2,011,384. W AND DESIGN. INT. CL. 32. REG. 10-29-1996.
 2,011,385. CEMSCANNER. INT. CL. 9. REG. 10-29-1996.
 2,011,386. SOFT AND DESIGN. INT. CL. 28. REG. 10-29-1996.
 2,011,390. BABY BLOCKS. INT. CL. 24. REG. 10-29-1996.
 2,011,392. SYNCHROFET. INT. CL. 9. REG. 10-29-1996.
 2,011,395. KEFKA'S DOMAIN. INT. CL. 9. REG. 10-29-1996.
 2,011,397. DESERT ROSE. INT. CL. 30. REG. 10-29-1996.
 2,011,398. ANTIGUA. INT. CL. 18. REG. 10-29-1996.
 2,011,403. WILLOW BAY PLUS. INT. CL. 25. REG. 10-29-1996.
 2,011,406. GATOR GOLD. INT. CL. 9. REG. 10-29-1996.
 2,011,408. MENTIS MEDICAL. INT. CL. 42. REG. 10-29-1996.
 2,011,415. NUMBER CRUNCHERS PRECISION JOURNALISM AND DESIGN. INT. CL. 42. REG. 10-29-1996.
 2,011,416. LAPSA DE PRIMERA AIR PARAGUAY AND DESIGN. INT. CL. 39. REG. 10-29-1996.
 2,011,417. MAIZORO CORN FLAKES AND DESIGN. INT. CL. 30. REG. 10-29-1996.
 2,011,419. EXPRESSREVIEW. INT. CL. 35. REG. 10-29-1996.
 2,011,421. THE TWO VIRGINS AND DESIGN. INT. CL. 30. REG. 10-29-1996.
 2,011,424. ITSY BITSY. INT. CL. 25. REG. 10-29-1996.
 2,011,426. DERMOLITH. INT. CL. 5. REG. 10-29-1996.
 2,011,428. ASTRODOME THE ORIGINAL AND DESIGN. INT. CL. 26. REG. 10-29-1996.
 2,011,429. GUIDO DI RICCIO. INT. CL. 25. REG. 10-29-1996.
 2,011,430. MAXICLEAR. INT. CL. 2. REG. 10-29-1996.
 2,011,431. ART&STUFF. INT. CLS. 9 AND 16. REG. 10-29-1996.
 2,011,432. MAXOVITE. INT. CL. 5. REG. 10-29-1996.
 2,011,438. TIV BY CYNTHIA JERRY AND DESIGN. INT. CL. 3. REG. 10-29-1996.
 2,011,439. BONE-ANZA. INT. CL. 18. REG. 10-29-1996.
 2,011,440. MACH 460 SOUND SYSTEM. INT. CL. 9. REG. 10-29-1996.
 2,011,441. BIKSTER. INT. CL. 12. REG. 10-29-1996.
 2,011,442. BOATSTER. INT. CL. 12. REG. 10-29-1996.
 2,011,443. BIKSTER. INT. CL. 12. REG. 10-29-1996.
 2,011,444. MISCELLANEOUS DESIGN. INT. CL. 9. REG. 10-29-1996.
 2,011,445. SFT. 10 PAK AND DESIGN. INT. CLS. 9 AND 28. REG. 10-29-1996.
 2,011,446. MISCELLANEOUS DESIGN. INT. CL. 42. REG. 10-29-1996.
 2,011,454. X IXTHOS (STYLIZED). INT. CL. 9. REG. 10-29-1996.
 2,011,455. SECURE SENTINEL (STYLIZED). INT. CL. 9. REG. 10-29-1996.
 2,011,459. ZITROVKA. INT. CL. 33. REG. 10-29-1996.
 2,011,460. RHODOCOMP. INT. CL. 1. REG. 10-29-1996.
 2,011,461. NORMANS. INT. CL. 33. REG. 10-29-1996.
 2,011,462. DYNAMICACHE. INT. CL. 9. REG. 10-29-1996.
 2,011,463. AMERICA'S PREMIER PAINT STORE AND DESIGN. INT. CL. 2. REG. 10-29-1996.
 2,011,470. BODY WATCH AND DESIGN. INT. CL. 14. REG. 10-29-1996.
 2,011,472. FIL2E3X. INT. CL. 36. REG. 10-29-1996.
 2,011,473. FLEX 123 (STYLIZED). INT. CL. 36. REG. 10-29-1996.
 2,011,474. CARDBAKER AND DESIGN. INT. CLS. 9 AND 16. REG. 10-29-1996.
 2,011,475. ARCHIVE PAPER COMPANY AND DESIGN. INT. CL. 16. REG. 10-29-1996.
 2,011,476. AUNT CORA'S DOWN HOME SEASONINGS AND DESIGN. INT. CL. 30. REG. 10-29-1996.
 2,011,477. DTED. INT. CL. 9. REG. 10-29-1996.
 2,011,478. N NOVA SPRING AND DESIGN. INT. CL. 28. REG. 10-29-1996.
 2,011,479. BALDOM AND DESIGN. INT. CLS. 29 AND 30. REG. 10-29-1996.
 2,011,481. MISCELLANEOUS DESIGN. INT. CL. 24. REG. 10-29-1996.
 2,011,483. FORTUS. INT. CL. 27. REG. 10-29-1996.
 2,011,484. COLORIT. INT. CL. 27. REG. 10-29-1996.
 2,011,487. TIMBUKTUU. INT. CLS. 30 AND 42. REG. 10-29-1996.
 2,011,490. SALTY PAWS NEWPORT AND DESIGN. INT. CL. 25. REG. 10-29-1996.
 2,011,492. TOM PETERS BUSINESS SCHOOL IN A BOX. INT. CL. 28. REG. 10-29-1996.
 2,011,496. CONNIE'S KIDS. INT. CL. 25. REG. 10-29-1996.
 2,011,501. GRANDPA'S ORCHARD AND DESIGN. INT. CL. 29. REG. 10-29-1996.
 2,011,503. SOHN ELECTROGRAPHIC. INT. CL. 7. REG. 10-29-1996.
 2,011,506. CELLULAR CLEAR AND SIMPLE. INT. CL. 42. REG. 10-29-1996.
 2,011,508. IREM SMART PARTNERS SAFETY MANAGEMENT ALLIANCE OF RESIDENTS AND TENANTS AND DESIGN. INT. CL. 42. REG. 10-29-1996.
 2,011,516. SOFTBANK. INT. CLS. 35 AND 41. REG. 10-29-1996.
 2,011,518. BECOOL (STYLIZED). INT. CLS. 1 AND 9. REG. 10-29-1996.

- 2,011,519. TRUE TEMPER TIMBERLAND AND DESIGN. INT. CL. 8. REG. 10-29-1996.
- 2,011,520. J JUSTSYSTEM (STYLIZED). INT. CL. 9. REG. 10-29-1996.
- 2,011,521. J JUSTSYSTEM (STYLIZED). INT. CL. 9. REG. 10-29-1996.
- 2,011,522. J JUSTSYSTEM (STYLIZED). INT. CL. 9. REG. 10-29-1996.
- 2,011,523. J JUSTSYSTEM (STYLIZED). INT. CL. 9. REG. 10-29-1996.
- 2,011,524. MISCELLANEOUS DESIGN. INT. CL. 9. REG. 10-29-1996.
- 2,011,529. ECUQUEST. INT. CL. 36. REG. 10-29-1996.
- 2,011,530. SYNTHESIS AND DESIGN. INT. CL. 42. REG. 10-29-1996.
- 2,011,531. RESOVIST. INT. CL. 5. REG. 10-29-1996.
- 2,011,532. PYRAMID. INT. CL. 28. REG. 10-29-1996.
- 2,011,533. IT'S TIME YOU GOT YOUR MONEY'S WORTH. INT. CL. 42. REG. 10-29-1996.
- 2,011,534. CLICKER REPLACEMENT TRANSMITTER FOR GARAGE DOOR & GATE OPENERS MODEL #100 AND DESIGN. INT. CL. 9. REG. 10-29-1996.
- 2,011,535. CLICKER REPLACEMENT TRANSMITTER FOR GARAGE DOOR & GATE OPENERS MODEL #200 AND DESIGN. INT. CL. 9. REG. 10-29-1996.
- 2,011,536. CLICKER REPLACEMENT TRANSMITTER FOR GARAGE DOOR & GATE OPENERS MODEL #300 AND DESIGN. INT. CL. 9. REG. 10-29-1996.
- 2,011,537. LIS AND DESIGN. INT. CL. 37. REG. 10-29-1996.
- 2,011,538. MR. & MRS. BABY HADDAD BROTHERS, INC. SINCE 1947 AND DESIGN. INT. CLS. 24 AND 25. REG. 10-29-1996.
- 2,011,540. THE SCHOLARSHIP DETECTIVE. INT. CL. 42. REG. 10-29-1996.
- 2,011,541. BAG OF WHIM. INT. CL. 18. REG. 10-29-1996.
- 2,011,546. MORTGAGES, INSURANCE & MORE. INT. CL. 9. REG. 10-29-1996.
- 2,011,547. S AND DESIGN. INT. CL. 9. REG. 10-29-1996.
- 2,011,548. SEJUS. INT. CL. 9. REG. 10-29-1996.
- 2,011,550. GAT AIRLINE GROUND SUPPORT AND DESIGN. INT. CL. 37. REG. 10-29-1996.
- 2,011,554. UNILINK. INT. CL. 38. REG. 10-29-1996.
- 2,011,556. TALK MESS. INT. CL. 41. REG. 10-29-1996.
- 2,011,558. M.X.I.. INT. CL. 25. REG. 10-29-1996.
- 2,011,560. FULLY LLOYDS' COOKED BARBEQUE COMPANY AND DESIGN. INT. CL. 29. REG. 10-29-1996.
- 2,011,561. KAI. INT. CL. 9. REG. 10-29-1996.
- 2,011,562. JENISYS AND DESIGN. INT. CL. 42. REG. 10-29-1996.
- 2,011,564. MISCELLANEOUS DESIGN. INT. CLS. 37 AND 42. REG. 10-29-1996.
- 2,011,565. MISCELLANEOUS DESIGN. INT. CLS. 37 AND 42. REG. 10-29-1996.
- 2,011,570. EAT WHERE YOU LOVE TO SHOP. SHOP WHERE YOU LOVE TO EAT.. INT. CL. 42. REG. 10-29-1996.
- 2,011,574. DRAG, DROP, DONE. INT. CL. 9. REG. 10-29-1996.
- 2,011,575. HACKER NATION. INT. CL. 16. REG. 10-29-1996.
- 2,011,577. HIDE SIDE LTD. (STYLIZED). INT. CL. 42. REG. 10-29-1996.
- 2,011,578. DARK GABLE. INT. CL. 41. REG. 10-29-1996.
- 2,011,581. DARBY'S DESIGNS AND DESIGN. INT. CL. 25. REG. 10-29-1996.
- 2,011,583. RUBBERDYNE AND DESIGN. INT. CL. 40. REG. 10-29-1996.
- 2,011,587. NETWORK 2000. INT. CL. 9. REG. 10-29-1996.
- 2,011,588. TAKE YOUR BEST SHOT. INT. CL. 41. REG. 10-29-1996.
- 2,011,589. QUICKFINGER. INT. CL. 25. REG. 10-29-1996.
- 2,011,590. HP AND DESIGN. INT. CL. 40. REG. 10-29-1996.
- 2,011,593. DAVID WINTER COTTAGES THE WEST COUNTRY COLLECTION. INT. CL. 20. REG. 10-29-1996.
- 2,011,594. BOW BELLS. INT. CL. 31. REG. 10-29-1996.
- 2,011,595. THE HERBALIST. INT. CL. 31. REG. 10-29-1996.
- 2,011,598. ZONE BRAIN. INT. CL. 41. REG. 10-29-1996.
- 2,011,599. SYNCHROBRAIN (STYLIZED). INT. CL. 9. REG. 10-29-1996.
- 2,011,601. THE REDWOODS GUEST COTTAGES AND DESIGN. INT. CL. 36. REG. 10-29-1996.
- 2,011,603. NEWSPAPER SPACE BANK AND DESIGN. INT. CL. 35. REG. 10-29-1996.
- 2,011,604. PROJECT INVOLVE AND DESIGN. INT. CL. 41. REG. 10-29-1996.
- 2,011,606. TRANSPORT FLIGHT AND DESIGN. INT. CL. 25. REG. 10-29-1996.
- 2,011,608. DEALERS ALLIANCE CREDIT CORP.. INT. CL. 36. REG. 10-29-1996.
- 2,011,610. STEAK AROUND AND DESIGN. INT. CL. 42. REG. 10-29-1996.
- 2,011,612. MCG MCGREW COLOR GRAPHICS AND DESIGN. INT. CL. 42. REG. 10-29-1996.
- 2,011,613. FILA AND DESIGN. INT. CL. 25. REG. 10-29-1996.
- 2,011,619. CROSS THE LINE. INT. CL. 41. REG. 10-29-1996.
- 2,011,620. GHOST SERIES TX. INT. CL. 9. REG. 10-29-1996.
- 2,011,621. SNOWFLAKE FAIRIES. INT. CL. 20. REG. 10-29-1996.
- 2,011,622. 4H AND DESIGN. INT. CL. 29. REG. 10-29-1996.
- 2,011,623. HONEY DEW DOUGHNUTS AND DESIGN. INT. CLS. 30 AND 42. REG. 10-29-1996.
- 2,011,628. A+ AND DESIGN. INT. CL. 35. REG. 10-29-1996.
- 2,011,631. CAN-DO KINDER GARDEN MODERN CURRICULUM PRESS AND DESIGN. INT. CL. 9. REG. 10-29-1996.
- 2,011,633. XONEX. INT. CL. 35. REG. 10-29-1996.
- 2,011,634. ELPASO - JUAREZ TROLLEY CO. AND DESIGN. INT. CL. 39. REG. 10-29-1996.
- 2,011,635. SEVEN 7 STARS AND DESIGN. INT. CL. 29. REG. 10-29-1996.
- 2,011,636. WIRELESS800. INT. CL. 38. REG. 10-29-1996.
- 2,011,637. TMS/WIN. INT. CL. 9. REG. 10-29-1996.
- 2,011,638. SKYWORD ACCESS. INT. CL. 9. REG. 10-29-1996.
- 2,011,640. VISUAL REALITY MORE THAN JUST AN IMAGE! AND DESIGN. INT. CL. 42. REG. 10-29-1996.
- 2,011,642. PRIVATE SPRING WATER. INT. CL. 42. REG. 10-29-1996.
- 2,011,643. FOCUS AMERICA!. INT. CL. 42. REG. 10-29-1996.
- 2,011,645. LITTLE CHARLIES CONVENIENCE FOODS AND DESIGN. INT. CLS. 29 AND 30. REG. 10-29-1996.
- 2,011,646. HTTP://WWW.PLAYBOY.COM. INT. CL. 42. REG. 10-29-1996.
- 2,011,647. INTER MART AND DESIGN. INT. CL. 35. REG. 10-29-1996.
- 2,011,649. ISOLOGGER. INT. CL. 9. REG. 10-29-1996.
- 2,011,650. PAY LESS FOR WIRELESS. INT. CL. 38. REG. 10-29-1996.
- 2,011,651. LE PETIT CAFE AND DESIGN. INT. CL. 42. REG. 10-29-1996.
- 2,011,653. ROYAL OSTRICH FARM. INT. CL. 29. REG. 10-29-1996.
- 2,011,655. MISCELLANEOUS DESIGN. INT. CL. 9. REG. 10-29-1996.
- 2,011,657. DOCUWEATHER, USA AND DESIGN. INT. CL. 42. REG. 10-29-1996.
- 2,011,658. FREMONT FUNDS AND DESIGN. INT. CL. 36. REG. 10-29-1996.
- 2,011,660. ORIGINAL LOCALS AND DESIGN. INT. CLS. 25 AND 28. REG. 10-29-1996.
- 2,011,661. PALLANTIS PICTURES. INT. CL. 9. REG. 10-29-1996.
- 2,011,663. OLD KENT BUSINESS RESOURCE CENTER. INT. CL. 36. REG. 10-29-1996.
- 2,011,664. FLAMINGO. INT. CL. 30. REG. 10-29-1996.
- 2,011,665. THE FUDGE BROWNIE AND DESIGN. INT. CL. 30. REG. 10-29-1996.
- 2,011,666. EDUCASE (STYLIZED). INT. CL. 16. REG. 10-29-1996.
- 2,011,668. THE POWER OF WIRELESS. INT. CL. 9. REG. 10-29-1996.
- 2,011,670. S ELITE ACCESS SYSTEMS INC. AND DESIGN. INT. CL. 9. REG. 10-29-1996.
- 2,011,674. 2D AND DESIGN. INT. CL. 9. REG. 10-29-1996.

- 2,011,675. FINAL SCORE AND DESIGN. INT. CL. 42. REG. 10-29-1996.
- 2,011,676. ANNUITYASSIST. INT. CL. 36. REG. 10-29-1996.
- 2,011,677. IHS INTERNATIONAL HOTEL SERVICES AND DESIGN. INT. CL. 37. REG. 10-29-1996.
- 2,011,678. SOLAR BUSTER AND DESIGN. INT. CL. 25. REG. 10-29-1996.
- 2,011,679. READY WILLING AND CABLE. INT. CL. 41. REG. 10-29-1996.
- 2,011,682. HRA AND DESIGN. INT. CL. 35. REG. 10-29-1996.
- 2,011,683. PROLOC. INT. CL. 20. REG. 10-29-1996.
- 2,011,691. MONURAL. INT. CL. 5. REG. 10-29-1996.
- 2,011,693. STRICTLY FAUX STRIPES & BORDERS. INT. CL. 16. REG. 10-29-1996.
- 2,011,694. BEING THE BEST COMES NATURALLY. INT. CL. 5. REG. 10-29-1996.
- 2,011,698. PANGASINAN AND DESIGN. INT. CL. 29. REG. 10-29-1996.
- 2,011,699. ROUND HILL AND DESIGN. INT. CL. 33. REG. 10-29-1996.
- 2,011,700. ROUND HILL AND DESIGN. INT. CL. 33. REG. 10-29-1996.
- 2,011,701. BLUE EAGLE AND DESIGN. INT. CL. 25. REG. 10-29-1996.
- 2,011,703. MISCELLANEOUS DESIGN. INT. CL. 18. REG. 10-29-1996.
- 2,011,709. ICEBOX BAKERS AND DESIGN. INT. CL. 30. REG. 10-29-1996.
- 2,011,713. BRIGHT GRAY PRODUCTIONS. INT. CL. 41. REG. 10-29-1996.
- 2,011,714. WORMY DOG SALOON EST 1992 STILLWATER, OK AND DESIGN. INT. CL. 25. REG. 10-29-1996.
- 2,011,716. OLD HOMESTEAD AND DESIGN. INT. CL. 20. REG. 10-29-1996.
- 2,011,717. FG (STYLIZED). INT. CL. 25. REG. 10-29-1996.
- 2,011,718. SLI COOLFOOT. INT. CL. 25. REG. 10-29-1996.
- 2,011,719. METALLIFE COMPRESSIVE STRESS TEXTURING AND DESIGN. INT. CL. 40. REG. 10-29-1996.
- 2,011,720. P AND DESIGN. INT. CL. 42. REG. 10-29-1996.
- 2,011,721. ZERO CONSUMPTION APM. INT. CL. 9. REG. 10-29-1996.
- 2,011,722. JUDY'S BAKERY AND DESIGN. INT. CL. 30. REG. 10-29-1996.
- 2,011,731. NURSES P.A.L.. INT. CL. 10. REG. 10-29-1996.
- 2,011,732. SPACE COAST CU ONLINE AND DESIGN. INT. CL. 36. REG. 10-29-1996.
- 2,011,733. BIG TOOL AND DESIGN. INT. CL. 25. REG. 10-29-1996.
- 2,011,735. ADVANCES PLUS. INT. CL. 42. REG. 10-29-1996.
- 2,011,736. ORANGE BOWL BASKETBALL CLASSIC. INT. CLS. 16, 25 AND 41. REG. 10-29-1996.
- 2,011,737. SHAUNCEYS AND DESIGN. INT. CL. 30. REG. 10-29-1996.
- 2,011,739. TOLL HOUSE AND DESIGN. INT. CL. 30. REG. 10-29-1996.
- 2,011,740. THE LIVING TREE COMPANY AND DESIGN. INT. CL. 42. REG. 10-29-1996.
- 2,011,742. COMPREHEND! (STYLIZED). INT. CL. 41. REG. 10-29-1996.
- 2,011,743. ANGEL QUEST AND DESIGN. INT. CL. 28. REG. 10-29-1996.
- 2,011,746. ENDANGERED SPECIES. INT. CL. 41. REG. 10-29-1996.
- 2,011,748. RESIII. INT. CL. 9. REG. 10-29-1996.
- 2,011,749. ARCH-DECO. INT. CL. 11. REG. 10-29-1996.
- 2,011,752. HALF ACRE. INT. CL. 42. REG. 10-29-1996.
- 2,011,753. DISA LINK. INT. CL. 38. REG. 10-29-1996.
- 2,011,754. MUSCLEMAN (STYLIZED). INT. CL. 9. REG. 10-29-1996.
- 2,011,757. CELL ENSEMBLE. INT. CL. 9. REG. 10-29-1996.
- 2,011,758. GEOSYSTEM AND DESIGN. INT. CL. 35. REG. 10-29-1996.
- 2,011,759. MOONLITE CHEESECAKES AND DESIGN. INT. CL. 30. REG. 10-29-1996.
- 2,011,761. NEO CARNIVAL. INT. CL. 28. REG. 10-29-1996.
- 2,011,762. SANSFIX (STYLIZED). INT. CL. 16. REG. 10-29-1996.
- 2,011,763. EASY OWN THE EASIEST WAY FOR YOUR CUSTOMERS TO OWN THEIR VEHICLES. INT. CL. 36. REG. 10-29-1996.
- 2,011,765. BATH CREATIONS. INT. CL. 27. REG. 10-29-1996.
- 2,011,769. SIMPLE TIMES AND DESIGN. INT. CL. 30. REG. 10-29-1996.
- 2,011,774. FUN N' FROSTY AND DESIGN. INT. CL. 29. REG. 10-29-1996.
- 2,011,775. ILLY CAFFE AND DESIGN. INT. CLS. 9, 11, 21, 30, 33 AND 42. REG. 10-29-1996.
- 2,011,776. FUN N' FROSTY. INT. CL. 29. REG. 10-29-1996.
- 2,011,779. TRUEDATA. INT. CL. 35. REG. 10-29-1996.
- 2,011,782. 3MUSKETEERS AND DESIGN. INT. CL. 30. REG. 10-29-1996.
- 2,011,784. IMLOGIX. INT. CL. 9. REG. 10-29-1996.
- 2,011,785. MILKY WAY AND DESIGN. INT. CL. 30. REG. 10-29-1996.
- 2,011,786. NAREOB. U.S. CL. 200. REG. 10-29-1996.
- 2,011,787. THE CANDLETREE COLLECTION, INC. AND DESIGN. INT. CL. 21. REG. 10-29-1996.
- 2,011,789. LUNCH BAG. INT. CL. 30. REG. 10-29-1996.
- 2,011,790. UTTERLY PERFECT PIZZA AND DESIGN. INT. CL. 30. REG. 10-29-1996.
- 2,011,791. CALIFORNIA NATURALS AND DESIGN. INT. CL. 29. REG. 10-29-1996.
- 2,011,794. REPTILE RATION (STYLIZED). INT. CL. 31. REG. 10-29-1996.
- 2,011,796. MISCELLANEOUS DESIGN. INT. CL. 37. REG. 10-29-1996.
- 2,011,797. HI MODE. INT. CL. 9. REG. 10-29-1996.
- 2,011,800. I.A.S.I.U. INTERNATIONAL ASSOCIATION OF SPECIAL INVESTIGATION UNITS FOUNDED IN 1984 TO COMBAT INSURANCE FRAUD AND DESIGN. INT. CL. 41. REG. 10-29-1996.
- 2,011,801. FIND OUT. BORDERS AND DESIGN. INT. CL. 42. REG. 10-29-1996.
- 2,011,803. MASALA. INT. CL. 16. REG. 10-29-1996.
- 2,011,805. LIQUIMATE. INT. CL. 9. REG. 10-29-1996.
- 2,011,810. TIFFIN. INT. CL. 33. REG. 10-29-1996.
- 2,011,811. OXYGEN. INT. CL. 32. REG. 10-29-1996.
- 2,011,812. IST NATIONWIDE MORTGAGE. INT. CL. 36. REG. 10-29-1996.
- 2,011,813. VUURTOREN. INT. CL. 33. REG. 10-29-1996.
- 2,011,818. MISCELLANEOUS DESIGN. INT. CL. 32. REG. 10-29-1996.
- 2,011,819. KRISPY KREME. INT. CL. 29. REG. 10-29-1996.
- 2,011,823. O'S GOLD AND DESIGN. INT. CL. 31. REG. 10-29-1996.
- 2,011,824. START RECORDS. INT. CL. 9. REG. 10-29-1996.
- 2,011,827. KITCHEN KUT. INT. CL. 29. REG. 10-29-1996.
- 2,011,828. MOO DIRT. INT. CL. 31. REG. 10-29-1996.
- 2,011,833. DILBERT. INT. CL. 9. REG. 10-29-1996.
- 2,011,834. STAGECOACH 401(K). INT. CL. 36. REG. 10-29-1996.
- 2,011,838. FORME (STYLIZED). INT. CL. 5. REG. 10-29-1996.
- 2,011,840. CEDARS HILL. INT. CL. 20. REG. 10-29-1996.
- 2,011,841. FOREFRONT. INT. CL. 9. REG. 10-29-1996.
- 2,011,849. ZOOMSCOPE (STYLIZED). INT. CL. 9. REG. 10-29-1996.
- 2,011,850. SILENT SWITCHER. INT. CL. 9. REG. 10-29-1996.
- 2,011,852. MISCELLANEOUS DESIGN. INT. CL. 30. REG. 10-29-1996.
- 2,011,856. RARE BREED. INT. CL. 31. REG. 10-29-1996.
- 2,011,858. PC FIT. INT. CL. 42. REG. 10-29-1996.
- 2,011,859. CUSTOMCALL. INT. CL. 35. REG. 10-29-1996.
- 2,011,860. SWING MAKER. INT. CL. 9. REG. 10-29-1996.
- 2,011,862. MISCELLANEOUS DESIGN. INT. CL. 41. REG. 10-29-1996.
- 2,011,863. CHAIRMAN 50. INT. CL. 3. REG. 10-29-1996.
- 2,011,869. PERFORMANCE SUCCESS INTERNATIONAL. INT. CL. 41. REG. 10-29-1996.
- 2,011,870. COWBOY VILLAGE RESORT. INT. CL. 42. REG. 10-29-1996.
- 2,011,872. THE LAKE MURRAY PORTFOLIO AND DESIGN. INT. CL. 36. REG. 10-29-1996.
- 2,011,874. A FINE INVESTMENT - A DAILY PLEASURE JANET'S ANTIQUES AND DESIGN. INT. CL. 42. REG. 10-29-1996.

- 2,011,877. WONDERVISION. INT. CL. 9. REG. 10-29-1996.
 2,011,880. HI! KOREAN. INT. CL. 9. REG. 10-29-1996.
 2,011,882. STABLE CHANGE AND DESIGN. INT. CL. 35. REG. 10-29-1996.
 2,011,883. CUSTOMER RESPONSIVE, RESULTS DRIVEN. INT. CL. 36. REG. 10-29-1996.
 2,011,886. FLUID CONTAINMENT AND DESIGN. INT. CL. 9. REG. 10-29-1996.
 2,011,890. WE GO WHERE YOU MOW. INT. CL. 37. REG. 10-29-1996.
 2,011,891. IDFA'S DAIRY INDUSTRY ONLINE AND DESIGN. INT. CLS. 38 AND 42. REG. 10-29-1996.
 2,011,892. OUT CLASSICS. INT. CL. 9. REG. 10-29-1996.
 2,011,893. TRANS-IT. INT. CL. 9. REG. 10-29-1996.
 2,011,896. TRIP. INT. CL. 28. REG. 10-29-1996.
 2,011,899. CONEXPORT V.I.P. AND DESIGN. INT. CL. 35. REG. 10-29-1996.
 2,011,900. AUDIONET. INT. CLS. 38 AND 41. REG. 10-29-1996.
 2,011,902. WITT AND DESIGN. INT. CL. 9. REG. 10-29-1996.
 2,011,905. WORD BENDER AND DESIGN. INT. CL. 40. REG. 10-29-1996.
 2,011,908. TOAD DESIGNS. INT. CL. 25. REG. 10-29-1996.
 2,011,914. E AND DESIGN. INT. CL. 9. REG. 10-29-1996.
 2,011,917. INCENTIVE GIFT CHEQUE (STYLIZED). INT. CL. 35. REG. 10-29-1996.
 2,011,919. HAYMEX. INT. CL. 22. REG. 10-29-1996.
 2,011,920. KRUPS TOASTRONIC. INT. CL. 11. REG. 10-29-1996.
 2,011,921. LIST XPRESS (STYLIZED). INT. CL. 9. REG. 10-29-1996.
 2,011,922. QUIKNET. INT. CL. 9. REG. 10-29-1996.
 2,011,923. SANDERELLA'S TOYS. INT. CL. 28. REG. 10-29-1996.
 2,011,924. TWINKY DUST. INT. CL. 28. REG. 10-29-1996.
 2,011,927. KEEPERS. INT. CL. 9. REG. 10-29-1996.
 2,011,931. PLAYGROUND. INT. CL. 9. REG. 10-29-1996.
 2,011,938. LANGUAGE WORKS SPELLING PROGRAM. INT. CL. 16. REG. 10-29-1996.
 2,011,939. TRUNKTRAC. INT. CL. 9. REG. 10-29-1996.
 2,011,940. 1-800-CAMPATT. INT. CL. 38. REG. 10-29-1996.
 2,011,943. PACKAGE AMERICA AND DESIGN. INT. CL. 39. REG. 10-29-1996.
 2,011,944. TONY'S DEEP DISH AND DESIGN. INT. CL. 30. REG. 10-29-1996.
 2,011,946. POWER CRYSTAL. INT. CL. 19. REG. 10-29-1996.
 2,011,947. GASTRONOMIC GOSSIP. INT. CL. 41. REG. 10-29-1996.
 2,011,949. C & R INDUSTRIES. INT. CL. 1. REG. 10-29-1996.
 2,011,951. THE CARD FOR YOUR CORNER OF THE WORLD. INT. CLS. 35 AND 36. REG. 10-29-1996.
 2,011,952. NEW WEST. INT. CL. 36. REG. 10-29-1996.
 2,011,953. TONY'S DEEP DISH AND DESIGN. INT. CL. 30. REG. 10-29-1996.
 2,011,954. CHRISTINE PHILLIPE (STYLIZED). INT. CL. 25. REG. 10-29-1996.
 2,011,955. SAM'S TRAVEL CLUB AND DESIGN. INT. CL. 39. REG. 10-29-1996.
 2,011,957. TOTAL FLY CONTROL. INT. CL. 16. REG. 10-29-1996.
 2,011,959. PRODUCT EXPERT. INT. CL. 9. REG. 10-29-1996.
 2,011,960. SIT ON THIS. INT. CL. 20. REG. 10-29-1996.
 2,011,962. STAGECOACH MONEY PURCHASE PENSION PLAN. INT. CL. 36. REG. 10-29-1996.
 2,011,963. STARS SPECIAL THANKS AWARDS FOR REMARKABLE SERVICE AND DESIGN. INT. CL. 35. REG. 10-29-1996.
 2,011,964. STARS AND DESIGN. INT. CL. 35. REG. 10-29-1996.
 2,011,965. STARS. INT. CL. 35. REG. 10-29-1996.
 2,011,967. FIESTA OLE (STYLIZED). INT. CL. 42. REG. 10-29-1996.
 2,011,968. TOBACCO JUNCTION DISCOUNT TOBACCO OUTLETS AND DESIGN. INT. CL. 42. REG. 10-29-1996.
 2,011,969. SES. INT. CL. 35. REG. 10-29-1996.
 2,011,970. FIT & FAT-FREE. INT. CL. 42. REG. 10-29-1996.
 2,011,974. DEKALB COUNTY EXPRESS TRACK CLUB, INC. AND DESIGN. INT. CL. 41. REG. 10-29-1996.
 2,011,976. WORKING TOGETHER TO SERVE YOU BETTER. INT. CL. 42. REG. 10-29-1996.
 2,011,978. MAKE IT FIT. INT. CL. 41. REG. 10-29-1996.
 2,011,979. HEMP. INT. CL. 28. REG. 10-29-1996.
 2,011,982. HAPPY TOURS. INT. CL. 39. REG. 10-29-1996.
 2,011,983. PERFECT BALANCE. INT. CL. 36. REG. 10-29-1996.
 2,011,984. Y-33 OCLV CARBON SERIES (STYLIZED). INT. CL. 12. REG. 10-29-1996.
 2,011,985. Y-11 OCLV CARBON AND DESIGN. INT. CL. 12. REG. 10-29-1996.
 2,011,986. QUIKSAND. INT. CL. 11. REG. 10-29-1996.
 2,011,989. TAIKO. INT. CL. 7. REG. 10-29-1996.
 2,011,992. JUMP-RING MASTER. INT. CL. 8. REG. 10-29-1996.
 2,011,993. PLAYBACK THEATRE AND DESIGN. INT. CL. 41. REG. 10-29-1996.
 2,011,994. MIDWEST POWER TOOL DIVISION AND DESIGN. INT. CL. 42. REG. 10-29-1996.
 2,012,003. THE LAST HOP! (STYLIZED). INT. CL. 21. REG. 10-29-1996.
 2,012,004. DECLARE. INT. CL. 42. REG. 10-29-1996.
 2,012,006. DNIB. INT. CL. 36. REG. 10-29-1996.
 2,012,007. VIAZZA. INT. CL. 25. REG. 10-29-1996.
 2,012,011. SHANK YOU AND DESIGN. INT. CL. 25. REG. 10-29-1996.
 2,012,014. COOKS CLUB. INT. CL. 24. REG. 10-29-1996.
 2,012,016. DIANE VON FURSTENBERG THE COLOR AUTHORITY (STYLIZED). INT. CLS. 18 AND 25. REG. 10-29-1996.
 2,012,017. CUSTOMPRINTS. INT. CLS. 39, 40 AND 42. REG. 10-29-1996.
 2,012,018. ACTI-MINCEUR. INT. CL. 3. REG. 10-29-1996.
 2,012,019. MAMA KIN AND DESIGN. INT. CL. 20. REG. 10-29-1996.
 2,012,021. CLYDESDALE. INT. CL. 21. REG. 10-29-1996.
 2,012,022. MISCELLANEOUS DESIGN. INT. CL. 21. REG. 10-29-1996.
 2,012,023. CLYDESDALE FOOTBALL. INT. CL. 21. REG. 10-29-1996.
 2,012,026. MISCELLANEOUS DESIGN. INT. CL. 25. REG. 10-29-1996.
 2,012,027. THISSOFTWARE COMPANY, INC. AND DESIGN. INT. CL. 9. REG. 10-29-1996.
 2,012,030. ELIZABETH WOOD AND DESIGN. INT. CL. 25. REG. 10-29-1996.
 2,012,031. STARTING BLOCKS. INT. CL. 36. REG. 10-29-1996.
 2,012,032. FRYDAY CLUB. INT. CL. 25. REG. 10-29-1996.
 2,012,033. DEATH STICK AND DESIGN. INT. CL. 25. REG. 10-29-1996.
 2,012,035. NYMPH MASTER AND DESIGN. INT. CLS. 25, 28 AND 42. REG. 10-29-1996.
 2,012,036. PDT. INT. CL. 42. REG. 10-29-1996.
 2,012,037. SPRINT SENSE LOCAL TOLL. INT. CL. 38. REG. 10-29-1996.
 2,012,044. THIS IS FOR YOU ANGEL. INT. CL. 25. REG. 10-29-1996.
 2,012,045. MISCELLANEOUS DESIGN. INT. CLS. 21 AND 25. REG. 10-29-1996.
 2,012,046. MIDNITE SNACK AND DESIGN. INT. CL. 25. REG. 10-29-1996.
 2,012,048. CHEM-FREE ORGANIC PEST CONTROL. INT. CL. 37. REG. 10-29-1996.
 2,012,049. KENDO PRODUCTS. INT. CL. 21. REG. 10-29-1996.
 2,012,052. SACRED DANCE OF ISHTAR. INT. CL. 41. REG. 10-29-1996.
 2,012,058. WESTIN CONNECTIONS. INT. CL. 35. REG. 10-29-1996.
 2,012,062. MISCELLANEOUS DESIGN. INT. CL. 25. REG. 10-29-1996.
 2,012,065. LIMITED JEANS AND DESIGN. INT. CL. 25. REG. 10-29-1996.

- 2,012,067. LIMITED JEANS ESTABLISHED '63 AND DESIGN. INT. CL. 25. REG. 10-29-1996.
- 2,012,068. DOMAINWEAR. INT. CL. 25. REG. 10-29-1996.
- 2,012,070. MARLO. INT. CL. 18. REG. 10-29-1996.
- 2,012,071. GOLD COAST. INT. CL. 18. REG. 10-29-1996.
- 2,012,072. AVID AND DESIGN. INT. CL. 22. REG. 10-29-1996.
- 2,012,073. NOTANONYMOUS (STYLIZED). INT. CL. 35. REG. 10-29-1996.
- 2,012,074. ELEPHANT WALK. INT. CLS. 25 AND 42. REG. 10-29-1996.
- 2,012,076. AUTOPUTTER AND DESIGN. INT. CL. 28. REG. 10-29-1996.
- 2,012,079. DIFFERENT FROM THE GROUND UP. INT. CLS. 36 AND 42. REG. 10-29-1996.
- 2,012,082. CHANGE THE WORLD. INT. CL. 25. REG. 10-29-1996.
- 2,012,084. TALK THE TALK. INT. CL. 32. REG. 10-29-1996.
- 2,012,085. TALK THE TALK. INT. CL. 25. REG. 10-29-1996.
- 2,012,086. SPARKLE RINSE. INT. CL. 3. REG. 10-29-1996.
- 2,012,089. FUTURES EXPRESS AND DESIGN. INT. CL. 36. REG. 10-29-1996.
- 2,012,090. ROMAIIKA. INT. CL. 16. REG. 10-29-1996.
- 2,012,092. GOLDEN A.M.. INT. CL. 25. REG. 10-29-1996.
- 2,012,093. CASTLE GEAR. INT. CL. 42. REG. 10-29-1996.
- 2,012,094. SEWCRAFT. INT. CL. 25. REG. 10-29-1996.
- 2,012,095. MISCELLANEOUS DESIGN. INT. CL. 20. REG. 10-29-1996.
- 2,012,096. BASIC FRIDAY. INT. CL. 25. REG. 10-29-1996.
- 2,012,097. COMPUQUEST. INT. CL. 41. REG. 10-29-1996.
- 2,012,099. WATERFRONT PUBLISHING. INT. CL. 42. REG. 10-29-1996.
- 2,012,102. EQUAL TIME ATHLETES. INT. CLS. 25 AND 42. REG. 10-29-1996.
- 2,012,104. PRIVATE ISSUE PRIVILEGES. INT. CL. 35. REG. 10-29-1996.
- 2,012,106. PROSPECTIVE. INT. CL. 16. REG. 10-29-1996.
- 2,012,107. INFONECTIONS. INT. CL. 42. REG. 10-29-1996.
- 2,012,109. STROKES AND DESIGN. INT. CLS. 28 AND 42. REG. 10-29-1996.
- 2,012,110. LOST WORLD ADVENTURES. INT. CL. 25. REG. 10-29-1996.
- 2,012,114. SWEET PETE. INT. CL. 14. REG. 10-29-1996.
- 2,012,116. HRCENTRAL. INT. CL. 35. REG. 10-29-1996.
- 2,012,117. TUCK-IN. INT. CL. 10. REG. 10-29-1996.
- 2,012,124. MISCELLANEOUS DESIGN. INT. CL. 32. REG. 10-29-1996.
- 2,012,128. DELIVERING MORE THAN JUST THE MESSAGE. INT. CL. 38. REG. 10-29-1996.
- 2,012,130. BC (STYLIZED). INT. CLS. 29 AND 30. REG. 10-29-1996.
- 2,012,132. COOKIE DIPPERS. INT. CL. 30. REG. 10-29-1996.
- 2,012,135. BIODERM AND DESIGN. INT. CLS. 5 AND 10. REG. 10-29-1996.
- 2,012,136. TITANIUM SPORTS SANDVIK TITANIUM AND DESIGN. INT. CLS. 12 AND 28. REG. 10-29-1996.
- 2,012,138. I AM FINE. INT. CL. 10. REG. 10-29-1996.
- 2,012,139. ACCESS PLUS. INT. CL. 9. REG. 10-29-1996.
- 2,012,142. X-TV. INT. CLS. 38 AND 41. REG. 10-29-1996.
- 2,012,146. 73 EASTING. INT. CL. 28. REG. 10-29-1996.
- 2,012,148. LIQUIBAND. INT. CL. 5. REG. 10-29-1996.
- 2,012,149. MR. SNIFFER. INT. CL. 5. REG. 10-29-1996.
- 2,012,152. OUTWORD. INT. CLS. 9 AND 16. REG. 10-29-1996.
- 2,012,153. ACE FEVER. INT. CL. 28. REG. 10-29-1996.
- 2,012,154. ISCASTAT. INT. CL. 5. REG. 10-29-1996.
- 2,012,155. ICE. INT. CL. 9. REG. 10-29-1996.
- 2,012,158. BOMBADIER. INT. CL. 16. REG. 10-29-1996.
- 2,012,161. SCHOLASTIC READER'S CHOICE AND DESIGN. INT. CLS. 9 AND 16. REG. 10-29-1996.
- 2,012,162. SAF-T-MED. INT. CL. 10. REG. 10-29-1996.
- 2,012,163. DAISY HILL PUPPIES. INT. CL. 25. REG. 10-29-1996.
- 2,012,165. HILITE U.S.A.. INT. CL. 9. REG. 10-29-1996.
- 2,012,170. CONTROLL. INT. CL. 10. REG. 10-29-1996.
- 2,012,171. THE SEPIA SUGGESTION BOX. INT. CL. 9. REG. 10-29-1996.
- 2,012,173. SMART-TIP. INT. CL. 10. REG. 10-29-1996.
- 2,012,175. TANGIE TOPPER. INT. CL. 25. REG. 10-29-1996.
- 2,012,178. EASTERVALE. INT. CL. 21. REG. 10-29-1996.
- 2,012,179. MISCELLANEOUS DESIGN. INT. CL. 9. REG. 10-29-1996.
- 2,012,180. GET REAL. INT. CL. 25. REG. 10-29-1996.
- 2,012,182. OHMEDA. INT. CL. 5. REG. 10-29-1996.
- 2,012,183. DR. KARR'S SUN-STATIN. INT. CL. 5. REG. 10-29-1996.
- 2,012,184. ALIVE. INT. CL. 13. REG. 10-29-1996.
- 2,012,187. SELTEK AND DESIGN. INT. CL. 42. REG. 10-29-1996.
- 2,012,188. FEMPATCH. INT. CL. 5. REG. 10-29-1996.
- 2,012,190. FLEX-GUARD. INT. CL. 28. REG. 10-29-1996.
- 2,012,194. BUSINESS96. INT. CL. 16. REG. 10-29-1996.
- 2,012,195. SDDS (STYLIZED). INT. CL. 37. REG. 10-29-1996.
- 2,012,196. X-CELL. INT. CL. 40. REG. 10-29-1996.
- 2,012,197. WIVOX. INT. CL. 9. REG. 10-29-1996.
- 2,012,200. 4D FIRST. INT. CL. 9. REG. 10-29-1996.
- 2,012,202. MCZEE AND DESIGN. INT. CL. 16. REG. 10-29-1996.
- 2,012,204. PLASFIT. INT. CL. 17. REG. 10-29-1996.
- 2,012,205. SWISS FONTINA AND DESIGN. INT. CL. 29. REG. 10-29-1996.
- 2,012,206. SCORE CARDING AND DESIGN. INT. CL. 9. REG. 10-29-1996.
- 2,012,209. MOD. INT. CL. 9. REG. 10-29-1996.
- 2,012,210. ATTACHE. INT. CL. 10. REG. 10-29-1996.
- 2,012,211. I (STYLIZED). INT. CL. 10. REG. 10-29-1996.
- 2,012,214. GAS/FLOWCON. INT. CL. 9. REG. 10-29-1996.
- 2,012,216. TIG REINSURANCE AND DESIGN. INT. CL. 36. REG. 10-29-1996.
- 2,012,217. SAFEGUARD. INT. CLS. 37 AND 42. REG. 10-29-1996.
- 2,012,220. VISUAL BANKER. INT. CL. 42. REG. 10-29-1996.
- 2,012,222. COMSORT. INT. CLS. 9 AND 16. REG. 10-29-1996.
- 2,012,223. GARLINNAISE. INT. CL. 30. REG. 10-29-1996.
- 2,012,224. TRAVELBANK AND DESIGN. INT. CL. 36. REG. 10-29-1996.
- 2,012,225. WHAT THE DOCTOR TAKES. INT. CL. 5. REG. 10-29-1996.
- 2,012,227. CHARTMATE. INT. CL. 9. REG. 10-29-1996.
- 2,012,228. MAN. INT. CL. 14. REG. 10-29-1996.
- 2,012,229. SURFMAP. INT. CL. 9. REG. 10-29-1996.
- 2,012,232. MISCELLANEOUS DESIGN. INT. CL. 41. REG. 10-29-1996.
- 2,012,234. REINER STIRRUP AND DESIGN. INT. CL. 10. REG. 10-29-1996.
- 2,012,236. A LITTLE INGENUITY THAT GOES A LONG WAY. INT. CL. 38. REG. 10-29-1996.
- 2,012,237. YES! INTERACTIVE BOOKS AND DESIGN. INT. CL. 16. REG. 10-29-1996.
- 2,012,238. MISCELLANEOUS DESIGN. INT. CL. 9. REG. 10-29-1996.
- 2,012,239. GLOBAL RESEARCH INSTITUTE. INT. CL. 35. REG. 10-29-1996.
- 2,012,240. CINNFULLY CRUNCHY. INT. CL. 30. REG. 10-29-1996.
- 2,012,241. 21ST CENTURY LIMITED AND DESIGN. INT. CL. 6. REG. 10-29-1996.
- 2,012,244. OPERATION SHOP SAFE. INT. CL. 36. REG. 10-29-1996.
- 2,012,247. PLAZCHEMCEK. INT. CL. 1. REG. 10-29-1996.
- 2,012,248. MODERN KIDS (STYLIZED). INT. CLS. 9 AND 11. REG. 10-29-1996.
- 2,012,250. SPACES SITE PROCUREMENT AND COST ESTIMATING SYSTEM AND DESIGN. INT. CL. 9. REG. 10-29-1996.
- 2,012,252. LERITONE. INT. CL. 5. REG. 10-29-1996.
- 2,012,253. FRAMESAKE. INT. CL. 16. REG. 10-29-1996.
- 2,012,255. COLORSOURCE. INT. CL. 42. REG. 10-29-1996.
- 2,012,258. GUARDIAN ANGEL. INT. CL. 16. REG. 10-29-1996.
- 2,012,259. MY FIRST HOCKEY. INT. CL. 28. REG. 10-29-1996.
- 2,012,260. LEADING THE WAY. INT. CLS. 35 AND 40. REG. 10-29-1996.
- 2,012,262. SUN-STATIN DR. KARR'S AND DESIGN. INT. CL. 3. REG. 10-29-1996.

- 2,012,263. A AND DESIGN. INT. CLS. 25 AND 41. REG. 10-29-1996.
- 2,012,264. MALAGA ESPANA BRANDY EXCELENCIA LARIOS AND DESIGN. INT. CL. 33. REG. 10-29-1996.
- 2,012,267. SWISS GOURMET TRADITIONAL ICE CREAMS & YOGURTS AND DESIGN. INT. CL. 30. REG. 10-29-1996.
- 2,012,268. EYEBAND. INT. CL. 9. REG. 10-29-1996.
- 2,012,271. HEALTHSOURCE. INT. CL. 42. REG. 10-29-1996.
- 2,012,274. POSTBOX. INT. CL. 9. REG. 10-29-1996.
- 2,012,275. CAL-GRO. INT. CL. 1. REG. 10-29-1996.
- 2,012,280. VISUAL OPTIONS. INT. CLS. 5, 9 AND 42. REG. 10-29-1996.
- 2,012,282. DEJUNO. INT. CL. 25. REG. 10-29-1996.
- 2,012,285. PSL ACCUMULATOR. INT. CL. 36. REG. 10-29-1996.
- 2,012,286. ADOBE TEACH. INT. CL. 9. REG. 10-29-1996.
- 2,012,290. CONTOUR ULTRA. INT. CL. 20. REG. 10-29-1996.
- 2,012,291. TEAM DITTLER. INT. CLS. 28 AND 42. REG. 10-29-1996.
- 2,012,292. PRODUCED WITH PRIDE BY TEAM DITTLER (STYLIZED). INT. CLS. 28 AND 42. REG. 10-29-1996.
- 2,012,293. REPORTVIEW. INT. CL. 9. REG. 10-29-1996.
- 2,012,294. TELEPATH. INT. CL. 9. REG. 10-29-1996.
- 2,012,295. CRIPPLE CREEK BAND. INT. CL. 41. REG. 10-29-1996.
- 2,012,296. MICRO BREW HOME BREWING SYSTEMS AND DESIGN. INT. CL. 32. REG. 10-29-1996.
- 2,012,297. GOLDEN DIJON. INT. CL. 29. REG. 10-29-1996.
- 2,012,298. MICAP. INT. CL. 2. REG. 10-29-1996.
- 2,012,299. GARDENA. INT. CL. 32. REG. 10-29-1996.
- 2,012,303. DA REF'. INT. CL. 25. REG. 10-29-1996.
- 2,012,305. WHERE ON EARTH. INT. CLS. 9 AND 42. REG. 10-29-1996.
- 2,012,306. CIRCLE OF TRANQUILITY AND DESIGN. INT. CL. 27. REG. 10-29-1996.
- 2,012,307. VISI-TECH (STYLIZED). INT. CL. 20. REG. 10-29-1996.
- 2,012,308. MISCELLANEOUS DESIGN. INT. CLS. 8, 9, 18 AND 28. REG. 10-29-1996.
- 2,012,309. DYNAMICS C/S+. INT. CL. 9. REG. 10-29-1996.
- 2,012,310. CYBERCITY ONLINE. INT. CL. 38. REG. 10-29-1996.
- 2,012,314. KWIK-KAP. INT. CL. 5. REG. 10-29-1996.
- 2,012,316. CLASSY COW. INT. CL. 16. REG. 10-29-1996.
- 2,012,317. QRANC. INT. CLS. 12 AND 25. REG. 10-29-1996.
- 2,012,318. TWIST-CORE. INT. CL. 10. REG. 10-29-1996.
- 2,012,319. SHOPPER'S DELIGHT. INT. CL. 42. REG. 10-29-1996.
- 2,012,320. SOPHIST-A-KIT. INT. CL. 21. REG. 10-29-1996.
- 2,012,321. KINSUI. INT. CL. 9. REG. 10-29-1996.
- 2,012,323. FRESH MAX. INT. CL. 16. REG. 10-29-1996.
- 2,012,324. SUPRABAG. INT. CL. 10. REG. 10-29-1996.
- 2,012,327. SAY IT AGAIN, SAM!. INT. CL. 28. REG. 10-29-1996.
- 2,012,329. WATCHD. INT. CL. 9. REG. 10-29-1996.
- 2,012,330. REPL. INT. CL. 9. REG. 10-29-1996.
- 2,012,331. LIBFT. INT. CL. 9. REG. 10-29-1996.
- 2,012,333. INFOPIEDIA. INT. CL. 9. REG. 10-29-1996.
- 2,012,335. INFOQUOTE. INT. CL. 38. REG. 10-29-1996.
- 2,012,339. TUTELAR. INT. CL. 10. REG. 10-29-1996.
- 2,012,340. CDP IMAGING SYSTEMS. INT. CLS. 37 AND 42. REG. 10-29-1996.
- 2,012,341. GET OUT AND STAY OUT. INT. CL. 25. REG. 10-29-1996.
- 2,012,344. ARMADA. INT. CL. 9. REG. 10-29-1996.
- 2,012,347. TODDLER'S BEST. INT. CL. 5. REG. 10-29-1996.
- 2,012,348. SIMPLICITY. INT. CL. 10. REG. 10-29-1996.
- 2,012,349. OPERALIA. INT. CL. 35. REG. 10-29-1996.
- 2,012,350. WRAPPID. INT. CL. 10. REG. 10-29-1996.
- 2,012,353. RM CANINE PARVO XL. INT. CL. 5. REG. 10-29-1996.
- 2,012,354. YOMAC. INT. CL. 16. REG. 10-29-1996.
- 2,012,357. PRIMORTALS. INT. CL. 42. REG. 10-29-1996.
- 2,012,363. BRAINLINK. INT. CL. 9. REG. 10-29-1996.
- 2,012,364. MAGNACAL. INT. CL. 1. REG. 10-29-1996.
- 2,012,366. PATRICIA MILLER. INT. CL. 42. REG. 10-29-1996.
- 2,012,369. VIDEO HELPER AND DESIGN. INT. CL. 9. REG. 10-29-1996.
- 2,012,370. THRIFTY MAID. INT. CL. 30. REG. 10-29-1996.
- 2,012,371. DRAGON KICK. INT. CL. 28. REG. 10-29-1996.
- 2,012,372. PLANT SOURCE. INT. CL. 5. REG. 10-29-1996.
- 2,012,374. MELODY OF THE WEST. INT. CL. 41. REG. 10-29-1996.
- 2,012,376. WILLIAMS ENTERTAINMENT. INT. CL. 28. REG. 10-29-1996.
- 2,012,378. HDS. INT. CLS. 35, 36 AND 42. REG. 10-29-1996.
- 2,012,382. AQUA PEN AND PAD. INT. CL. 16. REG. 10-29-1996.
- 2,012,383. CATHOLICARE. INT. CLS. 35, 36 AND 42. REG. 10-29-1996.
- 2,012,388. DISPATCHIT. INT. CL. 9. REG. 10-29-1996.
- 2,012,391. NEXT GENERATION AND DESIGN. INT. CL. 16. REG. 10-29-1996.
- 2,012,394. MISCELLANEOUS DESIGN. INT. CL. 41. REG. 10-29-1996.
- 2,012,395. MISCELLANEOUS DESIGN. INT. CL. 41. REG. 10-29-1996.
- 2,012,396. WORCESTER ICECATS AND DESIGN. INT. CL. 25. REG. 10-29-1996.
- 2,012,398. POST/LA. INT. CL. 35. REG. 10-29-1996.
- 2,012,399. PINSTRIPE PETITES. INT. CL. 25. REG. 10-29-1996.
- 2,012,400. C/S DEVELOPER. INT. CL. 9. REG. 10-29-1996.
- 2,012,403. SPONGECHEK. INT. CL. 10. REG. 10-29-1996.
- 2,012,404. MISCELLANEOUS DESIGN. INT. CL. 28. REG. 10-29-1996.
- 2,012,406. NETWORK FUNDSOURCE. INT. CL. 36. REG. 10-29-1996.
- 2,012,408. PROBOARD. INT. CL. 10. REG. 10-29-1996.
- 2,012,409. VINAIGRETTES FRESH SALADS AND DRESSINGS AND DESIGN. INT. CL. 42. REG. 10-29-1996.
- 2,012,410. PORTRAIT. INT. CL. 35. REG. 10-29-1996.
- 2,012,414. MISCELLANEOUS DESIGN. INT. CL. 16. REG. 10-29-1996.
- 2,012,415. ENCINA BUILDER. INT. CL. 9. REG. 10-29-1996.
- 2,012,416. NEWHALL RANCH AND DESIGN. INT. CL. 37. REG. 10-29-1996.
- 2,012,418. SANTA COUNTRY. INT. CL. 41. REG. 10-29-1996.
- 2,012,419. POWR-FLITE FAST DRY. INT. CL. 9. REG. 10-29-1996.
- 2,012,422. KIEL CENTER. INT. CL. 41. REG. 10-29-1996.
- 2,012,423. TASTE OF THE HILL. INT. CL. 42. REG. 10-29-1996.
- 2,012,424. POST RX AND DESIGN. INT. CL. 42. REG. 10-29-1996.
- 2,012,425. CHALK ART. INT. CL. 16. REG. 10-29-1996.
- 2,012,433. MAGNUM PURUP IMAGEMAKER. INT. CL. 9. REG. 10-29-1996.
- 2,012,434. BENCHPRO. INT. CL. 8. REG. 10-29-1996.
- 2,012,435. VOID. INT. CL. 28. REG. 10-29-1996.
- 2,012,436. MISCELLANEOUS DESIGN. INT. CL. 37. REG. 10-29-1996.
- 2,012,437. NEWORLD N AND DESIGN. INT. CL. 37. REG. 10-29-1996.
- 2,012,439. PROJECT PROMISE (STYLIZED). INT. CL. 42. REG. 10-29-1996.
- 2,012,441. CLORINA. INT. CL. 5. REG. 10-29-1996.
- 2,012,442. ATRIUS. INT. CL. 9. REG. 10-29-1996.
- 2,012,444. SPOTLIGHT. INT. CL. 9. REG. 10-29-1996.
- 2,012,448. D TECT AVISION AND DESIGN. INT. CL. 9. REG. 10-29-1996.
- 2,012,449. SUMMER SHEER. INT. CL. 25. REG. 10-29-1996.
- 2,012,450. JUST THE RIGHT CHEMISTRY. INT. CL. 1. REG. 10-29-1996.
- 2,012,451. ICONTERM. INT. CL. 9. REG. 10-29-1996.
- 2,012,452. ALLIED HEALTH PARTNERSHIP. INT. CL. 35. REG. 10-29-1996.
- 2,012,455. QUALYSNIFF. INT. CL. 9. REG. 10-29-1996.
- 2,012,456. SOF-COMFORT. INT. CL. 10. REG. 10-29-1996.
- 2,012,458. G.B.B. AND DESIGN. INT. CL. 28. REG. 10-29-1996.
- 2,012,459. CLEAR CHROME. INT. CL. 16. REG. 10-29-1996.

- 2,012,460. QUIKTRAK. INT. CL. 9. REG. 10-29-1996.
 2,012,461. STRATEGEN. INT. CL. 9. REG. 10-29-1996.
 2,012,464. KNIGHT AND DESIGN. INT. CL. 10. REG. 10-29-1996.
 2,012,465. PENPAK!. INT. CL. 9. REG. 10-29-1996.
 2,012,466. EARTH ANGEL AND DESIGN. INT. CL. 16. REG. 10-29-1996.
 2,012,467. BEACH FRIES. INT. CL. 29. REG. 10-29-1996.
 2,012,472. EXCEPTIONAL PERFORMANCE FOR EACH AND EVERY CUSTOMER. INT. CL. 36. REG. 10-29-1996.
 2,012,473. QUICK WIZ AND DESIGN. INT. CL. 9. REG. 10-29-1996.
 2,012,475. ULTIMATE GOLD CHECKING. INT. CL. 36. REG. 10-29-1996.
 2,012,476. LABMAX. INT. CL. 35. REG. 10-29-1996.
 2,012,478. DEL WEBB'S SUN CITY GEORGETOWN. INT. CL. 37. REG. 10-29-1996.
 2,012,479. OPTI-FILM. INT. CL. 1. REG. 10-29-1996.
 2,012,480. DOLE DARE. INT. CL. 29. REG. 10-29-1996.
 2,012,481. MEDILIFE. INT. CLS. 35, 39, 41 AND 42. REG. 10-29-1996.
 2,012,484. SAFE-KEY. INT. CL. 13. REG. 10-29-1996.
 2,012,489. MISCELLANEOUS DESIGN. INT. CL. 25. REG. 10-29-1996.
 2,012,492. NEVCO COMFORT HOLD. INT. CL. 10. REG. 10-29-1996.
 2,012,497. VENSHIELD. INT. CL. 10. REG. 10-29-1996.
 2,012,498. SAVORE. INT. CL. 42. REG. 10-29-1996.
 2,012,502. BUYERS GLOBAL EDGE. INT. CL. 42. REG. 10-29-1996.
 2,012,503. NORTHERN EXPRESS. INT. CL. 42. REG. 10-29-1996.
 2,012,504. ROLATAPE MEASURING SYSTEMS. INT. CL. 9. REG. 10-29-1996.
 2,012,505. NIGHTSIGHT. INT. CLS. 9 AND 10. REG. 10-29-1996.
 2,012,507. PRE MATT 800. INT. CL. 10. REG. 10-29-1996.
 2,012,508. BOW-WOW BOOKS AND DESIGN. INT. CL. 16. REG. 10-29-1996.
 2,012,509. SEARCH FOR THE STARS. INT. CLS. 16 AND 28. REG. 10-29-1996.
 2,012,510. ANIMATOR STUDIO. INT. CL. 9. REG. 10-29-1996.
 2,012,514. PREVENTION IN A DROP AND DESIGN. INT. CL. 5. REG. 10-29-1996.
 2,012,515. POT O' GOLD. INT. CL. 41. REG. 10-29-1996.
 2,012,517. PRIVATE WORLD. INT. CL. 36. REG. 10-29-1996.
 2,012,518. ANIMATION WITH AN ATTITUDE. INT. CL. 41. REG. 10-29-1996.
 2,012,519. PURE EYES. INT. CL. 5. REG. 10-29-1996.
 2,012,523. PHYTOCHARGED. INT. CL. 5. REG. 10-29-1996.
 2,012,524. BUSINESSBASE. INT. CL. 35. REG. 10-29-1996.
 2,012,525. OP OFFICE PLUS BUSINESS SOLUTIONS. INT. CL. 35. REG. 10-29-1996.
 2,012,526. MQS. INT. CL. 36. REG. 10-29-1996.
 2,012,528. OLAN. INT. CL. 25. REG. 10-29-1996.
 2,012,529. SUMMER CELEBRATIONS. INT. CL. 5. REG. 10-29-1996.
 2,012,533. PRAXISOFT. INT. CL. 9. REG. 10-29-1996.
 2,012,534. FOOD UPDATE FOOD UPDATE AEGIS FDLI AND DESIGN. INT. CL. 41. REG. 10-29-1996.
 2,012,535. CHAPARRITAS EL NARANJO AND DESIGN. INT. CL. 32. REG. 10-29-1996.
 2,012,536. POCK-A-ROOS!. INT. CL. 9. REG. 10-29-1996.
 2,012,537. SIMPLY KIDS. INT. CL. 9. REG. 10-29-1996.
 2,012,539. CALAIS. INT. CL. 9. REG. 10-29-1996.
 2,012,543. TRANSBATCH. INT. CL. 9. REG. 10-29-1996.
 2,012,544. LET IT SNOW. INT. CL. 21. REG. 10-29-1996.
 2,012,546. WE GOT THE POWER. INT. CL. 36. REG. 10-29-1996.
 2,012,547. PIE. INT. CL. 28. REG. 10-29-1996.
 2,012,548. PICO. INT. CL. 9. REG. 10-29-1996.
 2,012,553. C.2.C. AND DESIGN. INT. CL. 25. REG. 10-29-1996.
 2,012,555. THE ITALIAN CONNECTION. INT. CL. 42. REG. 10-29-1996.
 2,012,556. GENMARK. INT. CL. 36. REG. 10-29-1996.
 2,012,557. THINCELL. INT. CL. 9. REG. 10-29-1996.
 2,012,558. BESCORE AND DESIGN. INT. CL. 28. REG. 10-29-1996.
 2,012,559. MISCELLANEOUS DESIGN. INT. CL. 30. REG. 10-29-1996.
 2,012,561. WILD WATERMELON. INT. CL. 30. REG. 10-29-1996.
 2,012,562. WACKY SACKS. INT. CL. 32. REG. 10-29-1996.
 2,012,563. CHILACA GRILLE. INT. CL. 42. REG. 10-29-1996.
 2,012,564. JUBA NEW, FRESH BEVERAGES. INT. CL. 32. REG. 10-29-1996.
 2,012,566. CLUB GREEN. INT. CLS. 5, 19 AND 31. REG. 10-29-1996.
 2,012,567. BOTANICAL PLEASURES. INT. CLS. 3, 5, 20 AND 21. REG. 10-29-1996.
 2,012,568. TALENT SCOUT. INT. CL. 9. REG. 10-29-1996.
 2,012,569. SPYWARS. INT. CL. 28. REG. 10-29-1996.
 2,012,575. TO KEEP OFF WHAT YOU'VE GOTTEN OFF. INT. CL. 5. REG. 10-29-1996.
 2,012,579. RESOLVE 828. INT. CL. 3. REG. 10-29-1996.
 2,012,581. QUILTER'S KANDI. INT. CL. 26. REG. 10-29-1996.
 2,012,582. POP-UP PALS PIANO. INT. CL. 28. REG. 10-29-1996.
 2,012,584. ROUTE 101. INT. CL. 9. REG. 10-29-1996.
 2,012,585. HBP AND DESIGN. INT. CL. 25. REG. 10-29-1996.
 2,012,586. /TTN. INT. CL. 35. REG. 10-29-1996.
 2,012,587. KR SCIENCEBASE. INT. CL. 38. REG. 10-29-1996.
 2,012,588. THE ONE ASSET ALLOCATION ACCOUNT. INT. CL. 36. REG. 10-29-1996.
 2,012,589. SEA OF DREAMS. INT. CL. 3. REG. 10-29-1996.
 2,012,590. IMAGINATION. INT. CL. 41. REG. 10-29-1996.
 2,012,591. SKINNY MINNIES. INT. CL. 30. REG. 10-29-1996.
 2,012,594. BIRDALURE. INT. CL. 21. REG. 10-29-1996.
 2,012,595. NOTHING ELSE FEELS LIKE A CURRENT AFFAIR. INT. CL. 41. REG. 10-29-1996.
 2,012,597. PNC ASSET MANAGEMENT. INT. CL. 36. REG. 10-29-1996.
 2,012,598. GIZMO. INT. CL. 9. REG. 10-29-1996.
 2,012,600. MAJORITY 96. INT. CL. 42. REG. 10-29-1996.
 2,012,601. RYKOFF SEXTON THE "IN-DISPOSABLE" DISTRIBUTOR AND DESIGN. INT. CL. 42. REG. 10-29-1996.
 2,012,604. CONCENTRA. INT. CL. 9. REG. 10-29-1996.
 2,012,605. DETENSIONIZER. INT. CL. 10. REG. 10-29-1996.
 2,012,606. DE PUFF. INT. CL. 3. REG. 10-29-1996.
 2,012,608. ULTRASENSE AND DESIGN. INT. CL. 5. REG. 10-29-1996.
 2,012,609. QUATTRO. INT. CL. 28. REG. 10-29-1996.
 2,012,611. GERIMEND. INT. CL. 5. REG. 10-29-1996.
 2,012,612. CONCORDE. INT. CL. 28. REG. 10-29-1996.
 2,012,617. ARCADE TOYS AND DESIGN. INT. CL. 28. REG. 10-29-1996.
 2,012,619. COMPOSIT (STYLIZED). INT. CL. 9. REG. 10-29-1996.
 2,012,622. CANDY POPPER. INT. CL. 30. REG. 10-29-1996.
 2,012,625. MSN MUSICIAN TV. INT. CL. 41. REG. 10-29-1996.
 2,012,626. IMAGESOURCE. INT. CL. 2. REG. 10-29-1996.
 2,012,628. THE MOBILITY SOLUTION. INT. CL. 35. REG. 10-29-1996.
 2,012,629. ROLLERMAGIC. INT. CL. 16. REG. 10-29-1996.
 2,012,630. SOCIETY STYLE COLLECTION. INT. CL. 28. REG. 10-29-1996.
 2,012,632. IMPLUS EZ1. INT. CL. 10. REG. 10-29-1996.
 2,012,633. XENOPHAGE. INT. CL. 28. REG. 10-29-1996.
 2,012,634. SWITCHBACK. INT. CL. 9. REG. 10-29-1996.
 2,012,636. TANGIBLE MUSIC AND DESIGN. INT. CL. 9. REG. 10-29-1996.
 2,012,637. ASSOCIATION CONNECTIONS. INT. CL. 35. REG. 10-29-1996.
 2,012,640. SOFTSTAGE. INT. CL. 9. REG. 10-29-1996.
 2,012,641. DESIGNPOST. INT. CL. 9. REG. 10-29-1996.
 2,012,642. LOVE TO LEARN (STYLIZED). INT. CLS. 9 AND 16. REG. 10-29-1996.
 2,012,643. IMAGE HANDLER. INT. CL. 9. REG. 10-29-1996.
 2,012,644. GANG GREEN. INT. CL. 30. REG. 10-29-1996.
 2,012,647. FASTPAGE. INT. CL. 9. REG. 10-29-1996.
 2,012,650. PROMEND. INT. CL. 5. REG. 10-29-1996.

- 2,012,651. MYO MANAGER. INT. CL. 10. REG. 10-29-1996.
 2,012,657. CREOMULSION COMPLETE. INT. CL. 5. REG. 10-29-1996.
 2,012,659. PERRY GOLSHANI. INT. CL. 3. REG. 10-29-1996.
 2,012,660. OUTLAW. INT. CL. 28. REG. 10-29-1996.
 2,012,661. S'COOL BUS. INT. CL. 28. REG. 10-29-1996.
 2,012,662. B AND DESIGN. INT. CL. 9. REG. 10-29-1996.
 2,012,663. SPICE RACK. INT. CL. 3. REG. 10-29-1996.
 2,012,666. WOMEX. INT. CL. 35. REG. 10-29-1996.
 2,012,668. MISCELLANEOUS DESIGN. INT. CL. 16. REG. 10-29-1996.
 2,012,669. EVEREST. INT. CL. 16. REG. 10-29-1996.
 2,012,670. PYRAMID ADVENTURES. INT. CL. 9. REG. 10-29-1996.
 2,012,671. DOCRITE. INT. CL. 16. REG. 10-29-1996.
 2,012,672. DOCROS. INT. CL. 16. REG. 10-29-1996.
 2,012,674. MAGIC WALL. INT. CL. 20. REG. 10-29-1996.
 2,012,675. TEMPDBA. INT. CL. 42. REG. 10-29-1996.
 2,012,677. BLAZE BRONCO. INT. CL. 28. REG. 10-29-1996.
 2,012,678. PRETTY TREASURES. INT. CL. 28. REG. 10-29-1996.
 2,012,680. CTF REALITY CHECKLIST AND DESIGN. INT. CL. 16. REG. 10-29-1996.
 2,012,681. FINISH OF THE FUTURE. INT. CL. 20. REG. 10-29-1996.
 2,012,682. RUSHPLUSH. INT. CL. 28. REG. 10-29-1996.
 2,012,683. SONG SERVANT. INT. CL. 9. REG. 10-29-1996.
 2,012,684. ORLOCKULA. INT. CL. 16. REG. 10-29-1996.
 2,012,685. CHEF BUBBA'S SEA MART SEAFOOD AND DESIGN. INT. CL. 29. REG. 10-29-1996.
 2,012,687. BARRICADE GLOVE LINER. INT. CL. 10. REG. 10-29-1996.
 2,012,688. WHIZ KID KNOWLEDGE BALL. INT. CL. 28. REG. 10-29-1996.
 2,012,689. TLX COMMUNICATIONS AND DESIGN. INT. CL. 38. REG. 10-29-1996.
 2,012,691. MISCELLANEOUS DESIGN. INT. CL. 42. REG. 10-29-1996.
 2,012,692. OPERATION RIGHT TO KNOW. INT. CL. 42. REG. 10-29-1996.
 2,012,693. KALUGA. INT. CL. 28. REG. 10-29-1996.
 2,012,697. SMART HEART. INT. CL. 5. REG. 10-29-1996.
 2,012,699. DARING DICE. INT. CL. 28. REG. 10-29-1996.
 2,012,700. BLUE CHIP JAZZ. INT. CL. 9. REG. 10-29-1996.
 2,012,702. MISCELLANEOUS DESIGN. INT. CL. 28. REG. 10-29-1996.
 2,012,703. TOP OF THE HILL CLUB. INT. CL. 35. REG. 10-29-1996.
 2,012,704. OFF CENTER (STYLIZED). INT. CL. 16. REG. 10-29-1996.
 2,012,707. AQUA BLUE. INT. CL. 5. REG. 10-29-1996.
 2,012,708. JUNGLE JON'S. INT. CL. 30. REG. 10-29-1996.
 2,012,709. X5. INT. CL. 9. REG. 10-29-1996.
 2,012,712. PROTEUS AND DESIGN. INT. CL. 16. REG. 10-29-1996.
 2,012,716. SILENCER. INT. CL. 20. REG. 10-29-1996.
 2,012,717. LUXUREST. INT. CL. 20. REG. 10-29-1996.
 2,012,719. BROADWAY COMICS AND DESIGN. INT. CL. 16. REG. 10-29-1996.
 2,012,720. PRIMITIVE FROG. INT. CL. 25. REG. 10-29-1996.
 2,012,721. BEDTIME INN AND DESIGN. INT. CL. 42. REG. 10-29-1996.
 2,012,722. FIRST CELEBRATIONS. INT. CL. 28. REG. 10-29-1996.
 2,012,723. SHEERTECH. INT. CL. 23. REG. 10-29-1996.
 2,012,724. POLYSTOR. INT. CL. 9. REG. 10-29-1996.
 2,012,727. HOMETOWN HOLIDAYS. INT. CL. 20. REG. 10-29-1996.
 2,012,729. FEDEX USA AIRBILL. INT. CL. 16. REG. 10-29-1996.
 2,012,730. MONARCH. INT. CL. 9. REG. 10-29-1996.
 2,012,731. ANVIL. INT. CL. 28. REG. 10-29-1996.
 2,012,734. RICH & LASTING. INT. CL. 3. REG. 10-29-1996.
 2,012,735. COMMON KNOWLEDGE. INT. CL. 9. REG. 10-29-1996.
 2,012,736. PETRETEC. INT. CL. 40. REG. 10-29-1996.
 2,012,737. BABY'S FIRST KWAANZA. INT. CL. 28. REG. 10-29-1996.
 2,012,738. MY FIRST KWAANZA. INT. CL. 28. REG. 10-29-1996.
 2,012,739. MUNILAW. INT. CL. 9. REG. 10-29-1996.
 2,012,741. THE FLYOVER ZONE. INT. CL. 16. REG. 10-29-1996.
 2,012,742. JP DIRECTADVANTAGE (STYLIZED). INT. CL. 9. REG. 10-29-1996.
 2,012,743. T MAKER AND DESIGN. INT. CL. 16. REG. 10-29-1996.
 2,012,744. OXYDYNE. INT. CL. 10. REG. 10-29-1996.
 2,012,745. FASTBACK. INT. CL. 28. REG. 10-29-1996.
 2,012,747. ONE 2 ONE. INT. CLS. 3 AND 5. REG. 10-29-1996.
 2,012,748. METROPOD. INT. CLS. 35 AND 36. REG. 10-29-1996.
 2,012,749. NATURE'S WONDERS. INT. CL. 21. REG. 10-29-1996.
 2,012,750. PROTEIMER. INT. CLS. 1 AND 5. REG. 10-29-1996.
 2,012,751. SEVENTH WAVE. INT. CLS. 9 AND 25. REG. 10-29-1996.
 2,012,754. MY HEART HAS WINGS. INT. CL. 20. REG. 10-29-1996.
 2,012,759. SHOOT AND JAM GAME. INT. CL. 9. REG. 10-29-1996.
 2,012,762. HOOP COMMANDER. INT. CL. 9. REG. 10-29-1996.
 2,012,764. FUTURE SHOCK. INT. CL. 28. REG. 10-29-1996.
 2,012,765. GOLD ADVANTAGE. INT. CL. 35. REG. 10-29-1996.
 2,012,767. NANNY QUEST. INT. CL. 35. REG. 10-29-1996.
 2,012,773. QUIK STIK. INT. CL. 16. REG. 10-29-1996.
 2,012,775. FOR THOSE OF YOU WHO THINK YOU KNOW. INT. CL. 28. REG. 10-29-1996.
 2,012,776. SE-OPTIX. INT. CL. 11. REG. 10-29-1996.
 2,012,781. NORCARE. INT. CL. 5. REG. 10-29-1996.
 2,012,782. UPI'S PRESIDENTIAL ACCOUNT. INT. CL. 36. REG. 10-29-1996.
 2,012,783. ELASTICITY-A-DERM. INT. CL. 3. REG. 10-29-1996.
 2,012,785. THERMAFOCUS 360. INT. CL. 10. REG. 10-29-1996.
 2,012,790. CANINE FLEX PROTECT. INT. CL. 5. REG. 10-29-1996.
 2,012,791. SAY ALOE TO HEALTH. INT. CL. 5. REG. 10-29-1996.
 2,012,793. BALLROOM BEAUTIES COLLECTION. INT. CL. 28. REG. 10-29-1996.
 2,012,794. NEW DIMENSION SILVER. INT. CL. 31. REG. 10-29-1996.
 2,012,796. SKINNY SLIP. INT. CL. 25. REG. 10-29-1996.
 2,012,798. RUBI. INT. CL. 28. REG. 10-29-1996.
 2,012,799. TWISTED METAL. INT. CL. 28. REG. 10-29-1996.
 2,012,801. LANGUAGE WISE. INT. CL. 28. REG. 10-29-1996.
 2,012,803. FLEXIBLE FORTIFIER. INT. CL. 36. REG. 10-29-1996.
 2,012,804. DARAPLUS. INT. CL. 1. REG. 10-29-1996.
 2,012,806. NHL BREAK OUT '95 AND DESIGN. INT. CL. 41. REG. 10-29-1996.
 2,012,807. THE DEMOGRAPHIC DETECTIVE. INT. CL. 35. REG. 10-29-1996.
 2,012,808. KIDS' TOWN. INT. CL. 20. REG. 10-29-1996.
 2,012,809. TRADEWIND ACRYLIC AQUARIUMS AND DESIGN. INT. CL. 16. REG. 10-29-1996.
 2,012,810. SHAKIN' JAKE. INT. CL. 28. REG. 10-29-1996.
 2,012,811. THE GOLFER'S TOOL BELT AND DESIGN. INT. CL. 28. REG. 10-29-1996.
 2,012,812. TICKET MASTER AND DESIGN. INT. CLS. 39 AND 42. REG. 10-29-1996.
 2,012,813. WARGODS. INT. CL. 28. REG. 10-29-1996.
 2,012,815. BUBBLE PRINCESS. INT. CL. 28. REG. 10-29-1996.
 2,012,817. FACCIA BRUTTA AND DESIGN. INT. CL. 31. REG. 10-29-1996.
 2,012,818. BEAUTY RAVISH. INT. CL. 3. REG. 10-29-1996.
 2,012,819. PURE DECEIT. INT. CL. 3. REG. 10-29-1996.
 2,012,820. DOMAIN. INT. CL. 9. REG. 10-29-1996.
 2,012,822. T + +. INT. CL. 9. REG. 10-29-1996.
 2,012,823. NASAL-D. INT. CL. 5. REG. 10-29-1996.
 2,012,824. T + +. INT. CL. 36. REG. 10-29-1996.

- 2,012,826. SOFTNESS WORTH ITS SALT. INT. CL. 1. REG. 10-29-1996.
- 2,012,833. BLACK FISH TRADING CO. AND DESIGN. INT. CL. 25. REG. 10-29-1996.
- 2,012,834. ISOCLEAR. INT. CL. 5. REG. 10-29-1996.
- 2,012,835. THE WAR IS ON. INT. CL. 36. REG. 10-29-1996.
- 2,012,842. 1949 HAVANA MEMORIES AND DESIGN. INT. CL. 16. REG. 10-29-1996.
- 2,012,844. TIMEWRITER. INT. CL. 9. REG. 10-29-1996.
- 2,012,845. POUND OF PONS. INT. CL. 28. REG. 10-29-1996.
- 2,012,846. STAR TREK: DEEP SPACE NINE HARBINGER. INT. CL. 28. REG. 10-29-1996.
- 2,012,847. SNORE NO MORE. INT. CL. 5. REG. 10-29-1996.
- 2,012,849. CD-QUICKSHARE. INT. CL. 9. REG. 10-29-1996.
- 2,012,853. OSTEO-MED. INT. CL. 5. REG. 10-29-1996.
- 2,012,854. PASSPORT. INT. CL. 35. REG. 10-29-1996.
- 2,012,857. ESQ. ADVANTAGE AND DESIGN. INT. CL. 36. REG. 10-29-1996.
- 2,012,858. G.I. JOE EXTREME. INT. CL. 28. REG. 10-29-1996.
- 2,012,859. PHARMEXSCRIPT. INT. CL. 16. REG. 10-29-1996.
- 2,012,861. 1-800-GO-SALON. INT. CL. 35. REG. 10-29-1996.
- 2,012,862. PIZZA BONES. INT. CL. 16. REG. 10-29-1996.
- 2,012,864. PAW PUPPETS. INT. CL. 28. REG. 10-29-1996.
- 2,012,865. PRESSURE DROP. INT. CL. 28. REG. 10-29-1996.
- 2,012,867. SEA TREASURES. INT. CL. 3. REG. 10-29-1996.
- 2,012,870. NO-VEL. INT. CL. 5. REG. 10-29-1996.
- 2,012,871. SPITHEADS. INT. CL. 28. REG. 10-29-1996.
- 2,012,872. PRESIDIO. INT. CLS. 3, 4 AND 5. REG. 10-29-1996.
- 2,012,874. PUREX SUPREME. INT. CL. 3. REG. 10-29-1996.
- 2,012,875. MODULATE OS. INT. CL. 28. REG. 10-29-1996.
- 2,012,876. CITRI-BURN. INT. CL. 5. REG. 10-29-1996.
- 2,012,877. FFP. INT. CL. 3. REG. 10-29-1996.
- 2,012,879. SMUD MINI-PRESS. INT. CL. 28. REG. 10-29-1996.
- 2,012,882. BUTTONMANIA. INT. CL. 28. REG. 10-29-1996.
- 2,012,883. COLOR INTENSE 24. INT. CL. 3. REG. 10-29-1996.
- 2,012,885. MISCELLANEOUS DESIGN. INT. CL. 30. REG. 10-29-1996.
- 2,012,886. HOMEARTS. INT. CL. 42. REG. 10-29-1996.
- 2,012,887. MISCELLANEOUS DESIGN. INT. CLS. 1 AND 5. REG. 10-29-1996.
- 2,012,893. MISCELLANEOUS DESIGN. INT. CL. 28. REG. 10-29-1996.
- 2,012,894. RUNNING TRAINER. INT. CL. 14. REG. 10-29-1996.
- 2,012,895. MICROSLITS. INT. CL. 42. REG. 10-29-1996.
- 2,012,896. GREAT SHAKES. INT. CL. 30. REG. 10-29-1996.
- 2,012,897. SELDOM CRASH AIRLINES. INT. CL. 25. REG. 10-29-1996.
- 2,012,898. AUTOOCR. INT. CL. 9. REG. 10-29-1996.
- 2,012,900. SPORTTIPS & FACTS. INT. CL. 35. REG. 10-29-1996.
- 2,012,901. WASHINGTON ALTERNATIVE MEDICINE CENTER. INT. CL. 42. REG. 10-29-1996.
- 2,012,902. WALLPUZZLE. INT. CL. 28. REG. 10-29-1996.
- 2,012,906. GARIBALDI. INT. CL. 25. REG. 10-29-1996.
- 2,012,907. SHORT SHEETS AND DESIGN. INT. CL. 16. REG. 10-29-1996.
- 2,012,909. CATHOLIC YELLOW PAGES. INT. CL. 16. REG. 10-29-1996.
- 2,012,910. HOW CAN WE HELP YOU?. INT. CL. 37. REG. 10-29-1996.
- 2,012,913. THE FINE ART GAME. INT. CL. 28. REG. 10-29-1996.
- 2,012,914. OFFICIAL SEASON TICKET HOLDER. INT. CL. 25. REG. 10-29-1996.
- 2,012,916. CYBERCHAT. INT. CL. 9. REG. 10-29-1996.
- 2,012,918. MARGINAL VALUE ENGINE. INT. CL. 9. REG. 10-29-1996.
- 2,012,919. 1-800-BETTER TV. INT. CL. 38. REG. 10-29-1996.
- 2,012,921. SMARTCHIP. INT. CL. 9. REG. 10-29-1996.
- 2,012,923. HYDROPROTECTIVE FACTORS. INT. CL. 3. REG. 10-29-1996.
- 2,012,924. WEB WATCH. INT. CL. 16. REG. 10-29-1996.
- 2,012,926. ALL-SPORTS CALENDAR. INT. CL. 16. REG. 10-29-1996.
- 2,012,927. VISUAL BENEFITS. INT. CL. 9. REG. 10-29-1996.
- 2,012,929. VENTURE CAPITAL YEARBOOK. INT. CL. 16. REG. 10-29-1996.
- 2,012,930. VENTURE CAPITAL JOURNAL. INT. CL. 16. REG. 10-29-1996.
- 2,012,932. STOCK INVESTING BASICS. INT. CL. 16. REG. 10-29-1996.
- 2,012,935. CONNECTIVITY NEWS. INT. CL. 16. REG. 10-29-1996.
- 2,012,936. NEBRASKA'S BEST (STYLIZED). INT. CL. 42. REG. 10-29-1996.
- 2,012,937. GOOD VALUE FURNITURE AND DESIGN. INT. CL. 42. REG. 10-29-1996.
- 2,012,939. 14-IN-ONE. INT. CL. 8. REG. 10-29-1996.
- 2,012,941. BIG RIGS. INT. CL. 28. REG. 10-29-1996.
- 2,012,944. BATH OF THE MONTH CLUB (STYLIZED). INT. CL. 3. REG. 10-29-1996.
- 2,012,945. WORLDWIDE MEDIA GROUP. INT. CL. 35. REG. 10-29-1996.
- 2,012,946. HEALING WITH THE ENERGY OF ANGELS. INT. CL. 41. REG. 10-29-1996.
- 2,012,947. CHECKS BY PHONE. INT. CL. 36. REG. 10-29-1996.
- 2,012,948. LOUISVILLE. INT. CL. 12. REG. 10-29-1996.
- 2,013,303. ASTRO LITE. INT. CLS. 14 AND 42 ONLY. REG. 11-5-1996.
- 2,027,461. LENCH MOB RECORDS AND DESIGN. INT. CL. 25 ONLY. REG. 12-31-1996.
- 2,030,013. VICTORIA AND DESIGN. INT. CL. 29. REG. 1-14-1997.
- 2,030,380. NEW BOSTON AND DESIGN. INT. CL. 35. REG. 1-14-1997.
- 2,039,776. PERFECT PLUS. INT. CL. 26 ONLY. REG. 2-25-1997.
- 2,054,546. NATIONAL CORVETTE MUSEUM AND DESIGN. INT. CL. 20 ONLY. REG. 4-22-1997.
- 2,064,917. SPECIALTY LOOSE LEAF INC.. INT. CL. 9 ONLY. REG. 5-27-1997.
- 2,066,837. PARAMOUNT. INT. CL. 30 ONLY. REG. 6-3-1997.
- 2,068,453. S SAVINGS AND DESIGN. INT. CLS. 1, 6, 7, 8, 9, 11, 14, 16, 18, 20, 21, 24 AND 28 ONLY. REG. 6-10-1997.
- 2,072,349. SAMSONITE. INT. CL. 11 ONLY. REG. 6-17-1997.
- 2,072,384. SAMSONITE AND DESIGN. INT. CL. 11 ONLY. REG. 6-17-1997.
- 2,073,010. MISCELLANEOUS DESIGN. INT. CL. 4 ONLY. REG. 6-24-1997.
- 2,073,405. BULL MOOSE MUSIC. INT. CL. 35 ONLY. REG. 6-24-1997.
- 2,079,502. BREATH-EZE. INT. CL. 21 ONLY. REG. 7-15-1997.
- 2,142,504. CHANGE YOUR MIND CHANGE YOUR WORLD. INT. CLS. 25 AND 28 ONLY. REG. 3-10-1998.
- 2,144,922. DURAGRAPHIX. INT. CL. 2 ONLY. REG. 3-17-1998.
- 2,147,531. FIRST DISCOUNT TRAVEL. INT. CL. 35 ONLY. REG. 3-31-1998.

SECTION 18

- 865,068. CONSUL. U.S. CL. 46. REG. 2-18-1969.
- 1,258,360. LASERTRAK. INT. CL. 9. REG. 11-22-1983.
- 1,296,993. PATRICK HENRY UNIVERSITY. INT. CL. 41. REG. 9-18-1984.
- 1,306,351. FORTUNE MORTGAGE. INT. CL. 36. REG. 11-20-1984.
- 1,310,598. CREST. INT. CL. 1. REG. 12-25-1984.
- 1,387,856. THE EXTERIOR DECORATORS. INT. CL. 42. REG. 3-25-1986.
- 1,419,867. ULTIMAP. INT. CL. 9. REG. 12-9-1986.
- 1,453,986. NEXPERT. INT. CL. 9. REG. 8-25-1987.
- 1,459,666. CHAMPIONS FOR LIFE. INT. CL. 42. REG. 9-29-1987.
- 1,517,653. HELPWORKS. INT. CL. 42. REG. 12-20-1988.
- 1,543,597. PRIVATE LABEL. INT. CL. 25. REG. 6-13-1989.

1,544,670.	HAWAII'S FAVORITE. INT. CL. 29. REG. 6-20-1989.	2,286,259.	TREK ALLIANCE. INT. CL. 3. REG. 10-12-1999.
1,682,560.	SMARTONER. INT. CL. 1. REG. 4-14-1992.	2,288,154.	QUO AND DESIGN. INT. CL. 25. REG. 10-19-1999.
1,813,694.	DELIGHTFUL. INT. CL. 16. REG. 12-28-1993.	2,296,766.	THE TASTE OF MEXICO. INT. CLS. 29, 30 AND 32. REG. 11-30-1999.
1,949,484.	BEVERLY HILLS FARMERS MARKET. INT. CL. 30. REG. 1-16-1996.	2,298,803.	EL SABOR DE MEXICO. INT. CLS. 29, 30 AND 32. REG. 12-7-1999.
2,052,094.	SMARTQUEST. INT. CL. 38. REG. 4-15-1997.	2,315,251.	LUCENT AND DESIGN. INT. CL. 14. REG. 2-8-2000.
2,093,688.	BITE BLOCK. INT. CL. 3. REG. 9-2-1997.	2,466,556.	MAKING AIDS HISTORY. INT. CL. 36. REG. 7-3-2001.
2,113,733.	FLY GIRLS. INT. CL. 25. REG. 11-18-1997.	2,467,705.	COMCORK. INT. CL. 19. REG. 7-10-2001.
2,120,173.	ESSENTIAL. INT. CL. 38. REG. 12-9-1997.	2,468,457.	JOGGER FOGGER. INT. CL. 1. REG. 7-10-2001.
2,125,193.	NETFRONT. INT. CL. 9. REG. 12-30-1997.	2,472,289.	MAKING AIDS HISTORY. INT. CL. 25. REG. 7-24-2001.
2,130,585.	BEVERLY HILLS FARMERS MARKET. INT. CL. 29. REG. 1-20-1998.	2,513,661.	ESPERANZA AND DESIGN. INT. CL. 35. REG. 12-4-2001.
2,134,489.	CONFIDENTIAL. INT. CL. 9. REG. 2-3-1998.	2,564,218.	EMME NEW YORK BY MOLLY & EMILY. INT. CL. 25. REG. 4-23-2002.
2,137,969.	CALLWORX. INT. CL. 38. REG. 2-17-1998.	2,574,772.	FREE TEXAS LOTTO. INT. CL. 41. REG. 5-28-2002.
2,155,062.	STARONE (STYLIZED). INT. CL. 9. REG. 5-5-1998.	2,607,392.	REHYDRATE YOUR BODY/ REVITALIZE YOUR MIND/ RE-ENERGIZE YOUR SPIRIT. INT. CL. 3. REG. 8-13-2002.
2,195,059.	DR. KOBE (STYLIZED). INT. CLS. 3, 5 AND 29. REG. 10-13-1998.	2,610,369.	BUFFALO GAP. INT. CL. 25. REG. 8-20-2002.
2,207,652.	CAM-BUILT PROGRAMMING PLUS. INT. CL. 42. REG. 12-1-1998.		
2,224,662.	FLAMESTOP. INT. CL. 9. REG. 2-16-1999.		
2,265,263.	STABILIZER. INT. CL. 28. REG. 7-27-1999.		
2,286,258.	TREK ALLIANCE. INT. CL. 5. REG. 10-12-1999.		

* * * * *

TRADEMARK REGISTRATIONS AMENDED, CORRECTED, ETC.

The designation "U.S. Cl." appearing in this section refers to the U.S. class in effect prior to Sep. 1, 1973 rather than the international class which applies to applications filed on or after that date. For adoption of international classification see notice in the OFFICIAL GAZETTE of Jun. 26, 1973 (911 O.G. TM 210).

Any change to the registration will be indicated at the bottom of each entry under ELEMENTS AMENDED, CORRECTED OR RESTRICTED. With the exception of changes to the goods and services, additions to the registration will appear in asterisks and deletions of the registration will appear in brackets. Elements which are only changed will be listed with no punctuation. As to the goods/services statement, amendments to the goods/services will appear in asterisks and deletions will appear in brackets. In addition if any change to the goods/services occurs, the element "Goods/Services" will be listed under ELEMENTS AMENDED, CORRECTED OR RESTRICTED.

748,303. REG. 4-23-1963. PREMIER INDUSTRIES, INC. (WASHINGTON CORPORATION) 1019 PACIFIC AVENUE, SUITE 1501, TACOMA, WA, 98402, BY ASSIGNMENT, BY CHANGE OF NAME, BY MERGER, BY MERGER, BY MERGER WESTERN INSULFOAM CORPORATION (CORPORATION) SEATTLE, WA, SN 72-137,821. FILED 2-12-1962. PRINCIPAL REGISTER.

INSULFOAM

INT. CL. 19/U.S. CL. 12
FOR FOAMED, CELLULAR INSULATING MATERIAL.
FIRST USE 8-2-1961; IN COMMERCE 8-10-1961.

ELEMENTS AMENDED
ASSIGNMENT/NAME CHANGE
MARK

955,635. REG. 3-20-1973. PRINCESS SOFT TOYS, INC. (MINNESOTA CORPORATION) 7664 WEST 78TH STREET, MINNEAPOLIS, MN, 55435, SN 72-373,636. FILED 10-19-1970. PRINCIPAL REGISTER.

ANIMAL FAIR

INT. CL. 28/U.S. CL. 22
FOR FABRIC TOYS.
FIRST USE 10-0-1960; IN COMMERCE 10-0-1960.

ELEMENTS AMENDED
MARK

979,150. REG. 2-19-1974. AMERICAN THEATRE WING, INC. (NEW YORK CORPORATION) 225 PARK AVE. S., NEW YORK, NY, 10003, SN 72-442,239. FILED 11-27-1972. PRINCIPAL REGISTER.

TONY AWARDS

INT. CL. 41/U.S. CL. 107

TM 896

FOR GIVING OF DINNERS AND THE MAKING OF TELECASTS IN CONNECTION WITH THE RECOGNITION OF DISTINGUISHED ACHIEVEMENT IN THE THEATRE.

FIRST USE 3-28-1954; IN COMMERCE 3-28-1954.

ELEMENTS AMENDED
MARK

1,280,507. REG. 6-5-1984. LOMBARDINI S.R.L. (ITALY LTD LIAB CO) 42100 REGGIO EMILIA (ITALY), VIA CAVALLIERE DEL LAVORO ADELMO, LOMBARDINI, 2, ITALY., BY CHANGE OF NAME, BY MERGER ANONIMA COSTRUZIONE MOTORI ENDOTERMICI-A.C.M.E. S.P.A. JOINT STOCK COMPANY) VALDOBBIADENE, TREVISO, ITALY, SN 73-378,243. FILED 8-4-1982. PRINCIPAL REGISTER.

ACME MOTORI

OWNER OF ITALY REG. NO. 330,263, DATED 7-28-1981, EXPIRES 7-28-2001.

NO CLAIM IS MADE TO THE EXCLUSIVE RIGHT TO USE THE TERM "MOTORI", APART FROM THE MARK AS SHOWN.

"MOTORI" IS THE ITALIAN TERM FOR "MOTOR".

INT. CL. 7/U.S. CL. 23

FOR SINGLE OR MULTICYLINDER OTTO AND DIESEL ENGINES FOR MACHINES; SELF-PRIMING MOTOR PUMPS; CURRENT MOTOR DRIVEN ELECTRIC WELDING MACHINES; AND MOTOR DRIVEN COMPRESSORS; BULLDOZERS.

INT. CL. 12/U.S. CL. 19

FOR VEHICLES—NAMESLY, AUTOMOBILES, TRUCKS VANS, BOATS, AND TRACTORS; SINGLE OR MULTICYLINDER OTTO AND DIESEL ENGINES FOR USE IN VEHICLES .

ELEMENTS CORRECTED
OWNER ADDRESS
CITIZENSHIP
ENTITY
ASSIGNMENT/NAME CHANGE
OWNER NAME

1,286,844. REG. 7-24-1984. LOMBARDINI S.R.L. (ITALY LTD LIAB CO) 42100 REGGIO EMILIA (ITALY), VIA CAVALTERE DEL LAVORO ADELMO, LOMBARDINI, 2, ITALY., BY CHANGE OF NAME, BY MERGER ANONIMA COSTRUZIONE MOTORI ENDOTERMICI-A.C.M.E. S.P.A. CORPORATION) VALDOBBIADENE TREVISO, ITALY, SN 73-380,550. FILED 8-18-1982. PRINCIPAL REGISTER.



OWNER OF ITALY REG. NO. 330,262, DATED 7-28-1981, EXPIRES 7-28-2001.

INT. CL. 7/U.S. CL. 23

FOR SINGLE OR MULTICYLINDER OTTO AND DIESEL ENGINES FOR MACHINES AND BOATS; SELF-PRIMING MOTOR PUMPS; CURRENT MOTOR DRIVEN ELECTRIC WELDING MACHINES; MOTOR DRIVEN COMPRESSORS; AND BULLDOZERS.

INT. CL. 12/U.S. CL. 19

FOR VEHICLES—NAMELY, AUTOMOBILES, TRUCKS, VANS, BOATS AND TRACTORS; SINGLE OR MULTICYLINDER OTTO AND DIESEL ENGINES FOR USE IN LAND VEHICLES.

ELEMENTS CORRECTED

OWNER ADDRESS

CITIZENSHIP

ENTITY

ASSIGNMENT/NAME CHANGE

OWNER NAME

1,745,775. REG. 1-12-1993. THOMPSON PUBLISHING GROUP, INC. (D.C. CORPORATION) 5201 WEST KENNEDY BLVD., SUITE 905, TAMPA, FL, 33609, SN 74-268,734. FILED 4-24-1992. PRINCIPAL REGISTER.

THOMPSON PUBLISHING GROUP

NO CLAIM IS MADE TO THE EXCLUSIVE RIGHT TO USE "PUBLISHING GROUP", APART FROM THE MARK AS SHOWN.

INT. CL. 16/U.S. CL. 38

FOR HANDBOOKS, NEWSLETTERS, LOOSELEAF PUBLICATIONS IN THE FIELD OF LEGAL AND REGULATORY MATTERS.

FIRST USE 1-31-1985; IN COMMERCE 1-31-1985.

ELEMENTS AMENDED

OWNER NAME

OWNER ADDRESS

1,882,322. REG. 3-7-1995. SHIBOU, EARL (UNITED STATES INDIVIDUAL) 43 MUIR ROAD, WINNIPEG, MANITOBA, CANADA, R2X 2X7, SN 74-304,470. FILED 8-17-1992. PRINCIPAL REGISTER.

HASH JEANS

PRIORITY CLAIMED UNDER SEC. 44(D) ON CANADA APPLICATION NO. 599,198, FILED 2-17-1992, REG. NO. TMA430,939, DATED 7-29-1994.

NO CLAIM IS MADE TO THE EXCLUSIVE RIGHT TO USE "JEANS", APART FROM THE MARK AS SHOWN.

INT. CL. 26/U.S. CL. 40

FOR PANTS AND JEANS.

ELEMENTS AMENDED

MARK

1,963,460. REG. 3-19-1996. WATSON LABORATORIES, INC. (DELAWARE CORPORATION) 417 WAKARA WAY, SUITE 100, SALT LAKE CITY, UT, 84108, BY CHANGE OF NAME, BY CHANGE OF NAME THERATECH, INC. CORPORATION) SALT LAKE CITY, UT, SN 74-674,893. FILED 5-15-1995. PRINCIPAL REGISTER.

ANDRODERM

INT. CL. 5/U.S. CLS. 6, 18, 44, 46, 51 AND 52

FOR DRUG DELIVERY SYSTEMS, NAMELY TRANSDERMAL PATCHES FOR THE DELIVERY OF BIOLOGICALLY ACTIVE AGENTS.

FIRST USE 1-24-1995; IN COMMERCE 1-24-1995.

ELEMENTS CORRECTED

CITIZENSHIP

2,052,590. REG. 4-15-1997. SSM HEALTH CARE CORPORATION (MISSOURI CORPORATION) 477 N. LINDBERGH BLVD, ST. LOUIS, MO, 63141, SN 75-097,638. FILED 5-2-1996. PRINCIPAL REGISTER.

SSM HEALTH CARE

OWNER OF U.S. REG. NOS. 1,406,063 AND 1,576,711.

NO CLAIM IS MADE TO THE EXCLUSIVE RIGHT TO USE "HEALTH CARE SYSTEM", APART FROM THE MARK AS SHOWN.

INT. CL. 35/U.S. CLS. 100, 101 AND 102

FOR PHYSICIAN RECRUITMENT AND REFERRAL SERVICES; BUSINESS MANAGEMENT AND CONSULTATION IN THE FIELDS OF LAUNDRY SERVICES, ENVIRONMENTAL MANAGEMENT SERVICES AND MATERIAL MANAGEMENT SERVICES; HEALTH CARE COST CONTAINMENT.

FIRST USE 9-26-1986; IN COMMERCE 9-26-1986.

INT. CL. 37/U.S. CLS. 100, 103 AND 106

FOR LAUNDRY SERVICES FOR LINEN.

FIRST USE 9-26-1986; IN COMMERCE 9-26-1986.

INT. CL. 38/U.S. CLS. 100, 101 AND 104

FOR TELECOMMUNICATION SERVICES, NAMELY, ELECTRONIC MAIL AND TELEPHONE VOICE MESSAGING SERVICES.

FIRST USE 9-26-1986; IN COMMERCE 9-26-1986.

INT. CL. 41/U.S. CLS. 100, 101 AND 107

FOR EDUCATIONAL SERVICES, NAMELY, PROVIDING CLASSES, CONFERENCES, SEMINARS AND WORKSHOPS IN THE FIELDS OF HEALTH CARE, COMMUNITY OUTREACH, BUSINESS AND INDUSTRY WELLNESS AND HEALTH SCREENING.

FIRST USE 9-26-1986; IN COMMERCE 9-26-1986.
INT. CL. 42/U.S. CLS. 100 AND 101

FOR HEALTH CARE SERVICES; MEDICAL LABORATORY SERVICES; PHYSICAL, OCCUPATIONAL, SPEECH, AND CHEMICAL DEPENDENCY REHABILITATION SERVICES; PHYSICAL, OCCUPATIONAL, SPEECH, AND CHEMICAL DEPENDENCY THERAPY SERVICES; PSYCHIATRIC SERVICES; MEDICAL AND NUTRITIONAL COUNSELING; HOSPICES; MANAGED HEALTH CARE; PHYSICIAN HOSPITAL ORGANIZATIONS, RENTAL OF MEDICAL EQUIPMENT; PROVIDING INFORMATION IN THE AREA OF HEALTH CARE VIA ON-LINE COMPUTER DATA BASES.

FIRST USE 9-26-1986; IN COMMERCE 9-26-1986.

ELEMENTS AMENDED
MARK

2,061,101. REG. 5-13-1997. MAYA ROMANOFF CORPORATION, THE (ILLINOIS CORPORATION) 1730 W. GREENLEAF, CHICAGO, IL, 606262412, SN 75-098,311. FILED 3-3-1996. PRINCIPAL REGISTER.

SENTIMENTALE

THE ENGLISH TRANSLATION OF THE MARK IS "SENTIMENTAL".

INT. CL. 16/U.S. CLS. 2, 5, 22, 23, 29, 37, 38 AND 50
FOR WALL COVERING SAMPLE BOOKS.
FIRST USE 6-15-1995; IN COMMERCE 6-15-1995.

ELEMENTS CORRECTED
OWNER NAME

2,064,964. REG. 5-27-1997. MEREDITH CORPORATION (IOWA CORPORATION) 1716 LOCUST STREET, DES MOINES, IA, 503093023, SN 75-102,719. FILED 5-13-1996. PRINCIPAL REGISTER.

COUNTRY HOMES & GARDENS

OWNER OF U.S. REG. NOS. 1,614,503, 1,809,096 AND OTHERS.

SEC. 2(F).
INT. CL. 42/U.S. CLS. 100 AND 101
FOR MAIL ORDER BOOK CLUB SERVICES.
FIRST USE 1-0-1989; IN COMMERCE 1-0-1989.

ELEMENTS AMENDED
MARK

2,081,622. REG. 7-22-1997. FARNAM COMPANIES, INC. (ARIZONA CORPORATION) 301 W. OSBORN ROAD, PHOENIX, AZ, 85013, BY ASSIGNMENT ALEXANDER, RICHARD INDIVIDUAL) BENSLEM, PA, SN 75-157,386. FILED 8-28-1996. PRINCIPAL REGISTER.

SUREFLEX

INT. CL. 5/U.S. CLS. 6, 18, 44, 46, 51 AND 52

FOR NUTRITIONAL SUPPLEMENT FOR HORSES * NOT SOLD IN OR OTHERWISE DISTRIBUTED THROUGH GROCERY, DRUG, OR CONVENIENCE STORES *

FIRST USE 4-0-1994; IN COMMERCE 5-0-1994.

ELEMENTS AMENDED
GOODS/SERVICES

2,100,840. REG. 9-30-1997. RIVER POINT RESORT, INC. (MINNESOTA CORPORATION) P.O. BOX 397, ELY, MN, 55731, SN 75-050,947. FILED 1-29-1996. PRINCIPAL REGISTER.

PADDLE THE QUIET SIDE

INT. CL. 39/U.S. CLS. 100 AND 105

FOR ARRANGING TRAVEL TOURS, CANOE RENTAL AND TRAVEL GUIDE SERVICES.

FIRST USE 1-18-1994; IN COMMERCE 1-28-1994.

ELEMENTS CORRECTED
OWNER NAME

2,214,604. REG. 12-29-1998. MACKENZIE RIVER INTERNATIONAL, INC. (DELAWARE CORPORATION) 232 MAIN STREET, BOZEMAN, MT, 59715, SN 75-395,127. FILED 11-24-1997. PRINCIPAL REGISTER.

MACKENZIE RIVER PIZZA CO.

OWNER OF U.S. REG. NOS. 2,047,144 AND 2,080,651.
NO CLAIM IS MADE TO THE EXCLUSIVE RIGHT TO USE "PIZZA CO.", APART FROM THE MARK AS SHOWN.

INT. CL. 30/U.S. CL. 46

FOR PIZZA.
FIRST USE 4-15-1993; IN COMMERCE 4-15-1993.

INT. CL. 42/U.S. CLS. 100 AND 101
FOR RESTAURANT SERVICES.
FIRST USE 4-15-1993; IN COMMERCE 4-15-1993.

ELEMENTS CORRECTED
OWNER NAME

2,290,129. REG. 11-2-1999. HILLSTREET BEDS, LLC. (KENTUCKY LIMITED LIABILITY COMPANY) 1338 HULL STREET, LOUISVILLE, KY, 40204, SN 75-540,482. FILED 8-21-1998. PRINCIPAL REGISTER.

HILLSTREET

NO CLAIM IS MADE TO THE EXCLUSIVE RIGHT TO USE "BEDS", APART FROM THE MARK AS SHOWN.
INT. CL. 20/U.S. CLS. 2, 13, 22, 25, 32 AND 50
FOR FURNITURE.
FIRST USE 1-13-1998; IN COMMERCE 4-20-1998.

ELEMENTS AMENDED
MARK

2,304,787. REG. 12-28-1999. NIELSEN MEDIA RESEARCH, INC. (DELAWARE CORPORATION) 299 PARK AVENUE, NEW YORK, NY, 10171, SN 75-451,785. FILED 3-17-1998. PRINCIPAL REGISTER.

SPORTSQUEST

INT. CL. 35/U.S. CLS. 100, 101 AND 102
FOR MARKET RESEARCH SERVICES, NAMELY, MEDIA RESEARCH SERVICES RELATING TO THE LISTENING, VIEWING AND USAGE HABITS OF SIGNAL RECEIVING AUDIENCES; COLLECTING, CORRELATING AND PROVIDING INFORMATION ABOUT CHARACTERISTICS OF AUDIENCES OF SPORTS PROGRAMMING, INCLUDING PROGRAMMING RATING REPORTS, MEDIA RESEARCH RELATING TO AUDIENCE USE AND VIEWING OF SPORTS PROGRAMMING REGARDLESS OF SIGNAL TRANSMISSION AND/OR RECEIVING MEANS, AND DEMOGRAPHIC DATA REGARDING THE SIGNAL RECEIVING AUDIENCES; AND CONDUCTING TELEPHONE SURVEYS AND OTHER CONSUMER POLLING REGARDING PERSONAL MEDIA VIEWING AND USAGE, PRODUCT PURCHASING, PREFERENCES, AND AWARENESS, CURRENT EVENTS, SPORTS INTERESTS, BEHAVIOR, OPINIONS, AND RELATED ACTIVITIES, ADVERTISING AND BRAND AWARENESS AND RECOGNITION, AND CONSUMER DEMOGRAPHICS, AND CREATING REPORTS BASED ON AND PROVIDING SUCH INFORMATION AND ACCESS TO SUCH INFORMATION TO THIRD PARTIES.

FIRST USE 5-8-1998; IN COMMERCE 5-8-1998.

ELEMENTS CORRECTED
OWNER NAME

2,315,327. REG. 2-8-2000. MACKENZIE RIVER INTERNATIONAL, INC. (DELAWARE CORPORATION) 232 MAIN STREET, BOZEMAN, MT, 59715, SN 75-395,128. FILED 11-24-1997. PRINCIPAL REGISTER.

MACKENZIE RIVER PIZZA CO. IN THE RAW

OWNER OF U.S. REG. NOS. 2,047,144, 2,080,651 AND OTHERS.

INT. CL. 30/U.S. CL. 46
FOR TAKE AND BAKE PIZZA.
FIRST USE 9-1-1993; IN COMMERCE 9-1-1993.

ELEMENTS CORRECTED
OWNER NAME

2,330,692. REG. 3-21-2000. MACKENZIE RIVER INTERNATIONAL, INC. (DELAWARE CORPORATION) 232 MAIN STREET, BOZEMAN, MT, 59715, SN 75-398,986. FILED 12-2-1997. PRINCIPAL REGISTER.

CATCH IT ON THE FLY

INT. CL. 42/U.S. CLS. 100 AND 101
FOR RESTAURANT SERVICES.
FIRST USE 9-0-1993; IN COMMERCE 9-0-1993.

ELEMENTS CORRECTED
OWNER NAME

2,334,304. REG. 3-28-2000. NATIONAL MULTIPLE SCLEROSIS SOCIETY (NEW YORK CORPORATION) 733 THIRD AVENUE, 6TH FLOOR, NEW YORK, NY, 10017, SN 75-428,383. FILED 2-3-1998. PRINCIPAL REGISTER.

MS WALK

OWNER OF U.S. REG. NO. 1,906,946.
SEC. 2(F).
INT. CL. 36/U.S. CLS. 100, 101 AND 102
FOR CHARITABLE FUND RAISING SERVICES.
FIRST USE 12-31-1996; IN COMMERCE 12-31-1996.

ELEMENTS AMENDED
MARK

2,363,047. REG. 6-27-2000. BRAIN SURGERY WORLD WIDE, LLC (GEORGIA CORPORATION) 822 PENN AVENUE, ATLANTA, GA, 30308, SN 75-500,510. FILED 6-11-1998. PRINCIPAL REGISTER.

THE BRAND BUBBLE

NO CLAIM IS MADE TO THE EXCLUSIVE RIGHT TO USE "BRAND", APART FROM THE MARK AS SHOWN.

INT. CL. 35/U.S. CLS. 100, 101 AND 102
FOR BUSINESS MANAGEMENT CONSULTING SERVICES IN THE FIELDS OF MARKETING AND CORPORATE STRATEGIC PLANNING, AND ADVERTISING AGENCY SERVICES.

FIRST USE 2-0-1996; IN COMMERCE 3-0-1996.

ELEMENTS CORRECTED
OWNER NAME

2,393,808. REG. 10-10-2000. HYUNDAI MOTOR AMERICA (CALIFORNIA CORPORATION) 10550 TALBERT AVENUE, FOUNTAIN VALLEY, CA, 92728, SN 75-228,492. FILED 1-21-1997. PRINCIPAL REGISTER.

DRIVING IS BELIEVING

INT. CL. 12/U.S. CLS. 19, 21, 23, 31, 35 AND 44
FOR MOTOR VEHICLES AND STRUCTURAL PARTS.
FIRST USE 11-30-1996; IN COMMERCE 11-30-1996.
INT. CL. 41/U.S. CLS. 100, 101 AND 107

FOR EDUCATIONAL SERVICES, NAMELY, CONDUCTING SEMINARS AND TRAINING IN THE NATURE OF WORKSHOPS, CLASSES AND VIDEO TAPES IN THE SALE OF MOTOR VEHICLES.
FIRST USE 11-30-1996; IN COMMERCE 11-30-1996.

ELEMENTS CORRECTED
OWNER NAME
OWNER ADDRESS
ASSIGNMENT/NAME CHANGE

2,407,685. REG. 11-28-2000. AMERICAN AUTO GUARDIAN, INC. (ILLINOIS CORPORATION) 350 W. KENSINGTON RD., MT. PROSPECT, IL, 60056, BY ASSIGNMENT WEAR PROTECTION CORPORATION CORPORATION MOUNT PROSPECT, IL, SN 75-548,262. FILED 9-4-1998. PRINCIPAL REGISTER.

WEARPRO

INT. CL. 36/U.S. CLS. 100, 101 AND 102
FOR WARRANTY AND EXTENDED WARRANTY CONTRACTS APPLICABLE TO APPEARANCE PROTECTION PRODUCTS COVERING PAINT, FABRIC, VINYL/LEATHER FOR AUTOMOBILES, TRUCKS, BOATS, RECREATIONAL VEHICLES, SPORTS VEHICLES, AND OTHER VEHICLES.
FIRST USE 5-0-1998; IN COMMERCE 5-0-1998.

ELEMENTS CORRECTED
ASSIGNMENT/NAME CHANGE
OWNER NAME
OWNER ADDRESS

2,453,653. REG. 5-22-2001. YAMAHA CORPORATION (JAPAN CORPORATION) 10-1, NAKAZAWA-CHO, HAMAMATSU-SHI, SHIZUOKA, JAPAN., SN 75-574,238. FILED 10-20-1998. PRINCIPAL REGISTER.

XGFACTORY

OWNER OF U.S. REG. NO. 2,063,123.
INT. CL. 9/U.S. CLS. 21, 23, 26, 36 AND 38
FOR COMPUTER HARDWARE USED FOR COMPUTER MUSIC; COMPUTER SOFTWARE AND COMPUTER PROGRAMS FOR CREATING, RECORDING, MIXING, EFFECTING, REPRODUCING AND SEQUENCING SOUNDS, FOR USE IN THE FIELD OF MUSICAL SOUND RECORDING PRODUCTION; PRINTED CIRCUIT BOARDS *FOR* [OR] [OR] GENERATING, EFFECTING, RECORDING AND REPRODUCING SOUND; PRINTED CIRCUIT BOARDS *FOR* [OR] SEQUENCING MUSIC; ELECTRONIC MUSIC SEQUENCERS.
FIRST USE 9-4-1998; IN COMMERCE 9-4-1998.

ELEMENTS CORRECTED
[GOODS/SERVICES]

2,541,567. REG. 2-19-2002. PHARMACIA & UPJOHN COMPANY (DELAWARE CORPORATION) 100 ROUTE 206 NORTH, PEAPACK, NJ, 07977, SN 76-031,912. FILED 4-21-2000. PRINCIPAL REGISTER.

ROGAINE RESULTS

OWNER OF U.S. REG. NOS. 1,420,785, 2,161,275 AND 2,265,307.
INT. CL. 42/U.S. CLS. 100 AND 101
FOR PROVIDING HAIR CARE AND HAIR GROWTH INFORMATION.
FIRST USE 5-8-1998; IN COMMERCE 5-8-1998.

ELEMENTS CORRECTED
DATE OF FIRST USE
DATE OF FIRST USE IN COMMERCE

2,545,896. REG. 3-12-2002. BEHR GMBH & CO. (FED REP GERMANY LIMITED LIABILITY PARTNERSHIP) POSTFACH 30 09 20, D-70449 STUTTGART, FED REP GERMANY., SN 75-882,470. FILED 12-29-1999. PRINCIPAL REGISTER.

HEAT UP. COOL DOWN.

PRIORITY CLAIMED UNDER SEC. 44(D) ON FED REP GERMANY APPLICATION NO. 39938851611, FILED 7-3-1999, REG. NO. 39938851, DATED 7-3-1999, EXPIRES 7-31-2009.

INT. CL. 7/U.S. CLS. 13, 19, 21, 23, 31, 34 AND 35
FOR COOLING APPARATUS AND COOLING SYSTEMS FOR INTERNAL COMBUSTION ENGINES AND ALTERNATIVE DRIVES SUCH AS ELECTRIC MOTOR AND FUEL CELL FOR MOTOR VEHICLES, NAMELY, COOLING MODULES, OIL MODULES, EXHAUST GAS RETURN MODULES AND PARTS THEREFOR, NAMELY, COOLANT COOLERS, RADIATORS, REFRIGERANT CONDENSERS, CHARGE AIR COOLERS, OIL COOLERS, FANS AND FAN HOODS, FAN DRIVES, FAN COUPLINGS/CLUTCHES, FLUID FRICTION COUPLINGS AS WELL AS EXHAUST GAS HEAT TRANSFER MEANS, EXHAUST GAS RETURN VALVES, FUEL COOLERS, COOLANT PUMPS, COOLANT HOSES AND AUXILIARY HEATERS.

FIRST USE ; IN COMMERCE .
INT. CL. 9/U.S. CLS. 21, 23, 26, 36 AND 38
FOR SYSTEMS FOR THE MEASUREMENT AND CONTROL OF COOLANT TEMPERATURE IN LAND MOTOR VEHICLES COMPRISING SENSORS, PTC SENSORS AND ACTUATORS, SYSTEMS FOR TEMPERATURE AND CLIMATE CONTROL COMPRISING SENSORS AND ACTUATORS, OPERATING CONTROLLERS AND ELECTRICAL CONTROLLERS, SENSORS FOR MEASURING AIR AND COOLANT TEMPERATURE, PTC AUXILIARY HEATERS AND PTC REGULATORS; LAND VEHICLE INSTRUMENT PANELS COMPRISING DASH CONTROLS; COOLANT THERMOSTATS.

FIRST USE ; IN COMMERCE .
INT. CL. 11/U.S. CLS. 13, 21, 23, 31 AND 34

FOR HEATING, VENTILATION AND AIR CONDITIONING SYSTEMS AND THEIR PARTS FOR AUTOMOTIVE VEHICLES, NAMELY, AIR CONDITIONING SYSTEMS COMPRISING AIR CONDITIONERS, BLOWERS, FAN WHEELS, FAN DRIVES, INDOOR FILTERS, OPERATING CONTROLLERS AND ELECTRICAL CONTROLLERS, PNEUMATIC AND ELECTRICAL ACTUATORS, SENSORS FOR MEASURING AIR AND COOLANT TEMPERATURE, VALVES, HEAT TRANSFER MEANS SUCH AS HEATER CORES, REFRIGERANT EVAPORATORS AND CONDENSERS, PTC AUXILIARY HEATERS AND PTC REGULATORS, REFRIGERANT EXPANSION VALVES, COOLANT PUMPS, AND REFRIGERANT COMPRESSORS, REFRIGERANT TUBING, COLLECTORS AND DRYERS FOR REFRIGERANTS, AIR CONDITIONING COOLING MODULES, AND HEADLIGHTS.

FIRST USE ; IN COMMERCE .
 INT. CL. 12/U.S. CLS. 19, 21, 23, 31, 35 AND 44
 FOR LAND VEHICLE CONSOLE PARTS, NAMELY, AIR VENTS, CROSSBEAMS, WIRING HARNESSSES, AIR DUCTS, AND BUMPERS/SHOCK ABSORBERS.

FIRST USE ; IN COMMERCE .
 INT. CL. 37/U.S. CLS. 100, 103 AND 106
 FOR MAINTENANCE AND REPAIR OF AUTOMOTIVE ENGINE COOLING SYSTEMS AND HEATING/AIR CONDITIONING SYSTEMS.
 FIRST USE ; IN COMMERCE .

ELEMENTS CORRECTED
 ENTITY

2,552,843, REG. 3-26-2002. PININFARINA EXTRA S.R.L. (ITALY CORPORATION) CORSO STATI UNITI, 61, 10129 TORINO, ITALY., SN 74-725,346. FILED 9-1-1995. PRINCIPAL REGISTER.



PRIORITY CLAIMED UNDER SEC. 44(D) ON ITALY APPLICATION NO. T095C002475, FILED 7-28-1995, REG. NO. 657054, DATED 9-22-1995, EXPIRES 7-28-2005.

OWNER OF U.S. REG. NOS. 1,777,150, 1,854,151 AND OTHERS.
 INT. CL. 7/U.S. CLS. 13, 19, 21, 23, 31, 34 AND 35
 FOR PUMP AIR COMPRESSORS, [GRINDING POLISH MACHINES, BLOCK MILLING CUTTERS,] TORQUE MACHINES AND MOTORS FOR SAID MACHINES; [MOTORS AND ENGINES (EXCEPT FOR LAND VEHICLES); COUPLINGS AND TRANSMISSION COMPONENTS, NAMELY, SHAFTS, GEARS AND BELTS (ALL NOT FOR LAND VEHICLES) (EXCEPT FOR LAND VEHICLES); INCUBATORS FOR EGGS].
 FIRST USE 5-0-1995; IN COMMERCE 5-0-1995.

ELEMENTS CORRECTED
 FOREIGN RENEWAL REG. DATE

2,568,754, REG. 5-14-2002. CPAMERICA INTERNATIONAL, INC. (GEORGIA CORPORATION) 11801 RESEARCH DRIVE, ALACHUA, FL, 32615, BY CHANGE OF NAME ACCOUNTING FIRMS ASSOCIATED, INC. CORPORATION) GAINESVILLE, FL, SN 75-338,290. FILED 8-8-1997. PRINCIPAL REGISTER.



NO CLAIM IS MADE TO THE EXCLUSIVE RIGHT TO USE "INTERNATIONAL", APART FROM THE MARK AS SHOWN.

INT. CL. 42/U.S. CLS. 100 AND 101
 FOR ASSOCIATION SERVICES, NAMELY, PROMOTING THE INTERESTS OF CERTIFIED PUBLIC ACCOUNTANTS.
 FIRST USE 10-4-1999; IN COMMERCE 10-4-1999.
 INT. CL. 200/U.S. CL. 200
 FOR INDICATING MEMBERSHIP IN A GROUP OF CERTIFIED PUBLIC ACCOUNTANT FIRMS.
 FIRST USE 10-4-1999; IN COMMERCE 10-4-1999.

ELEMENTS CORRECTED
 ASSIGNMENT/NAME CHANGE
 CITIZENSHIP

2,579,894, REG. 6-11-2002. CREDITXPRT INC. (MARYLAND CORPORATION) 8600 LASALLE ROAD, SUITE 322, TOWSON, MD, 21268, BY MERGER, BY ASSIGNMENT NEURISTICS CORPORATION CORPORATION) HUNT VALLEY, MD, SN 76-056,172. FILED 5-25-2000. PRINCIPAL REGISTER.



NO CLAIM IS MADE TO THE EXCLUSIVE RIGHT TO USE "CREDIT", APART FROM THE MARK AS SHOWN.

INT. CL. 36/U.S. CLS. 100, 101 AND 102
 FOR [PROVIDING CREDIT BUREAU REPORTS, CREDIT SCORES, AND ANALYSIS THEREOF VIA A GLOBAL COMPUTER NETWORK;] SCORING CONSUMER CREDIT REPORTS OBTAINED FROM CREDIT BUREAUS; PROVIDING SCORING AND ANALYSIS OF CONSUMER CREDIT REPORTS.
 FIRST USE 9-1-2000; IN COMMERCE 9-1-2000.

ELEMENTS AMENDED
 GOODS/SERVICES

2,580,437. REG. 6-11-2002. FARNAM COMPANIES, INC. (ARIZONA CORPORATION) 301 WEST OSBORN ROAD, PHOENIX, AZ. 85013, SN 78-058,070. FILED 4-12-2001. PRINCIPAL REGISTER.

SURETIGHT

INT. CL. 5/U.S. CLS. 6, 18, 44, 46, 51 AND 52
FOR LINIMENTS, NAMELY, VETERINARY PREPARATIONS FOR COMPANION ANIMALS * NOT SOLD IN OR OTHERWISE DISTRIBUTED THROUGH GROCERY, DRUG, OR CONVENIENCE STORES *.
FIRST USE 7-17-2001; IN COMMERCE 7-17-2001.

ELEMENTS AMENDED
GOODS/SERVICES

2,589,807. REG. 7-2-2002. PALA BAND OF MISSION INDIANS, THE (UNITED STATES FEDERALLY RECOGNIZED INDIAN TRIBE), DBA PALA CASINO, 12194 PALA MISSION ROAD, PALA, CA. 92059, SN 76-188,637. FILED 1-2-2001. PRINCIPAL REGISTER.

PRIVILEGES

INT. CL. 41/U.S. CLS. 100, 101 AND 107
FOR CASINO ENTERTAINMENT SERVICES, NAMELY, PROVIDING CASINO FACILITIES AND ORGANIZING, CONDUCTING AND SPONSORING CASINO GAMING PROGRAMS, GAMING TOURNAMENTS AND RELATED INCENTIVE AWARD PROGRAMS.
FIRST USE 4-3-2001; IN COMMERCE 4-3-2001.

ELEMENTS CORRECTED
CITIZENSHIP
ENTITY

2,610,238. REG. 8-20-2002. UNIVERSITY FEDERAL CREDIT UNION (UNITED STATES FEDERALLY CHARTERED CREDIT UNION) 3305 STECK AVENUE, AUSTIN, TX, 78757, SN 75-857,437. FILED 11-24-1999. PRINCIPAL REGISTER.

WHEELS 101

INT. CL. 35/U.S. CLS. 100, 101 AND 102
FOR CAR BUYING SERVICES FOR NEW AND USED AUTOMOBILES, PROVIDED TO MEMBERS, NAMELY PROVIDING MEMBERS WITH EXTENSIVE INFORMATION AND ASSISTANCE IN CONNECTION WITH THE CAR-BUYING PURCHASE PROCESS, NAMELY, PROVIDING INFORMATION REGARDING SAFETY AND RELIABILITY OF SPECIFIC MAKES AND MODELS OF VEHICLES, PROVIDING INFORMATION REGARDING THE MAINTENANCE AND SAFETY HISTORIES OF INDIVIDUAL VEHICLES, PROVIDING INFORMATION REGARDING DEALER COSTS FOR NEW VEHICLES, LOCATING SPECIFIC VEHICLES FOR MEMBERS, PROVIDING INFORMATION AND SUGGESTIONS REGARDING BUYING NEW AND USED CARS AND SELLING USED CARS.
FIRST USE 1-1-2000; IN COMMERCE 1-1-2000.

ELEMENTS AMENDED
MARK

2,621,944. REG. 9-17-2002. KABUSHIKI KAISHA SEGA (JAPAN CORPORATION), DBA SEGA CORPORATION, 2-12, HANEDA 1-CHOME OHTA-KU, TOKYO 144-8531, JAPAN., BY ASSIGNMENT SEGA OF AMERICA DREAMCAST, INC. CORPORATION) SAN FRANCISCO, CA, SN 76-038,358. FILED 5-2-2000. PRINCIPAL REGISTER.

JET GRIND RADIO

NO CLAIM IS MADE TO THE EXCLUSIVE RIGHT TO USE "RADIO", APART FROM THE MARK AS SHOWN.
INT. CL. 9/U.S. CLS. 21, 23, 26, 36 AND 38
FOR COMPUTER GAME SOFTWARE AND VIDEO GAME SOFTWARE.
FIRST USE 10-31-2000; IN COMMERCE 10-31-2000.

ELEMENTS CORRECTED
ASSIGNMENT/NAME CHANGE
DBA/AKA
OWNER NAME
OWNER ADDRESS
CITIZENSHIP

2,636,440. REG. 10-15-2002. ELUMINIA LIGHTING TECHNOLOGIES, INC. (CANADA CORPORATION) 2189 KING ROAD, P.O. BOX # 520, KING CITY, ONTARIO L7B 1G3, CANADA., SN 76-049,675. FILED 5-17-2000. PRINCIPAL REGISTER.

ELUMINA

INT. CL. 11/U.S. CLS. 13, 21, 23, 31 AND 34
FOR LUMINESCENT PANELS HAVING CONTROL-LABLE LUMINANCE OUTPUT.
FIRST USE 3-0-2002; IN COMMERCE 3-0-2002.

ELEMENTS CORRECTED
OWNER NAME

2,644,906. REG. 11-5-2002. DAIMLERCHRYSLER AG (FED REP GERMANY CORPORATION) EPPLESTRASSE 225, STUTTGART, FED REP GERMANY, 70567, SN 75-584,146. FILED 11-6-1998. PRINCIPAL REGISTER.

DAIMLERCHRYSLER

PRIORITY CLAIMED UNDER SEC. 44(D) ON FED REP GERMANY APPLICATION NO. 39825488.5, FILED 5-7-1998, REG. NO. 39825488.5, DATED 7-2-1998, EXPIRES 5-31-2008.
OWNER OF U.S. REG. NOS. 93,698, 1,906,450 AND OTHERS.
INT. CL. 2/U.S. CLS. 6, 11 AND 16

FOR ANTI-RUST GREASES AND OILS; COLOR PIGMENTS, CORROSION INHIBITING PAINT TYPE COATINGS FOR COMMERCIAL MARINE USE; PAINT AND LACQUER GLAZES; LACQUER COATINGS; MOLDING COMPOUNDS, NAMELY COLORANTS USED IN THE MANUFACTURE OF PLASTIC; EXTERIOR PAINT, PAINT FOR INDUSTRIAL EQUIPMENT AND MACHINERY; PAINT FOR USE IN THE AUTOMOBILE, RAILWAY AND AEROSPACE INDUSTRIES; PRIMERS FOR PREPARING SURFACES TO BE PAINTED; NATURAL RESINS FOR USE IN THE MANUFACTURE OF ADHESIVES; RUST PRESERVATIVE COATINGS; SEALER COATINGS FOR USE IN THE AUTOMOBILE, RAILWAY AND AEROSPACE INDUSTRIES; UNDERCOATING FOR SURFACES TO BE PAINTED AND FOR VEHICLE CHASSIS; VARNISH.

FIRST USE ; IN COMMERCE .

INT. CL. 3/U.S. CLS. 1, 4, 6, 50, 51 AND 52

FOR PREPARATIONS FOR BODY AND BEAUTY CARE, NAMELY, TOILET WATER, AFTER SHAVE LOTION AND SHAVING CREAM, HAIR LOTIONS, PERFUMES, ESSENTIAL OILS FOR PERSONAL USE, TOILET SOAPS, TOOTH PASTE, NAIL VARNISH, NAIL CARE PREPARATIONS, LIPSTICKS, EYEBROW PENCILS, MASCARA.

FIRST USE ; IN COMMERCE .

INT. CL. 4/U.S. CLS. 1, 6 AND 15

FOR AUTOMOBILE AND AUTOMOTIVE LUBRICANTS AND GREASES; LUBRICANTS FOR AIRCRAFT ENGINES; LUBRICATION GREASE FOR VEHICLES; MOTOR OIL; NONCHEMICAL MOTOR OIL ADDITIVES.

FIRST USE ; IN COMMERCE .

INT. CL. 6/U.S. CLS. 2, 12, 13, 14, 23, 25 AND 50

FOR BASKETS OF COMMON METALS; PORTABLE METAL BUILDINGS; METAL CABLE WIRE; NON-ELECTRIC CABLES; METAL CHAINS; METAL CLOSURES FOR CONTAINERS; METAL CONTAINERS FOR STORING AND TRANSPORTING GOODS; METAL CYLINDERS FOR COMPRESSED GAS OR LIQUIDS, SOLD EMPTY; METAL KEY FOBS AND KEY RINGS; METAL LICENSE PLATES; METAL RAILROAD TIES AND RAILS; METAL ROCKET LAUNCHING PLATFORMS; METAL TANKS FOR FLUID STORAGE.

FIRST USE ; IN COMMERCE .

INT. CL. 7/U.S. CLS. 13, 19, 21, 23, 31, 34 AND 35

FOR AIR COMPRESSORS, NAMELY, AIR COMPRESSORS FOR VEHICLES; COMPRESSORS FOR AIR CONDITIONERS AND MACHINES; AIRCRAFT ENGINES AND AIRPLANE MOTORS; ALTERNATORS FOR LAND VEHICLES; AXLES FOR MACHINES; MACHINE PARTS, NAMELY ROLLER BEARINGS, BEARINGS AND BUSHINGS; BEARINGS FOR TRANSMISSION PARTS OF MACHINES; BELTS FOR MACHINES AND CONVEYORS; POWER TRANSMISSION BELTS FOR MACHINES; FAN BELTS FOR MOTORS AND ENGINES; CONVEYOR BELTS MADE OF WIRE; BOAT ENGINES AND MOTORS; INTERNAL COMBUSTION ENGINES FOR BOATS; BRAKES FOR MACHINES; ELECTRICALLY OPERATED BRUSHES FOR MACHINES; BRUSHES FOR MOTORS GENERATORS AND DYNAMOS; ROTARY AND WIRE BRUSHES FOR MACHINES; VEHICLE PARTS, NAMELY CARBURETORS; CARBURETORS AND/OR FUEL INJECTORS FOR INTERNAL COMBUSTION ENGINES; CATALYTIC CONVERTERS FOR MOTORS AND ENGINES; CENTRIFUGAL PUMPS; CENTRIFUGES; CLUTCHES FOR MACHINES; IGNITION PARTS FOR INTERNAL COMBUSTION ENGINES, NAMELY CONDENSERS; CONNECTING RODS FOR MACHINES, MOTORS AND ENGINES; TORQUE CONVERTERS, NOT FOR LAND VEHICLES; CONVEYORS; COUPLINGS FOR MACHINES; SHAFT COUPLINGS, NOT FOR LAND VEHICLES; MOBILE CRANES; CYLINDERS FOR VEHICLES OTHER THAN LAND VEHICLES; DIESEL ENGINES FOR STATIONARY USE; DYNAMOS; EMISSION REDUCTION UNITS FOR MOTORS AND ENGINES, NAMELY EGR VALVES AND PCV VALVES; ELECTRIC GENERATORS; ELECTRIC MOTORS FOR MACHINES; ELECTRONIC IGNITIONS FOR VEHICLES; ENGINE OR MOTOR MUFFLERS; AIRCRAFT ENGINES; INTERNAL COMBUSTION ENGINES FOR MACHINE OPERATION AND REPLACEMENT PARTS THEREFOR; ENGINES, DIESEL ENGINES AND GASOLINE ENGINES, NOT FOR LAND VEHICLES; FAN BELTS FOR MOTORS AND ENGINES; FANS FOR MACHINE ENGINES; FILTERS FOR MACHINES FOR STATIONARY USE; OIL, GAS AND AIR FILTERS FOR MOTORS AND ENGINES; MACHINE FLY-WHEELS; FUEL INJECTORS; TRANSMISSION GEARS FOR MA-

CHINES; GENERATORS FOR LAND VEHICLES; CONNECTING HOSES FOR VEHICLE RADIATORS; HYDRAULIC JACKS; STANDS FOR HYDRAULIC JACKS; HYDRAULIC TURBINES; ELECTRONIC IGNITIONS FOR VEHICLES; OIL PUMPS FOR USE IN MOTORS AND ENGINES; INTERNAL COMBUSTION ENGINE PARTS, NAMELY PISTON RINGS AND PISTONS; MACHINE OPERATED PLATFORMS CAPABLE OF ELEVATION ABOVE GROUND LEVEL AND USED FOR STORAGE; COOLING RADIATORS FOR MOTORS AND ENGINES; INDUSTRIAL ROBOTS; ROTARY BRUSHES FOR MACHINES; ROTARY PUMPS; MECHANICAL SHAFT COUPLINGS, NOT FOR LAND VEHICLE; SHOCK ABSORBERS FOR MACHINES; SPARK PLUGS; STARTERS FOR MOTORS AND ENGINES; SUCTION PUMPS; SUMP PUMPS; TURBOGENERATORS; VACUUM PUMPS; MACHINE VALVES; WATER PUMPS FOR USE IN MOTORS AND ENGINES; WINCHES.

FIRST USE ; IN COMMERCE .

INT. CL. 8/U.S. CLS. 23, 28 AND 44

FOR NAIL CLIPPERS AND FILES; HAND JACKS; KNIFE SHEATHS; POCKET KNIVES; MANICURE AND PEDICURE SETS; SCISSORS; HAND TOOLS, NAMELY SCREWDRIVERS; TABLEWARE, NAMELY KNIVES, FORKS AND SPOONS MADE OF PRECIOUS AND NON-PRECIOUS METAL.

FIRST USE ; IN COMMERCE .

INT. CL. 9/U.S. CLS. 21, 23, 26, 36 AND 38

FOR BURGLAR ALARMS; ANTENNAS; AUDIO CASSETTE DECKS FOR AUTOMOBILES; PRE-RECORDED AUDIO TAPES, CASSETTES AND COMPACT DISCS IN CONNECTION WITH AUTOMOBILES AND RELATED FUNCTIONS; BATTERIES; BATTERIES FOR VEHICLES; BATTERY CHARGERS; SAFETY EQUIPMENT, NAMELY BEACON LIGHTS; MARKER, NAVIGATIONAL AND SIGNALLING BUOYS; COAXIAL, COMPUTER, ELECTRICAL AND FIBER OPTIC CABLES; VIDEO CAMERAS; EYEGLASS CASES; COMPUTER AND SILICON CHIPS; ELECTRIC CIGARETTE LIGHTERS FOR LAND VEHICLES; CIRCUIT BOARDS; ELECTRICAL AND PRINTED CIRCUIT BOARDS; ELECTRICAL AND INTEGRATED CIRCUITS; MAGNETIC CODED CARDS AND CARD READERS; COMPACT DISC PLAYERS; COMPUTER MONITORS; COMPUTER PROGRAMS IN CONNECTION WITH AUTOMOBILES AND RELATED FUNCTIONS; COMPUTER UTILITY PROGRAMS; ELECTRICAL CONTROLLERS; CONVERTERS; ELECTRIC CONVERTERS; CRUISE CONTROLS FOR MOTOR VEHICLES; DATA PROCESSORS; MARINE DEPTH FINDERS; SMOKE DETECTORS; ELECTRIC LIGHT DIMMERS; OPTICAL DISCS; AUDIO DISCS AND VIDEO DISCS IN CONNECTION WITH AUTOMOBILES AND RELATED FUNCTIONS; ELECTRIC LUMINESCENT DISPLAY PANELS; LIGHT EMITTING DIODE DISPLAYS; EYEGLASSES; FIBER OPTIC LIGHT AND IMAGE CONDUITS; FIBER OPTICS; SAFETY EQUIPMENT, NAMELY FIRE ESCAPE LADDERS; FIRE EXTINGUISHERS; TELESCOPIC GUNSIGHTS; HELMETS FOR AEROSPACE USE; TELEPHONE APPARATUS, NAMELY INTERCOMS; LASERS NOT FOR MEDICAL USE; ELECTRONIC MOTION SENSITIVE SWITCHES; OCR OPTICAL CHARACTER RECOGNITION APPARATUS; PERISCOPES; SATELLITE PROCESSORS; MOVIE PROJECTORS; RADAR AND RADAR DETECTORS; RADIO CONTROLLED MINIATURE [SERIAL] * AERIAL * TARGETS; RADIOS; RADIOS FOR VEHICLES; RECEIVERS; LABORATORY ROBOTS; SATELLITES; SATELLITE PROCESSORS; SATELLITES FOR SCIENTIFIC PURPOSES; SEMICONDUCTORS AND SEMICONDUCTOR DEVICES; SIGNAL PROCESSORS; SILICON WAFERS; SIRENS FOR VEHICLES; SOLENOID VALVES; SUNGLASSES; ELECTRIC SWITCHES; ELECTRONIC MOTION SENSITIVE SWITCHES AND ELECTRONIC TOUCH SENSITIVE SWITCHES; TACHOMETERS; TELEVISION ANTENNAS; TRANSCIEVERS; ELECTRICAL TRANSFORMERS; RADIO TRANSMITTERS; VIDEO MONITORS; VIRTUAL REALITY SOFTWARE FOR AUTOMOTIVE AND AEROSPACE USE; VOLTAGE SURGE PROTECTORS AND SUPPRESSORS; WARNING TRIANGLES TO INDICATE VEHICLE BREAKDOWNS.

FIRST USE ; IN COMMERCE .

INT. CL. 11/U.S. CLS. 13, 21, 23, 31 AND 34

FOR AIR CONDITIONERS FOR VEHICLES; AIR CONDITIONING UNITS; AIR FILTERS FOR AIR CONDITIONING UNITS AND FOR DOMESTIC USE AND INDUSTRIAL INSTALLATIONS; AIR PURIFYING UNITS FOR COMMERCIAL USE; COOLANT RECOVERY SYSTEMS, COMPRISING RESERVOIRS, PUMPS, FILTERS, CLEANERS; DEHUMIDIFIERS; DESALINATION UNITS; WATER DISTILLING UNITS; ELECTRIC FANS; VENTILATING FANS FOR COMMERCIAL AND INDUSTRIAL USE; WATER FILTERING UNITS FOR PRODUCING POTABLE WATER FOR DOMESTIC USE; FLASHLIGHTS; HEAT PUMPS; SOLAR HEATING PANELS; HUMIDIFIERS; KEROSENE HEATERS; LAMPS; LIGHTS FOR VEHICLES; SEARCHLIGHTS; SOLAR COLLECTORS AND HEATING PANELS; VEHICLE HEADLIGHTS.

FIRST USE ; IN COMMERCE .

INT. CL. 13/U.S. CLS. 2 AND 9

FOR FIRE ALARMS; AMMUNITION; CASES AND SHELLS FOR LARGE SIZE AMMUNITION; SMALL ARMS AMMUNITION; AMMUNITION BAGS; ANTI-AIRCRAFT GUNS; ARMOR PIERCING AND WEAPONS PROJECTILES AND SHELLS; ARMORED TURRETS; ARTILLERY GUNS; FUSES FOR BLASTING; BOMB AND FLAME RELEASES; BOMBS; EXPLOSIVES FOR USE IN BOMBS; DETONATING CAPS; DETONATORS; EXPLOSIVES; FUSES; GRENADES; GUIDED MISSILES AND PROJECTILES; GRENADE AND ROCKET LAUNCHERS; LUMINOUS EXPLOSIVE FOG SIGNALS; MAGAZINES FOR WEAPONS; GUN AND MOBILE GUN MOUNTS; PROJECTING APPARATUS FOR GRENADES, BOMBS AND THE LIKE; SIGNAL ROCKETS; EXPLOSIVE SHELLS; SKY ROCKETS; FIREWORKS, NAMELY SPARKLERS; TRIPODS AND STANDS FOR FIREARMS; TORPEDOES; EXPLOSIVE TORPEDOES.

FIRST USE ; IN COMMERCE .

INT. CL. 14/U.S. CLS. 2, 27, 28 AND 50

FOR WATCHES; WATCH ATTACHMENTS, NAMELY, FOBBS, CHAINS AND BANDS.

FIRST USE ; IN COMMERCE .

INT. CL. 16/U.S. CLS. 2, 5, 22, 23, 29, 37, 38 AND 50

FOR ALMANACS; ANNIVERSARY BOOKS; ART PICTURES, ART PRINTS, GRAPHIC ART REPRODUCTIONS, PRINTED ART REPRODUCTIONS; ATLASES; PRINTED AWARDS; PAPER NAME BADGES; PAPER BAGS; PLASTIC OR PAPER BAGS, ENVELOPES AND POUCHES FOR MERCHANDISE PACKAGING; BALL-POINT PENS; PAPER BANNERS; BASKETS FOR DESK ACCESSORIES; LOOSE LEAF BINDERS; PRINTING BLOCKS; CLIP BOARDS; PICTURE BOOKS; CARD-BOARD BOXES, PAPER BOXES, PENCIL BOXES, STATIONERY BOXES, FILE BOXES FOR STORAGE OF BUSINESS AND PERSONAL RECORDS; BUMPER STICKERS; BUSINESS CARDS; CALENDAR DESK PADS, CALENDAR DESK STANDS, CALENDAR STANDS, CALENDARS, POCKET CALENDARS, WALL CALENDARS; CARDBOARD; CREDIT CARDS; CARDBOARD CARTONS; PEN CASES, PENCIL CASES; AUTOMOTIVE, RAILWAY AND AEROSPACE CATALOGS; AUTOMOTIVE, RAILWAY AND AEROSPACE COMPUTER AND COMPUTER PROGRAM MANUALS; PAPER CONTAINERS; DESK TOP PLANNERS; PAPER EMBLEMS, PRINTED EMBLEMS; ENVELOPES; FILE FOLDERS, HANGING FOLDERS; LETTER OPENERS; GENERAL FEATURE MAGAZINES; PAPER NAPKINS; NEWS BULLETINS; AUTOMOBILE, RAILWAY AND AEROSPACE NEWSLETTERS; MAGAZINE SUPPLEMENTS TO NEWSPAPERS; NEWSPAPERS FOR GENERAL CIRCULATION; NOTE BOOKS, NOTE PADS, NOTE PAPER; PEN OR PENCIL HOLDERS; PENCILS; PENS; INK PENS; PICTURES; DAILY PLANNERS, PERSONAL PLANNERS; GENERAL PURPOSE PLASTIC BAGS; PLAYING CARDS; POSTCARDS, PICTURE POSTCARDS; POSTERS; PRICE TAGS; PRINTED TEACHING MATERIALS IN FORM OF GAMES; WRITING PADS.

FIRST USE ; IN COMMERCE .

INT. CL. 17/U.S. CLS. 1, 5, 12, 13, 35 AND 50

FOR TEXTILE BAGS, ENVELOPES AND POUCHES FOR MERCHANDISE PACKAGING; ASBESTOS FOR USE IN THE MANUFACTURE OF BRAKE LININGS; ELECTRICAL CERAMIC INSULATORS; ELECTRICAL INSULATING TAPE; GLASS FIBER ELECTRICAL INSULATING TAPE; INSULATION FOR AIRCRAFT; INSULATORS FOR RAILWAY TRACKS; CLUTCH LININGS; PLASTIC IN BARS, BLOCKS, PELLETS, RODS, SHEETS AND TUBES FOR GENERAL INDUSTRIAL USE; PLASTIC IN EXTRUDED FORM FOR GENERAL INDUSTRIAL USE; RESINS IN EXTRUDED FORM FOR GENERAL INDUSTRIAL USE; RUBBER SHOCK ABSORBERS FOR INDUSTRIAL MACHINERY .

FIRST USE ; IN COMMERCE .

INT. CL. 18/U.S. CLS. 1, 2, 3, 22 AND 41

FOR HANDBAGS, BRIEFCASES, TEXTILE SHOPPING BAGS, BACKPACKS, LARGE AND SMALL SUITCASES, UMBRELLAS AND PARASOLS, WALLETS, PURSES.

FIRST USE ; IN COMMERCE .

INT. CL. 20/U.S. CLS. 2, 13, 22, 25, 32 AND 50

FOR PICTURE FRAMES; OFFICE FURNITURE; FURNITURE PARTS; PLASTIC KEY CHAIN TAGS, NON-METAL KEY CHAINS, NON-METAL KEY FOBBS, NON-METAL KEY HOLDERS, NON-METAL KEY RINGS, PLASTIC KEY TAGS, PLASTIC CARD KEYS; PLASTIC NOVELTY LICENSE PLATES; HAND HELD MIRRORS; NON-METAL MONEY CLIPS; PLASTIC NAME BADGES; PILLOWS; CLOTHESPINS; SHELVES; SIDEBOARDS.

FIRST USE ; IN COMMERCE .

INT. CL. 21/U.S. CLS. 2, 13, 23, 29, 30, 33, 40 AND 50

FOR BEER JUGS, BEER MUGS; PORTABLE BEVERAGE COOLERS; BEVERAGE GLASSWARE; BEVERAGE WARE; BOTTLE OPENERS; CLOTHES BRUSHES, BRUSHES FOR FOOTWEAR; COFFEE CUPS; COFFEE SERVICES NOT OF PRECIOUS METAL; COMB CASES; HAIR COMBS; COMMEMORATIVE PLATES; ALL PURPOSE PORTABLE HOUSEHOLD CONTAINERS; COOLERS FOR WINE; CORK HOLDERS; CORK SCREWS; CUPS; DRINKING GLASSES; PLATE GLASS FOR CARS; GLASS FOR SIGNAL LIGHTS OR HEADLIGHTS FOR VEHICLES; GLASS FOR VEHICLE WINDOWS; POLISHING LEATHER; TEA SETS.

FIRST USE ; IN COMMERCE .

INT. CL. 22/U.S. CLS. 1, 2, 7, 19, 22, 42 AND 50

FOR AWNINGS; COMMERCIAL NETS; CAMOUFLAGE NETS FOR VISUAL AND RADAR USES; WADDING FOR PADDING AND STUFFING; PADDING MATERIALS NOT OF RUBBER OR PLASTIC; RAW FIBROUS TEXTILE MATERIALS; ROPES; SACKS OR BAGS FOR THE TRANSPORTATION OR STORAGE OF MATERIALS IN BULK; SAILS; STRING; POLYESTER STUFFING FIBERS; CANVAS TARPULINS; TENTS.

FIRST USE ; IN COMMERCE .

INT. CL. 23/U.S. CL. 43

FOR THREAD; THREAD FOR TEXTILE USE; YARN.

INT. CL. 24/U.S. CLS. 42 AND 50

FOR FABRIC IMPERVIOUS TO GASES FOR AERONAUTICAL BALLOONS; FABRICS FOR AUTOMOTIVE, AEROSPACE AND RAILWAY USE; NYLON FABRIC; TOWELS; UPHOLSTERY FABRICS.

FIRST USE ; IN COMMERCE .

INT. CL. 25/U.S. CLS. 22 AND 39

FOR ARTICLES OF APPAREL, NAMELY, [T-SHIRT] * T-SHIRTS *, SWEATSHIRTS, TIES, GLOVES, ANORAKS, PONCHOS, JACKETS, VESTS, SWEATERS, SPORTS SHIRTS, SCARVES, BELTS; FOOTWEAR; HEADWEAR, NAMELY, HATS, CAPS, AVIATOR-TYPE CAPS.

FIRST USE ; IN COMMERCE .

INT. CL. 27/U.S. CLS. 19, 20, 37, 42 AND 50

FOR CARPETS FOR AUTOMOBILES; FLOOR MATS FOR VEHICLES; RUBBER MATS.

FIRST USE ; IN COMMERCE .

INT. CL. 28/U.S. CLS. 22, 23, 38 AND 50

FOR TOY AUTOMOBILES; PLUSH STUFFED TOY ANIMALS; JIGSAW PUZZLES; DOMINOES; SPORTS BALLS FOR USE IN BADMINTON, TENNIS, TABLE TENNIS, PADDLE BALL, RACKET BALL AND SQUASH GAMES; YO-YOS; BOARD GAMES, NAMELY, CHESS, CHINESE CHECKERS, NINE MEN'S MORRIS; TOY MODEL AUTOMOBILES; BALLOONS; WATER-SKI EQUIPMENT, NAMELY, METAL AND NYLON TOW ROPES; METAL TOW BARS.

FIRST USE ; IN COMMERCE .

INT. CL. 30/U.S. CL. 46

FOR COOKIES.

FIRST USE ; IN COMMERCE .

INT. CL. 34/U.S. CLS. 2, 8, 9 AND 17

FOR ASHTRAYS, NOT OF PRECIOUS METAL; CIGARETTE CASES, HOLDERS AND LIGHTERS NOT OF PRECIOUS METAL; CIGAR CUTTERS; CIGARETTE LIGHTERS NOT FOR LAND VEHICLES; MATCHES.
FIRST USE ; IN COMMERCE .

INT. CL. 35/U.S. CLS. 100, 101 AND 102

FOR ACCOUNTING SERVICES; BUSINESS ACQUISITION AND MERGER CONSULTATION; ADMINISTRATION OF CULTURAL AND EDUCATIONAL EXCHANGE PROGRAMS; ADVERTISING AGENCIES; IMPORT AND EXPORT AGENCIES; COST/PRICE ANALYSIS; ECONOMIC FORECASTING AND ANALYSIS; MARKET ANALYSIS AND RESEARCH; PROFIT SURVEY AND ANALYSIS; TELEPHONE ANSWERING SERVICE; BUSINESS APPRAISAL; ARRANGING AND CONDUCTING TRADE SHOW EXHIBITIONS IN THE FIELD OF AUTOMOBILES, RAILWAYS AND AEROSPACE; AUTOMOBILE SALVAGE AGENTS; BOOK-KEEPING; BUSINESS CONSULTATION AND INFORMATION; BUSINESS INVESTIGATIONS, BUSINESS PLANNING; LOCATION OF FREIGHT CARS BY COMPUTER; COMPUTERIZED DATA BASE MANAGEMENT; PROMOTING THE CONCERTS OF OTHERS; CONDUCTING BUSINESS RESEARCH AND SURVEYS; FOREIGN TRADE INFORMATION AND CONSULTATION; PERSONNEL MANAGEMENT CONSULTATION; DISSEMINATION OF ADVERTISING FOR OTHERS VIA AN ON-LINE ELECTRONIC COMMUNICATIONS NETWORK; ECONOMIC FORECASTING AND ANALYSIS; PROVIDING CONVENTION AND BUSINESS MEETINGS FACILITIES; PROVIDING FACILITIES FOR THE USE OF OFFICE EQUIPMENT AND MACHINERY; COMMERCIAL AND INDUSTRIAL MANAGEMENT ASSISTANCE; INVENTORY CONTROL; TRAVEL MANAGEMENT; CONDUCTING MARKETING STUDIES; BUSINESS MANAGEMENT; PROCUREMENT, NAMELY PURCHASING GOODS OR SERVICES IN THE AUTOMOTIVE, RAILWAY AND AEROSPACE INDUSTRIES; PRODUCT MERCHANDISING; PROFIT SURVEY AND ANALYSIS; PROMOTING SPORTS COMPETITIONS AND/OR EVENTS OF OTHERS; PROVIDING TELEVISION ADVERTISING FOR OTHERS; BUSINESS RESEARCH; TELEMARKETING; PROVIDING TRADE INFORMATION; STATE VEHICULAR REGISTRATION AND TITLE TRANSFER; AUTOMOBILE DEALERSHIPS; RETAIL STORE SERVICES FEATURING AUTOMOBILE PARTS AND ACCESSORIES.
FIRST USE ; IN COMMERCE .

INT. CL. 36/U.S. CLS. 100, 101 AND 102

FOR ACCIDENT INSURANCE UNDERWRITING; CREDIT CARD SERVICES; FINANCIAL ANALYSIS, CONSULTATION AND FORECASTING; FINANCIAL INFORMATION PROVIDED BY ELECTRONIC MEANS; FINANCIAL MANAGEMENT, PLANNING, PORTFOLIO MANAGEMENT AND RESEARCH; LEASE-PURCHASE FINANCING AND LOANS; FINANCING SERVICES; INSURANCE ADMINISTRATION; INSURANCE AGENCIES; INSURANCE BROKERAGE; INSURANCE CONSULTATION; RISK MANAGEMENT; ACCIDENT INSURANCE, ANNUITY, FIRE INSURANCE, GUARANTEE ASSURANCE, LIFE INSURANCE, MARINE INSURANCE, MEDICAL INSURANCE AND REINSURANCE UNDERWRITING; CHECK VERIFICATION; BILL PAYMENT SERVICES.
FIRST USE ; IN COMMERCE .

INT. CL. 37/U.S. CLS. 100, 103 AND 106

FOR REPAIR OF AERIAL NAVIGATION EQUIPMENT; AIRCRAFT REPAIR AND MAINTENANCE; AUTOMOBILE BODY REPAIR AND FINISHING FOR OTHERS; AUTOMOBILE AND VEHICLE CLEANING, DETAILING, GREASING, LUBRICATION, PAINTING, PINSTRIPING, POLISHING, REPAIR, MAINTENANCE AND WASHING; AUTOMOBILE SERVICE STATION AND GARAGE SERVICES; AUTOMOBILE UNDERCOATING SERVICES; INSTALLATION AND REPAIR OF BUSINESS AND OFFICE MACHINERY AND EQUIPMENT; COMPUTER INSTALLATION AND REPAIR; INSTALLATION OF COMPUTER NETWORKS AND SYSTEMS; RADIO REPAIR; RUSTPROOFING; SEAT COVERING SERVICES.
FIRST USE ; IN COMMERCE .

INT. CL. 38/U.S. CLS. 100, 101 AND 104

FOR ELECTRONIC MAIL SERVICES; ELECTRONIC TRANSMISSION OF DATA AND DOCUMENTS VIA COMPUTER TERMINALS; ELECTRONIC TRANSMISSION OF MESSAGES AND DATA; ELECTRONIC VOICE MESSAGING, NAMELY THE RECORDING, STORAGE AND SUBSEQUENT TRANSMISSION OF VOICE MESSAGES BY TELEPHONE; MOBILE RADIO COMMUNICATION; RENTAL OF TELECOMMUNICATIONS EQUIPMENT IN GENERAL; AUDIO AND VIDEO TELECONFERENCING; TELEMATIC SERVICES TELEVISION BROADCASTING; COMPUTER SERVICES, NAMELY, LEASING ACCESS TIME TO A COMPUTER DATABASE IN THE NATURE OF COMPUTER BULLETIN BOARDS IN THE FIELDS OF AUTOMOBILES, AEROSPACE, RAILWAYS AND TRANSPORTATION.
FIRST USE ; IN COMMERCE .

INT. CL. 39/U.S. CLS. 100 AND 105

FOR AIR TRANSPORTATION; AIRPLANE CHARTERING; AIRPORT SERVICES; AUTOMOBILE SALVAGE AND EMERGENCY TOWING; LEASING AND RENTAL OF AUTOMOBILES, VEHICLES AND TRUCKS; BUS CHARTERING; RENTAL OF VEHICLE PARKING SPACES; CHAUFFEUR SERVICES; COURIER SERVICES; EMERGENCY TRUCK TOWING; ARRANGING EXCURSIONS FOR TOURISTS; ARRANGING AND CONDUCTING JUNGLE AND SAFARI EXPEDITIONS; LEASING AND RENTAL OF GARAGE SPACE; TRAFFIC AND TRAVEL INFORMATION SERVICES; LAUNCH AND PLACEMENT IN PRESCRIBED ORBIT OF SATELLITES OF OTHERS; LEASING OF RAILROAD FLATCARS; LIMOUSINE SERVICES; RAILWAY TRANSPORT; RESCUE SERVICES; TAXI TRANSPORT; VEHICLE TOWING; ARRANGING TRAVEL TOURS; ARRANGING TRAVEL TOURS AS A BONUS PROGRAM FOR CREDIT CARD CUSTOMERS; TRAVEL AGENCY SERVICES, NAMELY MAKING RESERVATIONS AND BOOKINGS FOR TRANSPORTATION; TRUCK HAULING; CARGO UNLOADING; VEHICLE PARKING; STORAGE SERVICES FOR ARCHIVING AND RETRIEVING INFORMATION IN THE FIELD OF AUTOMOBILES FOR OTHERS.
FIRST USE ; IN COMMERCE .

INT. CL. 40/U.S. CLS. 100, 103 AND 106

FOR GALVANIZING; HEAT TREATMENT, COATING AND ACRYLIC FINISHING OF VEHICLES; MANUFACTURE OF CUSTOM MADE AUTOMOBILES; METAL CASTING, LAMINATING, PLATING, TEMPERING AND TREATMENT; INSERTING SOFTWARE PROTECTION PROGRAMS AND SECURITY PROGRAMS ONTO MAGNETIC MEDIA.
FIRST USE ; IN COMMERCE .

INT. CL. 41/U.S. CLS. 100, 101 AND 107

FOR AIRPLANE FLIGHT INSTRUCTION; AUTOMOBILE RACES; PUBLICATION OF BOOKS; CINEMA STUDIOS, CINEMA THEATERS; COMPUTER EDUCATION TRAINING SERVICES; ARRANGING AND CONDUCTING EDUCATIONAL CONFERENCES; EDUCATIONAL DEMONSTRATIONS; VEHICLE DRIVING INSTRUCTION; EDUCATION IN THE FIELD OF AUTOMOBILES; CONDUCTING CLASSES, SEMINARS, CONFERENCES AND WORKSHOPS IN THE FIELD OF COMPUTERS, AUTOMOBILES AND TRANSPORTATION AND DISTRIBUTING COURSE MATERIALS IN CONNECTION THEREWITH; GOLF TOURNAMENTS; MUSEUMS; PROVIDING CASINO FACILITIES.
FIRST USE ; IN COMMERCE .

INT. CL. 42/U.S. CLS. 100 AND 101

FOR AUTOMOBILE, MOTOR AND VEHICLE CLUBS; AUTOMOBILE REGISTRATION, NAMELY ASSIGNMENT OF VEHICLE IDENTIFICATION NUMBERS TO DETER THEFT; CAFES, CAFETERIAS; CANTEN SERVICES; COMPUTER CODE CONVERSION FOR OTHERS; COMPUTER CONSULTATION; LEASING OF COMPUTER FACILITIES; COMPUTER PROGRAMMING FOR OTHERS; ON LINE BATCH COMPUTER SERVICES; COMPUTER SITE DESIGN; UPDATING COMPUTER SOFTWARE; COMPUTER SOFTWARE DESIGN FOR OTHERS; LEASING OF COMPUTERS; RENTAL OF COMPUTERS AND SOFTWARE; INTELLECTUAL PROPERTY CONSULTATION; PATENT AGENCY AND INDUSTRIAL PROPERTY CONSULTATION; TELEPHONE HOTLINE COUNSELING, NAMELY OFFERING ADVICE REGARDING COMPUTERS AND AUTOMOBILES; RADAR DETECTION; ENGINEERING; MECHANICAL ENGINEERING; HOTEL SERVICES; RESEARCH AND CONSULTING IN THE FIELDS OF AEROSPACE ENGINEERING, AUTOMOBILES AND RAILWAYS; RESTAURANT SERVICES; RENTAL OF ROOMS; SCIENTIFIC RESEARCH; SPONSORING, DEVELOPING AND CARRYING OUT INTERNATIONAL STUDENT EXCHANGE PROGRAMS; AUTOMOBILE CLUBS.

FIRST USE ; IN COMMERCE .

ELEMENTS CORRECTED
GOODS/SERVICES

2,654,802. REG. 11-26-2002. AUTODESK, INC. (DELAWARE CORPORATION) 111 MCINNIS PARKWAY, SAN RAFAEL, CA, 94903, BY ASSIGNMENT BUZZSAW.COM CORPORATION) SAN FRANCISCO, CA, SN 76-038,588. FILED 4-27-2000. PRINCIPAL REGISTER.

BUZZSAW

INT. CL. 9/U.S. CLS. 21, 23, 26, 36 AND 38

FOR COMPUTER SOFTWARE FOR USE IN MANAGEMENT, STORAGE, AND RETRIEVAL OF SITE, VENDOR, AND SUB-CONTRACTOR INFORMATION AND DRAWINGS, PREPARATION OF BIDS AND PROPOSALS, AND CONTRACT MANAGEMENT, ALL IN THE FIELD OF COMMERCIAL AND INDUSTRIAL CONSTRUCTION PROJECTS.

FIRST USE 11-1-1999; IN COMMERCE 11-1-1999.

ELEMENTS CORRECTED
ASSIGNMENT/NAME CHANGE
OWNER NAME
OWNER ADDRESS

2,656,806. REG. 12-3-2002. FELLOWES, INC. (ILLINOIS CORPORATION) 1789 NORWOOD AVENUE, ITASCA, IL, 601431095, BY ASSIGNMENT NEATO LLC (CONNECTICUT), EAST HAVEN, CT, SN 75-602,705. FILED 12-10-1998. PRINCIPAL REGISTER.

MEDIAFACE

INT. CL. 9/U.S. CLS. 21, 23, 26, 36 AND 38

FOR COMPUTER PROGRAMS FOR CREATING LABELS FOR USE ON CD-ROMS, AUDIO AND VIDEO CASSETTE CONTAINERS, AND CONTAINERS FOR OTHER COMPUTER ACCESSORIES SUCH AS ZIP DRIVES.

FIRST USE 1-2-1998; IN COMMERCE 1-2-1998.

ELEMENTS CORRECTED
ASSIGNMENT/NAME CHANGE
OWNER ADDRESS

2,656,824. REG. 12-3-2002. ZIXIT.COM, INC. (DELAWARE CORPORATION) ONE GALLERIA TOWER, STE 1555, 13355 NOEL ROAD, DALLAS, TX, 15240, BY CHANGE OF NAME; BY CHANGE OF NAME; BY CHANGE OF NAME CUSTOMTRACKS OPERATING CORPORATION CORPORATION) DALLAS, TX, SN 75-660,620. FILED 3-15-1999. PRINCIPAL REGISTER.

ZIXMAIL

INT. CL. 9/U.S. CLS. 21, 23, 26, 36 AND 38

FOR COMPUTER SOFTWARE FOR THE ENCRYPTION AND AUTHENTICATION OF ELECTRONIC INFORMATION AVAILABLE ON A GLOBAL COMPUTER NETWORK, FOR GENERAL USE.

FIRST USE 12-1-1999; IN COMMERCE 12-1-1999.

ELEMENTS CORRECTED
ASSIGNMENT/NAME CHANGE

2,657,699. REG. 12-10-2002. GENERAL MILLS, INC. (DELAWARE CORPORATION) NUMBER ONE GENERAL MILLS BOULEVARD, MINNEAPOLIS, MN, 55426, SN 75-912,299. FILED 2-7-2000. PRINCIPAL REGISTER.



OWNER OF U.S. REG. NOS. 1,182,343 AND 1,666,000.
NO CLAIM IS MADE TO THE EXCLUSIVE RIGHT TO USE HEALTHY FOOD, APART FROM THE MARK AS SHOWN.

INT. CL. 30/U.S. CL. 46

FOR PROCESSED CEREAL USED AS A BREAKFAST OR SNACK FOOD.

FIRST USE 10-15-1999; IN COMMERCE 10-15-1999.

ELEMENTS CORRECTED
DISCLAIMER

2,662,858. REG. 12-17-2002. F & B GUDT FOOD HOLDINGS, INC. (DELAWARE CORPORATION) 269 WEST 23RD STREET, NEW YORK, NY, 10011, BY ASSIGNMENT, BY CHANGE OF NAME N & T RESTAURANT ASSOCIATES, INC. CORPORATION) NEW YORK, NY, SN 76-363,453. FILED 1-24-2002. PRINCIPAL REGISTER.

THE CHAMPION DOG

NO CLAIM IS MADE TO THE EXCLUSIVE RIGHT TO USE "DOG", APART FROM THE MARK AS SHOWN.

INT. CL. 30/U.S. CL. 46

FOR SANDWICHES, HOT DOG SANDWICHES AND VEGETARIAN HOT DOG SANDWICHES.

FIRST USE 5-20-2000; IN COMMERCE 5-20-2000.

ELEMENTS CORRECTED
ASSIGNMENT/NAME CHANGE

2,662,859. REG. 12-17-2002. F&B GUDT FOOD HOLDINGS, INC. (DELAWARE CORPORATION) 269 WEST 23RD STREET, NEW YORK, NY, 10011. BY ASSIGNMENT, BY CHANGE OF NAME N & T RESTAURANT ASSOCIATES, INC. CORPORATION) NEW YORK, NY, SN 76-363,454. FILED 1-24-2002. PRINCIPAL REGISTER.

2,669,534. REG. 12-31-2002. YAMANOUCHI PHARMACEUTICAL CO., LTD. (JAPAN CORPORATION) 3-11 NIHON-BASHI-HOUCHO, 2-CHOME CHUO-KU, TOKYO, JAPAN., BY ASSIGNMENT INOBYS LTD. CORPORATION) OAKLAND, CA, SN 75-754,104. FILED 7-19-1999. PRINCIPAL REGISTER.

THE FARM DOG

NO CLAIM IS MADE TO THE EXCLUSIVE RIGHT TO USE "DOG", APART FROM THE MARK AS SHOWN.
 INT. CL. 30/U.S. CL. 46
 FOR SANDWICHES, HOT DOG SANDWICHES AND VEGETARIAN HOT DOG SANDWICHES.
 FIRST USE 5-20-2000; IN COMMERCE 5-20-2000.

ELEMENTS CORRECTED
 ASSIGNMENT/NAME CHANGE

MACH I

INT. CL. 5/U.S. CLS. 6, 18, 44, 46, 51 AND 52
 FOR HUMAN AND ANIMAL DIETARY NUTRITIONAL SUPPLEMENTS AND MEDICATED ANIMAL FEED.
 FIRST USE 7-24-2002; IN COMMERCE 7-24-2002.

ELEMENTS CORRECTED
 ASSIGNMENT/NAME CHANGE
 OWNER NAME
 OWNER ADDRESS
 CITIZENSHIP

2,664,015. REG. 12-17-2002. GUESS?, INC. (DELAWARE CORPORATION) 1444 SOUTH ALAMEDA STREET, LOS ANGELES, CA, 90021, SN 76-076,175. FILED 6-22-2000. PRINCIPAL REGISTER.

2,670,916. REG. 1-7-2003. PEABODY MANAGEMENT, INC. (TENNESSEE CORPORATION) 5118 PARK AVE., SUITE 245, MEMPHIS, TN, 38117, SN 76-059,699. FILED 5-31-2000. PRINCIPAL REGISTER.

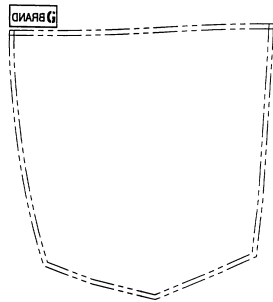

NO CLAIM IS MADE TO THE EXCLUSIVE RIGHT TO USE "BRAND", APART FROM THE MARK AS SHOWN.
 THE MARK CONSISTS OF THE WORD "BRAND" SPELLED BACKWARD, FOLLOWED BY THE LETTER "G". THE DOTTED OUTLINE OF A POCKET IS NOT PART OF THE MARK, BUT IS MERELY INTENDED TO SHOW THE POSITION OF THE MARK.
 INT. CL. 25/U.S. CLS. 22 AND 39

FOR MEN'S, WOMEN'S, BOYS', GIRLS', CHILDREN'S AND INFANT'S APPAREL, NAMELY, [UNDERWEAR, FOOTWEAR, SWIMWEAR, CAPS, HEADWEAR, APRONS,] ROBES, PAJAMAS, [HOSIERY, GLOVES, SUSPENDERS, BELTS, NECKTIES,] UNDERSHIRTS, [SOCKS,] SHIRTS, T-SHIRTS, SWEATPANTS, SWEATSHIRTS, KNIT TOPS, SKIRTS, PANTS, TROUSERS, SHORTS, SWEATERS, JEANS, VESTS, COATS, JACKETS, OVERALLS, BLAZERS, DRESSES, SCARVES, BLOUSES, CARDIGANS, [GOWNS,] GOLF SHIRTS, JOGGING SUITS, [TURTLENECKS,] SUITS AND POLO SHIRTS; [WOMEN'S PANTIES, BRAS, TANK TOPS, CROP TOPS, BUSTIERS, CAMISOLES, TAP PANTS, TEDDIES; MEN'S BRIEFS AND BOXER SHORTS]
 FIRST USE 10-0-2000; IN COMMERCE 10-0-2000.

ELEMENTS CORRECTED
 [GOODS/SERVICES]



OWNER OF U.S. REG. NOS. 1,535,837, 2,163,146 AND OTHERS.
 SEC. 2(F).
 INT. CL. 9/U.S. CLS. 21, 23, 26, 36 AND 38
 FOR [ORNAMENTAL MAGNETS;] MOUSE PADS.
 FIRST USE 3-0-1999; IN COMMERCE 0-0-1988.

ELEMENTS CORRECTED
 GOODS/SERVICES
 DATE OF FIRST USE

2,672,732. REG. 1-7-2003. PRECISE SOFTWARE SOLUTIONS, INC. (DELAWARE COMPANY) 690 CANTON STREET, WESTWOOD, MA, 02090, SN 76-057,314. FILED 5-25-2000. PRINCIPAL REGISTER.

PERFORMANCE IS OUR BUSINESS

INT. CL. 9/U.S. CLS. 21, 23, 26, 36 AND 38
 FOR COMPUTER SOFTWARE AND COMPUTER PROGRAMS FOR MONITORING, ANALYZING, REPORTING, AND SOLVING PERFORMANCE [ISSUE] * ISSUES * OF COMPUTER COMPONENTS AND COMPUTER PROGRAMS.
 FIRST USE 5-24-2000; IN COMMERCE 5-24-2000.

ELEMENTS CORRECTED
 GOODS/SERVICES

2,675,767. REG. 1-21-2003. SKYEPHARMA AG (SWITZERLAND CORPORATION) EPTINGER STRASSE 51, MUTTENZ, SWITZERLAND, CH5132, BY ASSIGNMENT DDS DRUG DELIVERY SERVICE GESELLSCHAFT ZUR FORDERUNG DER FORSCHUNG IN PHARMAZEUTISCHER TECHNOLOGIE UND BIOPHARMAZIE MBH CORPORATION) 24119 KRONSHAGEN, FED REP GERMANY, SN 75-419,681. FILED 1-20-1998. PRINCIPAL REGISTER.

DISSOCUBES

PRIORITY CLAIMED UNDER SEC. 44(D) ON FED REP GERMANY APPLICATION NO. 39734954.8, FILED 7-21-1997, REG. NO. 39734954, DATED 10-7-1997, EXPIRES 7-31-2007. INT. CL. 3/U.S. CLS. 1, 4, 6, 50, 51 AND 52

FOR LAUNDRY BLEACHING PREPARATIONS, LAUNDRY DETERGENT, FABRIC SOFTENER, ALL PURPOSE HOUSEHOLD CLEANING PREPARATIONS, SKIN SOAPS, PERFUME, ESSENTIAL OILS FOR PERSONAL USE; COSMETICS, NAMELY, MAKEUP, COMPACTS, COSMETIC PENCILS, EYE MAKEUP, EYE PENCILS, EYE SHADOW, EYEBROW PENCILS, EYELINERS, FACE POWDER, FOUNDATION MAKEUP, LIP GLOSS, LIPSTICK, LIP POMADES, ROUGE ASTRINGENTS FOR COSMETIC PURPOSES, AFTER-SHAVE LOTIONS, SHAVING BALM, NON-MEDICATED LIP BALM, BEAUTY MASKS, BODY CREAM, BODY POWDER, EYE CREAM, SKIN CLEANSING CREAM, SKIN CREAM, EYE MAKEUP REMOVER, FACIAL SCRUBS, FACIAL LOTION, BODY LOTION, SKIN MOISTURIZER, NAIL CARE PREPARATIONS, NAIL POLISH, SKIN CLARIFIERS, SKIN EMOLLIENTS, SKIN LIGHTENERS, SKIN TONERS, SUN BLOCK PREPARATIONS, SUN SCREEN PREPARATIONS, SUNTANNING PREPARATIONS, TOILET WATER AND WRINKLE REMOVING SKIN CARE PREPARATIONS; HAIR LOTIONS AND DENTIFRICES.

FIRST USE ; IN COMMERCE .
INT. CL. 5/U.S. CLS. 6, 18, 44, 46, 51 AND 52

FOR PHARMACEUTICAL, VETERINARY, AND SANITARY PREPARATIONS, NAMELY, ACNE MEDICATIONS, ACNE TREATMENT PREPARATIONS, VACCINE ADJUVANTS, ADJUVANTS FOR USE WITH VACCINES, ALCOHOL FOR TOPICAL USE, ALLERGY CAPSULES, ALLERGY MEDICATIONS, ALLERGY RELIEF MEDICATION, ALLERGY TABLETS, ANALGESIC BALM, ANALGESICS, ORAL ANALGESICS, TOPICAL ANALGESICS, ANESTHETIC FOR SURGICAL PURPOSES, ANESTHETICS FOR SURGICAL USE, ANTHELMINTICS, ANTI-INFECTIVES, ANTI-INFLAMMATORIES, ANTIARRHYTHMICS, ANTIBACTERIAL PHARMACEUTICALS, ANTIBIOTIC CREAMS, ANTIBIOTIC OINTMENTS, ANTIBIOTIC TABLETS, ANTIBIOTICS, ANTICONVULSANTS, ANTIDEPRESSANTS, ANTIEMETICS, ANTIPLATULANTS, ANTIHISTAMINES, ANTIHYPERTENSIVES, ANTIPARASITICS, ANTISEPTICS, ANTIVIRALS, ARTERIAL GRAFTS, ASTRINGENTS FOR MEDICINAL PURPOSES, MEDICATED LIP BALM, BRONCHIAL DILATORS, BRONCHODILATORS, BURN RELIEF MEDICATION, CALAMINE LOTION, CALCIUM CHANNEL BLOCKERS, MEDICATED CANDY FOR PAIN RELIEF, CARDIOVASCULAR PHARMACEUTICALS, CARDIOVASCULAR TREATMENT PREPARATIONS, CEMENT FOR BONES FOR MEDICAL USE, CENTRAL NERVOUS SYSTEM STIMULANTS, PHARMACEUTICAL PREPARATIONS FOR USE IN CHEMOTHERAPY, MEDICATED CHEWING GUM FOR PAIN RELIEF, COLD SORE TREATMENT PREPARATIONS, PREPARATIONS FOR TREATING COLDS, ORAL CONTRACEPTIVES, CONTRAST MEDIA FOR USE WITH X-RAY AND ULTRASOUND MEDICAL EQUIPMENT, COUGH DROPS, COUGH EXPECTORANTS, COUGH LOZENGES, COUGH SYRUPS, COUGH TREATMENT PREPARATIONS, HYDROCORTISONE CREAM, DECONGESTANT CAPSULES, DECONGESTANT NASAL SPRAYS, DECONGESTANTS, DENTAL RINSE, DERMATOLOGICALS, DIAGNOSTIC PREPARATIONS FOR CLINICAL OR MEDICAL LABORATORY USE, DIARRHEA MEDICATION, DIURETIC PREPARATIONS, EAR DROPS, EYE DROPS, NOSE DROPS, EMETIC PREPARATIONS, ENEMA PREPARATIONS, EXPECTORANTS, COUGH EXPECTORANTS, EYE DROPS, EYE WASHES, NUTRITIONAL ADDITIVES FOR LIVESTOCK FEED, FEED SUPPLEMENTS FOR LIVESTOCK, FUNGAL MEDICATIONS, TOPICAL GEL FOR MEDICAL AND THERAPEUTIC USE FOR THE

TREATMENT OF INFECTIOUS SKIN DISEASES, INFLAMMATORY SKIN DISEASES, SKIN IRRITATIONS, PSORIASIS AND NEURODERMATOSIS, GLAUCOMA AGENTS, MEDICATED HAIR CARE PREPARATIONS, HORMONES, PREPARATIONS FOR THE SUPPRESSION OF HORMONES, VETERINARY VACCINE FOR HORSES, HYDROCORTISONE, HYDROCORTISONE CREAM, HYPNOTICS, INSULIN, LAXATIVES, LINIMENTS, MEDICATED LOZENGES, THROAT LOZENGES, MEDICATED MOUTHWASH, MIGRAINE TREATMENT PREPARATIONS, VITAMIN AND MINERAL SUPPLEMENTS, MOTION SICKNESS TREATMENT PREPARATIONS, ANTICAVITY MOUTH RINSES, MUSCLE RELAXANTS, NASAL SPRAY PREPARATIONS, NOSE DROPS, SUPPOSITORIES, VACCINES, ANTIFUNGAL VAGINAL PREPARATIONS AND VITAMINS; DIETARY SUPPLEMENTS ADAPTED FOR MEDICAL USE, BABY FOOD, MEDICAL PLASTER, WOUND DRESSINGS, TOPICAL ANESTHETIC FOR RELIEVING TOOTH PAIN, ALL PURPOSE DISINFECTANTS, PREPARATIONS FOR DESTROYING VERMIN, FUNGICIDES FOR DOMESTIC USE AND HERBICIDES FOR DOMESTIC USE.

FIRST USE ; IN COMMERCE .

ELEMENTS CORRECTED
ASSIGNMENT/NAME CHANGE
OWNER NAME
OWNER ADDRESS
CITIZENSHIP

2,677,917. REG. 1-21-2003. TRAJECTORY, INC. (OHIO LIMITED LIABILITY COMPANY) 10633 LOVELAND - MADEIRA ROAD, SUITE 210, LOVELAND, OH, 45140, SN 76-399,931. FILED 4-23-2002. PRINCIPAL REGISTER.

TRAJECTORY

INT. CL. 35/U.S. CLS. 100, 101 AND 102
FOR PROVIDING CONSULTING SERVICES FOR THE ALLOCATION OF ECONOMIC AND CLINICAL RESOURCES FOR THE HEALTH CARE INDUSTRY.
FIRST USE 3-5-2002; IN COMMERCE 3-5-2002.

ELEMENTS CORRECTED
ENTITY

2,679,756. REG. 1-28-2003. MOTTURA SERRATURE DI SICUREZZA SPA (ITALY CORPORATION) STRADA ANTICA DI FRANZIA 34, 10057 SANT'AMBROGIO (TO), ITALY., SN 76-180,867. FILED 12-14-2000. PRINCIPAL REGISTER.



OWNER OF ITALY REG. NO. 830992, DATED 5-6-1999, EXPIRES 5-6-2009.

THE MARK CONSISTS OF, IN PART, OF A SAFETY LOCK CYLINDER PORTION OF A LOCK WITH A PATTERN CONSISTING OF THE LETTER "M" IN STYLED FORM IN THE TOP OF THE SAFETY LOCK CYLINDER PORTION.

INT. CL. 6/U.S. CLS. 2, 12, 13, 14, 23, 25 AND 50

FOR METAL SAFES; METAL STRONG BOXES FOR STORING JEWELRY AND DOCUMENTS; METAL ARMORED SECURITY DOORS; CYLINDERS FOR HIGH-SECURITY SAFETY LOCKS.
FIRST USE ; IN COMMERCE .

ELEMENTS CORRECTED
FOREIGN REG. NO.

FOR LEATHER AND IMITATIONS OF LEATHER GOODS MADE OF THESE MATERIALS, NAMELY, ANIMAL SKINS, HIDES, TRUNKS, TRAVELING BAGS, WALLETS, PURSES, ATTACHE CASES; UMBRELLAS, PARASOLS AND WALKING STICKS, WHIPS, HARNESSSES, AND SADDLERY.
FIRST USE ; IN COMMERCE .

INT. CL. 24/U.S. CLS. 42 AND 50
FOR LEATHER SEAT COVERS FOR FURNITURE.
FIRST USE ; IN COMMERCE .

ELEMENTS CORRECTED
FOREIGN REG. DATE

2,681,602. REG. 1-28-2003. LAIA AUGÉ POGE (SPAIN SPAIN JOINT INDIVIDUALS) BALMES 11, 17467 CAMALLERA, GIRONA, SPAIN., AND GUILLÉN AUGÉ POGE (SPAIN SPAIN JOINT INDIVIDUALS) BALMES 11, 17467 CAMALLERA, GIRONA, SPAIN., SN 75-942,255. FILED 3-13-2000. PRINCIPAL REGISTER.

2,684,106. REG. 2-4-2003. INTERTEK TESTING SERVICES NA INC. (MASSACHUSETTS CORPORATION) 440 EISENHOWER LANE, LOMBARD, IL, 60148, SN 75-852,706. FILED 11-18-1999. PRINCIPAL REGISTER.



RAM CONSULTING

OWNER OF U.S. REG. NO. 2,233,778.
NO CLAIM IS MADE TO THE EXCLUSIVE RIGHT TO USE "CONSULTING", APART FROM THE MARK AS SHOWN.

INT. CL. 42/U.S. CLS. 100 AND 101
FOR CONSULTING AND TESTING SERVICES FOR CONSUMER PRODUCT SAFETY.
FIRST USE 6-0-2000; IN COMMERCE 6-0-2000.

ELEMENTS CORRECTED
OWNER NAME

OWNER OF SPAIN REG. NO. 1580181, DATED 8-5-1992, RENEWED AS REG. NO. 1580181, DATED 2-20-2001, EXPIRES 6-16-2010.

INT. CL. 11/U.S. CLS. 13, 21, 23, 31 AND 34
FOR LAMPS FOR LIGHTING, GLASS LAMPS, SPHERICAL LAMPSHADES, LAMPSHADES AND LAMPS IN GENERAL FOR HOME USE.
FIRST USE 7-2-2001; IN COMMERCE 7-2-2001.

2,686,046. REG. 2-11-2003. SALSA MEX, INC. (CALIFORNIA CORPORATION) 2520 CACTUS RD., SUITE C, SAN DIEGO, CA, 92173, SN 76-379,900. FILED 3-6-2002. PRINCIPAL REGISTER.

ELEMENTS CORRECTED
OWNER ADDRESS
CITIZENSHIP
OWNER NAME
ENTITY



2,682,785. REG. 2-4-2003. BAVARIA LEDERVEREDELUNG GMBH (FED REP GERMANY LIMITED LIABILITY COMPANY) KREUZSTRASSE 51, D-71723 GROSSBOTTWAR, FED REP GERMANY., SN 76-323,292. FILED 10-10-2001. PRINCIPAL REGISTER.

TRICAST

OWNER OF U.S. REG. NO. 1,018,312.
THE STIPLING IS A FEATURE OF THE MARK AND DOES NOT INDICATE COLOR.

INT. CL. 30/U.S. CL. 46
FOR HOT SAUCE.
FIRST USE 7-0-1992; IN COMMERCE 7-0-1992.

PRIORITY CLAIMED UNDER SEC. 44(D) ON FED REP GERMANY APPLICATION NO. 30142930.8/1, FILED 7-16-2001, REG. NO. 30142930, DATED 12-17-2001, EXPIRES 7-31-2011.

INT. CL. 12/U.S. CLS. 19, 21, 23, 31, 35 AND 44
FOR LEATHER AND IMITATION OF LEATHER SEAT COVERS FOR MOTOR VEHICLE SEATS.
FIRST USE ; IN COMMERCE .
INT. CL. 18/U.S. CLS. 1, 2, 3, 22 AND 41

ELEMENTS CORRECTED
OWNER ADDRESS
MARK
DATE OF FIRST USE
DATE OF FIRST USE IN COMMERCE

2,689,794. REG. 2-25-2003. EXPEDIA, INC. (WASHINGTON CORPORATION) 13810 SE EASTGATE WAY, SUITE 400, BELLEVUE, WA, 98005, BY CHANGE OF NAME, BY ASSIGNMENT; BY ASSIGNMENT NEWTRADE INFORMATION TECHNOLOGIES INC. CORPORATION) MONTREAL, QUEBEC, SN 76-112,026. FILED 8-18-2000. PRINCIPAL REGISTER.

TRAVELSPACES NETWORK

PRIORITY CLAIMED UNDER SEC. 44(D) ON CANADA APPLICATION NO. 1063080, FILED 6-13-2000, REG. NO. TMA565214, DATED 7-25-2002, EXPIRES 7-25-2017.

NO CLAIM IS MADE TO THE EXCLUSIVE RIGHT TO USE "NETWORK", APART FROM THE MARK AS SHOWN. INT. CL. 42/U.S. CLS. 100 AND 101

FOR PROVIDING REAL-TIME HOTEL INFORMATION AND RESERVATION SERVICES VIA A GLOBAL COMPUTER NETWORK; CREATING AND MAINTAINING WEB SITES FOR OTHERS CONCERNING THE TRAVEL INDUSTRY; E-COMMERCE COMPUTER SOFTWARE DESIGN FOR THE TRAVEL INDUSTRY; COMPUTER SERVICES, NAMELY, PROVIDING AN ON-LINE INTERACTIVE DATABASE FEATURING TRAVEL INDUSTRY INFORMATION.

FIRST USE 1-0-2000; IN COMMERCE 1-0-2000.

ELEMENTS CORRECTED

CITIZENSHIP

ENTITY

OWNER NAME

OWNER ADDRESS

ASSIGNMENT/NAME CHANGE

2,691,860. REG. 3-4-2003. COMMUNICATION SYNERGY TECHNOLOGIES LLC. (DELAWARE LTD LIAB CO) 120 ALLENS CREEK ROAD, ROCHESTER, NY, 14618, BY CHANGE OF NAME MEDICAL SYNERGY TECHNOLOGIES LLC LTD LIAB CO) ROCHESTER, NY, SN 75-898,063. FILED 1-19-2000. PRINCIPAL REGISTER.

COMSYNTECH

INT. CL. 42/U.S. CLS. 100 AND 101

FOR PROVIDING TEMPORARY USE OF ON-LINE NON-DOWNLOADABLE SOFTWARE FOR USE IN THE FIELD OF ELECTRONIC DOCUMENT MANAGEMENT, NAMELY, DOCUMENT STORAGE; DOCUMENT DISTRIBUTION; USE IN TRANSCRIBING DOCUMENTS INTO AN ELECTRONIC FORMAT AND IN CREATING ELECTRONIC DOCUMENTS BY MEANS OF DICTATION.

FIRST USE 1-15-2002; IN COMMERCE 1-15-2002.

ELEMENTS CORRECTED

ENTITY

2,692,092. REG. 3-4-2003. GUERBET (FRANCE SOCIETE ANONYME) 15, RUE DES VANESSES, 93420 VILLEPINTE, FRANCE., SN 76-174,756. FILED 11-28-2000. PRINCIPAL REGISTER.

VISTAREM

PRIORITY CLAIMED UNDER SEC. 44(D) ON FRANCE APPLICATION NO. 003033959, FILED 6-14-2000, REG. NO. 003033959, DATED 6-14-2000, EXPIRES 6-14-2010.

INT. CL. 5/U.S. CLS. 6, 18, 44, 46, 51 AND 52

FOR PHARMACEUTICAL CONTRAST MEDIA FOR DIAGNOSIS IN MAGNETIC RESONANCE IMAGING.

ELEMENTS CORRECTED

OWNER ADDRESS

2,692,341. REG. 3-4-2003. FBS DISTRIBUTION CO., INC. (BRITISH COLUMBIA COMPANY) 704, 2071 KINGSWAY AVE., PORT COQUITLAM, BC, V3C 6N2, CANADA., SN 76-298,275. FILED 8-13-2001. PRINCIPAL REGISTER.

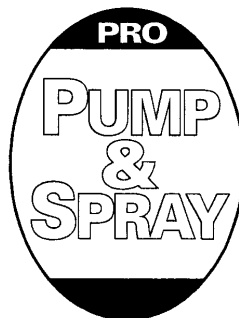

NO CLAIM IS MADE TO THE EXCLUSIVE RIGHT TO USE "PUMP & SPRAY", APART FROM THE MARK AS SHOWN.

INT. CL. 21/U.S. CLS. 2, 13, 23, 29, 30, 33, 40 AND 50

FOR EMPTY HAND-PUMPED SPRAY BOTTLES.

FIRST USE 10-0-1996; IN COMMERCE 10-0-1996.

ELEMENTS CORRECTED

OWNER ADDRESS

2,699,001. REG. 3-25-2003. BEST SOFTWARE, INC. (VIRGINIA CORPORATION) 11413 ISAAC NEWTON SQUARE, RESTON, VA, 201905005, BY ASSIGNMENT FENIMORE SOFTWARE GROUP, INC. CORPORATION), DBA CPA SOFTWARE, PENSACOLA, FL, SN 75-426,194. FILED 1-30-1998. PRINCIPAL REGISTER.



NO CLAIM IS MADE TO THE EXCLUSIVE RIGHT TO USE "CPASOFTWARE", APART FROM THE MARK AS SHOWN.

INT. CL. 9/U.S. CLS. 21, 23, 26, 36 AND 38

FOR COMPUTER PROGRAMS FOR TIME AND OFFICE MANAGEMENT NOT RELATING TO INTELLECTUAL PROPERTY OR THE MANAGEMENT OR MAINTENANCE THEREOF.

FIRST USE 5-0-1991; IN COMMERCE 5-0-1991.

ELEMENTS CORRECTED

OWNER NAME

2,700,703. REG. 3-25-2003. NETSIGNAL.COM, LLC (TEXAS LTD LIAB CO) 2525 PELICAN BAY, PLANO, TX, 75093, BY CHANGE OF NAME E-SIGNAL CORPORATION) PLANO, TX. SN 75-717,018. FILED 5-28-1999. PRINCIPAL REGISTER.

NETSIGNAL

INT. CL. 36/U.S. CLS. 100, 101 AND 102
FOR FINANCIAL MARKET ANALYSIS AND INVESTMENT RESEARCH SERVICES.
FIRST USE 1-1-2000; IN COMMERCE 1-1-2000.

ELEMENTS CORRECTED
ASSIGNMENT/NAME CHANGE
OWNER NAME
ENTITY

2,702,640. REG. 4-1-2003. BRIGHTSMITH, LLC (DELAWARE CORPORATION) 1202 NORTH ASHBROOKE DRIVE, WEST CHESTER, PA, 193803723, SN 78-091,872. FILED 11-6-2001. PRINCIPAL REGISTER.



INT. CL. 6/U.S. CLS. 2, 12, 13, 14, 23, 25 AND 50
FOR METAL ROOFING PRODUCTS, NAMELY METAL PANELS AND SHINGLES.
FIRST USE 3-29-2001; IN COMMERCE 6-1-2001.

ELEMENTS CORRECTED
ASSIGNMENT/NAME CHANGE

2,703,068. REG. 4-1-2003. VAN DYKE SOFTWARE, INC. (NEW MEXICO CORPORATION) 4848 TRAMWAY RIDGE DRIVE, N.E., ALBUQUERQUE, NM, 87111, SN 76-218,555. FILED 2-28-2001. PRINCIPAL REGISTER.

WE LISTEN. THEN WE MAKE SOFTWARE BETTER.

INT. CL. 9/U.S. CLS. 21, 23, 26, 36 AND 38
FOR COMPUTER SOFTWARE, NAMELY GENERAL-PURPOSE COMMUNICATIONS CONNECTIVITY SOFTWARE USE TO ESTABLISH AND MANAGE CONNECTIONS BETWEEN A COMPUTER AND COMPUTER NETWORKS.
FIRST USE 2-28-2001; IN COMMERCE 10-1-2001.

ELEMENTS CORRECTED
DATE OF FIRST USE

2,703,787. REG. 4-8-2003. ATOMIC AUSTRIA GMBH (AUSTRIA CORPORATION) LACKENGASSE 301, A-5541 ALTENMARKT, AUSTRIA., SN 76-264,371. FILED 5-29-2001. PRINCIPAL REGISTER.



PRIORITY CLAIMED UNDER SEC. 44(D) ON AUSTRIA APPLICATION NO. AM8785/2000, FILED 12-1-2000, REG. NO. 193035, DATED 12-28-2000, EXPIRES 12-28-2010.

NO CLAIM IS MADE TO THE EXCLUSIVE RIGHT TO USE "SNOW SYSTEMS" AND "SKI BOOT BINDING", APART FROM THE MARK AS SHOWN.

THE MARK CONSISTS OF THE WORDS SNOW SKI BOOT BINDING ATOMIC SYSTEMS APPEARING IN RED, A TRIANGLE DEVICE APPEARING ON A CIRCLE DEVICE WITH A RED BACKGROUND WITHIN AN ARBITRARY DEVICE..

INT. CL. 25/U.S. CLS. 22 AND 39

FOR CLOTHING, NAMELY BOOTS AND SHOES, SKI BOOTS, HEAD BANDS, SCARVES, CAPS; GLOVES; PULLOVERS, WIND JACKETS, TRAINING SUITS, SPORTS VESTS; SNOWBOARD CLOTHING, NAMELY, SNOWBOARD JACKETS, AND SNOWBOARD TROUSERS; SKI CLOTHING, NAMELY SKI JACKETS AND SKIING TROUSERS, PROTECTIVE SKIING AND SNOWBOARD JACKETS, TROUSERS AND PULLOVERS, T-SHIRTS, SWEATSHIRTS, PANTS, BLOUSES, SHIRTS, JACKETS, SWEATERS, OVERALLS, LEG WARMERS, VESTS AND ANORAKS, SNOWBOARD BOOTS AND PARTS, NAMELY, BUCKLES, TONGUES AND INNER SHOES.

FIRST USE ; IN COMMERCE .

INT. CL. 28/U.S. CLS. 22, 23, 38 AND 50

FOR ROLLER-SKATES, INLINE-SKATES, SKIS, SNOWBOARDS, SKIBOBS, SNOW SLEDS FOR RECREATIONAL USE AND SKI POLES; PARTS AND FITTINGS FOR ALL AFOREMENTIONED GOODS; SKI AND SNOWBOARD BINDINGS AS WELL AS THEIR PARTS; COVERS, BAGS AND CONTAINERS FOR SKIS, SNOWBOARDS AND SKI POLES, COVERS FOR SKI BINDINGS, SKI WAXES.

FIRST USE ; IN COMMERCE .

ELEMENTS CORRECTED
DESCRIPTION OF MARK

2,706,778. REG. 4-15-2003. PANDUIT CORP. (DELAWARE CORPORATION) 17301 RIDGELAND AVENUE, TINLEY PARK, IL, 60477, SN 76-406,332. FILED 5-13-2002. PRINCIPAL REGISTER.

FIBERRUNNER

INT. CL. 9/U.S. CLS. 21, 23, 26, 36 AND 38

FOR COMMUNICATION AND FIBER OPTIC CABLING AND ROUTING DEVICES, NAMELY, A RACEWAY SYSTEM COMPRISED PRIMARILY OF A RACEWAY, NAMELY, CHANNEL SECTIONS, ONE AND TWO PIECE MOUNTING DEVICES, FITTINGS, NAMELY COUPLERS, INSIDER CORNER, RIGHT ANGLES, DROP CEILING, RIGHT ANGLE ENTRANCE ENDS, OUTSIDE CORNER, TEE, END CAPS, REDUCERS, TRANSITIONS AND ENTRANCE ENDS, ELECTRICAL AND COMMUNICATION MOLDED [CORERS,] * CORNERS, * DIVIDER WALLS, WIRE RETAINERS, HANGING DEVICE BRACKETS, PRE-CUT BOX COVERS, HANGING BOXES AND INSTALLATION TOOLS SOLD AS A UNIT THEREWITH.

FIRST USE 10-0-2000; IN COMMERCE 10-0-2000.

ELEMENTS CORRECTED
GOODS/SERVICES

2,707,085. REG. 4-15-2003. ACCUMETRIC, LLC (KENTUCKY CORPORATION) 350 RING ROAD, ELIZABETHTOWN, KY, 42701. BY MERGER DYNATEX, INC. CORPORATION) ELIZABETHTOWN, KY, SN 78-063,592. FILED 5-15-2001. PRINCIPAL REGISTER.

DYNABLACK

INT. CL. 17/U.S. CLS. 1, 5, 12, 13, 35 AND 50
FOR GASKET SEALER FOR USE IN THE AUTOMOTIVE INDUSTRY AFTERMARKET, AND FOR REPAIR AND MAINTENANCE OF FARM EQUIPMENT, LIGHT INDUSTRIAL MACHINERY AND BOATS.

FIRST USE 3-1-2000; IN COMMERCE 3-1-2000.

ELEMENTS CORRECTED
ASSIGNMENT/NAME CHANGE
OWNER NAME

2,708,172. REG. 4-15-2003. FRANKFORD CANDY & CHOCOLATE COMPANY (PENNSYLVANIA CORPORATION) 2101 WASHINGTON AVENUE, PHILADELPHIA, PA, 19146, SN 76-371,098. FILED P.R. 2-14-2002; AM. S.R. 10-28-2002. SUPPLEMENTAL REGISTER.

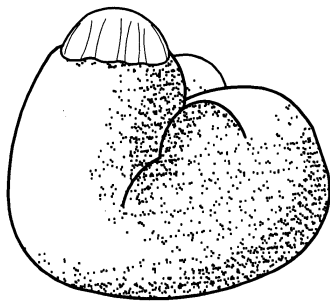

THE LINING AND STIPPLING SHOWN IN THE DRAWING ARE FOR SHADING PURPOSES ONLY AND ARE NOT FEATURES OF THE MARK AND DO NOT INDICATE COLOR.

THE MARK CONSISTS OF THE CONFIGURATION OF A CANDY CONFECTIONERY MADE ON THE SHAPE OF A CHICK WITH A ROOSTER'S CROWN OF COMB ON TOP OF ITS HEAD.

INT. CL. 30/U.S. CL. 46

FOR CANDY; MARSHMALLOWS; AND CHOCOLATE FILLED MARSHMALLOWS.
FIRST USE 12-1-2001; IN COMMERCE 12-1-2001.

ELEMENTS CORRECTED
CITIZENSHIP

2,708,245. REG. 4-22-2003. BLAA LONID H.F. (BLUE LAGOON LTD.) (ICELAND CORPORATION) VIKURBRAUT 62, 240 GRINDAVIK ISX, ICELAND., BY ASSIGNMENT BLUE LAGOON LTD. CORPORATION) 240 GRINDAVIK, ICELAND, SN 75-623,817. FILED 1-14-1999. PRINCIPAL REGISTER.



PRIORITY CLAIMED UNDER SEC. 44(D) ON ICELAND APPLICATION NO. 1453/98, FILED 7-16-1998, REG. NO. 1082, DATED 1-15-1999, EXPIRES 1-15-2009.

NO CLAIM IS MADE TO THE EXCLUSIVE RIGHT TO USE "ICELAND" , APART FROM THE MARK AS SHOWN. SEC. 2(F).

INT. CL. 3/U.S. CLS. 1, 4, 6, 50, 51 AND 52

FOR NON-MEDICATED BATH SALTS, NON-MEDICATED BATH OILS, BATH SOAPS, HAND SOAPS, SHOWER GEL, HAIR SHAMPOOS AND CONDITIONERS, SHAVING GEL; FACIAL AND BODY MASKS; SKIN CLEANSING MILK, SKIN CLEANSING CREAM, DAY AND NIGHT CREAM; HAND LOTION, NON-MEDICATED MOISTURE BARRIER SKIN OINTMENT FOR FACE AND BODY, OILS AND CREAMS FOR THE FACE AND BODY; SKIN CREAM; ANTI-AGING CREAMS; DISTILLED TONIC WATER FOR THE SKIN; REFRESHING AND MOISTURIZING PERFUME WATER SPRAY FOR THE BODY AND FACE; PERSONAL DEODORANTS; PERFUME OILS AND ESSENTIAL OILS FOR PERSONAL USE; ESSENTIAL OILS FOR THE BODY; PROTECTIVE SUNTAN OILS AND SUN CREAMS; MUD AND MUD SEDIMENT FOR USE ON BODY, FACE AND SCALP; NON-MEDICATED FACIAL AND BODY SCRUB; [DENITRIFIES] * DENTIFRICES * ; TOOTH PASTE AND NON-MEDICATED MOUTH WASH AND MOUTH RINSE.

FIRST USE ; IN COMMERCE .

INT. CL. 5/U.S. CLS. 6, 18, 44, 46, 51 AND 52

FOR MEDICATED SKIN CARE PREPARATIONS AND LOTIONS FOR USE IN THE THERAPEUTIC TREATMENT OF SKIN DISEASES; MEDICATED BATH SALTS, MEDICATED BATH OILS, MEDICATED SKIN CARE PREPARATION, NAMELY, MEDICATED FACIAL AND BODY SCRUB; MUD, SEDIMENT AND MUD CREAMS FOR THE SKIN AND SCALP; MEDICATED OINTMENT FOR RELIEF OF DRY AND OILY SKIN AND SCALING PROBLEMS, ACNE MEDICATIONS AND ACNE TREATMENT PREPARATIONS, NAMELY, OINTMENTS FOR USE IN THE TREATMENT OF ACNE.

FIRST USE ; IN COMMERCE .

INT. CL. 21/U.S. CLS. 2, 13, 23, 29, 30, 33, 40 AND 50

FOR CONTAINERS FOR HOUSEHOLD AND/OR KITCHEN USE NOT OF PRECIOUS METAL; HOUSEHOLD AND/OR KITCHEN UTENSILS, NAMELY, CONTAINERS FOR FOOD, BAKEWARE, PORTABLE AND NON PORTABLE BEVERAGE COOLERS AND DISPENSERS, ICE BUCKETS, NON-ELECTRIC JUICERS, PITCHERS, POTS, SERVING SPOONS, SERVING PLATTERS AND TRAYS NOT OF PRECIOUS METAL; DRINKING GLASSES AND MUGS; BEVERAGE GLASSWARE, PORCELAIN AND EARTHENWARE, NAMELY, PLATES, BOWLS, COFFEE POTS, TEA POTS, MUGS, PLATTERS, AND SERVING DISHES; HAIR COMBS; AND FACIAL SPONGES FOR APPLYING MAKE-UP, BODY SCRUB SPONGES, AND BATH SPONGES.

FIRST USE ; IN COMMERCE .
INT. CL. 24/U.S. CLS. 42 AND 50

FOR TOWELS AND WASHCLOTHS.
FIRST USE ; IN COMMERCE .

INT. CL. 25/U.S. CLS. 22 AND 39

FOR ARTICLES OF CLOTHING, NAMELY, SHIRTS, SWEATSHIRTS, SWEATPANTS, TRAINING SUITS, SHORTS, BATHING SUITS, ROBES, JACKETS, CAPS, HATS, VISORS, SLIPPERS, AND SANDALS.

FIRST USE ; IN COMMERCE .
INT. CL. 32/U.S. CLS. 45, 46 AND 48

FOR BEER; SOFT DRINKS AND TONIC WATER, AND OTHER NON-ALCOHOLIC BEVERAGES, NAMELY, MINERAL WATER, BOTTLED DRINKING WATER, AND SPRING WATER; FRUIT DRINKS AND FRUIT JUICES.

FIRST USE ; IN COMMERCE .
INT. CL. 39/U.S. CLS. 100 AND 105

FOR TRANSPORTATION RESERVATION AND BOOKING SERVICES; TRAVEL BOOKING AGENCIES; TRAVEL INFORMATION SERVICES; ARRANGING TRAVEL TOURS.

FIRST USE ; IN COMMERCE .
INT. CL. 42/U.S. CLS. 100 AND 101

FOR HOTELS AND RESTAURANTS; TRAVEL AGENCY SERVICES, NAMELY, MAKING RESERVATIONS AND BOOKINGS FOR TEMPORARY LODGING; PROVIDING TEMPORARY HOUSING ACCOMMODATION; SANATORIUMS; PROVIDING PUBLIC BATH FACILITIES; HEALTH AND BEAUTY SPA SERVICES; MEDICAL AND MEDICAL THERAPEUTIC SERVICES; SCIENTIFIC AND INDUSTRIAL RESEARCH RELATING TO SKIN CARE, THE TREATMENT OF SKIN DISEASE, AND THERAPEUTIC TREATMENT OF THE SKIN.

FIRST USE ; IN COMMERCE .

ELEMENTS CORRECTED
GOODS/SERVICES
ASSIGNMENT/NAME CHANGE

FOR SKIN AND BODY SOAPS; PERFUME; ESSENTIAL OILS FOR PERSONAL USE; AGENTS FOR BODY AND BEAUTY CARE, NAMELY, HAIR LOTIONS, DEODORANTS FOR PERSONAL USE, COSMETICS, NAMELY, MASCARA, EYE SHADOW, [EYELINER,] * EYELINERS * LIPSTICK, BLUSH, FACE [POWER,] * POWDER * LIP GLOSS, AND LIP LINERS, COSMETIC CREAMS, NAMELY, BODY CREAMS, COLD CREAMS, EYE CREAMS AND FACE CREAMS, AND HAIR TONICS, NAMELY, HAIR BLEACH, HAIR COLOR, HAIR CARE PREPARATIONS, HAIR CONDITIONERS, HAIR GEL, HAIR LIGHTENERS AND HAIR RELAXERS.

FIRST USE ; IN COMMERCE .
INT. CL. 14/U.S. CLS. 2, 27, 28 AND 50
FOR JEWELRY, FASHION JEWELRY.

INT. CL. 18/U.S. CLS. 1, 2, 3, 22 AND 41
FOR LEATHER, LEATHER IMITATIONS AND GOODS MADE THEREFROM, NAMELY, SHOULDER BAGS, SUITCASES, PURSES, SPORTS BAGS, BACKPACKS, TRAVEL BAGS, BEACH BAGS, COSMETIC BAGS SOLD EMPTY AND TOILETRY CASES SOLD EMPTY, AND SMALL LEATHER GOODS, NAMELY, WALLETS, BRIEFCASE-TYPE PORTFOLIOS AND KEY CHAINS; SUITCASES AND CARRY-ON BAGS.

FIRST USE ; IN COMMERCE .
INT. CL. 24/U.S. CLS. 42 AND 50
FOR TOWELS AND HANDKERCHIEFS MADE OF TEXTILE MATERIAL.

INT. CL. 25/U.S. CLS. 22 AND 39
FOR LEATHER BELTS.

INT. CL. 28/U.S. CLS. 22, 23, 38 AND 50
FOR DUMB-BELLS; ROLLER SKATES, ICE SKATES AND IN-LINE SKATES.

FIRST USE ; IN COMMERCE .

ELEMENTS CORRECTED
GOODS/SERVICES
FOREIGN REG. EXPIRATION DATE

2,710,656. REG. 4-29-2003. HALEKO HANSEATISCHES LEBENSMITTEL KONTOR GMBH & CO. OHG (FED REP GERMANY LIMITED LIABILITY COMPANY) HOLSTEINISCHER KAMP 1, D-22081, FED REP GERMANY., SN 76-277,330. FILED 6-27-2001. PRINCIPAL REGISTER.

2,712,646. REG. 5-6-2003. ALBERTSON'S, INC. (DELAWARE CORPORATION) 250 PARKCENTER BOULEVARD, BOISE, ID, 83726, SN 76-212,708. FILED 2-20-2001. PRINCIPAL REGISTER.

COUNTRY FARMS



OWNER OF FED REP GERMANY REG. NO. 39956517, DATED 1-13-2000, EXPIRES 9-30-2009.
OWNER OF U.S. REG. NOS. 2,263,986 AND 2,438,237.
INT. CL. 3/U.S. CLS. 1, 4, 6, 50, 51 AND 52

OWNER OF U.S. REG. NOS. 1,281,792, 1,406,965 AND 2,312,068.
INT. CL. 30/U.S. CL. 46
FOR BREAD; BAGELS.
FIRST USE 9-15-1977; IN COMMERCE 9-15-1977.

ELEMENTS AMENDED
OWNER ADDRESS

2,714,064. REG. 5-6-2003. ACQUA DI PARMA S.R.L. (ITALY LIMITED LIABILITY COMPANY) VIA S. STEFANO 16, 40125 BOLOGNA, ITALY., SN 76-105,295. FILED 8-8-2000. PRINCIPAL REGISTER.



PRIORITY CLAIMED UNDER SEC. 44(D) ON ITALY APPLICATION NO. 001243, FILED 4-19-2000, REG. NO. 00823647, DATED 4-19-2000, EXPIRES 4-19-2010. INT. CL. 3/U.S. CLS. 1, 4, 6, 50, 51 AND 52

FOR DEODORANTS FOR PERSONAL USE, PERFUMES, EAU DE TOILETTES, AFTER-SHAVE LOTIONS, AFTER-SHAVE BALMS, ASTRINGENTS, SKIN CLEANSERS, MAKE-UP REMOVING CREAMS AND LOTIONS, BEAUTY MASKS, TALCUM POWDER, SUN BLOCK, SUN SCREEN AND SUN TANNING PREPARATIONS; FOUNDATION CREAMS, COMPACTS, EYE-SHADOW, ROUGE, MASCARA, EYELINER AND LIP-LINER, LIP-STICKS, POWDER MAKE-UP, LIQUID MAKE-UP; NAIL CARE PREPARATIONS, NAIL ENAMEL, NAIL VARNISH REMOVER, NAIL TOP GLOSS HARDENERS, CUTICLE OIL; HAIR LOTIONS, SHAMPOOS AND DENTIFRICES.

FIRST USE 9-0-1999; IN COMMERCE 9-0-1999.

ELEMENTS CORRECTED
OWNER ADDRESS

2,714,462. REG. 5-6-2003. DASAN NETWORKS, INC. (REPUBLIC OF KOREA CORPORATION) 6F KOSMO TOWER, 1002 DAECHE-DONG, KANGNAM-KU, SEOUL, REPUBLIC OF KOREA., BY CHANGE OF NAME; BY CHANGE OF NAME DASAN CO., LTD. CORPORATION) KANGNAM-KU, SEOUL, REPUBLIC OF KOREA, SN 76-323,181. FILED 10-9-2001. PRINCIPAL REGISTER.

DASAN NETWORKS, INC.

NO CLAIM IS MADE TO THE EXCLUSIVE RIGHT TO USE "NETWORKS, INC.", APART FROM THE MARK AS SHOWN.

INT. CL. 9/U.S. CLS. 21, 23, 26, 36 AND 38

FOR COMPUTER NETWORK HUBS, SWITCHES AND ROUTERS; COMPUTER INTERFACE BOARDS; COMPUTER HARDWARE, NAMELY, MICROPROCESSORS; COMMUNICATIONS SOFTWARE FOR CONNECTING GLOBAL COMPUTER NETWORKS; COMPUTER E-COMMERCE SOFTWARE TO ALLOW USERS TO PERFORM ELECTRONIC BUSINESS TRANSACTIONS VIA A GLOBAL COMPUTER NETWORK; COMPUTER SOFTWARE FOR ACCESSING INFORMATION DIRECTORIES THAT MAY BE DOWNLOADED FROM A GLOBAL COMPUTER NETWORK; COMPUTER OPERATING PROGRAMS; COMPUTER SOFTWARE FOR USE IN INTERFACING GLOBAL COMPUTER NETWORKS AND FOR USE IN COMMUNICATIONS BETWEEN COMPUTERS.

FIRST USE 1-1-2001; IN COMMERCE 1-1-2001.

ELEMENTS CORRECTED
ASSIGNMENT/NAME CHANGE
OWNER ADDRESS

2,715,494. REG. 5-13-2003. AMERICAN COLLEGE OF RADIOLOGY (CALIFORNIA CORPORATION) 1891 PRESTON WHITE DRIVE, RESTON, VA, 20191, SN 76-412,904. FILED 5-28-2002. PRINCIPAL REGISTER.

QUALITY IS OUR IMAGE

INT. CL. 16/U.S. CLS. 2, 5, 22, 23, 29, 37, 38 AND 50
FOR PRINTED RESOURCE GUIDES IN THE FIELD OF RADIOLOGY.

FIRST USE 1-16-2001; IN COMMERCE 1-16-2001.

ELEMENTS CORRECTED
OWNER ADDRESS

2,716,889. REG. 5-20-2003. TURNER ENTERTAINMENT CO. (DELAWARE CORPORATION) 4000 WARNER BLVD., BLDG. 156, ROOM 5078, BURBANK, CA, 91522. BY ASSIGNMENT TOTO-LY OZ CORPORATION) PORTLAND, ME, SN 75-797,485. FILED 9-13-1999. PRINCIPAL REGISTER.

TOTO-LY OZ

INT. CL. 35/U.S. CLS. 100, 101 AND 102

FOR COMPUTERIZED ON-LINE ORDERING SERVICES FEATURING GIFTS AND COLLECTIBLES.

FIRST USE 4-6-1998; IN COMMERCE 4-6-1998.

ELEMENTS CORRECTED
ASSIGNMENT/NAME CHANGE

2,716,941. REG. 5-20-2003. ROMATEX S.R.L. (ITALY LIMITED LIABILITY COMPANY) VIA F. FERRER, 13 - 21052 BUSTO ARSIZIO, VARESE, ITALY., SN 76-075,315. FILED 6-22-2000. PRINCIPAL REGISTER.



PRIORITY CLAIMED UNDER SEC. 44(D) ON ITALY APPLICATION NO. MI2000C00665, FILED 6-6-2000, REG. NO. 828428, DATED 11-9-2000, EXPIRES 6-6-2010.

INT. CL. 25/U.S. CLS. 22 AND 39

FOR CLOTHING, NAMELY- PANTS, DRESSES, BLOUSES, SHIRTS, TROUSERS, SKIRTS, SHORTS, PULLOVERS, JUMPERS, CARDIGANS, WAISTCOATS, COATS, RAINCOATS, ANORAKS, JACKETS, SPORT SHIRTS, SPORT PANTS, SPORT SHORTS, SPORT SOCKS, OVERALLS, SWEATSHIRTS, SOCKS, PANTY-HOSE, HEADBANDS, HATS, CAPS, BONNETS, GLOVES, SCARVES, BOOTS, SHOES, SPORTS SHOES AND SLIPPERS ALL FOR CHILDREN AND TEENAGERS.

FIRST USE ; IN COMMERCE .

ELEMENTS CORRECTED
FOREIGN APPLICATION NO.

2,717,010. REG. 5-20-2003. CHILDREN'S HOME SOCIETY OF NEW JERSEY, THE (NEW JERSEY NOT FOR PROFIT CORPORATION) 635 SOUTH CLINTON AVENUE, TRENTON, NJ, 08611, SN 76-203,015. FILED 2-1-2001. PRINCIPAL REGISTER.

THE CHILDREN'S HOME SOCIETY OF NEW JERSEY

SEC. 2(F).
INT. CL. 41/U.S. CLS. 100, 101 AND 107
FOR EDUCATIONAL SERVICES, NAMELY PROVIDING TUTORING AND EDUCATIONAL RESOURCES TO FAMILIES IN THE FIELD OF CHILD WELFARE AND PARENTING; BIRTH PARENT AND PARENT EDUCATION SERVICES IN THE FIELD OF PARENTING; EDUCATIONAL SERVICES, NAMELY, CONDUCTING CLASSES, SEMINARS AND WORKSHOPS FOR AT RISK [YOUTHS] *YOUTH* UTILIZING TEACHERS AND PARENTS TO PREVENT YOUTH PROBLEMS; VOCATIONAL EDUCATION IN THE FIELD OF JOB SKILLS TRAINING; EDUCATIONAL SERVICES, NAMELY PROVIDING EARLY CHILDHOOD CLASSES, SEMINARS AND WORKSHOPS; EDUCATIONAL SERVICES, NAMELY CONDUCTING AN EARLY CHILDHOOD PROGRAM; EDUCATIONAL SERVICES, NAMELY, CONDUCTING CONFERENCES, SEMINARS AND WORKSHOPS ON EARLY CHILDHOOD DEVELOPMENT.

FIRST USE 3-17-1950; IN COMMERCE 3-17-1950.

ELEMENTS CORRECTED
GOODS/SERVICES

2,718,367. REG. 5-27-2003. U.S. POLYCHEMICAL HOLDING CORPORATION (NEW YORK CORPORATION) 584 CHESTNUT RIDGE ROAD, CHESTNUT RIDGE, NY, 10977, SN 75-873,431. FILED 12-16-1999. PRINCIPAL REGISTER.

DISPERSIT

INT. CL. 1/U.S. CLS. 1
FOR CHEMICALS FOR THE DISPERSION AND BIODEMEDIATION OF MARINE OIL SPILLS.
FIRST USE 3-8-1999; IN COMMERCE 4-18-1999.

ELEMENTS CORRECTED
OWNER NAME

2,718,663. REG. 5-27-2003. PIVOVARNA UNION D.D. (SLOVENIA CORPORATION) PIVOVARNISKA ULICA 2, SI-1000 LJUBLJANA, SLOVENIA., SN 76-325,444. FILED 10-4-2001. PRINCIPAL REGISTER.

ZALA

OWNER OF SLOVENIA REG. NO. 9570197, DATED 5-5-1997, EXPIRES 2-13-2005.
INT. CL. 32/U.S. CLS. 45, 46 AND 48

FOR BEER; MINERAL WATER; AERATED WATER; OTHER NON-ALCOHOLIC DRINKS, NAMELY, DRINKING WATER, FRUIT DRINKS, AND FRUIT JUICES; CONCENTRATES, SYRUPS AND POWDERS FOR MAKING FRUIT DRINKS .
FIRST USE ; IN COMMERCE .

ELEMENTS CORRECTED
OWNER NAME

2,718,719. REG. 5-27-2003. WEIDER NUTRITION INTERNATIONAL, INC. (DELAWARE CORPORATION) 2002 SOUTH 5070 WEST, SALT LAKE CITY, UT, 84104, SN 76-353,186. FILED 12-19-2001. PRINCIPAL REGISTER.

WEIDER
RESULTS.

OWNER OF U.S. REG. NOS. 1,361,341, 2,240,151 AND 2,502,331.
INT. CL. 5/U.S. CLS. 6, 18, 44, 46, 51 AND 52
FOR DIETARY SUPPLEMENTS; DIETARY SUPPLEMENTS POWDERED DRINK MIXES.
FIRST USE 1-8-2001; IN COMMERCE 1-8-2001.

ELEMENTS CORRECTED
PRIOR U.S. REGS.

2,720,445. REG. 6-3-2003. GEMELLI S.P.A. (ITALY JOINT STOCK COMPANY) CORSO VERCELLI, 16, 20145 MILAN, ITALY., SN 76-196,685. FILED 1-19-2001. PRINCIPAL REGISTER.

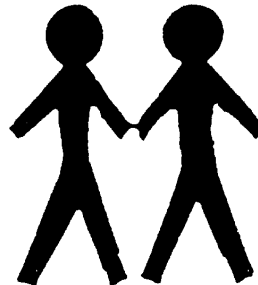

PRIORITY CLAIMED UNDER SEC. 44(D) ON ITALY APPLICATION NO. MI200C013617, FILED 12-13-2000, REG. NO. 00862485, DATED 4-9-2002, EXPIRES 12-13-2010.
INT. CL. 25/U.S. CLS. 22 AND 39

FOR CLOTHING, NAMELY, KNITWEAR, NAMELY, VESTS, TOPS, SWEATERS; JUMPERS; PULLOVERS; CARDIGANS; TWIN-SETS COMPRISED OF A CARDIGAN AND A SWEATER, OR A CARDIGAN AND A TOP OR A CARDIGAN AND A VEST; WAISTCOATS; SHIRTS; SWEATERS; TROUSERS; GLOVES; JEANS; JACKETS; COATS; STOCKINGS AND SOCKS; FOOTWEAR; HEAD WEAR.

FIRST USE ; IN COMMERCE .

ELEMENTS CORRECTED
FOREIGN APPLICATION NO.

2,720,500. REG. 6-3-2003. GOLDBERG, SAMANTHA (UNITED STATES INDIVIDUAL) 38 WEST 10TH STREET, APT. 6, NEW YORK, NY, 10011, SN 76-240,157. FILED 4-12-2001. PRINCIPAL REGISTER.

ALVIN & SPARKY

INT. CL. 25/U.S. CLS. 22 AND 39
FOR FOOTWEAR, NAMELY SLIPPERS AND HEADWEAR, NAMELY SCARVES.
FIRST USE 11-21-2000; IN COMMERCE 11-21-2000.
INT. CL. 28/U.S. CLS. 22, 23, 38 AND 50
FOR TOYS, NAMELY, STUFFED ANIMALS.
FIRST USE 11-21-2000; IN COMMERCE 11-21-2000.

ELEMENTS CORRECTED
DATE OF FIRST USE
DATE OF FIRST USE IN COMMERCE

2,720,663. REG. 6-3-2003. EV GROUP E. THALLNER GMBH (AUSTRIA CORPORATION) BADHORING 26, A-4780 SCHARDING/ST. FLORIAN, AUSTRIA., SN 76-329,070. FILED 10-23-2001. PRINCIPAL REGISTER.

HERCULES

INT. CL. 7/U.S. CLS. 13, 19, 21, 23, 31, 34 AND 35
FOR MACHINES AND STRUCTURAL PARTS THEREFOR, FOR THE PRODUCTION, TREATMENT, TRANSPORT AND PROCESSING OF ELECTRONIC COMPONENTS, ESPECIALLY SEMICONDUCTORS, IN THE FIELD OF MICROELECTRONIC, MEDICAL TECHNOLOGY, BIOTECHNOLOGY, SEMICONDUCTOR TECHNOLOGY AND MICROSYSTEMS TECHNOLOGY;
* MACHINES AND STRUCTURAL PARTS THEREFOR, FOR THE PRODUCTION, TREATMENT AND PROCESSING OF * SEMICONDUCTORS; MACHINES AND STRUCTURAL PARTS THEREFOR, FOR TREATMENT OF SURFACES OF ELECTRONIC COMPONENTS, ESPECIALLY WAFERS.
FIRST USE 12-31-1997; IN COMMERCE 12-31-1997.

ELEMENTS CORRECTED
GOODS/SERVICES

2,721,221. REG. 6-3-2003. UBS AG (SWITZERLAND COMPANY) BAHNHOFSTRASSE 45, ZURICH, SWITZERLAND, CH-8001, SN 76-438,906. FILED 8-6-2002. PRINCIPAL REGISTER.

ARM ALERT

NO CLAIM IS MADE TO THE EXCLUSIVE RIGHT TO USE "ARM", APART FROM THE MARK AS SHOWN.
INT. CL. 16/U.S. CLS. 2, 5, 22, 23, 29, 37, 38 AND 50
FOR PERIODICALS IN THE FIELD OF INVESTING AND INVESTMENTS; AND NEWSLETTERS IN THE FIELD OF SECURITIZED FINANCIAL PRODUCTS.
FIRST USE 4-0-1997; IN COMMERCE 4-0-1997.

ELEMENTS CORRECTED
OWNER ADDRESS

2,722,099. REG. 6-3-2003. BLUE HERON BIOTECHNOLOGY, INC. (DELAWARE CORPORATION) 22310 20TH AVENUE SE, BOTHELL, WA, 98021, BY CHANGE OF NAME FINCH TECHNOLOGIES, INC. CORPORATION) BOTHELL, WA, SN 76-200,868. FILED 1-25-2001. PRINCIPAL REGISTER.

BLUE HERON

INT. CL. 42/U.S. CLS. 100 AND 101
FOR RESEARCH AND DEVELOPMENT OF NEW PRODUCTS FOR OTHERS; TECHNICAL CONSULTING AND RESEARCH IN THE FIELD OF BIOTECH, MEDICAL, DIAGNOSTIC, VETERINARY AND AGRICULTURAL COMPANIES.
FIRST USE 1-0-2001; IN COMMERCE 2-0-2001.

ELEMENTS CORRECTED
ASSIGNMENT/NAME CHANGE
OWNER NAME

2,722,494. REG. 6-3-2003. IMPERIAL DAX COMPANY, INC. (NEW JERSEY CORPORATION) 120 NEW DUTCH LANE, FAIRFIELD, NJ, 07004, SN 76-359,221. FILED 1-16-2002. PRINCIPAL REGISTER.

DAX PLUS 3

OWNER OF U.S. REG. NO. 1,218,029.
INT. CL. 3/U.S. CLS. 1, 4, 6, 50, 51 AND 52
FOR HAIR SHAMPOOS, HAIR CONDITIONERS AND HAIR MOISTURIZERS.
FIRST USE 7-1-2002; IN COMMERCE 7-1-2002.

ELEMENTS CORRECTED
MARK

2,723,070. REG. 6-10-2003. PUILAETCO (BELGIUM CORPORATION) H. BEBROUXLAAN 46, 1160 BRUSSELS, BELGIUM., BY CHANGE OF NAME DE LAET, POSWICK & CO. BANQUIERS-BANKIERS CORPORATION) 1160 BRUSSELS, BELGIUM, SN 76-111,216. FILED 8-17-2000. PRINCIPAL REGISTER.

PUILAETCO

PRIORITY CLAIMED UNDER SEC. 44(D) ON ERPN CMNTY TM OFC APPLICATION NO. 1671825, FILED 5-23-2000, REG. NO. 001671825, DATED 7-17-2001, EXPIRES 7-17-2010.

INT. CL. 36/U.S. CLS. 100, 101 AND 102

FOR FINANCIAL AFFAIRS, NAMELY, FINANCIAL ANALYSIS, FINANCIAL PLANNING AND CONSULTATION, CAPITAL INVESTMENT CONSULTATION, FINANCIAL GUARANTEE AND SURETY; MONETARY AFFAIRS, NAMELY FINANCING SERVICES, BANKING, MONETARY EXCHANGE, AND CHECK VERIFICATION; SECURITIES CUSTODY SERVICES FOR OTHERS; CREDIT BUREAUS; CORPORATE FINANCE OF MERGERS AND ACQUISITIONS; CAPITAL INVESTMENT CONSULTATION SERVICES; VENTURE CAPITAL SERVICES, NAMELY, PROVIDING FINANCING TO EMERGING AND STARTUP COMPANIES.
FIRST USE 0-0-1991; IN COMMERCE 0-0-1991.

ELEMENTS CORRECTED
ASSIGNMENT/NAME CHANGE
OWNER NAME
OWNER ADDRESS

2,724,125. REG. 6-10-2003. PERLIER, INC. (DELAWARE CORPORATION) 300 KENNEDY DRIVE, SAYREVILLE, NJ, 08872, SN 78-076,557. FILED 7-31-2001. PRINCIPAL REGISTER.

ELARIA

INT. CL. 3/U.S. CLS. 1, 4, 6, 50, 51 AND 52

FOR LOTIONS FOR SKIN, HAIR, FACE, AND BODY; SKIN MOISTURIZER; SKIN CLEANSERS; SKIN CREAM; SKIN SOAP; WRINKLE REMOVING SKIN CARE PREPARATIONS; BATH BEADS; BATH CRYSTALS; [BATH] FOAM BATH; BATH GEL; BATH LOTION; BATH OIL; HAIR SHAMPOOS; HAIR SHAMPOO-CONDITIONERS; COSMETICS; PERFUMES.
FIRST USE 1-5-2001; IN COMMERCE 1-5-2001.

ELEMENTS CORRECTED
GOODS/SERVICES

2,725,314. REG. 6-10-2003. COMEDYLAB ENTERTAINMENT INC. (CANADA CORPORATION) 2649 BLOOR STREET WEST, TORONTO, ONTARIO, M8X 1A3, CANADA., SN 76-247,969. FILED 4-27-2001. PRINCIPAL REGISTER.

COMEDYLAB

INT. CL. 38/U.S. CLS. 100, 101 AND 104

FOR TELEVISION AND RADIO BROADCASTING; BROADCAST AND NARROW CAST OF COMEDY CONTENT VIA DIGITAL, TERRESTRIAL, CABLE, AND SATELLITE TELEVISION, RADIO, AND THE INTERNET; CABLE TELEVISION BROADCASTING.
FIRST USE 11-22-2002; IN COMMERCE 11-22-2002.

INT. CL. 41/U.S. CLS. 100, 101 AND 107

FOR TELEVISION SHOW PRODUCTION FOR CABLE AND CLOSED CAPTION, DEVELOPMENT AND WRITING OF COMEDY CONTENT FOR OTHERS; SCRIPT WRITING SERVICES; ENTERTAINMENT SERVICES, NAMELY PROVIDING TELEVISION AND RADIO PROGRAMMING IN THE FIELD OF COMEDY; ENTERTAINMENT, NAMELY A CONTINUING COMEDY SHOW DISTRIBUTED VIA THE INTERNET AND OVER TELEVISION, SATELLITE, AUDIO AND VIDEO MEDIA; TELEVISION PROGRAM SYNDICATION; PRODUCTION AND DISTRIBUTION OF RADIO AND TELEVISION PROGRAMS FOR OTHERS; DISTRIBUTION OF COMEDY CONTENT IN FILM, DIGITAL AND PRINT FORMAT VIA TELEVISION, RADIO, SATELLITE, AND THE INTERNET; ENTERTAINMENT SERVICES, NAMELY ORGANIZATION OF LIVE COMEDY EVENTS AND VENUES.
FIRST USE 11-22-2002; IN COMMERCE 11-22-2002.

ELEMENTS CORRECTED
OWNER ADDRESS

2,725,765. REG. 6-10-2003. V SECRET CATALOGUE, INC. (DELAWARE CORPORATION) 1105 NORTH MARKET STREET, WILMINGTON, DE, 19801, SN 76-975,225. FILED 4-2-2001. PRINCIPAL REGISTER.

VERY SEXY

INT. CL. 3/U.S. CLS. 1, 4, 6, 50, 51 AND 52

FOR PERSONAL CARE PRODUCTS, NAMELY, AFTERSHAVE, BLUSH, BODY MIST, BODY OIL, CLEANSER FOR THE FACE, COLOGNE, CREAM FOR THE BODY, CREAM FOR THE CUTICLES, CREAM FOR THE EYES, CREAM FOR THE FACE, CREAM FOR THE HANDS, DEODORANT, ESSENTIAL OILS, EYE SHADOW, LIP GLOSS, LIPSTICK, LOTION FOR THE BODY, LOTION FOR THE FACE, LOTION FOR THE HANDS, NON-MEDICATED LOTION FOR THE FEET, MAKEUP FOR THE FACE, [MASCARE,] * MASCARA * PERFUME, POWDER FOR THE BODY, SHOWER GEL, SOAP FOR THE BODY, SOAP FOR THE FACE, SOAP FOR THE HANDS AND TALCUM POWDER.
FIRST USE 10-14-2002; IN COMMERCE 10-14-2002.

INT. CL. 25/U.S. CLS. 22 AND 39

FOR CLOTHING, NAMELY, BRAS, FOUNDATION GARMENTS, HOSIERY, KNEE HIGHS, LINGERIE, PANTIES, PANTYHOSE, SOCKS, STOCKINGS, TIGHTS, UNDERPANTS AND UNDERWEAR.
FIRST USE 5-15-2001; IN COMMERCE 5-15-2001.

ELEMENTS CORRECTED
GOODS/SERVICES

2,726,294. REG. 6-17-2003. PROQUEST INFORMATION AND LEARNING COMPANY (DELAWARE CORPORATION) P.O. BOX 1346, 300 NORTH ZEEB ROAD, ANN ARBOR, MI, 48106, BY CHANGE OF NAME BELL & HOWELL INFORMATION AND LEARNING COMPANY CORPORATION) ANN ARBOR, MI, SN 76-063,559. FILED 5-23-2000. PRINCIPAL REGISTER.



INT. CL. 38/U.S. CLS. 100, 101 AND 104

FOR ELECTRONIC RETRIEVAL OF TEXTUAL AND GRAPHIC MATERIALS FROM NEWSPAPERS, PERIODICALS, JOURNALS, DISSERTATIONS AND OTHER PUBLICATIONS; ELECTRONIC TRANSMISSION OF DOCUMENTS AND DATA FROM PROPRIETARY DATABASES.

FIRST USE 7-0-1999; IN COMMERCE 7-0-1999.
INT. CL. 39/U.S. CLS. 100 AND 105

FOR COMPUTER SERVICES, NAMELY ELECTRONIC STORAGE OF TEXTUAL AND GRAPHIC MATERIALS FROM NEWSPAPERS, PERIODICALS, JOURNALS, DISSERTATIONS AND OTHER PUBLICATIONS.

FIRST USE 7-0-1999; IN COMMERCE 7-0-1999.
INT. CL. 41/U.S. CLS. 100, 101 AND 107

FOR ONLINE SERVICES, NAMELY, PROVIDING EDUCATIONAL, INSTRUCTIONAL, TEACHING, AND GENERAL REFERENCE MATERIALS FOR USE BY TEACHERS AND STUDENTS AT THE HIGH SCHOOL, COLLEGE, AND GRADUATE EDUCATIONAL LEVELS AND BY LIBRARIANS, IN A WIDE VARIETY OF FIELDS SUCH AS SCIENCE, HISTORY, BUSINESS, LITERATURE, AND HUMANITIES.

FIRST USE 12-0-1999; IN COMMERCE 1-0-2000.

ELEMENTS CORRECTED
ASSIGNMENT/NAME CHANGE

2,726,299. REG. 6-17-2003. LSTAG, INC. (DELAWARE CORPORATION) 5901-A PEACHTREE DUNWOODY RD., N.E., STE. 275, ATLANTA, GA, 30328, SN 76-076,872. FILED 6-26-2000. PRINCIPAL REGISTER.

AgIntegrator

THE MARK CONSISTS OF THE TERM "AGINTEGRATOR" IN SPECIAL FORM. THE LETTERS "A" AND "I" ARE IN UPPER CASE WHILE THE REMAINDER OF THE LETTERS ARE IN LOWER CASE.

INT. CL. 9/U.S. CLS. 21, 23, 26, 36 AND 38

FOR SOFTWARE FOR FACILITATING INFORMATION TRANSFER AMONG OR BETWEEN AN EXCHANGE AND A PARTY OR PARTIES FOR COMMODITY TRANSACTIONS, AND AMONG OR BETWEEN PARTIES FOR COMMODITY TRANSACTIONS, ESPECIALLY AGRICULTURAL COMMODITY BUSINESSES, AND AN EXCHANGE OR EXCHANGES AND A PARTY OR PARTIES, AND A BUSINESS OR BUSINESSES AND A PARTY OR PARTIES, IN PARTICULAR, BY EMPLOYMENT OF ELECTRONIC MESSAGE AND CONTROL WITH COMPUTERS BY WAY OF A DIRECT LINE, AN EXTRANET, AN INTRANET, AND THE GLOBAL COMMUNICATIONS NETWORK, WHERE AN INTERFACE IS PROVIDED FOR SOFTWARE APPLICATIONS TO COMMUNICATE .

FIRST USE 10-1-1999; IN COMMERCE 10-1-1999.
INT. CL. 38/U.S. CLS. 100, 101 AND 104

FOR ELECTRONIC MESSAGING SERVICES.
FIRST USE 10-1-1999; IN COMMERCE 10-1-1999.
INT. CL. 42/U.S. CLS. 100 AND 101

FOR PROVIDING TEMPORARY USE OF ON-LINE, NON-DOWNLOADABLE SOFTWARE FOR FACILITATING INFORMATION TRANSFER AMONG OR BETWEEN AN EXCHANGE AND A PARTY OR PARTIES FOR COMMODITY TRANSACTIONS, AND AMONG OR BETWEEN PARTIES FOR COMMODITY TRANSACTIONS, ESPECIALLY AGRICULTURAL COMMODITY BUSINESSES, AND AN EXCHANGE OR EXCHANGES AND A PARTY OR PARTIES, AND A BUSINESS OR BUSINESSES AND A PARTY OR PARTIES, IN PARTICULAR, BY EMPLOYMENT OF ELECTRONIC MESSAGE AND CONTROL WITH COMPUTERS BY WAY OF A DIRECT LINE, AN EXTRANET, AN INTRANET, AND THE GLOBAL COMMUNICATIONS NETWORK, WHERE AN INTERFACE IS PROVIDED FOR SOFTWARE APPLICATIONS TO COMMUNICATE; AND TECHNICAL SUPPORT SERVICES FOR COMPUTER SOFTWARE, NAMELY, PRODUCT INSTALLATION AND IMPLEMENTATION, SYSTEM ADMINISTRATION, END-USER TRAINING, REQUIREMENTS ANALYSES, AND SYSTEMS DESIGN.

FIRST USE 10-1-1999; IN COMMERCE 10-1-1999.

ELEMENTS CORRECTED
OWNER NAME
OWNER ADDRESS

2,727,928. REG. 6-17-2003. PUBLIC BROADCASTING SERVICE (D.C. CORPORATION) 1320 BRADDOCK PLACE, ALEXANDRIA, VA, 22314, SN 76-302,736. FILED 8-22-2001. PRINCIPAL REGISTER.

PBS PARENTS

OWNER OF U.S. REG. NOS. 1,235,634, 2,093,500 AND OTHERS.

INT. CL. 41/U.S. CLS. 100, 101 AND 107

FOR PROVIDING EDUCATIONAL AND ENTERTAINMENT INFORMATION CONCERNING TOPICS [OP] *OF * INTEREST TO FAMILIES, PARENTS AND CAREGIVERS VIA A GLOBAL COMPUTER NETWORK, AND THE DISTRIBUTION OF PRINTED MATERIALS IN CONNECTION THEREWITH.

FIRST USE 9-26-2002; IN COMMERCE 9-26-2002.

ELEMENTS CORRECTED
GOODS/SERVICES

2,727,932. REG. 6-17-2003. ANIMATO TECHNOLOGIES CORPORATION (DELAWARE CORPORATION) 600 N. PEARL, SUITE 1100, DALLAS, TX, 75201, BY CHANGE OF NAME SCA TECHNOLOGIES CORPORATION CORPORATION) DALLAS, TX, SN 76-303,639. FILED 8-21-2001. PRINCIPAL REGISTER.

ANIMATO

INT. CL. 42/U.S. CLS. 100 AND 101

FOR COMPUTER HARDWARE AND SOFTWARE CONSULTING SERVICES, NAMELY, CONSULTING SERVICES IN THE FIELD OF IMPLEMENTING, INTEGRATING AND SOURCING BUSINESS SYSTEMS SOFTWARE AND PROCESSES.

FIRST USE 1-15-2002; IN COMMERCE 1-15-2002.

ELEMENTS CORRECTED
ASSIGNMENT/NAME CHANGE
OWNER NAME

SEPT. 16, 2003

U.S. PATENT AND TRADEMARK OFFICE

TM 919

2,727,984. REG. 6-17-2003. GLOBAL IMPACT (D.C. CORPORATION) 66 CANAL CENTER PLAZA, SUITE 310, ALEXANDRIA, VA, 22314, BY CHANGE OF NAME INTERNATIONAL SERVICE AGENCIES, INC. CORPORATION) ALEXANDRIA, VA, SN 76-330,898. FILED 10-29-2001. PRINCIPAL REGISTER.

GLOBAL IMPACT

INT. CL. 36/U.S. CLS. 100, 101 AND 102
FOR CHARITABLE FUNDRAISING SERVICES.
FIRST USE 8-0-2002; IN COMMERCE 8-0-2002.

ELEMENTS CORRECTED
ASSIGNMENT/NAME CHANGE

2,729,807. REG. 6-24-2003. MYLEGALPROBLEM, INC. (PENNSYLVANIA CORPORATION) 11 STANWIX STREET 15TH FLOOR, PITTSBURGH, PA, 15222, SN 76-122,435. FILED 9-1-2000. PRINCIPAL REGISTER.

WHERE AMERICA FINDS A LAWYER

INT. CL. 42/U.S. CLS. 100 AND 101
FOR LEGAL INFORMATION AND SERVICES.
FIRST USE 2-0-2001; IN COMMERCE 2-0-2001.

ELEMENTS CORRECTED
OWNER ADDRESS

* * * * *

TRADEMARK REGISTRATIONS—NEW CERTIFICATES

New Certificates issued under section 7(e) of the Trademark Act of 1946 for the unexpired term of the original registrations.

2,481,900. SIRIUS. INT. CL. 9. AMPSPEAKER APS, DK-2680
SOLROD STRAND, COPENHAGEN, DENMARK. REG. 8-
28-2001. NEW CERT. SEC. 7(C) TO SIRIUS SATELLITE
RADIO INC., NEW YORK, NY.

ELLIOTTS, OAK BROOK, IL.

2,704,485. MONSTER SUB. INT. CL. 30. STARZ CLUB LTD.,
OAK BROOK, IL. REG. 4-8-2003. NEW CERT. SEC. 7(C) TO

2,707,469. PANIP. INT. CL. 42. PANIP, LLC, SAN DIEGO,
CA. REG. 4-15-2003. NEW CERT. SEC. 7(C) TO REGIS-
TRANT.

* * * * *

INDEX OF REGISTRANTS

SEPT. 16, 2003

(Registered; Renewed; Canceled; Amended, Corrected, etc.; New Certificates; 12c Publications.)

The designation "U.S. Cl." appearing in this section refers to the U.S. class in effect prior to Sep. 1, 1973 rather than the international class which applies to applications filed on or after that date. For adoption of international classification see notice in the OFFICIAL GAZETTE of Jun. 26, 1973 (911 O.G. TM 210).

- (I)STRUCTURE, INC., OMAHA, NE:
2,764,713, MULTIPLE CLASS, INT. CLS. 35 AND 42.
- "ALMDUDLER-LIMONADE" A. & S. KLEIN, VIENNA, AUSTRIA:
1,727,978, CANC. INT. CL. 32.
- A CHILD'S HAVEN, INC., OCALA, FL:
1,728,483, CANC. INT. CL. 42.
- A DEWEY DOES CORPORATION, S.I. NY FROM BRYSON, LNC., STATEN ISLAND, NY:
2,764,662, INT. CL. 25.
- A PC COMPUTER RENTAL CO., INC., CHARLESTOWN, MA:
2,763,026, PUB. 6-24-2003, INT. CL. 42.
- A PERFECT CIRCLE, LOS ANGELES, CA:
2,764,633, MULTIPLE CLASS, INT. CLS. 9, 25 AND 41.
- A. NELESSEN ASSOCIATES, INC., BELLE MEAD, NJ:
1,809,769, REN. 8-5-03, INT. CL. 42.
- A. SCHRETER & SONS CO., INC., BALTIMORE, MD:
740,061, CANC. U.S. CL. 39.
- A. SCHULMAN, INC., AKRON, OH:
2,763,190, PUB. 6-24-2003, INT. CL. 17.
- A. STURM & SONS, INC., MANAWA, WI:
1,726,951, CANC. INT. CL. 5.
- A.C.E. RECORDS, INC., HOUSTON, TX:
2,763,145, PUB. 6-24-2003, INT. CL. 9.
- A.C.T.A. S.P.A., 36100 VICENZA, ITALY:
2,763,708, PUB. 6-24-2003, INT. CL. 33.
- A.D. SUTTON & SONS, INC., NEW YORK, NY:
2,763,690, PUB. 6-24-2003, MULTIPLE CLASS, INT. CLS. 18 AND 21.
- A.E.R.O. AVIATION, INC., GRANITE CITY, IL:
2,764,438, PUB. 6-24-2003, INT. CL. 12.
- A.M. PLAYER, INC., COMMERCE, CA:
2,012,092, CANC. INT. CL. 25.
- A&E TELEVISION NETWORKS, NEW YORK, NY:
2,765,527, INT. CL. 41.
- A-BEE SYNDICATE, INC., NEW YORK, NY:
1,214,499, CANC. INT. CL. 21.
- A-1 COMPONENTS CORPORATION, HIALEAH, FL:
2,764,513, INT. CL. 9.
- AACER FLOORING, LLC, PESHTIGO, WI:
2,765,650, INT. CL. 19.
- AB CERNELLE COMPANY:
See— GRAMINEX L.L.C.
- ABB WATER METERS INC., OCALA, FL:
2,764,416, PUB. 6-24-2003, INT. CL. 9.
- ABBOTT LABORATORIES, ABBOTT PARK, IL:
2,012,347, CANC. INT. CL. 5.
- ABELE BERTOZZI S.P.A., 43100 PARMA, ITALY:
2,763,558, PUB. 6-24-2003, INT. CL. 29.
2,763,559, PUB. 6-24-2003, INT. CL. 29.
- ABN AMRO LEASE HOLDING N.V., 1314 CJ ALMERE-STAD, NETHERLANDS:
2,763,672, PUB. 6-24-2003, MULTIPLE CLASS, INT. CLS. 35, 36 AND 39.
- ABN AMRO NORTH AMERICA, INC., CHICAGO, IL:
2,763,726, PUB. 6-24-2003, INT. CL. 35.
- ABODIO STORES INCORPORATED, SEATTLE, WA:
1,214,460, CANC. INT. CL. 42.
- ABP CUSTOM MANUFACTURING INCORPORATED, MONROVIA, CA:
2,195,059, CANC. MULTIPLE CLASS, INT. CLS. 3, 5 AND 29.
- ABRATECH CORPORATION, SAUSALITO, CA:
1,770,644, REN. 8-5-03, INT. CL. 42.
- ABSECON MILLS, INC., COLONGE, NJ:
2,764,933, INT. CL. 24.
- ABSOLUTE SOFTWARE CORP., VANCOUVER, BRITISH COLUMBIA, CANADA:
2,765,018, INT. CL. 42.
- ABSORB-PLUS INC./ABSORBE-PLUS INC., TOWN OF MOUNT-ROYAL, QUEBEC, CANADA FROM ABSORB-PLUS TEXTILES INC., TOWN OF MOUNT-ROYAL, QUEBEC, CANADA:
2,763,051, PUB. 5-7-2002, INT. CL. 24.
- ABSORB-PLUS TEXTILES INC.:
See— ABSORB-PLUS INC./ABSORBE-PLUS INC.
- ABTOX, INC., MUDELEIN, IL:
2,012,247, CANC. INT. CL. 1.
- ABUNDANCE RESOURCE NETWORK, INC., ADDISON, TX:
2,763,384, PUB. 6-24-2003, INT. CL. 14.
- ABWA COMPANY, INC., THE, KANSAS CITY, MO:
1,728,141, CANC. INT. CL. 36.
1,728,476, CANC. INT. CL. 42.
- ACCELERATED CHRISTIAN EDUCATION, INC., LEWISVILLE, TX:
1,214,373, CANC. INT. CL. 41.
- ACCESS TECHNOLOGY SERVICES, INC., BOCA RATON, FL:
2,763,732, PUB. 6-24-2003, INT. CL. 35.
- ACCOR TECHNOLOGY, INC., BELLEVUE, WA:
2,763,285, PUB. 6-24-2003, INT. CL. 11.
- ACCOUNTING FIRMS ASSOCIATED, INC., GAINESVILLE, FL TO ACCOUNTING FIRMS ASSOCIATED, INC., GAINESVILLE, FL:
2,568,754, COR. MULTIPLE CLASS, U.S. CL. 200 INT. CL. 42.
- ACCUSOFT CORPORATION, NORTHBOROUGH, MA:
2,765,796, MULTIPLE CLASS, INT. CLS. 9 AND 42.
- ACH FOOD COMPANIES, INC., CORDOVA, TN, NATIONAL DAIRY PRODUCTS CORPORATION, NEW YORK, NY:
733,853, REN. 8-7-03, U.S. CL. 46 (INT. CL. 29).
- ACME BRUSH CORPORATION, JERICHO, NY:
740,002, CANC. U.S. CL. 29.
- ACORN PRODUCTS CO., INC.:
See— KEY CORPORATE CAPITAL INC.
- ACORN PRODUCTS CO., INC.:
See— KEY CORPORATE CAPITAL INC.
- ACOUSTICS FIRST CORPORATION, RICHMOND, VA:
2,765,076, INT. CL. 17.
- ACQUA DI PARMA S.R.L., 40125 BOLOGNA, ITALY:
2,714,064, COR. INT. CL. 3.
- ACTION CONCEPTS, INC., FORT WORTH, TX:
2,763,671, PUB. 6-24-2003, INT. CL. 35.
- ACTION COPY CO. CORP., EDMONTON, ALBERTA:
2,764,805, INT. CL. 18.
- ACTION LABS, INC., FARMINGDALE, NY:
2,012,876, CANC. INT. CL. 5.
- ACTIVE ORGANICS, INC., LEWISVILLE, TX:
2,763,066, PUB. 11-23-1999, INT. CL. 1.
- ACTIVISION, INC., SANTA MONICA, CA:
1,198,971, REN. 8-5-03, INT. CL. 28.

- ACUITY BRANDS, INC., ATLANTA, GA, HOLOPHANE COMPANY, INC., NEWARK, OH:
1,783,375. REN. 8-6-03. INT. CL. 11.
- AD*ITIVE, LLC, THE, NEW YORK, NY FROM ARNOLD COMMUNICATIONS, INC., BOSTON, MA:
2,764,718, INT. CL. 35.
- ADAMS, JAMES, ADRIAN, LOS OSOS, CA:
2,765,733, INT. CL. 19.
- ADAMSHAND INC, SHREWSBURY, MA, DBA THE INTERVIEW EXCHANGE:
2,763,976, PUB. 6-24-2003. INT. CL. 35.
- ADAX, INC., VERNON HILLS, IL:
2,011,530, CANC. INT. CL. 42.
- ADIS INTERNATIONAL LIMITED, AUCKLAND 10, NEW ZEALAND:
1,727,487, CANC. INT. CL. 16.
- ADKINS, MICHAEL, INDIANAPOLIS, IN:
2,765,812, INT. CL. 41.
- ADOBE SYSTEMS INCORPORATED, MOUNTAIN VIEW, CA:
2,012,286, CANC. INT. CL. 9.
- ADVANCED CONNECTOR SYSTEMS, INC., PHOENIX, AZ:
1,727,010, CANC. INT. CL. 6.
- ADVANCED DIELECTRIC TECHNOLOGIES, INC., TAUNTON, MA:
1,727,505, CANC. INT. CL. 16.
- ADVANCED ENGINE MANAGEMENT, INC., HAWTHORNE, CA:
2,763,222, PUB. 6-24-2003. MULTIPLE CLASS, INT. CLS. 7 AND 12.
- ADVANCED FLEXIBLE COMPOSITES, INC., LAKE IN THE HILLS, IL:
2,764,773, INT. CL. 17.
2,764,774, INT. CL. 17.
- ADVANCED MICRO DEVICES, INC., SUNNYVALE, CA:
2,764,567, INT. CL. 9.
- ADVANCED MOBILEHOME SYSTEMS, INC., POMPANO BEACH, FL:
1,215,831. REN. 8-4-03. INT. CL. 17.
- ADVANCED NEUROTECHNOLOGIES, INCORPORATED, COLORADO SPRINGS, CO:
2,012,363, CANC. INT. CL. 9.
- ADVANCED SETTLEMENTS, ORLANDO, FL:
2,765,700, INT. CL. 36.
- ADVANTEK, INC., MINNETONKA, MN:
2,763,341, PUB. 6-24-2003. MULTIPLE CLASS, INT. CLS. 7, 9, 16, 17, 37, 40 AND 42.
- ADVENTUS PRODUCT MARKETING, LLC, ST. PAUL, MN:
2,764,429, PUB. 6-24-2003. INT. CL. 3.
- AEA TECHNOLOGY PLC, OXFORDSHIRE, OX11 0QJ, UNITED KINGDOM:
2,763,193, PUB. 6-24-2003. INT. CL. 1.
- AEGIS ENTERTAINMENT, INC., LA JOLLA, CA, DBA WILDSTORM PRODUCTIONS:
2,012,435, CANC. INT. CL. 28.
- AEGON DIRECT MARKETING SERVICES, INC., BALTIMORE, MD:
2,765,185, INT. CL. 36.
- AERO INC., THE, SUNNYVALE, CA:
1,214,332, CANC. INT. CL. 37.
- AERO PRODUCTS INTERNATIONAL, INC., WAUCONDA, IL FROM IMAGINAIR, INC., WAUCONDA, IL:
2,764,818, MULTIPLE CLASS, INT. CLS. 20 AND 24.
2,764,851, MULTIPLE CLASS, INT. CLS. 20 AND 28.
- AERO PRODUCTS INTERNATIONAL, INC., WAUCONDA, IL:
2,765,804, INT. CL. 28.
2,765,805, INT. CL. 28.
2,765,806, INT. CL. 28.
- AEROGROUND, INC., S SAN FRANCISCO, CA:
1,800,255. REN. 8-7-03. INT. CL. 39.
- AETNA INC., BLUE BELL, PA:
2,765,645, INT. CL. 36.
- AEX- INDICES B.V., 1012 JW AMSTERDAM, NETHERLANDS:
2,763,215, PUB. 6-24-2003. MULTIPLE CLASS, INT. CLS. 35, 36 AND 41.
- AG SOURCE MAGAZINE, TULARE, CA:
2,763,852, PUB. 6-24-2003. INT. CL. 16.
- AGAM GROUP, LTD., THE, ELKRIDGE, MD:
2,764,740, INT. CL. 20.
- AGATE SOFTWARE, INC., LANSING, MI:
2,763,486, PUB. 6-24-2003. INT. CL. 9.
- AGHAMOHAMMAD, SHAHIN, NORTH HILLS, CA:
2,764,640, INT. CL. 25.
- AGILE SOFTWARE CORPORATION, SAN JOSE, CA:
2,763,333, PUB. 6-24-2003. INT. CL. 9.
- AGORICS, INC., LOS ALTOS, CA:
2,765,296, INT. CL. 9.
- AGRI LABORATORIES, LTD., ST. JOSEPH, MO:
2,763,854, PUB. 6-24-2003. MULTIPLE CLASS, INT. CLS. 16 AND 44.
- AGRITECH S.P.A., 48100 SAN MICHELE (RA), ITALY:
2,763,735, PUB. 6-24-2003. INT. CL. 30.
- AHA!WORKS, INCORPORATED, DALLAS, TX:
2,763,195, PUB. 6-24-2003. INT. CL. 35.
- AHARONI, AMOS, NEW YORK, NY:
2,012,906, CANC. INT. CL. 25.
- AIR CANADA, MONTREAL, QUEBEC, CANADA:
2,011,748, CANC. INT. CL. 9.
- AIR COMPRESSOR PRODUCTS, INC., JACKSONVILLE, FL:
1,727,060, CANC. INT. CL. 7.
- AIR PACIFIC LIMITED, SUVA, FIJI:
1,214,348, CANC. INT. CL. 39.
- AIR PACIFIC LIMITED, NADI, FIJI:
2,763,937, PUB. 6-24-2003. INT. CL. 39.
- AIRE SERV HEATING & AIR CONDITIONING, INC., WACO, TX:
2,763,655, PUB. 6-24-2003. MULTIPLE CLASS, INT. CLS. 9, 11 AND 37.
2,763,656, PUB. 6-24-2003. MULTIPLE CLASS, INT. CLS. 9, 11 AND 37.
- AIRIES TECHNOLOGY LIMITED, ST. HELIER, JERSEY, CHANNEL ISLANDS, ELECTRA POLYMERS & CHEMICALS LIMITED, KENT TN11 9SG, UNITED KINGDOM:
1,734,253. REN. 8-7-03. INT. CL. 2.
- AIROLITE COMPANY, THE, MARIETTA, OH:
398,421, CANC. U.S. CL. 34.
- AIRPORT SATELLITE PARKING LLC, NEWARK, NJ:
2,764,485, INT. CL. 39.
- AIRWALK INTERNATIONAL, LLC, GOLDEN, CO:
2,763,187, PUB. 6-24-2003. INT. CL. 18.
- AIWA CO., LTD., CHIYODA-KU, TOKYO, JAPAN:
1,228,251. REN. 8-7-03. INT. CL. 9.
- AKALP, PHILIP, AGOURA HILLS, CA:
2,764,009, PUB. 6-24-2003. INT. CL. 35.
2,764,010, PUB. 6-24-2003. INT. CL. 35.
2,764,011, PUB. 6-24-2003. INT. CL. 35.
- AKONA ADVENTURE GEAR, INC., CLARENCE CENTER, NY:
2,012,308, CANC. MULTIPLE CLASS, INT. CLS. 8, 9, 18 AND 28.
- AKORN PHARMACEUTICALS CANADA LIMITED, MARKHAM, ONTARIO L3R 3J9, CANADA:
2,011,290, CANC. INT. CL. 5.
- AKZO NOBEL CHEMICALS B.V., 3818 LE AMERSFOORT, NETHERLANDS:
2,763,612, PUB. 6-24-2003. INT. CL. 1.
- AKZO NOBEL COATINGS INC., LOUISVILLE, KY, AKZO COATINGS INC., LOUISVILLE, KY:
1,768,352. REN. 8-6-03. INT. CL. 2.
- AL HENDRICKSON TOYOTA, INC., COCONUT CREEK, FL:
2,765,293, INT. CL. 35.
- ALADDIN GAMING, LLC, LAS VEGAS, NV:
2,764,504, INT. CL. 42.
- ALASKA 13 CORPORATION, THE, ANCHORAGE, AK:
1,214,341, CANC. INT. CL. 38.
- ALBERT TROSTEL & SONS COMPANY, MILWAUKEE, WI:
1,820,938. REN. 8-5-03. INT. CL. 3.
1,829,144. REN. 8-2-03. INT. CL. 3.
- ALBERTSON'S, INC., BOISE, ID:
2,712,646, AM. INT. CL. 30.

ALCAN INC., MONTREAL, QUEBEC, CANADA, ALCAN ALUMINUM CORPORATION, CLEVELAND, OH:
1,242,673. REN. 8-7-03. INT. CL. 9.

ALCYONE LIMITED, NASSAU, BAHAMAS:
2,763,123, PUB. 6-24-2003. MULTIPLE CLASS, INT. CLS. 3, 5, 9, 16 AND 42.

ALDI INC., BATAVIA, IL:
1,728,725, CANC. INT. CL. 29.

ALDIVIA S.A., SAINT-GENIS-LAVAL CEDEX, FRANCE:
2,763,407, PUB. 6-24-2003. MULTIPLE CLASS, INT. CLS. 1, 3 AND 5.

ALEXANDER, KAREN R., COLUMBIA, SC AND COUNTS, BYRON D., COLUMBIA, SC:
2,765,653, INT. CL. 9.

ALEXANDER, RICHARD, BENSALEM, PA TO FARNAM COMPANIES, INC., PHOENIX, AZ:
2,081,622, AM. INT. CL. 5.

ALEXANIAN, GEORGE, FRESNO, CA:
2,765,215, INT. CL. 9.

ALFA LAVAL AUTOMATION AKTIEBOLAG, 205 22 MALMO, SWEDEN:
1,727,097, CANC. INT. CL. 9.

ALFRED DUNNER, INC., NEW YORK, NY:
2,763,923, PUB. 6-24-2003. INT. CL. 25.

ALIEN TECHNOLOGY CORPORATION, HAYWARD, CA:
2,764,925, INT. CL. 9.

ALIVE ENTERPRISES, INC., KIHAI, MAUI, HI:
2,764,827, INT. CL. 33.

ALIXPARTNERS, LLC, SOUTHFIELD, MI:
2,764,460, PUB. 6-24-2003. MULTIPLE CLASS, INT. CLS. 35, 36 AND 42.

ALL BETTER PRODUCTS, L.L.C., STUDIO CITY, CA:
2,764,986, INT. CL. 10.

ALL-STATE LEGAL SUPPLY CO., CRANFORD, NJ:
1,213,907, CANC. INT. CL. 16.

ALL-TEMP CORPORATION, LANCASTER, CA:
1,784,168. REN. 8-8-03. INT. CL. 21.

ALLABOUTLONGTERMCARE.COM, INC., DALLAS, TX:
2,765,594, INT. CL. 36.

ALLEGRO SOFTWARE DEVELOPMENT CORPORATION, BOXBOROUGH, MA:
2,763,035, PUB. 6-24-2003. INT. CL. 9.

ALLESEE ORTHODONTIC APPLIANCES, INC., STURTEVANT, WI:
2,763,231, PUB. 6-24-2003. INT. CL. 10.

ALLIANCE ENTERPRISES, INC., OLYMPIA, WA:
2,764,569, MULTIPLE CLASS, INT. CLS. 9 AND 42.

ALLIANCE MARKETING INTERNATIONAL CORPORATION, RANCHO CORDOVA, CA TO EMERGENT MORTGAGE CORP., GREENVILLE, SC:
1,728,021, CANC. INT. CL. 35.

ALLIANCE OF CHILDREN'S HOSPITALS, INC., SHAWNEE MISSION, KS:
1,721,012. REN. 8-7-03. U.S. CL. A.

ALLIANZ LIFE INSURANCE COMPANY OF NORTH AMERICA, MINNEAPOLIS, MN:
2,765,315, INT. CL. 36.

ALLIED INTERNATIONAL INC., ASHBURN, VA:
2,765,191, INT. CL. 30.

ALLIED MANUFACTURING, INC., CORONA, CA:
1,728,167, CANC. MULTIPLE CLASS, INT. CLS. 37 AND 42.

ALLIED MARKETING GROUP, INC., DALLAS, TX:
2,765,947, INT. CL. 14.

ALLIED NATIONAL, INC., KANSAS CITY, MO:
2,012,452, CANC. INT. CL. 35.

ALLOSOURCE, CENTENNIAL, CO:
2,763,682, PUB. 6-24-2003. INT. CL. 5.

ALLOY CLADDING COMPANY, INC., FORT MYERS, FL:
1,214,362, CANC. INT. CL. 40.

ALLPRO CORPORATION, TAMPA, FL:
2,011,267, CANC. INT. CL. 20.

ALLTECH, INC., NICHOLASVILLE, KY:
2,763,512, PUB. 11-5-2002. MULTIPLE CLASS, INT. CLS. 5 AND 31.

ALOECORP, INC., HARLINGEN, TX:
1,726,815, CANC. INT. CL. 1.

ALOHA HOUSEWARES, INC., MANSFIELD, TX:
2,765,422, INT. CL. 11.

ALON, INC., LEECHBURG, PA, ALON PROCESSING, INC., TARENTUM, PA:
1,771,085. REN. 8-6-03. MULTIPLE CLASS, INT. CLS. 6 AND 40.

ALONSO, JORGE, ENCINO, CA:
2,765,290, INT. CL. 42.

ALORICA INC., CHINO, CA:
2,763,647, PUB. 6-24-2003. MULTIPLE CLASS, INT. CLS. 9, 35 AND 42.

2,763,657, PUB. 6-24-2003. MULTIPLE CLASS, INT. CLS. 9, 35 AND 42.

ALPHA SYSTEMS LAB, INC., COSTA MESA, CA:
2,763,960, PUB. 6-24-2003. INT. CL. 9.

ALPHADIRECTIONS, INC., PORTSMOUTH, NH:
2,764,830, INT. CL. 35.

ALPHAQUEST, INC., SARATOGA, CA:
2,011,753, CANC. INT. CL. 38.

ALPINE USA LTD., BROOKLYN, NY:
2,764,747, INT. CL. 30.

ALTA NATURAL HERBS & SUPPLEMENTS LTD., VANCOUVER, BRITISH COLUMBIA, CANADA:
2,763,421, PUB. 6-24-2003. INT. CL. 5.

ALTAIRE PHARMACEUTICALS, INC., HOLBROOK, NY:
2,012,650, CANC. INT. CL. 5.

ALU-REX INC., ST-JEAN-CHRYSOSTOME (QUEBEC), CANADA:
2,765,860, INT. CL. 6.

ALUMINUM COMPANY OF AMERICA, PITTSBURGH, PA:
2,012,275, CANC. INT. CL. 1.

ALUMNI ASSOCIATION OF THE UNIVERSITY OF KANSAS, THE, LAWRENCE, KS:
2,764,703, INT. CL. 25.

AMBASSADORS FOR CHRIST INTERNATIONAL - USA, INC., MARIETTA, GA:
2,765,089, INT. CL. 16.
2,765,090, INT. CL. 41.

AMC, INC., ATLANTA, GA:
2,763,605, PUB. 6-24-2003. INT. CL. 35.
2,765,364, INT. CL. 35.

AMCO CORPORATION, CHICAGO, IL:
2,012,674, CANC. INT. CL. 20.

AMCON LABORATORIES, INC., ST. LOUIS, MO:
1,825,187. REN. 8-2-03. INT. CL. 21.

AMCOR SUNCLIPSE NORTH AMERICA, BUENA PARK, CA:
2,764,658, INT. CL. 17.

AMERALLOY STEEL CORPORATION, SAN ANTONIO, TX:
1,782,398. REN. 8-6-03. INT. CL. 6.

AMERICA ONLINE, INC., DULLES, VA:
2,763,974, PUB. 6-24-2003. INT. CL. 16.

AMERICA ONLINE, INC., DULLES, VA FROM COMPUTER INCORPORATED, COLUMBUS, OH:
2,764,476, INT. CL. 42.

AMERICA ONLINE, INC., DULLES, VA:
2,764,496, INT. CL. 9.

AMERICAN ACADEMY OF OPHTHALMOLOGY, INC., SAN FRANCISCO, CA:
2,763,591, PUB. 6-24-2003. INT. CL. 16.

AMERICAN ADVANCED POWER INC., FALL RIVER, MA:
2,764,402, PUB. 6-24-2003. INT. CL. 9.

AMERICAN AIRLINES, INC., FORT WORTH, TX:
1,728,208, CANC. INT. CL. 39.

AMERICAN APPRAISAL ASSOCIATES, INC., MILWAUKEE, WI:
1,214,324, CANC. INT. CL. 36.

AMERICAN ARBITRATION ASSOCIATION, NEW YORK, NY:
2,764,771, INT. CL. 42.

AMERICAN ASSOCIATION OF INDIVIDUAL INVESTORS, INC., CHICAGO, IL:
2,012,932, CANC. INT. CL. 16.

AMERICAN BUSINESS FORMS, INC., GLENWOOD, MN:
2,763,093, PUB. 11-28-2000. INT. CL. 42.

AMERICAN CANCER SOCIETY, INC., ATLANTA, GA:
2,764,403, PUB. 6-24-2003. INT. CL. 44.

- AMERICAN COED PAGEANTS, INC., PENSACOLA, FL:
1,728,271, CANC. INT. CL. 41.
- AMERICAN COLLEGE OF RADIOLOGY, RENTON, VA:
2,715,494, COR. INT. CL. 16.
- AMERICAN CYANAMID COMPANY (CURRENT OWNER)
(MAINE CORP.), WAYNE N.J.:
740,105, CANC. U.S. CL. 44.
- AMERICAN DAIRY QUEEN CORPORATION, EDINA, MN:
2,764,390, PUB. 6-24-2003. INT. CL. 30.
- AMERICAN DANCE THERAPY ASSOCIATION, COLUMBIA, MD:
1,809,630. REN. 8-6-03. MULTIPLE CLASS, INT. CLS. 41 AND 42.
1,809,632. REN. 8-6-03. MULTIPLE CLASS, INT. CLS. 41 AND 42.
- AMERICAN DIABETES ASSOCIATION, INC., ALEXANDRIA, VA:
2,765,931, INT. CL. 16.
- AMERICAN ENVELOPE COMPANY, CHICAGO, IL:
1,213,940, CANC. INT. CL. 16.
- AMERICAN EXPRESS COMPANY, NEW YORK, NY:
2,011,951, CANC. MULTIPLE CLASS, INT. CLS. 35 AND 36.
- AMERICAN FILM MARKETING ASSOCIATION, LOS ANGELES, CA:
2,012,398, CANC. INT. CL. 35.
- AMERICAN FOAM TECHNOLOGIES, INC., NEWPORT, RI:
2,765,876, INT. CL. 20.
- AMERICAN FOOD AND GUEST SERVICES, INC., BETHESDA, MD:
2,763,483, PUB. 6-24-2003. INT. CL. 43.
- AMERICAN HOSPITAL SUPPLY CORPORATION, EVANSTON, IL:
398,431, CANC. U.S. CL. 32.
- AMERICAN HOTEL & MOTEL ASSOCIATION, WASHINGTON, DC AND AMERICAN HOTEL & LODGING ASSOCIATION, WASHINGTON, DC:
2,763,113, PUB. 8-13-2002. MULTIPLE CLASS, INT. CLS. 16 AND 42.
- AMERICAN HOUSEKEEPING, USA INC., RENO, NV,
AMERICAN HOMES SYSTEMS, INC., RENO, NV:
1,750,421. REN. 8-4-03. INT. CL. 37.
- AMERICAN HOUSEKEEPING, USA INC., RENO, NV,
AMERICAN HOME SYSTEMS, INC., RENO, NV:
1,798,187. REN. 8-4-03. INT. CL. 37.
- AMERICAN INSTITUTE FOR MANAGING DIVERSITY, INC., ATLANTA, GA:
2,764,105, PUB. 6-24-2003. MULTIPLE CLASS, INT. CLS. 14, 16 AND 18.
- AMERICAN INTERNATIONAL GROUP, INC., NEW YORK, NY:
1,214,312, CANC. INT. CL. 36.
2,011,883, CANC. INT. CL. 36.
- AMERICAN LICORICE CO., BEND, OR:
2,765,497, INT. CL. 30.
- AMERICAN LOUDSPEAKER MANUFACTURERS ASSOCIATION, INC., PRINCETON JUNCTION, NJ:
2,763,606, PUB. 6-24-2003. INT. CL. 35.
- AMERICAN MANAGEMENT ASSOCIATIONS, NEW YORK, NY:
1,214,400, CANC. INT. CL. 41.
- AMERICAN MESSAGE SALES & MFG. CORP., SILVER CREEK, NY:
740,100, CANC. U.S. CL. 44.
- AMERICAN METER COMPANY, HORSHAM, PA:
2,763,869, PUB. 6-24-2003. INT. CL. 11.
- AMERICAN MOVIE CLASSICS COMPANY, WOODBURY, NY:
2,012,374, CANC. INT. CL. 41.
- AMERICAN NATIONAL RED CROSS, WASHINGTON, DC,
AKA AMERICAN RED CROSS:
1,727,578, CANC. INT. CL. 16.
- AMERICAN POLYMERS INC., LAS VEGAS, NV:
2,763,810, PUB. 6-24-2003. INT. CL. 2.
- AMERICAN POLYSTEEL, LLC, ALBUQUERQUE, NM:
2,765,803, INT. CL. 19.
- AMERICAN POP CORN COMPANY, SIOUX CITY, IA:
2,765,824, INT. CL. 30.
- AMERICAN PROMOTIONAL EVENTS, INC., FLORENCE, AL:
2,763,226, PUB. 6-24-2003. INT. CL. 13.
- AMERICAN PSYCHIATRIC PRESS, INC., WASHINGTON, DC:
2,012,271, CANC. INT. CL. 42.
- AMERICAN SOCIETY OF ASSOCIATION EXECUTIVES, WASHINGTON, DC:
1,727,469, CANC. INT. CL. 16.
- AMERICAN SPORTING GOODS CORPORATION, IRVINE, CA:
2,763,293, PUB. 6-24-2003. INT. CL. 25.
- AMERICAN SPORTS LICENSING, INC., WILMINGTON, DE
FROM DICK'S CLOTHING & SPORTING GOODS, INC., CORAOPOLIS, PA:
2,764,498, INT. CL. 35.
- AMERICAN STORES COMPANY, SALT LAKE CITY, UT:
2,011,976, CANC. INT. CL. 42.
- AMERICAN THEATRE WING, INC., NEW YORK, NY:
979,150, AM. U.S. CL. 107.
- AMERICAN TOURISTER, INC., WARREN, RI:
739,872, CANC. U.S. CL. 3.
- AMERICAN TRUCKSOURCE, INC., IRVING, TX:
2,765,846, INT. CL. 35.
2,765,847, INT. CL. 12.
2,765,848, INT. CL. 7.
- AMERICAN VALET & LIMOUSINE, INCORPORATED, PHOENIX, AZ:
2,764,206, PUB. 6-24-2003. INT. CL. 39.
- AMERICAN VETERINARY LABORATORY, INC., SAN ANGELO, TX:
1,726,954, CANC. INT. CL. 5.
- AMERICAN VETERINARY MEDICAL ASSOCIATION, SCHAUMBURG, IL:
1,784,359, REN. 8-6-03. INT. CL. 35.
- AMERICHoice CORPORATION, VIENNA, VA FROM
AMERICHoice HEALTH SERVICES, INC., VIENNA, VA:
2,764,133, PUB. 6-24-2003. INT. CL. 44.
- AMERICHoice HEALTH SERVICES, INC.:
See—AMERICHoice CORPORATION.
- AMERICO GROUP, INC., NEW YORK, NY:
2,012,096, CANC. INT. CL. 25.
- AMERIPLUS, INC., OLDSMAR, FL:
2,765,349, INT. CL. 3.
- AMERIQUEST MORTGAGE COMPANY, ORANGE, CA:
2,765,045, INT. CL. 36.
- AMERISTAR FENCE PRODUCTS, INC., TULSA, OK:
2,764,363, PUB. 6-24-2003. INT. CL. 6.
- AMERITECH CORPORATION, CHICAGO, IL:
2,052,094, CANC. INT. CL. 38.
- AMERSHAM BIOSCIENCES AB, SE-751 84 UPPSALA, SWEDEN, PHARMACIA P-L BIOCHEMICALS INC., MILWAUKEE, WI:
1,788,720. REN. 8-7-03. INT. CL. 1.
- AMERSHAM BIOSCIENCES UK LIMITED, BUCKINGHAMSHIRE HP7 9NA, UNITED KINGDOM, AMERSHAM INTERNATIONAL PLC, BUCKINGHAMSHIRE, ENGLAND:
1,770,934. REN. 8-8-03. INT. CL. 1.
- AMETEK, INC., NEW YORK, NY:
739,902, CANC. U.S. CL. 13.
- AMF BOWLING, INC., GOLDEN, CO:
2,011,863, CANC. INT. CL. 3.
- AMF MARES - S.P.A.:
1,214,139, CANC. INT. CL. 28.
- AMICUS LAW GROUP, PC, SEATTLE, WA:
2,763,856, PUB. 6-24-2003. INT. CL. 42.
- AMJAY ROPES AND TWINES LIMITED, NEWMARKET, ONTARIO L3Y 8E1, CANADA:
2,011,919, CANC. INT. CL. 22.
- AMKOR TECHNOLOGY, INC., WEST CHESTER, PA:
2,764,509, INT. CL. 9.
- AMODEX PRODUCTS INC., BRIDGEPORT, CT:
758,969. REN. 8-8-03. U.S. CL. 52 (INT. CL. 3).
- AMPEREX ELECTRONIC CORPORATION, HICKSVILLE, NY:
739,942, CANC. U.S. CL. 21.

- AMPSPEAKER APS, DK-2680 SOLROD STRAND, COPENHAGEN, DENMARK TO SIRIUS SATELLITE RADIO INC., NEW YORK, NY:
2,481,900 NEW CERT. 9-16-2003. INT. CL. 9.
- AMWAY CORPORATION, ADA, MI:
2,011,856, CANC. INT. CL. 31.
- ANABOLIC LABORATORIES, INC., LAKE FOREST, CA:
2,765,874, INT. CL. 5.
- ANALOG & DIGITAL PERIPHERALS, INC., TROY, OH:
1,727,282, CANC. INT. CL. 9.
- ANALYSES CONSEILS INFORMATIONS ACI, 75008 PARIS, FRANCE:
2,012,200, CANC. INT. CL. 9.
- ANCHOR HOCKING CORPORATION, LANCASTER, OH:
740,003, CANC. U.S. CL. 30.
- ANCHOR PHARMACIES, INC., HAMPSTEAD, MD:
2,764,715, INT. CL. 35.
- ANCIENNE FABRIQUE VACHERON & CONSTANTIN SOCIETE ANONYME, GENEVA, SWITZERLAND:
91,444, REN. 8-4-03. U.S. CL. 27 (INT. CL. 14).
- ANCIENT DRUM ENTERPRISES, LLC, SALINAS, CA:
2,764,140, PUB. 6-24-2003. INT. CL. 9.
- ANDE ROONEY INC., HIGHLAND, NY:
2,763,952, PUB. 6-24-2003. INT. CL. 21.
- ANDERSON, JOHN, ARCOLA, IL, DBA J & D METAL COMPANY:
1,214,151, CANC. INT. CL. 28.
- ANDERSON, MEGORY, SAN FRANCISCO, CA:
2,764,178, PUB. 6-24-2003. INT. CL. 41.
- ANDIN INTERNATIONAL INC., NEW YORK, NY:
2,764,490, MULTIPLE CLASS, INT. CLS. 20 AND 25.
- ANDREW BARCLAY HANSEN, WRENTHAM, MA:
1,773,249, REN. 8-6-03. INT. CL. 42.
- ANDRX PHARMACEUTICALS, INC., FT. LAUDERDALE, FL:
2,764,784, INT. CL. 5.
- ANGEL-CUSTODIO DALMAU SALMONS, BARCELONA, SPAIN:
2,763,282, PUB. 7-30-2002. INT. CL. 3.
- ANGIOLINK CORPORATION, TAUNTON, MA:
2,765,484, INT. CL. 10.
- ANGIULI, FRANK, LOS ANGELES, CA:
2,763,966, PUB. 6-24-2003. INT. CL. 25.
- ANHEUSER-BUSCH, INCORPORATED, ST. LOUIS, MO:
2,012,021, CANC. INT. CL. 21.
2,012,022, CANC. INT. CL. 21.
2,012,023, CANC. INT. CL. 21.
2,012,084, CANC. INT. CL. 32.
2,012,085, CANC. INT. CL. 25.
2,012,124, CANC. INT. CL. 32.
- ANHING CORPORATION, LOS ANGELES, CA:
2,764,319, PUB. 6-24-2003. MULTIPLE CLASS, INT. CLS. 30 AND 32.
- ANNAYAKE, 75008 PARIS, FRANCE:
2,763,529, PUB. 6-24-2003. INT. CL. 3.
- ANONIMA COSTRUZIONE MOTORI ENDOTERMICI-A.C.M.E. S.P.A., VALDOBBIADENE, TREVISO, ITALY TO ANONIMA COSTRUZIONE MOTORI ENDOTERMICI-A.C.M.E. S.P.A., VALDOBBIADENE, TREVISO, ITALY:
1,280,507, COR. MULTIPLE CLASS, INT. CLS. 7 AND 12.
- ANONIMA COSTRUZIONE MOTORI ENDOTERMICI-A.C.M.E. S.P.A., VALDOBBIADENE TREVISO, ITALY TO ANONIMA COSTRUZIONE MOTORI ENDOTERMICI-A.C.M.E. S.P.A., VALDOBBIADENE TREVISO, ITALY:
1,286,844, COR. MULTIPLE CLASS, INT. CLS. 7 AND 12.
- ANR FREIGHT SYSTEM, INC., DETROIT, MI:
1,214,352, CANC. INT. CL. 39.
- ANTENOR, N.V., ORLANDO, FL:
1,214,456, CANC. INT. CL. 42.
- ANTHONY HOME IMPROVEMENTS, INC., ELKINS PARK, PA:
2,764,030, PUB. 6-24-2003. INT. CL. 37.
- ANTIQUÉ DRAPERY ROD COMPANY, DALLAS, TX:
2,763,733, PUB. 6-24-2003. INT. CL. 2.
- ANTON HUMMEL VERWALTUNGS GMBH, 79183 WALDKIRCH, FED REP GERMANY:
2,765,192, MULTIPLE CLASS, INT. CLS. 9 AND 17.
- ANTON RIEMERSCHMID WEINBRENNEREI, LIKOR-UND ESSIGFABRIK GMBH & CO. KG, D-85435 ERDING, FED REP GERMANY:
2,011,810, CANC. INT. CL. 33.
- ANVIL SNOWBOARD CORPORATION, BOULDER, CO:
2,012,731, CANC. INT. CL. 28.
- ANY DESIGN MONOGRAM EMBROIDERY, INC., MELROSE, MA:
2,763,678, PUB. 6-24-2003. MULTIPLE CLASS, INT. CLS. 24 AND 25.
- AOIS TRANSACTION TRACKING, INC., DOWNERS GROVE, IL:
2,011,342, CANC. INT. CL. 36.
- AOS THERMAL COMPOUNDS, LLC, EATONTOWN, NJ:
2,765,059, INT. CL. 4.
- APCOM, INC., FRANKLIN, TN:
2,765,133, INT. CL. 11.
- APEX FITNESS, INC., PLEASANTON, CA:
2,765,270, INT. CL. 41.
- APEX JEWELRY INC., NEW YORK, NY:
2,765,075, INT. CL. 14.
- APEX PC SOLUTIONS, INC., REDMOND, WA:
2,012,634, CANC. INT. CL. 9.
- APOGEE SOFTWARE, LTD., GARLAND, TX:
2,012,633, CANC. INT. CL. 28.
- APOLLO PRODUCTS, INC., KANSAS CITY, MO:
2,765,155, MULTIPLE CLASS, INT. CLS. 3, 5, 26, 35 AND 42.
- APPLE COMPUTER, INC., CUPERTINO, CA:
2,763,155, PUB. 8-14-2001. INT. CL. 9.
- APPLETREE RESTAURANT, INC., NEW YORK, NY:
1,214,413, CANC. INT. CL. 42.
- APPLIED POLYMERICS, INC., MOUNT AIRY, NC:
2,763,626, PUB. 6-24-2003. INT. CL. 17.
- APPLIED RESEARCH ASSOCIATES INC., ALBUQUERQUE, NM:
1,767,767, REN. 8-6-03. INT. CL. 42.
- APPLIED SIGNAL TECHNOLOGY, INC., SUNNYVALE, CA FROM TRANSCENDENT TECHNOLOGIES, INC., SUNNYVALE, CA:
2,764,999, INT. CL. 9.
- APTE, INC., EVANSTON, IL:
2,765,900, INT. CL. 9.
- AQS, INC., HARTLAND, WI:
2,764,806, INT. CL. 9.
- AQUAFIL S.P.A., ARCO (TRENTO), ITALY:
2,763,131, PUB. 6-24-2003. MULTIPLE CLASS, INT. CLS. 1, 17, 22 AND 23.
- ARACHNID, INC., ROCKFORD, IL:
1,830,363, REN. 8-5-03. INT. CL. 16.
- ARATO DESIGN ASSOCIATES INC., WILLOWDALE, ONTARIO, M2H 2S5, CANADA:
1,771,505, REN. 8-7-03. INT. CL. 21.
- ARBOR HILL ASSOCIATES, INCORPORATED, NAPLES, NY:
2,764,551, INT. CL. 33.
- ARBORTEC INDUSTRIES LTD., MISSION, B.C., CANADA:
1,810,813, REN. 8-4-03. INT. CL. 22.
- ARBURG MASCHINENFABRIK HEHL & SOEHNE GMBH & CO. KG, D-7298 LOSSURG 1, FED REP GERMANY TO ARBURG GMBH & CO, LOSSBURG, FED REP GERMANY:
1,727,109, CANC. INT. CL. 9.
- ARCH CHEMICALS, INC., NORWALK, CT:
2,765,637, INT. CL. 1.
- ARCHIE COMIC PUBLICATIONS, INC., MAMARONECK, NY:
1,734,032, REN. 8-6-03. INT. CL. 16.
- ARCHIVE PAPER COMPANY, BROOMFIELD, CO:
2,011,475, CANC. INT. CL. 16.
- ARGUS CAPITAL LLC, TIBURON, CA:
2,763,822, PUB. 6-24-2003. INT. CL. 30.
- ARISTAR, INC., AKRON, OH:
2,765,352, INT. CL. 9.
- ARISTECH ACRYLICS LLC, FLORENCE, KY:
2,764,882, INT. CL. 17.

- ARISTOCRAT LEISURE INDUSTRIES PTY LTD, ROSEBERRY, NEW SOUTH WALES, 2018, AUSTRALIA:
2,011,406, CANC. INT. CL. 9.
- ARISTOCRAT TECHNOLOGIES AUSTRALIA PTY LTD., NEW SOUTH WALES, AUSTRALIA:
2,763,344, PUB. 6-24-2003. INT. CL. 9.
- ARIZONA SCIENCE CENTER, PHOENIX, AZ:
2,764,346, PUB. 6-24-2003. INT. CL. 41.
- ARKANSAS COMMUNITY FOUNDATION, INC., LITTLE ROCK, AR:
2,763,675, PUB. 6-24-2003. INT. CL. 41.
- ARLINGTON SOFTWARE CORPORATION, MONTREAL, QUEBEC, CANADA:
2,763,102, PUB. 6-24-2003. INT. CL. 35.
- ARN, RUSS, VANCOUVER, WA:
2,763,743, PUB. 6-24-2003. INT. CL. 7.
- ARNALDO CAPRAI GRUPPO TESSILE S.P.A., 06037-FOLOGNO (PG), ITALY:
2,765,178, MULTIPLE CLASS, INT. CLS. 24 AND 25.
- ARRAY BIOPHARMA INC., BOULDER, CO:
2,763,165, PUB. 6-24-2003. INT. CL. 42.
- ART A FACE COSMETICS LIMITED, REMUERA, AUCKLAND, NEW ZEALAND:
2,763,329, PUB. 6-24-2003. INT. CL. 3.
- ARTHUR COURT DESIGNS, INC., BRISBANE, CA:
2,764,714, INT. CL. 9.
- ARTHUR CRACK LIMITED, KENT, UNITED KINGDOM:
2,764,142, PUB. 6-24-2003. INT. CL. 33.
- ARTHUR LIBERMAN, M.D., P.A., SHORT HILLS, NJ:
2,012,225, CANC. INT. CL. 5.
- ARTISTDIRECT, INC., LOS ANGELES, CA:
2,764,726, INT. CL. 9.
- ARTWORKS PARTNERS, LLC, CINCINNATI, OH:
2,765,477, INT. CL. 41.
- ARUMEHSOFT, INC., CHICAGO, IL:
2,011,880, CANC. INT. CL. 9.
- AS WE GROW LLC, SEATTLE, WA:
2,765,716, INT. CL. 18.
- ASAHI MEDICAL CO., LTD., CHIYODA-KU, TOKYO, JAPAN:
2,764,730, MULTIPLE CLASS, INT. CLS. 9 AND 10.
- ASBURY AUTOMOTIVE GROUP L.L.C., STAMFORD, CT:
2,765,297, INT. CL. 37.
- ASCEND COMMUNICATIONS, INC., SAN FRANCISCO, CA TO ASCEND COMMUNICATIONS, INC., ALAMEDA, CA:
1,727,190, CANC. INT. CL. 9.
- ASEPTICO, INC., WOODINVILLE, WA:
2,763,740, PUB. 6-24-2003. INT. CL. 10.
- ASESORIA Y DESARROLLOS URREA, S.A. DE C.V., GUADALAJARA, JALISCO C.P. 44940, MEXICO:
2,763,366, PUB. 6-24-2003. INT. CL. 8.
- ASGROW SEED COMPANY, KALAMAZOO, MI:
2,011,823, CANC. INT. CL. 31.
- ASHLAND INC., LEXINGTON, KY:
1,728,678, CANC. INT. CL. 34.
- ASHLEY NETTIE, INC., NEW YORK, NY:
2,764,103, PUB. 6-24-2003. INT. CL. 25.
- ASHWORTH, INC., CARLSBAD, CA:
2,763,377, PUB. 6-24-2003. INT. CL. 14.
- ASM INTERNATIONAL N.V., 3723 BC BILTHOVEN, NETHERLANDS:
2,763,630, PUB. 6-24-2003. INT. CL. 7.
- ASOCIACION NACIONAL DEL CAFE, GUATEMALA CITY, GUATEMALA:
2,764,898, INT. CL. 30.
- ASPEN BENEFITS GROUP, INC., COEUR D'ALENE, ID:
2,765,281, INT. CL. 5.
- ASPEN INSTITUTE FOR HUMANISTIC STUDIES, NEW YORK, NY:
1,213,879, CANC. INT. CL. 16.
- ASPENWOOD ADVERTISING, INC., MINERAL WELLS, WV:
2,765,319, INT. CL. 35.
- ASSETHOUSE TECHNOLOGY LIMITED, GUILDFORD, SURREY, GU2 7RF, UNITED KINGDOM:
2,765,884, MULTIPLE CLASS, INT. CLS. 9, 35, 38 AND 42.
- ASSISTANCE FOOD AMERICA INC, MIAMI BEACH, FL:
2,764,248, PUB. 6-24-2003. INT. CL. 29.
- ASSOCIATED MATERIALS, INCORPORATED D/B/A AL-SIDE, CUYAHOGA FALLS, OH:
2,764,215, PUB. 6-24-2003. INT. CL. 19.
- ASSOCIATES OF CAPE COD, INCORPORATED, FALMOUTH, MA:
2,765,660, INT. CL. 9.
- ASSOCIATION OF AUTOMOTIVE AFTERMARKET DISTRIBUTORS, INC., MEMPHIS, TN:
1,728,061, CANC. INT. CL. 35.
- ASSOCIATION OF WEDDING GOWN SPECIALISTS, ORANGE, CT:
2,765,392, INT. CL. 37.
- ASTARTE FIBER NETWORKS, INC., BOULDER, CO:
1,727,219, CANC. INT. CL. 9.
- ASTRAZENECA AB, SWEDEN:
2,763,448, PUB. 1-21-2003. INT. CL. 5.
- ASTRUP COMPANY, CLEVELAND, OH:
2,765,787, INT. CL. 24.
- ASYST TECHNOLOGIES, INC., FREMONT, CA:
2,764,625, MULTIPLE CLASS, INT. CLS. 7 AND 9.
- AT WORK SALES CORPORATION, ORANGE BEACH, AL:
2,765,503, INT. CL. 25.
- AT&T CORP., NEW YORK, NY:
1,728,148, CANC. INT. CL. 36.
2,011,940, CANC. INT. CL. 38.
2,012,329, CANC. INT. CL. 9.
2,012,330, CANC. INT. CL. 9.
2,012,331, CANC. INT. CL. 9.
- ATHLON PHARMACEUTICALS, INC., BIRMINGHAM, AL:
2,764,357, PUB. 6-24-2003. INT. CL. 5.
- ATLANTEK MICROSYSTEMS PTY. LTD., MAWSON LAKES, AUSTRALIA:
2,764,152, PUB. 6-24-2003. INT. CL. 9.
- ATLANTIC RICHFIELD COMPANY, LOS ANGELES, CA:
1,214,243, CANC. INT. CL. 30.
- ATLANTIC STATES BANK, FORT MYERS, FL:
2,765,494, INT. CL. 36.
- ATLANTIC STATION LLC, ATLANTA, GA FROM ATLANTIC REDEVELOPMENT, L.L.C., ATLANTA, GA:
2,765,511, MULTIPLE CLASS, INT. CLS. 36 AND 37.
- ATLANTIC STATION, L.L.C., ATLANTA, GA FROM ATLANTIC REDEVELOPMENT, L.L.C., ATLANTA, GA:
2,765,509, MULTIPLE CLASS, INT. CLS. 36 AND 37.
- ATLANTIC WHOLESALERS INC., BROOKLYN, NY:
2,763,454, PUB. 6-24-2003. INT. CL. 12.
- ATLAS HOTELS, INC., SAN DIEGO, CA:
1,214,102, CANC. INT. CL. 25.
- ATLAS IMPORTS-EXPORTS, INC., BURLINGAME, CA, DBA ATLAS ASIA PACIFIC:
1,808,286, CANC. INT. CL. 1.
- ATLAS POWDER COMPANY, DALLAS, TX TO ORICA EXPLOSIVES TECHNOLOGY PTY LTD., MELBOURNE, VICTORIA 3001, AUSTRIA:
1,715,502, CANC. INT. CL. 13.
- ATM BENEFITS AND SERVICES LLC:
See— FSV PAYMENT SYSTEMS LTD.
- ATMEL CORPORATION, SAN JOSE, CA FROM ATMEL CORPORATION, SAN JOSE, CA:
2,764,526, INT. CL. 9.
- ATOFINA, 92800 PUTEAUX, FRANCE:
2,764,980, MULTIPLE CLASS, INT. CLS. 1, 3 AND 5.
- ATOMIC AUSTRIA GMBH, A-5541 ALTENMARKT, AUSTRIA:
2,703,787, COR. MULTIPLE CLASS, INT. CLS. 25 AND 28.
- ATRIUS TECHNOLOGIES, INC., FLOWER MOUND, TX:
2,012,442, CANC. INT. CL. 9.
- AUDIOVISUAL PRODUCERS, INC., FORT MYERS, IN:
1,214,395, CANC. INT. CL. 41.
- AUSON AB, SE-42147 VASTRA FROLUNDA, SWEDEN:
2,763,842, PUB. 6-24-2003. INT. CL. 17.
- AUSTIN QUANTUM SYSTEMS, INC., AUSTIN, TX:
2,763,075, PUB. 6-24-2003. INT. CL. 42.
- AUSTRALIAN BODY CARE ENTERPRISES, INC., SPARKS, NV:
2,012,853, CANC. INT. CL. 5.
- AUTO DETAILING SOLUTIONS, GILBERT, AZ:
2,764,407, PUB. 6-24-2003. INT. CL. 41.

AUTODESK, INC., SAN RAFAEL, CA:
2,012,510, CANC. INT. CL. 9.

AUTOMATED TRACKING SYSTEMS, INC., HUDSON, OH:
2,011,859, CANC. INT. CL. 35.

AUTOMATIC BUSINESS PRODUCTS, INC., NEW SMYRNA BEACH, FL:
2,012,859, CANC. INT. CL. 16.

AUTOMOTIVE SUPPLY COMPANY OF SOUTHERN CALIFORNIA, FONTANA, CA:
2,011,291, CANC. INT. CL. 7.

AUTONATION HOLDING CORP., FORT LAUDERDALE, FL FROM AUTONATION, INC., FORT LAUDERDALE, FL:
2,764,725, MULTIPLE CLASS, INT. CLS. 36 AND 39.

AUTOZONE, INC.:
1,728,577, CANC. INT. CL. 12.

AUTOZONE, INC., MEMPHIS, TN:
2,763,813, PUB. 6-24-2003. MULTIPLE CLASS, INT. CLS. 7 AND 9.

AVALON HILL GAME COMPANY, THE, BALTIMORE, MD:
1,214,161, CANC. INT. CL. 28.

AVANT-GARDE OPTICS, INC., PORT WASHINGTON, NY:
1,728,201, CANC. INT. CL. 39.

AVENTIS CROPS SCIENCE S.A. (SOCIETE ANONYME), 69009 LYON, FRANCE:
2,763,164, PUB. 2-4-2003. MULTIPLE CLASS, INT. CLS. 35 AND 38.

AVENTIS PHARMA HOLDING GMBH, FED REP GERMANY FROM HOECHST MARION ROUSSEL AG, FRANKFURT AM MAIN, FED REP GERMANY:
2,763,047, PUB. 6-24-2003. INT. CL. 5.

AVENTIS PHARMA S.A., BRIDGEWATER, NJ:
2,764,251, PUB. 6-24-2003. INT. CL. 5.

AVENUE A, INC., SEATTLE, WA:
2,765,675, INT. CL. 42.

AVFUEL CORPORATION, ANN ARBOR, MI:
1,773,248, REN. 8-8-03. INT. CL. 42.

AVIARA LAND ASSOCIATES LIMITED PARTNERSHIP, CARLSBAD, CA:
1,781,505, REN. 8-6-03. INT. CL. 25.

AVID OUTDOOR L.L.C., OLATHE, KS:
2,012,072, CANC. INT. CL. 22.

AVIONICS SPECIALTIES, INC., EARLYSVILLE, VA:
2,764,654, INT. CL. 9.

AVON PRODUCTS, INC., NEW YORK, NY:
2,012,923, CANC. INT. CL. 3.
2,765,581, INT. CL. 3.
2,765,590, INT. CL. 3.
2,765,695, INT. CL. 4.

AWAKE, INC., SAN FERNANDO, CA:
2,764,981, INT. CL. 25.

AXELROD, STEVE, W., FLINT, TX:
2,765,691, INT. CL. 28.

AXIA INCORPORATED, STATESVILLE, NC:
2,763,982, PUB. 6-24-2003. INT. CL. 7.

AYOMA INC., SAN FRANCISCO, CA FROM SHERIDAN INTERNATIONAL LTD., TOKYO, JAPAN:
2,764,651, MULTIPLE CLASS, INT. CLS. 3 AND 41.

AYRTON SENNA PROMOCOES E EMPREEDIMENTOS S/C LTDA., 02037-000 SAO PAULO, SP, BRAZIL:
2,764,671, INT. CL. 14.

AZEOTECH, INC., ASHLAND, OR:
2,764,413, PUB. 6-24-2003. INT. CL. 9.

A2D LP, HUMBLE, TX:
2,765,668, INT. CL. 35.

B & B CATERING, INC., CHICAGO, IL:
1,214,471, CANC. INT. CL. 42.

B & D PRODUCTIONS, ALEXANDRIA, KY:
2,011,678, CANC. INT. CL. 25.

B. BROS. PACKAGING, INC., EAGAN, MN:
2,764,100, PUB. 6-24-2003. INT. CL. 1.
2,764,101, PUB. 6-24-2003. INT. CL. 1.

B.F.C. INTERNATIONAL, INC., EL PASO, TX:
2,764,829, INT. CL. 41.

BABCOCK, JOSEPH T., FRANKLIN, TN:
2,763,667, PUB. 6-24-2003. INT. CL. 41.

BABE FARMS, INC., SANTA MARIA, CA:
2,765,714, INT. CL. 30.

BACHMAN, ALAN B., APPLE VALLEY, MN:
2,186,678, CANC. MULTIPLE CLASS, INT. CLS. 36 AND 42.

BACKSLAP ENTERTAINMENT INC., NEW YORK, NY:
2,765,538, INT. CL. 41.

BADGER METAL TECH, INC., MENOMONEE FALLS, WI:
2,011,719, CANC. INT. CL. 40.

BAIT CARE COMPANY, THE, CHALFON, PA:
2,765,061, INT. CL. 1.

BAKER HUGHES INCORPORATED, HOUSTON, TX:
1,726,832, CANC. INT. CL. 1.

BALL, TROY, E., TARPON SPRINGS, FL:
2,765,794, INT. CL. 42.

BALLARINI, PAOLO & FIGLI SPA, 46017 RIVAROLO MANTOVANO (MN), ITALY:
2,764,547, INT. CL. 21.

BALLY TOTAL FITNESS HOLDING CORPORATION, CHICAGO, IL, VERTICAL FITNESS & RACQUET CLUB, LTD., NEW YORK, NY:
1,773,050, REN. 8-5-03. INT. CL. 25.

BALZERS AKTIENGESELLSCHAFT, FURSTENTUM, LIECHTENSTEIN:
2,012,455, CANC. INT. CL. 9.

BANC ONE CORPORATION, COLUMBUS, OH:
2,012,588, CANC. INT. CL. 36.

BANDAI CO., LTD., TOKYO, JAPAN:
2,764,297, PUB. 6-24-2003. INT. CL. 9.

BANGKOK MARKET, INC., MAYWOOD, CA:
2,765,284, MULTIPLE CLASS, INT. CLS. 29, 30 AND 31.

BANK OF AMERICA CORPORATION, CHARLOTTE, NC:
2,765,619, MULTIPLE CLASS, INT. CLS. 9 AND 36.

BANKAMERICA BUSINESS CREDIT, INC. AS AGENT, PASADENA, CA:
2,393,808, COR. MULTIPLE CLASS, INT. CLS. 12 AND 41.

BANKNORTH GROUP, INC., PORTLAND, ME:
2,765,661, INT. CL. 36.

BANYAN RESEARCH, INC., CHARLOTTE, NC:
2,012,290, CANC. INT. CL. 20.

BARCHAS, SARAH, SONOITA, AZ, DBA HIGH HAVEN MUSIC:
2,764,279, PUB. 6-24-2003. INT. CL. 9.

BARCO INDUSTRIES, INC., READING, PA:
1,774,963, REN. 8-6-03. INT. CL. 8.

BARNES, JOHN WILLIAM, NASHVILLE, TN:
2,764,758, MULTIPLE CLASS, INT. CLS. 16 AND 25.

BARRERA, ALBERTO ANCHUSTEGUI, 54840 ESTADO DE MEXICO, MEXICO:
2,764,733, INT. CL. 39.

BARRINGTON GROUP, LTD., THE, GREEN BAY, WI:
2,011,472, CANC. INT. CL. 36.
2,011,473, CANC. INT. CL. 36.

BARRY CALLEBAUT NEDERLAND B.V., NL-1406 BA BUSSUM, NETHERLANDS, BENS DORP N. V., BUSSUM KINGDOM, NETHERLANDS:
580,682, REN. 8-2-03. U.S. CL. 46 (INT. CL. 30).

BARRY CALLEBAUT NEDERLAND B.V., NL-1406 BA BUSSUM, NETHERLANDS, CACAO-EN CHOCOLADE-FABRIEKEN BENS DORP N.V., BASSUM, NETHERLANDS:
953,195, REN. 8-2-03. U.S. CL. 46 (INT. CLS. 29 AND 30).

BARTH, ELLEN S., COLUMBIA, MD:
2,012,439, CANC. INT. CL. 42.

BARTLETT, GREG, A, CORONA, CA:
2,764,109, PUB. 6-24-2003. INT. CL. 29.

BARTON BRANDS, LTD., CHICAGO, IL:
740,135, CANC. U.S. CL. 49.

BASF AKTIENGESELLSCHAFT, LUDWIGSHAFEN AM RHEIN, FED REP GERMANY:
2,764,624, INT. CL. 1.

BASF CORPORATION, PARSIPPANY, NJ:
2,012,255, CANC. INT. CL. 42.

BASIC COMFORT, INC., DENVER, CO:
2,764,404, PUB. 6-24-2003. INT. CL. 20.
2,764,420, PUB. 6-24-2003. INT. CL. 20.
2,764,422, PUB. 6-24-2003. INT. CL. 24.

BASS BARBARIANS, INC., HAYWARD, CA:
2,764,609, INT. CL. 28.

- BATCHBAKERS L.L.C., EDEN PRAIRIE, MN:
2,011,709, CANC. INT. CL. 30.
- BATES FABRICS, INC., LEWISTON, ME:
1,214,035, CANC. INT. CL. 24.
- BATESVILLE SERVICES, INC., BATESVILLE, IN:
2,764,577, MULTIPLE CLASS, INT. CLS. 9, 16, 20, 35, 41 AND 42.
- BAUSCH & LOMB INCORPORATED, ROCHESTER, NY:
2,012,709, CANC. INT. CL. 9.
2,765,652, INT. CL. 9.
- BAVARIA LEDERVEREDELUNG GMBH, D-71723 GROSS-BOTTWAR, FED REP GERMANY:
2,682,785, COR. MULTIPLE CLASS, INT. CLS. 12, 18 AND 24.
- BAXTER INTERNATIONAL INC.:
1,214,016, CANC. INT. CL. 21.
- BAYDON SOLUTIONS LTD, DUBLIN, IRELAND:
2,764,170, PUB. 6-24-2003. INT. CL. 9.
- BAYER CORPORATION, ELKHART, IN:
1,726,958, CANC. INT. CL. 5.
2,011,957, CANC. INT. CL. 16.
- BAYER POLYMERS LLC, PITTSBURGH, PA FROM BAYER CORPORATION, PITTSBURGH, PA:
2,765,622, INT. CL. 1.
- BAYERISCHE HYPO- UND VEREINSBANK AG, D-80538 MUNICH, FED REP GERMANY:
2,763,755, PUB. 6-24-2003. INT. CL. 36.
- BAYLOR UNIVERSITY, WACO, TX:
2,764,260, PUB. 6-24-2003. INT. CL. 41.
- BAZAR GROUP, INC., THE, EAST PROVIDENCE, RI, I.P.S. JEWELRY, INC., EAST PROVIDENCE, RI, DBA IMPERIAL PEARL SYNDICATE, INC.:
1,244,398, REN. 8-7-03. INT. CL. 14.
- BB TECHNOLOGIES, INC., WILMINGTON, DE:
2,012,935, CANC. INT. CL. 16.
2,763,327, PUB. 6-24-2003. MULTIPLE CLASS, INT. CLS. 37 AND 42.
- BBA HOLDINGS, INC., WILMINGTON, DE:
2,765,062, MULTIPLE CLASS, INT. CLS. 20, 24 AND 35.
- BDH TWO, INC., WILMINGTON, DE TO WDP INVESTMENTS, INC., WILMINGTON, DE:
1,727,807, CANC. INT. CL. 27.
- BEACHWOOD PACKAGING CORPORATION, BEACHWOOD, OH:
2,765,353, INT. CL. 35.
- BEAR STEARNS COMPANIES INC., THE, NEW YORK, NY FROM BEAR STEARNS COMPANIES INC., THE, NEW YORK, NY:
2,764,900, INT. CL. 36.
- BEATNIK, INC., SAN MATEO, CA:
2,765,574, MULTIPLE CLASS, INT. CLS. 9, 16 AND 42.
- BEATTIE, TERRANCE JAMES, COSTA MESA, CA:
2,011,540, CANC. INT. CL. 42.
- BEATY FERTILIZER AND CHEMICAL COMPANY, INC., CLEVELAND, TN, DBA BEATY FERTILIZER COMPANY:
1,796,199, REN. 8-6-03. INT. CL. 1.
- BEAUTY HOLDING COMPANY, INC., HAMILTON HM12, BERMUDA FROM SALLY BEAUTY HOLDINGS, INC., HAMILTON HM 12, BERMUDA:
2,763,114, PUB. 6-24-2003. INT. CL. 35.
- BEAUTY HOLDING COMPANY, INC., HAMILTON HM12, BERMUDA FROM SALLY BEAUTY HOLDINGS, INC., HAMILTON, BERMUDA:
2,765,631, INT. CL. 3.
2,765,664, INT. CL. 3.
2,765,665, INT. CL. 3.
- BEAUTY HOLDING COMPANY, INC., HAMILTON, BERMUDA:
2,765,791, INT. CL. 21.
- BEB HOGAN CO., FORTH WORTH, TX:
1,213,964, CANC. MULTIPLE CLASS, INT. CLS. 18, 25 AND 28.
- BECHTOLD, JOSEPH A., CLEVELAND, OH:
2,765,346, INT. CL. 25.
2,765,347, INT. CL. 25.
2,765,348, INT. CL. 25.
- BECO, INC., PARK RIDGE, IL:
1,728,734, CANC. INT. CL. 35.
- BEDFORD INDUSTRIES, INC., WORTHINGTON, MN:
2,765,928, INT. CL. 10.
- BEHR GMBH & CO., D-70449 STUTTGART, FED REP GERMANY:
2,545,896, COR. MULTIPLE CLASS, INT. CLS. 7, 9, 11, 12 AND 37.
- BEICIP-FRANLAB, RUEIL MALMAISON, FRANCE:
2,763,237, PUB. 6-24-2003. MULTIPLE CLASS, INT. CLS. 9, 35 AND 42.
- BEIZER, ARNOLD L., HARTFORD, CT:
1,727,159, CANC. MULTIPLE CLASS, INT. CLS. 9 AND 16.
- BELKNAP, INC., LOUISVILLE, KY:
740,014, CANC. U.S. CL. 31.
- BELL & HOWELL INFORMATION AND LEARNING COMPANY, ANN ARBOR, MI TO BELL & HOWELL INFORMATION AND LEARNING COMPANY, ANN ARBOR, MI:
2,726,294, COR. MULTIPLE CLASS, INT. CLS. 38, 39 AND 41.
- BELL ATLANTIC CORPORATION, NEW YORK, NY:
1,728,175, CANC. INT. CL. 38.
- BELL/AGUSTA AEROSPACE COMPANY LLC, FORT WORTH, TX:
2,763,185, PUB. 6-11-2002. INT. CL. 42.
- BELLSOUTH CORPORATION, ATLANTA, GA:
2,011,506, CANC. INT. CL. 42.
- BELLSOUTH INTELLECTUAL PROPERTY CORPORATION, WILMINGTON, DE:
2,765,534, INT. CL. 38.
- BELZONA POLYMERICS LIMITED, NORTH YORKSHIRE, HG1 4AY, UNITED KINGDOM:
2,763,056, PUB. 3-7-2000. MULTIPLE CLASS, INT. CLS. 1 AND 2.
- BEMISS-JASON CORPORATION, NEWARK, CA:
1,727,847, CANC. INT. CL. 28.
- BENETTON GROUP S.P.A., TREVISO, ITALY:
2,763,332, PUB. 6-24-2003. INT. CL. 25.
- BENJI'S BED AND BREAKFAST, NORTON, MA:
2,764,708, INT. CL. 42.
- BENOW, INC., BEVERLY, MA FROM BENOW, INC., WAKEFIELD, MA:
2,765,626, INT. CL. 35.
- BENZIGER FAMILY WINERY LLC, GLEN ELLEN, CA:
2,764,823, INT. CL. 33.
- BERGEN BRUNSWIG CORPORATION, ORANGE, CA:
2,011,922, CANC. INT. CL. 9.
- BERKEBILE OIL COMPANY, INC., THE, SOMERSET, PA:
1,730,502, REN. 8-5-03. MULTIPLE CLASS, INT. CLS. 1, 2 AND 3.
- BERNARD ET CIE - LES SUCESSEURS DE PREGERMAN, 86310 SAINT SAVIN, FRANCE:
2,764,729, INT. CL. 25.
- BERNARDAUD PORCELAINES DE LIMOGES, S.A., 87000 LIMOGES, FRANCE:
2,763,073, PUB. 6-24-2003. MULTIPLE CLASS, INT. CLS. 4 AND 21.
- BERNAT YARN & CRAFT CORPORATION, UXBRIDGE, MA:
740,097, CANC. U.S. CL. 43.
- BERNSTEIN; RICHARD K., MAMARONECK, NY:
1,242,038, REN. 8-7-03. INT. CL. 16.
- BERTHOLD TYPES LIMITED, CHICAGO, IL:
1,727,475, CANC. INT. CL. 16.
1,727,528, CANC. INT. CL. 16.
- BET INTERACTIVE, L.L.C., WASHINGTON, DC:
2,764,018, PUB. 6-24-2003. INT. CL. 38.
- BETA PHARMA, INC., NEW HAVEN, CT:
2,763,277, PUB. 6-24-2003. INT. CL. 5.
- BETZ LABORATORIES, INC., TREVISO, PA:
2,012,479, CANC. INT. CL. 1.
- BEYOND SECURITY LTD., KFAR SABA, ISRAEL:
2,764,982, INT. CL. 42.
- BFC TEQUILA LIMITED, DUBLIN 22, IRELAND:
2,764,655, INT. CL. 33.
- BGR INFOTECH, INC., COLUMBIA, MD:
2,765,895, INT. CL. 41.

- BI PROPERTIES INC., GREENSBORO, NC:
1,727,698, CANC. INT. CL. 24.
- BI-RITE CORPORATION, WHEELING, IL:
2,012,070, CANC. INT. CL. 18.
2,012,071, CANC. INT. CL. 18.
- BIANCA USA INC., NEW BRUNSWICK, NJ:
2,763,929, PUB. 6-24-2003. INT. CL. 24.
- BIANCO, MONICA, ITALY:
2,764,613, MULTIPLE CLASS, INT. CLS. 18, 24 AND 25.
- BIC CORPORATION, MILFORD, CT:
2,765,738, INT. CL. 16.
- BICICLETAS DE ALAVA, S.A., 01006 VITORIA (ALAVA), SPAIN:
2,763,326, PUB. 6-24-2003. INT. CL. 12.
- BIDZ.COM, INC., LOS ANGELES, CA:
2,763,298, PUB. 6-24-2003. INT. CL. 35.
- BIELINSKI BROS. BUILDERS, INC., WAUKESHA, WI:
2,763,738, PUB. 6-24-2003. INT. CL. 37.
- BIG BENDS, LLC, PLAINWELL, MI:
2,764,088, PUB. 6-24-2003. INT. CL. 4.
- BIG ENTERTAINMENT, INC., BOCA RATON, FL:
2,012,357, CANC. INT. CL. 42.
- BILLY MARTIN'S WESTERN WEAR LA, INC., LOS ANGELES, CA:
2,764,230, PUB. 6-24-2003. INT. CL. 35.
- BINAR GRAPHICS, INC., SAN RAFAEL, CA:
2,011,310, CANC. MULTIPLE CLASS, INT. CLS. 9 AND 42.
- BINNEY & SMITH INC., EASTON, PA:
1,213,926, CANC. INT. CL. 16.
1,214,166, CANC. INT. CL. 28.
- BIO-CON LABS, INC., GAINESVILLE, FL:
2,011,986, CANC. INT. CL. 11.
- BIODERM, INC., TAMPA, FL:
2,012,135, CANC. MULTIPLE CLASS, INT. CLS. 5 AND 10.
- BIOMET, INC., WARSAW, IN:
2,764,510, INT. CL. 16.
- BIONORICA ARZNEIMITTEL GMBH, 92318 NEUMARKT, FED REP GERMANY:
1,726,952, CANC. INT. CL. 5.
- BIOSAFE SYSTEMS LLC, GLASTONBURY, CT:
2,765,685, INT. CL. 1.
- BIOSPHERE MEDICAL INC., ROCKLAND, MA:
2,764,226, PUB. 6-24-2003. INT. CL. 10.
- BIOTONIX INC., MONTREAL, QUEBEC, CANADA:
2,763,274, PUB. 6-24-2003. MULTIPLE CLASS, INT. CLS. 9 AND 42.
- BIRAL A/S, NEW YORK, NY, BIRAL LUBRICANTS NORWAY A/S, OSLO 5, NORWAY:
1,222,299, REN. 8-5-03. INT. CL. 4.
- BIRCH, WILLIAM B., ETNA, NH:
2,012,448, CANC. INT. CL. 9.
- BIRCHWOOD LABORATORIES, INC., EDEN PRAIRIE, MN:
1,197,582, REN. 8-4-03. INT. CL. 2.
- BIRD INCORPORATED:
1,213,987, CANC. INT. CL. 19.
- BIRD3, LAGUNA BEACH, CA:
2,763,291, PUB. 6-24-2003. INT. CL. 41.
- BISHOP, LEE N., BRANDON, FL:
2,012,720, CANC. INT. CL. 25.
- BIX PIX ENTERTAINMENT, INC., CHICAGO, IL:
2,764,393, PUB. 6-24-2003. INT. CL. 41.
- BJC HEALTH SYSTEM, ST. LOUIS, MO:
2,765,318, INT. CL. 35.
- BLAA LONID H.F. (BLUE LAGOON LTD.), 240 GRINDAVIK ISX, ICELAND TO BLUE LAGOON LTD., 240 GRINDAVIK, ICELAND:
2,708,245, COR. MULTIPLE CLASS, INT. CLS. 3, 5, 21, 24, 25, 32, 39 AND 42.
- BLACK FISH TRADING CO., BREWSTER, MA:
2,012,833, CANC. INT. CL. 25.
- BLACKETER, LOUANN, CANON CITY, CO:
2,764,187, PUB. 6-24-2003. INT. CL. 35.
- BLAIR, RICHARD L., LAKE ARROWHEAD, CA:
2,763,984, PUB. 6-24-2003. INT. CL. 31.
- BLANCHARD TRAINING AND DEVELOPMENT, INC., ESCONDIDO, CA:
2,765,271, INT. CL. 16.
- BLISS WORLD LLC, BROOKLYN, NY:
2,764,930, INT. CL. 3.
- BLIZZARD GESELLSCHAFT M.B.H., MITTERSILL, AUSTRIA:
1,214,154, CANC. INT. CL. 28.
- BLOCK FINANCIAL CORPORATION, KANSAS CITY, MO:
2,012,662, CANC. INT. CL. 9.
- BLOCKBUSTER INC., DALLAS, TX:
2,763,900, PUB. 6-24-2003. INT. CL. 28.
2,763,967, PUB. 6-24-2003. INT. CL. 41.
2,763,968, PUB. 6-24-2003. INT. CL. 41.
2,763,969, PUB. 6-24-2003. INT. CL. 41.
- BLUE CROSS AND BLUE SHIELD OF NEBRASKA, OMAHA, NE:
2,764,702, INT. CL. 9.
- BLUE RIDGE CAPITAL, L.L.C., NEW YORK, NY:
2,763,077, PUB. 7-23-2002. INT. CL. 36.
- BLUEARC CORPORATION, MOUNTAIN VIEW, CA:
2,764,965, MULTIPLE CLASS, INT. CLS. 9 AND 16.
- BLUEDESERT, LTD., KFAR MONASH, ISRAEL FROM BLUEDESERT LTD., KFAR MONASH, ISRAEL:
2,765,343, INT. CL. 18.
- BLUESOCKET, INC., BURLINGTON, MA:
2,765,016, MULTIPLE CLASS, INT. CLS. 9, 37 AND 42.
- BMG IMPORT-EXPORT, INC., NEW YORK, NY:
2,765,575, INT. CL. 25.
- BMG SPECIAL PRODUCTS, INC., NEW YORK, NY, ESSEX ENTERTAINMENT, INC., ENGLEWOOD CLIFFS, NJ:
1,771,212, REN. 8-6-03. INT. CL. 9.
- BNL EUROLENS, 01200 BELLEGARDE SUR VALSERINE, FRANCE:
2,763,924, PUB. 6-24-2003. INT. CL. 9.
- BOARD OF TRUSTEES OF THE ILLINOIS MATHEMATICS AND SCIENCE ACADEMY, AURORA, IL:
2,765,231, INT. CL. 42.
- BOAT LIFTS UNLIMITED, ODENTON, MD:
2,763,416, PUB. 8-13-2002. INT. CL. 7.
- BOATS N SUCH SUPERSTORES, INC., ORLANDO, FL FROM BOATS R US OF CENTRAL FLORIDA, INC., ORLANDO, FL:
2,765,067, MULTIPLE CLASS, INT. CLS. 35 AND 37.
- BOB JONES UNIVERSITY, INC., GREENVILLE, SC:
2,763,895, PUB. 6-24-2003. INT. CL. 41.
- BOBAROSA'S GOURMET, INC., CLEARWATER, FL:
2,765,929, INT. CL. 30.
- BOC GROUP PLC, THE, SURREY GU 20 6HJ, ENGLAND:
2,012,182, CANC. INT. CL. 5.
- BOCH, MICHAEL, S, RALEIGH, NC:
2,765,936, INT. CL. 35.
- BODDICKER, PAUL, CHANHASSEN, MN:
2,763,922, PUB. 6-24-2003. INT. CL. 35.
- BOEHME FILATEX, INC., REIDSVILLE, NC:
1,726,828, CANC. INT. CL. 1.
- BOEHRINGER INGELHEIM PHARMA KG, 55216 INGELHEIM AM RHEIN, FED REP GERMANY:
2,763,278, PUB. 6-24-2003. MULTIPLE CLASS, INT. CLS. 5 AND 10.
- BOGARD, 75015 PARIS, FRANCE:
2,763,158, PUB. 6-24-2003. INT. CL. 3.
- BOISE CASCADE CORPORATION, BOISE, ID:
740,040, CANC. U.S. CL. 37.
- BOISJOT, PATRICK, BRANFORD, CT, DBA LE PETIT CAFE:
2,011,651, CANC. INT. CL. 42.
- BOLTUN CORPORATION, TAINAN, TAIWAN:
1,825,742, REN. 8-6-03. INT. CL. 6.
- BOMBARDIER INC., MONTREAL, QUEBEC, CANADA:
2,012,232, CANC. INT. CL. 41.
- BOMBARDIER INC., VALCOURT, CANADA:
2,763,684, PUB. 6-24-2003. INT. CL. 12.
- BOMBARDIER INC., VALCOURT, QUEBEC:
2,763,685, PUB. 6-24-2003. INT. CL. 12.
- BONAR FLOORS LIMITED, DERBYSHIRE, DE5 3NT, ENGLAND:
2,763,095, PUB. 6-24-2003. INT. CL. 27.

- BONRAY DRILLING CORPORATION, OKLAHOMA CITY, OK:
1,214,337, CANC. INT. CL. 37.
- BOOKER, BRIAN C., CASTROVILLE, TX:
2,764,679, INT. CL. 37.
- BOOSTER ELECTRIC VEHICLES LIMITED, WEST YORKSHIRE HD3 3JB, UNITED KINGDOM:
2,011,277, CANC. INT. CL. 12.
- BOOTH ARLEN LEROY, HENRY, IL:
2,765,770, INT. CL. 24.
- BORDEN CHEMICAL INVESTMENTS, INC., WILMINGTON, DE, BORDEN, INC., COLUMBUS, OH:
1,251,443, REN. 8-4-03, INT. CL. 4.
- BORDERS PROPERTIES, INC., ANN ARBOR, MI:
2,011,801, CANC. INT. CL. 42.
- BOSCOMBE ENTERTAINMENT CORPORATION LIMITED, DORSET, UNITED KINGDOM FROM BOSCOMBE ENTERTAINMENT CORPORATION LIMITED, DORSET, UNITED KINGDOM:
2,764,868, MULTIPLE CLASS, INT. CLS. 9, 41 AND 42.
- BOSTON BROWNIE COMPANY, INC., AUBURNDALE, MA:
2,011,665, CANC. INT. CL. 30.
- BOSTWICK LABORATORIES OF AMERICA, LLC, RICHMOND, VA:
2,765,291, INT. CL. 44.
- BOURN & KOCH, INC., ROCKFORD, IL FROM FELLOWS CORPORATION, SPRINGFIELD, VT:
2,763,372, PUB. 6-24-2003, INT. CL. 9.
- BOWERS, NED C., LEESBURG, FL:
2,765,784, INT. CL. 6.
- BOWIT, LLC, COLUMBUS, OH:
2,765,541, INT. CL. 16.
- BOWRING, LARRY A., ARLINGTON, VA:
2,764,397, PUB. 6-24-2003, INT. CL. 16.
- BOY SCOUTS OF AMERICA, IRVING, TX:
2,765,350, INT. CL. 26.
- BR 111 IMPORTS & EXPORTS, INC., LAUREL, MD:
2,763,736, PUB. 6-24-2003, MULTIPLE CLASS, INT. CLS. 19 AND 35.
- BRADLEY, BURCE J., JEROME, ID:
2,765,865, INT. CL. 7.
- BRADLEY, SUSAN K., PALM BEACH GARDENS, FL:
2,763,687, PUB. 6-24-2003, MULTIPLE CLASS, INT. CLS. 9 AND 41.
- BRADY, CHRISTOPHER J., GRAND BLANC, MI AND WOODWARD, ORRIN A., GRAND BLANC, MI:
2,765,549, MULTIPLE CLASS, INT. CLS. 35 AND 41.
- BRAGANZA, MICHAEL V., OTTAWA, ONTARIO K2C 0V3, CANADA:
2,011,367, CANC. INT. CL. 35.
- BRAIN SURGERY WORLD WIDE, LLC, ATLANTA, GA:
2,363,047, COR. INT. CL. 35.
- BRANT CORPORATION, CONCORD, CA:
2,012,659, CANC. INT. CL. 3.
- BRASSFIELD, JERRY, LOS GATOS, CA:
2,764,622, INT. CL. 33.
- BRAVANTA, INC., SAN FRANCISCO, CA:
2,763,417, PUB. 6-24-2003, INT. CL. 35.
- BREAD & CIE, INC., SAN DIEGO, CA:
2,763,752, PUB. 6-24-2003, MULTIPLE CLASS, INT. CLS. 35 AND 43.
- BREAKTHROUGH, INC., LINCOLN, VA:
1,728,422, CANC. INT. CL. 42.
- BREVARO WORKFORCE DEVELOPMENT BOARD, INC., ROCKLEDGE, FL:
2,765,487, MULTIPLE CLASS, INT. CLS. 41 AND 42.
- BRI-LIN, INCORPORATED, ROCHESTER, NH:
2,764,329, PUB. 6-24-2003, INT. CL. 7.
- BRIAR PATCH PRIMITIVES, INC., ST. JOSEPH, MN:
2,764,077, PUB. 6-24-2003, INT. CL. 4.
- BRICKYARD TRADEMARKS, INC., HENDERSON, NV:
2,765,924, INT. CL. 41.
- BRIDGESTONE SPORTS CO., LTD., CHIYODA-KU, TOKYO 101, JAPAN:
2,265,263, CANC. INT. CL. 28.
- BRIGADE ELECTRONICS PLC, LONDON SE18 6BG, UNITED KINGDOM:
2,763,359, PUB. 6-24-2003, INT. CL. 9.
- BRIGGS MEDICAL SERVICES, INC., DES MOINES, IA:
2,012,773, CANC. INT. CL. 16.
- BRIGHT GRAY PRODUCTIONS, INC., WASHINGTON, DC:
2,011,713, CANC. INT. CL. 41.
- BRIGHT OF AMERICA, INC., OAKLAND, NJ, BRIGHT OF AMERICA, INC., SUMMERSVILLE, WV:
937,600, REN. 8-5-03, U.S. CL. 42 (INT. CL. 24).
- BRIGHT OF AMERICA, INC., SUMMERSVILLE, WV TO BRIGHT OF AMERICA, INC., OAKLAND, NJ:
937,600, CANC. U.S. CL. 38.
- BRING IT UP, INC., WESTLAKE VILLAGE, CA:
2,763,527, PUB. 6-24-2003, INT. CL. 3.
- BRITISH AIRWAYS PLC., WEST DRAYTON, UNITED KINGDOM:
2,763,343, PUB. 6-24-2003, MULTIPLE CLASS, INT. CLS. 35 AND 39.
- BRITISH KHAKI, INC., NEW YORK, NY:
1,727,726, CANC. INT. CL. 25.
- BRITTINGHAM SOFTWARE DESIGN, INC., CALIFON, NJ:
2,763,482, PUB. 6-24-2003, INT. CL. 9.
- BROADBAND SERVICES, INC., HIGHLANDS RANCH, CO:
2,765,851, INT. CL. 35.
- BROADBENT & WILLIAMS, INC., MADISON, WI:
2,012,068, CANC. INT. CL. 25.
- BROADCAST ELECTRONICS, INC., QUINCY, IL:
1,728,540, CANC. INT. CL. 9.
- BROADWAY FEAST CORPORATION, NEW YORK, NY:
2,764,494, MULTIPLE CLASS, INT. CLS. 21 AND 25.
- BROADWAY VIDEO, INC., NEW YORK, NY:
2,012,719, CANC. INT. CL. 16.
- BRONCO WINE COMPANY, CERES, CA:
2,764,056, PUB. 6-24-2003, INT. CL. 33.
2,765,507, INT. CL. 33.
- BRONDOW, INCORPORATED, HARRISON, NY:
1,726,904, CANC. INT. CL. 3.
- BROOKNAM ENTERTAINMENT, INC., BROOKLYN, NY:
2,764,604, MULTIPLE CLASS, INT. CLS. 25 AND 41.
- BROOKS BROTHERS, INC., NEW YORK, NY:
1,771,690, REN. 8-6-03, INT. CL. 30.
2,765,572, INT. CL. 25.
- BROTHA-MAN CO., BUFFALO GROVE, IL:
2,011,338, CANC. INT. CL. 25.
- BROTHER INDUSTRIES, LTD., NAGOYA, 467-8561, JAPAN:
1,774,210, REN. 8-5-03, INT. CL. 16.
- BROTHER INDUSTRY COMPANY, SAN JOSE, CA:
1,726,969, CANC. INT. CL. 5.
- BROUGHTON FARM SUPPLY, INC., BRIDPORT, VT:
2,763,502, PUB. 6-24-2003, INT. CL. 3.
- BROWN SUGAR DESIGNS, INC, TUSTIN, CA:
2,011,927, CANC. INT. CL. 9.
- BROWNE, ALAN J., VICTORVILLE, CA AND BROWNE, DOREEN M., VICTORVILLE, CA:
2,764,174, PUB. 6-24-2003, INT. CL. 25.
- BRUCE MAST & ASSOCIATES, INC., EXETER, NH:
2,763,623, PUB. 6-24-2003, INT. CL. 41.
- BRUCK LIGHTING SYSTEMS, INC., COSTA MESA, CA:
2,763,538, PUB. 6-24-2003, INT. CL. 11.
- BRUKER DALTONIK GMBH, D-28359 BREMEN, FED REP GERMANY:
2,763,414, PUB. 6-24-2003, INT. CL. 9.
- BRUNN, ALAN R., OWINGS MILLS, MD AND KNUPER, OTTO, OWINGS MILLS, MD:
2,011,479, CANC. MULTIPLE CLASS, INT. CLS. 29 AND 30.
- BRUSH WELLMAN, INC., CLEVELAND, OH:
2,011,518, CANC. MULTIPLE CLASS, INT. CLS. 1 AND 9.
- BS & B SAFETY SYSTEMS, INC., TULSA, OK:
2,764,516, INT. CL. 9.
- BT HUMAN RESOURCES CONSULTING, LLC, INDIANAPOLIS, IN:
2,765,825, INT. CL. 35.
- BTI AMERICAS, INC., NORTHBROOK, IL:
1,728,211, CANC. INT. CL. 39.
- BUBAR, DAVID N., DELMAR, NY:
2,763,491, PUB. 6-24-2003, INT. CL. 16.
- BUBBLE HEAD, INC., PENSACOLA, FL:
2,763,392, PUB. 6-24-2003, INT. CL. 21.

BUCKMAN LABORATORIES INTERNATIONAL, INC.,
MEMPHIS, TN:
2,764,721, INT. CL. 35.

BUCOL BUCHET-COLCOMBET, LYON, FRANCE:
1,214,027, CANC. MULTIPLE CLASS, INT. CLS. 24 AND
25.

BUDGETINNS.COM, INC, DENHAM SPRINGS, LA:
2,765,540, INT. CL. 42.

BUILD-A-BEAR WORKSHOP, INC., ST. LOUIS, MO:
2,765,702, INT. CL. 28.

BUITONI FOODS CORPORATION, SOUTH HACKENSACK,
NJ:
740,130, CANC. U.S. CL. 46.

BULL MOOSE MUSIC, PORTLAND, ME:
2,073,405, CANC. INT. CL. 35.

BUMBLE & BUMBLE OF MANHATTAN LTD., NEW YORK,
NY:
1,214,467, CANC. INT. CL. 42.

BUNGE CORPORATION, ST. LOUIS, MO:
2,012,130, CANC. MULTIPLE CLASS, INT. CLS. 29 AND
30.

BURCH CORPORATION, BIRMINGHAM, AL:
2,765,414, INT. CL. 11.

BUREAU OF THE PUBLIC DEBT, WASHINGTON, DC:
2,764,936, INT. CL. 9.

BURG AND ASSOCIATES, PLANO, TX:
2,765,450, INT. CL. 28.

BURLINGTON NORTHERN RAILROAD COMPANY, FORT
WORTH, TX TO BURLINGTON NORTHERN AND
SANTE FE RAILWAY COMPANY, THE, FORT WORTH,
TX:
1,728,576, CANC. INT. CL. 12.

BURNS BROS., INC., PORTLAND, OR:
2,012,224, CANC. INT. CL. 36.

BURNS-MILWAUKEE, INC., MILWAUKEE, WI:
1,762,681, REN. 8-6-03, INT. CL. 11.

BURROUGHS AND CHAPIN COMPANY, INC., MYRTLE
BEACH, SC:
2,764,040, PUB. 6-24-2003, INT. CL. 41.

BURROWS, SIBYL, W., NORTH RICHLAND HILLS, TX:
2,765,683, INT. CL. 6.

BUSCH PROPERTIES, INC., ST. LOUIS, MO:
1,791,969, REN. 8-6-03, INT. CL. 41.

BUSINESS NEWS PUBLISHING COMPANY II, LLC, TROY,
MI, CHILTON COMPANY, PHILADELPHIA, PA:
750,900, REN. 8-8-03, U.S. CL. 38 (INT. CL. 16).

BUTY-WAVE PRODUCTS CO., INC., LOS ANGELES, CA:
1,795,524, REN. 8-6-03, INT. CL. 3.

BUZZSAW.COM, SAN FRANCISCO, CA TO BUZZSAW-
COM, SAN FRANCISCO, CA:
2,654,802, COR. INT. CL. 9.

B2 HOLDINGS, LLC, AMHERST, MA:
2,765,720, INT. CL. 25.

C & K SYSTEMS, INC., FOLSOM, CA:
2,011,668, CANC. INT. CL. 9.

C I T C INC., CARLSTADT, NJ:
2,011,635, CANC. INT. CL. 29.

C.A.O. INTERNATIONAL, INC., NASHVILLE, TN:
2,765,489, INT. CL. 34.
2,765,490, INT. CL. 34.

C.A.S. SPORTS INTERNATIONAL INC., TORONTO, ON-
TARIO M6B 4J3, CANADA:
2,011,896, CANC. INT. CL. 28.

C.B. FLEET INVESTMENT CORPORATION, WILMING-
TON, DE, C. B. FLEET COMPANY, INCORPORATED,
LYNCHBURG, VA:
1,239,151, REN. 8-6-03, INT. CL. 5.

C.B. WEAR INC., WHITE PLAINS, NY:
2,011,496, CANC. INT. CL. 25.

C.I. FLORES CONDOR DE COLOMBIA S.A., 92331, BOGA-
TA, COLOMBIA, FLORES CONDOR DE COLOMBIA
LTDA., 92331, BOGOTA, COLOMBIA:
1,743,433, REN. 8-7-03, INT. CL. 31.

C.P. PAINTS, INC., PALM BEACH GARDENS, FL:
2,763,977, PUB. 6-24-2003, INT. CL. 2.

C-CURE CHEMICAL CO., INC., HOUSTON, TX:
1,310,598, CANC. INT. CL. 1.

CABELA'S INC., SIDNEY, NE:
1,800,806, REN. 8-2-03, INT. CL. 22.

CABLE & WIRELESS, INC., VIENNA, VA:
2,011,554, CANC. INT. CL. 38.

CABLEVISION SYSTEMS CORPORATION, WOODBURY,
NY:
2,120,173, CANC. INT. CL. 38.

CABRAIS, INC., LOS ANGELES, CA:
1,727,781, CANC. INT. CL. 25.

CADBURY LIMITED, BOURNVILLE, BIRMINGHAM, ENG-
LAND:
1,214,240, CANC. INT. CL. 30.

CADENCE DESIGN SYSTEMS, INC., SAN JOSE, CA:
2,011,757, CANC. INT. CL. 9.

CADUCIAN, INC., AUSTIN, TX:
2,764,755, MULTIPLE CLASS, INT. CLS. 9 AND 42.

CAE RANSOHOFF, INC., CINCINNATI, OH:
2,763,413, PUB. 6-24-2003, INT. CL. 7.

CAFE ENTERPRISES, INC., TAYLORS, SC:
2,764,091, PUB. 6-24-2003, INT. CL. 43.
2,764,092, PUB. 6-24-2003, INT. CL. 43.

CAFE Y COMPANIA SA. CAFE & CO. S.A., PEREIRA,
RISARALDA, COLOMBIA, DARIO CORREA PATINO &
CIA. S. EN C. S., 72441 PEREIRA, COLOMBIA:
1,705,253, REN. 8-4-03, INT. CL. 30.

CAFFE D'AMORE, INC., MONROVIA, CA:
2,764,045, PUB. 6-24-2003, INT. CL. 30.

CAIN SECURITY SYSTEMS, INC., ALEXANDRIA, VA, DBA
CAIN INTEGRATED SYSTEMS:
2,763,319, PUB. 6-24-2003, MULTIPLE CLASS, INT. CLS.
37 AND 42.

CAIN SECURITY SYSTEMS, INC., ALEXANDRIA, VA:
2,763,320, PUB. 6-24-2003, MULTIPLE CLASS, INT. CLS.
37 AND 42.

CAIN, MARTIN W., CHICAGO, IL:
2,012,267, CANC. INT. CL. 30.

CAIRE INC., BLOOMINGTON, MN:
2,012,210, CANC. INT. CL. 10.

CALIFORNIA AQUARIUM SUPPLY CORP., CERRITOS,
CA:
2,012,809, CANC. INT. CL. 16.

CALIFORNIA FAUCETS, HUNTINGTON BEACH, CA:
2,763,367, PUB. 6-24-2003, MULTIPLE CLASS, INT. CLS.
11 AND 21.

CALIFORNIA FEDERAL BANK, SAN FRANCISCO, CA:
2,763,590, PUB. 6-24-2003, INT. CL. 36.

CALIFORNIA INSTRUMENTS CORPORATION, SAN DIE-
GO, CA:
2,765,712, INT. CL. 7.

CALIFORNIA MILK PRODUCERS ADVISORY BOARD,
SOUTH SAN FRANCISCO, CA:
2,765,149, U.S. CL. A.

CALIFORNIA NEWSPAPERS PARTNERSHIP, DENVER,
CO:
2,764,016, PUB. 6-24-2003, INT. CL. 16.

CALIFORNIA SUPER NATURALS, INC., CITY OF COM-
MERCE, CA:
2,011,791, CANC. INT. CL. 29.

CALLAWAY GOLF COMPANY, CARLSBAD, CA, STAN
THOMPSON GOLF CLUB COMPANY, CULVER CITY,
CA:
1,239,514, REN. 8-4-03, MULTIPLE CLASS, INT. CLS. 25
AND 28.

CALLAWAY GOLF COMPANY, CARLSBAD, CA:
2,012,458, CANC. INT. CL. 28.
2,765,551, INT. CL. 28.
2,765,592, INT. CL. 25.
2,765,753, INT. CL. 25.

CALLIDUS TECHNOLOGIES, L.L.C., TYLER, TX:
2,765,138, INT. CL. 11.

CALLISON ARCHITECTURE, INC., SEATTLE, WA:
2,764,913, INT. CL. 42.

CALVET, 33300 BORDEAUX, FRANCE:
2,763,634, PUB. 6-24-2003, INT. CL. 33.

CALVILLO, JESUS E., SAN ANTONIO, TX:
2,763,161, PUB. 6-24-2003, INT. CL. 42.

- CALZATURIFICIO FRATELLI ROSSETTI S.P.A., MILAN, ITALY, CALZATURIFICIO ROSSETTI DEI F.LLI ROSSETTI RENATO E RENZO S.N.C., PARABIAGO, MILAN, ITALY:
959,447, REN. 8-2-03. U.S. CL. 39 (INT. CL. 25).
- CAM COMMERCE SOLUTIONS, INC., FOUNTAIN VALLEY, CA:
2,765,718, INT. CL. 35.
- CAM-BUILT PROGRAMMING PLUS, INC., BETHESDA, MD:
2,207,652, CANC. INT. CL. 42.
- CAMBRIDGE ASSOCIATES LLC, BOSTON, MA:
2,764,090, PUB. 6-24-2003. INT. CL. 36.
- CAMBRIDGE NEUROSCIENCE, INC., CAMBRIDGE, MA:
2,012,154, CANC. INT. CL. 5.
- CAMELBACK SKI CORPORATION, TANNERSVILLE, PA:
2,765,391, INT. CL. 41.
- CAMERON AUDIO NETWORKS, INC., DALLAS, TX:
2,011,900, CANC. MULTIPLE CLASS, INT. CLS. 38 AND 41.
- CAMILLUS CUTLERY CO., CAMILLUS, NY:
2,763,628, PUB. 6-24-2003. INT. CL. 8.
- CAMION TECHNOLOGIES, LLC, SHAWNEE, KS:
2,764,191, PUB. 6-24-2003. INT. CL. 42.
- CAMPISI FINANCIAL NETWORK, LLC, FAIRVIEW VILLAGES, PA:
2,765,237, INT. CL. 36.
- CAMPMINDER, LLC, NEW YORK, NY:
2,765,722, INT. CL. 42.
- CAMUS LA GRANDE MARQUE S.A., 16100 COGNAC, FRANCE:
1,727,996, CANC. INT. CL. 33.
- CAN, VIKTOR, LOS ANGELES, CA:
2,764,127, PUB. 10-9-2001. INT. CL. 14.
- CANADA LIFE ASSURANCE COMPANY, THE, ATLANTA, GA:
2,765,054, INT. CL. 36.
- CANADA WIRE AND CABLE LIMITED, DON MILLS, ONTARIO, CANADA:
1,213,818, CANC. MULTIPLE CLASS, INT. CLS. 9, 37, 38 AND 42.
- CANDLETREE COLLECTION, INC., THE, AIKEN, SC:
2,011,787, CANC. INT. CL. 21.
- CANDYBEARS LLC, LYNDHURST, NJ:
2,765,447, INT. CL. 30.
- CANNERY CASINO RESORTS, LLC, LAS VEGAS, NV:
2,764,094, PUB. 6-24-2003. INT. CL. 43.
2,764,095, PUB. 6-24-2003. INT. CL. 43.
- CANTERBURY ENGINEERING CO., INC., CHAMBLEE, GA:
1,728,353, CANC. INT. CL. 42.
- CANTERBURY ENTERPRISES, INC., CORONA, CA:
2,765,854, INT. CL. 21.
- CAP TOYS, INC., OAKLAND, NJ:
2,012,622, CANC. INT. CL. 30.
- CAPITAL BREWERY CO., INC., MIDDLETON, WI:
2,764,188, PUB. 6-24-2003. INT. CL. 32.
- CAPON, MICHAEL, KALISPELL, MT:
2,765,064, INT. CL. 25.
- CAPSICUM GROUP, L.L.C., BERWYN, PA FROM CAPSICUM GROUP, INC., BERWYN, PA:
2,765,339, INT. CL. 35.
- CAPSTONE PRESS, INC., MANKATO, MN:
2,763,151, PUB. 6-24-2003. INT. CL. 16.
- CAPUCINE & CAPUCIN, INC., NEW YORK, NY:
2,763,860, PUB. 6-24-2003. INT. CL. 25.
- CAR ELECTRONICS APS, COPENHAGEN, DENMARK:
2,764,687, INT. CL. 9.
- CAR WASH SUPERSTORE, LLC, COLLIERVILLE, TN:
2,765,919, INT. CL. 35.
- CARDOZA, MANNY G., SIMI VALLEY, CA:
2,012,369, CANC. INT. CL. 9.
- CARE REHAB & ORTHOPAEDIC PRODUCTS, INC., MCLEAN, VA:
2,763,892, PUB. 6-24-2003. INT. CL. 10.
- CAREY, MARK D., PUYALLUP, WA:
2,764,932, INT. CL. 41.
- CARIBBEAN CIGAR COMPANY, S.A., PANAMA CITY, PANAMA, NORTHSTAR IMPORTS, INC., MOUND, MN:
1,773,810, REN. 8-5-03. INT. CL. 34.
- CARITA, 75008 PARIS, FRANCE:
2,763,501, PUB. 6-24-2003. INT. CL. 44.
- CARLIN COMBUSTION TECHNOLOGY, INC., EAST LONGMEADOW, MA:
2,763,089, PUB. 4-30-2002. MULTIPLE CLASS, INT. CLS. 9 AND 11.
- CARLISE GROUP INSTRUMENTS, INC., THE, WALTHAM, MA, PHOTOVAC INC., THORNHILL, ONTARIO, CANADA:
1,220,637, REN. 8-4-03. INT. CL. 9.
- CARLTON CARDS, INC., DALLAS, TX:
1,213,910, CANC. INT. CL. 16.
- CARMICHAEL HOLDINGS, LLC, STURGIS, MI:
2,763,621, PUB. 6-24-2003. INT. CL. 9.
- CAROLINA MANUFACTURER'S SERVICE, INC., WINSTON-SALEM, NC:
2,012,854, CANC. INT. CL. 35.
- CARPENTER CO., RICHMOND, VA:
2,763,718, PUB. 6-24-2003. INT. CL. 20.
- CARPENTER PAPER COMPANY, GRAND RAPIDS, MI:
1,213,944, CANC. INT. CL. 16.
- CARROLL, LEO, SHELburne, VT:
2,011,575, CANC. INT. CL. 16.
- CARSMETICS, INC., CLEARWATER, FL:
2,763,846, PUB. 6-24-2003. INT. CL. 37.
- CARTER, RICKY S., PRAIRIEVILLE, LA:
2,764,189, PUB. 6-24-2003. INT. CL. 19.
- CARTOON NETWORK LP, LLLP, THE, ATLANTA, GA:
2,764,988, INT. CL. 28.
- CASCADE POLE AND LUMBER COMPANY, TACOMA, WA:
2,764,723, INT. CL. 19.
- CASCADE TOY, LTD., NORTH BEND, WA:
2,012,864, CANC. INT. CL. 28.
- CASE LOGIC, INC., LONGMONT, CO FROM H&L PRODUCTS, INC., RANCHO CUCAMONGA, CA:
2,765,617, INT. CL. 9.
- CASE MEDICAL, INC., RIDGEFIELD, NJ:
2,765,302, INT. CL. 3.
- CASEY'S FOOD PRODUCTS, INC., BLAKELY, GA:
1,727,889, CANC. INT. CL. 29.
- CASH MONEY CHEQUE CASHING INC., ETOBICOKE, ONTARIO M9R 3G1, CANADA:
2,763,218, PUB. 6-24-2003. MULTIPLE CLASS, INT. CLS. 16, 36, 38 AND 39.
- CASIO KEISANKI KABUSHIKI KAISHA, TOKYO, JAPAN, DBA CASIO COMPUTER CO., LTD.:
2,012,759, CANC. INT. CL. 9.
2,012,762, CANC. INT. CL. 9.
- CASIO KEISANKI KABUSHIKI KAISHA, SHINJUKU-KU, TOKYO, JAPAN, DBA CASIO COMPUTER CO., LTD.:
2,012,894, CANC. INT. CL. 14.
- CASSATT, CHRIS, ASPEN, CO:
2,012,862, CANC. INT. CL. 16.
- CASTER, 75008 PARIS, FRANCE:
2,763,765, PUB. 6-24-2003. INT. CL. 3.
2,763,766, PUB. 6-24-2003. INT. CL. 3.
- CASTROL LIMITED, SWINDON, WILTSHIRE, ENGLAND:
1,213,756, CANC. INT. CL. 4.
- CASTROL LIMITED, SWINDON, WILTSHIRE SN3 1RE, UNITED KINGDOM:
2,763,139, PUB. 6-24-2003. INT. CL. 4.
- CASTROL LIMITED, SWINDON, WILTSHIRE SN3 1RE, ENGLAND:
2,764,578, INT. CL. 37.
- CATALER CORPORATION, OGASA-GUN, SHIZUOKA-KEN, 437-1492, JAPAN:
2,764,533, INT. CL. 1.
- CATCO, INC., NEW YORK, NY:
2,012,871, CANC. INT. CL. 28.
- CATHOLICARE, NEWARK, NJ:
2,012,383, CANC. MULTIPLE CLASS, INT. CLS. 35, 36 AND 42.
- CATMULL, DALE ALBERT, IDAHO FALLS, ID:
2,765,755, INT. CL. 11.

- CAYS, JOHN, NUTLEY, NJ:
2,765,868, INT. CL. 42.
- CAYUSE VINEYARDS, L.L.C., WALLA WALLA, WA:
2,764,464, PUB. 6-24-2003, INT. CL. 33.
- CBeyond COMMUNICATIONS, LLC, ATLANTA, GA:
2,763,713, PUB. 6-24-2003, INT. CL. 38.
2,763,714, PUB. 6-24-2003, INT. CL. 38.
- CCMKS, L.L.C., HILLSBORO, KS:
2,764,085, PUB. 6-24-2003, INT. CL. 37.
- CCS INTERNATIONAL LTD., NEW YORK, NY:
2,011,620, CANC. INT. CL. 9.
- CD PEO PLUS LLC, ST. PETE BEACH, FL:
2,764,872, INT. CL. 35.
- CDG, INC., SOUTHFIELD, MI:
2,011,587, CANC. INT. CL. 9.
- CDK ASSOCIATES & CONSULTANTS, INC., BOSTON, MA:
2,764,928, INT. CL. 16.
- CECE & HEIDI LLC, BEVERLY HILLS, CA:
2,763,629, PUB. 6-24-2003, INT. CL. 28.
- CEDAR HILL LANDSCAPING, SOMERSET, NJ:
2,764,454, PUB. 6-24-2003, INT. CL. 44.
- CEDARBERG INDUSTRIES, INC., EAGAN, MN:
2,763,259, PUB. 6-24-2003, INT. CL. 17.
- CEDARMARK HOME CORPORATION, BELLEVUE, WA:
1,213,977, CANC. INT. CL. 19.
- CELESTE INDUSTRIES CORP., EASTON, MD:
2,763,459, PUB. 6-24-2003, INT. CL. 3.
- CELLULAR EXPORT INTERNATIONAL, INC., VAN NUYS, CA:
2,763,553, PUB. 6-24-2003, INT. CL. 9.
- CELLULAR ONE GROUP, DALLAS, TX:
2,155,062, CANC. INT. CL. 9.
- CELLULAR PROCESS CHEMISTRY, INC., KENNEWICK, WA:
2,764,649, MULTIPLE CLASS, INT. CLS. 9 AND 42.
- CENDANT MEMBERSHIP SERVICES HOLDINGS SUBSIDIARY, INC., NORWALK, CT FROM CENDANT MEMBERSHIP SERVICES, INC., STAMFORD, CT:
2,764,873, MULTIPLE CLASS, INT. CLS. 35, 36 AND 42.
- CENDANT PUBLISHING, INC., AURORA, CO:
1,728,032, CANC. MULTIPLE CLASS, INT. CLS. 35 AND 36.
- CENDANT PUBLISHING, INC., LAS VEGAS, NV, BENEFIT CONSULTANTS, INC., SAN CARLOS, CA:
1,785,811, REN. 8-7-03, INT. CL. 36.
- CENIXDIGICOM CO., LTD., KYUNGGI-DO 440-290, REPUBLIC OF KOREA:
2,764,711, INT. CL. 9.
- CENITEK INDUSTRIES, INC., WEST CHESTER, PA:
1,728,526, CANC. INT. CL. 7.
- CENTER FOR DOCUMENTARY STUDIES, DURHAM, NC:
2,765,934, INT. CL. 16.
- CENTER OF BEING, INC., THE, HOLMDEL, NJ:
2,012,946, CANC. INT. CL. 41.
- CENTERCORE GROUP, INC., THE, PLAINFIELD, NJ, CENTERCORE, INC., PLAINFIELD, NJ:
1,733,079, REN. 8-6-03, INT. CL. 20.
- CENTEX BUSINESS CONSULTANTS, L.C., AUSTIN, TX:
2,764,098, PUB. 6-24-2003, INT. CL. 41.
- CENTIV, INC., VERNON HILLS, IL FROM TEKGRAF, INC., VERNON HILLS, IL:
2,764,940, MULTIPLE CLASS, INT. CLS. 35 AND 42.
- CENTRO DE ESTUDIOS CEAC, S.A., BARCELONA, SPAIN:
960,137, REN. 8-8-03, U.S. CL. 107 (INT. CL. 41).
- CENTURY INCORPORATED, MIDWEST CITY, OK:
2,764,916, INT. CL. 28.
- CENTURY THEATRES, INC, SAN RAFAEL, CA, SYUFY ENTERPRISES, SAN FRANCISCO, CA:
1,831,626, REN. 8-6-03, INT. CL. 41.
- CERAMICA FLOOR GRES S.P.A., 41040 FIORANO MODENESE - MODENA, ITALY TO FLORIM CERAMICHE SOCIETA PER AZIONI, 41040 FLORANO MODENESE - MODENA, ITALY:
1,727,616, CANC. INT. CL. 19.
- CEREBIS, L.P., DALLAS, TX:
2,763,727, PUB. 6-24-2003, INT. CL. 9.
- CERVECERIA CUAUHEMOC MOCTEZUMA S.A. DE C.V., MONTERREY, NUEVO LEON, MEXICO:
1,727,715, CANC. INT. CL. 25.
- CERVECERIA MODELO, S.A. DE C.V., COL. ANAHUAC, 11320 MEXICO, D.F., MEXICO:
1,727,969, CANC. INT. CL. 32.
- CHAMBERS, ANITA M., GOLETA, CA:
2,765,696, INT. CL. 35.
- CHAMBERS, KRISTYN, AUSTIN, TX:
2,763,661, PUB. 6-24-2003, MULTIPLE CLASS, INT. CLS. 18 AND 25.
- CHAMPION INTERNATIONAL CORPORATION, STAMFORD, CT:
1,459,666, CANC. INT. CL. 42.
- CHAMPION SOLUTIONS GROUP, INC., BOCA RATON, FL:
2,763,756, PUB. 6-24-2003, INT. CL. 42.
- CHANDARIA, SACHEN, NAIROBI, KENYA:
2,764,867, INT. CL. 16.
- CHANNING BETE COMPnay, INC., SOUTH DEERFIELD, MA FROM CHANNING L. BETE CO., INC., SOUTH DEERFIELD, MA:
2,764,895, MULTIPLE CLASS, INT. CLS. 9 AND 16.
- CHAPIN COMPANY, THE, WAYZATA, MN:
2,763,382, PUB. 6-4-2002, INT. CL. 25.
- CHARLES RIVER ASSOCIATES INCORPORATED, BOSTON, MA:
1,738,574, REN. 8-6-03, MULTIPLE CLASS, INT. CLS. 35 AND 36.
- CHARM SCIENCES, INC., LAWRENCE, MA, PENICILLIN ASSAYS INC., BOSTON, MA:
1,217,168, REN. 8-4-03, INT. CL. 1.
- CHASE CORPORATION, BRAINTREE, MA, DBA ROYSTON LABORATORIES, INC.:
1,726,870, CANC. INT. CL. 2.
- CHATEAU INTERNATIONAL INC., NEW YORK, NY:
2,763,388, PUB. 6-24-2003, INT. CL. 18.
- CHAUMET INTERNATIONAL S.A., 75001 PARIS, FRANCE:
2,763,554, PUB. 6-24-2003, INT. CL. 14.
- CHEBA HUT FRANCHISING, INC., MESA, AZ FROM NICE DREAMS, INC, TEMPE, AZ:
2,763,444, PUB. 6-24-2003, INT. CL. 42.
- CHECKER MOTORS CORPORATION, KALAMAZOO, MI:
739,936, CANC. U.S. CL. 19.
- CHECKS BY PHONE, INC., BOYNTON BEACH, FL:
2,012,947, CANC. INT. CL. 36.
- CHECKS IN THE MAIL, INC., NEW BRAUNFELS, TX:
2,763,987, PUB. 6-24-2003, INT. CL. 16.
- CHEF BUBBA FINE FOODS, INC., DUNCANVILLE, TX:
2,012,685, CANC. INT. CL. 29.
- CHELO PUBLISHING, INC., NEW YORK, NY:
2,763,381, PUB. 6-24-2003, MULTIPLE CLASS, INT. CLS. 16 AND 41.
- CHELTON FIGHT SYSTEMS INC., BOISE, ID FROM SIERRA FLIGHT SYSTEMS INC., BOISE, ID:
2,765,528, INT. CL. 9.
- CHEMCORE INDUSTRIES, INC., AUSTIN, TX:
2,763,542, PUB. 6-24-2003, INT. CL. 19.
- CHEMICAL SPECIALTIES MANUFACTURERS ASSOCIATION, INC. (CSMA), WASHINGTON, DC:
2,765,554, INT. CL. 42.
- CHEMTECH FINISHING SYSTEMS, INC., FARMINGTON HILLS, MI:
2,763,146, PUB. 7-23-2002, INT. CL. 1.
- CHEN, BARRY C., SAN JOSE, CA:
2,011,599, CANC. INT. CL. 9.
- CHENE DEVELOPPEMENT, 75008 PARIS, FRANCE:
2,763,438, PUB. 6-24-2003, MULTIPLE CLASS, INT. CLS. 30 AND 31.
- CHENILLE KRAFT COMPANY, THE, GURNEE, IL:
2,012,845, CANC. INT. CL. 28.
- CHEROKEE INC., VAN NUYS, CA:
2,765,516, INT. CL. 28.
- CHESEBROUGH-POND'S INC., WILMINGTON, DE:
2,764,807, INT. CL. 3.
2,765,158, INT. CL. 3.
- CHESEBROUGH-PONDS, INC., WILMINGTON, DE:
2,765,336, INT. CL. 3.

- CHEVIOT BRIDGE PTY LTD, MELBOURNE, VICTORIA 3004, AUSTRALIA:
2,763,390, PUB. 6-24-2003. INT. CL. 33.
- CHEVRONTXACO CORPORATION, SAN FRANCISCO, CA:
2,764,313, PUB. 6-24-2003. MULTIPLE CLASS, INT. CLS. 35 AND 37.
- CHI LABORATORY SYSTEMS, INC., ANN ARBOR, MI:
2,012,476, CANC. INT. CL. 35.
- CHIARELLA, PETER, NAPA, CA:
2,764,418, PUB. 6-24-2003. INT. CL. 33.
- CHIC ACCESSORIES, LLC, SCOTTSDALE, AZ:
2,765,492, INT. CL. 5.
- CHICAGO GLUE MACHINE & SUPPLY CO., INC., BENSENVILLE, IL:
2,763,499, PUB. 6-24-2003. INT. CL. 1.
- CHICKILLO, CHRISTINE J., VALENCIA, CA:
2,011,470, CANC. INT. CL. 14.
- CHIEF APPAREL, NEW YORK, NY:
740,066, CANC. U.S. CL. 39.
- CHIHUAHUA, INC., FRESNO, CA:
1,214,244, CANC. INT. CL. 30.
- CHILDREN'S HOME SOCIETY OF NEW JERSEY, THE, TRENTON, NJ:
2,717,010, COR. INT. CL. 41.
- CHILDREN'S TELEVISION WORKSHOP, NEW YORK, NY:
1,214,379, CANC. INT. CL. 41.
- CHILDRESS, RONALD JR., HUNTSVILLE, AL:
2,765,128, INT. CL. 25.
- CHIPPER BY THE DOZEN, INC., MCHENRY, IL:
2,012,591, CANC. INT. CL. 30.
- CHIQUITA BRANDS, INC., CINCINNATI, OH:
2,012,299, CANC. INT. CL. 32.
2,012,323, CANC. INT. CL. 16.
- CHOCOLATE SOUP, INC., LEE'S SUMMIT, MO, HOUSE OF ASHLEY, INC., KANSAS CITY, MO:
958,988. REN. 8-7-03. U.S. CL. 39 (INT. CL. 25).
- CHOCOLATES TURIN, S.A. DE C.V., MEXICO, MEXICO:
2,763,180, PUB. 6-24-2003. INT. CL. 30.
- CHOICE MARKETING INC., ASTON, PA:
2,764,342, PUB. 6-24-2003. INT. CL. 16.
- CHOU FAMILY FOUNDATION, RALEIGH, NC:
2,763,611, PUB. 6-24-2003. INT. CL. 41.
- CHRISTIAN TEACHER'S AID, FENTON, MO:
2,765,198, INT. CL. 28.
- CHRISTIE ENTERPRISES, INC., KENILWORTH, NJ:
1,214,012, CANC. INT. CL. 21.
- CHRISTINE PHILLIPE CO., ROLLING HILLS ESTATES, CA:
2,011,954, CANC. INT. CL. 25.
- CHRISTUS ST. PATRICK HOSPITAL, LAKE CHARLES, LA:
2,764,998, INT. CL. 42.
- CHU FARMS, INC., WIMAUMA, FL:
2,765,565, INT. CL. 31.
- CHUMBLEY, JAMES F, EDMONDS, WA:
2,764,252, PUB. 6-24-2003. INT. CL. 26.
- CHUNG, YUN SOO, GARDENA, CA:
2,763,339, PUB. 6-24-2003. INT. CL. 5.
- CHURCH & DWIGHT COMPANY, GREEN RIVER, WY, CARTER-WALLACE, INC., NEW YORK, NY:
963,130. REN. 8-4-03. U.S. CL. 52 (INT. CL. 3).
963,131. REN. 8-4-03. U.S. CL. 52 (INT. CL. 3).
- CHURCH & DWIGHT COMPANY, GREEN RIVER, WY:
2,765,027, INT. CL. 3.
- CHURCH OF GOD IN CHRIST, INC., MEMPHIS, TN:
2,763,521, PUB. 6-24-2003. MULTIPLE CLASS, INT. CLS. 9, 16, 41 AND 45.
- CIA SECURITY SERVICES INC., HADDON HEIGHTS, NJ:
2,763,905, PUB. 6-24-2003. INT. CL. 45.
- CIBA-GEIGY CORPORATION, TARRYTOWN, NY:
2,012,519, CANC. INT. CL. 5.
- CIMARRON AIRCRAFT CORPORATION, EL RENO, OK:
2,012,897, CANC. INT. CL. 25.
- CIMCITIES, LLC, ATLANTA, GA:
2,763,821, PUB. 6-24-2003. MULTIPLE CLASS, INT. CLS. 35, 41, 42 AND 43.
- CINEBRIDGE VENTURES, INC., DEDHAM, MA:
2,765,012, INT. CL. 41.
- CIOLINO, WAYNE V., LONG BEACH, NY:
2,765,040, INT. CL. 21.
- CIRCLE OF BEAUTY, INC., NEW YORK, NY:
2,012,589, CANC. INT. CL. 3.
2,012,606, CANC. INT. CL. 3.
2,012,734, CANC. INT. CL. 3.
- CIRCLE OF FRIENDS PRODUCTS, LLC, CHATSWORTH, CA:
2,764,097, PUB. 6-24-2003. INT. CL. 5.
- CITICORP, NEW YORK, NY:
2,765,827, INT. CL. 36.
- CITIZENS FINANCIAL GROUP, INC., PROVIDENCE, RI:
2,765,365, INT. CL. 36.
- CITY OF GOLDEN, GOLDEN, CO:
2,765,317, INT. CL. 41.
- CITY OF SAN ANTONIO, SAN ANTONIO, TX:
2,763,880, PUB. 6-24-2003. INT. CL. 35.
- CLARK PAPER CONVERTING CORP., SOUTH EL MONTE, CA:
739,911, CANC. U.S. CL. 13.
- CLARK-MAYNARD, MARY ELIZABETH, COLUMBUS, OH, DBA M.E.C.M. ENTERPRISE:
1,727,806, CANC. INT. CL. 26.
- CLARK, STEVEN A., CAMBRIDGE, MA:
1,728,424, CANC. INT. CL. 42.
- CLARK, WILLIAM, JACKSONVILLE, FL:
2,763,758, PUB. 6-24-2003. INT. CL. 41.
- CLARK'S QUALITY ROOFING INCORPORATION, MURRAY, UT:
2,765,793, INT. CL. 37.
- CLARKE AMERICAN HOLDINGS, INC., WILMINGTON, DE:
2,765,692, INT. CL. 16.
- CLASSICAL CRUISES, INC., NEW YORK, NY:
2,763,099, PUB. 6-24-2003. INT. CL. 39.
- CLEANROOM SYSTEMS, INC., NORTH SYRACUSE, NY:
2,763,877, PUB. 6-24-2003. INT. CL. 11.
- CLEAR AS CRYSTAL PRODUCTIONS, INC., MELBOURNE, FL:
2,764,507, INT. CL. 9.
- CLEAR CHANNEL INTANGIBLES, INC., SAN ANTONIO, TX:
2,763,837, PUB. 6-24-2003. INT. CL. 35.
- CLER'ET, INC., PORTLAND, OR, HANCO, INC., PORTLAND, OR:
1,773,012. REN. 8-5-03. INT. CL. 21.
- CLEVELAND CENTER FOR INFORMATION & TECHNOLOGY, INC., CLEVELAND, OH:
2,765,916, INT. CL. 41.
- CLEVELAND FREE TIMES MEDIA, INC., CLEVELAND, OH:
2,763,275, PUB. 6-24-2003. MULTIPLE CLASS, INT. CLS. 16 AND 42.
- CLEVELAND INDIANS BASEBALL COMPANY LIMITED PARTNERSHIP, CLEVELAND, OH:
1,764,998. REN. 8-7-03. INT. CL. 41.
- CLEVELAND, DIANNA L., MISSION VIEJO, CA AND NAMISNIAK, LEE A., MISSION VIEJO, CA:
2,764,595, MULTIPLE CLASS, INT. CLS. 16 AND 41.
2,764,596, MULTIPLE CLASS, INT. CLS. 16 AND 41.
- CLICKDATE, INC., OREM, UT:
2,763,741, PUB. 6-24-2003. INT. CL. 45.
- CLICKER CORPORATION, THE, EL SEGUNDO, CA:
2,011,534, CANC. INT. CL. 9.
2,011,535, CANC. INT. CL. 9.
2,011,536, CANC. INT. CL. 9.
- CLIENTS & PROFITS, INC., OCEANSIDE, CA, DBA WORKING COMPUTER:
1,727,314, CANC. INT. CL. 9.
- CLOTHWORKS, INC., WILMETTE, IL:
1,214,028, CANC. MULTIPLE CLASS, INT. CLS. 24, 28 AND 42.
- CLOVER MFG. CO., LTD., OSAKA, JAPAN:
2,763,303, PUB. 6-24-2003. MULTIPLE CLASS, INT. CLS. 8, 16 AND 26.
- CLUB CAR, INC., AUGUSTA, GA:
2,011,332, CANC. INT. CL. 12.

- CMC MAGNETICS CORPORATION, TAIPEI, 104, TAIWAN:
2,764,854, INT. CL. 9.
- CMP MEDIA INC.:
See—CMP MEDIA LLC.
- CMP MEDIA LLC, MANHASSET, NY FROM CMP MEDIA INC., MANHASSET, NY:
2,765,840, INT. CL. 16.
- CMP MEDIA LLC, MANHASSET, NY:
2,765,905, MULTIPLE CLASS, INT. CLS. 35 AND 41.
- CNET NETWORKS, INC., SAN FRANCISCO, CA:
2,764,690, MULTIPLE CLASS, INT. CLS. 9, 35, 36, 38, 41 AND 42.
- CO-LIFTER, INC., RICHARDSON, TX:
1,792,488, REN. 8-2-03, INT. CL. 10.
- COASTAL CORPORATION, THE, HOUSTON, TX:
1,728,162, CANC. INT. CL. 37.
- COASTAL PET PRODUCTS, INC., ALLIANCE, OH:
2,765,707, INT. CL. 18.
- COASTAL PROPERTIES I, L.L.C., REHOBOTH BEACH, DE:
2,763,389, PUB. 6-24-2003, INT. CL. 42.
- COASTEL COMMUNICATIONS COMPANY, FRIENDS-WOOD, TX:
2,011,309, CANC. INT. CL. 38.
- COATS & CLARK INC., CHARLOTTE, NC:
2,765,342, INT. CL. 23.
- COBB, DIANA J., FINDLAY, OH:
2,012,741, CANC. INT. CL. 16.
- COBRA ELECTRONICS CORPORATION, CHICAGO, IL:
2,764,804, INT. CL. 9.
- COBURN SUPPLY COMPANY, INC., BEAUMONT, TX:
2,764,099, PUB. 6-24-2003, INT. CL. 35.
- COCCA, LORRAINE A., BOCA RATON, FL AND TURBEVILLE, GARY L., BOCA RATON, FL:
2,012,776, CANC. INT. CL. 11.
- COCK 'N BULL LTD., LOS ANGELES, CA:
395,298, CANC. U.S. CL. 45.
- CODILIS & STAWIARSKI, P.C., ENGLEWOOD, CO AND CODILIS & ASSOCIATES, P.C., OAKBROOK TERRACE, IL, DBA THE C & S GROUP:
1,728,137, CANC. INT. CL. 36.
- COFFEE MASTERS, INC., SPRING GROVE, IL:
2,763,272, PUB. 6-24-2003, INT. CL. 30.
- COFFEE TRADE SERVICES, INC., JERSEY CITY, NJ:
2,764,163, PUB. 6-24-2003, INT. CL. 30.
- COGNICHECK, INC., LYNCHBURG, VA:
2,765,486, INT. CL. 44.
- COGNITIO, LLC, CARMEL, IN:
2,764,078, PUB. 6-24-2003, INT. CL. 35.
- COHEN, JUSTIN, HOWARD, ARLINGTON, VA:
2,764,256, PUB. 6-24-2003, INT. CL. 28.
- COHEN, LAWRENCE M., DURANGO, CO:
2,764,213, PUB. 6-24-2003, INT. CL. 28.
- COHN; JACK MARSHALL, DENVER, CO, DBA THE DIPLOMA MILL:
1,213,936, CANC. INT. CL. 16.
- COILHOSE PNEUMATICS, MCMINNVILLE, OR:
2,763,252, PUB. 6-24-2003, INT. CL. 17.
- COKEM INTERNATIONAL, LTD., PLYMOUTH, MN:
2,763,742, PUB. 6-24-2003, INT. CL. 35.
- COLE, LELAND G., SAN CARLOS, CA:
1,727,388, CANC. INT. CL. 11.
1,727,389, CANC. INT. CL. 11.
- COLEMAN CABLE SYSTEMS, INC., WAUKEGAN, IL:
2,764,681, INT. CL. 9.
- COLEMAN, CHRISTINE Y., ATLANTA, GA:
2,763,472, PUB. 6-24-2003, INT. CL. 35.
- COLGATE-PALMOLIVE COMPANY, NEW YORK, NY:
2,765,725, INT. CL. 3.
- COLLABORATIVE BIOMEDICAL PRODUCTS, INC., BEDFORD, MA:
1,726,805, CANC. INT. CL. 1.
- COLLINS & AIKMAN FLOORCOVERINGS, INC., DALTON, GA:
2,764,962, INT. CL. 42.
- COLLINS INTERNATIONAL CO., LTD., FAIR LAWN, NJ:
2,012,178, CANC. INT. CL. 21.
- COLMAR INDUSTRIES, INC., LANCASTER, PA:
2,011,765, CANC. INT. CL. 27.
- COLONIAL REALTY LIMITED PARTNERSHIP, BIRMINGHAM, AL:
2,764,704, INT. CL. 36.
- COLORADO MEDICAL CENTER, P.C., DENVER, CO:
2,012,895, CANC. INT. CL. 42.
- COLORADO SCHOOL OF MINES, GOLDEN, CO, CSM ALUMNI FOUNDATION, INC., GOLDEN, CO, DBA COLORADO SCHOOL OF MINES ALUMNI ASSOCIATION:
1,771,375, REN. 8-2-03, MULTIPLE CLASS, INT. CLS. 16 AND 25.
- COLOREXPRT INC., TORONTO, CANADA:
2,011,263, CANC. MULTIPLE CLASS, INT. CLS. 9 AND 41.
- COLOSSEUM ATHLETICS CORPORATION, GARDENA, CA:
2,764,193, PUB. 6-24-2003, INT. CL. 25.
- COLSON ASSOCIATES, INC., CHICAGO, IL:
2,765,389, U.S. CL. 200.
2,765,390, U.S. CL. 200.
- COLUMBIA FOREST PRODUCTS, INC., PORTLAND, OR:
2,765,002, INT. CL. 35.
- COLUMBIA STEEL CASTING CO., INC., PORTLAND, OR:
982,728, REN. 8-4-03, U.S. CL. 1 (INT. CL. 1).
- COLUMBIAN ART WORKS, INC., MILWAUKEE, WI:
1,213,947, CANC. INT. CL. 16.
- COMEDYLAB ENTERTAINMENT INC., TORONTO, ONTARIO, M6S 1N7, CANADA:
2,725,314, COR. MULTIPLE CLASS, INT. CLS. 38 AND 41.
- COMERICA INCORPORATED, DETROIT, MI:
1,776,041, REN. 8-7-03, INT. CL. 36.
- COMITE INTERNATIONAL OLYMPIQUE, LAUSANNE, SWITZERLAND:
2,764,102, PUB. 6-24-2003, MULTIPLE CLASS, INT. CLS. 1, 3, 4, 5, 6, 9, 12, 14, 16, 18, 20, 21, 25, 26, 28, 29, 30, 32, 35, 36, 38, 39 AND 42.
- COMLINK WIRELESS, INC., CAROL STREAM, IL:
2,764,235, PUB. 6-24-2003, INT. CL. 38.
2,764,236, PUB. 6-24-2003, INT. CL. 38.
- COMMANDAY, MAURICE R., PALOS VERDES ESTATES, CA:
1,726,921, CANC. INT. CL. 3.
- COMMODITY NEWS SERVICES, INC., JERSEY CITY, NJ:
1,213,908, CANC. INT. CL. 16.
- COMMONWEALTH LAND TITLE INSURANCE COMPANY, PHILADELPHIA, PA:
2,011,893, CANC. INT. CL. 9.
- COMMONWEALTH OF PENNSYLVANIA, ACTING THROUGH THE PENNSYLVANIA DEPARTMENT OF TRANSPORTATION, HARRISBURG, PA:
2,763,498, PUB. 6-24-2003, MULTIPLE CLASS, INT. CLS. 14, 16, 18, 20, 25, 26 AND 28.
- COMMUNICATION SYNERGY TECHNOLOGIES LLC., ROCHESTER, NY TO MEDICAL SYNERGY TECHNOLOGIES LLC, ROCHESTER, NY:
2,691,860, COR. INT. CL. 42.
- COMPACT DISC INCORPORATED, SILVER SPRING, MD:
2,012,670, CANC. INT. CL. 9.
- COMPASS AI, INC., EL DORADO HILLS, CA:
2,765,419, INT. CL. 9.
- COMPASSEARNING, INC., SAN DIEGO, CA:
2,765,262, INT. CL. 16.
- COMPLETE BUSINESS SOLUTIONS, INC.:
See—COVANSYS CORPORATION.
- COMPOSITE ACOUSTICS DEVELOPMENT AND LICENSING, L.L.C., LAFAYETTE, LA:
2,764,792, INT. CL. 15.
- COMPOSITE ACOUSTICS DEVELOPMENT AND LICENSING, L.L.C., LAFAYETTE, LA:
2,764,793, INT. CL. 15.
- COMPREHENSIVE CARE CORPORATION, NEWPORT BEACH, CA:
1,198,289, CANC. INT. CL. 41.
- COMPRESSOR CONTROLS CORPORATION, DES MOINES, IA:
2,765,643, INT. CL. 9.

- COMPUCOM SYSTEMS, INC., DALLAS, TX:
1,784,614. REN. 8-7-03. INT. CL. 42.
- COMPUCREDIT CORPORATION, ATLANTA, GA:
2,764,575. INT. CL. 36.
- COMPUMEDICS LIMITED, ABBOTSFORD, VICTORIA,
AUSTRALIA FROM NEUROSOFT, INC., STERLING, VA:
2,764,732. INT. CL. 10.
- COMPUTER ASSOCIATES INTERNATIONAL, INC., ISLAN-
DIA, NY:
2,012,537. CANC. INT. CL. 9.
- COMPUTER EMPLOYMENT APPLICATIONS, INC., MIL-
WAUKEE, WI:
2,763,799. PUB. 6-24-2003. MULTIPLE CLASS, INT. CLS.
9, 35 AND 45.
- COMPUTER PRODUCTS CENTER, INC., IRVINE, CA:
2,012,165. CANC. INT. CL. 9.
- COMPUTERVISION CORPORATION, BEDFORD, MA:
2,012,640. CANC. INT. CL. 9.
2,012,641. CANC. INT. CL. 9.
- CON-WAL, INC., ROGERS, AR, DBA SOUTHWESTERN
SALES COMPANY:
2,765,845. INT. CL. 24.
- CONAGRA FOODS, INC., OMAHA, NE:
2,765,179. MULTIPLE CLASS, INT. CLS. 29 AND 30.
2,765,524. INT. CL. 30.
- CONAIR CIP, INC., STAMFORD, CT:
2,765,731. INT. CL. 3.
- CONAIRCIP, INC., STAMFORD, CT:
2,765,776. INT. CL. 11.
- CONAL INT'L TRADING CO., PASADENA, CA:
2,763,866. PUB. 6-24-2003. INT. CL. 25.
- CONCENTRA CORPORATION, CAMBRIDGE, MA:
2,012,604. CANC. INT. CL. 9.
- CONCENTRIC SYSTEMS, INC., ALPHARETTA, GA:
2,765,007. INT. CL. 9.
- CONCEPT OMEGA CORPORATION, SOMERSET, NJ:
1,727,258. CANC. INT. CL. 9.
- CONCHI, INC., NORTH MIAMI, FL:
2,763,025. PUB. 9-8-1992. INT. CL. 25.
- CONEXPORT V.I.P., 37012 BUSSOLENGO (VERONA),
ITALY:
2,011,899. CANC. INT. CL. 35.
- CONFLUENT SURGICAL, INC., WALTHAM, MA:
2,764,685. MULTIPLE CLASS, INT. CLS. 5 AND 10.
- CONFLUENT SURGICAL, INC., BOSTON, MA:
2,764,699. MULTIPLE CLASS, INT. CLS. 5 AND 10.
- CONG TY TRACH NHIEM HUU HAN SAN XUAT CO KHI
KEM NGHIA, HO CHI MINH CITY, VIETNAM, AKA
NGHIA NIPPERS PRODUCTION MECHANICAL ENGI-
NEERING CO., LTD.:
2,763,749. PUB. 6-24-2003. INT. CL. 8.
- CONGOLEUM CORPORATION, MERCERVILLE, NJ,
AMERICAN BILTRITE INC., WELLESLEY HILLS, MA:
1,777,273. REN. 8-6-03. INT. CL. 27.
- CONKLIN COMPANY, INC., SHAKOPEE, MN:
1,828,739. REN. 8-7-03. INT. CL. 3.
- CONNECTICUT TICK CONTROL LLC, NORWALK, CT:
2,765,667. INT. CL. 37.
- CONNECTION DISTRIBUTING CO., CLEVELAND, OH:
1,771,392. REN. 8-6-03. INT. CL. 16.
1,771,393. REN. 8-6-03. INT. CL. 16.
1,771,394. REN. 8-6-03. INT. CL. 16.
1,771,395. REN. 8-6-03. INT. CL. 16.
1,790,320. REN. 8-4-03. INT. CL. 16.
- CONSOLIDATED FINANCIAL CORPORATION, BINGHAM
FARMS, MI:
2,763,447. PUB. 6-24-2003. INT. CL. 36.
- CONSOLIDATED PROPERTY HOLDINGS, INC., LAS VE-
GAS, NV:
2,764,694. MULTIPLE CLASS, INT. CLS. 9, 11, 12, 20 AND
21.
- CONSTRUTODO, INC., HOUSTON, TX:
2,763,334. PUB. 6-24-2003. MULTIPLE CLASS, INT. CLS.
35, 36 AND 37.
- CONSUMER CREDIT COUNSELING SERVICES SOUTH-
WEST, INC., PHOENIX, AZ:
2,011,983. CANC. INT. CL. 36.
- CONSUMER TASK FORCE FOR AUTOMOTIVE ISSUES,
INC., WASHINGTON, DC:
2,012,680. CANC. INT. CL. 16.
- CONSUMERS DIGEST, INC., SKOKIE, IL:
1,728,011. CANC. INT. CL. 35.
- CONTAINER RECOVERY CORPORATION, ST. LOUIS, MO:
1,214,508. CANC. INT. CL. 37.
- CONTINENTAL BAKING COMPANY, ST. LOUIS, MO TO
INTERSTATE BRANDS CORPORATION, KANSAS CITY,
MO:
1,728,673. CANC. INT. CL. 30.
- CONTINENTAL GRAIN COMPANY, CHICAGO, IL:
740,127. CANC. U.S. CL. 46.
- CONTINENTAL LIGHTING IND., INC., HOUSTON, TX:
2,011,749. CANC. INT. CL. 11.
- CONTROL COMPONENTS, INC., RANCHO SANTA MAR-
GARITA, CA:
2,764,301. PUB. 6-24-2003. INT. CL. 9.
- CONTROL DATA CORPORATION, MINNEAPOLIS, MN:
739,992. CANC. U.S. CL. 26.
- CONTROL MICROSYSTEMS INC./MICROSYSTEMES DE
CONTROLE INC., KANATA, ONTARIO, CANADA:
2,763,060. PUB. 6-6-2000. INT. CL. 9.
- CONVEDIA CORPORATION, VANCOUVER, BC, CANADA
FROM STARVISION MULTIMEDIA CORPORATION,
VANCOUVER, BRITISH COLUMBIA V5C 6C6, CANA-
DA:
2,764,783. INT. CL. 9.
- CONWAY COMPANY, LLC, CINCINNATI, OH:
2,763,476. PUB. 6-24-2003. INT. CL. 36.
- CONWAY, DAVID, ENCINITAS, CA:
2,764,365. PUB. 6-24-2003. INT. CL. 35.
- CONWEST RESOURCES INC., SAN FRANCISCO, CA:
2,764,934. INT. CL. 9.
- COOK INCORPORATED, BLOOMINGTON, IN:
2,012,318. CANC. INT. CL. 10.
- COOKS CLUB, INC., HARRISON, NJ:
2,012,014. CANC. INT. CL. 24.
- COOLEY, ROBERT WILLIAM, NEW YORK, NY:
2,764,309. PUB. 6-24-2003. INT. CL. 41.
- COOPERATIVA AGRICOLA CONTROL PISQUERO DE
ELQUI Y LIMARI LIMITADA, CHILE:
2,764,000. PUB. 6-24-2003. INT. CL. 33.
- COOPERLABS LIMITED, CARPINTERIA, CA FROM DIFA
COOPER S.P.A., CARONNO PERTUSELLA, 21042, ITALY:
2,764,675. INT. CL. 3.
- COORDINATED COMPUTING TECHNOLOGIES, WINCHE-
STER, MA:
2,765,789. INT. CL. 9.
- COORS BREWING COMPANY, GOLDEN, CO:
2,765,372. INT. CL. 32.
- COPHAROS, INC., PONTE VEDRA BEACH, FL:
2,765,543. INT. CL. 42.
- COPY DUPLICATING PRODUCTS, INC., RICHFIELD, MN:
2,012,340. CANC. MULTIPLE CLASS, INT. CLS. 37 AND
42.
- CORAL RIDGE MINISTRIES MEDIA, INC., FORT LAU-
DERDALE, FL:
2,763,769. PUB. 6-24-2003. INT. CL. 45.
2,763,770. PUB. 6-24-2003. INT. CL. 9.
2,763,771. PUB. 6-24-2003. INT. CL. 18.
2,763,772. PUB. 6-24-2003. INT. CL. 9.
- CORAM, INC., DENVER, CO:
2,763,962. PUB. 6-24-2003. MULTIPLE CLASS, INT. CLS.
35, 40 AND 44.
2,763,963. PUB. 6-24-2003. MULTIPLE CLASS, INT. CLS.
35, 40 AND 44.
- CORE TECHNICAL SERVICES LTD., ABERDEEN, SCOT-
LAND:
2,763,780. PUB. 6-24-2003. INT. CL. 37.
2,763,781. PUB. 6-24-2003. INT. CL. 37.
- CORNERSTONE CONSULTING, INC., BARTLETT, TN:
2,765,749. INT. CL. 9.
- CORONADO PAINT COMPANY, INC., EDGEWATER, FL:
2,765,630. INT. CL. 2.
- CORPORATE CONNECTIVITY RESOURCES, INC., WO-
BURN, MA:
2,011,320. CANC. INT. CL. 9.

CORPORATE CREATIVE, INC., CHARLOTTE, NC:
2,763,273, PUB. 6-24-2003. INT. CL. 16.

CORRELOGIC SYSTEMS, INC., BETHESDA, MD:
2,765,320, INT. CL. 9.

CORSAIR CORPORATION, SPRINGFIELD, MO:
2,011,737, CANC. INT. CL. 30.

COSMAIR, INC., NEW YORK, NY:
2,012,747, CANC. MULTIPLE CLASS, INT. CLS. 3 AND 5.

COSMYL, INC., MEDLEY, FL:
2,763,043, PUB. 6-24-2003. INT. CL. 3.

COUNCIL OF CHILDBIRTH EDUCATION SPECIALISTS,
INC., EAST LYME, CT:
1,728,264, CANC. INT. CL. 41.

COUNCIL ON CERTIFICATION OF HEALTH, ENVIRON-
MENTAL AND SAFETY TECHNOLOGISTS, SAVOY, IL:
2,763,449, PUB. 6-24-2003. INT. CL. 42.

COUNTER ASSAULT, KALISPELL, MT:
2,468,457, CANC. INT. CL. 1.

COUNTESS MARA, INC., HIGHLAND, NY:
1,214,043, CANC. INT. CL. 25.

COUNTRY LIFE INSURANCE COMPANY, BLOOMING-
TON, IL:
1,728,144, CANC. INT. CL. 36.

COUNTRYMARK COOPERATIVE, INC., INDIANAPOLIS,
IN:
1,728,450, CANC. INT. CL. 42.

COURTROOM TELEVISION NETWORK LLC, NEW YORK,
NY:
2,764,888, INT. CL. 41.

COUSIN CORPORATION OF AMERICA, LARGO, FL:
2,764,132, PUB. 6-24-2003. INT. CL. 28.
2,765,735, INT. CL. 28.

COVANSYS CORPORATION, FARMINGTON HILLS, MI
FROM COMPLETE BUSINESS SOLUTIONS, INC., FARM-
INGTON HILLS, MI:
2,763,227, PUB. 6-24-2003. MULTIPLE CLASS, INT. CLS.
35 AND 42.

COWBOY VILLAGE RESORT LLC, JACKSON HOLE, WY:
2,011,870, CANC. INT. CL. 42.

CPASOFTWARE, PENSACOLA, FL, DBA FENIMORE SOFT-
WARE, INC. TO FENIMORE SOFTWARE GROUP, INC.,
PENSACOLA, FL, DBA CPA SOFTWARE:
2,699,001, COR. INT. CL. 9.

CPC SPECIALTY PRODUCTS, INC., ENGLEWOOD CLIFFS,
NJ:
566,424, CANC. U.S. CL. 46.

CR TECHNOLOGY, INC., LAGUNA NIGUEL, CA:
2,011,877, CANC. INT. CL. 9.

CRAFT HOUSE CORPORATION, TOLEDO, OH:
1,775,944, REN. 8-7-03. INT. CL. 28.

CRAFT, LOGAN, SANTA FE, NM AND CRAFT, BARBRA,
SANTA FE, NM:
2,765,903, INT. CL. 41.

CRAFTMASTER MANUFACTURING, INC., CHICAGO, IL:
2,763,902, PUB. 6-24-2003. INT. CL. 19.

CRAIG, DONNA GWEN, TAMPA, FL, DBA ANGEL QUEST:
2,011,743, CANC. INT. CL. 28.

CRANE CO., STAMFORD, CT, POLYVEND, INC., CON-
WAY, AR:
1,772,871, REN. 8-8-03. INT. CL. 9.

CRAWFORD SOFTWARE CONSULTING, INC., CHESTER,
NH:
2,763,942, PUB. 6-24-2003. INT. CL. 42.

CRAZY JOE'S, INC., CONCORD, NC:
1,214,408, CANC. INT. CL. 42.

CREASOURCE LTD., LONDON WIT 2PH, UNITED KING-
DOM:
2,765,130, MULTIPLE CLASS, INT. CLS. 16, 35, 41 AND
42.

CREATE! PRESS, INC., CARLSBAD, CA:
2,764,431, PUB. 6-24-2003. INT. CL. 28.

CREATIVE COMPUTER APPLICATIONS, INC., CALABA-
SAS, CA:
2,764,775, INT. CL. 9.

CREATIVE FORECASTING, INC., COLORADO SPRINGS,
CO:
2,765,177, MULTIPLE CLASS, INT. CLS. 9 AND 16.

CREATIVE PET PRODUCTS, INC., SPRING VALLEY, WI:
2,764,331, PUB. 6-24-2003. INT. CL. 45.

CREATIVE PHARMACY SOLUTIONS, INC., GRAPEVINE,
TX:
2,764,746, INT. CL. 9.

CREATIVE PRESENTATION RESOURCES LLC, SAN
FRANCISCO, CA:
2,763,494, PUB. 6-24-2003. INT. CL. 42.

CREATIVE TECHNOLOGY LTD., SINGAPORE 609921, SIN-
GAPORE:
2,763,565, PUB. 6-24-2003. INT. CL. 9.

CREATIVE TECHNOLOGY LTD., CREATIVE RESOURCE,
SINGAPORE:
2,764,482, INT. CL. 9.

CREDITBACK, INC., OREM, UT:
2,763,999, PUB. 6-24-2003. INT. CL. 35.

CREDITVIEW AS, OSLO, NORWAY:
2,765,940, MULTIPLE CLASS, INT. CLS. 35 AND 36.

CREDO S.A., 13004 MARSEILLE, FRANCE, CREDO SARL,
13004 MARSEILLE, FRANCE:
1,809,485, REN. 8-7-03. INT. CL. 34.

CREO INC., BURNABY, B.C. V5G 4M1, CANADA FROM
CREO PRODUCTS INC., BURNABY, B.C. V5G 4M1,
CANADA:
2,764,486, INT. CL. 9.

CRESCENT MOON STUDIOS, INC., MIAMI BEACH, FL:
1,773,853, REN. 8-7-03. INT. CL. 41.

CRESTAR FINANCIAL CORPORATION, RICHMOND, VA:
2,012,472, CANC. INT. CL. 36.

CRICKET PRODUCTIONS, INC., MIAMI, FL:
2,763,574, PUB. 6-24-2003. INT. CL. 41.

CRIDER AMERICAS, LLC, IRWINDALE, CA:
2,765,601, INT. CL. 40.

CRIDEN - S.N.C. DI BEDESCHI E C., REGGIO EMILIA,
ITALY:
1,727,739, CANC. INT. CL. 25.

CRN INTERNATIONAL, INC., HAMDEN, CT:
2,764,984, INT. CL. 35.

CROSSCARE LIMLTD, TALLAGHT, DUBLIN 24, IRE-
LAND:
2,764,572, INT. CL. 5.

CROSSTRAINING CLUB, INC., THE, OVERLAND PARK,
KS:
1,985,183, CANC. INT. CL. 41.

CROWE ROPE COMPANY, WARREN, ME TO CROWE
ROPE INDUSTRIES LLC, WATERVILLE, ME:
1,727,690, CANC. INT. CL. 22.

CROWN CORK & SEAL TECHNOLOGIES CORPORATION,
ALSIP, IL:
2,763,352, PUB. 6-24-2003. INT. CL. 20.

CRP ENTERPRISES, INC., SAN LUIS OBISPO, CA:
2,765,470, INT. CL. 9.

CRS HLOINGS, INC., WILMINGTON, DE, CARPENTER
STEEL COMPANY, THE, READING, PA:
571,273, REN. 8-8-03. U.S. CL. 14 (INT. CL. 6).

CRS HOLDINGS, INC., WILMINGTON, DE, CARPENTER
STEEL COMPANY, THE, READING:
571,270, REN. 8-8-03. U.S. CL. 14 (INT. CL. 6).

CRS HOLDINGS, INC., WILMINGTON, DE, CARPENTER
STEEL COMPANY, THE, READING, PA:
571,271, REN. 8-8-03. U.S. CL. 14 (INT. CL. 6).
571,272, REN. 8-8-03. U.S. CL. 14 (INT. CL. 6).

CRUMLEY, JONATHAN, CHATTANOOGA, TN:
2,764,266, PUB. 6-24-2003. INT. CL. 1.

CRUSADER CAPITAL MANAGEMENT, LLC, ORLANDO,
FL:
2,765,501, INT. CL. 36.

CRYSTAL VISION, LTD., SAWSTON, CAMBRIDGE CB2
4HN, ENGLAND:
2,763,082, PUB. 6-24-2003. INT. CL. 9.

CSA, INC., SOUTH EASTON, MA:
2,012,609, CANC. INT. CL. 28.

CSX TRANSPORTATION, INC., JACKSONVILLE, FL:
2,011,286, CANC. INT. CL. 39.

CT CORPORATION SYSTEM, NEW YORK, NY:
1,214,416, CANC. INT. CL. 42.

CUMMINS WEST, INC., SAN LEANDRO, CA:
2,763,442, PUB. 6-24-2003. MULTIPLE CLASS, INT. CLS. 7

- AND 9.
2,763,445, PUB. 6-24-2003. MULTIPLE CLASS, INT. CLS. 7 AND 9.
- CURAGEN CORPORATION, BRANFORD, CT:
2,763,845, PUB. 6-24-2003. INT. CL. 35.
- CURIOSITY KITS, INC., HUNT VALLEY, MD:
2,764,772, INT. CL. 28.
- CURRENT USA, INC., NORTH MANKAO, MN, CURRENT, INC., COLORADO SPRINGS, CO:
1,811,049, REN. 8-4-03. INT. CL. 35.
- CURRICULUM ASSOCIATES, INC., NORTH BILLERICA, MA:
2,763,385, PUB. 6-24-2003. INT. CL. 16.
- CURY, JILL, KENWOOD, CA, DBA RENAISSANCE SPA TREATMENTS:
2,012,944, CANC. INT. CL. 3.
- CUTLER-FEDERAL, INC., EATON PARK, FL:
739,861, CANC. U.S. CL. 2.
- CYBER VILLAGE ACADEMY, INC., ST. PAUL, MN:
2,765,145, INT. CL. 9.
- CYBERCORP HOLDINGS, INC., AUSTIN, TX:
2,763,701, PUB. 6-24-2003. INT. CL. 36.
- CYBORG SYSTEMS, INC., CHICAGO, IL:
1,728,546, CANC. INT. CL. 9.
- CYBOTECH CORPORATION, INDIANAPOLIS, IN:
1,213,809, CANC. INT. CL. 7.
- CYPHER, JOHN ALFRED, HOUSTON, TX:
2,765,609, INT. CL. 3.
- CYPRUS MINES CORPORATION, ENGLEWOOD, CO TO LUZENAC AMERICA, INC., ENGLEWOOD, CO:
1,728,511, CANC. INT. CL. 1.
- CYSIVE, INC., RESTON, VA:
2,765,476, INT. CL. 9.
- C3 ENTERTAINMENT, INC., GLENDALE, CA, SOITENLY STOOGES INC., SKOKIE, IL:
1,775,586, REN. 8-6-03. INT. CL. 42.
- C4CAST.COM, INC., PASADENA, CA:
2,764,590, INT. CL. 16.
- D & E INTERNATIONAL INC., TORTOLA, BR. VIRGIN ISLANDS:
2,764,785, INT. CL. 21.
- D & N GREENMAN, PHILADELPHIA, PA, AKA GREENMAN'S DELICATESSEN:
1,214,466, CANC. INT. CL. 42.
- D. MICHAEL CORPORATION, INDIANAPOLIS, IN:
2,765,822, INT. CL. 9.
- D.P. THAI TEES, INC., HONOLULU, HI:
2,764,108, PUB. 6-24-2003. INT. CL. 25.
- DA MUSIC, LITTLE SILVER, NJ:
2,012,700, CANC. INT. CL. 9.
- DAIEI, INC., THE, KOBE-SHI, JAPAN:
2,068,453, CANC. MULTIPLE CLASS, INT. CLS. 1, 6, 7, 8, 9, 11, 14, 16, 18, 20, 21, 24 AND 28.
- DAIMLERCHRYSLER AG, STUTTGART, FED REP GERMANY:
2,644,906, COR. MULTIPLE CLASS, INT. CLS. 2, 3, 4, 6, 7, 8, 9, 11, 13, 14, 16, 17, 18, 20, 21, 22, 23, 24, 25, 27, 28, 30, 34, 35, 36, 37, 38, 39, 40 AND OTHERS.
- DAIMLERCHRYSLER AG, 70567 STUTTGART, FED REP GERMANY:
2,763,101, PUB. 6-24-2003. MULTIPLE CLASS, INT. CLS. 7, 9, 12, 35, 37, 39 AND 42.
2,763,464, PUB. 6-24-2003. MULTIPLE CLASS, INT. CLS. 12, 28 AND 37.
2,763,815, PUB. 6-24-2003. INT. CL. 12.
- DAIMLERCHRYSLER CORPORATION, AUBURN HILLS, MI:
2,764,249, PUB. 6-24-2003. INT. CL. 12.
- DAIRY CREST LIMITED, SURBITON, SURREY KT6 5Q1, ENGLAND:
2,763,032, PUB. 6-24-2003. INT. CL. 29.
- DAIRY MART CONVENIENCE STORES, INC., ENFIELD, CT:
2,012,316, CANC. INT. CL. 16.
- DAISYSEED, INC., MORGANTOWN, WV:
2,763,911, PUB. 6-24-2003. INT. CL. 35.
- DAIWA SEIKO, INC., HIGASHIKURUME-CITY, TOKYO, JAPAN:
1,727,816, CANC. INT. CL. 28.
- DAN'S FAN CITY, INC., OLDSMAR, FL, DBA GULF COAST FANS, INC.:
1,727,363, CANC. INT. CL. 11.
- DAN'S FAN CITY, INC., OLDSMAR, FL:
2,764,417, PUB. 6-24-2003. INT. CL. 11.
- DANAHER POWER SOLUTIONS LLC, RICHMOND, VA, CYBEREX, INC., MENTOR, OH:
1,238,093, REN. 8-6-03. INT. CL. 9.
- DANNY'S BAR-B-QUE, INC., CARY, NC:
2,763,716, PUB. 6-24-2003. MULTIPLE CLASS, INT. CLS. 30 AND 43.
- DANTZLER, DEREK, WASHINGTON, DC:
2,011,578, CANC. INT. CL. 41.
- DAR PRODUCTS CORPORATION, BALTIMORE, MD:
1,727,841, CANC. INT. CL. 28.
- DART CONTAINER CORPORATION, MASON, MI:
1,727,005, CANC. INT. CL. 6.
- DASAN NETWORKS, INC., SEOUL, REPUBLIC OF KOREA TO DASAN CO., LTD., KANGNAM-KU, SEOUL, REPUBLIC OF KOREA:
2,714,462, COR. INT. CL. 9.
- DASSAULT SYSTEMES, S.A., 92156 SURESNES, CEDEX, FRANCE:
2,764,484, INT. CL. 9.
- DATA CONSULTANTS, INC., CENTREVILLE, VA:
2,011,754, CANC. INT. CL. 9.
- DATA RACE, INC., SAN ANTONIO, TX:
1,727,262, CANC. INT. CL. 9.
- DATA TRANSMISSION NETWORK, OMAHA, DE:
2,765,556, INT. CL. 9.
- DATADIRECT NETWORKS, INC., CHATSWORTH, CA:
2,764,691, INT. CL. 9.
- DATAPPOINT CORPORATION, SAN ANTONIO, TX:
1,213,813, CANC. INT. CL. 9.
1,213,871, CANC. INT. CL. 16.
- DATASTREAM SYSTEMS INCORPORATED, GREENVILLE, SC:
2,764,588, INT. CL. 42.
- DAUGHTERS OF HEAVEN MINISTRIES, INC., TULSA, OK:
2,763,681, PUB. 6-24-2003. MULTIPLE CLASS, INT. CLS. 41 AND 45.
- DAUPHANT-SENEAULT, MUSA, 97223 LE DIAMANTE, MARTINIQUE:
2,765,679, INT. CL. 41.
- DAVE WILSON NURSERY, INC, HICKMAN, CA:
2,764,989, INT. CL. 31.
- DAVID A. KOMATZ AND ASSOCIATES, INC., KALAMAZOO, MI:
2,765,366, INT. CL. 43.
- DAVID AUSTIN ROSES LIMITED, ALBRIGHTON, WOLVERHAMPTON, ENGLAND:
2,011,594, CANC. INT. CL. 31.
2,011,595, CANC. INT. CL. 31.
- DAVID BROWN CORPORATION PLC, HUDDERSFIELD, ENGLAND TO DAVID BROWN ENGINEERING LIMITED, LOCKWOOD HUDDERSFIELD, ENGLAND:
1,771,093, CANC. INT. CL. 12.
- DAVID BROWN ENGINEERING LIMITED, LOCKWOOD HUDDERSFIELD, ENGLAND, DAVID BROWN CORPORATION PLC, HUDDERSFIELD, ENGLAND:
1,771,093, REN. 8-8-03. INT. CL. 7.
- DAVID GREEN & ASSOCIATES, INC., TUCSON, AZ:
2,765,838, INT. CL. 35.
- DAVID SHEMAN CORPORATION, ST. LOUIS, MO, J. A. DOUGHERTY'S SONS, INC., DISTILLERS, PHILADELPHIA, PA:
757,015, REN. 8-4-03. U.S. CL. 49 (INT. CL. 9).
- DAVID, MURRAY JAMES, DELAND, FL:
2,765,737, INT. CL. 10.
- DAVIES & GAMBLE, LLC, ST. HELENA, CA:
2,765,202, INT. CL. 33.
- DAVIS GROUP OF COMPANIES CORP., MARKHAM, ONTARIO L3R 8N4, CANADA:
2,763,304, PUB. 7-16-2002. INT. CL. 16.

- DAVIS PIPING SPECIALTIES, INC., JERICHO, NY:
1,213,779, CANC. INT. CL. 6.
- DAVIS, JANINE, LYNNE, DALLAS, TX:
2,764,263, PUB. 6-24-2003. INT. CL. 30.
- DAVIS, LANE, NORTH HOLLYWOOD, CA:
1,727,755, CANC. INT. CL. 25.
- DAVISON OIL COMPANY, INC., MOBILE, AL:
2,763,857, PUB. 6-24-2003. MULTIPLE CLASS, INT. CLS. 1 AND 4.
- DAYLIGHT CORPORATION, TULSA, OK:
1,774,360. REN. 8-4-03. INT. CL. 30.
- DAYSTAR OF CALIFORNIA, SANTA ANA, CA:
1,214,059, CANC. INT. CL. 25.
- DAYSTAR, INC., PHOENIX, AZ:
2,008,485, CANC. INT. CL. 12.
- DC COMICS, NEW YORK, NY:
2,765,711, INT. CL. 28.
- DCI MARKETING, INC., MILWAUKEE, WI:
1,770,080. REN. 8-4-03. INT. CL. 20.
- DDS DRUG DELIVERY SERVICE GESELLSCHAFT ZUR FORDERUNG DER FORSCHUNG IN PHARMAZEUTISCHER TECHNOLOGIE UND BIOPHARMAZIE MBH, 24119 KRONSHAGEN, FED REP GERMANY TO DDS DRUG DELIVERY SERVICE GESELLSCHAFT ZUR FORDERUNG DER FORSCHUNG IN PHARMAZEUTISCHER TECHNOLOGIE UND BIOPHARMAZIE MBH, 24119 KRONSHAGEN, FED REP GERMANY:
2,675,767, COR. MULTIPLE CLASS, INT. CLS. 3 AND 5.
- DE JEAN PACKING COMPANY, BILOXI, MS TO DE JEAN PACKING COMPANY, INC., WILMINGTON, DE:
938,168, CANC. U.S. CL. 46.
- DE LA RUE INTERNATIONAL LIMITED, HAMPSHIRE RG22 4BS, UNITED KINGDOM:
2,763,166, PUB. 7-30-2002. INT. CL. 9.
- DE LAET, POSWICK & CO, BANQUIERS-BANKIERS, 1160 BRUSSELS, BELGIUM TO DE LAET, POSWICK & CO, BANQUIERS-BANKIERS, 1160 BRUSSELS, BELGIUM:
2,723,070, COR. INT. CL. 36.
- DE NATIONALE INVESTERINGSBANK N.V., 2517 KJ 'S-GRAVENHAGE, NETHERLANDS:
2,012,006, CANC. INT. CL. 36.
- DE WET EXCELSIOR FARMS (PROPRIETARY) LIMITED, ASHTON, 6715, SOUTH AFRICA:
2,764,863, INT. CL. 33.
- DEALERS ALLIANCE CREDIT CORP., ATLANTA, GA:
2,011,608, CANC. INT. CL. 36.
- DEAN HEALTH SYSTEMS, INC., MADISON, WI:
1,728,347, CANC. INT. CL. 42.
- DEAN INTELLECTUAL PROPERTY SERVICES, L.P., DALLAS, TX FROM SUIZA DAIRY GROUP, L.P., DALLAS, TX:
2,763,336, PUB. 6-24-2003. INT. CL. 29.
- DEAN PICKLE AND SPECIALTY PRODUCTS COMPANY, GREEN BAY, WI TO DEAN SPECIALTY INTELLECTUAL PROPERTY SERVICES, L.P., DALLAS, TX:
2,066,837, CANC. INT. CL. 30.
- DECAL SPECIALTIES, INC., PAOLI, PA:
2,763,862, PUB. 6-24-2003. INT. CL. 16.
- DECISION FOCUS INCORPORATED, MOUNTAIN VIEW, CA:
2,012,918, CANC. INT. CL. 9.
- DECISION SYSTEMS TECHNOLOGIES, INC., ROCKVILLE, MD:
1,799,836. REN. 8-6-03. INT. CL. 42.
- DEERE & COMPANY, MOLINE, IL, DEERE & COMPANY, MOLINE, IL:
91,860. REN. 8-4-03. U.S. CL. 23 (INT. CL. 7).
- DEERE & COMPANY, MOLINE, IL:
1,789,831. REN. 8-5-03. INT. CL. 4.
- DEFABO, JEROME, CRABTREE, PA AND DEFABO, MARY FRANCES, CRABTREE, PA:
1,773,260. REN. 8-6-03. INT. CL. 42.
- DEFENSE MAPPING AGENCY, FAIRFAX, VA:
2,011,477, CANC. INT. CL. 9.
- DEFENSIVE LIVING SYSTEMS, INC., ALBUQUERQUE, NM:
2,012,184, CANC. INT. CL. 13.
- DEFINITY HEALTH CORPORATION, MINNEAPOLIS, MN:
2,765,560, MULTIPLE CLASS, INT. CLS. 35 AND 42.
- DEGUSSA AG, 40474 DUSSELDORF, FED REP GERMANY:
2,763,596, PUB. 6-24-2003. INT. CL. 1.
2,763,597, PUB. 6-24-2003. INT. CL. 1.
2,763,791, PUB. 6-24-2003. MULTIPLE CLASS, INT. CLS. 9, 41 AND 42.
- DEGUSSA CORPORATION, RIDGEFIELD PARK, NJ:
2,012,870, CANC. INT. CL. 5.
- DEJA VU PUBLISHING COMPANY, BERKELEY, CA:
1,802,939. REN. 8-2-03. INT. CL. 41.
- DEJUNO WATCH CORPORATION, NEW YORK, NY:
2,012,282, CANC. INT. CL. 25.
- DEKALB COUNTY EXPRESS TRACK CLUB, INC., DECATUR, GA:
2,011,974, CANC. INT. CL. 41.
- DEL WEBB CORPORATION, PHOENIX, AZ:
2,012,478, CANC. INT. CL. 37.
- DELAWARE CAPITAL FORMATION, INC., WILMINGTON, DE FROM KALYN/SIEBERT, L.P., GATESVILLE, TX:
2,763,178, PUB. 6-24-2003. INT. CL. 12.
- DELCO ELECTRONICS CORPORATION, KOKOMO, IN:
2,012,294, CANC. INT. CL. 9.
- DELICIOUS KARMA LLC, PALO ALTO, CA:
2,764,143, PUB. 6-24-2003. INT. CL. 41.
- DELL ROMAINE COMPANIES, INC., NEWBURGH, IN:
2,765,896, INT. CL. 11.
- DELONGHI AMERICA, INC., SADDLE BROOK, NJ:
2,765,515, MULTIPLE CLASS, INT. CLS. 7 AND 11.
- DELOR, THOMAS, CLEARWATER, FL:
2,764,352, PUB. 6-24-2003. INT. CL. 38.
- DELOS SANTOS, JAMES R., PORT ANGELES, WA, DBA JRDS ENTERPRISES:
2,764,607, INT. CL. 28.
- DELPHI TECHNOLOGIES, INC., TROY, MI, C.A.V. LIMITED, ACTON, LONDON, ENGLAND:
947,567. REN. 8-2-03. U.S. CL. 23 (INT. CL. 7).
- DELTA CATFISH PROCESSORS, INC., INDIANOLA, MS:
1,214,235, CANC. INT. CL. 29.
- DELTAHAWK, INC., FRANKLIN, WI:
2,765,522, INT. CL. 7.
- DELTEC, INC., ST. PAUL, MN FROM SIMS DELTEC, INC., ST. PAUL, MN:
2,764,789, INT. CL. 10.
- DELTEC, INC., ST. PAUL, MN:
2,765,430, INT. CL. 10.
- DEMBOSE, EDMUND J., NAPLES, FL:
2,012,594, CANC. INT. CL. 21.
- DEMETRIOS, EAMES, SANTA MONICA, CA:
2,763,453, PUB. 6-24-2003. INT. CL. 41.
- DENSO SALES CALIFORNIA, INC., LONG BEACH, CA:
2,765,496, INT. CL. 12.
- DENTSPLY INTERNATIONAL INC., YORK, PA:
2,764,638, MULTIPLE CLASS, INT. CLS. 5 AND 10.
- DEPCO, INCORPORATED, HAUPPAUGE, NY:
2,763,425, PUB. 6-24-2003. INT. CL. 1.
- DERMARX CORPORATION, DENVER, CO:
2,012,611, CANC. INT. CL. 5.
- DEROYAL INDUSTRIES, INC., POWELL, TN:
2,764,277, PUB. 6-24-2003. INT. CL. 10.
- DESA IP, LLC, BOWLING GREEN, KY, SQUARE D COMPANY, PALATINE, IL:
1,238,082. REN. 8-4-03. INT. CL. 9.
- DESERT ROSE FOODS, INC., DERWOOD, MD:
2,011,397, CANC. INT. CL. 30.
- DESIGN HOTELS, INC., SAUSALITO, CA:
2,764,645, INT. CL. 42.
- DESTINY NETWORKS, MORGAN HILL, CA:
2,765,613, INT. CL. 9.
- DETERMINED PRODUCTIONS, INC., LARKSPUR, CA:
1,776,635. REN. 8-6-03. INT. CL. 28.
1,776,722. REN. 8-6-03. INT. CL. 35.
- DEUTSCH COMPANY METAL COMPONENTS DIVISION, THE, LOS ANGELES, CA:
1,213,792, CANC. INT. CL. 6.
- DEUTSCHE BANK AG, FRANKFURT AM MAIN, FED REP GERMANY:
2,764,172, PUB. 6-24-2003. MULTIPLE CLASS, INT. CLS.

- 36 AND 42.
DEVILBISS AIR POWER COMPANY, JACKSON, DE:
1,727,023, CANC. INT. CL. 7.
DEVON ENERGY CORPORATION, OKLAHOMA CITY, OK:
2,764,008, PUB. 6-24-2003. INT. CL. 4.
DEWAR, SAM D., FT. LAUDERDALE, FL:
2,765,611, INT. CL. 29.
DEWEY TRADING COMPANY, SANTA FE, NM:
1,727,702, CANC. INT. CL. 24.
DEWITT COMPANY, SIKESTON, MO:
2,763,550, PUB. 6-24-2003. INT. CL. 17.
2,763,551, PUB. 6-24-2003. INT. CL. 17.
2,763,552, PUB. 6-24-2003. INT. CL. 17.
DEWKS, LLC, NEWBURYPORT, MA:
2,764,972, INT. CL. 25.
DEXTER & CHANEY, INC., SEATTLE, WA:
2,011,841, CANC. INT. CL. 9.
DEZINE LTD., HUNTINGDON VALLEY, PA:
2,011,621, CANC. INT. CL. 20.
DHARMACON RESEARCH, INC., LAFAYETTE, CO:
2,763,330, PUB. 6-24-2003. INT. CL. 1.
DI GIORGIO CORP, CARTERET, NJ, SEEMAN BROTHERS,
NEW YORK, NY:
23,089, REN. 8-6-03. U.S. CL. 46 (INT. CLS. 1, 5, 29, 30, 31
AND 32).
DIAL BRANDS, INC., SCOTTSDALE, AZ:
2,765,799, INT. CL. 4.
DIAL CORP, THE, PHOENIX, AZ:
2,012,874, CANC. INT. CL. 3.
DIAMINTANGIBLES INTERNATIONAL, LTD., NASSAU,
BAHAMAS:
2,765,340, INT. CL. 14.
2,765,482, INT. CL. 14.
DIAMOND DATA SYSTEMS, INC., RICHARDSON, TX:
2,764,129, PUB. 6-24-2003. INT. CL. 9.
DIAMOND PRODUCTS COMPANY, MANGO, FL, GILL-
ETTE COMPANY, THE, BOSTON, MA:
1,771,001, REN. 8-6-03. INT. CL. 3.
DIANE VON FURSTENBERG STUDIO, NEW MILFORD,
CT:
2,012,016, CANC. MULTIPLE CLASS, INT. CLS. 18 AND
25.
DIATECT INTERNATIONAL CORPORATION, HEBER
CITY, UT:
2,763,473, PUB. 6-24-2003. INT. CL. 5.
DICK'S CLOTHING & SPORTING GOODS, INC.:
See—GENERAL ELECTRIC CAPITAL CORPORATION.
DIEBOLD, INCORPORATED, NORTH CANTON, OH:
2,765,606, MULTIPLE CLASS, INT. CLS. 37 AND 42.
DIESEL ONLY RECORDS, INC., BROOKLYN, NY:
1,727,211, CANC. INT. CL. 9.
DIGI INTERNATIONAL INC., MINNETONKA, MN:
2,765,124, INT. CL. 9.
DIGIGRAM, 38330 MONTBONNOT, FRANCE:
2,764,748, INT. CL. 9.
DIGITAL DEFENSE INCORPORATED, SAN ANTONIO, TX:
2,764,308, PUB. 6-24-2003. INT. CL. 42.
DIGITAL MAGNETIC SYSTEMS, INC., OKLAHOMA CITY,
OK:
1,213,890, CANC. INT. CL. 16.
DILETTANTE CHOCOLATES, INC., SEATTLE, WA, DILET-
TANTE, INC., THE, SEATTLE, WA:
1,256,305, REN. 8-6-03. INT. CL. 30.
DILLARD DEPARTMENT STORES, INC., LITTLE ROCK,
AR:
1,214,091, CANC. INT. CL. 25.
DILLARD'S INC., LITTLE ROCK, AR:
2,763,696, PUB. 6-24-2003. INT. CL. 25.
DILLARD'S, INC., LITTLE ROCK, AR, DILLARD DEPART-
MENT STORES, INC., LITTLE ROCK, AR:
1,788,858, REN. 8-8-03. INT. CL. 14.
DILMAR OIL COMPANY, INC., LATA, SC:
1,214,437, CANC. INT. CL. 42.
DIMC, INC., WILMINGTON, DE, DIMC, INC., WILMING-
TON, DE:
1,780,967, REN. 8-6-03. INT. CL. 2.
DIMENSION ONE SPAS, INC., VISTA, CA:
2,765,682, INT. CL. 28.
DIMEOLA & COMPANY, INC., BOCA RATON, FL:
2,764,244, PUB. 6-24-2003. INT. CL. 3.
DIMPLEX NORTH AMERICA LIMITED, CAMBRIDGE,
ONTARIO, CANADA:
2,765,167, INT. CL. 11.
DINICTA S.R.L., 31049 VALDOBBIADENE, TREVISO,
ITALY:
2,763,263, PUB. 6-24-2003. MULTIPLE CLASS, INT. CLS.
9, 10 AND 20.
DIORIO, JAMES J., DELAFIELD, WI:
2,763,107, PUB. 11-7-2000. INT. CL. 11.
DIRECTED AUDIO, INC., VISTA, CA FROM ORION
INDUSTRIES, INC., TEMPE, AZ:
2,763,024, PUB. 6-24-2003. INT. CL. 9.
DIRTBANC, LLC, WEBSTER GROVES, MO:
2,765,537, INT. CL. 37.
DISCOVERY COMMUNICATIONS, INC., BETHESDA, MD:
2,764,894, INT. CL. 41.
DISCOVERY COMMUNICATIONS, INC., SILVER SPRING,
MD:
2,765,823, INT. CL. 41.
DISCOVERY FOODS, HAYWARD, CA:
2,012,708, CANC. INT. CL. 30.
DISCOVERY ZONE L.P., CHICAGO, IL:
2,011,598, CANC. INT. CL. 41.
2,012,590, CANC. INT. CL. 41.
DISETRONIC LICENSING AG, 3400 BURGDORF, SWIT-
ZERLAND:
1,727,345, CANC. INT. CL. 10.
DISNEY ENTERPRISES, INC., BURBANK, CA:
2,763,378, PUB. 6-24-2003. INT. CL. 35.
DISPOTO, BRUNO, DELANO, CA, DBA BRUNO DISPOTO
COMPANY:
2,012,817, CANC. INT. CL. 31.
DISTILLERIE BUSNEL, CORMEILLES, FRANCE FROM
CIDRERIES ET SOPAGLY REUNIES, 93126 LA COUR-
NEUVE, FRANCE:
2,765,252, INT. CL. 33.
DISTRIBUTOR SOFTWARE SOLUTIONS, INC., BLUE
BELL, PA:
2,765,819, INT. CL. 9.
DITTLER BROTHERS, INCORPORATED, ATLANTA, GA:
2,012,291, CANC. MULTIPLE CLASS, INT. CLS. 28 AND
42.
2,012,292, CANC. MULTIPLE CLASS, INT. CLS. 28 AND
42.
DIVERSIFIED DATA PROCESSING & CONSULTING, INC.,
FERNDALE, MI:
2,765,125, INT. CL. 39.
DJF ENTERPRISES, CULVER CITY, CA:
2,764,664, INT. CL. 18.
DLJ LONG TERM INVESTMENT CORPORATION, CHICA-
GO, IL:
2,763,964, PUB. 6-24-2003. INT. CL. 36.
DMITRI, DON, BROOKLYN, NY:
2,764,396, PUB. 6-24-2003. INT. CL. 42.
DNA WEAR, INC., RICHMOND, CA:
2,765,520, MULTIPLE CLASS, INT. CLS. 40 AND 42.
DO IT BEST CORP., FORT WAYNE, IN, HARDWARE
WHOLESALEERS, INC., FORT WAYNE, IN:
1,800,456, REN. 8-6-03. INT. CL. 7.
DOBBS STANFORD CORPORATION, DALLAS, TX:
2,763,786, PUB. 6-24-2003. INT. CL. 9.
DOC LEE'S PEPPER COMPANY, INC., GREENSBORO, NC:
2,764,064, PUB. 6-24-2003. INT. CL. 30.
DOCRITE, INC., FORT LAUDERDALE, FL:
2,012,671, CANC. INT. CL. 16.
2,012,672, CANC. INT. CL. 16.
DOCUCORP INTERNATIONAL, INC., DALLAS, TX:
2,763,488, PUB. 6-24-2003. INT. CL. 42.
DOFASCO INC., HAMILTON, ONTARIO, CANADA:
1,213,795, CANC. INT. CL. 6.
DOHMEN CAPITAL HOLDINGS, INC., LOS ANGELES, CA:
2,763,663, PUB. 6-24-2003. INT. CL. 16.
DOLBY LABORATORIES LICENSING CORPORATION,
SAN FRANCISCO, CA:
2,763,068, PUB. 6-24-2003. INT. CL. 9.

- DOLE FOOD COMPANY, INC., WESTLAKE VILLAGE, CA:
2,012,480, CANC. INT. CL. 29.
- DOLLERO FIGUEROA, ARMANDO ERNESTO, LERMA,
EDO. DE MEXICO, MEXICO AND DOLLERO FIGUER-
OA, CARLO, LERMA, EDO. DE MEXICO, MEXICO:
2,763,116, PUB. 6-24-2003. INT. CL. 35.
- DOLPHIN CAPITAL AG, 81679 MUNCHEN, FED REP
GERMANY FROM FUNWORLD AG, 80333 MUNCHEN,
FED REP GERMANY:
2,763,169, PUB. 6-24-2003. MULTIPLE CLASS, INT. CLS.
9, 35 AND 41.
- DOMCO TARKETT INC., FARNHAM, QUEBEC J2N 1J7,
CANADA:
2,763,904, PUB. 6-24-2003. INT. CL. 27.
- DOMINICK'S FINER FOODS, INC., NORTHLAKE, IL:
2,011,275, CANC. INT. CL. 42.
- DON JONATHAN CRAVATS, INC., ALPARETTA, GA:
2,763,956, PUB. 6-24-2003. INT. CL. 25.
- DONALD, DOUGLAS D., ROSWELL, GA:
2,610,369, CANC. INT. CL. 25.
- DONE DEAL ADHESIVES LAB., INC., HUDSON, MA:
2,763,652, PUB. 6-24-2003. MULTIPLE CLASS, INT. CLS. 1
AND 17.
- DONGBU STEEL CO., LTD., SEO-KU, INCHON, REPUBLIC
OF KOREA:
2,765,038, INT. CL. 6.
- DONNELLY CORPORATION, HOLLAND, MI:
1,728,578, CANC. INT. CL. 12.
- DONNOVIN HOLDINGS, INC., LOOKOUT MOUNTAIN,
TN:
2,764,991, INT. CL. 3.
- DOOBIE BROTHERS CORP., THE, SONOMA, CA:
1,213,885, CANC. MULTIPLE CLASS, INT. CLS. 16 AND
41.
- DOOMZDAY ENTERTAINMENT, INC., BROOKLYN, NY:
2,765,795, INT. CL. 9.
- DOONEY & BOURKE, INC., SOUTH NORWALK, CT:
1,718,142, CANC. MULTIPLE CLASS, INT. CLS. 18 AND
25.
- DORGAN INVESTMENTS LIMITED, NASSAU, BAHAMAS:
2,763,728, PUB. 6-24-2003. INT. CL. 36.
- DORNIER MEDICAL SYSTEMS, INC., KENNESAW, GA:
2,012,785, CANC. INT. CL. 10.
- DOROTHEA HAYNES CHANDLER, COLUMBIA, MD, TA
THE GREEN FRAMER:
2,011,316, CANC. INT. CL. 16.
- DOS NACIONES, INC., EL PASO, TX, DBA EL PASO-
JUAREZ TROLLEY CO.:
2,011,634, CANC. INT. CL. 39.
- DOTT. CAV. F. PELONI S.P.A., 23032 BORMIO (SONDRIO),
ITALY:
1,727,999, CANC. INT. CL. 33.
- DOUBLEDAY BOOK & MUSIC CLUBS, INC., GARDEN
CITY, NY, DOUBLEDAY & COMPANY, INC., NEW
YORK, NY:
1,233,533, REN. 8-6-03. INT. CL. 16.
- DOUBLEDRIE, LLC, FRANKLIN, TN:
2,764,471, PUB. 6-24-2003. INT. CL. 25.
- DOUG JOHNSON, INC., JACKSON, WY, DBA HUCKLE-
BERRY MOUNTAIN CO.:
1,727,898, CANC. INT. CL. 30.
- DOUG JOHNSON, INC., JACKSON HOLE, WY:
2,012,644, CANC. INT. CL. 30.
- DOUGLASS, ELAINE, WASHINGTON, DC:
2,012,692, CANC. INT. CL. 42.
- DOW CHEMICAL COMPANY, THE, MIDLAND, MI:
2,012,209, CANC. INT. CL. 9.
- DPT LABORATORIES, LTD., SAN ANTONIO, TX:
2,764,853, MULTIPLE CLASS, INT. CLS. 40 AND 42.
- DR. PEPPER COMPANY, DALLAS, TX:
1,214,258, CANC. INT. CL. 32.
- DRACOO OF LYKENS, INC., LYKENS, PA:
2,763,906, PUB. 6-24-2003. INT. CL. 37.
- DRAGOCO GERBERDING & CO. AG, 37603 HOLZMINDEN,
FED REP GERMANY:
2,763,379, PUB. 6-24-2003. MULTIPLE CLASS, INT. CLS.
1, 2, 3, 29 AND 30.
- DREAM EVENTS, INC., SHARPSBURG, MD:
2,763,723, PUB. 6-24-2003. INT. CL. 41.
- DREAM IN COLOR, LLC, NEW YORK, NY:
2,765,287, INT. CL. 45.
- DREAMWELL, LTD, LAS VEGAS, NV, SIMMONS COM-
PANY, ATLANTA, GA:
1,773,632, REN. 8-6-03. INT. CL. 20.
- DREAMWERKS PRODUCTION GROUP, INC., BOCA RA-
TON, FL:
1,728,070, CANC. INT. CL. 35.
- DREXEL CHEMICAL COMPANY, MEMPHIS, TN, ANSUL
COMPANY, THE, MARINETTE, WI:
961,825, REN. 8-7-03. U.S. CL. 6 (INT. CL. 1).
- DREYER'S GRAND ICE CREAM, INC., OAKLAND, CA:
2,012,559, CANC. INT. CL. 30.
2,765,384, INT. CL. 30.
- DRIFT SURF, LLC, HONOLULU, HI:
2,764,123, PUB. 6-24-2003. INT. CL. 25.
- DRIVECON, INC., GURNEE, IL:
2,763,706, PUB. 6-24-2003. MULTIPLE CLASS, INT. CLS. 7
AND 9.
- DROGUERIA SARRA S.A., INC., CORAL GABLES, FL:
2,765,815, INT. CL. 5.
- DRUG FREE PENNSYLVANIA, INC., HARRISBURG, PA:
2,763,873, PUB. 6-24-2003. INT. CL. 41.
- DRUM DOCTORS LLC, NORTH HOLLYWOOD, CA:
2,765,157, INT. CL. 15.
- DT SWISS AG, CH-2504 BIEL, SWITZERLAND:
2,763,181, PUB. 6-24-2003. MULTIPLE CLASS, INT. CLS.
12 AND 25.
- DT SWISS AG, BIEL, SWITZERLAND:
2,763,188, PUB. 6-24-2003. MULTIPLE CLASS, INT. CLS.
12 AND 25.
- DTR ASSOCIATES LIMITED PARTNERSHIP, MARLBOR-
OUGH, MA:
2,763,811, PUB. 6-24-2003. INT. CL. 12.
- DUENSING, ROBERT, LENEXA, KS, DBA BEST REGARDS
AND DUENSING, CHERRIE, LENEXA, KS, DBA BEST
REGARDS:
2,764,228, PUB. 6-24-2003. INT. CL. 38.
- DUN & BRADSTREET, INC., SHORT HILLS, NJ, DUN &
BRADSTREET, INC., SHORT HILLS, NJ:
1,771,771, REN. 8-6-03. INT. CL. 35.
- DUN & BRADSTREET, INC., MURRAY HILL, NJ:
2,765,327, MULTIPLE CLASS, INT. CLS. 35 AND 36.
- DUNGAREES U.S.A., INC., MONTREAL, QUEBEC, CANA-
DA:
2,765,878, INT. CL. 25.
- DUNLOP SLAZENGER CORPORATION, GREENVILLE, SC:
2,012,875, CANC. INT. CL. 28.
- DUNN-EDWARDS CORPORATION, LOS ANGELES, CA:
2,763,530, PUB. 6-24-2003. INT. CL. 2.
- DUPONT DOW ELASTOMERS LLC, WILMINGTON, DE:
2,763,750, PUB. 6-24-2003. INT. CL. 1.
- DUPONT PHOTOMASKS, INC., ROUND ROCK, TX:
2,764,218, PUB. 6-24-2003. INT. CL. 42.
- DURA CORPORATION, SOUTHFIELD, MI:
398,413, CANC. U.S. CL. 19.
- DURA-TECH PROCESSES, INC., MANSFIELD, TX:
1,835,100, REN. 8-2-03. INT. CL. 2.
- DURAMAX MARINE, LLC, HIRAM, OH, LUCIAN Q.
MOFFITT, INC., AKRON, OH:
959,392, REN. 8-6-03. U.S. CL. 35 (INT. CL. 17).
- DURHAM GEO-ENTERPRISES, INC., STONE MOUNTAIN,
GA:
2,764,147, PUB. 6-24-2003. INT. CL. 9.
- DURKIN, RICHARD J., CORAL GABLES, FL:
1,975,383, CANC. INT. CL. 32.
- DUSINA'S, INC., WELCOME, NC:
1,728,420, CANC. INT. CL. 42.
- DUTCH HOUSING, INC., WHITE PIGEON, MI:
2,764,542, INT. CL. 19.
- DUVAL S.A., 95360 MONTMAGNY, FRANCE:
2,765,162, INT. CL. 6.
- DYNATEX, INC., ELIZABETHTOWN, KY TO DYNATEX,
INC., ELIZABETHTOWN, KY:
2,707,085, COR. INT. CL. 17.

- DYNNCDERMOTT PETROLEUM OPERATIONS COMPANY, NEW ORLEANS, LA:
1,834,010. REN. 8-6-03. MULTIPLE CLASS, INT. CLS. 35 AND 39.
- DYNO NOBEL INC., SALT LAKE CITY, UT, HERCULES POWDER COMPANY, WILMINGTON, DE:
95,099. REN. 8-6-03. U.S. CL. 9 (INT. CL. 13).
- E & H DISTRIBUTING CO., NORTH LAS VEGAS, NV, RYKOFF-SEXTON, INC., LOS ANGELES, CA, DBA S. E. RYKOFF & CO.:
1,796,784. REN. 8-2-03. INT. CL. 8.
1,799,957. REN. 8-2-03. INT. CL. 8.
- E AND E SPECIALTIES, INC., LAWRENCE, KS:
1,728,218. CANC. INT. CL. 40.
- E. & J. GALLO WINERY, MODESTO, CA:
2,765,561. INT. CL. 33.
- E. A. ISSA & BROS. LTD., KINGSTON 4, JAMAICA:
2,765,930. INT. CL. 43.
- E. ALKO INC., CHATSWORTH, CA:
2,763,643. PUB. 6-24-2003. INT. CL. 2.
- E. JAANG CORPORATION, WU GU HSIANG, TAIWAN:
2,763,849. PUB. 6-24-2003. INT. CL. 5.
- E.A.C. INDUSTRIES, INC., CHICAGO, IL:
739,975. CANC. U.S. CL. 23.
- E.H. SOLUTION SEASONING INC, BRONX, NY:
2,763,700. PUB. 6-24-2003. INT. CL. 30.
- E.I. DU PONT DE NEMOURS AND COMPANY, WILMINGTON, DE:
2,012,736. CANC. INT. CL. 40.
- E.S. ORIGINALS, INC., NEW YORK, NY:
1,728,629. CANC. INT. CL. 25.
- E-NETPIC.COM, INC., WEST PALM BEACH, FL:
2,765,047. MULTIPLE CLASS, INT. CLS. 9 AND 42.
- E-SIGNAL, PLANO, TX TO E-SIGNAL, PLANO, TX:
2,700,703. COR. INT. CL. 36.
- E-VANTAGE INTERNATIONAL, INC., LEXINGTON, MA:
2,763,520. PUB. 6-24-2003. INT. CL. 36.
- EADS COMPANY, INC., DOUGLASVILLE, GA:
1,214,288. CANC. INT. CL. 35.
1,214,289. CANC. INT. CL. 35.
- EAGLE FAMILY FOODS, INC., TARRYTOWN, NY:
2,764,903. INT. CL. 29.
- EAGLE MANUFACTURING COMPANY, WELLSBURG, WV:
2,763,474. PUB. 6-24-2003. INT. CL. 34.
- EAGLE REGISTRATIONS INC., DAYTON, OH:
2,763,446. PUB. 6-24-2003. INT. CL. 41.
- EAGLE RESEARCH CORPORATION, SCOTT DEPOT, WV:
2,764,022. PUB. 6-24-2003. MULTIPLE CLASS, INT. CLS. 37 AND 42.
- EAGLE ROCK ENTERTAINMENT LIMITED, LONDON SW181EZ, UNITED KINGDOM FROM EAGLE ROCK ENTERTAINMENT, PLC, WANDSWORTH LONDON, ENGLAND:
2,765,112. INT. CL. 9.
- EAGLE TRANSFER CORP., NEW YORK, NY:
1,214,354. CANC. INT. CL. 39.
- EAGLE WINDOW & DOOR, INC., DUBUQUE, IA, EAGLE WINDOW & DOOR, INC., DUBUQUE, IA:
1,743,934. REN. 8-4-03. INT. CL. 19.
- EAKINS, MILLARD, BOCA RATON, FL AND EAKINS, GALINA, BOCA RATON, FL:
2,012,553. CANC. INT. CL. 25.
- EARL CULLY HERITAGE TREES, INC., JACKSONVILLE, IL:
2,763,919. PUB. 6-24-2003. INT. CL. 31.
- EARL'S SUPPLY COMPANY, CARSON, CA:
1,726,992. CANC. INT. CL. 6.
- EARLY TIMES DISTILLERS COMPANY, LOUISVILLE, KY:
2,764,405. PUB. 6-24-2003. INT. CL. 33.
- EARTHRISE TRADING COMPANY, PETALUMA, CA:
2,012,790. CANC. INT. CL. 5.
2,012,791. CANC. INT. CL. 5.
- EARTHWORKS NATURAL ORGANIC PRODUCTS, MARTINS CREEK, PA:
2,763,290. PUB. 6-24-2003. INT. CL. 1.
- EARTHWORM PRODUCTIONS, LLC, STONE MOUNTAIN, GA:
2,764,440. PUB. 6-24-2003. INT. CL. 41.
- EASTERN AIR LINES, INC., MIAMI, FL:
1,213,872. CANC. INT. CL. 16.
- EASTLAND SHOE MFG. CORP., FREEPORT, ME:
1,253,838. REN. 8-7-03. INT. CL. 25.
- EASTMAN KODAK COMPANY, ROCHESTER, NY:
1,727,567. CANC. INT. CL. 16.
2,012,626. CANC. INT. CL. 2.
- EASY SWEATERS LLC, NEW YORK, NY:
2,765,118. INT. CL. 25.
- EAT, INC., CHAPEL HILL, NC:
2,763,941. PUB. 6-24-2003. INT. CL. 32.
- EBERHARDT, ROBERT M., WHEATON, IL:
2,764,591. INT. CL. 36.
- EBERT COMPOSITES CORPORATION, CHULA VISTA, CA:
2,765,627. INT. CL. 19.
- EBSCO INDUSTRIES, INC., BIRMINGHAM, AL:
2,764,227. PUB. 6-24-2003. INT. CL. 16.
- EB5 CORPORATION, PORTLAND, OR:
2,763,547. PUB. 6-24-2003. INT. CL. 3.
- ECKART GMBH & CO. KG, GA FROM ECKART-WERKE STANDARD-BRONZEPULVER-WERKE CARL ECKART GMBH & CO., FED REP GERMANY:
2,765,021. INT. CL. 2.
- ECKERD CORPORATION, LARGO, FL:
2,764,046. PUB. 6-24-2003. INT. CL. 40.
- ECOLAB, INC., ST PAUL, MN, ECONOMICS LABORATORY, INC., ST. PAUL, MN:
770,092. REN. 8-2-03. U.S. CL. 52 (INT. CL. 3).
- ECOLOGICAL FIBERS, INC., LUNENBERG, MA:
2,763,353. PUB. 8-27-2002. INT. CL. 16.
- ECOS TECHNOLOGIES, NEW YORK, NY:
2,764,779. INT. CL. 42.
- ECOTECH, INC., WINSTON-SALEM, NC:
2,763,432. PUB. 10-15-2002. MULTIPLE CLASS, INT. CLS. 1 AND 4.
- ECS AMERICA, INC., MOUNTAIN VIEW, CA:
1,727,154. CANC. INT. CL. 9.
- ECTEL LTD., PETACH-TIKVA 49517, ISRAEL:
2,764,794. INT. CL. 9.
- ECUCARE LIMITED LIABILITY COMPANY, WESTBROOK, ME:
2,011,529. CANC. INT. CL. 36.
- ED LEVIN, INC., CAMBRIDGE, NY:
2,765,308. INT. CL. 14.
- EDEAGROUP.COM, INC., DALLAS, TX:
2,765,314. INT. CL. 42.
- EDELSTEIN, SCOTT, W, ALAMEDA, CA AND BENJAMIN, MAIRA, M. ALAMEDA, CA:
2,765,535. INT. CL. 9.
- EDERIVATIVE.COM, INC., CHIYODA-KU, TOKYO 100-0014, JAPAN:
2,763,255. PUB. 3-11-2003. INT. CL. 36.
- EDIBA, INC., OKLAHOMA CITY, OK:
2,764,157. PUB. 6-24-2003. MULTIPLE CLASS, INT. CLS. 16 AND 41.
- EDISON PARKING CORPORATION:
See—EDISON PROPERTIES, LLC.
- EDISON PROPERTIES, LLC, NEWARK, NJ FROM EDISON PARKING CORPORATION, NEWARK, NJ:
2,763,386. PUB. 6-24-2003. INT. CL. 39.
- EDITOY AG:
See—JOKER, INC..
- EDUCATION DESIGN, INC., DENVER, CO:
2,011,666. CANC. INT. CL. 16.
- EDUCATIONAL COMMUNICATIONS, INC., NORTH-BROOK, IL:
1,214,291. CANC. INT. CL. 35.
- EDUCATIONAL TESTING SERVICE, PRINCETON, NJ:
1,727,311. CANC. MULTIPLE CLASS, INT. CLS. 9 AND 16.
1,772,125. REN. 8-2-03. MULTIPLE CLASS, INT. CLS. 9, 16 AND 42.
1,772,128. REN. 8-2-03. MULTIPLE CLASS, INT. CLS. 9, 16 AND 42.

- EDUCAUSE CORPORATION, BOULDER, CO:
2,764,019, PUB. 6-24-2003. INT. CL. 16.
2,764,020, PUB. 6-24-2003. INT. CL. 9.
- EDWARD RODRIGUEZ & CO., INC., TAMPA, FL:
2,012,749, CANC. INT. CL. 21.
- EDUARDO'S RESTAURANT, INC., CHICAGO, IL:
1,707,068, REN. 8-6-03. INT. CL. 42.
1,707,068, CANC. INT. CL. 30.
- EDWARDS LIFESCIENCES CORPORATION, IRVINE, CA:
2,765,073, INT. CL. 10.
- EFFECTIVENESS ENHANCEMENT, INC., LOUISVILLE, KY:
2,763,619, PUB. 6-24-2003. INT. CL. 41.
2,763,620, PUB. 6-24-2003. INT. CL. 41.
- EFPAC LIMITED, SWANSEA, WALES, UNITED KINGDOM
FROM IMAGITECH LIMITED, SWANSEA SA2 8PP, UNITED KINGDOM:
2,764,709, INT. CL. 9.
- EHARMONY.COM, INC., PASADENA, CA:
2,764,705, MULTIPLE CLASS, INT. CLS. 9 AND 42.
- EHLERT PUBLISHING GROUP, INC., MINNETONKA, MN:
1,728,041, CANC. INT. CL. 35.
- EHRET LITERATURE PUBLISHING CO., INC., DOBBS FERRY, NY:
1,213,889, CANC. INT. CL. 16.
- EISENORLD, INC., SUNRISE, FL:
2,765,363, INT. CL. 9.
- EJAY INTERNATIONAL, INC., GLENDORA, CA:
2,765,780, INT. CL. 18.
- EK SUCCESS, LTD., CLIFTON, NJ:
2,763,212, PUB. 6-24-2003. INT. CL. 16.
- EKTELON, SAN DIEGO, CA:
1,214,179, CANC. INT. CL. 28.
- EKWALL, MICHAEL ANDREW, PALO ALTO, CA:
2,764,314, PUB. 6-24-2003. INT. CL. 43.
- ELAM-T LIMITED, LONDON SE1 0AA, UNITED KINGDOM:
2,763,398, PUB. 2-18-2003. MULTIPLE CLASS, INT. CLS. 1, 9 AND 11.
- ELECTRIC INSURANCE COMPANY, BEVERLY, MA:
2,765,322, INT. CL. 36.
- ELECTRICAL INSULATION SUPPLIERS, INC., ATLANTA, GA:
1,727,596, CANC. INT. CL. 17.
- ELECTRO-MECHANICAL CORP., BRISTOL, VA:
2,765,577, INT. CL. 9.
- ELECTRON BEAM TECHNOLOGIES, INC., KANKAKEE, IL:
2,763,245, PUB. 7-24-2001. INT. CL. 6.
- ELECTRONIC DATA SYSTEMS CORPORATION, PLANO, TX:
2,012,107, CANC. INT. CL. 42.
- ELECTRONIC LABEL TECHNOLOGY, INC., BROKEN ARROW, OK:
2,764,048, PUB. 6-24-2003. INT. CL. 42.
- ELECTRONICS AND TELECOMMUNICATIONS RESEARCH INSTITUTE, YUSEONG-KU, DAEJEON, REPUBLIC OF KOREA:
2,763,575, PUB. 6-24-2003. INT. CL. 9.
- ELECTRONICS TECHNICIANS ASSOCIATION INTERNATIONAL INC., THE, GREENCASTLE, IN:
2,763,358, PUB. 6-24-2003. MULTIPLE CLASS, INT. CLS. 41 AND 42.
- ELEGANT USA, LLC, TOTOWA, NJ:
2,765,377, INT. CL. 22.
- ELITE ACCESS SYSTEMS, INC., ORANGE, CA:
2,011,670, CANC. INT. CL. 9.
- ELITEGROUP COMPUTER SYSTEMS, INC., FREMONT, CA:
1,727,155, CANC. INT. CL. 9.
- ELIZABETH WOOD INC., VERO BEACH, FL:
2,012,030, CANC. INT. CL. 25.
- ELKAY MANUFACTURING COMPANY, OAK BROOK, IL:
2,764,522, INT. CL. 11.
- ELLIPSYS TECHNOLOGIES, INC., APTOS, CA:
2,011,914, CANC. INT. CL. 9.
- ELLIS, KAREN, NEW YORK, NY:
2,764,580, INT. CL. 16.
2,764,581, INT. CL. 24.
- EM INDUSTRIES, INCORPORATED, HAWTHORNE, NY:
2,012,450, CANC. INT. CL. 1.
- EMBALLAGE WORKMAN INC., ST. LAURENT, QUEBEC, CANADA:
1,216,765, REN. 8-6-03. INT. CL. 22.
- EMBRY, JONATHAN D., MCLEAN, VA, DBA OPENING TECHNOLOGIES:
1,727,259, CANC. INT. CL. 9.
- EMCO BUILDING PRODUCTS LTD., LONDON, ONTARIO, N6A 5J9, CANADA FROM EMCO LIMITED, LASALLE, QUEBEC H8R 1R9, CANADA:
2,763,242, PUB. 6-24-2003. INT. CL. 19.
- EMCO LIMITED:
See—EMCO BUILDING PRODUCTS LTD.
- EMERSON ELECTRIC CO., ST. LOUIS, MO, RELIANCE ELECTRIC COMPANY, CLEVELAND, OH:
1,238,026, REN. 8-8-03. MULTIPLE CLASS, INT. CLS. 7 AND 9.
- EMIGRANT MORTGAGE COMPANY, INC., NEW YORK, NY:
2,764,835, INT. CL. 36.
- EMME NEW YORK, QUAKERTOWN, PA:
2,564,218, CANC. INT. CL. 25.
- EMMIS PUBLISHING, L.P., INDIANAPOLIS, IN:
2,764,219, PUB. 3-4-2003. INT. CL. 16.
- EMMONS, MICHELE T., CRAWFORDVILLE, FL:
2,011,794, CANC. INT. CL. 31.
- EMPACADORA DEL BAJIO, S.A., MEXICO CITY, 17, MEXICO:
1,214,228, CANC. INT. CL. 29.
- EMPIRE GENERAL LIFE ASSURANCE CORPORATION, OVERLAND PARK, KS:
2,765,429, INT. CL. 36.
- EMPIRE INDUSTRIES, INC., DELRAY BEACH, FL:
2,012,941, CANC. INT. CL. 28.
- EMPIRE MANUFACTURING COMPANY, WINDER, GA:
1,214,041, CANC. INT. CL. 25.
- EMPRESAS LA FAMOSA, INC., TOA BAJA, PUERTO RICO:
1,998,188, CANC. INT. CL. 30.
- EMPSON (U.S.A.) INC., ALEXANDRIA, VA:
2,765,399, INT. CL. 33.
- EMWARE, INC., SALT LAKE CITY, UT:
2,764,585, INT. CL. 9.
- ENCON ELECTRIC, L.P., PHILADELPHIA, PA:
2,764,767, INT. CL. 11.
- ENCON SAFETY PRODUCTS, INC., HOUSTON, TX:
2,763,709, PUB. 6-24-2003. INT. CL. 21.
- ENCORE COMPUTER U.S., INC., PLANTATION, FL:
2,011,266, CANC. INT. CL. 9.
- ENCORUS HOLDINGS LIMITED, DUBLIN 1, IRELAND:
2,763,567, PUB. 6-24-2003. MULTIPLE CLASS, INT. CLS. 9, 35, 36, 37, 41 AND 42.
- ENEFCO INTERNATIONAL LTD., AUBURN, ME:
2,764,036, PUB. 6-24-2003. INT. CL. 9.
- ENERGY BRANDS, INC.:
See—GLOBAL BRANDS, INC.
- ENHA GMBH, 66620 NONNWEILER, FED REP GERMANY:
2,763,579, PUB. 6-24-2003. INT. CL. 9.
- ENSO DESIGN, SEATTLE, WA:
2,764,149, PUB. 6-24-2003. INT. CL. 42.
- ENTERPRISE OIL PLC, LONDON, WC2N 5EJ, ENGLAND:
2,763,042, PUB. 6-24-2003. INT. CL. 36.
- ENTRAC TECHNOLOGIES INC., RICHMOND HILL, ONTARIO, CANADA:
2,763,824, PUB. 6-24-2003. INT. CL. 42.
- ENVIRONMENTAL PROTECTION AGENCY, WASHINGTON, DC:
1,728,419, CANC. INT. CL. 42.
- ENVIRONMENTAL SEALS LTD., KENT, UNITED KINGDOM:
2,763,792, PUB. 6-24-2003. INT. CL. 17.
2,763,793, PUB. 6-24-2003. INT. CL. 17.
- ENVIRONMENTAL SYSTEMS CORPORATION, KNOXVILLE, TN:
2,765,409, INT. CL. 37.

- ENVIRONMENTAL TECHNOLOGY, INC., SOUTH BEND, IN:
2,011,655, CANC. INT. CL. 9.
- ENVIRONMIST, INC., SHERIDAN, WY:
2,764,124, PUB. 10-1-2002. INT. CL. 19.
- ENZO BIOCHEM, INC., NEW YORK, NY:
2,764,481, MULTIPLE CLASS, INT. CLS. 1 AND 5.
- EPIK COMMUNICATIONS INCORPORATED, ORLANDO, FL:
2,765,136, INT. CL. 38.
- EPISCOPAL CARING RESPONSE TO AIDS, WASHINGTON, DC:
1,989,418, CANC. INT. CL. 42.
- EPITOPIX, LLC, WILLMAR, MN:
2,764,240, PUB. 6-24-2003. INT. CL. 5.
- EPIX HOLDINGS CORPORATION, TAMPA, FL:
2,764,857, MULTIPLE CLASS, INT. CLS. 35, 36 AND 42.
- EQUAL TIME ATHLETICS L.L.C., WAUSAU, WI:
2,012,102, CANC. MULTIPLE CLASS, INT. CLS. 25 AND 42.
- ERB INDUSTRIES, INC., WOODSTOCK, GA:
2,765,608, INT. CL. 9.
- ERGOSCIENCE, INC., BIRMINGHAM, AL:
2,763,677, PUB. 6-24-2003. INT. CL. 44.
- ERIC GOLDBERG ASSOCIATES, INC., NEW YORK, NY:
2,011,492, CANC. INT. CL. 28.
- ERIN ENGINEERING AND RESEARCH, INC., WALNUT CREEK, CA:
2,764,672, MULTIPLE CLASS, INT. CLS. 9 AND 42.
- ERNESTO MARINI S.R.L., GENOA, ITALY:
1,727,542, CANC. INT. CL. 16.
- ERNST & YOUNG U.S. LLP, NEW YORK, NY:
2,055,372, CANC. INT. CL. 35.
- ERNST W. DORN CO., INC., GARDENA, CA:
1,728,355, CANC. INT. CL. 42.
- ESAOTE S.P.A., I-15033 CASALE MONFERRATO, ITALY:
2,763,065, PUB. 4-15-2003. INT. CL. 10.
- ESE, INCORPORATED, MARSHFIELD, WI:
2,765,932, INT. CL. 9.
- ESOTERIX INC., AURORA, CO:
2,763,261, PUB. 4-15-2003. INT. CL. 42.
- ESOTERIX, INC., AUSTIN, TX:
2,764,033, PUB. 6-24-2003. INT. CL. 42.
- ESPE DENTAL AG, D-82229 SEEFELD, FED REP GERMANY:
2,763,241, PUB. 6-3-2003. MULTIPLE CLASS, INT. CLS. 5 AND 10.
- ESPOSITO JEWELRY, INC., PROVIDENCE, RI:
752,055, REN. 8-6-03. U.S. CL. 28 (INT. CL. 14).
- ESSIENT PHOTONICS, INC., DALLAS, TX:
2,763,495, PUB. 6-24-2003. INT. CL. 9.
- ETHAN INTERACTIVE, INC., COLUMBUS, OH:
2,763,879, PUB. 6-24-2003. INT. CL. 41.
- ETON DERMA LABORATORIES, INC., LOS ANGELES, CA:
2,012,183, CANC. INT. CL. 5.
- ETON DERMA LABORATORIES, INC., BEVERLY HILLS, CA:
2,012,262, CANC. INT. CL. 3.
- ETS MAURICE CHARTON:
See— GROUPE BERCHE.
- EUREKA HELLAS S.A., INDUSTRIAL AREA, GREECE:
2,765,514, MULTIPLE CLASS, INT. CLS. 3 AND 5.
- EURO TOOL, INC., LENEXA, KS:
2,011,849, CANC. INT. CL. 9.
- EURONAVY-TINTAS MARITIMAS E INDUSTRIAIS, SA, SETUBAL, PORTUGAL:
2,765,058, MULTIPLE CLASS, INT. CLS. 1, 2, 3 AND 17.
- EURPSVILLE USA, INC., MANHASSET, NY:
2,764,666, MULTIPLE CLASS, INT. CLS. 9, 16 AND 28.
- EV GROUP E. THALLNER GMBH, A-4780 SCHARDING/ST. FLORIAN, AUSTRIA:
2,720,663, COR. INT. CL. 7.
- EVANS FOOD PRODUCTS CO., CHICAGO, IL:
1,257,719, REN. 8-2-03. MULTIPLE CLASS, INT. CLS. 29 AND 30.
- EVE HOLDINGS INC., WILMINGTON, DE:
1,802,889, REN. 8-6-03. INT. CL. 34.
1,804,692, REN. 8-6-03. INT. CL. 34.
- EVENTSTYLE, INC., NEW YORK, NY:
2,764,224, PUB. 6-24-2003. INT. CL. 43.
- EVERBRITE, INC., GREENFIELD, WI:
2,765,212, MULTIPLE CLASS, INT. CLS. 9 AND 11.
- EVEREST VIT, INC., FLANDERS, NJ, VISUAL INSPECTION TECHNOLOGIES, INC., FLADERS, NJ:
1,783,984, REN. 8-4-03. INT. CL. 9.
- EVERON INTERNATIONAL LTD., SEOUL, REPUBLIC OF KOREA:
2,011,340, CANC. INT. CL. 9.
- EVERSOFT, INC., LONG BEACH, CA:
2,763,871, PUB. 6-24-2003. MULTIPLE CLASS, INT. CLS. 11 AND 37.
- EVO, INC., BEAVERTON, OR:
2,765,066, INT. CL. 11.
- EX-CELL HOME FASHIONS, INC., NEW YORK, NY:
2,764,764, INT. CL. 24.
- EXCELLMODES EXCLUSIVES, INC., NEW YORK, NY:
1,728,647, CANC. INT. CL. 25.
- EXCHANGE-A-BLADE LTD., DELTA BC, CANADA:
1,860,188, CANC. MULTIPLE CLASS, INT. CLS. 7 AND 37.
- EXCLUSIVELY ROSES, INC., MCLEAN, VA:
1,727,955, CANC. INT. CL. 31.
- EXECUTIVE INSURANCE AGENCY, INC.:
See— LIFE INSURANCE MARKETING CO., INC., THE.
- EXERHEALTH, INC., SALT LAKE CITY, UT:
2,012,404, CANC. INT. CL. 28.
- EXOPACK, L.L.C., SPARTANBURG, SC:
2,765,640, MULTIPLE CLASS, INT. CLS. 16, 17 AND 35.
- EXOPACK, LLC, SPARTANBURG, SC FROM EXO-TECH PACKAGING, L.L.C., SPARTANBURG, SC:
2,765,641, MULTIPLE CLASS, INT. CLS. 16, 17 AND 35.
- EXPANKO CORK COMPANY, INC., WEST CHESTER, PA:
2,467,705, CANC. INT. CL. 19.
- EXPLORER COMPETITION PRODUCTS, INC., CHULA VISTA, CA:
2,765,328, INT. CL. 12.
- EXPOCHARGER INTERNATIONAL, INC., HOLLISTON, MA:
2,764,335, PUB. 6-24-2003. INT. CL. 9.
- EXPRESS SCRIPTS, INC., MARYLAND HEIGHTS, MO:
2,011,419, CANC. INT. CL. 35.
- EXTRA RISK ASSOCIATES, INC., MOBILE, AL:
1,214,294, CANC. INT. CL. 36.
- EXTRACARE HEALTH SERVICES, MATAWAN, NJ:
2,763,062, PUB. 6-24-2003. INT. CL. 42.
- EXTREMIS AUDIO, LLC, SEATTLE, WA:
2,764,770, INT. CL. 9.
- EYE CARE COUNCIL, INC., TOPEKA, KS:
2,764,017, PUB. 6-24-2003. INT. CL. 35.
- EYELETS FOR INDUSTRY, INC., THOMASTON, CT:
1,728,220, CANC. INT. CL. 40.
- EYGN LIMITED, NASSAU, BAHAMAS:
2,764,029, PUB. 6-24-2003. INT. CL. 35.
- EZIFIX FASTENING SYSTEMS AUSTRALIA PTY LTD, GEEBUNG, QUEENSLAND, 4034, AUSTRALIA:
2,763,234, PUB. 6-24-2003. INT. CL. 19.
- F & F FINE WINES INTERNATIONAL INC., RUTHERFORD, NJ:
2,764,209, PUB. 6-24-2003. INT. CL. 35.
- F P C, INC., FOND DU LAC, WI:
1,213,849, CANC. INT. CL. 13.
- F. SCHUMACHER & CO., NEW YORK, NY:
1,728,661, CANC. INT. CL. 27.
- F.J. TIEMAN B. V., 3235 XK ROCKANJE, NETHERLANDS:
2,764,812, INT. CL. 9.
- F-SQUARED DENTAL, INC., WINFIELD, IL:
2,765,017, INT. CL. 10.
- FABASOFT AG, A-4040 PUCHENAU, AUSTRIA:
2,763,418, PUB. 6-24-2003. MULTIPLE CLASS, INT. CLS. 9, 41 AND 42.
- FABIAN, PATRICK, TILLEY, AB T0J 3K0, CANADA, TA FABIAN SEED FARMS:
2,764,906, INT. CL. 31.
- FAIGLE KUNSTSTOFFE GESELLSCHAFT M.B.H., A-6971 HARD, AUSTRIA:
2,763,395, PUB. 6-24-2003. MULTIPLE CLASS, INT. CLS.

- 1, 7 AND 17.
 FAIR GROUNDS CORPORATION, NEW ORLEANS, LA:
 2,764,847, INT. CL. 25.
 2,765,008, INT. CL. 36.
 FAIRFIELD UNIVERSITY, FAIRFIELD, CT:
 2,765,208, MULTIPLE CLASS, INT. CLS. 25 AND 41.
 FALCON WATERFREE TECHNOLOGIES, LLC, LOS ANGELES, CA:
 2,764,832, INT. CL. 11.
 FAMILY OF FAITH MINISTRIES, MODESTO, CA:
 2,764,606, INT. CL. 35.
 FAMILY VALUES TOUR LLC, BEVERLY HILLS, CA:
 2,763,636, PUB. 6-24-2003, INT. CL. 41.
 FANTASIAS MIGUEL, S.A. DE C.V., 06060, MEXICO:
 2,011,321, CANC. INT. CL. 26.
 FANTASY GOLF ADVENTURES INTERNATIONAL, LLC, GLEN BURNIE, MD:
 2,011,588, CANC. INT. CL. 41.
 FARAGHER FAMILY FARM, LLC, NEWPORT, KY, DBA OUR FAMILY FARM:
 2,764,693, INT. CL. 30.
 FARMLAND DAIRIES, WALLINGTON, NJ:
 2,011,774, CANC. INT. CL. 29.
 2,011,776, CANC. INT. CL. 29.
 FARMONT PRODUKTION GMBH & CO. KG, D-40549 DUSSELDORF, FED REP GERMANY:
 1,727,354, CANC. MULTIPLE CLASS, INT. CLS. 11 AND 12.
 FARNAM COMPANIES, INC., PHOENIX, AZ:
 2,580,437, AM. INT. CL. 5.
 FARO TECHNOLOGIES, INC., LAKE MARY, FL:
 1,775,007, REN. 8-7-03, MULTIPLE CLASS, INT. CLS. 9 AND 10.
 FARSHOUKH, SIRA, LOS ANGELES, CA:
 2,764,414, PUB. 6-24-2003, INT. CL. 25.
 FASA CORPORATION, CHICAGO, IL:
 2,011,364, CANC. INT. CL. 41.
 FASHION GROUP INTERNATIONAL, INC., THE, NEW YORK, NY:
 2,011,717, CANC. INT. CL. 25.
 FASHION TECH, INC., PORTLAND, OR:
 2,012,196, CANC. INT. CL. 40.
 FBS DISTRIBUTION CO., INC., BURNABY, BRITISH COLUMBIA V5C 6P3, CANADA:
 2,692,341, COR. INT. CL. 21.
 FEARON, HEPNER & RHODES, INC., HOUSTON, TX:
 2,763,028, PUB. 9-17-1996, INT. CL. 16.
 FEDERACION DE LOGIAS UNIDAS ORDEN CABALLERO DE LA LUZ, INC., MIAMI, FL:
 1,728,499, CANC. U.S. CL. 200.
 FEDERACION DE LOGIAS UNIDAS ORDEN CABELLERO DE LA LUZ, INC., MIAMI, FL:
 1,728,498, CANC. U.S. CL. 200.
 FEDERAL EXPRESS CORPORATION, MEMPHIS, TN:
 2,012,729, CANC. INT. CL. 16.
 2,764,608, INT. CL. 39.
 2,765,786, MULTIPLE CLASS, INT. CLS. 35 AND 39.
 FEDERAL HOME LOAN MORTGAGE CORPORATION, MCLEAN, VA:
 2,763,365, PUB. 6-24-2003, INT. CL. 36.
 2,764,941, INT. CL. 36.
 FEDERAL NATIONAL MORTGAGE ASSOCIATION, WASHINGTON, DC, DBA FANNIE MAE:
 2,764,619, INT. CL. 36.
 FEDERAL PAPER BOARD COMPANY, INC., MONTVALE, NJ:
 1,213,935, CANC. INT. CL. 16.
 FEDERAL SCREW WORKS, DETROIT, MI:
 2,763,036, PUB. 6-24-2003, INT. CL. 6.
 FELIX FOSTER, PFULLINGEN, FED REP GERMANY, INSTITUT DR. FRIEDRICH FORSTER, PRUFGERATEBAU, REUTLINGEN 1, FED REP GERMANY:
 1,198,507, REN. 8-6-03, INT. CL. 9.
 FELLOWES, INC., ITASCA, CT TO NEATO LLC, EAST HAVEN, CT:
 2,656,806, COR. INT. CL. 9.
 FELLOWS CORPORATION:
See—BOURN & KOCH, INC..
- FERFLOR S.A., F-69627 VILLEURBANNE CEDEX, FRANCE, BAT TARAFLEX, S.A., TARARE, FRANCE:
 1,215,968, REN. 8-7-03, INT. CL. 27.
 FERRAZZA, MICHAEL J., WEXFORD, PA:
 2,764,271, PUB. 6-24-2003, INT. CL. 36.
 FETISH FACTORY, INC., FORT LAUDERDALE, FL:
 2,765,941, INT. CL. 35.
 FETZER VINEYARDS, HOPLAND, CA, DOOLING, DANIEL F., BOONVILLE, CA, DBA MARIAH VINEYARDS:
 1,778,040, REN. 8-4-03, INT. CL. 33.
 FIALKOWSKI, BEN, BOISE, ID AND FIALKOWSKI, JEFF, BOISE, ID:
 1,728,459, CANC. INT. CL. 42.
 FIAT SOCIETA PER AZIONI, TORINO, ITALY:
 160,861, CANC. U.S. CL. 21.
 FIBREFORM WOOD PRODUCTS, INC., LOS ANGELES, CA:
 1,728,613, CANC. INT. CL. 20.
 FIDIA FAMACEUTICI SPA, I-350131 ABANO TERME, ITALY FROM FIDIA S.P.A., I-35031 ABANO TERME, ITALY:
 2,765,853, INT. CL. 5.
 FIDIA S.P.A.:
See—FIDIA FAMACEUTICI SPA.
 FIELDCENTRIX, INC., NEWPORT BEACH, CA:
 2,764,488, INT. CL. 9.
 FIELDER FINANCIAL & INSURANCE SERVICES, BURBANK, CA:
 2,011,676, CANC. INT. CL. 36.
 FIELDPOINT B.V., AMSTERDAM, NETHERLANDS:
 1,728,340, CANC. INT. CL. 42.
 FIELDPOINT B.V. CORPORATION, 1017 PS AMSTERDAM, NETHERLANDS:
 1,726,879, CANC. MULTIPLE CLASS, INT. CLS. 3, 5 AND 32.
 FIESTA OLE, INC., IDAHO FALLS, ID:
 2,011,967, CANC. INT. CL. 42.
 FILA SPORT S.P.A., BIELLA (VC), ITALY:
 2,011,613, CANC. INT. CL. 25.
 FINANZIARIA LES COPAINS S.P.A., 40138 BOLOGNA, ITALY:
 2,011,701, CANC. INT. CL. 25.
 FINCH TECHNOLOGIES, INC., BOTHELL, WA TO FINCH TECHNOLOGIES, INC., BOTHELL, WA:
 2,722,099, COR. INT. CL. 42.
 FINE ART DEVELOPMENTS, P.L.C., WEST YORKSHIRE BD4 6HW, ENGLAND:
 2,012,704, CANC. INT. CL. 16.
 FIRE CONCEPTS, INC., CRYSTAL LAKE, IL:
 2,764,901, INT. CL. 42.
 FIREMAN'S FUND MORTGAGE CORPORATION, FARMINGTON HILLS, MI TO SOURCE ONE MORTGAGE SERVICES CORPORATION, FARMINGTON HILLS, MI:
 1,728,690, CANC. INT. CL. 36.
 FIRESTOP PRODUCTS, INC., SCOTTSDALE, AZ:
 2,224,662, CANC. INT. CL. 9.
 FIRST BRANDS PROPERTIES INC., WILMINGTON, DE:
 1,727,577, CANC. INT. CL. 16.
 FIRST CAPITOL AG, INC., PLATTEVILLE, WI:
 2,012,089, CANC. INT. CL. 36.
 FIRST DATA CORPORATION, GREENWOOD VILLAGE, CO:
 2,763,975, PUB. 6-24-2003, INT. CL. 45.
 FIRST DISCOUNT TRAVEL, INC., ATLANTA, GA TO CARLSON TRAVEL NETWORK ASSOCIATES, INC., MINNEAPOLIS, MN:
 2,147,531, CANC. INT. CL. 35.
 FIRST ILR, LLC, BLOOMINGDALE, IL:
 2,765,088, MULTIPLE CLASS, INT. CLS. 35, 41 AND 42.
 FIRST NATIONWIDE BANK, SAN FRANCISCO, CA:
 2,011,812, CANC. INT. CL. 36.
 FIRST SOURCE FURNITURE GROUP LLC, NASHVILLE, TN, UNITED CHAIR COMPANY, INC., LEEDS, AL:
 1,737,643, REN. 8-4-03, INT. CL. 20.
 FIRST TANK CORPORATION, INC., FAIRFIELD, CA:
 2,764,929, MULTIPLE CLASS, INT. CLS. 37 AND 39.
 FIRST YEARS INC., THE, AVON, MA:
 2,012,348, CANC. INT. CL. 10.

- FIRSTLOGIC, INC., LACROSSE, WI, POSTALSOFT, INC., LACROSSE, WI:
1,793,462. REN. 8-5-03. MULTIPLE CLASS, INT. CLS. 9, 37 AND 41.
- FISH MART, INC., WEST HAVEN, CT:
2,763,335, PUB. 6-24-2003. INT. CL. 35.
- FITNESS CARE, INC., YORBA LINDA, CA:
2,765,330, INT. CL. 28.
- FITNESS INNOVATIONS INCORPORATED, PITTSBURGH, PA:
2,763,092, PUB. 6-24-2003. INT. CL. 41.
- FITZGERALD, JUNE, WINCHESTER, MA:
2,764,561, INT. CL. 16.
- FITZGERALDS LAS VEGAS LIMITED PARTNERSHIP, LAS VEGAS, NV:
2,012,515, CANC. INT. CL. 41.
- FITZPATRICK, ANNE MARIE, JIM THORPE, PA, DBA NATURE'S TRAIL:
2,765,747, INT. CL. 19.
- FL INDUSTRIES, INC., LIVINGSTON, NJ:
1,213,814, CANC. INT. CL. 9.
- FLAMENCO NETWORKS, INC., ALPHARETTA, GA FROM FLAMENCO CORPORATION, ALPHARETTA, GA, DBA FLAMENCO NETWORKS:
2,765,115, INT. CL. 38.
- FLAT-BACK CORPORATION, KATONAH, NY:
1,727,348, CANC. INT. CL. 10.
- FLEETWOOD ENTERPRISES, INC., RIVERSIDE, CA:
2,765,150, INT. CL. 12.
- FLETCHER, JAMES E., GREENEVILLE, TN:
2,764,426, PUB. 6-24-2003. INT. CL. 37.
- FLICHIA, GUS J., COLUMBUS, OH:
2,765,463, INT. CL. 30.
- FLOMO PLASTICS INDUSTRIAL CO., LTD., TAINAN, TAIWAN:
1,780,842. REN. 8-5-03. INT. CL. 16.
- FLOORCO INTERNATIONAL (NORTH AMERICA) INC., DALLAS, TX:
2,764,768, INT. CL. 19.
- FLORIDA ASSOCIATION OF SAFETY COUNCILS, INC., ORLANDO, FL:
2,765,562, INT. CL. 41.
2,765,563, INT. CL. 41.
- FLORIDA BOPPERS, INC., JACKSONVILLE, FL:
1,700,932, CANC. INT. CL. 41.
- FLORIDA LAWYERS MUTUAL INSURANCE COMPANY, ORLANDO, FL:
2,765,957, INT. CL. 36.
- FLORIDA PROSTATE INSTITUTE, DAVENPORT, FL:
2,765,241, INT. CL. 42.
- FLORIDA SAFETY ASSOCIATION, INC., ORLANDO, FL:
2,765,548, INT. CL. 41.
- FLOTTWEG GMBH, 84137 VILSBIBURG, FED REP GERMANY:
2,763,105, PUB. 4-23-2002. INT. CL. 7.
- FLOWER VILLAGE CIA. LTDA., QUITO, ECUADOR:
2,764,842, INT. CL. 31.
- FLOWERS BAKERIES BRANDS, INC., WILMINGTON, DE:
2,763,420, PUB. 6-24-2003. INT. CL. 30.
- FLOWERS YOUR WAY (INTERNATIONAL & WORLD-WIDE DELIVERY) ALL MAJOR CREDIT CARDS ACCEPTED CORPORATION, EDMONTON, ALBERTA, CANADA:
2,763,149, PUB. 6-24-2003. INT. CL. 35.
2,763,150, PUB. 6-24-2003. INT. CL. 35.
- FLS AUTOMATION A/S, DK-2500 VALBY, COPENHAGEN, DENMARK:
2,011,385, CANC. INT. CL. 9.
- FLS AUTOMATION A/S, DK-2500 VALBY, DENMARK:
2,012,214, CANC. INT. CL. 9.
- FLUID CONTAINMENT, INC., CONROE, TX:
2,011,886, CANC. INT. CL. 9.
- FLUID LINE PRODUCTS, INC., WILLOUGHBY, OH:
1,777,009. REN. 8-7-03. INT. CL. 6.
- FLY INDUSTRIES, LLC, COSTA MESA, CA:
2,113,733, CANC. INT. CL. 25.
- FLYMASTERS OF INDIANAPOLIS, INC., INDIANAPOLIS, IN:
1,775,938. REN. 8-2-03. INT. CL. 28.
- FLYNN, JOSEPH ROBERT, LARGO, FL AND GRAY, COLLEEN ANN, LARGO, FL:
2,764,136, PUB. 6-24-2003. INT. CL. 16.
- FMC CORPORATION, PHILADELPHIA, PA, ALGIN CORPORATION OF AMERICA, NEW YORK, NY:
573,997. REN. 8-6-03. U.S. CL. 6 (INT. CL. 1).
- FMC CORPORATION, PHILADELPHIA, PA:
2,765,141, INT. CL. 5.
- FMC TECHNOLOGIES, INC., CHICAGO, IL:
2,763,805, PUB. 6-24-2003. INT. CL. 7.
- FMC TECHNOLOGIES, INC., CHICAGO, IL FROM FMC TECHNOLOGIES, INC., CHICAGO, IL:
2,764,883, MULTIPLE CLASS, INT. CLS. 35, 40 AND 42.
- FMR CORP., BOSTON, MA:
2,764,388, PUB. 6-24-2003. INT. CL. 38.
2,765,742, INT. CL. 36.
- FOCAL POINT MARKETING, INC., BELLEVUE, WA:
2,012,536, CANC. INT. CL. 9.
- FOCUS ON THE FAMILY, COLORADO SPRINGS, CO:
2,765,850, MULTIPLE CLASS, INT. CLS. 35 AND 45.
- FOGARASSY, GUSZTAV UJFALUSI, MARSHALL, MN:
2,765,842, INT. CL. 16.
- FOOD AND DRUG LAW INSTITUTE, INC., THE, WASHINGTON, DC:
2,012,534, CANC. INT. CL. 41.
- FOOD INGREDIENTS SPECIALITIES S.A., VILLARS-SUR-GLANE, SWITZERLAND:
2,763,440, PUB. 6-24-2003. INT. CL. 16.
- FOOD SERVICES MANAGEMENT ASSOCIATES, PITTSBURGH, PA:
1,214,372, CANC. INT. CL. 41.
- FOODTOPIA, INC., NAPERVILLE, IL:
2,763,635, PUB. 6-24-2003. INT. CL. 35.
- FOOTPRINT SOFTWARE CORPORATION, EVANSTON, IL:
2,012,220, CANC. INT. CL. 42.
- FORD MOTOR COMPANY, DEARBORN, MI:
2,011,440, CANC. INT. CL. 9.
2,012,948, CANC. INT. CL. 12.
2,764,589, INT. CL. 35.
2,764,741, INT. CL. 36.
2,764,742, INT. CL. 42.
2,765,715, INT. CL. 16.
- FOREE HUNSICKER, INC., DALLAS, TX:
2,012,114, CANC. INT. CL. 14.
- FOREMOST FARMS USA, COOPERATIVE, BARABOO, WI:
2,763,040, PUB. 6-24-2003. MULTIPLE CLASS, INT. CLS. 29, 30 AND 32.
- FOREST SERVICE EMPLOYEES FOR ENVIRONMENTAL ETHICS, INC., EUGENE, OR:
2,764,358, PUB. 6-24-2003. INT. CL. 35.
- FORMSTORE INCORPORATED, FENTON, MO:
1,728,063, CANC. MULTIPLE CLASS, INT. CLS. 35, 40 AND 42.
- FORNI & FATTORIE S.P.A., 70022 ALTAMURA (BA), ITALY:
2,764,973, MULTIPLE CLASS, INT. CLS. 29, 30, 32 AND 33.
- FORSHEDA AKTIEBOLAG, FORSHEDA, SWEDEN:
1,213,803, CANC. MULTIPLE CLASS, INT. CLS. 7, 12 AND 17.
- FORT DEARBORN LIFE INSURANCE COMPANY, CHICAGO, IL:
2,012,803, CANC. INT. CL. 36.
- FORT HAYS STATE UNIVERSITY, HAYS, KS:
2,763,074, PUB. 6-24-2003. INT. CL. 41.
- FORT JAMES OPERATING COMPANY, NEENAH, WI, JAMES RIVER PAPER COMPANY, INC., RICHMOND, VA:
1,772,336. REN. 8-6-03. INT. CL. 16.
- FORTESCUE, JAMES M., WASHINGTON, NC:
2,764,282, PUB. 6-24-2003. INT. CL. 14.
- FORTIS, INC., NEW YORK, NY:
2,765,478, INT. CL. 36.
- FORTUNE SAVING BANK:
1,306,351, CANC. INT. CL. 36.

- FOSECO INTERNATIONAL LIMITED, NEHELLS, BIRMINGHAM B7 5JR, ENGLAND:
2,073,010, CANC. INT. CL. 4.
- FOSSA MEDICAL INC., BOSTON, MA FROM FOSSA INDUSTRIES, INC., BOSTON, MA:
2,765,354, INT. CL. 10.
- FOSTER BROTHERS FARM, INC., MIDDLEBURY, VT:
2,011,828, CANC. INT. CL. 31.
- FOSTER, KAY S., NEW YORK, NY:
2,764,724, INT. CL. 35.
- FOSTER, PAMELA C., DALLAS, TX:
2,012,568, CANC. INT. CL. 9.
- FOTONATION, INC., MILLBRAE, CA:
2,764,537, INT. CL. 9.
- FOUNDATION SOFTWARE, INC., BRUNSWICK, OH:
2,765,451, INT. CL. 9.
- FOUNDER HI-TECH CORPORATION, SOUTH SAN FRANCISCO, CA:
2,012,238, CANC. INT. CL. 9.
- FOUR PAWS PRODUCTS, LTD., HAUPPAUGE, NY:
1,797,036, REN. 8-5-03, INT. CL. 21.
- FOUR RIVERS SOFTWARE SYSTEMS, INC., PITTSBURGH, PA:
2,011,637, CANC. INT. CL. 9.
- FOURNIER, CHARLES L., KENT, WA:
1,728,607, CANC. INT. CL. 19.
- FOX RIVER MILLS, INC., OSAGE, IA:
2,764,428, PUB. 6-24-2003, INT. CL. 25.
- FRAMESAKE GREETINGS, INC., ANTIOCH, IL:
2,012,253, CANC. INT. CL. 16.
- FRANCESCO, ANTONIO, NEW YORK, NY:
1,767,746, REN. 8-6-03, INT. CL. 42.
- FRANCHISE OPPORTUNITIES.COM, LLC, FOREST PARK, GA:
2,763,136, PUB. 6-24-2003, MULTIPLE CLASS, INT. CLS. 35 AND 42.
- FRANCOTYP-POSTALIA AG & CO., D-16547 BIRKENWERDER, FED REP GERMANY:
2,763,508, PUB. 6-24-2003, MULTIPLE CLASS, INT. CLS. 9 AND 16.
- FRANK & BRYAN FOODS, INC., SPRING, TX:
2,011,285, CANC. INT. CL. 30.
- FRANK J. ITALIANO, INC., LA CROSSE, WI:
757,855, REN. 8-6-03, U.S. CL. 46 (INT. CL. 30).
- FRANK RUSSELL COMPANY, TACOMA, WA:
2,764,817, INT. CL. 41.
2,764,819, INT. CL. 9.
- FRANK'S NURSERY & CRAFTS, INC., TROY, MI FROM FRANK'S NURSERY AND CRAFTS, INC., TROY, MI:
2,765,096, INT. CL. 31.
- FRANKEL, ROBERT S., ENCINO, CA:
2,765,777, INT. CL. 35.
- FRANKFORD CANDY & CHOCOLATE COMPANY, PHILADELPHIA, PA:
2,708,172, COR. INT. CL. 30.
- FRANKLIN ESTIMATING SYSTEMS, INC., SALT LAKE CITY, UT:
1,727,303, CANC. INT. CL. 9.
- FRANKLIN SPORTS, INC., STOUGHTON, MA:
2,763,703, PUB. 6-24-2003, INT. CL. 28.
- FRANKLIN, IAN, BRACKLEY, NORTANTS NN13 6DQ, GREAT BRITAIN:
2,764,896, MULTIPLE CLASS, INT. CLS. 9 AND 16.
- FRANKLIN, JOYCE, LARKSPUR, CA:
2,764,334, PUB. 6-24-2003, INT. CL. 36.
- FRANKLY CONSULTING LLC., CHESTER, NJ:
2,764,886, INT. CL. 28.
- FRATERNAL ORDER OF POLICE, NASHVILLE, TN:
2,763,859, PUB. 6-24-2003, MULTIPLE CLASS, INT. CLS. 18 AND 25.
- FRED JOAILLIER, PARIS, FRANCE:
2,764,262, PUB. 6-24-2003, INT. CL. 14.
- FREEDOM COMMUNICATIONS, INC., IRVINE, CA:
1,974,521, CANC. INT. CL. 16.
- FREEDOM FEEDS, INC., URBANA, OH:
2,765,420, INT. CL. 31.
- FREELAND SYSTEMS, L.L.C., WESTFIELD, IN:
2,764,137, PUB. 7-30-2002, INT. CL. 9.
- FREI, DANIEL, 9404 RORSCHACHERBERG, SWITZERLAND:
2,763,760, PUB. 6-24-2003, INT. CL. 29.
- FREIGHTLINER LLC, PORTLAND, OR FROM FREIGHTLINER CORPORATION, PORTLAND, OR:
2,764,558, INT. CL. 12.
- FREMONT MUTUAL FUNDS, INC, SAN FRANCISCO, CA:
2,011,658, CANC. INT. CL. 36.
- FRESH AKTIEBOLAG, 360 32 GEMLA, SWEDEN:
2,764,914, INT. CL. 11.
- FRESH BRANDS, INC., SHEBOYGAN, WI:
2,765,261, INT. CL. 35.
- FRESH PACIFIC, FRESNO, CA, DBA MONTEREY EXPORT CO.:
1,775,404, REN. 8-6-03, INT. CL. 31.
- FRESHLAND PRODUCE LLC, YAKIMA, WA:
2,764,752, INT. CL. 29.
- FREUNDORFER INC., MARENGO, IL:
1,213,703, CANC. MULTIPLE CLASS, INT. CLS. 1 AND 7.
- FRIENDS OF BENJAMIN FRANKLIN HOUSE, US, THE, PHILADELPHIA, PA:
2,763,664, PUB. 6-24-2003, INT. CL. 36.
- FRISK INTERNATIONAL N.V., TECHNOLOGIELAAN 2, BELGIUM, LEKO N.V., 3200 AARSCHOT, BELGIUM:
1,806,290, REN. 8-6-03, INT. CL. 30.
- FRUGAL FLOWERS, INC., PRINCETON, NJ:
1,728,704, CANC. INT. CL. 42.
- FRUHBECK, GUILLERMO FRUHBECK, MONTECARLO, MONACO:
1,728,707, CANC. MULTIPLE CLASS, INT. CLS. 35, 36 AND 42.
1,728,708, CANC. MULTIPLE CLASS, INT. CLS. 35, 36 AND 42.
- FRUITS ET LEGUMES ERIC FRECHETTE INC., LEVIS, PROVINCE OF QUEBEC, CANADA:
2,765,134, MULTIPLE CLASS, INT. CLS. 31 AND 35.
- FRYDAY CLUB, INC., THE, NEW YORK, NY:
2,012,032, CANC. INT. CL. 25.
- FSV PAYMENT SYSTEMS LTD., HOUSTON, TX FROM ATM BENEFITS AND SERVICES LLC, HOUSTON, TX:
2,763,484, PUB. 6-24-2003, INT. CL. 9.
- FTJ FUNDCHOICE, L.L.C, KANSAS CITY, MO:
2,763,387, PUB. 4-9-2002, INT. CL. 36.
- FUCHS LUBRITECH GMBH, WEILERBACH, SWITZERLAND:
2,764,298, PUB. 6-24-2003, INT. CL. 4.
- FUEL QUALITY SERVICES, INC., FLOWERY BRANCH, GA:
2,763,052, PUB. 6-24-2003, INT. CL. 5.
- FUERTE, FERNANDO, TUCSON, AZ:
2,765,810, INT. CL. 29.
- FUJI HUNT PHOTOGRAPHIC CHEMICALS, INC., ALLENDALE, NJ:
2,763,816, PUB. 6-24-2003, INT. CL. 1.
- FUJITSU LIMITED, KANAGAWA 211-8588, JAPAN:
2,763,223, PUB. 6-24-2003, MULTIPLE CLASS, INT. CLS. 9, 35, 36, 37, 38, 39, 41 AND 42.
- FULTON PERFORMANCE PRODUCTS, INC., MOSINEE, WI FROM FULTON PERFORMANCE PRODUCTS, INC., MOSINEE, WI:
2,765,091, INT. CL. 12.
- FUNDACION CULTURAL OPERALIA, A.C., 11520 MEXICO D.F., MEXICO:
2,012,349, CANC. INT. CL. 35.
- FUNWORLD AG:
See—DOLPHIN CAPITAL AG.
- FUTURA COATINGS, INC., HAZELWOOD, MO:
2,763,819, PUB. 6-24-2003, INT. CL. 2.
- FUTURE FOODS, SANTA ROSA, CA:
1,749,745, REN. 8-5-03, INT. CL. 3.
- FUTURE STEEL HOLDINGS, LTD., BRAMPTON ONTARIO, CANADA, FUTURE STEEL BUILDINGS, LTD., BRAMPTON, ONTARIO, CANADA:
1,753,587, REN. 8-8-03, INT. CL. 6.
- FUTURE VISION HOLDING, INC., GREAT NECK, NY:
2,012,333, CANC. INT. CL. 9.
- G.D. SEARLE & CO., SKOKIE, IL:
2,765,833, INT. CL. 5.

- G.D.R. S.R.1., 20143 MILAN, ITALY:
2,011,429, CANC. INT. CL. 25.
- G.X. CLARKE & CO., JERSEY CITY, NJ:
2,764,795, INT. CL. 42.
- GA MODEFINE S.A., CH-1004 LAUSANNE, SWITZERLAND:
2,763,243, PUB. 6-11-2002. INT. CL. 3.
- GADGET SHOP LIMITED, THE, GLASGOW, SCOTLAND:
2,765,205, INT. CL. 35.
- GADZOOKS, INC., CARROLLTON, TX:
2,764,275, PUB. 6-24-2003. INT. CL. 3.
- GALIX SHOP, INC., NEW YORK, NY:
1,214,439, CANC. INT. CL. 42.
- GALLAGHER, MICHAEL, NAPA, CA:
2,765,883, INT. CL. 35.
- GANNETT SATELLITE INFORMATION NETWORK, INC., FRESNO, CA, DBA THE CINCINNATI ENQUIRER:
1,728,060, CANC. INT. CL. 35.
- GARCEAU, ARTHUR H., HOLLYWOOD, FL:
2,764,427, PUB. 6-24-2003. INT. CL. 3.
- GARDEN-FRESH FOODS, INC., MILWAUKEE, WI:
2,763,649, PUB. 6-24-2003. MULTIPLE CLASS, INT. CLS. 29 AND 30.
- GARDNER, MERLE F., GERMANTOWN, TN:
2,765,502, INT. CL. 9.
- GARDNER, MICHAEL STUART, REMUERA, NEW ZEALAND:
2,765,553, INT. CL. 20.
- GARLAND COMMERCIAL RANGES LIMITED, MISSISSAUGA, ONTARIO L4W 1X4, CANADA:
2,764,834, INT. CL. 11.
- GARRARD HOLDINGS LIMITED, LONDON W1S 4AS, UNITED KINGDOM:
2,763,828, PUB. 6-24-2003. INT. CL. 14.
- GARRETT BUILDING MATERIALS, L.L.C., OKLA. CITY, OK:
2,763,455, PUB. 6-24-2003. INT. CL. 35.
- GARRITY INDUSTRIES, INC., MADISON, CT:
2,764,803, INT. CL. 11.
- GAT AIRLINE GROUND SUPPORT, INC., MOBILE, AL:
2,011,550, CANC. INT. CL. 37.
- GATA BOX LTD., NEW YORK, NY:
2,012,722, CANC. INT. CL. 28.
- GATE CITY STEEL CORPORATION, OMAHA, NE:
1,213,793, CANC. INT. CL. 6.
- GATES & SONS, INC., DENVER, CO:
1,213,776, CANC. MULTIPLE CLASS, INT. CLS. 6 AND 19.
- GATEWAY 2000, INC., N. SIOUX CITY, SD:
1,727,205, CANC. INT. CL. 9.
- GATEWAY, INC., SAN DIEGO, CA:
2,764,618, INT. CL. 35.
- GAULDIN, MICHAEL G., ALEXANDRIA, VA:
2,764,113, PUB. 6-24-2003. INT. CL. 28.
- GAY, JODIE, HAMPSTEAD, NC AND GAY, TERRY, HAMPSTEAD, NC:
2,763,588, PUB. 6-24-2003. INT. CL. 28.
- GAYLORD ENTERTAINMENT COMPANY, NASHVILLE, TN:
2,765,288, MULTIPLE CLASS, INT. CLS. 35, 41, 43 AND 44.
- GAZ DE FRANCE, SERVICE NATIONAL, 75017 PARIS, FRANCE:
2,763,560, PUB. 6-24-2003. MULTIPLE CLASS, INT. CLS. 9, 16, 35, 38 AND 42.
- GAZZONI 1907 S.R.L., 40138 BOLOGNA, ITALY:
2,011,371, CANC. MULTIPLE CLASS, INT. CLS. 29, 30 AND 32.
- GCA INDUSTRIES, SCOTTSDALE, AZ:
2,763,646, PUB. 6-24-2003. INT. CL. 7.
- GDE SYSTEMS, INC., SAN DIEGO, CA:
2,011,376, CANC. MULTIPLE CLASS, INT. CLS. 9 AND 42.
- GDT GARABET DERMA TECHNOLOGY GMBH, HAMBURG, FED REP GERMANY:
2,764,183, PUB. 6-24-2003. MULTIPLE CLASS, INT. CLS. 5 AND 10.
- GEISINGER MEDICAL CENTER, DANVILLE, PA:
2,765,173, INT. CL. 42.
- GEL CONCEPTS LLC, WHIPPANY, NJ:
2,765,329, INT. CL. 3.
- GELCO PRODUCTS, INC., ALISO VIEJO, CA:
2,765,473, INT. CL. 20.
- GEM STORES, INC., JAMAICA, NY:
2,765,031, MULTIPLE CLASS, INT. CLS. 3 AND 21.
- GEMELLI S.P.A., 20145 MILAN, ITALY:
2,720,445, COR. INT. CL. 25.
- GEMINI INDUSTRIES, INC., CLIFTON, NJ:
1,727,362, CANC. INT. CL. 11.
2,763,254, PUB. 6-24-2003. INT. CL. 9.
- GEMINI SOUND PRODUCTS CORP., EDISON, NJ:
1,803,157, REN. 8-2-03. INT. CL. 9.
- GEMPSY FRANCE SA, 95200 SARCELLES, FRANCE:
2,763,572, PUB. 6-24-2003. INT. CL. 9.
- GENARGRICOLA-GENERALI AGRICOLTURA-JOINT STOCK COMPANY, TRIESTE, ITALY:
1,728,002, CANC. INT. CL. 33.
- GENEDTECT.COM LIMITED, AUCKLAND, NEW ZEALAND:
2,765,935, INT. CL. 1.
- GENERAC PORTABLE PRODUCTS, INC., JEFFERSON, WI FROM GENERAC PORTABLE PRODUCTS, INC., JEFFERSON, WI:
2,765,323, INT. CL. 7.
- GENERAL BINDING CORPORATION, SKOKIE, IL:
2,764,245, PUB. 6-24-2003. INT. CL. 16.
- GENERAL CABLE TECHNOLOGIES CORPORATION, HIGHLAND HEIGHTS, KY:
2,764,776, INT. CL. 9.
- GENERAL CONFERENCE OF CHRIST'S SANCTIFIED HOLY CHURCH, CAYCE, SC:
1,214,477, CANC. U.S. CL. 200.
- GENERAL ELECTRIC CAPITAL CORPORATION, STAMFORD, CT FROM DICK'S CLOTHING & SPORTING GOODS, INC., CORAOPOLIS, PA:
2,763,029, PUB. 7-7-1998. INT. CL. 25.
- GENERAL ELECTRIC COMPANY, SCHENECTADY, NY:
750,066, REN. 8-4-03. U.S. CL. 21 (INT. CL. 9).
- GENERAL ELECTRIC COMPANY, WATERFORD, NY:
1,244,903, REN. 8-5-03. INT. CL. 1.
1,773,956, REN. 8-5-03. INT. CL. 1.
- GENERAL ELECTRIC COMPANY, SCHENECTADY, NY:
2,764,120, PUB. 6-24-2003. MULTIPLE CLASS, INT. CLS. 7 AND 42.
- GENERAL MILLS IP HOLDINGS I, LLC, MINNEAPOLIS, MN:
2,765,790, INT. CL. 30.
- GENERAL MILLS, INC., MINNEAPOLIS, MN:
740,119, CANC. U.S. CL. 46.
- GENERAL MILLS, INC., MINNEAPOLIS, MN, COLOMBOS AND SONS CREAMERY ASSOCIATION, INCORPORATED, METHUEN, MA:
948,642, REN. 8-8-03. U.S. CL. 46 (INT. CLS. 1, 5, 29, 30, 31 AND 32).
- GENERAL MILLS, INC., MINNEAPOLIS, MN:
2,657,699, COR. INT. CL. 30.
2,765,704, INT. CL. 29.
- GENERAL MOTORS CORPORATION, DETROIT, MI:
1,727,423, CANC. INT. CL. 12.
1,727,434, CANC. INT. CL. 14.
2,054,546, CANC. INT. CL. 20.
2,765,723, INT. CL. 12.
- GENEROSO, GIUSEPPE, STATEN ISLAND, NY:
2,764,548, INT. CL. 42.
- GENESOF PHARMACEUTICALS, INC., SOUTH SAN FRANCISCO, CA FROM GENESOF, INC., SAN FRANCISCO, CA:
2,764,557, INT. CL. 1.
- GENI, INC., CARMEL, IN:
2,765,416, INT. CL. 5.
- GENKI CO., LTD., TOKYO 2-4-12, JAPAN FROM CRAVE ENTERTAINMENT, INC., RANCHO DOMINGUEZ, CA:
2,764,712, INT. CL. 9.

- GENOA SAVINGS AND LOAN COMPANY, THE, GENOA, OH:
2,764,347, PUB. 6-24-2003. INT. CL. 36.
- GENOVESE DRUG STORES, INC., MELVILLE, NY:
1,213,706, CANC. INT. CL. 1.
- GENPASS INC., FORT WASHINGTON, PA:
2,764,763, MULTIPLE CLASS, INT. CLS. 36 AND 37.
- GENSCI ORTHOBIOLOGICS, INC., IRVINE, CA:
2,763,763, PUB. 6-24-2003. MULTIPLE CLASS, INT. CLS. 5 AND 10.
- GENUARDI'S FAMILY MARKETS, L.P., NORRISTOWN, PA:
2,763,103, PUB. 3-19-2002. INT. CL. 35.
- GEORGIA CANCER COALITION, ATLANTA, GA:
2,763,884, PUB. 6-24-2003. MULTIPLE CLASS, INT. CLS. 16, 35, 36 AND 41.
2,763,898, PUB. 6-24-2003. MULTIPLE CLASS, INT. CLS. 16, 35, 36 AND 41.
- GEORGIA PUBLIC TELECOMMUNICATIONS COMMISSION, ATLANTA, GA:
2,764,719, INT. CL. 9.
- GEORGIA-PACIFIC CORPORATION, PORTLAND, OR:
1,213,898, CANC. INT. CL. 16.
- GEORGIA-PACIFIC RESINS, INC., ATLANTA, GA:
1,235,559, REN. 8-7-03. INT. CL. 1.
- GERBIG, SNELL/WEISHEIMER & ASSOCIATES, INC., WESTERVILLE, OH:
2,764,131, PUB. 9-24-2002. MULTIPLE CLASS, INT. CLS. 35, 41 AND 42.
- GFTA ANALYTICS INSTITUT GMBH, 40699 ERKRATH, FED REP GERMANY:
2,764,543, MULTIPLE CLASS, INT. CLS. 35, 36 AND 42.
- GIANCARLO PAOLI S.P.A., PORTO SANTELPIDIO, ITALY FROM GIANCARLO PAOLI S.R.L., PORTO SANTELPIDIO, ITALY:
2,765,687, MULTIPLE CLASS, INT. CLS. 18 AND 25.
- GIFTABLES, INC., CUPERTINO, CA:
2,765,769, INT. CL. 20.
- GIFTS IN KIND INTERNATIONAL, ALEXANDRIA, VA:
1,728,337, CANC. INT. CL. 42.
- GIG O' BYTE MUSIC, INC., SAN GERONIMO, CA:
2,012,683, CANC. INT. CL. 9.
- GILL STUDIOS, INC., SHAWNEE MISSION, KS:
1,808,189, REN. 8-8-03. INT. CL. 42.
- GILLET, DENNIS, S, ENCINITAS, CA:
2,765,604, INT. CL. 25.
- GILMORE ENTERPRISES WINDOW COVERINGS, INC., CHATSWORTH, CA:
2,763,721, PUB. 6-24-2003. MULTIPLE CLASS, INT. CLS. 17, 20 AND 24.
- GILMORE ENTERTAINMENT GROUP LLC, MYRTLE BEACH, SC:
2,763,266, PUB. 3-26-2002. INT. CL. 41.
2,765,927, INT. CL. 41.
- GILMORE, MATTHEW A., NEW YORK, NY:
2,765,491, INT. CL. 25.
- GIN YOUNG ENTERPRISE CO., LTD., TAIPEI, TAIWAN:
2,763,698, PUB. 6-24-2003. INT. CL. 19.
- GINFAX DEVELOPMENT LIMITED, CHAI WAN, HONG KONG:
2,763,363, PUB. 3-4-2003. INT. CL. 9.
- GISH BIOMEDICAL, INC., IRVINE, CA:
2,012,651, CANC. INT. CL. 10.
- GLACIER NUTRIENTS, LLC, RED LODGE, MT:
2,765,483, INT. CL. 5.
- GLASTON HOLDINGS LLP, NEW YORK, NY:
2,764,985, INT. CL. 41.
- GLAZE, INC., EDISON, NJ:
2,763,836, PUB. 6-24-2003. INT. CL. 8.
- GLEN WOOD COMPANY CORPORATION, THE, STUART, VA:
1,784,099, REN. 8-8-03. MULTIPLE CLASS, INT. CLS. 16, 25 AND 28.
- GLENWOOD DESIGNS, RANCHO DOMINGUEZ, CA:
2,764,180, PUB. 6-24-2003. MULTIPLE CLASS, INT. CLS. 11 AND 21.
- GLS BUSATTI DI SASSOLINI GIOVANNI & C. S.N.C., I-52031 ANGHARI - AREZZO, ITALY:
2,763,808, PUB. 6-24-2003. INT. CL. 24.
- GLOBAL BRANDS, INC., UPPER GRANDVIEW, NY FROM ENERGY BRANDS, INC., WHITESTONE, NY:
2,763,214, PUB. 6-24-2003. INT. CL. 32.
- GLOBAL CASH ACCESS, LLC, SUNNYVALE, CA:
2,764,949, MULTIPLE CLASS, INT. CLS. 9 AND 36.
- GLOBAL GAMES UNLIMITED, INC., MINNEAPOLIS, MN:
1,213,881, CANC. MULTIPLE CLASS, INT. CLS. 16 AND 28.
- GLOBAL RELAY COMMUNICATIONS INC., VANCOUVER, BRITISH COLUMBIA V6J 2H4, CANADA:
2,764,579, MULTIPLE CLASS, INT. CLS. 35, 38 AND 42.
- GLOBAL SERVICE SOLUTIONS, INC. ATLANTA, GA:
2,765,741, INT. CL. 36.
- GLOBAL UPHOLSTERY COMPANY, DOWNSVIEW PROVINCE, CANADA:
1,727,643, CANC. INT. CL. 20.
- GLUCHANICZ, PAUL, WAYNE, PA:
2,765,279, INT. CL. 35.
- GLUON NETWORKS, INC., COTATI, CA:
2,764,601, INT. CL. 9.
- GMB, INC., KING, NC, R. J. REYNOLDS TOBACCO COMPANY, WINSTON-SALEM, NC:
768,642, REN. 8-4-03. U.S. CL. 17 (INT. CL. 34).
1,271,008, REN. 8-2-03. INT. CL. 34.
1,783,609, REN. 8-4-03. INT. CL. 34.
1,821,600, REN. 8-2-03. INT. CL. 34.
- GMG CAPITAL INVESTMENTS, LLC, NEW YORK, NY:
2,765,087, INT. CL. 36.
- GMR FASHION INC., NEW YORK, NY:
2,764,549, INT. CL. 18.
- GOBAR, GLENNA M., SAN FRANCISCO, CA:
2,763,788, PUB. 6-24-2003. INT. CL. 44.
- GODINGER SILVER ART CO., LTD., NEW YORK, NY:
2,765,033, MULTIPLE CLASS, INT. CLS. 8 AND 14.
- GOLDBERG, SAMANTHA, NEW YORK, NY:
2,720,500, COR. MULTIPLE CLASS, INT. CLS. 25 AND 28.
- GOLDEN BOOKS PUBLISHING COMPANY, INC., NEW YORK, NY:
1,713,539, CANC. INT. CL. 16.
- GOLDWELL GMBH, DARMSTADT, FED REP GERMANY:
2,765,648, MULTIPLE CLASS, INT. CLS. 35, 41 AND 42.
- GOLFER'S WAREHOUSE, HARTFORD, CT:
1,739,986, REN. 8-4-03. INT. CL. 28.
- GOMBAR, RICK, LOS ANGELES, CA:
2,765,211, INT. CL. 41.
- GOOD DOG! INC., HUNTINGTON WOODS, MI:
2,763,109, PUB. 6-24-2003. INT. CL. 42.
- GOOD VALUE FURNITURE CORPORATION, CITY OF COMMERCE, CA:
2,012,937, CANC. INT. CL. 42.
- GOODIES FROM GOODMAN, INC., DALLAS, TX:
2,763,790, PUB. 6-24-2003. INT. CL. 35.
- GOODMAN, GERALD I., MIAMI, FL:
2,765,051, INT. CL. 5.
- GOODRICH CORPORATION, CHARLOTTE, NC FROM B.F. GOODRICH COMPANY, THE, CHARLOTTE, NC:
2,764,921, MULTIPLE CLASS, INT. CLS. 8, 14, 16, 18, 21, 24, 25 AND 28.
- GOSS INTERNATIONAL CORPORATION, WESTMONT, IL FROM GOSS GRAPHIC SYSTEMS, INC., WESTMONT, IL:
2,764,493, INT. CL. 7.
- GP PUBLICATIONS, INC., BRISBANE, CA:
2,012,391, CANC. INT. CL. 16.
- GPS (DELAWARE), INC., SAN BRUNO, CA:
2,012,872, CANC. MULTIPLE CLASS, INT. CLS. 3, 4 AND 5.
- GPT GLENDALE, INC., LAKELAND, FL:
2,763,182, PUB. 6-24-2003. INT. CL. 9.
- GRACIDA EQUIPOS MAGNETICOS, S.A. DE C.V., MONTERREY, NUEVO LEON, MEXICO:
2,763,324, PUB. 6-24-2003. INT. CL. 9.
- GRAFIX -N- TOONS STUDIOS, INC., WAPPINGER FALLS, NY:
2,765,873, INT. CL. 42.

- GRAJ & GUSTAVSEN, INC., NEW YORK, NY:
2,763,153, PUB. 6-24-2003. INT. CL. 35.
- GRAMINEX L.L.C., SAGINAW, MI FROM AB CERNELLE COMPANY, SWEDEN:
2,763,100, PUB. 6-24-2003. INT. CL. 5.
- GRANDE CHEESE COMPANY, BROWNSVILLE, WI:
1,386,932, CANC. INT. CL. 29.
- GRANDREAMS LIMITED, LONDON NW5 2JU, ENGLAND:
2,012,508, CANC. INT. CL. 16.
- GRANITEVILLE COMPANY, GRANITEVILLE, SC:
740,083, CANC. U.S. CL. 42.
- GRANT DESIGN COLLABORATIVE, INC., CANTON, GA FROM I.E., DESIGN LTD., CANTON, GA:
2,764,696, MULTIPLE CLASS, INT. CLS. 35 AND 42.
- GRATEFUL DEAD MERCHANDISING, SAN RAFAEL, CA TO GRATEFUL DEAD PRODUCTIONS, NOVATO, DE:
1,708,290, CANC. INT. CL. 25.
- GRATEFUL DEAD MERCHANDISING, INC., SAN RAFAEL, CA:
1,214,080, CANC. INT. CL. 25.
- GRAY, MICHAEL C., SAN JOSE, CA:
2,765,358, INT. CL. 35.
- GRAYLINE SIGHTSEEING ASSOCIATION, INC., NEW YORK, NY:
1,214,356, CANC. INT. CL. 39.
- GRE-USA CORPORATION, NEW YORK, NY:
1,728,147, CANC. INT. CL. 36.
- GREAT AMERICAN BOUQUET, LLC, MIAMI, FL:
2,765,773, INT. CL. 31.
- GREAT AMERICAN COSMETICS, INC., PORT WASHINGTON, NY:
2,012,883, CANC. INT. CL. 3.
- GREAT AMERICAN INSURANCE COMPANY, CINCINNATI, OH:
2,764,566, INT. CL. 36.
- GREAT AMERICAN LIFE INSURANCE COMPANY, LOS ANGELES, CA TO GREAT AMERICAN LIFE INSURANCE COMPANY, LOS ANGELES, CA:
1,214,315, CANC. INT. CL. 36.
- GREAT BAY SOAP COMPANY, RYE BEACH, NH:
2,764,657, INT. CL. 3.
- GREAT EXPECTATIONS, INC., TAHLEQUAH, OK:
2,764,190, PUB. 3-18-2003. INT. CL. 41.
- GREAT PLAINS SOFTWARE, INC., FARGO, ND:
2,012,309, CANC. INT. CL. 9.
- GREATENS, AMANDA, CINCINNATI, OH:
2,764,571, INT. CL. 3.
- GREATER CINCINNATI CHAMBER OF COMMERCE, CINCINNATI, OH:
2,765,338, MULTIPLE CLASS, INT. CLS. 21 AND 25.
- GREATER GREENVILLE CHAMBER OF COMMERCE, GREENVILLE, SC:
2,765,131, INT. CL. 35.
- GRECCO, MICHAEL, SANTA MONICA, CA:
2,764,162, PUB. 6-24-2003. INT. CL. 41.
- GRECIAN GOURMET, INC., YOUNGSTOWN, OH:
1,239,829, REN. 8-6-03. INT. CL. 42.
- GREEN FOODS CORPORATION, OXNARD, CA:
2,011,694, CANC. INT. CL. 5.
- GREEN VALLEY PRODUCE COOPERATIVE, SALINAS, CA, DBA GREEN VALLEY PRODUCE CO-OP:
1,214,250, CANC. INT. CL. 31.
- GREEN, WILHELMINA B., MONCKS CORNER, SC:
2,765,444, INT. CL. 25.
- GREENWAY RESEARCH LABS, INC., BURNSVILLE, MN:
2,765,345, INT. CL. 3.
- GREFENSTETTE, CARL M., PITTSBURGH, PA, DBA WORLDWIDE FILMWORKS:
2,764,204, PUB. 6-24-2003. INT. CL. 41.
- GREGORY S. WHIPPO, LAKE ZURICH, IL:
2,764,223, PUB. 6-24-2003. INT. CL. 17.
- GREIF BROS. CORPORATION, DELAWARE, OH:
1,727,008, CANC. INT. CL. 6.
- GRIFFIN VENTURES, INC., FLORENCE, AL:
2,011,968, CANC. INT. CL. 42.
- GROOVE NATION, INC., ATLANTA, GA:
2,763,380, PUB. 6-24-2003. INT. CL. 38.
- GROSSMAN, BARRY, LEVITTOWN, NY:
2,011,657, CANC. INT. CL. 42.
- GROUPE BERCHET, 01100 OYONNAX, FRANCE FROM ETS MAURICE CHARTON, FRANCE:
2,763,087, PUB. 7-3-2001. INT. CL. 12.
- GRUNAU ILLERTISSEN GMBH, 7918 ILLERTISSEN, FED REP GERMANY, CHEMISCHE FABRIK GRUNAU GESELLSCHAFT MIT BESCHRAENKTER HAFTUNG (GMBH), 7918 ILLERTISSEN, FED REP GERMANY:
1,783,749, REN. 8-6-03. INT. CL. 1.
- GRUNDFOS PUMPS CORPORATION, FRESNO, CA:
2,764,524, INT. CL. 7.
- GRUNER + JAHR PRINTING AND PUBLISHING CO., NEW YORK, NY, DBA GRUNER + JAHR USA PUBLISHING:
1,771,374, REN. 8-7-03. INT. CL. 16.
- GRUPPO CORDENONS S.P.A., MILAN, ITALY FROM CARTIERE DI CORDENONS S.P.A., 20145 MILAN, ITALY:
2,764,744, INT. CL. 16.
- GTE TELECOMMUNICATION SERVICES INCORPORATED, ATLANTA, GA:
2,011,963, CANC. INT. CL. 35.
2,011,964, CANC. INT. CL. 35.
2,011,965, CANC. INT. CL. 35.
- GUARDIAN LIFE INSURANCE COMPANY OF AMERICA, THE, NEW YORK, NY:
2,764,647, INT. CL. 36.
- GUARDIAN ROYALTY CORPORATION, SHARON, PA:
2,012,484, CANC. INT. CL. 13.
- GUERBET, 93420 VILLEPINTE, FRANCE:
2,692,092, COR. INT. CL. 5.
- GUESS?, INC., LOS ANGELES, CA:
2,664,015, COR. INT. CL. 25.
- GULA GULA REFEICOES LTDA., 22.440 - RIO DE JANEIRO, BRAZIL:
2,011,265, CANC. INT. CL. 42.
- GULF & WESTERN MANUFACTURING COMPANY, SOUTHFIELD, MI:
740,026, CANC. U.S. CL. 34.
- GULFSTREAM AEROSPACE CORPORATION, SAVANNAH, GA:
2,764,797, INT. CL. 9.
- GUM HAIR COMPANY LIMITED, ROMSEY, HAMPSHIRE, UNITED KINGDOM:
2,763,604, PUB. 6-24-2003. INT. CL. 3.
- GUMBERT, JERRY F., SIGEL, PA:
2,763,965, PUB. 6-24-2003. INT. CL. 25.
- GUND, INC., EDISON, NJ:
2,765,221, INT. CL. 28.
2,765,920, INT. CL. 28.
- GUNDERSEN LUTHERAN MEDICAL CENTER, INC., LACROSSE, WI, LUTHERAN HOSPITAL LACROSSE, LACROSSE, WI:
1,806,547, REN. 8-2-03. INT. CL. 42.
- GUNDERSON, MARY L., YANKTON, SD:
2,765,056, MULTIPLE CLASS, INT. CLS. 16 AND 41.
- GUSDORF CORPORATION, ST. LOUIS, MO:
1,213,994, CANC. INT. CL. 20.
- GUST, DAVID, CHICAGO, IL:
2,764,692, MULTIPLE CLASS, INT. CLS. 10 AND 21.
- GUSTAV PIRAZZI & COMP. KG, D - 63069 OFFENBACH, FED REP GERMANY:
2,763,192, PUB. 6-24-2003. INT. CL. 15.
- GUSTAVSBERG VVS AKTIEBOLAG, GUSTAVSBERG, S-134 00, SWEDEN:
1,213,775, CANC. MULTIPLE CLASS, INT. CLS. 6, 7, 11, 19, 20 AND 21.
- GUTHY-RENKER CORPORATION, PALM DESERT, CA:
2,012,702, CANC. INT. CL. 28.
- GUTMANN CUTLERY, INC., BELLINGHAM, WA, GUTMANN CUTLERY, INC., MOUNT VERNON, NY:
1,782,421, REN. 8-4-03. INT. CL. 8.
- GWB, INC., WILMINGTON, DE:
2,011,343, CANC. INT. CL. 25.

- G4 MEDIA, LLC, LOS ANGELES, CA:
2,764,283, PUB. 6-24-2003. INT. CL. 41.
2,764,284, PUB. 6-24-2003. INT. CL. 41.
2,764,285, PUB. 6-24-2003. INT. CL. 41.
2,764,286, PUB. 6-24-2003. INT. CL. 41.
- H & H INDUSTRIES, INC., ELMWOOD, IL:
2,765,304, INT. CL. 9.
- H. J. RASHTI & COMPANY, INC., NEW YORK, NY:
2,763,236, PUB. 6-24-2003. MULTIPLE CLASS, INT. CLS. 8, 10, 14, 16, 20, 24, 25 AND 28.
- H. SCHMINCKE & CO. GMBH & CO. KG, D-40699 ERKRATH, FED REP GERMANY:
2,011,762, CANC. INT. CL. 16.
- H.C. STARCK - V-TECH LTD., OHTA-KU, TOKYO 143-0016, JAPAN:
1,726,836, CANC. MULTIPLE CLASS, INT. CLS. 1 AND 6.
- H.S. HOSPITAL SERVICE S.P.A., 00040 POMEZIA (RM), ITALY:
2,765,220, MULTIPLE CLASS, INT. CLS. 5 AND 10.
- H-TECH, INC., WILMINGTON, DE, ISP INVESTMENTS INC., WILMINGTON, DE:
1,750,024, REN. 8-2-03. INT. CL. 11.
- HAAR, KENNETH W., LINCOLN, NE:
2,765,925, INT. CL. 28.
- HADDAD BROTHERS, INC., NEW YORK, NY:
2,011,538, CANC. MULTIPLE CLASS, INT. CLS. 24 AND 25.
- HAEGER, INCORPORATED, OAKDALE, CA:
2,765,053, INT. CL. 7.
- HAGANDER-OHLSSON AB:
See—PAXTER AB.
- HALEKO HANSEATISCHES LEBENSMITTEL KONTOR GMBH & CO. OHG, D-22081, FED REP GERMANY:
2,710,656, COR. MULTIPLE CLASS, INT. CLS. 3, 14, 18, 24, 25 AND 28.
- HALEKO HANSEATISCHES LEBENSMITTELKONTOR GMBH, D-22081 HAMBURG, FED REP GERMANY:
2,763,247, PUB. 2-11-2003. MULTIPLE CLASS, INT. CLS. 3, 14, 18, 24, 25 AND 28.
- HALF ACRE, INC., PROVINCETOWN, MA:
2,011,752, CANC. INT. CL. 42.
- HALFORD COMPANY, NASHVILLE, TN:
2,764,904, MULTIPLE CLASS, INT. CLS. 9 AND 35.
- HALLIBURTON ENERGY SERVICES, INC., CARROLLTON, TX:
2,764,937, INT. CL. 42.
- HALVORSON, GREGORY LYNN, MOUNT VERNON, WA AND HALVORSON, MARLYS ELAINE, MOUNT VERNON, WA:
2,763,693, PUB. 6-24-2003. INT. CL. 9.
- HAMBY, ROSCOE J. JR., RANCHO MURIETA, CA:
2,763,582, PUB. 6-24-2003. INT. CL. 35.
- HAMBY, ROSCOE J. JR., SLOUGHHOUSE, CA:
2,763,583, PUB. 6-24-2003. INT. CL. 35.
- HAMEED, FAROOK I., BROOKLYN, NY:
2,012,062, CANC. INT. CL. 25.
2,012,082, CANC. INT. CL. 25.
- HANA COBI CO., LTD., INCHEON, REPUBLIC OF KOREA:
2,765,867, INT. CL. 21.
- HANCOR, INC., FINDLAY, OH:
2,765,879, INT. CL. 17.
2,765,880, INT. CL. 17.
- HAND TOOL DESIGN CORPORATION, WILMINGTON, DE:
2,763,876, PUB. 6-24-2003. INT. CL. 7.
2,765,097, INT. CL. 8.
- HANGER ORTHOPEDIC GROUP, INC., BETHESDA, MD:
2,763,838, PUB. 6-24-2003. INT. CL. 10.
- HANKINS, STEVEN, WICHITA, KS:
2,764,371, PUB. 6-24-2003. INT. CL. 35.
- HANNAFORD BROS. CO., PORTLAND, ME:
2,011,312, CANC. INT. CL. 16.
- HANOVER ACCESSORIES, INC., PLYMOUTH, MN:
1,727,433, CANC. INT. CL. 14.
- HANRO AG (HANRO SA) (HANRO LTD.), LIESTAL, SWITZERLAND:
749,809, REN. 8-7-03. U.S. CL. 39 (INT. CL. 25).
- HANSEN'S TREE, LAWN & LANDSCAPING SERVICES, INC., ST. PETERS, MO:
2,764,041, PUB. 6-24-2003. INT. CL. 44.
- HANSGROHE, INC., ALPHARETTA, GA:
2,765,357, INT. CL. 11.
- HAPPY TOURS, SCOTTS VALLEY, CA:
2,011,982, CANC. INT. CL. 39.
- HARBOR PACKAGING, INC., POWAY, CA:
2,764,861, INT. CL. 16.
- HARCOURT BRACE JOVANOVIICH, INC., ORLANDO, FL:
1,213,938, CANC. INT. CL. 16.
- HARDSCAPE MATERIALS, INC., BIXBY, OK:
2,765,077, INT. CL. 11.
- HARGIS, GARY LAWTON, OWENSBORO, KY:
1,728,341, CANC. INT. CL. 42.
- HARKEN, INC., PEWAUKEE, WI:
964,047, REN. 8-6-03. U.S. CL. 19 (INT. CL. 12).
- HARLEM HIGH INC., NEW YORK, NY:
2,763,049, PUB. 6-24-2003. INT. CL. 25.
- HARLEQUIN ENTERPRISES LIMITED, DON MILLS, ONTARIO, CANADA:
1,213,917, CANC. INT. CL. 16.
- HARLEYSVILLE MUTUAL INSURANCE COMPANY, HARLEYSVILLE, PA:
1,214,318, CANC. INT. CL. 36.
- HARMON, ROBERT T., HILLSIDE, NJ:
1,728,386, CANC. INT. CL. 42.
- HARMONY OF THE SPHERES, INC., BUFFALO, NY:
2,765,029, INT. CL. 41.
- HARODITE FINISHING COMPANY, INC., THE, NORTH DIGHTON, MA:
740,086, CANC. U.S. CL. 42.
- HAROLD MANGELSEN & SONS, INC., OMAHA, NE:
2,012,567, CANC. MULTIPLE CLASS, INT. CLS. 3, 5, 20 AND 21.
- HARPER CORPORATION, FAIRFIELD, IA, DBA TEXAS FEATHERS, INC.:
2,765,421, INT. CL. 21.
- HARPERCOLLINS PUBLISHERS INC., NEW YORK, NY:
1,771,442, REN. 8-6-03. INT. CL. 16.
- HARRINGTON & KING PERFORATING CO., INC., THE, CHICAGO, IL:
2,763,587, PUB. 6-24-2003. MULTIPLE CLASS, INT. CLS. 6 AND 40.
- HARRINGTON-MCGILL, SISSY, EL CAJON, CA:
2,763,186, PUB. 6-24-2003. INT. CL. 31.
- HARRIS CORPORATION, MELBOURNE, FL:
2,011,392, CANC. INT. CL. 9.
2,764,996, INT. CL. 9.
2,765,400, INT. CL. 20.
2,765,431, INT. CL. 9.
- HARRIS RESEARCH, INC., LOGAN, UT:
2,763,429, PUB. 6-24-2003. INT. CL. 37.
2,763,431, PUB. 6-24-2003. INT. CL. 37.
- HARRISON, HUA, SEATTLE, WA AND HARRISON, GARY, SEATTLE, WA, DBA HARRISON TRADING COMPANY:
2,012,893, CANC. INT. CL. 28.
- HARRY MAJOR MACHINE, CLINTON TWP., MI:
2,764,952, INT. CL. 7.
- HART SCHAFFNER & MARX, CHICAGO, IL:
1,214,061, CANC. INT. CL. 25.
- HART, TERRY L., SANTA BARBARA, CA, DBA BAJA BOOKS:
1,727,207, CANC. MULTIPLE CLASS, INT. CLS. 9 AND 16.
- HARTE-HANKS TRANSPORTATION SERVICES, DEERFIELD BEACH, FL:
1,728,198, CANC. INT. CL. 39.
- HARTFORD FIRE INSURANCE COMPANY, HARTFORD, CT:
2,764,370, PUB. 6-24-2003. INT. CL. 36.
- HARTZ HOTEL SERVICES, INC., SECAUCUS, NJ, DBA GRAND HOSPITALITY:
2,763,331, PUB. 6-11-2002. INT. CL. 25.
- HARVARD INVESTMENTS, INC., SCOTTSDALE, AZ:
2,764,039, PUB. 6-24-2003. MULTIPLE CLASS, INT. CLS. 36 AND 37.
- 2,764,053, PUB. 6-24-2003. MULTIPLE CLASS, INT. CLS.

- 36 AND 37.
 HARVEY, TIMOTHY, JOHN, TEMECULA, CA:
 2,764,406, PUB. 6-24-2003. INT. CL. 9.
- HASBRO, INC., PAWTUCKET, RI:
 2,012,371, CANC. INT. CL. 28.
 2,012,810, CANC. INT. CL. 28.
 2,012,858, CANC. INT. CL. 28.
 2,765,256, INT. CL. 28.
- HASCO I.A. LIMITED, EARTH CITY, MO:
 2,764,749, INT. CL. 9.
- HASHIMOTO'S, LLC, DENVER, CO:
 2,763,578, PUB. 6-24-2003. INT. CL. 43.
- HATCHER, VIRGIL A., NEW YORK, NY:
 2,764,815, MULTIPLE CLASS, INT. CLS. 3, 5 AND 21.
- HATRAK, ROBERT STEPHEN, LAS VEGAS, NV:
 2,763,404, PUB. 6-24-2003. MULTIPLE CLASS, INT. CLS. 9 AND 35.
- HAXTON, CHRISTOPHER W, LOLO, MT:
 2,764,274, PUB. 6-24-2003. MULTIPLE CLASS, INT. CLS. 16, 18 AND 25.
- HAYNER HOYT CORPORATION, THE, SYRACUSE, NY:
 1,258,861, REN. 8-4-03. INT. CL. 37.
- HBO & COMPANY OF GEORGIA, ATLANTA, GA:
 1,728,024, CANC. INT. CL. 35.
- HDN CORPORATION, WILMINGTON, DE:
 2,011,819, CANC. INT. CL. 29.
- HEAD SPORT AG, A-6921 KENNELBACH, AUSTRIA:
 2,011,532, CANC. INT. CL. 28.
- HEAL WITH NATURE, INC., MESA, AZ:
 2,763,219, PUB. 6-24-2003. INT. CL. 5.
- HEALTH NET, INC., WOODLAND HILLS, CA:
 2,765,239, MULTIPLE CLASS, INT. CLS. 16 AND 41.
- HEALTH PHARM USA, INC., LITTLE ROCK, AR:
 2,012,847, CANC. INT. CL. 5.
- HEALTHCARE DELIVERY SYSTEMS, INC., SCOTTSDALE, AZ:
 2,012,378, CANC. MULTIPLE CLASS, INT. CLS. 35, 36 AND 42.
- HEALTHMEDIA, INC., ANN ARBOR, MI:
 2,764,839, MULTIPLE CLASS, INT. CLS. 16 AND 42.
 2,764,865, MULTIPLE CLASS, INT. CLS. 16 AND 42.
- HEALTHY HOME CENTER, INC., ST. PETERSBURG, FL FROM HEALTHY HOME CENTER, INC., SAINT PETERSBURG, FL:
 2,765,267, INT. CL. 2.
- HEALY & CO. SAN RAMON, CA:
 2,763,622, PUB. 6-24-2003. MULTIPLE CLASS, INT. CLS. 35 AND 42.
- HEARST COMMUNICATIONS, INC., NEW YORK, NY, NICKELS & LAUBER, INC., PHILADELPHIA, PA:
 168,186, REN. 8-6-03. U.S. CL. 39 (INT. CL. 25).
- HEARST CORPORATION, THE, NEW YORK, NY:
 2,012,691, CANC. INT. CL. 42.
 2,012,886, CANC. INT. CL. 42.
- HEARTLAND INTERNATIONAL TRADE SHOWS, INC., IOLA, WI:
 1,728,730, CANC. INT. CL. 35.
- HEARTLAND PREMIUM BEEF, INC., HUTCHINSON, KS:
 2,764,179, PUB. 6-24-2003. MULTIPLE CLASS, INT. CLS. 29, 31, 35 AND 44.
- HEAT AND CONTROL, INC., HAYWARD, CA:
 1,727,381, CANC. INT. CL. 11.
- HECKETT MULTISERV INTERNATIONAL N.V., 1951 JZ VELSEN-NOORD, NETHERLANDS:
 2,763,039, PUB. 12-25-2001. INT. CL. 7.
- HEDSTROM CORPORATION, ARLINGTON HEIGHTS, IL:
 2,765,953, INT. CL. 16.
- HEGARTY & COMPANY, CHICAGO, IL:
 1,214,266, CANC. INT. CL. 35.
- HEIDELBERGER DRUCKMASCHINEN AG, 69115 HEIDELBERG, FED REP GERMANY:
 2,763,441, PUB. 6-24-2003. MULTIPLE CLASS, INT. CLS. 9 AND 16.
- HEIDELBERGER DRUCKMASCHINEN AKTIENGESELLSCHAFT, 69115 HEIDELBERG, FED REP GERMANY:
 2,763,361, PUB. 6-24-2003. INT. CL. 9.
- HEISSNER GMBH, LAUTERBACH, FED REP GERMANY, HEISSNER K.G., LAUTERBACH (HESSEN), FED REP GERMANY:
 956,212, REN. 8-6-03. U.S. CL. 50 (INT. CL. 21).
- HELENE CURTIS, INC., WILMINGTON, DE, HELENE CURTIS, INC., CHICAGO, IL:
 1,775,676, REN. 8-7-03. INT. CL. 3.
- HELLENBRAND, INC., WAUAKEE, WI:
 1,767,365, REN. 8-4-03. INT. CL. 11.
- HELMUT FISCHER GMBH & CO. INSTITUT FUR ELEKTRONIK UND MESSTECHNIK, D-71069 SINDELFINGEN, FED REP GERMANY:
 2,763,603, PUB. 6-24-2003. INT. CL. 9.
- HELPWORKS, INC., LEBANON, IN:
 1,517,653, CANC. INT. CL. 42.
- HEMP BOARDS INC., MT. HOOD, OR:
 2,011,979, CANC. INT. CL. 28.
- HENKEL CONSUMER ADHEIVES, INC., AVON, OH FROM MANCO, INC., AVON, OH:
 2,765,836, MULTIPLE CLASS, INT. CLS. 1 AND 2.
- HENKEL CONSUMER ADHESIVES, INC., AVON, OH FROM MANCO, INC., AVON, OH:
 2,765,837, MULTIPLE CLASS, INT. CLS. 1 AND 2.
- HENKEL CORPORATION, RANCHO DOMINGUEZ, CA, JEFFREY MARTIN, INC., UNION, NJ:
 959,534, REN. 8-4-03. U.S. CL. 51 (INT. CL. 3).
- HENKEL CORPORATION, AMBLER, PA:
 1,213,758, CANC. INT. CL. 4.
- HENKEL KGAA, DUESSELDORF, FED REP GERMANY:
 2,763,347, PUB. 6-24-2003. INT. CL. 1.
 2,763,348, PUB. 6-24-2003. INT. CL. 1.
- HENKEL KOMMANDITGESELLSCHAFT AUF AKTIEN, DUSSELDORF-HOLTHAUSEN, FED REP GERMANY, HENKEL & CIE, GMBH, DUSSELDORF, FED REP GERMANY:
 749,615, REN. 8-4-03. U.S. CL. 5 (INT. CL. 16).
- HENRY F. TEICHMANN, INC., WASHINGTON COUNTY, PA:
 740,150, CANC. U.S. CL. 103.
- HENRY FRANCIS DUPONT WINTERTHUR MUSEUM, INC., THE, WINTERTHUR, DE:
 1,213,912, CANC. INT. CL. 16.
 1,213,998, CANC. INT. CL. 20.
 1,214,392, CANC. INT. CL. 41.
- HENSCHEL INDUSTRIE-TECHNIK GMBH, 34127 KASSEL, FED REP GERMANY FROM THYSSEN HENSCHEL INDUSTRIE-TECHNIK GMBH, KASSEL, FED REP GERMANY:
 2,764,918, INT. CL. 7.
- HERB STIRLING BRIDGMAN, CHERRY VALLEY, CA:
 2,764,630, INT. CL. 16.
- HERBA ENTERPRISE, INC., SAN FRANCISCO, CA:
 2,763,616, PUB. 6-24-2003. MULTIPLE CLASS, INT. CLS. 5 AND 30.
- HERBACEUTICALS, INC., NAPA, CA:
 2,763,936, PUB. 6-24-2003. INT. CL. 3.
- HERBERT KANNEGIESSER GMBH & CO., 32602 VLOTHO, FED REP GERMANY:
 2,764,653, INT. CL. 7.
- HERBERT STANLEY COMPANY, L.L.C., THE, GURNEE, IL, HERBERT STANLEY CORPORATION, THE, SKOKIE, IL:
 1,737,948, REN. 8-7-03. INT. CL. 5.
- HERITAGE MINISTRIES, WACO, TX:
 2,765,852, MULTIPLE CLASS, INT. CLS. 16 AND 41.
- HERITAGE PRESERVATION CORPORATION, SPARTANBURG, SC:
 2,763,659, PUB. 6-24-2003. INT. CL. 40.
- HERSEY CHOCOLAT E & CONFECTIONERY CORPORATION, WHEAT RIDGE, CO, BEATRICE FOODS CO., CHICAGO, IL:
 1,239,630, REN. 8-4-03. INT. CL. 30.
- HERSEY CHOCOLATE & CONFECTIONERY CORPORATION, WHEAT RIDGE, CO, HERSHEY FOODS CORPORATION, HERSHEY, PA:
 1,242,210, REN. 8-4-03. INT. CL. 28.

- HERSHEY CHOCOLATE & CONFECTIONERY CORPORATION, WHEAT RIDGE, CO, LEAF, INC., BANNOCKBURN, IL:
1,778,446. REN. 8-4-03. INT. CL. 30.
- HERZMAN AND COMPANY, INC., ENGLEWOOD CLIFFS, NJ:
2,012,094, CANC. INT. CL. 25.
- HESS MASCHINENFABRIK GMBH & CO. KG, BURBACH-WAHLBACH, FED REP GERMANY:
2,764,182, PUB. 6-24-2003. INT. CL. 7.
- HESTER INDUSTRIES, INC., MOOREFIELD, WV:
1,214,236, CANC. INT. CL. 29.
- HEWLETT-PACKARD COMPANY, PALO ALTO, CA:
2,011,590, CANC. INT. CL. 40.
- HEXCEL CORPORATION, PLEASANTON, CA:
2,764,731, INT. CL. 24.
- HEXIMER COMMUNICATIONS, INC., ALISO VIEJO, CA:
2,764,267, PUB. 6-24-2003. INT. CL. 42.
- HI-TEK RATIONS, INC, DUBLIN, GA:
2,764,360, PUB. 6-24-2003. INT. CL. 31.
- HICKORY FARMS, INC., MAUMEE, OH:
2,764,977, INT. CL. 29.
- HIDE SIDE, LTD., FISH CREEK, WI:
2,011,577, CANC. INT. CL. 42.
- HIGH END SYSTEMS, INC., AUSTIN, TX:
2,763,083, PUB. 6-24-2003. INT. CL. 11.
- HIGH MOUNTAIN PRESS, INC., SANTA FE, NM:
2,012,152, CANC. MULTIPLE CLASS, INT. CLS. 9 AND 16.
- HIGH TOWER SOFTWARE, INC., IRVINE, CA:
2,763,183, PUB. 6-24-2003. INT. CL. 9.
- HIGH TOWER SOFTWARE, INC., ALISO VIEJO, CA:
2,763,433, PUB. 6-24-2003. INT. CL. 9.
- HILL REFRIGERATION CORPORATION, TRENTON, NJ:
1,213,916, CANC. MULTIPLE CLASS, INT. CLS. 16 AND 41.
- HILL-ROM SERVICES, INC., BATESVILLE, IN, SUPPORT SYSTEMS INTERNATIONAL, INC., JOHNS ISLAND, SC:
1,239,269. REN. 8-4-03. INT. CL. 10.
- HILL, MARIANNE, LAS VEGAS, NV AND ALLEN, MICHAEL D., LAS VEGAS, NV:
2,764,659, INT. CL. 9.
- HILL, SANDRA D., ASHEVILLE, NC, DBA ESTARA:
2,012,052, CANC. INT. CL. 41.
- HILLSTREET BEDS, LLC., LOUISVILLE, KY:
2,290,129, AM. INT. CL. 20.
- HILTON TRADING CORPORATION, MIAMI, FL:
2,763,541, PUB. 6-24-2003. INT. CL. 9.
- HIMALAYAN INTERNATIONAL INSTITUTE OF YOGA SCIENCE AND PHILOSOPHY OF THE USA, HONESTALE, PA:
2,763,528, PUB. 6-24-2003. INT. CL. 41.
- HIRA COLLECTION INC., WALNUT, CA:
2,763,950, PUB. 6-24-2003. INT. CL. 25.
2,763,951, PUB. 6-24-2003. MULTIPLE CLASS, INT. CLS. 25 AND 35.
- HISAMITSU PHARMACEUTICAL CO., INC., SAGA, JAPAN:
2,764,238, PUB. 6-24-2003. INT. CL. 5.
- HJ SOCK GROUP LTD., HINCKLEY, UNITED KINGDOM:
2,764,303, PUB. 6-24-2003. INT. CL. 10.
- HNI RISK SERVICES, INC., NEW BERLIN, WI:
2,763,979, PUB. 6-24-2003. INT. CL. 36.
- HO, HELEN K., BETHESDA, MD:
2,763,370, PUB. 6-24-2003. INT. CL. 42.
- HOBIN, WILLIAM W, SANTA MONICA, CA:
2,764,816, INT. CL. 39.
- HODGES, ROBERT, ARTESIA, NM:
2,765,080, INT. CL. 32.
2,765,518, INT. CL. 35.
2,765,519, MULTIPLE CLASS, INT. CLS. 30 AND 35.
- HODGSON RUSS LLP, BUFFALO, NY:
2,763,633, PUB. 6-24-2003. INT. CL. 42.
- HOECHST AKTIENGESSELLSCHAFT, D-6230 FRANKFURT AM MAIN 80, FED REP GERMANY:
1,727,368, CANC. INT. CL. 11.
- HOECHST MARION ROUSSEL AG:
See— AVENTIS PHARMA HOLDING GMBH.
- HOECHST SCHERING AGREVO GMBH, 13342 BERLIN, FED REP GERMANY:
2,012,887, CANC. MULTIPLE CLASS, INT. CLS. 1 AND 5.
- HOFFMANN GROUP L.L.C., WICHITA, KS FROM GREEN-ACRE.COM, L.L.C., WICHITA, KS:
2,764,611, INT. CL. 5.
- HOFFMANN RESEARCH ASSOCIATES, INC., CHAPEL HILL, NC:
2,011,682, CANC. INT. CL. 35.
- HOFMANN WERKSTATT-TECHNIK GMBH, 64319 PFUNGSTADT, FED REP GERMANY:
2,011,382, CANC. INT. CL. 9.
- HOGAN ASSOCIATES, SAN FRANCISCO, CA:
1,214,238, CANC. INT. CL. 29.
- HOK GROUP, INC., ST. LOUIS, MO:
2,764,264, PUB. 6-24-2003. MULTIPLE CLASS, INT. CLS. 37 AND 42.
2,765,277, INT. CL. 35.
- HOLDEN, BONNIE, NEWPORT, RI:
2,011,490, CANC. INT. CL. 25.
- HOLDENER, TIM R., LOCKEFORD, CA:
2,765,479, INT. CL. 33.
- HOLLAND, PAMELA, NORTHPORT, NY:
2,765,821, MULTIPLE CLASS, INT. CLS. 29 AND 30.
- HOLNAM INC., DUNDEE, MI:
2,765,677, INT. CL. 19.
- HOLT TEXAS LTD, SAN ANTONIO, TX, DBA HOLT COMPANY OF TEXAS:
2,763,598, PUB. 6-24-2003. INT. CL. 41.
- HOLZER, ROBERT W., MAPLE GROVE, MN:
2,764,525, INT. CL. 37.
- HOME BUILDERS ASSOCIATION OF METROPOLITAN DENVER, DENVER, CO FROM KUROWSKI, JOHN, LITTLETON, CO:
2,764,574, U.S. CL. 200.
- HOME DYNAMICS, LLC, S. HACKENSACK, NJ:
2,764,735, INT. CL. 27.
- HOME FEDERAL BANK, HAMILTON, OH:
2,012,475, CANC. INT. CL. 36.
- HOME HEALTHCARE LABORATORY OF AMERICA, INC., FRANKLIN, TN:
2,763,543, PUB. 6-24-2003. INT. CL. 44.
- HOME INTERIORS & GIFTS, INC., CARRROLLTON, TX:
2,763,349, PUB. 6-24-2003. INT. CL. 35.
- HOME OF THE HEBERT CANDIES, INC., SHREWSBURY, MA:
1,800,968. REN. 8-6-03. INT. CL. 30.
- HOMECARE PREFERRED CHOICE, INC., FT. SMITH, AR:
1,775,589. REN. 8-7-03. INT. CL. 42.
- HOMEDAD SERVICES INCORPORATED, LANCASTER, NY:
2,764,222, PUB. 6-24-2003. INT. CL. 35.
- HOMESITE GROUP INCORPORATED, BOSTON, MA FROM HOMEOWNERS DIRECT CORPORATION, BOSTON, MA:
2,764,532, INT. CL. 36.
- HON TECHNOLOGY INC., MUSCATINE, IA:
2,765,426, INT. CL. 20.
- HONDA ELECTRONICS CO., LTD., AICH-KEN, JAPAN:
2,764,028, PUB. 6-24-2003. INT. CL. 9.
- HONDA GIKEN KOGYO KABUSHIKI KAISHA (HONDA MOTOR CO., LTD.), MINATO-KU, TOKYO 107, JAPAN:
2,765,385, INT. CL. 12.
- HONDA GIKEN KOGYO KABUSHIKI KAISHA (HONDA MOTOR CO., LTD.), TOKYO 107, JAPAN:
2,765,439, INT. CL. 12.
- HONDA GIKEN KOGYO KABUSHIKI KAISHA (HONDA MOTOR CO., LTD.), MINATO-KU, TOKYO 107, JAPAN:
2,765,839, MULTIPLE CLASS, INT. CLS. 37 AND 38.
- HONEY BAKE FARMS, INC., KANSAS CITY, MO:
1,214,245, CANC. INT. CL. 30.
- HONEY DEWASSOCIATES, INC., PLAINVILLE, MA:
2,011,623, CANC. MULTIPLE CLASS, INT. CLS. 30 AND 42.
- HONEYWELL INTERNATIONAL INC., MORRISTOWN, NJ:
2,765,050, INT. CL. 1.

- HOOGOVS TECHNICAL SERVICES ENERGY & ENVIRONMENT B.V., NL-1970 CA IJMUIDEN, NETHERLANDS: 2,011,335, CANC. MULTIPLE CLASS, INT. CLS. 1, 4, 6, 7, 11, 19, 37, 39 AND 42.
- HOOSON, KENNETH A., CLAYTON, NY, DBA CAPTAIN SPICER'S GALLERY: 2,012,045, CANC. MULTIPLE CLASS, INT. CLS. 21 AND 25.
- HOOTERS, INC., CLEARWATER, FL: 1,727,934, CANC. INT. CL. 30.
- HORIZON AG, LLC, MEMPHIS, TN: 2,763,639, PUB. 6-24-2003. INT. CL. 35.
- HORIZON DESIGNS LTD., 50 TOWN RANGE, GIBRALTAR: 2,764,660, INT. CL. 20.
- HORLER, KRISTEN M., MILL VALLEY, CA: 2,763,834, PUB. 6-24-2003. INT. CL. 41.
- HORMEL FOODS, LLC, AUSTIN, MN: 2,765,199, INT. CL. 29.
- HORNBY HOBBIES LIMITED, KENT CT9 4JX, UNITED KINGDOM: 2,763,753, PUB. 6-24-2003. INT. CL. 9.
- HORWICH, DAVID, WAYNE, PA: 2,764,909, INT. CL. 42.
- HORWITZ, LEWIS P., CENTURY CITY, CA: 2,764,044, PUB. 6-24-2003. INT. CL. 36.
- HOSPITALITY & LEISURE MANAGEMENT COMPANY INC, NASHVILLE, TN: 2,012,394, CANC. INT. CL. 41.
- HOTEL EMPLOYEES AND RESTAURANT EMPLOYEES INTERNATIONAL UNION, WASHINGTON, DC: 1,238,926. REN. 8-6-03. U.S. CL. 200.
- HOTJOBS.COM, LTD., NEW YORK, NY: 2,763,117, PUB. 2-20-2001. INT. CL. 35.
- HOUGHTON MIFFLIN COMPANY, BOSTON, MA: 2,765,159, INT. CL. 41.
- HOURLASS WINE COMPANY, INC., ST. HELENA, CA FROM SMITH, JEFFREY ROBERT, ST. HELENA, CA, DBA SWAN SPIRITS INTERNATIONAL: 2,764,766, INT. CL. 33.
- HOUSEHOLD INTERNATIONAL, INC., PROSPECT HEIGHTS, IL: 2,011,372, CANC. MULTIPLE CLASS, INT. CLS. 35 AND 36.
- HOUSEWARES AMERICA, INC., NEW YORK, NY: 2,765,225, INT. CL. 21.
- HOUSTON MCLANE COMPANY, INC., HOUSTON, TX: 2,011,428, CANC. INT. CL. 26.
- HOWARD BANK, N.A., THE, BURLINGTON, VT: 1,728,688, CANC. INT. CL. 36.
- HOYA CORPORATION, TOKYO, JAPAN: 2,764,156, PUB. 6-24-2003. INT. CL. 10.
- HPL TECHNOLOGIES, INC., SAN JOSE, CA: 2,763,566, PUB. 6-24-2003. MULTIPLE CLASS, INT. CLS. 9, 41 AND 42.
- HRCENTRAL CORPORATION, SALEM, OR: 2,012,116, CANC. INT. CL. 35.
- HSB RELIABILITY TECHNOLOGIES LLC, KINGWOOD, TX: 2,763,519, PUB. 6-24-2003. INT. CL. 35.
- HSC SOFTWARE, CARPINTERIA, CA: 2,011,561, CANC. INT. CL. 9.
- HSI SRERVICE CORP., NEWARK, DE, DENTAL PLAN, INC., DALLAS, TX: 1,782,527. REN. 8-4-03. INT. CL. 9.
- HUANG, YA-CHIN, TAINAN HSIEN, TAIWAN: 2,765,676, INT. CL. 28.
- HUBBELL INCORPORATED, ORANGE, CT: 2,765,410, INT. CL. 9.
- HUDSON NEWS COMPANY, EAST RUTHERFORD, NJ: 2,764,126, PUB. 6-24-2003. INT. CL. 35.
- HUDSON RESPIRATORY CARE INC., TEMECULA, CA, HUDSON OXYGEN THERAPY SALES COMPANY, LOS ANGELES, CA: 960,663. REN. 8-8-03. U.S. CL. 44 (INT. CL. 10).
- HUMPHRIES, WILLIAM C., FORT WAYNE, IN: 2,763,294, PUB. 6-24-2003. INT. CL. 42.
- 2,763,301, PUB. 6-24-2003. INT. CL. 42.
- HUNES HOME FURNISHINGS, INC., WILMINGTON, DE: 2,764,948, INT. CL. 35.
- HUNT HOLDINGS, INC., WILMINGTON, DE: 1,175,096, CANC. MULTIPLE CLASS, INT. CLS. 16 AND 17.
- HUNTER ENGINEERING COMPANY, BRIDGETON, MO: 2,765,266, INT. CL. 9.
- HUNTER PACIFIC LIMITED, TORTOLA, BR.VIRGIN ISLANDS: 2,764,605, INT. CL. 13.
- HUNTINGTON ALLOYS CORPORATION, HUNTINGTON, WV, INTERNATIONAL NICKLE COMPANY, INC., THE, NEW YORK, NY: 308,200. REN. 8-5-03. U.S. CL. 14 (INT. CL. 6).
- HUNTINGTON BANCSHARES INCORPORATED, COLUMBUS, OH: 1,728,135, CANC. INT. CL. 36.
- HUNTZINGER, THOMAS E., OCEANSIDE, CA: 2,764,415, PUB. 6-24-2003. INT. CL. 3.
- HUNZA, INC., DENVER, CO: 1,728,619, CANC. INT. CL. 25.
- HURRICANES HOCKEY LIMITED PARTNERSHIP, RALEIGH, NC: 2,764,963, INT. CL. 25.
- HY-VEE, INC., WEST DES MOINES, IA, HY-VEE FOOD STORES, INC., CHARITON, IA: 974,472. REN. 8-5-03. U.S. CL. 101 (INT. CL. 42).
- HYDER, TRACIE, D., HOLLADAY, UT: 2,764,201, PUB. 6-24-2003. MULTIPLE CLASS, INT. CLS. 35 AND 41.
- HYDRO-GEAR LIMITED PARTNERSHIP, SULLIVAN, IL: 2,763,814, PUB. 6-24-2003. MULTIPLE CLASS, INT. CLS. 7, 12, 41 AND 42.
- HYMITE APS, 2800 LYNGBY, DENMARK: 2,764,151, PUB. 6-24-2003. MULTIPLE CLASS, INT. CLS. 9 AND 40.
- HYPERION ANIMATION COMPANY, GLENDALE, CA: 2,012,518, CANC. INT. CL. 41.
- HYPNOTIC HATS, LTD., NEW YORK, NY: 1,727,777, CANC. INT. CL. 25.
- HYPOTENUSE, INC., VERONA, NJ: 1,780,735. REN. 8-5-03. INT. CL. 42.
- I AM FINE, INCORPORATED, BETHESDA, MD: 2,012,138, CANC. INT. CL. 10.
- I.S. ASSOCIATES, INC., TROY, MI: 2,764,164, PUB. 6-24-2003. MULTIPLE CLASS, INT. CLS. 9 AND 42.
- I-DEAL LLC, NEW YORK, NY FROM MERRILL LYNCH & CO., INC., NEW YORK, NY: 2,764,791, INT. CL. 36.
- IAN MACLEOD & CO. LTD., BROXBURN, UNITED KINGDOM: 2,765,782, INT. CL. 33.
- IATIA LIMITED, BOX HILL, VICTORIA 3128, AUSTRALIA FROM IATIA PTY LTD, BOX HILL, VICTORIA, AUSTRALIA: 2,763,321, PUB. 6-24-2003. INT. CL. 9.
- IATIA PTY LTD:
See— IATIA LIMITED.
- IB, LTD., THOUSAND OAKS, CA: 2,012,194, CANC. INT. CL. 16.
- IC COMM LLC, NEW YORK, NY: 2,765,566, INT. CL. 35.
- 2,765,567, INT. CL. 35.
- 2,765,568, INT. CL. 35.
- ICE TUBES, INC., TALLMADGE, OH: 2,763,406, PUB. 6-24-2003. INT. CL. 21.
- ICI AUSTRALIA OPERATIONS PROPRIETARY LIMITED:
See— ORICA AUSTRALIA PTY LTD.
- IDEAL CONCRETE BLOCK CO, WESTFORD, MA: 2,764,869, MULTIPLE CLASS, INT. CLS. 19 AND 42.
- 2,764,870, MULTIPLE CLASS, INT. CLS. 19 AND 42.
- IDEAS & INNOVATIONS, INC., LAKE LAND, FL: 2,765,253, INT. CL. 32.
- IDENTITYMINE, INCORPORATED, TACOMA, WA: 2,764,295, PUB. 6-24-2003. INT. CL. 42.

- IDG WORLD EXPO CORP., INC., FRAMINGHAM, MA FROM INTERNATIONAL DATA GROUP, INC., FRAMINGHAM, MA:
2,765,589, MULTIPLE CLASS, INT. CLS. 35, 41 AND 42.
- IDYON, LLC, GREENSBORO, NC:
2,764,720, INT. CL. 42.
- IEC LOGISTICS, INC., LAVERGNE, TN:
2,763,175, PUB. 6-24-2003. MULTIPLE CLASS, INT. CLS. 35 AND 39.
- IF AMERICA WOULD ONLY FOCUS, INC., SAN DIEGO, CA:
2,763,393, PUB. 6-24-2003. INT. CL. 42.
- IFASTGROUPE AND COMPANY, MARIEVELLE, QUEBEC, CANADA:
1,727,002, CANC. INT. CL. 6.
- IFCO ENTERPRISES, INC.:
See— INVISIBLE FENCE, INC.
- IGLOO PRODUCTS CORP., HOUSTON, TX:
1,214,013, CANC. INT. CL. 21.
- IGT, RENO, NV:
2,765,273, INT. CL. 9.
- IKANOS COMMUNICATIONS, FREMONT, CA:
2,765,217, INT. CL. 9.
- IL FORNAIO (AMERICA) CORPORATION, CORTE MADERA, CA, IL FORNAIO (AMERICA) CORPORATION, SAN FRANCISCO, CA, DBA IL FORNAIO:
1,828,418. REN. 8-5-03. MULTIPLE CLASS, INT. CLS. 29, 30 AND 33.
- ILLINOIS TOOL WORKS INC., GLENVIEW, IL:
2,763,403, PUB. 6-24-2003. MULTIPLE CLASS, INT. CLS. 9, 11, 12 AND 20.
2,764,337, PUB. 6-24-2003. INT. CL. 20.
- ILLYCAFFE S.P.A., 34147 TRIESTE, ITALY:
2,011,775, CANC. MULTIPLE CLASS, INT. CLS. 9, 11, 21, 30, 33 AND 42.
- IMAGEWEAR APPAREL CORP., WILMINGTON, DE FROM RED KAP APPAREL CORP., WILMINGTON, DE:
2,764,935, INT. CL. 25.
- IMAGINATION TECHNOLOGIES LTD., HERTFORDSHIRE WD4 8LZ, UNITED KINGDOM:
2,764,652, INT. CL. 9.
- IMAGISTICS INTERNATIONAL INC., TRUMBULL, CT FROM PITNEY BOWES OFFICE SYSTEMS, INC., TRUMBULL, CT:
2,764,139, PUB. 11-19-2002. MULTIPLE CLASS, INT. CLS. 35 AND 37.
- IMI NORGREN LIMITED, LICHFIELD, STAFFORDSHIRE, ENGLAND:
2,012,204, CANC. INT. CL. 17.
- IMMANUEL ENTERPRISES, LTD., HONOLULU, HI:
2,012,074, CANC. MULTIPLE CLASS, INT. CLS. 25 AND 42.
- IMMERSION GRAPHICS CORPORATION, COLUMBUS, GA:
2,764,421, PUB. 6-24-2003. INT. CL. 40.
- IMPACT COMMUNICATIONS, INC., NEW YORK, NY:
2,765,506, INT. CL. 41.
- IMPERIAL DAX COMPANY, INC., FAIRFIELD, NJ:
2,722,494, COR. INT. CL. 3.
- IMPERIAL HOME DECOR GROUP MANAGEMENT, INC., CLEVELAND, OH, REED DECORATIVE PRODUCTS LTD., TORONTO, ONTARIO, CANADA:
1,227,639. REN. 8-7-03. INT. CL. 27.
- IMPERIAL READING CORPORATION, NEW YORK, NY:
740,051, CANC. U.S. CL. 39.
- IMZ FERTIGUNGS-UND VERTRIEBSEGESELLSCHAFT FUR DENTALE TECHNOLOGIE MBH, 70794 FILDERSTADT, FED REP GERMANY:
2,764,586, INT. CL. 10.
- INCELLICO, INC., DURHAM, NC:
2,765,869, INT. CL. 42.
- INCREDIBLY EDIBLE DELITES, INC., BROOMALL, PA:
2,763,711, PUB. 6-24-2003. INT. CL. 29.
- INDEPENDENT FEATURE PROJECT WEST, SANTA MONICA, CA:
2,011,604, CANC. INT. CL. 41.
- INDEPENDENT STATIONERS, INC., INDIANAPOLIS, IN:
2,012,525, CANC. INT. CL. 35.
- INDEX NEWSPAPERS LLC, SEATTLE, WA FROM LOADED-FOR-BEAR PUBLISHING CO., SEATTLE, WA:
2,764,683, MULTIPLE CLASS, INT. CLS. 35 AND 42.
- INDEX-D, LLC, BRIDGEPORT, CT:
2,763,932, PUB. 6-24-2003. INT. CL. 35.
- INDIANAPOLIS ICE L.L.C., INDIANAPOLIS, IN:
2,764,592, INT. CL. 41.
- INDIANAPOLIS MOTOR SPEEDWAY CORPORATION, SPEEDWAY, IN:
1,214,389, CANC. INT. CL. 41.
- INDIGO MEDICAL, INCORPORATED, PALO ALTO, CA:
2,012,211, CANC. INT. CL. 10.
- INDOPCO, INC., BRIDGEWATER, NJ, DBA NATIONAL STARCH & CHEMICAL COMPANY:
2,765,673, INT. CL. 35.
2,765,750, INT. CL. 1.
- INDUSTRIES MAIBEC INC./MAIBEC INDUSTRIES INC., SAINTE-FOY, QUEBEC, CANADA:
2,764,629, INT. CL. 31.
- INDYMAC BANK, F.S.B., PASADENA, CA:
2,763,779, PUB. 6-24-2003. INT. CL. 36.
- INDYME ELECTRONICS, INC., SAN DIEGO, CA:
2,012,647, CANC. INT. CL. 9.
- INFINET MARKETING INTERNATIONAL, INC., AUSTIN, TX:
2,012,703, CANC. INT. CL. 35.
- INFINITY2, INC., SCOTTSDALE, AZ:
2,764,953, INT. CL. 5.
- INFLATABLE IMAGE TECHNOLOGIES, PTY. LIMITED, SYDNEY, AUSTRALIA:
2,763,462, PUB. 6-24-2003. MULTIPLE CLASS, INT. CLS. 19, 20 AND 22.
- INFLUENCE AT WORK, TEMPE, AZ:
2,764,667, INT. CL. 16.
- INFOGRAMS, INC., NEW YORK, NY:
2,765,448, INT. CL. 9.
- INFOPACK CONSULTING, INC., GARDEN CITY, NY:
2,764,158, PUB. 6-24-2003. INT. CL. 42.
- INFOPLUS, INC., NEEDHAM, MA TO WHITE DIRECTORY PUBLISHERS, INC., BUFFALO, NY:
1,727,456, CANC. INT. CL. 16.
- INFORMATION MANAGEMENT NETWORK, INC., NEW YORK, NY:
2,763,954, PUB. 6-24-2003. INT. CL. 41.
- INFORMATION SYSTEMS AUDIT AND CONTROL ASSOCIATION, ROLLING MEADOWS, IL:
2,765,910, MULTIPLE CLASS, INT. CLS. 9 AND 16.
- INFRASTRUCTUREWORLD.COM, MENLO PARK, CA:
2,763,176, PUB. 6-11-2002. INT. CL. 35.
- ING BANK OF CANADA, NORTH YORK, ONTARIO, M5J 2T7, CANADA:
2,763,138, PUB. 6-24-2003. INT. CL. 36.
- ING. ERICH PFEIFFER GMBFH, 78315 RADOLFZELL, FED REP GERMANY:
2,763,249, PUB. 6-24-2003. MULTIPLE CLASS, INT. CLS. 9, 10 AND 21.
- INGE-GLAS GMBH & CO. KG, 96465 NEUSTADT B. COBURG, FED REP GERMANY:
2,765,101, INT. CL. 28.
- INGENEUS CORPORATION, BRIDGETOWN, BARBADOS:
2,765,888, INT. CL. 42.
2,765,889, INT. CL. 42.
- INGENIOUS DESIGNS LLC, ST. PETERSBURG, FL:
2,765,369, INT. CL. 5.
- INGERSOLL-RAND COMPANY, WOODCLIFF LAKE, NJ, ARO EQUIPMENT CORPORATION, THE, BRYAN, OH:
583,712. REN. 8-4-03. U.S. CL. 13 (INT. CL. 7).
- INGRAM ENTERPRISES, INC., SPRINGFIELD, MO:
1,834,569. REN. 8-5-03. INT. CL. 13.
2,765,218, INT. CL. 13.
- INNER EXPANSION WORKSHOPS, INC., IRVINE, CA:
2,764,198, PUB. 6-24-2003. INT. CL. 41.
- INNODESK, INC., CLEVELAND, OH:
2,765,265, MULTIPLE CLASS, INT. CLS. 7 AND 16.
- INNOVASYS INC., FLAMBOROUGH, ONTARIO, L9H 7H9, CANADA:
2,763,050, PUB. 2-11-2003. INT. CL. 9.

- INNOVATIVE ANSWERS, INC., LAKE, MI:
2,763,757, PUB. 6-24-2003. INT. CL. 38.
- INNOVATIVE CEREAL SYSTEMS, LLC, WILSONVILLE, OR:
2,765,009, INT. CL. 42.
- INOBY'S LTD., OAKLAND, CA TO INOBY'S LTD., OAKLAND, CA:
2,669,534, COR. INT. CL. 5.
- INPHOMATCH, INC., CHANTILLY, VA:
2,763,785, PUB. 6-24-2003. MULTIPLE CLASS, INT. CLS. 38 AND 42.
- INRESCO PORTIFOLIOS LTD., ETNA, NH, BUYER'S RESOURCE, INC., DENVER, CO:
1,755,676, REN. 8-7-03. INT. CL. 36.
- INSCRIPT, LLC, CAMBRIDGE, MA:
2,764,669, INT. CL. 14.
- INSPIRATIONAL NETWORK, INC., THE, CHARLOTTE, NC:
2,764,706, INT. CL. 35.
- INSTAREAD CORPORATION, ORLANDO, FL:
1,258,360, CANC. INT. CL. 9.
- INSTITUT DE RECHERCHE BIOLOGIQUE, 78870 BAILLY, FRANCE:
2,012,252, CANC. INT. CL. 5.
- INSTITUTE FOR INTERNATIONAL RESEARCH, NEW YORK, NY:
2,765,405, INT. CL. 35.
- INSTITUTE OF ELECTRICAL AND ELECTRONICS ENGINEERS, INC, PISCATAWAY, NJ, DBA IEEE:
2,765,001, INT. CL. 16.
- INSTITUTE OF REAL ESTATE MANAGEMENT OF THE NATIONAL ASSOCIATION OF REALTORS, CHICAGO, IL:
2,011,508, CANC. INT. CL. 42.
- INSUL-VEST, INC., DALLAS, TX:
1,727,597, CANC. INT. CL. 17.
- INSURING THE CHILDREN OF SOUTHERN OHIO, CINCINNATI, OH:
2,763,262, PUB. 6-24-2003. INT. CL. 42.
- INSYSTEMS TECHNOLOGIES INC., MARKHAM, ONTARIO, L3R 9X1, CANADA:
2,764,518, MULTIPLE CLASS, INT. CLS. 9, 41 AND 42.
- INTEGRA DYNAMICS INC., CALGARY, ALBERTA, CANADA:
2,763,048, PUB. 6-24-2003. INT. CL. 11.
- INTEGRAL VISION, LAFAYETTE, CA:
2,763,096, PUB. 6-24-2003. INT. CL. 9.
- INTEGRAND ASSURANCE COMPANY, SAN JUAN, PUERTO RICO, VICTOR J. SALGADO & ASSOCIATES, SAN JUAN, PUERTO RICO:
1,794,422, REN. 8-6-03. INT. CL. 36.
1,794,425, REN. 8-6-03. INT. CL. 36.
- INTEGRAND ASSURANCE COMPANY, CORNER ENSENADA, SAN JUAN, PUERTO RICO, VICTOR J. SALGADO & ASSOCIATES, SAN JUAN, PUERTO RICO:
1,798,883, REN. 8-6-03. INT. CL. 36.
- INTEGRATED PRINT SOLUTIONS, INC., BRIDGEPORT, CT:
2,763,427, PUB. 10-1-2002. INT. CL. 42.
- INTEGRATED SYSTEMS, INC., SANTA CLARA, CA:
2,012,444, CANC. INT. CL. 9.
- INTEGREX VENTURES LLC, TOLEDO, OH:
2,765,634, INT. CL. 16.
- INTEGRITS CORPORATION, SAN DIEGO, CA:
2,764,576, INT. CL. 42.
- INTEGRITY TOYS, INC., JERSEY CITY, NJ:
2,764,350, PUB. 6-24-2003. INT. CL. 28.
- INTELLECT CORP., FORT LAUDERDALE, FL:
2,764,171, PUB. 4-8-2003. INT. CL. 9.
- INTELLECUTAL RESERVE, INC., SALT LAKE CITY, UT:
1,738,742, REN. 8-2-03. INT. CL. 42.
- INTELLIGENT DESIGNS 2000 CORPORATION, DENVER, CO:
2,765,382, INT. CL. 12.
- INTELLITECH CORPORATION, DURHAM, NH:
2,765,360, INT. CL. 9.
- INTELLIWORKS, INC., IRVINE, CA:
2,764,117, PUB. 6-24-2003. INT. CL. 35.
- INTER-IKEA SYSTEMS B.V., 1101 BL AMSTERDAM ZO, NETHERLANDS:
1,728,429, CANC. INT. CL. 42.
- INTERBREW, S.A., B-1000 BRUSSELS, BELGIUM:
2,763,094, PUB. 6-24-2003. INT. CL. 32.
- INTERCONTINENTALEXCHANGE, INC., ATLANTA, GA FROM INTERCONTINENTALEXCHANGE, L.L.C., ATLANTA, GA:
2,765,542, INT. CL. 36.
- INTERCONTINENTALEXCHANGE, INC., ATLANTA, GA FROM INTERCONTINENTALEXCHANGE, L.L.C., ATLANTA, GA:
2,765,544, INT. CL. 36.
- INTERCORP EXCELLE INC., WESTON, ONTARIO, CANADA:
2,763,945, PUB. 6-24-2003. INT. CL. 30.
- INTERFACE PEOPLE, LLC, CARROLLTON, TX:
2,764,323, PUB. 6-24-2003. INT. CL. 42.
- INTERGGS, INC., MISSION VIEJO, CA, DBA VERSADIAL SOLUTIONS:
2,764,316, PUB. 6-24-2003. INT. CL. 9.
- INTERLEGO A.G., ZUG, SWITZERLAND:
1,214,181, CANC. INT. CL. 28.
- INTERLOG USA, INC., SOUTH MINNEAPOLIS, MN:
2,764,161, PUB. 6-24-2003. MULTIPLE CLASS, INT. CLS. 35 AND 39.
- INTERMART CORP., THOUSAND OAKS, CA:
2,765,754, INT. CL. 36.
- INTERMART, INC., BURNSVILLE, MN:
2,011,647, CANC. INT. CL. 35.
- INTERMODAL TECHNOLOGIES, INC., NASHUA, NH:
1,727,414, CANC. INT. CL. 12.
- INTERMOUNTAIN HEALTH CARE, INC., SALT LAKE CITY, UT:
2,765,100, INT. CL. 41.
- INTERNATIONAL AID INC., SPRING LAKE, MI:
2,763,959, PUB. 6-24-2003. INT. CL. 25.
- INTERNATIONAL AMATEUR ATHLETIC FEDERATION, MC 98000 MONTE CARLO, MONACO:
2,763,268, PUB. 6-24-2003. MULTIPLE CLASS, INT. CLS. 6, 9, 12, 14, 16, 18, 25, 28, 32, 35, 36, 38, 41 AND 42.
- INTERNATIONAL ASSOCIATION OF SPECIAL INVESTIGATION UNITS, QUINCY, MA:
2,011,800, CANC. INT. CL. 41.
- INTERNATIONAL ASSOCIATION ON WATER QUALITY, LONDON, SWIH 9BT, ENGLAND:
2,011,273, CANC. MULTIPLE CLASS, INT. CLS. 16, 41 AND 42.
- INTERNATIONAL BROADCASTING SERVICES, LTD., PENN'S PARK, PA:
1,829,368, REN. 8-5-03. INT. CL. 16.
- INTERNATIONAL BUSINESS MACHINES CORPORATION, ARMONK, NY FROM LOTUS DEVELOPMENT CORPORATION, CAMBRIDGE, MA:
2,764,852, INT. CL. 9.
- INTERNATIONAL BUSINESS SUPPLIES, INC., SAVAGE, MD:
1,682,560, CANC. INT. CL. 1.
- INTERNATIONAL CHEMICAL COMPANY, PHILADELPHIA, PA:
2,764,006, PUB. 6-24-2003. MULTIPLE CLASS, INT. CLS. 2, 3 AND 4.
- INTERNATIONAL DAIRY FOODS ASSOCIATION, WASHINGTON, DC:
2,011,891, CANC. MULTIPLE CLASS, INT. CLS. 38 AND 42.
- INTERNATIONAL DATA GROUP, INC., FRAMINGHAM, MA:
2,012,335, CANC. INT. CL. 38.
2,012,924, CANC. INT. CL. 16.
2,764,121, PUB. 6-24-2003. MULTIPLE CLASS, INT. CLS. 16 AND 42.
2,764,650, MULTIPLE CLASS, INT. CLS. 16 AND 42.
2,765,559, MULTIPLE CLASS, INT. CLS. 35 AND 42.
- INTERNATIONAL ENTERTAINMENT GROUP, INC.:
See—WARREN MILLER ENTERTAINMENT, INC..

- INTERNATIONAL FAMILY ENTERTAINMENT, INC., LOS ANGELES, CA:
1,728,478, CANC. INT. CL. 42.
1,728,479, CANC. INT. CL. 42.
- INTERNATIONAL FLAVORS & FRAGRANCES INC., NEW YORK, NY:
2,765,321, INT. CL. 1.
- INTERNATIONAL FLORA TECHNOLOGIES, LTD., GILBERT, AZ:
2,764,436, PUB. 6-24-2003, INT. CL. 1.
- INTERNATIONAL GAMCO, INC., OMAHA, NE:
1,786,888, REN. 8-7-03, INT. CL. 28.
- INTERNATIONAL HOTEL SERVICES, INC., NORCROSS, GA:
2,011,677, CANC. INT. CL. 37.
- INTERNATIONAL LABORATORY TECHNOLOGY CORP., HOLLYWOOD, FL:
2,764,881, INT. CL. 5.
- INTERNATIONAL PAPER COMPANY, TUXEDO, NY:
2,765,586, INT. CL. 17.
- INTERNATIONAL REMOTE IMAGING SYSTEMS, INC., CHATSWORTH, CA:
2,765,121, MULTIPLE CLASS, INT. CLS. 5 AND 10.
- INTERNATIONAL SALT COMPANY, CLARKS SUMMIT, PA:
160,890, CANC. U.S. CL. 6.
- INTERNATIONAL SERVICE AGENCIES, INC., ALEXANDRIA, VA TO INTERNATIONAL SERVICE AGENCIES, INC., ALEXANDRIA, VA:
2,727,984, COR. INT. CL. 36.
- INTERNATIONAL TAEKWONDO ALLIANCE, PENSACOLA, FL:
2,011,862, CANC. INT. CL. 41.
- INTERNATIONAL TELEPRESENCE CORP., VANCOUVER, BRITISH COLUMBIA, CANADA:
2,012,268, CANC. INT. CL. 9.
- INTERNATIONAL TIME RECORDER LIMITED, TORONTO, ONTARIO M8Y 1E5, CANADA:
2,764,531, INT. CL. 9.
- INTERNATIONAL VERIFACT INC., TORONTO, ONTARIO, CANADA:
2,012,619, CANC. INT. CL. 9.
- INTERNATIONAL WINDOW FILM ASSOCIATION, MARTINSVILLE, VA:
2,764,037, PUB. 6-24-2003, INT. CL. 35.
- INTERNET ACCESS TECHNOLOGIES, INC., HOUSTON, TX:
2,764,860, INT. CL. 9.
- INTERNET CORPORATION FOR ASSIGNED NAMES AND NUMBERS, MARINA DEL REY, CA:
2,764,089, PUB. 6-24-2003, MULTIPLE CLASS, INT. CLS. 35 AND 42.
- INTERO REAL ESTATE SERVICES, INC., SAN JOSE, CA:
2,764,317, PUB. 6-24-2003, MULTIPLE CLASS, INT. CLS. 36 AND 42.
- INTERPOSE, INC., ALTAMONTE SPRINGS, FL:
2,011,959, CANC. INT. CL. 9.
- INTERPUBLIC GROUP OF COMPANIES, INC., THE, NEW YORK, NY FROM TRUE NORTH COMMUNICATIONS INC., CHICAGO, IL:
2,764,902, MULTIPLE CLASS, INT. CLS. 35 AND 39.
- INTERSCOPE RECORDS, INC., LOS ANGELES, CA:
1,728,258, CANC. INT. CL. 41.
- INTERSCOPE RECORDS, INC., LOS ANGELES, CA:
1,728,259, CANC. INT. CL. 41.
- INTERSEARCH CORPORATION, HORSHAM, PA:
2,011,969, CANC. INT. CL. 35.
- INTERSTATE BUSINESS MANAGEMENT, INC., DALLAS, TX:
2,763,653, PUB. 6-24-2003, INT. CL. 36.
- INTERTEC MARKET REPORTS, INC., OVERLAND PARK, KS:
1,727,493, CANC. INT. CL. 16.
- INTERTEK TESTING SERVICES NA INC., LOMBARD, IL:
2,684,106, COR. INT. CL. 42.
- INTERTRAIN PRODUCTIONS PTY LTD, SURREY HILLS VICTORIA 3127, AUSTRALIA:
2,763,240, PUB. 10-1-2002, INT. CL. 9.
- INTERVOICE LIMITED PARTNERSHIP, RENO, NV:
2,764,875, MULTIPLE CLASS, INT. CLS. 9, 35, 38 AND 42.
- INTRINSITY, INC., AUSTIN, TX:
2,765,942, INT. CL. 9.
- INTUIT INC., MOUNTAIN VIEW, CA:
2,763,973, PUB. 6-24-2003, INT. CL. 40.
2,764,455, PUB. 6-24-2003, INT. CL. 9.
- INVENTURE PLACE, INC., AKRON, OH:
2,765,525, MULTIPLE CLASS, INT. CLS. 16, 25 AND 41.
- INVERCAP, S.A. DE C. V., COL. VALLE OTE., MEXICO D.F., MEXICO:
2,763,613, PUB. 6-24-2003, MULTIPLE CLASS, INT. CLS. 35 AND 36.
- INVISIBLE CABLE ENTERPRISES PTY. LTD., DICKSON ACT 2602, AUSTRALIA:
2,012,155, CANC. INT. CL. 9.
- INVISIBLE FENCE, INC, GARRETT, IN FROM IFCO ENTERPRISES, INC., MALVERN, PA:
2,765,835, INT. CL. 9.
- IOWA STUDENT LOAN LIQUIDITY CORPORATION, DES MOINES, IA:
2,765,022, MULTIPLE CLASS, INT. CLS. 9 AND 36.
- IPALCO B.V., 3016 DE ROTTERDAM, NETHERLANDS:
1,771,106, REN. 8-7-03, INT. CL. 7.
- IPC PERIPHERALS PTE. LTD., SINGAPORE:
2,012,916, CANC. INT. CL. 9.
- IQSOLUTIONS, INC., ROCKVILLE, MD:
2,763,230, PUB. 6-24-2003, INT. CL. 35.
- IRIS CERAMICA - SOCIETA' PER AZIONI, 41042 FIORANO MODENESE (MODENA), ITALY:
2,763,595, PUB. 6-24-2003, INT. CL. 19.
- IRONLINK INC., CALGARY, ALBERTA T2W 3X6, CANADA FROM MULLEN LOGISTICS INC., CALGARY, ALBERTA, CANADA:
2,765,663, INT. CL. 39.
- IRONWORKS EXECUTIVE PARTNERS, INC., NEWFIELDS, NH:
2,764,628, INT. CL. 35.
- ISA INTERNATIONAL PLC., BRADFORD, WEST YORKSHIRE, BD1 3AZ, UNITED KINGDOM:
2,011,317, CANC. INT. CL. 16.
- ISLAND AUTOMATED MEDICAL SERVICES, INC., ST. PETERSBURG, FL:
2,764,468, PUB. 6-24-2003, INT. CL. 9.
- ISLAND FUN, INC., COSTA MESA, CA, GARRETT, MICHAEL, LAKEWOOD, CA, DBA NALU KAUAI:
1,772,457, REN. 8-7-03, INT. CL. 25.
- ISOVOLTA OSTERREICHISCHE ISOLIERSTOFFWERKE AKTIENGESELLSCHAFT, AUSTRIA:
1,780,286, REN. 8-5-03, INT. CL. 17.
- IT SOLUTIONS CONSULTING, INC., JENKINTOWN, PA:
2,763,503, PUB. 6-24-2003, INT. CL. 42.
- IT'S ACADEMIC OF ILLINOIS, INC., NORTHBROOK, IL:
2,764,942, INT. CL. 16.
- ITALIAN LEATHER S.P.A., BITONTO (BARI), ITALY:
2,011,703, CANC. INT. CL. 18.
- ITO PACKING CO., INC., REEDLEY, CA:
1,727,948, CANC. INT. CL. 31.
- ITSY BITSY, INC., BRIDGEWATER, NJ:
2,011,424, CANC. INT. CL. 25.
- IVIE TECHNOLOGIES, INC., LEHI, UT:
1,773,470, REN. 8-8-03, INT. CL. 9.
1,773,471, REN. 8-6-03, INT. CL. 9.
- IVREA, INC., QUINCY, MA:
2,765,734, INT. CL. 3.
- IVY LABORATORIES, INC., OVERLAND PARK, KS:
2,012,632, CANC. INT. CL. 10.
- IWATA-MEDEA, INCORPORATED, PORTLAND, OR:
2,763,717, PUB. 6-24-2003, INT. CL. 7.
- IXTHOS, INC., LEESBURG, VA:
2,011,454, CANC. INT. CL. 9.
- I3 MOBILE, INC., STAMFORD, CT:
2,764,148, PUB. 6-24-2003, MULTIPLE CLASS, INT. CLS. 38, 41 AND 42.
- J & B SAUSAGE CO., INC., WAELDER, TX:
1,273,745, REN. 8-6-03, INT. CL. 29.
- J & S CHEMICAL CORPORATION, CANTON, GA:
2,765,917, INT. CL. 4.

- J H CALIFORNIA TRADING CO, LOS ANGELES, CA:
2,763,795, PUB. 6-24-2003. INT. CL. 25.
- J. B. COMPUTER MANAGEMENT (JBCM), WOKINGHAM, BERKSHIRE, UNITED KINGDOM:
2,763,086, PUB. 6-24-2003. INT. CL. 35.
- J. M. SMUCKER COMPANY, THE, ORRVILLE, OH:
1,727,933, CANC. INT. CL. 30.
- J.A. BESNER & SONS (CANADA) LTD., MONTREAL, QUEBEC, CANADA FROM LA STRADA FASHIONS, INC., WARMINSTER, PA:
2,763,034, PUB. 6-24-2003. INT. CL. 25.
- J.F. SPORTS CO., CLEVELAND, OH:
1,732,446, REN. 8-8-03. INT. CL. 6.
- J.G. HOOK GROUP, LLC, NEW YORK, NY:
2,763,644, PUB. 6-24-2003. INT. CL. 25.
- J.S.C. SVETLANA, ST. PETERSBURG, RUSSIAN FEDERATION:
2,763,354, PUB. 1-29-2002. INT. CL. 9.
- J&B SAUSAGE COMPANY, INC., WAELDER, TX:
2,011,622, CANC. INT. CL. 29.
- JAC INVESTMENTS INC., ELK GROVE VILLAGE, IL:
2,763,624, PUB. 6-24-2003. MULTIPLE CLASS, INT. CLS. 35, 40 AND 42.
- JAC PRODUCTS, INC., ANN ARBOR, MI:
1,727,406, CANC. INT. CL. 12.
- JACK DANIEL'S PROPERTIES, INC., SAN RAFAEL, CA:
2,765,098, INT. CL. 33.
2,765,785, INT. CL. 33.
- JACK KELLMER COMPANY, PHILADELPHIA, PA:
959,352, REN. 8-8-03. U.S. CL. 28 (INT. CL. 14).
- JACK NADEL, INC., CULVER CITY, CA:
1,214,292, CANC. INT. CL. 35.
- JACK SEWING MACHINE CO., LTD. OF ZHEJIANG, TAIZHOU CITY, ZHEJIANG PROVINCE, CHINA:
2,764,375, PUB. 6-24-2003. INT. CL. 7.
- JACK WHITE PRODUCTIONS USA INC, WOODLAND HILLS, CA:
2,763,608, PUB. 6-24-2003. INT. CL. 25.
- JACK-POKER, LTD., KANSAS CITY, MO:
1,213,887, CANC. INT. CL. 16.
- JACKSON INTERNATIONAL TRADING COMPANY KURT D. BRUHL GESELLSCHAFT MBH & CO., GRAZ, AUSTRIA:
2,763,163, PUB. 6-24-2003. MULTIPLE CLASS, INT. CLS. 3, 18 AND 25.
- JACKSON ORGANIZATION, INC., THE, COLUMBIA, MD:
2,765,210, INT. CL. 35.
- JACOBSON, JENNIFER, ARLINGTON, VA:
2,011,562, CANC. INT. CL. 42.
- JACQUES BRITT INTERNATIONALE MODEN GMBH, 33609 BIELEFELD, FED REP GERMANY:
2,011,351, CANC. INT. CL. 25.
- JACUZZI INC., WALNUT CREEK, CA:
1,727,375, CANC. INT. CL. 11.
- JADO BATHROOM AND HARDWARE MANUFACTURING CORPORATION, CAMARILLO, CA:
2,012,681, CANC. INT. CL. 20.
- JAGGAR, DEAN ANDREW, SAN RAMON, CA:
2,011,640, CANC. INT. CL. 42.
- JAHSMAN, WILLIAM E., SALT LAKE CITY, UT:
2,764,237, PUB. 6-24-2003. INT. CL. 38.
- JAKQUMAR AG, 6300 ZUG, SWITZERLAND:
2,765,148, INT. CL. 17.
- JAMES BRESKI & COMPANY, CHICAGO, IL:
1,728,587, CANC. INT. CL. 14.
- JAMES, DAVID, F, TONBRIDGE, UNITED KINGDOM:
2,764,361, PUB. 6-24-2003. INT. CL. 20.
- JAN-MAR CABINETS, INC., MEDINA, OH:
1,727,665, CANC. INT. CL. 20.
- JANET H. HOOPES AND ELIZABETH J. BARBER PARTNERSHIP, THE, MADISON, WI, DBA JANET'S ANTIQUES:
2,011,874, CANC. INT. CL. 42.
- JARRITOS, INC., EL PASO, TX:
2,765,472, INT. CL. 32.
- JAVA JOES, INC., DES MOINES, IA:
2,011,487, CANC. MULTIPLE CLASS, INT. CLS. 30 AND 42.
- JDR ENTERPRISES, INC., ALPHARETTA, GA:
1,780,305, REN. 8-8-03. INT. CL. 19.
- JEAN PHILIPPE FRAGRANCES, INC., NEW YORK, NY:
1,799,925, REN. 8-5-03. INT. CL. 3.
- JEANNE PIERRE ORIGINALS, INC., NEW YORK, NY, JEANNE PIERRE ORIGINALS, INC., NEW YORK, NY:
1,778,994, REN. 8-7-03. INT. CL. 25.
- JEEPERS! INC., WALTHAM, MA:
1,728,327, CANC. INT. CL. 41.
- JEFFERY GROUP LTD., THE, TORONTO, ONTARIO, CANADA:
2,765,844, MULTIPLE CLASS, INT. CLS. 35 AND 41.
- JEFFREY MILLER CATERING CO., LANSDOWNE, PA:
2,763,346, PUB. 6-24-2003. MULTIPLE CLASS, INT. CLS. 35 AND 41.
- JEL SHOOTERS, INC., ANTIOCH, CA:
2,763,986, PUB. 6-24-2003. INT. CL. 30.
- JENKINS SERVICES, INC., AUSTIN, TX:
2,012,048, CANC. INT. CL. 37.
- JENKINS, LAWRENCE E., ARLINGTON, TX:
2,765,933, INT. CL. 16.
- JENNMAR CORPORATION, PITTSBURGH, PA:
2,765,383, INT. CL. 6.
- JENNY PRODUCTS, INC., SOMERSET, PA:
1,817,724, REN. 8-5-03. INT. CL. 7.
- JENNY PRODUCTS, INCORPORATED, SOMERSET, PA:
1,816,635, REN. 8-5-03. INT. CL. 7.
1,818,742, REN. 8-5-03. INT. CL. 7.
- JERALD DEVELOPMENT GROUP, INC., THE, WALL, NJ:
2,764,457, PUB. 6-24-2003. INT. CL. 37.
- JERRY, CYNTHIA, WASHINGTON, DC:
2,011,438, CANC. INT. CL. 3.
- JERSEY MARY BARBEQUE, INC., CHICAGO, IL:
2,765,915, INT. CL. 30.
- JET SUPPORT SERVICES, INC., CHICAGO, IL:
2,764,463, PUB. 6-24-2003. INT. CL. 37.
- JETRAM SALES, INC., ST. LOUIS, MO:
1,252,932, REN. 8-2-03. INT. CL. 16.
- JH BIOTECH, INC., VENTURA, CA:
1,726,811, CANC. INT. CL. 1.
- JIMENEZ, MICHAEL A., NORTHFIELD, NJ:
1,728,428, CANC. INT. CL. 42.
- JKE HOLDINGS, LTD., BELLEVUE, WA:
2,011,619, CANC. INT. CL. 41.
- JKG GROUP, INC., NEW YORK, NY:
2,763,548, PUB. 6-24-2003. INT. CL. 42.
- JO-DAN INTERNATIONAL, INC., ROCHESTER, MI:
2,012,139, CANC. INT. CL. 9.
- JOE VERDE GROUP, SAN JUAN CAPISTRANO, CA:
2,763,944, PUB. 6-24-2003. INT. CL. 41.
- JOHANSEN, CINDA, PALM SPRINGS, CA:
2,011,970, CANC. INT. CL. 42.
- JOHN FRIEDA PROFESSIONAL HAIR CARE, INC.:
See—KAO KABUSHIKI KAISHA.
- JOHN HENRY COMPANY, THE, LANSING, MI:
2,765,244, MULTIPLE CLASS, INT. CLS. 1, 8, 16, 20, 21 AND 26.
- JOHN HINE LIMITED, ALDERSHOT, HAMPSHIRE, ENGLAND:
2,011,593, CANC. INT. CL. 20.
- JOHN M. LUND PHOTOGRAPHY, SAN FRANCISCO, CA:
2,764,270, PUB. 6-24-2003. INT. CL. 16.
- JOHN PAUL MITCHELL SYSTEMS, SAUGUS, CA:
2,764,013, PUB. 6-24-2003. INT. CL. 3.
- JOHN SOLOMON, INC.:
See—QST INDUSTRIES, INC..
- JOHNS MANVILLE AB, SE-250 07 HELSINGBORG, SWEDEN:
2,763,580, PUB. 6-24-2003. INT. CL. 27.
2,763,581, PUB. 6-24-2003. INT. CL. 27.
- JOHNS MANVILLE INTERNATIONAL, INC., DENVER, CO:
2,763,127, PUB. 12-31-2002. INT. CL. 27.
- JOHNSON & JOHNSON, NEW BRUNSWICK, NJ:
2,765,036, INT. CL. 10.
- JOHNSON, DOUGLAS M., SEATTLE, WA:
2,765,186, INT. CL. 9.

- JOHNSON DIVERSEY, INC., STURTEVANT, WI, CHEMED CORPORATION, CINCINNATI, OH:
946,964. REN. 8-4-03. U.S. CL. 52 (INT. CL. 3).
- JOKER, INC., ALLEN, TX FROM EDITOY AG, CH-8614 BERTSCHIKON, SWITZERLAND:
2,763,126, PUB. 12-26-1995. MULTIPLE CLASS, INT. CLS. 3, 4, 5, 6, 8, 9, 11, 12, 14, 15, 16, 20, 21, 22, 24, 26, 27, 29, 30, 31, 32, 35, 36, 38, 39, 41 AND 42.
- JONATHON AARON ENTERPRISES, INC., HIGHLAND PARK, IL:
2,012,097, CANC. INT. CL. 41.
- JONES INVESTMENT CO., INC., WILMINGTON, DE:
1,727,727, CANC. INT. CL. 25.
- JONES, JEFFREY A., WEST BARNSTABLE, MA:
2,764,439, PUB. 6-24-2003. INT. CL. 16.
- JORDAN, JULIE, JACKSONVILLE, NY:
2,763,461, PUB. 7-16-2002. INT. CL. 43.
- JORDAN, PAUL, D. TEMPLE CITY, CA:
2,764,153, PUB. 6-24-2003. INT. CL. 9.
- JOSE PEMARTIN Y CIA. S.A., CADIZ, SPAIN:
740,133, CANC. U.S. CL. 47.
- JOSEPH ENTERPRISES, INC., SAN FRANCISCO, CA:
1,763,853. REN. 8-4-03. INT. CL. 20.
- JOSLYN STERILIZER CORPORATION, FARMINGTON, NY:
2,012,350, CANC. INT. CL. 10.
- JP FOODSERVICE, INC., COLUMBIA, MD:
2,012,742, CANC. INT. CL. 9.
- JRB COMPANY, INC., AKRON, OH:
2,763,589, PUB. 6-24-2003. INT. CL. 7.
- JUBA BEVERAGES CORPORATION, SEATTLE, WA:
2,011,811, CANC. INT. CL. 32.
2,012,564, CANC. INT. CL. 32.
- JUDGMENT STONE, INC., TRAFFORD, AL:
2,764,743, INT. CL. 20.
- JUDY WELLS INC., MARKHAM, ONTARIO L3R 3K7, CANADA:
2,763,287, PUB. 2-11-2003. INT. CL. 3.
- JUDY'S SPECIALTY FOODS, INC., EVANSTON, IL:
2,011,722, CANC. INT. CL. 30.
- JUKO-KAI INTERNATIONAL, INC., RICHARDSON, TX:
2,763,594, PUB. 6-24-2003. INT. CL. 41.
- JULIEN NEE FERRAND; AIMEE, MONTBRISON, FRANCE:
1,214,058, CANC. INT. CL. 25.
- JUNGLE LABORATORIES CORPORATION, CIBOLO, TX:
2,764,096, PUB. 6-24-2003. INT. CL. 1.
- JUNOT SYSTEMS, INC., HOUSTON, TX:
2,765,834, INT. CL. 9.
- JUST RACING, LTD., EDINA, MN:
2,011,365, CANC. MULTIPLE CLASS, INT. CLS. 18, 20, 21 AND 25.
- JUST TOYS, INC., NEW YORK, NY:
1,727,834, CANC. INT. CL. 28.
- K.B.E., LONG BRANCH, NJ:
2,764,700, INT. CL. 42.
- K.H. DE JONG'S EXPORHANDEL B.V., 9206 AN DRACHTEN, NETHERLANDS:
2,030,013, CANC. INT. CL. 29.
- KABA AG, WETZLKON, SWITZERLAND, BAUER KABA AG, 8620 WETZIKON, SWITZERLAND:
1,746,076. REN. 8-7-03. MULTIPLE CLASS, INT. CLS. 37 AND 42.
- KABUSHIKI KAISHA BIG JOHN, KURASHIKI-CITY, JAPAN, TA BIG JOHN CORPORATION:
2,764,259, PUB. 6-24-2003. INT. CL. 25.
- KABUSHIKI KAISHA HITACHI SEISAKUSHO, CHIYODAKU, TOKYO, JAPAN, DBA HITACHI, LTD.:
2,012,543, CANC. INT. CL. 9.
- KABUSHIKI KAISHA HITACHI SEISAKUSHO, TOKYO 101-8010, JAPAN, DBA HITACHI, LTD.:
2,763,312, PUB. 6-24-2003. INT. CL. 42.
- KABUSHIKI KAISHA JUSTSYSTEM, TOKUSHIMA, JAPAN:
2,011,520, CANC. INT. CL. 9.
2,011,521, CANC. INT. CL. 9.
2,011,522, CANC. INT. CL. 9.
2,011,523, CANC. INT. CL. 9.
- KABUSHIKI KAISHA KANSEI, OMIYA-SHI, SAITAMAKEN, JAPAN, DBA KANSEI CORPORATION:
2,011,272, CANC. MULTIPLE CLASS, INT. CLS. 9, 11 AND 12.
- KABUSHIKI KAISHA KOMATSU SEISAKUSHO, TOKYO, JAPAN:
2,765,863, INT. CL. 7.
- KABUSHIKI KAISHA SEGA, TOKYO 144-0043, JAPAN, DBA SEGA CORPORATION:
2,763,228, PUB. 6-24-2003. INT. CL. 41.
- KABUSHIKI KAISHA SEGA, OHTA-KU, TOKYO 144-0043, JAPAN, DBA SEGA CORPORATION AND KABUSHIKI KAISHA HITMAKER, OHTA-KU, TOKYO 144-0033, JAPAN, DBA HITMAKER CO., LTD.:
2,763,471, PUB. 6-24-2003. MULTIPLE CLASS, INT. CLS. 9, 28 AND 41.
- KABUSHIKIGAISYA GOTO KOQAKU KENKYUJYO, TOKYO, 183-830, JAPAN:
2,765,407, INT. CL. 9.
- KAFKO INTERNATIONAL INC., MISSISSAUGA, ONTARIO, CANADA, KAFKO MANUFACTURING LIMITED, MISSISSAUGA, ONTARIO, CANADA:
1,238,929. REN. 8-6-03. MULTIPLE CLASS, INT. CLS. 9 AND 11.
- KAISER FOUNDATION HEALTH PLAN, INC., OAKLAND, CA:
2,012,079, CANC. MULTIPLE CLASS, INT. CLS. 36 AND 42.
- KALIL BOTTLING COMPANY, TUCSON, AZ:
2,765,499, INT. CL. 32.
- KALYN/SIEBERT, L.P.:
See — DELAWARE CAPITAL FORMATION, INC..
- KAMA OF ILLINOIS, INC., LINCOLNSHIRE, IL:
2,765,274, INT. CL. 17.
- KAMADIA, RAHIM, HOUSTON, TX:
2,765,956, INT. CL. 36.
- KANEKA CORPORATION, KITA-KU, OSAKA, JAPAN:
2,763,776, PUB. 6-24-2003. INT. CL. 10.
- KANEKU CO., LTD., OHME-SHI, TOKYO, JAPAN:
1,262,552. REN. 8-6-03. MULTIPLE CLASS, INT. CLS. 29 AND 30.
1,262,553. REN. 8-6-03. MULTIPLE CLASS, INT. CLS. 29 AND 30.
- KANGAROO BRANDS, INC., MILWAUKEE, WI:
2,011,789, CANC. INT. CL. 30.
- KANTEK INC., E. ROCKAWAY, NY:
2,011,524, CANC. INT. CL. 9.
- KAO KABUSHIKI KAISHA, CHUO-KU, TOKYO 103-8210, JAPAN, TA KAO CORPORATION FROM JOHN FRIEDA PROFESSIONAL HAIR CARE, INC., WILTON, CT:
2,763,688, PUB. 6-24-2003. INT. CL. 3.
- KARLSBERG, RONALD P., BEVERLY HILLS, CA:
2,764,111, PUB. 6-24-2003. INT. CL. 9.
- KARNDEAN INTERNATIONAL LIMITED, WORCESTERSHIRE, ENGLAND:
2,763,041, PUB. 6-24-2003. INT. CL. 19.
- KARONA, INC., GRANDVILLE, MI:
1,771,471. REN. 8-6-03. INT. CL. 19.
- KARSH, AYALA, MEQUON, WI:
2,011,917, CANC. INT. CL. 35.
- KASTLE GESELLSCHAFT M.B.H., HOHENEMS, AUSTRIA:
1,214,202, CANC. INT. CL. 28.
- KATMANDU ENTERTAINMENT CORP., PHILADELPHIA, PA:
1,728,418, CANC. INT. CL. 42.
- KAUFMAN-PETERS LLC, GRAND RAPIDS, MI:
2,763,340, PUB. 5-28-2002. MULTIPLE CLASS, INT. CLS. 9 AND 16.
- KAUFMAN, GARY G. GALLATIN, TN:
2,765,760, INT. CL. 35.
- KAUFMAN, HALL & ASSOCIATES, INC., NORTHFIELD, IL, DBA KAUFMAN, HALL & ASSOCIATES:
2,765,875, INT. CL. 9.
- KBN CORPORATION, BLOOMINGTON, MN, DBA "A" PLUS STRATEGIC ALLIANCES:
2,011,628, CANC. INT. CL. 35.
- KC MOVIES LLC, INDEPENDENCE, MO:
2,764,760, INT. CL. 41.

- KCL CORPORATION, SHELBYVILLE, IN:
1,727,507, CANC. INT. CL. 16.
- KEENE, CRAIG, KANSAS CITY, MO:
2,764,344, PUB. 6-24-2003. INT. CL. 16.
- KEFORD COLLISION SERVICE, INC., NOVI, MI:
2,764,554, INT. CL. 37.
2,764,556, INT. CL. 37.
- KELLEY, SEAN, GRAY, ME:
2,765,730, INT. CL. 43.
- KELLY, PAUL J., SAN DIEGO, CA:
2,011,660, CANC. MULTIPLE CLASS, INT. CLS. 25 AND 28.
- KELLY, RONDA HAESSIG, CHICAGO, IL:
2,763,637, PUB. 6-24-2003. INT. CL. 14.
- KEMSLEY, SANDRA G., BLOOMFIELD HILLS, MI:
2,763,217, PUB. 6-24-2003. MULTIPLE CLASS, INT. CLS. 38 AND 41.
- KENNER PARKER TOYS INC.:
1,214,218, CANC. INT. CL. 28.
- KENPAL FARM PRODUCTS INC., CENTRALIA, ONTARIO, NOM IKO, CANADA:
2,764,002, PUB. 6-24-2003. INT. CL. 5.
- KENT INTERNATIONAL INC., PARSIPPANY, NJ:
2,765,406, INT. CL. 12.
- KENTUCKY UTILITIES COMPANY, LEXINGTON, KY:
2,011,322, CANC. INT. CL. 39.
- KEURIG, INCORPORATED, WAKEFIELD, MA:
2,765,943, INT. CL. 11.
- KEY CORPORATE CAPITAL INC., PORTLAND, ME FROM ACORN PRODUCTS CO., INC., LEWISTON, ME:
2,763,070, PUB. 6-24-2003. MULTIPLE CLASS, INT. CLS. 24 AND 25.
2,763,071, PUB. 6-24-2003. MULTIPLE CLASS, INT. CLS. 24 AND 25.
- KEYBOWL, INC., WINTER PARK, FL:
2,764,849, INT. CL. 9.
- KEYCORP, CLEVELAND, OH:
2,764,253, PUB. 6-24-2003. INT. CL. 36.
2,765,480, INT. CL. 36.
- KEYSTONE SPECIALTIES, INC., BAKERSTOWN, PA, DBA KEYSTONE PROMOTIONAL PRODUCTS:
2,012,509, CANC. MULTIPLE CLASS, INT. CLS. 16 AND 28.
- KEY3MEDIA EVENTS, INC., LOS ANGELES, CA FROM ZD EVENTS INC., FOSTER CITY, CA:
2,763,058, PUB. 8-29-2000. INT. CL. 35.
- KIDS FOR A CLEAN ENVIRONMENT, NASHVILLE, TN:
1,728,261, CANC. INT. CL. 41.
- KIDS VOTING USA, INC., TEMPE, AZ:
2,763,533, PUB. 6-24-2003. MULTIPLE CLASS, INT. CLS. 16 AND 35.
- KIDS-PROMOTION GMBH, LEDERERGASSE 6, FED REP GERMANY:
2,011,295, CANC. MULTIPLE CLASS, INT. CLS. 16, 25 AND 28.
- KIDVID, INC., ALPHARETTA, GA:
2,765,546, INT. CL. 9.
- KIEL CENTER PARTNERS, L.P., ST. LOUIS, MO:
2,012,422, CANC. INT. CL. 41.
2,012,423, CANC. INT. CL. 42.
- KIKKERLAND DESIGN, INC., NEW YORK, NY AND DOMINGUES, FRANCISCO BICALHO, NEW YORK, NY:
2,764,419, PUB. 6-24-2003. INT. CL. 28.
- KIKKERLAND DESIGNS, INC., NEW YORK, NY:
2,764,423, PUB. 6-24-2003. INT. CL. 28.
2,764,424, PUB. 6-24-2003. INT. CL. 28.
- KIKKERLAND DESIGNS, INC., NEW YORK, NY AND DONMIGUES, FRANCISCO BICALHO, NEW YORK, NY:
2,764,425, PUB. 6-24-2003. INT. CL. 28.
- KIKKOMAN CORPORATION, CHIBA, JAPAN:
2,764,500, INT. CL. 1.
- KILCULLEN, ROBERT J., FAIRFIELD, CT:
2,012,687, CANC. INT. CL. 10.
- KIMBALL INTERNATIONAL, INC., JASPER, IN:
2,765,445, INT. CL. 20.
- KINDERCARE LEARNING CENTERS, INC., HOUSTON, TX, KINDER-CARE LEARNING CENTERS, INC., PORTLAND, OR:
1,238,509, REN. 8-7-03. MULTIPLE CLASS, INT. CLS. 25 AND 28.
- KING INDUSTRIES, INC., NORWALK, CT:
1,254,979, REN. 8-6-03. INT. CL. 1.
- KING OF FANS, INC., FT. LAUDERDALE, FL:
2,764,205, PUB. 6-24-2003. INT. CL. 11.
- KING PAR CORPORATION, FLUSHING, MI:
2,763,091, PUB. 6-24-2003. INT. CL. 25.
- KINGSTON-MIAMI TRADING CORPORATION, MIAMI, FL:
1,727,939, CANC. INT. CL. 30.
- KINNEY SHOE CORPORATION, NEW YORK, NY TO VENATOR GROUP RETAIL, INC., NEW YORK, NY:
1,727,500, CANC. INT. CL. 16.
- KISIC, BLAS A., WOODLAND HILLS, CA:
2,764,203, PUB. 6-24-2003. INT. CL. 41.
- KIUCHI BREWERY GOSHKAISHA, NAKA-MACHI NAKAGUN IBARAKI, JAPAN:
2,763,789, PUB. 6-24-2003. INT. CL. 32.
- KIWO HOLDINGS, INC., WILMINGTON, DE:
2,763,980, PUB. 6-24-2003. INT. CL. 17.
- KLA-TENCOR TECHNOLOGIES CORPORATION, MILPITAS, CA FROM KLA-TENCOR CORPORATION, SAN JOSE, CA:
2,765,142, INT. CL. 9.
- KLEIN TOOLS, INC., SKOKIE, IL:
1,793,712, REN. 8-7-03. INT. CL. 22.
- KMART PROPERTIES, INC., TROY, MI:
2,011,463, CANC. INT. CL. 2.
- KNECHTEL, CHARLES DOBSON, NAPA, CA:
2,765,536, INT. CL. 14.
- KNIGHT MANUFACTURING, INC., ASHEVILLE, NC:
2,012,464, CANC. INT. CL. 10.
- KNIGHT-RIDDER INFORMATION, INC., MOUNTAIN VIEW, CA:
2,012,524, CANC. INT. CL. 35.
2,012,587, CANC. INT. CL. 38.
- KNOLL PRINTING AND PACKAGING, INC., ROSLYN HEIGHTS, NY:
2,765,918, MULTIPLE CLASS, INT. CLS. 16 AND 21.
- KNUCKLEHEAD INC., SAN FRANCISCO, CA:
2,012,046, CANC. INT. CL. 25.
- KOBOLD, MICHAEL, PITTSBURGH, PA:
2,765,200, INT. CL. 14.
- KOCOM CO., LTD., BUCHEON-CITY, KYUNGGI-DO, REPUBLIC OF KOREA, KOREA COMMUNICATION CO., LTD., BUCHEON-CITY, KYUNGGI-DO, REPUBLIC OF KOREA:
1,776,286, REN. 8-6-03. INT. CL. 9.
- KOEI CORPORATION, BURLINGAME, CA:
1,823,830, REN. 8-4-03. INT. CL. 28.
1,833,405, REN. 8-5-03. INT. CL. 28.
- KOHL'S ILLINOIS, INC., AURORA, IL:
2,765,474, INT. CL. 35.
- KOHLER CO., KOHLER, WI:
2,765,686, INT. CL. 11.
2,765,939, MULTIPLE CLASS, INT. CLS. 11 AND 20.
- KOLPIN OUTDOORS, INC., FOX LAKE, WI:
2,765,114, MULTIPLE CLASS, INT. CLS. 13 AND 18.
- KOLYNICZ, MARK, TROY, MI:
2,763,707, PUB. 6-24-2003. MULTIPLE CLASS, INT. CLS. 29 AND 30.
- KOMATSU FORKLIFT U.S.A., INC., COVINGTON, GA:
2,765,224, INT. CL. 12.
- KOMEX SYSTEM CO., LTD., SEOUL, REPUBLIC OF KOREA:
2,011,334, CANC. INT. CL. 9.
- KOMPANIA PIWOWARSKA S.A., 61-285 POZNAN, POLAND:
2,765,079, INT. CL. 32.
- KONAMI GAMING, INC., LAS VEGAS, NV:
2,763,364, PUB. 5-14-2002. INT. CL. 9.
- KONIG S.P.A., 23847 MOLTENO, ITALY:
2,763,154, PUB. 4-30-2002. INT. CL. 12.

- KONINKLIJKE PHILIPS ELECTRONICS N.V., EINDHOVEN, NETHERLANDS:
2,763,430, PUB. 6-24-2003. INT. CL. 9.
2,763,680, PUB. 6-24-2003. INT. CL. 8.
- KONINKLIJKE SANDERS B.V., 2321 GL LEIDEN, NETHERLANDS:
2,763,345, PUB. 6-24-2003. INT. CL. 3.
- KORAN, LINDA H., WESTERVILLE, OH:
2,763,972, PUB. 6-24-2003. MULTIPLE CLASS, INT. CLS. 9, 16 AND 41.
- KOSMAN, GARY LEE, GRANADA HILLS, CA:
2,765,701, INT. CL. 42.
- KOVAL, DANIEL, PAUL, STOCKBRIDGE, MA:
2,765,744, INT. CL. 14.
2,765,745, INT. CL. 14.
- KOVAX CORPORATION, ITABASHI-KU, TOKYO, JAPAN:
1,790,144, REN. 8-2-03. INT. CL. 7.
- KRAFT FOODS HOLDINGS, INC., NORTHFIELD, IL:
2,765,709, INT. CL. 21.
- KRAFT FOODS, INC., NORTHFIELD, IL:
2,011,852, CANC. INT. CL. 30.
2,012,561, CANC. INT. CL. 30.
- KRAUSE PUBLICATIONS, INC., IOLA, WI:
2,764,186, PUB. 6-24-2003. INT. CL. 16.
- KRONKOSKY CHARITABLE FOUNDATION, SAN ANTONIO, TX:
2,763,853, PUB. 6-24-2003. INT. CL. 41.
- KSIXTEEN LLC, NEW YORK, NY:
2,764,753, INT. CL. 36.
- KULITE TUNGSTEN CORPORATION, EAST RUTHERFORD, NJ:
2,012,745, CANC. INT. CL. 28.
- KUMHO & CO., INC., CHUNG-GU, SEOUL, REPUBLIC OF KOREA:
2,012,558, CANC. INT. CL. 28.
- KUN NAN ENTERPRISE LTD., TAN TZU, TAICHUNG HSIEN, TAIWAN:
1,727,820, CANC. INT. CL. 28.
- KUNDAN FOODS, INC., LOS ANGELES, CA:
2,763,080, PUB. 6-24-2003. MULTIPLE CLASS, INT. CLS. 29 AND 30.
- KVAERNER OILFIELD PRODUCTS, INC., HOUSTON, TX:
2,763,492, PUB. 6-24-2003. INT. CL. 22.
- KVM INTERNATIONAL FASHIONS LTD., LOS ANGELES, CA:
2,763,460, PUB. 6-24-2003. INT. CL. 25.
- KWIK TEK INC., DENVER, CO:
2,764,515, INT. CL. 28.
- KYRIAZIS, CYNTHIA, AMBLER, PA:
2,764,307, PUB. 6-24-2003. INT. CL. 41.
- KYSOR INDUSTRIAL CORPORATION, CADILLAC, MI:
739,908, CANC. U.S. CL. 13.
739,987, CANC. U.S. CL. 25.
- L & H TECHNOLOGIES, INC., CHARLOTTE, NC:
1,759,138, REN. 8-8-03. INT. CL. 11.
- L. L. BEAN, INC., FREEPORT, ME:
2,764,312, PUB. 6-24-2003. INT. CL. 35.
- L. NEGRIN & SONS, INC., NEW YORK, NY:
1,727,770, CANC. INT. CL. 25.
- L.B. EVANS' SON COMPANY, FITCHBURG, MA TO DANIEL GREEN ENTERPRISES, INC., NASHVILLE, TN:
1,715,920, CANC. INT. CL. 25.
- L.C. LICENSING, INC., NEW YORK, NY:
2,765,257, INT. CL. 25.
2,765,530, INT. CL. 25.
- L&L KILN MFG., INC., BOOTHWYN, PA:
2,764,387, PUB. 6-24-2003. INT. CL. 11.
- L'OREAL, PARIS, FRANCE:
2,763,497, PUB. 6-24-2003. INT. CL. 3.
- LA ROCHE-POSAY LABORATOIRE PHARMACEUTIQUE, LA ROCHE-POSAY, FRANCE:
2,763,571, PUB. 6-24-2003. MULTIPLE CLASS, INT. CLS. 3 AND 5.
- LA STRADA FASHIONS, INC.:
See— J.A. BESNER & SONS (CANADA) LTD..
- LA TECHNIQUE FRANCAISE DU NETTOYAGE:
See— RJMF.
- LAARS, INC., NEWPORT BEACH, CA:
2,765,423, INT. CL. 11.
- LABOR READY, INC., POULSBO, WA:
1,728,069, CANC. INT. CL. 35.
- LABORATOIRE GARNIER & CIE, PARIS, FRANCE:
2,763,800, PUB. 6-24-2003. INT. CL. 3.
2,763,848, PUB. 6-24-2003. INT. CL. 3.
- LABORATOIRES GOEMAR, 35400 SAINT MALO, FRANCE:
2,764,276, PUB. 6-24-2003. INT. CL. 5.
- LABORATORIES DR. N.G. PAYOT S.A., 9490, LIECHTENSTEIN, LABORATOIRES DU DR. N.G. PAYOT ETABLISSEMENT, VADUZ, LIECHTENSTEIN:
1,246,780, REN. 8-4-03. INT. CL. 3.
- LABORSAGE INCORPORATED, CAMAS, WA FROM EVENTSAGE INCORPORATED, CAMAS, WA:
2,765,122, INT. CL. 9.
- LACKAWANNA CHAPTER, RAILWAY & LOCOMOTIVE HISTORICAL SOCIETY, INC., MOUNTAINHOME, PA:
2,765,272, INT. CL. 25.
- LACO OVERSEAS, INC., MIAMI, FL:
2,763,532, PUB. 6-24-2003. INT. CL. 30.
- LADY BAY VINEYARD PTY LTD., WINGFIELD, SOUTH AUSTRALIA, AUSTRALIA:
2,764,122, PUB. 6-24-2003. INT. CL. 33.
- LADY MERICANA ASSOCIATES, INC., SCHAYER; EUGENE T., ATLANTA, GA, DBA LADY MERICANA ASSOCIATES:
1,257,588, REN. 8-2-03. INT. CL. 20.
- LAFEVER COMPANY, INC., CORNELL, IL:
1,771,726, REN. 8-8-03. INT. CL. 31.
- LAIA AUGE POGÉ, 17467 CAMALLERA, GIRONA, SPAIN AND GULLEN AUGE POGÉ, 17467 CAMALLERA, GIRONA, SPAIN:
2,681,602, COR. INT. CL. 11.
- LAIRD TECHNOLOGIES, INC., DELAWARE WATER GAP, PA, INSTRUMENT SPECIALTIES COMPANY, INC., DELAWARE WATER GAP, PA:
1,772,243, REN. 8-6-03. INT. CL. 9.
- LAKE & AIR, INC., SOUTH ST. PAUL, MN:
2,765,584, INT. CL. 35.
- LAKIN, GAY, KITTELY, ME:
2,763,868, PUB. 6-24-2003. MULTIPLE CLASS, INT. CLS. 29 AND 30.
- LAMB-WESTON, INC., KENNEWICK, WA:
2,765,222, INT. CL. 29.
- LAMBDA PHYSIK AG, GOTTINGEN, FED REP GERMANY:
2,765,758, INT. CL. 9.
- LAMEY-WELLEHAN, LEWISTON, ME:
2,765,230, INT. CL. 25.
- LAN CHILE S.A., SANTIAGO, CHILE:
2,763,428, PUB. 1-28-2003. INT. CL. 39.
- LANCASTER GLASS CORPORATION, LANCASTER, OH:
747,580, REN. 8-2-03. U.S. CL. 26 (INT. CL. 9).
- LANCER CORPORATION, CROFTON, MD:
2,012,467, CANC. INT. CL. 29.
- LANCÔME PARFUMS ET BEAUTE & CIE, PARIS, FRANCE:
2,763,875, PUB. 6-24-2003. INT. CL. 3.
- LAND O'LAKES, INC., NORTH ARDEN HILLS, MN:
1,726,940, CANC. INT. CL. 5.
- LAND O'LAKES, INC., ARDEN HILLS, MN:
2,012,794, CANC. INT. CL. 31.
- LAND-O-SUN DAIRIES, L.L.C., JOHNSON CITY, TN:
1,727,930, CANC. INT. CL. 30.
- LAND/WATER/SKY, L.L.C., BANDERA, TX:
2,764,409, PUB. 6-24-2003. INT. CL. 36.
- LANDA, INC., PORTLAND, OR:
1,727,374, CANC. INT. CL. 11.
- LANDSCAPE LOCATORS, LLC, WALNUT CREEK, CA:
2,765,779, INT. CL. 35.
- LANDSCAPE STRUCTURES, INC., DELANO, MN:
2,764,568, INT. CL. 28.
- LANE, JUVES, V, HICKSVILLE, NY:
2,765,432, INT. CL. 44.
- LANGE-STEGMANN COMPANY, ST. LOUIS, MO:
2,012,566, CANC. MULTIPLE CLASS, INT. CLS. 5, 19 AND 31.
- LANGER, INC., DEER PARK, NY:
2,765,370, INT. CL. 17.

- LANGLEY PRODUCTIONS INC., LOS ANGELES, CA, BARBOUR-LANGLEY PRODUCTIONS, INC., LOS ANGELES, CA:
1,804,846, REN. 8-5-03. INT. CL. 41.
- LANGUAGESPEED, INC., SANTA BARBARA, CA:
2,765,651, MULTIPLE CLASS, INT. CLS. 9, 16 AND 42.
- LANGVA, MARC D., WAYZATA, MN:
2,764,207, PUB. 6-24-2003. INT. CL. 36.
- LANTECH, INC., LOUISVILLE, KY:
1,728,536, CANC. INT. CL. 7.
- LANZA, JOSEPH, HAWTHORNE, NJ:
2,012,914, CANC. INT. CL. 25.
- LARGE BINOCULAR TELESCOPE CORPORATION, TUCSON, AZ:
2,765,242, INT. CL. 42.
- LARIMORE, TRACEE D., BROOKS, KY:
2,012,339, CANC. INT. CL. 10.
- LARIOS, S.A., 2400 MALAGA, SPAIN:
2,012,264, CANC. INT. CL. 33.
- LARRY LEE & ASSOCIATES, INC., CARLISLE, PA:
2,011,564, CANC. MULTIPLE CLASS, INT. CLS. 37 AND 42.
2,011,565, CANC. MULTIPLE CLASS, INT. CLS. 37 AND 42.
- LARRY MAHAN, INC., EL PASO, TX:
1,214,113, CANC. INT. CL. 25.
- LARSEN, ARIC P., KANEOHE, HI:
2,763,456, PUB. 6-24-2003. INT. CL. 25.
- LASER GARDEN, INC., KENILWORTH, IL:
2,607,392, CANC. INT. CL. 3.
- LASERLINE COMPANY, THE, STAMFORD, CT FROM MEAD CORPORATION, THE, DAYTON, OH:
2,765,030, INT. CL. 18.
- LATIS NETWORKS, INC., SUPERIOR, CO:
2,763,777, PUB. 6-24-2003. INT. CL. 45.
- LAURENCE ALTSHULER, M.D., P.C., OKLAHOMA CITY, OK:
2,764,242, PUB. 6-24-2003. MULTIPLE CLASS, INT. CLS. 35 AND 44.
- LAVA GROUP, INC., ATLANTA, GA:
2,764,257, PUB. 6-24-2003. INT. CL. 35.
- LAVAGGI, STEVEN, SANTA CLARITA, CA:
2,763,673, PUB. 6-24-2003. INT. CL. 35.
- LAVETT&CHIN, INC., BROOKLYN, NY:
2,764,856, INT. CL. 3.
- LAW AUDIT SERVICES, INC., WILTON, CT:
1,727,287, CANC. INT. CL. 9.
- LAWDEV, INC., SAN DIEGO, CA:
2,764,210, PUB. 6-24-2003. MULTIPLE CLASS, INT. CLS. 37, 41 AND 42.
- LAWRENCE TECHNOLOGIES, LLC, DALLAS, TX:
2,764,876, MULTIPLE CLASS, INT. CLS. 9 AND 42.
- LAWSON, CHRISTINA MARIE, LAS VEGAS, NV:
2,765,552, INT. CL. 35.
- LAXON CORPORATION, TORRANCE, CA:
2,765,866, INT. CL. 6.
- LAYTON PRODUCTIONS, INC., OREM, UT:
2,765,341, MULTIPLE CLASS, INT. CLS. 35 AND 41.
- LAZY RIVER PRODUCTIONS, INC., FAIRVIEW, UT:
2,764,199, PUB. 6-24-2003. INT. CL. 41.
- LBS ENTERPRISES, L.L.C., GLADEWATER, TX, DBA ALL-STATES COATINGS COMPANY:
1,726,842, CANC. INT. CL. 1.
- LBS ENTERPRISES, L.L.C., GLADEWATER, TX:
1,727,631, CANC. INT. CL. 19.
- LDT SYSTEMS, INC., CINCINNATI, OH:
2,765,899, INT. CL. 44.
- LE BLEU CORPORATION, ADVANCE, NC:
2,763,371, PUB. 6-24-2003. INT. CL. 32.
- LE'S INTERCONTINENTAL MONEY TRANSFER, INC., WESTMINSTER, CA:
2,764,340, PUB. 6-24-2003. INT. CL. 36.
- LEAD DATA USA, CERRITOS, CA:
2,765,063, INT. CL. 9.
- LEAD TECHNOLOGIES, INC., CHARLOTTE, NC:
2,012,643, CANC. INT. CL. 9.
- LEADER DRILLING, L.L.C., HOUSTON, TX:
2,764,631, INT. CL. 9.
- LEADERSHIP DEVELOPMENT GROUP, INC., APEX, NC:
2,764,273, PUB. 6-24-2003. INT. CL. 35.
- LEAGRE CHANDLER & MILLARD LLP, INDIANAPOLIS, IN:
2,765,471, INT. CL. 42.
- LEAN CONCEPTS, LLC, GRAND RAPIDS, MI:
2,764,862, INT. CL. 41.
- LEAPFROG ENTERPRISES, INC., EMERYVILLE, CA:
2,764,950, INT. CL. 41.
- LEARNING INTERNET, INC., THE, PORTLAND, OR:
2,765,004, MULTIPLE CLASS, INT. CLS. 41 AND 42.
- LEARNING WRAP-UPS, INC., LAYTON, UT:
2,763,896, PUB. 6-24-2003. INT. CL. 28.
- LEARNINGRX, INC., COLORADO SPRINGS, CO:
2,764,443, PUB. 6-24-2003. INT. CL. 16.
2,764,444, PUB. 6-24-2003. INT. CL. 16.
2,764,445, PUB. 6-24-2003. INT. CL. 16.
2,764,446, PUB. 6-24-2003. INT. CL. 16.
2,764,447, PUB. 6-24-2003. INT. CL. 16.
2,764,448, PUB. 6-24-2003. INT. CL. 16.
2,764,449, PUB. 6-24-2003. INT. CL. 16.
2,764,450, PUB. 6-24-2003. INT. CL. 16.
2,764,451, PUB. 6-24-2003. INT. CL. 16.
2,764,452, PUB. 6-24-2003. INT. CL. 16.
- LEBEDZ, DEANNA, NEW SMYRNA BEACH, FL:
1,727,925, CANC. INT. CL. 30.
- LEBHAR FRIEDMAN, INC., NEW YORK, NY:
2,763,642, PUB. 6-24-2003. INT. CL. 16.
- LECROY CORPORATION, CHESTNUT RIDGE, NY:
2,764,506, INT. CL. 9.
- LECTEC CORPORATION, MINNETONKA, MN:
2,012,834, CANC. INT. CL. 5.
- LEDERMAN, NATALIE F., MARBLEHEAD, MA:
2,012,682, CANC. INT. CL. 28.
- LEDERMANN GMBH, 72160 HORB AM NECKAR, FED REP GERMANY:
1,727,031, CANC. INT. CL. 7.
- LEE STEVENS INDUSTRIES, INC., BARTLETT, IL:
2,765,632, INT. CL. 18.
- LEE, JIN, W, CEDAR HILL, TX:
2,765,797, INT. CL. 30.
- LEE, JOON HEE, LOS ANGELES, CA:
2,763,299, PUB. 6-24-2003. INT. CL. 16.
- LEE, KEUN SUL, RANCH CUCAMONGA, CA, DBA KENS TRADING CO. INC.:
1,710,128, CANC. INT. CL. 25.
- LEGAL INFORMATION SOLUTIONS, INC., NORWELL, MA:
2,012,739, CANC. INT. CL. 9.
- LEGION LIGHTING CO., INC., BROOKLYN, NY:
1,794,854, REN. 8-7-03. INT. CL. 11.
- LEGION LIGHTING COMPANY, INC., BROOKLYN, NY:
2,763,835, PUB. 6-24-2003. INT. CL. 11.
- LEHMAN BROTHERS INC., NEW YORK, NY:
2,764,318, PUB. 6-24-2003. INT. CL. 36.
- LEHMANN & MICHELS GMBH & CO. KG, D-22525 HAMBURG, FED REP GERMANY:
2,763,410, PUB. 6-24-2003. INT. CL. 9.
- LEINER DAVIS GELATIN CORPORATION, GREAT NECK, NY:
1,726,800, CANC. INT. CL. 1.
1,726,801, CANC. INT. CL. 1.
- LEINER HEALTH PRODUCTS INC., CARSON, CA:
2,012,314, CANC. INT. CL. 5.
- LEISURE STATION CO., LTD., TAICHUNG, TAIWAN, TAIWAN:
2,765,438, INT. CL. 43.
- LEMAX, SAN DIEGO, CA:
2,763,697, PUB. 6-24-2003. INT. CL. 3.
- LENCH MOB PRODUCTIONS, INC., LOS ANGELES, CA:
2,027,461, CANC. INT. CL. 25.
- LENTHERIC LIMITED, WATFORD, HERTFORDSHIRE, WD24 7JG, UNITED KINGDOM:
2,763,487, PUB. 11-19-2002. INT. CL. 3.
- LEO BURNETT WORLDWIDE, INC., CHICAGO, IL:
2,764,820, INT. CL. 35.

- LES COLLECTIONS SHAN INC., LAVAL, QUEBEC, CANADA:
2,763,124, PUB. 9-3-2002. MULTIPLE CLASS, INT. CLS. 9, 21, 24 AND 25.
- LES FROMAGES SAPUTO LIMITEE / SAPUTO CHEESE LIMITED, ST-LEONARD, PROVINCE OF QUEBEC, CANADA:
2,764,656, INT. CL. 29.
- LES SYSTEMES DE FORMATION ET DE GESTION PERFORM INC., MONTREAL, PROVINCE OF QUEBEC, CANADA:
2,764,536, INT. CL. 41.
- LETRO PRODUCTS, INC., REDDING, CA:
2,764,838, MULTIPLE CLASS, INT. CLS. 7 AND 11.
- LETTIERI'S, INC., BURNSVILLE, MN:
2,765,914, INT. CL. 30.
- LETZER, SALLY, CALABASAS, CA:
2,764,477, INT. CL. 9.
- LEVI STRAUSS & CO., SAN FRANCISCO, CA:
1,728,638, CANC. INT. CL. 25.
2,765,706, INT. CL. 25.
- LEWIN, THOMAS M., MINNEAPOLIS, MN:
2,763,910, PUB. 6-24-2003. INT. CL. 16.
- LEX INTERNATIONAL, INC., PHOENIX, AZ:
2,763,878, PUB. 6-24-2003. INT. CL. 2.
- LHO WASHINGTON HOTEL TWO, LLC, BETHESDA, MD:
2,765,774, INT. CL. 43.
- LIBBEY GLASS INC., TOLEDO, OH:
2,764,560, INT. CL. 21.
- LIBERAL CALCULATOR COMPANY, THE, RALEIGH, NC:
2,012,095, CANC. INT. CL. 20.
- LIDDLE, DREW WESLEY, SAN CLEMENTE, CA:
1,727,745, CANC. INT. CL. 25.
- LIDL STIFTUNG & CO. KG, 74172 NECKARSULM, FED REP GERMANY:
2,763,233, PUB. 6-18-2002. INT. CL. 30.
2,763,279, PUB. 6-24-2003. INT. CL. 30.
2,763,283, PUB. 2-11-2003. MULTIPLE CLASS, INT. CLS. 29, 30 AND 33.
2,763,315, PUB. 6-24-2003. INT. CL. 29.
- LIDL STIFTUNG & CO. KG, NECKARSULM, FED REP GERMANY:
2,764,221, PUB. 6-24-2003. INT. CL. 31.
- LIFE INSURANCE MARKETING CO., INC., THE, WELLINGTON, FL FROM EXECUTIVE INSURANCE AGENCY, INC., BEACHWOOD, OH:
2,763,132, PUB. 6-24-2003. INT. CL. 36.
- LIFE TECHNOLOGIES, INC., GAITHERSBURG, MD:
1,726,812, CANC. INT. CL. 1.
1,726,845, CANC. INT. CL. 1.
- LIFELIKE BIRDS, INC., WEST CORNWALL, CT:
2,012,754, CANC. INT. CL. 20.
- LIFESTREAM TECHNOLOGIES, INC., POST FALLS, ID:
2,764,796, INT. CL. 9.
- LIFTING TECHNOLOGIES, INC., MISSOULA, MT:
1,752,240, REN. 8-6-03. INT. CL. 7.
- LIGHTYEAR TECHNOLOGIES (USA), INC., NORTH VANCOUVER, BRITISH COLUMBIA, CANADA FROM REND TECHNOLOGIES LTD., NORTH VANCOUVER, B.C., CANADA:
2,764,475, INT. CL. 9.
- LILIENBERG UNTERNEHMERFORUM, ERMATIGEN, SWITZERLAND:
2,763,104, PUB. 5-8-2001. MULTIPLE CLASS, INT. CLS. 16, 41 AND 42.
- LILLEY, JOHN K., LINDEN, VA AND LILLEY, ANGELA C., LINDEN, VA:
2,764,254, PUB. 6-24-2003. INT. CL. 39.
- LILLOEBE LLC, TRAVERSE CITY, MI:
2,765,705, INT. CL. 25.
- LIMCO, INC., WILMINGTON, DE:
2,012,065, CANC. INT. CL. 25.
2,012,067, CANC. INT. CL. 25.
2,764,529, INT. CL. 35.
- LIN, LUCY, MANHATTAN BEACH, CA AND BRAGADO, DANALEE, MANHATTAN BEACH, CA:
2,765,464, INT. CL. 25.
- LIN, SHI-LUNG, ALHAMBRA, CA:
2,764,983, INT. CL. 5.
- LIN, TING-SHENG, TAIPEI, TAIWAN:
2,764,325, PUB. 6-24-2003. INT. CL. 28.
- LINCOLN NATIONAL LIFE INSURANCE COMPANY, THE, FORT WAYNE, IN:
2,764,196, PUB. 6-24-2003. INT. CL. 36.
- LINCOLN PARK COLUMBUS DENTAL ASSOCIATES, LTD., CHICAGO, IL:
1,728,414, CANC. INT. CL. 42.
- LINCOLN TECHNICAL INSTITUTE, INC., WEST ORANGE, NJ:
2,764,920, INT. CL. 41.
- LINCOLN UNDERWRITERS, INC., DEERFIELD BEACH, FL:
2,765,260, INT. CL. 36.
- LINDEMANS WINES PTY LTD., ADELAIDE SA 5000, AUSTRALIA:
2,764,877, INT. CL. 33.
- LINDEN CORPORATION, WILMINGTON, DE:
2,765,694, MULTIPLE CLASS, INT. CLS. 3 AND 5.
- LINDWOOD FARM, INC., GREENSBURG, PA:
2,011,653, CANC. INT. CL. 29.
- LINEAS AEREAS PARAGUAYAS S.A., ASUNCION, PARAGUAY:
2,011,416, CANC. INT. CL. 39.
- LINGUISTIQUE ET INTELLIGENCE ARTIFICIELLE, 45000 ORLEANS, FRANCE, DBA LIDIA S.A:
2,764,665, INT. CL. 35.
- LINNEVAVERIET I HORRED AB, SWEDEN:
2,765,201, INT. CL. 24.
- LINSNER, JOSEPH, MICHAEL, CRANFORD, NJ:
2,764,412, PUB. 6-24-2003. MULTIPLE CLASS, INT. CLS. 16 AND 25.
- LINVATEC CORPORATION, LARGO, FL:
2,765,332, INT. CL. 10.
- LIPU MACHINE & ELECTRIC LTD., TAIWAN, R.O.C., CHINA, YANG IRON WORKS CO., LTD., TAIPEI, TAIWAN, TAICHUNG HSIEN, TAIWAN, TAIWAN:
1,239,984, REN. 8-7-03. MULTIPLE CLASS, INT. CLS. 7 AND 12.
- LIS HOLDINGS LIMITED, LOUDWATER, HIGH WYCOMBE, BUCKS HP10 9QR, UNITED KINGDOM:
2,011,537, CANC. INT. CL. 37.
- LISCO, INC., TAMPA, FL:
1,727,849, CANC. INT. CL. 28.
- LISTEN.COM, INC., SAN FRANCISCO, CA:
2,765,175, INT. CL. 42.
- LISTRO, PETER J., NEW YORK, NY:
2,011,797, CANC. INT. CL. 9.
- LITE-PREP SURFACE PREPARATION LLC, TALLMADGE, OH FROM LITE-PREP COMPANY, L.L.C., TALLMADGE, OH:
2,765,003, INT. CL. 7.
- LITEGLOW INDUSTRIES, INC., POMPANO BEACH, FL:
2,765,415, INT. CL. 11.
- LITERA CORP., MCLEANSVILLE, NC:
2,765,892, INT. CL. 9.
- LITMUS CONSULTING CORPORATION, THE, RANCHO SANTA FE, CA:
2,012,206, CANC. INT. CL. 9.
- LITTLE BONANZA, INC., RENO, NV:
2,763,468, PUB. 6-24-2003. INT. CL. 41.
- LITTLE FRENCH BAKERY L.L.C., THE, NORTH FREEDOM, WI:
2,765,736, INT. CL. 21.
- LITTLE KIDS, INC., PROVIDENCE, RI:
2,765,437, INT. CL. 28.
- LIVING TREE COMPANY, INC., THE, SEBASTOPOL, CA:
2,011,740, CANC. INT. CL. 42.
- LIVINGSTON INTERNATIONAL INC., TORONTO ONTARIO, CANADA:
2,764,150, PUB. 6-24-2003. INT. CL. 35.
- LIVINGSTONE JEWELRY CO., INC., LOS ANGELES, CA:
1,727,437, CANC. INT. CL. 14.
- LLOYD'S FOOD PRODUCTS, INC., ST. PAUL, MN:
2,011,560, CANC. INT. CL. 29.

- LOCKHEED MARTIN CORPORATION, BETHESDA, MD:
2,764,462, PUB. 6-24-2003. INT. CL. 14.
2,765,674, INT. CL. 42.
- LOCOMOTOR U.S.A. INC., LOS ANGELES, CA:
1,727,604, CANC. INT. CL. 18.
- LOCUS DIALOGUE INC., MONTREAL, QUEBEC H3B 1A7,
CANADA:
2,763,135, PUB. 6-24-2003. MULTIPLE CLASS, INT. CLS.
37 AND 42.
- LOG CABIN BBQ, FAIRFIELD GLADE, TN:
2,765,772, INT. CL. 43.
- LOGIC GENERAL, INC., TIGARD, OR:
2,012,260, CANC. MULTIPLE CLASS, INT. CLS. 35 AND
40.
- LOGILENT LEARNING SYSTEMS, INC., LAFAYETTE, CA
FROM CYBERSTATEU.COM, LAFAYETTE, CA:
2,764,912, MULTIPLE CLASS, INT. CLS. 41 AND 42.
- LOGO 7, INC., INDIANAPOLIS, IN:
2,012,180, CANC. INT. CL. 25.
- LONG MANUFACTURING LTD., OAKVILLE, ONTARIO,
CANADA:
2,763,141, PUB. 6-24-2003. INT. CL. 7.
- LONGABERGER COMPANY, THE, NEWARK, OH:
2,764,456, PUB. 6-24-2003. INT. CL. 8.
- LONGEVITY MAGAZINE INC., LARGO, FL:
2,765,713, INT. CL. 16.
- LORMAR S.R.L., 41012 CARPI (MO), ITALY:
2,764,745, INT. CL. 25.
- LOS ANGELES GAY AND LESBIAN COMMUNITY SER-
VICES CENTER, THE, LOS ANGELES, CA AND SAN
FRANCISCO AIDS FOUNDATION, THE, SAN FRANCIS-
CO, CA:
2,765,174, INT. CL. 25.
2,765,504, INT. CL. 36.
- LOS ANGELES ONCOLOGY MEDICAL GROUP, LOS AN-
GELES, CA:
2,765,209, INT. CL. 42.
- LOST WORLD ADVENTURES, INC., MARIETTA, GA:
2,012,110, CANC. INT. CL. 25.
- LOTTE CO., LTD., TOKYO, JAPAN:
2,764,688, INT. CL. 30.
2,764,689, INT. CL. 30.
- LOUISIANA-PACIFIC CORPORATION, PORTLAND, OR:
1,213,986, CANC. INT. CL. 19.
2,763,903, PUB. 6-24-2003. INT. CL. 19.
2,764,508, INT. CL. 19.
- LOVE TO LEARN, INC., WEST PALM BEACH, FL:
2,012,642, CANC. MULTIPLE CLASS, INT. CLS. 9 AND
16.
- LOVE, MICHAEL, INCLINE VILLAGE, NV:
2,011,307, CANC. INT. CL. 42.
- LOWSON, LINDA M., NEW YORK, NY:
2,012,239, CANC. INT. CL. 35.
- LPG SYSTEMS, 26000 VALENCE, FRANCE:
2,763,517, PUB. 6-24-2003. INT. CL. 9.
- LSTAG, INC., ATLANTA, GA:
2,726,299, COR. MULTIPLE CLASS, INT. CLS. 9, 38 AND
42.
- LUBECKI TECHNICAL HOLDINGS INC., GRANBY, QC.
J2G 9C6, CANADA:
1,727,599, CANC. INT. CL. 17.
- LUCKY STORES, INC., DUBLIN, CA:
1,214,443, CANC. INT. CL. 42.
- LUDLOW COMPOSITES CORPORATION, FREMONT, OH:
2,763,229, PUB. 6-24-2003. INT. CL. 27.
- LUEMME INC., MIAMI, FL:
1,727,743, CANC. INT. CL. 25.
- LUHR JENSEN & SONS, INC., HOOD RIVER, OR:
1,214,184, CANC. INT. CL. 28.
- LULY, ANN BOOTH, STUDIO CITY, CA:
2,763,748, PUB. 6-24-2003. INT. CL. 35.
- LURGI AG, FRANKFURT AM MAIN, FED REP GER-
MANY:
2,764,138, PUB. 6-24-2003. MULTIPLE CLASS, INT. CLS.
1, 4, 11, 37 AND 42.
- LUSTER PRODUCTS, INC., CHICAGO, IL:
2,764,677, INT. CL. 3.
- LUZHOU LAOJIAO STOCK CORPORATION, LIMITED,
LUZHOU CITY, SICHUAN PROVINCE, CHINA:
2,763,235, PUB. 3-18-2003. INT. CL. 33.
- LUZON IMPORTS, INC., BOSTON, MA:
1,821,581, REN. 8-7-03. INT. CL. 31.
- LYDALL, INC., MANCHESTER, CT:
1,213,997, CANC. INT. CL. 20.
1,214,031, CANC. INT. CL. 24.
- LYNDON LIFE INSURANCE COMPANY:
1,728,130, CANC. INT. CL. 36.
- LYONDELL-CITGO REFINNING LP, HOUSTON, TX,
ATLANTIC RICHFIELD COMPANY, NEW YORK, NY:
941,838, REN. 8-5-03. U.S. CL. 15 (INT. CL. 4).
- LYSOFORM DISINFECTANT LTD., CH-8750 GLARUS,
SWITZERLAND:
2,012,441, CANC. INT. CL. 5.
- LZB PROPERTIES, INC., MONROE, MI, LA-Z-BOY CHAIR
COMPANY, MONROE, MI:
1,770,607, REN. 8-6-03. INT. CL. 42.
- M. & R. DE MONCHY N.V., ROTTERDAM, NETHER-
LANDS:
1,214,138, CANC. INT. CL. 28.
- M. FORTUNOFF OF WESTBURY CORP., WESTBURY, NY:
1,387,856, CANC. INT. CL. 42.
- M. J. MORAN COMPANY, HARTFORD, CT:
2,012,699, CANC. INT. CL. 28.
- M&P ENTERTAINMENT, INC., TROY, MI:
2,011,556, CANC. INT. CL. 41.
- M-I HOLDINGS L.L.C., HOUSTON, TX FROM M-I L.L.C.,
HOUSTON, TX:
2,764,521, INT. CL. 1.
- M' LIS COMPANY, INC., THE, SALT LAKE CITY, UT:
2,763,200, PUB. 6-24-2003. MULTIPLE CLASS, INT. CLS. 3
AND 5.
- M'CLOUD, CALLOWAY GRETCHEN MARI, NELLYS-
FORD, VA:
2,763,669, PUB. 6-24-2003. INT. CL. 41.
- M'LIS COMPANY, INC., THE, SALT LAKE CITY, UT:
2,763,224, PUB. 6-24-2003. MULTIPLE CLASS, INT. CLS. 3
AND 5.
- MAACO ENTERPRISES, INC., KING OF PRUSSIA, PA:
2,764,069, PUB. 6-24-2003. INT. CL. 41.
- MACH 5 ENTERPRISES, LLC, CHATTANOOGA, TN:
2,765,557, INT. CL. 9.
- MACHO PRODUCTS, INC., SEBASTIAN, FL:
2,763,850, PUB. 6-24-2003. INT. CL. 28.
- MACINSTITUTE, INC., HOLLYWOOD, FL:
2,011,742, CANC. INT. CL. 41.
- MACKENZIE RIVER INTERNATIONAL, BOZEMAN, MT:
2,214,604, COR. MULTIPLE CLASS, INT. CLS. 30 AND
42.
2,330,692, COR. INT. CL. 42.
- MACKENZIE RIVER INTERNATIONAL, INC., BOZEMAN,
MT:
2,315,327, COR. INT. CL. 30.
- MACLEAN-HUNTER LIMITED, TORONTO, CANADA:
1,214,491, CANC. INT. CL. 16.
- MACPRICE, CYNTHIA M, OKLAHOMA CITY, OK:
2,765,569, INT. CL. 35.
- MACROFIRM CORPORATION, WAKEFIELD, MA:
2,764,610, MULTIPLE CLASS, INT. CLS. 9, 36, 37 AND 42.
- MADISON FILTER 981 LIMITED, LANCASHIRE, UNITED
KINGDOM FROM SCAPA GROUP PLC, BLACKBURN,
LANCASHIRE BB2 6AY, UNITED KINGDOM:
2,764,562, INT. CL. 7.
- MAGELLAN CORPORATION, SAN DIMAS, CA:
2,012,227, CANC. INT. CL. 9.
- MAGELLAN'S INTERNATIONAL TRAVEL CORPORA-
TION, SANTA BARBARA, CA, DBA MAGELLAN'S:
2,763,119, PUB. 1-16-2001. INT. CL. 35.
- MAGIC AMERICAN CORPORATION, CLEVELAND, OH:
2,012,086, CANC. INT. CL. 3.
- MAGIC SEASONING BLENDS, INC., NEW ORLEANS, LA:
1,727,471, CANC. INT. CL. 16.
- MAHABAZAAR.COM, INC., GAITHERSBURG, MD:
2,763,573, PUB. 6-24-2003. INT. CL. 30.

- MAIN ST. SUPPLY CO., LLC, MONROE, NC:
2,765,442, INT. CL. 35.
2,765,443, INT. CL. 35.
- MAINSTREAM ENGINEERING CORPORATION, ROCKLEDGE, FL:
1,782,740. REN. 8-7-03. INT. CL. 25.
- MAITAKE PRODUCTS, INC., RIDGEFIELD PARK, NJ:
2,765,248, INT. CL. 5.
- MAIZORO, S.A. DE C.V., 02300 MEXICO, D.F., MEXICO:
2,011,417, CANC. INT. CL. 30.
- MAJOR LEAGUE LACROSSE LLC, SECAUCUS, NJ:
2,764,954, INT. CL. 25.
2,764,955, INT. CL. 41.
2,764,956, INT. CL. 41.
2,764,957, INT. CL. 41.
2,764,958, INT. CL. 25.
2,764,959, INT. CL. 25.
2,764,960, INT. CL. 25.
- MAJORPOWER.COM CANADA CORPORATION, WESTMONT, PQ H3Z2S5 QUEBEC, CANADA FROM ZZZAP POWER LTD., WESTMOUNT, QUEBEC H3Z 2S5, CANADA:
2,763,072, PUB. 2-19-2002. INT. CL. 9.
- MAJZLER, GIANNA, FOUNTAIN VALLEY, CA, DBA GIANNA ROSE:
2,011,541, CANC. INT. CL. 18.
- MAKINO INC., MASON, OH:
2,763,938, PUB. 6-24-2003. INT. CL. 1.
- MALAMA PONO, LTD., OXNARD, CA FROM OUTRIGGER DUKE KAHANAMOKU FOUNDATION, HONOLULU, HI:
2,764,472, INT. CL. 25.
- MALIBU COMICS ENTERTAINMENT, INC., CALABASAS, CA:
2,012,158, CANC. INT. CL. 16.
- MALLET, TROY, HOUSTON, TX:
2,012,364, CANC. INT. CL. 1.
- MAN-AM CREATIONS, LTD., TAPPAN, NY:
2,012,228, CANC. INT. CL. 14.
- MANA PRODUCTS, INC., LONG ISLAND CITY, NY:
1,825,722. REN. 8-6-03. INT. CL. 3.
- MANAGED ACCOUNT REPORTS, INC., NEW YORK, NY:
2,011,318, CANC. INT. CL. 41.
- MANAGED HEALTH NETWORK, INC., SAN RAFAEL, CA:
2,764,573, INT. CL. 42.
- MANCO, INC.:
See—HENKEL CONSUMER ADHEIVES, INC..
- MANCO, INC.:
See—HENKEL CONSUMER ADHESIVES, INC..
- MANGAN COMMUNICATIONS, INC., DAVENPORT, IA:
2,765,801, INT. CL. 16.
- MANHATTAN INDUSTRIES, INC., NEW YORK, NY:
1,214,089, CANC. INT. CL. 25.
- MANNESMANN KIENZLE GMBH, D-7730 VS-VILLINGEN, FED REP GERMANY:
1,213,812, CANC. MULTIPLE CLASS, INT. CLS. 9 AND 16.
- MANNINGTON MILLS, INC., SALEM, NJ:
1,700,656, CANC. INT. CL. 27.
- MANSUETO, ROBERT F., CORONADO, CA:
2,763,894, PUB. 6-24-2003. INT. CL. 44.
- MANTAS, INC., FAIRFAX, VA:
2,765,015, MULTIPLE CLASS, INT. CLS. 9 AND 42.
- MAPA GMBH, GUMMI- UND PLASTIKWERKE, ZEVEN, FED REP GERMANY:
1,213,835, CANC. MULTIPLE CLASS, INT. CLS. 10 AND 21.
- MAPAL FABRIK FUR PRAZISIONSWERKZEUGE DR. KRESS KG, AALEN, FED REP GERMANY:
2,763,311, PUB. 6-24-2003. MULTIPLE CLASS, INT. CLS. 37, 38, 39 AND 42.
- MARATHON ENGINEERS/ARCHITECTS/PLANNERS, LLC, APPLETON, WI:
2,765,633, INT. CL. 42.
- MARBLE SPORTSWEAR, INC., BEVERLY HILLS, CA:
2,765,578, INT. CL. 25.
2,765,593, INT. CL. 25.
- MARED INDUSTRIES, INCORPORATED, VAN NUYS, CA:
2,763,306, PUB. 6-24-2003. INT. CL. 7.
- MARGARITELLI ITALIA S.P.A., SAN VENANZO (TR), ITALY:
2,764,892, INT. CL. 19.
- MARIE, INC., PROVO, UT:
2,763,645, PUB. 6-24-2003. INT. CL. 28.
- MARINEBIDEXCHANGE.COM, INC., DANIA, FL:
2,765,856, INT. CL. 35.
- MARINER INTERNATIONAL TRAVEL, INC., CLEARWATER, FL:
2,765,558, INT. CL. 39.
- MARK BRITTINGHAM ASSOCIATES, LLC, CALIFON, NJ:
2,763,481, PUB. 6-24-2003. INT. CL. 9.
- MARK CONTROLS CORPORATION, EVANSTON, IL:
160,916, CANC. U.S. CL. 35.
- MARK TRAVEL CORPORATION, THE, MILWAUKEE, WI:
2,765,105, MULTIPLE CLASS, INT. CLS. 39 AND 42.
- MARKET MEASURES/ COZINT L.P., EAST HANOVER, NJ FROM COZINT INTERACTIVE, INC., ANDOVER, MA:
2,765,235, INT. CL. 42.
- MARKET MONITOR INC., NEW YORK, NY:
1,728,731, CANC. INT. CL. 35.
- MARKET ONE, INC., VALLEY HEAD, AL:
2,763,079, PUB. 6-24-2003. INT. CL. 5.
- MARKETING-AGENTUR-FINANZIERUNGS-AG, CH-8152 GLATTBRUGG, SWITZERLAND:
1,727,648, CANC. MULTIPLE CLASS, INT. CLS. 20 AND 25.
- MARLAN, INC., GLEN ELLYN, IL:
1,727,935, CANC. INT. CL. 30.
- MARLO FURNITURE COMPANY, INC., ROCKVILLE, MD:
1,773,885. REN. 8-7-03. INT. CL. 42.
- MARLOW, NICK, BODEGA, CA, DBA BETTY BELTS:
2,763,953, PUB. 6-24-2003. INT. CL. 25.
- MARPAC INDUSTRIES, INC., WALDWICK, NJ:
1,728,516, CANC. INT. CL. 1.
- MARRIOTT INTERNATIONAL, INC., BETHESDA, MD, MARRIOTT CORPORATION, BETHESDA, MD:
947,709. REN. 8-6-03. U.S. CL. 100 (INT. CL. 42).
- MARS, INCORPORATED, MCLEAN, VA:
2,011,782, CANC. INT. CL. 30.
2,011,785, CANC. INT. CL. 30.
- MARSALIS MUSIC LLC, CAMBRIDGE, MA:
2,763,955, PUB. 6-24-2003. INT. CL. 9.
- MARTIN ROSS AND ROBBIE STANFORD PARTNERSHIP, THE, LOS ANGELES, CA:
2,765,441, INT. CL. 25.
- MARTY'S FOOD & WINE, INC., DALLAS, TX:
2,765,046, MULTIPLE CLASS, INT. CLS. 29, 30, 31, 33, 35 AND 42.
- MARUMAN GOLF USA, INC., NORCROSS, GA:
1,728,669, CANC. INT. CL. 28.
- MARVOL USA, NEW YORK, NY:
2,011,813, CANC. INT. CL. 33.
- MARY COHR, S.A., PARIS, 75002, FRANCE:
2,012,018, CANC. INT. CL. 3.
- MASALA MAGAZINE INC., NEW YORK, NY:
2,011,803, CANC. INT. CL. 16.
- MASCHINENFABRIK BERTHOLD HERMLE AG, D-78599 GOSHEIM, FED REP GERMANY:
2,763,408, PUB. 6-24-2003. MULTIPLE CLASS, INT. CLS. 6, 7, 9 AND 20.
2,763,409, PUB. 6-24-2003. MULTIPLE CLASS, INT. CLS. 6, 7, 9 AND 20.
- MASCHINENFABRIK RIETER AG, CH-8406 WINTERTHUR, SWITZERLAND:
1,727,020, CANC. INT. CL. 7.
- MASONIC HOME, INC., THE, CHARLTON, MA:
2,764,927, MULTIPLE CLASS, INT. CLS. 35, 36 AND 42.
- MASSEY FERGUSON CORP., DULUTH, GA, MASSEY-FERGUSON S.A., 60026 BEAUVAIS, CEDEX, FRANCE:
1,775,125. REN. 8-7-03. INT. CL. 12.
- MASTERCARD INTERNATIONAL INCORPORATED, PURCHASE, NY:
1,728,107, CANC. INT. CL. 36.

- MATCHNET PLC, BEVERLY HILLS, CA FROM FACE-LINK.COM, SAN JOSE, CA:
2,764,994, INT. CL. 42.
- MATSUI SHIKISO CHEMICAL CO., LTD., YAMASHINA-KU, KYOTO-SHI, KYOTO, JAPAN:
1,773,337, REN. 8-4-03, INT. CL. 2.
- MATSUSHITA ELECTRIC CORPORATION OF AMERICA, SECAUCUS, NJ:
2,012,274, CANC. INT. CL. 9.
- MATTEL, INC., EL SEGUNDO, CA:
2,012,259, CANC. INT. CL. 28.
2,012,630, CANC. INT. CL. 28.
2,012,661, CANC. INT. CL. 28.
2,012,677, CANC. INT. CL. 28.
2,012,678, CANC. INT. CL. 28.
2,012,693, CANC. INT. CL. 28.
2,012,793, CANC. INT. CL. 28.
2,012,815, CANC. INT. CL. 28.
2,012,879, CANC. INT. CL. 28.
2,764,582, INT. CL. 30.
2,765,539, MULTIPLE CLASS, INT. CLS. 6, 20 AND 28.
2,765,585, INT. CL. 28.
2,765,623, INT. CL. 28.
- MATTERHORN FINANCIAL SERVICES, INC., TIMONIUM, MD:
2,763,829, PUB. 6-24-2003, INT. CL. 36.
2,763,830, PUB. 6-24-2003, INT. CL. 36.
- MATTHEW C. WINN, WESTVILLE, NJ:
2,765,781, INT. CL. 3.
- MATTHEW CHOI ENTERPRISE, CYPRESS, CA, DBA - HOOKUP WIRELESS:
2,763,774, PUB. 6-24-2003, INT. CL. 35.
- MATTOS, LESLEY J., MOUNTAIN VIEW, CA:
2,765,223, INT. CL. 16.
- MAUCH, LARRY, A., LIVERMORE, CA:
2,764,351, PUB. 6-24-2003, INT. CL. 9.
- MAURICE SPORTING GOODS, INC., NORTHBROOK, IL:
2,012,612, CANC. INT. CL. 28.
- MAURITSON, THOMAS, HEALDSBURG, CA:
2,765,278, INT. CL. 33.
- MAUTZ PAINT CO., MADISON, WI:
1,213,727, CANC. INT. CL. 2.
- MAWE KNITTAX CORPORATION, LOS ANGELES, CA:
2,011,989, CANC. INT. CL. 7.
- MAX KATZ BAG COMPANY, INC., INDIANAPOLIS, IN:
739,863, CANC. U.S. CL. 2.
- MAXMEYER CAR S.R.L., 20161 MILANO, ITALY:
2,011,430, CANC. INT. CL. 2.
- MAXON CORPORATION, MUNCIE, IN:
2,765,156, INT. CL. 9.
- MAXWELL FOOTWEAR OF CALIFORNIA INC., NEW-HALL, CA, SAM & LIBBY, INC., SAN CARLOS, CA:
1,778,203, REN. 8-8-03, INT. CL. 42.
- MAYA ROMANOFF CORPORATION, THE, CHICAGO, IL:
2,061,101, COR. INT. CL. 16.
- MAYTAG CORPORATION, NEWTON, IA:
1,727,387, CANC. INT. CL. 11.
- MAZDA MOTOR CORPORATION, HIROSHIMA, JAPAN:
2,763,355, PUB. 6-24-2003, INT. CL. 12.
- MAZDA MOTOR CORPORATION, AKI-GUN, HIROSHIMA, JAPAN:
2,763,356, PUB. 6-24-2003, INT. CL. 12.
2,763,357, PUB. 6-24-2003, INT. CL. 12.
- MB QUART ELECTRONICS U.S.A., INC., WALPOLE, MA:
2,012,820, CANC. INT. CL. 9.
- MBO BINDER & CO. OF AMERICA, WESTHAMPTON, NJ:
2,764,292, PUB. 6-24-2003, MULTIPLE CLASS, INT. CLS. 7 AND 9.
- MBYN INC., SUNGNAM, KYUNGGI-DO, REPUBLIC OF KOREA:
2,763,172, PUB. 6-24-2003, INT. CL. 9.
- MCARTHUR PROFESSIONAL, INCORPORATED, ABBEVILLE, SC:
2,765,955, INT. CL. 35.
- MCC EVENTS, LLC, AUGUSTA, GA:
2,763,940, PUB. 6-24-2003, MULTIPLE CLASS, INT. CLS. 35 AND 41.
- MCC FOODS AMERICA, INC., CARSON, CA:
1,728,438, CANC. INT. CL. 42.
- MCCAIN FOODS LIMITED, FLORENCEVILLE, NEW BRUNSWICK, CANADA:
1,727,853, CANC. INT. CL. 29.
- MCCAULEY BROTHERS, INC., VERSAILLES, KY:
2,764,389, PUB. 6-24-2003, INT. CL. 31.
- MCCORMICK, AUSTIN HOLT, BURLINGTON, NC, DBA THE AUSTIN HOLT COMPANY:
2,513,661, CANC. INT. CL. 35.
- MCDONALD'S CORPORATION, OAK BROOK, IL:
2,011,570, CANC. INT. CL. 42.
- MCFARLAND, STEVEN M., SAN JOSE, CA, DBA UV SCIENCE:
1,726,859, CANC. INT. CL. 1.
- MCGAW, INC., IRVINE, CA:
2,012,170, CANC. INT. CL. 10.
- MCGILL SALES, INC., OMAHA, NE:
2,012,936, CANC. INT. CL. 42.
- MCGUIGAN, WILLIAM M., SAN DIEGO, CA:
2,012,811, CANC. INT. CL. 28.
- MCGURN, YOLANDA J., CASPER, WY:
2,012,354, CANC. INT. CL. 16.
- MCKESSON CORPORATION, SAN FRANCISCO, CA:
1,937,449, CANC. INT. CL. 39.
2,763,419, PUB. 6-24-2003, MULTIPLE CLASS, INT. CLS. 35 AND 42.
- MCL CREATION FACTORY, LTD., KOWLOON, HONG KONG:
2,764,291, PUB. 6-24-2003, MULTIPLE CLASS, INT. CLS. 18 AND 25.
- MCMILLEN, INC., NEW YORK, NY:
1,674,248, CANC. INT. CL. 20.
- MCNEILUS TRUCK AND MANUFACTURING, INC., DODGE CENTER, MN:
2,765,376, MULTIPLE CLASS, INT. CLS. 7 AND 12.
- MCO PROPERTIES INC., HOUSTON, TX:
1,728,168, CANC. INT. CL. 37.
- MCRAE'S, INC., BIRMINGHAM, AL:
2,765,740, INT. CL. 25.
- MCWILLIAM'S WINES PTY LIMITED, CHULLORA, NEW SOUTH WALES, 2190, AUSTRALIA:
2,765,123, INT. CL. 33.
- MDI PRODUCTS, LLC, SEBASTIAN, FL:
2,764,023, PUB. 6-24-2003, INT. CL. 40.
- MEAD CORPORATION, THE, DAYTON, OH:
2,764,061, PUB. 6-24-2003, INT. CL. 16.
2,764,070, PUB. 6-24-2003, INT. CL. 16.
2,764,071, PUB. 6-24-2003, INT. CL. 16.
2,764,072, PUB. 6-24-2003, INT. CL. 16.
- MEATS PLUS, INC., LODA, IL:
2,765,355, INT. CL. 29.
- MECA SOFTWARE, L.L.C., TRUMBULL, CT:
2,011,546, CANC. INT. CL. 9.
- MECALUX, S.A., BARCELONA, SPAIN:
1,790,425, REN. 8-7-03, INT. CL. 20.
- MECHOSHADE SYSTEMS, INC., LONG ISLAND CITY, NY:
2,765,011, INT. CL. 20.
- MED WORKS INC., LAKELAND, FL:
2,011,731, CANC. INT. CL. 10.
- MEDIA DESIGN GESELLSCHAFT FUR MULTIMEDIA UND ONLINE-PUBLISHING MBH, D-07549 GERA, FED REP GERMANY:
2,764,600, MULTIPLE CLASS, INT. CLS. 38 AND 42.
- MEDIA SPACE, INC., STAMFORD, CT:
2,011,603, CANC. INT. CL. 35.
- MEDIA SYNDICATION GLOBAL, INC., NEW YORK, NY:
2,765,871, INT. CL. 9.
- MEDIA TECHNOLOGY LIMITED, ROCKVILLE, MD:
2,012,764, CANC. INT. CL. 28.
- MEDICAL CHEMICAL CORPORATION, SANTA MONICA, CA:
739,877, CANC. U.S. CL. 6.
- MEDICAL INSTRUMENT DEVELOPMENT LABORATORIES, INC., SAN LEANDRO, CA, DBA - MID LABS, INC.:
2,012,324, CANC. INT. CL. 10.

MEDICAL MUTUAL INSURANCE COMPANY OF NORTH CAROLINA, RALEIGH, NC:
2,764,946, MULTIPLE CLASS, INT. CLS. 35 AND 42.

MEDISAVE PHARMACIES, INC., BATON ROUGE, LA:
2,012,481, CANC. MULTIPLE CLASS, INT. CLS. 35, 39, 41 AND 42.

MEDISERVE INFORMATION SYSTEMS, INC., TEMPE, AZ:
2,764,324, PUB. 6-24-2003. INT. CL. 9.

MEDIVANCE, INC., LOUISVILLE, CO:
2,764,777, INT. CL. 10.

MEDLOGIC GLOBAL CORPORATION, COLORADO SPRINGS, CO:
2,012,148, CANC. INT. CL. 5.
2,012,514, CANC. INT. CL. 5.

MEDO INDUSTRIES, INC., TARRYTOWN, NY:
1,773,384, REN. 8-2-03. INT. CL. 5.

MEDSTAR COMMUNICATION, INC., ALLENTOWN, PA:
2,011,735, CANC. INT. CL. 42.

MEDTRONIC, INC., MINNEAPOLIS, MN:
1,763,650, REN. 8-6-03. INT. CL. 10.

MEESE, INC., SADDLE BROOK, NJ:
2,763,943, PUB. 6-24-2003. INT. CL. 28.

MEGA BLOKS INC., MONTREAL, QUEBEC, CANADA FROM RITVIK HOLDINGS INC., ST. LAURENT (QC), CANADA:
2,765,283, INT. CL. 28.

MEGASCENE AB, 435 33 MOLNLYCKE, SWEDEN:
2,764,926, INT. CL. 25.

MEIER, RUDOLF, HARPSTEDT, FED REP GERMANY:
2,765,857, INT. CL. 20.

MELITTA HAUSHALTSPRODUKTE GMBH & CO. KOMMANDITGESELLSCHAFT, D-4950 MINDEN (WESTFALEN) 1, FED REP GERMANY:
1,727,380, CANC. INT. CL. 11.

MELKAZ INTERNATIONAL INC., FLUSHING, NY:
2,011,664, CANC. INT. CL. 30.

MELLEOS CAPITAL MANAGEMENT LLC, NEW YORK, NY:
2,765,232, INT. CL. 36.

MENARD, INC., EAU CLAIRE, WI:
2,765,258, INT. CL. 19.
2,765,259, INT. CL. 19.

MENASHA CORPORATION, NEENAH, WI, MENASHA CORPORATION, NEENAH, WI:
1,240,368, REN. 8-4-03. INT. CL. 20.

MENDOCINO BREWING COMPANY, INC., HOPLAND, CA:
2,011,818, CANC. INT. CL. 32.

MENDOCINO CELLARS LLC, HOPLAND, CA:
2,765,381, INT. CL. 33.

MENTIS, INC., COLORADO SPRINGS, CO:
2,011,408, CANC. INT. CL. 42.

MENTOR CORPORATION, SANTA BARBARA, CA:
2,765,401, INT. CL. 10.

MENTOR TALK, INC., NEW YORK, NY:
2,765,417, MULTIPLE CLASS, INT. CLS. 35 AND 41.
2,765,418, MULTIPLE CLASS, INT. CLS. 35 AND 41.

MENUS INTERNATIONAL, INC., ATLANTIC CITY, NJ:
1,214,492, CANC. INT. CL. 16.

MERCANTILE BANCORPORATION INC., ST. LOUIS, MO:
1,214,321, CANC. INT. CL. 36.

MERCEDES-BENZ AKTIENGESELLSCHAFT, 70327 STUTTGART, FED REP GERMANY:
2,011,347, CANC. INT. CL. 12.
2,011,348, CANC. INT. CL. 12.
2,011,349, CANC. INT. CL. 12.
2,011,350, CANC. INT. CL. 12.

MERCER HUMAN RESOURCE CONSULTING, INC., NEW YORK, NY FROM WILLIAM M. MERCER, INCORPORATED, NEW YORK, NY:
2,765,911, INT. CL. 35.

MERCIER, MAX, SALT LAKE CITY, UT, DBA MERCIER FOODS:
1,728,370, CANC. INT. CL. 42.

MERCK & CO., INC., WHITEHOUSE STATION, NJ:
764,209, REN. 8-6-03. U.S. CL. 18 (INT. CL. 5).
977,144, REN. 8-7-03. U.S. CL. 18 (INT. CL. 5).
979,811, REN. 8-7-03. U.S. CL. 18 (INT. CL. 5).
2,764,811, INT. CL. 42.

MERCK KGAA, DARMSTADT, FED REP GERMANY:
2,764,261, PUB. 6-24-2003. INT. CL. 3.

MEREDITH CORPORATION, DES MOINES, IA:
2,064,964, AM. INT. CL. 42.
2,763,820, PUB. 6-24-2003. MULTIPLE CLASS, INT. CLS. 16 AND 44.
2,765,386, INT. CL. 31.

MERELINDA FARM LLC, WHITMORE LAKE, MI, DBA ALPACA.COM LLC:
2,765,099, INT. CL. 25.

MERGE 2 MEDIA LLC, GRAND JUNCTION, CO:
2,763,686, PUB. 6-24-2003. INT. CL. 42.

MERIAL, 69002 LYON, FRANCE:
2,763,796, PUB. 6-24-2003. INT. CL. 5.

MERONA INDUSTRIES, INC., ATLANTA, GA:
1,727,283, CANC. INT. CL. 9.

MERRICK'S, INC., MIDDLETON, WI:
2,763,764, PUB. 6-24-2003. INT. CL. 5.

MERRILL LYNCH & CO., INC., NEW YORK, NY:
2,763,143, PUB. 6-24-2003. INT. CL. 36.

MERTEC LLC, ADEL, IA:
2,763,296, PUB. 6-24-2003. INT. CL. 31.

MERZ, INCORPORATED, GREENSBORO, NC:
2,765,316, INT. CL. 5.

MESQUIDA, ANTHONY, WESTMINSTER, CO:
2,011,992, CANC. INT. CL. 8.

METABOLIFE INTERNATIONAL, INC., SAN DIEGO, CA:
2,764,598, MULTIPLE CLASS, INT. CLS. 5 AND 25.

METAGENICS, INC., SAN CLEMENTE, CA:
2,011,838, CANC. INT. CL. 5.

METAL LUBRICANTS CO., CHICAGO, IL:
1,213,759, CANC. INT. CL. 4.
1,213,760, CANC. INT. CL. 4.

METAL MAMMOTH, INC., NORTHAMPTON, MA:
2,764,544, MULTIPLE CLASS, INT. CLS. 6, 14 AND 28.

METALLAMICS, INC., TRAVERSE CITY, MI:
1,727,026, CANC. INT. CL. 7.

METH COMMUNICATIONS GROUP LLC, PLYMOUTH MEETING, PA:
2,763,313, PUB. 6-24-2003. INT. CL. 35.

METROMEDIA STEAKHOUSES COMPANY, L.P., DALLAS, TX:
2,011,533, CANC. INT. CL. 42.

METROPLEX TELEPHONE COMPANY, DALLAS, TX, DBA METROCEL CELLULAR TELEPHONE COMPANY:
2,011,363, CANC. INT. CL. 38.

METROPOLITAN LIFE INSURANCE COMPANY, NEW YORK, NY:
2,765,792, MULTIPLE CLASS, INT. CLS. 36 AND 42.
2,765,818, INT. CL. 36.

METROPOLITAN SERVICE CORP., LINDENHURST, NY:
2,011,346, CANC. INT. CL. 11.

METROPOLITAN TRANSPORTATION AUTHORITY, NEW YORK, NY:
2,763,509, PUB. 6-24-2003. INT. CL. 43.
2,763,510, PUB. 6-24-2003. INT. CL. 43.

METZ BAKING COMPANY, SIOUX CITY, IA, NATIONAL BAKING COMPANY, CHICAGO, IL:
735,744, REN. 8-5-03. U.S. CL. 46 (INT. CL. 30).

MEX LATIN IMPORTS, LTD., AUSTIN, TX:
2,765,891, INT. CL. 33.

MEYER CREATIVITY ASSOCIATES, INC., CHICAGO, IL:
2,763,037, PUB. 5-21-2002. INT. CL. 41.

MEYER RESIDENTIAL LLC, HOUSTON, TX:
2,764,294, PUB. 6-24-2003. INT. CL. 36.

MEYERS, ROBERT, MIAMI, FL:
2,765,070, INT. CL. 9.

MEZGO (USA), INC., CALZADA DE TLALPAN NO. 3222, MEXICO:
2,012,535, CANC. INT. CL. 32.

MG-AH OPERATING, INC., DENVER, CO:
2,765,500, INT. CL. 43.

MGIC INVESTMENT CORPORATION, MILWAUKEE, WI:
1,703,849, CANC. INT. CL. 41.

MHB FEEDS, LLC, MITCHELL, SD, DBA MILLBROOK FEEDS, LLC:
2,765,817, INT. CL. 5.

- MIAMI TRIBE OF OKLAHOMA BUSINESS DEVELOPMENT AUTHORITY, MIAMI, OK:
2,765,289, INT. CL. 9.
- MICAP TECHNOLOGY CORPORATION, NILES, IL:
2,012,298, CANC. INT. CL. 2.
- MICHAELS MANAGEMENT SERVICES, LP, IRVING, TX:
2,765,378, INT. CL. 35.
- MICHELANGELO POMPEY PTY LIMITED, CASTLE HILL, NSW 2154, AUSTRALIA:
2,763,276, PUB. 6-24-2003. INT. CL. 2.
- MICHELIN NORTH AMERICA, INC., GREENVILLE, SC:
2,765,039, INT. CL. 12.
- MICHIGAN SPEECH COACHES, INC., TROY, MI:
2,765,638, INT. CL. 16.
- MICREL, INCORPORATED, SAN JOSE, CA:
2,765,013, INT. CL. 9.
2,765,014, INT. CL. 9.
- MICRO ARIZALA SYSTEMS, INC., ANN ARBOR, MI:
1,727,277, CANC. INT. CL. 9.
- MICRO BREW, LLC, MINNETONKA, MN:
2,012,296, CANC. INT. CL. 32.
- MICRO LINEAR CORPORATION, SAN JOSE, CA:
2,011,850, CANC. INT. CL. 9.
- MICROBURST TECHNOLOGIES, INC., ROCKLEDGE, FL:
2,763,084, PUB. 7-3-2001. INT. CL. 42.
- MICROFRAME, INC., EDISON, NJ:
2,011,455, CANC. INT. CL. 9.
- MICRON COMMUNICATIONS, INC., BOISE, ID:
2,012,179, CANC. INT. CL. 9.
- MICROPHOR, INC., WILLITS, CA:
1,727,361, CANC. INT. CL. 11.
- MICROSOFT CORPORATION, REDMOND, WA:
2,012,202, CANC. INT. CL. 16.
2,765,573, INT. CL. 25.
2,765,607, INT. CL. 9.
2,765,721, INT. CL. 9.
- MID ATLANTIC MEDICAL SERVICES, INC., ROCKVILLE, MD:
2,764,597, MULTIPLE CLASS, INT. CLS. 36 AND 42.
- MID PENINSULA ACTION FOR TOMORROW, PALO ALTO, CA:
2,764,202, PUB. 6-24-2003. INT. CL. 35.
- MIDAS INTERNATIONAL CORPORATION, CHICAGO, IL:
739,964, CANC. U.S. CL. 23.
- MIDAX, 92230 GENNEVILLIERS, FRANCE:
2,763,585, PUB. 6-24-2003. MULTIPLE CLASS, INT. CLS. 28 AND 43.
- MIDDENDORF, DWIGHT R., FEDERAL WAY, WA:
2,765,642, MULTIPLE CLASS, INT. CLS. 7 AND 12.
- MIDFIRST BANK, OKLAHOMA CITY, OK:
2,763,948, PUB. 6-24-2003. INT. CL. 36.
- MIDORI, INC., SEATTLE, WA:
1,829,484, REN. 8-2-03. INT. CL. 26.
- MIDWAY HOME ENTERTAINMENT INC., CHICAGO, IL:
2,764,546, INT. CL. 28.
- MIDWAY MANUFACTURING COMPANY, CHICAGO, IL:
2,012,813, CANC. INT. CL. 28.
- MIDWEST COMPUTER, INC., LOMBARD, IL:
2,763,841, PUB. 6-24-2003. INT. CL. 35.
- MIDWEST DIAGNOSTIC MANAGEMENT, LLC, MOKENA, IL:
2,765,890, INT. CL. 35.
- MIDWEST EXPRESS AIRLINES, INC.:
See— YX PROPERTIES, LLC.
- MIDWEST TELEVISION, INC., CHAMPAIGN, IL:
1,728,185, CANC. INT. CL. 38.
- MIDWESTERN PET FOODS, INC., EVANSVILLE, IN:
2,765,373, MULTIPLE CLASS, INT. CLS. 35 AND 45.
- MILANIAN, CYRUS, POMPANO BEACH, FL:
2,765,576, INT. CL. 35.
- MILE HI CHURCH OF RELIGIOUS SCIENCE, LAKEWOOD, CO:
2,765,582, MULTIPLE CLASS, INT. CLS. 9, 41 AND 42.
- MILLENNIUM MEDICAL TECHNOLOGIES, INC., SANTA FE, NM:
2,764,458, PUB. 6-24-2003. INT. CL. 10.
- MILLER & KREISEL SOUND CORPORATION, CHATSWORTH, CA:
1,239,216, REN. 8-6-03. INT. CL. 9.
- MILLER COMPANY, THE, MERIDEN, CT, MILLER COMPANY, THE, MERIDEN, CT:
1,249,575, REN. 8-8-03. INT. CL. 6.
- MILLER, SCOTT, VALPARAISO, IN AND RICHARDSON, ROBERT, LOCKPORT, IL:
2,765,180, INT. CL. 25.
- MILLIGAN, TIM, BOYNTON BEACH, FL:
2,764,919, INT. CL. 25.
- MILLIKEN & COMPANY, NEW YORK, NY:
749,834, REN. 8-4-03. U.S. CL. 42 (INT. CL. 24).
1,214,132, CANC. INT. CL. 27.
- MILLIKEN, TULSI, CARLSBAD, CA:
2,765,937, INT. CL. 42.
- MILLIPORE CORPORATION, BEDFORD, MA:
2,764,327, PUB. 6-24-2003. INT. CL. 7.
- MILTON SALES, INC., MALDEN, WV:
2,764,052, PUB. 6-24-2003. INT. CL. 28.
- MILTON, DAVID, SCARBOROUGH, ONTARIO MIN 269, CANADA:
2,763,098, PUB. 6-24-2003. INT. CL. 21.
- MILTON'S DISTRIBUTING CO., INC., NORWOOD, MA:
2,765,427, INT. CL. 35.
- MINDGIFTS, LLC, CHICAGO, IL:
2,765,739, INT. CL. 41.
- MINERAL DENT, INC., DETROIT, MI:
2,764,593, MULTIPLE CLASS, INT. CLS. 3 AND 5.
- MINITUBE OF AMERICA, INC., VERONA, WI:
2,765,312, INT. CL. 5.
- MINNESOTA DEPARTMENT OF AGRICULTURE, ST. PAUL, MN:
1,214,478, CANC. U.S. CL. A.
- MINNESOTA MUTUAL LIFE INSURANCE COMPANY, THE, ST. PAUL, MN:
2,011,952, CANC. INT. CL. 36.
- MINNESOTA SCIENTIFIC, INC., ST. PAUL, MN:
1,801,491, REN. 8-6-03. INT. CL. 10.
- MINORITY CORPORATE COUNSEL ASSOCIATION, WASHINGTON, DC:
2,765,862, INT. CL. 16.
- MINOTTI; PETER L., EASTON, PA, DBA PETER L. MINOTTI ENTERPRISES:
1,214,171, CANC. INT. CL. 28.
- MINUTEMAN, INC., WATERLOO, WI:
2,011,284, CANC. INT. CL. 6.
- MIPS TECHNOLOGIES, INC., MOUNTAIN VIEW, CA:
2,764,564, MULTIPLE CLASS, INT. CLS. 9, 16, 41 AND 42.
- MIRAE OPTICS CO., LTD., KYONGGI-DO, 430-016, REPUBLIC OF KOREA:
2,763,534, PUB. 6-24-2003. INT. CL. 10.
- MIRAGE LIMOUSINE SERVICE, INC., LONG ISLAND CITY, NY:
2,763,694, PUB. 12-3-2002. INT. CL. 39.
- MIRANDA WINES PTY LTD, GRIFFITH, NSW 2680, AUSTRALIA:
2,765,144, INT. CL. 33.
- MIRIAM COLLINS - PALM BEACH LABORATORIES CO., MINNEAPOLIS, MN, DBA PALM BEACH BEAUTY PRODUCTS:
1,214,480, CANC. INT. CL. 3.
- MIRSKY-MACNAMARA, ARLENE C., COVENTRY, CT, DBA ABUSE PREVENTION SPECIALISTS:
2,764,025, PUB. 6-24-2003. INT. CL. 16.
- MISSION CITY PRESS, INC., SAN ANTONIO, TX:
2,763,383, PUB. 6-24-2003. INT. CL. 41.
- MISSION MEDIA, INC., SARASOTA, FL:
2,011,431, CANC. MULTIPLE CLASS, INT. CLS. 9 AND 16.
- MISSIONARY ASSOCIATION OF MARY IMMACULATE, BELLEVILLE, IL:
2,765,324, INT. CL. 36.
- MISSIONSIX LLC., MAMMOTH LAKES, CA:
2,764,762, INT. CL. 25.
- MISSLER, CHUCK, COEUR D'ALENE, ID:
2,764,754, INT. CL. 9.

- MISTRAL LLC, SOLANA BEACH, CA:
2,764,014, PUB. 6-24-2003. INT. CL. 4.
- MITCHELL INTERNATIONAL, INC., SAN DIEGO, CA FROM THOMSON FINANCE S.A., CH 6300 ZUG, SWITZERLAND:
2,764,559, INT. CL. 35.
- MITCHELL, JANE A., TULSA, OK:
2,763,768, PUB. 6-24-2003. INT. CL. 16.
- MITSUBISHI ELECTRIC CORPORATION, CHIYODA-KU, TOKYO, JAPAN:
2,763,305, PUB. 6-24-2003. INT. CL. 7.
- MITSUBISHI HEAVY INDUSTRIES, LTD., TOKYO, JAPAN:
2,764,717, MULTIPLE CLASS, INT. CLS. 9, 37 AND 42.
- MITSUBISHI MOTORS NORTH AMERICA, INC., CYPRESS, CA FROM MITSUBISHI MOTOR SALES OF AMERICA, INC., CYPRESS, CA:
2,765,126, INT. CL. 12.
- MKS INC., WATERLOO, ON, CANADA FROM MORTICE KERN SYSTEMS INC., WATERLOO ONTARIO, CANADA:
2,763,360, PUB. 6-24-2003. INT. CL. 9.
- MMI COMPANIES, INC., DEEFIELD, IL:
1,728,132, CANC. INT. CL. 36.
- MN AIRLINES, LLC, MENDOTA, MN FROM SUN COUNTRY AIRLINES, INC., MENDOTA HEIGHTS, MN:
2,764,737, INT. CL. 39.
- MOBIL OIL CORPORATION, FAIRFAX, VA:
2,012,910, CANC. INT. CL. 37.
- MOBILE CENTREX, INC., RICHARDSON, TX:
2,763,882, PUB. 6-24-2003. MULTIPLE CLASS, INT. CLS. 38 AND 42.
- MOBILE COMPUTING SYSTEMS CORPORATION, BURLINGAME, CA:
2,012,465, CANC. INT. CL. 9.
- MOBO HOLDINGS (UK) LIMITED, WINCHMORE HILL, LONDON, N21 3RE, ENGLAND:
2,763,097, PUB. 6-24-2003. MULTIPLE CLASS, INT. CLS. 9, 16, 25, 35, 38, 41 AND 42.
- MODERN CURRICULUM PRESS, INC., CLEVELAND, OH:
2,011,631, CANC. INT. CL. 9.
- MODUFORM, INC., FITCHBURG, MA:
1,831,368, REN. 8-7-03. INT. CL. 20.
- MOEN INCORPORATED, NORTH OLMSTED, OH:
2,765,828, INT. CL. 11.
- MOLECULAR IMAGING CORPORATION, TEMPE, AZ:
2,012,548, CANC. INT. CL. 9.
- MOM'S KANDY KITCHEN, INC., REXBURG, ID:
2,763,989, PUB. 6-24-2003. INT. CL. 30.
- MONEYFITNESS.COM, INC., PLYMOUTH, MA:
2,764,859, MULTIPLE CLASS, INT. CLS. 36 AND 41.
- MONITORING TECHNOLOGY CORPORATION, FAIRFAX, VA:
2,764,119, PUB. 6-24-2003. INT. CL. 9.
- MONKEY WORLD LIMITED, DORSET BH20 6HH, ENGLAND:
2,763,134, PUB. 6-24-2003. MULTIPLE CLASS, INT. CLS. 6, 9, 16, 20, 21, 24, 25, 26, 28, 38 AND 41.
- MONSANTO TECHNOLOGY LLC, ST. LOUIS, MO:
2,765,658, INT. CL. 1.
2,765,659, INT. CL. 31.
- MONTGOMERY WARD & CO., INCORPORATED, CHICAGO, IL:
1,727,682, CANC. INT. CL. 21.
- MOONLITE FOODS, INC., CARPINTERIA, CA:
2,011,759, CANC. INT. CL. 30.
- MOORE NORTH AMERICA, INC., STAMFORD, CT:
2,765,550, INT. CL. 42.
- MOORE, MICHAEL, AURORA, CO:
2,764,330, PUB. 6-24-2003. INT. CL. 42.
- MOORE, NEAL L., SALT LAKE CITY, UT:
2,012,569, CANC. INT. CL. 28.
- MORENO, KAREN K., HAYWARD, WI:
2,764,848, INT. CL. 31.
- MORGAN STANLEY DEAN WITTER & CO., NEW YORK, NY:
1,728,104, CANC. INT. CL. 36.
- MORPHOTEK INC, PHILADELPHIA, PA:
2,765,555, INT. CL. 1.
- MORSE SHOE, INC., CANTON, MA:
1,727,750, CANC. INT. CL. 25.
- MORTGAGE BANKERS ASSOCIATION OF AMERICA, WASHINGTON, DC:
2,763,939, PUB. 6-24-2003. INT. CL. 35.
- MORTGAGE PARTNERSHIP OF AMERICA, L.L.C., ST. LOUIS, MO:
2,764,814, INT. CL. 36.
- MORTGAGE QUOTE SERVICE, INC., HOUSTON, TX:
2,012,526, CANC. INT. CL. 36.
- MORTICE KERN SYSTEMS INC.:
See—MKS INC..
- MORTON-NORWICH PRODUCTS, INC., GREENVILLE, SC:
1,213,743, CANC. INT. CL. 3.
- MOSAID TECHNOLOGIES INCORPORATED, KANATA, ONTARIO, CANADA:
2,764,563, MULTIPLE CLASS, INT. CLS. 9 AND 42.
- MOSS, GERALD, WEST SAND LAKE, NY:
2,765,172, INT. CL. 10.
- MOSSOP, CORNELISSEN CONSULTANTS INC., TORONTO, ONTARIO, CANADA:
2,763,267, PUB. 6-24-2003. INT. CL. 16.
- MOTIONWISE, LLC, BIRMINGHAM, MI:
2,764,250, PUB. 6-24-2003. INT. CL. 44.
- MOTIVATION EXCELLENCE, INC., SCHAUMBURG, IL:
2,765,120, INT. CL. 35.
2,765,163, INT. CL. 35.
- MOTO XTREME, INC., BOCA RATON, FL:
2,763,927, PUB. 6-24-2003. INT. CL. 35.
- MOTOROLA INC., BOYNTON BEACH, FL:
2,012,319, CANC. INT. CL. 42.
- MOTOROLA, INC., SCHAUMBURG, IL:
2,012,557, CANC. INT. CL. 9.
2,764,480, INT. CL. 9.
- MOTTURA SERRATURE DI SICUREZZA SPA, 10057 SANT'AMBROGIO (TO), ITALY:
2,679,756, COR. INT. CL. 6.
- MOULINEX S.A.:
See—SEB S.A..
- MOUNT CASHMERE INC., WHISTLER, BRITISH COLUMBIA, CANADA:
2,765,526, INT. CL. 25.
- MOZZETTI, MARIO, ROME, ITALY:
2,763,544, PUB. 6-24-2003. INT. CL. 30.
- MPORTAL, INC., MCLEAN, VA FROM MPORTAL.COM, INC., MCLEAN, VA:
2,764,756, MULTIPLE CLASS, INT. CLS. 9 AND 42.
- MPOWER ENTERTAINMENT, LLC, WOODLAND HILLS, CA:
2,764,969, INT. CL. 25.
- MRB, INC., PHILADELPHIA, PA:
2,763,888, PUB. 6-24-2003. INT. CL. 36.
- MRS. SMITH'S BRANDS, INC., SUWANEE, GA:
2,763,342, PUB. 6-24-2003. INT. CL. 30.
- MS. BUBBLES, INC., LOS ANGELES, CA:
2,763,744, PUB. 1-7-2003. INT. CL. 25.
- MSH SOUTH INC., WILMINGTON, DE:
2,763,470, PUB. 6-24-2003. INT. CL. 43.
- MSN COMMUNICATIONS, INC., BOONTON, NJ:
2,012,625, CANC. INT. CL. 41.
- MTC LEASING INC., BURLINGTON, ONTARIO, CANADA:
2,763,059, PUB. 1-23-2001. MULTIPLE CLASS, INT. CLS. 35 AND 37.
- MTG INC., FLORHAM PARK, NJ:
1,728,278, CANC. INT. CL. 41.
- MTS PRODUCTS, NORTHRIDGE, CA:
2,763,638, PUB. 6-24-2003. MULTIPLE CLASS, INT. CLS. 12, 18, 20 AND 28.
- MUELLER, MARK, CATAWISS, MO, DBA MARK MUELLER ENTERPRISES:
1,727,823, CANC. INT. CL. 28.
- MULTI-LINK, INC., NICHOLASVILLE, KY:
1,771,266, REN. 8-6-03. INT. CL. 9.
- MULTIFOODS DISTRIBUTION GROUP, INC., ENGLEWOOD, CO:
2,764,603, MULTIPLE CLASS, INT. CLS. 8 AND 16.
- MULTIMATIC INC.:
See—QUIKBLADE INC..

- MULTIMEDIA CHANNEL (HK) LIMITED, KOWLOON, HONG KONG:
2,764,697, INT. CL. 41.
- MULTIMEDIA GAMES, INC., AUSTIN, TX:
2,764,780, INT. CL. 9.
- MUMMERT, ROGER K., SYOSSET, NY:
2,011,947, CANC. INT. CL. 41.
- MUNCHKIN, INC., VAN NUYS, CA:
2,765,176, MULTIPLE CLASS, INT. CLS. 10 AND 28.
- MUNSON, LOUANN ELIZABETH STONE, SPRINGFIELD, VA:
2,764,734, INT. CL. 24.
- MURDICO, VINCENT A., ESCONDIDO, CA:
2,764,345, PUB. 6-24-2003. INT. CL. 35.
- MUREX S.A., PARIS 75116, FRANCE:
2,764,967, MULTIPLE CLASS, INT. CLS. 9 AND 42.
- MURPHY INDUSTRIES, INC., TULSA, OK, FRANK W. MURPHY MANUFACTURER, INC., TULSA, OK:
1,218,925. REN. 8-4-03. INT. CL. 9.
- MURPHY, JOHN P., OCEAN CITY, MD:
2,763,840, PUB. 6-24-2003. INT. CL. 6.
- MURRAY BROKERAGE LTD., MAUMEE, OH, UNIVERSAL FOOD MARKETING, INC., RHINELAND, MO:
1,751,435. REN. 8-6-03. INT. CL. 29.
- MURRAY, INC., BRENTWOOD, TN:
2,763,985, PUB. 6-24-2003. INT. CL. 7.
- MUSEUM OF MUSICAL INSTRUMENTS, THE, SANTA CRUZ, CA:
2,764,968, INT. CL. 41.
- MUSICA INTERNATIONAL, INC., MILL VALLEY, CA:
2,012,751, CANC. MULTIPLE CLASS, INT. CLS. 9 AND 25.
- MUSTAD INTERNATIONAL GROUP B.V., NL-1017 CG AMSTERDAM, NETHERLANDS:
2,763,660, PUB. 6-24-2003. MULTIPLE CLASS, INT. CLS. 6 AND 17.
- MY HONEY CO., RICHMOND, IL:
1,727,931, CANC. INT. CL. 30.
- MYLEGALPROBLEM, INC., PITTSBURGH, PA:
2,729,807, COR. INT. CL. 42.
- MYND CORPORATION, BLYTHEWOOD, SC, TOWERS, PERRIN, FORSTER & CROSBY, INC., PHILADELPHIA, PA:
1,753,628. REN. 8-7-03. INT. CL. 9.
- MYRIAGON CORPORATION, DALLAS, TX:
2,765,298, INT. CL. 9.
- MYSTIC APPAREL COMPANY, INC., MIDDLETOWN, NY, ANDMORE SPORTSWEAR CORP., PORT JERVIS, NY:
1,763,727. REN. 8-7-03. INT. CL. 25.
- MYTHIC ENTERTAINMENT, INC., FAIRFAX, VA:
2,765,764, MULTIPLE CLASS, INT. CLS. 9 AND 41.
- MZM, INC., WASHINGTON, DC:
2,763,767, PUB. 6-24-2003. MULTIPLE CLASS, INT. CLS. 35, 39 AND 42.
- M2 COMMUNICATIONS, INC., JERSEY CITY, NJ:
2,765,727, INT. CL. 9.
- M2L, INC., NEW YORK, NY:
2,764,333, PUB. 6-24-2003. INT. CL. 35.
- N & T RESTAURANT ASSOCIATES, INC., NEW YORK, NY TO N & T RESTAURANT ASSOCIATES, INC., NEW YORK, NY:
2,662,858, COR. INT. CL. 30.
2,662,859, COR. INT. CL. 30.
- N.V. BALTA INDUSTRIES, SINT-BAAFS-VIJVE, BELGIUM FROM N.V. ITC, IMPERIAL TUFTING COMPANY (DIVISION IVC), TIELT, BELGIUM:
2,765,065, INT. CL. 2.
- N.V. BEKAERT S.A., ZWEVEGEM, BELGIUM:
2,763,872, PUB. 6-24-2003. INT. CL. 17.
- N.V. ORGANON, 5349 OSS, NETHERLANDS:
2,764,239, PUB. 6-24-2003. INT. CL. 5.
- N-ABLE TECHNOLOGIES INTERNATIONAL, INC., DOVER, DE FROM NITROSOFT, INC., DOVER, DE:
2,764,891, MULTIPLE CLASS, INT. CLS. 9 AND 42.
- NA NUTEC CORPORATION, MOUNTAIN VIEW, CA:
2,012,451, CANC. INT. CL. 9.
- NABISCO BRANDS COMPANY, WILMINGTON, DE:
1,728,675, CANC. INT. CL. 30.
- NABISCO HOLDINGS CORP., PARSIPPANY, NJ:
2,011,292, CANC. INT. CL. 30.
- NABISCO, INC., PARSIPPANY, NJ:
2,011,366, CANC. INT. CL. 30.
- NACHNANI, GOBIND H., VIRGINIA BEACH, VA:
2,763,961, PUB. 6-24-2003. MULTIPLE CLASS, INT. CLS. 25 AND 35.
- NADER SOLIMAN, M.D., P.C., GERMANTOWN, MD:
2,012,901, CANC. INT. CL. 42.
- NAFCU SERVICE CORPORATION, ARLINGTON, VA:
2,763,506, PUB. 6-24-2003. MULTIPLE CLASS, INT. CLS. 16 AND 36.
- NALECZOWIANKA SP. Z O.O., 24-140 NALECZOW, POLAND:
2,764,386, PUB. 6-24-2003. INT. CL. 32.
- NAN JIN RONG BAO XIANG BAO, LIMITED, GU ROU DISTRICT, NAN JIN SHI, CHINA:
2,763,500, PUB. 6-24-2003. INT. CL. 9.
- NANNY QUEST, INC., PINEBROOK, NJ:
2,012,767, CANC. INT. CL. 35.
- NAPCO, INC, BATAVIA, IL:
2,763,216, PUB. 6-24-2003. MULTIPLE CLASS, INT. CLS. 30 AND 35.
- NAPIER, MICK, J, CHICAGO, IL:
2,765,571, INT. CL. 35.
- NASH, ALAN E., CANTON, MA:
2,765,591, INT. CL. 5.
- NATIOANL INSPECTION AND CONSULTANTS, INC., FORT MYERS, FL, NATIONAL INSPECTION AND CONSULTANTS, INC., CORAOPOLIS, PA:
1,239,790. REN. 8-7-03. INT. CL. 41.
- NATION PIZZA PRODUCTS, L.P., CHICAGO, IL, NATION ENTERPRISES LIMITED PARTNERSHIP, CHICAGO, IL:
1,768,794. REN. 8-8-03. MULTIPLE CLASS, INT. CLS. 29 AND 30.
1,787,200. REN. 8-7-03. INT. CL. 42.
- NATIONAL ACADEMY OF RECORDING ARTS & SCIENCES, INC., SANTA MONICA, CA:
2,764,001, PUB. 6-24-2003. MULTIPLE CLASS, INT. CLS. 36 AND 44.
- NATIONAL AERONAUTICS AND SPACE ADMINISTRATION, WASHINGTON, DC:
1,213,876, CANC. MULTIPLE CLASS, INT. CLS. 16 AND 42.
- NATIONAL ASPHALT PAVEMENT ASSOCIATION, LANHAM, MD:
2,764,570, INT. CL. 35.
- NATIONAL ASSOCIATION FOR STOCK CAR AUTO RACING, INC., DAVTONA BEACH, FL:
2,764,587, INT. CL. 25.
- NATIONAL ASSOCIATION OF COLLEGE STORES, INC., OBERLIN, OH:
2,012,637, CANC. INT. CL. 35.
- NATIONAL ASSOCIATION OF REO BROKERS, LIHUE, HI:
2,011,786, CANC. U.S. CL. 200.
- NATIONAL BOTANICAL INSTITUTE, WESTERN CAPE, SOUTH AFRICA:
2,764,514, INT. CL. 31.
- NATIONAL CANCER INSTITUTE, BETHESDA, MD:
1,775,617. REN. 8-5-03. U.S. CL. B.
- NATIONAL CITY CORPORATION, CLEVELAND, OH:
2,765,703, INT. CL. 36.
- NATIONAL ELECTRICAL CONTRACTORS ASSOCIATION, BETHESDA, MD:
2,765,938, INT. CL. 9.
- NATIONAL EMERGENCY NUMBER ASSOCIATION, INC., COLUMBUS, OH:
2,763,549, PUB. 6-24-2003. INT. CL. 41.
- NATIONAL FEDERATION OF INDEPENDENT BUSINESS, NASHVILLE, TN:
2,763,493, PUB. 6-24-2003. INT. CL. 35.
- NATIONAL FIRE PROTECTION ASSOCIATION, INC., QUINCY, MA:
2,765,949, INT. CL. 16.
- NATIONAL FOUNDATION FOR CANCER RESEARCH, INC., BETHESDA, MD:
2,763,863, PUB. 6-24-2003. MULTIPLE CLASS, INT. CLS. 35 AND 36.

- NATIONAL GRAPHICS, INC., ST. LOUIS, MO:
2,144,922, CANC. INT. CL. 2.
- NATIONAL HEALTH ADMINISTRATORS, INC., PEEKSKILL, NY:
2,765,598, MULTIPLE CLASS, INT. CLS. 35 AND 36.
- NATIONAL HOCKEY LEAGUE, NEW YORK, NY:
2,012,806, CANC. INT. CL. 41.
2,764,990, INT. CL. 16.
- NATIONAL HOUSEWARES MANUFACTURERS ASSOCIATION, ROSEMONT, IL:
2,763,890, PUB. 6-24-2003. INT. CL. 16.
- NATIONAL INSPECTION AND CONSULTANTS, INC., FT. MYERS, FL, NATIONAL INSPECTION AND CONSULTANTS, INC., FT. MYERS, FL:
1,231,322. REN. 8-7-03. INT. CL. 35.
- NATIONAL INSPECTION AND CONSULTANTS, INC., FORT MYERS, FL:
1,239,720. REN. 8-7-03. INT. CL. 35.
- NATIONAL INSPECTION AND CONSULTANTS, INC., FORT MYERS, FL, NATIONAL INSPECTION AND CONSULTANTS, INC., CORAOPOLIS, PA:
1,239,791. REN. 8-7-03. INT. CL. 41.
1,244,869. REN. 8-7-03. INT. CL. 42.
- NATIONAL INSTITUTE FOR HEALTHCARE RESEARCH, ROCKVILLE, MD:
2,764,976, MULTIPLE CLASS, INT. CLS. 16, 41 AND 42.
- NATIONAL INSTRUMENT COMPANY, INCORPORATED, BALTIMORE, MD:
2,764,910, INT. CL. 7.
- NATIONAL LEGAL CENTER FOR THE MEDICALLY DEPENDENT & DISABLED, INC., TERRE HAUTE, IN:
2,765,657, INT. CL. 42.
- NATIONAL LIFE INSURANCE COMPANY, MONTPELIER, VT:
2,012,857, CANC. INT. CL. 36.
- NATIONAL MOTORISTS ASSOCIATION, INC, WAUNAKEE, WI:
2,764,328, PUB. 6-24-2003. INT. CL. 35.
- NATIONAL MULTIPLE SCLEROSIS SOCIETY, NEW YORK, NY:
2,334,304, AM. INT. CL. 36.
- NATIONAL PODIATRY MANAGEMENT, INC., ATLANTA, GA:
2,012,748, CANC. MULTIPLE CLASS, INT. CLS. 35 AND 36.
- NATIONAL PROVISIONS, INC., MIAMI, FL:
2,763,861, PUB. 6-24-2003. INT. CL. 29.
- NATIONAL RESTAURANT ASSOCIATION, WASHINGTON, DC:
2,763,286, PUB. 6-24-2003. INT. CL. 42.
- NATIONAL SALES COMPANY, ST. LOUIS, MO:
2,763,909, PUB. 6-24-2003. INT. CL. 35.
- NATIONAL SAMPLES, INC., AZLE, TX, DBA NSI:
1,728,223, CANC. INT. CL. 40.
- NATIONAL TAX REFUND CENTER, INC., ATLANTA, GA:
2,764,391, PUB. 6-24-2003. INT. CL. 35.
- NATIONAL TELEPHONE SUPPLY COMPANY, THE, CLEVELAND, OH:
401,593. REN. 8-5-03. U.S. CL. 21 (INT. CL. 9).
- NATIONAL VETERANS BUSINESS DEVELOPMENT CORPORATION, ALEXANDRIA, VA:
2,765,906, INT. CL. 35.
- NATURAL ORGANICS INC., MELVILLE, NY:
2,765,475, INT. CL. 5.
- NATURAL SCIENCE INDUSTRIES, LTD., WEST HEMPSTEAD, NY:
2,765,204, INT. CL. 21.
- NATUS CORPORATION, EDINA, MN:
2,012,608, CANC. INT. CL. 5.
- NAUGHTON, DANIEL P., SAN DIEGO, CA:
2,765,759, MULTIPLE CLASS, INT. CLS. 9 AND 28.
- NAVIGATOR ELECTRONICS, INC., FT. LAUDERDALE, FL:
2,764,336, PUB. 6-24-2003. INT. CL. 35.
- NAZ-DAR COMPANY, CHICAGO, IL, DBA NAZ-DAR/KC:
1,726,839, CANC. INT. CL. 1.
1,726,841, CANC. INT. CL. 1.
- NBA PROPERTIES, INC., NEW YORK, NY:
2,012,489, CANC. INT. CL. 25.
2,764,087, PUB. 6-24-2003. INT. CL. 38.
- NBD BANCORP, INC., DETROIT, MI:
2,072,738, CANC. INT. CL. 36.
- NEIGHBORHOOD DRY CLEANING COMPANY, INC., THE, COCONUT CREEK, FL:
2,011,300, CANC. INT. CL. 37.
- NEILL CORPORATION, HAMMOND, LA:
2,763,189, PUB. 6-24-2003. MULTIPLE CLASS, INT. CLS. 11 AND 21.
- NELLCOR PURITAN BENNETT INCORPORATED, PLEASANTON, CA, NELLCOR INCORPORATED, HAYWARD, CA:
1,771,276. REN. 8-6-03. INT. CL. 10.
- NELSON INDUSTRIES, INC., STOUGHTON, WI:
1,727,286, CANC. INT. CL. 9.
- NEMSCHOFF CHAIRS, INC., SHEBOYGAN, WI:
2,765,301, INT. CL. 20.
- NEOPETS.COM, INC.:
See—NEOPETS, INC..
- NEOPETS, INC., GLENDALE, CA FROM NEOPETS.COM, INC., GLENDALE, CA:
2,763,300, PUB. 6-24-2003. INT. CL. 25.
- NEOPOST S.A., BAGNEUX, FRANCE:
2,764,320, PUB. 6-24-2003. MULTIPLE CLASS, INT. CLS. 7 AND 9.
- NESTLE-LE MUR COMPANY, THE, NEW YORK, NY:
160,827, CANC. U.S. CL. 6.
- NETFRONT COMMUNICATIONS, INC., MILPITAS, CA:
2,125,193, CANC. INT. CL. 9.
- NETTIE'S FLOWER GARDEN, INC., ST. LOUIS, MO:
2,765,326, INT. CL. 35.
- NETWORK EQUIPMENT TECHNOLOGIES, INC., FREMONT, CA:
2,765,564, INT. CL. 9.
- NETWORK EXECUTIVE SOFTWARE, INC., MAPLE GROVE, MN:
2,764,368, PUB. 6-24-2003. INT. CL. 9.
2,764,369, PUB. 6-24-2003. INT. CL. 9.
- NEUBERGER & BERMAN MANAGEMENT, INC., NEW YORK, NY:
2,011,362, CANC. INT. CL. 36.
- NEURISTICS CORPORATION, HUNT VALLEY, MD TO CREDITXPRT INC., TOWSON, MD:
2,579,894, AM. INT. CL. 36.
- NEURON DATA, INC., PALO ALTO, CA:
1,453,986, CANC. INT. CL. 9.
- NEVA, BETH A., FARGO, ND:
2,764,233, PUB. 6-24-2003. INT. CL. 16.
- NEVCO INTERNATIONAL INC., WEST HAVEN, CT:
2,012,492, CANC. INT. CL. 10.
- NEW AGE CONSULTANTS PTY LIMITED, RICHMOND, VIC, 3121, AUSTRALIA:
2,763,641, PUB. 6-24-2003. INT. CL. 9.
- NEW BOSTON SELECT GROUP, INC., WOBURN, MA:
2,030,380, CANC. INT. CL. 35.
- NEW CENTURY EXPOSITION LLC, NEW YORK, NY:
2,012,241, CANC. INT. CL. 6.
- NEW CHOICE FOOD, INC., IRWINDALE, CA:
2,765,187, INT. CL. 29.
- NEW ENERGY OPPORTUNITIES, INC., SUDBURY, MA:
2,763,318, PUB. 6-24-2003. INT. CL. 9.
- NEW ENGLAND HOCKEY TEAM LIMITED PARTNERSHIP, WORCESTER, MA:
2,012,396, CANC. INT. CL. 25.
- NEW IDEAS INTERNATIONAL, INC., THOMASVILLE, GA:
2,012,149, CANC. INT. CL. 5.
- NEW JERSEY EDUCATION ASSOCIATION, TRENTON, NJ:
2,764,075, PUB. 6-24-2003. INT. CL. 35.
- NEW JERSEY INSTITUTE FOR CONTINUING LEGAL EDUCATION, NEW BRUNSWICK, NJ:
1,825,540. REN. 8-4-03. INT. CL. 41.
- NEW JERSEY INSTITUTE FOR CONTINUING LEGAL EDUCATION, THE, NEW BRUNSWICK, NJ:
1,827,271. REN. 8-4-03. INT. CL. 9.
- NEW KNIGHT INC., PAOLI, PA:
2,012,049, CANC. INT. CL. 21.

- NEW LEVEL SADKHIN GROUP, INC., BROOKLYN, NY:
2,765,843, INT. CL. 42.
- NEW LIFE CHART, LLC, BELLEVUE, WA FROM LIFE-
CHART.COM, INC., MOUNTAIN VIEW, CA:
2,764,634, INT. CL. 9.
- NEW MEDIA CORPORATION, IRVINE, CA:
2,011,721, CANC. INT. CL. 9.
- NEW ORLEANS CENTER FOR CLINICAL RESEARCH,
INC., NEW ORLEANS, LA AND ORLANDO CLINICAL
RESEARCH CENTER, INC., ORLANDO, FL AND TOTAL
RENAL RESEARCH, INC., MINNEAPOLIS, MN:
2,765,904, INT. CL. 42.
- NEW PARADIGMS, INC., MARYLAND HEIGHTS, MO,
DBA NEW PARADIGMS:
2,764,473, INT. CL. 42.
- NEW YORK AIR BRAKE CORPORATION, WATERDOWN,
NY:
2,765,411, INT. CL. 9.
- NEW YORK CITY ICY COMPANY, NEW YORK, NY:
2,764,021, PUB. 6-24-2003. INT. CL. 35.
- NEW YORK STATE DEPARTMENT OF ECONOMIC DE-
VELOPMENT, ALBANY, NY:
2,765,227, INT. CL. 35.
2,765,228, INT. CL. 35.
- NEW YORK STOCK EXCHANGE, INC., NEW YORK, NY:
2,764,038, PUB. 6-24-2003. INT. CL. 36.
2,764,911, INT. CL. 36.
- NEW YORKER KERESKEDELMI KFT., 1053 BUDAPEST,
HUNGARY:
2,763,232, PUB. 5-7-2002. MULTIPLE CLASS, INT. CLS. 3,
9, 14, 16, 18, 25, 28, 32, 33 AND 42.
- NEW YORKER S.H.K. JEANS, GMBH, D-38112 BRAUNSCH-
WEIG, FED REP GERMANY:
2,763,064, PUB. 6-24-2003. MULTIPLE CLASS, INT. CLS.
3, 9, 14, 18, 25, 28 AND 32.
- NEWAY PACKAGING CORP, TORRANCE, CA:
2,764,107, PUB. 3-26-2002. INT. CL. 17.
- NEWDEAL, VIENNE, FRANCE:
2,764,535, INT. CL. 10.
- NEWELL OPERATING COMPANY, FREEPORT, IL, SHUR-
LINE MANUFACTURING CO., INC., LANCASTER, NY:
947,584, REN. 8-4-03. U.S. CL. 29 (INT. CL. 16).
- NEWELL OPERATING COMPANY, FREEPORT, IL, HOME
FASHIONS, INC., SANTA MONICA, CA:
1,772,373, REN. 8-8-03. INT. CL. 20.
- NEWFREY LLC, NEWARK, DE, EMHART INC., NEWARK,
DE:
1,775,712, REN. 8-8-03. INT. CL. 6.
- NEWFREY LLC, NEWARK, DE FROM EMHART INC.,
NEWARK, DE:
2,765,603, INT. CL. 6.
- NEWHALL LAND AND FARMING COMPANY, THE,
VALENCIA, CA:
2,012,416, CANC. INT. CL. 37.
- NEWORLD BUILDINGS, INC., MIAMI, FL:
2,012,436, CANC. INT. CL. 37.
2,012,437, CANC. INT. CL. 37.
- NEWSCALE, INC., OAKLAND, CA FROM CELOSIS, INC.,
ALAMEDA, CA:
2,764,643, MULTIPLE CLASS, INT. CLS. 9 AND 35.
- NEWSTRACK, INC., ENGLEWOOD, CO, DBA NEWS-
TRACK EXECUTIVE TAPE SERVICE, INC.:
1,213,830, CANC. INT. CL. 9.
- NEWTRADE INFORMATION TECHNOLOGIES INC., MON-
TREAL, QUEBEC TO NEWTRADE INFORMATION
TECHNOLOGIES INC., MONTREAL, QUEBEC:
2,689,794, COR. INT. CL. 42.
- NEXTEL COMMUNICATIONS, INC., RESTON, VA:
2,764,617, INT. CL. 38.
2,765,052, MULTIPLE CLASS, INT. CLS. 9 AND 38.
- NEY INC., MUNDELEIN, IL, J. M. NEY COMPANY, THE,
BLOOMFIELD, CT:
749,671, REN. 8-2-03. U.S. CL. 14 (INT. CL. 6).
- NIAGARA CONSERVATION CORP., CEDAR KNOLLS, NJ:
1,727,383, CANC. INT. CL. 11.
- NICE DE MEXICO, S.A. DE.C. V., GUADALAJARA JALIS-
CO, MEXICO:
2,765,135, INT. CL. 16.
- NICE DREAMS, INC:
See—CHEBA HUT FRANCHISING, INC.
- NICHIHA CORPORATION, MINATO-KU, NAGOYA 455-
8550, JAPAN:
2,765,368, INT. CL. 19.
- NICHINO AMERICA, INC., WILMINGTON, DE:
2,765,285, INT. CL. 5.
- NICHOLS, DAVID, PALMER, MA:
2,765,809, INT. CL. 3.
- NIELSEN MEDIA RESEARCH, NEW YORK, NY:
2,304,787, COR. INT. CL. 35.
- NIELSEN-KELLERMAN CO., INC., CHESTER, PA:
2,763,731, PUB. 6-24-2003. INT. CL. 9.
- NIKKISO CO. LTD., SHIBUYA-KU, TOKYO, JAPAN:
959,761, REN. 8-6-03. U.S. CL. 23 (INT. CL. 7).
- NIKKISO CO., LTD., SHIBUYA-KU, TOKYO, JAPAN:
960,811, REN. 8-4-03. U.S. CL. 23 (INT. CL. 7).
- NIKON INC., MELVILLE, NY:
2,012,730, CANC. INT. CL. 9.
- NINE WEST DEVELOPMENT CORPORATION, WILMING-
TON, DE:
2,765,670, INT. CL. 25.
- NINTENDO OF AMERICA INC., REDMOND, WA:
1,727,817, CANC. INT. CL. 28.
1,727,829, CANC. INT. CL. 28.
- NIPPON DENSHIN DENWA KABUSHIKI KAISHA DBA
NIPPON TELEGRAPH AND TELEPHONE CORPORA-
TION:
See—NTT COMMUNICATIONS KABUSHIKI KAISHA.
- NIPPON SEIKO KABUSHIKI KAISHA, TOKYO, JAPAN,
DBA NSK LTD.:
2,764,621, INT. CL. 7.
- NITIN ENTERPRISES INC., NEW YORK, NY:
2,012,044, CANC. INT. CL. 25.
- NIX, DAVID D., IRVING, TX:
2,763,207, PUB. 6-24-2003. INT. CL. 42.
- NOBSCOT CORPORATION, KAILUA, HI:
2,764,195, PUB. 6-24-2003. INT. CL. 9.
- NOLLMAN, JORDAN, CAMBRIDGE, MA:
2,764,339, PUB. 6-24-2003. INT. CL. 42.
- NOLTE PRECISE MANUFACTURING, INC., CINCINNATI,
OH:
2,765,672, INT. CL. 40.
- NOMA INTERNATIONAL, INC., FOREST PARK, IL:
2,012,544, CANC. INT. CL. 21.
2,012,727, CANC. INT. CL. 20.
- NOMINET UK, OXFORD OX4 6LB, UNITED KINGDOM:
2,763,225, PUB. 6-24-2003. MULTIPLE CLASS, INT. CLS.
9, 16, 35, 38, 41 AND 42.
- NOR-AM CHEMICAL COMPANY, WILMINGTON, DE:
1,213,764, CANC. INT. CL. 5.
- NORD ESTATE WINES, LLC, NAPA, CA:
2,764,054, PUB. 6-24-2003. INT. CL. 33.
- NORFOLK SOUTHERN CORPORATION, NORFOLK, VA:
2,765,440, INT. CL. 39.
- NORMAN INTERNATIONAL, INC., SANTA FE SPRINGS,
CA:
2,765,294, MULTIPLE CLASS, INT. CLS. 6, 19 AND 20.
- NORMANS WINES LIMITED, UNDERDALE, SOUTH AUS-
TRALIA 5032, AUSTRALIA:
2,011,461, CANC. INT. CL. 33.
- NORTH AMERICAN CABLE COMPANY, INC., AURORA,
IL:
2,763,270, PUB. 6-24-2003. INT. CL. 9.
- NORTH AMERICAN LUBRICANTS, PLEASANTON, CA:
2,765,872, INT. CL. 4.
- NORTH AMERICAN PUBLISHING COMPANY, PHILADE-
PHIA, PA, BROADCAST INFORMATION BUREAU, INC.,
SYOSSET, NY:
1,238,780, REN. 8-6-03. INT. CL. 38.
- NORTH AMERICAN SALT COMPANY, OVERLAND PARK,
KS:
2,012,826, CANC. INT. CL. 1.
- NORTH CAROLINA ASSOCIATION OF ELECTRIC COOP-
ERATIVES, INC., RALEIGH, NC:
2,763,775, PUB. 6-24-2003. INT. CL. 16.
- NORTH-40.COM LLC, DENVER, CO:
2,763,281, PUB. 6-24-2003. INT. CL. 41.

- NORTHLAND INVESTMENT CORPORATION, NEWTON, MA, NORTHLAND INVESTMENT CORPORATION, NEWTON, MA:
1,779,212. REN. 8-6-03. MULTIPLE CLASS, INT. CLS. 36 AND 37.
- NORTRADE INTERNATIONAL, INC., SANDY, UT:
2,012,781, CANC. INT. CL. 5.
- NORWOOD, NELSON BEDELL, AUSTIN, TX:
2,764,184, PUB. 6-24-2003. INT. CL. 9.
- NOTANONYMOUS, INC., NEW YORK, NY:
2,012,073, CANC. INT. CL. 35.
- NOVALOGIC, INC., CALABASAS, CA:
2,012,146, CANC. INT. CL. 28.
- NOVARTIS AG, BASEL, SWITZERLAND:
2,764,144, PUB. 6-24-2003. INT. CL. 5.
2,764,145, PUB. 6-24-2003. INT. CL. 5.
2,764,146, PUB. 6-24-2003. INT. CL. 5.
2,764,197, PUB. 6-24-2003. INT. CL. 5.
2,764,211, PUB. 6-24-2003. INT. CL. 9.
2,764,216, PUB. 6-24-2003. INT. CL. 9.
2,764,217, PUB. 6-24-2003. INT. CL. 10.
2,765,671, INT. CL. 39.
- NOVARTIS CORPORATION, NEW YORK, NY, CIBA-GEIGY LIMITED, TARRYTOWN, NY:
960,282. REN. 8-4-03. U.S. CL. 18 (INT. CL. 5).
- NOVATEC SA, 82000 MONTAUBAN, FRANCE:
2,763,110, PUB. 10-15-2002. INT. CL. 41.
- NOVATION ENVIRONMENTAL TECHNOLOGIES, INC., RENO, NV:
2,765,587, INT. CL. 11.
- NOVO NORDISK A/S, DK-2880 BAGSVAERD, DENMARK:
2,763,516, PUB. 6-24-2003. MULTIPLE CLASS, INT. CLS. 9, 42 AND 44.
- NOVOMIND AG, 22305 HAMBURG, FED REP GERMANY:
2,763,156, PUB. 6-24-2003. MULTIPLE CLASS, INT. CLS. 9, 38 AND 42.
- NOVOZYMES A/S, DK-2880 BAGSVAERD, DENMARK:
2,763,908, PUB. 6-24-2003. INT. CL. 5.
- NOVUS CREDIT SERVICES INC., RIVERWOODS, IL:
2,012,104, CANC. INT. CL. 35.
- NOWCASTING INTERNATIONAL LIMITED, COUNTY CLAIRE, IRELAND:
2,763,316, PUB. 6-24-2003. INT. CL. 42.
- NOWDOCS, INC.:
See—TAYLOR CORPORATION.
- NOXTECH, INC., IRVINE, CA:
1,728,509, CANC. MULTIPLE CLASS, INT. CLS. 7 AND 37.
- NSA INTERNATIONAL, INC., MEMPHIS, TN:
2,765,292, MULTIPLE CLASS, INT. CLS. 35 AND 42.
- NTT COMMUNICATIONS KABUSHIKI KAISHA, CHIYODA-KU, TOKYO, JAPAN, DBA NTT COMMUNICATIONS CORPORATION FROM NIPPON DENSHIN DENWA KABUSHIKI KAISHA, SHINJUKU-KU, TOKYO, JAPAN, DBA NIPPON TELEGRAPH AND TELEPHONE CORPORATION:
2,763,069, PUB. 11-12-2002. MULTIPLE CLASS, INT. CLS. 36, 37, 38, 39, 41 AND 42.
- NUMED, INC., NICHOLVILLE, NY:
2,764,376, PUB. 6-24-2003. INT. CL. 10.
- NUNN RACING LLC, INDIANAPOLIS, IN:
2,763,490, PUB. 6-24-2003. INT. CL. 41.
- NUPI S.P.A., IMOLA (BOLOGNA), ITALY:
2,764,112, PUB. 6-24-2003. MULTIPLE CLASS, INT. CLS. 11, 17 AND 19.
- NUPLA ACQUISITION CORPORATION, SUN VALLEY, CA, NUPLA CORPORATION, SUN VALLEY, CA:
1,791,305. REN. 8-7-03. INT. CL. 8.
- NUTRAPAK INC., YORBA LINDA, CA:
2,765,697, INT. CL. 29.
- NUTRITION & FITNESS, INC., FAYETTEVILLE, NC FROM NUTRITION & FITNESS, IMG, INC., FAYETTEVILLE, NC:
2,764,813, INT. CL. 5.
- NUVASIVE, INC., SAN DIEGO, CA:
2,764,826, INT. CL. 10.
- NYCO SA, 75008 PARIS, FRANCE:
2,763,401, PUB. 6-24-2003. INT. CL. 4.
- NYPH MASTER, NORTHRIDGE, CA:
2,012,035, CANC. MULTIPLE CLASS, INT. CLS. 25, 28 AND 42.
- NYX ENTERTAINMENT INC., ROCKVILLE, MD:
2,763,806, PUB. 6-24-2003. INT. CL. 41.
- O & S HOLDINGS, LLC, LOS ANGELES, CA:
2,765,732, INT. CL. 37.
- O. AMES CO., PARKERSBURG, WV:
1,727,082, CANC. INT. CL. 8.
- O.C. WHITE CO., THREE RIVERS, MA:
2,763,988, PUB. 6-24-2003. INT. CL. 11.
- O.R.S.T., INC., JEFFERSON, LA:
2,012,011, CANC. INT. CL. 25.
- O'KEEFFE'S INC., SAN FRANCISCO, CA:
2,765,864, INT. CL. 19.
- O'NEAL, LACEY, WASHINGTON, DC:
2,012,175, CANC. INT. CL. 25.
- O'SULLIVAN INDUSTRIES, INC., LAMAR, MO:
2,012,808, CANC. INT. CL. 20.
- OAKLEAF PLANTATION, L.L.C., JACKSONVILLE, FL:
2,765,238, INT. CL. 36.
- OAKLEY, INC., FOOTHILL RANCH, CA:
2,765,728, INT. CL. 9.
- OAKSTONE PUBLISHING LLC, BIRMINGHAM, AL:
2,763,191, PUB. 6-24-2003. MULTIPLE CLASS, INT. CLS. 9, 16 AND 35.
- OBERWEIS DAIRY, INC., NORTH AURORA, IL:
2,764,062, PUB. 6-24-2003. INT. CL. 35.
- OBJECT GROUP, INC., THE, CHICAGO, IL:
2,012,400, CANC. INT. CL. 9.
- OBJECT INTERNATIONAL, INC., AUSTIN, TX:
2,011,931, CANC. INT. CL. 9.
- OCCUNOMIX INTERNATIONAL LLC, NEW YORK, NY FROM OCCUNOMIX INTERNATIONAL INC., PORT JEFFERSON STATION, NY:
2,764,943, INT. CL. 9.
- OCEAN INFORMATION SYSTEMS, INC., COVINA, CA:
2,011,462, CANC. INT. CL. 9.
- OCEANZAR CORPORATION, OCEAN CITY, MD:
2,012,721, CANC. INT. CL. 42.
- OCTOPUS PRODUCTIONS, INC., TAMPA, FL:
2,011,746, CANC. INT. CL. 41.
- ODYSSEY ENTERPRISES, INC., SEATTLE, WA:
1,727,875, CANC. INT. CL. 29.
- OETTING'S DETASSELING, INC., SEWARD, NE:
1,728,056, CANC. INT. CL. 35.
1,728,057, CANC. INT. CL. 35.
- OFF MAIN FURNITURE, CORAL SPRINGS, FL:
2,764,411, PUB. 6-24-2003. MULTIPLE CLASS, INT. CLS. 20, 24 AND 35.
- OFNER, ANTON GERALD, (W) A-1190 VIENNA, AUSTRIA:
2,763,666, PUB. 6-24-2003. INT. CL. 12.
- ODGEN FOOD PRODUCTS CORPORATION, STOCKTON, CA:
398,428, CANC. U.S. CL. 46.
- OGLETHORPE POWER CORPORATION, TUCKER, GA:
2,011,758, CANC. INT. CL. 35.
- OHIO TOBACCO USE PREVENTION & CONTROL FOUNDATION, COLUMBUS, OH:
2,764,343, PUB. 6-24-2003. INT. CL. 35.
- OK FOODS, INC., FORT SMITH, AR:
2,763,511, PUB. 6-24-2003. INT. CL. 29.
- OLAN SAN LUIS S.A., QUILMES-PROVINCIA DE BUENOS AIRES, ARGENTINA:
2,012,528, CANC. INT. CL. 25.
- OLD HOMESTEAD, INC., FRANKSVILLE, WI:
2,011,716, CANC. INT. CL. 20.
- OLD KENT FINANCIAL CORPORATION, GRAND RAPIDS, MI:
2,011,663, CANC. INT. CL. 36.
- OLD STURBRIDGE, INC., STURBRIDGE, MA:
762,962. REN. 8-5-03. U.S. CL. 13 (INT. CL. 6).
- OLD WORLD INDUSTRIES, INC., NORTHBROOK, IL:
2,765,859, INT. CL. 3.
- OLGA'S KITCHEN, INC., TROY, MI:
2,765,085, INT. CL. 42.
- OLIN CORPORATION, STAMFORD, CT:
1,213,707, CANC. INT. CL. 1.

- OLIVER SPORT AUSTRALIA PTY. LTD., AUSTRALIA:
1,214,142, CANC. INT. CL. 28.
- OLSON, MARK D., COVINA, CA:
1,728,030, CANC. INT. CL. 35.
2,011,779, CANC. INT. CL. 35.
- OLSON, STEPHEN W., WHEATON, IL:
2,012,295, CANC. INT. CL. 41.
- OMNI HOTELS MANAGEMENT CORPORATION, HAMPSHIRE, NH:
1,214,422, CANC. INT. CL. 42.
1,214,424, CANC. INT. CL. 42.
- OMNIMOUNT SYSTEMS, INC., PHOENIX, AZ:
2,763,631, PUB. 6-24-2003. MULTIPLE CLASS, INT. CLS. 9 AND 20.
- ON TECHNOLOGY CORPORATION, CAMBRIDGE, MA:
2,012,735, CANC. INT. CL. 9.
- ONDRUS, THOMAS, CHAGRIN FALLS, OH:
1,727,076, CANC. INT. CL. 8.
- ONTARIO CRIPPLED CHILDREN'S CENTRE OPERATING AS THE HUGH MACMILLAN REHABILITATION CENTRE, THE, TORONTO, ONTARIO, M4G 1R8, CANADA:
2,012,197, CANC. INT. CL. 9.
- ONTARIO PAINT & WALLPAPER LIMITED, CONCORD, ON L4K 3S8, CANADA:
2,763,369, PUB. 6-24-2003. MULTIPLE CLASS, INT. CLS. 16 AND 27.
- ONYX ACCEPTANCE CORPORATION, FOOTHILL RANCH, CA:
2,763,826, PUB. 6-24-2003. INT. CL. 36.
2,763,827, PUB. 6-24-2003. INT. CL. 36.
- OON, YEONG KUANG, SCORESBY, VICTORIA 3179, AUSTRALIA:
2,763,256, PUB. 6-24-2003. INT. CL. 9.
- OPGEN, INC., MILWAUKEE, WI:
2,765,303, INT. CL. 42.
- OPRYLAND USA INC, NASHVILLE, TN:
2,012,395, CANC. INT. CL. 41.
- OPTICAL RESEARCH ASSOCIATES, PASADENA, CA:
1,786,562, REN. 8-7-03. INT. CL. 9.
- OPTICS LABORATORY, INC., EL MONTE, CA:
2,763,844, PUB. 6-24-2003. INT. CL. 5.
- OPTION CARE, INC., CHICO, CA:
1,728,451, CANC. INT. CL. 42.
- OPTISYS, INC., GLENDALE, AZ:
2,012,584, CANC. INT. CL. 9.
- OPUS MEDICAL, SAN JUAN CAPISTRANO, CA:
2,764,885, INT. CL. 10.
- ORAL ROBERTS UNIVERSITY, TULSA, OK:
2,142,504, CANC. MULTIPLE CLASS, INT. CLS. 25 AND 28.
- ORANGE BANG, INC., SYLMAR, CA:
1,220,228, REN. 8-2-03. INT. CL. 32.
1,223,619, REN. 8-2-03. INT. CL. 32.
- ORANGE BOWL COMMITTEE, INC., THE, MIAMI, FL:
2,011,736, CANC. MULTIPLE CLASS, INT. CLS. 16, 25 AND 41.
- ORCA VISION, INC., CHIYODA-KU, TOKYO, JAPAN:
2,763,170, PUB. 6-24-2003. MULTIPLE CLASS, INT. CLS. 9, 35, 36, 38, 39 AND 41.
- ORCAS INTERNATIONAL, INC., HACKETTSTOWN, NJ:
2,764,710, INT. CL. 5.
- ORE-CAL CORPORATION, LOS ANGELES, CA:
2,764,430, PUB. 6-24-2003. INT. CL. 29.
2,764,432, PUB. 6-24-2003. INT. CL. 29.
2,764,433, PUB. 6-24-2003. INT. CL. 29.
- ORICA AUSTRALIA PTY LTD, VICTORIA 3000, AUSTRALIA FROM ICI AUSTRALIA OPERATIONS PROPRIETARY LIMITED, VICTORIA, 3000, AUSTRALIA:
2,763,044, PUB. 10-2-2001. INT. CL. 3.
- ORICA AUSTRALIA PTY LTD, MELBOURNE, VICTORIA, 3000, AUSTRALIA:
2,763,054, PUB. 9-4-2001. INT. CL. 3.
- ORIGIN GROUP INC., THE, MARIETTA, GA:
2,764,728, INT. CL. 5.
- ORIGIN MEDSYSTEMS, INC., MENLO PARK, CA:
2,012,173, CANC. INT. CL. 10.
- ORIGINS NATURAL RESOURCES INC., NEW YORK, NY:
2,012,663, CANC. INT. CL. 3.
2,765,109, INT. CL. 3.
- ORION INDUSTRIES, INC.:
See—DIRECTED AUDIO, INC..
- ORKIN EXPANSION, INC., WILMINGTON, DE, ORKIN EXTERMINATING CO., INC., ATLANTA, GA:
568,406, REN. 8-6-03. U.S. CL. 103 (INT. CL. 37).
- ORLOWSKI, ROMUALD J., JACKSON, MI:
2,012,090, CANC. INT. CL. 16.
- ORLY INTERNATIONAL INC., CHATSWORTH, CA:
1,726,895, CANC. INT. CL. 3.
- ORRICK, HERRINGTON & SUTCLIFFE LLP, SAN FRANCISCO, CA:
2,763,337, PUB. 6-24-2003. INT. CL. 18.
- ORTHEON MEDICAL, WINTER PARK, FL:
2,763,719, PUB. 6-24-2003. INT. CL. 10.
- ORVIS COMPANY, INC., THE, MANCHESTER, VT:
2,765,032, INT. CL. 28.
- OSMENT MODELS, INC., LINN CREEK, MO:
2,765,926, INT. CL. 28.
- OSMOSE, INC., BUFFALO, NY:
2,763,317, PUB. 6-24-2003. MULTIPLE CLASS, INT. CLS. 1, 2, 3, 5, 6, 9, 17, 19, 35, 37, 40 AND 42.
- OSPAG OSTERREICHISCHE SANITAR-, KERAMIK- UND PORZELLAN-INDUSTRIE AG, WIEN, AUSTRIA:
1,214,010, CANC. INT. CL. 21.
1,214,011, CANC. INT. CL. 21.
- OTC CONVENTIONS, INC., ROLLING MEADOWS, IL:
1,998,147, CANC. INT. CL. 35.
- OTTO BOCK ORTHOPADISCHE INDUSTRIE GMBH & CO., DUDERSTADT, FED REP GERMANY, OTTO BOCK ORTHOPAEDISCHE INDUSTRIE KG, DUDERSTADT, FED REP GERMANY:
1,275,986, REN. 8-7-03. INT. CL. 10.
- OUT PUBLISHING, INC., NEW YORK, NY:
2,011,892, CANC. INT. CL. 9.
- OWENS-CORNING FIBERGLAS TECHNOLOGY INC., SUMMIT, IL:
2,765,762, INT. CL. 36.
- OXFORD FINANCE CORPORATION, ALEXANDRIA, VA:
2,764,398, PUB. 6-24-2003. INT. CL. 36.
- OXFORD LEARNING CENTRES, INC., LONDON, ONTARIO, CANADA:
2,763,437, PUB. 6-24-2003. INT. CL. 41.
- OXFORD RESOURCES CORP., MELVILLE, NY:
2,011,763, CANC. INT. CL. 36.
- OXYDYNE, INC., SALT LAKE CITY, UT:
2,012,744, CANC. INT. CL. 10.
- OZARK CLEANERS AND LAUNDRY, INCORPORATED, FAYETTEVILLE, AR:
2,011,796, CANC. INT. CL. 37.
- O2 HOLDINGS, LLC, NEW YORK, NY:
2,764,759, INT. CL. 41.
- P. H. GLATFELTER COMPANY, SPRING GROVE, PA:
740,038, CANC. U.S. CL. 37.
- P.T. ON CALL, P.S., VANCOUVER, WA:
2,764,661, INT. CL. 35.
- PACE AMERICAN, INC., MIDDLEBURY, IN:
2,765,081, INT. CL. 12.
- PACHECO CREATIVE ENTERPRISES, INC., MIAMI, FL:
2,765,615, INT. CL. 28.
- PACIFIC COAST FEATHER COMPANY, SEATTLE, WA:
2,764,727, INT. CL. 24.
- PACIFIC CORPORATION, YONGSAN-KU, SEOUL, REPUBLIC OF KOREA:
2,764,970, INT. CL. 3.
- PACIFIC DATAVISION, INC., SAN DIEGO, CA:
2,764,115, PUB. 6-24-2003. INT. CL. 9.
- PACIFIC HANDY CUTTER, INC., COSTA MESA, CA:
2,765,010, INT. CL. 8.
- PACIFIC PAINTBALL SUPPLY, INC., SANTA ROSA, CA:
2,763,759, PUB. 6-24-2003. INT. CL. 28.
- PACIFIC SUNWEAR OF CALIFORNIA, ANAHEIM, CA:
2,764,225, PUB. 6-24-2003. INT. CL. 25.
- PACIFIC TRANSDUCER CORP., LOS ANGELES, CA:
2,765,625, INT. CL. 42.

- PACKAGE AMERICA, INC., HENDERSONVILLE, TN:
2,011,943, CANC. INT. CL. 39.
- PACKAGING SERVICE CORPORATION OF KENTUCKY,
LOUISVILLE, KY:
1,727,328, CANC. INT. CL. 10.
- PACKETLIGHT NETWORKS, LTD., KFAR SABA, ISRAEL:
2,764,809, INT. CL. 9.
- PAGEMART, INC., DALLAS, TX:
2,012,128, CANC. INT. CL. 38.
- PAGING NETWORK, INC., PLANO, TX:
2,137,969, CANC. INT. CL. 38.
- PAICE CORPORATION, SILVER SPRING, MD:
2,763,325, PUB. 6-24-2003. INT. CL. 42.
- PAIN NET, INC., COLUMBUS, OH:
2,763,076, PUB. 6-24-2003. MULTIPLE CLASS, INT. CLS.
35, 41 AND 42.
- PAJAR SHOES CO. LTEE., MONTREAL, QUEBEC, CANA-
DA:
1,241,277, REN. 8-6-03. INT. CL. 25.
- PALA BAND OF MISSION INDIANS, THE, PALA, CA, DBA
PALA CASINO:
2,589,807, COR. INT. CL. 41.
- PALA INTERNATIONAL LIMITED, KOWLOON BAY,
KOWLOON, HONG KONG:
2,315,251, CANC. INT. CL. 14.
- PALL CORPORATION, EAST HILLS, NY, MEMTEC AMER-
ICA CORPORATION, TIMONIUM, MD:
1,745,687, REN. 8-6-03. INT. CL. 11.
- PALLOTTA TEAMWORKS, LOS ANGELES, CA:
2,466,556, CANC. INT. CL. 36.
2,472,289, CANC. INT. CL. 25.
- PALMER INTERNATIONAL, INC, SKIPPACK, PA:
2,763,970, PUB. 6-24-2003. INT. CL. 1.
- PALMETTO INSTITUTE, COLUMBIA, SC:
2,763,570, PUB. 6-24-2003. INT. CL. 35.
- PALOMAR COMMUNITY COLLEGE DISTRICT, SAN MAR-
COS, CA:
2,763,692, PUB. 6-24-2003. INT. CL. 41.
- PAN AMERICAN AGRICULTURE CORPORATION, OX-
NARD, CA:
2,764,278, PUB. 6-24-2003. INT. CL. 31.
- PAN-INTERNATIONAL INDUSTRIAL CORP., HSINTIEN
CITY, TAIPEI HSIEN, TAIWAN:
1,777,043, REN. 8-6-03. INT. CL. 9.
- PANAMA JACK INTERNATIONAL, INC., ORLANDO, FL:
2,765,778, INT. CL. 14.
- PANAMERICAN ASSOCIATES, INC., BOUNTIFUL, UT:
2,012,668, CANC. INT. CL. 16.
2,012,669, CANC. INT. CL. 16.
- PANDUIT CORP., TINLEY PARK, IL:
2,706,778, COR. INT. CL. 9.
- PANEL CONCEPTS, INC., SANTA ANA, CA:
1,727,653, CANC. INT. CL. 20.
- PANIP, LLC, SAN DIEGO, CA TO PANIP, LLC, SAN DIEGO,
CA:
2,707,469 NEW CERT. 9-16-2003. INT. CL. 42.
- PANZER, DANIEL, D-14469 POTSDAM, FED REP GER-
MANY:
2,763,206, PUB. 12-10-2002. INT. CL. 5.
- PAPER-PAK PRODUCTS, INC., LA VERNE, CA:
2,012,117, CANC. INT. CL. 10.
- PARADIGM GROUP, LC, HOLLADAY, UT, DBA THE
PARADIGM GROUP, LC:
2,765,160, INT. CL. 41.
- PARADIGM LEARNING, INC., TAMPA, FL:
2,763,531, PUB. 6-24-2003. INT. CL. 28.
- PARAGON VISION SCIENCES, INC., MESA, AZ:
2,764,938, INT. CL. 9.
- PARAMOUNT CAP MANUFACTURING CO., BOURBON,
MO:
1,214,053, CANC. INT. CL. 25.
- PARAMOUNT PICTURES CORPORATION, LOS ANGELES,
CA:
1,213,873, CANC. INT. CL. 16.
- PARAMOUNT PICTURES CORPORATION, NEW YORK,
NY:
1,213,874, CANC. INT. CL. 16.
- PARAMOUNT PICTURES CORPORATION, LOS ANGELES,
CA:
1,728,324, CANC. INT. CL. 41.
2,012,846, CANC. INT. CL. 28.
2,763,046, PUB. 6-24-2003. INT. CL. 41.
- PARBEL OF FLORIDA, INC., MIAMI, FL, HELENA RUBIN-
STEIN, INC., NEW YORK, NY:
952,291, REN. 8-6-03. U.S. CL. 51 (INT. CLS. 3 AND 5).
- PARK LI GROUP, LTD., NEW YORK, NY:
2,765,197, MULTIPLE CLASS, INT. CLS. 9 AND 42.
- PARKER LABORATORIES, INC., ORANGE, NJ:
1,256,591, REN. 8-6-03. INT. CL. 5.
- PARKER PEN PRODUCTS, EAST SUSSEX, ENGLAND,
PARKER PEN COMPANY, THE, JANESVILLE, WI:
1,240,247, REN. 8-4-03. INT. CL. 16.
- PARKER, GERALD C. SR., ELLINGTON, CT:
2,011,805, CANC. INT. CL. 9.
- PARKSON CORPORATION, FORT LAUDERDALE, FL:
1,771,098, REN. 8-6-03. INT. CL. 7.
- PARRISH, JANET H., CEDAR FALLS, IA:
2,765,680, INT. CL. 41.
- PARROTT, JAMES R., TAMPA, FL:
2,764,269, PUB. 6-24-2003. INT. CL. 9.
- PARSONS ENERGY & CHEMICALS GROUP, INC., READ-
ING, PA, GILBERT COMMONWEALTH, INC., READING,
PA:
1,775,026, REN. 8-7-03. INT. CL. 9.
- PARSONS TECHNOLOGY, INC., HIAWATHA, IA:
2,011,860, CANC. INT. CL. 9.
- PART'COM MANAGEMENT, PARIS, FRANCE:
2,764,258, PUB. 6-24-2003. MULTIPLE CLASS, INT. CLS.
35 AND 36.
- PARTNERS, A TASTEFUL CHOICE CO, SEATTLE, WA:
2,765,813, INT. CL. 30.
- PASCOMEX AG, WOHLN, SWITZERLAND:
1,726,819, CANC. INT. CL. 1.
- PASQUALI, PAOLO, 50039, VICCHIO DI MUGELLO, (FIRE-
NZE), ITALY:
2,765,078, MULTIPLE CLASS, INT. CLS. 29, 41 AND 42.
- PASS & SEYMOUR/LEGRAND, SYRACUSE, NY:
2,763,475, PUB. 6-24-2003. INT. CL. 38.
- PASTIS, STEPHAN, NEW YORK, NY:
2,764,074, PUB. 6-24-2003. INT. CL. 16.
- PATCH PRODUCTS, INC., BELOIT, WI:
2,012,902, CANC. INT. CL. 28.
- PATRICIA MILLER, INC., DALLAS, TX:
2,012,366, CANC. INT. CL. 42.
- PATRICK HENRY UNIVERSITY, LONGWOOD, FL:
1,296,993, CANC. INT. CL. 41.
- PATSYSTEMS (UK) LTD., LONDON, UNITED KINGDOM:
2,765,855, MULTIPLE CLASS, INT. CLS. 9 AND 35.
- PATZWALD, DAVID, DALLAS, TX:
2,765,404, INT. CL. 37.
- PAUL HARTMANN AG, HEIDENHEIM, FED REP GER-
MANY:
2,763,239, PUB. 6-24-2003. MULTIPLE CLASS, INT. CLS.
9, 35, 36, 38, 39, 41 AND 42.
- PAUL MUELLER COMPANY, SPRINGFIELD, MO:
1,794,226, REN. 8-5-03. INT. CL. 11.
- PAUL REED SMITH GUITARS, STEVENSVILLE, MD:
2,765,861, INT. CL. 15.
- PAULSON EQUIPMENT, INC., MINNETONKA, MN:
1,727,018, CANC. INT. CL. 7.
- PAXTER AB, 211 34 MALMO, SWEDEN FROM HAGAN-
DER-OHLSSON AB, 21134 MALMO, SWEDEN:
2,763,209, PUB. 8-20-2002. MULTIPLE CLASS, INT. CLS. 9
AND 42.
- PAYMENTECH, L.P., DALLAS, TX FROM PAYMENTECH,
L.L.C., DALLAS, TX:
2,765,189, INT. CL. 36.
- PC SPECIALISTS, INC., SAN DIEGO, CA:
2,765,153, MULTIPLE CLASS, INT. CLS. 35, 37 AND 42.
- PDA DIMENSIONS, INC., ATLANTA, GA:
2,012,388, CANC. INT. CL. 9.
- PEABODY MANAGEMENT, INC., MEMPHIS, TN:
2,670,916, COR. INT. CL. 9.
- PEAK LEARNING, INC., SAN LUIS OBISPO, CA:
2,763,394, PUB. 6-24-2003. MULTIPLE CLASS, INT. CLS.

- 35 AND 41.
 PEANUT WAGON, INC., SAN FRANCISCO, CA, DBA THE CLIFF HOUSE:
 1,781,933. REN. 8-7-03. INT. CL. 42.
 PEARCE, KENNETH, B., SAN DIMAS, CA:
 2,765,693. INT. CL. 45.
 PEARSON MEDICAL TECHNOLOGIES, LLC, ALEXANDRIA, LA:
 2,764,280. PUB. 6-24-2003. INT. CL. 9.
 PECO, INC., CHICAGO, IL:
 2,011,315. CANC. INT. CL. 25.
 PEGASUS CREEK, INC., AGOURA, CA:
 2,763,250. PUB. 5-28-2002. MULTIPLE CLASS, INT. CLS. 25 AND 41.
 PELLA CORPORATION, PELLA, IA:
 1,832,761. REN. 8-5-03. INT. CL. 19.
 PELLA PRODUCTS, INC., PELLA, MARION COUNTY, IA:
 2,763,078. PUB. 4-25-2000. INT. CL. 25.
 PENGUIN INDUSTRIES, INC., COATESVILLE, PA:
 2,012,939. CANC. INT. CL. 8.
 PENN CORPORATION, KALAMAZOO, MI:
 2,012,017. CANC. MULTIPLE CLASS, INT. CLS. 39, 40 AND 42.
 PENN RACQUET SPORTS, INC., PHOENIX, AZ:
 2,765,325. INT. CL. 28.
 PENNSYLVANIA FLEXIBLE METALLIC TUBING COMPANY, PHILADELPHIA, PA TO PENFLEX CORPORATION, FRAZER, PA:
 87,919. CANC. U.S. CL. 35.
 PENNWALT CORPORATION, PHILADELPHIA, PA:
 1,213,745. CANC. INT. CL. 3.
 1,213,746. CANC. INT. CL. 3.
 PENTAIR POOL PRODUCTS, INC., MOORPARK, CA:
 2,763,754. PUB. 6-24-2003. INT. CL. 11.
 PENWEST PHARMACEUTICALS CO., PATTERSON, NY:
 2,765,333. INT. CL. 42.
 PEOPLE FOR THE AMERICAN WAY, WASHINGTON, DC, CITIZENS FOR CONSTITUTIONAL CONCERNS, INC., WASHINGTON, DC:
 1,230,597. REN. 8-6-03. INT. CL. 42.
 PEOPLE FOR THE ETHICAL TREATMENT OF ANIMALS, INC., WASHINGTON, DC:
 1,728,500. CANC. U.S. CL. A.
 PEOPLECLICK, INC., RALEIGH, NC:
 2,765,026. INT. CL. 35.
 PEOPLES PUBLISHING GROUP, INC., THE, SADDLE BROOK, NJ:
 2,763,457. PUB. 6-24-2003. INT. CL. 16.
 PEOPLESOFT, INC., PLEASANTON, CA:
 1,764,141. REN. 8-4-03. INT. CL. 9.
 PEP BOYS MANNY, MOE & JACK OF CALIFORNIA, THE, PHILADELPHIA, PA:
 2,764,884. INT. CL. 12.
 PEP PRODUCTIONS, L.L.C., EDMOND, OK:
 2,764,047. PUB. 6-24-2003. MULTIPLE CLASS, INT. CLS. 16 AND 41.
 PEPSI CO., INC., PURCHASE, NY, PEPSICO, INC., PURCHASE, NY:
 960,516. REN. 8-2-03. U.S. CL. 45 (INT. CL. 32).
 PEPSICO, INC., PURCHASE, NY, PEPSICO, INC., PURCHASE, NY:
 956,179. REN. 8-2-03. U.S. CL. 45 (INT. CL. 32).
 PEPSICO, INC., PURCHASE, NY:
 2,765,647. INT. CL. 32.
 2,765,763. INT. CL. 32.
 2,765,798. INT. CL. 32.
 PER ANNUM, INC., NEW YORK, NY:
 2,764,154. PUB. 6-24-2003. INT. CL. 9.
 2,764,155. PUB. 6-24-2003. INT. CL. 9.
 PERDUE HOLDINGS, INC., WILMINGTON, DE:
 2,764,971. INT. CL. 29.
 PERFECT PLUS, INC., BEVERLY HILLS, CA:
 2,039,776. CANC. INT. CL. 26.
 PERFORMANCE APPAREL CORP., SAN LUIS OBISPO, CA:
 2,763,614. PUB. 6-24-2003. INT. CL. 24.
 PERFORMANCE SOLUTIONS INTERNATIONAL, LLC, RANDOLPH, NJ:
 2,765,726. INT. CL. 9.
 PERHOLTZ, JEFFREY, COVINGTON, KY AND SCOTT, SHAWN, COVINGTON, KY AND PHILLIPS, ANDREW, COVINGTON, KY AND PHILLIPS, ADAM, COVINGTON, KY:
 2,763,142. PUB. 7-30-2002. INT. CL. 41.
 PERLIER, INC., SAYREVILLE, NJ:
 2,724,125. COR. INT. CL. 3.
 PERMA-TEC GMBH & CO., KG, D-97717 EURDORF, FED REP GERMANY FROM SATZINGER GMBH & CO., D-97717 EUERDORF, FED REP GERMANY:
 2,764,523. INT. CL. 7.
 PERRICONE, NICHOLAS V., GUILFORD, CT:
 2,765,243. INT. CL. 3.
 PERSONAL SHELTER PROJECT, INC., LITTLETON, CO:
 2,763,526. PUB. 6-24-2003. INT. CL. 43.
 PERSSON, KENNETH J., NEWPORT BEACH, CA TO LUMINA INTERNATIONAL INC., PAN CHIAO CITY, TAIPEI HSIEN, TAIWAN:
 1,727,260. CANC. INT. CL. 9.
 PET INCORPORATED, ST. LOUIS, MO:
 2,011,612. CANC. INT. CL. 42.
 PETCRAFT, INC., HOLLYWOOD, CA:
 2,012,003. CANC. INT. CL. 21.
 PETER LETTERESE & ASSOCIATES, INC., FORT LAUDERDALE, FL:
 2,764,539. MULTIPLE CLASS, INT. CLS. 9, 16, 38 AND 41.
 PETERSON AMERICAN CORPORATION, SOUTHFIELD, MI:
 1,774,053. REN. 8-7-03. INT. CL. 6.
 PETERSON MANUFACTURING COMPANY, GRANDVIEW, MO:
 2,763,067. PUB. 6-24-2003. INT. CL. 35.
 PETRO CANADA, CALGARY, ALBERTA, CANADA, PETRO CANADA, CALGARY, ALBERTA, CANADA:
 1,770,917. REN. 8-6-03. INT. CL. 1.
 PETRO-TECH EXPOS, LTD., LISLE, IL:
 1,831,530. REN. 8-8-03. INT. CL. 35.
 PETROCHEMICALS COMPANY, INC., FT. WORTH, TX:
 740,140. CANC. U.S. CL. 52.
 PHARMACIA & UPJOHN COMPANY, PEAPACK, NJ:
 2,541,567. COR. INT. CL. 42.
 PHARMACY GOLD, INC., EAGAN, MN:
 2,012,765. CANC. INT. CL. 35.
 PHARMALYTICS, INC., UPPER MONTCLAIR, NJ:
 2,763,030. PUB. 6-24-2003. MULTIPLE CLASS, INT. CLS. 35 AND 42.
 PHARMAPLAN INTERNATIONAL GMBH, OBERURSEL 61440, FED REP GERMANY:
 2,763,600. PUB. 6-24-2003. MULTIPLE CLASS, INT. CLS. 35, 36, 37 AND 42.
 PHARMAVITE LLC, NORTHRIDGE, CA FROM PHARMAVITE LLC, MISSION HILLS, CA:
 2,765,424. INT. CL. 5.
 PHARMETRICS, INC., WATERTOWN, MA:
 2,764,858. INT. CL. 9.
 PHELPS - TIONTON MILLWORK, LLC., GREELEY, CO:
 2,011,683. CANC. INT. CL. 20.
 PHILCOX, SYDNEY, FAIRFAX, CA AND PHILCOX, ELIZABETH, FAIRFAX, CA:
 2,763,773. PUB. 6-24-2003. INT. CL. 28.
 PHILIPP BROTHERS CHEMICALS, INC., FORT LEE, NJ, VITAMIN PREMIXERS OF OMAHA, INC., OMAHA, NE:
 947,825. REN. 8-2-03. U.S. CL. 18 (INT. CL. 5).
 PHILLIPS CHEVROLET, INC., FRANKFORT, IL:
 2,763,599. PUB. 6-24-2003. MULTIPLE CLASS, INT. CLS. 25, 35, 37 AND 39.
 PHILLIPS, JOSH, J, SONOMA, CA:
 2,765,678. INT. CL. 31.
 PHOENIX HOME LIFE MUTUAL INSURANCE COMPANY, HARTFORD, CT:
 2,763,253. PUB. 6-24-2003. INT. CL. 36.
 PHOENIX INTANGIBLES HOLDING COMPANY, WILMINGTON, DE:
 2,765,236. INT. CL. 35.

- PHOENIX INTANGIBLES HOLDING COMPANY, GREENVILLE, DE:
2,765,387, INT. CL. 31.
2,765,388, INT. CL. 31.
2,765,402, INT. CL. 31.
- PHOENIX SCIENTIFIC, INC., ST. JOSEPH, MO:
2,764,623, INT. CL. 10.
- PHOENIX SUNS LIMITED PARTNERSHIP, PHOENIX, AZ:
2,764,632, INT. CL. 25.
- PHOENIX WIRELESS, INC., HATFIELD, PA:
2,765,958, INT. CL. 9.
- PHOTOWORKS, INC., SEATTLE, WA:
2,764,674, MULTIPLE CLASS, INT. CLS. 35, 38 AND 39.
- PHYSICIANS COMMITTEE FOR RESPONSIBLE MEDICINE, INC., WASHINGTON, DC:
2,764,004, PUB. 6-24-2003. MULTIPLE CLASS, INT. CLS. 16, 35, 41 AND 42.
2,764,005, PUB. 6-24-2003. MULTIPLE CLASS, INT. CLS. 16, 35 AND 42.
- PHYSICIANS INSURANCE COMPANY OF WISCONSIN, MADISON, WI:
2,764,032, PUB. 6-24-2003. INT. CL. 16.
- PIC USA, INC., FRANKLIN, KY:
2,763,881, PUB. 6-24-2003. INT. CL. 45.
- PICK-UP-PAN, INC., ELIZABETH, NJ:
2,763,556, PUB. 6-24-2003. MULTIPLE CLASS, INT. CLS. 11 AND 21.
- PIERNAS, ONDRE L., SAN DIEGO, CA:
2,763,883, PUB. 6-24-2003. INT. CL. 28.
- PIERRE FABRE DERMO-COSMETIQUE, 92100 BOLOGNE, FRANCE, SOMCI, PARIS, FRANCE:
1,244,081. REN. 8-6-03. INT. CL. 3.
- PIGGLY WIGGLY COMPANY, LEWISVILLE, TX:
2,763,847, PUB. 6-24-2003. INT. CL. 35.
- PILGRIM PARTNERS, INC., ALEXANDRIA, VA, DBA THE VIRGINIAN RESTAURANT:
2,763,870, PUB. 6-24-2003. MULTIPLE CLASS, INT. CLS. 25 AND 43.
- PILLSBURY COMPANY, THE, MINNEAPOLIS, MN:
2,764,538, INT. CL. 30.
- PININFARINA EXTRA S.R.L., 61, 10129 TORINO, ITALY:
2,552,843, COR. INT. CL. 7.
- PINNACLE WEST ENERGY CORPORATION, PHOENIX, AZ:
2,765,170, INT. CL. 40.
- PINNELL, BRUCE A., FALLSTON, MD:
2,011,301, CANC. INT. CL. 30.
- PIONEER HI-BRED INTERNATIONAL, INC., DES MOINES, IA:
2,012,106, CANC. INT. CL. 16.
- PIPEDREAM PRODUCTS, INC., CHATSWORTH, CA:
2,763,833, PUB. 6-24-2003. INT. CL. 5.
- PISCIOTTANO, MAURICE, MCMURRAY, PA:
2,763,540, PUB. 6-24-2003. INT. CL. 44.
- PITNEY BOWES OFFICE SYSTEMS, INC.:
See—IMAGISTICS INTERNATIONAL INC.
- PITTENGER, ROBERT, CINCINNATI, OH:
2,764,290, PUB. 6-24-2003. INT. CL. 9.
- PIVOVARNA UNION D.D., SI-1000 LJUBLJANA, SLOVENIA:
2,718,663, COR. INT. CL. 32.
- PIZZA PLUS NO. 4, INC., BRISTOL, TN:
1,832,967. REN. 8-6-03. INT. CL. 42.
- PLACO CORPORATION LIMITED, KOWLOON, HONG KONG:
2,765,069, INT. CL. 28.
2,765,083, INT. CL. 28.
- PLANET CURVE, INC., LITHONIA, GA:
2,763,798, PUB. 6-24-2003. INT. CL. 16.
- PLANTAIN PRODUCTS COMPANY, INC., TAMPA, FL:
2,764,497, INT. CL. 30.
- PLASCO, INC., GURNEE, IL:
1,727,335, CANC. INT. CL. 10.
- PLASTAG CORPORATION, ELK GROVE VILLAGE, IL:
2,763,289, PUB. 6-24-2003. INT. CL. 17.
- PLASTI-KOTE CO., INC., MEDINA, OH, CONSOLIDATED FOODS CORPORATION, MEDINA, OH:
960,248. REN. 8-2-03. MULTIPLE CLASS, U.S. CLS. 15 (INT. CL. 4), 16 (INT. CL. 2) AND 52 (INT. CL. 3).
- PLASTIPAK PACKAGING, INC., PLYMOUTH, MI:
2,764,512, MULTIPLE CLASS, INT. CLS. 20 AND 21.
- PLAYBACK THEATER INC., NEW PALTZ, NY, AKA PLAYBACK THEATRE COMPANY:
2,011,993, CANC. INT. CL. 41.
- PLAYBOY ENTERPRISES INTERNATIONAL, INC., CHICAGO, IL:
2,765,057, INT. CL. 5.
2,765,596, MULTIPLE CLASS, INT. CLS. 36 AND 41.
- PLAYBOY ENTERPRISES, INC., CHICAGO, IL:
740,024, CANC. U.S. CL. 33.
2,011,646, CANC. INT. CL. 42.
- PLAYMATES INTERACTIVE ENTERTAINMENT LTD., TSIMSHATSUI, KOWLOON, HONG KONG:
2,012,547, CANC. INT. CL. 28.
- PLAYMATES TOYS INC., COSTA MESA, CA:
2,765,282, INT. CL. 28.
- PLEASANT COMPANY, MIDDLETON, WI:
2,763,867, PUB. 6-24-2003. INT. CL. 20.
- PLEASANT DREAMERS, INC., CENTERVILLE, OH:
2,763,751, PUB. 6-24-2003. INT. CL. 25.
- PLOP GOLF COMPANY, CARLSBAD, CA:
2,011,858, CANC. INT. CL. 42.
- PLURI-CAPITAL (PCI) INC, JONQUIERE, PROVINCE OF QUEBEC, CANADA:
2,765,829, INT. CL. 40.
- PLYMOUTH RUBBER COMPANY, INC., CANTON, MA:
1,213,937, CANC. INT. CL. 16.
- PM COMPANY, CINCINNATI, OH:
2,763,160, PUB. 6-24-2003. INT. CL. 16.
- PML MICROBIOLOGICALS, INC., WILSONVILLE, OR:
2,764,738, INT. CL. 5.
- PNC BANK CORP., PITTSBURGH, PA:
1,728,123, CANC. INT. CL. 36.
2,012,597, CANC. INT. CL. 36.
- PNC FINANCIAL SERVICES GROUP, INC., THE, PITTSBURGH, PA, FORMERLY PNC BANK CORP.:
2,763,125, PUB. 6-24-2003. MULTIPLE CLASS, INT. CLS. 35 AND 36.
- PNC MORTGAGE CORP. OF AMERICA, VERNON HILLS, IL:
2,012,031, CANC. INT. CL. 36.
- POINT & CLICK SOFTWARE, INC., DELAWARE, OH:
2,763,557, PUB. 6-24-2003. INT. CL. 42.
- POLAN, NEAL, S., TORRANCE, CA:
2,764,300, PUB. 6-24-2003. MULTIPLE CLASS, INT. CLS. 35 AND 37.
- POLAND, LEILANI MAY, WINTER PARK, FL:
2,764,125, PUB. 6-24-2003. INT. CL. 35.
- POLAR FOCUS, INC., HADLEY, MA:
2,764,502, INT. CL. 6.
- POLAROID CORPORATION, CAMBRIDGE, MA:
732,138. REN. 8-6-03. U.S. CL. 26 (INT. CLS. 1, 9 AND 10).
- POLIMEROS Y DERIVADOS, S.A. DE C.V., 37240 LEON, GUANAJUATO, MEXICO:
2,011,481, CANC. INT. CL. 24.
- POLYMER GROUP, INC., NORTH CHARLESTON, SC:
2,765,168, INT. CL. 1.
- POLYMERIC RESOURCES CORPORATION, WAYNE, NJ:
2,764,057, PUB. 6-24-2003. INT. CL. 1.
- POLYSTOR, CORPORATION, DUBLIN, CA:
2,012,724, CANC. INT. CL. 9.
- POMMES DE CLAIRE ORCHARDS, INC., HIGHLAND, NY:
2,765,140, INT. CL. 14.
- POMMES DE CLAIRE, INC., NEW YORK, NY:
2,765,371, INT. CL. 14.
- POOLE ENTERPRISE, INC., CLAYTON, NC:
2,012,775, CANC. INT. CL. 28.
- PORSCHE DESIGN PRODUKTE VERTRIEBSGESELLSCHAFT M.B.H., OSTERREICH, AUSTRIA:
2,011,441, CANC. INT. CL. 12.
2,011,442, CANC. INT. CL. 12.
2,011,443, CANC. INT. CL. 12.
- PORTE, T. J., DENVER, CO:
1,727,075, CANC. INT. CL. 8.
- POST RX LIMITED PARTNERSHIP, BALTIMORE, MD:
2,012,424, CANC. INT. CL. 42.

- POST-TENSIONING INSTITUTE, PHOENIX, AZ:
2,764,086, PUB. 6-24-2003. MULTIPLE CLASS, INT. CLS. 16 AND 35.
- POTOMAC ELECTRIC POWER COMPANY, WASHINGTON, DC:
2,764,668, INT. CL. 25.
- POULSEN ROSER APS, FREDENSBORG, DENMARK:
1,777,370, REN. 8-8-03. INT. CL. 31.
- POWERTREND CORPORATION, SHILLINGTON, PA:
2,763,111, PUB. 6-24-2003. INT. CL. 9.
- PPG INDUSTRIES OHIO, INC., CLEVELAND, OH:
2,765,183, INT. CL. 2.
- PR NEWSWIRE ASSOCIATION, INC., NEW YORK, NY:
2,765,196, INT. CL. 35.
- PRACTICAL RENT-A-CAR SYSTEMS, INC., JACKSON, MS,
SPIRIT RENT-A-CAR, INC., BARTLESVILLE, OK:
1,239,769, REN. 8-7-03. INT. CL. 39.
- PRACTICAL RENT-A-CAR SYSTEMS, INC., LAS VEGAS, NV:
1,728,189, CANC. INT. CL. 39.
- PRACTICAL SOLUTIONS, INC., COLLEGE PARK, GA:
2,763,108, PUB. 6-24-2003. INT. CL. 42.
- PRACTICAL SYSTEMS, INC., TARPON SPRINGS, FL:
2,012,877, CANC. INT. CL. 3.
- PRAESIDIUM, INC., ARLINGTON, TX:
2,763,463, PUB. 6-24-2003. INT. CL. 36.
- PRAIRIE SYSTEMS, INC., OMAHA, NE:
2,011,921, CANC. INT. CL. 9.
- PRAXISOFT, INC., ASHBURN, VA:
2,012,533, CANC. INT. CL. 9.
- PRECISE SOFTWARE SOLUTIONS, INC., WESTWOOD, MA:
2,672,732, COR. INT. CL. 9.
- PRECISION DYNAMICS, INC., PHOENIX, AZ:
2,763,121, PUB. 6-24-2003. INT. CL. 41.
- PRECISION FOODS, INC., ST. LOUIS, MO, ALBERTO-CULVER COMPANY, MELROSE PARK, IL:
1,239,603, REN. 8-4-03. INT. CL. 29.
- PRECISION RUBBER PLATE CO., INC., INDIANAPOLIS, IN:
2,765,362, INT. CL. 7.
- PREMIER HEALTH SYSTEMS, INC., LAS VEGAS, NV:
2,012,697, CANC. INT. CL. 5.
- PREMIER HEALTHCARE ASSOCIATES, P.C., AURORA, IL:
2,011,720, CANC. INT. CL. 42.
- PREMIER SYSTEM INTEGRATORS, INC., SMYRNA, TN:
2,765,203, MULTIPLE CLASS, INT. CLS. 35 AND 40.
- PREMIUM ESPRESSO, LLC, ARLINGTON HEIGHTS, IL:
2,765,309, INT. CL. 30.
- PRESIDENT FOODS (HK), TUEN MUN, HONG KONG,
MANYUNG TRADING LTD., TORONTO, ONTARIO,
MSG 1T6, CANADA:
1,816,049, REN. 8-6-03. INT. CL. 30.
- PRESS-A-LITE CORPORATION, WEST CHICAGO, IL:
1,727,392, CANC. INT. CL. 11.
- PRESSURE-LUBE, INC., MENOMONEE FALLS, WI:
2,763,514, PUB. 6-24-2003. INT. CL. 4.
- PRESTIGE TOY CORPORATION, NEW YORK, NY:
2,012,737, CANC. INT. CL. 28.
2,012,738, CANC. INT. CL. 28.
- PREVIEWS INCORPORATED, GREENWICH, CT:
1,214,277, CANC. INT. CL. 35.
- PREZ, VICTOR DES, NEWPORT BEACH, CA, DBA LO-TEK:
1,727,783, CANC. MULTIPLE CLASS, INT. CLS. 25 AND 28.
- PRIMA COMMUNICATIONS, INC., ROCKLIN, CA:
2,012,712, CANC. INT. CL. 16.
- PRIMAL ELEMENTS, INC., GARDEN GROVE, CA:
2,764,997, MULTIPLE CLASS, INT. CLS. 3 AND 4.
- PRIME COMMUNITY PUBLICATIONS, INC., MAPLE GROVE, MN:
2,763,864, PUB. 6-24-2003. INT. CL. 9.
- PRINCESS SOFT TOYS, INC., MINNEAPOLIS, MN:
955,635, AM. U.S. CL. 22.
- PRINCETON DELIVERY SYSTEMS, INC., CANAL WINCHESTER, OH:
2,764,866, INT. CL. 12.
- PRIVATE SPRING WATER CO., FOSTER CITY, CA:
2,011,642, CANC. INT. CL. 42.
- PRO-TECH RESPIRATORS, INC., SMITHFIELD, RI:
1,727,175, CANC. INT. CL. 9.
- PRO-TEL PRODUCTS, INC., BEVERLY HILLS, CA:
2,765,137, INT. CL. 16.
- PROBOARD, INC, LLC., PORTLAND, OR:
2,012,408, CANC. INT. CL. 10.
- PROBUSINESS SERVICES, INC., PLEASANTON, CA:
2,764,800, MULTIPLE CLASS, INT. CLS. 9, 16, 35, 36 AND 41.
2,765,190, INT. CL. 36.
- PROCEDES CHENEL INTERNATIONAL, 92170 VANVES, FRANCE:
2,763,292, PUB. 6-24-2003. MULTIPLE CLASS, INT. CLS. 6, 16, 19, 20 AND 24.
- PROCTER & GAMBLE COMPANY, THE, CINCINNATI, OH:
2,764,644, INT. CL. 16.
2,765,580, INT. CL. 3.
- PRODUCTIVE ENVIRONMENTS, INC., SOUTHBORO, MA:
1,772,950, REN. 8-7-03. INT. CL. 16.
- PRODUCTIVITY-QUALITY SYSTEMS, INC., MIAMISBURG, OH, PRODUCTIVITY-QUALITY SYSTEMS, INC., MIAMISBURG, OH:
1,703,263, REN. 8-4-03. INT. CL. 16.
- PRODUCTOS INDUSTRIALIZADOS DE SALTILLO, S. DE R.L. DE C.V., 25280 SALTILLO, COAHUILA, MEXICO:
2,763,396, PUB. 6-24-2003. INT. CL. 30.
- PROFESSIONAL TRAINING SERVICES, INC., PALATINE, IL:
2,765,084, INT. CL. 41.
- PROFILE NETWORK INC., SKOKIE, IL, DBA SPORTS PROFILES:
2,763,213, PUB. 6-24-2003. INT. CL. 41.
- PROGRAM FIT, INCORPORATED, DUNCANNON, PA:
2,764,367, PUB. 6-24-2003. INT. CL. 16.
- PROGRESSIVE PRODUCE CO., COMMERCE, CA, DBA PATHFINDER TRUCKING:
1,774,450, REN. 8-6-03. INT. CL. 39.
- PROGRESSIVE SUSPENSION INC., HESPERIA, CA:
2,763,839, PUB. 6-24-2003. MULTIPLE CLASS, INT. CLS. 8 AND 12.
- PROGRESSIVE TECHNOLOGY IN LIGHTING, INC., HOLLAND, MI, DBA PROLIGHT:
1,727,398, CANC. INT. CL. 11.
- PROJECT CONSULTING SERVICES, INC., METAIRIE, LA:
2,764,786, INT. CL. 42.
- PROMO DEPOT, INC., JACKSONVILLE, FL:
2,763,536, PUB. 11-12-2002. INT. CL. 40.
- PROPPER MANUFACTURING COMPANY, INC., LONG ISLAND CITY, NY:
581,325, REN. 8-8-03. U.S. CL. 44 (INT. CL. 10).
- PROPRIETARY COMPUTER SYSTEMS, INC., VAN NUYS, CA:
1,214,285, CANC. INT. CL. 35.
- PROSTRONG, INC., OAKVILLE, CT:
2,765,649, INT. CL. 3.
- PROTEIN DELIVERY, INC., DURHAM, NC:
2,012,750, CANC. MULTIPLE CLASS, INT. CLS. 1 AND 5.
- PROVATION MEDICAL, INC., MINNEAPOLIS, MN:
2,765,893, INT. CL. 9.
- PROVEN WINNERS NORTH AMERICA, L.L.C., CAMPBELL, CA:
2,764,287, PUB. 6-24-2003. INT. CL. 1.
- PROVERBIAL INC., NEW YORK, NY:
2,012,818, CANC. INT. CL. 3.
2,012,819, CANC. INT. CL. 3.
- PRUDENTIAL INSURANCE COMPANY OF AMERICA, THE, NEWARK, NJ:
2,012,285, CANC. INT. CL. 36.
- PSI UPSILON FRATERNITY, PAOLI, PA:
960,141, REN. 8-7-03. U.S. CL. 200.
- PSYCHEMEDICS CORPORATION, CAMBRIDGE, MA:
2,012,036, CANC. INT. CL. 42.
- PSYCHIC DISCOVERY NETWORK, INC., BOCA RATON, FL:
2,011,946, CANC. INT. CL. 19.
- PUBLIC BROADCASTING SERVICE, ALEXANDRIA, VA:
2,727,928, COR. INT. CL. 41.

- PUBLIC DATA CORPORATION, NEW YORK, NY:
2,763,489, PUB. 6-24-2003. INT. CL. 36.
- PUBLIC INTEREST DATA, INC., ALEXANDRIA, VA:
2,764,907, INT. CL. 35.
- PUBLIX ASSET MANAGEMENT COMPANY, LAKELAND,
FL, PUBLIX SUPER MARKETS, INC., LAKELAND, FL:
1,772,104, REN. 8-7-03. INT. CL. 42.
- PUBLIX INFORMATION PRODUCTS, INC., SUNNYVALE,
CA TO SYLLABUS PRESS, INC., SUNNYVALE, CA:
1,704,227, CANC. INT. CL. 16.
- PULL-A-PART, INC., NORCROSS, GA:
2,763,465, PUB. 6-24-2003. MULTIPLE CLASS, INT. CLS.
35 AND 39.
- PURE WATER CORPORATION, SEATTLE, WA:
2,011,370, CANC. INT. CL. 32.
- PURICLE INC., IRVINE, CA:
2,765,908, INT. CL. 21.
- PURPLE POTAMUS, INC., ALEXANDRIA, VA:
1,808,089, REN. 8-7-03. INT. CL. 41.
- PURUP PREPRESS A/S, DK-8520 LYSTRUP, DENMARK:
2,012,433, CANC. INT. CL. 9.
- PYUNG AN TEXTILE CO., LTD., SEOUL, REPUBLIC OF
KOREA:
2,765,375, INT. CL. 25.
- PYXIS CORPORATION, SAN DIEGO, CA:
2,764,684, INT. CL. 9.
- QRANC USA, INC., BIG BEAR LAKE, CA:
2,012,317, CANC. MULTIPLE CLASS, INT. CLS. 12 AND
25.
- QST INDUSTRIES, INC., CHICAGO, IL FROM JOHN
SOLOMON, INC., SOMERVILLE, MA:
2,763,264, PUB. 6-24-2003. INT. CL. 16.
- QUABAUG CORPORATION, NORTH BROOKFIELD, MA:
1,214,103, CANC. INT. CL. 25.
- QUALITY OF LIFE LABS, INC., PURCHASE, NY:
2,765,885, INT. CL. 5.
- QUANTUM CHEMICAL CORPORATION:
1,213,725, CANC. INT. CL. 1.
- QUANTUM CORPORATION, MILPITAS, CA:
2,765,102, INT. CL. 9.
- QUEST SOFTWARE, INC., IRVINE, CA FROM KL GROUP
INC., TORONTO, ONTARIO:
2,764,751, INT. CL. 9.
- QUICKFINGER, INC., BRECKENRIDGE, CO:
2,011,589, CANC. INT. CL. 25.
- QUICKSWING, INC., WOODBURY, MN:
2,765,268, INT. CL. 28.
2,765,269, INT. CL. 28.
- QUIET CORE, INC., BETHLEHEM, PA:
1,780,288, REN. 8-5-03. INT. CL. 17.
- QUIKBLADE INC., MARKHAM, ONTARIO, CANADA
FROM MULTIMATIC INC., MARKHAM, ONTARIO:
2,763,053, PUB. 1-15-2002. INT. CL. 28.
- QUIKSILVER, INC., HUNTINGTON BEACH, CA:
2,765,669, INT. CL. 18.
- QUIXOTE PARTNERS LLC, GREENWOOD VILLAGE, CO:
2,765,300, INT. CL. 36.
- R & O TRANSPORTATION LLC, WILDER, KY, CHIQUITA
BRANDS, INC., CINCINNATI, OH:
1,772,587, REN. 8-2-03. INT. CL. 39.
- R.A. PHILLIPS INDUSTRIES, INC., SANTA FE SPRINGS,
CA:
2,765,307, INT. CL. 12.
- R.G. BARRY (TEXAS) L.P., PICKERINGTON, OH:
2,764,401, PUB. 6-24-2003. INT. CL. 25.
- R.M. PALMER COMPANY, WEST READING, PA:
2,012,132, CANC. INT. CL. 30.
- RA BRANDS, L.L.C., MADISON, NC, REMINGTON ARMS
COMPANY, INC., MADISON, NC:
1,786,679, REN. 8-5-03. INT. CL. 13.
- RA BRANDS, LLC, MADISON, NC, REMINGTON ARMS
COMPANY, INC., MADISON, NC:
1,776,874, REN. 8-6-03. INT. CL. 42.
- RACHEL PERRY, INC., CHATSWORTH, CA:
1,726,884, CANC. INT. CL. 3.
- RADIO FREQUENCY SYSTEMS GMBH, HANNOVER, FED
REP GERMANY, KABEL-UND METALLWERKE GUTE-
HOFFNUNGSHUTTE AKTIENGESELLSCHAFT, 3000
HANNOVER, FED REP GERMANY:
958,889, REN. 8-2-03. U.S. CL. 21 (INT. CL. 9).
- RADIOCRAFT, INC., SOUTHBOROUGH, MA:
1,728,181, CANC. MULTIPLE CLASS, INT. CLS. 38 AND
41.
- RADIOPATH, LLC, REDMOND, WA:
2,763,171, PUB. 6-24-2003. INT. CL. 9.
- RADISSON HOTELS INTERNATIONAL, INC., MINNEAPO-
LIS, MN:
2,765,717, INT. CL. 43.
- RADIUS FOOTWEAR INC., MONTREAL, QUEBEC, H8T
3E4, CANADA:
2,011,323, CANC. INT. CL. 25.
- RAFFERTY, DANA M., RAMSEY, NJ:
2,012,555, CANC. INT. CL. 42.
- RAIDTRONICS, INC., CITY OF INDUSTRY, CA:
2,763,627, PUB. 6-24-2003. INT. CL. 9.
- RAILINC CORP., CARY, NC:
2,765,226, INT. CL. 42.
- RAINFOREST CAFE, INC., HOPKINS, MN:
2,764,487, INT. CL. 25.
- RAM DYNAMICS, INC., RANDOLPH, NJ:
2,012,675, CANC. INT. CL. 42.
- RAM GOLF CORPORATION, MELROSE PARK, IL:
1,214,204, CANC. INT. CL. 28.
- RAMBUS INC., LOS ALTOS, CA:
2,764,400, PUB. 6-24-2003. INT. CL. 42.
- RANBAXY LABORATORIES LIMITED, NEW DELHI, DEL-
HI, INDIA:
2,765,814, MULTIPLE CLASS, INT. CLS. 16 AND 44.
- RANDOM HOUSE, INC., NEW YORK, NY:
1,213,922, CANC. INT. CL. 16.
- RANIR/DCP CORPORATION, WEST ORANGE, NJ:
2,765,481, INT. CL. 21.
- RAO, POTLURI M., SEATTLE, WA AND RAO, CATHERINE
MCDOLE, SEATTLE, WA:
1,810,621, REN. 8-5-03. INT. CL. 9.
- RAPID DISPLAYS, INC., CHICAGO, IL:
2,765,398, INT. CL. 28.
- RAPIDFIRE, ALLENTOWN, PA:
2,763,858, PUB. 6-24-2003. INT. CL. 11.
- RAPTORBYTES INC., CAMROSE ALBERTA, CANADA:
2,763,173, PUB. 6-24-2003. INT. CL. 42.
- RASMUSSEN, MARK A., PLACENTIA, CA:
2,012,585, CANC. INT. CL. 25.
- RATH, MATTHIAS, NL-7609 KL ALMELO, NETHER-
LANDS:
2,763,522, PUB. 6-24-2003. MULTIPLE CLASS, INT. CLS.
5, 30 AND 32.
- RAUSA, CHARLES J. JR, RANCHO CUCAMONGA, CA
AND RAUSA, DOROTHY E., RANCHO CUCAMONGA,
CA:
2,011,675, CANC. INT. CL. 42.
- RAVARINO & FRESCHI, INC., ST. LOUIS, MO:
398,438, CANC. U.S. CL. 46.
398,439, CANC. U.S. CL. 46.
- RAVELLA, JOSEPH A., ROUGEMONT, NC:
2,012,456, CANC. INT. CL. 10.
- RAY ENTERPRISES INC., CASSTOWN, OH, DBA SHARP-N-
LUBE:
2,011,890, CANC. INT. CL. 37.
- RAY, JAN, DUBLIN, OH AND IRELAN, ROSE, DUBLIN,
OH:
2,012,327, CANC. INT. CL. 28.
- RAYNOR CANADA INC., MISSISSAUGA, ONTARIO, CA-
NADA, DBA RICHARDS-WILCOX CANADA:
2,764,833, INT. CL. 36.
- RAZAC PRODUCTS, INC., NEWARK, NJ:
2,011,353, CANC. INT. CL. 3.
- RCMI INVESTMENT MANAGEMENT, INC., BURLIN-
GAME, CA:
2,011,636, CANC. INT. CL. 38.
- READING VENTURE ONE L. L. C., BIRMINGHAM, MI:
2,764,583, INT. CL. 41.

- REAL LIFE MARKETING, LLC, PORTLAND, OR:
2,764,289, PUB. 6-24-2003. MULTIPLE CLASS, INT. CLS. 35 AND 41.
- RECAPS, LLC, BELLEVUE, WA:
2,764,646, INT. CL. 5.
- RECEIT IT INTERNATIONAL, INC., COPIAGUE, NY:
2,765,374, INT. CL. 37.
- RECIPROCAL GROUP, THE, RICHMOND, VA:
1,728,076, CANC. MULTIPLE CLASS, INT. CLS. 36 AND 42.
- RECKITT BENCKISER N.V., HOOFDDORP, NETHERLANDS:
2,764,175, PUB. 6-24-2003. INT. CL. 3.
- RECKITT BENCKISER N.V., 2132 NZ HOOFDDORP, NETHERLANDS:
2,765,887, MULTIPLE CLASS, INT. CLS. 1 AND 3.
- RECOT, INC., PLEASANTON, CA:
1,774,728, REN. 8-5-03. INT. CL. 30.
- RECOT, INC., WILMINGTON, DE:
2,012,297, CANC. INT. CL. 29.
- RECREATIONAL EQUIPMENT, INC., SUMNER, WA:
2,765,752, INT. CL. 25.
- RECRUITMINDS, LLC, POINT PLEASANT, NJ:
2,764,410, PUB. 6-24-2003. INT. CL. 35.
- RED CHIP COMPANY LTD., TORTOLA, BR.VIRGIN ISLANDS:
2,763,607, PUB. 6-24-2003. INT. CL. 9.
- RED CHIP COMPANY LTD., TORTOLA, BR.VIRGIN ISLANDS FROM HARRIS CORPORATION, MELBOURNE, FL:
2,764,479, INT. CL. 9.
- REED ELSEVIER INC., NEWTON, MA:
2,763,423, PUB. 6-24-2003. INT. CL. 16.
- REED SMITH LLP, PITTSBURGH, PA, REED SMITH SHAW & MCCLAY, PITTSBURGH, PA:
1,735,449, REN. 8-8-03. INT. CL. 42.
- REED, DANIEL M., BYRON, CA:
2,763,140, PUB. 1-15-2002. INT. CL. 9.
- REED, ROBERT, GRAND BLANC, MI:
2,012,684, CANC. INT. CL. 16.
- REFLECT SYSTEMS, INC., DALLAS, TX FROM REFLECTION SYSTEMS, INC., DALLAS, TX:
2,765,783, INT. CL. 9.
- REFRATECHNIK HOLDING GMBH, 85737 ISMANING, FED REP GERMANY, REFRATECHNIK GMBH, GOTTINGEN, FED REP GERMANY:
1,239,453, REN. 8-7-03. INT. CL. 19.
- REGAL ENTERPRISES LIMITED, CHAI WAN, HONG KONG:
2,012,248, CANC. MULTIPLE CLASS, INT. CLS. 9 AND 11.
- REGGAE SUNSPASH, INC., BEVERLY HILLS, CA:
2,763,027, PUB. 11-16-1993. MULTIPLE CLASS, INT. CLS. 14, 25 AND 41.
- REGIONAL PERFORMING ARTS CENTER, INC., PHILADELPHIA, PA:
2,765,882, INT. CL. 41.
- REGIONS FINANCIAL CORPORATION, BIRMINGHAM, AL, FIRST ALABAMA BANK, BIRMINGHAM, AL:
1,703,721, REN. 8-2-03. INT. CL. 36.
- REGLERA, LLC, DENVER, CO:
2,764,050, PUB. 6-24-2003. INT. CL. 42.
- REID-PROVIDENT LABORATORIES, INC., ATLANTA, GA:
739,934, CANC. U.S. CL. 18.
- REID, WILLIAM BURCH, FLORENCE, AL:
2,765,425, INT. CL. 25.
- REIFENHAUSER GMBH & CO MASCHINENFABRIK, D-53839 TROISDORF, FED REP GERMANY:
2,765,119, INT. CL. 7.
- REINER, IRVIN J., HOUSTON, TX:
2,012,234, CANC. INT. CL. 10.
- REINIGER, RICHARD W., STAMFORD, CT:
2,011,840, CANC. INT. CL. 20.
- REIS, MARY ELLEN, PEACHAM, VT:
2,763,221, PUB. 6-24-2003. INT. CL. 42.
- RELA, INC., BOULDER, CO:
2,012,497, CANC. INT. CL. 10.
- RELIANCE HOUSING FOUNDATION, INC., FT. LAUDERDALE, FL:
2,763,610, PUB. 6-24-2003. INT. CL. 36.
2,763,615, PUB. 6-24-2003. INT. CL. 36.
- RELIANT RESOURCES, INC., HOUSTON, TX FROM RELIANT ENERGY, INCORPORATED, HOUSTON, TX:
2,764,995, INT. CL. 9.
- RELIZON SNE INC., WILMINGTON, DE, REYNOLDS AND REYNOLDS COMPANY, THE, DAYTON, OH:
1,773,586, REN. 8-6-03. INT. CL. 16.
- RELLER, PAUL, TAMPA, FL:
1,728,325, CANC. INT. CL. 41.
- RELOACTION, PLEASANTON, CA, RELOCATION CONSULTANTS OF NORTHERN CALIFORNIA, INC., PLEASANTON, CA:
1,788,967, REN. 8-5-03. INT. CL. 39.
- RELOCATION RESOURCES, INC., NORWELL, MA:
2,012,628, CANC. INT. CL. 35.
- RELTEK CORPORATION, MONROEVILLE, PA:
1,789,229, REN. 8-6-03. INT. CL. 9.
- RENE MATERIAUX COMPOSITES LTEE/RENE COMPOSITE MATERIALS LTD., BEAUCE, P.Q., CANADA:
1,802,012, REN. 8-7-03. INT. CL. 12.
- REPACA, INC., LOS ANGELES, CA:
2,012,595, CANC. INT. CL. 41.
- RESOURCES FOR ORGANIZATIONS, INC., EDEN PRAIRIE, MN:
1,727,527, CANC. INT. CL. 16.
- RESTAURANT VENTURES, INC., NEW YORK, NY:
2,012,498, CANC. INT. CL. 42.
- RESTEK CORPORATION, BELLEFONTE, PA:
1,734,518, REN. 8-6-03. INT. CL. 9.
- RESTREPO, MONICA ESTRADA, BOGOTA, D.C., COLOMBIA:
2,764,893, INT. CL. 36.
- RESTRUCTION CORPORATION, SEDALIA, CO:
2,763,258, PUB. 6-24-2003. INT. CL. 37.
- REVERE MILLS, INC., NILES, IL:
2,765,255, INT. CL. 24.
- REVLON CONSUMER PRODUCTS CORPORATION, NEW YORK, NY:
2,765,748, INT. CL. 3.
- REXNORD CORPORATION, MILWAUKEE, WI:
1,727,027, CANC. INT. CL. 7.
- REYNOLDS CONSUMER PRODUCTS, INC., RICHMOND, VA, DBA PRESTO PRODUCTS COMPANY:
2,012,529, CANC. INT. CL. 5.
- REYNOLDS METALS COMPANY, RICHMOND, VA:
1,728,595, CANC. INT. CL. 16.
- REYNOLDS, CLAYTON M., III, ALTAMONTE SPRINGS, FL:
2,012,605, CANC. INT. CL. 10.
- RF MONOLITHICS, INC., DALLAS, TX TO RF MONOLITHICS, INC., DALLAS, TX:
1,727,305, CANC. INT. CL. 9.
- RG DELAWARE, INC., WILMINGTON, DE:
2,765,830, INT. CL. 9.
- RHONE GROUP LLC, NEW YORK, NY:
2,763,466, PUB. 6-24-2003. INT. CL. 36.
- RHONE MERIEUX, INC., ATHENS, GA:
2,012,353, CANC. INT. CL. 5.
- RHONE-POULENC CHIMIE, 92400 COURBEVOIE, FRANCE:
2,011,460, CANC. INT. CL. 1.
- RICE, MARC, DAVIE, FL:
2,765,037, INT. CL. 28.
- RICH PRODUCTS CORPORATION, BUFFALO, NY:
2,765,154, INT. CL. 30.
- RICH-SEAPAK CORPORATION, ST. SIMONS ISLAND, GA:
2,765,380, INT. CL. 30.
- RICHARD'S OF CHESTNUT HILL, INC., WEST BRIDGEWATER, MA:
2,763,931, PUB. 6-24-2003. INT. CL. 30.
- RICHARDSON ELECTRONICS, LTD., LAFOX, IL:
2,764,104, PUB. 6-24-2003. INT. CL. 37.
- RICHARDSON, TODD, WILMINGTON, IL:
2,011,908, CANC. INT. CL. 25.

- RICHMOND PLYWOOD CORPORATION LIMITED, VAN-
COUVER, BC V6C 1S4, CANADA:
2,765,139, INT. CL. 19.
- RICKETTS, EROL R., HEMPSTEAD, NY:
1,727,265, CANC. INT. CL. 9.
- RICOLA AG, 4242 LAUFEN, SWITZERLAND:
2,763,794, PUB. 6-24-2003. MULTIPLE CLASS, INT. CLS. 5
AND 30.
- RICQLES-ZAN S.A., SAINT-OUEN (SEINE), FRANCE:
21,900, CANC. U.S. CL. 51.
- RIDERWARE CO INC, TUCSON, AZ:
2,764,359, PUB. 6-24-2003. INT. CL. 28.
- RIDGEVIEW MEDICAL CENTER, MUNICIPAL HOSPITAL
OF THE CITY OF WACONIA, WACONIA, MN:
1,728,382, CANC. INT. CL. 42.
- RIDLEY BLOCK OPERATIONS, INC., MANKATO, MN:
2,765,469, INT. CL. 5.
- RIEBEEK KELDER BEPERK, WESTERN CAPE, SOUTH
AFRICA:
2,764,614, INT. CL. 33.
- RIGGS, MARY, CHICAGO, IL:
2,011,938, CANC. INT. CL. 16.
- RILEY & GEEHR, INC., EVANSTON, IL:
1,727,570, CANC. INT. CL. 16.
- RIMBALL MARKETING AND DEVELOPMENT, INC.,
EVANSTON, IL:
2,012,303, CANC. INT. CL. 25.
- RINGSIDE, INC., LENEXA, KS:
2,764,007, PUB. 6-24-2003. INT. CL. 28.
- RINGTAIL SOLUTIONS PTY LIMITED, MELBOURNE, VIC
2300, AUSTRALIA:
2,763,167, PUB. 5-21-2002. MULTIPLE CLASS, INT. CLS.
9, 35, 38 AND 42.
2,763,168, PUB. 5-21-2002. MULTIPLE CLASS, INT. CLS.
9, 35, 38 AND 42.
- RINGWALT, TOMMY, ENFIELD, CT:
2,764,067, PUB. 6-24-2003. INT. CL. 10.
- RISI, JOSEPH S., SANTA BARBARA, CA:
2,763,194, PUB. 6-24-2003. INT. CL. 37.
- RITE-OFF, INC., SEAFORD, DE:
2,012,425, CANC. INT. CL. 16.
- RITZ-CARLTON HOTEL COMPANY, L.L.C., THE, BETHES-
DA, MD:
2,765,635, INT. CL. 41.
2,765,636, INT. CL. 42.
- RIVER CITY GROUP, LLC, THE, ST. CHARLES, MO:
2,763,415, PUB. 6-24-2003. INT. CL. 35.
- RIVER POINT RESORT, INC., ELY, MN:
2,100,840, COR. INT. CL. 39.
- RIVER RANCH FRESH FOODS, LLC, SALINAS, CA:
2,763,978, PUB. 6-24-2003. INT. CL. 31.
- RIVER WEST BRANDS, LLC, CHICAGO, IL FROM COW
TOWN GROUP, INC., CHICAGO, IL:
2,765,761, INT. CL. 3.
- RIVERSIDE TELEPHONE COMPANY, INC., SAG HARBOR,
NY:
2,012,517, CANC. INT. CL. 36.
- RIVIERE, EMMANUEL, ANGEAC-CHARENTE, FRANCE
AND RIVIERE, ANNE-MARIE, PLAUZAT, FRANCE AND
RIVIERE, NATHALIE, ANGEAC-CHARENTE, FRANCE
AND RIVIERE, DOMINIQUE, ANGEAC-CHARENTE,
FRANCE, RIVIERE; PHILIPPE, ANGEAC, CHARENTE,
FRANCE:
1,238,690, REN. 8-6-03. INT. CL. 33.
- RJMF, PARIS, FRANCE FROM LA TECHNIQUE FRAN-
CAISE DU NETTOYAGE, 75019 PARIS, FRANCE:
2,763,205, PUB. 6-24-2003. MULTIPLE CLASS, INT. CLS.
35, 36, 37, 38, 39, 40 AND 42.
- RLX TECHNOLOGIES, INC., THE WOODLANDS, TX
FROM ROCKETLOGIX, INC., PLANO, TX:
2,764,887, MULTIPLE CLASS, INT. CLS. 9, 37 AND 42.
- ROAD CHAMPS, INC., MALIBU, CA:
2,764,944, INT. CL. 28.
- ROAD RUNNER HOLDCO LLC, HERNDON, VA:
2,765,508, INT. CL. 38.
- ROBBINS RESEARCH INTERNATIONAL, INC., SAN DIE-
GO, CA, ROBBINS, ANTHONY J., SAN DIEGO, CA:
1,735,369, REN. 8-8-03. INT. CL. 41.
- ROBERT ABBOTT HOLDING, INC., FOSTER CITY, CA:
2,764,353, PUB. 6-24-2003. INT. CL. 35.
- ROBERT FORBIS, INC., NAPLES, FL:
2,765,881, INT. CL. 37.
- ROBERT KRUPS GMBH & CO. KG, D-42719 SOLINGEN,
FED REP GERMANY:
2,011,920, CANC. INT. CL. 11.
- ROBERT LEROY LEIBOWITZ, M.D., LOS ANGELES, CA:
2,763,434, PUB. 6-24-2003. INT. CL. 42.
2,763,435, PUB. 6-24-2003. INT. CL. 42.
2,763,436, PUB. 6-24-2003. INT. CL. 42.
- ROBERT TALBOTT, INC., CARMEL VALLEY, CA:
2,765,403, INT. CL. 14.
- ROBERTEX ASSOCIATES, INC., TUCKER, GA:
1,214,129, CANC. INT. CL. 27.
- ROBERTS ENTERPRISES, INC., SILVER SPRINGS, FL:
2,764,027, PUB. 6-24-2003. INT. CL. 36.
- ROBINIT, INC., BRONX, NY:
1,214,095, CANC. INT. CL. 25.
- ROBINSON, MICHAEL D., ANGELFIRE, NM:
2,765,708, INT. CL. 11.
- ROBINWARE CORPORATION, ELK GROVE VILLAGE, IL:
1,786,290, REN. 8-7-03. INT. CL. 2.
- ROCA PRODUCTIONS INCORPORATED, CULVER CITY,
CA:
2,012,382, CANC. INT. CL. 16.
- ROCHE DIAGNOSTICS GMBH, 68305 MANNHEIM, FED
REP GERMANY:
2,763,699, PUB. 6-24-2003. MULTIPLE CLASS, INT. CLS.
9, 36, 41 AND 44.
- ROCK MOUNTAIN CORP. LTD., NOOSA HEADS Q1D,
AUSTRALIA:
2,764,602, INT. CL. 41.
- ROCKEFELLER GROUP, INC., NEW YORK, NY:
1,214,000, CANC. INT. CL. 20.
2,764,024, PUB. 6-24-2003. INT. CL. 38.
- ROCKET SCIENCE GAMES, INC., SAN FRANCISCO, CA:
2,012,865, CANC. INT. CL. 28.
- ROCKY MOUNTAIN ADVENTURES, LLC, PORT JEFFER-
SON STATION, NY:
2,763,496, PUB. 2-11-2003. INT. CL. 43.
- ROCKY MOUNTAIN NATIONAL RENDEZVOUS, LAKE-
WOOD, CO:
2,763,515, PUB. 6-24-2003. INT. CL. 41.
- ROD MCLELLAN CO., SAN MATEO, CA:
2,765,048, INT. CL. 31.
- RODALE INC., EMMAUS, PA:
2,765,954, INT. CL. 16.
- RODEO REALTY, INC., NORTHRIDGE, CA:
2,763,302, PUB. 6-24-2003. INT. CL. 36.
- RODGERS INSTRUMENTS LLC, HILLSBORO, OR:
2,765,110, INT. CL. 9.
- ROGER & GALLET S.A., PARIS, FRANCE:
1,213,967, CANC. MULTIPLE CLASS, INT. CLS. 18 AND
25.
- ROGER SANTANDER CORP., JERSEY CITY, NJ:
2,011,698, CANC. INT. CL. 29.
- ROGUE VALLEY NATURAL SPRINGS, INC., GRANTS
PASS, OR:
2,764,947, INT. CL. 1.
- ROLAND, INC., IDAHO FALLS, ID:
2,765,656, MULTIPLE CLASS, INT. CLS. 29 AND 30.
- ROLATAPE CORPORATION, SPOKANE, WA:
2,012,504, CANC. INT. CL. 9.
- ROLF INSTITUTE OF STRUCTURAL INTEGRATION, THE,
BOULDER, CO:
1,727,478, CANC. INT. CL. 16.
- ROMATEX S.R.L., VARESE, ITALY:
2,716,941, COR. INT. CL. 25.
- RONSON CORPORATION, WOODBRIDGE, NJ:
2,765,068, INT. CL. 8.
- ROSE ART INDUSTRIES, INC., LIVINGSTON, NJ:
2,012,882, CANC. INT. CL. 28.
2,763,451, PUB. 9-3-2002. INT. CL. 16.
- ROSEN, DAVID B., LEXINGTON, MA, DBA SOFTWARE
INNOVATIONS:
2,763,033, PUB. 6-24-2003. INT. CL. 9.

- ROSENBERG INSTITUTIONAL EQUITY MANAGEMENT, ORINDA, CA:
1,728,087, CANC. INT. CL. 36.
- ROSENHAUS, STEVEN S., NEW YORK, NY:
2,765,359, INT. CL. 3.
- ROSETTA INPHARMATICS LLC, KIRKLAND, WA FROM ROSETTA INPHARMATICS, INC., KIRKLAND, WA:
2,765,111, MULTIPLE CLASS, INT. CLS. 9, 16 AND 42.
- ROSS WILLOUGHBY COMPANY, THE, COLUMBUS, OH:
2,011,994, CANC. INT. CL. 42.
- ROSS, LAURA K., WASHINGTON, PA, DBA THE TOFFEE HOUSE:
2,764,461, PUB. 6-24-2003. INT. CL. 30.
- ROSSMAN, THOMAS, CLOVERDALE, IN:
2,764,311, PUB. 6-24-2003. INT. CL. 41.
- ROSSOUW, DENISE, WEST HOLLYWOOD, CA:
2,763,778, PUB. 6-24-2003. INT. CL. 26.
- ROTH KASE U.S.A., LTD., MONROE, WI:
1,773,774, REN. 8-8-03. INT. CL. 29.
- ROTH-KASE AG, 8610 USTER, SWITZERLAND:
2,012,205, CANC. INT. CL. 29.
- ROTH, OTTO, NEW YORK, NY TO BEATRICE CHEESE, INC., WAUKESHA, WI:
152,263, CANC. U.S. CL. 46.
- ROUND HILL CELLARS, ST. HELENA, CA:
2,011,699, CANC. INT. CL. 33.
2,011,700, CANC. INT. CL. 33.
- ROUSH PRODUCTS COMPANY, INC., CEDAR RAPIDS, IA:
2,011,377, CANC. INT. CL. 30.
2,011,378, CANC. INT. CL. 30.
- ROUTE 66, L.P., NEW YORK, NY:
2,764,503, INT. CL. 12.
- ROWE INTERNATIONAL, INC., GRAND RAPIDS, MI:
2,764,781, INT. CL. 9.
- ROY F. WESTON, INC., WEST CHESTER, PA:
2,765,434, MULTIPLE CLASS, INT. CLS. 35, 37 AND 42.
- ROYAL APPLIANCE MFG. CO., CLEVELAND, OH:
1,727,133, CANC. INT. CL. 9.
- ROYAL MORTGAGE CORP., PRINCETON, NJ:
2,765,948, INT. CL. 36.
- ROYAL RUBBER & MANUFACTURING COMPANY, SOUTH GATE, CA:
1,217,659, REN. 8-6-03. INT. CL. 27.
- ROYAL WINE CORPORATION, BAYONNE, NJ:
2,765,923, INT. CL. 33.
- ROYCE UNION BICYCLE COMPANY, MIAMISBURG, OH:
2,764,181, PUB. 6-24-2003. INT. CL. 12.
- RP FINANCIAL, LC, ARLINGTON, VA:
2,765,129, INT. CL. 36.
- RPM/BELGIUM, NAAMLOZE VENNOOTSCHAP, B-8700 TIELT, BELGIUM:
2,764,106, PUB. 10-22-2002. MULTIPLE CLASS, INT. CLS. 2, 19 AND 27.
- RUBBERDYNE, INCORPORATED, CUYAHOGA FALLS, OH:
2,011,583, CANC. INT. CL. 40.
- RUBBERMAID INCORPORATED, WOOSTER, OH, LEE/ROWAN COMPANY, ST. LOUIS, MO:
1,762,080, REN. 8-6-03. INT. CL. 20.
- RUBBERSTAMPEDE PARTNERSHIP, OAKLAND, CA:
2,011,386, CANC. INT. CL. 28.
- RUBI SPORTS TECHNOLOGY, INC., MONROVIA, CA:
2,012,798, CANC. INT. CL. 28.
- RUCKSTUHL AG, LANGENTHAL, SWITZERLAND:
1,214,127, CANC. INT. CL. 27.
- RUEDA, DANIEL, 75016 PARIS, FRANCE:
2,764,808, INT. CL. 9.
- RUOCCHIO, ALBERT C., RALEIGH, NC:
2,764,392, PUB. 6-24-2003. INT. CL. 28.
- RURAL CELLULAR CORPORATION, ALEXANDRIA, MN:
2,764,501, MULTIPLE CLASS, INT. CLS. 35, 36 AND 38.
- RUSHTON, THOMAS L., WILMINGTON, NC AND RUSHTON, KIMBERLY L., WILMINGTON, NC:
2,765,146, MULTIPLE CLASS, INT. CLS. 16 AND 25.
- RUSSEAU, KATHLEEN, ROCHESTER HILLS, MI:
2,012,320, CANC. INT. CL. 21.
- RUTGERS, THE STATE UNIVERSITY OF NEW JERSEY, NEW BRUNSWICK, NJ:
2,764,505, INT. CL. 25.
- RUTHERFORD GROUP, LA JOLLA, CA:
2,763,928, PUB. 6-24-2003. INT. CL. 31.
- RWD DISTRIBUTORS, INC., NEW YORK, NY, DBA RAVENSCROFT:
2,764,059, PUB. 6-24-2003. INT. CL. 21.
- RWK DESIGN, INC., FRANKFORT, IL:
2,763,739, PUB. 6-24-2003. INT. CL. 42.
- RX/IBR CORPORATION, HOUSTON, TX:
2,764,641, INT. CL. 5.
- RYAN'S PROPERTIES, INC., GREER, SC:
2,012,563, CANC. INT. CL. 42.
- RYCAM, INC., CARTER LAKE, IA:
2,765,024, INT. CL. 25.
- RYKOFF-SEXTON, INC., LOS ANGELES, CA:
2,012,601, CANC. INT. CL. 42.
- S. C. JOHNSON & SON, INC., RACINE, WI:
2,011,358, CANC. INT. CL. 5.
2,765,462, INT. CL. 3.
- S.A. MAXWELL CO., NORTHFIELD, IL:
2,011,693, CANC. INT. CL. 16.
- S.A.S. ORNAMENTAL INC., EL PASO, TX, DBA THE 807 CO.:
2,764,517, INT. CL. 25.
- S.F.C. DESIGN INC., HONOLULU, HI:
1,214,057, CANC. INT. CL. 25.
- S.S. SARNA INC., MANHASSET, NY:
2,763,568, PUB. 6-24-2003. INT. CL. 35.
- S.T.A.N.D.U.P., INC., KANSAS CITY, MO:
2,763,926, PUB. 6-24-2003. INT. CL. 45.
- S.V.V. SALES, INC., SEATTLE, WA, DBA ARCADA COMMUNICATIONS:
2,011,650, CANC. INT. CL. 38.
- S-TEK, INC., CULVER CITY, CA:
2,012,190, CANC. INT. CL. 28.
- SAAB AUTOMOBILE AB, 461 80 TROLLHATTAN, SWEDEN:
2,763,309, PUB. 6-24-2003. MULTIPLE CLASS, INT. CLS. 9, 12 AND 37.
- SAAB AUTOMOBILE AB, SWEDEN:
2,763,310, PUB. 6-24-2003. MULTIPLE CLASS, INT. CLS. 9, 12 AND 37.
- SABAN ENTERTAINMENT, INC., LOS ANGELES, CA:
2,765,602, INT. CL. 28.
- SABORMEX, S.A. DE C.V., COL. APATLACO, MEXICO, LA SIERRA BRANDS, INC., VINELAND, NJ:
955,872, REN. 8-4-03. U.S. CL. 46 (INT. CLS. 1, 5, 29, 30, 31 AND 32).
- SACRAMENTO KINGS LIMITED PARTNERSHIP, L.P., SACRAMENTO, CA:
2,763,812, PUB. 6-24-2003. INT. CL. 41.
- SAF-T-MED, INC., DALLAS, TX:
2,012,162, CANC. INT. CL. 10.
- SAFE AMERICA FOUNDATION, INC., MARIETTA, GA:
2,764,385, PUB. 6-24-2003. INT. CL. 41.
- SAFEGUARD INTERNATIONAL LIMITED, BUCKINGHAMSHIRE, ENGLAND:
2,012,217, CANC. MULTIPLE CLASS, INT. CLS. 37 AND 42.
- SAFESEC CORPORATION, ONTARIO, CA, FORMERLY REVOLVING DOOR CONTROL, INC.:
2,763,513, PUB. 6-24-2003. MULTIPLE CLASS, INT. CLS. 6, 7, 9 AND 19.
- SAFETY TODAY, INC., GAHANNA, OH:
2,765,547, MULTIPLE CLASS, INT. CLS. 10 AND 20.
- SAFETY VISION, L.P., HOUSTON, TX:
2,764,130, PUB. 6-24-2003. INT. CL. 9.
- SAINT-GOBAIN CALMAR INC., CITY OF INDUSTRY, CA:
2,765,113, INT. CL. 21.
- SAKAR INTERNATIONAL INC., EDISON, NJ:
2,763,695, PUB. 6-24-2003. MULTIPLE CLASS, INT. CLS. 9 AND 28.
- SALANT CORPORATION, NEW YORK, NY:
740,046, CANC. U.S. CL. 39.
- SALAS, ROBERT, DONNA, TX:
2,765,886, INT. CL. 25.

- SALLY BEAUTY HOLDINGS, INC.:
See— BEAUTY HOLDING COMPANY, INC.
- SALONI PORTUGAL-MATERIAIS DE CONSTRUCAO LDA., 2795 CARNAXIRE (LISBOA), PORTUGAL:
 2,763,504, PUB. 6-24-2003. MULTIPLE CLASS, INT. CLS. 19 AND 35.
- SALSA MEX, INC., SAN DIEGO, CA:
 2,686,046, COR. INT. CL. 30.
- SAM DICK INDUSTRIES, INC., SEATTLE, WA:
 1,727,199, CANC. MULTIPLE CLASS, INT. CLS. 9 AND 11.
- SAMHILL CORPORATION, NEW YORK, NY, DBA SAMHILL ENTERPRISES, INC.:
 1,727,315, CANC. INT. CL. 9.
- SAMICK MUSIC CORPORATION, CITY OF INDUSTRY, CA:
 2,765,898, INT. CL. 15.
- SAMSONITE CORPORATION, DENVER, CO:
 1,792,559, REN. 8-5-03. MULTIPLE CLASS, INT. CLS. 16 AND 18.
 2,072,349, CANC. INT. CL. 11.
- SAMSONITE CORPORATION, DENVER, CA:
 2,072,384, CANC. INT. CL. 11.
- SAMTACK COMPUTER INC., MARKHAM, ONTARIO, CANADA:
 2,763,085, PUB. 6-24-2003. INT. CL. 9.
- SAMUEL AARON, INC., LONG ISLAND CITY, NY, SERVICE MERCHANDISE COMPANY, INC., BRENTWOOD, TN:
 1,766,432, REN. 8-4-03. INT. CL. 42.
- SANDAR INDUSTRIES, INC., ATLANTIC BEACH, FL:
 2,764,310, PUB. 6-3-2003. INT. CL. 7.
- SANDERELLA'S TOYS, INC., BALTIMORE, MD:
 2,011,923, CANC. INT. CL. 28.
 2,011,924, CANC. INT. CL. 28.
- SANDVIK SPECIAL METALS CORPORATION, KENNEWICK, WA:
 2,012,136, CANC. MULTIPLE CLASS, INT. CLS. 12 AND 28.
- SANDY SPRING BANK, OLNEY, MD:
 2,763,373, PUB. 6-24-2003. INT. CL. 36.
 2,763,374, PUB. 6-24-2003. INT. CL. 36.
- SANGAMON COMPANY, THE, TAYLORVILLE, IL:
 2,011,474, CANC. MULTIPLE CLASS, INT. CLS. 9 AND 16.
- SANITARY BOARD OF THE WESTERN LAKE SUPERIOR SANITARY DISTRICT, DULUTH, MN:
 2,765,286, INT. CL. 1.
- SANNAEDLE INSU CO., LTD., SEOUL, REPUBLIC OF KOREA:
 2,764,678, INT. CL. 9.
- SANTA MONICA BAYKEEPER, MARINA DEL REY, CA:
 2,764,483, INT. CL. 42.
- SANTALUCIA ALIMENTOS LTDA., PORTO ALEGRE (RS), BRAZIL:
 2,764,922, INT. CL. 30.
- SARA LEE CORPORATION, WINSTON-SALEM, NC:
 2,012,449, CANC. INT. CL. 25.
- SARA LEE CORPORATION, WINSTON-SALEM, NC FROM SARAMAR, L.L.C., CHICAGO, IL:
 2,764,141, PUB. 6-24-2003. INT. CL. 25.
- SARA LEE GLOBAL FINANCE, L.L.C., WILMINGTON, DE:
 2,764,466, PUB. 6-24-2003. INT. CL. 25.
- SARAMAR CORPORATION, DOVER, DE:
 1,689,131, CANC. INT. CL. 25.
- SARAMAR, L.L.C.:
See— SARA LEE CORPORATION.
- SARSAPARILLA DECO DESIGNS LTD., INC., WEST NEW YORK, NJ TO APPLETREE ART PUBLISHERS, INC., W NEW YORK, NJ:
 1,727,680, CANC. INT. CL. 21.
- SASSOVER, NATHAN, LOS ANGELES, CA:
 2,764,079, PUB. 6-24-2003. INT. CL. 5.
 2,764,080, PUB. 6-24-2003. INT. CL. 5.
 2,764,081, PUB. 6-24-2003. INT. CL. 5.
 2,764,082, PUB. 6-24-2003. INT. CL. 5.
- SASTRE, ALEJANDRO, MIAMI, FL:
 2,011,444, CANC. INT. CL. 9.
- SATAKE USA, INC., HOUSTON, TX:
 2,765,897, INT. CL. 7.
- SATIN FINISH HARDWOOD FLOORING LIMITED, WESTON, ONTARIO M9N 1R8, CANADA:
 2,764,757, INT. CL. 2.
- SAUL ZAENTZ COMPANY, THE, BERKELEY, CA, DBA TOLKIEN ENTERPRISES:
 2,765,513, MULTIPLE CLASS, INT. CLS. 16, 25 AND 28.
- SAVAGE UNIVERSAL CORPORATION, NEW YORK, NY:
 1,213,939, CANC. INT. CL. 16.
- SAVIN CORPORATION, STAMFORD, CT:
 2,763,992, PUB. 6-24-2003. INT. CL. 35.
- SAVVIER, INC., TORRANCE, CA:
 2,763,632, PUB. 6-24-2003. INT. CL. 35.
- SAX, EDWARD, LOXAHATCHEE, FL:
 2,765,132, MULTIPLE CLASS, INT. CLS. 1, 19 AND 37.
- SAYTR, OMAHA, NE:
 2,764,372, PUB. 6-24-2003. INT. CL. 18.
- SAZERAC COMPANY, INC., NEW ORLEANS, LA:
 1,214,486, CANC. INT. CL. 9.
 2,765,276, INT. CL. 33.
- SB MANUFACTURING INC., WICHITA, KS:
 2,763,818, PUB. 6-24-2003. INT. CL. 7.
- SC LICENSING, SOUTH EASTON, MA:
 2,764,381, PUB. 6-24-2003. INT. CL. 26.
- SC LICENSING CORP, SOUTH EASTON, MA:
 2,764,382, PUB. 6-24-2003. INT. CL. 26.
 2,764,383, PUB. 6-24-2003. INT. CL. 26.
 2,764,384, PUB. 6-24-2003. INT. CL. 26.
 2,764,394, PUB. 6-24-2003. INT. CL. 26.
- SCA TECHNOLOGIES CORPORATION, DALLAS, TX TO SCA TECHNOLOGIES CORPORATION, DALLAS, TX:
 2,727,932, COR. INT. CL. 42.
- SCANCOM INTERNATIONAL A/S, 4220 KORSOR, DENMARK:
 2,763,561, PUB. 6-24-2003. MULTIPLE CLASS, INT. CLS. 17 AND 20.
- SCANLAN INTERNATIONAL, INC., SAINT PAUL, MN:
 1,823,664, REN. 8-6-03. INT. CL. 10.
- SCHER, ROBERT, RANCHO PALOS VERDES, CA:
 2,765,467, INT. CL. 20.
- SCHERING AKTIENGESELLSCHAFT, D-13342 BERLIN, FED REP GERMANY:
 2,011,531, CANC. INT. CL. 5.
- SCHERING CORPORATION, KENILWORTH, NJ:
 2,763,458, PUB. 7-9-2002. INT. CL. 44.
- SCHERING-PLOUGH HEALTHCARE PRODUCTS, INC., MEMPHIS, TN, SCHOLL, INC., MEMPHIS, TN:
 1,255,028, REN. 8-7-03. MULTIPLE CLASS, INT. CLS. 3, 5, 10 AND 25.
- SCHERING-PLOUGH HEALTHCARE PRODUCTS, INC., MEMPHIS, TN:
 1,802,534, REN. 8-7-03. INT. CL. 3.
- SCHIMELFENIG, JAY D., WAHPETON, ND:
 2,764,243, PUB. 6-24-2003. INT. CL. 40.
- SCHLUSSEL, JOSEPH, NEW YORK, NY:
 2,763,761, PUB. 6-24-2003. INT. CL. 16.
- SCHNEIDER ELECTRIC INDUSTRIES SA, 92500 RUEIL MALMAISON, FRANCE:
 2,763,162, PUB. 1-28-2003. INT. CL. 9.
- SCHNEIDER ELECTRIC INDUSTRIES SA, RUEIL MALMAISON, FRANCE:
 2,764,128, PUB. 1-28-2003. MULTIPLE CLASS, INT. CLS. 9 AND 16.
- SCHNEIDER, LONE, SAN FRANCISCO, CA AND SCHNEIDER, CHRISTIAN, SAN FRANCISCO, CA, DBA IDEA-GARDEN:
 2,764,880, INT. CL. 35.
- SCHOENEMAN ENTERPRISES, INC., NEW YORK, NY:
 1,543,597, CANC. INT. CL. 25.
- SCHOLASTIC INC., NEW YORK, NY:
 1,213,892, CANC. INT. CL. 16.
 2,012,161, CANC. MULTIPLE CLASS, INT. CLS. 9 AND 16.
- SCHOLASTIC, INC., NEW YORK, NY:
 1,213,884, CANC. MULTIPLE CLASS, INT. CLS. 16 AND 41.

- SCHOTT GLAS, D-55122 MAINZ, FED REP GERMANY:
1,727,148, CANC. INT. CL. 9.
- SCHOTTENSTEIN STORES CORPORATION, COLUMBUS, OH, DBA VALUE CITY FURNITURE:
2,765,466, MULTIPLE CLASS, INT. CLS. 11, 14, 20, 21 AND 24.
2,765,468, INT. CL. 20.
2,765,521, INT. CL. 35.
- SCHRODERS PUBLIC LIMITED COMPANY, LONDON EC2 V 6DS, ENGLAND:
1,728,109, CANC. INT. CL. 36.
- SCHUNK GMBH & CO. KG, D-74348 LAUFFEN/NECKAR, FED REP GERMANY:
2,764,799, INT. CL. 7.
- SCHWAN'S SALES ENTERPRISES, INC., MARSHALL, MN:
2,011,645, CANC. MULTIPLE CLASS, INT. CLS. 29 AND 30.
2,011,944, CANC. INT. CL. 30.
2,011,953, CANC. INT. CL. 30.
- SCIENTIFIC INSTRUMENT SERVICES, INC., RINGOES, NJ:
2,763,804, PUB. 6-24-2003. INT. CL. 9.
- SCORE INTERNATIONAL LIMITED, SLOUGH, ENGLAND:
739,899, CANC. U.S. CL. 13.
- SCOTIA HOLDINGS PLC, GUILDFORD, SURREY GU1 IBA, ENGLAND:
2,011,426, CANC. INT. CL. 5.
- SCOTT HAZELCORN MEMORIAL CHILDREN'S FOUNDATION, NEW YORK, NY:
2,763,891, PUB. 6-24-2003. MULTIPLE CLASS, INT. CLS. 36 AND 41.
- SCOTT, RAY, PINTLALA, AL:
2,765,395, INT. CL. 28.
2,765,396, INT. CL. 28.
- SCREEN IRRIX, NEW ROCHELLE, NY:
2,765,681, INT. CL. 25.
- SCREENING FOR MENTAL HEALTH, INC., WELLESLEY, MA:
2,763,901, PUB. 6-24-2003. INT. CL. 35.
- SCRIPTURA, INC., NEW ORLEANS, LA:
2,763,562, PUB. 6-24-2003. INT. CL. 16.
- SCT CORPORATION, BALTIMORE, MD, TA JEPPI NUT COMPANY:
1,727,893, CANC. INT. CL. 29.
- SCUDDER TRUST COMPANY, SALEM, NH:
2,765,710, INT. CL. 36.
- SEA-LAND SERVICE, INC., TOWNSHIP OF BERNARDS, NJ:
2,012,502, CANC. INT. CL. 42.
- SEALY TECHNOLOGY LLC, TRINITY, NC:
2,763,184, PUB. 6-24-2003. INT. CL. 20.
- SEARCH WEST, INC., LOS ANGELES, CA:
1,214,293, CANC. INT. CL. 35.
- SEARS, ROEBUCK AND CO., CHICAGO, IL:
1,727,067, CANC. INT. CL. 7.
- SEARS, ROEBUCK AND CO., HOFFMAN ESTATES, IL:
2,012,399, CANC. INT. CL. 25.
2,764,442, PUB. 6-24-2003. INT. CL. 35.
- SEB S.A., F-69134 ECULLY CEDEX, FRANCE FROM MOULINEX S.A., F-14123 CORMELLES LE ROYAL, FRANCE:
2,763,081, PUB. 6-24-2003. MULTIPLE CLASS, INT. CLS. 11 AND 21.
- SECOND HARVEST FOOD BANK OF MIDDLE TENNESSEE, INC., NASHVILLE, TN:
2,763,762, PUB. 6-24-2003. INT. CL. 35.
- SECOND NATIONAL BANK OF WARREN, WARREN, OH:
2,764,012, PUB. 6-24-2003. INT. CL. 36.
- SECURE SYSTEMS LIMITED, WESTERN PERTH, AUSTRALIA:
2,763,399, PUB. 6-24-2003. INT. CL. 9.
- SECURITIES DATA PUBLISHING INC., NEW YORK, NY:
2,012,929, CANC. INT. CL. 16.
2,012,930, CANC. INT. CL. 16.
- SEDGWICK, INC., NEW YORK, NY:
1,727,198, CANC. MULTIPLE CLASS, INT. CLS. 9 AND 36.
- SEDUS STOLL AG, WALDSHUT-TIENGEN, FED REP GERMANY:
2,764,168, PUB. 2-4-2003. INT. CL. 20.
- SEGA OF AMERICA DREAMCAST, INC., SAN FRANCISCO, CA TO SEGA OF AMERICA DREAMCAST, INC., SAN FRANCISCO, CA:
2,621,944, COR. INT. CL. 9.
- SEGALL, E.M., PEMBROKE PINES, FL:
2,763,958, PUB. 6-24-2003. INT. CL. 43.
- SEI CHEMICAL INC., LAS VEGAS, NV:
2,765,877, INT. CL. 2.
- SEIKO CORPORATION OF AMERICA, MAHWAH, NJ:
1,728,590, CANC. INT. CL. 14.
- SEIKO KAKOKI KABUSHIKI KAISHA, AMAGASAKI CITY, HYOGO PREFECTURE 661, JAPAN, DBA SEIKOW CHEMICAL ENGINEERING AND MACHINERY LIMITED:
1,242,580, REN. 8-2-03. INT. CL. 7.
- SEIP, TODD, CARSON CITY, NV AND WILLARD, TANYA, CARSON CITY, NV:
2,011,733, CANC. INT. CL. 25.
- SEJUS CORPORATION, LAKE OSWEGO, OR:
2,011,547, CANC. INT. CL. 9.
2,011,548, CANC. INT. CL. 9.
- SEL-LEB MARKETING, INC., PATERSON, NJ:
2,765,310, INT. CL. 3.
- SELMOSOFT INC., PACIFICA, CA:
2,765,306, INT. CL. 9.
- SELTEK, INC., DALLAS, TX:
2,012,187, CANC. INT. CL. 42.
- SELTZER, KAUFMANN & MCGRAW, INC., BLOOMFIELD HILLS, MI:
2,012,900, CANC. INT. CL. 35.
- SEMROCK, INC., ANNAPOLIS, MD:
2,764,824, INT. CL. 9.
- SENDTEC, INC., ST. PETERSBURG, FL:
2,764,362, PUB. 6-24-2003. MULTIPLE CLASS, INT. CLS. 35 AND 42.
- SENSATIONAL LEGGWEAR, INC., LEXINGTON, NC:
2,011,718, CANC. INT. CL. 25.
- SENSITECH, INC., BEVERLY, MA:
2,763,855, PUB. 6-24-2003. MULTIPLE CLASS, INT. CLS. 9 AND 42.
- SENSOR DYNAMICS, INC., FREMONT, CA:
2,012,505, CANC. MULTIPLE CLASS, INT. CLS. 9 AND 10.
- SENTRY HARDWARE CORPORATION, DES PLAINES, IL:
1,214,414, CANC. INT. CL. 42.
- SEQUENT, INC., COLUMBUS, OH FROM ALLIED EMPLOYER RESOURCES, INC., COLUMBUS, OH:
2,765,449, INT. CL. 35.
- SER SOLUTIONS, INC., DULLES, VA FROM PORTAL CONNECT, INC., HERNDON, VA:
2,764,874, INT. CL. 37.
- SERTA, INC., ITASCA, IL, SERTTA ASSOCIATES, INC., CHICAGO, IL:
581,897, REN. 8-7-03. U.S. CL. 32 (INT. CL. 20).
- SERTA, INC., ITASCA, IL, SERTA ASSOCIATES, INC., WILMINGTON, DE:
582,463, REN. 8-7-03. U.S. CL. 32 (INT. CL. 20).
- SERTA, INC., ITASCA, IL, SERTA ASSOCIATES, INC., CHICAGO, IL:
582,464, REN. 8-7-03. U.S. CL. 32 (INT. CL. 20).
- SERVICE AMERICA CORPORATION, STAMFORD, CT:
2,012,409, CANC. INT. CL. 42.
- SESAME WORKSHOP, NEW YORK, NY, MUPPETS, INC., NEW YORK, NY:
961,949, REN. 8-4-03. U.S. CL. 22 (INT. CL. 28).
961,950, REN. 8-4-03. U.S. CL. 22 (INT. CL. 28).
- SET PRODUCTS, INC., MACEDONIA, OH:
728,415, CANC. U.S. CL. 12.
- SETTON, FRANK, NEW YORK, NY:
2,011,606, CANC. INT. CL. 25.
- SEUNGSUN LIM, LLC, WILMINGTON, DE:
2,288,154, CANC. INT. CL. 25.
- SFCC, INC., OVERLAND PARK, KS:
2,763,115, PUB. 6-24-2003. MULTIPLE CLASS, INT. CLS. 35 AND 42.
- SHABBY CHIC, INC., LOS ANGELES, CA:
2,763,467, PUB. 6-24-2003. INT. CL. 24.
2,763,507, PUB. 6-24-2003. MULTIPLE CLASS, INT. CLS. 21 AND 24.

- SHAKLEE CORPORATION, SAN FRANCISCO, CA:
1,727,365, CANC. INT. CL. 11.
2,012,823, CANC. INT. CL. 5.
- SHAMBLÉN, JEANETTE, FISHERS, IN:
2,764,765, INT. CL. 36.
- SHAPIRO, LINDA S., LOS ANGELES, CA:
2,763,689, PUB. 6-24-2003. INT. CL. 14.
- SHARED BASE LIMITED, BELLSHILL, UNITED KINGDOM:
2,764,134, PUB. 6-24-2003. MULTIPLE CLASS, INT. CLS. 9, 38 AND 42.
- SHARP KABUSHIKI KAISHA A/T/A SHARP CORPORATION, OSAKA 545-8522, JAPAN:
2,765,106, INT. CL. 9.
- SHAW, STEPHAN, BALDWIN, NY:
2,764,177, PUB. 6-24-2003. INT. CL. 30.
- SHAYNA'S KITCHEN, INC., BEDMINSTER, NJ:
2,011,790, CANC. INT. CL. 30.
- SHEFRIN, DAVID K., WEST LINN, OR:
2,763,577, PUB. 6-24-2003. INT. CL. 5.
- SHELBY TISSUE, INC., MEMPHIS, TN:
1,813,694, CANC. INT. CL. 16.
- SHEPPARD MULLIN RICHTER & HAMPTON LLP, COSTA MESA, CA:
2,764,380, PUB. 6-24-2003. INT. CL. 42.
- SHERIDAN BROADCASTING CORPORATION, PITTSBURGH, PA:
2,763,576, PUB. 6-24-2003. INT. CL. 41.
- SHERIDAN RESEARCH COMPANY, WINNETKA, IL:
2,012,861, CANC. INT. CL. 35.
- SHERMAN; PATRICIA J., DBA SHERMAN GAMES:
1,214,147, CANC. INT. CL. 28.
- SHERMAN, TAMARA, ARLINGTON, VA, DBA LINGUISTRONICS:
1,213,950, CANC. MULTIPLE CLASS, INT. CLS. 16 AND 41.
- SHERRY, MARK, GRANADA HILLS, CA:
2,765,093, INT. CL. 9.
- SHERWIN-WILLIAMS COMPANY, THE, CLEVELAND, OH:
2,764,499, INT. CL. 2.
- SHERWOOD BRANDS, LLC, ROCKVILLE, MD:
2,764,939, INT. CL. 30.
2,765,756, INT. CL. 30.
2,765,757, INT. CL. 30.
- SHERWOOD PARTNERS, INC., LOS ANGELES, CA FROM ISCRIBE, INC., SAN MATEO, CA:
2,764,615, INT. CL. 42.
- SHERWOOD SERVICES AG, SCHAFFHAUSEN, SWITZERLAND:
2,763,674, PUB. 6-24-2003. INT. CL. 10.
- SHIBOU, EARL, WINNIPEG, MANITOBA, CANADA:
1,882,322, AM. INT. CL. 26.
- SHIFTING FREQUENCIES, L.L.C., DALLAS, TX:
2,763,885, PUB. 6-24-2003. INT. CL. 21.
- SHINKO CORPORATION, BUCHEON-CITY, KYUNGKIDO, REPUBLIC OF KOREA:
2,765,246, MULTIPLE CLASS, INT. CLS. 9 AND 15.
- SHIRE LABORATORIES, INC., ROCKVILLE, MD:
2,764,810, INT. CL. 1.
- SHISEIDO CO., LTD., TOKYO 104-10, JAPAN:
2,012,867, CANC. INT. CL. 3.
- SHISEIDO COMPANY, LTD., TOKYO 104-8010, JAPAN:
2,765,313, INT. CL. 3.
- SHOGAKUKAN PRODUCTION CO., LTD., TOKYO, 101-8415, JAPAN:
2,765,452, INT. CL. 28.
2,765,453, INT. CL. 28.
2,765,454, INT. CL. 28.
2,765,455, INT. CL. 28.
2,765,456, INT. CL. 28.
2,765,457, INT. CL. 28.
2,765,458, INT. CL. 28.
2,765,459, INT. CL. 28.
2,765,460, INT. CL. 28.
- SHOMI, INC., NEW YORK, NY:
2,011,558, CANC. INT. CL. 25.
- SHONAN HALLOWS K.K. (JAPAN), FUJISAWA, KANAGAWA, JAPAN:
2,765,006, MULTIPLE CLASS, INT. CLS. 3 AND 42.
- SHOPKO STORES, INC., GREEN BAY, WI:
2,011,403, CANC. INT. CL. 25.
- SHOTT, GEORGE C. JR., FT. HOOD, TX:
2,764,722, INT. CL. 42.
- SHUNFAR INTERNATIONAL, INC., ROWLAND HEIGHTS, CA:
2,763,662, PUB. 6-24-2003. INT. CL. 30.
- SHYANG INFORMATION CORPORATION, TAIPEI, TAIWAN:
2,011,674, CANC. INT. CL. 9.
- SIAM CEMENT PUBLIC CO., LTD. THE, BANGSUE, BANGKOK, THAILAND. SIAM CEMENT CO., LTD., THE, BANGSUE, BANGKOK 10800, THAILAND:
1,731,134, REN. 8-7-03. INT. CL. 19.
- SIC GMBH, D-41472 NEUSS, FED REP GERMANY:
2,763,177, PUB. 11-12-2002. MULTIPLE CLASS, INT. CLS. 9, 35, 38, 41 AND 42.
- SICHUAN CHANGHONG ELECTRONICS GROUP CORPORATION, MIANYANG, SICHUAN PROVINCE, CHINA:
2,763,691, PUB. 6-24-2003. INT. CL. 11.
- SICO COMPANY, THE, MOUNT JOY, PA:
2,765,620, INT. CL. 35.
- SIDERA, INC., SANTA CRUZ, CA:
2,765,533, INT. CL. 9.
- SIEGERS SEED COMPANY, HOLLAND, MI:
2,765,485, INT. CL. 31.
- SIEMENS AKTIENGESELLSCHAFT, MUNICH, FED REP GERMANY:
2,763,683, PUB. 6-24-2003. INT. CL. 10.
- SIEMENS AKTIENGESELLSCHAFT, MUNCHEN, FED REP GERMANY:
2,763,746, PUB. 6-24-2003. INT. CL. 9.
- SIEMER & HAND TRAVEL, INC., SAN FRANCISCO, CA:
2,764,302, PUB. 6-24-2003. INT. CL. 39.
- SIG TECHNOLOGY AG (SIG TECHNOLOGY LTD.), 8212 NEUHAUSEN AM RHEINFALL, SWITZERLAND:
2,763,702, PUB. 6-24-2003. MULTIPLE CLASS, INT. CLS. 7, 35 AND 42.
- SIGE SEMICONDUCTOR INC., OTTAWA, ONTARIO, CANADA:
2,765,042, INT. CL. 9.
- SIGNATURE FRUIT COMPANY LLC, MODESTO, CA:
2,764,469, PUB. 6-24-2003. INT. CL. 29.
- SIGNATURE RESEARCH, INC., CALUMET, MI:
2,763,832, PUB. 6-24-2003. INT. CL. 42.
- SIGNS & GLASSWORKS, INC., VISTA, CA:
2,012,459, CANC. INT. CL. 16.
- SILICON GRAPHICS, INC., MOUNTAIN VIEW, CA:
1,783,257, REN. 8-4-03. INT. CL. 9.
- SILICON LABORATORIES, INC., AUSTIN, TX:
2,765,247, INT. CL. 9.
- SILK, MARGO, MOORESTOWN, NJ AND GIORDANO, GLORIA, CHERRY HILL, NJ:
2,765,495, INT. CL. 6.
- SILKIES, INC., VISTA, CA:
2,763,525, PUB. 6-24-2003. INT. CL. 26.
- SILVA, ROBERT, BROOKLYN, NY:
2,765,104, INT. CL. 9.
- SILVER SADDLE RANCH & CLUB, INC., CALIFORNIA CITY, CA:
2,763,747, PUB. 6-24-2003. MULTIPLE CLASS, INT. CLS. 41 AND 44.
- SILVER SPRING GARDENS, INC., EAU CLAIRE, WI:
2,765,743, MULTIPLE CLASS, INT. CLS. 29 AND 30.
- SILVERMAN, MICHAEL D., CAMARILLO, CA, DBA HYDROPHONICS:
1,727,306, CANC. INT. CL. 9.
- SILVERSTEIN, ROBERT, HOLLYWOOD, FL AND SILVERSTEIN, GLORIA, HOLLYWOOD, FL:
2,012,842, CANC. INT. CL. 16.
- SILVERWINGS PRODUCTIONS, INCORPORATED, DES MOINES, IA:
2,764,255, PUB. 6-24-2003. INT. CL. 41.

- SIMEX, AUSSENHANDELSGESELLSCHAFT SAVELSBERG KG, D-52428 JULICH, FED REP GERMANY: 2,011,459, CANC. INT. CL. 33.
- SIMON & SCHUSTER, INC., NEW YORK, NY: 2,763,546, PUB. 6-24-2003. INT. CL. 9.
- SIMON, CELIA, CHARLESTON, SC, PARFUMS JAMAICA, LTD., KINGSTON 10, JAMAICA: 952,834, REN. 8-4-03. U.S. CL. 51 (INT. CL. 3).
- SIMON, CELIA, CHARLESTON, SC, PARFUMS JAMAICA LIMITED, KINGSTON 10, ST. ANDREW, JAMAICA: 962,203, REN. 8-4-03. U.S. CL. 51 (INT. CL. 3).
- SIMON, UDO, 90409 NURNBERG, FED REP GERMANY: 2,763,137, PUB. 6-24-2003. MULTIPLE CLASS, INT. CLS. 35, 38, 41 AND 42.
- SIMPLE TIMES, INC., AUSTIN, TX: 2,011,769, CANC. INT. CL. 30.
- SIMPLETECH, INC., SANTA ANA, CA FROM SIMPLE TECHNOLOGY, INC, SANTA ANA, CA: 2,764,843, INT. CL. 9.
- SIMPLEX STRIP DOORS, INC., UPLAND, CA: 1,727,408, CANC. INT. CL. 12.
- SIMPLICITY PATTERN CO. INC., NEW YORK, NY TO SIMPLICITY PATTERN CO. INC., NEW YORK, NY: 1,213,895, CANC. INT. CL. 16.
- SIMSURGERY AS, 0161 OSLO, NORWAY: 2,763,351, PUB. 6-24-2003. MULTIPLE CLASS, INT. CLS. 9, 10, 41 AND 42.
- SINCLAIR OIL CORPORATION, SALT LAKE CITY, UT: 2,764,247, PUB. 6-24-2003. INT. CL. 36.
- SINGAPORE EXCHANGE LIMITED, #19-00 SGX CENTRE 1, SINGAPORE: 2,764,975, INT. CL. 35.
2,765,019, INT. CL. 35.
2,765,020, INT. CL. 36.
- SINT, INC., WILMINGTON, DE: 2,765,034, INT. CL. 20.
- SINTERAMA S.P.A., 13876 SANDIGLIANO (BIELLA), ITALY: 2,763,251, PUB. 6-24-2003. MULTIPLE CLASS, INT. CLS. 23 AND 24.
- SIRIOS CAPITAL MANAGEMENT, L.P., BOSTON, MA: 2,764,552, INT. CL. 36.
- SIRIUS PUBLISHING, INC., SCOTTSDALE, AZ: 2,011,445, CANC. MULTIPLE CLASS, INT. CLS. 9 AND 28.
- SIROPERIE MEURENS, 4880 AUBEL, BELGIUM: 2,011,501, CANC. INT. CL. 29.
- SIT ON THIS, INC., ATLANTA, GA: 2,011,960, CANC. INT. CL. 20.
- SIX CONTINENTS HOTELS, INC., ATLANTA, GA FROM BASS HOTELS & RESORTS, INC., ATLANTA, GA: 2,764,550, INT. CL. 42.
- SIX FLAGS OVER GEORGIA, LTD., ATLANTA, GA TO SIX FLAGS CORPORATION, ARLINGTON, TX: 1,214,380, CANC. INT. CL. 41.
- SIX FLAGS THEME PARKS, INC., OKLAHOMA CITY, OK: 2,764,964, INT. CL. 41.
- SKATENATION PLUS, LLC, GLEN ALLEN, VA: 2,764,979, MULTIPLE CLASS, INT. CLS. 25 AND 41.
- SKF INDUSTRIES, INC., PHILADELPHIA, PA: 1,213,790, CANC. INT. CL. 6.
- SKIN AN APOTHECARY, INC., DAYTON, OH: 2,763,654, PUB. 6-24-2003. MULTIPLE CLASS, INT. CLS. 3 AND 35.
- SKOLNICK, PAUL, BELLEAIR BLUFFS, FL, DBA NUMBER CRUNCHERS: 2,011,415, CANC. INT. CL. 42.
- SKYBRATIONS, LLC, MERRIMACK, NH: 2,764,349, PUB. 6-24-2003. INT. CL. 39.
- SKYLIFT, INC., LORAIN, OH: 2,764,441, PUB. 6-24-2003. INT. CL. 7.
- SKYLIGHTS UNLIMITED, HUNTINGTON BEACH, CA: 2,763,807, PUB. 6-24-2003. INT. CL. 19.
- SKYTEL CORP., WASHINGTON, DC: 2,011,638, CANC. INT. CL. 9.
- SLATKIN, DANA LYNN, BEVERLY HILLS, CA TO BEVERLY HILLS FARMERS MARKET, INC., LOS ANGELES, CA: 1,949,484, CANC. INT. CL. 30.
- SLATKIN, DANA LYNN, LOS ANGELES, CA: 2,130,585, CANC. INT. CL. 29.
- SLAUGHTER WILLIAM R., FORSYTH, GA AND SLAUGHTER CONNIE D., FORSYTH, GA: 2,765,765, INT. CL. 41.
- SLEEPER CONCEPTS, INC., MONETT, MO: 2,765,570, INT. CL. 20.
- SLIWA; CURTIS, NEW YORK, NY: 1,214,049, CANC. MULTIPLE CLASS, INT. CLS. 25 AND 42.
- SMALL PAWS RESCUE, INC., TULSA, OK: 2,763,479, PUB. 6-24-2003. INT. CL. 39.
- SMALL WORLD NETWORKS, INC., BOZEMAN, MT FROM BAYLESS & ASSOCIATES, INC., BOZEMAN, MT: 2,765,654, INT. CL. 42.
- SMART PRODUCTS, INC., TEMPE, AZ: 2,765,055, INT. CL. 9.
- SMEAD MANUFACTURING COMPANY, HASTINGS, MN: 2,764,822, INT. CL. 9.
- SMITH & NEPHEW, INC., MEMPHIS, TN: 1,727,325, CANC. INT. CL. 10.
- SMITH, EASTERN A., ATLANTA, GA FROM SMITH, EASTERN A., ATLANTA, GA: 2,764,173, PUB. 6-24-2003. INT. CL. 16.
- SMITH, EASTERN A.:
See—SMITH, EASTERN A.
- SMITH, JOSEPH, BOCA RATON, FL: 2,763,478, PUB. 6-24-2003. INT. CL. 5.
- SMITHKLINE BEECHAM BIOLOGICALS MANUFACTURING S.A., RIXENSART, BELGIUM: 2,764,110, PUB. 6-24-2003. INT. CL. 5.
- SMITHKLINE BEECHAM CORPORATION, PHILADELPHIA, PA: 2,764,616, MULTIPLE CLASS, INT. CLS. 3, 5 AND 21.
- SMITHSONIAN INSTITUTION, WASHINGTON, DC: 1,728,255, CANC. INT. CL. 41.
- SMOKE ON THE WATER CHILI COOK OFF, CHARLESTON, WV: 2,763,592, PUB. 6-24-2003. INT. CL. 41.
- SMS ENTERPRISES, INC., WILMINGTON, DE, DELTA COMPUTER SYSTEMS, INC., ALTOONA, PA: 1,777,049, REN. 8-6-03. INT. CL. 9.
- SNIDERMAN, ANDREA, CALABASAS, CA: 2,764,993, MULTIPLE CLASS, INT. CLS. 16 AND 20.
- SNK CORPORATION OF AMERICA, TORRANCE, CA: 2,011,761, CANC. INT. CL. 28.
- SNOWSHORE NETWORKS, INC., CHELMSFORD, MA: 2,765,000, INT. CL. 9.
- SOCIETA PER AZIONI LUCCHESI OLII E VINI, 55100 LUCCA, ITALY: 2,763,737, PUB. 6-24-2003. INT. CL. 29.
- SOCIETE CIVILE DE CHATEAU LAFITE-ROTHSCHILD, PARIS, FRANCE: 1,214,263, CANC. INT. CL. 33.
- SOCIETE DE TRANSFORMATION DES ELASTOMERES A USAGES MEDICAUX ET INDUSTRIELS, 93120 LA COURNEUVE, FRANCE: 2,764,116, PUB. 4-30-2002. MULTIPLE CLASS, INT. CLS. 10 AND 17.
- SOCIETE DELPHES INC., MONTREAL, QUEBEC H2Y 2G1, CANADA: 2,763,106, PUB. 6-24-2003. INT. CL. 42.
- SOCIETE DES PRODUITS NESTLE S.A., 1800 VEVEY, SWITZERLAND: 2,011,439, CANC. INT. CL. 18.
2,011,739, CANC. INT. CL. 30.
2,012,562, CANC. INT. CL. 32.
- SOCIETE GENERALE, 75009 PARIS, FRANCE: 1,727,466, CANC. MULTIPLE CLASS, INT. CLS. 16, 35 AND 36.
- SOCIETY FOR INDUSTRIAL AND APPLIED MATHEMATICS, PHILADELPHIA, PA: 1,590,289, REN. 8-6-03. INT. CL. 42.

- SOCIETY OF AUTOMOTIVE ENGINEERS, INC., WARREN-DALE, PA:
1,214,444, CANC. INT. CL. 42.
- SOCIETY OF PHOTO-OPTICAL INSTRUMENTATION ENGINEERS, BELLINGHAM, WA:
1,770,889, REN. 2-4-2003. INT. CL. 42.
- SOFTBANK AMERICA INC., SANTA MONICA, CA:
2,011,516, CANC. MULTIPLE CLASS, INT. CLS. 35 AND 41.
- SOFTOOL CORPORATION, GOLETA, CA:
2,012,460, CANC. INT. CL. 9.
- SOFTPROS CONSULTING, INC., OCEANPORT, NJ:
2,765,614, INT. CL. 42.
- SOFTPROTEC CO., GWANGJU, REPUBLIC OF KOREA:
2,763,196, PUB. 6-24-2003. INT. CL. 9.
- SOFTSPIKES, INC., ROCKVILLE, MD:
2,763,063, PUB. 6-24-2003. INT. CL. 28.
- SOFTWARE SHELF INTERNATIONAL, INC., SAN CARLOS, CA:
2,134,489, CANC. INT. CL. 9.
- SOGEPOR INTERNATIONAL B.V., 1276 HD HUISEN, NETHERLANDS:
1,213,869, CANC. MULTIPLE CLASS, INT. CLS. 14, 18, 25 AND 42.
- SOHN MANUFACTURING, INC., ELKHART LAKE, WI, DBA SOHN MFG., INC.:
2,011,503, CANC. INT. CL. 7.
- SOLAR RETREAT, HOUSTON, TX:
2,765,597, INT. CL. 42.
- SOLARTECH INC, HARRISON TOWNSHIP, MI:
2,764,366, PUB. 6-24-2003. INT. CL. 9.
- SOLMET TECHNOLOGIES, INC., CANTON, OH:
1,800,285, REN. 8-7-03. INT. CL. 42.
- SOLOHILL ENGINEERING, INC., ANN ARBOR, MI:
2,764,093, PUB. 6-24-2003. INT. CL. 1.
- SOLOMON, DANE, SANTA MONICA, CA AND TURPIN, TOM, SANTA MONICA, CA:
2,765,699, INT. CL. 37.
- SOLUTIA INC., ST. LOUIS, MO:
2,765,413, INT. CL. 17.
- SOLUTIONS PHARMACY, INC., TOA BAJA, PUERTO RICO:
2,763,152, PUB. 6-24-2003. MULTIPLE CLASS, INT. CLS. 35 AND 39.
- SOLVAY PHARMACEUTICALS B.V., WEESP, NETHERLANDS:
2,763,912, PUB. 6-24-2003. INT. CL. 5.
2,763,913, PUB. 6-24-2003. INT. CL. 5.
2,763,915, PUB. 6-24-2003. INT. CL. 5.
2,763,916, PUB. 6-24-2003. INT. CL. 5.
- SOMA NETWORKS, INC., TORONTO, ONTARIO M5V 1R2, CANADA:
2,763,201, PUB. 6-24-2003. INT. CL. 37.
- SOMA NETWORKS, INC., SAN FRANCISCO, CA:
2,763,202, PUB. 6-24-2003. INT. CL. 42.
2,763,203, PUB. 6-24-2003. INT. CL. 9.
- SONGSEARCH, LLC, REDLANDS, CA:
2,763,288, PUB. 6-24-2003. INT. CL. 41.
- SONS OF CONFEDERATE VETERANS, INC., COLUMBIA, TN:
2,764,268, PUB. 6-24-2003. INT. CL. 35.
- SONY CORPORATION, SHINAGWA-KU, TOKYO, JAPAN:
2,012,195, CANC. INT. CL. 37.
- SONY ELECTRONICS INC., PARK RIDGE, NJ:
2,763,618, PUB. 6-24-2003. INT. CL. 9.
- SONY INTERACTIVE ENTERTAINMENT, INC., NEW YORK, NY:
2,012,799, CANC. INT. CL. 28.
- SOONER PIPE & SUPPLY CORPORATION, TULSA, OK:
1,239,159, REN. 8-6-03. MULTIPLE CLASS, INT. CLS. 6, 7 AND 8.
- SOPREMA, 67100 STRASBOURG, FRANCE:
1,213,972, CANC. INT. CL. 19.
- SORTOR, PAULINE H., SAN FRANCISCO, CA AND SORTOR, WILLIAM H., SAN FRANCISCO, CA:
2,011,421, CANC. INT. CL. 30.
- SOS COMPUTER SYSTEMS, INC., OREM, UT:
2,764,850, INT. CL. 9.
- SOS CUETARA, S.A., MADRID, SPAIN FROM CUETARA, S.A., 28599 VILLAREJO DE SALVANES (MADRID), SPAIN:
2,764,695, INT. CL. 30.
- SOTERA'S, INC., LAS VEGAS, NV:
2,763,946, PUB. 6-24-2003. INT. CL. 43.
- SOUPER SALAD, INC., SAN ANTONIO, TX, SOUPER SALAD FRANCHISES, INC., HOUSTON, TX:
1,247,369, REN. 8-4-03. INT. CL. 42.
- SOURCECHECK, LLC., HENDERSON, NV:
2,764,159, PUB. 6-24-2003. MULTIPLE CLASS, INT. CLS. 35, 42 AND 45.
- SOUTH FLORIDA BAKERY, INC., MIAMI, FL:
2,763,679, PUB. 6-24-2003. INT. CL. 30.
- SOUTHCORP WINES PTY LIMITED, ARTARMON, NSW, AUSTRALIA:
2,764,322, PUB. 6-24-2003. INT. CL. 33.
- SOUTHEAST STORAGE & DEVELOPMENT COMPANY, LLC, BLUFFTON, SC:
2,764,042, PUB. 6-24-2003. INT. CL. 39.
- SOUTHERN COMFORT PROPERTIES, INC., SAN RAFAEL, CA:
2,764,961, INT. CL. 11.
- SOUTHWEST MANUFACTURERS & DISTRIBUTORS, INC., FORT WORTH, TX, DBA SOUTHWEST MANUFACTURERS, INC.:
2,012,419, CANC. INT. CL. 9.
- SOUTHWEST RESEARCH INSTITUTE, SAN ANTONIO, TX:
2,763,197, PUB. 3-11-2003. INT. CL. 25.
- SP MINISTRIES, GLEN ELLYN, IL:
2,765,216, INT. CL. 41.
- SPA DE SOLEIL, INC., SUN VALLEY, CA:
2,765,512, INT. CL. 5.
- SPACE COAST CREDIT UNION, MELBOURNE, FL:
2,011,732, CANC. INT. CL. 36.
- SPACE NEEDLE CORPORATION, SEATTLE, WA:
2,764,031, PUB. 6-24-2003. INT. CL. 21.
- SPALDING & EVENFLO COMPANIES, INC., TAMPA, FL:
1,214,167, CANC. INT. CL. 28.
- SPALDING EDUCATION FOUNDATION, GLENDALE, AZ:
1,728,263, CANC. INT. CL. 41.
- SPAN-AMERICA MEDICAL SYSTEMS, INC., GREENVILLE, SC:
2,012,507, CANC. INT. CL. 10.
- SPANISH BROADCASTING SYSTEM, INC., COCONUT GROVE, FL:
2,763,720, PUB. 6-24-2003. INT. CL. 41.
- SPARTAN CHEMICAL COMPANY, INC., MAUMEE, OH:
1,237,899, REN. 8-6-03. INT. CL. 2.
- SPEAKEASY FILMS, INC., MILWAUKEE, WI:
2,764,118, PUB. 6-24-2003. INT. CL. 41.
- SPECIALTY LIGHTING, INC., SHELBY, NC:
1,728,560, CANC. INT. CL. 11.
- SPECIALTY LOOSE LEAF, INC., HOLYOKE, MA:
2,064,917, CANC. INT. CL. 9.
- SPECIALTY TAPES DIVISION OF RSW INC., FRANKSVILLE, WI:
1,736,563, REN. 8-6-03. INT. CL. 17.
- SPECK INDUSTRIAL CONTROLS, INC., MOORESTOWN, NJ:
2,763,368, PUB. 6-24-2003. MULTIPLE CLASS, INT. CLS. 35 AND 37.
- SPECTRAL WEB, INC., HOWARD BEACH, NY:
2,764,326, PUB. 6-24-2003. INT. CL. 35.
- SPECTRUM MANAGEMENT, L.L.C., CARROLLTON, TX:
2,765,193, INT. CL. 37.
2,765,194, INT. CL. 35.
2,765,195, INT. CL. 42.
- SPEECHWORKS INTERNATIONAL, INC., BOSTON, MA:
2,765,086, INT. CL. 9.
- SPES EDITORIAL, S.L., BARCELONA, SPAIN FROM BIBLOGRAF, S.A., 08015 BARCELONA, SPAIN:
2,764,478, INT. CL. 9.
- SPICE ENTERTAINMENT, INC., CHICAGO, IL:
2,764,840, MULTIPLE CLASS, INT. CLS. 5 AND 10.
2,764,841, INT. CL. 10.

- SPIELO MANUFACTURING INCORPORATED, MONCTON, NEW BRUNSWICK, CANADA:
2,012,153, CANC. INT. CL. 28.
2,765,775, INT. CL. 9.
- SPIN MASTER LTD., TORONTO ONTARIO, CANADA FROM SPIN MASTER TOYS, LTD., TORONTO, M5A 192, ONTARIO:
2,764,787, INT. CL. 28.
- SPORTCRAFT, LTD., BERGENFIELD, NJ:
1,727,811, CANC. INT. CL. 28.
- SPORTS AUTHORITY MICHIGAN, INC., THE, FORT LAUDERDALE, FL:
2,764,801, MULTIPLE CLASS, INT. CLS. 25, 41 AND 42.
2,764,802, MULTIPLE CLASS, INT. CLS. 25, 41 AND 42.
2,765,240, INT. CL. 24.
- SPORTS CAR CLUB OF AMERICA, INC., ENGLEWOOD, CO, AKA SCCA:
1,728,266, CANC. INT. CL. 41.
- SPOT INTERNATIONAL, INC., SANTA ANA, CA:
2,764,855, INT. CL. 25.
- SPOT WALL, INC., ENCINO, CA:
2,764,844, MULTIPLE CLASS, INT. CLS. 19 AND 37.
- SPRATLEY, DWIGHT C., SUFFOLK, VA:
2,764,879, INT. CL. 42.
- SPRINGS LICENSING GROUP, INC., FORT MILL, SC, SPRINGS INDUSTRIES, INC., FORT MILL, SC:
1,741,379, REN. 8-6-03, INT. CL. 24.
- SPRINT COMMUNICATIONS COMPANY L.P., KANSAS CITY, MO:
2,012,037, CANC. INT. CL. 38.
- SPRINT PUBLISHING & ADVERTISING, INC., OVERLAND PARK, KS:
2,763,715, PUB. 6-24-2003, INT. CL. 16.
- SPS TECHNOLOGIES, INC., JENKINTOWN, PA:
2,765,234, INT. CL. 6.
- SPSS, INC., CHICAGO, IL:
2,012,461, CANC. INT. CL. 9.
- SQUARE CO., LTD., TOKYO, JAPAN:
2,011,395, CANC. INT. CL. 9.
- SSM HEALTH CARE CORPORATION, ST. LOUIS, MO:
2,052,590, AM. MULTIPLE CLASS, INT. CLS. 35, 37, 38, 41 AND 42.
- ST. CLAIRE, LISETTE, M., HOLLYWOOD, CA:
2,765,595, INT. CL. 31.
- ST. JOHN KNITS, INC., IRVINE, CA:
2,764,341, PUB. 6-24-2003, INT. CL. 35.
- ST. JON LABORATORIES, INC., HARBOR CITY, CA TO VIRBAC CORPORATION, FORT WORTH, TX:
2,079,502, CANC. INT. CL. 21.
- ST. JUDE MEDICAL, INC., ST. PAUL, MN:
2,765,605, MULTIPLE CLASS, INT. CLS. 41 AND 42.
- STA-RITE INDUSTRIES, INC., MILWAUKEE, WI, SIMER PUMP COMPANY, MINNEAPOLIS, MN:
958,956, REN. 8-7-03, U.S. CL. 23 (INT. CL. 7).
- STAB S.R.L., 44031 AMBROGIO, FERRARA, ITALY:
2,763,307, PUB. 6-24-2003, INT. CL. 7.
2,763,308, PUB. 6-24-2003, INT. CL. 9.
- STAC ELECTRONICS, SAN DIEGO, CA:
2,012,849, CANC. INT. CL. 9.
- STADLER CORPORATION, BEDFORD, MA:
1,727,371, CANC. MULTIPLE CLASS, INT. CLS. 11 AND 17.
- STAFFMD, INC., HOMOSASSA, FL:
2,763,823, PUB. 6-24-2003, INT. CL. 35.
- STAFFORD INSURANCE COMPANY, BOSTON, MA:
2,765,331, INT. CL. 36.
- STAMM, JILL, PHOENIX, AZ FROM STAMM, JILL, PHOENIX, AZ:
2,765,041, INT. CL. 16.
- STANER ELETRONICA LTDA., SN-KM 68 PRESIDENTE PRUDENTE - SP, BRAZIL:
2,764,923, INT. CL. 9.
- STANLEY G. ALEXANDER, INC., TUSTIN, CA, DBA ALEXANDER'S MOVING AND STORAGE, INC.:
2,764,304, PUB. 6-24-2003, MULTIPLE CLASS, INT. CLS. 16, 35, 36 AND 39.
- STANLEY WORKS, THE, NEW BRITAIN, CT:
1,213,811, CANC. MULTIPLE CLASS, INT. CLS. 8 AND 21.
- STARKEY LABORATORIES, INC., EDEN PRAIRIE, MN:
2,763,921, PUB. 6-24-2003, INT. CL. 10.
2,765,690, INT. CL. 10.
- START RECORDS, INC., GRANADA HILLS, CA:
2,011,824, CANC. INT. CL. 9.
- STARZ CLUB LTD., OAK BROOK, IL TO ELLIOTTS' OFF BROADWAY DELI, INC., OAK BROOK, IL:
2,704,485 NEW CERT. 9-16-2003, INT. CL. 30.
- STARZ ENCORE GROUP LLC, ENGLEWOOD, CO:
2,763,422, PUB. 6-24-2003, INT. CL. 41.
- STATE BAR OF WISCONSIN, MADISON, WI:
2,764,231, PUB. 6-24-2003, MULTIPLE CLASS, INT. CLS. 35 AND 41.
- STATE EMPLOYEES FEDERAL CREDIT UNION, ALBANY, NY:
2,764,769, INT. CL. 36.
- STEADHAM, CHARLES V., JR., GAINESVILLE, FL, DBA BLADE AGENCY:
1,770,386, REN. 8-6-03, INT. CL. 35.
- STEAK AROUND, INC., ALEXANDRIA, VA:
2,011,610, CANC. INT. CL. 42.
- STEARNS PACKAGING CORPORATION, MADISON, WI:
2,763,204, PUB. 6-24-2003, INT. CL. 3.
- STEBBEN, GREGG, MONTEREY, CA:
2,763,734, PUB. 6-24-2003, INT. CL. 41.
- STEELE AND ASSOCIATES, INC., KINGSTON, WA, DBA STEELE INC.:
1,726,825, CANC. INT. CL. 1.
- STEIN, ALEX, HUDSON, OH:
2,765,639, INT. CL. 25.
- STELLA NOVA, CHARLESTON, SC:
1,781,004, REN. 8-7-03, MULTIPLE CLASS, INT. CLS. 3 AND 42.
- STEPA A/S, 8900 RANDERS, DENMARK:
2,765,161, INT. CL. 21.
- STEPHANOU, DIMITRI J., HAVRE DE GRACE, MD:
2,012,223, CANC. INT. CL. 30.
- STEPHENWOLF THEATRE COMPANY, THE, CHICAGO, IL:
2,764,686, INT. CL. 41.
- STERLING AUTOMATION, INC., MAPLE PLAIN, MN:
2,763,118, PUB. 6-24-2003, INT. CL. 40.
- STERLING PRODUCTS, INC., WOOD DALE, IL:
2,765,043, MULTIPLE CLASS, INT. CLS. 35, 37, 40 AND 42.
2,765,367, INT. CL. 7.
- STEVE JACKSON GAMES INCORPORATED, AUSTIN, TX:
2,011,305, CANC. INT. CL. 38.
- STEVE WOODS ENTERPRISES, INC., DALLAS, TX, DBA ACCESS TECHNOLOGY SYSTEMS:
2,012,921, CANC. INT. CL. 9.
- STEVENS, THOMAS HAROLD, MARBLE, NC, DBA T. H. STEVENS ASSOCIATES:
2,764,399, PUB. 6-24-2003, INT. CL. 35.
- STEVENSON, PAUL E., JR., WOODLAND HILLS, CA:
2,012,033, CANC. INT. CL. 25.
- STEWART-WARNER ALEMITE LICENSCO, INC., WILMINGTON, DE:
2,765,952, INT. CL. 8.
- STF TECHNOLOGIES, INC., CONCORDIA, MO:
2,012,898, CANC. INT. CL. 9.
- STIFTUNG CAESAR, 53111 BONN, FED REP GERMANY:
2,763,397, PUB. 6-24-2003, MULTIPLE CLASS, INT. CLS. 9, 16 AND 42.
- STITS AIRCRAFT, RIVERSIDE, CA, AKA STITS POLY-FIBER AIRCRAFT COATINGS:
1,213,729, CANC. INT. CL. 2.
- STOCK OPTION ANALYZER.COM, INC., MABLETON, GA:
2,765,841, INT. CL. 9.
- STOKELY USA, INC., OCONOMOWOC, WI:
1,214,226, CANC. INT. CL. 29.
- STONE INTERNATIONAL, LLC, TAYLORS, SC FROM UMBRO INTERNATIONAL, INC., GREENVILLE, SC:
2,763,038, PUB. 6-24-2003, INT. CL. 25.
- STONE WELL BODIES & EQUIPMENT, INC., GENOA, NY:
2,764,825, INT. CL. 12.

- STONIER TRANSPORTATION GROUP, INC., JACKSONVILLE, FL:
2,764,066, PUB. 6-24-2003. INT. CL. 39.
- STOP & SHOP SUPERMARKET COMPANY, THE, BOSTON, MA:
2,011,661, CANC. INT. CL. 9.
- STRATAGENE, LA JOLLA, CA:
1,777,563, REN. 8-5-03. INT. CL. 1.
- STRATEGIC COMMUNICATIONS GROUP, INC., SILVER SPRING, MD:
2,764,374, PUB. 6-24-2003. INT. CL. 35.
- STRATOS INDUSTRIES, INC., SHINGLE SPRINGS, CA:
2,012,844, CANC. INT. CL. 9.
- STREAMLINE INDUSTRIES, INC., GARDEN CITY, NY:
2,012,581, CANC. INT. CL. 26.
- STREEM COMMUNICATIONS, LLC, LOVES PARK, IL:
2,763,886, PUB. 6-24-2003. INT. CL. 38.
2,763,887, PUB. 6-24-2003. INT. CL. 38.
2,763,889, PUB. 6-24-2003. INT. CL. 38.
- STROKES' FRANCHISING INC., REDWOOD CITY, CA:
2,012,109, CANC. MULTIPLE CLASS, INT. CLS. 28 AND 42.
- STROMBECKER CORPORATION, CHICAGO, IL:
947,852, REN. 8-6-03. U.S. CL. 22 (INT. CL. 28).
- STRONG INDUSTRIES INC., NORTHUMBERLAND, PA:
2,763,981, PUB. 6-24-2003. INT. CL. 11.
- STRONG, MARY ELLEN, ATLANTA, GA:
2,011,476, CANC. INT. CL. 30.
- STROUDS ACQUISITION CORPORATION, CITY OF INDUSTRY, CA:
2,763,710, PUB. 6-24-2003. INT. CL. 35.
- STRYKER CORPORATION, KALAMAZOO, MI:
2,765,393, INT. CL. 10.
- STUDIOCANAL IMAGE S.A., BOULOGNE-BILLANCOURT, FRANCE FROM CANAL+ D.A., 92100 BOULOGNE BILLANCOURT, FRANCE:
2,765,044, INT. CL. 16.
- STUFFY BEAR FACTORY, LAS VEGAS, NV:
2,763,584, PUB. 6-24-2003. MULTIPLE CLASS, INT. CLS. 28 AND 35.
- SUAREZ CORPORATION INDUSTRIES, N. CANTON, OH:
2,012,310, CANC. INT. CL. 38.
- SUCCESS STRATEGIES, INC., NAPA, CA:
1,728,270, CANC. INT. CL. 41.
- SUE J. INC., SAN FRANCISCO, CA, DBA JOAN WALTERS:
1,727,796, CANC. INT. CL. 25.
- SUITESPEED, INC., LOUISVILLE, CO:
2,764,315, PUB. 6-24-2003. INT. CL. 42.
- SUIZA DAIRY GROUP, L.P.:
See— DEAN INTELLECTUAL PROPERTY SERVICES, L.P..
- SULZER METCO (US) INC., WESTBURY, NY:
2,765,164, INT. CL. 11.
2,765,165, INT. CL. 11.
- SUMMERHAWK, KENDALL, TUCSON, AZ:
2,764,265, PUB. 6-24-2003. INT. CL. 41.
- SUMMIT INDUSTRIES, INC., MARIETTA, GA:
2,012,657, CANC. INT. CL. 5.
- SUN CHEMICAL CORPORATION, FORT LEE, NJ:
959,183, REN. 8-6-03. U.S. CL. 11 (INT. CL. 2).
2,763,957, PUB. 6-24-2003. INT. CL. 42.
- SUN GARDEN PACKING COMPANY, INC., SAN JOSE, CA:
2,011,827, CANC. INT. CL. 29.
- SUN ORCHARD FRUIT COMPANY, INC., BURT, NY, DBA SUN ORCHARD BRAND:
2,764,185, PUB. 6-24-2003. INT. CL. 29.
- SUN PACIFIC SHIPPERS, INC., EXETER, CA, EXETER ORCHARDS ASSOCIATION, EXETER, CA:
574,495, REN. 8-2-03. U.S. CL. 46 (INT. CL. 31).
- SUN PHARMACEUTICALS CORP., WESTPORT, CT:
2,093,688, CANC. INT. CL. 3.
- SUN TELEVISION & APPLIANCES, INC., COLUMBUS, OH:
2,012,473, CANC. INT. CL. 9.
- SUN VALLEY WATERBEDS, INC., PHOENIX, AZ:
1,213,989, CANC. INT. CL. 20.
- SUNBEAM PLASTICS CORPORATION, EVANSVILLE, IN:
1,214,001, CANC. INT. CL. 20.
- SUNDAY RIVER SKIWAY CORPORATION, BETHEL, ME:
2,763,724, PUB. 6-24-2003. MULTIPLE CLASS, INT. CLS. 41 AND 43.
- SUNLINE EXPRESS SYSTEMS, INC., BROOKLYN, NY:
1,773,840, REN. 8-6-03. INT. CL. 39.
- SUNMARK OF NEW MEXICO, INC., ALBUQUERQUE, NM:
2,011,446, CANC. INT. CL. 42.
- SUNPETALS, INCORPORATED, MIAMI, FL:
1,727,960, CANC. INT. CL. 31.
- SUNSET GOLF, INC., LOUDONVILLE, OH:
2,764,003, PUB. 6-24-2003. INT. CL. 28.
- SUNSET HEALTH PRODUCTS, INC., LOS ANGELES, CA:
2,765,184, INT. CL. 5.
- SUNWEST SCREEN GRAPHICS LTD., WINNIPEG, MANITOBA, CANADA:
2,763,782, PUB. 6-24-2003. MULTIPLE CLASS, INT. CLS. 16 AND 40.
- SUPER SOLUTIONS CORPORATION, EDEN PRAIRIE, MN, AKA SSC:
1,728,427, CANC. INT. CL. 42.
- SUPERIOR GRAPHITE COMPANY, CHICAGO, IL:
2,763,174, PUB. 6-11-2002. MULTIPLE CLASS, INT. CLS. 1 AND 4.
- SUPERIOR MANUFACTURING GROUP, INC., CHICAGO, IL:
2,765,147, INT. CL. 27.
2,765,461, INT. CL. 27.
- SUPERIOR PRODUCTS CO., INC., SOUTH ROXANA, IL:
2,764,395, PUB. 6-24-2003. INT. CL. 3.
- SUPERIOR PRODUCTS, INC., ELKRIDGE, MD:
2,764,321, PUB. 6-24-2003. INT. CL. 19.
- SUPERIOR SURGICAL MFG. CO., INC., SEMINOLE, FL:
1,727,778, CANC. INT. CL. 25.
- SUPERSTATION, INC., ATLANTA, GA:
2,765,264, INT. CL. 41.
- SUPINO, WENDY, LAKE FOREST, FL:
2,764,519, MULTIPLE CLASS, INT. CLS. 18 AND 21.
- SUPPLYMAN, INC., LOS ANGELES, CA:
2,763,797, PUB. 6-24-2003. INT. CL. 35.
- SUPREME OIL COMPANY, ENGLEWOOD, NJ:
2,763,061, PUB. 6-8-1999. MULTIPLE CLASS, INT. CLS. 29, 30 AND 33.
- SUTTON HAY DAY, INC., BETHESDA, MD, HAY DAY, INC., WESTPORT, CT:
1,248,739, REN. 8-6-03. INT. CL. 42.
1,261,271, REN. 8-6-03. INT. CL. 42.
- SVENGALI MERCHANDISING INCORPORATED, ALLSTON, MA:
2,012,019, CANC. INT. CL. 20.
- SWAIM, TERRY B., RALEIGH, NC:
1,727,610, CANC. INT. CL. 18.
- SWANSON, MICKEY, HOUSTON, MS:
2,765,771, INT. CL. 9.
- SWEAZY, JILL A., ORANGEBURG, SC:
2,765,023, INT. CL. 5.
- SWEDISH MEATS, EK. FOR, JOHANNESHOV, SWEDEN:
2,763,157, PUB. 6-24-2003. INT. CL. 29.
- SWEET FANCY MOSES, INC., MORRO BAY, CA:
2,764,015, PUB. 6-24-2003. INT. CL. 41.
- SWEET LADY JANE, INC., LOS ANGELES, CA:
2,765,505, INT. CL. 30.
- SWETT & CRAWFORD, CHICAGO, IL:
1,728,079, CANC. INT. CL. 36.
- SWIFT BRANDS COMPANY, GREELEY, CO:
2,763,893, PUB. 6-24-2003. INT. CL. 29.
- SWISS CHALET FINE FOODS, INC., MIAMI, FL:
2,765,624, INT. CL. 35.
- SWIZA S.A., DELEMONT, SWITZERLAND, MATTHEW NORMAN SA, COURROUX, SWITZERLAND:
1,237,218, REN. 8-6-03. INT. CL. 14.
- SWIZZELS, INC., HOBOKEN, NJ:
1,214,241, CANC. INT. CL. 30.
- SX BUROWAREN PRODUKTIONS UND HANDELS GMBH, A-1231 VIENNA, AUSTRIA:
2,763,601, PUB. 6-24-2003. MULTIPLE CLASS, INT. CLS. 6, 7 AND 16.
2,763,602, PUB. 6-24-2003. MULTIPLE CLASS, INT. CLS. 6, 7 AND 16.

- SYMMETRY CONSULTING, INC., DOWNINGTOWN, PA:
2,764,246, PUB. 6-24-2003. INT. CL. 35.
- SYNAPSE, INC., HUNTSVILLE, AL FROM INTEGRATED TECHNOLOGIES SYSTEMS, INC., HUNTSVILLE, AL:
2,764,931, INT. CL. 9.
- SYNERGY SYSTEMS, LLC, SAN DIEGO, CA:
2,763,284, PUB. 10-9-2001. INT. CL. 9.
- SYNTHECOMM, INC., LILBURN, GA:
2,011,939, CANC. INT. CL. 9.
- SYNTRONIC INSTRUMENTS, INC., ADDISON, IL:
2,012,434, CANC. INT. CL. 8.
- SYPRIS SOLUTIONS, INC, LOUISVILLE, KY:
2,763,897, PUB. 6-24-2003. MULTIPLE CLASS, INT. CLS. 40 AND 42.
- SYSCO CORPORATION, HOUSTON, TX:
2,763,825, PUB. 6-24-2003. INT. CL. 16.
- SYSTEMS RESEARCH & DEVELOPMENT, LAS VEGAS, NV:
2,764,899, INT. CL. 35.
- T/MAKER COMPANY, MOUNTAIN VIEW, CA:
2,012,743, CANC. INT. CL. 16.
- TAB PRODUCTS CO., LLC, MAYVILLE, WI, TAB PRODUCTS CO., PALO ALTO, CA:
1,222,541. REN. 8-7-03. INT. CL. 16.
- TABLETOPS UNLIMITED, INC., GARDENA, CA:
2,763,995, PUB. 6-24-2003. INT. CL. 21.
2,763,996, PUB. 6-24-2003. INT. CL. 21.
2,763,997, PUB. 6-24-2003. INT. CL. 21.
2,763,998, PUB. 6-24-2003. INT. CL. 21.
- TACTILE SYSTEMS TECHNOLOGY, INC., EAST BETHEL, MN:
2,765,826, INT. CL. 10.
- TAIKO PHARMACEUTICAL CO., LTD., OSAKA, 564-0032, JAPAN:
2,765,028, INT. CL. 5.
- TAKATA KABUSHIKI KAISHA, TOKYO, JAPAN, TA TAKATA CORPORATION:
2,763,439, PUB. 6-24-2003. MULTIPLE CLASS, INT. CLS. 18 AND 25.
- TAKEDA CHEMICAL INDUSTRIES, LTD., HIGASHI-KU, OSAKA, JAPAN:
1,213,766, CANC. INT. CL. 5.
- TAMKO ROOFING PRODUCTS, INC., JOPLIN, MO:
1,727,633, CANC. INT. CL. 19.
- TANGIBLE MUSIC, INC., MERRICK, NY:
2,012,636, CANC. INT. CL. 9.
- TANGLE INC., SOUTH SAN FRANCISCO, CA:
1,779,055. REN. 8-8-03. INT. CL. 28.
- TAPIOCA EXPRESS, INC., ALHAMBRA, CA:
2,764,241, PUB. 6-24-2003. INT. CL. 30.
- TARA TOY CORPORATION, HAUPPAUGE, NY:
2,012,629, CANC. INT. CL. 16.
- TARGET BRANDS, INC., MINNEAPOLIS, MN, MARSHALL FIELD & COMPANY, CHICAGO, IL:
1,779,123. REN. 8-4-03. INT. CL. 30.
- TARGET LICENSING CORP., NEW YORK, NY:
1,728,641, CANC. INT. CL. 25.
- TARO INDUSTRIES LTD., CALGARY, ALBERTA, CANADA TO EVI OIL TOOLS CANADA LTD., CALGARY, ALBERTA, CANADA:
1,727,035, CANC. INT. CL. 7.
- TASTYFOOD INDUSTRIES (S) PTE LTD, JURONG TOWN, SINGAPORE:
2,763,452, PUB. 6-24-2003. INT. CL. 29.
- TATUNG SCIENCE & TECHNOLOGY, INC., FREMONT, CA:
2,764,782, INT. CL. 9.
- TAWA SUPERMARKET, INC., BUENA PARK, CA:
2,765,436, INT. CL. 30.
- TAYLOR CORPORATION, NORTH MANKATO, MN FROM NOWDOCS, INC., ALISO VIEJO, CA:
2,763,564, PUB. 6-24-2003. MULTIPLE CLASS, INT. CLS. 9 AND 42.
- TAYLOR CORPORATION, NORTH MANKATO, MN:
2,764,348, PUB. 6-24-2003. INT. CL. 40.
2,765,698, INT. CL. 16.
- TAYLOR MEDIA PRODUCTIONS, INC., SAN ANTONIO, TX:
1,728,304, CANC. INT. CL. 41.
- TAYLOR, PURCELL, JR., CINCINNATI, OH:
2,012,004, CANC. INT. CL. 42.
- TBAC INVESTMENT TRUST, ARLINGTON, TX AND SUPERBA, INC., LOS ANGELES, CA:
2,763,803, PUB. 6-24-2003. MULTIPLE CLASS, INT. CLS. 9, 16, 18, 20 AND 25.
- TBC CORPORATION, MEMPHIS, TN TO DOUGLAS BATTERY MANUFACTURING COMPANY, WINSTON-SALEM, NC:
2,013,303, CANC. MULTIPLE CLASS, INT. CLS. 14 AND 42.
- TEAM AMERICA HEALTH & FITNESS, INC., THOUSAND OAKS, CA. EXER-GENIE, INC., FULLERTON, CA:
749,723. REN. 8-2-03. U.S. CL. 22 (INT. CL. 28).
- TEAM DUNN INC, COPPELL, TX:
2,765,532, INT. CL. 36.
- TECH ENTERPRISES INC., MADISON, WI:
2,763,586, PUB. 6-24-2003. INT. CL. 3.
- TECHMETALS, INC., DAYTON, OH:
2,765,361, INT. CL. 40.
- TECHNIFOR, 01700 MIRIBEL, FRANCE:
2,764,492, INT. CL. 7.
- TECHNOLOGIES SEPIA INC., ST-JEAN-SUR-RICHELIEU, (QUEBEC), CANADA:
2,012,171, CANC. INT. CL. 9.
- TED PELLA INC., REDDING, CA:
2,764,924, INT. CL. 9.
- TEE TIME ENTERPRISES, INC., ATLANTA, GA:
2,764,408, PUB. 6-24-2003. INT. CL. 35.
- TEEN MANIA MINISTRIES, INC., GARDEN VALLEY, TX:
2,765,909, INT. CL. 45.
- TEEWUEN, GERARDUS LEONARDUS MATHIEU, 6041 CW ROERMOND, NETHERLANDS:
2,763,129, PUB. 8-27-2002. MULTIPLE CLASS, INT. CLS. 5, 29 AND 30.
- TEEVEE TOONS, INC., NEW YORK, NY:
2,012,321, CANC. INT. CL. 9.
- TEGAN, CHARLES G., NORTON, MA:
2,764,837, INT. CL. 5.
- TEITELBAUM, MICHAEL L., NEW YORK, NY:
2,764,114, PUB. 6-24-2003. INT. CL. 40.
- TEKMAX, INC., FRANKFORT, MI:
2,764,049, PUB. 6-24-2003. INT. CL. 7.
- TELECT, INC., LIBERTY LAKE, WA:
2,763,375, PUB. 6-24-2003. INT. CL. 9.
- TELEFLEX INCORPORATED, LIMERICK, PA:
2,011,331, CANC. INT. CL. 9.
- TELEGLOBE, INC., MONTREAL (QUEBEC), CANADA:
2,012,236, CANC. INT. CL. 38.
- TELEMAC CORPORATION, LOS ANGELES, CA:
2,764,612, MULTIPLE CLASS, INT. CLS. 9 AND 42.
- TELEMANAGEMENT FORUM, MORRISTOWN, NJ:
2,765,901, INT. CL. 16.
2,765,902, INT. CL. 9.
- TELIA AB (PUBL), SWEDEN:
2,763,088, PUB. 2-19-2002. MULTIPLE CLASS, INT. CLS. 9, 37, 38, 41 AND 42.
- TELIGENT, INC., HERNDON, VA:
2,764,670, INT. CL. 35.
- TELMEMOR-E, INC., NEW YORK, NY:
2,765,103, INT. CL. 9.
- TEMIS FRANCE, PARIS, FRANCE:
2,765,629, INT. CL. 9.
- TEMPUS INTERNATIONAL CORPORATION, MIAMI, FL:
2,764,229, PUB. 6-24-2003. INT. CL. 14.
- TENNIS CORPORATION OF AMERICA, CHICAGO, IL:
968,885. REN. 8-6-03. U.S. CL. 101 (INT. CLS. 35 AND 42).
- TERLITZKY, STEPHEN FENNING, NYC, NY:
2,765,820, INT. CL. 5.
- TERRA VAC INC., SAN JUAN, PUERTO RICO:
1,727,106, CANC. MULTIPLE CLASS, INT. CLS. 9 AND 37.
- TERRY SAVAGE PRODUCTIONS, LTD., CHICAGO, IL:
2,764,599, INT. CL. 9.
- TESSENDERLO CHEMIE N.V., 3980 TESSENDERLO, BELGIUM:
1,771,043. REN. 8-8-03. MULTIPLE CLASS, INT. CLS. 5 AND 29.

TEST-RITE PRODUCTS CORP., ONTARIO, CA:
1,775,819, REN. 8-6-03. INT. CL. 11.

TESTOUT CORPORATION, PLEASANT GROVE, UT:
2,764,272, PUB. 6-24-2003. INT. CL. 41.

TETON CAPITAL ADVISERS, JACKSON, WY:
2,764,905, INT. CL. 36.

TETRADATA CORPORATION, GREENVILLE, SC:
2,763,295, PUB. 6-24-2003. INT. CL. 9.

TEXAS CLASSROOM TEACHERS ASSOCIATION, AUSTIN, TX:
2,764,434, PUB. 6-24-2003. INT. CL. 35.

TEXAS COFFEE COMPANY, INC., BEAUMONT, TX:
2,764,055, PUB. 6-24-2003. INT. CL. 30.

TEXAS MEDICAL FOUNDATION, AUSTIN, TX:
2,764,165, PUB. 6-24-2003. MULTIPLE CLASS, INT. CLS. 35 AND 44.

TEXAS PROFESSIONAL BASEBALL, INC., DALLAS, TX:
2,012,263, CANC. MULTIPLE CLASS, INT. CLS. 25 AND 41.

TEXTILE GRAPHICS, INC., NUNICA, MI:
1,710,148, CANC. INT. CL. 25.

TEXTRON INC., PROVIDENCE, RI:
1,213,786, CANC. INT. CL. 6.
1,213,862, CANC. INT. CL. 14.

TFH-EB, INC., COLUMBUS, OH, DBA THE WATERWORKS:
2,765,035, INT. CL. 37.

TH. LANGEVELD B.V., 2161 LE LISSE, NETHERLANDS:
1,727,952, CANC. INT. CL. 31.

THE ADMINISTRATORS OF THE TULANE EDUCATIONAL FUND, NEW ORLEANS, LA:
2,765,767, INT. CL. 16.

THE ANTIOCH COMPANY, YELLOW SPRINGS, OH:
1,727,768, CANC. INT. CL. 25.

THE ARIZONA SPORTS FOUNDATION, TEMPE, AZ:
2,763,665, PUB. 6-24-2003. INT. CL. 41.

THE CHRISTIAN FAMILY PUBLICATION, INC., PELHAM, AL:
2,765,951, INT. CL. 16.

THE CLARK FOUNDATION, NEW YORK, NY:
2,765,912, INT. CL. 9.

THE COMPUTING TECHNOLOGY INDUSTRY ASSOCIATION, INC., OAKBROOK TERRACE, IL:
2,763,668, PUB. 6-24-2003. U.S. CL. B.

THE CUSTOMER CONNECTION, INC., ESCONDIDO, CA:
2,764,373, PUB. 6-24-2003. INT. CL. 35.

THE F.A.C.E. COMPANY, L.L.C., WILMINGTON, DE:
2,764,043, PUB. 6-24-2003. INT. CL. 3.

THE FOREIGN CANDY COMPANY, INC., HULL, IA:
2,763,991, PUB. 6-24-2003. INT. CL. 30.

THE FOREIGN LANGUAGE SOCIETY LLC, MALIBU, CA:
2,765,950, INT. CL. 41.

THE J. M. SMUCKER COMPANY, ORRVILLE, OH:
2,763,784, PUB. 6-24-2003. MULTIPLE CLASS, INT. CLS. 29 AND 30.

THE JACKSON ORGANIZATION, INC., COLUMBIA, MD:
2,765,214, INT. CL. 35.

THE MEAD CORPORATION, DAYTON, OH:
2,763,917, PUB. 6-24-2003. INT. CL. 16.
2,763,918, PUB. 6-24-2003. INT. CL. 16.

THE NATIONAL ARBOR DAY FOUNDATION, INC., LINCOLN, NE:
2,764,076, PUB. 6-24-2003. INT. CL. 30.

THE NATIONAL EXCHANGE CLUB, TOLEDO, OH:
2,763,650, PUB. 6-24-2003. U.S. CL. 200.
2,763,651, PUB. 6-24-2003. U.S. CL. 200.

THE NATIONAL URBAN TECHNOLOGY CENTER, INC., NEW YORK, NY:
2,763,112, PUB. 6-24-2003. MULTIPLE CLASS, INT. CLS. 37 AND 42.

THE NOONAN GROUP, INC., LOS ANGELES, CA:
2,763,949, PUB. 6-24-2003. INT. CL. 25.

THE NUTRACEUTICAL MEDICINE COMPANY INC., DUNCAN, BC, CANADA:
2,763,729, PUB. 6-24-2003. INT. CL. 5.

THE OHIO MANUFACTURERS' ASSOCIATION, COLUMBUS, OH:
2,764,377, PUB. 6-24-2003. INT. CL. 35.

THE PENNY PROJECT, INC., NEW YORK, NY:
2,765,662, INT. CL. 36.

THE PROCTER & GAMBLE COMPANY, CINCINNATI, OH:
2,765,802, INT. CL. 3.

THE QUIZNO'S MASTER LLC, DENVER, CO FROM QUIZNO'S CORPORATION, THE, DENVER, CO:
2,765,143, INT. CL. 42.

THE SHERWIN-WILLIAMS COMPANY, CLEVELAND, OH:
2,764,354, PUB. 6-24-2003. INT. CL. 35.

THE SIMON PARTNERSHIP, GRAND FORKS, BRITISH COLUMBIA, CANADA:
2,763,210, PUB. 6-24-2003. INT. CL. 25.

THE SPORTS NETWORK INC., TORONTO, ONTARIO, CANADA:
2,763,411, PUB. 6-24-2003. MULTIPLE CLASS, INT. CLS. 38 AND 41.

THE SSI GROUP, INC., MOBILE, AL:
2,763,057, PUB. 6-24-2003. MULTIPLE CLASS, INT. CLS. 9 AND 42.

THE TJX COMPANIES, INC., FRAMINGHAM, MA:
2,763,851, PUB. 6-24-2003. INT. CL. 25.

THE TRUSTEE OF NYT MANAGEMENT SERVICES, A MASSACHUSETTS BUSINESS TRUST, THE TRUSTEE COMPRISING NYT GROUP SERVICES LLC, A DELAWARE LIMITED LIABILITY COMPANY, TAMPA, FL:
2,763,198, PUB. 6-24-2003. INT. CL. 35.

THE TRUSTEES OF THE UNIVERSITY OF PENNSYLVANIA, PHILADELPHIA, PA:
2,764,864, INT. CL. 38.

THE VINUM CORPORATION, BARRINGTON HILLS, IL:
2,765,913, INT. CL. 20.

THE WORKFLOW AUTOMATION CORPORATION, ONTARIO, CANADA:
2,763,055, PUB. 6-24-2003. INT. CL. 9.

THELONIOUS MUSIC CORP, NEW YORK, NY:
2,764,355, PUB. 6-24-2003. INT. CL. 9.
2,764,356, PUB. 6-24-2003. INT. CL. 9.

THEODORE PRESSER COMPANY, BRYN MAWR, PA:
740,041, CANC. U.S. CL. 37.

THERATECH, INC., SALT LAKE CITY, UT TO THERATECH, INC., SALT LAKE CITY, UT:
1,963,460, COR. INT. CL. 5.

THERION BIOLOGICS CORPORATION, CAMBRIDGE, MA:
2,763,725, PUB. 6-24-2003. MULTIPLE CLASS, INT. CLS. 5 AND 42.

THERMAX, INC., RENO, NV:
2,012,707, CANC. INT. CL. 5.

THERMO FORMA INC., MARIETTA, OH:
2,765,071, INT. CL. 11.

THERMOPLAST INC., LAVAL, QUEBEC, CANADA:
2,763,199, PUB. 6-24-2003. INT. CL. 19.

THERMOWINE, INC., RANCHO SANTA MARGARITA, CA:
2,763,914, PUB. 6-24-2003. INT. CL. 11.

THETA INSTRUMENT CORPORATION, FAIRFIELD, NJ:
739,990, CANC. U.S. CL. 26.

THEURER, HAROLD JR., BROOKLYN, NY:
2,765,808, INT. CL. 14.

THINK OF IT! INC., VENTURA, CA:
2,763,545, PUB. 6-24-2003. INT. CL. 28.

THINKING CAP, INC., GREER, SC:
2,765,428, INT. CL. 16.

THIOKOL CORPORATION, OGDEN, UT:
2,012,229, CANC. INT. CL. 9.

THIRD PERSON, INC., MILWAUKEE, WI:
2,763,648, PUB. 6-24-2003. INT. CL. 42.

THISOFTWARE COMPANY, INC., HOUSTON, TX:
2,012,027, CANC. INT. CL. 9.

THOMAS & BETTS INTERNATIONAL, INC., SPARKS, NV:
2,765,005, INT. CL. 9.

THOMAS PUBLISHING COMPANY, NEW YORK, NY:
2,763,640, PUB. 6-24-2003. INT. CL. 42.

THOMAS, ROBERT G., EUGENE, OR:
2,764,169, PUB. 6-24-2003. INT. CL. 21.

THOMPSON MEDICAL COMPANY, INC., NEW YORK, NY:
1,210,213, CANC. INT. CL. 5.

THOMPSON PUBLISHING GROUP, INC., TAMPA, FL:
1,745,775, AM. INT. CL. 16.

- THOMPSON, TERESA L., WILBUR BY THE SEA, FL:
2,764,212, PUB. 6-24-2003. INT. CL. 6.
- THOMSON & GLENNON INC., STILLWATER, OK, DBA WORMY DOG SALOON:
2,011,714, CANC. INT. CL. 25.
- THOMSON MULTIMEDIA INC., INDIANAPOLIS, IN FROM THOMSON CONSUMER ELECTRONICS, INC., INDIANAPOLIS, IN:
2,764,716, INT. CL. 9.
- THOMSON, HOWARD M., OAKFIELD, TN:
2,765,689, INT. CL. 7.
- THOR TECH, INC., IMLAY CITY, MI:
2,765,394, INT. CL. 12.
- THORNTON OIL CORPORATION, LOUISVILLE, KY:
2,765,249, INT. CL. 35.
- THOSE CHARACTERS FROM CLEVELAND, INC., CLEVELAND, OH:
2,764,908, INT. CL. 28.
- THURMAN & JACKSON DESIGN ASSOCIATES, INC., LONG BEACH, CA, DBA DIRECT GRAPHICS:
2,012,909, CANC. INT. CL. 16.
- THURSDAY LLC, WHITEHOUSE STATION, NJ:
2,763,676, PUB. 6-24-2003. INT. CL. 25.
- TI APOLLO LIMITED, WEST MIDLANDS B69 2DF, ENGLAND:
1,727,812, CANC. INT. CL. 28.
- TICKETMASTER CORPORATION, LOS ANGELES, CA:
2,012,812, CANC. MULTIPLE CLASS, INT. CLS. 39 AND 42.
2,765,655, MULTIPLE CLASS, INT. CLS. 16 AND 35.
- TIDY CAR INC., CHEEKTOWAGA, NY:
1,213,740, CANC. MULTIPLE CLASS, INT. CLS. 3 AND 37.
- TIERONE BANK, LINCOLN, NE:
2,763,505, PUB. 6-24-2003. INT. CL. 36.
- TIFFANY AND COMPANY, NEW YORK, NY FROM FRAIMAN ASSOCIATES, INC., NEW YORK, NY:
2,764,527, INT. CL. 14.
- TIG HOLDINGS, INC., NEW YORK, NY:
2,012,216, CANC. INT. CL. 36.
- TIGER ELECTRONICS, INC., VERNON HILLS, IL:
2,012,582, CANC. INT. CL. 28.
2,012,801, CANC. INT. CL. 28.
- TIKIGAQ CORPORATION, ANCHORAGE, AK:
2,763,925, PUB. 6-24-2003. MULTIPLE CLASS, INT. CLS. 37 AND 42.
- TILLOTTS PHARMA AG, 4417 ZIEFEN, SWITZERLAND:
2,763,443, PUB. 6-24-2003. MULTIPLE CLASS, INT. CLS. 5 AND 42.
- TIMAC, 35400 SAINT-MALO, FRANCE:
2,764,698, INT. CL. 5.
- TIMBERLAND COMPANY, THE, STRATHAM, NH:
2,764,528, INT. CL. 25.
- TIMCAL SA (TIMCAL AG) (TIMCAL LTD), 6743 BODIO, SWITZERLAND:
1,726,807, CANC. INT. CL. 1.
- TIME SERVICES, INC., FT. WAYNE, IN:
1,214,274, CANC. INT. CL. 35.
- TIMELY INDUSTRIES, A DIVISION OF S.D.S. INDUSTRIES, INC., PACOIMA, CA:
2,764,915, INT. CL. 6.
- TIMES MIRROR COMPANY, THE, LOS ANGELES, CA, DBA LOS ANGELES TIMES:
1,727,496, CANC. INT. CL. 16.
- TIMES MIRROR MAGAZINES, INC.:
See—TIME4 MEDIA, INC..
- TIME4 MEDIA, INC., NEW YORK, NY FROM TIMES MIRROR MAGAZINES, INC., NEW YORK, NY:
2,763,120, PUB. 6-24-2003. INT. CL. 42.
- TISHCON CORP., WESTBURY, NY:
2,764,520, INT. CL. 5.
2,765,206, INT. CL. 3.
2,765,207, INT. CL. 3.
- TITAN INTERCONTINENTAL, S.A., CALI, COLOMBIA:
2,764,978, INT. CL. 36.
- TITANIC LLC, CHICAGO, IL:
2,764,491, INT. CL. 12.
- TIXON CORPORATION, DETROIT, MI:
1,727,299, CANC. INT. CL. 9.
- TLN, INC., LENEXA, KS:
2,012,250, CANC. INT. CL. 9.
- TLX COMMUNICATIONS, INC., BATON ROUGE, LA:
2,012,689, CANC. INT. CL. 38.
- TOBLER'S FLOWERS, INCORPORATED, KANSAS CITY, MO:
2,763,907, PUB. 6-24-2003. INT. CL. 35.
- TOCCI, JEFFREY W., WELLESLEY, MA:
2,764,831, INT. CL. 28.
- TODAY COMMUNICATIONS, INC., OVERLAND PARK, KS:
2,765,127, INT. CL. 42.
- TOLERANS INGOL, INC., WANAMASSA, NJ:
2,763,133, PUB. 6-24-2003. INT. CL. 7.
- TOM AND JERRY BOYS' WEAR INC., NEW YORK, NY:
1,214,069, CANC. INT. CL. 25.
- TOMASSO BROTHERS, INC., NEW BRITAIN, CT:
2,763,920, PUB. 6-24-2003. MULTIPLE CLASS, INT. CLS. 41 AND 43.
- TOMJANOVICH, RUDY, HOUSTON, TX, DBA RUDY T SALES:
2,012,026, CANC. INT. CL. 25.
- TOPCO ASSOCIATES, INC., SKOKIE, IL:
1,751,873, REN. 8-6-03. INT. CL. 16.
- TOPCODER, INC., GLASTONBURY, CT:
2,764,034, PUB. 6-24-2003. INT. CL. 9.
2,764,035, PUB. 6-24-2003. INT. CL. 41.
- TOPIC RADIO, INC., RESEARCH TRIANGLE PARK, NC:
2,764,966, INT. CL. 42.
- TOPIFRAM LABORATORIES, INC., ENGLEWOOD CLIFFS, NJ:
1,726,907, CANC. MULTIPLE CLASS, INT. CLS. 3 AND 5.
- TOPPS MILLING CO., INC., BOSSIER CITY, LA:
1,238,866, REN. 8-7-03. INT. CL. 42.
- TORN RANCH, INC., SAN RAFAEL, CA:
1,727,890, CANC. INT. CL. 29.
- TOTAL LIFE CREATIONS, INC., SELAH, WA:
2,012,414, CANC. INT. CL. 16.
- TOTAL RENAL CARE, INC., TORRANCE, CA:
1,983,091, CANC. INT. CL. 42.
- TOTO-LY OZ, PORTLAND, ME TO TOTO-LY OZ, PORTLAND, ME:
2,716,889, COR. INT. CL. 35.
- TOUCHTRAK SYSTEMS, INC., PORT HURON, MI:
2,763,238, PUB. 6-24-2003. INT. CL. 9.
- TOWN & COUNTRY JEWELRY MANUFACTURING CORPORATION, CHELSEA, MA:
1,725,467, CANC. INT. CL. 14.
- TOY WORKS, INC., THE, MIDDLE FALLS, NY:
1,214,025, CANC. MULTIPLE CLASS, INT. CLS. 24 AND 28.
- TOYO BOSEKI KABUSHIKI KAISHA (TOYOBO CO., LTD.), KITA-KU, OSAKA, JAPAN:
2,763,338, PUB. 6-24-2003. INT. CL. 17.
- TOYOTA JIDOSHA KABUSHIKI KAISHA, AICHI-KEN, JAPAN, TA TOYOTA MOTOR CORPORATION:
1,728,572, CANC. INT. CL. 12.
- TOYOTA JIDOSHA KABUSHIKI KAISHA, AICHI-KEN, JAPAN, TA TOYOTA MOTOR CORPORATION:
1,811,508, REN. 8-7-03. INT. CL. 12.
- TRABELCO, N.V., WILLEMSTAD, CURACAO, NETHERLANDS ANTILLES:
2,764,594, INT. CL. 9.
- TRACIE MARTYN, INC., NEW YORK, NY:
2,763,314, PUB. 6-24-2003. INT. CL. 42.
- TRACTMANAGER, LLC, SADDLE BROOK, NJ:
2,763,704, PUB. 6-24-2003. INT. CL. 42.
2,763,705, PUB. 6-24-2003. INT. CL. 42.
- TRADEMARK HOLDINGS, INC., WILMINGTON, DE, MARSH SUPERMARKETS, INC., YORKTOWN, IN:
1,251,873, REN. 8-4-03. INT. CL. 40.
- TRADESOURCE, INC., CHARLESTON, SC:
1,728,199, CANC. INT. CL. 39.
- TRADITIONAL MEDICINALS, INC., SEBASTOPOL, CA:
1,727,926, CANC. INT. CL. 30.

- TRAJECTORY, INC., LOVELAND, OH:
2,677,917, COR. INT. CL. 35.
- TRAMUTOLA, LLC, OAKLAND, CA FROM TRAMUTOLA,
LARRY, OAKLAND, CA, DBA TRAMUTOLA COMPANY:
2,765,628, MULTIPLE CLASS, INT. CLS. 35 AND 41.
- TRANS PACIFIC INSURANCE COMPANY, NEW YORK,
NY:
1,782,899, REN. 8-6-03, INT. CL. 36.
- TRANS UNION CORPORATION, CHICAGO, IL:
2,012,410, CANC. INT. CL. 35.
- TRANSACT ART, INC., SAN DIEGO, CA:
2,764,987, MULTIPLE CLASS, INT. CLS. 35, 36 AND 42.
- TRANSACTION CONSULTANTS, INC., LIGHTHOUSE
POINT, FL:
2,765,894, MULTIPLE CLASS, INT. CLS. 35 AND 36.
- TRANSARC CORPORATION, PITTSBURGH, PA:
2,012,415, CANC. INT. CL. 9.
- TRANSCRIPTION NETWORK, INC., THE, WASHINGTON,
DC:
2,012,586, CANC. INT. CL. 35.
- TRANSFORMATION SOFTWARE, INC., GUELPH, ONTAR-
IO NIG 3M5, CANADA:
2,764,836, INT. CL. 9.
- TRAVEL HARMONY, HERNDON, VA:
2,764,306, PUB. 6-24-2003, INT. CL. 39.
- TRAVEL INCORPORATED, DULUTH, GA:
2,764,167, PUB. 6-24-2003, INT. CL. 39.
- TRAVELBEE, PAULA M., SYLVANIA, OH, DBA SPIRIT TO
SPIRIT:
2,764,637, MULTIPLE CLASS, INT. CLS. 16 AND 25.
- TRAVELONLINE.COM LLC, SPRINGFIELD, NJ:
2,764,545, INT. CL. 39.
- TREASURES & TRINKETS, INC., MANCHESTER, CT:
2,012,466, CANC. INT. CL. 16.
- TREASURES AND TRINKETS, INC., MANCHESTER, CT:
2,012,258, CANC. INT. CL. 16.
- TREE OF LIFE, INC., SAINT AUGUSTINE, FL:
2,765,182, INT. CL. 29.
- TREK ALLIANCE, INC., TRUCKEE, CA:
2,286,258, CANC. INT. CL. 5.
2,286,259, CANC. INT. CL. 3.
- TREK BICYCLE, CORP, WATERLOO, WI:
2,011,985, CANC. INT. CL. 12.
- TREK BICYCLE, CORP., WATERLOO, WI:
2,011,984, CANC. INT. CL. 12.
- TREMCO INCORPORATED, BEACHWOOD, OH:
1,773,616, REN. 8-7-03, INT. CL. 19.
- TRI STAR MARKETING, INC., URBANA, IL:
2,764,379, PUB. 6-24-2003, INT. CL. 30.
- TRI-MARK TECHNOLOGIES, INC., BUFFALO GROVE, IL:
2,012,822, CANC. INT. CL. 9.
2,012,824, CANC. INT. CL. 36.
- TRIBORO QUILT MANUFACTURING CORPORATION,
WHITE PLAINS, NY:
2,011,390, CANC. INT. CL. 24.
- TRIFUS N.A., LLC, CHICAGO, IL:
2,765,644, INT. CL. 41.
- TRIMBLE, LYNN, JUPITER, FL:
2,763,563, PUB. 6-24-2003, INT. CL. 24.
- TROLL ASSOCIATES, INC., MAHWAH, NJ:
1,214,450, CANC. INT. CL. 42.
- TROMLEY INDUSTRIAL HOLDINGS, INC., TUALATIN,
OR, DBA REDFORD-CARVER FOUNDRY PRODUCTS
COMPANY:
2,764,701, INT. CL. 7.
- TROPICAL CHEESE INDUSTRIES, INC., PERTH AMBOY,
NJ:
2,296,766, CANC. MULTIPLE CLASS, INT. CLS. 29, 30
AND 32.
2,298,803, CANC. MULTIPLE CLASS, INT. CLS. 29, 30
AND 32.
- TROPICAL FOREST COSMETICS, HOLLY HILL, FL:
2,763,658, PUB. 6-24-2003, INT. CL. 3.
- TROPICAL SMOOTHIE FRANCHISE DEVELOPMENT
CORPORATION, SHALIMAR, FL:
2,763,722, PUB. 6-24-2003, INT. CL. 43.
- TRS QUALITY, INC., FORT WORTH, TX, TANDY COR-
PORATION, FT. WORTH, TX, DBA RADIO SHACK:
1,258,372, REN. 8-6-03, INT. CL. 9.
- TRUCKLOAD USA, INC., DALLAS, TX FROM TRUCK-
LOAD USA, INC., DALLAS, TX:
2,764,761, INT. CL. 35.
- TRUDELL MEDICAL INTERNATIONAL, LONDON, ON-
TARIO, CANADA:
2,764,635, INT. CL. 10.
- TRUE TEMPER HARDWARE COMPANY, CAMP HILL, PA:
2,011,519, CANC. INT. CL. 8.
- TRUSERVE CORPORATION, CHICAGO, IL, RADIATOR
SPECIALTY COMPANY, CHARLOTTE, NC:
751,518, REN. 8-8-03, U.S. CL. 13 (INT. CL. 11).
- TRUSTEES OF AMERICA'S DRIVE-IN TRUST, A PENN-
SYLVANIA BUSINESS TRUST, COMPRISING KENNETH
L. KEYMER, RONALD L. MATLOCK AND JANICE C.
GEORGE, ALL UNITED STATES CITIZENS, THE, RENO,
NV:
2,765,599, INT. CL. 42.
- TRUSTEES OF DARTMOUTH COLLEGE, HANOVER, NH,
DBA DARTMOUTH COLLEGE:
1,727,764, CANC. INT. CL. 25.
- TRUTH HARDWARE CORPORATION, OWATONNA, MN,
SPX CORPORATION, MUSKEGON, MI:
1,773,904, REN. 8-5-03, INT. CL. 7.
- TRUTH HARDWARE CORPORATION, OWATONNA, MN:
2,765,151, INT. CL. 6.
- TRW VALVES LIMITED, WEDNESBURY, ENGLAND:
739,966, CANC. U.S. CL. 23.
- TSI BRANDS, INC., WILMINGTON, DE:
2,764,305, PUB. 6-24-2003, INT. CL. 25.
- TUBI STYLE S.R.L., UBERSETTO DI FIORANO (MODENA),
ITALY:
2,765,311, INT. CL. 7.
- TUFF TURTLE PUBLISHING, LLC, CROFTON, MD:
2,765,684, INT. CL. 16.
- TUFTS UNIVERSITY, MEDFORD, MA:
2,763,323, PUB. 6-24-2003, INT. CL. 41.
- TUMARO'S INC., LOS ANGELES, CA:
2,764,541, INT. CL. 30.
- TUPAC AMARU SHAKUR FOUNDATION, WEST HOLLY-
WOOD, CA:
2,763,817, PUB. 6-24-2003, INT. CL. 41.
- TURBO TEC COMPANY LIMITED, KOWLOON, HONG
KONG:
2,765,116, INT. CL. 28.
- TUZLACI, OMAR, MONTECILLOS, ALAJUELA, COSTA
RICA:
2,765,245, INT. CL. 25.
- TVC ADVANCED LEARNING LIMITED, BALLYBRIT, CO.
GALWAY, IRELAND FROM TVC MEDIA LIMITED,
BALLYBRIT, CO. GALWAY, IRELAND:
2,764,798, MULTIPLE CLASS, INT. CLS. 9, 16 AND 41.
- TVSM INC., HORSHAM, PA:
2,011,679, CANC. INT. CL. 41.
- TWENTIETH CENTURY FOX FILM CORPORATION, LOS
ANGELES, CA:
2,764,489, INT. CL. 41.
2,764,736, INT. CL. 41.
- TWENTIETH CENTURY-FOX FILM CORPORATION, LOS
ANGELES, CA:
1,256,722, REN. 8-2-03, MULTIPLE CLASS, INT. CLS. 9
AND 41.
- TWIN LABORATORIES INC., HAPPAUGE,, NY, TWIN
LABORATORIES, INC., RONKONKOMA, NY:
1,773,392, REN. 8-6-03, INT. CL. 5.
- TWO'S COMPANY, INC., MOUNT VERNON, NY:
2,764,530, MULTIPLE CLASS, INT. CLS. 8, 16, 20 AND 21.
- TXDC., L.P., IRVING, TX FROM ZALE DELAWARE, INC.,
IRVING, TX:
2,763,244, PUB. 6-24-2003, INT. CL. 14.
- TY INC., WESTMONT, IL:
2,765,600, INT. CL. 28.
- TYCO ELECTRONICS LOGISTICS AG, CH-9323 STEINACH,
SWITZERLAND, AUGAT, INC., ATTLEBORO, MA:
926,737, REN. 8-4-03, U.S. CL. 21 (INT. CL. 9).

- TYLEND, EUGENE J., PARSIPPANY, NJ:
1,726,855, CANC. INT. CL. 1.
- TYLER DISTRIBUTION INC., GRESHAM, OR, DBA PRE-
VAIL CORPORATION:
2,012,372, CANC. INT. CL. 5.
- TYPE A MULTIMEDIA NETWORK, CHICAGO, IL:
2,764,293, PUB. 6-24-2003. INT. CL. 42.
- TYSON & ASSOCIATES, INC., HAWTHORNE, CA:
2,011,432, CANC. INT. CL. 5.
- TYWIN COMMUNICATIONS LLC, RARITAN, NJ:
2,765,944, INT. CL. 16.
- U.S. GRANULES CORPORATION, PLYMOUTH, IN:
2,763,971, PUB. 6-24-2003. INT. CL. 6.
- U.S. GREEN BUILDING COUNCIL, WASHINGTON, DC:
2,763,993, PUB. 6-24-2003. MULTIPLE CLASS, INT. CLS.
41 AND 42.
2,763,994, PUB. 6-24-2003. MULTIPLE CLASS, INT. CLS.
41 AND 42.
- U.S. HEALTH CLUB, INC., HASTINGS-ON-HUDSON, NY:
2,764,676, INT. CL. 35.
- U.S. INDUSTRIES, INC., NEW YORK, NY:
740,055, CANC. U.S. CL. 39.
740,056, CANC. U.S. CL. 39.
- U.S. POLYCHEMICAL MARINE CORP., CHESTNUT
RIDGE, NY:
2,718,367, COR. INT. CL. 1.
- U.S. POWER, INC., MENTOR, OH:
1,744,270, REN. 8-7-03. INT. CL. 7.
- U-WATCH RECORD, LLC, WHITE PLAINS, NY FROM
WHOLE OATS ENTERPRISES, WHITE PLAINS, NY:
2,763,930, PUB. 6-24-2003. INT. CL. 9.
- UBELL; AL, BROOKLYN, NY:
1,214,368, CANC. INT. CL. 41.
- UBS AG, ZURICH, SWITZERLAND:
2,721,221, COR. INT. CL. 16.
- UBS AG, CH-8001, ZURICH, SWITZERLAND:
2,764,051, PUB. 6-24-2003. INT. CL. 36.
- ULTIMAP CORPORATION, MINNEAPOLIS, MN:
1,419,867, CANC. INT. CL. 9.
- ULTIMATE MEDIUM, INDIANAPOLIS, IN:
2,765,907, INT. CL. 38.
- ULTIMATE PERFORMANCE PRODUCTS, INC., LA JOLLA,
CA:
1,773,112, REN. 8-7-03. INT. CL. 30.
- ULTRAVIT ENTERPRISES, INC., PASADENA, CA:
2,012,575, CANC. INT. CL. 5.
- UMBRO INTERNATIONAL, INC.:
See— STONE INTERNATIONAL, LLC.
- UNB CORP., CANTON, OH:
2,765,213, INT. CL. 36.
- UNCLE BEN'S, INC., HOUSTON, TX:
2,764,648, INT. CL. 11.
- UNCLE ERNIE'S GOURMET COOKIES, INC., BETHLE-
HEM, PA:
1,727,895, CANC. INT. CL. 30.
- UNICENTRIC, INC., PITTSBURGH, PA:
2,763,809, PUB. 6-24-2003. INT. CL. 42.
- UNIFI, INC., GREENSBORO, NC:
2,012,723, CANC. INT. CL. 23.
- UNIMAX GIFTWARE LIMITED, TSIM SHA TSUI, KOW-
LOON, HONG KONG:
2,765,275, INT. CL. 28.
- UNION INDUSTRIAL GAS & SUPPLY, INC., IRVING, TX:
2,765,108, MULTIPLE CLASS, INT. CLS. 37, 39 AND 40.
- UNIQUE IMAGES, INC., CLEARWATER, FL:
2,012,926, CANC. INT. CL. 16.
- UNITED FEATURE SYNDICATE, INC., NEW YORK, NY:
2,011,833, CANC. INT. CL. 9.
2,012,163, CANC. INT. CL. 25.
- UNITED GROCERS, LTD., RICHMOND, CA:
160,910, CANC. U.S. CL. 46.
- UNITED LIFE AGENCY SERVICES, L.L.C., GARDEN CITY,
NY:
2,765,092, MULTIPLE CLASS, INT. CLS. 9 AND 36.
- UNITED PRESIDENTIAL LIFE INSURANCE COMPANY,
KOKOMO, IN:
2,012,782, CANC. INT. CL. 36.
- UNITED STATES DISTILLED PRODUCTS COMPANY,
PRINCETON, MN, DBA EAGLE DISTILLED PRODUCTS
CO.:
1,801,664, REN. 8-7-03. INT. CL. 33.
- UNITED STATES POSTAL SERVICE, WASHINGTON, DC:
2,763,450, PUB. 6-24-2003. MULTIPLE CLASS, INT. CLS.
35 AND 42.
- UNITED STATES SATELLITE BROADCASTING COM-
PANY, INC., ST. PAUL, MN:
2,012,919, CANC. INT. CL. 38.
- UNITED STATES STEEL CORPORATION, PITTSBURGH,
PA FROM UNITED STATES STEEL LLC, PITTSBURGH,
PA:
2,765,171, INT. CL. 36.
- UNITED WAY OF AMERICA, ALEXANDRIA, VA:
2,011,643, CANC. INT. CL. 42.
- UNITRON PRODUCTS, INC., BRONX, NY:
2,764,281, PUB. 6-24-2003. INT. CL. 6.
- UNIVERSAL CITY STUDIOS LLLP, UNIVERSAL CITY, CA,
CASTLE FILMS, INC., NEW YORK, NY:
398,909, REN. 8-7-03. U.S. CL. 26 (INT. CL. 9).
- UNIVERSAL CITY STUDIOS LLLP, UNIVERSITY CITY, CA,
UNIVERSAL CITY STUDIOS, INC., UNIVERSAL CITY,
CA:
1,780,656, REN. 8-7-03. INT. CL. 41.
- UNIVERSAL MEDICAL PRODUCTS, INC., LAURENCE
HARBOR, NJ:
2,763,130, PUB. 6-24-2003. INT. CL. 10.
- UNIVERSAL TECHNOLOGY CORP., WILMINGTON, DE:
1,728,150, CANC. MULTIPLE CLASS, INT. CLS. 37 AND
42.
- UNIVERSITY FEDERAL CREDIT UNION, AUSTIN, TX:
2,610,238, AM. INT. CL. 35.
- UNIVERSITY MEDICAL PRODUCTS/USA, INC., IRVINE,
CA:
2,012,783, CANC. INT. CL. 3.
- UNIVERSITY OF AKRON, THE, AKRON, OH:
2,764,821, INT. CL. 41.
- UNIVERSITY OF CENTRAL FLORIDA, ORLANDO, FL:
2,764,026, PUB. 6-24-2003. INT. CL. 42.
- UNIVERSITY OF NEW HAMPSHIRE, DURHAM, NH:
2,765,621, INT. CL. 41.
- UNIVERSITY OF NOTRE DAME DU LAC, THE, NOTRE
DAME, IN:
1,238,220, REN. 8-6-03. MULTIPLE CLASS, INT. CLS. 14,
16, 20, 21, 24 AND 25.
1,238,220, CANC. INT. CL. 26.
- UNIVERSITY OF WASHINGTON, SEATTLE, WA:
1,262,471, REN. 8-6-03. INT. CL. 25.
- UP-STATISTICS CORPORATION, WOODLAND HILLS, CA:
2,763,257, PUB. 3-19-2002. INT. CL. 16.
- UPALI INTERNATIONAL LIMITED, HONG KONG:
1,214,220, CANC. MULTIPLE CLASS, INT. CLS. 29 AND
30.
- UPIB, INC., HAMILTON, BERMUDA:
2,764,084, PUB. 6-24-2003. INT. CL. 36.
- UPJOHN COMPANY, THE, KALAMAZOO, MI:
739,923, CANC. U.S. CL. 18.
739,932, CANC. U.S. CL. 18.
- UPSTANDING SYSTEMS, INC., MISSION VIEJO, CA:
1,728,554, CANC. INT. CL. 9.
- URBAN BOTANICA, INC., NEW YORK, NY:
2,763,593, PUB. 6-24-2003. INT. CL. 3.
- US CONVERGION, LLC, NORCROSS, GA:
2,765,334, INT. CL. 38.
- US ONCOLOGY, INC., HOUSTON, TX:
2,763,539, PUB. 6-24-2003. INT. CL. 35.
- USA AIRMOBILE, INC., FT. LAUDERDALE, FL:
2,765,446, INT. CL. 9.
- USA TRACK & FIELD, INC., INDIANAPOLIS, IN:
2,764,739, INT. CL. 41.
- UTILITY TRAILER MANUFACTURING CO., CITY OF
INDUSTRY, CA:
2,764,889, INT. CL. 12.
2,764,890, INT. CL. 12.
- UYL, RICHARD S. DEN, HOLLAND, MI:
1,195,429, REN. 8-6-03. INT. CL. 42.

- V SECRET CATALOGUE, INC., WILMINGTON, DE:
2,725,765, COR. MULTIPLE CLASS, INT. CLS. 3 AND 25.
- VA, INC., ROCHESTER, NY:
2,763,625, PUB. 6-24-2003. INT. CL. 9.
- VAGABOND SKOR VARBERG AB, 432 19 VARBERG, SWEDEN:
2,763,535, PUB. 6-24-2003. INT. CL. 18.
- VAIL SUMMIT RESORTS, INC., KEYSTONE, CO:
1,727,435, CANC. INT. CL. 14.
- VAL SKINNER FOUNDATION, BAY HEAD, NJ:
2,765,666, INT. CL. 28.
- VALENTE, JOHN, SAN DIEGO, CA:
2,765,545, INT. CL. 35.
- VALENTINE, JAMES R., SAN LUIS OBISPO, CA:
2,012,076, CANC. INT. CL. 28.
- VALLEY PACKAGING CORP., PULASKI, TN:
2,763,555, PUB. 6-24-2003. MULTIPLE CLASS, INT. CLS. 16 AND 20.
- VALLEYBROOK INTERNATIONAL VENTURES, INC., AB-
BOTSFORD, BRITISH COLUMBIA, CANADA:
2,764,378, PUB. 6-24-2003. INT. CL. 31.
- VALU-CAST PRODUCTS, INC., ROCKFORD, IL:
2,012,617, CANC. INT. CL. 28.
- VAN CAO, GARLAND, TX:
2,764,208, PUB. 6-24-2003. INT. CL. 3.
- VAN DEN BERGH FOODS, INC., WILMINGTON, DE:
2,012,240, CANC. INT. CL. 30.
- VAN DYKE SOFTWARE, INC., ALBUQUERQUE, NM:
2,703,068, COR. INT. CL. 9.
- VAN KAMPEN AMERICAN CAPITAL DISTRIBUTORS,
INC., OAKBROOK TERRACE, IL:
2,012,835, CANC. INT. CL. 36.
- VAN LAW FOOD PRODUCTS, INC., FULLERTON, CA:
2,765,060, INT. CL. 30.
- VANCE, CHRISTOPHER MICHAEL, NESA, AZ:
1,727,382, CANC. INT. CL. 11.
- VANDEVCO LIMITED, VANCOUVER, WA:
2,763,426, PUB. 6-24-2003. INT. CL. 36.
- VANITY FAIR, INC., WILMINGTON, DE:
2,012,796, CANC. INT. CL. 25.
- VANMOOR, ARTHUR, BOCA RATON, FL:
2,764,680, INT. CL. 42.
- VANTICO INC., BREWSTER, DE, CIBA-GEIGY CORPORA-
TION, ARDSLEY, NY:
1,773,326, REN. 8-4-03. INT. CL. 1.
- VARASTEH, VAHDAT, SAN DIEGO, CA:
2,765,788, INT. CL. 20.
- VARIAN MEDICAL SYSTEMS, INC., PALO ALTO, CA:
2,764,565, MULTIPLE CLASS, INT. CLS. 9 AND 10.
- VARIFLEX, INC., MOORPARK, CA:
2,012,660, CANC. INT. CL. 28.
- VARIFORM, INC., KEARNEY, MO:
2,765,397, INT. CL. 19.
- VASOS IMPORT, INC., LANSING, MI:
2,765,107, INT. CL. 30.
- VCON, LTD., HERZLIAH, ISRAEL:
2,012,344, CANC. INT. CL. 9.
- VEBE LENVINYL B.V., 8281 JV GENEMUIDEN, NETHER-
LANDS:
2,011,483, CANC. INT. CL. 27.
2,011,484, CANC. INT. CL. 27.
- VECTOR ESP, INC., HOUSTON, TX:
2,763,391, PUB. 6-24-2003. MULTIPLE CLASS, INT. CLS. 41 AND 42.
- VECTOR SCM, LLC, NOVI, MI FROM CNF TRANSPORTA-
TION INC., PALO ALTO, CA:
2,764,878, MULTIPLE CLASS, INT. CLS. 9, 35, 36 AND 39.
- VECTOR, INC., WESTMINSTER, CA:
2,763,148, PUB. 6-24-2003. MULTIPLE CLASS, INT. CLS. 41 AND 42.
- VEDA INCORPORATED, ALEXANDRIA, VA:
1,214,367, CANC. INT. CL. 41.
- VEGA TRADING CO., INC., NEW YORK, NY:
865,068, CANC. U.S. CL. 46.
- VEGE CHIP CO. PTY LTD, THE, QUEENSLAND, AUSTRA-
LIA FROM TRUSTEES OF THE WAI LAN YOGA TRUST,
MALIBU, CA:
2,764,917, INT. CL. 29.
- VELASQUEZ, TANIA D., CAPE CORAL, FL:
2,763,933, PUB. 6-24-2003. INT. CL. 41.
- VELOCITY EXPRESS CORPORATION, BLOOMINGTON,
MN FROM UNITED SHIPPING & TECHNOLOGY, INC.,
BLOOMINGTON, MN:
2,765,219, MULTIPLE CLASS, INT. CLS. 35 AND 39.
- VELOCITY 3PL, INC., OBETZ, OH:
2,764,065, PUB. 6-24-2003. INT. CL. 35.
- VENTLAB CORPORATION, MOCKSVILLE, NC:
2,763,787, PUB. 6-24-2003. INT. CL. 10.
- VENTURA FOODS, LLC, CITY OF INDUSTRY, CA:
1,727,854, CANC. INT. CL. 29.
- VENTURE STORES, INC., O'FALLON, MO:
2,011,271, CANC. INT. CL. 25.
- VENTURES IN EDUCATION, NEW YORK, NY:
1,795,331, REN. 8-8-03. INT. CL. 41.
- VERIDIAN CORPORATION, ARLINGTON, VA:
2,765,152, INT. CL. 35.
- VERIO INC., ENGLEWOOD, CO:
2,765,517, INT. CL. 42.
- VERITEL TECHNOLOGIES INC., NEW YORK, NY:
2,764,474, MULTIPLE CLASS, INT. CLS. 35, 38 AND 42.
- VERMONT ORGANIC FARMERS, LLC, RICHMOND, VT:
2,764,214, PUB. 6-24-2003. U.S. CL. A.
- VERPLEX SYSTEMS, INC., MILPITAS, CA:
2,765,356, INT. CL. 9.
- VERSATA, INC., OAKLAND, CA:
2,763,248, PUB. 6-24-2003. MULTIPLE CLASS, INT. CLS. 9
AND 42.
- VERSATILE ENTERTAINMENT INC., NEW YORK, NY:
2,765,299, INT. CL. 41.
- VESTJYSKE SLAGTERIER A.M.B.A., 7600 STRUER, DEN-
MARK:
1,728,724, CANC. INT. CL. 29.
- VETOQUINOL S.A., 70200 LURE, FRANCE:
1,771,037, REN. 8-8-03. INT. CL. 5.
- VEXURE, INC, JACKSONVILLE, FL:
2,764,068, PUB. 6-24-2003. INT. CL. 35.
- VI-JON LABORATORIES, INC., ST. LOUIS, MO, DBA VI-
JON, INC.:
2,763,159, PUB. 6-24-2003. INT. CL. 5.
2,765,074, INT. CL. 3.
- VIACOM INTERNATIONAL INC., NEW YORK, NY:
2,764,296, PUB. 6-24-2003. INT. CL. 28.
- VIC TOKAI, INC., TORRANCE, CA:
2,011,478, CANC. INT. CL. 28.
- VICTORIA ACQUISITION GROUP, INC., WARWICK, RI:
1,695,305, CANC. INT. CL. 14.
- VICTORIA'S SECRET STORES, INC., REYNOLDSBURG,
OH:
1,773,351, REN. 8-6-03. INT. CL. 3.
- VIDEO MONITORING SERVICES OF AMERICA, L.P., NEW
YORK, NY:
2,764,951, MULTIPLE CLASS, INT. CLS. 35 AND 42.
- VIDEO VENTURES JOINT VENTURE, BALTIMORE, MD:
2,012,222, CANC. MULTIPLE CLASS, INT. CLS. 9 AND
16.
- VIEW ENGINEERING, INC., SIMI VALLEY, CA:
2,765,583, INT. CL. 9.
- VIEWCAST.COM, INC., DALLAS, TX, DBA VIEWCAST
CORPORATION:
2,764,459, PUB. 6-24-2003. INT. CL. 9.
- VIEWLOGIC SYSTEMS, INC., MARLBORO, MA:
1,727,317, CANC. INT. CL. 9.
- VIEWSONIC CORPORATION, WALNUT, CA:
2,764,682, INT. CL. 9.
- VIKING OFFICE PRODUCTS, INC., DELRAY BEACH, FL:
1,765,095, REN. 8-7-03. INT. CL. 42.
- VIOLET POT, LLC, THE, CHERRY HILL, NJ:
2,765,858, INT. CL. 21.
- VIRGINIA HOSPITAL CENTER ARLINGTON HEALTH
SYSTEM, ARLINGTON, VA:
2,763,523, PUB. 6-24-2003. MULTIPLE CLASS, INT. CLS. 9,
16 AND 44.
2,763,524, PUB. 6-24-2003. MULTIPLE CLASS, INT. CLS. 9,
16 AND 44.

- VISA INTERNATIONAL SERVICE ASSOCIATION, FOSTER CITY, CA:
1,720,735. REN. 8-7-03. MULTIPLE CLASS, INT. CLS. 37 AND 38.
- VISI-TECH INC., CHESTNUT HILL, MA:
2,012,307, CANC. INT. CL. 20.
- VISIO CORPORATION, SEATTLE, WA:
2,011,574, CANC. INT. CL. 9.
- VISION EXPRESS GROUP LIMITED, NOTTINGHAM, UNITED KINGDOM:
2,012,280, CANC. MULTIPLE CLASS, INT. CLS. 5, 9 AND 42.
- VISIONARY COMMUNICATIONS, INC., GILLETTE, WY:
2,764,453, PUB. 6-24-2003. MULTIPLE CLASS, INT. CLS. 9 AND 42.
- VISIONSITE CORPORATION, PORTLAND, OR:
2,763,220, PUB. 1-29-2002. MULTIPLE CLASS, INT. CLS. 35 AND 42.
- VISIONTEL COMMUNICATIONS, LLC, ELIOT, ME:
2,765,433, INT. CL. 5.
- VISIPLEX INSTRUMENTS CORP., ELMSFORD, NY:
2,011,784, CANC. INT. CL. 9.
- VISTA HEALTH PLAN, INC., HOLLYWOOD, FL:
2,763,831, PUB. 6-24-2003. INT. CL. 36.
- VISUAL ANALYTICS, INCORPORATED, POOLESVILLE, MD:
2,763,990, PUB. 6-24-2003. INT. CL. 9.
- VISUAL BENEFITS, INC., TUCKER, GA:
2,012,927, CANC. INT. CL. 9.
- VITA CUBE SYSTEMS, INC., DENVER, CO:
2,764,160, PUB. 6-24-2003. INT. CL. 5.
- VITA SOURCE, INC., REDLANDS, CA:
2,012,579, CANC. INT. CL. 3.
- VITAFOAM, INC., HIGH POINT, NC:
2,012,716, CANC. INT. CL. 20.
2,012,717, CANC. INT. CL. 20.
- VITAMIN RETAILER MAGAZINE, INC., OJAI, CA:
2,764,083, PUB. 6-24-2003. INT. CL. 16.
- VITAMINS 4 LESS INC., NORTH HAMPTON, NH:
2,764,511, INT. CL. 35.
- VITAMONT (SOCIETE ANONYME), MONFLANQUIN 47150, FRANCE:
2,763,402, PUB. 6-24-2003. INT. CL. 32.
- VITASOY INTERNATIONAL HOLDINGS LIMITED, NEW TERRITORIES, HONG KONG:
2,765,529, MULTIPLE CLASS, INT. CLS. 29 AND 30.
- VITRA PATENTE AG, CH-4132 MUTTENZ, SWITZERLAND:
2,763,899, PUB. 6-24-2003. INT. CL. 20.
- VMWARE, INC., PALO ALTO, CA:
2,764,540, INT. CL. 9.
- VOLKSWAGEN AKTIENGESELLSCHAFT, D-38436, WOLFSBURG, FED REP GERMANY:
2,765,831, MULTIPLE CLASS, INT. CLS. 7, 12 AND 28.
2,765,832, MULTIPLE CLASS, INT. CLS. 7, 12 AND 28.
- VOLKSWAGEN OF AMERICA, INC., AUBURN HILLS, MI:
2,765,254, INT. CL. 12.
- VOLLRATH GROUP, INC., GALLAWAY, TN:
2,012,403, CANC. INT. CL. 10.
- VOXCOM INCORPORATED, EDMONTON T6E 5V7, ALBERTA, CANADA:
2,764,584, MULTIPLE CLASS, INT. CLS. 37 AND 42.
- VOYANT TECHNOLOGIES, INC., WESTMINSTER, CO:
2,765,946, INT. CL. 9.
- VSM MEDTECH LTD., VANCOUVER, BC V6B 1N2, CANADA:
2,763,297, PUB. 6-24-2003. INT. CL. 10.
- VTECH INDUSTRIES, INC., WHEELING, IL:
2,012,688, CANC. INT. CL. 28.
- VULCAN CHEMICAL TECHNOLOGIES, INC., WEST SACRAMENTO, CA:
1,726,821, CANC. MULTIPLE CLASS, INT. CLS. 1 AND 5.
- VYGON, 95440 ECOUEN, FRANCE:
2,763,518, PUB. 6-24-2003. INT. CL. 10.
- W. L. GORE & ASSOCIATES, INC., NEWARK, DE:
2,012,341, CANC. INT. CL. 25.
- W. NEUDORFF GMBH KG, EMMERTHAL 1, FED REP GERMANY:
2,764,299, PUB. 6-24-2003. INT. CL. 5.
- W. R. GRACE & CO.-CONN., NEW YORK, NY:
2,012,804, CANC. INT. CL. 1.
- W. R. GRACE & CO.-CONN., COLUMBIA, MD:
2,765,412, INT. CL. 1.
- W.O. HARPER PLUMBING CO., AUSTIN, TX:
2,763,947, PUB. 6-24-2003. INT. CL. 37.
- W&A MANUFACTURING COMPANY, LLC, ALLENTOWN, PA:
2,702,640, COR. INT. CL. 6.
- WACHOVIA CORPORATION, CHARLOTTE, NC:
2,765,351, INT. CL. 36.
- WACKENHUT CORPORATION, THE, CORAL GABLES, FL:
1,214,267, CANC. MULTIPLE CLASS, INT. CLS. 35 AND 42.
- WACKENHUT RESOURCES, PALM BEACH GARDENS, FL:
2,763,260, PUB. 6-24-2003. INT. CL. 35.
- WACKER POLYMER SYSTEMS GMBH & CO. KG, D-84489 BURGHAUSEN, FED REP GERMANY:
2,763,405, PUB. 6-24-2003. MULTIPLE CLASS, INT. CLS. 1, 2, 16 AND 17.
- WADA FARMS POTATOES, INC., PINGREE, ID:
2,764,060, PUB. 6-24-2003. INT. CL. 31.
- WADE, JEROME, CRETE, IL:
2,012,546, CANC. INT. CL. 36.
- WAI YUEN TONG MEDICINE COMPANY LIMITED, KOWLOON, HONG KONG:
2,763,480, PUB. 6-24-2003. INT. CL. 5.
- WAKEFERN FOOD CORP., ELIZABETH, NJ:
2,765,295, INT. CL. 29.
- WAL-MART STORES, INC., BENTONVILLE, AR:
2,011,955, CANC. INT. CL. 39.
- WALDMANN KG, D-75217 BIRKENFELD, FED REP GERMANY:
2,763,424, PUB. 6-24-2003. INT. CL. 14.
- WALKER MACRAE INC., MANCHESTER, NH:
2,763,485, PUB. 6-24-2003. INT. CL. 36.
- WALKER, JULIET E.K., CHICAGO, IL:
2,764,220, PUB. 6-24-2003. INT. CL. 41.
- WALKINE, KATHY, BROOKLYN, NY:
2,764,553, MULTIPLE CLASS, INT. CLS. 29 AND 30.
- WALL STREET RADIO.NET, BOULDER, CO:
2,764,778, MULTIPLE CLASS, INT. CLS. 9, 16, 36 AND 41.
- WALLEN, RONALD E., VALLEY CENTER, CA:
2,011,869, CANC. INT. CL. 41.
- WALNUT STREET SECURITIES, INC., ST. LOUIS, MO:
2,012,556, CANC. INT. CL. 36.
- WALSH MEDIA INC, OAK BROOK, IL:
2,763,730, PUB. 6-24-2003. INT. CL. 38.
- WALSH, STEPHEN, SILVER LAKE, NH:
2,765,335, INT. CL. 28.
- WALTER HEIMLER INC., NEW YORK, NY:
2,765,768, MULTIPLE CLASS, INT. CLS. 6 AND 18.
- WALTER SOMERS LIMITED, HALESOWEN, WEST MIDLANDS, ENGLAND:
1,213,781, CANC. INT. CL. 6.
- WALTERS SCOTTY JOE, RAGLAND, AL:
2,765,531, INT. CL. 25.
- WALTON, EDWARD W., SARASOTA, FL:
2,765,117, MULTIPLE CLASS, INT. CLS. 5 AND 10.
- WAMPOLE LABORATORIES, INC., PRINCETON, NJ, CARTER-WALLACE, INC., NEW YORK, NY:
1,775,696. REN. 8-6-03. INT. CL. 5.
- WANDERING RECORDS, INC., PORTLAND, OR:
2,764,828, INT. CL. 9.
- WANG, CHENG-CHUNG, TAIPEI, R.O.C., TAIWAN:
1,214,159, CANC. INT. CL. 28.
- WANG, ROBERT, FAIRFAX, VA:
2,763,376, PUB. 8-13-2002. INT. CL. 9.
- WARMINSTER FIBERGLASS, SOUTHAMPTON, PA:
1,728,603, CANC. INT. CL. 19.
- WARNACO U.S., INC., MILFORD, CT, WARNACO INC., BRIDGEPORT, CT:
1,257,652. REN. 8-2-03. INT. CL. 25.
- WARNER CHILCOTT PLC, BUBLIN 2, IRELAND, F. H. FAULDING & CO. LTD., SOUTH AUSTRALIA, AUSTRALIA:
1,259,073. REN. 8-6-03. INT. CL. 5.

- WARNER-LAMBERT COMPANY, MORRIS PLAINS, NJ:
2,012,188, CANC. INT. CL. 5.
- WARREN LABORATORIES, INC., ABBOTT, TX, WARREN COSMETICS, INC., HOUSTON, TX:
1,239,105, REN. 8-6-03. INT. CL. 3.
- WARREN LABORATORIES, INC., ABBOTT, TX:
1,253,338, REN. 8-8-03. INT. CL. 5.
- WARREN MILLER ENTERTAINMENT, INC., NEW YORK, NY FROM INTERNATIONAL ENTERTAINMENT GROUP, INC., BOULDER, CO:
2,764,135, PUB. 6-24-2003. INT. CL. 41.
- WASCH, KEN, WASHINGTON, DC:
2,012,600, CANC. INT. CL. 42.
- WASTE MANAGEMENT, INC., HOUSTON, TX:
2,765,337, INT. CL. 37.
- WATERFRONT PUBLISHING, INC., CHARLESTON, SC:
2,012,099, CANC. INT. CL. 42.
- WATKINS MANUFACTURING CORPORATION, VISTA, CA:
2,764,470, PUB. 6-24-2003. INT. CL. 11.
- WATSON PHARMACEUTICALS, INC., CORONA, CA:
2,764,846, INT. CL. 5.
- WATSON, DANIEL L. JR., LAMPE, MO:
2,764,974, INT. CL. 5.
- WATTS RADIANT, INC., SPRINGFIELD, MO:
2,765,169, MULTIPLE CLASS, INT. CLS. 6, 11 AND 17.
- WAV, INC., WEST CHICAGO, IL:
2,763,362, PUB. 6-24-2003. INT. CL. 35.
- WAVE SYSTEMS CORP., LEE, MA:
2,763,874, PUB. 6-24-2003. INT. CL. 42.
- WAWONA PROPERTY MANAGEMENT, INC., YOSEMITE NATIONAL PARK, CA:
2,011,601, CANC. INT. CL. 36.
- WAYNE HUMMER INVESTMENTS, L.L.C., CHICAGO, IL:
2,765,729, INT. CL. 36.
- WAYNE S. LOCKARD & SONS, INC., INDIANA, PA:
2,012,503, CANC. INT. CL. 42.
- WAYSIDE FURNITURE SHOPS, INC., THE, MILFORD, CT:
1,727,663, CANC. INT. CL. 20.
- WAY2CALL COMMUNICATIONS LTD., TEL AVIV, ISRAEL:
2,763,271, PUB. 6-24-2003. INT. CL. 9.
- WEAR ME APPAREL, NEW YORK, NY:
2,764,192, PUB. 6-24-2003. INT. CL. 25.
- WEAR PROTECTION CORPORATION, MOUNT PROSPECT, IL TO WEAR PROTECTION CORPORATION, MOUNT PROSPECT, IL:
2,407,685, COR. INT. CL. 36.
- WEDBUSH MORGAN SECURITIES, INC., LOS ANGELES, CA:
2,763,179, PUB. 11-12-2002. INT. CL. 36.
- WEDCOM INC.:
See— WEDDINGCHANNEL.COM, INC..
- WEDDINGCHANNEL.COM, INC., LOS ANGELES, CA FROM WEDCOM INC., LOS ANGELES, CA:
2,763,090, PUB. 6-24-2003. MULTIPLE CLASS, INT. CLS. 35 AND 39.
- WEIDER NUTRITION GROUP, INC., SALT LAKE CITY, UT:
2,012,523, CANC. INT. CL. 5.
- WEIDER NUTRITION INTERNATIONAL, INC., SALT LAKE CITY, UT:
2,718,719, COR. INT. CL. 5.
- WEIL, ELIZABETH JOYCE, SONOMA, CA, DBA WORD-BENDER:
2,011,905, CANC. INT. CL. 40.
- WEINGARTEN REALTY MANAGEMENT COMPANY, HOUSTON, TX:
2,012,244, CANC. INT. CL. 36.
- WEISELMAN, DAVID M., GARDENA, CA, DBA W.K. LEATHERS:
2,011,398, CANC. INT. CL. 18.
- WEISS & WINTER GMBH, D-19336 BAD WILSNACK, FED REP GERMANY:
2,763,265, PUB. 6-24-2003. INT. CL. 16.
- WEISS, ADELLE, NORTH HARWICH, MA:
2,012,306, CANC. INT. CL. 27.
- WEISS, MICHAEL J., WASHINGTON, DC:
2,012,807, CANC. INT. CL. 35.
- WEISS, WENDY, NEW YORK, NY:
2,764,234, PUB. 6-24-2003. MULTIPLE CLASS, INT. CLS. 35 AND 41.
- WELD MOLD COMPANY, BRIGHTON, MI:
968,148, REN. 8-6-03. U.S. CL. 34 (INT. CL. 9).
- WELGEMOED, MORGAN SHAUN, LOS ANGELES, CA:
2,765,807, INT. CL. 25.
- WELLA CORPORATION, THE, ENGLEWOOD, NJ:
1,201,689, REN. 8-5-03. INT. CL. 3.
- WELLMAN COMPANY, YUBA CITY, CA:
1,214,249, CANC. INT. CL. 31.
- WELLS FARGO & COMPANY, SAN FRANCISCO, CA:
2,011,834, CANC. INT. CL. 36.
2,011,962, CANC. INT. CL. 36.
- WELLS FARGO HOME MORTGAGE, INC., DES MOINES, IA:
2,765,870, INT. CL. 36.
- WELLSOURCE, INC., CLACKAMAS, OR:
2,763,609, PUB. 6-24-2003. MULTIPLE CLASS, INT. CLS. 9, 16, 35, 41, 42 AND 44.
- WELSH, JAMES R., BOWIE, MD:
2,011,949, CANC. INT. CL. 1.
- WEMCO, INC., NEW ORLEANS, LA:
2,012,007, CANC. INT. CL. 25.
- WENG SENG HENG MEDICAL HALL SDN BHD, 10300 PENANG, MALAYSIA:
2,765,049, INT. CL. 5.
- WENNEKER; WILLEM AART, EV NOORDWIJK AAN ZEE, NETHERLANDS:
1,213,854, CANC. INT. CL. 14.
- WENTE BROS., LIVERMORE, CA:
2,763,712, PUB. 6-24-2003. INT. CL. 33.
- WES BRANDT'S BILLIARD SUPPLY, INC., MIAMI, FL:
2,011,283, CANC. INT. CL. 42.
- WESLO, INC., LOGAN, UT TO ICON HEALTH & FITNESS, INC., LOGAN, UT:
1,727,846, CANC. INT. CL. 28.
- WESSCO INTERNATIONAL, LOS ANGELES, CA:
2,763,569, PUB. 6-24-2003. INT. CL. 35.
- WEST ALTERNATIVE MEDICINE, INC., HIALEAH, FL:
2,765,646, INT. CL. 5.
- WEST INDIES BY COMPQNY, THE, ST. THOMAS, US VIRGIN ISLANDS, WEST INDIES BAY COMPANY, MINNEAPOLIS, MN:
749,522, REN. 8-6-03. U.S. CL. 51 (INT. CL. 3).
- WEST LAKE USA IMPORT/EXPORT CORP., UNION, NJ:
1,727,984, CANC. INT. CL. 32.
- WEST PHARMACEUTICAL SERVICES, INC., LIONVILLE, PA:
2,764,871, INT. CL. 10.
- WESTAFF SUPPORT, INC., WALNUT CREEK, CA:
2,763,783, PUB. 6-24-2003. INT. CL. 35.
- WESTBEACH SPORTS, INC., VANCOUVER, BC, CANADA, WESTBEACH SURF COMPANY LTD., VANCOUVER, B.C., CANADA:
1,771,357, REN. 8-7-03. MULTIPLE CLASS, INT. CLS. 14, 18, 25 AND 28.
- WESTCO SCIENTIFIC INSTRUMENTS, INC., DANBURY, CT:
2,765,095, INT. CL. 9.
- WESTERMAYER, ARLENE, CHAPIN, SC:
2,011,872, CANC. INT. CL. 36.
- WESTERN HOLDINGS, L.L.C., CASPER, WY:
2,765,811, INT. CL. 5.
- WESTERN INSULFOAM CORPORATION, SEATTLE, WA TO PREMIER INDUSTRIES, INC., TACOMA, WA:
748,303, AM. U.S. CL. 12.
- WESTERN PACIFIC TELECOMMUNICATIONS, CARSON, CA:
2,763,617, PUB. 6-24-2003. INT. CL. 38.
- WESTERN PENNSYLVANIA CONSERVANCY, PITTSBURGH, PA:
2,765,344, INT. CL. 32.
- WESTERN VIRGINIA FOUNDATION FOR THE ARTS AND SCIENCES, ROANOKE, VA:
2,763,537, PUB. 6-24-2003. INT. CL. 35.

- WESTGARD QC, INC., MADISON, WI:
2,765,166, INT. CL. 9.
- WESTIN HOTEL COMPANY, SEATTLE, WA:
2,012,058, CANC. INT. CL. 35.
- WESTINGHOUSE ELECTRIC CO. LLC, PITTSBURGH, PA,
COMBUSTION ENGINEERING, INC., WINDSOR, CT:
975,242, REN. 8-7-03. U.S. CL. 26 (INT. CL. 9).
- WESTON MEDICAL TRAINING SYSTEMS, INC., FORT
COLLINS, CO:
2,765,082, MULTIPLE CLASS, INT. CLS. 9 AND 16.
- WGM SAFETY CORP., READING, PA:
2,012,539, CANC. INT. CL. 9.
- WHAM-O, INC., EMERYVILLE, CA, KRANSCO, SAN
FRANCISCO, CA:
1,773,088, REN. 8-2-03. INT. CL. 28.
- WHEAT, FIRST SECURITIES, INC., RICHMOND, VA:
2,012,406, CANC. INT. CL. 36.
- WHEELER, JOHN, NASHVILLE, TN:
2,765,072, INT. CL. 9.
- WHERE'S WINE LLC, SAN FRANCISCO, CA FROM ZAHN,
ELYCE R., SAN FRANCISCO, CA:
2,765,688, INT. CL. 39.
- WHIRLPOOL PROPERTIES INC., BENTON HARBOR, MI:
2,011,311, CANC. INT. CL. 8.
- WHIRLPOOL PROPERTIES, INC., ST. JOSEPH, MI:
2,764,636, INT. CL. 7.
- WHIRLWIND STEEL BUILDINGS, INC., HOUSTON, TX:
2,764,642, INT. CL. 6.
- WHITE CASTLE SYSTEM, INC., COLUMBUS, OH:
2,012,093, CANC. INT. CL. 42.
- WHITE HAT VENTURES, LLC, AKRON, OH:
2,765,610, INT. CL. 41.
- WHITESTONE ACQUISITION CORP., BLOOMINGTON, IN:
2,763,843, PUB. 6-24-2003. INT. CL. 16.
- WHITNEY DESIGN, INC., ST. LOUIS, MO:
2,765,816, INT. CL. 21.
- WHOLE FOODS MARKET IP, INC., AUSTIN, TX FROM
WHOLE FOODS MARKET SERVICES, INC., AUSTIN, TX:
2,763,122, PUB. 6-24-2003. INT. CL. 4.
- WHOLE FOODS MARKET SERVICES, INC.:
See— WHOLE FOODS MARKET IP, INC..
- WHOLE HOG, INC., SAN FRANCISCO, CA:
1,775,520, REN. 8-6-03. INT. CL. 41.
- WHOLE OATS ENTERPRISES:
See— U-WATCH RECORD, LLC.
- WHOSHOME, INC., MADISON, WI:
2,764,435, PUB. 6-24-2003. INT. CL. 36.
2,764,437, PUB. 6-24-2003. INT. CL. 36.
- WICKERSHAM JEWELERS, INC., BAKERSFIELD, CA:
2,763,935, PUB. 6-24-2003. INT. CL. 35.
- WIDMER BREWING COMPANY, PORTLAND, OR:
2,011,384, CANC. INT. CL. 32.
- WIENER SPIELKARTENFABRIK FERD. PIATNIK &
SOHNE, A-1140 VIENNA, AUSTRIA:
2,012,913, CANC. INT. CL. 28.
- WILBANKS INTERNATIONAL, INC., HILLSBORO, OR:
1,774,954, REN. 8-7-03. INT. CL. 7.
- WILDE COSMETICS GMBH, D-65344 ELTVILLE, FED REP
GERMANY:
2,763,328, PUB. 12-3-2002. MULTIPLE CLASS, INT. CLS.
8, 11 AND 21.
- WILDFUN XTREME SPORTS, LAS VEGAS, NV:
2,763,246, PUB. 6-24-2003. MULTIPLE CLASS, INT. CLS.
39, 41 AND 42.
- WILEY CORK COMPANY, INC., WILMINGTON, DE:
1,213,980, CANC. INT. CL. 19.
- WILKHAHN WILKENING & HAHNE GMBH & CO., AM
DEISTER 2, FED REP GERMANY:
1,780,311, REN. 8-7-03. INT. CL. 20.
- WILLIAM COOK EUROPE APS, DK-4632 BJAEVERSKOV,
DENMARK:
2,764,288, PUB. 6-24-2003. INT. CL. 10.
- WILLIAM M. BIRD AND COMPANY, INC., CHARLESTON,
SC:
2,763,983, PUB. 6-24-2003. INT. CL. 35.
- WILLIAM M. MERCER, INCORPORATED:
*See— MERCER HUMAN RESOURCE CONSULTING,
INC..*
- WILLIAM POLL, INC., NEW YORK, NY:
2,763,211, PUB. 6-24-2003. INT. CL. 29.
- WILLIAMS ELECTRONICS GAMES, INC., CHICAGO, IL:
2,012,376, CANC. INT. CL. 28.
- WILLIAMS LEARNING NETWORK, INC., ROCKVILLE,
MD:
1,727,138, CANC. INT. CL. 9.
- WILLIAMS, DALE J., OMAHA, NE:
2,765,746, INT. CL. 35.
- WILLIAMS, JASON COCHISE, NORCROSS, GA:
2,765,588, INT. CL. 41.
- WILLIS, CARRON C., BRADENTON, FL, DBA DARBY'S
DESIGNS:
2,011,581, CANC. INT. CL. 25.
- WILSON AUDIO SPECIALTIES, INC., PROVO, UT:
2,011,902, CANC. INT. CL. 9.
- WILSON LEARNING CORPORATION, EDINA, MN, AS-
SESSMENT DESIGNS, INC., WINTER PARK, FL:
1,198,347, REN. 8-4-03. MULTIPLE CLASS, INT. CLS. 16
AND 41.
- WILTON FOODS, INC., SPRINGDALE, AR, BERNAN FOOD
INC., NEWARK, NJ:
1,239,600, REN. 8-6-03. INT. CL. 29.
1,239,601, REN. 8-6-03. INT. CL. 29.
- WIN WIN EXPORT/IMPORT, INC., S. EL MONTE, CA:
2,763,865, PUB. 6-24-2003. INT. CL. 25.
- WINDHAM BRANNON, P.C., ATLANTA, GA:
2,764,200, PUB. 6-24-2003. MULTIPLE CLASS, INT. CLS.
35, 36 AND 42.
- WINGRA TECHNOLOGIES, LLC, MADISON, WI:
2,765,849, INT. CL. 9.
- WINGS OUTREACH, CEDAR FALLS, IA:
1,728,252, CANC. INT. CL. 41.
- WINN-DIXIE STORES, INC., JACKSONVILLE, FL:
2,012,370, CANC. INT. CL. 30.
- WINNER FOOD PRODUCTS LIMITED, KOWLOON, HONG
KONG:
2,012,885, CANC. INT. CL. 30.
- WINNER SHOES CO., LTD., TAICHUNG HSIEN, TAIWAN:
2,765,280, INT. CL. 25.
- WINNERCOMM, INC., TULSA, OK:
2,764,364, PUB. 6-24-2003. MULTIPLE CLASS, INT. CLS.
38 AND 41.
- WIP TECHNOLOGIES, INC., WILMINGTON, DE, R. D.
WERNER CO., INC., GREENVILLE, PA:
1,773,397, REN. 8-6-03. INT. CL. 6.
- WISNIEWSKI, DAVID A., FAIR OAKS, CA, DBA TAXIWAY
MEDIA:
2,765,719, INT. CL. 35.
- WITHROW PHARMACEUTICAL, PICO RIVERA, CA:
2,765,233, MULTIPLE CLASS, INT. CLS. 3 AND 5.
- WIZARD CO., INC., PARSIPPANY, NJ:
1,728,190, CANC. INT. CL. 39.
- WIZARD PUBLICATIONS, INC., LIHU'E, HI:
2,763,801, PUB. 6-24-2003. INT. CL. 16.
2,763,802, PUB. 6-24-2003. INT. CL. 16.
- WM. E. WRIGHT CO., WEST WARREN, MA:
740,076, CANC. U.S. CL. 40.
- WM. H. LEAHY ASSOCIATES, INC., NORTHBROOK, IL:
2,764,063, PUB. 6-24-2003. INT. CL. 32.
- WM. STEINEN MFG. CO., PARSIPPANY, NJ:
1,727,024, CANC. INT. CL. 7.
- WNBA ENTERPRISES, LLC, SECAUCUS, NJ:
2,763,280, PUB. 6-24-2003. INT. CL. 42.
2,764,555, INT. CL. 25.
- WNYC RADIO, NEW YORK, NY:
2,763,934, PUB. 6-24-2003. INT. CL. 41.
- WOLF, DANIEL, NEW YORK, NY:
2,012,142, CANC. MULTIPLE CLASS, INT. CLS. 38 AND
41.
- WOLVERINE WORLD WIDE, INC., ROCKFORD, MI:
1,727,763, CANC. INT. CL. 25.
- WOOD WYANT INC., MONTREAL, QUEBEC, CANADA,
WYANT & COMPANY LIMITED, LACHINE QUEBEC,
CANADA:
1,772,736, REN. 8-8-03. MULTIPLE CLASS, INT. CLS. 16
AND 21.

- WOODARD, EMHARDT, NAUGHTON, MORIARTY & MCNETT LLP, INDIANAPOLIS, IN:
2,764,467, PUB. 6-24-2003. INT. CL. 42.
- WOODEN DOOR, LTD., BARRINGTON, IL:
1,214,464, CANC. INT. CL. 42.
- WOODEX BEARING COMPANY, INC., GEORGETOWN, ME:
1,816,620, REN. 8-7-03. INT. CL. 6.
- WOODS INDUSTRIES, INC., CARMEL, IN:
2,012,598, CANC. INT. CL. 9.
- WOOLRICH WOOLEN MILLS, WOOLRICH, PA:
1,214,112, CANC. INT. CL. 25.
- WOOLWORTH CANADA INC., WESTON, ONTARIO, CANADA:
2,011,369, CANC. INT. CL. 42.
- WOORI BANK, SEOUL 100-792, REPUBLIC OF KOREA:
2,765,493, INT. CL. 36.
- WORDEX, SAN LEANDRO, CA:
1,213,903, CANC. INT. CL. 16.
- WORDMASON, INC., SILVER SPRING, MD:
1,728,052, CANC. MULTIPLE CLASS, INT. CLS. 35 AND 42.
- WORK AT HOME AND LOVE IT, CORP., DELRAY BEACH, FL:
2,765,094, INT. CL. 35.
- WORKING SOLO, INC., NEW PALTZ, NY:
2,764,194, PUB. 6-24-2003. MULTIPLE CLASS, INT. CLS. 16 AND 35.
- WORLD BIRDING CENTER, INC., MISSION, TX:
2,764,897, INT. CL. 41.
- WORLD FUEL SERVICES, INC., MIAMI SPRINGS, FL:
2,765,616, INT. CL. 35.
- WORLD MERCHANDISE EXCHANGE, INC., NEW CANAAN, CT:
2,012,666, CANC. INT. CL. 35.
- WORLD PERSPECTIVES, INC., WASHINGTON, DC:
1,213,927, CANC. INT. CL. 16.
- WORLD WATERPARK ASSOCIATION, OVERLAND PARK, KS:
2,763,350, PUB. 6-24-2003. INT. CL. 42.
- WORLD WRESTLING FEDERATION ENTERTAINMENT, INC., STAMFORD, CT:
2,765,751, INT. CL. 28.
- WORLDWIDE BEVERAGE COMPANY, DUNWOODY, GA:
2,012,896, CANC. INT. CL. 30.
- WORLDWIDE MEDIA GROUP LTD., BURNHAM, BUCKINGHAMSHIRE SL1 7JT, ENGLAND:
2,012,945, CANC. INT. CL. 35.
- WORLDWIDE RESTAURANT CONCEPTS, INC., SHERMAN OAKS, CA FROM SIZZLER INTERNATIONAL, INC., CULVER CITY, CA:
2,765,523, INT. CL. 16.
- WOW! ENTERTAINMENT, INC., LOS ANGELES, CA:
2,012,418, CANC. INT. CL. 41.
- WRIGHT HEALTH ASSOCIATES, INC., KETTERING, OH:
1,728,023, CANC. MULTIPLE CLASS, INT. CLS. 35 AND 42.
- WRIGHT MEDICAL TECHNOLOGY, INC., ARLINGTON, TN:
2,765,465, INT. CL. 5.
- WRIGHT, DWAYNE V, DECATUR, GA:
2,765,766, INT. CL. 42.
- WRIGHT, EULA H., WINCHESTER, VA, DBA HILL HIGH FARM:
2,764,992, INT. CL. 31.
- WRIGHT, JESSE M., CENTENNIAL, CO:
2,765,945, INT. CL. 9.
- WUDEL, INC., MESA, AZ:
2,011,357, CANC. INT. CL. 29.
- WYKO INDUSTRIAL SERVICES LIMITED, WEST MIDLANDS, B62 8WG, ENGLAND:
2,765,305, INT. CL. 17.
- X CONCEPTS, LLC, ESCONDIDO, CA:
2,765,435, INT. CL. 28.
- X*PRESS INFORMATION SERVICES, LTD., DENVER, CO:
2,012,305, CANC. MULTIPLE CLASS, INT. CLS. 9 AND 42.
- X-LARGE LICENSING, LLC, LOS ANGELES, CA:
2,765,181, INT. CL. 28.
- XANODYNE PHARMACAL, INC., FLORENCE, KY:
2,765,408, INT. CL. 5.
- XCALIBER INTERNATIONAL LTD., L.L.C., PRYOR, OK:
2,765,618, INT. CL. 34.
- XCU CAPITAL CORPORATION, INC., CARLSBAD, CA:
2,764,332, PUB. 6-24-2003. INT. CL. 36.
- XL CAPITAL LTD, HAMILTON, HM 11, BERMUDA:
2,765,188, INT. CL. 36.
- XO COMMUNICATION, INC., RESTON, VA FROM CONCENTRIC NETWORK CORPORATION, SAN JOSE, CA:
2,764,495, INT. CL. 42.
2,764,534, MULTIPLE CLASS, INT. CLS. 38 AND 42.
- XO COMMUNICATIONS, INC., RESTON, VA FROM NEXTELINK COMMUNICATIONS, INC., MCLEAN, VA:
2,764,788, INT. CL. 37.
2,764,790, INT. CL. 38.
- XO ENERGY BEVERAGE CORP., NEW YORK, NY FROM NATU CORP., NEW YORK, NY:
2,765,229, INT. CL. 32.
- XO ENERGY BEVERAGE CORP., NEW YORK, NY FROM NATU CORP., NEWYORK, NY:
2,765,250, INT. CL. 32.
- XO ENERGY BEVERAGE CORP., NEW YORK, NY FROM NATU CORP., NEW YORK, NY:
2,765,251, INT. CL. 32.
- XOBJEX CORPORATION, CHICAGO, IL:
2,765,612, INT. CL. 9.
- XONEX CORPORATION, HOUSTON, TX:
2,011,633, CANC. INT. CL. 35.
- XPEDITE CONSULTING, LLC, SAN RAFAEL, CA:
2,764,176, PUB. 6-24-2003. INT. CL. 9.
- XPOINT CORPORATION, NORCROSS, GA:
2,012,293, CANC. INT. CL. 9.
- XPORTATION SAFETY CONCEPTS, INC. (XSCI), COLORADO SPRINGS, CO:
2,764,663, INT. CL. 40.
- XTZ INDUSTRIES, INC., EDMONDS, WA:
2,764,673, INT. CL. 30.
- YAHOO! INC., SUNNYVALE, CA:
2,763,745, PUB. 6-24-2003. INT. CL. 41.
- YALE UNIVERSITY, NEW HAVEN, CT:
2,763,400, PUB. 6-24-2003. INT. CL. 36.
- YAMAHA CORPORATION, HAMAMATSU-SHI, SHIZUOKA-KEN, JAPAN:
1,727,454, CANC. INT. CL. 15.
- YAMAHA CORPORATION, SHIZUOKA, JAPAN:
2,453,653, COR. INT. CL. 9.
- YAMAMOTO ENTERPRISES, LLC, TEMPE, AZ:
2,765,025, INT. CL. 9.
- YASHA FABRIC, INC., LOS ANGELES, CA:
2,763,144, PUB. 6-24-2003. INT. CL. 24.
- YBOR HOLDINGS, LLC, TAMPA, FL:
2,765,800, INT. CL. 41.
- YENKIN-MAJESTIC PAINT CORPORATION, COLUMBUS, OH:
1,726,872, CANC. INT. CL. 2.
- YES! ENTERTAINMENT CORPORATION, PLEASANTON, CA:
2,012,237, CANC. INT. CL. 16.
- YIANILOS, PETER N., PRINCETON, NJ:
2,764,626, INT. CL. 9.
2,764,627, INT. CL. 39.
- YICK LUNG CO., INC., HONOLULU, HI:
1,544,670, CANC. INT. CL. 29.
- YK AMERICA INTERNATIONAL, INC., EL MONTE, CA:
2,764,166, PUB. 6-24-2003. MULTIPLE CLASS, INT. CLS. 10 AND 28.
- YOKELS SOFTWARE, INC., LAS VEGAS, NV:
2,765,498, INT. CL. 9.
- YONI DIAMONDS, INC., NEW YORK, NY:
2,765,579, INT. CL. 14.
- YOSHA! ENTERPRISES, INC., WESTFIELD, NJ:
2,765,488, INT. CL. 30.
- YOSHIKAWA, KAZUhide, OSAKA, JAPAN:
2,763,412, PUB. 6-24-2003. INT. CL. 11.

- YOTTAYOTTA, INC., EDMONTON, ALBERTA T6H 5S4, CANADA:
2,765,263, INT. CL. 9.
2,765,379, INT. CL. 9.
- YOUNG, JERALD W., STATE COLLEGE, PA:
2,011,882, CANC. INT. CL. 35.
- YX PROPERTIES, LLC, OMAHA, NE FROM MIDWEST EXPRESS AIRLINES, INC., OAK CREEK, WI:
2,763,031, PUB. 6-24-1997, INT. CL. 39.
- Z-INTERNATIONAL, INC., NORTH KANSAS CITY, MO:
2,012,907, CANC. INT. CL. 16.
- Z-WORLD, INC., DAVIS, CA:
2,765,921, INT. CL. 9.
- ZALE DELAWARE, INC.:
See— TXDC, L.P.
- ZAMBON GROUP S.P.A., 20091 BRESSO (MI), ITALY:
2,011,691, CANC. INT. CL. 5.
- ZAMPINI, JAMES W., PERRY, OH, DBA NEW PLANTS:
1,773,798, REN. 8-2-03, INT. CL. 31.
- ZANER-BLOSER, INC., COLUMBUS, OH:
2,763,322, PUB. 6-24-2003, MULTIPLE CLASS, INT. CLS. 16 AND 41.
- ZAPRUTSKY, STANISLAV, AVENTURA, FL:
2,011,978, CANC. INT. CL. 41.
- ZAVORAL, ERNEST, CANFIELD, OH AND SLATER, JANE, BUTLER, PA:
2,764,845, INT. CL. 21.
- ZD EVENTS INC.:
See— KEY3MEDIA EVENTS, INC.
- ZEEKS, INC., WASHINGTON, DC:
2,765,510, MULTIPLE CLASS, INT. CLS. 9, 35 AND 41.
- ZEELANDER, INC., LOS ANGELES, CA:
2,763,045, PUB. 6-24-2003, INT. CL. 25.
- ZEITOUN, M. FRANCK SALOMON, L'PLESSIS TREVISE, FRANCE:
2,764,750, INT. CL. 25.
- ZEKS AIR DRIER CORPORATION, WEST CHESTER, PA:
2,764,639, MULTIPLE CLASS, INT. CLS. 7, 9 AND 11.
- ZELLMER, WESTON, LANE, FOUNTAIN VALLEY, CA:
2,764,338, PUB. 6-24-2003, INT. CL. 28.
- ZELLWEGER ANALYTICS, INC., LINCOLNSHIRE, IL, DBA MDA SCIENTIFIC:
2,011,649, CANC. INT. CL. 9.
- ZENECA LIMITED, LONDON, ENGLAND, ICI AMERICAS INC., WILMINGTON, DE:
1,245,735, REN. 8-6-03, INT. CL. 5.
- ZENKER, DAVID M., VALLEY VIEW, TX:
2,574,772, CANC. INT. CL. 41.
- ZHEJIANG YINLUN MACHINERY CO., LTD., TIANTAI COUNTY, ZHEJIANG, CHINA:
2,763,670, PUB. 6-24-2003, INT. CL. 7.
- ZIAJA LTD. ZAKLAD PRODUKCJI LEKOW SPOLKA Z O.O., GDANSK-MATAMIA, POLAND:
2,763,477, PUB. 6-24-2003, MULTIPLE CLASS, INT. CLS. 3 AND 5.
- ZIMAIL.COM, INC., DALLAS, TX TO CUSTOMTRACKS OPERATING CORPORATION, DALLAS, TX:
2,656,824, COR. INT. CL. 9.
- ZIPPMARK, INC., WILMINGTON, DE, ZIPPO MANUFACTURING COMPANY, BRADFORD, PA:
1,207,903, REN. 8-4-03, MULTIPLE CLASS, INT. CLS. 8 AND 28.
- ZN VISION TECHNOLOGIES AG, 44801 BOCHUM, FED REP GERMANY:
2,763,269, PUB. 2-25-2003, MULTIPLE CLASS, INT. CLS. 9, 38, 39 AND 42.
- ZONE, INC., AMHERST, MA, D.P. DOUGH, INC., AMHERST, MA:
1,781,634, REN. 8-6-03, INT. CL. 30.
- ZTEK CO., LOUISVILLE, KY:
1,727,206, CANC. INT. CL. 9.
- ZUFLE, T. TYLER, GRETNA, LA:
1,727,268, CANC. INT. CL. 9.
- ZWICKER KNITTING MILLS, APPLETON, WI:
1,214,048, CANC. INT. CL. 25.
- ZZZAP POWER LTD.:
See— MAJORPOWER.COM CANADA CORPORATION.
- 1010DATA, INC., NEW YORK, NY FROM KZS GROUP, LLC, THE, NEW YORK, NY:
2,764,620, INT. CL. 35.
- 1029894 ONTARIO INC., ST. LAURENT, QUEBEC, CANADA:
2,763,208, PUB. 6-24-2003, INT. CL. 10.
- 1361382 ONTARIO INC., FRANKFORD, ONTARIO K0K 2C0, CANADA, DBA CG TIPS:
2,763,128, PUB. 6-24-2003, INT. CL. 8.
- 1401654 ONTARIO INC., KING CITY, ONTARIO L7B 1G3, CANADA:
2,636,440, COR. INT. CL. 11.
- 1492 HOSPITALITY GROUP, INC., HOCKESSIN, DE:
2,764,073, PUB. 6-24-2003, INT. CL. 41.
- 24 HOUR FITNESS USA, INC., SAN RAMON, CA:
2,764,465, PUB. 6-24-2003, INT. CL. 41.
- 3RD STOREE MUSIC, LLC., LOS ANGELES, CA:
2,764,232, PUB. 6-24-2003, INT. CL. 41.
- 3W GMBH, 81379 MUNCHEN, FED REP GERMANY:
2,764,945, INT. CL. 35.
- 4LIFE RESEARCH, L.C., SANDY, UT:
2,765,922, INT. CL. 3.
- 7-ELEVEN, INC., DALLAS, TX:
2,764,707, INT. CL. 32.
- 900EMAIL, ARVADA, CO:
2,764,058, PUB. 6-24-2003, INT. CL. 38.
- 911 SKINCARE.COM, LLC, NAPLES, FL:
2,763,147, PUB. 7-9-2002, INT. CL. 35.

* * * * *